

# SERVICE PARTS LIST

MULTIFUNCTIONAL DIGITAL SYSTEMS  
**e-STUDIO555/655/755/855**

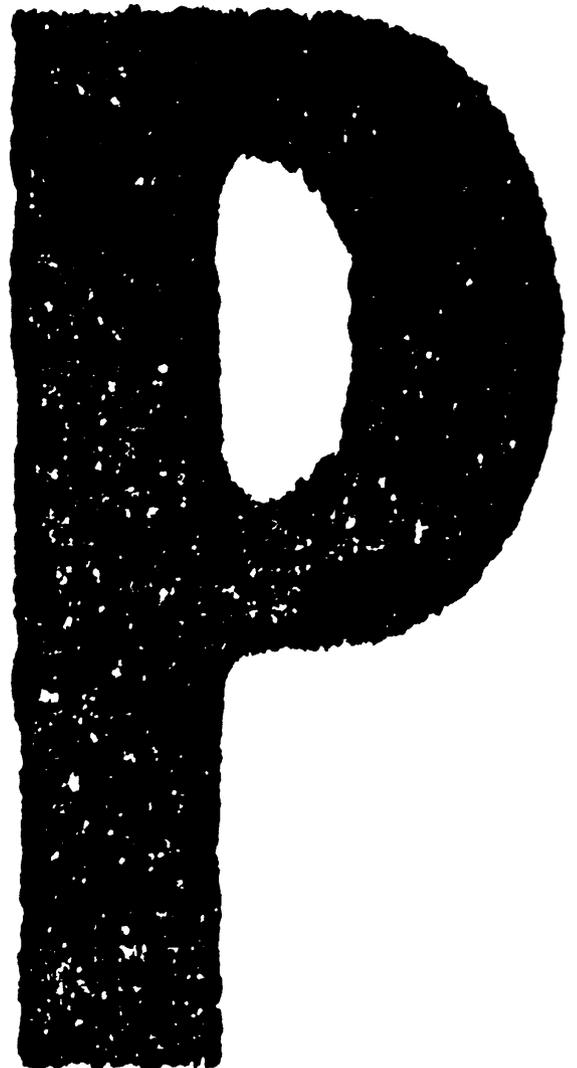

© 2009 TOSHIBA TEC CORPORATION All rights reserved

Under the copyright laws, this manual cannot be reproduced in any form without prior written permission of TOSHIBA TEC CORPORATION. No patent liability is assumed, however, with respect to the use of the information contained herein.

# EXPLANATION OF SERVICE-PARTS LIST

## 1. HOW TO READ THE PARTS LIST

- (1) Number of pieces  
The number of pieces in the list denotes total pieces used per unit. But the numbers in the list for PACKING MATERIAL and ACCESSORY denote total pieces used per machine.
- (2) One pack of screws in the list includes 50 pieces.
- (3) ABBREVIATED CODES

QTY/PAC	{	QTY.....one piece
		PAC.....one pack
		1/P.....one piece packed in polyethylene bag
		1/S.....one piece packed in special pack
		1/C.....one piece packed in carton box
		1/PP.....one piece packed in paper and polyethylene bag
		1/KP.....one piece packed in polyethylene bag with cardboard
		1/D.....one piece packed in polyethylene-cushion bag
		1/SB.....one piece packed in shielding bag
N/A.....not available		

P	{	P.....PURPOSE
		A.....ADD
		B.....DELETE
		C.....CHANGE
		D.....QTY, CHANGE
		E.....MISENTRY
		F.....OMISSION

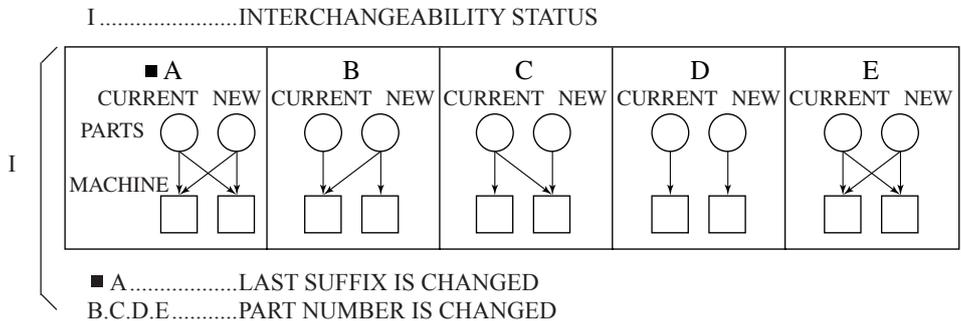

## 2. HOW TO PLACE ORDER FOR PARTS

- (1) The parts handled as service parts are only those with their "Q'TY/PACK" column listed with a quantity other than "N/A\*\*\*\*" or "SUPPLY".  
Those parts with "N/A\*\*\*\*" are listed only for the purpose of showing the mechanical construction, those listed with "SUPPLY" are handled only as a sales item, and therefore both types of parts are not supplied as service parts.
- (2) Orders for any parts which form a component of a semi-assembled unit are not acceptable.  
Note: All the screws and nuts used are ISO standard.

## 3. REGION

NAD.....115V	50/60Hz, NORTH AMERICA, SOUTH AMERICA
TWD.....110/220V	50/60Hz, TAIWAN
SAD.....127V/60Hz, SAUDI ARABIA	
ASD.....220-240V	50/60Hz, ASIA, SOUTH AMERICA, etc.
ASU.....220-240V	50/60Hz, ASIA, etc.
AUD.....220-240V	50/60Hz, AUSTRALIA
MJD.....220-240V	50/60Hz, EUROPE
CND.....220-240V	50/60Hz, CHINA
KRD.....220-240V	50/60Hz, KOREA

# CONTENTS

COVER-1-ASM .....	1	DEVELOPER-1-ASM .....	43
COVER-2-ASM .....	2	DEVELOPER-2-ASM .....	44
CONTROL-PANEL-ASM .....	3	TONNER-DRIVE-ASM .....	45
LOWER-FRAME-ASM .....	4	USED-TONER/AUGER-ASM .....	46
UPPER-FRAME-ASM .....	5	RECYCLE/AUGER-ASM .....	47
FEED-DRIVE-ASM .....	6	CLEANER-1-ASM .....	48
PAPER-FEED-ASM .....	7	CLEANER-2-ASM .....	49
TANDEM-LCF-1-ASM .....	8	CLEANER-3-ASM .....	50
TANDEM-LCF-2-ASM .....	9	DARWER-ASM .....	51
MANUAL-FEED-DRIVE-1-ASM .....	10	ELECTRIC-ASM .....	52
MANUAL-FEED-DRIVE-2-ASM .....	11	LGC-ASM .....	53
MANUAL-TRAY-ASM .....	12	SYS-ASM .....	54
REVERSE-DRIVE-ASM .....	13	HARNESS-SYS .....	71
REVERSE-OPEN-GUIDE-1-ASM .....	14	HARNESS-LGC-1 .....	72
REVERSE-OPEN-GUIDE-2-ASM .....	15	HARNESS-LGC-2 .....	73
ALIGNING-ROLLER-ASM .....	16	HARNESS-PLG/PS/RADF .....	74
TRANSPORT-ROLLER-ASM .....	17	RADF-FEED-1-ASM .....	81
TRANSPORT-BELT-DRIVE-1-ASM .....	18	RADF-FEED-2-ASM .....	82
TRANSPORT-BELT-DRIVE-2-ASM .....	19	RADF-FEED-3-ASM .....	83
TRANSPORT-BELT-GUIDE-1-ASM .....	20	RADF-FEED-4-ASM .....	84
TRANSPORT-BELT-GUIDE-2-ASM .....	21	RADF-FEED-5-ASM .....	85
TRANSPORT-BELT-CASE-1-ASM .....	22	RADF-FEED-6-ASM .....	86
TRANSPORT-BELT-CASE-2-ASM .....	23	RADF-FEED-DRIVE-ASM .....	87
FUSER-DRIVE-ASM .....	24	RADF-HINGE-ASM .....	88
FUSER-1-ASM .....	25	RADF-REAR-FRAME-ASM .....	89
FUSER-2-ASM .....	26	RADF-COVER-ASM .....	90
FUSER-3-ASM .....	27	RADF-GUIDE-OPEN-ASM .....	91
FUSER-4-ASM .....	28	RADF-PLATEN-ASM .....	92
FRONT-FRAME-ASM .....	29	RADF-TRAY-ASM .....	93
REAR-FRAME-1-ASM .....	30	JIGS & GREASE .....	201
REAR-FRAME-2-ASM .....	31	DOWNLOAD JIGS .....	202
LASER-OPT-ASM .....	32	SUPPLIES .....	203
DUCT-ASM .....	33	REPLACE UNIT .....	204
OPTICAL-FRAME-ASM .....	34	PM-KIT .....	205
OPTICAL-DRIVE-ASM .....	35		
CRG-1-ASM .....	36		
CRG-2-ASM .....	37		
OPTICAL-ELECTRIC-ASM .....	38		
CHARGER-DRIVE-ASM .....	39		
MAIN-CHARGER-ASM .....	40		
DRUM/DRUM-DRIVE ASM .....	41		
DEV DRIVE/STAY-ASM .....	42		

1. COVER-1-ASM

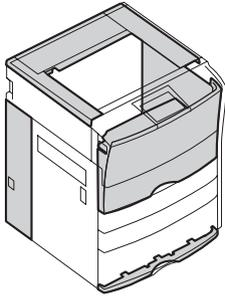

2. COVER-2-ASM

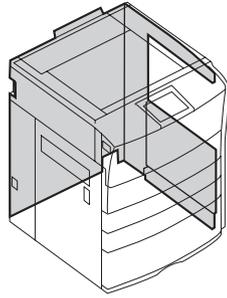

3. CONTROL-PANEL-ASM

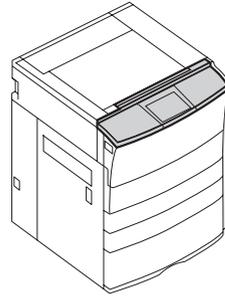

4. LOWER-FRAME-ASM

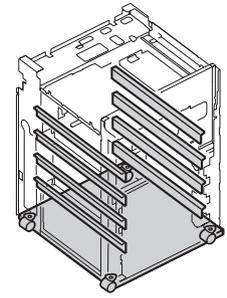

5. UPPER-FRAME-ASM

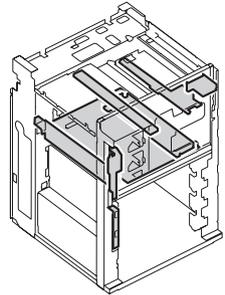

6. FEED-DRIVE-ASM

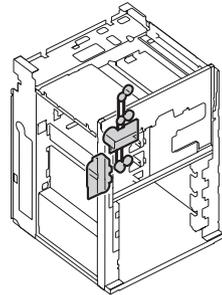

7. PAPER-FEED-ASM

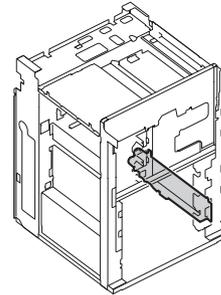

8. TANDEM-LCF-1-ASM

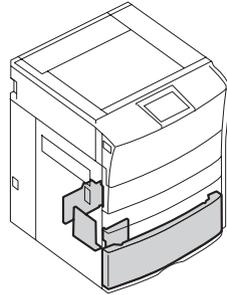

9. TANDEM-LCF-2-ASM

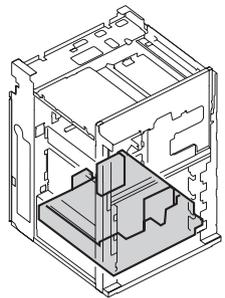

10. MANUAL-FEED-DRIVE-1-ASM

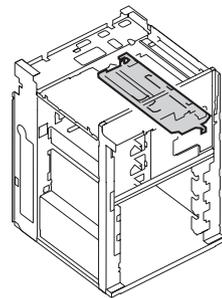

11. MANUAL-FEED-DRIVE-2-ASM

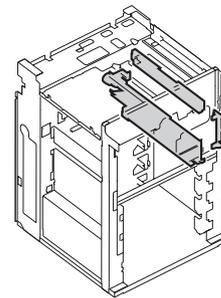

12. MANUAL-TRAY-ASM

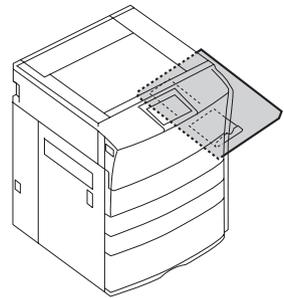

13. REVERSE-DRIVE-ASM

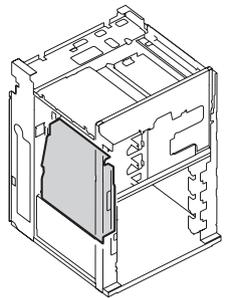

14. REVERSE-OPEN-GUIDE-1-ASM

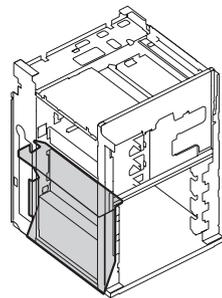

15. REVERSE-OPEN-GUIDE-2-ASM

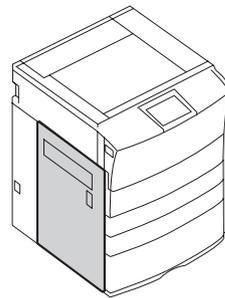

16. ALIGNING-ROLLER-ASM

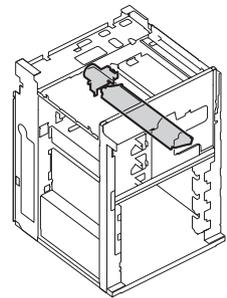

17. TRANSPORT-ROLLER-ASM

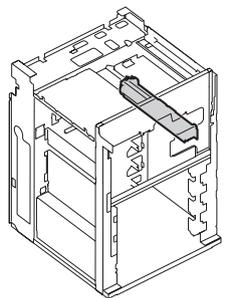

18. TRANSPORT-BELT-DRIVE-1-ASM

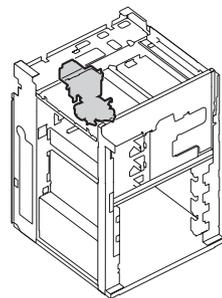

19. TRANSPORT-BELT-DRIVE-2-ASM

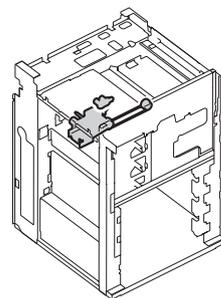

20. TRANSPORT-BELT-GUIDE-1-ASM

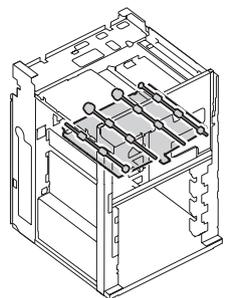

21. TRANSPORT-BELT-GUIDE-2-ASM

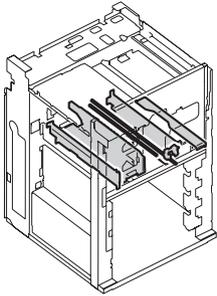

22. TRANSPORT-BELT-CASE-1-ASM

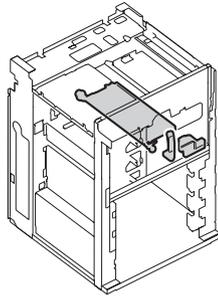

23. TRANSPORT-BELT-CASE-2-ASM

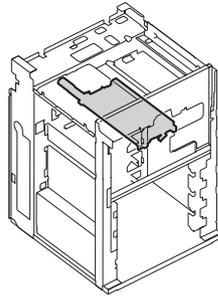

24. FUSER-DRIVE-ASM

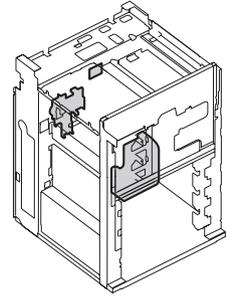

25. FUSER-1-ASM

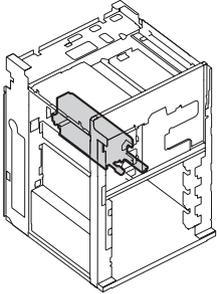

26. FUSER-2-ASM

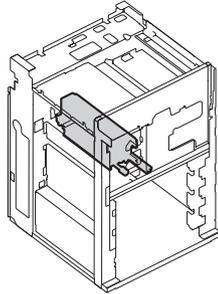

27. FUSER-3-ASM

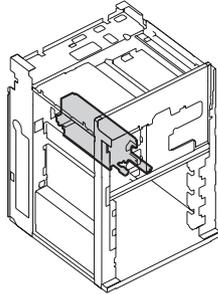

28. FUSER-4-ASM

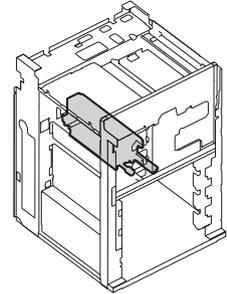

29. FRONT-FRAME-ASM

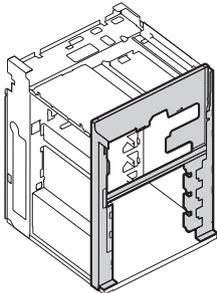

30. REAR-FRAME-1-ASM

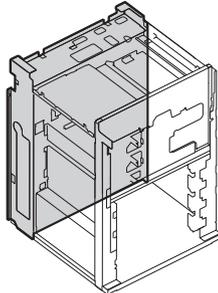

31. REAR-FRAME-2-ASM

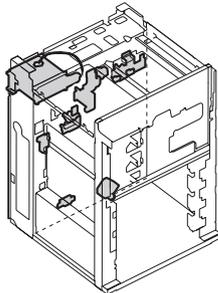

32. LASER-OPT-ASM

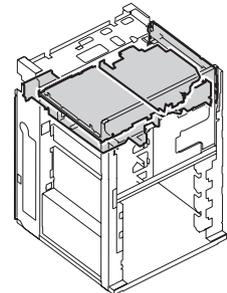

33. DUCT-ASM

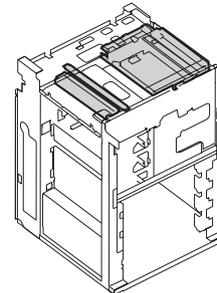

34. OPTICAL-FRAME-ASM

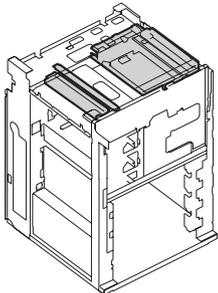

35. OPTICAL-DRIVE-ASM

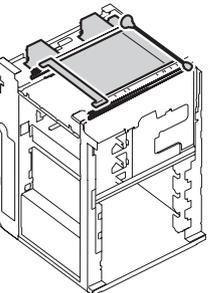

36. CRG-1-ASM

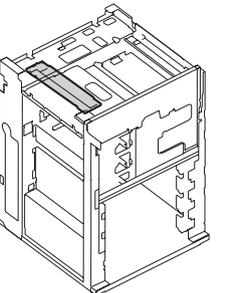

37. CRG-2-ASM

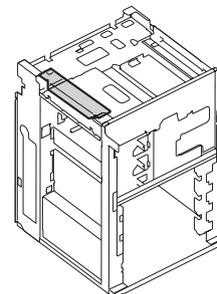

38. OPTICAL-ELECTRIC-ASM

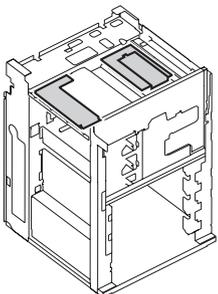

39. CHARGER-DRIVE-ASM

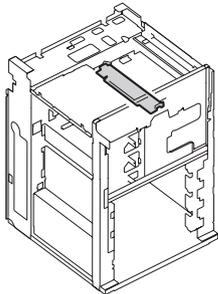

40. MAIN-CHARGER-ASM

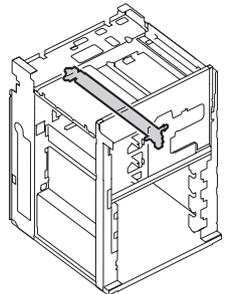

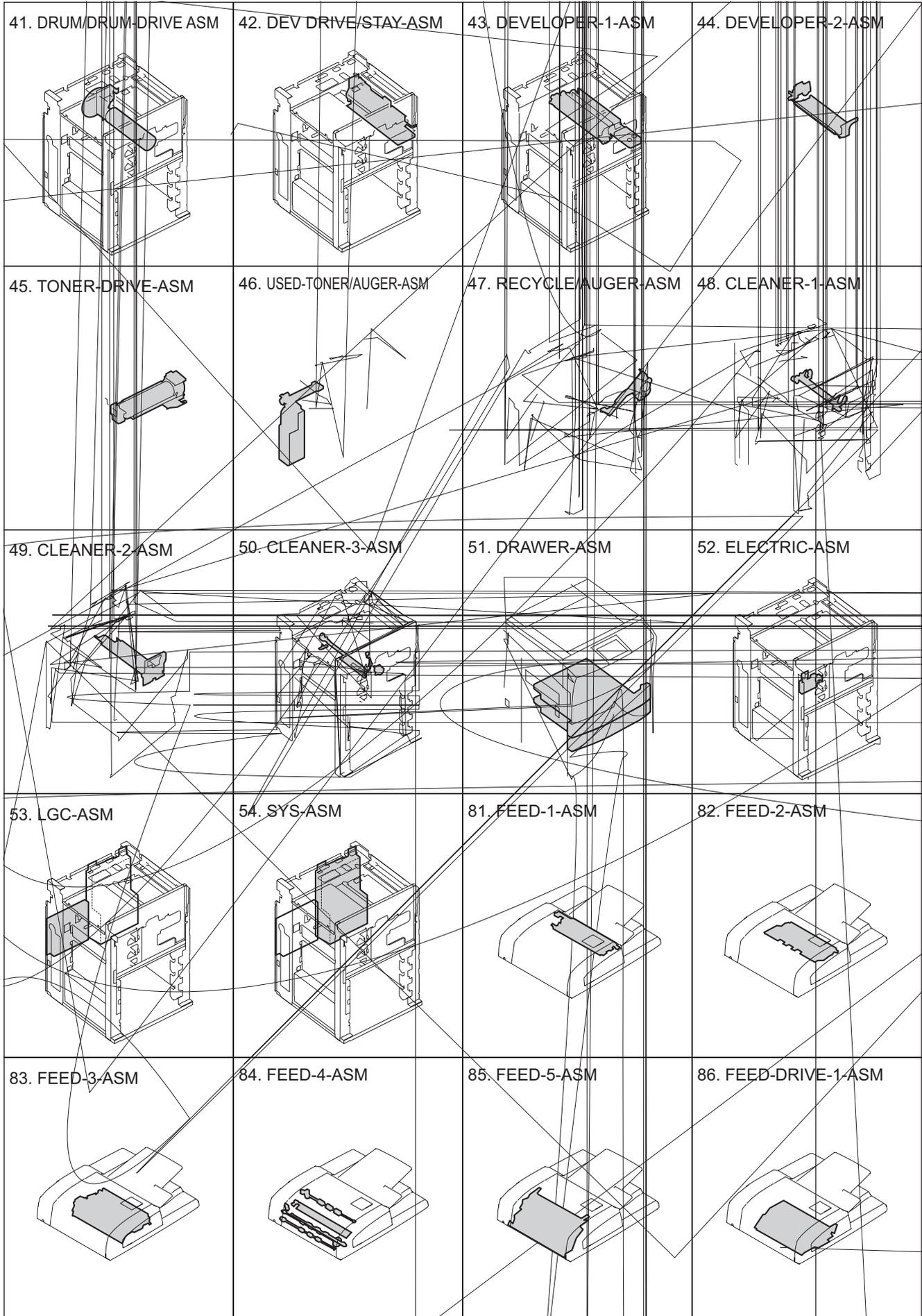

87. FEED-DRIVE-2-ASM

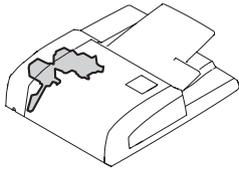

88. HINGE-ASM

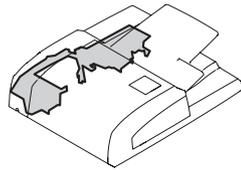

89. REAR-FRAME-1-ASM

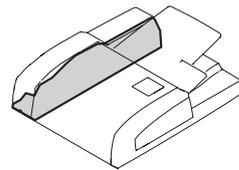

90. COVER-ASM

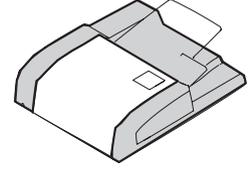

91. GUIDE-OPEN-ASM

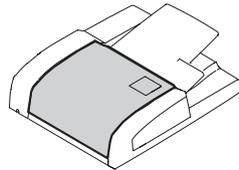

92. PLATEN-ASM

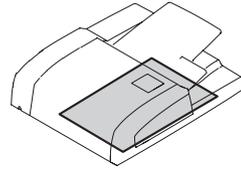

93. TRAY-ASM

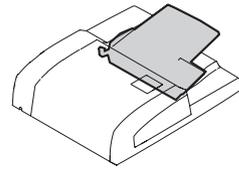





ITEM No.	PART No.	PART NAME	Q'TY / PAGE	Q'TY / PACK	REMARKS
1	6LE04448100	COVER-FRONT-LWR-N	1	1/PP	
2	6LE04453000	HINGE-COV-F-LWR	1	1/P	
3	F0-01393000	CA-0124B	1	1/P	
4	6LE03148000	PUSHER-SW-REV-390A	1	1/P	
5	6LE04451000	BRKT-CATCH-MG	1	1/P	
6	6LE13139000	LBL-TNR-IN	1	1/KP	
7	6LE04447100	COVER-FRONT-UPR-N	1	1/PP	
8	6LE04494000	HINGE-COV-F-UPR	1	1/P	
9	F0-01394000	CA-0131B	1	1/P	
10	6LE04450000	PUSHER-SWTNR-390	1	1/P	
11	6LE04495000	SPG-T-2R9XR55-HNDL	1	1/KP	
12	6LE04449100	COVER-FRONT-HNDL-N	1	1/P	
13	6LE04496000	COV-INNER-CTR-390	1	1/PP	
15	6LE08072000	COV-SCREW-390	2	1/P	
16	6LE04456100	ASY-COVER-BYP_N	1	1/PP	
17	6LA15048000	CUSHION-COV-BYP-N	1	5/P	
18	6LE04458000	COVER-WIN-LCF	1	1/PP	
19	6LE04459000	COVER-LATCH-LCF	1	1/P	
20	6LE07500000	COV-IN-COMP-390	1	1/PP	
21	6LE04410000	COV-INNER-R-390	1	1/PP	
22	6LA06563000	LBL-W-DRUM-PS	1	1/KP	
23	6LH69313000	COVER-TOP-C-H100T	1	1/PP	
24	6LE04438300	COVER-TOP-R_H100N	1	1/PP	
25	6LE04473000	COVER-LEFT-U	1	1/PP	
26	6LE04455000	PIN-HINGE-F-55	1	1/P	
27	6LE04454000	PIN-HINGE-UPR	1	1/P	
28	6LH69303000	COVER-TOP-L-H100T	1	1/PP	
29	6LH69327100	LBL-DF-CLNG-H100T	1	1/KP	
30	6LE04472000	COVER-LEFT-R	1	1/PP	
31	6LE04474000	COVER-DF-CNT-FW	1	1/P	
32 A	6LH73601000	ASYS-EMBLEM-555	1	1/P	e-STUDIO555
32 B	6LH73601100	ASYS-EMBLEM-655	1	1/P	e-STUDIO655
32 C	6LH73601200	ASYS-EMBLEM-755	1	1/P	e-STUDIO755
32 D	6LH73601300	ASYS-EMBLEM-855	1	1/P	e-STUDIO855
33	6LA00741000	COVER-SW-PW	1	1/P	
34	6LE04493000	COV-HINGE-UPR-1	2	1/P	
35 A	6LH67902000	LBL-PM-H100	1	1/KP	MJD
36 A	4406359210	LBL-TNR-CAU-3-E	1	1/KP	MJD
37	6LE16209000	ASYS-CLOTH-SCN	1	1/P	
38	6LA06850000	TRAY-FW	1	1/PP	
101	X0-02251000	S/TPP/FHEXM-4X8-NI	7	10/P	
102	X0-02247000	S/TPP/FHEXM-3X8-NI	8	10/P	
103	X0-02589000	S/TPD3/FHEXM-4X8-ZU3	18	10/P	
104	6LA08934000	SCR-M4X8ITSR-NI	8	10/P	
105	X0-02252000	S/TPP/FHEXM-4X10-NI	1	10/P	

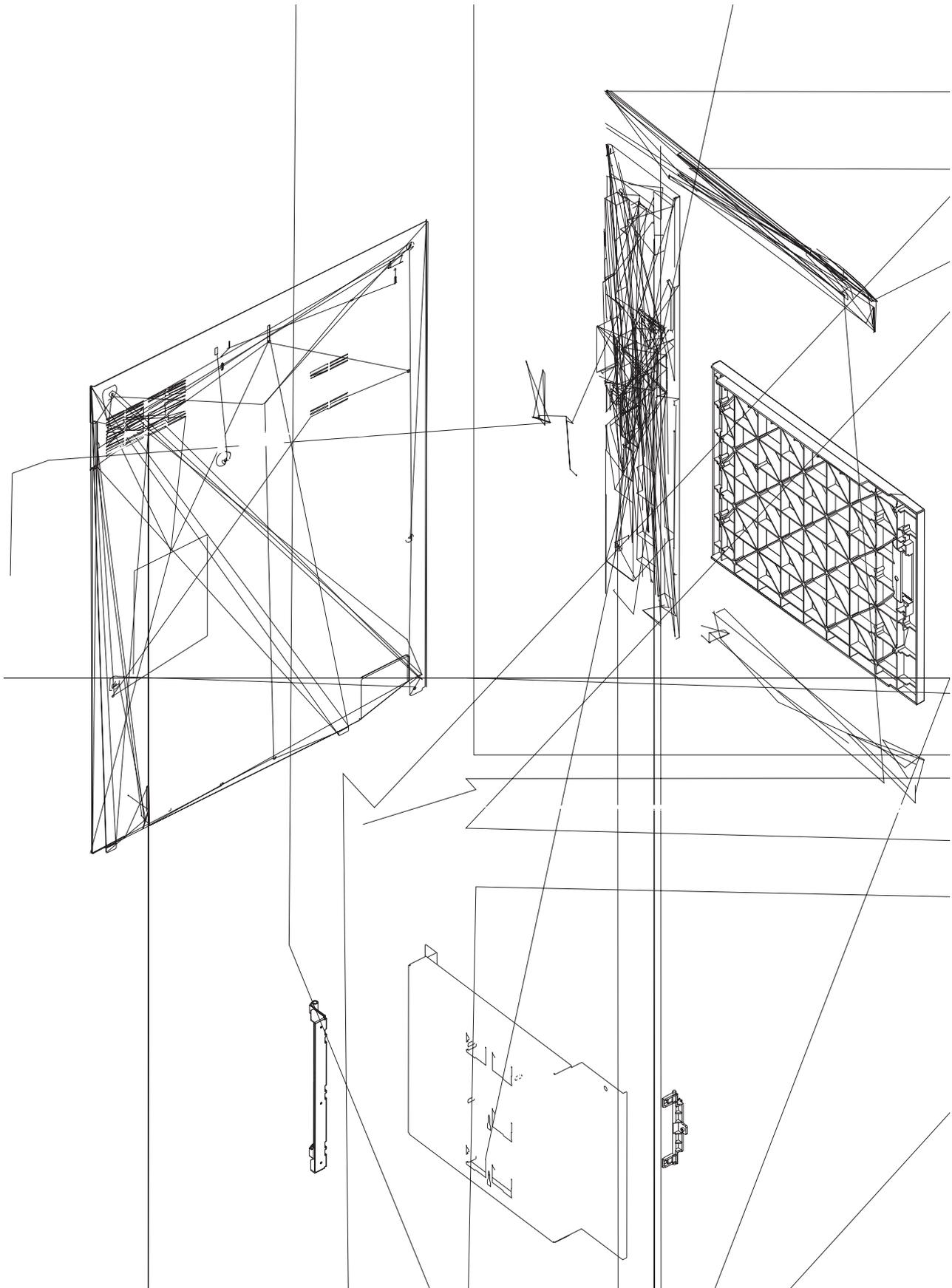



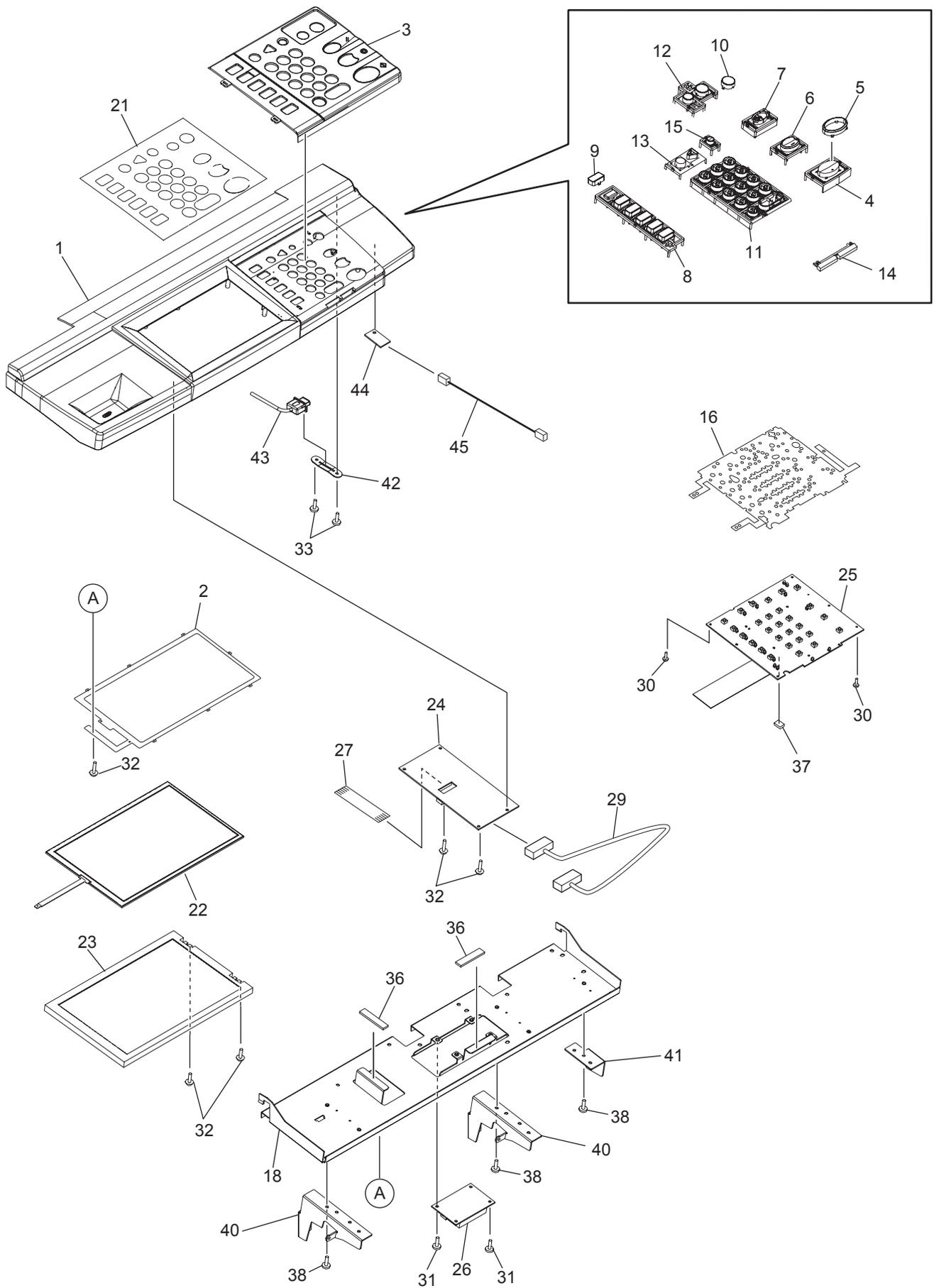









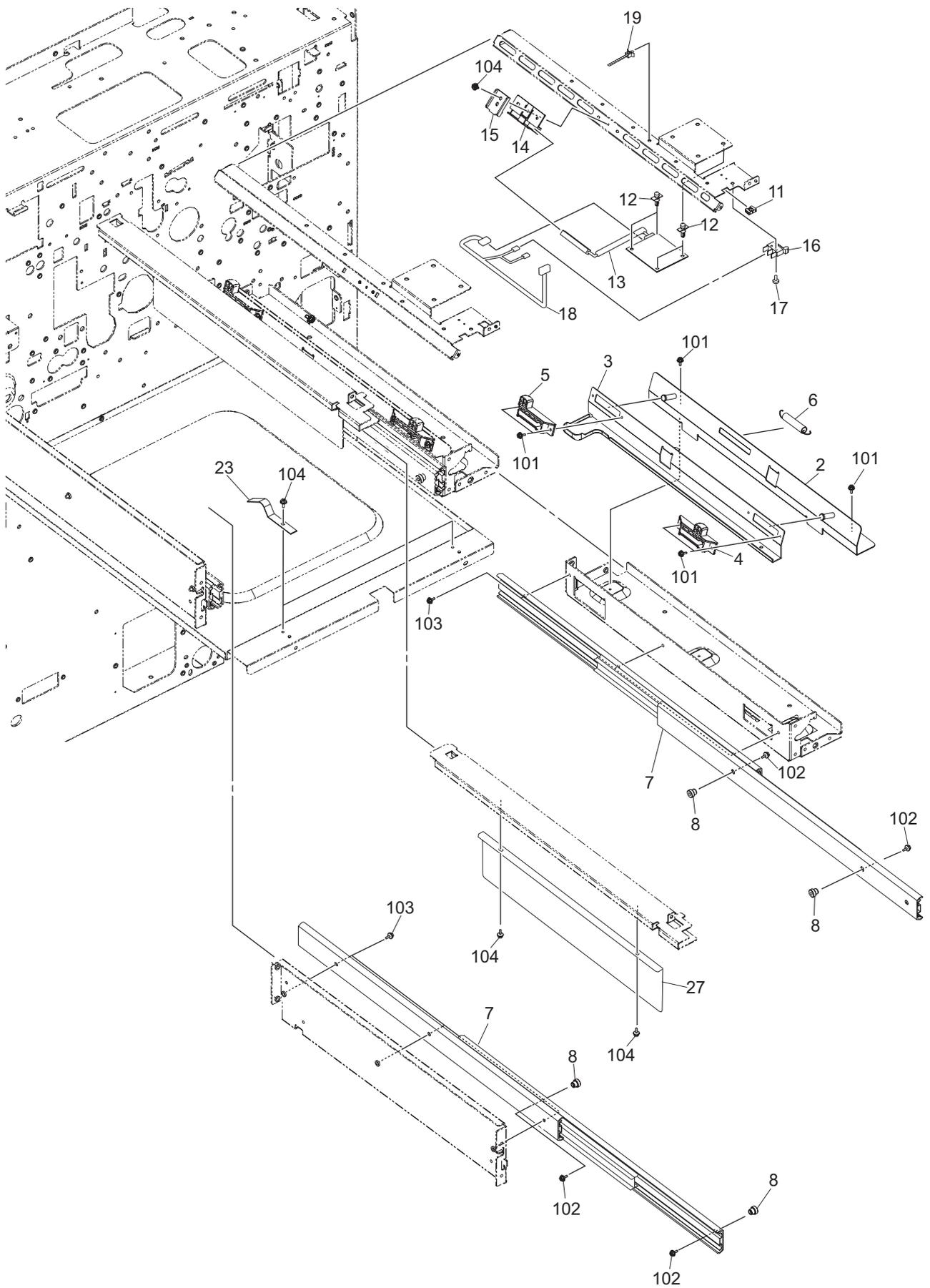



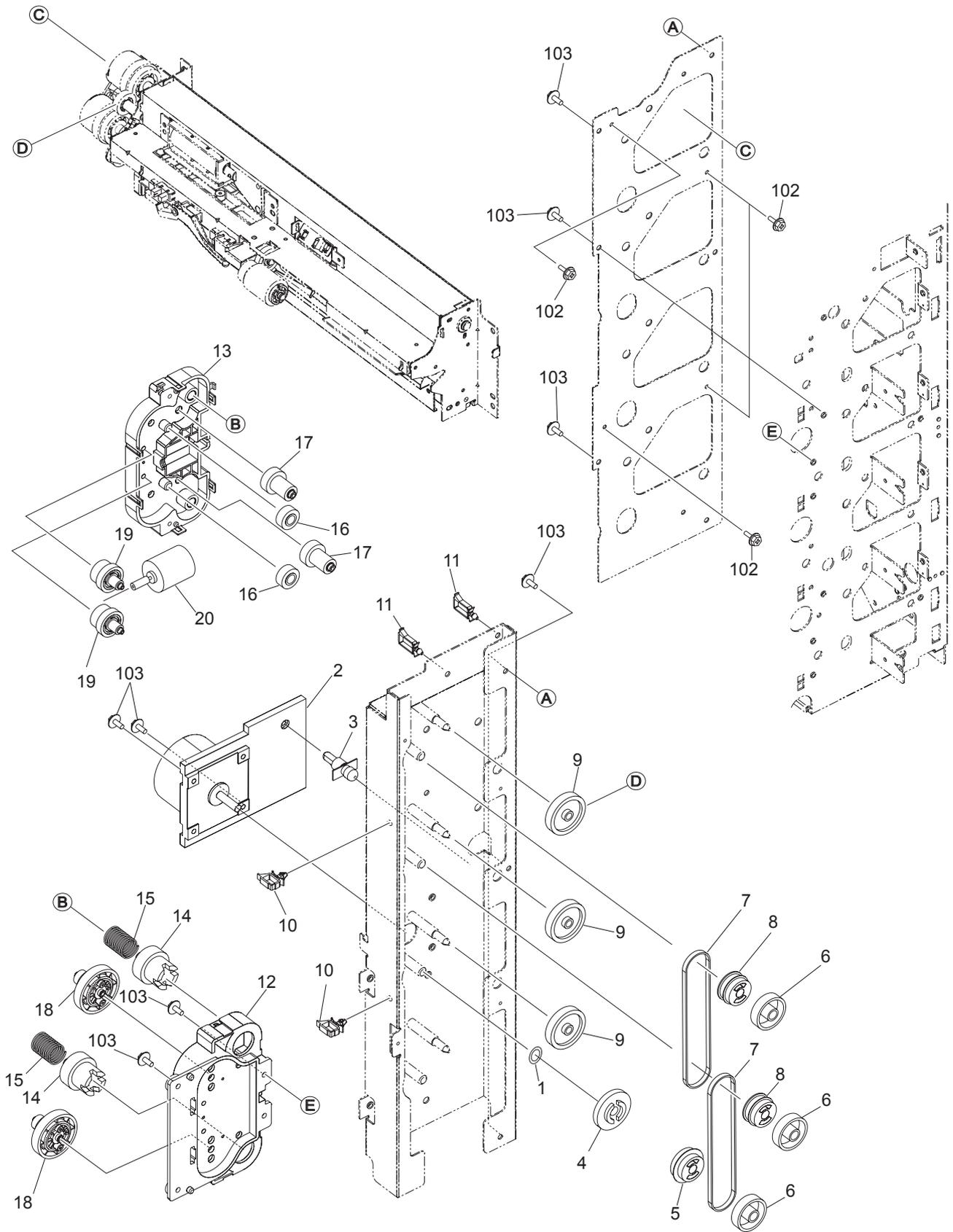



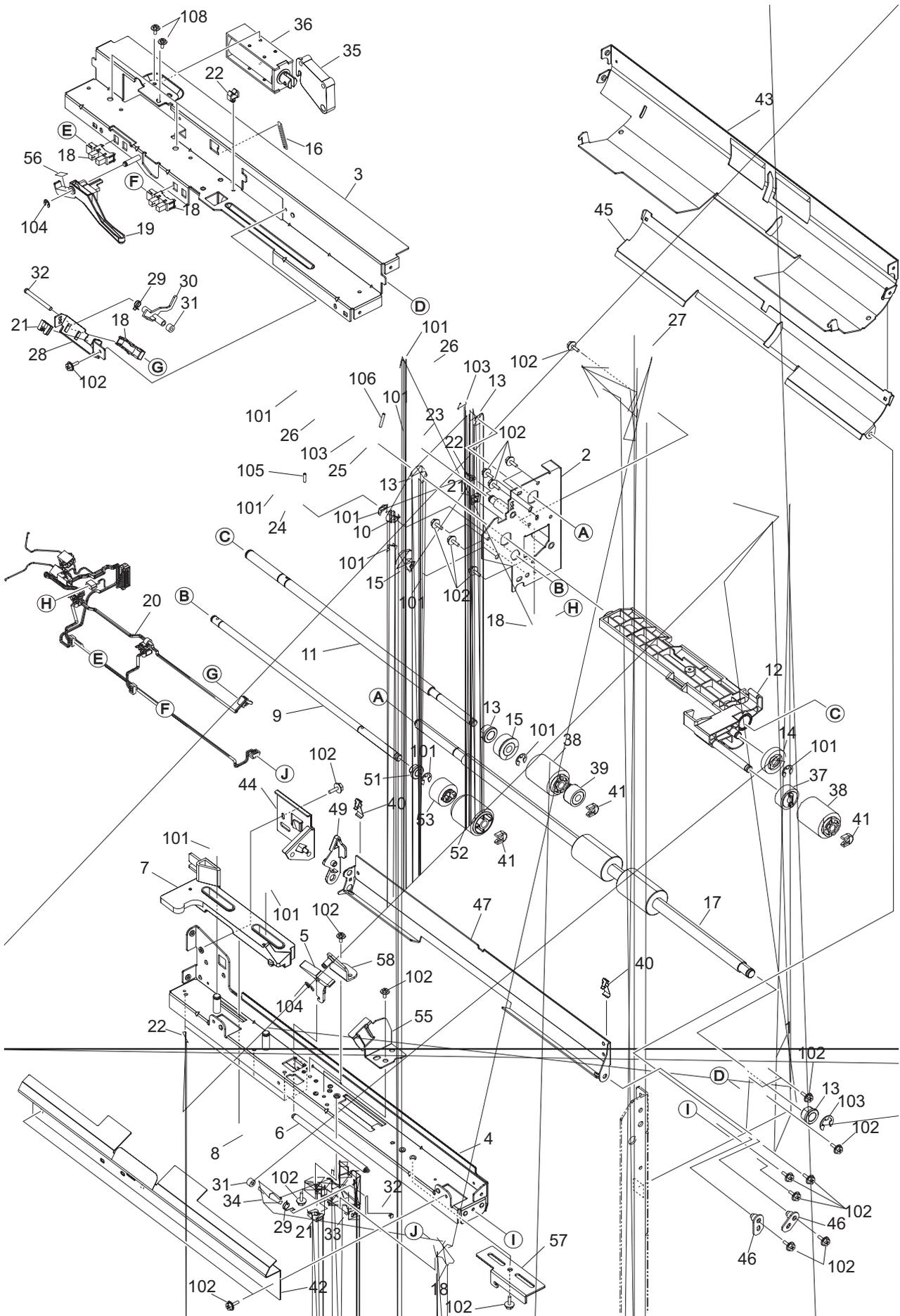

ITEM No.	PART No.	PART NAME	Q'TY / PAGE	Q'TY / PACK	REMARKS
1	6LA03812000	FRAME-F/S-F	1	1/P	For Tandem LCF For Cassette
2	6LA03826000	K-FRAME-F/S-R	1	1/P	
3 A	6LA03731000	K-STAY-FEED-T	1	1/P	
3 B	6LA03831000	K-STAY-FEED	1	1/P	
4	6LE05748000	ASYS-STAY-SPT-390	1	1/P	
5	6LA04036000	LEVER-SPT-ROL	1	1/P	
6	6LA04041000	SPE061-050-0495	1	5/P	
7	6LA04031000	LEVER-P/U-DOWN	1	1/P	
8	6LA03887000	SPE090-090-0531	1	5/P	
9	6LE05725000	ASYS-SHAFT-SPT-ROL	1	1/P	
10	4407734980	BUSH-6-GCB	1	5/P	
11	6LA14783000	SHAFT-FEED-ROL	1	1/P	
12	6LE05730000	ASYS-ARM-PU-ROL	1	1/PP	
13	6LH23442000	BUSH-8X12X8F-NU4	4	5/P	
14	6LA03897000	GEAR-08S026-06	1	1/P	
15	6LE05774000	K-GEAR-08S022-LW-390	2	1/P	For Tandem LCF For Cassette
16 A	6LA03873000	SPE-P/U-110	1	5/P	
16 B	6LA03874000	SPE-P/U-75	1	5/P	
17	6LE05727000	ROLLER-FS-TR	1	1/KP	
18	C0-10813000	GP1A73ARJ00F	5	1/P	
19	6LA03870000	ACT-SW-EMPTY	1	1/P	
20	6LE09603000	HRNS-FS-UNIT-390	1	1/P	
21	F0-00120000	ES-0505	3	5/P	
22	F0-01250000	MSB-1207	8	5/P	
23	4400972560	GEAR-1.0-18	1	1/P	
24	4407906230	GEAR-08-30	1	1/P	
25	4406349590	GEAR-08S020-08	1	1/P	
26	6LA15184000	CLUCH-G28-08D	2	1/D	
27	6LA03972000	COVER-F/S-CLT	1	1/P	
28	6LA03883000	BRKT-SW-TR-F/S	1	1/P	
29	6LA03876000	SPA-ACT-FS	2	5/P	
30	6LA03881000	ACT-SW-TR-F/S	1	1/P	
31	6LE05749000	CUSH-ACTR-STOP-390	2	1/P	
32	6LE03108000	PIN-ACTR	2	1/P	
33	6LA03953000	BRKT-SW-SPT	1	1/P	
34	6LA03951000	ACT-SW-SPT	1	1/P	For Tandem LCF For Tandem LCF
35 B	6LA03740000	LEVER-P/U-SND	1	1/P	
36 B	6LA15257000	SOL-PICK-340	1	1/D	
37	6LA03898000	GEAR-08S022-06	1	1/P	
38	6LA04047000	ASYS-ROL-FEED	2	1/P	
39	6LE05773000	CLUTCH-6-RW-390	1	1/P	
40	6LA03950000	SPL-F/S-TR	2	1/P	
41	4407972860	STOP-RING-6-5	3	5/P	
42	6LA04038000	ASYS-GUIDE-FS-E	1	1/C	
43	6LA03862000	GUIDE-FEED-U	1	1/PP	
44	6LA03987000	K-BRKT-GID-FEED	1	1/P	
45	6LA04043000	GUIDE-FEED-L-T	1	1/P	
46	6LE05756000	HLDR-GUIDE-FS	2	1/P	
47	6LA03944000	GUIDE-F/S-TR-U	1	1/P	
49	6LA03947000	HOLDER-F/S-TR	1	1/P	
51	6LA03977000	BUSH-F6-GCB	1	5/P	
52	6LA04042000	ASYS-ROL-SPT	1	1/P	
53	6LH04750000	TL-SEP-ROL-Y-N	1	1/P	
55	6LA04032000	BRAK-SPT	1	1/P	
56	6LA03877000	SHEET-DUMP-EMP	1	5/P	
57	6LE05718000	BRKT-HOLD-SP-390	1	1/P	
58	6LA04033000	ASYS-LEVER-SPT	1	1/P	
101	X0-00966000	RR/E-5-SS	12	10/P	
102	X0-02593000	S/TPD3/FHEXM-3X8-ZU3	22	10/P	
103	X0-00968000	RR/E-7-SS	3	10/P	
104	X0-00964000	RR/E-3-SS	2	10/P	
105	X0-00979000	P/PRL/AH7-2X8-SS	1	10/P	
106	X0-01526000	P/PRL/AH7-2X12-SS	1	10/P	







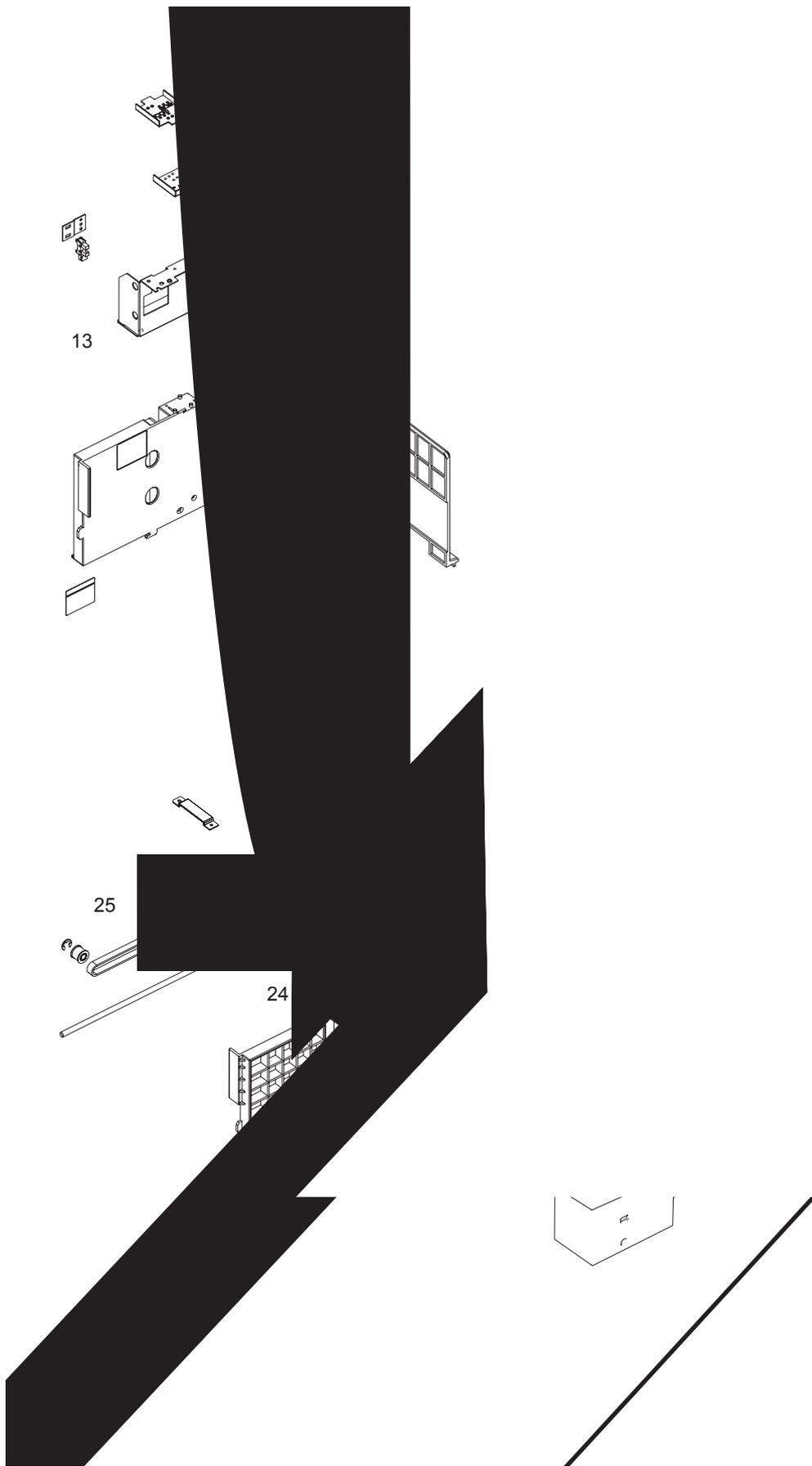



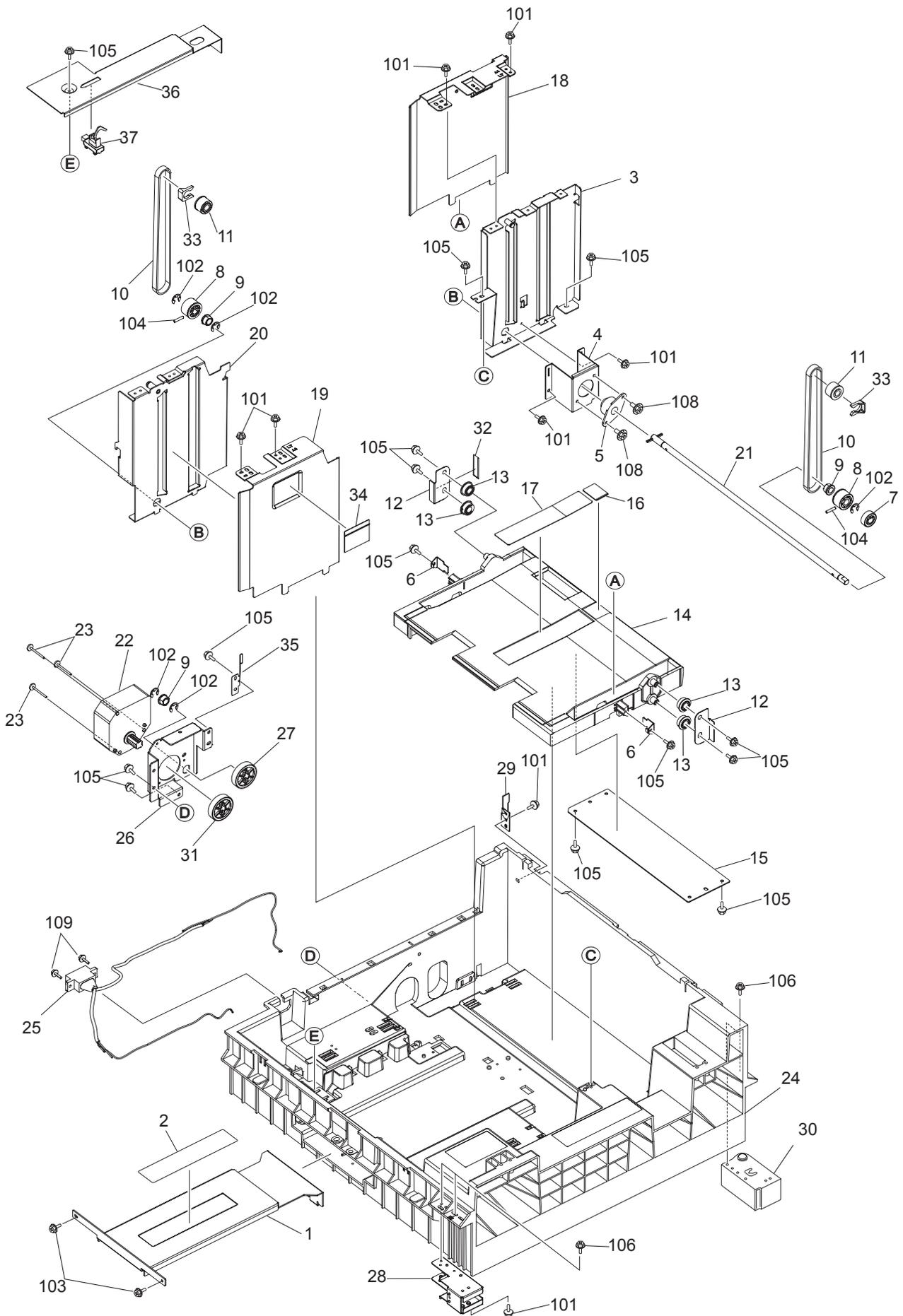

ITEM No.	PART No.	PART NAME	Q'TY / PAGE	Q'TY / PACK	REMARKS
1	6LA93658000	BRKT-COV-BELT	1	1/P	
2	6LA93863000	LBL-P-SET-TRY-L	1	5/P	
3	6LA15091000	K-GUIDE-SIDE-RF	1	1/P	
4	6LA93680000	BRKT-DAMPER	1	1/P	
5	6LE03901000	OIL-DAMPER-390	1	1/P	
6	6LA93679000	BRKT-BELT-STOP	2	1/P	
7	6LA93797000	GEAR-DUMP-Z18	1	1/P	
8	6LA93798000	PLY-BRKT	2	1/P	
9	6LH23442000	BUSH-8X12X8F-NU4	3	5/P	
10	6LA14353000	BLT.SY-426-3GT	2	1/P	
11	6LA93775000	PLY/T-3-020	2	1/P	
12	6LA04814000	BRKT-ROL-STOP	2	1/P	
13	6LA93774000	PLY-TRAY-ROL	4	1/P	
14	6LE03907000	ASYS-TRAY-LCF	1	1/PP	
15	6LA93713000	PLT-BALANCER	1	1/P	
16	6LA04847000	PAD-TRAY	1	1/KP	
17	6LA93864000	LBL-P-SET-TRY-R	1	1/KP	
18	6LA04835000	K-FENCE-SIDE-R-F	1	1/P	
19	6LA04803000	FENCE-SIDE-R-R	1	1/P	
20	6LA15092000	K-GUIDE-SIDE-RR-N	1	1/D	
21	6LA04815000	K-SFT-TRAY	1	1/P	
22	6LE09179000	MDC-SLIDER-390	1	1/D	
23	6LA08931000	SCREW-BKT-MOT	3	10/P	
24	6LE03716000	K-CST-TLCF	1	1/C	
25	6LE09483000	HRNS-TLCF-IN-390	1	1/P	
26	6LA04818000	BRKT-MOT-SLID	1	1/P	
27	6LA04821000	GEAR-10H033-08	1	1/P	
28	6LA04822000	BRKT-CAH-T-LCF	1	1/P	
29	6LA04824000	SPL-LEVER-LCF	1	1/P	
30	6LA04841000	ASYS-LOCK-TNDM	1	1/P	
31	6LA04829000	GEAR-MOT-Z33	1	1/P	
32	6LA04853000	MYLAR-BRKT-ROL	1	1/KP	
33	41306265000	STOP-RING-8	2	1/P	
34	6LA93862000	LBL-P-LIMIT	1	1/P	
35	6LA04809000	SPL-EARTH-LCF	1	1/P	
36	6LA93656000	BRKT-COV-P-END	1	1/P	
37	6LH69961000	SNSR-TLCF-EMP-H100	1	1/C	
101	X0-02593000	S/TPD3/FHEXM-3X8-ZU3	8	10/P	
102	X0-00968000	RR/E-7-SS	4	10/P	
103	X0-02230000	S/FHEXM-M3X6-NI	2	10/P	
104	X0-01169000	P/PRL/AH7-3X14-SS	3	10/P	
105	X0-02247000	S/TPP/FHEXM-3X8-NI	15	10/P	
106	X0-00077000	S/PAN/SWWP-M3X8-NI	4	10/P	
107	X0-02595000	S/TPD3/FHEXM-3X12-ZU3	1	10/P	
108	X0-02589000	S/TPD3/FHEXM-4X8-ZU3	2	10/P	
109	X0-02248000	S/TPP/FHEXM-3X10-NI	2	10/P	

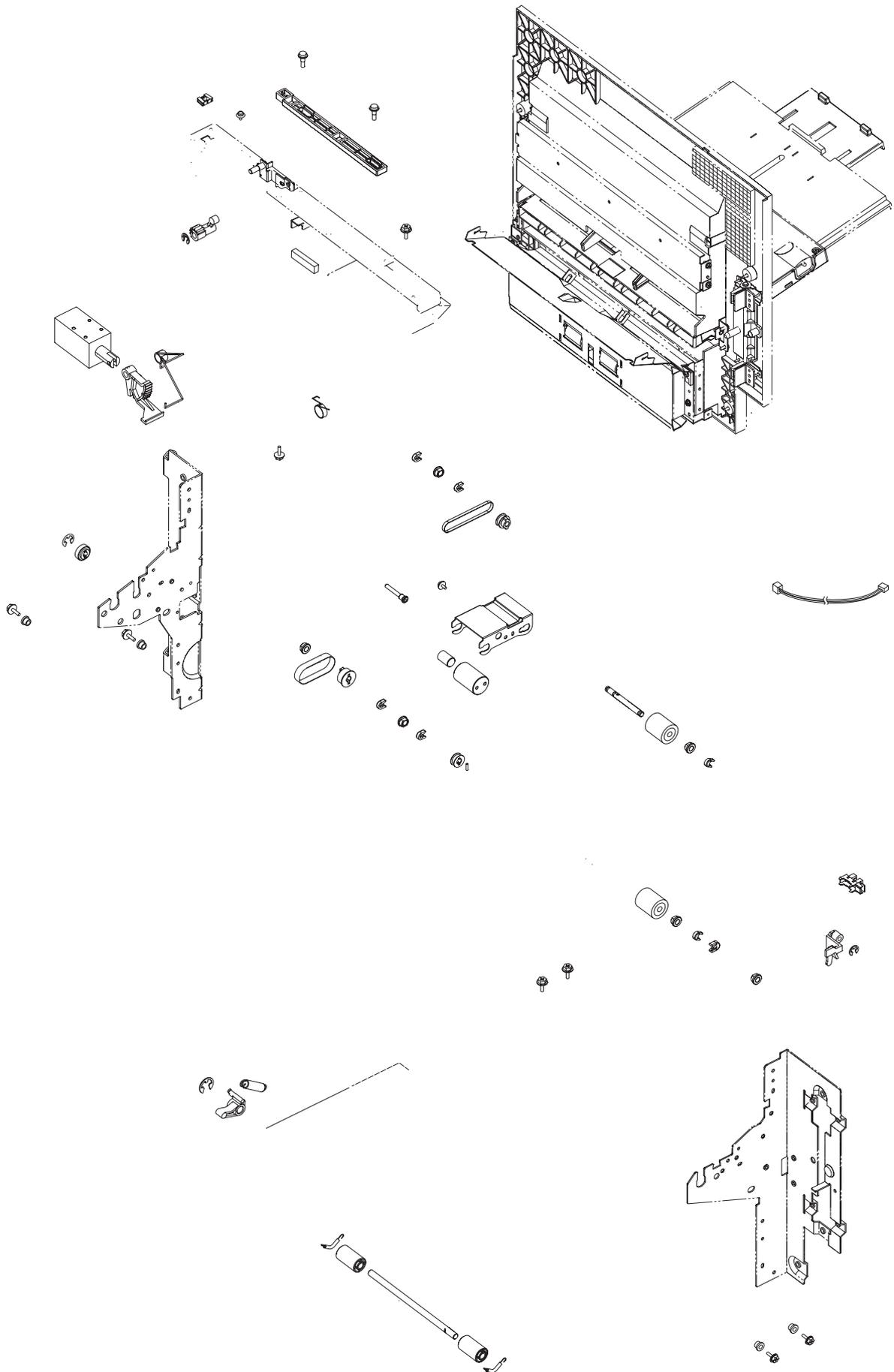

ITEM No.	PART No.	PART NAME	Q'TY / PAGE	Q'TY / PACK	REMARKS
1	6LA15837000	REINF-BRKT-BYP	1	1/P	
2	6LA15838000	REINF-MOULD-BYP	2	5/P	
4	6LA04708000	LEVER-STOPPER	2	1/P	
5	6LA04716000	SPRING-STOP-1	2	5/P	
6	6LA14349000	K-BRKT-STOPPER	2	1/D	
7	6LA04712000	SPRING-SND-LVR	1	5/P	
8	6LA15259000	SOL-SFB-340	1	1/D	
9	6LA04690000	LINK-SND-GEAR	1	1/P	
10	6LA04691000	LEVER-GEAR	1	1/P	
11	6LA04707000	SLIDER-STOPPER	1	1/P	
12	6LA08938000	SCREW-SOCKET	2	10/P	
13	F0-00120000	ES-0505	1	5/P	
14	6LA04638000	K-STAY-GUIDE-L	1	1/P	
15	6LA04635000	LEV-ROL-SEP	1	1/P	
16	6LA04715000	SPE060-080-0236	1	5/P	
17	6LA04672000	IDLR-BYPS-D16	2	1/P	
18	6LA04673000	SFT-IDL-TRS-BYP	1	1/P	
19	6LA04677000	SPRING-SFT-TRS	2	5/P	
20	6LA04630000	GUIDE-P-U	1	1/P	
21	4407980920	BUSH-4-5	4	5/P	
22	6LA04662000	K-STAY-BYP-M	1	1/P	
23	C0-10813000	GP1A73ARJ00F	1	1/P	
24	6LA04653000	LVR-PAPER-SW	1	1/P	
25	6LE09606000	HRNS-SFB-PSW-390	1	1/P	
26	6LA04627000	BLT/T-154-2GT-4	1	1/P	
27	6LA04692000	BRKT-PICK-BYP	1	1/P	
28	6LE03438000	SHAFT-PICK	1	1/P	
29	6LA04706000	K-SHAFT-FED-BYP	1	1/P	
30	6LE03439000	SHAFT-PICK-BRKT	1	1/P	
31	4400884670	PLY-20-ROL	1	1/P	
32	4402813680	PLY-20	1	1/P	
33	4407972860	STOP-RING-6-5	7	5/P	
34	6LA04626000	BLT/T-108-S2M-7	1	1/P	
35	4401773050	K-ROL-FED-CW-H	1	1/P	
36	6LA04694000	K-RLR-P/U-24	1	1/P	
37	4407734980	BUSH-6-GCB	3	5/P	
38	44201492000	BUSH-6-POM	3	5/P	
39	6LA04721000	PLY/T-S2M-28-06	1	1/P	
40	4401777990	K-GEAR-20-08-OW	1	1/P	
41	6LA04742000	DMPR-SLIDER	2	1/P	
42	6LA04743000	DMPR-PICK-UP	1	1/P	
43	6LE03440000	WEIGHT-20-30	1	1/P	
44	6LA04697000	WEIGHT-10-15	1	1/P	
46	6LA04646000	CUSHION-ACT-BYP	1	5/P	
47	6LA04745000	CUSHION-GUIDE-P-U	1	1/P	
101	X0-00964000	RR/E-3-SS	1	10/P	
102	X0-02551000	S/PAN/SWWP-M3X6-ZU3	6	10/P	
103	X0-00965000	RR/E-4-SS	1	10/P	
104	X0-00966000	RR/E-5-SS	2	10/P	
105	X0-00979000	P/PRL/AH7-2X8-SS	1	10/P	
106	6LA08935000	SCR-M3X6BISR-NI	14	10/P	
107	X0-02590000	S/TPD3/FHEXM-4X10-ZU3	4	10/P	

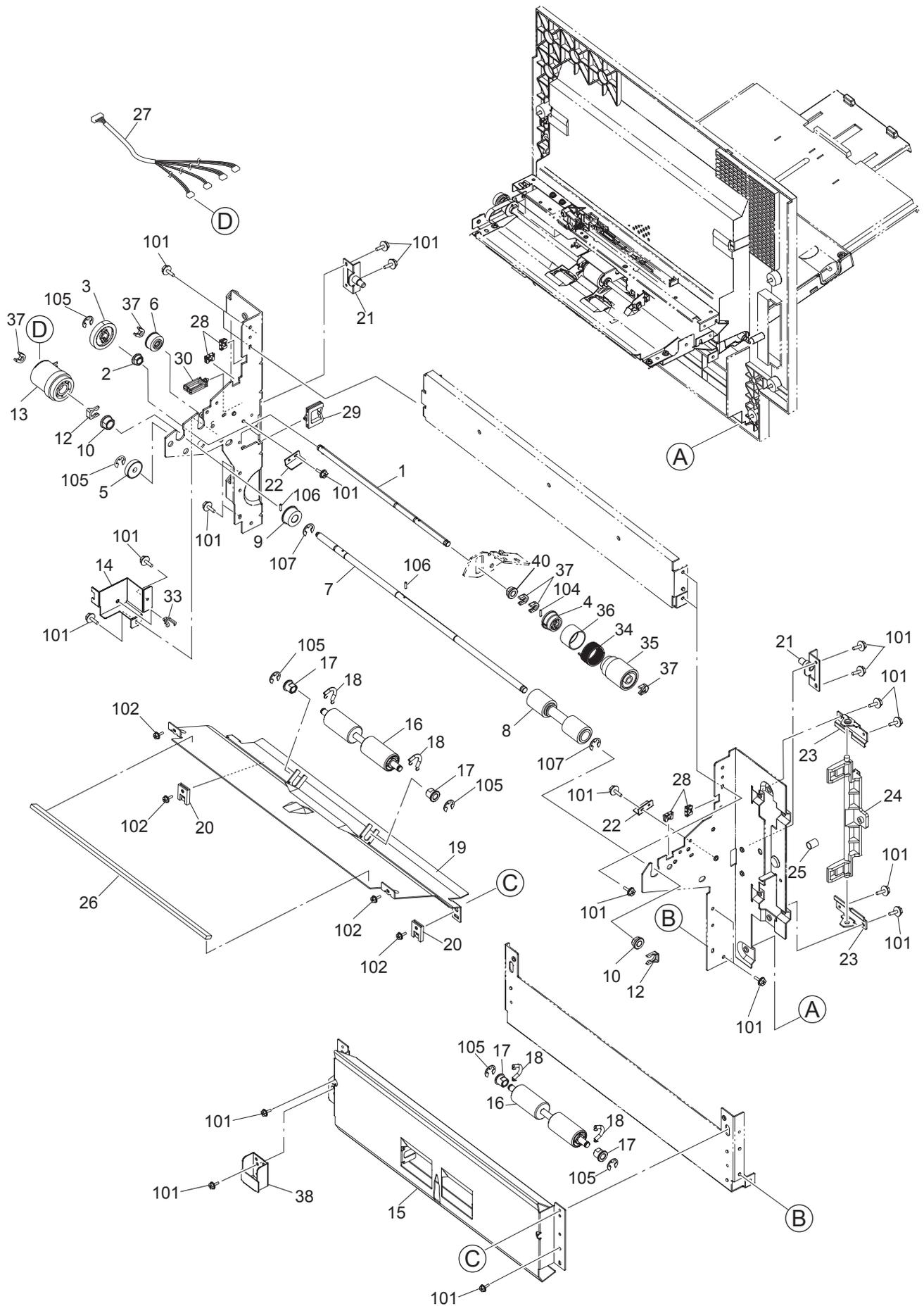

ITEM No.	PART No.	PART NAME	Q'TY / PAGE	Q'TY / PACK	REMARKS
1	6LA04674000	K-SHAFT-SEP	1	1/P	
2	44201492000	BUSH-6-POM	1	5/P	
3	4407906230	GEAR-08-30	1	1/P	
4	4408307270	ARBOR-16-POM-S	1	1/P	
5	4406342070	GEAR-10S020-06	1	1/P	
6	6LE03441000	K-GEAR-08S022-RB-390	1	1/P	
7	6LE03401000	SHAFT-RLR-TRS	1	1/P	
8	6LA04665000	K-RLR-TRS	1	1/P	
9	6LA04720000	PLY/T-S2M-28-08	1	1/P	
10	6LH23442000	BUSH-8X12X8F-NU4	2	5/P	
12	4400336190	STOP-RING-8	2	5/P	
13	6LA04768000	CLUTCH-G28-08-33F	1	1/D	
14	6LA04637000	BRKT-CLT	1	1/P	
15	6LA04661000	GUIDE-LCF-ENT-L	1	1/P	
16	6LE05723000	ROLLER-IDLE-390	2	1/KP	
17	4407976990	BUSH-D6-GCB	4	1/P	
18	6LA05687000	SPRING-500-ADU	4	1/P	
19	6LA04641000	GUIDE-ROL-TRS-U	1	1/P	
20	6LA04642000	SPCR-GUIDE-ROL	2	1/P	
21	6LA04631000	K-HLDR-TRAY	2	1/P	
22	6LA04790000	STOPPER-TRAY	2	1/P	
23	6LA04651000	KNOB-HINGE	2	1/P	
24	6LE03422100	KNOB-COV-PFP-N	1	1/P	
25	6LA04152000	SPC-KNOB-STOP	1	5/P	
26	6LA04732000	CUSHION-GUIDE-TRS	1	1/KP	
27	6LE09605000	HRNS-SFB-MAIN-390	1	1/P	
28	F0-00120000	ES-0505	4	5/P	
29	F0-00047000	EDS-1717U	1	10/P	
30	F0-01299000	LWS-2111Z	1	1/P	
33	4400902490	BAND-PS100	1	5/P	
34	4406347640	SPR-1.0-15.55-S	1	5/P	
35	4406347610	K-ROL-SPT-CW-S	1	1/P	
36	4408307890	COVER-SP-CL	1	1/P	
37	4407972860	STOP-RING-6-5	5	5/P	
38	6LA04740000	BRKT-PUSH-F/S	1	1/P	
40	6LA03977000	BUSH-F6-GCB	1	5/P	
101	6LA08935000	SCR-M3X6BISR-NI	19	10/P	
102	X0-02593000	S/TPD3/FHEXM-3X8-ZU3	4	10/P	
104	X0-00979000	P/PRL/AH7-2X8-SS	1	10/P	
105	X0-00966000	RR/E-5-SS	6	10/P	
106	X0-01526000	P/PRL/AH7-2X12-SS	2	10/P	
107	X0-00968000	RR/E-7-SS	2	10/P	



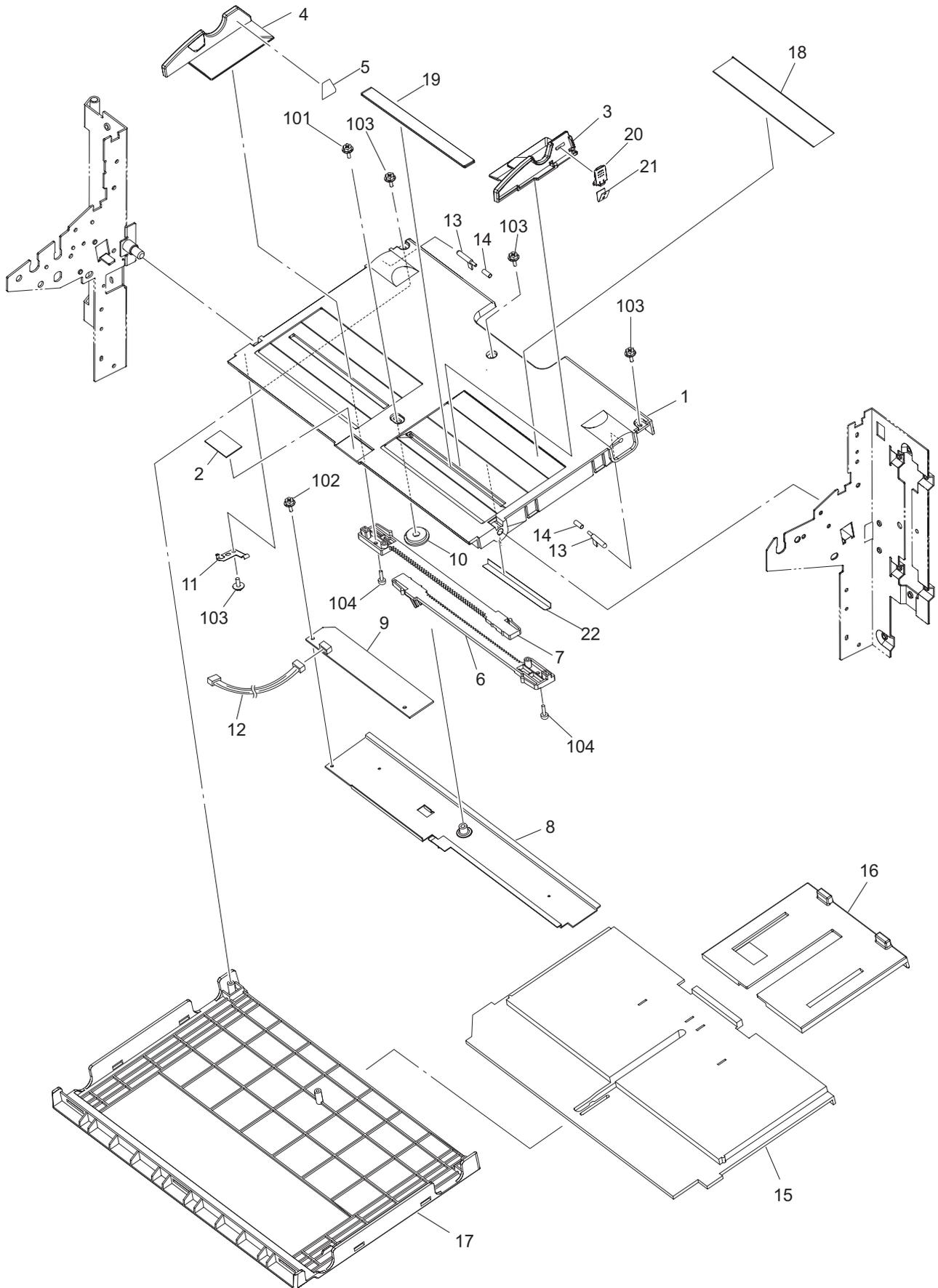









102

101

105

14

ITEM No.	PART No.	PART NAME	Q'TY / PAGE	Q'TY / PACK	REMARKS
2	F0-01243000	LWS-1211Z	4	5/P	
4	6LE03135000	ROLLER-EXIT-L-390	1	1/KP	
5	F0-01390000	LNR-1680HHRPOP15LY13	2	1/P	
6	6LA05664000	GEAR-10S019-08	1	1/P	
7	6LA05652000	K-BRKT-EXIT-U	1	1/P	
8	6LA05682000	GUIDE-REV-O-340	1	1/PP	
9	6LE03115000	ASYS-GUIDE-REV-MID	1	1/KP	
10	6LH73618000	GATE-H100	1	1/KP	
11	4407734980	BUSH-6-GCB	2	5/P	
12	6LH17925000	ARM-GATE-BR	1	1/P	
13	6LE05753000	CUSH-ARM-GATE-390	1	1/P	
14	X0-00980000	P/PRL/AH7-2X10-SS	1	10/P	
15	4407972860	STOP-RING-6-5	1	5/P	
17	6LA05744000	BRKT-HINGE-OP-L	1	1/P	
18	F0-00120000	ES-0505	2	5/P	
19	6LE05754000	ASY-ROL-EXIT-390	2	1/D	
21	6LA05658000	SPL-FUS-EX	1	1/P	
22	4406310100	ROL-12*10	1	5/P	
23	6LE03141000	SHAFT-4X22	1	1/P	
24	6LE05723000	ROLLER-IDLE-390	2	1/KP	
25	4407976990	BUSH-D6-GCB	4	1/P	
26	6LA05687000	SPRING-500-ADU	4	1/P	
27	6LE03137000	ASYS-BRKT-HIG-OP-U	1	1/P	
28	6LA05666000	GEAR-10S020-08	1	1/P	
29	6LE05752000	BRUSH-SUS-E-390	1	1/KP	
30	6LE03143000	ASY-ROL-EXT-U	4	1/P	
31	F0-01248000	ESC-0912	1	10/P	
32	6LA05696000	MYLAR-GUIDE-M39	2	1/P	
33	6LA05697000	MYLAR-GUIDE-M95	2	1/KP	
36	6LA05413000	RING-EXIT-24-W	2	5/P	
37	6LA15757000	BRKT-EXIT-U-COV	1	1/P	
101	X0-02592000	S/TPD3/FHEXM-3X6-ZU3	17	10/P	
102	X0-00964000	RR/E-3-SS	2	10/P	
103	X0-00966000	RR/E-5-SS	5	10/P	
104	X0-00965000	RR/E-4-SS	1	10/P	
105	X0-00968000	RR/E-7-SS	4	10/P	
106	X0-01526000	P/PRL/AH7-2X12-SS	1	10/P	
108	X0-02593000	S/TPD3/FHEXM-3X8-ZU3	3	10/P	

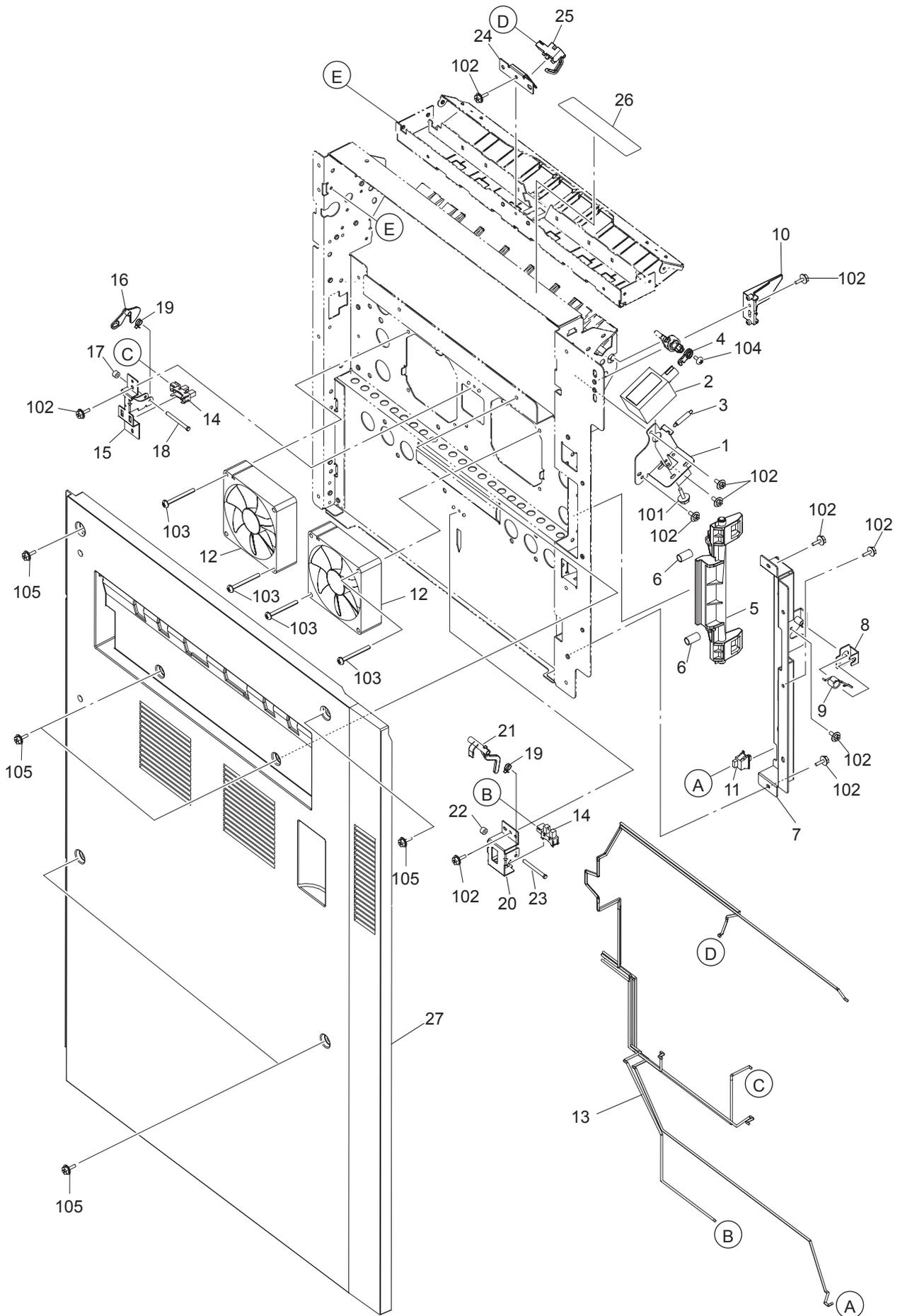





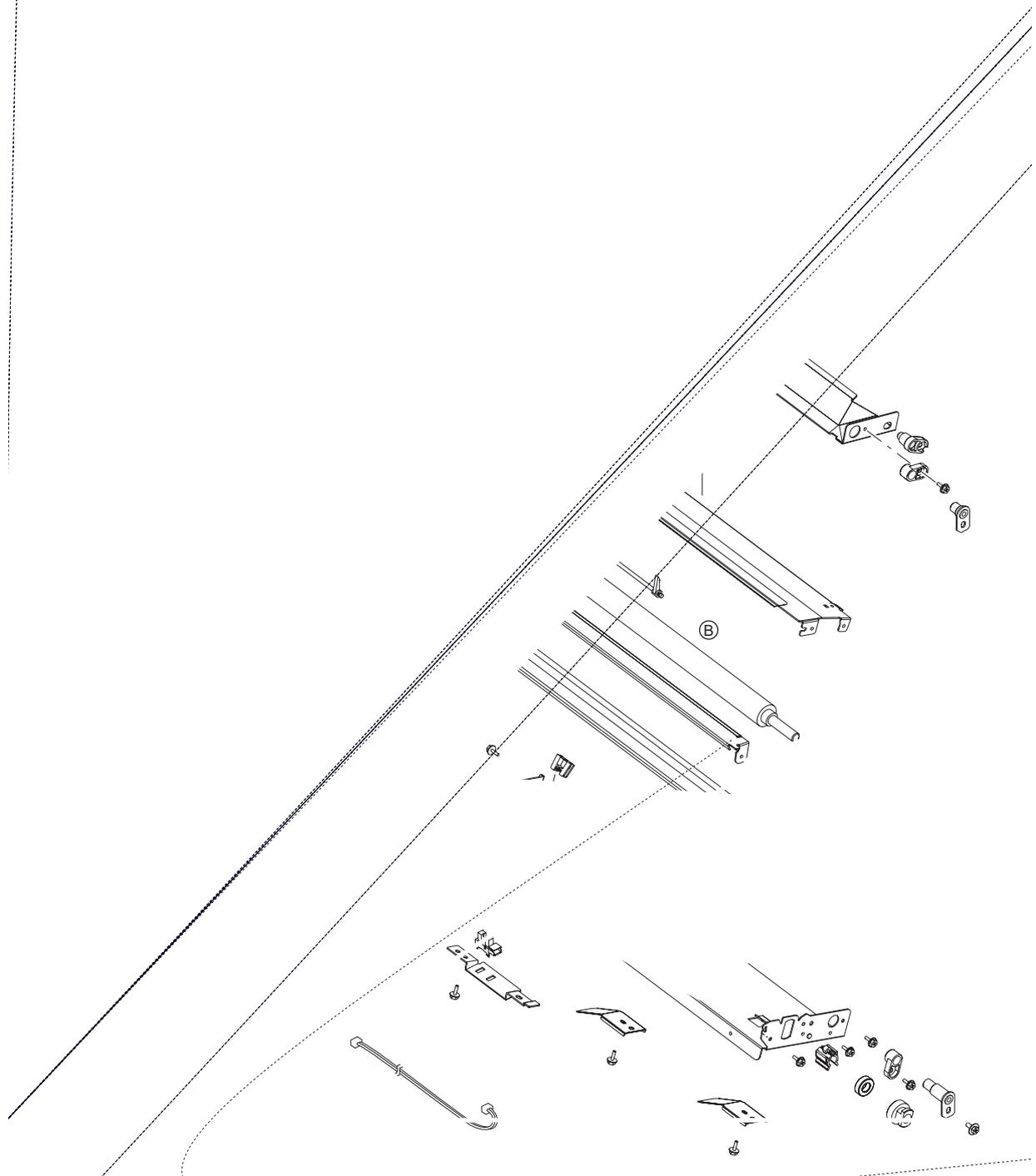

ITEM No.	PART No.	PART NAME	Q'TY / PAGE	Q'TY / PACK	REMARKS
1	4406349800	SPL-PUSH-RGST	2	1/P	
2	6LE05745000	FRAME-RGST-390	1	1/P	
3	6LA15024000	ACTUATOR-RGST-N	1	1/P	
4	4401772510	SPL-ACT-RGT	1	1/P	
5	6LA03326000	BRKT-SW-RGT-340	1	1/P	
6	C0-10813000	GP1A73ARJ00F	1	1/P	
7	6LE09602000	HRNS-RGTSW-390	1	1/P	
8	6LE05769000	ROL-RGST-D-390	1	1/KP	
9	4407547320	GEAR-0.8-25	1	1/P	
10	6LE05720000	ROLL-RGST-U-390	1	1/KP	
11	F0-00991000	L-1680HH	2	5/P	
12	4406349770	BUSH-RGST-D	2	1/P	
13	4406349790	CLIP-RGST	1	1/P	
14	6LA08949000	SPRING-1150	2	5/P	
15	4406349850	BUSH-RGST-UNIT	4	1/P	
16	6LA03335000	K-GUIDE-RGST-L	1	1/P	
17	4406349920	K-GUIDE-TR	1	1/KP	
18	4406349880	SPL-ROL-RGST	1	1/P	
19	6LE05767000	ASYS-BRK-BRS-RGT-L-390	1	1/KP	
20	4406349590	GEAR-08S020-08	1	1/P	
21	4406349550	BUSH-RGST-U	2	5/P	
22	F0-00023000	696T12ZZ1MC3E	2	1/P	
23	6LE05719000	PULLY-3GT16-06-390	1	1/P	
25	6LA03341000	GUIDE-RGST-U	1	1/P	
26	6LE09196000	MOTRS-RGT-390	1	1/C	
29	6LE05747000	BRKT-MOT-RGST-390	1	1/P	
32	4401772280	SUPPORT-GUIDE-P	2	1/P	
33	4406350060	BLT/T-174-3GT-4	1	1/P	
34	6LA03350000	K-JNT-GUIDE-U-S	2	1/P	
35	6LA03380000	K-JNT-RGT-FRT-R	1	1/P	
36	F0-00120000	ES-0505	1	5/P	
101	X0-02593000	S/TPD3/FHEXM-3X8-ZU3	17	10/P	
102	X0-00963000	RR/E-2-SS	1	10/P	
103	X0-01526000	P/PRL/AH7-2X12-SS	2	10/P	
104	X0-02235000	S/FHEXM-M4X8-NI	2	10/P	
105	X0-00968000	RR/E-7-SS	1	10/P	
106	X0-00966000	RR/E-5-SS	2	10/P	
107	X0-02589000	S/TPD3/FHEXM-4X8-ZU3	6	10/P	
108	X0-00094000	S/PAN/SWWP-M3X10-NI	1	10/P	



ITEM No.	PART No.	PART NAME	Q'TY / PAGE	Q'TY / PACK	REMARKS
1	6LE05701000	ASYS-FRM-TRANS	1	1/D	
2	6LE09520000	MOTRS-MT-390	1	1/C	
3	6LE05703000	SHAFT-TRANS	1	1/P	
4	6LE05706000	BRKT-ACTR-TRANS	1	1/P	
5	C0-10813000	GP1A73ARJ00F	1	1/P	
6	6LE05704000	ACTUATOR-TRANS	1	1/D	
7	6LE05770000	SPG-T-TRANS-ACTR	1	1/P	
8	6LA03543000	SPL-GUIDE-ROL2	1	1/P	
9	F0-00226000	KGLS-6RT	4	5/P	
10	6LE09140000	PWA-F-MOT2-390MT	1	1/C	
11	6LE09237000	HRNS-MIDTR-390	1	1/P	
12	6LA03557000	GUIDE-ADU-EX-L1	1	1/P	
13	6LA03558000	GUIDE-ADU-EX-L2	1	1/P	
14	6LA03584000	K-BKT-JNT-TRANS	1	1/P	
15	6LA03581000	SPRING-TRANS-R	1	5/P	
16	6LE05758000	ROLL-TRANS-390	2	1/P	
17	F0-01390000	LNR-1680HHRPOP15LY13	2	1/P	
18	6LA04720000	PLY/T-S2M-28-08	1	1/P	
19	6LE05713000	BLT_SY-S2M-124-6	1	1/P	
20	X0-01526000	P/PRL/AH7-2X12-SS	1	10/P	
21	F0-01248000	ESC-0912	2	10/P	
22	F0-00736000	LWS-0711Z	3	5/P	
23	6LE05717000	GUIDE-ROL-T-L-390	1	1/D	
24	6LE05746000	SPL-GUIDE-ROL1-390	1	1/D	
25	6LE09175000	K-VARIST-390	1	1/D	
26	6LE05712000	SUPPORT-GUIDE	1	1/P	
27	4401772280	SUPPORT-GUIDE-P	3	1/P	
28	6LA03552000	GEAR-10S021-06	1	1/P	
29	6LA03553000	GEAR-10S034-08	1	1/P	
30	6LE05708000	ASYS-BRKT-TRANS-G	1	1/D	
31	6LA03570000	CAP-STUD-SFB	1	1/P	
32	6LA03576000	SPC-064-060-0110	1	5/P	
33	6LA03575000	SPC-079-070-0110	1	5/P	
34	6LA03578000	BRKT-HOLD-SP	1	1/P	
35	6LE05759000	SHAFT-TRANS-390	1	1/P	
101	X0-02593000	S/TPD3/FHEXM-3X8-ZU3	15	10/P	
102	X0-02230000	S/FHEXM-M3X6-NI	4	10/P	
103	X0-00963000	RR/E-2-SS	1	10/P	
104	X0-00968000	RR/E-7-SS	5	10/P	
105	X0-02589000	S/TPD3/FHEXM-4X8-ZU3	3	10/P	

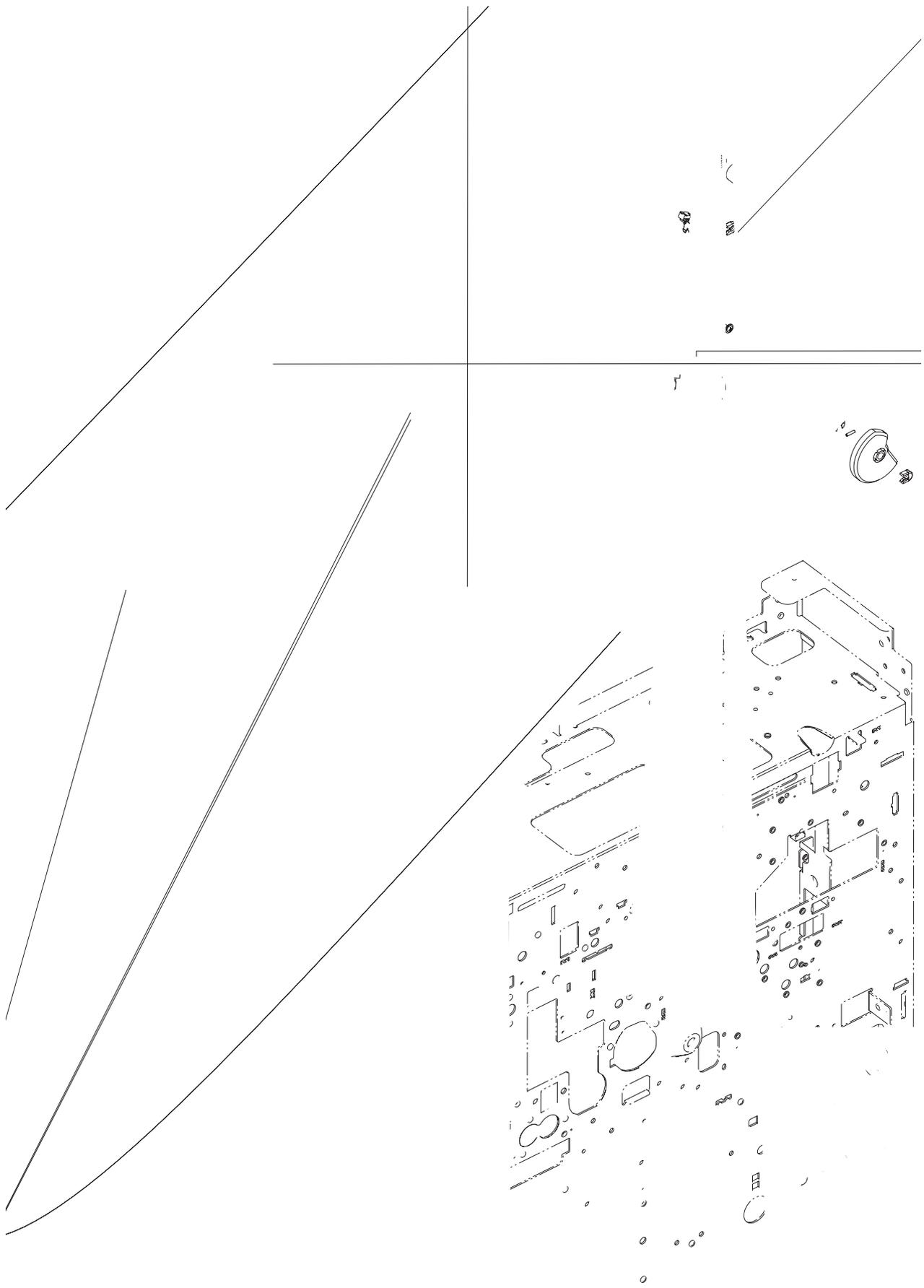



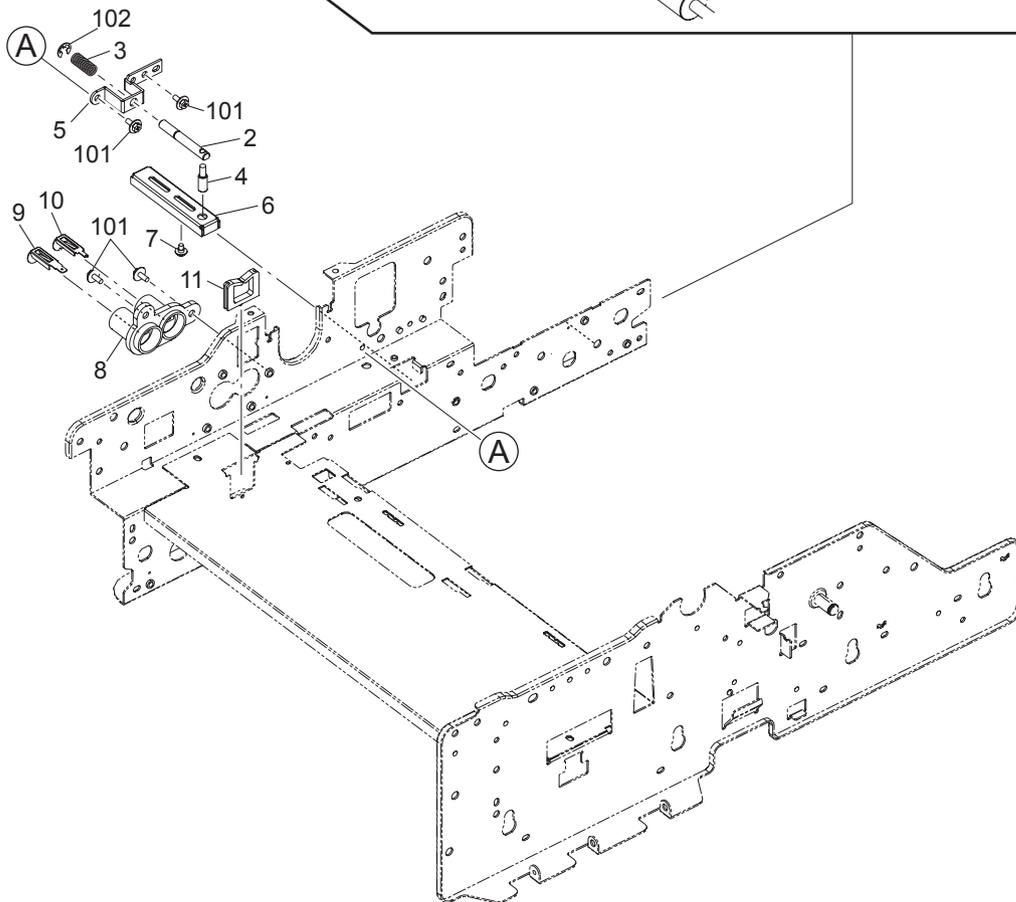
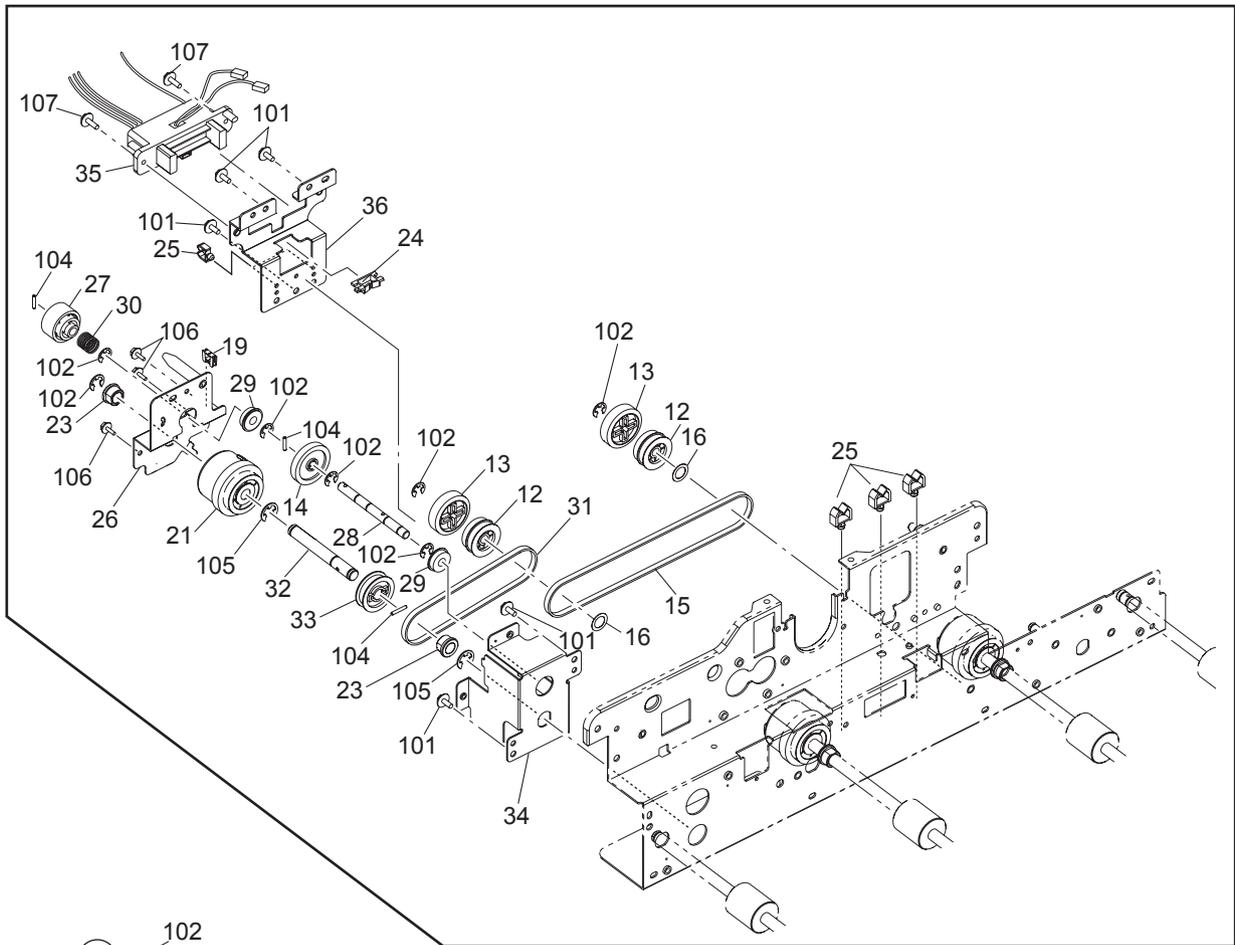

ITEM No.	PART No.	PART NAME	Q'TY / PAGE	Q'TY / PACK	REMARKS
2	6LE08848000	SHAFT-LOCK-HDL-390	1	1/P	
3	4406337960	SPC089-070-0200	1	5/P	
4	4406338130	SCREW-STOP-H	1	10/P	
5	4406338420	BRKT-STOP-SFT	1	1/P	
6	4406338400	ACTR-STOP-SFT	1	1/P	
7	6LA08932000	SCREW-ACTR-TRU	1	10/P	
8	4406337970	TERMINAL-TRU	1	1/P	
9	4406337980	PLATE-TERM-TRU1	1	1/P	
10	4406338010	PLATE-TERM-TRU2	1	1/P	
11	F0-00047000	EDS-1717U	1	10/P	
12	4406546980	PLY/T-3GT25TWIN	2	1/P	
13	4406546990	GEAR10S28-06TWN	2	1/P	
14	4406342080	GEAR-10S028-06	1	1/P	
15	6LA06121000	BLT/T-375-3GT-4	1	1/P	
16	6LA06340000	WAS-06-95-Z13-P	2	10/P	
19	F0-00120000	ES-0505	1	5/P	
21	6LA15184000	CLUCH-G28-08D	1	1/D	
23	6LH23442000	BUSH-8X12X8F-NU4	2	5/P	
24	F0-01248000	ESC-0912	1	10/P	
25	F0-01250000	MSB-1207	4	5/P	
26	6LE08846000	ASYS-PLT-CPG-TR	1	1/P	
27	6LA06320000	CPG-DRIVE-TRANS	1	1/P	
28	6LE08857000	SHAFT-CPG-TRANS	1	1/P	
29	F0-01482000	RNR-1560ZZRP0P24LY121	2	1/P	
30	6LA06330000	SPC098-080-150	1	5/P	
31	6LA06120000	BLT/T-249-3GT-4	1	1/P	
32	6LA14346000	SHAFT-CLH-CPG	1	1/P	
33	6LA06337000	PLY/T-3GT025-08	1	1/P	
34	6LE08843000	BRKT-CPG-TRS-390	1	1/P	
35	6LE09132000	HRNS-ADU-390	1	1/P	
36	6LE08842000	BRKT-CNT-TR-390	1	1/P	
101	X0-02589000	S/TPD3/FHEXM-4X8-ZU3	9	10/P	
102	X0-00966000	RR/E-5-SS	8	10/P	
104	X0-01526000	P/PRL/AH7-2X12-SS	3	10/P	
105	X0-00967000	RR/E-6-SS	2	10/P	
106	6LA08935000	SCR-M3X6BISR-NI	3	10/P	
107	X0-02591000	S/TPD3/FHEXM-4X12-ZU3	2	10/P	



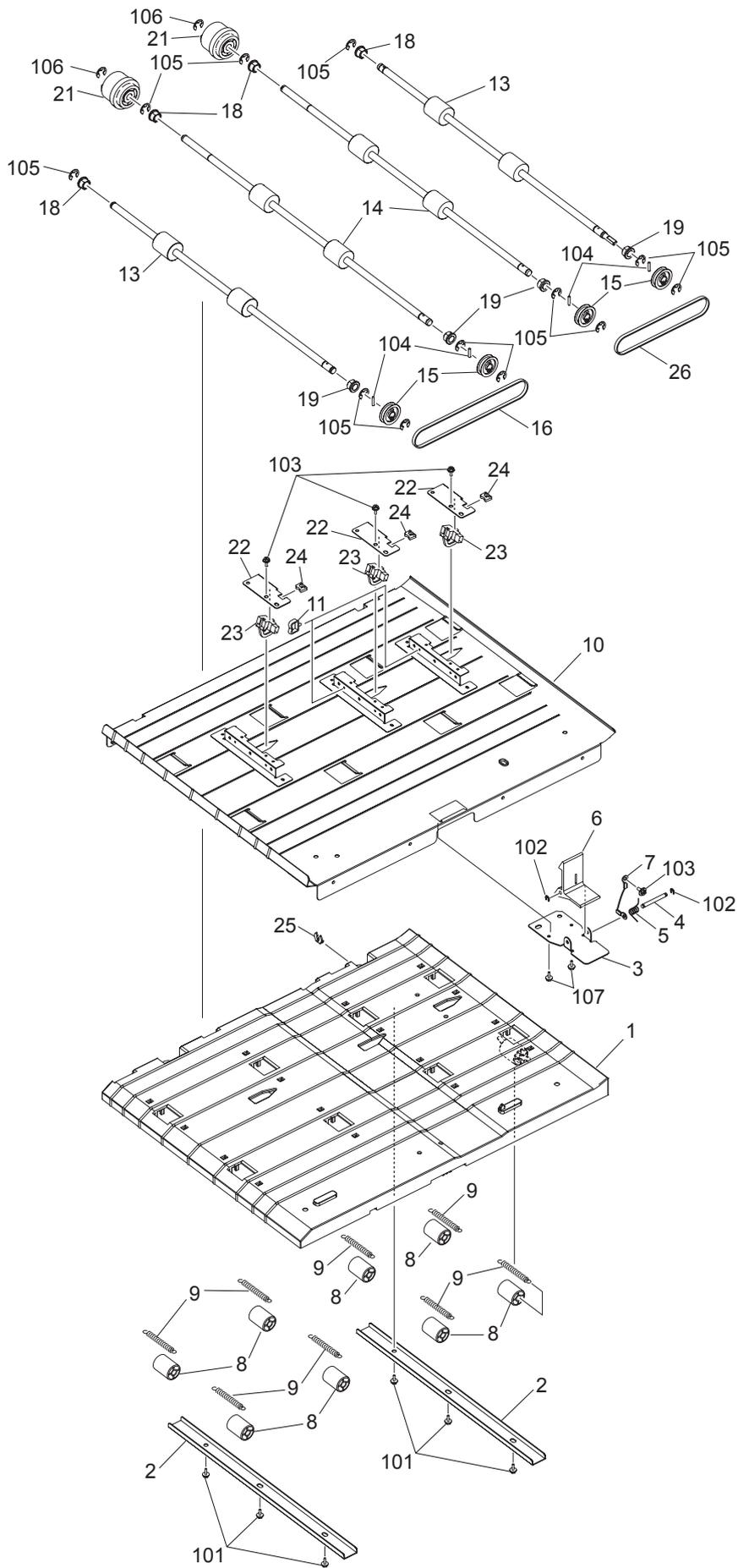



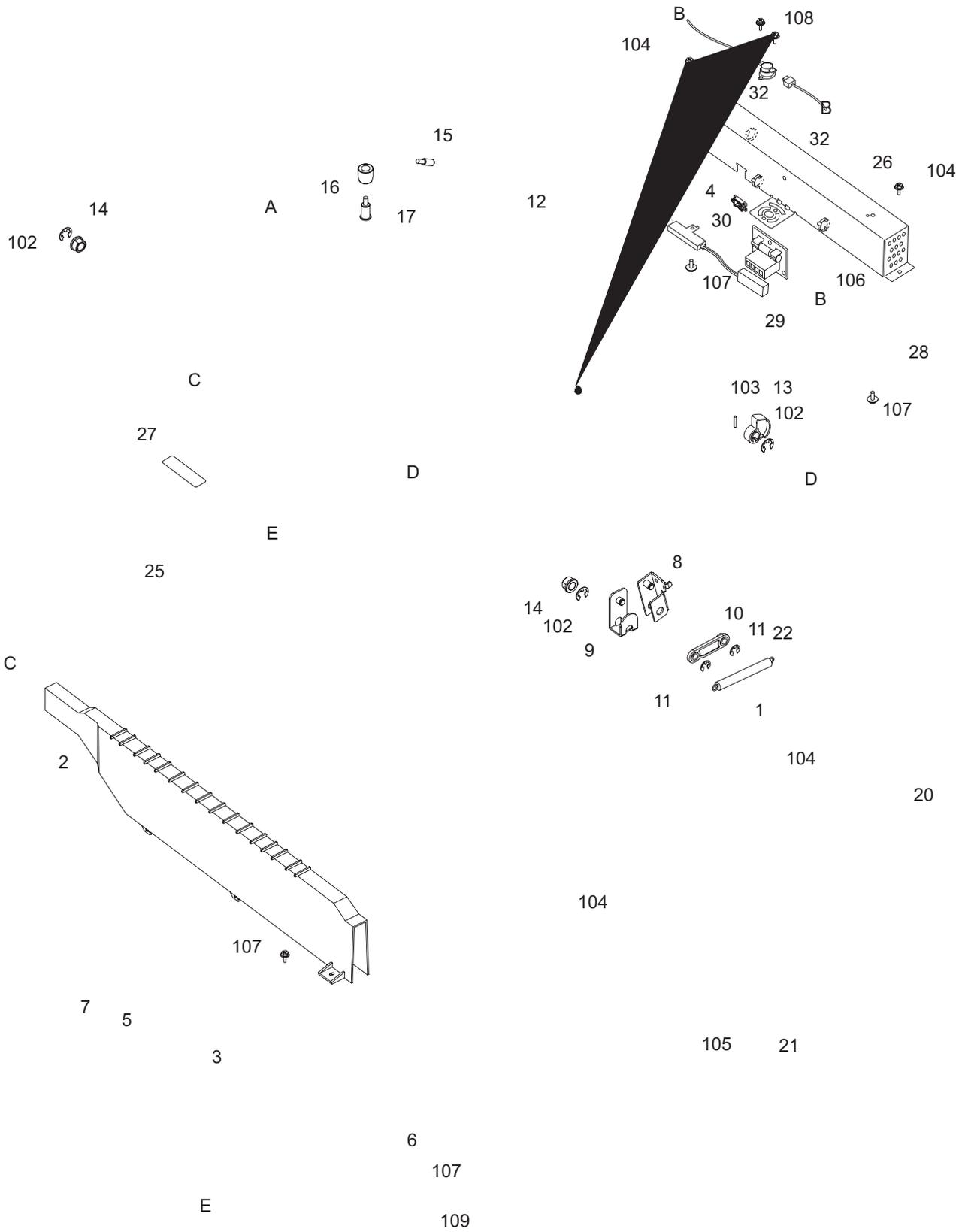

ITEM No.	PART No.	PART NAME	Q'TY / PAGE	Q'TY / PACK	REMARKS
1	6LE08805000	COVER-IN-TRU	1	1/P	
2	6LA02792000	DUCT-TRU	1	1/PP	
3	6LE16206000	SEAL-TRU-CR	1	1/KP	
4 B	F0-01248000	ESC-0912	2	10/P	ASD,ASU,AUD,ARD,SAD
5	F0-00047000	EDS-1717U	1	10/P	
6	6LA02793000	PL-EARTH-C-SUB	1	1/P	
7	6LE09616000	HRNS-HVT-TR2-390	1	1/P	
8	6LA02812000	ASYS-BRKT-LNK-F	1	1/P	
9	6LA02815000	ASYS-BRKT-LNK-H	1	1/P	
10	4406338380	PLATE-LINK-H	1	1/P	
11	X0-00966000	RR/E-5-SS	2	10/P	
12	6LE08828000	SHAFT-HANDLE-TRU	1	1/P	
13	6LA02804000	CAM-F-TRU	1	1/P	
14	4400802080	BUSH-8	2	5/P	
15	4406338130	SCREW-STOP-H	1	10/P	
16	4406339490	COLLAR-STP-HDL	1	1/P	
17	4406339500	SCREW-HANDLE	1	10/P	
20	6LE08818000	LBL-ADU-OPEN	1	1/KP	
21	6LE08801000	HANDLE-TRU-390	1	1/P	
22	4406338300	SPE080-100-0530	1	5/P	
25	6LA02823000	SCREW-RAIL-TRU	2	5/P	
26 B	6LA02845000	BRKT-DH-L-340	1	1/P	ASD,ASU,AUD,ARD,SAD
27 A	6LE08831000	LBL-W-HOT-STAY-390	1	5/P	ASD,ASU,AUD,ARD,SAD
28 B	E0-10980000	HF05N132	2	1/D	SAD
28 C	E0-10981000	HF05N442	2	1/D	ASD,ASU,AUD,ARD
29 B	6LA07432000	HRNS-DHT-L-340	1	1/P	ASD,ASU,AUD,ARD,SAD
30 B	6LE09411100	PWA-F-FUS-390UE	1	1/C	ASD,ASU,AUD,ARD,SAD
31 B	6LE71198000	THRMST-CS-7SA	1	1/C	ASD,ASU,AUD,ARD,SAD
32 B	F0-00021000	SKB-80MZ	3	10/P	ASD,ASU,AUD,ARD,SAD
101	X0-02593000	S/TPD3/FHEXM-3X8-ZU3	3	10/P	
102	X0-00968000	RR/E-7-SS	3	10/P	
103	X0-01526000	P/PRL/AH7-2X12-SS	1	10/P	
104	X0-02589000	S/TPD3/FHEXM-4X8-ZU3	4	10/P	
105	X0-02235000	S/FHEXM-M4X8-NI	1	10/P	
106 B	F0-00340000	SPLSN-4U	3	5/P	ASD,ASU,AUD,ARD,SAD
107	X0-02592000	S/TPD3/FHEXM-3X6-ZU3	2	10/P	
108 B	X0-00676000	S/TPS/BID-3X6-NI	2	10/P	ASD,ASU,AUD,ARD,SAD
109	F0-01248000	ESC-0912	1	10/P	

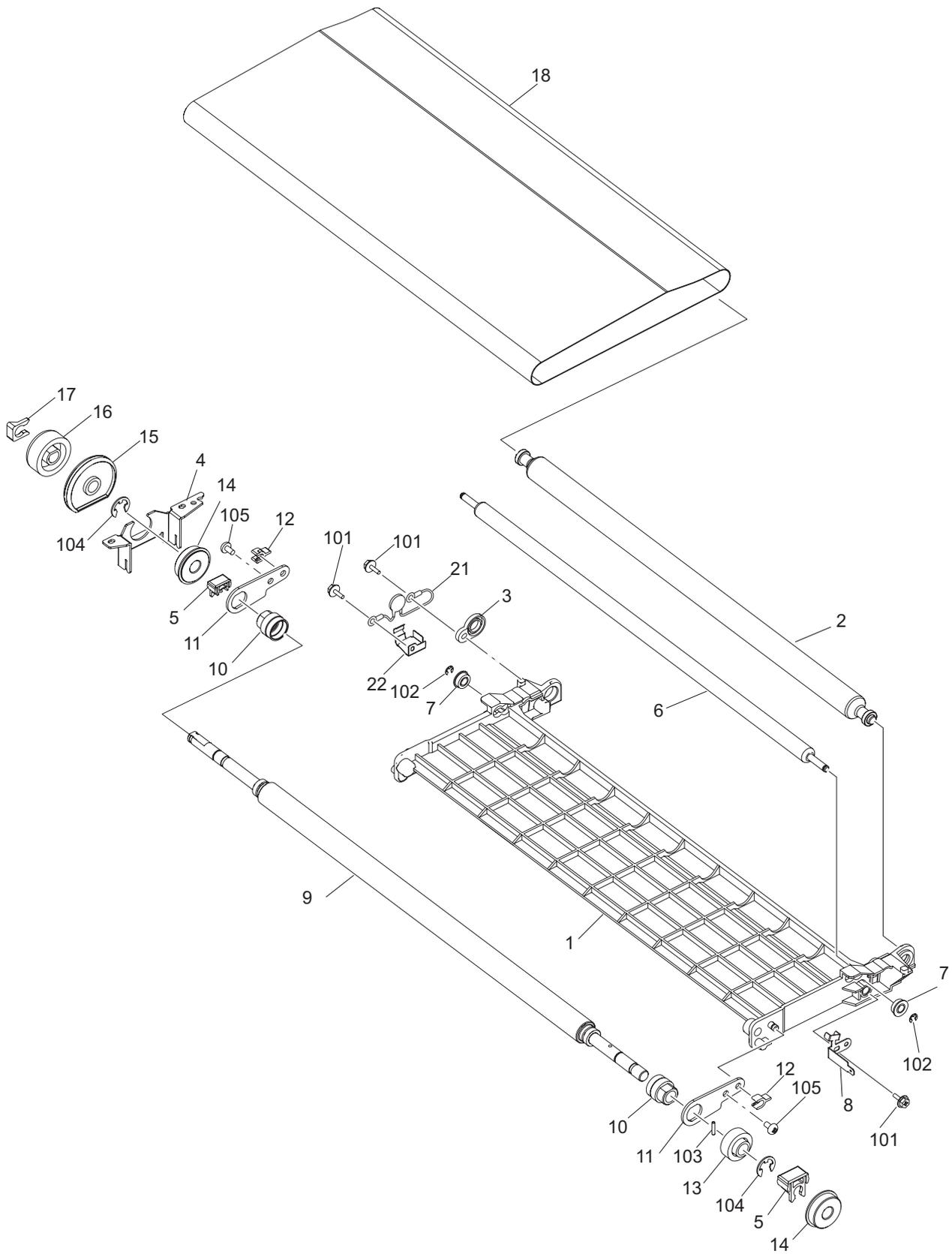



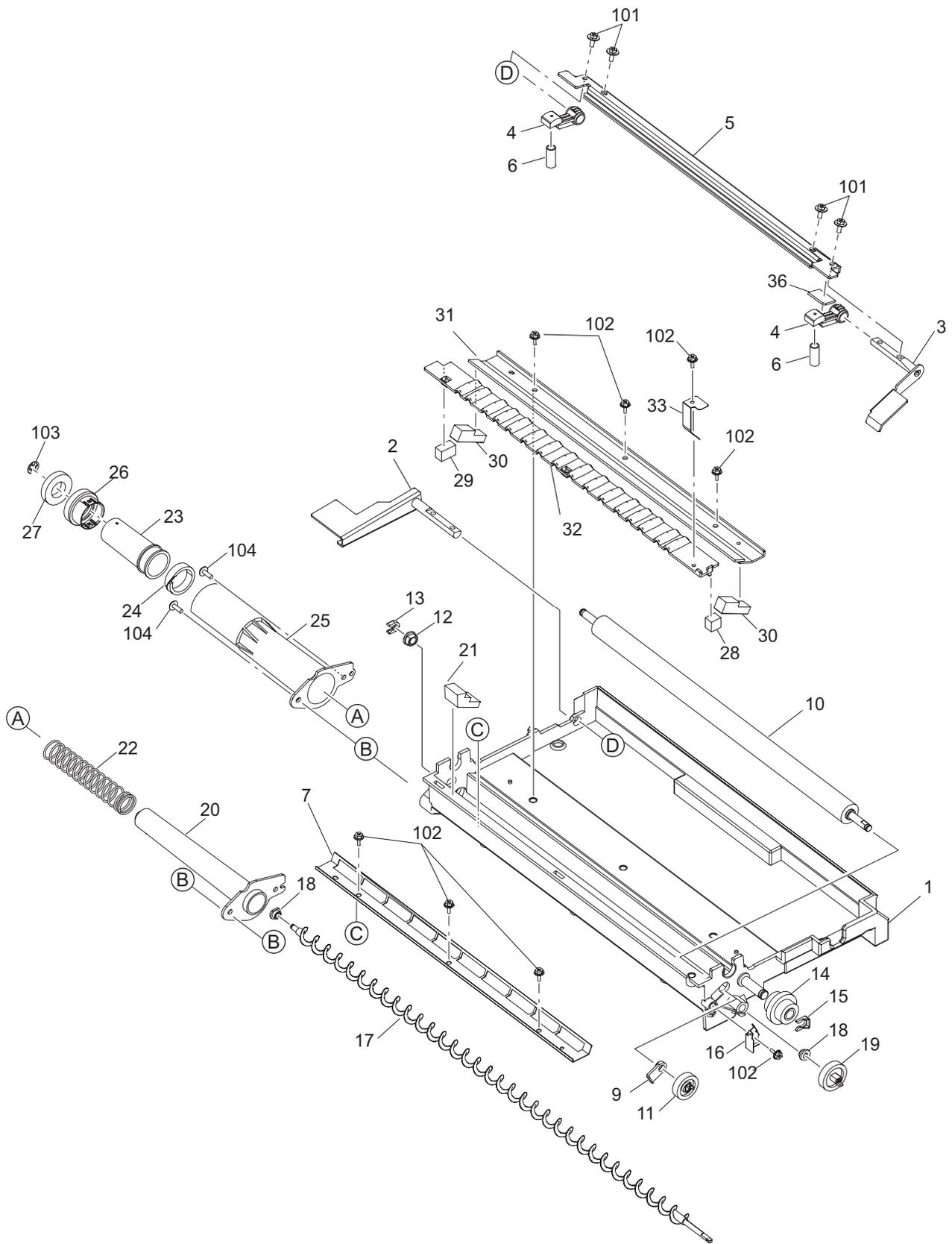







ITEM No.	PART No.	PART NAME	Q'TY / PAGE	Q'TY / PACK	REMARKS
1	6LA05484000	K-BRKT-FUS-MOT	1	1/P	
2	4406325850	K-GR10S23/05H50	1	1/P	
3	4363260910	SPC-075-055-200	1	5/P	
4	6LA05500000	COVER-FUS-GEAR	1	1/P	
5	6LE09157000	MOTRD-HTR-390	1	1/C	
6	6LE03100000	GEAR-5H50_P3GT17-6	1	1/P	
7	6LE09788000	HRNS-LGC-FUS-390	1	1/P	
8	6LA14468000	SPC068-080-160	2	5/P	
9	E0-08333000	AGX206F	1	1/D	
10	6LA05488000	STUD-ADU-CUP	1	1/P	
11	6LE03101000	BLT_SY-3GT-339-6	1	1/P	
12	6LA05494000	PLY/T-3GT021-06	1	1/P	
13	F0-00340000	SPLSN-4U	1	5/P	
14	F0-00838000	HL-28-0-V0	2	1/P	
15	F0-01243000	LWS-1211Z	2	5/P	
16 A	6LE06718000	ASYS-PS-IH-390U	1	1/C	NAD
16 B	6LE06718400	ASYS-PS-IH-H100E	1	1/C	MJD,ASD,ASU,AUD,ARD
16 C	6LE06718300	ASYS-PS-IH-390S	1	1/C	SAD
17	6LE09166000	FAND-8025-390	1	1/D	
18	6LE06722000	ASYS-DUCT-FUS-PWA-390	1	1/PP	
19	6LE06624000	COV-PWA-IH	1	1/P	
20	6LA06571000	LBL-W-HOT-340	1	1/KP	
21	6LE06691000	PLATE-COVER-IH	1	1/KP	
22	6LA05538000	BRKT-IH-FAN	1	1/P	
23	X0-02593000	S/TPD3/FHEXM-3X8-ZU3	1	10/P	
24	F0-01299000	LWS-2111Z	2	1/P	
25	6LE13137000	LBL-FUS-TNR-IN	1	1/KP	
27 B	6LE06692000	SHIELD-IH	1	1/KP	MJD,ASD,ASU,AUD,ARD
28	6LA05537000	BRKT-IH-GND	1	1/P	
30	6LE06648000	ASYS-DUCT-FUS-L-390	1	1/PP	
31	6LE09915000	HRNS-DH-CONNECT-390	1	1/P	
101	X0-00966000	RR/E-5-SS	1	10/P	
102	6LA14330000	S/TPS/HEX/R-M4X12	1	10/P	
103	4406326040	SCREW-D4-18-M3	2	10/P	
104	6LH36359000	SCREW-M3-D4X2.3	1	10/P	
105 A	X0-02247000	S/TPP/FHEXM-3X8-NI	7	10/P	NAD,SAD
105 B	X0-02247000	S/TPP/FHEXM-3X8-NI	11	10/P	MJD,ASD,ASU,AUD,ARD
106	6LE06667000	SCREW-M3-D4-7-ZU3	1	5/P	
107	6LH36358000	SCREW-M3-D3.5X5.5	1	10/P	
108	X0-02235000	S/FHEXM-M4X8-NI	1	10/P	
109	X0-02589000	S/TPD3/FHEXM-4X8-ZU3	5	10/P	
110	X0-02230000	S/FHEXM-M3X6-NI	1	10/P	
111	X0-02217000	S/PAN/SWWP-M4X8-ZU3	1	10/P	
112	X0-00434000	S/BID-M3X8-NI	2	10/P	
113	X0-02590000	S/TPD3/FHEXM-4X10-ZU3	2	10/P	

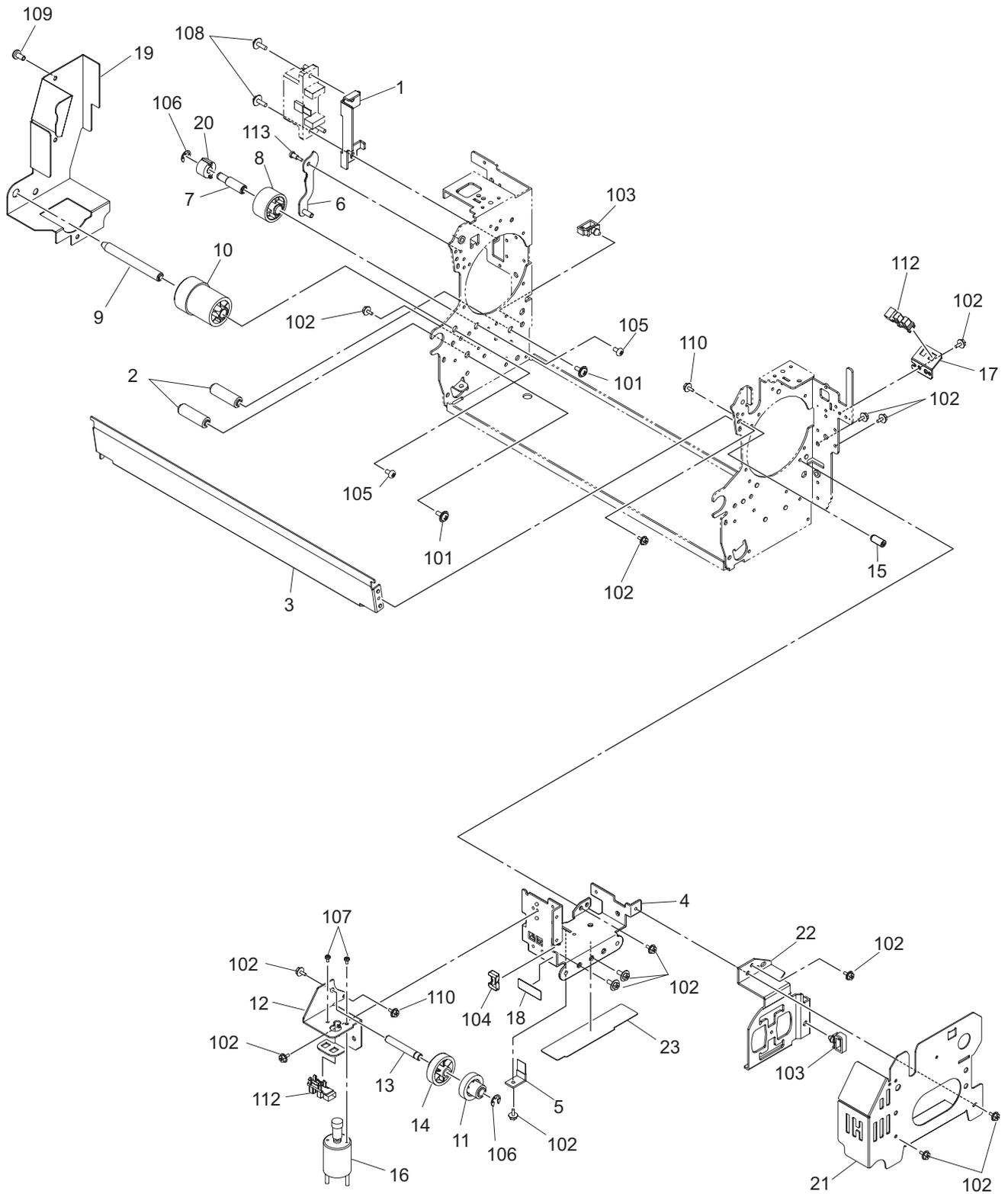



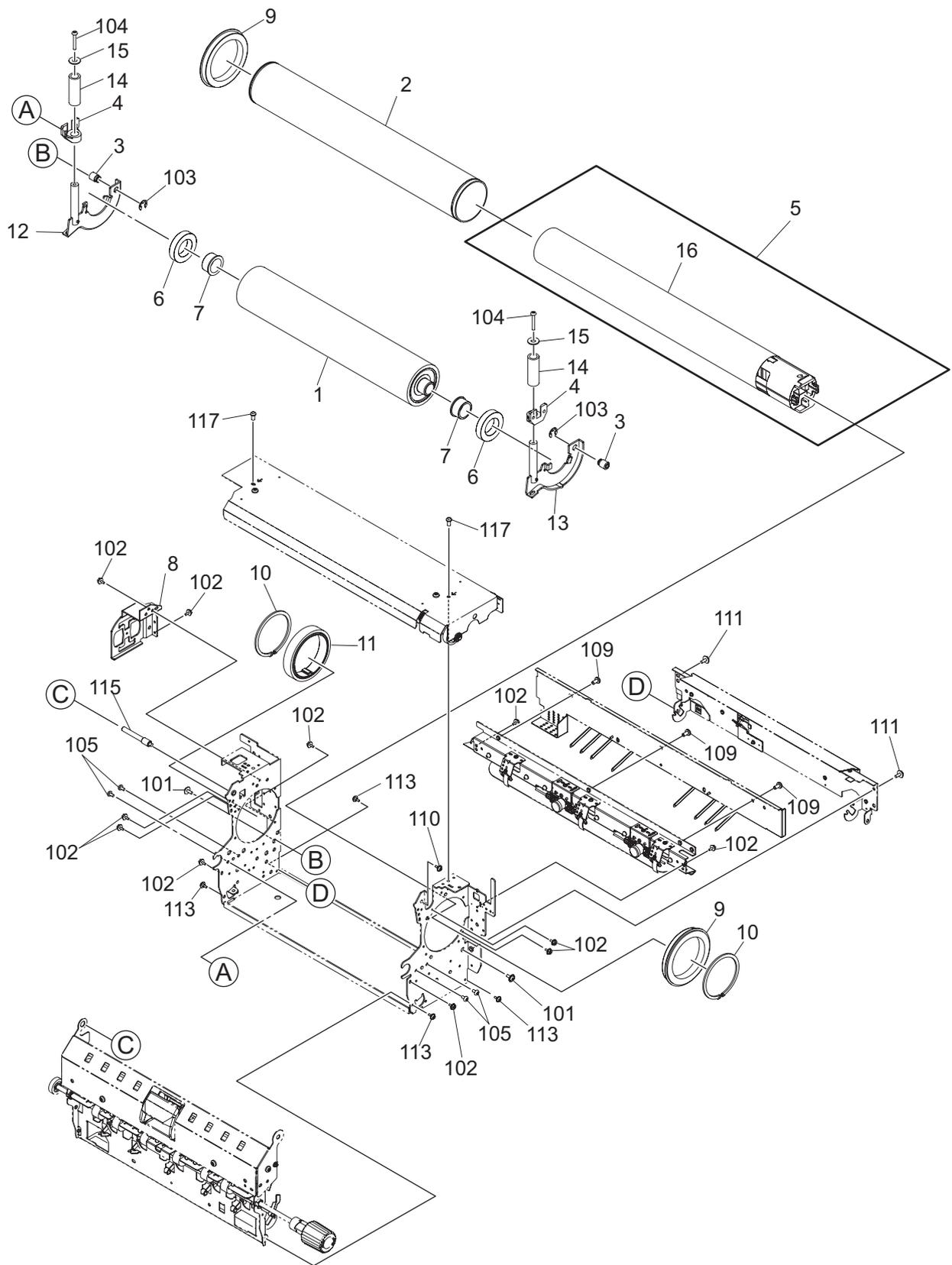



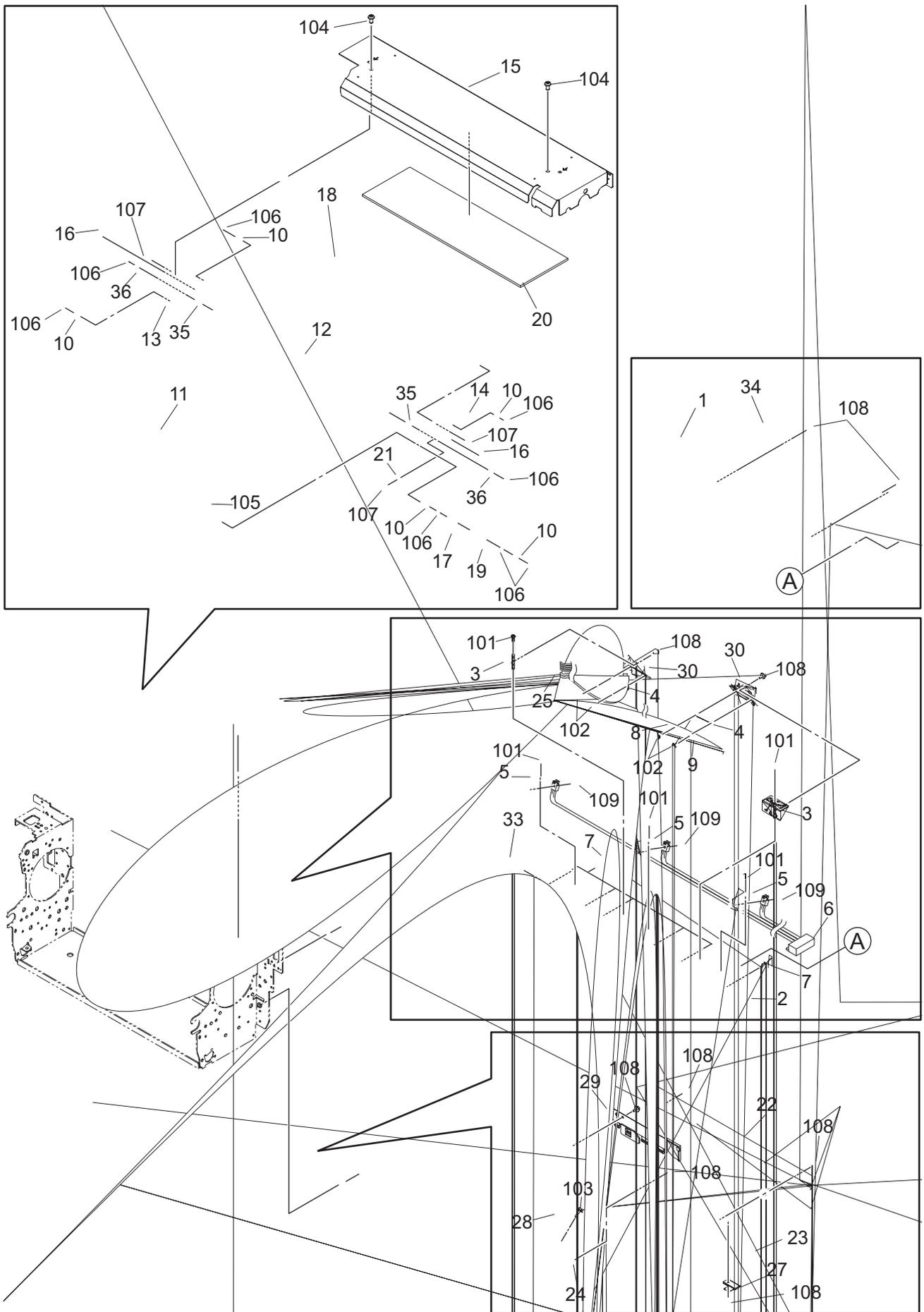

ITEM No.	PART No.	PART NAME	Q'TY / PAGE	Q'TY / PACK	REMARKS
1	6LA05313000	BRKT-FUS-ENT-U	1	1/PP	
2	6LA05304000	GUIDE-FUS-ENT-U	1	1/P	
3	6LA05310000	BRKT-THERMO-H/R	2	1/P	
4	6LA07172000	THRMST-340-FUS	2	1/C	
5	6LA05309000	BRKT-THMS-H/R	3	1/P	
6	6LE09681000	THMS-HTR-U-390FS	1	1/C	
7	F0-00032000	PLWS-1-46B	6	5/P	
8	6LE09437000	HRNS-IH-AC1-390	1	1/P	
9	6LA07431000	HRNS-IH-AC2-340	1	1/P	
10	4401759090	BUSH-6	5	5/P	
11	6LE19372000	CW-6000	1	1/S	
12	6LE19373000	PR-6000W	1	1/S	
13	6LE06634000	BRKT-WEB-R-390	1	1/P	
14	6LE06633000	BRKT-WEB-F-390	1	1/P	
15	6LA05444000	GUARD-FUS-CLN-U	1	1/PP	
16	6LA08943000	SPE-050-050-216	2	5/P	
17	6LA05455000	GEAR-08S35-06-F	1	1/P	
18	6LA05454000	BRKT-FUS-WEB-E	1	1/P	
19	6LA05452000	GG08S035/08S14L	1	1/P	
20	6LA05470000	SHEET-FUS-CLN-U	1	1/KP	
21	6LA05472000	SPL-FUS-F	1	1/P	
22	4406325090	GUIDE-FUS-ENT-L	1	1/P	
23	6LE06662000	BRKT-FUS-ENT-L390	1	1/P	
24	6LE06663000	BRKT-THMS-L390	1	1/P	
25	6LE09155000	HRNS-FUS-390	1	1/P	
27	6LE06669000	BRUSH-SUS-HR	1	1/KP	
28	4406379760	THMS-HTR-L-300	1	1/C	
29	4406325120	COV-THMS-HT-FUS	1	1/P	
30	6LE06758000	K-HLD-THERMO	2	1/P	
33	6LA05286000	SHEET-FUS-ENT-U	1	1/KP	
34	6LE06630000	ASYS-GUIDE-EN-390	1	1/KP	
35	6LA05468000	BRG-ONEWAY-6-H	2	1/P	
36	6LA05458000	SPACER-FUS-WEB	2	5/P	
101	X0-02069000	S/TPS/BID-3X6-ZU3	5	10/P	
102	X0-02551000	S/PAN/SWWP-M3X6-ZU3	4	10/P	
103	X0-02232000	S/FHEXM-M3X10-NI	1	10/P	
104	4401759180	SCREW-FUSER-M4	2	10/P	
105	X0-01526000	P/PRL/AH7-2X12-SS	1	10/P	
106	X0-00966000	RR/E-5-SS	8	10/P	
107	6LH36359000	SCREW-M3-D4X2.3	3	10/P	
108	X0-02592000	S/TPD3/FHEXM-3X6-ZU3	9	10/P	
109	X0-00094000	S/PAN/SWWP-M3X10-NI	3	10/P	



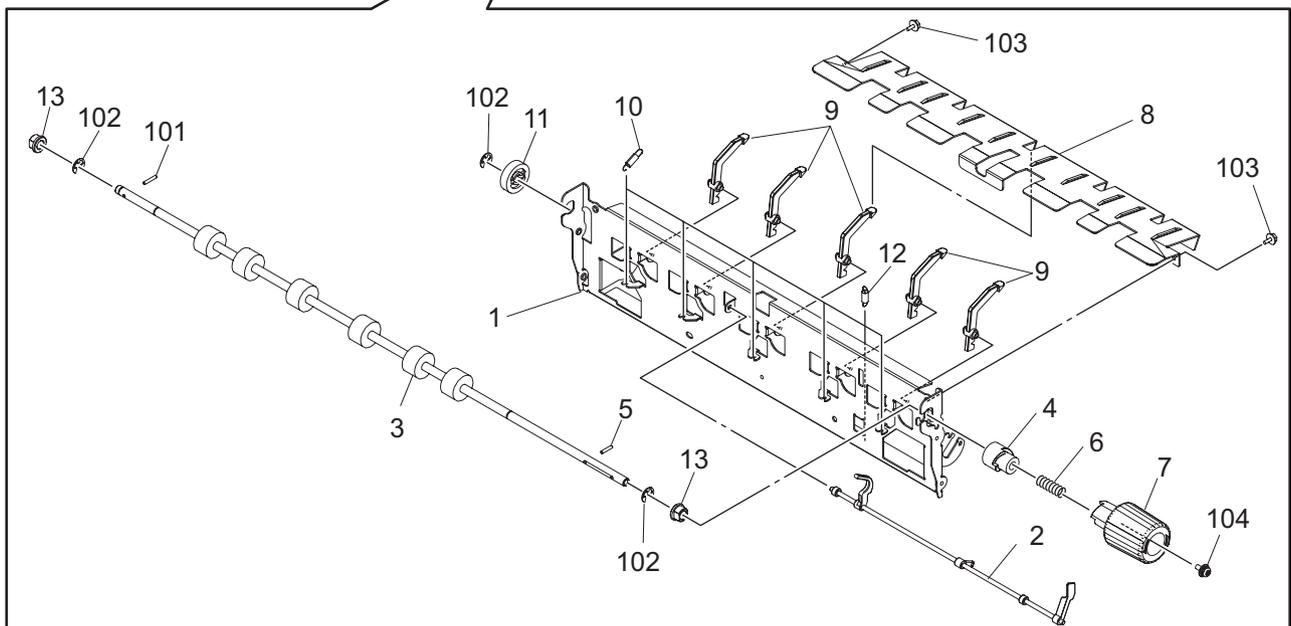
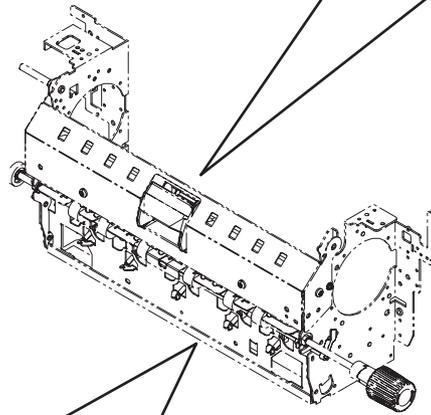
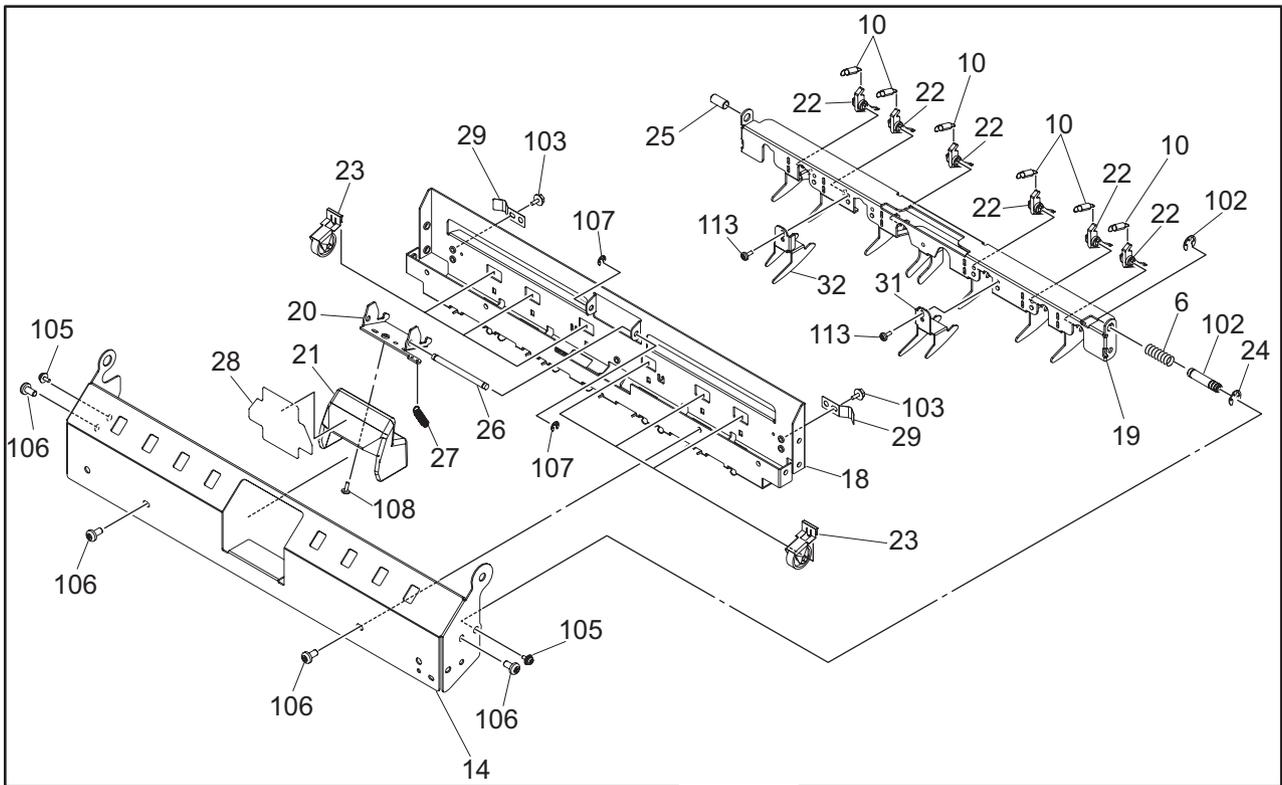



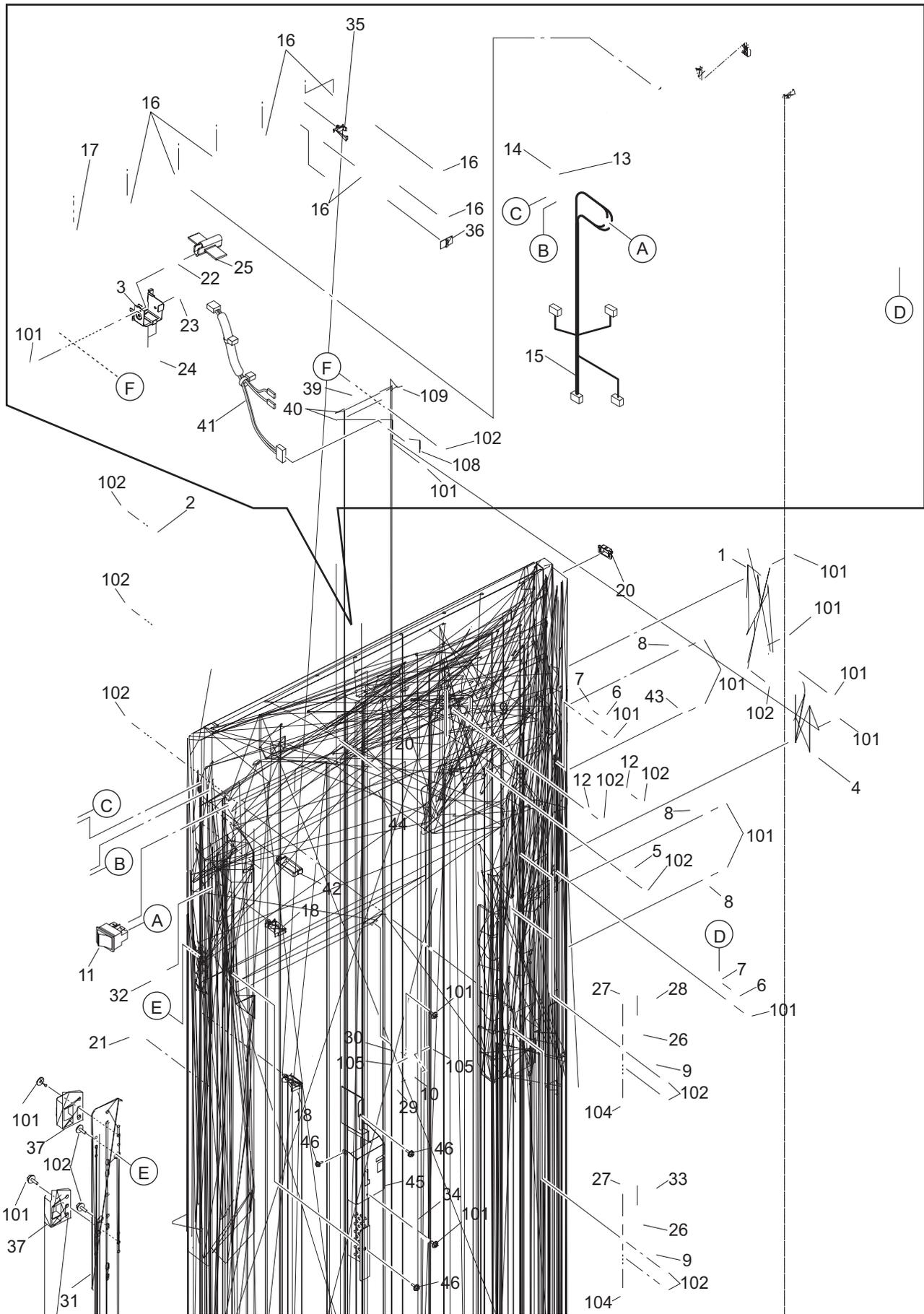

ITEM No.	PART No.	PART NAME	Q'TY / PAGE	Q'TY / PACK	REMARKS
1	6LE06335000	BRKT-HINGE-UPR	1	1/P	
2	6LA00950000	BRKT-F/S-UNIT	1	1/P	
3	6LH68507000	BRKT-DOOR-SW-H100	1	1/P	
4	6LE06338000	ASYS-BRKT-HINGE-LWR	1	1/P	
5	6LE05714000	ASYS-BRKT-POS-TRANS	1	1/P	
6	6LA04796000	BRKT-SENS-OPEN	2	1/P	
7	C0-10813000	GP1A73ARJ00F	2	1/P	
8	6LA04151000	STOPPER-KNOB	3	1/P	
9	6LA04492000	HOLDER-LOCK-CST	3	1/P	
10	4406343710	SHAFT-GUIDE-OP	1	1/P	
11	E0-08497000	AJ8W200WWF	1	1/D	
12	4406333430	BUSH-DEV	2	5/P	
13	6LE09205000	HRNS-FRONT-390	1	1/P	
14	6LE09209000	HRNS-SIDE-390	1	1/P	
15	6LH69820000	HRNS-MAIN-SW-H100	1	1/P	
16	F0-00736000	LWS-0711Z	9	5/P	
17	F0-01243000	LWS-1211Z	1	5/P	
18	F0-01299000	LWS-2111Z	3	1/P	
19	F0-00120000	ES-0505	1	5/P	
20	F0-01248000	ESC-0912	1	10/P	
21	4406509170	BD/W-TWS-3027	1	1/P	
22	6LH68508000	STUD-DOOR-SW-H100	1	1/P	
23	4408354010	STOPPER-REAR	1	1/P	
24	E0-08442000	FA1L-AA22	1	1/D	
25	6LH68509000	GUIDE-SW-DOOR-H100	1	1/P	
26	6LA04493000	HOOK-LOCK-CST	3	1/P	
27	6LA04494000	STUD-LOCK-CST	3	5/P	
28	6LA04495000	SPE080-100-0320	3	5/P	
29	4406343720	ROLL-GUIDE-OPEN	1	5/P	
30	6LE06351000	BRKT-HOLDER-RLR-390	1	1/P	
31	6LE03146000	ASYS-LOCK-EXIT-F-390	1	1/P	
32	6LA06575000	LBL-W-HOT-ANGL	1	1/KP	
33	6LA04851000	SPE075-100-0320	1	5/P	
34	6LE06341000	GUIDE-PUSH-DOOR-390	1	1/P	
35	F0-00367000	RLWS-1TV0	1	10/P	
36	F0-00837000	P-25	1	5/P	
37	6LA05785000	HOOK-LOCK-EXIT	2	1/P	
39	6LE06400000	BRKT-SW-TNR-MAIN	1	1/P	
40	44204394000	SCREW20*D23	2	10/P	
41	6LE09240000	HRNS-FRT-USW-390	1	1/P	
42	F0-00026000	LWS-4U	1	5/P	
43	6LA15052000	STOPPER-KNOB-BYP	1	1/P	
44	6LA47644000	LBL-CAU-LSR-350	1	1/KP	
45	6LE06310000	COVER-AGL-L-U-390	1	1/C	
46	6LA08934000	SCR-M4X8ITSR-NI	3	10/P	
101	X0-02593000	S/TPD3/FHEXM-3X8-ZU3	16	10/P	
102	X0-02589000	S/TPD3/FHEXM-4X8-ZU3	18	10/P	
104	X0-02231000	S/FHEXM-M3X8-NI	2	10/P	
105	X0-00966000	RR/E-5-SS	2	10/P	
108	E0-01853000	CS1A-B2CA	1	1/D	
109	E0-08294000	DE2L-BALG	1	1/D	

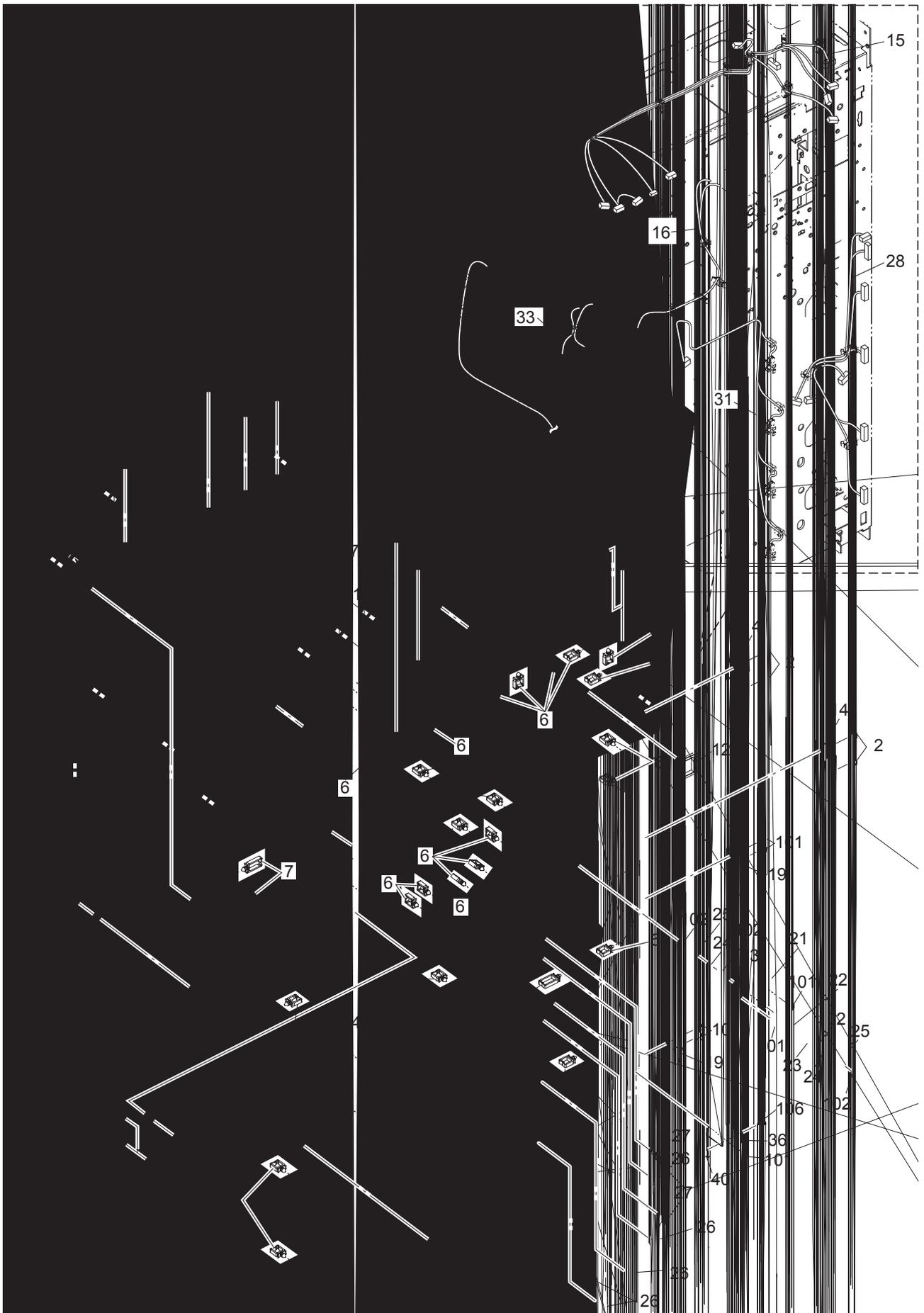

ITEM No.	PART No.	PART NAME	Q'TY / PAGE	Q'TY / PACK	REMARKS
2	6LA08934000	SCR-M4X8ITSR-NI	4	10/P	
4	F0-00027000	SPS-3U	1	5/P	
5	F0-00342000	SPLSN-6U	1	5/P	
6	F0-01243000	LWS-1211Z	34	5/P	
7	F0-01299000	LWS-2111Z	8	1/P	
8	F0-00047000	EDS-1717U	6	10/P	
9	F0-01248000	ESC-0912	5	10/P	
10	6LE05412000	BUSH-KG-016L-SYS	1	1/P	
11	F0-00343000	SPLSN-8U	4	5/P	
12	4406509170	BD/W-TWS-3027	2	1/P	
14	6LA04747000	BRKT-HINGE-BYP	2	1/P	
15	6LH69852000	HRNS-PLG-SYS-H100	1	1/P	
16	6LE09118000	HRNS-HVT-M-390	1	1/P	
17	6LE09119000	HRNS-HVT-TR-390	1	1/P	
18	4406349900	K-JOINT-RGT	1	1/P	
19	6LA04139000	K-BKT-HINGE-FED	2	1/P	
20	6LA01386000	SEAL-FRAME-R	1	1/KP	
21	6LA04261000	BRKT-DRIVE-MID	1	1/P	
22	6LA04262000	SHAFT-DRIVE-MID	1	1/P	
23	4407734980	BUSH-6-GCB	2	5/P	
24	X0-01526000	P/PRL/AH7-2X12-SS	2	10/P	
25	6LA04263000	GEAR-10S035-06	2	1/P	
26	C0-10813000	GP1A73ARJ00F	4	1/P	
27	F0-00370000	OCB-375	4	5/P	
28	6LE09412000	ASY-HRNS-CST-390	1	1/P	
29	6LA01199000	GSKT-10-10-50	1	5/P	
31	6LA07340000	HRNS-LGC-BTM-340	1	1/P	
33	6LE09116000	HRNS-HVT-BRS-390	1	1/P	
34	6LH69989000	HRNS-LGC-REV-H100	1	1/P	
35	6LE09278000	HRNS-LGC-DEVM-390	1	1/P	
36	6LE05763000	BRKT-HINGE-STOP-390	1	1/P	
37	4401772280	SUPPORT-GUIDE-P	1	1/P	
38	6LA03350000	K-JNT-GUIDE-U-S	1	1/P	
39	6LA05330000	BRKT-FUS-DRV	1	1/P	
40	6LE05764000	BRKT-HINGE-STOP-SUB	1	1/P	
41	F0-00736000	LWS-0711S	2	5/P	
42	6LA01041000	COVER-TLCF-FRM	1	1/P	
101	X0-02589000	S/TPD3/FHEXM-4X8-ZU3	23	10/P	
102	X0-00966000	RR/E-5-SS	4	10/P	
103	X0-02593000	S/TPD3/FHEXM-3X8-ZU3	4	10/P	
104	F0-00119000	EMT-4N	1	1/P	
105	X0-01285000	S/BID-M4X6-NC	1	10/P	
106	6LA08935000	SCR-M3X6BISR-NI	1	10/P	

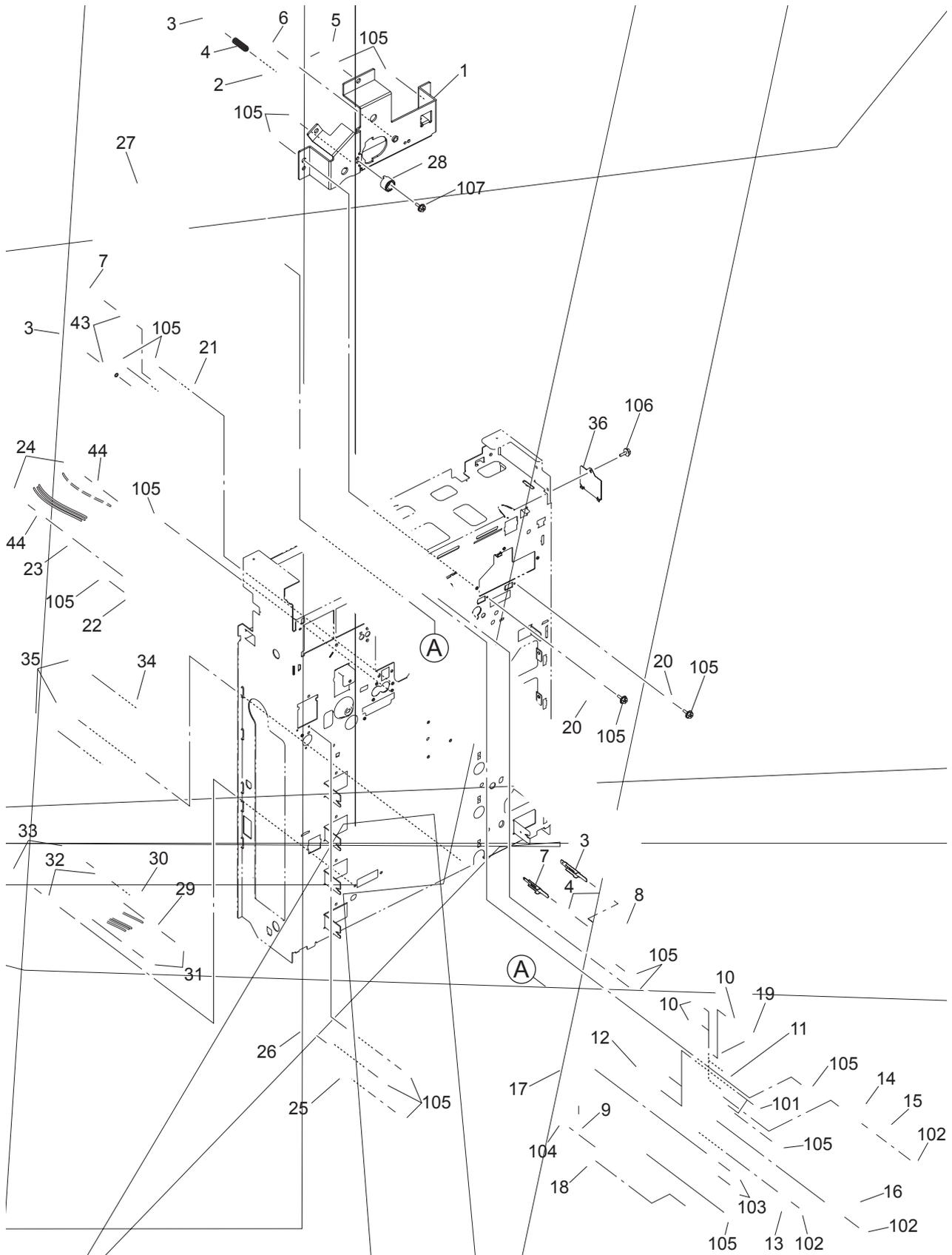

ITEM No.	PART No.	PART NAME	Q'TY / PAGE	Q'TY / PACK	REMARKS
1	6LE06334000	BRKT-DRV-SUB	1	1/P	
2	4406333770	TERM-BIAS-SUB	1	1/P	
3	4402308980	PLT-TERMINAL-R1	3	1/P	
4	4402308950	SPC055-050-0200	3	5/P	
5	4406333780	SPE060-050-184	1	5/P	
6	6LE06406000	SCREW-CH-M	1	10/P	
7	4402308970	PLT-TERMINAL-R2	2	1/P	
8	4406330810	TERMINAL-FRAME	1	1/P	
9	6LE06405000	LINK-SND-CLN	1	1/P	
10	4400902490	BAND-PS100	3	5/P	
11	6LE04116000	ASYS-BRKT-MOT-CLN-390	1	1/P	
12	6LE09545000	MOTRD-AUG-390CCW	1	1/D	
13	4401760590	GEAR-25-F	1	1/P	
14	4406329770	K-GEAR15-PLY53	1	1/P	
15	6LE06403000	BLT/T-2GT156-60	1	1/P	
16	4406329780	GEAR15-55	1	1/P	
17	6LA15256000	SOL-SCRP-340	1	1/D	
18	6LA02238000	LEVER-CLAW-1	1	1/P	
19	F0-00120000	ES-0505	1	5/P	
20	4406333430	BUSH-DEV	2	5/P	
21	4406340260	TERM-FRAME-TRU	1	1/P	
22	6LA06405000	BRKT-CNT-R-340	1	1/P	
23	6LE09191000	HRNS-LGC-ADU-390	1	1/P	
24	4406343540	SCREW-SOCKET	2	1/P	
25	6LA05752000	K-BRKT-HIG-EX-U	1	1/P	
26	F0-00019000	OCB-875	1	10/P	
27	6LE09270000	HRNS-FUR-MOT-390	1	1/P	
28	6LE04520000	DETECTOR-DEV-390	1	1/P	
29	6LE09488000	HRNS-LGC-TLCF-390	1	1/P	
30	6LA93647000	BRKT-DRW	1	1/P	
31	6LE68371000	SCREW-CON	2	10/P	
32	6LA04817000	SPC-DRAW	2	5/P	
33	6LE68317000	SCREW-DRW-CON	2	10/P	
34	6LE68351000	M/DC-TRAY-UP	1	1/D	
35	6LA08931000	SCREW-BKT-MOT	3	10/P	
36	6LE06344000	BLIND-KEY-CTR-390	1	1/P	
44	6LA08950000	SPC074-070-0145	2	5/P	
101	X0-02254000	S/PAN/SWWS-M2.6X4-NI	2	10/P	
102	X0-00966000	RR/E-5-SS	5	10/P	
103	X0-02231000	S/FHEXM-M3X8-NI	2	10/P	
104	X0-02251000	S/TPP/FHEXM-4X8-NI	1	10/P	
105	X0-02589000	S/TPD3/FHEXM-4X8-ZU3	18	10/P	
106	X0-02230000	S/FHEXM-M3X6-NI	1	10/P	
107	X0-02592000	S/TPD3/FHEXM-3X6-ZU3	1	10/P	



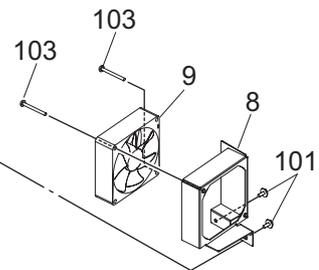
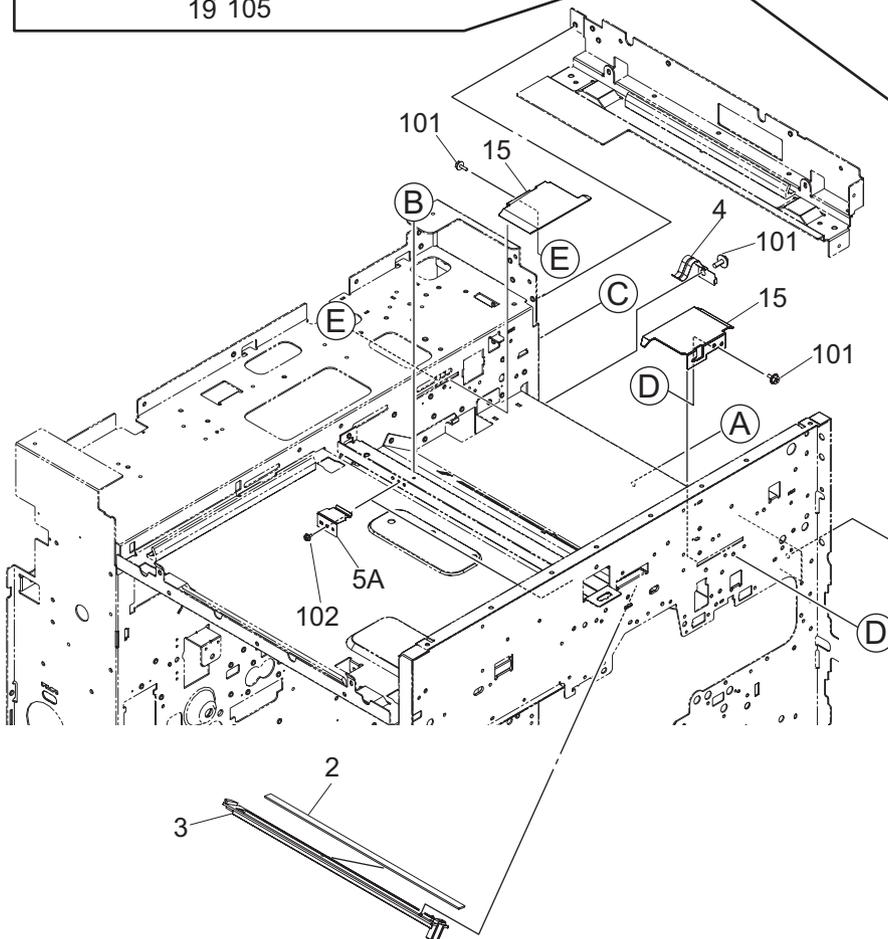
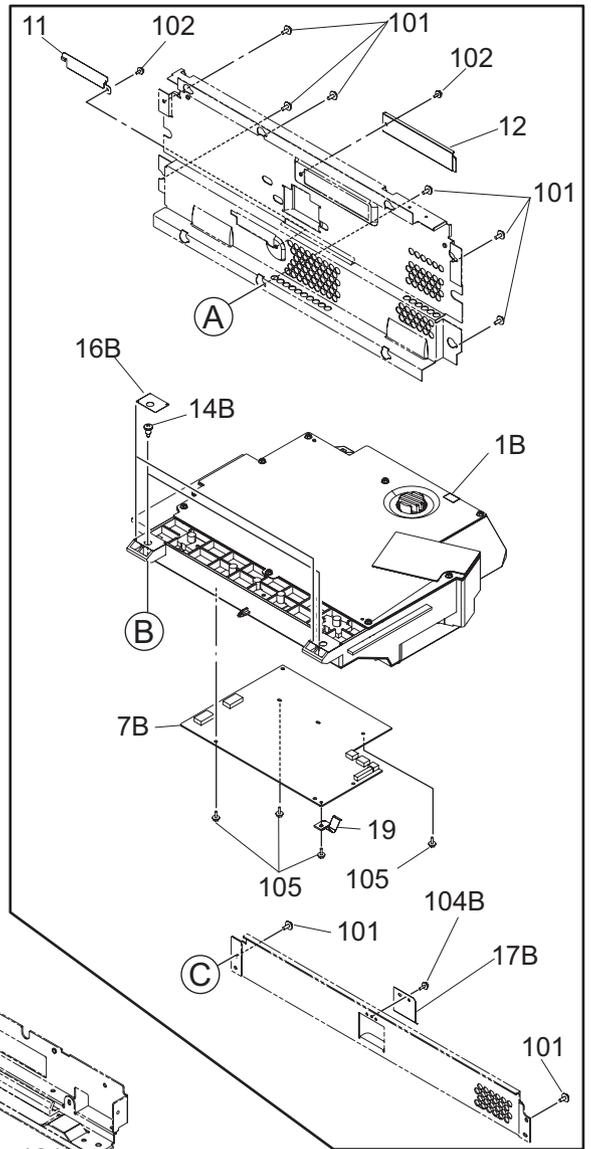
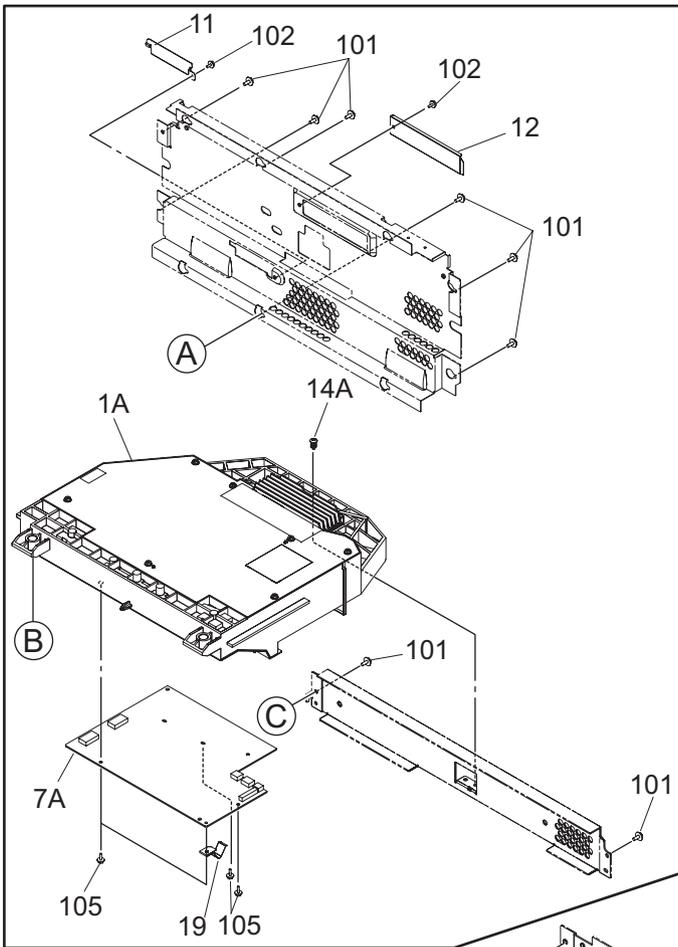







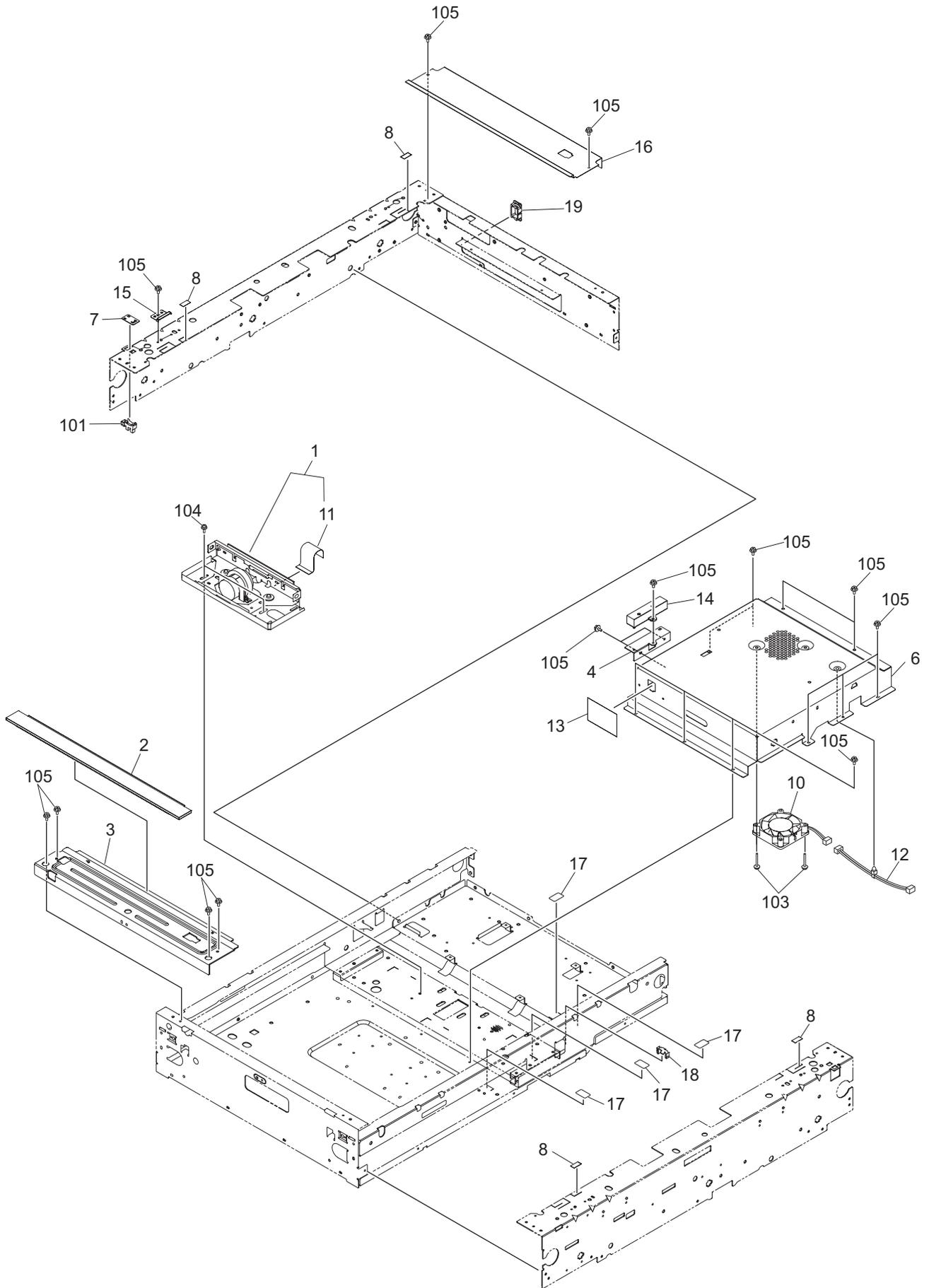



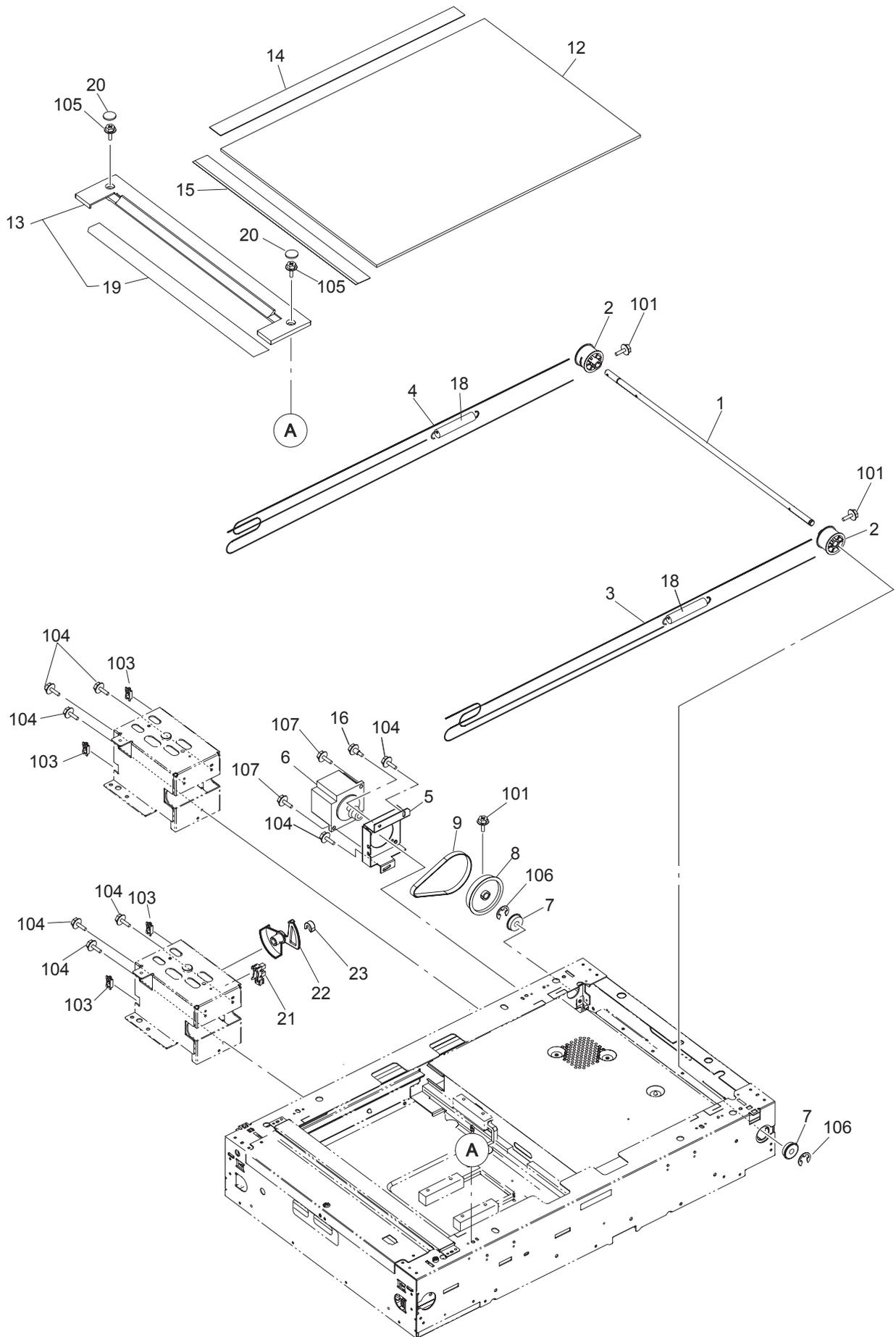





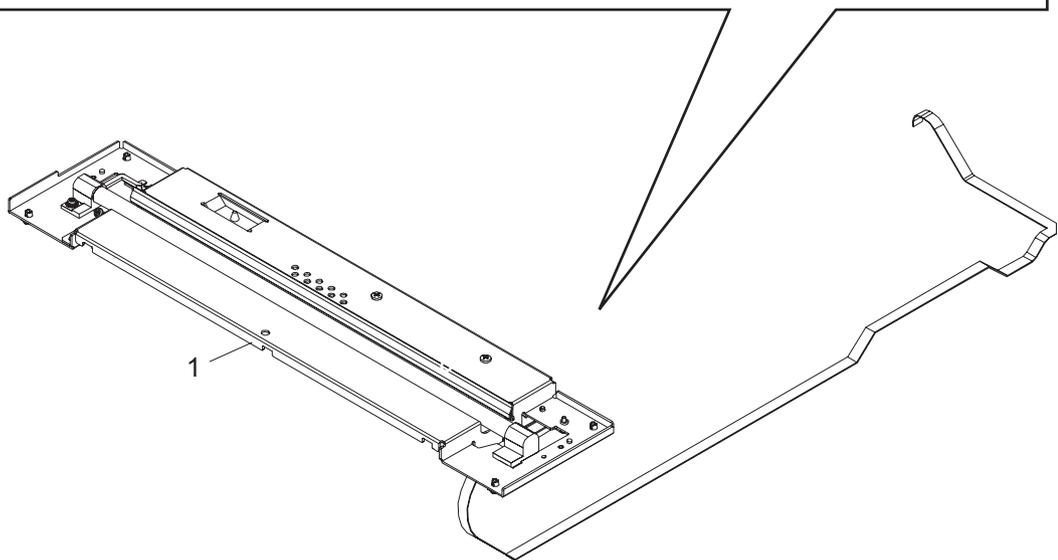
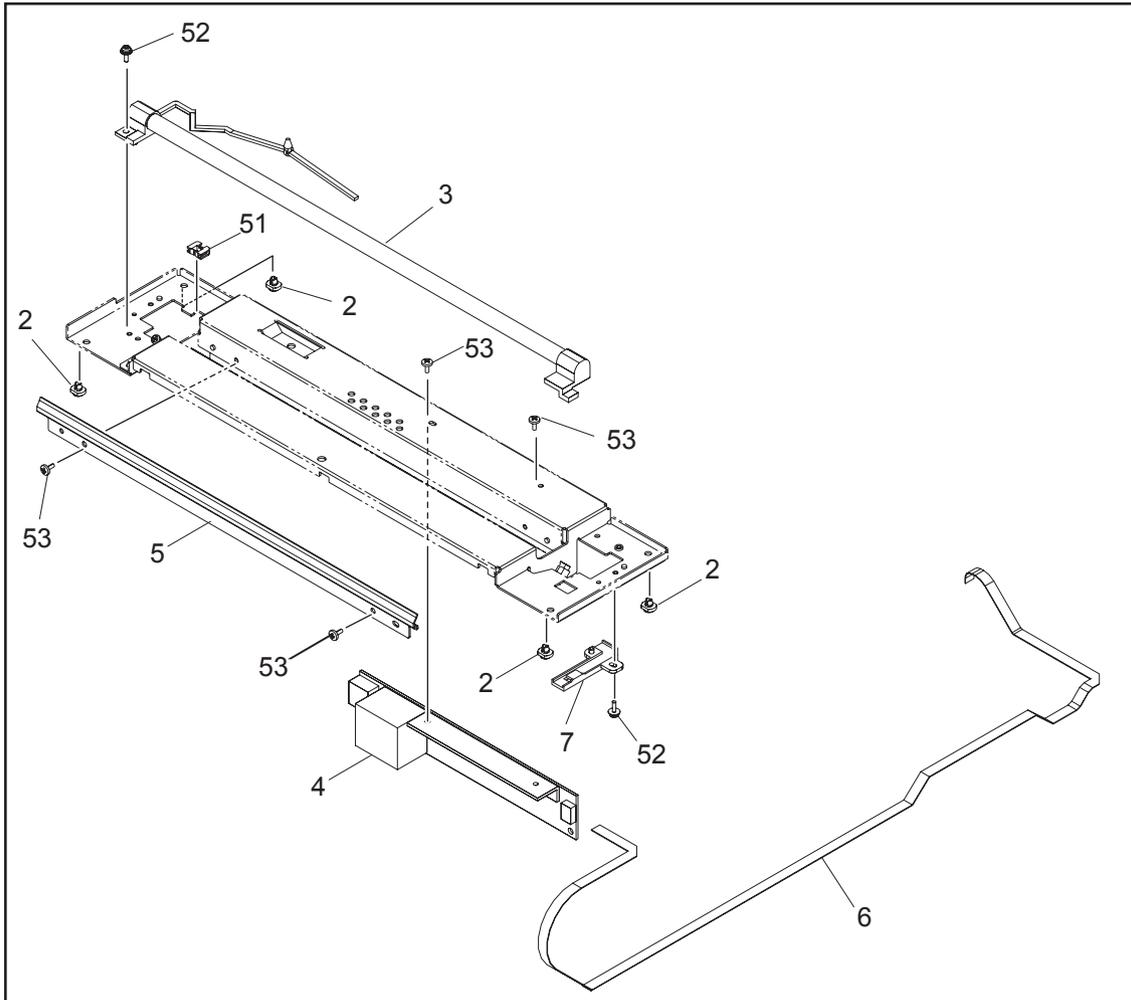



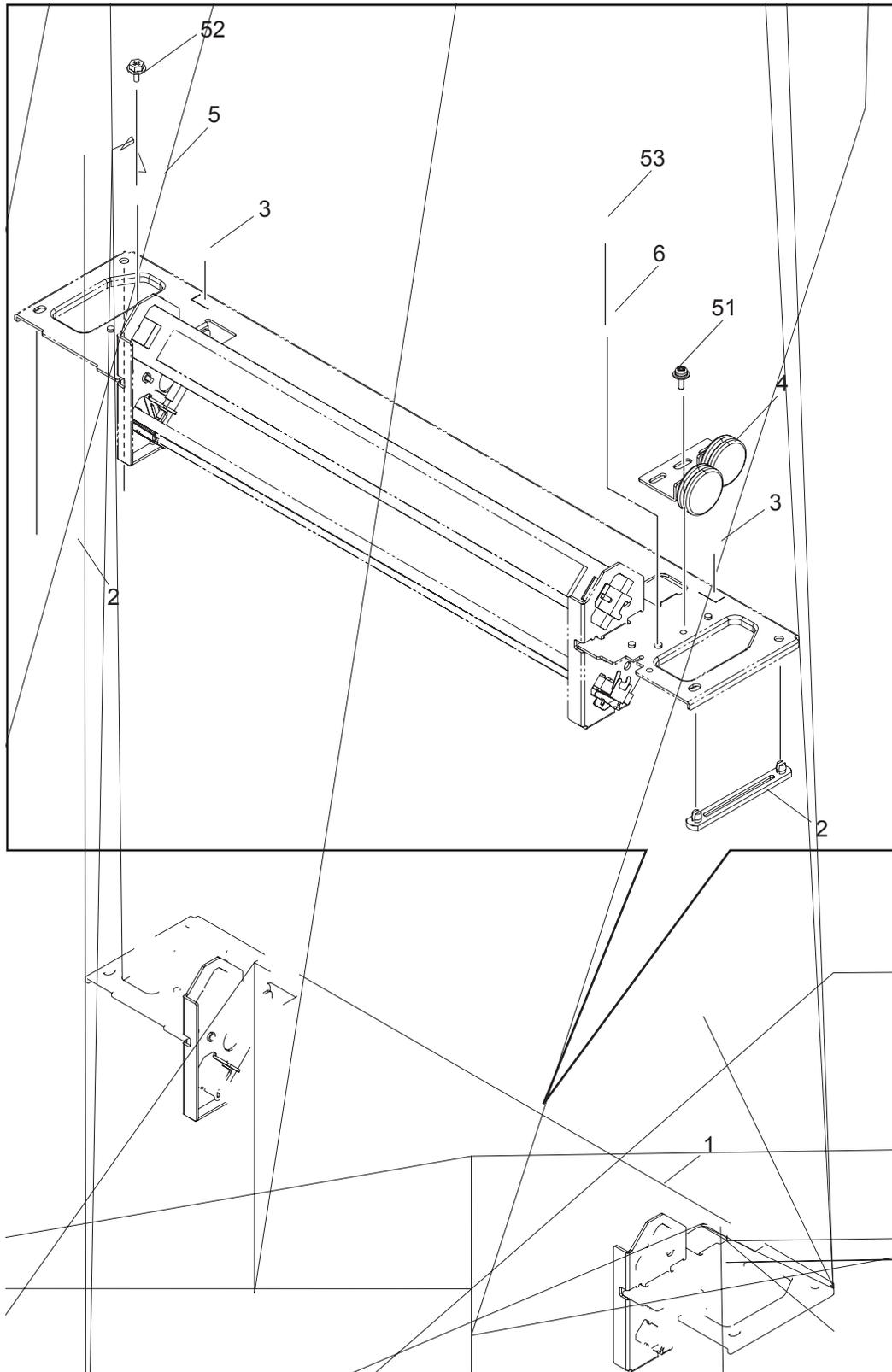



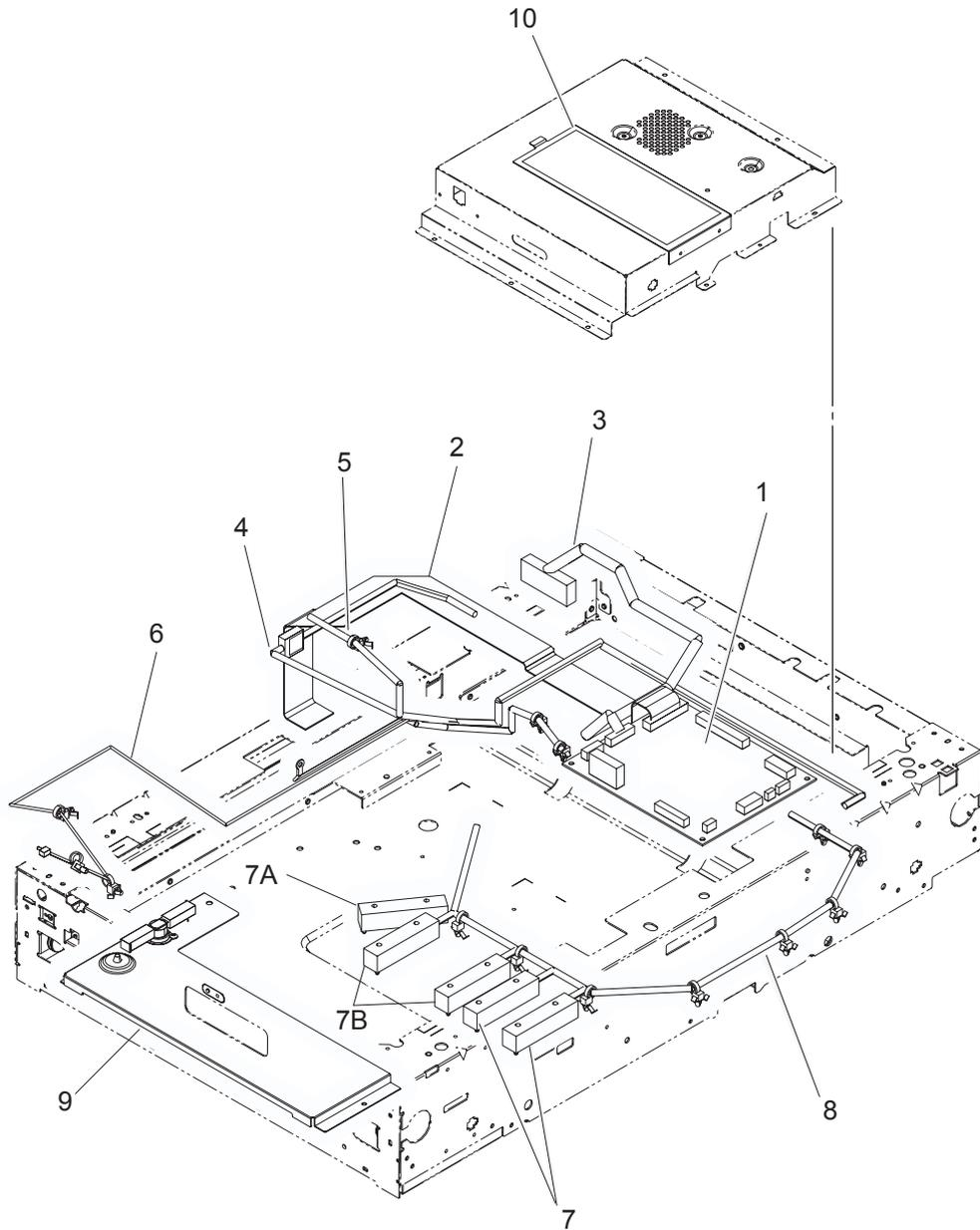



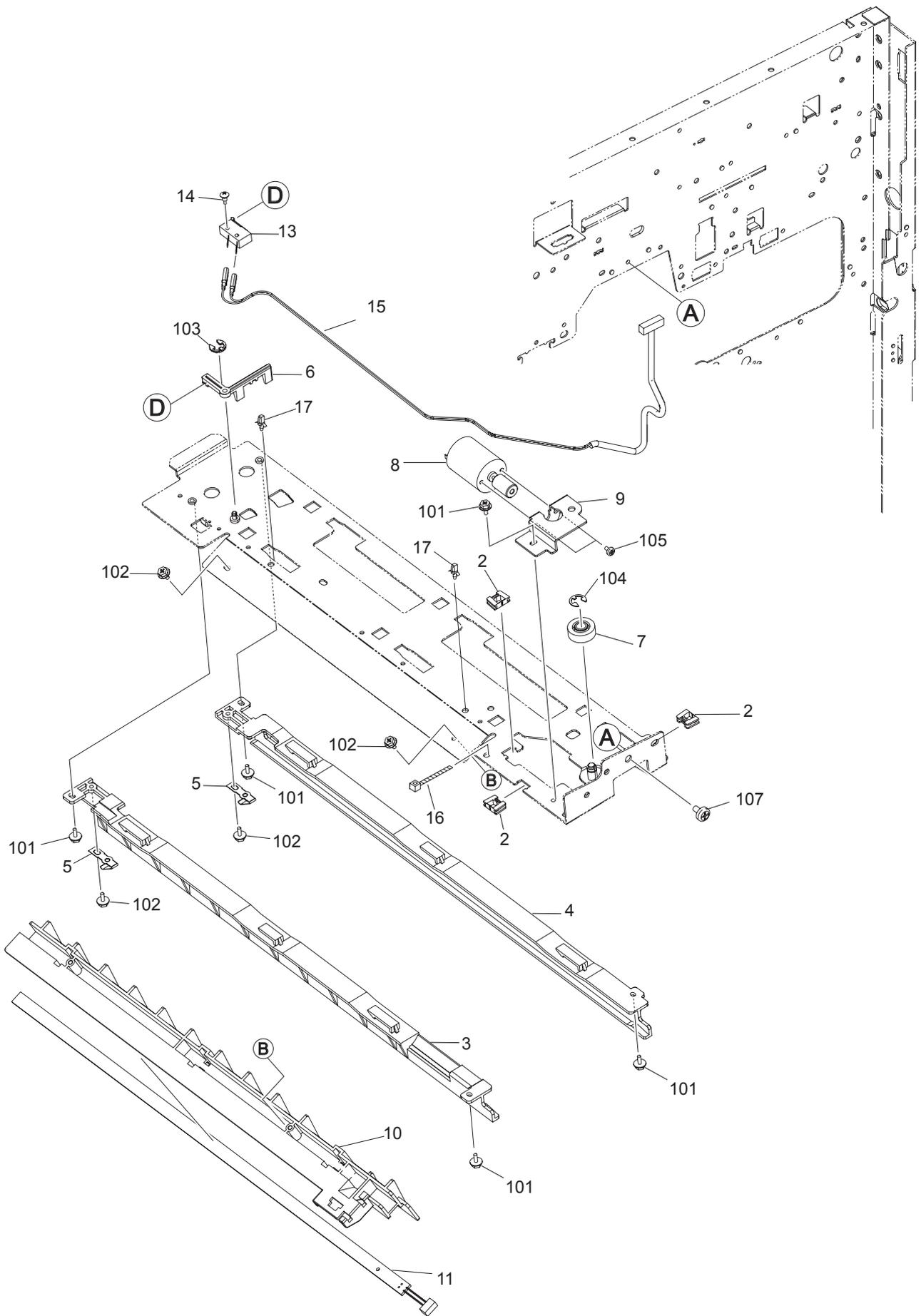





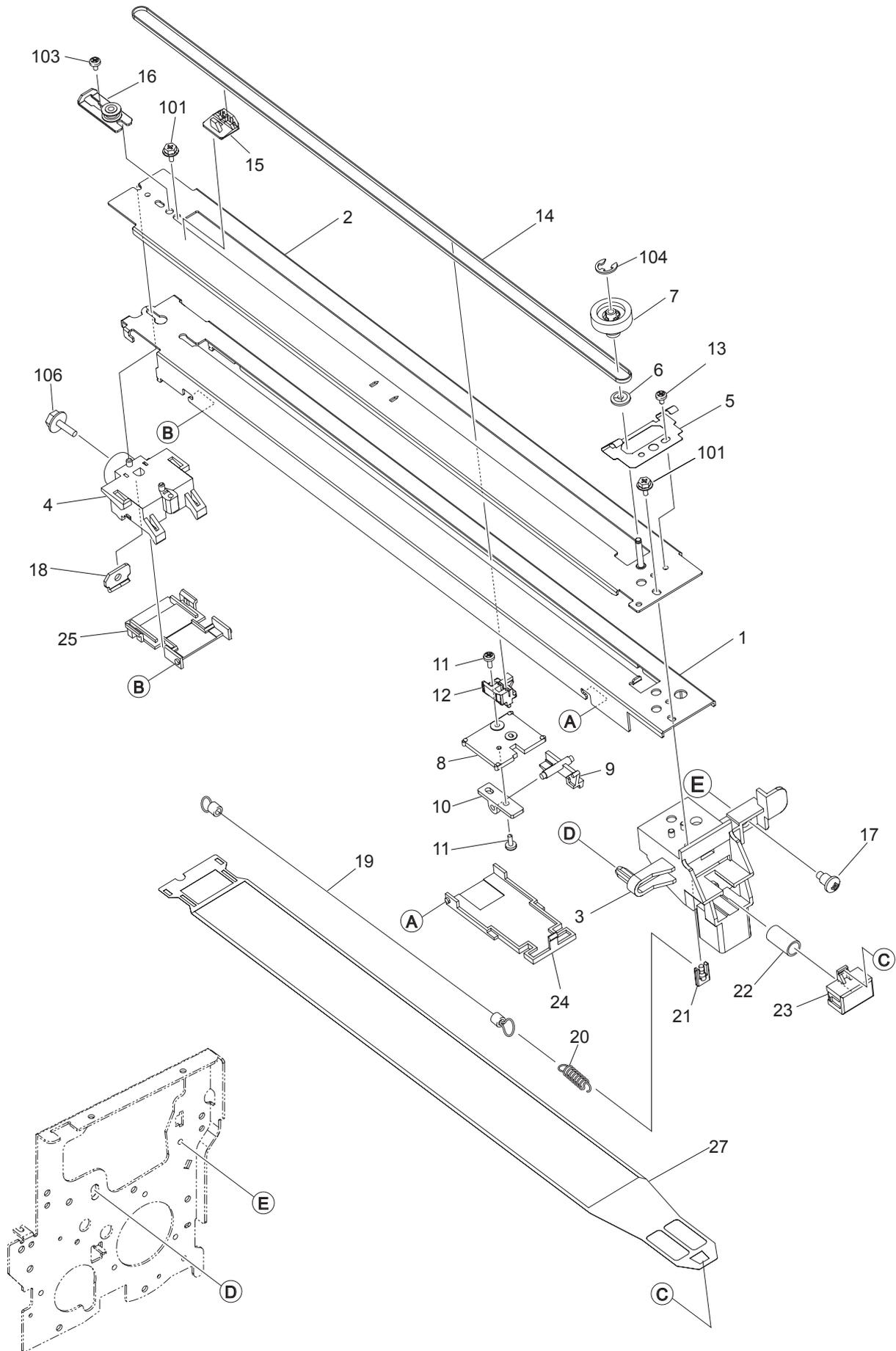



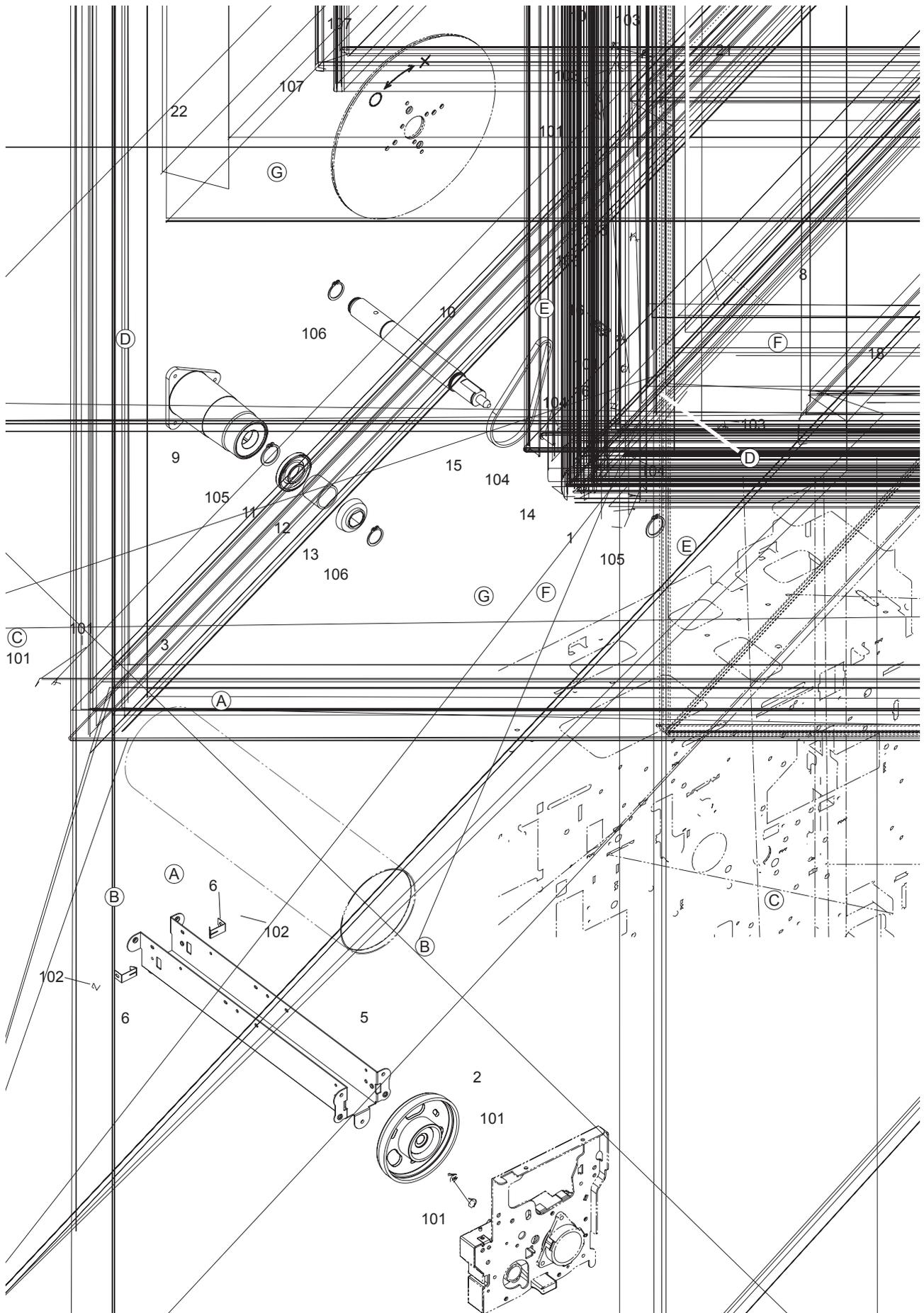



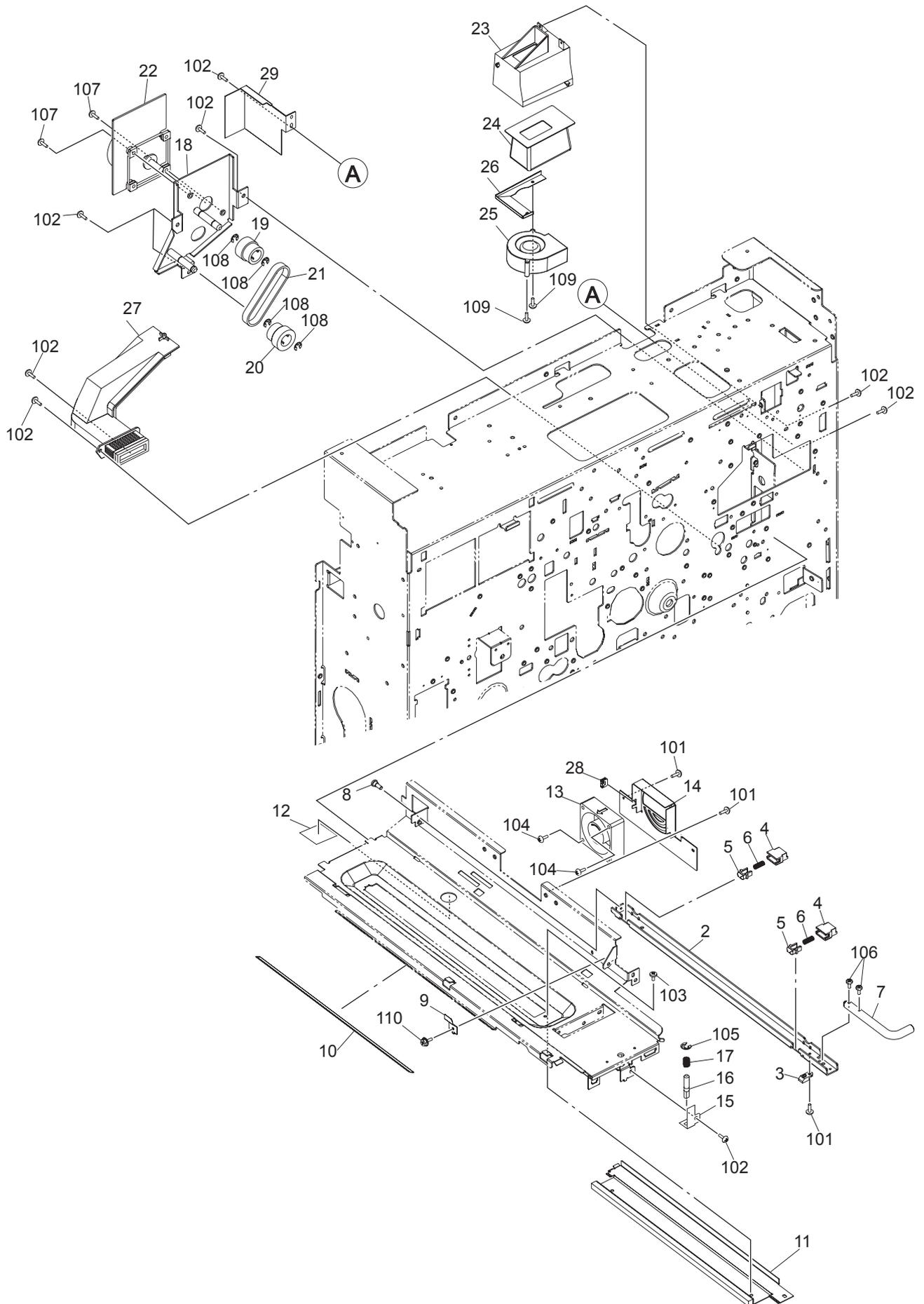

ITEM No.	PART No.	PART NAME	Q'TY / PAGE	Q'TY / PACK	REMARKS
2	4406333940	BKT-SET-DEV-300	1	1/P	
3	4406333930	PUSHER-GUIDE	1	5/P	
4	4402203810	HOLDER-PUSHER	2	1/P	
5	4402203800	PUSHER-DEV	2	1/P	
6	6LA08947000	SPC057-090-0210	2	5/P	
7	6LA02482000	LEV-SET-DEV-340	1	1/P	
8	6LA08930000	PIN-BKT-CON-H	1	10/P	
9	4401767560	SPL-SET-DEV	1	1/P	
10	4408847750	INS-ENT-DRM-85	1	1/KP	
11	6LA15093000	K-BKT-BRS-RGT-340-U	1	1/KP	
12	4406333950	MYLAR-STAY-DEV	1	1/KP	
13	6LE09167000	FAND-6015-390	1	1/D	
14	6LA02485000	BRKT-FAN-DUCT	1	1/P	
15	6LA03181000	BRKT-STUD-L	1	1/P	
16	6LA03182000	STUD-TNR-L	1	5/P	
17	6LA03183000	SPC-TNR-L	1	5/P	
18	4406333610	K-BRKT-DRV-DEV	1	1/P	
19	4406333680	K-GP48-3GT25	1	1/P	
20	4406333690	K-GP25-3GT25	1	1/P	
21	4406333670	BLT/T-195-3GT-9	1	1/P	
22	6LE09160000	MOTRD-DEV-390	1	1/C	
23	6LE06330000	BOX-FILTER-FAN-390	1	1/P	
24	4406334920	FILTER-DEV-F300	1	1/C	
25	6LE09187000	FAND-DEV-390	1	1/D	
26	6LE04527000	PLT-NUT-FAN-390	1	1/P	
27	6LA02510000	K-DUCT-DEV	1	1/P	
28	F0-00120000	ES-0505	1	5/P	
29	6LA01079000	WALL-MOT-DEV	1	1/P	
101	X0-02593000	S/TPD3/FHEXM-3X8-ZU3	3	10/P	
102	X0-02589000	S/TPD3/FHEXM-4X8-ZU3	8	10/P	
103	X0-02235000	S/FHEXM-M4X8-NI	1	10/P	
104	X0-02067000	S/TPS/PAN-4X20-ZU3	2	10/P	
105	X0-00967000	RR/E-6-SS	1	10/P	
106	X0-02060000	S/TPS/PAN-3X16-ZU3	2	10/P	
107	X0-02590000	S/TPD3/FHEXM-4X10-ZU3	2	10/P	
108	X0-00968000	RR/E-7-SS	4	10/P	
109	X0-00461000	S/BID-M4X35-NI	2	10/P	
110	6LA08935000	SCR-M3X6BISR-NI	1	10/P	

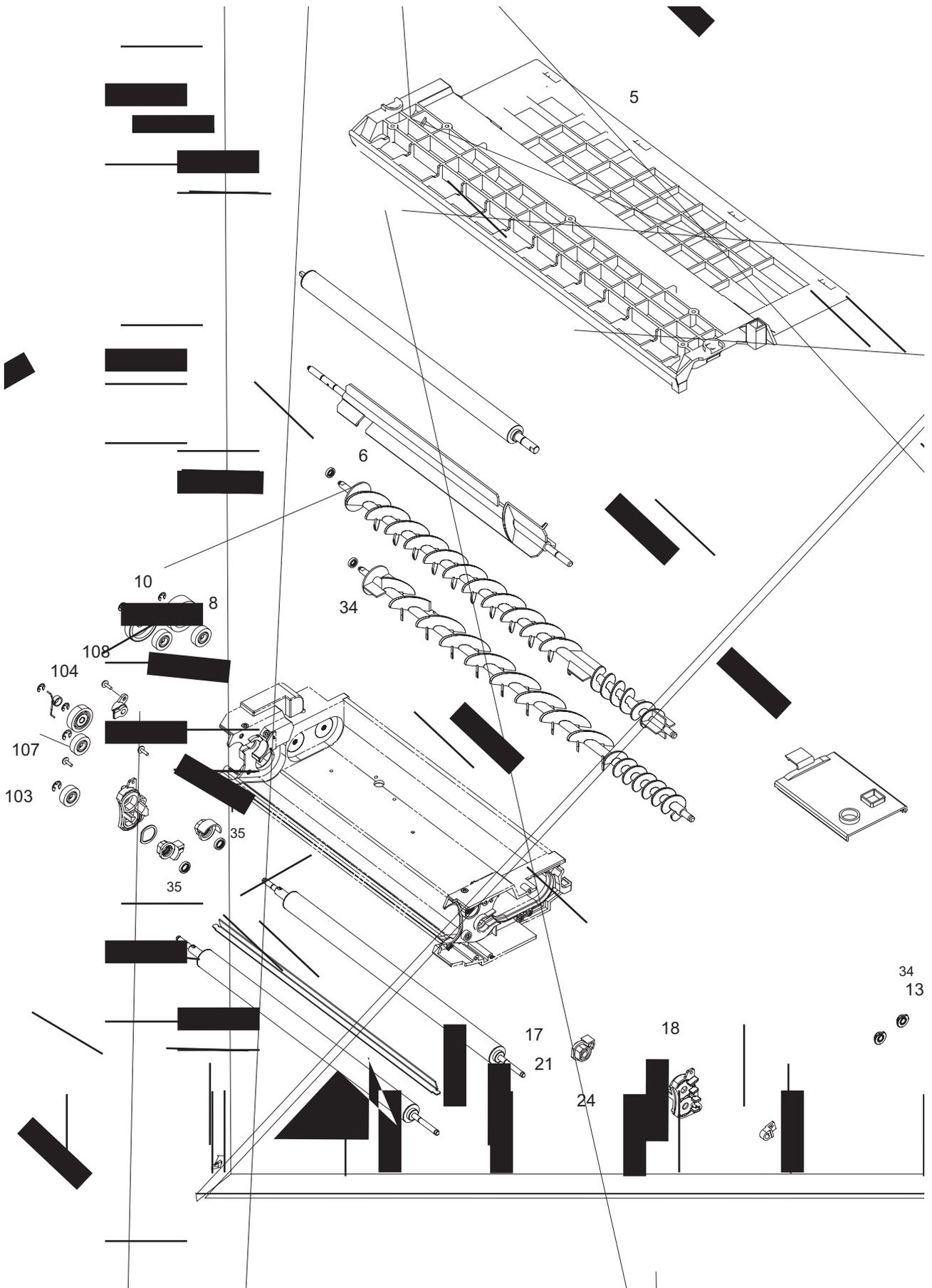

ITEM No.	PART No.	PART NAME	Q'TY / PAGE	Q'TY / PACK	REMARKS
1 A	6LE04535000	ASYS-GEAR-10H023-R	1	1/P	e-STUDIO555/655
1 B	6LE04538000	ASYS-GEAR-10H020-R	1	1/P	e-STUDIO755/855
2	4406332690	WALL-MIXER-300	1	1/C	
3	4406332460	PADDLE-DEV-300	1	1/P	
4	6LA02416000	ASYS-BUSH-PDL-F	1	1/P	
5	6LE04525000	ASY-COV-DEV-390	1	1/C	
6	6LA02410000	MIXER-1-340	1	1/C	
7	6LA02412000	K-MIXER-2-340	1	1/C	
8	F0-01204000	626DDM3MTLY13	2	1/P	
9	4406332590	GEAR-08S045-06	1	1/P	
10 A	6LE04513000	GEAR-10H19_08S45-390	1	1/P	e-STUDIO555/655
10 B	4406332600	GG10H024/08S045	1	1/P	e-STUDIO755/855
11	6LA02430000	K-NOZZLE-MIXER	1	1/P	
12	6LA02436000	COV-NOZLE-MIX	1	1/P	
13	6LA65696000	BUSH-6X12X4R8F	2	5/P	
14	4406332450	ROLLER-MGN-TR	1	1/C	
15 A	6LE04505000	BUSH-MGHI-TR-R-390	1	1/P	e-STUDIO555/655
15 B	4406332740	BUSH-MGHI-TR-R	1	1/P	e-STUDIO755/855
16	F0-01206000	L-1680DDRPOP25LY13	1	1/P	
17	6LA02380000	ROLLER-MGN-U340	1	1/C	
18	6LA02398000	SHIELD-MG-U-F-6	1	1/P	
19	4406332770	K-SHIELD-MG-U-R	1	1/P	
20	6LA02381000	ROLLER-MGN-L340	1	1/C	
21	6LA02399000	SHIELD-MG-L-F-6	1	1/P	
22	4406332800	K-SHIELD-MG-L-R	1	1/P	
23	4406332820	SCRAPER-MG-L	1	1/P	
24	4406333280	SEAL-MG-SIDE2	2	5/P	
25	6LA02386000	K-HLDR-MG-F340	1	1/P	
26	6LA02384000	HLDR-MG-HI-L-6	1	1/P	
27	6LA02385000	HLDR-MG-HI-U-6	1	1/P	
28 A	6LE04503000	ASYS-HLDR-MG-R-390	1	1/P	e-STUDIO555/655
28 B	4406332530	K-HLDR-MG-R	1	1/P	e-STUDIO755/855
29	4406332650	GEAR-10H017-MG	2	1/P	
30	6LE04512000	GEAR-10H025-390	1	1/P	
31	6LA08940000	SPA-PSH-MG-100	2	5/P	
32 A	6LE04510000	GEAR-10H015_08S16-390	1	1/P	e-STUDIO555/655
32 B	6LA02454000	GEAR-10H018-PDF	1	1/P	e-STUDIO755/855
33	4406332550	GEAR-10H023-TR	1	1/P	
34	4401949290	SEAL-VC6-10-2.5	4	1/P	
35	4406333150	SEAL-VC8-12-2.5	3	1/P	
101	X0-02231000	S/FHEXM-M3X8-NI	4	10/P	
102	X0-00964000	RR/E-3-SS	2	10/P	
103	X0-00965000	RR/E-4-SS	4	10/P	
104	X0-00966000	RR/E-5-SS	5	10/P	
105	X0-00968000	RR/E-7-SS	1	10/P	
106	X0-01724000	S/BID-M3X4-BSNI	3	10/P	
107	X0-00057000	S/PAN-M3X6-NI	4	10/P	
108	X0-02247000	S/TPP/FHEXM-3X8-NI	1	10/P	



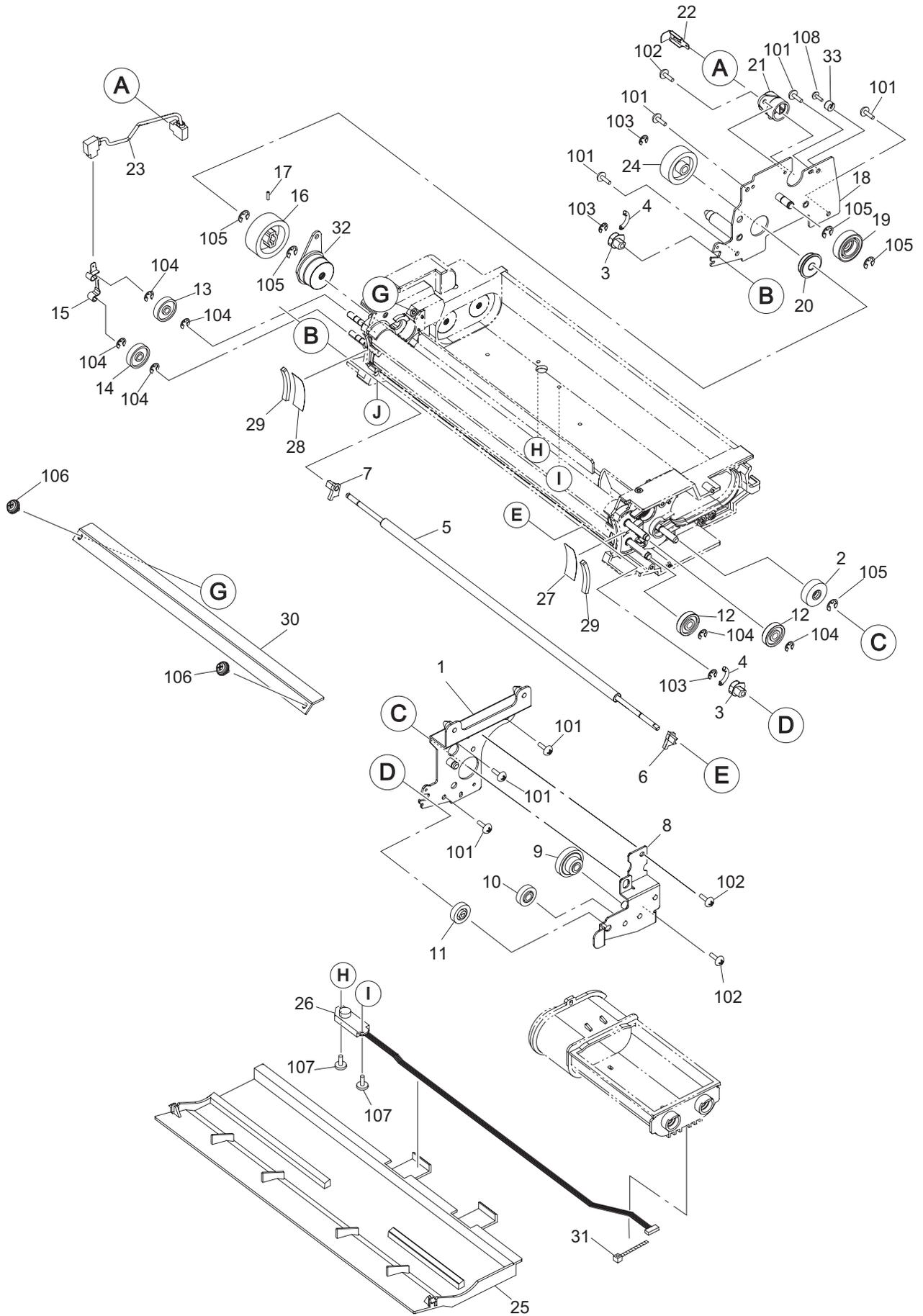

ITEM No.	PART No.	PART NAME	Q'TY / PAGE	Q'TY / PACK	REMARKS
1 A	6LE04504000	ASYS-PLT-DEV-F-390	1	1/P	e-STUDIO555/655
1 B	6LA02403000	K-PLT-DEV-F-340	1	1/P	e-STUDIO755/855
2	6LE04536000	ASYS-GEAR-10H019-F	1	1/P	
3	6LA02423000	BUSH-GAP-DEV-RE	2	5/P	
4	6LA02448000	SPRING-RE-340	2	5/P	
5	6LA02422000	ROLLER-RE	1	1/P	
6	6LA02428000	SHLD-ROL-RE-F	1	1/P	
7	6LA02429000	SHLD-ROL-RE-R	1	1/P	
8 A	6LE04502000	ASYS-BRKT-DEV-RE-390	1	1/P	e-STUDIO555/655
8 B	6LA02440000	K-BRKT-DEV-RE	1	1/P	e-STUDIO755/855
9	6LA02451000	GG08S030/08S016	1	1/P	
10	6LA02452000	GEAR-08S020-IR	1	1/P	
11	6LA02453000	GEAR-08S020-RE	1	1/P	
12	6LA02409000	ROLLER-GUIDE-6	2	1/P	
13	4406332850	ROLLER-GUIDE	1	1/P	
14	4406333300	ROLLER-GUIDE-RL	1	1/P	
15	6LA02460000	PLT-BIAS-MG-340	1	1/P	
16 A	6LE04512000	GEAR-10H025-390	1	1/P	e-STUDIO555/655
16 B	4406332630	GEAR-10H031-PDR	1	1/P	e-STUDIO755/855
17	X0-00980000	P/PRL/AH7-2X10-SS	1	10/P	
18 A	6LE04514000	ASYS-PLT-DEV-R-390	1	1/D	e-STUDIO555/655
18 B	6LA02405000	K-PLT-DEV-R-340	1	1/P	e-STUDIO755/855
19	6LE04537000	ASYS-GEAR-10H024-IDR	1	1/P	
20	4407637290	BRG-626-DD-NXR	1	1/P	
21	4406333080	TERM-BIAS-DEV	1	1/P	
22	4406333090	PLT-BIAS-DEV	1	1/P	
23	6LA07416000	HRNS-BIAS-MG-340	1	1/P	
24	4406332640	GEAR-10H027-PDR	1	1/P	
25	6LE04543000	ASYS-DUCT-DEV-390	1	1/PP	
26	6LE09165000	SNSR-ATC-390	1	1/C	
27	6LA02425000	SEAL-SIDE-DR-F	1	5/P	
28	6LA02426000	SEAL-SIDE-DR-R	1	5/P	
29	4406333580	SEAL-SIDE-D-FLT	2	1/P	
30	4406333260	K-DOCTOR-MG-TR	1	1/P	
31	F0-00017000	T18S	1	10/P	
32	6LA02414000	ASYS-BUSH-PDL-R	1	1/P	
33	6LE04520000	DETECTOR-DEV-390	1	1/P	
101	X0-02247000	S/TPP/FHEXM-3X8-NI	7	10/P	
102	X0-02593000	S/TPD3/FHEXM-3X8-ZU3	3	10/P	
103	X0-00964000	RR/E-3-SS	3	10/P	
104	X0-00965000	RR/E-4-SS	6	10/P	
105	X0-00966000	RR/E-5-SS	5	10/P	
106	X0-00067000	S/PAN/SWWP-M3X6-BSNI	2	10/P	
107	X0-01724000	S/BID-M3X4-BSNI	2	10/P	
108	X0-02592000	S/TPD3/FHEXM-3X6-ZU3	1	10/P	

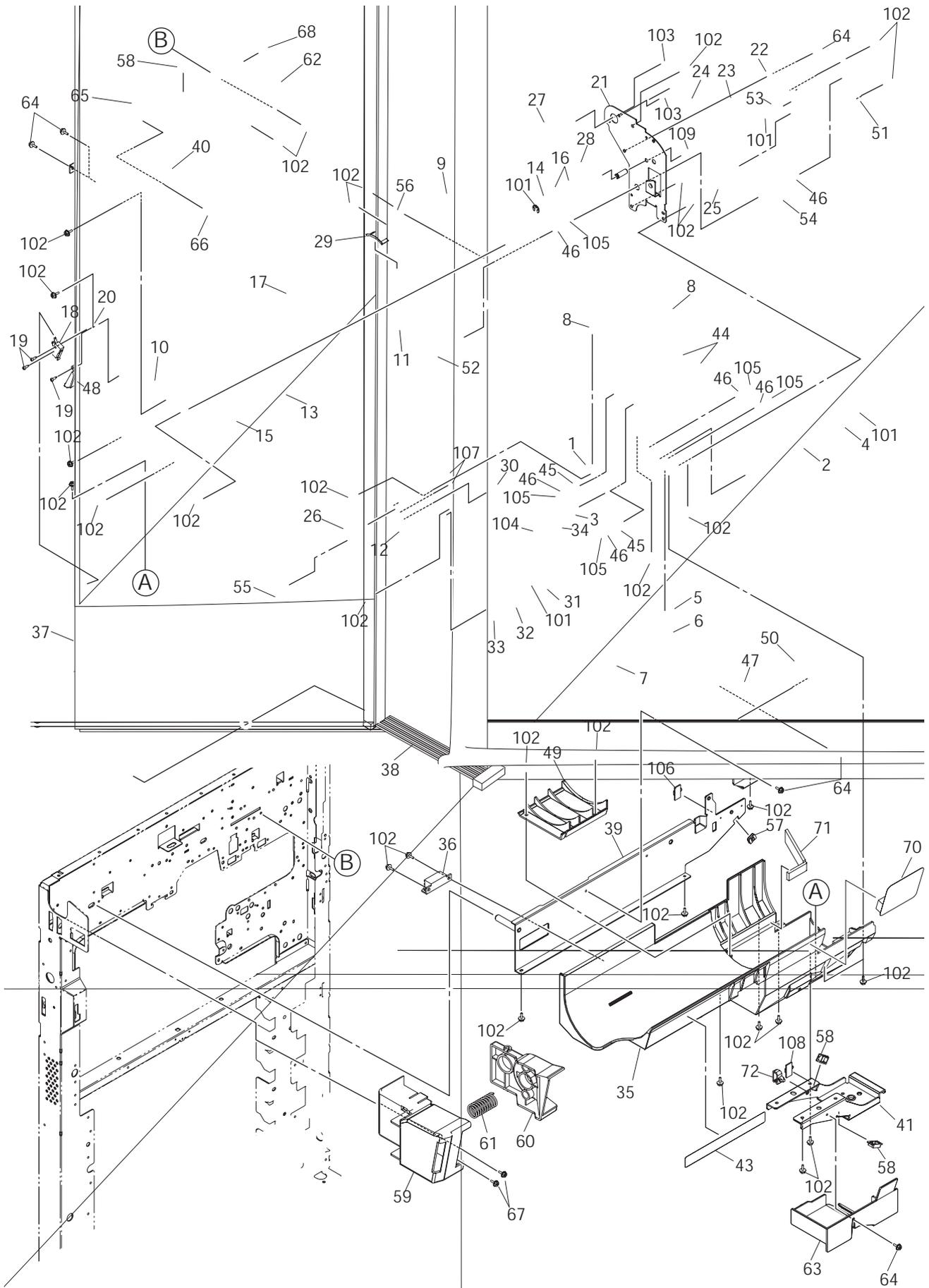

ITEM No.	PART No.	PART NAME	Q'TY / PAGE	Q'TY / PACK	REMARKS
1	6LE08502000	HOP-SUB-TNR-390	1	1/P	
2	6LA03087000	AUG-HOP-SUB-N	1	1/P	
3	6LA02367000	BUSH-0613-06F-M	1	5/P	
4	6LA03220000	BUSH-HOPPER	1	5/P	
5	6LA03085000	SEAL-SHUTTER-N	1	5/KP	
6	6LA03083000	SHUTTER-HOP-N	1	1/P	
7	6LA03084000	SPC-SHT-N	1	1/P	
8	6LE08578000	SEAL-HOPPER-N-390	2	1/KP	
9	6LE08503000	HOLDER-CPL-390	1	1/P	
10	6LE08540000	COVER-CPL-390	1	1/D	
11 A	6LE08587600	ASYS-CPL-BTL-H100HU	1	1/PP	ARD,NAD
11 B	6LE08587700	ASYS-CPL-BTL-H100HE	1	1/PP	MJD
11 C	6LE08587300	ASYS-CPL-BTL-390D	1	1/PP	ASD,ASU,AUD,SAD
12	6LE08517000	ASYS-BKT-MOT-AUG	1	1/P	
13	F0-01343000	VR90A-BM1231A0	1	5/P	
14	F0-01344000	VR14A-BM1210A0	1	1/P	
15	6LA03106000	SEAL-WAS-90108	1	5/P	
16	6LA03107000	SEAL-WAS-1426	2	5/P	
17	6LA03108000	GSKT-TNR-DRV	1	1/P	
18	E0-12172000	SSM13F3	1	1/D	
19	44204394000	SCREW20*D23	3	10/P	
20	6LA03098000	BRKT-SW-340	1	1/P	
21	6LE08509000	BRKT-DRV-BTL1-390	1	1/P	
22	6LE08511000	ASYS-BKT-DR-BTL2-390	1	1/P	
23	6LA03236000	GP08S17/2GT072	1	1/P	
24	6LA03146000	BLT/T-244-2GT-4	1	1/P	
25	6LE08554000	GG08S066/10S017/08S018	1	1/P	
26	6LE09546000	MOTRD-AUG-390CW	1	1/D	
27	6LE09626000	MOTRD-TNR-390N	1	1/C	
28	6LA03145000	GEAR10S047-06	1	1/P	
29	6LE08583000	MYLAR-CPL	1	1/C	
30	6LE08522000	GG08S043/08S017	1	1/P	
31	6LE08523000	GG08S044/08S017	1	1/P	
32	6LE08521000	GP08S018/2GT058	1	1/P	
33	6LA04627000	BLT/T-154-2GT-4	1	1/P	
34	6LA03140000	GEAR-08S036-06	1	1/P	
35	6LE08524000	HLDR-BOTTLE-390	1	1/PP	
36	F0-01393000	CA-0124B	1	1/P	
37	6LE09555000	HRNS-TNR-HOP2-390	1	1/P	
38	6LE09646000	HRNS-TNR-HOP1-390	1	1/P	
39	6LE08533000	ASYS-BKT-TNR-U-390	1	1/P	
40	6LE08528000	BRKT-TNR-U-SUB-390	1	1/P	
41	6LE08529000	BRKT-TNR-L-390	1	1/P	
42	6LE08584000	STUD-N-A-390	1	1/P	
43	6LE08565000	STICK-DRV-TNR-390	1	1/KP	
44	6LE08541000	PDL-TNR-DRV-SUB	2	1/P	
45	6LA03089000	GEAR-08S020-04	2	1/P	
46	6LA02920000	BUSH-0410-05F-M	6	5/P	
47	6LE08567000	ASYS-COVER-BTL-390	1	1/PP	
48	6LE08580000	COVER-SW-390	1	1/P	
49	6LE08525000	COV-HLDR-BTL	1	1/P	
50	6LE13138000	LBL-O-ALI-TNR-390	1	1/KP	
51	6LE08555000	BRKT-CLN-SENS	1	1/P	
52	6LE08569000	ASYS-PDL-SENS	1	1/C	
53	6LE08568000	GEAR-08S20-7	1	1/P	
54	6LE08556000	GEAR-08S50-5	1	1/P	
55	6LE09256000	HRNS-TNRHOP-MOT-390	1	1/P	
56	C0-10817000	TSP15D10C-01	1	1/C	
57	F0-00120000	ES-0505	1	5/P	
58	F0-01248000	ESC-0912	3	10/P	
59	6LE08534000	HLDR-PLGR-BTL-390	1	1/P	
60	6LA03155000	PLGR-CATCH-BLT	1	1/P	
61	6LA03153000	SPC-CATCH	1	5/P	





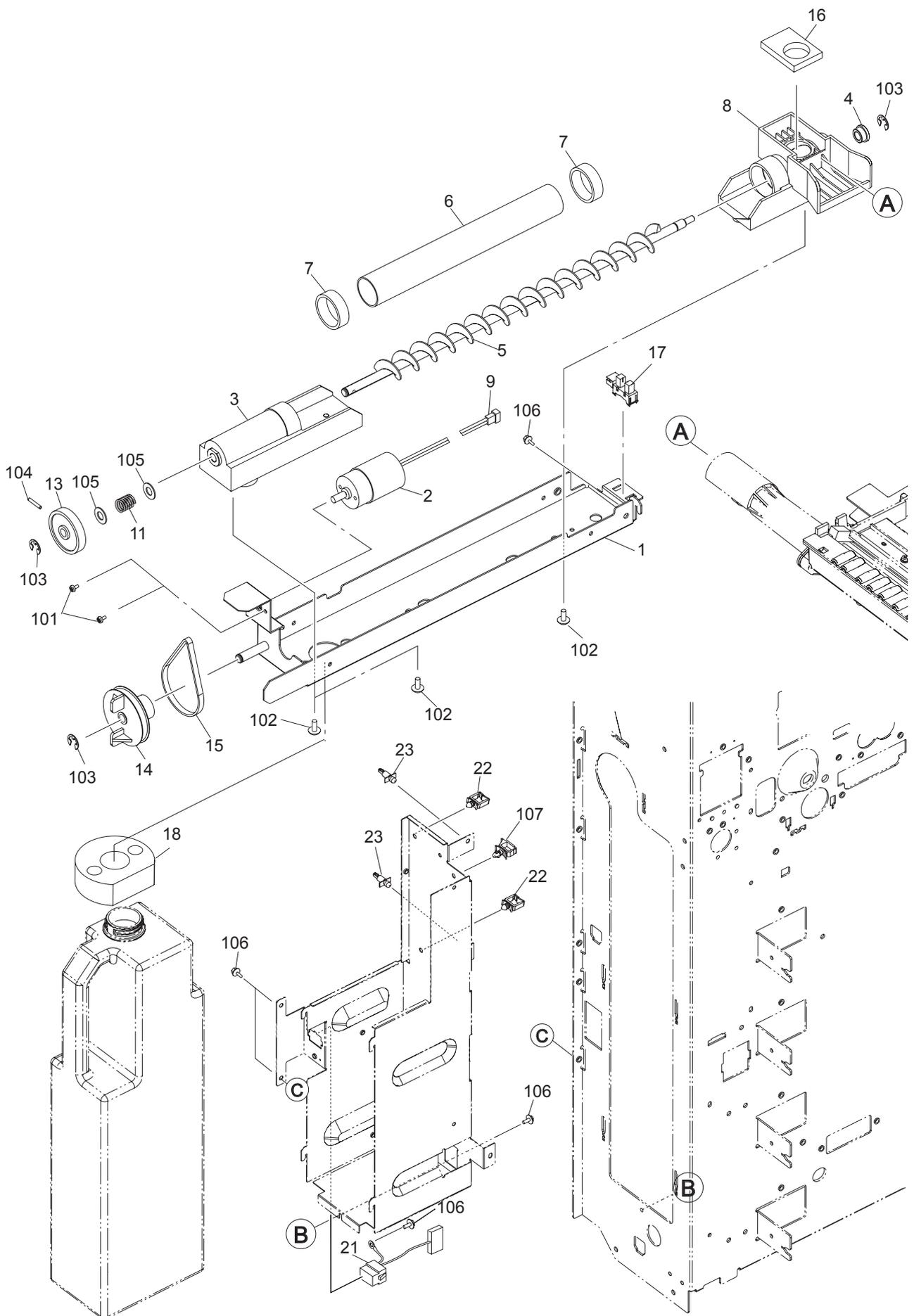





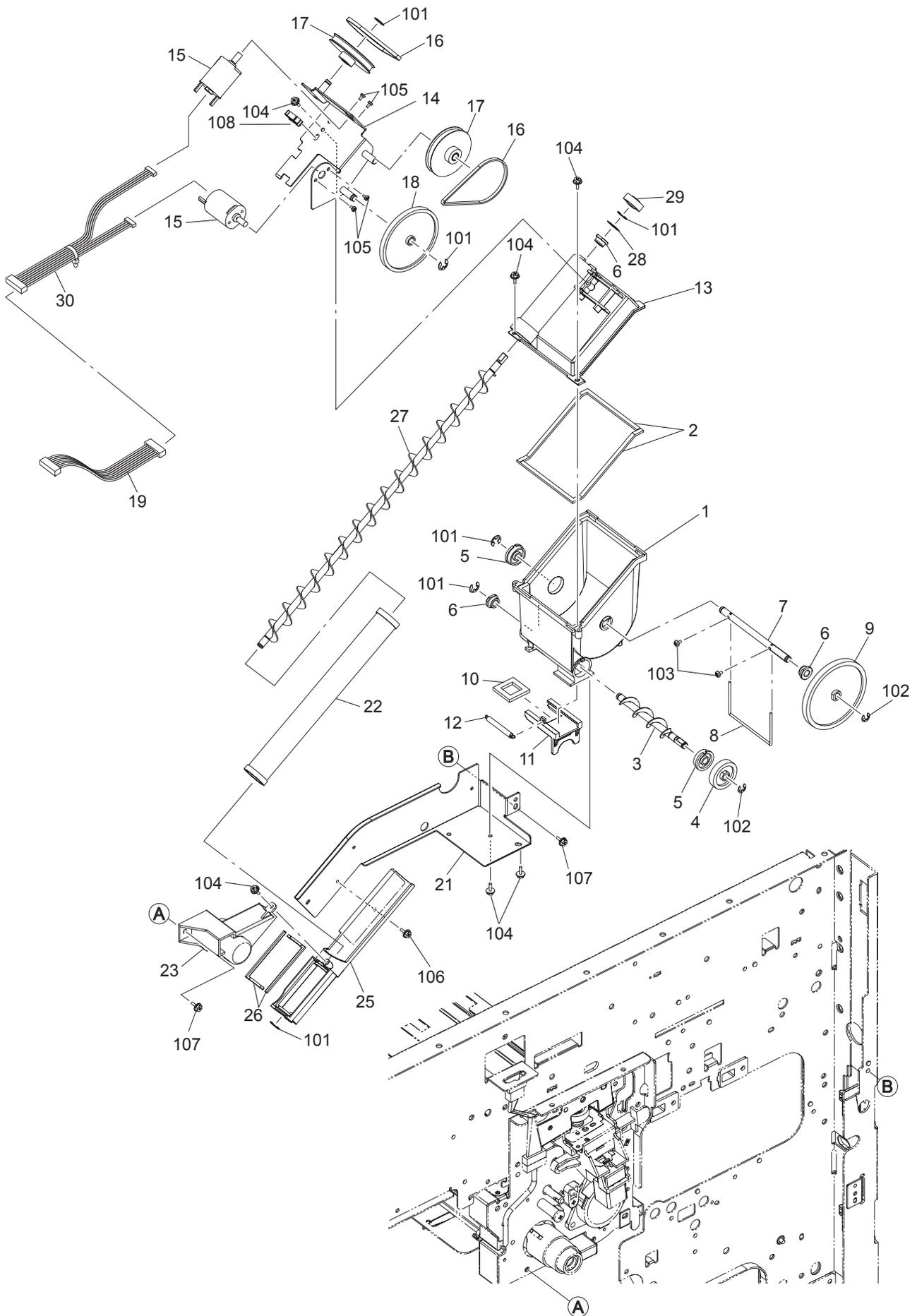



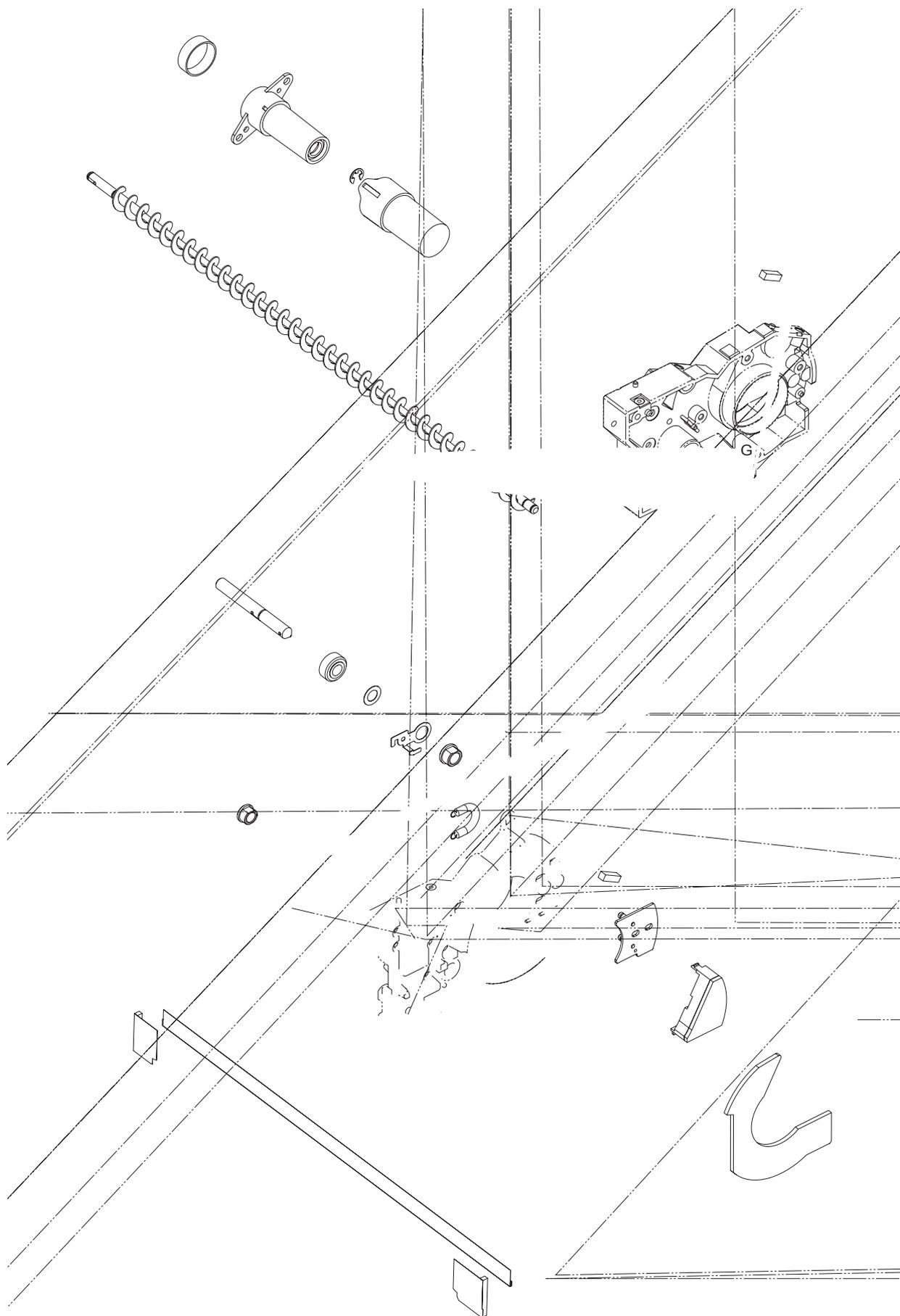

ITEM No.	PART No.	PART NAME	Q'TY / PAGE	Q'TY / PACK	REMARKS
2	4401904390	SFT-SCRPR-BRSH	1	1/P	
3	6LA02732000	SPC-BRSH-CLN	1	5/P	
4	6LA02646000	SEAL-SIDE-CLN-F	1	1/P	
5	4401904180	SEAL-SIDE-BLD-F	1	5/P	
6	4406329960	SEAL-SIDE-DRM-F	1	1/P	
7	6LA02704000	SEAL-CL-REC	1	5/KP	
8	6LA02669000	SEAL-SIDE-CLN-R	1	1/P	
9	4401904190	SEAL-SIDE-BLD-R	1	5/P	
10	4406329970	SEAL-SIDE-DRM-R	1	1/P	
11	4401904860	SEAL-ROOF-L	2	10/P	
12	6LA02675000	PLATE-DRM-GAP	1	1/P	
13	4406329300	SCREW-DRM-GAP	4	10/P	
14	6LA02680000	K-COV-GAP-F	1	1/P	
15	6LA02685000	K-PLATE-DRM-GAP	1	1/P	
16	6LA02688000	SPE-050-040-158	1	5/P	
17	6LA02689000	K-COV-GAP-R	1	1/P	
18	6LE04133000	AUG-CLN-390	1	1/KP	
19	6LA02700000	BASE-NOZZLE-CLN	1	1/P	
20	6LA02701000	SEAL-BASE-NOZ	1	5/P	
21	6LE04126000	SPC-NOZZLE-390	1	1/P	
22	6LA02703000	SHUTTER-NOZZLE	1	1/P	
23	6LA02367000	BUSH-0613-06F-M	2	5/P	
24	6LA02711000	K-SFT-BRUSH-340	1	1/P	
25	X0-00980000	P/PRL/AH7-2X10-SS	2	10/P	
26	4401904450	GEAR-15	1	1/P	
27	4406328750	K-SEAL-S-REC-F	1	1/KP	
28	4406328760	K-SEAL-S-REC-R	1	1/KP	
29	4406328620	K-BLADE-REC-300	1	1/KP	
30	6LA02368000	BUSH-0814-08F-M	1	5/P	
31	6LE04128000	ASYS-VRST-CLN	1	1/D	
32	4401762250	GEAR-25	1	1/P	
33	6LA02719000	GEAR-23-30	1	1/P	
34	6LA02713000	PLT-BIAS-BRSH	1	1/P	
35	4407010320	WASHER-8*14*03	1	10/P	
36	4401904430	GEAR-16	1	1/P	
38	6LE19369000	B-6000	1	1/S	
101	X0-00967000	RR/E-6-SS	1	10/P	
102	X0-00965000	RR/E-4-SS	1	10/P	
103	X0-00966000	RR/E-5-SS	3	10/P	
104	X0-02230000	S/FHEXM-M3X6-NI	3	10/P	
105	X0-02052000	S/TP/PAN2/S-4X10-NI	1	10/P	
106	X0-02252000	S/TPP/FHEXM-4X10-NI	6	10/P	
107	X0-02251000	S/TPP/FHEXM-4X8-NI	2	10/P	

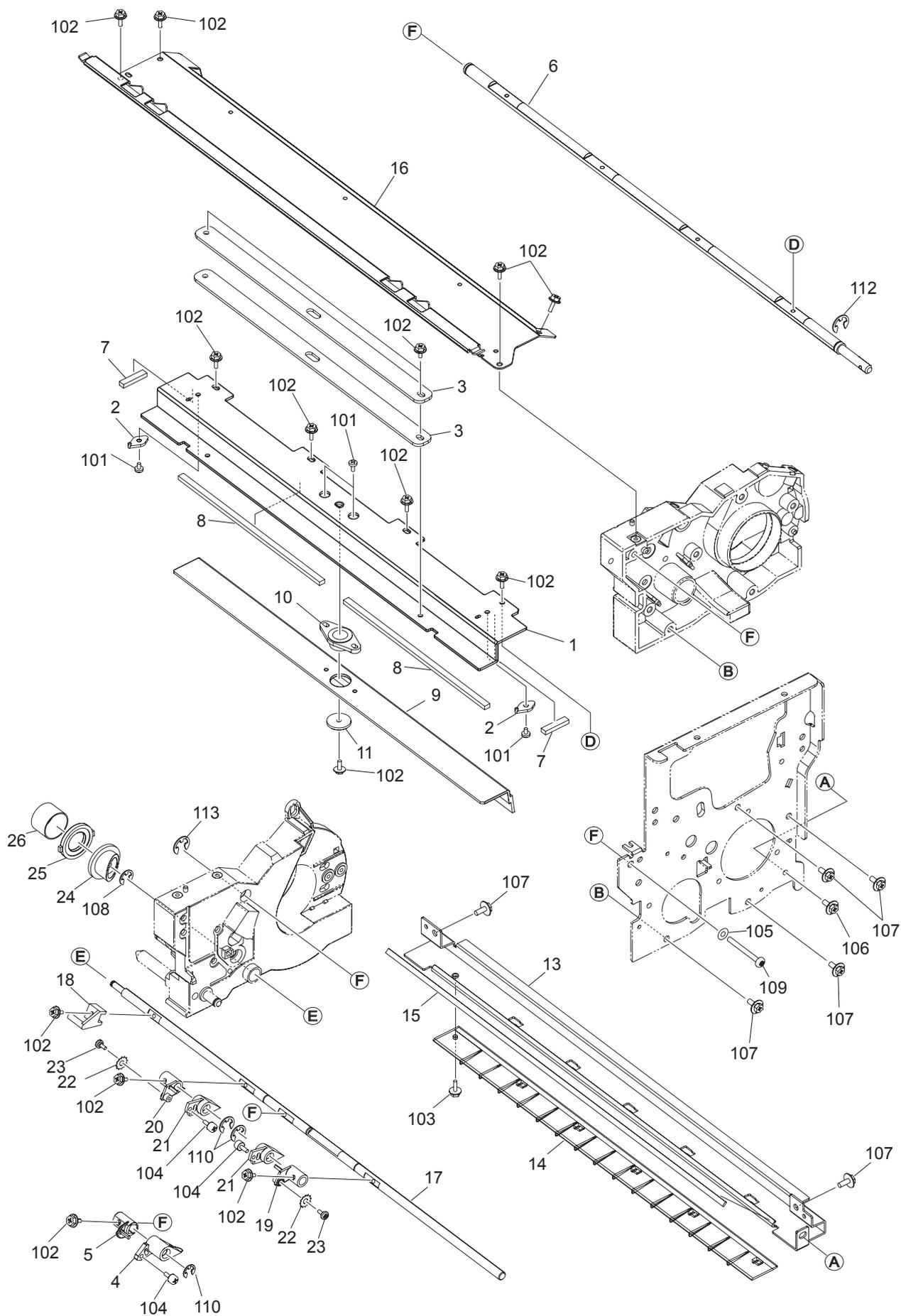



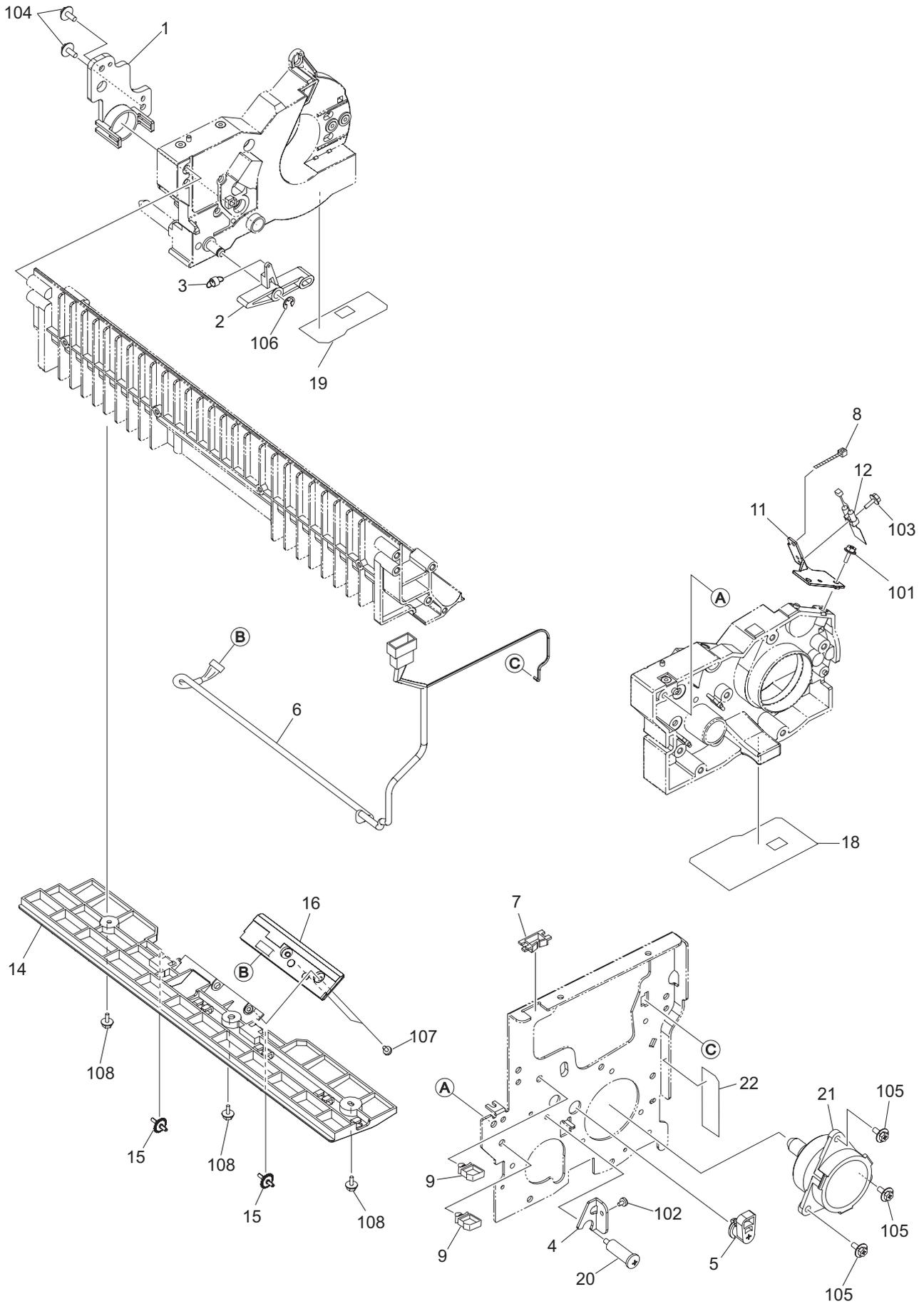





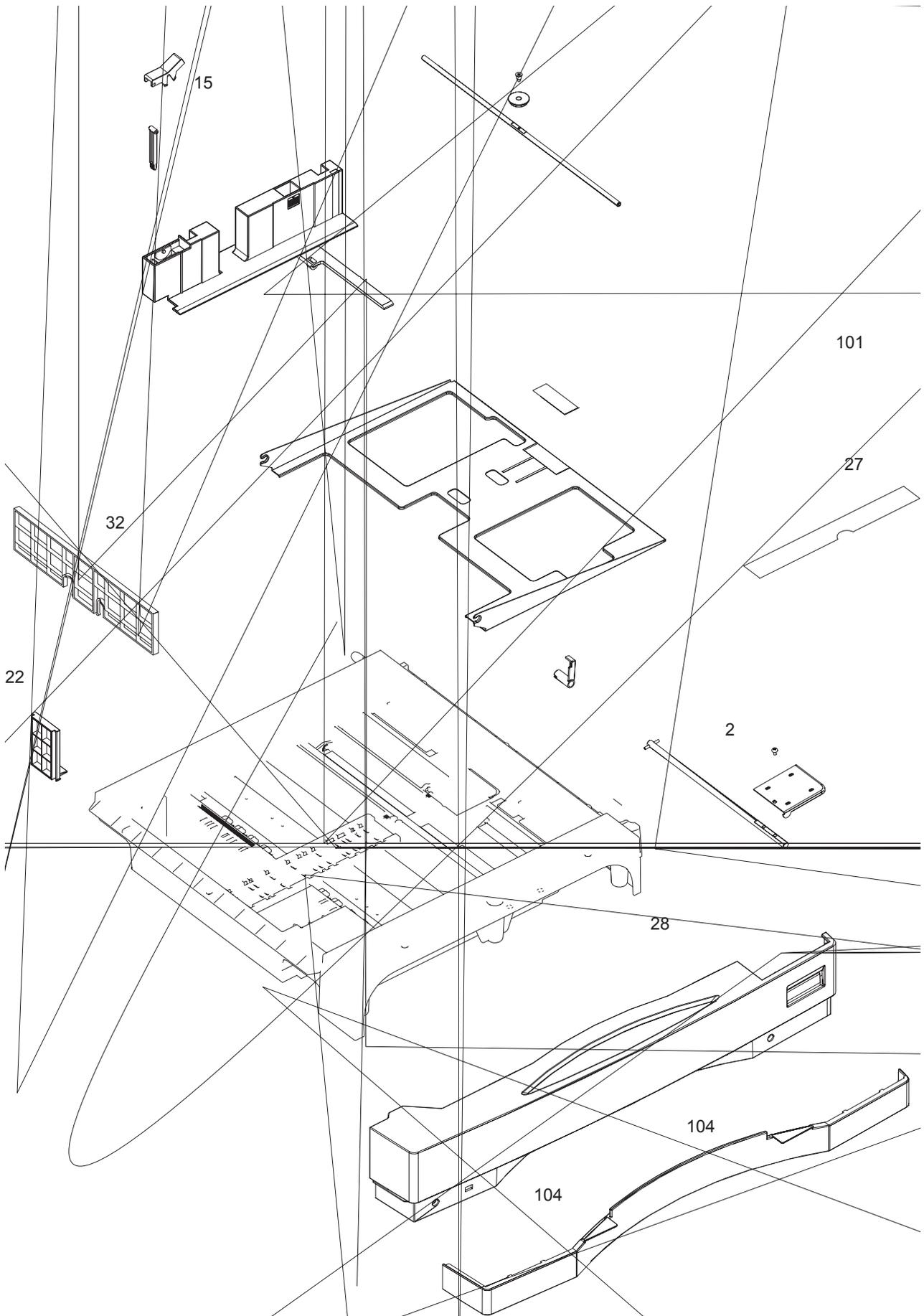

ITEM No.	PART No.	PART NAME	Q'TY / PAGE	Q'TY / PACK	REMARKS
1	6LA15843100	CASSETTE-390B	1	1/PP	
2	6LE03700000	ASYS-SHAFT-TRAY-UP	1	1/P	
3	6LA04446000	LEVER-SENS	1	1/P	
4	6LA14516000	LVR-ELV-CST	1	1/P	
5	4400908680	CUSHION-CST	2	1/KP	
6	6LA15842100	SIDE-WALL-F-390B	1	1/PP	
7	6LA15847000	PLT-LVR-CST-340	1	1/P	
8	6LE03710000	LVR-LOCK-CST	1	1/P	
9	6LA15844000	PLT-LOCK-CST-340	1	1/P	
11	6LA56695000	SPC-LVR-WALL-F	1	1/P	
12	6LA15841100	SIDE-WALL-R-390B	1	1/PP	
13	6LA29058000	LEVER-LOCK-WALL-RER	1	1/P	
14	6LA04433000	WALL-LOCK-R-340	1	1/P	
15	41305546000	SPL-LOCK-WALL-R	1	1/P	
16	6LE03702000	SHAFT-GUIDE	1	1/P	
17	6LA04463000	BRKT-SHAFT	1	1/P	
18	41306029000	GER-PINION-20-AT	1	1/P	
19	6LA04456000	SCREW-PINION	1	5/P	
20	6LE03714000	TRAY-390	1	1/PP	
21	6LA04500000	PAD-CST-340	1	5/P	
22	6LA29061000	WALL-CSSTT-END	1	1/P	
23	6LE04404000	COVER-CSSTT-LWR	1	1/PP	
24	6LE04403000	COVER-CSSTT-UPR	1	1/PP	
26 A	6LE03708000	SIZE-CST-390-UC	1	1/KP	NAD
26 B	6LE03709000	SIZE-CST-390-E	1	1/KP	MJD,ASD,ASU,AUD,ARD,SAD
27 A	6LE03707000	LBL-O-CST-390	1	1/KP	AUD,NAD
27 B	6LE03711000	LBL-O-CST-390	1	1/KP	MJD,ASD,ASU,ARD,SAD
28	6LE03713000	BRKT-CST-POS-390	1	1/P	
29	6LA04487000	STUD-CST-POS	1	5/P	
30	6LA14327000	BRKT-FIX-PINION	1	1/P	
31	6LA14466000	CAP-LEVER-SENS	1	1/P	
32	6LE03705000	WALL-END-TAB390	1	1/PP	
33 B	6LE03712000	LBL-CST-LCD-SUB	1	5/P	MJD
101	X0-01989000	S/TPP/BID-3X8-NI	4	10/P	
102	X0-02235000	S/FHEXM-M4X8-NI	4	10/P	
103	X0-02230000	S/FHEXM-M3X6-NI	1	10/P	
104	X0-02251000	S/TPP/FHEXM-4X8-NI	8	10/P	
105	X0-02247000	S/TPP/FHEXM-3X8-NI	2	10/P	
106	6LA15906000	WSHR-M4-CST-F340	2	10/P	





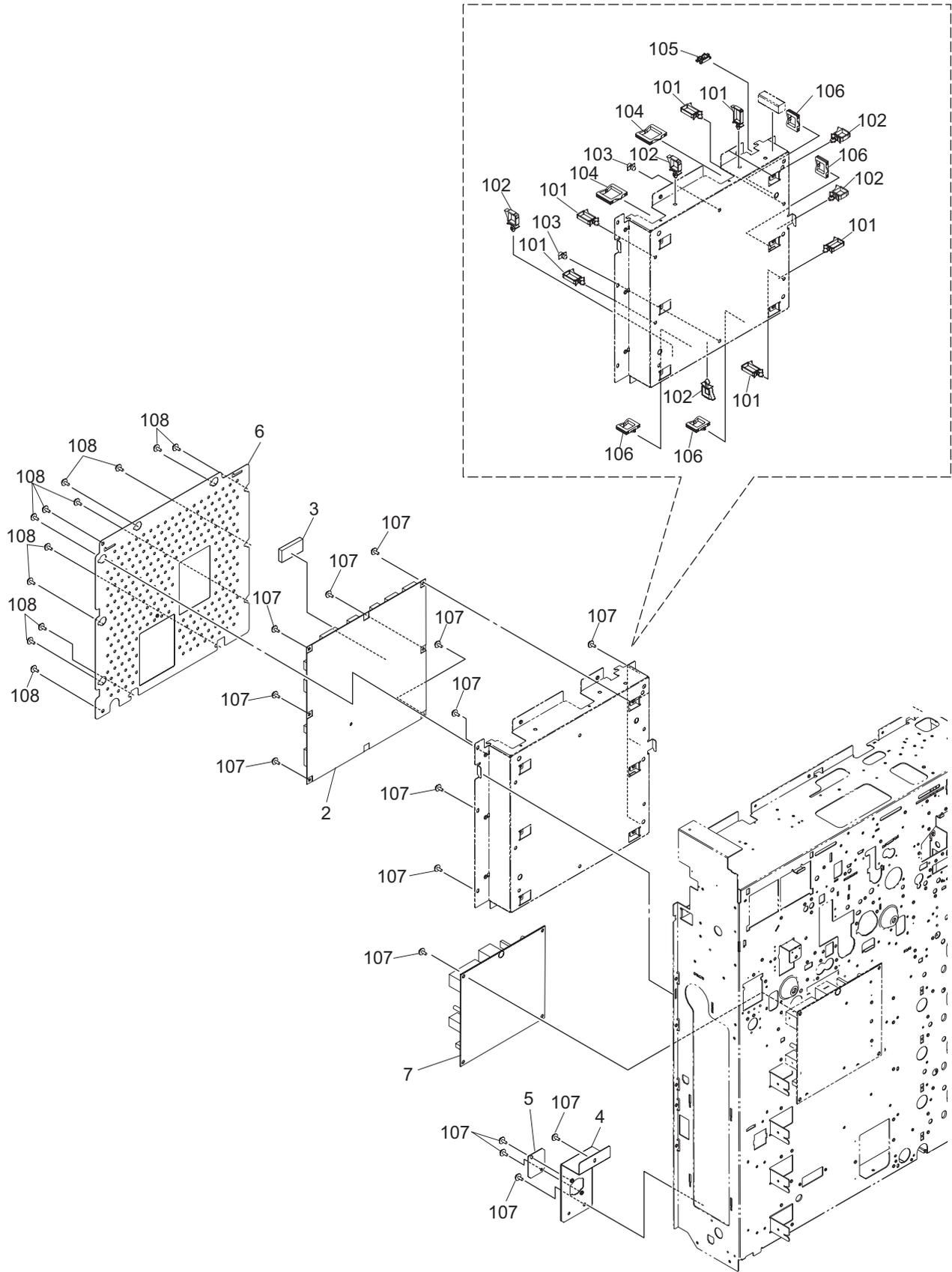









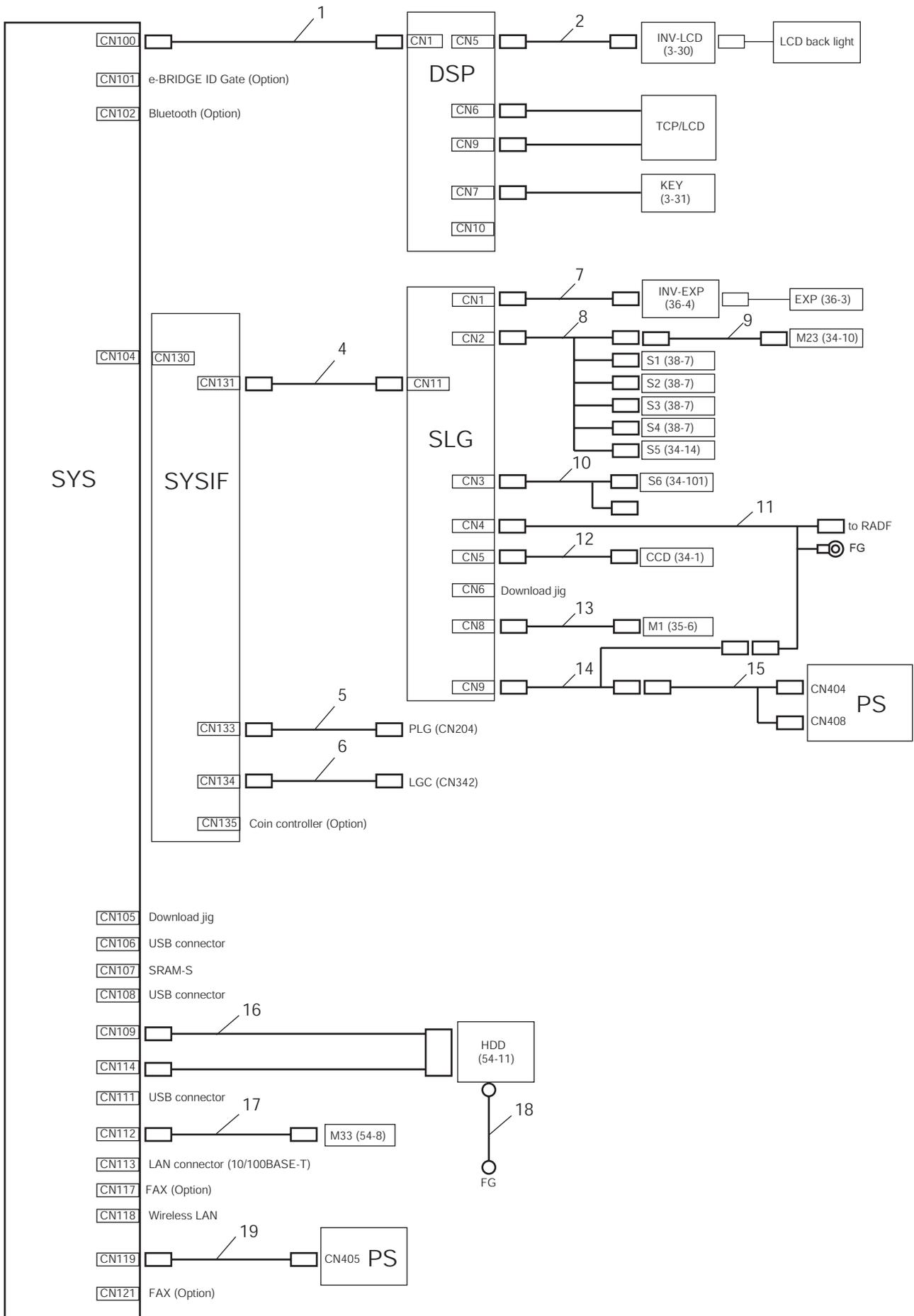



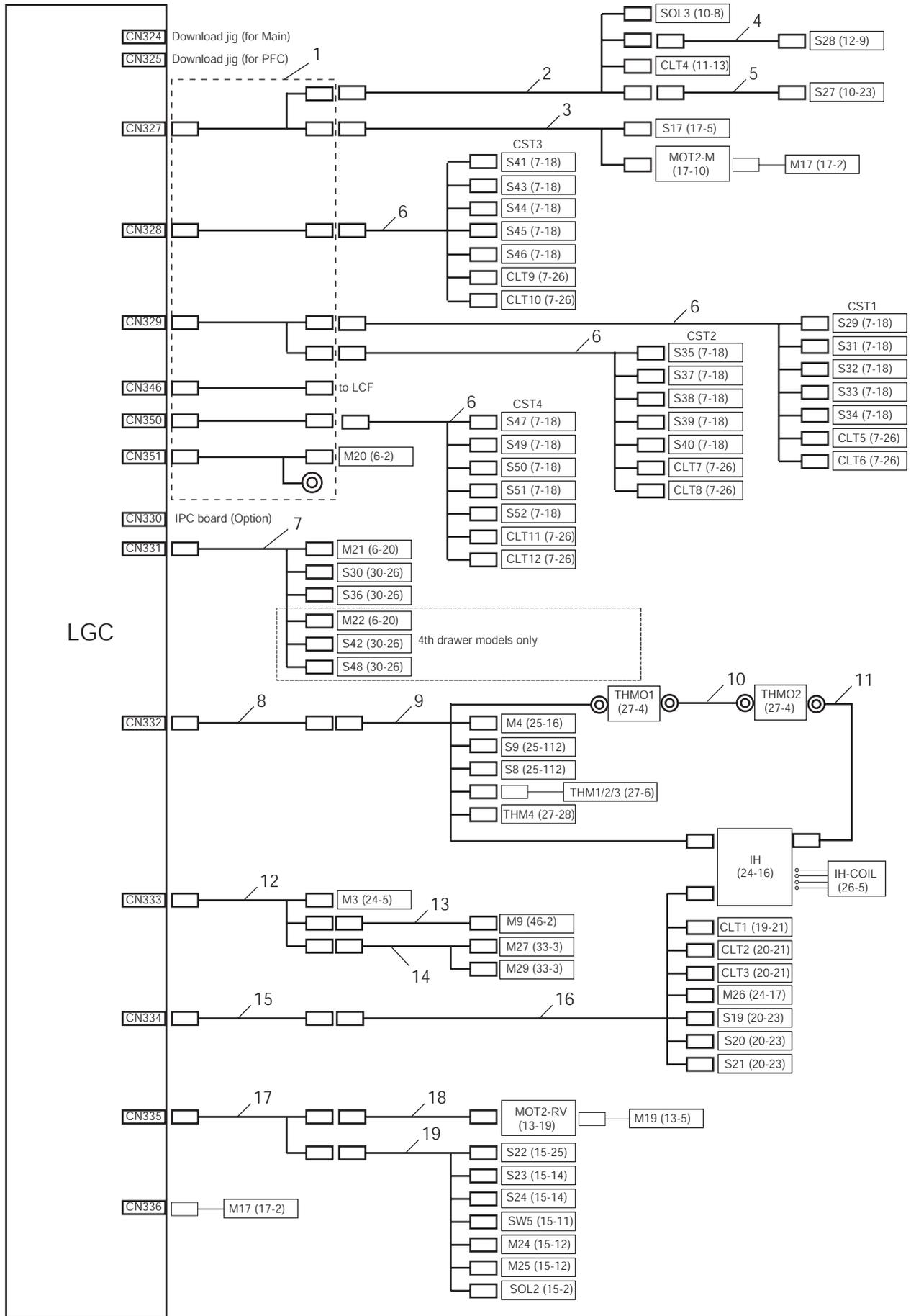



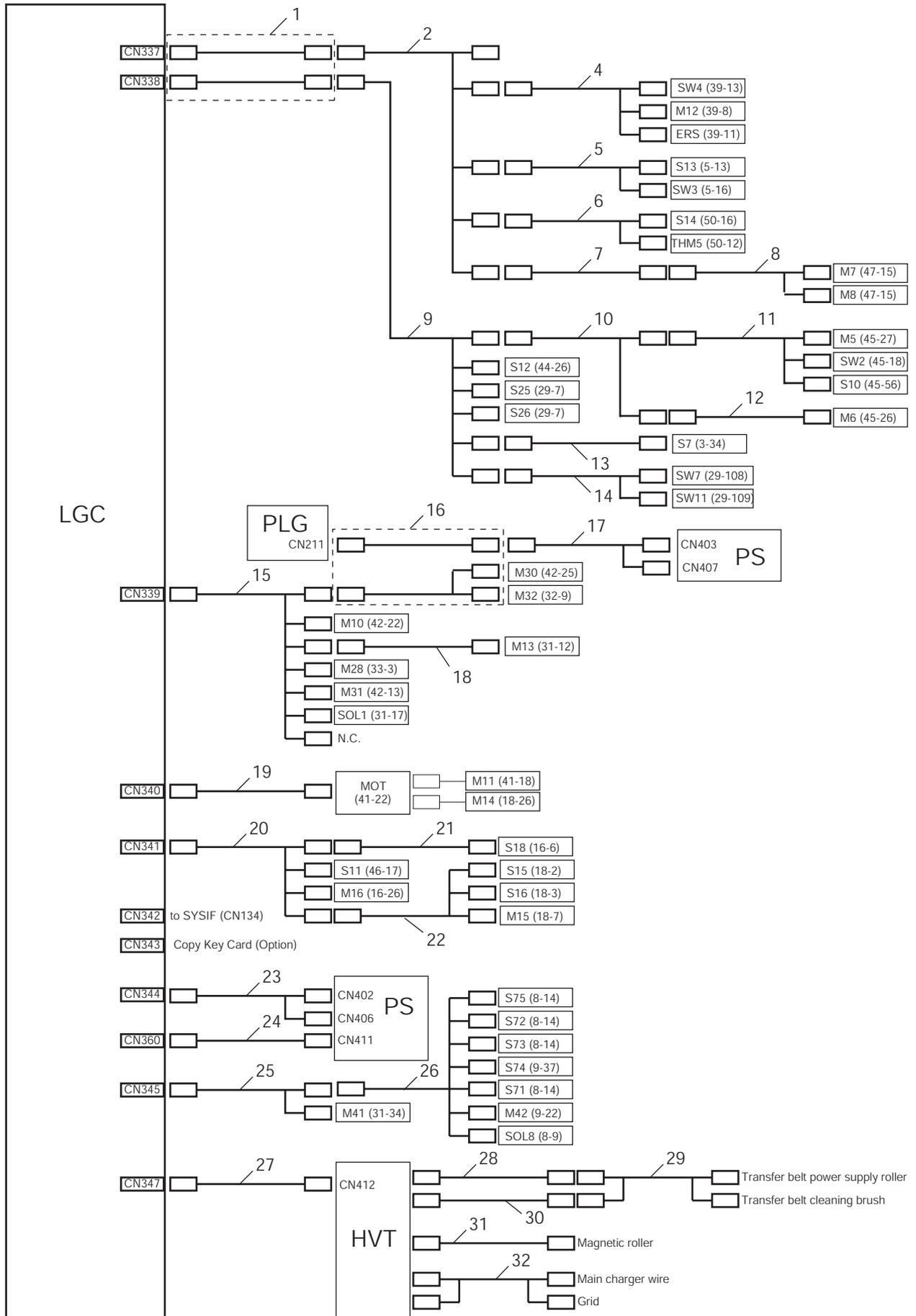



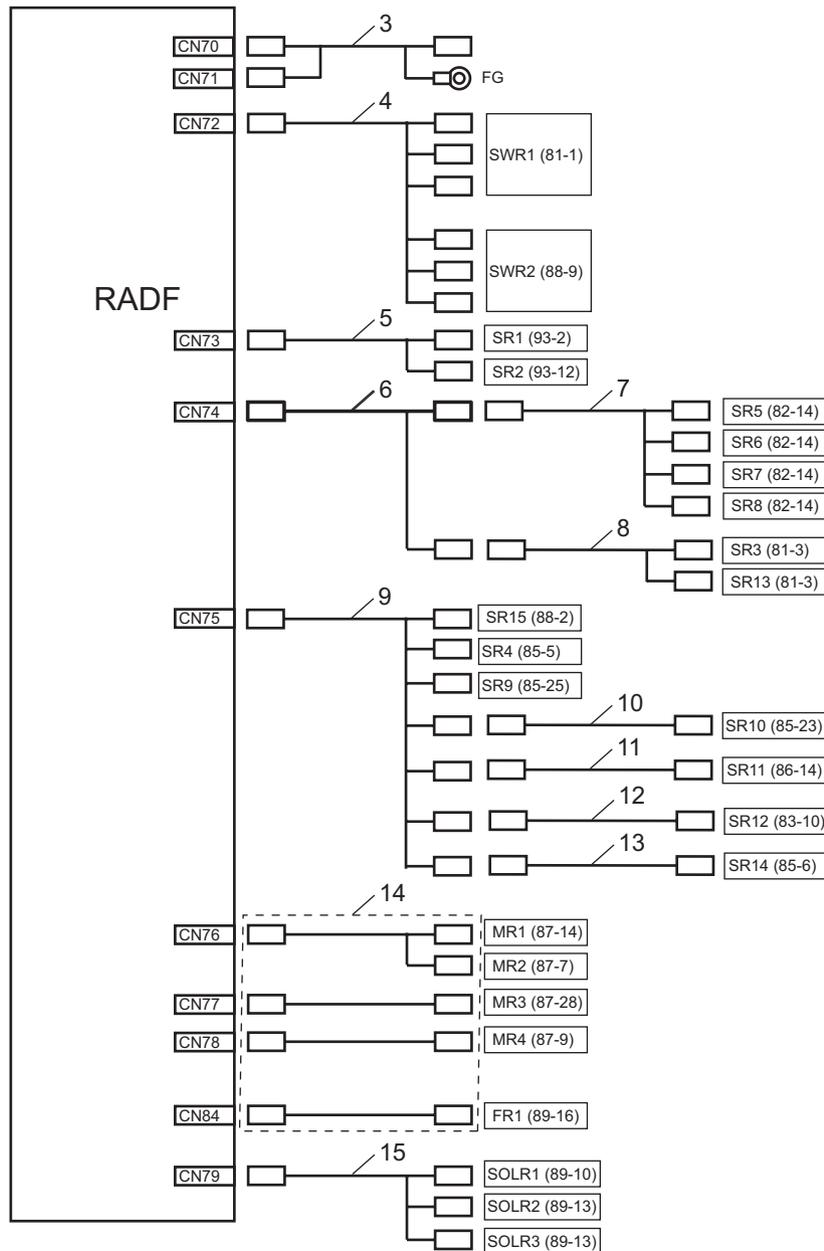
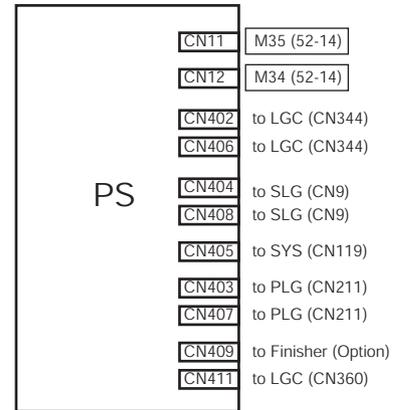
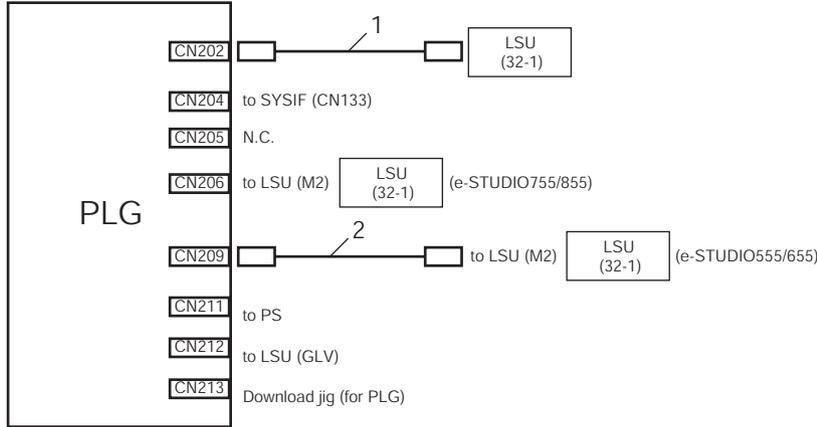





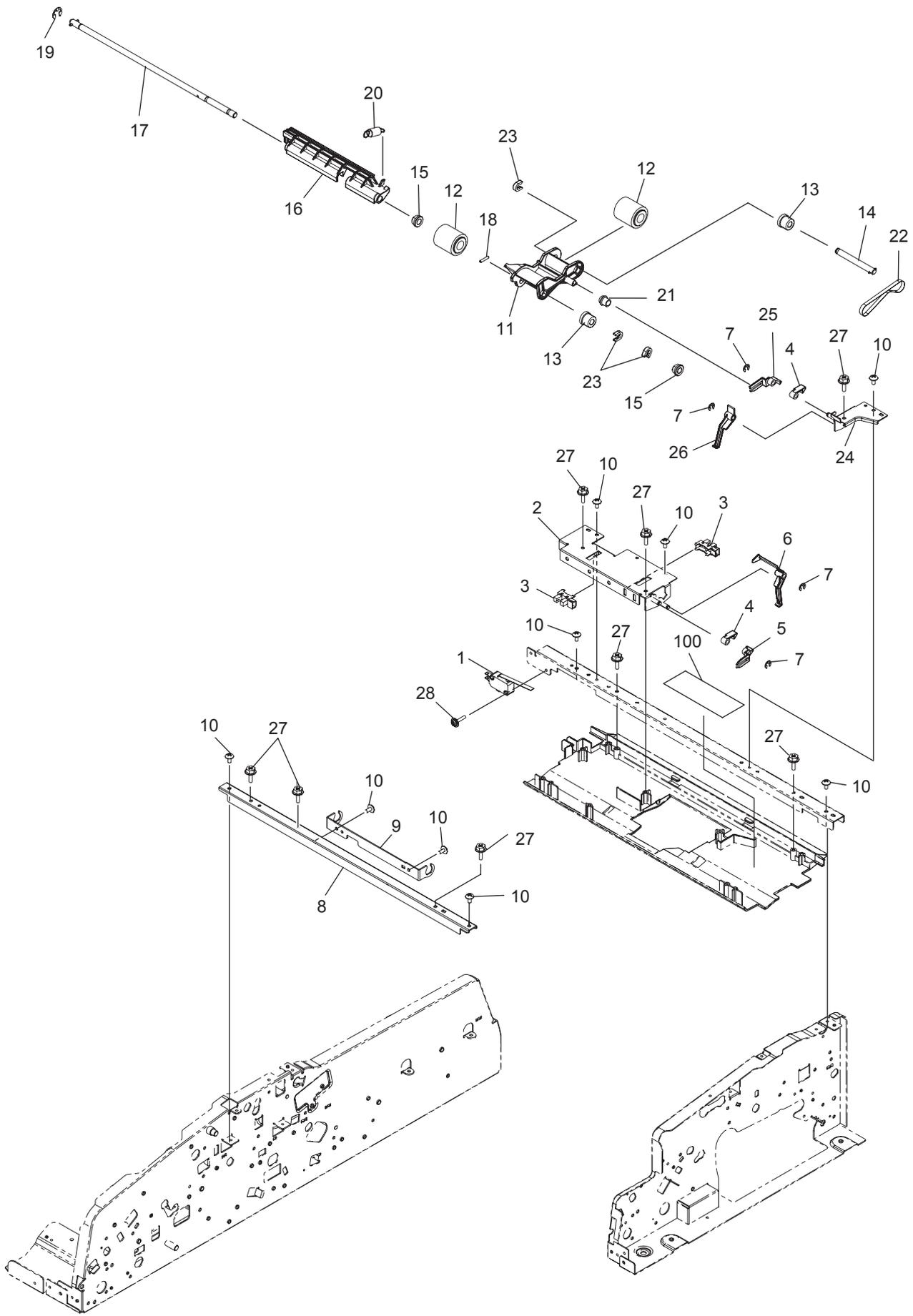



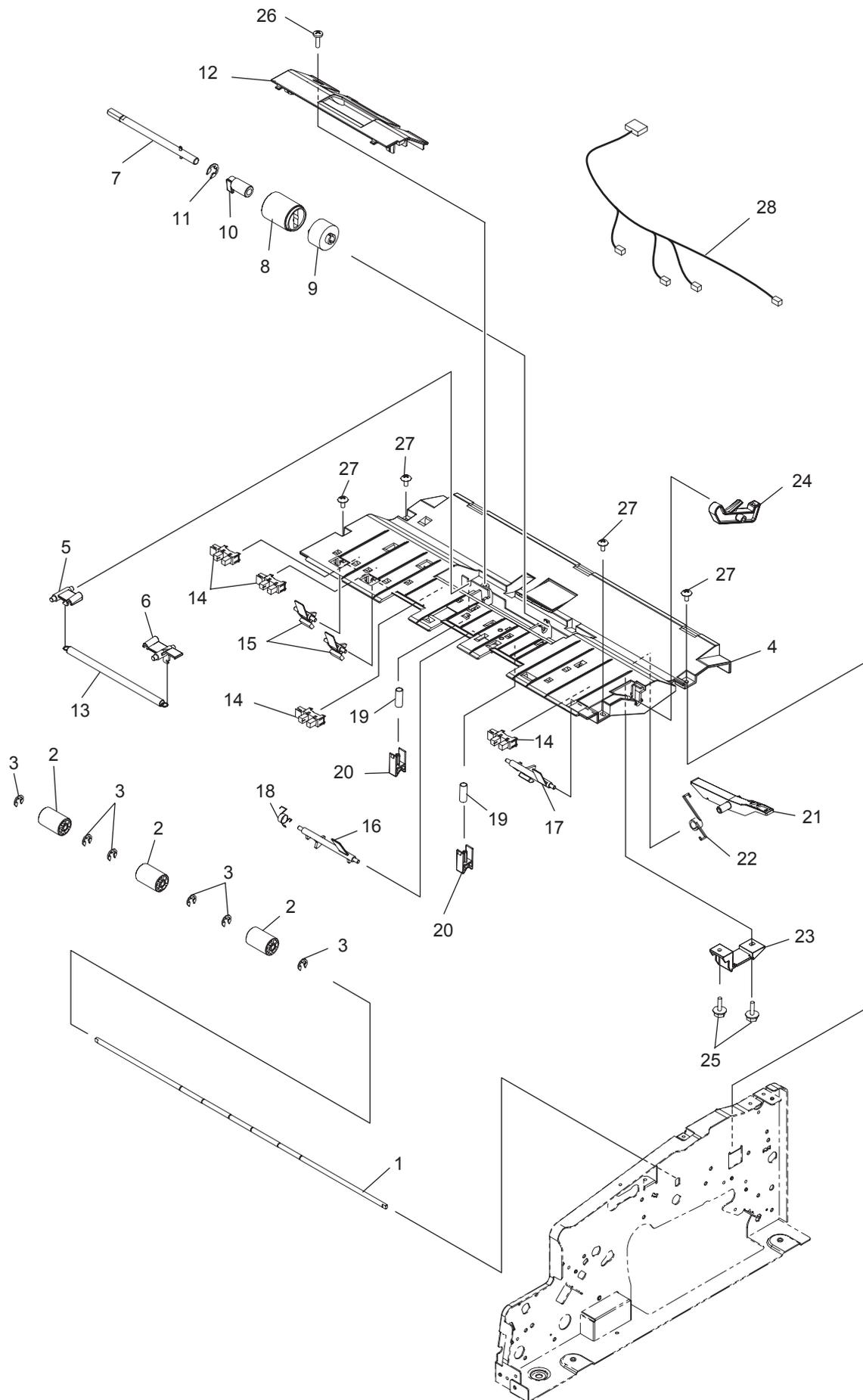



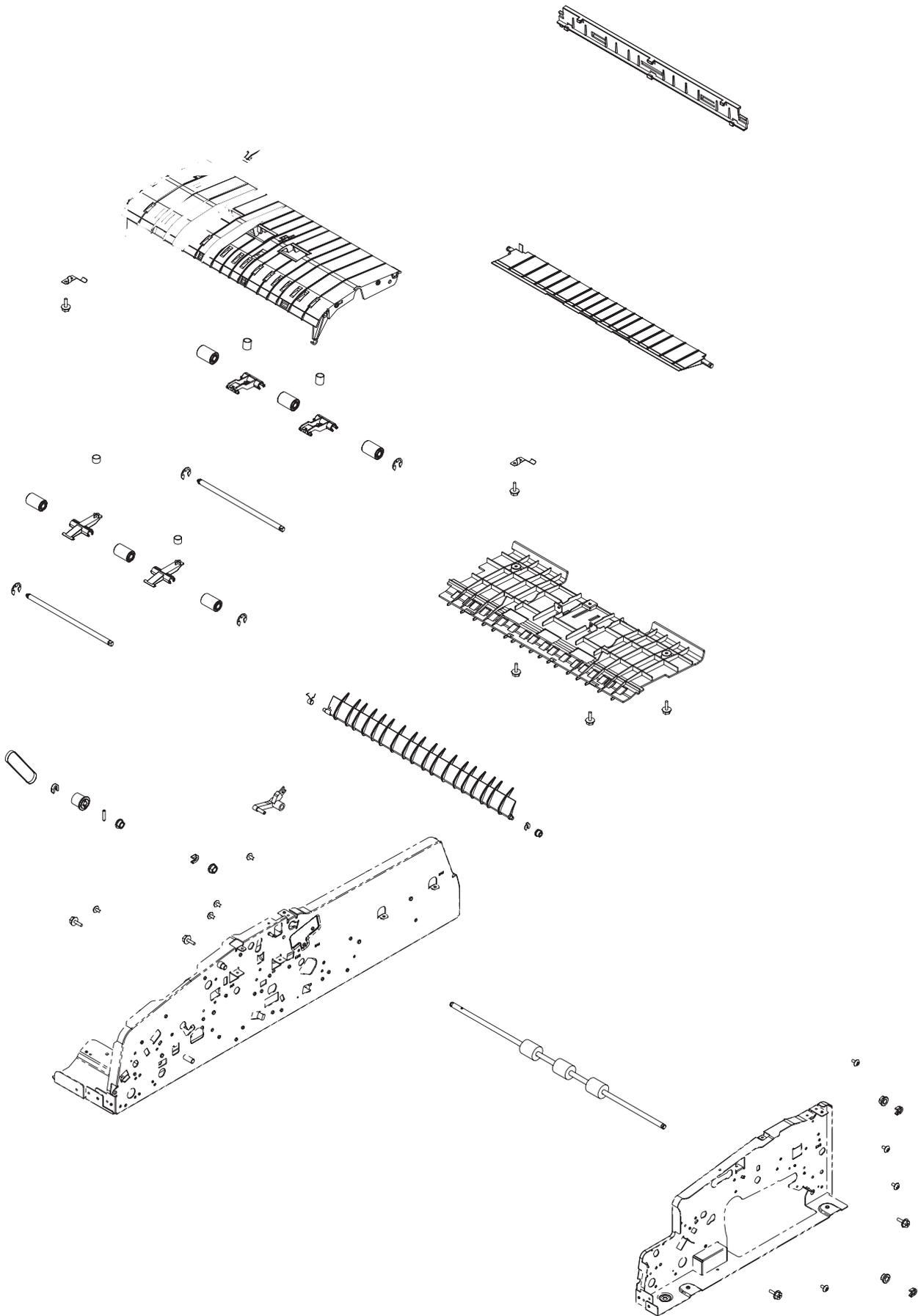

ITEM No.	PART No.	PART NAME	Q'TY / PAGE	Q'TY / PACK	REMARKS
1	6LH06595000	GUIDE-SB-U-TQ	1	1/PP	
2	6LH06623000	SPR-ERTH-SB	1	1/P	
3	6LA08935000	SCR-M3X6BISR-NI	9	10/P	
4	6LH06500000	GUIDE-SB-IN	1	1/PP	
5	6LH06677000	SFT-EXIT-SB-D6	2	1/P	
6	6LH06530000	ROL-IDL-D15-D6-POM	3	1/P	
7	X0-00966000	RR/E-5-SS	4	10/P	
8	6LH06552000	LEV-DELTA	2	1/P	
9	6LH06678000	SPR-SB-IN	2	1/P	
10	C0-10813000	GP1A73ARJ00F	1	1/P	
11	6LH06582000	LEVER-OUT-SENS	1	1/P	
12	6LH06681000	SPR-SENS-OUT	1	1/P	
13	6LH06526000	ROL-IDL-D16-POM	3	1/P	
14	6LH06554000	LEV-EXIT	2	1/P	
15	6LH06680000	SPR-SB-OUT	2	1/P	
16	6LH06646000	ROL-TRANS-RVS	1	1/KP	
17	6LH06618000	SPL-GUIDE-CUSION	2	1/P	
18	6LH06539000	GUIDE-SB-IN-D	1	1/PP	
19	6LH06816000	GATE-EXIT-SFT	1	1/KP	
20	6LH06682000	SPR-GATE-EXIT	1	1/P	
21	X0-02247000	S/TPP/FHEXM-3X8-NI	9	10/P	
22	6LH06812000	STOP-RING-3	1	5/P	
23	4400536230	BUSH-4-7	1	5/P	
24	6LH06531000	PULLY-MAIN-ALNG	1	1/P	
25	6LH06567000	LVR-FLAP-EXIT-TQ	1	1/P	
26	6LH06746000	BLT-TRANS-RVS	1	1/P	
30	6LE49739000	BUSH-6X10X6F-SBK	2	5/P	
31	6LH06646000	ROL-TRANS-RVS	2	1/KP	
32	6LB12138000	PIN-2X10	1	10/P	
33	6LE49743000	STOP-RING-6-5-POM	2	5/P	
34	6LH06636000	STAY-ORG-SUB	1	1/P	
35	6LH06313000	HRNS-RADF-EXIT-430	1	1/P	
36	6LH06683000	SPG-FLAP-EXIT-TQ	1	1/P	
37	6LH06700000	ASYS-FLAP-EXIT-TQ	1	1/PP	

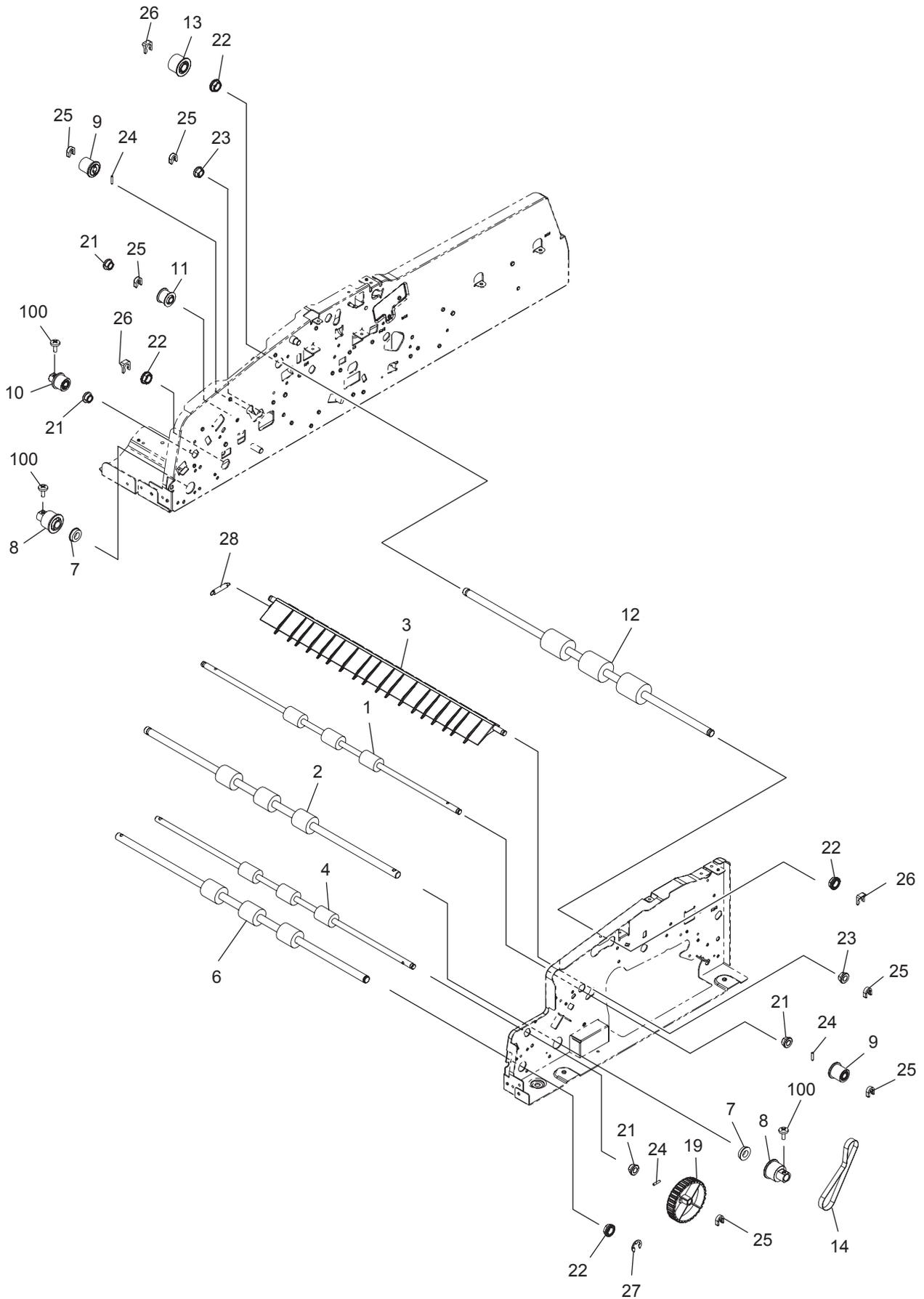





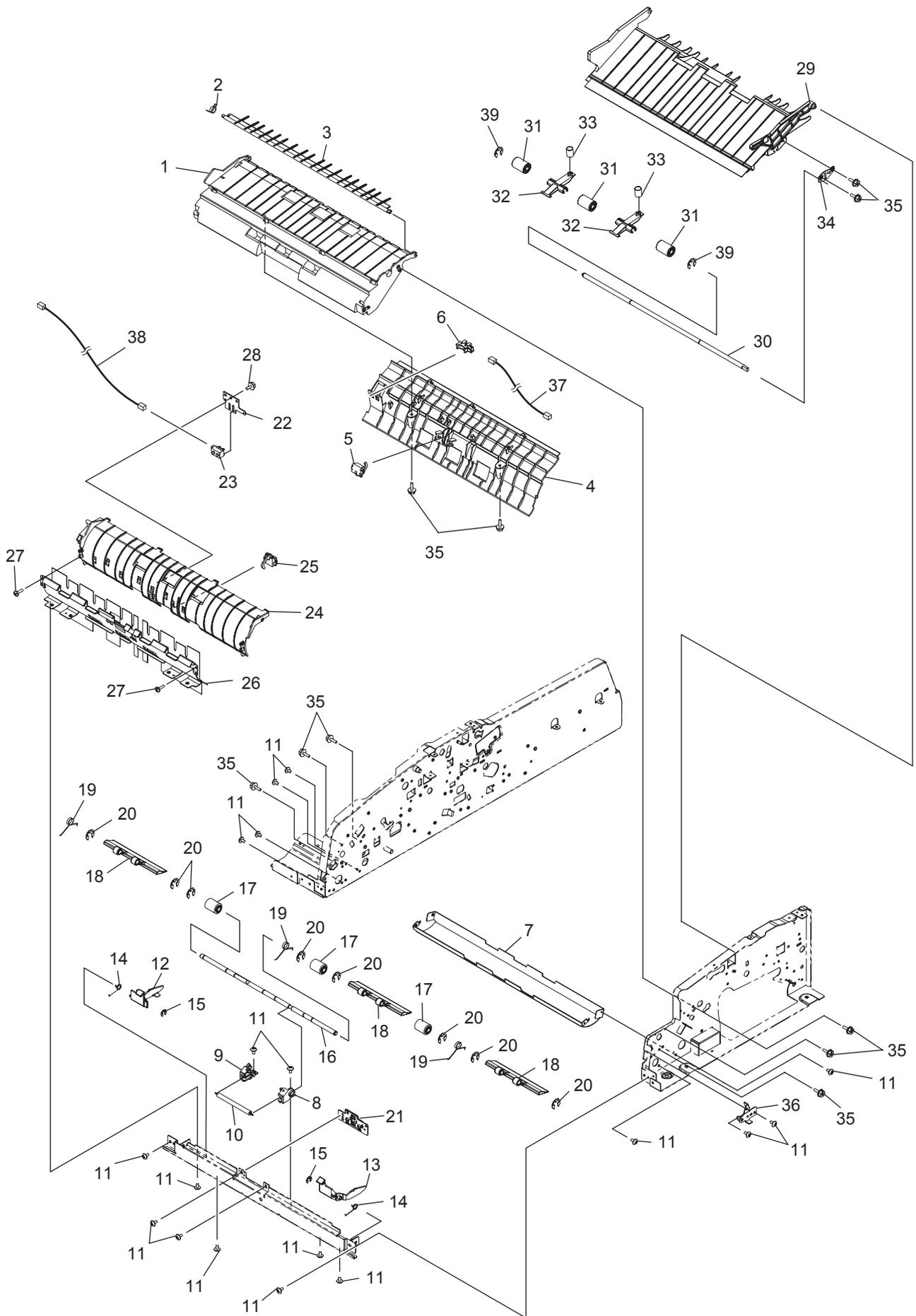



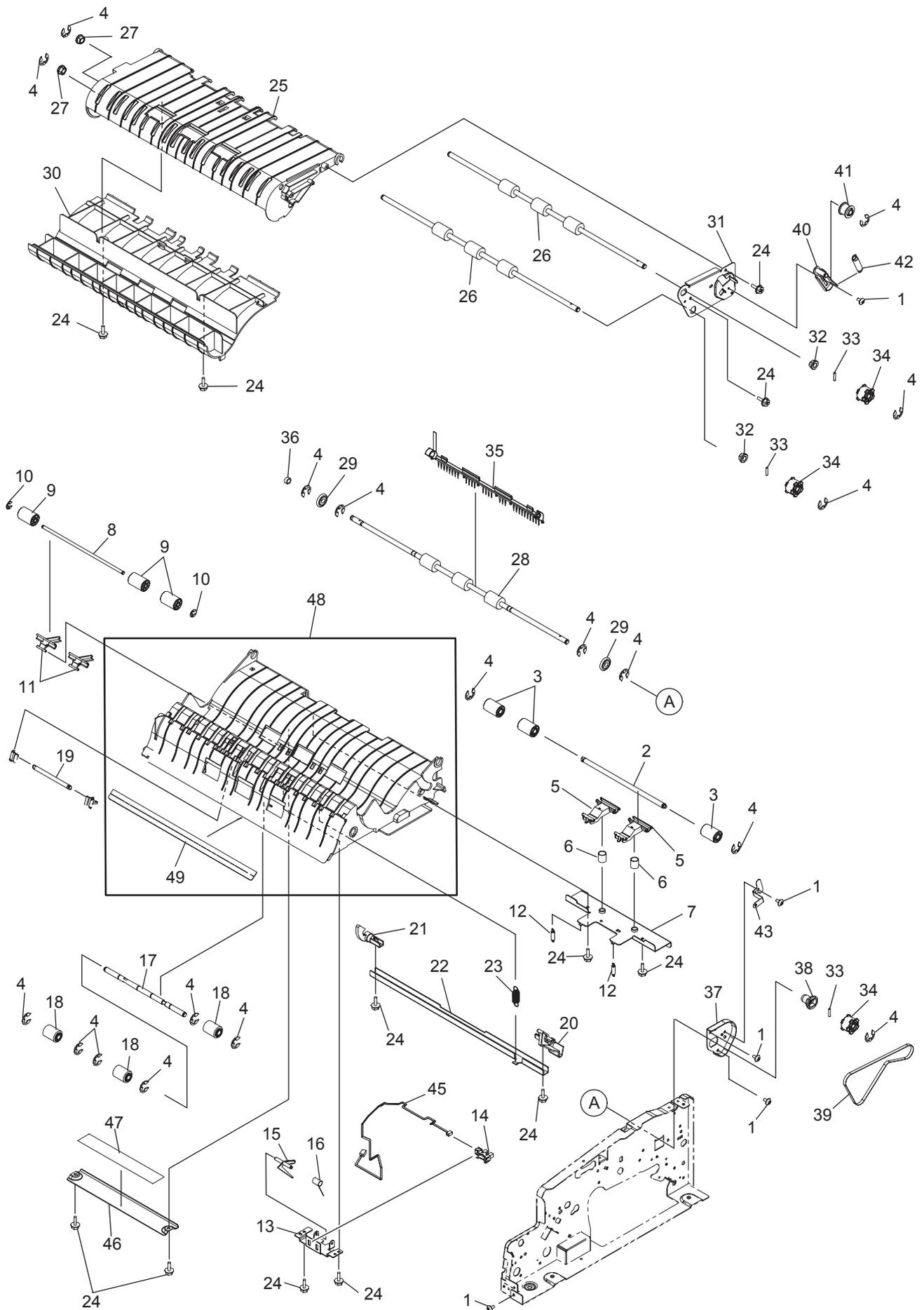

ITEM No.	PART No.	PART NAME	Q'TY / PAGE	Q'TY / PACK	REMARKS
1	6LA08935000	SCR-M3X6BISR-NI	6	10/P	
2	6LH06677000	SFT-EXIT-SB-D6	1	1/P	
3	6LH06526000	ROL-IDL-D16-POM	3	1/P	
4	X0-00966000	RR/E-5-SS	18	10/P	
5	6LH06554000	LEV-EXIT	2	1/P	
6	6LH06680000	SPR-SB-OUT	2	1/P	
7	6LH06583000	BRKT-LEV-EXIT	1	1/P	
8	6LH06687000	SFT-EXIT-D4	1	1/P	
9	6LH06527000	ROL-IDL-D16-D4-POM	3	1/P	
10	X0-00964000	RR/E-3-SS	2	10/P	
11	6LH06534000	LEV-EXIT-R	2	1/P	
12	6LH06688000	SPR-LEV-EXIT	2	1/P	
13	6LH06586000	BRKT-BACK-EXIT-SNS	1	1/P	
14	C0-15172000	GP1A173LCS2F	1	1/C	
15	6LH06546000	ACTR-BACK-EXIT	1	1/P	
16	6LH06690000	SPR-BACK-SNS	1	1/P	
17	6LH06652000	SFT-IDL-RD-OUT	1	1/P	
18	6LH06637000	ASYS-ROL-RD-IN-IDL	3	1/P	
19	6LH06708000	SPR-LEV-READ-IN	1	1/P	
20	6LH06549000	LEVER-GUIDE-LOCK-F	1	1/P	
21	6LH06550000	LEVER-GUIDE-LOCK-R	1	1/P	
22	6LH06579000	BRKT-GUIDE-OPEN	1	1/P	
23	6LH06693000	SPR-GUIDE-EXIT-OPEN	1	1/P	
24	X0-02247000	S/TPP/FHEXM-3X8-NI	12	10/P	
25	6LH06515000	GUIDE-EXIT-IN	1	1/PP	
26	6LH06647000	ROL-EXIT-SB	2	1/KP	
27	44201492000	BUSH-6-POM	2	5/P	
28	6LH06648000	ROL-EXIT	1	1/KP	
29	6LH06802000	ROL-COL-TQ	2	1/P	
30	6LH06516000	GUIDE-EXIT-IN-L	1	1/PP	
31	6LH06578000	PLATE-DRV-EXIT-F	1	1/P	
32	6LE49739000	BUSH-6X10X6F-SBK	2	5/P	
33	6LB12138000	PIN-2X10	3	10/P	
34	6LH06529000	PULLY-EXIT	3	1/P	
35	6LH06800000	ASYS-SHUT-EXIT-TQ	1	1/KP	
36	6LH23444000	BUSH-GCB-6-4-NU4	1	1/P	
37	6LH06599000	PLT-GUIDE-EXIT	1	1/P	
38	6LH06522000	BUSH-GUIDE-EXIT-F	1	1/P	
39	6LH06697000	BLT-EXIT-F	1	1/P	
40	6LE50110000	ASYS-PLT-TNSN	1	1/P	
41	6LE50098000	ROL-TNSN-FEED	1	1/P	
42	6LH06698000	SPR-TNSN-READ-10N	1	1/P	
43	6LH06796000	SPR-ERTH-FR	1	1/C	
45	6LH06314000	HRNS-RADF-EXITR-430	1	1/P	
46	6LH06584000	BRKT-GUIDE-PUSH	1	1/P	
47	6LH06772000	LBL-PUSH-TQ	1	1/KP	
48	6LH06604000	ASYS-GUIDE-EXIT	1	1/C	
49	6LH06605000	MYLAR-GUIDE-EXIT	1	1/KP	

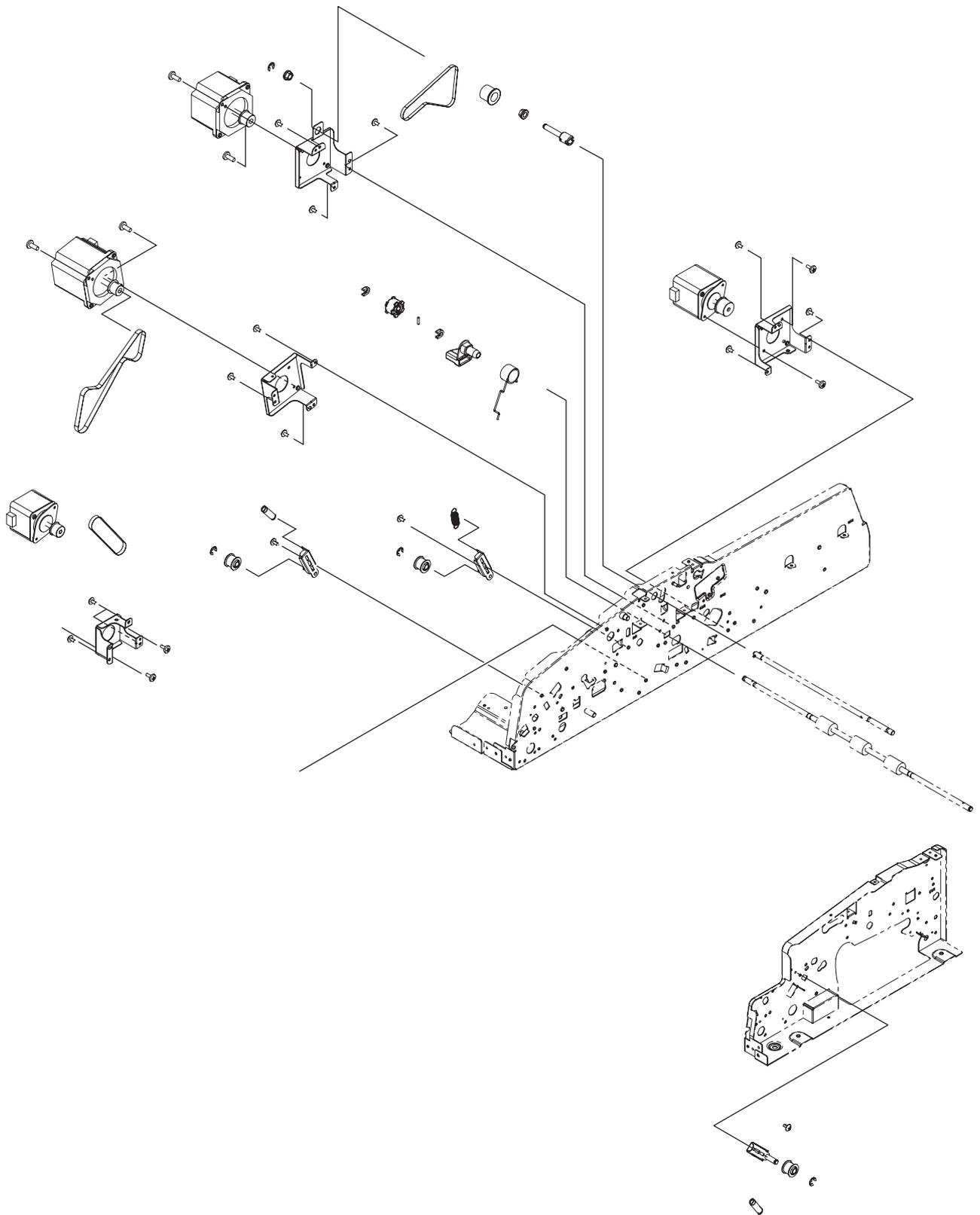



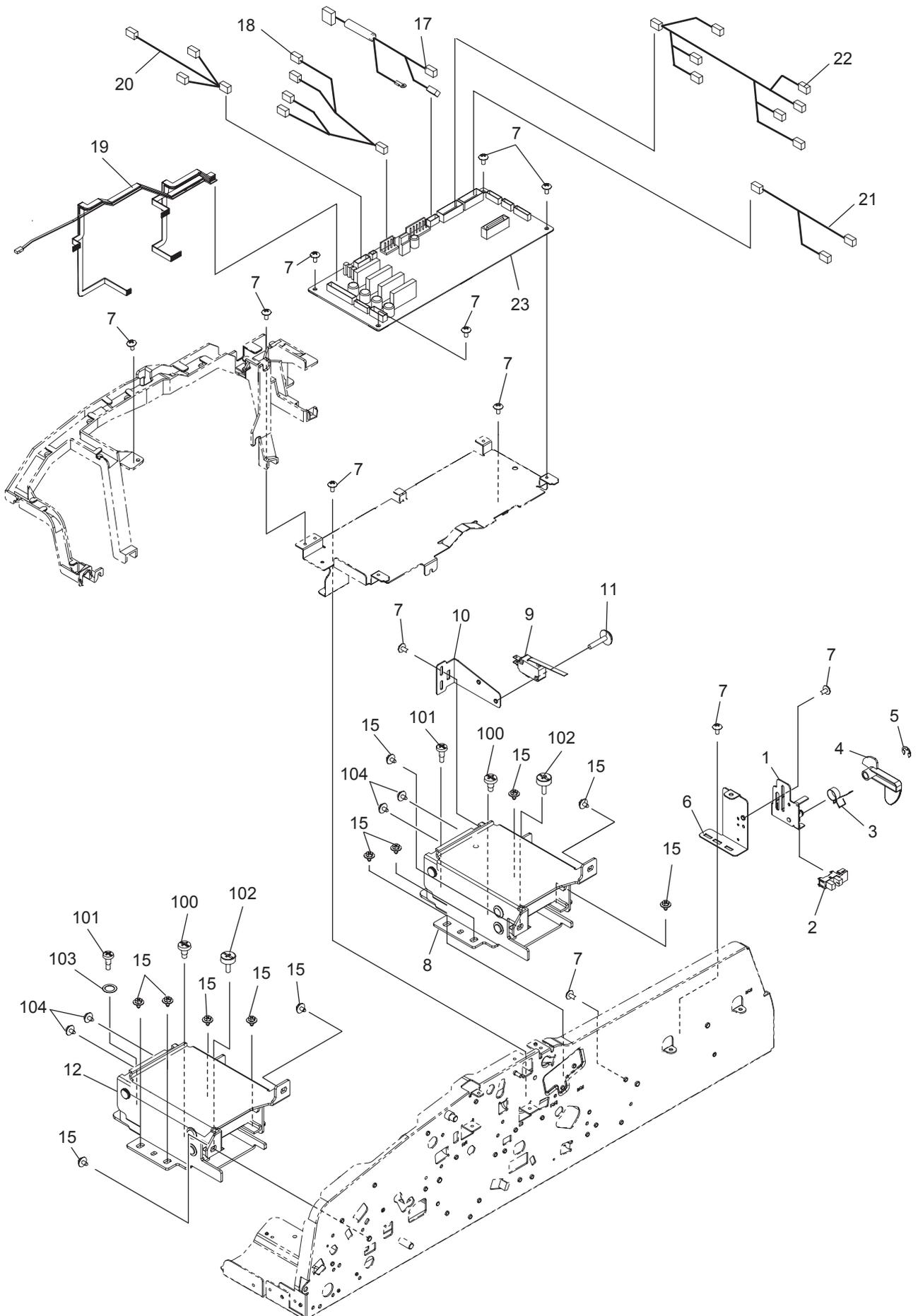





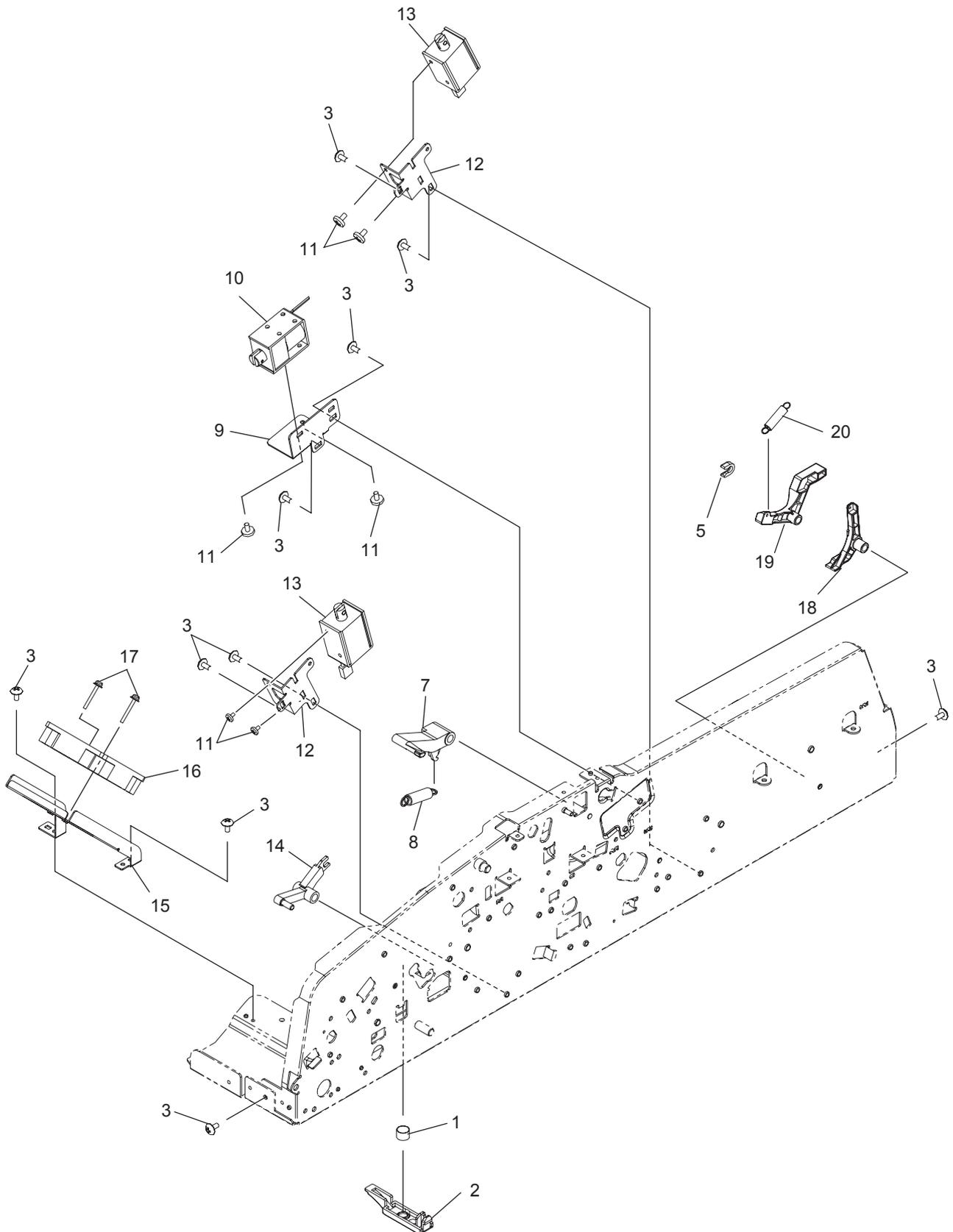



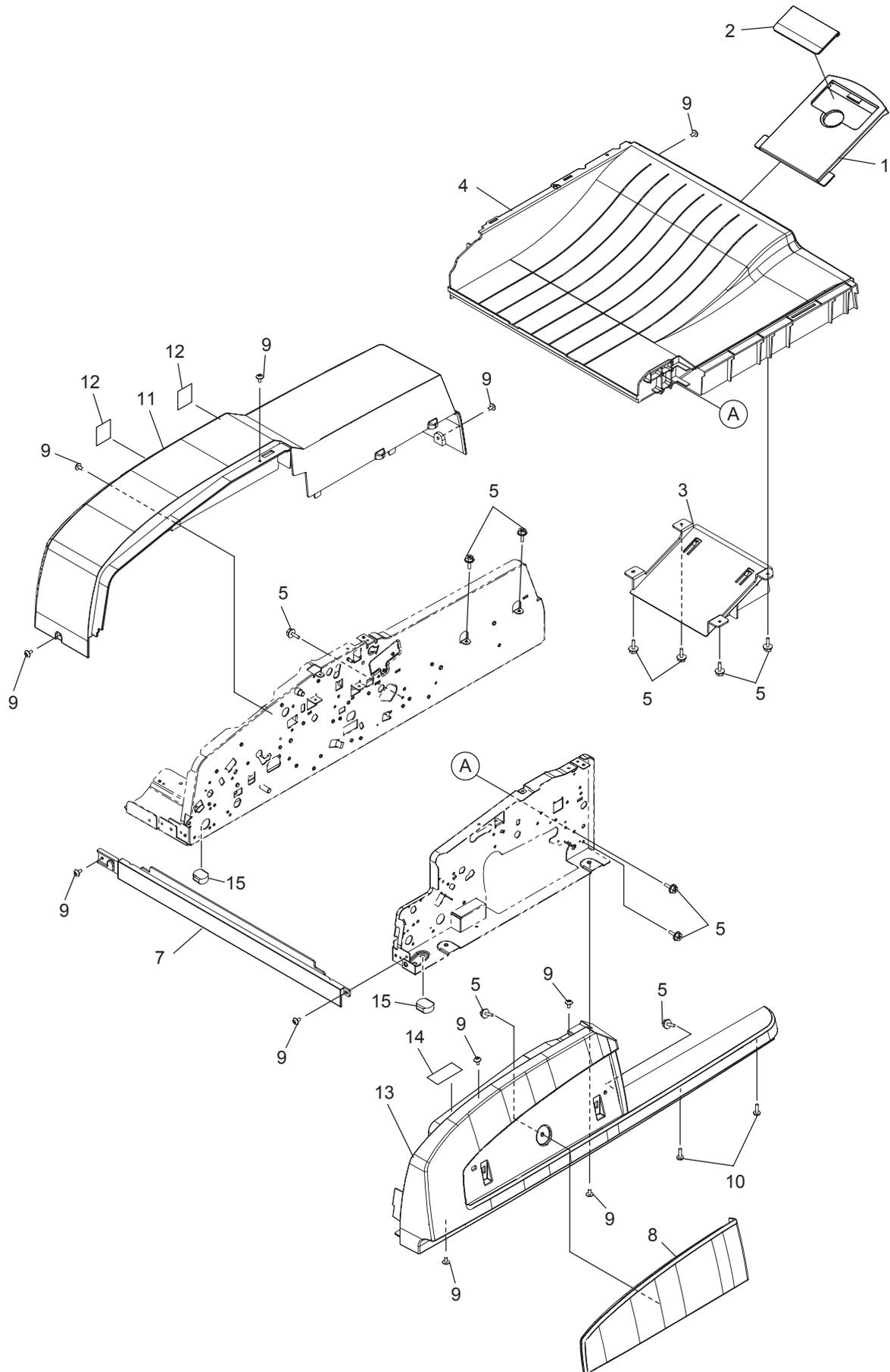



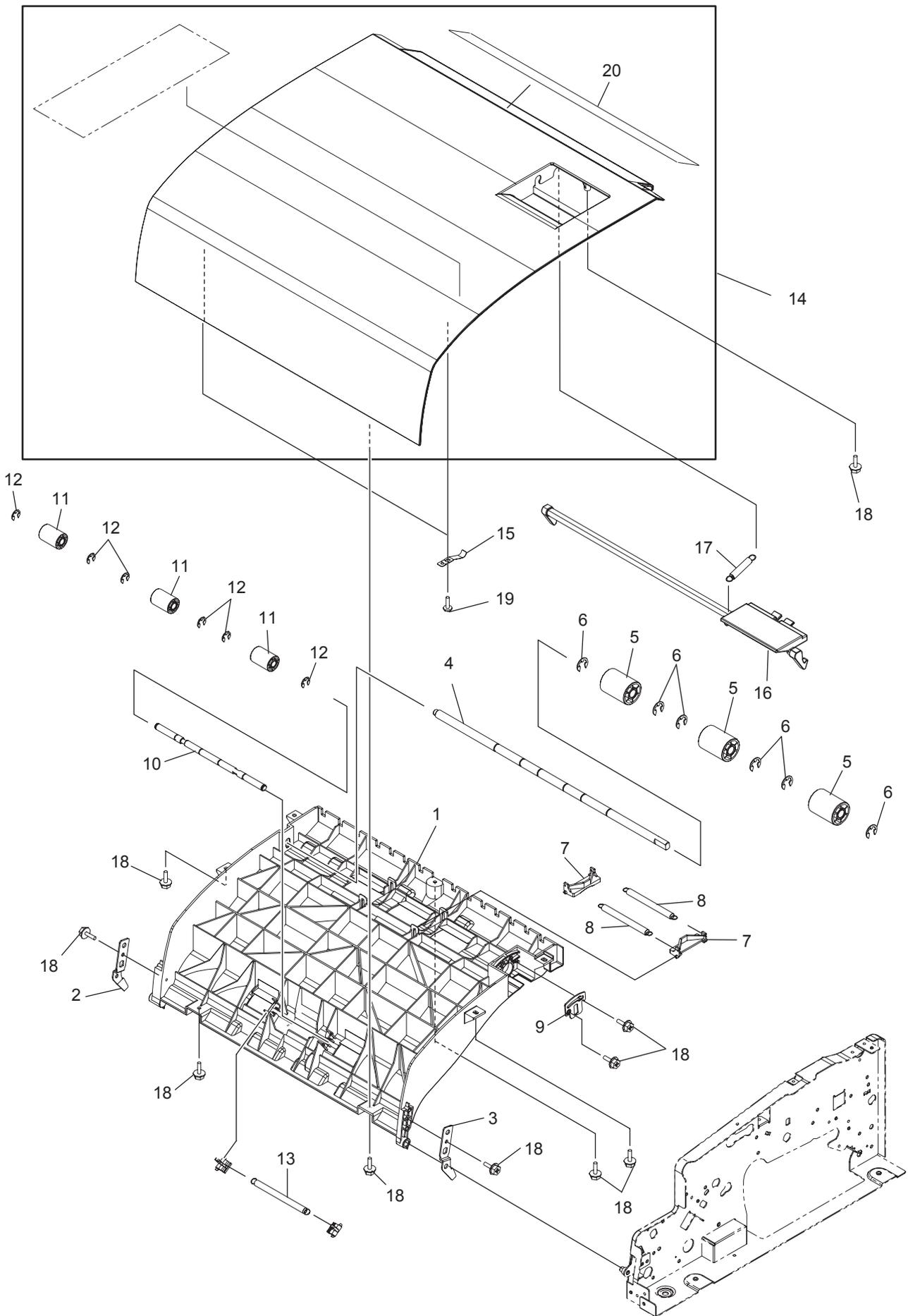



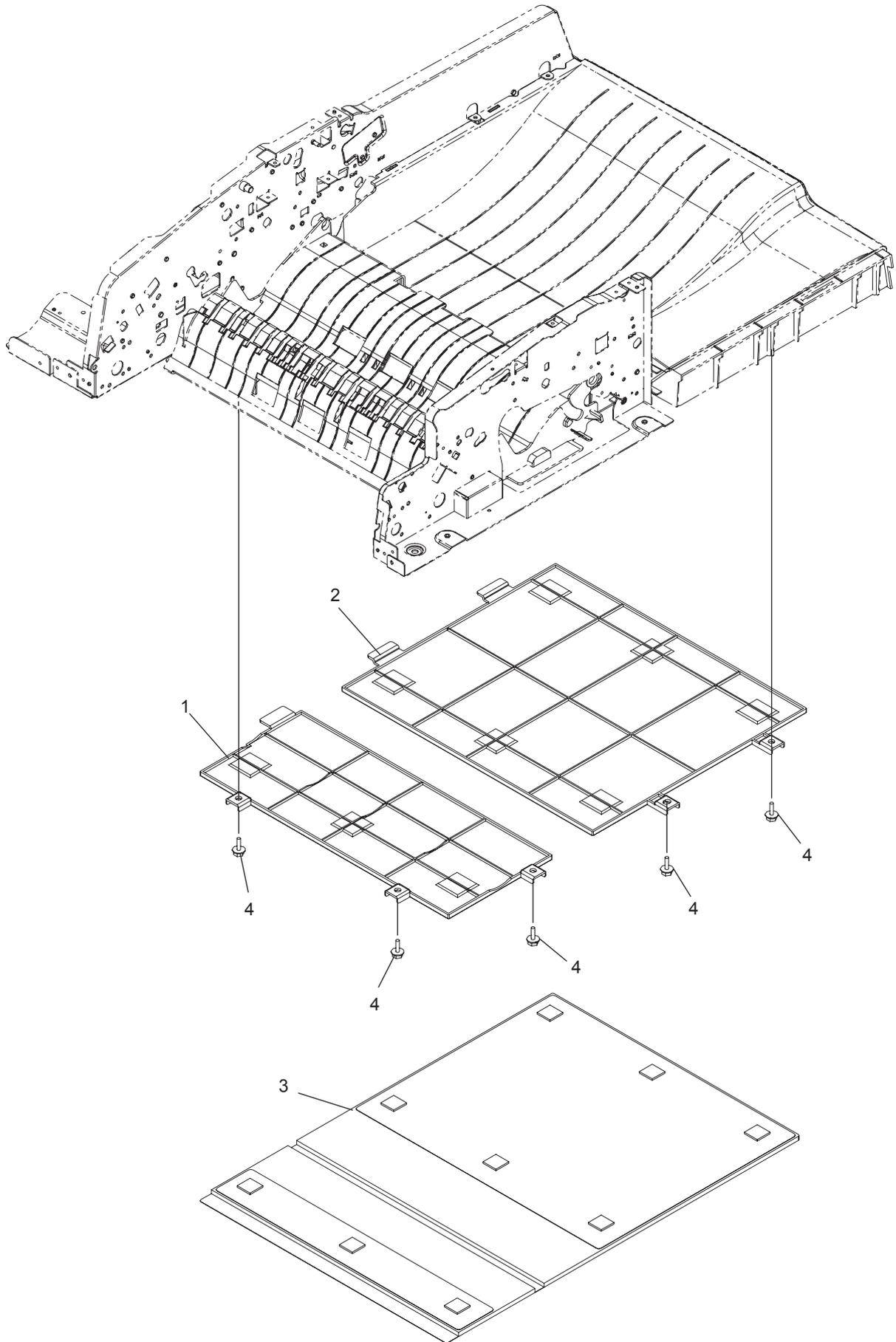





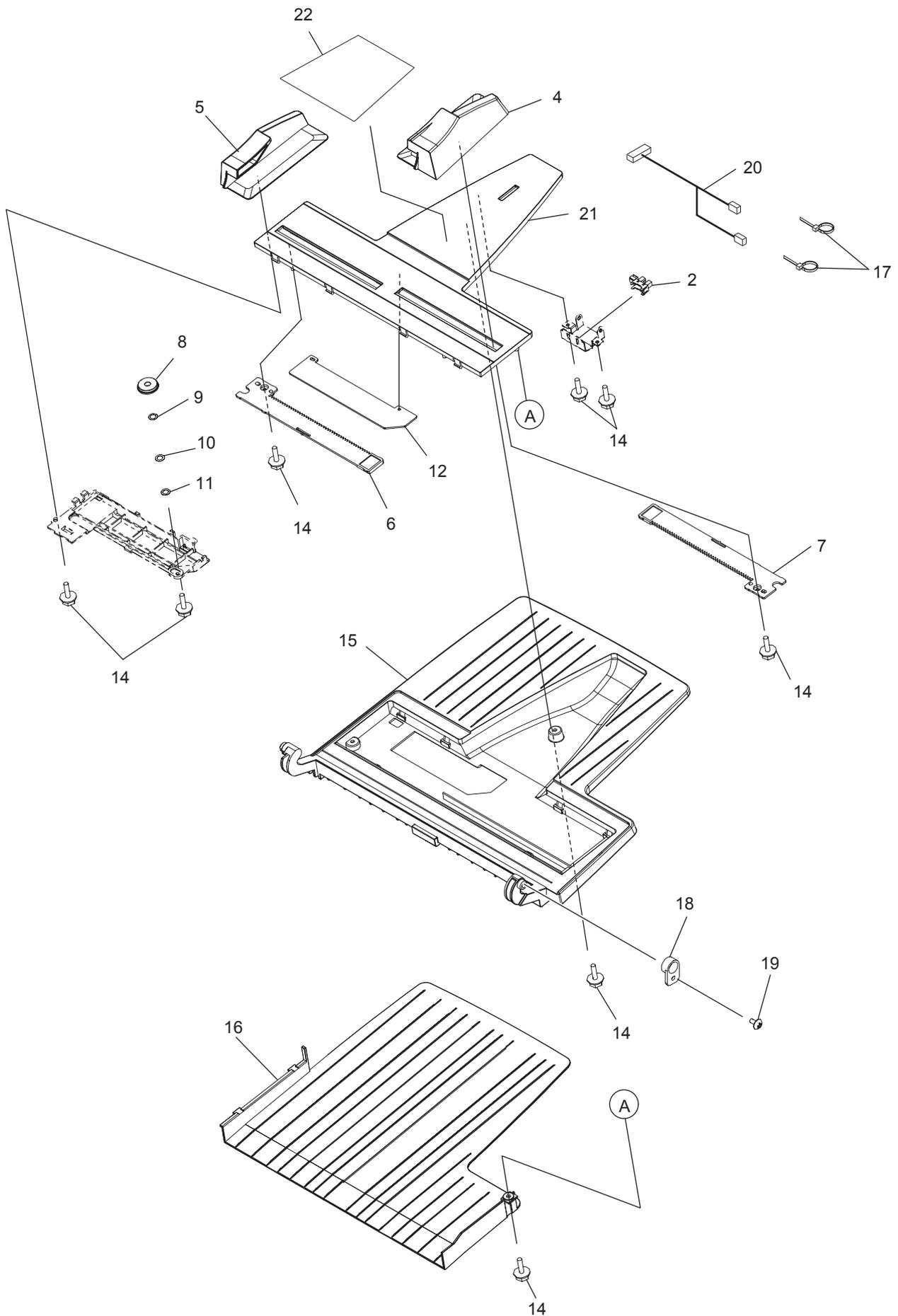



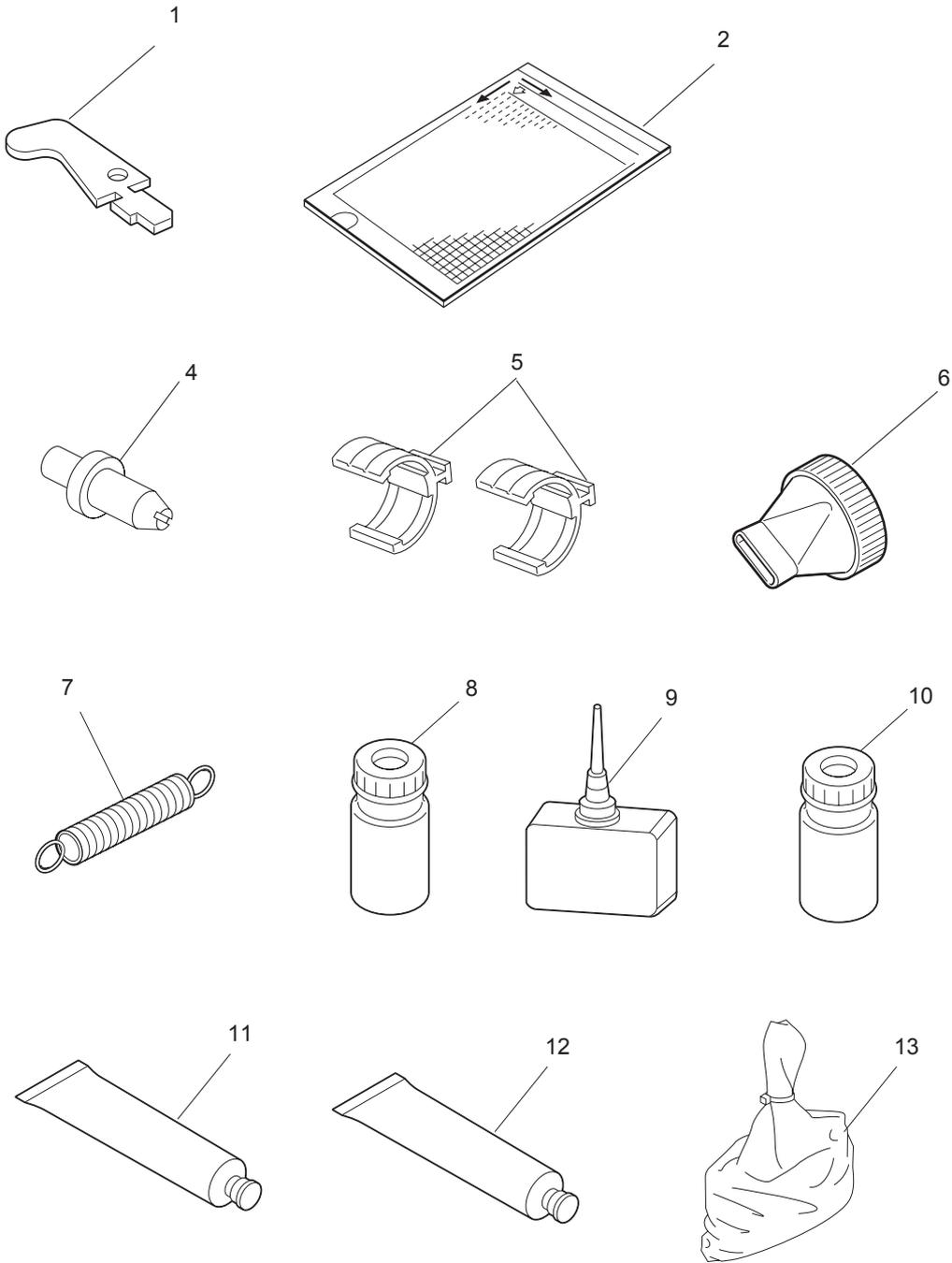



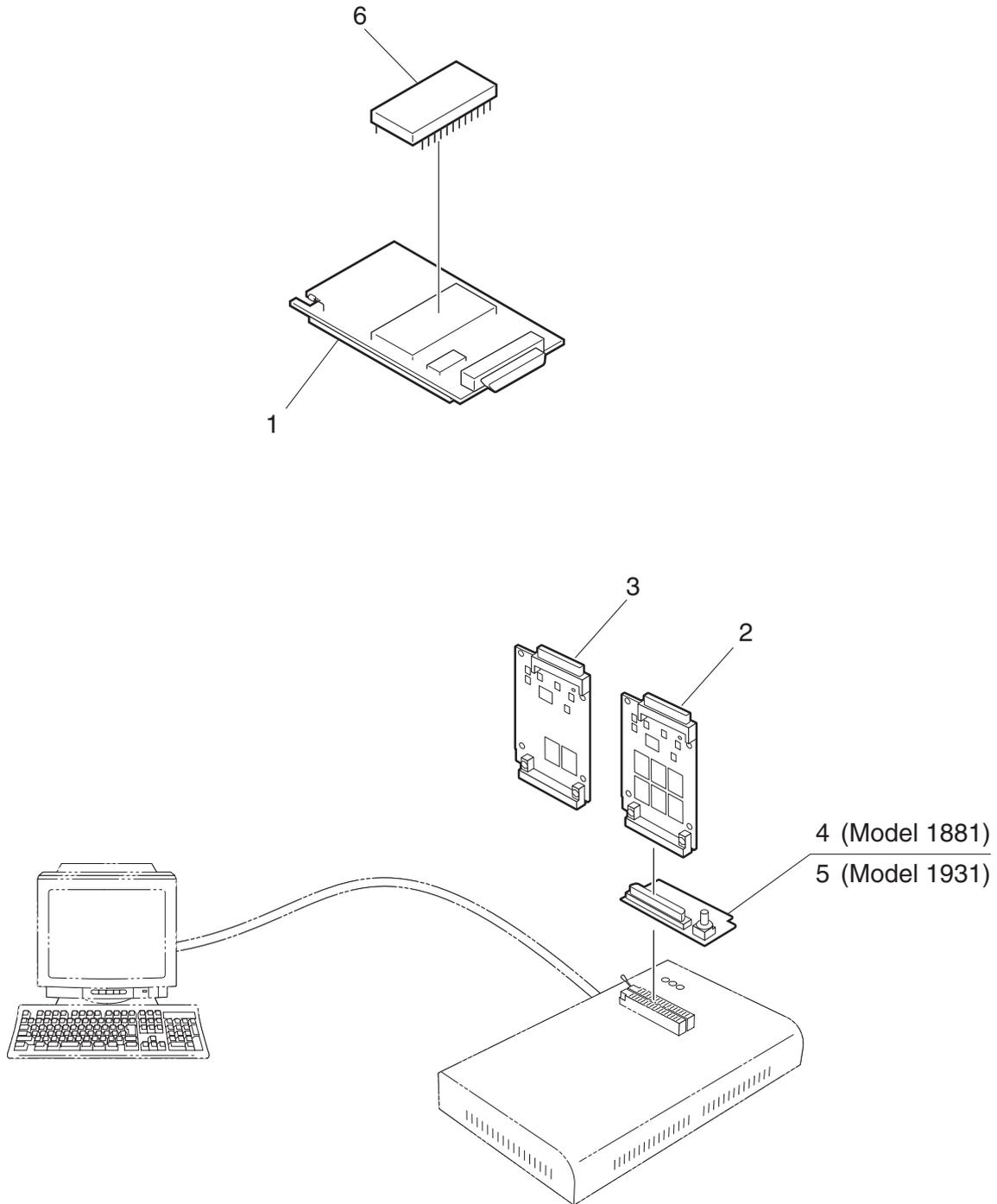



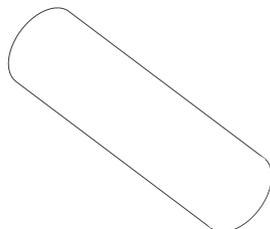
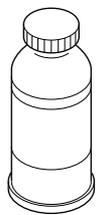





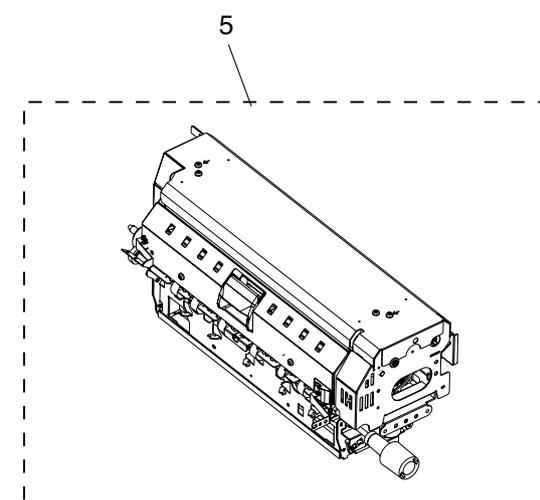
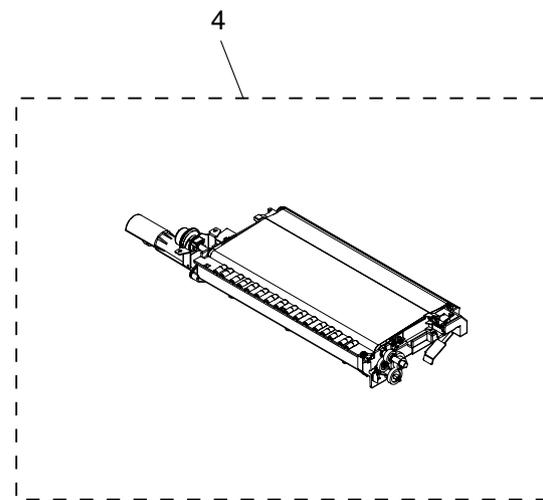
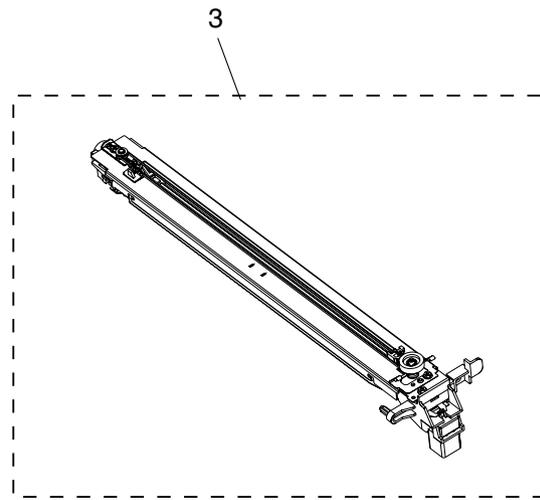
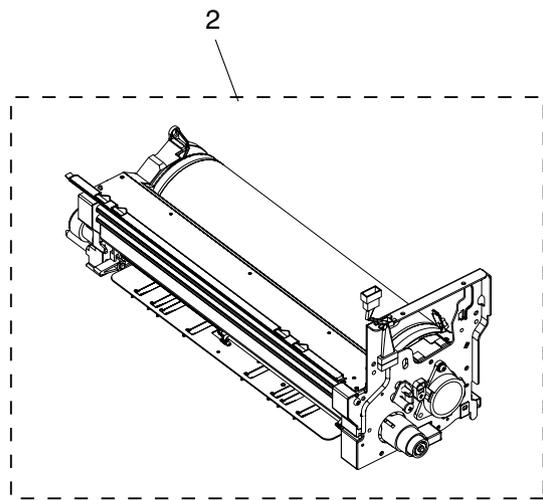
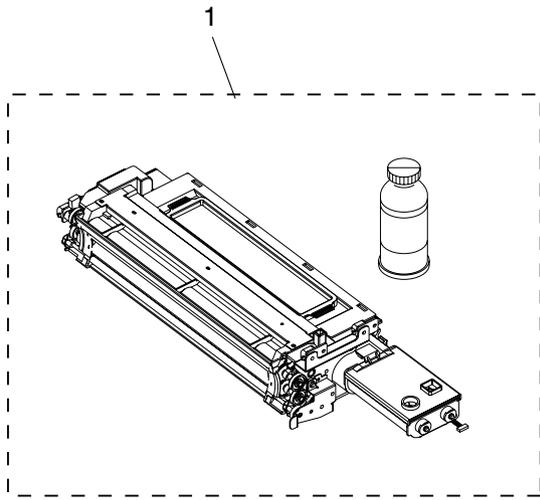



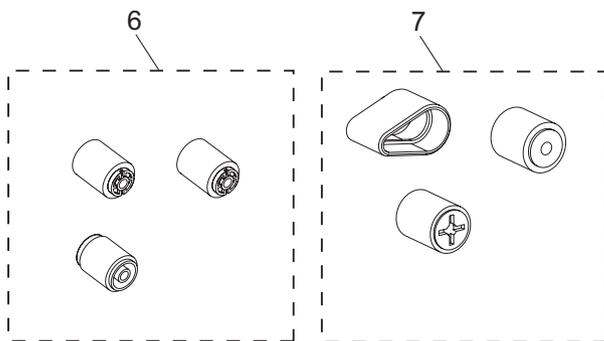
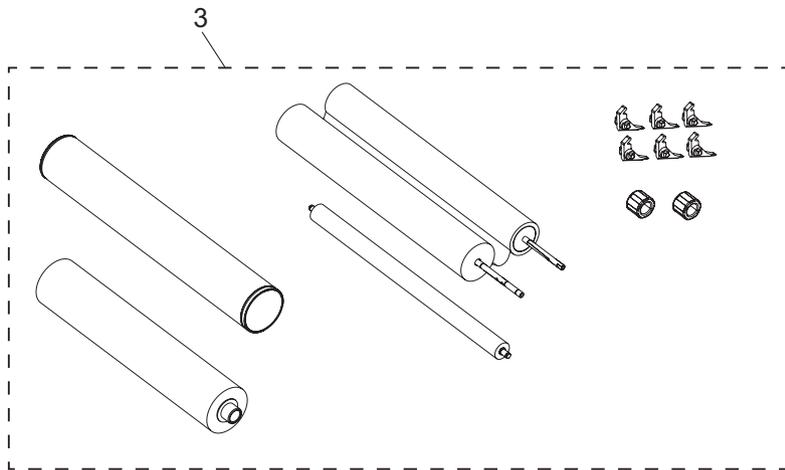
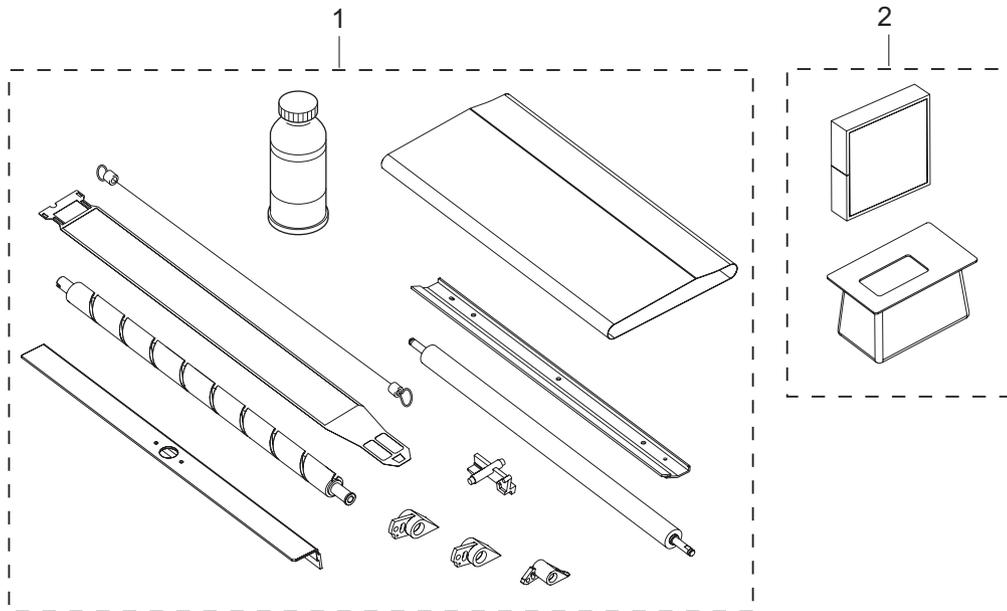





**TOSHIBA**

**TOSHIBA TEC CORPORATION**

2-17-2, HIGASHIGOTANDA, SHINAGAWA-KU, TOKYO, 141-8664, JAPAN