

SP C340DN / SP C342DN
Machine Codes: M0AG / M0AH
Field Service Manual

Important Safety Notices

Warnings, Cautions, Notes

In this manual, the following important symbols and notations are used.

WARNING

- A Warning indicates a potentially hazardous situation. Failure to obey a Warning could result in death or serious injury.

CAUTION

- A Caution indicates a potentially hazardous situation. Failure to obey a Caution could result in minor or moderate injury or damage to the machine or other property.

Important

- Obey these guidelines to avoid problems such as misfeeds, damage to originals, loss of valuable data and to prevent damage to the machine.

Note

- This information provides tips and advice about how to best service the machine.

General Safety Instructions

For your safety, please read this manual carefully before you use this product. Keep this manual handy for future reference.

Safety Information

Always obey the following safety precautions when using this product.

Safety During Operation

In this manual, the following important symbols and notations are used.



[A]: ON

[B]: OFF

[C]: Push ON/ Push OFF

[D]: Standby

Switches and Symbols

Where symbols are used on or near switches on machines for Europe and other areas, the meaning of each symbol conforms with IEC60417.

Safety

Prevention of Physical Injury

1. Before disassembling or assembling parts of the machine and peripherals, make sure that the machine and peripheral power cords are unplugged.
2. The plug should be near the machine and easily accessible.
3. Note that some components of the machine and the paper tray unit are supplied with electrical voltage even if the main power switch is turned off.
4. Always unplug the power cord from the power source before you move the product. Before you move the machine, arrange the power cord so it will not fall under the machine.
5. Disconnect all peripheral units (finisher, LCT, etc.) from the mainframe before you move the machine.
6. If any adjustment or operation check has to be made with exterior covers off or open while the main switch is turned on, keep hands away from electrified or mechanically driven components.
7. The machine drives some of its components when it completes the warm-up period. Be careful to keep hands away from the mechanical and electrical components as the machine starts operation.
8. The inside and the metal parts of the fusing unit become extremely hot while the machine is operating. Be careful to avoid touching those components with your bare hands.
9. To prevent a fire or explosion, keep the machine away from flammable liquids, gases, and aerosols.
10. Do not use flammable sprays or solvent in the vicinity of the machine. Also, avoid placing these items in the vicinity of the machine. Doing so could result in fire or electric shock.
11. To avoid fire or explosion, never use an organic cleaner near any part that generates heat.
12. Clean the floor completely after accidental spillage of silicone oil or other materials to prevent slippery surfaces that could cause accidents leading to hand or leg injuries.
13. Never remove any safety device unless it requires replacement. Always replace safety devices immediately.
14. Never do any procedure that defeats the function of any safety device.
15. Modification or removal of a safety device (fuse, switch, etc.) could lead to a fire and personal injury. Always test the operation of the machine to ensure that it is operating normally and safely after removal and replacement of any safety device.

-
16. For replacements use only the correct fuses or circuit breakers rated for use with the machine. Using replacement devices not designed for use with the machine could lead to a fire and personal injuries.
 17. For machines installed with the ADF/ARDF:
When a thick book or three-dimensional original is placed on the exposure glass and the ARDF cover is lowered, the back side of the ARDF rises up to accommodate the original. Therefore, when closing the ARDF, please be sure to keep your hands away from the hinges at the back of the ARDF.
 18. When using a vacuum cleaner around the machine, keep others away from the cleaner, especially small children.
 19. For machines installed with the anti-tip components:
The anti-tip components are necessary for meeting the requirements of IEC60950-1, the international standard for safety. The aim of these components is to prevent the products, which are heavy in weight, from toppling as a result of people running into or leaning onto the products, which can lead to serious accidents such as persons becoming trapped under the product. (U.S.: UL60950-1, Europe: EN60950-1) Therefore, removal of such components must always be with the consent of the customer. Do not remove them at your own judgment.

Health Safety Conditions

1. For the machines installed with the ozone filters:
 - Never operate the machine without the ozone filters installed.
 - Always replace the ozone filters with the specified types at the proper intervals.
2. The machine, which use high voltage power source, can generate ozone gas. High ozone density is harmful to human health. Therefore, locate the machine in a large well ventilated room that has an air turnover rate of more than 50m³/hr/person.
3. Toner and developer are non-toxic, but if you get either of them in your eyes by accident, it may cause temporary eye discomfort. Try to remove with eye drops or flush with water as first aid. If unsuccessful, get medical attention.

Observance of Electrical Safety Standards

1. The machine and its peripherals must be installed and maintained by a customer service representative who has completed the training course on those models with exceptions on some machines where the installation can be handled by the user.

Safety and Ecological Notes for Disposal

1. Do not incinerate toner bottles or used toner. Toner dust may ignite suddenly when exposed to an open flame.

-
2. Dispose of used toner, developer, organic photoconductors, and AIO unit in accordance with local regulations. (These are non-toxic supplies.)
 3. Dispose of replaced parts in accordance with local regulations.
 4. When keeping used lithium batteries in order to dispose of them later, do not put more than 100 batteries per sealed box. Storing larger numbers or not sealing them apart may lead to chemical reactions and heat build-up.
 5. The danger of explosion exists if a battery of this type is incorrectly replaced. Replace only with the same or an equivalent type recommended by the manufacturer. Discard used batteries in accordance with the manufacturer's instructions.

Handling Toner

- Work carefully when removing paper jams or replacing toner bottles or cartridges to avoid spilling toner on clothing or the hands.
- If toner is inhaled, immediately gargle with large amounts of cold water and move to a well-ventilated location. If there are signs of irritation or other problems, seek medical attention.
- If toner gets on the skin, wash immediately with soap and cold running water.
- If toner gets into the eyes, flush the eyes with cold running water or eye wash. If there are signs of irritation or other problems, seek medical attention.
- If toner is swallowed, drink a large amount of cold water to dilute the ingested toner. If there are signs of any problem, seek medical attention.
- If toner spills on clothing, wash the affected area immediately with soap and cold water. Never use hot water! Hot water can cause toner to set and permanently stain fabric.
- Always store toner and developer supplies such as toner and developer packages, cartridges, bottles (including used toner and empty bottles and cartridges), and AIO unit out of the reach of children.
- Always store fresh toner supplies or empty bottles or cartridges in a cool, dry location that is not exposed to direct sunlight.
- Do not use a vacuum cleaner to remove spilled toner (including used toner). Vacuumed toner may cause a fire or explosion due to sparks or electrical contact inside the cleaner. However, it is possible to use a cleaner designed to be dust explosion-proof. If toner is spilled over the floor, sweep up spilled toner slowly and clean up any remaining toner with a wet cloth.

Handling the development unit cooling system

For the machines installed the development cooling system:

1. The development unit cooling system circulates propylene glycol from a sealed tank through hoses that pass behind cooling plates on the sides of each development unit.
2. The coolant tank is located at the bottom of the cooling box on the back of the main machine.

-
3. Always obey local laws and regulations if you need to dispose of a tank or the propylene glycol coolant.
 4. The tank must never be emptied directly into a local drainage system, river, pond, or lake.
 5. Contact a professional industrial waste disposal organization and ask them to dispose of the tank.

Laser Safety

The Center for Devices and Radiological Health (CDRH) prohibits the repair of laser-based optical units in the field. The optical housing unit can only be repaired in a factory or at a location with the requisite equipment. The laser subsystem is replaceable in the field by a qualified Customer Engineer. The laser chassis is not repairable in the field. Customer engineers are therefore directed to return all chassis and laser subsystems to the factory or service depot when replacement of the optical subsystem is required.

WARNING

- Use of controls, or adjustment, or performance of procedures other than those specified in this manual may result in hazardous radiation exposure.

WARNING FOR LASER UNIT

WARNING:

Turn off the main switch before attempting any of the procedures in the Laser Unit section. Laser beams can seriously damage your eyes.

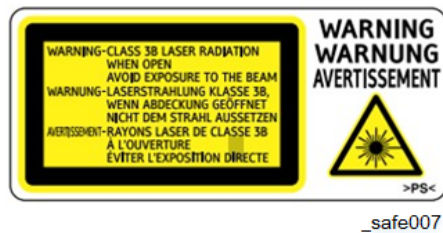
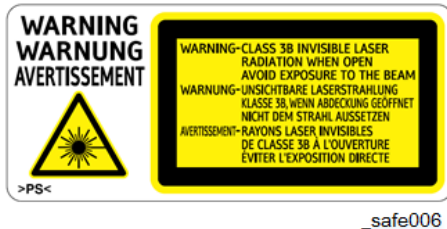

Safety Instructions for the Color Controller

Fuse

The color controller uses a double pole fuse. If this fuse blows, be sure to replace it with an identical fuse.

Batteries

1. Always replace a battery with the same type of battery prescribed for use with the color controller unit. Replacing a battery with any type other than the one prescribed for use could cause an explosion.
2. Never discard used batteries by mixing them with other batteries or other refuse.

-
3. Always remove used batteries from the work site and dispose of them in accordance with local laws and regulations regarding the disposal of such items.

Symbols, Abbreviations and Trademarks

This manual uses several symbols and abbreviations. The meaning of those symbols and abbreviations are as follows:

	Clip ring
	Screw
	Connector
	Clamp
	E-ring
SEF	Short Edge Feed
LEF	Long Edge Feed

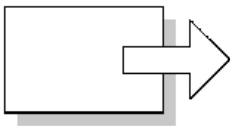

Short Edge Feed (SEF)

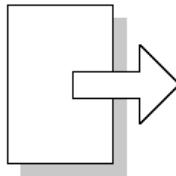

Long Edge Feed (LEF)

Trademarks

Microsoft[®], Windows[®], and MS-DOS[®] are registered trademarks of Microsoft Corporation in the United States and /or other countries.

PostScript[®] is a registered trademark of Adobe Systems, Incorporated.

PCL[®] is a registered trademark of Hewlett-Packard Company.

Ethernet[®] is a registered trademark of Xerox Corporation.

PowerPC[®] is a registered trademark of International Business Machines Corporation.

Other product names used herein are for identification purposes only and may be trademarks of their respective companies. We disclaim any and all rights involved with those marks.

TABLE OF CONTENTS

Symbols, Abbreviations and Trademarks.....	1
Trademarks.....	1
1. Product Information	
<hr/>	
Specifications.....	11
Machine Configuration.....	12
Mainframe (M0AG/M0AH) and Option.....	12
Controller Options.....	12
Guidance for Those Who Are Familiar with Predecessor Products.....	14
2. Installation	
<hr/>	
Installation Requirements.....	15
Environment.....	15
Machine level.....	16
Machine Space Requirement.....	16
Power Requirements.....	16
Installation Procedure.....	17
USB Device Server Option Type M19 (D3BC-28, -29).....	18
Component Check.....	18
Interface Board Surface.....	19
Installation Procedure.....	19
What Do the LED Indications Mean?.....	23
IP Address Setting.....	23
3. Preventive Maintenance	
<hr/>	
Preventive Maintenance.....	27
4. Replacement and Adjustment	
<hr/>	
Notes on the Main Power Switch.....	29
Push Switch.....	29
Characteristics of the Push Switch (DC Switch).....	29
Shutdown Method (How to Turn OFF the Main Power).....	30
Forced Shutdown	31
Before You Start.....	32
Special Tool.....	33
Exterior Covers.....	34
Rear Cover.....	34

Operation Panel.....	35
Right Cover.....	36
Left Cover.....	36
Front Cover Unit.....	37
Laser Optics.....	39
Caution Decal Location.....	39
LD Safety Switch.....	40
Laser Optics Housing Unit.....	40
After replacing the laser optics housing unit.....	43
AIO Cartridge.....	44
AIO Cartridge (All In One Cartridge)	44
Black AIO Motor.....	44
Color AIO Motor.....	47
Image Transfer.....	49
Image Transfer Belt Unit.....	49
After installing a new image transfer belt unit.....	50
Agitator Motor.....	50
ITB (Image Transfer Belt) Contact Motor.....	51
ITB (Image Transfer Belt) Contact Sensor.....	52
TM (Toner Mark) Sensor Base.....	53
Waste Toner Bottle Set Sensor.....	54
Waste Toner Overflow Sensor.....	55
Air Intake Fan.....	56
Paper Transfer.....	58
Transfer Unit.....	58
After installing a new transfer unit or transfer roller.....	58
Transfer Roller.....	58
After installing a new transfer roller.....	60
Registration Roller.....	60
Reinstalling the registration roller unit.....	61
Registration Sensor.....	61
Registration Clutch.....	62
By-pass and Duplex Clutch.....	63

Duplex Sensor.....	64
Image Fusing.....	66
Fusing Unit.....	66
After installing a new fusing unit.....	66
Fusing Lamp.....	66
Thermostat.....	69
Thermistors.....	70
When installing the thermistors: center and end.....	71
Transport/Fusing Motor.....	72
Paper Feed and Exit.....	74
Paper Feed Clutch.....	74
Paper Feed Roller.....	74
Separation Pad.....	75
By-pass Separation Pad.....	76
By-pass Pick-up and Feed Rollers.....	77
By-pass Pick-up Roller.....	77
By-pass Feed Roller.....	78
When installing the by-pass pick-up and feed rollers.....	80
Paper End Sensor.....	80
By-pass Paper End Sensor.....	81
Paper Exit Sensor.....	82
Electrical Components.....	83
Operation Panel Board Unit (SP C340DN).....	83
Eco Night Sensor (SP C340DN).....	83
Operation Panel Board Unit (SP C342DN).....	84
Eco Night Sensor (SP C342DN).....	87
Media Slot Board (SP C342DN).....	87
Controller Board.....	89
When installing the new Controller Board.....	92
EGB (Engine Board).....	92
When installing the new EGB.....	93
Fuses on the EGB.....	94
Interlock Switches.....	95

Fusing Fan Motor.....	96
LSU Fan Motor.....	97
ID Chip Board.....	98
PSU.....	99
Fuse.....	102
High Voltage Power Supply Board.....	102
Temperature/Humidity Sensor.....	103
Tray Set Sensor.....	103
NVRAM/EEPROM.....	104
NVRAM on the Controller.....	104
EEPROM on the EGB (Engine Board).....	105

5. Service Maintenance Reference

Service Program.....	107
Configuration Page Information.....	108
Overview.....	108
To Print the Configuration Page from the Machine.....	108
Firmware Update.....	109
Types of Firmware.....	109
Before You Begin.....	110
Updating Firmware.....	111
File Arrangement.....	111
Update Procedure.....	112
Error Handling.....	114
Power Failure.....	114
NVRAM Data Upload/Download.....	114
Uploading NVRAM Data.....	114
Downloading NVRAM Data.....	115
Handling Firmware Update Errors.....	116
Error Message Table.....	116
SD Card Appli Move.....	118
Overview.....	118
Move Exec.....	118
Undo Exec.....	119

Card Save Function.....	121
Overview.....	121
Card Save:.....	121
Procedure.....	121
Error Messages.....	122

6. Troubleshooting

Error Messages.....	125
Overview.....	125
Error Messages List.....	125
SC Conditions.....	128
Summary.....	128
Engine SC.....	129
SC 2xx (Laser Optics Error).....	129
SC 3xx (Charge Error).....	130
SC 4xx (Image Transfer and Transfer Error).....	131
SC 5xx (Motor and Fusing Error).....	132
SC 6xx (Communication and Other Error).....	137
Controller SC.....	137
SC641-00 , -01, -02, -03, -04.....	137
SC670-01, -02.....	138
SC816-00 to -96, -99.....	139
SC817-00.....	140
SC819-00 [0x5032].....	141
SC819-00 [0x6261], [0x696e], [0x766d], Others.....	142
SC840-00.....	143
SC841-00.....	143
SC842-00 to -02.....	144
SC845-01 to -05.....	144
SC853-00.....	145
SC854-00.....	145
SC855-01.....	146
SC855-02.....	146
SC858-00, -01, -02, -30, -31.....	147

SC859-00, -01, 02, -10.....	148
SC860-00.....	149
SC862-00.....	150
SC863-00.....	150
SC863-01, -02 to -23.....	151
SC864-01, -02 to -23.....	151
SC865-00, -01, -02 to -23, -50 to -73.....	152
SC866-00.....	153
SC867-00 to -02.....	153
SC868-00, -02.....	154
SC872-00.....	155
SC873-00.....	155
SC874-xx.....	156
SC875-01, -02.....	157
SC878-00, -01, -02, -03, -20.....	157
SC899-00.....	158
SC900-00.....	159
SC990-00.....	159
SC991-00.....	160
SC992-00.....	160
SC997-00.....	160
Image Problems.....	162
Overview.....	162
Checking a Sample Printout.....	162
Printer Driver Setting for Printing a Sample.....	163

7. Detailed Description

Product Overview.....	165
Component Layout.....	165
Engine.....	165
Paper Path.....	166
Drive Layout.....	167
Parts Layout.....	168
Engine	168

Process Control.....	171
Overview.....	171
Process Control Flow.....	171
Process Control Self-check.....	172
Laser Exposure.....	175
Overview.....	175
Optical Path.....	176
LD Safety Switch.....	176
MUSIC (Mirror Unit Skew and Interval Correction).....	177
AIO (All In One) Cartridge.....	178
Overview.....	178
Drive.....	179
OPC Charge and Cleaning.....	180
Waste Toner Collection from the OPC.....	180
Toner Mixing and Transport	181
Development Mechanism.....	182
Toner Near End and End Detection.....	182
B&W Print Priority.....	182
Paper Feed.....	183
Overview.....	183
Drive and Paper End Detection.....	184
Paper Feed.....	184
Paper End Detection.....	184
Tray Lift.....	185
By-pass Feed.....	186
By-pass Paper Feed.....	186
By-pass Bottom Plate Lift.....	187
Duplex.....	189
Drive.....	189
Image Transfer	192
Overview.....	192
Drive and Transfer Belt Roller Bias.....	193
Transfer Belt Contact.....	193

ITB (Image Transfer Belt) Cleaning Unit.....	194
Transfer Roller Overview.....	194
Paper Transfer and Discharge.....	195
Transfer Roller.....	195
Paper Transfer Bias.....	195
Discharge Plate.....	195
Waste Toner Collection.....	196
Fusing and Exit.....	197
Overview.....	197
Drive.....	198
Pressure Release Mechanism.....	198
Temperature Control.....	199
Fusing unit related SC codes.....	202
Anti-Humidity Mode.....	202
Energy Saver.....	202
Eco Night Mode.....	203
ECO Night Sensor.....	203
Timer to Turn Off.....	204
Timer to Turn On.....	204
Brightness Sensor Level.....	205
Weekly Timer.....	206
Related SPs.....	206



1. Product Information

Specifications

See "Appendices" for the followings;

- General Specifications
- Supported Paper Sizes

Machine Configuration

1

Mainframe (M0AG/M0AH) and Option

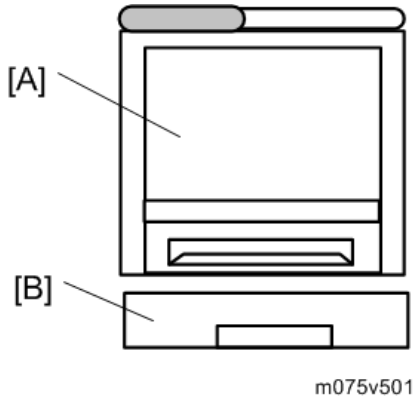

Model	Model No.	Call out	Description
SP C340DN / SP C342DN	M0AG/ M0AH	[A]	Auto-duplex model
Paper Feed Unit TK1220	G849	[B]	New

Controller Options

Item	Model No.	Description
Camera Direct Print Card Type P10 *	M500-32	New
IEEE 1284 Interface Board Type M19	D3C0-17	SP 5300DN
IEEE802.11a/g Interface Unit Type M24	M500-08	SP 5300DN
Hard Disk Drive Option Type P10 *	M500-33	New
VM Card (Type P8) *	M500-09, 10, 11	SP 5300DN (HDD is required.)
XPS Direct Print Option Type P10 *	M500-31	New
USB Device Server Option Type M19 *	D3BC-28, 29	SP 5300DN

* For SP C342DN

Guidance for Those Who Are Familiar with Predecessor Products

1

Model→	SP C320DN	SP C340DN	SP C342DN
Module ↓			
Controller	09A GW	GW+15S	GW+15S
Operation panel	Four-line LCD	Four-line LCD	4.3" operation panel
Exterior color of printer	"Urban light gray"	"Intelligent gray"	"Intelligent gray"
Optional Paper Feed unit and its exterior color	TK1010 "Urban light gray"	TK1220 "Intelligent gray"	TK1220 "Intelligent gray"
AIO	Common (*Note)	New / common(*Note)	Common (*note)

Note: AIO Interchangeability

Model→	SP C320DN (SP C242DN, SP C242SF)	SP C340DN	SP C342DN
AIO ↓			
7.2K/6.6K AIO	Yes	No	Yes Common with SP C320DN/SP C242DN/SP 242SF
2.8K/2.8K AIO	Yes	Yes Common with SP C320DN/SP C242DN/SP 242SF	Yes Common with SP C320DN/SP C242DN/SP 242SF
5.0K/5.0K AIO (New)	No	Yes	No

Yes: This type of AIO can be used.

No: This type of AIO cannot be used.

2. Installation

Installation Requirements

Environment

2

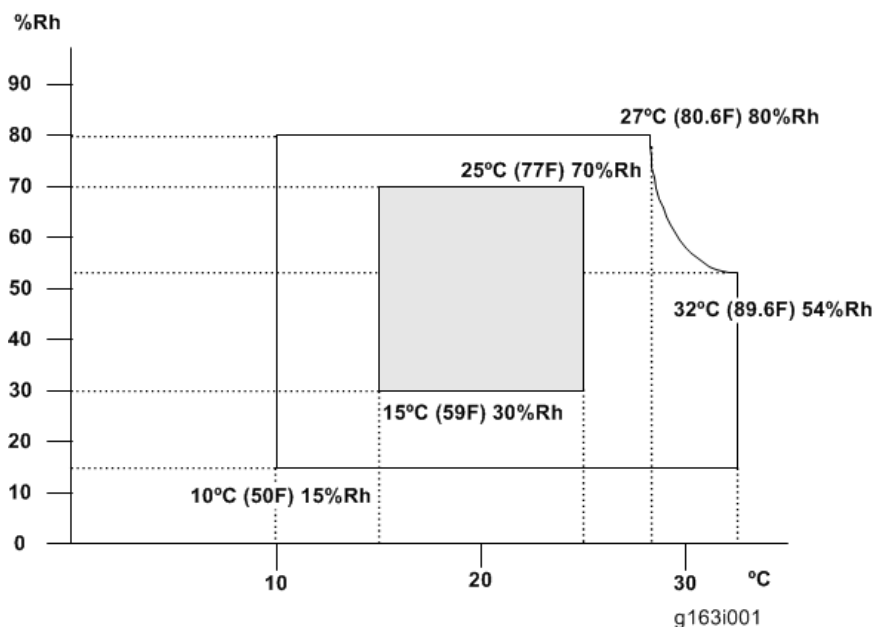

1. Temperature Range: 10°C to 32°C (50°F to 89.6°F)
2. Humidity Range: 15% to 80% RH
3. Ambient Illumination: Less than 2,000 lux (do not expose to direct sunlight)
4. Ventilation: 3 times/hr/person
5. Do not put the machine in areas that get sudden temperature changes. This includes:
 - Areas directly exposed to cool air from an air conditioner
 - Areas directly exposed to heat from a heater.
6. Do not put the machine in areas that get exposed to corrosive gas.
7. Do not install the machine at locations over the following heights above sea level.
All areas except for North America: 2,000 m (6,560 ft.)
North America: 2,500 m (8,125 ft.)
8. Put the machine on a strong, level base. (Inclination on any side must be no more than 5 mm.)
9. Do not put the machine in areas with strong vibrations.

Machine level

Front to back: Within 5 mm (0.2") of level

Right to left: Within 5 mm (0.2") of level

Machine Space Requirement

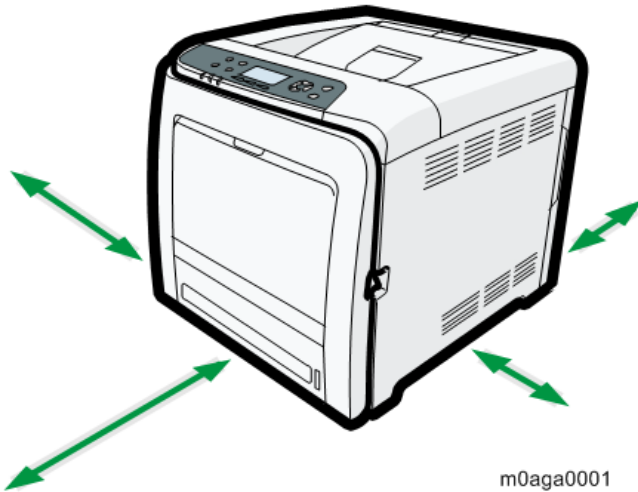

Put the machine near the power source with these clearances:

- Left side: Over 20 cm (7.9 inches)
- Rear: Over 10 cm (4 inches)
- Right side: Over 10 cm (4 inches)
- Front: Over 70 cm (27.5 inches)

Power Requirements

CAUTION

- Make sure that the plug is tightly connected to the outlet.
- Avoid multi-wiring.
- Make sure that you ground the machine.

Input voltage level	120 V, 60 Hz: More than 11 A (for North America) 220 V to 240 V, 50 Hz/60 Hz: More than 6 A (for Europe/ Asia)
Permitted voltage fluctuation:	10%

Do not set anything on the power cord.

Installation Procedure

Refer to the Quick Installation Guide for details about installing the machine.

 **Note**

- To enable the machine for the maintenance by the service technician, the meter-charge mode must be set to "1 (On)" with SP5930-001.

USB Device Server Option Type M19 (D3BC-28, -29)

NA only: This option is installed by a CE.

Other areas: This option is installed by the end user.

2

Component Check

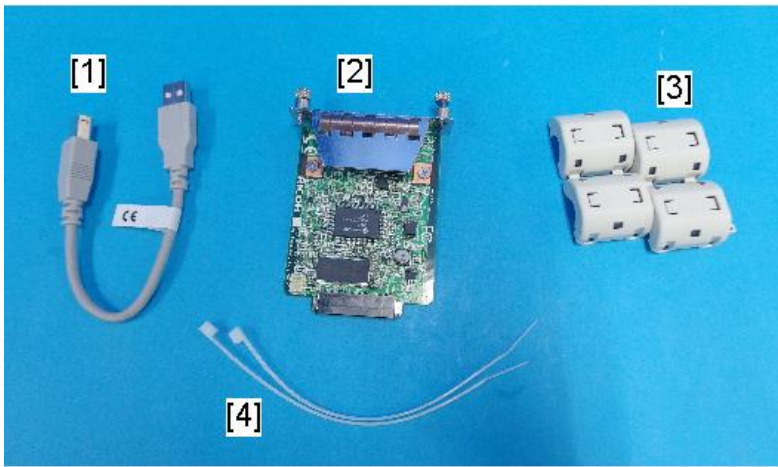

d238m0666

No	Items	Q'ty
1	USB cable	1
2	Interface board	1
3	Ferrite core	2
4	Cable ties	2

Note

- An Ethernet cable, which is not packed with this option, is required.

Interface Board Surface

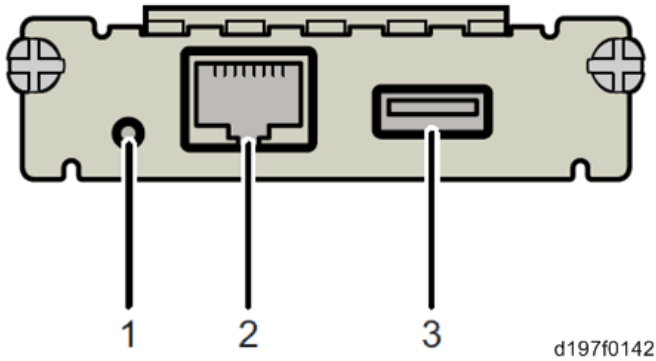

No.	Item	Description
1	Switch	Used to reset to the factory settings.
2	Ethernet port	Used to connect the Ethernet cable.
3	USB port	Used to connect this option to the main machine. Do not use with other options.

Installation Procedure

★ Important

- When you install this option to the main machine for the first time, the interface board must be connected directly to your PC to set up the IP address and other network settings.

1. Turn off the main power switch, and unplug the power cord from the wall socket.

2. Remove the cable cover.

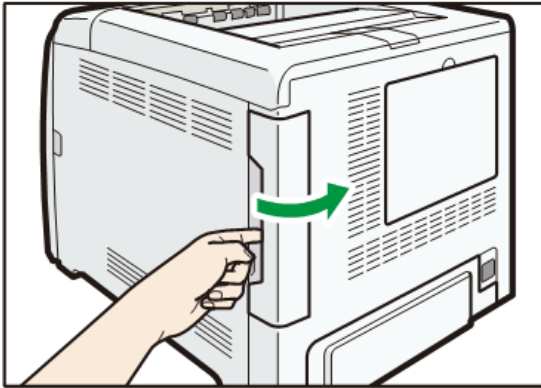

m0aga0074

3. Loosen the two screws and remove the slot cover.



m0aga0075

4. Fully insert the interface board.

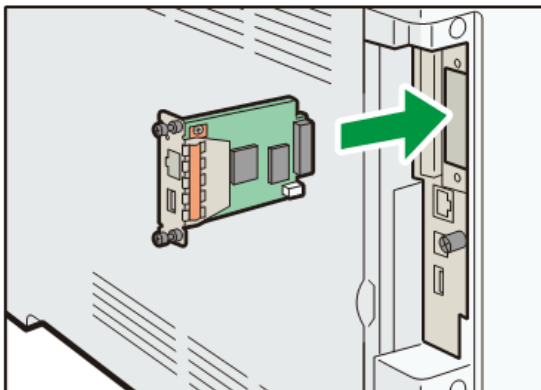

m0aga0076

5. Tighten the two screws to secure the interface board.

- Using the supplied USB cable, connect the printer and USB print server unit.

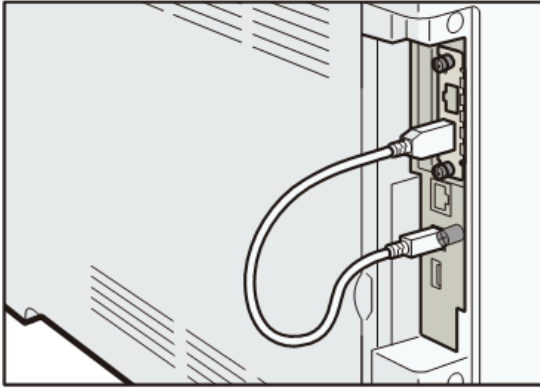

m0aga0077

- Mount the ferrite cores on the Ethernet cable, while looping the cable at 3 cm (approx. 1.2 inch) [A] from each end of the cable.

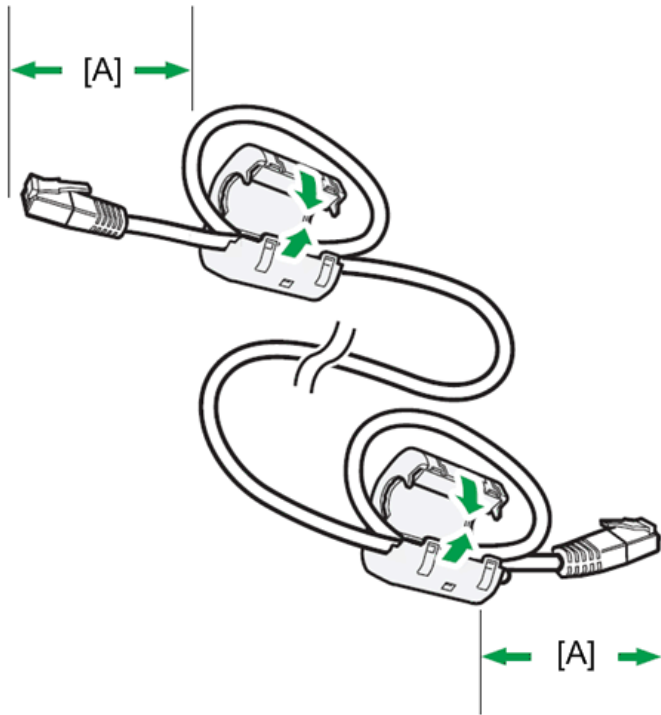

d197f0147

8. Fix each ferrite core with a cable tie [A].

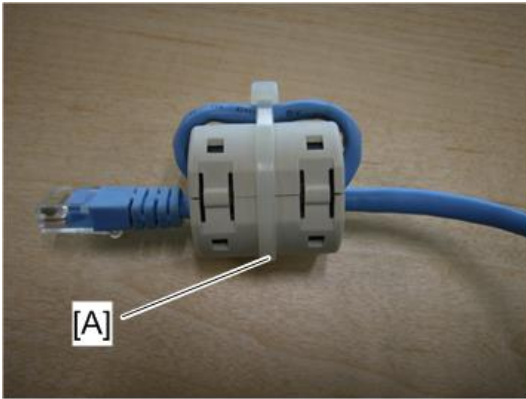

m0aga0078

9. Connect the Ethernet cable to the Ethernet socket on this option.

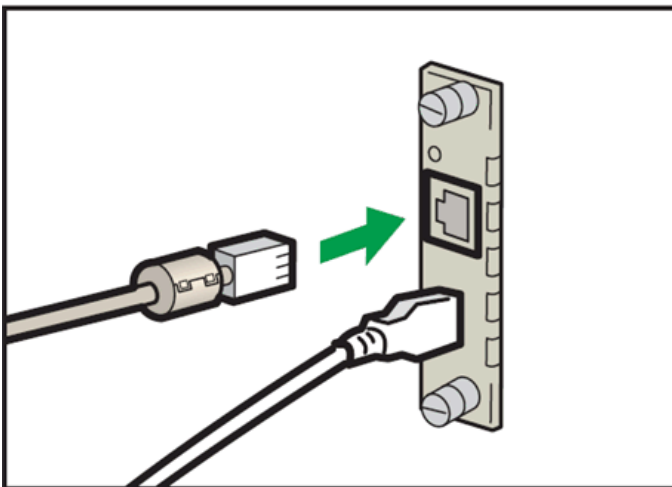

d197f0148

10. Insert the other end of the Ethernet cable to the PC that you will use to make the network settings for this option.
11. Plug the power cord into the wall socket and turn on the main power switch.

Note

- Do not unplug the USB connector while the machine is recognizing this option. It may take between 30 seconds to 1 minute to finish recognizing it (the LEDs by the connector light up when finished; see below). If unplugged, connect the cable again.

What Do the LED Indications Mean?

When this option is properly installed and recognized by the main machine, the LED indicators light up under the following conditions.

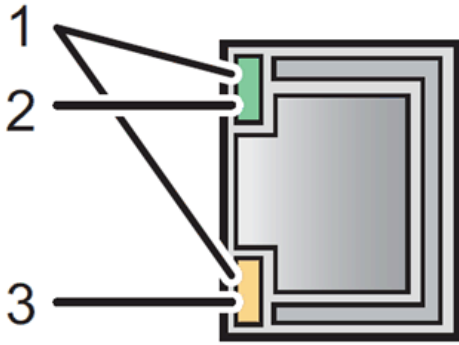

d197f0149

No.	Light Color	Lights Up When:
1	Green and Yellow	1000BASE-T operates
2	Green	10BASE-T operates
3	Yellow	100BASE-TX operates

IP Address Setting

This section describes how to set an IP address on this option manually. The IP address can be on the same network segment, or it can be on a different network segment to share a single printer with devices on multiple networks.

★ Important

- You cannot change the IP address for this option from the operation panel of the main machine. The setting must be done from a web browser on your PC.
 - The network setting of this option is initially assigned as follows:
IP address: 192.168.100.100 / Subnet mask: 255.255.255.0
 - The network setting of your PC must be in the same network segment to change the network setting of this option.
- Make a note of the current network settings of your PC.
 - Change the IP address on your PC to [192.168.100.xxx (*0 - 255)].
 - Change the subnet mask on your PC to [255.255.255.0].
 - Open a web browser.

5. Type [http://192.168.100.100/] in the address bar.
6. Press the Enter key.

Note

- The setting screen for this option appears.

7. Click [Network Setting].

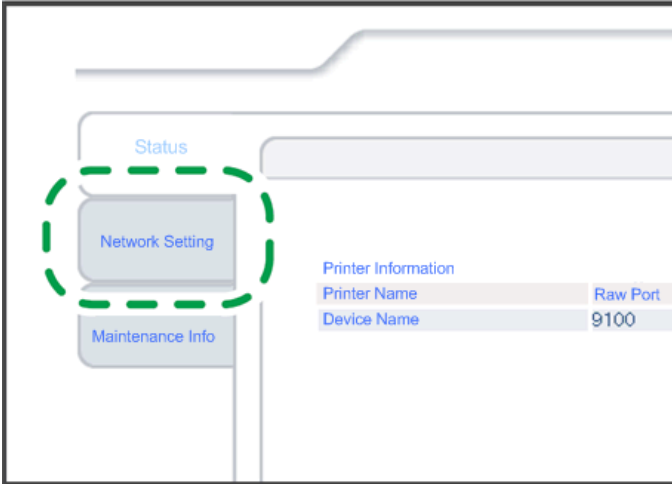

d197f0134

8. Type [root] in the user name textbox and click [OK].
9. Input [IP Address], [Subnet Mask] and [Default Gateway].



d197f0135

10. Set other items if needed.
11. Press [Set].

12. Close the web browser.
13. Disconnect the Ethernet cable from the PC.
14. Connect the Ethernet cable to a network device (e.g. switching hub).
15. Set the IP address of this option in the printer driver that will be used.

3. Preventive Maintenance

Preventive Maintenance

See "Appendices" for the "Preventive Maintenance".

4. Replacement and Adjustment

Notes on the Main Power Switch

Push Switch

The main power button of this machine has been changed to a push-button switch (push button) from the conventional rocker switch. The push switch has characteristics and specifications different from the rocker switch. Care must be taken when replacing and adjusting parts.

Characteristics of the Push Switch (DC Switch)

Power is supplied to the machine even when the main power switch is turned OFF.

The push switch in this machine uses DC (direct current). Therefore, if the AC power cord is connected to an electrical outlet, power is supplied to the controller board, the operation unit and other modules even when the main power is turned OFF. When replacing the controller board and the operation unit in this state, not only these boards, it will damage other electrical components.

Only one of the AC lines for the fusing unit is shut off when you turn OFF the main power; the other line carries current even when you turn off the main power switch.

So, when performing maintenance work such as replacing parts, in addition to turning OFF the main power with the push switch, always unplug the AC power cord.

When you disconnect the power cord from the AC wall outlet, inside the machine there is still residual charge.

When you disconnect the power cord from the AC wall outlet, inside the machine for a while there is still residual charge. Therefore, if you remove boards in this state, it can cause a blown fuse or memory failure.

- How to remove the residual charge inside the machine

After you unplug the power cord from the AC wall outlet, in order to remove the residual charge from inside the machine, be sure to press the main power switch. Thus, the charge remaining in the machine is released, and it is possible to remove boards.

When you reconnect the AC power cord into an AC wall outlet, the machine will start automatically.

In order to remove the residual charge, push the main power switch while you disconnect the AC power cord. At that time, the power ON flag inside the machine is set. Therefore, after you finish work on the machine and reconnect the power cord to the AC, even if you do not press the main power switch, the machine will start automatically and the moving parts will begin to move. **When working on moving parts, be careful that fingers or clothes do not get caught.**

Note

- Automatic restart deals with cases when you accidentally unplugged the AC power cord or unexpected power outages. By keeping the power flag ON, after the resumption of power, the machine will start up automatically.

In rare cases, when you reconnect the AC power cord to a power outlet, the machine does not start automatically. In this case, the machine has not failed. The cause is due to the timing of releasing the residual charge. If you press the main power switch while the residual charge was already released, the power ON flag will not be set. At this time, start the machine manually by pressing the main power switch.

Shutdown Method (How to Turn OFF the Main Power)

4

1. Press the main power switch [A] on the machine.

Note

- When the shutdown is complete, the LED on the operation panel is turned OFF.



m0aga0002

2. Disconnect the power cord.

Note

- Wait three minutes to access the internal parts such as the controller board.

CAUTION

- If some LEDs on any of the boards are blinking or lit, current is still flowing.
- After the shutdown process, the main power is turned OFF automatically.

Note

- **How to start from shutdown:**

To start the machine, press the main power switch. However, if you press the main power switch between the beginning and the end of a shutdown, the machine will not start.

Forced Shutdown

In case normal shutdown does not complete for some reason, the machine has a forced shutdown function.

To make a forced shutdown, press and hold the main power switch for 6 seconds.

In general, do not use the forced shutdown.

Important

- **Forced shutdown may damage the hard disk and memory, and can cause damage to the machine. Use a forced shutdown only if it is unavoidable.**

Before You Start

CAUTION

- If there are printer jobs in the machine, print out all jobs in the printer buffer.
- Turn off the main power switch and unplug the machine before you do the procedures in this section.

Important

- Always touch a grounded surface to discharge static electricity from your hands before you handle SD cards, printed circuit boards, NVRAM or memory boards.

Special Tool

- SD card

Exterior Covers

⚠ CAUTION

- Turn off the main power switch and unplug the printer before you do the procedures in this section.

Rear Cover

1. Remove the rear tray cover [A]. (hooks)
2. Remove the interface cover [B]. (hooks)
3. Remove the HDD cover [C]. (hooks)

4



m0aga0003

4. Remove the rear cover [A]. (🔧 x 8)

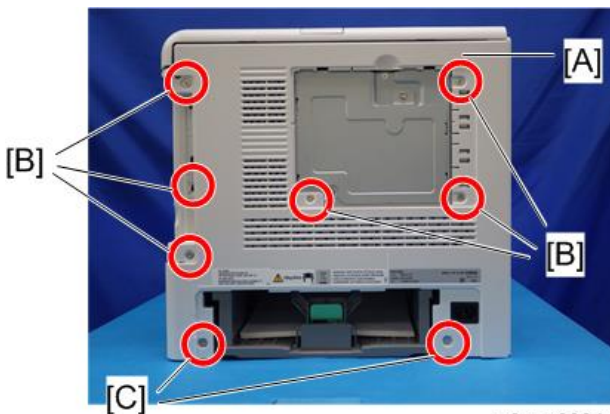

m0aga0004

⬇ Note

- Upper screws [B]: "M3x6 x 6, Lower screws [C]: "M4x10" x 2

Operation Panel

1. Open the top cover [A].

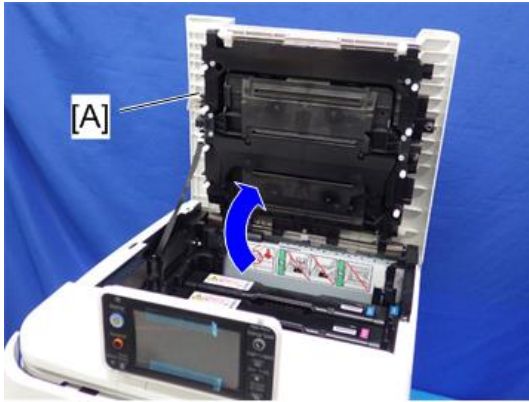

m0aga0005

2. Open the front cover [A].
3. Remove the front harness cover [B]. (⚙️ x 1)

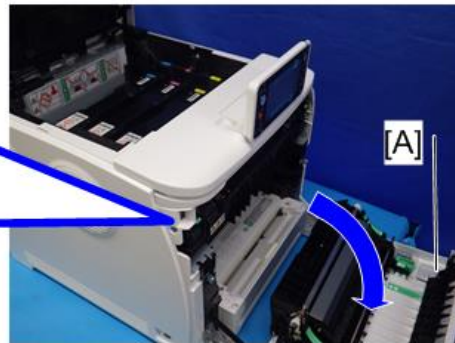
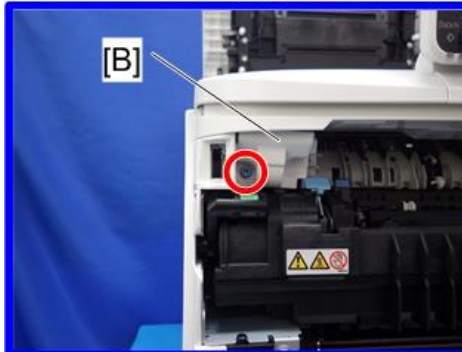

m0aga0006

4. Remove the operation panel [A]. (⚙️ x 2, 🛠️ x 1)

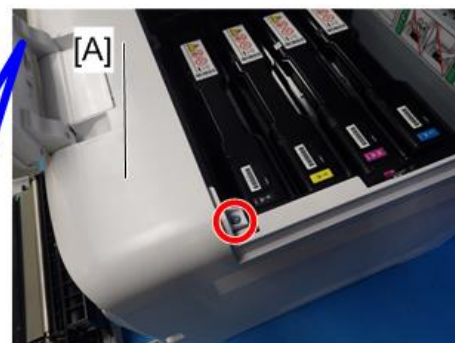
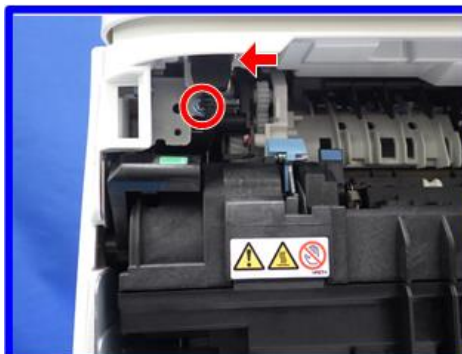

m0aga0007

Right Cover

1. Remove the rear cover. (page 34 "Rear Cover")
2. Remove the operation panel. (page 35 "Operation Panel")
3. Remove the right cover [A]. (⚙️ x 4)

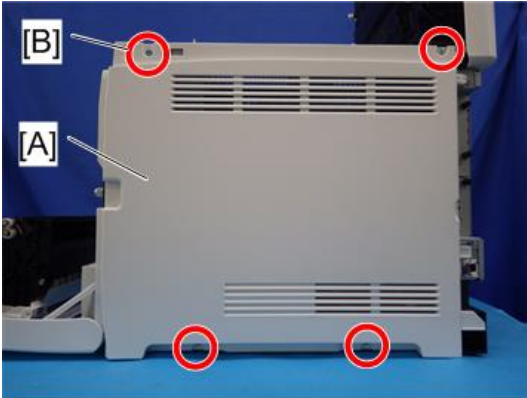

m0aga0008

↓ Note

- Top front screw [B]: M3x8, others: M4x10

Left Cover

1. Remove the operation panel. (page 35 "Operation Panel")
2. Remove the left cover [A]. (⚙️ x 3, hook at arrow mark)

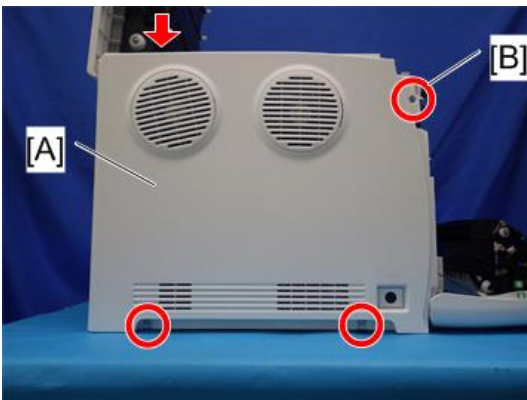

m0aga0009

↓ Note

- Top front screw [B]: M3x8, others: M4x10

Front Cover Unit

1. Remove the left cover. (page 36 "Left Cover")
2. Remove the rear cover. (page 34 "Rear Cover")
3. Remove the operation panel. (page 35 "Operation Panel")
4. Remove the transfer unit. (page 58 "Transfer Unit")
5. Remove the right cover. (page 36 "Right Cover")
6. Close the front cover [A].
7. Remove the spring [B]. (🔩 x 1)

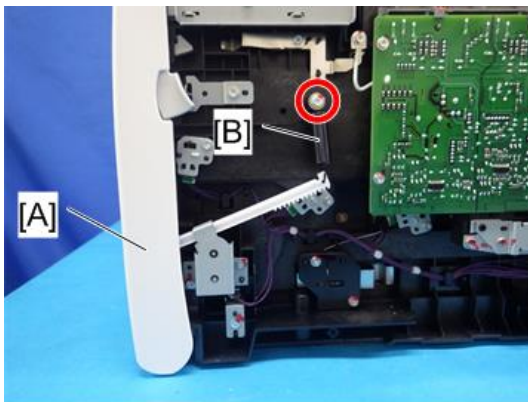

m0aga0010

⚠ CAUTION

- Do not remove the spring [B] with the front cover open. The strong tension of the spring can cause injury.

8. Remove the cover link gear unit [A]. (🔩 x 2)

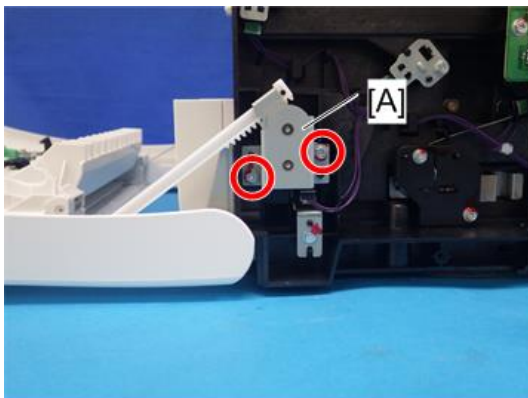

m0aga0011

9. Remove the power switch assembly [A]. (⚙️ x 3, 📏 x 1, 🛠️ x 2)

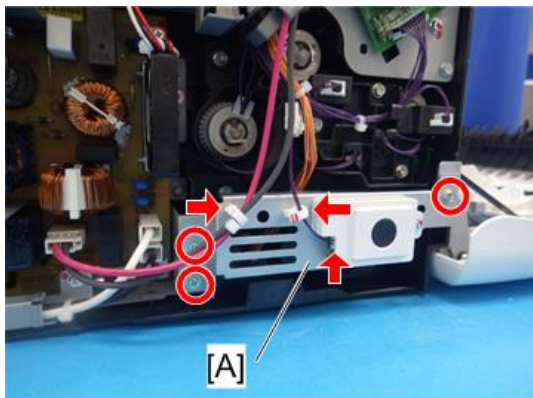

m0aga0012

10. Release the belt [A].

11. Remove the front cover unit [B] (⚙️ x 4)



m0aga0013

Laser Optics

⚠ WARNING

- Turn off the main power switch and unplug the printer before beginning any of the procedures in this section. Laser beams can cause serious eye injury.

Caution Decal Location

Caution decal is attached as shown below.



m0aga0014

4

⚠ WARNING

- Be sure to turn off the main power switch and disconnect the power plug from the power outlet before beginning any disassembly or adjustment of the laser unit. This printer uses a class IIIb laser beam with a wavelength of 780 nm and an output of 11 mW. The laser can cause serious eye injury.

LD Safety Switch

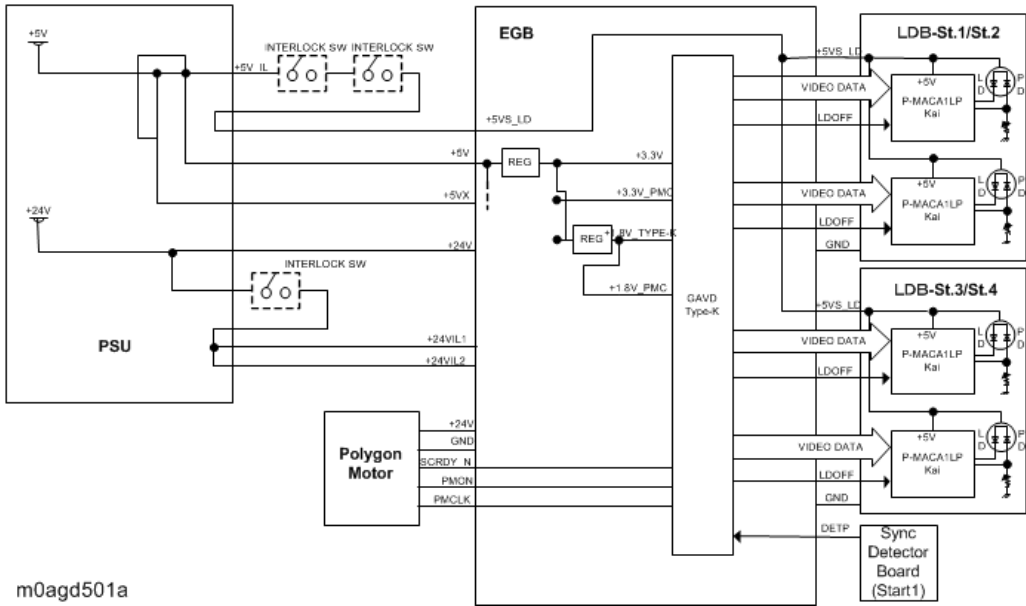

A safety switch turns off when the front cover or the right door is opened. As a result, the relay on the PSU cuts off the power supply (+5V) to the four LD boards. (The electric circuits go through the EGB.) This system prevents unexpected laser emission, and ensures user safety and technician safety.

Laser Optics Housing Unit

1. Remove the rear cover. (page 34 "Rear Cover")
2. Remove the controller box cover. (page 89 "Controller Board")
3. Disconnect the three harnesses from CN302, 303 and 304 on the EGB (🔌 x 3).

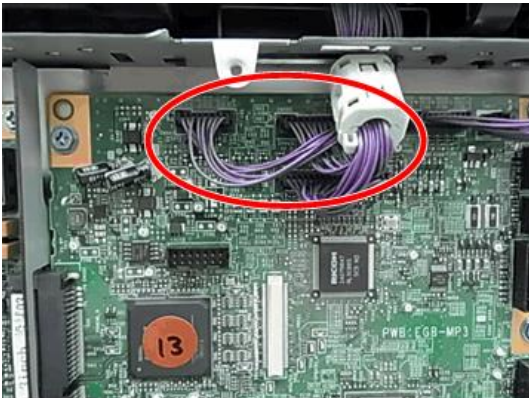

m0aga0015

4. Open the top cover [A].



5. Lift up the hook of the harness guide [A] at the rear-left frame and slide the harness guide to the right.

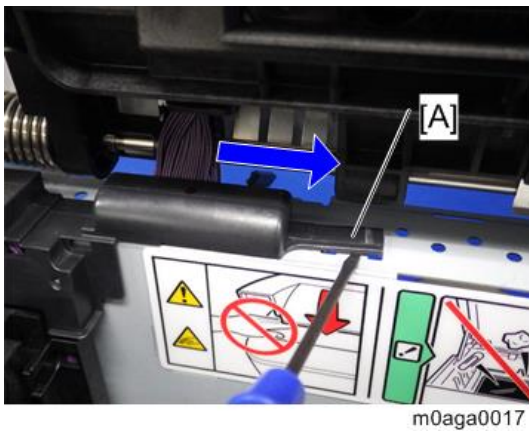

6. Remove the springs [A] (left side and right side).

7. Remove the stoppers [B] (⚙️ x 2 each; left side and right side)

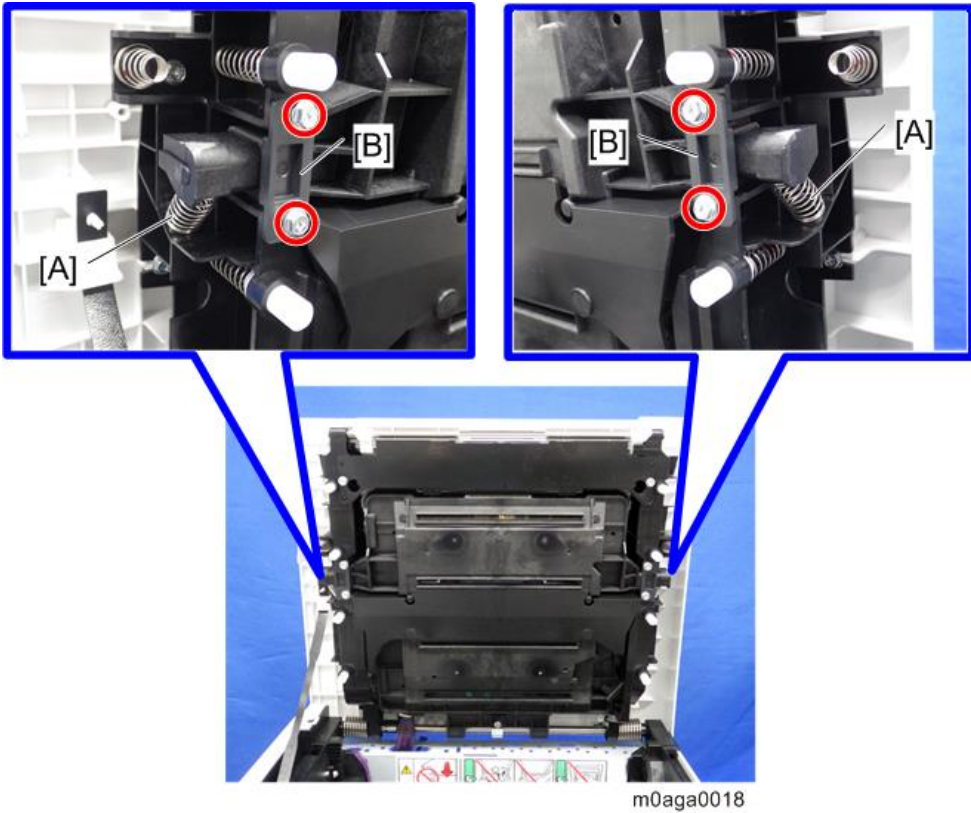

8. Remove the laser optics housing unit [A] from the top cover and place it on the main body.

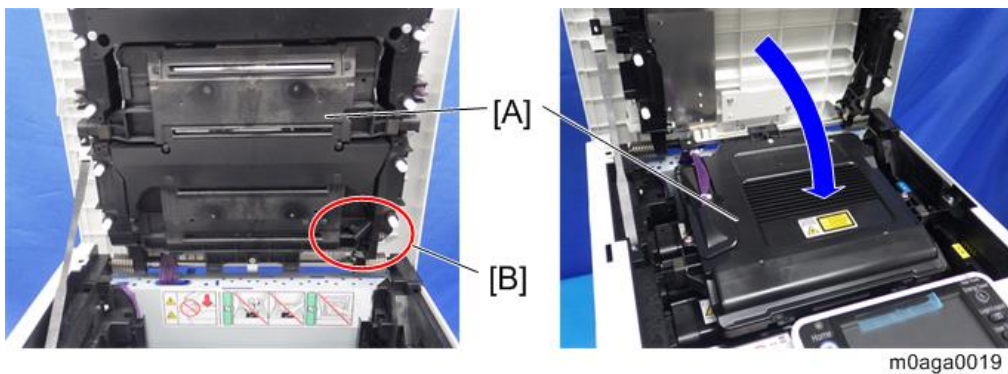

⚠️ Note

- Always use two hands when carrying the laser optics housing unit. Be sure not to drop the laser optics housing unit.

- When removing the laser optics housing unit, the circled area [B] might become stuck in the frame or other parts. Remove the laser optics housing unit carefully.

9. Take out the harnesses [A] (🔧 x 1).

10. Pull out the harnesses from the rear side.

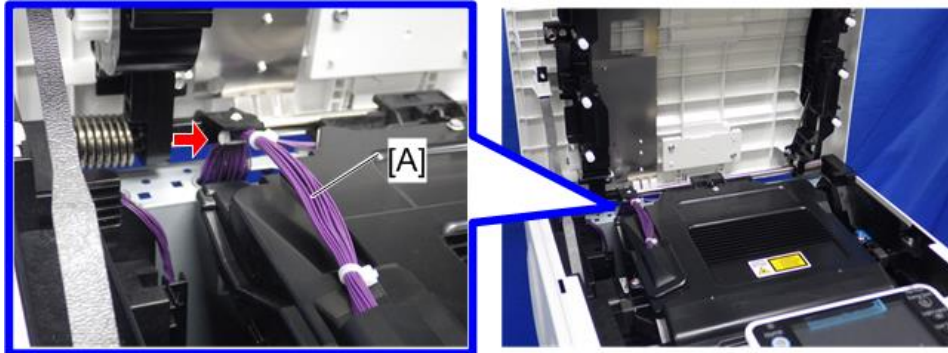

m0aga0020

11. Remove the laser optics housing unit [A].

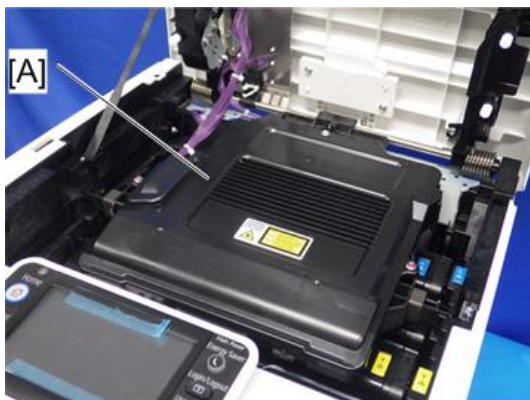

m0aga0021

After replacing the laser optics housing unit

1. Turn on the machine.
2. Execute "LPoS. Adj:Rough" with SP2-120-001, and then execute "LPoS. Adj:Fine" with SP2-120-002.
3. Adjust the registration settings for each tray and for the front and rear sides of the paper with SP1-001 and SP1-002 if necessary.

AIO Cartridge

AIO Cartridge (All In One Cartridge)

1. Open the top cover.
2. Remove the AIO cartridge [A].



m075r522

4

Black AIO Motor

1. Remove the left cover. (page 36 "Left Cover")
2. Remove the interlock switch base. (page 95 "Interlock Switches")
3. Disconnect the fusing connector [A].
4. Remove the fusing harness guide [B] (2 x 2)

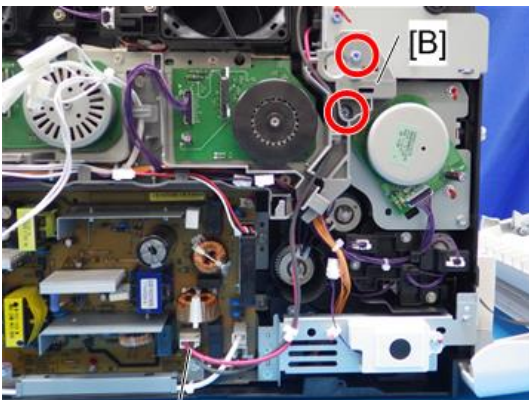

m0aga0022

[A]

5. Disconnect the connectors shown by arrows in the picture below and take aside all harnesses on the harness guide [C].
6. Remove the harness guide [C]. (⚙️ x 4)

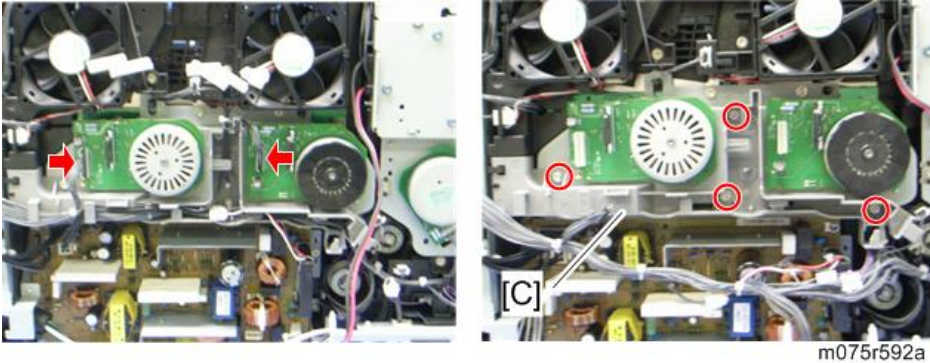

7. Remove the controller box cover. (page 89 "Controller Board")
8. Disconnect the connector (CN308) on the EGB (x 1).
9. Remove the LSU fan base [D] (⚙️ x 2, 🛠️ x 2).

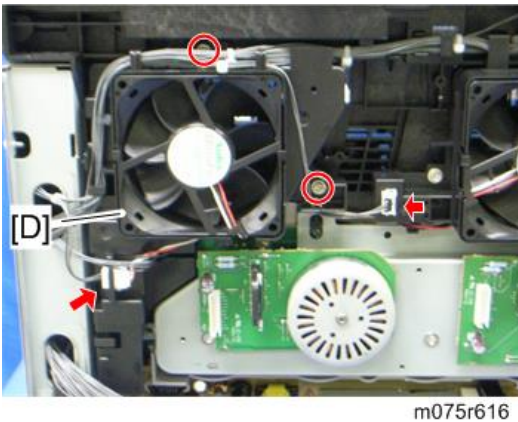

10. Remove the drive unit [E] (⚙️ x 4).

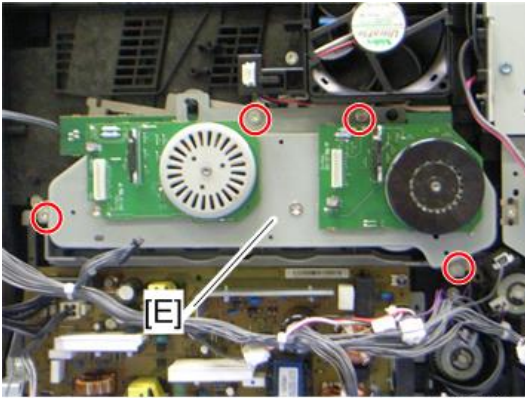

m075r594

11. Remove the image transfer unit gear [F] (washer x 1).

12. Remove the AIO gears [G] (washer x 1 each).

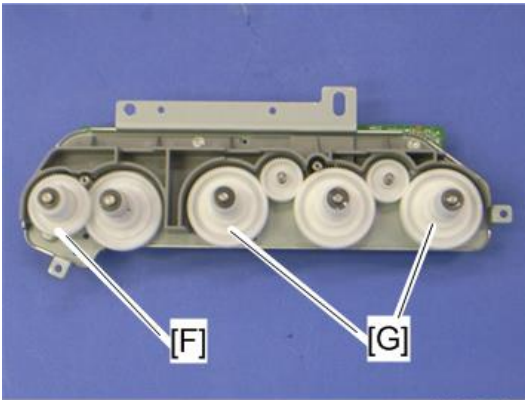

m075r595b

13. Remove the drive unit guide [H] (⚙️ x 3).

14. Remove the AIO gear [I].

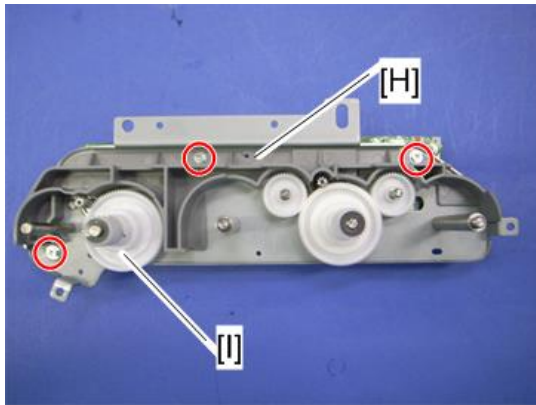

m075r610

15. Remove the black AIO motor [J] (⌀ x 3)

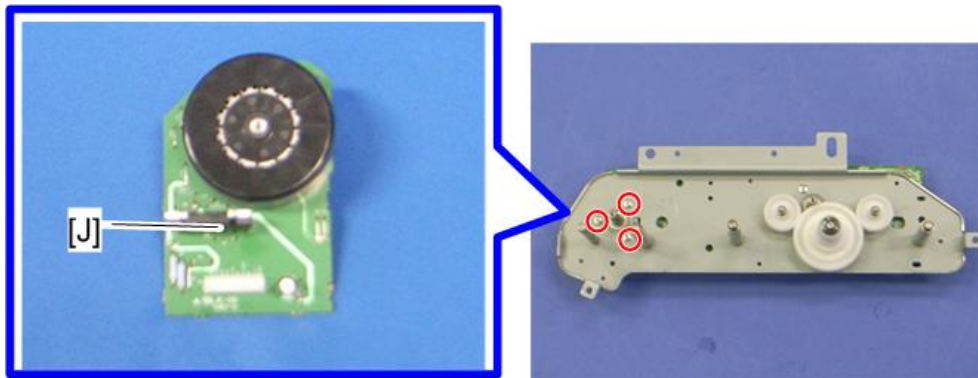

m075r598a

Color AIO Motor

1. Remove the drive unit. (page 44 "Black AIO Motor")
2. Remove the image transfer unit gear [A] (washer x 1).

3. Remove the color AIO gear [B] (washer x 1).

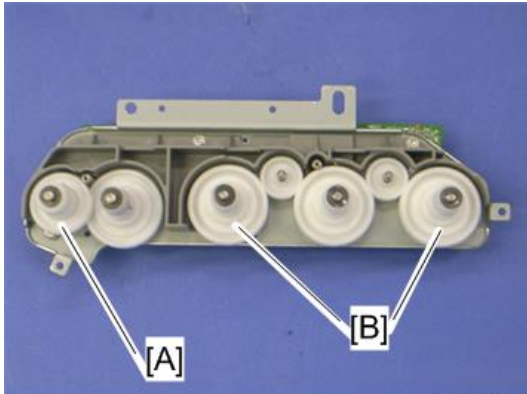

m075r595a

4. Remove the drive unit guide [C] (⚙ x 3).

5. Remove the AIO gear and idle gear [D].

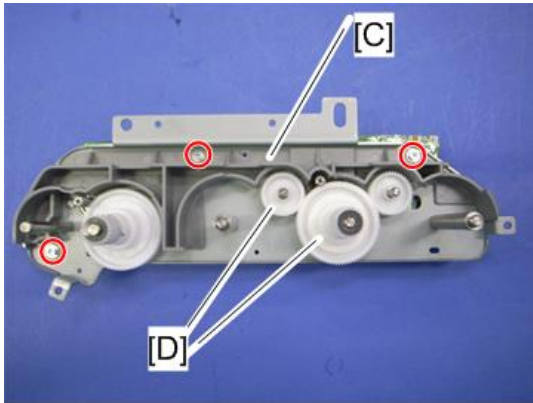

m075r611

6. Remove the color AIO motor [E] (⚙ x 3).

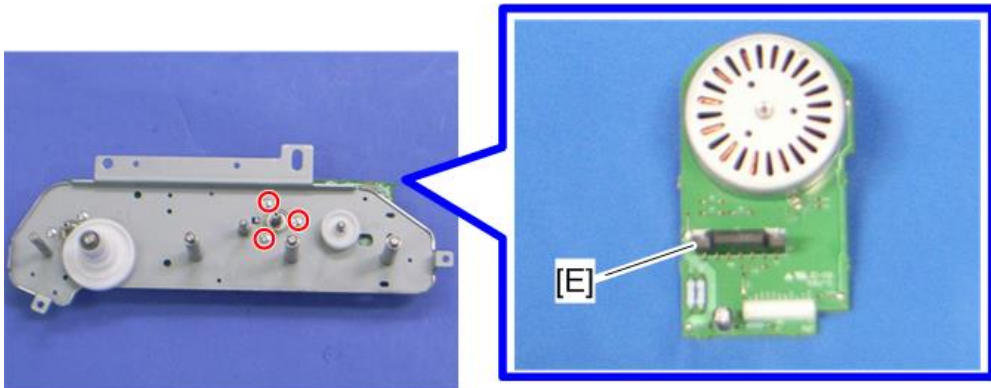

m075r596a

Image Transfer

Image Transfer Belt Unit

1. Remove all the AIO cartridges. (page 44 "AIO Cartridge (All In One Cartridge) ")
2. Remove the transfer unit. (page 58 "Transfer Unit")
3. Remove the waste toner bottle [A].
4. Remove the two screws [B].

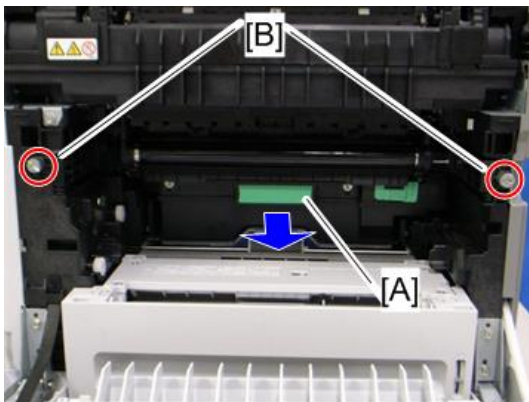

g163r523

5. Grab the handles [A], and then pull out the image transfer belt unit [B].

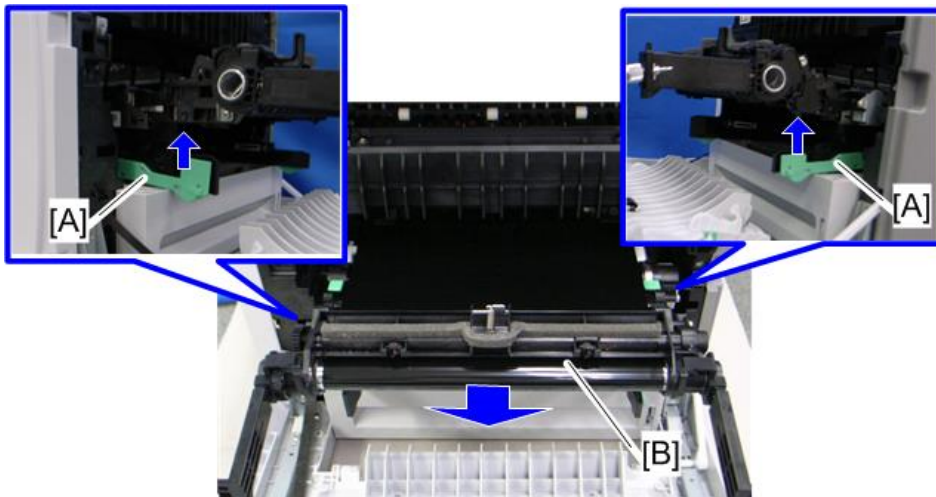

g163r524a

After installing a new image transfer belt unit

Execute SP2-120-009 (Transfer Belt Adj) after installing a new image transfer belt unit.

Agitator Motor

1. Remove the right cover. (page 36 "Right Cover")
2. Remove the motor bracket [A] (⚙️ x 2).

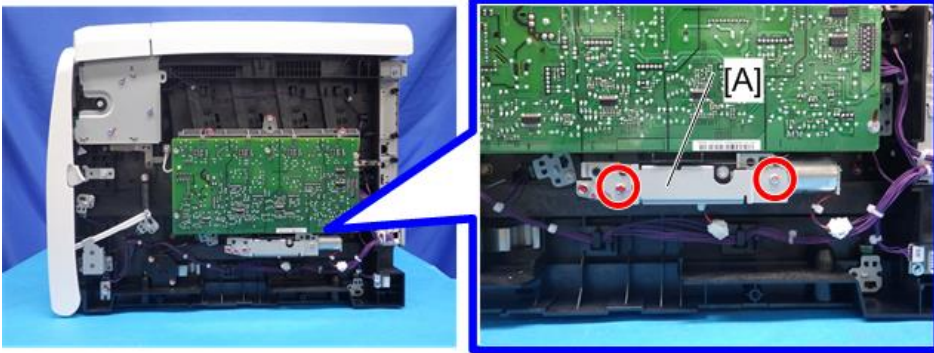

m0aga0023

3. Remove the agitator motor assembly [A] (⚙️ x 1, ⚙️ x 1).

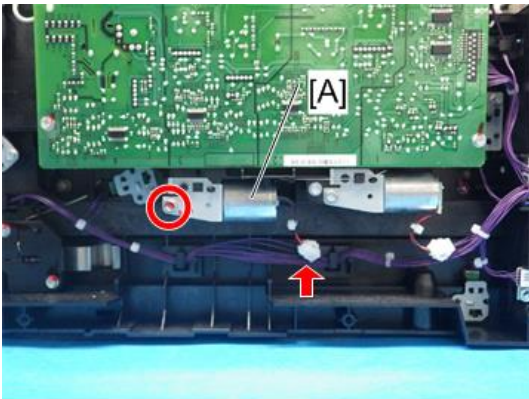

m0aga0024

4. Remove the agitator motor [A] (⚙️ x 2).

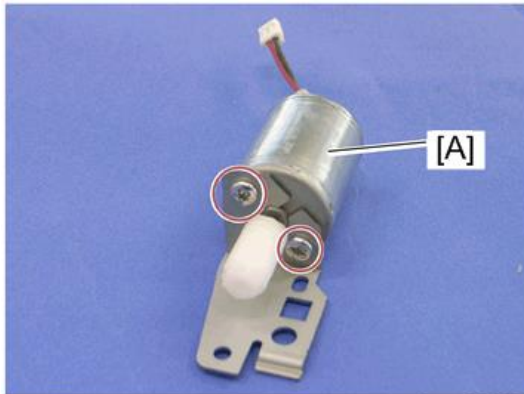

m0aga0025

4

ITB (Image Transfer Belt) Contact Motor

1. Remove the agitator motor. (page 50 "Agitator Motor")
2. Release the wire [A].
3. Remove the ITB contact motor assembly [B] (⚙️ x 1, ⚙️ x 1).

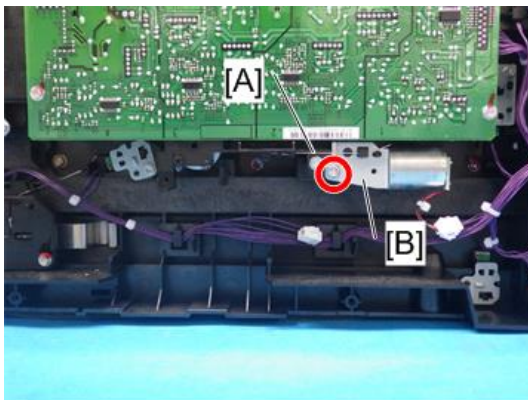

m0aga0026

4. Remove the ITB contact motor [A] (🔩 x 2).



m0aga0027

4

ITB (Image Transfer Belt) Contact Sensor

1. Remove the right cover. (page 36 "Right Cover")
2. Remove the ITB contact sensor assembly [A] (🔩 x 1, 📏 x 1).

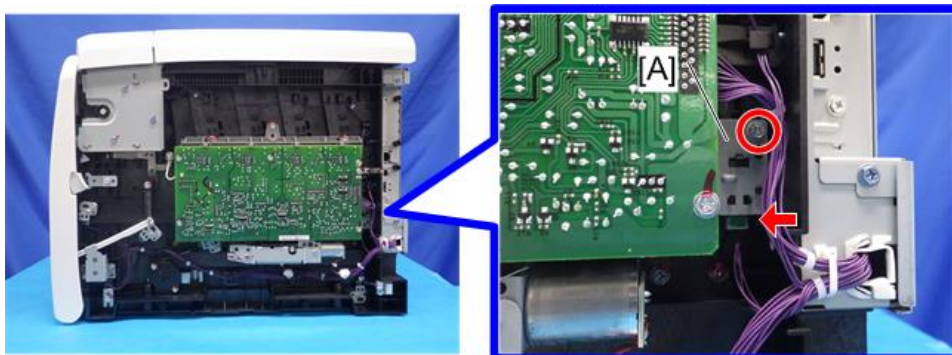

m0aga0028

3. Remove the ITB contact sensor [A] (hooks).

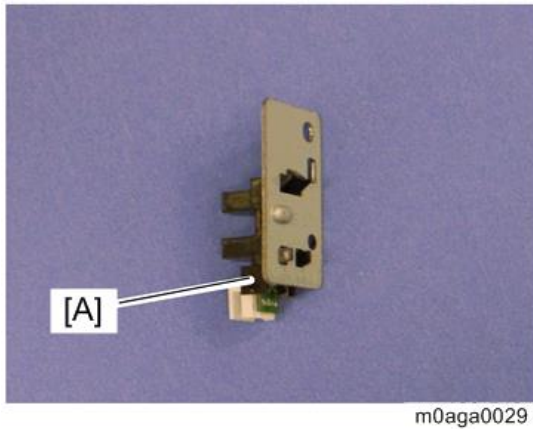

4

TM (Toner Mark) Sensor Base

1. Open the top cover.
2. Remove all AIO cartridges. (page 44 "AIO Cartridge (All In One Cartridge) ")
3. Slide the ITB unit to the front side or remove it.
4. Remove the rear cover. (page 34 "Rear Cover")
5. Remove the controller box cover. (page 89 "Controller Board")
6. Disconnect CN305 on the EGB ( x 1).



7. Remove the harness cover [A] (hooks).

8. Remove the TM sensor base [B].

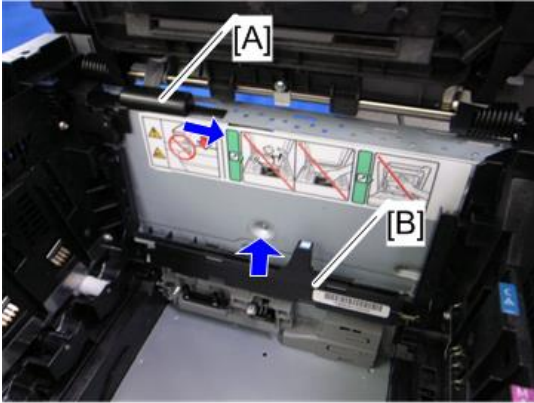

g163r531

Waste Toner Bottle Set Sensor

1. Remove all AIO cartridges. (page 44 "AIO Cartridge (All In One Cartridge) ")
2. Image transfer belt unit. (page 49 "Image Transfer Belt Unit")
3. Remove the EGB. (page 92 "EGB (Engine Board)")
4. Remove two screws [A] for the waste toner sensor base.

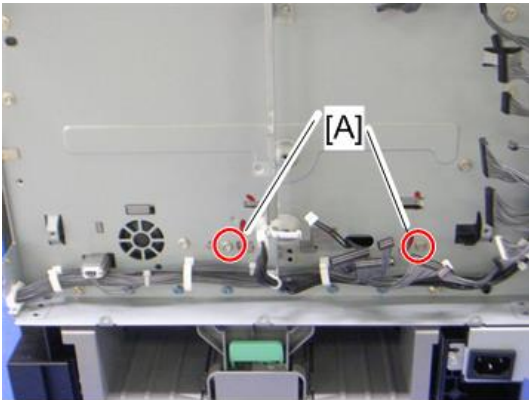

m075r532

5. Remove the waste toner sensor base [B].

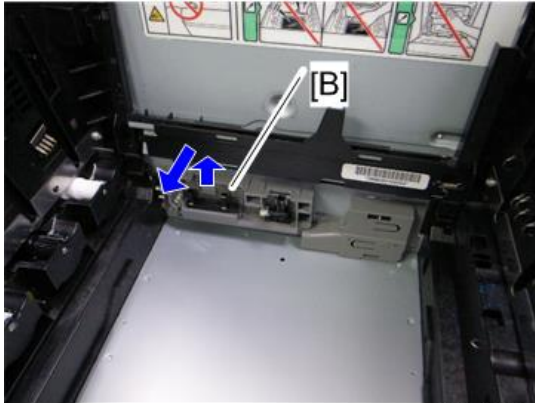

g163r533

6. Remove the sheet at the bottom of the waste toner bottle set sensor.
7. Waste toner bottle set sensor [C] (hooks,  x 1)

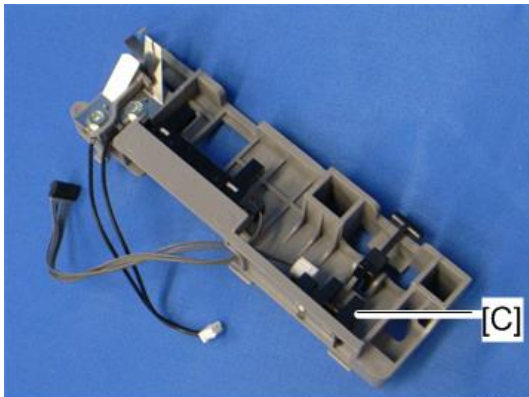

g163r534

 **Note**

- When reinstalling the waste toner bottle set sensor, connect it to the white connector of the harness.

Waste Toner Overflow Sensor

1. Remove all AIO cartridges. (page 44 "AIO Cartridge (All In One Cartridge) ")
2. Remove the image transfer belt unit (page 49 "Image Transfer Belt Unit")
3. Remove the EGB. (page 92 "EGB (Engine Board)")
4. Remove the waste toner sensor base. (page 54 "Waste Toner Bottle Set Sensor")

5. Remove the sheet [A] securing the three hooks of the waste toner overflow sensor (at the bottom of this sensor base).

Note

- Reattach this sheet after reinstalling the waste toner overflow sensor.

6. Waste toner overflow sensor [B] (hooks,  x 1)

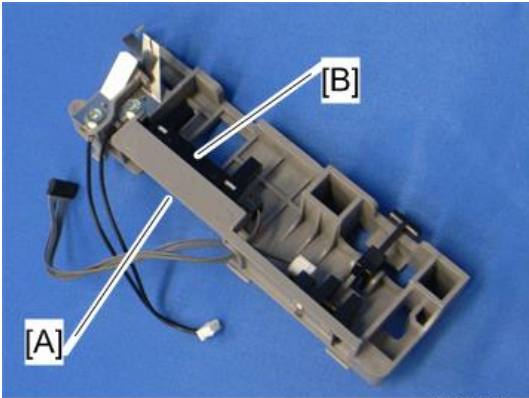

g163r534a

Note

- When reinstalling the waste toner overflow sensor, connect it to the black connector of the harness.

Air Intake Fan

1. Remove all AIO cartridges. (page 44 "AIO Cartridge (All In One Cartridge) ")
2. Remove the image transfer belt unit (page 49 "Image Transfer Belt Unit")
3. Remove the EGB. (page 92 "EGB (Engine Board)")
4. Remove the waste toner sensor base. (page 54 "Waste Toner Bottle Set Sensor")
5. Remove two screws [A] for the air intake fan base.

6. Disconnect the harness [B].

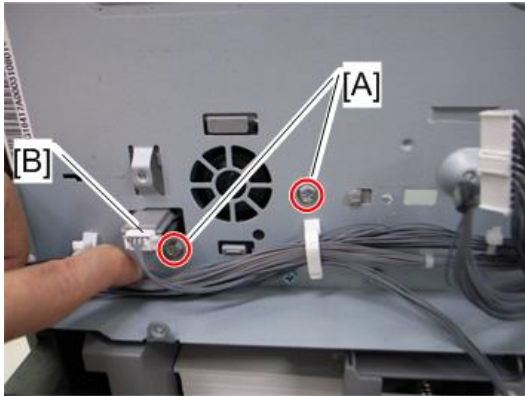

g163r535

7. Remove the air intake fan base [C].

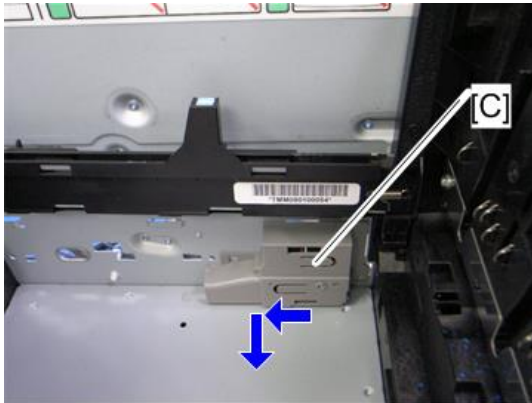

g163r536

8. Remove the air intake fan [D] (1 x 1).

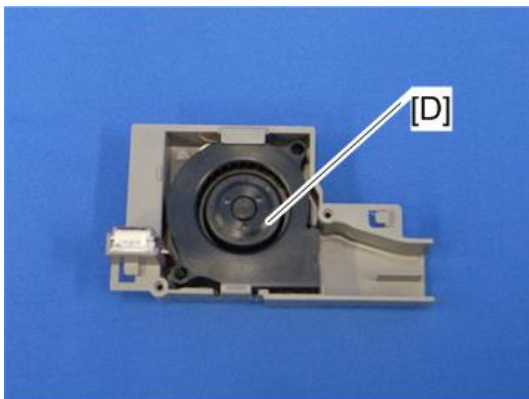

g163r537

Paper Transfer

Transfer Unit

1. Open the front cover.
2. Release the locks [A].
3. Remove the transfer unit [B]

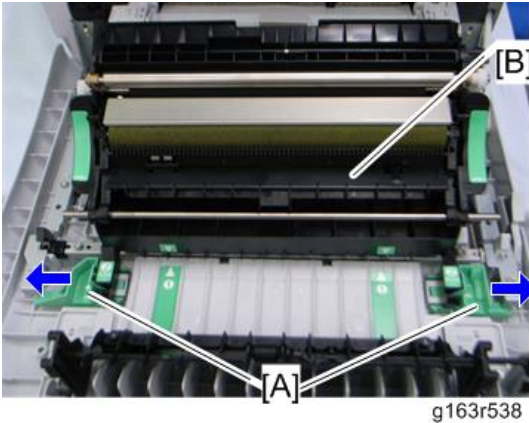

4

After installing a new transfer unit or transfer roller

The counter for the transfer unit must be reset after installing a new transfer unit or transfer roller. However, the counter for the transfer unit is also reset automatically if the fusing unit is replaced with a new one. Follow the correct procedure, depending on which parts you replaced. See below for the possible cases:

Installing a new transfer unit or transfer roller with a new fusing unit

- No operation is required to reset the transfer unit counter.

Installing a new transfer unit or transfer roller without a new fusing unit

- Enter the SP mode, and then execute SP7-804-022 to reset the transfer unit counter.

Installing a new fusing unit without a new transfer unit or transfer roller

- Enter the SP mode, and then execute SP7-805-022 to recall the previous transfer unit counter.

Transfer Roller

1. Remove the transfer unit. (page 58 "Transfer Unit")

2. Release the two hooks [A] at both sides of the transfer unit.

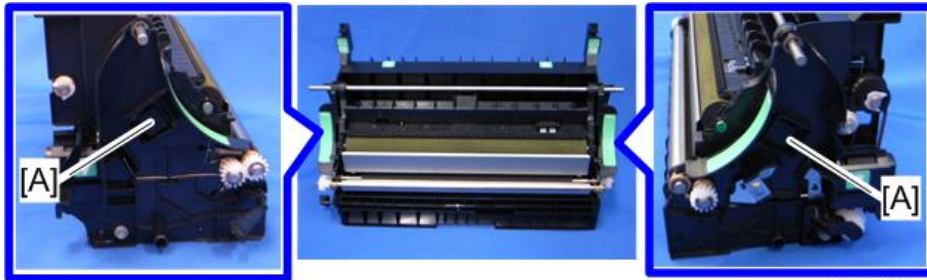

g163r539a

3. Open the transfer roller unit [B] and remove it.

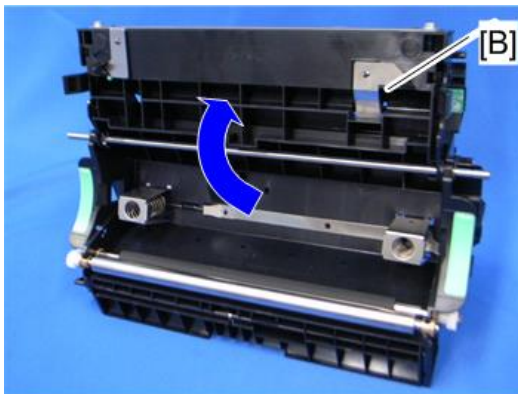

g163r542

4. Remove the transfer roller assembly [C] (⚙ x 2).

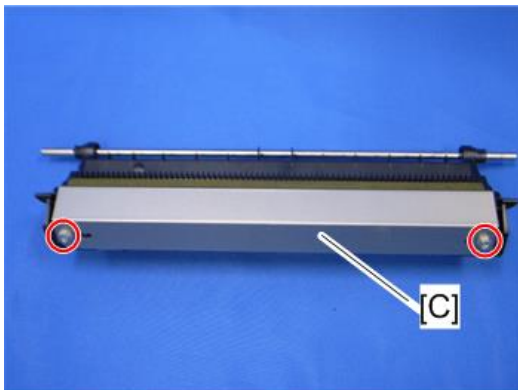

g163r700

5. Release the holder [D] at the left side of the transfer roller unit (hook).

6. Remove the transfer roller [E].

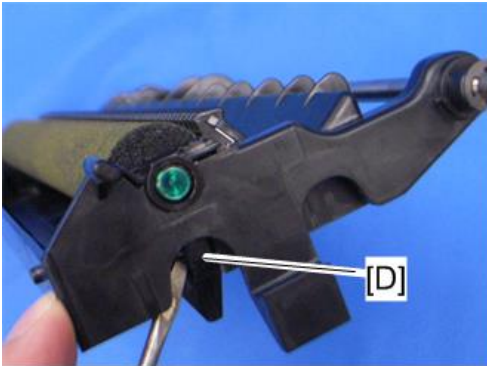

g163r701

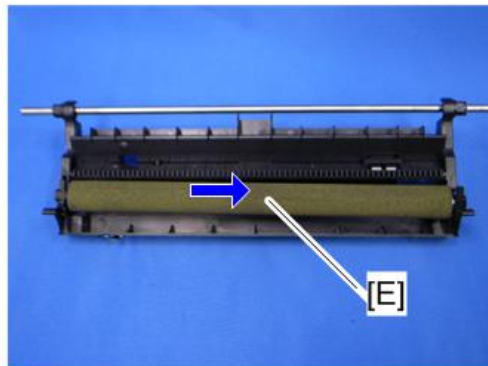

g163r702

4

After installing a new transfer roller

The counter for the transfer unit must be reset after installing a new transfer roller. For details, see page 58 "After installing a new transfer unit or transfer roller".

Registration Roller

1. Remove the transfer unit. (page 58 "Transfer Unit")
2. Remove the transfer roller unit. (page 58 "Transfer Roller")
3. Remove the tension springs [A] (both sides).
4. Remove the registration idle roller [B] (Ⓢ x 2, gear x 1, bushing x 2).
5. Remove the registration roller [C] (Ⓢ x 2, gear x 2, bushing x 2).

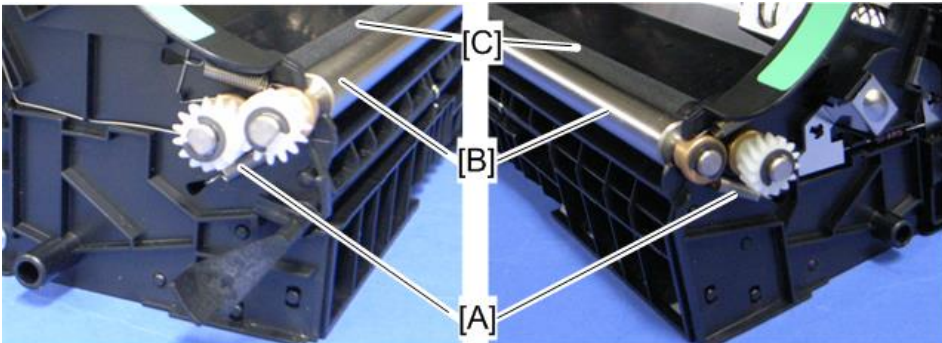

g163r543a

Reinstalling the registration roller unit

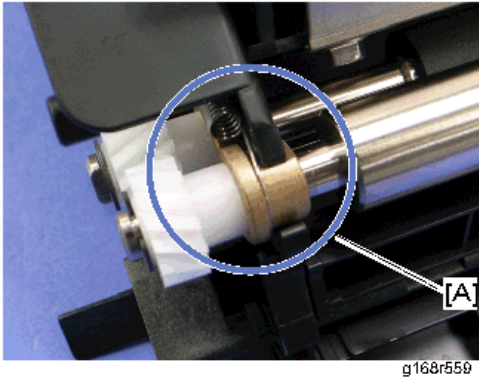

When installing the tension spring, make sure that the tension spring correctly hooks onto the bushing of the registration idle roller as shown above [A].

⚠ CAUTION

- Make sure to reinstall the registration idle roller the correct way around.

Registration Sensor

1. Remove the right Cover. (page 36 "Right Cover")
2. Registration sensor assembly [A] (🔧 x 1, 📏 x 1)

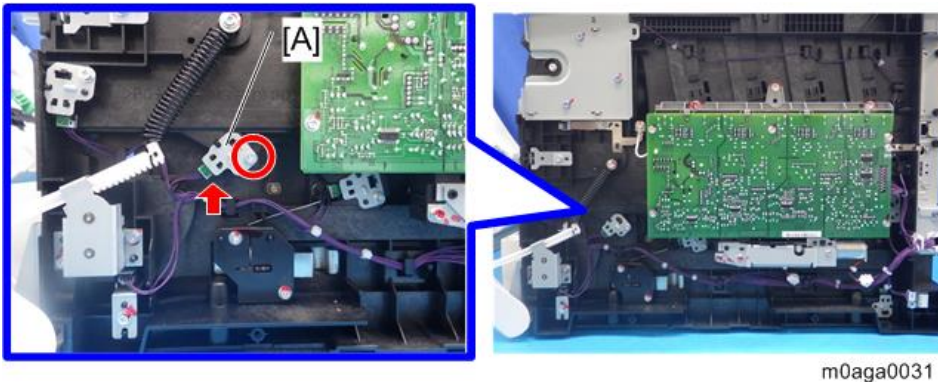

3. Remove the registration sensor [B] (hooks).

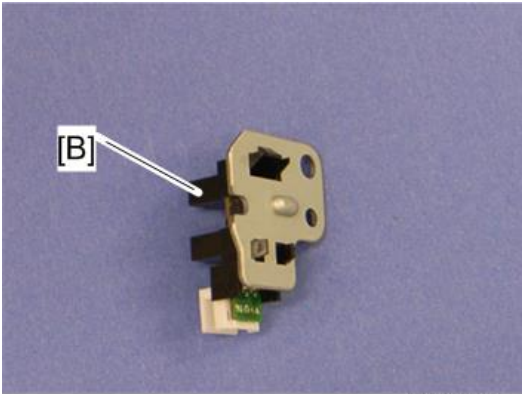

g168r562a

4

Registration Clutch

1. Remove the left cover. (page 36 "Left Cover")
2. Remove the main switch bracket. (page 37 "Front Cover Unit")
3. Remove the paper feed clutch. (page 74 "Paper Feed Clutch")
4. Remove the transport/fusing motor. (page 72 "Transport/Fusing Motor")
5. Remove the lower transport gear unit [A] (⚙ x 3, ⚙ x 3).

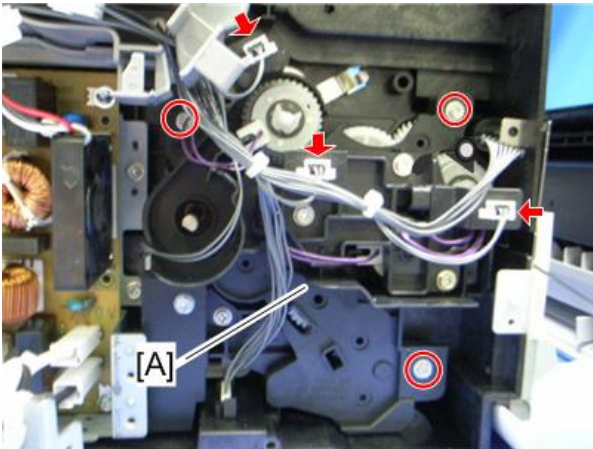

m075r546

6. Remove the registration clutch [B] (⌚ x 1, ⌚ x 1).

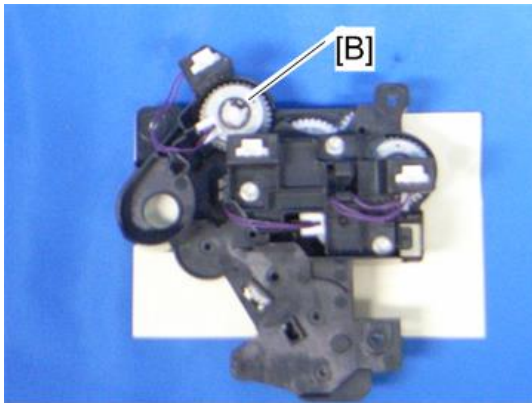

m075r547

By-pass and Duplex Clutch

1. Remove the lower transport gear unit. (page 62 "Registration Clutch")
2. Remove the cover [A] (⌚ x 3).

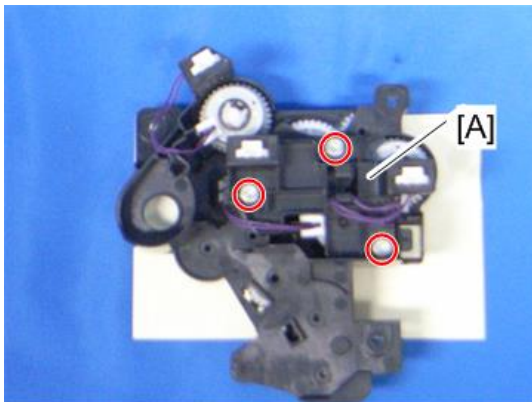

m075r547a

3. Remove the by-pass clutch [B] (⌚ x 1, ⌚ x 1).

4. Remove the duplex clutch [C] (⚙️ x 1, 🛠️ x 1).

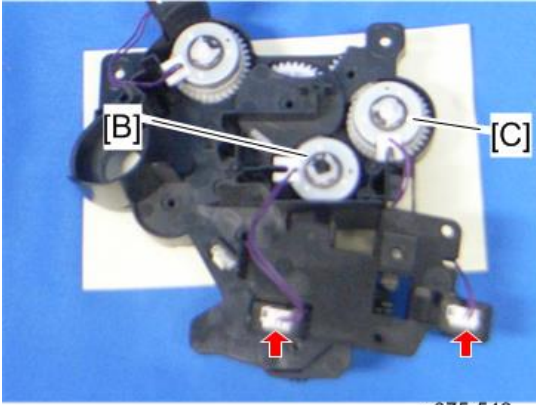

m075r548

Duplex Sensor

1. Remove the right cover. (page 36 "Right Cover")
2. Remove the duplex sensor assembly [A] (🛠️ x 1, 🛠️ x 1).

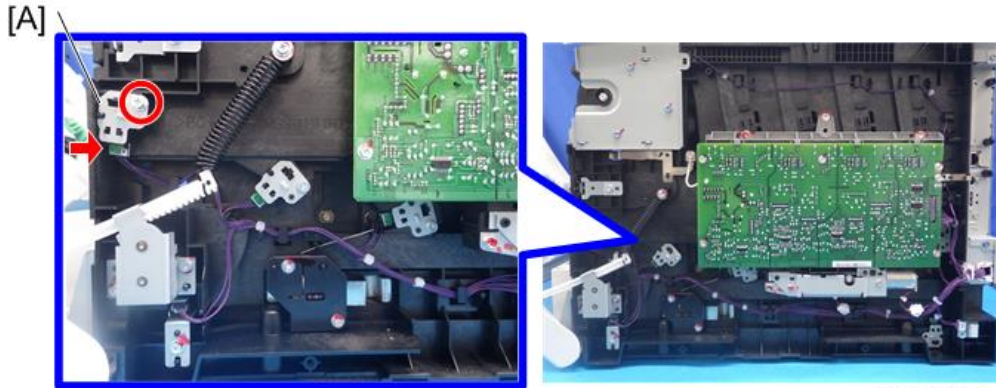

m0aga0072

3. Remove the duplex sensor [B] (hooks).

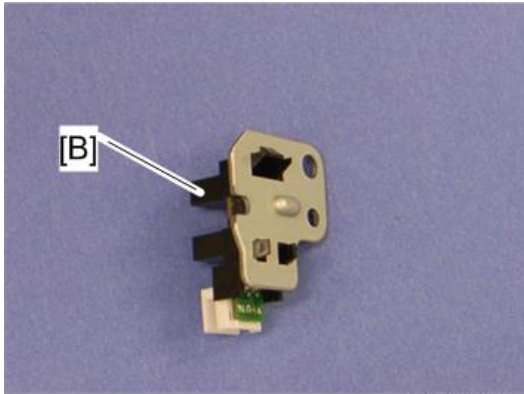

g168r562a

Image Fusing

⚠ CAUTION

- Make sure that the fusing unit is cool before you touch it. The fusing unit can be very hot.
- Make sure to restore the insulators, shields, etc after you service the fusing unit.

Fusing Unit

1. Open the front cover.
2. Hold the fusing unit lock levers [A].
3. Remove the fusing unit [B].

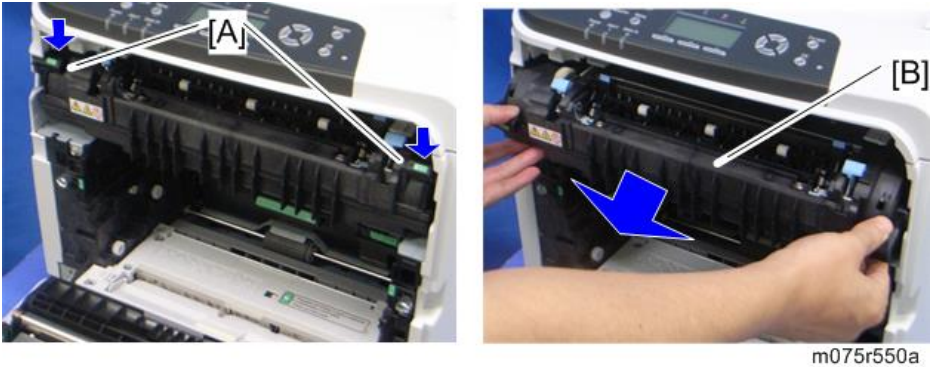

After installing a new fusing unit

This unit has a new unit detection function. No operation is required to reset the fusing unit counter. However, the new unit detection function of this unit automatically resets the transfer unit counter.

If a new fusing unit is installed without a new transfer unit:

Enter the SP mode, and then execute the SP7-805-022 to recall the transfer unit's previous counter.

Fusing Lamp

1. Remove the fusing unit. (page 66 "Fusing Unit")
2. Remove screws [A] on the pressure release lever knobs.

Do not remove the pressure release lever knobs at this time.

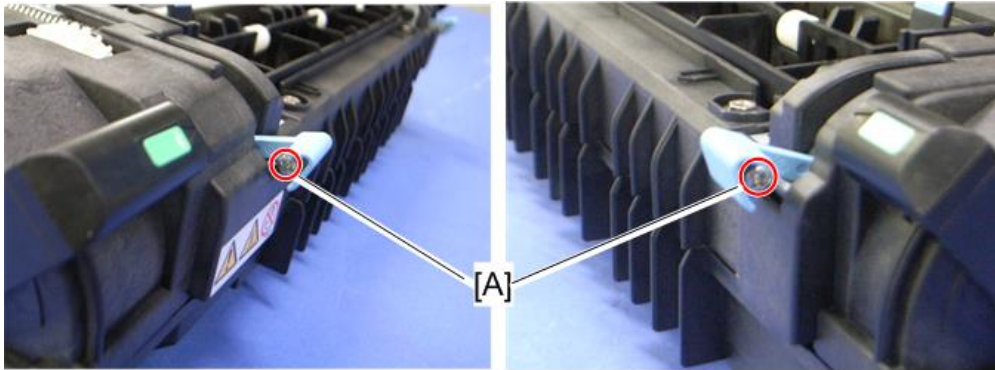

m075r558

3. Move both pressure release levers [B] to the upper position (less pressure position).
4. Remove the pressure release lever knobs.

⚠ CAUTION

- Do not place the fusing unit with its rear entrance guide down. Otherwise, the fusing rear entrance guide can be broken.

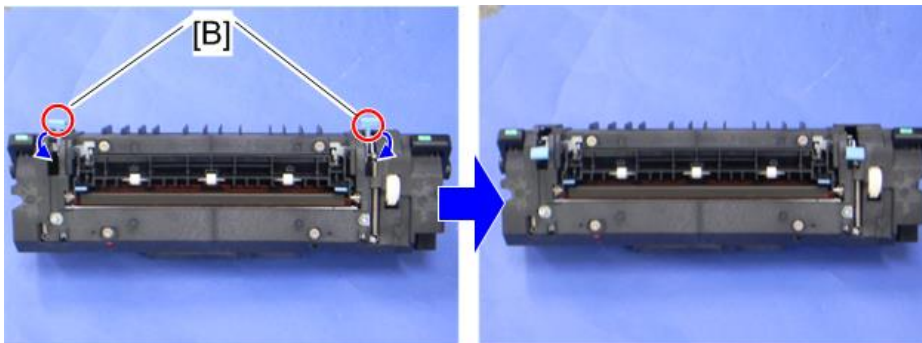

m075r605a

5. Remove two screws [C] at the left and right edges of the fusing unit.

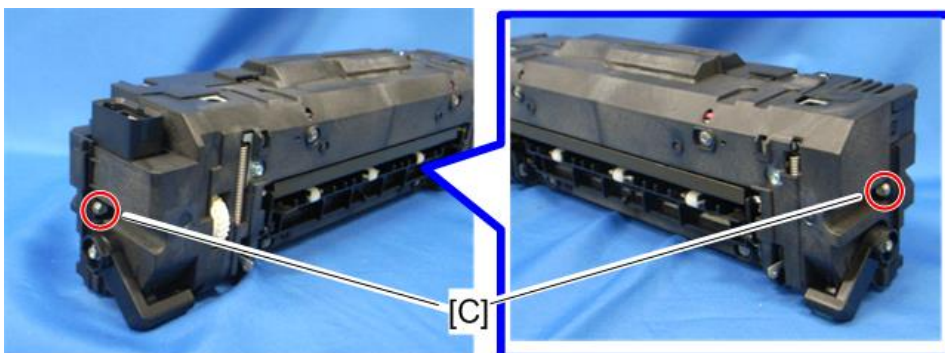

m075r554a

6. Remove four screws on the fusing upper cover [D].

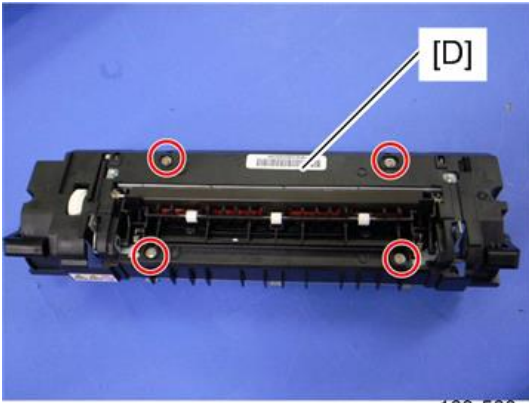

g163r560

7. Release four hooks [E] of the fusing upper cover, and then remove the fusing upper cover [F].

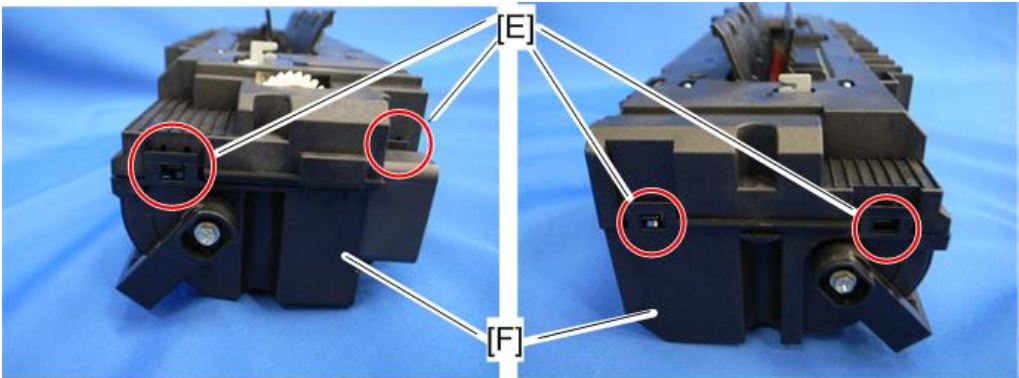

g163r556

g163r557

8. Remove the fusing lower guide front plate [G] (⚙ x 3).

9. Remove the fusing lower cover [H] (⚙ x 3).

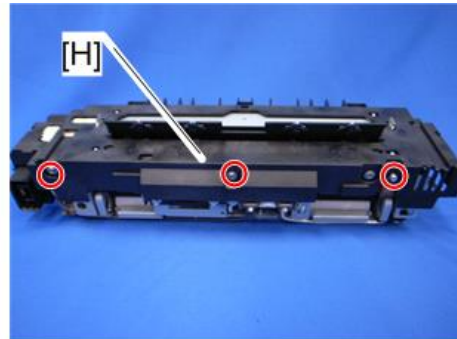
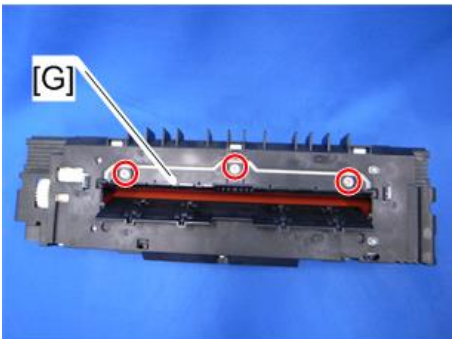

g163r606a

10. Remove two screws [I].

11. Remove the fusing lamp right stay [J] (⚙ x 1).

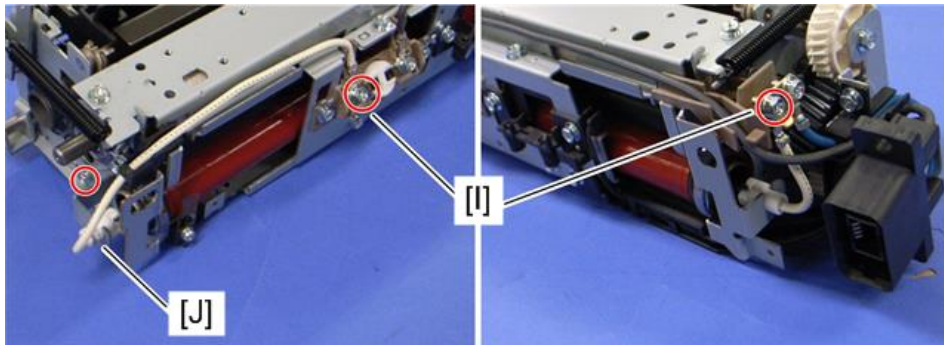

g163r561a

12. Remove the fusing lamp [K].

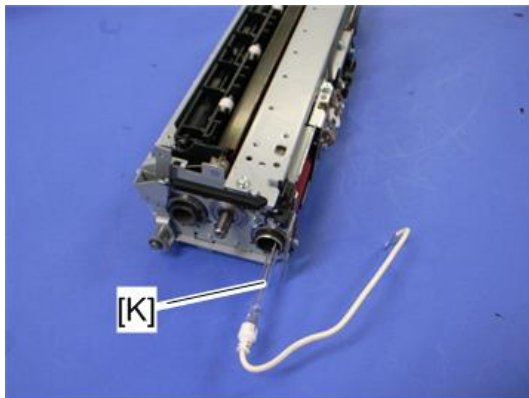

g163r563

4

Thermostat

1. Remove the fusing unit. (page 66 "Fusing Unit")
2. Remove the fusing upper cover. (page 66 "Fusing Lamp")

3. Remove the thermostat [A] (⚙️ x 2).

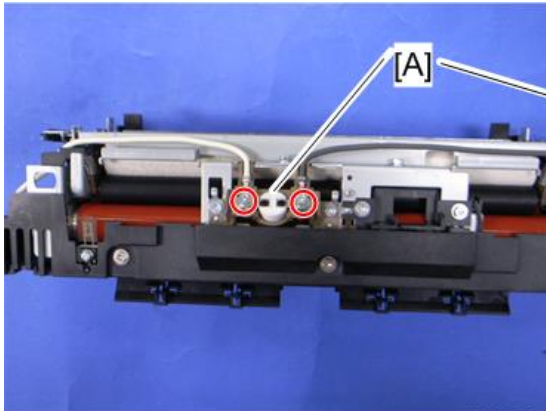

g163r703



g163r704

Thermistors

1. Remove the fusing unit. (page 66 "Fusing Unit")
2. Remove the fusing upper cover. (page 66 "Fusing Lamp")
3. Remove the fusing lower cover. (page 66 "Fusing Lamp")
4. Disconnect the thermistor connector [A].

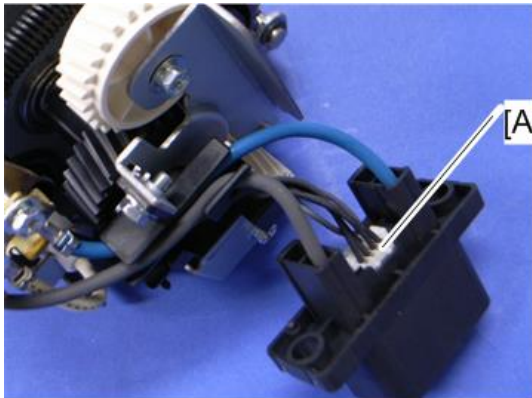

g163r705

5. Remove the cable guide [B] (⚙️ x 2).
6. Remove the thermostat bracket [C] (⚙️ x 4).

7. Remove the thermistor: center [D] (⚙ x 1).

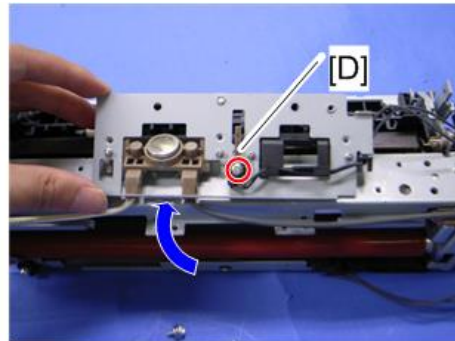
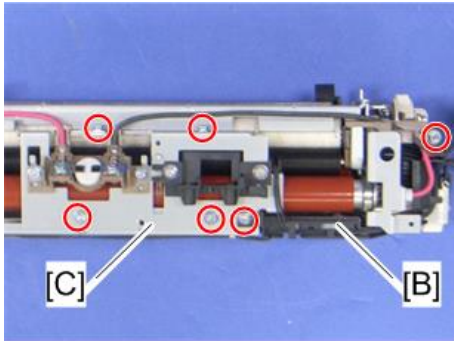

m075r706a

8. Remove the thermistor: end [E] (⚙ x 1)

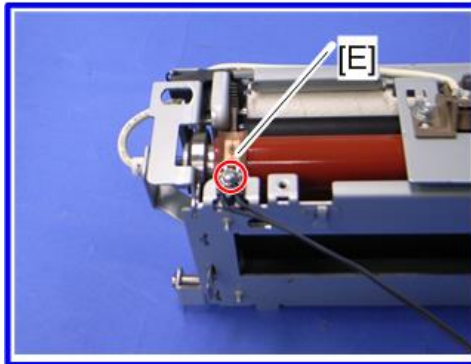

m075r709

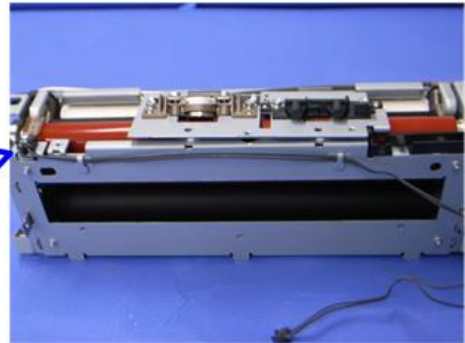

m075r708

When installing the thermistors: center and end

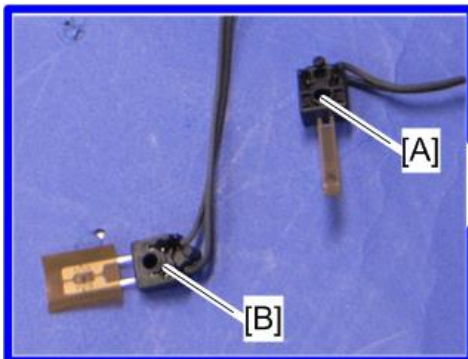

g163r711

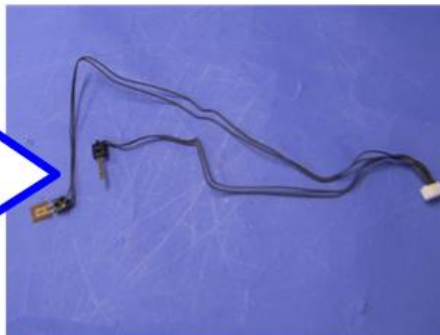

g163r710

Do not mix up the two thermistors;

- [A]: Thermistor: center
- [B]: Thermistor: end

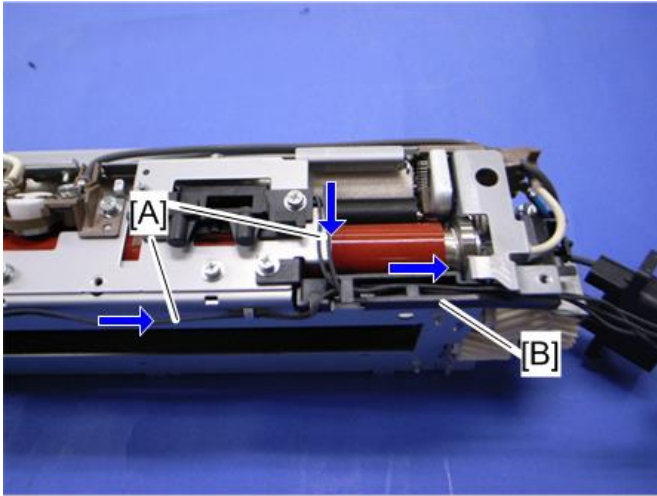

g163r712

Set the cables [A] of the two thermistors along the cable guide [B].

Transport/Fusing Motor

1. Remove the rear cover. (page 34 "Rear Cover")
2. Remove the left cover. (page 36 "Left Cover")
3. Disconnect the fusing cables [A].
4. Remove the fusing harness guide [B] (⚙ x 2)

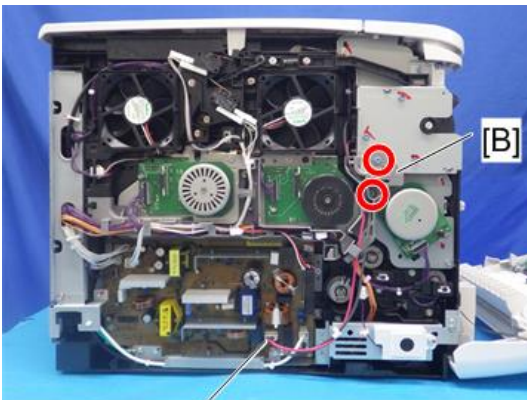

m0aga0032

5. Pull out the ITB unit [C] (⚙ x 2).

6. Remove the transport/fusing motor assembly [D] (⚙️ x 3, 📡 x 1).

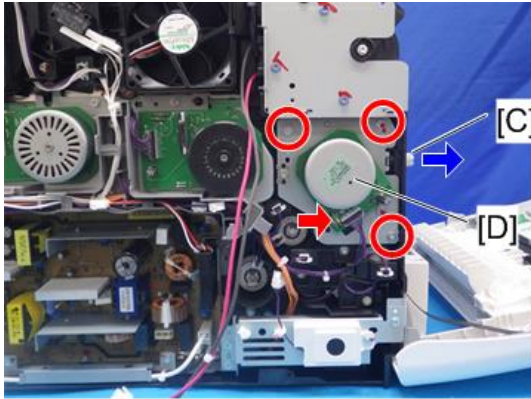

m0aga0033

7. Remove the motor bracket [E] (⚙️ x 2, ground plate x 1).
8. Remove the transport/fusing motor [F] (⚙️ x 3).

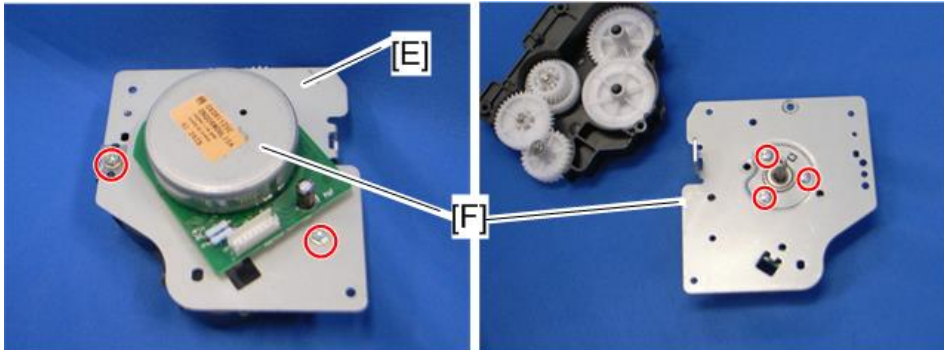

g163r566a

Paper Feed and Exit

Paper Feed Clutch

1. Remove the rear cover. (page 34 "Rear Cover")
2. Remove the left cover. (page 36 "Left Cover")
3. Remove the paper feed clutch [A] (🔧 x 1, 📁 x 1).

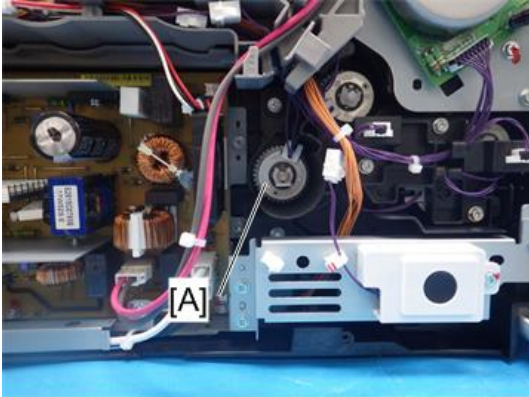

m0aga0034

Paper Feed Roller

1. Pull out the tray.
2. Open the front cover.
3. Remove the transfer unit. (page 58 "Transfer Unit")
4. Remove the paper feed clutch. (page 74 "Paper Feed Clutch")
5. Slide the paper feed roller [A] to the right side (hook).

- Slide the paper feed shaft [B] to the left side (☞ x 1).

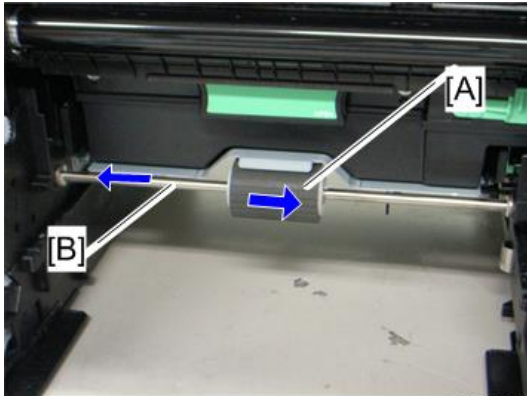

g163r569

- Remove the paper feed roller [C] (☞ x 1).

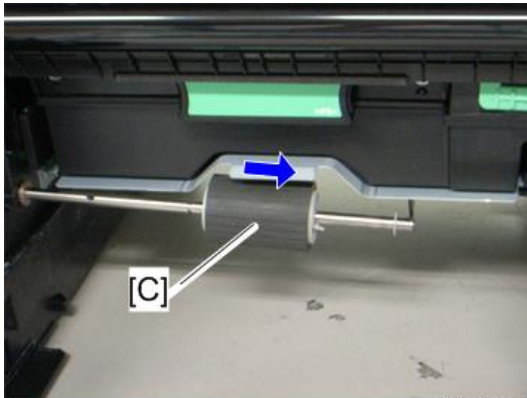

g163r570

Separation Pad

- Pull out the tray.
- Push down the bottom plate [A].

3. Remove the separation pad [B] (hooks, spring x 1)

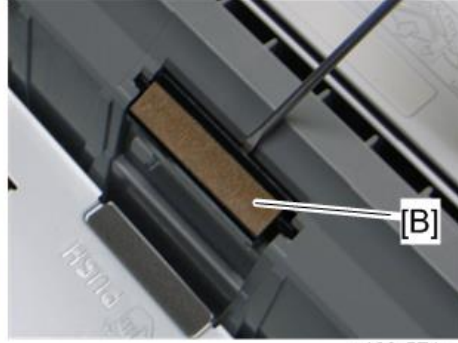
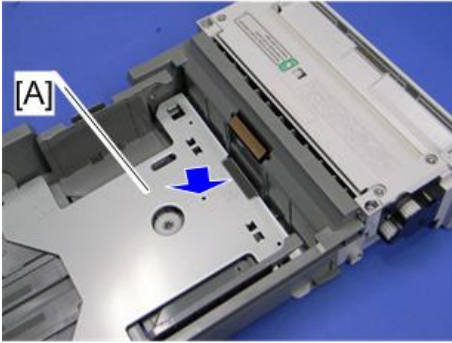

g163r571a

4

↓ Note

- When reinstalling the separation pad, make sure that the sheet [C] is not placed under the separation pad. The right side image below shows incorrect installation.

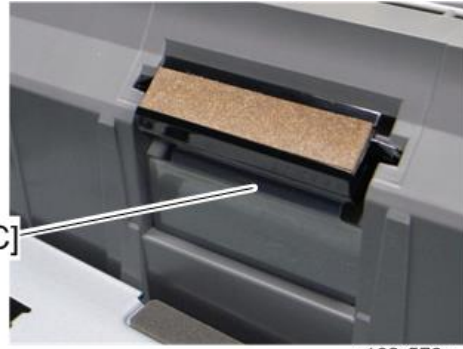
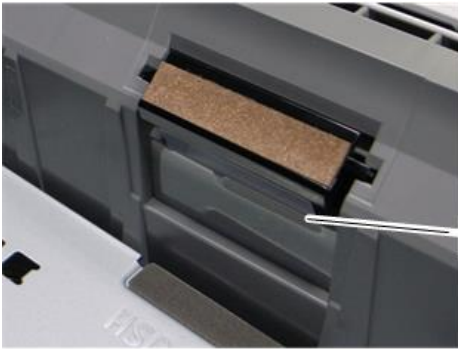

g163r573a

By-pass Separation Pad

1. Pull out tray 1.

2. Remove the by-pass feed unit [A] (⌀ x 4).

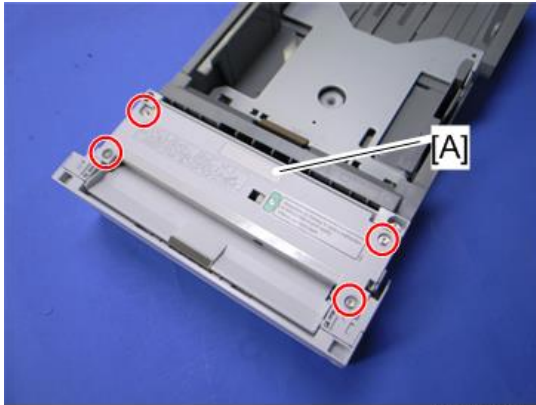

g163r713

3. Remove the by-pass separation pad [B].

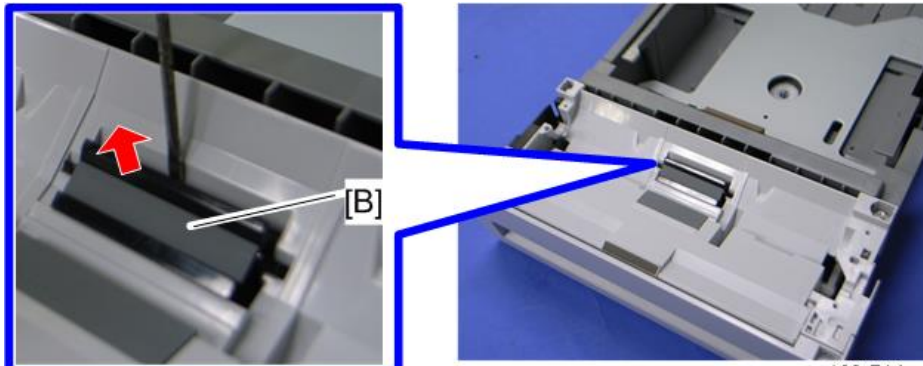

g163r714a

By-pass Pick-up and Feed Rollers

By-pass Pick-up Roller

1. Pull out tray 1.
2. Remove the by-pass feed unit. (page 76 "By-pass Separation Pad")

3. Remove the clip [A].

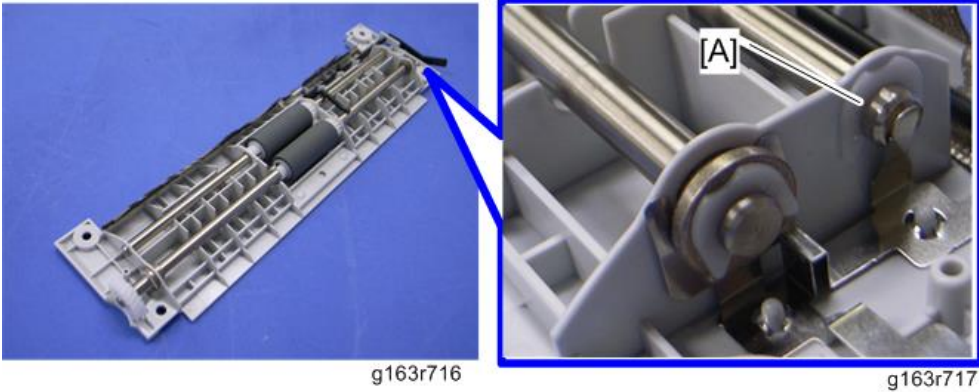

4

4. Pull out the by-pass pick-up roller shaft [B] (bushing x 1).

5. Remove the pick-up roller [C].

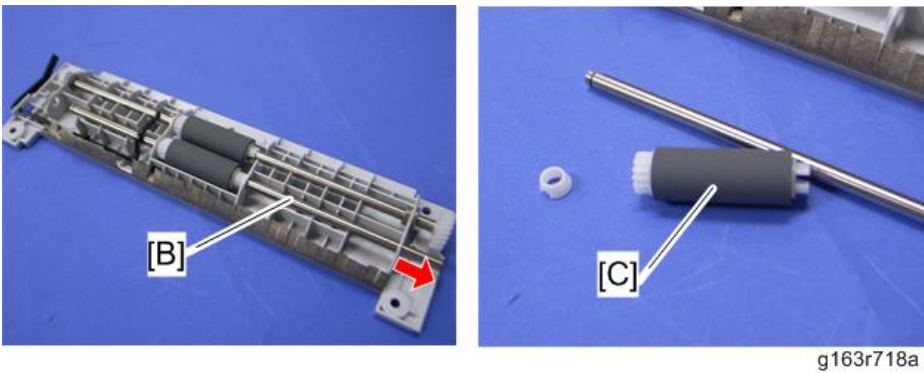

By-pass Feed Roller

1. Pull out tray 1.
2. Remove the by-pass feed unit. (page 76 "By-pass Separation Pad")

3. Remove the bushing [A] at the by-pass feed roller shaft (⌀ x 1).

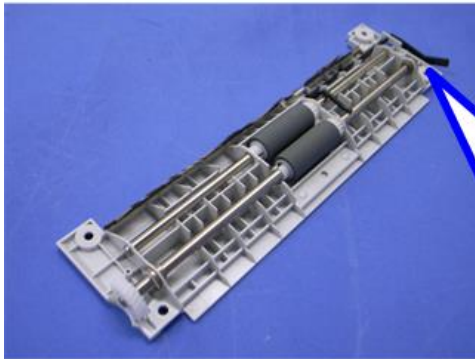

g163r716a

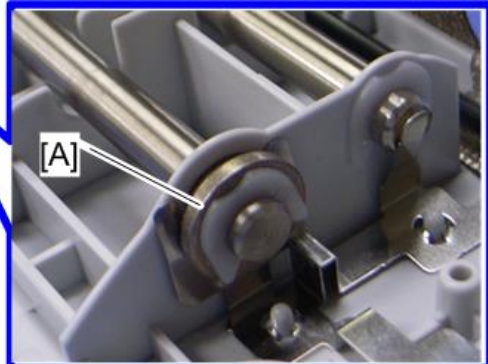

g163r717a

4. Pull out the by-pass feed roller shaft [B] (bushing x 1).
5. Remove the pick-up roller [C].

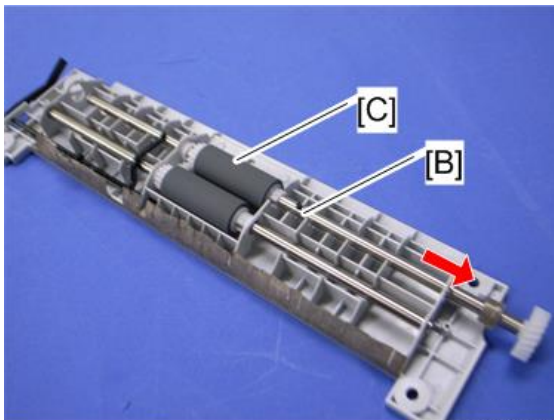

g163r720

When installing the by-pass pick-up and feed rollers

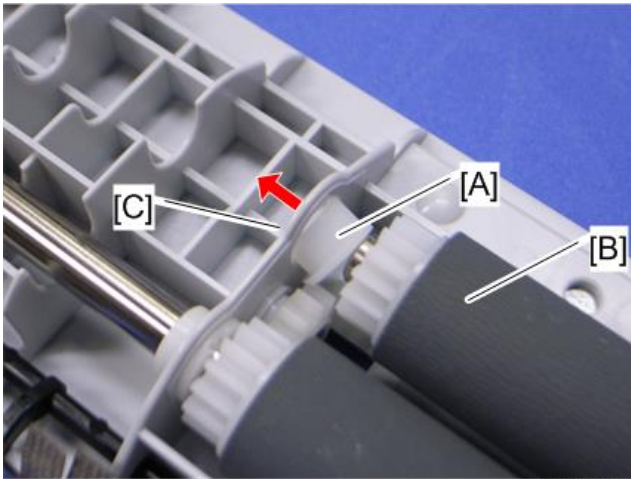

g163r721

Make sure that the small plastic bushing [A] is correctly inserted between the pick-up or feed roller [B] and roller support plate [C].

Paper End Sensor

1. Remove the rear cover. (page 34 "Rear Cover")
2. Remove the right cover. (page 36 "Right Cover")
3. Remove the paper end sensor assembly [A] (⚙️ x 1, 📄 x 1).

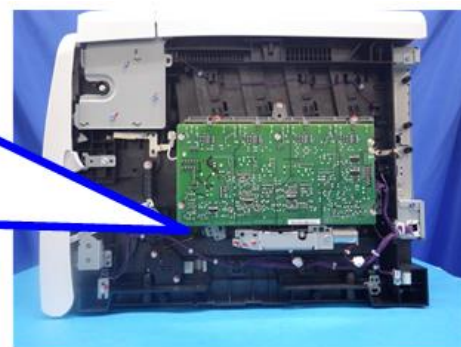
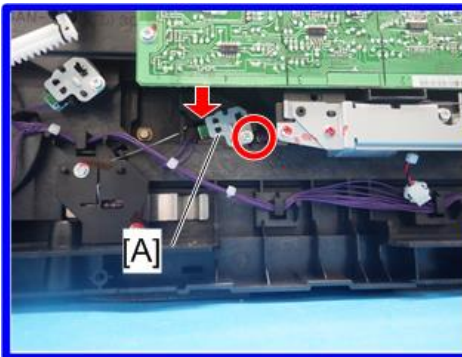

m0aga0035

4. Paper end sensor [B] (hooks)

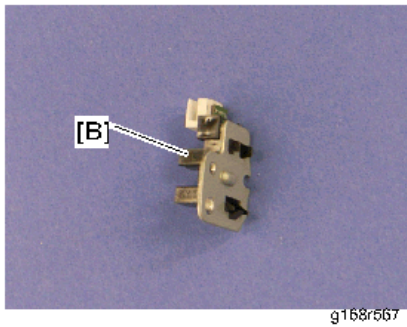

By-pass Paper End Sensor

4

1. Pull out the tray.
2. Remove the rear cover. (page 34 "Rear Cover")
3. Remove the right cover. (page 36 "Right Cover")
4. Remove the by-pass paper end sensor bracket [A] (🔧 x 1, 📏 x 1).

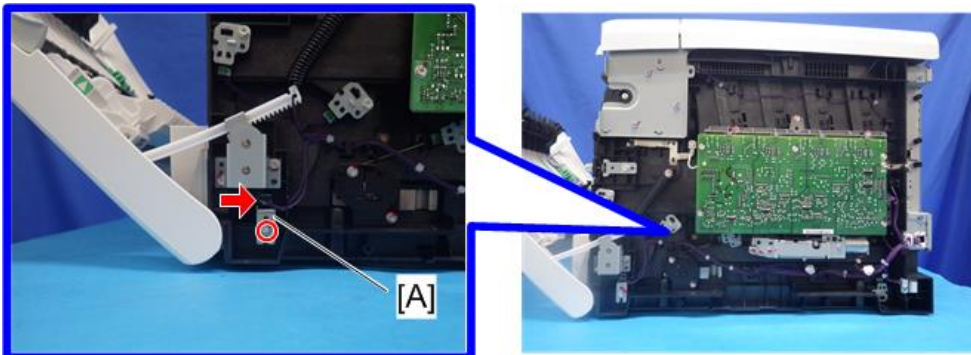

m0aga0036

5. Remove the by-pass paper end sensor [B] (hooks).

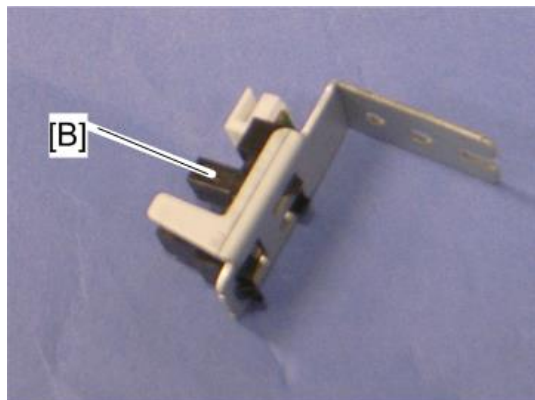

m075r620

Paper Exit Sensor

1. Remove the operation panel. (page 35 "Operation Panel")
2. Remove the sheet at the bottom of the paper exit sensor.
3. Remove the paper exit sensor [A] (hooks,  x 1).

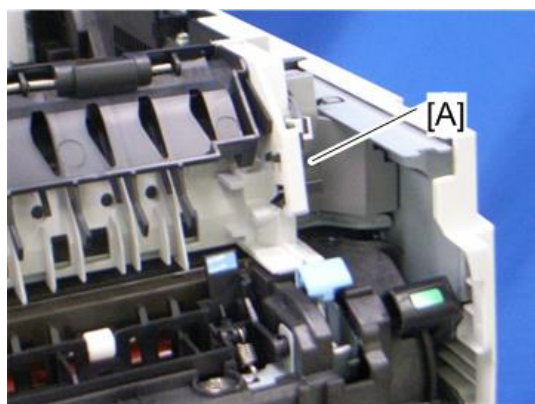

m075r576

Electrical Components

Operation Panel Board Unit (SP C340DN)

1. Remove the operation panel. (page 35 "Operation Panel")
2. Remove the eco night sensor [A] (🔧 x 1, hooks)
3. Remove the harness [B] (🔧 x 1)
4. Remove the operation panel board unit [C]

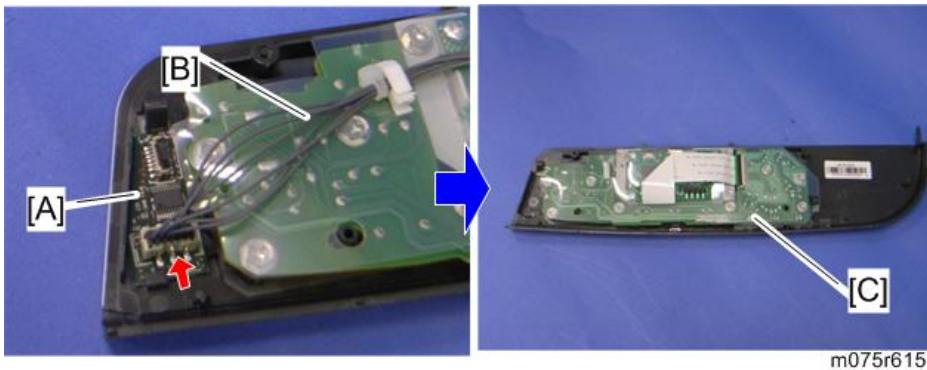

4

Eco Night Sensor (SP C340DN)

1. Remove the operation panel. (page 35 "Operation Panel")
2. Remove two screws on the bottom of the operation panel.
3. Remove the operation panel cover [A] (hooks).

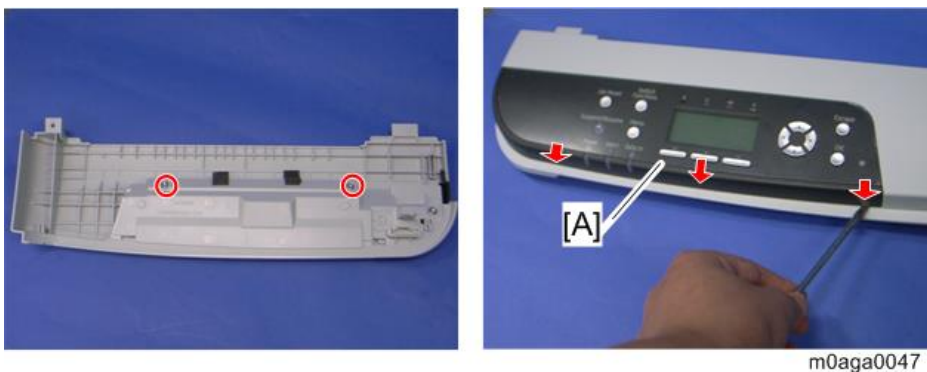

4. Remove the eco night sensor [B] (🔧 x 1, hooks).

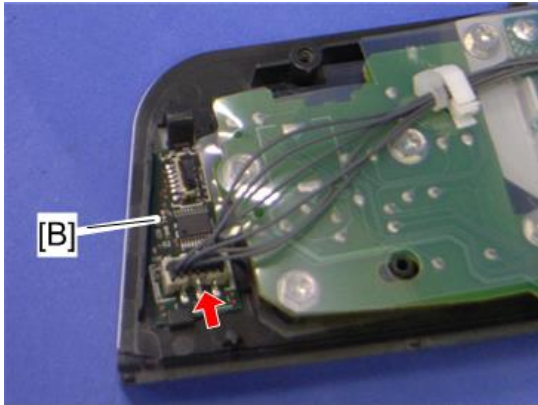

m075r614

4

Operation Panel Board Unit (SP C342DN)

1. Remove the operation panel. (page 35 "Operation Panel")
2. Remove the operation panel bottom cover [A] (🔧 x 9).

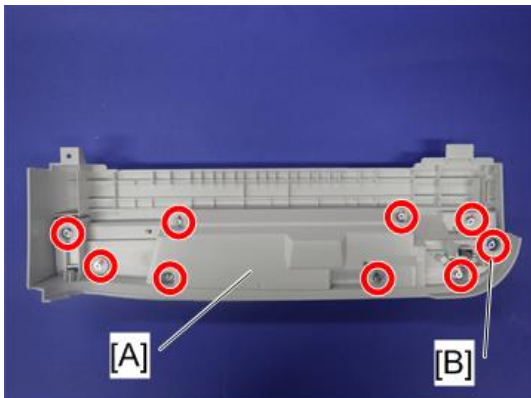

m0aga0038

↓ Note

- Rightmost screw [B]: M3x6 (blue), others: M3x10

3. Remove the operation panel left arm cover [A] (⚙️ x 1).

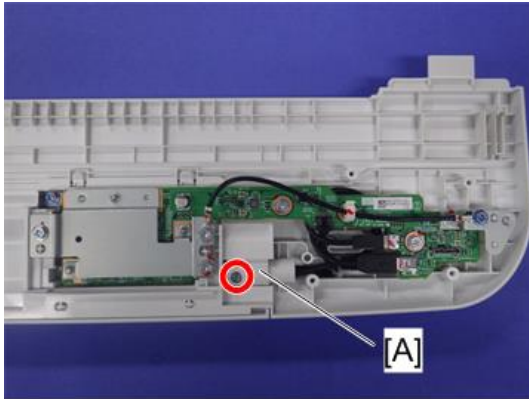

m0aga0039

4. Remove the media slot board. (page 87 "Media Slot Board (SP C342DN)")
5. Remove the operation panel right arm cover [A] (⚙️ x 1).

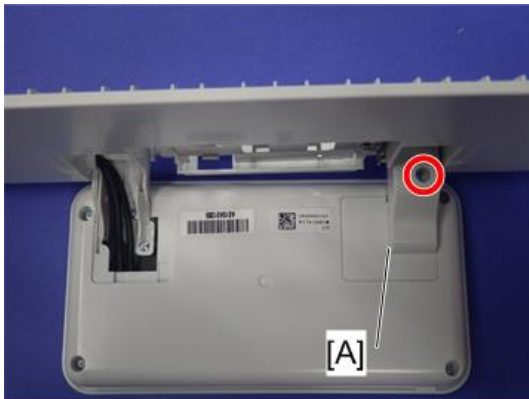

m0aga0040

6. Remove the LCD panel rear cover [A] (🔩 x 10, 📏 x 3)

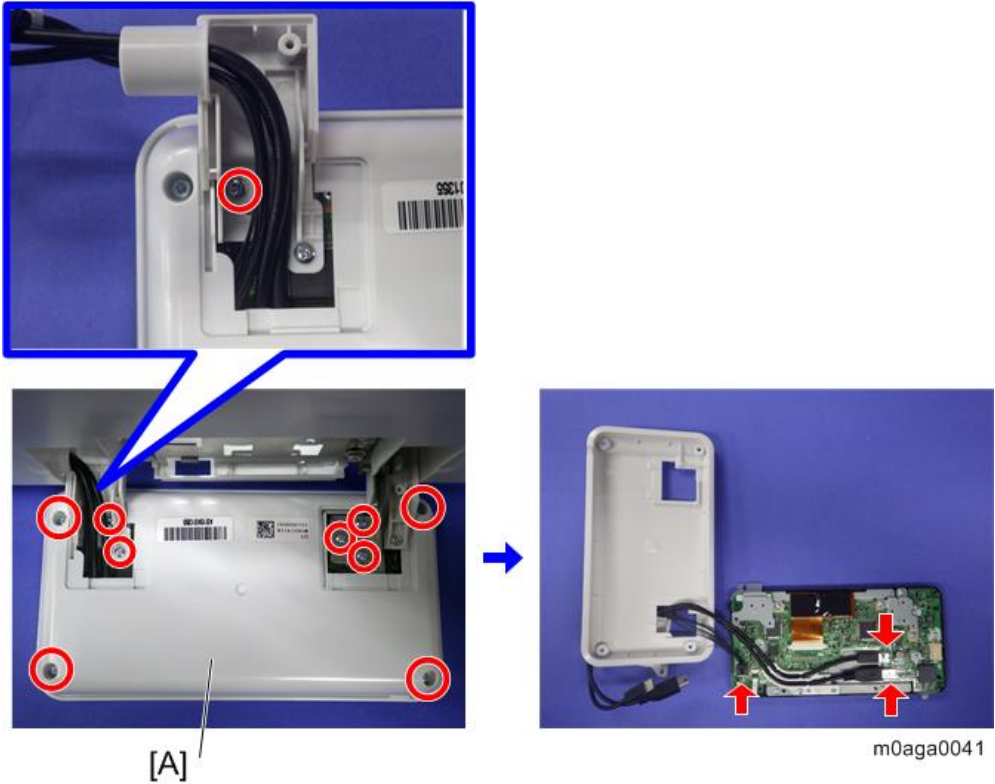

7. Remove the brackets [A] (🔩 x 7).

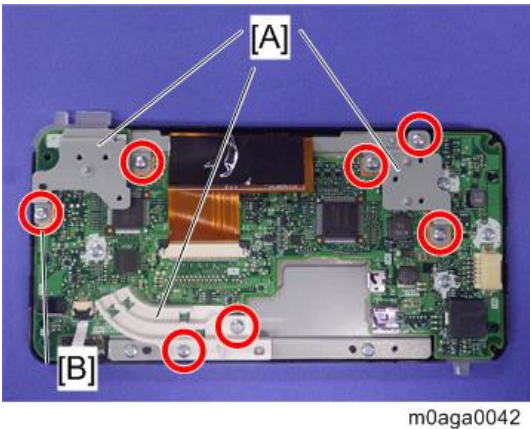

⬇️ Note

- Leftmost screw [B]: 2x6 tapping screw, others: M2x3

8. Remove the operation panel board [A] (⚙️ x 5, 📱 x 2).

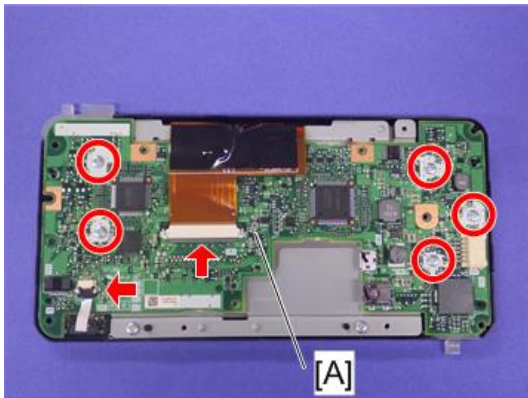

m0aga0043

Eco Night Sensor (SP C342DN)

1. Remove the operation panel board. (page 84 "Operation Panel Board Unit (SP C342DN)")
2. Remove the eco night sensor [A]. (📱 x 1)

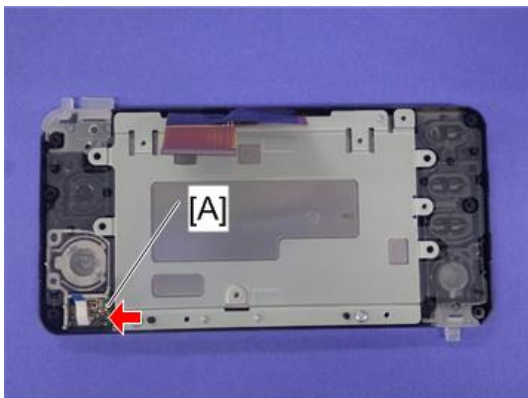

m0aga0044

Media Slot Board (SP C342DN)

1. Remove the operation panel. (page 35 "Operation Panel")

2. Remove the operation panel bottom cover [A] (🔩 x 9).

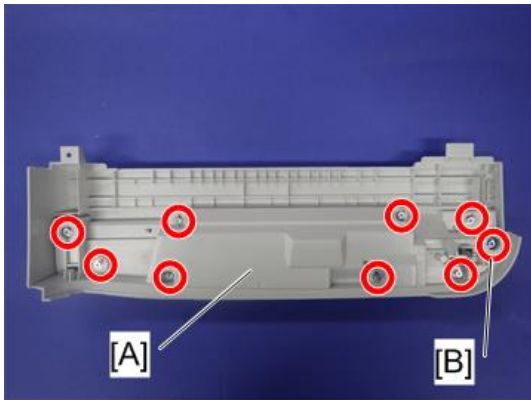

m0aga0038

↓ Note

- Rightmost screw [B]: M3x6 (blue), others: M3x10

3. Remove the media slot board with bracket [A] (🔩 x 7, 📏 x 3, 📏 x 1).

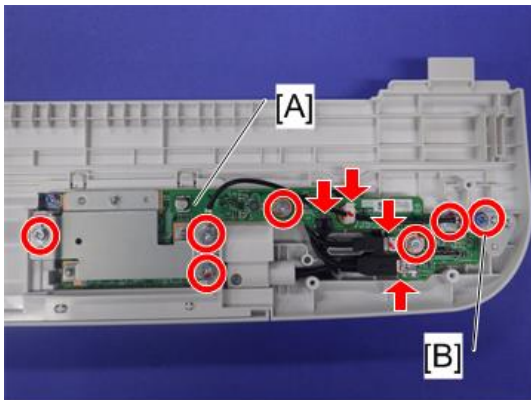

m0aga0045

↓ Note

- Rightmost screw [B]: M3x6 (blue), others: M3x10

4. Remove the media slot board [A] from the bracket [B] (⚙ x 3).

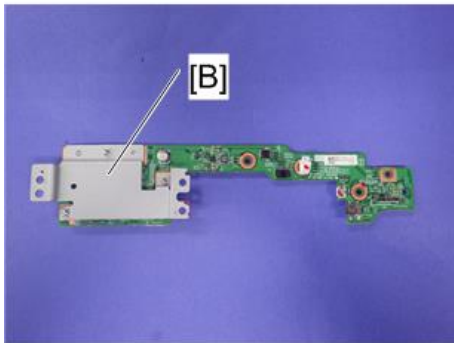
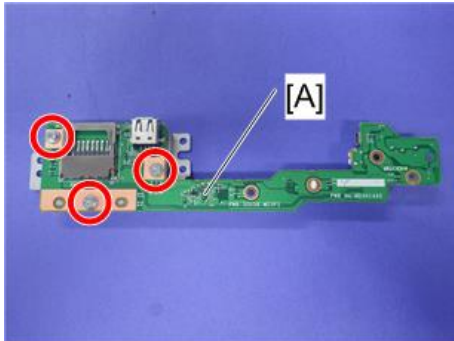

m0aga0046

4

Controller Board

★ Important

- Always touch a grounded surface to discharge static electricity from your hands before you handle SD cards, printed circuit boards, NVRAM or memory boards.
1. Check if the optional HDD is installed. If it is, remove it.
 2. Remove the rear cover. (page 34 "Rear Cover")

3. Controller box cover [A] (🔩 x 10)

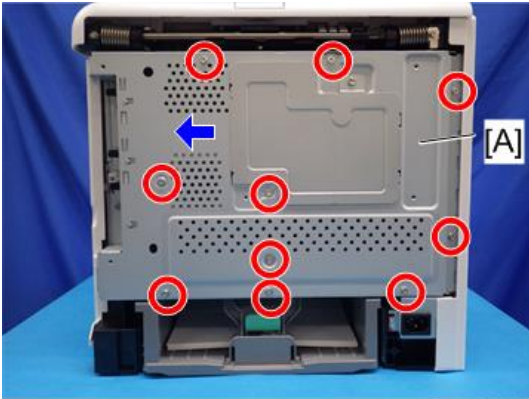

m0aga0048

4

4. Interface bracket [A] (🔩 x4)

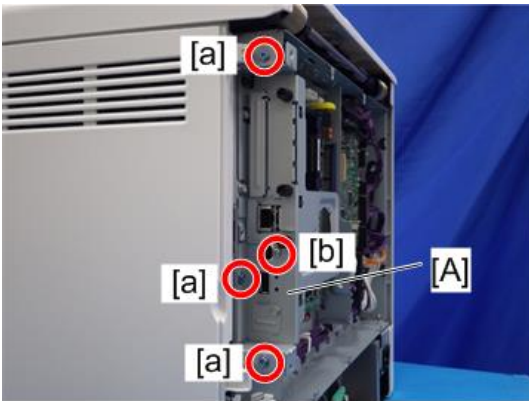

m0aga0049

- [a]: M3x6 tapping (blue)
- [b]: M3x6 tapping blind

5. Controller board unit [A] (⚙ x 4)



m0aga0050

6. Remove the rails [A].

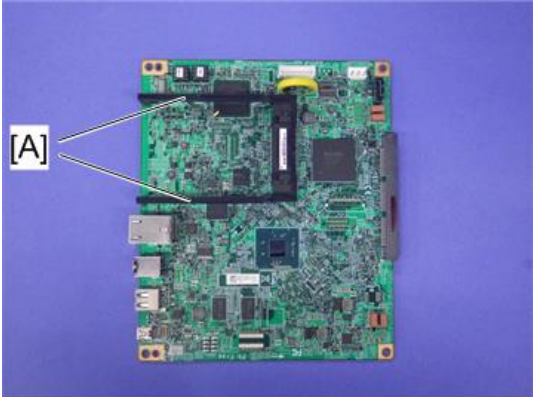

m0aga0051

7. Remove the NVRAMs [A] from the controller board [B].

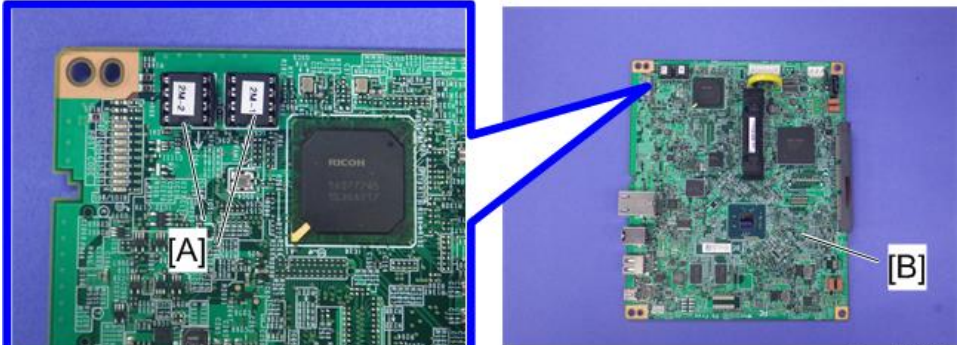

m0aga0052

When installing the new Controller Board

1. Remove the NVRAMs from the old controller board.
2. Install the NVRAM with the "1" label in the right-hand slot on the new controller board with the mark [A] pointing downward.

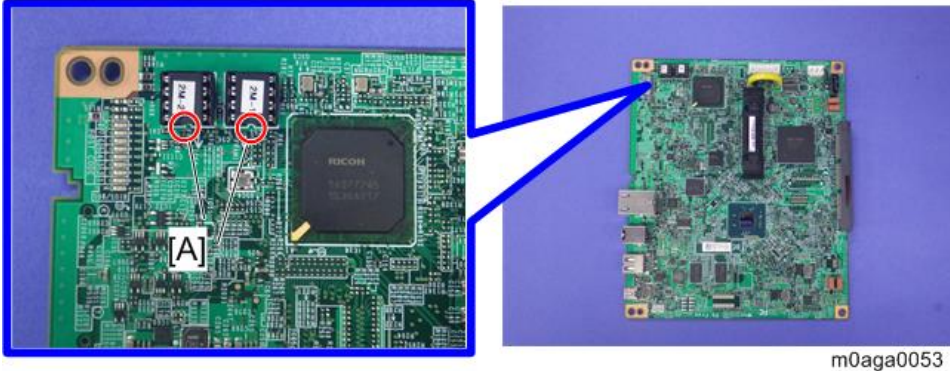

3. Install the NVRAM with the "2" label in the left-hand slot on the new controller board with the mark [A] pointing downward.
4. Replace the NVRAMs if the NVRAMs on the old controller board are defective.

⚠ CAUTION

- Keep the NVRAMs away from objects that can cause static electricity. Static electricity can damage NVRAM data.
- Make sure that NVRAM 1 is correctly installed in the right-hand slot and NVRAM 2 is correctly installed in the left-hand slot on the controller board. Otherwise, the machine will not operate.

EGB (Engine Board)

★ Important

- Always touch a grounded surface to discharge static electricity from your hands before you handle SD cards, printed circuit boards, EEPROM or memory boards.
1. Remove the controller board. (page 89 "Controller Board")

2. Remove the EGB [A] (⚙️ x 6, 🛠️ x all).

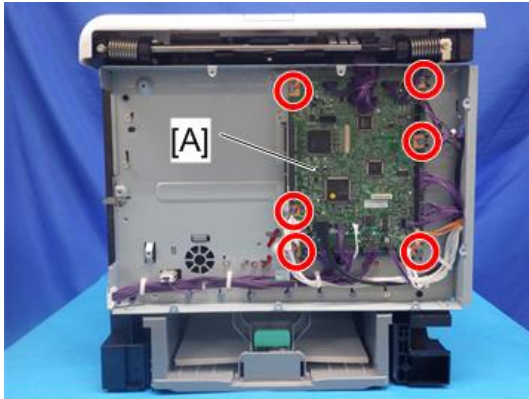

m0aga0054

3. Remove the EEPROM [A].



m0aga0055

When installing the new EGB

1. Remove the EEPROM from the old EGB.

2. Install the old EEPROM on the new EGB with the mark [A] pointing as shown below.

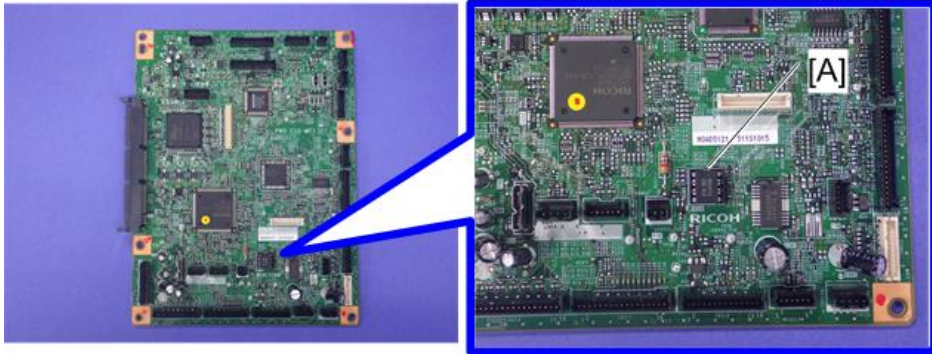

m0aga0056

4

3. Replace the EEPROM if the EEPROM on the old EGB is defective.

⚠ CAUTION

- Keep the EEPROM away from objects that can cause static electricity. Static electricity can damage EEPROM data.
- Make sure that the EEPROM is correctly installed on the EGB.

Fuses on the EGB

See below for the locations and specifications of fuses on the EGB.

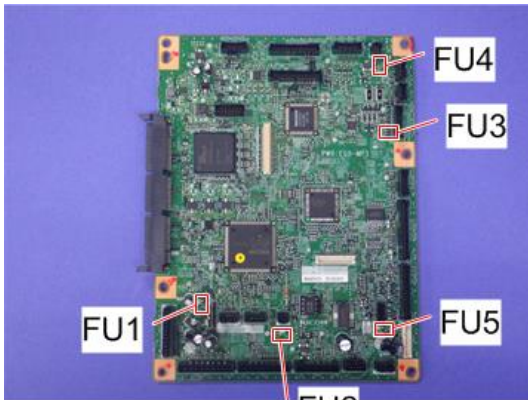



m0aga0073

Address	Rated voltage	Rated current
FU1	36 V	2.0 A
FU2	36 V	0.8 A
FU3	36 V	2.0 A

Address	Rated voltage	Rated current
FU4	36 V	2.0 A
FU5	36 V	2.0 A

Interlock Switches

1. Remove the operation panel. (page 35 "Operation Panel")
2. Remove the rear cover. (page 34 "Rear Cover")
3. Remove the left cover. (page 36 "Left Cover")
4. Remove the spring [A].
5. Remove the interlock switch base [B] ( x 4,  x all).

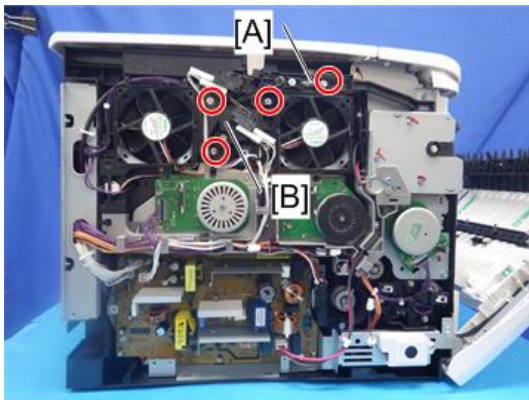

m0aga0057

↓ Note

- Remove all connectors after the interlock switch base has been removed.

6. Remove two interlock switches [C] at the outside of the base and one interlock switch [D] at the inside of the base (hooks).

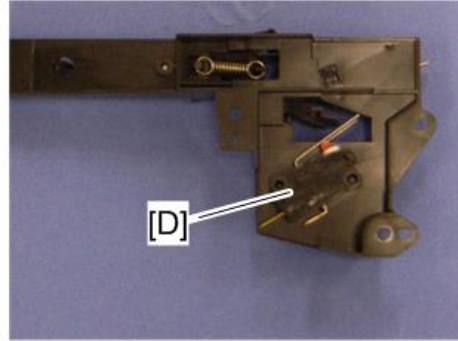
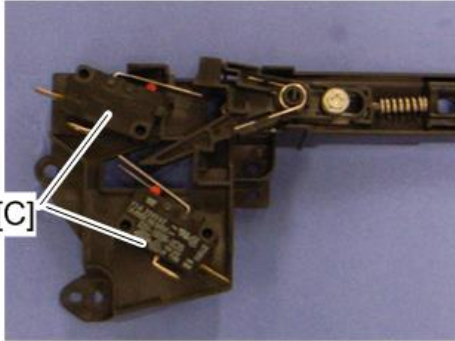

g165r620a

Fusing Fan Motor

1. Remove the interlock switch base. (page 95 "Interlock Switches")
2. Remove the fusing fan base [A] (🔧 x 2, 📏 x 1).

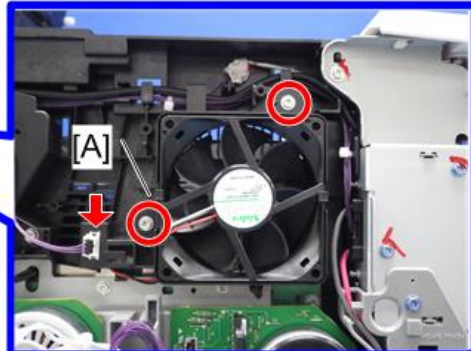
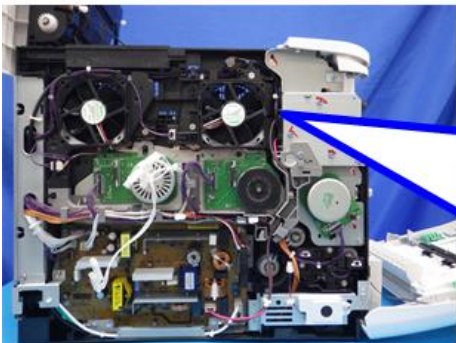

m0aga0058

3. Remove the fusing fan motor [B] (hooks,  x 1).

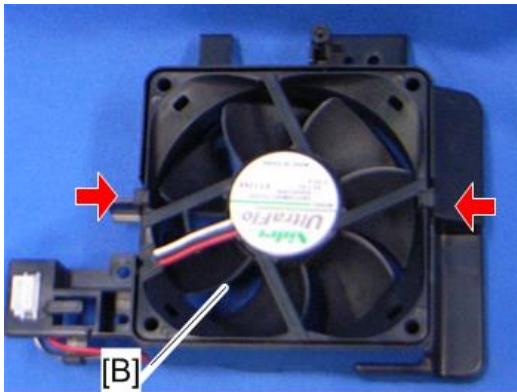

g163r624

CAUTION

- Install the fusing fan motor with its decal facing the outside of the machine.
- Make sure the fan cable is facing the correct direction (note the correct direction before you remove the fan). Note that the fusing fan motor label should be upside down.

LSU Fan Motor

1. Remove the rear cover. (page 34 "Rear Cover")
2. Remove the left cover. (page 36 "Left Cover")
3. Remove the LSU fan motor [A] (hooks,  x 1)

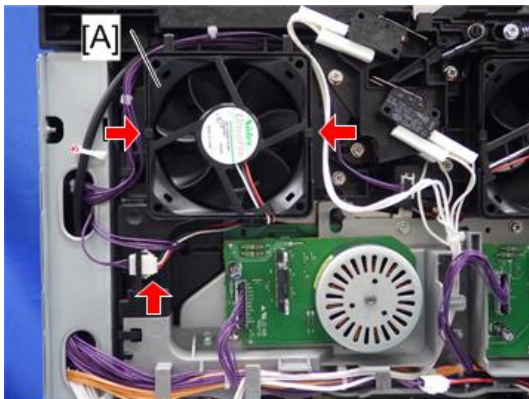

m0aga0059

CAUTION

- Install the LSU fan motor, orienting it as shown in above photo, with its decal facing the outside of the machine.

- When reinstalling the LSU fan motor, make sure that its cable is oriented as shown above and that the decal is visible. (If the decal is not visible, the motor is installed backwards.)

ID Chip Board

1. Remove the left cover. (page 36 "Left Cover")
2. Remove the controller box cover. (page 89 "Controller Board")
3. Disconnect the connector (CN308) on the EGB (🔧 x 1).
4. Remove the interlock switch base. (page 95 "Interlock Switches")
5. Remove the fusing fan base. (page 96 "Fusing Fan Motor")
6. Take the harnesses aside around the LSU fan base [A].
7. Remove the LSU fan base [A] (🔧 x 2, 📏 x 1)

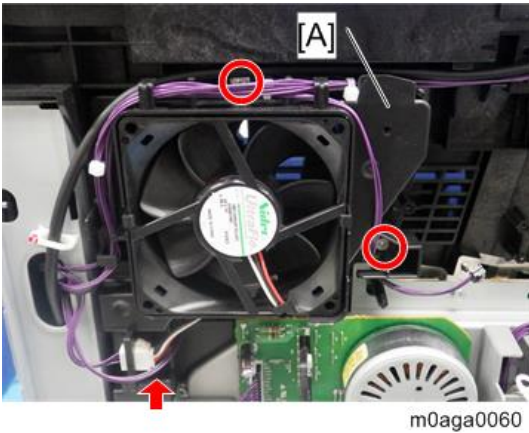

8. Remove the drive unit. (Black AIO Motor)
9. Remove the ID Chip Board [A] (🔧 x 3, 📏 x 1).

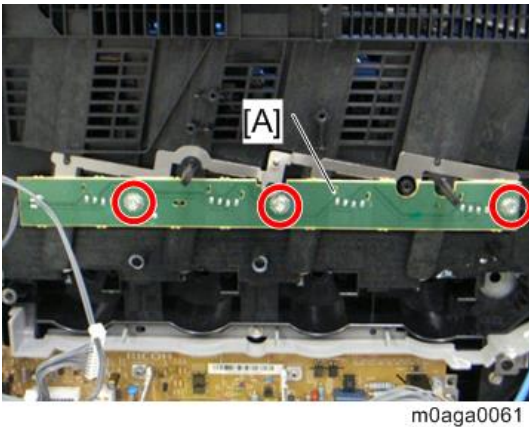

PSU

⚠ CAUTION

- Turn off the main power switch and unplug the power cord before replacing the PSU.
- Do not touch the areas outlined in red in the following diagrams when replacing the PSU. Residual charge on the board may cause electric shock.
 - NA models

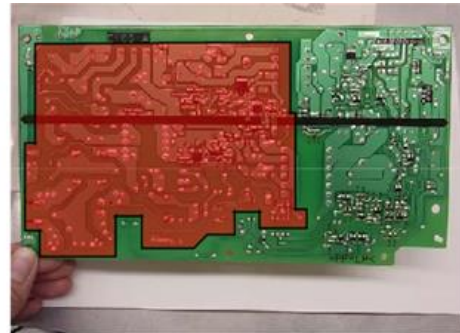
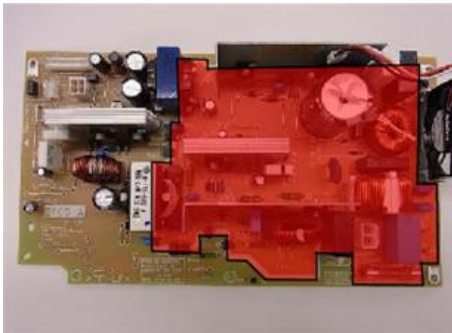

m0ada0001

- EU/AA models

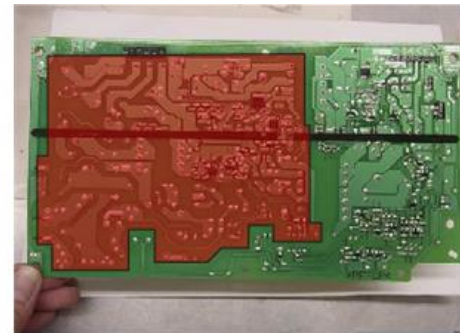
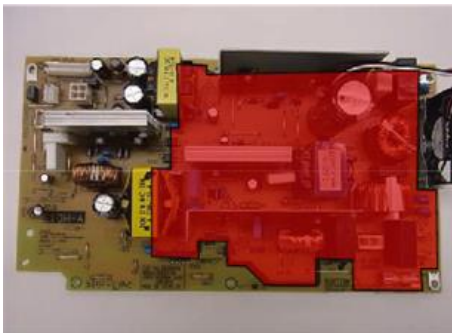

m0aga0080

1. Remove the rear cover. (page 34 "Rear Cover")
2. Remove the left cover. (page 36 "Left Cover")
3. Remove the ground cable [A] (⚡ x 1).

4. Remove the power cord bracket [B] (⚙️ x 2)

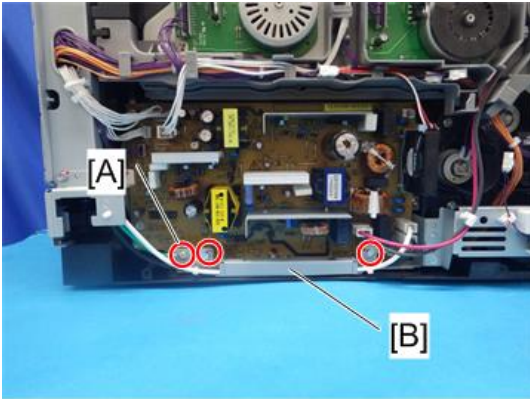

m0aga0062

5. Remove the AC inlet assembly [A] (⚙️ x 3, 🛠️ x 2).

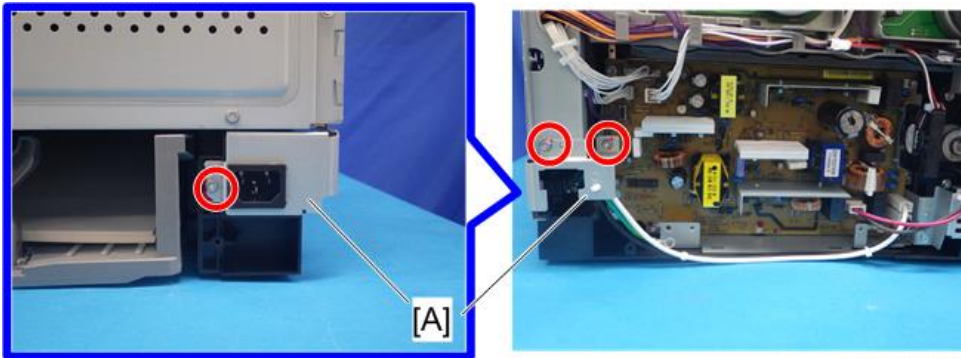

m0aga0063

6. Remove the power switch assembly [A] (⚙️ x 3, 🛠️ x 2, 🛠️ x 1)

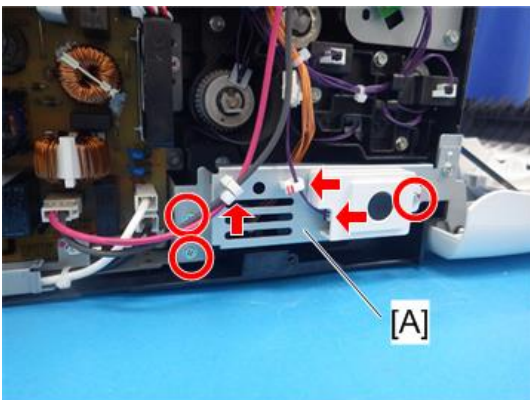

m0aga0064

7. Remove the PSU bracket [A] (⚙️ x 4, 🛠️ x all).

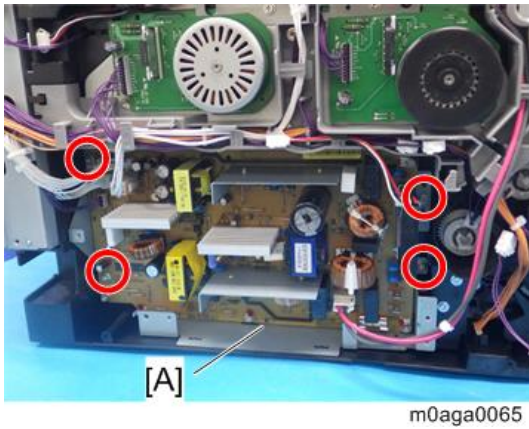

8. Remove the PSU [A] (x 5)

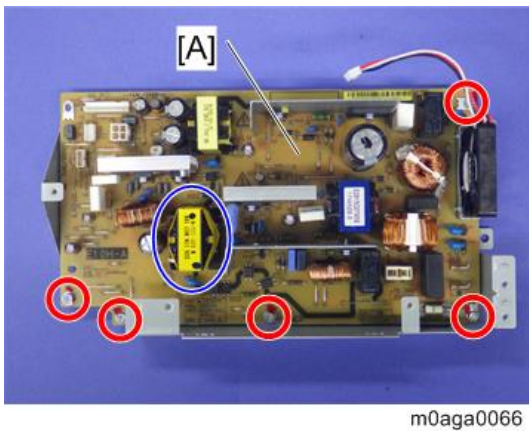

★ Important

- There are two types of PSUs for this model. Do not install the wrong PSU in the machine.
- The PSU with a yellow transistor (circled in blue in the above photo) is for EU/ASIA models and the PSU with a white transistor is for NA models.



m0aga0081

4

Fuse

There is a removable fuse on the PSU.

Fuse No.	Rating
FU101: NA	15 A, 250V
FU101: EU, ASIA	6.3A, 250V

⚠ CAUTION

- Use the correct rating fuse for the fuse replacement. Do not use a fuse of the wrong rating, or the machine may be damaged.
- Never try direct connection of PSU circuit without a fuse.

High Voltage Power Supply Board

1. Remove all AIO cartridges.
2. Remove the right cover. (page 36 "Right Cover")

3. Remove the High Voltage Power Supply Board [A] (⚙️ x 7, ground cable x 1, 📡 x 1)

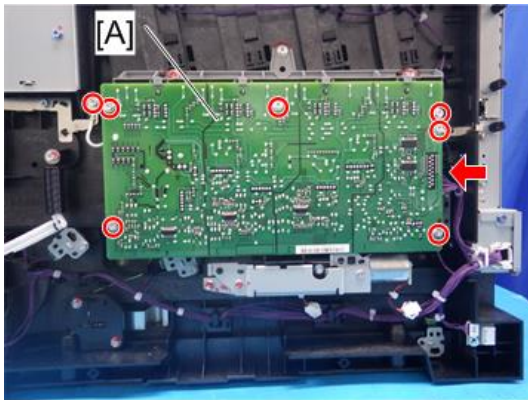

m0aga0067

4

Temperature/Humidity Sensor

1. Remove the right cover. (page 36 "Right Cover")
2. Remove the temperature/humidity sensor [A] (⚙️ x 1, 📡 x 1)

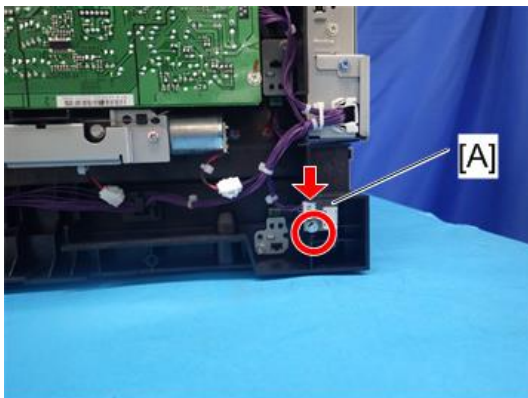

m0aga0068

Tray Set Sensor

1. Remove the right cover. (page 36 "Right Cover")

2. Remove the tray set sensor assembly [A] (🔧 x 1, 📏 x 1).

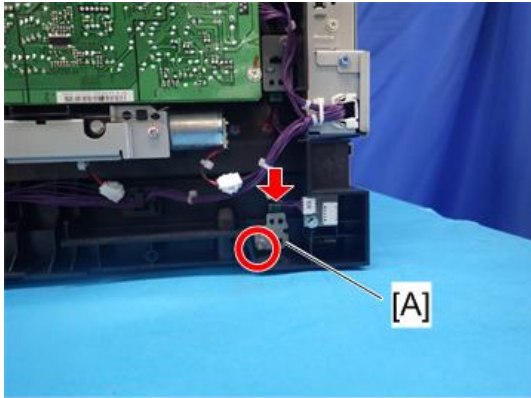

m0aga0069

3. Remove the tray set sensor [B] (hooks)

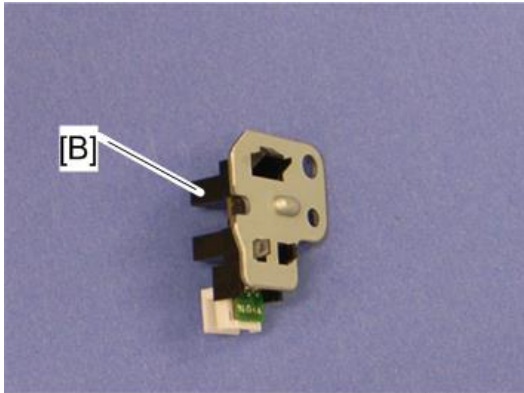

g168r562a

NVRAM/EEPROM

Note

- The following procedures explain how to replace a defective NVRAM/EEPROM. For how to move an existing (not defective) NVRAM/EEPROM to a new EGB (Engine Board) or Controller Board, refer to the "EGB (Engine Board)" or "Controller Board" replacement procedures.

When replacing an old NVRAM/EEPROM with a new one, a setting is required. Follow the procedure described below.

NVRAM on the Controller

1. Insert an SD card in the lower SD slot.
2. Plug in, and then turn on the main power switch.

3. Start the SP mode.
4. Use SP5-990 to print out the SMC reports ("SP Mode Data" and "Logging Data") if possible.
5. Use SP5-824-001 to upload the NVRAM data if possible.
6. Turn off the main power switch and unplug the power cord.
7. Remove the SD card from the lower SD slot.
8. Replace the NVRAM on the controller and reassemble the machine.
9. Insert the SD card in the lower SD slot.
10. Plug in the power cord.
11. Turn on the main power switch.
12. Start the SP mode.
13. Use SP5-825-001 to download the NVRAM data if possible. If it can be done, the following steps are not required.
14. Use Memory Clear (SP5-801) to reset this data:
 - SCS (SP5-801-003)
 - PRT (SP5-801-008)
 - NCS (SP5-801-011)
15. Do Counter Clear (SP7-810).
16. Make these contract-related settings:
 - Counter Method (SP5-045)
 - Telephone Number Setting > Fax Telephone Number (SP5-812-002) if the meter charge mode (SP5-930-001) is "ON" (enabled)
17. Enter the SP mode changes previously made at the factory and the field.

EEPROM on the EGB (Engine Board)

For this procedure, you must know the device number and the destination code (step 8).

1. Start the SP mode.
2. Use SP5-990 to print out the SMC reports ("SP Mode Data" and "Logging Data") if possible.
3. Turn off the main power switch and unplug the power cord.
4. Replace the EEPROM on the EGB and reassemble the machine.
5. Plug in the power cord.
6. Turn on the main power switch.
7. Start the SP mode.
8. Contact your supervisor to enter the machine's device number.

 **Note**

- SC542 may be displayed until the machine's device number and destination code are programmed properly.
9. Turn the main power switch off and on.
 10. Start the SP mode.
 11. Use SP5-801-002 to reset the engine settings.
 12. Reset the meter charge settings (SP5-930-001).
 13. Enter the SP mode changes previously made at the factory and the field.
 14. Replace all maintenance kits with new ones.

5. Service Maintenance Reference

Service Program

See "Appendices" for the followings;

- Service SP
- Engine SP

Configuration Page Information

Overview

The configuration page for this model has information about the machine's status. Print this sheet as shown below. Check the configuration page when doing machine maintenance.

To Print the Configuration Page from the Machine

Before turning on the machine

1. Hold down the "OK" key, and then turn on the main switch of the printer while holding down the "OK" key.
2. Keep holding down the "OK" key for approximately 5 seconds.

When the machine power is on

1. Press the "Menu" key.
2. Press the "▲" or "▼" key to select "List/Test Print", and then press the "#Enter" key.
3. Press the "#Enter" key at "Config. Page".

Firmware Update

To update the firmware for this machine, you must have the new version of the firmware downloaded onto an SD (Secure Digital) Card. The SD Card is inserted into SD Card Slot 2 (lower slot) on the right side of the controller box.

Types of Firmware

There are several types of firmware as shown below.

Type of firmware	Function	Location of firmware	Message shown
Engine	Printer engine control	EGB Flash ROM	Engine
System	Operating system	Controller flash ROM	System
NFA	Feature application		NFA
WebSystem	Web Service application		Web Support
Netfile Application	Feature application		Network DocBox
NIB/DESS	Network interface/Security control		Network Support
Printer (EXP)	Feature application		Printer
RPCS (EXP)	Feature application		RPCS
Summary Font (EXP)	Font		Font EXP
PS3	PS3 language		PS3

PDF	PDF language	Controller flash ROM	PDF
PS3 Font	Font		PS3 Font
PCL (EXP)	Feature application		PCL
PCL Font	Font		PCL Font
Power Saving Sys	Power saving control		Power Saving Sys
Operation Panel*	Operation panel control		OpePanel
Operation Panel Font*	Font		OpeFont
Animation*	Animation		animation
Data Erase	HDD overwrite security application		Data Erase Onb
PictBridge*	PictBridge control	PictBridge SD card	Option PctBrdg
Device-SDK*	SDK application	VM card	SDK

* SP C342DN only.

Before You Begin

An SD card is a precision device. Always observe the following precautions when you handle SD cards:

- Always switch the machine off before you insert an SD card. Never insert the SD card into the slot with the power on.
- Do not remove the SD card from the service slot after the power has been switched on.
- Never switch the machine off while the firmware is downloading from the SD card.
- Keep SD cards in a safe location where they are not exposed to high temperature, high humidity, or exposure to direct sunlight.
- Always handle SD cards with care. Do not bend or scratch them. Do not let the SD card get exposed to shock or vibration.
- Make sure that the write protection of an SD card is unlocked when you download an application to it. If not, downloading fails and a download error (e.g. Error Code 44) occurs during a firmware upgrade.

Keep the following points in mind when you use the firmware update software:

- "Upload" means to send data from the machine to the SD card. "Download" means to send data from the SD card to the machine.

- To select an item on the LCD, press the appropriate key on the operation panel.
- Make sure that the machine is disconnected from the network to prevent a print job for arriving while the firmware update is in progress before you start the firmware update procedure.

Updating Firmware

File Arrangement

How the Program Works:

The firmware-update program for this machine searches the folder romdata for necessary firmware. When you save the firmware in an SD card, make the folder 'romdata'. You must not make the folder 'romdata' in another folder.

↓ Note

- Do not make another firmware-update program folder in the folder 'romdata'.
- Otherwise, it may cause a malfunction for the firmware updating. You just keep only one firmware update program folder in the folder 'romdata'.

The firmware program contains the file information. Before downloading the firmware from an SD card, the firmware-update program reads the file information. The firmware is downloaded only when the file information is correct.

↓ Note

- The file information can identify the firmware, but this information does not guarantee that the data is not corrupted.

Example

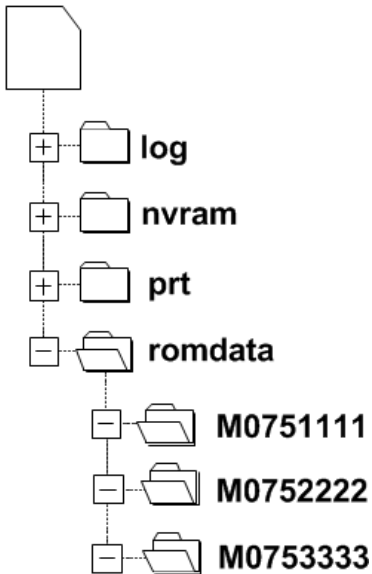

m075s901a

When you save the firmware, we recommend that you arrange folders and files as follows:

- In the folder romdata, make only one folder and use this folder for one model. Use the machine code as the name of this folder.
- When you save some files other than firmware, make a new folder outside romdata. Save the files in this folder. Do not save any file outside the folders. (The diagram shows an example. Three folders, log, nvramdata, and prt, are outside romdata. These folders can store debug logs, NVRAM data, and captured files respectively.)

Update Procedure

1. Turn off the main power switch.
2. Disconnect the printer from the network.
3. Remove the SD slot cover from SD slot 2 (🔑 x 1).

↓ Note

- Do not use slot 1 (upper slot). Slot 1 is for customer use.
4. Turn the SD card face to the rear side of the printer, and insert it into slot 2.
 5. Slowly push the SD card into the slot until it clicks.
 6. Make sure that the SD card is locked in place.

Note

- To remove the SD card, push it in until it clicks, and release it slowly. The slot pushes out the SD card.

7. Open the front cover of the machine.
8. Turn on the main power switch.
9. Wait until a firmware name is shown on the display (about 1 minute).

Note

- The firmware name is read from inside the firmware. The firmware name is not changed even if you change the file name on your PC.

10. If the necessary firmware name is shown on the display, check the firmware version with the left-arrow or right-arrow keys. Pressing the left or right-arrow key shows a firmware name, firmware version and serial number in order.
11. To use a different firmware, push the up-arrow key or the down-arrow key to find the necessary firmware.

Note

- Controller, engine and operation panel firmware cannot be updated at the same time. It is recommended to update firmware modules one by one.

12. To select the firmware, push the OK key. Make sure that the selected firmware is highlighted.
13. If you update more than one firmware program at the same time, find each of them and select each of them. Make sure that the selected firmware is highlighted.

Note

- If the customer has used all of the slots, you have to keep an empty slot for this procedure. Ask the customer to temporarily remove the SD card in slot 2.

14. To start firmware update, push the "UpDate" key. While each firmware is downloaded, the underscores on the operation panel are replaced by stars.
15. Wait until the message "Update done" is shown.
16. Turn off the main power switch.
17. Remove the SD card from the slot 2.
18. Attach the slot cover to the SD card slot 2 (🔑 x 1).
19. Connect the printer to the network physically.
20. Turn on the main power switch.
21. Print the Configuration Page to check that the every firmware is correctly updated: Menu > List/Test Print > Config. Page

Error Handling

An error code is shown if an error occurs during the download. Error codes have the letter "E" and a number. If an error occurs, the firmware is not correctly downloaded; see the error code table (page 116 "Handling Firmware Update Errors") and do the necessary steps. After this, download the firmware again.

Power Failure

If firmware update is interrupted by power failure, the firmware is not correctly downloaded. In this condition, machine operation is not guaranteed. You have to download the firmware again.

NVRAM Data Upload/Download

5

CAUTION

- Turn off the main power switch before you insert or remove an SD card. Make sure that the controller and the EGB are correctly connected.

Uploading NVRAM Data

Copy the data from the NVRAM to an SD card (referred to as "to upload NVRAM data" in this section) before you replace the NVRAM. If you cannot upload NVRAM data, manually input the necessary settings referring to the factory settings sheet stored inside the front door of the mainframe after replacing the NVRAM.

1. Prepare a formatted SD card.
2. Make sure that the write-protection on the SD card is off.
3. Start the SP mode.
4. Select SP5990-001 (ALL (Data List)).
5. Do the SP.
6. See if the SMC Report is correctly output.

Note

- You may need the SMC Report when the machine did not complete an NVRAM data upload or download ("Downloading NVRAM Data") correctly.
7. Go out of the SP mode.
 8. Turn off the main power switch.
 9. Insert an SD card into SD card slot 2.
 10. Turn on the main power switch.

11. Start the SP mode.
12. Select SP5-824-001 (NVRAM Upload).
13. Push the "OK" key. The upload starts.
 - When uploading ends correctly, the following file is made: NVRAM\serial_number.NV where "NVRAM" is the folder name in the SD card and "serial_number.NV" is the file name with the extension ".NV". The serial number of the printer is used as the file name. For example, if the serial number is M0750017, the file name is "M0750017.NV".
14. Go out of the SP mode.
15. Turn off the main power switch.
16. Remove the SD card from SD card slot 2.
17. Install the SD slot cover to SD card slot 2.
18. Mark the SD card with, for example, the machine code. You need this SD card when you download NVRAM data ("Downloading NVRAM Data").

Note

- One SD card can store the NVRAM data from two or more machines.

Downloading NVRAM Data

Copy the data from the SD card to the NVRAM (referred to as "to download NVRAM data" in this section) after you replace the NVRAM. If you cannot download NVRAM data, manually input the necessary settings referring to the factory settings sheet stored inside the front door of the mainframe.

1. Make sure that the main power switch is off. If it is on, turn it off.
2. Make sure that you have the correct SD card that contains the necessary NVRAM data.
3. Insert the SD card into SD card slot 2.
4. Turn on the main power switch.
5. Start the SP mode.
6. Select SP5-825-001 (NVRAM Download).
7. Push the "OK" key. The download starts.

Note

- The machine cannot do the download if the file name in the SD card is different from the serial number of the printer ("Uploading NVRAM Data").
8. Go out of the SP mode.
 9. Turn off the main power switch.
 10. Remove the SD card from SD card slot 2.
 11. Install the SD slot cover on SD card slot 2.

12. Turn on the main power switch.
13. Check that the NVRAM data is correctly downloaded.

★ Important

- This procedure does not download the following data to the NVRAM:
 - Total Count
 - Serial Number

Handling Firmware Update Errors

An error message shows in the first line if an error occurs during a download. The error code consists of the letter "E" and a number ("E20", for example).

5

Error Message Table

Code	Meaning	Solution
20	Cannot map logical address	Make sure the SD card is inserted correctly.
21	Cannot access memory	HDD connection incorrect or replace hard disks.
22	Cannot decompress compressed data	Incorrect ROM data on the SD card or data is corrupted.
23	Error occurred when ROM update program started	Controller program abnormal. If the second attempt fails, replace controller board.
24	SD card access error	Make sure SD card inserted correctly, or use another SD card.
30	No HDD available for stamp data download	HDD connection incorrect or replace hard disks.
31	Data incorrect for continuous download	Insert the SD card with the remaining data required for the download, the re-start the procedure.
32	Data incorrect after download interrupted	Execute the recovery procedure for the intended module download, then repeat the installation procedure.
33	Incorrect SD card version	Incorrect ROM data on the SD card, or data is corrupted.

34	Module mismatch - Correct module is not on the SD card)	SD update data is incorrect. Acquire the correct data (Japan, Overseas, OEM, etc.) then install again.
35	Module mismatch – Module on SD card is not for this machine	SD update data is incorrect. The data on the SD card is for another machine. Acquire correct update data then install again.
36	Cannot write module – Cause other than E34, E35	SD update data is incorrect. The data on the SD card is for another machine. Acquire correct update data then install again.
40	Engine module download failed	Replace the update data for the module on the SD card and try again, or replace the EGB board.
42	Operation panel module download failed	Replace the update data for the module on the SD card and try again, or replace the LCDC.
43	Stamp data module download failed	Replace the update data for the module on the SD card and try again, or replace the hard disks.
44	Controller module download failed	Replace the update data for the module on the SD card and tray again, or replace controller board.
50	Electronic confirmation check failed	SD update data is incorrect. The data on the SD card is for another machine. Acquire correct update data then install again.

SD Card Appli Move

Overview

The service program "SD Card Appli Move" (SP5-873) lets you copy application programs from one SD card to another SD card.

Do not try to copy the VM card or the HDD encryption unit to another SD card.

You cannot run application programs from Slot 2. However you can move application programs from Slot 2 to Slot 1 with the following procedure.

- Make sure that the target SD card has enough space, and put it in slot 1.
- Enter SP5873 "SD Card Appli Move".
- Then move the application from the SD Card in Slot 2 to the card in slot 1.

Note

- Do steps 1-2 again if you want to move another application program.
- Exit the SP mode.

Be very careful when you do the SD Card Appli Move procedure:

- The data necessary for authentication is transferred with the application program from an SD card to another SD card. Authentication fails if you try to use the SD card after you copy the application program from one card to another card.
- Do not use the SD card if it has been used before for other purposes. Normal operation is not guaranteed when such an SD card is used.
- Keep the SD card in a safe place after you copy the application program from the card to another card. This is done for the following reasons:
 1. The SD card can be the only proof that the user is licensed to use the application program.
 2. You may need to check the SD card and its data to solve a problem in the future.

Move Exec

The menu "Move Exec" (SP5-873-001) lets you copy application programs from the original SD card to another SD card.

Important

- **Do not turn ON the write protect switch of the system SD card or application SD card on the machine. If the write protect switch is ON, a download error (e.g. Error Code 44) occurs during a firmware upgrade or application merge.**

1. Turn the main switch off.

2. Make sure that an SD card is in SD Card Slot 1. The application program is copied to this SD card.
3. Insert the SD card with the application program in SD Card Slot 2. The application program is copied from this SD card.
4. Turn the main switch on.
5. Start the SP mode.
6. Select SP5-873-001 "Move Exec."
7. Follow the messages shown on the operation panel.
8. Turn the main switch off.
9. Remove the SD card from SD Card Slot 2.
10. Turn the main switch on.
11. Check that the application programs run normally.

Undo Exec

5

"Undo Exec" (SP5-873-002) lets you copy back application programs from an SD card to the original SD card. You can use this program when, for example, you have mistakenly copied some programs by using Move Exec (SP5-873-001).

★ Important

- **Do not turn ON the write protect switch of the system SD card or application SD card on the machine. If the write protect switch is ON, a download error (e.g. Error Code 44) occurs during a firmware upgrade or application merge.**

1. Turn the main switch off.
2. Insert the original SD card in SD Card Slot 2. The application program is copied back into this card.
3. Insert the SD card with the application program in SD Card Slot 1. The application program is copied back from this SD card.
4. Turn the main switch on.
5. Start the SP mode.
6. Select SP5-873-002 "Undo Exec."
7. Follow the messages shown on the operation panel.
8. Turn the main switch off.
9. Remove the SD card from SD Card Slot 2.

↓ Note

- This step assumes that the application programs in the SD card are used by the machine.
10. Turn the main switch on.

11. Check that the application programs run normally.

Card Save Function

Overview

Card Save:

- The Card Save function is used to save print jobs received by the printer on an SD card with no print output. Card Save mode is toggled using printer Bit Switch #1 bit number 4. Card Save will remain enabled until the SD card becomes full, or until all file names have been used.
- Captures are stored on the SD card in the folder /prt/cardsave. File names are assigned sequentially from PRT00000.prn to PRT99999.prn. An additional file PRT.CTL will be created. This file contains a list of all files created on the card by the card save function.
- Previously stored files on the SD card can be overwritten or left intact. Card Save SD has "Add" and "New" menu items.
 - **Card Save (Add):** Appends files to the SD Card. Does not overwrite existing files. If the card becomes full or if all file names are used, an error will be displayed on the operation panel. Subsequent jobs will not be stored.
 - **Card Save (New):** Overwrites files in the card's /prt/cardsave directory.

Limitation:

- Card Save cannot be used with PJL Status Readback commands. PjL Status Readbacks will not work. In addition they will cause the Card Save to fail.

Procedure

1. Turn the main power switch OFF.
2. Insert the SD card into the service slot (lower) of the controller board. Then turn the power ON.

Note

- To determine which slot is the service slot, please see the service manual.

3. Enter SP mode.
4. Select "Service" and press "OK" button twice.
5. Select "Bit Switch 1" and press "OK" button.

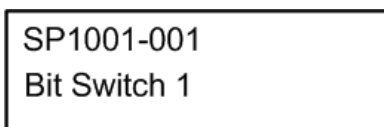

m001t100

- Use the arrow key to turn "Bit Switch 1" and press "OK" and use the arrow key to turn bit 4 to "1 (ON)". The result should look like: **00010000**. By doing this Card Save option will appear in "List/Test Print".

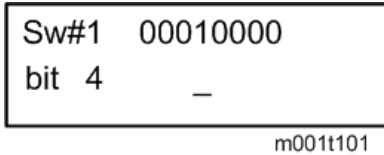

- Press the "Escape" button several times, and use arrow key to select "End" to exit SP Mode.
- Press the "Menu" button.
- Use the arrow key and select "List/Test Print".

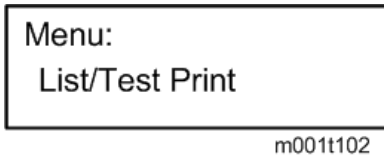

- Use the arrow key and select "Cardsave (ADD) or Cardsave (New)".

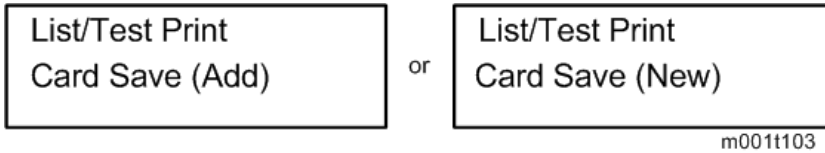

- To enable the newly configured settings, select "#" button and then press the "Escape" button to exit the "List/Test Print" menu.
- Send a job to the printer.
- As soon as the printer receives the data, it will be stored on the SD card automatically with no print output. Nothing is displayed on the screen indicating that a Card Save operation was successful.
- Press the "Suspend/Resume" button and then the "Escape" button to exit Card Save mode.
- Change the Bit Switch Settings back to the default **00000000**.
- Remove the SD card after main power switch is turned off.

Error Messages

Card Save error messages:

- Init error:** A card save process (e.g. card detection, change to kernel mode) failed to initialize.
- Card not found:** Card cannot be detected in the slot.
- No memory:** Insufficient working memory to process the job.
- Write error:** Failed to write to the card.

- **Other error:** An unknown error occurred.

If an error occurs, pressing "OK" will cause the device to discard the job and return to the ready state.

6. Troubleshooting

Error Messages

Overview

The error messages will be displayed on the LCD of the operation panel if the machine has a problem. These can be recovered by a customer.

Error Messages List

000	Cover Open
	The front or top cover is open.
	<ol style="list-style-type: none">1. Close the front or top cover.2. Replace the interlock switches or actuator mechanism.
010	AIO Set Error (Black)
011	AIO Set Error (Magenta)
012	AIO Set Error (Cyan)
013	AIO Set Error (Yellow)
	<ul style="list-style-type: none">• Black AIO not set• Defective connection of the ID chip terminal on the black AIO
	<ol style="list-style-type: none">1. Install the AIO (black, magenta, cyan or yellow).2. Reinstall or replace the AIO (black, magenta, cyan or yellow).
015	ITB (Image Transfer Belt) Unit Set Error
	<ul style="list-style-type: none">• ITB unit not set• The machine does not detect any signal from the TM sensors while the ITB contact motor is initializing.
	Install the ITB unit.

016	Fusing Unit Set Error
	<ul style="list-style-type: none"> Fusing unit not set Disconnected or defective harness of the fusing unit
	<ol style="list-style-type: none"> Install the fusing unit. Check or replace the harness of the fusing unit Replace the fusing unit.
070	Printing Error 1: No Paper
	<ul style="list-style-type: none"> No paper in the tray
	Put paper in the tray.
071	Printing Error 2: Paper Size Error
	<ul style="list-style-type: none"> Paper size mismatch between selected paper size and detected paper size
	Load correct size paper in the tray or select correct paper size.
072	Duplex Error: Job Data Delay
	<ul style="list-style-type: none"> Job data for the 2nd side is not sent to the machine for specified time while paper is fed in the duplex path.
	Send print job data again.
087	Life End: Yellow AIO
	<ul style="list-style-type: none"> Consumed toner exceeds in the toner end limit. Collected toner exceeds in the waste toner limit.
	Replace the yellow AIO
088	Waste Toner Bottle: Near Full
089	Waste Toner Bottle: Full
	<ul style="list-style-type: none"> Waste toner bottle near-full or full
	Replace the waste toner bottle.

090	ITB (Image Transfer Belt) Unit Near End
091	ITB Unit End
	<ul style="list-style-type: none"> ITB unit near end or end
	Replace the ITB unit.
092	Fusing Unit: Near End
	<ul style="list-style-type: none"> Fusing unit near end
	Replace the fusing unit.
999	Color Registration (MUSIC) Error
	<ul style="list-style-type: none"> Color registration (MUSIC) failure
	This error is not displayed even if this error occurs. It is just logged. This error is automatically recovered after the color registration (MUSIC) has been done successfully.

SC Conditions

Summary

This machine issues an SC (Service Call) code if an error occurs on the machine. The error code can be seen on the LCD of the operation panel.

Make sure that you understand the following points;

1. All SCs are logged.
2. At first, always turn the main switch off and on if an SC code is issued.
3. First, disconnect then reconnect the connectors before you replace the PCBs, if the problem concerns electrical circuit boards.
4. First, check the mechanical load before you replace motors or sensors, if the problem concerns a motor lock.
5. Fusing related SCs: To prevent damage to the machine, the main machine cannot be operated until the fusing related SC has been reset by a service representative.
 - How to reset; Execute SP5-810-001 to clear SC541, SC542, SC543, SC545 or SC548.

There are 4 levels of service call conditions.

Level	Definition	Reset Procedure
A	To prevent damage to the machine, the main machine cannot be operated until a service representative has reset the SC.	Do SP 5810, and then turn the main power switch off and on.
B	SCs that disable only the features that use the defective item. Although these SCs are not shown to the user under normal conditions, they are displayed on the operation panel only when the defective feature is selected.	Turn the operation switch or main switch off and on.
C	The SC history is updated. The machine can be operated as usual.	The SC will not be displayed. Only the SC history is updated.
D	Turning the main switch off then on resets SCs displayed on the operation panel. These are redisplayed if the error occurs again.	Turn the operation switch off and on.

Engine SC

SC 2xx (Laser Optics Error)

202 D	<p>Polygon motor error 1: ON timeout</p> <p>The polygon mirror motor does not reach the targeted operating speed within 5 sec. after turning on or changing speed</p>
203 D	<p>Polygon motor error 2: OFF timeout</p> <p>The polygon mirror motor does not leave the READY status within 3 sec. after the polygon motor switched off.</p>
204 D	<p>Polygon motor error 3: XSCRDY signal error</p> <p>The SCRDY_N signal remains HIGH for 350 ms while the LD unit is firing.</p> <ul style="list-style-type: none"> • Polygon motor/driver board harness loose or disconnected • Polygon motor/driver board defective • Laser optics unit defective • IPU (EGB) defective <ol style="list-style-type: none"> 1. Replace the interface harness of the laser optics unit. 2. Replace the laser optics unit. 3. Replace the EGB (Engine Board).
220 D	<p>Laser Synchronizing Detection Error: [K]/[Y]</p> <p>The laser synchronizing detection signal for LDB [K]/[Y] is not output after the LDB unit has turned on while the polygon motor is rotating normally.</p>

222	Laser Synchronizing Detection Error: [M]/[C]
D	The laser synchronizing detection signal for LDB [M]/[C] is not output after the LDB unit has turned on while the polygon motor is rotating normally.
	<ul style="list-style-type: none"> • Disconnected cable from the laser synchronizing detection unit or defective connection • Defective laser synchronizing detector • Defective LDB • Defective EGB <ol style="list-style-type: none"> 1. Check the connectors. 2. Replace the laser optics unit. 3. Replace the EGB.

240	LD error
D	The IPU (EGB) detects a problem at the LD unit.
	<ul style="list-style-type: none"> • Worn-out LD • Disconnected or broken harness of the LD. <ol style="list-style-type: none"> 1. Replace the laser optics unit.

SC 3xx (Charge Error)

300	High voltage power output error
D	The measured voltage is not correct when the EGB measures each charge output (charge, development, image transfer belt unit, and transfer unit).
	<ul style="list-style-type: none"> • Disconnected or defective high voltage harness • Defective high voltage power supply • Defective EGB <ol style="list-style-type: none"> 1. Check or replace the harnesses. 2. Replace the high voltage power supply board 3. Replace the EGB. 4. Replace the AIOs.

396 D	<p>Black drum motor error</p> <p>The LOCK signal error is detected when the EGB monitors the black drum motor state. (This monitoring is done immediately after power-on, when the motor starts rotating, and immediately after the motor stops.)</p> <ul style="list-style-type: none"> • Disconnected or defective motor harness. • Motor slips due to excessive load <ol style="list-style-type: none"> 1. Check the harness from the black drum motor. Replace it if necessary.
397 D	<p>Color drum motor error</p> <p>The LOCK signal error is detected when the EGB monitors the color drum motor state. (This monitoring is done immediately after power-on, when the motor starts rotating, and immediately after the motor stops.)</p> <ul style="list-style-type: none"> • Disconnected or defective motor harness. • Motor slips due to excessive load <ol style="list-style-type: none"> 1. Check the harness from the color drum motor. Replace it if necessary.

SC 4xx (Image Transfer and Transfer Error)

445 D	<p>ITB (Image Transfer Belt) Unit: Home Position Error</p> <p>The ITB contact sensor does not detect the home position of the ITB for 5 seconds after the ITB unit initialization has been done.</p> <p>ITB (Image Transfer Belt) Unit: Contact Position Error</p> <p>The ITB contact sensor does not detect the contact position of the ITB for 5 seconds after the ITB unit has moved to the contact position.</p> <p>ITB (Image Transfer Belt) Unit: No-contact Position Error</p>
	<p>The ITB contact sensor does not detect the home position of the ITB for 5 seconds after the ITB unit has moved to no-contact position.</p>

	<ul style="list-style-type: none"> • Defective ITB contact motor • Defective ITB contact sensor • Defective ITB unit <ol style="list-style-type: none"> 1. Replace the ITB contact motor. 2. Replace the ITB contact sensor. 3. Replace the ITB unit.
--	--

480	Agitator Motor Error
D	The agitator motor error is detected twice for 10 msec during the initialization at power-on or after the cover is closed.
	<ul style="list-style-type: none"> • Disconnected or defective harness • Defective agitator motor <ol style="list-style-type: none"> 1. Check or replace the harness. 2. Replace the agitator motor.

SC 5xx (Motor and Fusing Error)

500	Transport/Fusing Motor Error
D	The LOCK signal error is detected when the EGB monitors the transport/fusing motor state. (This monitoring is done immediately after power-on, when the motor starts rotating, and immediately after the motor stops.)
	<ul style="list-style-type: none"> • Disconnected or defective motor harness. • Motor slips due to excessive load <ol style="list-style-type: none"> 1. Check the harness from the transport/fusing motor. Replace it if necessary.

530	LSU Fan Motor Error
D	A LOCK signal is not detected for more than ten seconds while the motor START signal is on and if this error occurs twice consecutively, this SC is issued.
	<ul style="list-style-type: none"> • Disconnected or defective motor harness. • Defective LSU fan motor <ol style="list-style-type: none"> 1. Check or replace the motor harness. 2. Replace the LSU fan motor.

531 D	<p data-bbox="241 250 481 280">Fusing Fan Motor Error</p> <p data-bbox="241 309 1177 378">A LOCK signal is not detected for more than ten seconds while the motor START signal is on and if this error occurs twice consecutively, this SC is issued.</p> <ul data-bbox="266 407 717 580" style="list-style-type: none"> <li data-bbox="266 407 717 437">• Disconnected or defective motor harness. <li data-bbox="266 456 717 580">• Defective LSU fan motor <ol data-bbox="312 501 717 580" style="list-style-type: none"> <li data-bbox="312 501 717 531">1. Check or replace the motor harness. <li data-bbox="312 550 717 580">2. Replace the fusing fan motor.
532 D	<p data-bbox="241 637 513 666">Air Intake Fan Motor Error</p> <p data-bbox="241 695 1177 764">A LOCK signal is not detected for more than ten seconds while the motor START signal is on and if this error occurs twice consecutively, this SC is issued.</p> <ul data-bbox="266 793 717 966" style="list-style-type: none"> <li data-bbox="266 793 717 823">• Disconnected or defective motor harness. <li data-bbox="266 842 717 966">• Defective air intake fan motor <ol data-bbox="312 887 717 966" style="list-style-type: none"> <li data-bbox="312 887 717 917">1. Check or replace the motor harness. <li data-bbox="312 936 717 966">2. Replace the air intake fan motor.
533 D	<p data-bbox="241 1023 458 1052">PSU Fan Motor Error</p> <p data-bbox="241 1081 1177 1150">A LOCK signal is not detected for more than ten seconds while the motor START signal is on and if this error occurs twice consecutively, this SC is issued.</p> <ul data-bbox="266 1179 717 1352" style="list-style-type: none"> <li data-bbox="266 1179 717 1209">• Disconnected or defective motor harness. <li data-bbox="266 1228 717 1352">• Defective PSU fan motor <ol data-bbox="312 1274 717 1352" style="list-style-type: none"> <li data-bbox="312 1274 717 1303">1. Check or replace the motor harness. <li data-bbox="312 1323 717 1352">2. Replace the PSU fan motor.

541	Thermistor Error
A	<p data-bbox="241 309 772 341">The thermistor output is less than 0°C for 6 seconds.</p> <ul style="list-style-type: none"> <li data-bbox="266 374 540 399">• Disconnected thermistor <li data-bbox="266 419 594 444">• Defective harness connection <ol style="list-style-type: none"> <li data-bbox="312 466 827 491">1. Check the harness connection of the thermistor. <li data-bbox="312 511 584 537">2. Replace the fusing unit. <p data-bbox="241 556 417 588">★ Important</p> <ul style="list-style-type: none"> <li data-bbox="266 609 1171 713">• Execute "SC Reset; Fusing SC" with SP5-810-001 to recover the machine after completing the recovery procedure. Otherwise, the machine continues to issue this SC code and cannot be operated.
542	Print Ready Temperature Error
A	<ul style="list-style-type: none"> <li data-bbox="266 838 1012 864">• The heating roller temperature increase during a set time is not correct. <li data-bbox="266 883 1195 948">• The fusing temperature does not reach the print ready temperature within a set time after the fusing lamp has turned on. <ul style="list-style-type: none"> <li data-bbox="266 981 495 1007">• Defective thermistor <li data-bbox="266 1027 852 1052">• Incorrect power supply input at the main power socket <li data-bbox="266 1072 513 1097">• Defective fusing lamp <ol style="list-style-type: none"> <li data-bbox="312 1119 714 1144">1. Check the voltage of the wall outlet. <li data-bbox="312 1164 577 1189">2. Replace the fusing unit <li data-bbox="312 1209 598 1234">3. Replace the fusing lamp. <p data-bbox="241 1254 417 1285">★ Important</p> <ul style="list-style-type: none"> <li data-bbox="266 1307 1171 1411">• Execute "SC Reset; Fusing SC" with SP5-810-001 to recover the machine after completing the recovery procedure. Otherwise, the machine continues to issue this SC code and cannot be operated.

543 A	<p>High Temperature Detection Error</p> <p>This SC is issued if one of following conditions occurs:</p> <ul style="list-style-type: none"> • The thermistor (center) detects 245°C or thermistor (end) detects 230°C. • The thermistor (center) detects a 14°C increment or more for five seconds at 220°C or more or the thermistor (end) detects a 9°C increment or more for five seconds at 160°C (Warming Up), 170 °C (Standby), or 180°C (Print) or more. <ul style="list-style-type: none"> • Defective I/O control (EGB) • Defective EGB <ol style="list-style-type: none"> 1. Replace the EGB <p>★ Important</p> <ul style="list-style-type: none"> • Execute "SC Reset; Fusing SC" with SP5-810-001 to recover the machine after completing the recovery procedure. Otherwise, the machine continues to issue this SC code and cannot be operated.
545 A	<p>Heating Lamp Full-Power Error</p> <p>The fusing lamp is fully-powered for a certain time while the fusing unit stays in the stand-by mode and is not rotating.</p> <ul style="list-style-type: none"> • Deformed thermistor • Thermistor not in the correct position • Defective fusing lamp <ol style="list-style-type: none"> 1. Replace the fusing unit. 2. Replace the fusing lamp. <p>★ Important</p> <ul style="list-style-type: none"> • Execute "SC Reset; Fusing SC" with SP5-810-001 to recover the machine after completing the recovery procedure. Otherwise, the machine continues to issue this SC code and cannot be operated.
547 D	<p>Zero Cross Error</p> <p>The zero cross signal is not detected for three seconds even though the fusing lamp relay is on after turning on the main power or closing the front door.</p> <ul style="list-style-type: none"> • Defective fusing lamp relay <ol style="list-style-type: none"> 1. Turn the main power switch off and on.

548 A	<p>Low Temperature Error</p> <p>The center thermistor detects 90°C or less for 4 seconds.</p> <ul style="list-style-type: none"> • Defective fusing lamp • Defective thermistor <ol style="list-style-type: none"> 1. Replace the fusing unit. 2. Replace the fusing lamp. <p>★ Important</p> <ul style="list-style-type: none"> • Execute "SC Reset; Fusing SC" with SP5-810-001 to recover the machine after completing the recovery procedure. Otherwise, the machine continues to issue this SC code and cannot be operated.
557 D	<p>Zero Cross Frequency Error</p> <p>The detection error occurs ten times consecutively in ten zero cross signal detections. This error is defined when the detected zero cross signal is 17 or less/27 or more for 0.2 seconds.</p> <ul style="list-style-type: none"> • Defective fusing lamp relay • Unstable input power source <ol style="list-style-type: none"> 1. Check the power supply source. 2. Replace the fusing unit.
559 D	<p>Consecutive Fusing Jam</p> <p>The paper jam counter for the fusing unit reaches 3. The paper jam counter is cleared if the paper is fed correctly.</p> <p>This SC is activated only when this function is enabled with "Fuser SC Detect" in the SP Mode 2 tab.</p> <ul style="list-style-type: none"> • Defective fusing unit • Defective fusing control <ol style="list-style-type: none"> 1. Clear this SC to send a command after a jam removal. 2. Turn off this function after a jam removal.

SC 6xx (Communication and Other Error)

660 D	Serial Number Error
	The serial number stored in the memory (EGB) is not correct.
	<ul style="list-style-type: none"> • NVRAM defective • EGB replaced without original NVRAM <ol style="list-style-type: none"> 1. Check the serial number. 2. If the stored serial number is incorrect, contact your supervisor.
669 D	NVRAM Error
	An unexpected value exists in the initialization flag of the NVRAM
	<ul style="list-style-type: none"> • NVRAM not initialized • Defective NVRAM <ol style="list-style-type: none"> 1. Initialize the NVRAM. 2. Replace the NVRAM. 3. Replace the EGB.
690 D	GAVD Communication Error
	The ID of the GAVD is not identified during initialization.
	The chip ID of the GAVD cannot be detected by the machine at power-on.
	<ul style="list-style-type: none"> • Defective EGB <ol style="list-style-type: none"> 1. Replace the EGB.

Controller SC

SC641-00, -01, -02, -03, -04

Error Name

Engine to Controller Communication Error (No Response)

Type

D

Symptoms

The controller sent a data frame by RAPI protocol, but there was no response after trying 3 times, once every 100ms.

Possible Causes

- The controller board or software is defective.
- The engine board or software is defective.
- The controller board and the engine board are not connected properly.

Troubleshooting Procedures

- SP C342DN: Check that the screw shown in the picture is fixed.



m0aga0082

- Check the connection between the controller board and engine board.
- Turn the main power OFF then ON.

SC670-01, -02

Error Name

SC670-01: Engine Start Up Error

SC670-02: Engine Down at Start Up (No SC Reboot)

Type

D

Symptoms

- SC670-01
 - A /ENGRDY signal was not asserted at power ON or recovery from Energy Save.
 - There is no response from the EC/PC/SC command within 70 secs after the main power was turned ON.
 - Writing onto the Rapi driver failed (the other party could not be found through PCI).

- SC670-02

After a /ENGRDY signal is asserted, there is an unexpected engine down.

Possible Causes

- SC670-01

The engine board failed to start up.

- SC670-02

The engine board was reset at an unexpected time.

Troubleshooting Procedures

1. Check if new firmware is available for the engine and controller boards. (SC670-02 only)

- If there is new firmware, update the boards.
- If there is no new firmware, proceed to the next step.

2. Reconnect the engine board and the controller board.

If the SC does not recur, no further action is necessary. If the SC recurs, proceed to the next step.

3. Replace the boards in the following order.

- Engine board
- Controller board, or the board between the controller and the engine
- PSU

SC816-00 to -96, -99

Error Name

SC816-00: Energy Save I/O Subsystem Failure Detection

SC816-01: Energy Save I/O Subsystem Error

SC816-02, -07, -10, -11, -12: Energy Save I/O Subsystem Error: sysarch (LPUX_GET_PORT_INFO) Error

SC816-03: Energy Save I/O Subsystem Error: STR Transition Failure

SC816-04: Energy Save I/O Subsystem Error: Kernel Communication Driver Interruption

SC816-05, -06: Energy Save I/O Subsystem Error: Preparation for STR Transition Failed

SC816-08: Energy Save I/O Subsystem Error: sysarch (LPUX_ENGINE_TIMERCTRL) Error

SC816-09: Energy Save I/O Subsystem Error: sysarch (LPUX_RETURN_FACTOR_STR) Error

SC816-13, -15 to -18, -20: Energy Save I/O Subsystem Error: Open () Error

SC816-14: Energy Save I/O Subsystem Error: Memory Address Error

SC816-19: Energy Save I/O Subsystem Error: Double Open () Error

SC816-22: Energy Save I/O Subsystem Error: Parameter Error

SC816-23, -24, -35: Energy Save I/O Subsystem Error: Read () Error

SC816-25: Energy Save I/O Subsystem Error: Write () Error

SC816-26, -27, -28: Energy Save I/O Subsystem Error: Write () Communication Retry Error

SC816-29, -30: Energy Save I/O Subsystem Error: Read () Communication Retry Error

SC816-36 to -99: Energy Save I/O Subsystem Error: Subsystem Error

Type

D

Symptoms

The Energy Save I/O Subsystem has detected an error.

Possible Causes

- The Energy Save I/O Subsystem itself is malfunctioning.
- The Energy Save I/O Subsystem detects a controller board error (no response).
- An error was detected during preparation for transition to STR.

Troubleshooting Procedures

Generally, these are fatal errors.

Turn the main power OFF then ON. If the problem is not solved, there is a problem with the hardware. Replace the controller board.

SC817-00

Error Name

Monitor Error: File Detection/Digital Signature Error

Type

D

Symptoms

- The bootloader failed to read the diagnostic module, kernel, or root file system.
- The digital signature of the bootloader SD card with a diagnostic module, kernel, or root file system cannot be checked.

Possible Causes

- The diagnostic module, kernel, or root file system in the SD card does not exist or is corrupted.
- The diagnostic module, kernel, or root file system in the SD card was tampered with.

Troubleshooting Procedures

- Update the ROM of the controller system.
- Use a bootloader SD card that has a valid digital signature.

SC819-00 [0x5032]

Error Name

Kernel Halt: HAIC-P2 Error

Type

D

Symptoms

An error has occurred in the HAIC-P2 (the compression/decompression module in the ASIC).

Possible Causes

- If EFI controller is installed:

When HAIC-P2 compression/decompression data is sent from the EFI controller to the GW controller, a decoding error (P2ERR) occurred due to a flaw in the data.

In such a case, check with EFI.

The types of P2ERR errors are as follows:

- T-ERR (Terminal Error): This error
- H-ERR (Code Error): Unlikely to occur because an IP is sent.
- L-ERR (Incorrect Line Length): The contents that were verified during the combined debug with EFI.
- If EFI controller is not installed:
 - The code data in the HDD is corrupted for some reason (for example, the HDD is defective).
 - The code data in the NVRAM is corrupted for some reason (for example, the memory is defective).
 - The ASIC is defective.
 - Due to a fault in the software, data other than the code data is decompressed.

If the problem cannot be solved by replacing the hardware, check with IMH.

Troubleshooting Procedures

- Turn the main power OFF then ON.
- Replace the HDD.
- Replace the NVRAM.
- Replace the controller board.

- Re-install or update the software.

SC819-00 [0x6261], [0x696e], [0x766d], Others

Error Name

SC819-00 [0x6261]: Kernel Halt: HDD Error

SC819-00 [0x696e]: Kernel Halt: gwinit Processing End

SC819-00 [0x766d]: Kernel Halt: VM Full

SC819-00 (Character string displayed): Kernel Halt: Others

Type

D

Symptoms

- [0x6261]
There is no error reply from the HDD. Even though initialization was successful, the file system data received is corrupted.
- [0x696e], [0x766d]
Unknown
- (Character string displayed)
There is a discrepancy in the OS.

Possible Causes

- [0x6261]
A sudden cut in the power supply when writing data to the HDD.
- [0x696e]
If the SCS process ends for some reason, the gwinit process will also end (this is in accordance with gwinit specifications). As a result, the kernel will also come to a halt (this is in accordance with kernel specifications).
- [0x766d]
Too much RAM is used during system processing.
- (Character string displayed)
 - There is a bug in the software.
 - There is insufficient memory.
 - The hardware (RAM, FLASH memory, CPU) is malfunctioning.

Troubleshooting Procedures

- [0x6261]
Replace or remove the HDD.

- [0x696e], [0x766d]
Nil
- (Character string displayed)
 - When there is a software bug, identify the conditions causing the bug, and contact the software engineer.
 - When there is insufficient memory, replace with an expanded memory.

SC840-00

Error Name

EEPROM Access Error

Type

D

Symptoms

- A reading error occurred during I/O processing, and after three subsequent retries reading still failed.
- A writing error occurred during I/O processing.

Possible Causes

The EEPROM is defective.

Troubleshooting Procedures

Nil

SC841-00

Error Name

EEPROM Read Data Error

Type

D

Symptoms

Mirrored data of the EEPROM is different from the original data in EEPROM.

Possible Causes

Data in the EEPROM is overwritten for some reason.

Troubleshooting Procedures

Nil

SC842-00 to -02

Error Name

SC842-00: Nand-Flash Verification Error

SC842-01: Nand-Flash Block Threshold Over Error

SC842-02: Nand-Flash Block Deletion Over Error

Type

C

Symptoms

- SC842-00
During remote ROM update or ROM update, the SCS detected a write error (verify error) regarding the data written to the Nand-Flash.
- SC842-01
At startup or recovery from Energy Save, the Nand-Flash status is read and the number of unusable blocks exceeded the threshold.
- SC842-02
At startup or recovery from Energy Save, the Nand-Flash status is read and the number of deleted blocks exceeded the threshold.

Possible Causes

- SC842-00
Nand-Flash is damaged.
- SC842-01
The number of unusable blocks have exceeded the threshold.
- SC842-02
The number of deleted blocks have exceeded the threshold.

Troubleshooting Procedures

Turn the main power OFF then ON.

Replace the controller board.

SC845-01 to -05

Error Name

Hardware Error during Firmware Auto Update

Type

D

Symptoms

Cannot complete firmware update while retrying three times.

Possible Causes

Hardware-related error occurs in a board.

The branch number of this SC represents where the error occurs.

-01: BiCU

-02: Controller Board

-03 or -04: Operation panel board

-05: FCU

Troubleshooting Procedures

Replace the board that causes the SC.

SC853-00

Error Name

Bluetooth Device Connection Error

Type

D

Symptoms

Bluetooth (USB) option is connected when the main power is ON.

Possible Causes

Bluetooth (USB) option cannot be connected while the main power is ON.

Troubleshooting Procedures

Turn ON the main power after the option is connected to the USB port.

SC854-00

Error Name

Bluetooth Device Disconnection

Type

B

Symptoms

The Bluetooth hardware (USB type) was removed after startup.

Possible Causes

The Bluetooth hardware (USB type) was removed after startup.

Troubleshooting Procedures

Connect the Bluetooth hardware (USB type) before turning ON the main power.

SC855-01

Error Name

Wireless LAN board error (driver attachment failure)

Type

B

Symptoms

Wireless LAN board error (wireless LAN card: 802.11 is covered)

Possible Causes

- Defective wireless LAN board
- Loose connection

Troubleshooting Procedures

- Turn the main power off/on.
- Replace the wireless LAN board

SC855-02

Error Name

Wireless LAN board error (driver initialization failure)

Type

B

Symptoms

Wireless LAN board error (wireless LAN card: 802.11 is covered)

Possible Causes

- Defective wireless LAN board
- Loose connection

Troubleshooting Procedures

- Turn the main power off/on.
- Replace the wireless LAN board

SC858-00, -01, -02, -30, -31

Error Name

SC858-00: Data Encryption Conversion Error (Key Acquisition Error)

SC858-01: Data Encryption Conversion Error (HDD Key Setting Error)

SC858-02: Data Encryption Conversion Error (NVRAM Read/Write Error)

SC858-30: Data Encryption Conversion Error (NVRAM Before Conversion Error)

SC858-31: Data Encryption Conversion Error (Other Errors)

Type

A

Symptoms

A serious error occurred after data conversion when updating the encryption key.

Possible Causes

- SC858-00, -01
 - Data such as the USB Flash is corrupted.
 - A communication error is caused by electrostatic noise.
 - The controller board is defective.
- SC858-02

The NVRAM is defective.
- SC858-30

There is a software error (for example, the parameters used for conversion are invalid).
- SC858-31

The controller board is defective.

Troubleshooting Procedures

- SC858-00, -31

Replace the controller board.
- SC858-01, -30

Turn the main power OFF then ON.
If the error persists, replace the controller board.
- SC858-02
 - Replace the NVRAM.
 - Replace the controller board.

SC859-00, -01, 02, -10

Error Name

SC859-00: Data Encryption Conversion HDD Conversion Error

SC889-01: Data Encryption Conversion HDD Conversion Error (HDD Check Error)

SC859-02: Data Encryption Conversion HDD Conversion Error (Power Failure During Conversion)

SC859-10: Data Encryption Conversion HDD Conversion Error (Data Read/Write Command Error)

Type

B

Symptoms

- SC859-00, -01

When updating the data encryption key, HDD data was not converted correctly. During conversion, only the error screen is displayed and there is no SC. The SC is displayed after the machine is turned OFF and ON.

- SC859-02

When updating the data encryption key, NVRAM/HDD conversion was incomplete. During conversion, only the error screen is displayed and there is no SC. The SC is displayed after the machine is turned OFF and ON.

- SC859-10

When updating the data encryption key, an abnormal DMAC return value (such as DMAC time-out or serial communication error) was detected for two or more times. During data conversion, only the error screen is displayed and there is no SC. The SC is displayed after the machine is turned OFF and ON.

Possible Causes

- SC859-00, -01

- HDD conversion was specified for data encryption key update, but the HDD was removed.
- Power was cut during data encryption key update.
- There was a HDD error or electrostatic noise during data encryption key update.

- SC859-02

Power was cut during data encryption key update.

- SC859-10

There was a HDD error or electrostatic noise during data encryption key update.

Troubleshooting Procedures

- SC859-00, -01, -10

- Check the HDD connection.
- Format the HDD.
- If the HDD is defective, replace it.
- SC859-02

After restart, a screen instructing the user to format the HDD is displayed.

SC860-00

Error Name

HDD Startup Error At Main Power On (HDD Error)

Type

B

Symptoms

- The HDD is connected but the driver detected the following errors:
 - SS_NO.T_READY:/* (-2)HDD does not become READY*/
 - SS_BAD_LABEL:/* (-4)Wrong partition type*/
 - SS_READ_ERROR:/* (-5)Error occurred while reading or checking the label*/
 - SS_WRITE_ERROR:/* (-6) Error occurred while writing or checking the label*/
 - SS_FS_ERROR:/* (-7) Failed to repair the file system*/
 - SS_MOUNT_ERROR:/* (-8) Failed to mount the file system*/
 - SS_COMMAND_ERROR:/* (-9) Drive not responding to command*/
 - SS_KERNEL_ERROR:/* (-10) Internal kernel error*/
 - SS_SIZE_ERROR:/* (-11) Drive size too small*/
 - SS_NO_PARTITION:/* (-12) The specified partition does not exist*/
 - SS_NO_FILE:/* (-13) Device file does not exist*/
- The driver attempted to acquire the HDD status but there was no response.

Possible Causes

- The HDD is not formatted.
- The label data is damaged.
- The HDD is defective.

Troubleshooting Procedures

Format the HDD (done through SP mode).

SC862-00

Error Name

Bad Sector: MAX (HDD Rrror)

Type

B

Symptoms

There are 101 bad sectors in HDD

Possible Causes

SC863 is issued during reading HDD because of a bad sector. Then SC 862 is issued when the bad sector count reaches 101.

Troubleshooting Procedures

Format the HDD (SP4-911-002).

(The HDD should be replaced)

6

SC863-00

Error Name

HDD Data Read Error

Type

B

Symptoms

Data in HDD cannot be read correctly.

Possible Causes

There is a bad sector in the HDD.

Troubleshooting Procedures

1. Turn the main power OFF then ON.
2. Format the HDD through SP mode.
3. Replace the HDD if:
 - this SC occurs more than 10 times.
 - this SC occurs in a short time interval.
 - it takes 30 seconds to finish the start-up.

SC863-01, -02 to -23

Error Name

HDD Data Read Error

Type

D

Symptoms

HDD data cannot be read.

Possible Causes

- SC863-01
A bad sector was generated during operation. (An error occurred in an area that does not belong to a partition, such as the disk label area.)
- SC863-02 to -23
A bad sector was generated during operation. (An error occurred in partitions from "a" (SC863-02) to "v" (SC863-23).

Troubleshooting Procedures

Replace the HDD when:

- this SC occurred ten times or more, and
- the error recurs at short intervals.
- the SC repeatedly occurs in the same situation (for example, at power ON).
- startup takes a long time when the main power is turned ON.

It takes a long time for the operation panel to become ready after power ON because it takes time to access the HDD. Normally, HDD access after power ON takes about 5 secs. If the machine is not waiting for the engine to be ready and it still takes 20 to 30 seconds or more, there may be a problem with the HDD. Check if HDD-related SCs such as SC860 and SC863 are also occurring frequently. Print the SC log data to check them.

SC864-01, -02 to -23

Error Name

HDD Data CRC Error

Type

D

Symptoms

During HDD operation, the HDD did not respond to a CRC error query.

Possible Causes

- SC864-01
A bad sector was generated during operation. (An error occurred in an area that does not belong to a partition, such as the disk label area.)
- SC864-02 to -23
A bad sector was generated during operation. (An error occurred in partitions from "a" (SC863-02) to "v" (SC863-23).

Troubleshooting Procedures

- Format the HDD.
- Replace the HDD.

SC865-00, -01, -02 to -23, -50 to -73

Error Name

SC865-00, -01, -02 to -23: HDD Access Error

SC865-50 to -73: HDD Access Timeout Error

Type

D

Symptoms

- SC865-00, -01, -02 to -23
During HDD operation, the HDD returned an error.
- SC865-50 to -73
There was no response from the HDD (time-out). The area where the error occurred is unknown.

Possible Causes

- SC865-00
The HDD returned an error that does not constitute SC863 (bad sector) or SC864 (CRC error).
- SC865-01
The HDD returned an error that does not constitute SC863 (bad sector) or SC864 (CRC error). (An error occurred in an area that does not belong to a partition, such as the disk label area.)
- SC865-02 to -23
The HDD returned an error that does not constitute SC863 (bad sector) or SC864 (CRC error). (An error occurred in partitions from "a" (SC863-02) to "v" (SC863-23).
- SC865-50 to -73

The HDD did not respond to the read/ write command from the machine (DMA transfer).

Troubleshooting Procedures

- SC865-00, -01, -02 to -23
Replace the HDD.
- SC865-50 to -73
Check if the HDD power cord and communication cable are properly connected.
If the problem is not solved after reconnecting the cord or cable, replace the HDD.

SC866-00

Error Name

SD Card Authentication Error

Type

B

Symptoms

An error has occurred with the license used for the electronic authentication of an application in the SD card.

Possible Causes

The program data in the SD card is invalid.

Troubleshooting Procedures

Store a valid program in the SD card.

SC867-00 to -02

Error Name

SD Card Removed Error

Type

D

Symptoms

The application SD card was removed.

Possible Causes

The application SD card was removed from the slot (mount point: /mnt/sd*).

SC867-00: /mnt/sd0

SC867-01: /mnt/sd1

SC867-02: /mnt/sd2

Troubleshooting Procedures

Turn the main power OFF then ON.

SC868-00, -02

Error Name

SD Card Access Error

Type

D

Symptoms

During operation, the SD controller returned an error. (An error occurred at mount point: /mnt/sc0).

Note

- The slot number is displayed in the sub code. The detailed code is on the SMC Print, and provides details about the error.
- -2, or no code number refers to device access error.

Possible Causes

- The SD card is defective.
- The SD controller is defective.

Troubleshooting Procedures

- In the case of an application SD Card:
 1. Turn the main power OFF. Check that the SD card is properly inserted.
 2. Turn the main power ON.
 3. If a SC is detected, replace the SD card.
 4. If the SC recurs, replace the controller board.
- In the case of a user SD Card:

If it is a file system error, reformat the SD card (using the specified SD formatter).

If it is a device access error, perform the following procedure.

 1. Turn the main power OFF. Check that the SD card is properly inserted.
 2. Turn the main power ON.
 3. If the SC recurs, replace with another user SD card.
 4. If the SC recurs, replace the controller board.

Note

- Do not format the SD card that comes with the machine, or an optional SD card. Only format the SD card used for tasks such as updating.

SC872-00

Error Name

HDD Mail Reception Error

Type

B

Symptoms

A HDD error was detected when the main power is turned ON.

Possible Causes

- The HDD is defective.
- The main power was turned OFF when the machine was accessing the HDD.

Troubleshooting Procedures

- Format the HDD (SP5-832-007).
- Replace the HDD.

When the above steps are taken, the following information will be initialized.

- Partly received partial mail messages
- POP3 messages that are received and already read. (All messages on the mail server are handled as new messages.)

SC873-00

Error Name

HDD Mail Reception Error

Type

B

Symptoms

A HDD error was detected when the main power is turned ON.

Possible Causes

- The HDD is defective.
- The main power was turned OFF when the machine was accessing the HDD.

Troubleshooting Procedures

- Format the HDD (SP5-832-007).
- Replace the HDD.

When the above steps are taken, the following information will be initialized.

- Mail text
- Default sender name and password(SMB/FTP/NCP)
- Administrator mail address
- Scan to email history

SC874-xx

Error Name

- SC874-05: Delete All Error (Delete Data Area): Read Error
- SC874-06: Delete All Error (Delete Data Area): Write Error
- SC874-09: Delete All Error (Delete Data Area): No response from HDD
- SC874-10: Delete All Error (Delete Data Area): Error in Kernel
- SC874-12: Delete All Error (Delete Data Area): No Designated Partition
- SC874-13: Delete All Error (Delete Data Area): No Device File
- SC874-14: Delete All Error (Delete Data Area): Start Option Error
- SC874-15: Delete All Error (Delete Data Area): No Designated Sector Number
- SC874-16: Delete All Error (Delete Data Area): hdderase Execution Failure
- SC874-41: Delete All Error (Delete Data Area): Other Fatal Errors
- SC874-42: Delete All Error (Delete Data Area): End by Cancellation
- SC874-61 to SC874-65: Delete All Error (Delete Data Area): Library Error
- SC874-66: Delete All Error (Delete Data Area): Unavailable
- SC874-67: Delete All Error (Delete Data Area): Erasing Not Finished
- SC874-68: Delete All Error (Delete Data Area): HDD Format Failure (Normal Operation)
- SC874-69: Delete All Error (Delete Data Area): HDD Format Failure (Abnormal Operation)
- SC874-70: Delete All Error (Delete Data Area): Unauthorized Library
- SC874-99: Delete All Error (Delete Data Area): Other Errors

Type

D

Symptoms

- An error occurred when deleting data in the HDD or NVRAM.

- Erasing All Memory (deleting all data in the HDD/NVRAM) was executed but the Erase All Memory option was not installed.

Possible Causes

- An error occurred in the program for deleting the HDD.
- An error occurred when deleting data on the NVRAM.
- The Erase All Memory option was not installed.

Troubleshooting Procedures

- Turn the main power OFF then ON, and then execute Erase All Memory again from the user tools. (However, if there is a defective sector or other problem with the HDD, the error will recur.)
- Reinstall the Erase All Memory option.

SC875-01, -02

Error Name

SC875-01: Delete All Error (Delete HDD): hddchack -i Error

SC875-02: Delete All Error (Delete HDD): Failed to Delete Data

Type

D

Symptoms

An error was detected before the deletion of HDD data starts (Failed to erase data/ failed to logically format HDD).

Possible Causes

- HDD logical formatting failed.
- The modules failed to erase the data.

Troubleshooting Procedures

Turn the main power OFF then ON.

SC878-00, -01, -02, -03, -20

Error Name

SC878-00: TPM Authentication Error

SC878-01: USB Flash Error

SC878-02: TPM Error

SC878-03: TCSD Error

SC878-20: Random Number Generator Error

Type

D

Symptoms

- SC878-00
At startup, the system's hash in the TPM and the USB's hash do not match. As a result, authentication by TPM failed.
- SC878-01
There is an error in the file system of the USB flash memory.
- SC878-02
There is an error in the TPM or TPM driver.
- SC878-03
An error occurred in the TPM software stack.
- SC878-20
An error occurred when doing self-check against seed for random number generated.

6

Possible Causes

- SC878-00
 - The system module was not updated via the correct update route.
 - The USB flash memory is malfunctioning.
- SC878-01
The file system of the USB flash memory is corrupted.
- SC878-02, -20
The TPM is defective.
- SC878-03
 - The TPM software stack cannot start.
 - A file required by the TPM software stack is missing.

Troubleshooting Procedures

Turn the main power Off then ON. If the SC recurs, replace the controller board.

SC899-00

Error Name

Software Performance Error (Signal Reception End)

Type

D

Symptoms

Unknown

Possible Causes

This error occurs when a GW program behaves abnormally.

Troubleshooting Procedures

- In the case of a hardware fault, replace the hardware.
- In the case of a software fault, turn the main power OFF then ON. Then update the firmware.

SC900-00**Error Name**

Electronic Counter Error

Type

D

Symptoms

The electronic total counter value is not the specified value.

This error is detected when the counter moves forward.

Possible Causes

- The NVRAM connection is not correct.
- The NVRAM is defective.
- The NVRAM data is corrupted.
- The data was written in the wrong area due to external factors.
- When PRT received signals at SRM, the requested count is not completed.

Troubleshooting Procedures

Replace the NVRAM.

SC990-00**Error Name**

Software Performance Error

Type

D

Symptoms, Possible Causes

Unknown

Troubleshooting Procedures

Nil

SC991-00

Error Name

Software Error (Operation Can Continue)

Type

C

Symptoms

The software performed in an unexpected way. By taking recovery measures, further operation is possible.

Possible Causes

- The parameter is invalid.
- There is insufficient work memory.
- This SC is caused by errors that are not normally detected from the hardware.

Troubleshooting Procedures

Nil

SC992-00

Error Name

Undefined SC

Type

D

Symptoms

An undefined SC has occurred.

Possible Causes

There is a bug in the software.

Troubleshooting Procedures

Turn the main power OFF then ON.

SC997-00

Error Name

Application Function Selection Error

Type

D

Symptoms

The application did not function normally after pressing the application key on the operation panel.

Possible Causes

There is a bug in the software.

Troubleshooting Procedures

- Check if the options required by the application (RAM, DIMM, boards) are installed properly.
- Check whether downloaded applications are correctly configured.

SC998-00

Error Name

Application Start Error

Type

D

Symptoms

- After power ON, no application program was registered to the system within the specified period of time. (No application started or ended normally.).
- Even though the application started up, it cannot be rendered due to an unknown fault.

Possible Causes

- There is a bug in the software.
- The options required by the application (RAM, DIMM, board) are not installed.

Troubleshooting Procedures

- Turn the main power OFF then ON.
- Check the RAM, DIMM, and boards.
- Check the application configurations.
- Replace the controller board.

Image Problems

Overview

Image problems may appear at regular intervals that depend on circumstances of certain components. The following diagram shows the possible symptoms (black or white dots at regular intervals).

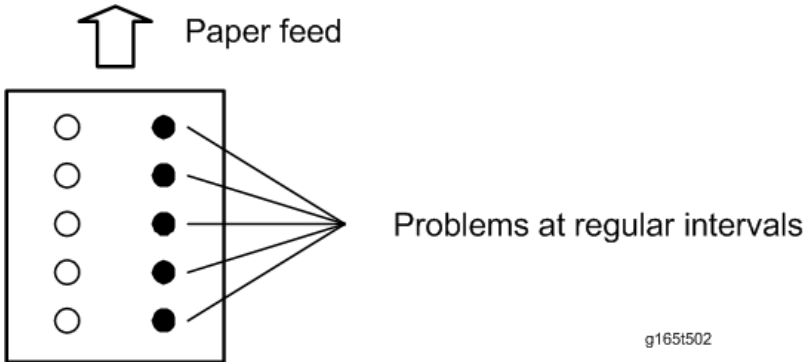

- Abnormal image at 24-mm intervals: Image transfer belt unit
- Colored spots at 38-mm intervals: AIO cartridge (Development roller)
- Abnormal image at 60-mm intervals: Transfer roller
- Colored spots at 75-mm intervals: AIO cartridge (OPC drum)
- Abnormal image at 110-mm intervals: Fusing unit (Pressure roller)
- Abnormal image at 141.3-mm intervals: Fusing unit (Fusing belt)

Checking a Sample Printout

Print out a mono-color pattern (all K, C, M, or Y), which will clarify if the cause is a problem with one of the AIO cartridges, Image transfer belt, image transfer roller, or the fusing unit. A sample page is provided with the printer driver's CD. You can print the sample page from the printer driver's CD. Before printing, you have to adjust the printer driver settings to make the problem become obvious. For details about adjusting the settings, refer to "Printer Driver Setting for Printing a Sample" described below.

- Occurs with 1-3 colors: AIO cartridge(s) failure
- Occurs with all four colors: Image transfer belt, transfer roller or fusing unit failure

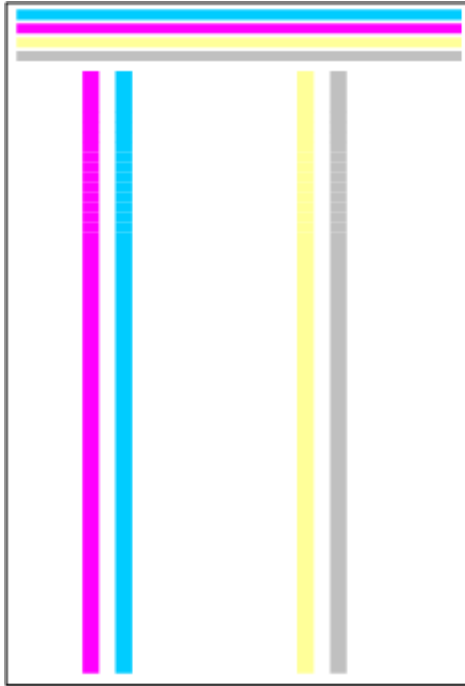

g165c502

6

Printer Driver Setting for Printing a Sample

1. Click "Properties" on the printer driver.
2. Click "Printing Preferences" in the property screen.
3. Click "Detailed Settings" tab in the printing preferences screen.

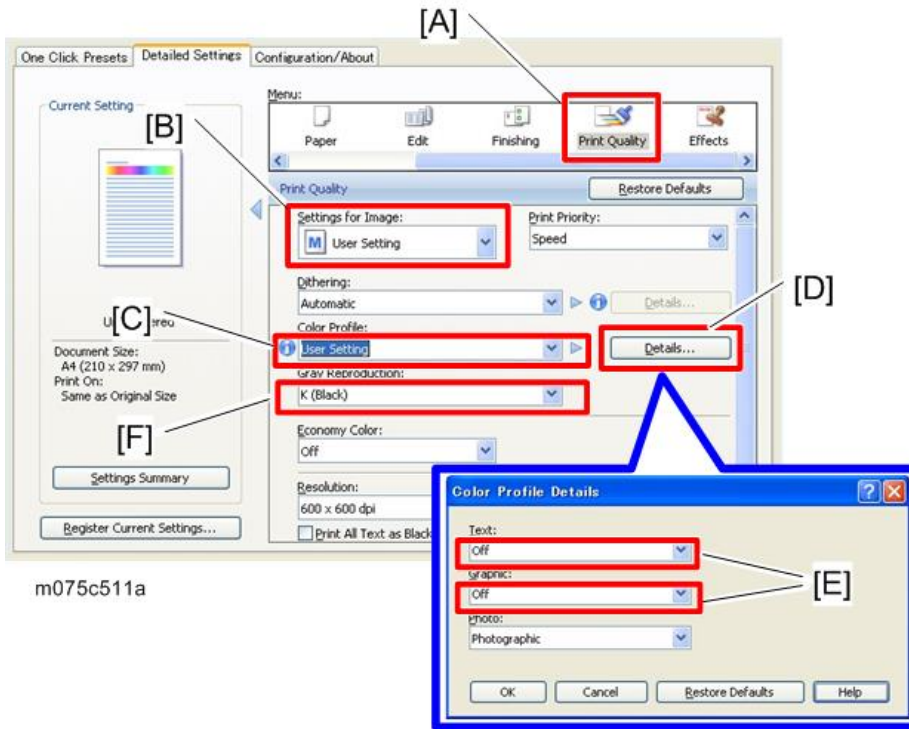

4. Click "Print Quality" [A] in the Menu.
5. Select "User Setting" from the pull-down menu in the "Settings for Image" [B].
6. Select "User Setting" from the pull-down menu in the "Color Profile" [C].
7. Press "Details..." [D], and then select "Off" from the pull-down menus [E] in the "Text:" and "Graphic".
8. Select "K (Black)" from the pull-down menu in the "Gray Reproduction" [F].

7. Detailed Description

Product Overview

Component Layout

Engine

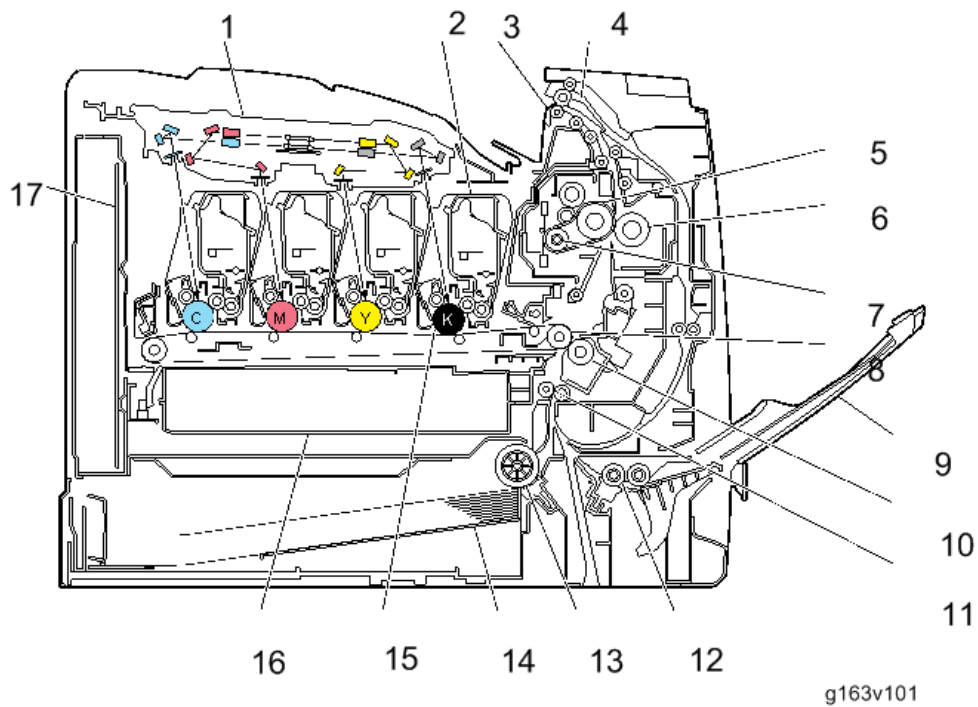

1. Laser Optics Housing Unit	10. Transfer Roller
2. Print Cartridge (AIO)	11. Registration Roller
3. Paper Exit	12. By-pass Feed Roller
4. Inverter Path	13. Paper Feed Roller
5. Fusing Belt	14. Tray 1
6. Pressure Roller	15. OPC (AIO)
7. Fusing Lamp	16. Waste Toner Bottle
8. ITB (Image Transfer Belt) Unit	17. EGB/Controller Board
9. By-pass Tray	

Paper Path

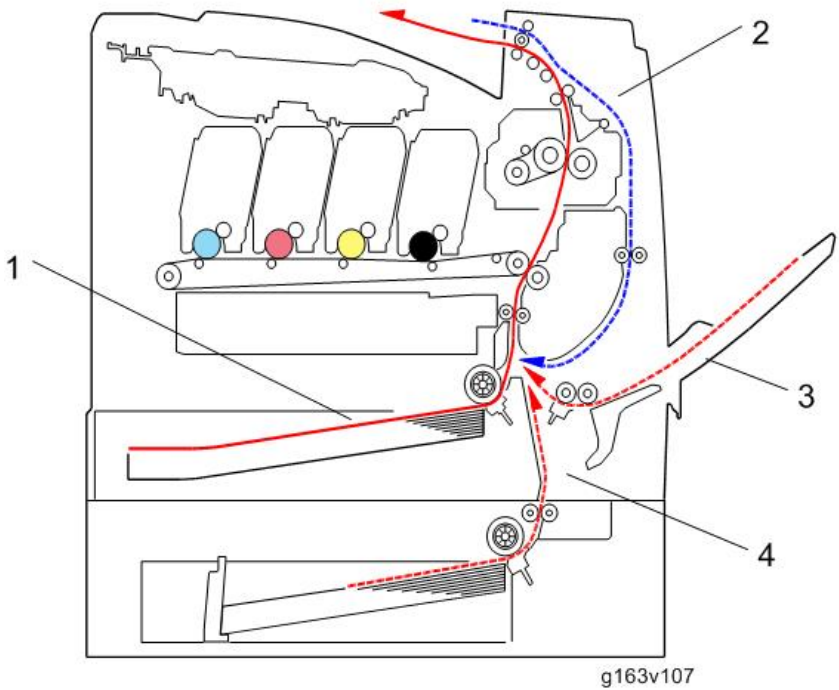

1. Paper path from tray 1 to the output tray
2. Paper path in the duplex path
3. Paper path from the by-pass tray
4. Paper path from optional tray 2 to the output tray

Drive Layout

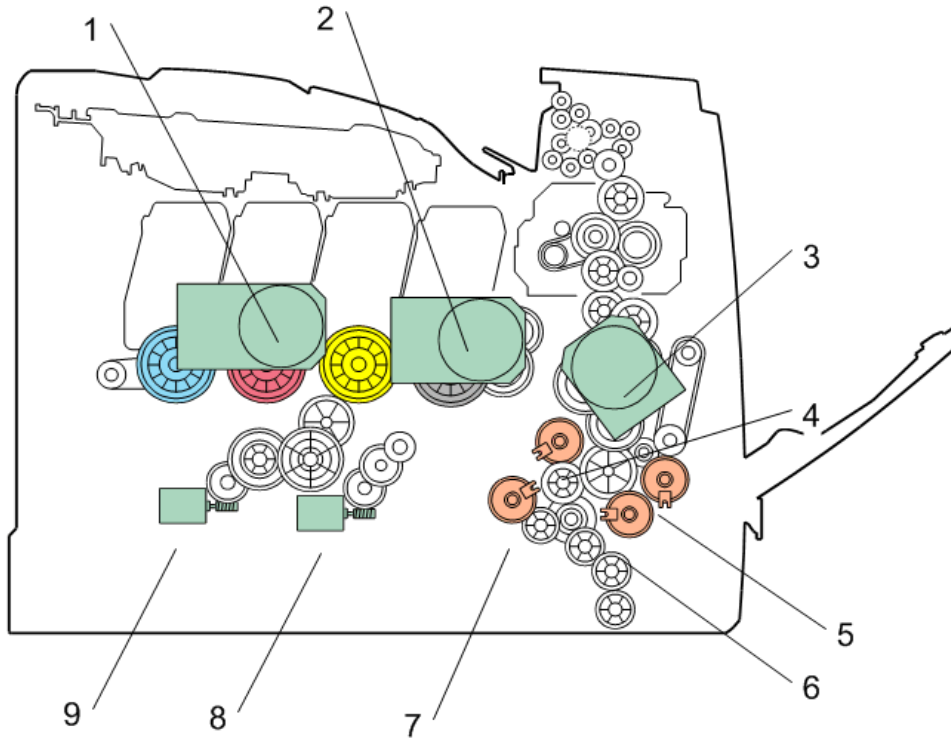

g163v102

1. Color AIO Motor

2. Black AIO Motor

3. Transport/Fusing Motor

4. Registration Clutch

5. Duplex Clutch

6. By-pass Clutch

7. Paper Feed Clutch

8. Agitator Motor

9. ITB (Image Transfer Belt) Contact Motor

- **Color AIO Motor:**

This drives the color AIO cartridges (Cyan, Magenta and Yellow)

- **Black AIO Motor:**

This drives the black AIO and the ITB (Image Transfer Belt).

- **Transport/Fusing Motor:**

This drives the fusing unit, paper feed roller, registration roller and paper exit roller via the paper feed clutch, registration clutch and gears.

- **Registration Clutch:**

This transfers drive from the transport/fusing motor to the registration roller.

- **Duplex Clutch:**

This transfers drive from the transport/fusing motor to the duplex roller.

- **By-pass Clutch**

This transfers drive from the transport/fusing motor to the by-pass feed section.

- **Paper Feed Clutch:**

This transfers drive from the transport/fusing motor to the paper feed roller.

- **Agitator Motor:**

This moves the agitators in the waste toner bottle.

- **ITB Contact Motor:**

This moves the ITB into contact with and away from the color OPCs.

Parts Layout

Engine

7

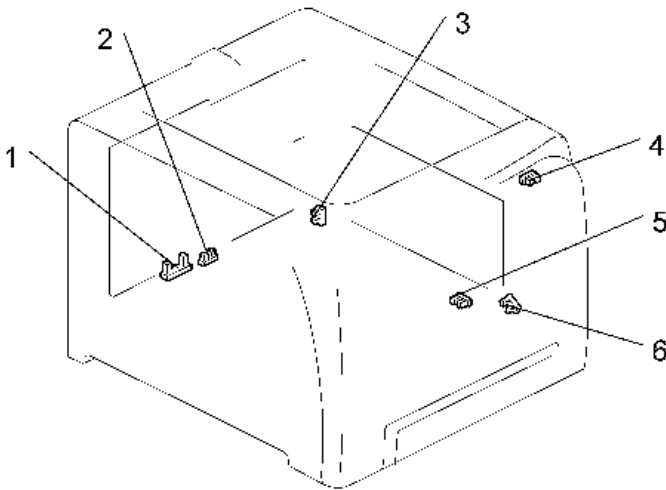

g165v105

No.	Parts Name	Description
1	Waste Toner Overflow Sensor	This sensor detects whether the waste toner bottle is full.

2	Waste Toner Bottle Set Sensor	This sensor detects whether the waste toner bottle is set.
3	ITB Contact Sensor	This sensor detects whether the image transfer belt is in contact with the color OPCs (C, M, Y).
4	Paper Exit Sensor	This sensor detects a paper jam in the fusing unit, paper exit path and duplex path.
5	Paper End Sensor	This sensor detects paper end and whether the tray is set.
6	Registration Sensor	This sensor detects a paper jam at the paper feed, by-pass feed and registration roller, and also determines the paper size based on the sensor on-off time.

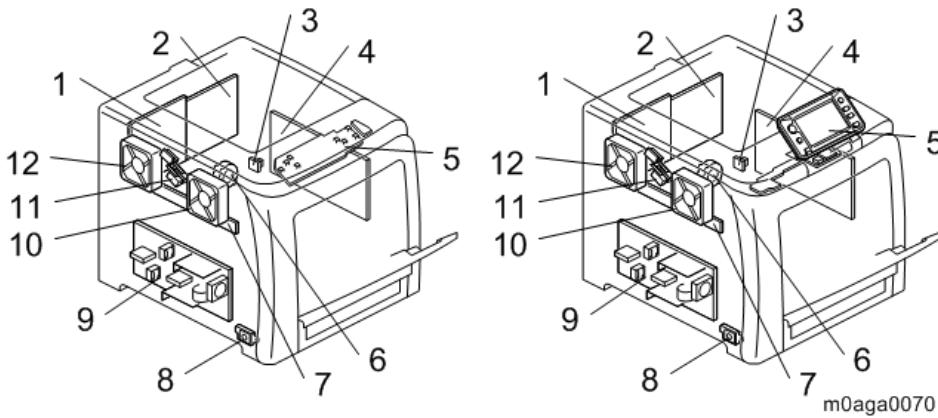

No.	Parts Name	Description
1	EGB (Engine Board)	This board controls all of the machine, input/output, drivers and input/output connections and the handshake with the Controller.
2	Controller Board	This board controls the memory, all applications and all peripheral devices.
3	Temperature/Humidity Sensor	This sensor detects the relative temperature and humidity around the machine.
4	High Voltage Power Supply Board	This board supplies the charge to the image transfer roller and high voltage for the charge roller, transfer roller and the development roller.

5	Operation Panel Board	This board controls the operation of the operation panel keys and LEDs.
6	Air Intake Fan	This motor intakes air from the rear side.
7	ID Chip Board	This board relays the ID chip data of each AIO from/to the EGB.
8	Main Switch	This switch provides power to the machine.
9	PSU (Power Supply Unit)	This supplies DC power for the EGB, fusing unit and interlock switches.
10	Fusing Fan Motor	This motor exhausts air around the fusing unit.
11	Interlock Switches	These switches turn off DC power when the front cover or top cover is open.
12	LSU Fan Motor	This motor exhausts air around the laser optics housing unit.

Process Control

Overview

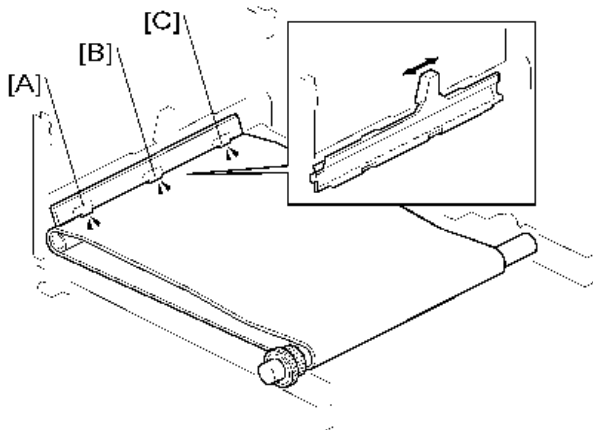

g165d305

This machine has these two forms of process control:

- Potential control
- Toner supply control

Process control uses these components:

- Three TM (Toner Mark) sensors (left [A], center [B], and right [C]). Only the center TM sensor (direct-reflection and diffusion type) is used for process control. The left and right TM sensors (direct-reflection type) are used for line positioning and other adjustments.
- Temperature/humidity sensor at the rear right of the machine.

Process Control Flow

1. TM sensor correction (Vsg adjustment)

The center TM sensor checks the bare transfer belt's reflectivity and the machine calibrates the TM sensors.

2. Development bias control

The machine makes a 7-gradation pattern on the transfer belt for each toner color. The pattern has 7 squares (the sequence is as follows: 7 yellow squares, 7 cyan squares, 7 magenta squares and 7 black squares). Each of the squares is 10 mm x 17 mm, and is a solid-color square. To make the squares, the machine changes the development bias and charge roller voltage. The difference between development bias and charge roller voltage is always the same.

The center TM sensor detects the densities of the 7 solid-color squares for each color. The machine calculates an appropriate development bias from this data.

This control takes about 32 seconds to be completed.

3. LD power control

For LD power control, the machine does the same sequence described in "2 Development bias control". Finally, the machine calculates an appropriate LD power.

4. MUSIC (Mirror Unit Skew and Interval Control)

The machine uses the TM sensors to measure sample lines deposited on the ITB, and corrects color image registration adjustment based on the sensor readings. Sample lines are made on the left, center and right of the ITB.

This control takes about 19 seconds to be completed.

Process Control Self-check

This machine does potential control with a procedure that is known as the process control self-check. This procedure is done at these 7 times.

Timing	Execution Mode
1. Initial Power-ON	<ul style="list-style-type: none"> • Development Bias Control and MUSIC (approx. 32 seconds) • MUSIC only (approx. 19 seconds) • No Execution <p>The processes that are done depend on some conditions, as described after this table.</p>
2. Recovery from Sleep Mode	
3. Front or Top Cover Open/Close	
4. Ready Status	
5. Before Job	
6. Page End	
7. Job End	

1. Initial

- Toner amount control and MUSIC start automatically immediately after the power is turned on, if one of the following conditions occurs.
 - 1) New AIO detection
 - 2) New ITB (Image Transfer Belt) unit detection (after transfer unit life counter is reset with SP mode)
 - 3) Environment (temperature and humidity) change detection.

- MUSIC starts automatically immediately after the power is turned on (there is toner amount control) if conditions other than described above occur.
2. Recovery from Sleep Mode
 - Toner amount control and MUSIC start automatically when the machine comes back from energy saver mode, if one of following conditions occurs.
 - 1) New AIO detection
 - 2) New ITB (Image Transfer Belt) unit detection (after transfer unit life counter is reset with SP mode)
 - 3) Environment (temperature and humidity) change detection.
 - MUSIC starts automatically (there is toner amount control) when the machine comes back from energy saver mode, if the following condition occurs.
 - 1) The previous MUSIC was done if there was a high temperature inside the machine.
 3. Immediately after the front or top cover is closed
 - No adjustment is done when the front or top cover is closed, if one of the following conditions occurs.
 - 1) After paper jam detection and New AIO detection
 - 2) New ITB unit detection (after transfer unit life counter is reset with SP mode)
 - 3) No environment change
 - Toner amount control and MUSIC start automatically when the front or top cover is closed, if conditions other than described above occur.
 4. Ready status:
 - Toner amount control and MUSIC start automatically when the machine stays in the ready condition and the environment has changed.
 5. Before a job:
 - MUSIC starts automatically before a job if the previous MUSIC was done when there was a high temperature inside the machine and a specified time has elapsed.
 - MUSIC starts automatically before a job if the machine is turned on in a low temperature condition and a specified time has elapsed.
 6. Page end:
 - Toner amount control and MUSIC start automatically between pages when the machine detects an environment change.
 - Toner amount control and MUSIC start automatically between pages when the machine has copied/printed 200 pages since the previous process control.
 - Toner amount control and MUSIC interrupt a job and start automatically between pages when the machine has copied/printed 250 pages since the previous process control.

- MUSIC starts automatically between pages when the machine has copied/printed 100 pages in the same job since the previous process control.
- MUSIC starts automatically between pages when the polygon motor has been rotating for 180 seconds.
- MUSIC interrupts a job and starts automatically between pages when the polygon motor has been rotating for 300 seconds.

7. Job end:

- Toner amount control and MUSIC start automatically after a job when the machine gets a request to execute the toner amount control and MUSIC.
- MUSIC starts automatically after a job when the machine gets a request to execute MUSIC.

Laser Exposure

Overview

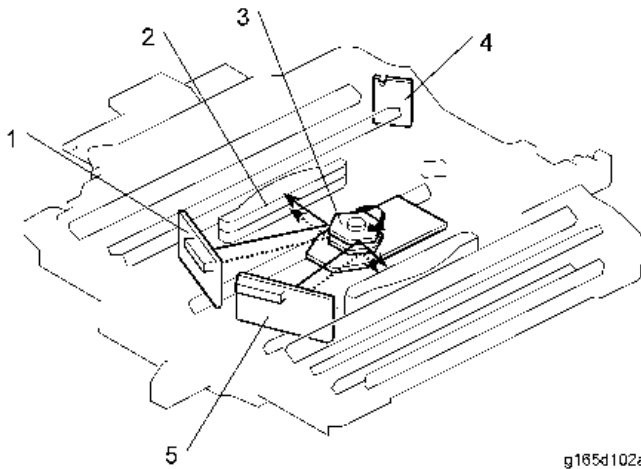

1. LD unit - C/M

2. F-theta Lens

3. Polygon Mirror Motor

4. Synchronization Detector Board

5. LD unit - K/Y

7

This machine uses two LDB units and one polygon mirror motor to produce latent images on four OPC drums (one drum for each color toner).

There are two hexagonal mirrors. The polygon mirror motor rotates the mirrors clockwise and each mirror reflects beams from LD unit.

The laser beam from the LD unit - C/M is directed to the F-theta lens at the rear side by the polygon mirrors. The laser beam from the LD unit - K/Y is directed to the F-theta lens at the front side by the polygon mirrors.

Laser exposure for magenta and cyan starts from the left side of the drum, but for yellow and black it starts from the right side of the drum. This is because the units for magenta and cyan are on the other side of the polygon mirror from the units for yellow and black.

The machine has one laser synchronization detector board (LSD) as shown above. The board detects four colors. The LSD detects the start of the main scan.

Optical Path

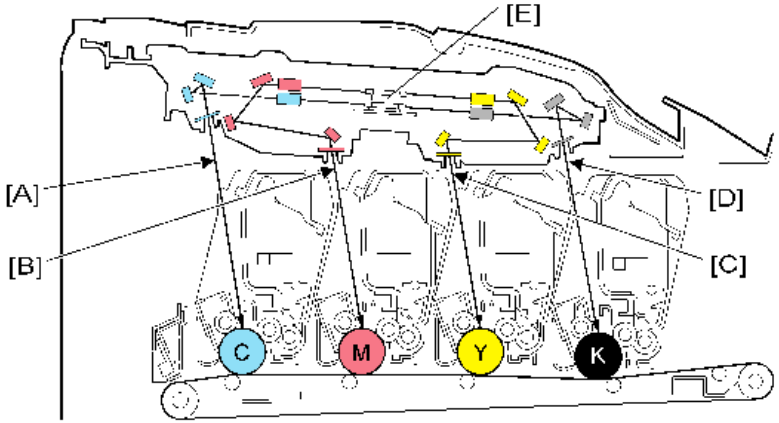

g165d101

The laser beams for magenta [B] and yellow [C] are sent to the upper part of the polygon mirror [E]. The laser beams for cyan [A] and black [D] are sent to the lower part of the polygon mirror.

LD Safety Switch

7

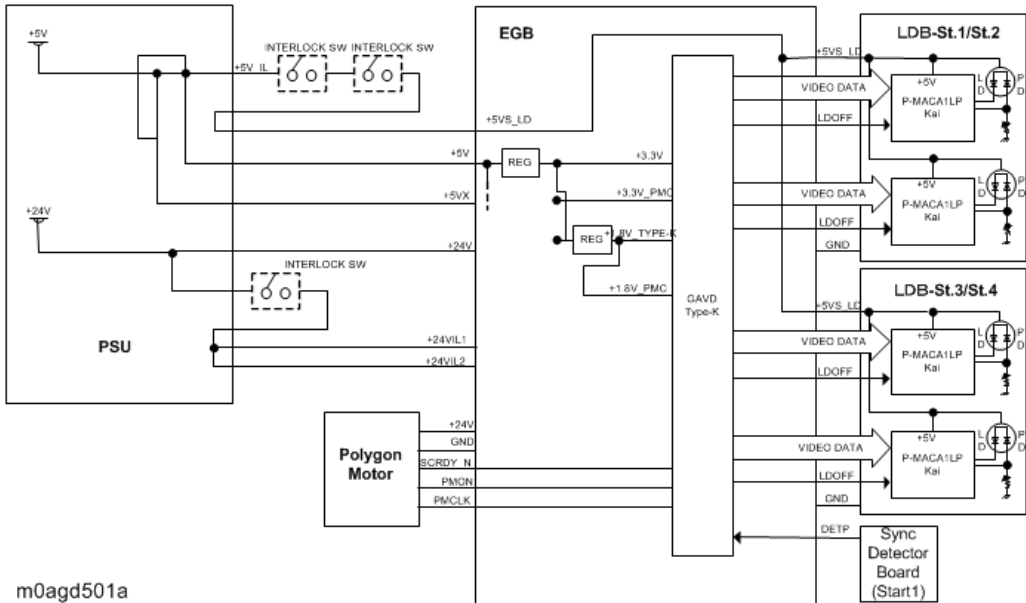

m0agd501a

A safety switch turns off when the front cover or the right door is opened. As a result, the relay on the PSU cuts off the power supply (+5V_IL) to the two LD boards. (The electric circuits go through the EGB.) This system prevents unexpected laser emission, and ensures user safety and technician safety.

MUSIC (Mirror Unit Skew and Interval Correction)

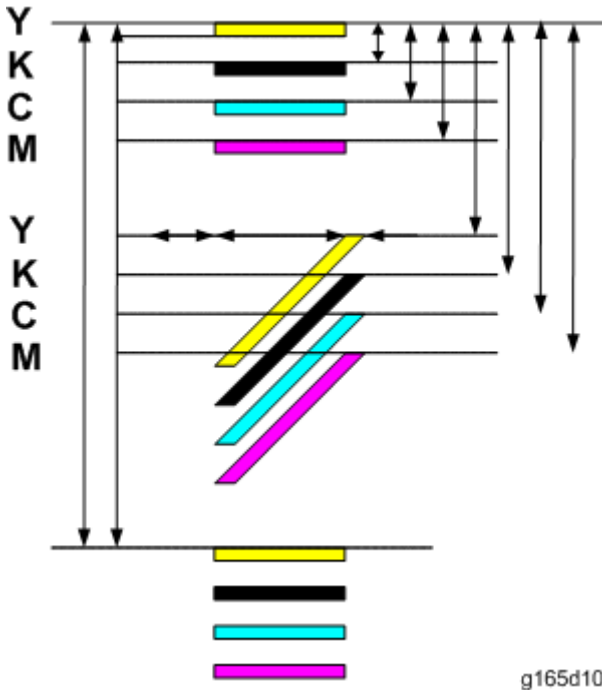

During MUSIC, the line patterns above are made on the transfer belt 16 times for fine adjustment or 8 times for rough adjustment. The spaces between the lines (YY, KK, CC, MM, KY, KC, KM) are measured by the front, center, and rear TM sensors. The controller reads the average of the spaces, and adjusts these items:

- Sub scan line position for YCM
- Main scan line position for KYCM
- Magnification ratio for KYCM
- Phase control

The transfer-belt-cleaning unit cleans the transfer belt after the patterns are measured.

The execution timing for MUSIC is explained in the Process Control section (page 171 "Process Control").

AIO (All In One) Cartridge

Overview

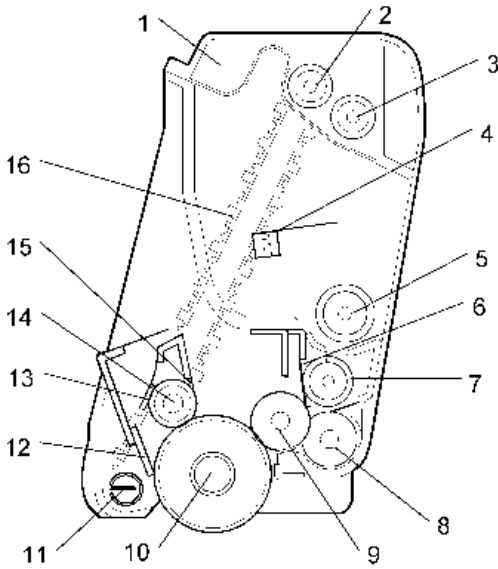

g165d202

1. Waste Toner Container

2. Transport Belt Shaft

3. Waste Toner Collection Coil

4. Toner Agitator

5. Upper Mixing Roller

6. Development Blade

7. Lower Mixing Roller

8. Toner Supply Roller

9. Development Roller

10. OPC

11. Waste Toner Collection Coil

12. OPC Cleaning Blade

13. Charge Roller Cleaner 2

14. Charge Roller

15. Charge Roller Cleaner 1

16. Waste Toner Transport Belt

This machine uses the AIO system. Each AIO consists of the waste toner tank, print cartridge, development unit, and PCU. This gives the user easy replacement procedures and helps to make the engine module more compact. The waste toner bottle is smaller than other full-color printers because the waste toner from the OPC is collected in the waste toner tank of each AIO.

The diameter of the OPC is 24 mm and the diameter of the development roller is 12 mm.

Drive

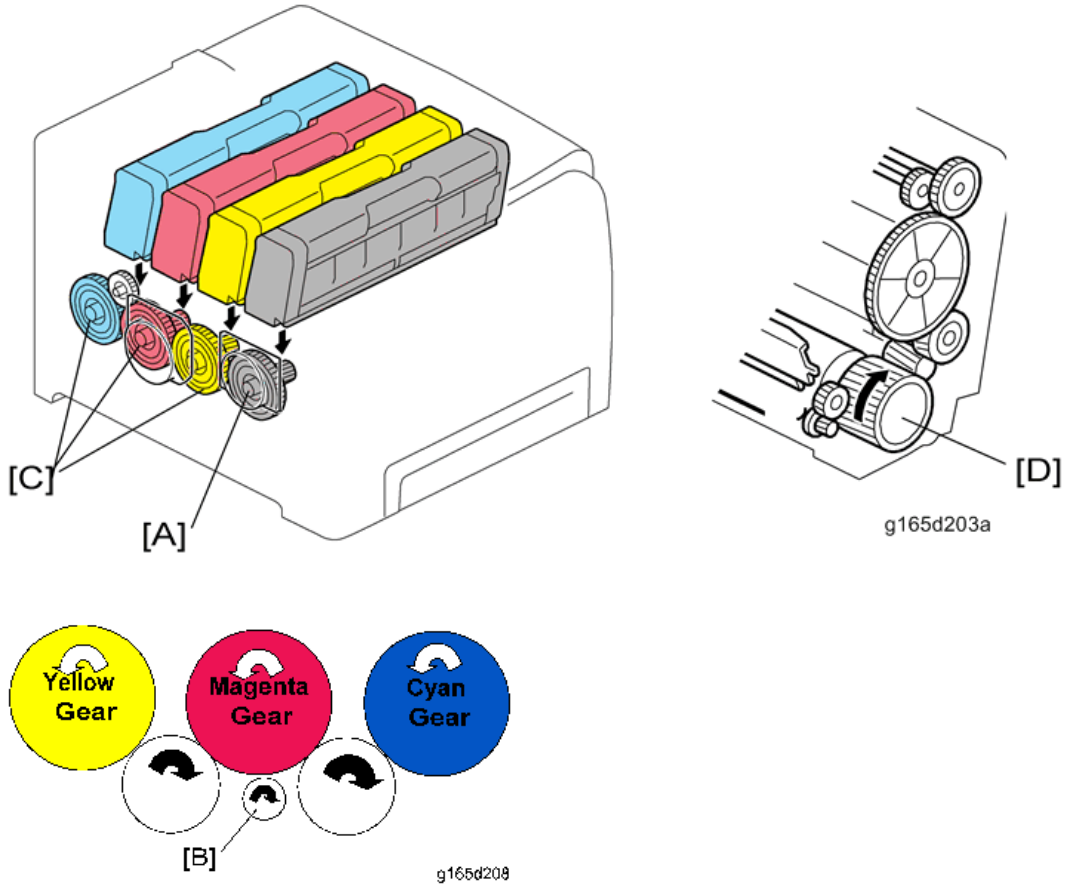

The black AIO motor drives the gear [A] for the black AIO. The color AIO motor drives the gears [B] and color gears [C] for the cyan, magenta and yellow AIOs through gears. Each of these gears engages with a gear [D] in the OPC, and this gear drives the rollers in the AIO through other gears.

OPC Charge and Cleaning

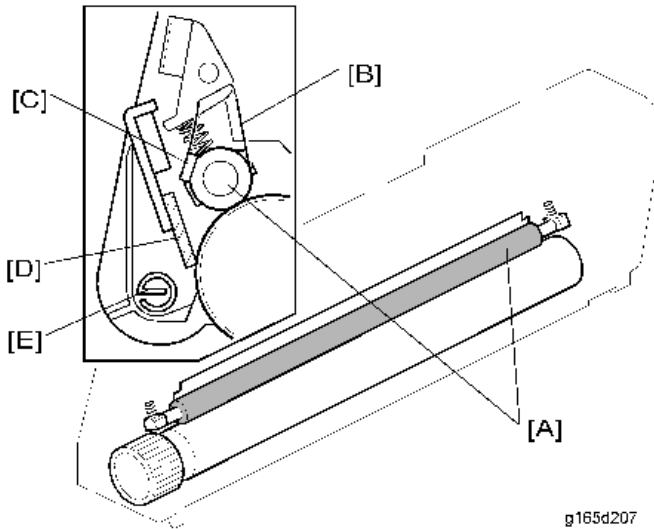

This machine uses a charge roller [A]. The charge roller gives the drum surface a negative charge. The high voltage supply board, which is at the left side of the machine, applies a dc and ac voltage (at a constant current) to the roller. The ac voltage helps to make sure that the charge given to the drum is as constant as possible.

The machine automatically controls the charge roller voltage when process control is done.

The charge roller cleaner 1 [B] and charge roller cleaner 2 [C], which always touch the charge roller, clean the charge roller. The OPC cleaning blade [D] removes the waste toner on the OPC. The toner collection coil [E] moves the toner to the waste toner transport belt.

Waste Toner Collection from the OPC

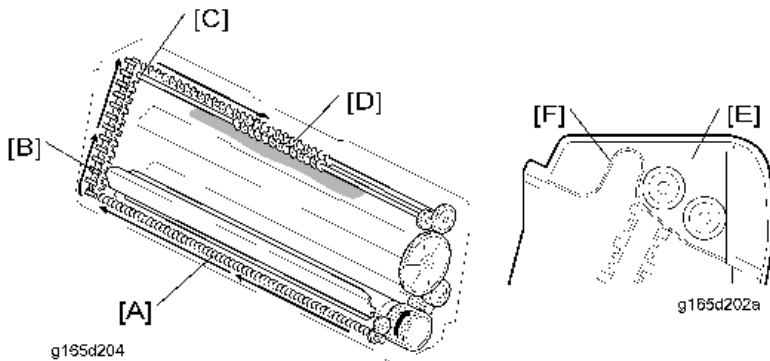

The waste toner collection coil [A] transports waste toner from the OPC to the right side of the AIO. After that, the waste toner transport belt [B], which is driven by the transport belt shaft [C], lifts waste toner up to the waste toner tank [E].

The collected waste toner is moved to the left side of the AIO by the waste toner collection coil [D] and transport belt shaft [C].

A flexible sheet [F] separates the unused toner area from the waste toner area. The waste toner area becomes larger as more toner is consumed.

Toner Mixing and Transport

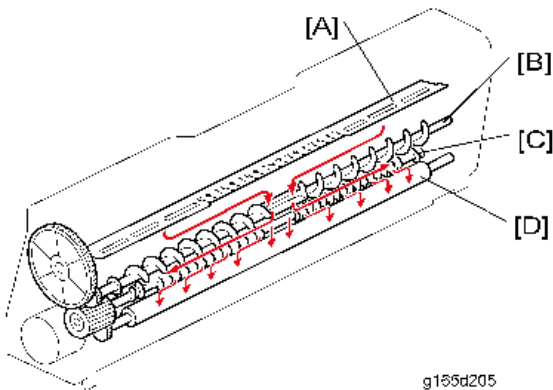

The toner moves as shown in the above drawing. The toner agitator [A] mixes the toner so that it is transported evenly to the mixing rollers. The upper mixing roller [B] moves toner to the center, then the lower mixing roller [C] moves toner to the right and left sides. Finally, the toner supply roller [D] supplies toner to the development roller. This mixing mechanism prevents toner hardening and uneven image density in the outputs.

Development Mechanism

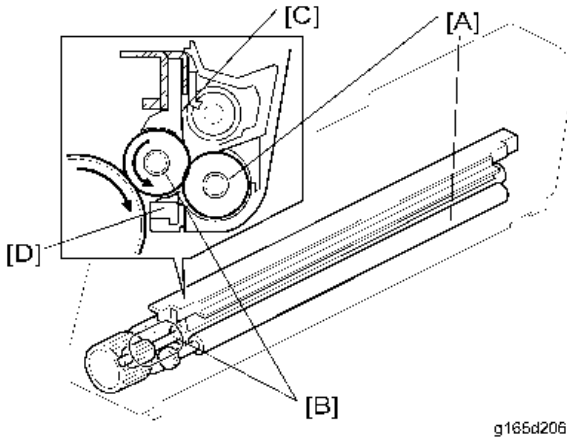

This machine does not use developer, so a TD sensor is not necessary. In each AIO unit, the toner supply roller [A] supplies toner to the development roller [B]. Electrostatic attraction generated by the friction between the toner supply roller and development roller moves toner to the surface of the development roller, and the doctor blade [C] makes sure that the layer of toner on the development roller has an even thickness.

The discharge sheet [D] removes development roller bias.

Toner Near End and End Detection

The machine uses the following to detect Toner Near End and Toner End:

- Pixel count (memory chip on the AIO)
- AIO rotation distance (memory chip on the AIO)

Once Toner Near End occurs, about 400 pages (A4, 5% coverage) can be printed until Toner End.

B&W Print Priority

You can specify whether or not to reduce the consumption of color toner. When this function is enabled, it may take longer to start printing a color page.

Default: **[Off]**

- On
- Off

Paper Feed

Overview

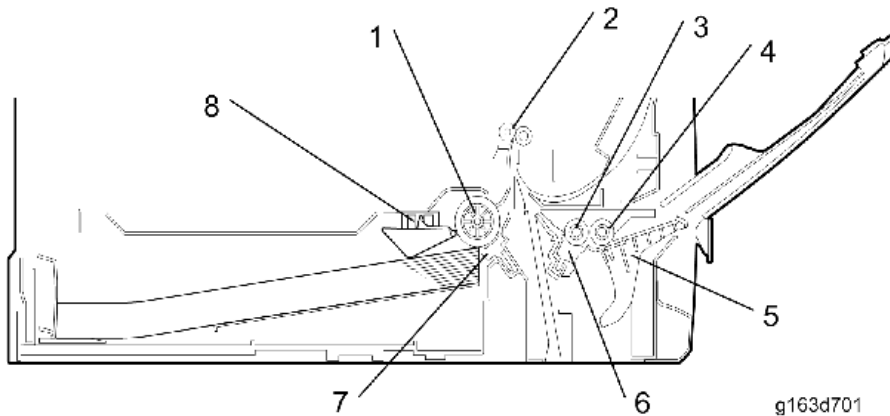

1. Paper Feed Roller	5. By-pass Bottom Plate
2. Registration Roller	6. By-pass Separation Pad
3. By-pass Feed Roller	7. Separation Pad
4. By-pass Pick-up Roller	8. Paper End Sensor

This machine has a paper tray (500 sheets) and a by-pass paper feed (100 sheets).

The paper feed mechanism uses a friction pad system.

The paper end sensor detects whether paper is installed in the tray.

This machine does not have automatic paper size detection. The machine determines the paper size from the on-off timing of the registration sensor. If the paper type which is selected at the PC does not match the paper size measured by the registration sensor, the machine issues a paper jam alert and stops the motors.

Drive and Paper End Detection

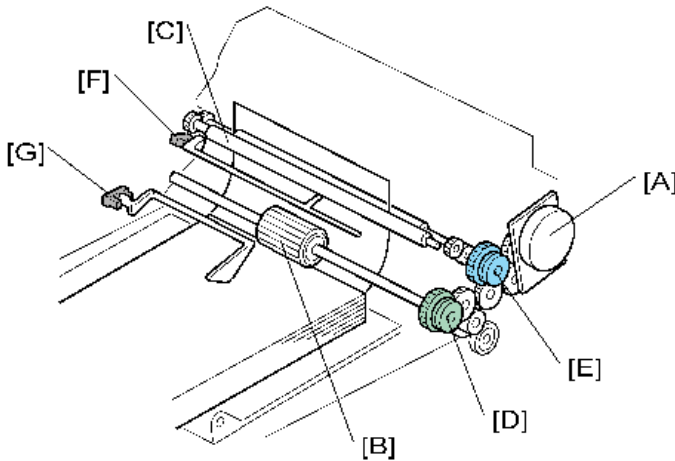

g165d702

Paper Feed

The transport/fusing motor [A] controls the paper feed roller [B] and registration roller [C] with the paper feed clutch [D], registration clutch [E] and gears. (The transport/fusing motor also controls the fusing unit and paper exit roller.) The paper feed roller feeds a sheet of paper to the registration roller [C].

When the registration sensor [F] detects a sheet of paper, the machine makes a paper buckle at the registration roller to correct paper skew. After that, the registration clutch turns on, and then the registration roller transports a sheet of paper to the transfer roller unit.

Paper End Detection

There is a paper end sensor [G] in the tray. The feeler drops into the cutout in the bottom plate and the actuator interrupts the paper end sensor.

Tray Lift

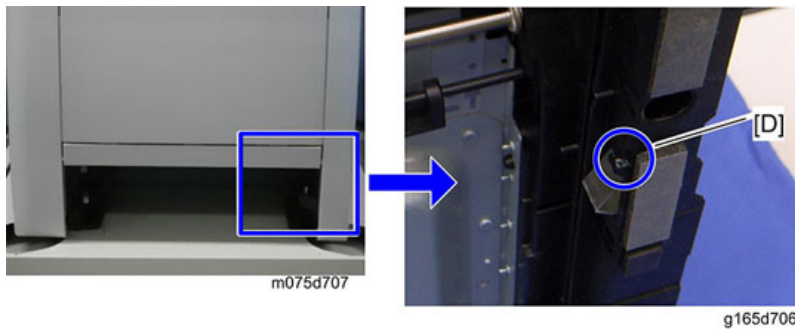
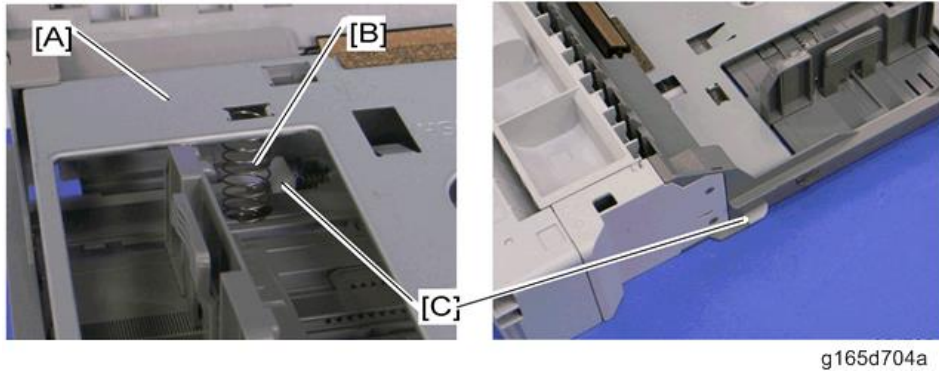

The bottom plate [A] is lifted by the springs [B] in the tray when the tray is inserted in the machine, and the bottom tray lock lever [C] is released by the projection [D] at the right side of the tray set location. There is no tray lowering mechanism for these models. Therefore, you must press down the bottom plate when you insert the tray in the machine.

By-pass Feed

By-pass Paper Feed

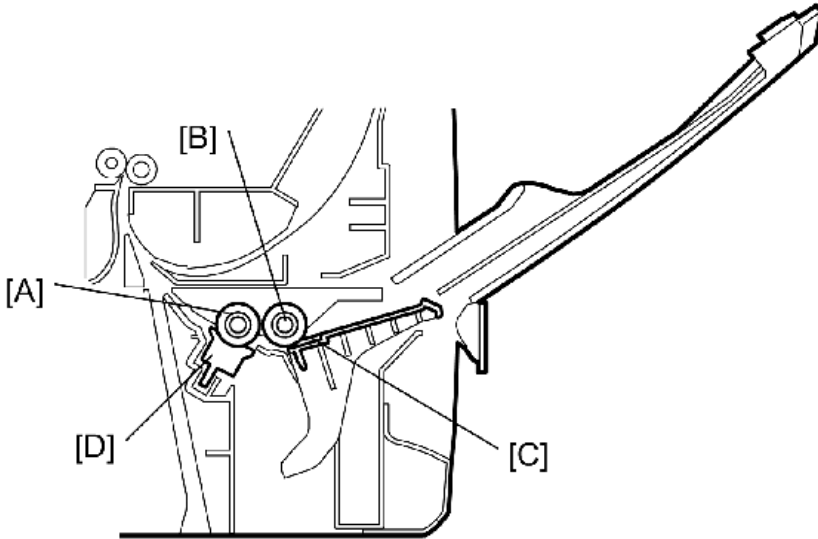

g163d702

7

The by-pass feed section composes of the by-pass feed roller [A], by-pass pick-up roller [B], by-pass bottom plate [C] and friction pad [D]. The by-pass feed roller and by-pass pick-up roller are driven by the fusing/transport motor. When the by-pass clutch is activated after the by-pass paper end sensor has detected paper on the by-pass tray, the drive power to the by-pass rollers is applied.

By-pass Bottom Plate Lift

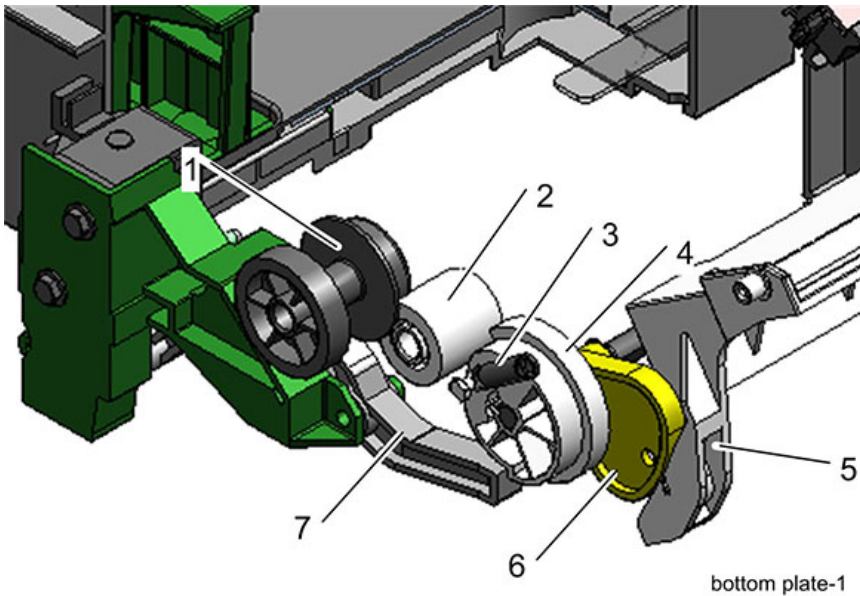

1. By-pass bottom plate drive gear (at mainframe)
2. Idle gear (at tray 1)
3. Spring
4. By-pass bottom plate gear (at tray 1)
5. By-pass bottom plate (at tray 1)
6. Cam (at tray 1)
7. By-pass solenoid lever (at mainframe)

The by-pass bottom plate gear [4] is linked to cams [6] (right and left side). When the by-pass bottom plate gear rotates, two cams push down and release the by-pass bottom plate [5] (down and up).

However, the by-pass bottom plate is lowered to its lowest position and stays there after tray installation or machine's power-on. For details, see the following descriptions.

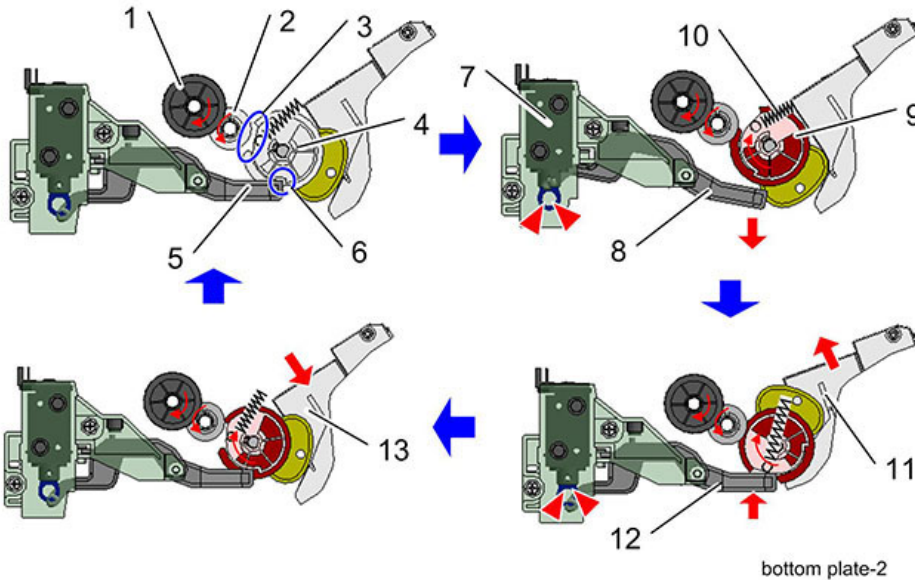

Idle gear [2] is driven by the transport/fusing motor (not shown) via the paper feed clutch (not shown) and by-pass bottom plate drive gear [1]. These gears always rotate while the paper feed clutch is turned on. The idle gear [2] connects to the by-pass bottom plate gear [4]. This gear has a part with no teeth [3] and a guide for the by-pass solenoid lever [5]. Therefore, drive from the transport/fusing motor is not transmitted to the by-pass bottom plate gear [4] when the by-pass bottom plate gear is at its home position (upper left drawing). At this position, the by-pass bottom plate gear [4] is forced to rotate by the spring tension. However, the by-pass solenoid lever [5] stops the by-pass bottom plate gear from rotating because this lever is resting against a step [6] on the guide on the by-pass bottom plate gear.

- This linkage between the solenoid lever and the step on the by-pass bottom plate gear is released when tray 1 is pulled out from the machine.
- When tray 1 is installed or the machine starts to initialize, the solenoid lever turns on (lever down) and off (lever up) to lower the by-pass bottom plate (home position).

When the by-pass solenoid [7] turns on after a by-pass mode job has been selected, the by-pass solenoid lever [8] is lowered away from the step, and releases the by-pass bottom plate gear. As a result, the by-pass bottom plate gear [9] is rotated clockwise by spring tension [10], and then the teeth of the by-pass bottom plate gear [9] are linked to the idle gear.

After the by-pass bottom plate gear has rotated about 45 degrees, two cams lift the by-pass bottom plate [11]. The by-pass solenoid turns off and its lever [12] is lifted just after the by-pass bottom plate gear has rotated. While the bottom plate is lowered, a sheet of paper on the by-pass tray is fed to the registration roller.

After the by-pass bottom plate gear has rotated 90 degrees from the home position of the by-pass bottom plate, the by-pass bottom plate [13] starts to be lowered by two cams. Finally, the by-pass bottom plate returns to its home position and the by-pass bottom plate is lowered to its lowest position again.

Duplex

Drive

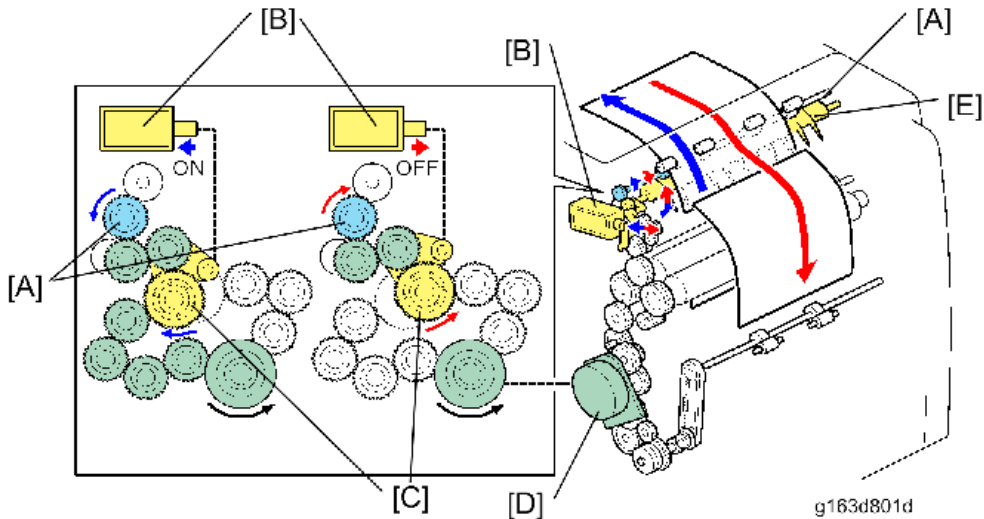

The paper exit roller [A] rotates forward and in reverse. The direction of rotation is changed by the paper exit solenoid [B] and movable gear [C], even though the transport/fusing motor [D] rotates only forward.

When a simplex job is selected, the paper exit solenoid [B] always turns off and the paper exit roller rotates [A] forward. While the paper exit roller [A] rotates forward, the paper exit path is opened by the paper exit junction gate [E].

When a duplex job is selected, the paper exit solenoid [B] turns on and changes the position of the movable gear [C]. Changing the movable gear position makes the paper exit roller [A] rotate in reverse. While the paper exit roller [A] rotates in reverse, the paper exit path is closed by the paper exit junction gate [E].

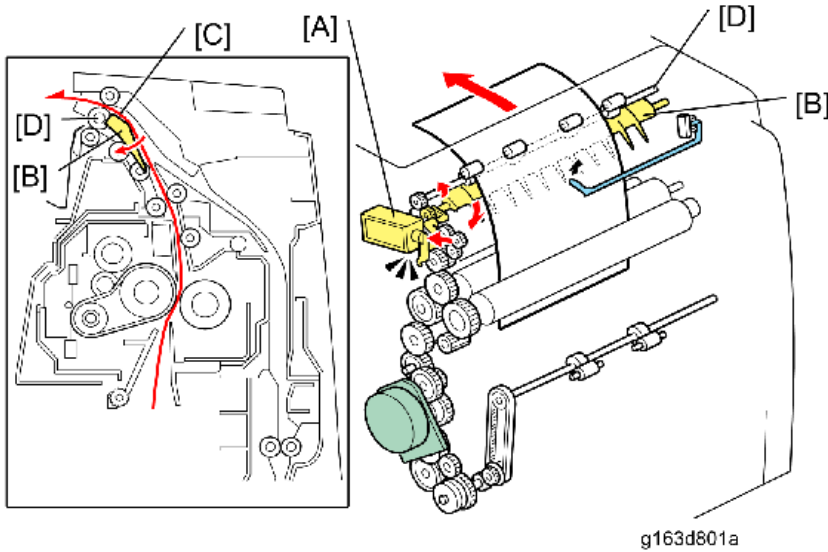

When a duplex job is selected, the paper exit solenoid [A] turns on, and this moves the paper exit junction gate [B] to open the duplex inverter path [C].

The paper exit solenoid also changes the rotation direction of the paper exit roller as explained earlier.

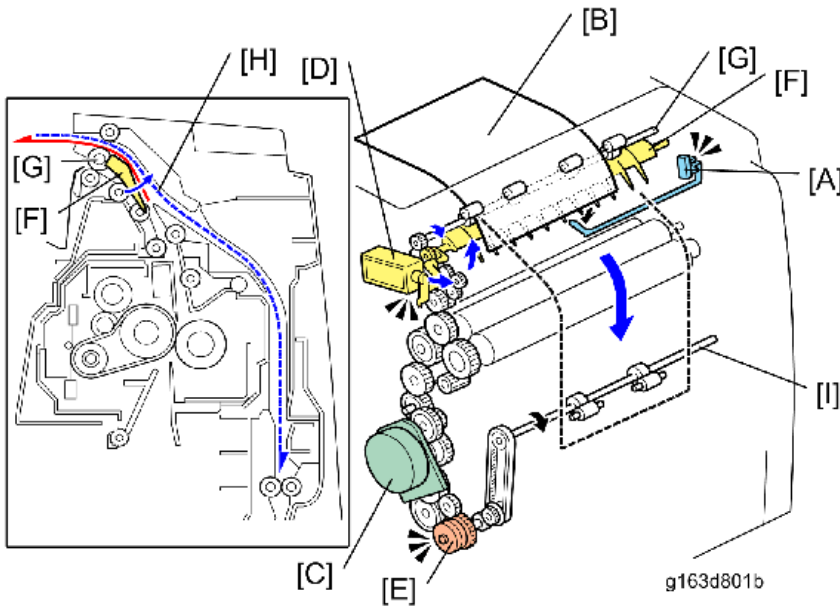

After printing the first side of the duplex print, the paper is fed to the exit, with the paper exit solenoid [D] off, until the paper exit sensor [A] detects the trailing edge of the paper [B]. Then, the transport/fusing motor [C] stops temporarily, the paper exit solenoid [D] turns on and the duplex clutch [E] turns on.

When the paper exit solenoid [D] turns on, it changes the positions of the paper exit junction gate [F] and movable gear. As a result, the paper exit roller [G] rotates in reverse and the sheet of paper is fed

into the duplex path [H] after the transport/fusing motor [A] starts again. The sheet of paper is transported by the duplex transport roller [I] to the registration roller.

Image Transfer

Overview

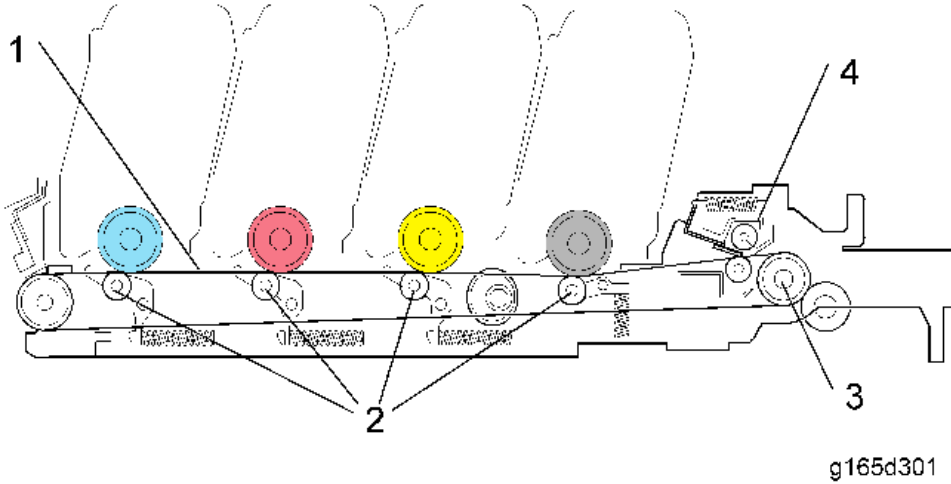

7

1. Image Transfer Belt	3. ITB Drive Roller
2. ITB (Image Transfer Belt) Roller	4. ITB Cleaning Unit

The toner is moved from the four OPC drums to the image transfer belt. For a full color print, all four colors are moved from the PCUs to the transfer belt at the same time. The transfer roller then moves the four-color toner image from the transfer belt to the paper.

The ITB cleaning unit removes remaining toner from the surface of the ITB after image transfer.

Drive and Transfer Belt Roller Bias

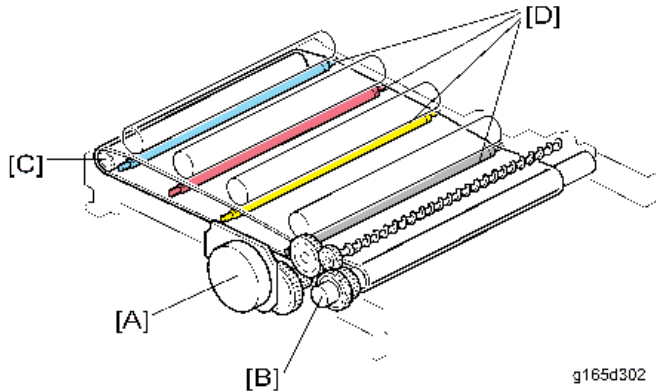

The black AIO motor [A] controls the transfer belt drive roller [B]. The belt tension roller [C] adds tension to the transfer belt to help to turn this belt.

The image transfer belt rollers [D] are charged from terminal plates to move the toner from the PCUs to the image transfer belt.

Transfer Belt Contact

7

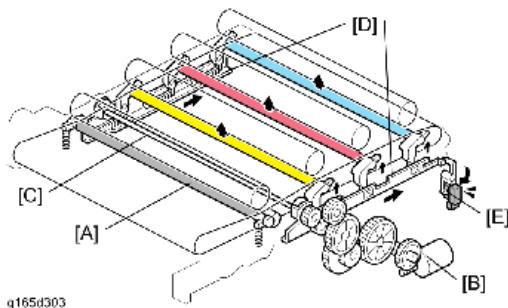

The transfer belt does not touch the color OPC drums (cyan, magenta and yellow) when the machine makes a black and white print.

The transfer belt contact motor [B] turns the CMY contact cam shaft [C] when the machine starts to make a color print. The CMY contact cams slide the right and left sliders [D] and these sliders lift the belt transfer rollers for each OPC drum (CMY) to the transfer belt. Because of this mechanism, the life of the transfer belt is longer (it is not necessary for the transfer belt to touch the color OPC drums when the machine makes a black and white print). However, if the customer selects "Off" with the "ACS" setting, the four OPC drums always touch the image transfer belt.

The ITB (image transfer belt) contact sensor [E] detects if the image transfer rollers for each OPC drum (CMY) touch the transfer belt. If they do not touch the transfer belt during color printing, the machine stops and shows SC 445, 446, or 447.

ITB (Image Transfer Belt) Cleaning Unit

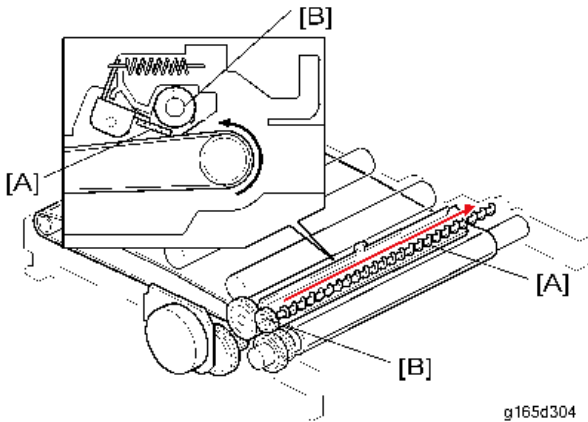

g165d304

7

The ITB cleaning blade [A] in the cleaning unit removes remaining toner on the image transfer belt after image transfer to the paper. The toner collection coil [B] moves the collected waste toner to the outlet for the waste toner bottle.

The ITB cleaning unit has a shutter mechanism at the outlet for the waste toner bottle. When the ITB unit is removed, the shutter closes the outlet to prevent waste toner from falling.

Transfer Roller Overview

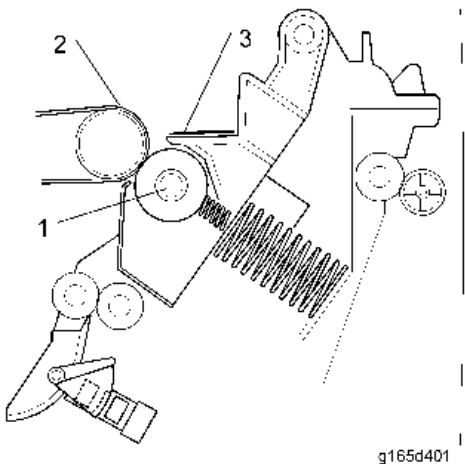

g165d401

1. Transfer Roller
2. Image Transfer Belt
3. Discharge Plate

Paper Transfer and Discharge

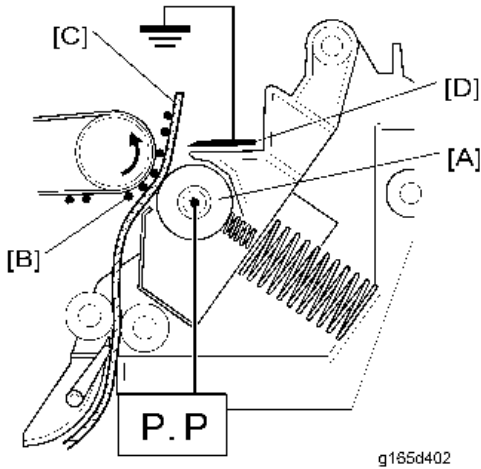

Transfer Roller

The transfer roller [A] is always pressed against the image transfer belt by pressure from a spring. The transfer roller moves toner images [B] from the transfer belt to the paper. When a sheet of paper [C] goes between the transfer roller and the transfer belt, the transfer roller turns with the paper.

Paper Transfer Bias

The high voltage power supply (HVPS) supplies electricity to the transfer roller. The transfer roller is positively charged. The right end of the transfer unit is attached to the terminal from the HVPS when you close the front cover.

Discharge Plate

The transfer unit has a discharge plate [D] above the transfer roller. The discharge plate removes charge that was applied to the paper during paper transfer. This helps paper move away from the transfer roller.

Waste Toner Collection

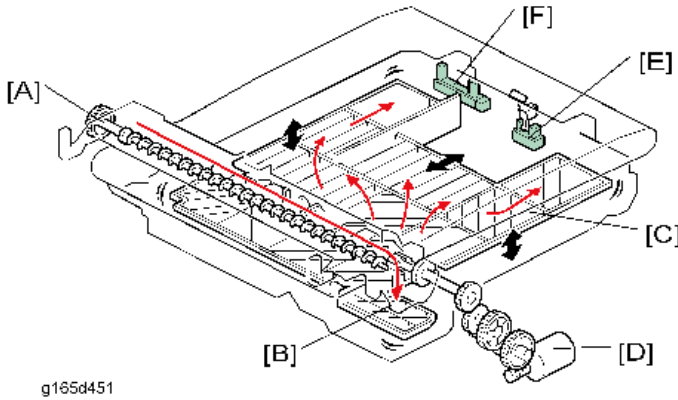

The waste toner collection coil [A] moves collected waste toner from the ITB (image transfer belt) unit to the entrance [B] of the waste toner bottle. The agitator plate [C] levels the collected waste toner in the waste toner bottle. It is driven by the agitator motor [D].

The waste toner bottle set sensor [E] detects whether the waste toner bottle is set. If it is not set, "Waste Toner Bottle" appears on the LCD of the machine.

The waste toner overflow sensor [F] detects whether the waste toner bottle is full. If it is full, "Replace the Waste Toner Bottle" appears on the LCD of the machine. 400 more pages can be printed, then the machine stops.

Fusing and Exit

Overview

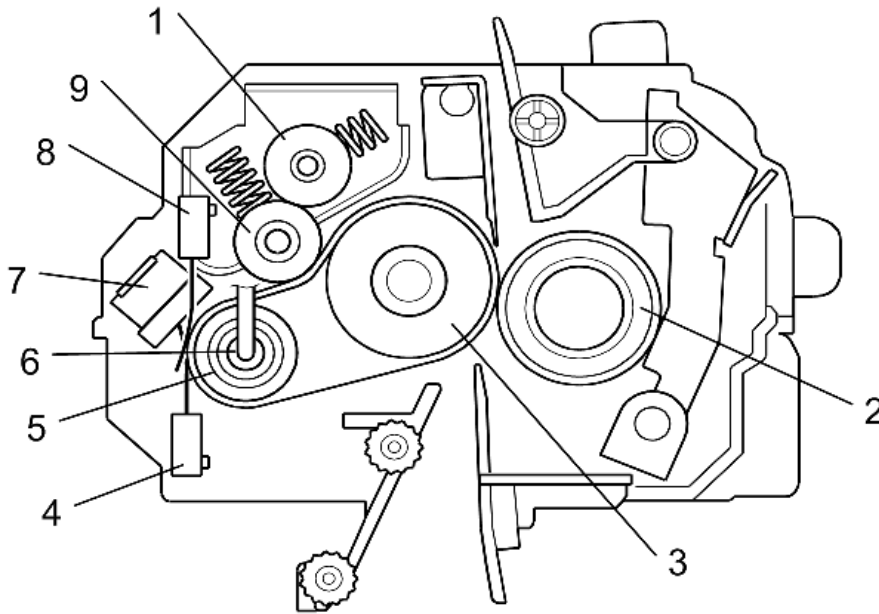

g163d601

1. Cleaning Roller	6. Fusing Lamp
2. Pressure Roller	7. Thermostat
3. Hot Roller	8. Thermistor (Center)
4. Thermistor (Right)	9. Fusing Tension Roller
5. Heating Roller	

Drive

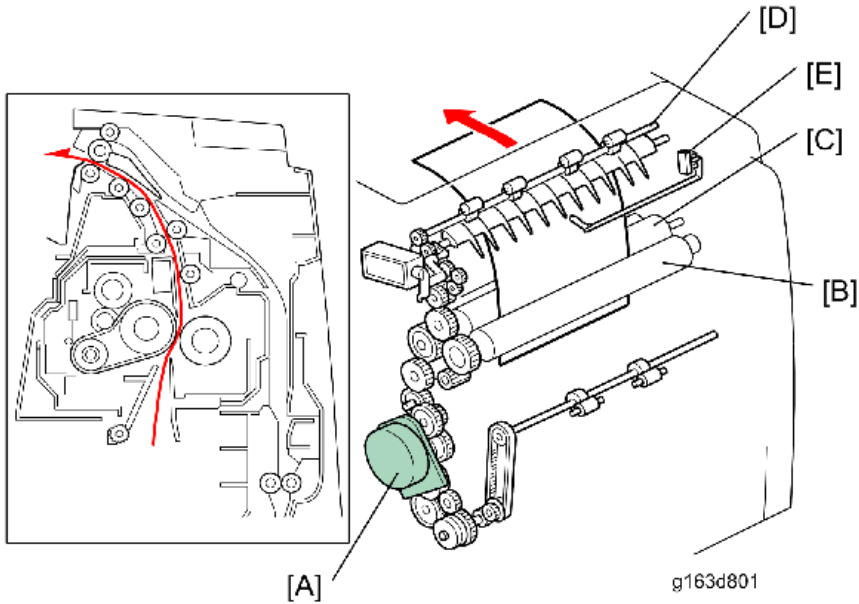

7

The transport/fusing motor [A] drives the pressure roller [B], hot roller [C] and paper exit roller [D] (via gears). The paper exit sensor [E] detects the trailing edge of the paper to determine the stop timing for the transport/fusing motor. It also checks whether a paper jam occurs at the fusing unit or paper exit.

Pressure Release Mechanism

The springs always apply the correct pressure to the nip between the pressure roller and hot roller. When releasing the pressure release levers, the pressure roller moves away from the hot roller. If a paper jam occurs in the fusing unit, releasing these levers makes it easy to remove jammed paper.

Temperature Control

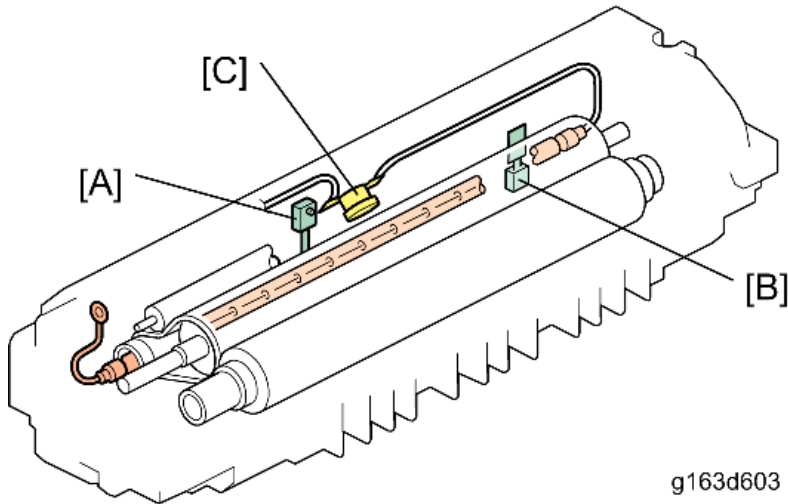

The fusing unit has these components for temperature control:

- The fusing thermistors [A] [B] send a signal when the fusing temperature goes past the threshold.
- The central thermistor [A] is the one that is used for fusing temperature control.
- The fusing thermostat [C] breaks the electric circuit when the fusing temperature goes past the threshold. The thermostat is on the same electrical circuit as the fusing lamp, so the fusing lamp turns off if the fusing thermostat breaks the electrical circuit.

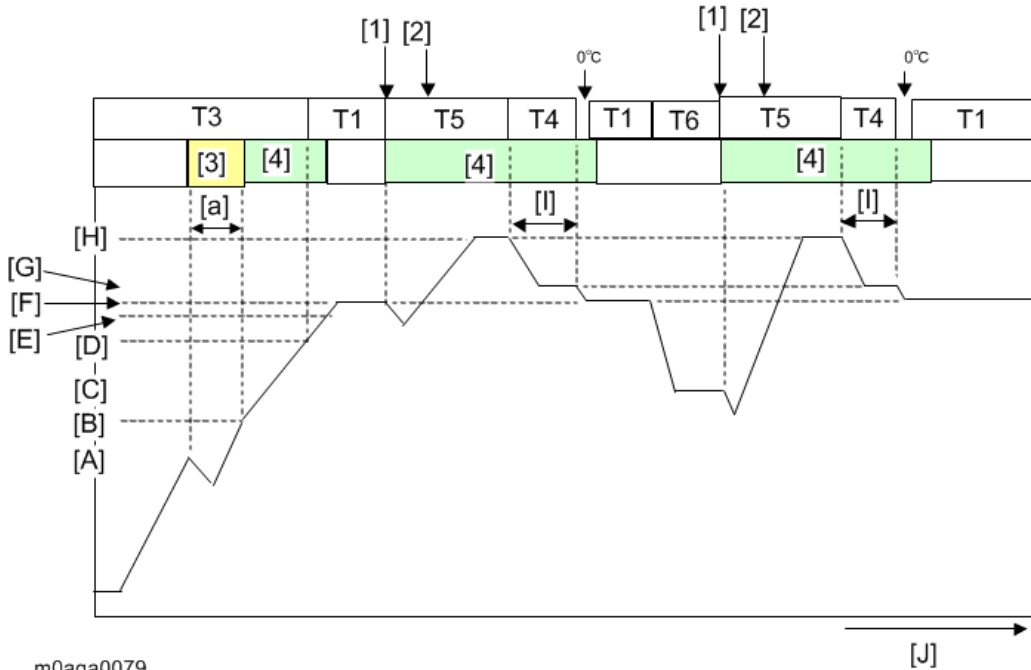

m0aga0079

- [A]: Idling ready temperature (60°C)
The fusing unit starts to rotate (idling) in the half speed [a].
- [B]: Normal speed idling ready temperature (120°C)
- [C]: 10 seconds recovery temperature (120°C)
This is the low power mode for printing. This temperature is lower than the target temperature [F] and saves power. This mode is adjustable (default: 1 minute) with the "Low Power Mode" setting in the user mode.
- [D]: Reload temperature (120°C)
This is the temperature to display the print ready message on the LCD.
- [E]: Warm-up target temperature (140°C)
This is the temperature to start exposing [2] if the machine gets a print job [1].
- [F]: Print ready temperature (160°C)
This is the temperature to wait for a print job.
- [G]: Target temperature after 1st print (This depends on the target temperature of each paper type; see the table below)
The machine keeps this temperature for 5 pages after the 1st print time.
- [H]: First print temperature (target temperature + 10°C)
The machine keeps this temperature for the first printing time.
- [I]: Printing

- [J]: Elapsed Time

Target Temperature for Each Paper Type and Print Mode

Paper Type/ Print Mode	Target Temperature	
	NA	EU
Thin: B&W	157°C	
Thin: Color	147°C	151°C
Thin: B&W 1200 dpi	144°C	
Thin: Color 1200 dpi	140°C	
Plain: B&W	160°C	164°C
Plain: Color	155°C	159°C
Plain: B&W 1200 dpi	157°C	
Plain: Color 1200 dpi	148°C	
Middle Thick: B&W	167°C	
Middle Thick: Color	160°C	164°C
Middle Thick: B&W 1200 dpi	163°C	
Middle Thick: Color 1200 dpi	150°C	
Thick 1: B&W	158°C	
Thick 1: Color	154°C	
Thick 2: B&W	164°C	
Thick 2: Color	156°C	
Thick 3: B&W/ Color	158°C	
Post Cards	161°C	
Envelopes	155°C	
Preprinted or Color Paper: B&W	167°C	

Paper Type/ Print Mode	Target Temperature	
	NA	EU
Preprinted or Color Paper: Color	160°C	164°C
Preprinted or Color Paper: B&W 1200 dpi	163°C	
Preprinted or Color Paper: Color 1200 dpi	150°C	
Bond: B&W	164°C	
Bond: Color	156°C	
Cardstock: B&W/Color	158°C	
Coated Paper	150°C	
OHP	180°C	

7

Fusing unit related SC codes

If one of the fusing unit components (such as thermistors, thermostat, fusing lamp etc.) is defective, the following SC codes may be issued. For details, refer to the SC code list in the chapter "Troubleshooting".

- SC541, 542, 543, 544, and 545

If one of these SC codes is issued, execute SP5-810-001 (SC Reset).

Anti-Humidity Mode

To reduce paper curl in high temperature and humidity environments, the fusing unit does idle rotation before a job, if the customer enables this function in the user mode.

- Mode 1: No fusing idling, transfer roller voltage is increased
- Mode 2: Fusing unit rotates for 30 seconds before a job, transfer roller voltage is increased.
- Mode 3: Fusing unit rotates for 60 seconds before a job, transfer roller voltage is increased.

Energy Saver

There are two modes for energy saving.

- Low power mode:

This keeps the fusing temperature at 140°C for a specified time (adjustable with "Power Saver" in the user mode) while the machine waits for the next print job.

- Sleep mode:

This turns off power to the engine unit after the time specified with "Power Saver" has passed.

Eco Night Mode

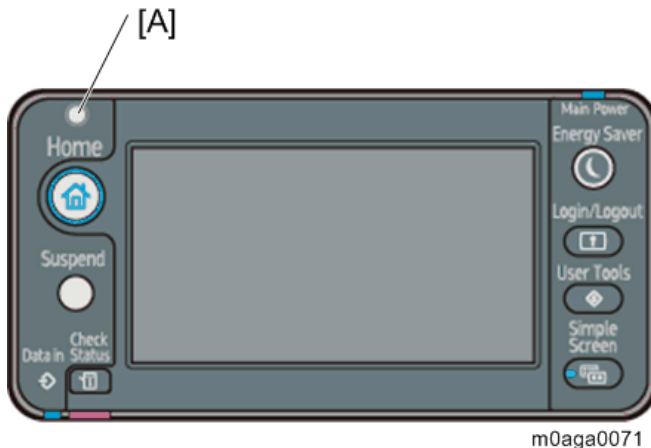

ECO Night Sensor

The ECO Night Sensor (ambient light sensor) [A] enables the printer to automatically turn off and on the main power when changes in the ambient light level are detected.

You can specify how the printer performs when the ECO Night Sensor detects changes in the ambient light level.

When Weekly Timer is set to [Daily] or [Day of the Week], the printer does not turn on even if [ECO Night Sensor] is set to [Power Off and On] and the time for turning on the main power specified in [Timer to Turn On] elapses.

Default: **[Power Off Only]**

- Power Off Only
The printer turns off the main power when the ECO Night Sensor detects a low ambient light level.
- Power Off and On
The printer turns off the main power when a decrease in the ambient light level is detected. It turns on the main power when an increase in the ambient light level is detected.
- Inactive
The ECO Night Sensor is disabled.

Timer to Turn Off

You can specify how long the printer waits to turn off the main power when the ECO Night Sensor detects a low ambient light level.

The timer is reset when:

- The sensor detects changes in the ambient light level.
- Any key on the control panel is pressed or printing is performed.
- The main power switch is turned on.
- The printer configuration screen is displayed on the control panel.
- The printer settings are changed using Web Image Monitor.
- The printer settings are imported or exported.
- A program is downloaded.
- The printer resumes Fusing Unit Off mode.
- The printer enters Sleep mode.

Default: **[120 minutes]**

- 1 minute
- 5 minutes
- 30 minutes
- 60 minutes
- 120 minutes

Timer to Turn On

You can specify how long the printer waits before it turns on the main power when the ECO Night Sensor detects an increase in the ambient light level.

The timer is reset when:

- The sensor detects changes in the ambient light level.
- The ECO Night Sensor setting is changed.
- The main power is turned on.
- The printer enters Sleep mode.

Default: **[1 minute]**

- 1 minute
- 5 minutes
- 30 minutes
- 60 minutes
- 120 minutes

Brightness Sensor Level

Brightness Sensor Level to Turn Off

You can set the brightness threshold for the sensor to turn off the main power.

Default: **0**

- 0 (Dark) - 15 (Bright)

Level 0 (Very dark): Equivalent to a moonlit night

Level 5 (Dark): Equivalent to a dimly-lit room

Level 7 (Dim): Equivalent to a room at sunset

Level 9 (Bright): Equivalent to a brightly lit room at night

Level 15 (Very bright): Equivalent to a sunlit room

Brightness Sensor Level to Turn On

You can set the brightness threshold for the sensor to turn on the main power.

Default: **8**

- 0 (Dark) - 15 (Bright)

Level 0 (Very dark): Equivalent to a moonlit night

Level 5 (Dark): Equivalent to a dimly-lit room

Level 7 (Dim): Equivalent to a room at sunset

Level 9 (Bright): Equivalent to a brightly lit room at night

Level 15 (Very bright): Equivalent to a sunlit room

You can set a lower value for [Brightness Sensor Level to Turn Off] than the one for [Brightness Sensor Level to Turn On].

Brightness levels are based on ambient light. The actual brightness level may differ depending on the environment in which the printer is used.

Weekly Timer

You can set the timer for the printer to turn off and on the main power or enter and exit Sleep mode every day or on specified days of the week. Detailed settings for Weekly Timer, such as setting the day or time to enable Weekly Timer, can be configured using Web Image Monitor.

When Weekly Timer is set to [Daily (Web Preset Time)] or [Day of Week (Preset Time)], the printer does not turn on even if [Mode Setting] in [ECO Night Sensor] is set to [Auto Power Off and On] and the time for turning on the main power specified in [Timer to Turn On] elapses.

Default: **[Inactive]**

- Daily (Web Preset Time)
- Day of Week(Preset Time)
- Inactive

Related SPs

7

5-810-001 [Fusing SC Reset]-[Fusing SC Reset]:

Resets a type A service call condition. Turn the main power switch off and on after resetting the SC code.

MEMO

MEMO

SP C340DN / SP C342DN
Machine Codes: M0AG / M0AH

Appendices

TABLE OF CONTENTS

1. Appendix: Specifications

- General Specifications..... 3
 - Mainframe..... 3
 - Engine..... 3
 - Controller..... 5
 - Option..... 6
 - Paper Feed Unit..... 6
- Supported Paper Sizes..... 7

2. Appendix: Preventive Maintenance

- Preventive Maintenance..... 11
 - User Replaceable Items..... 11
 - Yield Items..... 11
 - Service Maintenance..... 12

3. Appendix: SP Mode Tables

- Service Mode..... 13
 - SP1-XXX (Service Mode)..... 13
- Engine SP1-xxx..... 28
 - SP1-XXX (Feed)..... 28
- Engine SP2-xxx..... 31
 - SP2-XXX (Drum)..... 31
- Engine SP3-xxx and SP4-xxx..... 38
 - SP3-XXX (Process)..... 38
 - SP4-XXX (Scanner)..... 38
- Engine SP5-xxx..... 39
 - SP5-XXX (Mode)..... 39
- Engine SP7-xxx..... 70
 - SP7-XXX (Data Log)..... 70
- Engine SP8-xxx..... 86
 - SP8-XXX (Data Log 2)..... 86
 - Keys and abbreviations in Data Log 2..... 86
- Input and Output Check..... 108
 - Input Check Table..... 108
 - Output Check Table..... 111

4. Appendix: Machine Swap

Exchange and Replace Procedure.....	113
Instruction.....	113
Before the substitute machine gets to the customer site.....	113
When the substitute machine gets to the customer site.....	113
Cleaning Points after Machine Arrival at Depot.....	113

1. Appendix: Specifications

General Specifications

Mainframe

Engine

Type	Desktop		
Technology	Laser beam scanning and electro-photographic printing		
	Mono-component toner development		
	4-drum tandem method		
Memory	2 GB		
Resolution (dpi)	600 x 600 dpi (Speed Mode) 600 x 600 dpi (2bit) 1200 x 1200 dpi equivalent (Fine Mode)		
Printing Speed	General Paper	A4	One-sided printing: 25 pages per minute Two-sided printing: 25 pages per minute
		Letter	One-sided printing: 26 pages per minute Two-sided printing: 26 pages per minute
First Print Speed (A4/LT, SEF, Std. Tray)	Mono		13.5 sec or less
	F/C		13.5 sec or less
Duplex Printing	A4, LT, B5, LG, Exe		Automatic
Dimensions (W x D x H)	400 x 480 x 387 mm/ 15.8 x 18.9 x 15.2 inch		
Weight	SP C340DN/SP C342DN: Approx. 29 kg (63.9 lb.)		

Input capacity	Standard	Std Tray	500 sheets
		Bypass tray	100 sheets
	Optional Paper Tray	Paper Feed Unit	500 sheets x 1
	Max		Up to 1,100 sheets
Output capacity	Standard Tray	Face down	Up to 150 sheets (A4/LT, 80g/m ² or 20lb)
Input Paper Size	Standard Tray		A4, B5, A5, Legal, Letter, Executive, Foolscap, Folio, F (8"x13"), A6 Custom size: Min. 148mm x 210mm (5.8"x8.3"), Max. 216mm x 356mm (8.5"x14.0")
	Bypass Tray		A4, B5, A5, Legal, Letter, HLT, Executive, Foolscap, Folio, F(8"x13"), B6, A6 Custom size: Min. 64mm x 125mm (2.5" x 4.9"), Max. 216mm x 1260mm (8.5" x 49.6")
	Optional Paper Tray		A4, Letter
Media Type		Std.Tray	Thin Paper / Plain Paper / Middle Thick Paper / Thick Paper / Recycled Paper / Color Paper / Special Paper / Letterhead Paper / Preprinted Paper / Cardstock Paper / Label Paper / Glossy Paper / Coated Paper (Glossy)
		Bypass Tray	Thin Paper / Plain Paper / Middle Thick Paper / Thick Paper / Recycled Paper / Color Paper / Special Paper / Letterhead Paper / Preprinted Paper / Bond Paper / Cardstock Paper / Label Paper / Glossy Paper / Envelope / Coated Paper (Glossy) / Coated Paper (Matted)
		Op.Paper Feed Unit	Thin Paper / Plain Paper / Middle Thick Paper / Thick Paper / Recycled Paper / Color Paper / Special Paper / Letterhead Paper / Preprinted Paper / Cardstock Paper

Paper Weight	Standard Tray		60-163 g/m ² (16-43 lb)
	Bypass tray		60-220 g/m ² (16-59 lb)
	Duplex		60-90 g/m ² (16-24 lb)
	Op. Paper Tray	Paper Feed Unit	60-163 g/m ² (16-43 lb)
Rating Power Spec.	NA version		120V, 60Hz
	EU version		220 - 240V, 50/60Hz
Power Consumption	NA version	Max.	1300W or less
		Energy Saver	1.0 W or less
	EU version	Max.	1300W or less
		Energy Saver	1.0 W or less
Warm-up Time			SP C340DN: 16 seconds SP C342DN: 20 seconds
Energy Save Mode	Sleep Mode		Adjustable SP C340DN: Off, 1, 5, 15, 30, 45, 60, 120, 240 min.: Default 1 min. SP C342DN: Off, 1 to 60 min.: Default 1 min.
Sound Pressure Level (ISO7779)	Standby/Energy Saver		Mainframe: Less than 28 dB(A)
			System: Less than 28 dB(A)
	Printing		Mainframe: FC: 50.0 dB
			System: FC: 53.0 dB(A)

Controller

CPU	1.46 GHz
-----	----------

Interface	Standard	Gigabit Ethernet (10BASE-T/ 100BASE-TX/ 1000BASE-T), USB2.0, USB2.0-Host
	Optional	IEEE1284 ECP Parallel, IEEE 802.11 a/g Wireless LAN, USB device server (10BASE-T/ 100BASE-TX/ 1000BASE-T)
Language		PCL5c/6, PostScript 3 emulation, PDF emulation, PictBridge (Option), XPD (Option)
Font		PCL: 45 fonts + International Fonts 13 fonts PS3, PDF: 136 fonts
Operating Systems		Windows Vista, 7, 8, 8.1, 10, Server 2003, 2003 R2, 2008, 2008 R2, 2012, 2012 R2 (32-bit, 64-bit) Mac OS X (v 10.7 or later),
Network Protocols		TCP/IP, IPX/SPX

Option

Paper Feed Unit

Paper Tray (500x1)	Paper Size	A4, Letter
	Paper Weight	60-163g/m ² (16-43lb)
	Paper capacity	500 sheets x 1 tray
	Dimensions (W x D x H)	400 × 480 × 127 mm (15.8 × 18.9 × 5.0 inches)
	Weight	6.1 kg (13.5 lb.)

Supported Paper Sizes

A	Supported and the size is molded in the tray. Need to select paper size by operation panel/driver.
B	Supported but size is not molded in the tray. Need to select paper size by operation panel/driver.
C	Need to input paper size by operation panel and driver.
N	Not supported.

Type		SEF/ LEF	Size	Input Tray			Auto. Dup.
				Std. Tray	Option PFU	Bypass Tray	
Plain Paper	A4	SEF	210x297	A	A	B	B
		LEF	297x210	N	N	N	N
	B5	SEF	182x257	A	N	B	B
		LEF	257x182	N	N	N	N
	A5	SEF	148x210	A	N	B	N
		LEF	210x148	N	N	N	N
	B6	SEF	128x182	N	N	B	N
		LEF	182x128	N	N	N	N
	A6	SEF	105x148	N	N	B	N
		LEF	148x105	N	N	N	N

Type		SEF/ LEF	Size	Input Tray			Auto. Dup.
				Std. Tray	Option PFU	Bypass Tray	
Plain Paper	DLT	SEF	11" x 17"	N	N	N	N
	Legal	SEF	8 1/2" x 14"	A	N	B	B
	Letter	SEF	8 1/2" x 11"	A	A	B	B
		LEF	11" x 8 1/2"	N	N	N	N
	Half Letter	SEF	5 1/2" x 8 1/2"	N	N	C	N
	Executive	SEF	7 1/4" x 10 1/2"	A	N	B	B
		LEF	10 1/2" x 7 1/4"	N	N	N	N
	F	SEF	8" x 13"	B	N	B	B
	Foolscap	SEF	8 1/2" x 13"	B	N	B	B
	Folio	SEF	8 1/4" x 13"	B	N	B	B
Plain Paper	8 Kai	SEF	267 x 390	N	N	N	N
	16 Kai	SEF	195 x 267	B	N	B	N
		LEF	267 x 195	N	N	N	N
Envelope	Com10	SEF	4 1/8" x 9 1/2"	N	N	B	N
	Monarch	SEF	3 7/8" x 7 1/2"	N	N	B	N
	C6	SEF	114 x 162	N	N	B	N
	C5	SEF	162 x 229	N	N	B	N
	DL Env	SEF	110 x 220	N	N	B	N

Type		SEF/ LEF	Size	Input Tray			Auto. Dup.
				Std. Tray	Option PFU	Bypass Tray	
Custom	Width		64-90mm (2.5" x 3.5")	N	N	C	N
			90-148mm (3.6" x 5.8")	N	N	C	C
			148-216mm (5.8" x 8.5")	C	N	C	C
	Length		125-210mm (4.9" x 8.3")	N	N	C	N
			210-240mm (8.3" x 9.4")	C	N	C	N
			240-356mm (9.4" x 14.0")	C	N	C	C
			356-1260mm (14.0" x 49.6")	N	N	C	N

2. Appendix: Preventive Maintenance

Preventive Maintenance

User Replaceable Items

Item	Replacement Timing
Print Cartridge (AIO)	Starter/Short: Approx. 2.8 k prints/cartridge Long: 5.0 k prints/cartridge (SP C340DN) Long: 7.2 k for BK, 6.6 k for CMY prints/cartridge (SP C342DN)
Maintenance Kit	Fusing Unit Transfer Roller Unit Approx. 90 k prints/unit
Image Transfer Belt Unit	Approx. 90 k prints/unit
Waste Toner Bottle	Approx. 55 k prints/bottle (See condition 4)

Condition:

1. An A4 (8.5"x11")/5% chart was used to measure the above replacement timing except the Print Cartridge (AIO).
2. The condition was standard temperature and humidity.
3. The expected yield measurement for the Print Cartridge (AIO) is based on ISO 19798 (ISO chart, continuous prints).
4. These replacement timings may change depending on the circumstances and printing conditions.
5. The replacement timing of the Maintenance Kit (Fusing Unit and Transfer Roller Unit), Transfer Belt Unit and Waste Toner Bottle were measured at 3P/J when the printer is used 50% for color and 50% for black-and-white

Yield Items

The following items are not user replaceable items. However, replacement at its yield is required for the following items to maintain the printing operation.

Item	Yield
Paper Feed Roller	Approx. 200 k prints
Separation Pad	Approx. 200 k prints

2

Service Maintenance

To enable the machine for the maintenance by the service technician, the meter-charge mode must be set to "1 (On)" with SP5930-001.

PM items serviced by the service technician are designated as user replaceable items and yield items.

The following table shows the expected yield values for PM items when replacing them by the service technician with the meter-charge mode on.

	Meter-charge Mode On
Image Transfer Belt Unit	135 K
Maintenance Kit (Fusing Unit and Transfer Roller Unit)	135 K

The replacement timing for the customer maintenance is set earlier than the target yield for the service maintenance in order to ensure that the parts of the machine are replaced before an image problem occurs.

3. Appendix: SP Mode Tables

Service Mode

SP1-XXX (Service Mode)

1001	Bit Switch		
001	Bit Switch 1	0	1
	bit 0	DFU	-
	bit 1	Responding with the hostname as the sysName	Model name (PnP name)
		<p>This BitSwitch can change the value of the sysName.</p> <p>0 (default): Model name (PnP name) such as "MP C401SP"</p> <p>1: Host name</p>	
	bit 2	DFU	-
	bit 3	No I/O Timeout	0: Disabled 1: Enabled
		Enables/Disables MFP I/O Timeouts. If enabled, the MFP I/O Timeout setting will have no affect. I/O Timeouts will never occur.	
	bit 4	SD Card Save Mode	0: Disabled 1: Enabled
		If this bit switch is enabled, print jobs will be saved to the GW SD slot and not output to paper.	
	bit 5	[PS and PDF] Paper size error margin	±5pt ±10pt
		When a PS job is printed by using a custom paper size, the job might not be printed because of a paper size mismatch caused by a calculation error. By default, the error margin for matching to a paper size is ±5 points. By enabling this BitSwitch, the error margin for matching to a paper size can be extended to ±10 points.	

	bit 6	Color balance switching	0: Disabled	1: Enabled
		<p>When a PS job is printed by using a custom paper size, the job might not be printed because of a paper size mismatch caused by a calculation error. By default, the error margin for matching to a paper size is ± 5 points. By enabling this BitSwitch, the error margin for matching to a paper size can be extended to ± 10 points.</p> <p>Note: If both BitSwitch #2-0, BitSwitch #2-4 and BitSwitch #1-6 are configured to "1", the configuration of #2-0 will be given priority and the color balance of 09S and earlier models will be used.</p>		
	bit 7	[RPCS,PCL]: Printable area frame border	0: Disable	1: Enable
		Prints all RPCS and PCL jobs with a border around the printable area.		

1001	Bit Switch			
002	Bit Switch 2		0	1
	bit 0	Color balance switching	0: Disabled	1: Enabled
		<p>This BitSwitch can be used to restore the color balance to match that of previous models. If this BitSwitch is set to "1" (Enabled), the color balance from 09S and earlier models will be used.</p> <p>Note: If both BitSwitch #2-0 and BitSwitch #2-4 are configured to "1", the configuration of #2-0 will be given priority and the color balance of 09S and earlier models will be used.</p>		
	bit 1	DFU	-	-
	bit 2	DFU	-	-
	bit 3	[PCL5e/c,PS]: PDL Auto Switching	0: Enable	1: Disable
		<p>Enables/disable the MFPs ability to change the PDL processor mid-job.</p> <p>Some host systems submit jobs that contain both PS and PCL5e/c. If Auto PDL switching is disabled, these jobs will not be printed properly.</p>		
	bit 4	DFU	-	-
	bit 5	DFU	-	-
	bit 6	Switch dither	0: Use normal dither	1: Use alternative dither
		See RTB#RD014018.		

	bit 7	DFU	-	-
--	-------	-----	---	---

1001	Bit Switch			
003	Bit Switch 3		0	1
	bit 0	DFU	-	-
	bit 1	DFU	-	-
	bit 2	[PCL5e/c]: Legacy HP compatibility	0: Disabled	1: Enabled
	<p>Uses the same left margin as older HP models such as HP4000/HP8000.</p> <p>In other words, the left margin defined in the job (usually "<ESC>*r0A") will be changed to "<ESC>*r1A".</p>			
	bit 3	DFU	-	-
	bit 4	DFU	-	-
	bit 5	DFU	-	-
	bit 6	DFU	-	-
	bit 7	DFU	-	-

1001	Bit Switch			
004	Bit Switch 4 DFU		0	1

1001	Bit Switch			
005	Bit Switch 5		0	1
	bit 0	DFU	-	-
	bit 1	Multiple copies if a paper size or type mismatch occurs	0: Disable (Single copy)	1: Enable (Multiple copy)
	<p>If a paper size or type mismatch occurs during the printing of multiple copies, only a single copy is output by default. Using this BitSw, the device can be configured to print all copies even if a paper mismatch occurs.</p>			

	bit 2	Prevent SDK applications from altering the contents of a job.	0: Disable	1: Enable
		<p>Enable: SDK applications will not be able to alter print data. This is achieved by preventing SDK applications from accessing a module called the "GPS Filter".</p> <p>Note: The main purpose of this bit switch is for troubleshooting the effects of SDK applications on data.</p>		
	bit 3	[PS] PS Criteria	Pattern3	Pattern1
		<p>Change the number of PS criterion used by the PS interpreter to determine whether a job is PS data or not.</p> <p>Pattern3: includes most PS commands.</p> <p>Pattern 1: A small number of PS tags and headers</p>		
	bit 4	Increase max number of the stored jobs.	0: Disabled (100)	1: Enabled
		<p>Changes the maximum number of jobs that can be stored on the HDD. The default (disabled) is 100. If this is enabled, the max. will be raised to 750 or 1000 depending on the model.</p>		
	bit 5	DFU	-	-
	bit 6	Method for determining the image rotation for the edge to bind on.	0: Disable	1: Enable
		<p>If enabled, the image rotation will be performed as they were in the specifications of older models for the binding of pages of mixed orientation jobs.</p> <p>The old models are below:</p> <ul style="list-style-type: none"> - PCL: Pre-04A models - PS/PDF/RPCS:Pre-05S models 		
	bit 7	Letterhead mode printing	0: Disable	1: Enable (Duplex)
		<p>Routes all pages through the duplex unit.</p> <p>If this is disabled, simplex pages or the last page of an odd-paged duplex job are not routed through the duplex unit. This could result in problems with letterhead/preprinted pages.</p> <p>Only affects pages specified as Letterhead paper.</p>		

1001	Bit Switch
------	------------

006	Bit Switch 6 DFU	-	-
-----	------------------	---	---

1001	Bit Switch		
006	Bit Switch 7 DFU	-	-

1001	Bit Switch			
008	Bit Switch 8	0	1	
	bit 0	DFU	-	
	bit 1	DFU	-	
	bit 2	DFU	-	
	bit 3	[PCL,PS]: Allow BW jobs to print without requiring User Code	0: Disabled	1:Enabled (allow BW jobs to print without a user code)
	BW jobs submitted without a user code will be printed even if usercode authentication is enabled.			
	 Note <ul style="list-style-type: none"> Color jobs will not be printed without a valid user code. 			
	bit 4	DFU	-	-
	bit 5	DFU	-	-
	bit 6	PCL, PS: Forced BW print	0: Disabled	1: Enabled
Switches whether to ignore PDL color command.				
bit 7	DFU	-	-	

1001	Bit Switch		
009	Bit Switch 9	0	1

	bit 0	PDL Auto Detection timeout of jobs submitted via USB or Parallel Port (IEEE 1284).	0: Disabled (Immediately)	1: Enabled (10 seconds)
		To be used if PDL auto-detection fails. A failure of PDL autodetection doesn't necessarily mean that the job can't be printed. This bit switch tells the device whether to time-out immediately (default) upon failure or to wait 10 seconds.		
	bit 1	DFU	-	-
	bit 2	Job Cancel	0: Disabled (Not cancelled)	1: Enabled (Cancelled)
		<p>Enable: All jobs will be cancelled after a jam occurs.</p> <p>Note: If this bit switch is enabled, printing under the following conditions might result in problems:</p> <ul style="list-style-type: none"> - Job submission via USB or parallel port - Spool printing (WIM > Configuration > Device Settings > System) 		
	bit 3	DFU	-	-
	bit 4	Timing of the PjL Status ReadBack (JOB END) when printing multiple collated copies.	0: Disabled	1: Enabled
		<p>This bit switch determines the timing of the PjL USTATUS JOB END sent when multiple collated copies are being printed.</p> <p>Disable (=0 (default)):</p> <p>JOB END is sent by the device to the client after the first copy has completed printing. This causes the page counter to be incremented after the first copy and then again at the end of the job.</p> <p>Enable (=1):</p> <p>JOB END is sent by the device to the client after the last copy has finished printing. This causes the page counter to be incremented at the end of each job.</p>		

	bit 5	Display UTF-8 text in the operation panel	0: Enabled	1: Disabled
		<p>Enable (=0): Text composed of UTF-8 characters can be displayed in the operation panel.</p> <p>Disable (=1): UTF-8 characters cannot be displayed in the operation panel.</p> <p>For example, job names are sometimes stored in the MIB using UTF-8 encoded characters. When these are displayed on the operation panel, they will be garbled unless this bit switch is enabled (=0).</p>		
	bit 6	Disable super option	0: Enabled	1: Disabled
		<p>Switches super option disable on / off. If this is On, multiple jobs are grouped at LPR port. PDL settings are enabled even jobs that are specified queue names are sent.</p>		
	bit 7	Enable/Disable Print from USB/SD's Preview function	0: Enabled	1: Disabled
		<p>Determines whether print from USB/SD will have the Preview function.</p> <p>Enabled (=0): Print from USB/SD will have the Preview function.</p> <p>Disabled (=1): Print from USB/SD will not have the Preview function.</p>		
1001	Bit Switch			

010	Bit Switch A		0	1
	bit 0	DFU	-	-
	bit 1	DFU	-	-
	bit 2	DFU	-	-
	bit 3	DFU	-	-
	bit 4	DFU	-	-
	bit 5	Store and Skip Errored Job locks the queue	0: Queue is not locked after SSEJ	1: Queue locked after SSEJ
	If this is 1, then after a job is stored using Store and Skip Errored Job (SSEJ), new jobs cannot be added to the queue until the stored job has been completely printed.			
bit 6	Allow use of Store and Skip Errored Job if connected to an external charge device.	0: Does not allow SSEJ with ECD	1: Allows SSEJ with ECD	
	If this is 0, Store and Skip Errored Job (SSEJ) will be automatically disabled if an external charge device is connected. Note: We do not officially support enabling this bit switch (1). Use it at your own risk.			
bit 7	DFU	-	-	

1001	Bit Switch			
011	Bit Switch B		0	1
	bit 0	DFU	-	-
	bit 1	Print job interruption	Does not allow interruption	Allow interruption
		0 (default): Print jobs are not interrupted. If a job is promoted to the top of the print queue, it will wait for the currently printing job to finish. 1: If a job is promoted to the top of the queue, it will interrupt the currently printing job and start printing immediately.		

bit 2	Switch for enabling or disabling Limitless Paper Feeding for the Bypass Tray	0: Enabled	1: Disabled
<p>When the Bypass Tray is the target of the Auto Tray Select and Any Size/Type is configured for the Tray Setting Priority setting of the Bypass Tray, this BitSwitch can switch the behavior whether or not Limitless Paper Feeding is applied to the Bypass Tray. * The default is Enabled (=0).</p> <p>* Limitless Paper Feeding will try a matching tray of the next highest priority if a job specified to Auto Tray Select as the tray setting is submitted and the tray runs out of paper.</p>			
<p>Enabled (=0: Default): Limitless Paper Feeding is applied to the Bypass Tray. If a tray other than the Bypass Tray matches the job's paper size and type but has run out of paper, printing will occur from the Bypass Tray.</p> <p>Disabled (=1): Limitless Paper Feeding is not applied to the Bypass Tray. If a tray other than the Bypass Tray matches the job's paper size and type but has run out of paper, printing will stop and an alert will appear on the LCD screen, stating that the tray has run out of paper. This prevents unexpected use of the Bypass Tray.</p> <p>Limitations when this BitSwitch is set to "1":</p> <ul style="list-style-type: none"> - The "Paper Tray Priority: Printer" setting must be configured to a tray other than the Bypass Tray. - Jobs that contain more than one paper size cannot be printed. 			
bit 3	DFU	-	-
bit 4	Add "Apply Auto Paper Select" is the condition that decides if the device's paper size or paper type should be overwritten.	0: Enabled	1: Disabled
<p>If this BitSwitch is set to "1" (enabled), the "Apply Auto Paper Select" setting will decide if the paper size or paper type that is specified in the device settings should be overwritten by the job's commands when "Tray Setting Priority" is set to "Driver/Command" or "Any Type".</p> <ul style="list-style-type: none"> - Apply Auto Paper Select = OFF: Overwritten (priority is given to the job's commands) - Apply Auto Paper Select = ON: Not overwritten (priority is given to the device settings) 			
bit 5	DFU	-	-

	bit 6	DFU	-	-
	bit 7	DFU	-	-

1001	Bit Switch			
012	Bit Switch C		0	1
	bit 0	DFU	-	-
	bit 1	DFU	-	-
	bit 2	DFU	-	-
	bit 3	DFU	-	-
	bit 4	DFU	-	-
	bit 5	Change the user ID type displayed on the operation panel	0:Enabled	1:Disabled
	<p>As of 15S models, the Login User Name can be displayed on the operation panel. The user ID type displayed on the operation panel can be changed by configuring BitSwitch #12-5 as follows:</p> <ul style="list-style-type: none"> - 0 (default): Login User Name - 1: User ID. If this is enabled, User ID will be displayed, which is equivalent to the behavior exhibited in 14A and earlier models. 			
	bit 6	Ability to use AirPrint	0:Enabled	1:Disabled
<p>For 15S and later models that support AirPrint, AirPrint can be disabled by changing this Bit Switch from 0 (default) to 1.</p>				
bit 7	DFU	-	-	

1003	[Clear Setting]			
1003 1	Initialize System			
	Initializes settings in the "System" menu of the user mode.			
1003 3	Delete Program			

1004	[Print Summary]			
------	-----------------	--	--	--

1004 1	Service Summary
	Prints the service summary sheet (a summary of all the controller settings).

1005	[Display Version]
1005 1	Printer Version
	Displays the version of the controller firmware.

1007	[Supply Display]		
	Enables or disables the display for information on each supply.		
1007 001	Development	*CTL	[0 or 1 / 0 / 1 /step] 0: OFF, 1: ON
1007 002	PCU	*CTL	
1007 003	Transfer	*CTL	
1007 004	Int. Transfer	*CTL	
1007 005	Transfer Roller	*CTL	
1007 006	Fuser	*CTL	
1007 007	Fuser Oil	*CTL	

1101	[ToneCtlSet] Toner Control Setting		
	Recalls a set of gamma settings. This can be either a) the factory setting, b) the previous setting, or c) the current setting.		
1101 1	Tone (Factory)	*CTL	
1101 2	Tone (Prev.)		
1101 3	Tone (Current)		

1102	[ToneCtlSet] Toner Control Setting		
	Selects the printing mode (resolution) for the printer gamma adjustment.		

1102 1	<ul style="list-style-type: none"> • 00: *1200x1200Photo • 01: 600x600Text • 02: 1200x1200Text • 03: 1200x600Text • 04: 600x600Photo • 05: 1200x600Photo
--------	--

1103	[PrnColorSheet] Print Color Sheet
	Prints the test page to check the color balance before and after the gamma adjustment.
1103 1	ToneCtlSheet (Toner Control Sheet)
1103 2	ColorChart

1104	[ToneCtlValue] Toner Control Value		
	Adjusts the printer gamma for the mode selected in the Mode Selection menu.		
1104 001	Set Black 1	*CTL	[0 to 255 / 16 / 1/step]
1104 021	Set Cyan 1	*CTL	
1104 041	Set Magenta 1	*CTL	
1104 061	Set Yellow 1	*CTL	
1104 002	Set Black 2	*CTL	[0 to 255 / 32 / 1/step]
1104 022	Set Cyan 2	*CTL	
1104 042	Set Magenta 2	*CTL	
1104 062	Set Yellow 2	*CTL	
1104 003	Set Black 3	*CTL	[0 to 255 / 48 / 1/step]
1104 023	Set Cyan 3	*CTL	
1104 043	Set Magenta 3	*CTL	
1104 063	Set Yellow 3	*CTL	

1104 004	Set Black 4	*CTL	[0 to 255 / 64 / 1/step]
1104 024	Set Cyan 4	*CTL	
1104 044	Set Magenta 4	*CTL	
1104 064	Set Yellow 4	*CTL	
1104 005	Set Black 5	*CTL	[0 to 255 / 80 / 1/step]
1104 025	Set Cyan 5	*CTL	
1104 045	Set Magenta 5	*CTL	
1104 065	Set Yellow 5	*CTL	
1104 006	Set Black 6	*CTL	[0 to 255 / 96 / 1/step]
1104 026	Set Cyan 6	*CTL	
1104 046	Set Magenta 6	*CTL	
1104 066	Set Yellow 6	*CTL	
1104 007	Set Black 7	*CTL	[0 to 255 / 112 / 1/step]
1104 027	Set Cyan 7	*CTL	
1104 047	Set Magenta 7	*CTL	
1104 067	Set Yellow 7	*CTL	
1104 008	Set Black 8	*CTL	[0 to 255 / 128 / 1/step]
1104 028	Set Cyan 8	*CTL	
1104 048	Set Magenta 8	*CTL	
1104 068	Set Yellow 8	*CTL	
1104 009	Set Black 9	*CTL	[0 to 255 / 144 / 1/step]
1104 029	Set Cyan 9	*CTL	
1104 049	Set Magenta 9	*CTL	
1104 069	Set Yellow 9	*CTL	

1104 010	Set Black 10	*CTL	[0 to 255 / 160 / 1/step]
1104 030	Set Cyan 10	*CTL	
1104 050	Set Magenta 10	*CTL	
1104 070	Set Yellow 10	*CTL	
1104 011	Set Black 11	*CTL	[0 to 255 / 176 / 1/step]
1104 031	Set Cyan 11	*CTL	
1104 051	Set Magenta 11	*CTL	
1104 071	Set Yellow 11	*CTL	
1104 012	Set Black 12	*CTL	[0 to 255 / 192 / 1/step]
1104 032	Set Cyan 12	*CTL	
1104 052	Set Magenta 12	*CTL	
1104 072	Set Yellow 12	*CTL	
1104 013	Set Black 13	*CTL	[0 to 255 / 208 / 1/step]
1104 033	Set Cyan 13	*CTL	
1104 053	Set Magenta 13	*CTL	
1104 073	Set Yellow 13	*CTL	
1104 014	Set Black 14	*CTL	[0 to 255 / 224 / 1/step]
1104 034	Set Cyan 14	*CTL	
1104 054	Set Magenta 14	*CTL	
1104 074	Set Yellow 14	*CTL	
1104 015	Set Black 15	*CTL	[0 to 255 / 240 / 1/step]
1104 035	Set Cyan 15	*CTL	
1104 055	Set Magenta 15	*CTL	
1104 075	Set Yellow 15	*CTL	

1105	[ToneCtlSave] Toner Control Save		
	Saves the print gamma (adjusted with the Gamma Adj.) as the new Current Setting. Before the machine stores the new "current setting", it moves the data stored as the "current setting" to the "previous setting" memory-storage location.		

1106	[Toner Limit]		
	Adjusts the maximum toner amount for image development.		
1106 1	Toner Limit Value	*CTL	[100 to 400 / 230 / 1 %/step]

1108	[Ext. Toner Save]		
1108 001	Mode 1: Text		DFU
1108 002	Mode 2: Text		
1108 003	Mode 1: Image		
1108 004	Mode 2: Image		
1108 005	Mode 1: Line		
1108 006	Mode 2: Line		
1108 007	Mode 1: Paint		
1108 008	Mode 2: Paint		

1109	[EconomyColor]		
	Adjusts the toner density rate for each print mode.		
1109 1	Text	*CTL	[0 to 999 / 80 / 1 %/step]
1109 2	Image	*CTL	[0 to 999 / 50 / 1 %/step]
1109 3	Line	*CTL	[0 to 999 / 30 / 1 %/step]
1109 4	Paint	*CTL	[0 to 999 / 30 / 1 %/step]

Engine SP1-xxx

SP1-XXX (Feed)

3

1001	[Lead Edge Reg.] Leading Edge Registration		
002	T1:NorSpd 0.3mm	*EGB	[-9.0 to 9.0 / 0 / 0.3 mm/step]
003	T1:HlfSpd 0.3mm	*EGB	[-9.0 to 9.0 / 0 / 0.3 mm/step]
006	T2:NorSpd 0.3mm	*EGB	[-9.0 to 9.0 / 0 / 0.3 mm/step]
007	T2:HlfSpd 0.3mm	*EGB	[-9.0 to 9.0 / 0 / 0.3 mm/step]
014	ByPas:NorSpd 0.3mm	*EGB	[-9.0 to 9.0 / 0 / 0.3 mm/step]
015	ByPas:HlfSpd 0.3mm	*EGB	[-9.0 to 9.0 / 0 / 0.3 mm/step]
018	Dup:NorSpd 0.3mm	*EGB	[-9.0 to 9.0 / 0 / 0.3 mm/step]
021	Dup:HlfSpd 0.3mm	*EGB	[-9.0 to 9.0 / 0 / 0.3 mm/step]
063	T1:LowSpd 0.3mm	*EGB	[-9.0 to 9.0 / 0 / 0.3 mm/step]
065	ByPas:LowSpd 0.3mm	*EGB	[-9.0 to 9.0 / 0 / 0.3 mm/step]
066	Dup:LowSpd 0.3mm	*EGB	[-9.0 to 9.0 / 0 / 0.3 mm/step]
100	Mar.pos 0:OFF1:ON	*EGB	[0 or 1 / 0 / -/step]

1002	[S-to-S Reg.] Side-to-Side Registration		
001	By-pass 0.0846mm	*EGB	[-63 to 63 / 0 / 0.0846 mm /step]
002	Tray1 0.0846mm	*EGB	
003	Tray2 0.0846mm	*EGB	
004	Duplex 0.0846mm	*EGB	

1003	[Paper Buckle] Paper Buckle		
------	-----------------------------	--	--

002	Tray1 0.1mm	*EGB	[-10.0 to 10.0 / 0.0 / 0.1 mm/step]
006	Tray2 0.1mm	*EGB	
014	By-pass 0.3mm	*EGB	
018	Duplex 0.1mm	*EGB	

1100	[Lead Edge Reg.] Leading Edge Registration		
002	T1:NorSpd 0.3mm	*EGB	[0 to 9.0 / 0 / 0.3 mm/step]
003	T1:HlfSpd 0.3mm	*EGB	[0 to 9.0 / 0 / 0.3 mm/step]
006	T2:NorSpd 0.3mm	*EGB	[0 to 9.0 / 0 / 0.3 mm/step]
007	T2:HlfSpd 0.3mm	*EGB	[0 to 9.0 / 0 / 0.3 mm/step]
014	ByPas:NorSpd 0.3mm	*EGB	[0 to 9.0 / 0 / 0.3 mm/step]
015	ByPas:HlfSpd 0.3mm	*EGB	[0 to 9.0 / 0 / 0.3 mm/step]
018	Dup:NorSpd 0.3mm	*EGB	[0 to 9.0 / 0 / 0.3 mm/step]
021	Dup:HlfSpd 0.3mm	*EGB	[0 to 9.0 / 0 / 0.3 mm/step]
063	T1:LowSpd 0.3mm	*EGB	[0 to 9.0 / 0 / 0.3 mm/step]
065	ByPas:LowSpd 0.3mm	*EGB	[0 to 9.0 / 0 / 0.3 mm/step]
066	Dup:LowSpd 0.3mm	*EGB	[0 to 9.0 / 0 / 0.3 mm/step]

1102	[S-to-S Reg.] Side-to-Side Registration		
001	By-pass 0.34mm	*EGB	[-15 to 15 / 0 / 0.34 mm /step]
002	Tray1 0.34mm	*EGB	
003	Tray2 0.34mm	*EGB	
004	Duplex 0.34mm	*EGB	

1101	[Flicker Control]		
001	Flicker Control	*EGB	[0 or 1 / 0 / 1 /step] 0: OFF, 1: ON

1105	[Temp. Adj.] Temperature Adjustment		
001	Fusing Temp.	*EGB	[1 to 16 / 16 / 1 /step]
	16: No adjustment		8: -16°C
	15: -2°C		7: -18°C
	14: -4°C		6: -20°C
	13: -6°C		5: -22°C
	12: -8°C		4: -24°C
	11: -10°C		3: -26°C
	10: -12°C		2: -28°C
	9: -14°C		1: -30°C
1159	[Fusing JAM SC] Fusing JAM SC Setting		
001	Detect 0:OFF 1:ON	*EGB	[0 or 1 / 0 / 1 /step] 0: OFF, 1: ON
1190	[Print Support]		
001	FullDetc.0:OFF1:ON	*EGB	[0 or 1 / 0 / 1 /step] 0: OFF, 1: ON
002	FullDetc.Clear	EGB	[EXECUTE]
003	SSizeSup0:OFF 1:ON	*EGB	[0 or 1 / 0 / 1 /step] 0: OFF, 1: ON
004	Exe. AF Paper set	EGB	[EXECUTE]
005	FullDetc.Offset	*EGB	[-150 to 150 / 0 / 1 sheet/step]

Engine SP2-xxx

SP2-XXX (Drum)

2101	[Color Regist.]		
001	[K]:Main Reg. D	*EGB	[-127 to 127 / 0 / 1 /dot]
002	[M]:Main Reg. D	*EGB	[-127 to 127 / 0 / 1 /dot]
003	[C]:Main Reg. D	*EGB	[-127 to 127 / 0 / 1 /dot]
004	[Y]:Main Reg. D	*EGB	[-127 to 127 / 0 / 1 /dot]
013	[M]:Sub Reg. L	*EGB	[-127 to 127 / 0 / 1 /line]
014	[C]:Sub Reg. L	*EGB	[-127 to 127 / 0 / 1 /line]
015	[Y]:Sub Reg. L	*EGB	[-127 to 127 / 0 / 1 /line]
021	[K]:Sub Reg. D	*EGB	[0 to 15 / 0 / 1 /sub-dot]
022	[M]:Sub Reg. D	*EGB	[0 to 15 / 0 / 1 /sub-dot]
023	[C]:Sub Reg. D	*EGB	[0 to 15 / 0 / 1 /sub-dot]
024	[Y]:Sub Reg. D	*EGB	[0 to 15 / 0 / 1 /sub-dot]

2104	[Magnifi. Adj.]		
001	[K]:M Mag 0.001%	*EGB	[-1200 to 1200 / 0 / 1 /dot]
002	[M]:M Mag 0.001%	*EGB	[-1200 to 1200 / 0 / 1 /dot]
003	[C]:M Mag 0.001%	*EGB	[-1200 to 1200 / 0 / 1 /dot]
004	[Y]:M Mag 0.001%	*EGB	[-1200 to 1200 / 0 / 1 /dot]

2109	[Test Print]		
001	Test Print Exe	-	
002	Image Pattern 1	-	[0 to 127 / 0 / 1 /step]

	0: Grid (512 dot pitch) 2: Grid Horizontal (128dot pitch) 4: Grid / vertical line (128dot pitch) 8: Horizontal line / 2dot (4dot pitch) 16: Vertical line / 2dot (4dot pitch) 32: Horizontal line / 1 dot (2dot pitch) 64: Vertical line / 1dot (2 dot pitch)		
003	Image Pattern 2	-	[0 to 127 / 0 / 1 /step]
	0: Belt 2: Solid 4: 4 x 4 dot (8dot pitch) 8: 2 x 2 dot (4dot pitch) 16: 1 x 1 dot (2dot pitch) 32: Grid / skew 1dot (512dot pitch) 64: Grid / skew 1dot (128dot pitch)		
004	Print Page	-	[0 to 127 / 0 / 1 page /step]
005	Feed Source	-	[0 to 2 / 0 / 1 /step] 0: Tray 1, 1: By-pass, 2: Tray 2
006	Print Mode	-	[0 or 1 / 0 / 1 /step] 0: Simplex, 1: Duplex
007	Color	-	[0 to 7 / 0 / 1 /step]
	0: Black, 1: Magenta, 2: Cyan, 3: Yellow, 4: Red (Yellow and Magenta), 5: Green (Yellow and Cyan), 6: Blue (Magenta and Cyan), 7: Full Color		

2120	[Auto Adjustment] Manual Line Position Adjustment Execution		
001	LPos. Adj: Rough	-	
002	LPos. Adj: Fine	-	
003	LSpd LPos. Adj	-	
004	Adjustment	-	

005	ProCon 0:OFF 1:ON	*EGB	[0 or 1 / 0 / 1 /step] 0:OFF, 1:ON
006	MUSIC 0:OFF 1:ON	*EGB	[0 or 1 / 0 / 1 /step] 0:OFF, 1:ON
007	Tnr Cnt 0:OFF 1:ON	*EGB	[0 or 1 / 0 / 1 /step] 0:OFF, 1:ON
008	Color Regi. Adj	*EGB	
009	Transfer Belt Adj	*EGB	

2152	[Area Shading]		
006	[K]:Area0	*EGB	[0 to 255 / 100 / 1 /step]
007	[K]:Area1	*EGB	[0 to 255 / 100 / 1 /step]
008	[K]:Area2	*EGB	[0 to 255 / 100 / 1 /step]
009	[K]:Area3	*EGB	[0 to 255 / 100 / 1 /step]
010	[K]:Area4	*EGB	[0 to 255 / 100 / 1 /step]
011	[K]:Area5	*EGB	[0 to 255 / 100 / 1 /step]
012	[K]:Area6	*EGB	[0 to 255 / 100 / 1 /step]
013	[K]:Area7	*EGB	[0 to 255 / 100 / 1 /step]
014	[K]:Area8	*EGB	[0 to 255 / 100 / 1 /step]
017	[M]:Area0	*EGB	[0 to 255 / 100 / 1 /step]
018	[M]:Area1	*EGB	[0 to 255 / 100 / 1 /step]
019	[M]:Area2	*EGB	[0 to 255 / 100 / 1 /step]
020	[M]:Area3	*EGB	[0 to 255 / 100 / 1 /step]
021	[M]:Area4	*EGB	[0 to 255 / 100 / 1 /step]
022	[M]:Area5	*EGB	[0 to 255 / 100 / 1 /step]
023	[M]:Area6	*EGB	[0 to 255 / 100 / 1 /step]
024	[M]:Area7	*EGB	[0 to 255 / 100 / 1 /step]

025	[M]:Area8	*EGB	[0 to 255 / 100 / 1 /step]
028	[C]:Area0	*EGB	[0 to 255 / 100 / 1 /step]
029	[C]:Area1	*EGB	[0 to 255 / 100 / 1 /step]
030	[C]:Area2	*EGB	[0 to 255 / 100 / 1 /step]
031	[C]:Area3	*EGB	[0 to 255 / 100 / 1 /step]
032	[C]:Area4	*EGB	[0 to 255 / 100 / 1 /step]
033	[C]:Area5	*EGB	[0 to 255 / 100 / 1 /step]
034	[C]:Area6	*EGB	[0 to 255 / 100 / 1 /step]
035	[C]:Area7	*EGB	[0 to 255 / 100 / 1 /step]
036	[C]:Area8	*EGB	[0 to 255 / 100 / 1 /step]
039	[Y]:Area0	*EGB	[0 to 255 / 100 / 1 /step]
040	[Y]:Area1	*EGB	[0 to 255 / 100 / 1 /step]
041	[Y]:Area2	*EGB	[0 to 255 / 100 / 1 /step]
042	[Y]:Area3	*EGB	[0 to 255 / 100 / 1 /step]
043	[Y]:Area4	*EGB	[0 to 255 / 100 / 1 /step]
044	[Y]:Area5	*EGB	[0 to 255 / 100 / 1 /step]
045	[Y]:Area6	*EGB	[0 to 255 / 100 / 1 /step]
046	[Y]:Area7	*EGB	[0 to 255 / 100 / 1 /step]
047	[Y]:Area8	*EGB	[0 to 255 / 100 / 1 /step]

2162	[Area Mag. Cor.]		
001	[K]:Area1	*EGB	[-255 to 255 / 0 / 1 /sub-dot]
002	[K]:Area2	*EGB	[-255 to 255 / 0 / 1 /sub-dot]
003	[K]:Area3	*EGB	[-255 to 255 / 0 / 1 /sub-dot]
004	[K]:Area4	*EGB	[-255 to 255 / 0 / 1 /sub-dot]
005	[K]:Area5	*EGB	[-255 to 255 / 0 / 1 /sub-dot]

006	[K]:Area6	*EGB	[-255 to 255 / 0 / 1 /sub-dot]
007	[K]:Area7	*EGB	[-255 to 255 / 0 / 1 /sub-dot]
008	[K]:Area8	*EGB	[-255 to 255 / 0 / 1 /sub-dot]
013	[M]:Area1	*EGB	[-255 to 255 / 0 / 1 /sub-dot]
014	[M]:Area2	*EGB	[-255 to 255 / 0 / 1 /sub-dot]
015	[M]:Area3	*EGB	[-255 to 255 / 0 / 1 /sub-dot]
016	[M]:Area4	*EGB	[-255 to 255 / 0 / 1 /sub-dot]
017	[M]:Area5	*EGB	[-255 to 255 / 0 / 1 /sub-dot]
018	[M]:Area6	*EGB	[-255 to 255 / 0 / 1 /sub-dot]
019	[M]:Area7	*EGB	[-255 to 255 / 0 / 1 /sub-dot]
020	[M]:Area8	*EGB	[-255 to 255 / 0 / 1 /sub-dot]
025	[C]:Area1	*EGB	[-255 to 255 / 0 / 1 /sub-dot]
026	[C]:Area2	*EGB	[-255 to 255 / 0 / 1 /sub-dot]
027	[C]:Area3	*EGB	[-255 to 255 / 0 / 1 /sub-dot]
028	[C]:Area4	*EGB	[-255 to 255 / 0 / 1 /sub-dot]
029	[C]:Area5	*EGB	[-255 to 255 / 0 / 1 /sub-dot]
030	[C]:Area6	*EGB	[-255 to 255 / 0 / 1 /sub-dot]
031	[C]:Area7	*EGB	[-255 to 255 / 0 / 1 /sub-dot]
032	[C]:Area8	*EGB	[-255 to 255 / 0 / 1 /sub-dot]
037	[Y]:Area1	*EGB	[-255 to 255 / 0 / 1 /sub-dot]
038	[Y]:Area2	*EGB	[-255 to 255 / 0 / 1 /sub-dot]
039	[Y]:Area3	*EGB	[-255 to 255 / 0 / 1 /sub-dot]
040	[Y]:Area4	*EGB	[-255 to 255 / 0 / 1 /sub-dot]
041	[Y]:Area5	*EGB	[-255 to 255 / 0 / 1 /sub-dot]
042	[Y]:Area6	*EGB	[-255 to 255 / 0 / 1 /sub-dot]
043	[Y]:Area7	*EGB	[-255 to 255 / 0 / 1 /sub-dot]

044	[Y]:Area8	*EGB	[-255 to 255 / 0 / 1 /sub-dot]
-----	-----------	------	--------------------------------

2181	[LPos. Adj Result] Line Position Adjustment Result ([Color], Value, Unit)		
2181 001	[K]: Skew	*EGB	[-999 to 999 / 0 / 1 μm/step]
2181 011	[M]: Skew	*EGB	[-999 to 999 / 0 / 1 μm/step]
2181 021	[C]: Skew	*EGB	[-999 to 999 / 0 / 1 μm/step]
2181 031	[Y]: Skew	*EGB	[-999 to 999 / 0 / 1 μm/step]

2186	[MUSIC Record] Automatic Line Position Adjustment Record		
2186 007	Result	*EGB	[0 to 999999 / 0 / 1 /step]
	MUSIC executing: 0000 MUSIC success: xxx1 ("x": any numbers) Pattern detection error: xxx2 ("x": any numbers) Skew error: 0003 Bend error: 0004 Sub-scan shift error: 0005 Main-scan shift error: 0006 D-phase error: 0007 MUSIC interruption: 0008 No MUSIC execution: 0009		
2186 008	Execution	*EGB	[0 to 9999 / 0 / 1 /step]
2186 009	Failure	*EGB	[0 to 9999 / 0 / 1 /step]

2190	[Transfer Adj]		
001	Belt Cleaning	*EGB	[0 or 1 / 1 / 1 /step] 0: Off, 1: On
002	Paper Trans:Side1	*EGB	[-15 to 15 / 0 / 1 /μA]
003	Paper Trans:Side2	*EGB	[-15 to 15 / 0 / 1 /μA]

004	Media Type	*EGB	[0 to 19 / 0 / 1 /step]
-----	------------	------	-------------------------

2191	[Laser Unit]		
001	LD Default Set	EGB	[EXECUTE]
011	Bk Data	*EGB	[-255 to 255 / 0 / 1 /step]
012	M Data	*EGB	[-255 to 255 / 0 / 1 /step]
013	C Data	*EGB	[-255 to 255 / 0 / 1 /step]
014	Y Data	*EGB	[-255 to 255 / 0 / 1 /step]

2907	[ACS SW: FC Mode]		
001	Cont.Mono Sheet	*EGB	-
	[0 or 1 / 1 / -/step] 0: Document counter, 1: Page counter		

Engine SP3-xxx and SP4-xxx

SP3-XXX (Process)

3901	[Auto Adjustment]		
3901 001	TD Setting Exe	*EGB	
3901 002	TD Setting Result	*EGB	
3901 003	Detail Result K	*EGB	
3901 004	Detail Result M	*EGB	
3901 005	Detail Result C	*EGB	
3901 006	Detail Result Y	*EGB	

SP4-XXX (Scanner)

4901	[Auto Adjustment]		
4901 001	Laser-TM Sn Cnt	*EGB	

Engine SP5-xxx

SP5-XXX (Mode)

5001	[All Indicators On] (SP C340DN only)		
5001 001	All Indicators On	CTL	[EXECUTE]

5009	[Add Display Language] (SP C342DN only)		
5009 201	Bit SW	*CTL	[0 to 255 / 0 / 1]
5009 202	Bit SW	*CTL	[0 to 255 / 0 / 1]
5009 203	Bit SW	*CTL	[0 to 255 / 0 / 1]
5009 204	Bit SW	*CTL	[0 to 255 / 0 / 1]
5009 205	Bit SW	*CTL	[0 to 255 / 0 / 1]
5009 206	Bit SW	*CTL	[0 to 255 / 0 / 1]
5009 207	Bit SW	*CTL	[0 to 255 / 0 / 1]

5024	[mm/inch Display Selection]		
5024 001	0:mm 1:inch	*CTL	[0 or 1 / 1(USA), 0(Others) / 1] 0: mm 1: inch

5045	[Accounting counter]		
5045 001	Counter Method	*CTL	[0 to 7 / 1 / -] 0: Developments, 1: Pages, 2: Coverage range, 3: Pages and Economy Color (color count up mode), 4: Pages and Economy Color (B&W count up mode), 7: Coverage (YMC)

5051	[TonerRefillDetectionDisplay]		
------	-------------------------------	--	--

5051 001	-	*CTL	[0 or 1 / 0 / -] 0: ON 1: OFF
----------	---	------	-------------------------------------

5055	[Display IP Address]		
5055 001	-	*CTL	[0 or 1 / 0 / -] 0: OFF 1: ON

5061	[Toner Remaining Icon Display Change] (SP C342DN only)		
5061 001	-	*CTL	[0 or 1 / 0 / -] 0: Not display 1: Display

5074	[Home Screen Login] (SP C342DN only)		
5074 002	Login Setting	*CTL	[0 to 255 / 0 / -]
5074 050	Show Home Edit Menu	*CTL	[0 to 2 / 0 / -]
5074 091	Function Setting	*CTL	[0 to 2 / 0 / -] 0: Function disable 1: SDK application 2: Legacy application (reserved)
5074 092	Product ID	*CTL	[0x00 to 0xffff / - / -]
5074 093	Application Screen ID	*CTL	[0 to 255 / 0 / -]

5075	[USB Keyboard] (SP C342DN only)		
5075 001	Display setting	*CTL	[0 to 1 / 0 / -] 0: Disable 1: Enable

5083	[LED Light Switch Setting]		
------	----------------------------	--	--

5083 001	Toner Near End	*CTL	[0 to 1 / 0 / -] 0: OFF 1: ON
5083 002	Waste Toner Near End	*CTL	[0 to 1 / 0 / -] 0: OFF 1: ON

5169	[CE Login]		
5169 001	CE Login	*CTL	[0 or 1 / 0 / -] 0: Off, 1: On

5191	[Mode Set]		
5191 001	Power Str Set	*CTL	[0 or 1 / 0 / -] 0: Off, 1: On

5195	[Limitless SW]		
5195 001	-	*CTL	[0 or 1 / 0 / -] 0: Productivity Precede 1: Use paper up

5302	[Set Time]		
5302 002	Time difference	*CTL#	[-1440 to 1440 / NA, EU, CH / 1 minute/step] NA: -300 , EU: 60 , CH: 480

5305	[Auto Off Set]		
5305 101	Auto Off Limit Set	*CTL	[0 or 1 / 0 / -] 0: Off, 1: On

5307	[Summer Time]		
5307 001	ON/OFF	-	[0 to 1 / 1 / -] 0: Off, 1: On

5307 003	Rule Set(Start)	-	NA: 04100010 , EU: 035(4)00010 , ASIA: 105(4)00010
5307 004	Rule Set(End)	-	NA: 105(4)60000 , EU: 105(4)00000 , ASIA: 03100000

5401	[Access Control]		
5401 104	Authentication Time	*CTL	[0 to 255 / 0 / 1 sec/step]
5401 162	Extend Certification Detail	*CTL	[0 to 0xff / 0 / 1 /step]
5401 200	SDK1 UniqueID	*CTL	[0 to 0xFFFFFFFF / 0 / 1 / step]
5401 201	SDK1 Certification Method	*CTL	[0 to 0xFF / 0 / 1 / step]
5401 210	SDK2 UniqueID	*CTL	[0 to 0xFFFFFFFF / 0 / 1 / step]
5401 211	SDK2 Certification Method	*CTL	[0 to 0xFF / 0 / 1 / step]
5401 220	SDK3 UniqueID	*CTL	[0 to 0xFFFFFFFF / 0 / 1 / step]
5401 221	SDK3 Certification Method	*CTL	[0 to 0xFF / 0 / 1 / step]
5401 230	SDK Certification Device	*CTL	[0 to 0xff / 0 / 1 / step]
5401 240	Detail Option	*CTL	[0 to 0xff / 0 / 1 / step]

5402	[Access Control]		
5402 101	SDKJ1 Limit Setting	*CTL	[0 to 0xFF / 0 / 1 / step]
5402 102	SDKJ2 Limit Setting	*CTL	[0 to 0xFF / 0 / 1 / step]
5402 103	SDKJ3 Limit Setting	*CTL	[0 to 0xFF / 0 / 1 / step]
5402 104	SDKJ4 Limit Setting	*CTL	[0 to 0xFF / 0 / 1 / step]
5402 105	SDKJ5 Limit Setting	*CTL	[0 to 0xFF / 0 / 1 / step]
5402 106	SDKJ6 Limit Setting	*CTL	[0 to 0xFF / 0 / 1 / step]
5402 107	SDKJ7 Limit Setting	*CTL	[0 to 0xFF / 0 / 1 / step]

5402 108	SDKJ8 Limit Setting	*CTL	[0 to 0xFF / 0 / 1 / step]
5402 109	SDKJ9 Limit Setting	*CTL	[0 to 0xFF / 0 / 1 / step]
5402 110	SDKJ10 Limit Setting	*CTL	[0 to 0xFF / 0 / 1 / step]
5402 111	SDKJ11 Limit Setting	*CTL	[0 to 0xFF / 0 / 1 / step]
5402 112	SDKJ12 Limit Setting	*CTL	[0 to 0xFF / 0 / 1 / step]
5402 113	SDKJ13 Limit Setting	*CTL	[0 to 0xFF / 0 / 1 / step]
5402 114	SDKJ14 Limit Setting	*CTL	[0 to 0xFF / 0 / 1 / step]
5402 115	SDKJ15 Limit Setting	*CTL	[0 to 0xFF / 0 / 1 / step]
5402 116	SDKJ16 Limit Setting	*CTL	[0 to 0xFF / 0 / 1 / step]
5402 117	SDKJ17 Limit Setting	*CTL	[0 to 0xFF / 0 / 1 / step]
5402 118	SDKJ18 Limit Setting	*CTL	[0 to 0xFF / 0 / 1 / step]
5402 119	SDKJ19 Limit Setting	*CTL	[0 to 0xFF / 0 / 1 / step]
5402 120	SDKJ20 Limit Setting	*CTL	[0 to 0xFF / 0 / 1 / step]
5402 121	SDKJ21 Limit Setting	*CTL	[0 to 0xFF / 0 / 1 / step]
5402 122	SDKJ22 Limit Setting	*CTL	[0 to 0xFF / 0 / 1 / step]
5402 123	SDKJ23 Limit Setting	*CTL	[0 to 0xFF / 0 / 1 / step]
5402 124	SDKJ24 Limit Setting	*CTL	[0 to 0xFF / 0 / 1 / step]
5402 125	SDKJ25 Limit Setting	*CTL	[0 to 0xFF / 0 / 1 / step]
5402 126	SDKJ26 Limit Setting	*CTL	[0 to 0xFF / 0 / 1 / step]
5402 127	SDKJ27 Limit Setting	*CTL	[0 to 0xFF / 0 / 1 / step]
5402 128	SDKJ28 Limit Setting	*CTL	[0 to 0xFF / 0 / 1 / step]
5402 129	SDKJ29 Limit Setting	*CTL	[0 to 0xFF / 0 / 1 / step]
5402 130	SDKJ30 Limit Setting	*CTL	[0 to 0xFF / 0 / 1 / step]
5402 141	SDKJ1 Product ID	*CTL	[0 to 0xffffffff / 0 / 1 / step]
5402 142	SDKJ2 Product ID	*CTL	[0 to 0xffffffff / 0 / 1 / step]
5402 143	SDKJ3 Product ID	*CTL	[0 to 0xffffffff / 0 / 1 / step]

5402 144	SDKJ4 Product ID	*CTL	[0 to 0xffffffff / 0 / 1 / step]
5402 145	SDKJ5 Product ID	*CTL	[0 to 0xffffffff / 0 / 1 / step]
5402 146	SDKJ6 Product ID	*CTL	[0 to 0xffffffff / 0 / 1 / step]
5402 147	SDKJ7 Product ID	*CTL	[0 to 0xffffffff / 0 / 1 / step]
5402 148	SDKJ8 Product ID	*CTL	[0 to 0xffffffff / 0 / 1 / step]
5402 149	SDKJ9 Product ID	*CTL	[0 to 0xffffffff / 0 / 1 / step]
5402 150	SDKJ10 Product ID	*CTL	[0 to 0xffffffff / 0 / 1 / step]
5402 151	SDKJ11 Product ID	*CTL	[0 to 0xffffffff / 0 / 1 / step]
5402 152	SDKJ12 Product ID	*CTL	[0 to 0xffffffff / 0 / 1 / step]
5402 153	SDKJ13 Product ID	*CTL	[0 to 0xffffffff / 0 / 1 / step]
5402 154	SDKJ14 Product ID	*CTL	[0 to 0xffffffff / 0 / 1 / step]
5402 155	SDKJ15 Product ID	*CTL	[0 to 0xffffffff / 0 / 1 / step]
5402 156	SDKJ16 Product ID	*CTL	[0 to 0xffffffff / 0 / 1 / step]
5402 157	SDKJ17 Product ID	*CTL	[0 to 0xffffffff / 0 / 1 / step]
5402 158	SDKJ18 Product ID	*CTL	[0 to 0xffffffff / 0 / 1 / step]
5402 159	SDKJ19 Product ID	*CTL	[0 to 0xffffffff / 0 / 1 / step]
5402 160	SDKJ20 Product ID	*CTL	[0 to 0xffffffff / 0 / 1 / step]
5402 161	SDKJ21 Product ID	*CTL	[0 to 0xffffffff / 0 / 1 / step]
5402 162	SDKJ22 Product ID	*CTL	[0 to 0xffffffff / 0 / 1 / step]
5402 163	SDKJ23 Product ID	*CTL	[0 to 0xffffffff / 0 / 1 / step]
5402 164	SDKJ24 Product ID	*CTL	[0 to 0xffffffff / 0 / 1 / step]
5402 165	SDKJ25 Product ID	*CTL	[0 to 0xffffffff / 0 / 1 / step]
5402 166	SDKJ26 Product ID	*CTL	[0 to 0xffffffff / 0 / 1 / step]
5402 167	SDKJ27 Product ID	*CTL	[0 to 0xffffffff / 0 / 1 / step]
5402 168	SDKJ28 Product ID	*CTL	[0 to 0xffffffff / 0 / 1 / step]
5402 169	SDKJ29 Product ID	*CTL	[0 to 0xffffffff / 0 / 1 / step]

5402 170	SDKJ30 Product ID	*CTL	[0 to 0xffffffff / 0 / 1 / step]
----------	-------------------	------	----------------------------------

5404	[User Code Count Clear]		
5404 001	User Code Count Clear	*CTL	Clears all counters for users.
5404 101	User Code Count Clear Permit Setting	*CTL	[0 or 1 / 0 / 1 / step]

5411	[LDAP Certification]		
5411 004	Easy Certification	*CTL	[0 or 1 / 1 / -] 0: Off, 1: On
5411 005	Password Null Not Permit	*CTL	[0 or 1 / 1 / -] 0: Password NULL not permitted. 1: Password NULL permitted.
5411 006	Detail Option	*CTL	Bit 0 Guest Certification 0: OFF (default), 1: ON

5412	[Access Control]		
5412 100	Encrypt Mode	*CTL	[0 to 0xFF / 0x1F / -]

5413	[Lockout Setting]		
001	Lockout On/Off	*CTL	[0 or 1 / 0 / -] 0: Off, 1: On
002	Lockout Threshold	*CTL	[1 to 10 / 5 / 1/step]
003	Cancel On/Off	*CTL	[0 or 1 / 0 / -] 0: Off, 1: On
004	Cancel Time	*CTL	[1 to 999 / 60 / 1 min./step]

5414	[Access Mitigation]		
001	Mitigation On/Off	*CTL	[0 or 1 / 0 / -] 0: Off, 1: On

002	Mitigation Time	*CTL	[0 to 60 / 15 / 1 min./step]
-----	-----------------	------	-------------------------------------

5415	[Password Attack]		
001	Permission Number	*CTL	[0 to 100 / 30 / 1 attempt/step]
002	Detect Time	*CTL	[1 to 10 / 5 / 1 sec./step]

5416	[Access Information]		
001	User Max Num	*CTL	[50 to 200 / 200 / 1 users/step]
002	Password Max Num	*CTL	[50 to 200 / 200 / 1 password/step]
003	Monitor Interval	*CTL	[1 to 10 / 3 / 1 sec./step]

5417	[Access Attack]		
001	Permission Number	*CTL	[0 to 500 / 100 / 1/step]
002	Attack Detect Time	*CTL	[10 to 30 / 10 / 1 sec./step]
003	Cert Wait	*CTL	[0 to 9 / 3 / 1 sec./step]
004	Attack Max Num	*CTL	[50 to 200 / 200 / 1 attempt/step]

5420	[User Auth]		
041	Printer	*CTL	[0 or 1 / 0 / 1] 0: On, 1: Off
051	SDK1	*CTL	[0 or 1 / 0 / 1] 0: ON. 1: OFF
061	SDK2		
071	SDK3		

5481	[Auth. Error Code]		
001	System Log Disp	*CTL	[0 or 1 / 0 / 1] 0: Off, 1: On
002	Panel Disp (SP C342DN only)	*CTL	[0 or 1 / 0 / 1] 0: Off, 1: On

5501	[PM Alarm]		
001	PM Alarm Level	*CTL	[0 to 9999 / 0 / 1] 0: Alarm off 1 to 9999: Alarm goes off when Value (1 to 9999) x 1000 > PM counter

5504	[Jam Alarm]		
001	-	*CTL	[0 to 3 / 3 / 1] 0: Z 1: L 2: M 3: H
002	Threshold	*CTL	[1 to 99 / 10 / 1]

5505	[Error Alarm]		
001	Error Alarm	*CTL	[0 to 255 / SP C340DN: 4, SP C342DN: 6 / 1] 0: Alarm Off
002	Threshold	*CTL	[1 to 99 / 5 / 1]

5507	[Supply/CC Alarm]		
001	Paper Supply Alarm	*CTL	[0 or 1 / 0 / 1] 0: OFF 1: ON
006	WasteTonerBottle Supply Alarm	*CTL	[0 to 2 / 1 / 1] 0: OFF 1: Supply Call ON 2: CC Call ON
007	Tensya Supply Alarm	*CTL	[0 or 1 / 1 / 1] 0: OFF 1: ON

008	Fuser Supply Alarm	*CTL	[0 or 1 / 1 / 1] 0: OFF 1: ON
009	Cartridge Supply Alarm	*CTL	[0 or 1 / 1 / 1] 0: OFF 1: ON
080	Toner Call Timing	*CTL	[0 or 1 / 0 / 1] 0: Toner bottle replacement 1: Less than toner threshold
081	Toner Call Threshold:Bk	CTL	[10 to 90 / 10 / 10%/step]
128	Interval :Others	*CTL	[250 to 10000 / 1000 / 1page/step]
133	Interval :A4	*CTL	[250 to 10000 / 1000 / 1page/step]
134	Interval :A5	*CTL	[250 to 10000 / 1000 / 1page/step]
142	Interval :B5	*CTL	[250 to 10000 / 1000 / 1page/step]
164	Interval: LG	*CTL	[250 to 10000 / 1000 / 1page/step]
166	Interval :LT	*CTL	[250 to 10000 / 1000 / 1page/step]
172	Interval :HLT	*CTL	[250 to 10000 / 1000 / 1page/step]
5508	[CC Call] (SP C342DN only)		
001	Jam Remains	*CTL	[0 or 1 / 1 / 1] 0: Disable 1: Enable
002	Continuous Jams	*CTL	[0 or 1 / 1 / 1] 0: Disable 1: Enable
003	Continuous Door Open	*CTL	[0 or 1 / 1 / 1] 0: Disable 1: Enable

011	Jam Detection: Time Length	*CTL	[3 to 30 / 10 / 1min/step]
012	Jam Detection: Continuous Count	*CTL	[2 to 10 / 5 / 1time/step]
013	Door Open: Time Length	*CTL	[3 to 30 / 10 / 1min/step]

5515	[SC/Alarm Setting]		
001	SC Call	*CTL	[0 or 1 / 1 / 1]
002	Service Parts Near End Call	*CTL	0: OFF 1: ON
003	Service Parts End Call	*CTL	
004	User Call	*CTL	
006	Communication Test Call	*CTL	
007	Machine Information Notice	*CTL	
008	Alarm Notice	*CTL	
009	Non Genuine Tonner Ararm	*CTL	
010	Supply Automatic Ordering Call	*CTL	
011	Supply Management Report Call	*CTL	
012	Jam/Door Open Call	*CTL	
050	Timeout:Manual Call	*CTL	[1 to 255 / 5 / 1min/step]
051	Timeout:Other Call	*CTL	[1 to 255 / 10 / 1min/step]

5517	[Get Machine Information]		
031	Get SMC Info: Retry Interval	*CTL	[10 to 255 / 10 / 1min/step]

5728	[Network Setting]		
001	NAT Machine Port1	*CTL	[1 to 65535 / 49101 / 1]
002	NAT UI Port1	*CTL	[1 to 65535 / 55101 / 1]
003	NAT Machine Port2	*CTL	[1 to 65535 / 49102 / 1]
004	NAT UI Port2	*CTL	[1 to 65535 / 55102 / 1]
005	NAT Machine Port3	*CTL	[1 to 65535 / 49103 / 1]
006	NAT UI Port3	*CTL	[1 to 65535 / 55103 / 1]
007	NAT Machine Port4	*CTL	[1 to 65535 / 49104 / 1]
008	NAT UI Port4	*CTL	[1 to 65535 / 55104 / 1]
009	NAT Machine Port5	*CTL	[1 to 65535 / 49105 / 1]
010	NAT UI Port5	*CTL	[1 to 65535 / 55105 / 1]
011	NAT Machine Port6	*CTL	[1 to 65535 / 49106 / 1]
012	NAT UI Port6	*CTL	[1 to 65535 / 55106 / 1]
013	NAT Machine Port7	*CTL	[1 to 65535 / 49107 / 1]
014	NAT UI Port7	*CTL	[1 to 65535 / 55107 / 1]
015	NAT Machine Port8	*CTL	[1 to 65535 / 49108 / 1]
016	NAT UI Port8	*CTL	[1 to 65535 / 55108 / 1]
017	NAT Machine Port9	*CTL	[1 to 65535 / 49109 / 1]
018	NAT UI Port9	*CTL	[1 to 65535 / 55109 / 1]
019	NAT Machine Port10	*CTL	[1 to 65535 / 49110 / 1]
020	NAT UI Port10	*CTL	[1 to 65535 / 55110 / 1]
101	PacketCapture	CTL	[0 or 1 / 0 / 1] 0: Disabled 1: Enabled

102	PacketCapture:mode	CTL	[0 or 1 / 0 / 1] 0: Header only 1: All
103	PacketCapture:interface	CTL	[0 to 3 / 0 / 1] 0: Auto select 1: Operation panel interface 2: Ethernet interface 3: Wireless interface
104	PacketCapture:length	CTL	[54 to 65535 / 128 / 1]
105	PacketCapture:broadcast	CTL	[0 or 1 / 0 / 1] 0: Disabled 1: Enabled
106	PacketCapture:specify port	CTL	[0 or 1 / 0 / 1] 0: Off 1: On
107	PacketCapture:portnumber	CTL	[0 to 65535 / 0 / 1]
108	PacketCapture:time	CTL	-

5730	[Extended Function Setting] (SP C342DN only)		
010	Expiration Prior Alarm Set	*CTL	[0 to 999 / 20 / 1 day/step]

5731	[Counter Effect]		
001	Change Mk1 Cnt(Paper->Combine)	*CTL	[0 or 1 / 0 / 1] 0: Disable, 1: Enable

5745	[DeemedPowerConsumption]		
211	Controller Standby	*CTL	[0 to 9999 / 0 / 1]
212	STR	*CTL	[0 to 9999 / 0 / 1]
213	Main Power Off	*CTL	[0 to 9999 / 0 / 1]

214	Scanning and Printing	*CTL	[0 to 9999 / 0 / 1]
215	Printing	*CTL	[0 to 9999 / 0 / 1]
216	Scanning	*CTL	[0 to 9999 / 0 / 1]
217	Engine Standby	*CTL	[0 to 9999 / 0 / 1]
218	Low Power Consumption	*CTL	[0 to 9999 / 0 / 1]
219	Silent condition	*CTL	[0 to 9999 / 0 / 1]
220	Heater Off	*CTL	[0 to 9999 / 0 / 1]

5749	[Import/Export]		
001	Export	CTL	[EXECUTE]
101	Import	CTL	[EXECUTE]

5751	[Key Event Encryption Setting]		
001	Password	CTL	[0 to 255 / 0 / 1]

5801	[Memory Clear]		
001	All Clear	CTL	[EXECUTE]
002	Engine	EGB	[EXECUTE]
003	SCS	CTL	[EXECUTE]
004	IMH	CTL	[EXECUTE]
005	MCS	CTL	[EXECUTE]
008	Printer	CTL	[EXECUTE]
010	GWWS	CTL	[EXECUTE]
011	NCS	CTL	[EXECUTE]
014	Clear DCS Setting	CTL	[EXECUTE]
015	Clear UCS Setting	CTL	[EXECUTE]
016	MIRS Setting	CTL	[EXECUTE]

017	CCS	CTL	[EXECUTE]
018	SRM Memory Clr	CTL	[EXECUTE]
019	LCS Memory Clr	CTL	[EXECUTE]
021	ECS	CTL	[EXECUTE]
025	Websys	CTL	[EXECUTE]
026	PLN	CTL	[EXECUTE]
027	SAS	CTL	[EXECUTE]
028	Rest Webservice	CTL	[EXECUTE]

5802	[Test Setting]		
001	Free Run	-	Performs a free run on the printer engine.
002	MskMargin0:ON1:OFF	-	[0 or 1 / 0 / -] 0: Mask ON, 1: Mask OFF

5803	[Input Check]		
	See 'Input Check Table'		

5804	[Output Check]		
	See 'Output Check Table'		

5810	[Fusing SC Reset]		
001	Fusing SC		Resets a type A service call condition. Turn the main power switch off and on after resetting the SC code.

5812	[Service TEL]		
001	Telephone	*CTL	
002	Facsimile	*CTL	

003	Supply (SP C342DN only)	*CTL	
004	Operation (SP C342DN only)	*CTL	
101	Disp Inquiry (SP C342DN only)	*CTL	[0 or 1 / 0 / -] 0: Do not display, 1: Display

5816	[NRS Function]		
001	I/F Setting	*CTL	[0 to 2 / 2 / 1/step]
002	CE Call	*CTL	[0 or 1 / 1 / 1/step]
003	Function Flag	*CTL	[0 or 1 / 0 / 1/step]
007	SSL Disable	*CTL	[0 to 1 / 0 / 1/step]
008	RCG Connect T/O	*CTL	[1 to 90 / 30 / 1 second/step]
009	RCG Write Timeout	*CTL	[0 to 100 / 60 / 1 second/step]
010	RCG Read Timeout	*CTL	[0 to 100 / 60 / 1 second/step]
011	Port 80	*CTL	[0 to 1 / 0 / 1/step]
013	RFU Timing	*CTL	[0 or 1 / 1 / -]
014	RCG Error Cause	CTL	[0 or 1 / 0 / 1] 0: Initial state, normal condition 1: Error
021	Function Flag	*CTL	[0 or 1 / 0 / -]
023	Connect Mode (N/M)	*CTL	0: Internet connection 1: Dial-up connection
061	NotiTime ExpTime	*CTL	
062	HTTP Proxy use	*CTL	
063	HTTP Proxy Host	*CTL	
064	HTTP Proxy Port	*CTL	
065	HTTP Proxy AutUsr	*CTL	

066	HTTP Proxy AutPass	*CTL	
067	Cer Updt Cond	*CTL	
068	Cer Abnml Cause	*CTL	
069	Cer Updt ReqlID	*CTL	
083	Firm Updating	*CTL	
085	Firm UpUsr Conf	*CTL	
086	Firmware Size	*CTL	
087	CERT: MacroVsn	*CTL	
088	CERT: PAC Vsn	*CTL	
089	CERT: ID2 Code	*CTL	
090	CERT: Subject	*CTL	
091	CERT: SeriNum	*CTL	
092	CERT: Issuer	*CTL	
093	CERT: St ExpTime	*CTL	
094	CERT: End ExpTime	*CTL	
102	CERT:Encrypt Level	*CTL	[1 to 2 / 1 / 1]
103	Client Communication Method	CTL	[0 to 3 / 0 / 1]
104	Client Communication Limit	CTL	[1 to 7 / 7 / 1]
115	Network Information Waiting timer	CTL	[5 to 255 / 5 / 1sec/step]
200	Poling Man Exc	-	
201	Instl: Condition	*CTL	
202	Instl: ID #	*CTL	
203	Instl: Reference	*CTL	
204	Instl: Ref Rslt	*CTL	

205	Instl: Ref Section	*CTL	
206	Instl: Rgsltn	*CTL	
	Executes Cumin Registration.		
207	Instl: Rgsltn Rst	*CTL	
208	Error Code		
209	Instl Clear	*CTL	
240	CommErrorTime	*CTL	
241	CommErrorCode 1	*CTL	
242	CommErrorCode 2	*CTL	
243	CommErrorCode 3	*CTL	
244	CommErrorState 1	*CTL	
245	CommErrorState 2	*CTL	
246	CommErrorState 3	*CTL	
247	SSL Error Count	*CTL	
248	Other Err Count	*CTL	
250	Print Com Log	CTL	

5821	[NRS Address]		
002	RCG IP Address (used for NRS)	*CTL	[00000000h to FFFFFFFFh / 00000000h / 1 / step]
003	RCG Port Number	*CTL	[0 to 65535 / 443 / 1]
004	RCG IPv4 URL Path	*CTL	
005	RCG IPv6 Address	*CTL	
006	RCG IPv6 URL Path	*CTL	
007	RCG Host Name	*CTL	
008	RCG Host URL Path	*CTL	

5824	[NVRAM Upload]		
001	NVRAM Upload	#	

5825	[NVRAM Download]		
001	NVRAM Download	#	

5828	[Network Setting]		
050	1284 Compatible	*CTL	[0 or 1 / 1 / -] 0: Disabled, 1: Enabled
052	ECP	*CTL	[0 or 1 / 1 / -] 0: Disabled, 1: Enabled
065	Job Spool	*CTL	[0 or 1 / 0 / -] 0: Disabled, 1: Enabled
066	HD job Clear	*CTL	[0 or 1 / 1 / 1/step] 0: ON, 1: OFF
069	Job Spool (Protocol)	*CTL	[0 or 1 / 1 / 1/step] 0: Off, 1: On Bit switches: <ul style="list-style-type: none"> • Bit 0: LPR • Bit 1: FPT • Bit 2: IPP • Bit 3: SMB • Bit 4: Not used. • Bit 5: DIPRINT • Bits 6 and 7: Reserved
087	Protocol usage	*CTL	[0 or 1 / 0x00000000 / 1 bit]
090	TELNET (0: OFF, 1: ON)	*CTL	[0 or 1 / 1 / 1/step] 0: Disabled, 1: Enabled
091	Web (0: OFF, 1: ON)	*CTL	[0 or 1 / 1 / 1/step] 0: Disabled, 1: Enabled

145	Active IPv6 Link	-	
147	Active IPv6 Stat (1)	-	
149	Active IPv6 Stat (2)	-	
151	Active IPv6 Stat (3)	-	
153	Active IPv6 Stat (4)	-	
155	Active IPv6 Stat (5)	-	
156	IPv6 Manual Addr	*CTL	
158	IPv6 Gateway Add	*CTL	
161	IPv6 Stateless Auto Setting	*CTL	[0 or 1 / 1 / 1 /step] 0: Disable, 1: Enable
219	IPsec Aggressive Mode Setting	CTL	[0 or 1 / 0 / 1]
236	Web Item visible	*CTL	[0 x 0000 to 0 x ffff / 0 x ffff] 0: Not displayed, 1: Displayed bit0: Net RICOH bit1: Consumable Supplier bit2-15: Reserved (all)
237	Web shopping link visible	*CTL	[0 or 1 / 1 / 1] 0: Not display, 1:Display
238	Web supplies Link visible	*CTL	[0 or 1 / 1 / 1] 0: Not display, 1:Display
239	Web Link1 Name	*CTL	
240	Web Link1 URL	*CTL	
241	Web Link1 visible	*CTL	[0 or 1 / 1 / 1] 0: Not display, 1:Display
242	Web Link2 Name	*CTL	Same as "-239"
243	Web Link2 URL	*CTL	Same as "-240"
244	Web Link2 visible	*CTL	Same as "-241"

249	DHCPv6 DUID	CTL	[- / - / -]
-----	-------------	-----	-------------

5832	[HDD] HDD Initialization	*CTL	
001	HDD Formatting (ALL)		

5840	[IEEE 802.11]		
006	Channel MAX	*CTL	EU: [1 to 13 / 13 / 1/step] NA/ AS: [1 to 11 / 11 / 1/step]
007	Channel MIN	*CTL	EU: [1 to 13 / 1 / 1/step] NA/ AS: [1 to 11 / 1 / 1/step]
011	WEP Key Select	*CTL	[00 to 11 / 00 / 1 binary] 00: Key #1 01: Key #2 (Reserved) 10: Key #3 (Reserved) 11: Key #4 (Reserved)
045	WPA Debug Lvl	*CTL	[1 to 3 / 3 / 1] 1: Info, 2: warning, 3: error
046	11w	*CTL	[0 to 2 / 0 / 1 / step]
047	PSK Set Type	*CTL	[0 or 1 / 0 / 1 / step]

5841	[Supply Name Setting] (SP C342DN only)		
001	Toner Name Setting:Black	*CTL	
002	Toner Name Setting:Cyan	*CTL	
003	Toner Name Setting:Yellow	*CTL	
004	Toner Name Setting:Magenta	*CTL	
009	WasteTonerBottle	*CTL	

101	DrumUnit: Black	*CTL	
102	DrumUnit: Color	*CTL	

5842	[GWWS Analysis]		
001	Setting 1	*CTL	[8bit / 00000000 / - / step]
002	Setting 2	*CTL	[8bit / 00000000 / - / step]

3

5844	[USB]		
001	Transfer Rate	*CTL	[0001 or 0004 / 0004 / -] 0001: Full speed, 0004: Auto Change
002	Vendor ID	*CTL	Displays the vendor ID.
003	Product ID	*CTL	Displays the product ID.
004	Device Release Num	*CTL	Displays the device release version number.
005	Fixed USB Port	*CTL	[0 to 2 / 0 / 1 / step]
006	PnP Model Name		
007	PnP Serial Number		
008	Mac Supply Level	*CTL	[0 or 1 / 1 / 1 / step]
009	USB Toggle Clear Mode	*CTL	[0 or 1 / 0 / 1 / step]
100	Notify Unsupport	*CTL	[0x00 to 0x01 / 0x01 / 1 / step]

5846	[UCS Setting]		
010	LDAP Search Timeout	*CTL	[1 to 255 / 60 / 1]
041	Fill Addr Acl Info	*CTL	[- / - / -] [Execute]

043	Addr Book Media	*CTL	[0 to 30 / 0 / 1] 0: Unconfirmed 1: SD Slot 1 2: SD Slot 2 3: SD Slot 3 4: USB Flash ROM 10: SD Slot 10 20: HDD 30: Nothing
047	Initialize Local Address Book	CTL	[- / - / -] [Execute]
049	Initialize LDAP Addr Book	CTL	[- / - / -] [Execute]
050	Initialize All Addr Book	CTL	[- / - / -] [Execute]
051	Backup All Addr Book	CTL	[- / - / -] [Execute]
052	Restore All Addr Book	CTL	[- / - / -] [Execute]
053	Clear Backup Info	CTL	[- / - / -] [Execute]
060	Search Option	*CTL	[0x00 to 0xff / 0x0f / 1]
	<p>This SP uses bit switches to set up the fuzzy search options for the UCS local address book.</p> <p>Bit: Meaning</p> <p>0: Checks both upper/lower case characters</p> <p>1: Japan Only</p> <p>2: Japan Only</p> <p>3: Japan Only</p> <p>4 to 7: Not Used</p>		

062	Complexity Option 1	*CTL	[0 to 32 / 0 / 1]
063	Complexity Option 2	*CTL	[0 to 32 / 0 / 1]
064	Complexity Option 3	*CTL	[0 to 32 / 0 / 1]
065	Complexity Option 4	*CTL	[0 to 32 / 0 / 1]
094	Encryption Stat	*CTL	[0 to 255 / - / 1]

3

5848	[Web Service]		
004	ac: UD	*CTL	0000: Disabled, 0001: Enabled
009	ac: Job Ctrl	*CTL	0000: OFF, 0001: ON
011	ac: Dev Mng	*CTL	
022	ac:Uadmin	*CTL	
024	Access Ctrl: Log Service (Lower 4bits)	*CTL	
025	Access Ctrl: Rest WebService (Lower 4bits)	*CTL	
150	Log Operation Mode	*CTL	[0 to 3 / 0 / 1 /step]

5848	[LogTrans]		
217	Setting: LastTime	*CTL	[0 to 2 / 0 / 1 /step] 0: Transmitting OFF, 1: Always Transmitting, 2: Interval Transmitting

5849	[Installation Date]		
001	Display	*CTL	0000: Disabled, 0001: Enabled
002	Print	*CTL	[0 or 1 / 1 / -] 0: No Print, 1: Print
003	Total Counter	*CTL	

5851	[Bluetooth]		
001	mode	*CTL	[0 or 1 / 0 / 1/step]

5856	[Remote ROM Update]		
002	Local Port		[0 or 1 / 0 / 1/step] 0: Disable, 1: Enable

5858	[Collect Machine Info]		
001	0:OFF 1:ON	CTL	[0 or 1 / 1 / 1]
002	Save To (0:HDD 1:SD)	CTL	[0 or 1 / 0 / 1]
003	Make Log Trace Dir	CTL	[0 or 1 / 0 / 0]
101	Failure Occuring Date	CTL	[0 to 20371212 / 0 / 1]
102	Tracing Days	CTL	[1 to 180 / 2 / 1day/step]
103	Acquire Fax Address(0:OFF 1:ON)	CTL	[0 or 1 / 0 / 1]
111	Acquire All Info & Logs	CTL	[0 or 1 / 0 / 1]
121	Acquire Configuration Page	CTL	[0 or 1 / 0 / 1]
122	Acquire Font Page	CTL	[0 or 1 / 0 / 1]
123	Acquire Print Setting List	CTL	[0 or 1 / 0 / 1]
124	Acquire Error Log	CTL	[0 or 1 / 0 / 1]
131	Acquire Fax Info	CTL	[0 or 1 / 0 / 1]
141	Acquire All Debug Logs	CTL	[0 or 1 / 0 / 1]
142	Acquire Controller Debug Logs Only	CTL	[0 or 1 / 0 / 1]
143	Acquire Engine Debug Logs Only	CTL	[0 or 1 / 0 / 1]
144	Acquire Opepanel Debug Logs Only	CTL	[0 or 1 / 0 / 1]

145	Acquire FCU Debug Logs Only	CTL	[0 or 1 / 0 / 1]
5860	[SMTP/ POP3/ IMAP4]		
002	SMTP Srv Port No.	*CTL	[1 to 65535 / 25 / 1/step]
003	SMTP Auth.	*CTL	[0 or 1 / 0 / 1/step] 0: Disable, 1: Enable
006	SMTP Auth Encryp	*CTL	[0 to 2 / 0 / 1/step] 0: Automatic, 1: Not encrypt, 2: Encrypt
007	POP before SMTP	*CTL	[0 or 1 / 0 / 1/step] 0: Disable, 1: Enable
008	POP to SMTP Wait	*CTL	[0 to 10000 / 300 / 1 ms/step]
009	Mail Receive Pro	*CTL	[1 to 3 / 1 / 1/step] 1: POP3, 2: IMAP4, 3: SMTP
013	POP3/IMAP4 Auth.	*CTL	[0 to 2 / 0 / 1/step] 0: Automatic, 1: Not encrypt, 2: Encrypt
014	POP3 Srvr Port No.	*CTL	[1 to 65535 / 110 / 1/step]
015	IMAP4 Srv Port	*CTL	[1 to 65535 / 143 / 1/step]
016	SMTP Rx Port No	*CTL	[1 to 65535 / 25 / 1/step]
017	Mail Rx Interval	*CTL	[2 to 1440 / 3 / 1 minute/step]
019	Mail Keep Setting	*CTL	[0 to 2 / 0 / 1/step] 0: Not keeping 1: Keeping All 2: Keeping the only error e-mail
020	ParMail Rec TOut	*CTL	[1 to 168 / 72 / 1 h/step]
021	MDN Res RFC2298	*CTL	[0 or 1 / 1 / -] 0: No, 1: Yes

022	SMTP Aut FiledRep	*CTL	[0 or 1 / 0 / 1/step] 0: No. "From" item not switched, 1: Yes. "From" item switched.
025	SMTP Auth DirectSet	*CTL	Bit switch 0: LOGIN Bit switch 1: PLAIN Bit switch 2: CRAM MD5 Bit switch 3: DIGEST MD Bit switch 4 - 7: Not used
026	S/MIME: MIME Header Setting	*CTL	[0 to 2 / 0 / 1] 0: Microsoft Outlook Express standard 1: Internet Draft standard 2: RFC standard
028	S/MIME: Authentication Check	*CTL	[0 or 1 / 0 / 1] 0: Check 1: No check

5866	[E-Mail Report]		
001	Report Validity	*CTL	[0 or 1 / 0 / 1/step] 0: Enable, 1: Disable
005	Add Date Filed	*CTL	[0 or 1 / 0 / 1/step] 0: Off, 1: On

5869	[RAM Disk Setting]		
001	Mail Function	*CTL#	[0 or 1 / 0 / 1/step] 0: On, 1: Off

5870	[Common Key Info Writ]		
001	Writing	*CTL	
003	Initialize	*CTL	
004	Writing: 2048bit	*CTL	

5873	[SD Card Appli Move]		
001	Move Exec		See 'SD Card Appli Move'.
002	Undo Exec		See 'SD Card Appli Move'.

5875	[SC Auto Reboot]		
001	Reboot Setting	* CTL	[0 or 1 / 0 / 1]
002	Reboot Type	*CTL	[0 or 1 / 0 / 1] 0: Manual reboot 1: Automatic reboot

5878	[Option Setup]		
001	Data Overwrite Security		
002	HDD Encryption		

5886	[Firm Update Setting]		
101	Skip Version Check	*CTL	[0 or 1 / 0 / 1/step]

5887	[SD Get Counter]		
------	------------------	--	--

5888*	[Personal Information Protect]		
	[0 to 1 / 0 / 1} 0: No authentication, No protection for logs 1: No authentication, Protected logs (only an administrator can see the logs)		

5893	[SDK Application Counter]	*CTL	-
	Displays the counter name of each SDK application.		
001	SDK-1		
002	SDK-2		
003	SDK-3		

004	SDK-4
005	SDK-5
006	SDK-6
007	SDK-7
008	SDK-8
009	SDK-9
010	SDK-10
011	SDK-11
012	SDK-12

5901	[High Humi. Mode] High Humid Paper Mode	*ENG	-
001	0:OFF 1:ON		
002	1:MD1 2:MD2 3:MD3		

5902	[Mono Pri. Mode]	*ENG	-
001	0:OFF 1:ON		

5903	[Service Setting]		
001	Special Ctl Mode	*EGB	[0 to 127 / 0 / -]
002	EndCtl 0:OFF 1:ON	*EGB	[0 or 1 / 1 / -]
003	Fuser Add Time	*EGB	[0 to 175 / 0 / -]
004	Engine Setting1	*EGB	Not used
005	Engine Setting2	*EGB	Not used
006	Engine Setting3	*EGB	Not used

5905	[Toner low. Mode]		
------	-------------------	--	--

3. Appendix: SP Mode Tables

001	0:OFF 1:ON	*EGB	[0 or 1 / 1 / -] 0: OFF, 1: ON
-----	------------	------	-----------------------------------

5907	[Plug/ Play] Plug/Play Name Selection		
001	*CTL	[0 to 8 / 0 / 1/step]	

5930	[Meter Click Ch.] Meter Click Charge		
001	Meter Click Ch.	*EGB	[0 or 1 / 0 / -] 0: OFF, 1: ON
002	Maint. Mode	*EGB	[0 or 1 / 0 / -] 0: Not displayed, 1: Displayed

5990	[SP Print Mode]		
001	All (Data List)	CTL	
002	SP (Mode Data List)	CTL	
004	Logging Data	CTL	
005	Diagnostic Report	CTL	
006	Non-Default	CTL	
007	NIB Summary	CTL	
024	SDK/J Summary	CTL	
025	SDK/J Application Info	CTL	
026	Printer SP	CTL	

5992	[SP Text Mode]		
001	All (Data List)	CTL	
002	SP (Mode Data List)	CTL	
004	Logging Data	CTL	
005	Diagnostic Report	CTL	

006	Non-Default	CTL	
007	NIB Summary	CTL	
024	SDK/J Summary	CTL	
025	SDK/J Application Info	CTL	
026	Printer SP	CTL	

Engine SP7-xxx

SP7-XXX (Data Log)

3

7002	[Total Cnt Disp] Total Counter Display		
001	Color Counter	*EGB	
002	Mono Counter	*EGB	

7304	[Total Cnt Disp] Total Counter Display		
001	Duplex Counter	*EGB	

7401	[Total SC Counter]		
001	Total SC Counter	*CTL	[0 to 9999 / 0 / 1/step]

7403	[SC History]		
001	Latest	*CTL	
002	Latest 1	*CTL	
003	Latest 2	*CTL	
004	Latest 3	*CTL	
005	Latest 4	*CTL	
006	Latest 5	*CTL	
007	Latest 6	*CTL	
008	Latest 7	*CTL	
009	Latest 8	*CTL	
010	Latest 9	*CTL	

7404	[SC991 History]		
------	-----------------	--	--

001	Latest	*CTL	
002	Latest 1	*CTL	
003	Latest 2	*CTL	
004	Latest 3	*CTL	
005	Latest 4	*CTL	
006	Latest 5	*CTL	
007	Latest 6	*CTL	
008	Latest 7	*CTL	
009	Latest 8	*CTL	
010	Latest 9	*CTL	

7502	[Counter-Paper Jam]		
001	Counter-Paper Jam	*CTL	[00000 to 65535 / - / 1 sheet/step]
002	Total Jam Counter	*CTL	[00000 to 65535 / - / 1 sheet/step]

7504	[Paper Jam/Loc] Paper Jam Location		
001	At Power On	*CTL	
017	PFU: Relay On	*CTL	
019	Regist On: Bypass	*CTL	
020	Regist On: T1	*CTL	
022	Regist On: PFU	*CTL	
023	Regist On: Duplex	*CTL	
024	Regist Off	*CTL	
025	Paper Exit On	*CTL	
032	Paper Exit Off	*CTL	
052	Duplex On	*CTL	
054	Duplex Off	*CTL	

7506	[Paper Jam/Size]		
006	A5 LEF	*CTL	[0 to 9999 / 0 / 1 sheet/step]
044	HLT LEF	*CTL	
133	A4 SEF	*CTL	
134	A5 SEF	*CTL	
142	B5 SEF	*CTL	
164	LG SEF	*CTL	
166	LT SEF	*CTL	
172	HLT SEF	*CTL	
255	Others	*CTL	

7507	[Dsply-P Jam Hist] Paper Jam History Display		
001	Latest	*CTL	Displays the 10 most recently detected paper jams.
002	Latest 1	*CTL	
003	Latest 2	*CTL	
004	Latest 3	*CTL	
005	Latest 4	*CTL	
006	Latest 5	*CTL	
007	Latest 6	*CTL	
008	Latest 7	*CTL	
009	Latest 8	*CTL	
010	Latest 9	*CTL	

7514	[Paper Jam Count by Location]		
001	At Power On	*CTL	Paper is not fed at power on. [0000 to 9999 / - / 1/step]
017	PFU: Relay On	*CTL	[0000 to 9999 / - / 1/step]

019	Regist On: Bypass	*CTL	[0000 to 9999 / - / 1/step]
020	Regist On: T1	*CTL	[0000 to 9999 / - / 1/step]
022	Regist On: PFU	*CTL	[0000 to 9999 / - / 1/step]
023	Regist On: Duplex	*CTL	[0000 to 9999 / - / 1/step]
024	Regist Off	*CTL	[0000 to 9999 / - / 1/step]
025	Paper Exit On	*CTL	[0000 to 9999 / - / 1/step]
032	Paper Exit Off	*CTL	[0000 to 9999 / - / 1/step]
052	Duplex On	*CTL	[0000 to 9999 / - / 1/step]
054	Duplex Off	*CTL	[0000 to 9999 / - / 1/step]

7516	[Paper Size Jam Count]		
	Displays occurring count of transfer paper jams by each paper size.		
006	A5 LEF	*CTL	[0 to 9999 / 0 / 1 sheet/step]
044	HLT LEF	*CTL	
133	A4 SEF	*CTL	
134	A5 SEF	*CTL	
142	B5 SEF	*CTL	
164	LG SEF	*CTL	[0 to 9999 / 0 / 1 sheet/step]
166	LT SEF	*CTL	
172	HLT SEF	*CTL	
255	Others	*CTL	

7520	[Update Log]		
001	ErrorRecord1	*CTL	[0 to 255 / 0 / 1]
002	ErrorRecord2	*CTL	[0 to 255 / 0 / 1]
003	ErrorRecord3	*CTL	[0 to 255 / 0 / 1]
004	ErrorRecord4	*CTL	[0 to 255 / 0 / 1]

005	ErrorRecord5	*CTL	[0 to 255 / 0 / 1]
006	ErrorRecord6	*CTL	[0 to 255 / 0 / 1]
007	ErrorRecord7	*CTL	[0 to 255 / 0 / 1]
008	ErrorRecord8	*CTL	[0 to 255 / 0 / 1]
009	ErrorRecord9	*CTL	[0 to 255 / 0 / 1]
010	ErrorRecord10	*CTL	[0 to 255 / 0 / 1]
011	Auto:StartDate1 (SP C342DN only)	*CTL	[0 to 0 / 0 / 0]
012	Auto:StartDate2 (SP C342DN only)	*CTL	[0 to 0 / 0 / 0]
013	Auto:StartDate3 (SP C342DN only)	*CTL	[0 to 0 / 0 / 0]
014	Auto:StartDate4 (SP C342DN only)	*CTL	[0 to 0 / 0 / 0]
015	Auto:StartDate5 (SP C342DN only)	*CTL	[0 to 0 / 0 / 0]
021	Auto:EndDate1 (SP C342DN only)	*CTL	[0 to 0 / 0 / 0]
022	Auto:EndDate2 (SP C342DN only)	*CTL	[0 to 0 / 0 / 0]
023	Auto:EndDate3 (SP C342DN only)	*CTL	[0 to 0 / 0 / 0]
024	Auto:EndDate4 (SP C342DN only)	*CTL	[0 to 0 / 0 / 0]
025	Auto:EndDate5 (SP C342DN only)	*CTL	[0 to 0 / 0 / 0]
031	Auto:Piecemark1 (SP C342DN only)	*CTL	[0 to 0 / 0 / 0]
032	Auto:Piecemark2 (SP C342DN only)	*CTL	[0 to 0 / 0 / 0]

033	Auto:Piecemark3 (SP C342DN only)	*CTL	[0 to 0 / 0 / 0]
034	Auto:Piecemark4 (SP C342DN only)	*CTL	[0 to 0 / 0 / 0]
035	Auto:Piecemark5 (SP C342DN only)	*CTL	[0 to 0 / 0 / 0]
041	Auto:Version1 (SP C342DN only)	*CTL	[0 to 0 / 0 / 0]
042	Auto:Version2 (SP C342DN only)	*CTL	[0 to 0 / 0 / 0]
043	Auto:Version3 (SP C342DN only)	*CTL	[0 to 0 / 0 / 0]
044	Auto:Version4 (SP C342DN only)	*CTL	[0 to 0 / 0 / 0]
045	Auto:Version5 (SP C342DN only)	*CTL	[0 to 0 / 0 / 0]
051	Auto:Result1 (SP C342DN only)	*CTL	[0 to 255 / 0 / 1]
052	Auto:Result2 (SP C342DN only)	*CTL	[0 to 255 / 0 / 1]
053	Auto:Result3 (SP C342DN only)	*CTL	[0 to 255 / 0 / 1]
054	Auto:Result4 (SP C342DN only)	*CTL	[0 to 255 / 0 / 1]
055	Auto:Result5 (SP C342DN only)	*CTL	[0 to 255 / 0 / 1]
056	Auto:Result6 (SP C342DN only)	*CTL	[0 to 255 / 0 / 1]
057	Auto:Result7 (SP C342DN only)	*CTL	[0 to 255 / 0 / 1]
058	Auto:Result8 (SP C342DN only)	*CTL	[0 to 255 / 0 / 1]

059	Auto:Result9 (SP C342DN only)	*CTL	[0 to 255 / 0 / 1]
060	Auto:Result10 (SP C342DN only)	*CTL	[0 to 255 / 0 / 1]

7801	[Memory/Version/PN] Memory Version and Part Number Display		
255	Memory/Version/ PN	*CTL	

3

7803	[PM Counter] (Sheets or Rotations (%), Unit, [Color]) ITB Unit: Image Transfer Belt Unit, 2TR: Paper Transfer Unit		
001	Paper	*EGB	[0 to 9999999 / 0 / 1 sheet/step]
009	ITB Unit Cnt	*EGB	
010	ITB Rotate DistA	*EGB	[0 to 9999999 / 0 / 1 mm/step]
011	Fusing Cnt	*EGB	[0 to 9999999 / 0 / 1 sheet/step]
012	Fusing RotateDist	*EGB	[0 to 9999999 / 0 / 1 mm/step]
018	2TR CntA	*EGB	[0 to 9999999 / 0 / 1 sheet/step]
019	2TR CntB	*EGB	
020	2TR DistA	*EGB	[0 to 9999999 / 0 / 1 mm/step]
021	2TR DistB	*EGB	
028	Waste Toner Cnt	*EGB	[0 to 9999999 / 0 / 1 sheet/step]
045	ITB Rotate Dist%	*EGB	[0 to 999 / 0 / 1 %/step]
060	ITB Rotate DistB	*EGB	[0 to 999 / 0 / 1 mm/step]
100	TotalCnt Col&Mono	*EGB	[0 to 9999999 / 0 / 1 sheet/step]

7804	[Unit Cnt Clear] Unit Counter Reset (Sheets, Unit, [Color]) ITB Unit: Image Transfer Belt Unit, 2TR: Paper Transfer Unit		
------	--	--	--

001	Paper		
009	ITB Unit Cnt	-	
010	ITB Rotate DistA	-	
011	Fusing Cnt	-	
012	Fusing RotateDist	-	
016	Waste Oner Cnt	-	
020	2TR Dist&CntA	-	
021	2TR Dist&CntB	-	
022	2TR Dist&CntA, B		
060	ITB Rotate DistB	-	
100	Engine All Init	-	

7805	[Unit Cnt Restore] Unit Counter Restore 2TR: Paper Transfer Unit		
022	ITB Unit Cnt	-	

7807	[Reset-SC/ Jam]		
001	Reset-SC/ Jam	-	

7810	[Unit Cnt Clear] Unit Counter Reset		
001	Engine Cnt Init	-	

7812	[Total Cnt Clear] Total Counter Reset		
001	Color Counter	-	
002	Mono Counter	-	
003	Duplex Counter	-	
100	Color & Mono	-	

7832	[Display-Self-Diag] Display Self-Diagnostic Result		
001	Display-Self-Diag	-	

7836	[Resident Memory]		
001		-	

3

7853	[AIO Replace Cnt] AIO Replacement Counter Display		
005	High Yield K	*EGB	[0 to 255 / 0 / 1/step]
006	High Yield M	*EGB	
007	High Yield C	*EGB	
008	High Yield Y	*EGB	
009	Short Yield K	*EGB	[0 to 255 / 0 / 1/step]
010	Short Yield M	*EGB	
011	Short Yield C	*EGB	
012	Short Yield Y	*EGB	

7855	[Coverage Range]		
001	Coverage Range 1	*CTL	[0 to 100 / 5 / 1%/step]
002	Coverage Range 2	*CTL	[0 to 100 / 20 / 1%/step]

7901	[Assert Info]		
001	File Name	*CTL	
002	Number of Lines	*CTL	
003	Location	*CTL	

7906	[Pre.Unit Cnt Disp] Previous Unit Counter Display ITB Unit: Image Transfer Belt Unit, 2TR: Paper Transfer Unit		
------	---	--	--

008	ITB Unit Cnt	*EGB	[0 to 9999999 / 0 / 1 sheet/step]
010	Fusing Cnt	*EGB	
019	2TR Cnt	*EGB	
020	2TR Dis	*EGB	[0 to 9999999 / 0 / 1 mm/step]
034	ITB Rotate Dist%	*EGB	[0 to 9999999 / 0 / 1%/step]
042	ITB Rotate Dist	*EGB	[0 to 9999999 / 0 / 1 mm/step]
043	Fusing RotateDist	*EGB	

7931	[K AIO Information] Black AIO Information		
001	Machine Serial ID	-	
002	Cartridge Ver	-	
003	Brand ID	-	
004	Area ID	-	
005	Product Type ID	-	
006	Color ID	-	
007	Maintenance ID	-	
008	New Product Info.	-	
009	Recycle Count	-	[-128 to 128 / - / 1/step]
011	Manufacturing ID	-	
012	Remaining Amount	-	[0 to 100 / 100 / 1%/step]
013	EDP Code	-	
014	End History	-	
015	Refill Info.	-	[0 to 255 / - / 1 /step]
016	Attach:TtlCounter	-	[0x00000000 to 0xffffffff / - / 1 sheet/step]
017	Attach:ClrCounter	-	[0x00000000 to 0xffffffff / - / 1 sheet/step]
018	End:Total Counter	-	[0x00000000 to 0xffffffff / - / 1 sheet/step]

019	End:Color Counter	-	[0x00000000 to 0xffffffff / - / 1 sheet/step]
022	Unit Counter	-	[0x00000000 to 0xffffffff / - / 1 sheet/step]
023	Size Counter	-	[0 to 255 / - / 1%/step]
024	Type Counter	-	[0 to 255 / - / 1%/step]
025	SleepRec/Pon	-	
026	Procon Result	-	
027	MUSIC Result	-	
028	PconRotateDist	-	[0x00000000 to 0xffffffff / - / 1 mm/step]
029	Forced Printing	-	[0 to 255 / 50 / 1 sheet/step].
030	Env Paper Rate	-	[0 to 255 / - / 1 %/step]
031	Simp/Dup Rate	-	
032	RefMode Cnt	-	[0 to 255 / - / 1 /step]
033	Consumed Amount	-	[0x00000000 to 0xffffffff / - / 0.0001 mg/step]
034	Recovered Amount	-	[0x00000000 to 0xffffffff / - / 0.0001 mg/step]
035	Recycle A	-	[0 to 255 / - / 200 m/1 step]
036	Recycle B	-	
037	Recycle C	-	
038	Recycle D	-	
039	TotalPconRotateDis	-	[0 to 255 / - / 1 mm/step]
040	Machine Serial No	-	

7932	[M AIO Information] Magenta AIO Information
------	---

001	Machine Serial ID	-	
002	Cartridge Ver	-	
003	Brand ID	-	
004	Area ID	-	
005	Product Type ID	-	
006	Color ID	-	
007	Maintenance ID	-	
008	New Product Info.	-	
009	Recycle Count	-	[-128 to 128 / - / 1/step]
011	Manufacturing ID	-	
012	Remaining Amount	-	[0 to 100 / 100 / 1%/step]
013	EDP Code	-	
014	End History	-	
015	Refill Info.	-	[0 to 255 / - / 1 /step]
016	Attach:TtlCounter	-	[0x00000000 to 0xffffffff / - / 1 sheet/step]
017	Attach:ClrCounter	-	[0x00000000 to 0xffffffff / - / 1 sheet/step]
018	End:Total Counter	-	[0x00000000 to 0xffffffff / - / 1 sheet/step]
019	End:Color Counter	-	[0x00000000 to 0xffffffff / - / 1 sheet/step]
022	Unit Counter	-	[0x00000000 to 0xffffffff / - / 1 sheet/step]
023	Size Counter	-	[0 to 255 / - / 1%/step]
024	Type Counter	-	[0 to 255 / - / 1%/step]
025	SleepRec/Pon	-	
026	Procon Result	-	
027	MUSIC Result	-	
028	PconRotateDist	-	[0x00000000 to 0xffffffff / - / 1 mm/step]
029	Forced Printing	-	[0 to 255 / 50 / 1 sheet/step].

030	Env Paper Rate	-	[0 to 255 / - / 1 %/step]
031	Simp/Dup Rate	-	
032	RefMode Cnt	-	[0 to 255 / - / 1 /step]
033	Consumed Amount	-	[0x000000000 to 0xffffffff / - / 0.0001 mg/step]
034	Recovered Amount	-	[0x000000000 to 0xffffffff / - / 0.0001 mg/step]
035	Recycle A	-	[0 to 255 / - / 200 m/1 step]
036	Recycle B	-	
037	Recycle C	-	
038	Recycle D	-	
039	TotalPconRotateDis	-	[0 to 255 / - / 1 mm/step]
040	Machine Serial No	-	

7933	[C AIO Information] Cyan AIO Information		
001	Machine Serial ID	-	
002	Cartridge Ver	-	
003	Brand ID	-	
004	Area ID	-	
005	Product Type ID	-	
006	Color ID	-	
007	Maintenance ID	-	
008	New Product Info.	-	
009	Recycle Count	-	[-128 to 128 / - / 1/step]
011	Manufacturing ID	-	
012	Remaining Amount	-	[0 to 100 / 100 / 1%/step]
013	EDP Code	-	

014	End History	-	
015	Refill Info.	-	[0 to 255 / - / 1 /step]
016	Attach:TilCounter	-	[0x000000000 to 0xffffffff / - / 1 sheet/step]
017	Attach:ClrCounter	-	[0x000000000 to 0xffffffff / - / 1 sheet/step]
018	End:Total Counter	-	[0x000000000 to 0xffffffff / - / 1 sheet/step]
019	End:Color Counter	-	[0x000000000 to 0xffffffff / - / 1 sheet/step]
022	Unit Counter	-	[0x000000000 to 0xffffffff / - / 1 sheet/step]
023	Size Counter	-	[0 to 255 / - / 1%/step]
024	Type Counter	-	[0 to 255 / - / 1%/step]
025	SleepRec/Pon	-	
026	Procon Result	-	
027	MUSIC Result	-	
028	PconRotateDist	-	[0x000000000 to 0xffffffff / - / 1 mm/step]
029	Forced Printing	-	[0 to 255 / 50 / 1 sheet/step].
030	Env Paper Rate	-	[0 to 255 / - / 1 %/step]
031	Simp/Dup Rate	-	
032	RefMode Cnt	-	[0 to 255 / - / 1 /step]
033	Consumed Amount	-	[0x000000000 to 0xffffffff / - / 0.0001 mg/ step]
034	Recovered Amount	-	[0x000000000 to 0xffffffff / - / 0.0001 mg/ step]
035	Recycle A	-	[0 to 255 / - / 200 m/1 step]
036	Recycle B	-	
037	Recycle C	-	
038	Recycle D	-	
039	TotalPconRotateDis	-	[0 to 255 / - / 1 mm/step]

040	Machine Serial No	-	
-----	-------------------	---	--

7934	[Y AIO Information] Yellow AIO Information		
001	Machine Serial ID	-	
002	Cartridge Ver	-	
003	Brand ID	-	
004	Area ID	-	
005	Product Type ID	-	
006	Color ID	-	
007	Maintenance ID	-	
008	New Product Info.	-	
009	Recycle Count	-	[-128 to 128 / - / 1/step]
011	Manufacturing ID	-	
012	Remaining Amount	-	[0 to 100 / 100 / 1%/step]
013	EDP Code	-	
014	End History	-	
015	Refill Info.	-	[0 to 255 / - / 1 /step]
016	Attach:TtlCounter	-	[0x00000000 to 0xffffffff / - / 1 sheet/step]
017	Attach:ClrCounter	-	[0x00000000 to 0xffffffff / - / 1 sheet/step]
018	End:Total Counter	-	[0x00000000 to 0xffffffff / - / 1 sheet/step]
019	End:Color Counter	-	[0x00000000 to 0xffffffff / - / 1 sheet/step]
022	Unit Counter	-	[0x00000000 to 0xffffffff / - / 1 sheet/step]
023	Size Counter	-	[0 to 255 / - / 1%/step]
024	Type Counter	-	[0 to 255 / - / 1%/step]
025	SleepRec/Pon	-	
026	Procon Result	-	

027	MUSIC Result	-	
028	PconRotateDist	-	[0x000000000 to 0xffffffff / - / 1 mm/step]
029	Forced Printing	-	[0 to 255 / 50 / 1 sheet/step].
030	Env Paper Rate	-	[0 to 255 / - / 1 %/step]
031	Simp/Dup Rate	-	
032	RefMode Cnt	-	[0 to 255 / - / 1 /step]
033	Consumed Amount	-	[0x000000000 to 0xffffffff / - / 0.0001 mg/step]
034	Recovered Amount	-	[0x000000000 to 0xffffffff / - / 0.0001 mg/step]
035	Recycle A	-	[0 to 255 / - / 200 m/1 step]
036	Recycle B	-	
037	Recycle C	-	
038	Recycle D	-	
039	TotalPconRotateDis	-	[0 to 255 / - / 1 mm/step]
040	Machine Serial No	-	

7952	[Life Period Set]		
001	Transfer Unit	-	[1 to 100 / 100 / %]

7956	[Supply Near End]		
001	Detect.Timing Set	-	[0 to 2 / 1 / 1/step] 0: Earlier, 1: Normal, 2: Later

Engine SP8-xxx

SP8-XXX (Data Log 2)

The counters in Data Log 2 are commonly used in multiple machines. Data Log 2 includes the counters of the functions or units that are not supported by Model MD-P2. The counters in Data Log 2 are cleared by SP5-801 (Memory Clear) or SP7-808 (Counter Reset).

3



Keys and abbreviations in Data Log 2

Program-related keys and abbreviations	
T:	The grand total of the counters of all application programs
P:	The counter of the printer application program excluding the events related to the document server
O:	The counter of other application programs including remote application programs

8001	[T: Total Jobs]	*CTL	Total jobs
8004	[P: Total Jobs]	*CTL	
The number of times the application program starts a job [0 to 99999999 / 0 / 1]			

- The jobs interrupted by paper jams or some other errors are also counted.
- The jobs executed by SPs are not counted.

8061	[T: FIN Jobs]	*CTL	Finish, post-print processing jobs
8064	[P: FIN Jobs]	*CTL	
8067	[O: FIN Jobs]	*CTL	
The number of times the application program uses the finisher [0 to 99999999 / 0 / 1]			
001	Sort	The number of times the application program starts the sort mode	

002	Stack	The number of times the application program starts the stack mode
003	Staple	The number of times the application program starts the staple mode
004	Booklet	The number of times the application program starts the booklet mode  Note <ul style="list-style-type: none"> The counter of the staple mode (003) can also increase.
005	Z-Fold	The number of times the application program starts the Z-fold mode  Note <ul style="list-style-type: none"> The booklet mode is not included.
006	Punch	The number of times the application program starts the punch mode  Note <ul style="list-style-type: none"> The counter of the printer application program (P:) can also increase.
007	Other	(Reserved)
008	Inside-Fold	Not used
009	Three-In-Fold	Not used
010	Three-OUT-Fold	Not used
011	Four-Fold	Not used
012	KANNON-Fold	Not used
013	Perfect-Bind	Not used
014	Ring-Bind	Not used
015	3rd Vendor	Not used

8071	[T: Jobs/PGS]	*CTL	Jobs/ Pages	
8074	[P: Jobs/PGS]	*CTL		
8077	[O: Jobs/PGS]	*CTL		
The number of jobs that try to output a specific number of pages [0 to 9999999/ 0 / 1]				
-001	1 Page	-008	21 to 50 Pages	
-002	2 Pages	-009	51 to 100 Pages	
-003	3 Pages	-010	101 to 300 Pages	
-004	4 Pages	-011	301 to 500 Pages	
-005	5 Pages	-012	501 to 700 Pages	
-006	6 to 10 Pages	-013	701 to 1000 Pages	
-007	11 to 20 Pages	-014	1001 to Pages	

- The jobs interrupted by paper jams or some other errors are also counted.
- If a job is suspended and restarted later, the job is seen as one job.

8381	[T: Total PrtPGS]	*CTL	Total print pages	
8384	[P: Total PrtPGS]	*CTL		
8387	[O: Total PrtPGS]	*CTL		
The number of sheets that the application program tries to print (excluding the pages printed in the SP mode) [0 to 9999999/ 0 / 1]				

The following pages are not counted as printed pages:

- Blank pages in a duplex printing job
- Blank pages inserted as document covers, chapter title sheets, and slip sheets
- Reports printed to confirm counts
- All reports done in the service mode (service summaries, engine maintenance reports, etc.)
- Test prints for machine image adjustment
- Error notification reports
- Partially printed pages as the result of a printer jam

8391	[LSize PrtPGS]		
001	A3 /DLT, Larger	*CTL	The number of sheets printed on A3/DLT and larger sizes [0 to 99999999 / 0 / 1]
003	BannerPaper	*CTL	The number of sheets printed on banner paper [0 to 99999999 / 0 / 1]

8411	[Prints/Duplex]		
	Prints/Duplex	*CTL	The number of sheets used in duplex printing [0 to 99999999 / 0 / 1]

- The counter increases by +1 when both sides (front/back) are printed. The counter does not increase when one of the two sides is not printed (e.g., the last page of the documents that have three pages, five pages, seven pages, and so on).

8421	[T: PrtPGS/Dup Comb]	*CTL	Print pages/ Duplex printing combine
8424	[P: PrtPGS/Dup Comb]	*CTL	
8427	[O: PrtPGS/Dup Comb]	*CTL	
	The number of sheets used in binding and combining [0 to 99999999 / 0 / 1]		
001	Simplex> Duplex	*CTL	
004	Simplex Combine	*CTL	
005	Duplex Combine	*CTL	
006	2>	*CTL	2 pages on 1 side (2-Up)
007	4>	*CTL	4 pages on 1 side (4-Up)
008	6>	*CTL	6 pages on 1 side (6-Up)
009	8>	*CTL	8 pages on 1 side (8-Up)
010	9>	*CTL	9 pages on 1 side (9-Up)
011	16>	*CTL	16 pages on 1 side (16-Up)
012	Booklet	*CTL	

013	Magazine	*CTL	
014	2-in-1 + Booklet	*CTL	
015	4-in-1 + Booklet	*CTL	
016	6-in-1 + Booklet	*CTL	
017	8-in-1 + Booklet	*CTL	
018	9-in-1 + Booklet	*CTL	
019	2-in-1 + Magazine	*CTL	
020	4-in-1 + Magazine	*CTL	
021	6-in-1 + Magazine	*CTL	
022	8-in-1 + Magazine	*CTL	
023	9-in-1 + Magazine	*CTL	
024	16-in-1 + Magazine	*CTL	

- These counters are useful for the users who want to know how much paper they have saved.
- Partially printed sheets are also counted as 1 page (e.g, the last page in the 4-Up mode is only partially printed when the documents have 5, 6, or 7 pages, 9, 10, or 11 pages, 13, 14, or 15 pages, and so on.).
- Here is a summary of how the counters work in the booklet and magazine modes.

Booklet		Magazine	
Original Pages	Count	Original Pages	Count
1	1	1	1
2	2	2	2
3	2	3	2
4	2	4	2
5	3	5	4
6	4	6	4
7	4	7	4

Booklet		Magazine	
Original Pages	Count	Original Pages	Count
8	4	8	4

8431	[T: PrtPGS/ImgEdt]	*CTL	Print pages/ Image editing performed on the original with the copier GUI
8434	[P: PrtPGS/ImgEdt]	*CTL	
8437	[O: PrtPGS/ImgEdt]	*CTL	
The number of pages that the application program handles in a specific way [0 to 99999999 / 0 / 1]			
001	Cover/Slip Sheet	*CTL	The number of cover sheets or slip sheets inserted Note • A duplex-printed cover is counted as two.
002	Series/Book	*CTL	The number of pages printed in series (one side) or in the booklet mode
003	User Stamp	*CTL	The number of pages where stamps were applied (including page numbering and date stamping)

8441	[T: PrtPGS/Ppr Size]	*CTL	Print pages/ Paper size
8444	[P: PrtPGS/Ppr Size]	*CTL	
8447	[O: PrtPGS/Ppr Size]	*CTL	
The number of sheets of a specific paper size that the application program uses [0 to 99999999 / 0 / 1]			
001	A3	007	LG
002	A4	008	LT
003	A5	009	HLT
004	B4	010	Full Bleed
005	B5	254	Other (Standard)
006	DLT	255	Other (Custom)

These counters do not distinguish between LEF and SEF.

8451	[PrtPGS/Ppr Tray]	*CTL	Print pages/ Paper tray
	The number of sheets fed from a specific tray [0 to 99999999/ 0 / 1]		
001	Bypass Tray	*CTL	By-pass Tray
002	Tray 1	*CTL	Printer
003	Tray 2	*CTL	Paper Tray Unit (Optional)
004	Tray 3	*CTL	(Not used)
005	Tray 4	*CTL	(Not used)
006	Tray 5	*CTL	(Not used)
007	Tray 6	*CTL	(Not used)
008	Tray 7	*CTL	(Not used)
009	Tray 8	*CTL	(Not used)
010	Tray 9	*CTL	(Not used)
011	Tray 10	*CTL	(Not used)
012	Tray 11	*CTL	(Not used)
013	Tray 12	*CTL	(Not used)
014	Tray 13	*CTL	(Not used)
015	Tray 14	*CTL	(Not used)
016	Tray 15	*CTL	(Not used)

8461	[T: PrtPGS/Ppr Type]	*CTL	Print pages/ Paper type
8464	[P: PrtPGS/Ppr Type]	*CTL	
	The number of sheets of specific paper types [0 to 99999999/ 0 / 1]		
001	Normal	005	Normal (Back)
002	Recycled	006	Thick (Back)

003	Special	007	OHP
004	Thick	008	Other

- These counters increase when the paper is output. On the other hand, the PM counter increases (to measure the service life of each feed roller) when the paper is fed.
- Blank sheets (covers, chapter covers, slip sheets) are also counted.
- During duplex printing, a sheet printed on two sides and a sheet printed on one side are both counted as 1.

8471	[PrtPGS/Mag]	*CTL	Print pages/ Magnification
	The number of pages magnified or reduced [0 to 9999999/ 0 / 1]		
001	to 49%	8471 004	101% to 200%
002	50% to 99%	8471 005	201% to
003	100%		

- Some application programs (on the computer) can specify the magnification setting of the printer driver (e.g., MS Excel). In a case like this, SP8-471 recognizes the setting and increases the corresponding counter. Other application programs can magnify or reduce the print images on their own. In a case like this, SP8-471 does not recognize the magnification setting of the application programs and increase the counter of 100%.
- Magnification adjustment conducted on the document server is not counted.
- Blank cover sheets and slip sheets are regarded as 100%.

8481	[T: PrtPGS/TonSave]	*CTL	Print pages/ Toner save
8484	[P: PrtPGS/TonSave]	*CTL	
	The number of pages printed with the toner save feature activated [0 to 9999999/ 0 / 1]		

- These counters display the same result.

8501	[T: PrtPGS/Col Mode]	*CTL	Print pages/ Color mode
8504	[P: PrtPGS/Col Mode]	*CTL	
8507	[O: PrtPGS/Col Mode]		

	The number of pages printed in a specific color mode [0 to 99999999 / 0 / 1]		
001	B/W	051	B/W(Banner)
002	Mono Color	052	Full Color(Banner)
003	Full Color	053	Single Color(Banner)
004	Single Color	054	Two Color(Banner)
005	Two Color		

8511	[T: PriPGS/Emul]	*CTL	Print pages/ Emulation
8514	[P: PriPGS/Emul]	*CTL	
	The number of pages printed by the printer emulation mode [0 to 99999999 / 0 / 1]		
001	RPCS	009	PDF
002	RPDL	010	PCL5e/5c
003	PS3	011	PCL XL
004	R98	012	IPDL-C
005	R16	013	BM-Links (for local models only)
006	GL/GL2	014	Other
007	R55	015	IPDS
008	RTIFF	016	XPS

- These counters display the same result.

8521	[T: PriPGS/FIN]	*CTL	Print pages/ Finish post-print processing
8524	[P: PriPGS/FIN]	*CTL	
	The number of pages processed by the finisher [0 to 99999999 / 0 / 1]		
001	Sort	009	Three-IN-Fold

002	Stack	010	Three-OUT-Fold
003	Staple	011	Four Fold
004	Booklet	012	KANNON-Fold
005	Z-Fold	013	Perfect-Bind
006	Punch	014	Ring-Bind
007	Other	015	3rd Vendor
008	Inside Fold		

- Even if the pages are too many for the finisher to staple, all pages are counted (including unstapled pages).
- The counter of stapling (003) increases by +1 when the paper is transported from the printer to the tray of the finisher. Even if a paper jam occurs on this path, the counter (003) increases. If the same job is retried, the counter (003) increases once again.

8531	[Staples]	*CTL	Staples
001	Staples [0 to 99999999 / 0 / 1]		
002	Stapless [0 to 99999999 / 0 / 1]		

8551	[P:FIN Books]	*CTL	Booklet finishing
8554	[P:FIN Books]	*CTL	Booklet finishing
001	Perfect-Bind		
002	Ring-Bind		

8561	[T:A Sheet Of Paper]	*CTL	
8564	[P:A Sheet Of Paper]	*CTL	
001	Total: Over A3/DLT	003	Duplex: Over A3/DLT
002	Total: Under A3/DLT	004	Duplex: Under A3/DLT

8581	[T: Counter]	*CTL	Total counter
	The number of outputs in a specific color mode [0 to 99999999 / 0 / 1]		
001	Total	018	Full Color Print
002	Total: Full Colo	019	Mono Color Print
003	B&W/Single Color	020	Full Color Total
004	Development: CMY	021	Mono Color Total
005	Development: K	022	Full Color Print
008	Print: Color	023	Eco Color Print
009	Print: B/W	024	Eco Color Print
010	Total: Color	025	Total Color (Eco)
011	Total: B/W	026	Total B/W (Eco)
012	Full Colour: A3	027	Total Color (Eco)
013	Full Colour: B4	028	Development: CMY (A3)
014	Full Colour Print	029	Development: K (A3)
015	Mono Colour Print	030	Total: Color (A3)
016	Full Color GPC	031	Total: B/W (A3)
017	Twin Mode Print	-	-

8584	[P: Counter]	*CTL	Print counter
	The number of outputs in a specific color mode [0 to 99999999 / 0 / 1]		
001	B/W	004	Single Color
002	Mono Color	005	Two Color
003	Full Color		

8591	[O: Counter]	*CTL	Other counter
------	--------------	------	---------------

	The number of A3/DLT, duplex printing, or staples [0 to 99999999 / 0 / 1]		
001	A3/DLT	005	Banner
002	Duplex	-	-

- Note that these counters are not for the printer application program.

8601	[CvgCounter]	*CTL	
	The coverage rate of B/W printing or Color printing/ The number of prints out in B/W printing or Color printing [0 to 99999999 / 0 / 1]		
001	Cvg: BW %	022	Cvg Counter 2
002	Cvg: FC %	023	Cvg Counter 3
011	Cvg: BW Pages	031	CvgCounter 1(YMC)
012	Cvg: FC Pages	032	CvgCounter 2(YMC)
021	Cvg Counter 1	033	CvgCounter 3(YMC)

8604	[P:CvgCounter]	*CTL	
	The coverage rate of B/W printing or Color printing/ The number of prints out in B/W printing or Color printing [0 to 99999999 / 0 / 1]		
001	Cvg: BW %	003	Cvg: Two Color %
002	Cvg: Single Color %	004	Cvg: Full Color %

8617	[SDK Apli Counter]	*CTL	
	The number of prints by each SDK application. [0 to 99999999 / 0 / 1]		
001	SDK-1	007	SDK-7
002	SDK-2	008	SDK-8
003	SDK-3	009	SDK-9

004	SDK-4	010	SDK-10
005	SDK-5	011	SDK-11
006	SDK-6	012	SDK-13

8621	Func Use Counter		
	-		
001	Function-001	*CTL	[0 to 99999999 / 0 / 1/step]
002	Function-002	*CTL	
003	Function-003	*CTL	
004	Function-004	*CTL	
005	Function-005	*CTL	
006	Function-006	*CTL	[0 to 99999999 / 0 / 1/step]
007	Function-007	*CTL	
008	Function-008	*CTL	
009	Function-009	*CTL	
010	Function-010	*CTL	
011	Function-011	*CTL	[0 to 99999999 / 0 / 1/step]
012	Function-012	*CTL	
013	Function-013	*CTL	
014	Function-014	*CTL	
015	Function-015	*CTL	
016	Function-016	*CTL	[0 to 99999999 / 0 / 1/step]
017	Function-017	*CTL	
018	Function-018	*CTL	
019	Function-019	*CTL	
020	Function-020	*CTL	

3

021	Function-021	*CTL	[0 to 99999999 / 0 / 1/step]
022	Function-022	*CTL	
023	Function-023	*CTL	
024	Function-024	*CTL	
025	Function-025	*CTL	
026	Function-026	*CTL	[0 to 99999999 / 0 / 1/step]
027	Function-027	*CTL	
028	Function-028	*CTL	
029	Function-029	*CTL	
030	Function-030	*CTL	
031	Function-031	*CTL	[0 to 99999999 / 0 / 1/step]
032	Function-032	*CTL	
033	Function-033	*CTL	
034	Function-034	*CTL	
035	Function-035	*CTL	
036	Function-036	*CTL	
037	Function-037	*CTL	
038	Function-038	*CTL	
039	Function-039	*CTL	
040	Function-040	*CTL	

041	Function-041	*CTL	[0 to 999999999 / 0 / 1/step]
042	Function-042	*CTL	
043	Function-043	*CTL	
044	Function-044	*CTL	
045	Function-045	*CTL	
046	Function-046	*CTL	
047	Function-047	*CTL	
048	Function-048	*CTL	
049	Function-049	*CTL	
050	Function-050	*CTL	
051	Function-051	*CTL	[0 to 999999999 / 0 / 1/step]
052	Function-052	*CTL	
053	Function-053	*CTL	
054	Function-054	*CTL	
055	Function-055	*CTL	
056	Function-056	*CTL	
057	Function-057	*CTL	
058	Function-058	*CTL	
059	Function-059	*CTL	
060	Function-060	*CTL	
061	Function-061	*CTL	[0 to 999999999 / 0 / 1/step]
062	Function-062	*CTL	
063	Function-063	*CTL	
064	Function-064	*CTL	

8771	[Dev Counter]	*CTL	Development counter
------	---------------	------	---------------------

	The number of rotations of the development rollers [0 to 99999999 / 0 / 1]		
001	Total	004	M
002	K	005	C
003	Y		

8781	[TonerBotollInfo] Toner Bottle Information		
001	Last [BK]	*EGB	The number of toner bottles (bottles) already replaced [0 to 99999999 / 0 / 1]
002	Last [Y]	*EGB	
003	Last [M]	*EGB	
004	Last [C]	*EGB	

8801	[Toner Remain]	*CTL	Toner remain
001	K	*CTL	The percentage of the remaining toner [0 to 100 / 0 / 1]
002	Y	*CTL	
003	M	*CTL	
004	C	*CTL	

8811	[Eco Counter]		
	-		
001	Eco Total	*CTL	[0 to 999999999 / 0 / 1/step]
002	Color	*CTL	
003	Full Color	*CTL	
004	Duplex	*CTL	
005	Combine	*CTL	

006	Color (%)	*CTL	[0 to 100 / 0 / 1% / step]
007	Full Color (%)	*CTL	
008	Duplex (%)	*CTL	
009	Combine (%)	*CTL	
010	Paper Cut (%)	*CTL	
051	Sync Eco Total	*CTL	[0 to 999999999 / 0 / 1/step]
052	Sync Color	*CTL	
053	Sync Full Color	*CTL	
054	Sync Duplex	*CTL	
055	Sync Combine	*CTL	
056	Sync Color(%)	*CTL	[0 to 100 / 0 / 1% / step]
057	Sync Full Color(%)	*CTL	
058	Sync Duplex(%)	*CTL	
059	Sync Combine(%)	*CTL	
060	Sync Paper Cut(%)	*CTL	
101	Eco Totalr>Last	*CTL	[0 to 999999999 / 0 / 1/step]
102	Color>Last	*CTL	
103	Full Color>Last	*CTL	
104	Duplex>Last	*CTL	
105	Combine>Last	*CTL	
106	Color(%):Last	*CTL	[0 to 100 / 0 / 1% / step]
107	Full Color (%):Last	*CTL	
108	Duplex (%):Last	*CTL	
109	Combine (%):Last	*CTL	
110	Paper Cut (%):Last	*CTL	

151	Sync Eco Totalr>Last	*CTL	[0 to 99999999 / 0 / 1/step]
152	Sync Color>Last	*CTL	
153	Sync Full Color>Last	*CTL	
154	Sync Duplex>Last	*CTL	
155	Sync Combine>Last	*CTL	
156	Sync Color(%):Last	*CTL	[0 to 100 / 0 / 1% / step]
157	Sync Full Color(%):Last	*CTL	
158	Sync Duplex(%):Last	*CTL	
159	Sync Combine(%):Last	*CTL	
160	Sync Paper Cut(%):Last	*CTL	

8851	[Cvr Cnt: 0-10%] Coverage Counter (Sheets, [Color]) S: Sheets		
	[0 to 9999999 / 0 / 1 sheet/step] (*EGB)		
011	0 - 2%: BK	031	5 - 7%: Bk
012	0 - 2%: Y	032	5 - 7%: Y
013	0 - 2%: M	033	5 - 7%: M
014	0 - 2%: C	034	5 - 7%: C
021	3 - 4%: BK	041	8 - 10%: Bk
022	3 - 4%: Y	042	8 - 10%: Y
023	3 - 4%: M	043	8 - 10%: M
024	3 - 4%: C	044	8 - 10%: C

8861	[Cvr Cnt: 11-20%] Coverage Counter (Sheets, [Color]) S: Sheets		
8871	[Cvr Cnt: 21-30%] Coverage Counter (Sheets, [Color]) S: Sheets		

8881	[Cvr Cnt: 31%-] Coverage Counter (Sheets, [Color]) S: Sheets		
001	[K]	*EGB	The number of printed sheets of a specific coverage ratio [0 to 9999999/ 0 / 1]
002	[Y]	*EGB	
003	[M]	*EGB	
004	[C]	*EGB	

- For example, SP8-851-001 displays the number of printed sheets whose black-coverage ratio is 0 percent through 10 percent. SP8-881-004 displays the number of scanned sheets whose cyan-coverage ratio is 31 percent or higher.

8891	[Page/Toner Bottle] (Sheets, [Color]) S: Sheets		
001	[K]	*EGB	The number of printed sheets [0 to 9999999/ 0 / 1]
002	[Y]	*EGB	
003	[M]	*EGB	
004	[C]	*EGB	

8901	[Page/Ink Prev1]		
001	[K]	*EGB	The number of printed sheets with the previously replaced units [0 to 99999999/ 0 / 1]
002	[Y]	*EGB	
003	[M]	*EGB	
004	[C]	*EGB	

8911	[Page/Ink Prev2]		
001	[K]	*EGB	The number of printed sheets with the units that was replaced before the previous unit. [0 to 99999999/ 0 / 1]
002	[Y]	*EGB	
003	[M]	*EGB	
004	[C]	*EGB	

8921	[Cvr Cnt/Total]		
	Displays the total coverage and total printout number for each color.		
001	Coverage (%) Bk	*CTL	[0 to 2147483647 / 0 / 1% / step]
002	Coverage (%) Y	*CTL	
003	Coverage (%) M	*CTL	
004	Coverage (%) C	*CTL	
011	Coverage /P: Bk	*CTL	[0 to 99999999 / 0 / 1/step]
012	Coverage /P: Y	*CTL	
013	Coverage /P: M	*CTL	
014	Coverage /P: C	*CTL	
031	Coverage (%):Eco Bk	*CTL	[0 to 2147483647 / 0 / 1% / step]
032	Coverage (%):Eco Y	*CTL	
033	Coverage (%):Eco M	*CTL	
034	Coverage (%):Eco C	*CTL	
041	Coverage /P:Eco Bk	*CTL	[0 to 99999999 / 0 / 1/step]
042	Coverage /P:Eco Y	*CTL	
043	Coverage /P:Eco M	*CTL	
044	Coverage /P:Eco C	*CTL	

	[Machine Status]	*CTL	Machine status
8941	The amount of time the machine spends in a specific mode [0 to 99999999 / 0 / 1]		
001	Operation Time	*CTL	The engine is operating. The counter does not include the time when the data is being saved in the HDD (while engine is not operating).

002	Standby Time	*CTL	The engine is not operating. The counter includes the time when the data is being saved in the HDD. The counter does not include the time when the machine is in the Energy Saver Mode, the Low Power Mode, or the Off Mode.
003	Energy Save Time	*CTL	The machine is in the Energy Saver Mode. The counter includes the time when the background printing is being executed.
004	Low Power Time	*CTL	The machine is in the Low Power Mode. The counter includes the time when the engine is on in the Energy Saver Mode. The counter also includes the time when the background printing is being executed.
005	Off Mode Time	*CTL	The machine is in the Off Mode. The counter includes the time when the background printing is being executed. The counter does not include the time when the main power switch is off.
006	SC	*CTL	The total downtime caused by SC codes
007	PrtJam	*CTL	The total downtime caused by paper jams
008	OrgJam	*CTL	The total downtime caused by original jams
009	Supply PM Unit E	*CTL	The total downtime caused by toner ends

8961	[Electricity Status]		
	-		
001	Ctrl Standby Time	*CTL	[0 to 99999999 / 0 / 1/step]
002	STR Time	*CTL	
003	Main Power Off Time	*CTL	
004	Reading and Printing Time	*CTL	

005	Printing Time	*CTL	[0 to 99999999 / 0 / 1/step]
006	Reading Time	*CTL	
007	Eng Waiting Time	*CTL	
008	Low Power State Time	*CTL	
009	Silent State Time	*CTL	
010	Heater Off State Time	*CTL	
011	LCD on Time	*CTL	
101	Silent Print	*CTL	

8999	[AdminCounter]	*CTL	Coverage Counter Total
001	Total	*CTL	Displays the administrator counter in the UP mode. [0 to 99999999 / 0 / 1]
006	Printer: FC	*CTL	
007	Printer: FC	*CTL	
008	Printer: OneC	*CTL	
009	Printer: TwoC	*CTL	
013	Duplex	*CTL	
026	Printer: Full Color (%)	*CTL	
027	Printer: BW (%)	*CTL	
028	Printer: Single Color (%)	*CTL	
029	Printer: Two Color (%)	*CTL	

Input and Output Check

Input Check Table

SP5803 -xxx	Input Check
006	AIO Seri No K-001
007	AIO Seri No K-002
008	AIO Seri No K-003
009	AIO Seri No K-004
010	AIO Seri No K-005
011	AIO Seri No C-001
012	AIO Seri No C-002
013	AIO Seri No C-003
014	AIO Seri No C-004
015	AIO Seri No C-005
016	AIO Seri No M-001
017	AIO Seri No M-002
018	AIO Seri No M-003
019	AIO Seri No M-004
020	AIO Seri No M-005
021	AIO Seri No Y-001
022	AIO Seri No Y-002
023	AIO Seri No Y-003
024	AIO Seri No Y-004
025	AIO Seri No Y-005

026	TM Sensor R-PWM
027	TM Sensor C-PWM
028	TM Sensor L-PWM
029	Dev. Bias K
030	Dev. Bias M
031	Dev. Bias C
032	Dev. Bias Y
033	LD Power K
034	LD Power M
035	LD Power C
036	LD Power Y
037	Charge Output K
038	Charge Output Col
039	S-Scan Reg Adj:M
040	S-Scan Reg Adj:C
041	S-Scan Reg Adj:Y
042	M-Scan Reg Adj:M
043	M-Scan Reg Adj:C
044	M-Scan Reg Adj:Y
045	M-Scan Reg SubA:M
046	M-Scan Reg SubA:C
047	M-Scan Reg SubA:Y
048	M-MagA:M 0.001%
049	M-MagA:C 0.001%
050	M-MagA:Y 0.001%
051	Skew: K

052	Skew: M
053	Skew: C
054	Skew: Y
055	Consumed Amount K
056	Consumed Amount M
057	Consumed Amount C
058	Consumed Amount Y
101	WasteToner Detect
	0: Not full, 1: Full
102	WTBottle Detect
	0: Not set, 1: Set
104	PFU Set Detect
	0: Not set, 1: Set
105	PFU Paper Sensor
	0: No paper detected, 1: Paper detected
106	PFU Reply Sensor
	0: No paper detected, 1: Paper detected
107	Main Paper Set Sn
	0: No paper detected, 1: Paper detected
108	Regist Sensor
	0: No paper detected, 1: Paper detected
109	Paper Exit Sn
	0: No paper detected, 1: Paper detected
110	Bypass PaperEndSn
	0: No paper detected, 1: Paper detected

111	Duplex Sensor
	0: No paper detected, 1: Paper detected
114	Tray Set Detect
	0: Not set, 1: Set
115	Door Open Detect
	0: Door close, 1: Door open

Output Check Table

5804	Output Check
001	BK Motor:1/1
002	BK Motor:1/2
003	BK Motor:1/2.5
004	Color Motor:1/1
005	Color Motor:1/2
006	Color Motor:1/2.5
007	Fusing Mtr:1/1
008	Fusing Mtr:1/2
009	Fusing Mtr:1/2.5
010	ITB Contact Motor
011	Agitator M:Intl
012	Agitator M:Print
013	Duplex:Fwd/Normal
014	Duplex:Fwd/Low
015	Duplex:Rev/Normal
016	Duplex:Rev/Low

017	LSU Fan:Normal
018	LSU Fan:Low
019	Fusing Fan:Normal
020	Fusing Fan:Low
021	Air In Fan:Normal
022	PSU Fan:Normal
023	Regist Clutch
024	PFU P-Feed Clutch
025	PFU Relay Clutch

4. Appendix: Machine Swap

Exchange and Replace Procedure

If the machine exchange and replacement is required, arrange to send a machine without the four print cartridges (AIO) to the customer site.

Instruction

Instruct the customer to do the following procedure.

4

Before the substitute machine gets to the customer site

- Print the configuration page.

When the substitute machine gets to the customer site

1. Remove the four print cartridges (AIO) from the problem machine.
2. Install the four print cartridges (AIO) into the substitute machine.
3. Input the customer settings which are printed on the configuration page by using the "Menu" on the operation panel.
4. Send back the problem machine to the repair center.

Cleaning Points after Machine Arrival at Depot

1. Open the front cover.
2. Release the locks [A].

3. Remove the transfer unit [B].

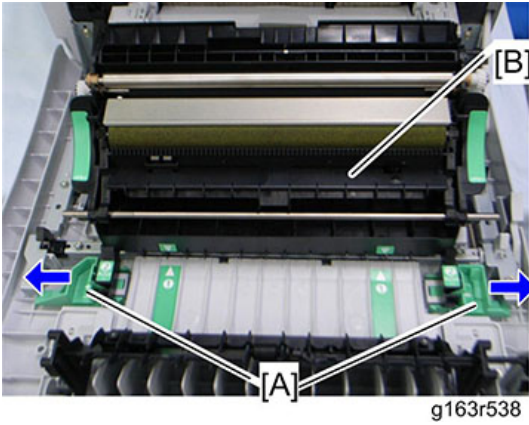

4. Remove the waste toner bottle [A].

5. Remove the two screws [B].

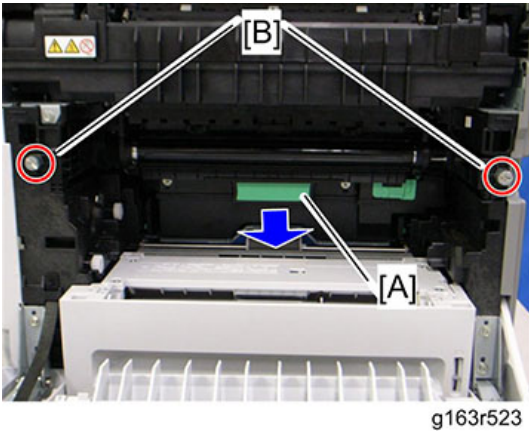

6. Grab the handles [A], and then pull out the image transfer belt unit [B].

7. Remove the waste toner bottle.

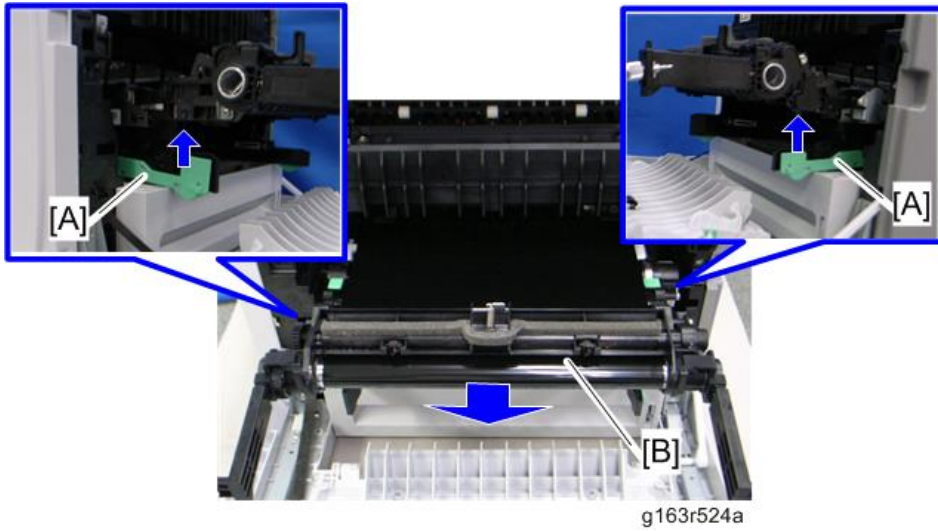

8. Clean inside the machine, especially around the circled area [A].

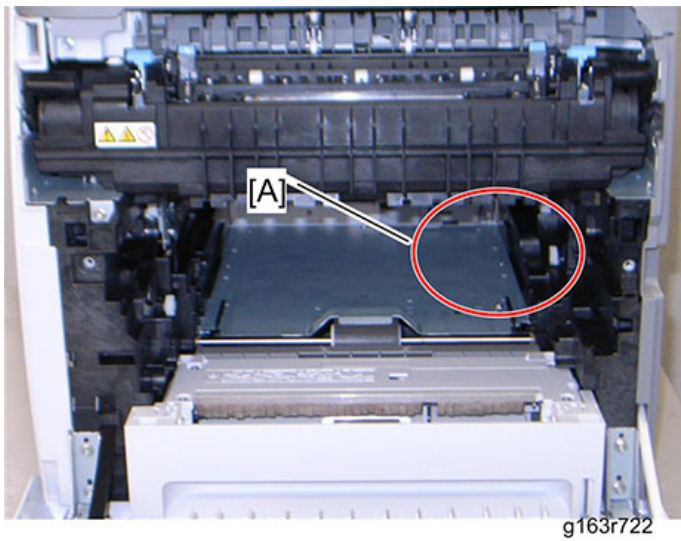

- 9. Clean the circled area at the waste toner bottle [A] and circled area [B] at image transfer belt unit.

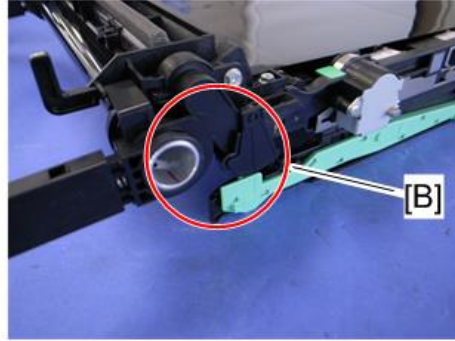
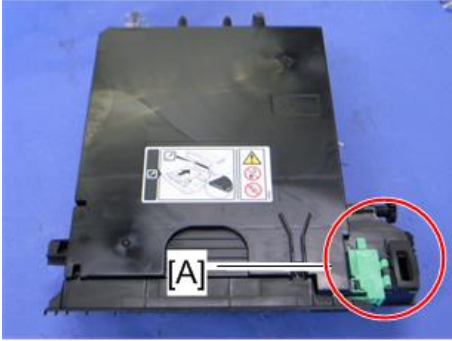

g163r723a

4

- 10. Reassemble the machine.