

**Pro C651EX/Pro C751EX/Pro C751
Machine Code: D074/D075/M044**

Field Service Manual

July 2011

Safety, Symbols, Trademarks

Conventions











These manuals cover three machines: M074, M075, and M044.













- The M074 and M075 are the copier versions. They both have the ARDF and scanner unit.
- The M044 is the printer version. It has neither ARDF nor scanner unit.

The following notations are used in text to indicate were a component, SC code, SP code, etc. apply to a specific machine.

Notation in Text	Meaning
D074	Applies to D074 only
D075	Applies to D075 only
D074/D075	Applies to D074/D074 but not M044
M044	Applies to M044 only

Symbols Used in Text

Symbol	What it means
	Binding screw (shoulder hexagonal head)
	Binding screw (round flathead)
	Black screw (heavy, fusing unit, TCRU)
	Bushing
	C-ring
	Connector
	E-ring
	FFC (Flat Film Connector)
	FFC (Flat Film Connector)
	Gear
	Harness clamp

Symbol	What it means
	Harness clamp (metal: fusing unit)
	Hook (or tab release)
	Knob screw (black)
	Knob screw (sliver)
	Pivot screw
	Screw (common screw)
	Shoulder screw
	Spring
	Standoff
	Stud screw
	Tapping screw (for plastic)
	Timing belt

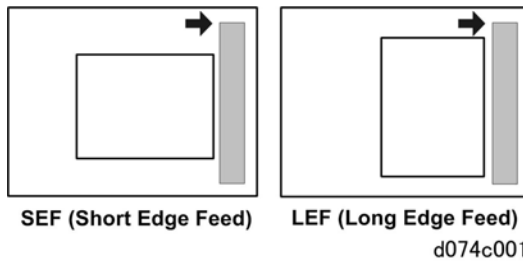

The notations "SEF" and "LEF" describe the direction of paper feed. The arrows indicate the direction of paper feed.

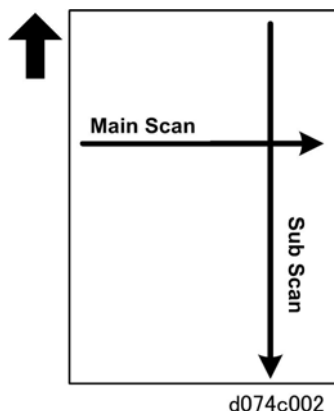

In this manual "Main Scan" means "Horizontal" and "Sub Scan" means "Vertical", both relative to the direction of paper feed.

Warnings, Cautions, Notes

In this manual, the following important symbols and notations are used.

WARNING

- A Warning indicates a potentially hazardous situation. Failure to obey a Warning could result in death or serious injury.

CAUTION

- A Caution indicates a potentially hazardous situation. Failure to obey a Caution could result in minor or moderate injury or damage to the machine or other property.

Important

- Obey these guidelines to avoid problems such as misfeeds, damage to originals, loss of valuable data and to prevent damage to the machine

Note

- This information provides tips and advice about how to best service the machine.

Commonly Used Terms and Abbreviations

Here is a list of commonly used terms and abbreviations that are used throughout the Field Service Manual and Appendices.

Terms	Meaning
(ccw)	Counter-clockwise rotation of a drum, roller, gear, etc.

Terms	Meaning
(cw)	Clockwise rotation of a drum, roller, gear, etc.
BW	Black and white (monochrome) copying or printing
Bank	Paper Bank (1st, 2nd Tray of the main machine)
CIT	Cover Interposer Tray (D518) (option)
FC	Full Color copying or printing
FIN	Finisher (D512/D513) (option)
HCS	High Capacity Stacker (D515) (option)
ITB	Image Transfer Belt
JG	Junction Gate
LCIT	Large Capacity Input Tray
LD	Laser Diode (Laser Unit)
LDB	Laser Diode Board (Laser Unit)
LE	Leading Edge
LSDB	Laser Synchronization Detection Board (Laser Unit)
MFU	Multi Folding Unit (D521) (option)
MUSIC	Mirror Unit Skew Interval Correction
PCDU	Photoconductor Development Unit
PFU	Paper Feed Unit (for Tray 1 and Tray 2: Pickup and feed rollers, sensors, solenoids)
PTB	Paper Transport Belt
PTR	Paper Transfer Roller
PTU	Paper Transfer Unit
RB	Ring Binder (D519) (option)
TCRU	Trained Customer Replacement Units
TE	Trailing Edge

Terms	Meaning
TM	Toner Mark sensors, the three sensors of the ITB sensor array. They detect MUSIC patterns on the ITB. In this manual, these are the ID/MUSIC sensors, but you may see "TM" in the SP mode.
TM/P	"Toner Mark/Photo"-sensor. The "P" refers to the center sensor of the ITB sensor array. In this manual, "ID/MUSIC sensors" is used. However, you may see "TM/P" in the SP mode.
TRM	Trimmer Unit (D520) (option)
VTU	Vertical Transport Unit (paper feed between paper banks and right drawer)
YCMK	Yellow, Cyan, Magenta, black

General Safety Instructions

For your safety, please read this manual carefully before you use this product. Keep this manual handy for future reference.

Safety Information

Always obey the following safety precautions when using this product.

Safety During Operation

In this manual, the following important symbols and notations are used.

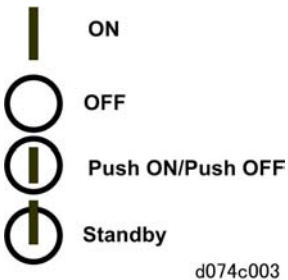

Switches and Symbols

Where symbols are used on or near switches on machines for Europe and other areas, the meaning of each symbol conforms with IEC60417.

Responsibilities of the Customer Engineer

Customer Engineer

Maintenance shall be done only by trained customer engineers who have completed service training for the machine and all optional devices designed for use with the machine.

Reference Material for Maintenance

- Maintenance shall be done using the special tools and procedures prescribed for maintenance of the machine described in the reference materials (service manuals, technical bulletins, operating instructions, and safety guidelines for customer engineers).
- Use only consumable supplies and replacement parts designed for use with the machine.

Before Installation, Maintenance

Shipping and Moving the Machine

CAUTION

- Work carefully when lifting or moving the machine. If the machine is heavy, two or more customer engineers may be required to prevent injuries (muscle strains, spinal injuries, etc.) or damage to the machine if it is dropped or tipped over.
- Personnel moving or working around the machine should always wear proper clothing and footwear. Never wear loose fitting clothing or accessories (neckties, loose sweaters, bracelets, etc.) or casual footwear (slippers, sandals, etc.) when lifting or moving the machine.
- Always unplug the power cord from the power source before you move the machine. Before you move the product, arrange the power cord so it will not fall under the machine.

Power

WARNING

- Always disconnect the power plug before doing any maintenance procedure. After switching off the machine, power is still supplied to the main machine and other devices. To prevent electrical shock, switch the machine off, wait for a few seconds, then unplug the machine from the power source.
- Before you do any checks or adjustments after turning the machine off, work carefully to avoid injury. After removing covers or opening the machine to do checks or adjustments, never touch electrical components or moving parts (gears, timing belts, etc.).

-
- After turning the machine on with any cover removed, keep your hands away from electrical components and moving parts. Never touch the cover of the fusing unit, gears, timing belts, etc.

Installation, Disassembly, and Adjustments

CAUTION

- After installation, maintenance, or adjustment, always check the operation of the machine to make sure that it is operating normally. This ensures that all shipping materials, protective materials, wires and tags, metal brackets, etc., removed for installation, have been removed and that no tools remain inside the machine. This also ensures that all release interlock switches have been restored to normal operation.
- Never use your fingers to check moving parts causing spurious noise. Never use your fingers to lubricate moving parts while the machine is operating.

Special Tools

CAUTION

- Use only standard tools approved for machine maintenance.
- For special adjustments, use only the special tools and lubricants described in the service manual. Using tools incorrectly, or using tools that could damage parts, could damage the machine or cause injuries.

During Maintenance

General

CAUTION

- Before you begin a maintenance procedure: 1) Switch the machine off, 2) Disconnect the power plug from the power source, 3) Allow the machine to cool for at least 10 minutes.
- Avoid touching the components inside the machine that are labeled as hot surfaces.

Safety Devices

WARNING

- Never remove any safety device unless it requires replacement. Always replace safety devices immediately.
- Never do any procedure that defeats the function of any safety device. Modification or removal of a safety device (fuse, switch, etc.) could lead to a fire and personal injury. Always test the

operation of the machine to ensure that it is operating normally and safely after removal and replacement of any safety device.

- For replacements use only the correct fuses or circuit breakers rated for use with the machine. Using replacement devices not designed for use with the machine could lead to a fire and personal injuries.

Organic Cleaners

CAUTION

- During preventive maintenance, never use any organic cleaners (alcohol, etc.) other than those described in the service manual.
- Make sure the room is well ventilated before using any organic cleaner. Use organic solvents in small amounts to avoid breathing the fumes and becoming nauseous.
- Switch the machine off, unplug it, and allow it to cool before doing preventive maintenance. To avoid fire or explosion, never use an organic cleaner near any part that generates heat.
- Wash your hands thoroughly after cleaning parts with an organic cleaner to prevent contamination of food, drinks, etc. which could cause illness.
- Clean the floor completely after accidental spillage to prevent slippery surfaces that could cause accidents leading to hand or leg injuries. Use dry rags to soak up spills.

Lithium Batteries

WARNING

- Always replace a lithium battery on a PCB with the same type of battery prescribed for use on that board. Replacing a lithium battery with any type other than the one prescribed for use on the board could lead to an explosion or damage to the PCB.
- Never discard used batteries by mixing them with other trash. Remove them from the work site and dispose of them in accordance with local laws and regulations regarding the disposal of such items.

Ozone Filters

CAUTION

- Always replace ozone filters as soon as their service life expires (as described in the service manual).
- An excessive amount of ozone can build up around machines that use ozone filters if they are not replaced at the prescribed time. Excessive ozone could cause personnel working around the machine to feel unwell.

-
- To avoid possible accumulation of ozone in the work area, locate the machine in a large well ventilated room that has an air turnover rate of more than 50 m³/hr/person.

Power Plug and Power Cord

WARNING

- Before servicing the machine (especially when responding to a service call), always make sure that the power plug has been inserted completely into the power source. A partially inserted plug could lead to heat generation (due to a power surge caused by high resistance) and cause a fire or other problems.
- Always check the power plug and make sure that it is free of dust and lint. Clean it if necessary. A dirty plug can generate heat which could cause a fire.
- Inspect the length of the power cord for cuts or other damage. Replace the power cord if necessary. A frayed or otherwise damaged power cord can cause a short circuit which could lead to a fire or personal injury from electrical shock.
- Check the length of the power cord between the machine and power supply. Make sure the power cord is not coiled or wrapped around any object such as a table leg. Coiling the power cord can cause excessive heat to build up and could cause a fire.
- Make sure that the area around the power source is free of obstacles so the power cord can be removed quickly in case of an emergency.
- Make sure that the power cord is grounded (earthed) at the power source with the ground wire on the plug.
- Connect the power cord directly into the power source. Never use an extension cord.
- When you disconnect the power plug from the power source, always pull on the plug, not the cable.

After Installation, Servicing

Disposal of Used Items

WARNING

- Never incinerate used toner or toner cartridges.
- Toner or toner cartridges thrown into a fire can ignite or explode and cause serious injury. At the work site always carefully wrap used toner and toner cartridges with plastic bags to avoid spillage before disposal or removal.

⚠ CAUTION

- Always dispose of used items (developer, toner, toner cartridges, OPC drums, etc.) in accordance with the local laws and regulations regarding the disposal of such items.
- To protect the environment, never dispose of this product or any kind of waste from consumables at a household waste collection point. Dispose of these items at one of our dealers or at an authorized collection site.
- Return used drums to the service center for handling in accordance with company policy regarding the recycling or disposal of such items.

⚠ CAUTION

- The development unit cooling system circulates propylene glycol from a sealed tank through hoses that pass behind cooling plates on the sides of each development unit.
- The coolant tank is located at the bottom of the cooling box on the back of the main machine.
- Always obey local laws and regulations if you need to dispose of a tank or the propylene glycol coolant.
- The tank must never be emptied directly into a local drainage system, river, pond, or lake.
- Contact a professional industrial waste disposal organization and ask them to dispose of the tank.

Points to Confirm with Operators

At the end of installation or a service call, instruct the user about use of the machine. Emphasize the following points.

- Show operators how to remove jammed paper and troubleshoot other minor problems by following the procedures described in the operating instructions.
- Point out the parts inside the machine that they should never touch or attempt to remove.
- Confirm that operators know how to store and dispose of consumables.
- Make sure that all operators have access to an operating instruction manual for the machine.
- Confirm that operators have read and understand all the safety instructions described in the operating instructions.
- Demonstrate how to turn off the power and disconnect the power plug (by pulling the plug, not the cord) if any of the following events occur: 1) something has spilled into the product, 2) service or repair of the product is necessary, 3) the product cover has been damaged.
- Caution operators about removing paper fasteners around the machine. They should never allow paper clips, staples, or any other small metallic objects to fall into the machine.

Special Safety Instructions for Toner

Accidental Physical Exposure

CAUTION

- Work carefully when removing paper jams or replacing toner bottles or cartridges to avoid spilling toner on clothing or the hands.
- If toner is inhaled, immediately gargle with large amounts of cold water and move to a well ventilated location. If there are signs of irritation or other problems, seek medical attention.
- If toner gets on the skin, wash immediately with soap and cold running water.
- If toner gets into the eyes, flush the eyes with cold running water or eye wash. If there are signs of irritation or other problems, seek medical attention.
- If toner is swallowed, drink a large amount of cold water to dilute the ingested toner. If there are signs of any problem, seek medical attention.
- If toner spills on clothing, wash the affected area immediately with soap and cold water. Never use hot water! Hot water can cause toner to set and permanently stain fabric.

Handling and Storing Toner

WARNING

- Toner, used toner, and developer are extremely flammable.
- Never store toner, developer, toner cartridges, or toner bottles (including empty toner bottles or cartridges) in a location where they will be exposed to high temperature or an open flame.

CAUTION

- Always store toner and developer supplies such as toner and developer packages, cartridges, and bottles (including used toner and empty bottles and cartridges) out of the reach of children.
- Always store fresh toner supplies or empty bottles or cartridges in a cool, dry location that is not exposed to direct sunlight.

Toner Disposal

WARNING

- Never attempt to incinerate toner, used toner, or empty toner containers (bottles or cartridges). Burning toner can explode and scatter, causing serious burns.
- Always wrap used toner and empty toner bottles and cartridges in plastic bags to avoid spillage. Follow the local laws and regulations regarding the disposal of such items.

-
- Dispose of used toner and toner cartridges at one of our dealers or at an authorized collection site. Always dispose of used toner cartridges and toner bottles in accordance with the local laws and regulations regarding the disposal of such items.

Safety Instructions for the Machine

Prevention of Physical Injury

1. Before disassembling or assembling parts of the machine and peripherals, make sure that the machine and peripheral power cords are unplugged.
2. The plug should be near the machine and easily accessible.
3. Note that some components of the machine and the paper tray unit are supplied with electrical voltage even if the main power switch is turned off.
4. If any adjustment or operation check has to be made with exterior covers off or open while the main switch is turned on, keep hands away from electrified or mechanically driven components.
5. If the [Start] key is pressed before the machine completes the warm-up period (the [Start] key starts blinking red and green), keep hands away from the mechanical and the electrical components, because the machine starts making copies as soon as the warm-up period is completed.
6. The inside and the metal parts of the fusing unit become extremely hot while the machine is operating. Be careful to avoid touching those components with your bare hands.

WARNING

- To avoid the danger of fire or explosion, keep the machine away from flammable liquids, gases, and aerosols.

Health Safety Conditions

1. Never operate the machine without the ozone filters installed.
2. Always replace the ozone filters with the specified types at the proper intervals.
3. To avoid possible accumulation of ozone in the work area, locate the machine in a large well ventilated room that has an air turnover rate of more than 30m³/hr/person.
4. Toner and developer are non-toxic, but if you get either of them in your eyes by accident, it may cause temporary eye discomfort. Try to remove with eye drops or flush with water as first aid. If unsuccessful, get medical attention.

Observance of Electrical Safety Standards

1. The machine and its peripherals must be installed and maintained by a customer service representative who has completed the training course on those models.

2. The NVRAM on the system control board has a lithium battery which can explode if replaced incorrectly. Replace the NVRAM only with an identical one. The manufacturer recommends replacing the entire NVRAM. Do not recharge or burn this battery. Used NVRAM must be handled in accordance with local regulations.

Safety and Ecological Notes for Disposal

1. Never incinerate toner bottles or used toner. Toner dust may ignite suddenly when exposed to an open flame.
2. Dispose of used toner, developer, and organic photoconductors in accordance with local regulations. (These are non-toxic supplies.)
3. Dispose of replaced parts in accordance with local regulations.
4. When keeping used lithium batteries in order to dispose of them later, do not put more than 100 batteries per sealed box. Storing larger numbers or not sealing them apart may lead to chemical reactions and heat build-up.

CAUTION

- The danger of explosion exists if a battery of this type is incorrectly replaced.
- Replace only with the same or an equivalent type recommended by the manufacturer. Discard used batteries in accordance with the manufacturer's instructions.

Laser Safety



1. The Center for Devices and Radiological Health (CDRH) prohibits the repair of laser-based optical units in the field.
2. The optical housing unit can only be repaired in a factory or at a location with the requisite equipment.
3. The laser subsystem is replaceable in the field by a qualified Customer Engineer.
4. The laser chassis is not repairable in the field.
5. Customer engineers are therefore directed to return all chassis and laser subsystems to the factory or service depot when replacement of the optical subsystem is required.

WARNING

- Use of controls, or adjustment, or performance of procedures other than those specified in this manual may result in hazardous radiation exposure.
- Turn off the main switch before attempting any of the procedures in the Laser Unit section. Laser beams can seriously damage your eyes.

Safety Instructions for the Fiery Controller

Fuse

CAUTION

- The Fiery controller uses a double pole fuse. If this fuse blows, be sure to replace it with an identical fuse.

Batteries

- Always replace a battery with the same type of battery prescribed for use with the Fiery controller unit. Replacing a battery with any type other than the one prescribed for use could cause an explosion.
- Never discard used batteries by mixing them with other batteries or other refuse.
- Always remove used batteries from the work site and dispose of them in accordance with local laws and regulations regarding the disposal of such items.

Trademarks

- Microsoft[®], and Windows[®] are registered trademarks of Microsoft Corporation in the United States and /or other countries.
- PostScript[®] is a registered trademark of Adobe Systems, Incorporated.
- PCL[®] is a registered trademark of Hewlett-Packard Company.
- Ethernet[®] is a registered trademark of Xerox Corporation.
- PowerPC[®] is a registered trademark of International Business Machines Corporation.
- Fiery is a registered trademark of Electronics for Imaging (EFI), Inc.
- Other product names used herein are for identification purposes only and may be trademarks of their respective companies. We disclaim any and all rights involved with those marks.

New Features

Main Machines

Model Numbers and Names

The "Production No." numbers in the 2nd column of the table below are used exclusively in the manuals to refer to different machines. The names in the 1st and 3rd columns are not used in the service manuals.

Production Name	Production No.	Model Name
Taurus C1a (65 ppm)	D074	Pro C651EX
Taurus C1b (75 ppm)	D075	Pro C751EX
Taurus P1 (75 ppm)	M044	Pro C751

Base Machine

D074/D075

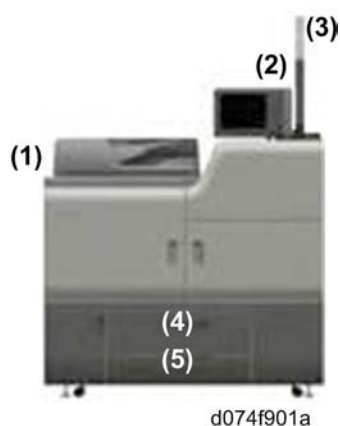

No.	Copier D074 (65 ppm)/D075 (75 ppm)
(1)	ARDF
(2)	Touch-panel operation with LCD (SVGA)
(3)	Attention light (standard), no installation required.

No.	Copier D074 (65 ppm)/D075 (75 ppm)
(4)	1st Tray, tandem tray, fixed size A4 (or LT) 1000 + 1000 sheets (80 g/m ²)
(5)	2nd Tray, universal cassette, 500 sheets (80 g/m ²)

M044

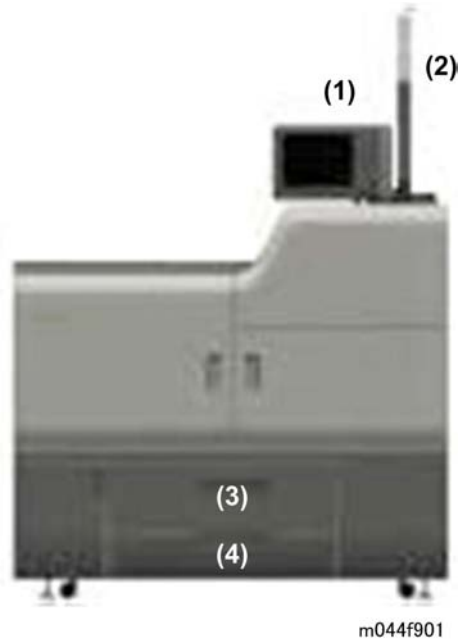

(1)	Touch-panel operation with LCD (SVGA)
(2)	Attention light (standard), no installation required.
(3)	1st Tray, tandem tray, fixed size A4 (or LT) 1000 + 1000 sheets (80 g/m ²)
(4)	2nd Tray, universal cassette, 500 sheets (80 g/m ²)

Base Configuration

D074/D075

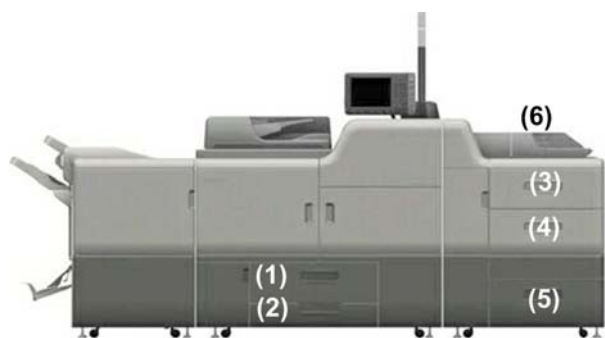

d074f902

No.	Paper Source	Paper Capacity	Total
(1)	Main 1st Tray	1000 + 1000	2000
(2)	Main 2nd Tray	500	500
(3)	LCIT 1st Tray	1000	1000
(4)	LCIT 2nd Tray	2000	2000
(5)	LCIT 3rd Tray	1000	1000
(6)	Bypass Tray	500	500
		Total (80g/m²)	7000

- Only one LCIT is available
- Two finisher models are available: The D512 which performs corner stapling and booklet stapling, and the D513 which performs corner stapling only.
- The finisher (7) in the illustration above is the Booklet Finisher D512.

M044

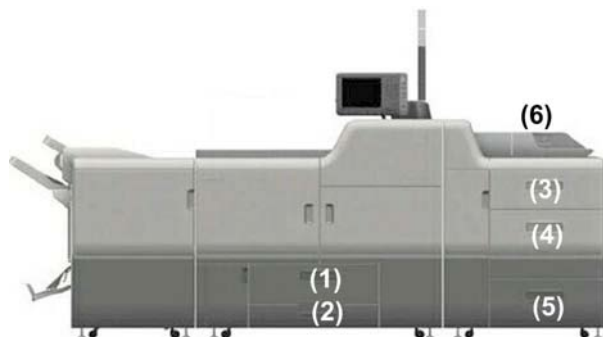

m044f902

No.	Paper Source	Paper Capacity	Total
(1)	Main 1st Tray	1000 + 1000	2000
(2)	Main 2nd Tray	500	500
(3)	LCIT 1st Tray	1000	1000
(4)	LCIT 2nd Tray	2000	2000
(5)	LCIT 3rd Tray	1000	1000
(6)	Bypass Tray	500	500
		Total (80g/m²)	7000

- Only one LCIT is available.
- Two finisher models are available: The D512 which performs corner stapling and booklet stapling, and the D513 which performs corner stapling only.
- The finisher (7) in the illustration above is the Booklet Finisher D512 .

Full System

D074/D075

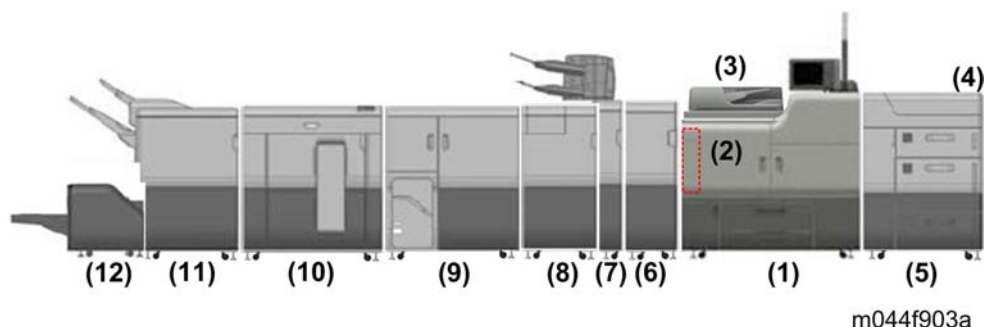

No.	Unit	Comment
(1)	Main machine D074/D075	Copier
(2)	Decurler Unit (D544)	Inside the left side of the main machine.
(3)	ARDF	Feeds originals for copying
(4)	Multi Bypass Tray (D517)	Requires LCIT
(5)	A3/DLT LCIT (D516)	Only one LCIT available
(6)	Buffer Pass Unit (D548)	Not shown. This is a cooling unit, recommended for use with the Multi Folding Unit.
(7)	Cover Interposer Tray (D518)	Feeds covers from two trays
(8)	Multi Folding Unit (D521)	Straight through, or 6 types of folds
(9)	Ring Binder (D519)	Ring binding with 50/100 sheet plastic rings
(10)	High Capacity Stacker (D515)	Stacking capacity: 2500 to 5000 sheets
(11)	Finisher (D512)	Corner/booklet stapling
(12)	Trimmer Unit (D520)	Automatically trims edges of booklets

- The illustration above does not show the Buffer Pass Unit and the Decurler Unit.
- A later section ("Main Machine and Peripherals") gives more information about system peripherals and configurations.
- The two tone color scheme, dark and light gray, with rounded corners and soft lines are distinctive features of these machines.



d074f905

- Most screws are recessed or hidden with easily removed plastic covers to enhance the overall smooth appearance of the main machine and peripheral units.

M044

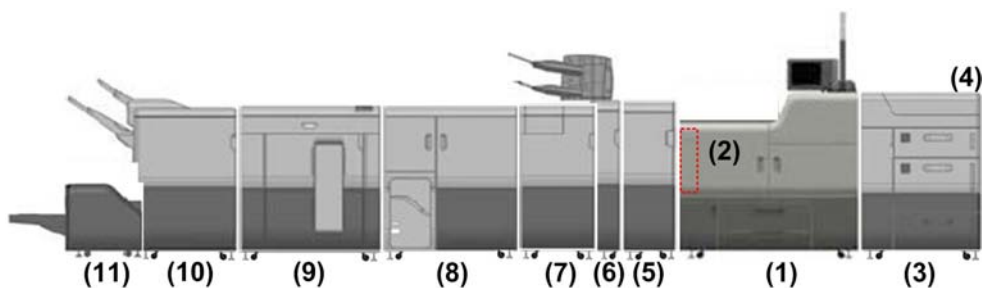

m044f903

No.	Unit	Comment
(1)	Main machine M044	Printer
(2)	Decurler Unit (D544)	Inside the left side of the main machine.
(3)	A3/DLT LCIT (D516)	Only one LCIT available
(4)	Multi Bypass Tray (D517)	Requires LCIT
(5)	Buffer Pass Unit (D548)	Not shown. This is a cooling unit, recommended for use with the Multi Folding Unit.
(6)	Cover Interposer Tray (D518)	Feeds covers from two trays
(7)	Multi Folding Unit (D521)	Straight through, or 6 types of folds
(8)	Ring Binder (D519)	Ring binding with 50/100 sheet plastic rings
(9)	High Capacity Stacker (D515)	Stacking capacity: 2500 to 5000 sheets
(10)	Finisher (D512)	Corner/booklet stapling

No.	Unit	Comment
(11)	Trimmer Unit (D520)	Automatically trims edges of booklets

- A later section ("Main Machine and Peripherals") gives more information about system peripherals and configurations.
- The two tone color scheme, dark and light gray, with rounded corners and soft lines is a distinctive features of this machine.



d074f905

- Most screws are recessed or hidden with easily removed plastic covers to enhance the overall smooth appearance of the main machine and peripheral units.

New Features

New Toner

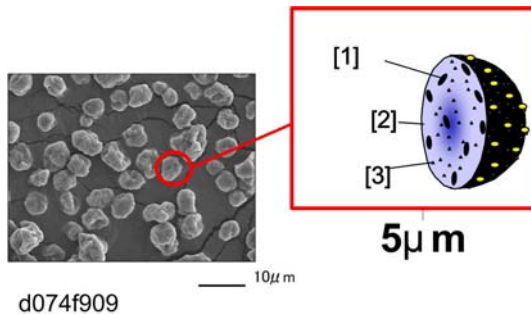

d074f909

This machine uses new toner (SPR-Ce γ). This toner is an extremely fine oil-less chemical toner of uniform particle size. This enables a smoother toner surface after fusing, and good adhesion to thick paper. A grain of toner, approximately 5 μm in diameter, is comprised of [1] wax, [2] polyester resin, and [3] colorant.

- This new toner has a low melting point. Less energy is consumed by the fusing unit and image quality is improved.
- No lubrication oil is required in the fusing unit.

-
- The new toner also allows printing on a wider range of media, including cotton and linen texture paper.

Thicker Print Media

The machine automatically adjusts the printing speed for heavy stock paper (paper thicker than 220 g/m²). The printing speed can be slowed down by as much as 30% for some types of thick paper.

Better Paper Folding

The optional Multi Folding Unit can be used with this machine. It can fold paper in the range 64 to 105 g/m², including coated paper. Multiple page folding with up to three sheets can be done with paper in the range 64 to 80 g/m². The Multi Folding Unit performs six types of folds, including Z-folding.

Wide Range of Peripheral Units

The lineup of main peripheral units available for this machine includes:

- Decurl Unit
- A3/DLT LCIT
- Buffer Pass Unit
- Multi Bypass Tray
- Cover Interposer Tray
- Multi Folding Unit
- Ring Binder
- High Capacity Stacker
- Finisher
- Trimmer Unit

These peripheral units are available with earlier machines. However, for this machine they have rounded covers to match those of the main machine, and some of them have been modified slightly to improve their performance. (▶ p.57)

Fiery Base Controller



The base controller of this machine is the Fiery standard controller [1] (Color Controller E-41A), with FACI [2] available as an option. (The FACI Kit allows the operator to manage jobs more efficiently near the machine.)

- Although this machine also has the GW controller, there are no GW printer applications. All printing features are provided by the Fiery E-41A external controller.
- The D074/D075 is equipped with both GW and Fiery scanner functions. Both features are available at any time when the GW and Fiery controllers are connected via the same network.
- However, @Remote can acquire only a limited amount of information via the Fiery controller network port. For full functionality with @Remote, the system must be connected via the GW controller network as well. (This means the machine needs two IP addresses for full function support with @Remote.)

GW Controller

The Data Overwrite Security and Data Encryption applications will be provided together from the factory on one SD card. The machine will be shipped with this SD card in Slot 1 (application slot).

New Drum Design

The drums have been enhanced to improve performance and lengthen service life (1200K for the D074 and 1350 K for the D075/M044). The external layer of the drum is composed of durable material that is resistant to wear. Its electrostatic properties have also been improved to promote stable charging during long print jobs.

Single Direction Development

The development unit uses "trickle developing" where toner in each toner bottle is pre-mixed with a small amount of developer. In the single-direction development system, the function of the development auger is split between a development auger and a recovery auger. The recovery auger collects developer of reduced characteristics to prevent its re-use. Recovered developer is delivered to the agitator auger directly. This system prevents density fluctuation during high color coverage and large volume printing.

Drum Drive Control



d074f913

This machine uses a continuous feedback system to adjust the rotation speed of each drum motor. A drum drive sensor mounted on the drive shaft and inside the motor casing [1] of the development motor monitors fluctuation in drum speed and feeds this information back to the machine. The machine adjusts

for any deviation from the prescribed speed to maintain the correct drum speed. This system minimizes color registration errors. This motor casing should never be disassembled.

Decurl Unit

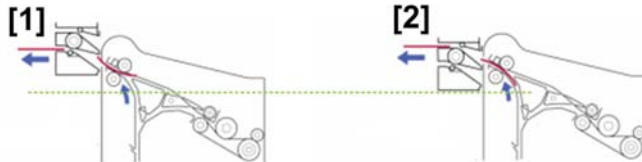

d074f914

A decurl unit (available as an option) fits compactly into the left side of the main machine. The decurl unit has no purge tray (the purge tray is built into the main machine). The decurl unit is designed to correct both convex and concave curling, a common problem with thin paper, and prints with high toner coverage. The decurl unit has two paper paths. The lower paper path [1] corrects face curling (concave curling), and the upper path [2] corrects back curling (convex curling). The decurl unit is raised and lowered with an operator setting to select the paper path, depending on which type of correction is needed.

Improved Fusing

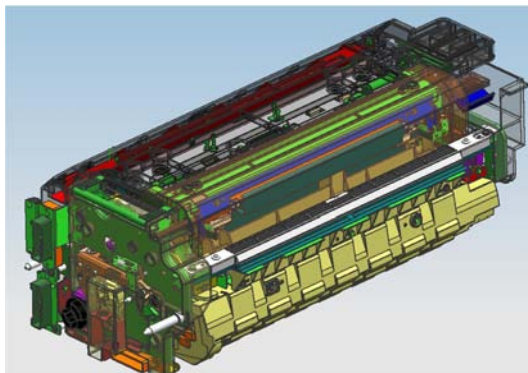

d074f915

The fusing unit is compact. Although the fusing unit is relatively light at 17 kg (37 lb.), it is capable of exerting enough pressure for printing on thick and heavily textured paper. The fusing unit can be lifted and carried easily by one service technician. The fusing unit has a web cleaning mechanism to clean the fusing belt. There is no oil lubrication system for the fusing belt.

Improved Paper Path

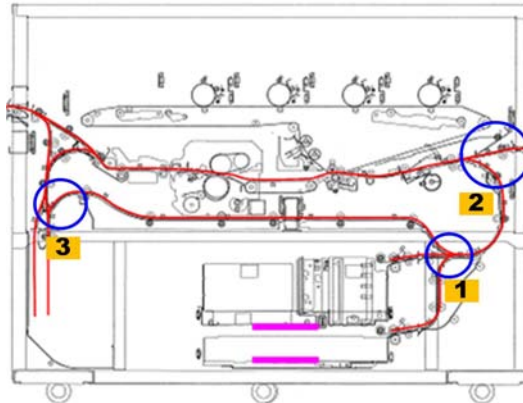

d074f916

To support printing on 300 g/m² paper and duplex printing on paper up to 256 g/m², the arcs in the curvature of the paper path are wider at three critical turning points:

- [1] Paper feed (2nd tray, 1st tray, and duplex path junction where these paths merge)
- [2] Paper entrance from LCIT and paper registration
- [3] Inverter/duplex path. The number of shift rollers has been increased from two to four to accommodate postcards and large-size thick paper.

Purge Tray



d074f926

After a jam occurs, paper in the paper path that has not yet exited the main machine is shunted to the purge tray on the left side of the main machine. This eliminates the time consuming task of searching for every sheet remaining in the main machine or LCIT after a jam occurs downstream. The operator can remove the paper at the jam point as instructed and then collect other sheets from the purge tray by opening the left front door. The purge tray is behind the left front door and next to the used toner bottle.

New ITB/PTR Separation Mechanism

There is a new motor in the ITB unit that functions as a PTR separation mechanism.

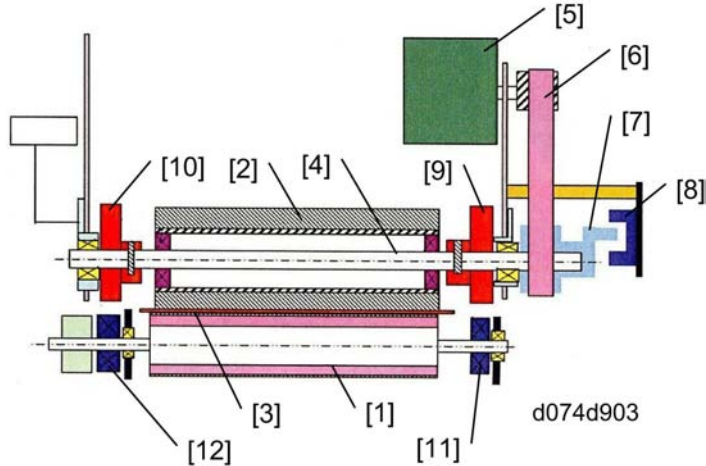

When the right drawer is closed, a strong spring below the PTR unit rotates two cams up that lock the PTR [1] in the up position against the bias roller [2] of the ITB unit above.

The ITB [3] and paper pass between the bias roller above and PTR below.

The bias roller rotates freely around the cam shaft [4]. When the PTR separation motor [5] turns on, the belt [6] turns the cam shaft counter-clockwise until the actuator [7] of the PTR separation sensor [8] rotates out of the sensor gap (this stops the motor). At this point, the front [9] and rear [10] cams are pushing down on the front [11] and rear [12] collars of the PTR. This separates the PTR from the bias roller. When the machine switches on the separation motor again, it rotates the cam shaft and cams clockwise and up. This releases the pressure of the cams on the PTR below, and the PTR and bias roller come together.

The cams are rotated down to separate the bias roller and the PTR at the following times:

- **Ready mode.** After the machine enters Ready mode. This keeps the PTR separated from the bias roller. If the rollers were to remain in contact while the machine is idle, the hard surface of the PTR would deform the shape of the soft bias roller.
- **Thick Paper.** Just before thick paper enters the nip of the bias roller and PTR, the cams are rotated down briefly to widen the nip for the thicker paper, and then rotated up again to close the nip. This action eliminates "shock jitter" which can occur when the leading edge of thick paper enters a narrow nip.
- **Belt Lubrication Mode.** The cams are rotated down to open the nip for lubrication of the belt after the ITB has been replaced, for example.

The cams remain up and the rollers pressed together in all other cases, for color and monochrome printing, process control, and MUSIC adjustments, and so on. This mechanism is unique in that the mechanism that separates the rollers has been moved from the PTR unit to the ITB unit. The PTR separation motor, PTR separation sensor, and cam shaft are in the ITB unit. The PTR separation motor

and separation sensor are on the front of the ITB unit. In previous machines, this mechanism consisted of a PTR lift motor in the PTR unit below the ITB unit.

Ease of Use

Paper Library

The Paper Library presents paper settings that can be set up easily and then saved as profiles for future use. For more about this feature, please refer to the Operation Instructions.

Operation Panel



d074f968

The operation panel features an easy-to-access design with a 10.4 inch LCD and touch-panel. The tilt and angle of the operation panel can be easily adjusted by the operator to reduce glare on the LCD. The standard position of the operation panel can be extended and tilted down so that the machine can be operated with the operator seated. This special adjustment must be done by a service technician.

Toner Bottles



d074f927

The toner bottles are designed for easy handling and replacement. The large knob handles on the ends of the toner bottles make them easy to grip for removal. They can be replaced by the operator from a seated position.

Maximized Operation Time

Active Tray Indicators

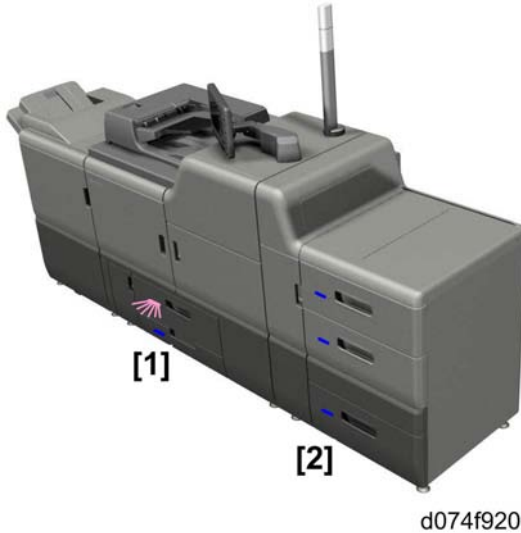

All five paper trays, the two trays of the main machine [1] and three trays of the LCIT [2], have LEDs that light and remain on while the tray is feeding paper. This alerts the operator about which tray is being used. If an indicator is on, the tray cannot be opened as long as paper is feeding from that tray. The operators can re-fill any tray that is not in use while the machine is printing.

Attention Light

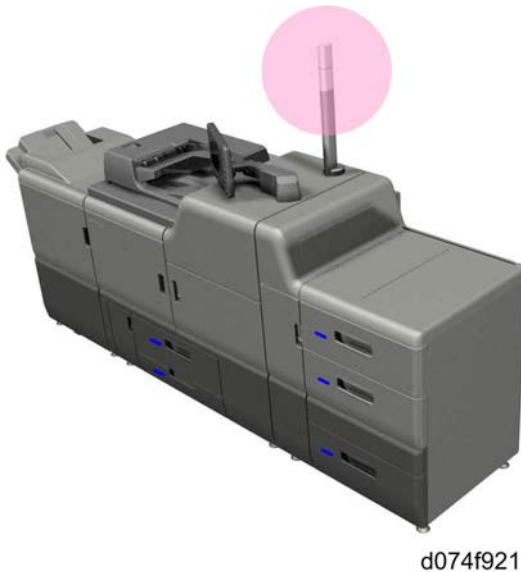

To minimize down time in a high-volume printing environment, the attention light alerts operators immediately when a problem occurs so they can respond quickly. The attention light is slightly higher, making it easier to see from any direction. The attention light is standard (not an option).

TCRU (Trained Customer Replaceable Units)

The TCRU system is designed to allow trained operators to replace key components of the machine that are designated as "TCRU units" without the assistance of a service technician. This greatly reduces down time if a key component requires replacement. A total of eight units can be replaced by TCRU trained operators:

- Drum cleaning unit (PCDU)
- OPC Drum (PCDU)
- Charge roller unit (PCDU)
- Fusing unit
- Fusing cleaning unit
- Paper transfer roller unit
- ITB cleaning unit
- Paper feed roller sets (two sets, one for each tray of the main machine, three sets, one for the each tray of the LCIT, and one set for the bypass tray on top of the LCIT)

Liquid Cooling System

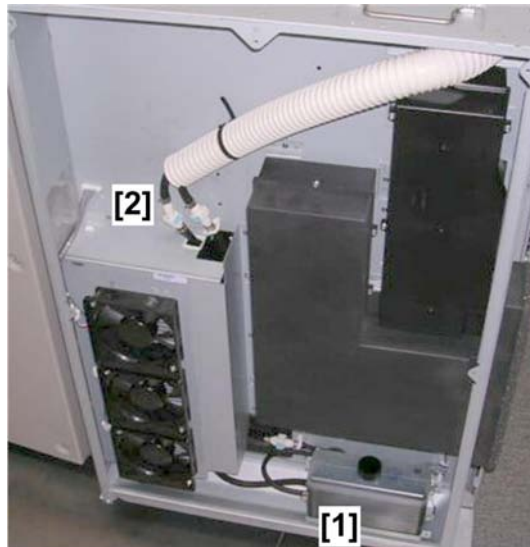

d074f922

In addition to the air cooling ducts and fans, this machine is equipped with a liquid cooling system that keeps the temperature of the developer in the PCDUs at the correct level for optimum performance. Liquid coolant is pumped from a tank [1] and circulated across the cooling jackets of each development

unit through two hoses [2]. The coolant keeps the toner/developer at optimum temperature. This system has two advantages over a circulating air cooling system.

- First, the liquid cooling system requires much less space.
- Second, the liquid cooling system maximizes operation time because the machine does not need to halt operation temporarily for a PCDU to cool if temperature exceeds the upper limit.

The liquid cooling unit is a robust design. Its tubing is guaranteed for 20 years of use at 70°C (158°F).

Rate of evaporation of coolant:

- 150 cc/7 years at 32°C (90°F) running 24 hours/day with FC duplexing.
- 86 cc/7 years at 25°C (77°F) running 24 hours/day with FC duplexing.

Non-Interruptive Toner Replenishment

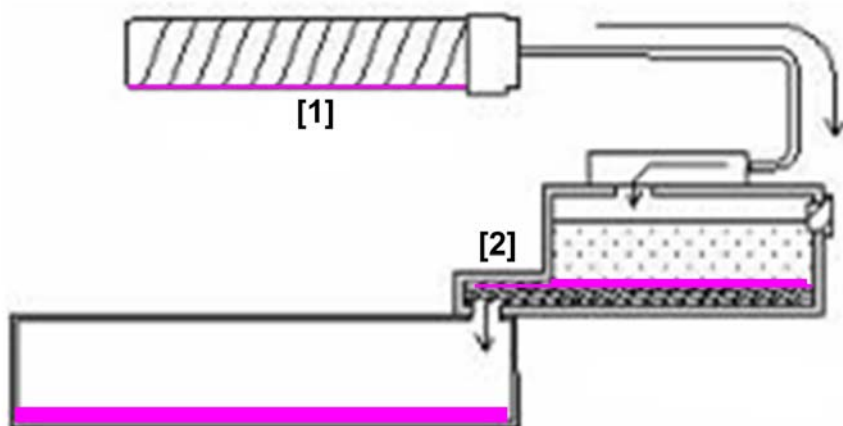

d074f923

An empty toner bottle [1] can be replaced while the machine is printing. After the machine signals toner end for a bottle, there is still enough toner in the sub hopper [2] for the machine to print 480 sheets (A4 LT @ 5% coverage). This gives the operator sufficient time to replace an empty bottle without shutting down the machine.

Non-Interruptive Used Toner Bottle Replacement

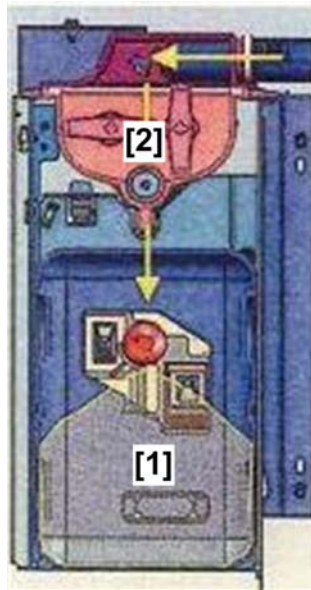

d074f924

After the used toner bottle [1] becomes full, it can be removed and replaced with an empty bottle while the machine is operating. The reservoir [2] above the bottle can continue to receive and hold used toner while the bottle is out of the machine. (A spring loaded stopper tightly seals the toner port between the reservoir and bottle when the bottle is removed.) The bottle replacement is done by the service technician (or operator if an empty toner bottle is available). However, the service technician must remove the full bottle and empty it at the service center. A full toner bottle will not be emptied at the work site.

@Remote

This machine supports @Remote. Both the embedded @Remote function (Cumin) or external device (such as Basil) are available for this machine. Either can be enabled (or installed) at the work site. @Remote monitors information about the machine and relays this data (counters, supply levels, device status, device failures, etc.) via the @Remote Gateway to a remote service center. This information is used to optimize servicing.

Other New Features

Laser Unit

The skew motor in the laser unit adjusts the position of the mirrors to correct color registration. This is a new motor. In previous machines, a small motor attached to the BTL did this adjustment. The new VCSEL technology also improves mechanical performance by reducing the number of revolutions of the polygon motors. This extends the service life of the motors and also reduces motor noise.

Only two SP settings are required after a laser unit is replaced. There are no service parts inside the laser unit. If a problem occurs in the field, the laser unit is replaced.

Process Control

New toner control technology samples MUSIC patterns rapidly at specified intervals. Increasing the number of samples from the patterns ensures even density in filled areas. (In previous machines, patterns were sampled during process control after each printed sheet.)

New Boards



d074r786

- **TDRB** (Transfer Drive Relay Board) [A]. This is a new board located in the center of the ITB unit that controls operation of the ITB components.

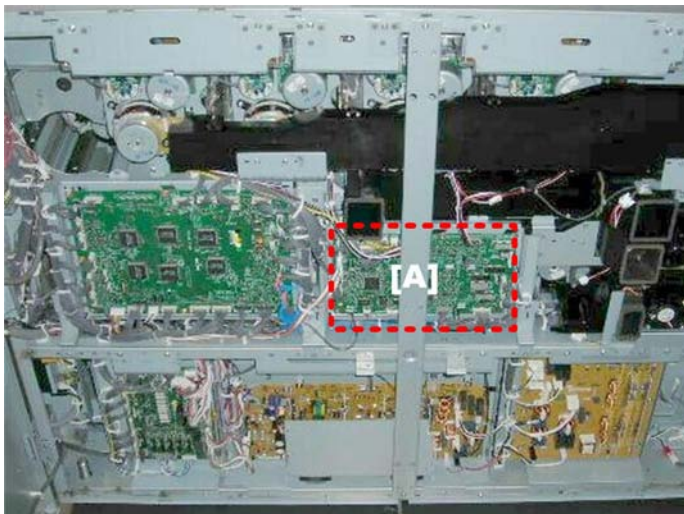

d074r787

- **TDCU.** (Transfer Drive Control Unit) [A]. Located on the back of the machine, controls operation of the fusing motor, drum motors, development motor, PTR motor, and transfer timing motor. Also controls the following via the TDRB: ITB sensor, ITU set sensor, and ITB motor.



d074r788

- **Power Packs.** Three power packs for processes around the drum are arranged across the back of the machine for easier access: (1) CB Power Pack (CK) [charge and development bias for C and K], (2) Potential Sensor Power pack (x4 one above each drum), and (3) CB Power Pack (YM) [charge and development bias for Y and M].



d074r785

- **IOB [A]/ BCU [B].** The BCU is mounted behind the IOB. The IOB swings down so that the BCU can be checked and serviced without removing the IOB.

New Sensor



d074r789

- **2nd Tray Motor Sensor.** In the ITB unit, in addition to the 2nd tray lift motor sensor 1 ① (above the 2nd tray lift motor), a 2nd Lift Motor (K) Sensor 2 ② has been added at the rear right corner of the ITB unit.

TABLE OF CONTENTS

- Safety, Symbols, Trademarks..... 1
 - Conventions..... 1
 - Warnings, Cautions, Notes..... 3
 - Commonly Used Terms and Abbreviations..... 3
 - General Safety Instructions..... 5
 - Responsibilities of the Customer Engineer..... 6
 - Before Installation, Maintenance..... 6
 - During Maintenance..... 7
 - After Installation, Servicing..... 9
 - Special Safety Instructions for Toner..... 11
 - Safety Instructions for the Machine..... 12
 - Safety Instructions for the Fiery Controller..... 14
 - Trademarks..... 14
- New Features..... 15
 - Main Machines..... 15
 - Full System..... 19
 - New Features..... 21
- 1. Product Information**

- Specifications..... 51
- Main Machine and Peripherals..... 52
 - Main Peripherals..... 52
 - Other Options (Not Shown Above)..... 55
- Guidance for Those Who Are Familiar with Predecessor Products..... 57
 - Main Machine Specifications 57
 - Peripherals..... 67
- Overview..... 83
 - Machine Layout..... 83
 - Paper Paths..... 85
 - Main Motors 87
- 2. Installation**

- Installation Requirements..... 91
 - Operating Environment..... 91
 - Power Requirements..... 92

Machine Level.....	93
Space Requirements.....	94
Switching the System On/Off.....	97
Main Machine.....	99
Accessories.....	99
Installation Flow.....	100
Installation: Power Off.....	101
Installation: Power On.....	129
Fiery Controller Connection and Setup.....	130
Fiery Controller Setup.....	133
Paper Library Data Installation.....	137
Paper Trays.....	138
Printing an SMC Report.....	139
Test Color Print (D074/D075).....	139
ACC Adjustment (D074/D075).....	140
MUSIC Color Registration Adjustment.....	142
Checking the Print Quality.....	143
TCRU Setting.....	160
Tray Heaters.....	161
Moving the Machine.....	162
A3/11"x17" Tray Unit (B331-14).....	175
Accessories.....	175
Installation.....	175
Decurler Unit (D544).....	180
Accessories.....	180
Installation.....	181
Curl Correction.....	192
A3/DLT LCIT (D516).....	194
Accessories.....	194
Installation.....	195
LCIT (D516) Tray Heaters.....	210
Multi Bypass Tray (D517).....	216
Accessories.....	216

Installation.....	216
Buffer Pass Unit Type 5010 (D548).....	234
Accessory Check.....	234
Installation.....	235
Cover Interposer Tray (D518).....	245
Accessories.....	245
Installation.....	246
Multi Folding Unit (D521).....	256
Accessories.....	256
Installation.....	257
Ring Binder (D519).....	266
Accessories.....	266
Before You Begin.....	267
Installation Procedure.....	268
Centering Paper in the Paper Path.....	275
After Installation.....	280
High Capacity Stacker (D515).....	282
Accessories.....	282
Installation.....	283
Finishers (D512/D513).....	294
Accessories.....	294
Installation.....	295
Punch Unit PU5020 NA, EU, SC (D449-17, -27, -28).....	305
Installation.....	306
Trimmer Unit (D520).....	315
Accessories.....	315
Installation.....	316
Common Adjustments.....	322
Height and Level Adjustment.....	322
Skew and Side-to-Side Registration.....	324
GW Controller Options.....	335
Overview.....	335
VM Card Type R (D554) D074/D075.....	337

3. Preventive Maintenance

PM Counter Display.....	339
Opening the PM Counter.....	339
PM Parts Screen Details.....	340
PM Tables for Main Machines.....	343
PM Parts List Key.....	343
Optics (D074/D075).....	343
Development.....	344
Around the Drum.....	344
Image Transfer Unit.....	346
Paper Transfer Unit.....	346
Fusing Unit.....	347
Filters.....	348
Main Paper Feed.....	348
Main Paper Transport.....	349
Inverter, Exit.....	350
Duplexer.....	351
ARDF (D074/D075).....	351
PM Tables for Peripherals.....	355
LCIT (D516).....	355
Multi-Bypass Tray (D517).....	356
Decurler Unit (D544).....	356
Cover Interposer Tray (D518).....	356
Multi-Folding Unit (D521).....	357
Ring Binder (D519).....	357
High Capacity Stacker (D515).....	358
Booklet Finisher (D512/D513).....	359
Trimmer Unit (D520).....	360
Lubrication Points.....	361
Fusing Unit Main Drive Gears.....	361
Cleaning, Lubrication Around Fusing Unit Heating Roller.....	361
Cleaning and Lubrication Around Pressure Roller.....	363
Lubrication Around Hot Roller.....	365

Cleaning Points.....	367
Overview.....	367
Inspection and Cleaning.....	367

4. Replacement and Adjustments

General Cautions.....	393
Rear Boxes.....	393
Drum.....	393
PCDU.....	394
ITB Unit.....	394
Scanner Unit (D074/D075).....	395
Laser Unit.....	395
Development.....	395
Cleaning.....	396
Fusing Unit.....	396
Paper Feed.....	396
Used Toner.....	396
Fiery Controller.....	396
Liquid Coolant Disposal.....	397
Special Tools and Lubricants.....	398
Special Tools.....	398
Lubricants.....	398
Common Procedures.....	399
Turning the Machine On/Off.....	399
Opening the Rear Boxes.....	400
Removing Doors, Covers.....	401
Pulling Out and Closing the Left Drawer.....	407
Removing the Right Drawer.....	408
Pulling Out the ITB Unit.....	410
Removing the Canopy Cover.....	415
Removing PCDUs.....	426
Removing the ITB Cleaning Unit.....	430
Removing the PTR Unit.....	432
Removing the Fusing Unit, Fusing Cleaning Unit, Covers.....	433

Removing the PTB Unit.....	438
Removing the Left Drawer.....	440
Removing the Paper Feed Units (PFU).....	441
Removing the Vertical Transport Unit (VTU).....	444
Operation Panel.....	452
Changing the Operation Panel Position.....	452
Operation Panel PCBs, Touch Panel Unit.....	456
Touch Panel Position Adjustment.....	460
ARDF.....	461
ARDF Covers.....	461
Original Feed Unit.....	463
Feed Belt, Pickup Roller.....	464
Bottom Plate Position Sensor.....	465
Interval, Original Width, Skew Correction Separation Sensors.....	466
Original Length Sensors.....	467
Cover Open, Original Set, Bottom Plate, Pickup Roller HP, Feed-Out Sensors.....	468
ARDF Position Sensor, APS Start Sensor.....	469
Original Registration Sensor Exit Sensors.....	470
ARDF Separation Roller.....	471
ARDF Transport Belt.....	472
ARDF Control Board.....	477
ARDF Bottom Plate Lift Motor.....	478
ARDF Feed Motor, ARDF Transport Motor.....	478
ARDF Pick-up Roller Lift Motor.....	479
Scanner Unit.....	480
Exposure Glass.....	480
Right, Left Plate Covers.....	481
Lens Block, Paper Size Sensors.....	483
Exposure Lamp.....	484
Scanner Motor.....	485
Scanner HP Sensor.....	486
Scanner Interface Board (SIOB).....	486
Scanner Wire.....	487

Scanner Unit Cooling Fan.....	488
Lamp Regulator Board and Fan.....	489
Wire Re-installation, Scanner Position Adjustment.....	493
Laser Unit.....	495
Laser Units.....	495
YM Laser Unit Removal: D074/D075.....	495
YM Laser Unit Removal: M044.....	505
Removing the CK Laser Unit: D074/D075/M044.....	508
Toner Shield Glass.....	515
Toner Supply.....	517
Toner Bottle Port Cleaning.....	517
Toner Supply Unit Removal.....	518
Toner Supply Clutch.....	524
Toner Pump Clutch.....	526
Toner End Sensor.....	527
RFID Boards, RFID CPU.....	528
Toner Bottle Motors.....	530
Toner Supply Motor.....	534
Used Toner Collection.....	536
Used Toner Bottle.....	536
Used Toner Transport Motor, Sensor, Timing Belt.....	537
Used Toner Bottle Motor.....	540
Used Toner Bottle Sensors, Bottle Set Switch.....	542
Photoconductor Development Unit (PCDU).....	547
PCDU Replacement.....	547
Vent Filter.....	550
Drum Charge Unit.....	551
Drum Cleaning Unit.....	552
Drum Replacement.....	553
Development Unit Replacement.....	558
Replacing Developer.....	559
PCDU Parts Replacement.....	567
Drum Cleaning Unit Gears.....	569

Drum Cleaning Blade.....	570
Drum Lubrication Blade.....	573
Drum Lubrication Bar.....	575
Drum Lubrication Roller.....	577
Drum Cleaning Motors, Development Motors, Drum Motors.....	579
Liquid Cooling Unit.....	583
Drum Cooling Unit Fan Replacement.....	585
Charge Roller Cleaning Roller Solenoids.....	586
Potential Sensors (YMCK).....	588
TD Sensor.....	590
Image Transfer Belt (ITB) Unit.....	592
ITB Cleaning Unit.....	592
ITB Cleaning Unit Removal.....	593
Cleaning Blade.....	594
Lubrication Roller.....	595
Lubrication Bar.....	596
Lubrication Blade.....	598
Transfer Belt Replacement.....	599
After Transfer Belt Replacement.....	607
ITB Unit Cover Plates.....	608
ID/MUSIC Sensor Fan.....	609
PTR Separation Motor.....	610
1st Lift Motor (YMC).....	611
Transfer Belt Drive Motor.....	612
2nd Lift Motor (K).....	613
Belt Centering Motor.....	616
PTR/ITB Cleaning Unit Motor.....	617
ID Sensor/MUSIC Sensors.....	619
PTR Separation Sensor.....	621
1st Lift Motor Sensor (YMC).....	621
Belt Centering Roller HP Sensor.....	622
Belt Centering Sensor.....	623
2nd Lift Motor Sensor 1 (K).....	626

2nd Lift Motor Sensor 2 (K).....	627
Transfer Belt Speed Sensor.....	627
Front Overrun Sensor.....	629
Rear Overrun Sensor.....	630
Image Transfer Rollers.....	631
ITB Bias Roller.....	633
ITB Transfer Power Pack.....	635
TDRB.....	640
ITB Cleaning Unit Cover Set Switch.....	641
ITB Cleaning Unit Set Switch.....	643
Right Anti-Condensation Heater.....	644
Left Anti-Condensation Heater.....	645
ITB Unit Thermostat.....	645
Paper Feed.....	647
Main Machine Tray Removal.....	647
PFU Pick-up, Feed, Separation Rollers.....	649
Paper End Sensor.....	650
Pickup Roller Lift Sensor.....	650
Paper Feed Sensor.....	651
Pickup Roller Solenoid.....	651
Separation Roller Solenoid.....	653
Tray 1 Rear Fence Return Sensor (Left Tandem Tray).....	654
Tray 1 Rear Fence HP Sensor (Left Tandem Tray).....	655
Tray 1 Right Tray Paper Sensor (Right Tandem Tray).....	655
Bottom Plate Lift Wire.....	656
Paper Feed Motors, Grip Motors.....	658
Lift Motors (Tray 1, Tray 2).....	664
Tray 1 Solenoids.....	667
Vertical Transport Unit.....	670
Bank Exit Motor.....	670
Vertical Transport Motor.....	671
Main Relay Sensor 1.....	672
Bank Exit Sensor.....	673

1st Transport Sensor.....	674
Vertical Transport Sensor.....	675
2nd Transport Sensor.....	676
Right Drawer.....	677
Right Drawer Front Cover.....	677
Shift Unit	677
Registration Entrance Motor.....	680
Registration Timing Motor.....	683
Registration Gate Motor.....	684
Shift Roller Motor.....	686
Shift Unit Motor	688
Shift Timing Motor.....	690
CIS Fan.....	690
Main Relay Sensor 2.....	691
Main Relay Sensor 3.....	692
LCIT Relay Sensor 2.....	693
Double-Feed Sensor 1 (LED).....	693
Double-Feed Sensor 2 (Receptor).....	694
Shift Unit Sensor.....	695
Registration Gate Sensor.....	695
CIS.....	696
Transfer Timing Sensor.....	697
Duplex Transport Sensor 4.....	698
Duplex Transport Sensor 5.....	699
DRB.....	700
Separation Power Pack.....	702
Paper Transfer Roller (PTR) Unit.....	708
PM Parts List: Replacement.....	708
PTR Servicing SP Codes.....	708
Cleaning.....	709
Separation Plate.....	710
Lubrication Bar.....	710
Lubrication Blade.....	712

Lubrication Roller.....	713
PTR (Paper Transfer Roller).....	714
Cleaning Roller.....	716
PTR/ITB Cleaning Unit Motor.....	717
Paper Separation Power Pack.....	719
Paper Transport Belt (PTB) Unit.....	720
Paper Transport Belts.....	720
PTB Sensor.....	720
PTB Fans.....	721
Pressure Roller Fan.....	721
Belt Cooling Fan.....	722
Fusing Unit.....	724
Before You Begin.....	724
Periodic Cleaning.....	726
Periodic Lubrication.....	728
Heating Roller Fusing Lamps.....	728
Heating Roller.....	741
Hot Roller, Fusing Belt.....	744
Pressure Roller Fusing Lamps, Pressure Roller.....	751
Hot Roller Thermistor (Front).....	761
Hot Roller NC Sensor (Center).....	762
Heating Roller NC Sensors.....	763
Heating Roller Rear Thermistor.....	765
Heating Roller Thermostats.....	768
Heating Roller Thermostat (Center).....	769
Pressure Roller Sensors (Front and Rear).....	771
Fusing Motor, Pressure Roller Lift Motor.....	772
Fusing Cleaning Unit.....	777
Fusing Cleaning Unit PM Parts.....	777
Web Supply Roller.....	777
Web Contact Roller.....	783
Brake.....	784
Web End Sensor.....	785

Web Motor.....	787
Left Drawer.....	789
Exit Relay Motor.....	789
Invert Exit Motor.....	790
Duplex Transport Motor 1.....	793
Web Motor.....	794
Belt Cooling Fan.....	795
Exit Motor.....	796
Duplex Inverter Motor.....	798
Exit Unit Entrance Sensor.....	800
Exit JG Sensor.....	800
Duplex Transport Sensor 1.....	801
Duplex Transport Sensor 2.....	802
Duplex Transport Sensor 3.....	802
Exit Relay Sensor.....	803
Purge Relay Sensor.....	803
Duplex Invert Sensor.....	804
Exit Sensor.....	804
Web End Sensor.....	805
Purged Paper Sensor.....	805
Duplex Motors and Rollers.....	807
Main Boards, HDD Units.....	808
CB Power Pack (CK).....	808
CB Power Pack (YM).....	810
Potential Sensor Power Pack.....	812
AC Drive Board.....	814
PSU 2, PSU 2 Fans.....	816
Relay Board (RYB).....	821
TDCU.....	823
PSU 1, PSU 1 Fans.....	826
IOB/BCU.....	830
Controller Board (GW), NVRAM, Controller Board Fan.....	833
IPU.....	836

HDD Units.....	837
Controller Box Fans.....	840
Fans and Filters.....	843
Before You Refer to This Section.....	843
Fan Layout.....	844
Ozone Exhaust Fans (YMCK), Ozone Collection Fan.....	848
Toner Supply Cooling Fan.....	852
Heat Sink Intake Fan.....	854
Heat Sink Exhaust Fan.....	856
Fusing Exit Exhaust Fan.....	857
Drive Exhaust Fan.....	860
Belt Cleaning Exhaust Fan.....	862
Stray Toner Exhaust Fan.....	865
Paper Cooling Intake Fan.....	867
Paper Cooling Exhaust Fan.....	869
Fusing Unit Transport Exhaust Fan.....	870
Duplex Exhaust Fans.....	871
Used Toner Intake Fan.....	873
ITB Intake Fan.....	875
Cooling Box Fans.....	877
Ozone Filter, Air Filters.....	883
Air Filter.....	884
Control Box Filter.....	884
ITB Area Filters.....	885
Paper Exit Fans.....	885
Firmware Update.....	887
Before You Begin.....	887
Firmware Update Procedure.....	887
Verifying the Firmware Update.....	889
Fiery Controller System Update.....	891

5. System Maintenance

Service Program Mode.....	897
---------------------------	-----

6. Troubleshooting

SC Table Key.....	899
SC Tables.....	901
SC100: Scanning 1.....	901
SC200: Image Writing.....	904
SC300: Development.....	914
SC400: Around the Drum.....	923
SC500: Paper Feed, Transport, Duplexing.....	936
SC600: Communications.....	955
SC700: Peripherals.....	961
SC 800: Firmware.....	1004
SC900: Other.....	1014
Special Troubleshooting Procedures.....	1020
Clearing SC471, SC475 or SC476.....	1020
SP3812 001 (Development Fill) Errors.....	1022
Process Control Troubleshooting.....	1022
MUSIC Adjustment Result.....	1031
Troubleshooting for Image Quality Problems.....	1032
Development-related Troubleshooting.....	1032
Color Toner Spotting/Staining.....	1035
Toner Scatter.....	1043
Color Loss.....	1046
Density Problems.....	1052
Gloss Problems.....	1072
Fusing-related Troubleshooting.....	1073
Troubleshooting for Paper Delivery Problems.....	1077
Frequent Paper Misfeeds.....	1077
Messages Reporting Paper Misfeeds.....	1079
Paper Skew.....	1086
Wrong Detection of Skew.....	1088
Double Feeding.....	1088
Wrong Detection of Double Feeding.....	1090
Paper Misfeeding.....	1091

Paper Feed Problems Affecting Image Quality.....	1093
Attaching the Tab Sheet Holder.....	1105
Cleaning the Paper Feed Path.....	1107
No Error Message at Initializing of the Double Feed Sensors.....	1114
Efficient SP for Paper Jam Analyzing.....	1114
Troubleshooting for Options.....	1115
Finisher SR5030/ Booklet Finisher SR5040.....	1115
Multi-Folding Unit.....	1127
Buffer Pass Unit.....	1138
High Capacity Stacker.....	1139
LCIT RT5060.....	1144
Cover Interposer Tray CI5020.....	1149
Multi Bypass Tray BY5010.....	1150
Troubleshooting for Throughput.....	1152
Reducing the Waiting Time Prior to Printing.....	1152
Throughput When Printing on Paper with a Thickness Equivalent to Paper Weight 6 or 7.....	1152
Throughput when Printing Black-and-White Jobs and Color Jobs.....	1153
Fuses.....	1155
Blown Fuse Conditions.....	1155
Jam Codes.....	1157
Paper Late Jams: Main Machine.....	1157
Paper Lag Jams: Main Machine.....	1159
Finisher Jams (D512/D513) Jam Code Table.....	1161
Cover Interposer Tray CI5020 (D518) Jam Code Table.....	1162
Trimmer Unit TR5040 (D520) Jam Code Table.....	1163
Multi Folding Unit FD5010 (D521) Jam Code Table.....	1164
High Capacity Stacker SK5020 (D515) Jam Code Table.....	1165
Ring Binder RB5010 (D519) Jam Code Table.....	1166
Buffer Pass Unit Type (5010 D548) Jam Code Table.....	1167
ARDF Jam Code Table.....	1168
D074/D075, M044 Jam Displays.....	1169



1. Product Information

Specifications

1

See "Appendices" for the following information:

- Main Specifications
- Peripheral Specifications

Main Machine and Peripherals

1

Main Peripherals

D074/D075

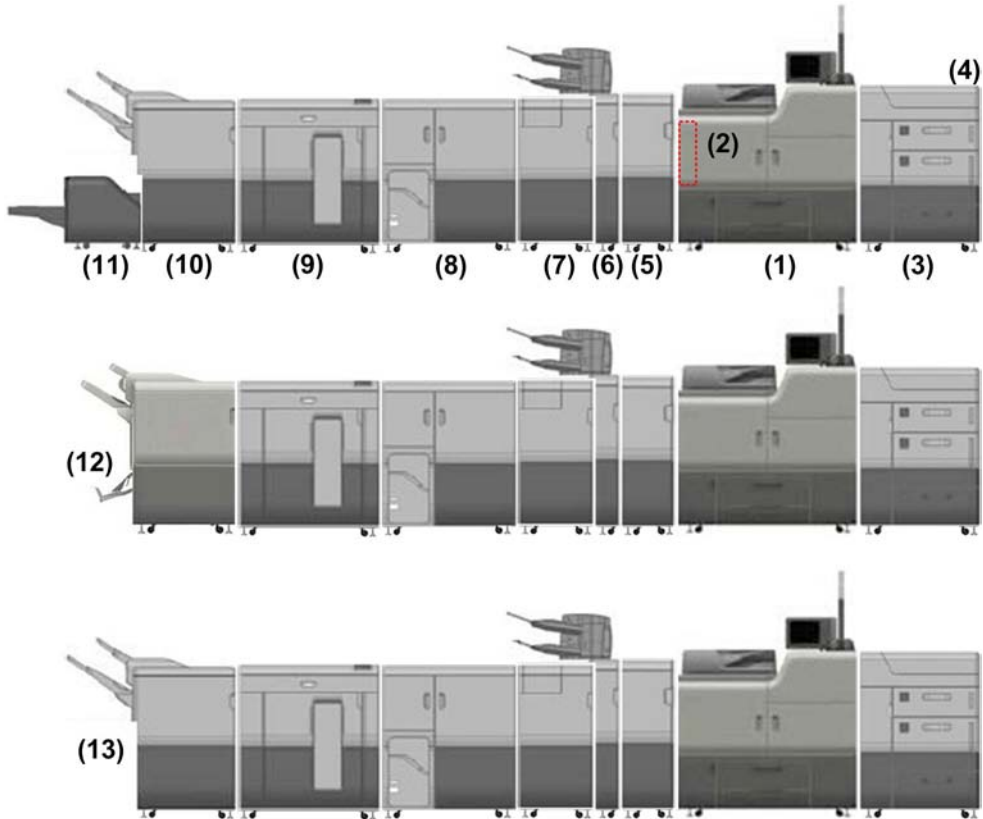

d074f904

No.	Unit	Comment
(1)	Main machine D074/D075	Copier
(2)	Decurler Unit (D544)	Inside the machine
(3)	A3/DLT LCIT (D516)	Only one LCIT available
(4)	Multi Bypass Tray (D517)	Requires LCIT

No.	Unit	Comment
(5)	Buffer Pass Unit (D548)* ¹	Cools paper with 8 fans before it goes to downstream peripherals. This option is recommended for use with the High Capacity Stacker.
(6)	Cover Interposer Tray (D518) * ¹	Feeds covers from two trays
(7)	Multi Folding Unit (D521)	Straight through, or 6 types of folds
(8)	Ring Binder (D519) * ¹	Ring binding with 50/100 sheet plastic rings
(9)	High Capacity Stacker (D515) * ¹	Stacking capacity: 2500 to 5000 sheets
(10)	Booklet Finisher (D512)	Booklet stapling with Trimmer Unit.
(11)	Trimmer Unit (D520) * ¹	Automatically trims open edges of booklets
(12)	Finisher (D512)	Booklet stapling without Trimmer Unit.
(13)	Finisher (D513)	Corner stapling only.

*¹: These peripherals are released at the same as the Pro C751 (M044) launch.

Notes:

- If the Trimmer Unit (11) is not installed, the booklet tray for the Booklet Finisher (D512) must be installed to hold stapled booklets. (The booklet tray must be removed in order to install the Trimmer Unit.)
- The Trimmer Unit (11) cannot be installed with the Finisher (D513) (13). This finisher performs only corner and flat stapling (no booklet stapling). The Trimmer Unit processes booklet-stapled stacks only.
- If the Multi Folding Unit (7) is installed, the Booklet Finisher (10) or Finisher (13) must also be installed.

M044

1

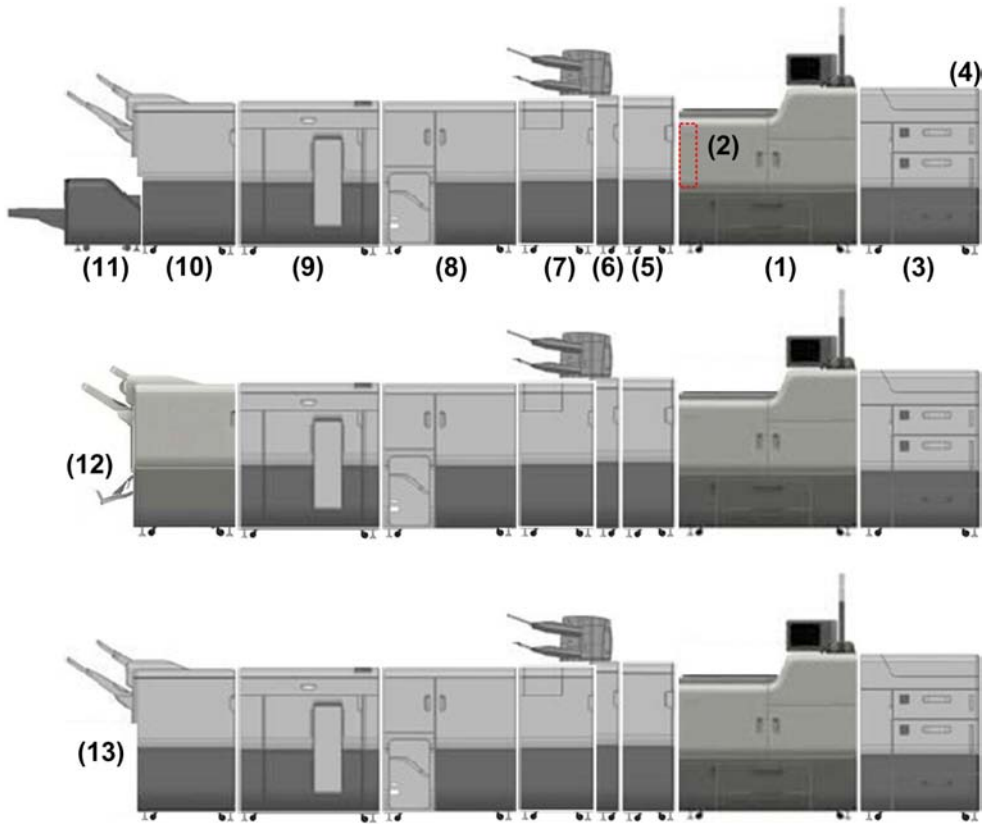

m044f904

No.	Unit	Comment
(1)	Main machine M044	Printer
(2)	Decurl Unit (D544)	Installed inside the machine
(3)	A3/DLT LCIT (D516)	Only one LCIT available
(4)	Multi Bypass Tray (D517)	Requires LCIT
(5)	Buffer Pass Unit (D548)	Cools paper with 8 fans before it goes to downstream peripherals. This option is recommended for use with the High Capacity Stacker.
(6)	Cover Interposer Tray (D518)	Feeds covers from two trays
(7)	Multi Folding Unit (D521)	Straight through, or 6 types of folds

No.	Unit	Comment
(8)	Ring Binder (D519)	Ring binding with 50/100 sheet plastic rings
(9)	High Capacity Stacker (D515)	Stacking capacity: 2500 to 5000 sheets
(10)	Booklet Finisher (D512)	Booklet stapling with Trimmer Unit.
(11)	Trimmer Unit (D520)	Automatically trims open edges of booklets
(12)	Finisher (D512)	Booklet stapling without Trimmer Unit.
(13)	Finisher (D513)	Corner stapling only.

Notes:

- If the Trimmer Unit (11) is not installed, the booklet tray for the Booklet Finisher (D512) must be installed to hold stapled booklets. (The booklet tray must be removed in order to install the Trimmer Unit.)
- The Trimmer Unit (11) cannot be installed with the Finisher (D513) (13). This finisher performs only corner and flat stapling (no booklet stapling). The Trimmer Unit processes booklet-stapled stacks only.
- If the Multi Folding Unit (7) is installed, the Booklet Finisher (10) or Finisher (13) must also be installed.

Other Options (Not Shown Above)

Type	Option	Comment
Main Machine	Original Tray	Holds originals to be copied
	Key Counter	Key counter device for customers
	USB 2.0/SD Slot Type E (TBD)	Allows direct sending of jobs to USB 2.0 or SD card storage.
	A3/11"x17" Tray Unit (B331-12)	Converts 1st tray (tandem tray) to large capacity tray.
Finisher (D512/D513)	Punch Unit (D449)	Installed inside the Finisher (D512/D513)
Controller Option	VM Card	VM ware (Calypso)
	@Remote	Basil/UZ-A1

Notes

- The USB Host and Cumin-N (for @Remote) are standard (no installation required).
- Cumin-M and File Format Converter are not available.

Guidance for Those Who Are Familiar with Predecessor Products

1

Main Machine Specifications

Maximum Printing Area

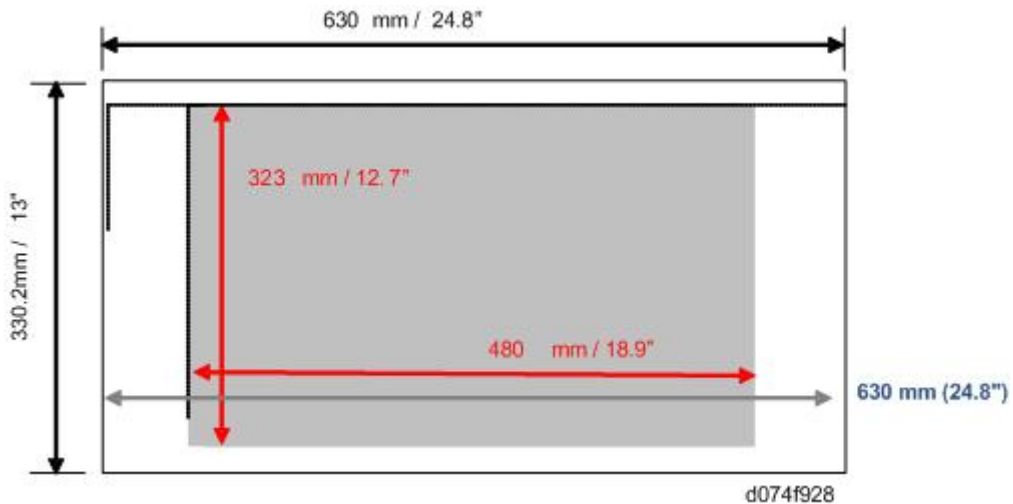

The maximum printing area is 320 x 480 (12.6 x 18.9 in.). Length can be expanded up to 630 mm (24.8 in.) with SP 5150-1. This allows full-bleed printing with A3 (11 x 17 in.) to preserve crop marks and borders.

Warm-up Time

Warm-up time: 300 sec. This is longer than many previous machines, such as the D014/D015 which has a warm-up time of less than 90/75 sec.)

ARDF

The ARDF on the D074/D075 is basically the same as that used with the D014/D015. However, there are some minor differences:

- Design changes in the front cover, rear cover, feed cover, and handles.
- Color of the external covers has changed.
- Shoulder screws are rounded.
- Harness routing has changed.
- Length and color of the interface cable have changed.
- Speed is faster (426 mm/s), compared to D014/D015 (394 mm/s)

- Magnification range is 66% to 400% (D014/D015 is 50% to 400%)

Laser Unit

The machine automatically "reads" a new laser unit and only two SP code settings are required. With previous machines when a laser unit was replaced, the technician had to set several SP codes for the new laser unit. With older machines, the SP settings that had to be entered were printed on a label attached to the new unit. This procedure has been eliminated.

ITB Unit

- This machine uses two motors that raise and lower the ITB. One motor operates the left tray (YMC) and one motor operates the right tray (K).

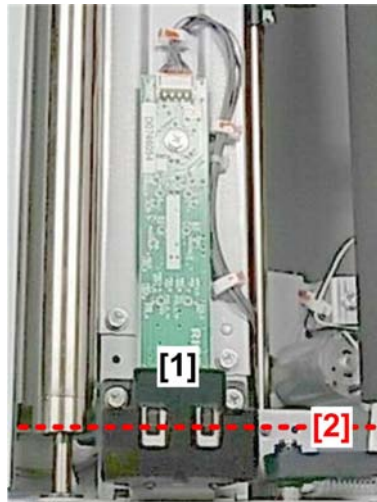

d074f929

- A belt speed sensor [1] reads an encoder strip under the front edge of the ITB [2] to monitor the speed of the belt. (The photo above shows a top view of the sensor with the ITB removed. The red dotted line represents the front edge of the ITB.) This is not a new mechanism. But in previous machines, the encoder strip was on the back edge of the belt and the encoder sensor was at the left rear corner of the ITB unit. In this machine, the encoder strip is on the front edge of the belt and the encoder sensor is at the front right corner of the ITB unit. The ITB must be installed with the encoder strip at the front edge of the belt. The image transfer belts of some previous machines could be installed in either direction because there was no encoder strip on either edge of the belt.
- In the D016, the belt centering sensor was comprised of a photosensor mounted above the belt and above a free-swinging actuator touching the edge of the belt. The sensor detected belt deviation from center by measuring the angle of reflection from the top of the actuator.

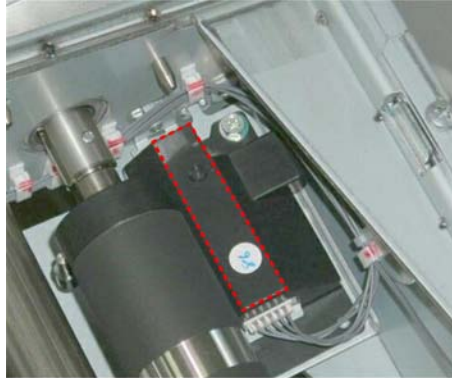

d074f933

The belt centering sensor for this machine is simpler. A small CIS inside the cover (shown above with the ITB removed) is below the rear edge of the belt. It monitors the position of the belt directly. The pendulum actuator mechanism has been replaced with this new detection mechanism.

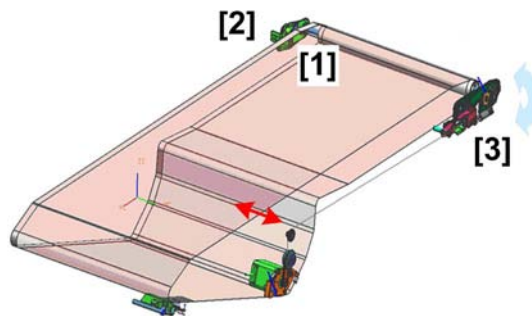

d074f912

- This machine uses the same steering control mechanism used in the D016 that checks and corrects the positioning of the ITB to keep it centered to prevent color offset in images. An ITB feedback sensor (a photosensor), located at the right upper corner [1] of the ITB unit constantly monitors the position of the ITB. If the ITB shifts forward or backward, the steering control motor [2] (located on the left front of the ITB unit) corrects the position of the belt with the steering control mechanism [3]. This system eliminates physical wear on the edge of the belt that would be caused by an ITB guide fence.

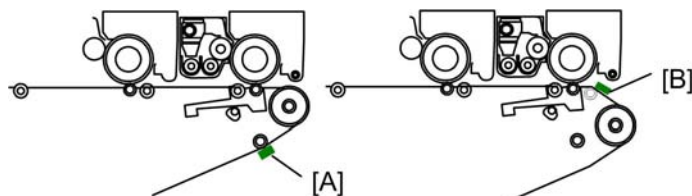

d074f034

- The location of the ITB sensor array (ID and MUSIC sensors) has changed. In previous machines, the ITB sensor array [A] is located farther downstream and below the ITB. In this machine, the ITB sensor array [B] is located above the ITB on the right end of the ITB unit below the K_PCDU.

1

Paper: Trays, Transport, etc.

Paper Transport Unit

The paper is held onto the paper transfer belt by three fans: Rear, Front, Center (not two fans).

Compared to previous machines:

- The paper transport unit frame of this machine is made of plastic, making it lighter for TCRU operators to handle.
- The unit is easier to remove with its drive intact

Paper Cooling Unit

Previous machines have four belts in the paper cooling unit. To improve the accuracy and efficiency of paper feed, one large belt is used in these machines.

Paper Registration

The high-precision paper registration unit of earlier machines has been adopted for use in this machine. The position of the paper in the paper path is corrected twice by the paper registration unit in the main machine, once to correct for skew in the sub scan direction and once for side-to-side registration in the main scan direction.

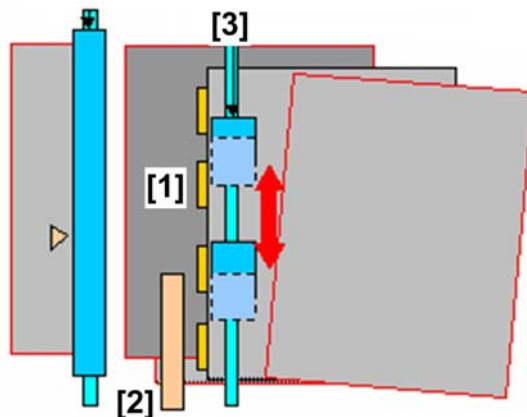

d074f908

- **Skew correction.** The paper pauses very briefly in the registration unit, as its leading edge hits a raised registration gate [1] to buckle the paper and align it.
- **Side-to-side adjustment.** After the registration gate lowers, the paper passes through the shift roller unit. In this unit, a CIS [2] detects the paper's front edge to determine if the paper has shifted forward or back. If adjustment is needed, the shift roller unit [3] holds the paper and moves forward or back to adjust the paper position before the paper feeds to the paper transfer roller.

The combination of laser VCSEL technology and double paper registration correction ensures that paper is always precisely positioned in the paper path. Paper registration is done once in the main machine. There is no paper registration correction mechanism in the optional LCIT.

Shift Unit

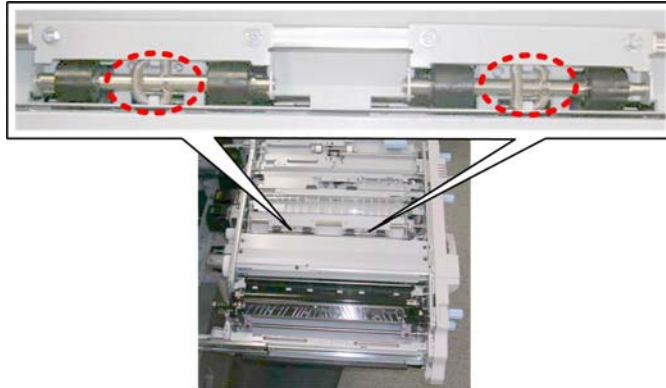

d074f936

The visible springs at the top of the shift unit were weak in previous machines. These springs have been replaced with stronger springs. The photo above shows the old springs. The new springs are black.

Heaters

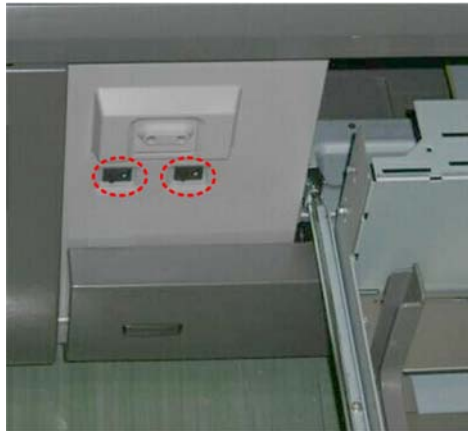

d074f930

There are two heater switches on the front of the machine. The left switch controls the operation of the paper bank heaters of the main machine and the LCIT heaters. The right switch controls the operation of the ITB heaters.

- When these switches are set to ON, the heaters switch on when the main machine is switched off (or enters energy save mode), and then switch off when the main machine is switched on again (or leaves energy save mode).

- When these switches are set to OFF, the heaters do not switch on when the main machine is switched off (or enters energy save mode). Both heaters are switched OFF before the machine leaves the factory.
- When these switches are set to ON and SP5965-1 is set to "1", the heaters always remain on.

Common Cleaning Mechanisms

One basic cleaning and lubrication mechanism is used in key components of the machine.

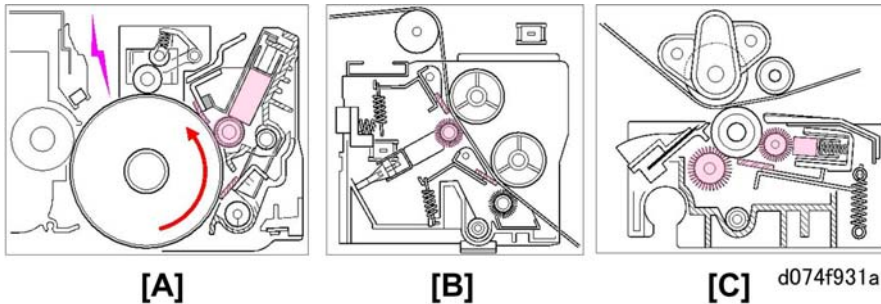

A cleaning blade [1], lubrication bar [2], lubrication roller [3], and lubrication blade [4] comprise the cleaning mechanisms (with some variation) in the following units:

- [A] Drum cleaning unit
- [B] ITB cleaning unit
- [C] PTR cleaning unit

↓ Note

- Only the PTR cleaning unit has a cleaning brush roller (5).

All of these units use a dry lubricant (Zinc Stearate) supplied by a lubrication bar and lubrication roller.

Retraction to Reduce Wear

As in previous machines, this machine employs mechanisms to separate important parts subject to pressure and wear during normal operation. These mechanisms reduce wear on parts and prolong service life of important components.

- **ITB and OPC drum separation mechanism**

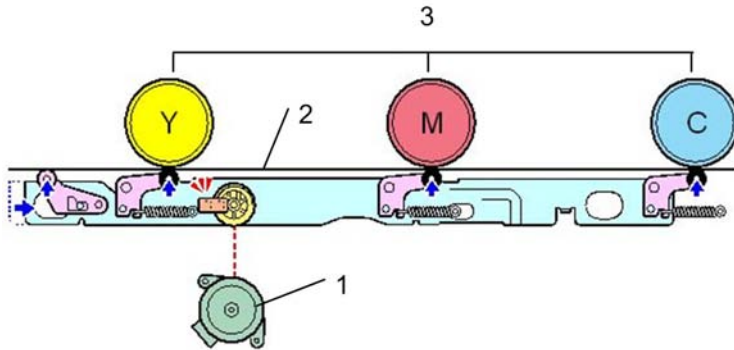

d074f971

The 1st lift motor (1) raises and lowers the 1st tray (2). The tray is raised against the bottoms of the YMC drums for full color printing. The tray is lowered for black and white printing, and remains down while the machine is idle. This prevents wear on the drums and the ITB and prevents deformation of the ITB bias rollers below the drums.

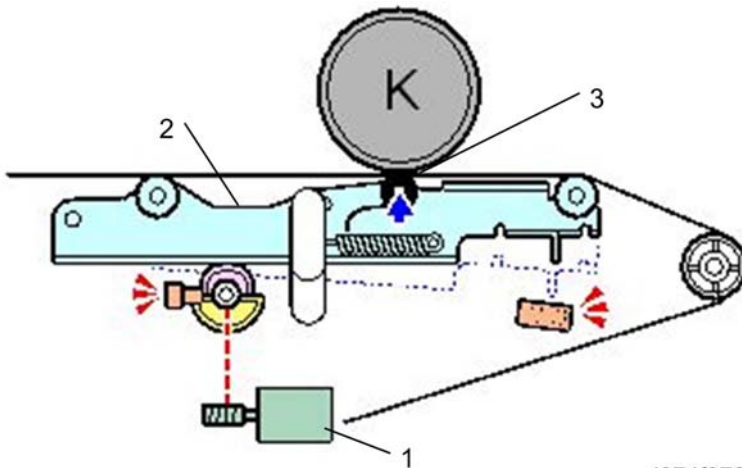

d074f972

The 2nd lift motor (1) raises and lowers tray 2 (2). The tray is raised against the bottom of the black drum only while the machine is operating. The tray remains down while the machine is idle. This reduces wear on the ITB and prevents deformation of the ITB bias roller below the drum.

- ITB and PTR separation

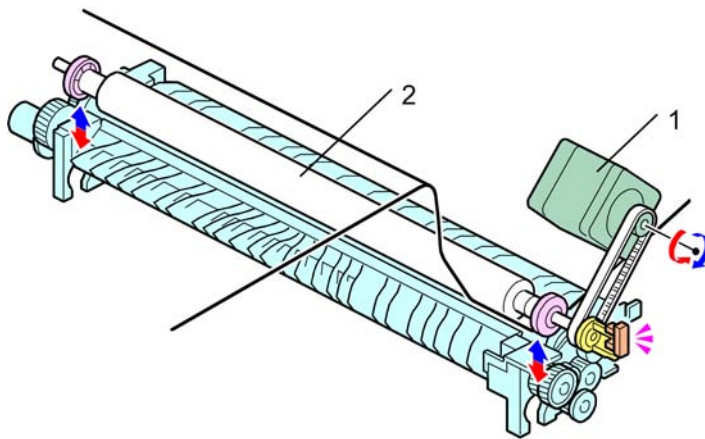

d074f973

A PTR separation motor (1) raises and lowers the ITB bias roller (2). The roller remains down against the PTR roller below to transfer the toner image from the ITB to the paper between the rollers. While the machine is idle, the motor rotates two cams to raise the ITB bias roller away from the PTR below. This prevents deformation of the soft ITB bias roller. In this machine, the ITB bias roller is raised and lowered. In previous machines, the PTR was raised and lowered to separate the rollers.

- **Pressure and hot roller separation**

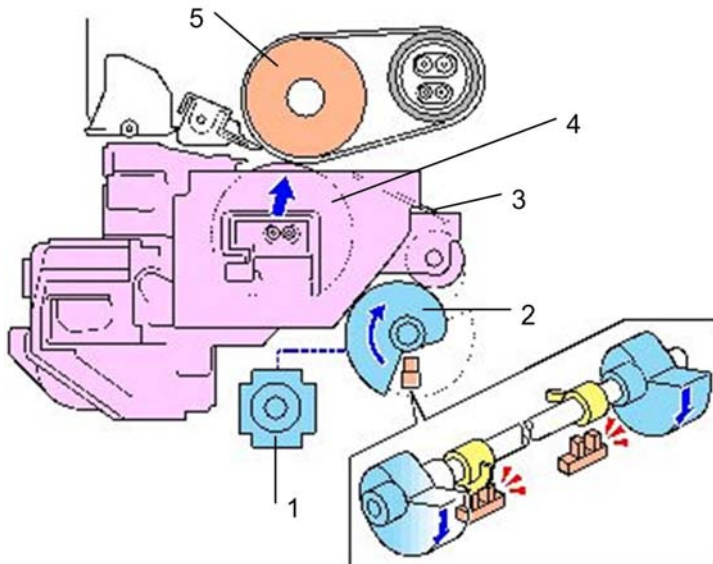

d074f974

A pressure roller lift motor (1) rotates large cams (2) that raise and lower the pressure roller lift arm (3). The lift arm applies pressure to the pressure roller (4) below the stationary hot roller (5) above. During a job, this mechanism can vary the pressure applied to the paper and fusing belt between the nip of the

pressure roller and hot roller. When the machine is idle, the cams are rotated down to prevent the deformation of the soft sponge surface of the hot roller.

Photo Conductor Development Units (PCDU)

1

Charge Unit

- This machine uses charge rollers to charge the drums. There are no charge corona units. This reduces the amount of ozone created in and around the machine.

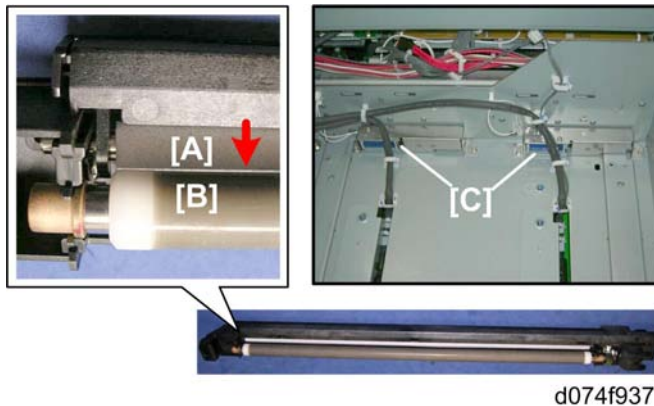

- There is a charge roller cleaning roller [A] above each charge roller [B] in each PCDU. This cleaning roller is lowered to clean the charge roller every 1,000 prints. The solenoids [C] that operate these rollers are mounted behind the laser units.

Drum Cleaning Unit

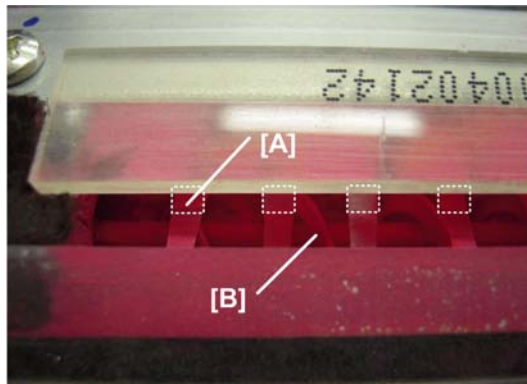

- Mylars [A] have been added above the used toner transport coil [B] in each PCDU. The slight vibration set up by the auger turning against the mylar prevents used toner from clumping when it is transported out of the back of the unit.

- The brush cleaning roller in the drum cleaning unit has been eliminated. The drum cleaning unit is comprised of the drum cleaning blade, lubrication bar, lubrication roller, and lubrication blade.

1

Fusing Belt Cleaning

- The fusing cleaning unit of previous machines had a fusing belt cleaning roller between the fusing belt below and the cleaning fabric above. The roller scavenged toner, dust, etc. from the surface of the fusing belt. In this machine the cleaning roller has been eliminated. The cleaning fabric touches the surface of the fusing belt directly.
- There is no oil supply mechanism for lubricating the fusing belt in this machine.

GW Controller Options

The base controller for this machine is the Fiery controller. However, the GW controller is still provided.

- Data Overwrite and HDD Encryption will be provided with the machine in Slot 1. Both must be enabled with User Tools.
- A VM card option will also be available.
- The GW controller is still required for @Remote because the functionality of the Fiery controller with @Remote is limited.

Process Control

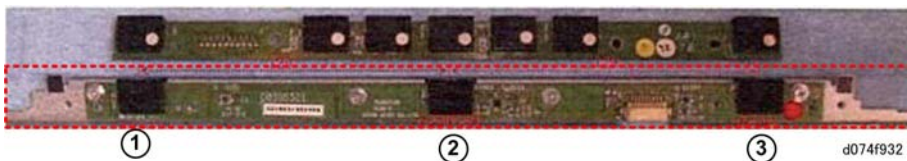

- The number of sensors in the ITB sensor array has been reduced. The D016, for example, had seven sensors as shown above: three MUSIC sensors and four ID sensors. This machine has only three sensors. Only the middle sensor ② functions as an ID sensor, but all three sensors function as MUSIC sensors.
- There are two temperature/humidity sensors used during process control. One is located on the left, below the used toner bottle motor. Another is on the right near the K_PCDU. In previous machines, the left sensor was higher and near the Y_PCDU.

RFID with Toner Bottles

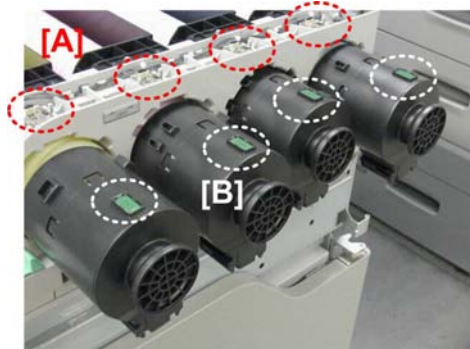

d074f938

This machine uses RFID (Radio Frequency IDentification) technology. Each reader PCB [A] is paired with a tag PCB [B] on top of each toner bottle. The tag PCBs are the toner bottle ID chips. The reader PCBs can read/write data to/from the ID chips.

Peripherals

General

- The covers of all peripheral units have been re-designed to match the shape and color of the main machine.
- The breaker switches have been removed from all peripheral units (with the exception of the Ring Binder which still has a breaker switch). The only breaker switches in the system are on the main machine and the Ring Binder.

Decurl Unit



d074f939

- The Decurl Unit is inside the left side of the main machine.

LCIT

1



d074f946

The illustration above shows the LCIT without the Multi Bypass Unit installed on top.

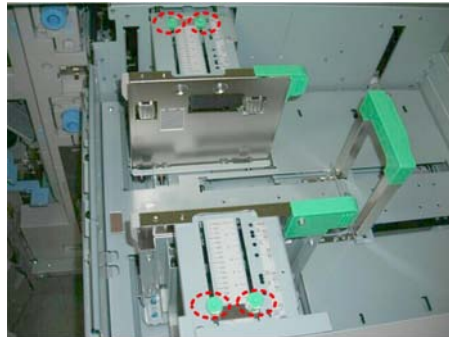

d074f940

Side fence adjustment

The side fence adjustment mechanism of the LCIT has been re-designed to make it easier to change paper sizes. The side fences can be adjusted just by loosening the screws and sliding the fences. The screws do not need to be removed.

No CIS unit

There is no CIS adjustment at installation. The LCIT has no CIS unit. The side-to-side registration is done with a CIS in the main machine. The LCIT does not have a CIS unit for paper registration. Side-to-side registration is performed once in the registration unit of the main machine.

New paper release mechanism

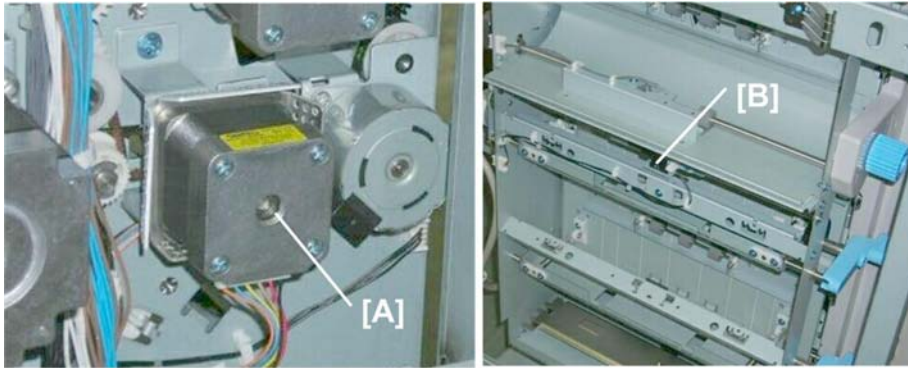

d074f941

There is a new mechanism at the paper exit to retract the exit idle roller from the paper. This releases the paper for side-to-side registration in the main machine. The mechanism consists of a retractor motor [A] on the back of the unit and the idle roller HP sensor [B] at the LCIT paper exit.

Jam release lever



d074f942

The LCIT jam release mechanism has been re-designed for "one-action" removal.

Rollers



d074f943

The LCIT rollers are black but their construction and shape are the same as the previous model.

Coated Paper

The LCIT can handle coated paper without replacement of the pick-up rollers, feed rollers, and separation rollers.

Multi Bypass Tray



d074f947

The Multi Bypass Tray is installed on top of the LCIT.

New Lift Motor



d074f944

The Bypass Tray lift motor has been replaced with a new motor.

Buffer Pass Unit



d074f945

Installed on the left side of the main unit, this option provides a paper path that allows paper and toner to cool before it is fed to downstream peripherals. This prevents toner from sticking to other sheets of paper after stacking. It has a total of 8 fans. The DC motor is slightly slower than the motor of the previous model. This option is recommended for use with the Multi Folding Unit.

Cover Interposer Tray

1



d074f948

Paper Path

The CIT is taller than the previous model. The paper feed path is 20 mm longer but there are no added rollers.

Installation

- The black mylar is no longer required for connection to the next peripheral unit downstream.
- The separate joint brackets (x2) for docking have been replaced with a T-bar just like all the other peripherals.

Lift Motor



d074f949

The lift motor has been replaced with a new type of motor.

Multi Folding Unit

1



d074f953

General Changes

- Glossy paper mode (half speed). 1st fold motor, crease motor have been replaced by motors capable of slower speeds to accommodate half-speed mode for glossy paper.
- Elimination of stripe tracks at the leading edges of folded coated paper. The ribs of the gate-fold guide plate have been removed and replaced with a smooth surface.
- Up to 3 sheets of paper can now be folded (64 to 80 g/m²)
- Coated paper can be folded.
- The relay guide is now the same as other peripheral units.
- Two accessories have been discarded (proof tray auxiliary trays).

Modifications to Improve Performance

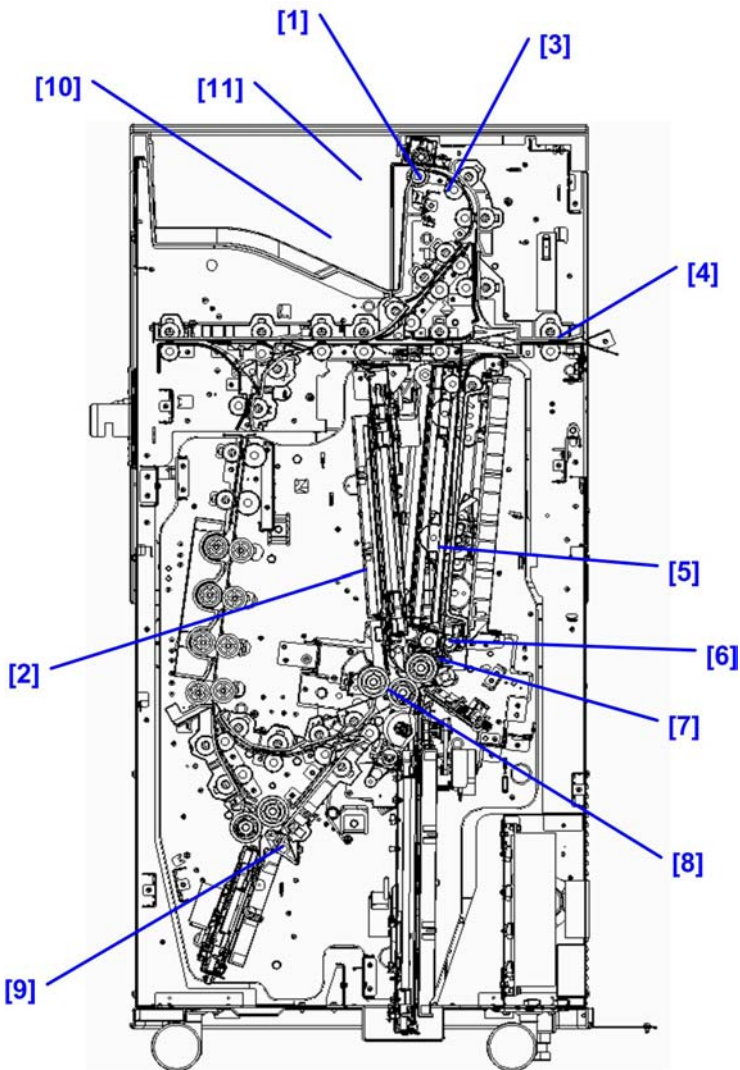

d074f957

[1]	Roller marks on coated paper. The exit roller has been replaced with the same type of roller used in the High Capacity Stacker to reduce roller marks on coated paper.
[2]	Gate folded (FM6) cloth coated paper fold position. The gap before and after the guide plate of the 2nd stopper has been widened to accommodate cloth coated paper for gate folding.

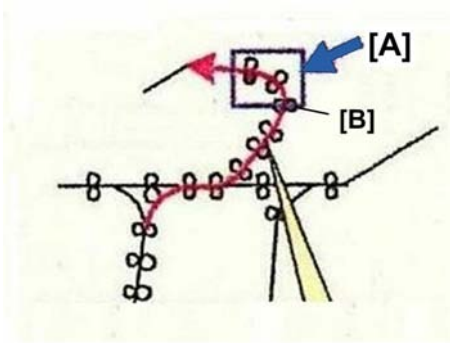

d074f963

[3]

Improved feed-out of small Z-folded paper. An extra drive roller [A] above the exit roller [B] at the top tray exit has been added to improve feed-out of small Z-Folded (FM1) paper.

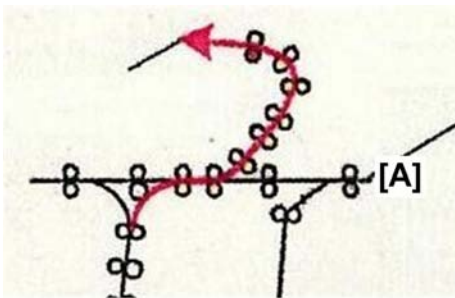

d074f958

[4]

Improvement in multiple folding. The entrance roller [A] and other transport rollers are driven independently. This allows effective control of the line speed while paper is fed from the main machine.

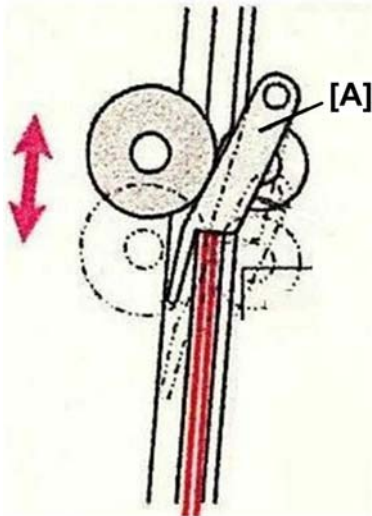

d074f960

[5]

Elimination of roller marks during multiple folding. The movement of the TE stop pawl [A] raises and lowers the paper for registration. At the same time, the transport rollers stop rotating to prevent the rollers from marking the paper.

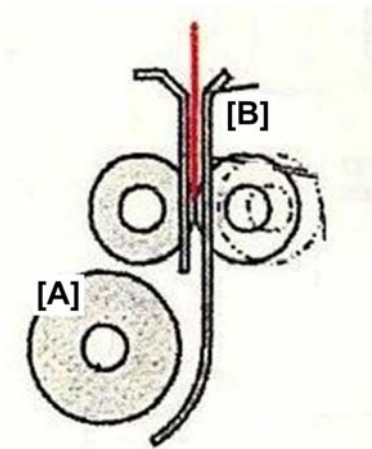

d074f959

[6]

Elimination of possible damage to leading edges of paper. Above the 1st feed roller [A], the guide plate [B] above the nip has been lengthened, and the width of the path has been narrowed to prevent distortion of the leading edges of paper.

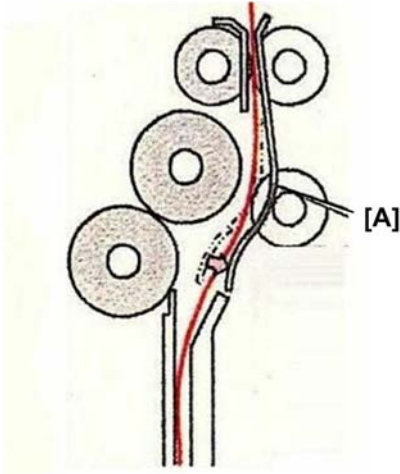

d074f965

[7]

Improved folding for coated paper. The guide plate [A] can be moved to widen the space in the turn of the transport path for easier folding with the fold plate.

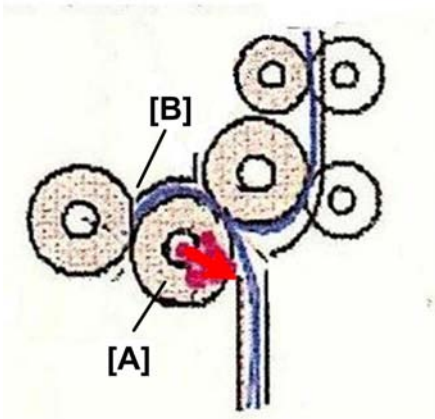

d074f961

[8]

Elimination of roller marks when two sheets are folded. When two sheets are folded at the same time, the 2nd fold roller [A] pulls away to widen the 2nd nip [B].

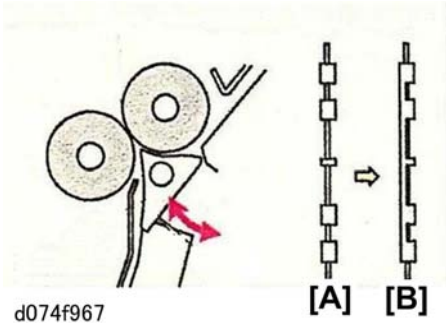

[9]

Elimination of wrinkling in gate-folded large paper sizes. The shape of the FM6 pawl [A] has been changed [B] to prevent the wrinkling of large paper sizes during FM6 (gate) folding.

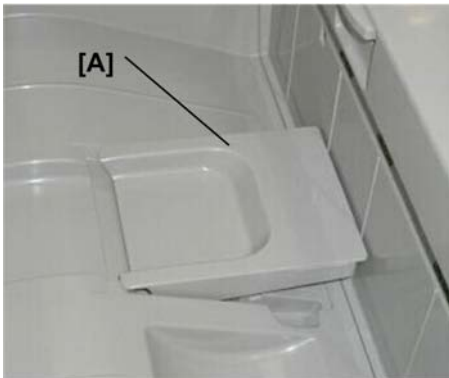

[10]

Early top tray full alert with FM1 folding large paper sizes. An auxiliary tray [A] is provided to keep Z-folded paper (FM1) flat in the tray so that a trailing edge does not trigger an early tray-full alert in the top tray.

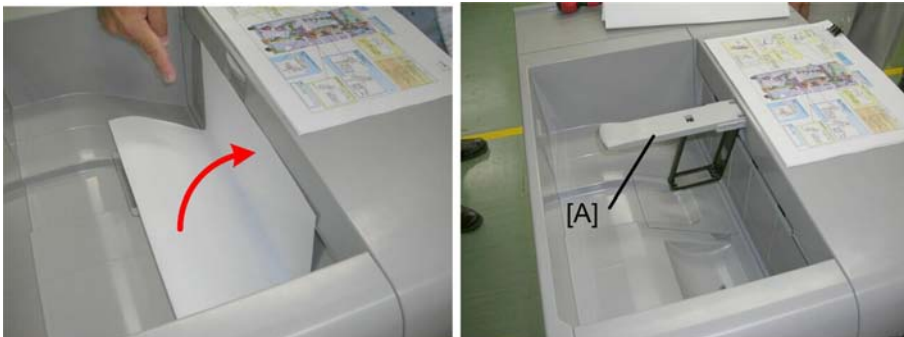

[11]

Early top tray full alert with FM3 folding. The trailing edge of a multi-folded sheet can occasionally open and trigger an early top tray alert. A flexible fold depressor [A] is provided as an accessory to prevent folded paper (especially FM3 Letter Fold-out sheets) from triggering an early tray full alert in the top tray.

1

Ring Binder



d074f950

The differences in the Ring Binder Unit are very minor:

- The rear and top covers are metal.

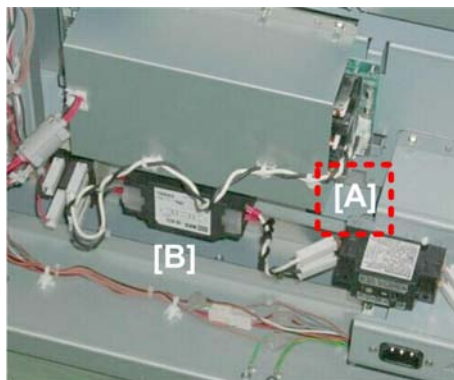

d074f951

- The surge PCB [A] has been removed and a noise filter [B] has been added.

High Capacity Stacker

1



d074f952

Minor changes in the High Capacity Stacker:

- The operation and LED panel have been moved from right to left side at front edge.
- The door catch has changed slightly (a "bump" roller has been added.)
- Capacity: 5,000 sheets (SRA3, A4 LT) on the shift tray, and 250 sheets on the proof tray. Total: 5,250 sheets.
- This machine allows installation of **only one** High Capacity Stacker in the system. (Some previous models allowed two High Capacity Stackers.)
- One roll-away cart is provided with the stacker. Additional carts are available as options.

Finishers and Punch Unit

1



d074f954

This machine supports two finishers:

- D512 Booklet Finisher (shown above) that performs both corner and booklet stapling. (Max. stack: 20 sheets with paper 80 g/m²)
- D513 Staple Finisher that performs corner stapling only.

Minor changes:

- Side-to-side registration can be adjusted manually on the finisher. The side-to-side registration with an SP code at installation has been eliminated.
- The stacking buffer where paper is shunted long enough for the unit to staple the downstream stack can hold 5 sheets of paper.

Trimmer Unit



d074f955

Minor changes:

- **Transport belt.** The color of the transport belt was changed to white. This prevents dirty images on A3 Full-bleed paper.
- **Entrance guide.** The shape of the movable entrance guide has been modified to prevent pages from slipping.

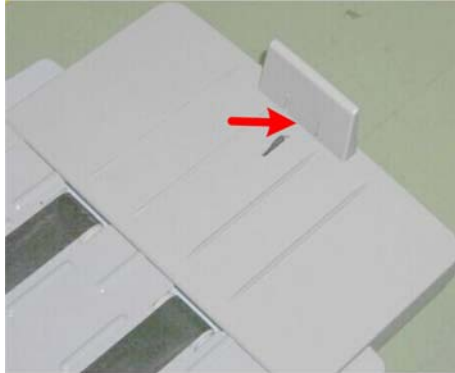

d074f956

- **New sensor.** A new sensor has been added inside the booklet tray. The new sensor detects when the end stopper is installed or removed for limitless output on the tray.

Overview

Machine Layout

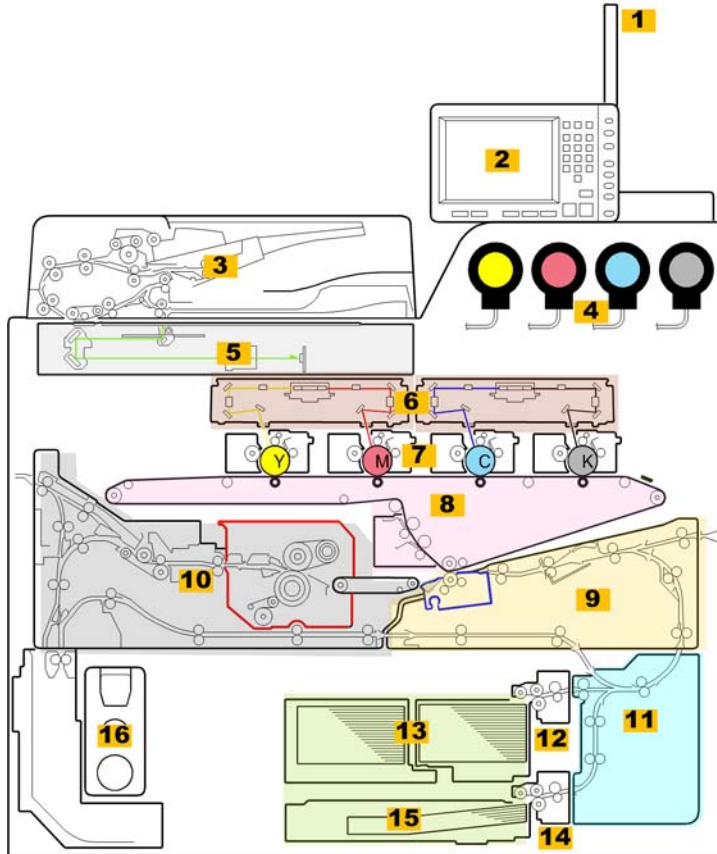

d074f975

1	Attention Light	9	Right Drawer
2	Operation Panel	10	Left Drawer
3	ARDF (D074/D075)	11	Vertical Transport Unit
4	Toner Bank	12	PFU (Tray 1)
5	Scanner Unit (D074/D075)	13	Tray 1 (Tandem Tray)
6	Laser Units	14	PFU (Tray 2)
7	PCDUs	15	Tray 2 (Universal Tray)

8	ITB Unit	16	Used Toner Bottle
---	----------	----	-------------------

1

- **Attention Light.** Provided with the machine (not an option) but requires installation.
- **Operation Panel.** Requires installation. Standard installation for operating the machine while standing, or easy-access installation for operating the machine from a sitting position.
- **ARDF.** Standard auto reverse document feeder (D074/D074).
- **Toner Bank.** Holds four toner bottles, one for each color (YMCK).
- **Scanner Unit.** Color or black-and-white scanning (D074/D075).
- **Laser Units.** There are two laser units. Each laser unit handles two colors (YM, CK).
- **PCDUs.** Photoconductor development units. One for each color (YMCK). Each unit contains the drum (and charge unit), development unit, and cleaning unit.
- **ITB Unit.** Image Transfer Belt Unit. The image is transferred from the drum to the ITB and then transferred from the ITB to the paper.
- **Right Drawer.** Holds the paper registration unit, PTR (Paper Transfer Roller) unit, and the right-half of the duplex path.
- **Left Drawer.** Holds the PTB (Paper Transport Belt), fusing unit, paper cooling unit, exit unit, and the left half of the duplex path.
- **Vertical Transport Unit.** Feeds paper from the paper bank (Tray 1, Tray 2) to the registration unit above.
- **PFU (Tray 1).** Paper Feed Unit for Tray 1. Contains the pickup roller, feed rollers, separation roller, and grip rollers that feed paper from Tray 1.
- **Tray 1 (Tandem Tray).** Contains a left tray and a right tray. When paper runs out in the right tray, the left stack is shifted to the right tray to continue feeding paper when a large job is in progress. Tray 1 can be opened to replenish the left tray while paper continues to feed from the locked right tray. Feeds LT/A4 paper.
- **PFU (Tray 2).** Paper Feed Unit for Tray 2. Contains the pickup roller, feed rollers, separation roller, and grip rollers that feed paper from Tray 2.
- **Tray 2 (Universal Tray).** Adapts to a variety of paper sizes. The inner tray can be easily removed. Automatic paper size detection.
- **Used Toner Bottle.** Holds used toner transported from the PCPU development units, PCPU cleaning units, ITB cleaning unit, and PTR cleaning unit. The machine can continue to print while the bottle is removed.

Paper Paths

D074/D075

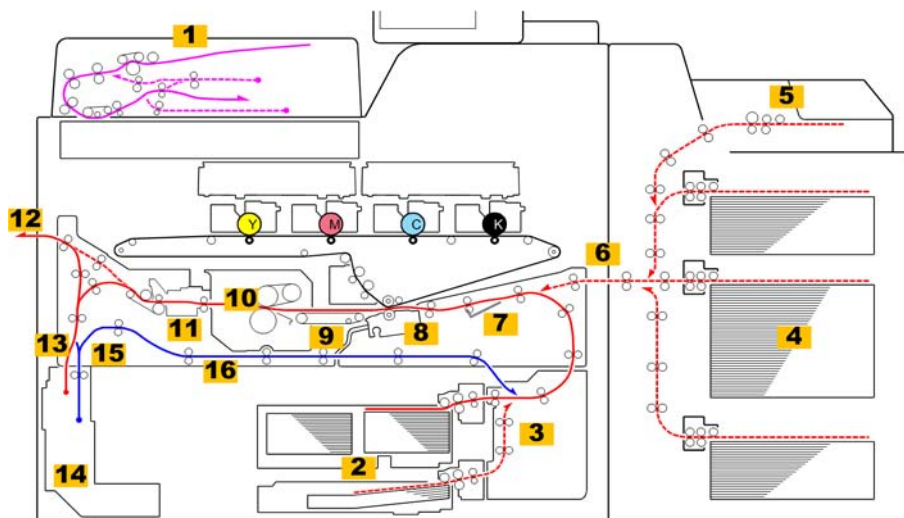

d074v102

No.	Item	Comment
1	Original Path	ARDF (D074/D075 Only)
2	Paper Bank	Tray 1 (Tandem: 2,000 sheets), Tray 2 (Universal: 500 sheets)
3	Vertical Paper Path	Path for paper from where paper from the paper bank and duplex path converge.
4	LCIT	Tray 3 (1,000 sheets), Tray 4 (2,000 sheets), Tray 5 (1,000 sheets)
5	Multi Bypass Unit	Tray 6 (500 sheets)
6	Paper Entrance	From LCIT and Multi Bypass Unit (options)
7	Paper Registration Unit	Corrects paper skew and side-to-side registration for all paper (including paper fed from the LCIT/Multi Bypass Unit)
8	Paper Transfer	Toner image transferred from ITB to paper
9	Transport Belt	Transports paper between paper transfer roller and fusing unit. Three fans hold the paper in the paper path. Fans (not rollers) are used to hold the paper in the paper path because the toner is not yet fused.

No.	Item	Comment
10	Fusing Unit	Fuses the toner image to paper
11	Paper Cooling	Cools paper to reduce curl before it exits or descends to the duplex paper path
12	Paper Exit	Common paper exit for all paper
13	Inverter/Exit Tray	Paper is fed into this tray, and reverse fed to invert it for face-down output.
14	Purge Tray	Bottom of the inverter/exit tray. All paper in the paper path of the main machine is shunted here when a jam occurs downstream.
15	Paper Invert/Switchback	Paper is stopped and reverse fed here to feed it into the duplex paper path for printing the 2nd side of the sheet.
16	Duplex Paper Path	Transports paper back to the upper horizontal feed path for paper registration and printing on the second side.

M044

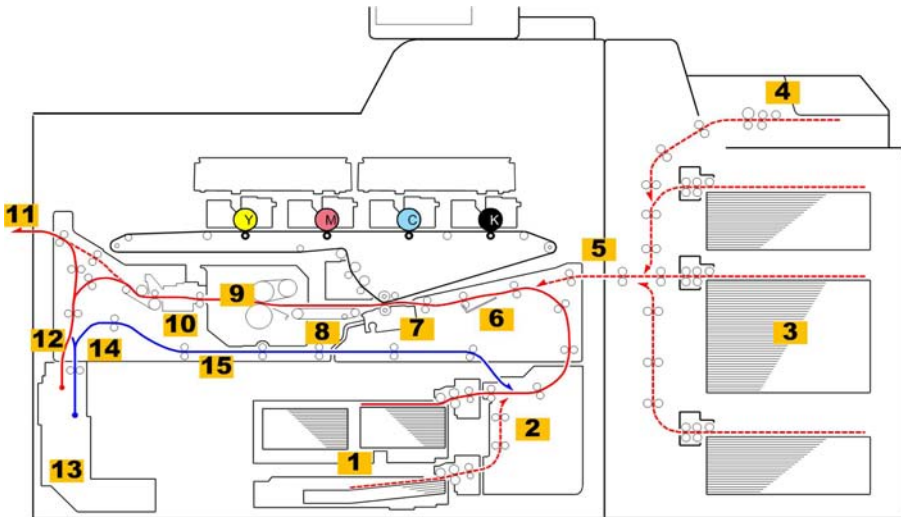

m044v102

No.	Item	Comment
1	Paper Bank	Tray 1 (Tandem: 2,000 sheets), Tray 2 (Universal: 500 sheets)

No.	Item	Comment
2	Vertical Paper Path	Path for paper from where paper from the paper bank and duplex path converge.
3	LCIT	Tray 3 (1,000 sheets), Tray 4 (2,000 sheets), Tray 5 (1,000 sheets)
4	Multi Bypass Unit	Tray 6 (500 sheets)
5	Paper Entrance	From LCIT and Multi Bypass Unit (options)
6	Paper Registration Unit	Corrects paper skew and side-to-side registration for all paper (including paper fed from the LCIT/Multi Bypass Unit)
7	Paper Transfer	Toner image transferred from ITB to paper
8	Transport Belt	Transports paper between paper transfer roller and fusing unit. Three fans hold the paper in the paper path. Fans (not rollers) are used to hold the paper in the paper path because the toner is not yet fused.
9	Fusing Unit	Fuses the toner image to paper
10	Paper Cooling	Cools paper to reduce curl before it exits or descends to the duplex paper path
11	Paper Exit	Common paper exit for all paper
12	Inverter/Exit Tray	Paper is fed into this tray, and reverse fed to invert it for face-down output.
13	Purge Tray	Bottom of the inverter/exit tray. All paper in the paper path of the main machine is shunted here when a jam occurs downstream.
14	Paper Invert, Switchback	Paper is stopped and reverse fed here to feed it into the duplex paper path for printing the 2nd side of the sheet.
15	Duplex Paper Path	Transports paper back to the upper horizontal feed path for paper registration and printing on the second side.

Main Motors

Here is a list of the main motors inside the machine. This list is not complete, but this perspective drawing shows you the approximate location of the main motors viewed from the back of the machine.

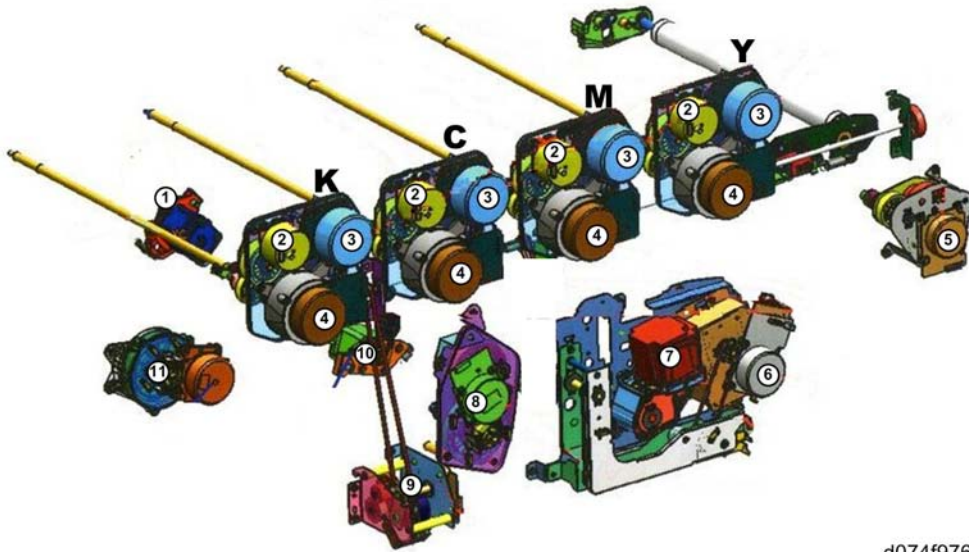

d074f976

No.	Name
①	ITB Lift Motor K (on back of ITB unit)
②	Drum Cleaning Motors
③	Development Motors
④	Drum Motors
⑤	Exit Motor
⑥	Fusing Motor
⑦	Pressure Roller Lift Motor
⑧	PTR Motor
⑨	Used Toner Collection Motor (Main)
⑩	Belt Centering Motor (on back of ITB unit)
⑪	ITB Drive Motor (on back of ITB unit)

Notes:

- There is a drum cleaning motor, development motor, and drum motor for each PCDU (YMCK).



d074r005

- To access most of these motors for servicing, both rear doors must be opened. Some boards and air ducts may also require removal.

2. Installation

Installation Requirements

Operating Environment

Recommended Temperature/Humidity Range for Operation

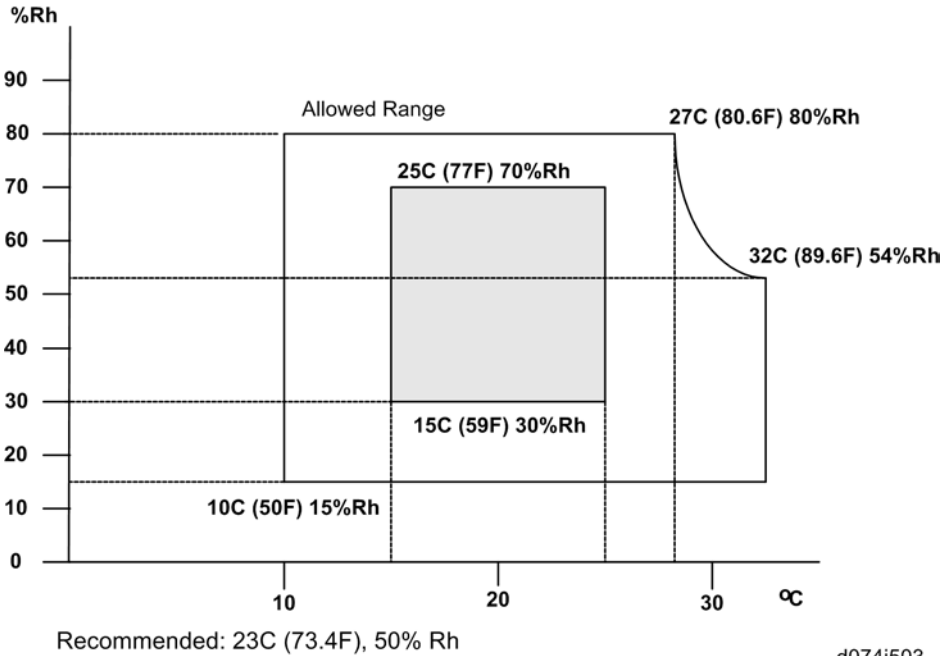

Item	Details
Target Temperature & Humidity	23°C (73.4°F), 50% RH
Temperature range	10° to 32°C (10° to 90°F)
Humidity range	15 to 80% RH
Ambient illumination	Less than 1500 lux
Ventilation	Air turnover rate of more than 30m ³ /hr/person
Ambient dust	Less than 0.10 mg/m ³

★ Important

- If the machine is installed in a location where the ambient temperature is more than 30°C (86°F), do not run full color printing longer than 2 hours, and never turn the main power switch off immediately after a long print job. Leave the machine on so that the fans can expel the hot air from the machine and cool the electronic components.
 - If this machine is to be used in a location where both temperature and humidity are high, the tray heaters should be turned on. The tray heaters for the paper bank are built in. Just open the 1st and 2nd tray and turn them on.
1. If the installation site has air-conditioners or heaters, put the machine in a location that agrees with these conditions:
 - Where there are no sudden temperature changes from low to high, or high to low.
 - Where the machine will not be directly exposed to cool air from an air conditioner in the summer.
 - Where the machine will not be directly exposed to reflected heat from a heater in the winter
 2. Do not put the machine where it will be exposed to gases like ammonia that can cause corrosion.
 3. Put the machine on a strong level surface. The front and rear of the machine must be level ± 2.5 mm (0.1").
 4. Never put the machine where it can be subjected to strong vibration.
 5. Never connect the machine to a power source shared with other electrical devices.
 6. The machine can generate an electromagnetic field which can cause interference with radio or television reception.

Power Requirements

⚠ WARNING

- Make sure that the wall outlet is near the mainframe.
- Keep the area around the power outlet open and free of clutter so the operator can get to it easily and quickly.
- Make sure the plug connection to the power outlet is tight..
- Do not connect more than one electrical device to the same power outlet.
- Be sure to ground the machine.
- Never place anything on the cord and never wrap the cord around itself or around another object.

Input voltage level

North America	208 to 240V, 50/60 Hz: More than 20 A
---------------	---------------------------------------

Europe/Asia	220/230/240V, 50/60 Hz: More than 16 A
-------------	--

Permissible voltage fluctuation: $\pm 10\%$

Breaker Switch

The machine is equipped with a breaker switch located at the rear, lower right corner. Inspect and test the breaker switch at least once a year.

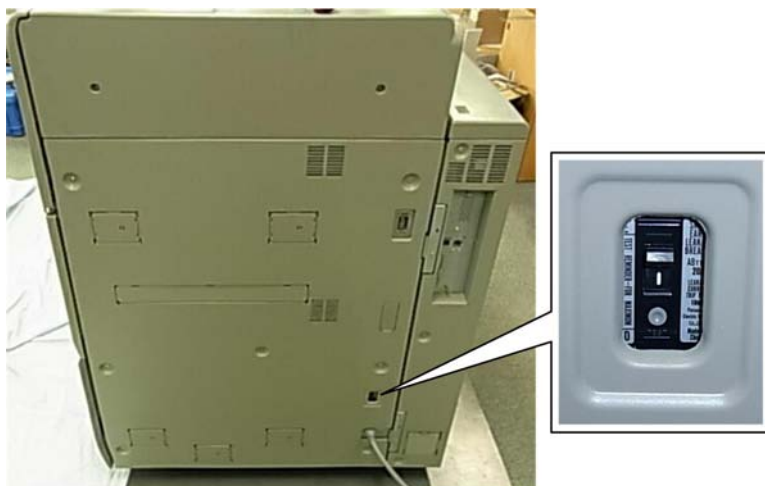

d074i801

★ Important

- If the breaker switch appears dirty and covered with soot, it probably requires replacement.

Machine Level

D074/D075



d074i802

M044

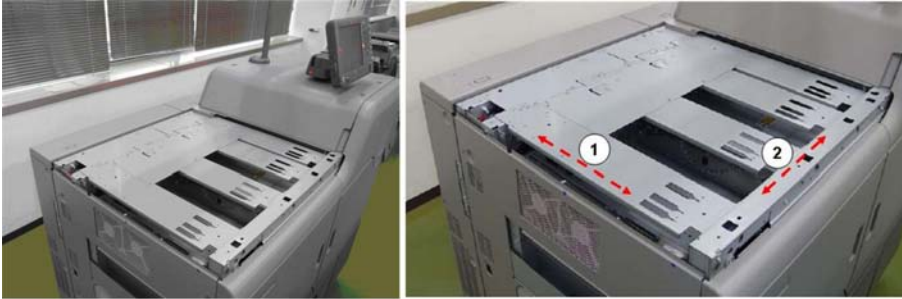

m044i802

The covers should be removed before leveling the machines.

①	Front to rear	Less than 5.0 mm (0.2") away from level
②	Right to left	Less than 5.0 mm (0.2") away from level

The machine feet can be rotated to raise and lower each corner of the machine until it is level.

Space Requirements

Put the mainframe near the power source. Consideration should be given not only to machine operation, but servicing the machine as well, with front doors and rear boxes fully open.

Space Around the Main Machine

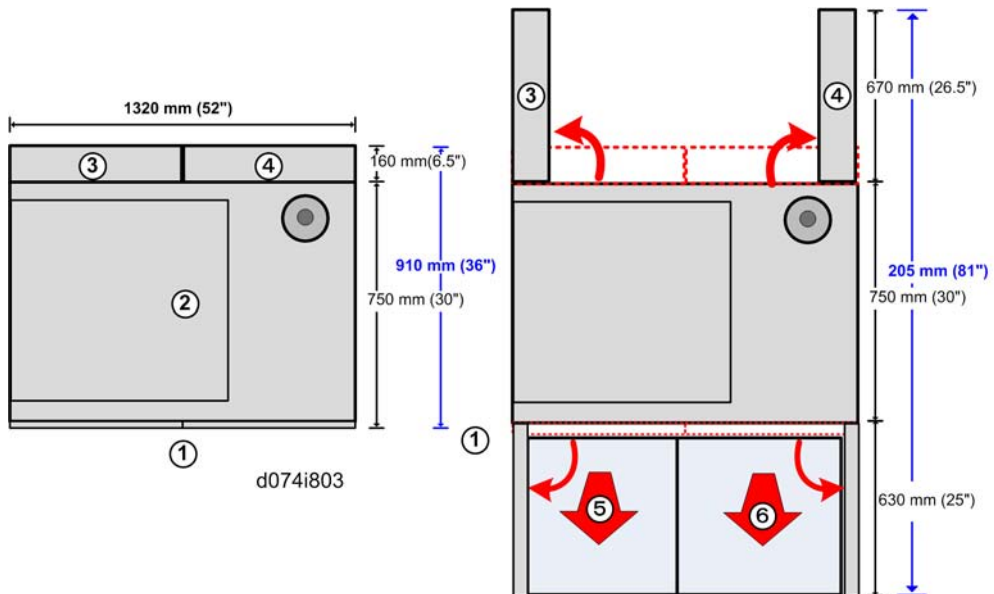

The illustration above is a top view of the main machine. This illustration is not drawn to scale. Measurements are rounded up slightly, but they will allow you to estimate how much space will be required to work around the machine and service the machine without moving it.

- Approximately 670 mm (26.5 in.) clearance required behind the machine with both rear boxes open.
- Approximately 630 mm (25 in.) at the front of the machine with both front doors open.

No.	Part	Range of Movement
①	Front Doors	Both doors swing open to the front
②	Main Machine	Remains stationary.
③	Cooling Box	Swings open to the rear (🔑 x3)
④	Controller Box	Swings open to the rear (🔑 x3)
⑤	Left Drawer	Slides open to the front for servicing (fusing unit, etc.)
⑥	Right Drawer	Slides open to the front for servicing (registration unit, etc.)

- The rear boxes (cooling box and controller box) are on hinges and can be swung open to the rear in order to service parts on the back of the machine (motors, sensors, etc.).
- The front doors swing open to the front, and then the left drawer or right drawer (or the ITB unit as well) can be pulled out the front of the machine on their rails for servicing.

Total Space Required

2

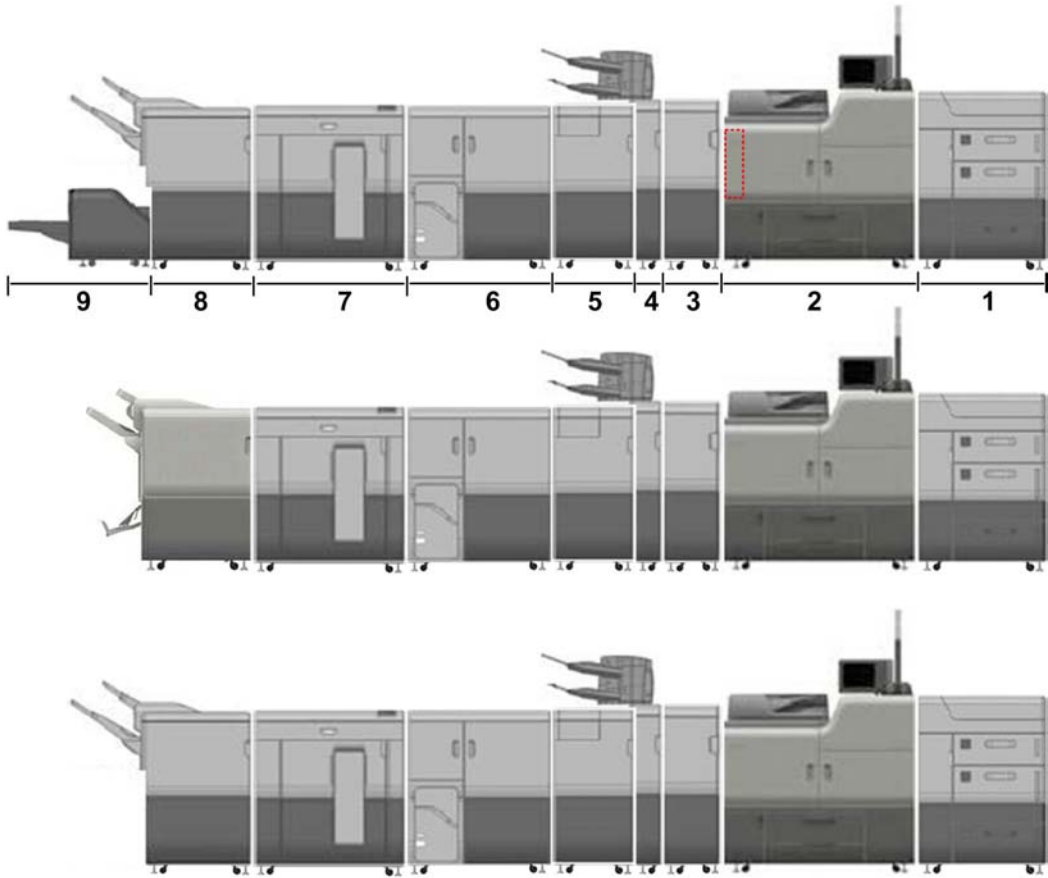

d074i804

No.	Unit	mm	in.
1	A3/DLT LCIT	880	35
2	Main machine	1320	52
3	Buffer Pass Unit* ¹	330	13
4	Cover Interposer Tray* ¹	164	7
5	Multi Folding Unit	470	19
6	Ring Binder* ¹	870	35
7	High Capacity Stacker* ¹	900	36
8	Finisher	990	39

No.	Unit	mm	in.
9	Trimmer Unit* ¹	1115	44
	Total 1 (mm, in.)	7,422 mm	292 in.
	Total 2 (m, ft.)	7.4 m	25 ft

*1: These peripherals are schedule for release with the M044..

Notes:

- The Decurl Unit is not listed because it is installed inside the left side of the main machine.
- The Multi Bypass Tray is not listed because it is installed on top of the LCIT.
- The Buffer Pass Unit (3) is required for the Multi Folding Unit (5).
- Only one High Capacity Stacker (7) can be installed in the line.
- If the Trimmer Unit (9) is not installed, the booklet tray for the Booklet Finisher (D512) must be installed to hold stapled booklets. (The booklet tray must be removed in order to install the Trimmer Unit.)
- The Trimmer Unit (9) cannot be installed with the Finisher (D513). This finisher performs only corner and flat stapling (no booklet stapling). The Trimmer Unit processes booklet-stapled stacks only.

Switching the System On/Off

Main Power and Operation Power Switch

Main Power Switch

The main power switch is located inside the front left door. This machine should be left on at the end of the work day.

CAUTION

- This switch should always be turned off before servicing the machine.

Operation Switch

The operation switch is located on the operation panel. This is the switch that the operator uses to turn the machine on and off and the beginning and end of each work day.

CAUTION

- Never turn off the main power switch when its power LED is lit or flashing.
- To prevent damage to the hard disk or memory, push the operation switch to turn the power off, wait for the power LED to go off, and then turn the main power switch off.
- Never turn off the main power switch of the mainframe before shutting down the Fiery controller.

The correct shut down procedure for the Fiery controller is described below.

Power On with Fiery Controller

1. Turn on the main power switch of the main machine.
2. Turn on the switch on the back of the Fiery Controller box.
3. Press and turn on the switch on the front of the Fiery Controller box.

Turning the System Off

On the Fiery controller operation panel:

1. Press the [Fiery] tab.
2. Press the [Restart Fiery] button.
3. Press the [Shut Down" button.

On the Main Machine

1. Push the operation switch on the operation panel to turn the power off.
2. Wait for the operation switch power LED to stop flashing.

★ Important

- **Never turn off the main power switch when the power LED is lit or flashing.**
3. After the power LED goes off, open the left front door.
 4. Turn the main power switch off.

Main Machine

Accessories

D074/D075/M044

2

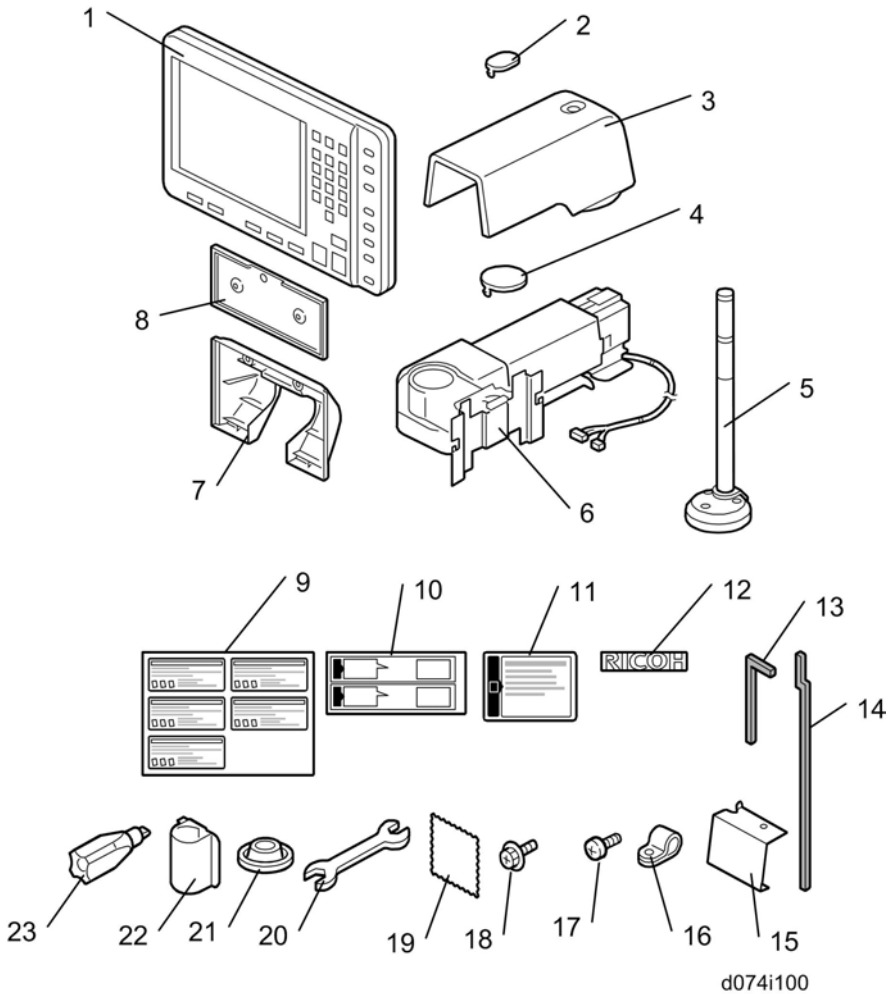

No.	Description	Q'ty
1.	Operation Panel	1
2.	Screw Cover - Small	1
3.	Arm Cover	1

No.	Description	Q'ty
4.	Screw Cover - Large	1
5.	Attention Light	1
6.	Arm	1
7.	Rear Cover - Convex	1
8.	Rear Cover - Flat	1
9.	Original Set Decals (D074/D075)	1
10.	Paper Set Decals	1
11.	Ink Jet Paper Caution Decal (NA only)	1
12.	Logo Plate (NA only)	1
13.	Sponge Strip - L	1
14.	Sponge Strip - Long Hooked	1
15.	Harness Cover	1
16.	Nylon Clamp	1
17.	Screws (M4x6)	4
18.	Screws (M4x8)	11
19.	Cleaning Cloth (D074/D075)	1
20.	Wrench	1
21.	Shoes	4
22.	Fusing Roller Knob Holder	1
23.	Fusing Roller Knob	1

Installation Flow

Procedure
Installation: Power Off

Procedure	
	Unpack
	Install Attention Light
	Install Operation Panel
	Connect ARDF (D074/D075)
	Attach Fusing Roller Knob Holder
	Level the Main Machine
	Test Breaker Switch
	Install Toner Bottles
Installation: Power On	
	Connect Main Machine to Power Source and Power On
	Start Toner Fill
	SP3051-001 (Manual Toner Fill)
	Initialize Process Control
	SP3020-001 (Process Setup)
	SP3012-001 to check whether initialization was successful
	Exit SP Mode and Power Off
Fiery Controller Connection	
Fiery Controller Setup	
Paper Library Data Installation	
Finishing the Installation	

Installation: Power Off

CAUTION

- The unit must be connected to a power source that is close to the unit and easily accessible.

- Make sure that the main machine is switched off and that its power cord is disconnected before doing the following procedures.

Rating Voltages for Connection Points

⚠ CAUTION

- Be sure to plug cable connectors into the correct sockets.

Right Side

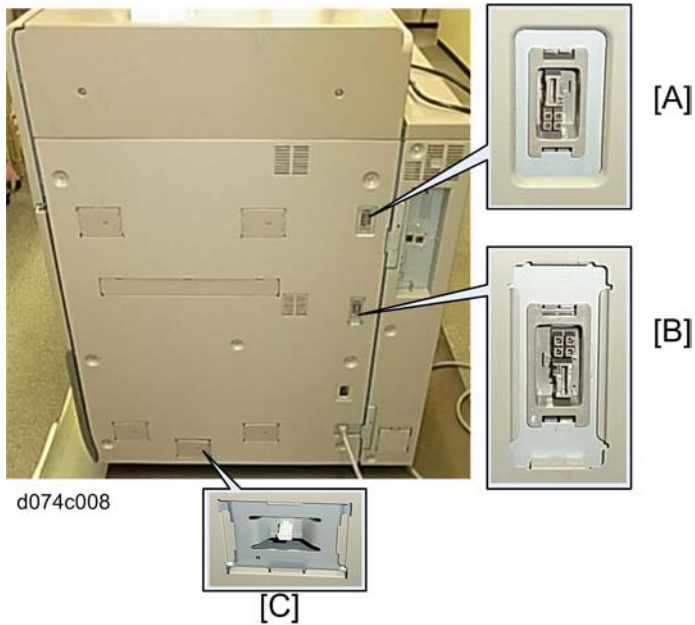

- ARDF Max. DC24V (D0074/D075)
- LCIT [B]: Max. DC24V
- LCIT Anti-condensation Heaters [C]: Max. AC 230V \pm 10%

Left Side

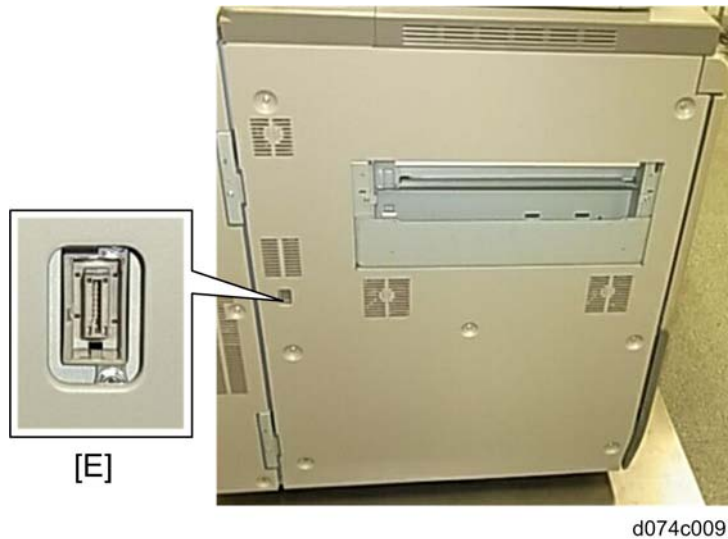

- Finisher [E]: Max. DC24V

Unpack

Removal from Pallet

The main machine must be removed from its pallet with a forklift.

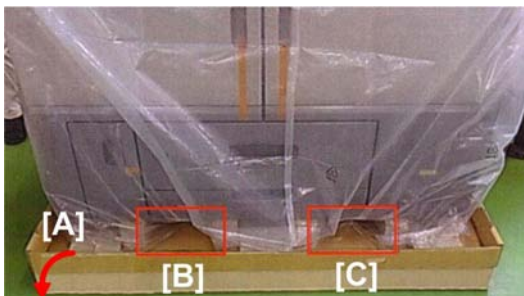

1. Knock down the front edge of the cardboard [A].
2. Insert the arms of the forklift at [B] and [C].

Shrink Wrap, Bubble Wrap

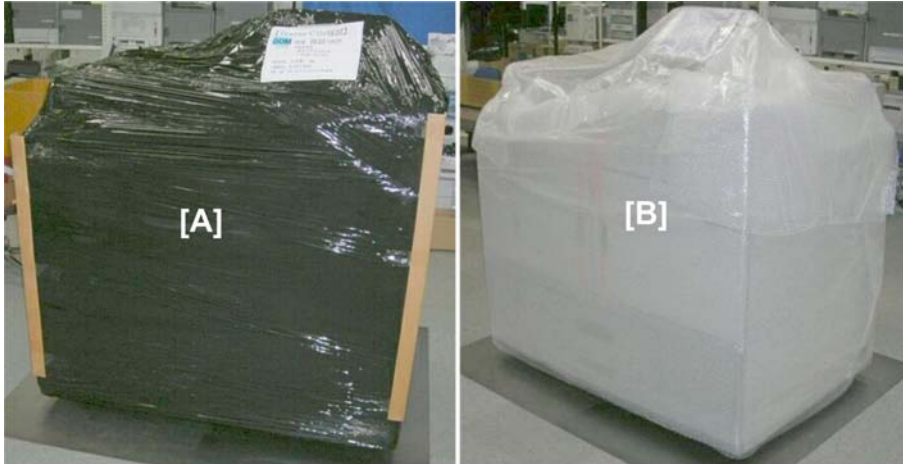

d074i808

3. Remove shrink wrap [A] and bubble wrap [B].

External Tape

4. Remove the tape from the front and right side.
5. Remove tape at the rear and left side.

Shipping Rod

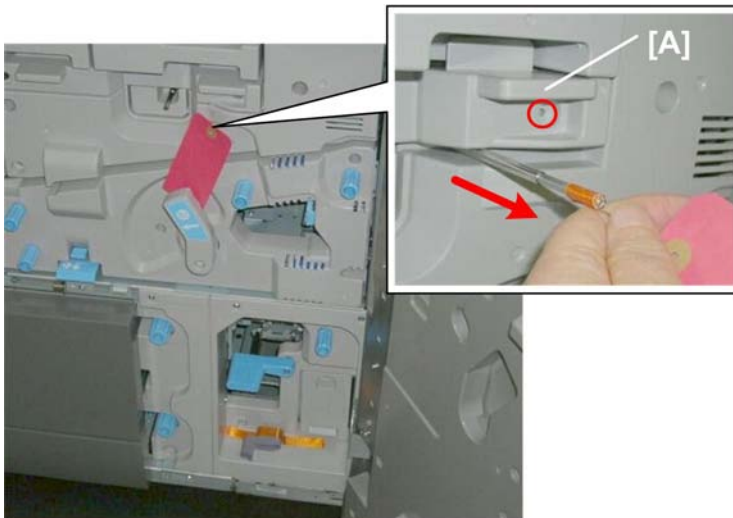

d074i812

6. Open the front door.
7. Remove cover [A] ( x2).
8. Pull out the shipping rod.

ITB Lever

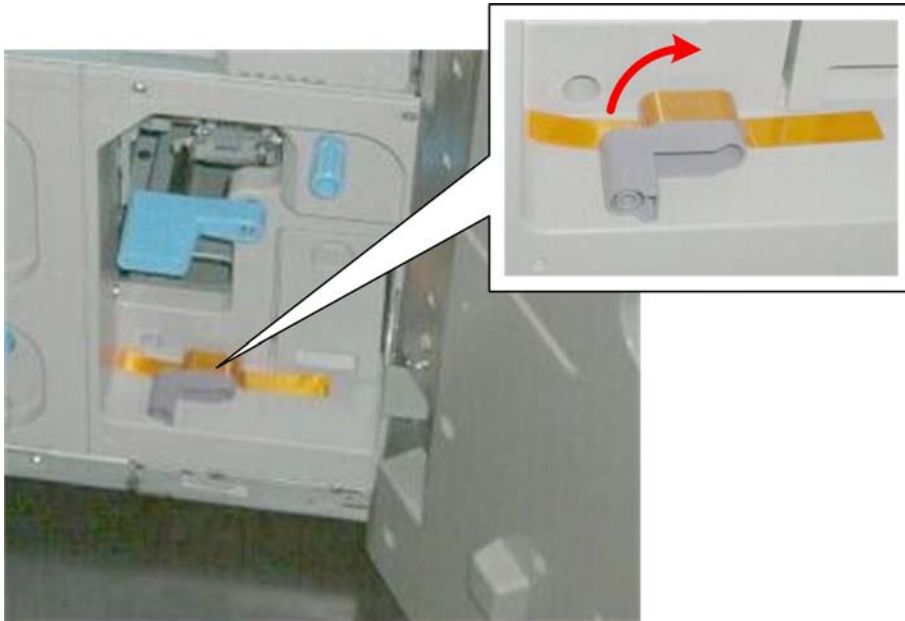

d074i813

9. Remove the tape and ITB lever.

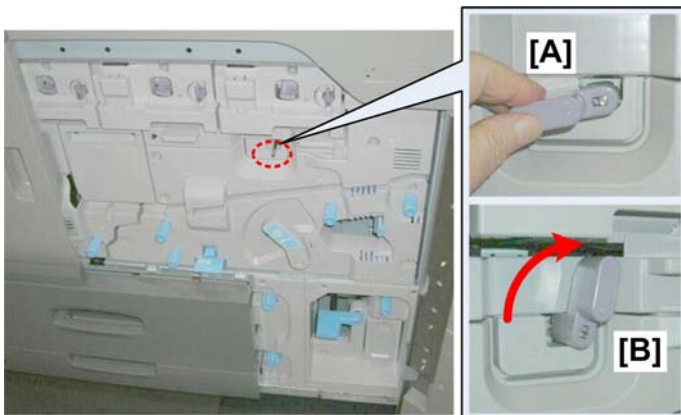

d074i814

10. Attach the ITB lever [A] to the tip of the bare shaft.
11. Rotate the lever up [B] to lock the ITB in place.

Right Drawer



d074i895

12. Lower the handle.
13. Pull the right drawer out until it stops.
14. Remove the tape.

Paper Trays

15. Pull out the top tray and remove any tape and packing material.
16. Pull out the bottom tray and remove any tape and packing material.

Factory Settings Sheet



d074r992

17. The Factory Settings Sheet is stored at the factory under the used toner bottle.
18. Remove the sheet and keep it in a safe place.

Attention Light

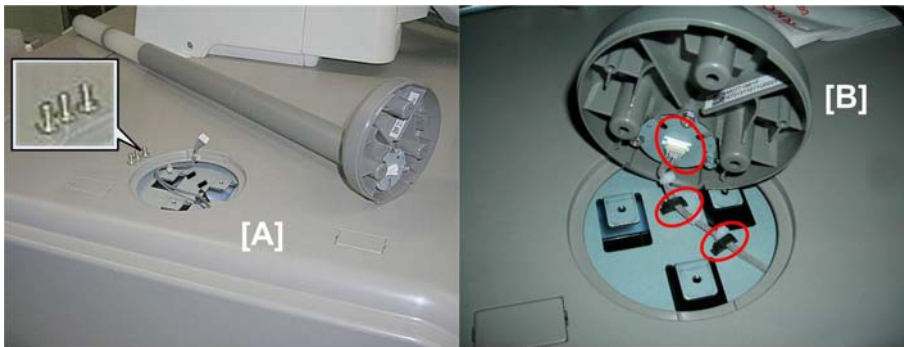

d074i815

1. The attention light is installed on the top rear edge [A] with accessory screws (🔩 x3 M4x6).

⬇️ Note

- The three screws must be removed from their holes (these screws are not accessories).

2. Connect the light [B] (🔌 x1, 🛠️ x2).



d074i816

3. Set the base of the light [A] in the socket so that the back of the socket [B] fits into the knockout.
4. Fasten the base to the main machine (🔩 x3).

Operation Panel Installation

2

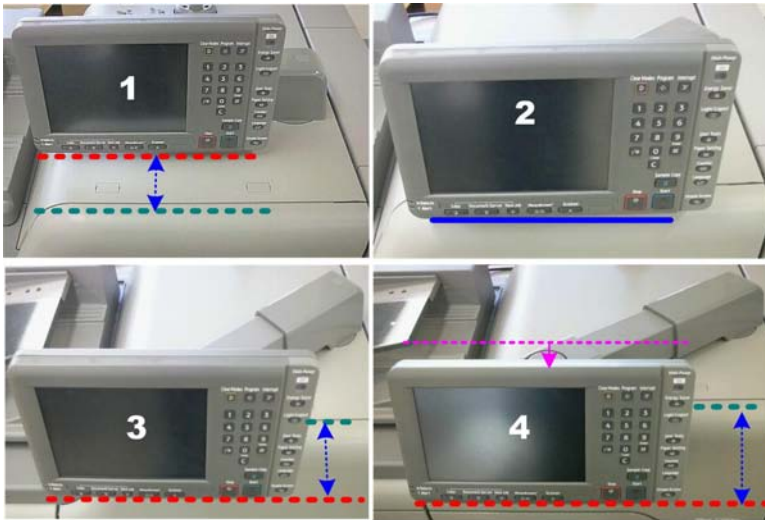

d074i816a

There are four possible ways to configure the operation panel when it is installed.

Config.	Description
1	Standard. The support arm is perpendicular to the right side of the machine and the operation panel is recessed from the front of the machine.
2	Standard Diagonal. The support arm is set at an angle so that the operation panel is flush with the front of the machine.
3	Standard Diagonal Extended. The support arm is set an angle (same as Configuration 2) and the arm is extended so that the operation panel extends beyond the front of the machine.
4	Easy Access (Sitting Position). This is the same as Configuration 3 but the operation panel is removed and re-hung on lower hooks so it is lower. This allows access to the operation panel from a sitting position.

- This installation procedure describes how to install the operation panel with Configuration 1 or 4.
- For more about how to install the operation panel with Configuration 2 or 3, refer to the Replacement and Adjustment section. (p.452)

Install Operation Panel: Standard Installation

2

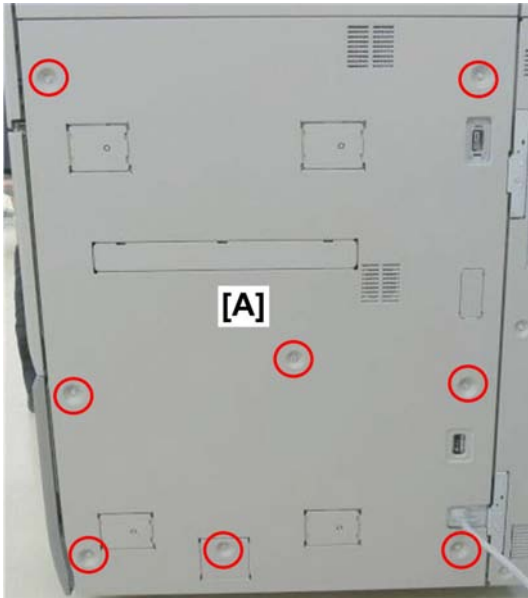

d074i860

1. Remove the right cover [A] ( x8).

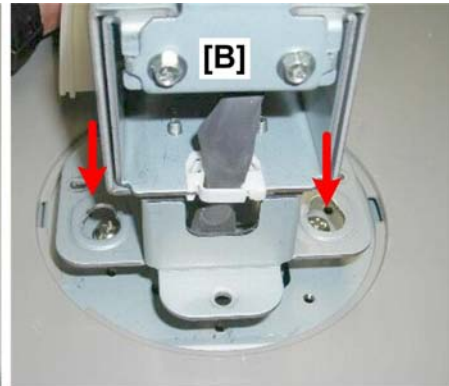
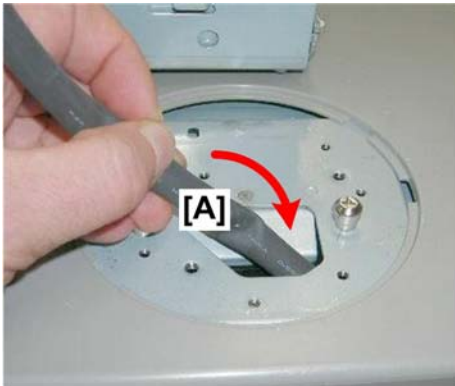

d074i863

2. Set the arm on the machine and route the harness [A] down through the hole.
3. Reach inside the right side of the machine and pull the harness down to take up all of the slack.
4. Set the base of the arm [B] on the shoulder screws.

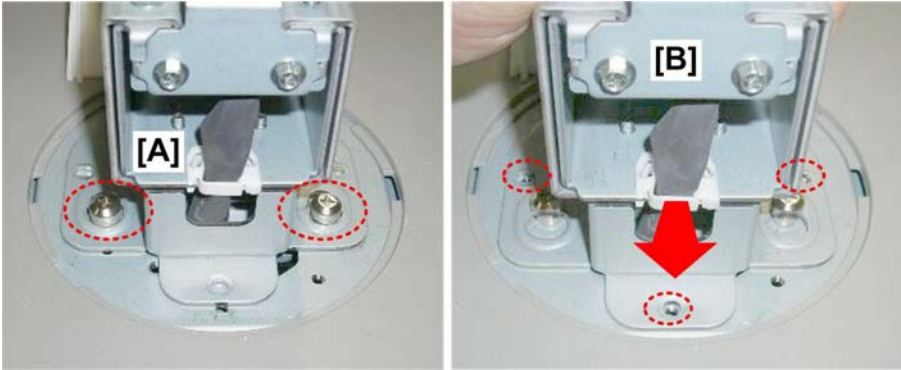

d074i864

5. Make sure that the base of the arm [A] is flat and that the wide ends of the keyholes on both sides are centered on the shoulder screws.
6. Push the base of the arm [B] to the left to lock the narrow ends of the keyholes onto the shoulder screws.
7. Make sure that the three screw holes in the base are aligned with the three holes below.

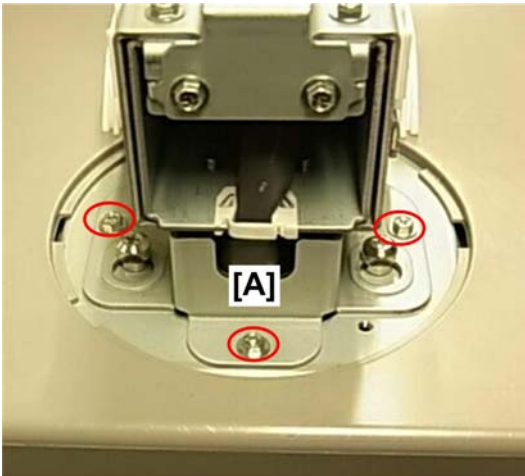

d074i865

8. Fasten the base of the arm [A] ( x3).

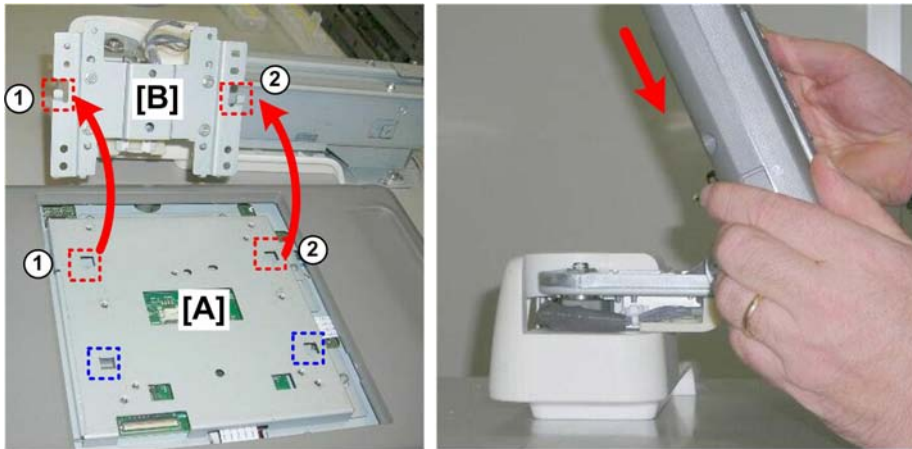

d074i866

9. Set the back of the operation panel [A] in front of the mounting plate [B].
 - There are four cutouts on the back of the operation panel [A] and two hooks on the mounting plate [B]
 - The bottom cutouts ①, ② in the operation panel [A] are attached to the two hooks ①, ② on the mounting plate [B].
 - The other two cutouts on the back of the operation panel [A] (marked blue in the photo above) are not used.
10. Attach the operation panel to the mounting plate as shown on the right.

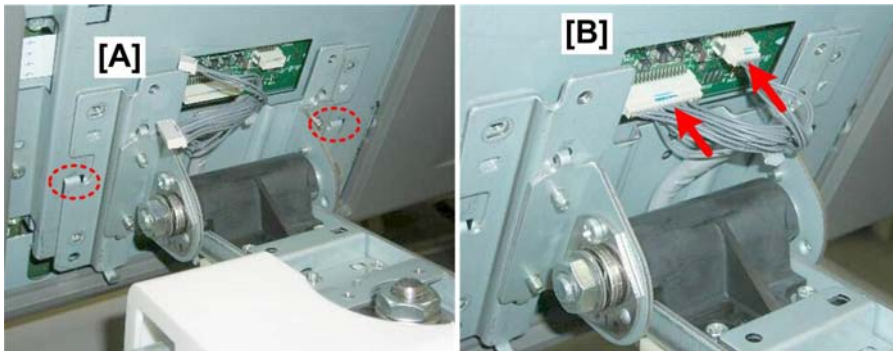

d074i867

11. At the back of the operation panel, make sure that both hooks are connected securely.
12. Connect the harnesses at [B] (🔌 x2).

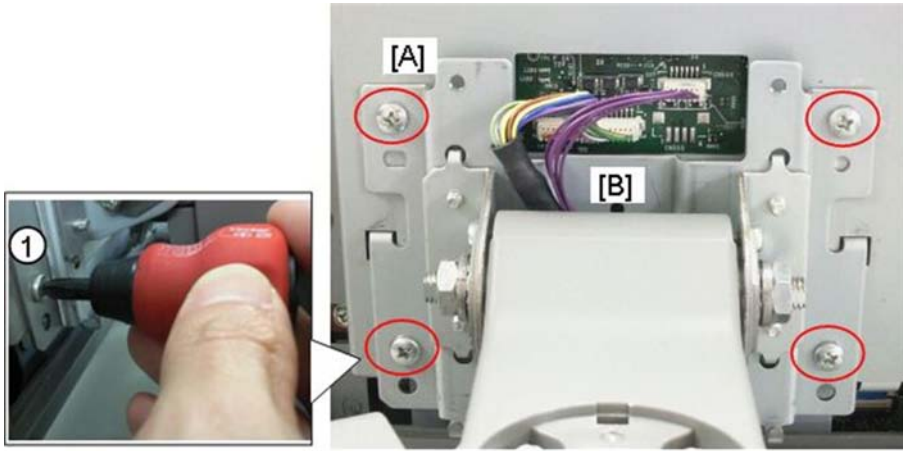

d074i868

13. Fasten the back of the operation panel [A] to the mounting bracket [B] ( x4 M4x6). You will need a short screwdriver to attach the screw at ①.

★ Important

- You must use the M4x6 screws to fasten the operation panel at this step. If you use the longer screws (M4x8) they could touch and damage the operation panel board.



d074i871

14. Attach the convex rear cover to the back of the operation panel ( x2).



d074i872

15. Attach the flat rear cover above the lower cover ( x2).



d074i872a

16. Attach the arm cover ( x2).



d074i873

17. Attach the screw covers on the top of the support arm, small screw cover at [A] and large cover at [B].

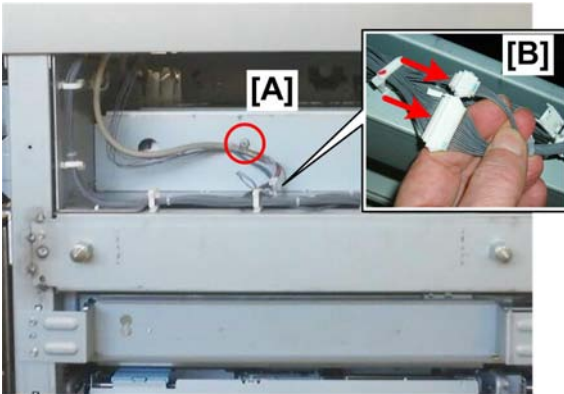

d074i874

18. On the right side of the machine where the right cover was removed:

[A] Fasten the nylon clamp ( x1).

[B] Connect the operation panel harnesses ( x2).

19. Re-attach the right cover ( x7).

Operation Panel: Easy Access Installation

Follow this procedure to install the operation panel for easy access so it can be used from a sitting position.

1. Do Steps 1 to 4 of the previous procedure for the standard installation.

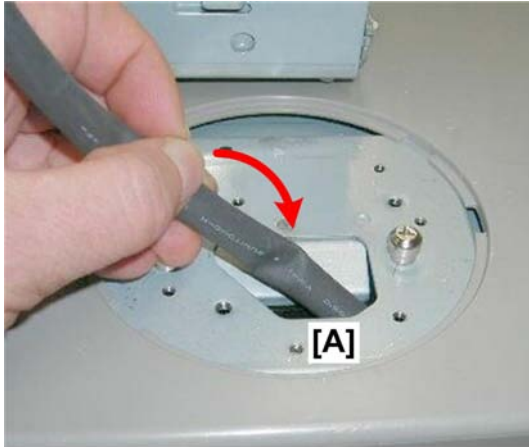

d074i863a

2. Route harness [A] down through the hole.

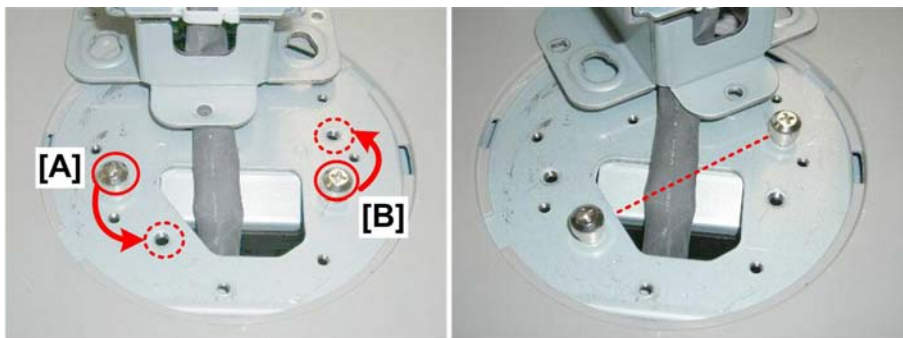

d074r289a

3. Remove shoulder screw [A] and re-fasten it at the lower hole (⚙️ x1).
4. Remove shoulder screw [B] and re-fasten it at the upper hole (⚙️ x1). The screws should now be diagonally opposite one another as shown above.

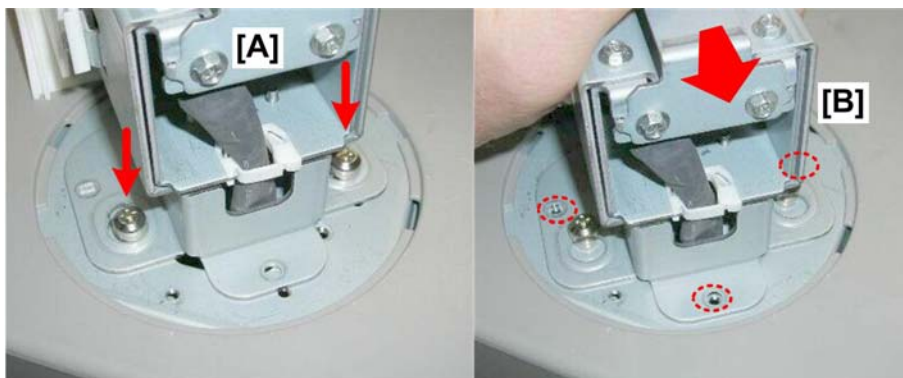

d074r290

5. Set the base of the arm [A] on the shoulder screws.

6. Make sure the base of the arm is flat against the top of the machine.
7. Push the support arm to the right to lock the base onto the shoulder screws. You can see the three holes of the base aligned with the holes below.

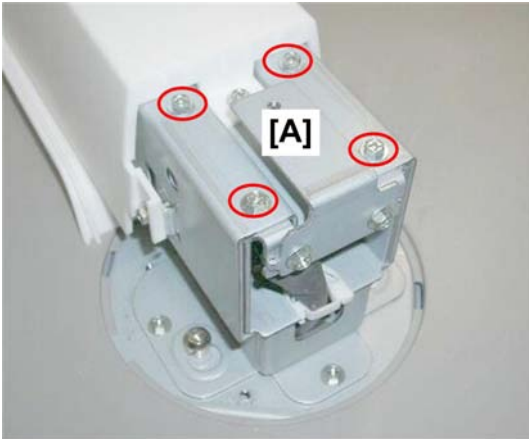

d074r291

8. Attach the base [A] ( x3).

★ Important

- Make sure that these screws are fastened tightly.

9. Remove the screws on top of the support arm [B] ( x4). **Keep these screws.**



d074r292

10. At the bottom of the base [A], open the clamp and pull a short length of the harness out of the hole ( x1).
11. Slowly push the arm [B] to the left to extend it.

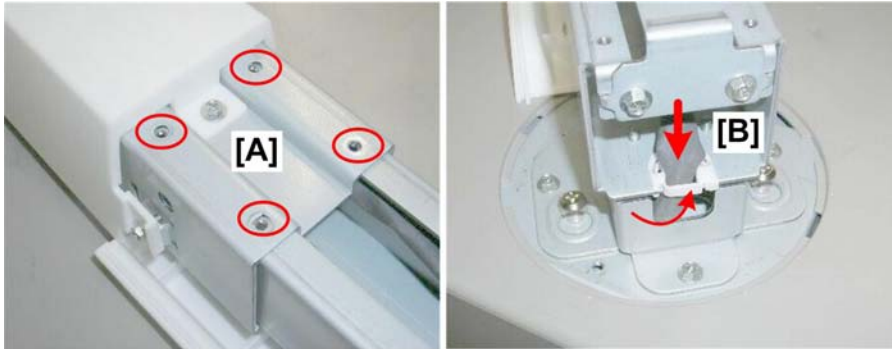

d074r293

12. Push the arm [A] to the left until the holes on the top of the arm are aligned with the four holes below.
13. At [A] re-attach the screws you removed in Step 9 ( x4).

★ Important

- Make sure that these screws are fastened tightly.

14. At the base of the arm [B], push the harness into the hole and close the clamp ( x1).

Display Installation for Easy Access



d074r294

1. Remove cover [A] ( x1).
2. Push harness [B] down behind the mounting plate.

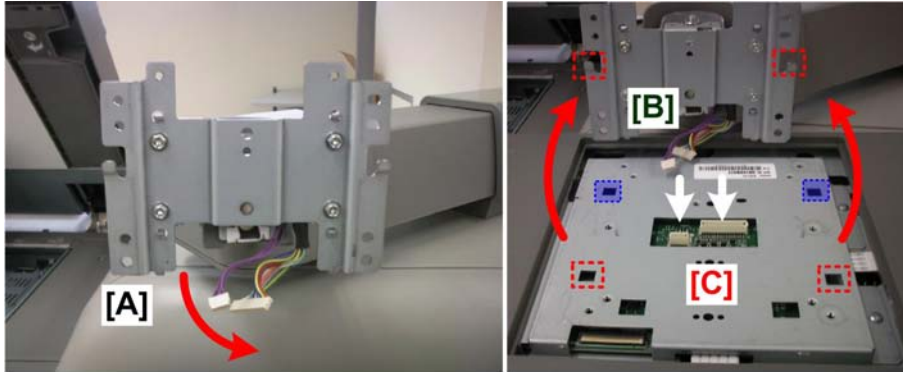

d074r294a

3. Position the back of the operation panel near the mounting plate.
4. Connect the operation panel harness [B] (E) x2).
5. Raise the operation panel and hang the cutouts [C] (marked with red dotted lines) on the hooks (also marked with red dotted lines) .

★ Important

- You must hang the operation panel using the cutouts [C]. Do not use the cutouts closest to the mounting plate (marked with blue squares).

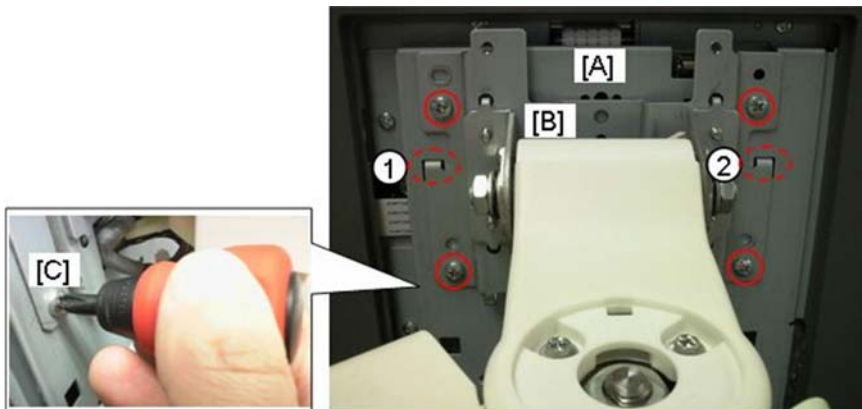

d074r295

6. Check the hooks at ① and ② to make sure that the operation panel [A] is hung correctly on the mounting plate [B].
7. Fasten the operation panel and mounting plate together (⚙ x4 M4x6). (You will need a short screwdriver to attach screw [C]).

★ Important

- You must use the M4x6 screws to fasten the operation panel at this step. If you use the longer screws (M4x8) they could touch and damage the operation panel board.

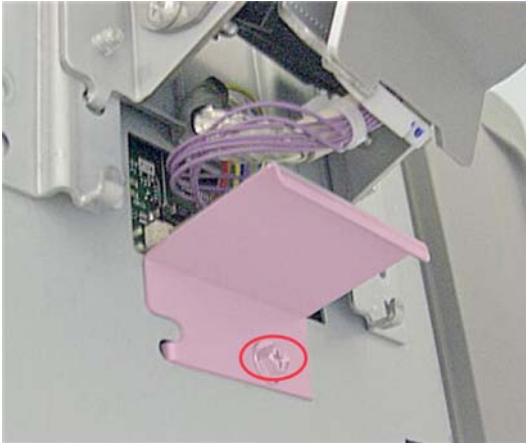

d074r869a

8. Fasten the harness cover to the back of the operation panel ( x1).



d074i869b

9. **Loosen** the swivel screw so that you have the full range of horizontal movement for adjusting the position of the operation panel. **Do not remove this screw!**

Cover Attachment



d074r296

1. Attach the convex plate [A] at the top (x).
2. Attach the flat plate [B] at the bottom (x).

★ Important

- In Configurations 1, 2, 3, the convex plate [A] is attached below, and the flat plate [B] is attached above.
- For this installation (Configuration 4), the positions of these plates are reversed as shown above. (The convex plate is attached above and the flat plate below.)

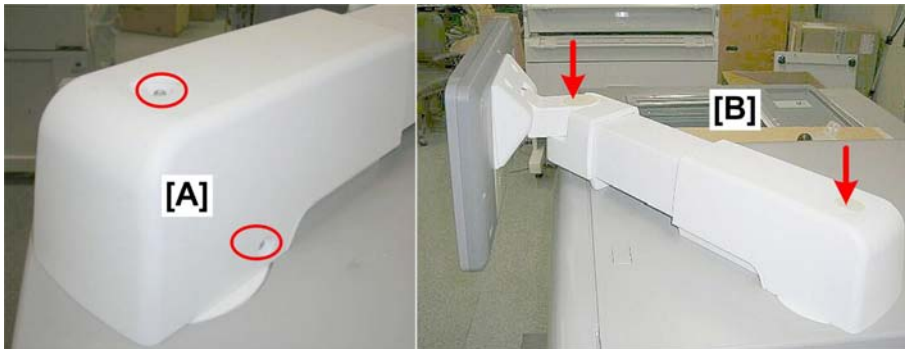

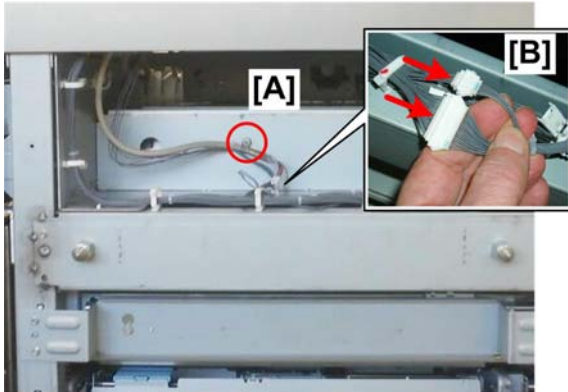

d074r297

3. Attach the arm cover [A] (x2).
4. Attach the large and small screw covers [B].
5. Attach the support arm outer cover [B] (x2).



d074i874

6. On the right side of the machine where the right cover was removed:
 - [A] Fasten the nylon clamp ( x1).
 - [B] Connect the operation panel harnesses ( x2).
7. Re-attach the right cover ( x7).

Opening the Toner Bank Door

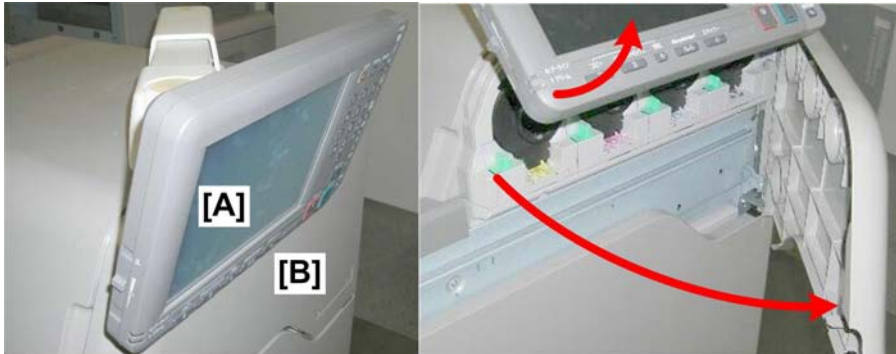

d074r298

- With the operation panel [A] fully depressed, the toner bank door [B] cannot be opened.
- To open the toner bank door, swing the operation panel up, and then open the door.

Connect ARDF (D074/D075)

2



d074i817

1. Connect the ARDF I/F cable on the right side of the machine.

Attach Fusing Roller Knob Holder

A fusing roller knob is provided as an accessory.

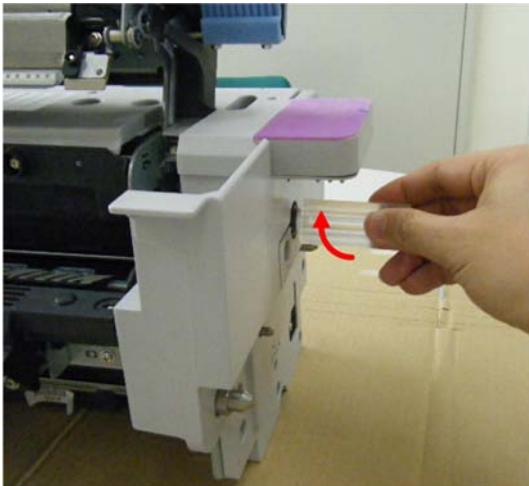

d074r303a

This knob can be attached as shown and rotated by hand to feed jammed paper out of the fusing unit. This knob is stored in a holder that must be attached to the inside surface of the left front door. (Procedure described below.)

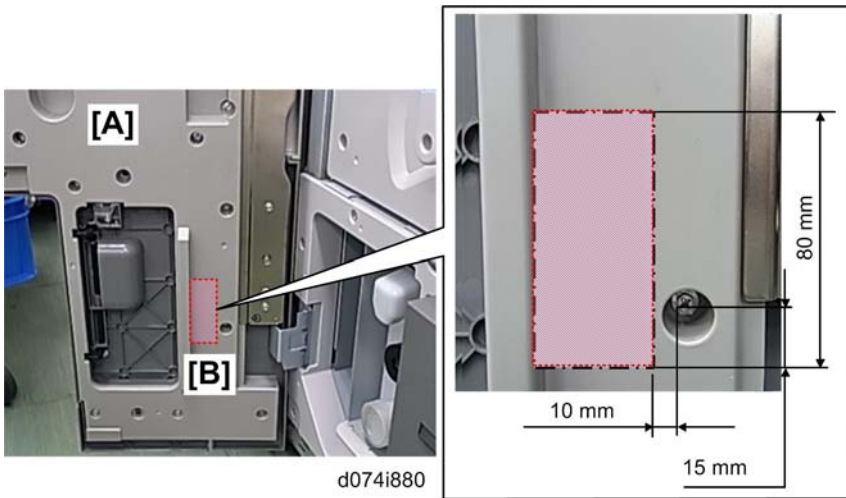

d074i880

1. Open the left front door [A].
2. Use a clean cloth and alcohol to clean the surface around [B] on the inner surface of the left front door.

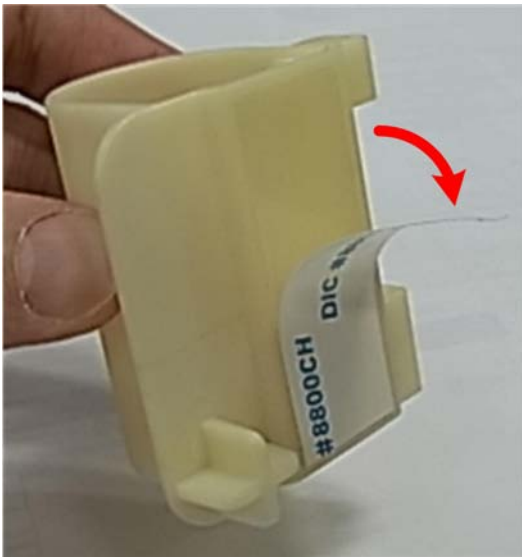

d074i881

3. Peel the strip from the back of the holder to expose its adhesive surface.

2



d074i882

4. Attach the holder to the door.

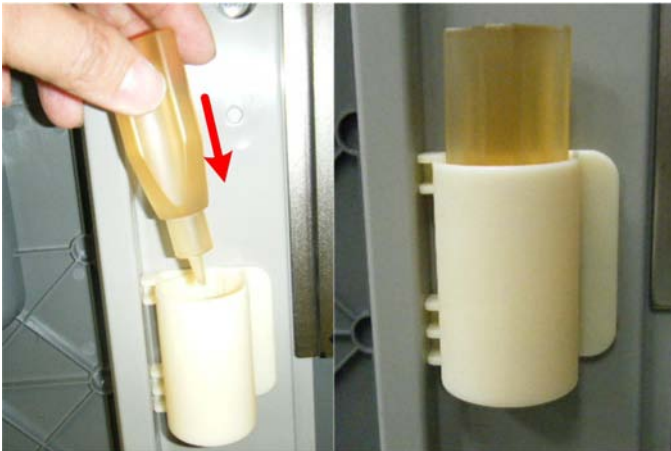

d074i883

5. Set the knob in the holder and close the door.

Level the Main Machine

The machine must be leveled front-to-rear and side-to-side within ± 2.5 mm/1000 mm.

1. Install the leveling shoes, one at each corner of the main machine. Adjust the height of the legs so that the machine is level left-to-right.
2. Adjust the height of the legs so that the machine is level front-to-back.

★ Important

- These leveling adjustments are critical. The level of all the peripheral options (LCIT, Finisher, etc.) must be adjusted to match the level adjustment of the main machine.

Test Breaker Switch



d074i854

The breaker switch is at the bottom corner of the rear right side of the machine. The optional ring binder also has a breaker switch.

The breaker switches should be tested at installation and after that at least once a year:

- After prolonged use, if the breaker switch is covered with soot, this could indicate that the switch has malfunctioned or been damaged.
- To prevent damage to the breaker switch, installation of a voltage stabilizer (constant voltage transformer) is recommended for work sites where there is significant fluctuation in the AC power source.

To test the breaker switch:

1. Plug the power cord into its power source.

★ Important

- Do not turn on the main machine. The main machine must be off.

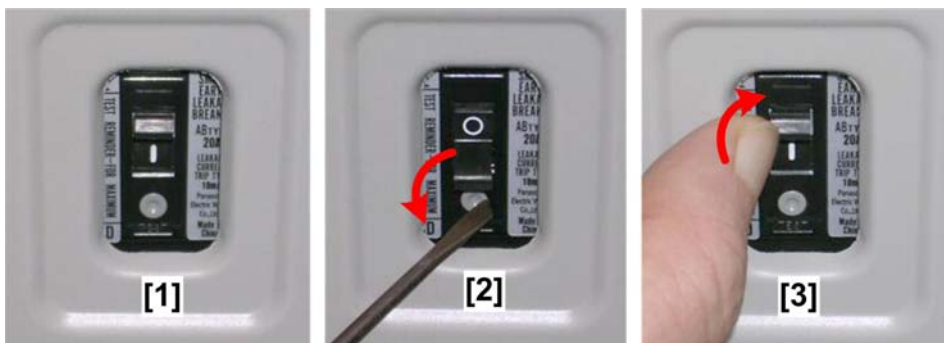

d074i855

2. To test the breaker switch:

- [1] is the normal position of the breaker switch test button.

- Use the tip of a small screwdriver or pen to push the breaker test button. The breaker switch should flip to the "O" position [2]. This indicates that the breaker switch is operating normally.
- If the breaker switch does not flip to the "O" position, the switch must be replaced.
- Push the switch up to the "I" position [3] for normal operation.

★ Important

- The main machine will not turn on if the breaker switch is not returned to the "I" position as shown at [1].

Install Toner Bottles

★ Important

- The toner bottles contain pre-mixed toner and developer.

Toner Bottle Installation

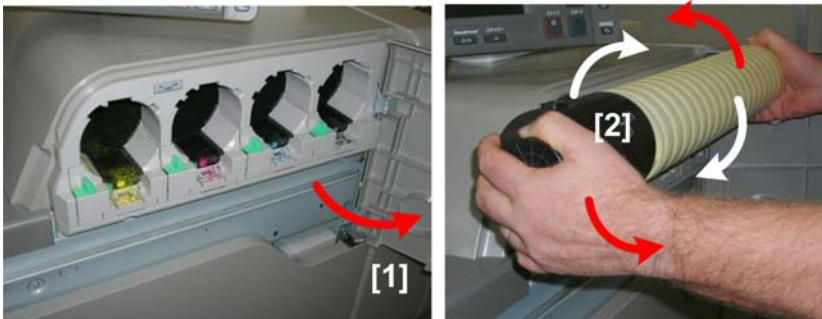

d074i818

1. Open the toner bank door [1].
2. Remove the yellow toner bottle [2] from its package.
3. Rock the bottle gently on its long axis to loosen the contents of the toner bottle.

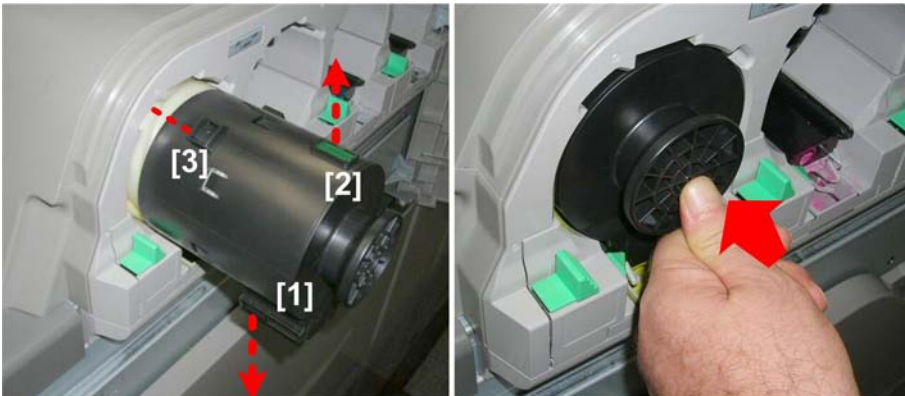

d074i819

4. Insert the bare end of the bottle into the machine.
5. Turn the bottle so that the toner port [1] is down and the RFID chip [2] is up, with the protrusions [3] lined up with the grooves of the cover.

★ Important

- The front end of each toner bottle has protrusions that fit snugly into grooves in each color holder. These grooves are arranged in a unique pattern to prevent installation of a toner bottle accidentally in the wrong position.
 - If a bottle does not slide easily into the holder, make sure that the green RFID chip is facing up and the protrusions on the front end of the bottle match the pattern of the cutouts around the mouth of the holder.
6. Push the bottle in until you hear it click and lock.



d074i820

7. Repeat Steps 2 to 6 to install the other toner bottles from left to right in this order: Y, M, C, K. Be sure to rock each toner bottle along its length before you insert it.

Attach Decals

D074/D075

2

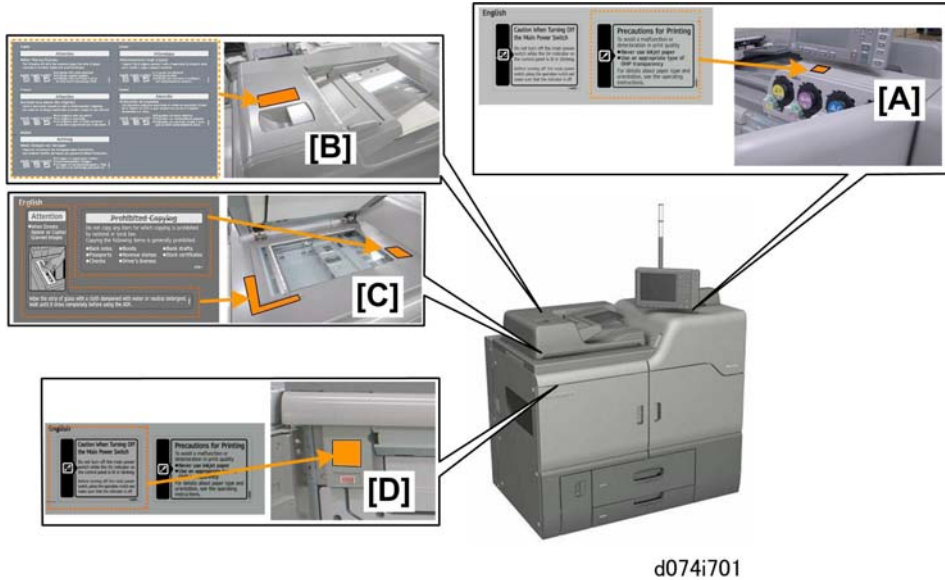

d074i701

1. Attach the decals at the locations shown above.
 - [A] Precautions for Printing decal
 - [B] Original Set Precautions decal
 - [C] Cleaning, Prohibited Copying decals
 - [D] Caution When Turning Off the Main Power Switch decal

M044

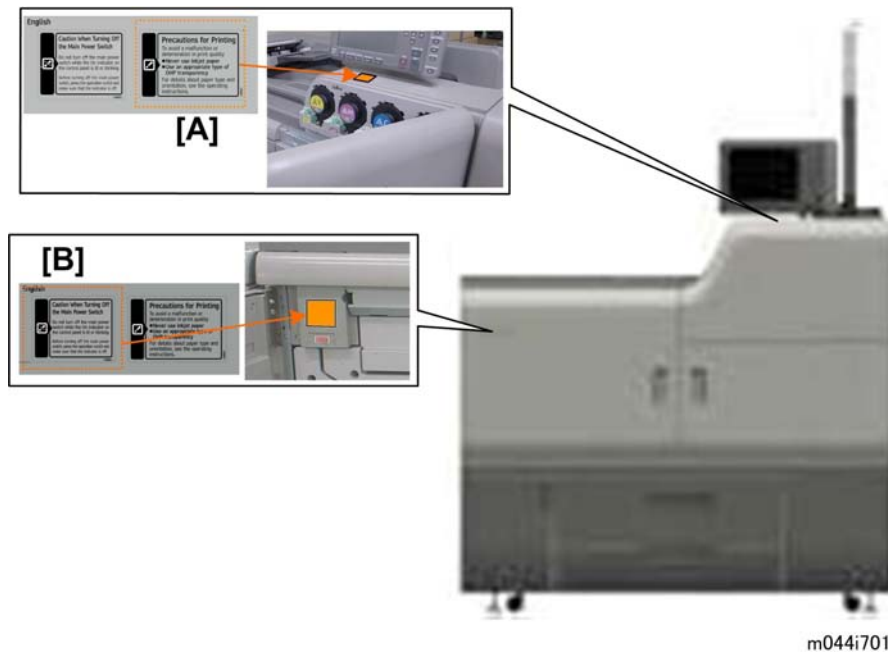

2

1. Attach the decals at the locations shown above.
 - [A] Precautions for Printing decal
 - [B] Caution When Turning Off the Main Power Switch decal

Installation: Power On

Connect Main Machine to Power Source and Power On

1. Connect the power cord of the main machine to the power source.
2. Turn on the main power switch.
 - ⬇ **Note**

 - The main power switch is behind the open left front door.
3. Watch the operation panel. The operation panel LED will light red, and you will see the "Door Open" alert on the operation panel.

Start Toner Fill

1. Execute SP3051-1.
2. Watch the operation panel.

3. When you see "Complete", this means the machine has filled the sub hoppers of the toner supply unit.

Initialize Process Control

2

1. Leave the front doors closed.
2. Execute **SP3020-001** to start process control. (Process control sets the machine for optimum operation based on the conditions around the drums.)
3. Watch the operation panel. When you see "Complete", the process control settings are done.
4. Check with **SP3012-001** to make sure that initialization was successful.

Exit SP Mode and Power Off

1. Exit the SP mode.
2. Push the operation power switch on the operation panel to switch the machine off.
3. Switch the main power switch off.

Fiery Controller Connection and Setup

Connect EFI Box to Main Machine

Note

- Refer to the Fiery controller service manual for more details about the installation requirements for the controller.
1. Make sure the main power switch behind the left front door is off.
 2. Set the Fiery controller box on the floor.



d074i857

3. Connect the shielded cable to the lower network cable slot of the Fiery Controller box.

★ Important

- You must use the shielded cable provided with the accessories to connect the Fiery Controller box and the main machine.



d074i858

4. Connect the other end of the shielded cable to the controller box of the main machine. The correct connection point is marked "External CTL".



d074i858a

5. Connect the cable from the client network to the upper network cable slot.

Connect the EFI Box Power Cord

2



d074i856

1. Connect the power cord to the back of the controller box.
2. Connect the other end of the power cord to a power source.

Power On with Fieri Controller

1. Turn on the main power switch of the main machine.



d074i858b

2. Turn on the switch on the back of the Fieri Controller box.



d074i858c

3. Press and turn on the switch on the front of the Fiery Controller box.

Fiery Controller Setup

Fiery Controller Selection

1. Enter the SP mode.
2. Set **SP5193-001** to "6" (Fiery controller).

Fiery Language Selection

If the operator wants to use a language other than English to operate the Fiery controller, the language selection must be done first. To select a different language, the Fiery system must be re-installed. For details, the Field Service Manual for the Color Controller: E-41A.

Fiery Controller Settings

You must do the Fiery controller settings immediately after you turn the machine on for the first time.

- Make sure that that the Activity light on the Controller LCD is flashing green and then go to the machine's operation panel.
1. Wait for the "Please wait" message to go off.
 2. Press the "Fiery" tab on the LCD after the Fiery operating menu has appeared.
 3. Press the "Setup" button on the operation panel.
 4. The "Login" screen appears.
 5. Press the "Password" button to open the soft keyboard.

6. Enter "Fiery. 1" with the soft keyboard, and then press the "OK" button.
 - Password entry is case sensitive (the machine distinguishes between lower case and upper case letters).
 - Use the "Shift" button to enter a capital letter.
7. The setup screen appears after you enter the password correctly.

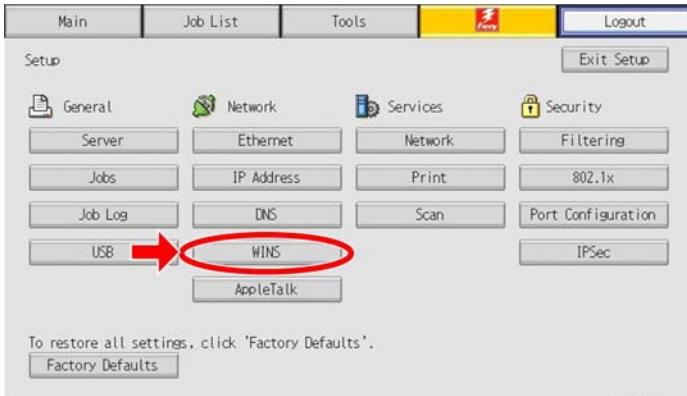

g178i555

8. Press the "WINS" button.

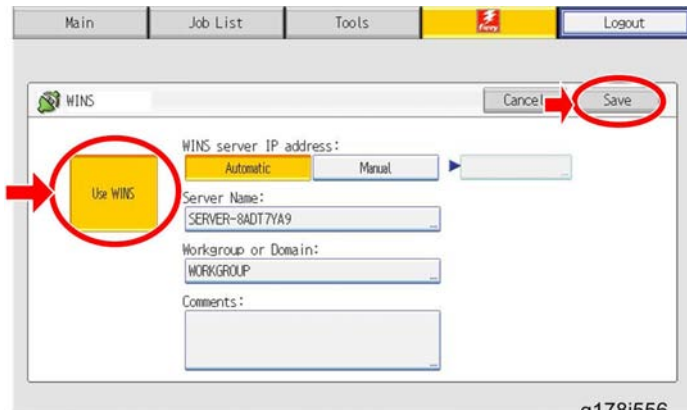

g178i556

9. Press the "Use WINS" button to disable this function then "Save".

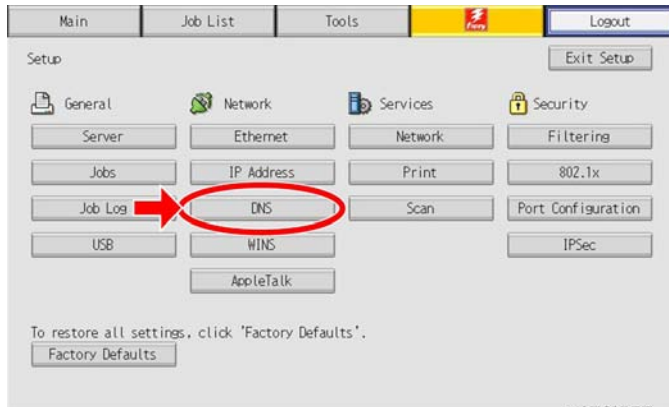

g178i557

10. Press the "DNS" button.

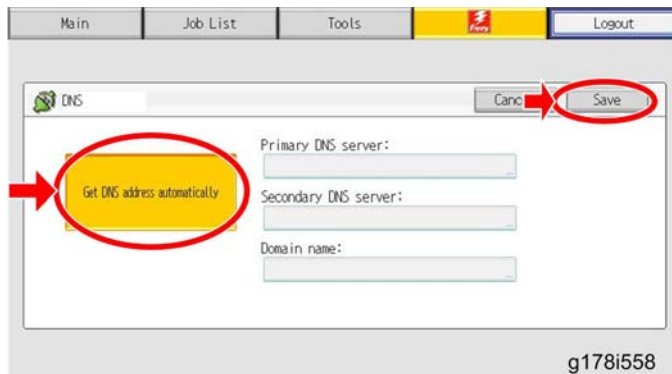

g178i558

11. Press "Get DNS address automatically" to disable this function, and then press "Save". The button color turns gray to indicate that this button is disabled.

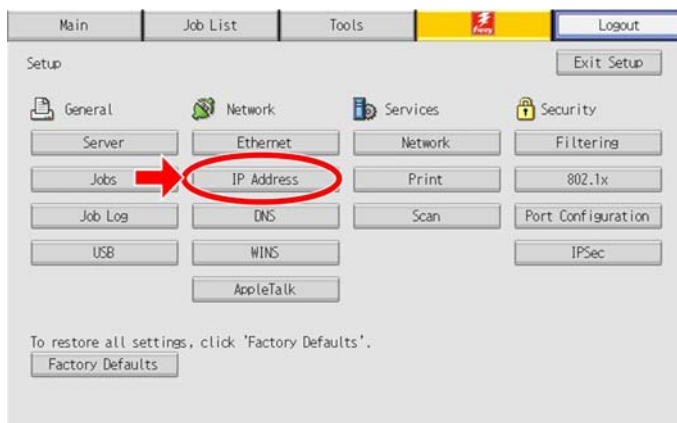

g178i559

12. Press "IP Address" to enter the IP address.

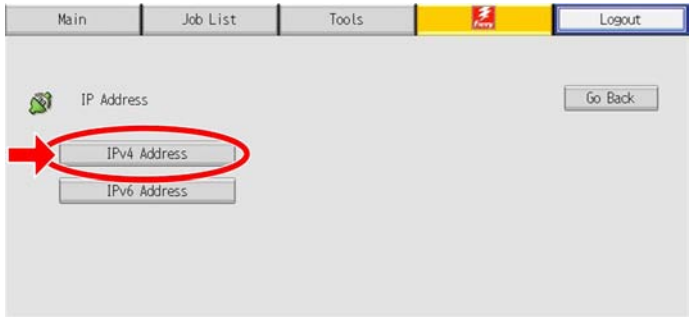

g178i560

13. Press "IPVd Address".

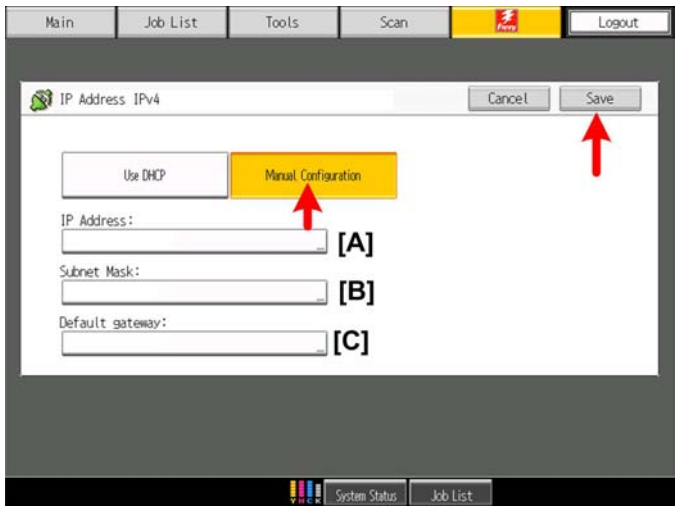

d074r001b

14. Press the "Manual Configuration Button".
15. Press the "IP Address" bar [A] to enter the IPv4 address, and then enter the IPv4 address.
 - The soft keyboard appears
 - Enter the IP address with the soft keyboard, and then press the "OK" button.
16. Press the "Subnet Mask" bar [B] to enter the subnet mask IP, and then enter the subnet mask IP.
 - The soft keyboard appears.
 - Enter the IP address with the soft keyboard, and then press the "OK" button.
17. Press the "Default gateway" bar [C] to enter the default gateway IP address, and then enter the default gateway IP address.
 - The soft keyboard appears.
 - Enter the IP address with the soft keyboard, and then press the "OK" button.
18. Press the "Save" button after IP address setting has been completed.
19. Press the "Go Back" button, then the "Exit Setup" button.

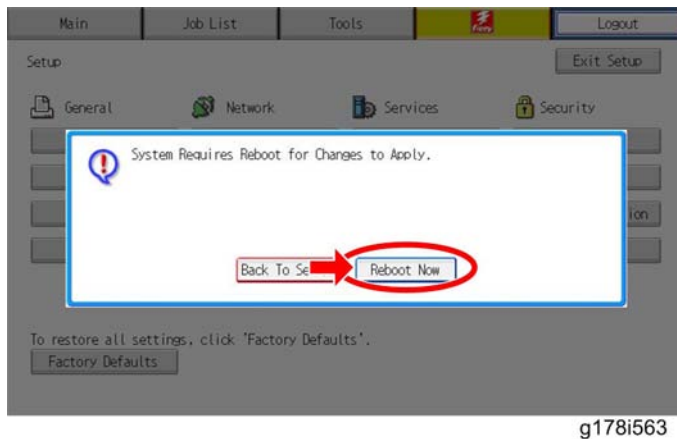

g178i563

20. Press the "Reboot Now" button.
21. The Fiery server and copier system automatically turn off to reboot.

Paper Library Data Installation

Follow this procedure to install the Paper Library data.

1. Create a folder in the root directory of an SD card and name the folder "mqp".
2. Copy the paper database file into the "mqp" folder, and then rename the copied file "library.mqp".
3. Make sure that the machine is turned off.
4. Insert the SD card which has the "library.mqp" file into SD card Slot 2 (lower slot) on the right side of the controller box.
5. Turn on the machine.
6. Make sure that the data version of the SD card is newer than the data version of the flash ROM on the controller. If not, prepare the latest data version of the Paper Library on an SD card.
 - The version of the data on the SD card can be checked with **SP5711-202**.
 - The version of the data in the flash ROM on the controller can be checked with **SP5711-201**.

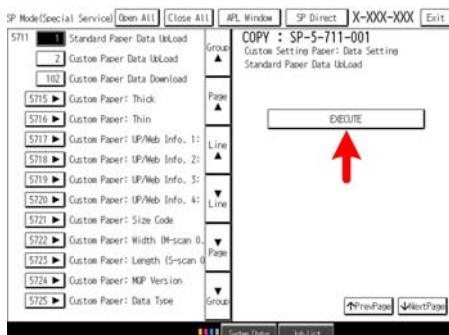

d095i612a

7. Enter SP5-711-001, and then touch [EXECUTE].

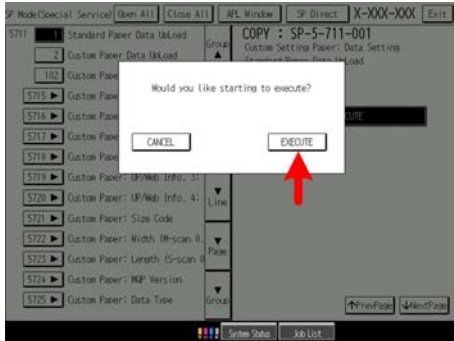

d095i612b

8. Next, touch [EXECUTE] again.



d095i613

9. When the machine displays "Completed" and prompts you to re-boot, touch [Exit] to leave the SP mode.
10. Turn off the machine and remove the SD card from SD card Slot 2.
11. Turn on the machine.
12. Check the Paper Library data version with SP5-711-201 (Flash ROM) to confirm that the Paper Library data has been updated.

Paper Trays

Loading the Paper Trays

Load each paper tray.

1. Move the side fence and bottom fence to the correct positions for the paper.
2. Attach the paper size decals to the front of the paper cassette trays and the tandem tray.
3. Load the left side of Tray 1 (tandem tray).
4. Close Tray 1 and confirm that the machine moves the stack in the left side of the tray to the empty right side of the tray.

- Fill Tray 1 and Tray 2 with paper with the A4/LT paper provided with the machine.

Note

- The size of the paper in Tray 2 is detected automatically.

Tray Paper Settings

2

- Press the [Paper Settings] key on the operation panel.
- Select the Tray icon.



d095i809

- Select the paper type and paper weight for each tray.

Note

- The paper type and paper weight for the paper provided with the machine should be set to "Plain Paper" and "Weight 2".

Printing an SMC Report

Print the SMC report. This is a complete list of all SP settings and defaults.

- Go into the SP mode.
- Do **SP5990-6** to print a list of the non-default SP code settings for future reference.
 - The SP5990-1 (All) printout is about 140 pages single-sided.
 - SP5990-6 (non-default) requires only about 5 sheets.
- Keep the SMC report in a safe location with the factory setting sheet under the used toner bottle.

Test Color Print (D074/D075)

- Make sure that A3 or DLT paper is in one of the trays. Use the same type of paper that the customer normally uses for color output.

2. Place a "Color Chart C-4" on the exposure glass.
3. Select the Full Color mode and print one copy of the chart. (This is the copy that you will use in the ACC procedure if calibration is necessary.)
4. Check the quality of the copy with the operators.
If the quality of the color is satisfactory, ACC adjustment is not necessary.
-or
If the quality of the color is not satisfactory, do the ACC adjustment described in the next section.

ACC Adjustment (D074/D075)

Automatic color calibration (ACC) is done at the factory with the procedure below.

- Do this procedure only if the color quality is not satisfactory.
 - If you do this procedure at installation, use the A4/LT paper provided with the machine.
1. Make sure that you have a copy of the C4 Color Chart before you begin, and write "Before ACC adjustment" in the Memo box.
 2. Push [User Tools].
 3. To print a color pattern, select "Maintenance"> "Auto Color Calibration".
 4. Touch [Start].

Machine will start self-check before printing test pattern
Press [Start Printing].

5. Touch [Start Printing].

Now self-checking.
Test pattern will be printed.
Please wait.

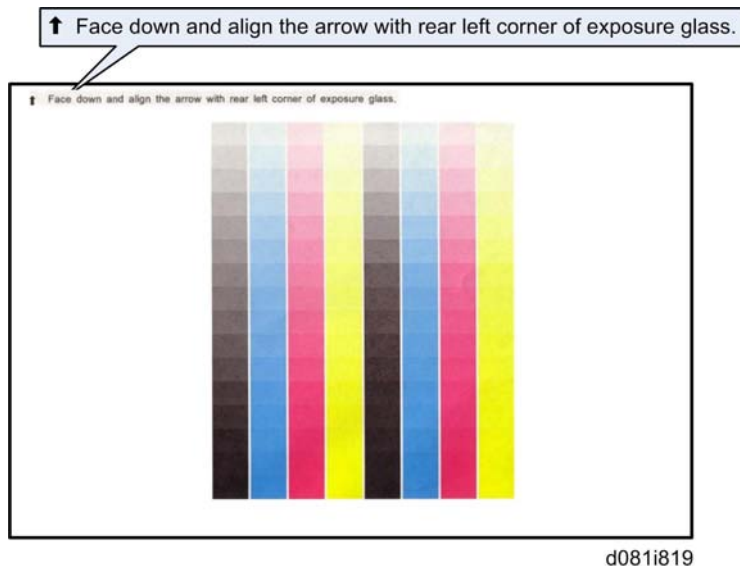

The machine does process control, and then it prints a test pattern.

Place Test Pattern on the exposure glass correctly.

Then press [Start Scanning]

6. Remove the C-4 test chart placed on the exposure glass during the previous procedure.
7. Place the color test pattern face-down that you made in Step 4 and 10 sheets of blank paper on the color test pattern.
8. Make sure that the arrow and notation on the color test pattern ("Face down and align the arrow with the rear left corner of the exposure glass.") is at the rear left corner.
9. Touch [Start Scanning] on the display. The machine scans the pattern once.
 - If you see this message the "Scanning failed..." message after you press [Start Scanning], check the position of the pattern on the exposure glass.
 - Make sure that the arrow on the test pattern is in the upper left corner of the exposure glass.
10. Remove the pattern from the exposure glass and replace it with the C-4 Color Chart.
11. Touch [Exit] three times to return to the Copy mode screen.
12. Make another Full Color copy of the C4 Color Chart, and write "After ACC adjustment" in the Memo box..

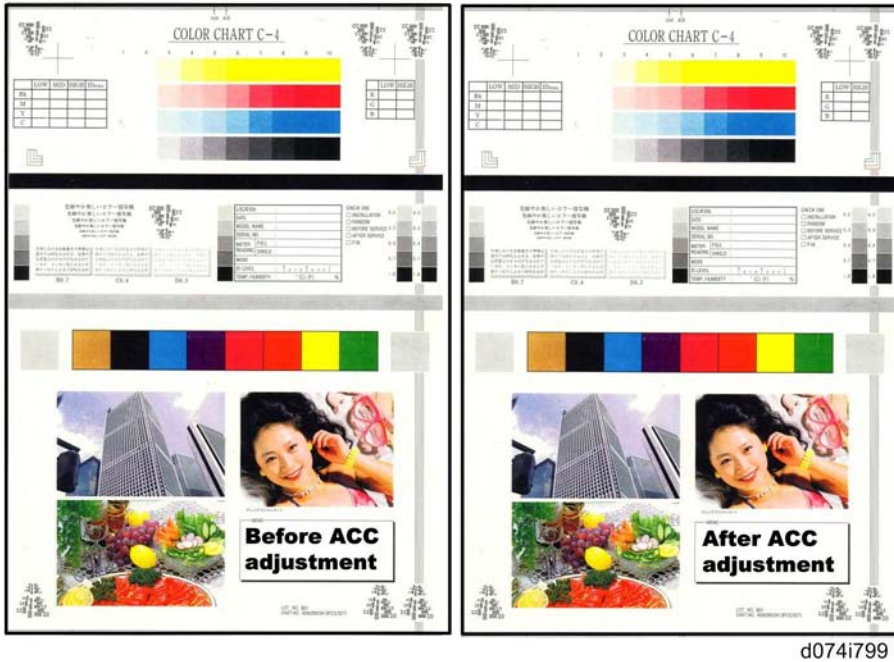

13. Compare the results of the first copy marked "Before ACC adjustment" and the second copy marked "After ACC adjustment".

If the results of the second copy after ACC adjustment are better than the results of the copy before adjustment, you are finished.

-or-

If the results of the second copy are worse than the results of the first copy:

- Push the [User Tools] key.
- Touch "Maintenance"> "Auto Color Calibration"> "Previous Setting".

14. If the operator is satisfied with neither the first nor second copy:

- Enter the SP mode and do SP301 1-2 to execute process control.
- Do this procedure again from Step 2.

MUSIC Color Registration Adjustment

1. Push [User Tools].
2. Touch [Maintenance]> [Color Registration].
3. Touch [OK].

This completes color registration.

Checking the Print Quality

The print quality must be checked after installation before the customer starts to use the machine. Here is a list of the points that must be checked and adjusted if necessary.

- **Color Image Check.** Make sure that the PS test page has solid colors without imperfections (no blotches, no scratches). Confirm that the density differences in the PS test pattern are clearly visible.
- **Color Registration Check.** Make sure that the grid lines on the test pattern are superimposed correctly.
- **Ruled Line Check.** Make sure that the grid lines on the test pattern are not scratched.
- **Image Shift Check between 1st and 2nd Pages.** Print a test pattern and fold it in half vertically and horizontally. Make sure that the vertical and horizontal center lines on the printed test pattern are not shifted with respect to the fold lines.
- **Image Skew Check.** Make sure the distance between the image edge and paper edge at two points in the main-scan direction and two points in the sub-scan direction are the same.
- **Front and Rear Image Density Check.** Check printing density on the front and back of pages by checking another test print.

The procedures for each of these checks are described below.

Color Image Check

Before You Begin...

- Use "T6000 (70W)", Mondi: Color Copy 100gsm or Hammermill Color COPY digital 28 lb (105gsm) paper to check the image quality of the printout.
- To do these checks at installation, use the accessory paper provided with the machine

Procedure

1. Turn on the main power switch.
2. Press the "Fiery" tab on the LCD.
3. Press the "Printable Info" button.
4. Press the "PS Test Page" button, and then the "OK" button.



5. Confirm that each 100% pattern [A] has a solid color without imperfections (no blotches, no scratches).
6. Make sure that the difference in the density between the 60% [B] and 50% [C] patterns is clearly obvious.

Recovery

Do one or both of these procedures if you see a problem on the printout.

1. If you detected a solid color problem in the 100% patterns, enter the SP mode, and then execute process control manually with SP301 1-2 (Density Adjustment).
2. If you could not see any difference between the 50% and 60% patterns, execute color calibration with the "Fiery Controller".

Color Registration Check

Procedure for Copier (D074/D075)

1. Turn on the main power switch.
2. Set a sheet of paper on the original tray of ADF.
3. Enter the SP mode and then select SP2109-3.
4. Select Pattern 8 (Grid Pattern Large), and then touch [OK].
5. Do **SP5070-1** (Switching Print Application), select "3" (Copy), and then touch "COPY Window".
6. Select a paper Tray and print mode (simplex or duplex).
7. Select the "Full Color" mode.

★ Important

- Make sure that the "Full Color" mode is selected. Otherwise, the color registration check cannot be done correctly.

8. Press the [Start] key on the operation panel.
9. Confirm that the grid lines for each color are superimposed correctly.

Recovery

Do this procedure if you see the lines do not overlap correctly.

1. Exit from SP2109-3 and then select **SP3011-4** (Full MUSIC).
2. Do SP2109-3 to print out Grip Pattern Large and then check the test pattern again.

Procedure for Printer (M044)

1. Turn on the main power switch.
2. Enter the SP mode and then select **SP2109-3**.
3. Select Pattern 8 (Grid Pattern Large), and then touch [OK].
4. Press the "APL Window" button at the top of the LCD.
5. Select a paper tray and print mode (simplex or duplex).
6. Prepare the PC for printing.
7. Print a test page with the Fiery printer driver.
8. Confirm that the grid lines for each color are superimposed correctly.

Note

- Do not use the [Print] button on the LCD to print the test pattern. Only a black and white image will be output if you use the [Print] button on the LCD. The color registration check requires a color image output.
- Make sure that the test page has black, red, green, and blue colors.

Recovery

Do this procedure if you see the lines do not overlap correctly.

1. Exit from SP2109-3 and then select **SP3011-4** (Full MUSIC).
2. Do SP2109-3 to print out Grip Pattern Large and then check the test pattern again.

Ruled Line Check

Before You Begin...

- Use "T6000 (70W)", Mondi: Color Copy 100gsm or Hammermill Color COPY Digital 28 lb (105gsm) paper to check the image quality of the printout.
- To do these checks at installation, use the accessory paper provided with the machine.

Procedure for Copier (D074/D075)

1. Turn on the main power switch.
2. Set a sheet of paper on the original tray of ADF.
3. Enter the SP mode and then select **SP2109-003**.

4. Select the Pattern No. 8 (Grid Pattern Large), and then touch [OK].
5. Print out the grid pattern sample for each single color with **SP2109-5**.

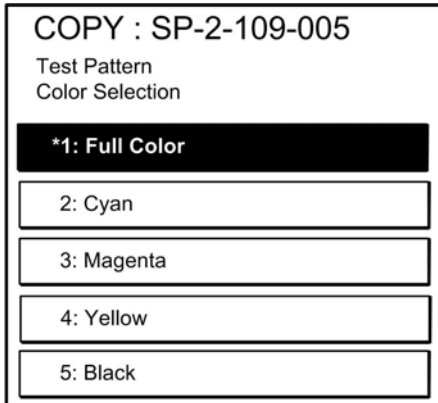

d074r988

6. Do **SP5070-1** (Switching Print Application), select "3" (Copy), and then touch "COPY Window".
7. Select a paper Tray and print mode (simplex or duplex).
8. Select the "Full Color" mode.
 - ★ **Important**
 - Make sure that the "Full Color" mode is selected. Otherwise, the color registration check cannot be done correctly.
9. Press the [Start] key on the operation panel. A grid pattern prints for the selected color.
10. Repeat this procedure for each color (2: C, 3: M, 4: Y, 5: K).

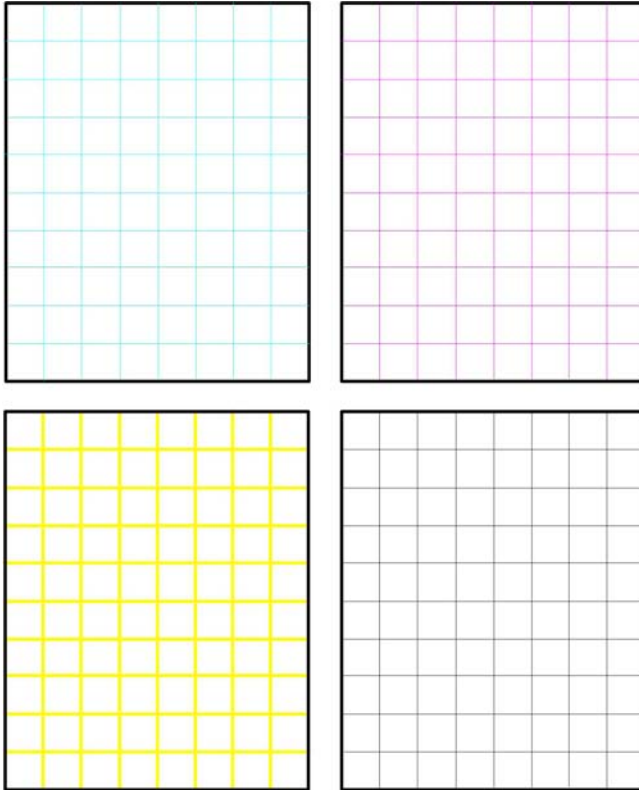

d074r994

11. Check that the grid lines for each single color test pattern are not scratchy.

Recovery

Do this procedure if you see any scratches in the lines.

1. Enter the SP mode and execute **SP3011-2** (Density Adjustment).
2. Repeat the Ruled Line Check.

Procedure for Printer (M044)

1. Turn on the main power switch.
2. Enter the SP mode and then select **SP2109-3**.
3. Select Pattern 8 (Grid Pattern Large), and then touch [OK].
4. Print out the grid pattern sample for each color with **SP2109-5**.
5. Press the "APL Window" button at the top of the LCD.
6. Select a paper tray and print mode (simplex or duplex).
7. Prepare the PC for printing.
8. Print a test page with the Fiery printer driver. A grid pattern prints for the selected color.
9. Repeat this procedure for each color (2:C, 3:M, 4:Y, 5:K).

10. Confirm that the grid lines for each color test pattern are not scratched.

Note

- Do not use the [Print] button on the LCD to print the test pattern. Only a black and white image will be output if you use the [Print] button on the LCD. The color registration check requires a color image output.
- Make sure that the color is correct for each test pattern.

2

Recovery

Do this procedure if you see the lines do not overlap correctly.

1. Exit from SP2109-3 and then select **SP301 1-4** (Full MUSIC).
2. Do SP2109-3 to print out Grip Pattern Large and then check the test pattern again.

Image Shift Check between the 1st and 2nd Pages

Before You Begin...

- Use "T6000 (70W)", Mondi: Color Copy 100gsm or Hammermill Color Copy Digital 28 lb (105gsm) paper to check the image quality of the printout.
- To do these checks at installation, use the accessory paper provided with the machine

Procedure

1. Turn on the main power switch.
2. Press the "User Tool" button, and then the "Adjustment Settings for Skilled Operators" button.
3. **For the D074/D075 only:**
 - Select "0703: Switch Print Screen"
 - Select "Printer", then touch [OK] (Default: Copy).
4. Select "0101:Adjust Image Position With Feed Direction".
5. Press the "To Print Screen" button on the top of the LCD.
6. Select Tray and duplex print mode.
7. Press the [Print] button, and then [OK] to print the "Adjustment Printing" test pattern.

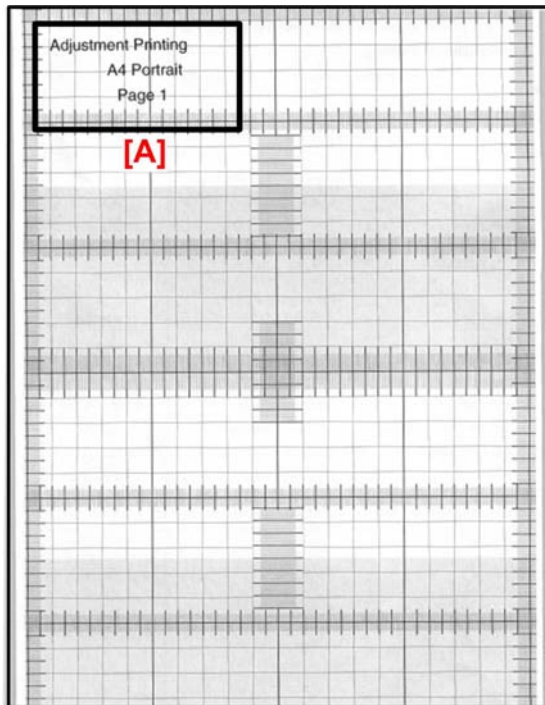

g178r916

Note

- The information [A] indicates the paper size and side (1st or 2nd).

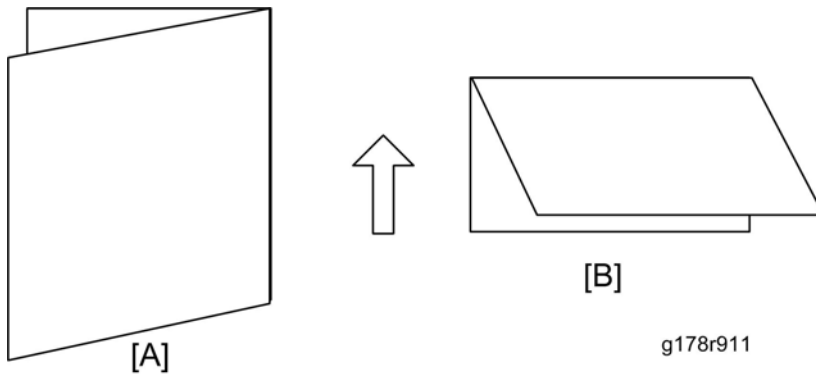

g178r911

8. Fold the printed test pattern in half vertically [A] and horizontally [B].

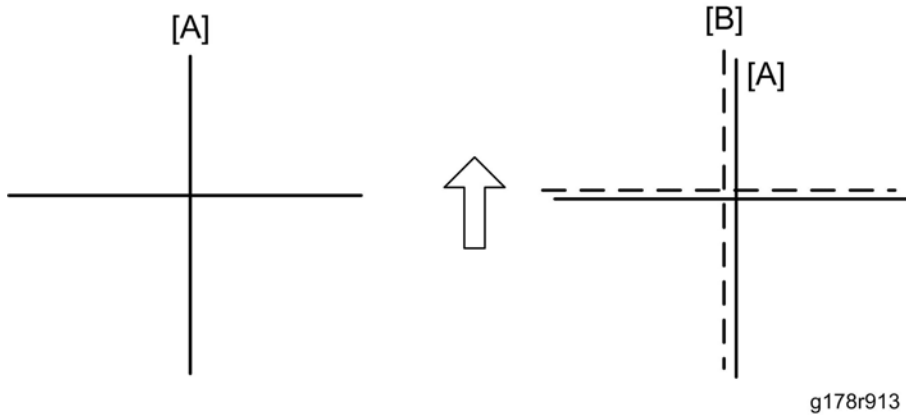

9. Check the vertical and horizontal center lines [A] on the 1st page of the printed test pattern (shown as solid lines in the above diagram).
 - Make sure these lines are not shifted away from the fold lines [B] (shown as dotted lines in the above diagram).
 - Acceptable shift range: ≤ 1 mm
 - The diagram on the left above shows no image shift.
 - The diagram on the right shows a test pattern where the lines have shifted.
10. Check the 2nd side of the test pattern to see if the lines have or have not shifted as on the 1st page. Acceptable shift range: ≤ 1 mm

Before You Begin Adjustment

- Adjustments for sub-scan shift and main-scan shift are required at machine installation.
- To adjust the sub-scan shift and main-scan shift, use the user program mode or SP mode described below.
- The adjustment for sub-scan shift can be done for each paper weight.
- The adjustment for main-scan shift can be done for each paper tray.

Adjustment

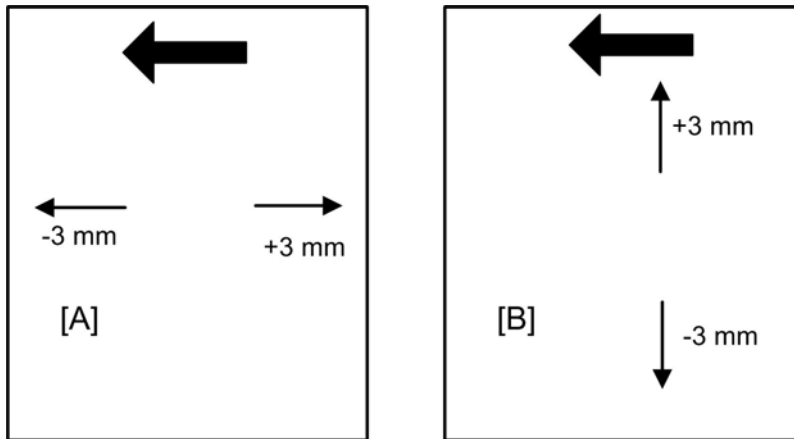

g178r914

1. Adjust the sub-scan shift [A] on the 1st page with "0101:Adjust Image Position With Feed Direction" of the UP Skilled Operators mode or **SP1001-001** to -007.
2. To adjust the sub scan shift [A]:

Use "0101: Adjust Image Position With Feed Direction" on the Skilled Operators mode to adjust the sub scan shift.

-or-

Execute SP1001-1 to 7.

- Enter a minus (-) value to shift the image towards the leading edge.
- Enter a plus (+) value to shift the image towards the trailing edge.

3. To adjust the main-scan shift [B] on the 1st and 2nd pages:

Use "0102:Adjust Image Position Across Feed Direction" in the Skilled Operators mode

-or-

Execute SP1003-1 to 7.

- Enter a minus (-) value to shift the image towards the front edge.
- Enter a plus (+) value to shift the image towards the rear edge.

4. Print out the test pattern in the User Tools mode and then check the printed test pattern.

↓ Note

- Side 1 and Side 2 can be adjusted together in the Skilled Operator mode with this machine.
- If fine adjustment is needed, we recommend using the Custom Paper Profile.
- Side 1 and Side 2 can be fine adjusted separately (main scan, sub scan, magnification) with the Custom Paper Profile feature described below.

Adjustment with Custom Paper Profile

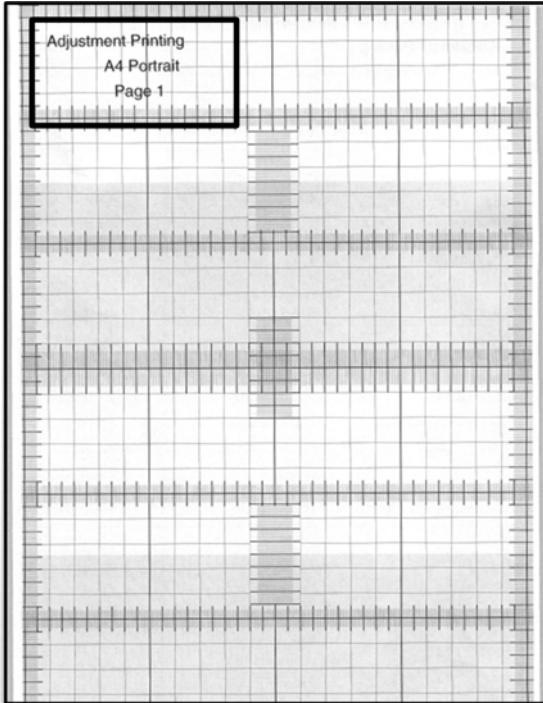

g178r916a

The main does not use the Custom Paper Profile when it prints the pattern above.

Tray image adjustment is done using the Custom Paper Profile after image shift is checked in the customer print job, and then adjustment is done in Advanced Settings.

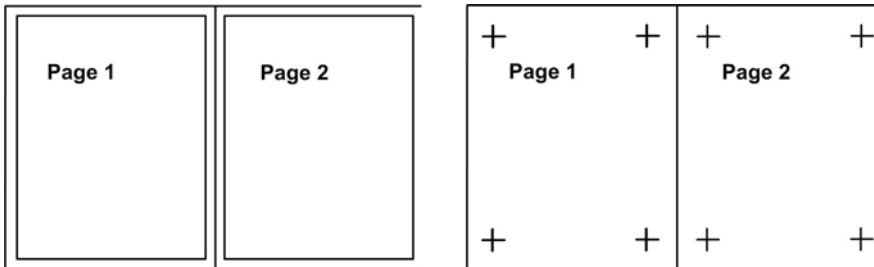

d074r989

The frame and crop mark data are printed on both sides of the paper when a print job is done to check the amount of shift between the front and back of the paper

Procedure

1. Before you start, check the content of the duplex printed paper of the tray for which the adjustment is to be done.
2. On the operation panel touch [User Tools] > [Login], and then after logging in touch [Admin] > [Paper Setting].

3. Select the tray for which the adjustment is to be done.
4. Select the Custom Paper Profile, and then touch [Advanced Settings].

A list of items that can be adjusted is listed in the table below. For more details about adjustment ranges and other details, please refer to the "Adjustment Item Menu Guide: TCRU/ORU."

No.	Item	Description
08	Adj Image Position ofSide1 With Feed	Adjust the horizontal position of the image to be printed on the side 1 of the paper.
09	Adj Image Position ofSide2 With Feed	Adjust the horizontal position of the image to be printed on the side 2 of the paper.
10	Adj Image Position ofSide1 Across Feed	Adjust the vertical position of the image to be printed on the side 1 of the paper.
11	Adj Image Position ofSide2 Across Feed	Adjust the vertical position of the image to be printed on the side 2 of the paper.
15	Adj Magnification of Side1 Across Feed	Adjust the vertical image scaling on the side 1 of the paper according to the paper expansion or shrinkage.
16	Adj Magnification of Side1 With Feed	Adjust the horizontal image scaling on the side 1 of the paper according to the paper expansion or shrinkage.
17	Adj Magnification of Side2Across Feed	Adjust the vertical image scaling on the side 2 of the paper according to the paper expansion or shrinkage.
18	Adj Magnification of Side2With Feed	Adjust the horizontal image scaling on the side 2 of the paper according to the paper expansion or shrinkage.

5. Touch [OK] after you change a setting to save it and return to the Profile screen.
6. Do a test print and check the results.

Image Skew Check

Before You Begin...

- Use "T6000 (70W)", Mondi: Color Copy 100gsm or Hammermill Color COPY Digital 28 lb (105gsm) paper to check the image quality of the printout.
- To do these checks at installation, use the accessory paper provided with the machine

Procedure: Measurement Using the "Adjustment Printing" Test Pattern

1. Turn on the main power switch.
2. M074/M075: Open SP5070-1 (Switching Print Application), and then select "6" (Printer) (D074/D075).
3. Touch the "COPY Window" (D074/D075) or "APL Window" (M044) button at the top of the display.
4. Select a tray and the duplex print mode.
5. Touch [Print] to print the "Adjustment Printing" test pattern.

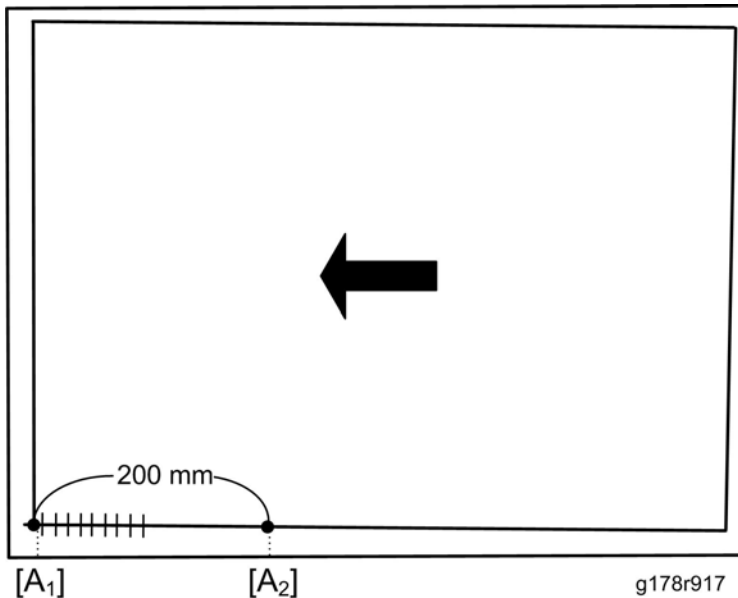

6. Measure the distance in the main scan direction between the image edge and paper edge at points [A₁] and [A₂] shown above.

Acceptable range: $[A_1] - [A_2] < \pm 0.5 \text{ mm}$ (A4 or LT SEF or more)

Procedure: Measurement Using "Trimming Area" Test Pattern

1. Turn on the main power switch.
2. Open SP5070-1 (Switching Print Application), and then select "6" (Printer) (D074/D075).
3. Do SP2109-3 and select Pattern 14 (Trimming Area), and then touch [OK].
4. Touch "COPY Window" (D074/D075) or "APL Window" (M044) at the top of the display.
5. Select a tray and the duplex mode.
6. Touch [Print] to print the Trimming Area test pattern.
7. Measure the distance in the main scan direction between the image edge and paper edge at points [A₁] and [A₂] shown above.



Acceptable range: $[A_1] - [A_2] < \pm 0.5 \text{ mm}$ (A4 or LT SEF or more)

Procedure: Adjustment

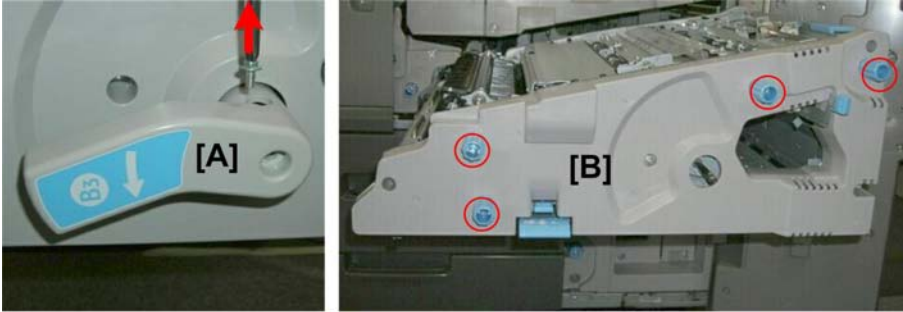
1. After checking the gap between [A₁] and [A₂] described above, turn off the power of the machine, and then pull out the power cord.
2. Pull out the right drawer until it stops.



d074r037

3. Remove handle **B3** [A] ( x1).
4. Remove the knobs [B] (x4) ( x1 each)

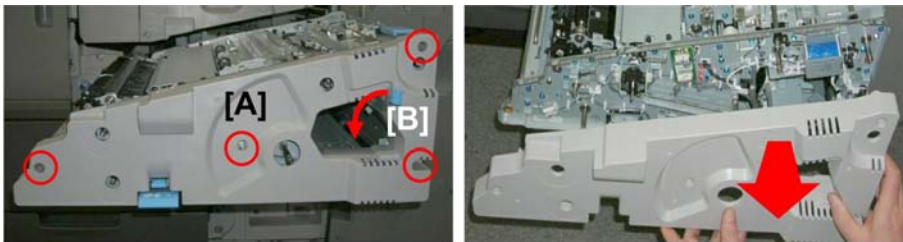

d074r038

5. Disconnect the faceplate [A] ( x4).
6. Lower plate [B] so that it floats free.
7. Remove the faceplate. You may need to release plate [B] to free the faceplate.



d074r993

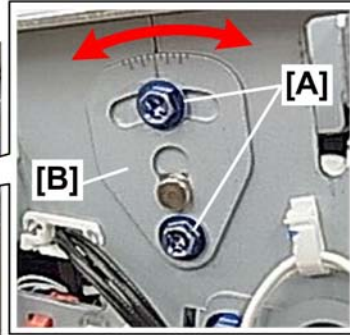

8. Loosen the screws [A] on adjustor [B].
9. Move adjustor [B] left or right to adjust the image skew.

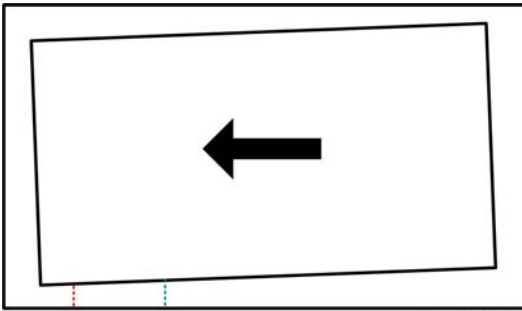

d074r993a



A1 **A2**

- If $[A1] < [A2]$ move the adjustor to the right to compensate for the size of the gap ($A2 - A1$).
One notch on the scale = 0.15 mm

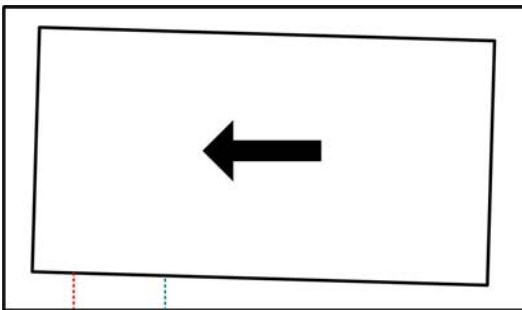

d074r993b



A1 **A2**

- If $[A1] > [A2]$ move the adjustor to the left to compensate for the size of the gap ($A1 - A2$).
One notch on the scale = 0.15 mm

10. Tighten the screws on the adjustor, and then re-assemble the machine.
11. Re-connect the power cord, and then turn on the machine.
12. Check the image skew again.

Front and Rear Image Density Check

2

Before You Begin...

- Use "T6000 (70W)", Mondi: Color Copy 100gsm or Hammermill Color COPY Digital 28 lb (105 gsm) paper to check the image quality of the printout.
- To do these checks at installation, use the accessory paper provided with the machine

Procedure for D074/D075

Do this procedure to check the ruled lines on the output.

1. Turn on the main power switch.
2. Set a sheet of paper on the original tray of ADF.
3. Enter the SP mode and open **SP2109-003**.
4. Select the No. 26 (Full Dot Pattern) in the test pattern list, and then touch [OK].

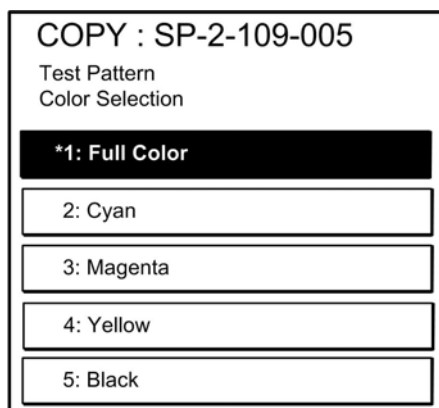

d074r988

5. Print out the solid image for each single color with SP2109-005: 2:Cyan, 3:Magenta, 4:Yellow, 5:Black.

★ Important

- Do not select "1: Full Color" when a solid image is printed out. Too much toner coverage can cause the fusing unit to malfunction.
6. Do SP5070-1 (Switching Print Application), select "3" (Copy), and then touch "COPY Window".
 7. Select a paper Tray and print mode (simplex or duplex).
 8. Select the "Full Color" mode.

★ Important

- **Make sure that the "Full Color" mode is selected. Otherwise, the color registration check cannot be done correctly.**
9. Press the [Start] key on the operation panel.
 10. Confirm that there is no difference in the density of the solid image on the front and rear for each color.

Procedure for M044

1. Turn on the main power switch.
2. Enter the SP mode and open **SP2109-3**.
3. Select Pattern No. 26 (Full Dot Pattern), and then touch [OK].
4. Print out the solid image for each color with SP2109-5 (2:Cyan, 3:Magenta, 4:Yellow, 5:Black).

★ Important

- **Do not select "1: full Color" when a solid image is printed out. Too much toner coverage can cause the fusing unit to malfunction.**
5. Touch "APL Window" at the top of the LCD.
 6. Select a paper tray and print mode (simplex or duplex),
 7. Prepare the PC for printing.
 8. Print a test page with the Fiery printer driver. A solid image prints for the selected color.
 9. Confirm that there is no difference in the density of the solid image on the front and rear for each color.

↓ Note

- Do not use the [Print] button on the LCD to print the test pattern. Only a black and white image will be output if you use the [Print] button on the LCD. The color registration check requires a color image output.
- Make sure that the color is correct for each test pattern.

Recovery

If there is a problem in the test, do these SP codes.

- **SP2113-001 (K)**
- **SP2113-002 (C)**
- **SP2113-003 (M)**
- **SP2113-004 (Y)**

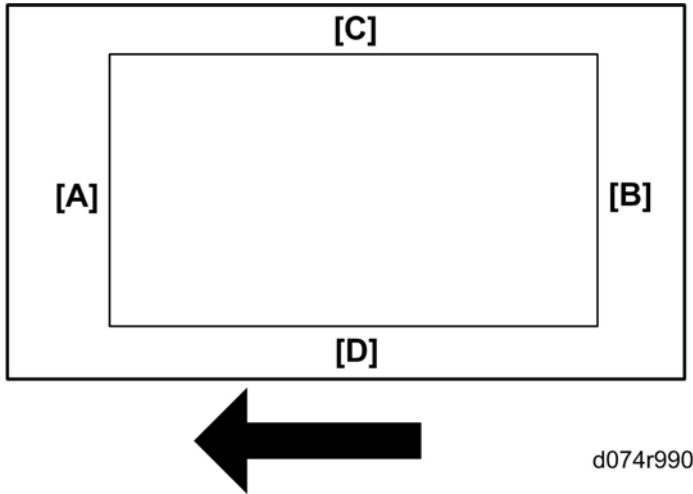

d074r990

In the illustration above the black arrow shows direction of feed and:

[A]	Leading edge
[B]	Trailing edge
[C]	Top
[C]	Bottom

Supplementary Explanation on the Front and Rear Image Density Check

Full coverage test patterns can be created using two colors for further verification of the front and rear image density check.

1. Open SP2109-3 and select a test pattern to print.
2. Open SP2109-5 and select "1" (Full Color).
3. Open SP2109-6 to 9 and confirm that each is set to default "15" (Density 100%).

SP Mode (Service)
Open All
Close All
COPY Window
SP Direct
X-XXX-XXX
Exit

2109	<input type="text" value="3"/> <input checked="" type="text" value="5"/> <input type="text" value="6"/> <input type="text" value="7"/> <input type="text" value="8"/> <input type="text" value="9"/> <input type="text" value="2111"/> ▶ <input type="text" value="2112"/> ▶ <input type="text" value="2113"/> ▶	Pattern Selection Color Selection Density: K Density: C Density: M Density: Y Forced Line Position Adj TM/P Sensor Test Adjust LR Density Difference	Group ▲ Page ▲ Line ▲ Line ▼	COPY : SP-2-109-005 Test Pattern Color Selection <div style="background-color: black; color: white; padding: 2px; margin: 2px 0;">*1: Full Color</div> <input type="text" value="2: Cyan"/> <input type="text" value="3: Magenta"/> <input type="text" value="4: Yellow"/> <input type="text" value="5: Black"/>
------	--	--	---	---

d074r991

For example, if you do the test prints with the settings below, the two colors of the C and Y toner will create full-green coverage.

- Select SP2109-003 "No.26 (Full Dot Pattern)".
- Select SP2109-005 "1" (Full Color)
- Open SP2109-006 (Density: K) and -008 (Density: M), and then change both settings from "15" to "0".
- Open SP2109-007 (Density: C) and -009 (Density: Y), and then make sure that both settings are set to "15" (default settings).

TCRU Setting

If the client is participating in the TCRU program, the TCRU feature must be initialized so the TCRU setting menus can be displayed.

1. Go into the SP mode.
2. Execute **SP5185-001** (TCRU: Set Machine).

Tray Heaters

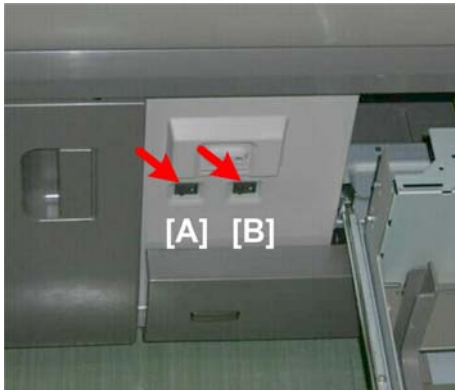

d074f978

2

There are two heater switches on the front of the machine.

- The left switch [A] controls the operation of the paper bank heaters of the main machine and the LCIT heaters. This heater prevents the collection of moisture around the paper feed trays. It should be switched on when there the machine is subject to high humidity.
- The right switch [B] controls the operation of the ITB unit heaters. This heater keeps the area around the ITB warm to facilitate cold starts. It should be switched on in areas where it is cold, especially in the early morning hours.
- If the temperature sensor (a thermostat) inside the machine will automatically shut the heaters off if the internal temperature becomes too high.

When these switches are ON:

- The heaters turn on when the main machine is turned off (or enters energy save mode).
- The heaters turn off when the main machine is turned on again (or leaves energy save mode).

When these switches are OFF:

- The heaters do not turn on when the main machine is turned off (or enters energy save mode).
- Both heaters are turned OFF before the machine leaves the factory.

When these switches are ON and SP5965-1 is set to "1", the heaters always remain on.

1. Open the top tray.
2. Press the left switch [A] to set up the main machine tray bank heaters and the LCIT heaters.
3. Press the right switch [B] to set up the ITB unit heaters.

★ Important

- Do not switch on the heaters unless they are needed.
- Please explain to the operator that while the heaters can improve machine performance when humidity is high or temperatures are low, the heaters will consume slightly more power.

- Set SP5965-1 to "1" if you want to have the heaters on at all times. Use this setting only if the work area is extremely humid or exceptionally cold.

Moving the Machine

2

The machine is extremely heavy. When it is necessary to move the machine even a short distance to re-locate it, apply pressure only on the areas that are marked with red squares in the illustrations below.

Pushing the Machine

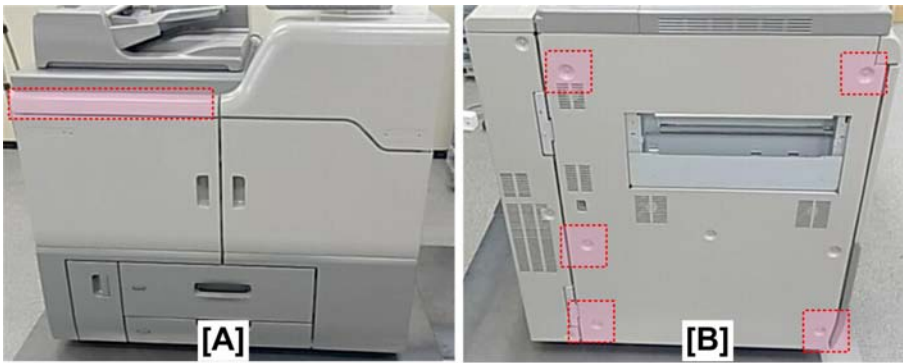

d074i893

[A]	Front
[B]	Left Side

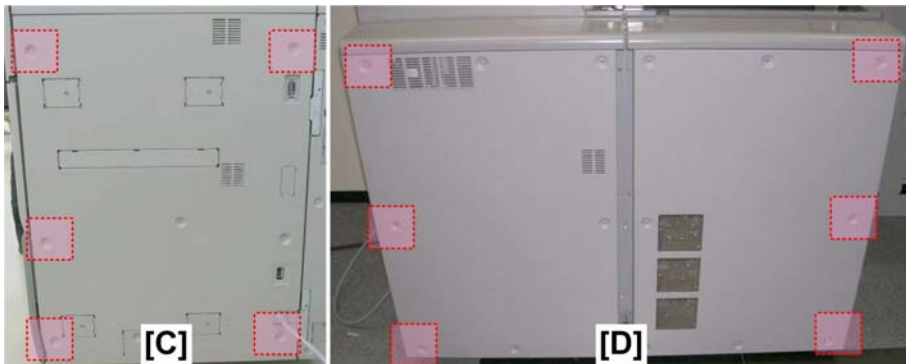

d074i894

[C]	Right Side
[D]	Rear

Removing the Rear Boxes

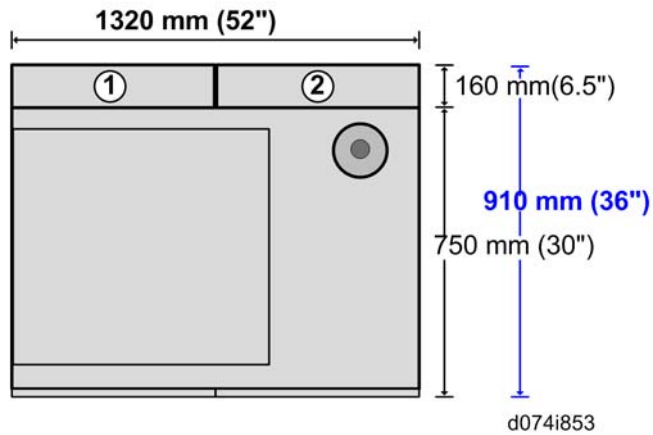

2

If the machine cannot fit through a door, the cooling box ① and controller box ② can be removed. With both boxes removed the machine is 750 mm (30 in.) wide.

Cooling Box



d074i831

1. If the ARDF is connected, disconnect it (D074/D075).

2



d074i832

2. Remove the screws on the flat edge of the cooling box door [1] ( x3).



d074i833

3. Slowly, swing the cooling box open.

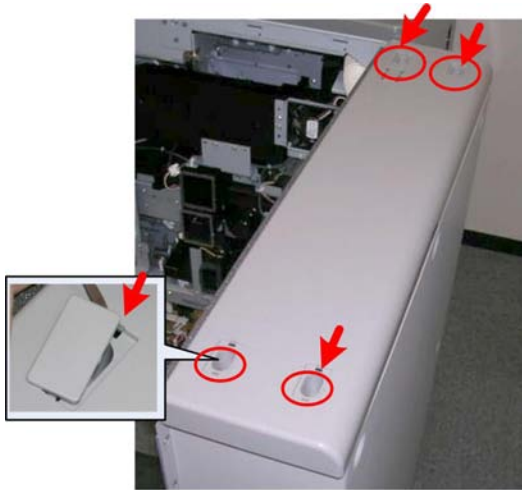

d074i834

4. On top of the box, remove the screw covers (x4) and screws ( x4).



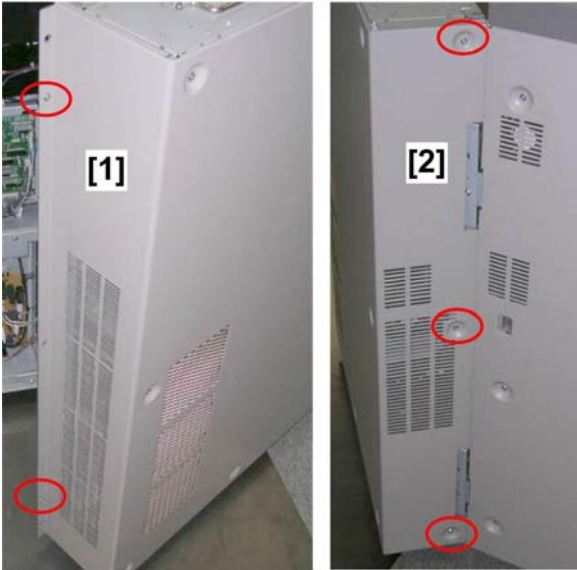

d074i835

5. Remove the top cover.



d074i836

6. On the open side of the box [1], remove the screws ( x2).
7. On the hinged side of the box [2], remove the screws ( x3).

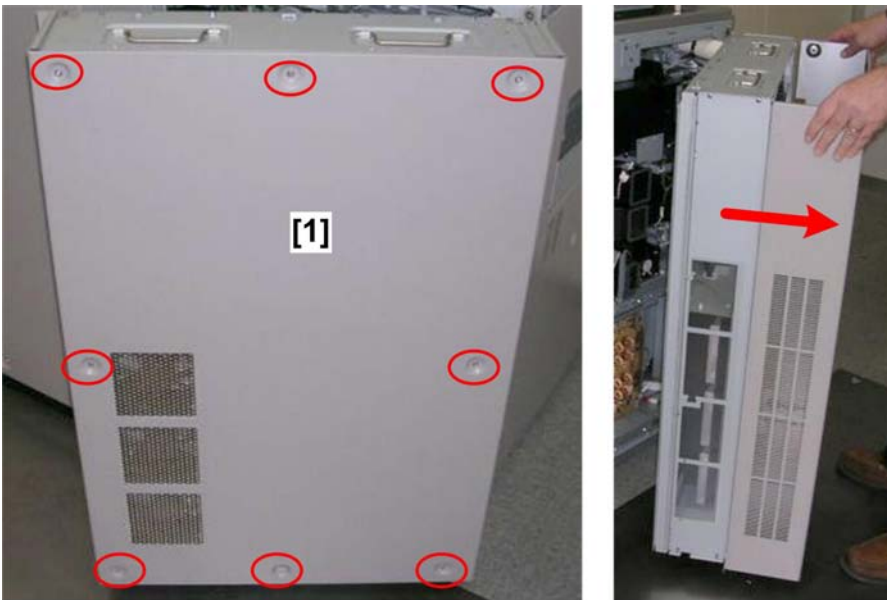

d074i837

8. On the back of the cooling box [1], remove the screws ( x8).
9. Remove the cooling box cover.

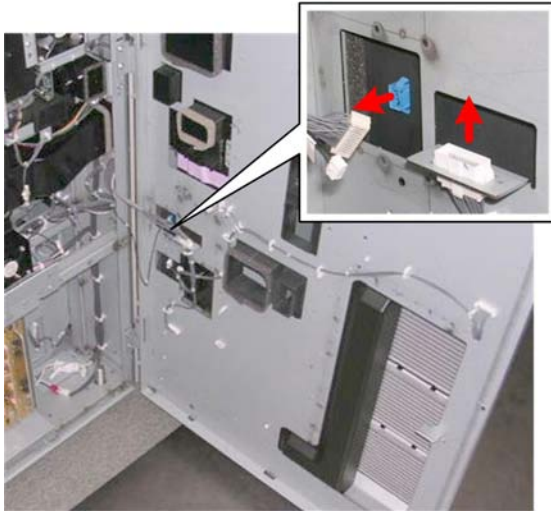

d074i838

10. Disconnect the harnesses (🔌 x2).

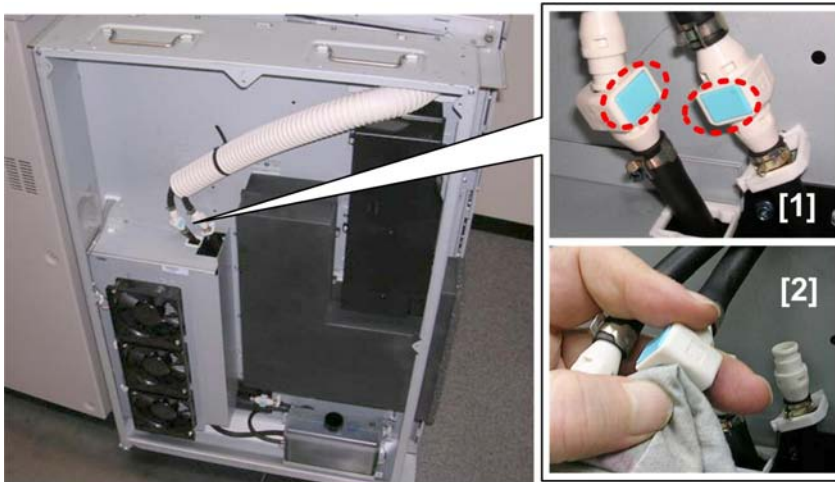

d074i839

11. Depress the release buttons [1] on both coolant hoses to disconnect them.
 12. Use a cloth to soak up any fluid leakage from the hoses.

★ Important

- There will be a small amount of leakage.
- If there is a large amount of leakage, re-connect the hoses and disconnect them again.
- Cover the ends of the hoses with a plastic bag when you move the machine, to prevent drops of the liquid from getting on the customer's floor.

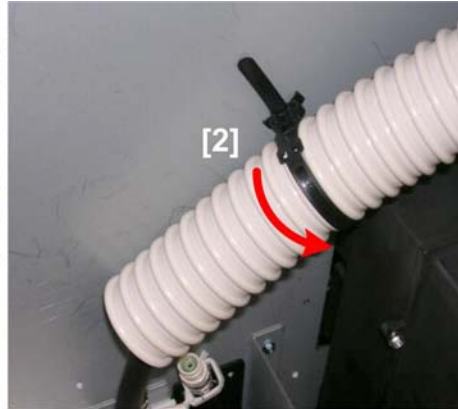
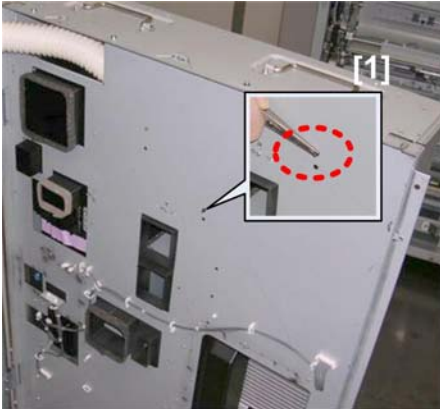

d074i840

13. On the inside panel, release the hose conduit band at [1] (⚙ x1).
14. Pull the hose conduit [2] away from the box.

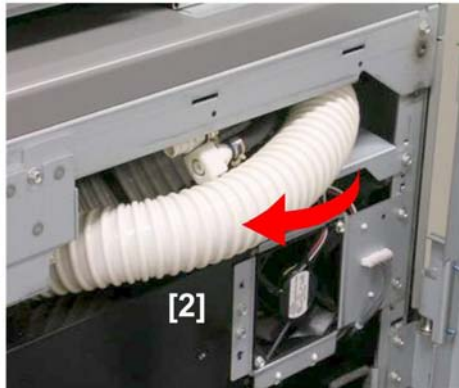

d074i841

15. Slowly pull the hose conduit and hoses [1] out of the cooling box.
16. Stow the conduit [2] inside the machine.

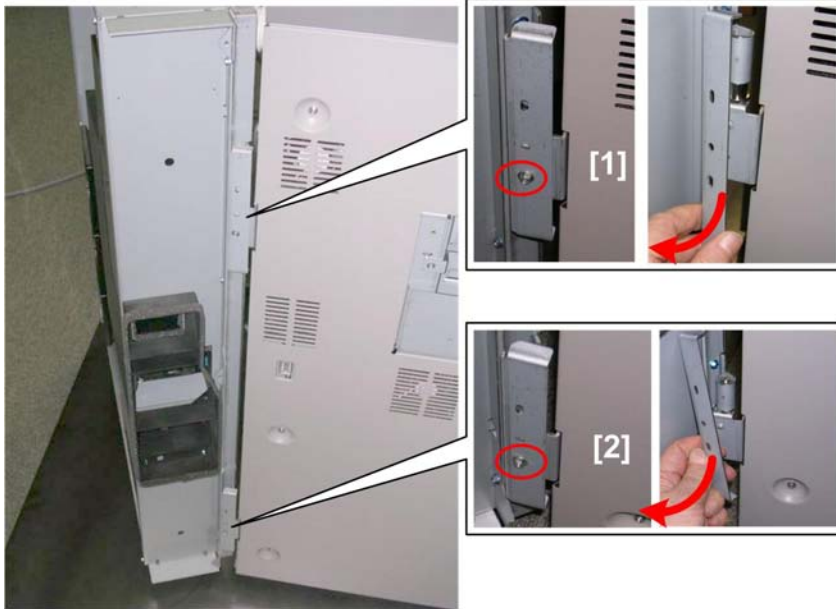

d074i842

17. Remove upper hinge cover [1] (⚙️ x1).
18. Remove lower hinge cover [2] (⚙️ x1).



d074i843

19. Raise the handles.

↓ **Note**

- The cooling box weighs about 16 kg (36 lb).

20. Lift the box off its hinges and set it down.

Controller Box

2

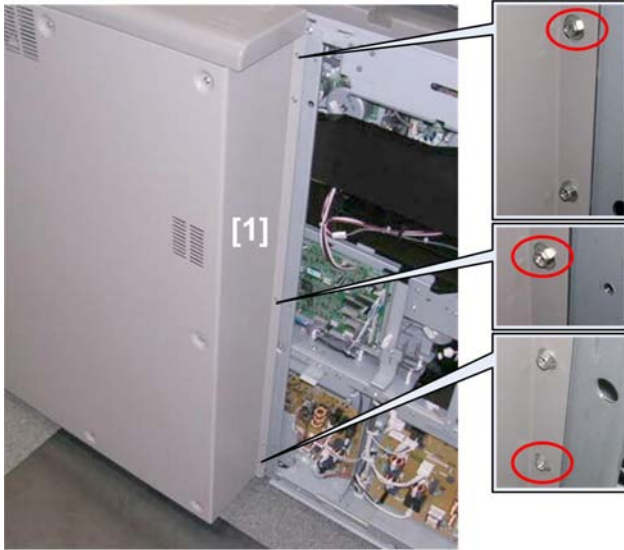

d074i844

1. Remove the screws from the flat edge of the controller box door ( x3).



d074i845

2. Slowly, swing the controller box open.



d074i846

3. On top of the box, remove the screw covers (x4) and screws ( x4).





d074i847

4. Remove the top cover.



d074i848

5. On the hinged side of the box [1], remove the screws ( x3).
6. On the open side of the box [2], remove the screws ( x2).

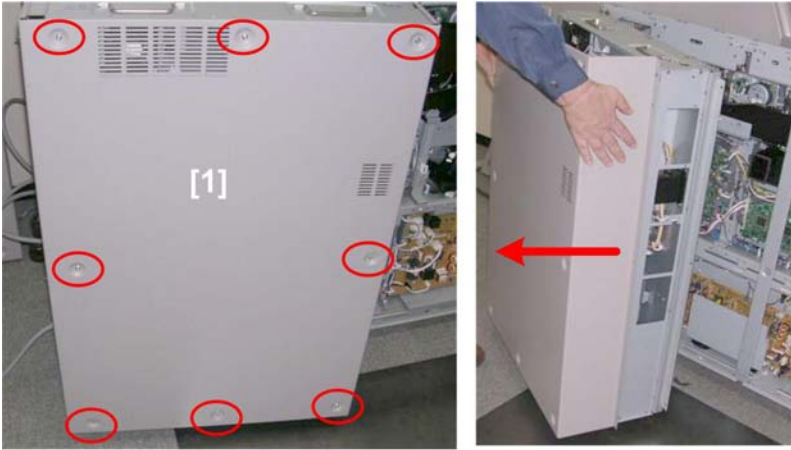

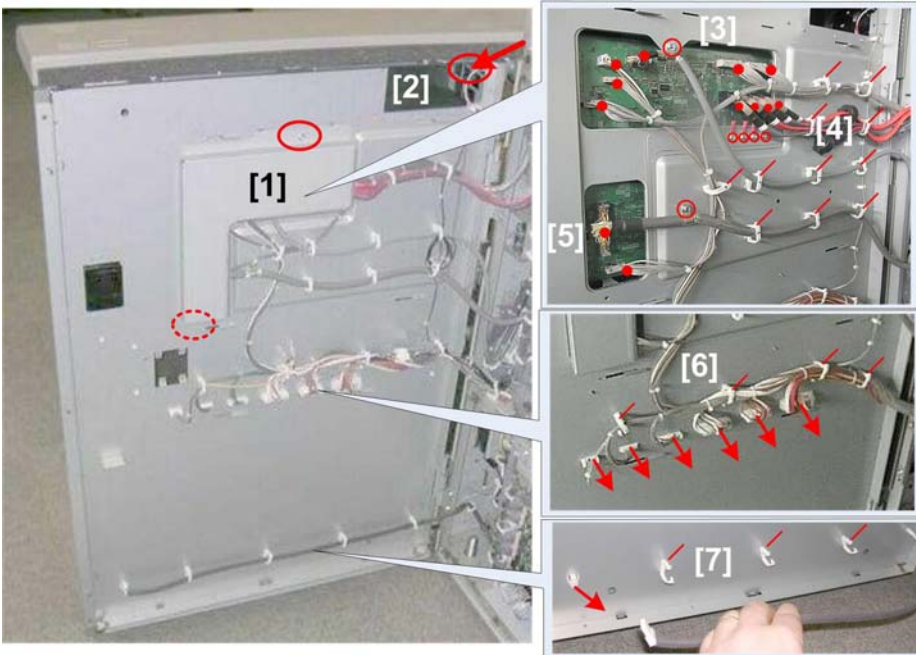

d074i849

7. On the back of the controller box [1], remove the screws ( x8).
8. Remove the controller box cover.
9. Swing the controller box open.



d074i850

10. Remove plate [1] ( x2).
11. Disconnect fan harness [2] ( x1,  x1).

★ Important

- The fan harness is thin and much smaller than the other harnesses. Be sure to disconnect it.

12. Disconnect:

[3] Harnesses (🔌 x5, 📡 x8) and the ground clamp (🔧 x1).

[4] HDD connectors and ground wires (🔌 x4, 📡 x2, 🔧 x4).

[5] Harnesses, ground wire, clamps (🔌 x2, 🔧 x1, 📡 x3).

[6] Harnesses, clamps (🔌 x6, 📡 x4)

[7] Harness (🔌 x1, 📡 x3)

⬇️ **Note**

- There are 7 fan harness connectors at [6]. They can be re-connected in any order.

13. At [7], disconnect the harness (🔌 x1, 📡 x4).

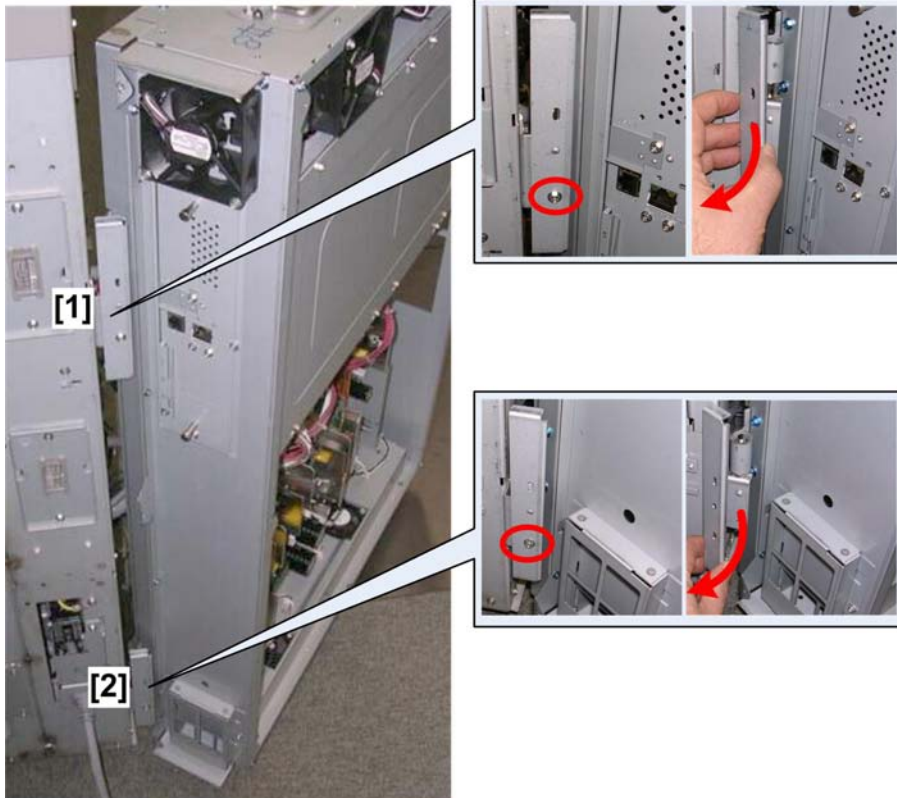

d074i851

14. Remove upper hinge cover [1] (🔧 x1).

15. Remove lower hinge cover [2] (🔧 x1).

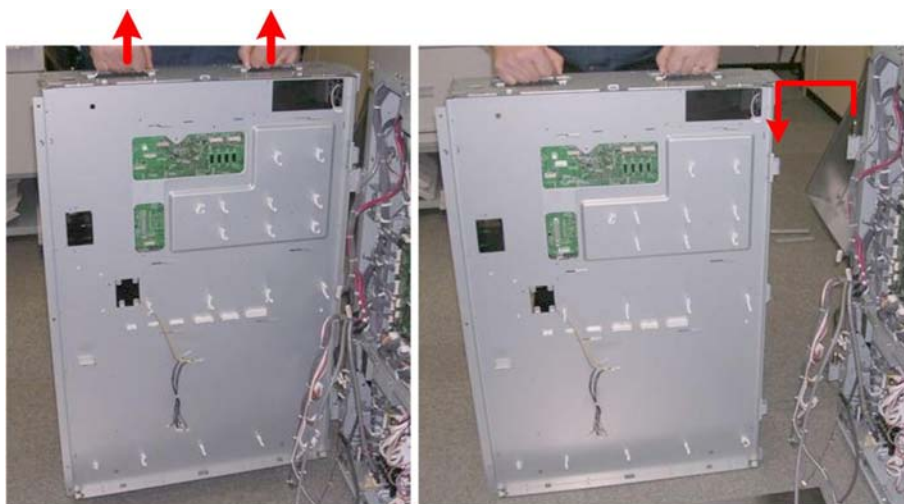

d074i852

16. Raise the handles [1].

Note

- The cooling box weighs about 21 kg (47 lb).

17. Lift the box [2] off its hinges and set it down.

A3/11"x17" Tray Unit (B331-14)

Accessories

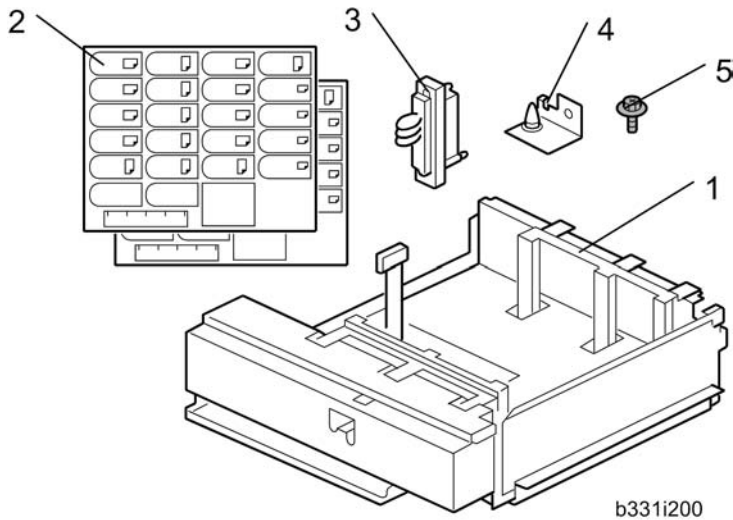

2

Check the quantity and condition of the accessories in the box against the following illustration and list.





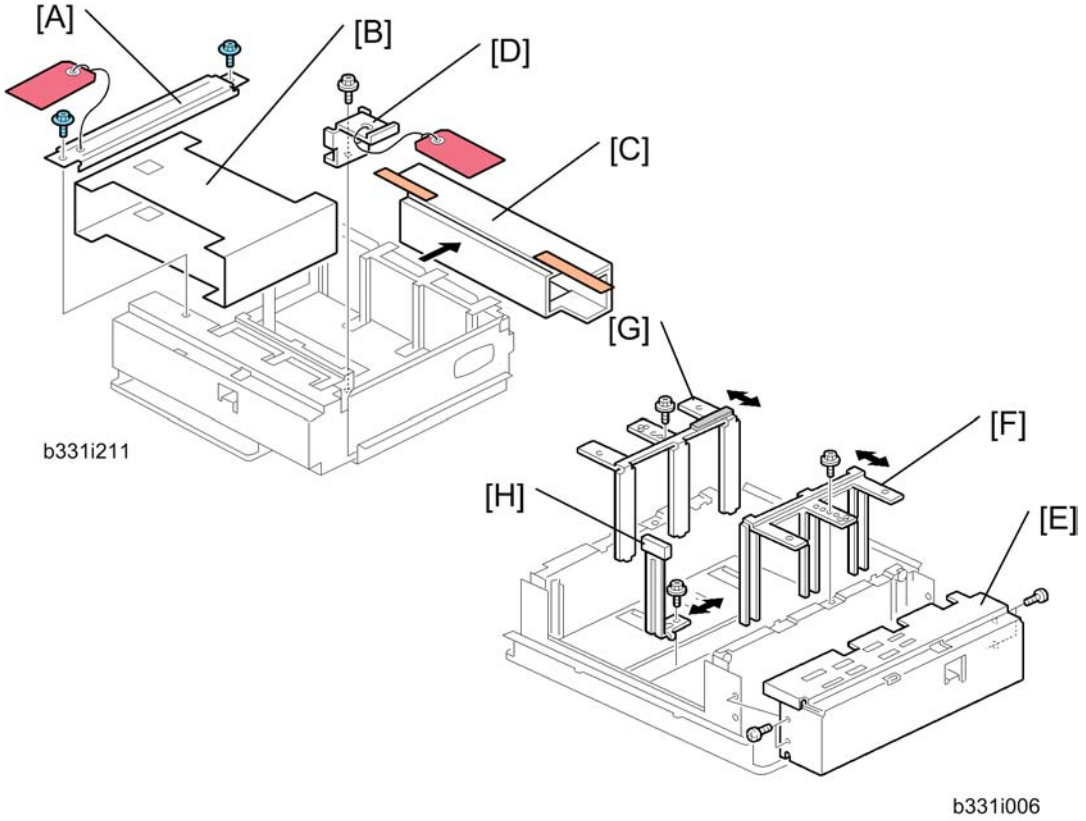

No.	Description	Q'ty
1.	A3/DLT Tray	1
2.	Paper Size Decals	2
3.	Short Connector	1
4.	Pin Bracket	1
5.	Screw	2

Installation



⚠ CAUTION

- The unit must be connected to a power source that is close to the unit and easily accessible.
- Make sure that the main machine is switched off and that its power cord is disconnected before doing the following procedures.



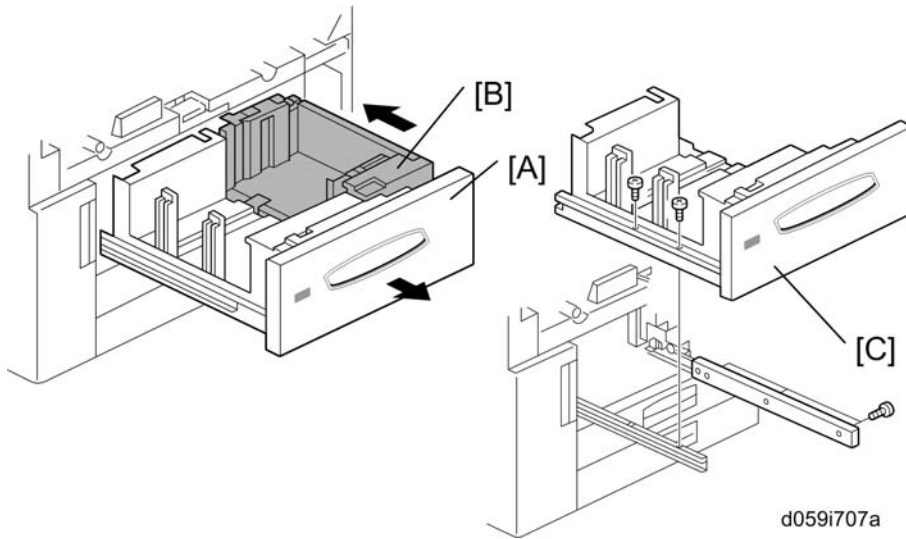

1. Remove the stay [A] ( x2).
2. Remove the retainers [B] [C] and the shipping material [D] ( x1).
3. Check the position of the front and back side fences and make sure that they are set for DLT or A3.
4. If you need to adjust the positions of the side fences for the paper to be loaded in the tray, remove the front panel [E] ( x4).
5. Remove the fences and adjust their positions for the paper to be loaded:
 - [F] Front fence ( x1)
 - [G] Back fence ( x1)
 - [H] End fence ( x1)

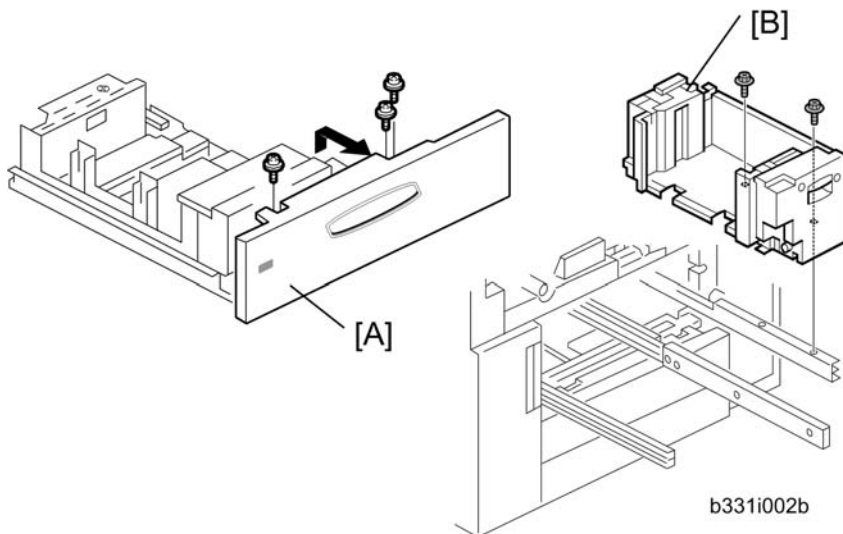

6. Open the front doors.
7. Pull out the tandem feed tray [A] completely.
8. Push the right tandem tray [B] into the machine.
9. Remove the left tandem tray [C] ( x2 left,  x3 right).



10. From the left tandem tray, remove the front cover [A] ( x3).
11. Pull out the right tandem tray [B] then remove it ( x2).

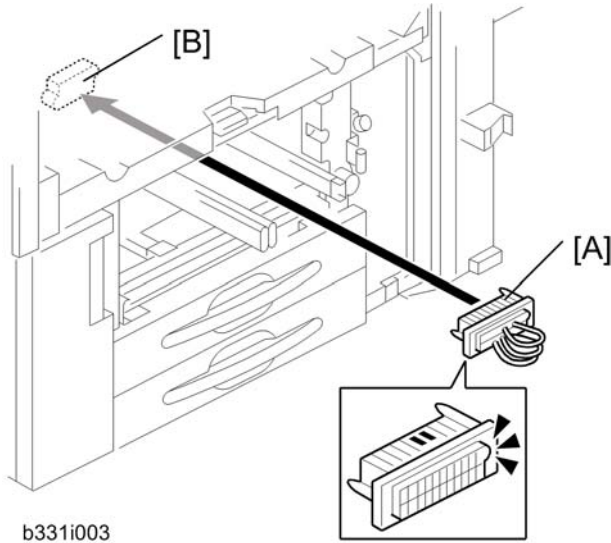

b331i003

12. Insert the short connector [A] into the socket inside the machine [B].

Note

- Hold the connector as shown in the illustration.

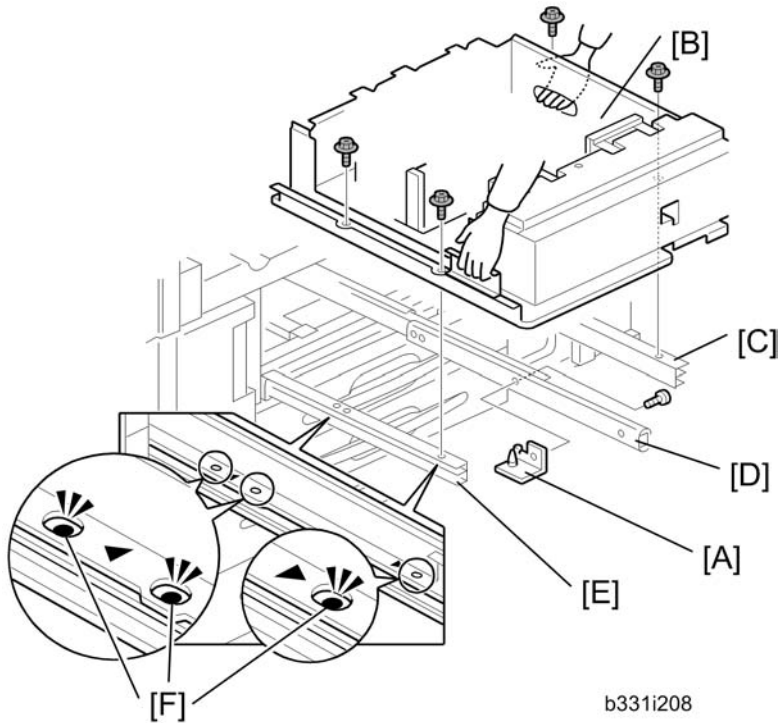

b331i208

13. Using the screw removed in Step 9, attach the pin bracket [A] to the center rail.

14. Using the screws removed in Steps 11 for the right rail and screws provided in the accessories for the left rail, install the tray [B] on the right rail [C], center rail [D], and left rail [E].

- Make sure that three screw holes [F] are visible before tightening the tray.

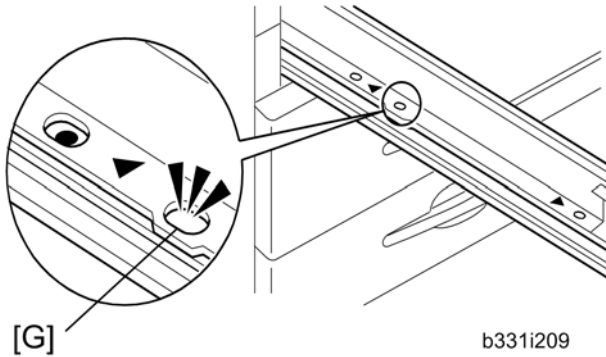

- If one of the three screw holes is not visible [G], the paper tray cannot be opened after the paper tray is closed.
- Tighten the screw holes indicated by triangle marks.
- Make sure that the pin on the bracket [C] is put through the hole in the bottom plate of the tray.

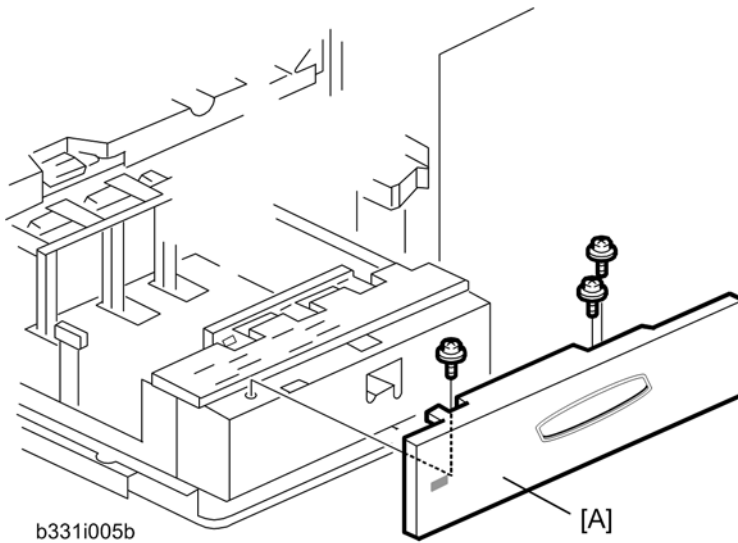

15. Re-install the front cover [A] ( x3).
16. Use **SP5959-2** to select the paper size for Tray 1 (A3 or DLT).
17. After selecting the paper size, switch the machine off and on to change the indicator on the operation panel.

Decurler Unit (D544)

Accessories

2

Check the quantity and condition of the accessories in the box against the following illustration and list.



No.	Description	Q'ty
1.	Main Board unit	1
2.	Harness A (for motor)	1
3.	Harness B (for sensor)	1
4.	Screw (M4×8)	12
5.	Clamp (Black)	1
6.	Clamp (White)	2
7.	Sheet for upper/lower path adjustment	1
8.	Safety plate	1
9.	Connector guide plate A	1

No.	Description	Q'ty
10.	Connector guide plate C	1
11.	Decurler Unit	1

Installation

2

⚠ CAUTION

- The unit must be connected to a power source that is close to the unit and easily accessible.
- Make sure that the main machine is switched off and that its power cord is disconnected before doing the following procedures.

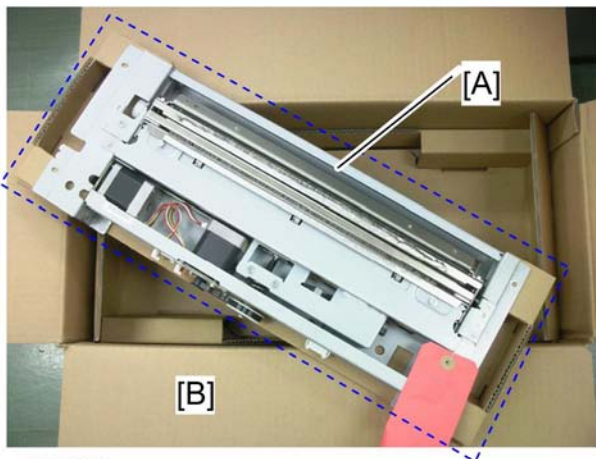

d544i029

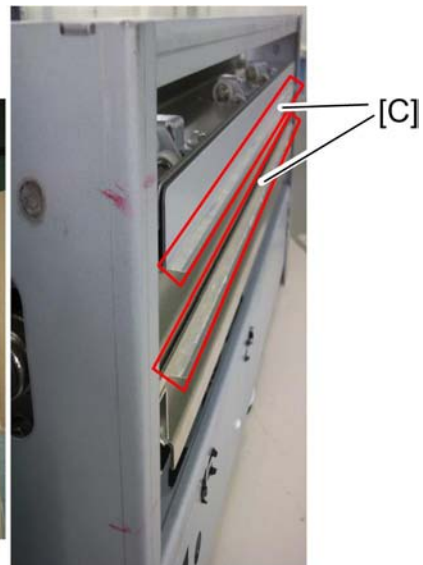

1. Prepare a place to lay the Decurler Unit [A].
2. Lay the Decurler Unit [A] on the carton box [B] as shown above so that the entrance gate of the decurler unit does not touch any object or the floor.
 - Keep this position before attaching this unit to the main machine.

⚠ CAUTION

- Do not lay the Decurler Unit on the floor with the entrance gate of the decurler unit facing downward. Otherwise, the mylars [C] on the entrance gate may be bent or folded.

2



d544i002

3. Remove the left cover of the main machine ( x7).

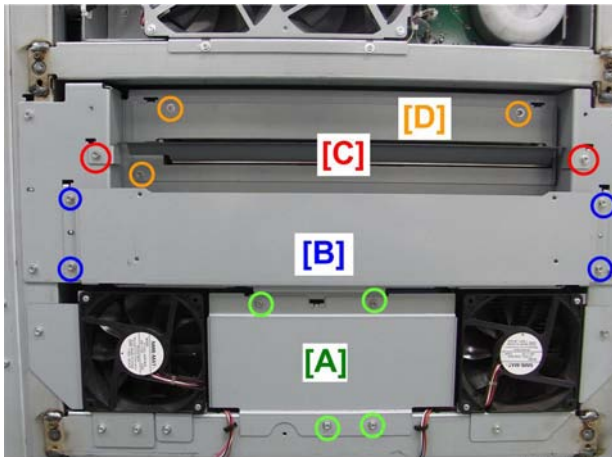

★ Important

- Support the cover with your hand when you remove the last screw, to prevent the cover from falling.



d544i003

4. Remove:

- [A] Bracket ( x4).
- [B] Side stay ( x4).
- [C] Guide plate ( x2).

[D] Noise reduction plate ( x3).

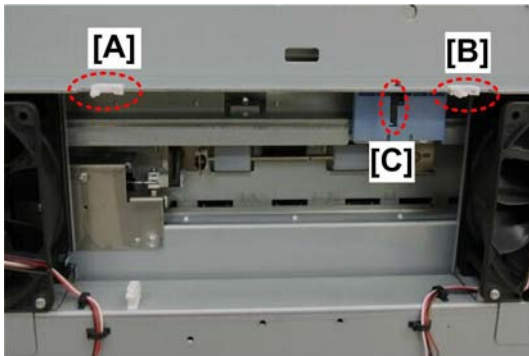

d544i004

5. Attach **white** clamps [A] and [B] ( x2).

6. Attach **black** clamp [C] ( x1).

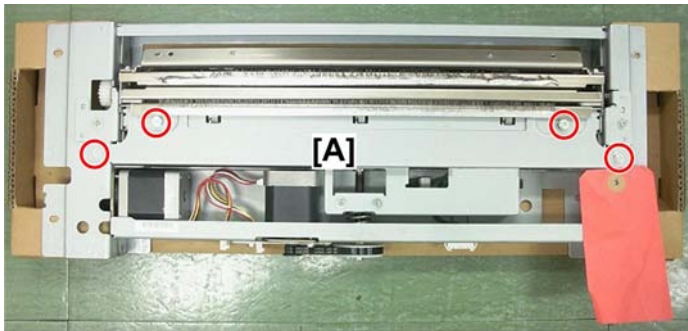

d544i027

7. Remove shipping plate [A] from the Decurler Unit ( x4).

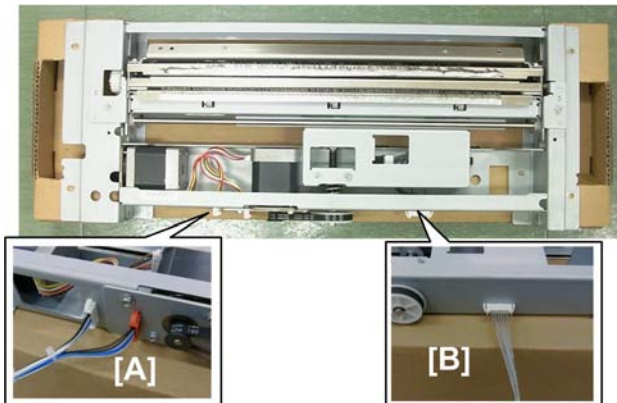

d544i005

8. Lay the Decurler Unit down at the location prepared in Step 1.

9. Connect accessory harness A at [A] ( x2).

★ Important

- The connectors at [A] have the same shape. Connect the white connector on the left (white-to-white) and the red connector on the right (red-to-red) as shown above.

10. Connect accessory harness B at [B] (🔧 x1).

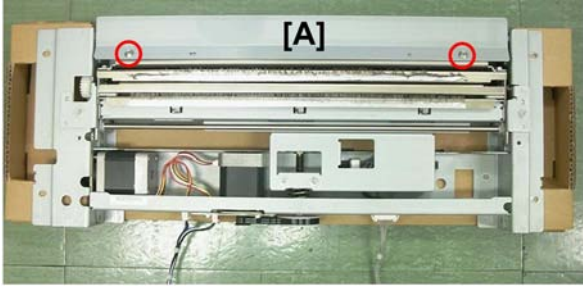

d544i006

11. Align the safety plate [A] with the embossed guide and fasten it (🔧 x2).

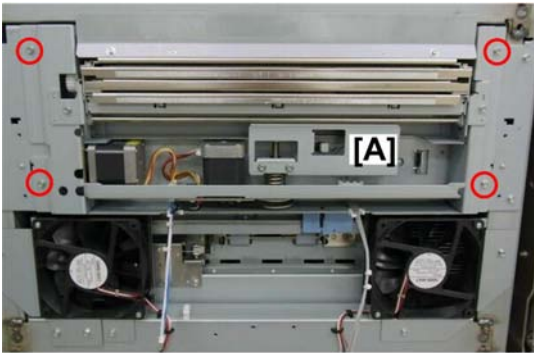

d544i007

12. Install the Decurler Unit [A] on the left side of the main machine (🔧 x4).

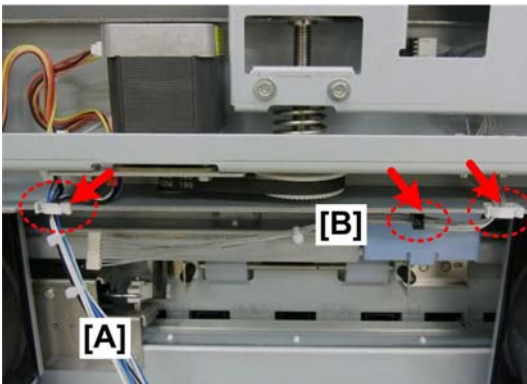

d544i008

13. Route accessory harness A [A] (for the motor) through the white clamp, and close the clamp (🔧 x1).

14. Route accessory harness B [B] (for the sensor) through the black clamp and the white clamp, and close the clamps (🔧x2).

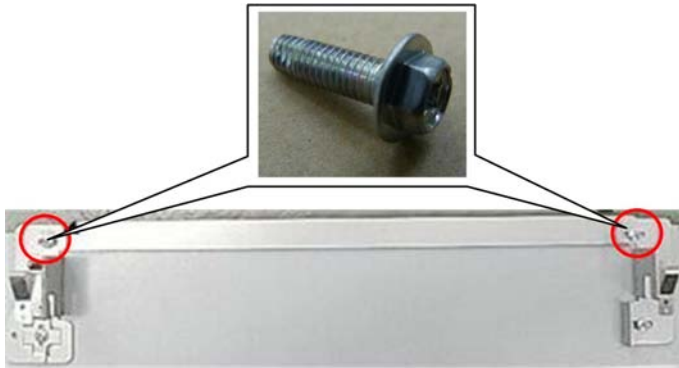

d544i009

15. On the front side at both ends of the connection bracket of the first downstream unit, remove the screws and replace them with the accessory screws provided (🔧 x2 M4x8).

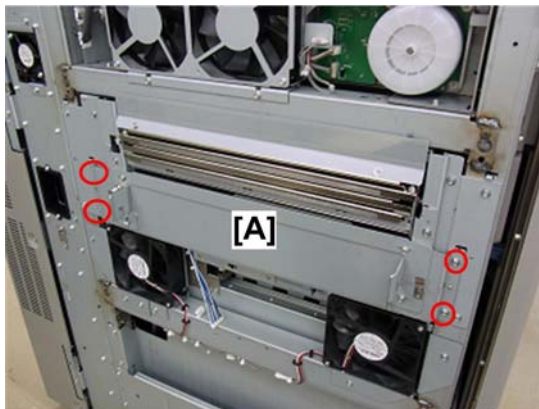

d544i028

16. Re-attach the bracket [A] (🔧 x4).

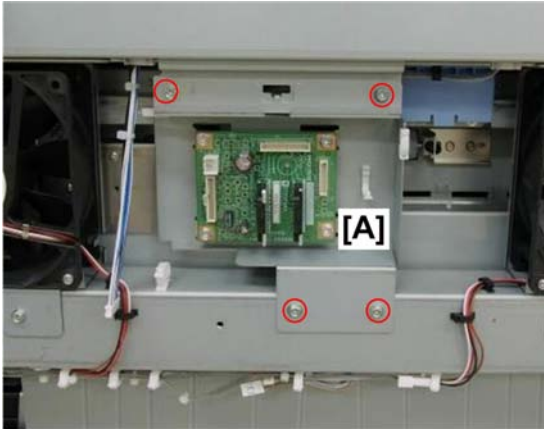



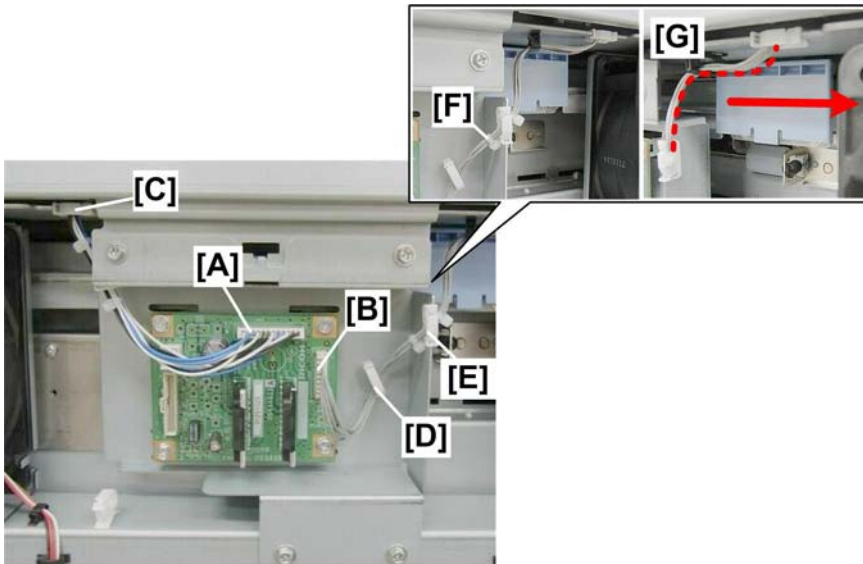

d544i010

17. Align the bracket [A] of the board unit with the embossed guide and fasten it ( x4).



d544i011

18. Connect accessory harness A at [A] ( x1).
19. Connect accessory harness B at [B] ( x1).
20. Route harness A through white clamp [C] and close the clamp ( x1).
21. Route harness B through clamps [D] and [E] and close the clamps ( x2).
22. At [F], make sure that the band is on the left side of the clamp.

★ Important

- There must be no slack in harness B at [G]. This prevents the harness from interfering with the left drawer when it is pulled out.

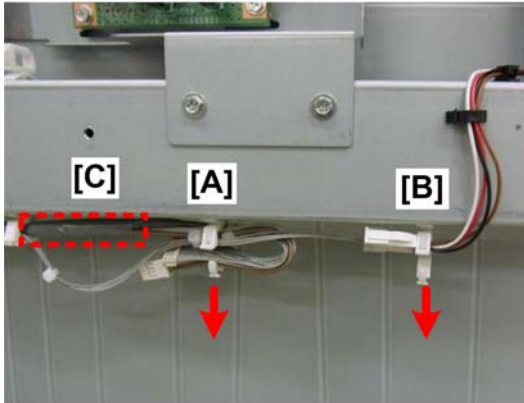

d544i025

23. Release the unconnected harnesses at [A] and [B] from the main machine (🔧x2).

★ **Important**

- Do not remove the heavy tape at [C]. This tape prevents the harnesses from interfering with re-installation of the left cover.

24. Close the clamps again around the connected fan harnesses.

★ **Important**

- These fan harnesses must be clamped correctly at their original positions.

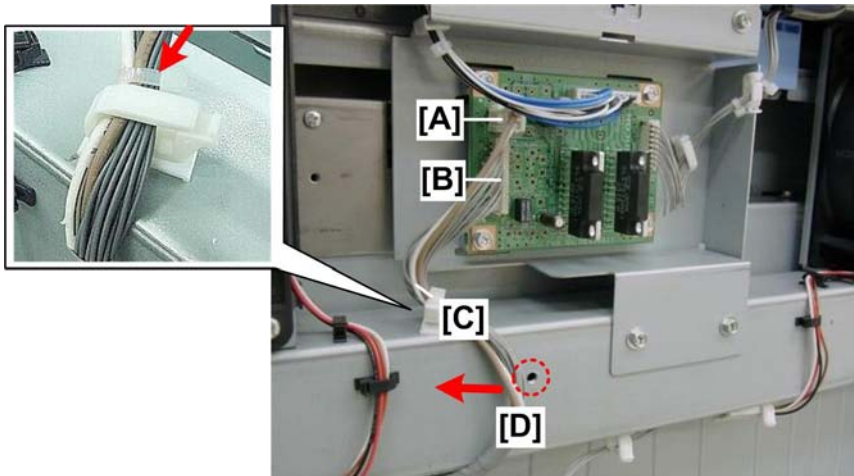

d544i026

25. Connect the harnesses [A] and [B] to the board (🔧x2).

26. Clamp the harness at [C] (🔧x1).

27. Check the following:

- Make sure that the sealed band on the harness [C] is positioned above the clamp as shown above.

- The taped portion of the harness [D] should be positioned away from the right cover screw hole as shown. This prevents the harness from interfering with re-installation of the cover.

Installing the Guide Plate

★ Important

2

- There are two connector guide plates "A" and "C".
- You must select the correct guide plate for the peripheral unit that will be connected to the left side of the main machine.
- Each guide plate is marked to tell you which guide plate to install. Refer to the table below.

Downstream Unit	Letter Embossed on Plate
Multi Folding Unit	A
Ring Binder	
Cover Interposer Tray	
Finisher (D512 or D513)	C
High Capacity Stacker	
Buffer Pass Unit	Not Required

1. If the Buffer Pass Unit is to be installed, skip this section and go to the next section.

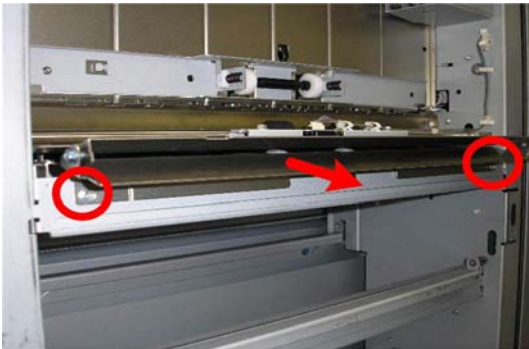

d999i013

2. Remove the guide plate from the right side of the downstream unit ( x2). **Keep these screws in a safe place!**



3. Select the correct guide plate ("A" or "C") for the peripheral unit. The guide plate in the illustration above is marked "A" (for Multi Folding Unit, Ring Binder, or Cover Interposer Tray).



4. Attach the guide plate with the screws removed in Step 2.

When you attach guide plate **A** to the downstream unit:

- There are two sets of holes on guide plate **A**.
- Attach the screws to the outer holes (marked above by the red arrows) if the next downstream unit is the Multi Folding unit.
- Attach the screws to the inner holes (marked by the blue arrows) if the Ring Binder or Cover Interposer Tray is the next downstream unit.

SP Settings

1. Switch on the machine and enter the SP mode.

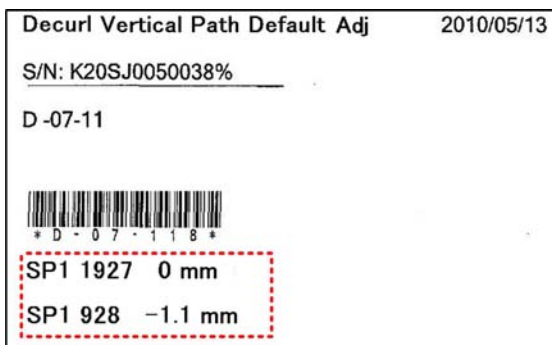

2. Refer to the accessory sheet and enter the settings for SP1927 and SP1928.
3. Exit SP mode and turn off the main machine.

Docking

2



d999i018

1. Connect the downstream peripheral unit to the main machine.
2. Dock the downstream peripheral unit.
3. Turn on the main machine.
4. Make sure that the front door of the main machine and decurler unit are both closed.
5. Do **SP5804-210**. This sets the upper path in the decurler unit as the default paper path.

★ Important

- If either door is open when you execute SP5804-210, the machine will issue SC593.
- In this occurs, execute SP5804-209, make sure both doors are closed, then cycle the machine off/on and execute SP4804-210 again.

6. Turn off the main machine.
7. Check if the upper path of the decurler unit is positioned as the default paper path.

↓ Note

- Two procedures are described below. Do the procedure for whichever peripheral unit you are installing.

Guide Plate A

Follow this procedure if plate "A" is installed for:

- Multi Folding Unit
- Ring Binder
- Cover Interposer Tray

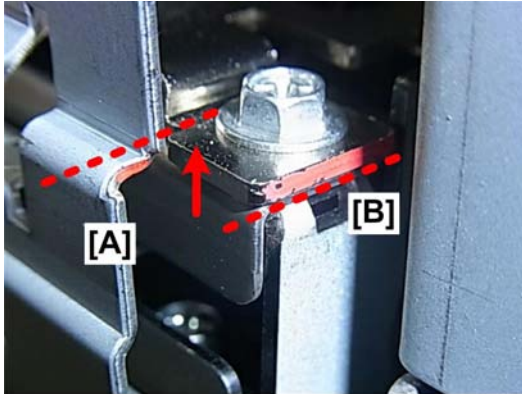

d999i020

1. Look down between the machine and unit and locate the red reference points.
 - [A] is the red reference point on the downstream unit.
 - [B] is the red reference point on the Decurler Unit.
2. Remove the rear cover of the peripheral unit.
3. Adjust the leveling bolts on the left side of the main machine (front and rear corners) until reference points [A] and [B] are at the same height.

Guide Plate C

Follow this procedure if plate "C" is installed for:

- High Capacity Stacker
- Finisher (D512 or D513)

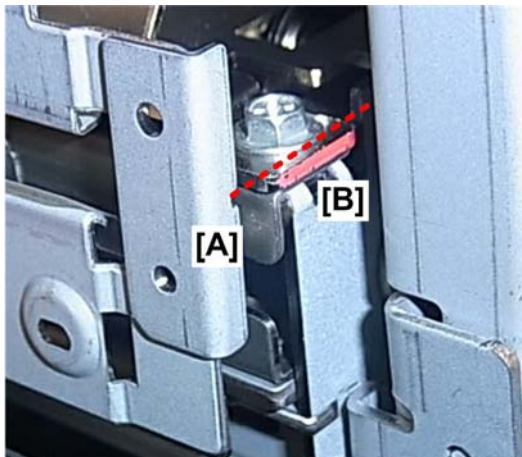

d999i021

1. Look between the machine and unit and locate the reference points.
 - [A] is the cutout on **guide plate C** attached to the main machine.
 - [B] is the red reference point on the on the Decurler Unit.

2. Remove the rear cover of the finisher.
3. Adjust the leveling bolts on the left side of the main machine (front and rear corners) until the cutout [A] and reference point [B] are at the same height.

Curl Correction

2

SP Mode Adjustments

Turn on the machine and do some test prints and check for excessive curling.

★ Important

- Do test prints with paper feed from each paper tray.



d999i022



d999i023

Back Curl [A]

Back curling (convex curling) occurs when the leading and trailing edges of the sheets curl under.

Face Curl [B]

Face curling (concave curling) occurs when the leading and trailing edges of the sheets curl up.

Curl Correction

Curl correction is done with settings in the SP mode. There are six SP codes for curl correction, one for each paper tray.

Paper Source		SP No.	Range
Tray 1	1st Tray: Main Machine	SP1906 001	[0 to 5 / 3 / 1]
Tray 2	2nd Tray: Main Machine	SP1906 002	
Tray 3	Top Tray: LCIT	SP1906 003	
Tray 4	Middle Tray: LCIT	SP1906 004	
Tray 5	Bottom Tray: LCIT	SP1906 005	
Tray 6	Multi Bypass Tray: On top of LCIT	SP1906 006	

1st Tray Main Machine: SP1906 001

This is the list of settings (range) for Tray 1. These settings are identical for each paper tray.

Setting	Used For	Sample
1	Slight Face Curl	Sample [B] in previous illustration.
2	Excessive Face Curl	
3	None. This is the normal default setting.	No pressure applied by soft roller.
4	Slight Back Curl	Sample [A] in previous illustration.
5	Excessive Back Curl	

Tray Heaters

If the machine is being used where humidity is high:

- Turn on the tray heaters of the main unit. This will prevent moisture from collecting around and in the paper trays while the machine is idle or switched off.
- If the LCIT is installed, recommend installing the optional tray heaters in the LCIT. This will prevent moisture from collecting around and the paper trays in the LCIT while the machine is idle or switched off.

A3/DLT LCIT (D516)

Accessories

Check the quantity and condition of the accessories in the box against the following illustration and list.

2

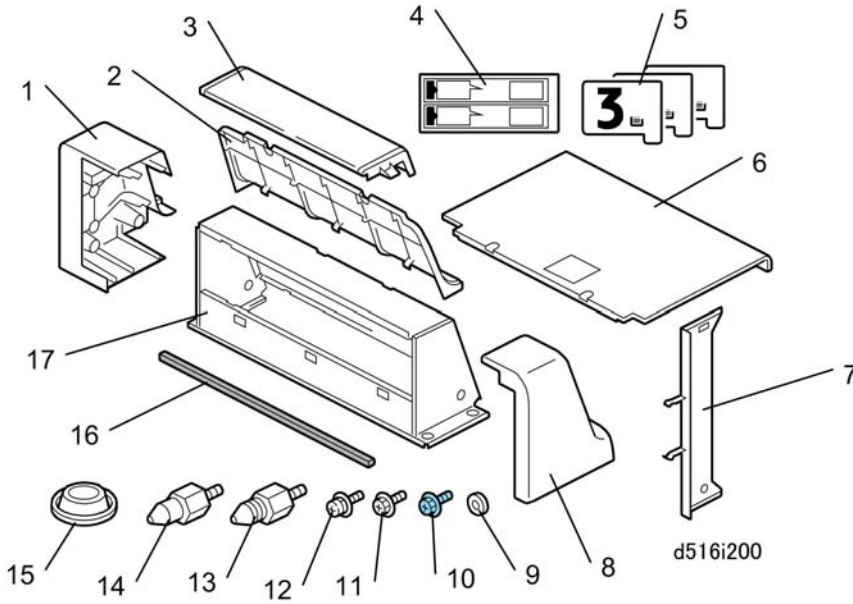

No.	Description	Q'ty
1.	Rear Cover	1
2.	Side Cover	1
3.	Top Cover	1
4.	Decals - Paper Set	3
5.	Tray Number Decals	3
6.	Flat Cover (for Bypass Tray D517)	1
7.	Tab Fences	3
8.	Front Cover	1
9.	Washer	1
10.	Screws (M4x8) - Blue	2

No.	Description	Q'ty
11.	Screws (M4x8) - Silver	10
12.	Binding Screw (with lock washer)	1
13.	Upper Joint Pins (Grooved)	2
14.	Lower Joint Pins (Smooth)	2
15.	Leveling Shoes	4
16.	Sponge Strip	1
17.	Frame – Sheet Metal	1

Installation

⚠ CAUTION

- The unit must be connected to a power source that is close to the unit and easily accessible.
- Make sure that the main machine is switched off and that its power cord is disconnected before doing the following procedures.

Tapes, Retainers

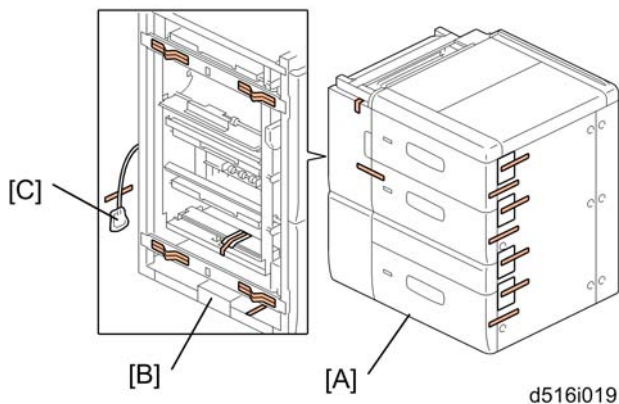

1. At the front [A] and right, remove all visible tapes.
2. On the left [B], remove visible tapes.
3. Remove tape and cover from the I/F connector [C].

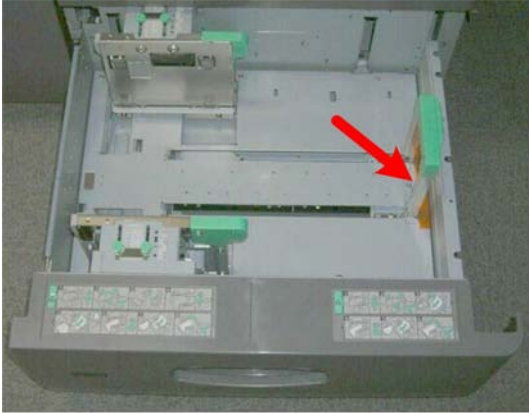

d516i020

4. Open each drawer and remove the tape.

Covers

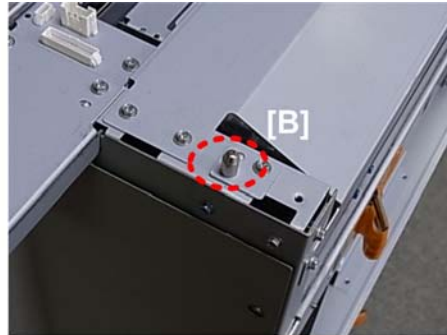
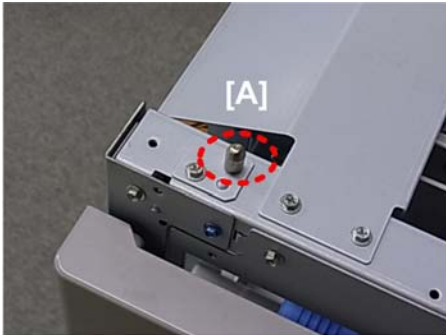

d516i001

1. Locate the positioning pins at the front [A] and rear [B].



d516i002

2. Position the holes on the bottom of the frame with the positioning pins at the front and back, and set the frame [A] on the left side of the unit.

3. Make sure that the holes and positioning pins [B] are engaged at the front and back.

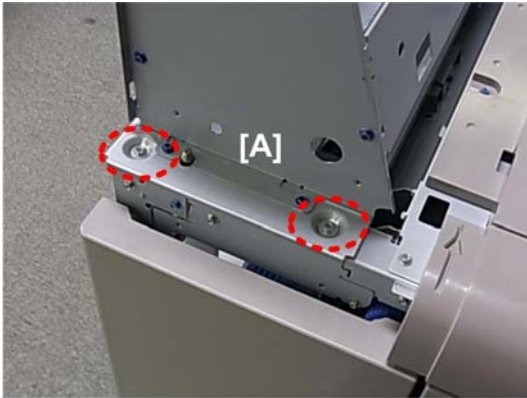

d516i003

4. At the front, fasten the base of the frame [A] ( x2 M4x8).

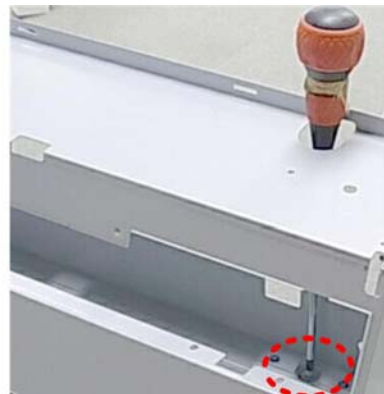
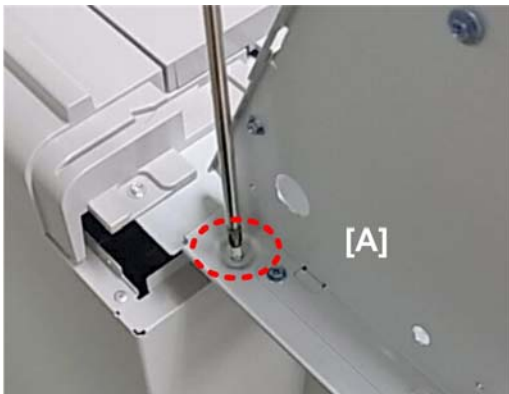

d516i004

5. At the rear, fasten the base of the frame [A] ( x2 M4x8).

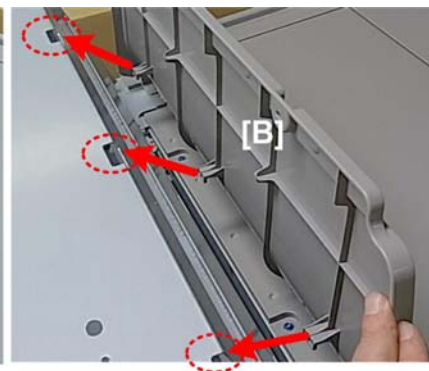
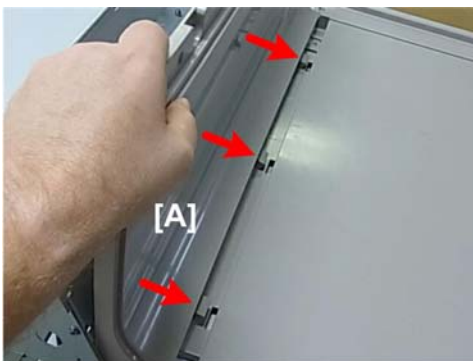

d516i005

6. Attach the right cover to the right side of the frame.

- First, set the bottom tabs of the right cover [A] into the cutouts in the flat plate.

- Next, set the claws on the left side of the right cover [B] into the holes in the frame.



d516i006

7. Check the left side under the top of the frame [A], and make sure that the claws and holes are matched correctly and that the right cover is flat against the right side of the frame.
8. Fasten the right cover [B] to the frame ( x2 M4x8).



d516i007

9. Set the top cover on top of the frame.
 - Insert the claws [A] on the left underside of the top cover into the holes in the frame.
 - At the same time, insert the tabs on the top left edge of the top cover [B] into the holes in the frame.



d516i008

10. Make sure the top cover is flat against the frame.



d516i009

11. Fasten the top cover at the front [A] and rear [B] ( x2 M4x8).

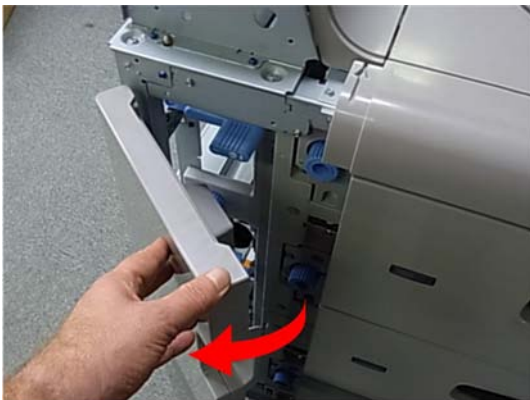

d516i010

12. Open the front door.

2

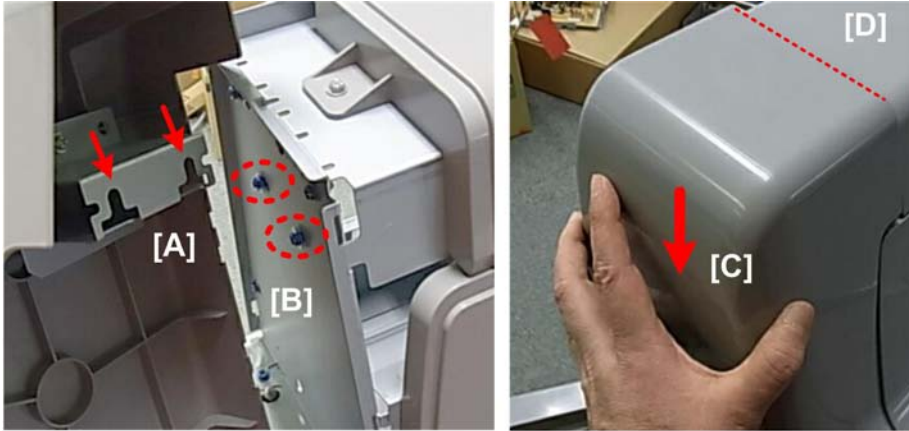

d516i011

- 13. Hang the keyholes in the bracket on the back of the front cover [A] onto the shoulder screws of the front frame plate [B].
- 14. Slide front cover [C] down until the top is flat and level with the top of the top cover [D].

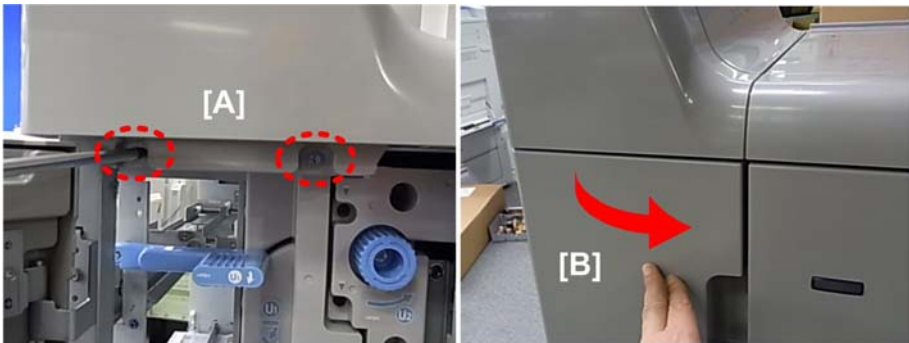

d516i012

- 15. Attach the front cover [A] ( x2 M4x8)
- 16. Close the front door [B].

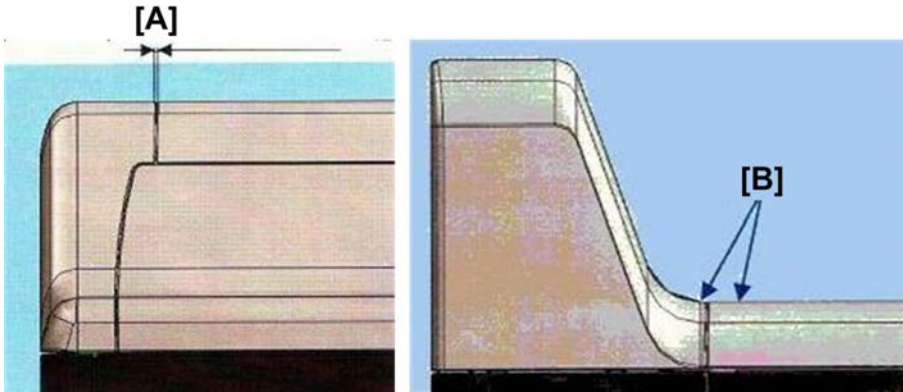

d516i013

17. Make sure the front cover is set correctly.

- Top right edge [A]
- Bottom right edge [B]



d516i014

18. Hang the keyholes in the bracket on the back of the rear cover [A] onto the shoulder screws of the rear frame plate [B].

19. Slide the cover [C] down so that the cover joints are at the same level.

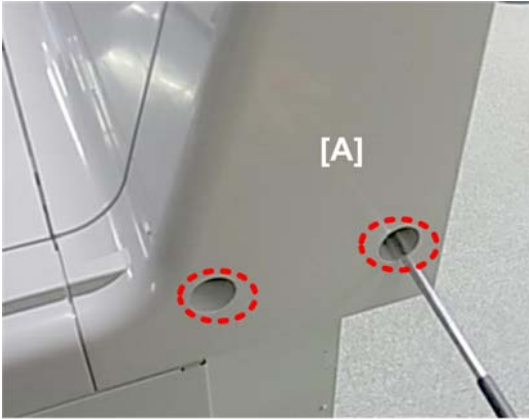

d516i015

20. Fasten the rear cover [A] ( x2 M4x8).

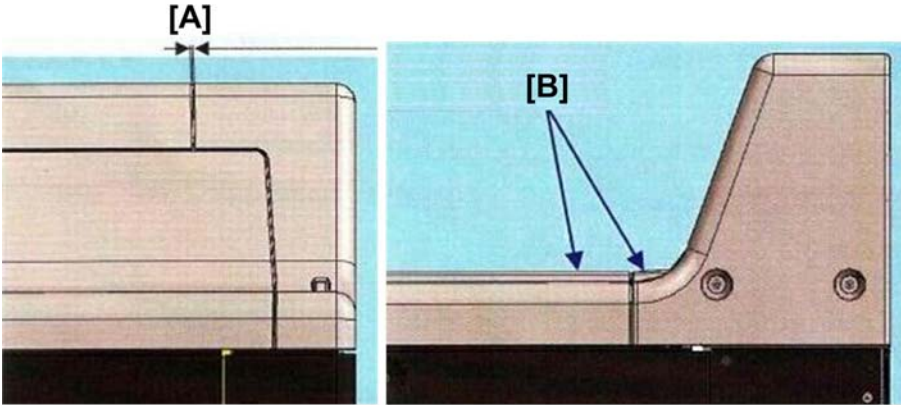

d516i016

21. Make sure the rear cover is set correctly.

- Top left edge [A]
- Bottom left edge [B]



d516i017

22. Peel the tape from the back of the sponge strip.
23. Attach the sponge strip [A] to the top left edge of the unit.

Docking

★ Important

- If you are going to install the Multi Bypass Tray or the LCIT tray heaters (or both), do this now before you dock the LCIT to the right side of the main machine.
- (p.216)

Ground Plate

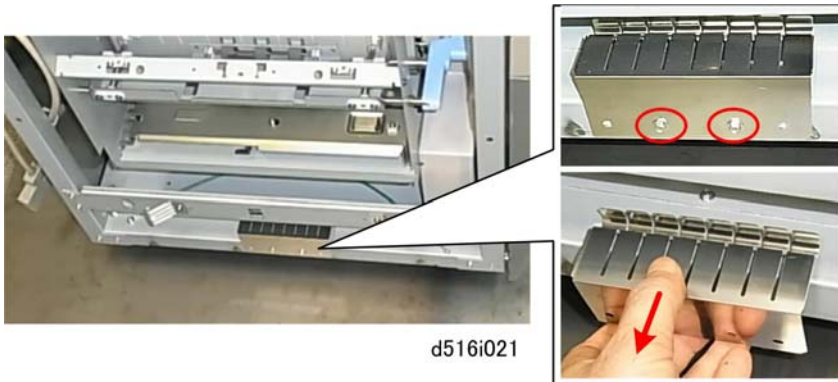

1. At the base of the left side of the unit, remove the ground plate ( x2). Keep these screws.

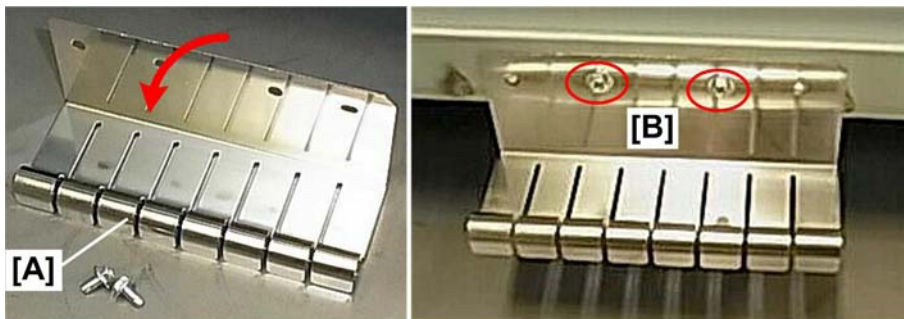

d516i022

2. Turn the plate over so that the fins [A] are pointing down.
3. Re-attach the plate [B] at the same holes, using the screws that you just removed ( x2).

Covers, Joint Brackets

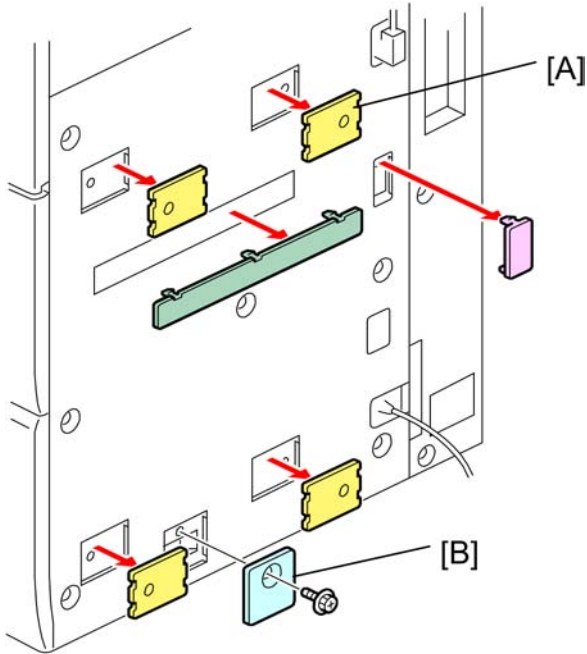

d516i023

4. Use the tip of a small screwdriver [A] to remove the six snap-off cover plates from the left side of the main machine.
5. The heater connection point cover [B] requires removal of one screw ( x1).

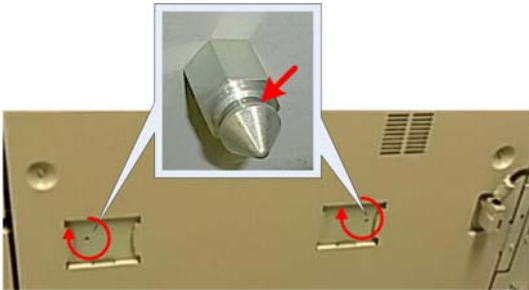

d516i024

6. Attach the two joint pins with the grooved heads to the top two holes.

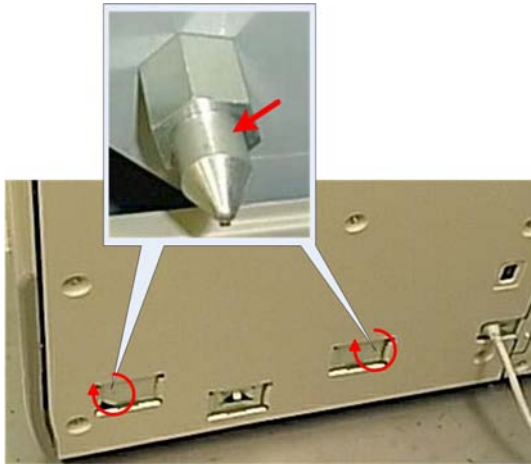

d516i025

7. Attach the two joint pins with the smooth heads to the bottom two holes.

Ground Wire

- If the LCIT tray heaters are to be installed, follow steps from 8 to 12. If not, skip these steps.

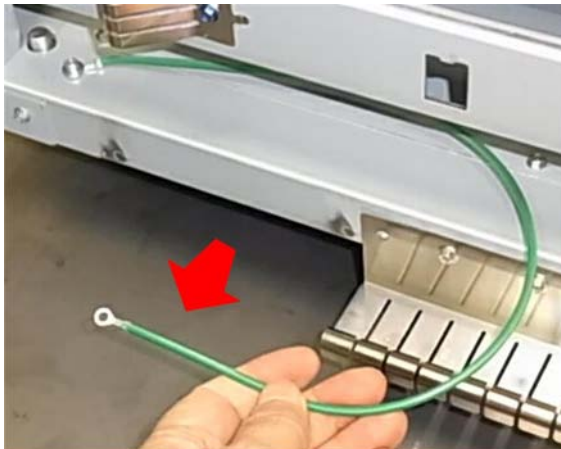

d516i026

8. Pull the ground wire out of the machine.
9. Push the unit toward the side of the main machine until the unit and main machine are about 30 cm (1 ft.) apart.

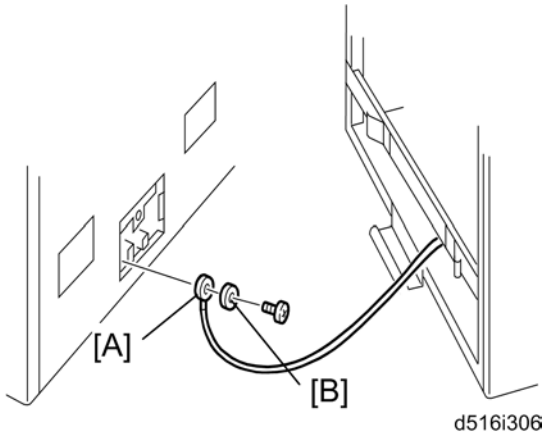

10. Attach the ground wire [A] with the washer [B] to the base of the main machine (ground screw;  x1).

Note

- The ground screw is provided with the accessories of the LCIT. It has a wide flat head and one washer permanently attached.



d516i028

11. Locate the ground wire [A] between the main machine and LCIT.
12. Push it into the base of the LCIT [B] and confirm that it is straight.

★ Important

- In order prevent damage to the ground wire, make sure that it is straight so that it will not be pinched between the main machine and LCIT after they are pushed together.

Docking

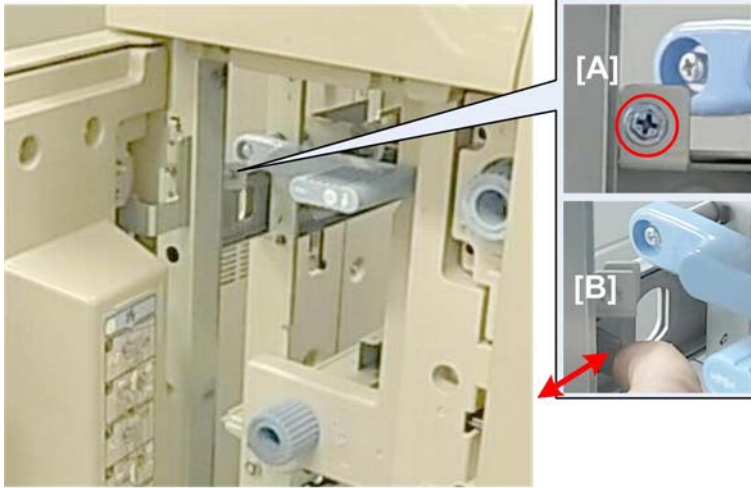

d516i029

13. Open the front door of the LCIT.
14. Remove the lock screw [A] ( x1). **Keep this screw!**
15. Pull the spring loaded lever [B] forward and let it snap back to confirm that it is moving freely.

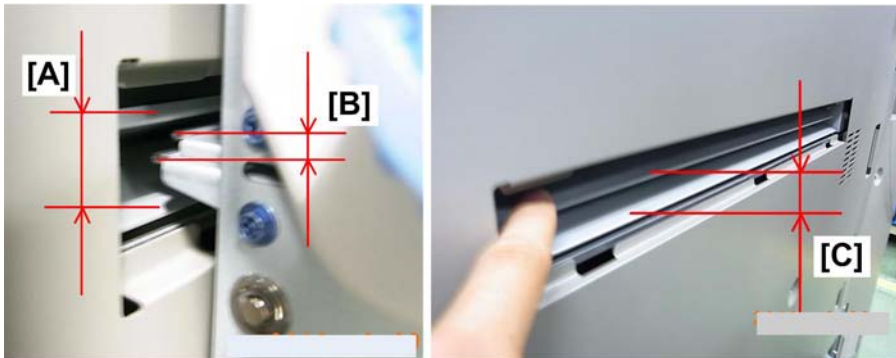

d074i886

16. Push the LCIT close to the right side of the main machine.
17. On the left side of the main machine [A], check the height of the LCIT paper exit [B].
18. Move the main machine entrance plate [C] up and down and confirm that it does not contact the paper exit of the LCIT.

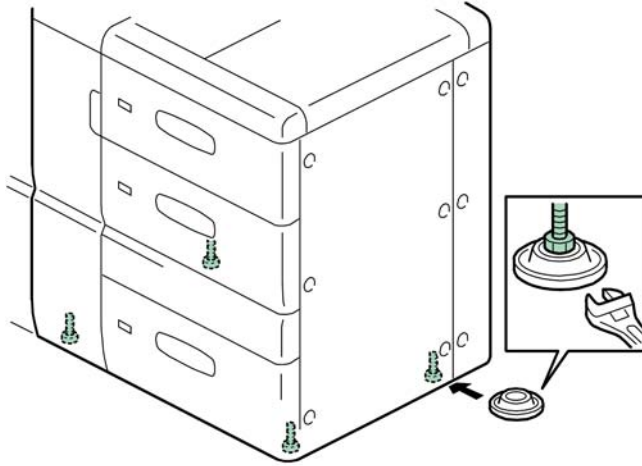

d516i202

19. If the main machine entrance plate does touch the LCIT exit, adjust the height of the LCIT. (p. 322)



d516i030

20. Line up the joint brackets on the main machine with the holes in the LCIT.
21. Slowly push the LCIT against the main machine. You will hear the lock bar of the LCIT lock onto the upper joint pins on the right side of the main machine.



d516i031

22. Open the front door.
23. Re-attach the lock screw [A] ( x1).
24. Hang one tab fence [B].

Note

- Three tab fences are provided, but only one can be stored inside the LCIT. Give the remaining two tab fences to the operator for safekeeping.

I/F Cable Connection



d516i032

25. Attach the LCIT I/F cable to the right side of the machine.

Tray Number Decals

One tray number decal is provided for each tray. Follow this procedure to attach each decal.

Tray	Decal No.
Top	3
Middle	4
Bottom	5

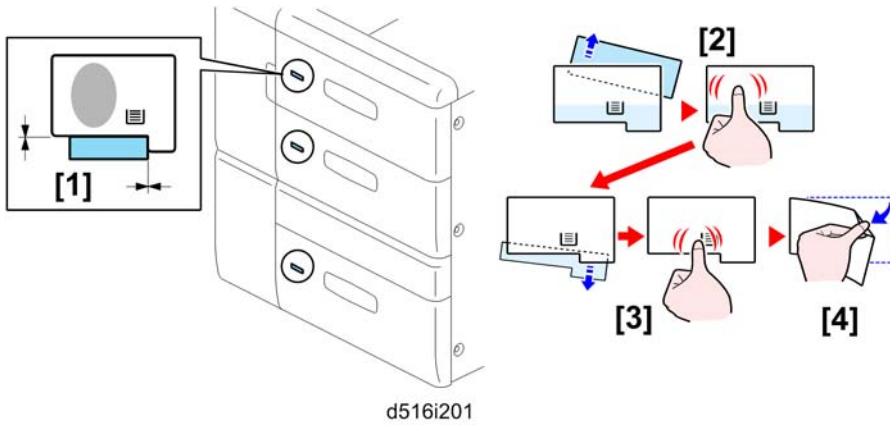

1. Attach the decal [1] above the tray LED.
2. Pull the back strip [2] from behind the upper part of the decal, and then press where the strip was removed.
3. Pull the back strip [3] from behind the lower part of the decal, and then press where the strip was removed.
4. Pull the clear sheet [4] from the surface of the decal.

LCIT (D516) Tray Heaters

Accessories

Check the accessories against the list below.

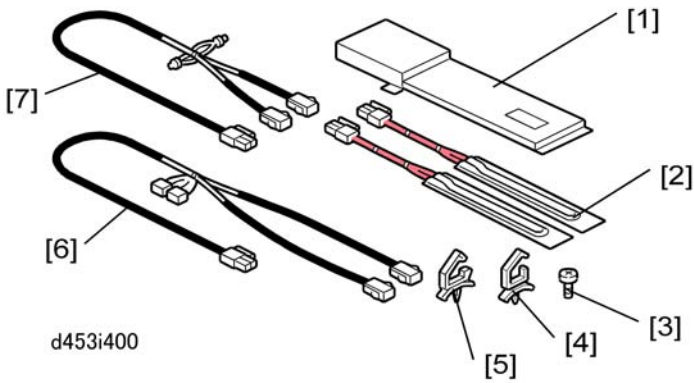

d453i400

No.	Description	Qty
1.	Cover Plate	1
2.	Heaters (230V 18W)	2
3.	Screws (M4x6)	7
4.	Harness Clamps (small)	2
5.	Harness Clamps (large)	2
6.	Relay Harness (long)	1
7.	Relay Harness (short)	1

★ Important

- The accessory kit contains items for this and other LCIT units.
- Only the items shown below are required for this LCIT.

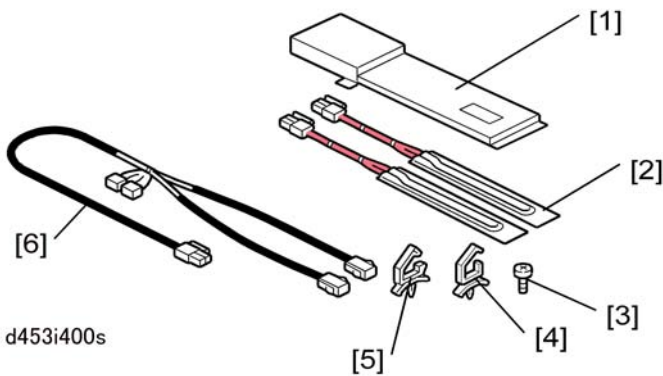

d453i400s

Installation

⚠ CAUTION

- Make sure that the main machine is switched off and that its power cord is disconnected before doing the following procedure.
1. If there is paper in the paper trays, open each tray and remove the paper.

2

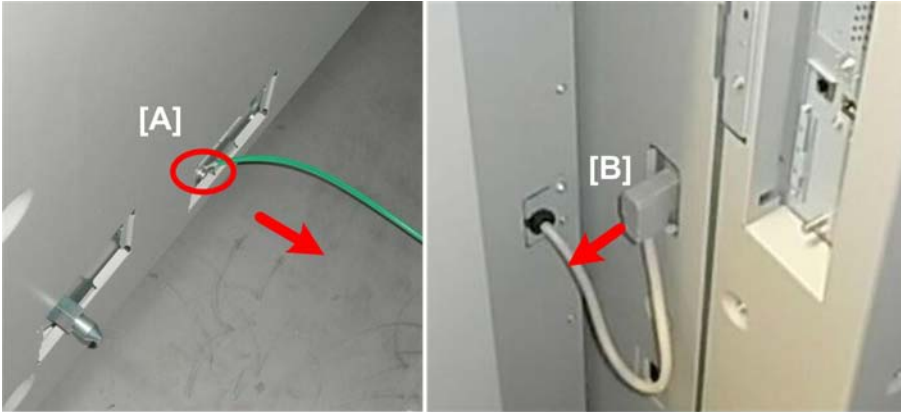

d453i451

2. If the LCIT is already installed, disconnect it and pull it about 30 cm (12 in.) away from the side of the main machine.
3. Disconnect ground wire [A].
4. Disconnect the LCIT I/F connector [B].
5. Pull out the top drawer. (This makes it easier to remove the right cover of the LCIT.)



d453i452

6. Remove the screws from the right cover of the LCIT ( x6).
7. Hold the bottom of the right cover, push it to the left to disconnect the hooks at the top edge of the cover, and pull it away.

8. Close the top tray.

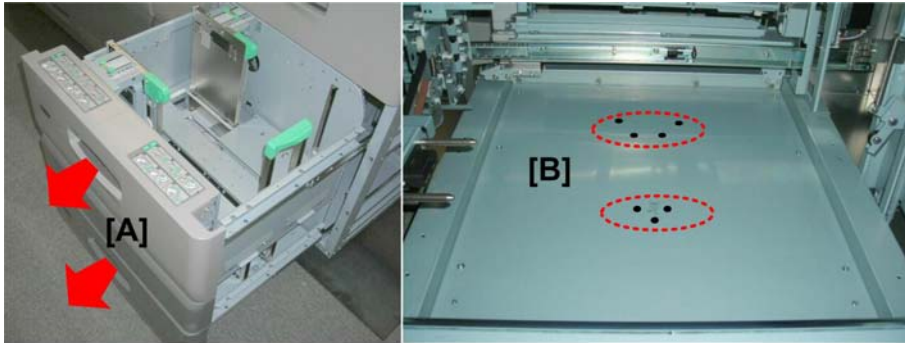



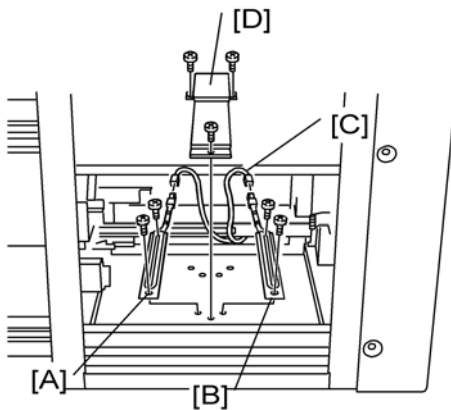

d453i453

9. Pull out the middle tray and bottom tray [A] until they stop.
 10. Look into the right side of the LCIT and locate the holes [B] where the heaters will be installed.



d453i122

11. Attach the front heater [A] ( x2).
12. Attach the rear heater [B] ( x2).
13. Pass the relay harness [C] through the right side of the LCIT and connect it to the heaters ( x2).
14. Attach the cover plate [D] ( x3).
15. Load paper in the paper trays.
16. Push the trays into the LCIT.
17. Reattach the right cover ( x6).

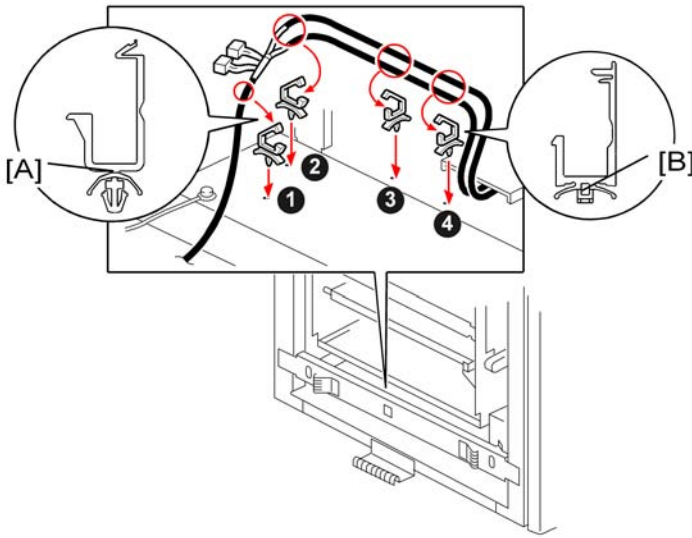

d453i401a

18. Close the clamps around the harnesses (🔧x4).

Note

- Be sure to use the correct type of clamps. On the left use type [A], and on the right use type [B].

19. Set the harnesses in the clamps, then close them (🔧x4).

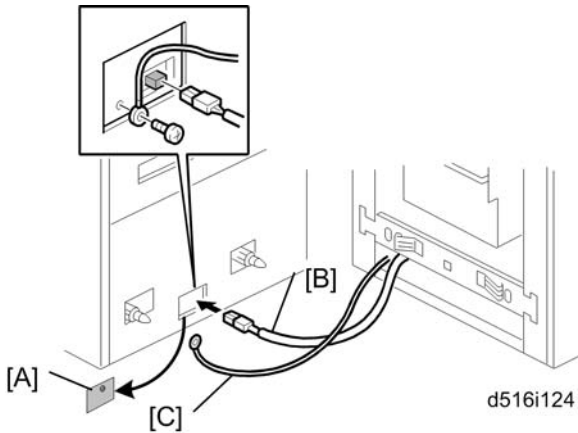

d516i124

20. Remove the cover [A] (🔧x1).

21. Attach the LCIT relay harness [B] to the mainframe.

22. Reconnect the ground wire [C] to the mainframe (🔧x1).

23. Dock the LCIT to the mainframe.

- Lock bar (🔧x1)
- Interface cable

★ Important

- Confirm that the relay harness and the ground wire are not pinched between the mainframe and the LCIT.
- Be sure to pull out the top tray before you try to re-install the right cover. (It is easier to re-install the cover with the top tray open.)

Multi Bypass Tray (D517)

Accessories

2

Check the quantity and condition of the accessories in the box against the following illustration and list.

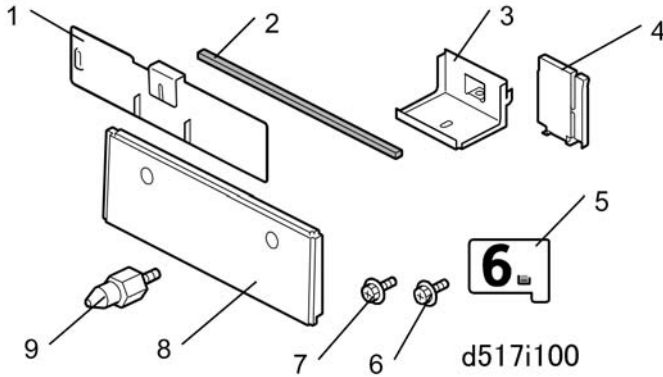

No.	Description	Q'ty
1.	Tab Sheet Fence	1
2.	Sponge Strip	1
3.	Bracket	1
4.	End Fence	1
5.	Decal (Tray 6)	1
6.	Screws (M4x8)	2
7.	Screws (M4x6)	4
8.	Left Cover	1
9.	Joint Pins	2

Installation

⚠ CAUTION

- The unit must be connected to a power source that is close to the unit and easily accessible.

- Make sure that the main machine is switched off and that its power cord is disconnected before doing the following procedures.

Before You Begin...

- The Multi Bypass Unit must be installed on the LCIT before the LCIT is docked to the mainframe.
- If the LCIT is already installed, it must be disconnected from the mainframe before installation of the Multi Bypass Unit.

2



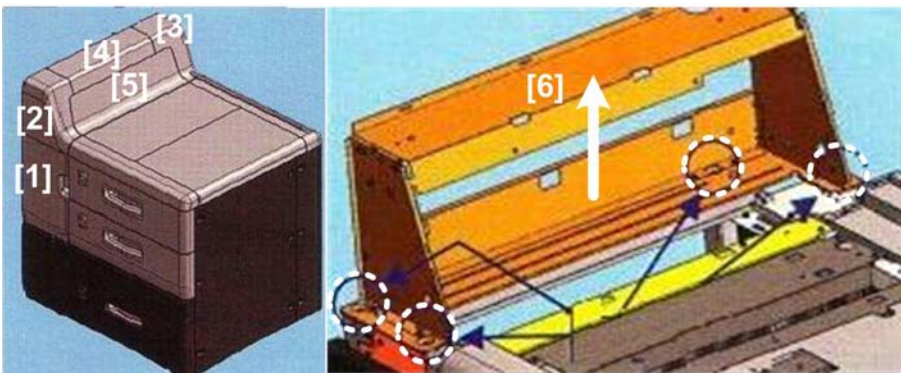

If the LCIT Has Already Been Installed...

Skip to the next section if you are installing the LCIT and bypass tray together.

1. If the LCIT is connected to the machine, disconnect it.
2. To prevent damage to the connectors and ground wire, before pulling the LCIT away from the mainframe:
 - Pull the LCIT about 20 cm (8") away from the main machine.
 - Disconnect the connectors and the ground wire ( x1 M4x8)
 - Pull the LCIT completely away from the machine.
3. Remove the sheet metal frame on the left top edge of the LCIT, and its covers:



d516i018

4. Open the front door [1].
5. Remove the covers:
 - [2] Front cover ( x2 M4x8).
 - [3] Rear cover ( x2 M4x8).
 - [4] Top cover ( x2 M4x8).
 - [5] Side cover ( x2 M4x8)
6. Remove the frame [6]

★ Important

- Do not remove the sponge strip from the left side of the frame.

Unpacking

2

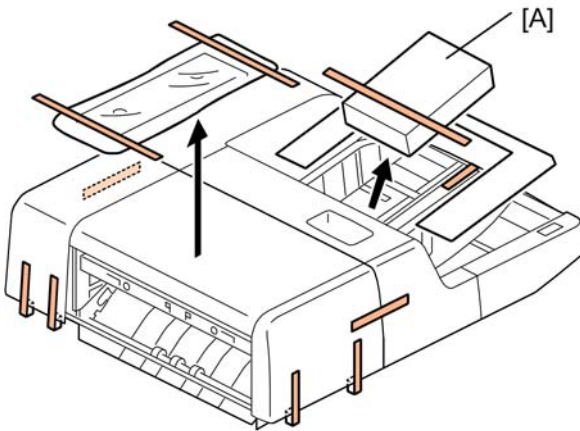

d517i101

1. Remove the accessory packet [A] and open it.
2. Remove all tape and shipping materials.

Flat Covers

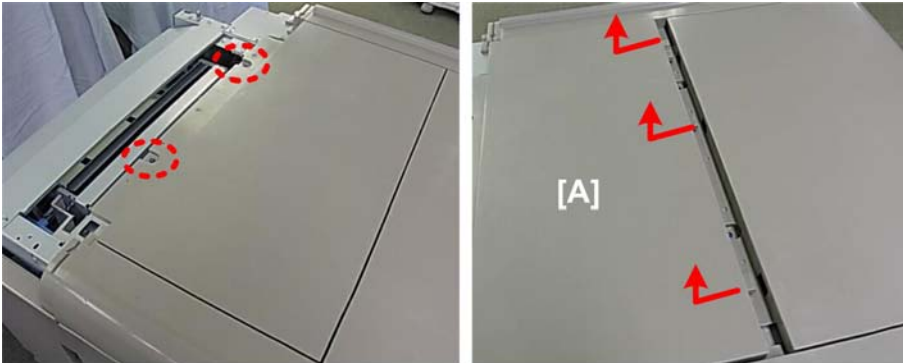

d517i002

1. Remove the left top cover [A] ( x2 M4x8).



d517i003

2. Disconnect the right top cover [A] ( x2 M4x8). **Keep these screws!** You need them to attach the next cover.
3. Slide the cover to the right to disconnect the claws under the right edge, then lift it off.

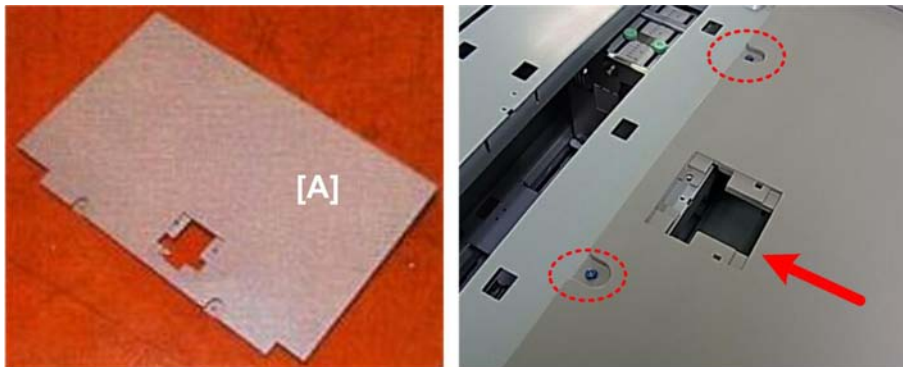

d517i004

4. Attach the top cover [A] with the screws removed from the previous flat cover ( x2 M4x8).
 - This large cover is provided with the LCIT accessories.
 - This large cover (like the previous cover) has three large claws under the right edge. Make sure these claws engage in the holes in the LCIT frame.

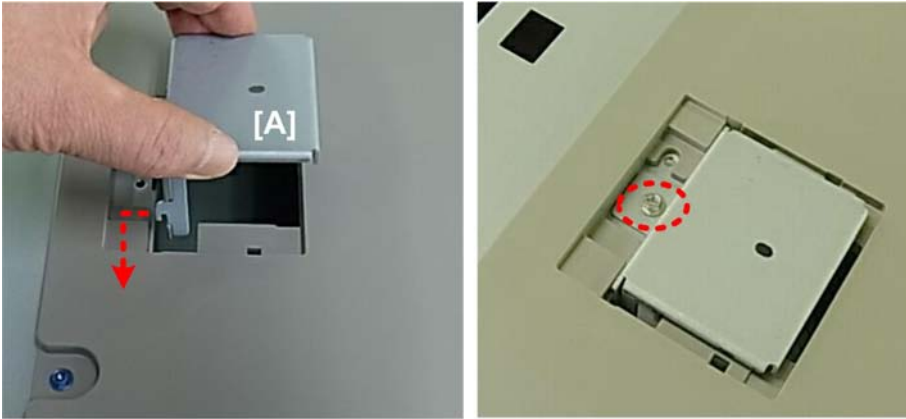

d517i005

5. Set the bracket [A] and fasten it ( x1 M4x6).

Mounting and Connecting the Bypass Unit



d517i006

1. Attach the joint pins [A] and [B].

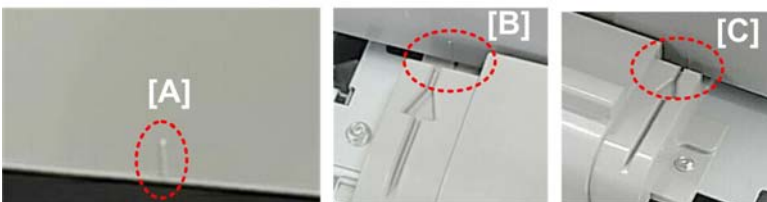

d517i007

2. Locate the alignment marks for the bypass unit.

- Two thin vertical lines [A] on the bypass unit (one on the front, one on the rear).
- Two arrows on the LCIT frame cover [A] at the front, [B] at the rear.
- These lines and arrows must be aligned correctly when you mount the bypass tray on top of the LCIT.

CAUTION

- The bypass unit weights 20 kg (44 lb.). You may need assistance to set the bypass unit on top of the LCIT.

2



d517i008

3. Pick up the bypass unit on its left side [A] and right side [B].

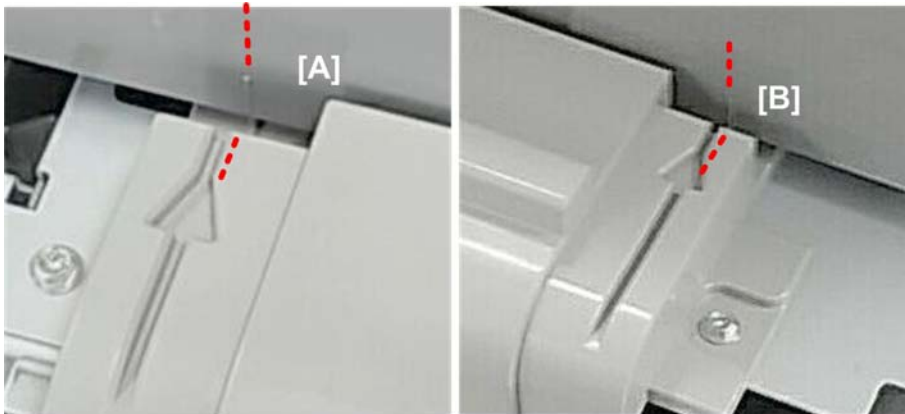

d517i007a

4. Set the bypass unit on top of the LCIT. Align the thin lines on the front [A] and rear [B] of the bypass covers with the arrows on the front and rear sides of the LCIT frame.

Important

- Aligning these points ensures that the holes on the bottom of the bypass unit will slip easily over the vertical joint pins on the LCIT.



d517i009

5. Open the bypass unit.



d517i010

6. Remove the front cover [A] ( x1 M4x8).

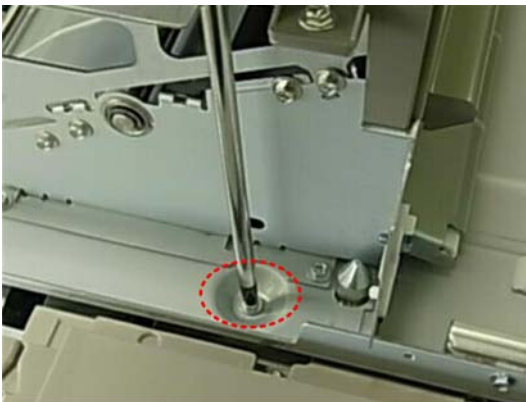

d517i011

7. Fasten the front side of the bypass unit ( x1 M4x6).

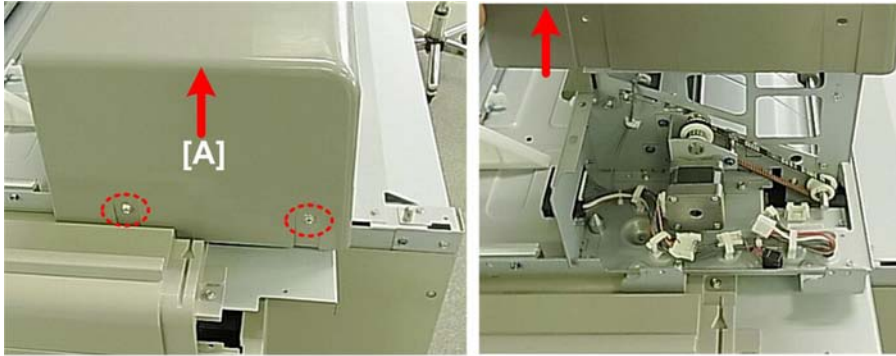

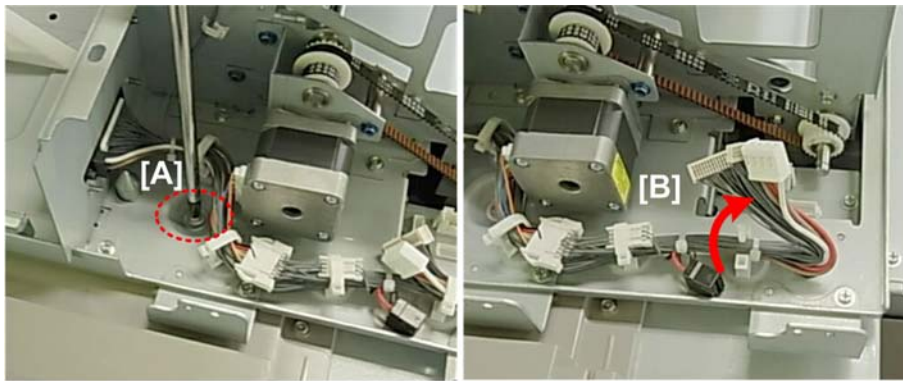

d517i012

8. Remove the rear cover [A] ( x2 M4x8).





d517i013

9. Fasten the rear side [A] of the bypass unit ( x1 M4x6).
10. Free the harnesses [B] ( x1).



d517i014

11. Connect and clamp the harnesses ( x3,  x1).

Bypass Covers

2

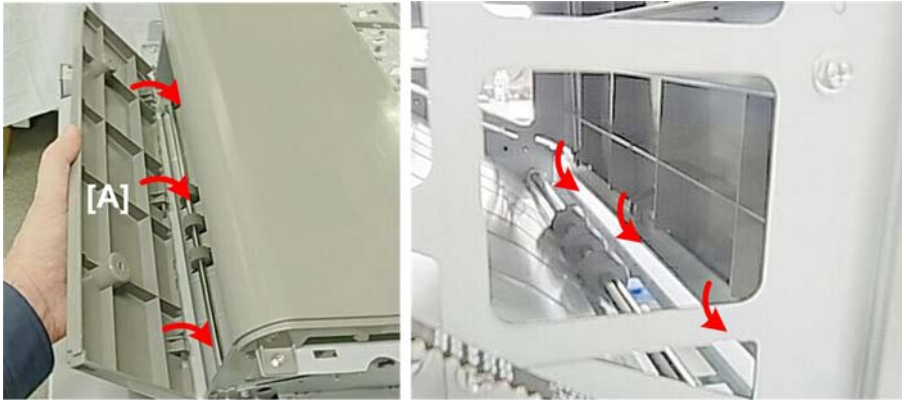

d517i015

1. Set the left cover [A]. Make sure that the claws are set correctly in their holes.



d517i016

2. Fasten the left cover [A] ( x2, M4x8).

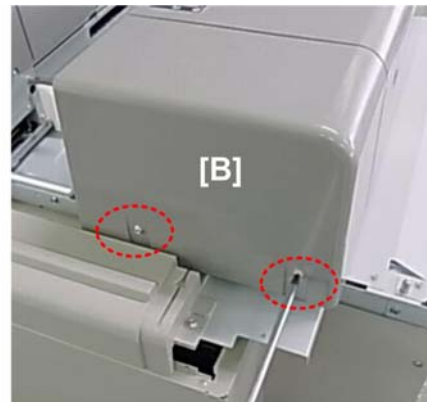
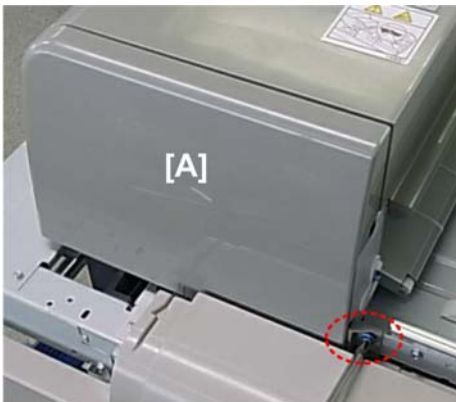

d517i017

3. Re-attach:

[A] Front cover ( x1 M4x8)

[B] Rear cover ( x2 M4x8)

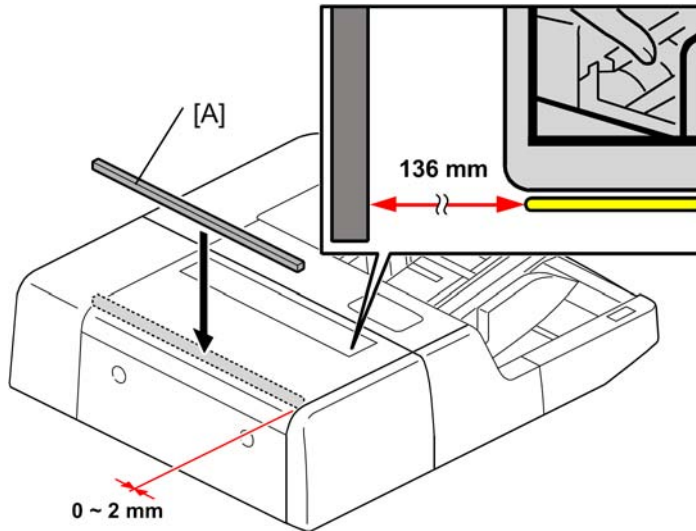

d517i018

4. Remove the tape from the sponge strip [A].
5. Position the sponge strip to the left side of the bypass unit.

LCIT Covers

Note

- The frame, covers, screws and sponge strip in this section are provided with the LCIT accessories.



d517i019

1. Remove the right stay [A] from the frame ( x2 M4x8).

2

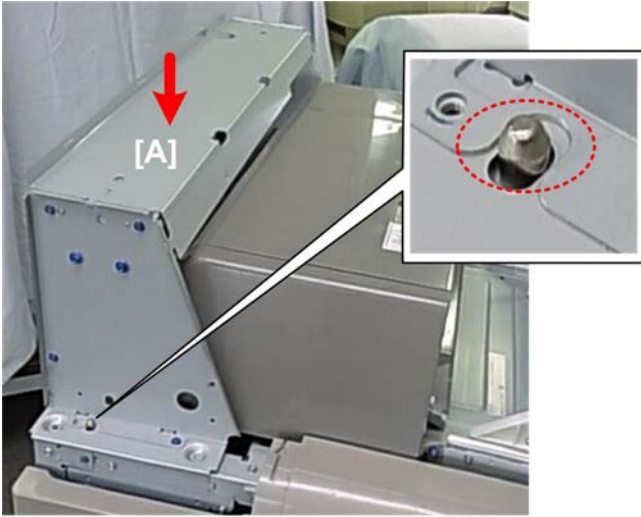

2. Position the holes on the bottom of the frame with the positioning pins at the front and back, and set the frame [A] on the left side of the unit.
3. Make sure that the holes and positioning pins are engaged at the front and back.

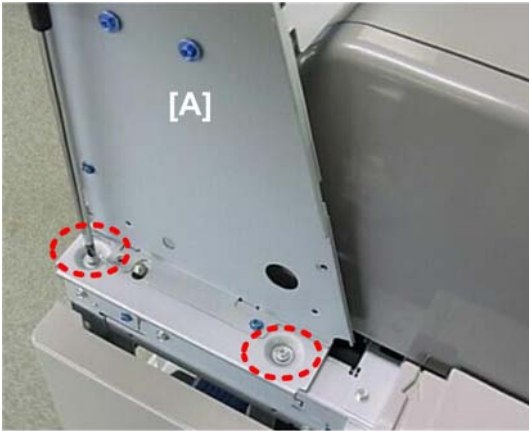

d517i021

4. At the front, fasten the base of the frame [A] ( x2 M4x8).



d517i022

5. At the rear, fasten the base of the frame [A] ($\times 2$ M4x8).



d517i023

6. Set the top cover on top of the frame.

- Insert the claws [A] on the left underside of the top cover into the holes in the frame.
- At the same time, insert the tabs on the top left edge of the top cover [B] into the holes in the frame.

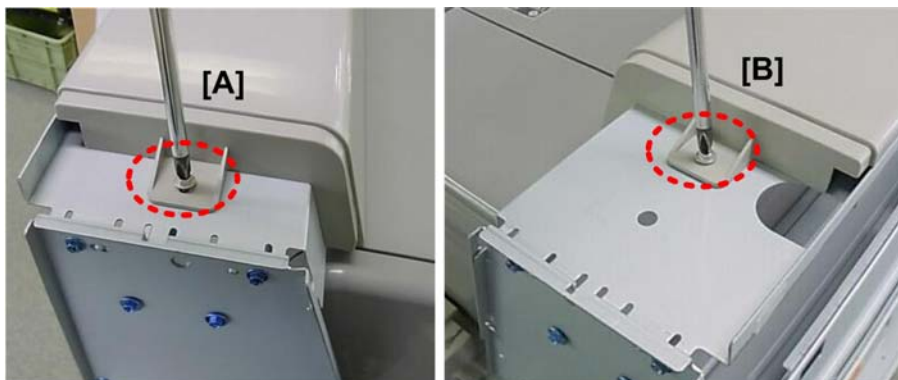

d517i024

7. Fasten the top cover.

[A] Front ( x1 M4x8)

[B] Rear ( x1 M4x8)

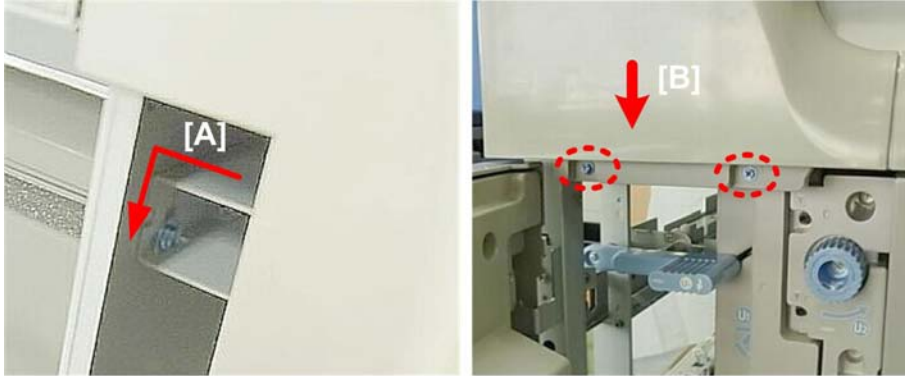

d517i025

8. Open the front door.
9. Hang the keyholes in the bracket [A] on the back of the front cover onto the shoulder screws of the front frame plate.
10. Slide the front cover [B] down until the top is flat and level with the top of the top cover.
11. Fasten the front cover ( x2 M4x8).
12. Close the front door.

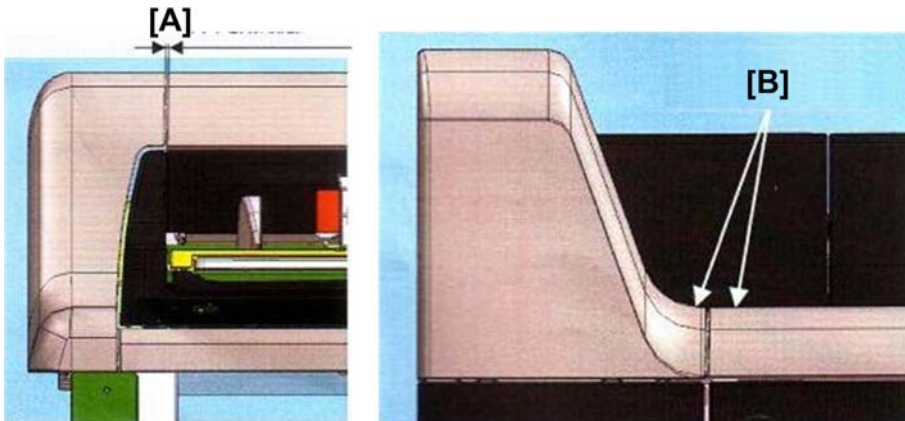

d517i026

13. Make sure the front cover is set correctly.
 - Top front edge [A]
 - Bottom front edge [B]

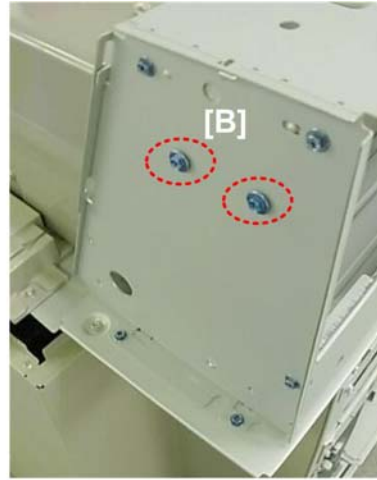
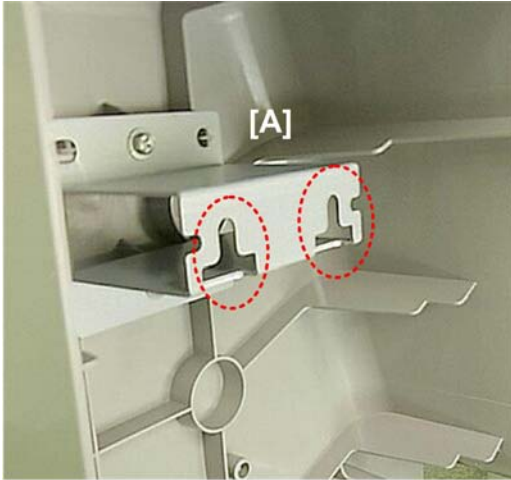

d517i027

14. Hang the keyholes in the bracket on the back of the rear cover [A] onto the shoulder screws of the rear frame plate [B].

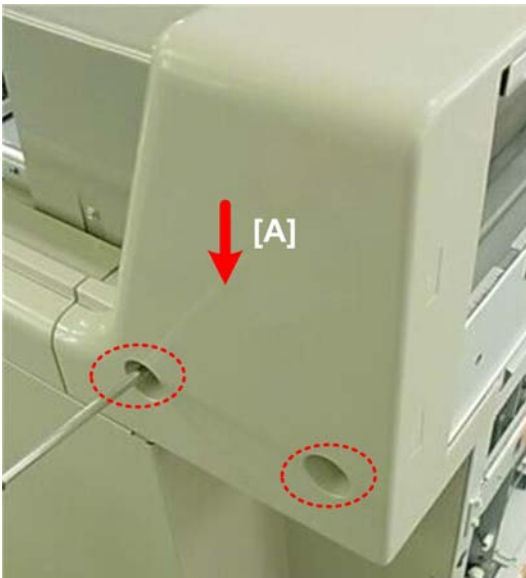

d517i028

15. Slide the cover [A] down so that the cover joints are at the same level.
16. Fasten the rear cover ( x2 M4x8).

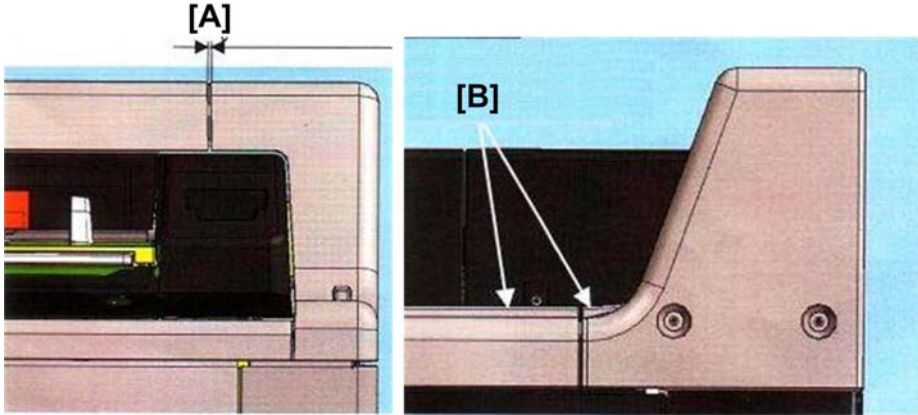

d517i029

17. Make sure the rear cover is set correctly.

- Top rear edge [A]
- Bottom rear edge [B]



d517i030

18. Peel the tape from the back of the sponge strip if the sponge strip has not been attached to the LCIT.

19. Attach the sponge strip [A] to the left edge of the frame.

20. Close the bypass unit [B].

End fence and tab sheet fence

Note

- The items in this section are bypass unit accessories.

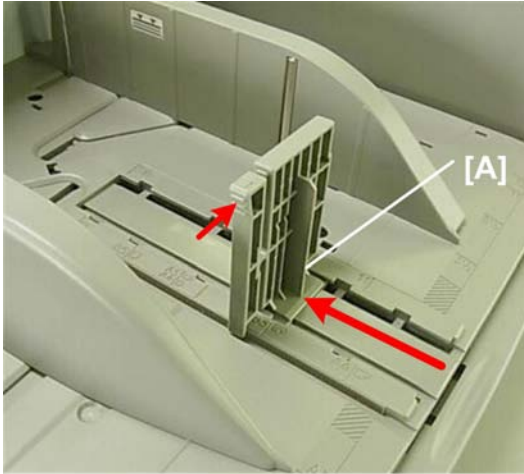

d517i031

1. Set the end fence [A].

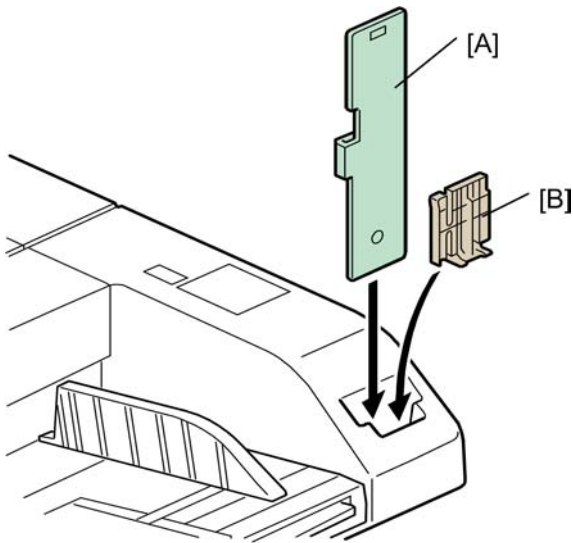

d517i033

2. Store the tab sheet fence [A] as shown. Also store the end fence [B] here if the customer does not need to use it at this time.

Attaching the Tray Number Decals

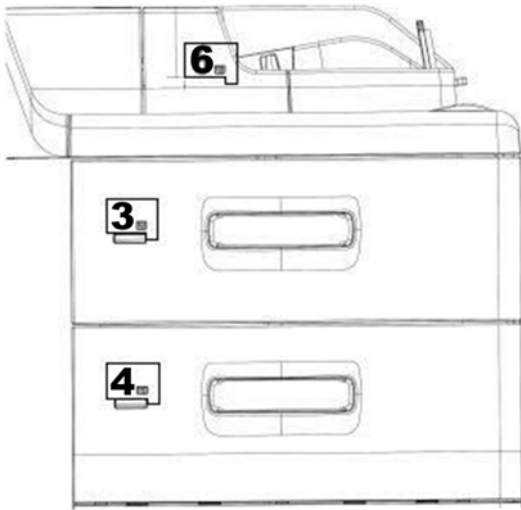

d517i199

1. Attach the number decals to the front of the unit as shown above.

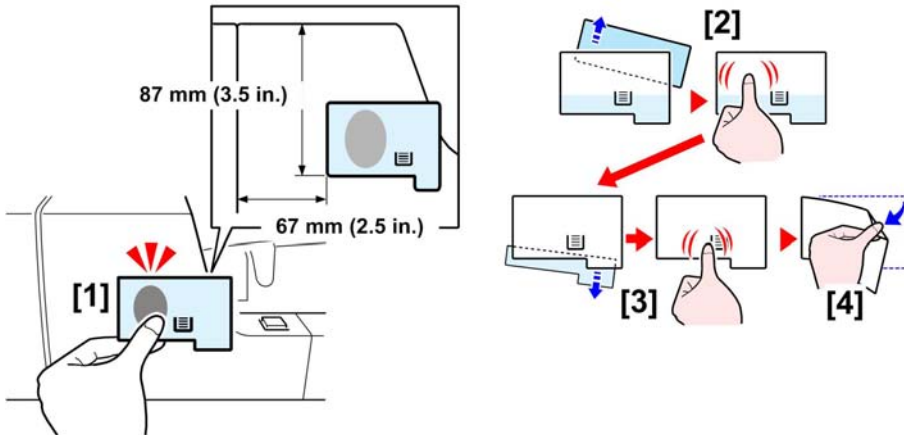

d517i200

2. First, attach the "6" decal [1] at the position shown.
3. Pull the back strip [2] from behind the upper part of the decal, and then press where the strip was removed.
4. Pull the back strip [3] from behind the lower part of the decal, and then press where the strip was removed.
5. Pull the clear sheet [4] from the surface of the decal.
6. Follow the same procedure to attach the "3" and "4" decals.

Docking, Height Adjustment

Follow the procedures in the LCIT installation section to complete this installation.

- Docking (p.203)
- Height adjustment (p.322)

Buffer Pass Unit Type 5010 (D548)

Accessory Check

2

Check the quantity and condition of the accessories in the box against the following list:

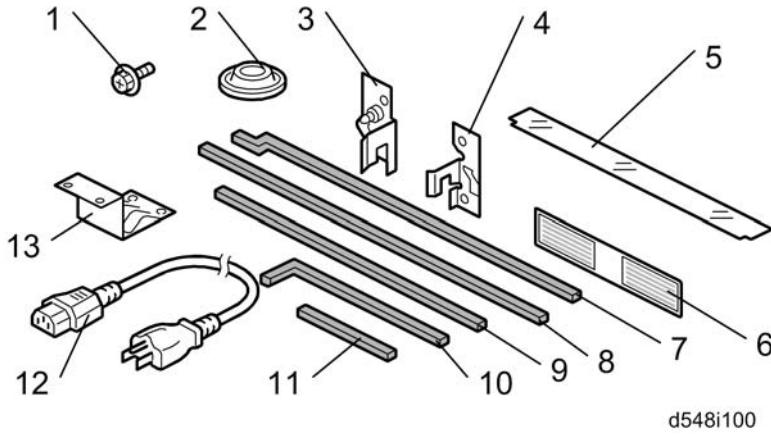

No.	Description	Q'ty
1.	Screws	6
2.	Leveling Shoes	4
3.	Docking Bracket (L)	1
4.	Docking Bracket (R)	1
5.	Mylars	4
6.	Caution Decal for Multi Power Sources	1
7.	Sponge Strip - Long Hooked	1
8.	Sponge Strip - Long Straight	1
9.	Sponge Strip - Medium Straight	3
10.	Sponge Strip - L	1
11.	Sponge Strip - Short Straight	1
12.	Power Cord	1
13.	Ground Plate	1

Installation

⚠ CAUTION

- The unit must be connected to a power source that is close to the unit and easily accessible.
- Make sure that the main machine is switched off and that its power cord is disconnected before doing the following procedures.
- The buffer pass unit is unstable and can fall over easily. To avoid personal injury or damage to the unit, use caution when you pull out the buffer pass unit drawer until the unit has been docked to the main machine.
- The power cord that comes with the buffer pass unit is for use with this equipment only. Do not use it with other appliances. Doing so could result in fire or electric shock.

2

Unpacking

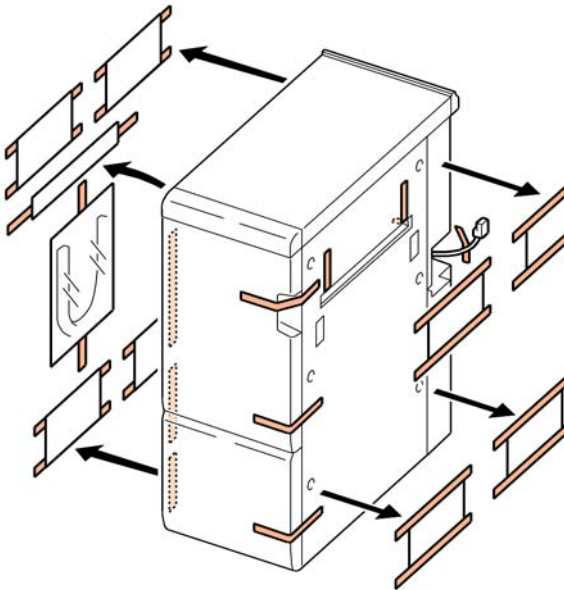

d548i101

1. Remove all visible external tapes on the external surfaces.
2. Open the front door and remove all visible tapes.

⚠ CAUTION

- There are no tapes inside the unit.
- The unit is top heavy and unstable. Use caution when you pull out the buffer pass unit drawer until this unit has been docked to the main machine.

2

Ground Plate, Unit Entrance Mylars

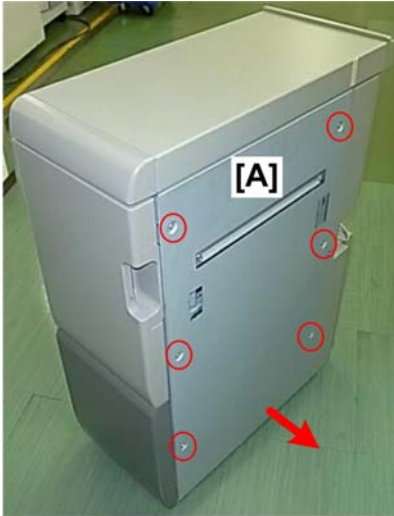

d666i010

1. Remove the right cover of the buffer pass unit ( x6).

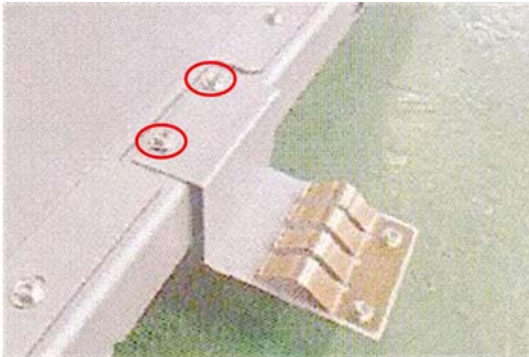

d666i011

2. Attach the ground plate ( x2).

Buffer Unit Entrance Mylars

This procedure describes how to attach two mylars to the entrance guide of the Buffer Unit.

1. Check the main machine and determine if the Decurler Unit option is installed.
 - If the Decurler Unit option is installed, do not install the mylars. Re-attach the right cover, and go to 'Docking the Unit'.
 - If the Decurler Unit is not installed, follow this procedure to attach two mylars to the entrance guide of the Buffer Unit.

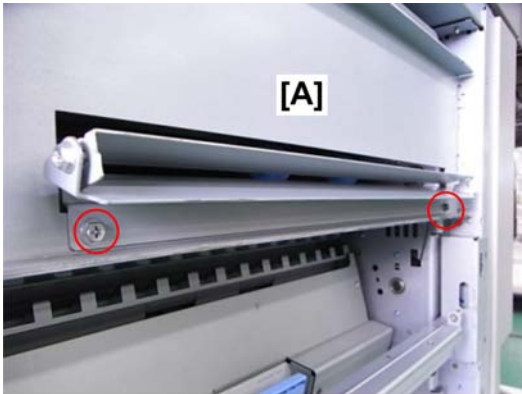

d548i250

2

2. On the right side of the Buffer Unit, remove the entrance guide [A] ( x2).

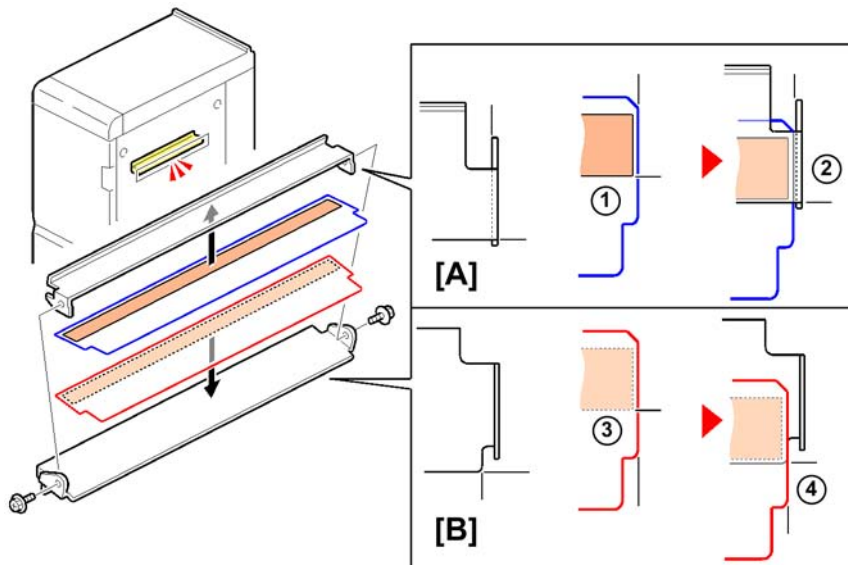

d548i251

3. One mylar is attached to the underside of the upper plate of the Buffer Unit entrance guide [A].
- Select one mylar ① and remove the tape.
 - Position the mylar as shown ② and attach it to the underside of the upper plate.
4. One mylar is attached to the topside of the bottom plate of the Buffer Unit entrance guide [B].
- Select one mylar ③ and remove the tape.
 - Position the mylar as shown ④ and attach it to the topside of the lower plate.
5. Re-attach the entrance guide, and then re-attach the right cover.

Sponges

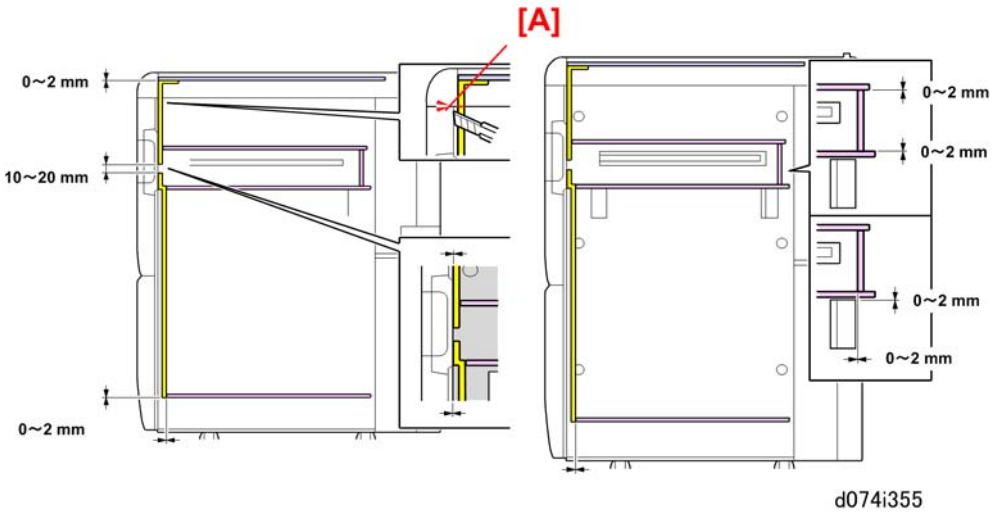

1. Remove the tape from each sponge strip and attach them to the right side of the unit as shown above.

↓ Note

- The two yellow sponge strips in the illustration are provided as accessories with the main machine. The other strips are accessories provided with this peripheral unit.
2. After attaching all sponges, use a sharp cutter to cut the sponge on the corner at [A].

Docking the Unit to the Mainframe

Joint Brackets

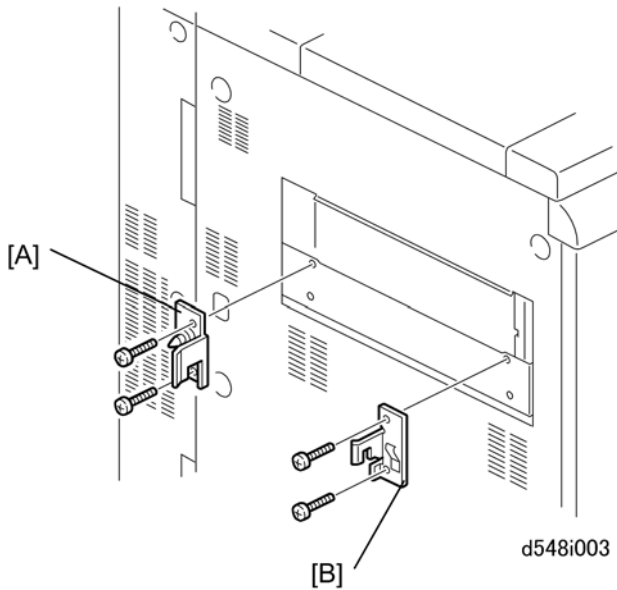

1. Attach the docking brackets to the main machine:

[A] Rear ( x2)

[B] Front ( x2)

2. Open the front door.

Docking



1. Pull out the locking lever ( x 1).
2. Push the buffer pass unit against the main machine.

2

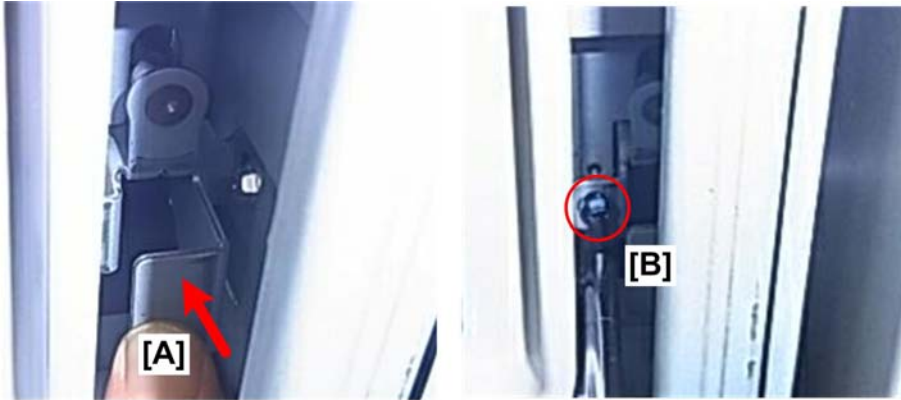

d666i005

3. Push in the lock lever and fasten it with the screw just removed ( x 1).



d666i006

4. Connect the I/F cable of the buffer pass unit to the socket of the main machine.

Removing the Shipping Brackets

2

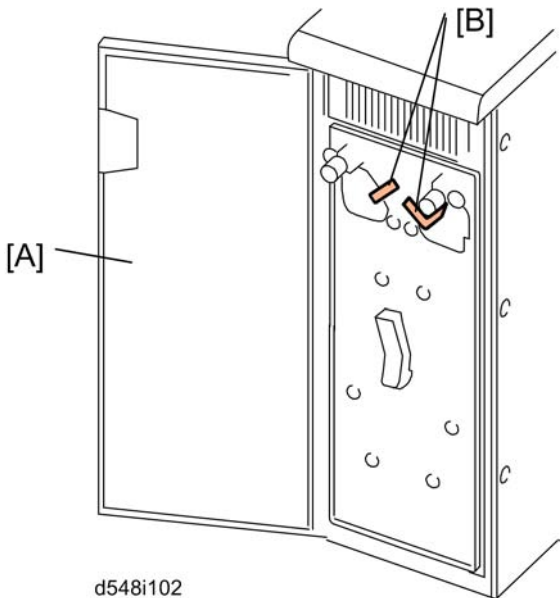

1. Open the front door [A] and remove tapes [B].

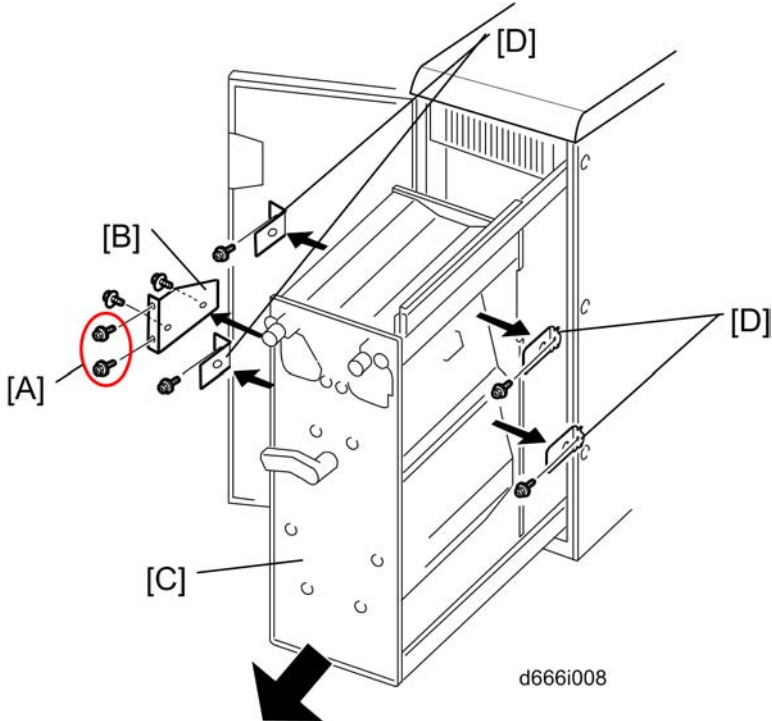



2. Remove two screws [A] on the clamp bracket [B].

3. Slowly pull out the buffer pass unit drawer [C].

⚠ CAUTION

- Work carefully! The unit is unstable with the drawer pulled out and can tip over easily before it is docked to the main machine.

4. Remove the clamp bracket [B] ( x 2).
5. Remove the four shipping brackets [D] ( x 1 each).
6. Push in the buffer pass unit drawer [C].
7. Close the front door.

Connecting the Downstream Peripheral

Connection Bracket

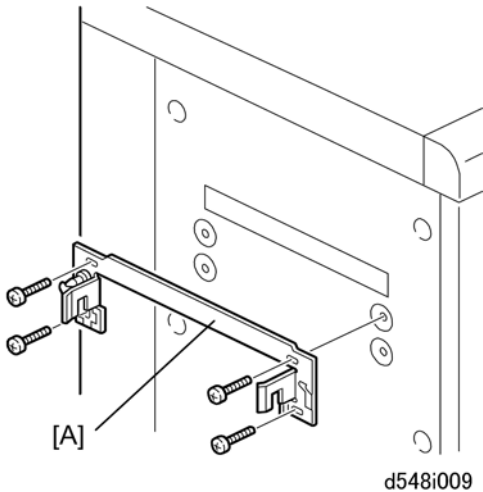

1. Attach the docking bracket provided with the downstream peripheral to the left side [A] of the buffer pass unit ( x4).

Downstream Unit Mylars

★ Important

- Two mylars must be attached to the upper and lower plates on the entrance guide of the downstream unit.

1. Remove the entrance guide of the downstream unit ( x2).

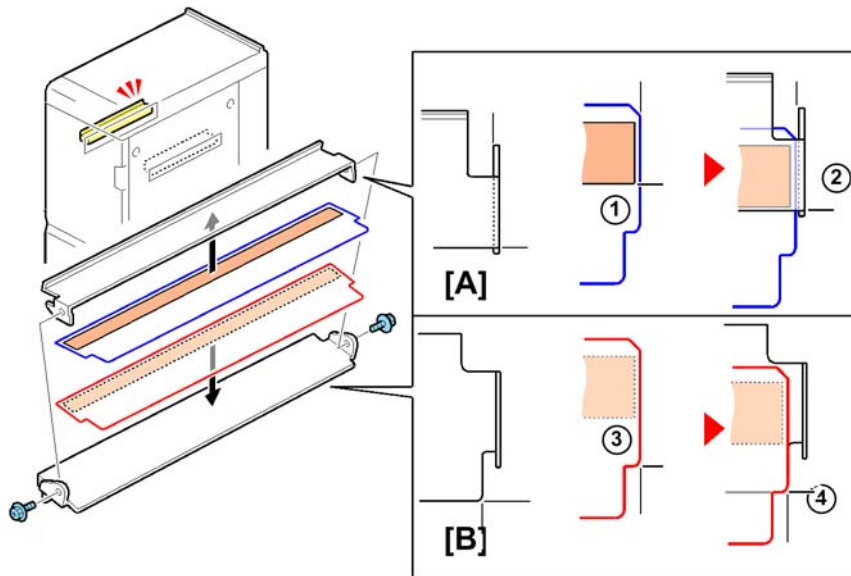

d548i252

2. One mylar is attached to the underside of the upper plate of the downstream unit entrance guide [A].
 - Select one mylar ① and remove the tape.
 - Position the mylar as shown ② and attach it to the underside of the upper plate.
3. One mylar is attached to the topside of the bottom plate of the downstream entrance guide [B].
 - Select one mylar ③ and remove the tape.
 - Position the mylar as shown ④ and attach it to the topside of the lower plate.
4. Re-attach the entrance guide, and then re-attach the right cover.
5. Re-attach the entrance guide to the downstream unit ( x2).

Connect the Power Cord

1. Connect the power cord to the buffer pass unit and connect the other end of the cord to a power outlet.

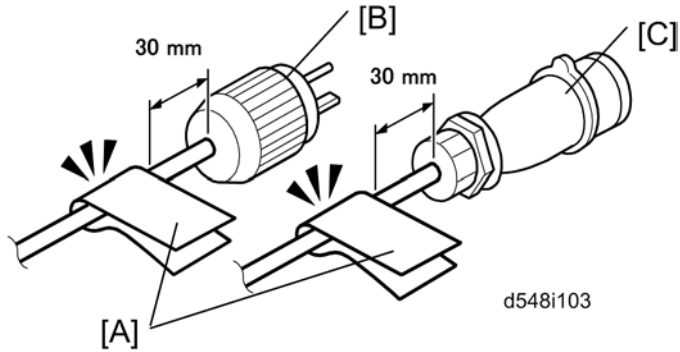

2. Approximately 30 mm (1 in.) from the plug, attach the caution decal [A] for multi power sources to power plug [B] (NA) or [C] (EU) of the main machine.

Leveling the Unit

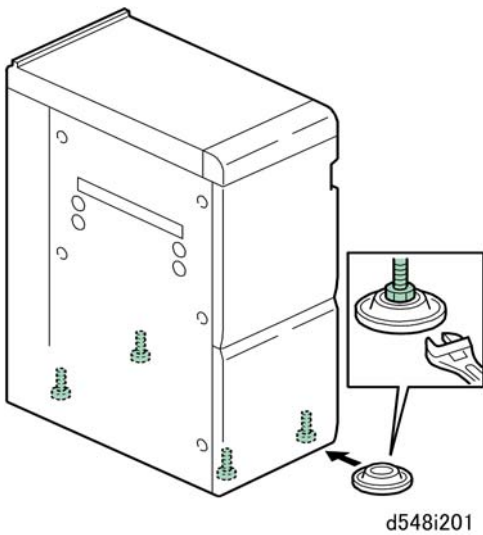

1. Set the leveling shoes and adjust the height of the unit. (p.322)
2. Load some B4 paper in the 2nd tray of the main machine, and make several copies.
3. Check paper skew and side-to-side registration and correct if necessary. (p.324)

Cover Interposer Tray (D518)

Accessories

Check the quantity and condition of the accessories in the box against the following illustration and list.

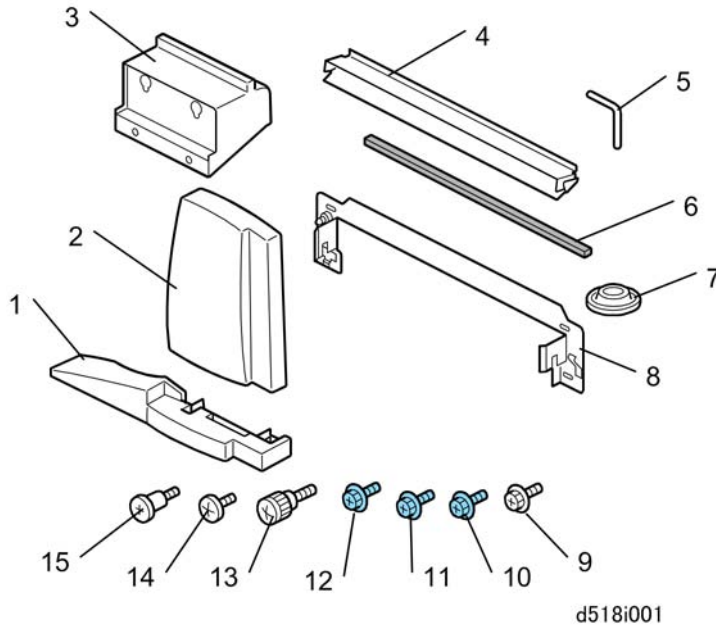

No.	Description	Q'ty
1.	Base Cover (Tray Unit)	1
2.	Front Cover	1
3.	Spacer	1
4.	Relay Guide Plate	1
5.	"L" Hinge Pins (Tray Unit Front Cover)	2
6.	Sponge Strip	1
7.	Leveling Shoes	4
8.	Joint Bracket	1
9.	Screw (M4x8)	4

No.	Description	Q'ty
10.	Screw (M3x8)	1
11.	Screw (M3 x 6)	2
12.	Screw (M4 x 8)	2
13.	Knob Screw	3
14.	Flat Knob Screw (M3 x 8)	1
15.	Shoulder Screw	2

Installation

⚠ CAUTION

- The unit must be connected to a power source that is close to the unit and easily accessible.
- Make sure that the main machine is switched off and that its power cord is disconnected before doing the following procedures.

Tapes

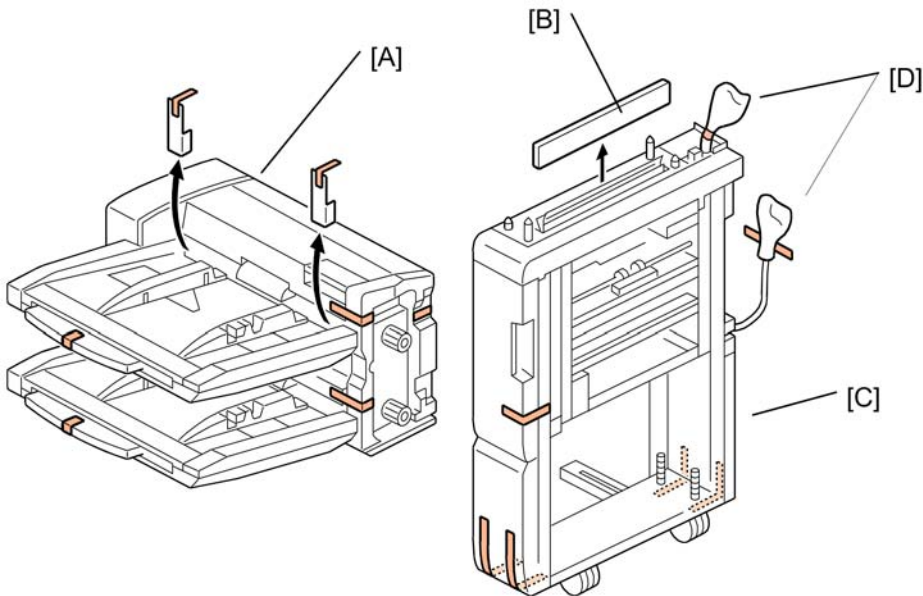

d518i002

1. Remove all the tape and shipping materials from the tray unit [A].

2. Remove all tape and shipping material [B] from the transport unit [C].
3. Remove tape and covers from both connectors [D].



Sponge Strips, Relay Guide Plate, Ground Plate

★ Important

- There are two procedures for installation of the sponge strips.
- Follow "Procedure 1" below if the Cover Interposer Tray will be connected to the Buffer Pass Unit.
- Follow "Procedure 2" if the Cover Interposer Tray will be connected directly to the main machine (more sponge strips are required).

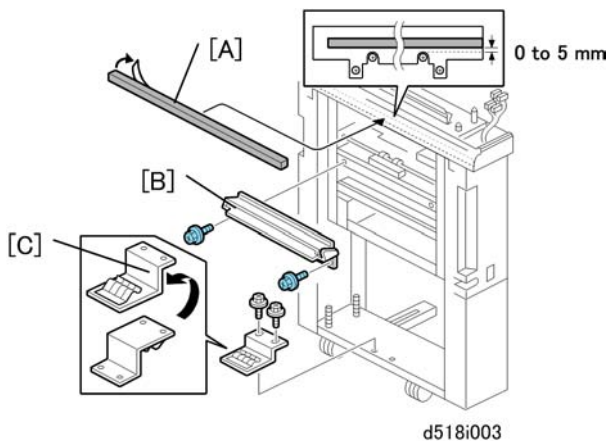
Procedure 1



1. Peel the tape from the back of the sponge strip [A] and attach it as shown.
2. Attach the relay guide plate [B] ( x2).
3. Remove the ground plate [C] from the bottom cross-piece ( x2).
4. Turn the ground plate over.
5. Reattach the ground plate with the same screws as shown ( x2).

Procedure 2

1. Attach the relay guide plate and ground plate as described in "Procedure 1" above.

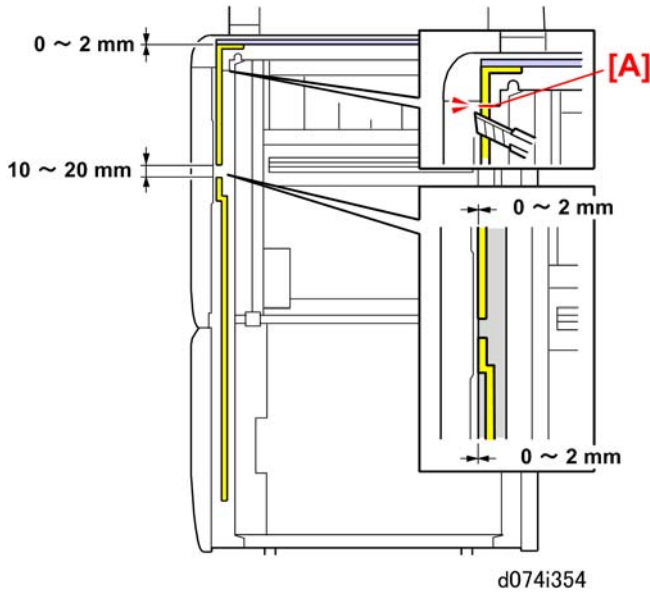

2. Remove the tape from each sponge strip and attach them to the right side of the unit as shown above.

Note

- The two yellow sponge strips in the illustration are provided as accessories with the main machine. The horizontal sponge strip is provided with the Cover Interposer Tray.

3. After attaching all sponges, use a sharp cutter to cut the sponge on the corner at [A].

Docking

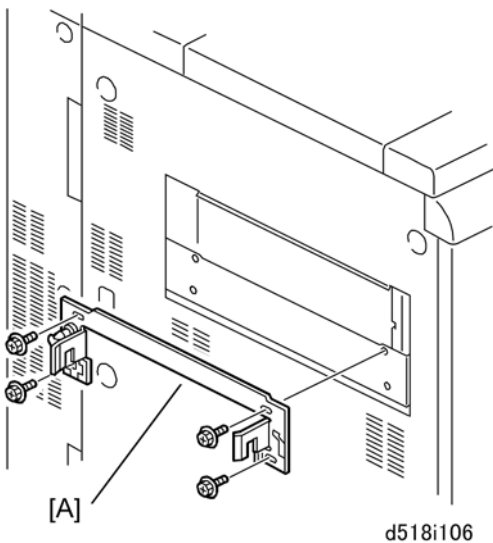

1. If the upstream unit is the main machine, remove the interface connector cover.
2. Attach the joint bracket [A] to the upstream unit ( x4).

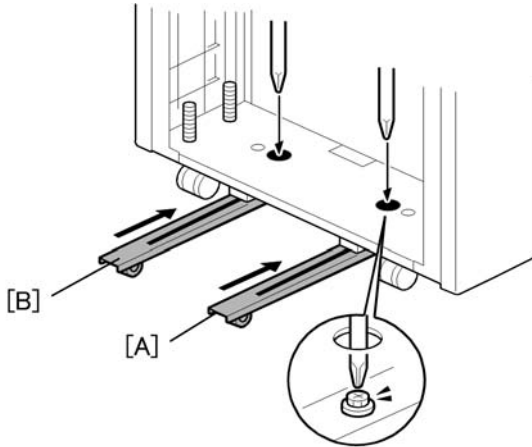

d518i004

3. Push the unit close to the upstream unit.
4. Loosen the screws for the rear runner [A] and front runner [B]
5. Push the runners in and re-fasten them with the screws.

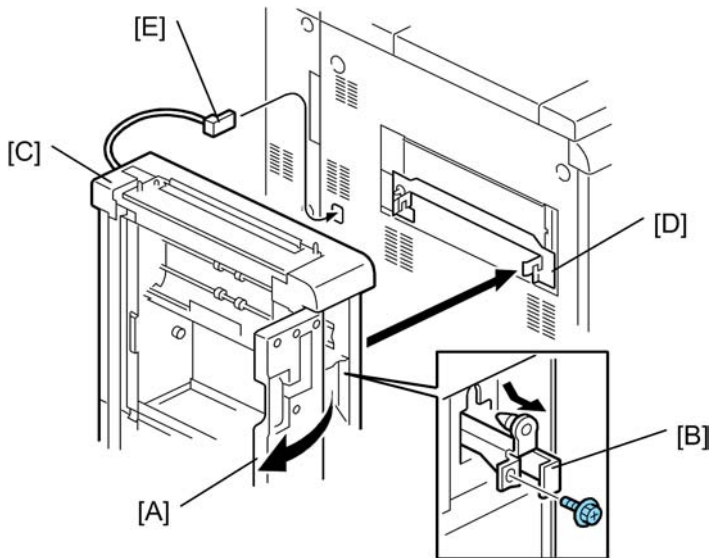

d518i005

6. Open the front door [A] of the cover interposer tray.
7. Remove the screw of the lock bar [B]. **Keep this screw.**
8. Pull out the lock bar until it stops.
9. Push the unit [C] against the upstream unit so that the lock bar is below the joint bracket [D].

10. Connect the unit's cable [E] to the upstream unit.
11. Push in the lock bar [B] and fasten it with the screw removed in **Step 7**.
12. Close the front door.





Dock the Downstream Peripheral Unit

2

Important

- The tray unit of the cover interposer peripheral is supported by both the cover interposer transport unit and the top of the downstream peripheral unit.
- The next peripheral device downstream must be docked to the cover interposer tray relay unit (the base) before the cover interposer tray unit can be installed.

Go to the appropriate section to dock the next downstream peripheral unit before installing the tray unit of the cover interposer tray:



- Multi Folding Unit ( p.256)
- Ring Binder ( p.266)
- High Capacity Stacker ( p.282)
- Finishers ( p.294)

CAUTION

- Never attempt to mount the tray unit of the cover interposer tray until the next downstream peripheral unit has been docked to the transport unit (base) of the cover interposer tray.
- To prevent bending the frame of the tray unit and damaging its alignment, always remove the tray unit from the cover interposer tray transport unit at the following times: 1) Before disconnecting either the cover interposer tray or the next downstream peripheral unit, or 2) Before doing any maintenance on either the cover interposer tray or the next downstream peripheral unit.

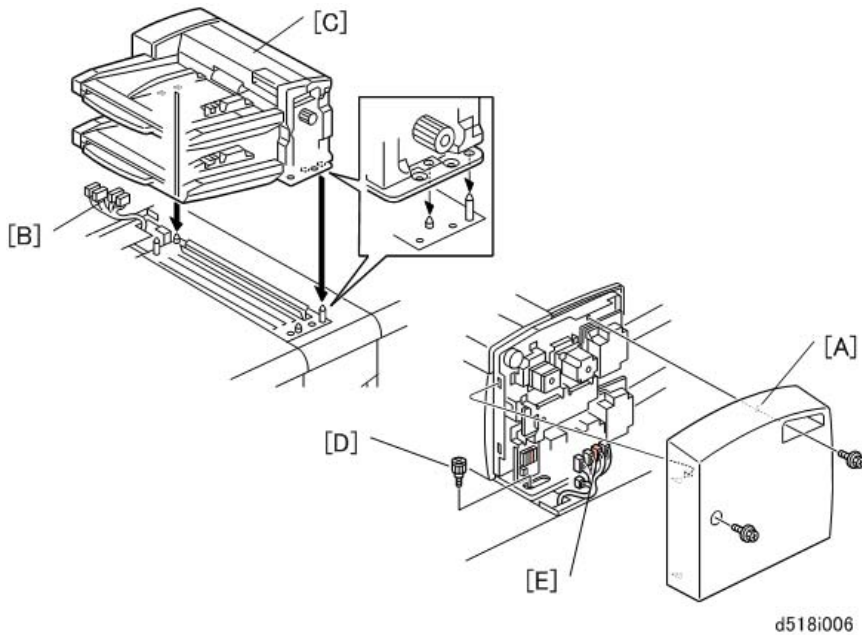

Mounting the Tray Unit

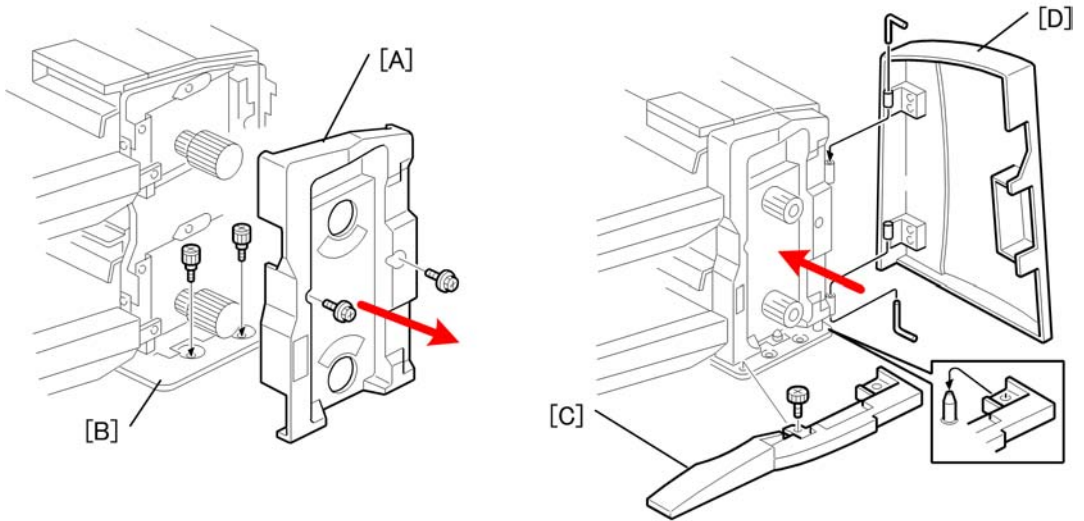

1. Remove the rear cover [A] ( x2). **Keep these screws.**
2. Confirm that the connectors [B] are free.
3. Place the tray unit [C] on top of the cover interposer transport unit and the downstream unit.
4. Attach the knob screw [D] ( x1).
5. Connect the harness connectors [E] ( x5).
6. Reattach the rear cover with the screws removed in Step 1.



d518i007

7. Remove the front inner cover [A] from the tray unit ( x2).
8. Fasten the tray unit to the top of the transport unit with the knob screws [B] ( x2).
9. Attach the base cover [C] (Flat knob screw;  x1).

★ Important

- Make sure the holes in the cover match the positions of the reference pins.

10. Use the two "L" hinges to attach the door [D] to the front inner cover [A].

↓ Note

- It is easier to connect the door to the front inner cover before re-attaching the cover to the tray unit.

11. Re-attach the front inner cover [A] (with door attached) ( x2).
12. If the Buffer Pass Unit is installed, remove its rear cover.

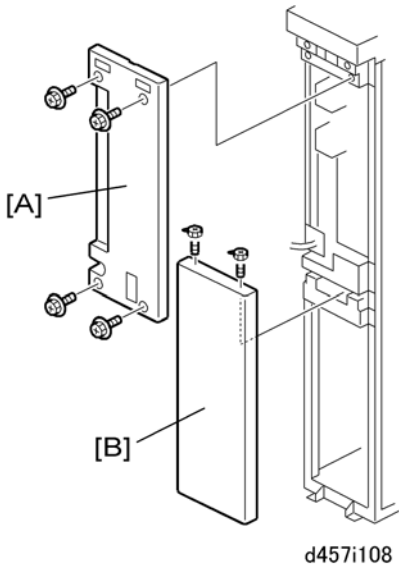



13. At the back of the cover interposer tray, remove:

[A] Upper cover ( x4)

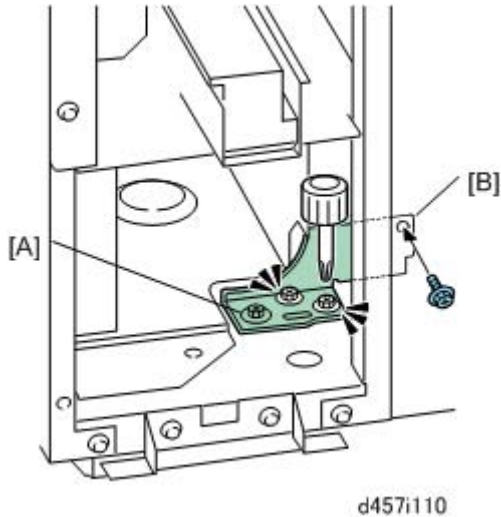
[B] Lower cover ( x2)



14. With the rear covers of both the buffer pass unit and cover interposer unit removed, use a short screwdriver to loosen bracket [A] ( x2).

15. Fasten the bracket to the buffer pass unit at [B] ( x1).

16. Tighten the screws ( x3).

17. Re-attach the rear covers.



d518i302

18. Attach the shoulder screws to the front of the unit (🔩x2).

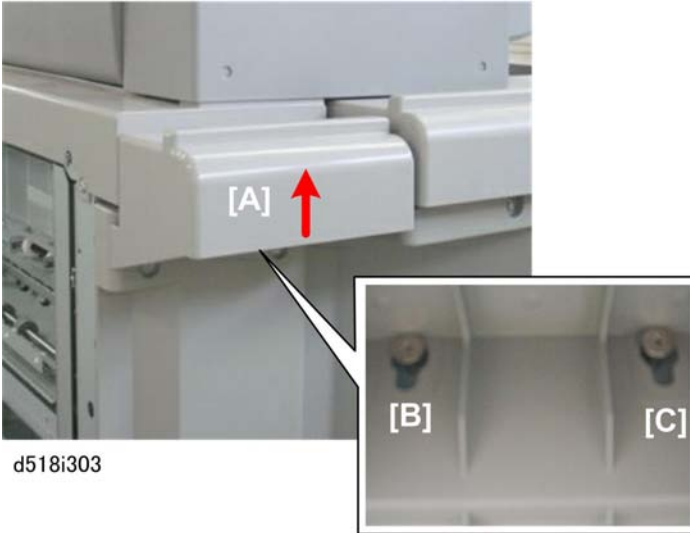

d518i303

19. Set the spacer [A].

- Hang wide ends of the keyholes of the side of the spacer over the heads of the shoulder screws.
- Slide the spacer up to set the heads of the shoulder screws in the narrow end of the keyholes [B] and [C].





d518i304

20. Fasten the spacer to the unit ( x2 M4x8)

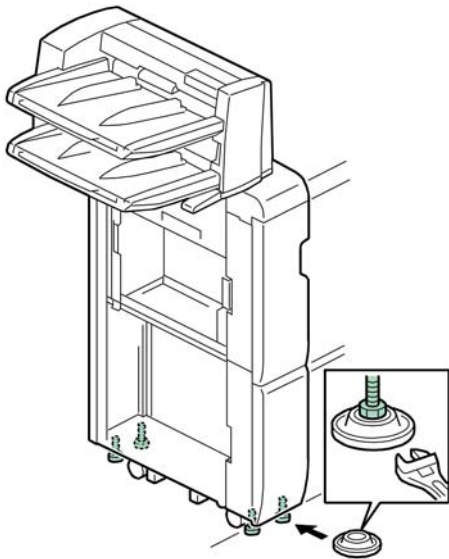
Finishing the Installation



d518i301

1. Set the leveling shoes and adjust the height of the unit. ( p.322)
2. Load some B4 paper in the 2nd tray of the main machine, and make several copies.
3. Check paper skew and side-to-side registration and correct if necessary. ( p.324)

Multi Folding Unit (D521)

Accessories

2

Check the quantity and condition of the accessories in the box against the following illustration and list.

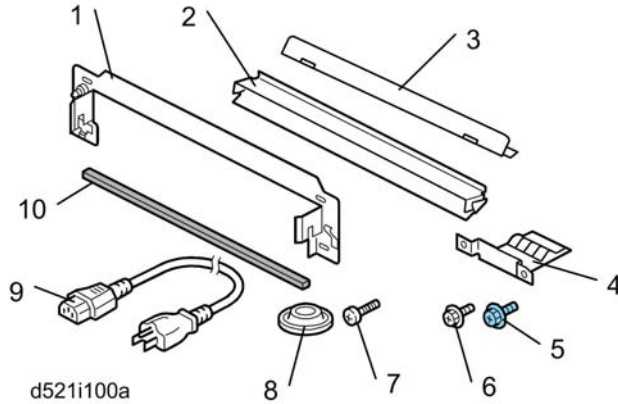

No.	Description	Q'ty
1.	Joint Bracket	1
2.	Paper Guide	1
3.	Mylar (for downstream unit)	1
4.	Ground Plate	1
5.	Screws M3x6	2
6.	Screws M3x6	2
7.	Screws M4x14	4
8.	Leveling Shoes	5
9.	Power Cord*1	1
10.	Sponge Strip	1

*1: In China, do not use the power cord provided with this unit. Contact your supervisor and use the power cord specified for use in China.

Installation

⚠ CAUTION

- The unit must be connected to a power source that is close to the unit and easily accessible.
- Make sure that the main machine is switched off and that its power cord is disconnected before doing the following procedures.

2

Tapes

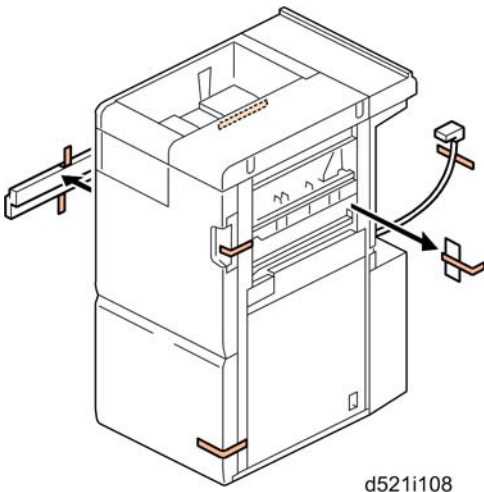

1. Remove all tape and packing material from the front, left, rear, and right sides.

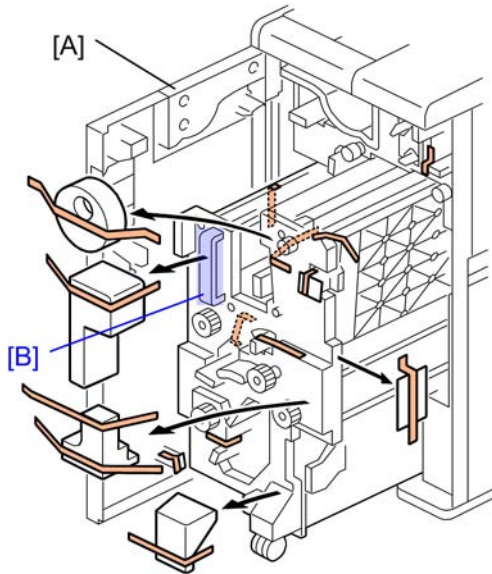

d521i102

2. Open the front door [A].
3. Grip handle [B] and slowly pull the fold unit out of the machine.
4. Remove all tape and packing material from inside.

Paper Guide, Sponge Strips

★ Important

- There are two procedures for installation of the sponge strips.
- Follow "Procedure 1" below if the Multi Folding Unit will be connected to another peripheral unit.
- Follow "Procedure 2" if the Multi Folding Unit will be connected directly to the main machine (more sponge strips are required).

Procedure 1

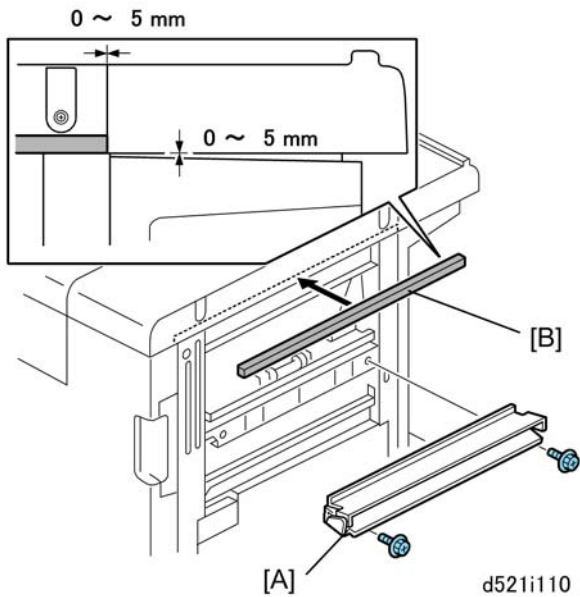

1. Attach the paper guide [A] ($\times 2$ M3x6).
2. Peel the tape from the sponge strip [B] and attach the strip to the top right edge of the unit.

Procedure 2

3. Attach the paper guide as described in "Procedure 1" above.

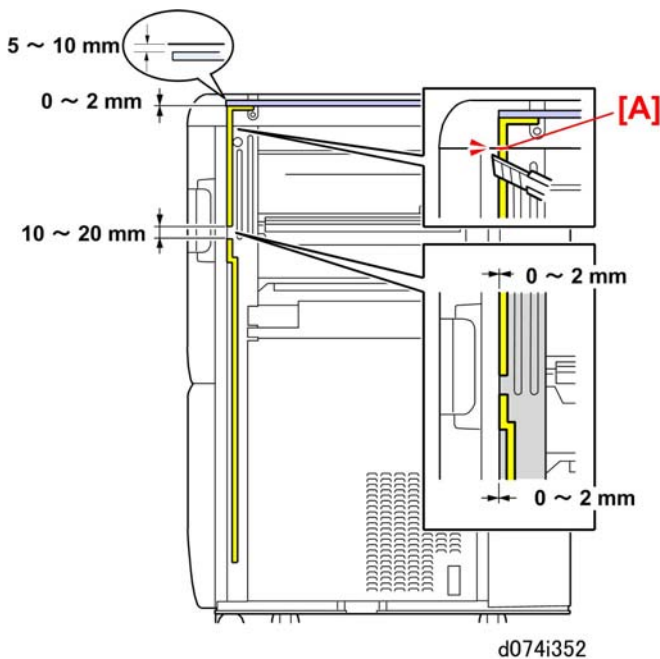

4. Remove the tape from each sponge strip and attach them to the right side of the unit as shown above.

Note

- The two yellow sponge strips in the illustration are provided as accessories with the main machine. The horizontal sponge strip is provided with the Multi Folding Unit.
5. After attaching all sponges, use a sharp cutter to cut the sponge on the corner at [A].

2

Ground Plate

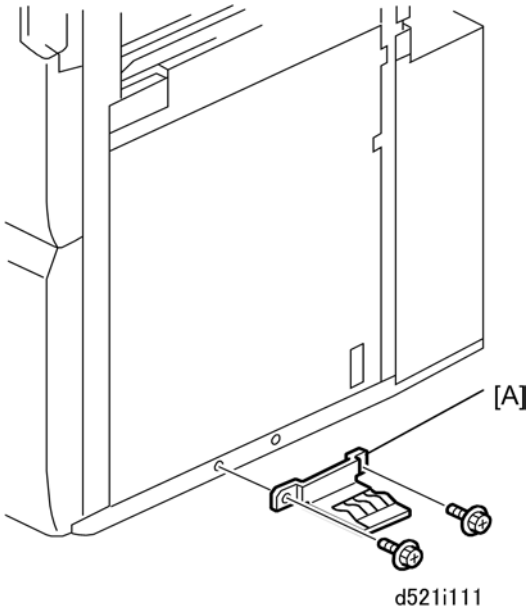

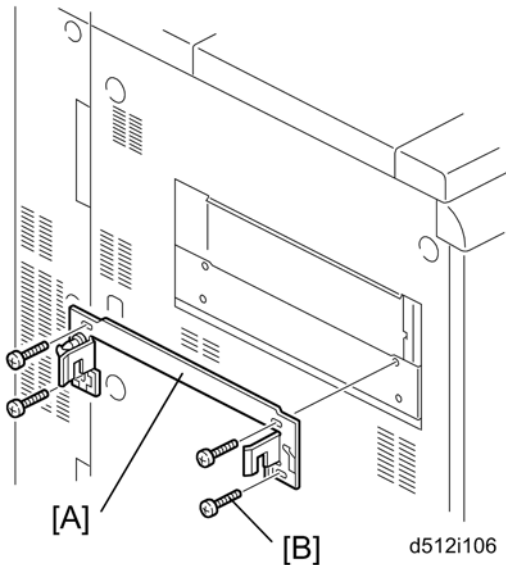

1. Attach the ground plate [A] to the lower right edge of the unit ( x2 M3x6).

Docking

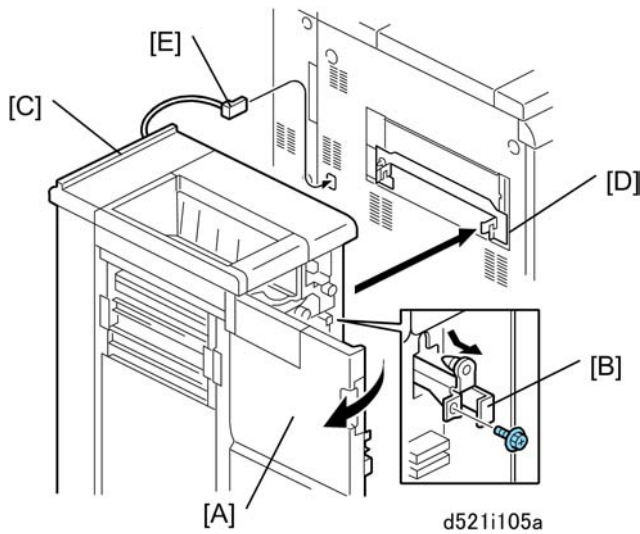

1. Fasten the joint bracket [A] to the left side of the upstream unit ( x4 M4x14).



2. Open the front door [A].
3. At the front right corner, remove the screw of the lock bar [B] ( x1 M3x6). **Keep this screw.**
4. Push in the lock bar.
5. Slowly push the unit [C] against the left side of the upstream unit (or main machine) so that the lock bar is directly and squarely under the arms of the joint bracket.
6. Pull out the lock bar so it slides up into the notches in the arms on both ends of the joint bracket [D].
7. Fasten the lock bar by re-attaching the screw removed in **Step 3** ( x1).

8. Connect the I/F cable [E] to the upstream unit (or main machine).

Note

- If you are docking to the main machine, you must first remove the plastic cap at the I/F cable connection point.

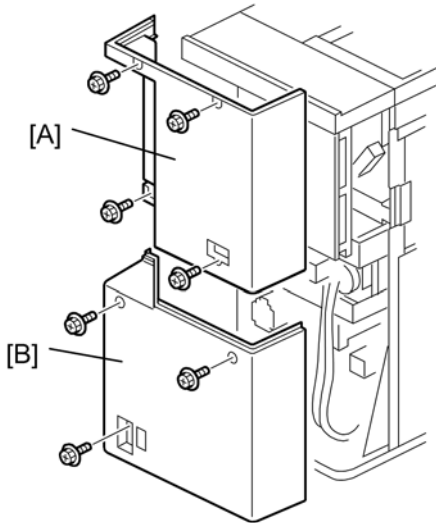

d521i113

9. Remove:

[A] Rear upper cover ( x4)

[B] Rear lower cover ( x3)

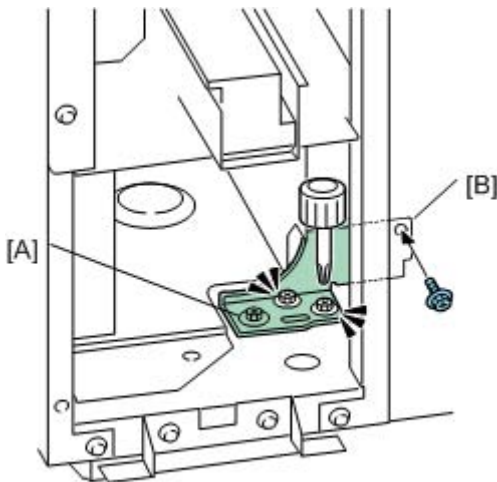

d457i110

10. Use a short screwdriver to loosen bracket [A] ( x2).

11. Fasten the bracket to the upstream unit at [B] ( x1).

12. Tighten the screws ( x3).
13. Re-attach the rear covers.

Removing Parts for the Cover Interposer Tray (D518)

Three parts must be removed before the tray unit of the cover interposer tray can be mounted on top of the Multi Folding Unit.



2

1. Open the front door.

★ Important

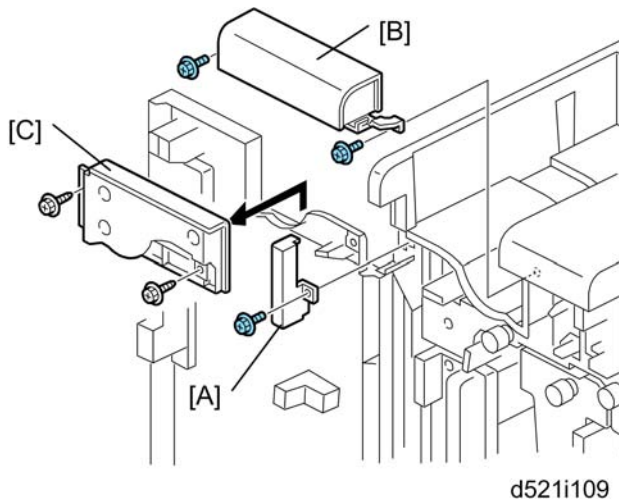
- The following parts require removal only if the upstream unit is the Cover Interposer Tray (D518).
- These parts must be removed so that the tray unit of the Cover Interposer Tray will fit on top of the Multi Folding Unit.



2. Remove:
 - [A] Bracket ( x1)
 - [B] Cross-piece ( x2)
 - [C] Metal plate from the door ( x2)
3. After removing [B] and [C], reattach [A].

Power Cord

2

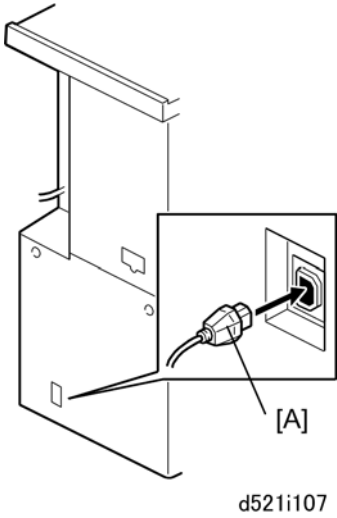

1. Insert the power cord socket [A] into the power connection point.

★ Important

- In China, do not use this power cord provided with this unit. Contact your supervisor and use the power cord specified for use in China.

2. Connect the power supply cord plug to a power outlet.

Finishing the Installation

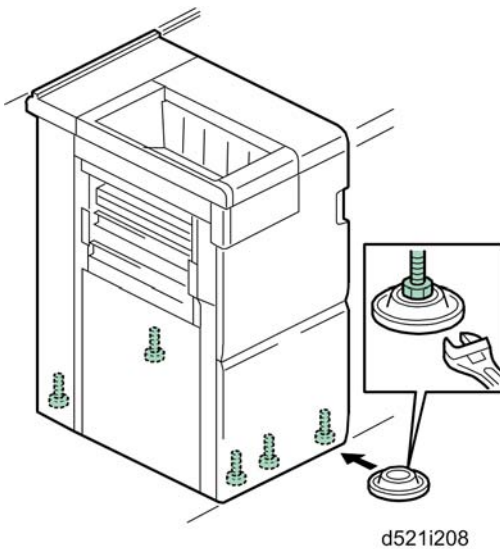

1. Set the leveling shoes and adjust the height of the unit. (p.322)

2. Load some B4 paper in the 2nd tray of the main machine, and make several copies.
3. Check paper skew and side-to-side registration and correct if necessary. (p.324)

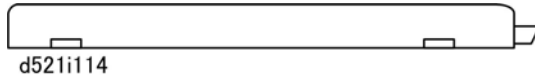

4. Peel the tape from the accessory mylar strip.

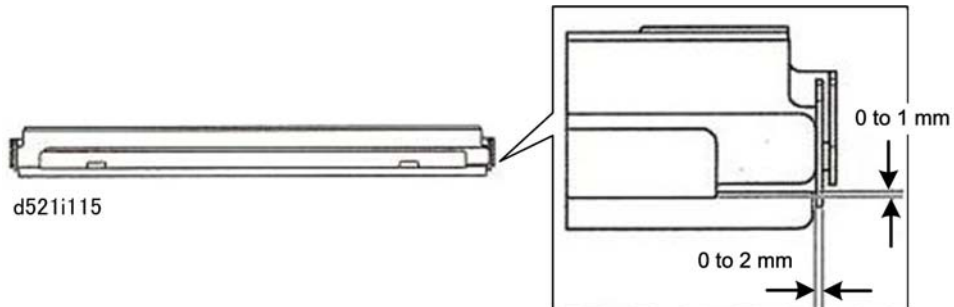

5. Attach the mylar to the top of the downstream paper guide as shown above (top view).

Auxiliary Tray, Fold Depressor

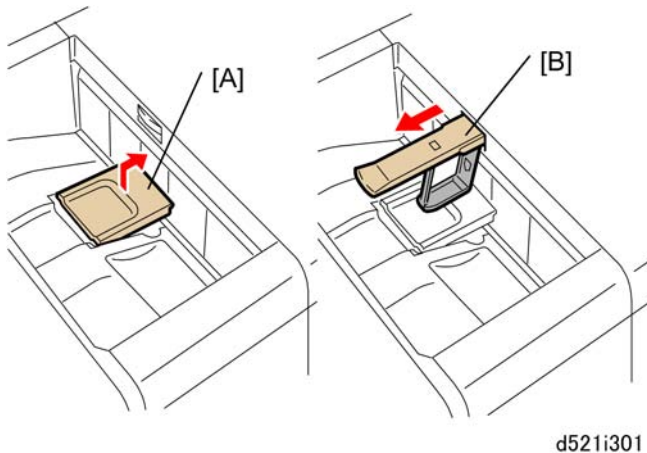

1. Set the auxiliary tray [A] or flexible page depressor [B] when required.

Note

- These items are available. They are not accessories.
- The auxiliary tray [A] keeps Z-folded paper (FM1) flat in the tray so that the trailing edges do not trigger an early tray full alert in the top tray.
- The flexible page depressor [B] prevents folded paper (especially FM3 Letter Fold-out sheets) from opening out and triggering an early tray full alert in the top tray.
- Both items can be installed together. Install [A], and then install [B].

Ring Binder (D519)

Accessories

2

Check each accessory against the list below to make sure that you have everything.

No.	Item	Q'ty
1.	Docking Bracket	1
2.	Entrance Guide Plate	1
3.	Sponge Strip	1
4.	Power Cord	1
5.	Ring Opener	1
6.	Ring Supply Level Indicator	1
7.	Screws (M4 x 14)	4
8.	Tapping Screws (M3 x 6)	4
9.	Leveling Shoes	4
10.	Ground (Earth) Plate	1

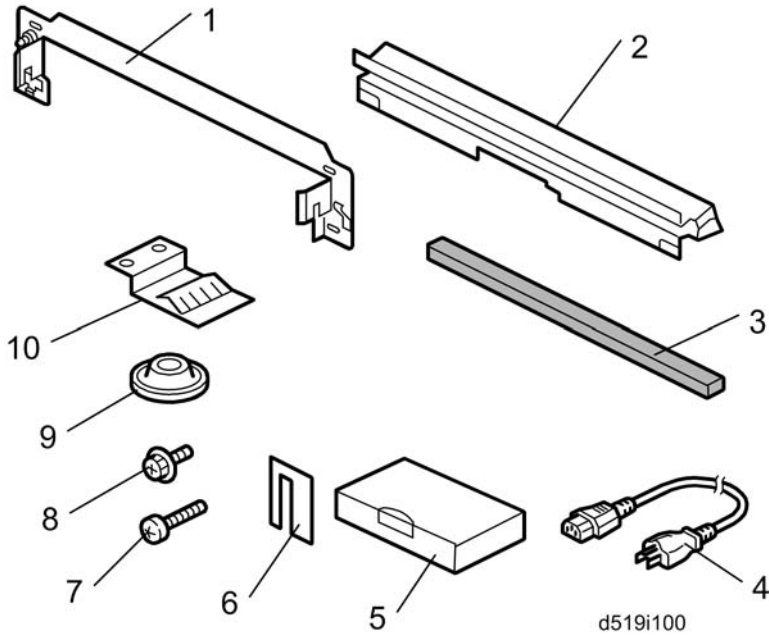

Before You Begin

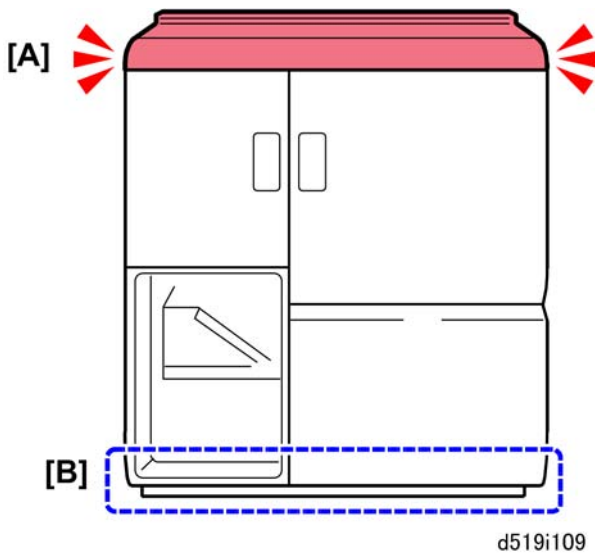

The ring binder weighs 140 kg (308 lb.).

IMPORTANT: To prevent bending or breaking the top cover, never lift the unit by its top cover [A]. Always raise the unit from the base [B].

Installation Procedure

⚠ CAUTION

- The unit must be connected to a power source that is close to the unit and easily accessible.
- Make sure that the main machine is switched off and that its power cord is disconnected before doing the following procedure.

2

Remove All Shipping Materials

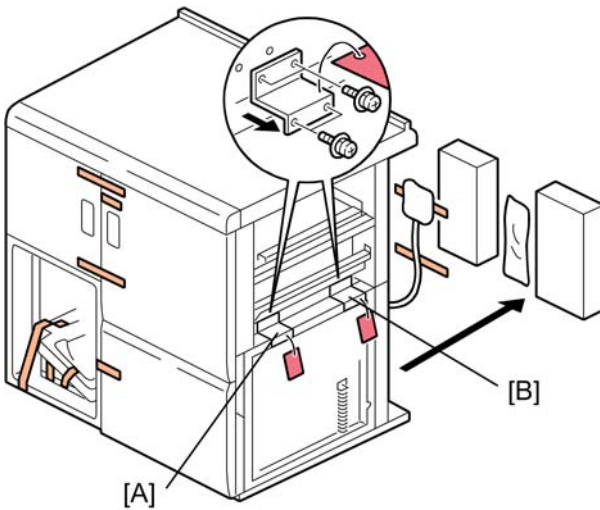

d519i101

1. Remove all visible tapes, cushion, two accessory boxes, and wrapping material attached to the outside of the unit.

2. Remove:

[A] Brace x1 ( x4)

[B] Brace x1 ( x4)

★ Important

- Do not discard these braces. They must be reattached to the unit before it is moved or shipped to another location.

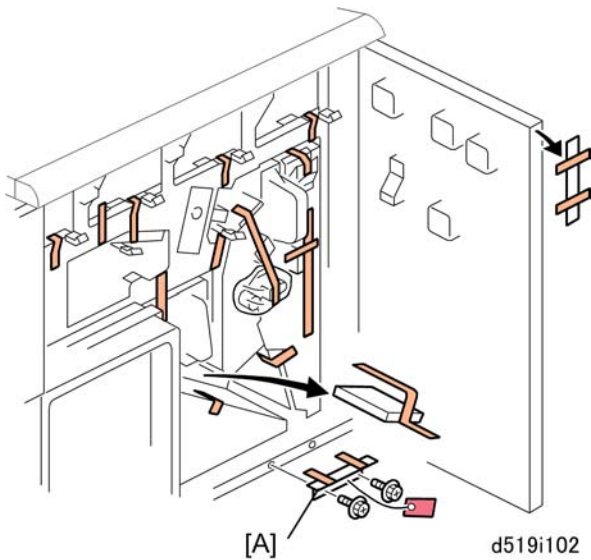

3. Open the right door and left door.
4. Remove all tapes and packing material.
5. Remove the brace and red tag [A] ( x2).

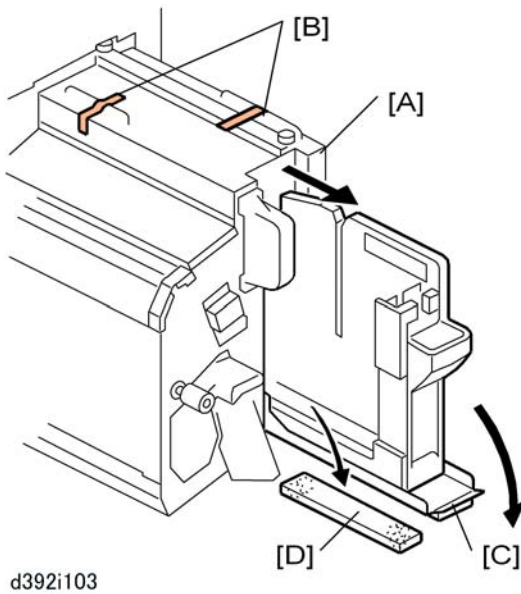

6. Pull the binder unit [A] out of the unit until it stops.
7. Remove the tape [B] on top of the unit.
8. Pull down the ring cartridge handle and cover [C].
9. Pull the ring cartridge out and remove the cushion [D].

10. Push the ring cartridge in and close its cover.
11. Push the binder unit into the unit.
12. Close the left front door and right front door.

Prepare the Unit for Docking



2

★ Important

- There are two procedures for installation of the sponge strips.
- Follow "Procedure 1" below if the Ring Binder will be connected to another peripheral unit.
- Follow "Procedure 2" if the Ring Binder will be connected directly to the main machine (more sponge strips are required).

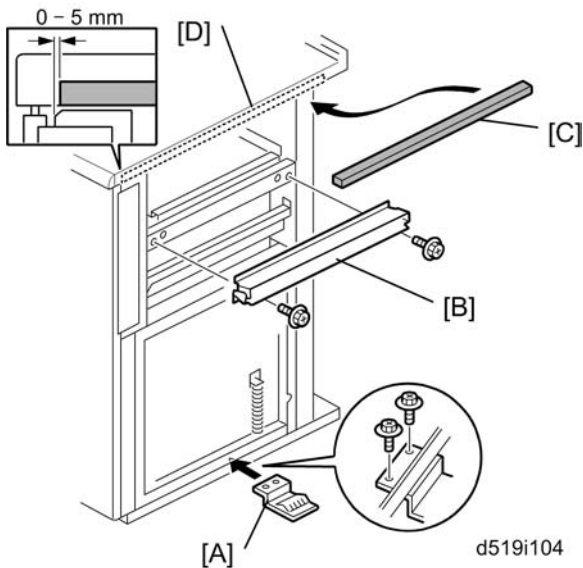
Procedure 1



1. Attach the ground plate [A] ( x2).
2. Attach the entrance guide plate [B] ( x2).
3. Remove the tape from the back of the sponge strip [C].
4. Attach the sponge strip to the top edge [D] of the unit as shown above.

Procedure 2

1. Attach the ground plate and entrance guide as described in "Procedure 1" above.

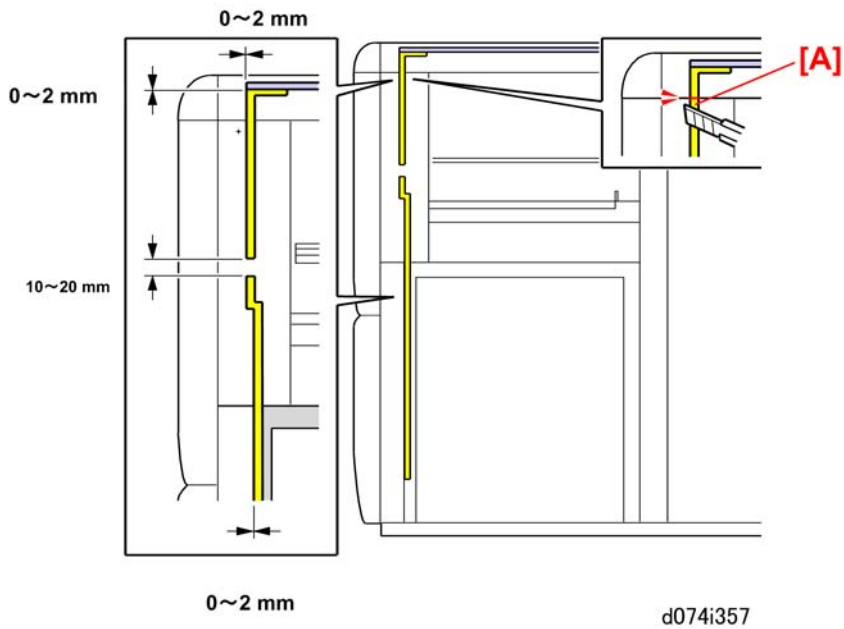

- Remove the tape from each sponge strip and attach them to the right side of the unit as shown above.

Note

- The two yellow sponge strips in the illustration are provided as accessories with the main machine. The horizontal sponge strip is provided with the Ring Binder.

- After attaching all sponges, use a sharp cutter to cut the sponge on the corner at [A].

Prepare the Main Machine for Docking

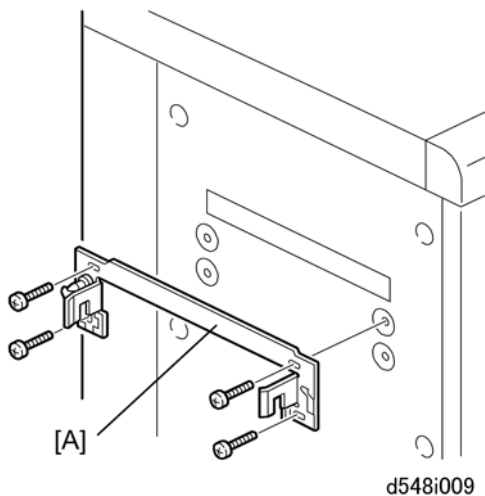

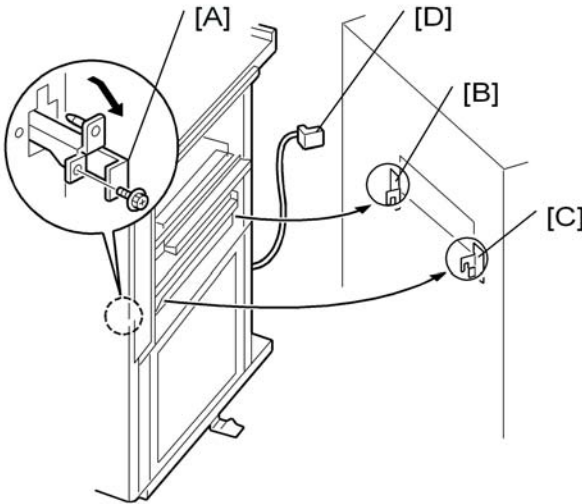

1. Attach the docking bracket [A] (M4x14  x4).

Dock the Unit to the Main Machine



d392i106

1. Open the right door of the unit.
2. Pull out the locking lever [A] ( x1).
3. Align the right side of the unit with the docking brackets [B] and [C] on the left side of the main machine, and then slowly push the unit onto the brackets.
4. Connect the unit's I/F cable [D] to the main machine.
5. Push in the locking lever and check that it slides into the slots of the docking brackets.
6. Check that the top edge of the unit is parallel with the left edge of the main machine.
7. Refasten the locking lever [A] ( x1) and close the right front door.

Install the Shoes and Level the Unit

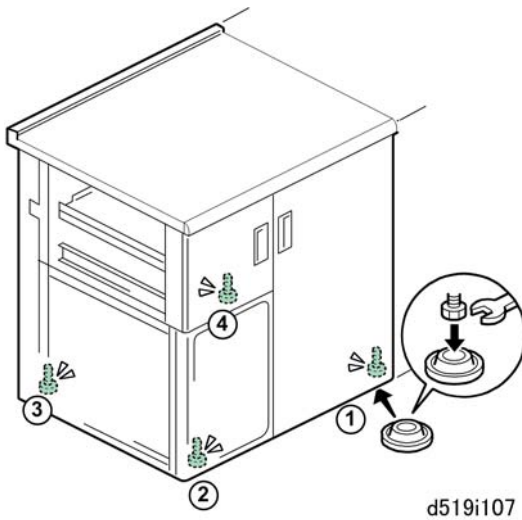

1. Set the leveling shoes (x4) under the feet of the unit.
2. Open the right front door and left front door.
3. Place a level on the frame.
4. Use a wrench to turn the nut at each foot until the machine is level.

Attach Ring Supply Level Indicator

1. Open the front door.
2. Pull out the ring binder.
3. Lift the ring supply cartridge out of the top of the binder unit.

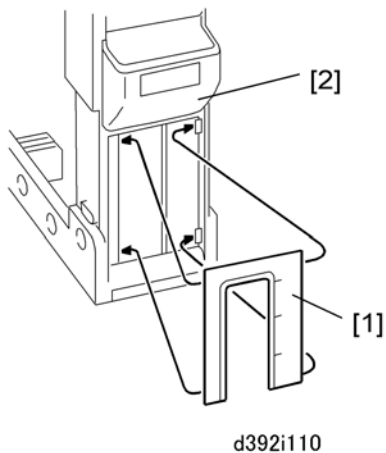

4. Set the ring supply level indicator [1] behind the tabs on the side of the ring supply cartridge [2].

Test the Breaker Switch

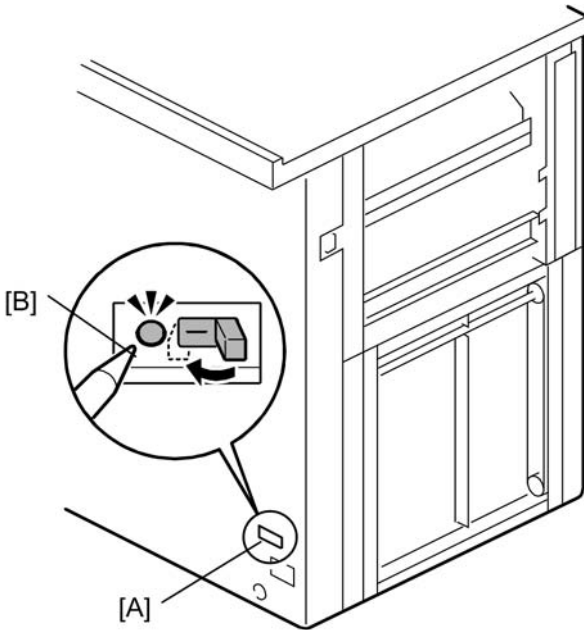

d392i108

1. If the main machine is on, turn it off.
2. Confirm that the breaker switch [A] is set to the right.

↓ Note

- The breaker switch is at the bottom of the left rear corner near the power cord. When it is set to the right, you should see a straight line (-).
3. Connect the power cord to the finisher, then connect the other end to a power supply outlet.
 4. Use the sharp point of a pen [B] or similar tool to push in the breaker switch until it snaps to the off position. (You should see "0".)
 5. If the breaker does not snap to the off position:
 - Check that the power cord is correctly connected to the finisher and power supply.
 - Push the breaker switch again to see if it snaps to the off position.
 - If the breaker switch does not snap to the off position, it must be replaced.
 6. Be sure to reset the breaker switch to the on (-) position.

Centering Paper in the Paper Path

At installation you must confirm that the paper is exiting the ring binder correctly and do the necessary correction if required. There are two checks:

- The paper should be centered in the paper path.
- The paper should feed straight out of the ring binder.

2

Checking and Correcting Side-to-Side Registration

Checking Side-to-Side Registration

Do this check to confirm that the paper is centered in the paper path.

1. Make sure that the I/F cable of the ring binder unit is connected.
2. If the finisher is connected to the left side of the ring binder, disconnect it and pull it away from the left side of the ring binder.
3. Execute a run by feeding paper (A4 or LT) from Tray 2 of the host machine (punching only, no ring binding).

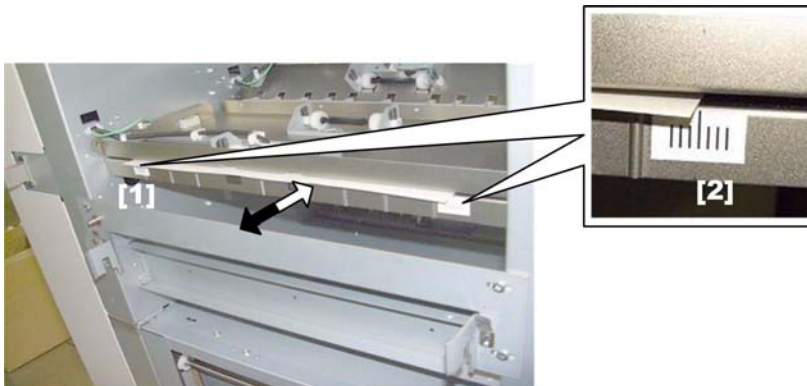

d3912r0204a

4. During the run, each sheet of paper briefly protrudes about 5 to 10 mm before it switches back into the ring binder and feeds to the punch unit, as shown above.
 - There are two scales on the left side of the ring binder below the paper exit.
 - The rear scale [1] is for LT-size paper and the front scale [2] is for A4-size paper. Be sure to read the correct scale for the paper size in use.
5. Check the position of the paper on the scale to determine if the paper is centered.

★ Important

- Read the rear scale for LT-size paper and the front scale for A4-size paper.
- The scale lines are spaced 1 mm apart.
- The edges of the paper should be at the center line and not deviate more than ± 2 mm.

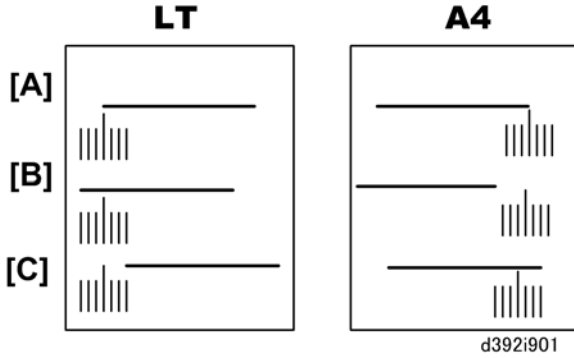

[A]	Leading/trailing edges centered. No adjustment necessary.
[B]	Leading/trailing edges offset to the rear more than 2 mm. Adjustment required.
[C]	Leading/trailing edges offset to the front more than 2 mm. Adjustment required.

6. If the edge of the paper is on the scale at the center [A], no adjustment is required.

-or-

If the edge of the paper is ± 2 mm off the center line on the scale, adjustment is required. Do the procedure in the next section.

Correcting Side-to-Side Registration: Bracket Adjustment

1. Disconnect the ring binder from the upstream unit.

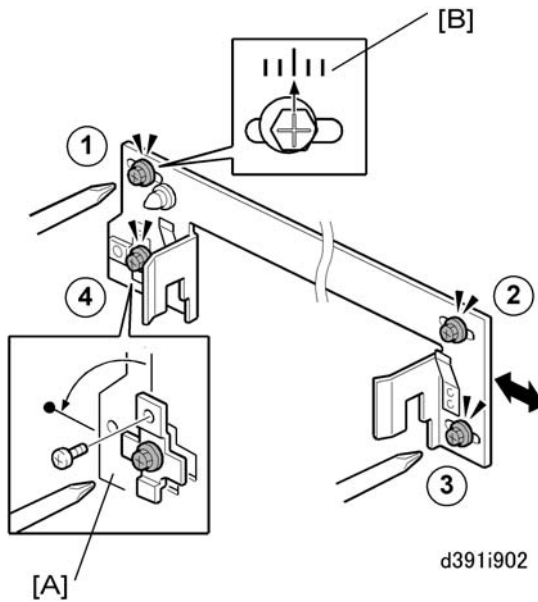

2. On the docking bracket attached to the upstream unit, loosen screws ①, ②, ③, and ④.

3. Remove bracket [A] ( x1), rotate it 90 degrees, and re-fasten the screw. Changing the position of this bracket aligns the oval cut-out horizontally and frees the joint bracket so it can slide side-to-side.
4. Look at the scale [B].
5. Slide the bracket to the left or right and tighten the screw.
If the deviation from center was toward the front, slide the bracket to the rear and tighten the screw (1).
-or-
If the deviation from center was toward the rear, slide the bracket to the front and tighten screw (1).
6. Tighten screws (2), (3), and (4).
7. Do another test run to check the results of the adjustment.

Checking and Correcting Skew

Checking for Paper Skew

Do this check to confirm that the paper is not skewed in the paper path.

1. Make sure that the I/F cable of the ring binder unit is connected.
2. If the finisher is connected to the left side of the ring binder, disconnect it and pull it away from the left side of the ring binder.
3. Execute a straight-through run (no ring binding, no punching) with A3 or DLT from Tray 2 of the host machine.

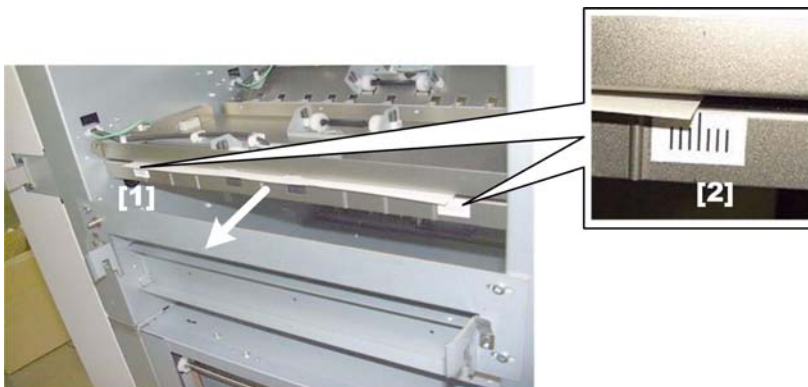

d3912r0204b

4. During the run, each sheet of paper exits the side of the ring binder, as shown above.
 - There are two scales on the left side of the ring binder below the paper exit.
 - The rear scale [1] is for DLT-size paper and the front scale [2] is for A3-size paper. Be sure to read the correct scale for the paper size in use.
5. Check the position of the paper on the scale to determine if the paper skews as it exits.

★ Important

- Read the rear scale for DLT-size paper and front scale for A3-size paper.
- The scale lines are spaced 1 mm apart.
- The paper must not deviate more than ± 2 mm on the scale.

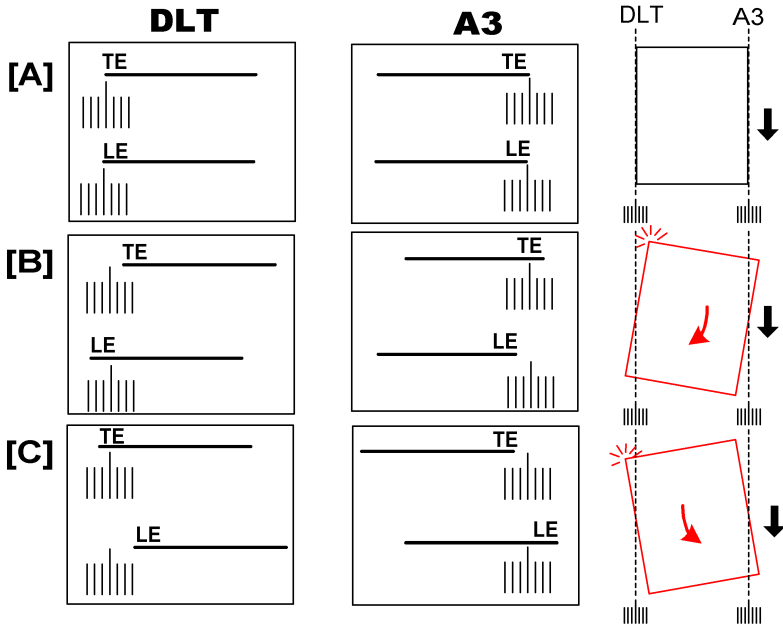

d392i904

[A]	Centered. No adjustment necessary.
[B]	Trailing edge skew to the front, total skew more than ± 2 mm. Adjustment required.
[C]	Trailing edge skew to the rear, total skew more than ± 2 mm. Adjustment required.

Correcting Skew

1. Disconnect the ring binder from the upstream unit.



d392i905

- Remove the spacers from the right side of the ring binder at the base ( x2).

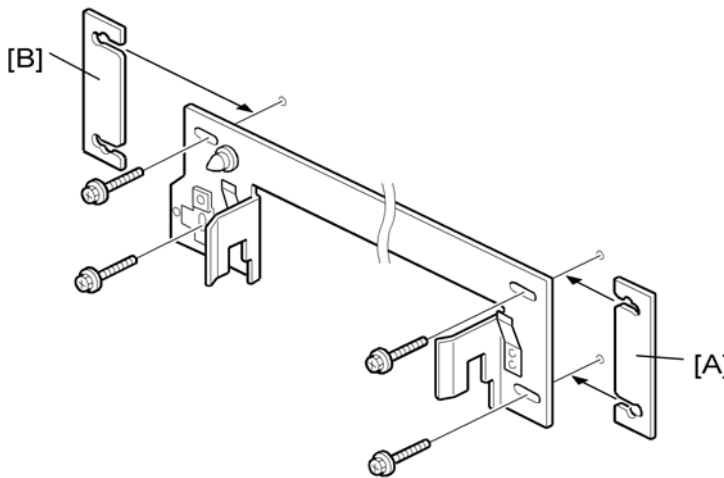

d392i906

- On the docking bracket attached to the upstream unit, loosen the screws.
- Insert a spacer and tighten the screws.

If the trailing edge is skewing toward the **front** of the machine, insert a spacer [A] under the **rear** end of the bracket and tighten the screws.

-or-

If the trailing edge is skewing toward the **rear** of the machine, insert a spacer [B] under the **front** end of the bracket and tighten the screws.

- To another run to check the adjustment. If skew is still present, insert another spacer.

After Installation

Confirm that the operators understand the following important points:

- Decals attached to the machine that provide guidance for removing paper jams. Point out the decal locations.
- Detailed instructions on removing ring jams are provided in the operating instructions under "Removing Jammed Ring Combs".
- When pulling out and pushing in the binder unit on its rails, always grip the binder unit by its handle (**Mc8**).



d392r902

CAUTION

- Always grip handle **Mc8** when pulling out or pushing in the binder unit.
- Never touch any other surface of the binder unit when it is moving on its rails.
- To avoid injury to the fingers, never push on the top of the binder unit to slide it back into the finisher as shown above.



d519i910

- Never store paper, extra rings, manuals or any other material below the output tray. Obstacles in this area (shown in red in the illustration below) will interfere with the raising and lowering of the tray and cause an error.

High Capacity Stacker (D515)

Accessories

Check the quantity and condition of the accessories in the box against the following illustrations and lists.

High Capacity Stacker (D515)

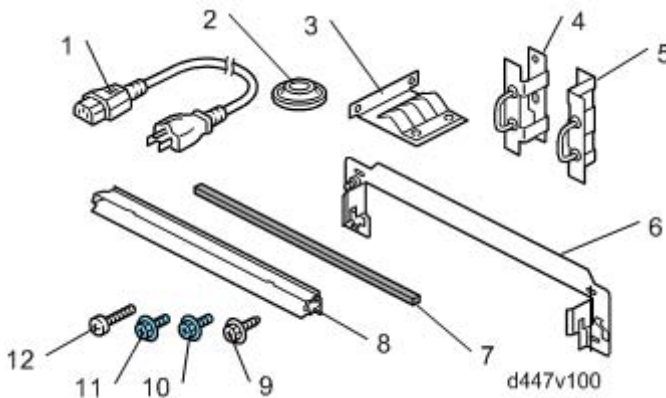

No.	Description	Q'ty
1.	Power Cord*1	1
2.	Leveling Shoes	4
3.	Ground Plate	1
4.	Lock Hasp – Left*2	1
5.	Lock Hasp – Right	1
6.	Joint Bracket	1
7.	Sponge Strip	1
8.	Paper Guide	1
9.	Screws M4x8	2
10.	Screws M3x6	4
11.	Screws M4x6	2
12.	Screws M4x14	4

*1: In China, do not use this power cord provided with this unit's accessories. Contact your supervisor and use the power cord specified for use in China.

*2: A lock is not provided.

Roll-Away Cart Type 5010 (D456-17)

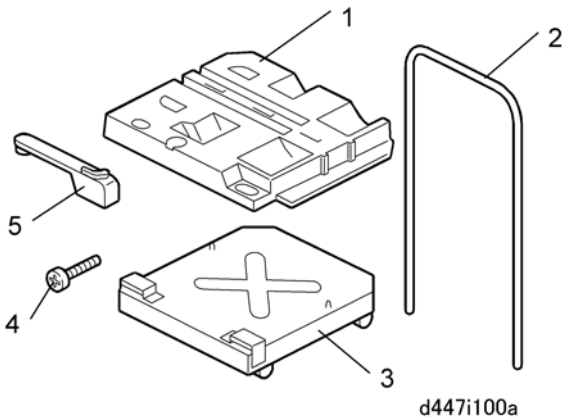

2

No.	Description	Q'ty
1.	Paper Tray	1
2.	Tray Cart Handle	1
3.	Tray Cart Base	1
4.	Screws M10x25	2
5.	Paper Press Lever	1

Installation

⚠ CAUTION

- The unit must be connected to a power source that is close to the unit and easily accessible.
- Make sure that the main machine is switched off and that its power cord is disconnected before doing the following procedure.

Shipping Tapes

2

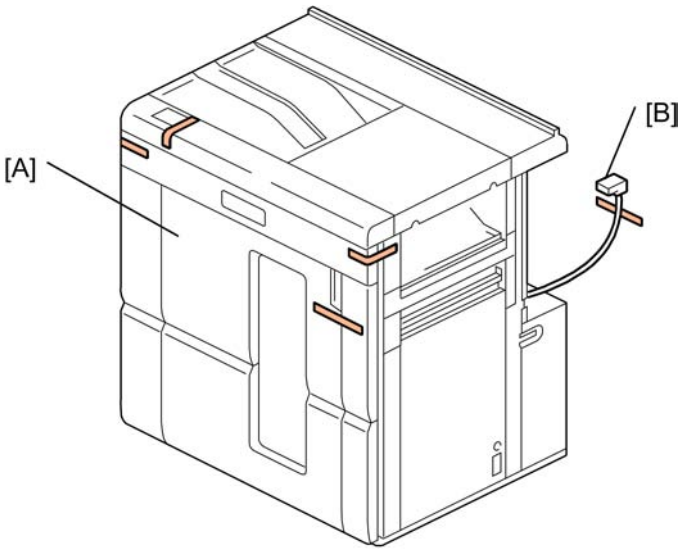

d515i101

1. Remove all visible tape from the front [A] and back [B].

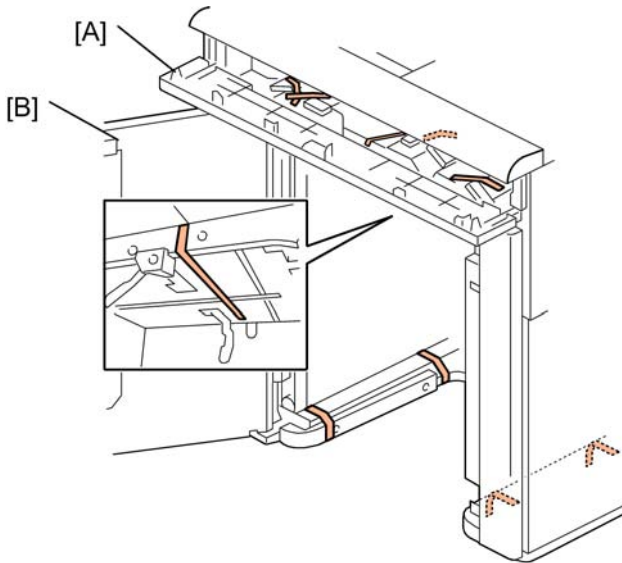

d515i102

2. Open the front panel [A] and remove all visible tapes.
3. Open the front door [B] and remove all visible tapes.

Paper Guide, Sponge Strips, Ground Plate

★ Important

- There are two procedures for installation of the sponge strips.
- Follow "Procedure 1" below if the High Capacity Stacker will be connected to another peripheral unit.
- Follow "Procedure 2" if the High Capacity Stacker will be connected directly to the main machine (more sponge strips are required).

2

Procedure 1

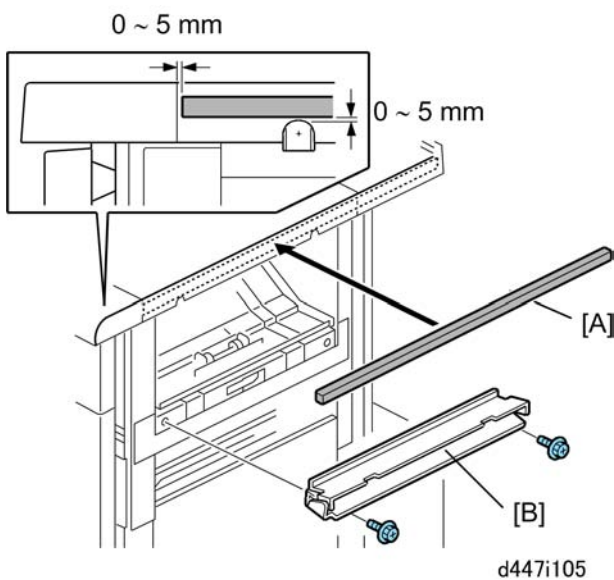

1. Remove the tape from the sponge strip [A] and attach the strip to the top right edge of the unit.

↓ Note

- The sponge strip closes the gap between the High Capacity Stacker and the upstream unit to prevent paper or other objects from falling between the units.
2. Fasten the paper guide [B] to the right side of the unit ( x2).

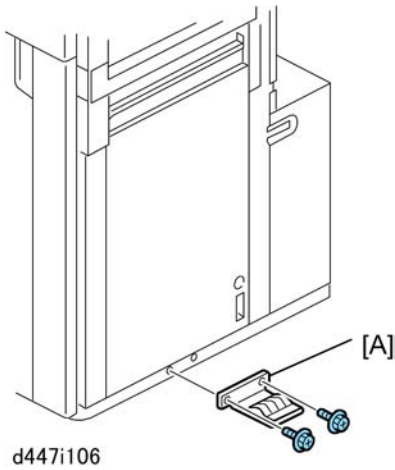

3. Attach the ground plate [A] to the bottom right edge of the unit ($\times 2$ M3x6).

★ Important

- If the High Capacity Stacker will be docked to the left side of the main machine, more sponge strips must be attached.

Procedure 2

1. Attach the paper guide and ground plate as described in "Procedure 1" above.

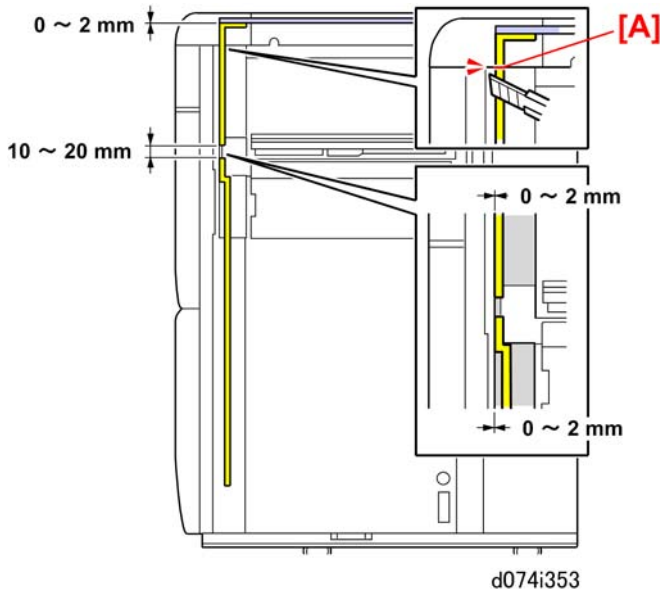

2. Remove the tape from each sponge strip and attach them to the right side of the unit as shown above.

Note

- The two yellow sponge strips in the illustration are provided as accessories with the main machine. The horizontal sponge strip is provided with the High Capacity Stacker.
3. After attaching all sponges, use a sharp cutter to cut the sponge on the corner at [A].

Docking

2

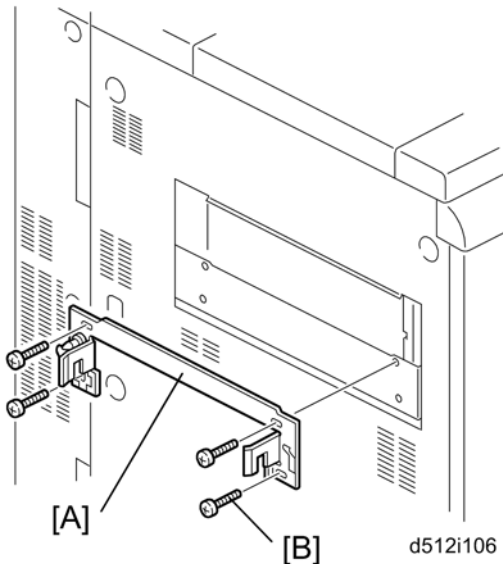

1. Fasten the joint bracket [A] to the upstream unit ( x4).

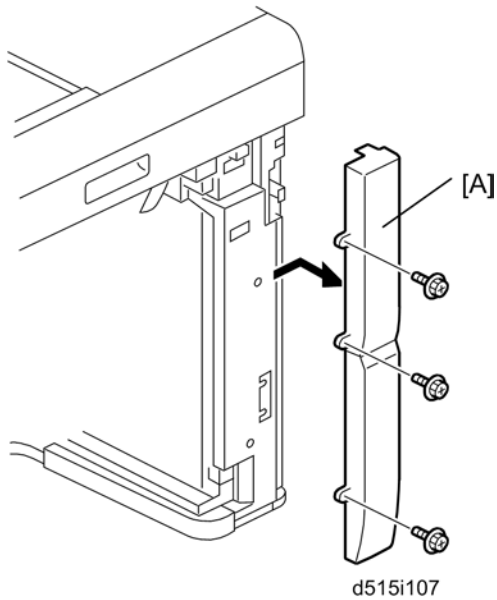

★ Important

- If this unit is to be installed on the left side of the Multi Folding Unit, use three M4x20 screws and one M4x14 screw.
 - The screw [B] (front-lower) must be "M4x14". The other three screws must be "M4x20". Otherwise, these screws may interfere with the upstream unit.
 - M4x20 screws are provided with the Multi Folding Unit.
2. Open the front door.

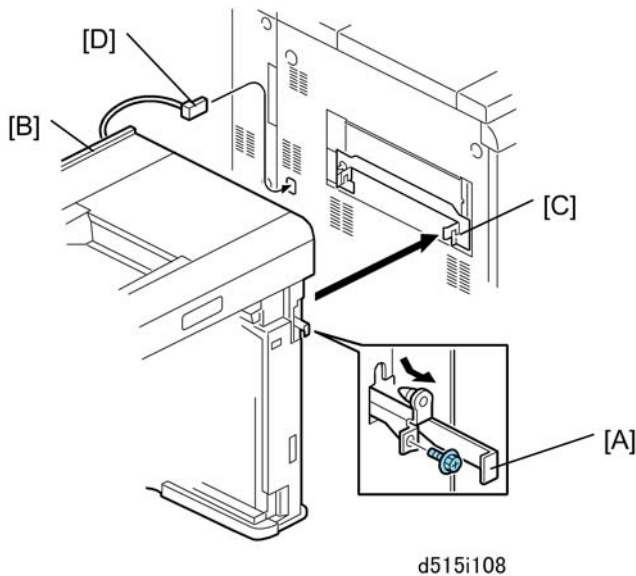

3. Remove the front right cover [A] ( x3).



4. At the front right corner, remove the screw of the lock bar [A] ( x1 M3x6). **Keep this screw.**
5. Pull the lock bar toward you until it stops.
6. Slowly push the unit [B] against the left side of the upstream unit (or main machine) so that the lock bar is directly and squarely under the arms of the joint bracket [C].
7. Push the lock bar in completely so that it slides up into the notches in the arms on both ends of the joint bracket.
8. Fasten the lock bar by re-attaching the screw removed in **Step 4.** ( x1).

9. Attach the I/F cable [D] to the upstream unit.

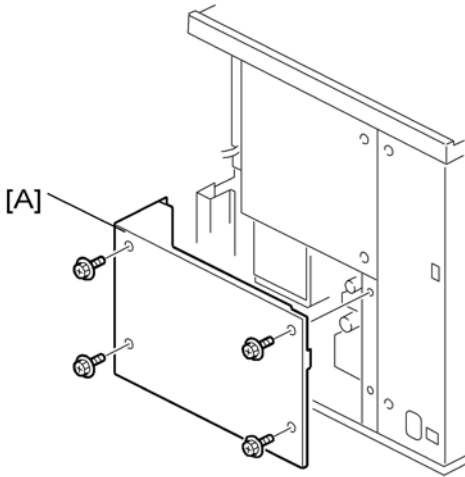

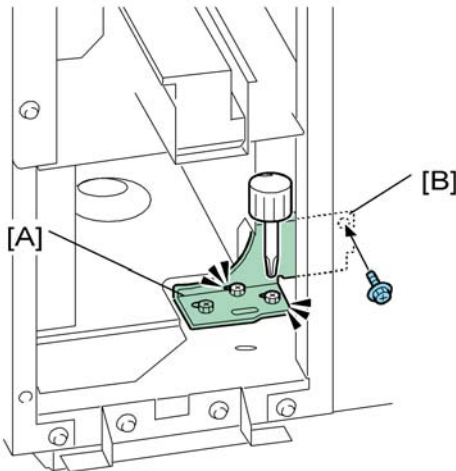

d447i109

10. Remove the right rear lower cover [A] ( x4).





d447i109a

11. Use a short screwdriver to loosen bracket [A] ( x2).
12. Fasten the bracket to the upstream unit at [B] ( x1).
13. Tighten the screws ( x3).
14. Re-attach the rear covers.

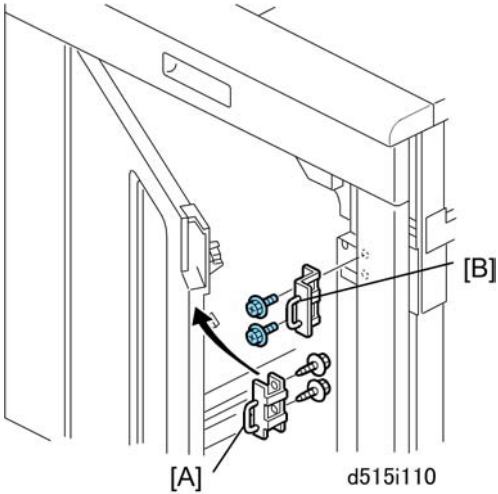
Lock Hasps



1. Fasten left lock hasp [A] ( x2) to the door.
2. Fasten right lock hasp [B] to the door frame ( x2).

Height Adjustment

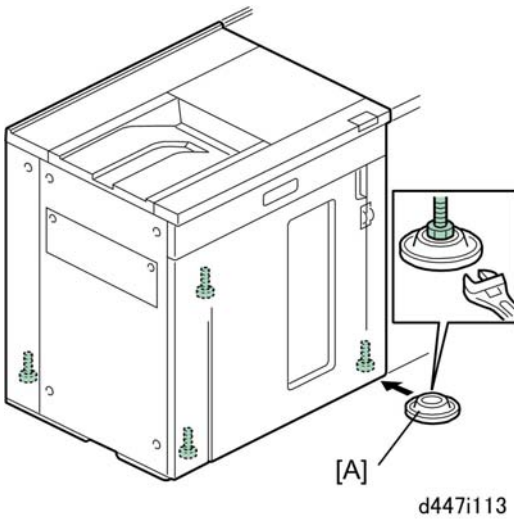

1. Set the leveling shoes [A].
2. Adjust the height of the unit and make sure that it is level.

Finishing the Installation

1. Connect the power cord to the unit.

★ Important

- In China, do not use this power cord provided with this unit's accessories. Contact your supervisor and use the power cord specified for use in China.
2. Set the leveling shoes and adjust the height of the unit. (📖 p.322)
 3. Load some B4 paper in the 2nd tray of the main machine, and make several copies.
 4. Check paper skew and side-to-side registration and correct if necessary. (📖 p.324)

2

Docking: Downstream

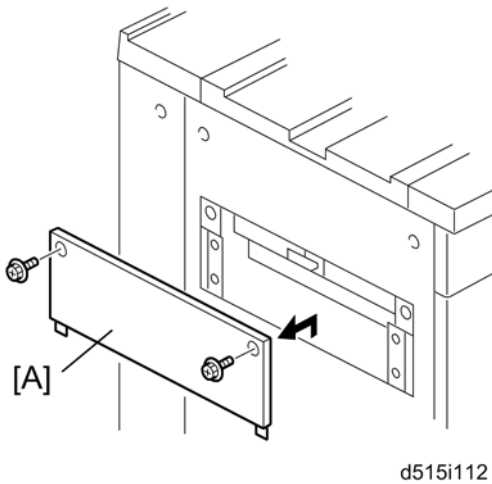

★ Important

- Do this procedure only if another peripheral device will be installed downstream.
1. Remove the left exit cover [A] from the left side of the unit (🔧 x2).

Roll-Away Cart (D456)

2

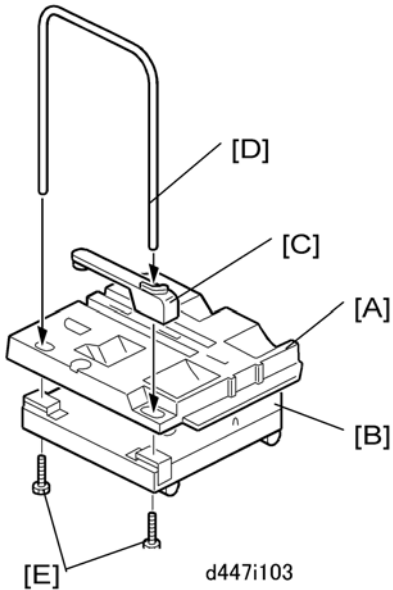

1. Align the holes in the brackets of the paper tray [A] with the studs on the tray base [B].
2. Set the holes over the studs.
3. Set the paper press lever [C] into the recessed cut-out in the paper tray.
4. Insert the ends of the tray cart handle [D] into the handle holes. One end of the handle passes through the paper press lever on the paper tray.

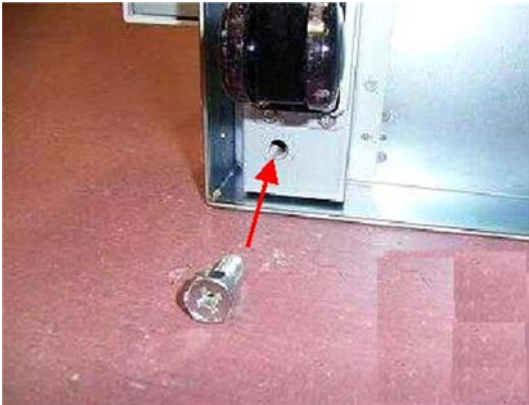

5. Lay the assembly down with the handles on the floor.
6. Fasten the end of each handle ( x 1 each, M10x25).
7. Make sure that both screws [E] are fastened securely.

8. Set the cart upright on its casters.

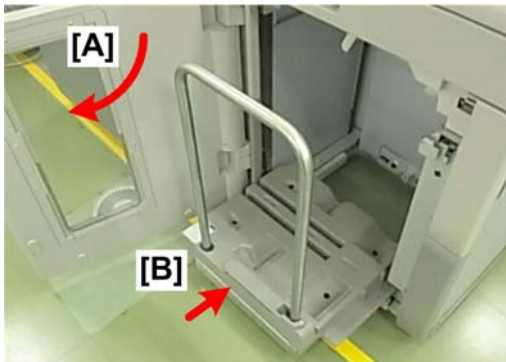

d515i111

9. Open the front door [A].
10. Push the tray cart [B] into the unit and close the door.

Finishers (D512/D513)

Accessories

2

Check the quantity and condition of the accessories in the box against the following illustration and list.

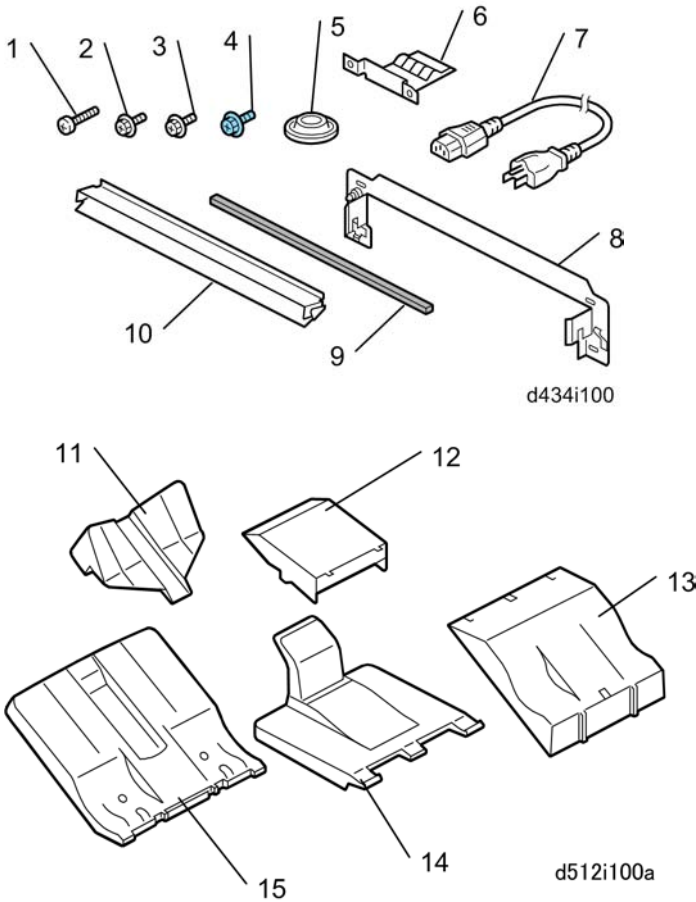

No.	Description	Q'ty
1.	Screws M4x14 (Joint Bracket)	4
2.	Screws M3x8 (Shift Tray)	4
3.	Screws M3x6 (Ground Plate)	2
4.	Screws M3x6 (Paper Guide)	2
5.	Leveling Shoes	4

No.	Description	Q'ty
6.	Ground Plate	1
7.	Power Cord* ¹	1
8.	Joint Bracket	1
9.	Sponge Strip	1
10.	Paper Guide	1
11.	Auxiliary Tray – Glossy Paper	1
12.	Auxiliary Tray – Z-Fold Paper	1
13.	Auxiliary Tray – Coated Thin Paper	1
14.	Booklet Tray (D512)	1
15.	Shift Tray	1

*¹: In China, do not use this power cord provided with this unit's accessories. Contact your supervisor and use the power cord specified for use in China.

Installation

CAUTION

- The unit must be connected to a power source that is close to the unit and easily accessible.
- Make sure that the main machine is switched off and that its power cord is disconnected before doing the following procedure.

Tapes, Retainers, Shipping Plates

Important

- The shipping plates prevent the staple unit from moving during transport. The plates should be kept and re-attached before the unit is transported to another location.

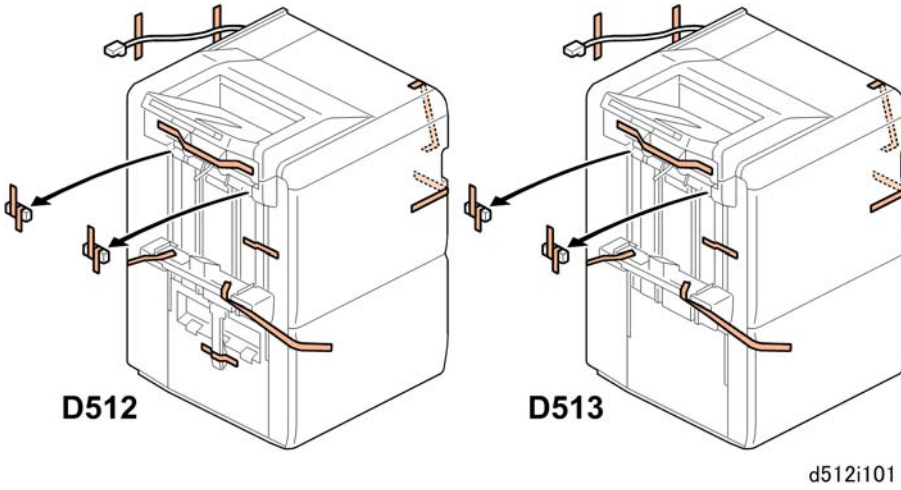

1. Remove all tapes and packing material from the external covers.

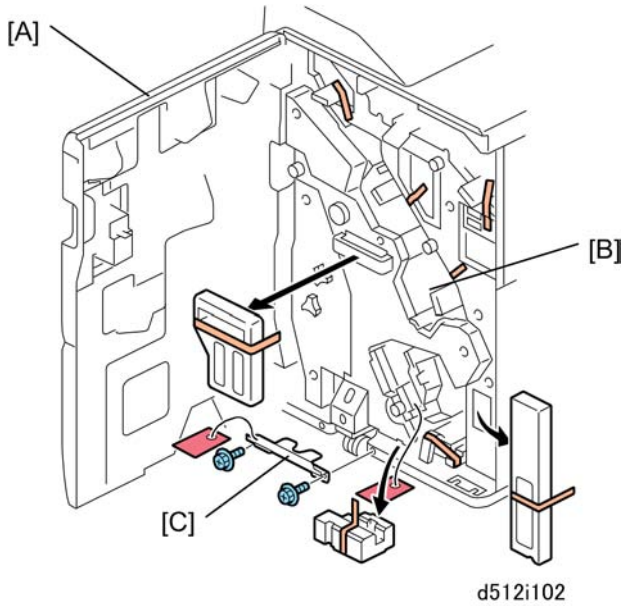

2. Open the front door [A].
3. Remove:
 - [B] Tapes, retainers inside
 - [C] Tag, wire, shipping plate (2x)

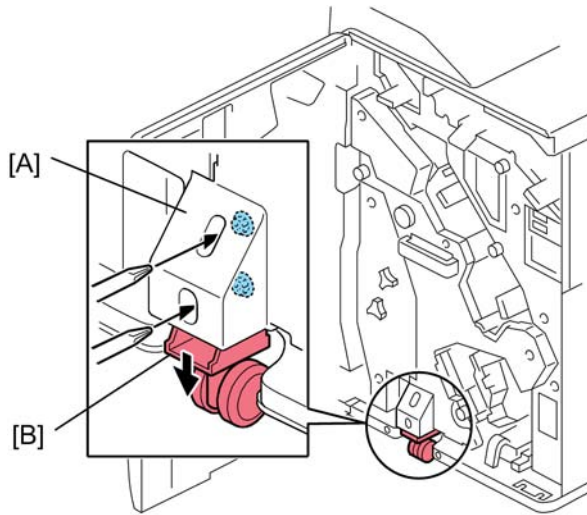

d512i103

4. Loosen the screws of the caster cover [A] ( x2).
5. Push the caster [B] down until it touches the floor.
6. With the caster touching the floor, tighten the caster cover screws.

CAUTION

- This prevents the unit from tipping over when you pull out the staple unit.

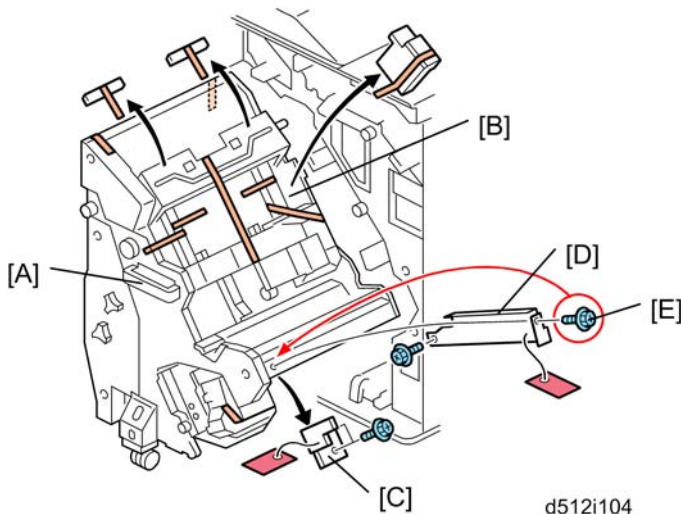

d512i104

7. Grip handle [A] and slowly pull the staple unit out until it stops.
8. Remove:
 - [B] All tapes, retainers
 - [C] Tag, wire, shipping plate ( x2)

[D] Tag, wire, shipping plate ( x2)

9. Re-attach screw [E] where it was removed.

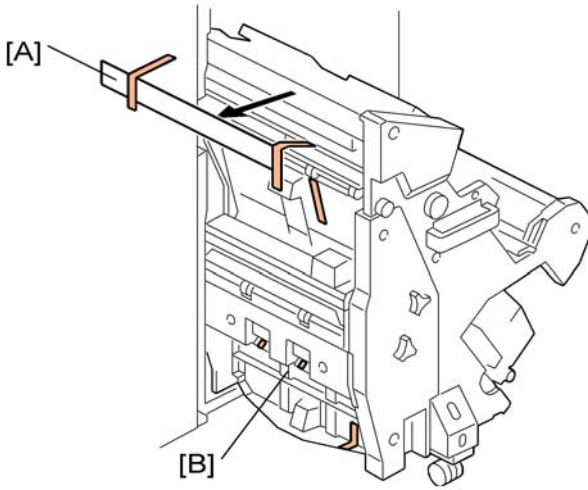

d434i104

10. Remove:

[A] Tapes, retainer

[B] Tapes

Ground Plate, Sponge Strips

★ Important

- There are two procedures for installation of the sponge strips.
- Follow "Procedure 1" below if the "Finisher" will be connected to another peripheral unit.
- Follow "Procedure 2" if the "Finisher" will be connected directly to the main machine (more sponge strips are required).

Procedure 1

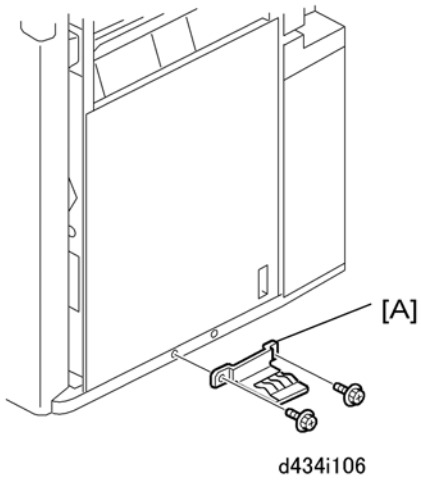

1. Attach the ground plate [A] to the bottom right edge of the unit ($\times 2$ M3x6).

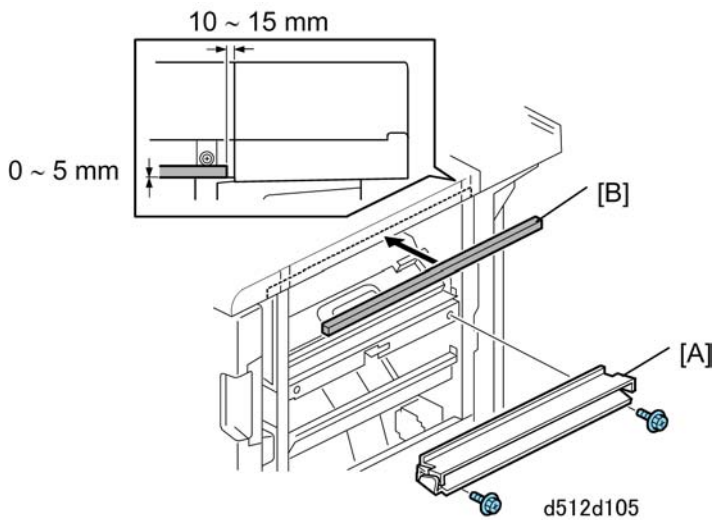

2. Attach the paper guide [A] ($\times 2$ M3x6).
3. Peel the tape from the sponge strip [B] and attach the strip to the top right edge of the unit.

Procedure 2

1. Attach the paper guide and ground plate as described in "Procedure 1" above.

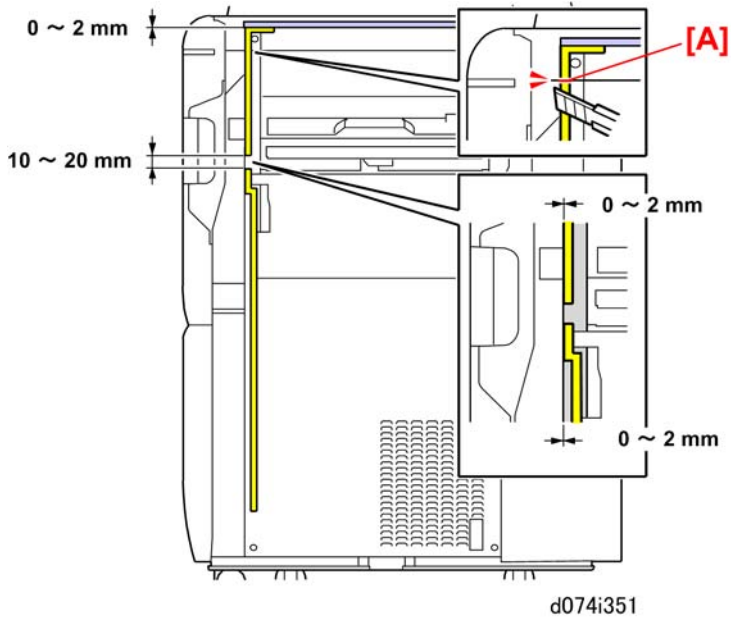

2. Remove the tape from each sponge strip and attach them to the right side of the unit as shown above.

Note

- The two yellow sponge strips in the illustration are provided as accessories with the main machine. The horizontal sponge strip is provided with the Finisher.

3. After attaching all sponges, use a sharp cutter to cut the sponge on the corner at [A].

Booklet Tray, Shift Tray

2

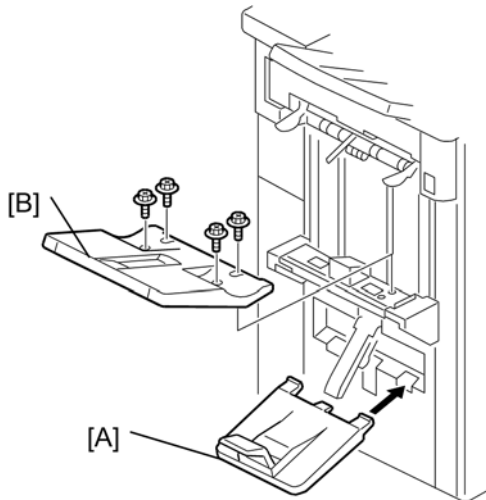

d512i107

1. Attach the booklet tray [A] to the notch in the left cover (no screws).
2. Attach the shift tray [B] to the left side of the unit ( x4 M3x8).

Docking

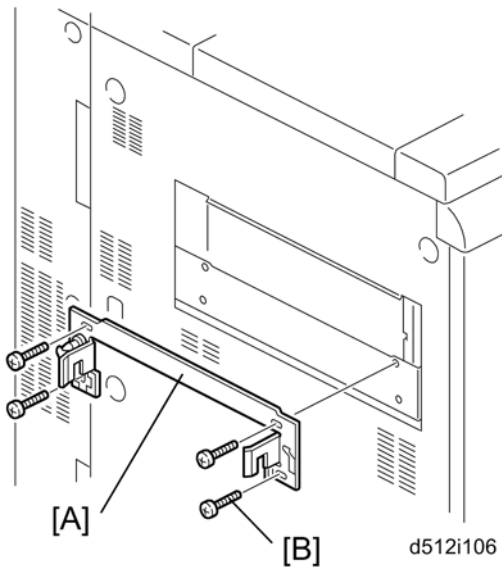

d512i106

1. Fasten the joint bracket [A] to the upstream unit ( x4 M4x14).

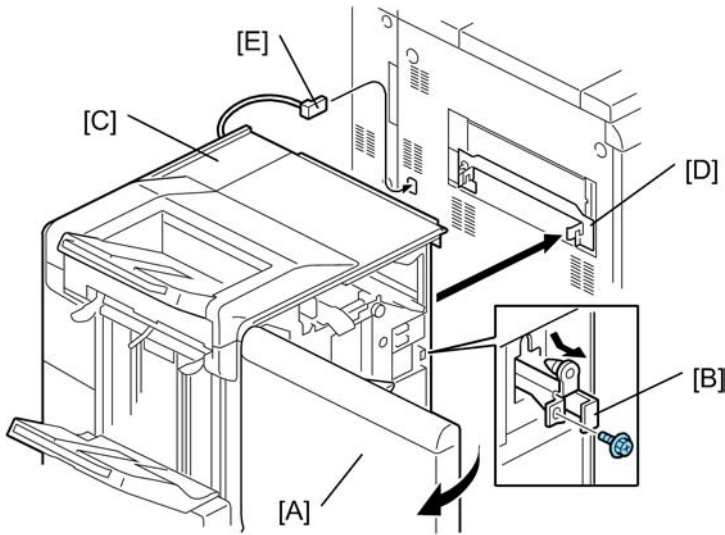

d512i108

2. Open the front door [A] of the unit.
3. At the front right corner, remove the screw of the lock bar [B] (ϕ x1 M3x6). **Keep this screw.**
4. Pull the lock bar toward you until it stops.
5. Slowly push the unit [C] to the left side of the upstream unit (or main machine) so that the lock bar is directly and squarely under the arms of the joint bracket [D].
6. Attach the I/F cable [E] to the upstream unit.

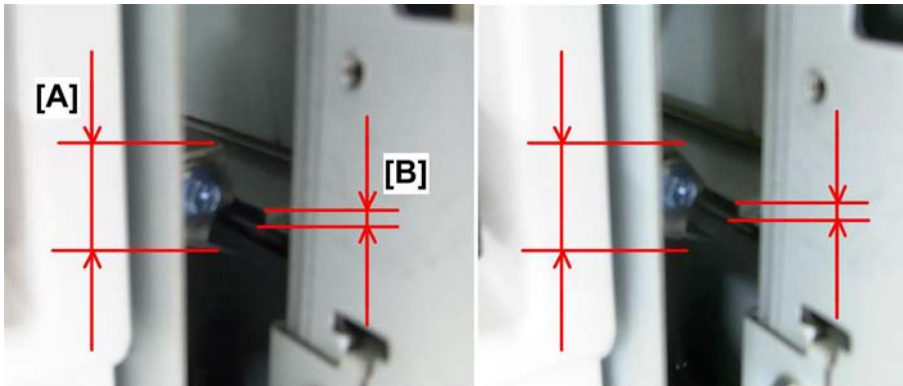



d074i887

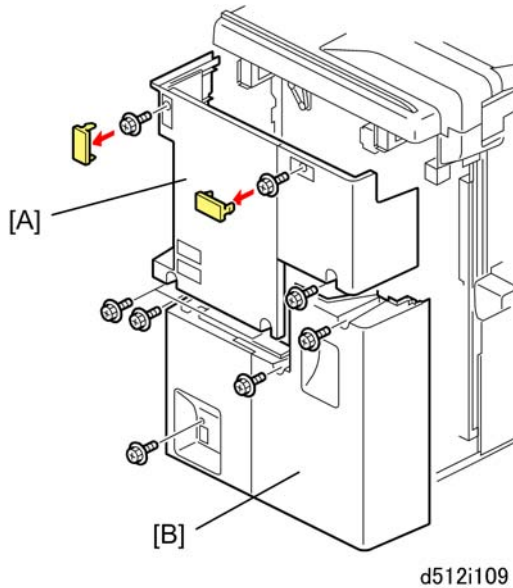

7. Push the finisher close to the side of the upstream unit.
8. Confirm that the height of the finisher entrance [A] is at the same height as the upstream unit's paper exit [B].
9. Push the finisher closer to the side of the upstream unit, and then once again confirm that the height of the finisher entrance still matches the height of the upstream unit exit.
10. If the exit and entrance are not at the same height, adjust the height of the finisher. (p.322)

11. Push the finisher against the side of the upstream unit.
12. Push the lock bar in completely so that it slides up into the notches in the arms on both ends of the joint bracket.
13. Fasten the lock bar by re-attaching the screw removed in **Step 3**. ( x1)

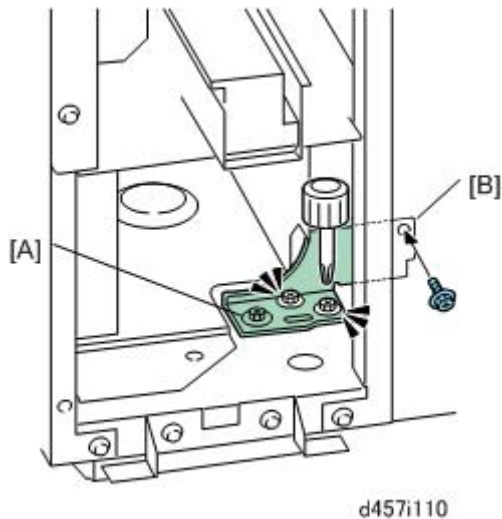

14. Remove:
 - [A] Rear upper cover (Capsx2,  x5)
 - [B] Rear lower cover ( x4)



15. Use a short screwdriver to loosen bracket [A] ( x3).
16. Fasten the bracket to the upstream unit at [B] ( x1).

17. Tighten the screws ( x3).
18. Re-attach the rear covers.

Auxiliary Trays

1. Instruct the operator about when to use these auxiliary trays, as explained below.

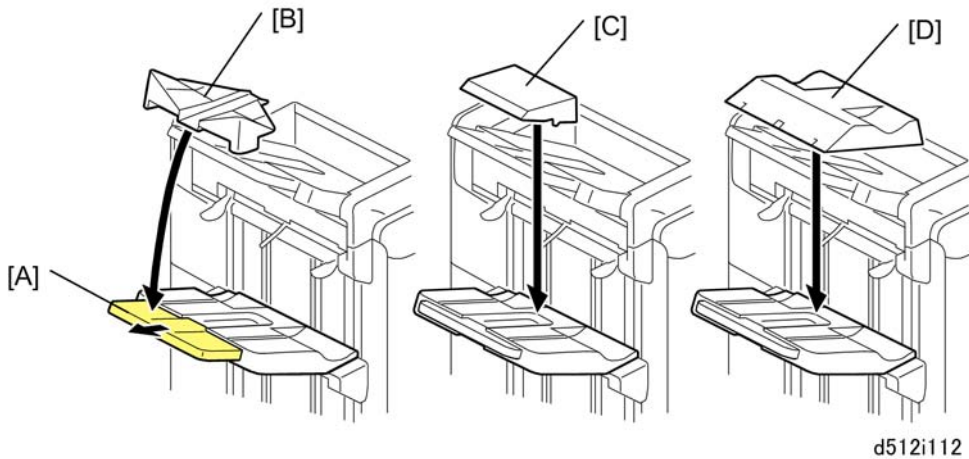



- Before feeding glossy paper, pull out the extension [A] of the shift tray and mount the glossy paper auxiliary tray [B].
- Before feeding Z-folded paper from the Multi Folding Unit, set the Z-fold auxiliary tray [C] on the shift tray.
- Before feeding coated thin paper from the Multi Folding Unit, set the coated thin paper auxiliary tray [D].

Finishing the Installation

1. Connect the power cord to the unit

★ Important

- In China, do not use this power cord provided with this unit's accessories. Contact your supervisor and use the power cord specified for use in China.
2. Set the leveling shoes and adjust the height of the unit. ( p.322)
 3. Load some B4 paper in the 2nd tray of the main machine, and make several copies.
 4. Check paper skew and side-to-side registration and correct if necessary. ( p.324)

Punch Unit PU5020 NA, EU, SC (D449-17, -27, -28)

Accessories

Check the quantity and condition of the accessories in the box against the following illustration and list.

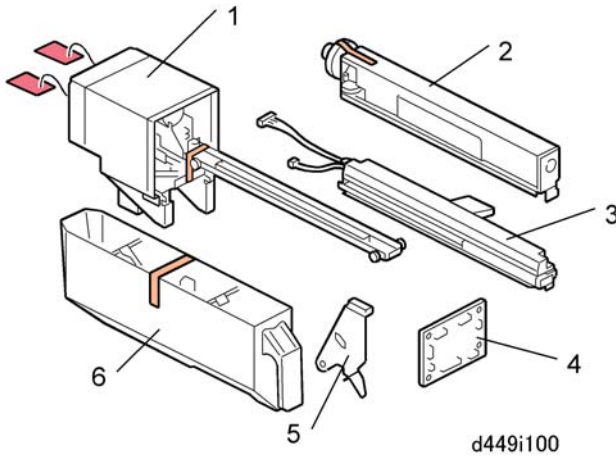

No.	Description	Q'ty
1.	Punch Drive Unit	1
2.	Punch Unit	1
3.	Punch Registration Unit	1
4.	Punch Control Board	1
5.	Sensor Arm and Sensor	1
6.	Punch-out Hopper	1
7.	Harness: Long	1
8.	Harness: Board Relay	1
9.	Spring	1
10.	Step Screw	1
11.	Screws M3x6	9

Installation

⚠ CAUTION

- Make sure that the main machine is switched off and that its power cord is disconnected before doing the following procedure.

2

Shipping Materials

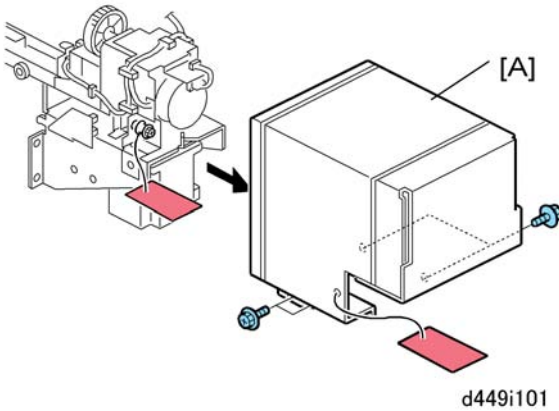

1. Remove motor protector plate [A] ( x4).

Rear Cover

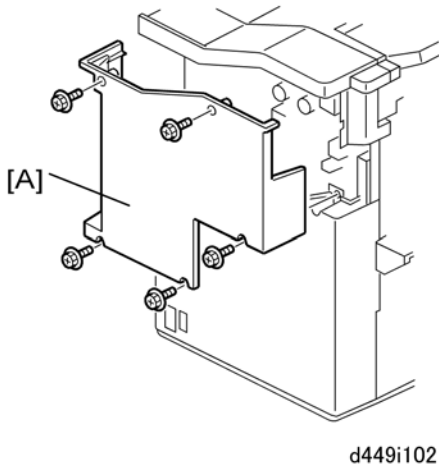

1. Remove upper rear cover [A] ( x4).

Right Upper Panel

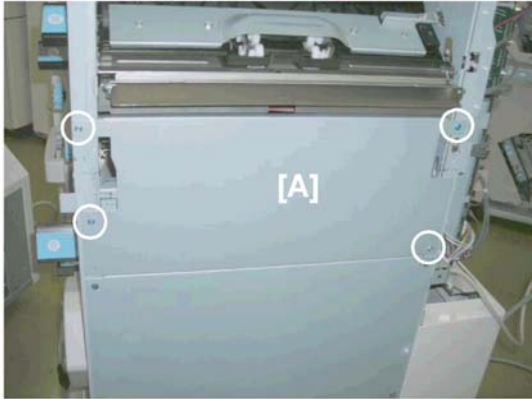

d449i117

1. Remove the right upper panel [A] ( x4).

Punch Registration Unit

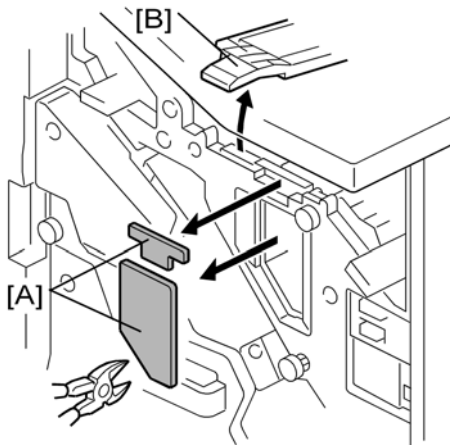

d449i103

1. Use a pair of nippers to remove knockouts [A].
2. Raise and open lever "RB3" [B].

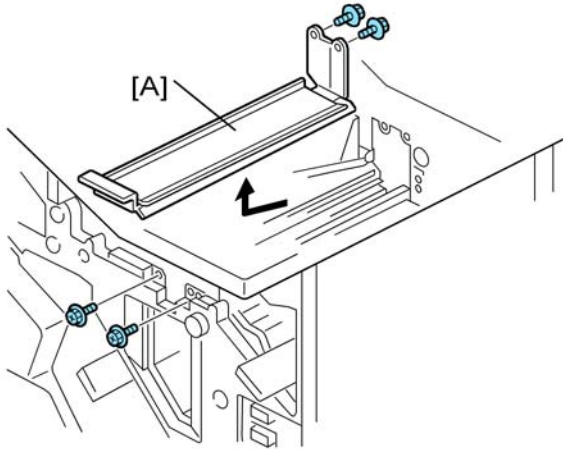

d449i104

3. Remove plate [A] and discard it ( x4).

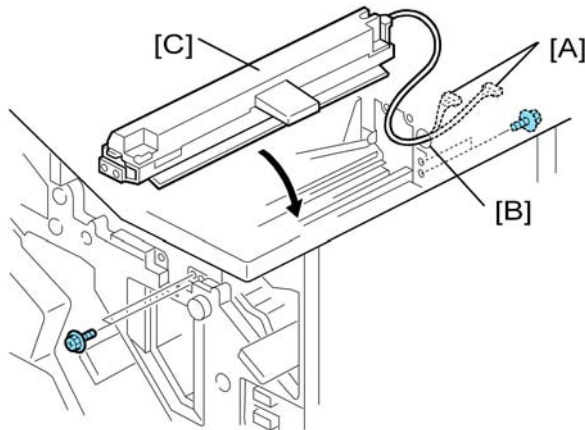

d449i105

4. Insert the harness connectors [A] through the hole [B].
5. Make sure the harness connectors are through the hole completely and visible at the rear of the machine.
6. Set and fasten the punch registration unit [C] ( x4, 2 screws each at front and back).

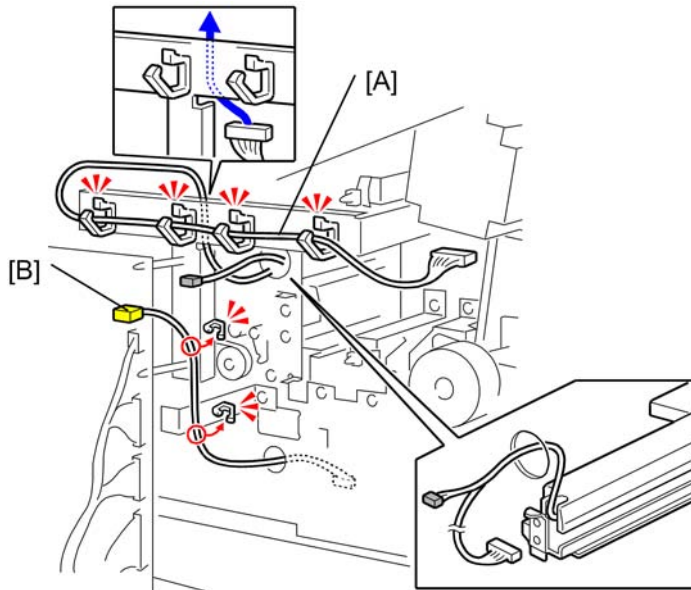

d449i106

7. Clamp harness [A] (🔧 x4).
8. Clamp harness [B] (🔧 x2).

Sensor Arm

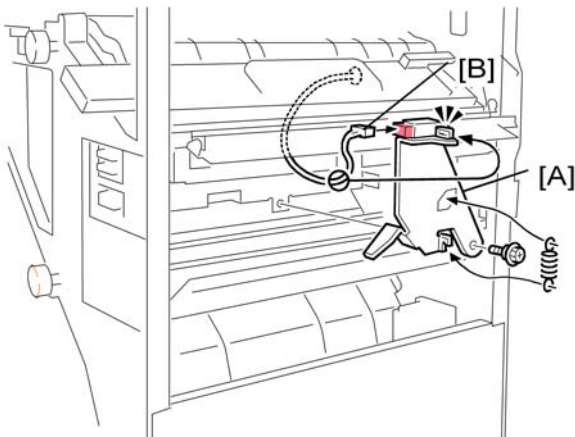

d449i107

1. Attach sensor arm [A] (🔩 x1 Step Screw, Spring x1).
2. Make sure the sensor arm swings freely on the step screw and spring.
3. Attach harness [B] to the sensor on top of the arm.

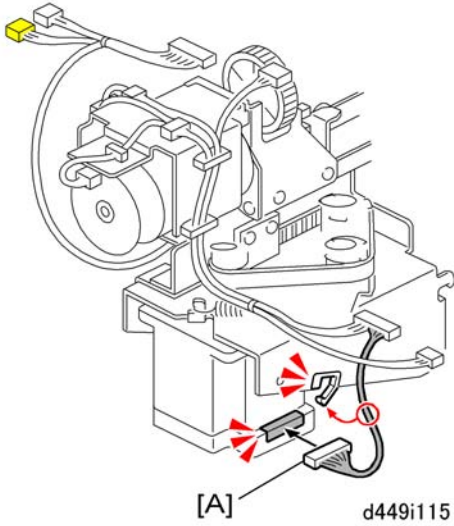

Punch Drive Unit, Punch Unit

2

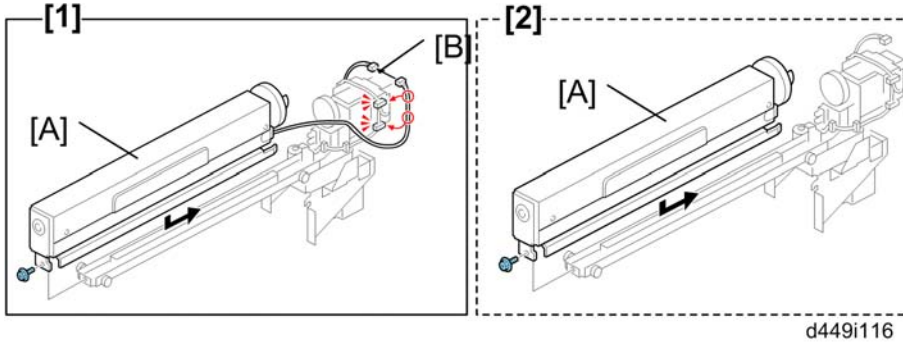

1. On the punch unit, connect harness [A] ( x1,  x1).



2. Attach the punch mechanism [A] to the rails of the punch unit ( x1).
 - If you are installing the punch unit for Europe [1], connect the harness [B] ( x1,  x2).
 - The punch unit for North America [2] has no punch switching motor, so this harness is not required.

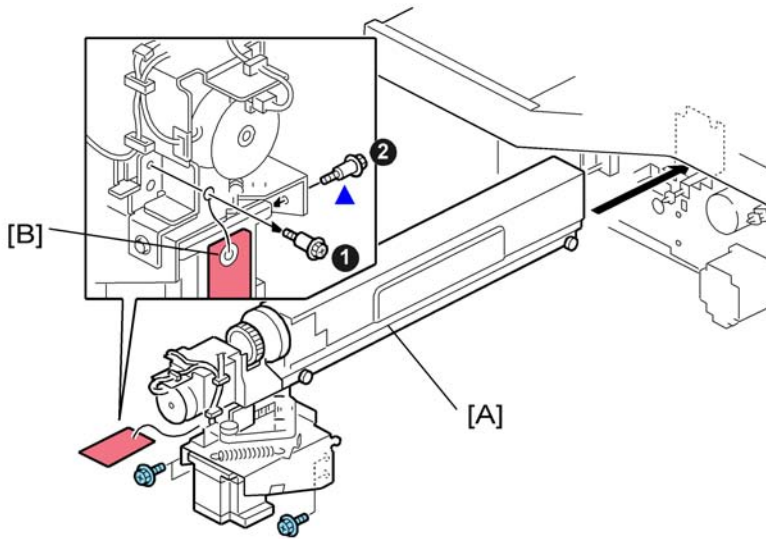

d449i108

3. At the front, insert the punch unit [A] into the finisher and fasten it ( x4).
4. Remove the shoulder screw with red tag [B], and detach the tag and wire.
5. After removing the screw from hole ①, re-attach it at hole ②.

★ Important

- This screw must remain attached to the punch unit.
- Before removing the punch unit from the finisher, the screw must be removed from hole ② and re-attached at hole ①. This stabilizes the punch unit and prevents it from wobbling from side to side while it is being removed and handled after removal.

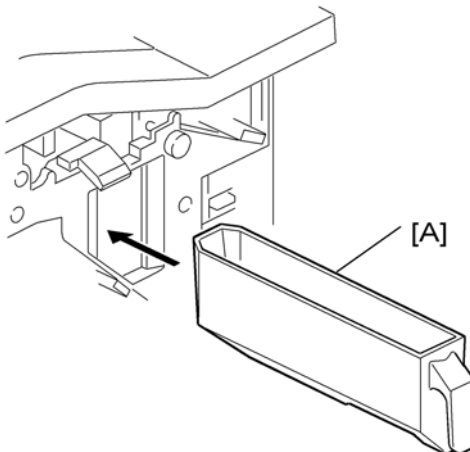

d449i109

6. At the front, slide the punch-out hopper [A] into the finisher.

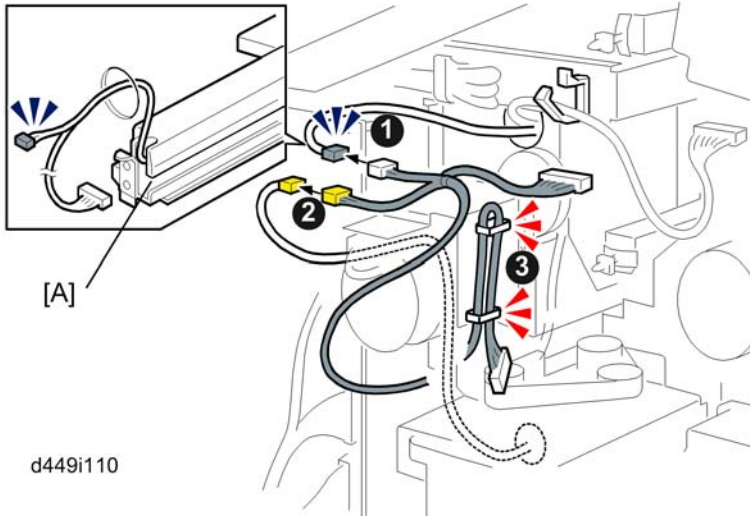

d449i110

7. Route the harnesses from the CIS unit [A] through the hole.
8. Connect the harnesses at ① and ② (E x2).
9. If you are installing the punch unit for Scandinavia, fasten the extra connector (not used) at ③ (E x1).

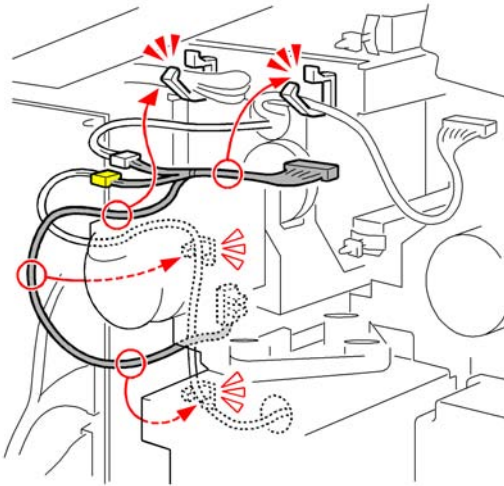

d449i110a

10. Finish clamping the harnesses as shown above.

Punch Control Board

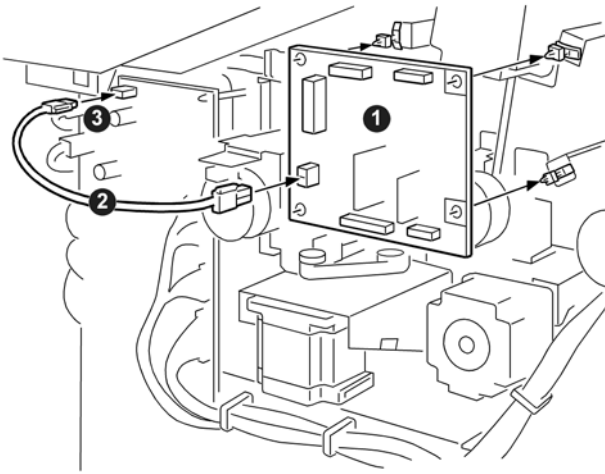

d449i111

1. Install the punch control board ① (Standoffs x4, no screws).
2. Connect the punch relay harness ② to the punch control board and punch main control board ③.

Final Connection

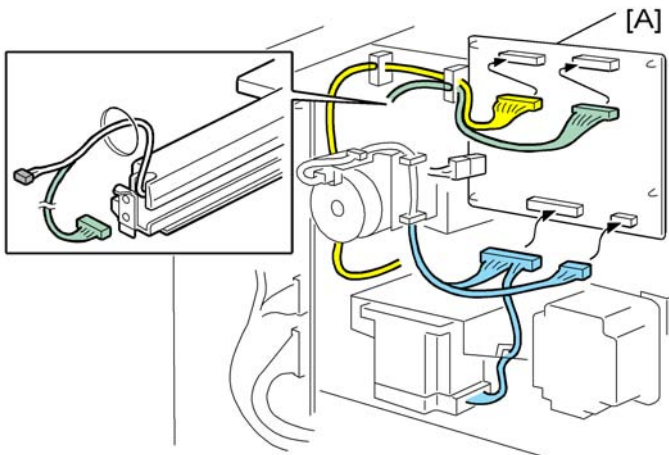

d449i112

1. Fasten the connectors to the punch unit PCB [A] (ⓐ x2).

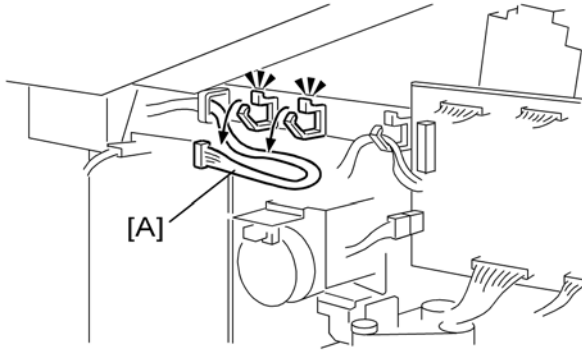

449i113

2. Release harness [A] from the frame (🔧 x2).

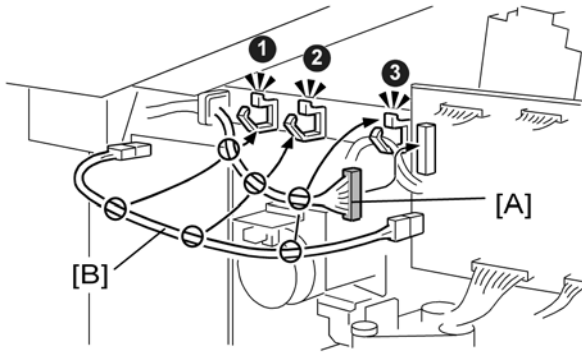

d449i114

3. Connect harness [A] to the punch control board (🔧 x1).

4. Gather harness [A] and the board relay harness [B] and clamp them (🔧 x3).

Trimmer Unit (D520)

★ Important

- The Trimmer Unit can be installed only with the Booklet Finisher (D512) (not the Finisher D513).

Accessories

2

Check the quantity and condition of the accessories in the box against the following illustration and list.

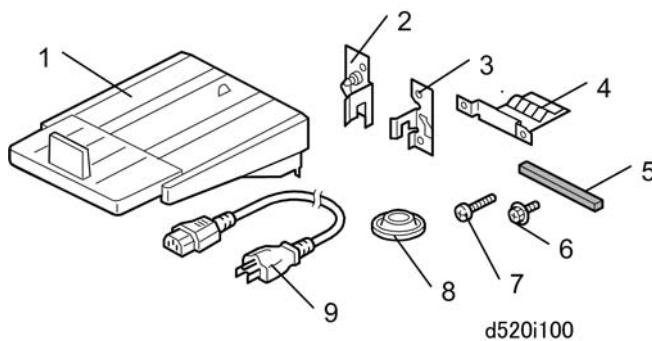

No.	Description	Q'ty
1.	Output Tray* ¹	1
2.	Joint Bracket – Left (Marked "L")	1
3.	Joint Bracket – Right (Marked "R")	1
4.	Ground Plate	1
5.	Sponges	2
6.	Screws (M3x6 for Ground Plate)	2
7.	Screws (M4x10 for Joint Bracket)	4
8.	Leveling Shoes	4
9.	Power Cord	1

*¹: Screws (x2) for the output tray are attached to the left side of the unit.

Installation

⚠ CAUTION

- The unit must be connected to a power source that is close to the unit and easily accessible.
- Make sure that the main machine is switched off and that its power cord is disconnected before doing the following procedure.

2

Tapes, Stopper Plate

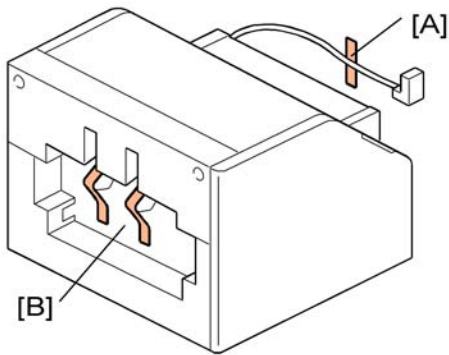

d455i101

1. Remove the tape on the right side to free the I/F cable [A].
2. Remove the tape from the left side [B].

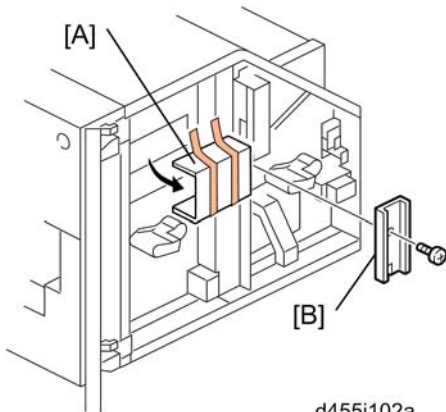

d455i102a

3. Open the front door and remove the retainer [A].
4. Remove the stopper plate [B] (⚙ x1).



⬇ Note

- Keep the stopper plate. It should be re-installed before transporting the unit to a new location.

Output Tray

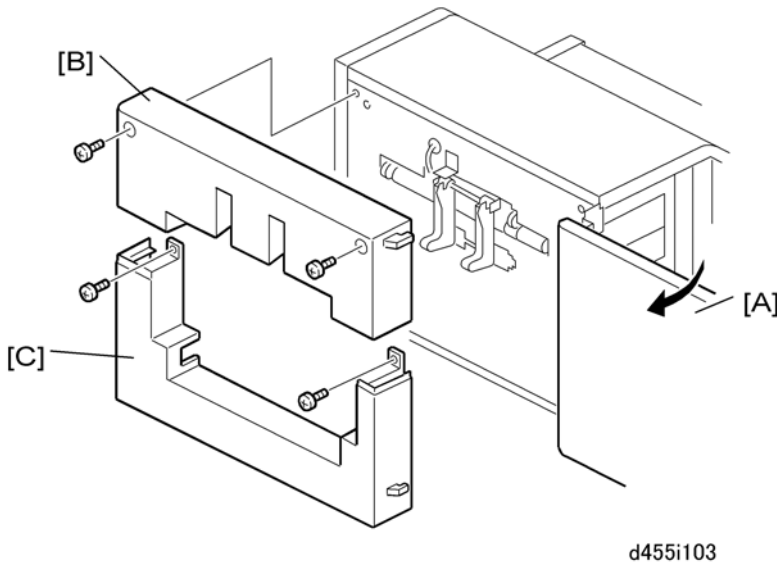
2



1. Make sure that the front door [A] is open.
2. Remove:
 - [B] Left upper cover ( x2)
 - [C] Left lower cover ( x2)

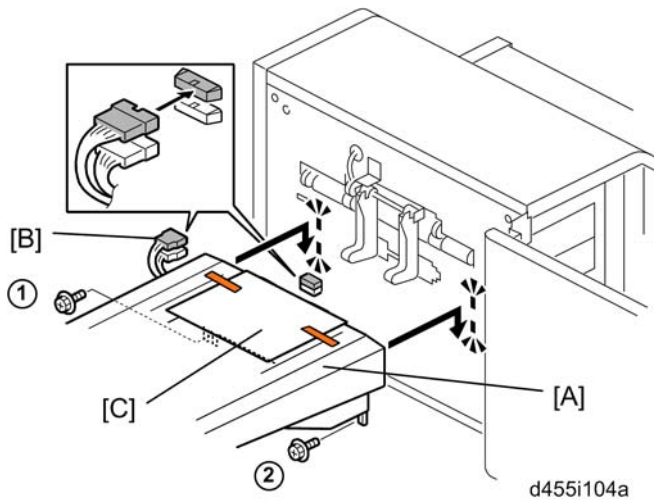

3. Remove the screws ① and ② from the left side.
4. Use the removed screws to attach the output tray [A].
5. Connect the output tray at [B].
6. Remove the sheet [C] of paper.

★ Important

- Do not remove this sheet [C] of paper before connecting the output tray to the trimmer unit.

7. Reattach the left lower cover and left upper cover.

Ground Plate

2

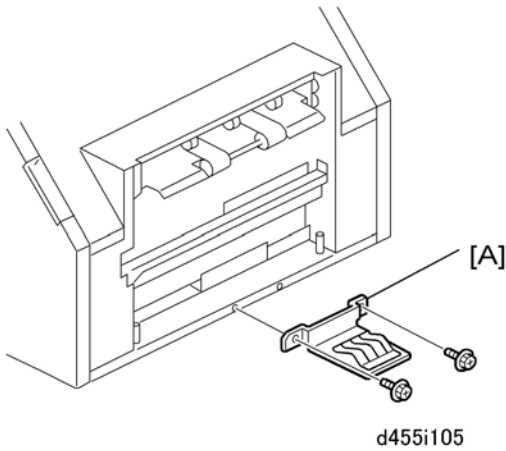

1. Attach the ground plate [A] to the right bottom edge ( x2 M3x6).

Preparing the Booklet Finisher (D512) for Docking

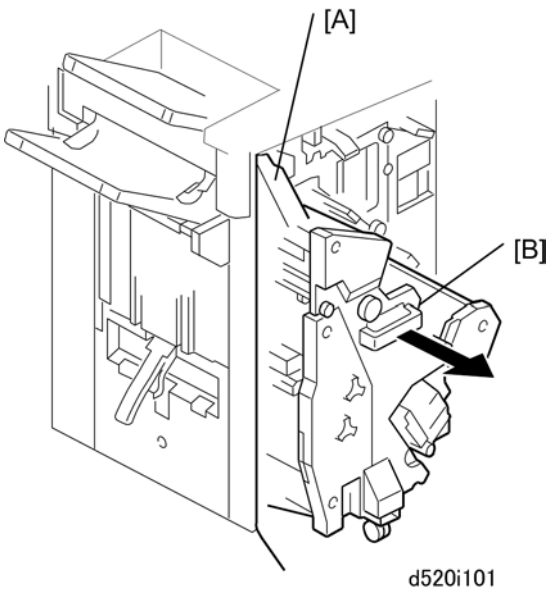



1. Open the front door [A] of the finisher.

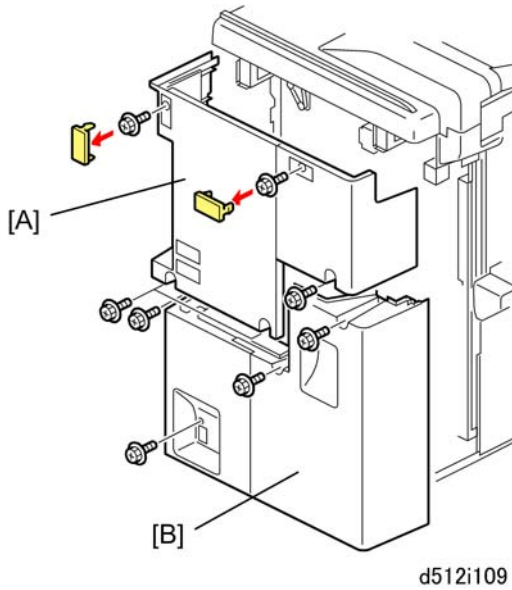

2. Pull out the staple unit [B].

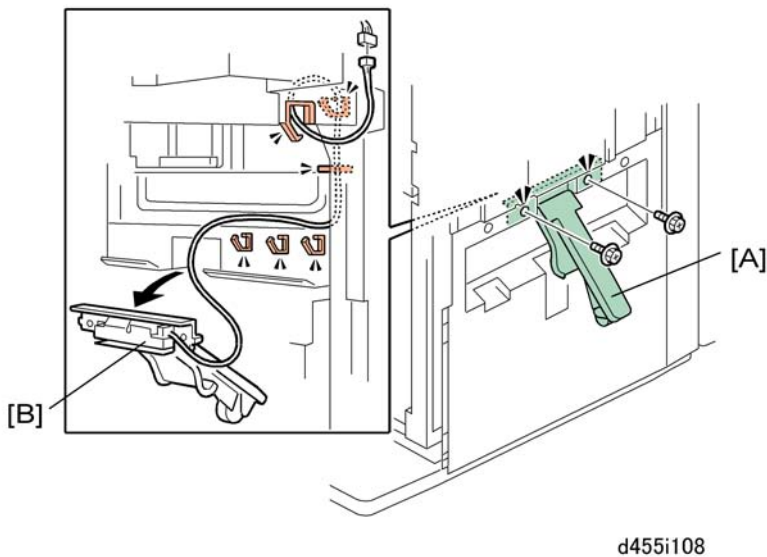

3. At the rear of the finisher, remove:

- [A] Rear upper cover (Capsx2,  x5)
- [B] Rear lower cover ( x4)





4. Unfasten the booklet tray sensor actuator arm [A] ( x2).
5. Disconnect the actuator arm [B] and remove it ( x5,  x1).
6. Store the actuator arm in a safe location for future use.

7. Reinstall the rear upper and lower cover.

Docking

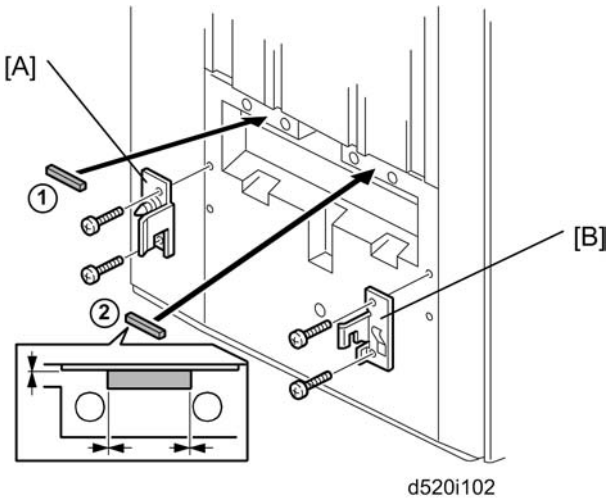

2

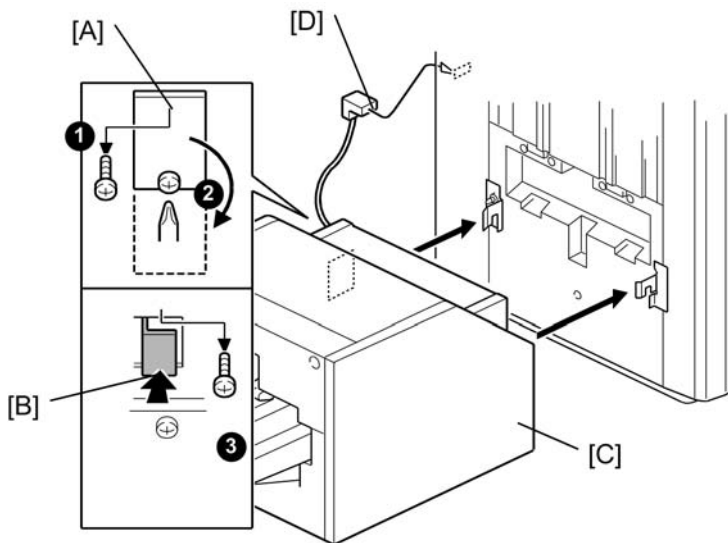

1. Attach:
 - [A] Left joint bracket, marked "L" ( x2, M4x10)
 - [B] Right joint bracket, marked "R" ( x2, M4x10)
2. Peel the tape from the back of the sponges and attach sponges ① and ②.





3. At the rear, remove screw ① from plate [A].

4. Loosen screw ② and lower the plate so that you can see the lock bar [B].
5. Remove the lock bar screw ③ ( x1 M3x6). **Keep this screw.**
6. Push the lock bar [B] until it is unlocked.
7. Slowly push the unit [C] against the left side of the finisher so that the lock bar is directly and squarely under the arms of the joint brackets.
8. At the rear, pull the lock bar [B] toward you so that it slides up into the notches in the arms of the joint brackets.
9. Fasten the lock bar by re-attaching the screw removed in **Step 5.** ( x1).
10. Connect the unit I/F cable [D] to the finisher.
11. Connect the plug of the power cord to the power source.

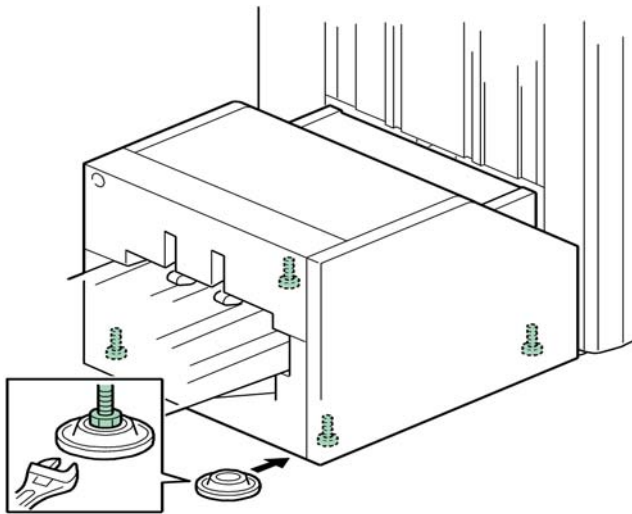
Finishing the Installation



d520i111

1. Set the leveling shoes and adjust the height of the unit. ( p.322)
2. Load some B4 paper in the 2nd tray of the main machine, and make several copies.
3. Check paper skew and side-to-side registration and correct if necessary. ( p.324)

Common Adjustments

Height and Level Adjustment

2

Before you begin:

- The main machine should be installed first and adjusted to level front-to-back, and side-to-side.
- Note the settings on the leveling gauge. Due to the length of the paper path with optional peripheral units installed, it is extremely important that every unit be leveled to match the front-to-back and side-to-side measurements of the main machine.
- The height and level of each peripheral unit must be adjusted at installation.
- The height and level of each unit must be adjusted before testing for the presence of skew and checking that side-to-side registration is correct.

Setting the Leveling Shoes

★ Important

- Do this procedure near each caster where an adjustable bolt is provided.
- The number of leveling shoes will differ, depending on which unit you are leveling.



d059i821

1. Turn the **lower** nut to lower the bolt.

↓ Note

- The upper bold is spot-welded to the frame and does not move.

2. Set a leveling shoe below the bolt.



d059i822

3. Continue to turn the lower nut until it stops against the shoe.
4. Set a level on the front, rear, and side edges to determine if the unit is level.
5. Adjust the height at each corner until the unit is level.

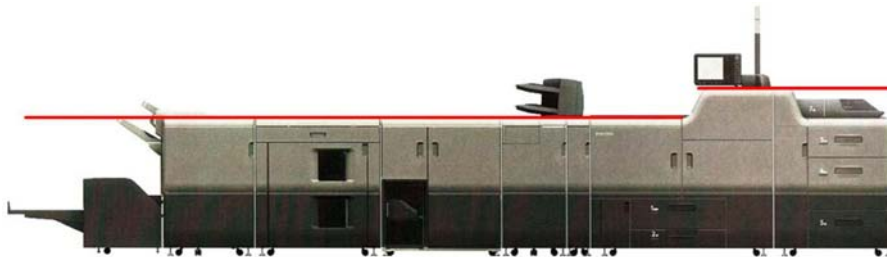

d074i897

6. Check the results of the adjustments.
 - The top of the first peripheral unit on the left must be at the same height as the left side of the main machine.
 - The tops of the other peripheral units on the left where the units are joined must be at the same height.
 - The top of the LCIT on the right must be at the same height as the right side of the main machine.



d074i898

- Make sure that the plate at the paper exit on the left side of the main machine [A] moves freely and is not bent. It must be able to move to handle thick paper.
- Between the right side of the main machine and the LCIT, make sure that the LCIT guide plate moves freely and does not interfere with the main machine guide plate.

Skew and Side-to-Side Registration

Overview

The paper feed path is extremely long when many peripheral units are installed. In such a long path, the cumulative effect of paper skew or deviation in side-to-side registration may require adjustment.

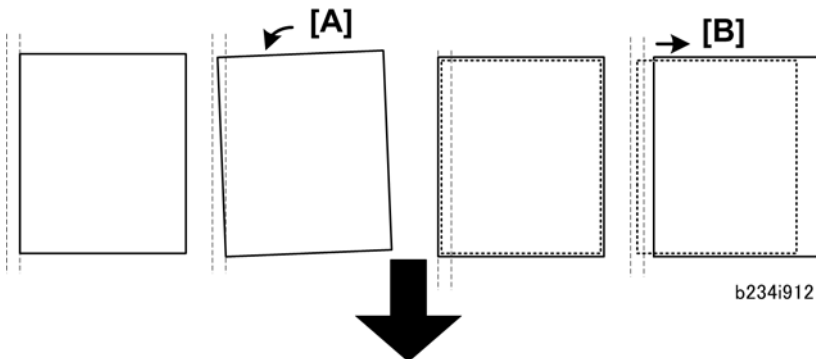

b234i912

- Skew [A] occurs when the trailing edge of the paper rotates away from the direction of paper feed.
- If side-to-side registration shift [B] occurs, the sheet remains straight but shifts left or right away from center of the paper path.

★ Important

- Before adjusting skew manually, be sure to enter the SP mode and set SP1206 to "2" (OFF).

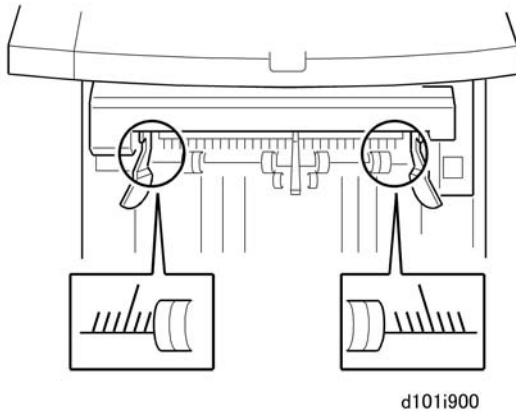

Scales

- Skew and side-to-side registration are checked with graduated scales (shown above) where paper exits the units.
- The scales are provided so that you can visually check and measure the amount of skew or deviation in side-to-side registration.
- A scale for detecting skew and checking side-to-side registration ("S-to-S") is provided on the following peripheral units.
- Correction for both skew and side-to-side registration are possible.

Name	Skew	S-to-S	Comment
LCIT	---	---	Correction is done in the registration unit of the main machine.
Other Peripheral Units	Yes	Yes	Correction for both skew and side-to-side registration are possible when the unit is attached to the upstream unit with the single bracket.

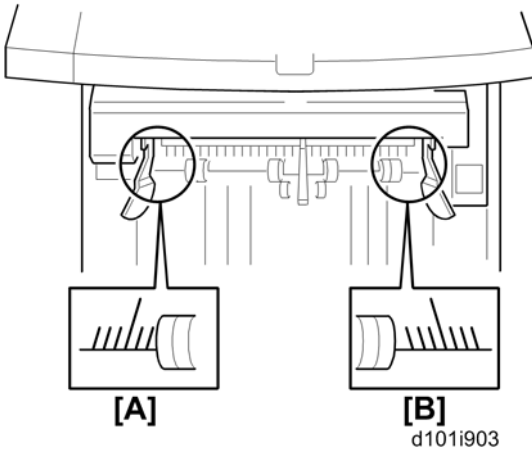

Use either the rear scale or front scale, depending on the type of paper used in your area:

- Rear [A]: **DLT** SEF (LT LEF for Ring Binder)
- Front [B]: **A3** SEF (A4 LEF for Ring Binder)

The illustrations below show where the scale for each peripheral unit is located:

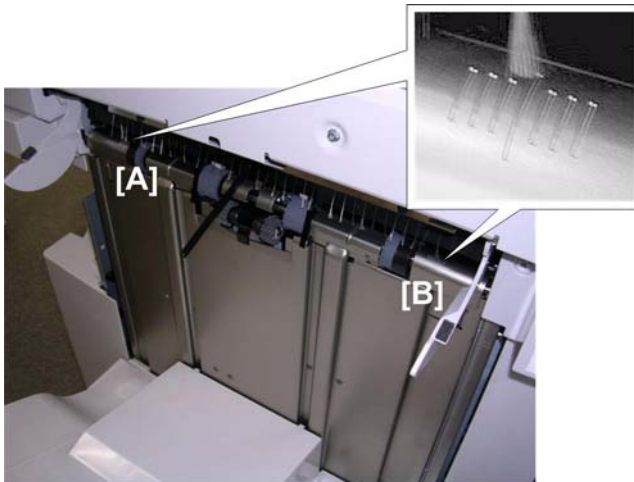

d059i813

- [A]: DLT/ [B]: A3

The illustration above shows the scale on the left side of the Booklet Finisher (D512) tray. The same scale is at approximately the same position (paper exit) for the following units:

- Multi Folding Unit: Proof Tray, or Left Exit
- Ring Binder: Left Exit
- High Capacity Stacker: Proof Tray

In the illustration below:

- The RED lines indicate the single-piece brackets where adjustments can be done to eliminate skew and to correct side-to-side registration.
- The GREEN lines indicated 2-piece joint brackets where adjustment is not possible between the finisher and trimmer unit.



Unit	Name	Comment
[1]	LCIT	
[2]	Main Machine	
[3]	Decurler Unit (inside main machine)	Inside main machine
[4]	Cover Interposer Tray	
[5]	Multi Folding Unit	
[6]	Ring Binder	
[7]	High Capacity Stacker	
[8]	Finisher (D513 or D512)	D513 or D512
[9]	Trimmer Unit (Joint Brackets x2)	Joint Brackets x2

Note: The Trimmer Unit [9] does not have the single bracket for the upstream unit that allows side-to-side adjustment with shims (described below).

Here are some general rules for testing and adjusting for paper skew or a shift in side-to-side registration.

1. After installation of each peripheral device, do some test prints and check for the presence of skew, and check that side-to-side registration is correct.
2. When you detect a problem with skew or side-to-side registration, do the adjustment on the joint bracket attached to the peripheral unit **upstream of the unit where the problem occurred**.
3. Side-to-side registration is corrected by shifting the upstream joint bracket left or right. (See the next procedure.)
4. Skew is eliminated by inserting spacers (shims) under the rear or front end of the joint bracket. These attached by screws to the peripheral units before they leave the factory.

Checking Side-to-Side Registration

Do this procedure to confirm that the paper is centered in the paper path.

1. Make sure that the I/F cable of the unit is connected to the upstream unit.
2. Disconnect the unit to the left of the unit to be tested.
3. Execute a run by feeding paper from Tray 2 of the host machine.

Note

- If you are testing the Ring Binder, execute the run by feeding paper (A4 or LT LEF) from Tray 2 of the host machine (punching only, no ring binding). (The Ring Binder cannot accept a larger paper size.) Feed A3 SEF for other units.
4. When each sheet exits, check the position of the paper on the scale to see if the paper is centered.
 - Read the **rear scale** for **DLT**-size paper.
 - Read the **front scale** for **A3**-size paper.
 - If you are testing the ring binder, read the **rear scale** for **LT LEF** paper and the **front scale** for **A4 LEF** paper. With the Ring Binder, the paper does not exit. It will switch back and feed to the punch unit.
 - The scale lines are spaced 2 mm apart.
 5. The paper must not deviate more than ± 2 mm on the scale.

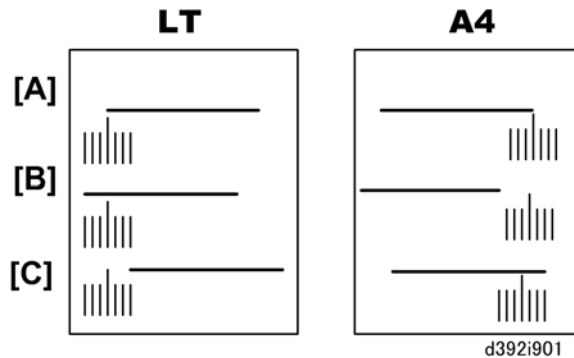

[A]	Leading/trailing edges centered. No adjustment necessary.
[B]	Leading/trailing edges offset to the rear by more than 2 mm. Adjustment required.
[C]	Leading/trailing edges offset to the front by more than 2 mm. Adjustment required.

If the edge of the paper is on the scale at the center [A], no adjustment is required.

-or-

If the edge of the paper is ± 2 mm off the center line on the scale, adjustment is required. Do the procedure in the next section.

Correcting Side-to-Side Registration

Each peripheral unit for this machine has the same single-piece connection bracket shown below. This adjustment can be done for every unit on the connection bracket attached to the upstream unit

1. Enter the SP mode and set SP1206 to "2" (OFF).
2. Disconnect the peripheral unit from the upstream unit.

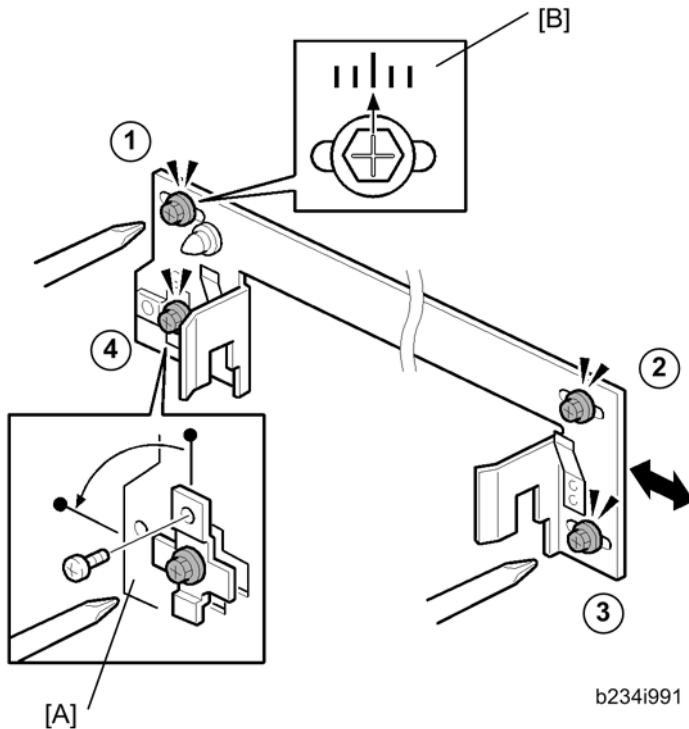

3. On the joint bracket attached to the upstream unit, loosen screws ①, ②, ③, and ④.
4. Remove bracket [A] ($\times 1$), rotate it 90 degrees, and re-fasten the screw. Changing the position of this bracket aligns the oval cut-out horizontally and frees the joint bracket so it can slide from side to side.
5. Look at the scale [B].
6. Slide the bracket to the left or right and tighten the screw.
7. If the deviation from center was toward the front, slide the bracket to the rear and tighten screw ①.
-or-
If the deviation from center was toward the rear, slide the bracket to the front and tighten screw ①.
8. Tighten screws ②, ③, and ④
9. Do another test run, so that you can check the results of the adjustment.
10. When you are finished, enter the SP mode and re-set SP1206 to "1".

Detecting Paper Skew

Do this check to detect the presence of skew in the paper path.

1. Make sure that the I/F cable of the unit is connected to the upstream unit.
2. If a peripheral unit is connected on the left side, disconnect it and pull it away.

3. Execute a straight-through run.
4. Check the scale where each sheet exits.
 - The **rear scale** is for **DLT**-size paper.
 - The **front scale** [2] is for **A3**-size paper.
 - Be sure to read the correct scale for the paper size in use.

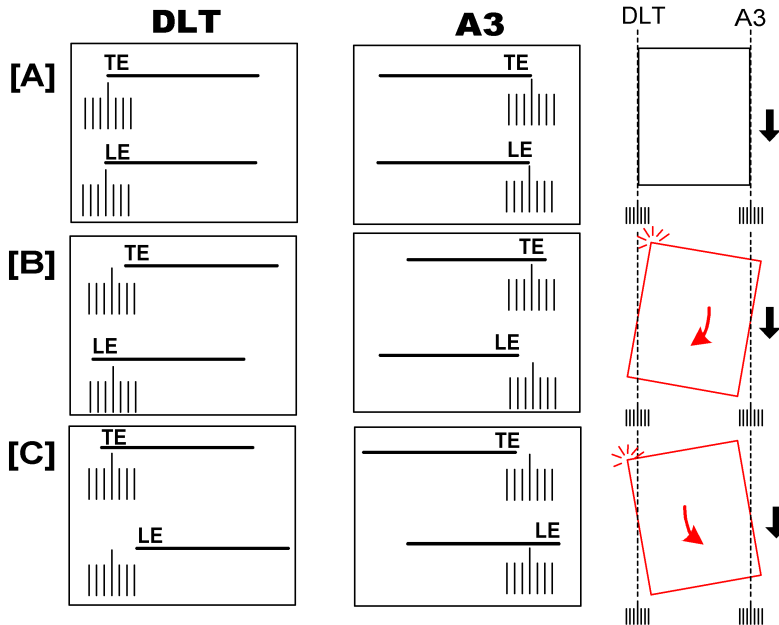

d392i904

[A]	Centered. No adjustment necessary.
[B]	Trailing edge skew to the front, total skew more than ± 2 mm. Adjustment required.
[C]	Trailing edge skew to the rear, total skew more than ± 2 mm. Adjustment required.

Correcting Skew

1. Enter the SP mode and set SP1206 to "2" (OFF).
2. Disconnect the peripheral unit from the upstream unit.
3. Locate and remove the spacers from the peripheral unit where the problem occurred.

Locating and Removing Spacers

The photos below show where you can find the spacers for each unit.

2

Multi Folding Unit (D521)





d454i111

High Capacity Stacker (D515)





d059i817

1. Open the front door.
2. Remove the right lock hasp [A] ( x2).
3. Remove the right front cover [B] ( x2).
4. Remove the spacers ( x1).

Finisher (D512/D513)



d059i818

1. Open the front door ( x1).
2. Remove the spacers ( x1).

Inserting Spacers

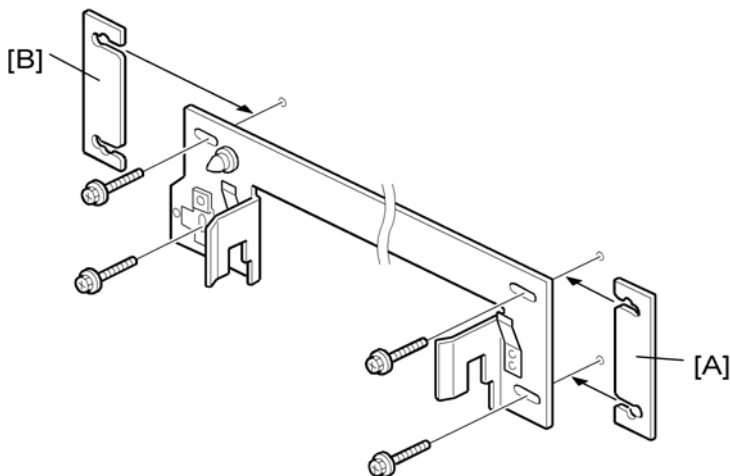

d392i906

1. Loosen the screws ( x4) of the joint bracket attached to the peripheral upstream of the unit where the problem occurred.

2. Insert a spacer and tighten the screws.

If the trailing edge of the paper is **skewing toward the front** of the machine, insert a spacer [A] under the **rear end of the bracket** and tighten the screws.

-or-

If the trailing edge is **skewing toward the rear** of the machine, insert a spacer [B] under the **front end of the bracket** and tighten the screws.

3. Do another run to check the adjustment. If skew is still present, insert another spacer.
 - Each spacer is 2 mm thick.
 - Only two spacers are provided, so the maximum adjustment is 4 mm (using two spacers).
4. Enter the SP mode and re-set SP1206 to "1".

GW Controller Options

Overview

Available Options

2

The VM Card (an SD card) is the only option available for this machine.

↓ Note

- The Security & Encryption SD card contains both the HDD Encryption and Data Overwrite Security applications. This SD card is shipped with the machine in SD card Slot 1.

Controller Board Slots

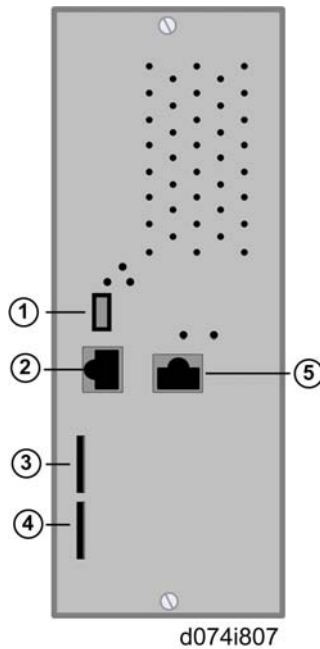

No.	Name	Function
①	USB Host	Japan only
②	Web Monitor	Connection point for Web Monitor
③	Slot 1	Applications: Data Overwrite Security, HDD Encryption

No.	Name	Function
④	Slot 2	VM Card, Service slot for firmware update
⑤	EFI	Gigabit Ethernet. Connection for Fiery Controller

2

Application Move

“Move Exec” (SP5873-1) moves one application program from the original SD card to another SD card. The application program is moved from Slot 2 to Slot 1.

1. Turn off the main power switch.
2. Remove the SD card slot cover ( x1).
3. Insert the original SD card with the application in Slot 2.
4. Insert the SD card to receive the application in Slot 1.
5. Turn on the main power switch.
6. Enter the SP mode and do SP5873-1 “Move Exec”.
7. Follow the messages on the operation panel to complete the procedure.
8. Exit the SP mode.
9. Turn off the main power switch.
10. Remove the original SD card from Slot 2.
11. Leave the other SD card in Slot 1.
12. Turn on the main power switch.
13. Check that the application program runs normally.
14. Tell the customer to store the original SD card in a safe place.

Undo Exec

“Undo Exec” (SP5873-2) restores an application to its original SD card. The application is moved from Slot 2 to Slot 1.

1. Turn off the main power switch.
2. Remove the SD card slot cover ( x1).
3. Insert the SD card that currently holds the application in Slot 2.
4. Insert the original SD card to receive the restored application in Slot 1.
5. Turn on the main power switch.
6. Enter the SP mode and do SP5873-2 “Undo Exec”.
7. Follow the messages on the operation panel to complete the procedure.

8. Exit the SP mode.
9. Turn off the main power switch.
10. Remove both SD cards.
11. Insert the SD card with the restored application in Slot 1.
12. Turn on the main power switch.
13. Check that the application operates normally.

VM Card Type R (D554) D074/D075

The VM card application cannot be moved to another SD card. However, other applications can be moved onto the VM card.

1. Turn off the machine.

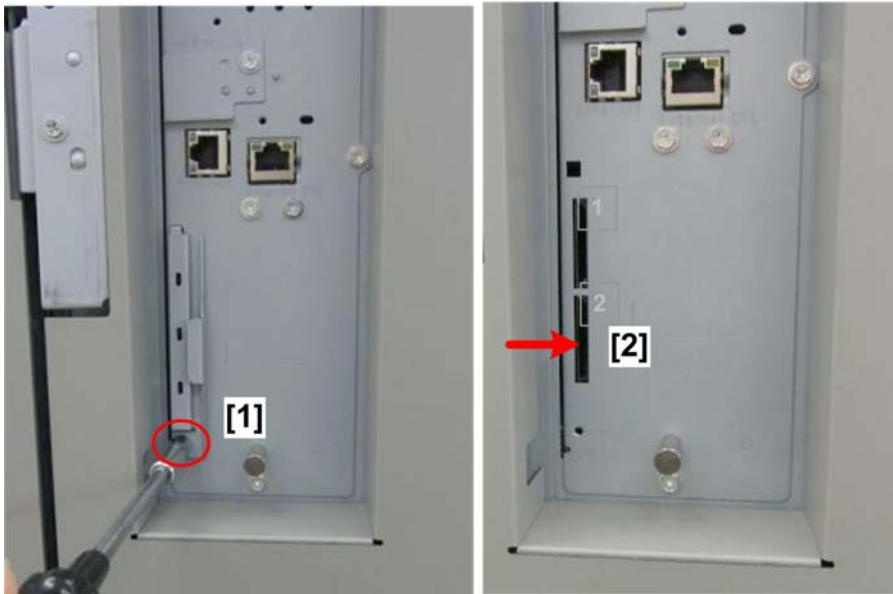

d074i541a

2. Remove the SD card slot cover [1] (x1).
3. Turn the SD-card label face [2] to the rear of the machine. Then push it slowly into slot 2 (lower slot) until you hear a click.
4. Reattach the SD card slot cover.
5. Switch the machine on.

2

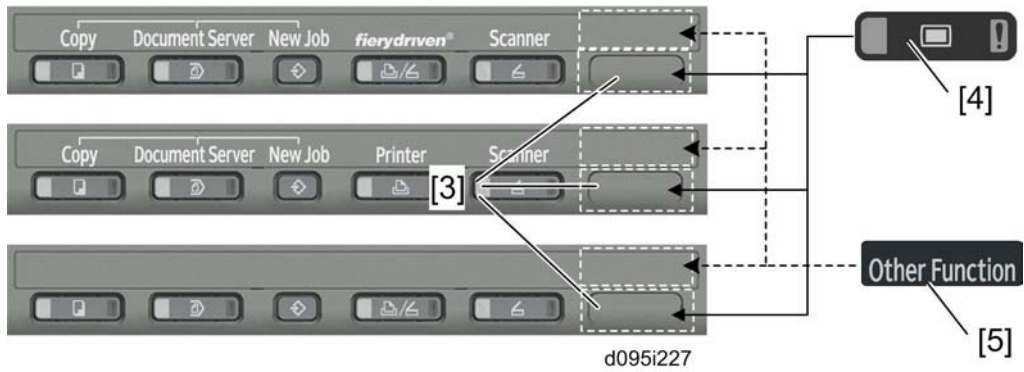

6. On the operation panel, remove the bottom blank keytop [3] and replace it with the keytop provided [4].
7. For NA and AA models, attach the decal [5] to the copier.

3. Preventive Maintenance

PM Counter Display

The PM Counter main menu and submenu allows you to review the PM counts for both units and individual components.

Opening the PM Counter

1. Enter the SP mode.

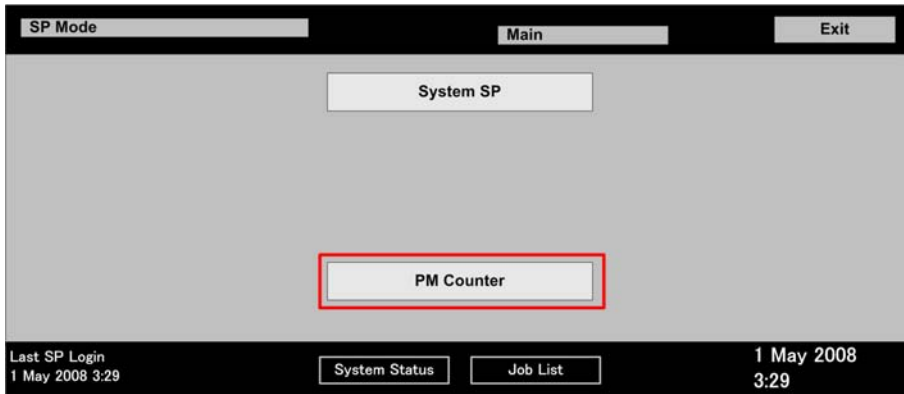

d074p901

2. Touch [PM Counter].

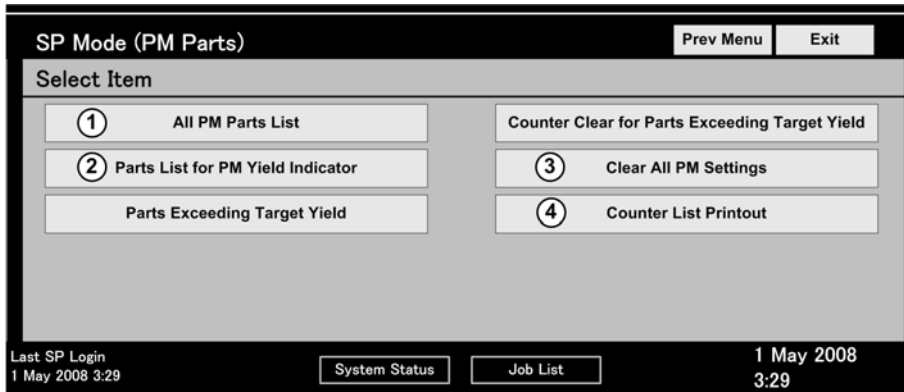

d074p902

All PM Parts List. Displays all PM items (all PM items, not only PM units). Lists all PM items regardless of PM yield indicator settings.

Parts list for PM yield indicator. Displays on the items with their PM yield indicator settings set to "Yes".

Clear all PM settings. Resets all PM counter settings to "0" at the same time. PM items can be reset one by one with the [Clear] button.

Counter list print out. Prints the PM counter on paper.

PM Parts Screen Details

All PM Parts list: Main Menu

3

The "All PM Parts list" displays all PM units and individual items. This list shows all PM items, regardless of their "PM yield indicator settings".

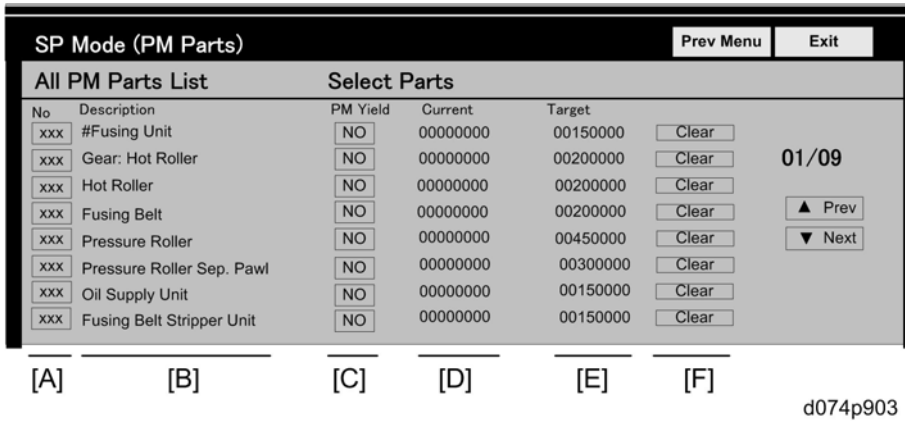

[A]: Number buttons. Pressing a number button opens a submenu.

[B]: Descriptions. The # mark denotes a "unit" (not individual item).

[C]: PM yield buttons. Function is the same as the "PM yield indicator settings" button.

[D]: Current PM counter value.

[E]: Target PM interval. This can be changed by pressing a number button [A].

[F]: PM counter clear button. Function is the same as the [Clear current counter] button.

Number Button Submenu

Press any number button to open the submenu for a part. In the example below, the number button [001] #Development Unit was pressed.

xxx	#Fusing Unit	
Current counter	0010892	[A] <input type="button" value="Clear current counter"/>
Target yield	0300K	[B] <input type="button" value="Change Target Yield"/>
Latest1	0014846	[C] PM yield indicator settings <input type="button" value="No"/> <input checked="" type="button" value="Yes"/>
Latest2	[D] 0000000	
Latest3	0000000	
<input type="button" value="Exit"/>		<input type="button" value="▲Prev"/> <input type="button" value="▼Next"/>

d074p904

[A]: Clear current counter. Press to reset the selected PM counter (in this example 001 #Development Unit) to "0". You can also clear the settings by pressing the [Clear] button on the right side of the PM Counter Main Menu ([F] in the previous section).

[B]: Change target yield. Press the change the target PM yield. To change the setting:

- Press [Change target yield]
- Enter the number for the new target with the 10-key pad.
- Press [#] on the operation panel.

[C]: PM yield indicator settings. [Yes] is the default. Press [No] to remove the current item from the "Parts list for PM yield indicator".

- When set to "Yes", items marked with the # mark (# = a unit) will not have their individual items displayed automatically in the "Parts list for PM yield indicator list".
- When set to "No", items marked with the # mark (# = a unit) only the individual components will appear in the list (the units will not appear).

[D]: PM counter history. This is a summary of the most recent counts

- Latest 1. The latest PM count since the unit (or part) was replaced.
- Latest 2. The previous PM count since the unit (or part) was replaced.
- Latest 3. The previous but one PM count since the unit (or part) was replaced.

Parts List for PM Yield Indicator

This list shows the PM Parts Main Menu with only items set to "Yes" displayed.

JAN 23, 2002 11:09PM

SP Mode(PM Parts) Prev. Menu Exit

Parts list for PM yield indicator Select parts

No	Description	Exceed	Current	Target	
001	#K:PCU	[A]	0010892	0300K	Clear
017	#M:PCU		0005570	0300K	Clear
033	#C:PCU		0005223	0300K	Clear
049	#Y:PCU		0005514	0300K	Clear
065	ITB		0025738	0600K	Clear
066	#ITB Cleaning Unit		0025738	0300K	Clear
070	#PTR Unit		0025738	0600K	Clear

01/02
▲Prev
▼Next

d074p905

Note the following:

- The # mark denotes a unit.
- Items without the # (for example, 065 ITB) denote individual components.
- An asterisk (*) will appear in the Exceed column [A] to show items that have exceeded their target PM yields.

PM Tables for Main Machines

PM Parts List Key

Column	Meaning	Notations	
Part	Name of the component, unit	Name of the part	
By	Person responsible	S	Service technician
		U	User
		T	TCRU trained user at work site
At	Interval for checking, cleaning, replacement	Example: 300K where K = 1000, or 300,000 printed sheets. (Recorded in Log Counter)	
Action	What must be done	I	Inspect
		C	Clean
		L	Lubricate
		R	Replace
Comment	What to use	Materials required for cleaning, lubrication	

3

Optics (D074/D075)

Part	By	At	Action	Comments
White Plate (under ARDF)	S	600K	I/C	Optics cloth
1st Mirror	S	600K	I/C	Optics cloth
2nd Mirror	S	600K	I/C	Optics cloth
3rd Mirror	S	600K	I/C	Optics cloth
Original Width Sensors (APS)	S	600K	I/C	Dry cloth
Exposure Glass* ¹	S, U	300K	I/C	Ricoh cleaner
Exposure Lamp	S	300K	I/C	Dry cloth

Part	By	At	Action	Comments
Guide Rail (2-level both ends)	S	600K	I/C	Alcohol damp cloth
ARDF Exposure Glass* ¹	S, U	300K	I/C	Ricoh cleaner
Dust Filter	S	600K	I/C	Blower brush
Toner Shield Glass* ¹	S	300K	I/C	Optics cloth

*¹: Clean these parts at every service call.

Development

Part	By	At	Action	Comments	
Developer	D074	S	750K	R	Vacuum clean old toner from toner collection roller.
	D075/M044	S	900K	R	
Filter	D074	S	750K	R	
	D075/M044	S	900K	R	
Gears	S	300K	C		
Toner Supply Unit	S	300K	I/C		
Heat shield plate	---	S,U	---	C	Clean every time the PCDU is pulled out.

Around the Drum

Part	By	At	Action	Comments
Drum Cleaning Unit* ¹	S,T			
Cleaning Blade	S	300K* ²	R	This blade does not include the side seals below. Replace both parts at the same time.

Part		By	At	Action	Comments
Side Seals		S	300K* ²	R	These are required for installing a new drum cleaning blade.
Lubrication Roller		S	300K* ²	R	
Lubrication Bar		S	300K* ²	R	
Lubrication Blade		S	300K* ²	R	This blade does not include the side seals below. Replace both parts at the same time.
Side Seals		S	300K* ²	R	These are required for installing a new drum lubrication blade.
Lubrication Roller Coupling		S	300K* ²	R	
Gears		S	300K* ²	R	
Charge Unit* ¹		S, T	300K	R	
Drum* ¹	D074	S, T	980K	R	
	D075/M044	S, T	1100K		
Potential Sensor		S	600K	I/C	Dry cloth
QL		S	600K	I/C	Dry cloth
Used Toner Bottle		S, U	Full	R or I/C	When tank becomes full.

*1:	TCRU qualified operators can replace these units. Service Technicians can replace the unit and also disassemble the unit and replace individual parts.
*2:	The PM life of these parts is calculated by referring to the rotations of the drum. The PM Parts Replacement message is displayed when the drum rotations reach the timing equal to 300K sheets outputs with 25 P/J, A4 LEF (LT LEF) and simplex mode. As a result, the timing of the PM Parts Replacement message may be different from the PM counter (number of outputs) of the drum.

Image Transfer Unit

Part	By	At	Action	Comments
ITB	S	1600K	R	
Transfer Belt Speed Sensor	S	300K	I/C	Water damp cloth; SP adjustment needed after cleaning
ID Sensor	S	300K	I/C	Water damp cloth
Belt Centering Sensor	S	600K	I/C	Blower brush
ITB Unit Internal Rollers	S	600K	I/C	Water damp cloth
Bias Roller	S	1800K	R	
ITB Cleaning Unit* ¹	T			
ITB Cleaning Blade	S	600k	R	
ITB Lubrication Roller	S	600K	R	
ITB Lubrication Bar	S	600K	R	
ITB Lubrication Blade	S	600K	R	

*1: TCRU qualified operators can replace this unit. Service Technicians can replace the unit and also disassemble the unit and replace individual parts.

Paper Transfer Unit

Part	By	At	Action	Comments
PTR Cleaning Unit* ¹	T			
PTR Cleaning Blade	S	300K	R	
PTR Lubricant Bar	D074	S	450K	R
	D075/M044	S	500K	R
PTR Anti-Static Brush	S	300K	R	
PTR	S	300K	R	

Part	By	At	Action	Comments
Paper Sensors	S, T	300	I/C	Dry cloth to wipe away paper dust, toner

*1:	TCRU qualified operators can replace this unit and clean paper sensors. Service Technicians can replace the unit and also disassemble the unit and replace individual parts.			
-----	--	--	--	--

3

Fusing Unit

Part	By	At	Action	Comments
Fusing Unit* ¹	T			
Fusing Belt	S	650K	R	
Hot Roller	S	650K	R	
Pressure Roller	S	650K	R	
Pressure Roller Bearings	S	650K	R	
Hot Roller Separation Plate	S	300K	I/C	
Pressure Roller Separation Plate	S	300K	I/C	Dry cloth to wipe away paper dust, toner
Fusing Unit Entrance Guide	S	300K	I/C	
Pressure Roller Contact Thermistor	S	650K	I/C	
Heating Roller Contact Thermistor	S	650K	I/C	
Hot Roller Contact Thermistor	S	650K	I/C	
Main Gears	S	650K	L	FLUOTRIBO MG grease
Hot Roller Bearings	S	650K	L	
Heating Roller Bearings	S	650K	I/C	
Web Cleaning Unit* ¹	T			
Cleaning Web	S	450K	R	
Web Tension Roller	S	450K	R	

Part	By	At	Action	Comments
Web Stopper	S	450K	R	

*1:	TCRU qualified operator can replace these units. Service Technician can replace the unit and also disassemble the unit to clean and replace individual parts.			
-----	---	--	--	--

3

Filters

Part	By	At	Action	Comments
Dust Filter	S	600K	R	
Ozone Filters	D074	S	1200K	R
	D075/M044	S	1350K	R

Main Paper Feed

Part	By	At	Action	Comments
1st Pick-up Roller (x1)	S, U	100K	I/C	Water damp cloth
		1000K	R	
1st Feed Roller (x1)	S, U	100K	I/C	Water damp cloth
		1000K	R	
1st Separation Roller (x1)	S, U	100K	I/C	Water damp cloth
		1000K	R	
2nd Pick-up Roller (x1)	S, U	100K	I/C	Water damp cloth
		1000K	R	
2nd Feed Roller (x1)	S, U	100K	I/C	Water damp cloth
		1000K	R	
2nd Separation Roller (x1)	S, U	100K	I/C	Water damp cloth
		1000K	R	

Part	By	At	Action	Comments
2nd Feed Guide Plate (x1)	S	100K	I/C	Dry cloth
2nd Feed Sensor (x1)	S, U	100K	I/C	Blower brush
2nd Vertical Transport Sensor (x1)	S	100K	I/C	
2nd Paper End Sensor (x1)	S, U	100K	I/C	Water damp cloth
2nd Grip Drive Roller (x1)	S	100K	I/C	
2nd Grip Idle Roller (x1)	S	100K	I/C	
Vertical Transport Drive Roller (x3)	S	100K	I/C	
Vertical Transport Idle Roller (x3)	S	100K	I/C	

3

Main Paper Transport

Part	By	At	Action	Comments
Transfer Timing Drive Roller (x1)	S	100K	I/C	Water damp cloth
Transfer Timing Idle Roller (x1)	S	100K	I/C	
Transfer Timing Sensor (x1)	S	100K	I/C	Blower brush
Shift Drive Roller (x1)	S	100K	I/C	Water damp cloth
Shift Idle Roller (x1)	S, U	100K	I/C	
Registration Timing Drive Roller (x1)	S	100K	I/C	Dry cloth
Registration Timing Idle Roller (x1)	S, U	100K	I/C	Water damp cloth
Registration Timing Sensor (x1)	S, U	100K	I/C	Blower brush
Registration Entrance Drive Roller (x1)	S	100K	I/C	Water damp cloth
Registration Entrance Idle Roller (x1)	S, U	100K	I/C	
Entrance Drive Roller (LCT) (x1)	S	100K	I/C	Dry cloth
Entrance Idle Roller (LCT)	S, U	100K	I/C	
Dust Collection Unit (x1)	S	100K	I/C	Empty bin, wipe with dry cloth

Part	By	At	Action	Comments
Double-Feed Sensor (x2)	S	100K	I/C	Blower brush
Upper Relay Sensor (x2)	S	100K	I/C	
Relay Sensor (LCT) (x2)	S	100K	I/C	
CIS Sensor (x1)	S	100K	I/C	
Guide Plate Sensor (x1)	S, U	100K	I/C	Water damp cloth
Relay Drive Roller (Main) (x1)	S	100K	I/C	
Relay Idle Roller (Main) (x1)	S, U	100K	I/C	

Inverter, Exit

Part	By	At	Action	Comments
Cooling Roller (x1)	S	100K	I/C	Water damp cloth
Cooling Belt (x1)	S, U	100K	I/C	
Exit Anti-Static Brush (x1)	S, U	100K	I/C	Dry cloth, replace if deformed
Exit Drive Roller (Main) (x1)	S, U	100K	I/C	Water damp cloth
Exit Idle Roller (Main) (x1)	S, U	100K	I/C	
Exit Transport Roller (x1)	S, U	100K	I/C	Dry cloth
Inverter Relay Roller (x1)	S	100K	I/C	Water damp cloth
Inverter Exit Roller (x1)	S	100K	I/C	
Exit Sensor (x3)	S, U	100K	I/C	Blower brush
Inverter Roller (x1)	S	100K	I/C	Water damp cloth

Duplexer

Part	By	At	Action	Comments
Duplex Anti-Static Brush (x1)	S, U	100K	I/C	Dry cloth. Replace if deformed.
Duplex Switchback Roller (x1)	S, U	100K	I/C	Water damp cloth
Duplex Switchback Sensor (x1)	S, U	100K	I/C	Blower brush
Purged Paper Sensor (x1)	S, U	100K	I/C	
Duplex Transport Rollers (x8)	S, U	100K	I/C	Water damp cloth
Duplex Timing Rollers (Drive, Idle) (x2)	S, U	100K	I/C	
Duplex Transport Sensors (x2)	S, U	100K	I/C	Blower brush

ARDF (D074/D075)

Part	By	At	Action	Comments
External Covers	S	120K	I/C	Alcohol or water, dry cloth
Feed Belt	S	120K	R	
Pick-up Roller	S	120K	R	
Separation Roller	S	120K	R	
Original Length Sensors	S	120K	C	Blower brush
Skew Correction Sensor				
Interval Sensor				
Registration Sensor				
Paper Exit Sensor				
Lower Inverter Sensor				
Separation Sensor				
Upper Inverter Sensor				

3

Part	By	At	Action	Comments
White Cover	S, U	120K	C	Alcohol or water, dry cloth
Transport Belt	S	120K	R	
Feed Drive Gears	S	120K	L	G501 Grease
Grip Roller	S	120K	C	Alcohol or water, dry cloth
Transport Rollers				
Scanner Rollers (Entrance/Exit)				
Exit Rollers				
Inverter Rollers (Lower, Exit, Upper)				
Idle Rollers	S	120K	C	Alcohol or water, dry cloth

SP Setting Summary

Task	Details	Installation	PM Parts																	
			Development Unit	Developer	Drum Charge Unit	Drum	Drum Cleaning Unit	ITB	Belt Cleaning Unit	PTR Unit	Fusing Unit	Fusing Web Cleaning Unit								
1	PM Parts																			
2	Set Toner Bottle	Applicable part only	Yes	Yes	Yes	Yes	Yes	Yes	Yes	Yes	Yes	Yes	Yes	Yes	Yes	Yes	Yes	Yes	Yes	Yes
3	Open Front Doors	Both left, right doors	Yes	Yes	Yes	Yes	Yes	Yes	Yes	Yes	Yes	Yes	Yes	Yes	Yes	Yes	Yes	Yes	Yes	Yes
4	Main Power ON		Yes	Yes	Yes	Yes	Yes	Yes	Yes	Yes	Yes	Yes	Yes	Yes	Yes	Yes	Yes	Yes	Yes	Yes
5	Enter SP Mode		Yes	Yes	Yes	Yes	Yes	Yes	Yes	Yes	Yes	Yes	Yes	Yes	Yes	Yes	Yes	Yes	Yes	Yes
6	Reset PM Part	Applicable part only	Yes	Yes	Yes	Yes	Yes	Yes	Yes	Yes	Yes	Yes	Yes	Yes	Yes	Yes	Yes	Yes	Yes	Yes
7	Install Developer	SP3024-001(K) SP3024-002 (C) SP3024-003 (M) SP3024-004 (Y)	Yes	Yes	Yes	Yes	Yes	Yes	Yes	Yes	Yes	Yes	Yes	Yes	Yes	Yes	Yes	Yes	Yes	Yes
8	Developer File OK?	Results for YMCK reading left to right.	Yes	Yes	Yes	Yes	Yes	Yes	Yes	Yes	Yes	Yes	Yes	Yes	Yes	Yes	Yes	Yes	Yes	Yes
9	Apply Lubricant	1. Close left/right doors. 2. Open right door. 3. SP2310-1 4. Close right door.								Yes										
10	Close Front Door		Yes	Yes	Yes	Yes	Yes	Yes	Yes	Yes	Yes	Yes	Yes	Yes	Yes	Yes	Yes	Yes	Yes	Yes
11	Wait for Warmup ("Ready")	Wait 5 min. for the "Ready" message on the operation panel.	Yes	Yes	Yes	Yes	Yes	Yes	Yes	Yes	Yes	Yes	Yes	Yes	Yes	Yes	Yes	Yes	Yes	Yes
12	Manual Toner Fill	SP3051-001	Yes	Yes	Yes	Yes	Yes	Yes	Yes	Yes	Yes	Yes	Yes	Yes	Yes	Yes	Yes	Yes	Yes	Yes
13	Cleaning	SP3032-001 (All) SP3032-02 (GMY) SP3032-03 (K) SP3032-04 (C) SP3032-05 (M) SP3032-06 (Y)						Yes												
14	Initialize TD Sensor	SP3030-01 (All) SP3030-02 (GMY) SP3030-03 (K) SP3030-04 (C) SP3030-05 (M) SP3030-06 (Y)		Yes																
15	Confirm TD Sensor Initialization	SP3031-001	Yes	Yes	Yes	Yes	Yes	Yes	Yes	Yes	Yes	Yes	Yes	Yes	Yes	Yes	Yes	Yes	Yes	Yes
16	Initialize Process Control	Results for YMCK, reading left to right. SP3020-001	Yes	Yes	Yes	Yes	Yes	Yes	Yes	Yes	Yes	Yes	Yes	Yes	Yes	Yes	Yes	Yes	Yes	Yes
17	Confirm Process Control Initialization	SP3012-001	Yes	Yes	Yes	Yes	Yes	Yes	Yes	Yes	Yes	Yes	Yes	Yes	Yes	Yes	Yes	Yes	Yes	Yes
18	Exit SP Mode		Yes	Yes	Yes	Yes	Yes	Yes	Yes	Yes	Yes	Yes	Yes	Yes	Yes	Yes	Yes	Yes	Yes	Yes

d074p910b

This is a quick reference table that tells you which SP codes to execute for PM part and unit replacements.

PM Tables for Peripherals

Column	Meaning	Notations	
Part	Name of the component, unit	Name of the part	
***K	Interval for checking, cleaning, replacement	Example: 300K where K = 1000, or 300,000 printed sheets. (Recorded in Log Counter)	
		I	Inspect
		C	Clean
		L	Lubricate
		R	Replace
Note	What to use, etc.	Materials required for cleaning, lubrication	

3

LCIT (D516)

The PM interval is for the number of sheets that have been fed.

Part	500K	1000K	Note
Transport guide plate	I/C	300K	Clean with damp, clean cloth
Grip rollers (drive, idle rollers)	I/C		
Transport rollers	I/C		
Pick-up rollers (4th, 5th, 6th tray) *1	I/C	I/R	
Paper feed roller (4th, 5th, 6th tray) *1	I/C	I/R	
Separation rollers (4th, 5th, 6th tray) *1	I/C	I/R	

1. At 300K, display the PM Counts for the pick-up, feed, and separation rollers.
2. Replace if "Target" has been exceeded.

* 1	These rollers can be replaced by a TCRU trained operator for each tray.
--------	---

Multi-Bypass Tray (D517)

The PM interval is for the number of sheets that have been fed.

Part	500K	1000K	Note
Transport guide plate	I/C		
Grip rollers (drive, idle rollers)	I/C		
Pick-up roller* ¹	I/C	I/R	
Paper feed roller* ¹	I/C	I/R	
Separation roller* ¹	I/C	I/R	

- At 1000K, display the PM Counts for the pick-up, feed, and separation rollers.
- Replace if "Target" has been exceeded.

* 1	These rollers can be replaced by a TCRU trained operator for each tray.
--------	---

Decurler Unit (D544)

Part	500K	Note
Transport guide plate	I/C	Clean with damp (alcohol or water) cloth
Decurler rollers (drive, idle roller)	I/C	
Transport rollers (drive, idle roller)	I/C	
Purge tray paper sensors (x3)	I/C	

Cover Interposer Tray (D518)

The PM interval is for the number of sheets that have been fed.

Part	60K	As Needed	Note
Drive rollers		C	Dry cloth
Idle rollers		C	
Feed belt	R		
Separation roller	R		
Pick-up roller	R		
Sensors		C	Blower brush.
Drive gears		I	Lubricate with very small amount of G501.

Multi-Folding Unit (D521)

Part	PM Visit	Notes
Rollers (drive, idle rollers)	I/C	Alcohol, clean cloth
Anti-static brush	I/C	
Shafts	I/C	Lubricate with silicone oil if noisy.
Sensors	I/C	Blower brush
Positioning roller	I/C	Inspect for scratches or nicks
Fold rollers (1st, 2nd, 3rd)	I/C	Alcohol, clean cloth
Crease rollers (drive, idle roller)	I/C	

Ring Binder (D519)

Periodically inspect and clean the parts listed in the table below.

Item	Action
Horizontal Transport Path	
Anti-static brushes	Blower brush

Item		Action
	Horizontal transport path sensors	Blower brush
	Drive rollers, idle rollers	Damp cloth
Switchback Unit		
	Anti-static brushes	Blower brush
	Switchback area sensors	Blower brush
	Drive rollers, idle rollers	Damp cloth
Binder Unit		
	Paddle roller	Blower brush
	Transport path sensors	Blower brush
	Drive rollers, idle rollers	Damp cloth

High Capacity Stacker (D515)

Part	500K	PM Visit	
Rollers (drive, idle rollers)	I/C	I/C	Alcohol, clean cloth
Anti-static brush	I/C	I/C	
Shafts	I/C	I/C	Lubricate with silicone oil if noisy.
Sensors	I/C	I/C	Blower brush
Sub jogger fences	I/C	I/C	Alcohol, clean cloth
Main jogger fences	I/C	I/C	
LE stopper	I/C	I/C	

Booklet Finisher (D512/D513)

Main

Part	5000K	25000K	
Rollers (drive, idle)	I/C		Alcohol, clean cloth
Discharge brush	I/C		
Shafts	I/C		Lubricate with silicone oil if noisy
Sensors	I/C		Blower brush
Jogger fences	I/C		Tighten screws
Staple trimmings hopper	I/C		Empty hopper
Alignment brush roller		I/R	See below
Positioning roller		I/R	
Drag roller (sponge)		I/R	

- At 25000K, display the PM Counts for the alignment brush roller, positioning roller, and drag sponge roller.
- Replace if "Target" has been exceeded.

Punch Unit

Part	20000K	
Punch unit	I/C	<ul style="list-style-type: none"> • Display PM Count for punch unit. • Replace if "Target" has been exceeded.

Staplers

Part	50000K	200000K	
Corner stapler	I/R		<ul style="list-style-type: none"> • Display PM Count. • Replace if "Target" exceeded.
Booklet Staplers (x2)		I/R	

Trimmer Unit (D520)

Part	PM Visit	
Rollers (drive, idle rollers)	I/C	Water, clean cloth
Belts	I/C	
Discharge brush	IC	Cloth, blower brush
Roller shafts		Lubricate with silicone oil if noisy
Sensors	I/C	Blower brush
Paper trimmings hopper	I/C	Empty, make sure the operator knows how to empty the hopper
Trimming Blade	R	Replace the blade after 400K. SP7989 (Trim Count) displays the total count.

3

Lubrication Points

Fusing Unit Main Drive Gears

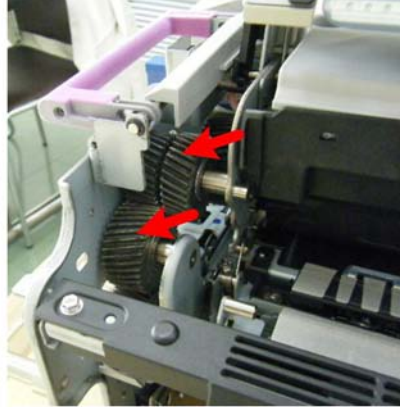
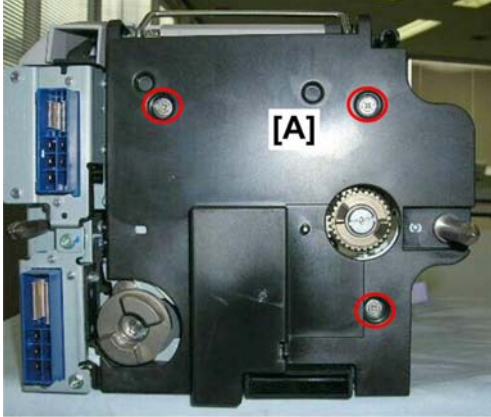

d074r303

1. Remove the rear plate [A] ( x3).
2. Apply FLUOTRIBO MG Grease to the two gears marked by red arrows. Apply about 2 g at both points.

Cleaning, Lubrication Around Fusing Unit Heating Roller

Do the following procedures before reassembling the fusing unit.

Part Name	Interval	Action
Heating Roller Thermistors (x2)	650K	Clean

3

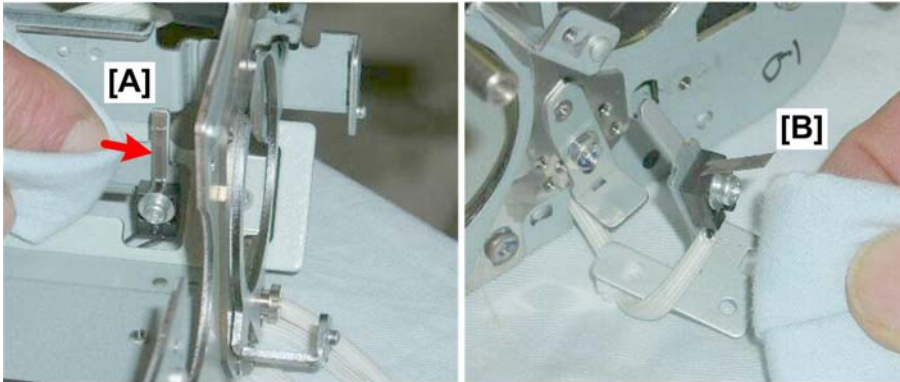

d074r405

1. Use a dry cloth to remove toner and paper dust from the surface of the thermistors:

[A] Front

[B] Rear



d074r405a

2. Rotate the races to make sure the contact surfaces of the bearings and race turn freely. If the races do not rotate freely, they must be replaced.

3. Insert the heating roller at the front end of the unit.

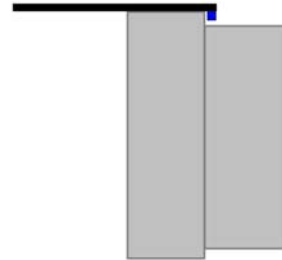
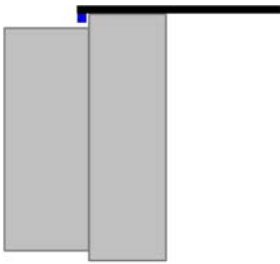

d074r404d

4. The flanges must be set so that both edges of the fusing belt rim overlap the collar of the flanges.

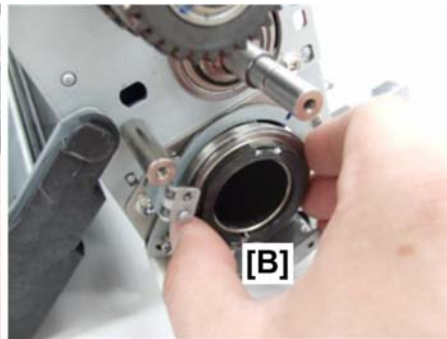
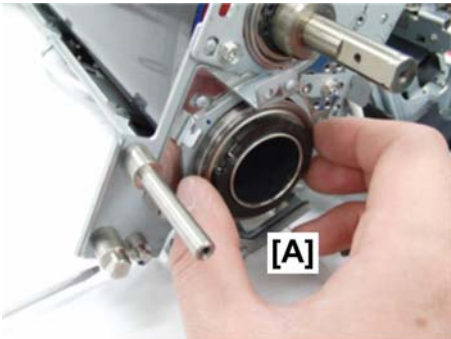

d074r404e

5. Re-attach the bearing races at the front [A] and rear [B].

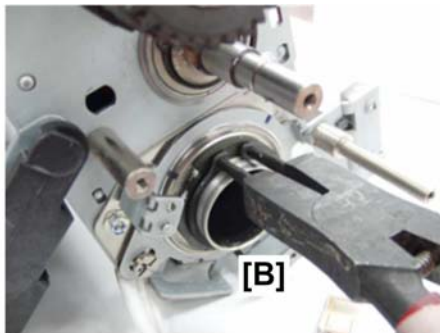
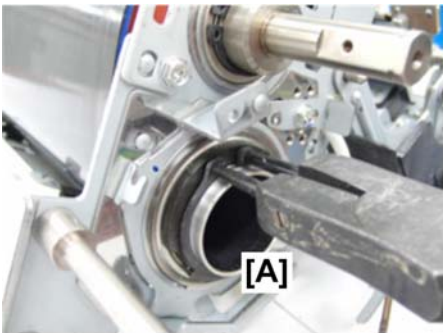

d074r404f

6. Re-attach the C-rings at the front and rear.

Cleaning and Lubrication Around Pressure Roller

Do these procedures before re-assembling the fusing unit.

Part Name	Interval	Action
Pressure roller thermistor	650K	Clean

3

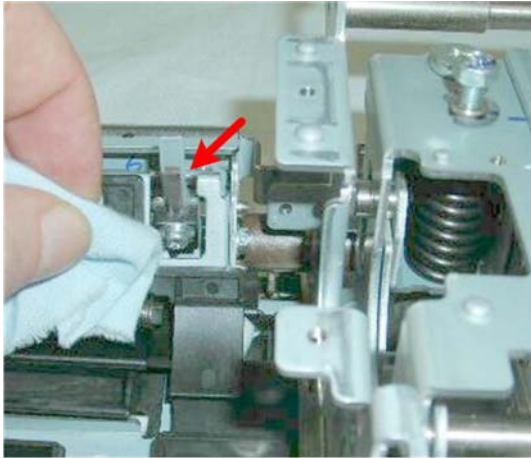

d074r407

1. Use a dry cloth to remove toner and paper dust from the sensitive surface of the thermistor.

Part Name	Interval	Action
Pressure Roller Bearing Races (x2)	650K	Lubricate

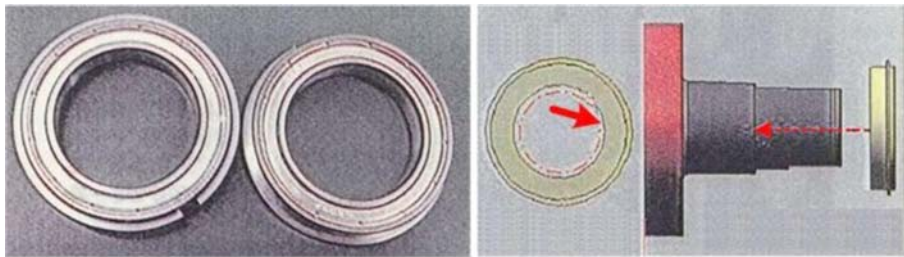

d074r408

2. Use a small brush to apply FLUROTRIBO MG Grease to the pressure roller bearing races.

Lubrication Around Hot Roller

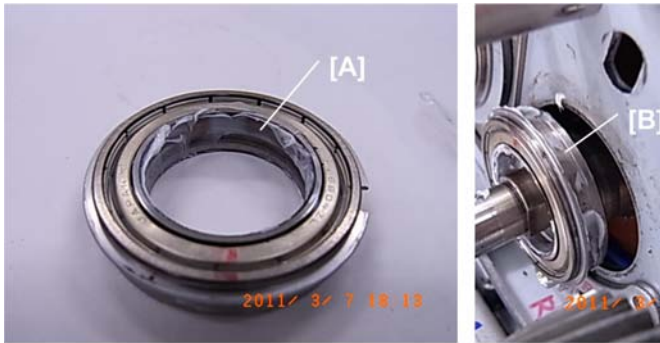

d074r997

1. Use a small brush to apply FLUOTRIBO MG grease to the front bearing race:
[A] Inner surface of bearing race
[B] Set bearing race and apply to outer surface



d074r998

2. Install the front bearing race.

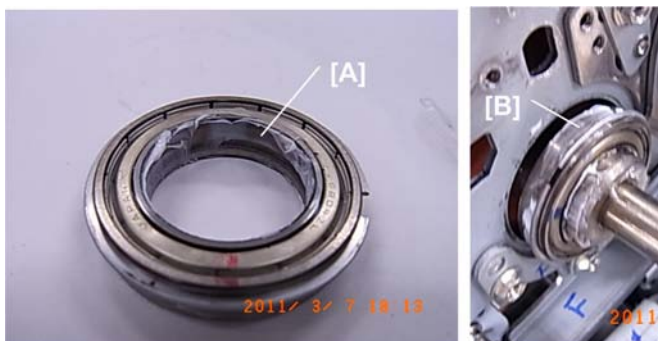

d074r999

3. Use a small brush to apply FLUOTRIBO MG grease to the rear bearing race:

[A] Inner surface of bearing race

[B] Set rear bearing race and apply to outer surface

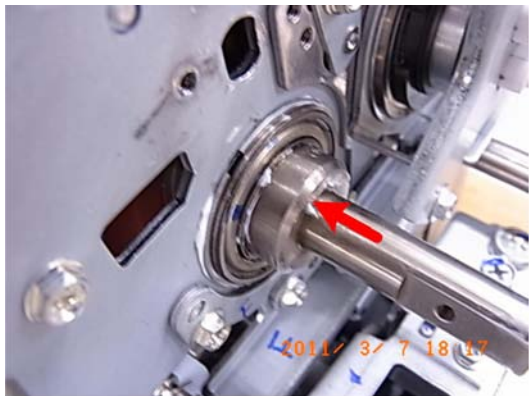

d074r001a

4. Install the rear bearing race.

Cleaning Points

Overview

This section describes how to clean the rollers and sensors in the paper path with minimal disassembly. Four units comprise the paper path.

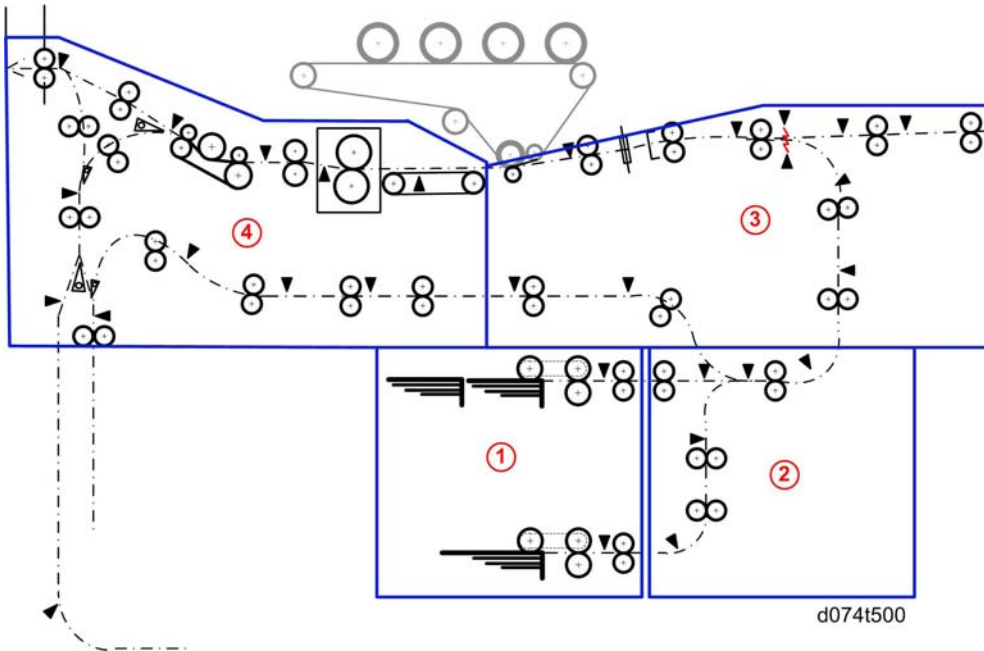

①	Paper Bank	Paper supply, 1st Tray, 2nd Tray
②	Vertical Transport Unit	Relays paper to right drawer
③	Right Drawer	Paper registration, PTR unit, 2nd half of duplex path
④	Left Drawer	PTB, fusing unit, paper cooling unit, 1st half of duplex path

Inspection and Cleaning

Before You Begin

Here are some rules to follow for cleaning rollers and sensors.

Roller Cleaning

- Clean rollers with a dry cloth.
- Try to avoid touching the surfaces of the rollers with bare hands.

Sensor Cleaning

- Clean sensors with a blower brush. Do not use cloth or tissue paper.
- Most of the sensors are below holes in plates so you may not be able to see them.
- Insert tip of the blower brush into the hole and squeeze it to blow any paper dust off the sensor.

3

1st Tray, 2nd Tray

1. Turn the machine off and disconnect it from its power source.
2. Allow the machine to cool for at least 20 minutes.

⚠ CAUTION

- Make sure that the main machine is switched off and that its power cord is disconnected before doing the following procedures.

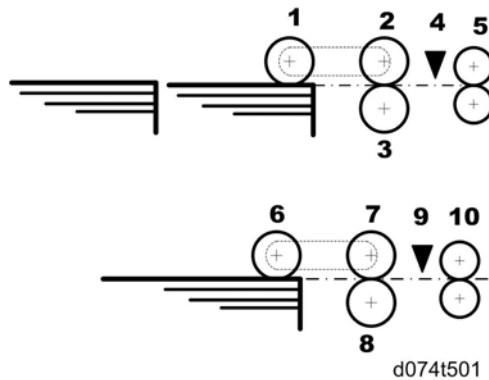

1st Tray		2nd Tray	
1	1st Pickup Roller	6	2nd Pickup Roller
2	1st Paper Feed Roller	7	2nd Paper Feed Roller
3	1st Separation Roller	8	2nd Separation Roller
4	1st Paper Feed Sensor	9	2nd Paper Feed Sensor
5	1st Grip Rollers	10	2nd Grip Rollers

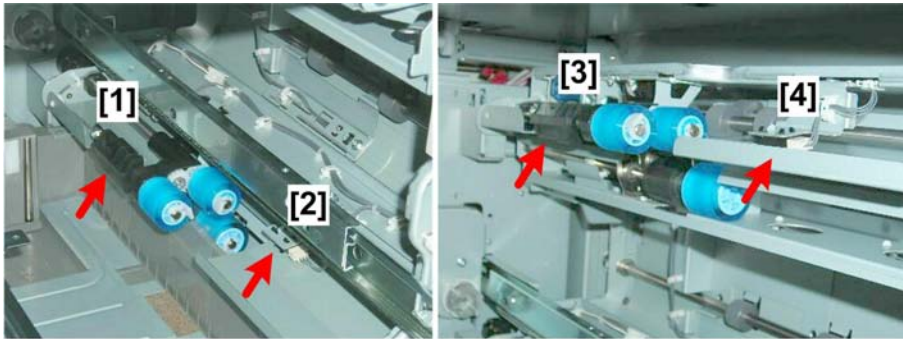

d074t505

3

1. Remove the right half of Tray 1. This will allow you to see the rollers of Tray 2 and Tray 1. (p. 647)
2. Clean the rollers with a dry cloth.
3. Blower brush: 2nd paper end sensor [1] and 2nd paper feed sensor [2].
4. Blower brush: 1st paper end sensor [3] and 1st paper feed sensor [4].

Vertical Transport Unit

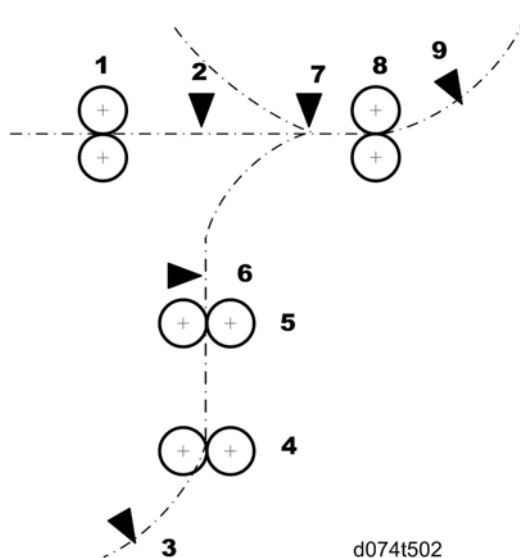

d074t502

1	Horizontal Transport Rollers	6	Vertical Transport Sensor
2	1st Transport Sensor	7	Bank Exit Sensor
3	2nd Transport Sensor	8	Bank Exit Rollers

4	Lower Transport Rollers	9	Main Relay Sensor 1
5	Upper Transport Rollers		

3



d074t506

1. Open the right front door.
2. Lower lever [1] to release the lower and upper transport plates [2].

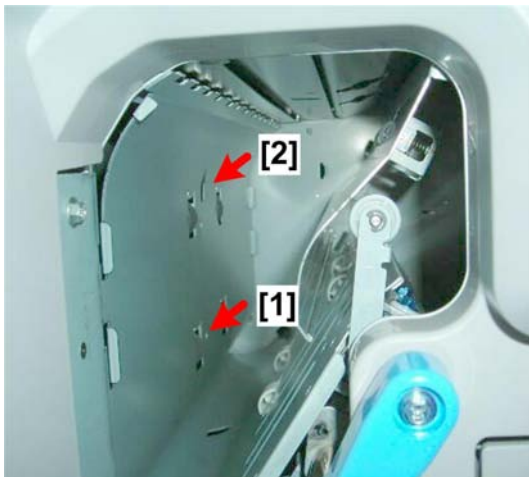

d074t507

3. Blower brush:
[1] 2nd Transport sensor
[2] Vertical transport sensor



d074t508

4. Dry cloth:
 - [1] Lower transport drive rollers
 - [2] Upper transport drive rollers
5. Turn the knob as you hold the cloth against the rollers.

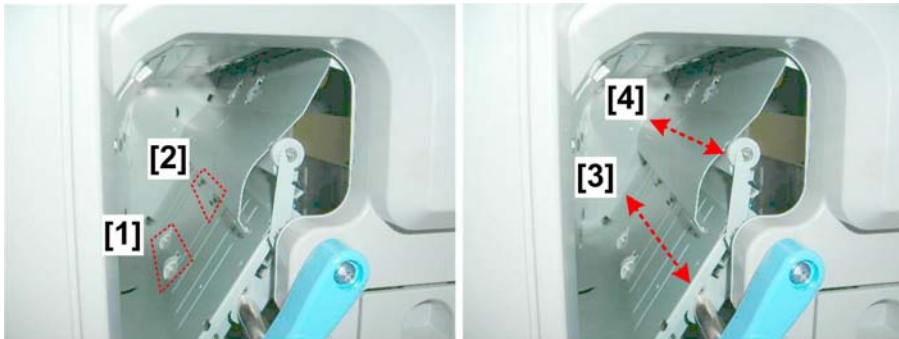

d074t509

6. Dry cloth:
 - [1] Lower transport idle rollers
 - [2] Upper transport idle rollers
 - [3] 2nd Vertical plate
 - [4] 1st Vertical plate

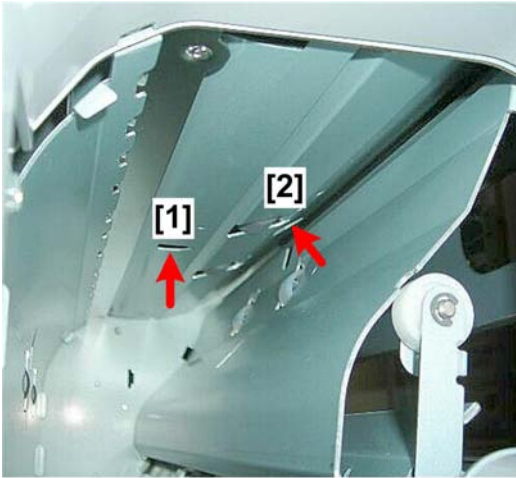

d074t510

7. Blower brush:

- [1] Bank exit sensor
- [2] Main relay sensor 1



8. Dry cloth:

- [1] Bank exit drive rollers
- [2] Bank exit idle rollers

Right Drawer

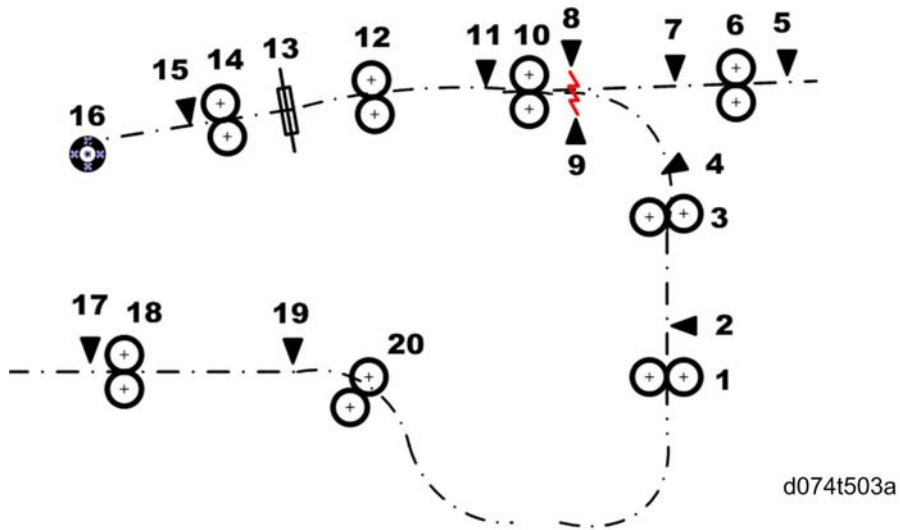

3

1	Main Relay Rollers	11	Registration Timing Sensor
2	Main Relay Sensor 2	12	Shift Rollers* ¹
3	Registration Entrance Rollers	13	CIS (Shift Unit)
4	Main Relay Sensor 3	14	Transfer Timing Rollers
5	LCT Relay Sensor 1	15	Transfer Timing Sensor
6	LCT Relay Rollers	16	PTR (Paper Transfer Roller)
7	LCT Relay Sensor 2	17	Duplex Transport Sensor 6
8	Double-Feed Sensor (Emitter)	18	Duplex Transport Rollers 5
9	Double-Feed Sensor (Receptor)	19	Duplex Transport Sensor 7
10	Registration Timing Rollers	20	Duplex Transport Rollers 6

*¹ Shift drive roller cleaning requires disassembly.



d074t511a

1. Lower the lever [1] and pull out the right drawer [2] until it stops.

3

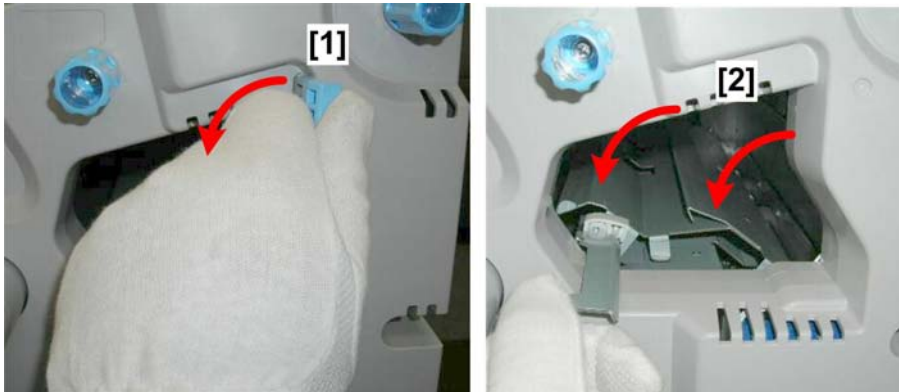

d074t513

2. On the right side of the drawer, lower lever [1] to release the plates [2].



d074t514

3. Hold the dry cloth against the relay drive rollers [1].
4. At the right lower corner of the drawer, slowly rotate the roller shaft [2].

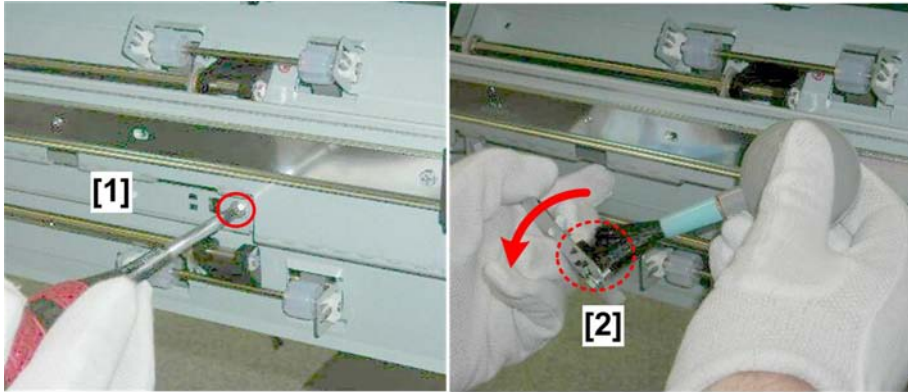

d074t516

5. Disconnect main relay sensor 1 bracket [1] and turn it over so that you can see the sensor ( x1).
6. Blower brush: main relay sensor 1 [2].

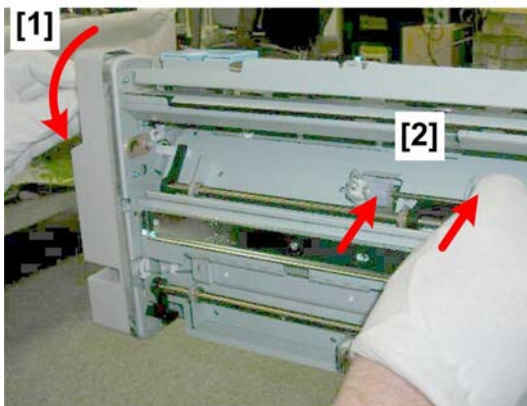

d074t517

7. Rotate knob [1].
8. Dry cloth: Registration entrance idle rollers [2].

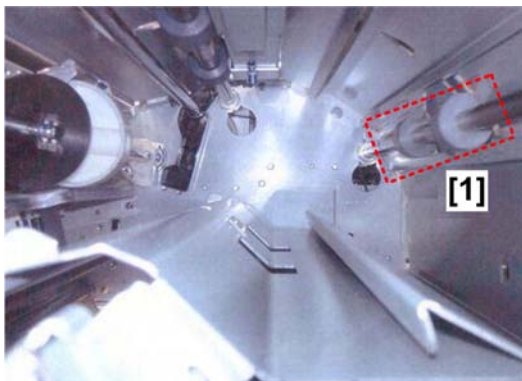

d074r001c

- 9. Dry cloth: Registration entrance driver rollers [1].

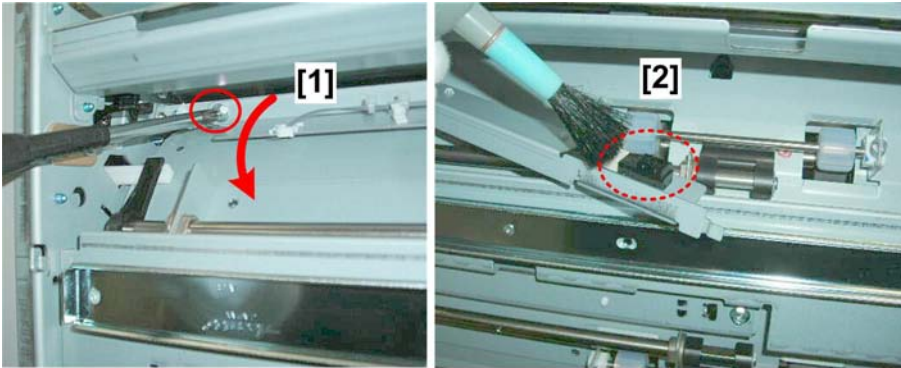

d074t520

- 10. Disconnect main relay sensor 3 bracket [1] and turn it over so that you can see the main relay sensor ( x1).
- 11. Blower brush: Main relay sensor 3 [2]

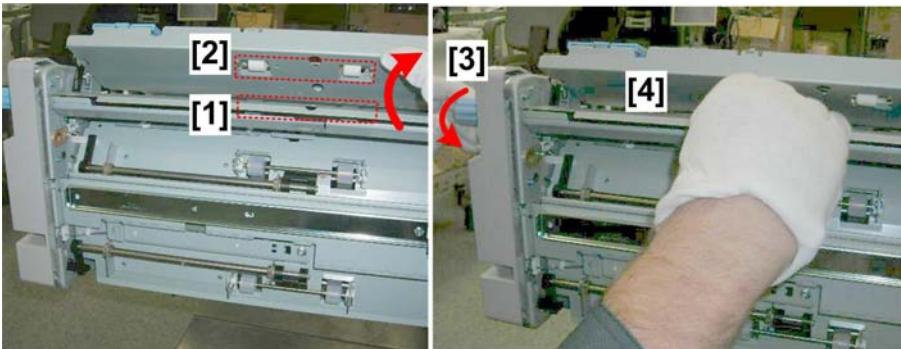

d074t518

- 12. Open the plate on the top right of the drawer so that you can see the LCT relay drive rollers [1] and LCT relay idle rollers [2].
- 13. Turn knob [3].
- 14. Hold a dry cloth between the plates and the rollers to clean both idle and drive rollers as they rotate [4].

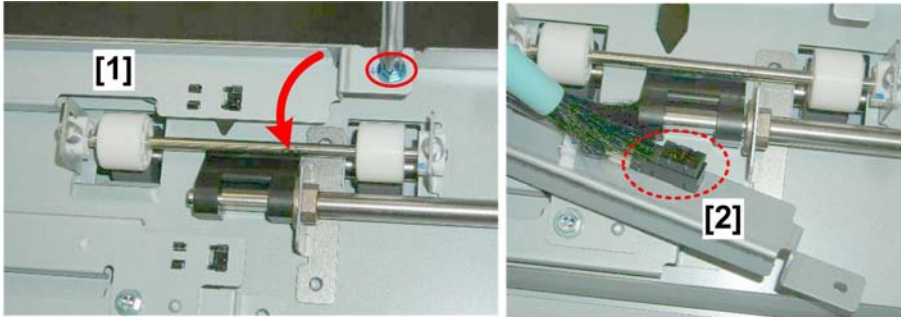

d074t522

- 15. Disconnect the LCT relay sensor 1 bracket [1] and turn it over so that you can see the sensor ( x1).
- 16. Blower brush: LCT relay sensor 1 [2].



d074t524

- 17. Disconnect the LCT relay sensor 2 bracket [1] and turn it over so that you can see the sensor ( x2).
- 18. Blower brush: LCT relay sensor 2 [2].

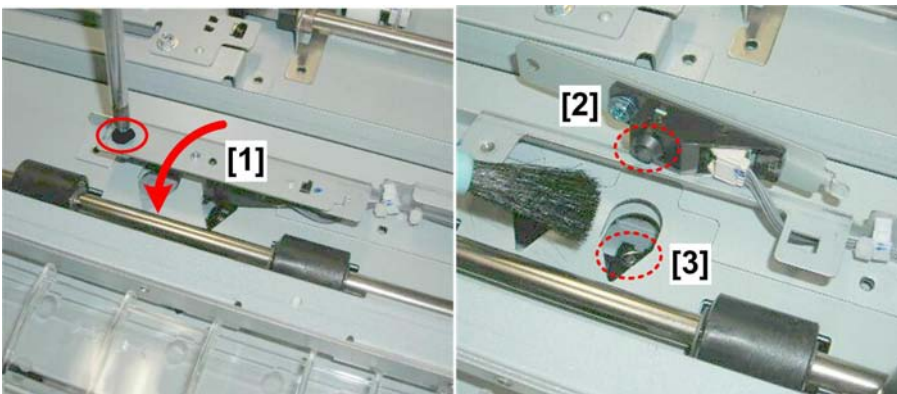

d074t526

- 19. Remove the double-feed sensor bracket [1] and turn it over so that you can see the top sensor (x1).
- 20. Blower brush: Double-feed sensor (receptor) [2].
- 21. Blower brush: Double-feed sensor (LED) [3].



d074t527

- 22. Turn the knob at the front.
- 23. Dry cloth: Registration timing idle rollers [1]
- 24. Inside the right drawer, while turning the knob, Dry cloth: Registration timing drive rollers [2]

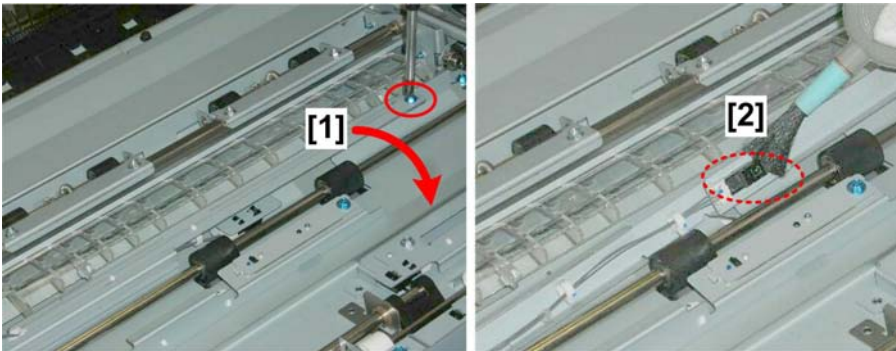

d074t529

- 25. Disconnect the registration timing sensor bracket [1] and turn it over so that you can see the sensor.
- 26. Blower brush: Registration timing sensor [2].

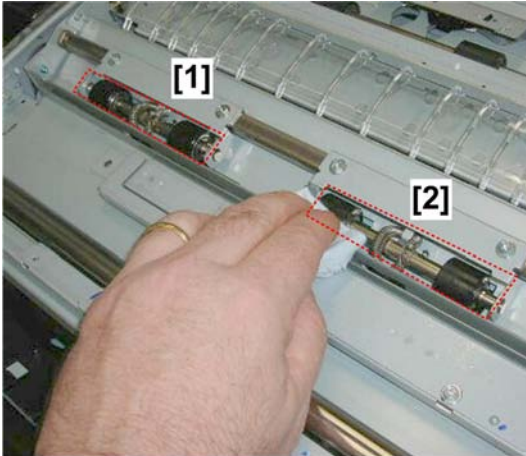

d074t530

27. Dry cloth:

[1] Shift idle rollers (rear)

[2] Shift idle rollers (front)

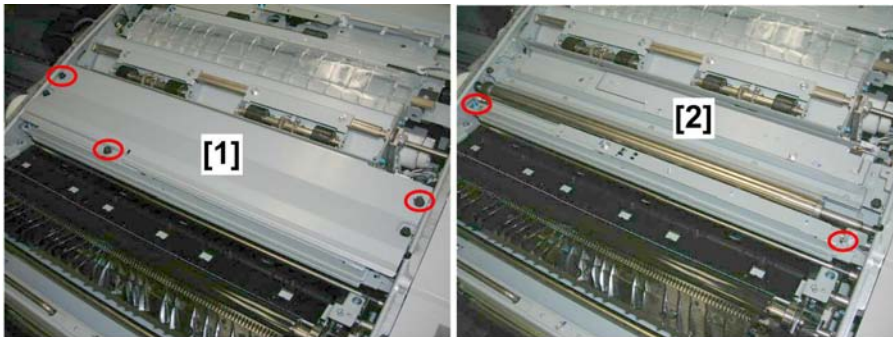

d074t531

28. Remove the dust tray cover plate [1] ( x3).

29. Remove the dust tray [2] ( x2).

3



d074t532

- 30. If there is any paper dust in the tray, empty it into a waste bin.
- 31. Use a dry cloth to wipe the tray clean.

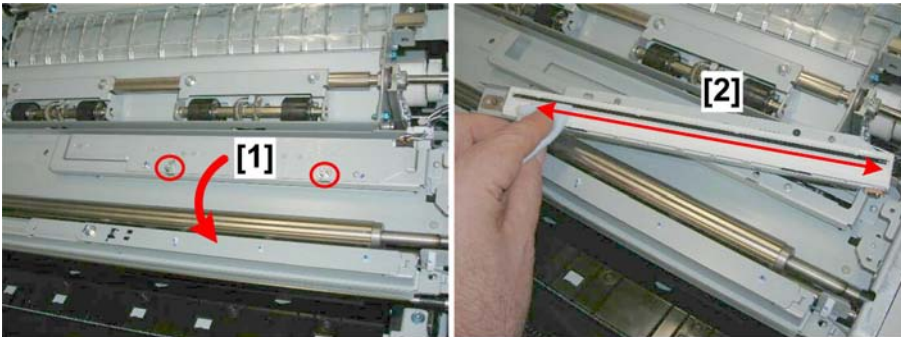

d074t533

- 32. Disconnect the CIS bracket [1] and turn it over so that you can see the clear surface of the CIS (2).
- 33. Use a damp cloth and then a dry cloth to wipe the surface [2] clean.

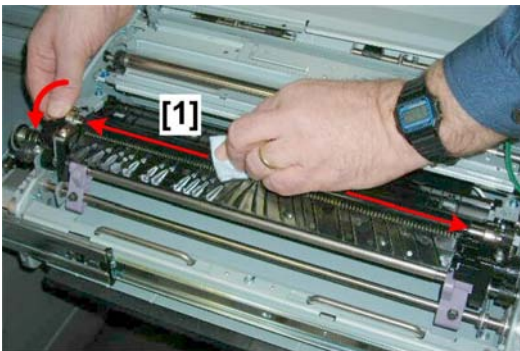

d074t533a

- 34. While slowly turning the roller gear at the rear, clean the PTR with a dry cloth.

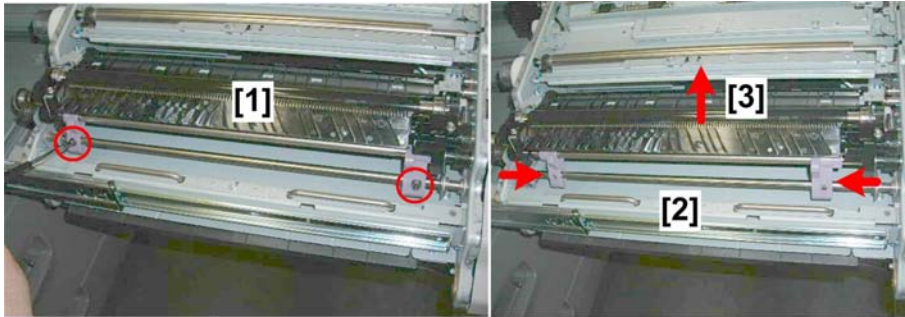

d074t534

35. Disconnect the PTR unit [1] support arms ( x2).
36. Push both disconnected arms toward the center [2] until they stop.
37. Remove the PTR unit [3].

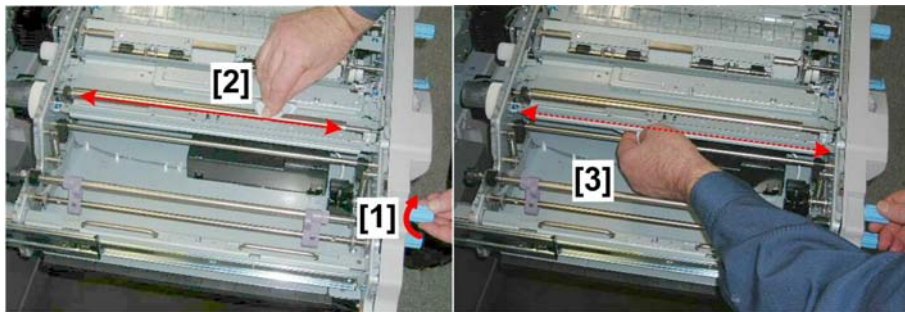

d074t535

38. Turn knob [1].
39. Dry cloth: Transfer timing idle roller.
40. While turning the knob, Dry cloth: Transfer timing drive roller [3].

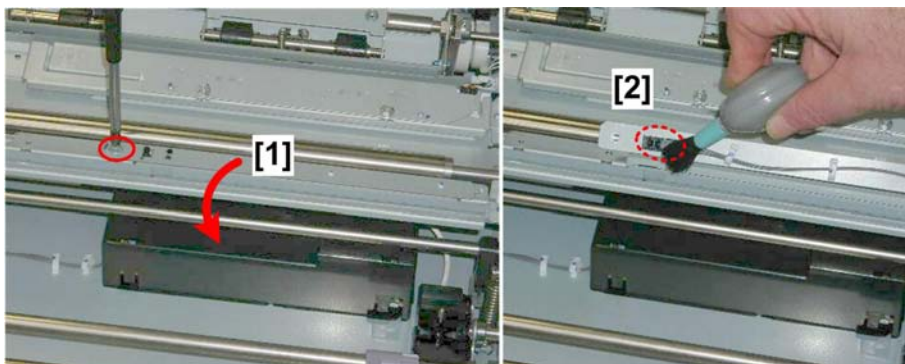

d074t537

41. Disconnect the transfer timing sensor bracket [1] and turn it over so that you can see the sensor ( x1).

42. Blower brush: Transfer timing sensor [2].

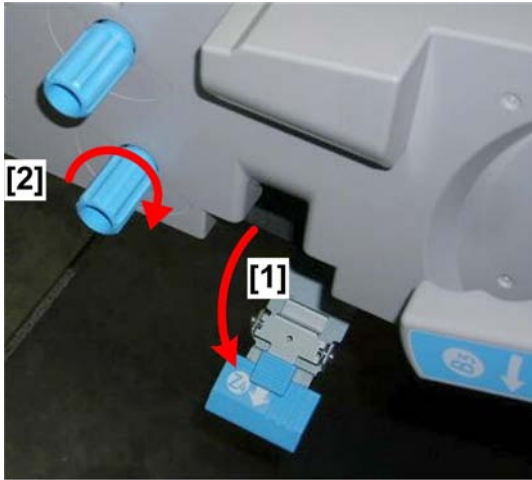

d074t538

43. At the front right corner of the drawer, lower the duplex transport path plate (Z4) [1].

44. Rotate the duplex transport roller knob [2].

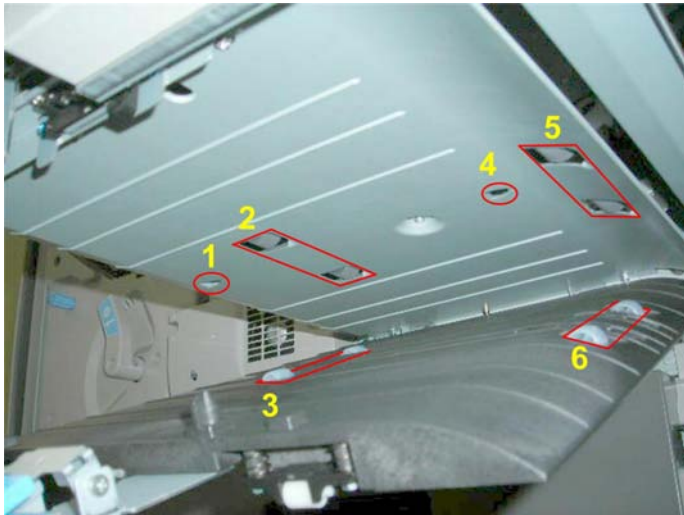

d074t539

45. Under the right drawer, clean the rollers (as you rotate the knob) and sensors.

1	Duplex transport sensor 6	Blower brush
2	Duplex transport drive rollers 5	Dry cloth
3	Duplex transport idle rollers 5	Dry cloth
4	Duplex transport sensor 7	Blower brush

5	Duplex transport drive rollers 6	Dry cloth
6	Duplex transport idle rollers 6	Dry cloth

Left Drawer

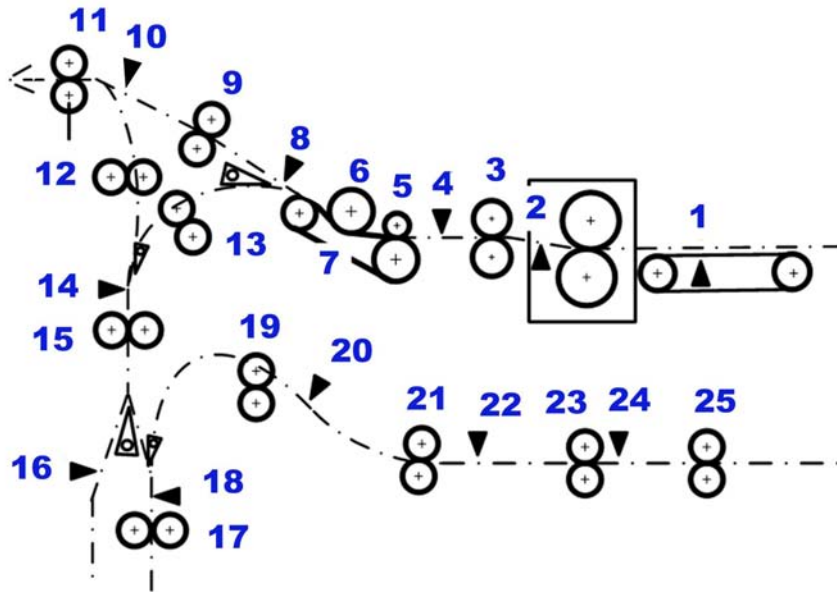

d074t504a

1	PTB Sensor	14	Exit Relay Sensor
2	Fusing Exit Sensor	15	Invert Exit Rollers 1
3	Exit Unit Entrance Rollers	16	Purge Relay Sensor
4	Cooling Unit Entrance Sensor	17	Duplex/Invert Rollers*1
5	Cooling Unit Entrance Rollers	18	Duplex/Invert Sensor
6	Cooling Pipe Roller	19	Duplex Transport Rollers 1
7	Cooling Belt	20	Duplex Transport Sensor 1
8	Exit JG Sensor	21	Duplex Transport Rollers 2
9	Exit Relay Rollers	22	Duplex Transport Sensor 2
10	Exit Sensor	23	Duplex Transport Rollers 3

11	Exit Rollers	24	Duplex Transport Sensor 3
12	Invert Exit Rollers 2	25	Duplex Transport Rollers 4
13	Invert Entrance Rollers* ¹		

*¹ Cleaning requires disassembly.

3

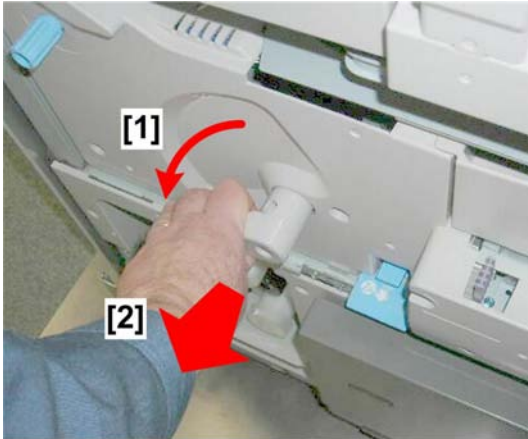

d074t540

1. Lower handle [1] and pull out the left drawer [2].

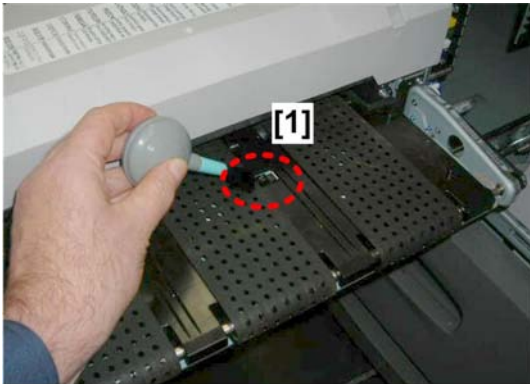

d074t541

2. Blower brush: PTB sensor [1]

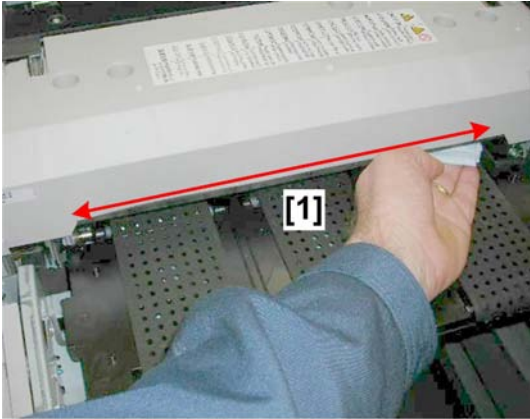

d074t542

- 3. Dry cloth: Fusing unit entrance plates [1]

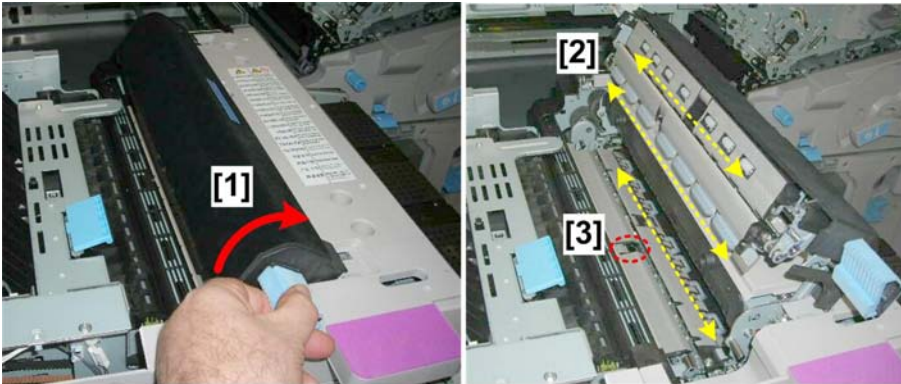

d074t543

- 4. Open the top of the fusing unit [1]
- 5. Dry cloth: Rollers, strippers, plates [2]
- 6. Blower brush: Fusing unit exit sensor [3]

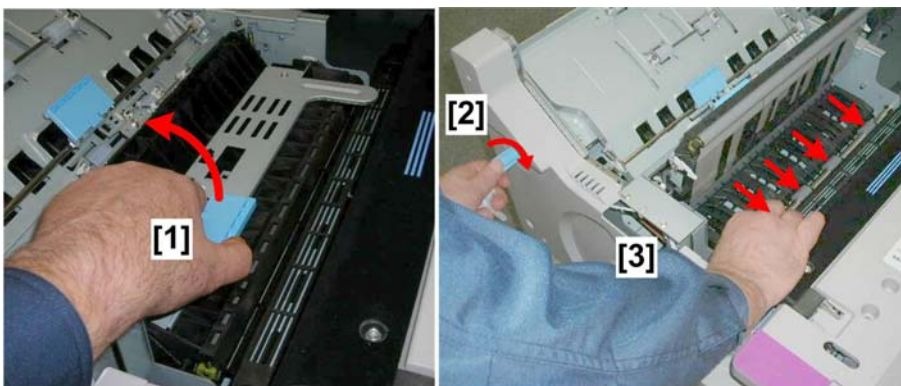

d074t544

3

- 7. Open the cooling unit entrance cover [1]
- 8. Turn knob [2].
- 9. Dry cloth: Exit unit entrance rollers [3]

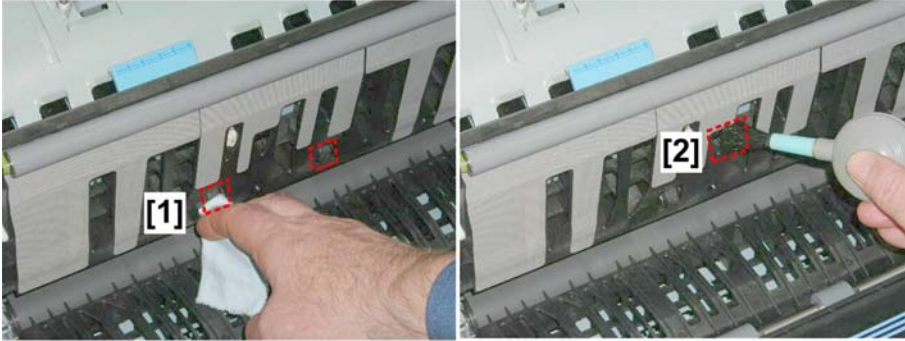

d074t545

- 10. Dry cloth: Cooling unit entrance rollers [1]
- 11. Blower brush: Cooling unit entrance sensor [2]
- 12. Close the cooling unit entrance cover.

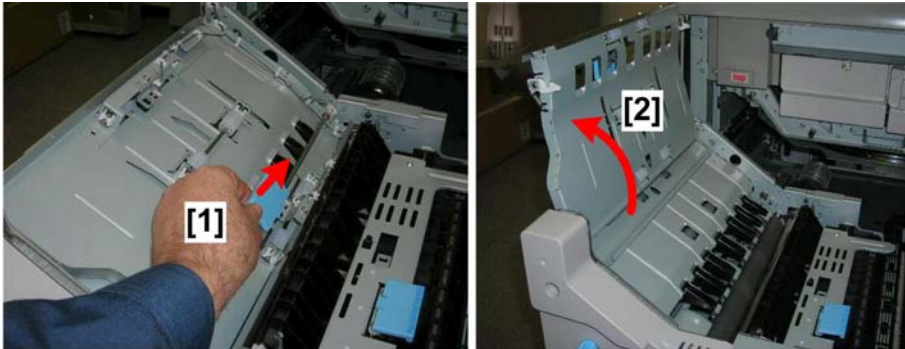

d074t546

- 13. Raise and open the transport cover [1].

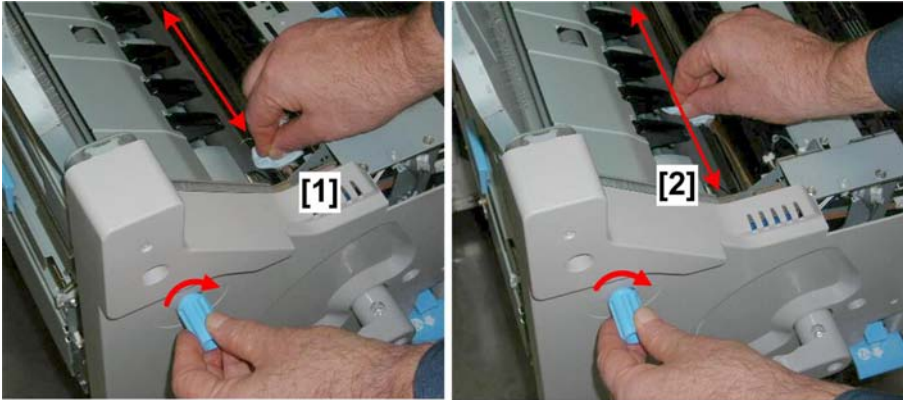

d074t547

14. Turn the knob.
15. Dry cloth:
 - [1] Cooling belt
 - [2] Cooling pipe roller

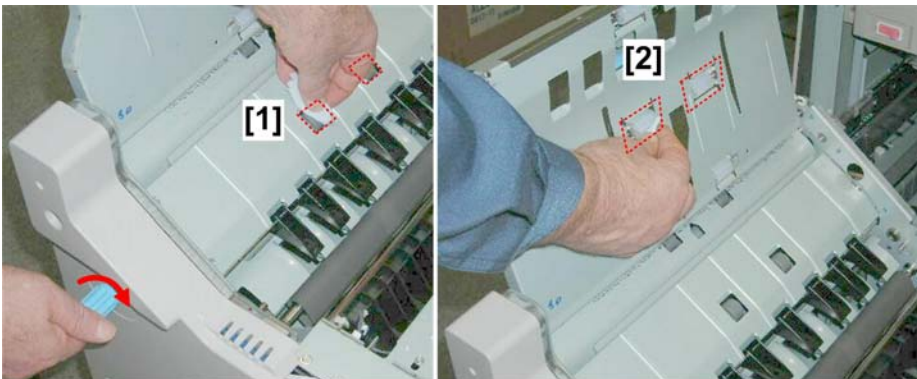

d074t548

16. Dry cloth:
 - [1] Exit relay drive rollers
 - [2] Exit relay idle rollers

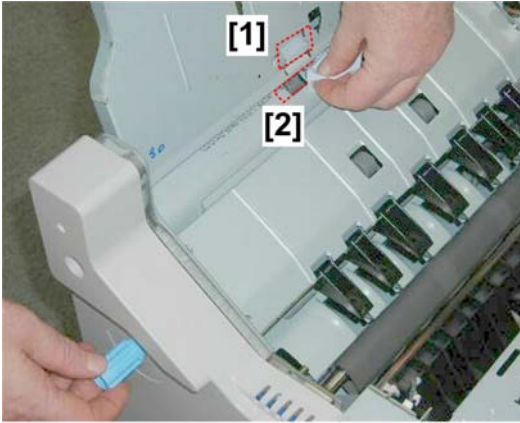

d074t549

17. Dry cloth:

[1] Exit idle roller

[2] Exit drive roller

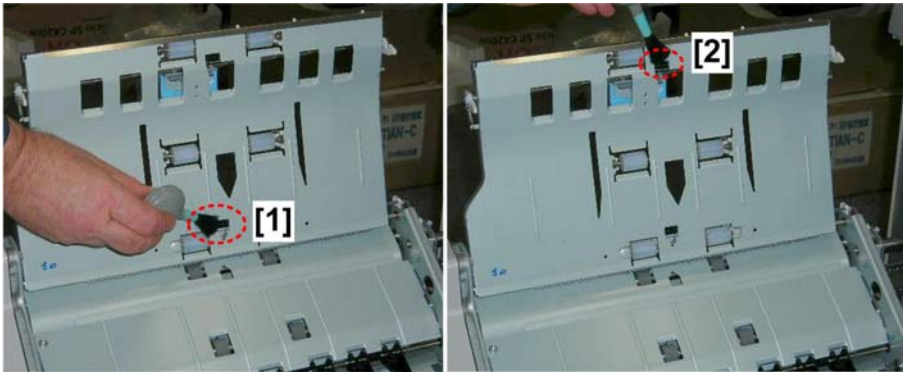

d074t550

18. Blower brush:

[1] Exit sensor

[2] Exit JG sensor

19. Lower and close the transport cover,



d074t551

20. Open the inverter/exit transport cover [1].

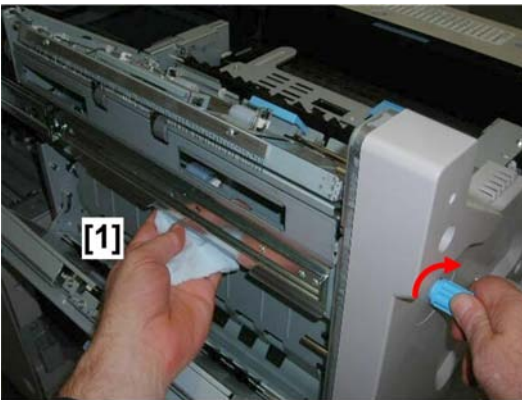

d074t552

21. Turn the knob.

22. Dry cloth: Invert exit rollers 2 [1]

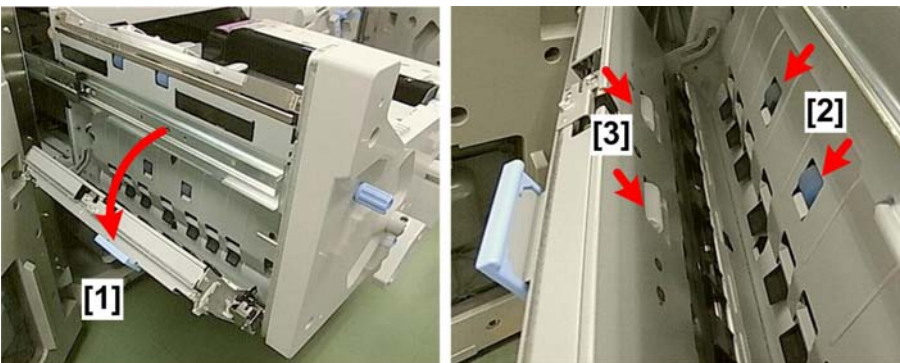

d074t553

23. Open the left feed unit [1].

24. Clean with a damp cloth (thoroughly wrung out):

[2] Invert exit drive rollers 1

[3] Invert exit idle rollers 1

3



d074t554

25. Blower brush:

[1] Exit relay sensor

[2] Duplex/invert sensor



d074t555

26. Use a hand-held vacuum cleaner to clean the anti-static brush near the exit rollers.



d074t557

27. Release and lower the duplex transport path plate (Z4) [1].

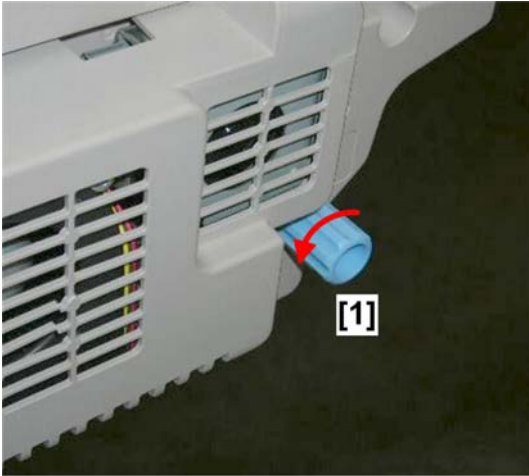

d074t558

28. Rotate the duplex transport roller knob [1].

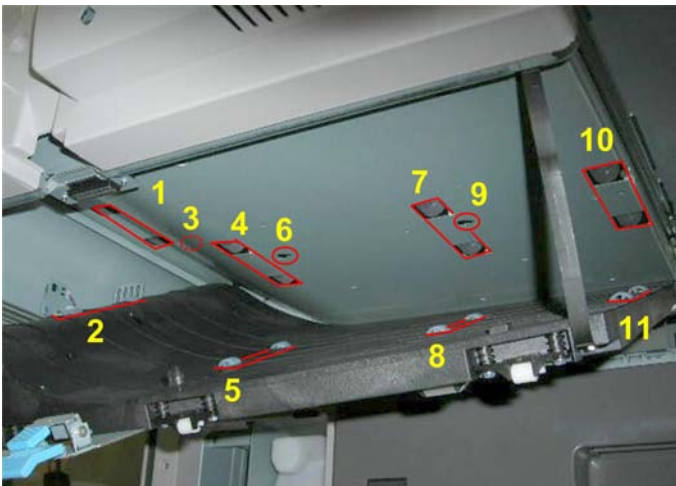

d074t559

1	Duplex transport drive roller 1	Dry cloth
2	Duplex transport idle roller 1	Dry cloth
3	Duplex transport sensor 1	Blower brush
4	Duplex transport drive roller 2	Dry cloth
5	Duplex transport idle roller 2	Dry cloth
6	Duplex transport sensor 2	Blower brush
7	Duplex transport drive roller 3	Dry cloth

8	Duplex transport idle roller 3	Dry cloth
9	Duplex transport sensor 3	Blower brush
10	Duplex transport drive roller 4	Dry cloth
11	Duplex transport idle roller 4	Dry cloth

Purged Paper Sensor

3

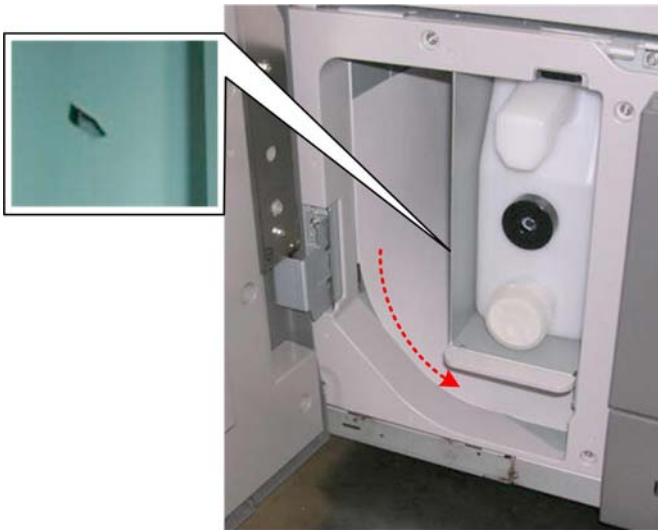

d074t556

1. Open the left front door.
2. If there is paper in the purge tray, remove it.
3. Blower brush: Purged paper sensor

4. Replacement and Adjustments

General Cautions

CAUTION

- This machine has a Fiery controller (server type). The Fiery controller must be shut down before turning off the power supply to the main machine.
- Always turn off the Fiery controller first on the Fiery operation panel before turning off the main power switch of the machine.
- To prevent damage to the ITB, drum, or development unit when removing them or putting them back into the machine, never switch off the main power switch or operation power switch while the machine is operating.

Rear Boxes

Exercise caution when operating the machine with the rear boxes open, especially the cooling box:

- This machine has many fans and ventilation ducts to expel ozone, paper dust, and hot air from around the PCDUs and other areas inside the machine.
- If you service the machine and then check printing operation with the rear boxes open, dust or gases may adhere to the OPC drums and cause problems with image output (white block patterns for example).
- Normally, process control can handle such minor problems, but if you want to recover the print quality as soon as possible, print several sheets with solid color images.

Drum

The organic photoconductor (OPC) drums are very sensitive to light and ammonia gas. When handling an OPC drum:

1. Never expose a drum to direct sunlight.
2. Never expose a drum to direct light of more than 1,000 lux for more than a minute.
3. Never touch a drum surface with bare hands. If the drum surface is touched or becomes dirty, wipe it with a dry cloth or clean it with a damp cotton ball. Wipe with a dry cloth after cleaning with damp cotton.
4. Never use alcohol to clean a drum. Alcohol can dissolve the drum surface and damage it permanently.
5. Store drums in a cool, dry place.

6. The photo-conductive layer of a drum is very thin and scratches easily. Always handle a drum with care.
7. Never expose a drum to corrosive gases such as ammonia.
8. Always dispose of used drums in accordance with local laws and regulations.

PCDU

1. To prevent scratching a drum or the ITB, always lower the ITB before you remove a PCDU or pull out the ITB unit.
2. The charge rollers should always be replaced together as a set.

4



d074r052

3. Before you push the PCDU into the machine, you must confirm:
 - Charge unit lock lever [1] is down and locked
 - Cleaning unit lever [2] is up and locked.

ITB Unit

1. Never touch the surface of the ITB surface with bare hands.
2. Pull the ITB unit out of the machine only when it is absolutely necessary.
3. Always work carefully around the ITB (to avoid dropping tools, screws, etc.) when it is pulled out of the machine.
4. Before installing a new ITB, clean all the rollers and the inner surface of the ITB unit with a dry cloth to prevent the new belt from slipping.

Scanner Unit (D074/D075)

1. When installing a new exposure glass, always make sure that the white paint mark is at the rear left corner.
2. Clean the exposure glass with alcohol or glass cleaner to reduce the amount of static electricity on the glass surface.
3. Use a cotton pad dampened with water or a blower brush to clean the scanner optics.
4. Never bend or twist the exposure lamp cables.
5. Never disassemble a lens unit. Attempting to disassemble a lens unit will throw the lens and the copy image out of focus.
6. Never attempt to adjust a CCD positioning screw. Doing so will throw the CCD out of position.

4

Laser Unit

1. Never open the laser unit. The laser units are replaced as units in the field.

Development

1. Avoid nicking or scratching the development roller.
2. Place a development unit on a sheet of paper after removing it.
3. Always clean the drive gears after removing used developer.
4. Always dispose of used developer in accordance with local regulations.
5. Never load any type of developer or toner into the development unit other than those specified for this machine. Doing so will cause poor print quality and toner scattering.
6. Immediately after replacing the developer, be sure to execute the SPs to initialize the developer/toner.
7. Never do SP3030 with used developer.
8. When using a vacuum cleaner to clean the development unit casing, always ground the casing with your fingers to avoid damaging the toner density sensor with static electricity.
9. The TD sensor must be initialized:
 - After replacing developer. (Initialize the TD sensor only for the PCDU where the developer was replaced.)
 - Never initialize the TD sensor more than once. Initializing the TD sensor more than once can cause toner scatter inside the machine.

Cleaning

1. When servicing cleaning unit components, avoid nicking the edges of the cleaning blades.
2. Never touch the edges or surfaces of a cleaning blade with bare hands.
3. Before disassembling a cleaning unit, place a sheet of paper under it to catch stray toner or dry lubricant.

Fusing Unit

1. Never handle fusing lamps and rollers with bare hands.
2. Make sure that the fusing lamps are positioned correctly and do not touch the inner surface of the rollers.

Paper Feed

When replacing the pick-up, feed, and separation rollers in tray 1 or 2 of the main machine, trays 3, 4, 5 of the LCIT, or tray 6 (bypass tray):

- Use only rollers specified for use with this machine or peripheral unit.
- When handling the new rollers, avoid touching the surfaces of the rollers.

Used Toner

1. Check the level of the used toner in the used toner bottle at every service visit.
2. Always dispose of used toner in accordance with local laws and regulations.
3. Never attempt to incinerate used toner.

Fiery Controller

1. Use the "Shut Down" button on the operation panel to turn off the Fiery controller.
2. Never turn off the main power switch of the mainframe before shutting down the Fiery controller. Here is the correct shut down sequence for the Fiery and the main machine:

On the Fiery controller operation panel:

- Press the [Fiery] tab.
- Press the [Restart Fiery] button.
- Press the [Shut Down] button.

To shut down the main machine

- Push the operation switch to turn the power off
- When the power LED goes off, turn the main power switch off. Never turn off the main power switch when the power LED is lit or flashing.

Liquid Coolant Disposal

- The coolant tank is located at the bottom of the cooling box on the back of the main machine.
- The coolant tank holds the propylene glycol coolant that circulates from the tank through hoses that pass behind the cooling plates on the sides of the four development units.
- Always obey local laws and regulations if you need to dispose of a tank or coolant.
- The tank must never be emptied directly into a local drainage system, river, pond, or lake.
- Contact a professional industrial waste disposal organization and ask them to dispose of the tank.

Special Tools and Lubricants

Special Tools

D074/D075

Part No.	Description
A0069104	Scanner Positioning Pin (4 pcs./set)
A0929503	Test Chart-C4 (3 pcs./set)
A0299387	Digital Multi-meter: FLUKE 87
B6455010	SD Card
C401 9503	20x Magnification Scope

M044

Part No.	Description
A0299387	Digital Multi-meter: FLUKE 87
B6455010	SD Card
C401 9503	20x Magnification Scope

Lubricants

Part No.	Description
A2579300	Grease Barrierta - S552R
52039502	Silicone Grease G-501
B132 9700	Drum Setting Powder
VSSG 9002	FLUOTRIBO MG Grease

Common Procedures

This section describes important procedures that are referenced in other replacement and adjustment procedures. Service technicians must be familiar with the basic procedures before servicing the machine.

Turning the Machine On/Off

Turning the Machine On

1. Turn on the Fiery controller.
2. Switch on the main switch of the main machine.

4

Turning the Machine Off

On the Fiery controller operation panel:

1. Press the [Fiery] tab.
2. Press the [Restart Fiery] button.
3. Press the [Shut Down] button.

On the main machine

1. Push the operation switch on the operation panel to turn the power off.
2. Wait for the operation switch power LED to stop flashing.

★ Important

- **Never turn off the main power switch when the power LED is lit or flashing.**
3. After the power LED goes off, open the left front door.
 4. Turn the main power switch off.

Opening the Rear Boxes

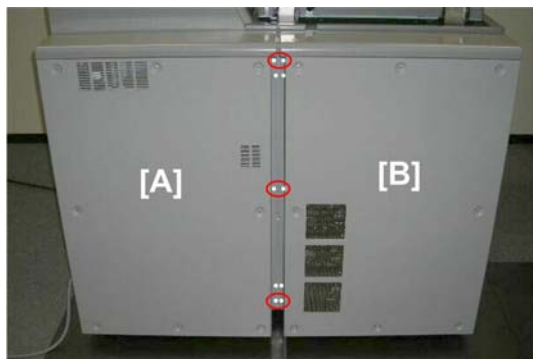

d074r004

1. On the right edge of the controller box [A] and the left edge of the cooling box [B], remove the top, middle, and bottom screws ( x6).



d074r005

2. Swing open both boxes.

Removing Doors, Covers

Right Front Door

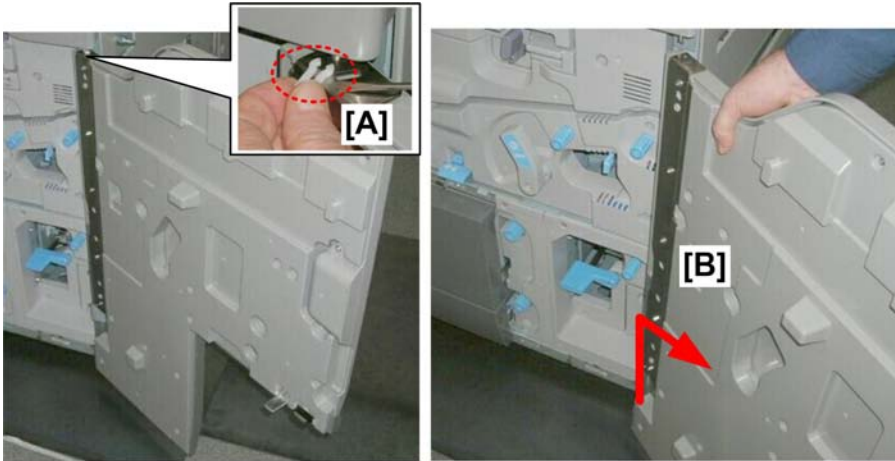

d074r001

1. Open the right front door.
2. Use the tip of a small screwdriver to release and remove the lock clip [A].
3. Lift the door [B] off the bottom hinge and remove it.

Left Front Door

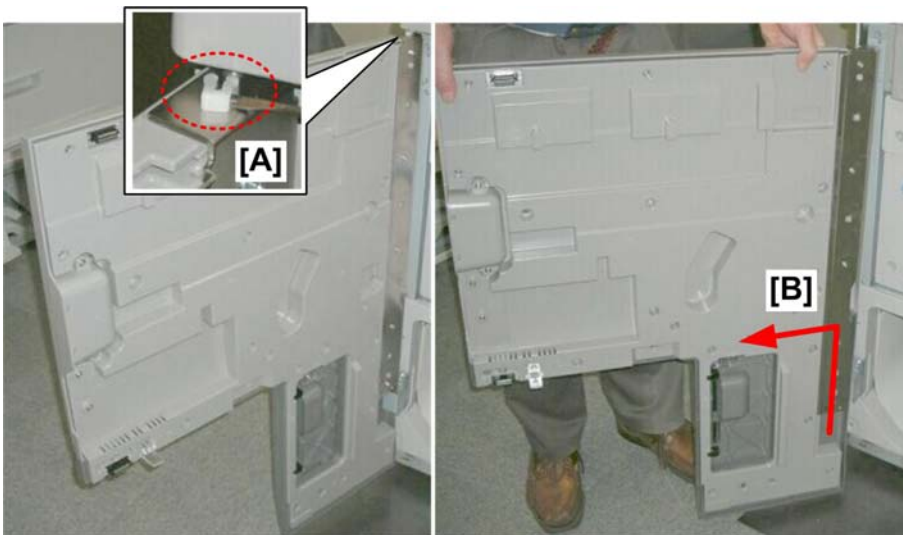

d074r002

1. Open the left front door.
2. Use the tip of a small screwdriver to release and remove the lock clip [A].
3. Lift the door [B] off the bottom hinge and remove it.

Left Cover

4



d074r003

1. Remove the left cover [A] ( x7).

Cooling Box Covers



d074r006

1. On the left edge of the cooling box [A], remove the top, middle, and bottom screws ( x3).
2. Swing the cooling box open.





d074r007

3. Use the tip of a small screwdriver to remove the screw covers (x4) on the top of the cooling box [A].
4. Remove the screws where the covers were removed ( x4).
5. Remove the top of the cooling box.

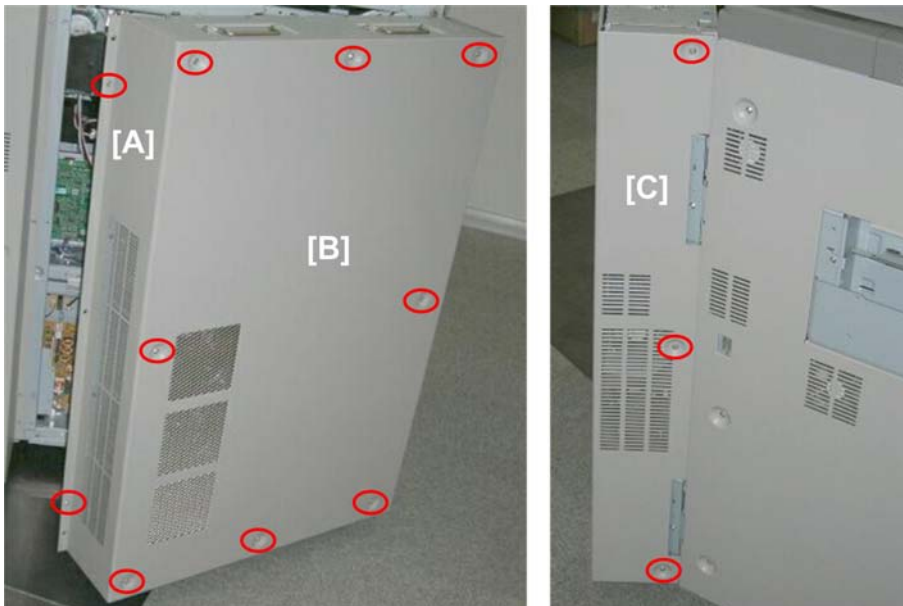
4



d074r008

6. Disconnect:
 - [A] Left side ( x2)
 - [B] Back ( x8)
 - [C] Right side ( x3)



d074r009

7. Remove the cover.

Controller Box Covers



d074r010

1. On the side of the main machine, disconnect the ARDF [A] on the D0704/D075 (E x1).
2. On the right edge of the controller box [B], remove the top, middle, and bottom screws (x3).
3. Swing the controller box open.

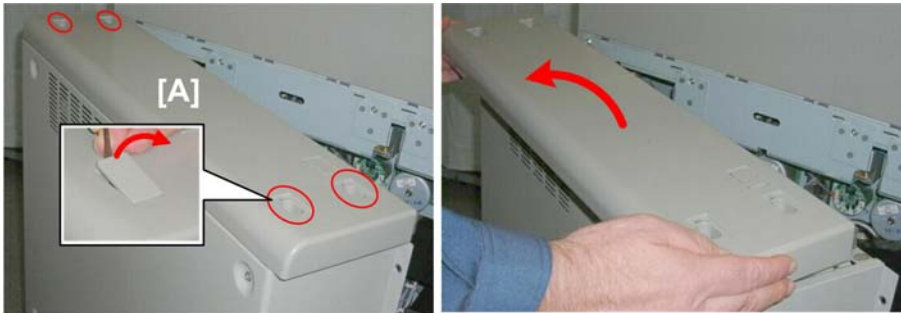



d074r011

4. Use the tip of a small screw driver to remove the screw covers (x4) on the top of the controller box [A].
5. Remove the screws where the covers were removed ( x4).
6. Remove the top of the controller box.

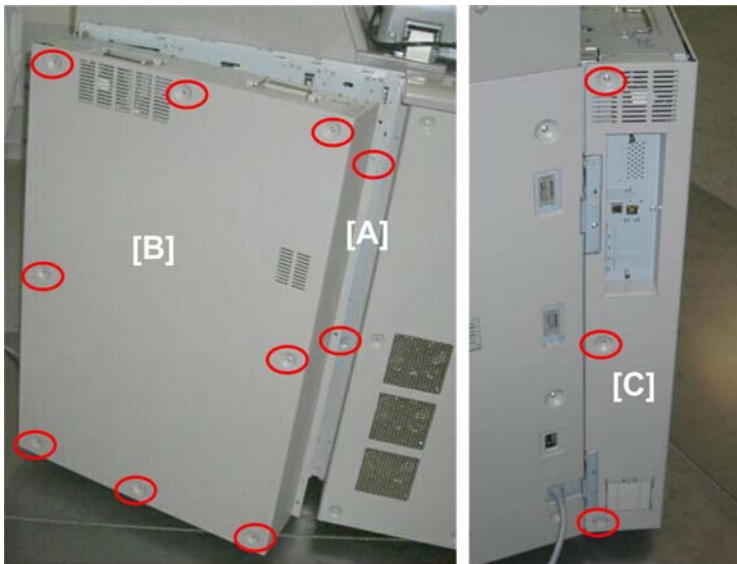
4



d074r012

7. Disconnect:
 - [A] Right side ( x2)
 - [B] Back ( x8)
 - [C] Left side ( x3)

4



d074r013

8. Remove the controller box cover.

Right Cover

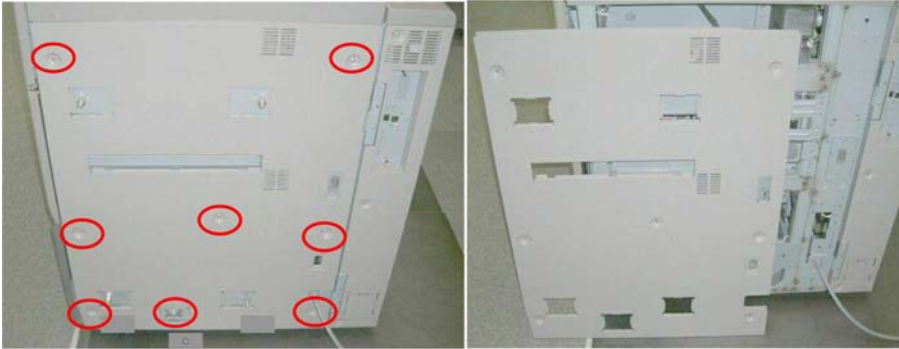

m044r014

1. Remove the right cover ( x8).

Pulling Out and Closing the Left Drawer

Pulling Out the Left Drawer

1. Make sure that the system is off and confirm that the machine power cord is disconnected from the power source.
2. Spread a drop cloth or some paper in front of the machine.
3. Prepare a flat clean surface where you can place the fusing unit after it has been removed.
4. Open both front doors.

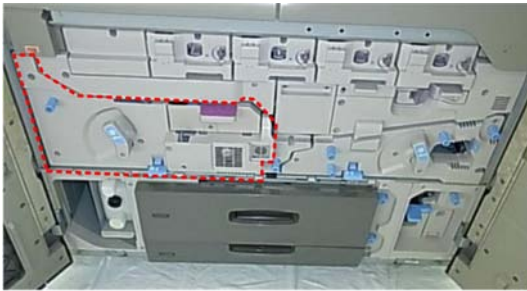

d074u401

5. The fusing unit is in the left drawer.

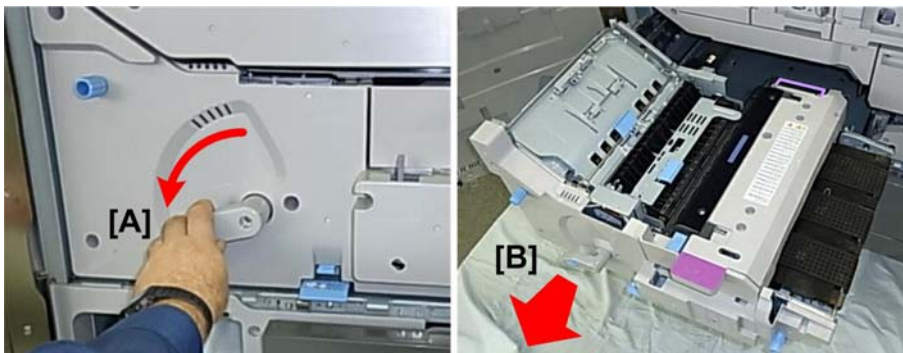

d074u402

6. Lower the lock lever [A].
7. Pull the fusing unit [B] out completely until it stops.

Closing the Left Drawer

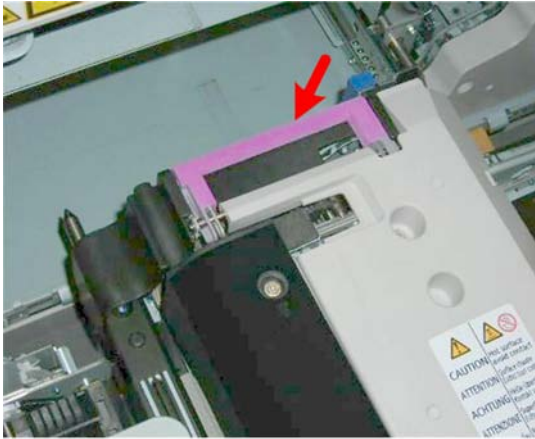

d074u414

The rear fusing unit handle is spring loaded to keep it down and completely flat when not in use.

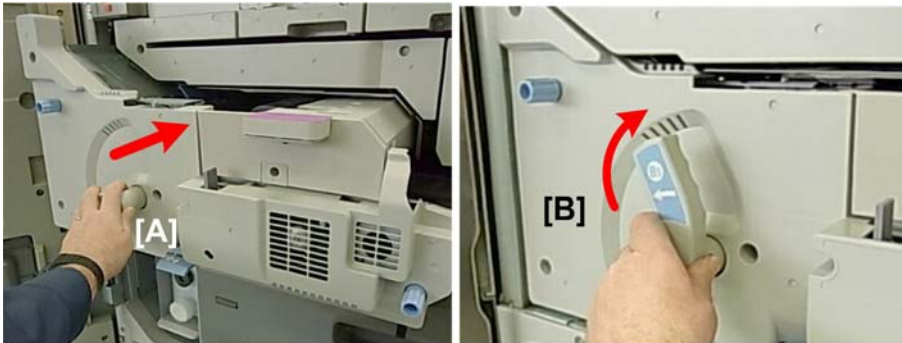

d074u415

1. Push the left drawer [A] slowly into the machine until it locks in place.
 - The left drawer should move smoothly into the machine.
 - Never force the left drawer into the machine if you feel any resistance.
 - If you feel resistance, stop pushing and pull the left drawer out again. Check the wire handle at the back of the fusing unit, and make sure that this handle is down completely.

Removing the Right Drawer

⚠ CAUTION

- Removal of the right drawer unit requires two people.
- One person cannot lift and move the right drawer unit.

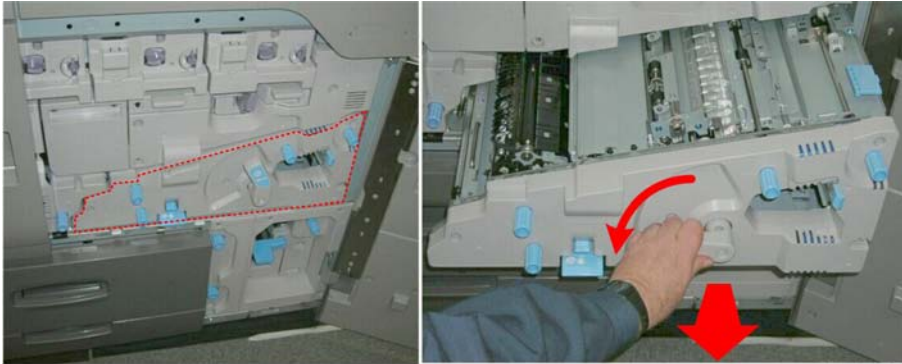



d074r036

1. Lower the handle.
2. Pull the right drawer out until it stops.

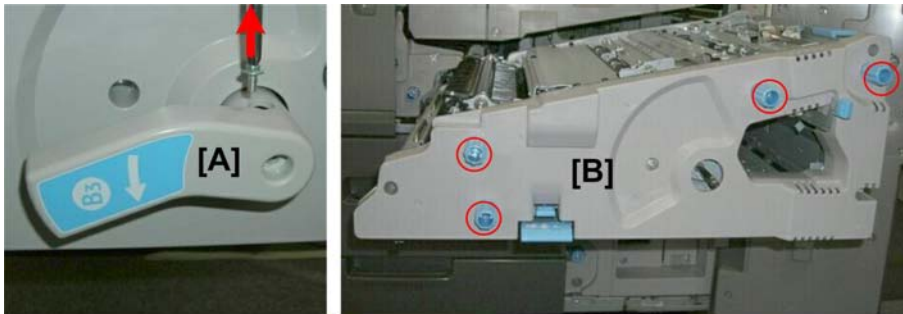
4



d074r037

3. Remove handle B3 [A] ( x1).
4. Remove the knobs [B] (x4) ( x1 each).

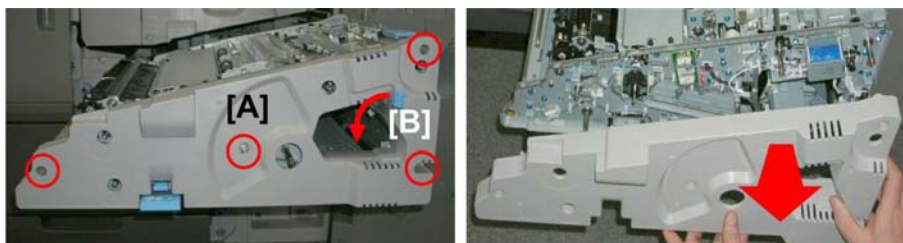

d074r038

5. Disconnect the faceplate [A] ( x4).
6. Lower plate [B] so that it floats free.
7. Remove the faceplate. You may need to move plate [B] to free the faceplate.

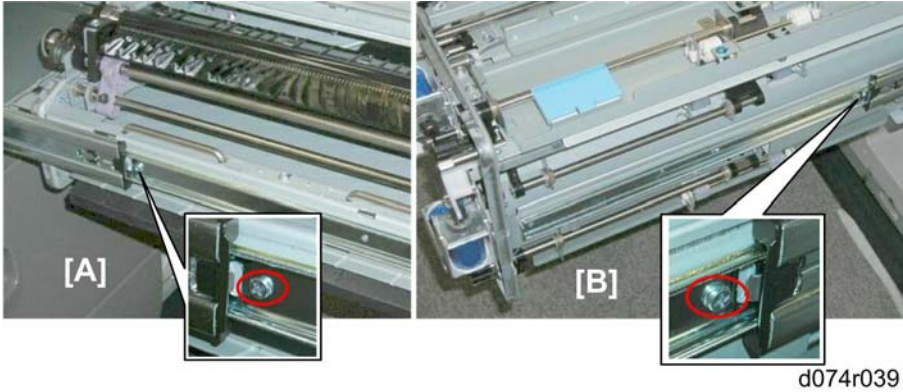

4

8. Remove:

[A] Screw on the left rail ( x1)

[B] Screw on the right rail ( x1)



9. With one person on each side of the unit, lift it off the rails as shown above.

 **CAUTION**

- The unit is extremely heavy. Two persons are required to lift the unit off the rails (and to re-install it).

Pulling Out the ITB Unit

Before Pulling Out the ITB Unit and PCDUs

 **CAUTION**

- At job end or when the machine is switched off, both sides of the ITB unit are lowered and separated from the drums.

- However, after a power failure or accidental disconnection of the power cord, or after the machine issues an SC code after a malfunction, both or one side of the ITB may remain up against the drums.
- To avoid damage to the ITB and drums, both sides of the ITB must be checked and lowered before the ITB unit and PCDUs can be pulled out of the unit

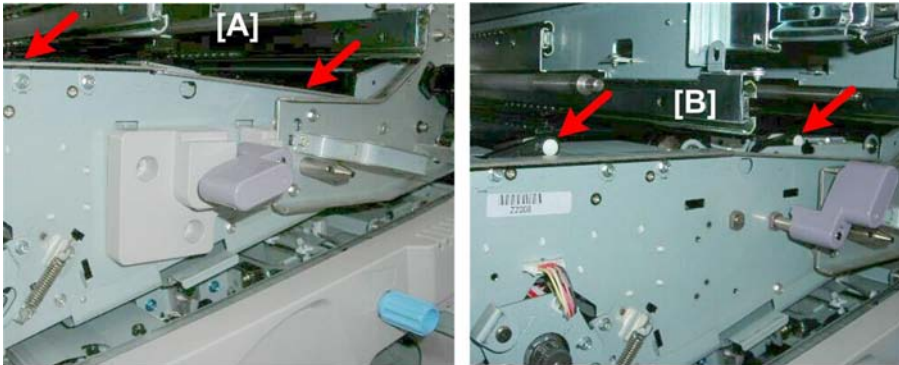

d074r040a

1. Always check the front edge of the ITB at two points [A] before you pull the ITB unit out of the machine.
2. If you see either white cap [B] (or both), this means the ITB lift motors have failed to lower the belt when the machine was powered off.

CAUTION

- If you see the belt up as shown at [B], the ITB must be lowered manually before the ITB unit is pulled out of the machine.



d074r040b

3. To lower the left half of the ITB unit, turn the gear until the left side of the belt is down and you no longer see the left white cap.

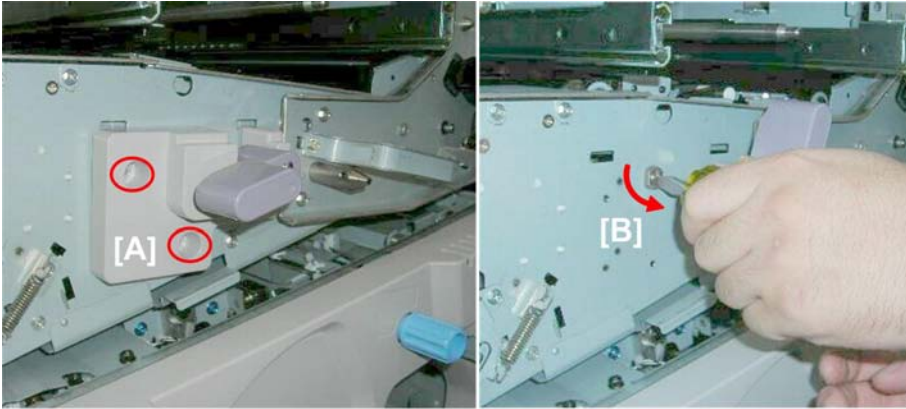

d074r040c

4

4. To lower the right half of the ITB unit, remove cover [A] ( x2).
5. Turn screw [B] until the right half of the ITB is down and you no longer see the right white cap.



d074r040d

6. Check again to make sure that both caps are down.
7. With both caps down, the ITB unit can be pulled out.

1st Stop Position



d074r041

1. Lower the ITB lever [A].
2. Remove the ITB lever lock plate [B] ( x2).

4



d074r042

3. Remove the right ITB plate [A] ( x2).



d074r043

4. Remove the left ITB plate [A] ( x2).

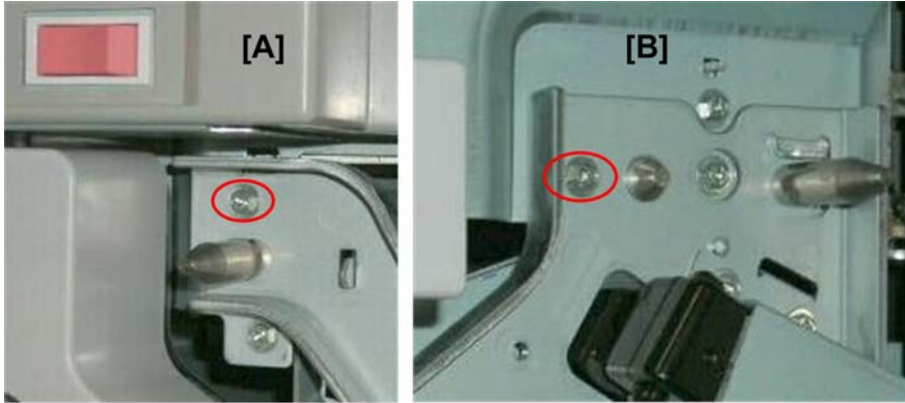

d074r044

4

5. Disconnect:

[A] Left end of ITB unit ( x1)

[B] Right end of ITB unit ( x1)

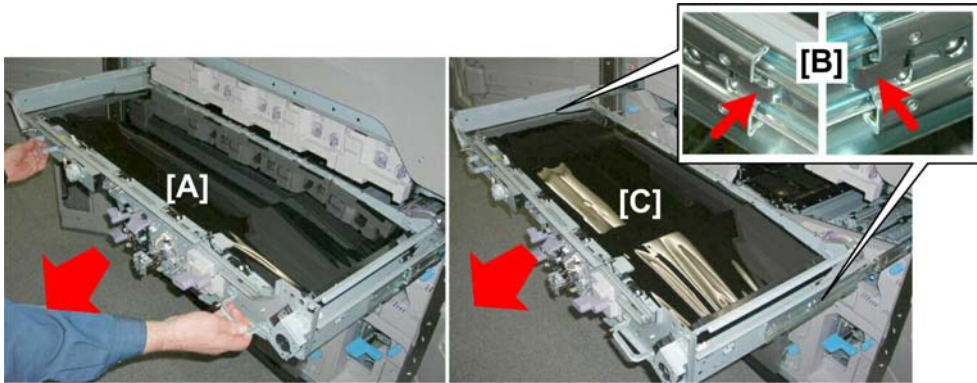

d074r045

6. Grip both handles of the ITB unit [A] and pull it out until it stops. This is the first stop position.

2nd Stop Position

1. Depress the rail release levers [B] on both sides of the ITB unit tray and pull it out until it stops. This is the second stop position.

★ Important

- Never leave the ITB unit out and fully extended longer than necessary.

Re-installation



d074r046

4

Before you push the ITB unit into the machine:

- Make sure handle **B3** [A] below the ITB unit tray is down. You cannot push the ITB unit tray into the machine if this lever is up.
- You must depress the rail lock levers [B] in on both sides of the tray. (The rail locks engage automatically when the ITB tray is pulled out completely.)

Removing the Canopy Cover

The procedure for removal of the canopy cover for the D074/D075 is different from the procedure for the M044.

- **D074/D075.** The ARDF and some covers around the exposure glass on the left side of the machine must be removed.
- **M044.** Only three plastic covers need to be removed on the left side of the machine.

In addition, the toner bank door, attention light, operation panel, and toner bank cover must be removed for all models.

Canopy Cover: D074/D075

Before you can remove the canopy cover, you must remove the ARDF and some plates around the exposure glass.

ARDF

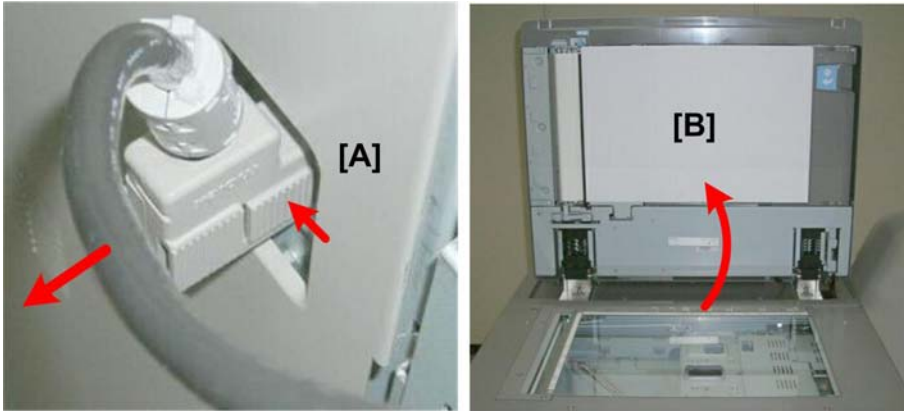

d074r015

4

1. On the right side of the machine, disconnect the ARDF [A] (🔌 x1). (Press in at [1] to release then pull out [2].)
2. Raise the ARDF [B].



d074r016

3. Remove the ARDF base screws (🔩 x2).

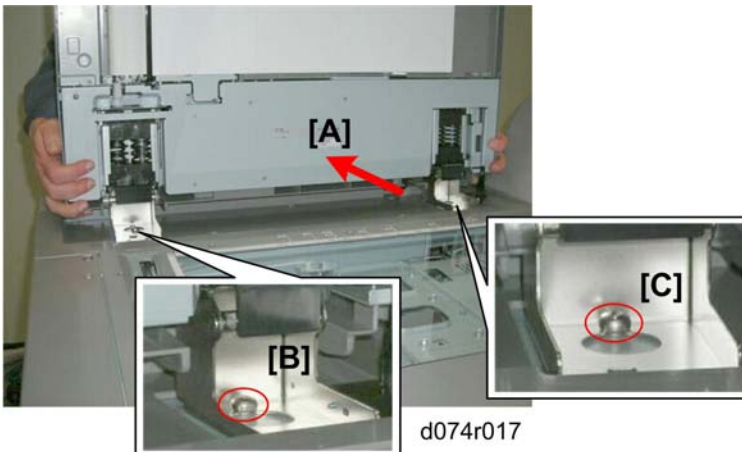

d074r017

★ Important

- Confirm that the ARDF cable has been disconnected from the right side of the machine before you lift the ARDF off the machine.

4. Grip the base of the ARDF [A] on both sides.
5. Pull the ARDF toward you to free the shoulder screws [B] and [C] from the keyholes of the plates.
6. Lift the ARDF off the machine and set it down.

Around the Exposure Glass

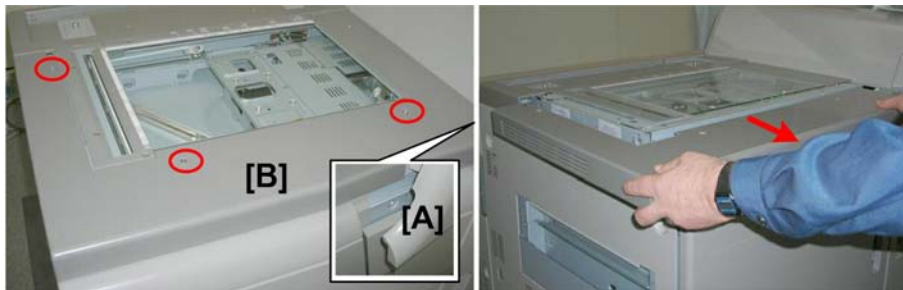

d074r018

7. Open the toner bank door [A].
8. Remove the front "L" plate [B] ( x3).

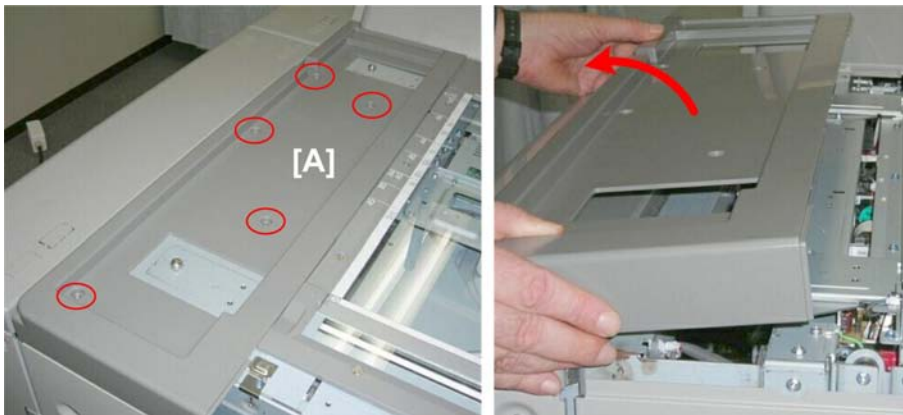

d074r019

9. Remove the rear plate [A] ( x5).
10. Go to "Canopy Cover Removal Continued (D074/D075/M044)" below to complete removal of the canopy cover.

Canopy Cover: M044

The M044 has no ARDF or exposure glass. You need to remove only three plastic covers before you can remove the canopy cover.

1. Confirm that the machine is switched off and disconnected from the power source.

Rear Cover

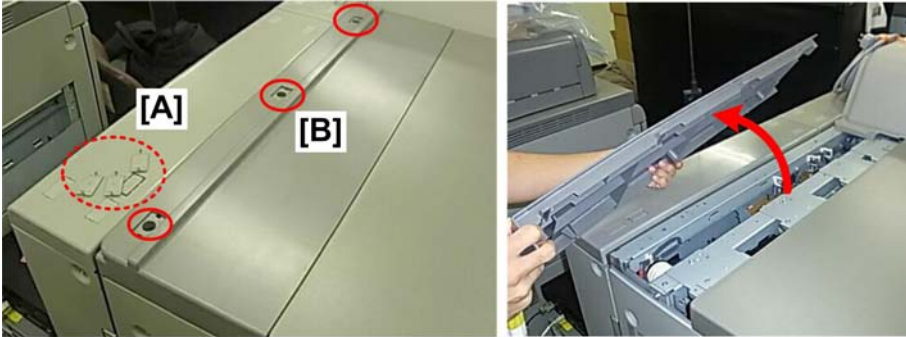

m004c001

2. Use the tip of a small screwdriver to remove the three screw hole covers [A].
3. Disconnect cover [B] and remove it ( x3).

Center Cover

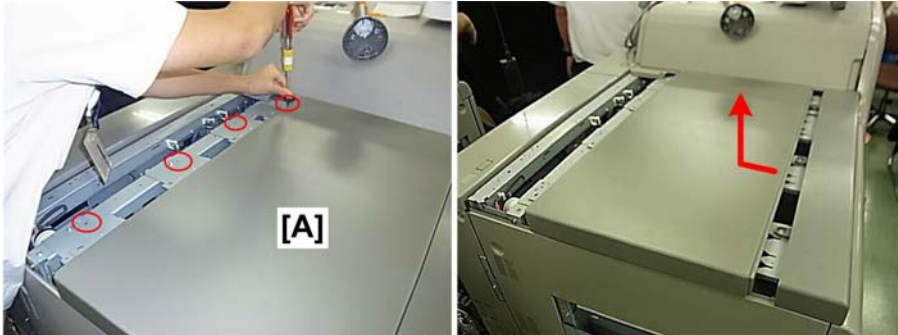

m004c002

4. Disconnect center cover [A] and remove it ( x4).

Front Cover



m004c003

5. Disconnect front cover [A] and remove it ( x3).
6. Go to the next section to complete removal of the canopy cover.

4

Canopy Cover Removal Continued (D074/D075/M044)

Toner Bank Door

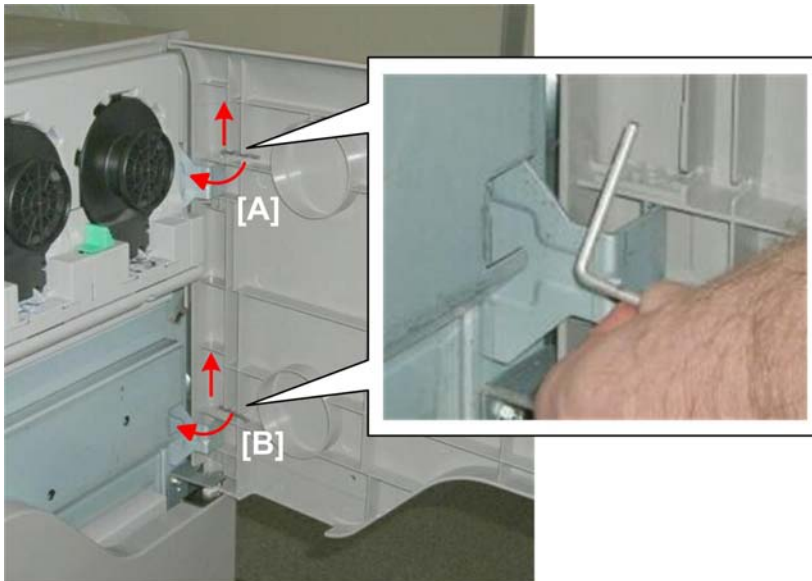

d074r021

1. Open the toner bank door.
2. To remove the top hinge [A], swing the "L" hinge pin out [1] and pull it up [2] to remove it.
3. Remove the bottom "L" hinge pin [B] and remove the door.

Attention Light

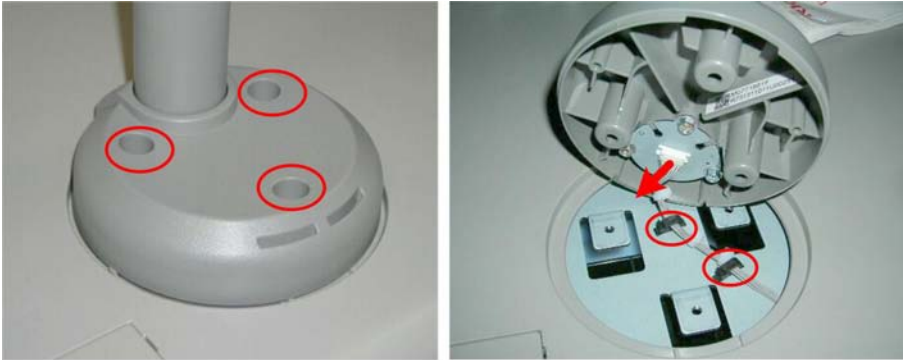

d074r022

4

4. Remove the base screws of the attention light (🔩 x3).
5. Lay the light on its side and disconnect it (🔌 x1, 🗑️ x2).

Operation Panel

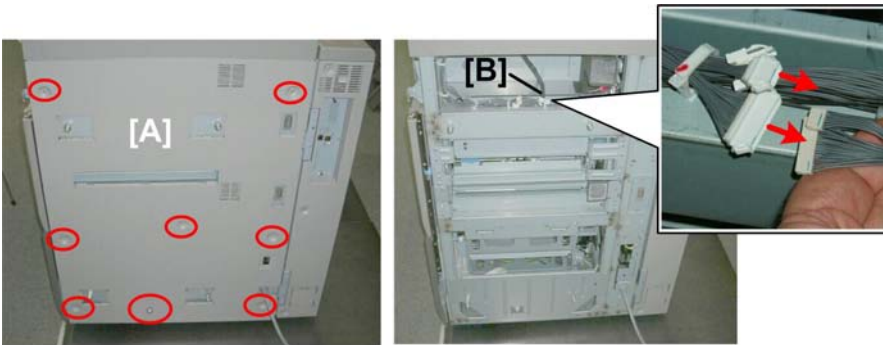

d074r023

6. Remove the right cover [A] (🔩 x8).
7. Disconnect the operation panel harness at [B] (🔌 x2).
8. Inside the machine, disconnect the harness cable (🔩 x1).

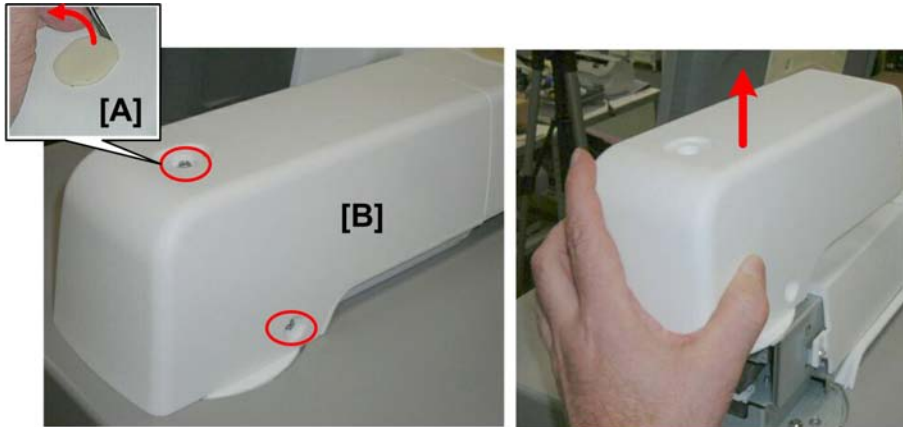

d074r024

9. Use the tip of a small screwdriver to remove screw cover [A].
10. Remove arm cover [B] ( x2).

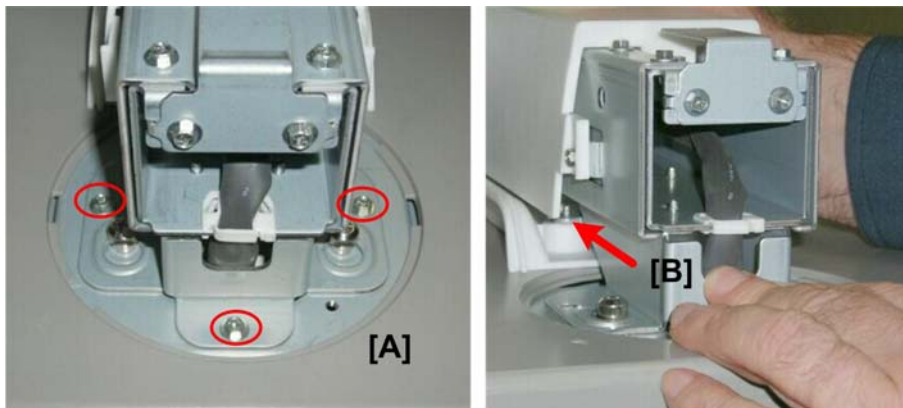

d074r025

11. Disconnect the base of the operation panel [A] ( x3).
12. Push the arm [B] away to slide the shoulder screws out of the keyholes.
13. Lift the operation panel and set it slightly to the left.

4



d074r026

14. Pull the operation panel harness out of the hole.
15. Lift the operation panel off the machine and set it down.

Canopy Cover

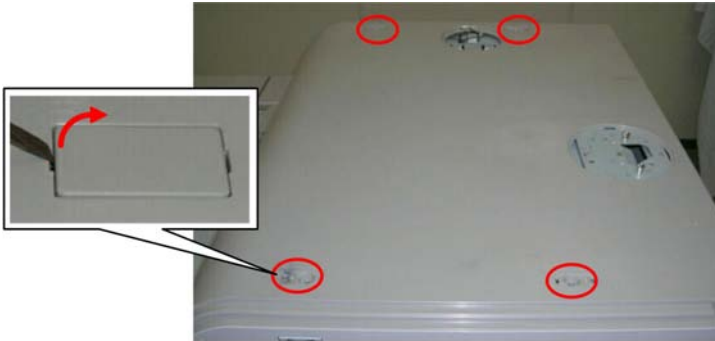



d074r027

16. Use the tip of a small screwdriver to remove the screw covers.
17. Remove the screws where the covers were removed ( x4).



d074r028

18. At the front [A], remove a screw ( x1).
19. At the rear [B] (near the scanner unit), remove a screw ( x1).

4



d074r029

20. Disconnect the cover on the left ( x2).
21. Lift the canopy cover off.

Toner Bank Cover

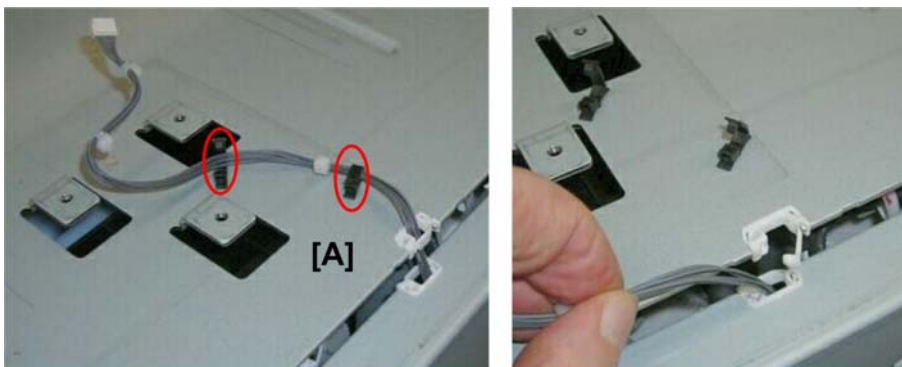

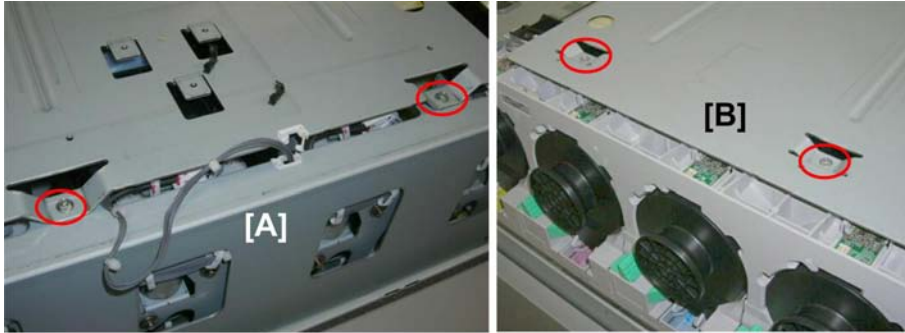

d074r030

22. At the rear [A], disconnect the attention light harness ( x3).



d074r031

4

- 23. Disconnect the cover at the rear [A] ( x2).
- 24. Disconnect the cover at the front [B] ( x2).



d074r032

- 25. Disconnect the cover on the left side [A] ( x4).
- 26. Lift the canopy cover off.

Toner Bottles



d074r033

- 27. Push the toner bottle release lever [A] of each bottle to the left. Each bottle will pop out as it is released.
- 28. Remove each bottle.

Toner Bottle Cradles

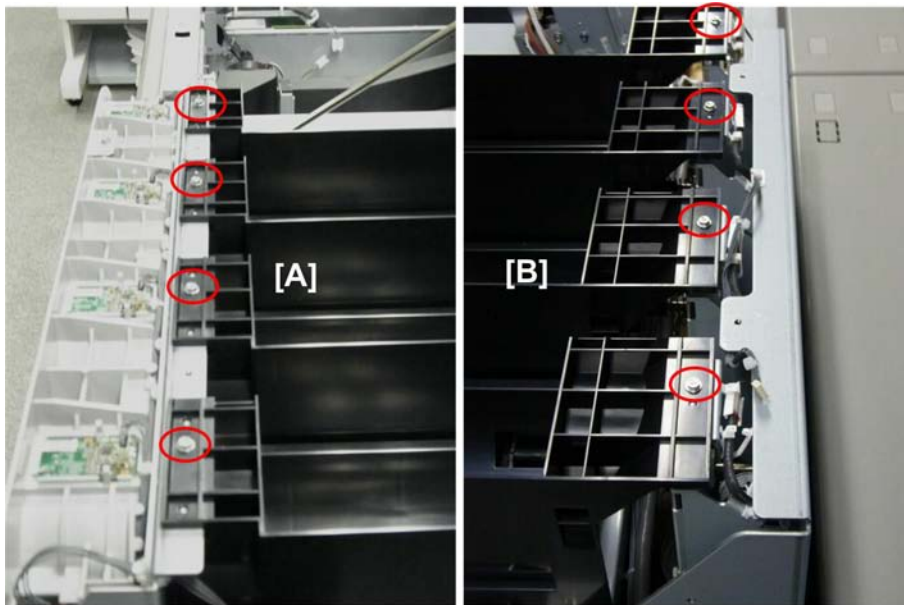

d074r034

29. Disconnect each cradle:

[A] Front ( x4)

[B] Rear ( x4)



d074r035

30. Remove each cradle (x4) and set it aside.

 **Note**

- The cradles are identical. They can be re-installed at any position.

Removing PCDUs

⚠ CAUTION

- At job end or when the machine is switched off, both sides of the ITB unit are lowered and separated from the drums.
- However, after a power failure or accidental disconnection of the power cord, or after a the machine issues an SC code after a malfunction, both or one side of the ITB may remain up against the drums.
- To avoid damage to the ITB and drums, both sides of the ITB must be checked and lowered before the ITB unit and PCDUs can be pulled out of the unit

4

1. Spread a drop cloth or some paper in front of the machine.
2. Open both front doors.

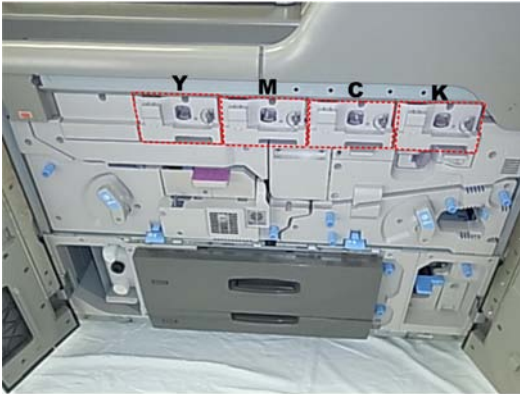

d074r102a

3. There are four PCDUs (YMCK).



d074r102b

- Lower the ITB release lever. (This separates the ITB from the bottoms of the drums so that the surface of the ITB or drum will not be scratched when a PCU is removed.)

To Remove the Y_PCDU or M_PCDU Lock Screw



d074r102c

4

- Remove the PCDU lock screw.

To Remove the C_PCDU or K_PCDU Lock Screw



d074r102d

- A plate must be removed before you can remove the two PCDUs on the right.

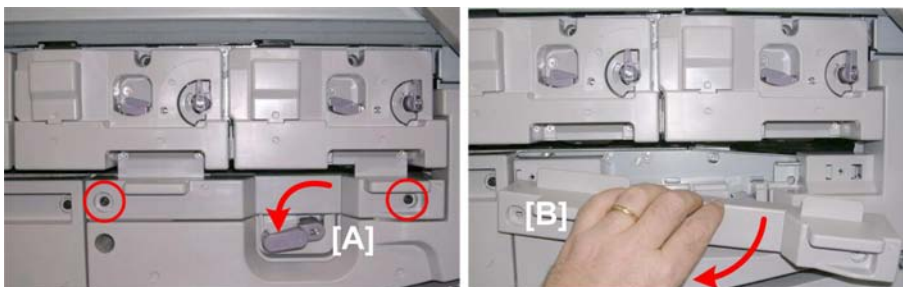

d074r102e

7. Make sure that the ITB lever [A] is down.
8. Remove the screws and remove the plate [B].



d074r102f

9. Remove the PCDU lock screw.

To Remove a PCDU



d074r068

10. Depress the PCDU lock lever [A] and pull the PCDU out slowly until it stops.
11. Remove lock screw [B] ( x1).
12. Lift the PCDU [C] off the rails and then lay the PCDU on the prepared surface.

★ Important

- Place the PCDU upright on a flat clean surface.
- There is only a small gap between the surface of the drum and the table surface, so the surface must be smooth, flat, and clean.
- To avoid damage to the surface of the drum, never place the PCDU on a carpet or rough cloth.

13. Push the PCDU rails into the machine.

Re-Installation

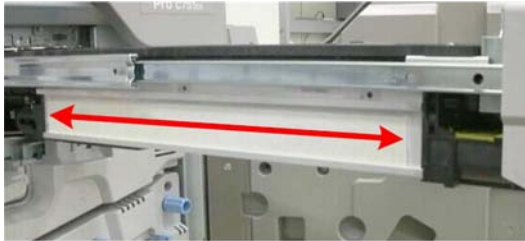

d074r987

1. Always check the left side of the PCDU before you push it back into the machine. (This is the shield plate that conducts heat away from the development unit.)
2. If you see any toner on the plate, wipe it off with a clean dry cloth.

⚠ CAUTION

- To prevent toner scatter or gear damage, never apply excessive force on the PCDU when you push it into the machine.
3. After you push the PCDU into the machine, make sure that PCDU is locked correctly.



d074r915

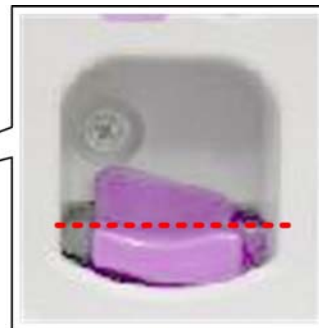

- When the PCDU is locked correctly, the top of the lock lever is straight as shown above.

4

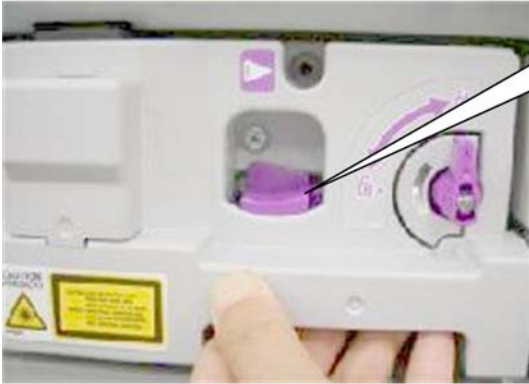

d074r916

- If the PCDU is not locked correctly, the top of the lock lever is slanted slightly down to the left as shown above.
4. If the PCDU lock lever is not locked correctly, pull the PCDU out about 30 mm (1.5 in.) and push it in again so the top of the lock lever is level.

Removing the ITB Cleaning Unit

1. Make sure that the system is off and confirm that the machine power cord is disconnected from the power source.
2. Spread a drop cloth or some paper in front of the machine.
3. Open both front doors.



d074u201

4. The ITB cleaning unit is below the PCDUs.

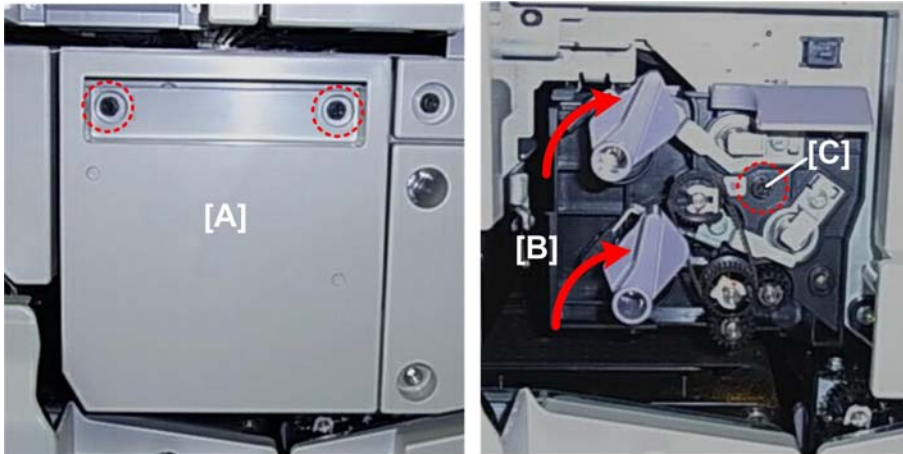

d074u202

5. Remove the two screws and cover [A].
6. Raise both levers [B].
7. Remove screw [C].

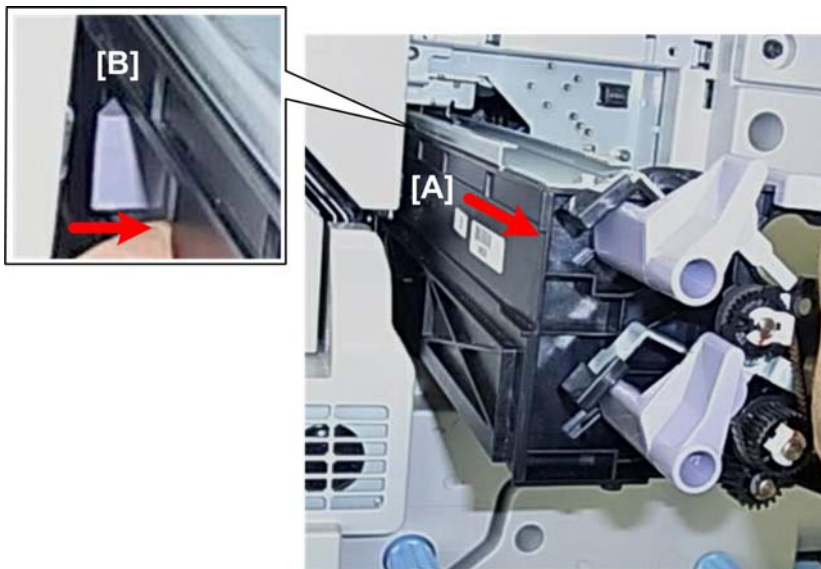

d074u203

8. There is a tab release on the left side of the ITB cleaning unit. Pull the cleaning unit [A] about half way out.
9. Press tab release [B] to the right.

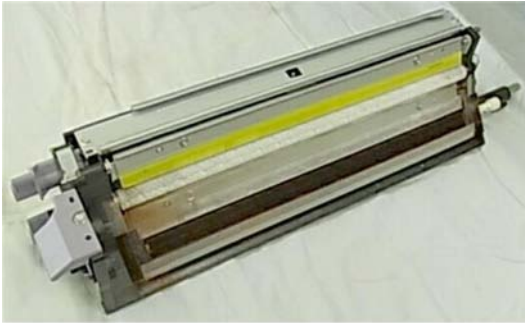

d074u204

10. Pull out the ITB cleaning unit.

4

Removing the PTR Unit

1. Make sure that the system is off and confirm that the machine power cord is disconnected from the power source.
2. Spread a drop cloth or some paper in front of the machine.
3. Open both front doors.

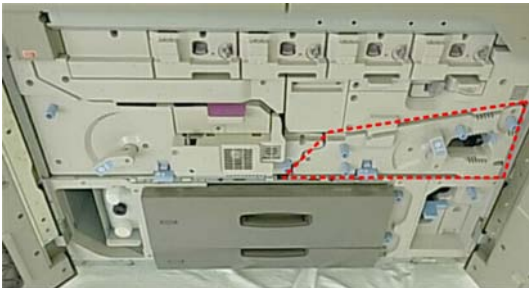

d074u301

4. The PTR unit is located in the right drawer unit.



d074u302

5. Lower lever [A] and pull out the right drawer [B] completely until it stops.

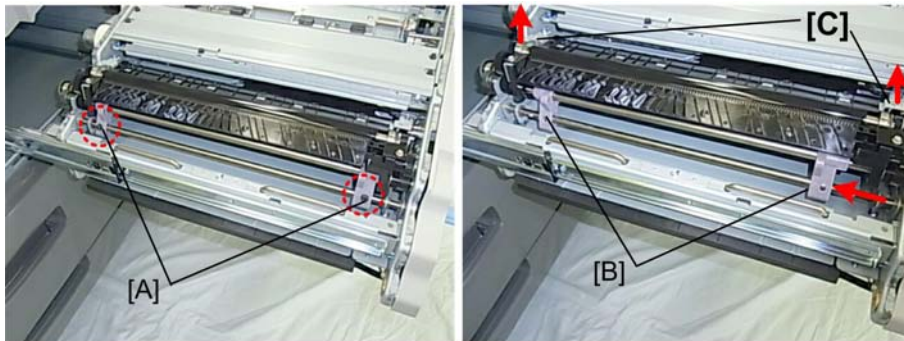

d074u303

6. Remove two screws [A].
7. Push both arm supports [B] in toward the center until they stop.
8. Grip both ends of the unit by the metal handles [C].

4

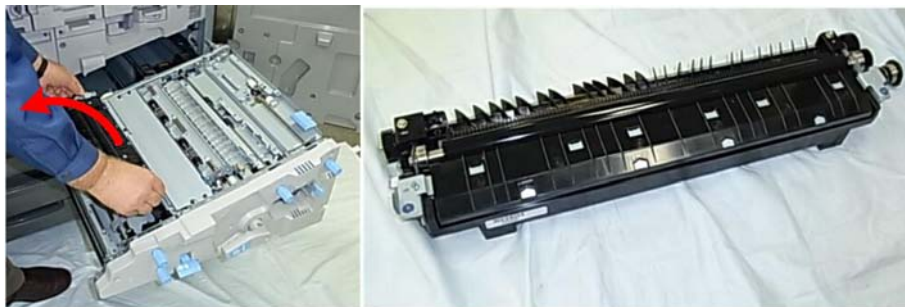

d074u304

9. Rotate the unit toward you to disconnect it from the shaft below and remove it.

Removing the Fusing Unit, Fusing Cleaning Unit, Covers

Preparation

1. Make sure that the system is off and confirm that the machine power cord is disconnected from the power source.
2. Spread a drop cloth or some paper in front of the machine.
3. Prepare a flat clean surface where you can place the fusing unit after it has been removed.
4. Open both front doors.

Removing the Fusing Unit from the Machine



d074u401

4

1. The fusing unit is in the left drawer.

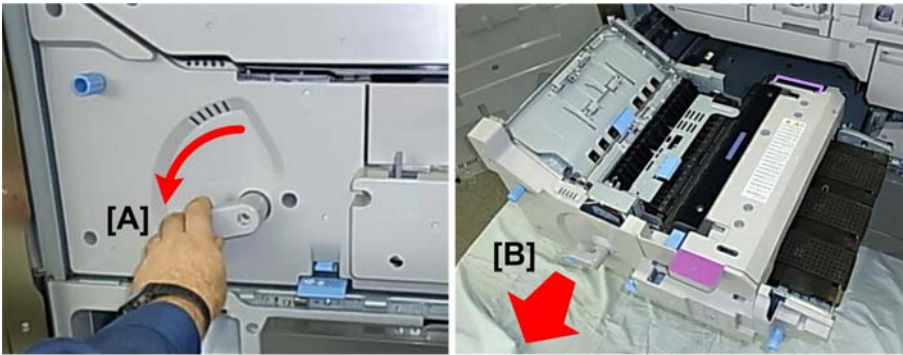

d074u402

2. Lower the lock lever [A].
3. Pull the fusing unit [B] out completely until it stops.

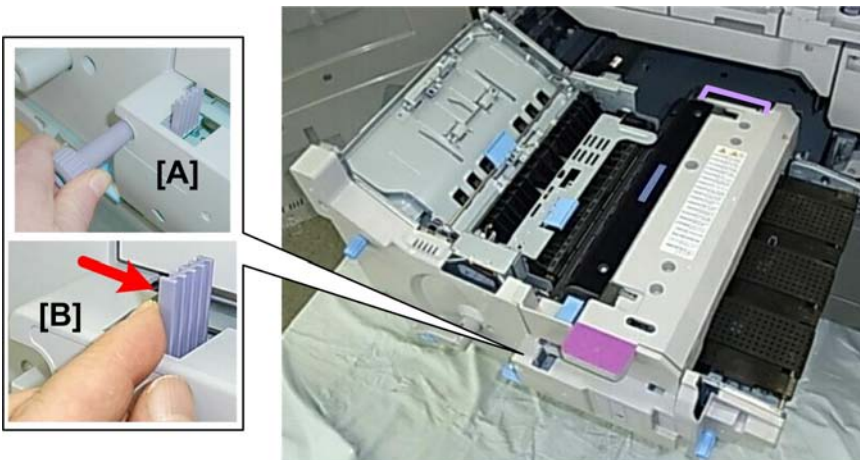

d074u403

4. Remove screw [A].

5. Push lock lever [B] to the right.



d074u404

6. Raise the fusing exit idle roller cover [A].
7. Raise the wire handle [B] and grip the front of the fusing unit [C].

Note

- The fusing unit weighs about 17 kg (37 lb.).

8. Lift the fusing unit out of the left drawer and set it on a flat clean surface.

Removing the Fusing Cleaning Unit

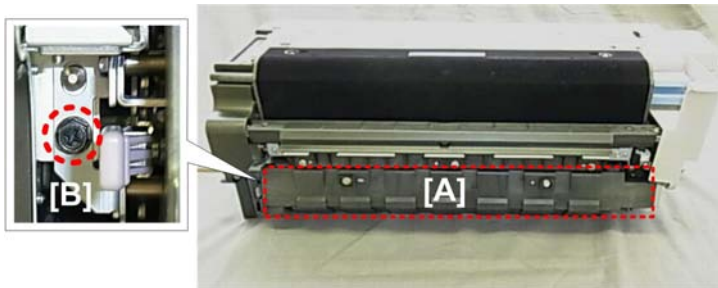

d074u405

1. Position the fusing unit so that the fusing cleaning unit [A] is facing you.
2. Remove screw [B].

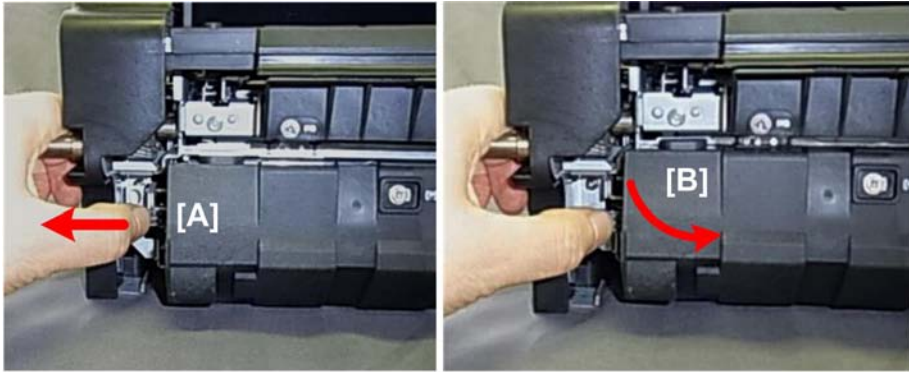

d074u406

4

- 3. Push plastic-capped lever [A] to the left.
- 4. The fusing cleaning unit [B] will pop out slightly.

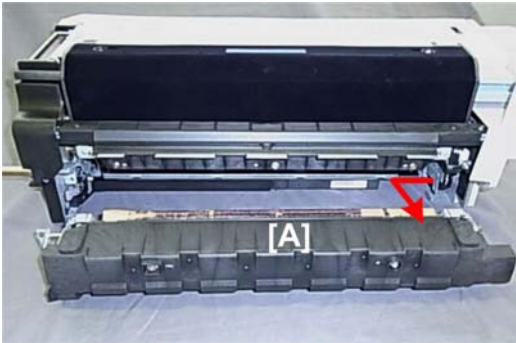

d074u407

- 5. Push the unit [A] slightly to the left to disconnect the shafts on the right, then pull it out of the fusing unit.

Cover Removal

The fusing unit covers must be removed to service thermistors and sensors in the fusing unit



d074r410



4

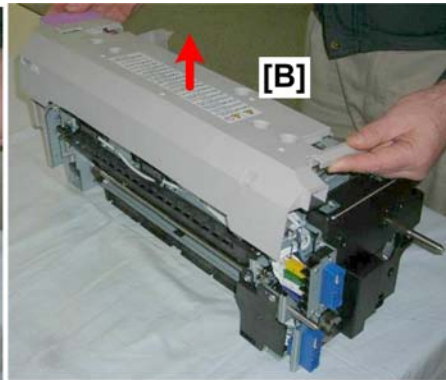
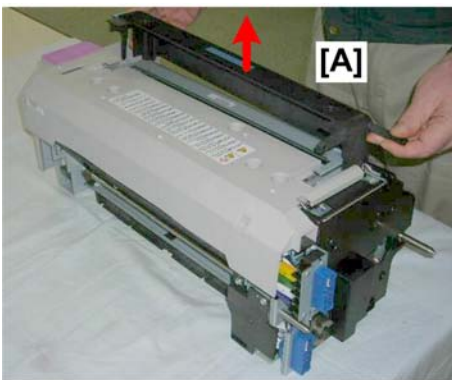

1. Remove the fusing unit from the machine and place it on a flat clean surface.



d074r411

2. Remove:

[A] Separation unit cover ( x1,  x1)

[B] Top cover ( x1,  x2)

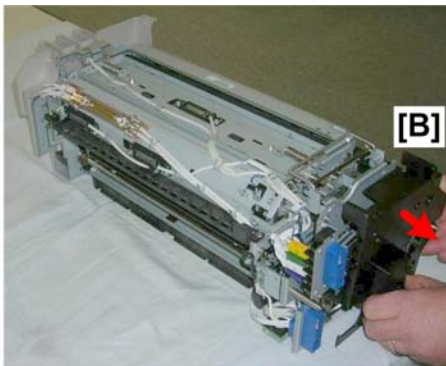
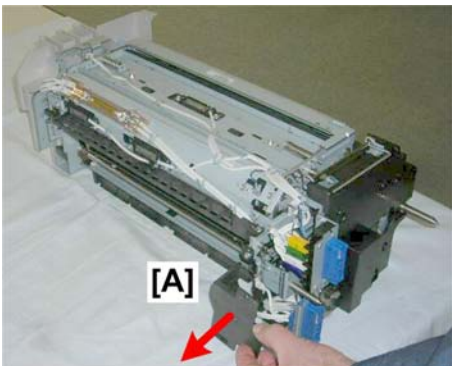

d074r412

3. Remove:

[A] Rear harness cover (🔧 x1)

[B] Rear cover (🔧 x3)

Removing the PTB Unit

1. Open the front doors.
2. Pull out the left drawer until it stops.
3. Remove the fusing unit (🔧 p.433).

4



d074r752

4. Remove the left drawer cover (🔧 x8).

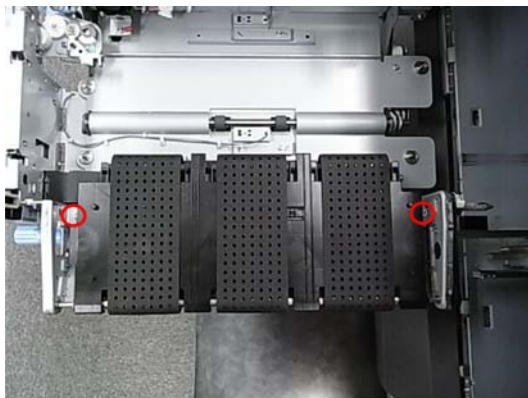

d074r737

5. Raise the PTB unit (🔧 x2).

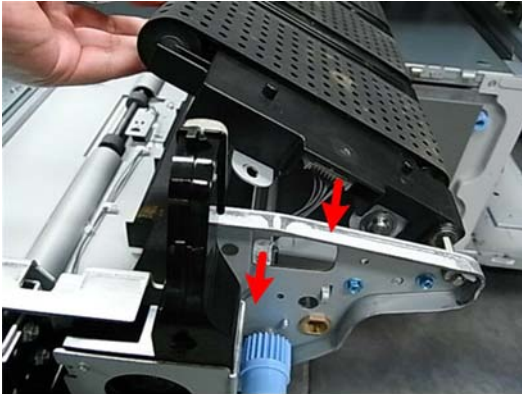

d074r738

6. Disconnect the PTB unit (🔌 x1, 🛠 x1).

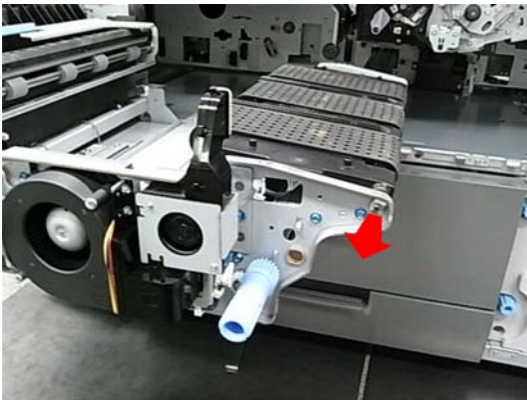

d074r739

7. Disconnect the clamp and shaft.

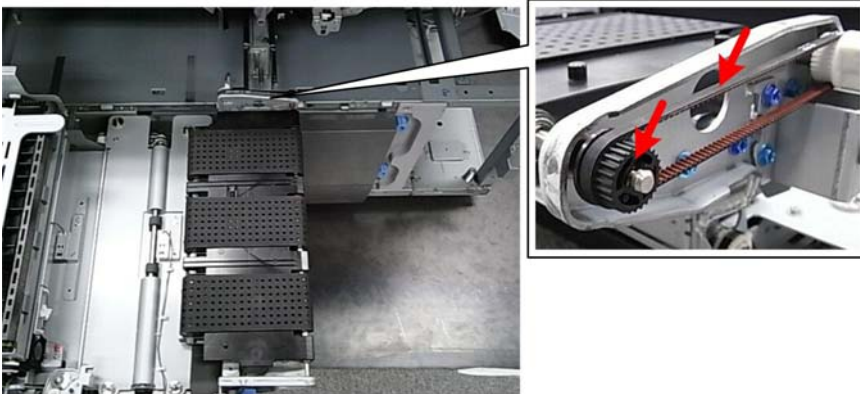

d074r740

8. Remove the PTB drive belt.

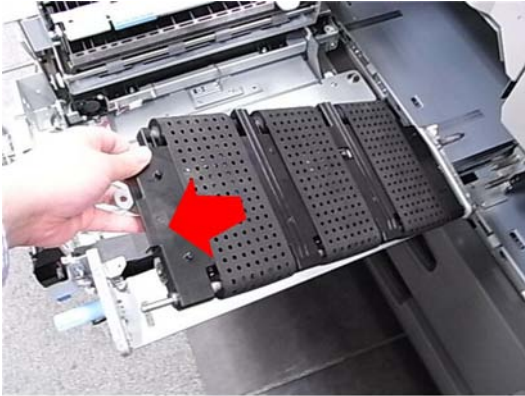

d074r741

4

9. Remove the PTB unit.

Removing the Left Drawer

★ Important

- The left drawer is heavy. Two people are required for this procedure.
1. Open the front doors.
 2. Pull the left drawer out until it stops.
 3. Remove the fusing unit (p.433)

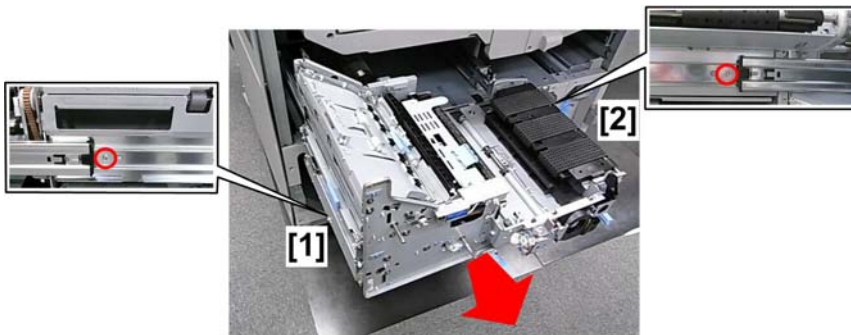

d074r750

4. Remove the lock screws:
 - [1] Left lock screw (x1)
 - [2] Right lock screw (x1)

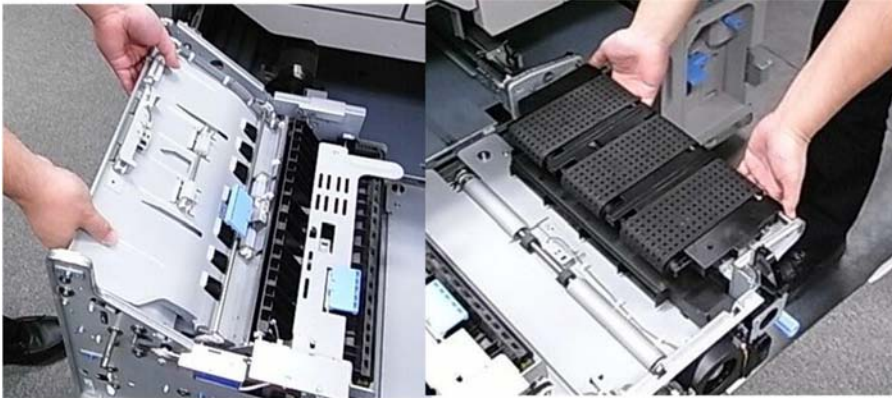

d074r751

5. With one person on the left side and one on the right as shown, lift the left drawer off its rails and set it on a flat surface.

4

Removing the Paper Feed Units (PFU)

Tray 1 Paper Feed Unit Removal

1. Open Tray 1 and remove the right tandem tray (x2).

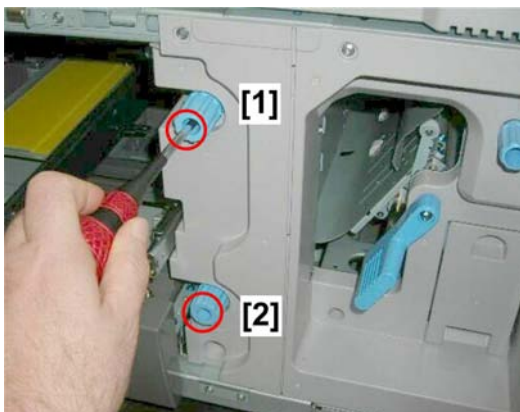

d074r440

2. Remove knobs [1] and [2] ( x1 each).

4

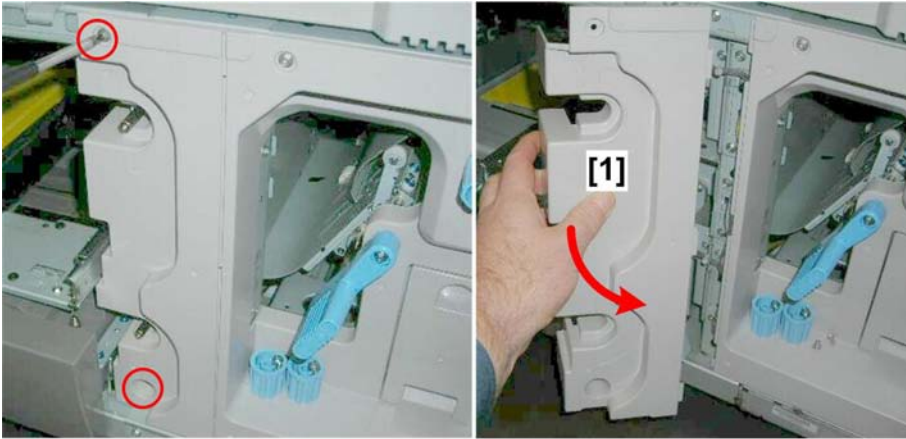

d074r441

3. Remove cover [1] (🔩 x2).

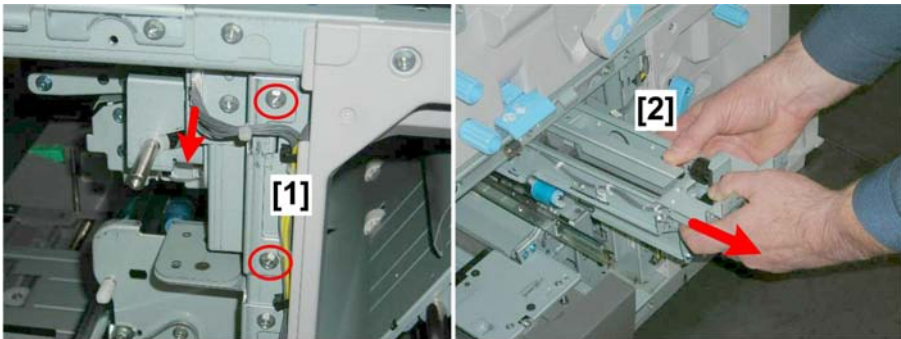

d074r442

4. Disconnect the front bracket [1] (🔌 x1, 🔩 x2).

5. Remove the Tray 1 PFU [2].

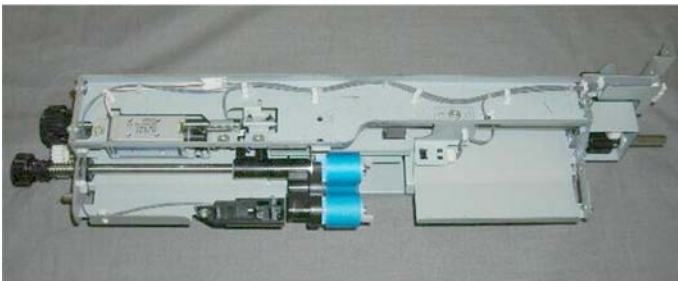

d074r442a

6. Lay the PFU on a clean flat surface.

Tray 2 Paper Feed Unit Removal

1. Open Tray 1 and remove the right tandem tray (x2).

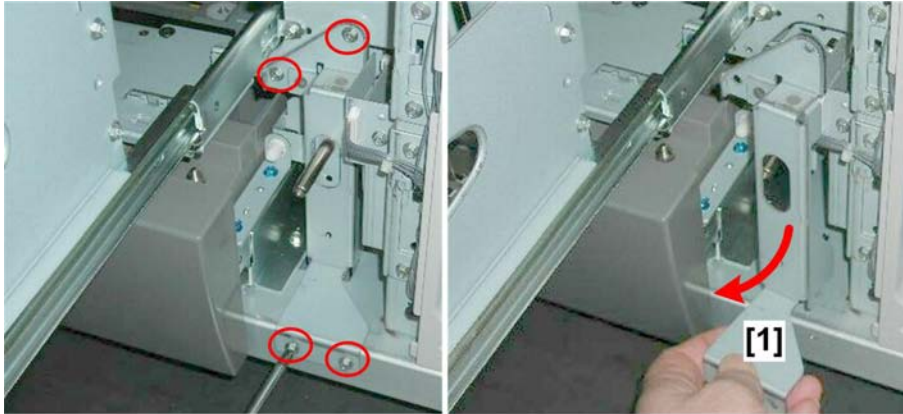

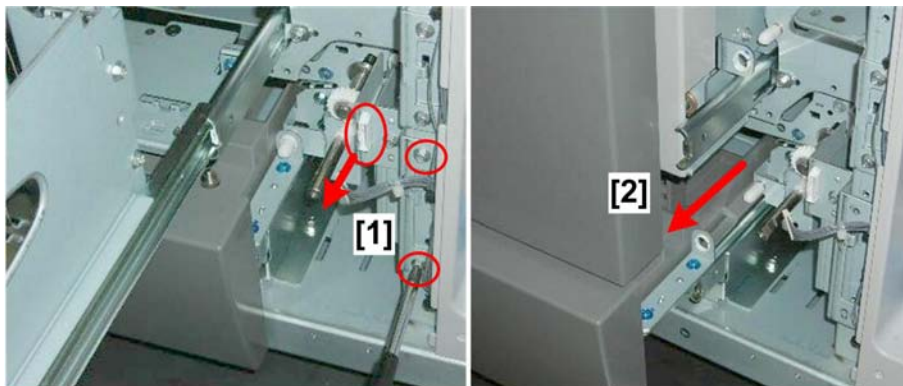

d074r443

2. Remove bracket [1] ( x4).



d074r444

3. Disconnect the front bracket [1] ( x1,  x2).
4. Pull out Tray 2 [2].

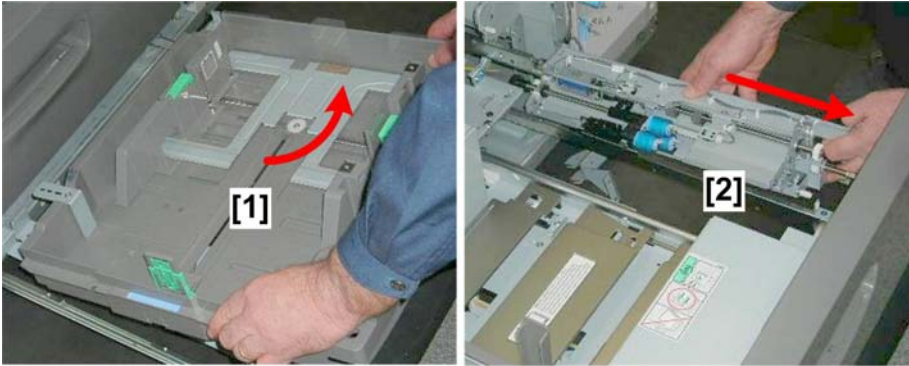

d074r445

4

- 5. Remove the inner tray [1] of Tray 2.
- 6. Remove the Tray 2 PFU [2].

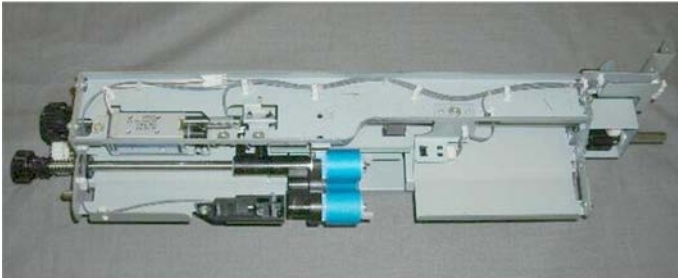



d074r442a

- 7. Lay the PFU on a clean flat surface.

Removing the Vertical Transport Unit (VTU)



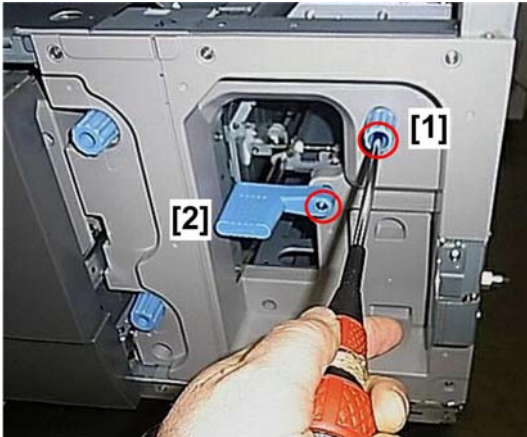

d074r529

1. The vertical transport unit is located at the lower right corner of the main machine.
2. Open the right door.
3. If the LCIT is connected, disconnect it and pull it away from the machine.
4. Remove the right cover of the main machine ( x7).
5. Open Tray 1 and remove the right tandem tray ( x2).
6. Open the right drawer.



d074r530

7. Remove:
 - [1] Knob ( x1)
 - [2] Lever ( x1)

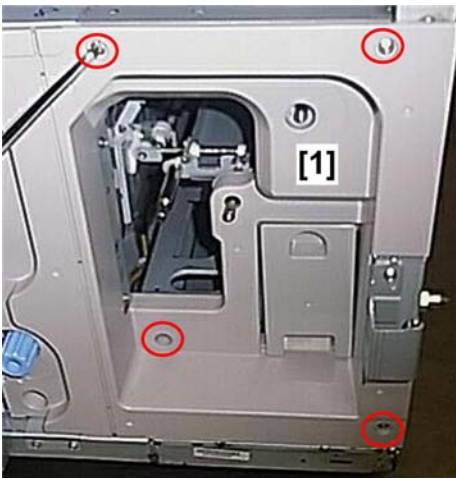

d074r531

8. Disconnect cover [1] ( x4).

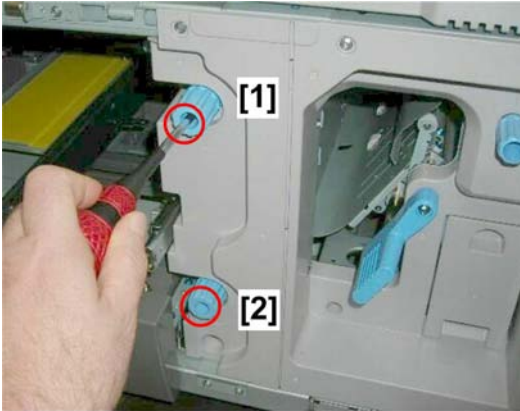

d074r440

4

9. Remove knobs [1] and [2] ( x1 each).

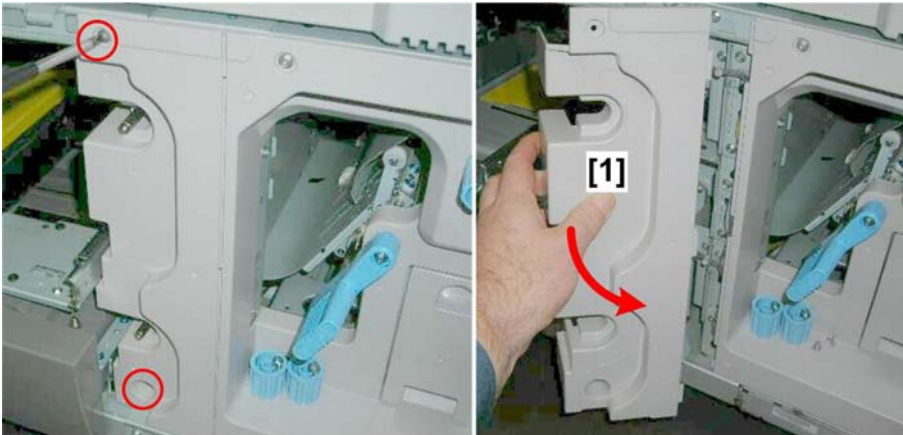

d074r441

10. Remove cover [1] ( x2).

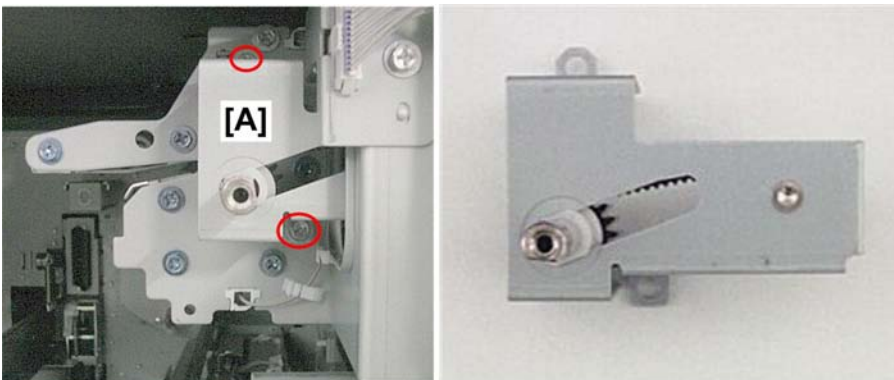

d074r996

11. Where you removed the cover in the previous step, remove the drive gear bracket [A] ( x2).



d074r532

12. Remove the funnel holder ( x1).



d074r533

13. Remove cover [1].



d074r534

14. On the right side of the machine, remove the lower cover [2] ( x7,  x1).



d074r535

15. Pull the lower cover to the side. You do not need to disconnect the harness.



d074r536

16. Disconnect the top bracket [1] of the vertical transport unit. ( x3)



d074r537

17. Disconnect the front bracket [1] ( x2)

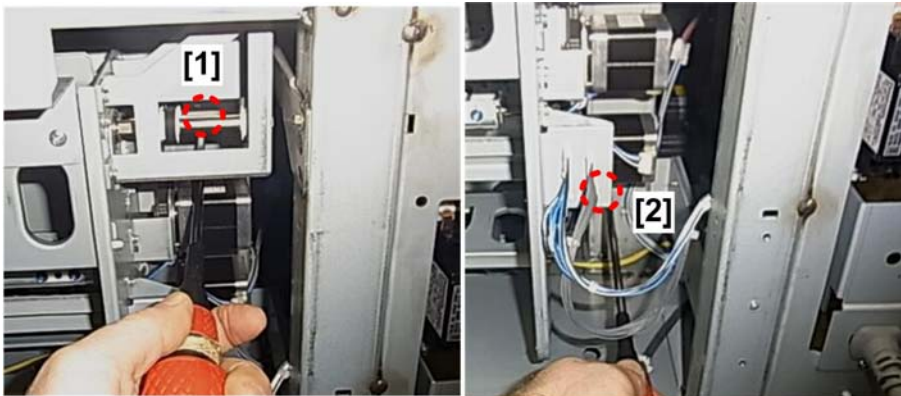

d074r538

18. Remove the rear bracket top screw [1] and bottom screw [2] ( x2). These screws are difficult to see but they are at the same height as the front bracket screws.

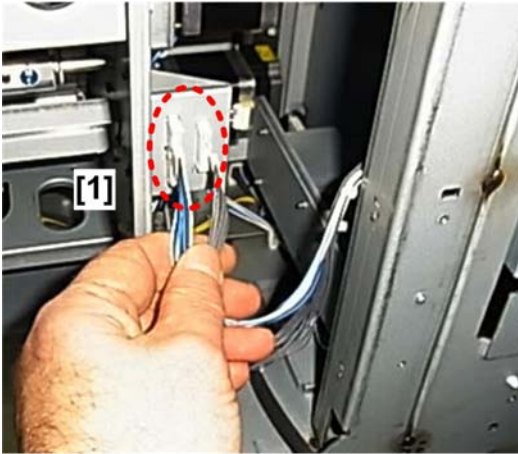

d074r539

- 19. Disconnect the unit (E x2).
- 20. Pull out the right drawer until it stops.

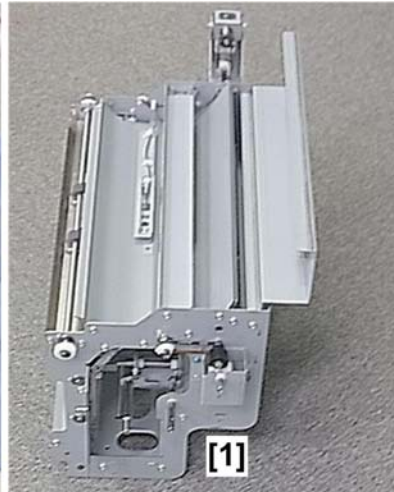

d074r540

- 21. Slide the unit slightly to the right and remove it.

Re-installation

- 1. Make sure that the right drawer is open.

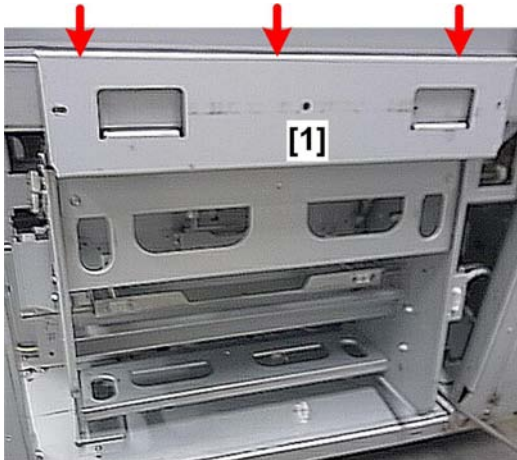

d074r541

2. Hang the top bracket of the vertical transport unit [1] on the machine frame.

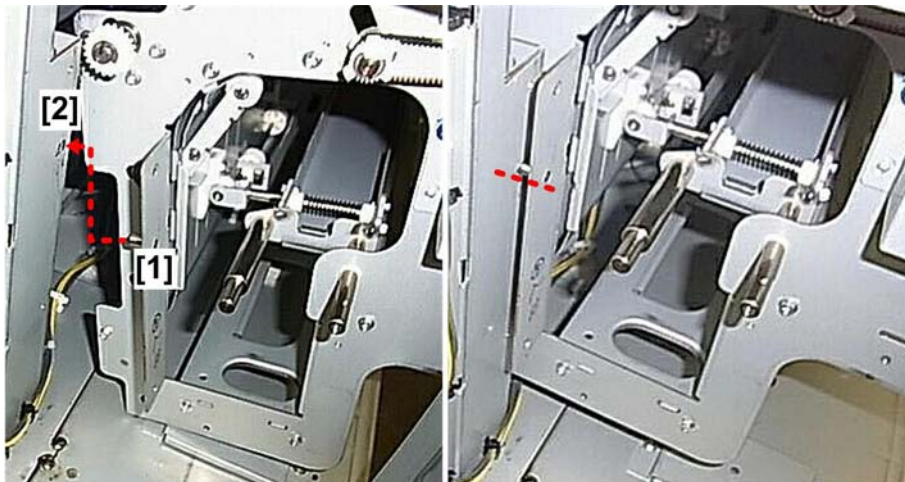

d074r542

3. Hold the unit level and insert the front guide pin [1] into the hole in the main frame [2].
 - There are two of these pins, one at the front (shown above) and one at the rear.
 - Check the top bracket and make sure that the front and rear ends of the bracket are flat against the frame.
 - If the rear end of the bracket is not flat, the rear pin is not inserted correctly.
 - Repeat the procedure and hold the unit as level as possible when you insert the front pin.

Operation Panel

Changing the Operation Panel Position

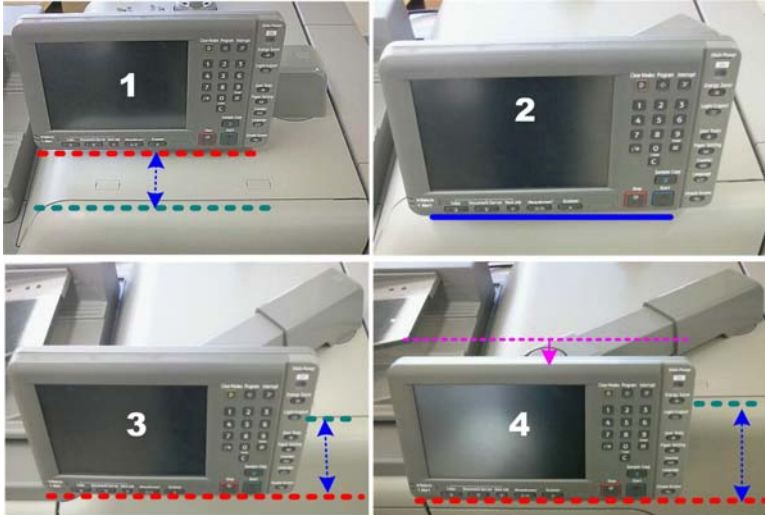

d074i816a

There are four possible ways to configure the operation panel when it is installed.

Config.	Description
1	Standard. The support arm is perpendicular to the right side of the machine and the operation panel is recessed from the front of the machine. This procedure is described in the Installation section.
2	Standard Diagonal. The support arm is set at an angle so that the operation panel is flush with the front of the machine. Described in this section.
3	Standard Diagonal Extended. The support arm is set an angle (same as Configuration 2) and the arm is extended so that the operation panel extends beyond the front of the machine. Described in this section.
4	Easy Access (Sitting Position). This is the same as Configuration 3 but the operation panel is removed and re-hung on lower hooks so it is lower. This allows access to the operation panel from a sitting position. This procedure is described in the Installation section.

- The installation procedure describes how to install the operation panel with Configuration 1 or 4.

- Refer to this section if you need to remove the operation panel and re-install it with Configuration 2 or 3.

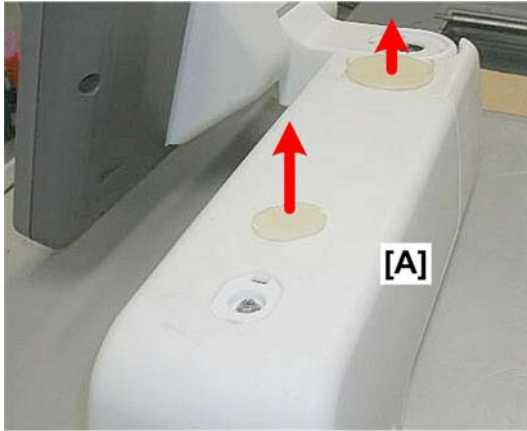

d074r281

1. Remove the screw covers of the arm support [A] (x2).

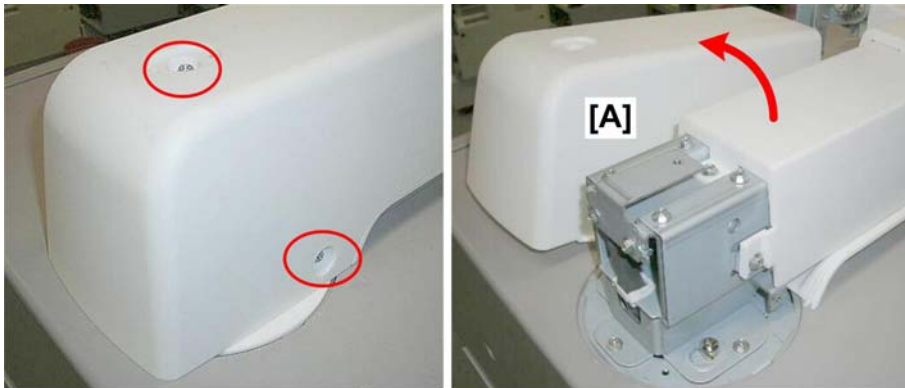

d074r287

2. Remove the arm cover [A] ( x2).

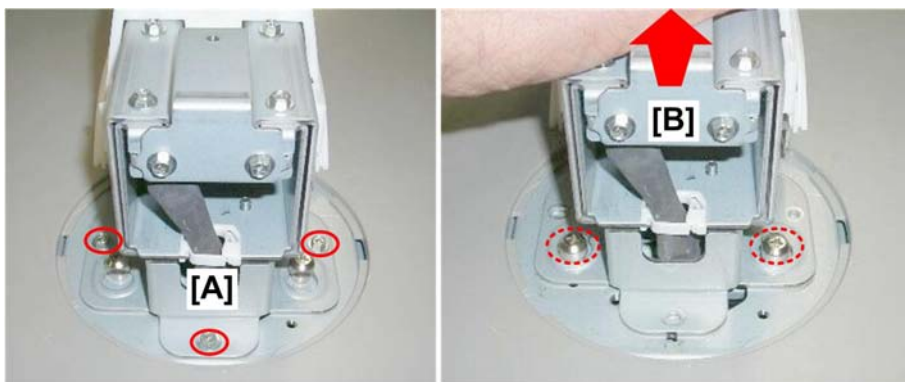

d074r288

3. Disconnect the arm base [A] ( x3).
4. Push the arm to the left, to disconnect the shoulder screws from the narrow ends of the keyholes on the base.

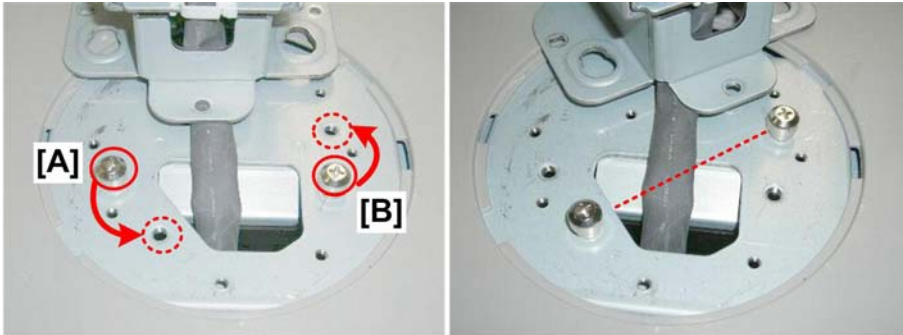



d074r289a

5. Lift the base off the shoulder screws and set it a short distance from the hole, as shown.

★ Important

- The harness is connected below. Pull the support arm away only a very short distance.

6. Remove shoulder screw [A] and re-fasten it at the lower hole ( x1).
7. Remove shoulder screw [B] and re-fasten it at the upper hole ( x1).

The screws should now be diagonally opposite one another as shown above.

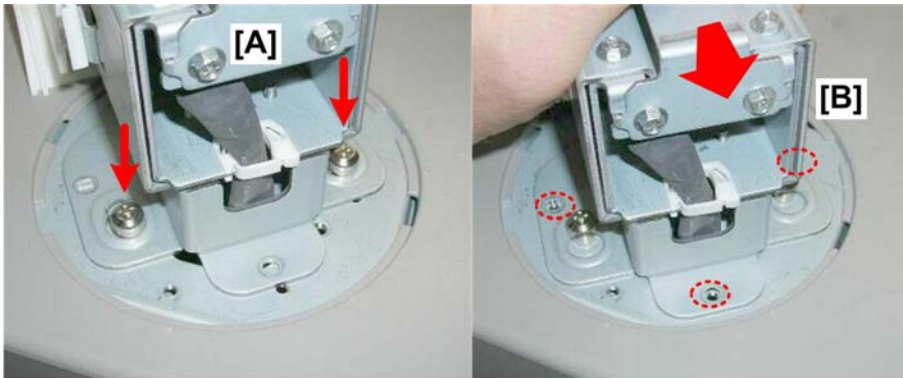

d074r290

8. Set the base of the support arm [A] onto the shoulder screws.
9. Make sure the base is flat against the top of the machine.
10. Push the support arm to the right to lock the base onto the shoulder screws. You can see the three holes of the base aligned with the holes below.
11. Re-attach the base screws [B] ( x3).

★ Important

- Make sure that these screws are fastened tightly.

12. This completes the adjustment for **Configuration 2**. Re-attach the cover.

-or-

Do the next procedure if you want to extend the arm for **Configuration 3**.

To Extend the Support Arm

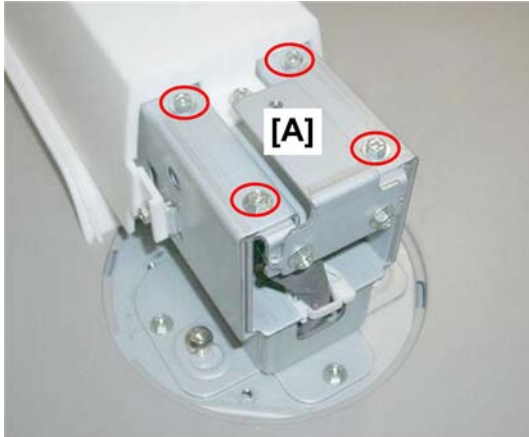

d074r291

1. Remove the screws on top of the support arm [A] ($\times 4$). **Keep these screws .**



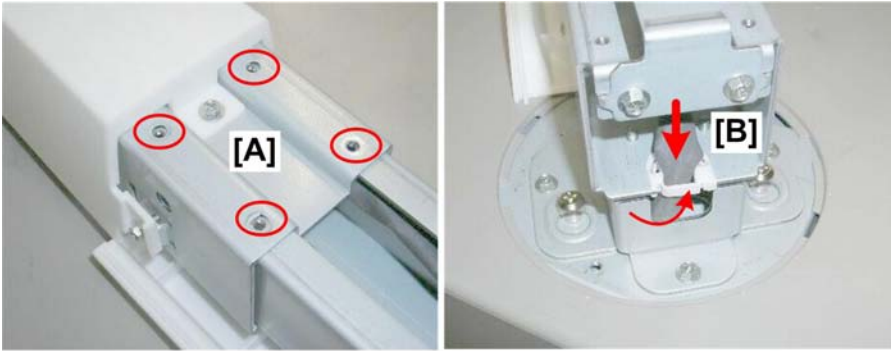

d074r292

2. At the bottom of the base [A], open the clamp and pull a short length of the harness out of the hole to create some slack in the harness ($\times 1$).
3. Slowly push the support arm [B] to the left to extend it.



d074r293

4

4. Push the arm [A] to the left until the holes on the top of the arm are aligned with the four holes below.
5. Re-attach the screws you removed in Step 1 ( x4).
6. Push the harness [B] into the hole, and then clamp it ( x1).

★ Important

- Make sure that these screws are fastened tightly.

This completes the installation for **Configuration 3**.

Operation Panel PCBs, Touch Panel Unit

Operation Panel Removal

1. Follow Steps 1 to 6 of the previous procedure "Adjustment for Easy Access".

Rear Cover

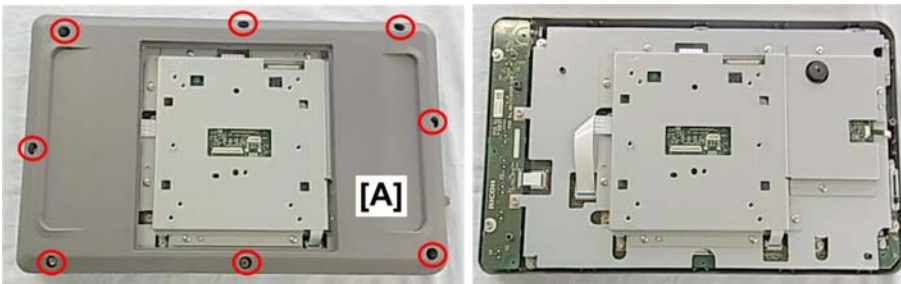

d074r330

2. Remove the rear cover [A] ( x8).

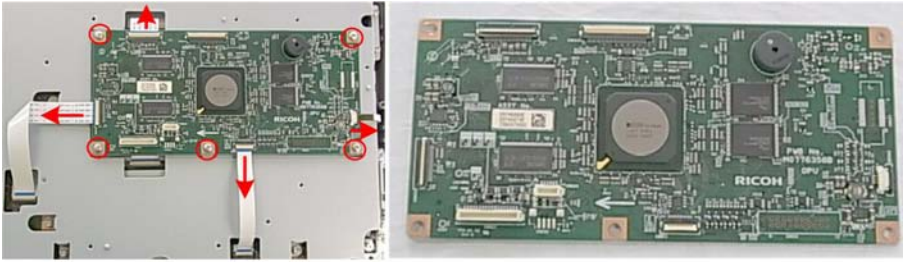

d074r331

3. Disconnect and remove the OPU ( x3, FFC Thin x1,  x5)

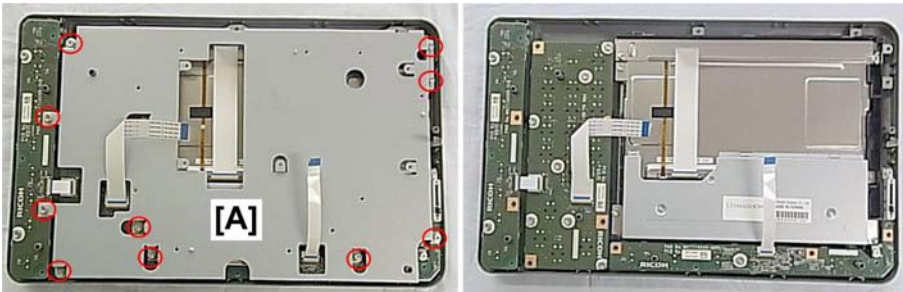

d074r332

4. Remove the PCB cover [A] ( x10).



d074r333

There are three boards on the back of the operation panel.



- ① Sub Keys PCB
- ② Main Keys PCB
- ③ Application Keys PCB

Sub Keys PCB

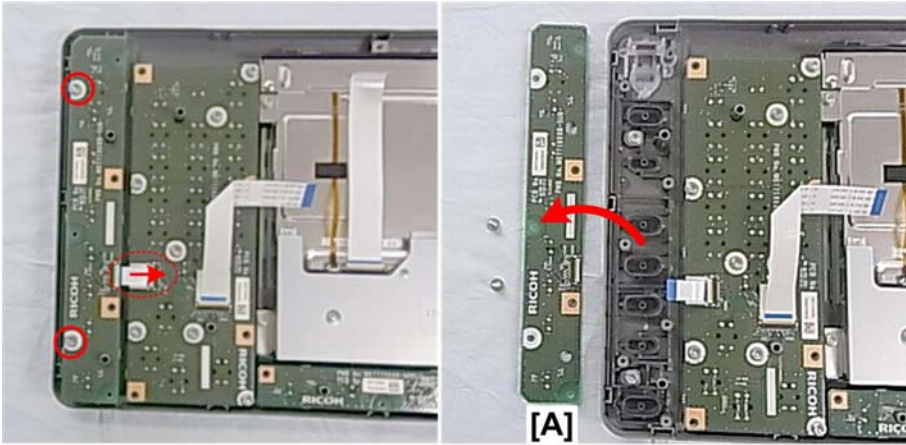
4



d074r334

5. Disconnect and remove the sub keys PCB [A] ( x1,  x2)

Main Keys PCB

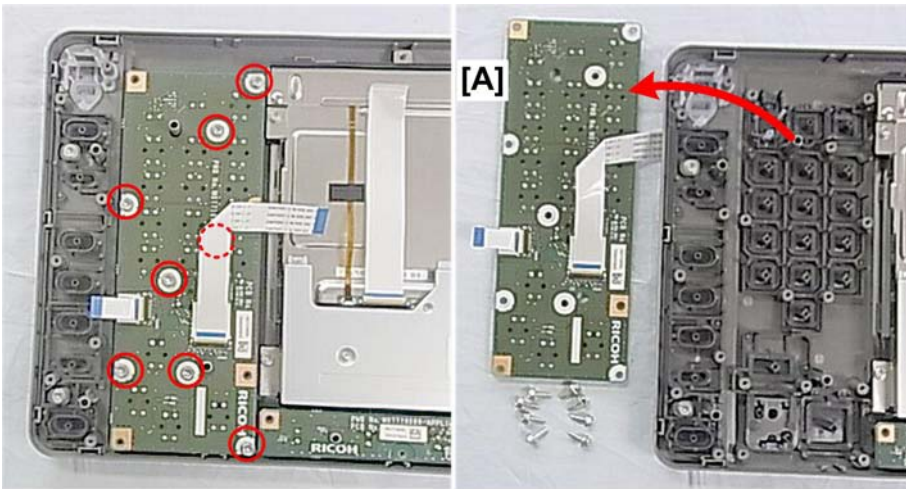

d074r335

6. Remove the main keys PCB [A] ( x8).

Application Keys PCB

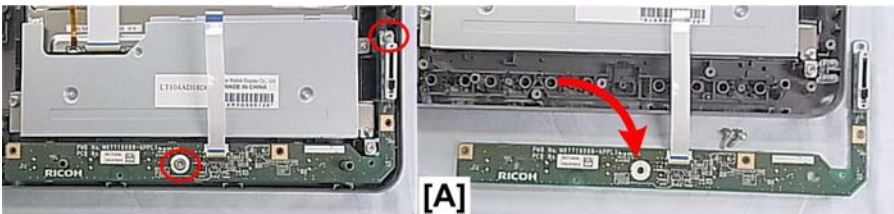

d074r336

7. Remove the application keys PCB [A] ( x2).

Touch Panel Unit with LCD

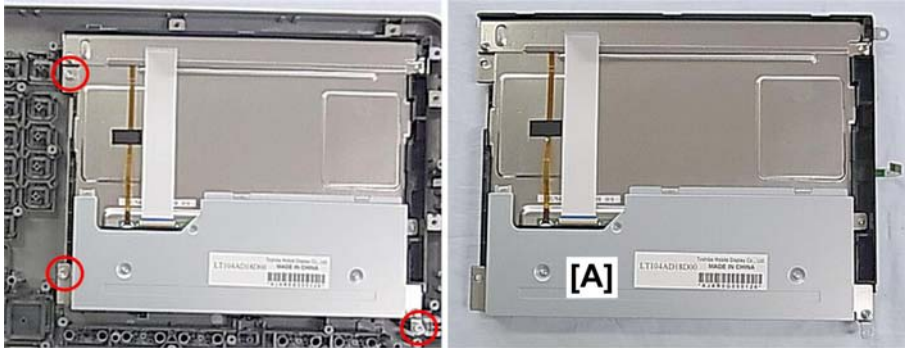

d074r337

8. Remove the touch panel unit [A] ( x3).

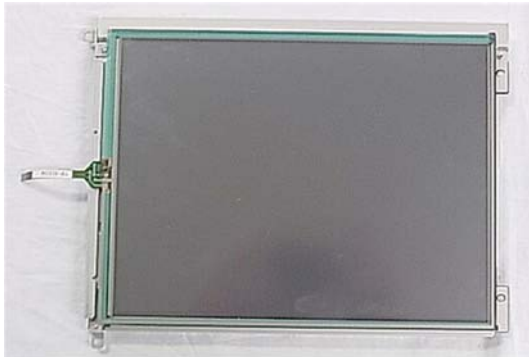

d074r338

This is a front view of the removed touch panel unit.

Re-installation

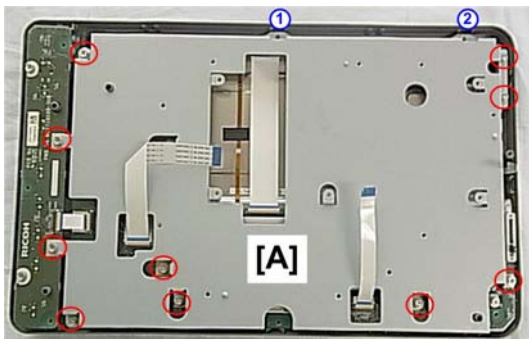

d074r339

- When you re-attach the PCB cover [A], fasten the screws as shown ( x10).
- Do not fasten screws at ① and ②. These holes are for rear cover screws.

Touch Panel Position Adjustment

It is necessary to calibrate touch panel:

- After replacing the operation panel.
- After replacing the controller board.
- If the touch panel detection function is not operating correctly.

★ Important

- **Do not use items [2] to [9] on the Self-Diagnostic Menu. These items are for design use only.**
1. Press [Reset], press [1] [9] [9] [3], and then press [Clear] 5 times to open the Self-Diagnostics menu.

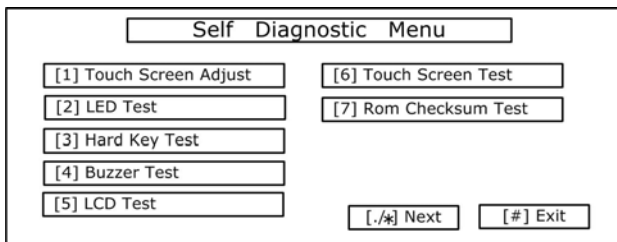

b178r548

2. On the touch screen press "Touch Screen Adjust" (or press "1").
3. Use a pointed (not sharp) tool to press the upper left mark .

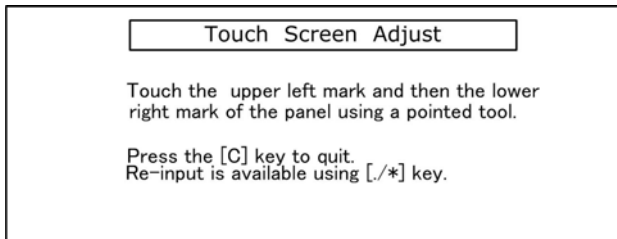

b178r549

4. Press the lower right mark when  shows.
5. Press [#] OK on the screen when you are finished.
6. Touch [#] Exit on the screen to close the Self-Diagnostic menu. Save the calibration settings.

ARDF

ARDF Covers

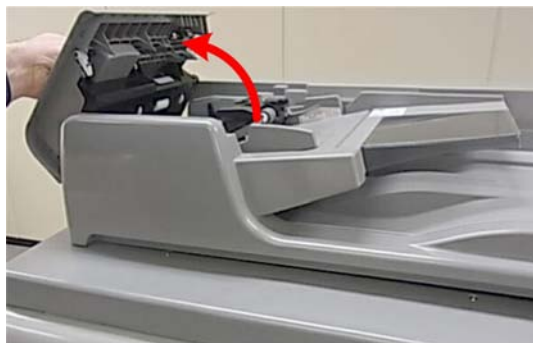

d074r792

1. Open the feed cover.



d074r793

2. Remove the screws on the top edge of the front cover ( x2).





d074r794

3. Press down on the right end of the cover to release the tab and remove the cover.

4



d074r795

4. Remove screw [1] on the top edge of the rear cover ( x1).
5. Remove screw [2] on the back of the rear cover ( x1).



d074r796

6. Remove the rear cover.

Original Feed Unit

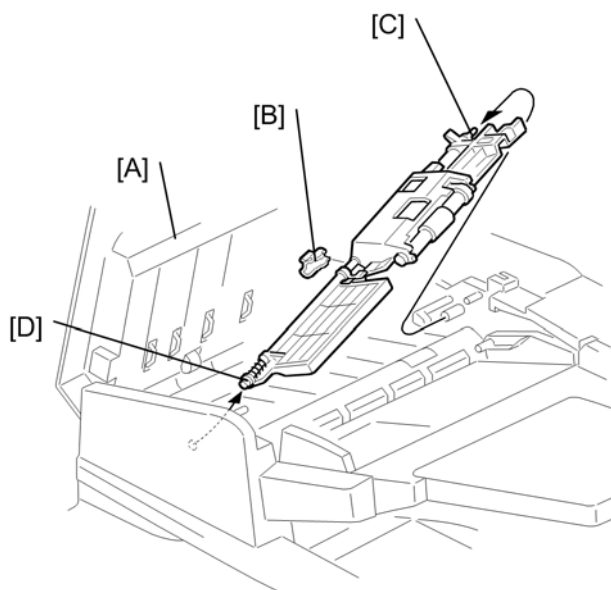

d132r105

1. Open the feed cover [A].
2. Remove the snap fitting [B].
3. Pull [C] toward you slightly to disconnect the rear end of the shaft.
4. Disconnect the front end of the shaft [D].

Feed Belt, Pickup Roller

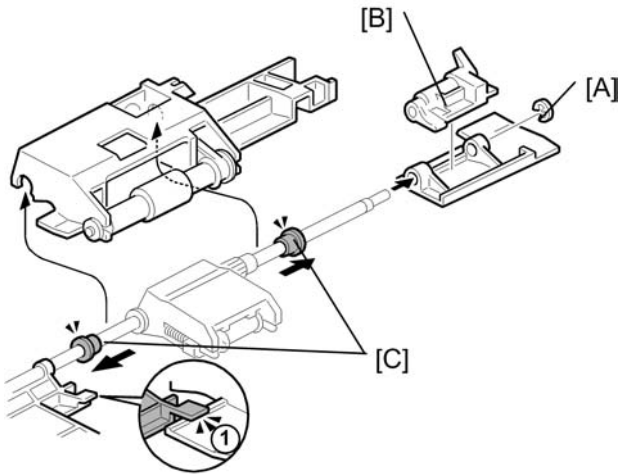

d132r106

1. Remove

- Original feed unit (p.463)
- [A] E-ring (x1)
- [B] Cover
- [C] Slide out (x2)

Note

- At re-assembly, make sure that the tab ① on the front guide plate is above the pick-up roller unit.

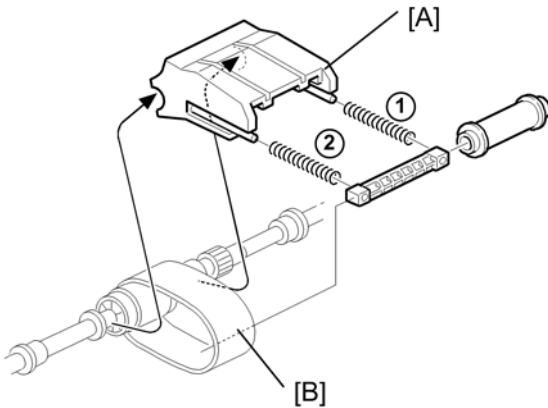

d132r107

2. Slowly remove:

[A] Feed belt holder

[B] Feed belt

↓ **Note**

- Do not let springs ① and ② fall out and get lost.

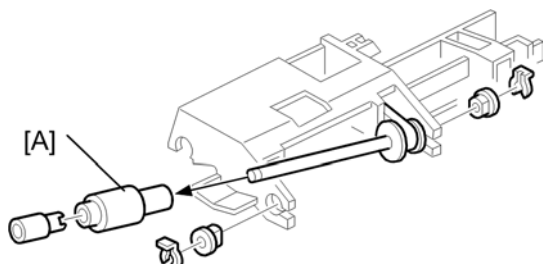

d132r106a

3. Remove the ARDF pickup roller [A].

Bottom Plate Position Sensor

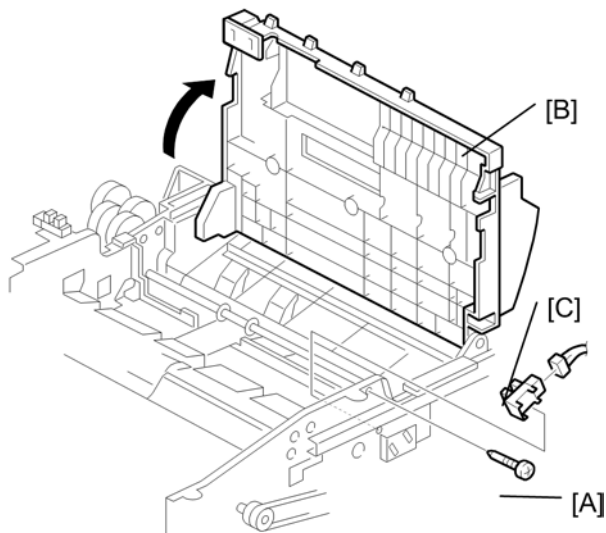

d132r117

1. Remove:

- Front cover (p.461)
- Original feed unit (p.463)

2. Remove the pivot screw [A] (x1)

3. Raise the bottom plate [B].

4. Remove the bottom plate position sensor [C] (x1, x3).

Interval, Original Width, Skew Correction Separation Sensors

4

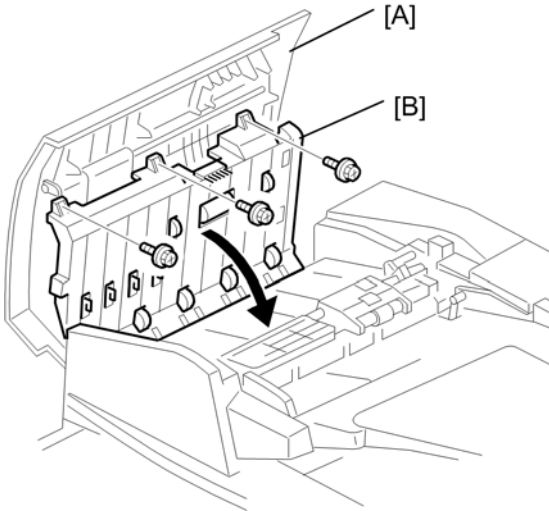

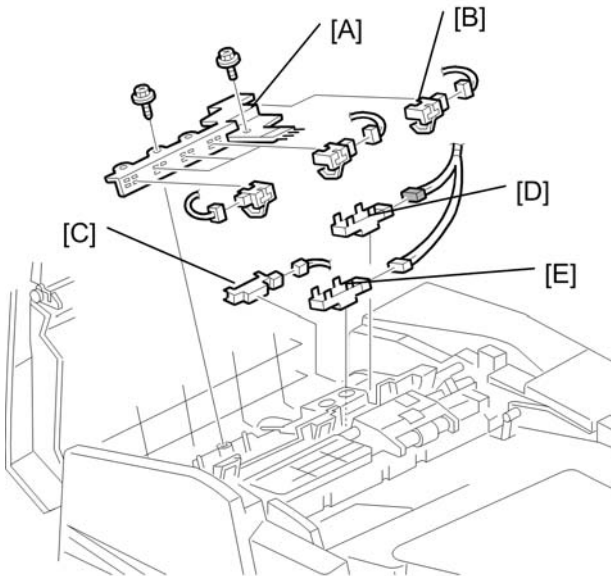

d132r110

1. Open the feed cover [A].
2. Remove guide plate [B] ( x 3).



d132r111

3. Remove
[A] Width sensor assembly ( x 2)
[B] Original width sensors ( x 5)

[C] Interval sensor ( x1)



[D] Skew correction sensor ( x1)

[E] Separation sensor ( x1)

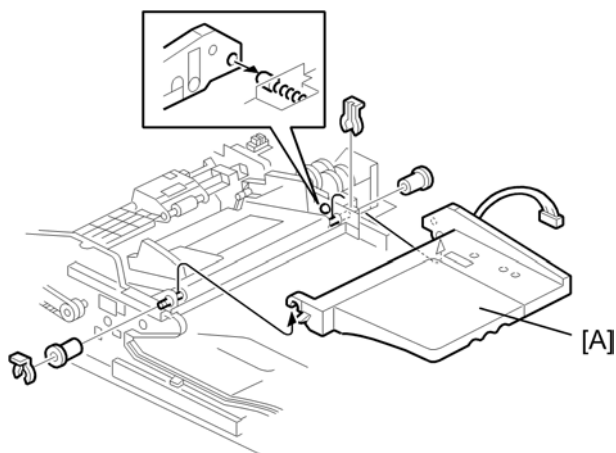
Original Length Sensors



d132r109a

1. Remove the front and rear covers ( p.461)
2. Remove the original tray [A] ( x2, Collars x2).

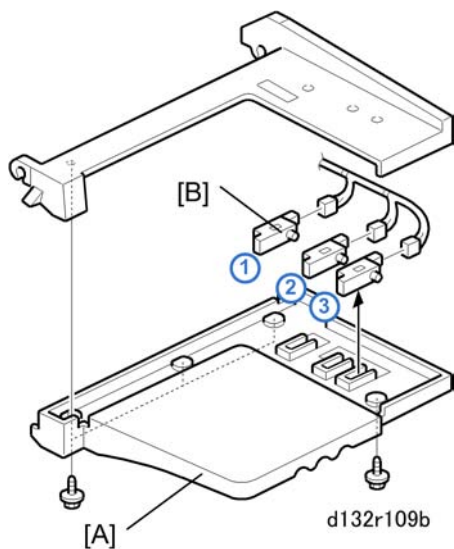

d132r109b

3. Disconnect the lower cover [A] ( x4).
4. Disconnect sensors at [B]:

- ① B5 original length (📄 x1)
- ② A4 original length (📄 x1)
- ③ LG original length (📄 x1)

Cover Open, Original Set, Bottom Plate, Pickup Roller HP, Feed-Out Sensors

4

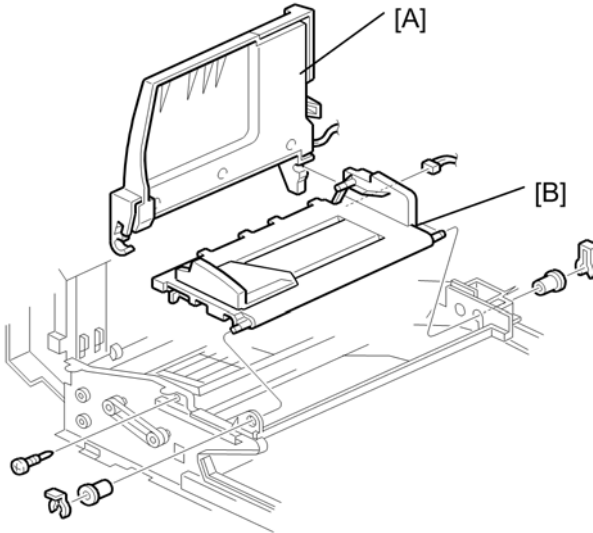



d132r116

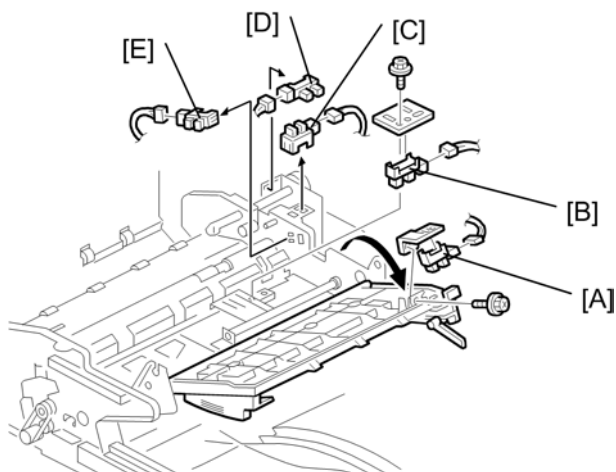

1. Remove the front and rear covers (🔧 p.461)
2. Remove
 - [A] Original tray (📄 x1, 🛠️ x2, Collars x2)
 - [B] Lift tray (📄 x1, 🛠️ x1)



d132r118

3. Disconnect and remove

[A] Original set sensor ( x1,  x1)

[B] Upper inverter sensor ( x1,  x1)

[C] Feed cover sensor ( x1)

[D] Pickup roller HP sensor ( x1)

[E] Bottom plate position sensor ( x1)

ARDF Position Sensor, APS Start Sensor

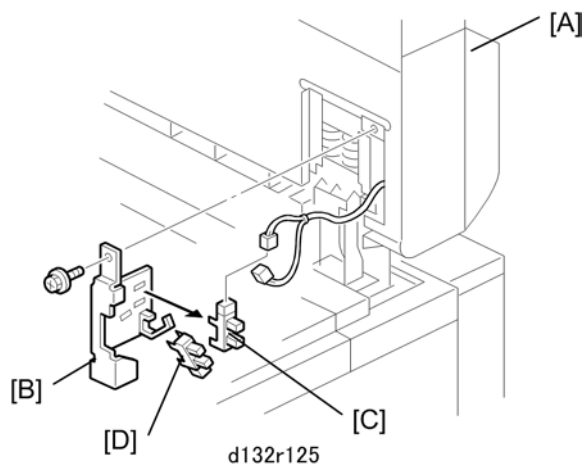

d132r125

1. Raise the ARDF [A] to the vertical position.

[B] APS assembly ( x1)



[C] ARDF position sensor ( x1,  x3)

[D] APS start sensor ( x1,  x)

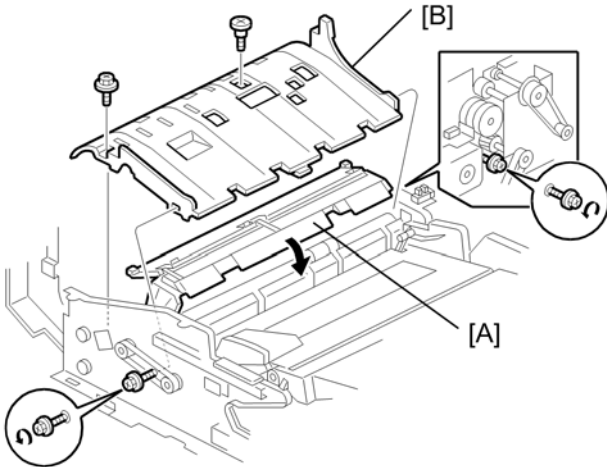
Original Registration Sensor Exit Sensors



d132r112

1. Remove
 - Front and rear covers, feed cover ( p.461)
 - Original feed unit ( p.463)
2. Rotate the inverter guide [A] 180 degrees.
3. Remove the original guide plate [B] ( x4).

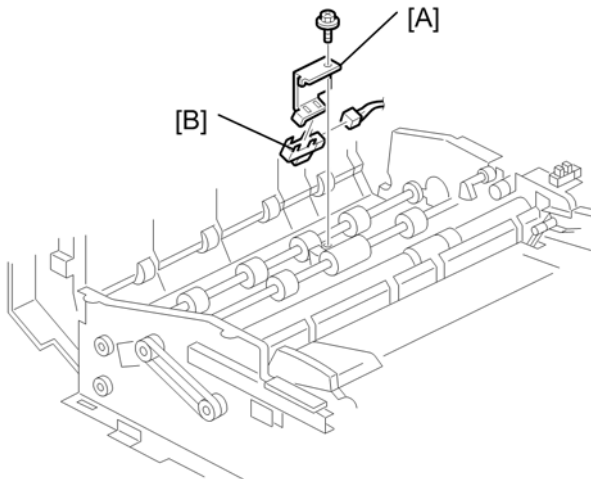

d132r113

4. Remove
[A] Assembly ( x1)

[B] Registration sensor ( x1)

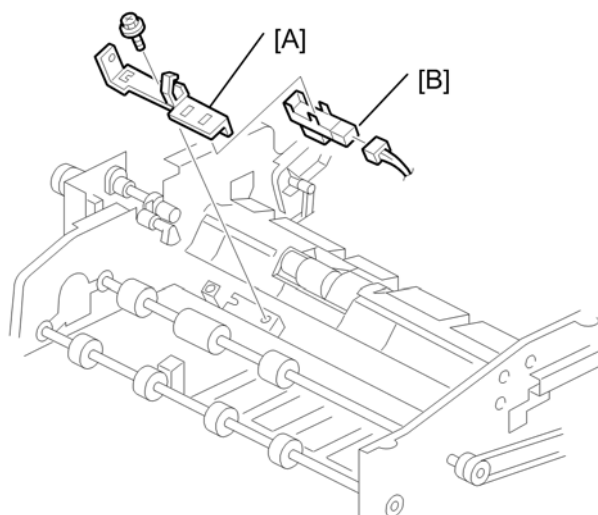

d132r115

5. Remove:

[A] Assembly ( x1)

[B] Original exit sensor ( x1)

ARDF Separation Roller

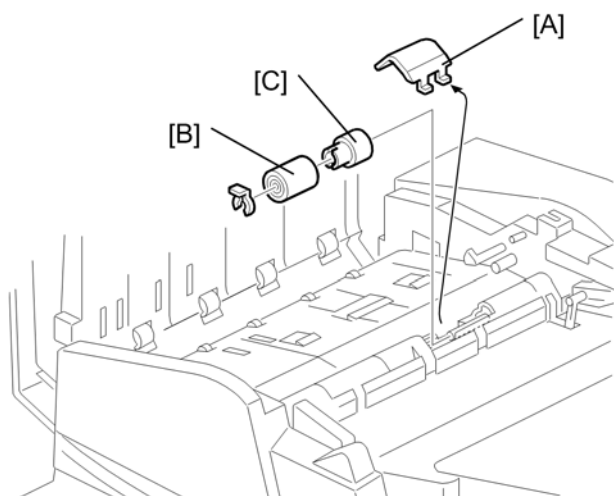

d132r108

1. Open the feed cover.
2. Remove the original feed unit. ( p.463)

3. Remove:

[A] Separation roller cover. Use the tip of a small flathead screwdriver.

[B] Separation roller ( x 1)

[C] Torque limiter

ARDF Transport Belt

Removing the ARDF Transport Belt Assembly

4

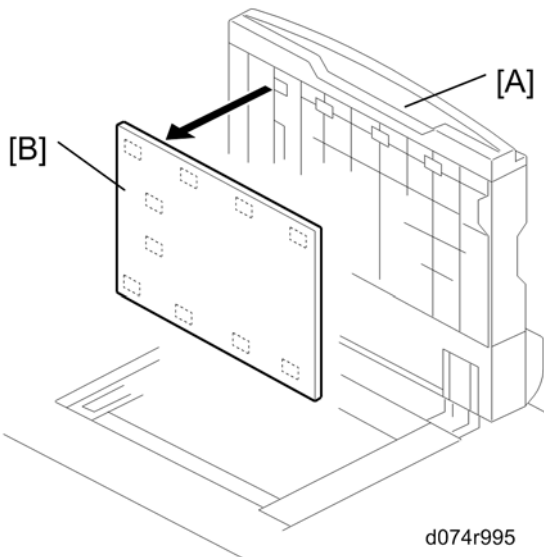

1. Open the feed cover.
2. Remove the ARDF front cover. ( p.461)
3. Raise the ARDF [A] to the vertical position.
4. Pull off the white cover [B] (Velcro fasteners).

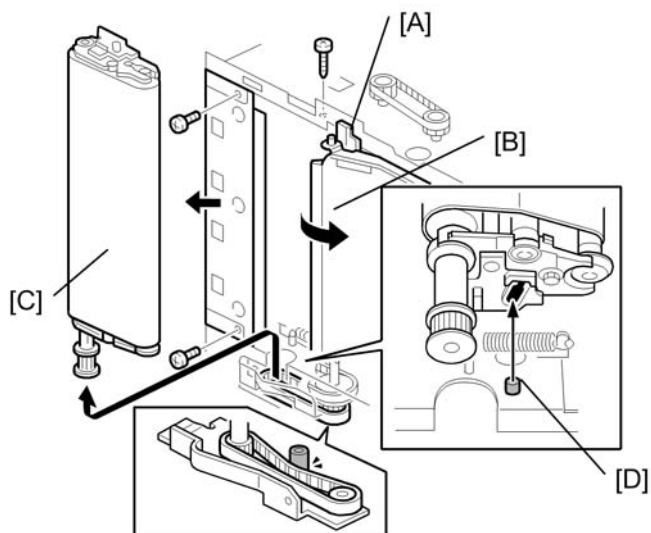

d132r126

5. Release the stopper pin [A] of the transport guide [B].
6. Remove the transport belt unit [C] (Pin screw x1).



★ Important

- At re-installation, attach the timing belt as shown then insert the pin screw [D].

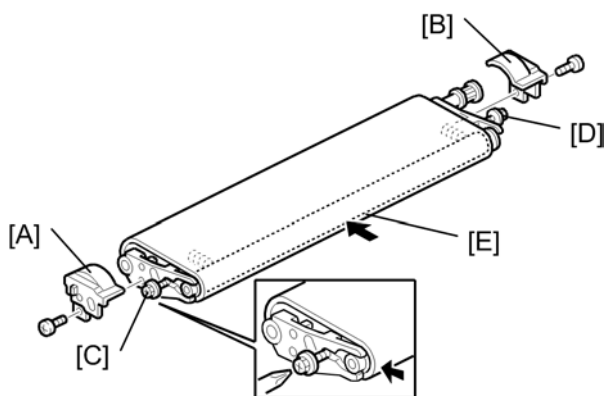
Removing the Belt



d132r127

1. Remove the front plastic cover [A] ( x1).
2. Remove the rear plastic cover [B] ( x1).
3. Loosen the front lock screw [C]. **Do not remove.**
4. Loosen the rear lock screw [D]. **Do not remove.** This releases the spring-loaded tension on the belt.

5. Grip the roller in the center [E] then squeeze the belt to bring the rollers together.
6. While squeezing the belt and rollers together in the center, tighten screws [C] and [D]. This compresses the spring and releases tension on the belt.

★ Important

- To avoid stripping the threads of the screws, do not apply excessive force to these screws!

7. Release the belt.
8. Make sure that the belt is loose and that the rollers do not move.
9. Repeat Steps 5 and 6 if the rollers expand and tighten the belt.

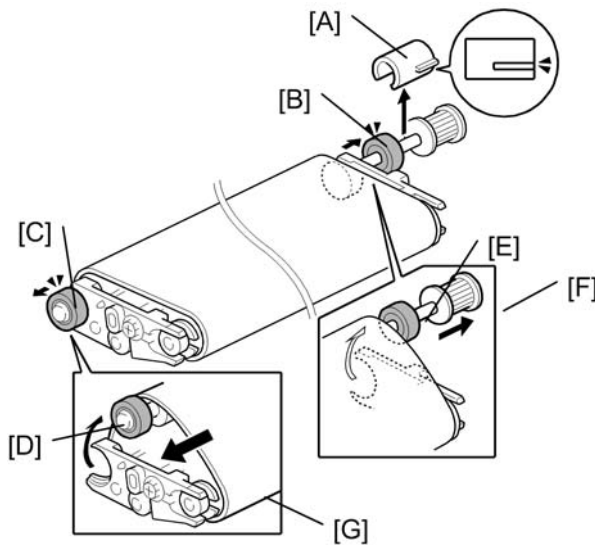

d132r139

10. Remove the Teflon sleeve [A].
11. Push the rear shaft bearing [B] out of its bracket.
12. Push the front shaft bearing [C] out of its bracket.
13. Push the front end of the shaft [D] over the top of the bracket.
14. Push the rear end of the shaft [E] over the top of the bracket.
15. Pull the shaft [F] out of the belt.
16. Pull the belt [G] toward the front to remove it.
17. Slide the new belt over the assembly.
18. Insert the shaft [F] into the new belt, snap the shaft into its brackets, and push in the shaft bearings.



d132r139a

19. Make sure that studs on the underside of the belt [H] are aligned with the grooves of the Teflon rollers on each end of the shaft below.

4

Reinstalling the Belt

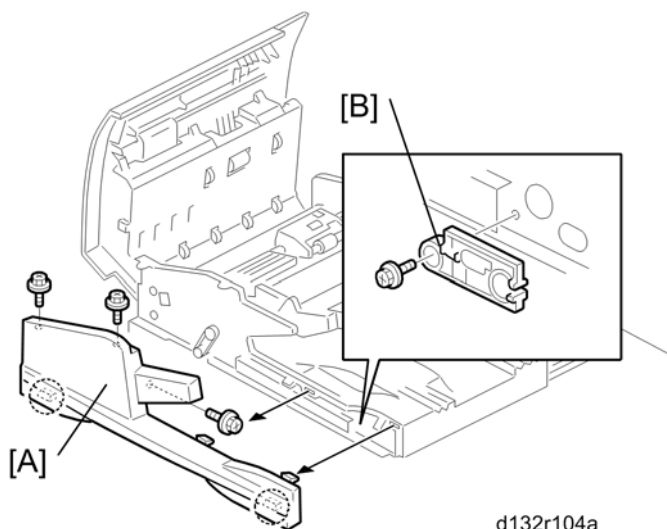

d132r104a

1. Remove the ARDF front cover [A].
2. Take out the special tool [B].

⬇ Note

- The special tool [B] is attached to the front side plate. It is used to adjust the tension on the belt on both ends of the shaft.

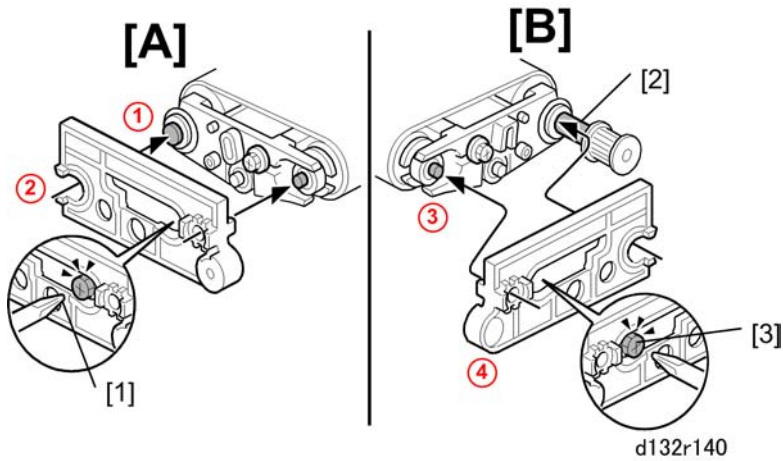

4

3. Fit the special tool onto the front [A].
4. Slowly loosen the front lock screw [1] until you see the tip of the shaft (① aligned with the hole ②), then tighten the screw.

★ Important

- To avoid stripping the threads of the screws, do not apply excessive force to these screws!

5. Remove the special tool and fit it onto the rear [B].
6. If the Teflon sleeve has been reattached at [2], remove it. Do not reattach the sleeve until after adjusting the belt tension. (The special tool does not fit over the rear end with the Teflon sleeve attached.)
7. Slowly loosen the rear lock screw [3] until you see the tip of the shaft (③ aligned with the hole ④) then tighten the screw.
8. Re-install the Teflon sleeve.
9. Re-install the front and rear plastic cover.
10. Reinstall the transport belt assembly in the ARDF.

Reattaching the White Cover

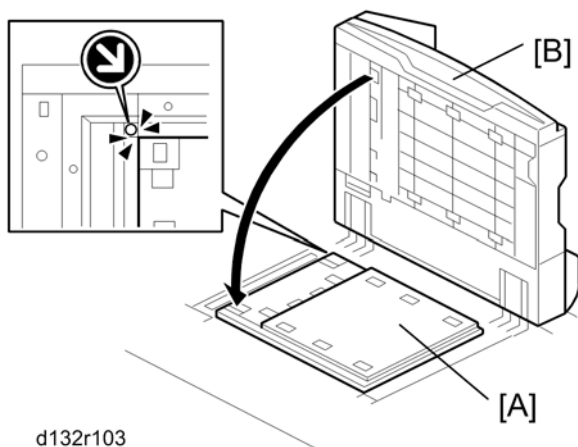

d132r103

1. With its white side down, set the cover [A] on the exposure glass.
2. Make sure the upper left corner is aligned with the arrow at the corner of the exposure glass.
3. Close the ARDF [B] on top of the cover.

ARDF Control Board

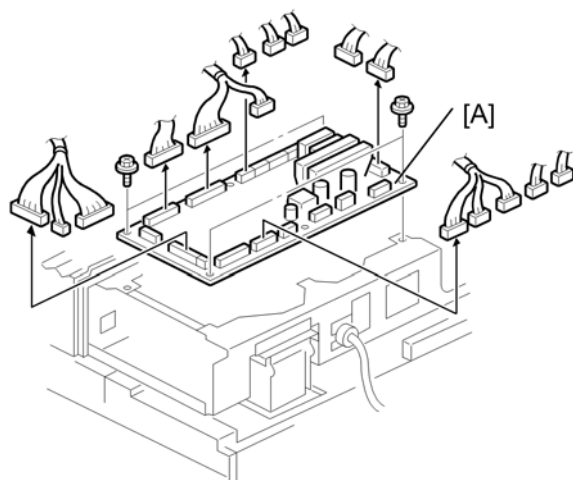

d132r124

1. Remove the ARDF rear cover (p.461)
2. Remove the ARDF control board [A] (screw x17, screw x4).

ARDF Bottom Plate Lift Motor

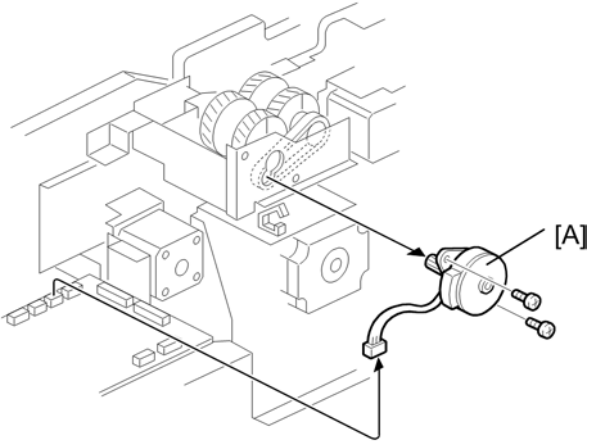

d132r121

1. Open the feed cover.
2. Remove the ARDF rear cover (p.461)
3. ARDF bottom plate lift motor [A] (x1, x2, x1)

ARDF Feed Motor, ARDF Transport Motor

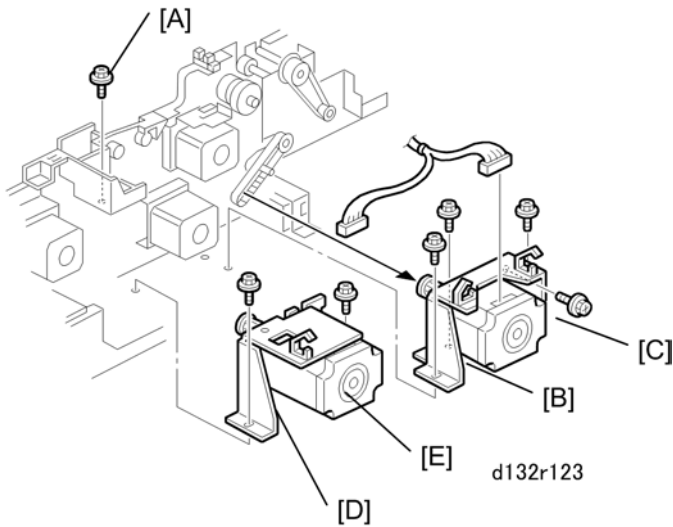

d132r123

1. Open the feed cover.
2. Remove the ARDF rear cover (p.461).

↓ **Note**





- The right motor must be removed before the left motor.

3. Remove:

[A] Screw ( x1)

[B] Feed motor assembly ( x4,  x1,  x1,  x1)

[C] Feed motor ( x2)

[D] Transport motor assembly ( x2,  x1,  x1,  x1)

[E] Transport motor ( x2)

↓ **Note**



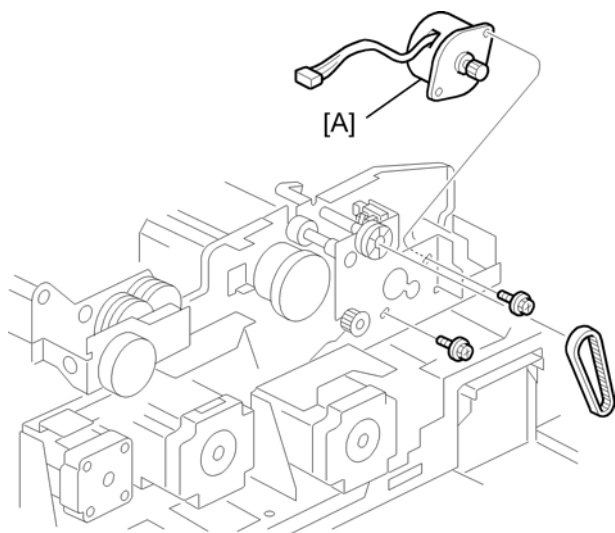

- Re-installation is easier if you first set the spring tension with the screws and then fasten the motor bracket with screws.

4

ARDF Pick-up Roller Lift Motor



d132r120

1. Open the feed cover.
2. Remove the ARDF rear cover ( p.461).
3. Remove the pickup roller lift motor [A] ( x2,  x1,  x1).

Scanner Unit

Exposure Glass

4

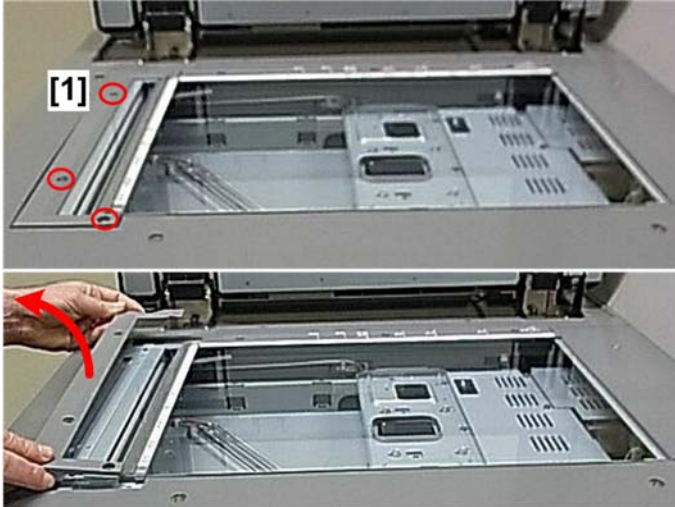

d074r797

1. Remove the left plate ( x3).

 **Note**

- Screw [1] is a larger screw.

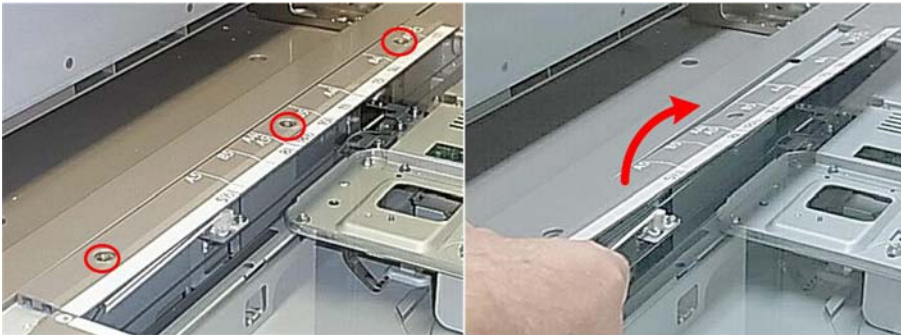

d074r798

2. Remove the rear scale ( x3).



d074r799

3. Carefully slide the right rear corner out of the groove at [1] and then remove the exposure glass.

4

Right, Left Plate Covers

Remove these covers to allow easier access to the plates of the scanner unit below.



d074r800

1. Remove the exposure glass. (p.480)
2. Remove the right plate ( x1). (This is a larger screw.)

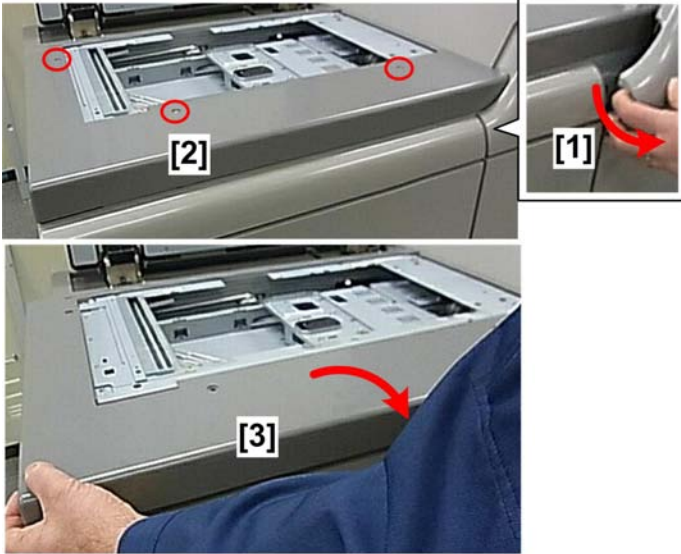

d074r801

3. Open the toner bank door [1].
4. Disconnect the front plate [2] (⚙️ x3).
5. Remove the front plate [3].



d074r802

Lens Block, Paper Size Sensors

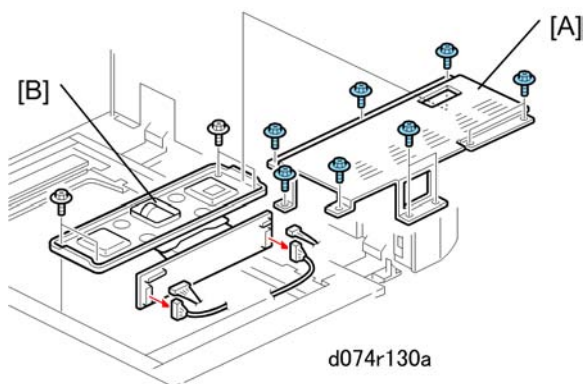



1. Before you remove the lens block, note the settings of the following SP codes that are used for ADF density adjustments for R, G, B.

- SP4609-2
- SP4610-2
- SP4611-2

2. Remove the exposure glass. (p.480)

[A] Lens cover ( x9)

[B] Lens block ( x4,  x4)

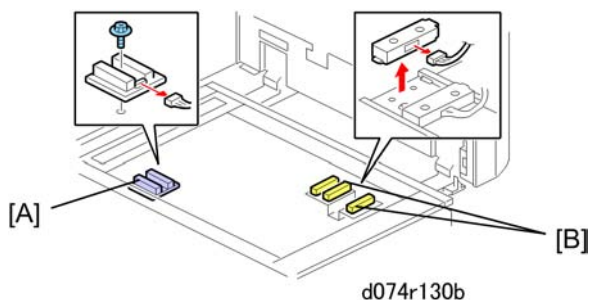

3. Remove the lens block carefully to avoid damaging the attached PCB.
4. Do not touch the paint-locked screws on the lens block.

[A] Original width sensor ( x1,  x1)

[B] Original length sensors x2 (No screws,  x1 each)

5. After replacing the lens block, do the following SP codes.

SP4008 001	Sub Scan Mag	Sub Scan Magnification Adjustment
SP4010 001	Sub Scan Reg	Sub Scan Registration Adjustment

SP4011 001	Main Scan Reg	Main Scan Registration Adjustment
------------	---------------	-----------------------------------

6. After lens block replacement, do some copy samples with the ADF. Check these points:

- Do the copies have background?
- Is the copy output of the ADF and platen mode different?

If these problems occur, restore the following SP codes to their previous settings (noted in Step 1), or adjust these SP codes until the background is acceptable.

- SP4609-2
- SP4610-2
- SP4611-2

4

Exposure Lamp

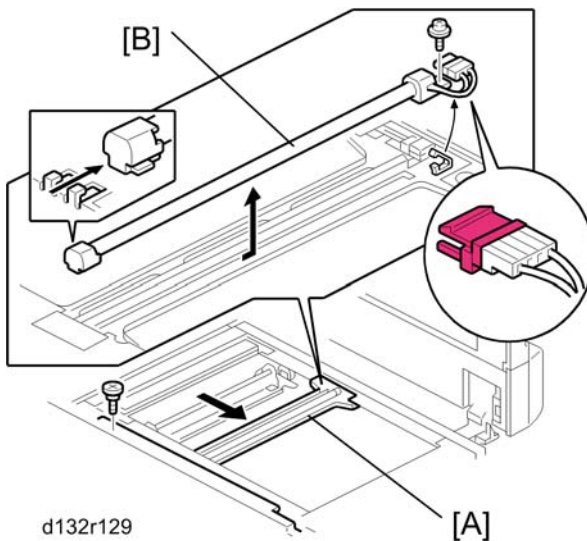

1. Remove the exposure glass. (p.480)
2. Slide the 1st scanner [A] to the cutout in the frame.
3. Remove the exposure lamp [B] (⚙️ x1, 📦 x1, 🔧 x1).

★ Important

- Never touch the surface of the exposure lamp with bare fingers.
- Work carefully to avoid damaging the relay plugs attached to the rear ends of the lamp.

Scanner Motor

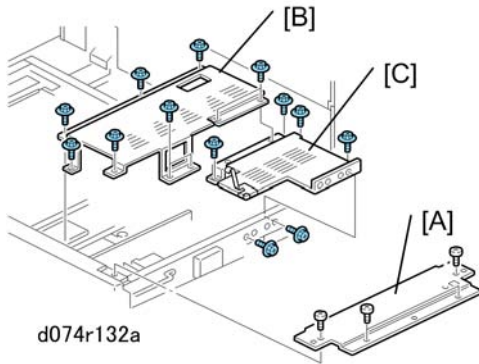

d074r132a

1. Do the first two procedures in this section to remove the exposure glass and right and left covers.
2. Remove:



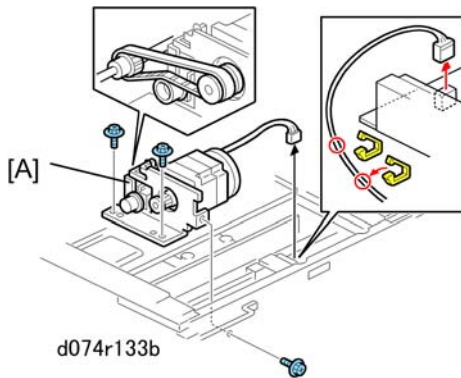

[A] Bracket ( x4)

[B] Lens cover ( x9)

[D] Right lens cover ( x5)





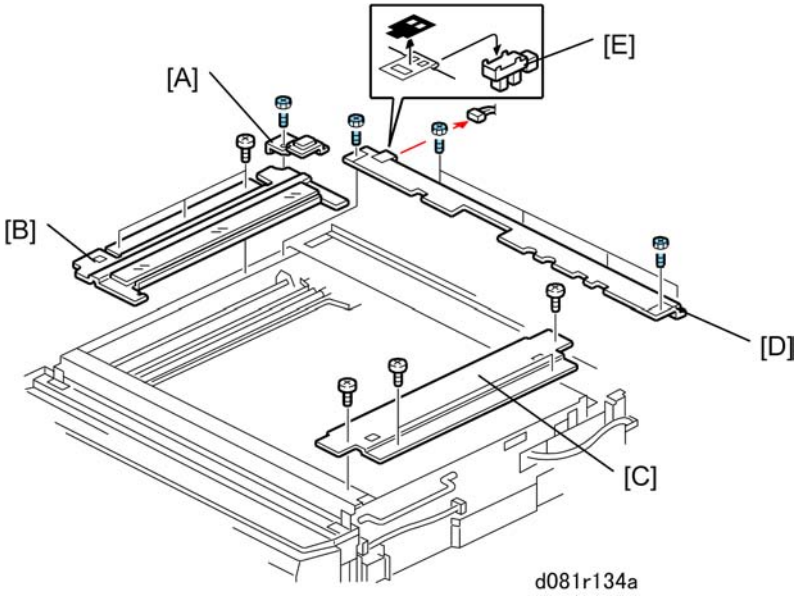

d074r133b

3. Remove the scanner motor assembly [A] ( x1,  x2,  x1,  x3).
4. Remove the scanner motor ( x2).

Scanner HP Sensor



1. Remove ARDF, Exposure Glass, and Covers
2. Remove:
 - [A] Ground plate ( x1)
 - [B] Left stay ( x3)
 - [C] Right stay ( x4)
 - [D] Rear stay ( x6)
 - [E] Scanner HP sensor ( x1)

Scanner Interface Board (SIOB)

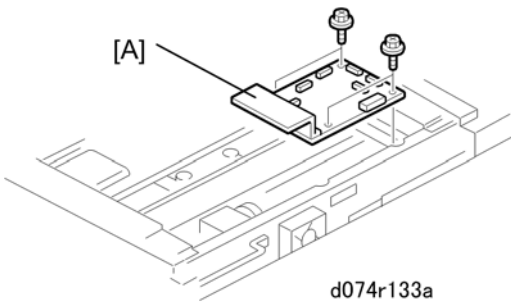

1. Remove:
 - ADF



- Exposure glass
- Covers
- Right stay, rear stay
- Lens cover

2. Remove the scanner interface board [A] (x8, x4).

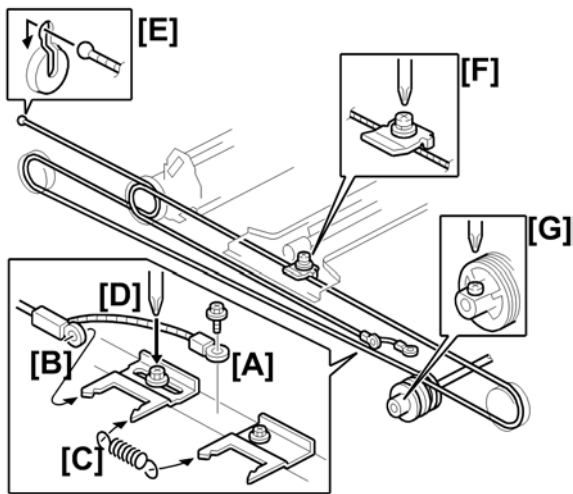
Scanner Wire



d081r137

1. Remove the wire ground [A] ( x1).
2. Disconnect the head of wire [B] from tension bracket 1.
3. Remove spring [C].
4. Loosen the screw [D] of tension bracket 1.
5. Disconnect the end of wire at [E].
6. Remove lock bracket [F] of the 1st scanner ( x1).
7. Disconnect the wire from the pulley [G] ( x1).
8. Remove the wire from the scanner.

Scanner Unit Cooling Fan

4



d074r803

1. Remove covers and exposure glass. (p.480)

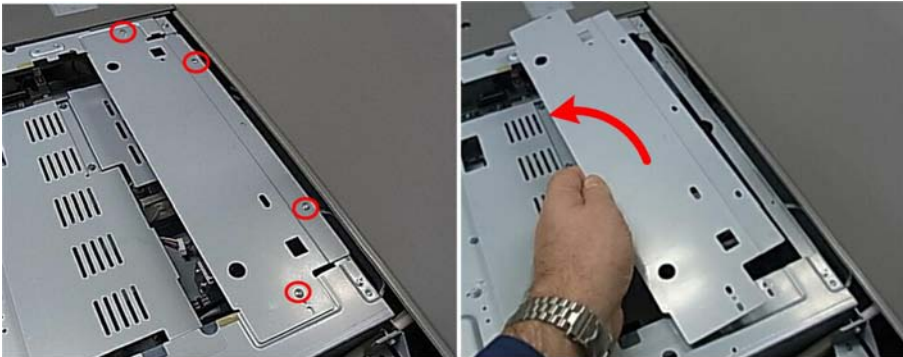

d074r804

2. Remove the right metal cover plate (x4).

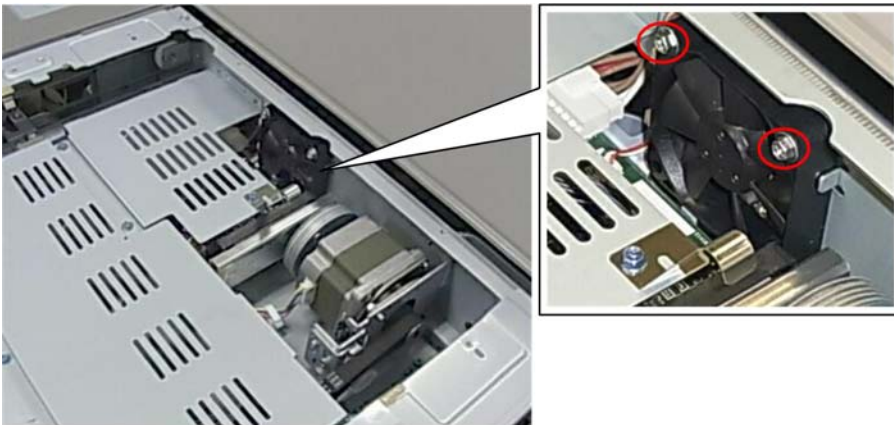

d074r805

3. Disconnect the motor ( x2).



d074r806

4. Remove the motor ( x2,  x1).

4

Lamp Regulator Board and Fan

1. Remove ARDF, covers, and exposure glass. ( p.480)



d074r807

2. At the front, disconnect the scanner unit ( x2).

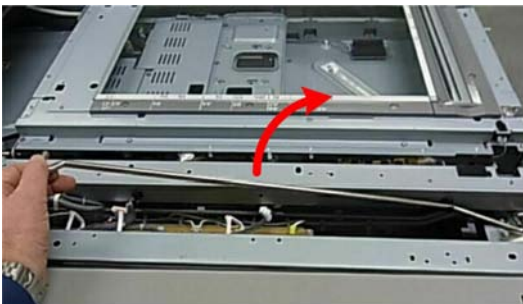

d074r808

3. At the rear, remove the scanner support arm (🔧x2).



4. Disconnect the right rear corner hinge [A] of the scanner unit (🔧x2).
5. Open the clamps and free large harness [B] (🔧x2).

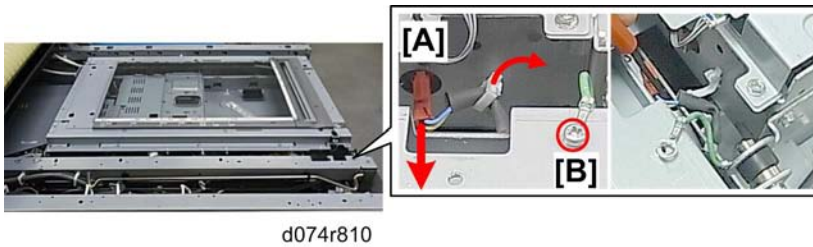

6. At the left rear corner, disconnect the scanner heater [A] (🔧x1, 🔧x1).
7. Disconnect ground wire [B] (🔧x1).

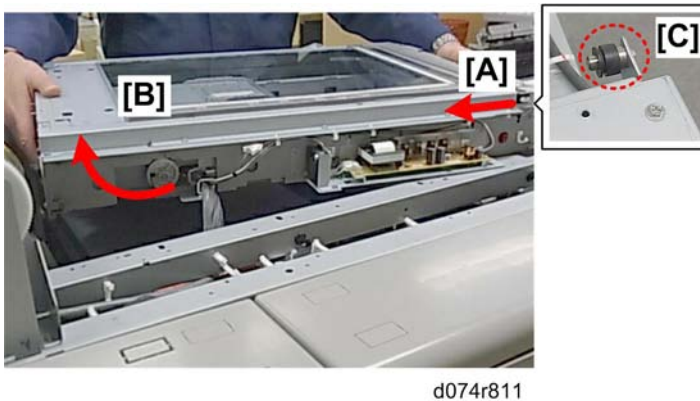

8. At the front of the machine, slowly push the scanner unit off the left hinge [A], then rotate the right side of the unit [B] slightly counter-clockwise and set it down.
9. Make sure that the rubber grommet [C] does not come off its shaft and fall down into the machine.

⬇️ **Note**

- If the rubber grommet comes off the shaft as shown above, remove it and re-attach it to the shaft of the scanner unit.

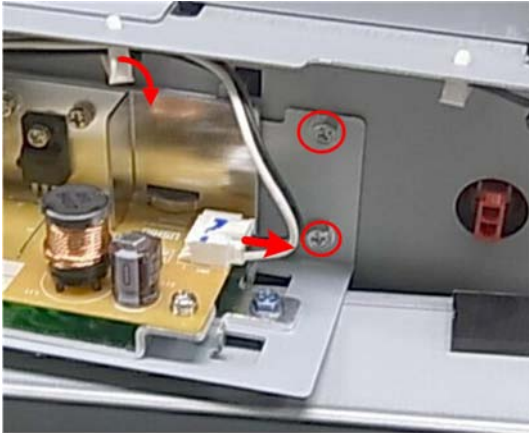

d074r812

10. At the rear, disconnect the right end of the lamp regulator board bracket (🔧 x1, 📏 x1, 🔧 x2).

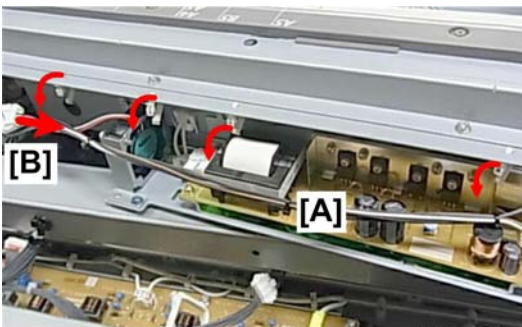

d074r813

11. Free cable harness [A] (🔧 x4).
 12. Disconnect the fan at [B] (📏 x1).

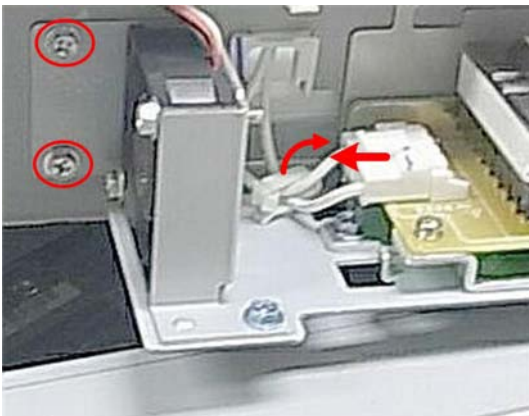

d074r814

13. Disconnect the left end of the lamp regulator board bracket (🔧 x2).



d074r815

14. Remove the lamp regulator board bracket with the board and fan attached.

4

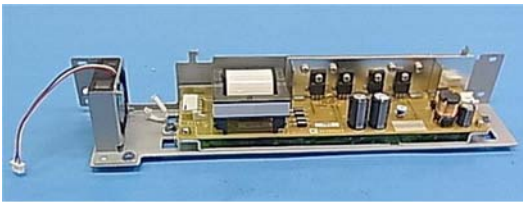

d074r816

15. Set the bracket on a flat clean surface.

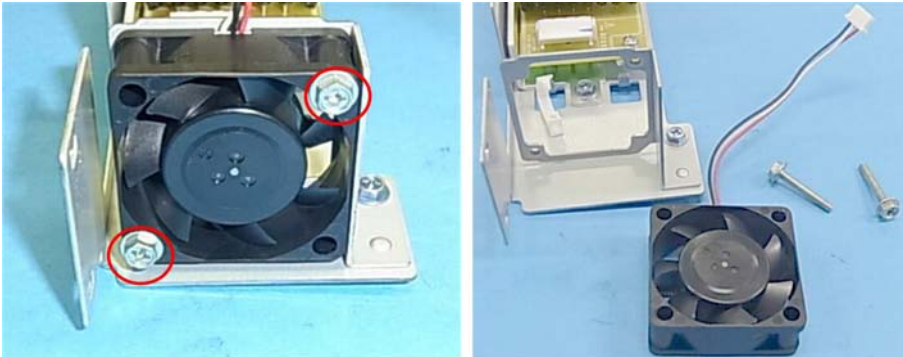

d074r817

16. Remove the lamp regulator board fan ( x2).

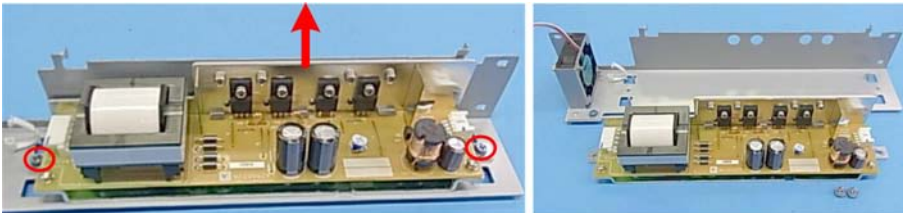

d074r818

17. Remove the lamp regulator board.

Wire Re-installation, Scanner Position Adjustment

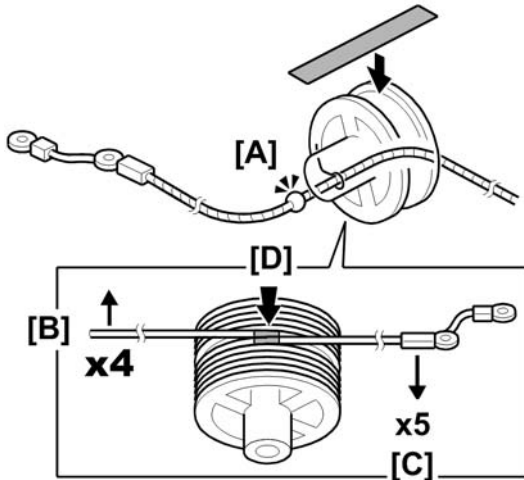

d081r136

1. Place the bead [A] on the middle of the wire on the pulley openings.
2. Wind the ball end of the wire [B] 4 times.
3. Wind the other end of the wire [C] 5 times.
4. Attach tape [D] across the pulley to temporarily hold the wires in place.

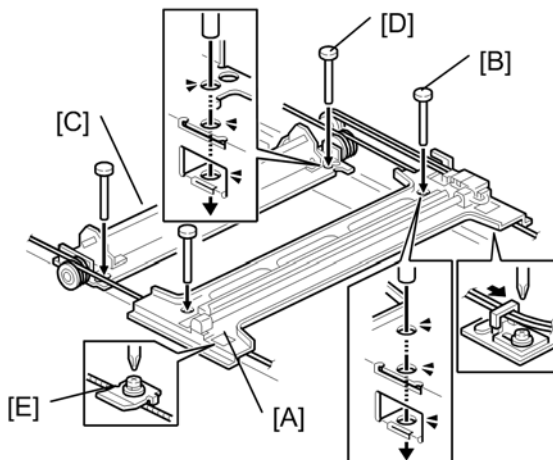

d081r138

5. Position the 1st scanner [A] so that its holes are aligned, and insert the positioning pins [B] (x4).
6. Position the 2nd scanner [C] so that its holes are aligned, and insert the positioning pins [D].
7. Attach the lock bracket [E] to fasten the wire to the 1st scanner.
8. Tighten the screw of tension bracket.

9. Attach the pulley and tighten its lock screw.
10. Remove the four positioning pins.
11. Remove the tape from the pulley.
12. Slowly push the scanner left and right to confirm that the wires are engaged correctly. The 1st and 2nd scanners should move smoothly.

Laser Unit

Laser Units

Before You Begin

WARNING

- Turn off the main power switch and unplug the machine before performing any procedure in this section. Laser beams can seriously damage the eyes and cause permanent blindness.

Important

- An accidental static discharge could damage the laser diode board attached to the lens block unit.
- Touch a metal surface to discharge any static electricity from your hands.
- The polygon motors rotate at extremely high speed and continue to rotate after the machine has been turned off.

CAUTION

- The scanner unit of the D074/D075 is very heavy and needs to be propped up with a support rod during servicing. Never remove the support rod during servicing.

There are two laser units.

- The unit on the left is for yellow and magenta (YM).
- The unit on the right is for cyan and black (CK).

The removal procedures for each machine are different.

- The D074/D075 has an ARDF that must be removed, and the scanner unit must be propped up with a support rod for servicing.
- The M044 has no ARDF or scanner unit, so removal of the laser unit is much easier.

YM Laser Unit Removal: D074/D075

1. Confirm that the machine is switched off and disconnected from the power source.
2. If the LCIT is installed, disconnect it and pull it away from the right side of the machine.

Attention Light



d074c101

4

3. Remove the attention light ( x3,  x2,  x1).

ARDF



d074c100

4. On the right side of the machine, disconnect the ARDF.



5. Raise the ARDF.
6. Remove the base screws (⌀ x2).
7. Grip the ARDF from behind, and pull it toward you to disengage the base plates from the shoulder screws on the left and right.



8. While holding the ARDF at the base, lift it off.

Plates Around the Exposure Glass

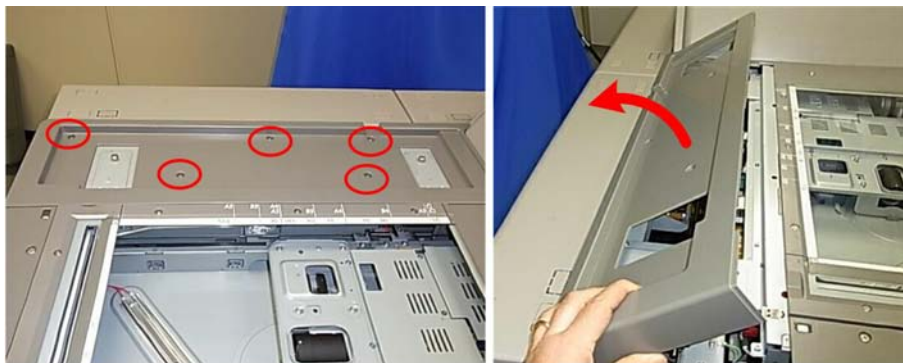

9. Remove the rear cover plate (🔩 x5).

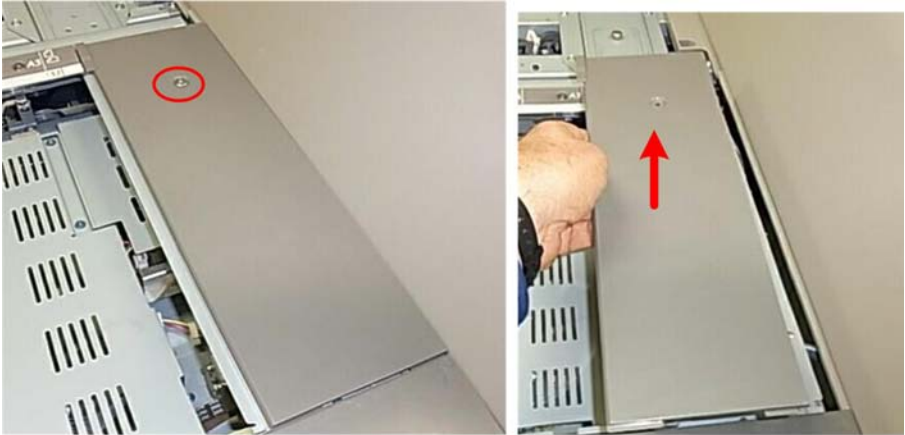

d074c105

10. Remove the right cover plate (🔩 x1).



d074c106

11. Remove the front cover plate (🔩 x3).

Note

- [1] is a larger screw.

ARDF Base Plates

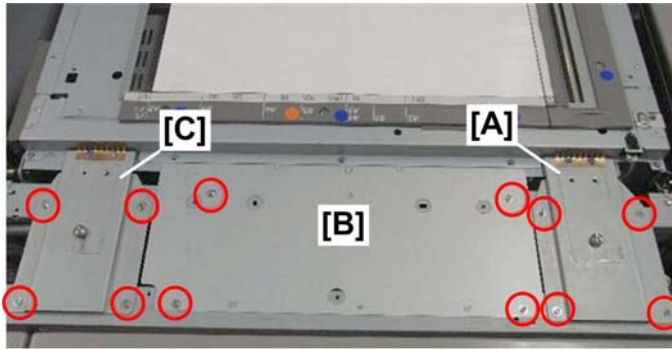

d074c107

12. Remove:

[A] ARDF base plate ( x4)[B] ARDF base plate ( x4)[C] Shield plate ( x4)

 **Note**

- It is not necessary to remove the exposure glass.

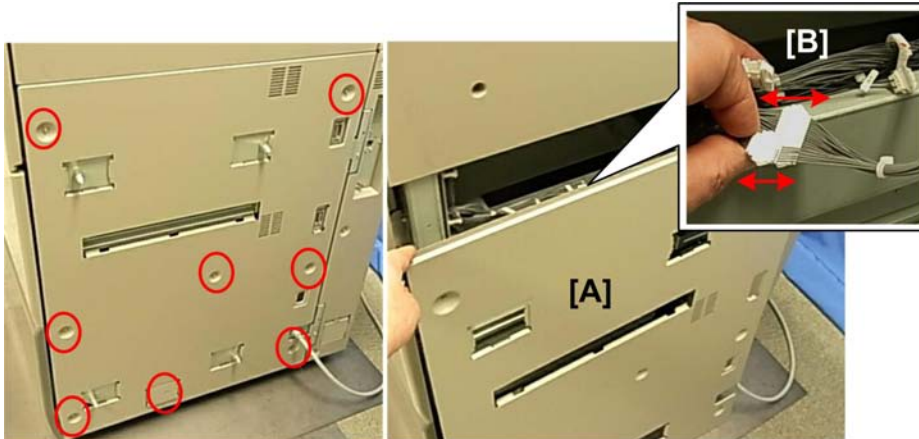
Operation Panel

d074c108

13. Remove the right cover [A] ( x7).14. Disconnect the operation panel ( x2).15. Disconnect the harness cable inside the machine ( x1).

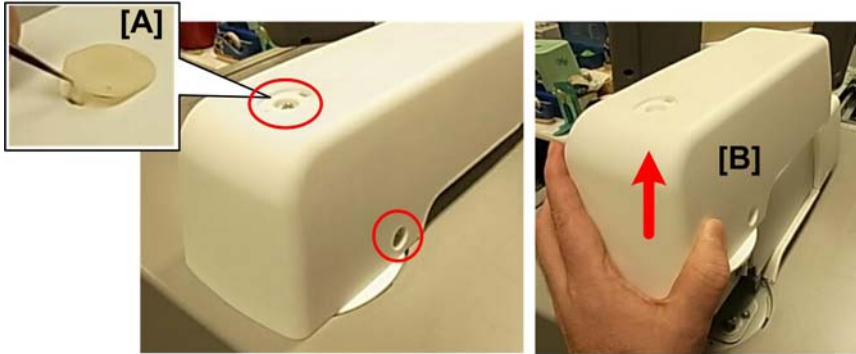

d074c109

4

- 16. Remove screw cover [A].
- 17. Remove the operation panel arm cover [B] ( x2).

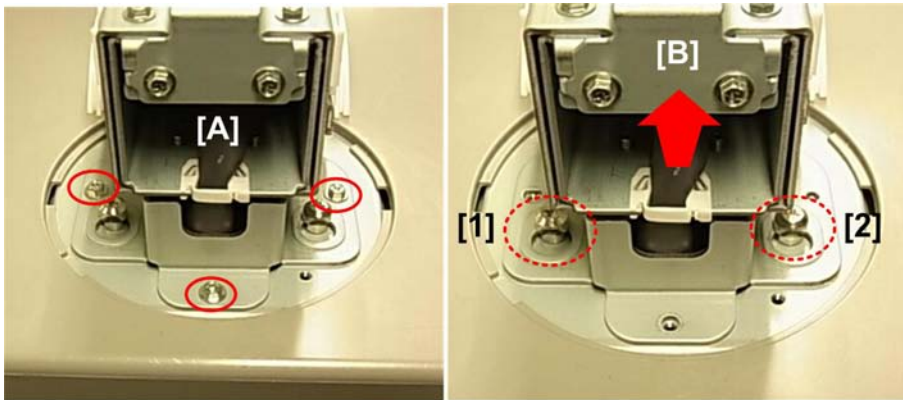

d074c110

- 18. Disconnect the operation panel arm [A] ( x3).
- 19. Push the end of the arm [B] to disengage the base plate from shoulder screws [1] and [2].



d074c111

- 20. Pull the arm off its base and pull the harness up through the plate.

- Lift the operation panel off the main machine.

Toner Bank Canopy

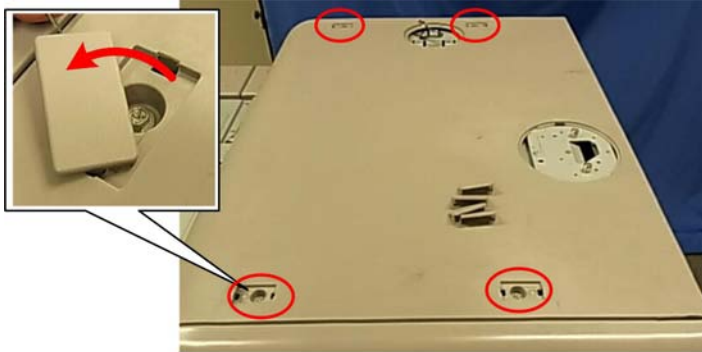

d074c112

- Remove the four screw covers from the top of the canopy, and then remove the screws ( x4).



d074c113

- On the right side of the machine, remove the canopy side screws ( x2).

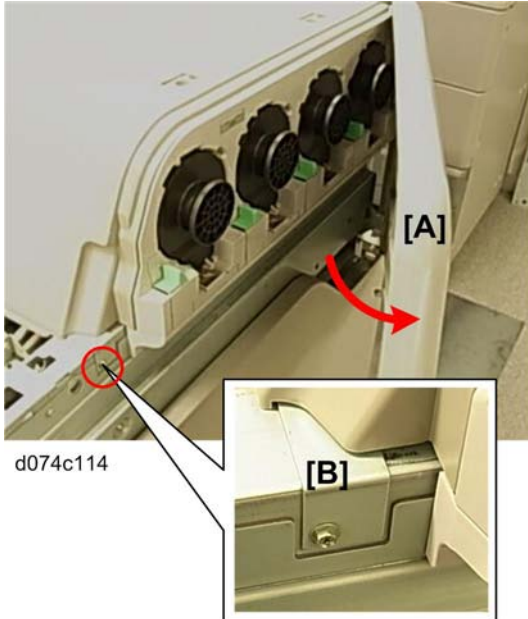

24. Open the toner bank door [A].

25. Remove screw [B] ( x1).

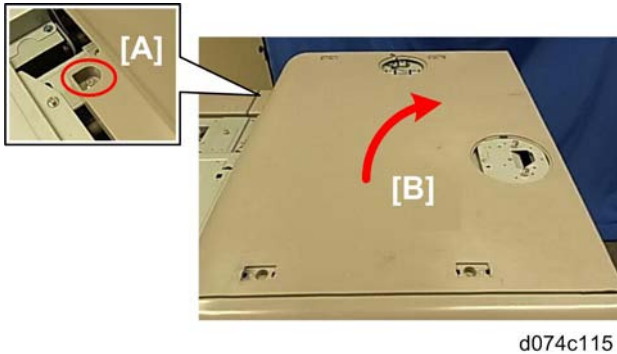

26. At the left rear corner of the canopy [A], remove the screw ( x1).

27. Remove the toner bank canopy [B].

Raising the Scanner Unit

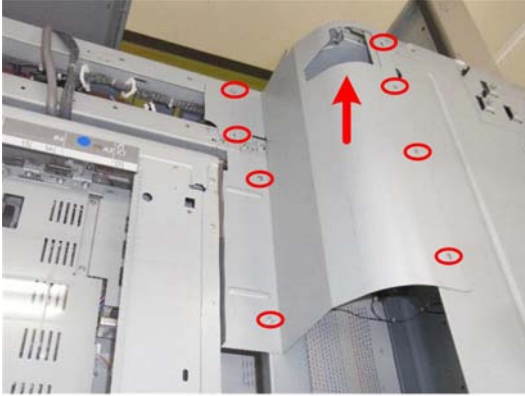

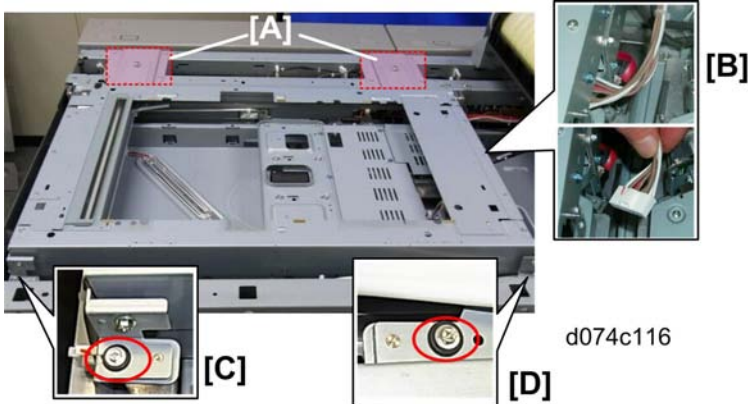

d074c115a

28. Remove the shield plate ( x8).



d074c116

29. Make sure both ARDF base plates have been removed ( x4 ea.).
30. At the front of the machine, disconnect the scanner unit at [B] ( x1).
31. Disconnect the scanner unit at [C] and [D] ( x2).



d074c117

32. At the back of the machine, behind the scanner unit, remove the scanner unit support arm.

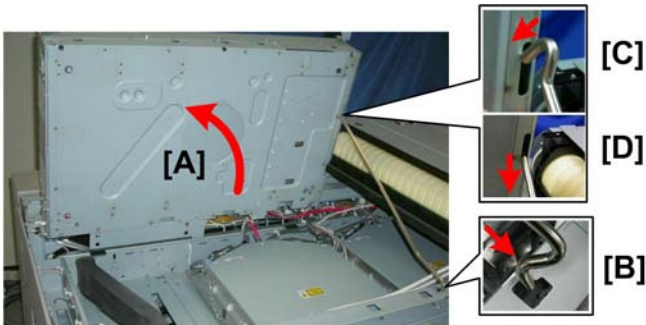

d074c118

4

33. Raise the scanner unit [A].

34. Set the base of the scanner unit support arm in hole [B].

35. Set the top of the arm in hole [C].

36. Push the top of the arm [D] down to lock it.

Removing the YM Laser Unit

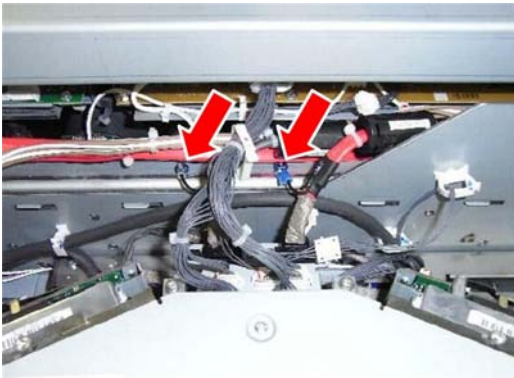

d074c118c

37. Disconnect the ground wires ( x2),



d074c119

38. At the rear, disconnect the YM laser unit (E) x6).
39. Remove the YM laser unit screws (T) x4).
40. Grip the chain handles on either side, and lift the YM laser unit out of the machine.

YM Laser Unit Removal: M044

1. Confirm that the machine is switched off and disconnected from the power source.

Rear Cover

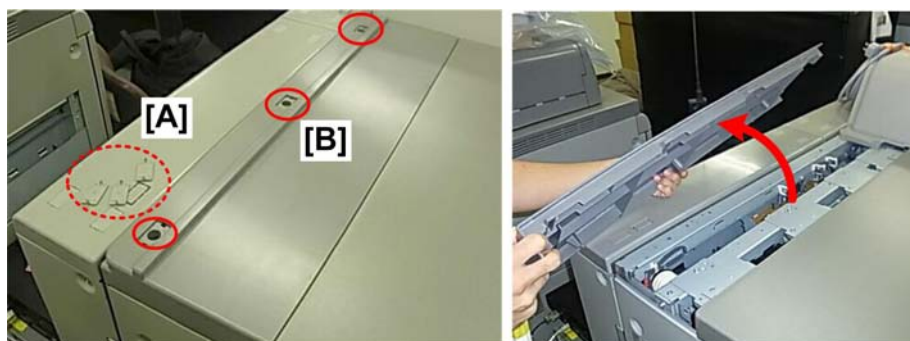

m004c001

2. Use the tip of a small screwdriver to remove the three screw hole covers [A].
3. Disconnect cover [B] and remove it (T) x3).

Center Cover

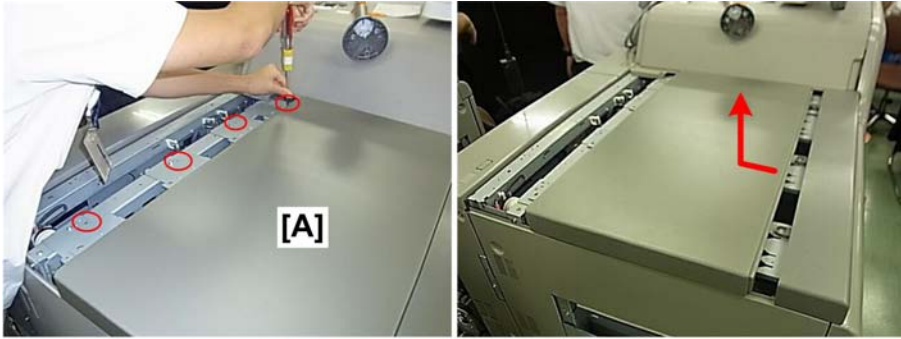

m004c002

4. Disconnect the center cover [A] and remove it ( x4).

4

Front Cover



m004c003

5. Disconnect the front cover [A] and remove it ( x3).

Metal Cover Plates

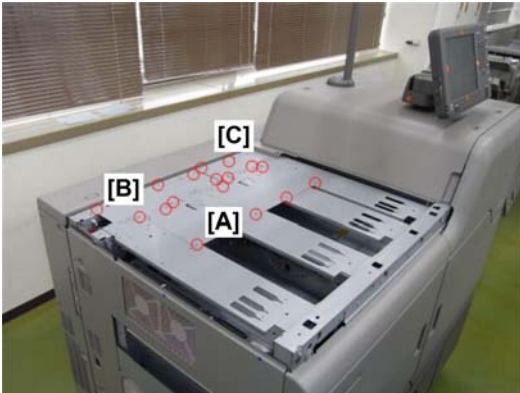

m004c003a

6. Remove metal cover plates:

[A] Plate ( x7)

[B] Plate ( x6)

[C] Plate ( x4)



m004c004

7. At the rear [A], disconnect the three metal cover plates on the right ( x3).

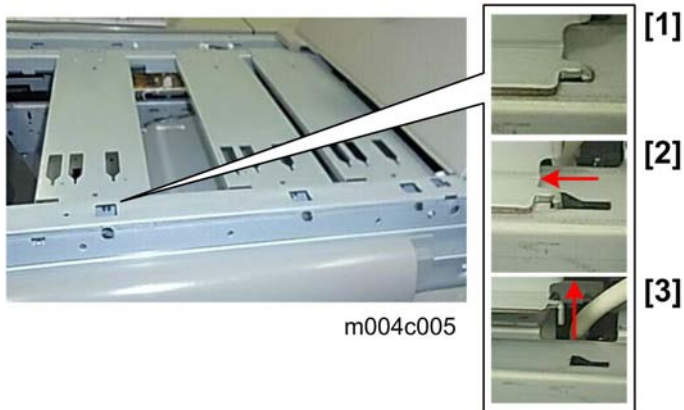

8. Each plate is fastened with a hook [1].

- Slide the plate to the left to disconnect the hook [2]
- Pull the disconnected hook out of the hole [3] and remove the plate.



m004c006

9. Remove the three plates.

Note

- Plate [A] does not need to be removed.

YM Laser Unit

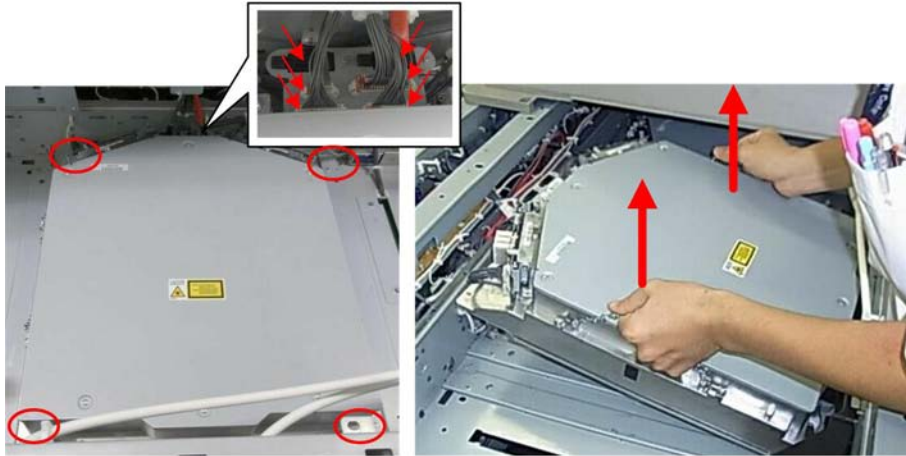

m004c007

10. At the rear, disconnect the YM laser unit (E) x6).
11. Remove the YM laser unit screws (T) x4).
12. Grip the chain handles on either side, and lift the YM laser unit out of the machine.

Removing the CK Laser Unit: D074/D075/M044

1. Confirm that the machine is switched off and disconnected from the power source.
2. Do the following:

D074/D075

- If you are removing the right laser unit from the D074/D075, do the procedure for D074/D075 YM Laser Unit removal as far as raising the scanner unit. (Raising the scanner unit is not required.)

M044

- If you are removing the right laser unit from the M044, do the procedure for M044 YM Laser Unit Removal as far as removing the three plastic covers. (The three metal covers do not need to be removed.)

Toner Bank Door

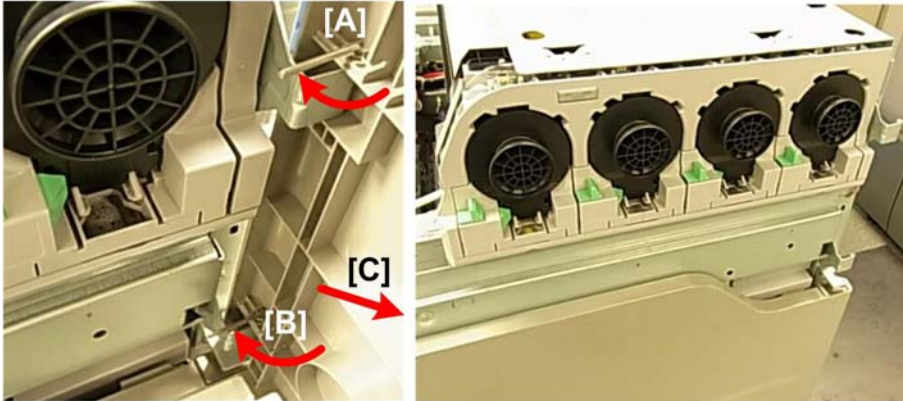

d074c120

3. To remove the toner bank door:

- Swing out the "L" pin of hinge [A].
- Swing out the "L" pin of hinge [B].
- Remove both "L" pins.
- Remove the door [C].

Toner Bank Cover Plate

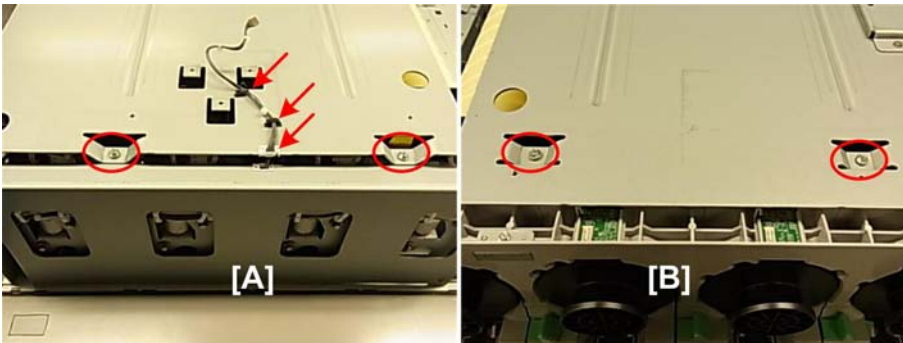

d074c121

4. At the rear [A], disconnect the attention light harness (🔌x3).
5. Disconnect the toner bank plate (🔧x2).
6. At the front [B], disconnect the toner bank plate (🔧x2).



d074c122

4

7. Remove the toner bank plate.

Toner Bottles

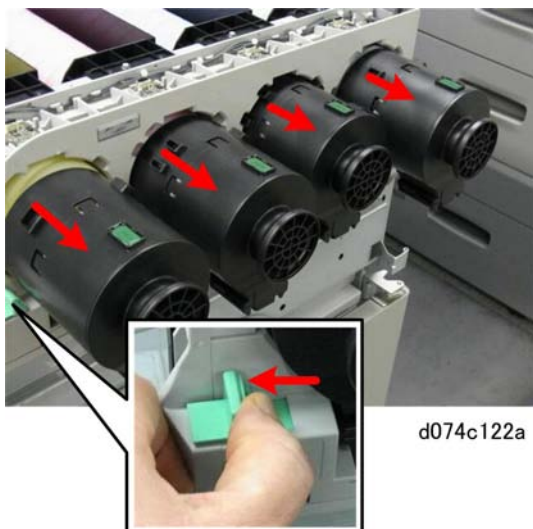



d074c122a

8. Push each lever to unlock each toner bottle and remove all the toner bottles.

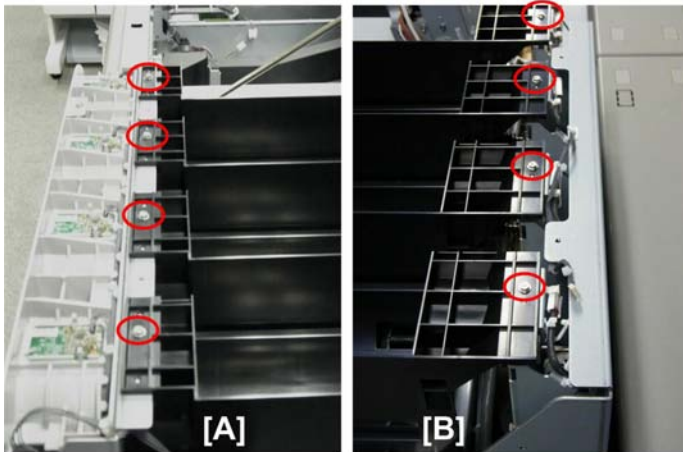
Toner Bottle Cradles



d074c123

9. At the front [A], disconnect the toner bottle cradles ( x4).
10. At the rear [B], disconnect the toner bottle cradles ( x4).

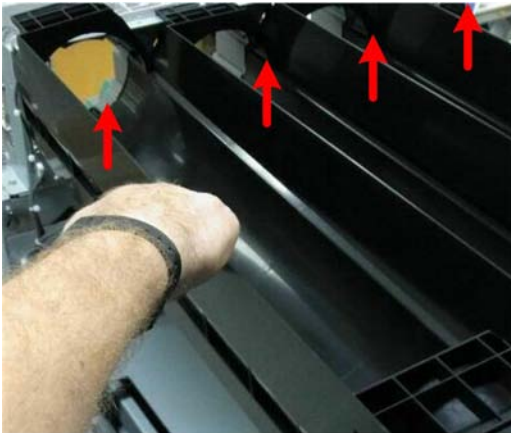

D074c123a

11. Remove the four toner bottle cradles.

 **Note**

- The cradles are identical. They can be re-installed at any position.

CK Laser Unit

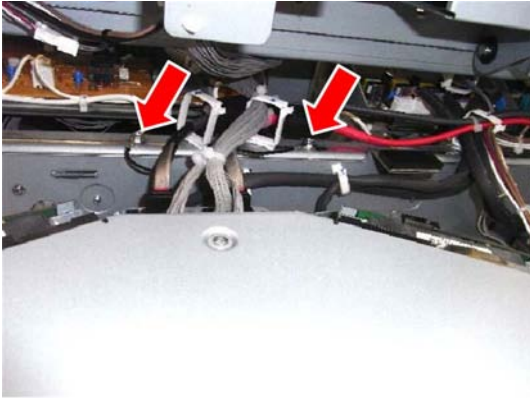



d074c118d

4

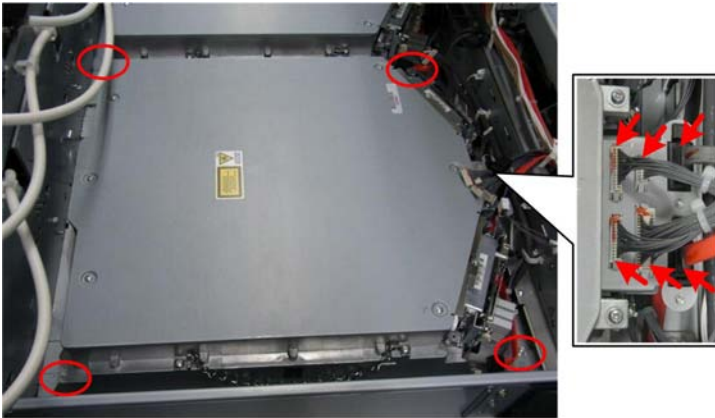
- 12. Disconnect the two ground wires ( x2).



d074c124

- 13. At the rear, disconnect the CK laser unit ( x6).
- 14. Remove the CK laser unit screws ( x4).

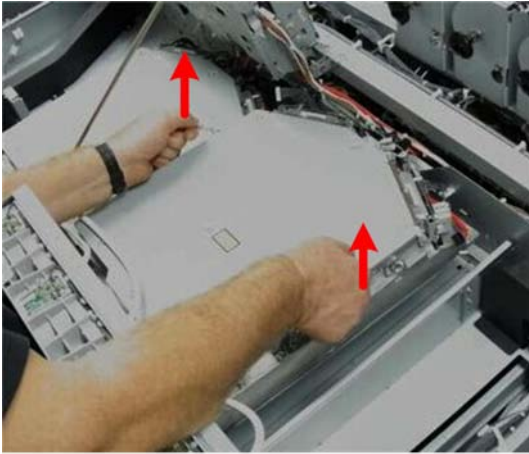

d074c125

15. Grip the chain handles on either side, and lift the CK laser unit out of the machine.

4

Re-installation (D074, D075, M044)

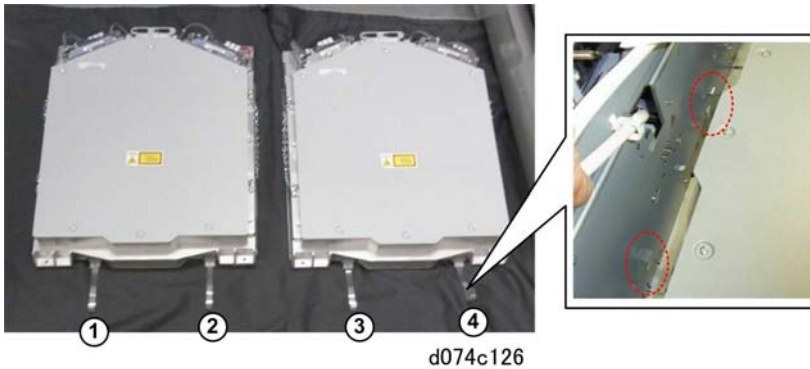

d074c126

1. There are two mylars attached to each laser unit. After you re-install a laser unit, confirm that both these mylars are visible and pointing up at the bottom of the laser unit..

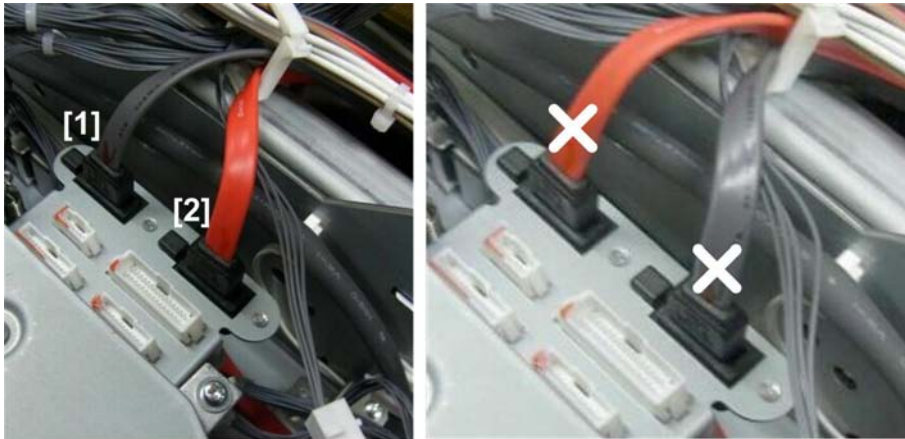

d074c127

2. When you re-connect a laser unit, confirm that the rear cables are connected correctly. The gray cable [1] must be connected on the left, and the red cable [2] must be connected on the right.

★ Important

- The cable connectors have identical shapes. Do not reverse them when you re-connect a laser unit.
- This rule applies to both laser units (gray on the left, red on the right).



d074c127a

The illustration on the right shows how reversing the connection of the rear cables can adversely affect image reproduction.

SP Adjustments After Laser Unit Replacement

After the laser unit is replaced, two SP codes must be executed: SP2108-1 for the CK LD unit and SP2108-2 for the YM LD unit. These SP codes set the operation parameters for the laser unit (main scan registration, main scan magnification, shading, and bow skew adjustment).

1. Enter the SP mode.
2. Execute the SP codes in the table below.

No.	Name
SP2108-1	Image Parameter - K/C Writing Unit
SP2108-2	Image Parameter - Y/M Writing Unit

↓ **Note**

- SP codes are written on an A5-size sheet of paper provided with the laser unit.

Toner Shield Glass

1. Remove the PCDU. (p.547)



d074r782

2. Remove cover plate [A] (x1).



d074r783

3. Pull the shield straight out of the machine.

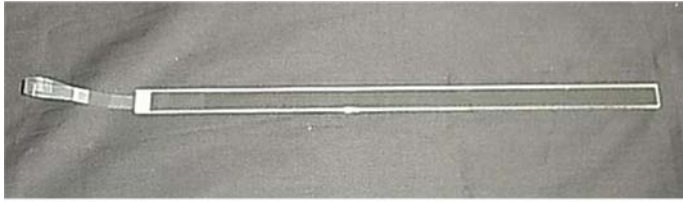

d074r784

Toner Supply

Toner Bottle Port Cleaning

1. Open the toner bank door.



d074r081

2. Remove all the toner bottles.
 - Push each lock lever [1] to the left. The bottle will pop out.
 - Grasp the bottle by its knob handle [2] and remove the bottle.

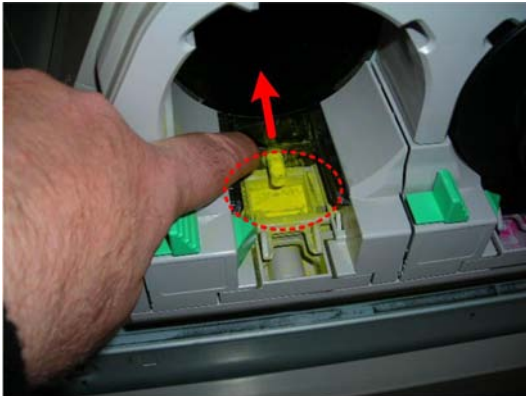

d074r082

3. At the bottom edge of each toner bottle cradle, push back the spring-loaded nozzle cover to expose the plunger.
4. Use a vacuum cleaner to pull away loose toner.

★ Important

- To avoid toner scattering, never use a blower brush to clean these areas.

Toner Supply Unit Removal

What You Need...



d074r060

- You will need a large damp cloth and a clamp when you disconnect the toner hose from the toner sub hopper.
- Spread some clean paper on a flat surface where you can set the PCDU after it has been removed.
- Spread some paper on a flat surface to catch scattered toner.

Covers

1. Confirm that the machine is switched off and disconnected from the power source.

D074/D075



d074r061

1. Remove the "L" cover [A] (🔧x3).

M044

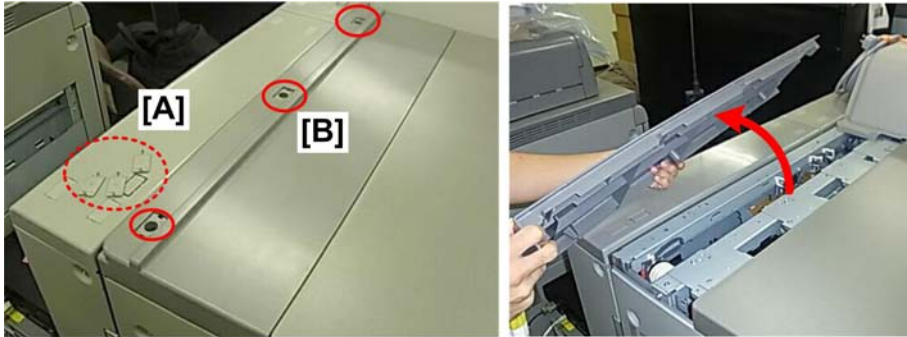

m004c001

1. Use the tip of a small screwdriver to remove the three screw hole covers [A].
2. Disconnect cover [B] and remove it ( x3).

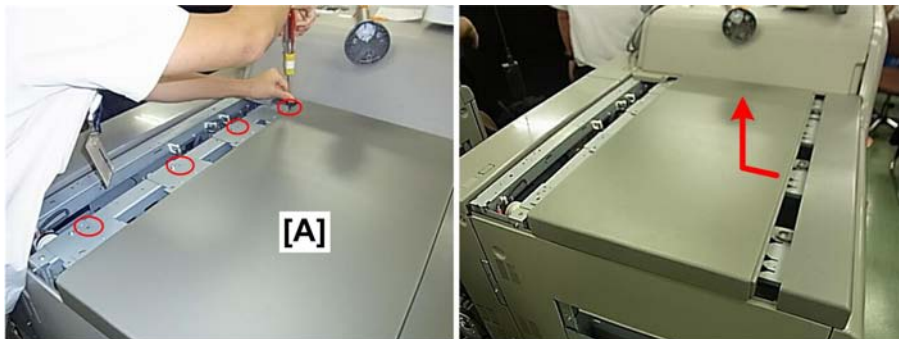

m004c002

3. Disconnect center cover [A] and remove it ( x4).



m004c003

D074/D075/M044 Continued

1. Disconnect front cover [A] and remove it ( x3).

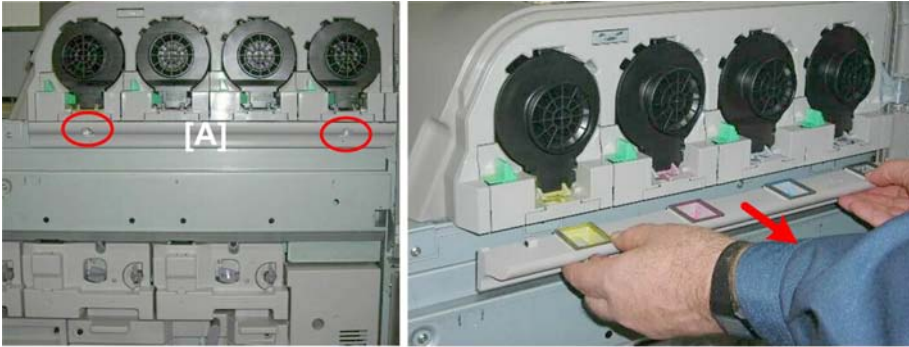

d074r062

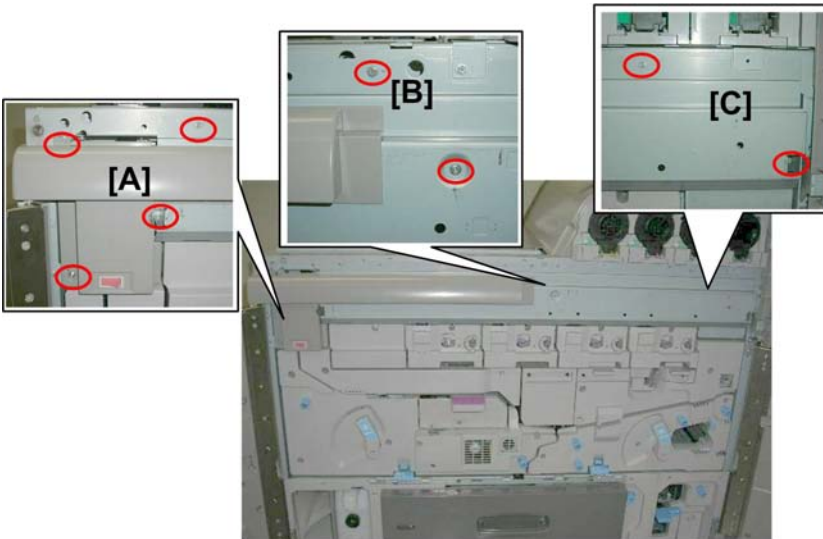

4

2. Remove the toner port tray [A] ( x2).



m044r063

3. Disconnect the toner supply unit cover:

- [A] Left end ( x4)
- [B] Center ( x2)
- [C] Right end ( x2)

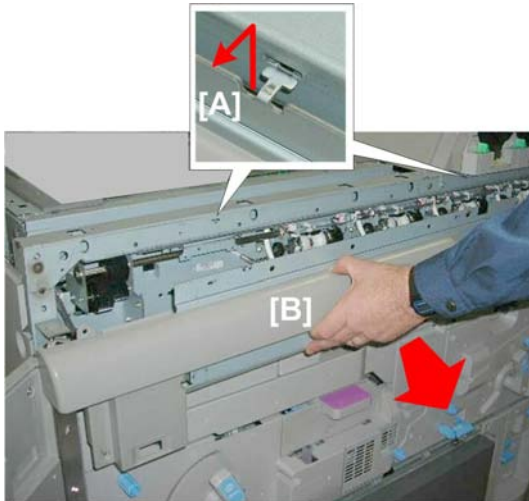

m044r064

4. Lift the cover up [A] and then pull it toward you [B] to remove it.

PCDU



d074r068

↓ Note

- There is a toner supply unit above each PCDU. To work on a toner supply unit, the PCDU below must be removed.

1. Depress the PCDU lock lever [A] and pull the PCDU out slowly until it stops.
2. Remove lock screw [B] ( x1).
3. Lift the PCDU [C] off the rails, and then lay the PCDU on the prepared surface.

★ Important

- Place the PCDU upright on a flat clean surface.
- There is only a small gap between the surface of the drum and the table surface so the surface must be smooth, flat, and clean.
- To avoid damage to the surface of the drum, never place the PCDU on a carpet or rough cloth.

4. Push the PCDU rails into the machine.

Supply Unit

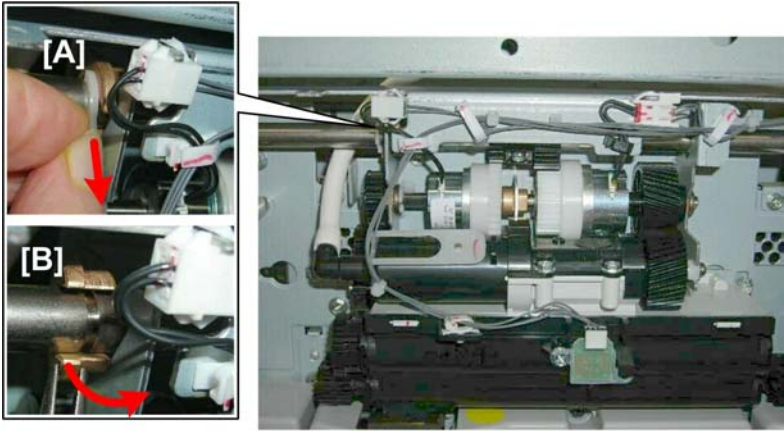

d074r065

1. At the upper left corner of the toner supply unit, disconnect the unit from the toner supply motor drive shaft:

[A] Snap ring ( x1)

[B] Bushing ( x1)

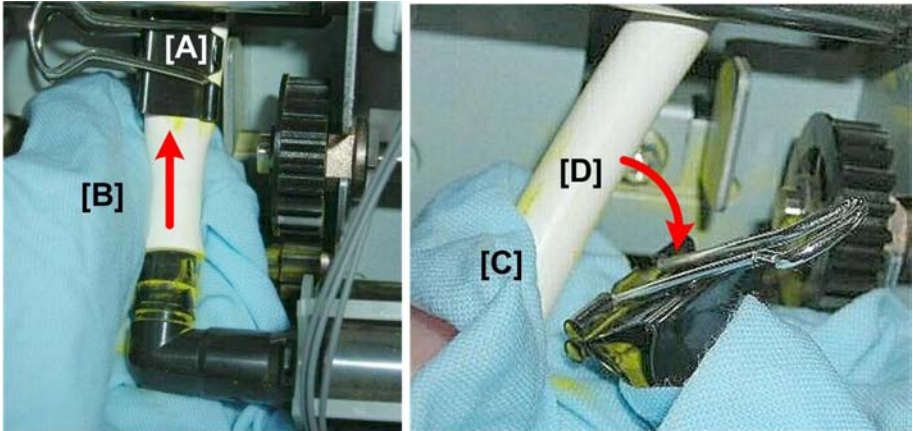

d074r066

2. Attach a clip at [A] to clamp the toner supply tube.
3. Wrap the hose connection with a damp cloth [B] and very slowly pull the tube off the nozzle.
4. While holding the cloth over the mouth of the tube [C], remove the clip [D].

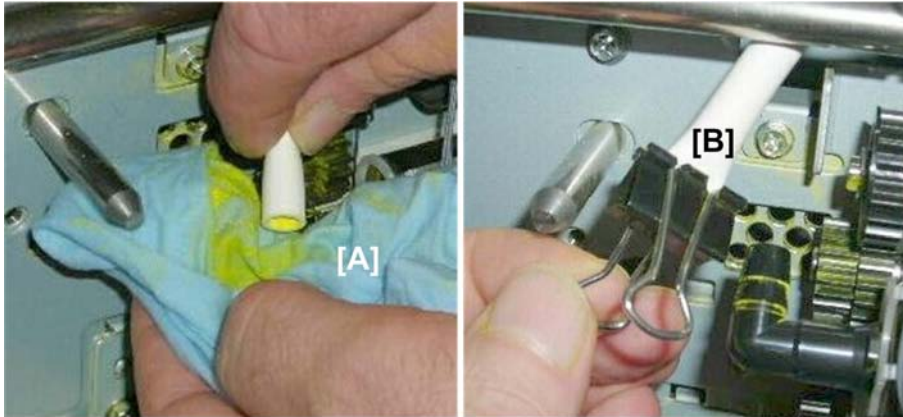

d074r067

5. Slowly and very carefully tap the open mouth of the tube [A] until toner stops flowing.
6. Re-attach the clip [B] to close the mouth of the hose.

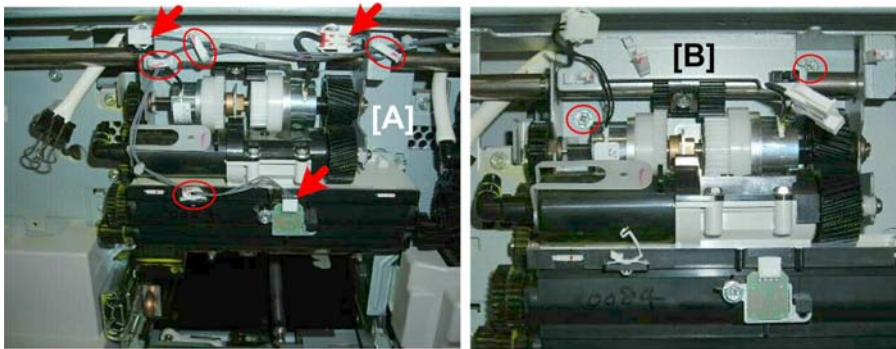

d074r069

7. Disconnect the supply unit:
 - [A] Connectors and harnesses (🔌 x4, 📡 x3).
 - [B] Top of the bracket (🔩 x2)



d074r070

8. Disconnect the bottom of the bracket [A] (🔩 x1).

9. Lift the unit [B] off its hooks and remove it.

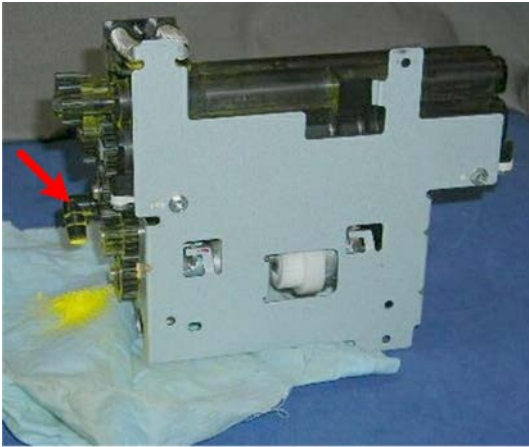

d074r071

10. Set the toner supply unit on some paper or waste cloth.
11. Tap the nozzle of the sub hopper nozzle until no more toner comes out.

★ Important

- Before servicing the unit, taping or plugging the nozzle is recommended to prevent toner scattering from the open nozzle.

Re-installation

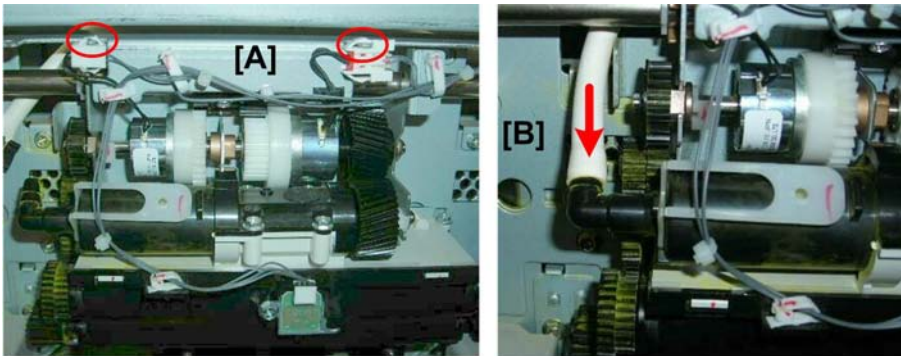

d074r080

- Be sure to re-set the harness connectors [A] on their pegs.
- Confirm that the connection of the toner supply tube [B] and sub hopper nozzle is straight and tight.

Toner Supply Clutch

1. Remove the toner supply unit. (p.518)

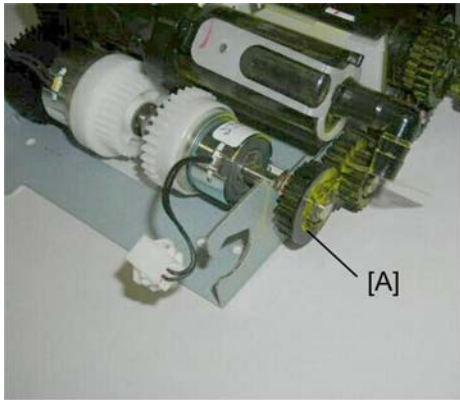

d074r072

2. Remove drive gear [A] (Ⓒ x1).

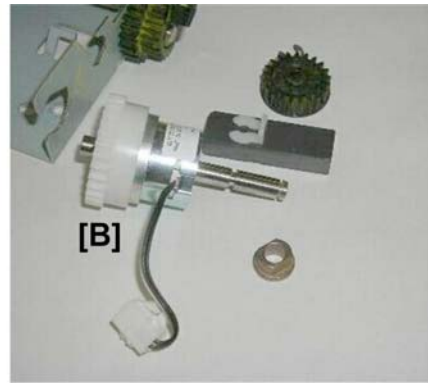
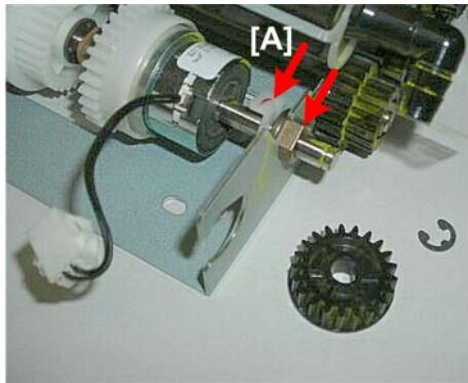

d074r073

3. Disconnect shaft [A] (Ⓓ x1, ■ x1).
4. Remove the toner supply clutch [B].

Re-installation

4

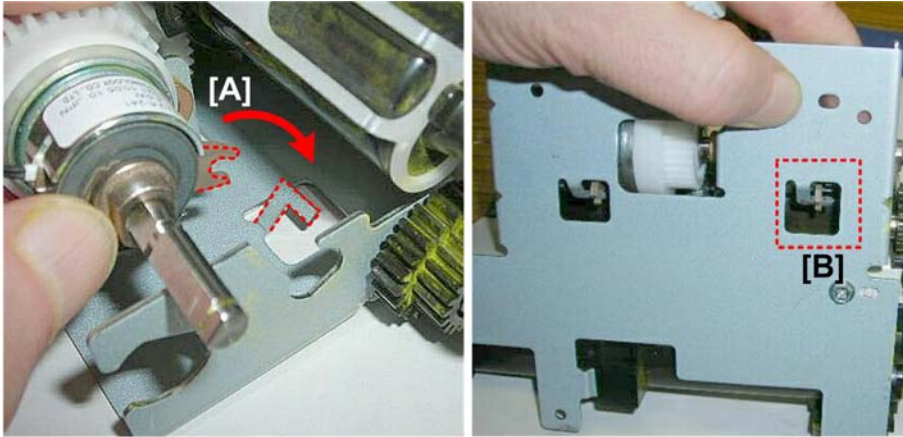

d074r074

- Make sure that the lock arm [A] of the clutch engages the pawl.
- On the other side of the unit, you can look through the cut-out [B] to confirm that the lock arm and pawl are engaged.

Toner Pump Clutch

1. Remove the toner supply unit. (▶ p.518)
2. Remove the toner supply clutch. (▶ p.524)

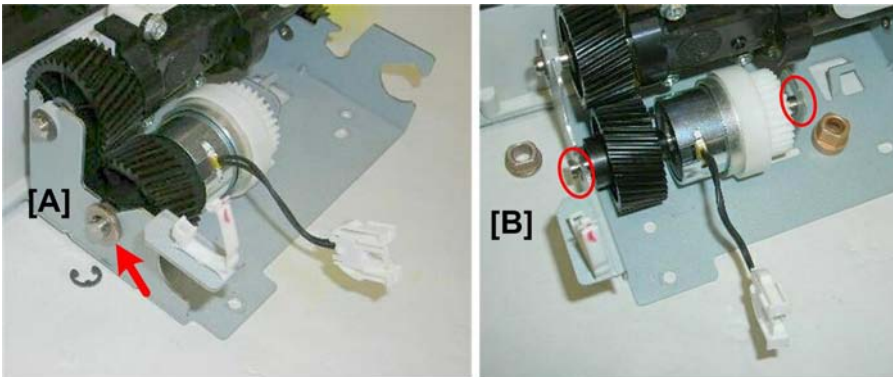

d074r075

3. Disconnect the shaft [A] (⊙ x1).
4. Release both ends of the shaft [B] (■ x2).



d074r076

- Remove the toner pump clutch.

Re-installation

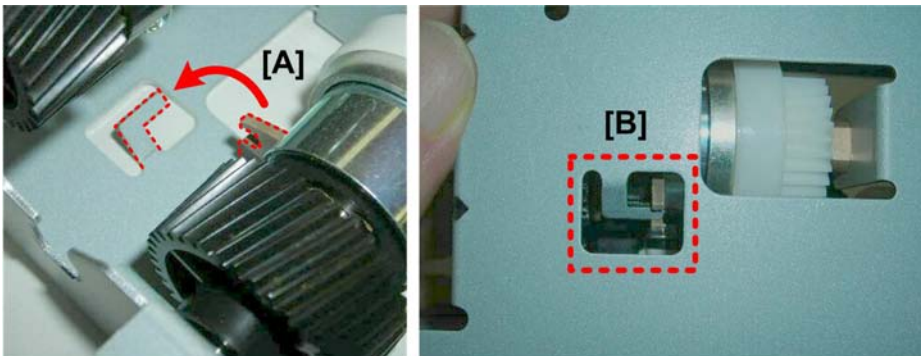



d074r077

- Make sure that the lock arm [A] of the clutch engages the pawl.
- On the other side of the unit, you can look through the cut-out [B] to confirm that the lock arm and pawl are engaged.

Toner End Sensor

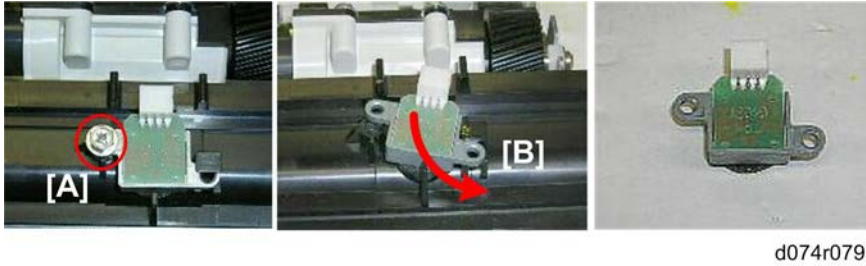
- Remove the toner supply unit. (p.518)



2. Disconnect the toner end sensor [A] ( x1).
3. Twist the sensor [B] slightly to the right (counter-clockwise) and remove it.

★ Important

- Do not touch the rear surface of the toner end sensor.
- To avoid damaging the sensitivity of the sensor, handle it carefully during removal.

4

RFID Boards, RFID CPU

RFID Boards

1. Remove the canopy cover and toner bank cover plate. ( p.415)

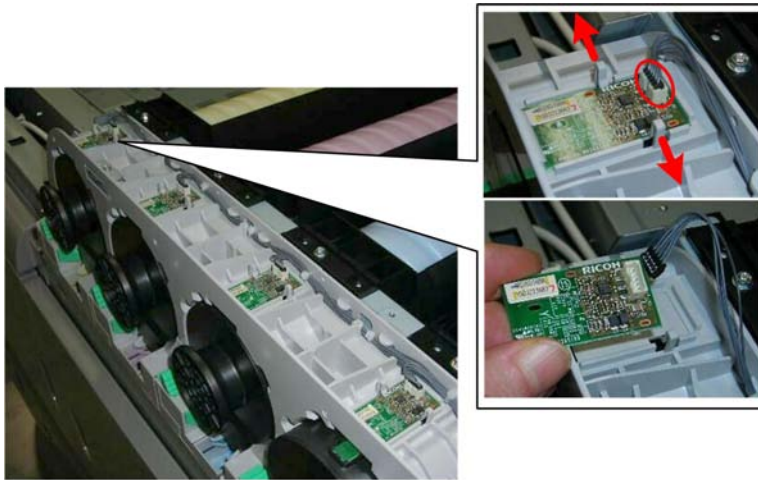

d074r083

2. Remove the RFID board ( x2,  x1).

RFID CPU

1. Remove: ( p.415)

- Canopy cover
- Toner bank cover plate
- Toner bottles and toner bottle cradles



d074r084

The RFID CPU is behind the plate on the right side of the toner bank faceplate.

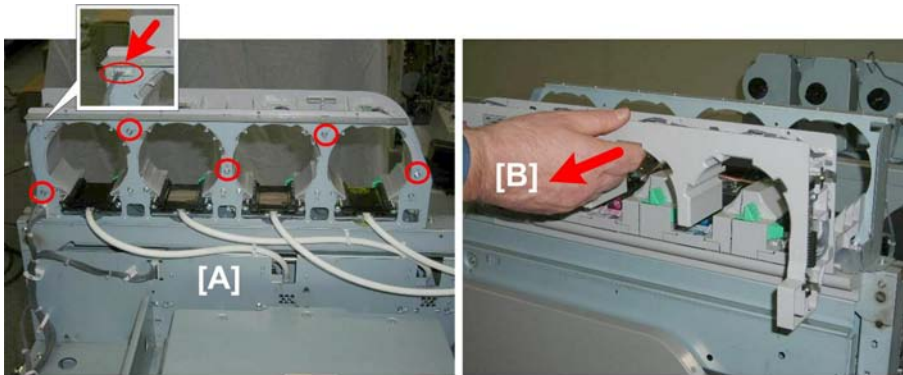

d074r085

2. From the rear [A], disconnect the toner bottle frame (🔌 x1, 🛠️ x5).
3. Remove the frame [B].

4

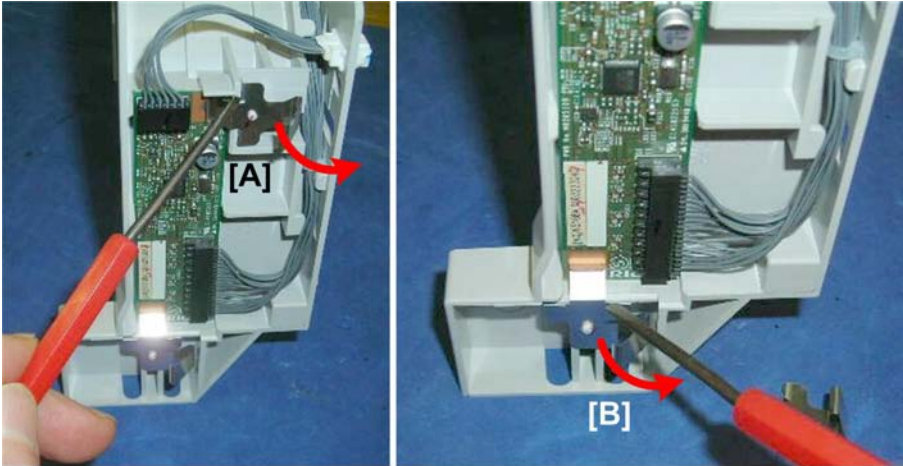

d074r086

4. Disconnect leaf springs [A] and [B].

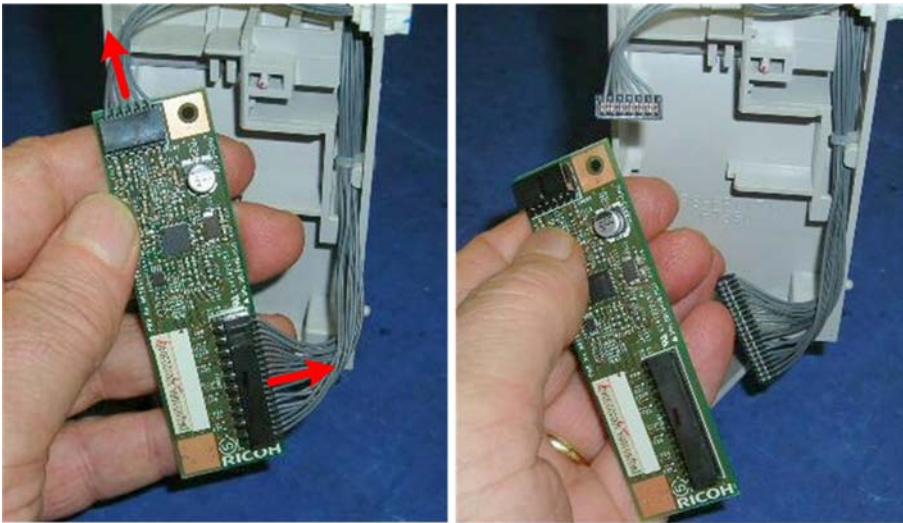

d074r087

5. Remove the RFID CPU and disconnect it (E) x2).

Toner Bottle Motors

1. Remove: (I) p.415)
 - Canopy cover
 - Toner bank cover plate

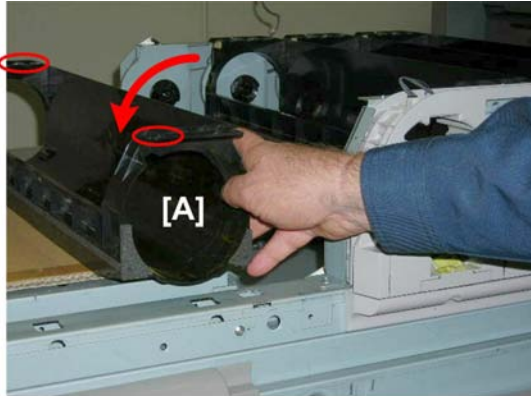

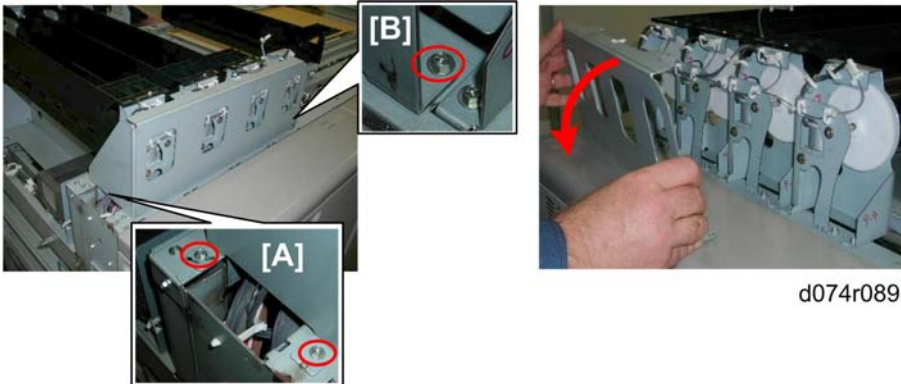

d074r088

2. Remove the toner bottle cradle [A] for the motor to be removed.



d074r089

3. Disconnect the toner bottle motor plate:
[A] Right side ( x2)
[B] Left side ( x1)
4. Remove the plate.

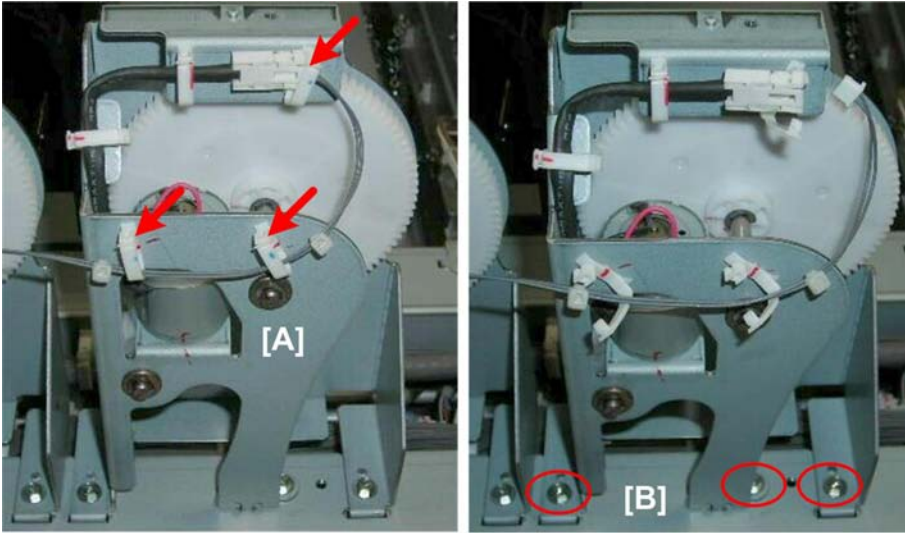

d074r090

5. Disconnect the motor mount:
- [A] Harness [🔌x2, 📦x1]
 - [B] Base (🔩x3)

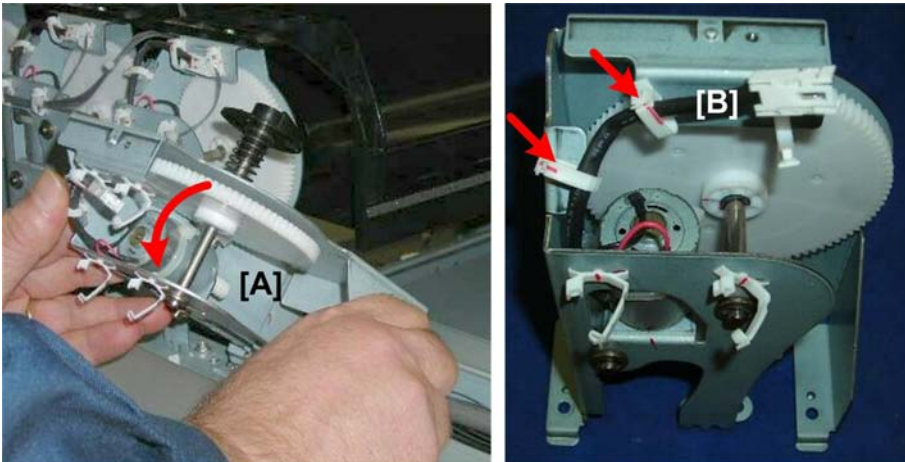

d074r091

6. Rotate the motor mount [A] toward you and remove it.
7. Set the motor mount upright on a flat surface.
8. Release harness [B] (🔌x2).



d074r092

4

9. Disconnect:

[A] Rear end of shaft (Ⓢ x1, ■ x1)

[B] Front end of shaft (Ⓢ x1, ■ x1)

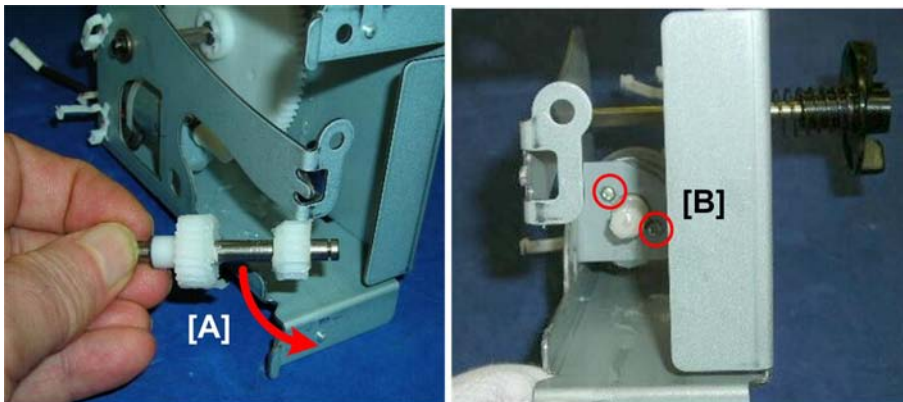

d074r093

10. Remove the drive shaft [A].

11. Disconnect the motor [B] (⚙ x2).

4

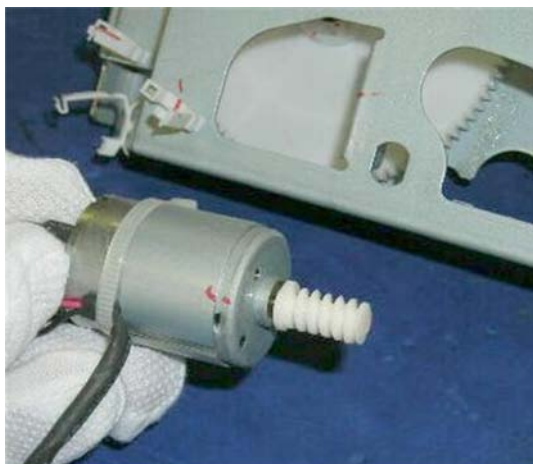

d074r094

12. Remove the toner bottle motor.

Toner Supply Motor

Before You Begin...



d074r095

The toner supply motor is on the left front corner of the machine. To access this motor, you must remove:

- Left top cover.
- Left cover.

Toner Supply Motor

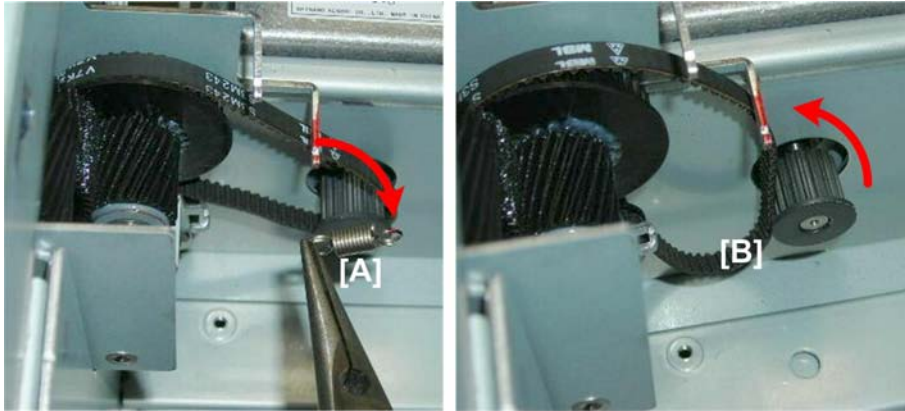

d074r096

1. Inside the left front corner, disconnect spring [A] (🔧 x1).
2. Disconnect the motor drive shaft [B] (⚙️ x1).

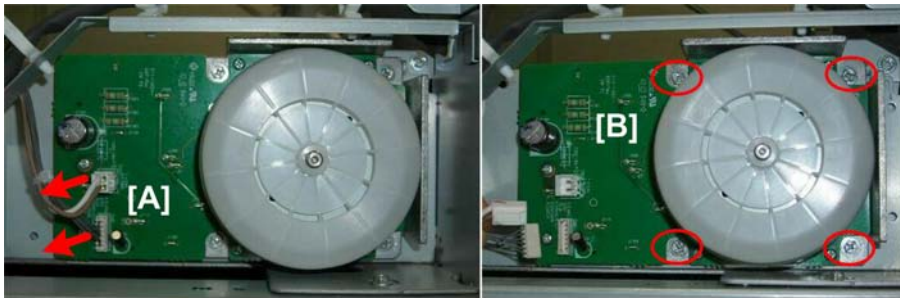

d074r097

3. Outside the front left corner, disconnect the harnesses [A] (🔌 x2).
4. Disconnect the motor [B] (🔧 x4).



d074r098

5. Remove the motor.

Used Toner Collection

Used Toner Bottle

4



d074r489

1. The used toner bottle is located at the lower left corner of the main machine behind the left door. Just pull it out by its handle.



d074r499

2. The cap of the used toner bottle has a reverse thread. Turn it clockwise to remove it.

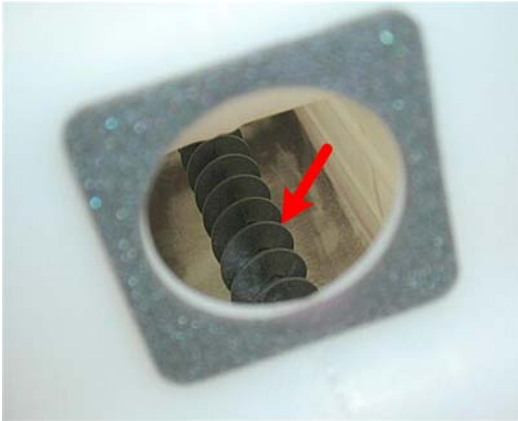

d074r986

4

3. After emptying the used toner bottle, check the auger inside the bottle and make sure that there are no clumps of used toner sticking to the auger.
4. If you see any clumping on the auger, gently tap the sides of the bottle to shake them loose, then empty the bottle again.

Used Toner Transport Motor, Sensor, Timing Belt

Transport Motor

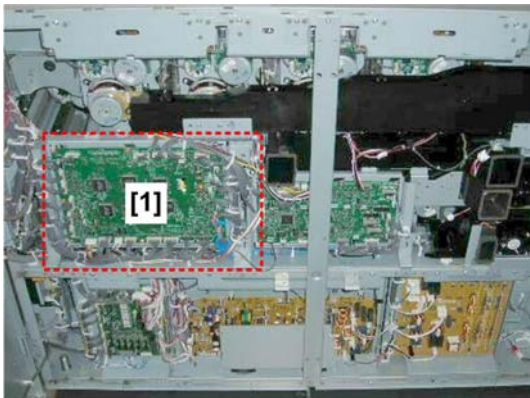

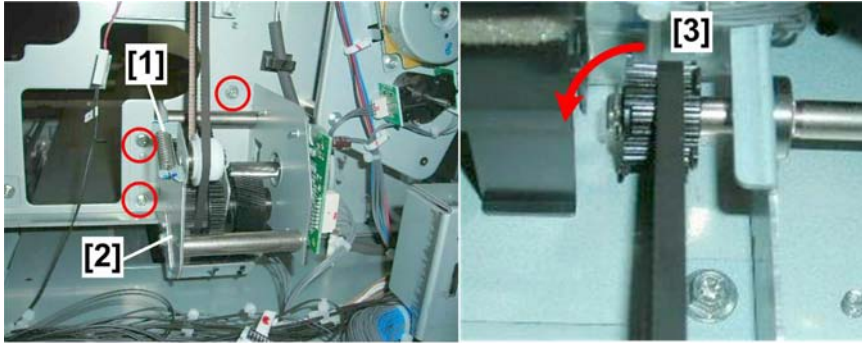

d074r470

1. Remove the IOB. (p.830)



d074r471

4

2. Remove the spring [1] ( x1).
3. Disconnect the motor assembly [2] ( x4).
4. At the top [3], slide the timing belt off the gear.
5. Remove the motor with the timing belt.

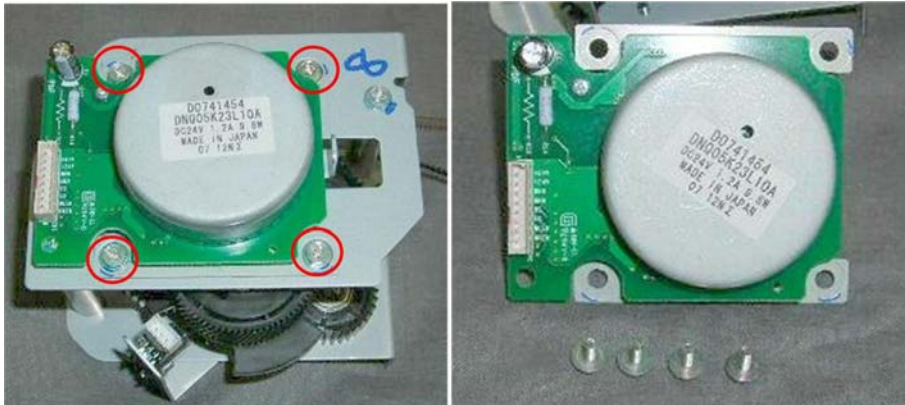



d074r472

6. Remove the motor from the assembly ( x4).

Used Toner Transport Motor Sensor



d074r473

1. Remove the sensor assembly [1] ( x1).
2. Remove the sensor [2] ( x3).

Timing Belt

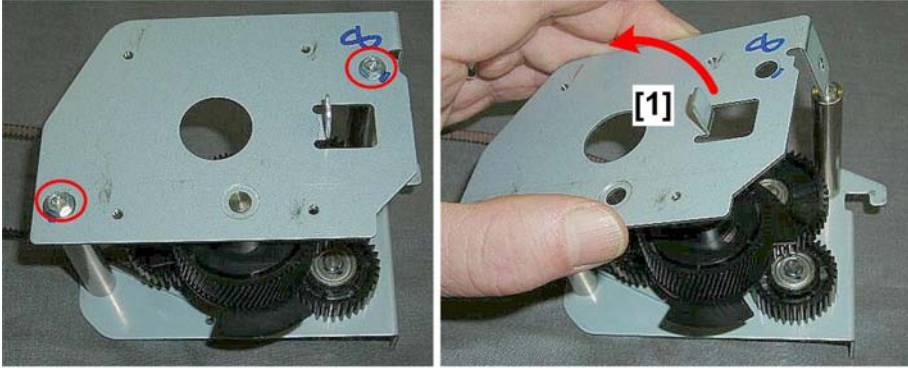

d074r474

1. Remove the assembly [1] ( x2).

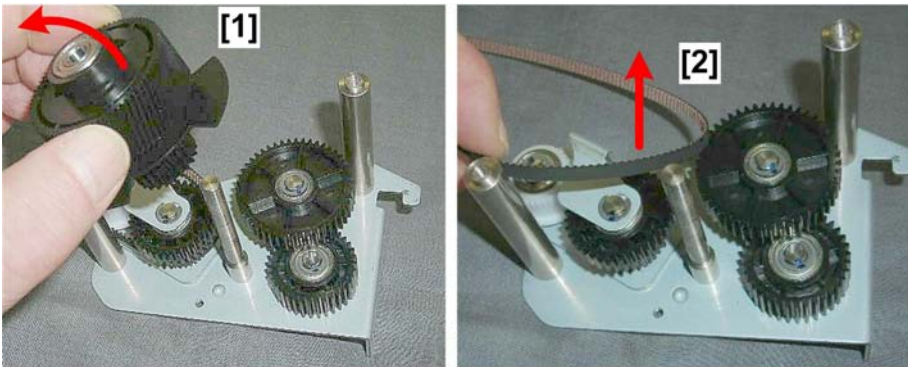

d074r475

2. Remove the actuator gear [1].
3. Remove the timing belt [2].

Used Toner Bottle Motor

4

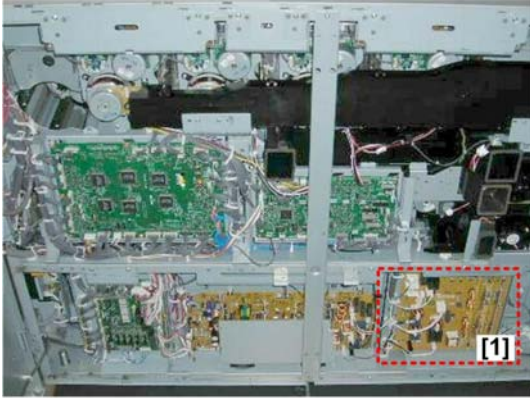

d074r476

1. Remove the used toner bottle at the front of the machine.
2. Remove the AC drive board [1]. (🔧 p.814)

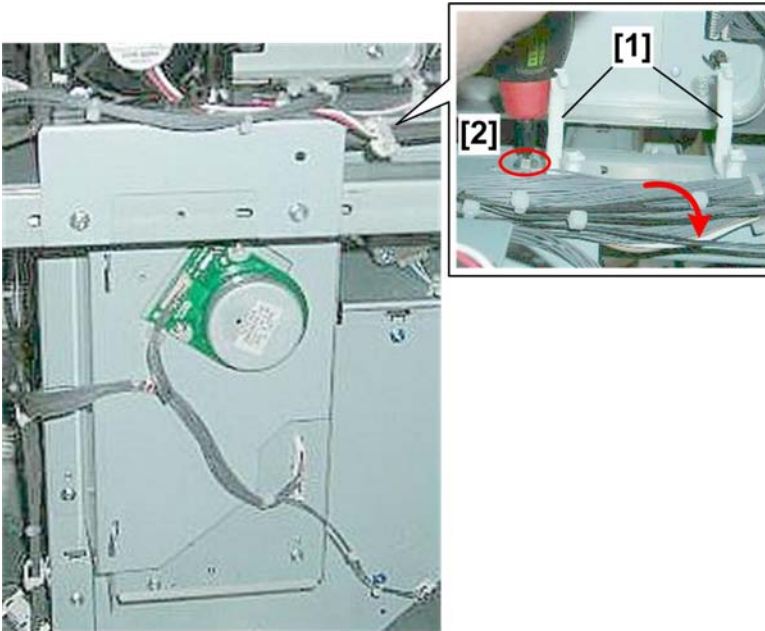

d074r477

3. Open the two large clamps [1] and take out the harness, so that you can see the screw (🔩 x2).
4. Remove the screw [2] (🔩 x1). You will need a short screwdriver to remove this screw.

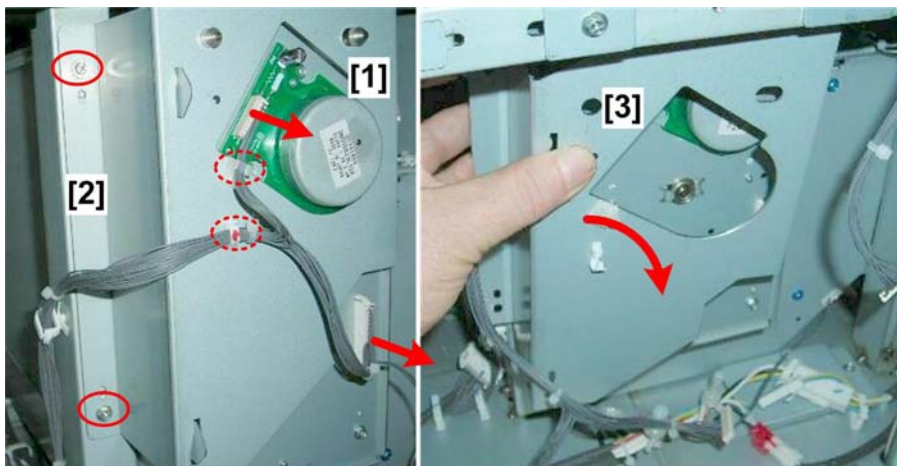

d074r478

5. Disconnect the motor [1] (🔧x2, 📏x2).
6. Disconnect the plate [2] (🔧x2).
7. Remove the plate [3].

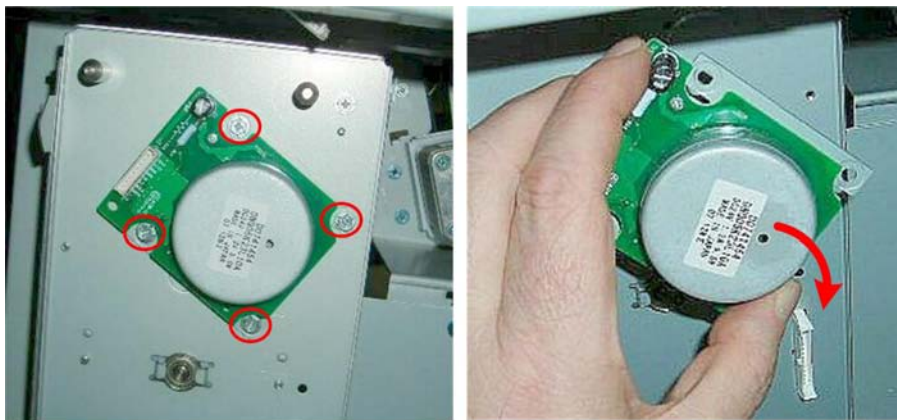

d074r479

8. Remove the motor (🔧x4).

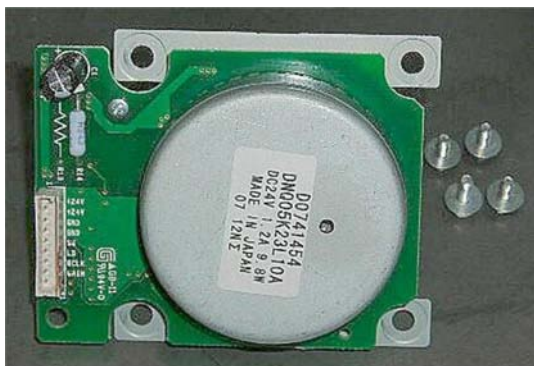

d074r480

4

Used Toner Bottle Sensors, Bottle Set Switch

1. Remove the used toner bottle at the front of the machine.



d074r490

2. At the rear, open the controller box and the cooling box. (▶ p.400)
3. Remove the AC drive board [1]. (▶ p.814)

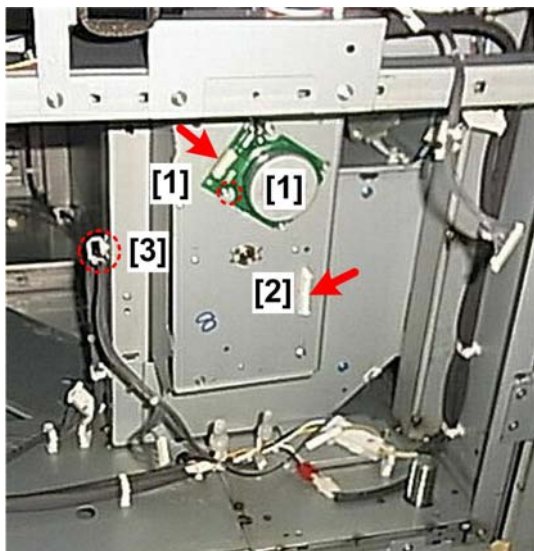

d074r491

4. Disconnect the toner bottle motor [1] (🔌 x1, 🛠️ x1). You do not need to remove the motor.
5. Disconnect connector [2] (🔌 x1).
6. Open clamp [3] and pull away the harnesses (🛠️ x1).

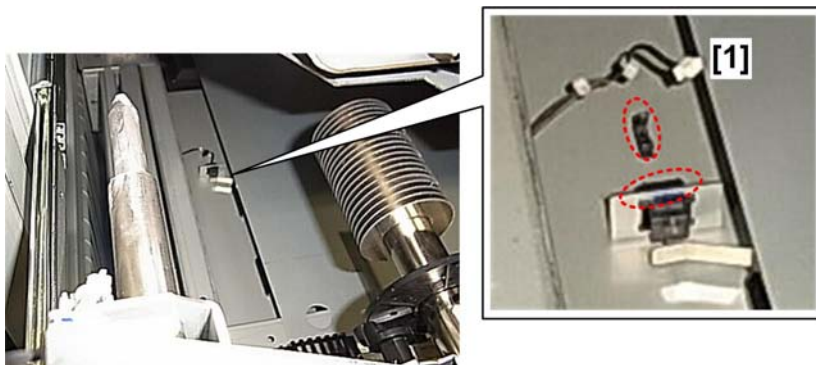

d074r492

7. At the front of the machine, pull out the left drawer.
8. Disconnect the left drawer set sensor [1] (🛠️ x1, 🔌 x1)

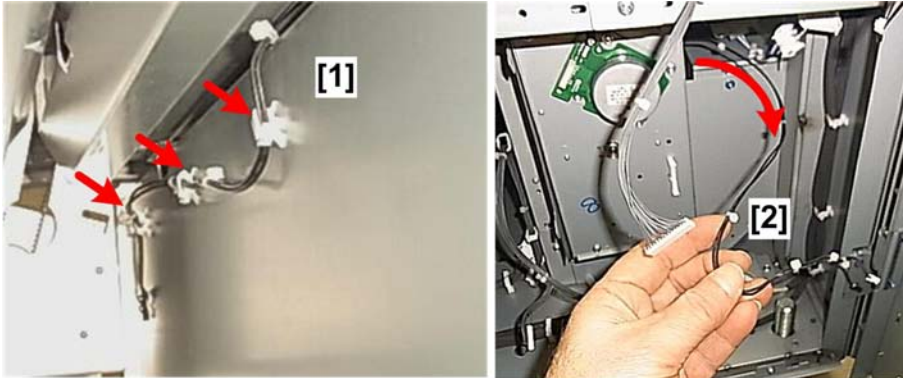

d074r493

- 4 9. Inside the used toner bottle well, unclamp the left drawer set sensor harness [1] (🔧x3).
- 10. At the rear, slowly pull the disconnected harness [2] out of the machine.

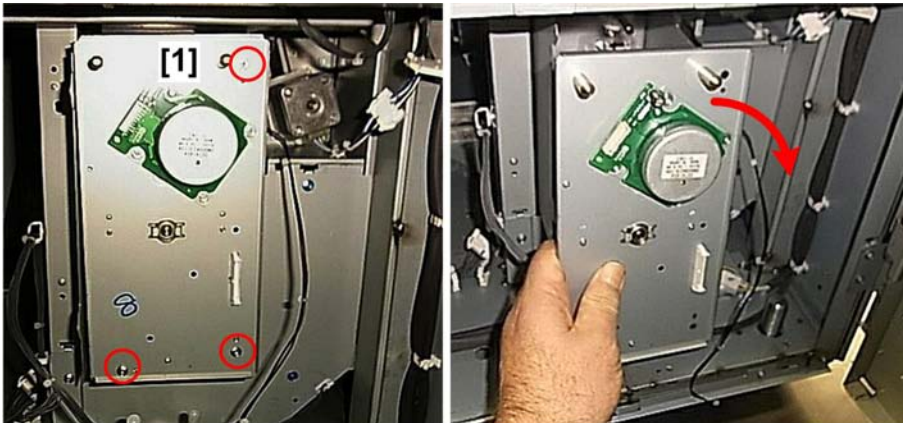

d074r494

- 11. Remove the rear plate [1] with the motor attached (🔧x3).

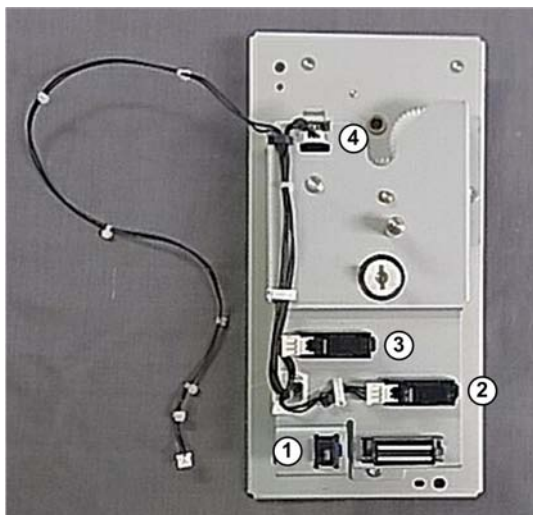

d074r495

12. Set the plate on a flat surface.

①	Used Toner Bottle Set Switch
②	Toner Bottle Near Full Sensor
③	Toner Bottle Full Sensor
④	Toner Bottle Motor Sensor

Used Toner Bottle Set Switch

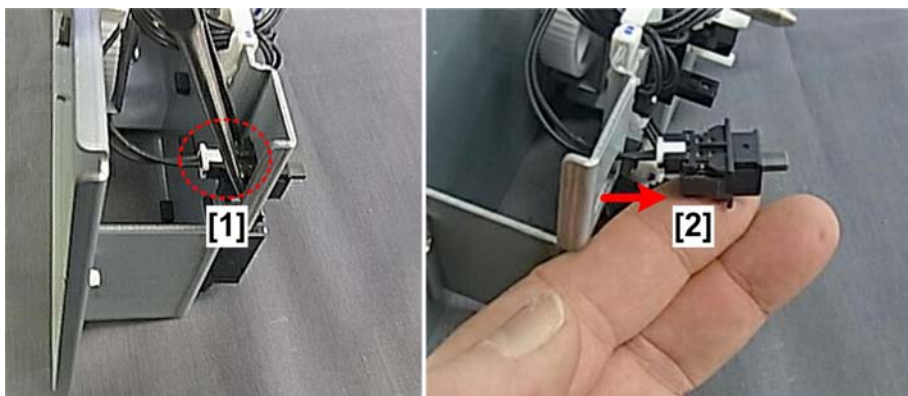

d074r496

1. Use a pair of needle-nose pliers to pinch and release the base of the switch [1].
2. Push the switch [2] out and disconnect it (EJ x1).

Near Full, Full Sensors

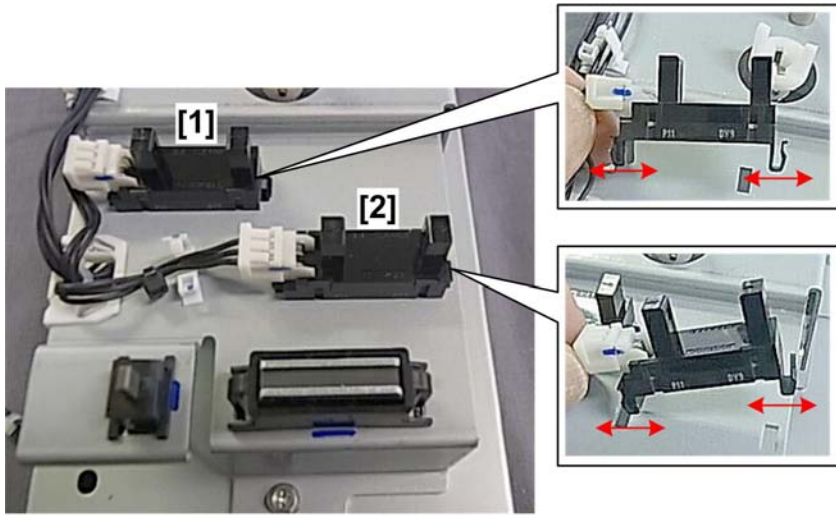

d074r497

1. Pinch the two prongs at the base of the bottle full sensor [1] (or the bottle near-full sensor [2]) to release and remove it.
2. Disconnect the sensor (🔌 x1).

Toner Bottle Motor Sensor



d074r498

1. Disconnect the sensor harness [1] (🔌 x1).
2. Disconnect the sensor [2] (🔌 x1, ▼ x3).

Photoconductor Development Unit (PCDU)

PCDU Replacement

1. Remove the PCDU and replace it with a new one. (p.426)



d074r926

2. Raise the drum bracket [1], and dust the exposed surface of the drum with the resin pad.

★ Important

- Do not apply powder near the development unit entrance seal [3].

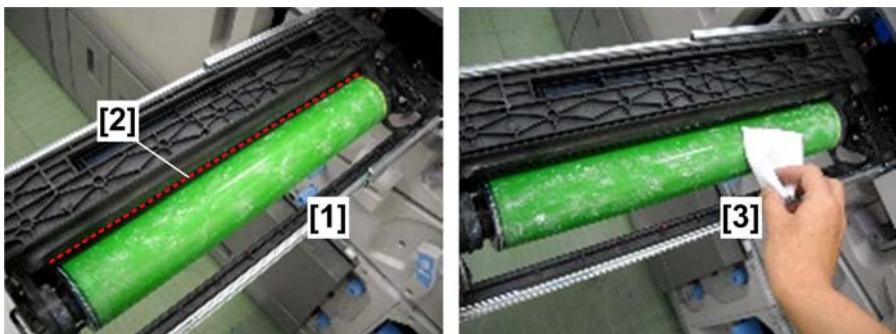

d074r927

★ Important

- [1] shows too much powder on the drum.
- If an excessive amount of powder enters the development unit entrance seal [2], this can cause poor image reproduction. Remove excess powder with a clean dry cloth [3].



d074r928

4

3. Rotate the drum slowly until the applied powder is no longer visible.
4. The machine should be OFF.
5. Open both front doors.
6. Turn the main power switch ON.
7. Enter the SP mode.
8. Reset the counter for the replaced unit or unit part.
9. Install the developer.
10. Execute the SP code to fill the PCDU with the new developer.

Replaced Developer	Do This SP
Black	SP3024-001 (K)
Cyan	SP3024-002 (C)
Magenta	SP3024-003 (M)
Yellow	SP3024-004 (Y)

11. Do **SP3025-001** to confirm that each PCDU was filled successfully.
12. Close the front doors.
13. Wait for about 5 minutes. When you hear an audible beep and see "Ready" displayed on the operation panel, you are ready to continue.
14. Do one or more of the SP codes listed below, whichever is appropriate, to initialize TD sensors.

★ Important

- Choose the correct SP code.
- Initialize the TD sensor only for the development units that were replaced.
- Never initialize the TD sensor of a development unit that has not been replaced.

Condition	SP Code	TD Sensor Initialization
All development units replaced.	3030-01 (All)	All TD sensors (YMCK)
CMY development units replaced.	3030-02 (CMY)	Color TD sensors only (CMY)
K development unit replaced.	3030-03 (K)	Black TD sensor only.
C development unit replaced.	3030-04 (C)	Cyan TD sensor only.
M development unit replaced.	3030-05 (M)	M TD sensor only.
Y development unit replaced.	3030-06 (Y)	Y TD sensor only.

15. Do **SP3031-001** to confirm successful TD sensor initialization.
16. You will see a 4-digit code. Each digit represents one unit "YMCK". A "1111" display indicates that each TD sensor was initialized successfully.
17. Execute these SP codes.

SP	What It Does
3020-001	Initializes process control.
3012-001	Confirms successful initialization of process control.

18. Exit the SP mode.

Re-Installation

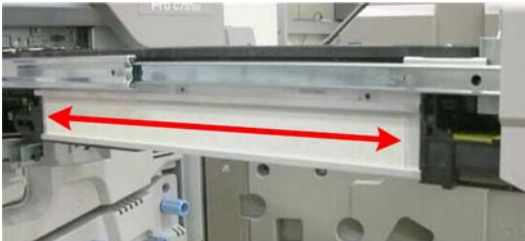

d074r987

1. Always check the left side of the PCDU before you push it back into the machine. (This is the shield plate that conducts heat away from the development unit.)
2. If you see any toner on the plate, wipe it off with a clean dry cloth.

⚠ CAUTION

- To prevent toner scatter or gear damage, never apply excessive force on the PCDU when you push it into the machine.

3. After you push the PCDU into the machine, make sure that PCDU is locked correctly.

4

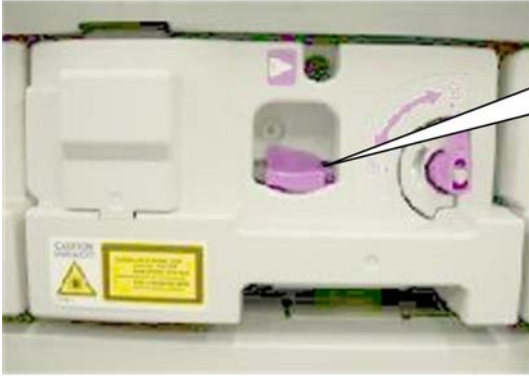

d074r915

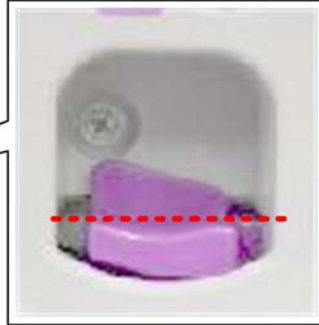

- When the PCDU is locked correctly, the top of the lock lever is straight as shown above.



d074r916

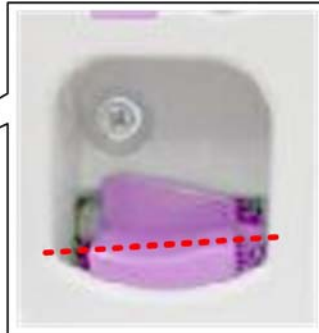

- If the PCDU is not locked correctly, the top of the lock lever is slanted slightly down to the left as shown above.

4. If the PCDU lock lever is not locked correctly, pull the PCDU out about 30 mm (1.5 in.) and push it in again so the top of the lock lever is level.

Vent Filter

1. Pull out the PCDU. (p.426)



d074r781

2. Lift the filter off the top of the PCDU.

Drum Charge Unit

4

1. Turn off the machine and disconnect its power plug.
2. Pull out the PCDU (p.426)

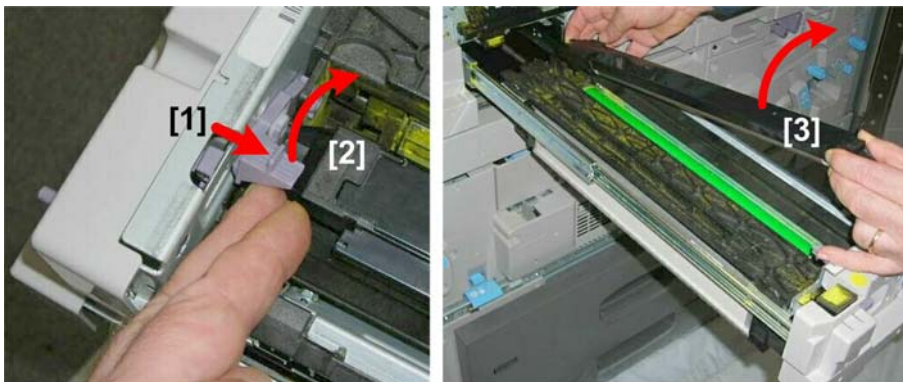

d074r048

3. Press the drum charge unit lock lever to the rear [1] to unlock it and then raise it [2].
4. Lift the front end of the charge unit [3] and remove it.
5. Lay the charge unit on a clean surface with the roller side up.

After Replacing a Drum Charge Unit

1. The machine power must be OFF.
2. Open both front doors.
3. Turn the main power switch ON.
4. Enter the SP mode.
5. Reset the counter for the replaced drum charge unit.

6. Close the front doors.
7. Wait for about 5 minutes. When you hear an audible beep and see "Ready" displayed on the operation panel, you are ready to continue.
8. Execute these SP codes.

SP	What It Does
3020-001	Initializes process control.
3012-001	Confirms successful initialization of process control.

9. Exit the SP mode.

4

Drum Cleaning Unit

1. Turn off the machine and disconnect its power plug.
2. Pull out the PCDU (p.426)
3. Remove the drum charge unit (p.551)

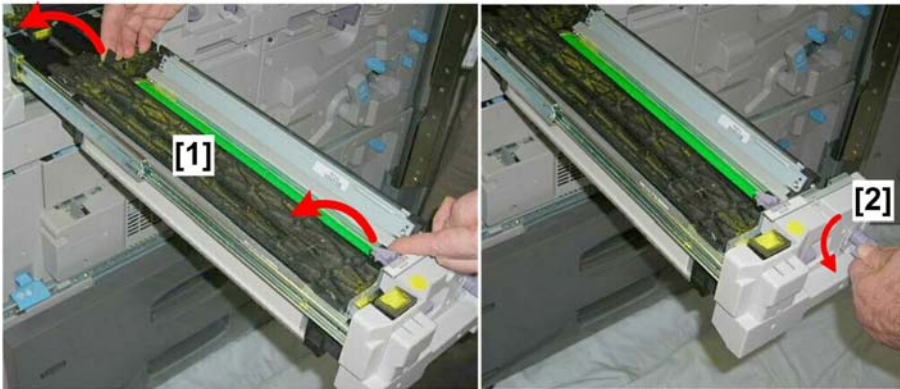

d074r049

4. Raise the drum wing [1] to the vertical position.
5. Lower the cleaning unit lock lever [2].

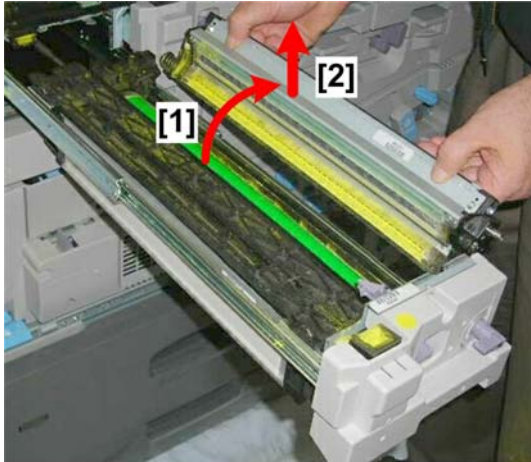

d074r050

6. Roll the cleaning unit toward you [1] and lift it straight up [2].

Drum Replacement

Drum Removal

1. Turn off the machine and disconnect its power plug.
2. Pull out the PCDU (p.426)
3. Remove the drum charge unit (p.551)
4. Remove the drum cleaning unit (p.552)



d074r050a

5. Grip both ends of the drum wing and lift the drum out.

6. Lay the drum on a flat clean surface and cover it with a piece of clean paper.

Installing a New Drum



d074r920

1. Stand the new drum on its end with the drive gear [1] up.

★ Important

- Always hold the drum steady by gripping it at the drum gear [1]. Never touch the surface of the drum.

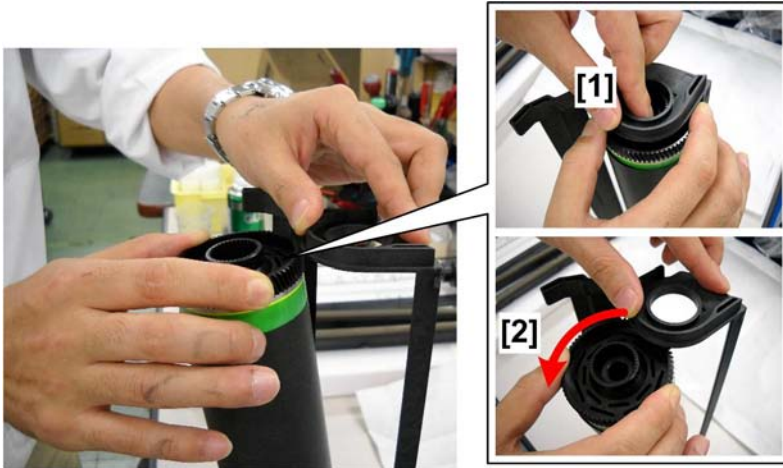

d074r921

2. While holding the frame [1] steady, depress the drum [2] slightly and separate it from the frame.



d074r922

3. Remove the protective sheet from the new drum.

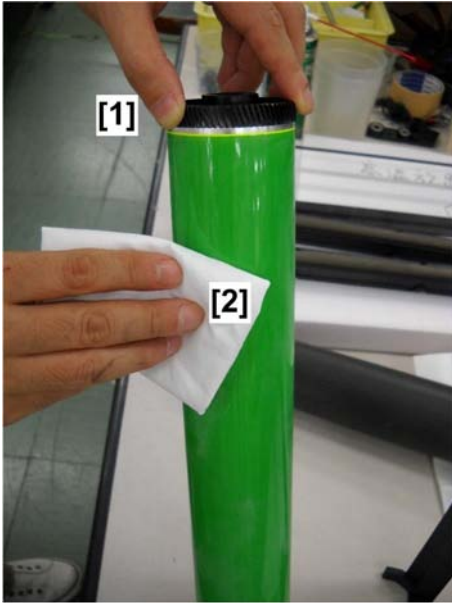

d074r923

4. While holding the drum upright by the drive gear [1], use the resin pad [2] to dust the drum lightly.
5. Turn the drum as you dust it to make sure that the entire surface is covered.

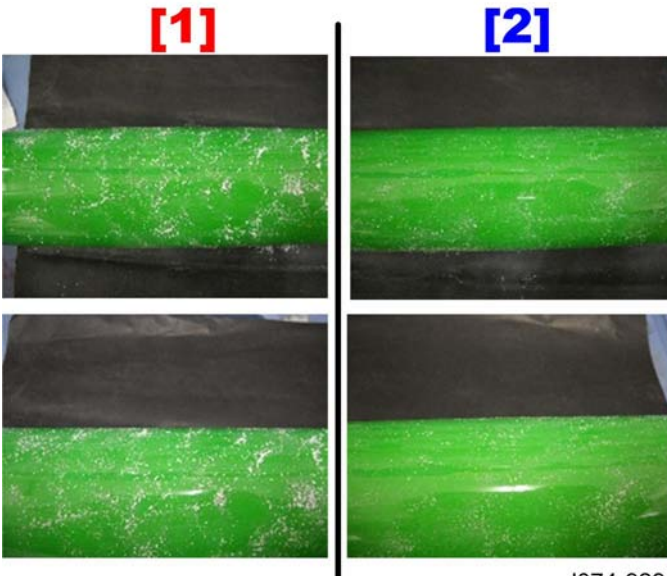

d074r929

6. Do not apply too much powder to the drum.
 - [1] shows too much powder on the drum.
 - [2] shows the correct amount of powder on the dusted drum.
 - Excess powder can be removed with a clean dry cloth.

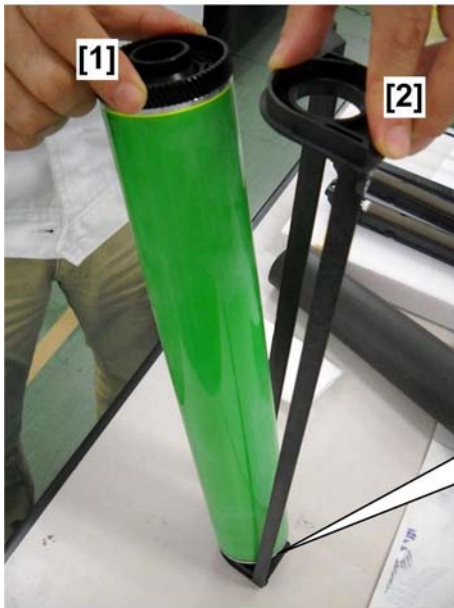

d074r924



7. While pressing down slightly on the drive-gear end of the drum [1], set the end of the frame [2] over the end of the drum.



d074r925

8. Inspect the surface of the drum and make sure that there are no scratches, dirt, etc. on the surface of the drum.

9. Re-install the drum in the PCDU.

After Replacing a Drum

1. The machine should be OFF.
2. Open both front doors.
3. Turn the main power switch ON.
4. Reset the counter for the replaced drum.
5. Close the front doors.
6. Wait for about 5 minutes. When you hear an audible beep and see "Ready" displayed on the operation panel, you are ready to continue.
7. Execute these SP codes.

SP	What It Does
3020-001	Initializes process control.
3012-001	Confirms successful initialization of process control.

8. Exit the SP mode.

Development Unit Replacement

1. Turn off the machine and disconnect its power plug.
2. Pull out the PCDU (p.426)
3. Remove the drum charge unit (p.551)
4. Remove the drum cleaning unit (p.552)
5. Remove the drum (p.553)

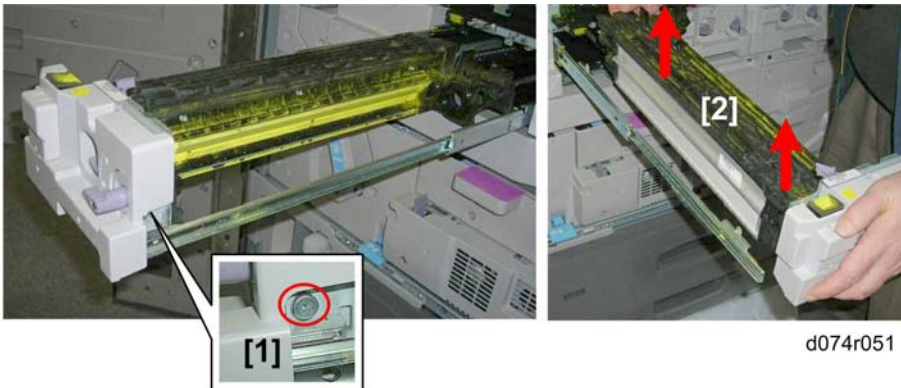

6. Unfasten the development unit [1] (🔧 x1).
7. Lift the development unit off the rails [2].

Replacing Developer

Emptying the Development Unit

1. Remove the PCDU (📄 p.426)
2. Remove the development unit (📄 p.558)

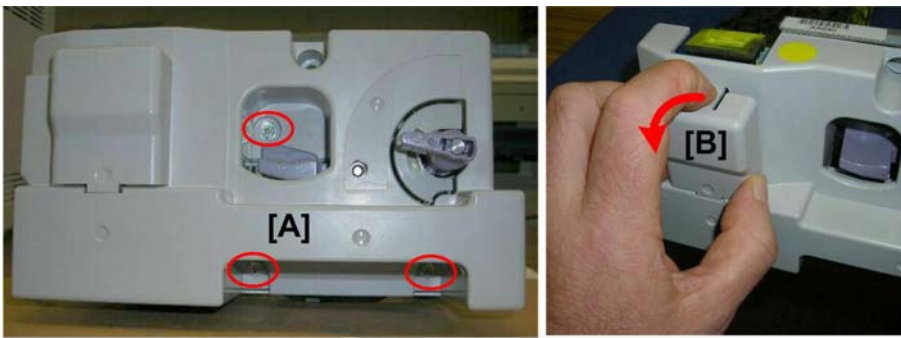

d074r100

3. Unfasten the front plate [A] (🔧 x3).
4. Remove the developer supply port cover [B].



d074r101

5. Depress the PCDU lock [A].
6. Remove the front cover [B] (🔧 x3).

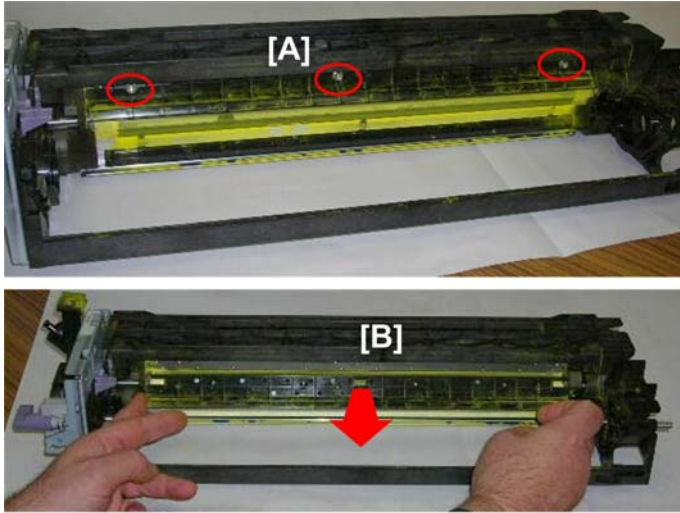

d074r102

7. Disconnect the entrance seal [A] ( x3).
8. Remove the entrance seal [B].



d074r103

9. Remove the developer supply port cap [A].
10. Spread some paper or plastic to catch the old developer.
11. Hold the development unit [B] on end over the paper with the open port down, and pour the old developer onto the paper.
12. Keep dumping the developer, until you see what resembles curls of smoke.



d074r104

4

13. Lay the development unit flat.
14. Rotate the development roller [A] (counter-clockwise) to loosen the developer inside the sleeve.
15. Once again, hold the development unit [B] on end over the paper with the open port down, and dump the developer until you see what resembles curls of smoke.

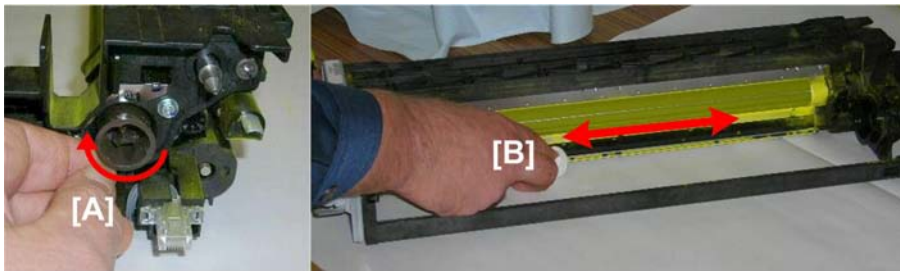

d074r105

16. Rotate the development roller [A] (clockwise).
17. As you continue to rotate the roller, use a vacuum cleaner to clean all the developer from the top of the sleeve. The illustration above shows the area to be cleaned. When this area is free of loose developer, you are finished.
18. Re-assemble the PCDU and install it in the machine.



d074r052

- 4
19. Before you push the PCDU into the machine, you must confirm:
- Charge unit lock lever [1] is down and locked
 - Cleaning unit lever [2] is up and locked.

Installing New Developer



1. Open both front doors.
2. Throughout the following procedures, pay close attention to the opening and closing of the front doors.
3. Connect the power cord of the main machine to the power source.
4. Turn on the main power switch.

Note

- The main power switch is behind the open left front door.
5. Watch the operation panel. The operation panel LED will light red, and you will see the "Please Wait" and then "Door Open" on the operation panel.
 6. Reset the PM counter for the developer(s) that you replaced.



d074i888

7. Remove the developer funnel cover [1] from the right lower corner of the machine ( x1).
8. Disconnect the funnel [2] from the back of the cover ( x2).

CAUTION

- The front doors must remain open.
- Turning on the machine with the front doors open prevents the machine from performing the initial process control self-check.
- If the front doors are closed, the drums will start rotating with no toner in the PCDUs.
- If the drums rotate with no toner in the PCDUs, this can cause the cleaning blades to catch on a dry drum and damage the drum surface



d074i889

9. Remove the developer port cap cover [1] on the front of the PCDU so that you can see the port cap [2].

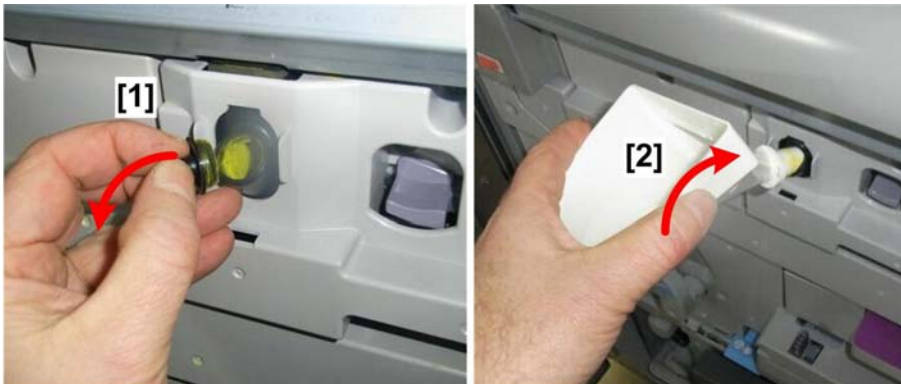

d074i890

10. Remove the port cap [1].
11. Insert the narrow end of the funnel [2] into the open port of the PCDU.

4



d074i891

12. Make sure that the inserted funnel is parallel with the top edge of the machine.
13. Select the developer pack. Make sure the pack is the correct color for the PCDU.
14. Shake the developer pack vigorously. This ensures that all the developer will flow through the funnel into the PCDU.



d074i892

15. Open **SP3024**. See the table below.
16. Cut off the top of the developer pack along the dotted line.
17. Set the open end of the package down in the funnel so that the developer starts pouring into the PCDU.
18. While still holding the package, select the correct number (001 to 004) for the package color and press [EXECUTE].

★ Important

- Make sure that you execute the correct SP code for the color of the developer that you are replacing!

SP	Initializes	Color	Comment
3024-001	K	Black	The PCDU starts operating and it takes about 30 seconds to complete.
3024-002	C	Cyan	
3024-003	M	Magenta	
3024-004	Y	Yellow	

19. Shake the developer pack gently to make sure that all the developer drains into the machine.
20. When the SP execution is finished, tap the edge of the pack to avoid spillage when the pack is removed.
21. Remove the emptied developer pack.

★ Important

- Check the pack to see if any developer remains. If a substantial amount of developer did not go into the PCDU, repeat the SP3024 execution.
 - The 30 sec. time interval for execution of SP3024 can be adjusted. If more time is needed to empty the power pack, increase the PCDU run time with SP3024-11.
22. Remove the funnel.
 23. Re-attach the developer port cap.
 24. Clean the funnel thoroughly before installing another developer pack or storing it in the machine.
 25. Do **SP3025-1** (Dev Fill OK? to confirm that developer installation succeeded).

You will see a 4-digit number: 1 1 1 1. Reading from left-to-right each number is a result code for the Y, M, C, K developer execution with SP3024. Check the results against the table below.

Code	Meaning	Comment
0	No execution	Default
1	Succeeded	No problems
2	No developer exited	Before execution, TD sensor output was above 1.5V (developer present).
3	No developer entered	After execution, TD sensor output was below 1.5V (no developer present).
4	Used toner bottle full	The used toner bottle was detected full.
5	Development motor lock	The development motor was not operating.

Code	Meaning	Comment
6	Used toner transport lock	One or both motors locked: Used Toner Transport Motor or Used Toner Bottle Motor.
9	Forced abort	Front doors were closed, machine was powered off, or some other event interrupted execution.

Close Both Front Doors

1. Close both front doors.
2. Switch to the copy display (or print display for the M044). Watch the operation panel display. You will see "Please Wait"
After you see "Ready", wait at least 5 minutes for the machine to complete its warm-up cycle.
3. Do not leave the SP mode.

Initialize TD Sensors

1. Leave the front doors closed.
2. Execute **SP3030-001** (Init. TD Sensor) to initialize the TD sensor of each development unit.

★ Important

- Be sure to select the correct number for the PCDU where the developer was replaced.

SP3030	Init TD Sensor :Exe
001	Execute: ALL
002	Execute: COL
003	Execute: K
004	Execute: C
005	Execute: M
006	Execute: Y

★ Important

- Failure to initialize the TD sensor will cause incorrect readings of the toner density.
3. Watch the operation panel. First, you will see "Complete" and then a four-digit number will appear.
 4. Do **SP3031-001** to confirm successful TD sensor initialization.
 - A "1111" display indicates successful initialization of each development unit (YMCK).

- If a TD sensor fails to initialize, the machine will display an SC code. Follow the instructions under the indicated SC code to correct the problem.

Initialize Process Control

1. Leave the front doors closed.
2. Execute **SP3020-001** to start process control. (Process control sets the machine for optimum operation based on the conditions around the drums.)
3. Watch the operation panel. When you see "Complete", the process control settings are done.
4. Do **SP3012-001** to confirm that initialization was successful.

Exit SP Mode and Power Off

1. Exit the SP mode.
2. Push the operation power switch on the operation panel to switch the machine off.
3. Switch the main power switch off.

PCDU Parts Replacement

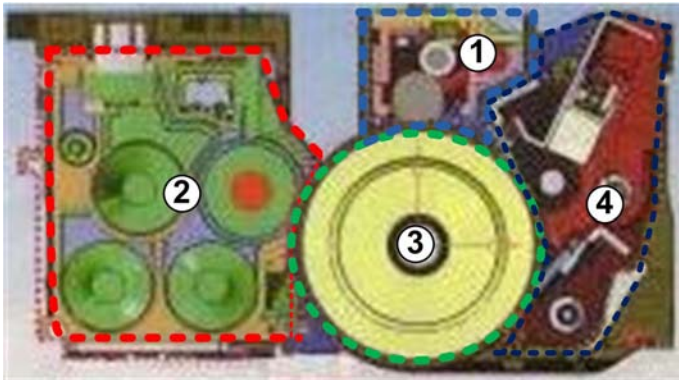

d074r108a

	Item	PM Interval	
		D074	D075/M044
①	Charge Unit	300 K	
	Developer, Vent Filter	750K	900K
②	Development Unit	5250K	6000K
③	OPC Drum	1200K	1350K
④	Drum Cleaning Unit	300 K	

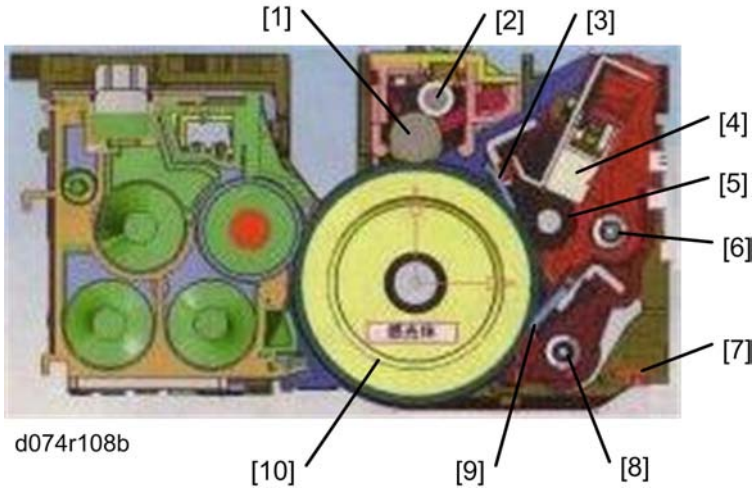

1	Charge Roller
2	Charge Roller Cleaning Roller
3	Drum Lubrication Blade
4	Drum Lubrication Bar
5	Drum Lubrication Roller
6	Lubricant Collection Coil
7	Quenching Lamp (QL)
8	Toner Collection Coil
9	Drum Cleaning Blade
10	OPC Drum

PM Parts List

PM Part Name	Interval	Replaced By
Gears (21Z: Front)	300K	Service Technician, or TCRU
Gears (Idle: 20Z: Front)	300K	Service Technician, or TCRU
Gears (Idle: 31Z: Front)	300K	Service Technician, or TCRU
Gears (19Z: Front)	300K	Service Technician, or TCRU

PM Part Name	Interval	Replaced By
Cleaning Unit Coupling	300K	Service Technician, or TCRU
Drum Lubrication Roller	300K	Service Technician, or TCRU
Drum Lubrication Bar	300K	Service Technician, or TCRU
Drum Lubrication Blade	300K	Service Technician, or TCRU
Drum Cleaning Blade	300K	Service Technician, or TCRU

Drum Cleaning Unit Gears

4

1. Remove the drum cleaning unit from the PCDU. (▶ p.552)



d074r109

2. Remove the front plate [A] (▶ x2).



d074r110

3. Remove gears ① to ④.



d074r111

4

4. Remove the last gear (Ⓒ x1).
5. Replace the gears at the front.

①	Gears (Idle 20Z)
②	Gear (21Z)
③	Gears (Idle 31Z)
④	Gear (21Z)

Drum Cleaning Blade

1. Remove:
 - PCDU (🔧 p.426)
 - Drum cleaning unit from the PCDU (🔧 p.552)
 - Drum cleaning unit gears (🔧 p.569)

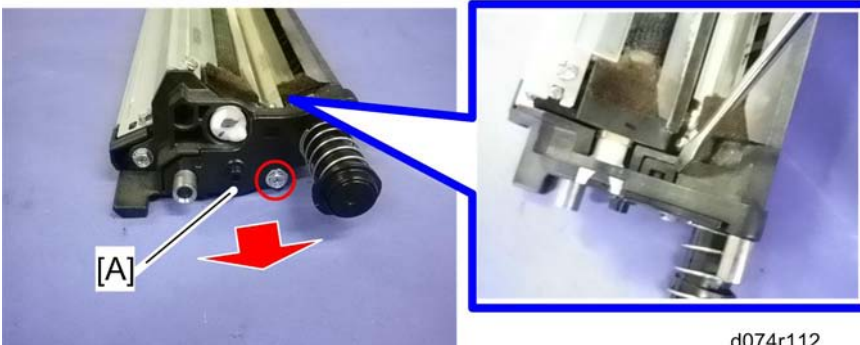

d074r112

2. Rear plate [A] (🔧 x1, hook)

↓ **Note**

- Place the drum cleaning unit on a sheet of paper, and then remove the rear plate. Used toner may spill out from the cleaning unit after removing the rear plate [A].

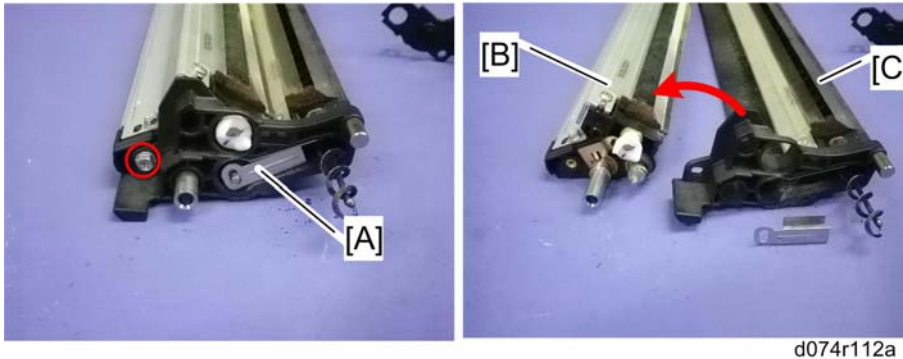

d074r112a

- Vibration plate [A]
- Separate the lubrication unit [B] and cleaning unit [C] ( x1).



d074r113

- Disconnect the cleaning blade:

[A] Front ( x1)

[B] Rear ( x1)

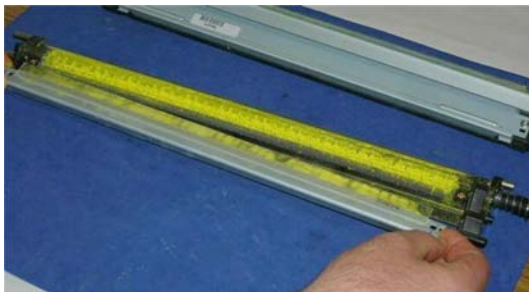

d074r114

- Remove the cleaning blade.

When installing a new drum cleaning blade

When installing a new drum cleaning blade, side seals must be replaced with new parts. Follow the replacement procedure for the side seals as shown below.



d074r056

4

1. Remove the side seals [A] on the cleaning unit.

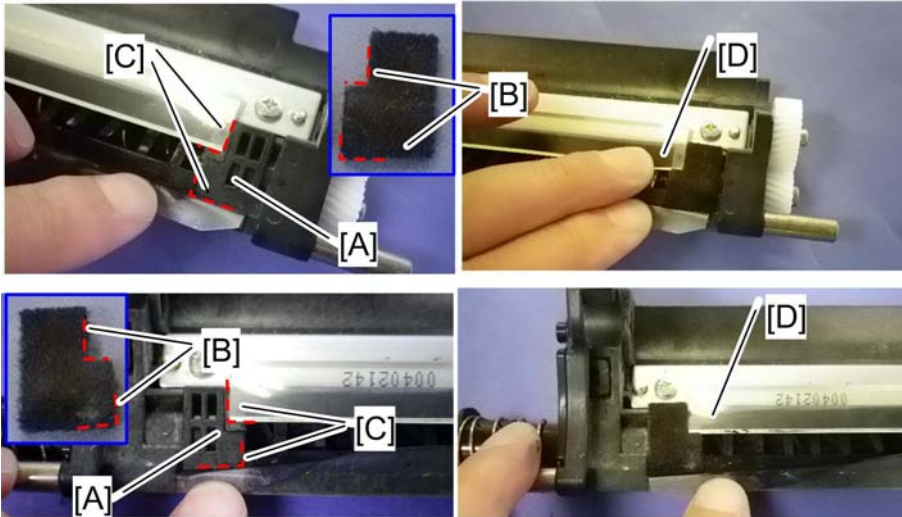

d074r057



2. Clean the area [A] where the side seals were attached with alcohol and a cloth.
3. Attach new side seals to both sides of the cleaning unit.
 - Align the edges [B] of the side seal with the edges [C] of the cleaning unit and cleaning blade, and then attach it.
 - Check that the drum cleaning blade does not hook the side seal when pressing the drum cleaning blade [D].

When reattaching the cleaning unit and lubrication unit

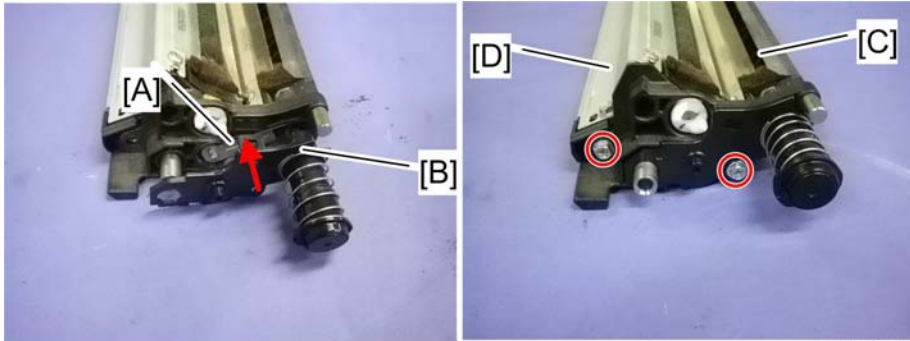
1. Attach the cleaning unit and lubrication unit.
2. Install the drum cleaning unit gears and front plate first.







d074r055

3. Install the vibration plate [A] in the rear of the cleaning unit.
4. Attach the rear plate [B] to the cleaning unit ( x1, hook).
5. Secure the cleaning unit [C] and lubrication unit [D] ( x1).



4

Drum Lubrication Blade

1. Remove:
 - PCDU ( p.426)
 - Drum cleaning unit from the PCDU ( p.552)
 - Drum cleaning unit gears ( p.569)
 - Separate the lubrication unit and cleaning unit. ( p.570)



d074r115

1. Disconnect the lubrication blade:
 - [A] Front ( x1)
 - [B] Rear ( x1)

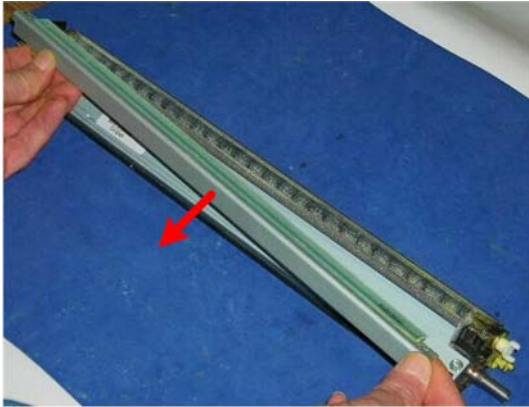

d074r116

4

2. Remove the lubrication blade.

When installing a new lubrication blade

When installing a new lubrication blade, side seals must be replaced with new parts. Follow the replacement procedure for the side seals as shown below.



d074r053

1. Remove the side seals [A] on the lubrication unit.

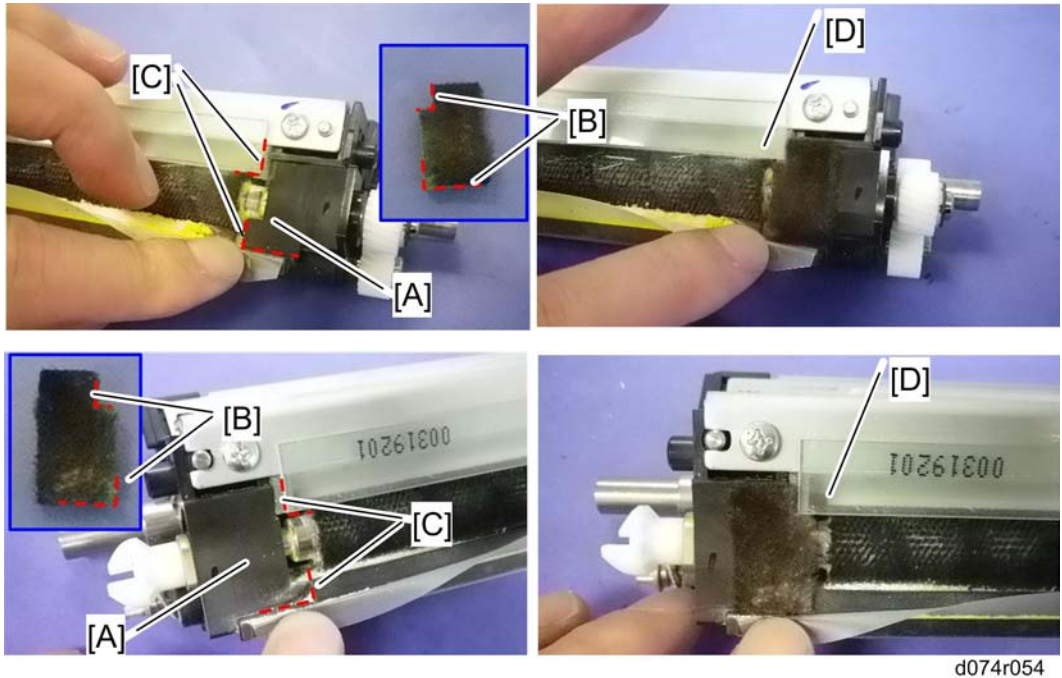

1. Clean the area [A] where the side seals were attached with alcohol and a cloth.
2. Attach new side seals to both sides of the lubrication unit.
 - Align the edges [B] of the side seal with the edges [C] of the lubrication unit and lubrication blade, and then attach it.
 - Check that the lubrication blade does not hook the side seal when pressing the lubrication blade [D].

Drum Lubrication Bar

1. Remove:
 - PCDU (p.426)
 - Drum cleaning unit from the PCDU (p.552)
 - Drum cleaning unit gears (p.569)
 - Separate the lubrication unit and cleaning unit. (p.570)

★ Important

- The lubrication bar must be removed before the lubrication roller, and re-installed after the lubrication roller.



d074r117

2. Disconnect the lubrication bar cover plate stay [A] ( x2).

4

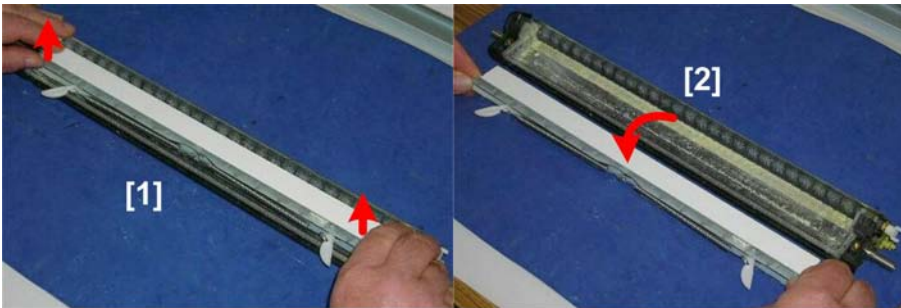

d074r118

3. Raise the left and right ends of the lubrication bar base [1]. The spring arms will pop on both ends.

4. Lift the bar [2] and place it flat on the table.

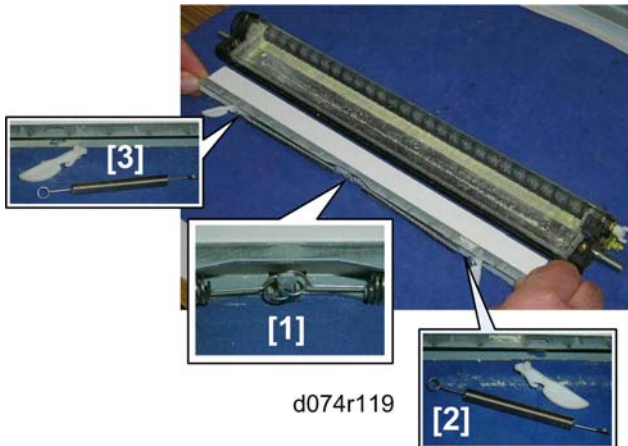

d074r119

5. Disconnect the springs and arms:

[A] Center ( x2)

[B] Front ( x1, Arm x1)

[C] Rear ( x1, Arm x1)

★ Important

- Do not discard these springs and arms. They are not provided as service parts and must be re-attached to the new lubrication bar.

Drum Lubrication Roller

1. Remove the drum lubrication blade (p.573)

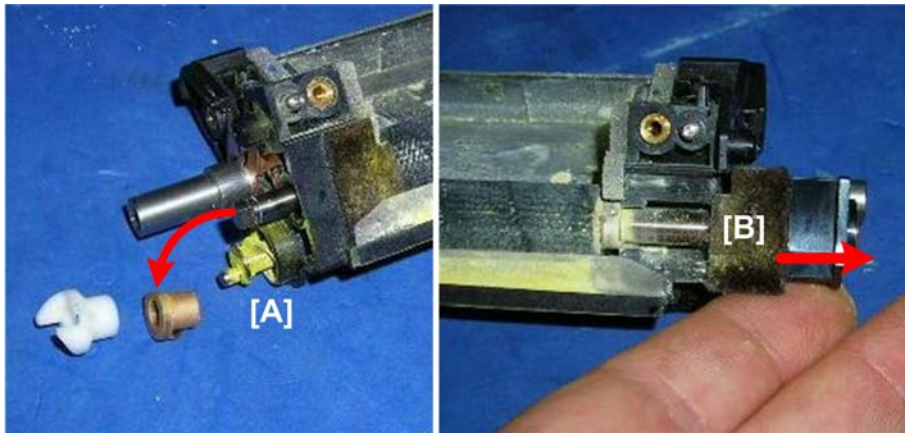

d074r120

2. Disconnect the rear end [A] of the roller (Coupling x1 19Z, x1).
3. To disconnect the front end of the roller, push the lock plate [B] off to release the end of the roller.

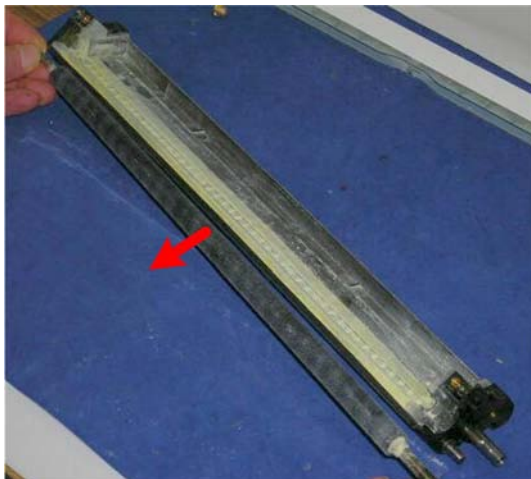

d074r121

4. Remove the lubrication roller.

Re-installation



x_pcd_u_17_22

4

- Before pushing a PCDU into the machine, always make sure that the PCDU lock lever is down and locked.
- Always push the PCDU in slowly and firmly until you hear it lock.

After Replacing a Drum Cleaning Blade or Drum

1. The machine should be OFF.
2. Open both front doors.
3. Turn the main power switch ON.
4. Reset the counter for the replaced unit or parts.
5. Close the front doors.
6. Wait for about 5 minutes. When you hear an audible beep and see "Ready" displayed on the operation panel, you are ready to continue.
7. Do one or more of the SP codes listed below, whichever is appropriate, to clean and lubricate the drum of the unit where the unit or parts were replaced.

Condition	SP Code	Cleaning Done For:
All cleaning units replaced.	3032-01 (All)	All units (YMCK)
CMY cleaning units replaced.	3032-02 (CMY)	Color units only (CMY)
K cleaning unit replaced.	3032-03 (K)	Black unit only.
C cleaning unit replaced.	3032-04 (C)	Cyan unit only.
M cleaning unit replaced.	3032-05 (M)	M unit only.
Y cleaning unit replaced.	3032-06 (Y)	Y unit only.

- Execute these SP codes.

SP	What It Does
3020-001	Initializes process control.
3012-001	Confirms successful initialization of process control.

- Exit the SP mode.

Drum Cleaning Motors, Development Motors, Drum Motors

4

Before Removing Any Motor

- Open the controller box and cooling box on the back of the machine. (p.400)

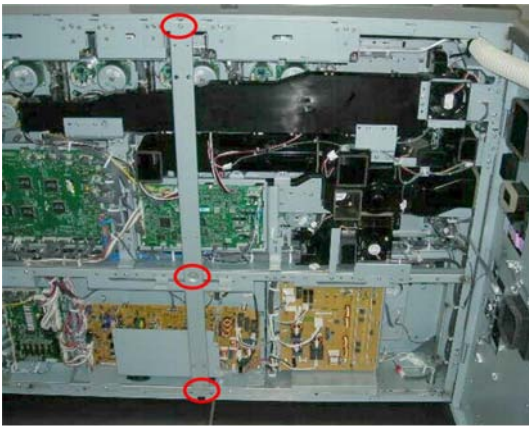

d074r123

- Remove the center stay (3).

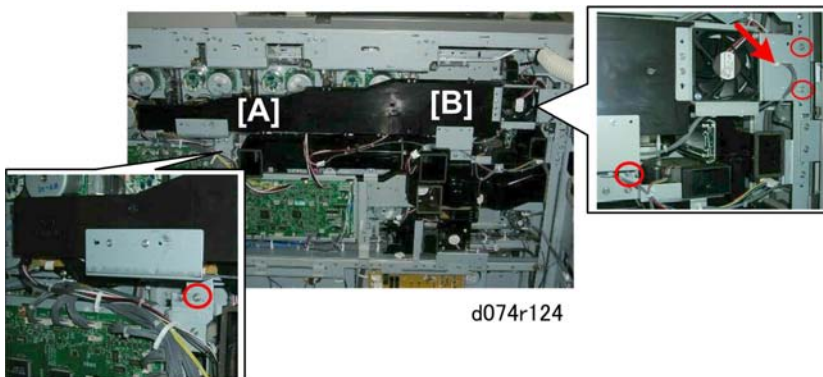

d074r124

- Disconnect the horizontal cooling duct:

[A] Left (🔧 x1)

[B] Right (🔧 x1, 🔧 x3)

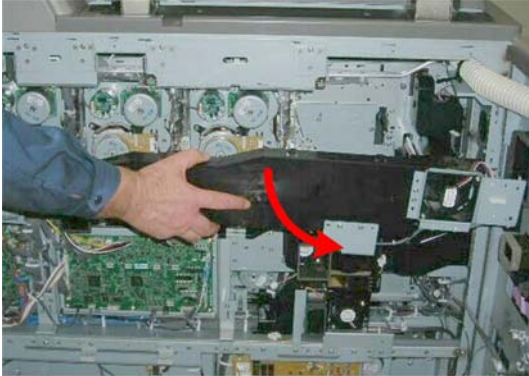

d074r125

4. Remove the horizontal cooling duct.

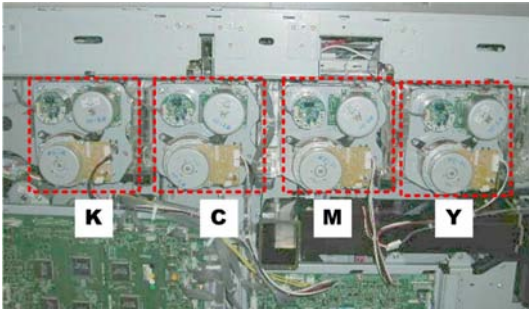

d074r126

Viewed from the rear, the sets of motors from left to right are KCMY

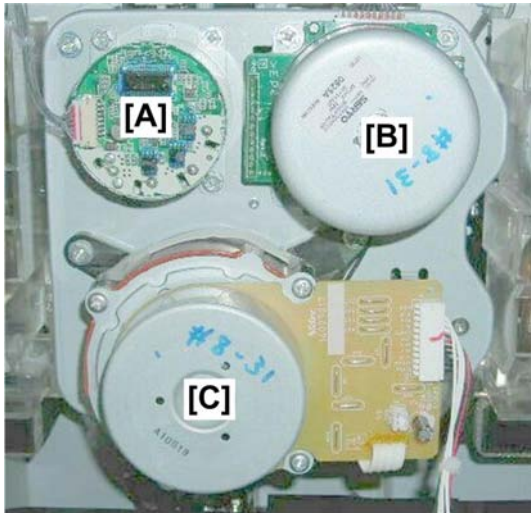

d074r127

There are three motors in each set:

- [A] Cleaning motor
- [B] Development motor
- [C] Drum motor

Drum Cleaning Motor

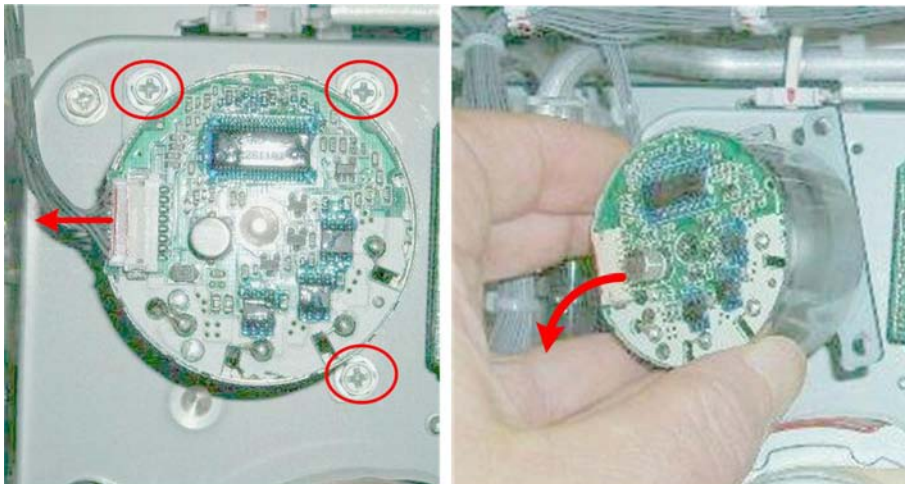

d074r128

1. Prepare for motor removal (🔧 p.579)
2. Remove the motor (🔧 x1, 🛠️ x3).

Development Motor

4

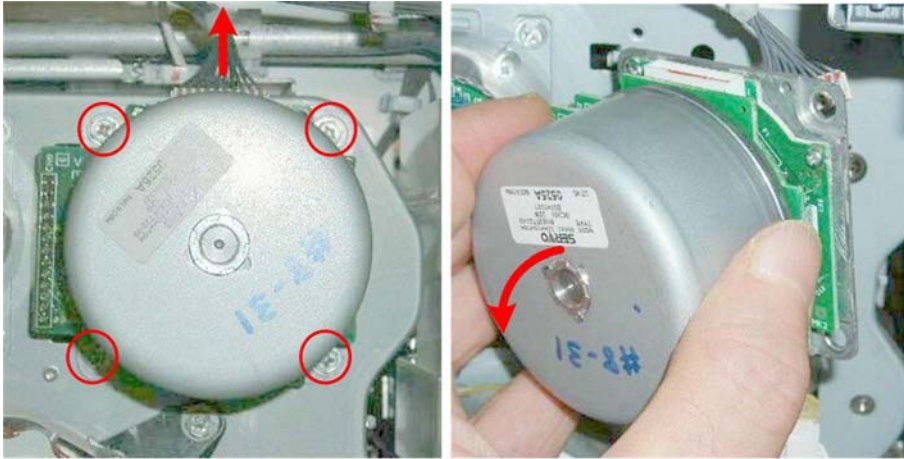

d074r129

1. Prepare for motor removal (p.579)
2. Remove the motor (E x1, T x3).

Drum Motor

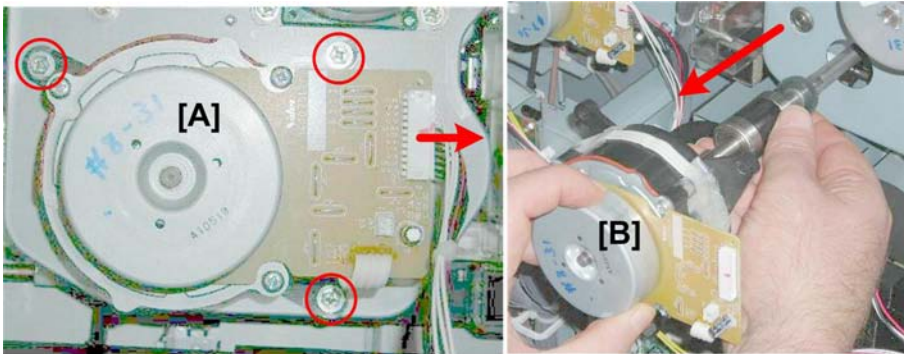

d074r130

1. Prepare for motor removal (p.579)
2. Disconnect the motor [A] (E x1, T x3).
3. As you slowly remove the motor [B], support the long drive shaft with your other hand.



d074r131

4. Disconnect the motor drive shaft [A] from the motor [B] and separate them ( x1).

★ Important

- Never disassemble the motor [B]. There are no serviceable parts inside the motor.
- If the motor is taken apart, it is very difficult to re-assemble correctly because the parts are spring loaded.

Liquid Cooling Unit

1. Remove the cooling box cover ( x13 M4x8). ( p.402)

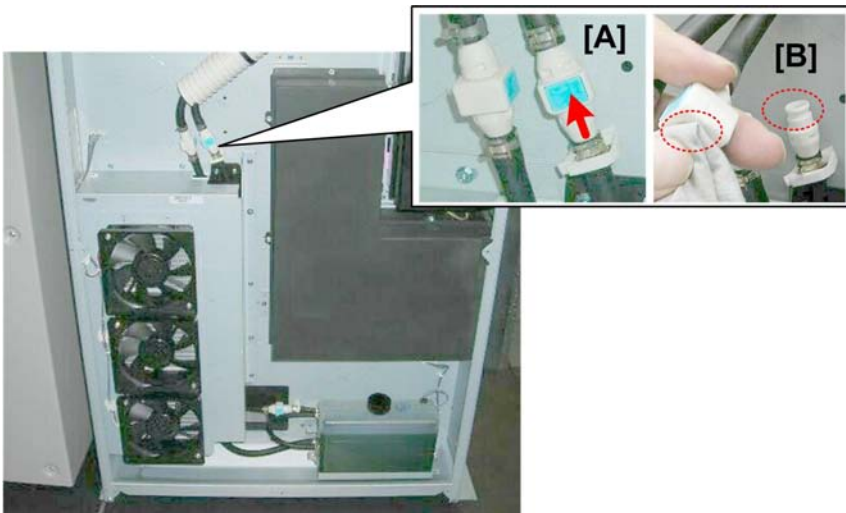

d074r132

2. Disconnect the hose at [A].
- Press the blue release buttons on both sides of the coupling to disconnect.

- Use a dry rag to soak up any coolant leakage around the open ends of the couplings [A] and [B].

★ Important

- There will be a small amount of leakage. If there is a large amount of leakage, re-connect the hoses and then disconnect them again.

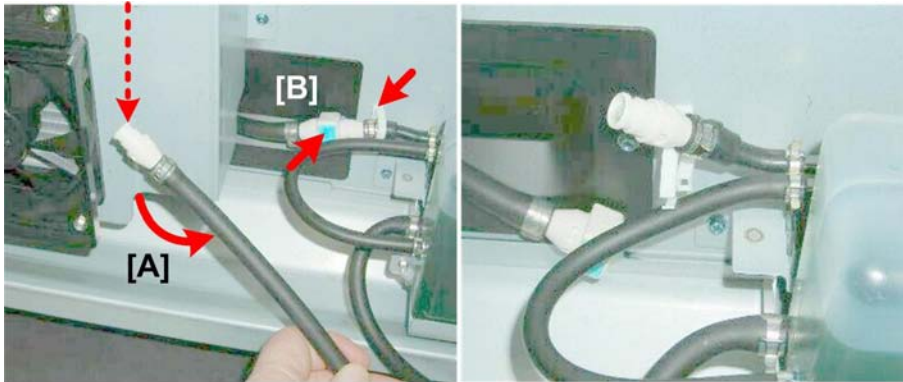

d074r133

3. Pull the long tube [A] down and out of the duct.
4. Disconnect the hose at [B] (🔧x1).
 - Press the blue release buttons on both sides of the coupling to disconnect.
 - Use a dry rag to soak up any coolant leakage around the open ends of the couplings.

★ Important

- There will be a small amount of leakage. If there is a large amount of leakage, re-connect the hoses and then disconnect them again.

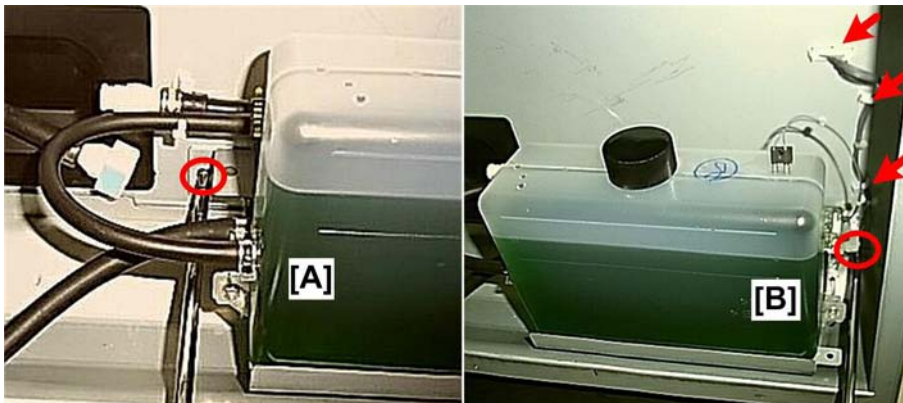

d074r134

5. On the left [A], disconnect the base (🔧x1).
6. On the right [B], disconnect the base and harness (🔧x1, 🛠x2, 📦x1)

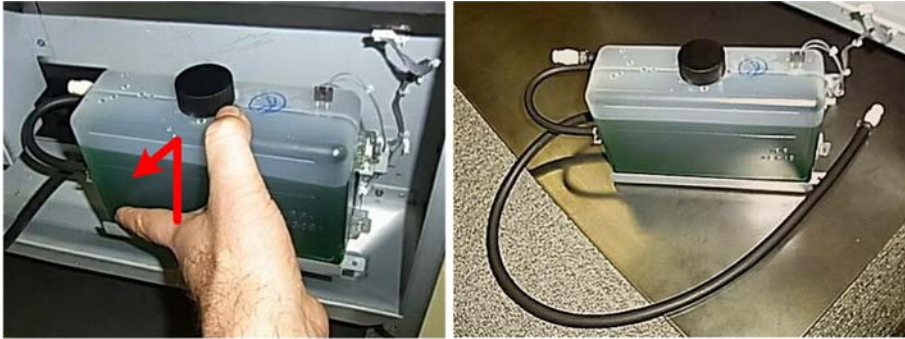

d074r135

7. Lift the tank straight up and remove it.

4

Re-installation

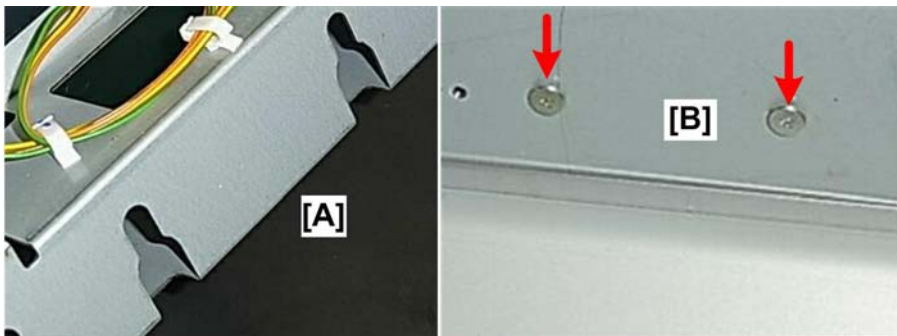

d074r135a

1. Set the keyholes [A] over the shoulder screws [B] to position the base of the tank correctly.



Tank and Coolant Disposal

- The liquid coolant is propylene glycol.
- Always obey local laws and regulations if you need to dispose of a tank or coolant.
- The tank must never be emptied directly into a local drainage system, river, pond, or lake.
- Contact a professional industrial waste disposal organization and ask them to dispose of the tank.

Drum Cooling Unit Fan Replacement

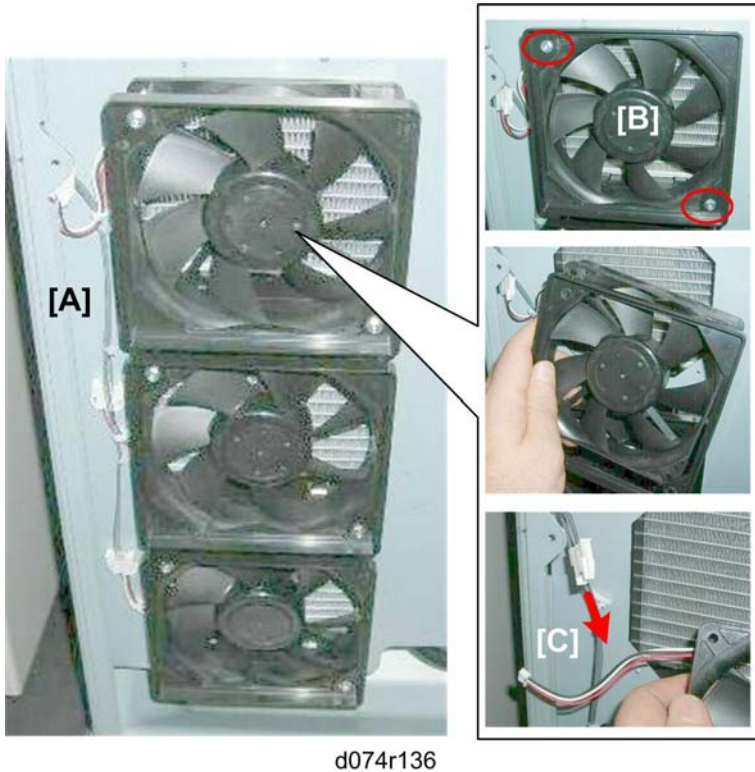
1. Remove the cooling box cover ( x13 M4x8). ( p.402)



2. There are three fans [A].
3. Disconnect the fan [B] ( x2 M3x30).
4. Disconnect the fan harness [C] ( x1,  x1)

Charge Roller Cleaning Roller Solenoids

The four charge roller solenoids (one for each PCPU charge roller) are located on top of the machine below the laser units.

1. Remove the laser unit for the solenoid that needs to be replaced. ( p.495)
 - The Y, M solenoids are behind laser unit 1 on the left.
 - The C, K, solenoids are behind laser unit 2 on the right
 - You will need a short screwdriver (or ratchet driver) to remove the screws of the solenoids below the raised scanner unit (Y, M solenoids)

Y Charge Roller Cleaning Roller Solenoid

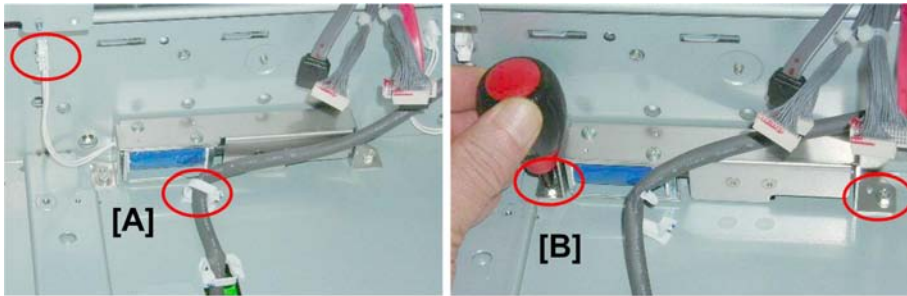

d074r137

2. Free the harnesses [A] (🔧 x1, 🗑️ x1).
3. Disconnect the solenoid assembly [B] (🔧 x2).

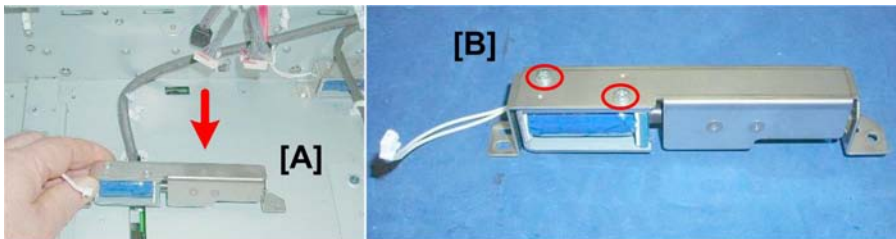

d074r138

4. Remove the solenoid [A].
5. Disconnect the solenoid [B] from the bracket (🔧 x2).

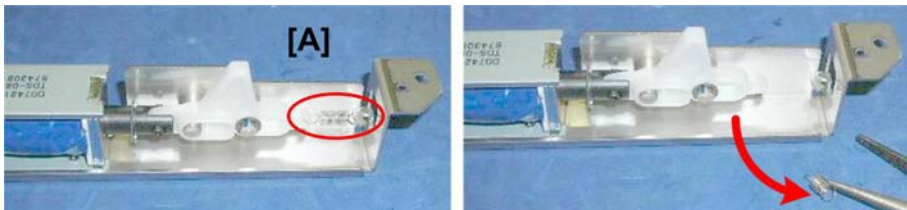

d074r139

6. Disconnect the spring [A] (🔧 x1).

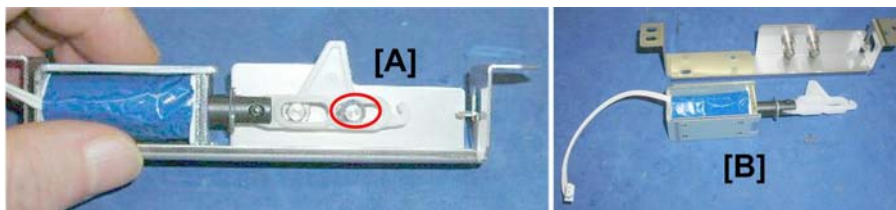

d074r140

7. Disconnect the solenoid plunger [A] from the bracket (🔧 x1).
8. Remove the solenoid [B] with plunger attached.

Potential Sensors (YMCK)

The potential sensors are under the laser units and above the PCDUs.

- There is one potential sensor for each PCDU.
 - Dirt or dust around or on the potential sensor probe or window can cause errors (SC405 to SC413).
1. Remove the laser unit above the affected potential sensor. (🔧 p.495)

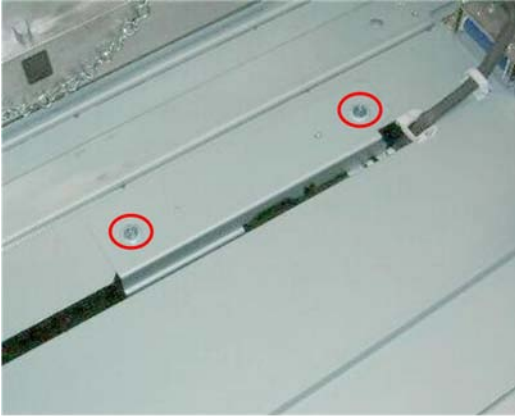

d074r981

2. Disconnect the sensor bracket (🔧 x2).



d074r982

3. Disconnect the sensor harness at the end of the bracket (🔧 x2).
4. Lift the bracket out.

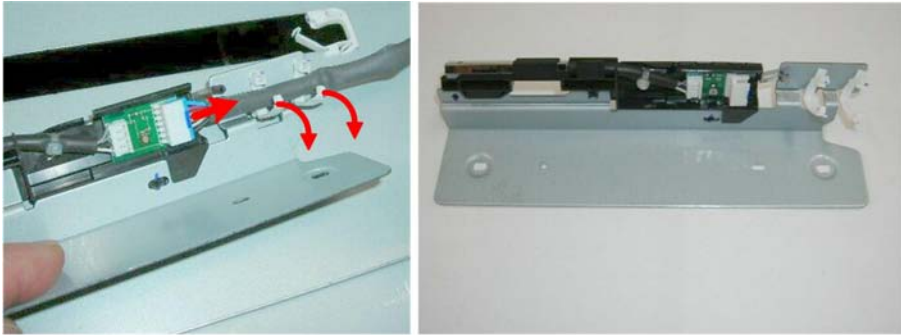

d074r983

5. Turn the bracket over.
6. Disconnect the harness (🔌 x1, 🗑️ x2).



d074r984

7. The sensor can be separated easily from the bracket (it is held in place by snap tabs) if it needs to be replaced.

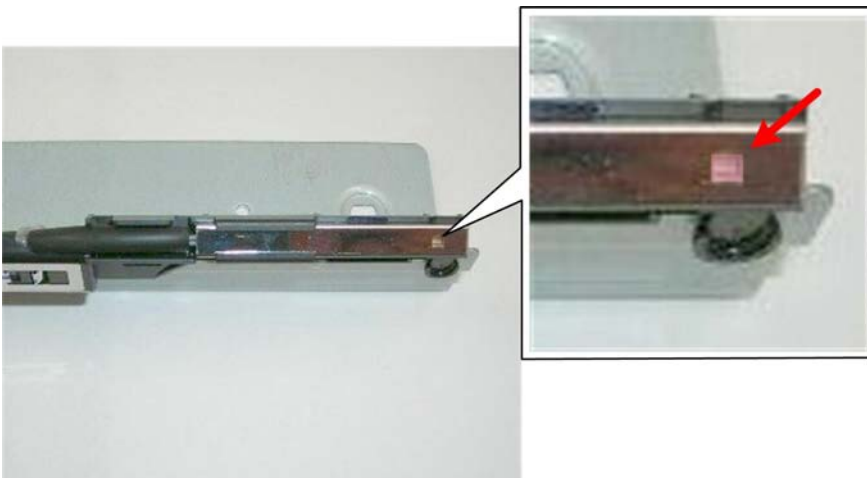

d074r985

8. The potential sensor probe and window should be cleaned with a blower brush and a clean dry cloth. (It does not need to be separated from the bracket for cleaning.)

TD Sensor

1. Turn off the machine and disconnect its power plug.
2. Remove the development unit (p.558)



d074r931

3. Tape the toner supply port to prevent toner spillage.

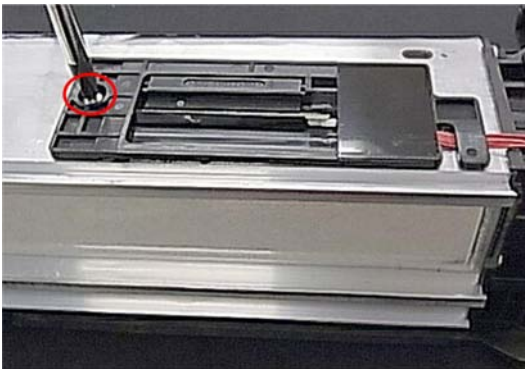

d074r932

4. Disconnect the TD sensor plate ( x1).

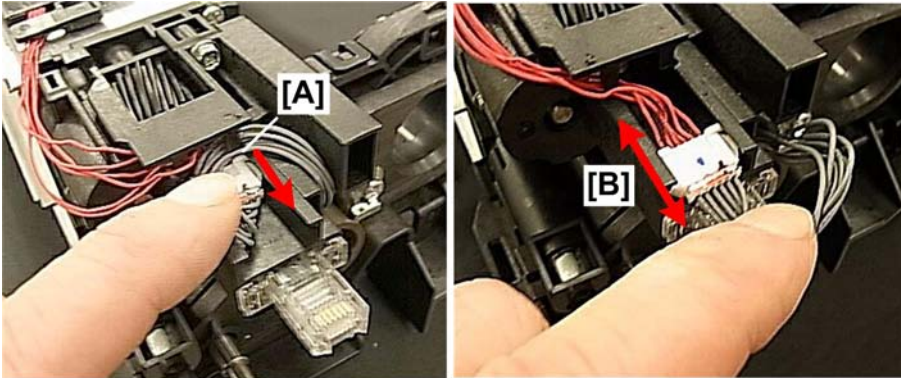

d074r933

5. Pull the harness out from behind the tab [A].
6. Disconnect the harnesses [B] (⏏ x1).

4

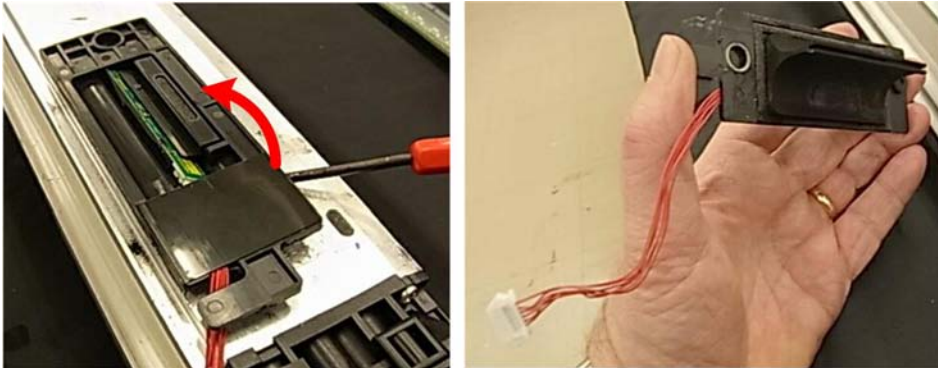

d074r934

7. Pry the sensor plate and sensor off the bottom of the development unit.

Image Transfer Belt (ITB) Unit

ITB Cleaning Unit

4

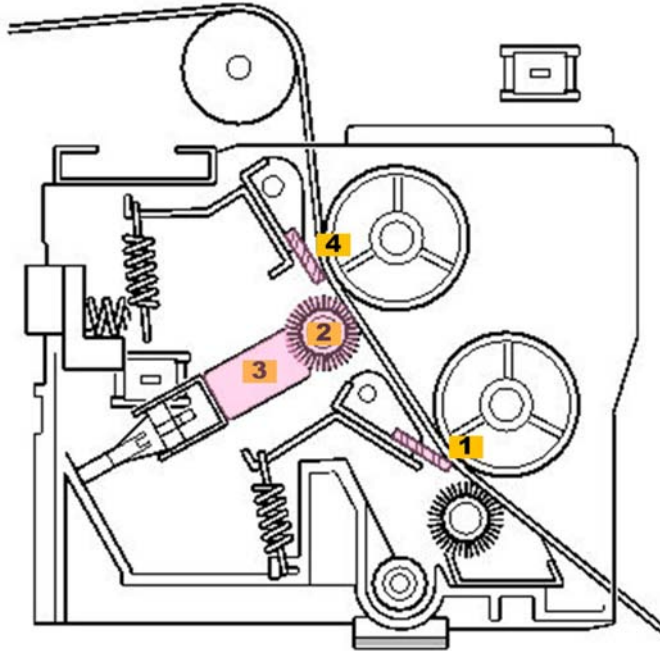

d074r143

PM Parts List

No.	PM Part Name	Replacement Interval
[1]	ITB Cleaning Blade	600K
[2]	ITB Lubrication Roller	600K
[3]	ITB Lubrication Bar	600K
[4]	ITB Lubrication Blade	600K

ITB Cleaning Unit Removal

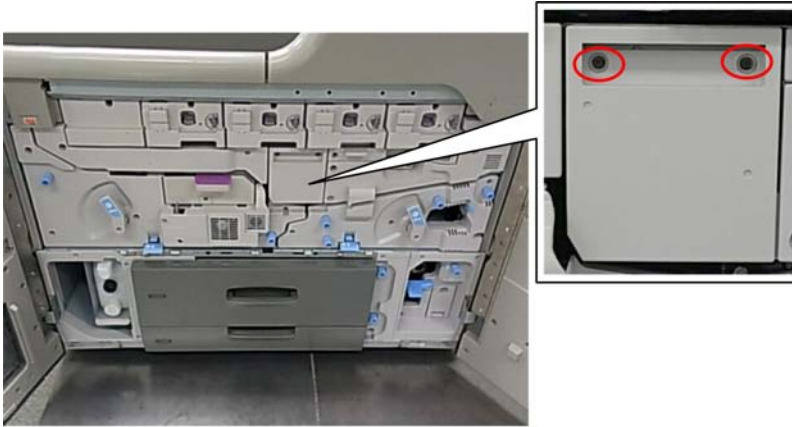

d074r150

1. Spread some paper or a drop cloth on a table where you can place the ITB cleaning unit for disassembly.
2. Remove the cleaning unit cover ( x2).

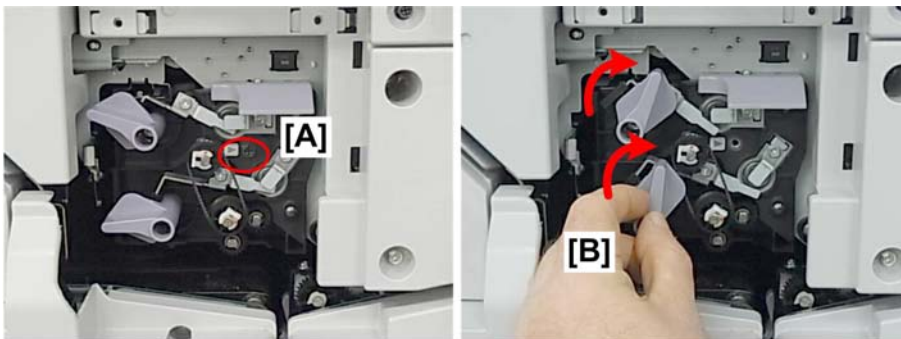

d074r151

3. Remove screw [A] ( x1).
4. Raise both levers [B].

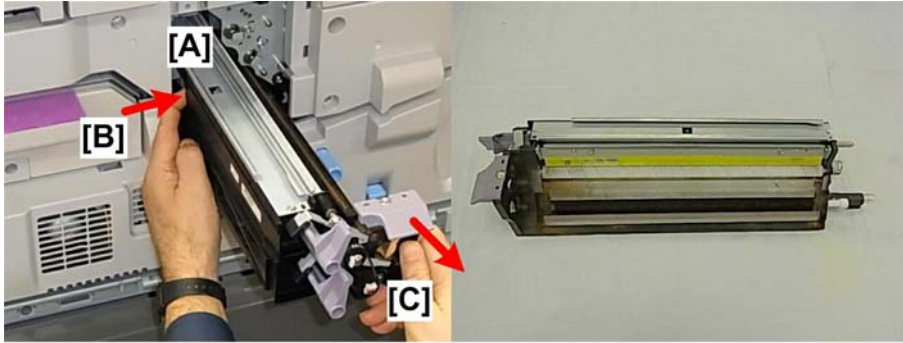

d074r152

4

5. Pull the cleaning unit out slowly until it stops at [A].
6. Press the release tab [B].
7. Pull the unit [C] out completely and lay it on a table covered with paper or a drop cloth.

Cleaning Blade

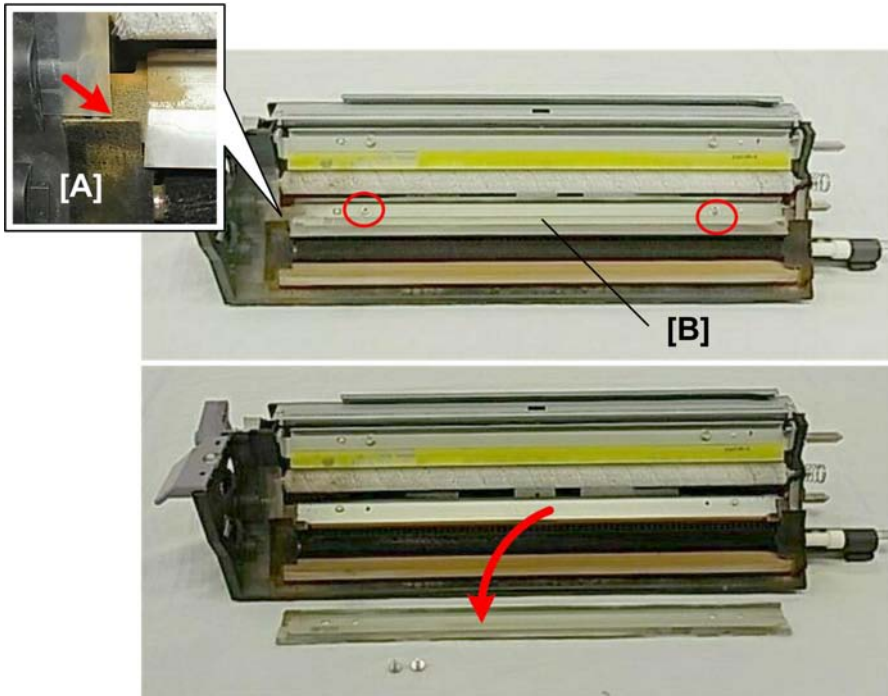

d074r153

1. ITB cleaning unit (p.430)

★ Important





- When removing and re-installing blades, work carefully to avoid damaging the sponge seals [A] at the ends of the blade. These sponge seals cannot be replaced in the field.

2. Remove the cleaning blade [B] ( x2).

Lubrication Roller



d074r154

1. ITB cleaning unit ( p.430)
2. Disconnect the roller at the front ( x1,  x1,  x1,  x1).

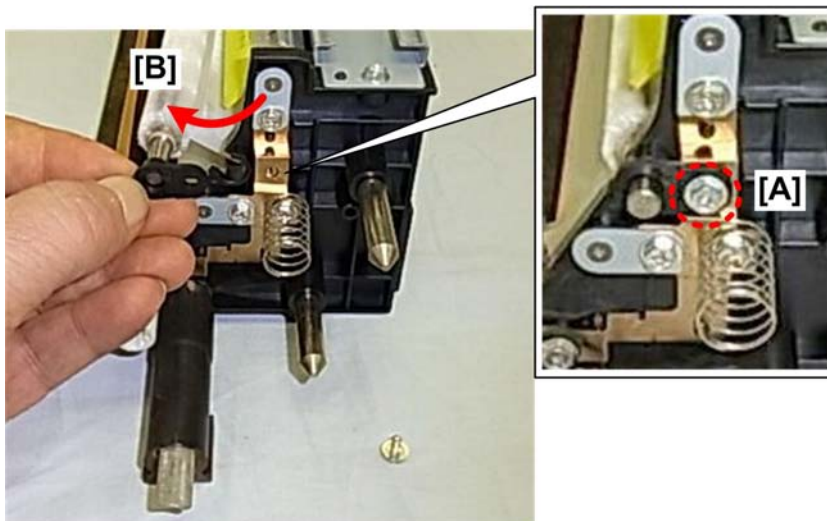

d074r155

3. Remove screw [A] ( x1).
4. Move the roller [B] slightly to the left.

4

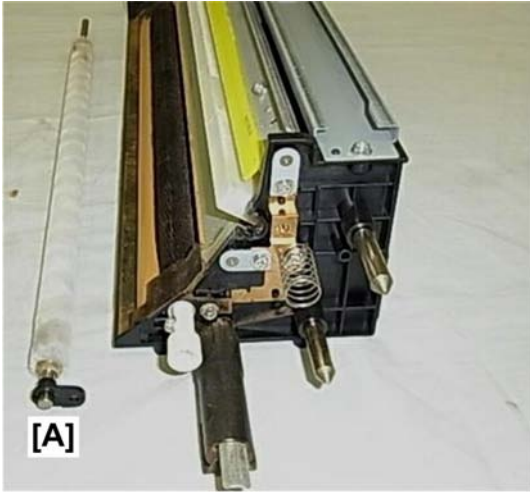

d074r156

5. Remove the roller [A].

Lubrication Bar

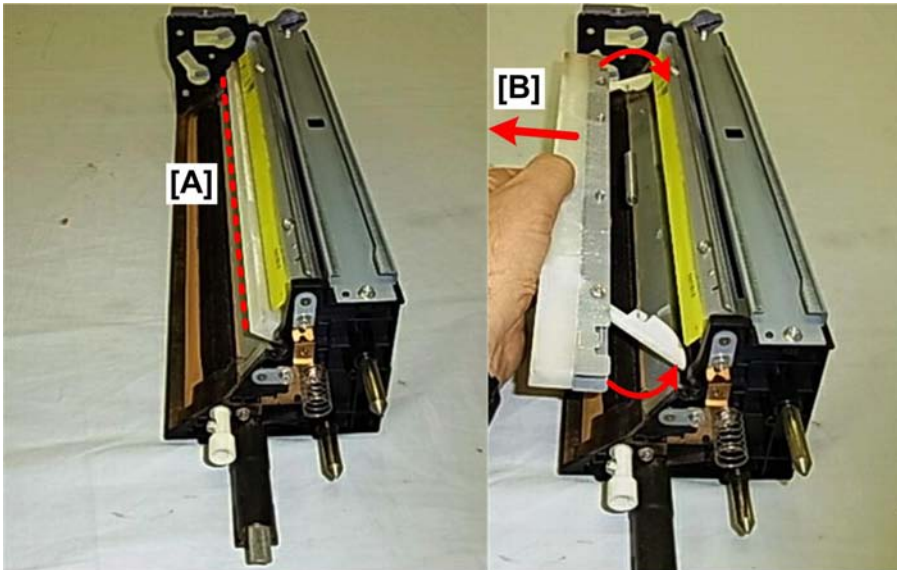

d074r157

1. ITB cleaning unit (p.430)
2. Lift the edge of the lubrication bar [A] (the spring loaded arms will pop out).
3. Remove the lubrication bar [B].

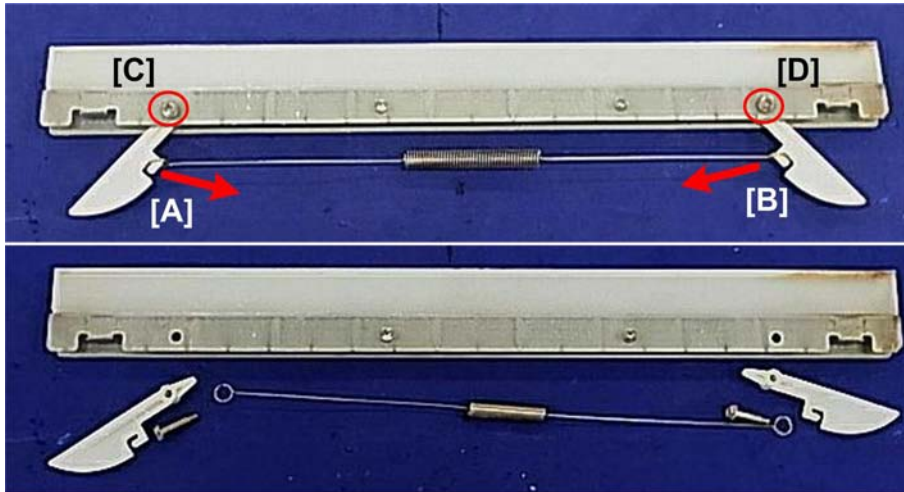

d074r158

4. Disconnect the spring from the arms [A] and [B] (🔧 x1).
5. Remove the arms [C] and [D] (🔧 x2).

★ Important

- Do not discard these springs and arms. They are not provided as service parts and must be re-attached to the new lubrication bar.

Lubrication Blade

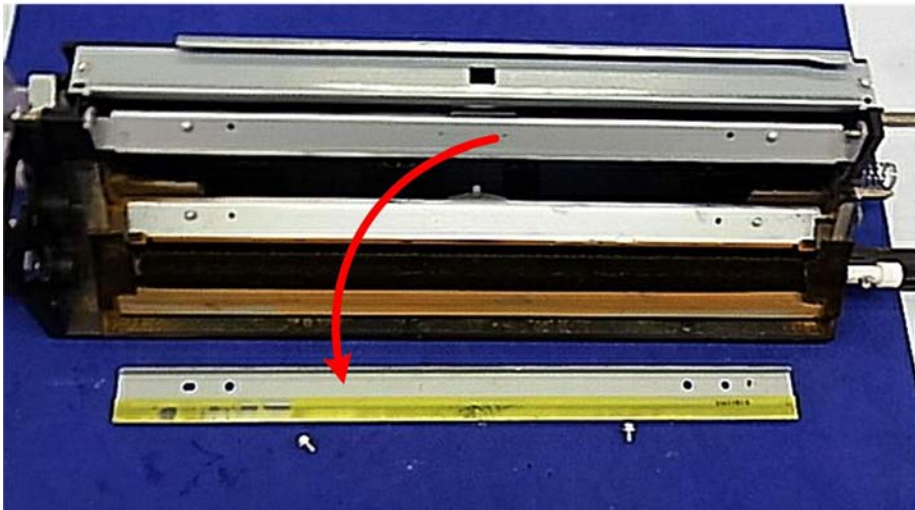
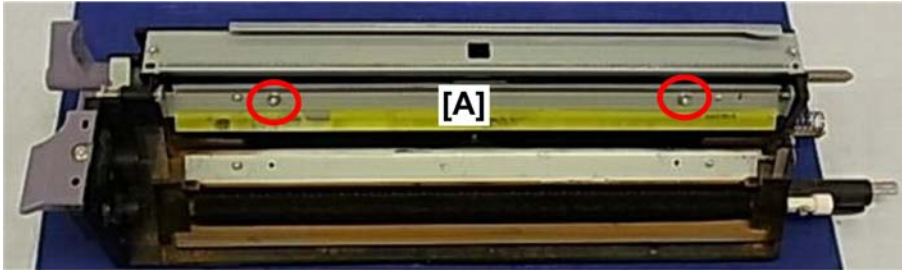

d074r159

1. ITB cleaning unit (p.430)

★ Important

- When removing and re-installing blades, work carefully to avoid damaging the sponge seals at the ends of the blade. These sponge seals cannot be replaced in the field.

2. Remove the lubrication blade [A] ( x2).

After Replacement

1. Install the cleaning unit.
 - Keep the levers in the unlocked position.
 - Do not attach the cove yet.
2. Make sure that the machine power is OFF.
3. Remove the PTR unit.
4. Turn the main power switch ON and close both front doors.
5. Enter the SP mode.

6. Reset the counter for the replaced unit or parts.
7. Open the right front door and execute SP2301-1 (Force Lubricant - Belt Cleaning).
8. Immediately after executing, close the right door to run the above SP
9. Wait for about 5 minutes. When you see "Completed" displayed on the operation panel, you are ready to continue.
10. Re-install the PTR unit.
11. Rotate both levers of the ITB cleaning unit counter clockwise and re-install the front cover.
12. Execute these SP codes.

SP	What It Does
3020-001	Initializes process control.
3012-001	Confirms successful initialization of process control.

13. Exit the SP mode.

Transfer Belt Replacement

Transfer Belt Removal

1. Pull the ITB unit out to the 2nd stop position. (p.410)

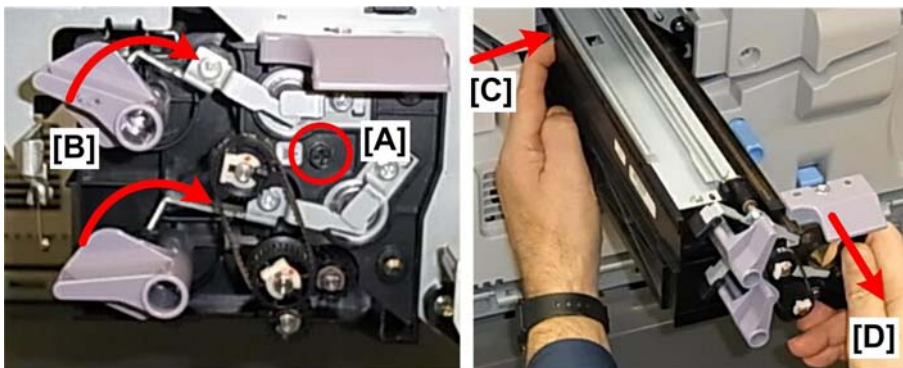

d074r160

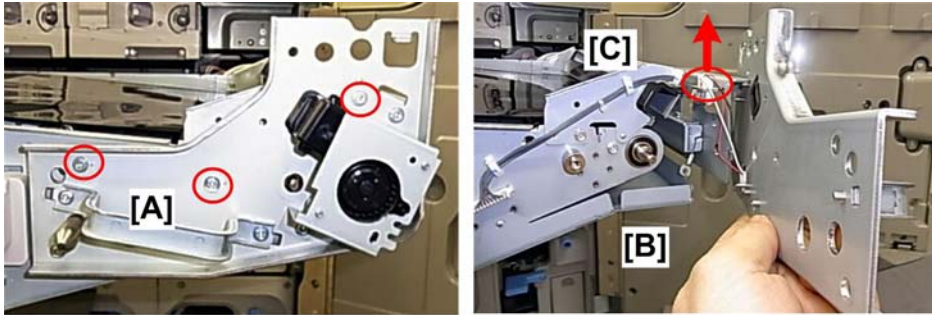

2. Remove screw [A] (x1).
3. Raise both levers [B].
4. Pull the cleaning unit out slowly until it stops.
5. Press the release lever [C].
6. Pull the cleaning unit [D] out.

Right Handle



d074r161



4

7. Disconnect the handle plate [A] ( x3).
8. Slowly swing the handle to the right [B].
9. Disconnect harness [C] ( x1).

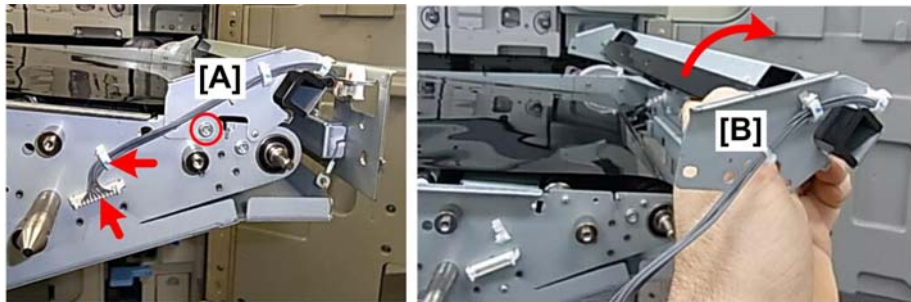
ID Sensor/MUSIC Sensor Plate



d074r162

10. Disconnect plate [A] ( x1,  x1,  x1).
11. Remove the sensor plate [B].

Lower Cover Plate



d074r163

12. Disconnect the lower cover plate at [A] ( x1).

13. The plate will drop and be held by the small cable [B].

Guide Plate

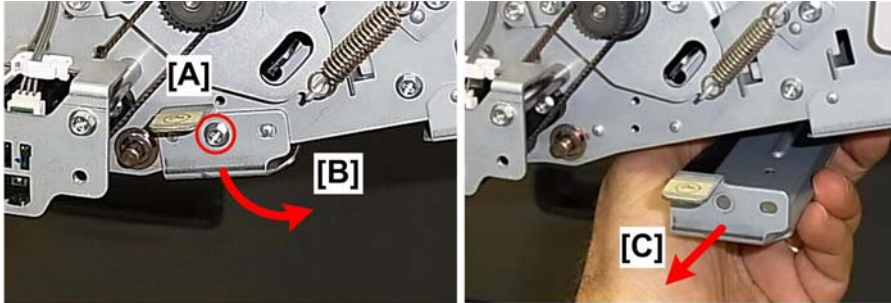

d074r164

14. Disconnect the guide plate [A] (⚙ x1).
 15. Lower the guide plate slightly [B] and pull it out [C].

Belt Speed Sensor Bracket, Left Handle



d074r165

16. At the front edge of the ITB unit, remove the belt speed sensor bracket [A] (⚙ x1).

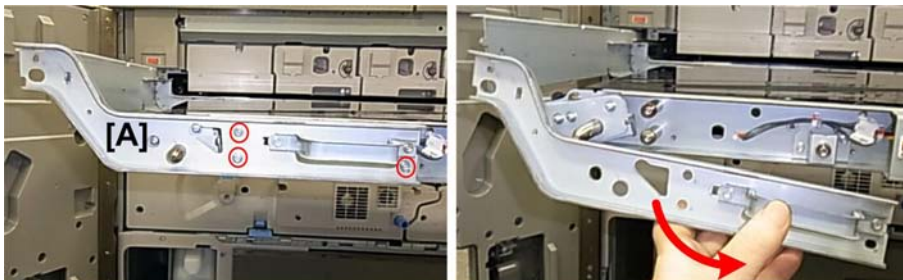

d074r166

17. Remove the left handle plate [A] (⚙ x3).

Belt Tension Roller, Removing the ITB

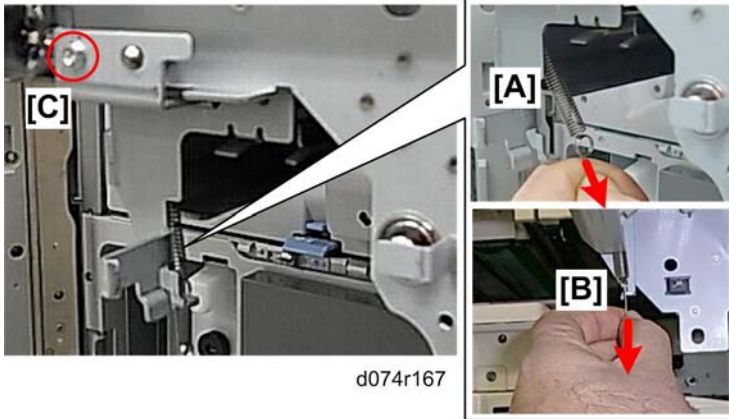

4

- 18. Disconnect the front spring [A].
- 19. Disconnect the rear spring [B].

Note

- Do not remove these springs. Let them hang free. They will not fall off.

- 20. Disconnect the belt tension roller assembly [C] ( x1).

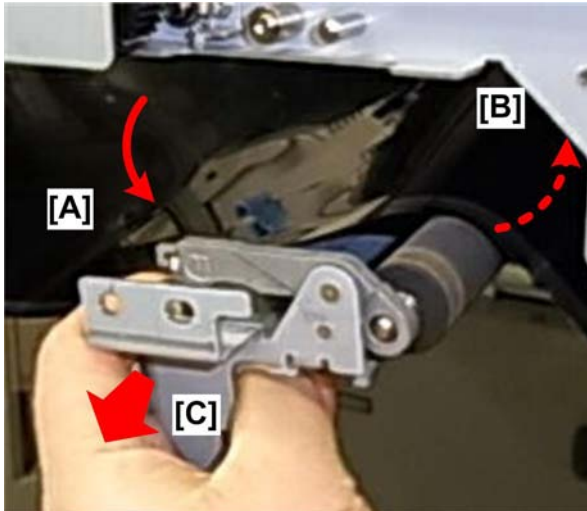

- 21. Slowly lower the belt tension roller assembly [A], while you support the other end of the roller with your other hand [B] under the ITB unit.
- 22. Remove the tension roller assembly [C] and tension roller.



d074r169

23. Removal of the tension roller relieves tension on the transfer belt and it will sag.

Note

- You will see an encoding strip on the front edge of the transfer belt. The transfer belt must be re-installed with this strip on the front edge as shown above.



d074r170

24. Slowly remove the transfer belt.

Transfer Belt Installation

4

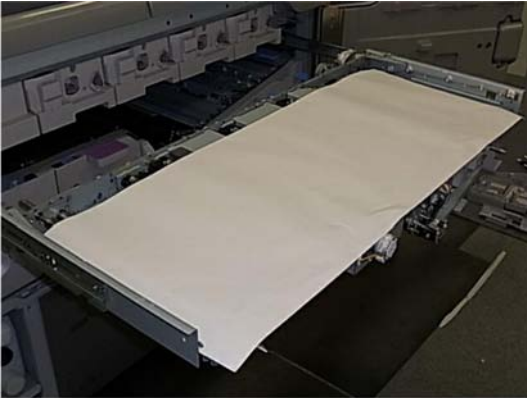

d074r171

1. Before re-installing the transfer belt, cover the top of the ITB unit with a long sheet of paper.

Note

- A sheet of paper is provided as an accessory with a new transfer belt.
- If you are re-installing the same transfer belt, you can cover the top of the unit with several sheets of A3 paper. (The paper prevents the front edge of the belt from catching on top of the unit.)

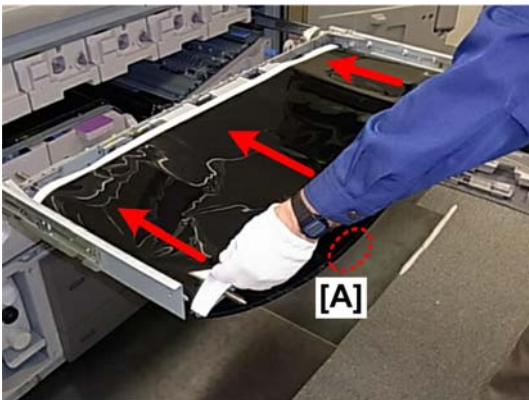

d074r172

2. Confirm that the encoding strip is on the front edge of the belt [A].

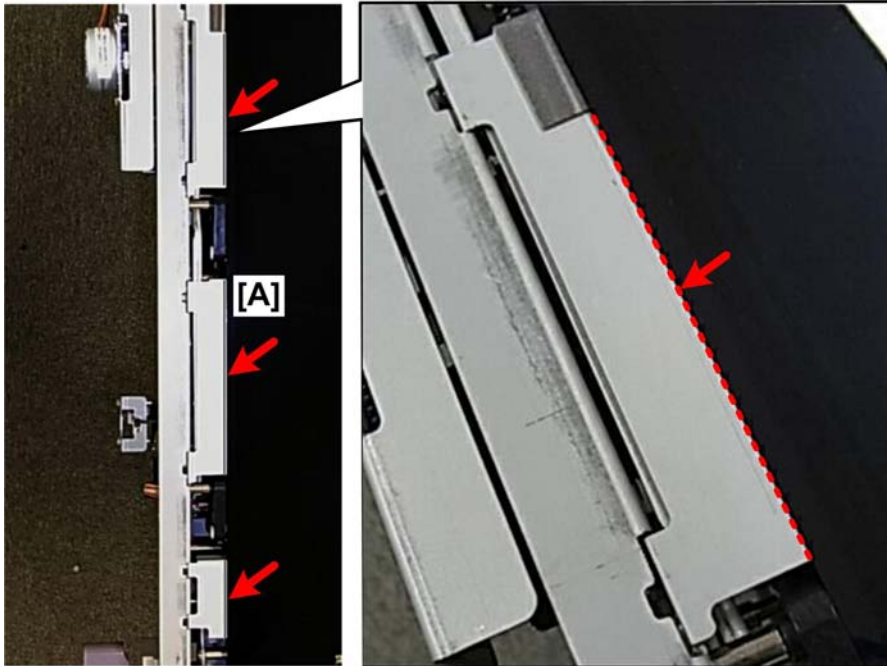

d074r173

3. Make sure that the front edge of the belt is parallel with the straight lines embossed on the plates at three locations [A]. This ensures correct alignment of the belt.

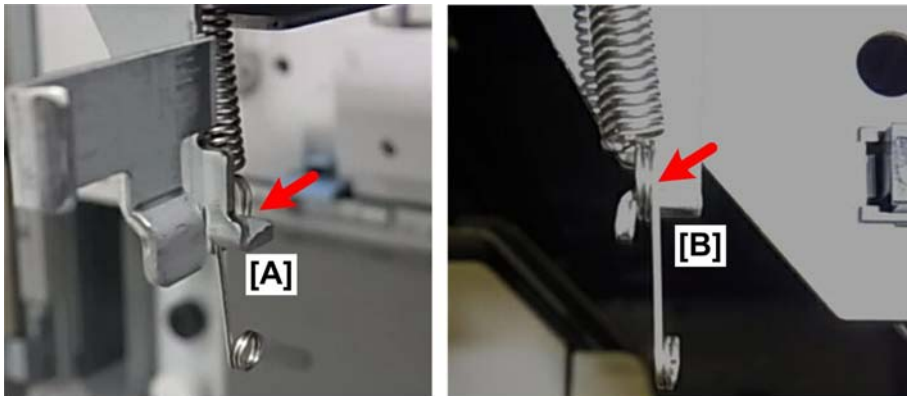

d074r174

4. Re-attach the springs of the tension roller at the front [A] and rear [B] as shown above.

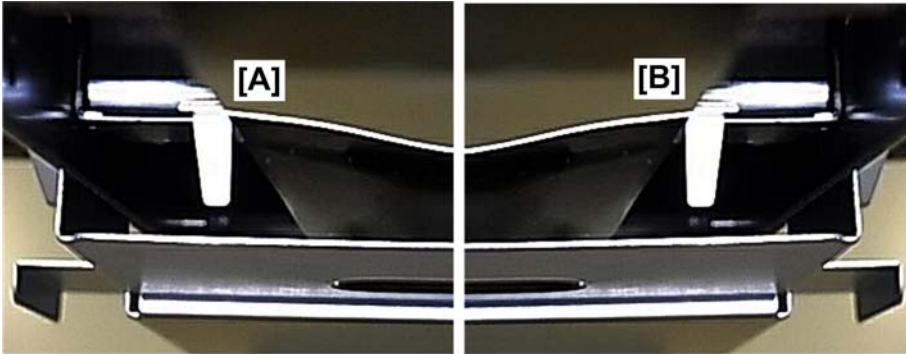

d074r175

4

5. Before you re-attach the tension roller assembly:

- Look under the ITB unit, and make sure that the actuators of the rear overrun sensor [A] and front overrun sensor [B] are visible near the rear and front edges of the belt.
- Check the alignment of the belt again at the top front edge (see Step 3).

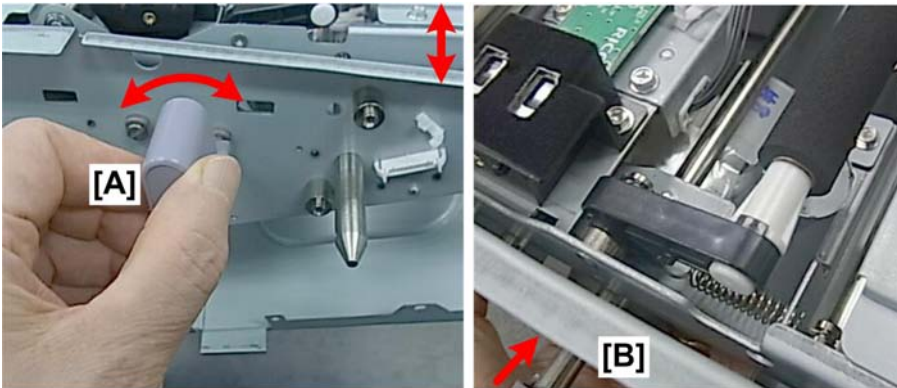

d074r176

6. Before you slide the ITB unit into the machine, turn the ITB lever [A] to confirm that the lift plate raises and lowers.

The plate should move up and down smoothly.

-or-

If the action of the ITB lever is loose and the lift plate does not move, this means the right lift plate is in the up position.

- Reach under the unit [B] and turn the white drive gears of the 2nd lift motor (K) to lower the lift plate until it is down.
- Turn the ITB lever [A] again to confirm that the lift plate moves up and down smoothly.
- Turn the ITB lever [A] to the down position so that the lift plate and transfer belt are down.

★ Important

- **Never push the ITB unit into the machine with the lift plate in the up position.**

After Transfer Belt Replacement

1. The machine power must be OFF.
2. Open both front doors.
3. Remove the front cover of the ITB cleaning unit.
4. Rotate both levers of the ITB cleaning unit clockwise to retract the blades from the ITB.
5. Remove the PTR unit. (▶ p.432)
6. Turn the main power switch ON and close both front doors.
7. Enter the SP mode.
8. Reset the counter for the replaced ITB belt.
9. Open the right front door and execute SP2310-1 (Force Lubricant - Belt Cleaning).
10. Immediately after executing, close the right door to run the above SP.
11. Wait for about 5 minutes. When you see "Completed" displayed on the operation panel, you are ready to continue.

★ Important

- Do not open any door or remove the used toner bottle while lubrication is in progress.

12. Re-install the PTR unit.
13. Rotate both levers of the ITB cleaning unit counter-clockwise and re-install the front cover.
14. Do SP2912-1. This SP adjusts the strength of the LED beam of the ITB feed-back sensors (main sensor and sub sensor).
15. Do SP2914-1. This SP code resets the ITB feed-back sensors.

After a new ITB has been installed, or the original belt re-installed, the physical condition of the belt should be checked. The three ID/MUSIC sensors (Rear, Center, Front) scan the belt to detect nicks and scratches.

Belt Check

1. First, execute SP2310-1 to clean and lubricate the belt.
2. Do SP3011 to manually execute process control.
3. Do SP3012-1 to confirm the successful initialization of process control.
4. Do these SP codes to confirm the scan results:
 - SP2112-15
 - SP2112-16
 - SP2112-17
5. Each SP execution should return a "0". If an SP returns any value other than "0", do Steps 2, 3 again..

6. After repeated executions, if one or more of the SP codes continues to return any value other than "0", the belt is damaged and must be replaced.

ITB Unit Cover Plates

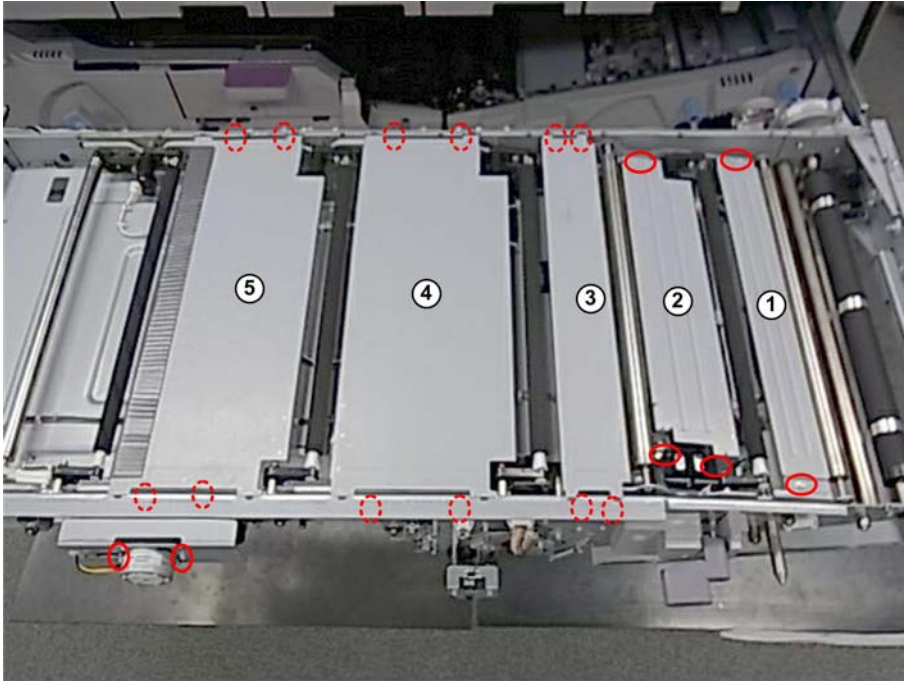

d074r227

After the transfer belt has been removed, there are five plates on top of the ITB unit that must be removed for some procedures.

Pull the ITB unit out to the 2nd stop position. (p.410)

1. Transfer belt (p.599)
2. Plate ① (x2)
3. Plate ② (x3)
4. Plate ③ (x4)
5. Plate ④ (x4)
6. Plate ⑤ (x6)

In order to remove the front screws, you must first disconnect the 1st lift motor (YMC) (p.611)

ID/MUSIC Sensor Fan

1. Pull the ITB unit out to the 1st stop position (p.410)

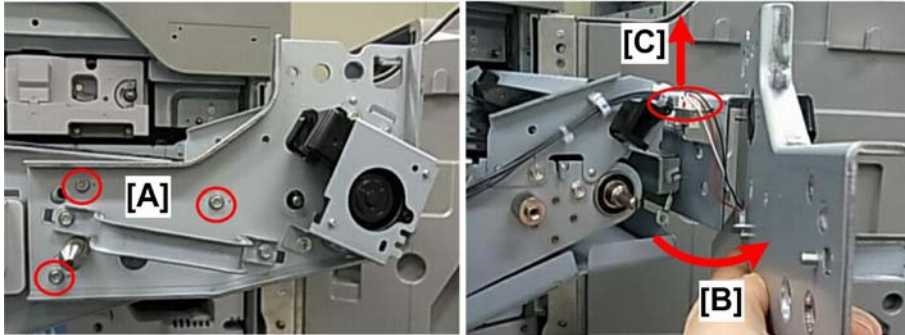

d074r177

2. Disconnect the right handle plate [A] (⚙️ x3).
3. Swing the plate [B] slowly to the right.
4. Disconnect the fan harness [C] (🔌 x1) and remove the handle.



d074r178

5. Disconnect the fan motor assembly (⚙️ x3)

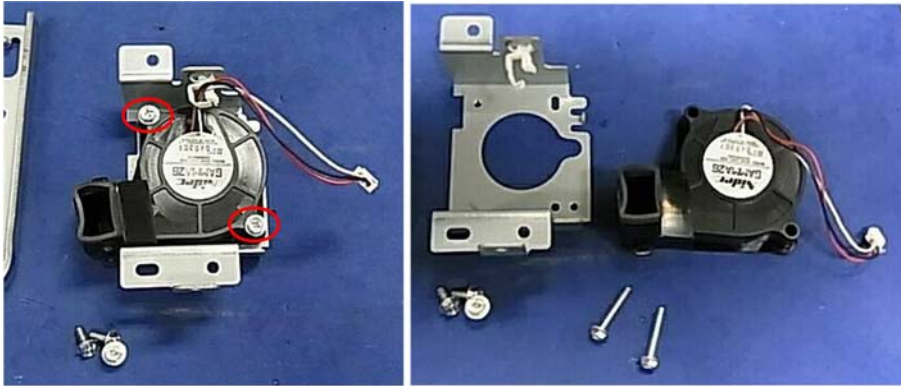

d074r179

4

6. Remove the fan motor ( x2).

PTR Separation Motor

1. Pull the ITB unit out to the 1st stop position. ( p.410)

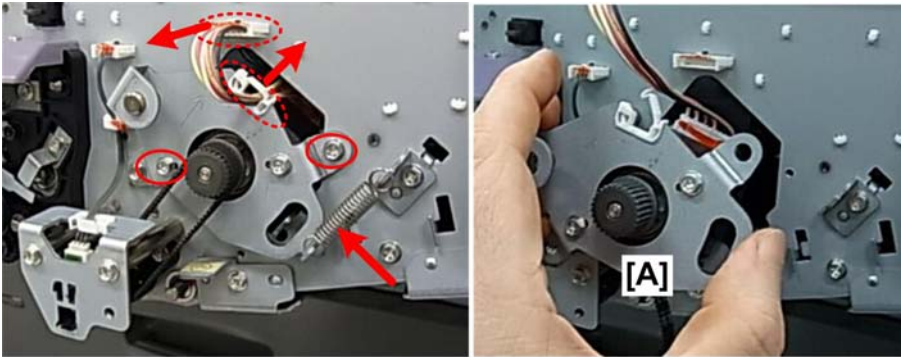

d074r180

2. Remove the motor assembly [A] ( x1,  x1,  x1,  x2)

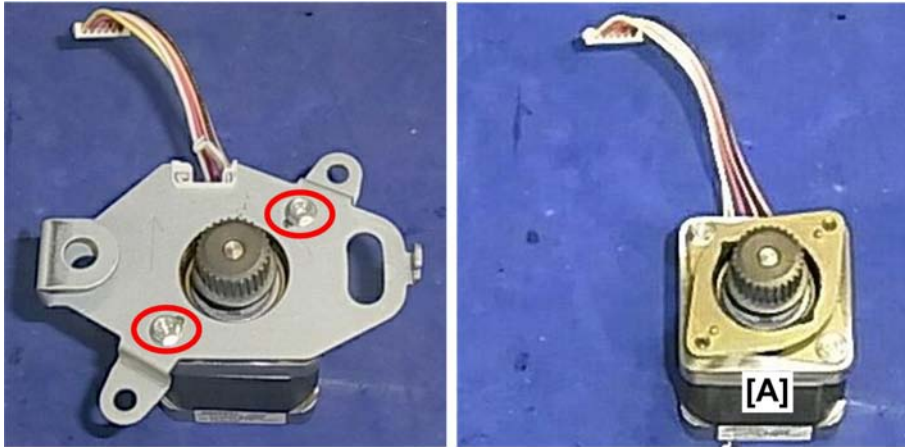

d074r181

3. Remove the motor [A] ( x2).

1st Lift Motor (YMC)

1. Pull the ITB unit out to the 1st stop position. ( p.410)

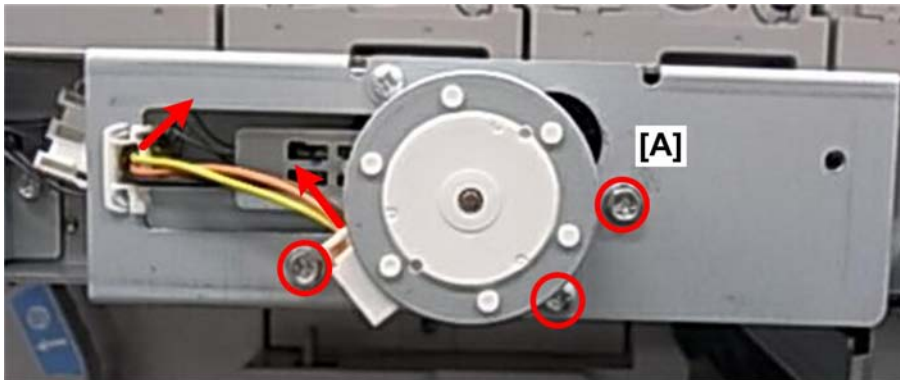

d074r182

2. Remove the motor assembly [A] ( x1,  x1,  x3).

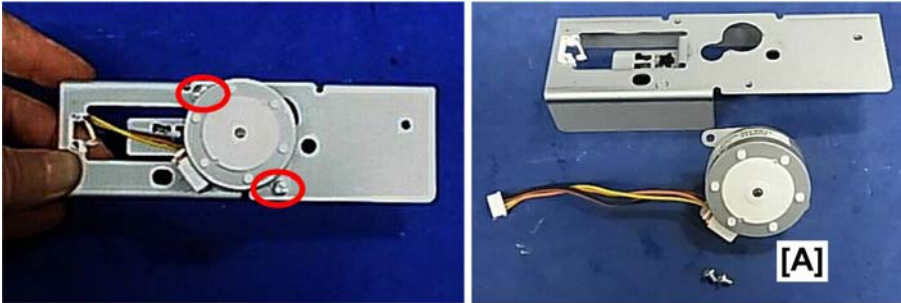

d074r184

3. Remove the motor [A] ( x2).

4

Transfer Belt Drive Motor

1. Pull the ITB unit out to the 2nd stop position. ( p.410)

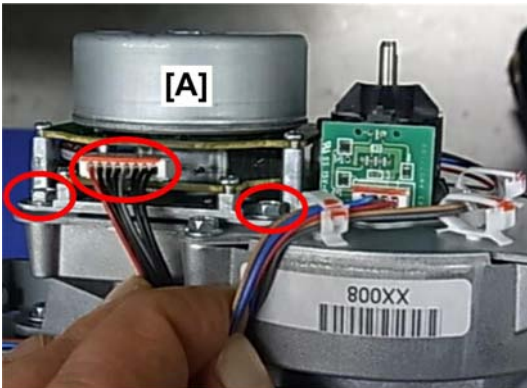

d074r185

2. At the top of the right rear corner of the ITB unit, disconnect the motor [A] ( x1,  x2).

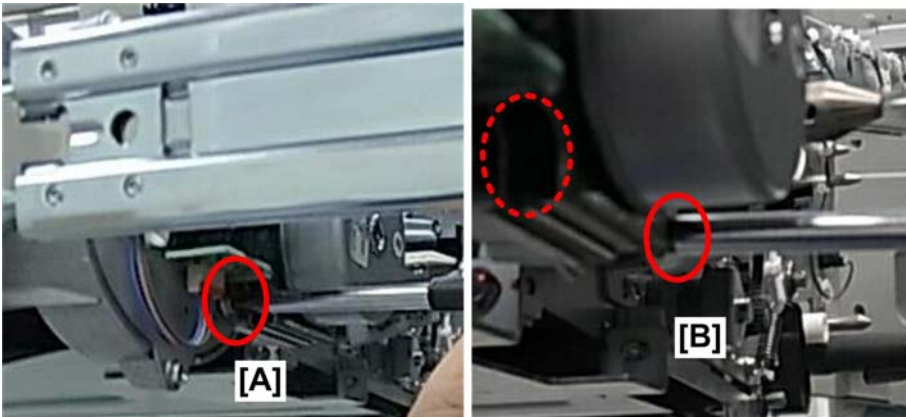

d074r186

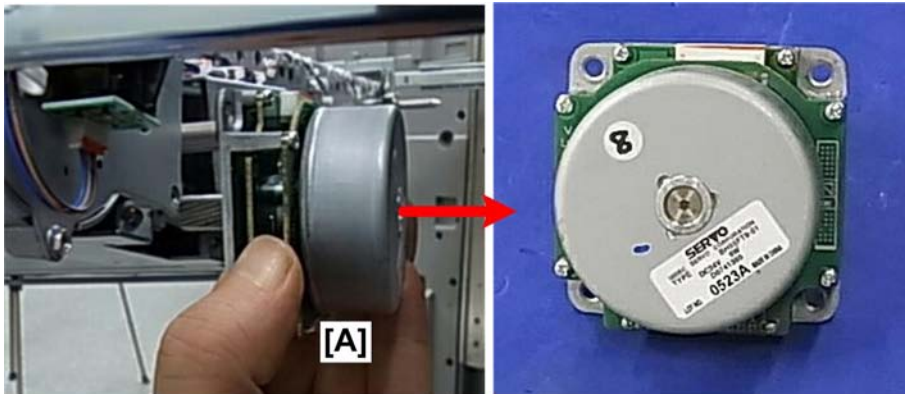

3. Below the ITB unit, remove screw [A] and screw [B] ( x2).



d074r187

4. Remove the transfer belt drive motor [A].

2nd Lift Motor (K)

1. Pull the ITB unit out to the 2nd stop position. ( p.410)
2. Transfer belt ( p.599)
3. ITB unit cover plate ③ ( p.608)

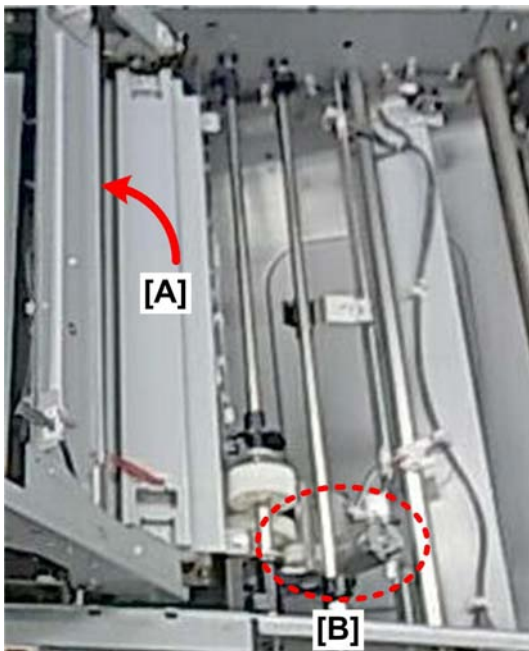

d074r188

4. Raise the lift assembly [A] so that you can see the 2nd lift motor [B].



d074r189

5. Disconnect the front end of the shaft [A] (Ⓢ x1).
6. Disconnect the rear end of the shaft [B] (Ⓢ x1).

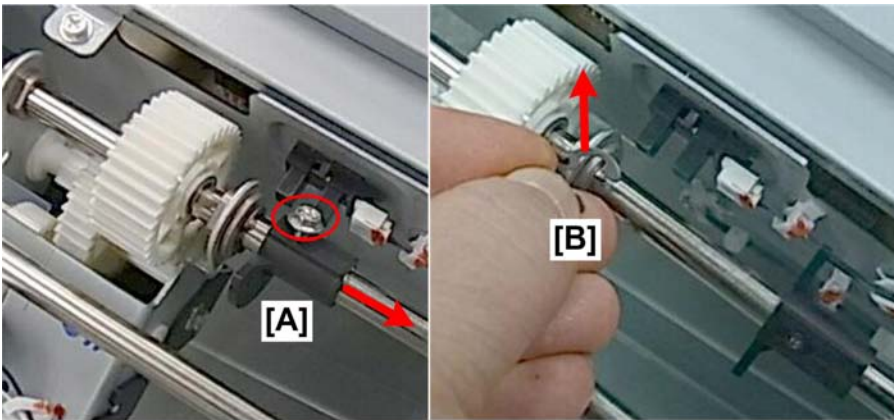

d074r190

7. Remove screw [A] (Ⓢ x).
8. Remove e-ring [B] (Ⓢ x).

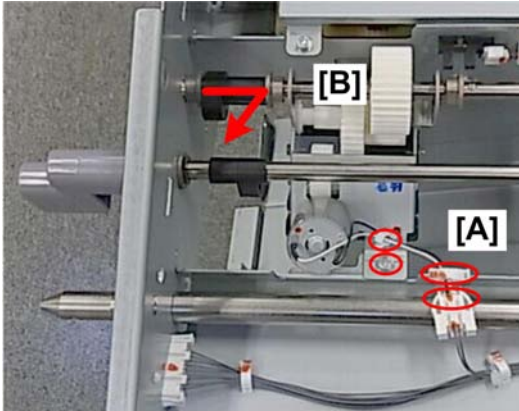

d074r191

9. Disconnect the motor harness [A] and the motor (⚙️ x1, ⚙️ x2, 🔧 x1)
10. Push the shaft to the right to disconnect it at the front [B], lower it, and pull it out from below the ITB unit.

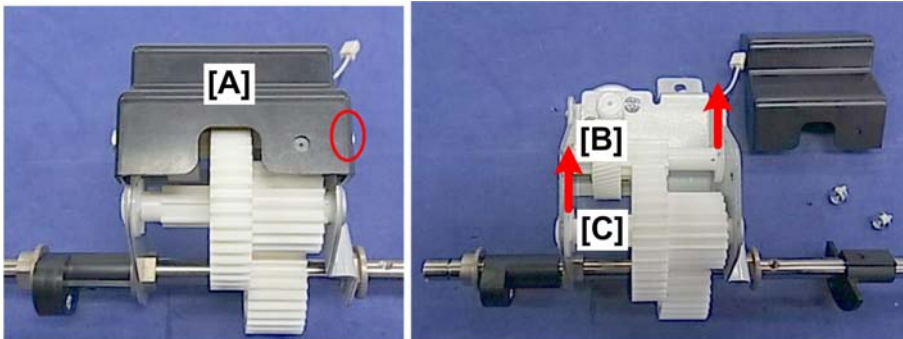

d074r192

11. Remove the cover [A] (🔧 x2).
12. Disconnect and remove gears [B] and [C] (⚙️ x2, ⚙️ x2).

4

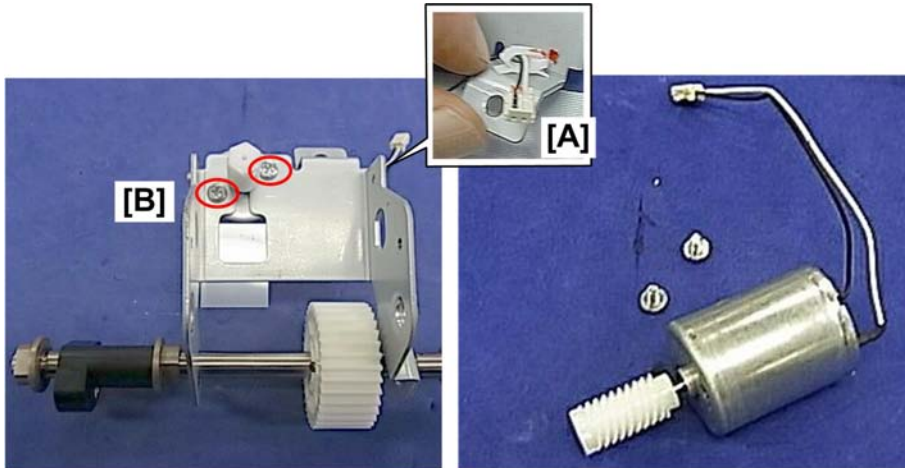

d074r193

- 13. Make sure the harness is disconnected at [A] (🔌x1).
- 14. Remove the motor [B] (🔧x2)

Belt Centering Motor

- 1. Pull the ITB unit out to the 2nd stop position. (📄p.410)
- 2. Transfer belt (📄p.599)

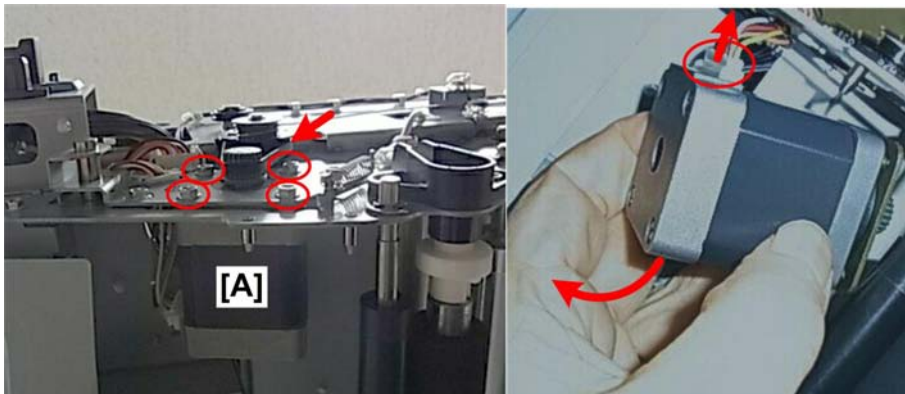

d074r194

- 3. Below the ITB unit at the rear, disconnect the motor [A] (🔌x1, 🛠x4).
- 4. Remove the motor (🔧x1).



d074r195

Re-installation

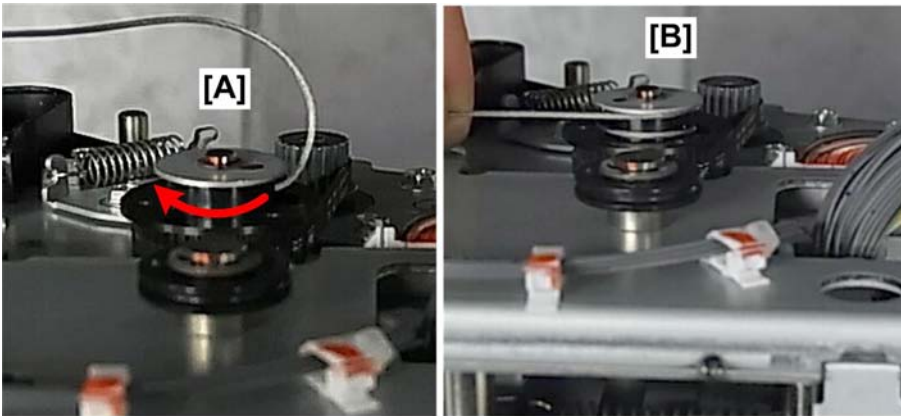

d074r196

1. Look down at the back of the ITB unit and check the spool [A].
2. If the cable is free as shown above, wrap it once around the spool (counter-clockwise). [B] shows the cable wound on the spool correctly.

PTR/ITB Cleaning Unit Motor

This motor has two functions. It drives the PTR and all the moving parts of the ITB cleaning unit.

1. Open the cooling box and controller box. (▶ p.400)

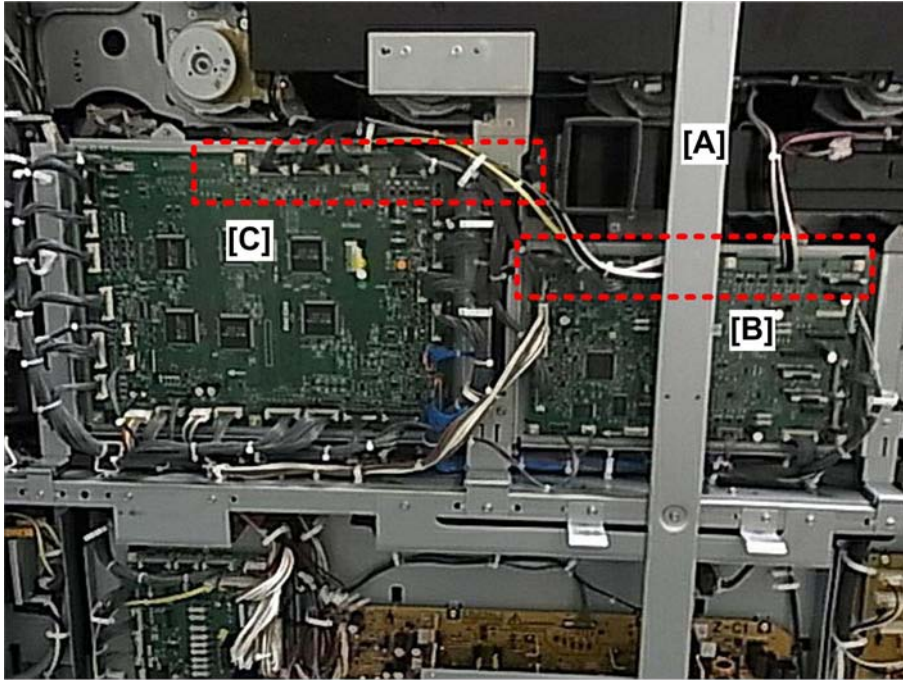

d074r197

2. Remove the center stay [A] ( x3).
3. Disconnect clamps and connectors of the TDCU around [B].
4. Disconnect clamps and connectors of the TDCU around [C].

 **Note**

- These boards can be lowered on their bottom hinges after the top connectors and clamps are disconnected. You do not need to disconnect all clamps and connectors.

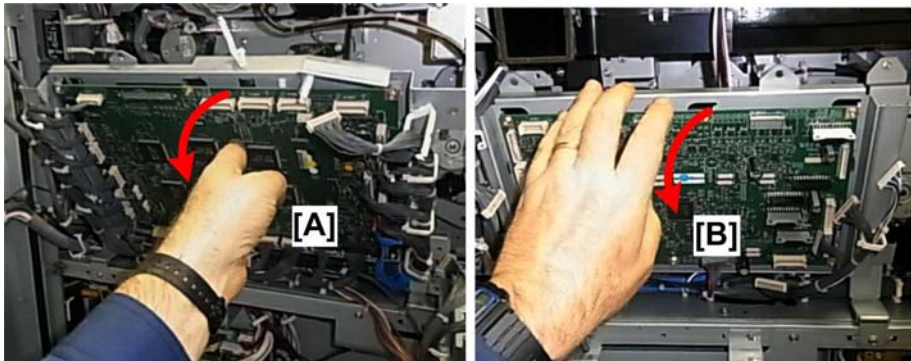

d074r198

5. Lower the IOB [A] and TDCU [B].

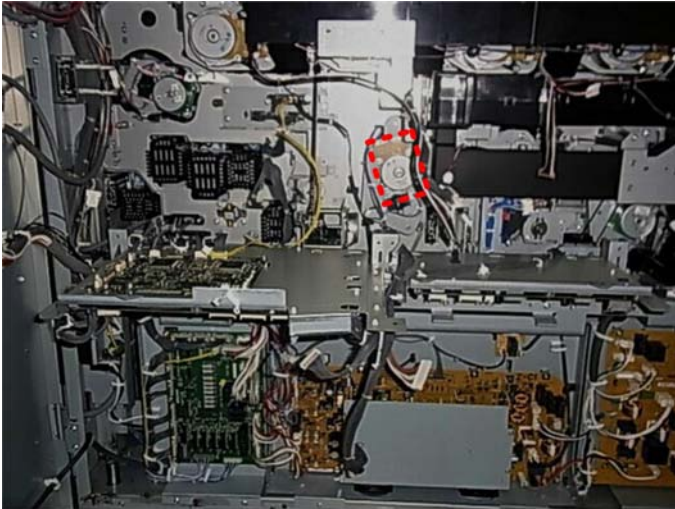

d074r199

6. After the boards are lowered, you can see the ITB cleaning unit motor.



d074r200

7. Remove the motor (🔧 x2, 📏 x1, 🔩 x4).

ID Sensor/MUSIC Sensors

1. Pull the ITB unit out to the 1st stop position. (📄 p.410)

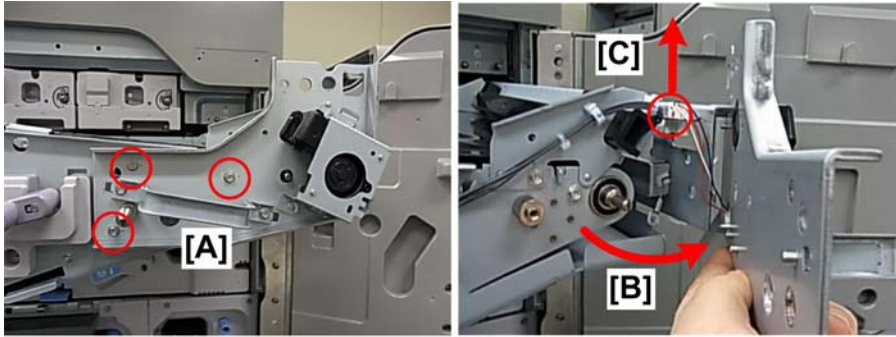

d074r201

4

2. Disconnect the handle plate [A] (x3).
3. Slowly swing the handle plate to the right [B].
4. Disconnect the harness [C] (x1).

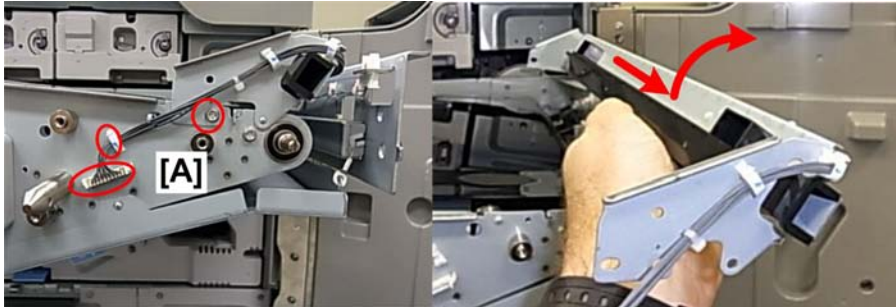

d074r202

5. Disconnect the plate [A] and remove it (x1, x1, x1).



d074r203

6. Remove the sensor board (x5, x1, x6).

After ID/MUSIC Sensor Replacement

Do the following procedure after installing new ID/MUSIC sensors and re-assembling the machine.

1. Plug in the power cord and turn on the machine.
2. Enter the SP mode.

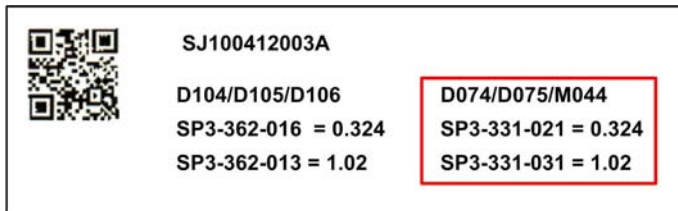

d0704r144

3. Refer to the sheet provided with the new ID/MUSIC sensor set.
4. Do the SP codes for D074/D075/M044 on the right side of the sheet (enclosed in the red box in the illustration above). The numbers on the left are for another machine.
5. Next, do SP3011-1 (Manual Process Control).
6. Do SP3012-1 to confirm successful complete of process control initialization.

4

PTR Separation Sensor

1. Pull the ITB unit out to the 1st stop position. (p.410)

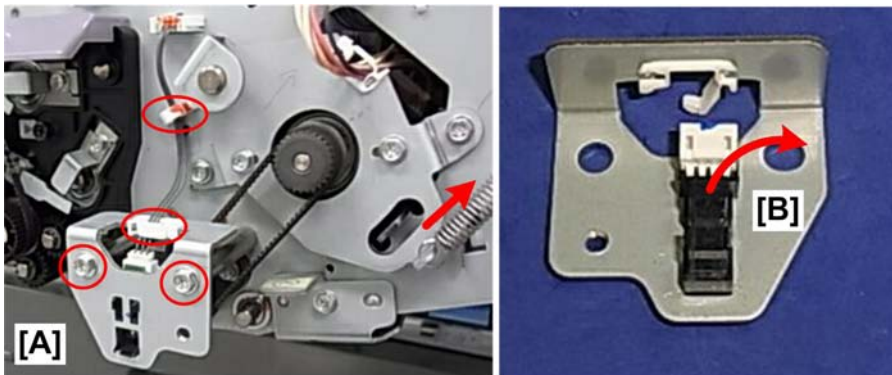

d074r204

2. Remove the PTR separation motor assembly [A] (⚙️ x1, 🛠️ x1, 📦 x1, 🔧 x2).
3. Remove the sensor [B] (📦 x1, 🔧 x3).

1st Lift Motor Sensor (YMC)

1. Pull the ITB unit out to the 1st stop position. (p.410)

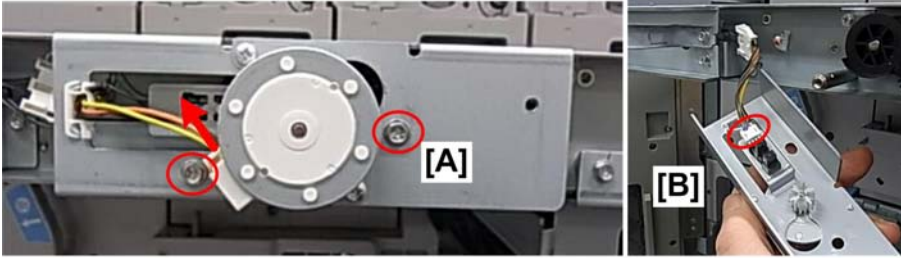

d074r205

2. Remove the sensor assembly [A] (🔧 x1, 🛠️ x1, 🛠️ x2).
3. Disconnect the sensor [B] (🔌 x1)

4

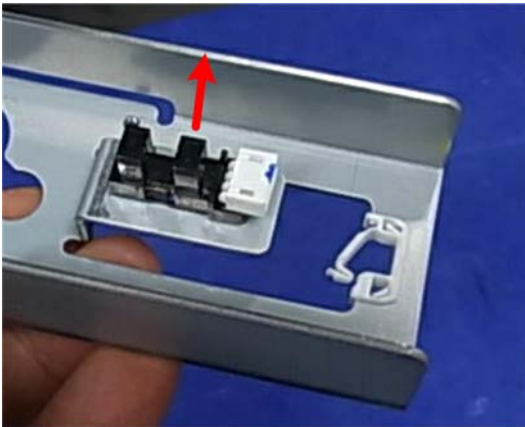

d074r206

4. Remove the sensor (🔧 x3).

Belt Centering Roller HP Sensor

1. Pull the ITB unit out to the 2nd stop position. (📖 p.410)

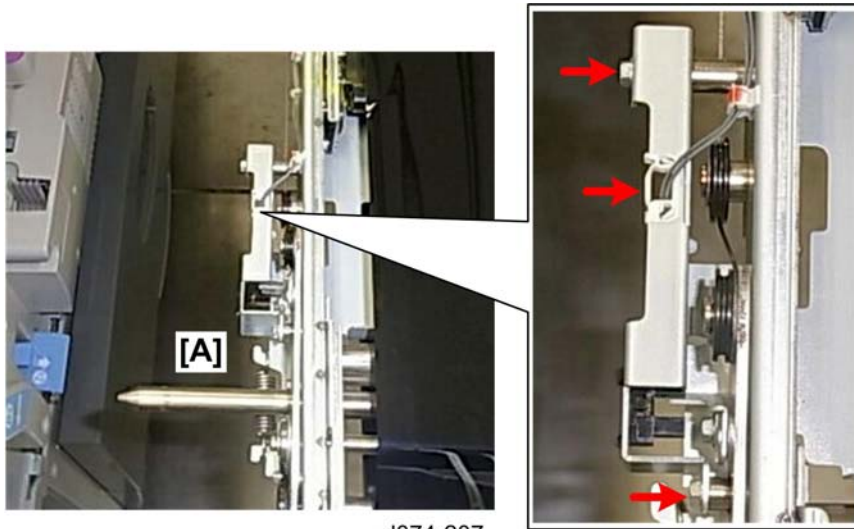

d074r207

2. At the top of the left rear corner of the ITB unit [A], disconnect the sensor assembly (🔧 x1, 🔩 x2)

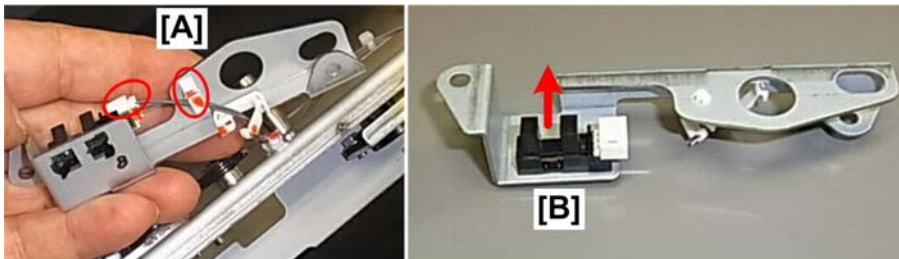

d074r208

3. Disconnect at [A] (🔧 x1, 🔩 x1).
4. Disconnect the sensor [B] (🔩 x3).

Belt Centering Sensor

1. Pull the ITB unit out to the 2nd stop position. (🔧 p.410)
2. Transfer belt (🔧 p.599)

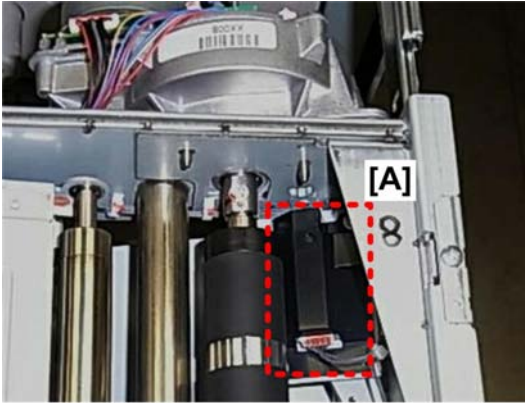

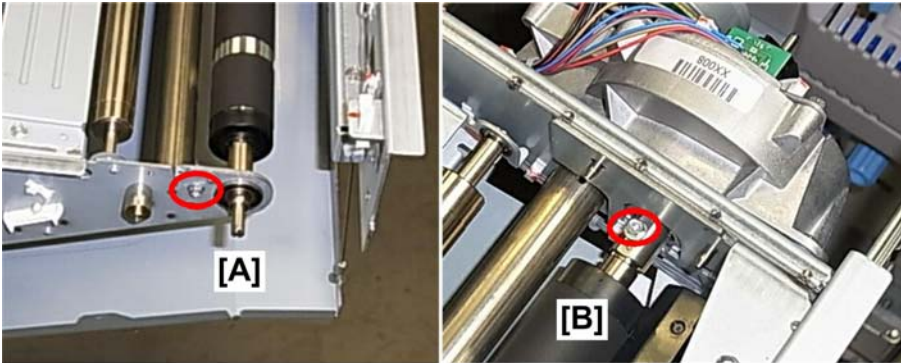

d074r209

- 4
3. The belt centering sensor is located at the rear upper right corner [A] of the ITB unit.



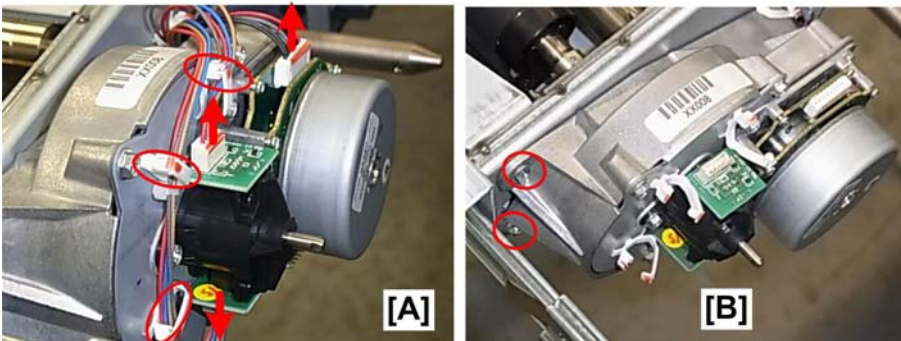

d074r210

4. Disconnect the front end of the ITB drive roller [A] ( x1).
5. Disconnect the rear end of the ITB drive roller [B] ( x1).



d074r211

6. Behind the ITB unit, disconnect the transfer belt drive motor and drive train [A] ( x3,  x3).
7. Remove the drive train screws on the right [B] ( x2).

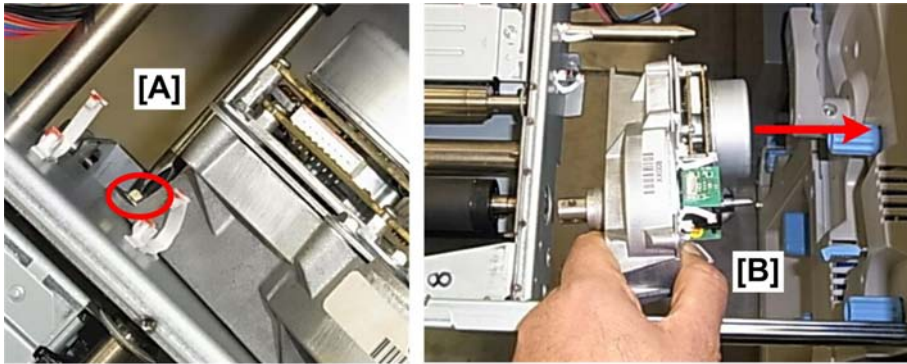

d074r212

8. Remove the drive train screw on the left [A] ( x2).
9. Remove the ITB drive train with the transfer belt drive motor attached [B].

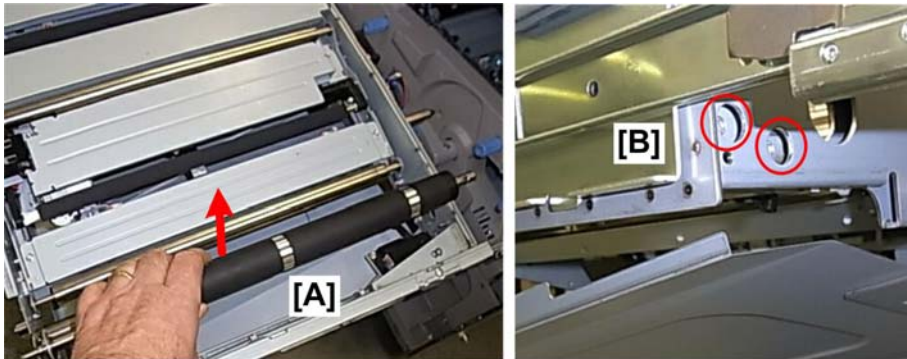

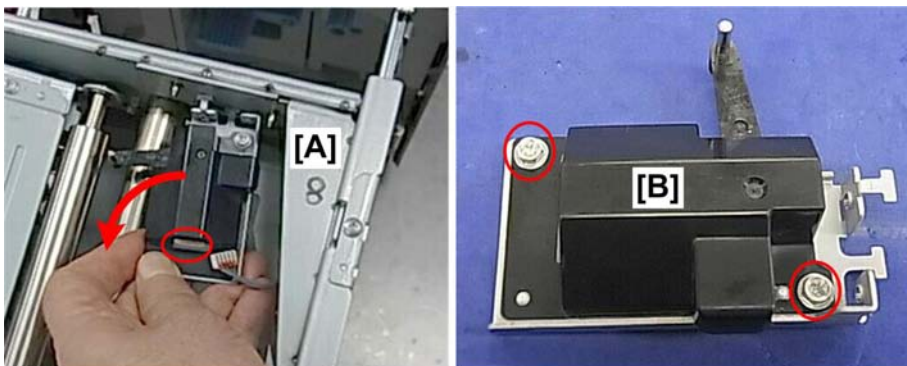

d074r213

10. Remove the ITB drive roller [A].
11. At the bottom right rear corner [B], remove the sensor assembly ( x2).



d074r214

12. At the top, remove the belt centering sensor assembly [A] ( x1).
13. Remove cover [B] ( x2).

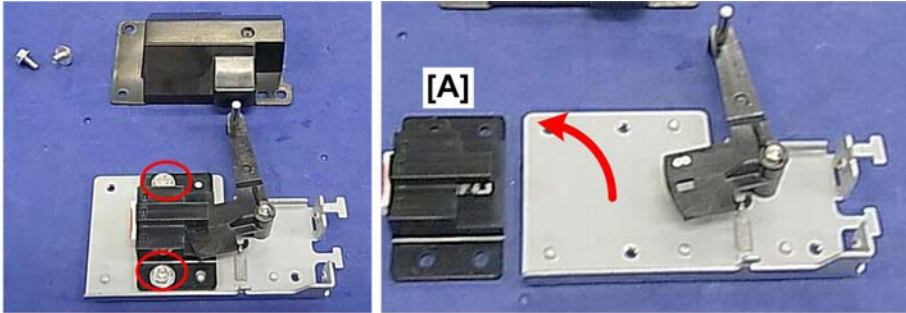

d074r215

14. Remove the belt centering sensor [A] (⚙️ x2).

4

2nd Lift Motor Sensor 1 (K)

1. Pull the ITB unit out to the 2nd stop position. (⚙️ p.410)
2. Transfer belt (⚙️ p.599)
3. ITB unit cover plate ③ and ④ (⚙️ p.608)

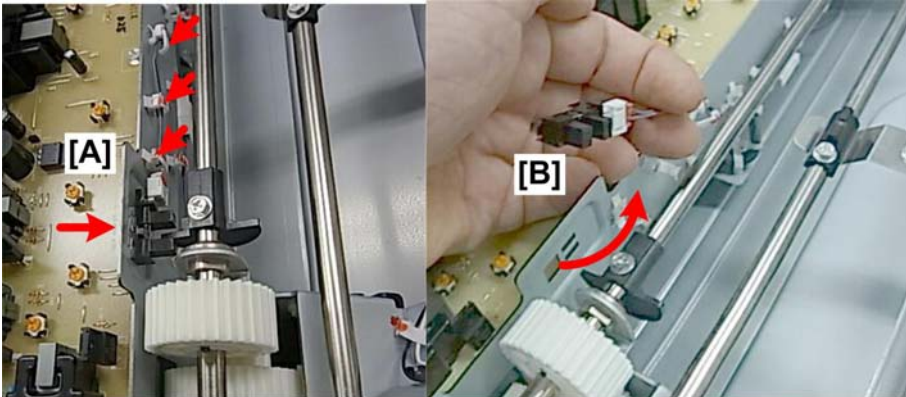

d074r218

4. Disconnect the sensor from the plate [A] (⚙️ x3, ▼ x3).
5. Disconnect the sensor [B] (⚙️ x1).

Re-installation

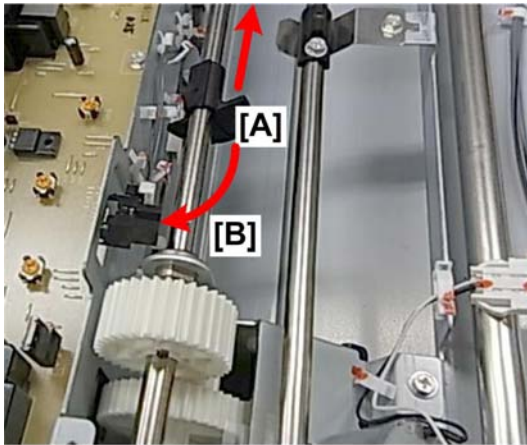

d074r219

1. Disconnect and slide the actuator [A] toward the rear.
2. Re-connect and set the sensor [B] (⚙️ x1, 🛠️ x3, 🔧 x3).

4

2nd Lift Motor Sensor 2 (K)

1. Pull the ITB unit out to the 2nd stop position. (📖 p.410)
2. Transfer belt (📖 p.599)
3. ITB unit cover plate ③ (📖 p.608)

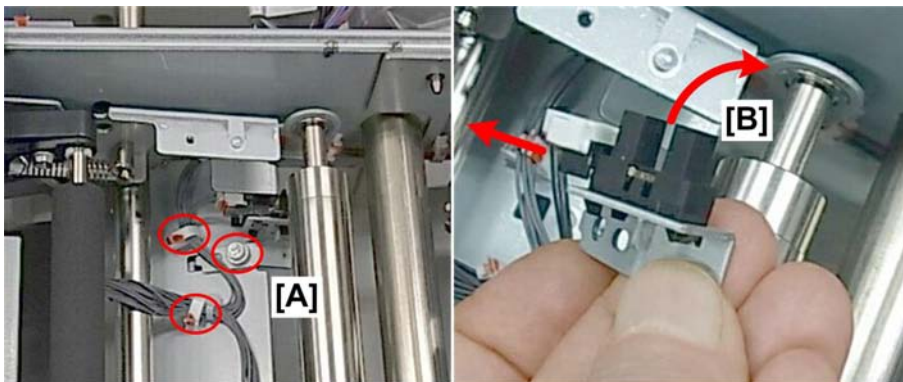

d074r220

4. At the top right rear corner of the ITB unit [A], remove the sensor assembly (🛠️ x2, 🔧 x1).
5. Remove the sensor [B] (⚙️ x1, 🔧 x3).

Transfer Belt Speed Sensor

1. Pull the ITB unit out to the 2nd stop position. (📖 p.410)

- 2. Transfer belt (p.599)
- 3. ITB unit cover plate ① (p.608)

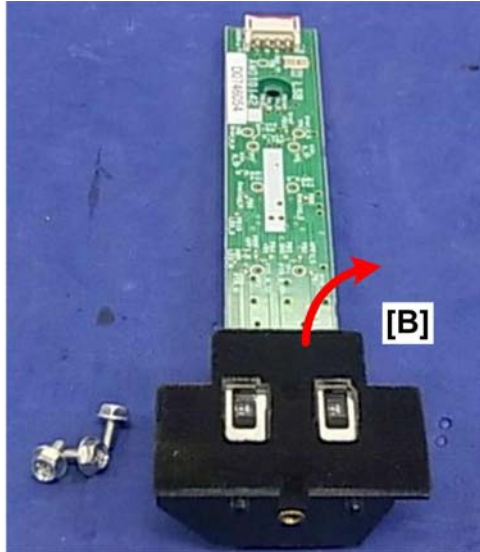
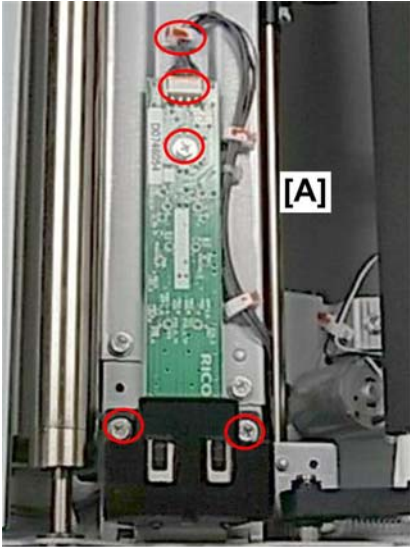

d074r221

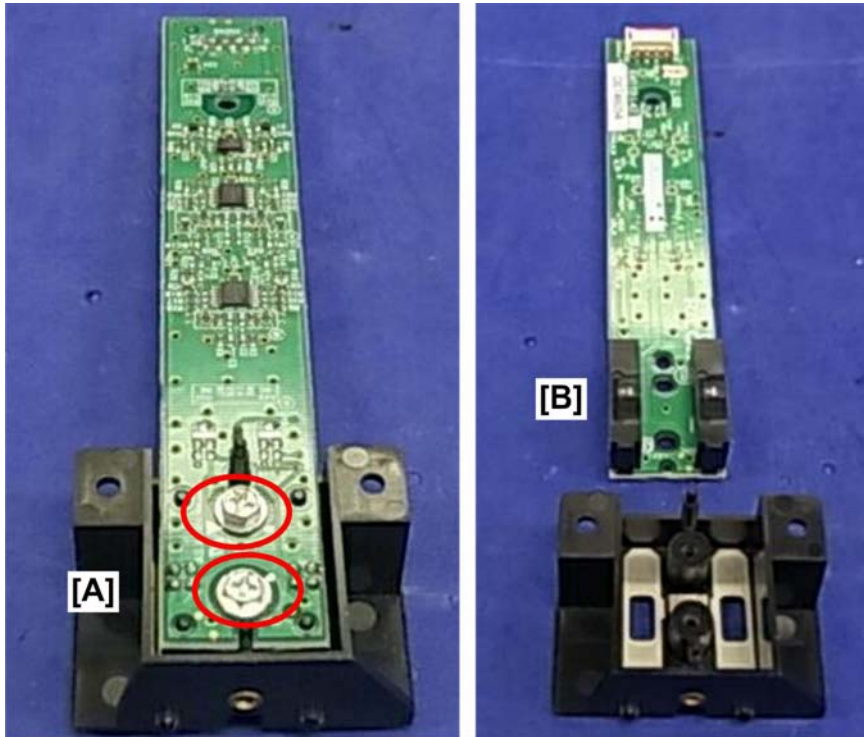

- 4. Remove the belt speed sensor assembly [A] (⚙️x1, 📦x1, 🔧x3).
- 5. Turn the sensor assembly [B] over.



d074r222

6. Separate the bracket [A] and sensor [B] ( x2).
7. Enter the SP mode and set the following SP codes to their default settings after replacing or cleaning the transfer belt speed sensor:
 - SP2920-1
 - SP2912-1
 - SP2914-1



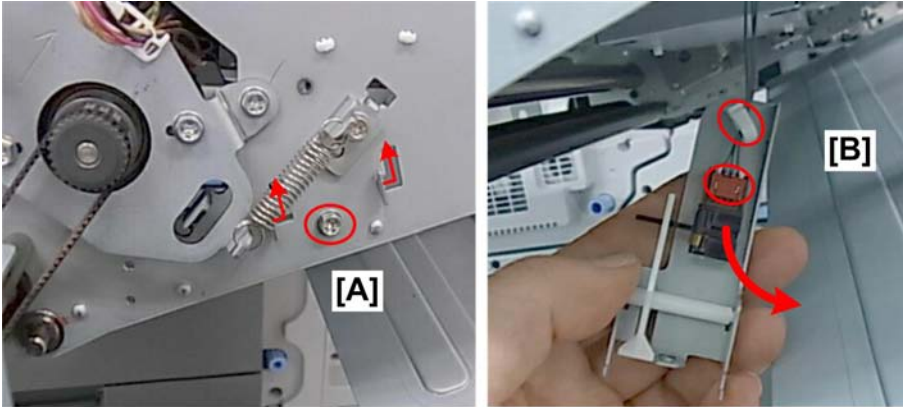

Front Overrun Sensor

1. Pull the ITB unit out to the 2nd stop position. ( p.410)
2. Transport belt ( p.599)





d074r223

4

3. At the front [A], disconnect the sensor bracket ( x1).
4. Grip the bracket under the ITB unit, then push it to the right and then up.
5. Remove the sensor [B] ( x1,  x1,  x3).

Rear Overrun Sensor

1. Pull the ITB unit out to the 2nd stop position. ( p.410)
2. Transport belt ( p.599)

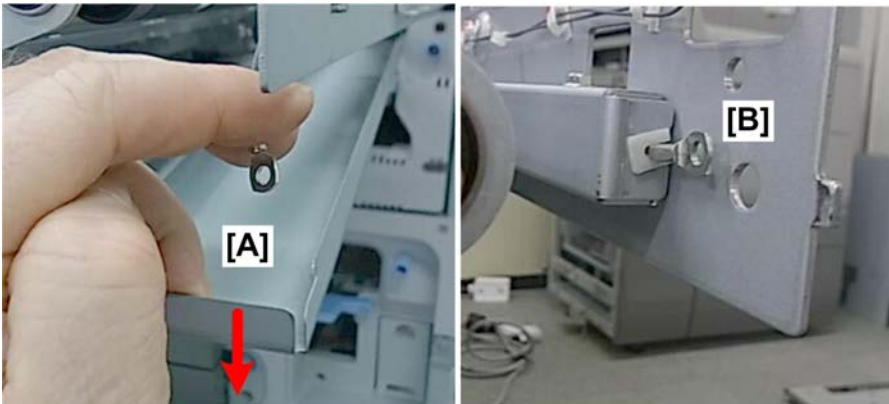

d074r224

3. Disconnect the bottom cover plate [A] and lower the plate. The spring loaded cable retracts automatically to [B].

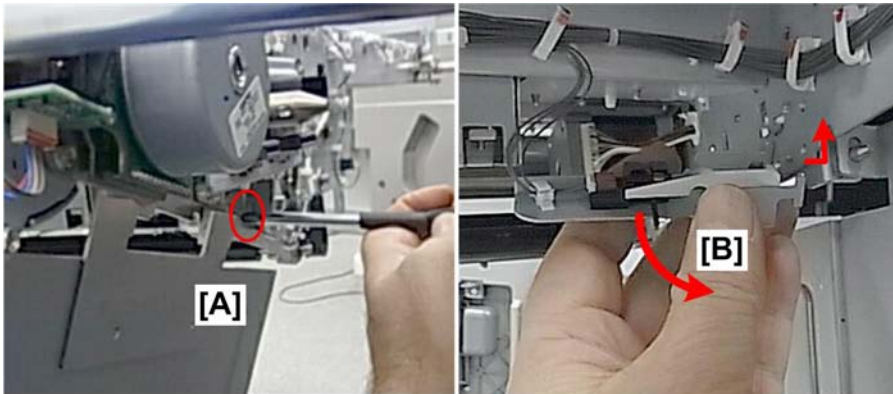

d074r225

4. Behind the ITB unit [A], remove the sensor bracket screw.
5. Remove the bracket [B] and lower it.

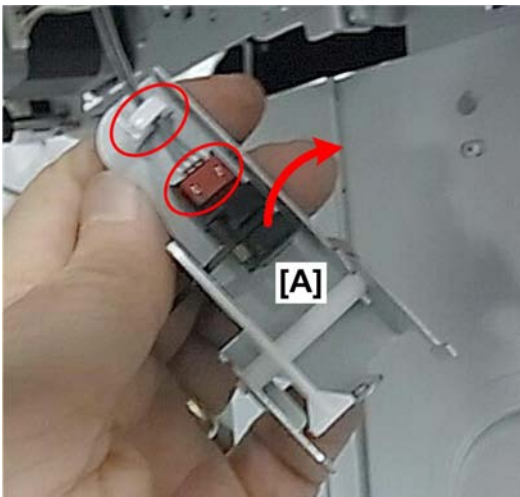

d074r226

6. Remove the sensor [A] (📷 x1, 📷 x1, 📷 x3).

Image Transfer Rollers

1. Pull the ITB unit out to the 2nd stop position. (📷 p.410)
2. Transport belt (📷 p.599)



d074r228

↓ Note

- There are four image transfer rollers. The following procedure is the same for each image transfer roller.
- The image transfer rollers should all be replaced together at 1800K.

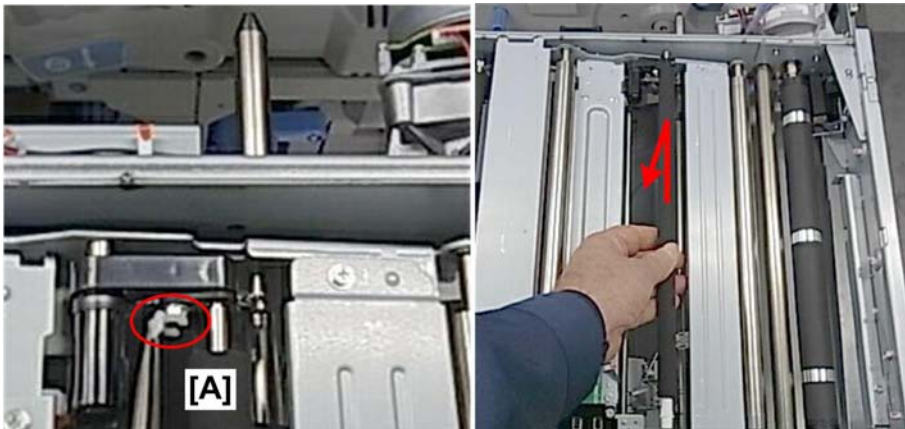

d074r229

3. At the rear, disconnect the image transfer roller [A] (⊗x1).
4. Slide the roller to the rear so that the front end disconnects from the coupling, and then remove the roller.

ITB Bias Roller

Note

- The bias roller should be replaced every 1800K.
- Pull the ITB unit out to the 2nd stop position. (p.410)
 - Transport belt (p.599)

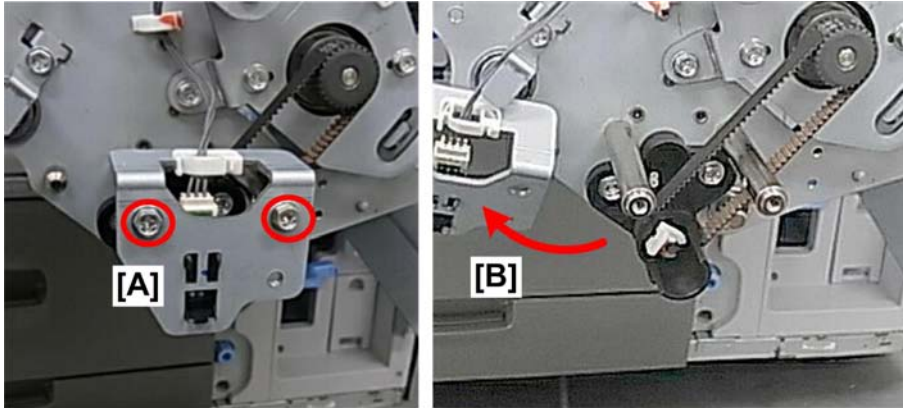

d074r230

- Disconnect the sensor assembly [A] (x2).
- Push the assembly to the side [B]. (You do not need to disconnect the sensor.)

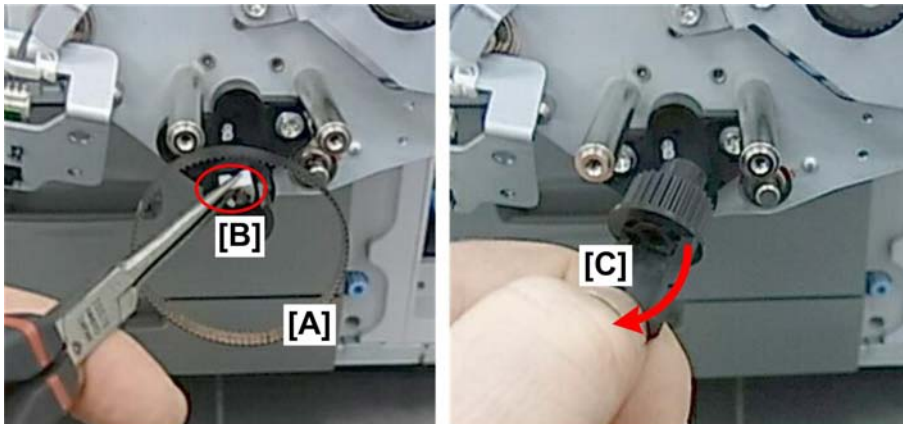

d074r231

- Disconnect the timing belt [A] (x1).
- Disconnect the end of the bias roller [B] (x1).
- Remove the actuator [C].

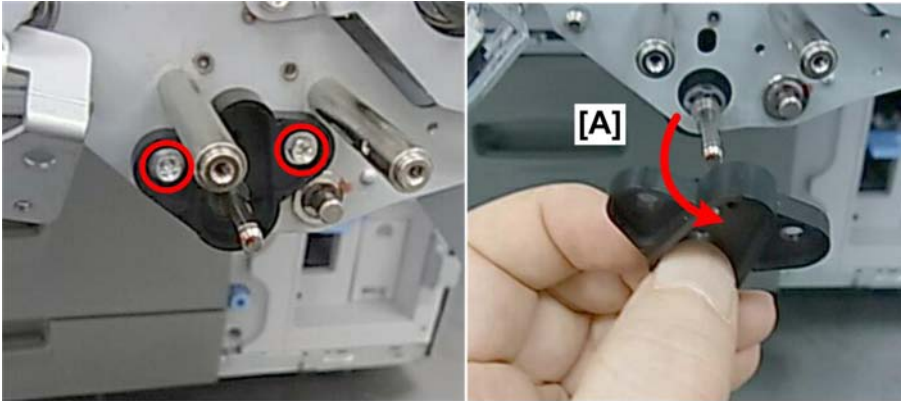

d074r232

4

8. Remove bracket [A] ( x2).

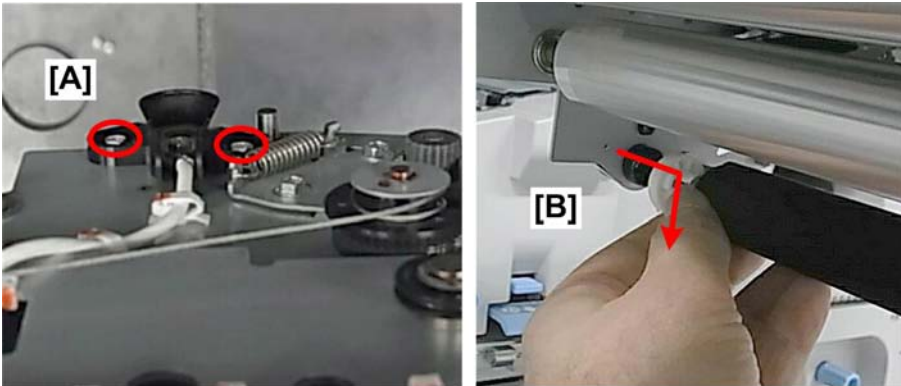

d074r233

9. At the rear bottom edge of the ITB unit [A] (top view), remove the screws, but do not remove the black bracket ( x2).

★ Important

- If you pull out the black bracket at the rear, the bias roller will fall.

10. Under the rear edge of the ITB unit [B], pull the rear end of the bias roller out and remove the roller.

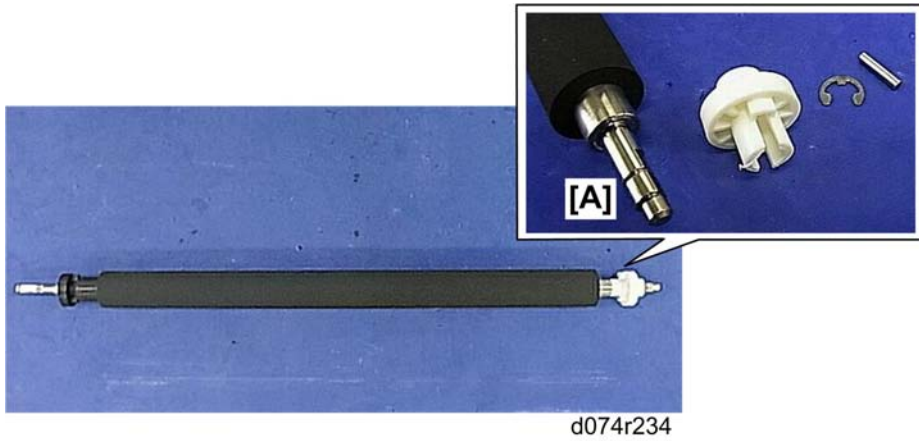

11. Remove the coupling from the rear end [A] of the bias roller (Ⓒ x1, Pin x1).

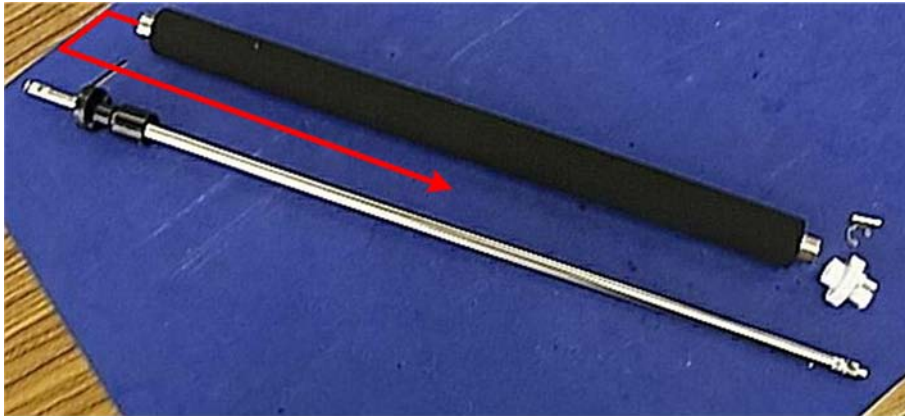

12. Pull the shaft out the front end of the bias roller.

ITB Transfer Power Pack

1. Pull the ITB unit out to the 2nd stop position. (p.410)
2. Transport belt (p.599)
3. ITB unit cover plate ③ and ④ (p.608)
4. Image transfer roller (p.631)

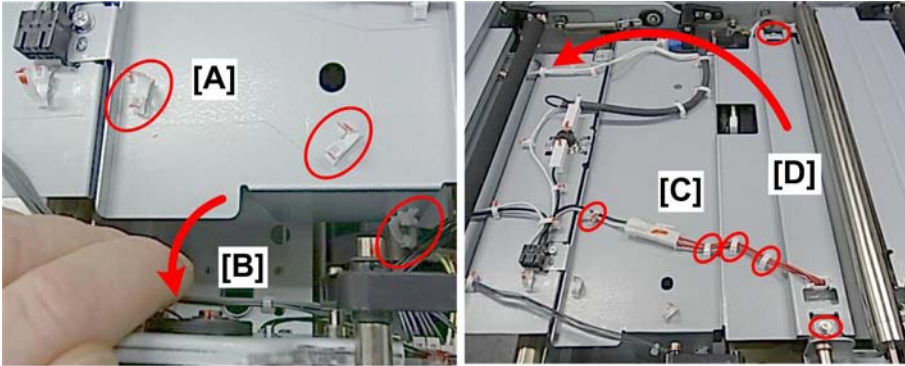

d074r237

4

5. At the front edge [A] where you removed the two plates, free the harness [B] from the plate below (🔧x3).
6. Free the right heater harness at the center [C], remove the right heater plate, and then move the plate [D] to the left side (🔧x3, 🛠️x2).

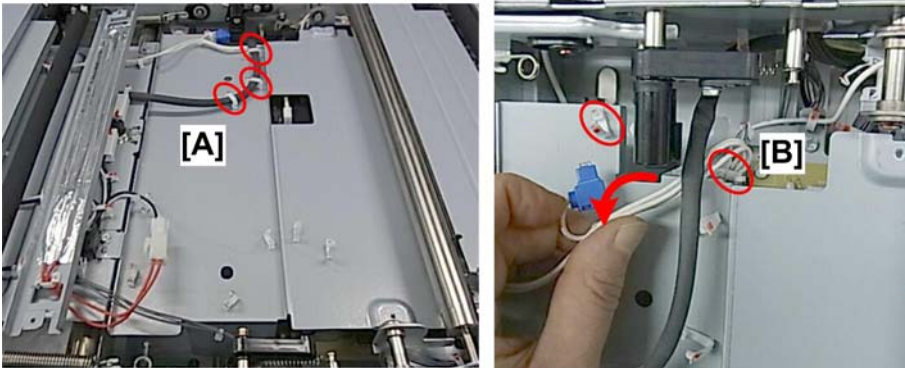

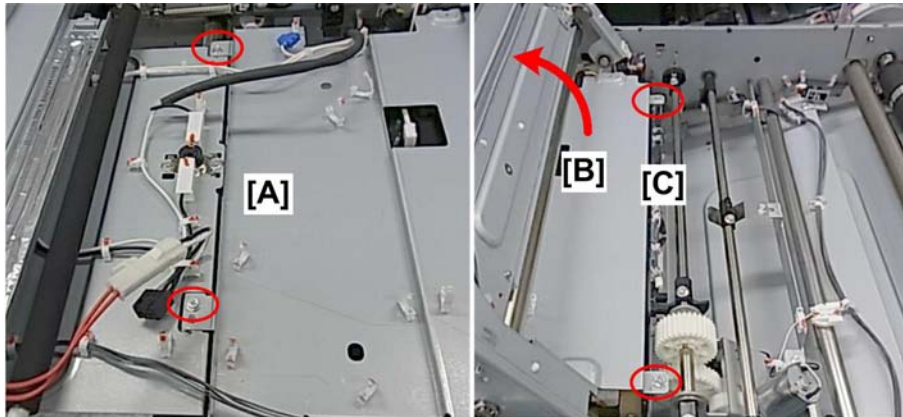

d074r239

7. Free the gray harness [A] at the rear.
8. At the rear, disconnect harness [B] (🔧x2, 🛠️x1)



d074r240

9. Disconnect the plate on the left side [A] ( x2).
10. Raise the lift arm [B] and disconnect the plate on the right [C] ( x2).

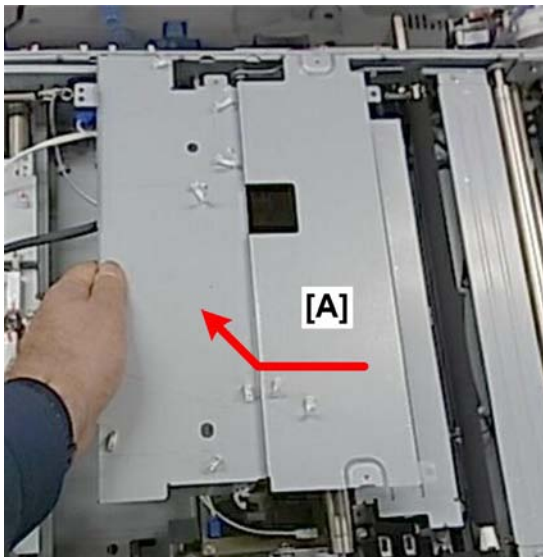

d074r241

11. Remove the transfer power pack cover plate [A].

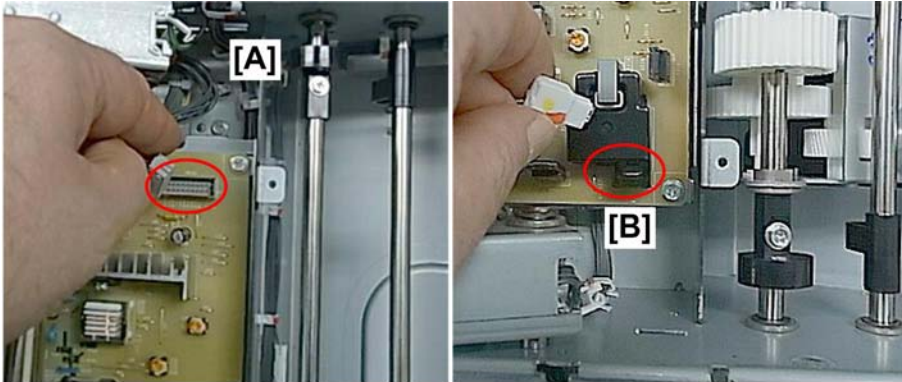

d074r242

4

12. Disconnect the transfer power plate:

[A] Right top corner (🔩 x1)

[B] Right bottom corner (🔩 x1)

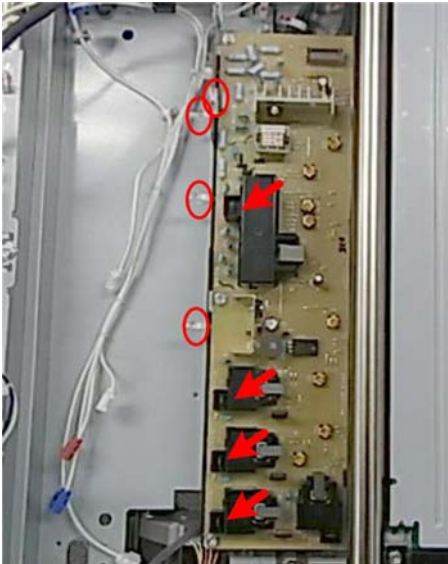

d074r243

13. Disconnect the left side of the transfer power pack (🔩 x7, 🛢️ x4).

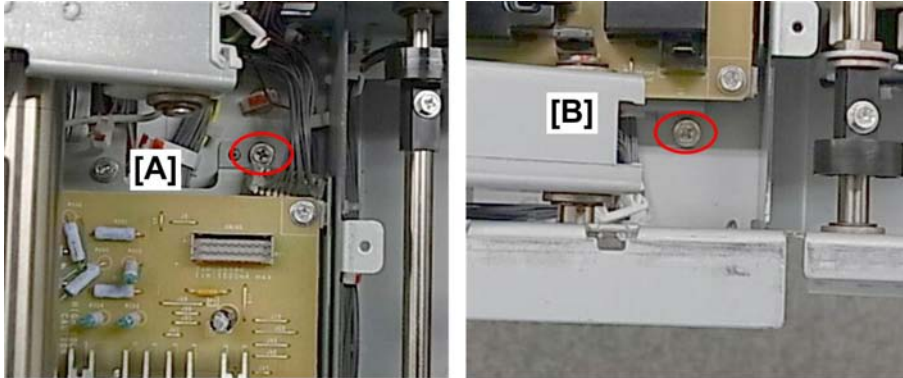

d074r244

14. Disconnect the right side of the power pack bracket:

[A] Right top corner ( x1)

[B] Right bottom corner ( x1)

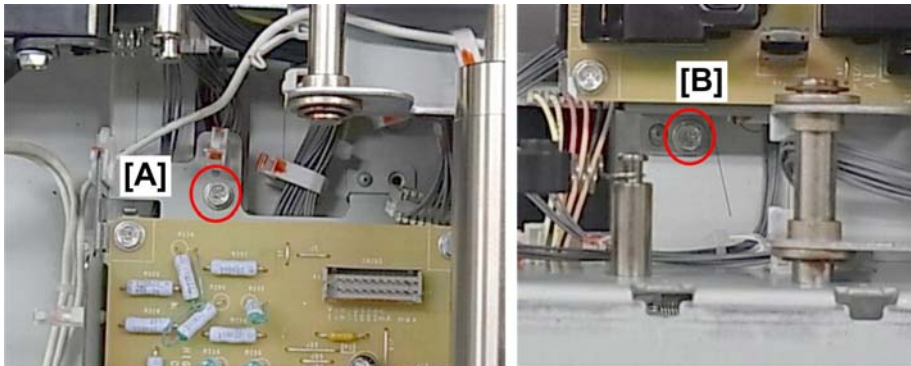

d074r245

15. Disconnect the left side of the power pack bracket:

[A] Left top corner ( x1)

[B] Left bottom corner ( x1)

4

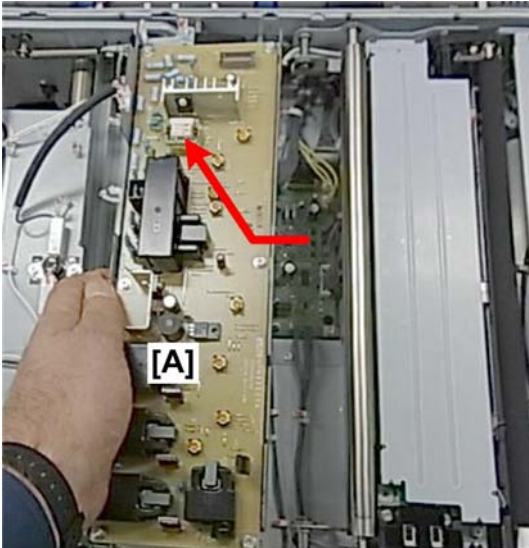

d074r246

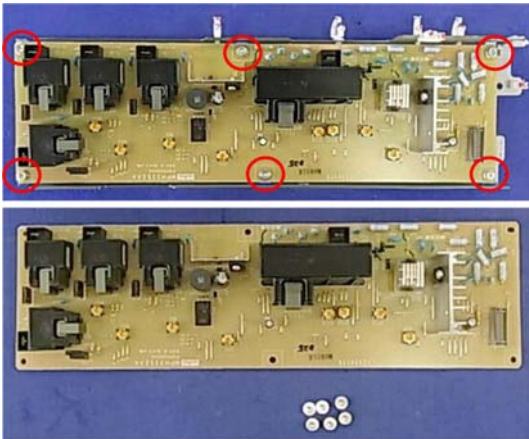

16. Remove the transfer power pack [A].



d074r247

17. Remove the transfer power pack from its bracket ( x6).

TDRB

1. Pull the ITB unit out to the 2nd stop position. ( p.410)
2. Transport belt ( p.599)
3. Remove the ITB transfer power pack. (See the previous section.) The TDRB is under the transfer power pack.

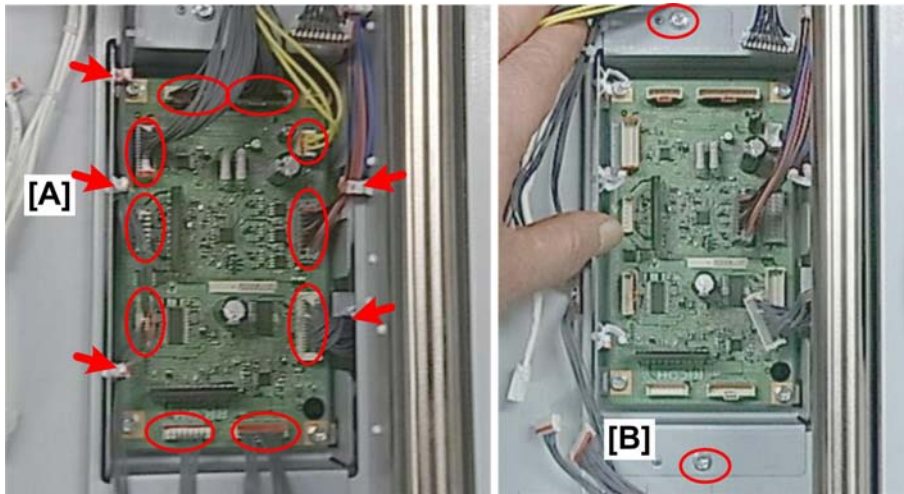

d074r248

4. Disconnect the TDRB [A] (🔌x5, 📌x10).
5. Disconnect the TDRB bracket [B] (🔩x2).
6. Remove the TDRB on its bracket.



d074r249

7. Remove the TDRB from the bracket (🔩x4).

ITB Cleaning Unit Cover Set Switch

1. Pull the ITB unit out to the 2nd stop position. (📖p.410)

2. Transport belt (🔧 p.599)

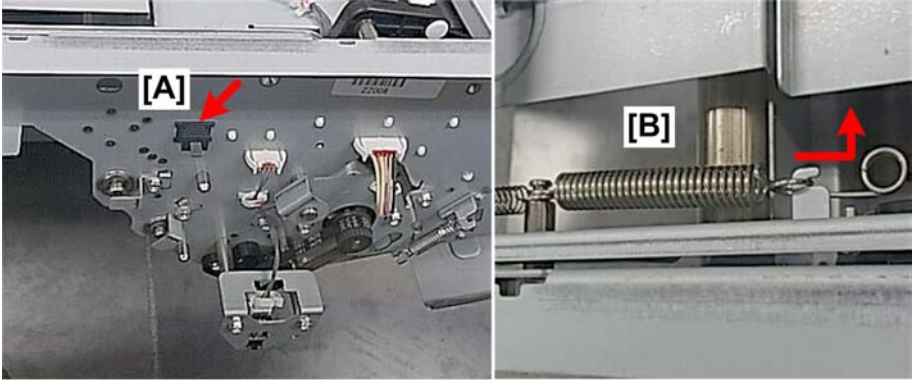

d074r250

- 3. The cleaning unit cover set switch [A] is on the front plate of the ITB unit.
- 4. Behind the front plate and above the switch, remove the spring [B] (🔧 x1).

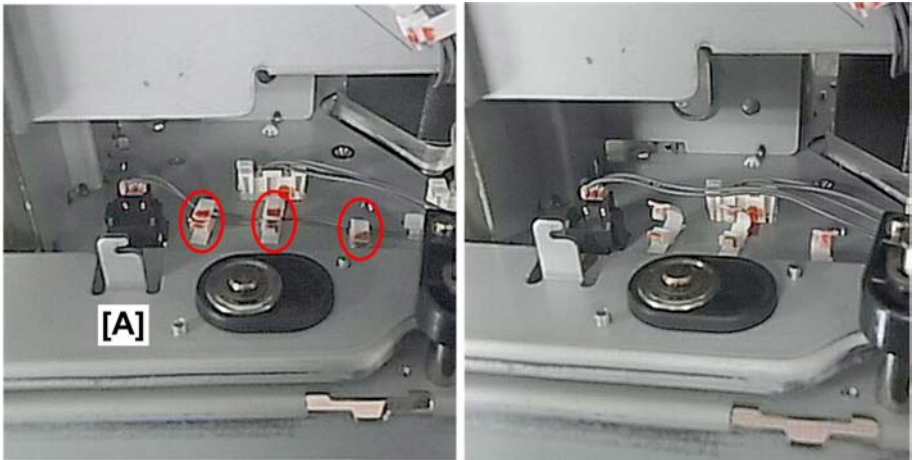

d074r251

- 5. Disconnect the switch harness [A] (🔧 x3).

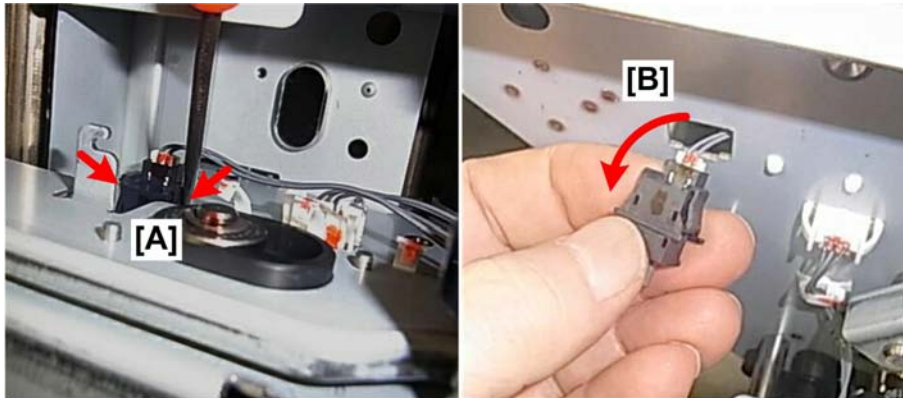

d074r252

6. Use the flat tip of a small screwdriver to press in each side of the switch [A] to release it from its slot.
7. Pull the switch [B] out the front and disconnect it (🔌 x1).

4

ITB Cleaning Unit Set Switch

1. Pull the ITB unit out to the 2nd stop position. (🔧 p.410)
2. Transport belt (🔧 p.599)

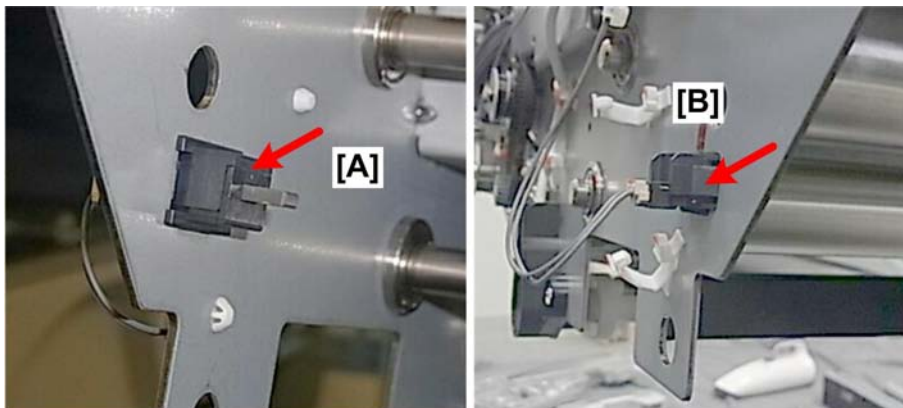

d074r253

3. The cleaning unit set switch [A] is on the inner side of the rear panel, just above the rear end of the bias roller.
4. At the rear [B], disconnect the switch harness (🔌 x2).
5. Press in both sides of the switch to release it. (You can probably do this with your fingers.)

4

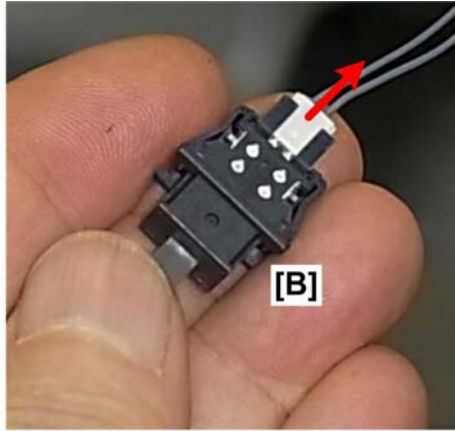
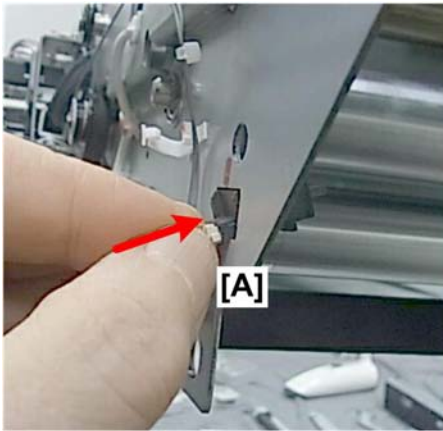

d074r254

6. Push the switch [A] through the hole.
7. Disconnect the switch [B] (🔧 x1).

Right Anti-Condensation Heater

1. Pull the ITB unit out to the 2nd stop position. (🔧 p.410)
2. Transport belt (🔧 p.599)
3. ITB unit cover plate ③ and ④ (🔧 p.608)

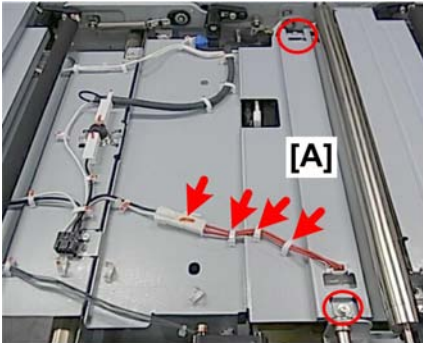

d074r256

4. Near the bottom of the right heater plate [A], disconnect the harness (🔧 x3, 📦 x1).
5. Disconnect the right heater plate and turn it over (🔧 x2).
6. The heater is taped to the underside of the plate.

Left Anti-Condensation Heater

1. Pull the ITB unit out to the 2nd stop position. (🔧 p.410)
2. Transport belt (🔧 p.599)
3. ITB unit cover plate ⑤ (🔧 p.608)

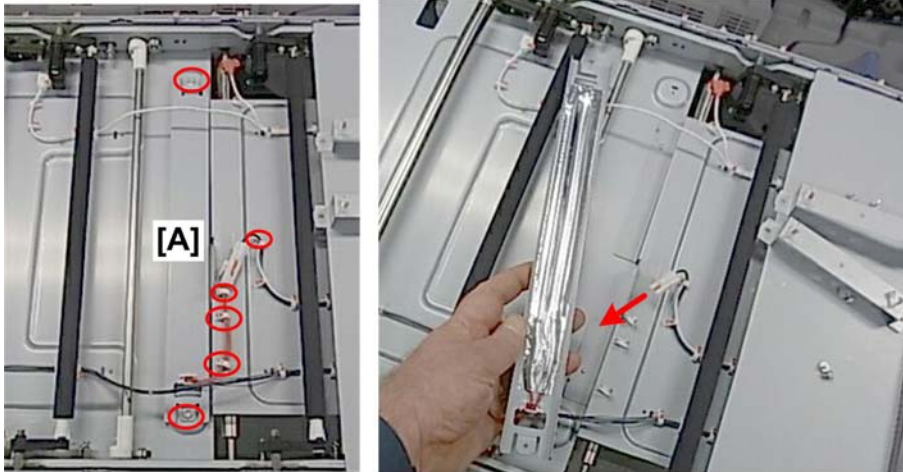

d074r257

4. The left heater is under plate [A].
5. Disconnect the harness (🔧 x4, 📁 x1).
6. Disconnect the left heater plate and turn it over (🔧 x2).
7. The heater is taped to the underside of the plate.

ITB Unit Thermostat

1. Pull the ITB unit out to the 2nd stop position. (🔧 p.410)
2. Transport belt
3. ITB unit cover plate ④ (🔧 x4) (🔧 p.608)

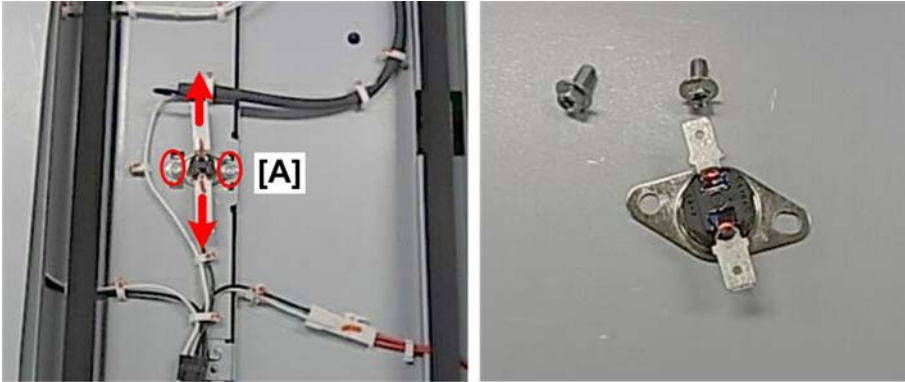

d074r255

4

4. Disconnect the thermostat [A] (🔪 x2, 🔩 x2).

⚠ WARNING

- Always replace a blown thermostat with the same type.
- Never attempt to reset a blown thermostat by manipulating the edges of the black cover with a screw driver.
- Resetting a thermostat manually could cause the thermostat to fail and cause a fire.

Paper Feed

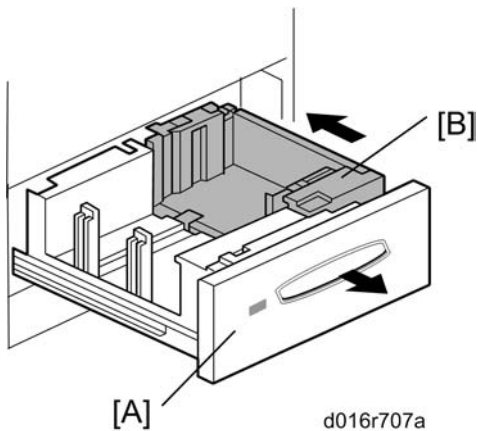

Main Machine Tray Removal

Tray 1

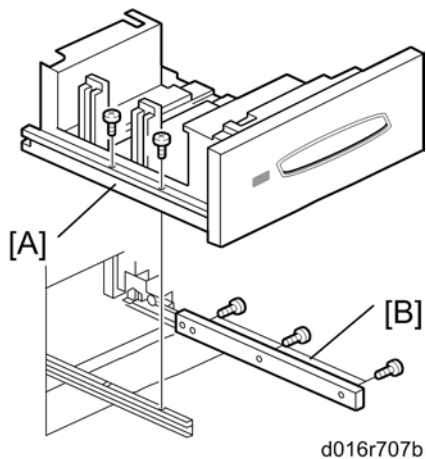

1. Pull out Tray 1 [A] completely so that the right tandem tray [B] separates from the left side.
2. Push the right tandem tray [B] into the machine.



3. Disconnect the left rail [A] ( x2 M4x4).
4. Disconnect the right rail [B] and remove the tray ( x3 M4x6).

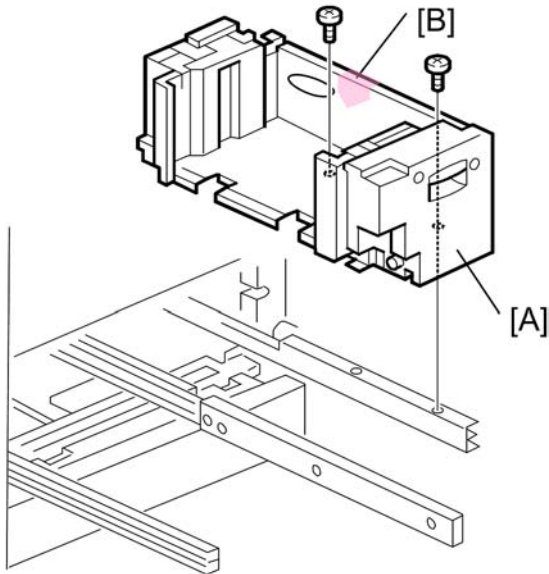

g178r986a

5. Pull out the right tandem tray [A] and remove it ( x2).

★ Important

- Work carefully to avoid bending or damaging the mylar [B] on the side plate of the tray. This mylar prevents paper in the tray from hitting the reverse roller before it is ready to feed.

Re-installation

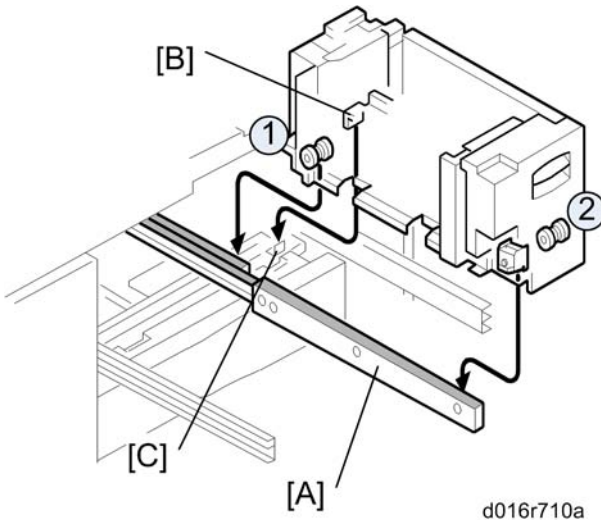

d016r710a

- When you re-install the right tandem tray, make sure that the wheels ride on slide rail [A].
- Also, make sure that the tandem tray stopper [B] is set behind stopper [C] (inside the machine).

Tray 2 (Universal Tray)

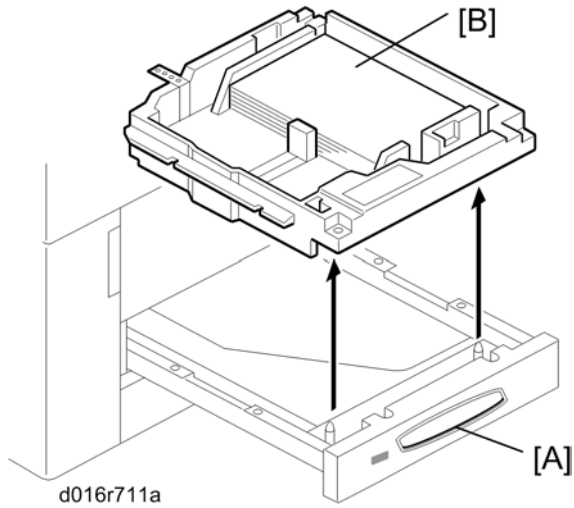

1. Pull out Tray 2 [A].
2. Lift the inner tray [B] out of the tray.

4

PFU Pick-up, Feed, Separation Rollers

1. Tray 1 or Tray 2 (p.441)

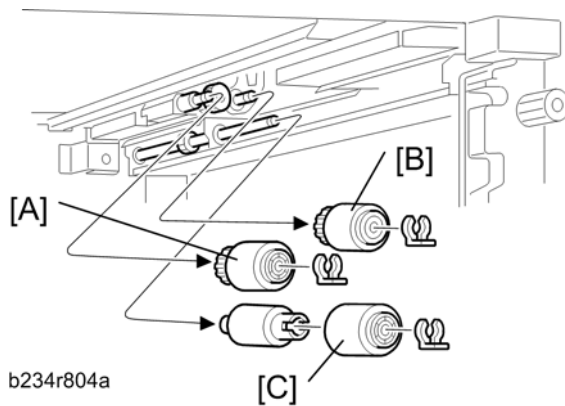

2. Remove:
 - [A] Pick-up roller (x1)
 - [B] Feed roller (x1)
 - [C] Separation roller (x1)

★ Important

- The feed rollers of the main machine and LCIT are not interchangeable because they turn in different directions.
- After replacing a feed roller in the main machine, make sure that it turns counter-clockwise in the direction of paper feed.
- Avoid touching the surfaces of these rollers with bare hands.

3. Reset the PM counter to zero for replaced rollers.

Paper End Sensor

4

1. PFU (🔗 p.441)

↓ Note

- The procedure below is the same for both tray 1 and tray 2 paper feed units.

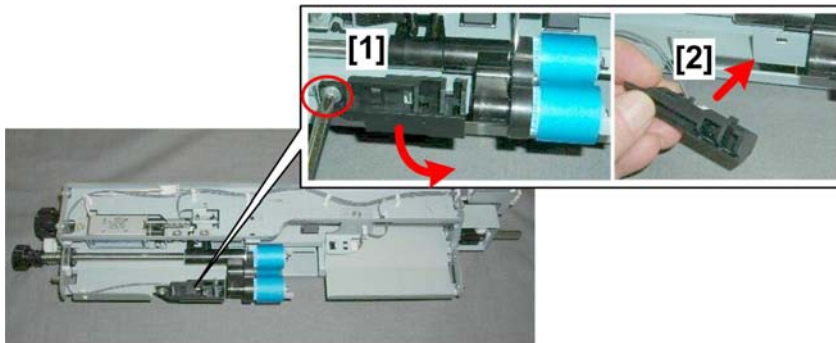

d074r446

2. Disconnect the pickup roller lift sensor [1] (🔧 x1).
3. Remove the sensor [2] (🔧 x1, 🔩 x4).

Pickup Roller Lift Sensor

1. PFU (🔗 p.441)

↓ Note

- The procedure below is the same for both tray 1 and tray 2 paper feed units.

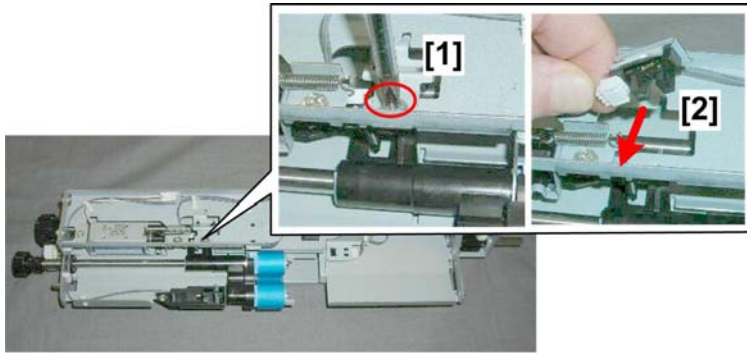

d074r447

2. Remove the sensor assembly [1] (🔧 x1).
3. Remove the sensor [2] (🔧 x1, 🔩 x4).

4

Paper Feed Sensor

1. PFU (🔧 p.441)

↓ Note

- The procedure below is the same for both tray 1 and tray 2 paper feed units.

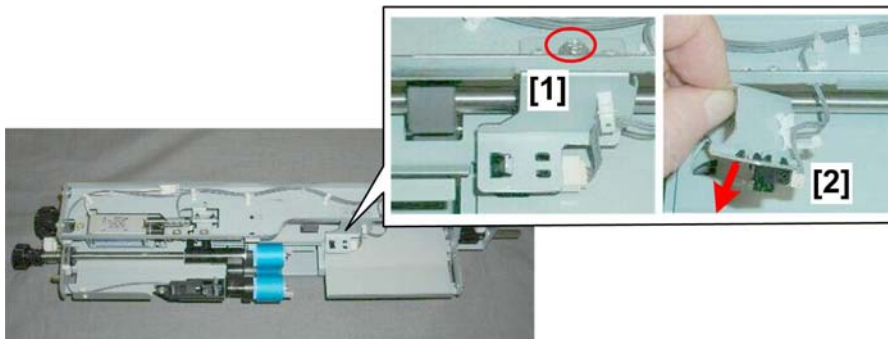

d074r448

2. Remove the sensor assembly [1] (🔧 x1).
3. Remove the sensor [2] (🔧 x1, 🔩 x3).

Pickup Roller Solenoid

1. PFU (🔧 p.441)

↓ Note

- The procedure below is the same for both tray 1 and tray 2 paper feed units.

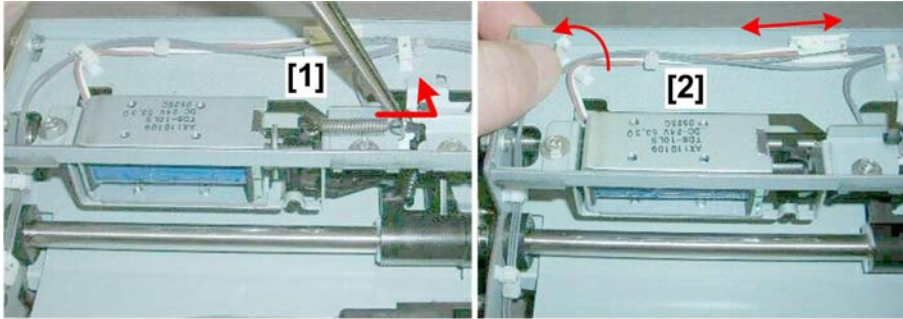

d074r449

2. On top of the PFU, disconnect spring [1] (🔧 x1).
3. Disconnect harness [2] (🔌 x1, 📡 x1).

4

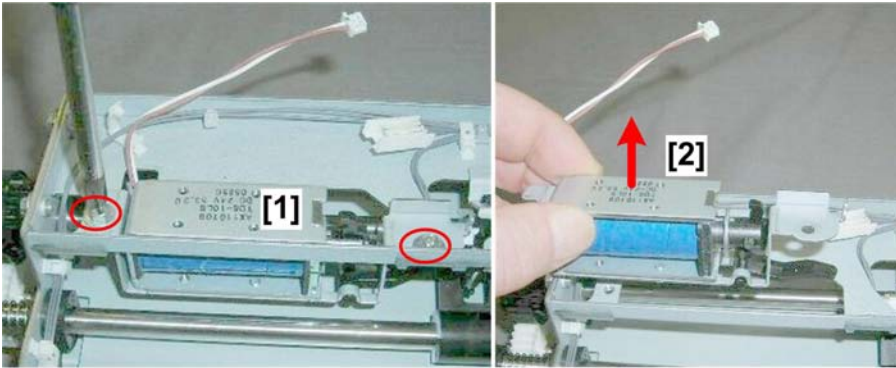

d074r450

4. Disconnect the solenoid bracket [1] (🔧 x2).
5. Remove the solenoid and bracket [2].

Re-installation

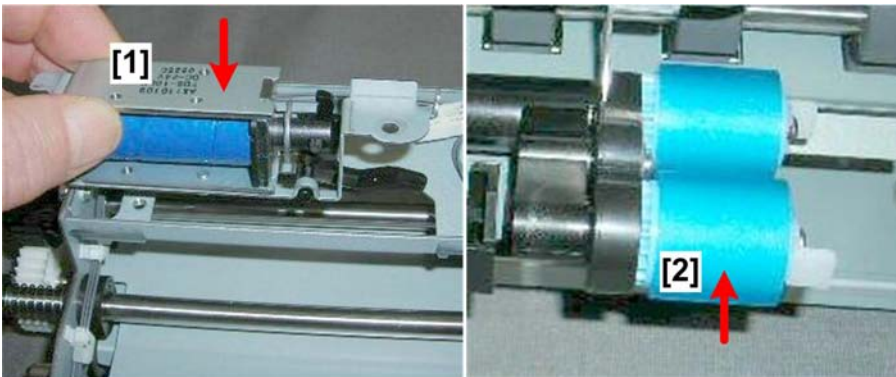

d074r451

1. When you re-install the pickup roller solenoid [1], raise the pickup roller [2] and then lower it after the solenoid is set. This ensures that the actuator is positioned correctly.

- Depress the pickup roller and make sure that it bounces up and down.

★ Important

- If the actuator of the solenoid is not positioned correctly, the pickup roller will catch on the frame and jam the right tandem tray when the PFU is re-installed.
- After re-installing the PFU, set the right tandem tray on its rails without installing its screws. Then slowly push the right tray into the machine and then pull it out to make sure that it does not jam.

Separation Roller Solenoid

- PFU (p.441)

↓ Note

- The procedure below is the same for both tray 1 and tray 2 paper feed units.



d074r452

- Turn the PFU upside down.
- On the bottom of the PFU, disconnect spring [1] (⚙️ x1).
- Disconnect harness [2] (🔌 x1, 📡 x1).

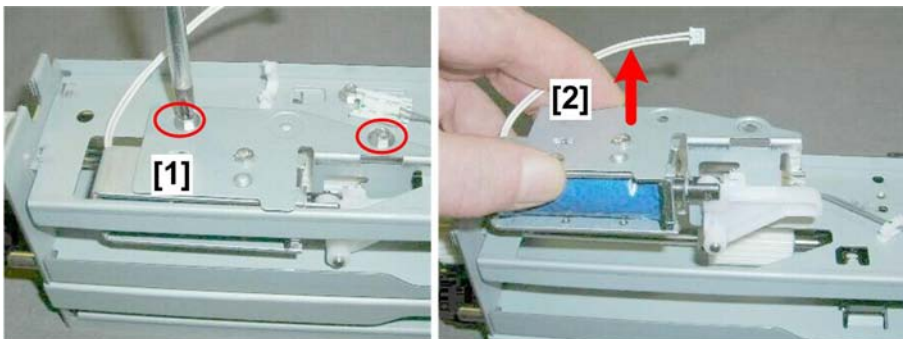

d074r453



- Disconnect the solenoid bracket [1] (🔧 x2).

6. Remove the solenoid and bracket [2].

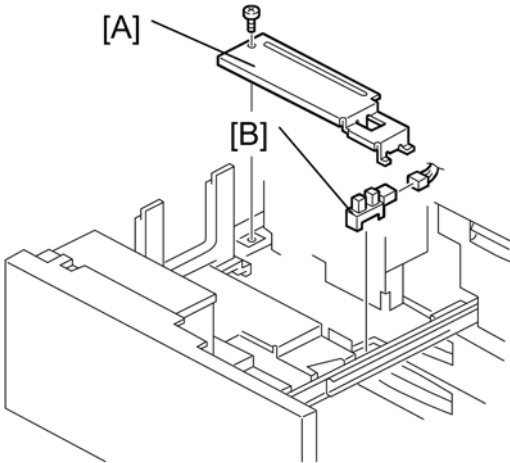
Tray 1 Rear Fence Return Sensor (Left Tandem Tray)



d016r987a

1. Pull out Tray 1.
2. Push the right tandem tray into the machine.
3. Remove:
 - [A] Rear bottom plate ( x1)
 - [B] Rear fence return sensor ( x1)

Tray 1 Rear Fence HP Sensor (Left Tandem Tray)

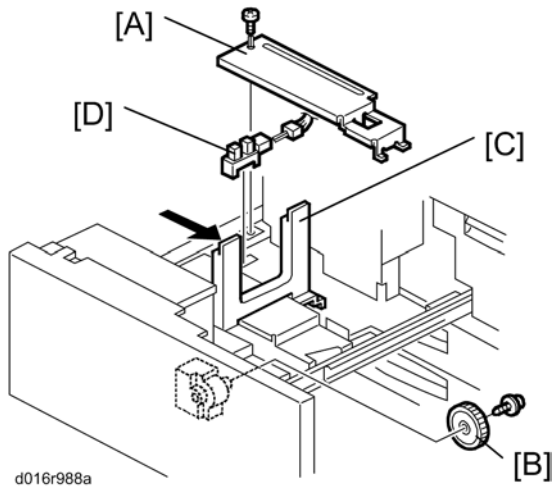

1. Pull out Tray 1.
2. Push the right tandem tray into the machine.
3. Remove:
 - [A] Rear bottom plate
 - [B] Rear fence transport gear
4. Push the left fence [C] to the right.
5. Remove the rear fence HP sensor [D] (EJ x1).

Tray 1 Right Tray Paper Sensor (Right Tandem Tray)

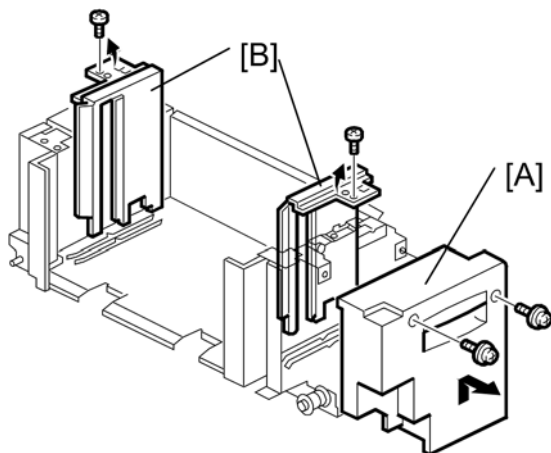

b234r999a

1. Right tandem tray (p.647)

2. Remove:

[A] Cover (x2)

[B] Side fences (x2)

Note

- When re-installing the side fences, make sure that they are positioned correctly (A4: Outer, LT: Inner)

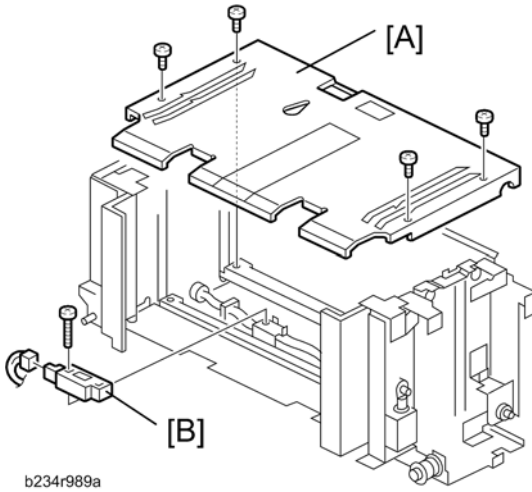

3. Remove:

[A] Bottom plate (x4)

[B] Right tray paper sensor (x1, x1)

Bottom Plate Lift Wire

Note



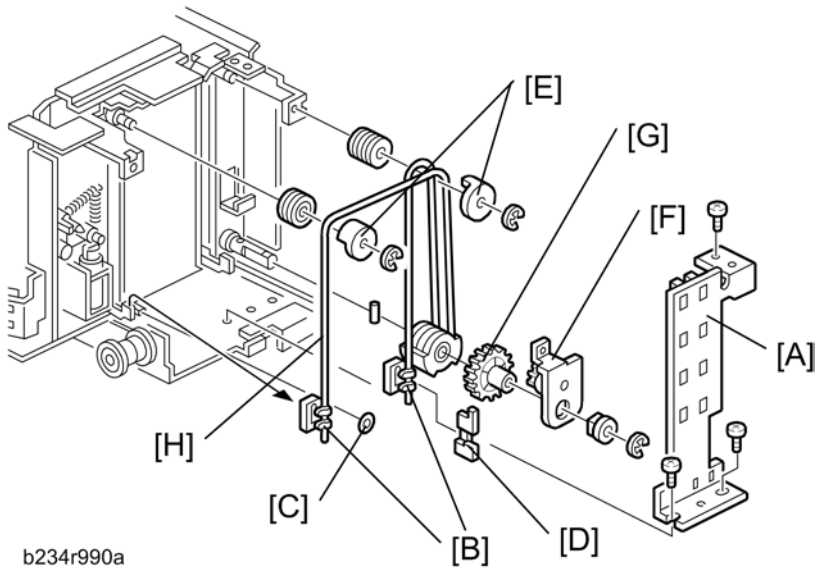

- Before you remove the rear bottom plate lift wire, you must remove the front bottom plate lift wire.
- The removal procedure is the same for both wires.

1. Right tandem tray (p.647)

2. Remove the right tandem tray cover (x2).



b234r990a

3. At the front, remove sensor assembly [A] ( x3).
4. Lift the front bottom plate slightly, unhook the wire stoppers [B], and then remove stopper [C] and actuator [D].
5. Remove:
 - [E] Wire covers ( x2).
 - [F] Bracket (front only) ( x1,  x1,  x1)
 - [G] Gear (front only)
 - [H] Bottom plate lift wire

Re-installation (Bottom Plate Lift Wire)

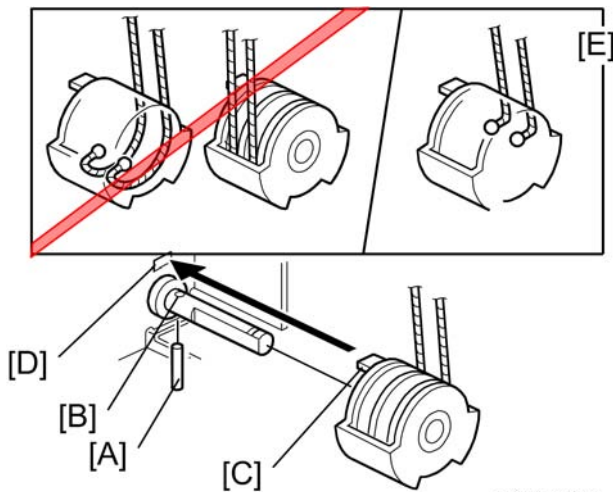

b234r991a

1. Set positioning pin [A] in hole [B].
2. Set projection [C] in hole [D].
3. Position the wire [E] correctly without crossing the wires.

Paper Feed Motors, Grip Motors

1. Open the cooling box and controller box. (☞ p.400)

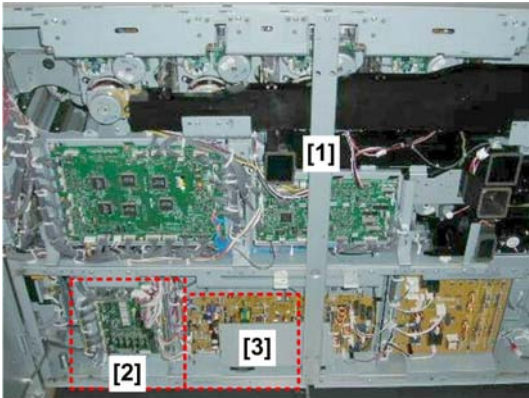

d074r500

2. Remove the center stay [1] (☞ x3).
3. Remove the relay board [2] (☞ Relay Board).
4. Remove PSU 2 [3] (☞ PSU 2).

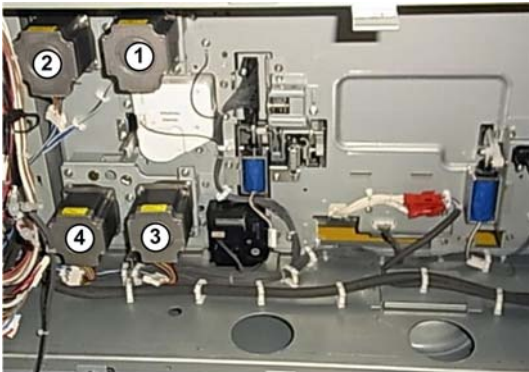

d074r501

①	Tray 1 Paper Feed Motor
②	Tray 1 Grip Motor
③	Tray 2 Paper Feed Motor

④	Tray 2 Grip Motor
---	-------------------

- The paper feed and grip motor pairs of each tray must be removed together (they are attached to one bracket).
- The following steps describe removal of the Tray 1 motors. The procedure for removal of the Tray 2 motors is the same.

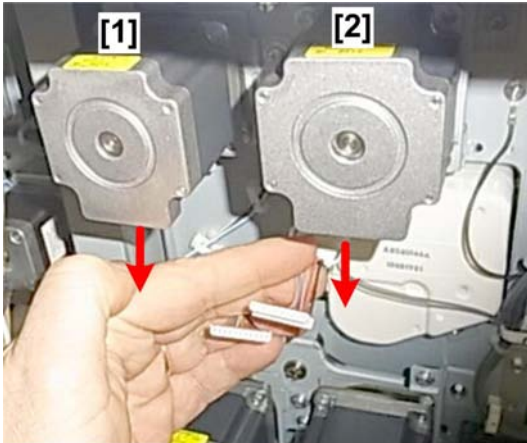

d074r502

5. Disconnect the grip motor [1] and the paper feed motor [2] (🔌 x2).

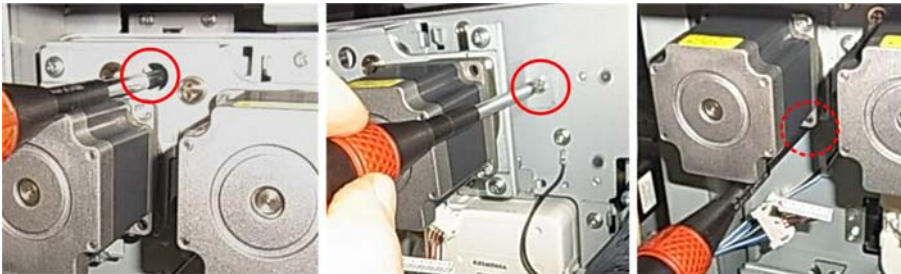

d074r503

6. Disconnect the motor mount bracket (🔧 x3).



d074r504

4

7. Remove the motor mount bracket with both motors attached.

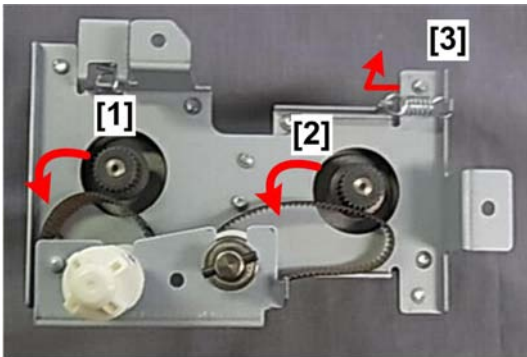

d074r505

8. Disconnect:

- [1] Grip motor timing belt (⊗ x1)
- [2] Paper feed timing belt (⊗ x1)
- [3] Paper feed bracket spring (⌘ x1)

Paper Feed Motor

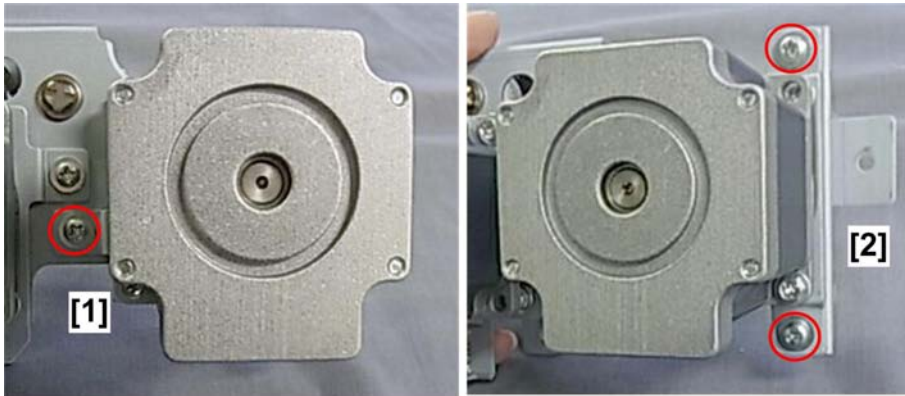

d074r506

1. Disconnect the bracket on the left [1] and on the right [2] ( x3).

4

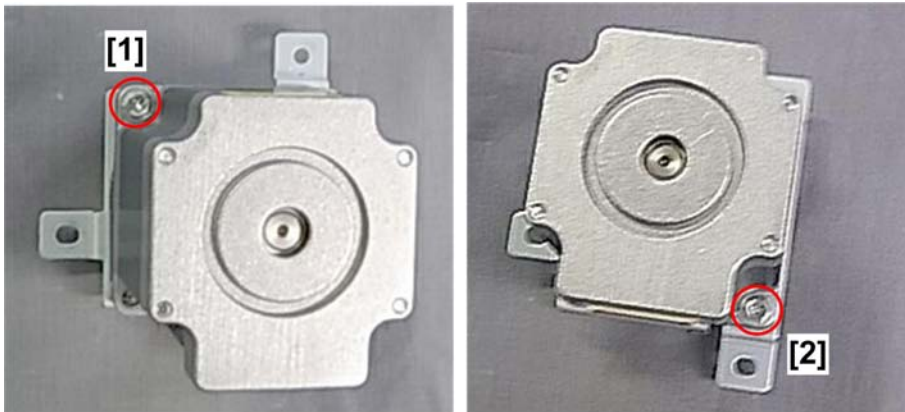

d074r507

2. Disconnect the motor at the top [1] and the bottom [2] ( x2).

4



d074r508

Grip Motor

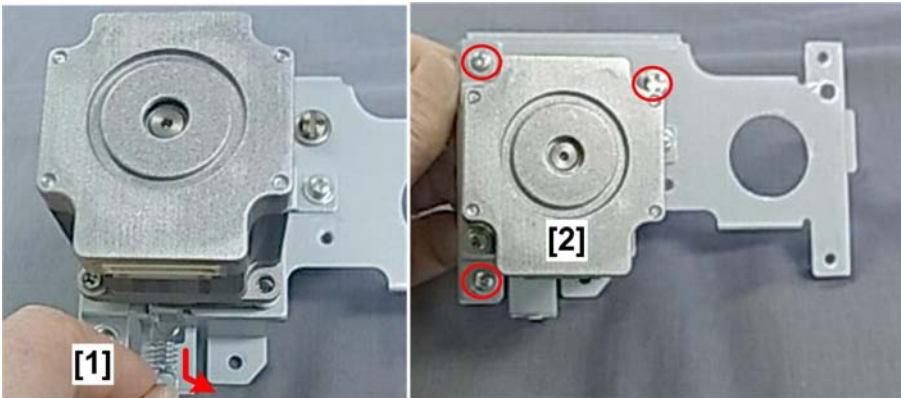

d074r509

1. Disconnect the spring [1] (🔧 x1).
2. Disconnect the bracket of the motor [2] (🔧 x3).

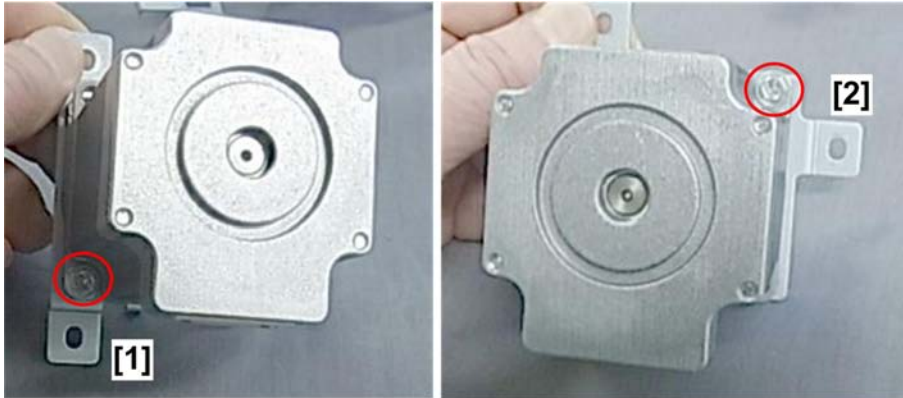

d074r510

3. Disconnect the motor at the bottom [1] and top [2] (⚙️ x2).

4



d074r511

Timing Belts

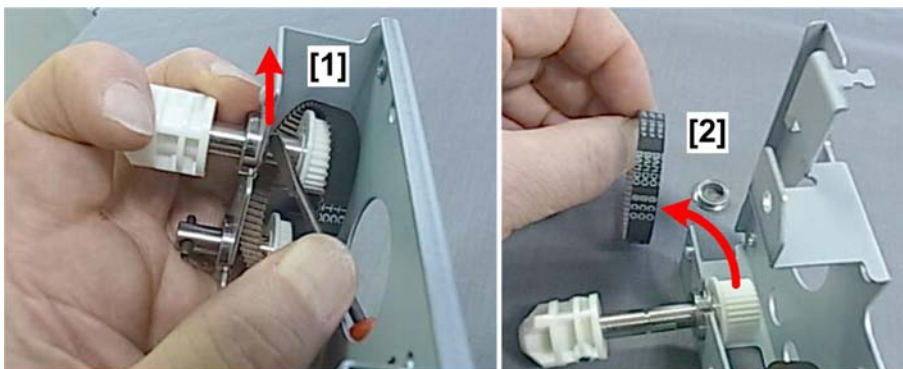

d074r512

1. Use the tip of a small screwdriver to remove the e-ring [2] (Ⓢ x1).

2. Remove the timing belt [2] (⊗ x1).

Lift Motors (Tray 1, Tray 2)

1. Open the cooling box and controller box. (🔧 p.400)

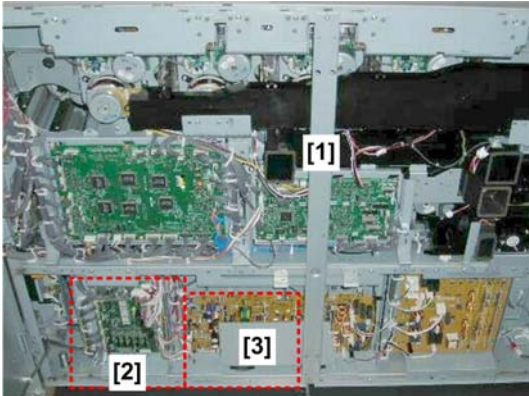

d074r500

2. Remove the center stay [1] (🔧 x3).
3. Remove the relay board [2] (🔧 Relay Board).
4. Remove PSU 2 [3] (🔧 PSU 2).



d074r513

5. ① is the tray lift motor for Tray 1, and ② is the tray lift motor for tray 2.

Tray 1 Lift Motor

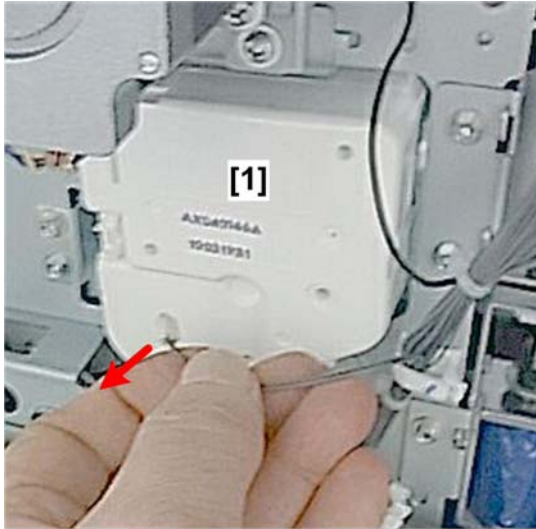

d074r514

1. Disconnect the motor [1] (🔧x1).

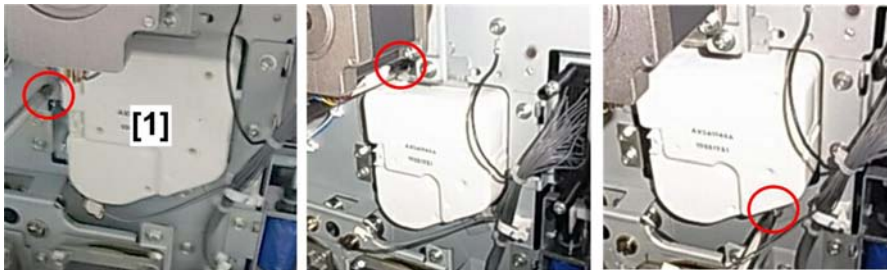

d074r515

2. Disconnect the motor [1] (🔧x3).

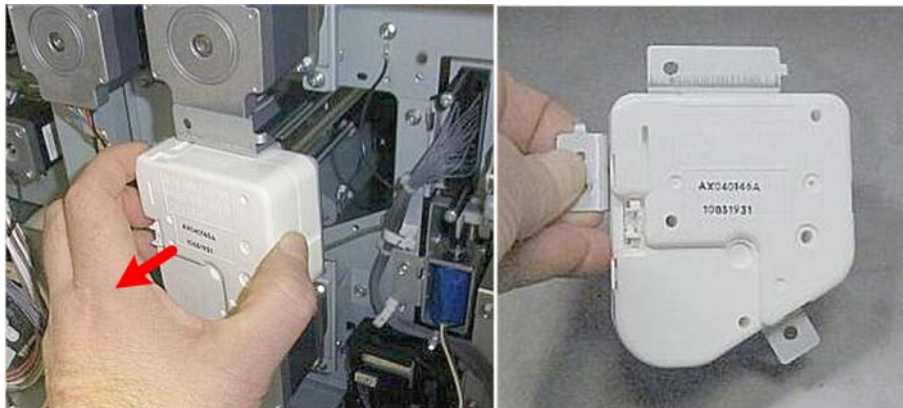

d074r516

3. Remove the motor.

Tray 2 Lift Motor

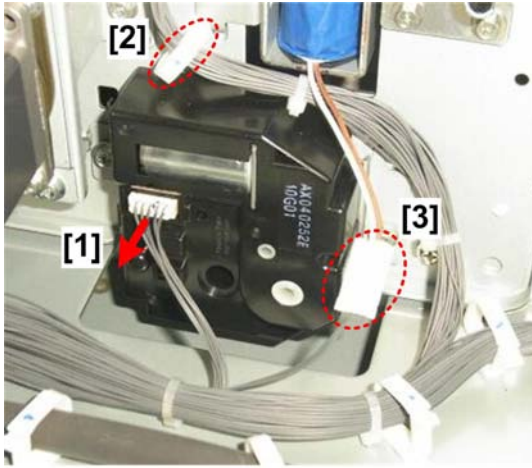

d074r517

1. Disconnect the motor at [1] (🔌 x1).
2. Open clamp [2] (🔧 x1).
3. Disconnect harness [3] (🔌 x1).

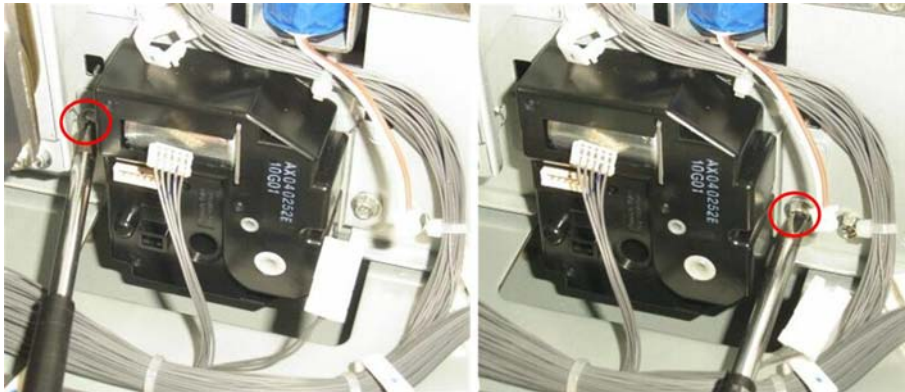

d074r518

4. Disconnect the motor (🔧 x2).



d074r519

5. Remove the motor.

4

Tray 1 Solenoids

1. Open the cooling box and controller box. (p.400)

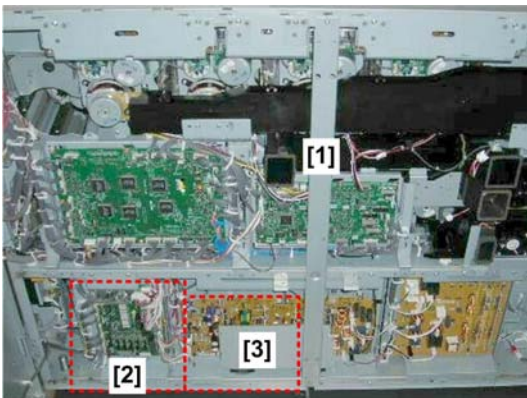

d074r500

2. Remove the center stay [1] (x3).
3. Remove the relay board [2] (Relay Board).
4. Remove PSU 2 [3] (PSU 2).

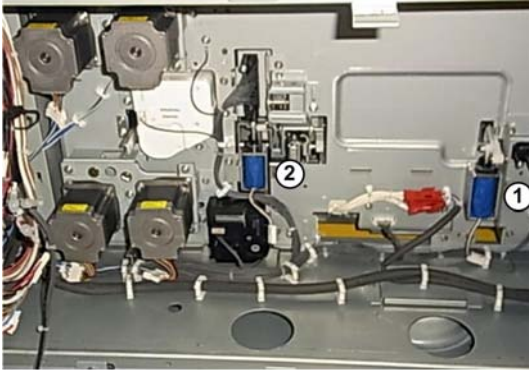

d074r520

4

①	Tray 1 Left Tray Lock Solenoid
②	Tray 1 Right Tray Lock Solenoid

Tray 1 Left Tray Lock Solenoid

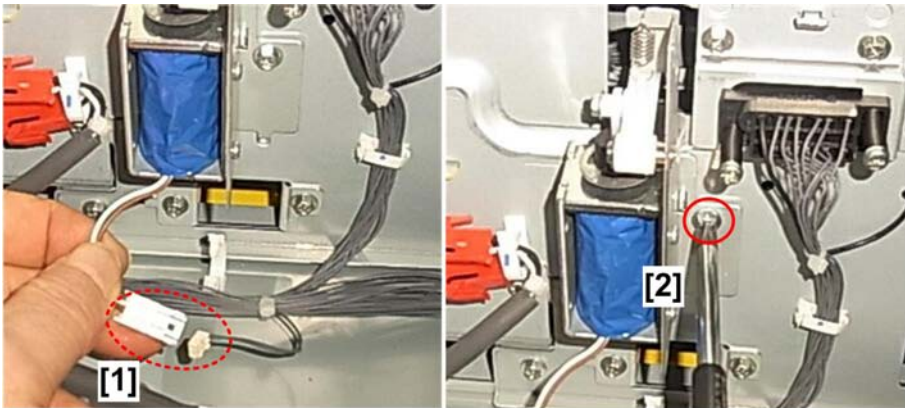

d074r521

1. Disconnect the solenoid [1] (✂ x1).
2. Disconnect the solenoid bracket [2] (🔪 x1).



d074r522

3. Remove the solenoid.

Tray 1 Right Tray Solenoid

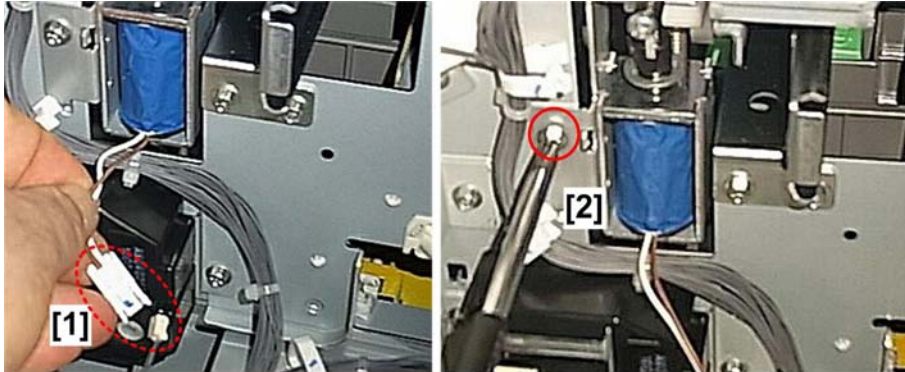

d074r523

1. Disconnect the solenoid [1] (✂ x1).
2. Disconnect the solenoid bracket [2] (🔪 x1).

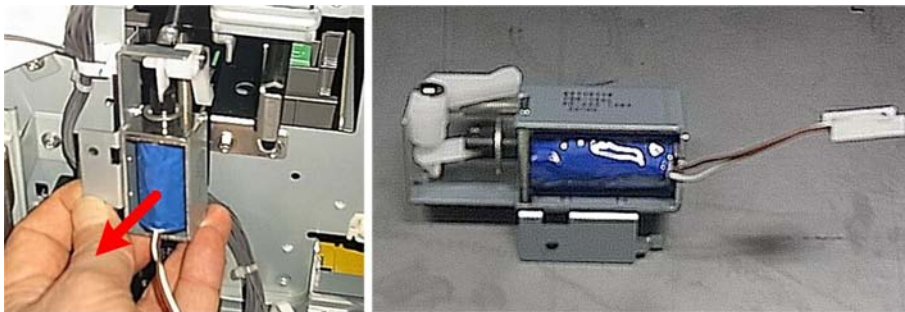

d074r524

3. Remove the solenoid.

Vertical Transport Unit

Bank Exit Motor

4

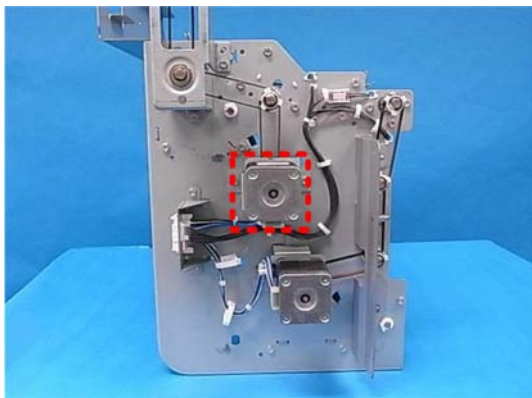

d074r641

1. Vertical transport unit (p.444)

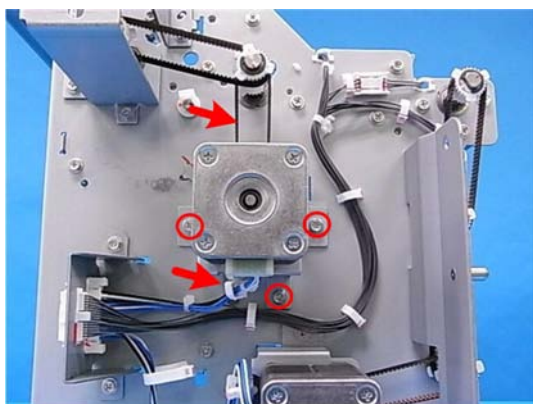

d074r642

2. Disconnect and remove the motor bracket (🔌x1, 📏x1, 🔧x3, ⚙️x1).

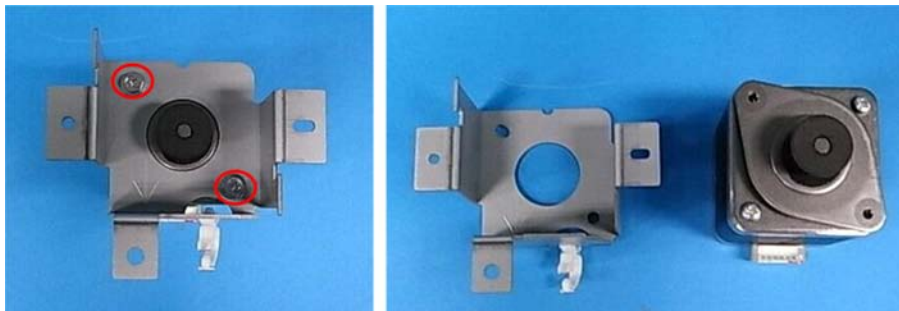

d074r643

3. Separate the motor from the bracket ( x2).

4

Vertical Transport Motor

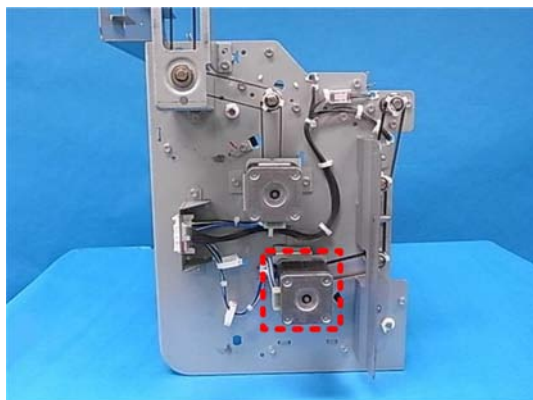



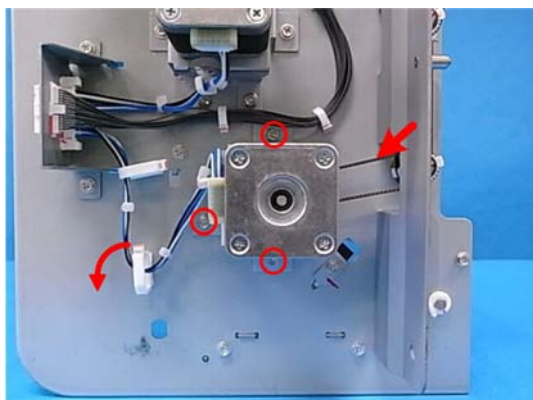

d074r644

1. Vertical transport unit ( p.444)



d074r645

2. Disconnect and remove the motor bracket ( x1,  x1,  x3,  x1).

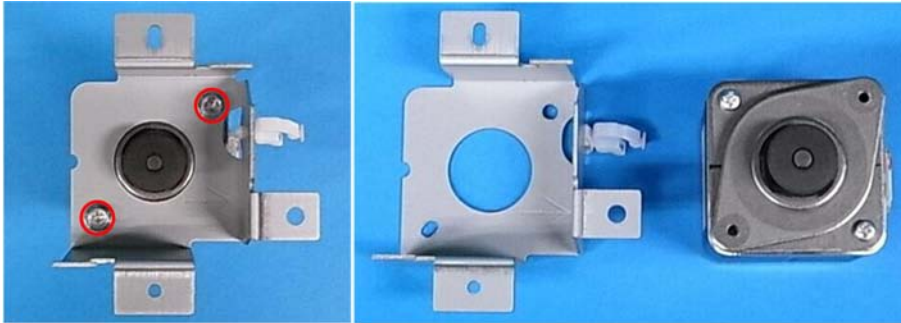

d074r646

3. Separate the motor from the bracket ( x2).

4

Main Relay Sensor 1



d074r647

1. Vertical transport unit ( p.444)







d074r648

2. Disconnect the long bracket ( x2).



d074r649

3. Disconnect and remove the sensor ( x1,  x1,  x1,  x4).

Bank Exit Sensor

4





d074r650

1. Vertical transport unit ( p.444)



d074r651

2. Disconnect and remove the sensor ( x1,  x1,  x1,  x4).

1st Transport Sensor

4



d074r652

1. Vertical transport unit (🔧 p.444)

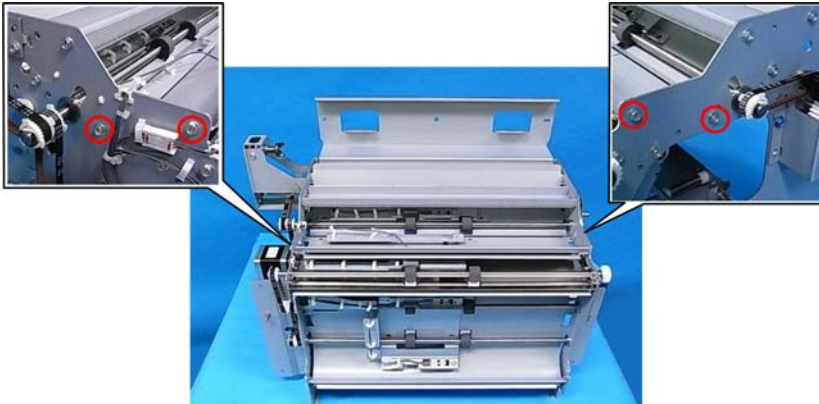

d074r653

2. Remove the wide bracket (🔧 x4).



d074r654

3. Disconnect and remove the sensor (🔧 x1, 🛠️ x1, 📦 x1, 🔧 x4).

Vertical Transport Sensor



d074r655

1. Vertical transport unit (🔧 p.444)

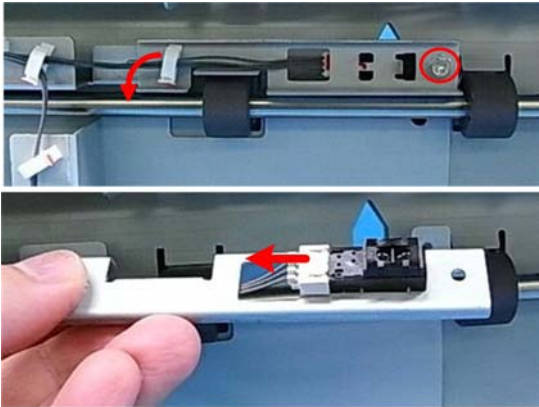

d074r656

2. Disconnect and remove the sensor (🔧 x1, 📏 x1, 📦 x1, 📦 x4).

2nd Transport Sensor

4



d074r657

1. Vertical transport unit (🔧 p.444)

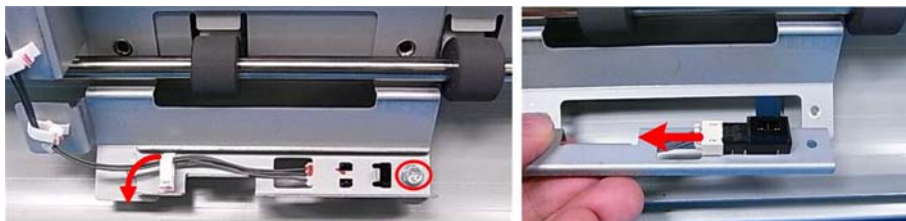

d074r658

2. Disconnect and remove the sensor (🔧 x1, 📏 x1, 📏 x1, 📏 x4).

Right Drawer

Right Drawer Front Cover

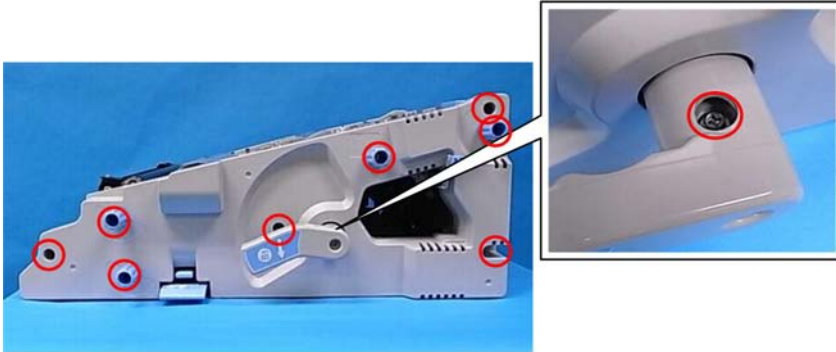

d074r660

1. Open the front doors.
2. Pull out the right drawer until it stops.
3. Right drawer (p.408)
4. Remove the front cover and handle B3 (x9).

Shift Unit

1. Right drawer (p.408)

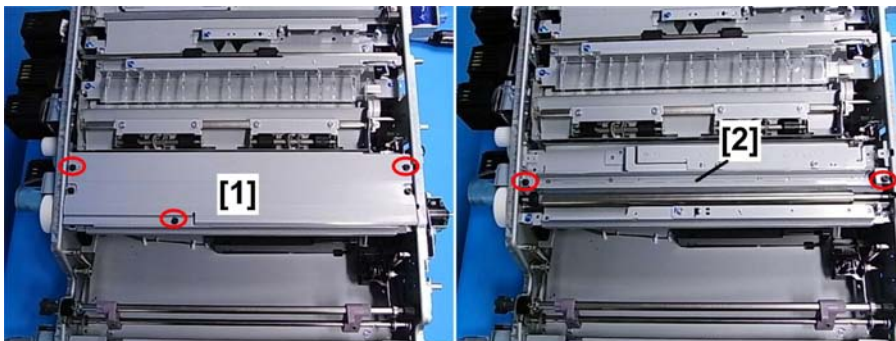

d074r661

2. Remove:
 - [1] Cover (x3)
 - [2] Dust tray (x2)

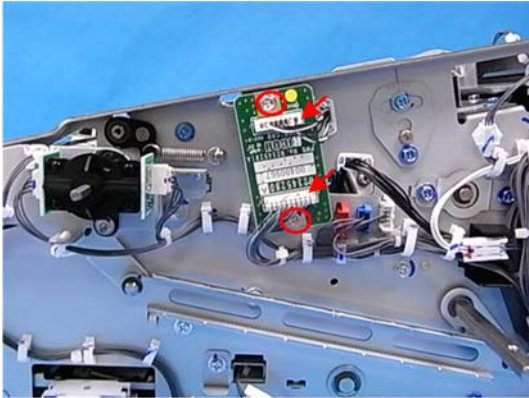

d074r662

4

3. Remove the relay board (🔧 x2, 🛠️ x2).

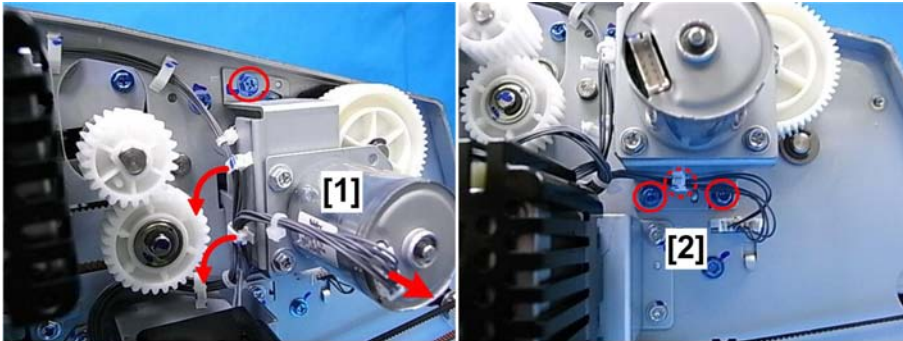

d074r663

4. Disconnect and remove the transfer timing motor.

[1] Side (🔧 x1, 🛠️ x1, 🛠️ x1)

[2] Bottom (🔧 x1, 🛠️ x2)

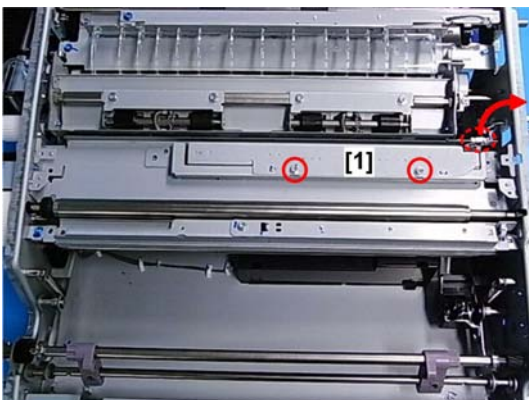

d074r664

5. Remove the CIS [1] (🔧 x2, 🛠️ x1, 🛠️ x1).

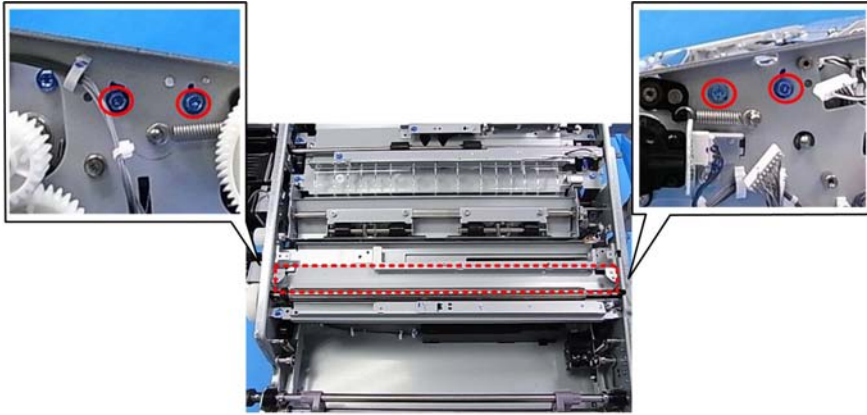

d074r665

6. Remove the guide ( x4).

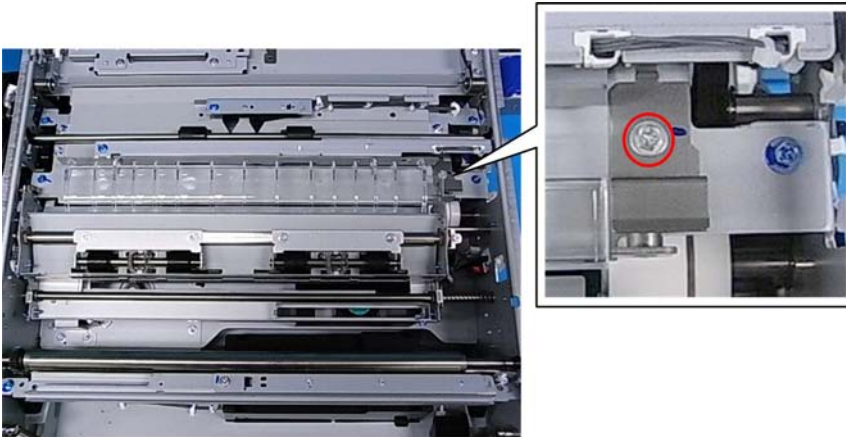

d074r666

7. Remove the plate ( x1).

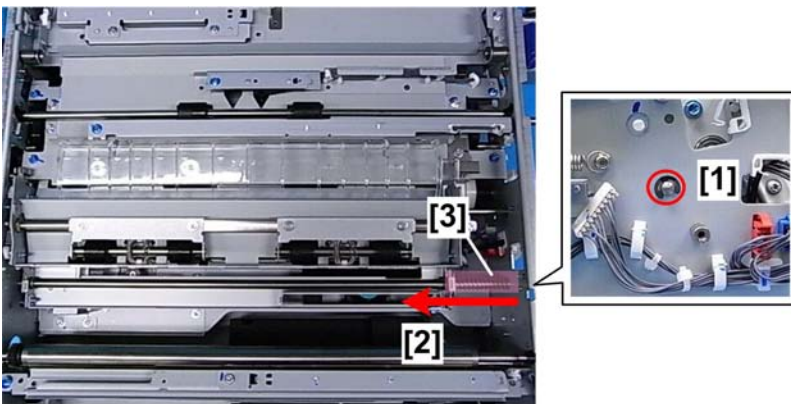

d074r667

8. Remove e-ring [1] (Ⓒ x1).
9. Slide the shift unit [2] to the left.
10. Remove spring [3] (🔧 x1).

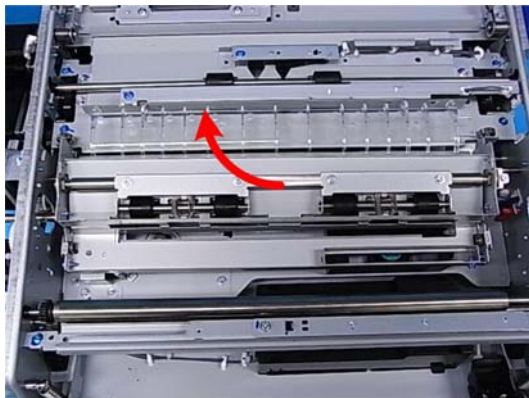

d074r668

11. Remove the shift unit.

Registration Entrance Motor

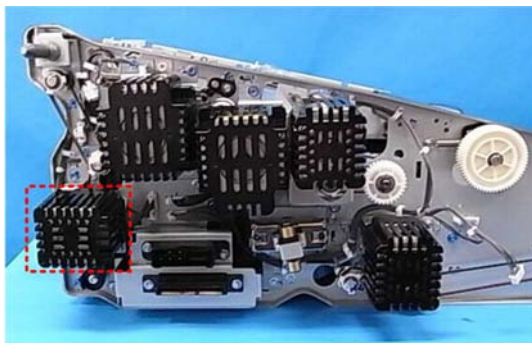

d074r669

1. Right drawer (📄 p.408)

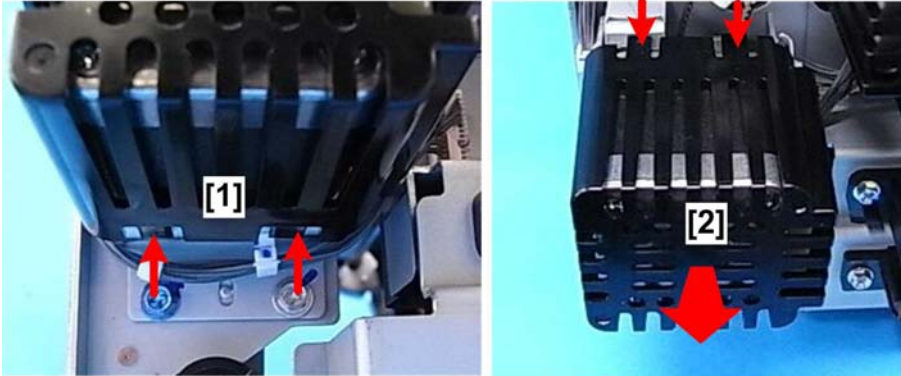

d074r670

2. Press the tab releases on the bottom [1] and top [2] and remove the motor cover.

4

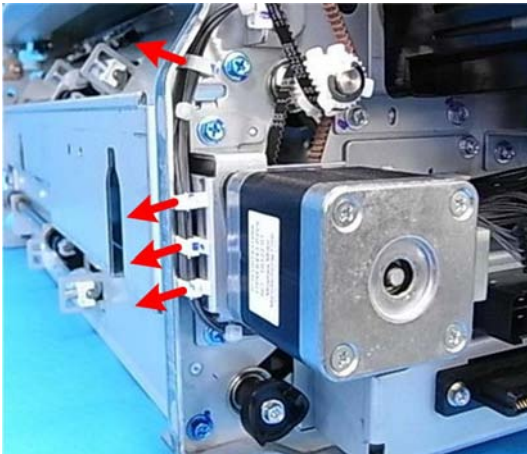



d074r671

3. Release the clamps (🔧x4).

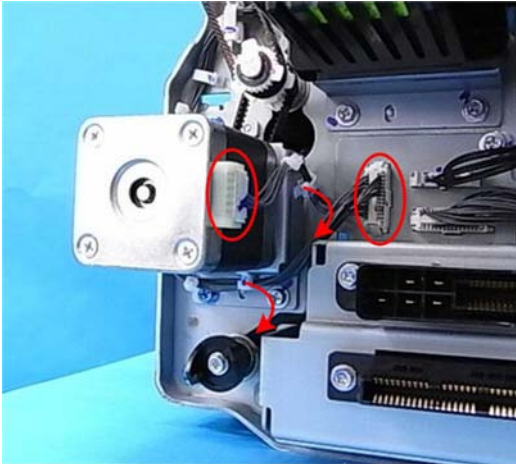
4



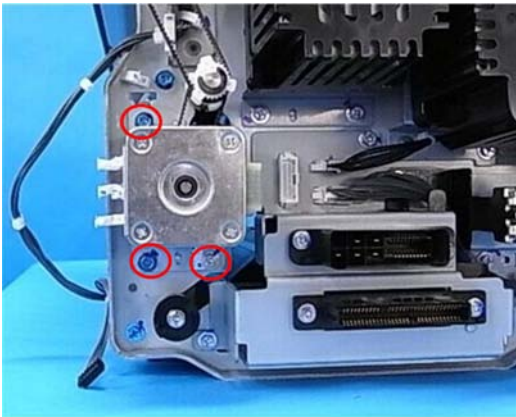

d074r672

4. Disconnect the motor ( x2,  x2).



d074r673

5. Remove the motor ( x2,  x1).

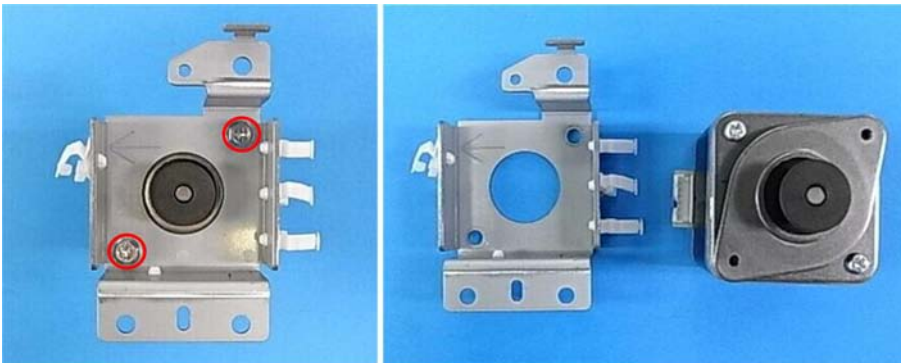

d074r674

6. Separate the motor and the bracket ( x2).

Registration Timing Motor

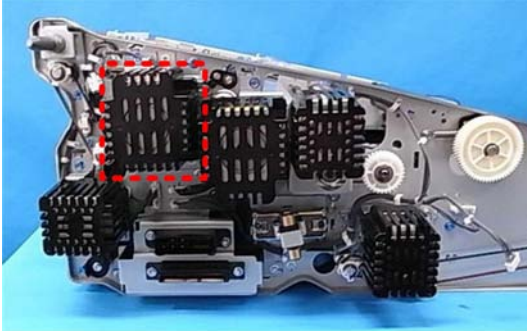

d074r675

1. Right drawer (p.408)

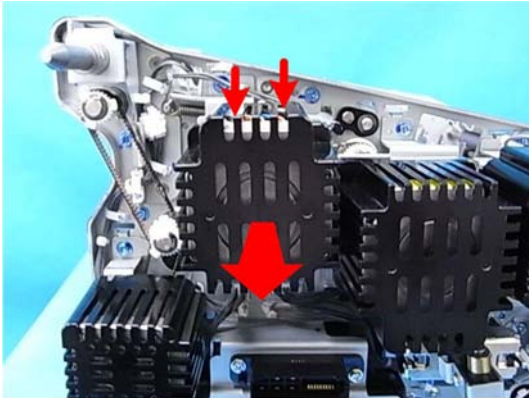

d074r676

2. Press the tab releases and remove the motor cover.

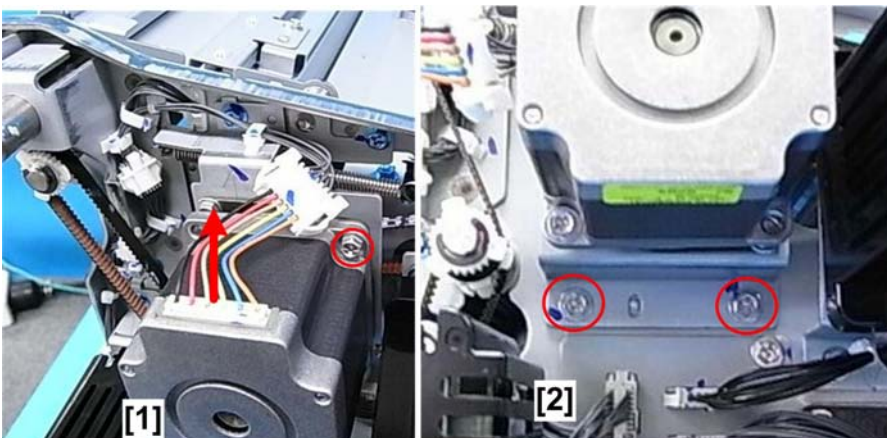

d074r677

3. Disconnect the motor:

[1] Top (🔧 x1, 🛠️ x1)

[2] Bottom (🛠️ x2)

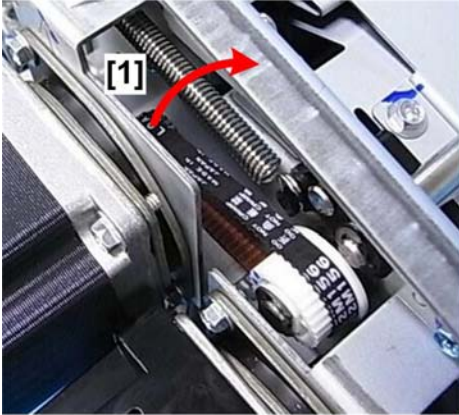

d074r678

4. Disconnect the timing belt [1] (🌀 x1).

5. Separate the motor [2] and the bracket (🛠️ x2).

Registration Gate Motor

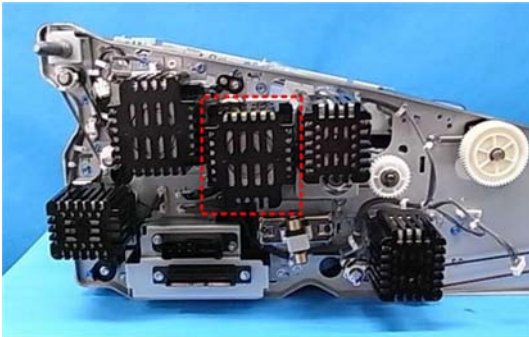

d074r679

1. Right drawer (📄 p.408)

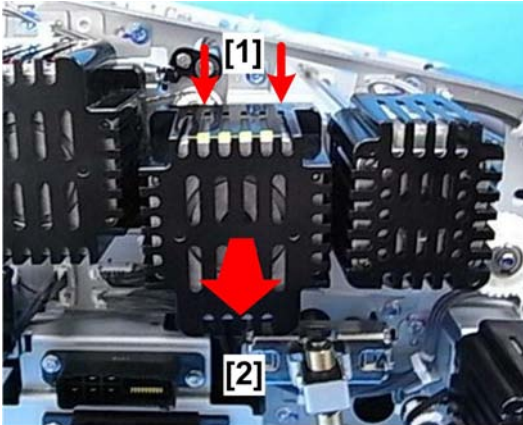

d074r680

2. Press the tab releases [1] and remove the motor cover [2].



d074r681

3. Remove the motor:

[1] Top (x1)

[2] Bottom (🔩 x1, 🛠️ x1, 🔑 x2)

4



d074r682

4. Separate the motor and the bracket ( x2).

Shift Roller Motor

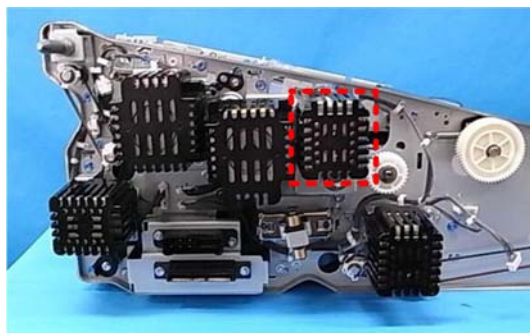

d074r683

1. Right drawer ( p.408)

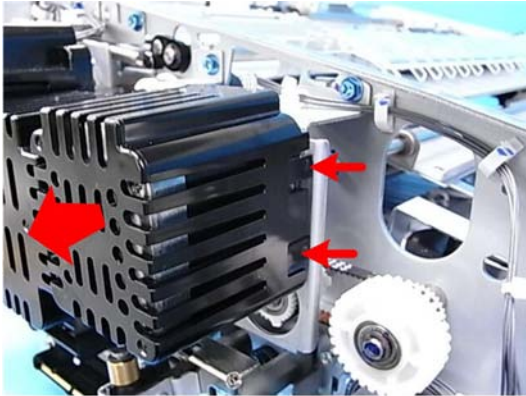

d074r684

2. Press the tab releases and remove the motor cover.

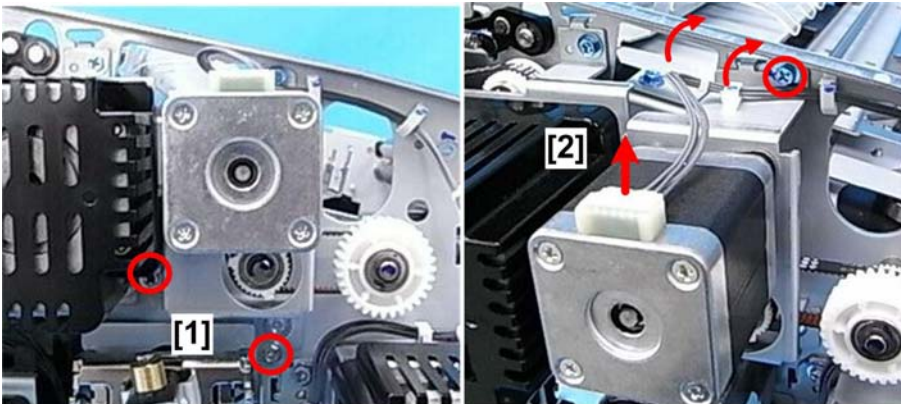

4



d074r685

3. Remove the motor:

[1] Bottom ( x2)

[2] Top ( x1,  x2,  x1)

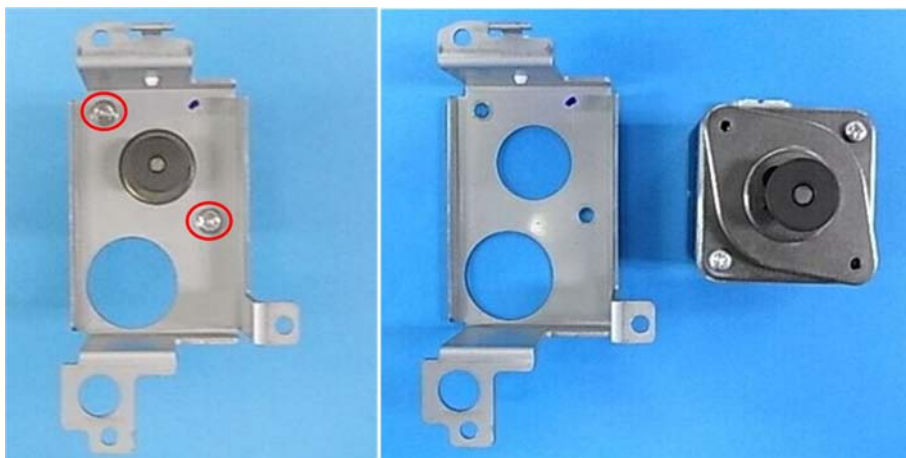

4



d074r686

4. Separate the motor and the bracket ( x2).

Shift Unit Motor

1. Right drawer ( p.408)
2. Shift unit ( p.677)

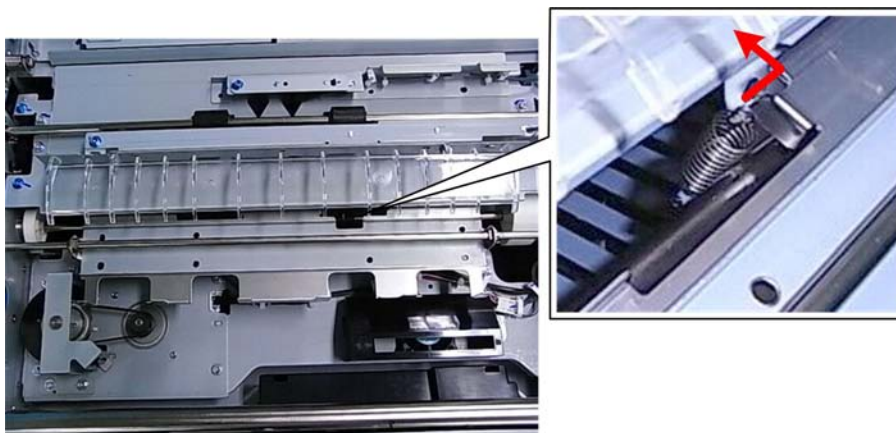

d074r687

3. Remove the registration gate spring ( x1).

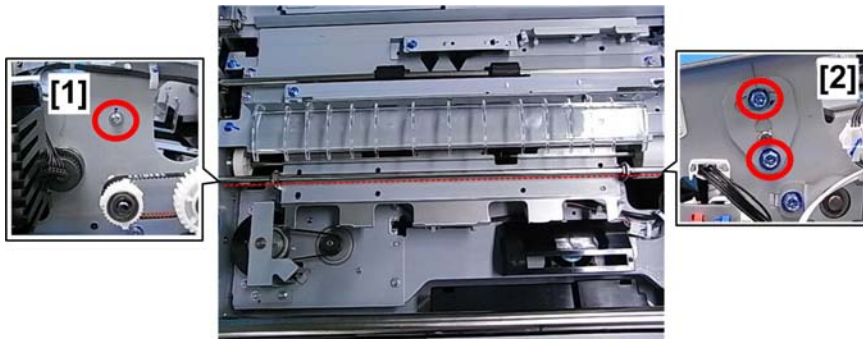

d074r688

4. Remove the registration gate and its shaft:

[1] Rear ( x1)

[2] Front ( x2).

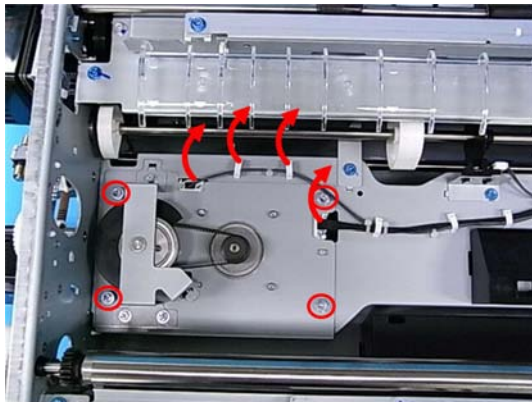

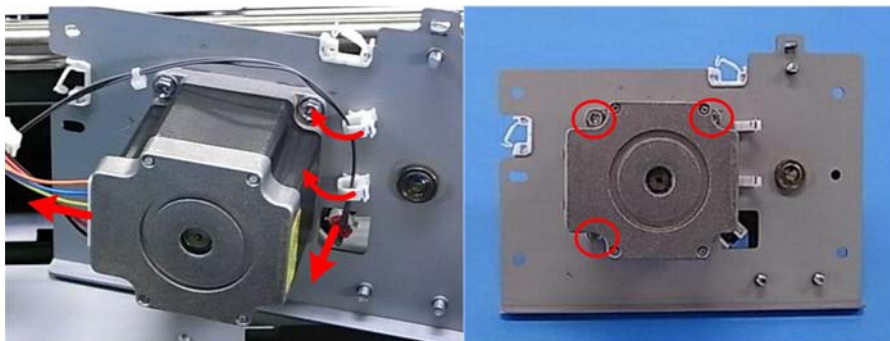

d074r689

5. Disconnect the motor mount ( x4,  x4)



d074r690



6. Separate the motor and the mount ( x2,  x2,  x3).

Shift Timing Motor

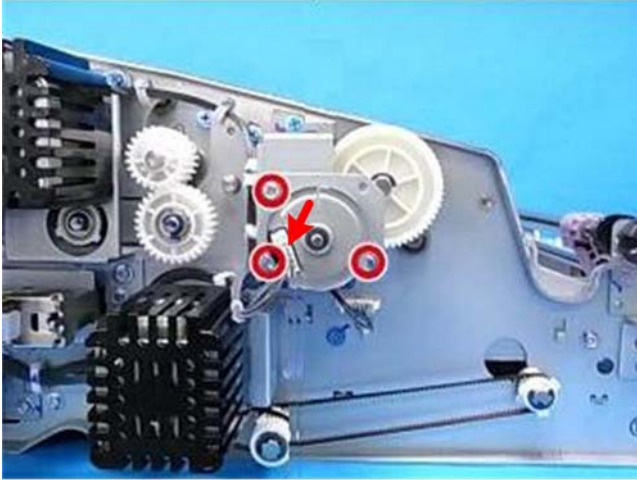
1. Right drawer (▣ p.408)



d074r691

2. Disconnect the motor bracket ( x3,  x1).

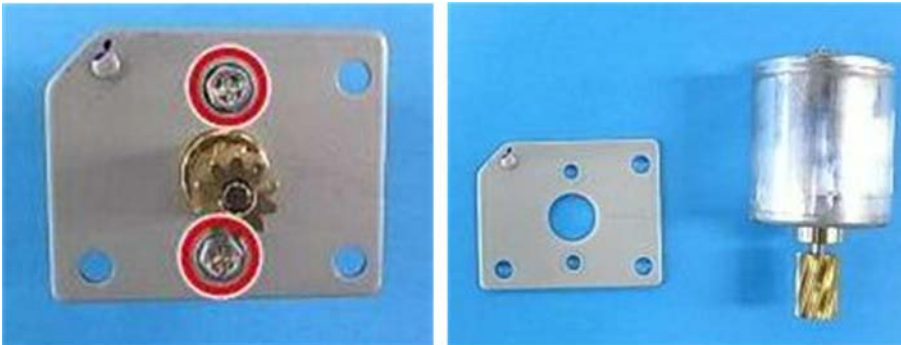

d074r692

3. Separate the motor and the bracket ( x2).

CIS Fan

1. Right drawer (▣ p.408)
2. Shift unit (▣ p.677)

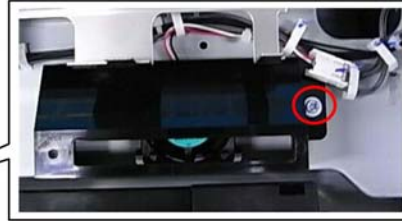

d074r693

3. Remove the fan cover ( x1).

4

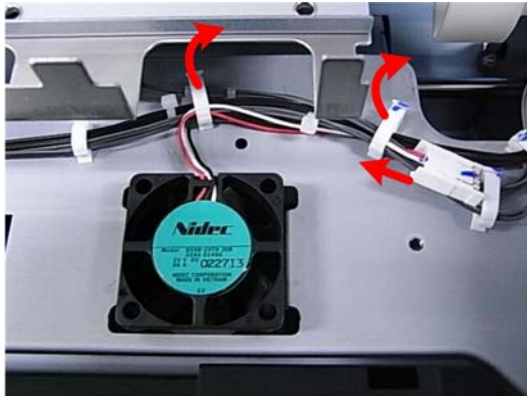

d074r694

4. Remove the fan ( x2,  x1).

Main Relay Sensor 2

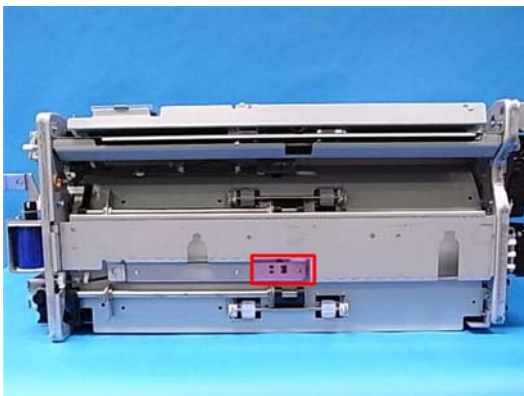

d074r695

1. Open the front doors and pull out the right drawer until it stops.

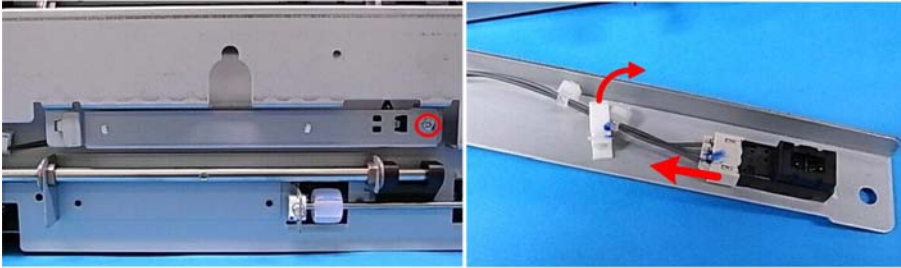

d074r696

2. Disconnect the sensor bracket and remove the sensor ( x1,  x1,  x1,  x3).

4

Main Relay Sensor 3

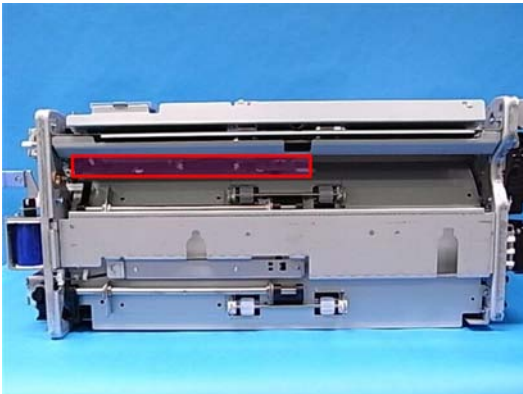

d074r697

1. Open the front doors and pull out the right drawer until it stops.

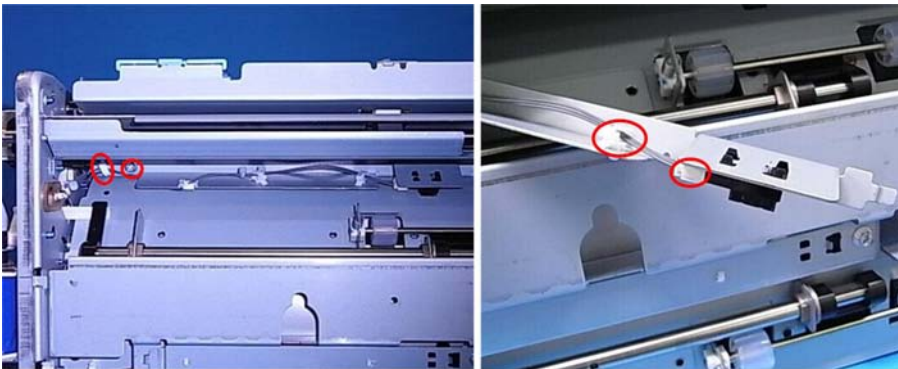

d074r698



2. Disconnect the sensor bracket and remove the sensor ( x2,  x1,  x1,  x3).

LCIT Relay Sensor 2

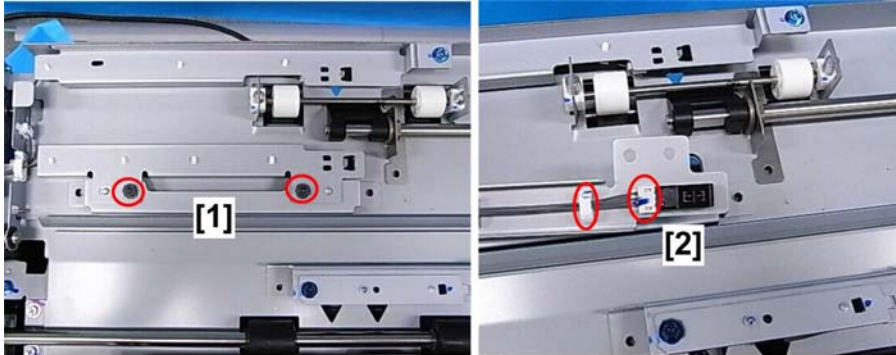
1. Open the front doors and pull out the right drawer until it stops.



d074r699



2. Disconnect the sensor bracket [1] ( x2).
3. Disconnect the sensor ( x1,  x1).

Double-Feed Sensor 1 (LED)

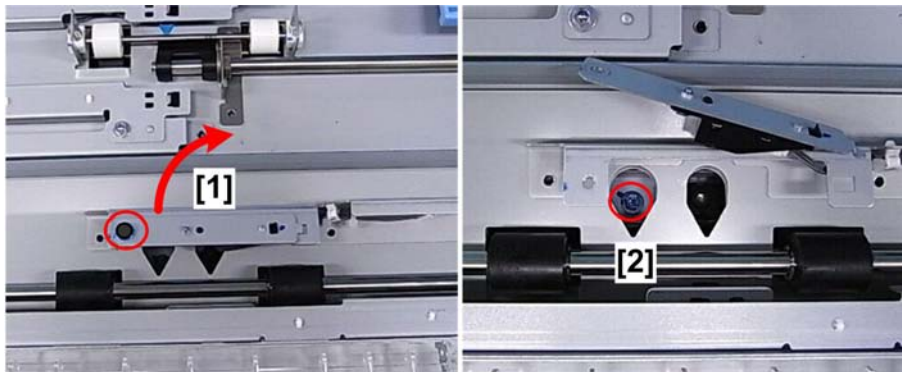
1. Open the front doors and pull out the right drawer until it stops.



d074r700

2. Remove bracket [1] ( x1).
3. Remove screw [2] ( x1).



d074r701

4

4. Disconnect the sensor (🔧 x1).

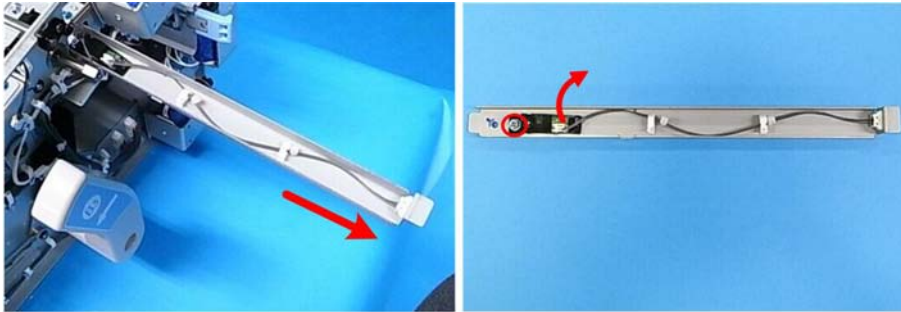

d074r702

5. Pull out the sensor bracket and disconnect the sensor (🔧 x1, 📦 x1).

Double-Feed Sensor 2 (Receptor)



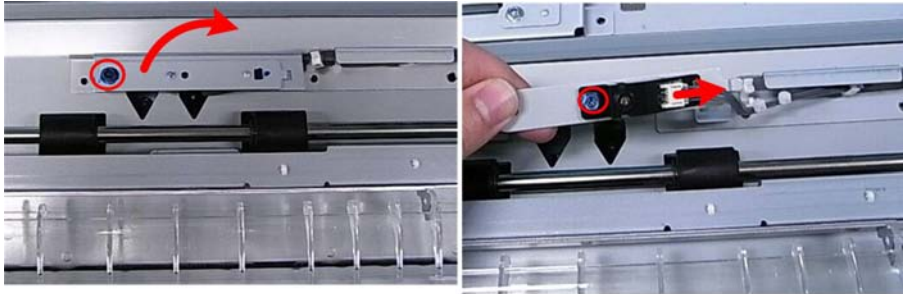

d074r703

1. Open the front doors and pull out the right drawer until it stops.



d074r704

2. Disconnect the sensor bracket and remove the sensor ( x1,  x1,  x1).



Shift Unit Sensor

4

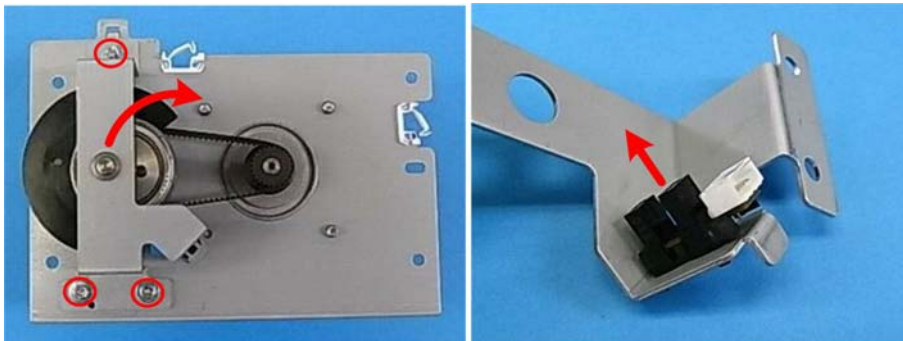

1. Shift motor mount ( p.688)



d074r705

2. Remove the sensor bracket and remove the sensor ( x3,  x3).

Registration Gate Sensor

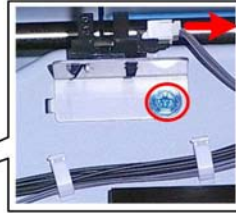
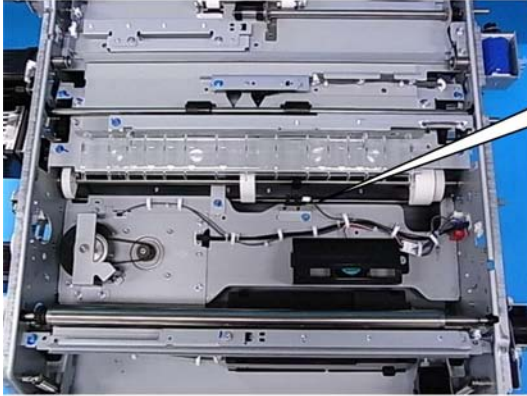

1. Remove:
 - Right drawer ( p.408)
 - Shift unit ( p.677)

Registration gate ( p.688)



d074r706

4

1. Remove the sensor ( x1,  x1,  x3).

CIS

1. Open the front doors and pull out the right drawer until it stops.



d074r707

2. Remove the cover ( x3).



d074r708

3. Remove the CIS assembly ( x2,  x1,  x1).

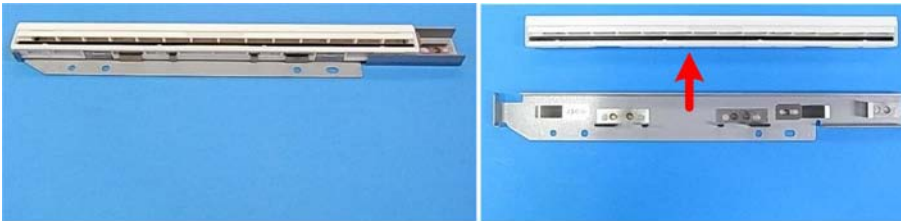

d074r709

4. Separate the CIS and its bracket.

Transfer Timing Sensor

1. Open the front doors and pull out the right drawer until it stops.

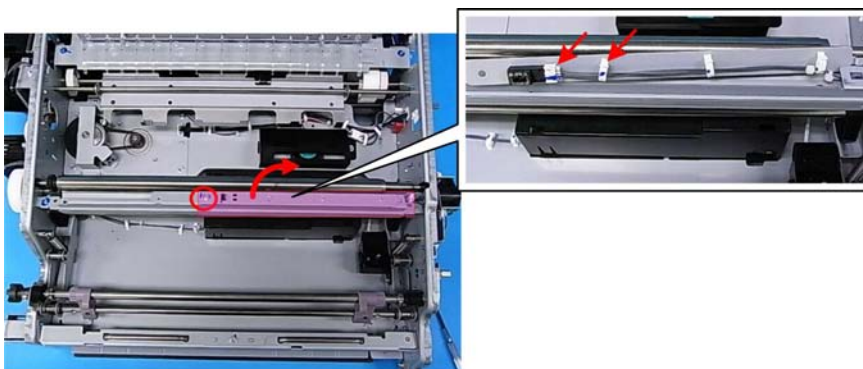

d074r710

2. Remove the sensor bracket and disconnect the sensor ( x1,  x1,  x1).

Duplex Transport Sensor 4

1. Open the front doors and pull out the right drawer until it stops.



d074r711

2. Duplex transport sensor 4 is on the left bottom edge of the drawer unit.

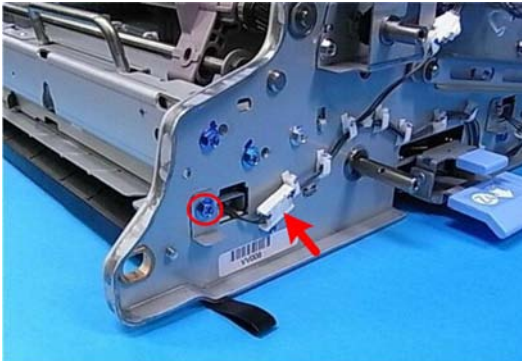

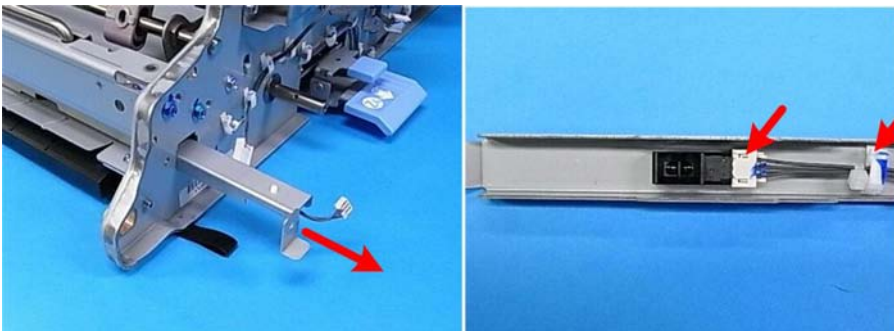

d074r712

3. Disconnect the sensor bracket ( x1,  x1).



d074r713

4. Pull out the sensor bracket and disconnect the sensor ( x1,  x1).

Duplex Transport Sensor 5

1. Open the front doors and pull out the right drawer until it stops.

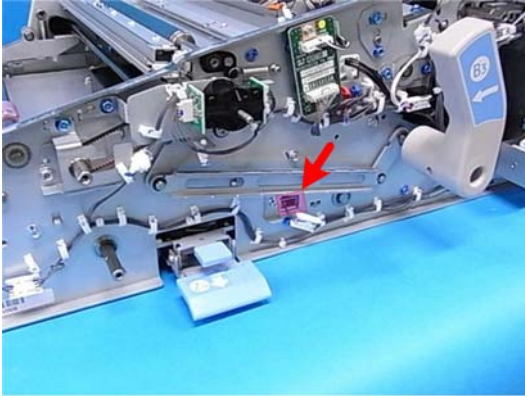

d074r714

2. Duplex Transport Sensor 5 is located at the bottom front edge of the drawer unit.

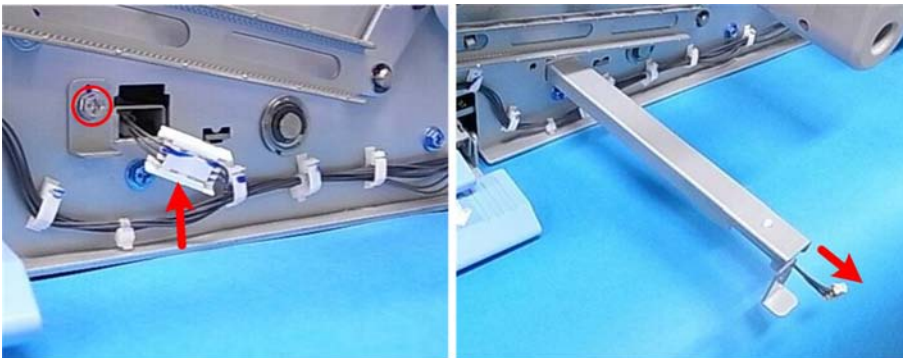

d074r715

3. Disconnect the sensor bracket and pull it out (🔧 x1, 📦 x1).

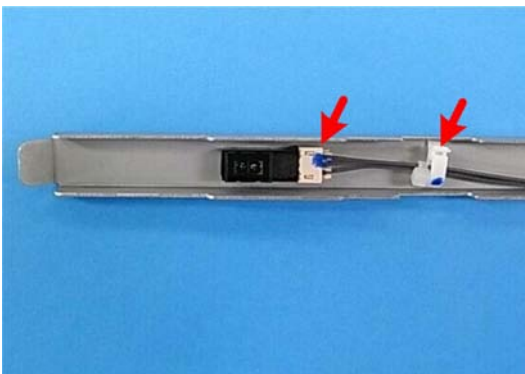

d074r716

4. Disconnect the sensor (🔌x1, 📦x1).

DRB

1. Right drawer (📖 p.408)

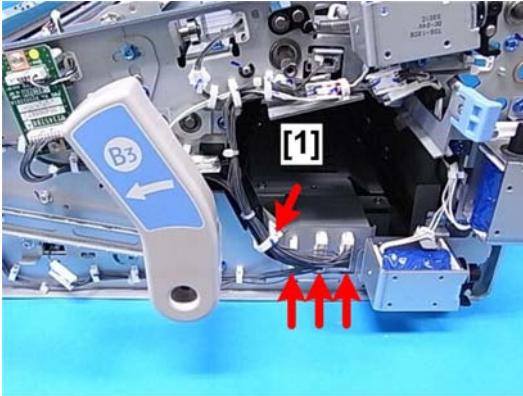

d074r717

2. Disconnect the front [1] of the DRB (🔌x1, 📦x3).

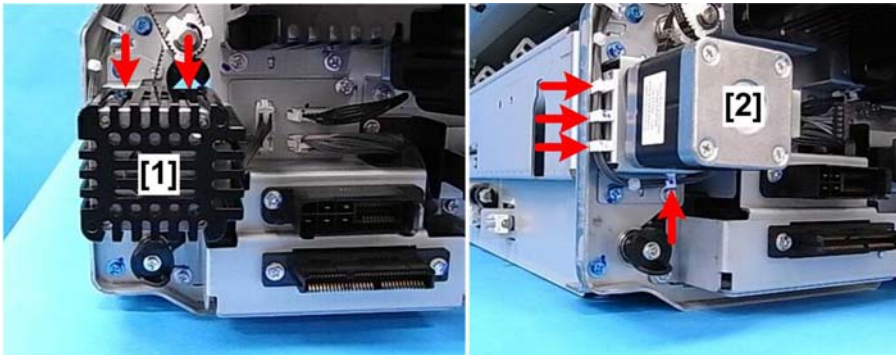

d074r718

3. At the rear, press the tab releases and remove the cover of the registration entrance motor [1].
4. Disconnect the harness [2] (🔌x4).

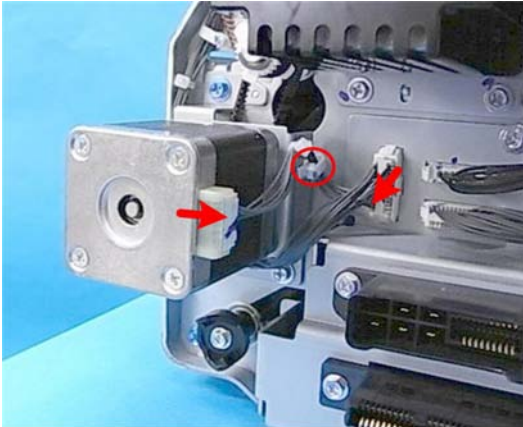

d074r719

5. Disconnect the motor (⚙️ x2, 🔌 x1).

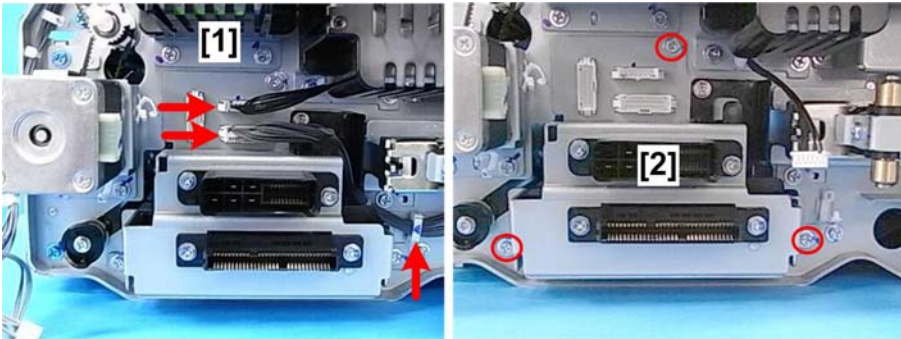

d074r720

6. Disconnect the harnesses at [1] (⚙️ x2).
7. Disconnect the bracket [2] (⚙️ x3).

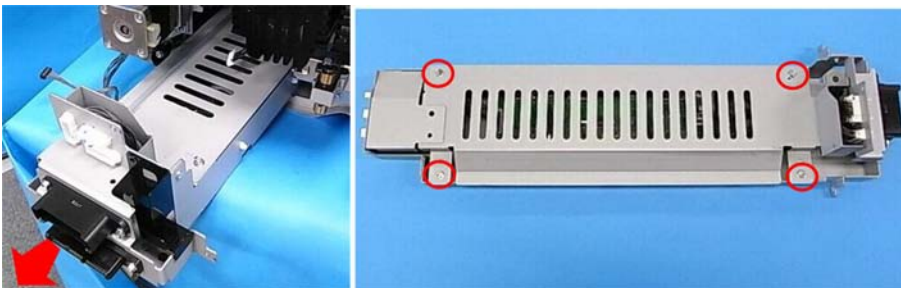

d074r721

8. Pull the assembly out of the drawer unit.
9. Disconnect the bracket (⚙️ x4).

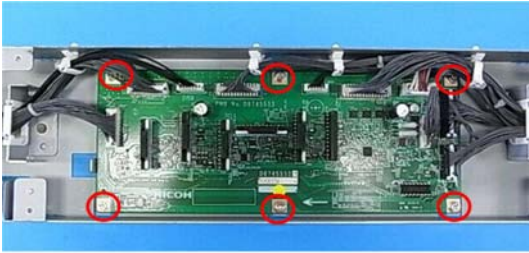





d074r722

10. Remove the DRB ( x6,  x All

4

Separation Power Pack

1. Remove:

- Right drawer ( p.408)
- PTR unit ( p.432)
- Shift Unit ( p.677)
- Transfer Timing Sensor ( p.697)



d074r723

2. Remove the bracket ( x1,  x1).

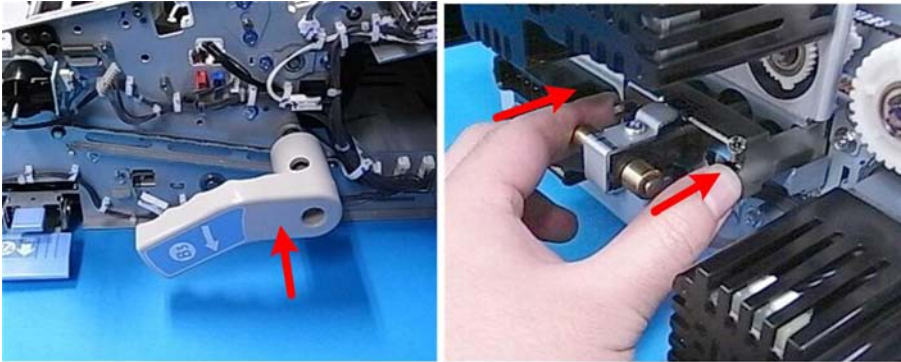

d074r724

3. Set lever **B3** at the front.
4. Push in on the brackets at rear.

4

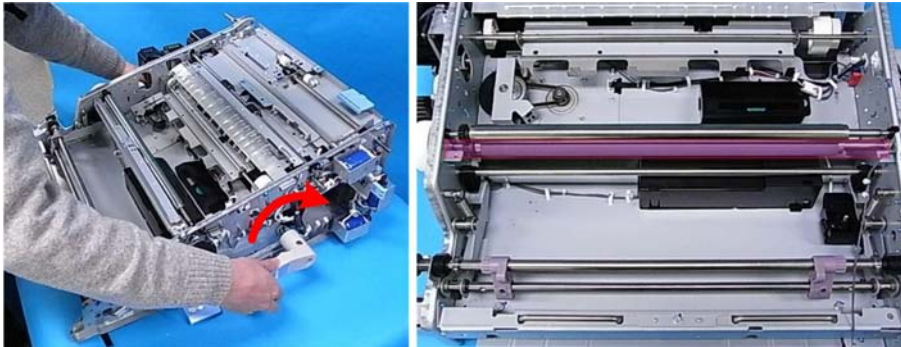

d074r725

5. While pressing both ends, raise the lever to the upright position.

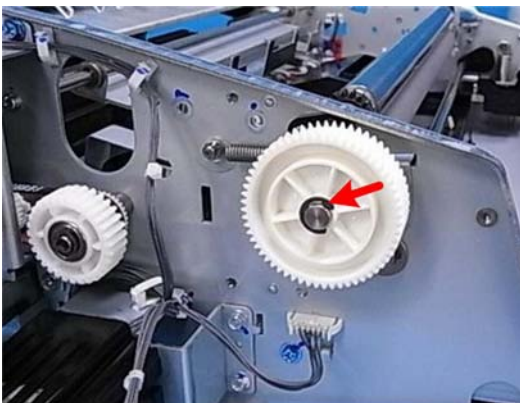

d074r726

6. Disconnect the end of the transport roller (Ⓒ x1).

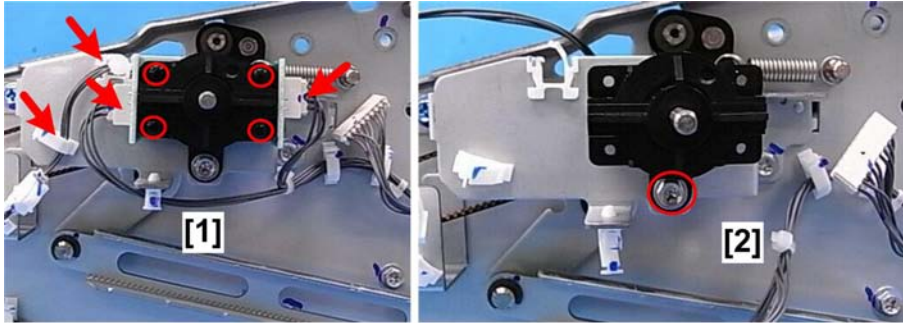

d074r727

- 7. Disconnect the transfer timing roller encoder [1] (🔌x2, Pins x4, 📡x2).
- 8. Remove the encoder [2] (🔧x1).

4

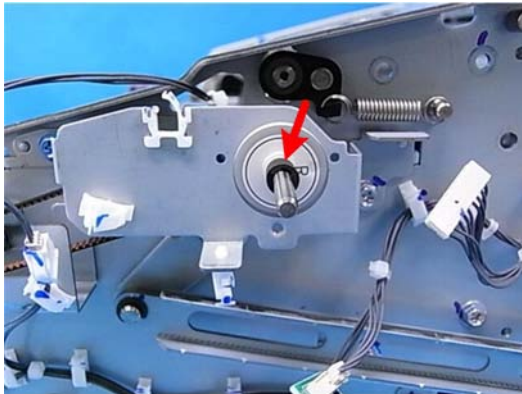

d074r728

- 9. Remove the encoder stopper (🔪x1).

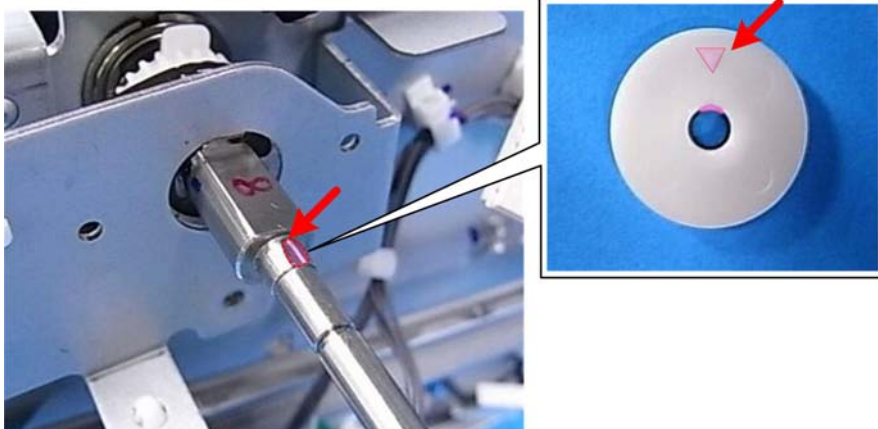



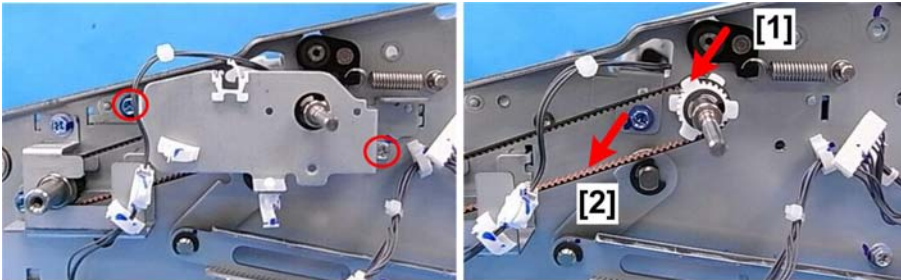

d074r729

Re-Installation

- When you re-install the stopper on the shaft, be sure to align the groove of the shaft with the tab of the stopper.
- The small triangle on the stopper indicates the location of the tab.





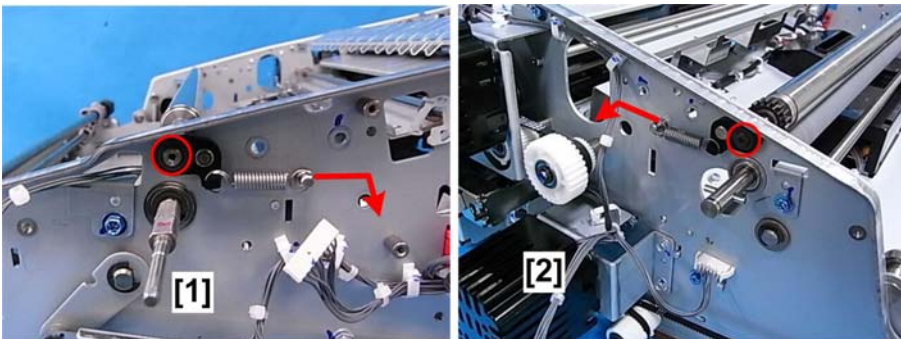

d074r730

1. Remove the bracket ( x1,  x1).
2. Remove:
 - [1] Gear ( x1)
 - [2] Belt ( x1)



d074r731

3. Disconnect both ends of the shift drive roller:
 - [1] Front ( x1,  x1)
 - [2] Rear ( x1,  x1)



d074r732

4

4. Remove the shift drive roller.



d074r733

5. Disconnect the springs on both sides of the tension arm (🔧 x2).

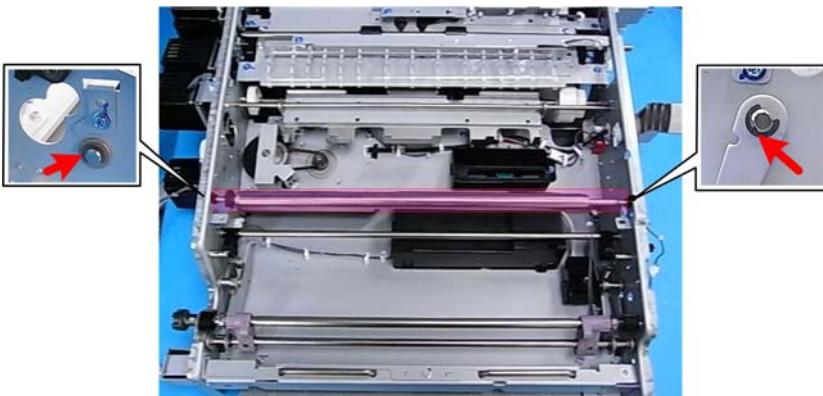

d074r734

6. Disconnect the tension arm (🔧 x2).

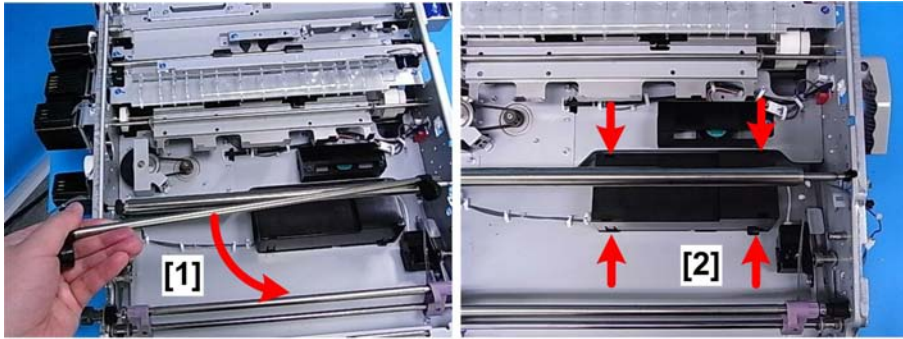

d074r735

7. Remove the tension arm [1].
8. Depress the tab releases and remove the power pack cover [2] (▼ x4).

4

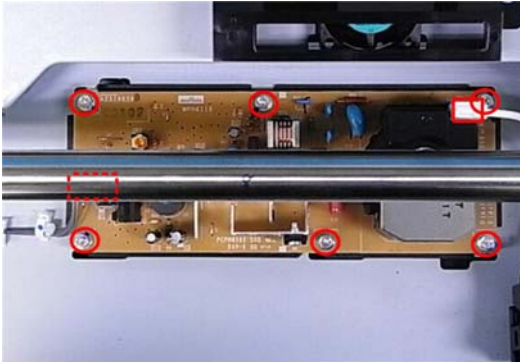

d074r736

9. Remove the separation power pack (⏏ x2, 🔩 x6).

Paper Transfer Roller (PTR) Unit

4

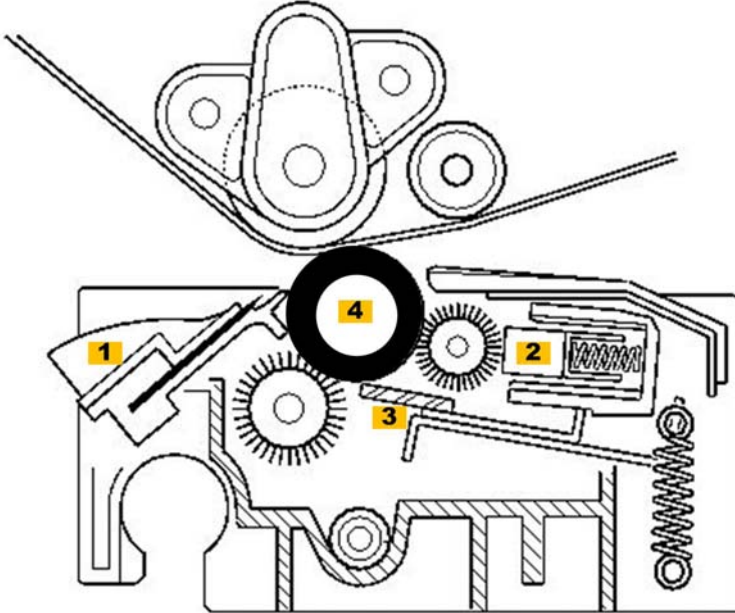

d074r260a

PM Parts List: Replacement

No.	PM Part Name	Interval
[1]	PTR Separation Plate	300K
[2]	PTR Lubrication Bar	450K (D074) 500K (D075/M044)
[3]	PTR Cleaning Blade	300K
[4]	Paper Transfer Roller (PTR)	600K

PTR Servicing SP Codes

You must execute these SP codes after replacing and the PTR unit or replacing parts.

1. The machine power must be OFF.
2. Open both front doors.

3. Turn the main power switch ON.
4. Enter the SP mode.
5. Reset the counter for the replaced unit or parts.
6. Close the front doors.
7. Wait for about 5 minutes. When you hear an audible beep and see "Ready" displayed on the operation panel, you are ready to continue.
8. Execute these SP codes.

SP	What It Does
3020-001	Initializes process control.
3012-001	Confirms successful initialization of process control.

9. Exit the SP mode.

4

Cleaning

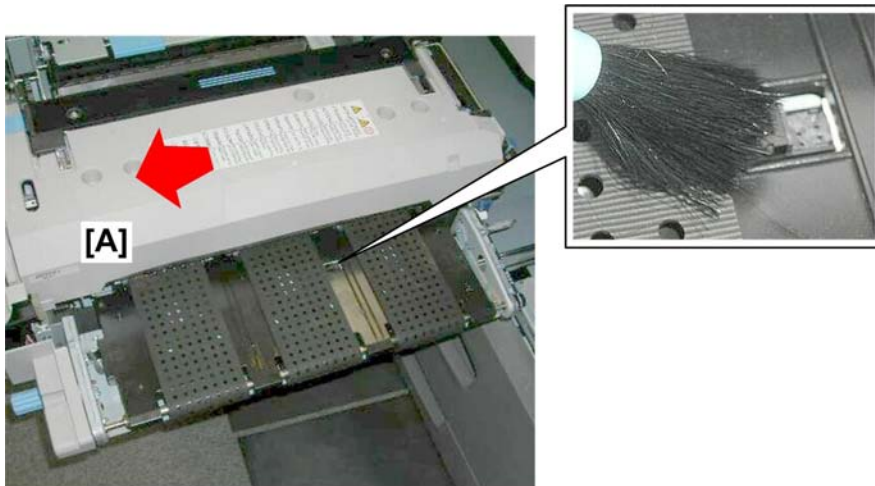



d074t260

No.	PM Part Name	Interval	Replaced By
[A]	PTB Sensor	300K	Service Technician, or TCRU

Separation Plate



1. PTR unit ( p.432)
2. Disconnect the separation plate at the rear [A] and front [B] ( x2).

4

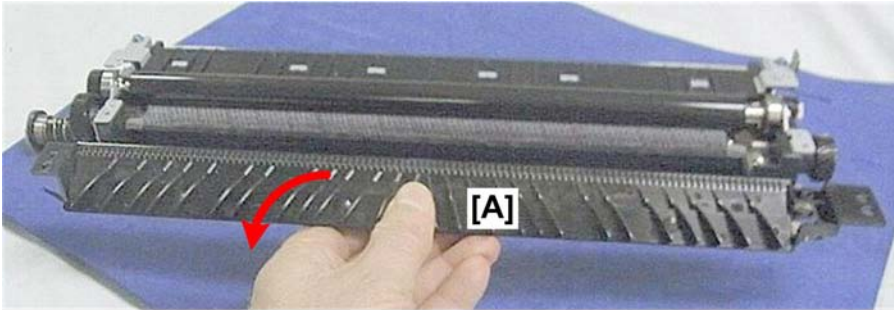

d074r264

3. Remove the separation plate [A].
4. After replacement, do the SP codes. ( p.708)

Lubrication Bar

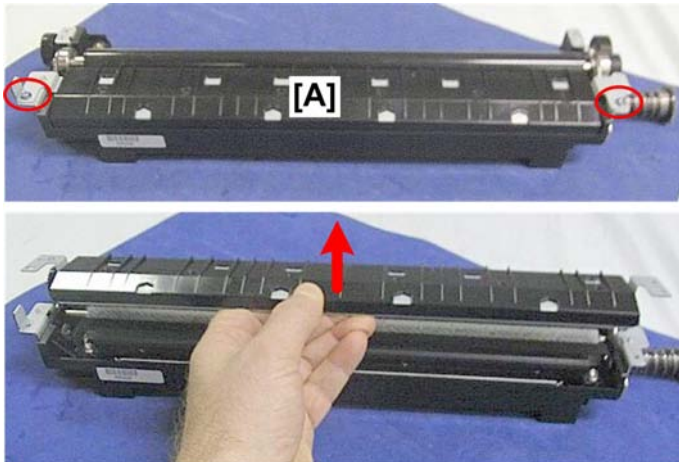

d074r265

1. PTR unit (p.432)
2. Remove the entrance guide plate [A] (x2).

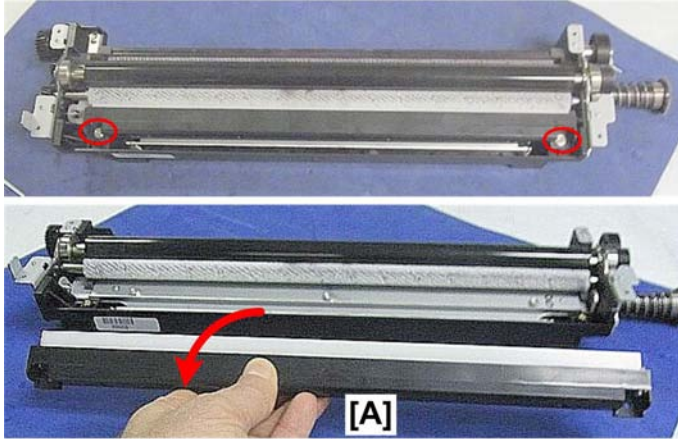

d074r266

3. Remove the lubrication bar casing [A] (x2).

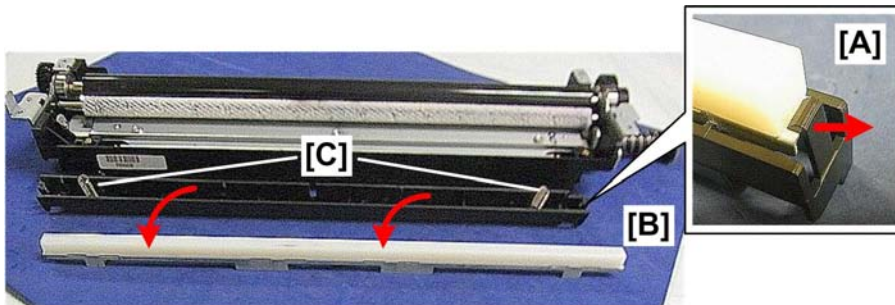

d074r267

4. Release the bar on either end [A] and remove it [B] (x2).

★ Important

- Do not remove the springs [C]. The springs must be positioned as shown above for re-installation. Do not lose them (they can easily fall out of the casing if it is handled carelessly).

5. After replacement, do the SP codes. (p.708)

Lubrication Blade

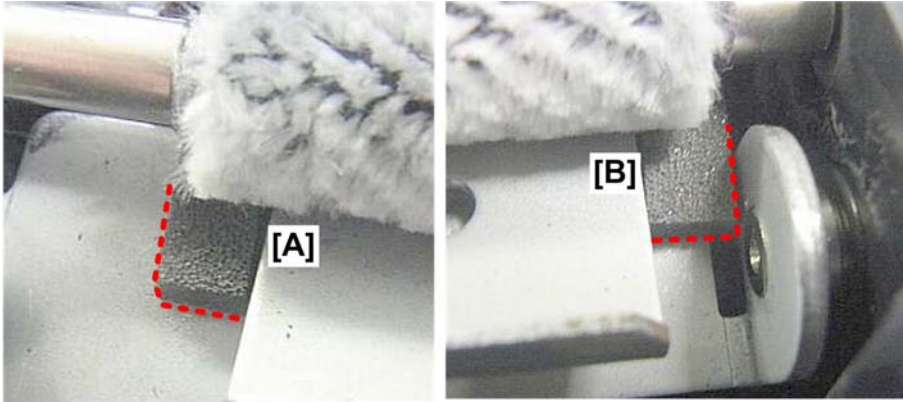

d074r267a

★ Important

- When removing and re-installing blades, work carefully to avoid damaging the sponge seals [A] and [B] at the ends of the blade. These sponge seals are fragile and cannot be replaced in the field.

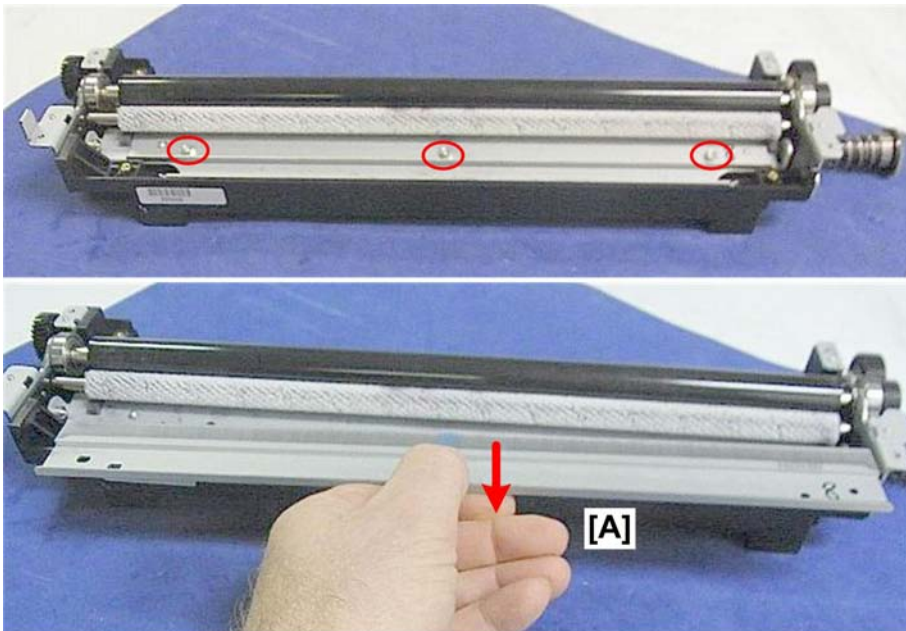

d074r268

1. PTR unit (p.432)
2. Remove the lubrication blade.
3. After replacement, do the SP codes. (p.708)

Lubrication Roller

1. PTR unit (p.432)
2. Remove:
 - Lubrication bar (p.710)
 - Lubrication blade (p.712)

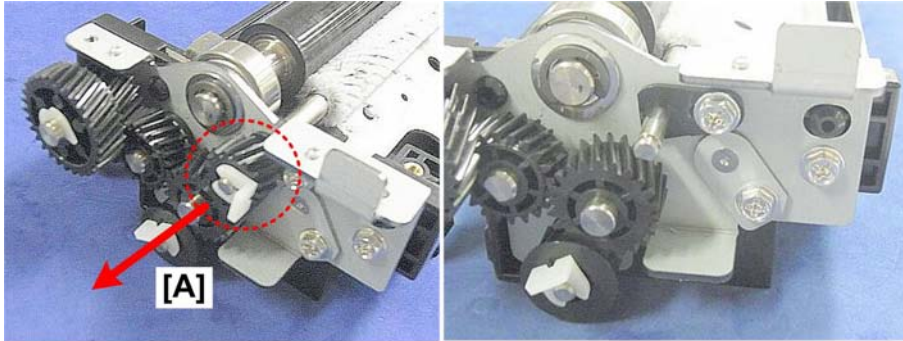

d074r269

3. At the front [A], remove the gear (x1).

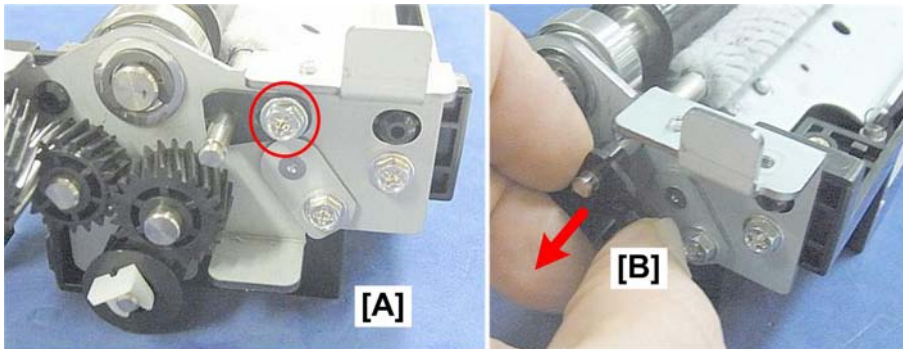

d074r270

4. At the front [A], disconnect and remove the lock plate [B] (x2).

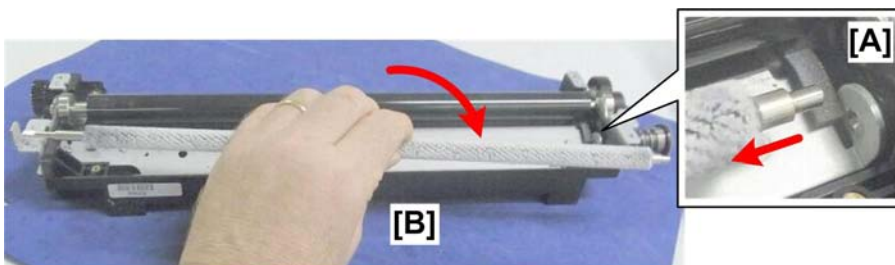

d074r271

5. Pull out the rear end of the shaft [A] and remove the roller [B].

6. After replacement, do the SP codes. (☞ p.708)

PTR (Paper Transfer Roller)

1. PTR unit (☞ p.432)
2. Remove:
 - Lubrication bar (☞ p.710)
 - Lubrication blade (☞ p.712)
 - Lubrication roller (☞ p.713)

4

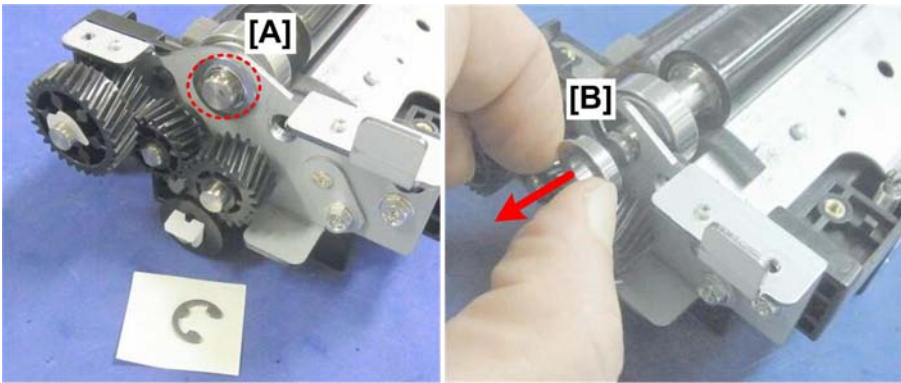

d074r272

3. Disconnect the front end of the roller [A] (☞ x1).
4. Remove the ring bearing [B].

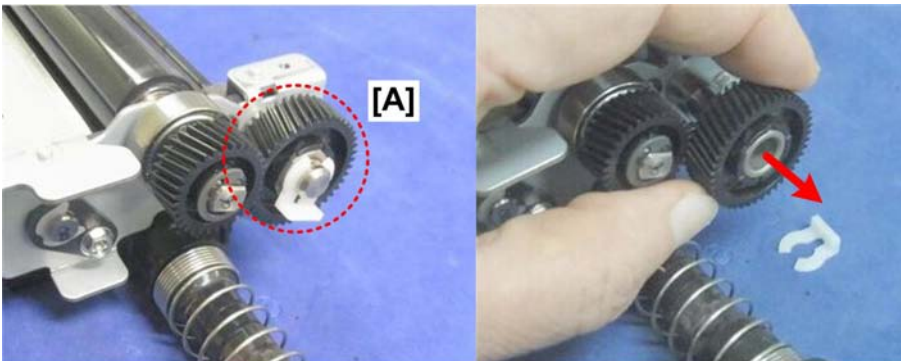

d074r273

5. At the rear, remove the gear [A] (☞ x1).

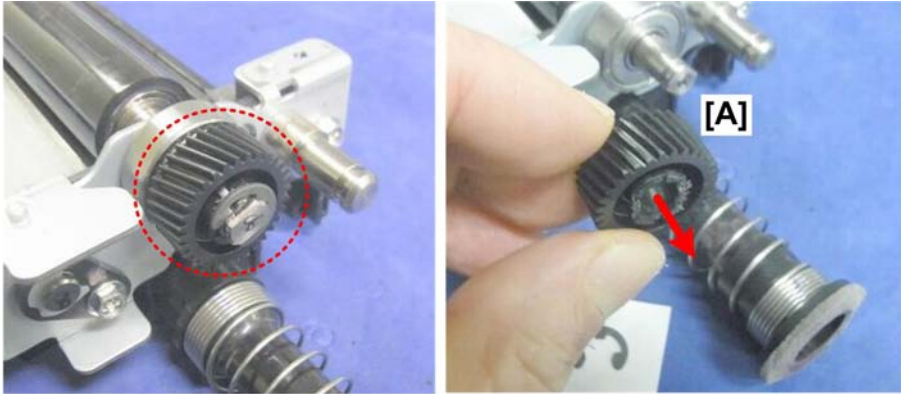

d074r274

6. Remove the other gear [A] (Ⓢx1).



d074r275

7. Remove the ring bearing and bearing race from the shaft.



d074r276

8. Remove the PTR [A].

9. After replacement, do the SP codes. (p.708)

Cleaning Roller

1. PTR unit (p.432)
2. Remove:
 - Lubrication bar (p.710)
 - Lubrication blade (p.712)
 - Lubrication roller (p.713)
 - PTR (See the previous section.)

4



d074r277

3. At the front, remove the gear [A] (x1).

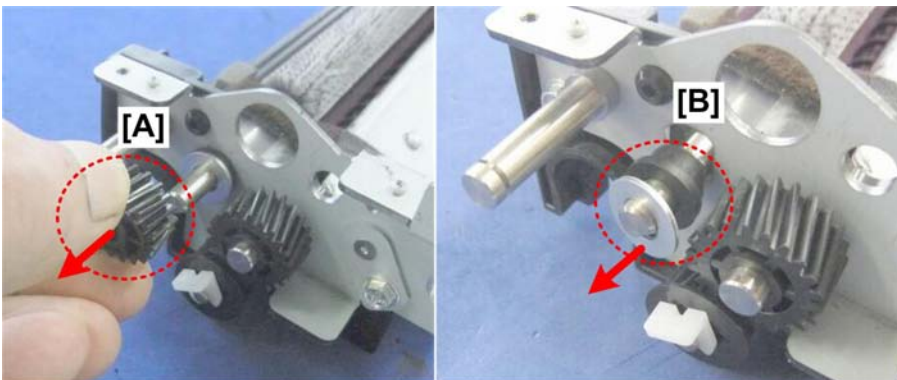

d074r278

4. Remove the gear [A].
5. Remove the washer and bushing [B].

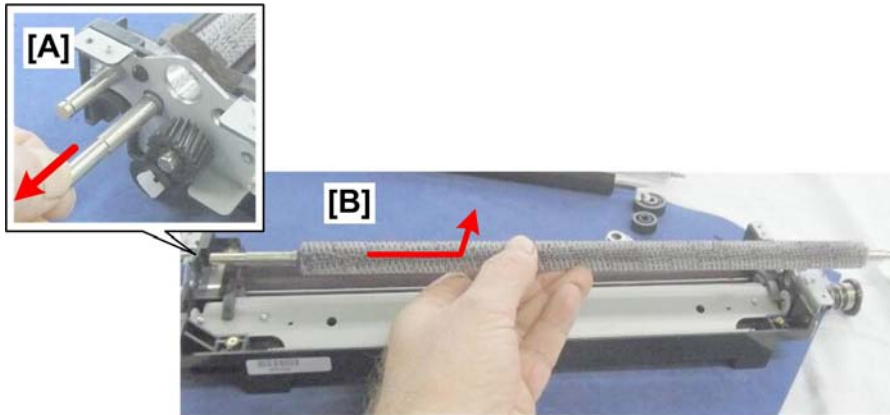

d074r279

6. At the front, pull out the shaft [A] and remove the cleaning roller [B].

Re-installation

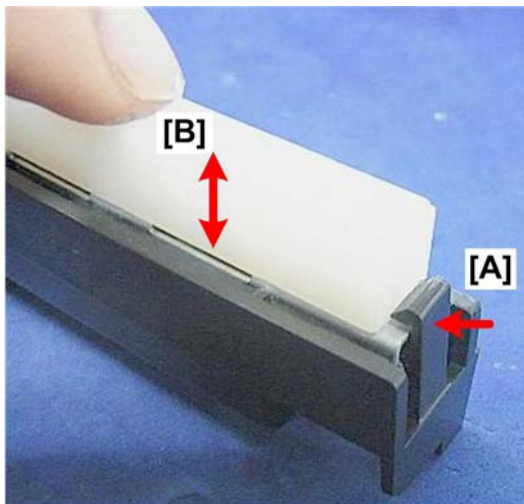

d074r280

1. Attach the pawl [A] to the top of the metal bar base.
2. Push the top of the bar [B] lightly. The spring should bounce up and down.
If the bar does not bounce, make sure the springs under the lubrication bar are set correctly.
3. After replacement, do the SP codes. (p.708)

PTR/ITB Cleaning Unit Motor

This motor has two functions. It drives the PTR and all the moving parts of the ITB cleaning unit.

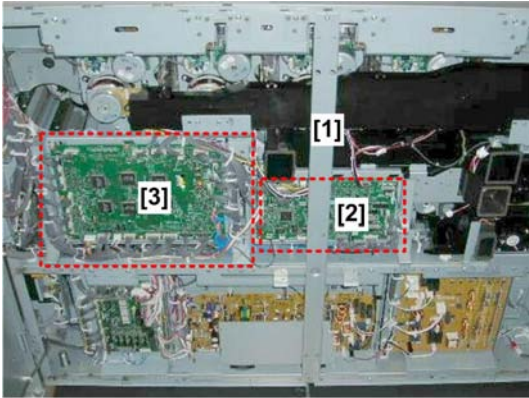

d074r481

4

1. Open the rear boxes. (🔧 p.400)
2. Remove the center stay [1]. (🔧 x3).
3. Lower the TDCU [2]. (🔧 p.823)
4. Lower the IOB [3]. (🔧 p.830)

⬇️ **Note**

- Both of these boards can be lowered without removing all the connectors and removing the boards. Just remove the top edge connectors and enough of the harnesses that will allow you to lower the boards.

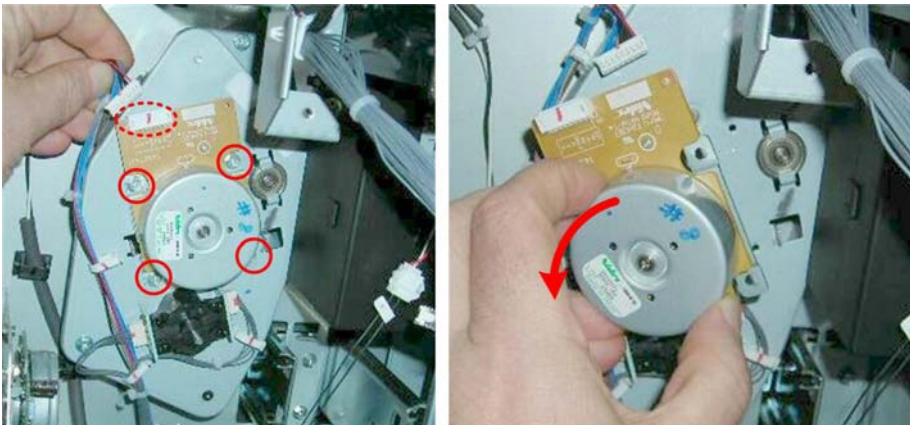

d074r482

5. Remove the motor (🔧 x1, 🛠️ 4).



d074r483

Paper Separation Power Pack

The paper separation power pack is located near the center of the right drawer. (p.408)

Paper Transport Belt (PTB) Unit

Paper Transport Belts

1. PTB (📄 p.438)

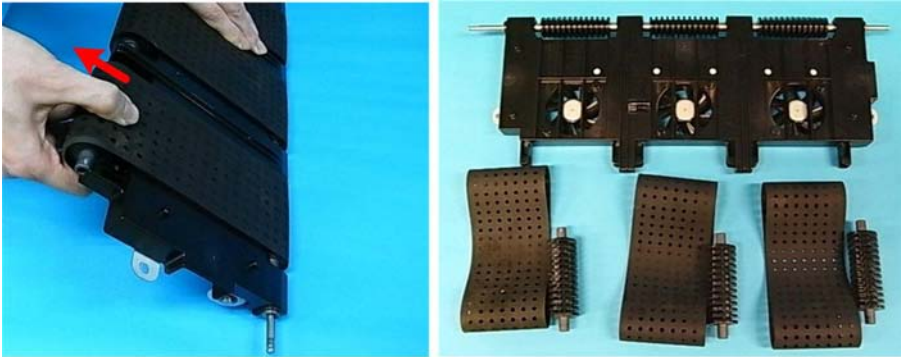

d074r742

2. Pull the roller in the direction of the arrow to disconnect the belt from the roller.
3. Repeat this procedure for each belt.

PTB Sensor

1. PTB unit (📄 p.438)
2. Paper transport belts (📄 p.720)



d074r744

3. Remove the sensor bracket and disconnect the sensor (🔩 x1, 📄 x1, ▼ x3).

PTB Fans

1. PTB unit (📄 p.438)
2. Paper transport belts (📄 p.720)

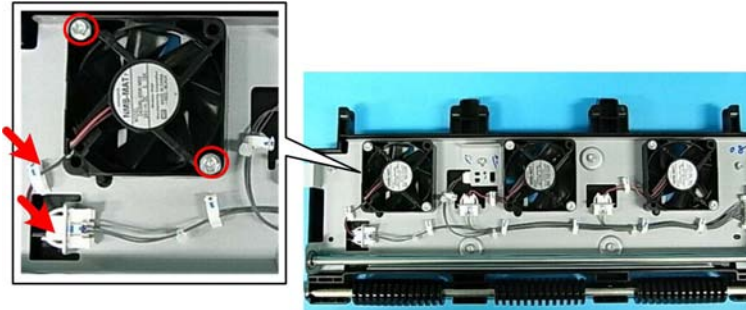

d074r743

3. Remove the fan (🔧 x1, 📄 x1, 🔧 x2). The procedure is the same for each fan.

Pressure Roller Fan

1. Left drawer cover (📄 p.438)

⬇ Note

- Only cover removal is necessary.

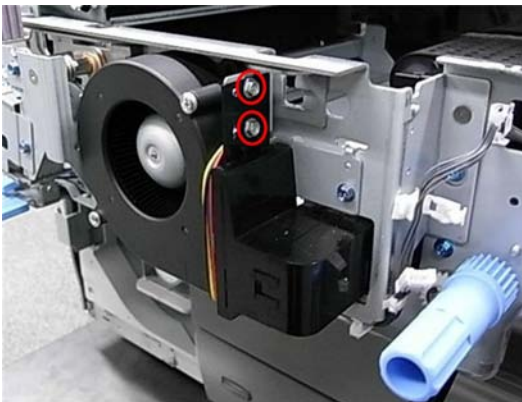



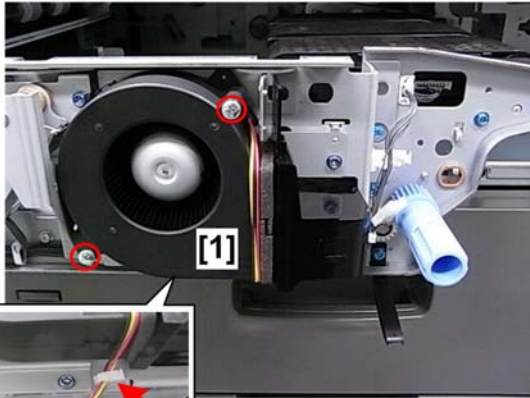

d074r745

2. Disconnect the right side of the duct (🔧 x2).

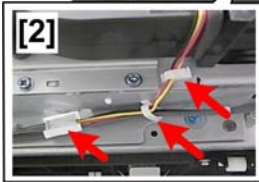

d074r746



3. Disconnect the fan and remove it:
- [1] Front ( x2)
 - [2] Bottom ( x2,  x1)

Belt Cooling Fan

1. Left drawer cover ( p.438)

 **Note**

- Only cover removal is necessary.

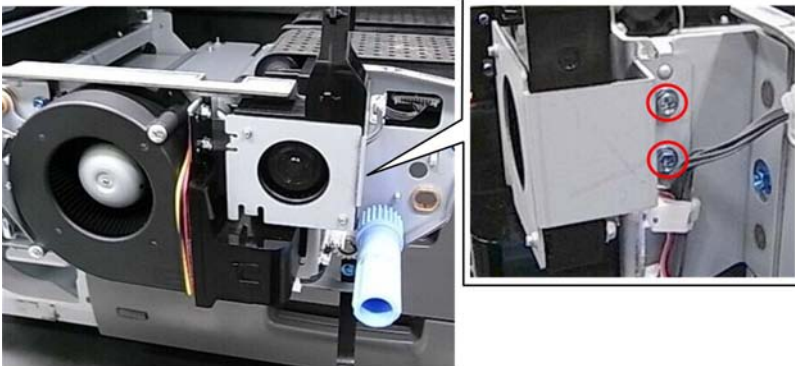

d074r747

2. Remove the fan bracket ( x2).

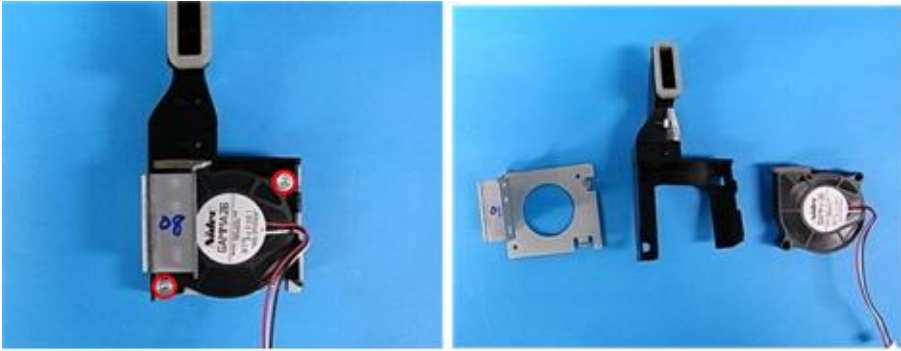

d074r748

3. Separate the duct, bracket, and fan ( x2).

Fusing Unit

Before You Begin...

⚠ WARNING

- The fusing unit can become very hot during normal operation.
- Before removing the fusing unit, switch the machine off and wait at least 10 min. for the fusing unit to cool so it can be removed and handled safely.

4

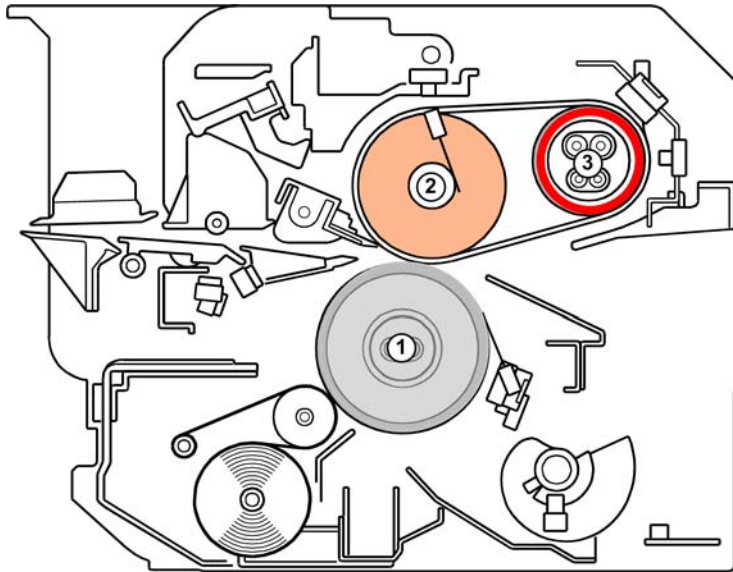

d074r299

①	Pressure Roller
②	Hot Roller
③	Heating Roller

Specifications

Nip time	45 ms	
Print speed	D074	65 ppm (B&W, FC)
	D075, M044	75 ppm (B&W, FC)

Warm-up time	Less than 300 sec.
--------------	--------------------

	Interval	
Removing the Fusing Unit		
Periodic Cleaning, Lubrication		
Fusing Belt Stripper Plate	300K	Clean
Pressure Roller Stripper Plate	300K	Clean
Entrance Guide Plate	300K	Clean
Main Drive Gears	650K	Lubricate
Fusing Unit		
Heating Roller Fusing Lamps		
Heating Roller		
Hot Roller	650K	Replace
Fusing Belt	650K	Replace
Hot Roller Thermistors	650K	Clean
Hot Roller Bearings	650K	Lubricate
Pressure Roller Fusing Lamp		
Pressure Roller	650K	Replace
Pressure Roller Thermistors	650K	Clean
Pressure Roller Bearings	650K	Replace

Notes

- **Periodic Cleaning, Lubrication.** This can be done by simply removing the fusing unit from the machine ( x1). Disassembly of the fusing unit is not required.
- **Fusing Unit.** Full disassembly of the fusing unit is required at 650K. All these parts must be serviced together.

Periodic Cleaning

The following parts can be cleaned or lubricated without disassembling the fusing unit.

Cleaning

Part Name	Interval	Cleaning By
Fusing belt stripper plate	300K	Service Technician, or TCRU
Pressure roller stripper plate	300K	Service Technician, or TCRU
Entrance guide plate	300K	Service Technician, or TCRU

4

Lubrication

Part Name	Interval	Cleaning By
Main drive gears	650K	Service Technician

Fusing Belt Stripper Plate



d074r300

1. Use a dry cloth to clean the stripper plate on the fusing belt.

Pressure Roller Stripper Plate

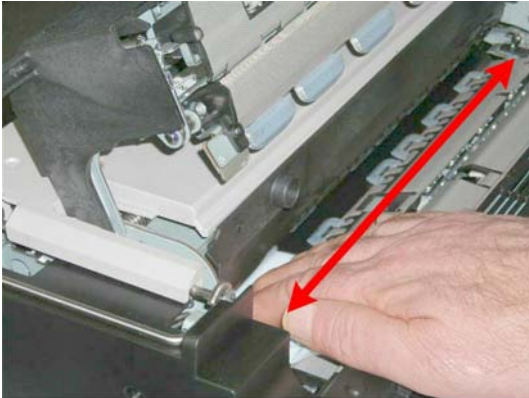

d074r301

1. Use a dry cloth to clean the stripper plate on the pressure roller.

Entrance Guide Plate

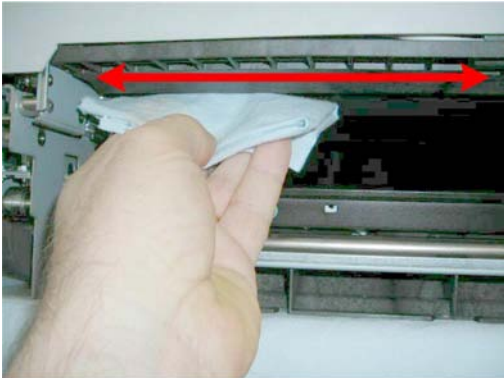

d074r302

1. Use a dry cloth to clean the entrance guide plate.

Periodic Lubrication

Main Drive Gears

4

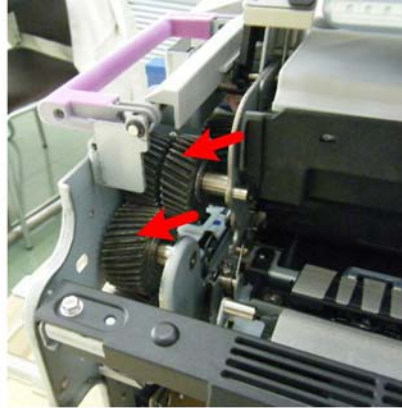
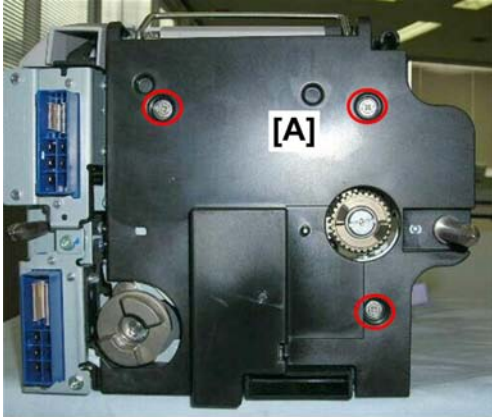

d074r303

1. Fusing cleaning unit (p.433)
2. Remove the rear plate [A] (x3).
3. Apply FLUOTRIBO MG Grease to the two rollers marked by red arrows. Apply about 2 g at both points

Heating Roller Fusing Lamps

1. Fusing cleaning unit (p.433)

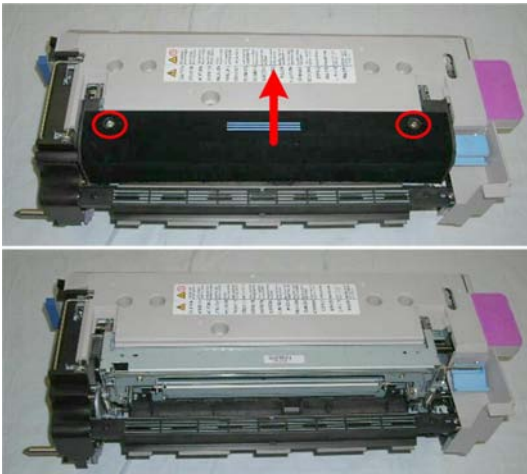

d074r341

2. Remove screws (🔩 x1, 🔩 x1).
3. Remove the separation unit cover.

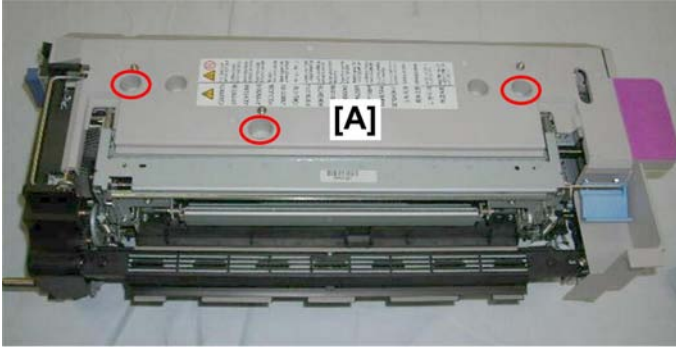

d074r342

4. Remove the screws of the top cover [A] (🔩 x1, 🔩 x2)

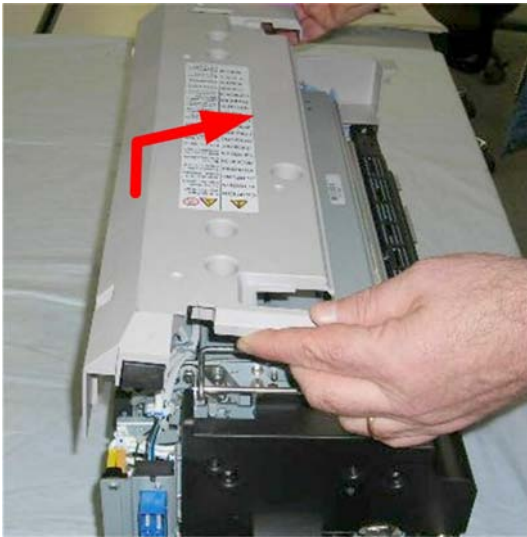

d074r343

5. Remove the top cover.

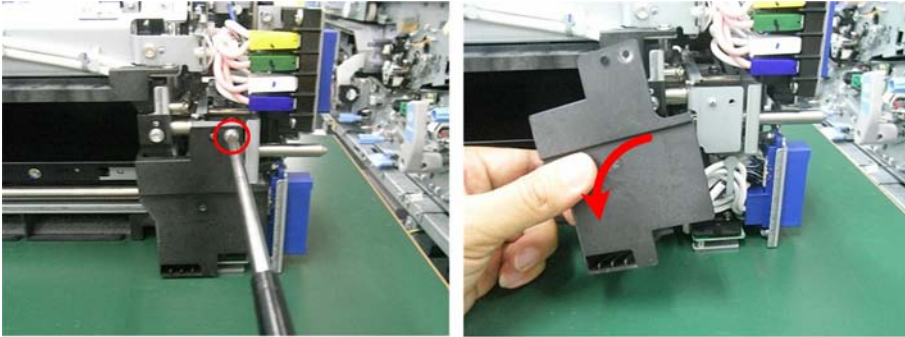

d074r344

4

6. Carefully, remove the rear harness cover (🔩 x1).

★ Important

- The bottom of the cover is held in place by a tab and post.

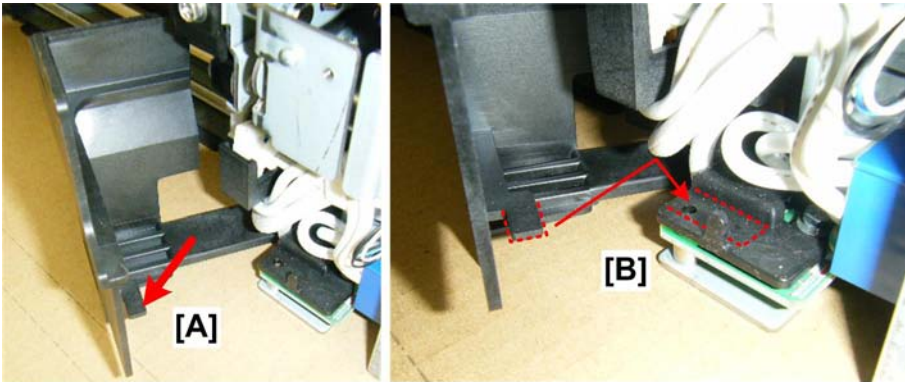

d074r344a

- The tab [A] is fragile and can break easily.
- The tab must be positioned behind the post [B] when the cover is re-installed. This positions the cover correctly so that the cover screw can be re-attached.

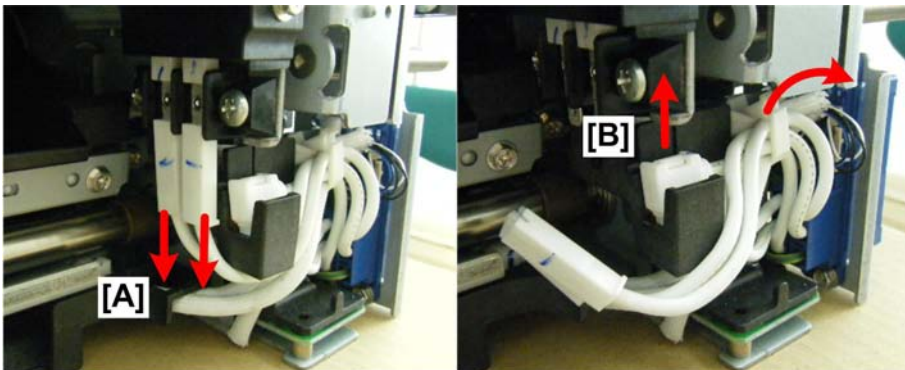

d074r345

7. Disconnect bayonet connectors [A] (🔌 x2).
8. Disconnect connector [B] (🔌 x1, 🗑️ x1).

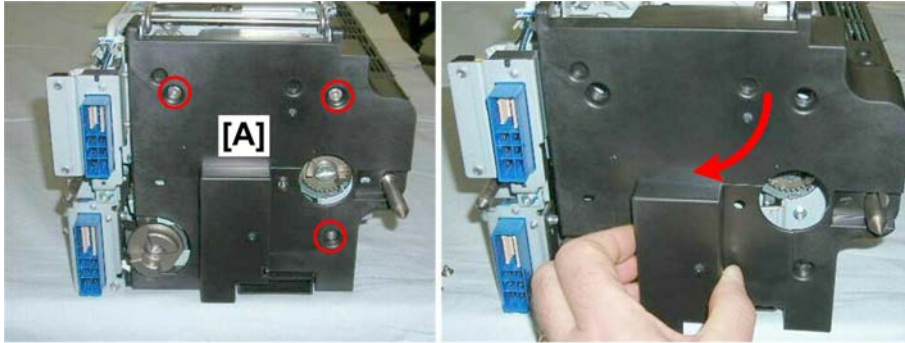

d074r346

9. Remove the rear cover [A] (🔑 x3).

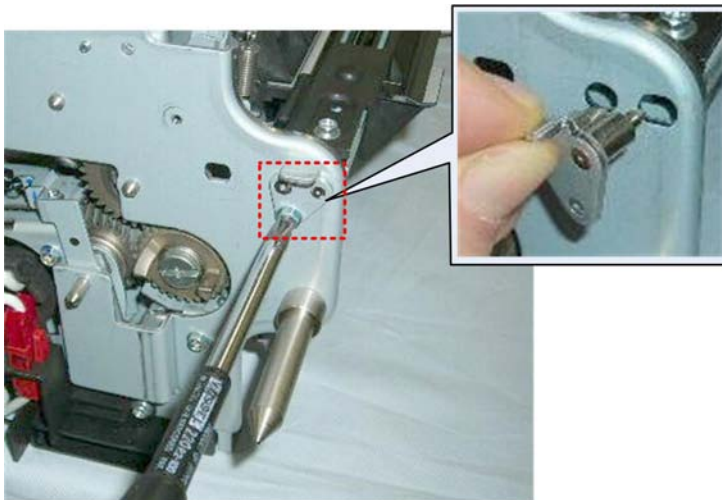

d074r347

10. Remove the lock plate (🔑 x1 M3x6).

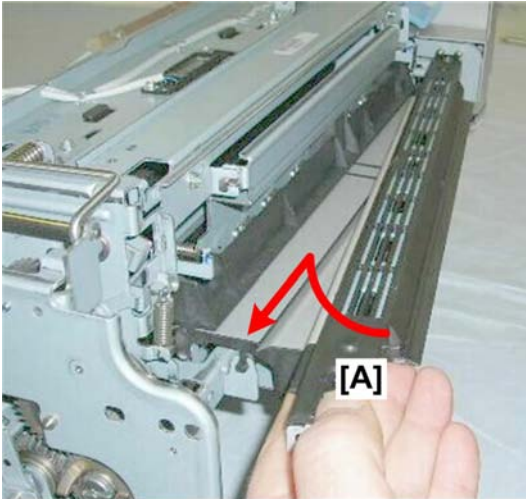

d074r348

11. Remove the guide plate [A].

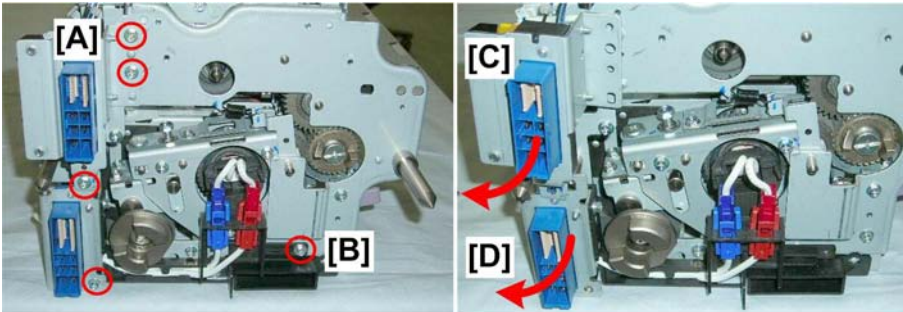

d074r349

12. Remove the screws on the left [A] ( x4 M3x6).

13. Remove the screw on the right [B] ( x1).

14. Pull connectors [C] and [D] slightly to the left.

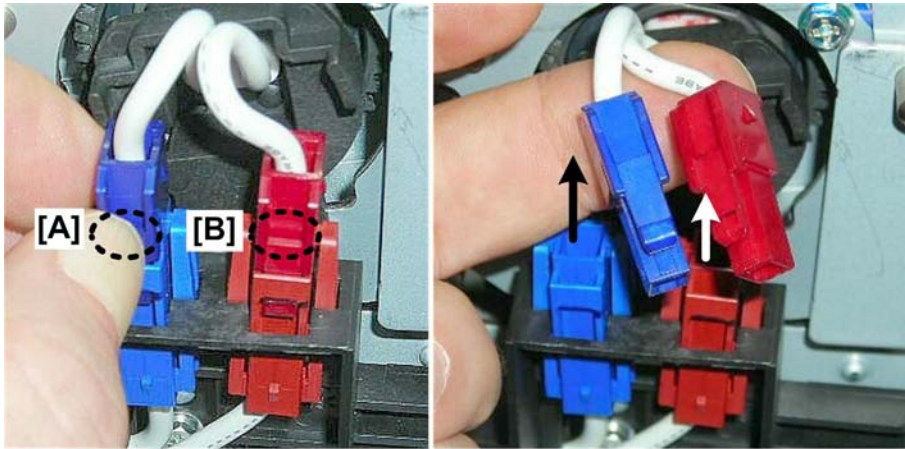

d074r350

4

15. Press in on the sides of the connectors [A] and [B] to release them.
16. Pull the connectors up to disconnect them (👉 x2).

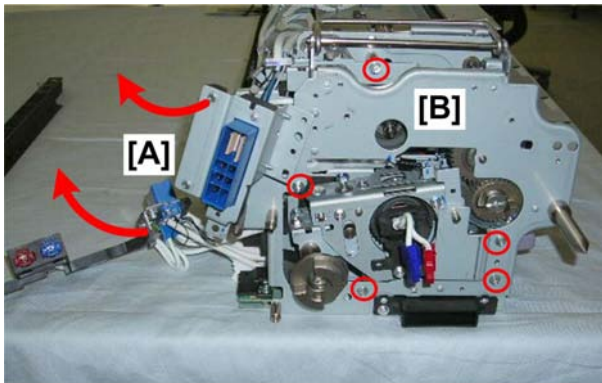

d074r351

17. Pull away the drawer connector [A].
18. Disconnect the rear frame [B] (🔩 x5 M3x6).

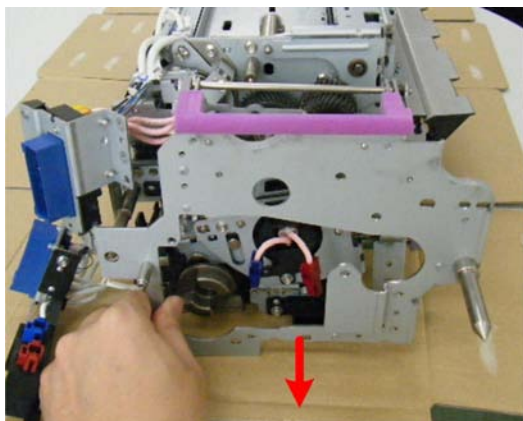

d074r352

4

19. Remove the rear frame.

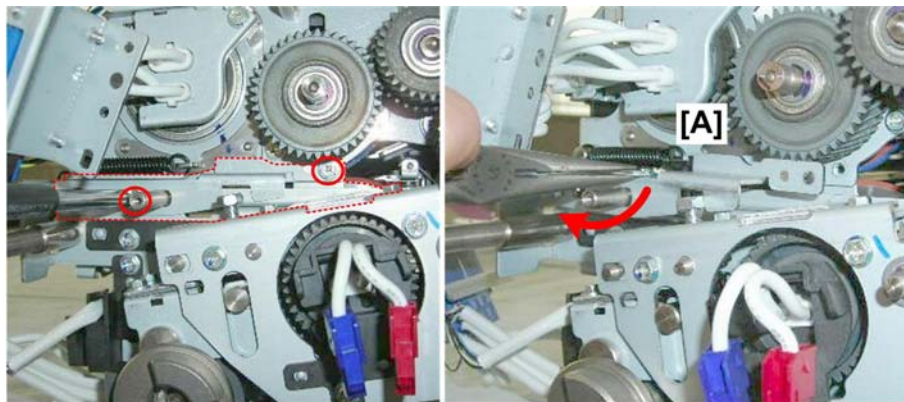

d074r353

20. Remove the rear lift plate [A] ( x2 M3x6).

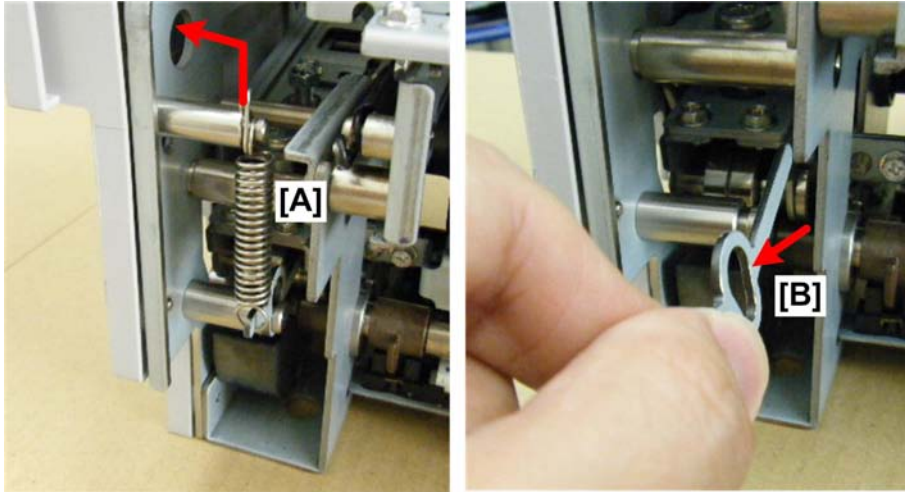

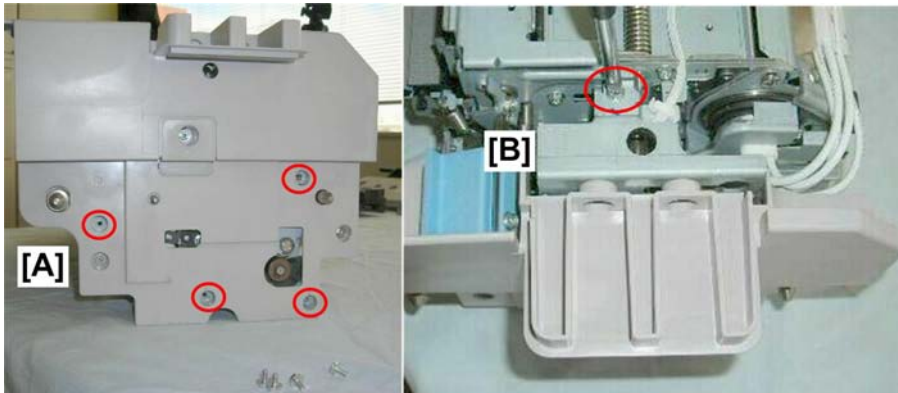

d074r353a

21. At the front, remove spring [A] (x1).
22. Remove lever [B].



d074r354

23. At the front, remove screws [A] ( x4 M3x6).
24. At the top, behind the cover, remove screw [B] ( x1 M3x6).

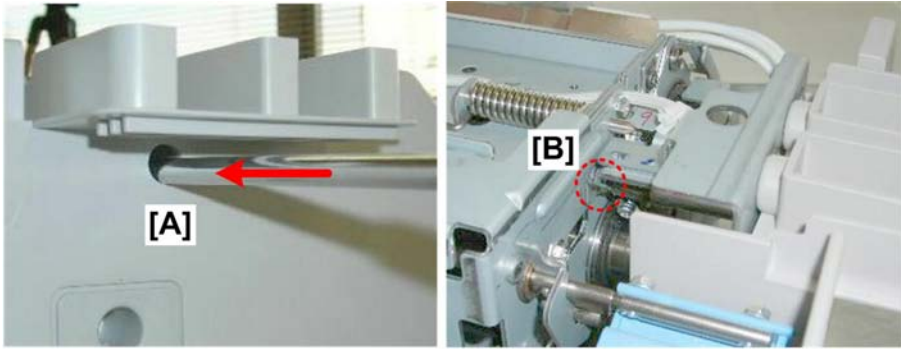

d074r355

4

- 25. Insert a long screwdriver through hole [A].
- 26. Remove the screw [B] ( x1 M3x6).

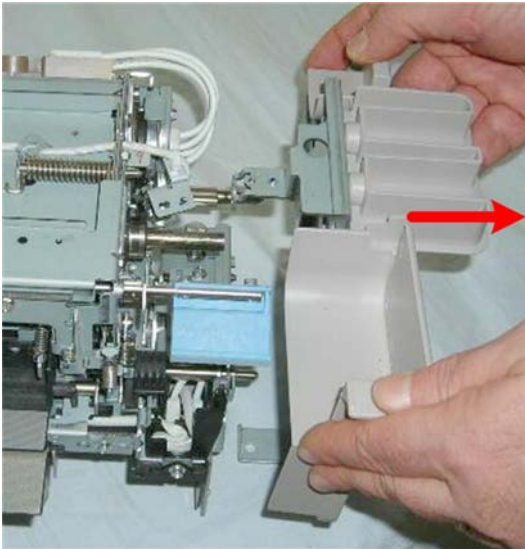

d074r356

- 27. Remove the front cover.

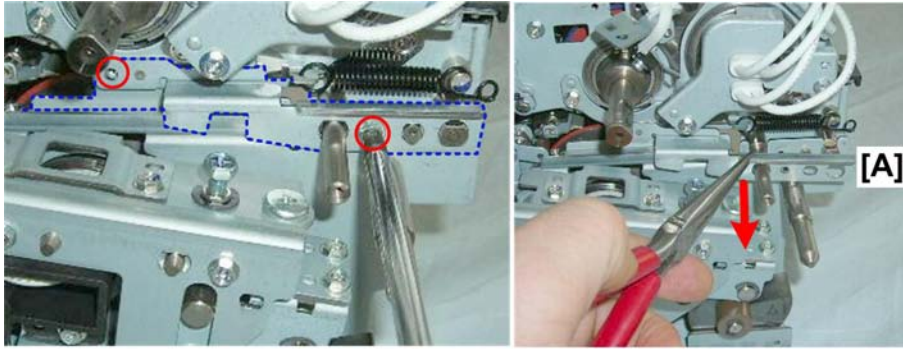

d074r357

28. Remove the front lift plate [A] (ϕ x2 M3x6).

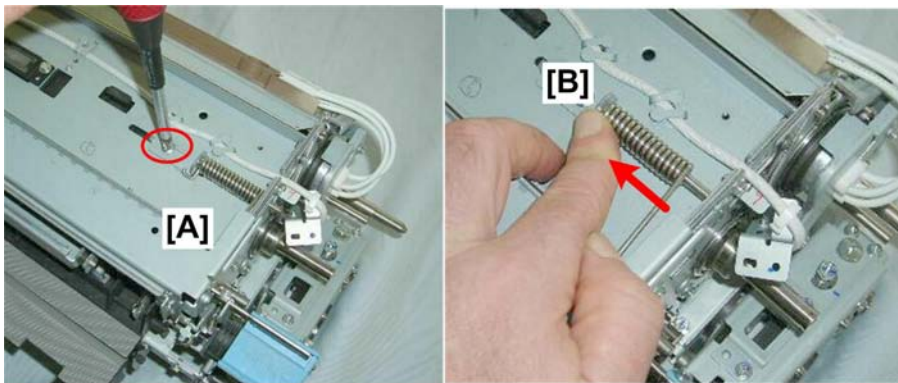

d074r358

29. Loosen screw [A] (ϕ x1 M3x6).
30. Slide plate [B] away from the front.

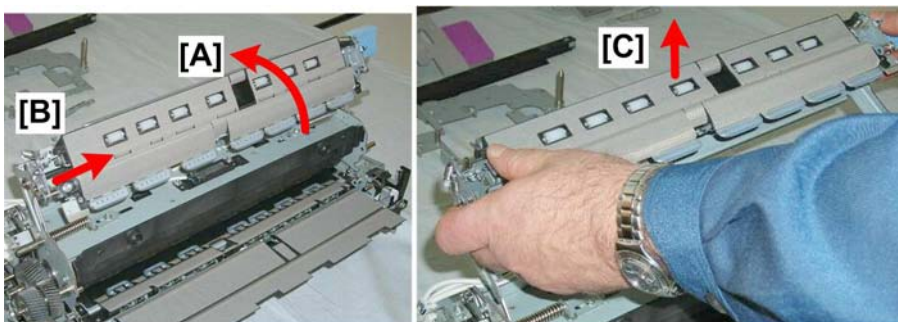

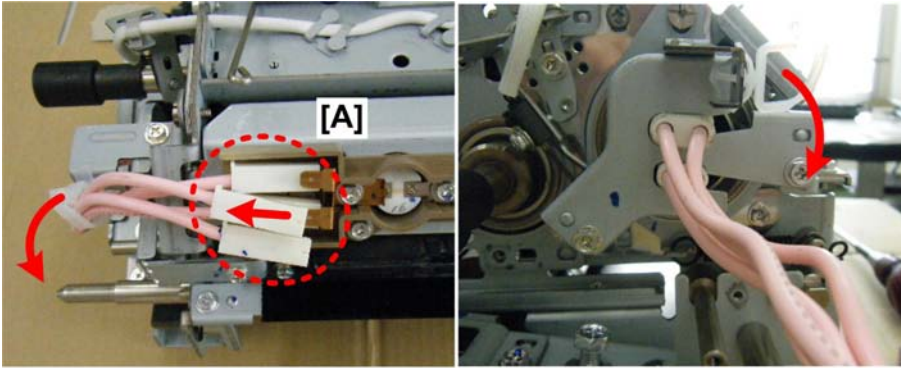

d074r359

31. Raise the paper separation unit [A].
32. Disconnect it on the left [B].
33. Lift and remove the unit [C].



d074r360

4

34. At the front, disconnect the ground connectors at [A] ( x4,  x1) and then pull the harnesses away from the unit.

Note

- These are ground connectors so they do not need to be re-connected in any particular order.

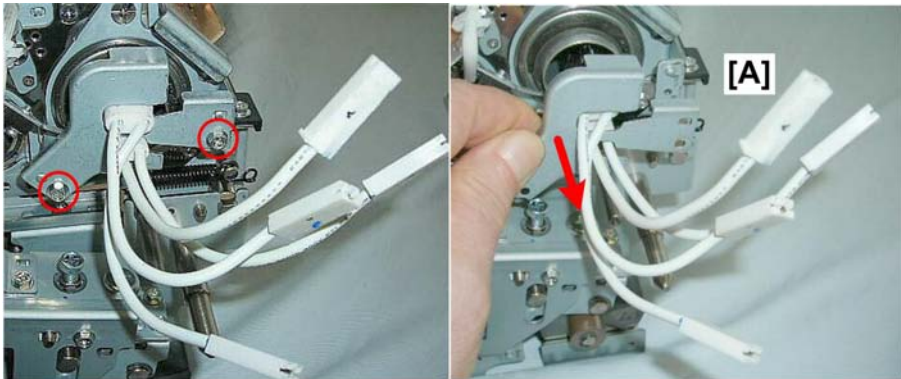

d074r361

35. Remove the fusing lamp holder [A] ( x3 M3x6).

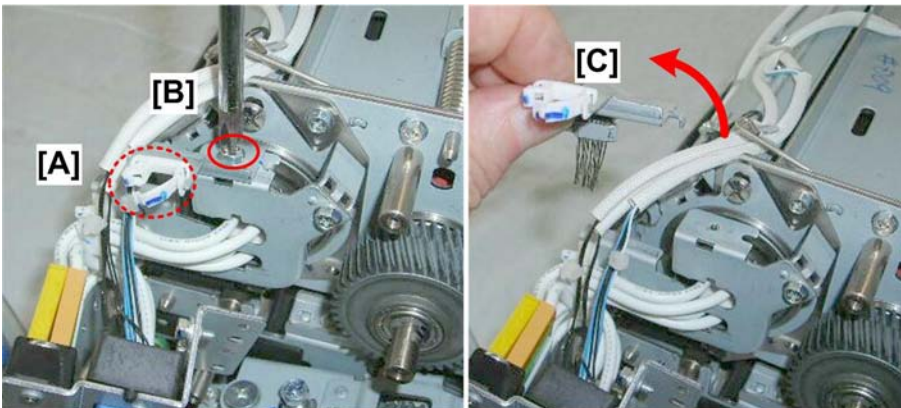

d074r362

36. At the rear:

- Open the clamp at [A] (🔧x1).
- Remove screw [B] (🔩 x2 M3x6).
- Remove the anti-static brush [C].

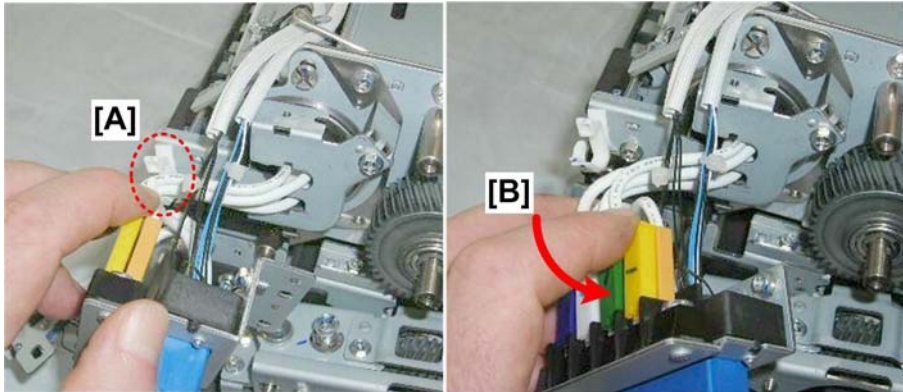

d074r363

37. Open clamp [A] (🔧x1).

38. Pull the connector assembly [B] out slightly.

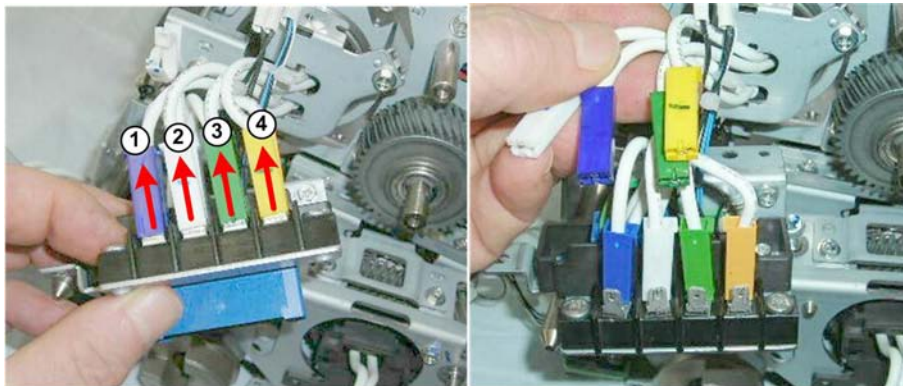

d074r364

39. Mark these connectors 1 to 4 before you remove them. (The colors may be different than those in the photo.)

★ Important

- These connectors must be re-connected in the same order.

40. Disconnect the bayonet connectors (🔩 x4).



d074r365

4

41. Remove the rear fusing lamp holder [A] ($\times 2$ M3x6).

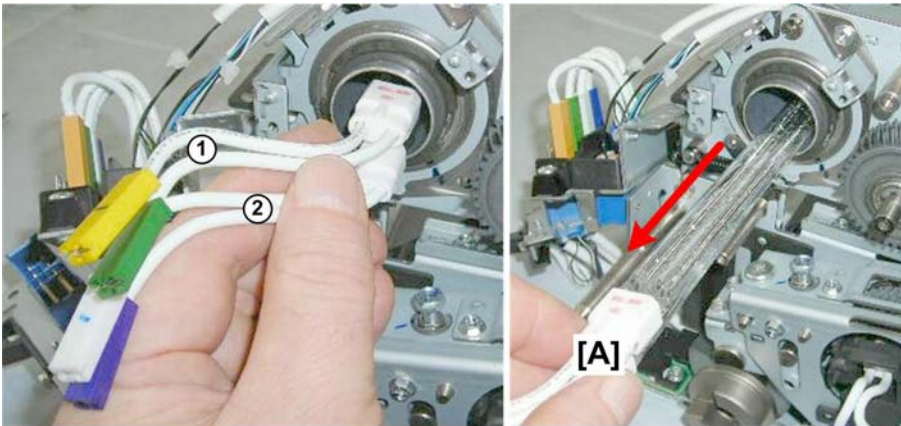

d074r366

42. Note the positioning of the top ① and bottom ② fusing lamps. They must be re-installed as shown in the photo.

43. Pull the fusing lamps [A] slowly out of the heating roller.

Re-installation

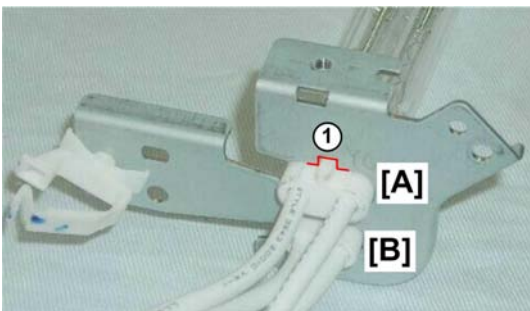

d074r367

- When re-installing the heating roller fusing lamps, make sure that the sleeves of the dual lamps are inserted correctly as shown above.

- The end of the lamp with the large projection [A] faces up toward the thermostats, and the lamp with the small projection [B] faces down.
- This arrangement ensures that they are re-installed correctly.

Heating Roller

1. Heating roller fusing lamps (🔧 p.728)



d074r368

2. Disconnect both ends of the upper entrance guide plate (🔧 x2 Right).

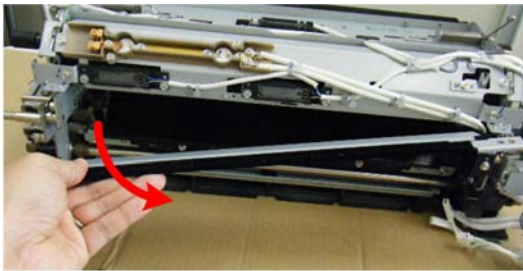

d074r368a

3. Remove the upper entrance guide plate.

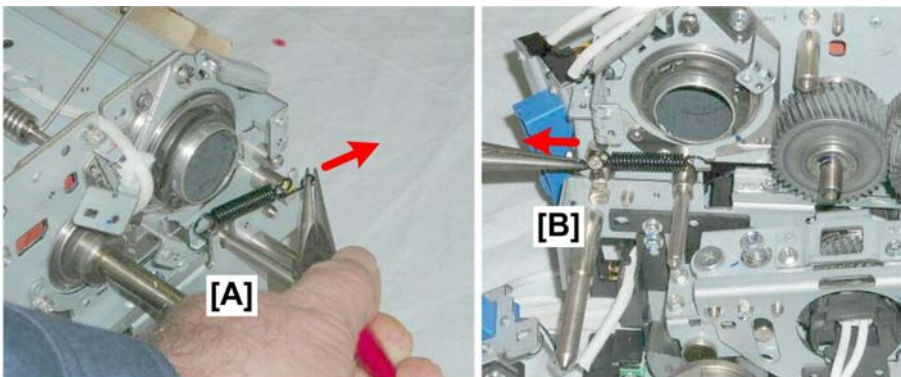

d074r370

4. Disconnect and remove springs:
[A] Front (🔧 x1).

[B] Rear ( x1).



d074r371

4

- 5. At the rear [A], use a pair of spreaders to remove the C-ring.
- 6. Remove the bearing race [B].

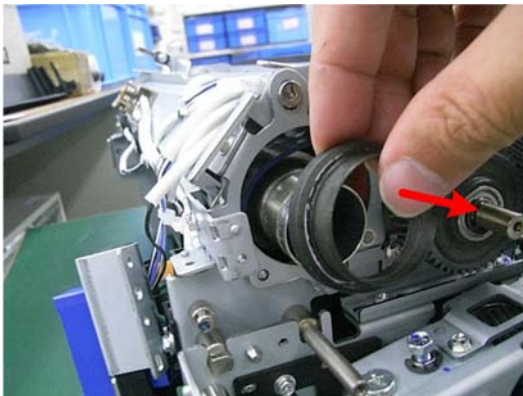

d074r371a

- 7. Remove the belt flange.

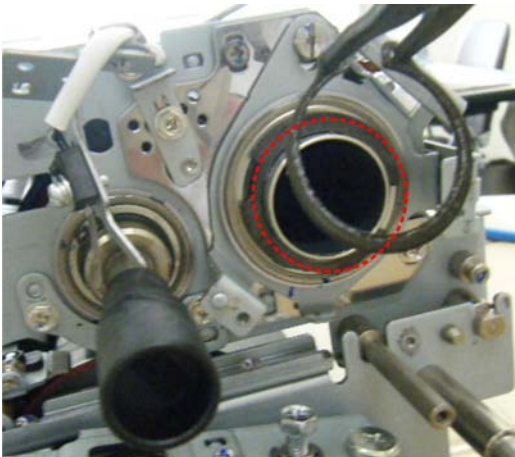

d074r371b

- At the front, remove the C-ring.

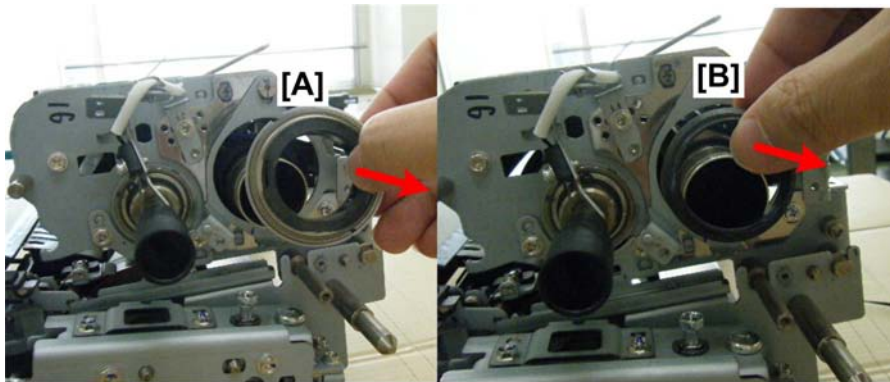

d074r371c

- Remove bearing race [A].
- Remove flange [B].
- Pull out the heating roller.

Re-installation

Always inspect and clean a heating roller for contamination by grease before re-installing it. Grease contamination can cause uneven heating on the surface of the roller and cause problems during fusing.

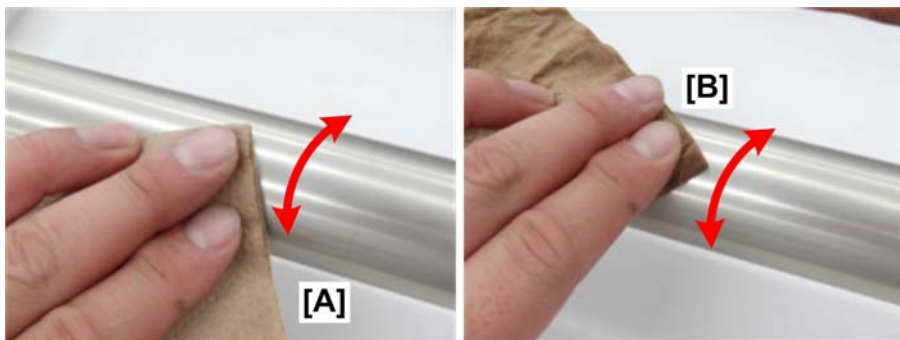

d074r371g

- Clean the entire surface of the heating roller with a dry cloth [A].
- Next, clean the entire surface with a cloth dampened with water (not alcohol) [B].
- Finally, clean the entire surface once more with a dry cloth.

Hot Roller, Fusing Belt

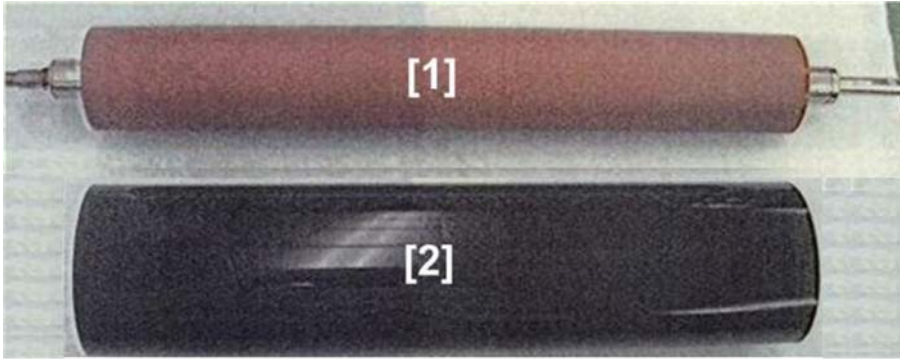

d074r375

4

No.	PM Part Name	Service Life
[1]	Hot Roller	650K
[2]	Fusing Belt	650K

1. Fusing lamps (p.728)
2. Heating roller (p.741)

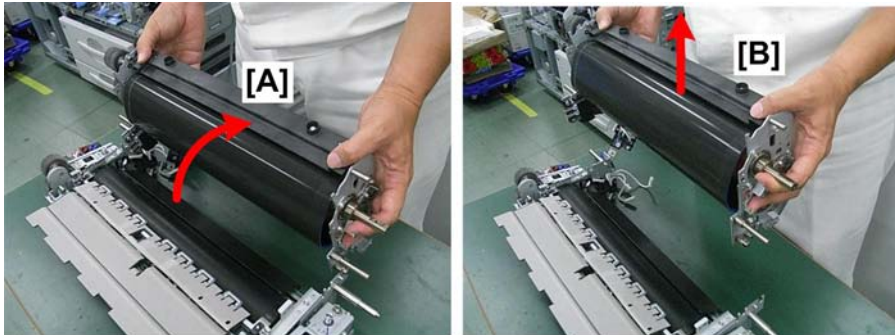

d074r374

3. Raise the unit [A] up to the vertical position.
4. Remove the upper unit [B].

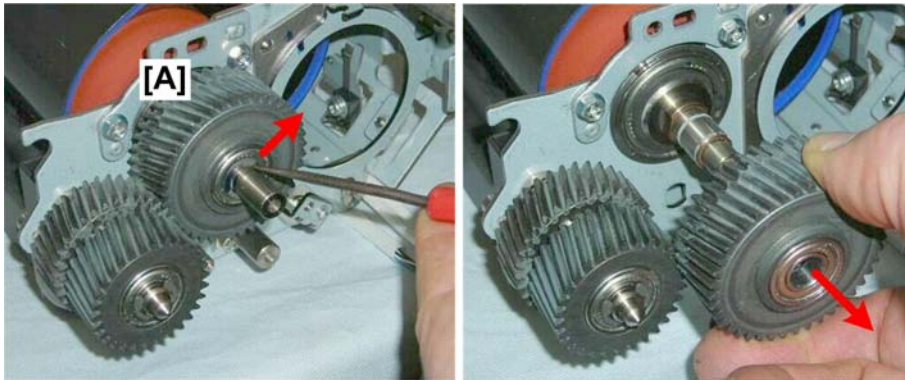

d074r376

5. At the rear [A], remove the main fusing drive gear (Ⓒx1).

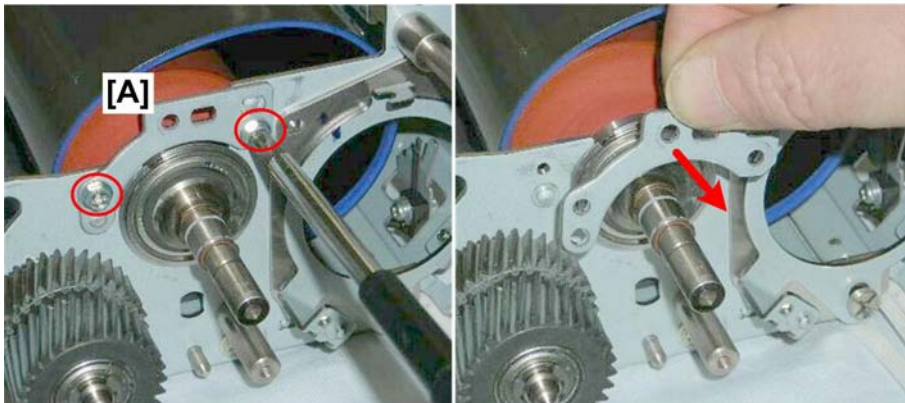

d074r377

6. At the same location, remove the rear arch plate (⚙x2 M3x6).

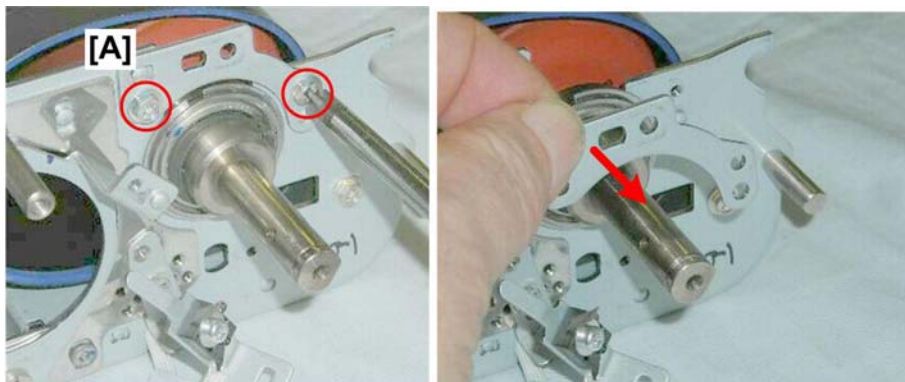

d074r378

7. At the front, remove the front arch plate (⚙x2 M3x6).

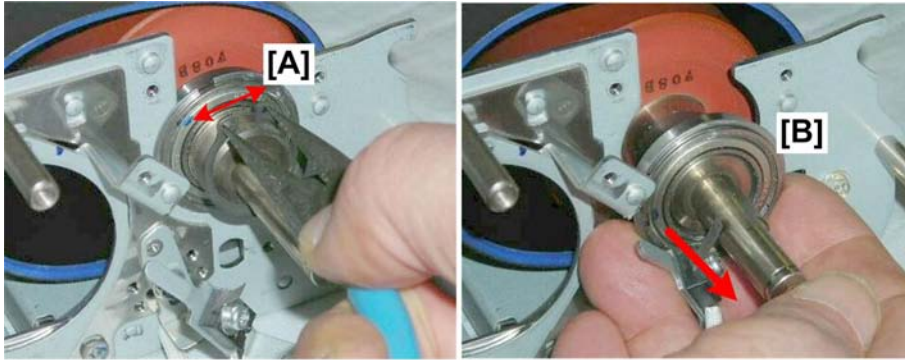

d074r379

4

8. Use a pair of spreaders to remove C-ring [A].
9. Remove the bearing race [B].

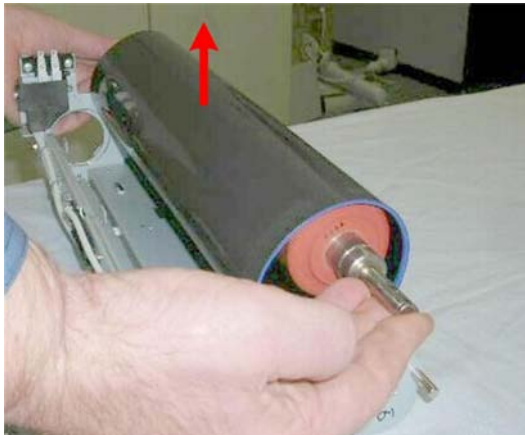

d074r380

10. Remove the hot roller and fusing belt [A] together.
11. Pull the hot roller out of the belt.

Before Hot Roller Re-installation

Always inspect and clean a hot roller for contamination by grease before re-installing it. This is especially important for a removed roller that is to be re-installed.

- Grease on the surface of the hot roller can cause the surface of the roller to peel.
- If peeled particles reach the surface of the heating roller, this can cause glossy patches or streaks to appear on prints.

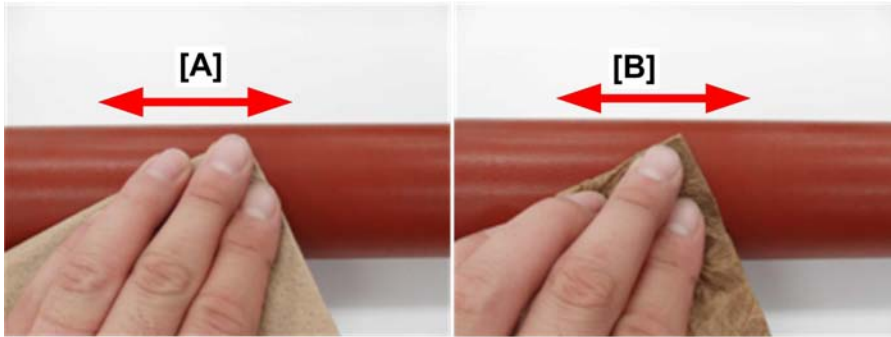

d074r381

To clean the surface of a hot roller

1. Clean the entire surface of the hot roller with a dry cloth [A].
2. Next, clean the entire surface with a cloth dampened with water (not alcohol) [B].
3. Finally, clean the entire surface once more with a dry cloth.

After New Hot Roller Installation

A newly installed hot roller may have a tendency to catch and cause spurious noise. Do the following procedure to avoid this problem.



d075r001

1. Remove the top cover screws (🔩 x2, 🔩 x1).

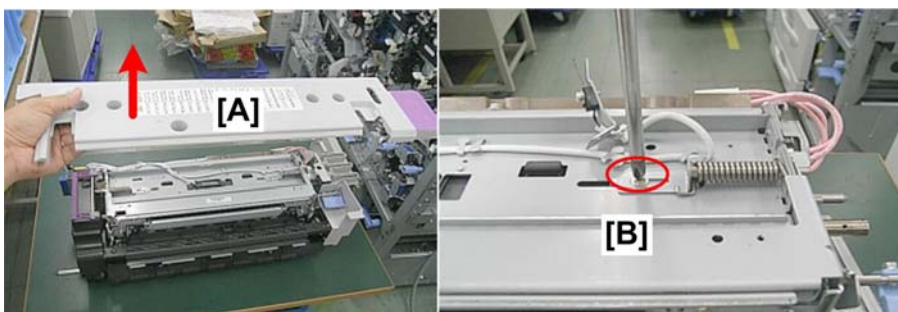

d075r002

2. Remove top cover [A].

3. Loosen screw [B] ( x1 M3x6).

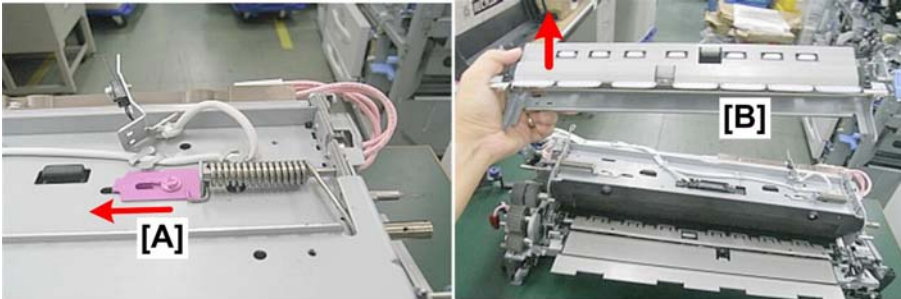

d075r003

4

4. Slide plate [A] to the rear.

5. Remove separation unit [B].

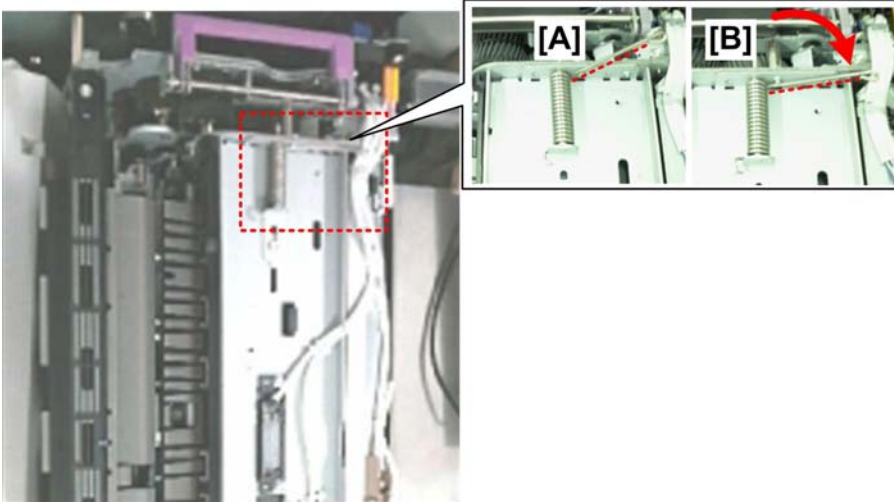

d074r005

6. Lower the spring arm for position [A] to [B] as shown above.

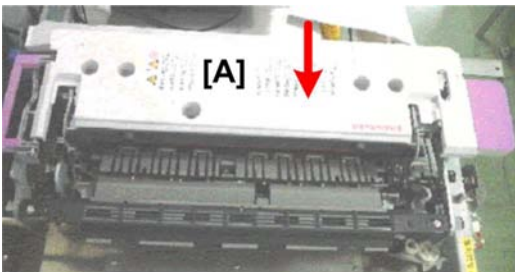

d075r004

7. Re-attach the top cover [A] ( x1,  x2).

8. Turn the machine on.

9. Wait a few moments for the pressure roller to move to the start position.
10. Enter the SP mode.
 - Switch ON SP5805-102 (Output Check - Press Roller Lift Motor (Up)).
 - If you hear no belt noise, or if the belt makes noise and then goes off, switch ON SP5805-101 (Output Check - Press Roller Lift Motor (HP))
 - If the roller noise does not stop, switch ON SP5804-114 (Output Check - Fusing Motor: High Speed) and with SP5804-114 ON do SP5805-102 and then wait for the noise to stop.
 - Once the noise stops, switch SP5805-101 ON, switch SP5804-114 OFF, and then exit the SP mode.
 - After doing these SP codes, be sure the remove the cover and reassemble the fusing unit.

Cleaning, Lubrication

Do the following procedures before reassembling the fusing unit.

Part Name	Interval	Action
Heating Roller Thermistors (x2)	650K	Clean

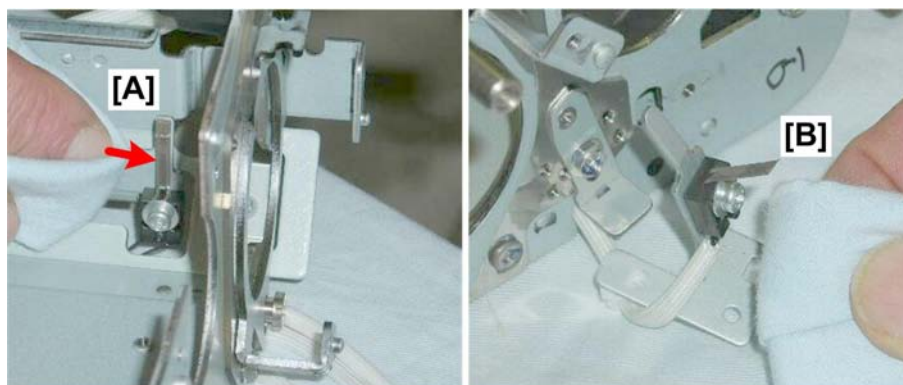

d074r405

1. Use a dry cloth to remove toner and paper dust from the surface of the thermistors:
 - [A] Front
 - [B] Rear



d074r405a

2. Rotate the races to make sure the contact surfaces of the bearings and race turn freely. If the races do not rotate freely, they must be replaced.

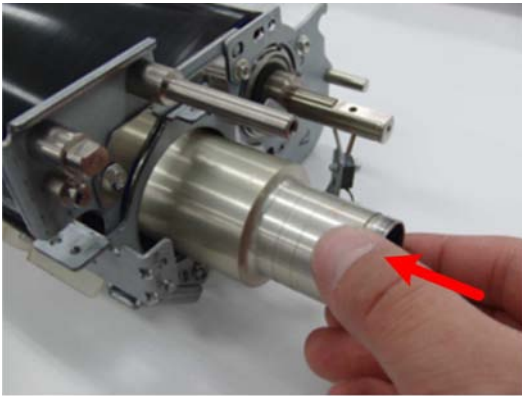

d074r404c

3. Insert the heating roller

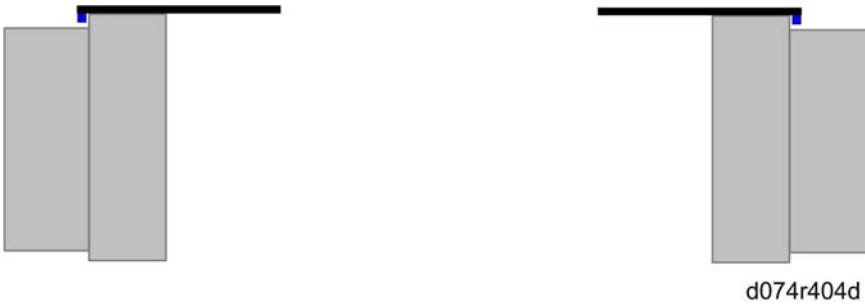

4. The flanges must be set so that both edges of the fusing belt rim overlap the collar of the flanges.

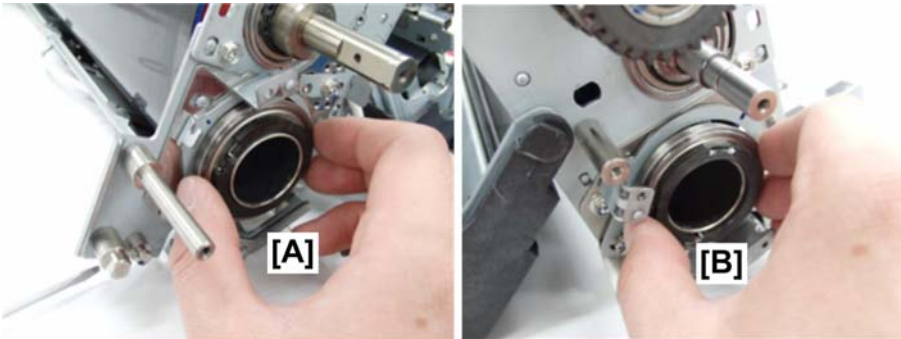

5. Re-attach the bearing races at the front [A] and rear [B].

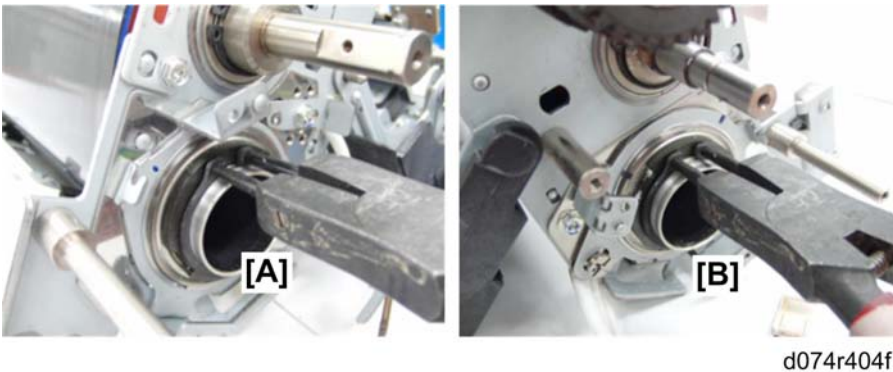

6. Re-attach the C-rings at the front and rear.

Pressure Roller Fusing Lamps, Pressure Roller

1. Fusing lamps (p.728)
2. Heating roller (p.741)
3. Hot roller and fusing belt (p.744)



d074r382

4

PM Parts

No.	PM Part Name	Interval	Action
[1]	Pressure roller	650K	Replace
[2]	Pressure roller bearings	650K	Lubricate



d074r383

4. Remove the lower exit guide plate [A] (2 x M3x6).

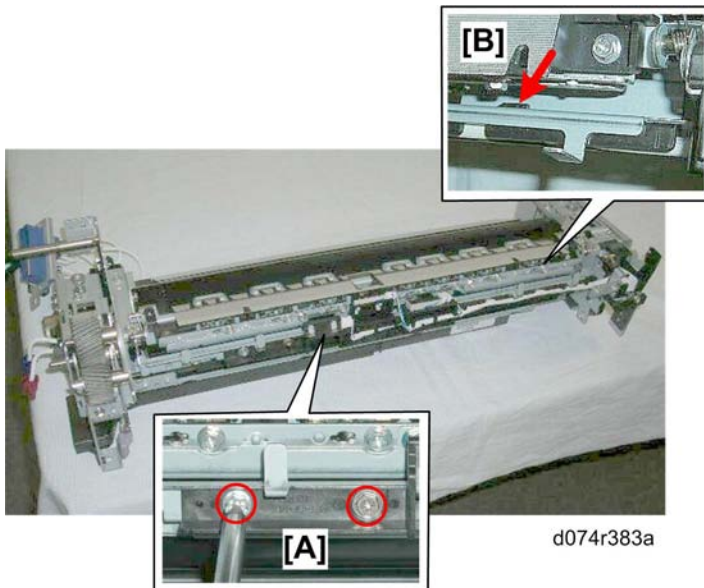

5. Disconnect the sensor bracket [A] (⚙️ x1 Left, ⚙️ x1 Right).

⬇️ **Note**

- These screws are different. Be sure to re-attach them at the correct location.
- A horizontal hook at [B] also holds the sensor bracket.

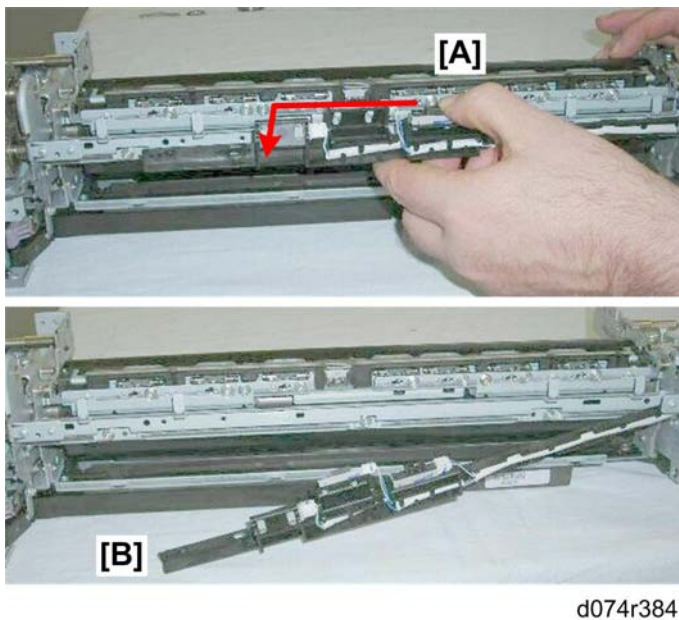

6. Slide the sensor bracket [A] to the left to unfasten the hook.
7. Pull the bracket [B] away from the frame. It is not necessary to disconnect the harnesses

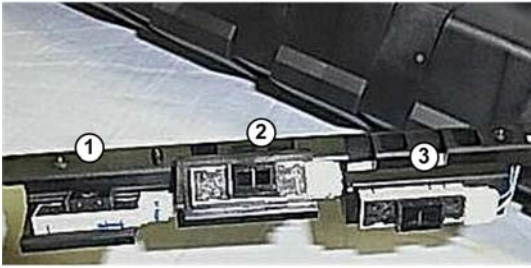

d074d640

①	Pressure Roller Paper Sensor	Monitors pressure roller
②	Accordion Jam Sensor	Monitors fusing belt
③	Fusing Exit Sensor	Monitors fusing exit

4

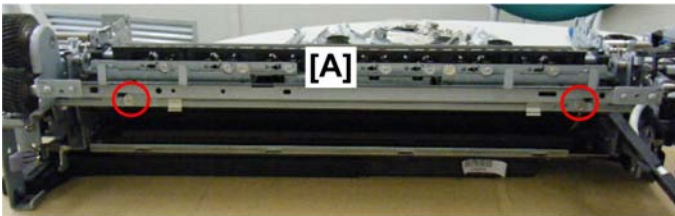

d074r385

8. Disconnect the pressure roller separation unit [A] ( x2 M3x6).

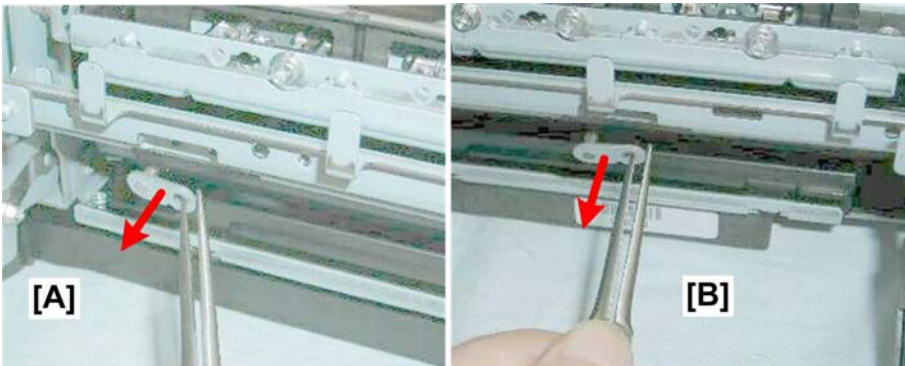

d074r386

9. Remove the peg lock plates:

[A] Rear

[B] Front

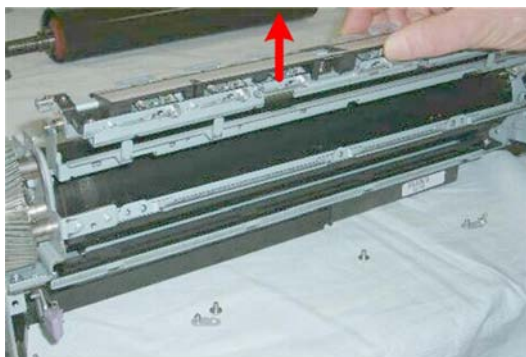

d074r387

10. Remove the separation unit.

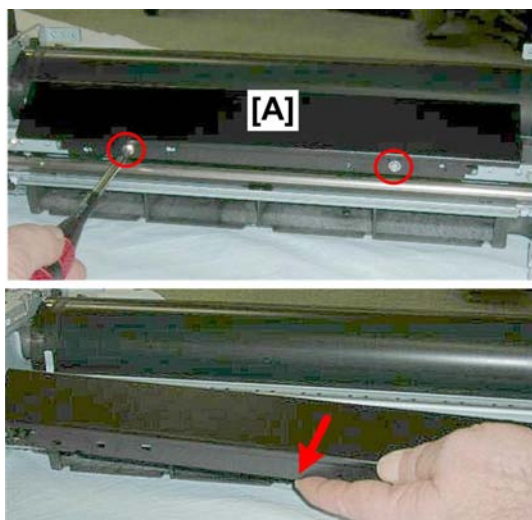

d074r388

11. Remove the entrance lower guide plate cover [A] (⚙️ x2 M3x6).

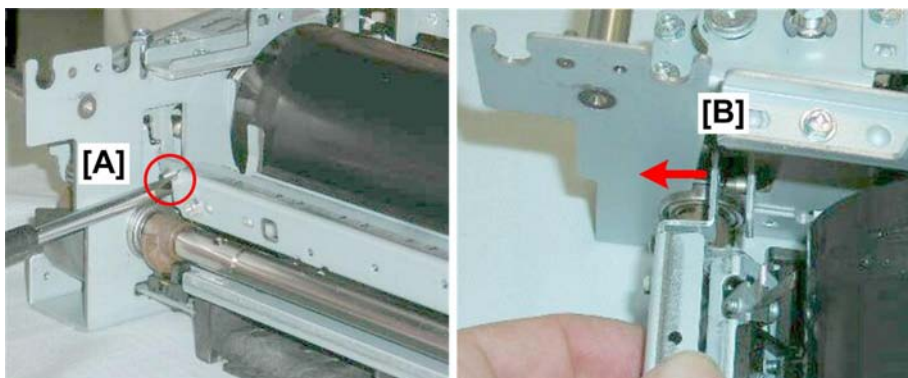

d074r389

12. At the front, remove screw [A] (⚙️ x1 M3x6).

13. Separate the guide plate [B] slightly at the front only. (Do not remove the guide.)

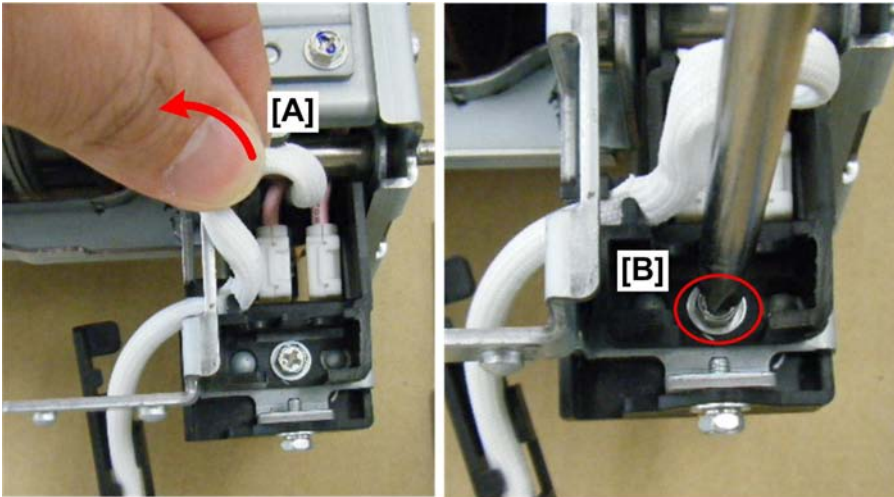

d074r390

14. At the front, locate coiled harness [A] and pull it out.

15. Remove screw [B] (⚙️ x1).

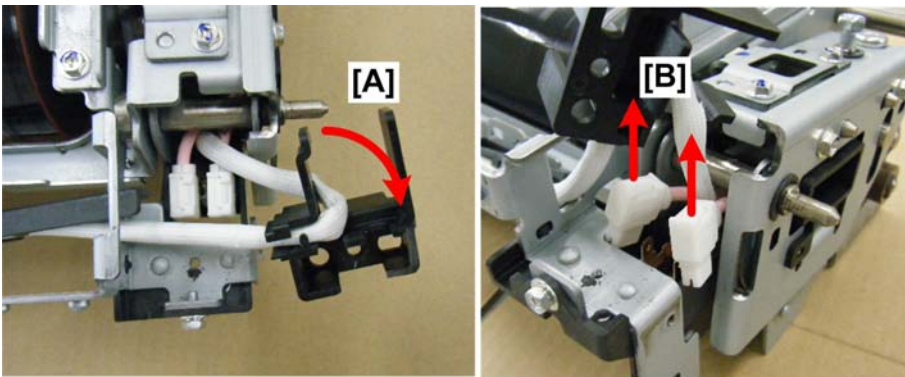

d074r391

16. Remove bracket [B] with the harness still attached.

17. Disconnect connectors [B] (🔌 x2).

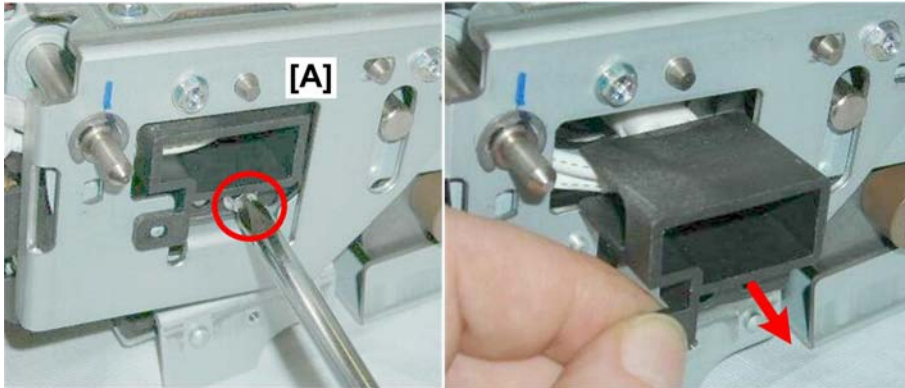

d074r394

18. Remove the fusing lamp holder [A] ( x1).

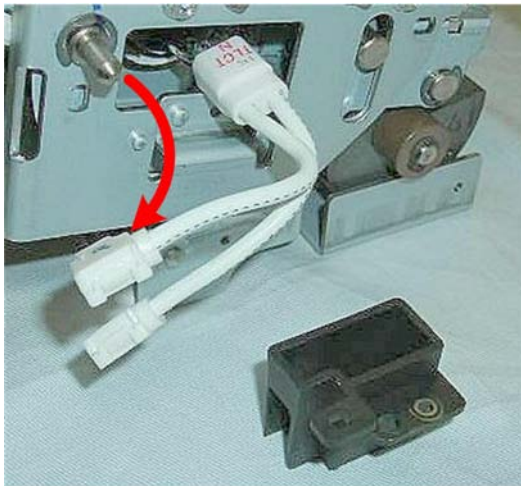

d074r395

19. Pull the lamp connectors out of the unit.



d074r396

20. At the rear [A], remove the fusing lamp holder ( x1).



d074r397

4

- 21. Use a small rubber band to fasten the ends of the fusing lamps [A] together. This prevents these fusing lamp connectors from catching during removal and re-installation.
- 22. At the front [B], pull the fusing lamps out of the pressure roller.



d074r398

- 23. Lay the pressure roller fusing lamp on a flat clean surface.

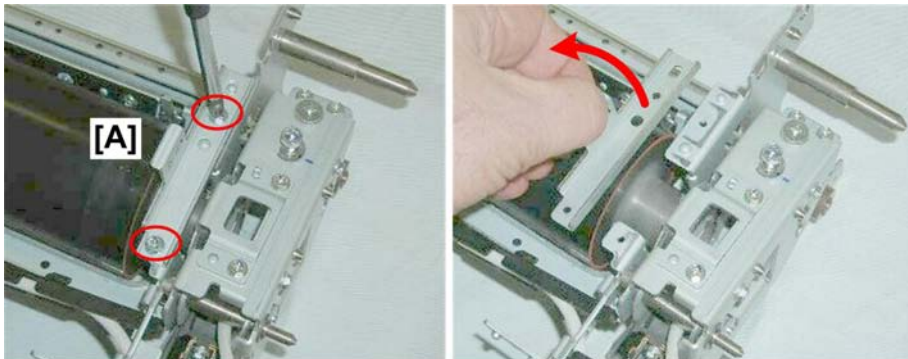

d074r399

- 24. Remove the front positioning plate [A] ( x2 M3x6).

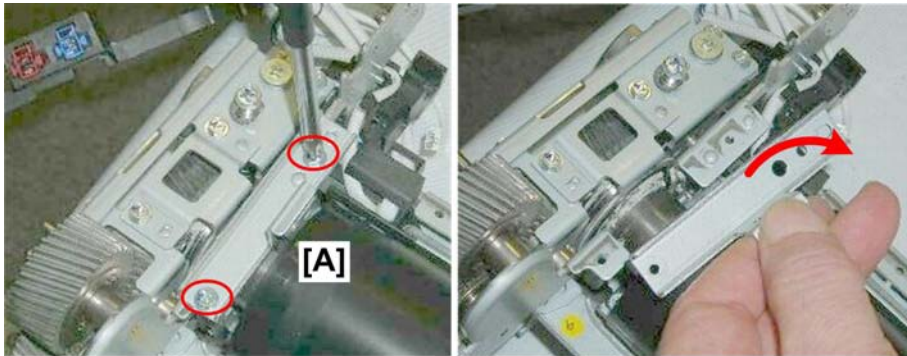

d074r400

25. Remove the rear positioning plate ($\times 2$ M3x6).

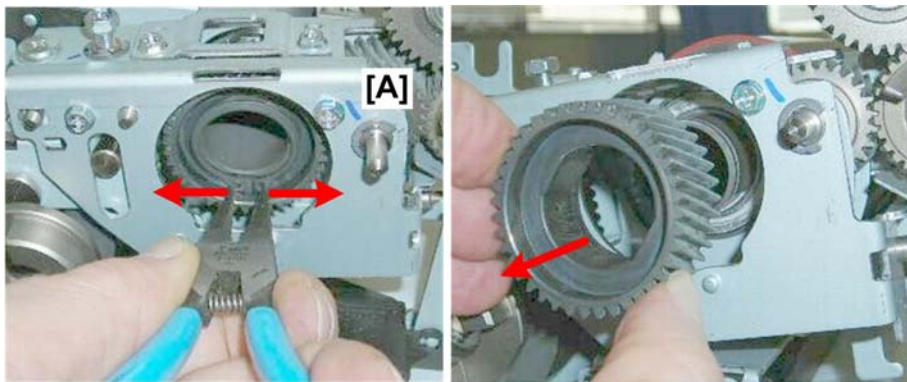

d074r401

26. At the rear [A], use a pair of spreaders to remove the C-ring of the pressure roller gear.
27. Remove the gear.

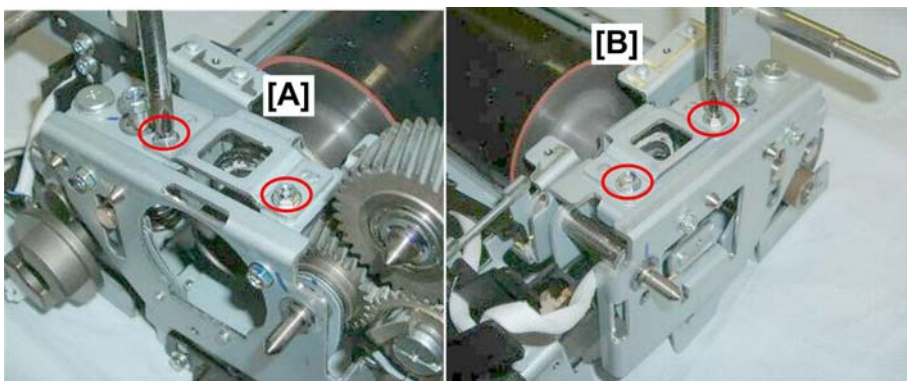

d074r402

28. Disconnect:
[A] Rear ring handle ($\times 2$ M3x6).

[B] Front ring handle ( x2 M3x6).

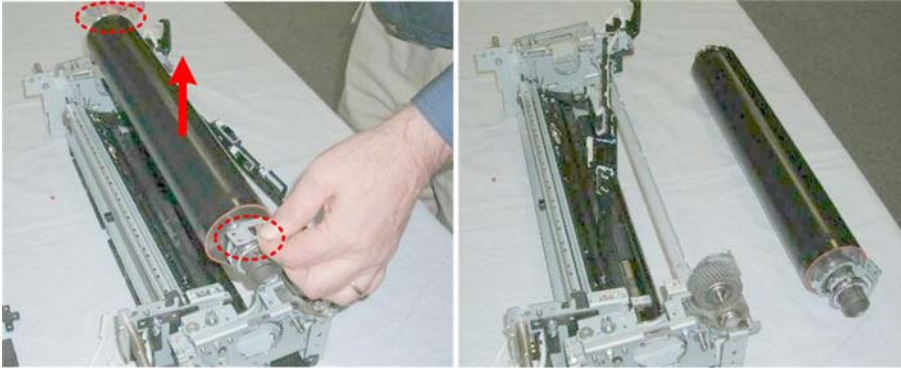

d074r403

29. Lift and remove the pressure roller, and then place it on a flat clean surface.

Cleaning and Lubrication

Do these procedures before re-assembling the fusing unit.

Part Name	Interval	Action
Pressure roller thermistor	650K	Clean

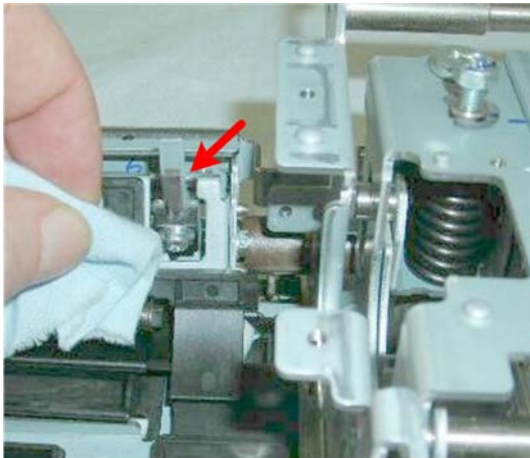

d074r407

1. Use a dry cloth to remove toner and paper dust from the sensitive surface of the thermistor.

Part Name	Interval	Action
Pressure Roller Bearing Races (x2)	650K	Lubricate

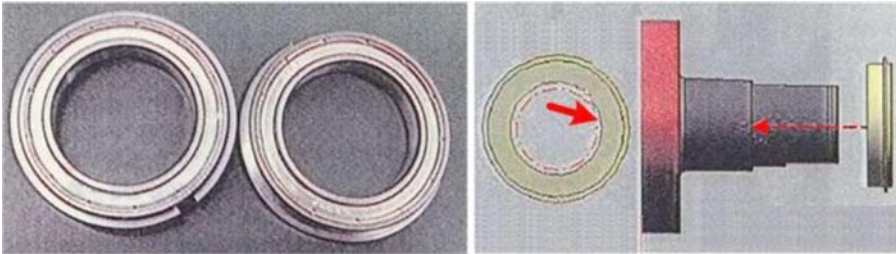

d074r408

2. Use a small brush to apply FLUOTRIBO MG Grease to the pressure roller races.

Hot Roller Thermistor (Front)

4

1. Fusing unit covers (p.433)

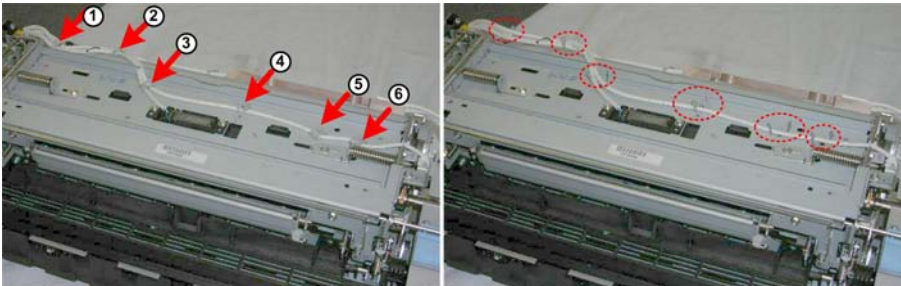

d074r413

2. Open the six pairs of clamps on top of the unit (x12).

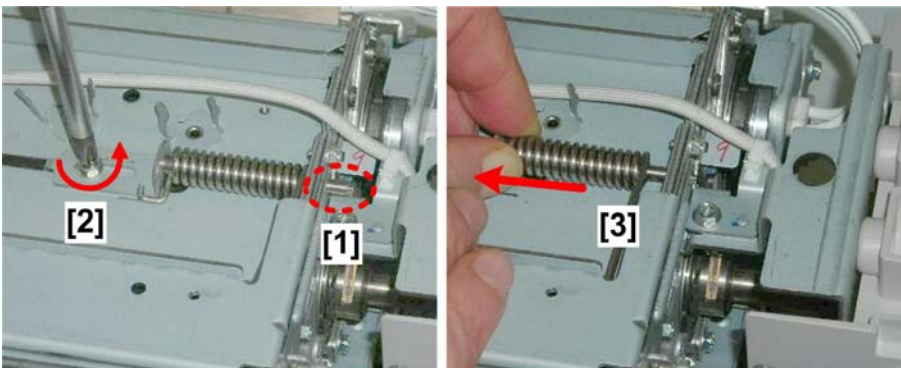

d074r414

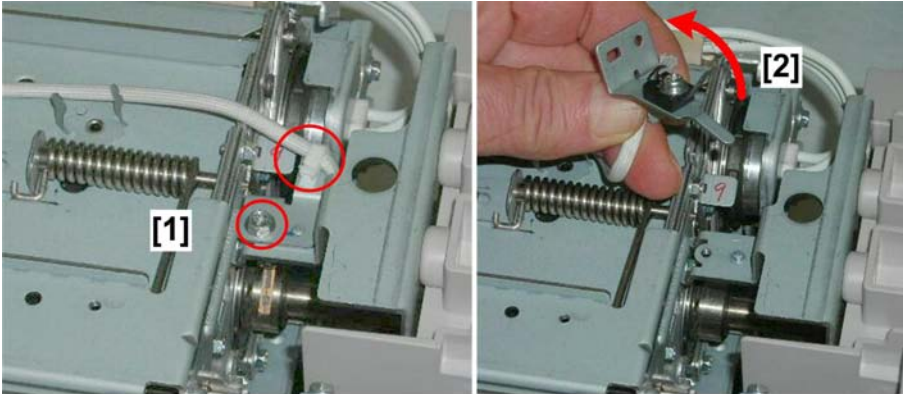

Connection pin [1] blocks removal of the hot roller thermistor.

3. **Loosen** screw [2]. Do not remove it.
4. Slide the spring and pin [3] to the rear.





d074r415

4

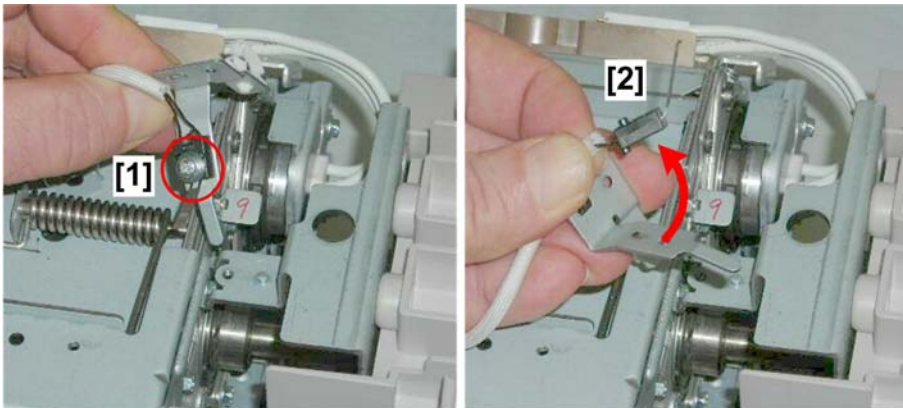
- 5. Disconnect the thermistor bracket [1] ( x1,  x1).
- 6. Remove the thermistor bracket [2].



d074r416

- 7. Disconnect:
 - [1] Bracket ( x1)
 - [2] Thermistor ( x1)

Hot Roller NC Sensor (Center)

- 1. Fusing unit covers ( p.433)

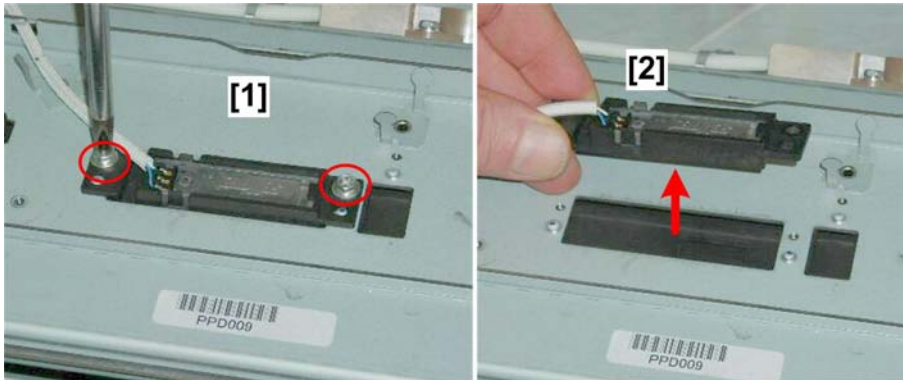

d074r417

2. Disconnect the sensor [1] ( x2)
3. Remove the sensor [2] and set it aside. (It is still connected to the harness.)

4

Heating Roller NC Sensors

1. Fusing unit covers ( p.433)

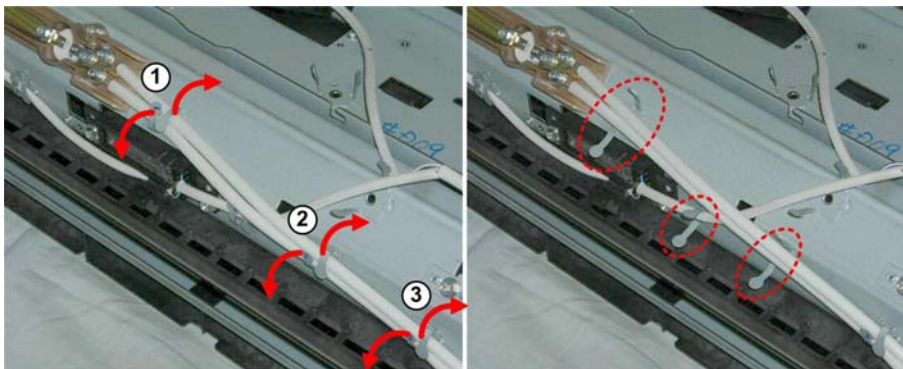

d074r418

2. Open the three pairs of metal clamps ( x6).

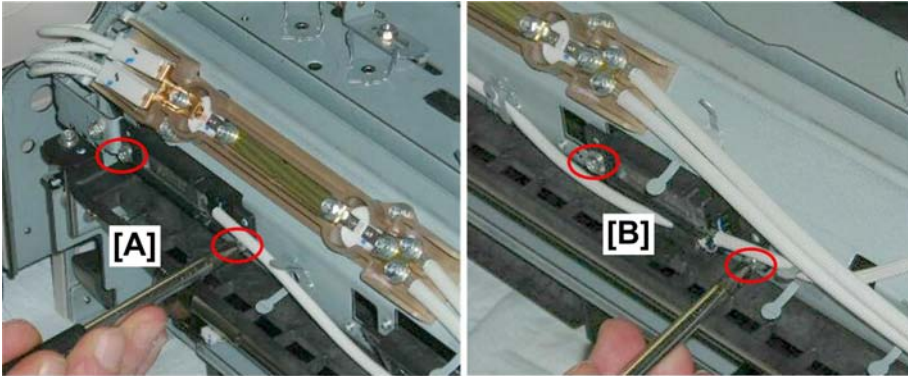

d074r419

4

3. Disconnect:

[A] Heating Roller NC Sensor: Front ( x2)

[B] Heating Roller NC Sensor: Center ( x2)



d074r420

4. Disconnect the upper entrance guide plate [1] ( x2).

5. At the center of the loosened guide plate, free the harness [2] and pull out the center heating roller NC sensor [3].

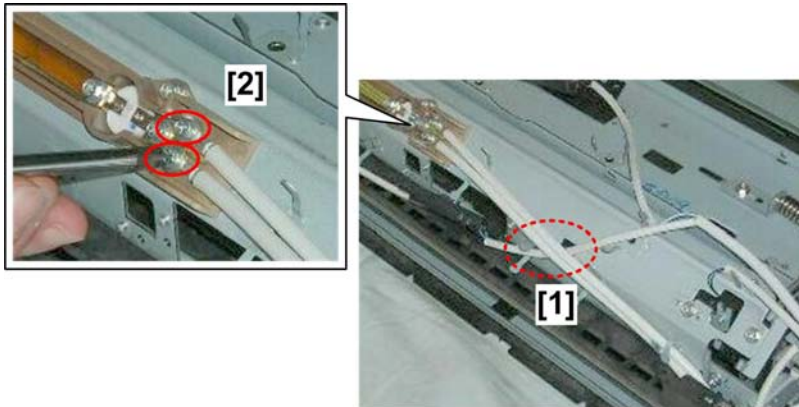

d074r421

The thermostat harness [1] blocks the harness of the heating roller sensor.

6. Disconnect the thermostat harnesses [2] (⚙️ x2).
7. Pull both sensors and the harness free.

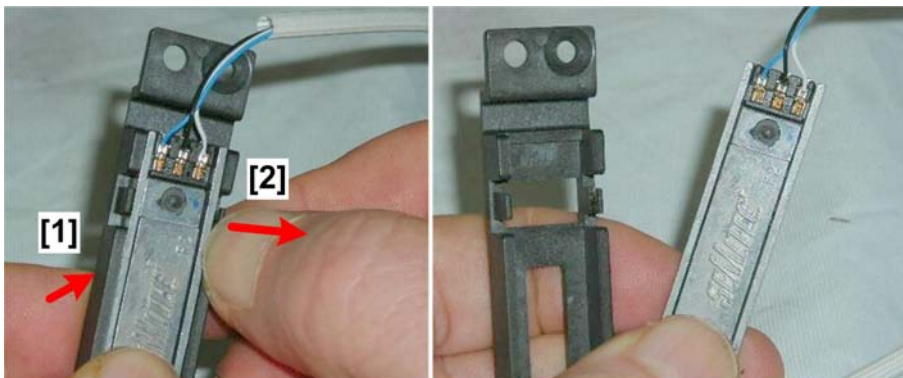

d074r422

8. Separate both heating roller NC sensors from their brackets.
 - While pressing gently on the front of the sensor [1], open the pawl at [2] (⚙️ x1).
 - Only one side has a pawl. Be sure to push open the arm with the pawl.

Heating Roller Rear Thermistor

1. Fusing unit covers (📄 p.433)

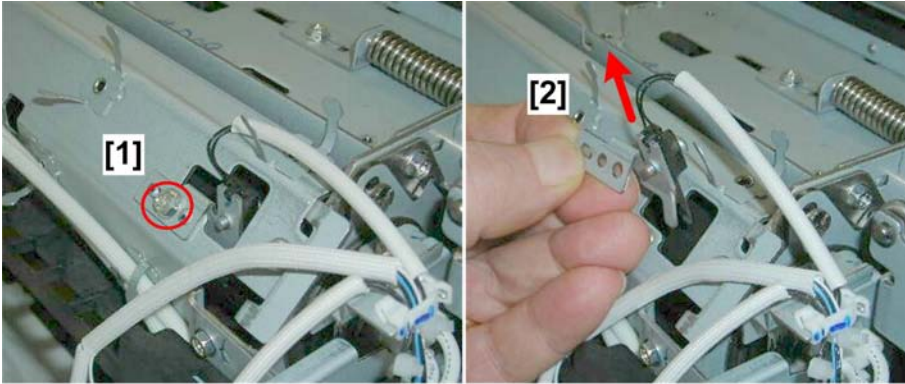

d074r423

4

- 2. Disconnect the thermistor bracket [1] ( x1).
- 3. Remove the bracket and thermistor [2].

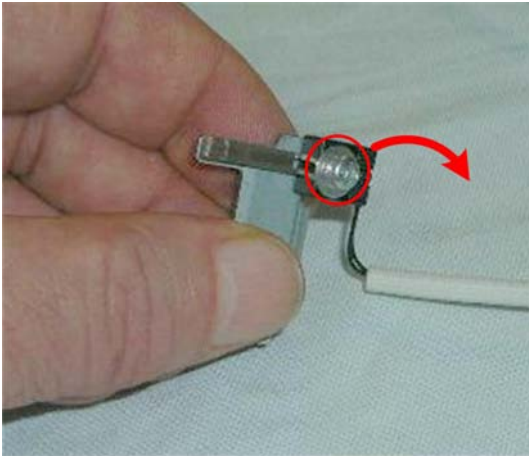

d074r424

- 4. Separate the thermistor and bracket.

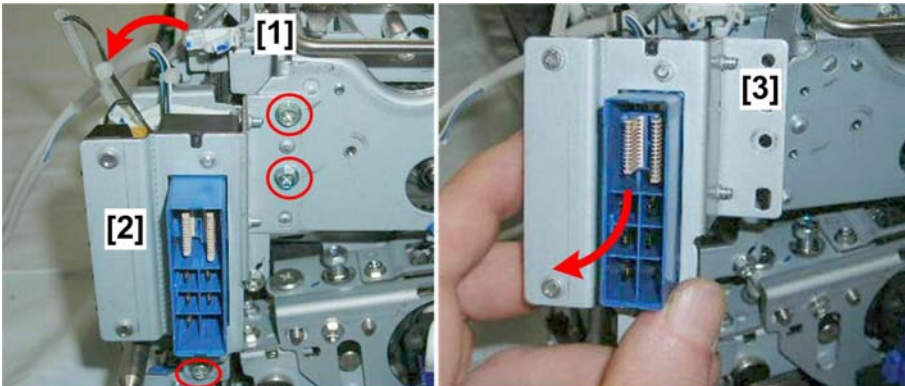

d074r425

5. At the rear, free the harnesses [1] (🔧x1).
6. Disconnect the upper connector bracket [2] (🔧x3).
7. With the harnesses still connected, pull the disconnected connector bracket [3] a short distance away from the unit.

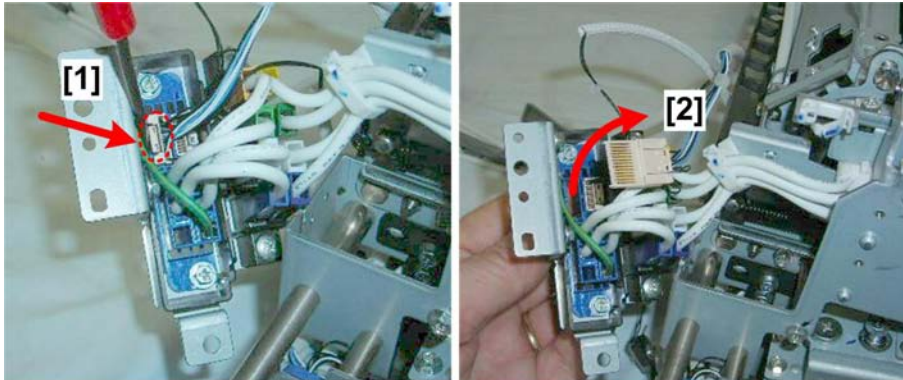

d074r426

8. Use the tip of a small screwdriver to release the first harness connector [1].
9. Press the edge of the connector [2] from below to remove it.

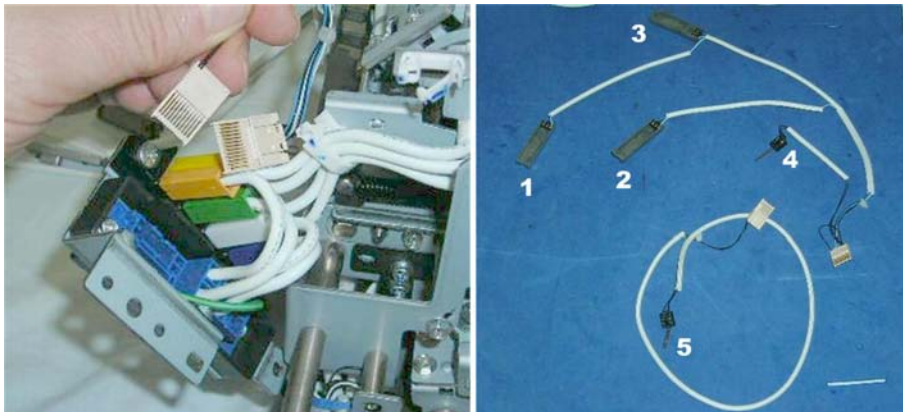

d074r427

10. Follow the same procedure to release and remove the 2nd connector.
11. Remove the harnesses with the thermistors and NC sensors attached.

1	Heating Roller NC Sensor - Front
2	Heating Roller NC Sensor - Center
3	Hot Roller NC Sensor
4	Heating Roller Thermistor (rear)

5	Hot Roller Thermistor (front)
---	-------------------------------

Heating Roller Thermostats

Heating Roller Thermostat (Front)

1. Fusing unit covers (p.433)

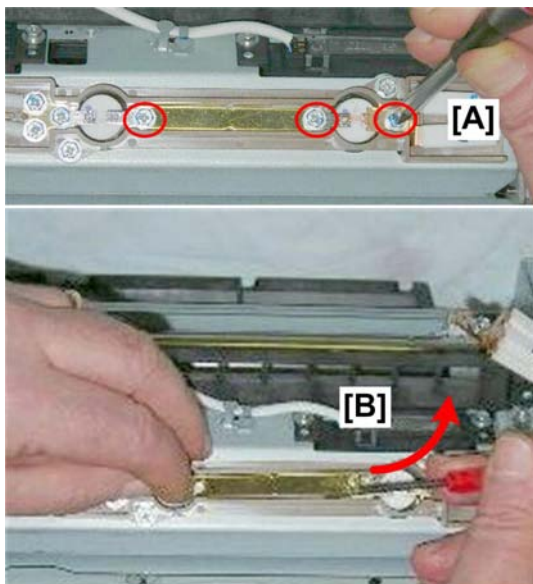

d074r428

2. At the front, disconnect the thermostat [A] (x3).
3. Remove the gold strip [B].

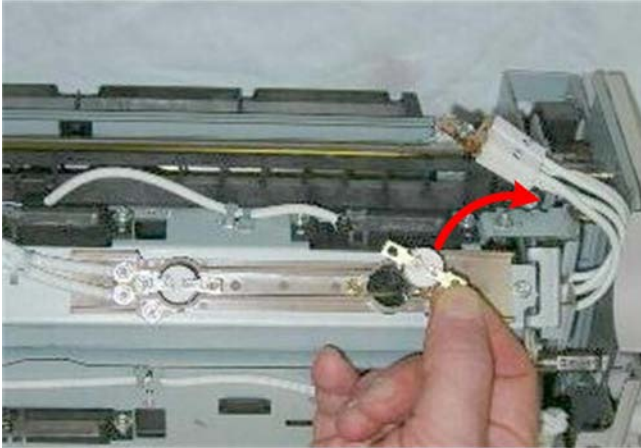

d074r429

4. Remove the front hot roller thermostat.

4

Heating Roller Thermostat (Center)

1. Fusing unit covers (p.433)

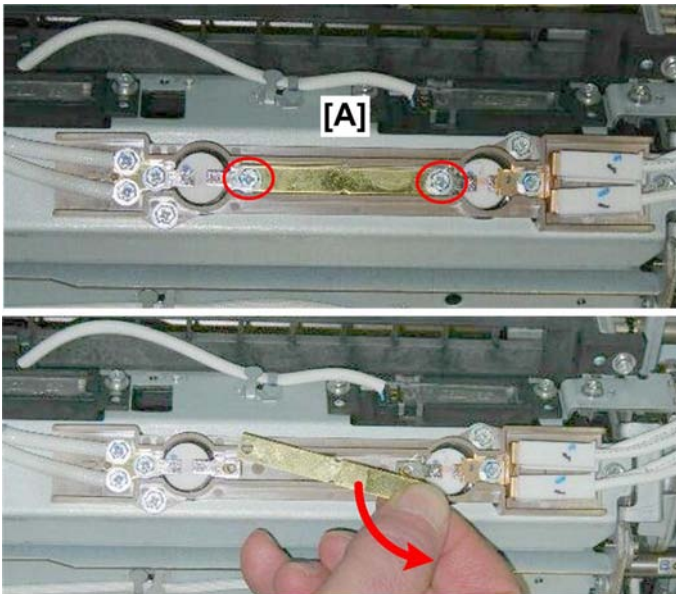

d074r430

2. Disconnect the gold strip [A] (x2).
3. Remove the gold strip.

4

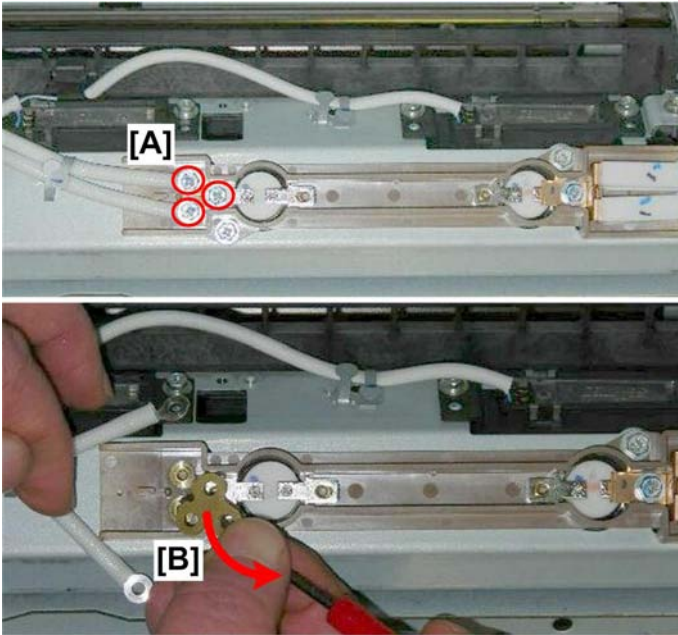

d074r431

4. Disconnect the thermistor [A] ( x3).
5. Remove the gold leaf [B].

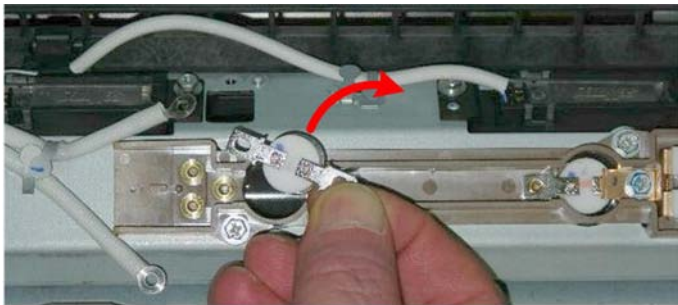

d074r432

6. Remove the thermostat.



d074r433

⚠ WARNING

- To prevent a fire, never attempt to reset a blown thermostat by manipulating the exposed edges of the black cover with a screwdriver, or by hitting it on a table.
- A thermostat that has been reset manually could fail if the unit overheats and cause a fire.
- Always replace a blown thermostat with a new one.



Pressure Roller Sensors (Front and Rear)

↓ Note

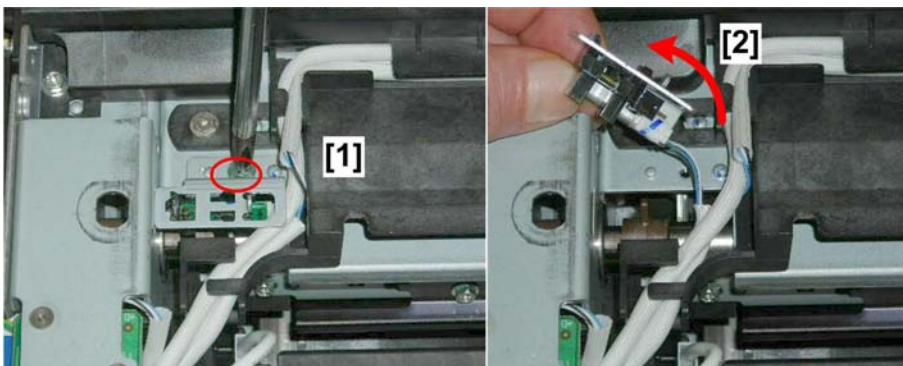
- You do not need to remove any covers for this procedure.
1. Remove the fusing unit from the machine and turn it upside down. (p.433)





d074r434

2. At the rear, disconnect the sensor bracket [1] ( x1).
3. Raise the sensor bracket [2] with the sensor connected.
4. Separate the sensor and bracket ( x1,  x4).



d074r435



5. At the front, disconnect the sensor bracket [1] ( x1).
6. Raise the sensor bracket [2] with the sensor connected.
7. Separate the sensor and bracket ( x1,  x4).

After Installing a New Fusing Unit

1. The machine power must be OFF.
2. Open both front doors.
3. Turn the main power switch ON.
4. Enter the SP mode.
5. Reset the counter for the replaced unit or parts.
6. Close the front doors.
7. Wait for about 5 minutes. When you hear an audible beep and see "Ready" displayed on the operation panel, you are ready to continue.
8. Exit the SP mode.

Fusing Motor, Pressure Roller Lift Motor

Preparation

1. The fusing motor and pressure roller lift motor are at the same location behind the TDCU.
2. Open both rear boxes ( x3). ( p.400)

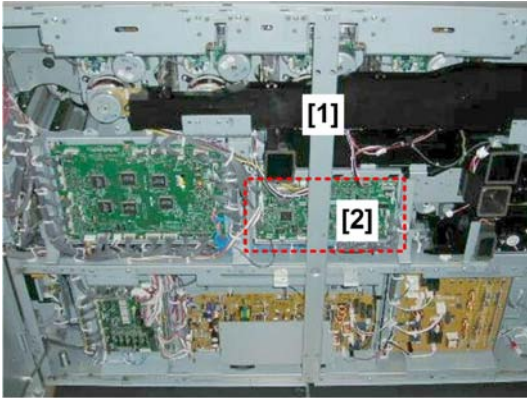

d074r460

3. Remove the center stay [1] and the TDCU [2]. (▶ TDCU)

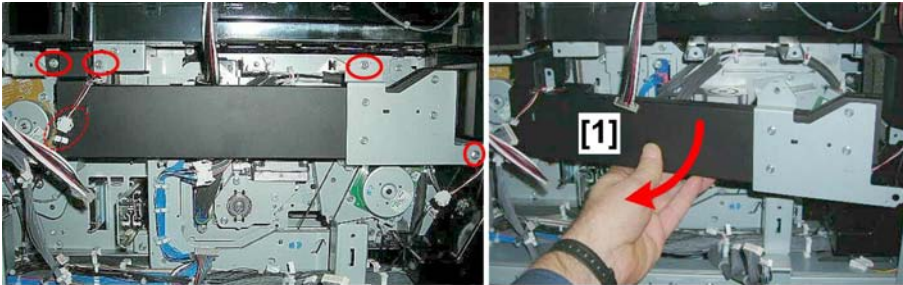

d074r461

4. Remove the cooling air duct [1] (▶ x1, ▶ x4).

Fusing Motor

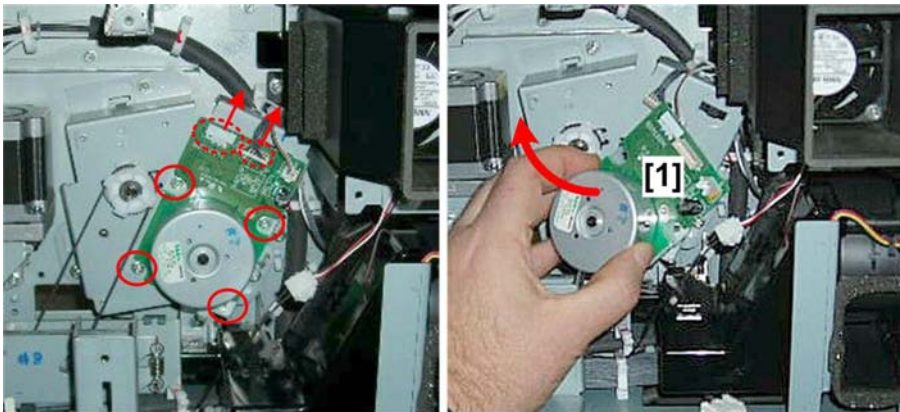

d074r462

1. Remove the fusing motor [1] (▶ x2, ▶ x4).

4



d074r463

Pressure Roller Lift Motor

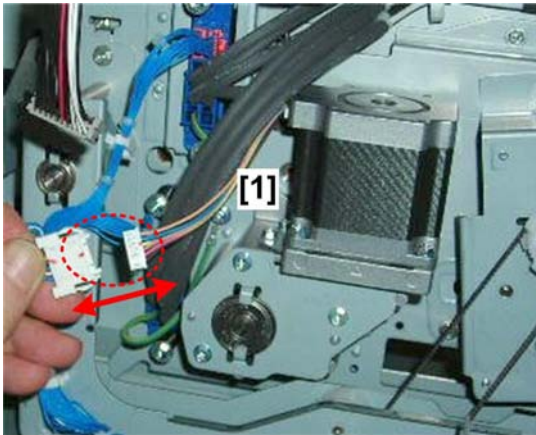

d074r464

1. Disconnect the motor harness [1] (📎 x1)



d074r465

2. Disconnect the pressure roller lift motor drive assembly:

[1] Left ( x2)

[2] Right ( x1)

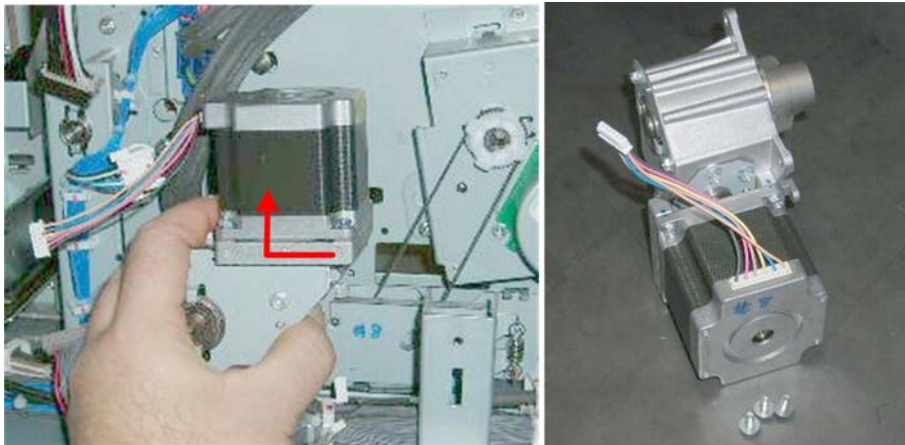

d074r466

3. Remove the pressure roller lift motor assembly.

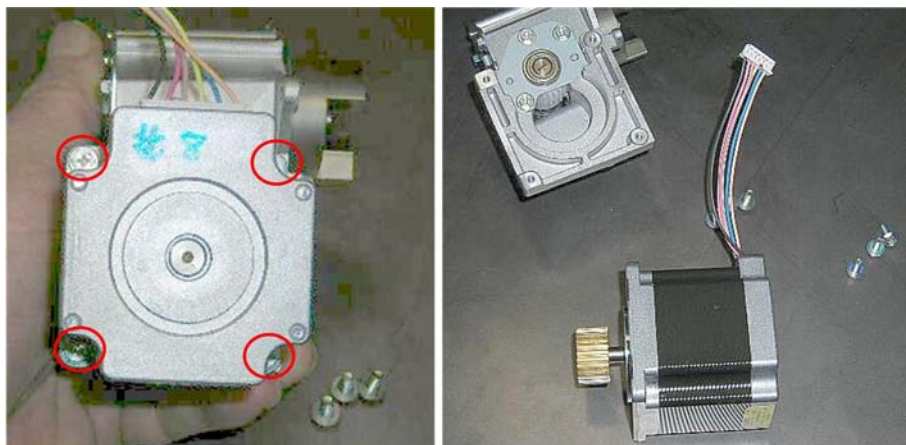

d074r467

4

4. Remove the motor from the drive bracket ( x4).

Fusing Cleaning Unit

Fusing Cleaning Unit PM Parts

	Interval
Fusing Belt Cleaning Unit	
Web Contact Roller	450K
Cleaning Web	450K
Brake	450K

4

Notes

- **Web Cleaning Unit.** The web cleaning unit can be serviced at 450K. Remove the web cleaning unit and disassemble. Disassembly of the fusing unit is not required.

Web Supply Roller

1. Fusing cleaning unit (p.433)

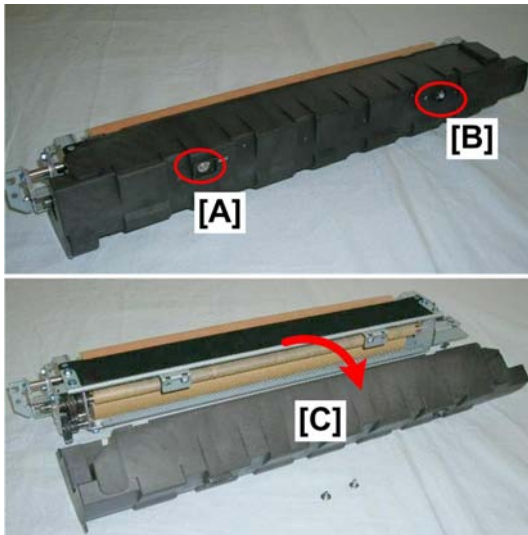

d074r307

2. Remove:
[A] Screw (x1)

[B] Screw ( x1 M3x8)

3. Remove the cleaning unit cover [C].



d074r308

4. Remove stay 1 [A] ( x4).



d074r309

5. Remove the 1st bracket [A] ( x2).

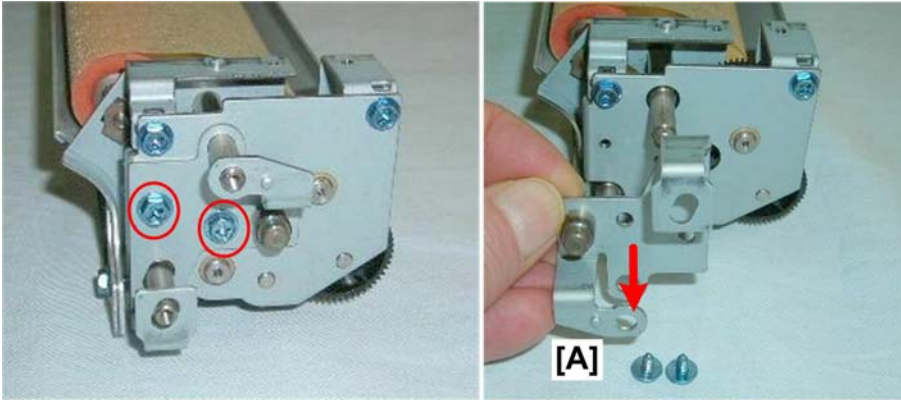

d074r310

6. Remove the 2nd bracket [A] ( x2).

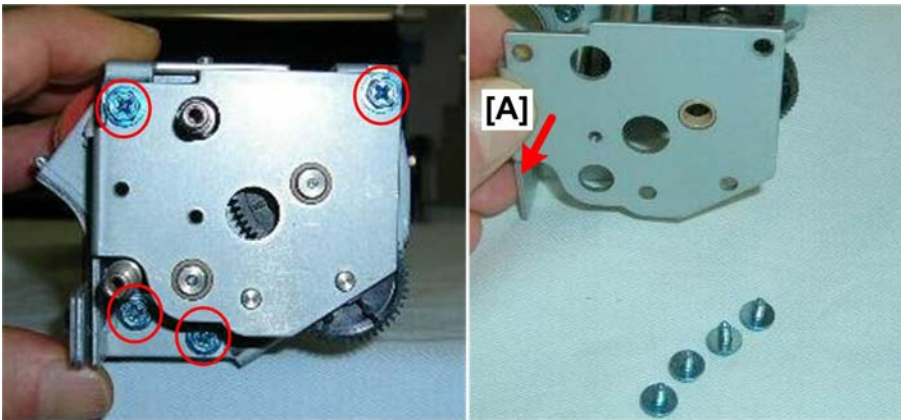

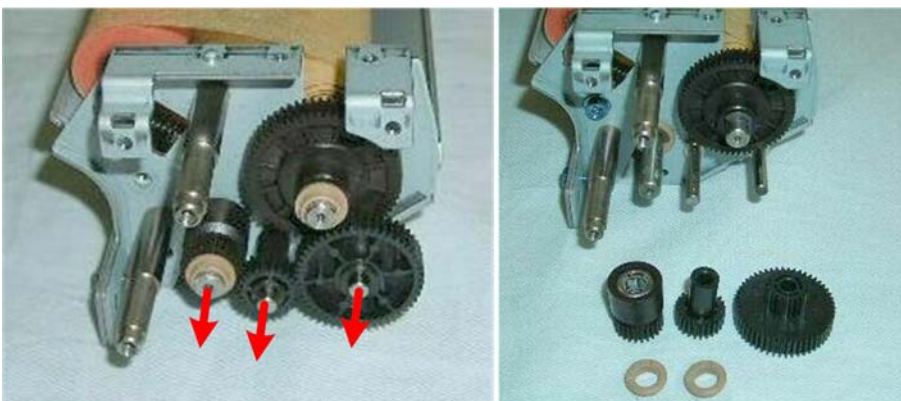

d074r311

7. At the rear, remove the inner cover [A] ( x4).



d074r312

8. Remove gears and spacers ( x3,  x2).



d074r313

4

9. Disconnect stay 2 at the rear ( x2).

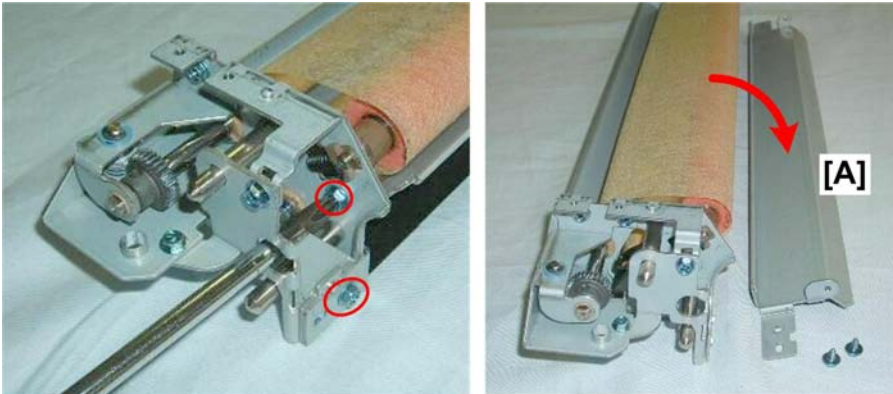



d074r314

10. Disconnect stay 2 [A] at the front and remove it ( x2 M3x6, M3x8).



d074r315

11. Disconnect the side screws ( x3).
12. Disconnect the top screw ( x1).
13. Remove the front outer bracket [A].

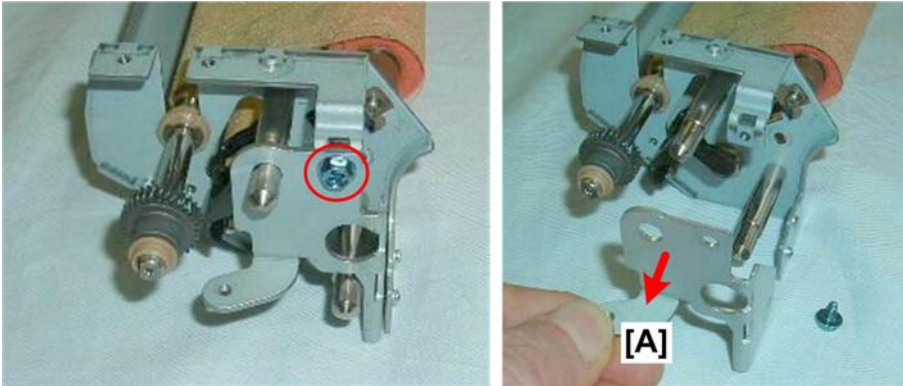

d074r316

14. Remove the front inner bracket [A] ( x1).

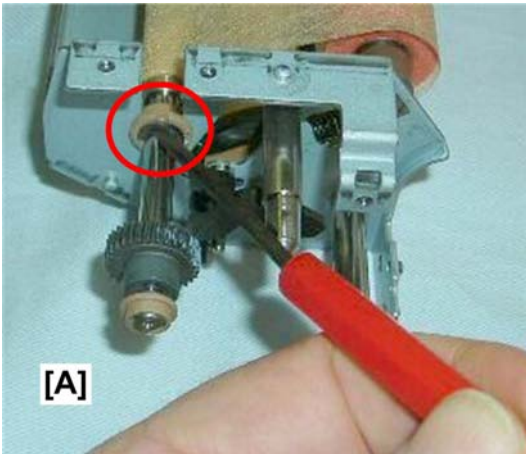



d074r317

15. At the front [A], disconnect the take-up roller ( x1).



d074r318

16. At the rear [A], disconnect the take-up roller ( x2,  x1).



d074r319

17. Lift the take-up roller out of the frame.

4

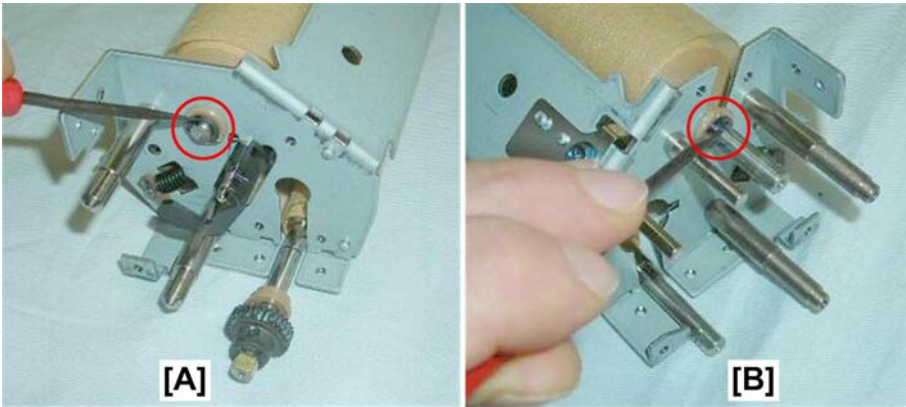

d074r320

18. Disconnect the supply roller at the front [A] (Ⓒ x1).

19. Disconnect the supply roller at the rear [B] (Ⓒ x1).

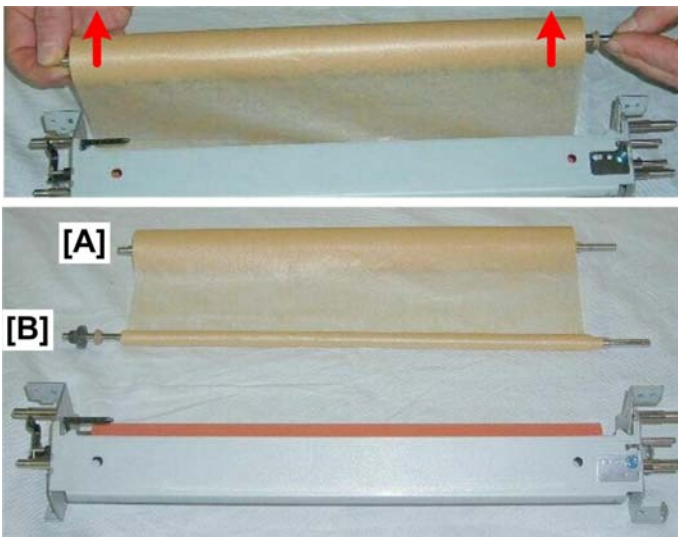

d074r321

20. Lift the supply roller out of the frame.
21. Separate the supply roller [A] and take-up roller [B] together from the frame.

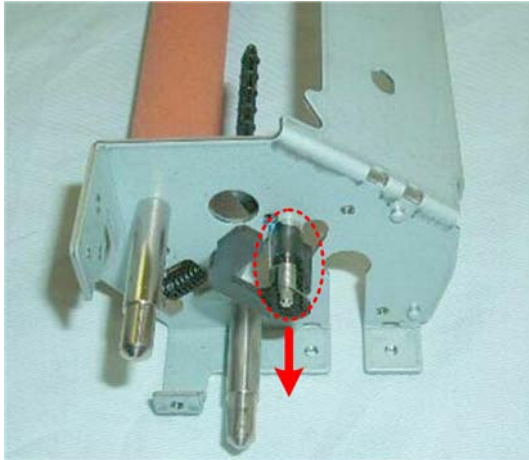

d074r322

22. Remove the web end actuator ( x1).

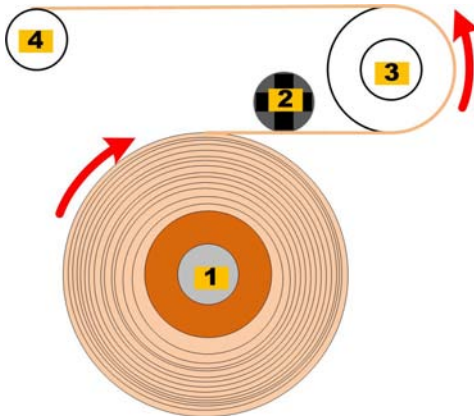

d074r318a

↓ Note

- Note carefully how the web is routed from the supply roller [1] under the actuator [2], and over the contact roller [3] to the take-up roller [4]. Make sure the unit is re-assembled this way.

Web Contact Roller

1. Fusing cleaning unit ( p.433)

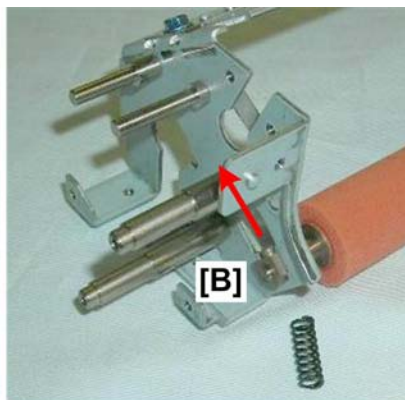
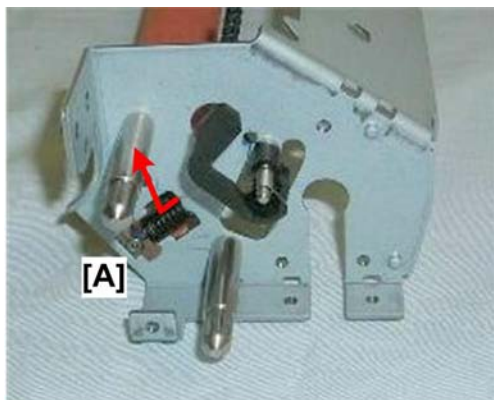

d074r323

4

1. Remove the fusing unit cleaning web supply roller. (See the previous section)
2. Release and remove tension springs [A] and [B] at either end of the roller.



d074r324

3. Remove the roller.

Brake

1. Fusing cleaning unit (p.433)

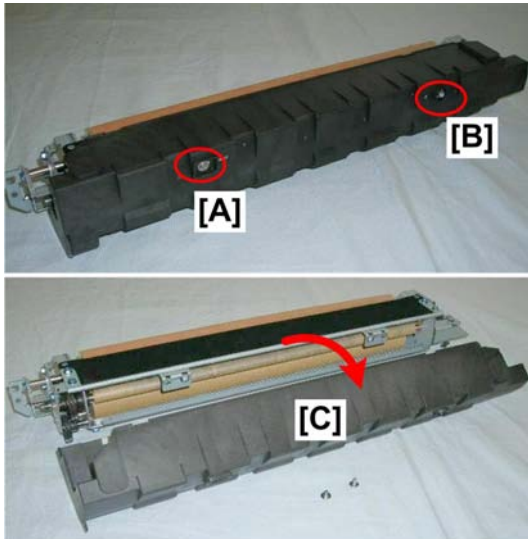

d074r307

2. Remove the cleaning unit cover [A] ( x)2.

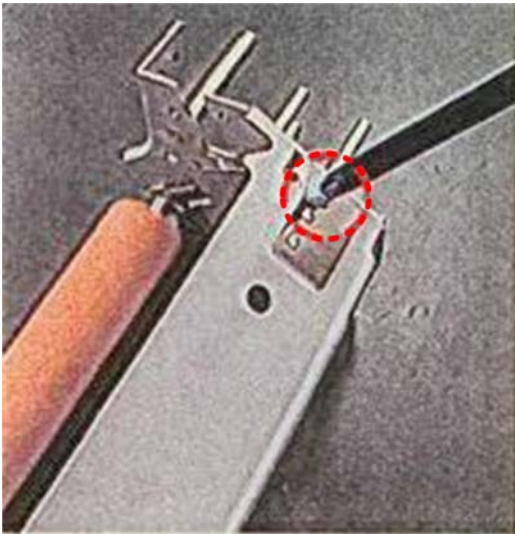

d074r325

3. Remove the brake.

Web End Sensor

The web end sensor is mounted on the left drawer below the front left corner of the fusing unit.

1. Fusing unit ( p.433)

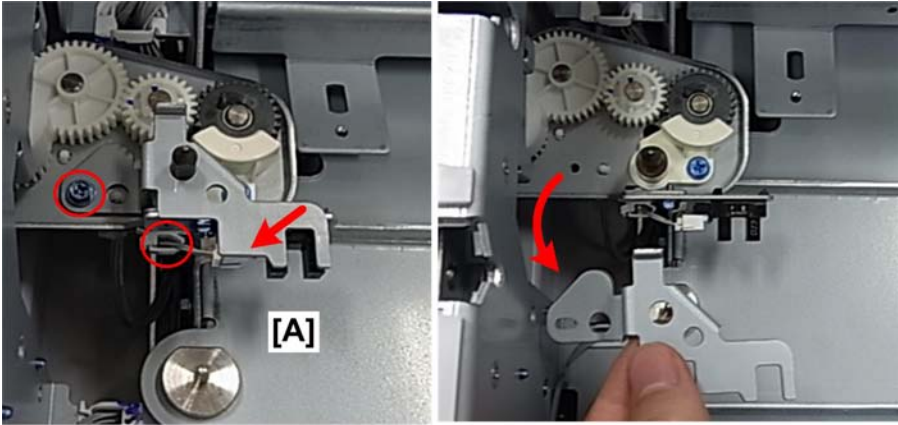

d074r326

4

- 2. Locate the web end sensor cover [A] where you just removed the fusing unit.
- 3. Remove the web end sensor cover [B] (🔩 x1, 🛠️ x1).

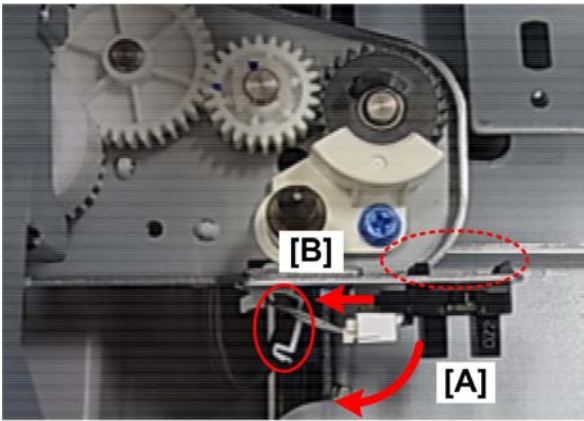

d074r327

- 4. Disconnect the web end sensor at [A] and [B] (🔌 x1, 🛠️ x1, ⚠️ x3).

Web Motor

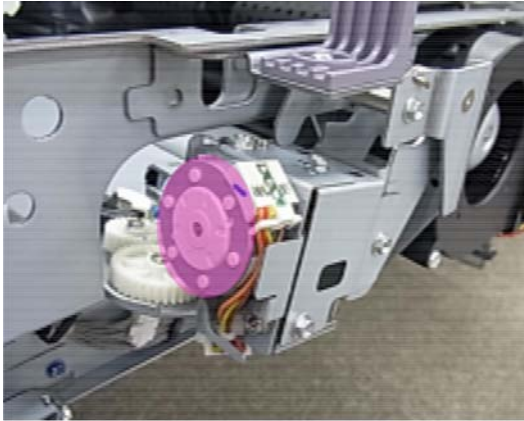

d074r765

1. Fusing unit (p.433)

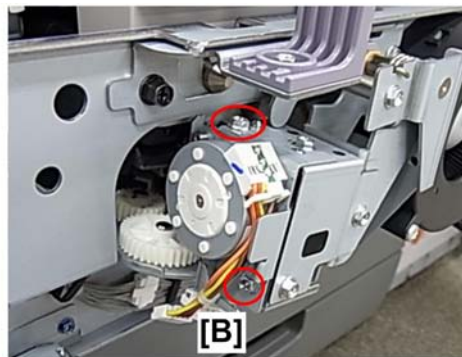
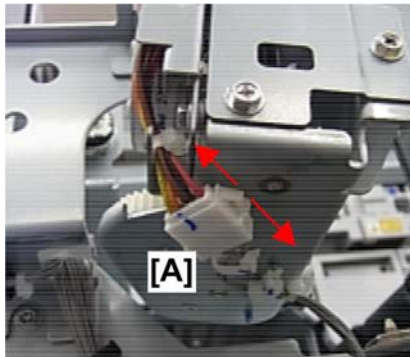

d074r766

2. Disconnect the motor at [A] (x1).
3. Disconnect the motor bracket at [B] (x2 M3x6).

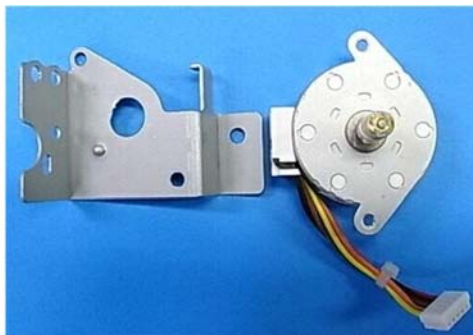
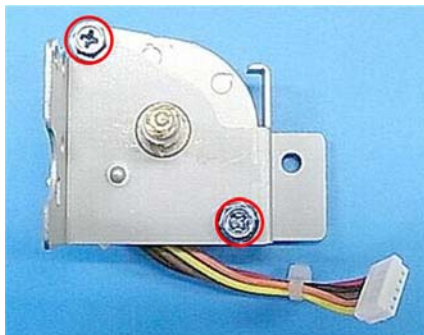

d074r767

4. Separate the motor and the bracket (x2 M3x6).

After Replacing or Servicing the Fusing Cleaning Unit

1. The machine power must be OFF.
2. Open both front doors.
3. Turn the main power switch ON.
4. Enter the SP mode.
5. Reset the counter for the replaced unit or parts.
6. Close the front doors.
7. Wait for about 5 minutes. When you hear an audible beep and see "Ready" displayed on the operation panel, you are ready to continue.
8. Exit the SP mode.

Left Drawer

Exit Relay Motor

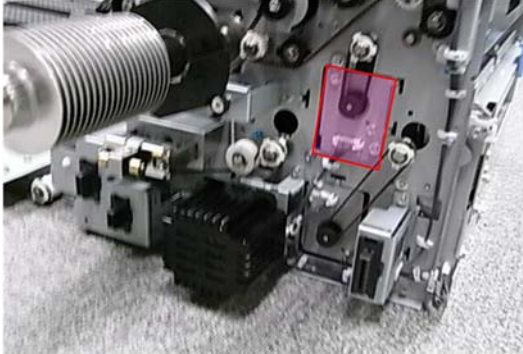

d074r753

1. Left drawer (p.440).
2. The shaded area above shows the location of the motor.

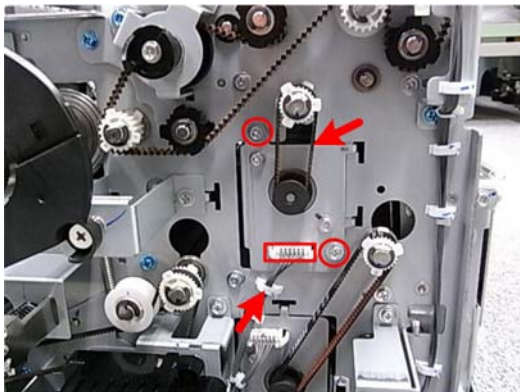

d074r754

3. Remove the motor bracket (🔧 x1, 📏 x1, 🔩 x2, ⚙️ x1).

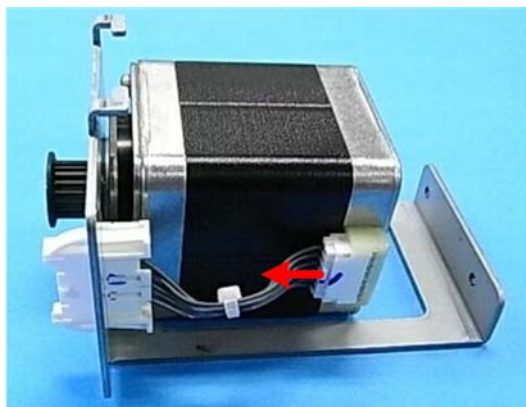

d074r755

4

4. Disconnect the motor harness ( x1).

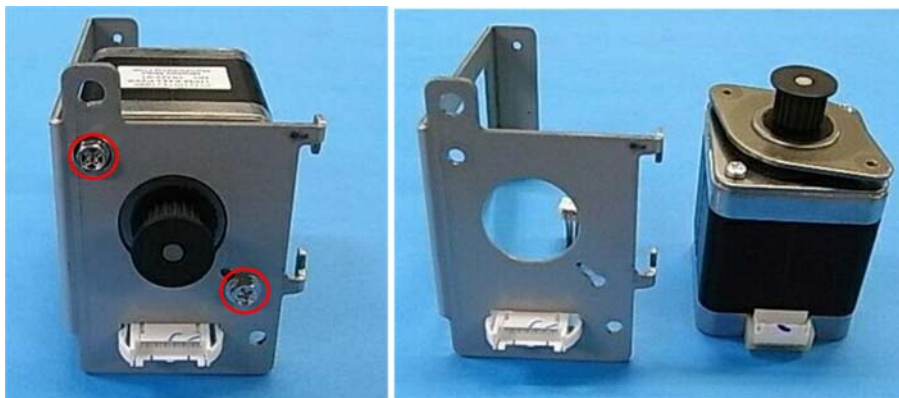

d074r756

5. Separate the motor and the bracket ( x2).

Invert Exit Motor

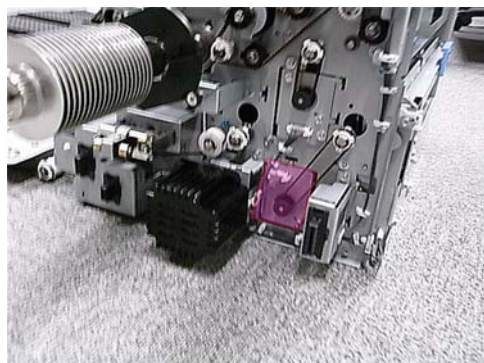

d074r757

1. Left drawer (🔧 p.440)
2. The shaded area above shows the location of the motor.

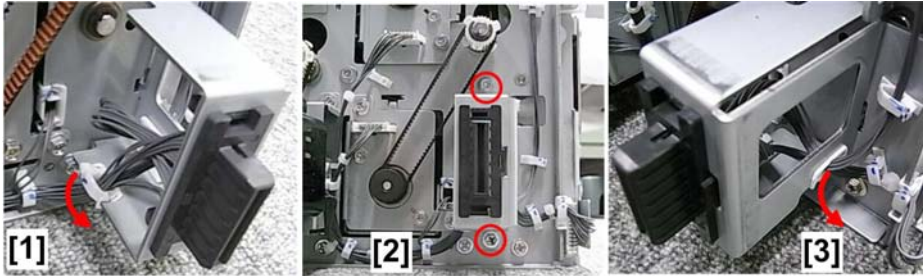

d074r758

3. Disconnect the drawer connector to the right of the motor, so that you can move it out of the way:

[1] Left (🔧 x1)

[2] Top, bottom (🔧 x2)

[3] Right (🔧 x1)

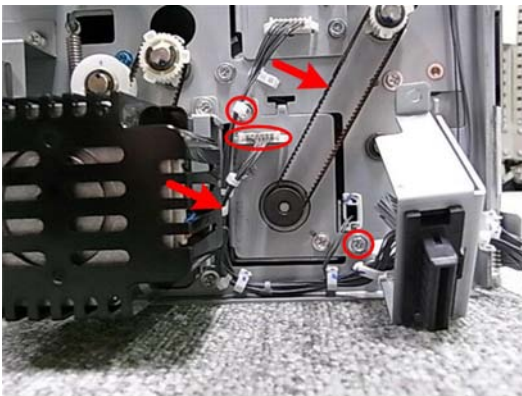

d074r759

4. Disconnect the motor bracket (🔧 x1, 📏 x1, 🔧 x2, ⚙️ x1)

4



d074r760

4

5. Disconnect the motor harness (🔌 x1).

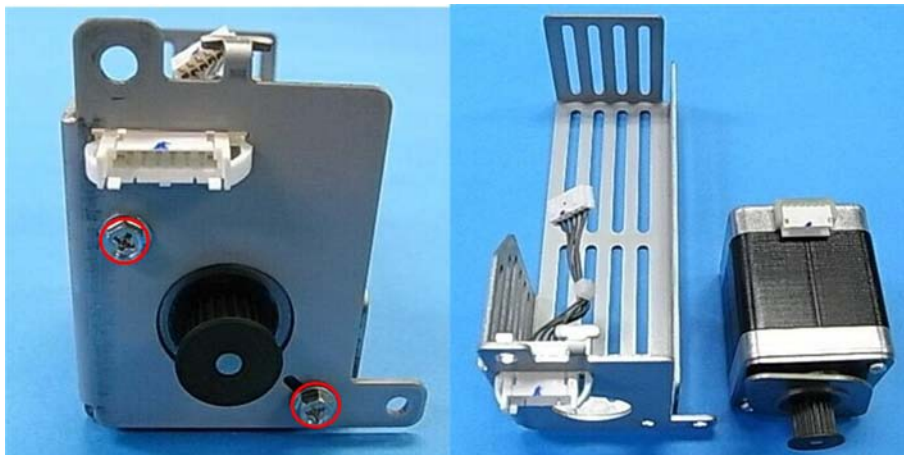

d074r761

6. Separate the motor and the bracket (🔧 x2).

Duplex Transport Motor 1

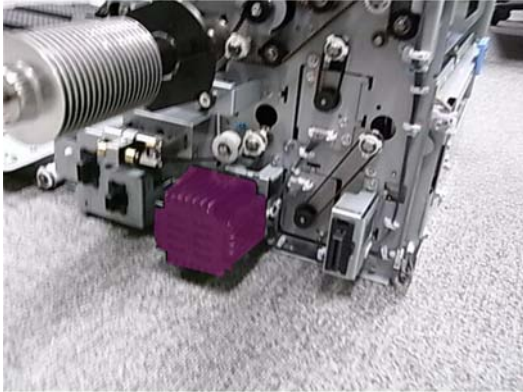

d074r762

1. Left drawer (p.440)
2. The shaded area above shows the location of the motor.

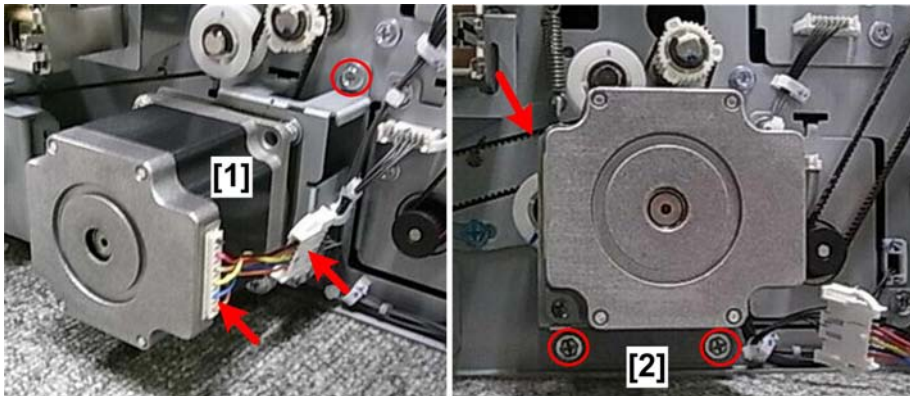

d074r763

3. Disconnect the motor bracket:
 - [1] Right (🔩 x1, 🛠️ x1, 🛠️ x1)
 - [2] Bottom (🛠️ x2, 🛠️ x1)



d074r764

4. Separate the motor and the bracket ( x2).

4

Web Motor

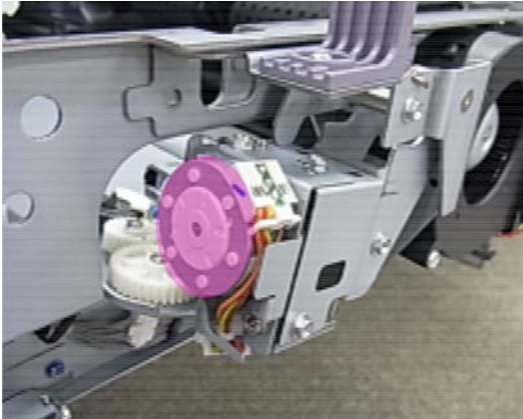

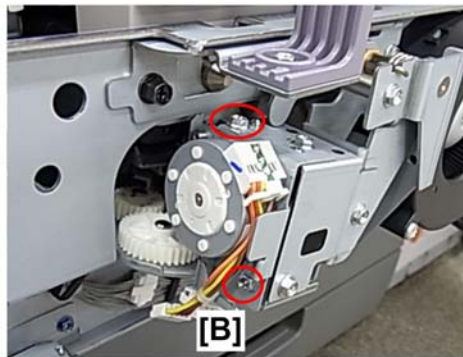
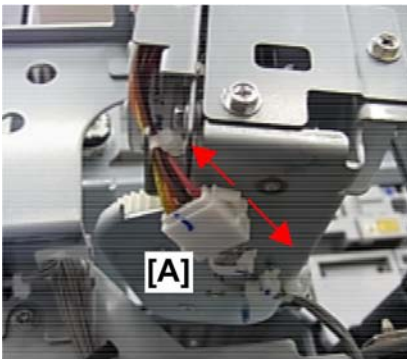

d074r765

1. Fusing unit ( p.433)
2. The shaded area above shows the location of the motor.



d074r766

3. Disconnect the motor at [1] ( x1).

4. Disconnect the motor bracket at [2] ( x1).

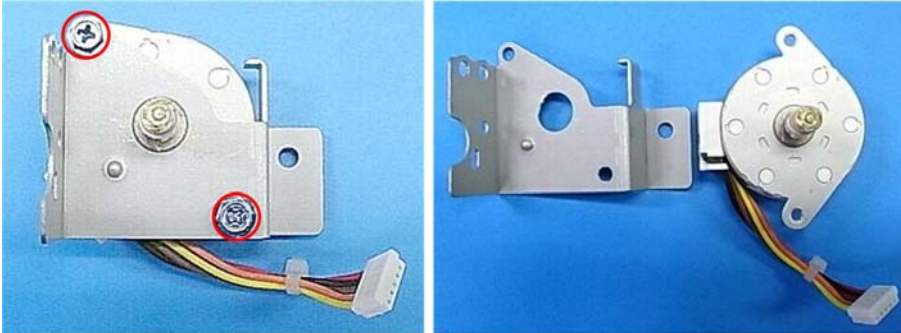

d074r767

5. Separate the motor and the bracket ( x2).



4

Belt Cooling Fan

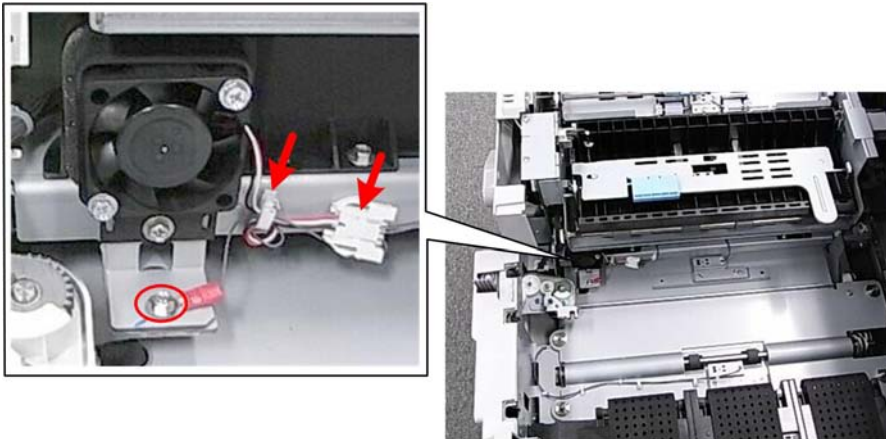
1. Left drawer ( p.440)



d074r768

2. Disconnect the fan and the bracket ( x1,  x1,  x1).

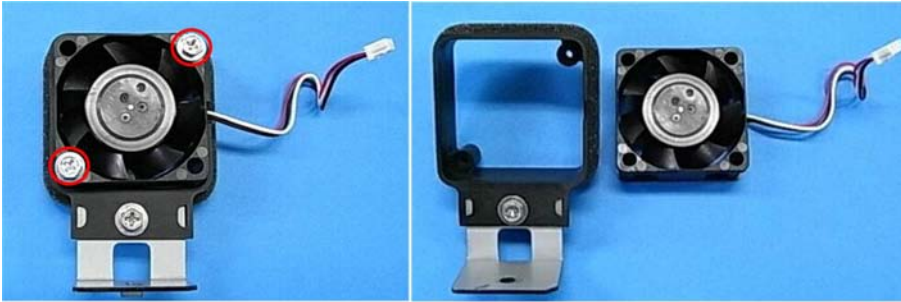

d074r769

3. Separate the fan and the bracket (x2).

4

Exit Motor

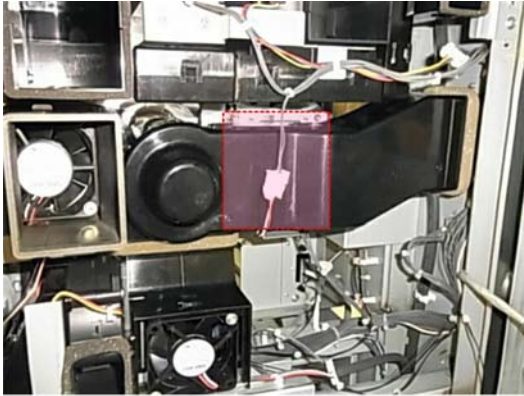

d074r819

1. Open the cooling box door. (p.400)
2. The exit motor is mounted on the back of the main machine behind a cooling duct. The shaded area above shows the location of the motor.

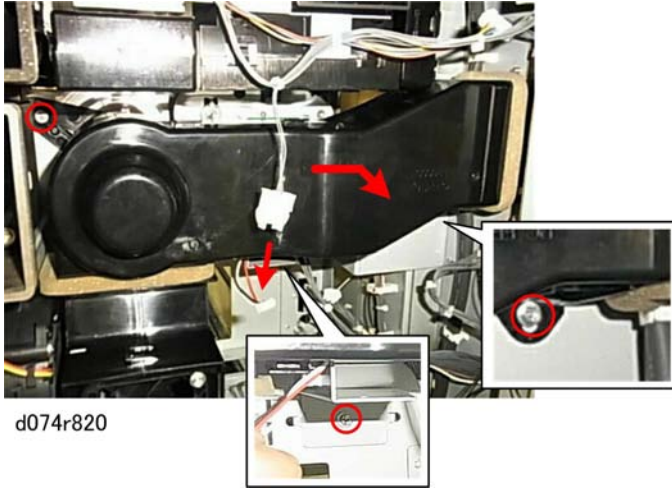

d074r820

3. Remove the duct ( x1,  x3).

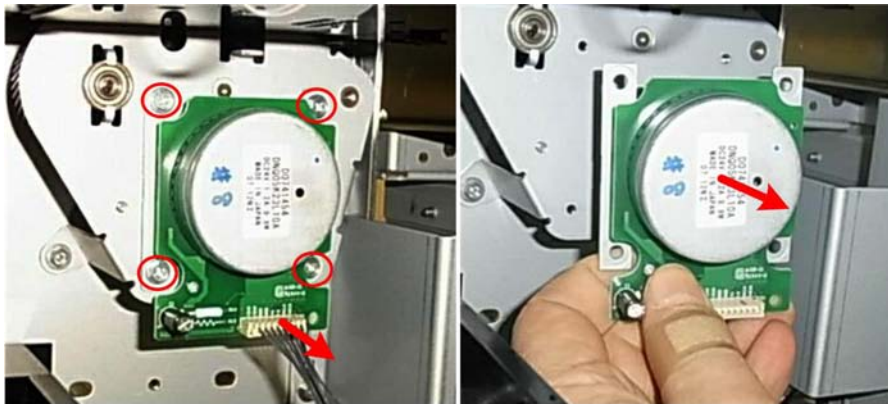

d074r821

4. Remove the motor ( x4).



d074r822

Duplex Inverter Motor

The duplex inverter motor is mounted on the back of the machine.

1. Open the cooling box (p.400)
2. Left cover (p.402)



d074r826

3. Remove the purged paper tray (x4).

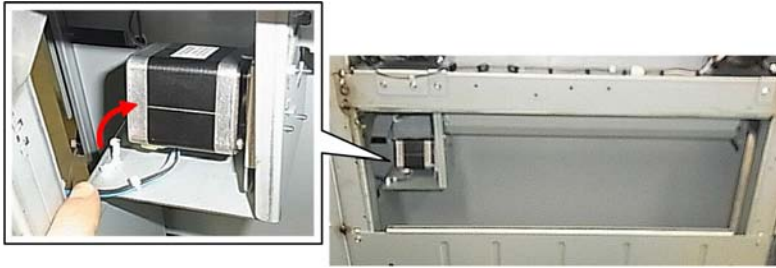

d074r827

4. Disconnect the motor (🔌x1).

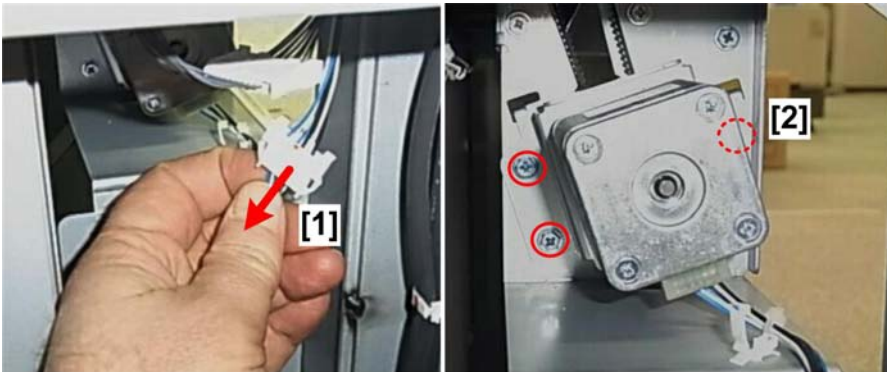

d074r828

5. At the rear, disconnect the motor (🔌x1, 🔩x3).

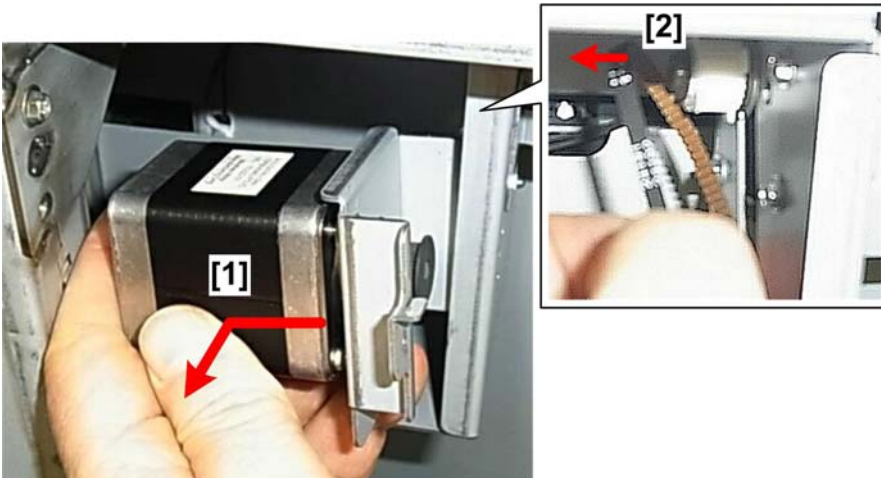

d074r829

6. At the side, remove the motor [1].
7. Remove the timing belt [2] (🌀x1).

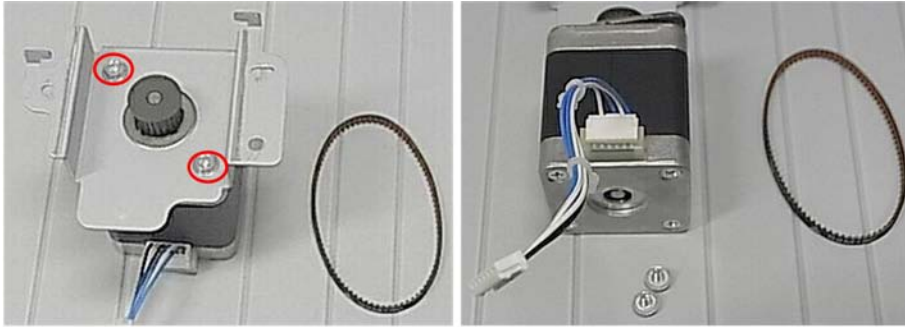

d074r830

8. Separate the motor and motor bracket ( x2).





4

Exit Unit Entrance Sensor

1. Left drawer unit ( p.440)



d074r770

2. Remove the bracket [1] ( x2).
3. Remove the sensor [2] ( x1,  x1,  x3).

Exit JG Sensor

1. Left drawer unit ( p.440)

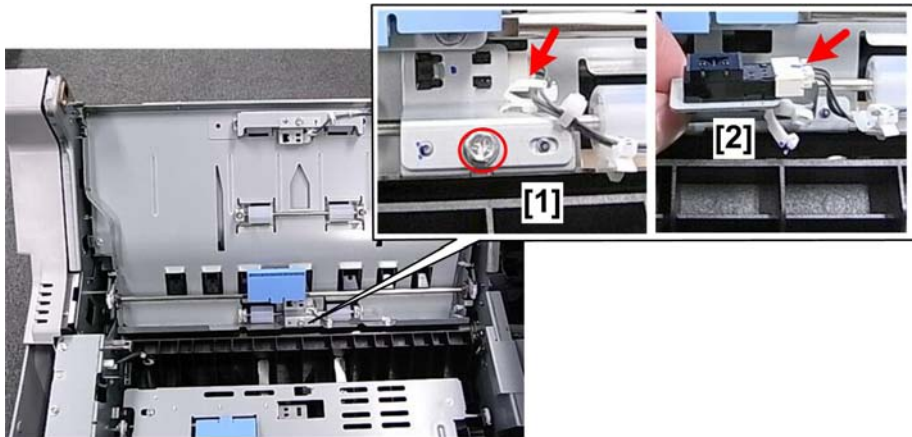

d074r771

2. Disconnect the sensor bracket [1] (🔧 x1, 📏 x1).
3. Disconnect the sensor [2] (📏 x1, 🔧 x3).

4

Duplex Transport Sensor 1

1. Pull out the left drawer until it stops and remove its front cover.

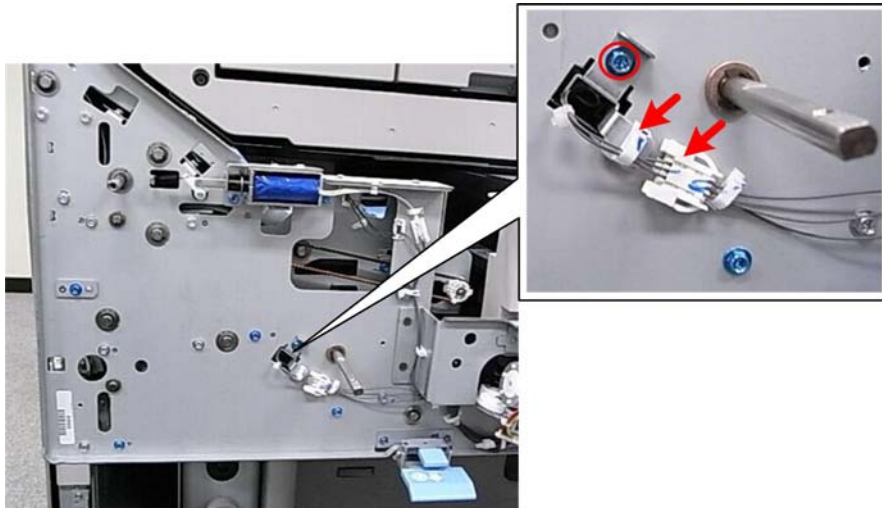

d074r772

2. Disconnect the sensor (📏 x1, 📏 x1, 🔧 x1).

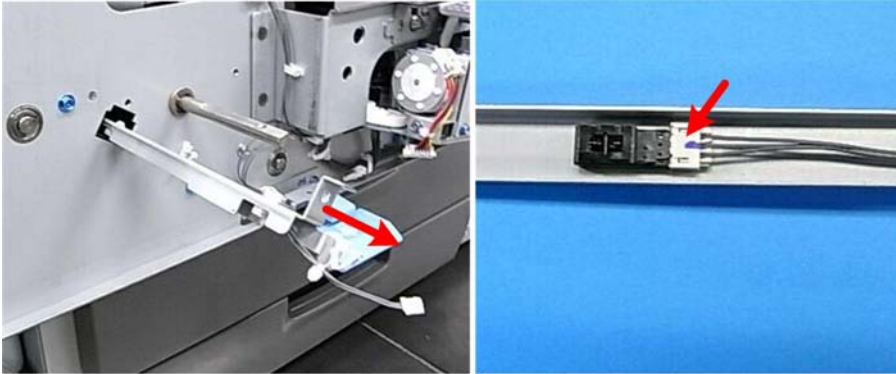

d074r773

4

3. Pull the sensor bracket out of the left drawer unit and disconnect the sensor (🔌 x1, 🔌 x3).

Duplex Transport Sensor 2

1. Fusing unit (📄 p.433)

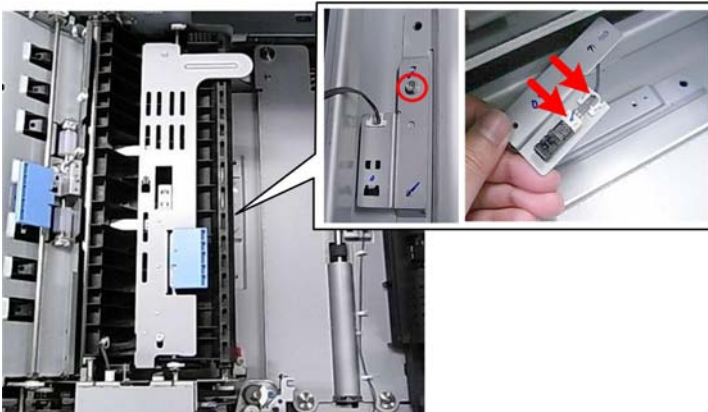

d074r774

2. Disconnect the sensor bracket and remove the sensor (🔌 x1, 🔌 x1, 🔌 x1, 🔌 x3).

Duplex Transport Sensor 3

1. Fusing unit (📄 p.433)

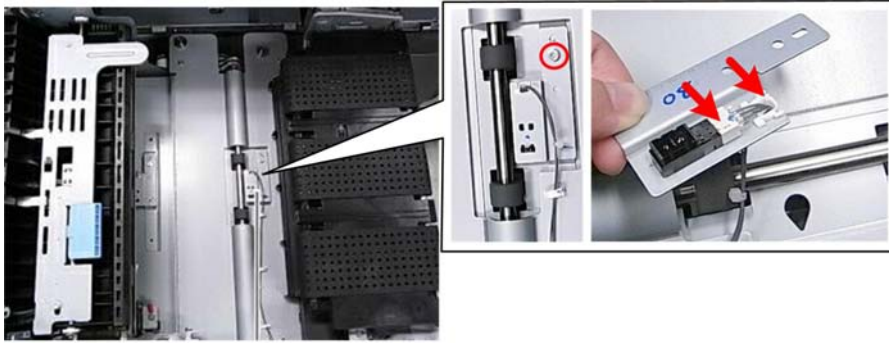

d074r775

2. Disconnect the sensor bracket and remove the sensor ( x1,  x1,  x1,  x3).



4

Exit Relay Sensor

1. Open the front doors and pull out the left tray until it stops.



d074r776

2. Open the exit guide [1].
3. Disconnect the sensor bracket [2] and remove the sensor ( x1,  x1,  x3).

Purge Relay Sensor

1. Open the front doors and pull out the left tray until it stops.



d074r777

2. Disconnect the sensor bracket and remove the sensor ( x1,  x1,  x3).

Duplex Invert Sensor

1. Open the front doors and pull out the left tray until it stops.

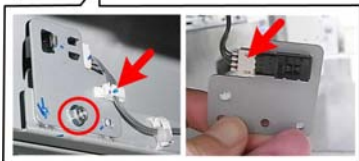

d074r778



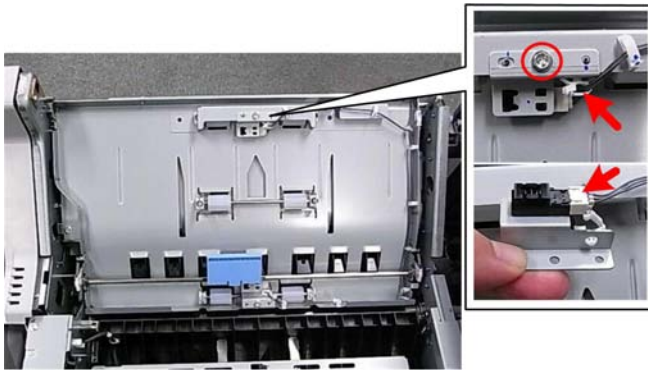

2. Under the left drawer unit, disconnect the sensor bracket and sensor ( x1,  x1,  x1,  x3)

Exit Sensor

1. Open the front doors and pull out the left tray until it stops.



d074r779

2. Raise the transport cover.
3. Disconnect the sensor bracket and remove the sensor ( x1,  x1,  x1,  x3).



4

Web End Sensor

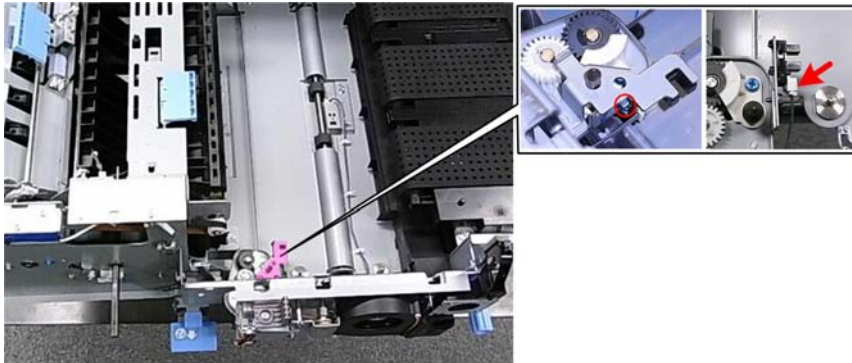

1. Fusing unit ( p.433)



d074r780

2. Disconnect the sensor bracket and remove the sensor ( x1,  x1,  x3).

Purged Paper Sensor

1. Left cover ( p.402)
2. Remove the lower left inner cover ( x7).



d074r823

3. Remove the base plate ( x7).

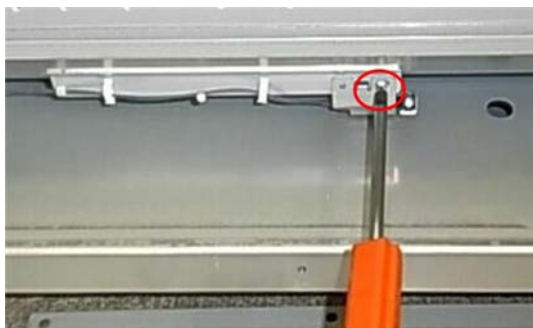

d074r824

4. Disconnect the sensor bracket ( x1).



d074r825

5. Remove the sensor ( x1,  x1).

Duplex Motors and Rollers

The duplex path is split between the left drawer and the right drawer. Identify the component that requires servicing or replacement, then go to the appropriate section of the manual.

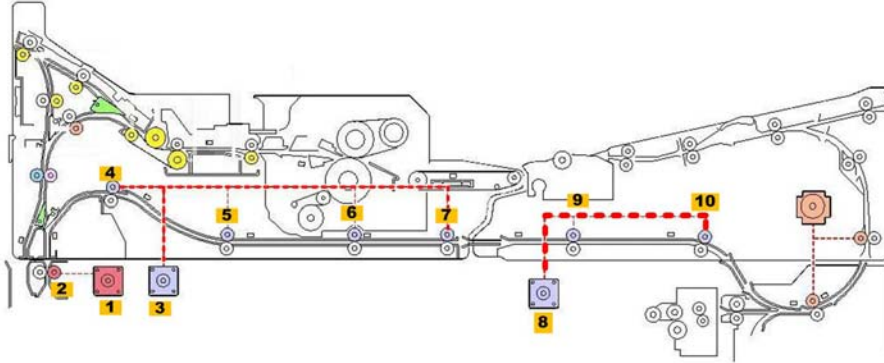

d074r977

	Left Drawer		Right Drawer
1	Duplex Invert Motor	6	Duplex Transport Roller 3
2	Duplex Invert Rollers	7	Duplex Transport Roller 4
3	Duplex Transport Motor 1	8	Duplex Transport Motor 2
4	Duplex Transport Roller 1	9	Duplex Transport Roller 5
5	Duplex Transport Roller 2	10	Duplex Transport Roller 6

- For a duplex component in the left drawer, see p.440 "Removing the Left Drawer".
- For a duplex component in the right drawer, see p.408 "Removing the Right Drawer"



Main Boards, HDD Units

CB Power Pack (CK)

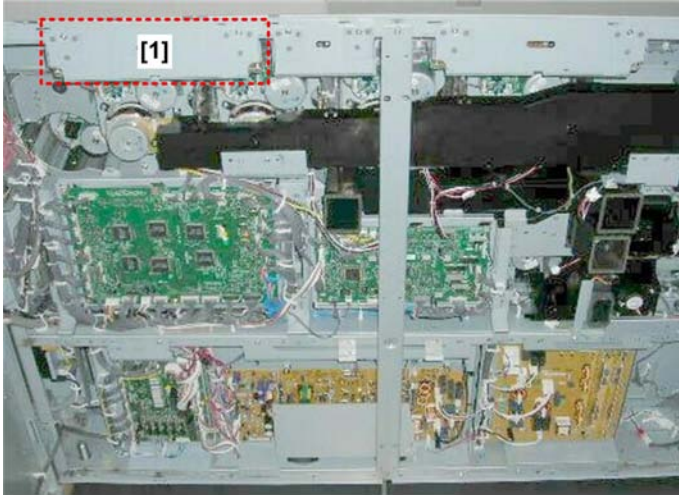
4



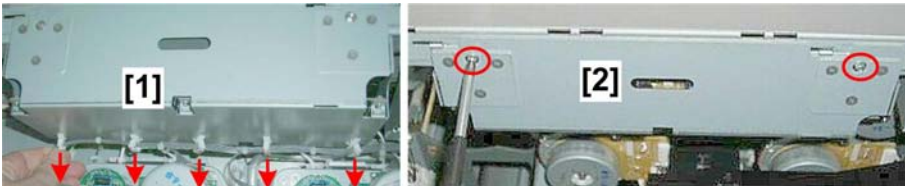

d074r550

1. Open the rear boxes ( x6). ( p.400)
2. The CB power pack (CK) is located at [1].





d074r551

3. Under the power pack [1], open the clamps and free the harnesses ( x5).
4. Disconnect the power pack bracket [2] ( x2).



d074r552

5. Slide the bracket [1] slightly to the left and lower it.
6. Disconnect the power pack [2] ( x6,  x4)

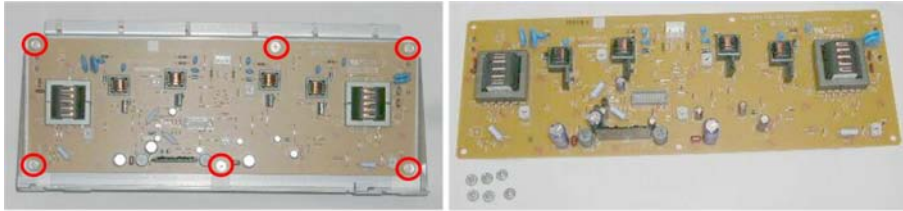

d074r553

7. Place the bracket on a flat surface and remove the power pack (🔩 x6).

Re-installation



d074r553a

★ Important



- After re-installing the power pack, check the motor connections below and make sure that they are not loose or disconnected.

CB Power Pack (YM)

4





d074r554

1. Open the rear boxes ( x6). ( p.400)
2. The CB power pack (YM) is located at [1].



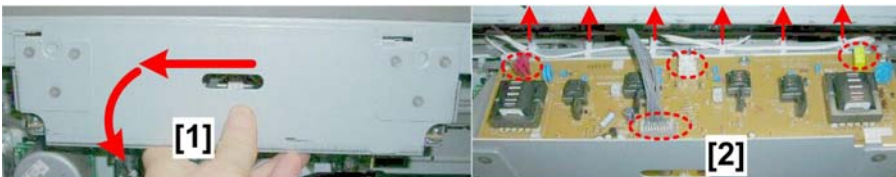

d074r555

3. Under the power pack [1], open the clamps and free the harnesses ( x3).
4. Disconnect the power pack bracket [2] ( x2).



d074r556

5. Slide the bracket [1] slightly to the left and lower it.
6. Disconnect the power pack [2] ( x6,  x4).

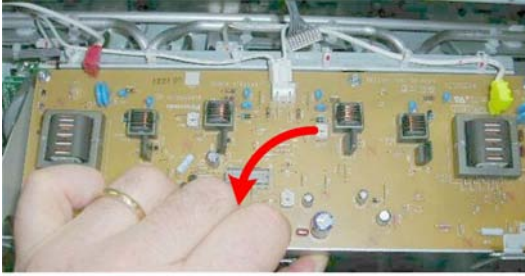

d074r557

7. Remove the power pack bracket and lay it on a flat surface.



d074r558

8. Remove the power pack ( x6).

Re-installation



d074r559

★ Important



- After re-installing the power pack, check the motor connections below and make sure that they are not loose or disconnected.

Potential Sensor Power Pack

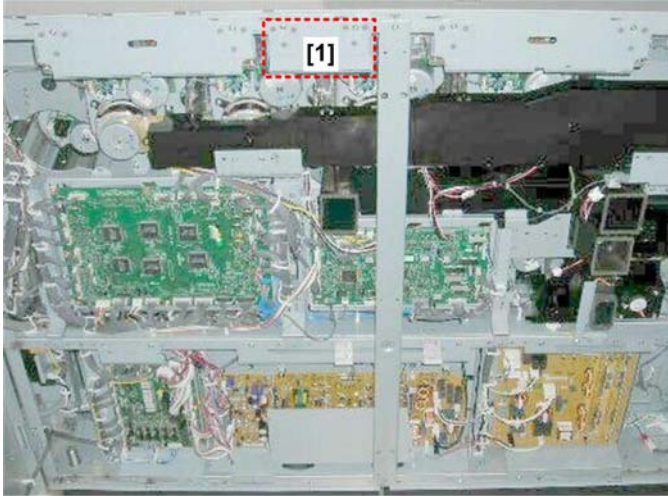
4





d074r560

1. Open the rear boxes ( x6). ( p.400)
2. The potential sensor power pack is located at [1].



d074r561

3. Under the power pack [1], open the clamps and free the harnesses ( x3).
4. Disconnect the power pack bracket [2] ( x2).



d074r562

5. Slide the bracket [1] slightly to the left and lower it.
6. Disconnect the power pack [2] (⚡ x3).



d074r563

7. Remove the power pack bracket and lay it on a flat surface.

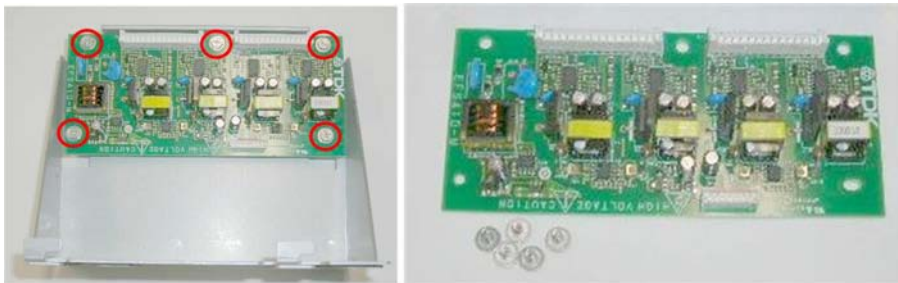

d074r564

8. Remove the power pack (⚡ x6).

Re-installation



d074r565

4



★ Important

- After re-installing the power pack, check the motor connection below and make sure that it is not loose or disconnected.

AC Drive Board



d074r566

1. Open the rear boxes ( x6). ( p.400)
2. The AC drive board is located at [1].

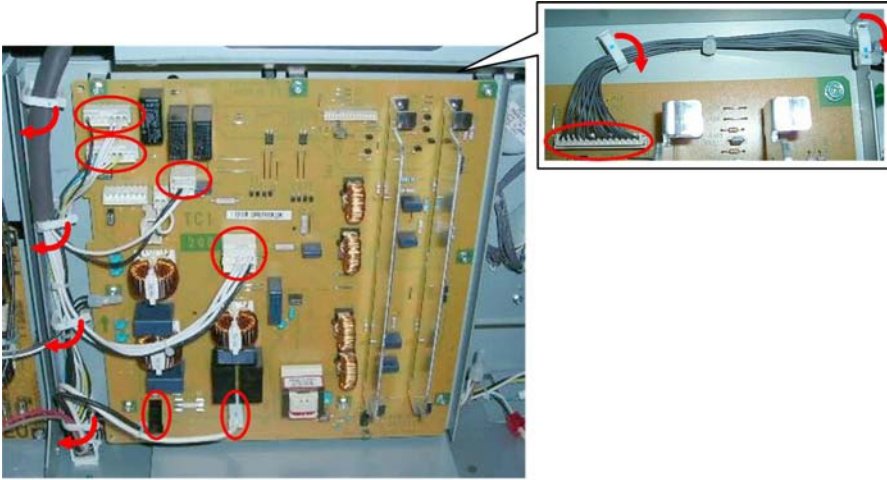

d074r567

4

3. Disconnect the board (🔌x6, 📁x7).

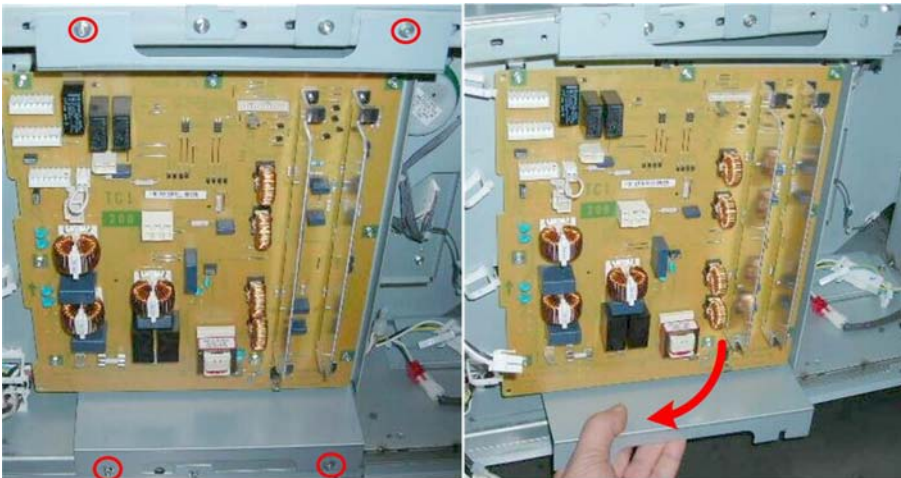

d074r568

4. Disconnect the board bracket and remove it (🔩x4).

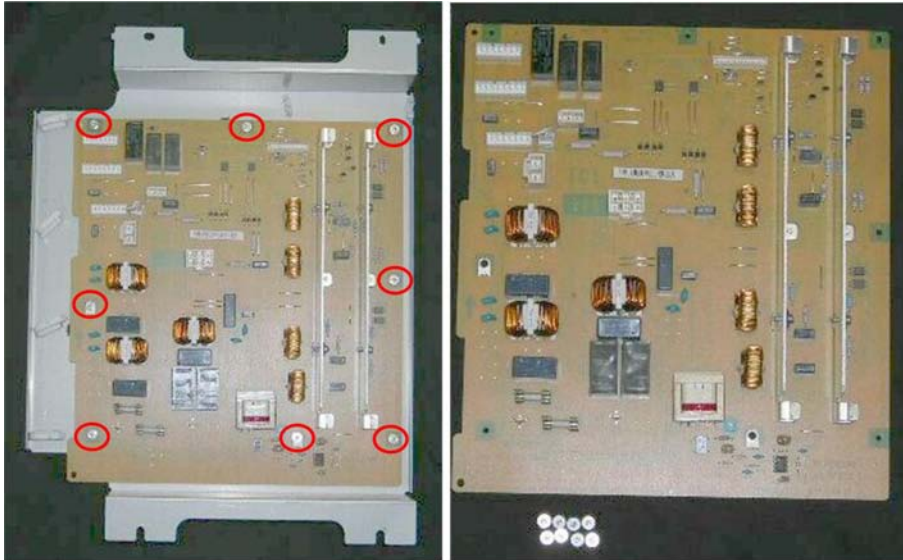



d074r569

5. Lay the bracket on a flat surface and remove the board ( x8).

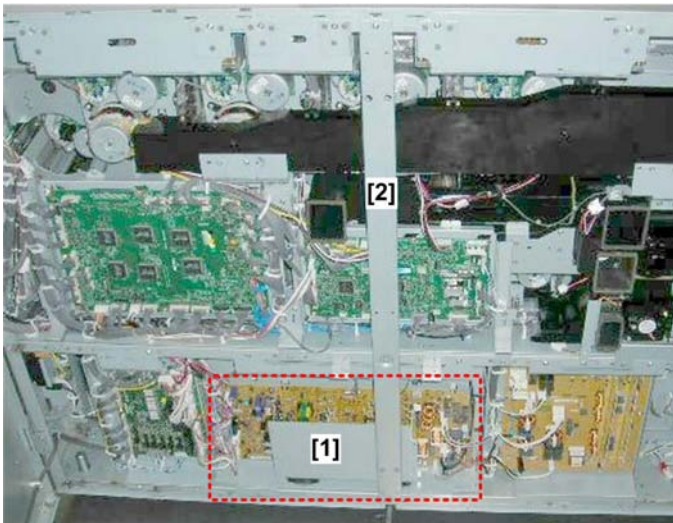
PSU 2, PSU 2 Fans



d074r570

1. Open the rear boxes ( x6). ( p.400)
2. PSU 2 is located at [1].
3. Remove the center stay [2] ( x3).

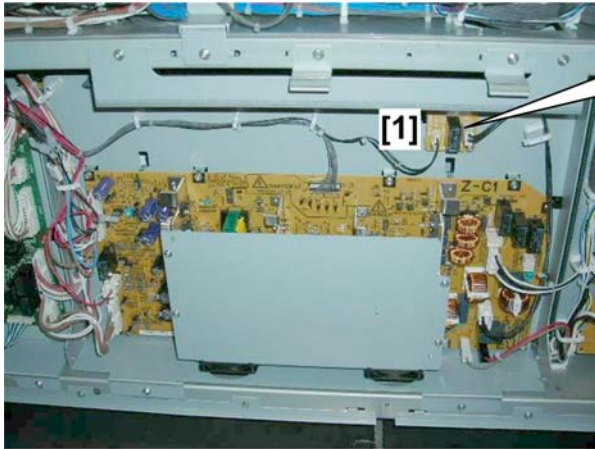



d074r571

↓ Note

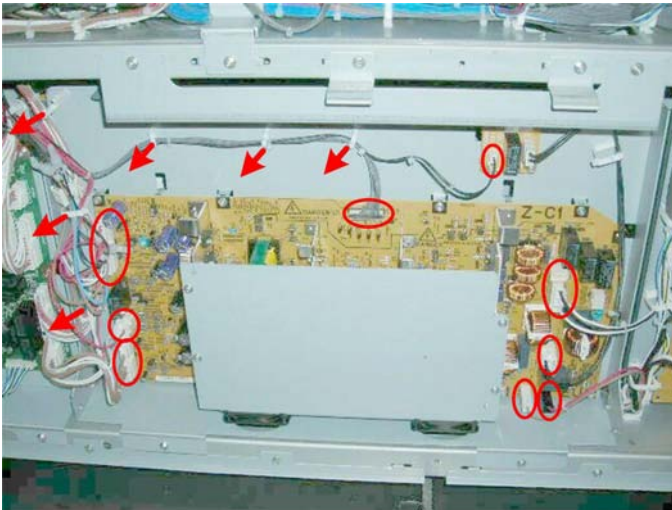
- The AC relay board [1] can be removed without removing PSU 2 ( x3,  x2).



d074r572

4. Disconnect the board ( x6,  x6).

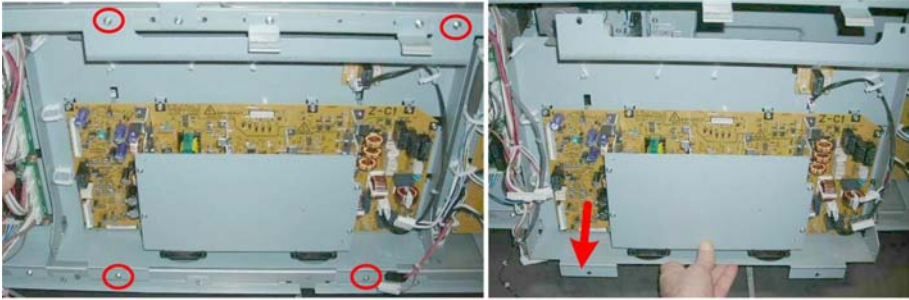



d074r573

- 5. Disconnect the bracket and remove it ( x4).
- 6. Lay the bracket on a flat surface.

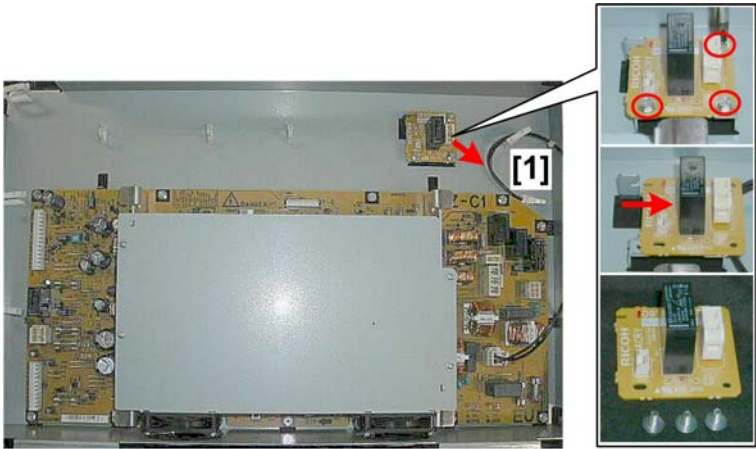
4



d074r574

- 7. Disconnect the AC relay board [1] ( x3,  x1).
- 8. Slide the board to the right and remove it.

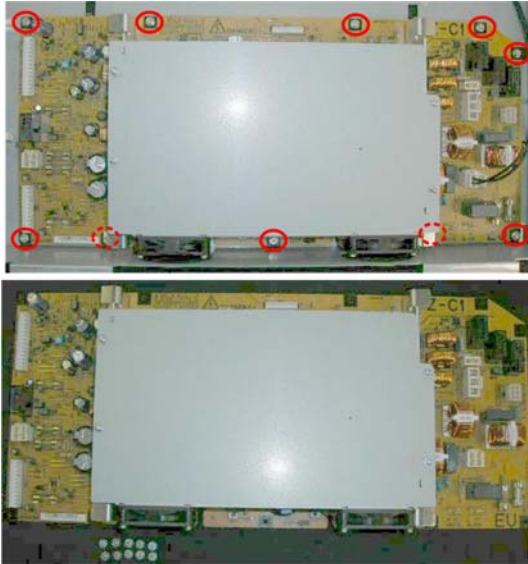



d074r575

9. Remove the board ( x10).

PSU 2 Fans



d074r576

1. Remove the fans ( x1,  x2 each).



d074r577

2. Remove the shield plate ( x4).

Note

- There are no fuses under the shield plate.
- If you are replacing the board, be sure to install this plate over the new board.

4





d074r578

3. There are four fuses on the left [1] and two fuses on the right [2].

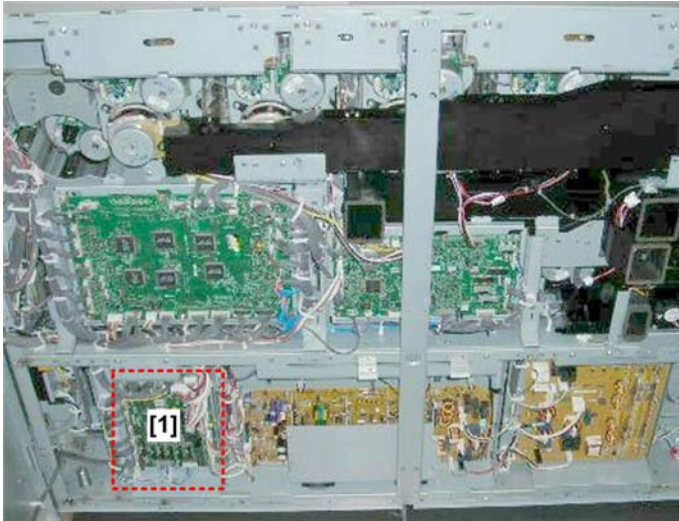
Relay Board (RYB)



d074r579

1. Open the rear boxes ( x6). ( p.400)
2. The relay board is located at [1].

4

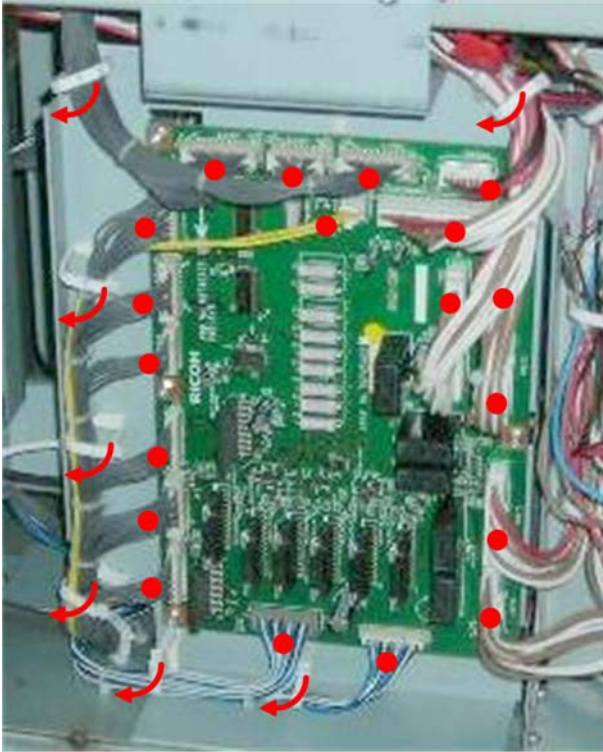

d074r580

3. Disconnect the board (🔌x7, 📁x19)

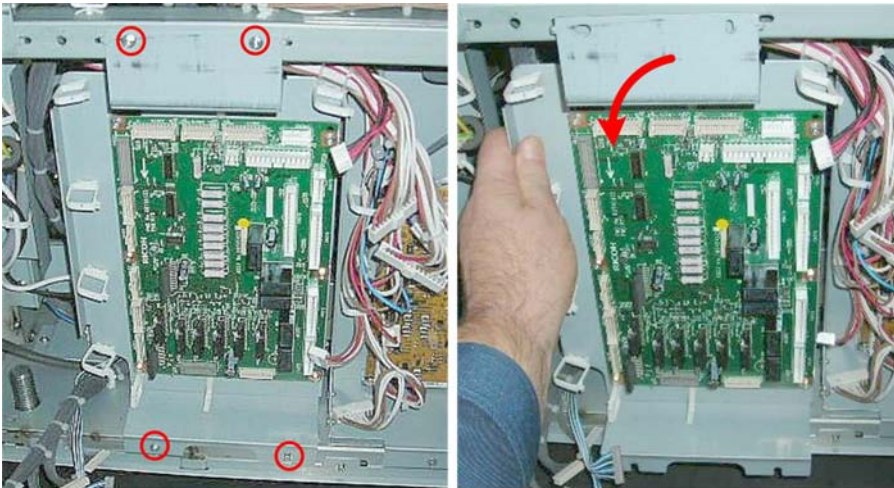

d074r581

- 4. Disconnect the bracket and remove it (🔧x4).
- 5. Lay the bracket on a flat surface.





d074r582

- Remove the board ( x6).

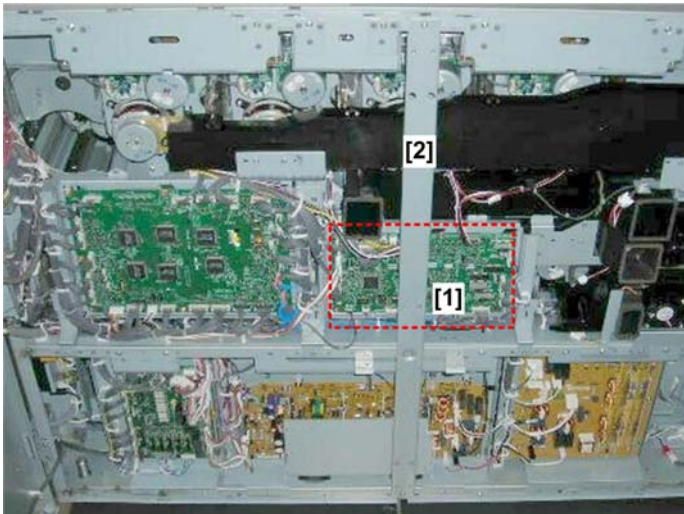
TDCU



d074r583

- Open the rear boxes ( x6). ( p.400)
- The TDCU is located at [1].

3. Remove the center stay [2] ( x3).

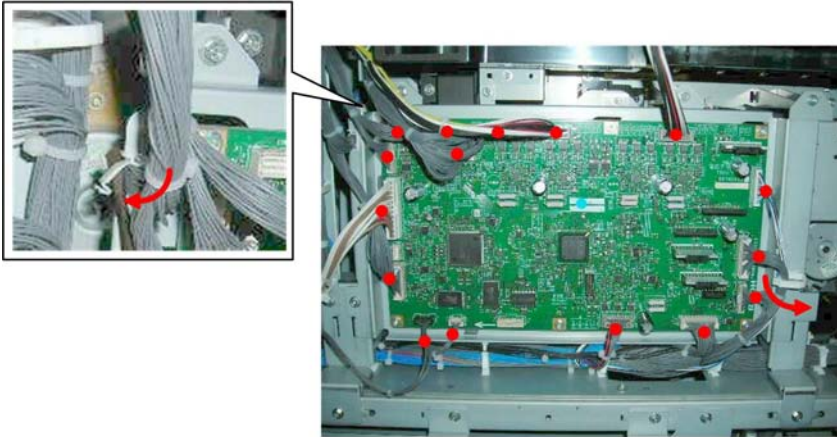

d074r584

4. Disconnect the board ( x2,  x16).

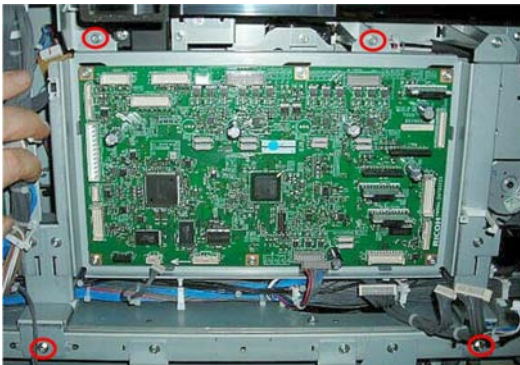

d074r585

5. Disconnect the bracket ( x4).

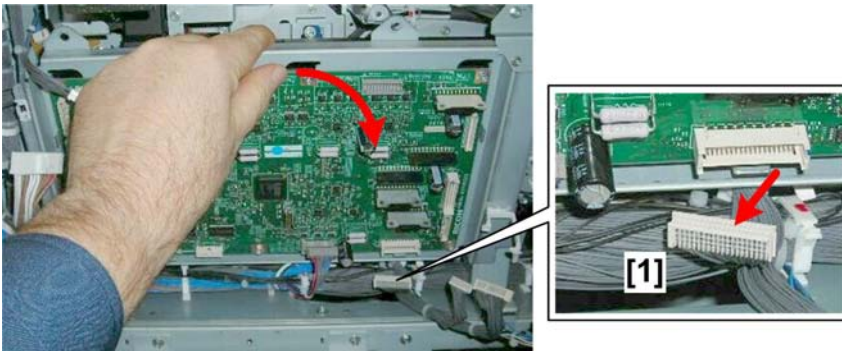

d074r586

6. Lower the board slowly until it stops.

★ Important

- Do not try to remove the bracket and board.
- Connector [1] is attached to the back of the board and must be disconnected before the bracket can be removed.

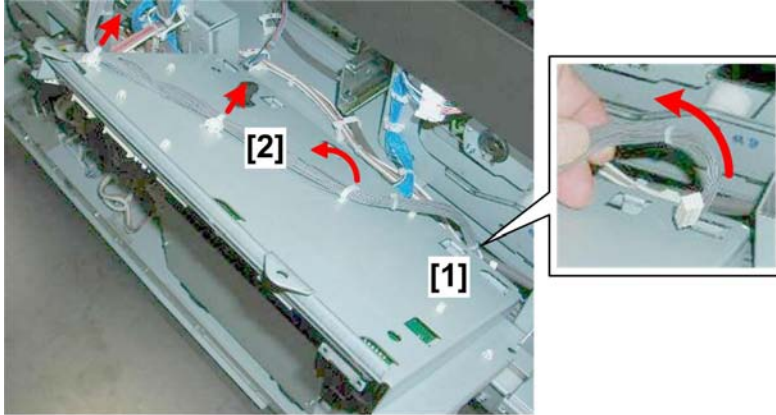

d074r587

7. On the back of the board, pull out the harness connector [1].
8. Disconnect the harness from the back of the board [2] (⚙️ x2, 🛠️ x1).



d074r588

9. Remove the bracket and lay it on a flat surface.

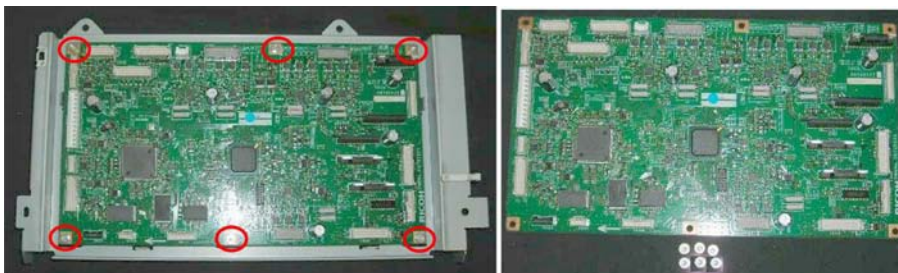

d074r589



10. Remove the board (🛠️ x6).

PSU 1, PSU 1 Fans

4



d074r590

1. Open the controller box ( x6). ( p.400)
2. Remove the controller box covers. ( p.404)
3. PSU 1 is at the bottom of the controller box.

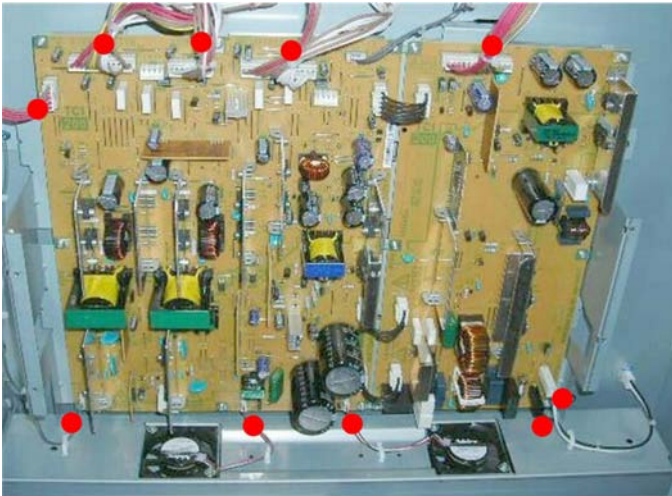

d074r591

4. Disconnect the board ( x10).

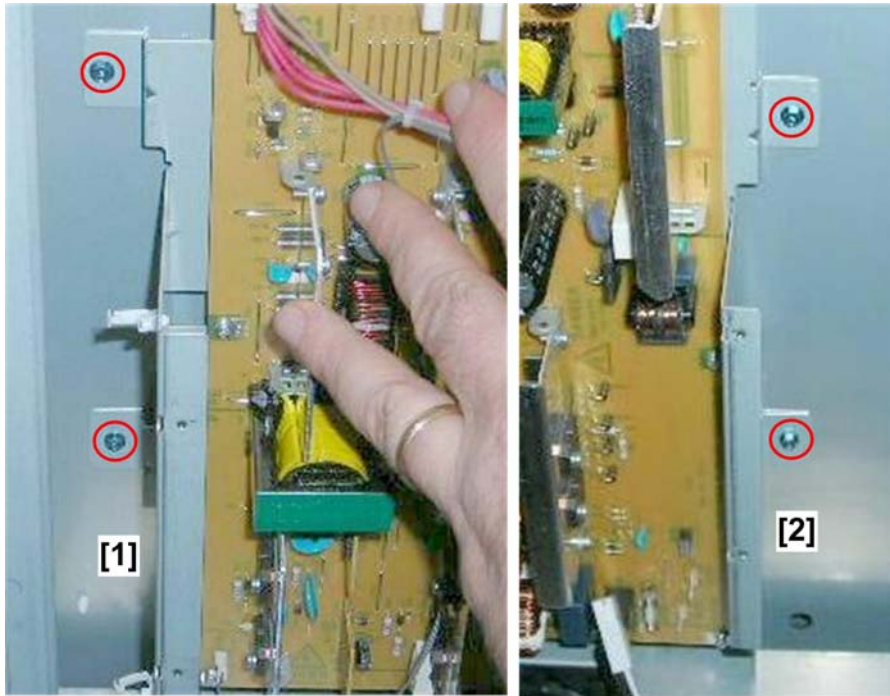

d074r592

5. Disconnect the bracket:

[1] Left side ( x2)

[2] Right side ( x2)

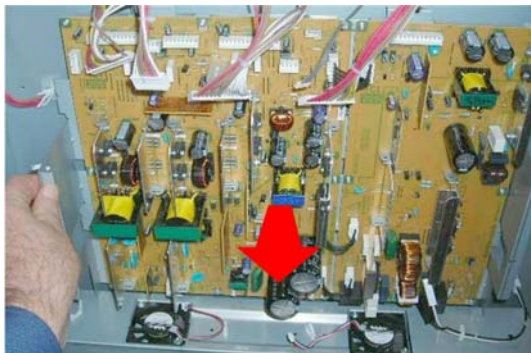

d074r593

6. Remove the bracket and lay it on a flat surface.

4

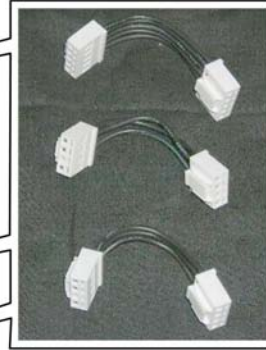

d074r594

7. Remove the three bridge harnesses ( x6).

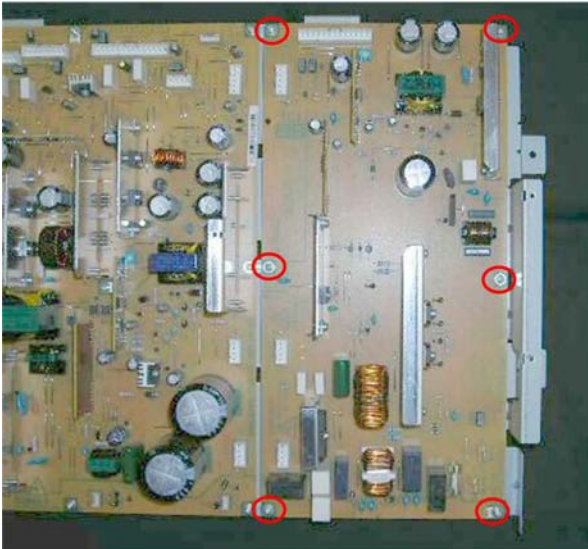

d074r595

8. Remove the right board ( x6).

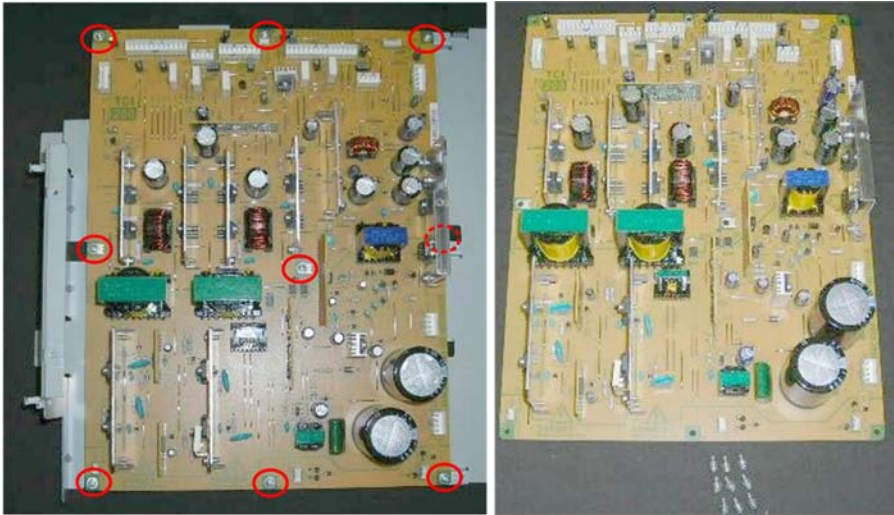



d074r596

9. Remove the left board ( x9).

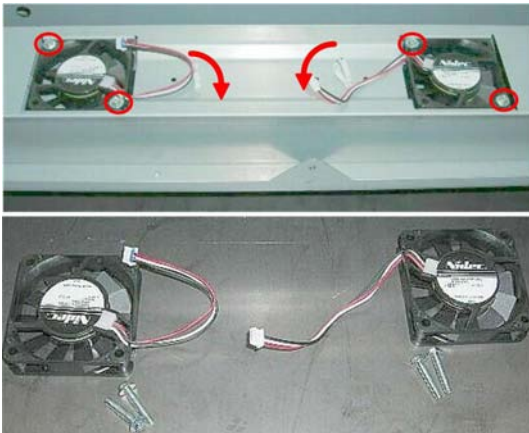
Fans



d074r597

1. At the base of the controller box, remove the fans ( x1,  x2 each).



IOB/BCU

Lowering the IOB

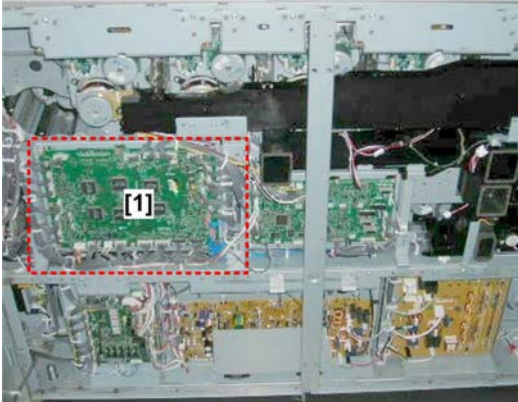
4



d074r598

1. Open the rear boxes ( x6). ( p.400)
2. The IOB and BCU are located at [1].

 **Note**

- The BCU is not visible. It is mounted on the back of the IOB.

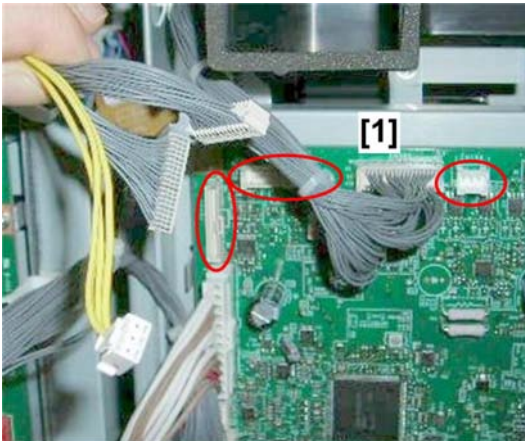

d074r599

3. To the right of the IOB, disconnect the TDCU [1] ( x3).

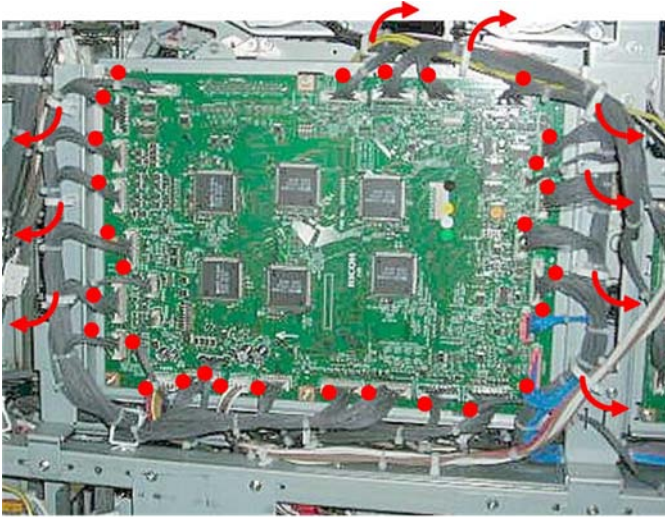

d074r600

4. Disconnect the IOB (🔌x9, 📁x29).



d074r601

5. Lower the IOB [1] to the horizontal position so that you can see the BCU [2].

Note



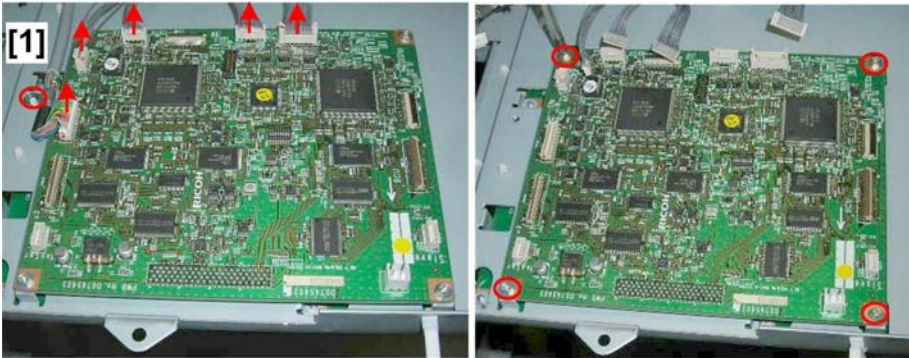

- This platform is stable enough to allow removal of the BCU.

BCU



d074r602

4

1. Disconnect harness [1] ( x1,  x1).
2. Disconnect the other harnesses ( x4).
3. Disconnect the BCU ( x4).



d074r603

4. Remove the BCU.

Removing the IOB

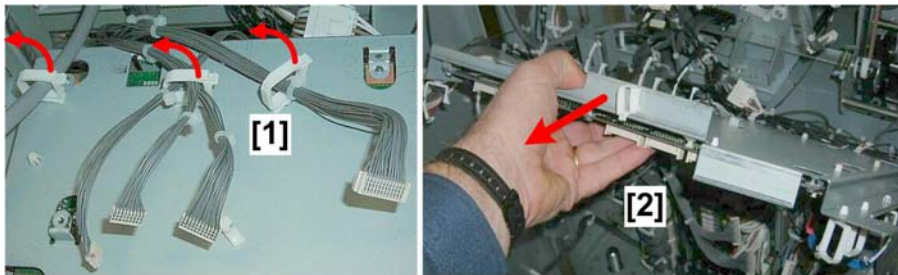

d074r604

1. Disconnect harnesses [1] on the back of the IOB where the BCU was removed ( x3).

- Remove the bracket and lay it on a flat surface.

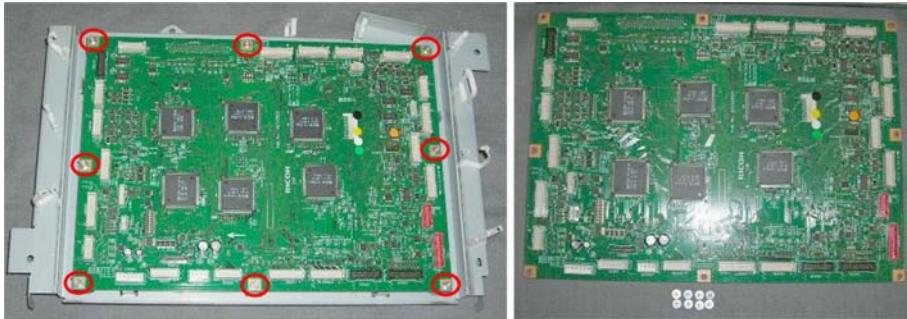



d074r605

- Remove the IOB ( x8).



4

Controller Board (GW), NVRAM, Controller Board Fan

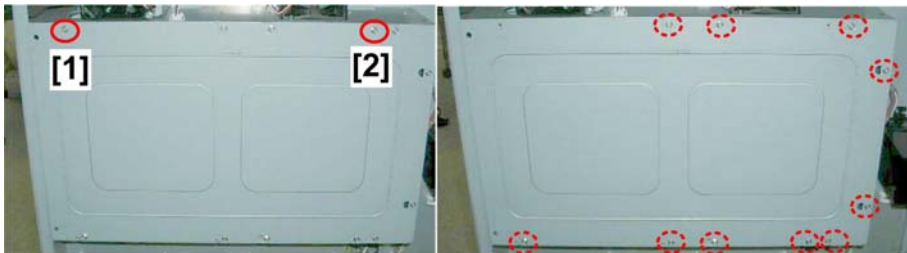
- Open the controller box ( x6). ( p.400)
- Controller box covers ( p.404)



d074r606

- The controller board is behind the slide cover.
- Remove** screws [1] and [2] ( x2).
- Loosen** the other screws ( x10). You do not need to remove all of these screws.



d074r607

- Slide the cover to the left and remove it.

4

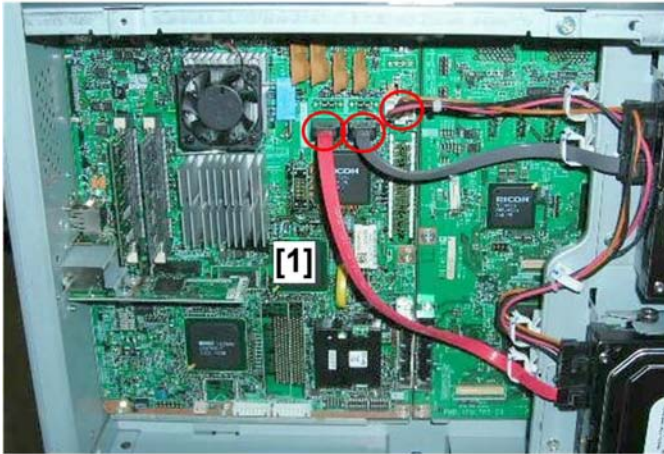

d074r608

- 7. Disconnect the HDD unit at [1] (🔧x3).
- 8. On the side of the controller box, disconnect the controller board bracket [2] (🔧x3).



d074r609

- 9. Remove the bracket and lay it on a flat surface.



d074r609b

- Remove the board [1] ( x6).

NVRAM

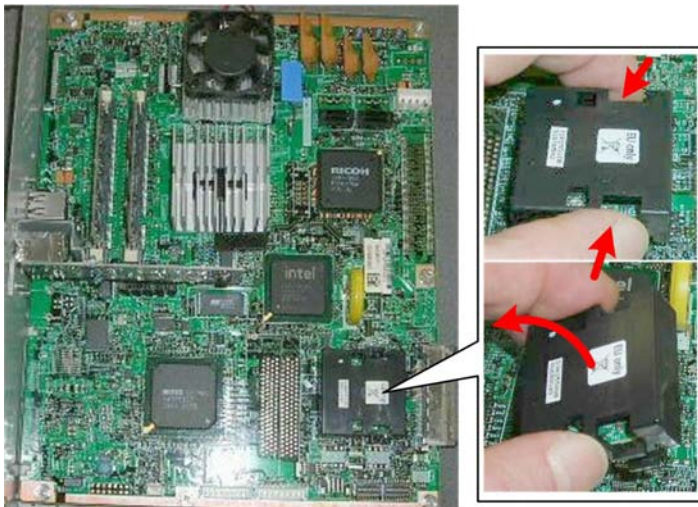

d074r609a

- Press in the sides of the NVRAM and remove it.

Controller Board Fan



d074r610

4

1. Remove the fan (🔩 x1, 🛠️ x2).

IPU

1. Follow the previous procedure to remove the controller board.

⬇️ Note

- You do not need to pull out the controller board.
- Just pull it out far enough to separate the controller board and IPU.



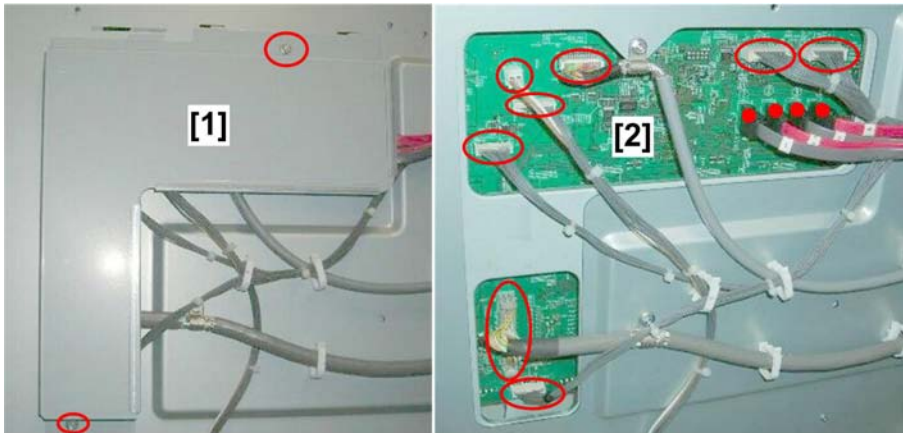

d074r611

2. Disconnect and remove the HDD bracket (🛠️ x4).



d074r612



3. On the other side of the controller box, remove shield plate [1] ( x2).
4. Disconnect the IPU [2] ( x12).



d074r613



5. On the other side of the controller box, remove the IPU ( x2,  x8).

HDD Units

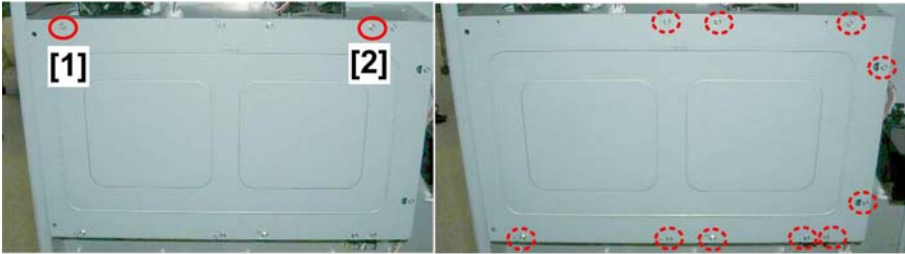
1. Open the controller box ( x6). ( p.400)
2. Controller box covers ( p.404)



d074r606

3. The HDD unit is behind the slide cover.
4. **Remove** screws [1] and [2] ( x2).
5. **Loosen** the other screws ( x10). You do not need to remove all of these screws.

4

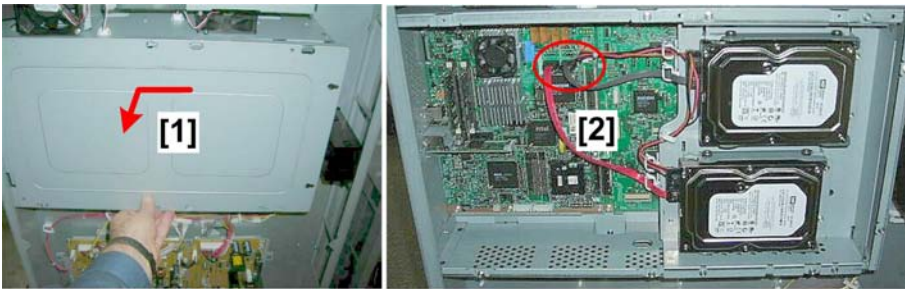

d074r607a

6. Slide the cover [1] to the left and remove it.
7. Disconnect the HDD unit [2] ( x3).



d074r615

8. Remove the HDD bracket and lay it on a flat surface ( x4).



d074r616

9. Disconnect the HDD (🔌 x2).



d074r617

10. Disconnect the HDD from the base bracket (🔧 x4).



d074r618

11. Disconnect the HDD from the floating bracket (🔧 x4).

★ Important

- Do not remove the four rubber grommets from the screw holes of the bracket.



d074r619

Re-installation





d074r620

★ Important

- When you re-attach the HDD unit bracket, do not tighten the four screws.
- These screws must remain up so the slide cover can be re-installed. Tighten these four screws after the slide cover has been re-attached.



Controller Box Fans

1. Open the controller box ( x6). ( p.400)
2. Controller box covers. ( p.404)

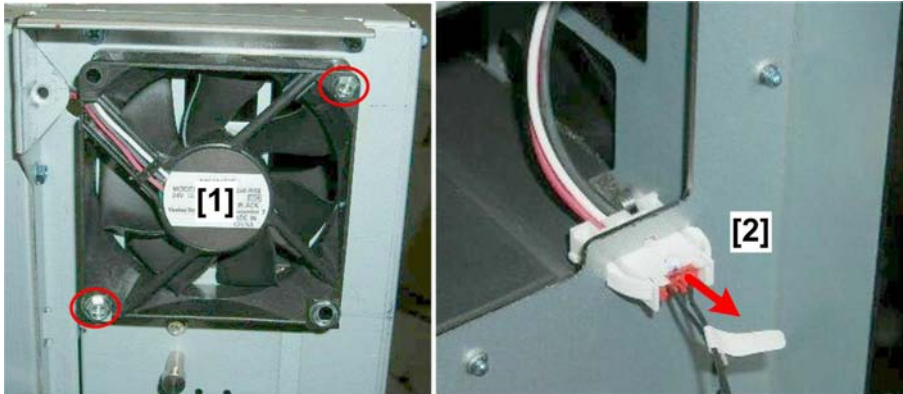
Left Corner Fan



d074r621

1. Disconnect the fan [1] on the corner ( x2).
2. Disconnect the fan at the rear and remove it ( x1).

Top Fans

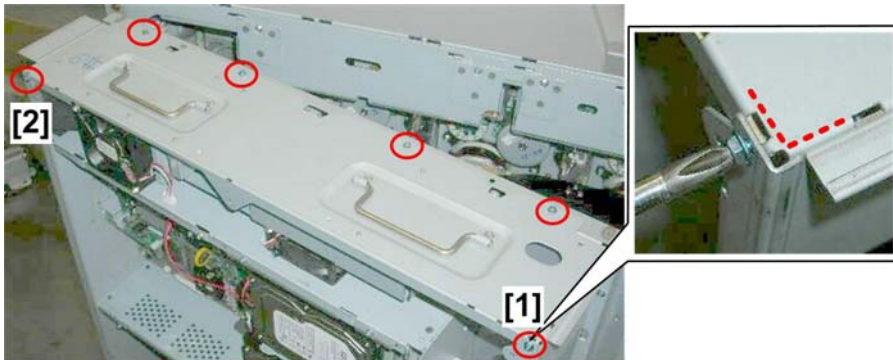

d074r622

1. Disconnect the top of the controller box ( x6).

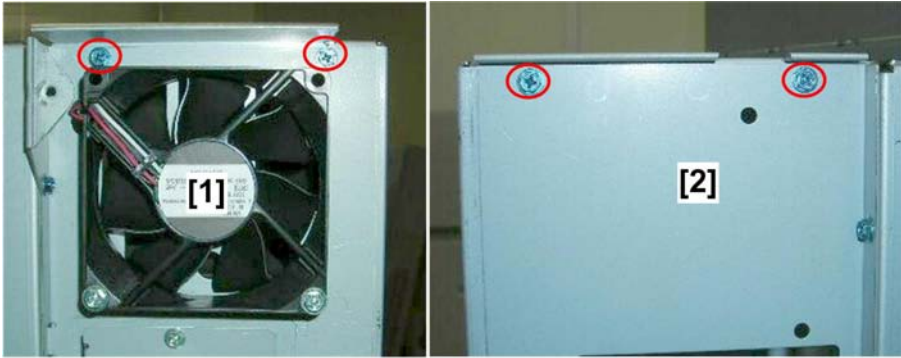

★ Important

- At the corners [1] and [2], note that the cover is tucked behind the vertical frame. The cover must be re-attached in the same way.



d074r623

4

- 2. Disconnect the left end of the cover [1] ( x1).
- 3. Disconnect the right end of the cover [2] ( x2).

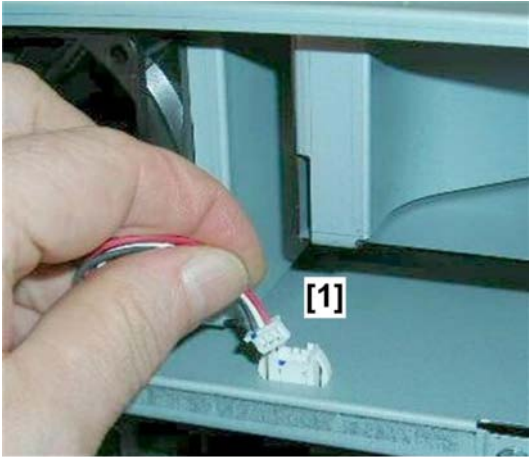

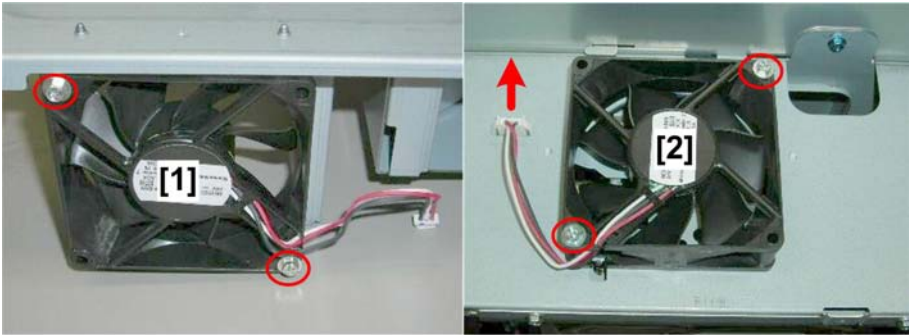

d074r624

- 4. Disconnect the vertical connector [1] ( x1).











d074r625

- 5. Remove the vertical fan [1] ( x2).
- 6. Remove the horizontal fan [2] ( x1,  x2).

Fans and Filters

Before You Refer to This Section

The removal procedures for the following fans are described in other sections of the Replacement and Adjustment section of this manual.

Fan	See
CIS Fan	( p.408 "Removing the Right Drawer")
Controller Board Fan	( p.808 "Main Boards, HDD Units")
Controller Box Drive Exhaust Fan	
Controller Box Exhaust Fan 1 (Top)	
Controller Box Exhaust Fan 2 (Top)	
Controller Box Intake Fan 1 (Bottom)	
Controller Box Intake Fan 2 (Bottom)	
Development Unit Cooling Fan 1	( p.547 "Photoconductor Development Unit (PCDU)")
Development Unit Cooling Fan 2	
Development Unit Cooling Fan 3	
ID/MUSIC Sensor Fan	( p.592 "Image Transfer Belt (ITB) Unit")
ITB Belt Cleaning Cooling Fan	( p.440 "Removing the Left Drawer")
Lamp Regulator Cooling Fan	( p.480 "Scanner Unit")
PSU 2 Cooling Fan 1	( p.816 "PSU 2, PSU 2 Fans")
PSU 2 Cooling Fan 1	( p.816 "PSU 2, PSU 2 Fans")
PSU 2 Intake Fans (x2)	( p.808 "Main Boards, HDD Units")
PTB Fan - Center	
PTB Fan - Front	
PTB Fan - Rear	

Fan	See
PTB Fans	(p.720 "Paper Transport Belt (PTB) Unit")
Pressure Roller Fan	
Scanner Unit Cooling Fan	(p.480 "Scanner Unit")
Toner Supply Cooling Fan	(p.517 "Toner Supply")

Fan Layout

4

Left Drawer

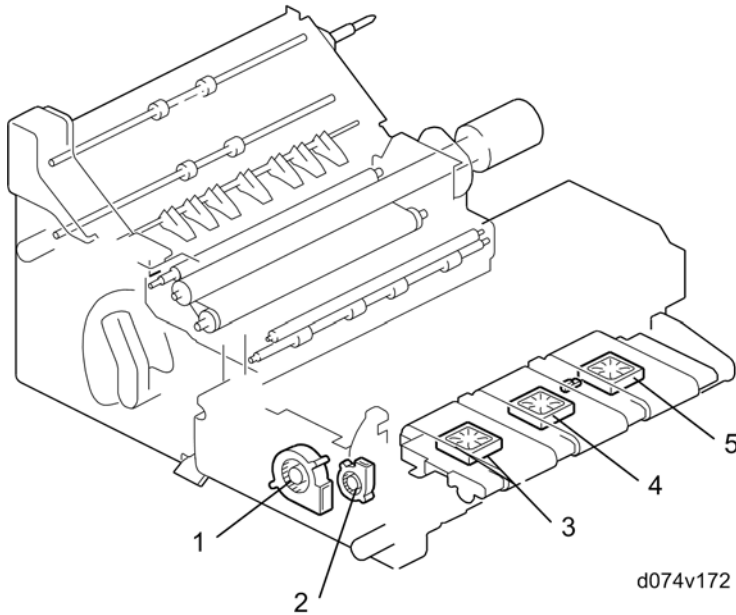

1	Pressure Roller Fan
2	ITB Belt Cooling Fan
3	PTB Fan - Front
4	PTB Fan - Center
5	PTB Fan - Rear

Inside the Main Machine

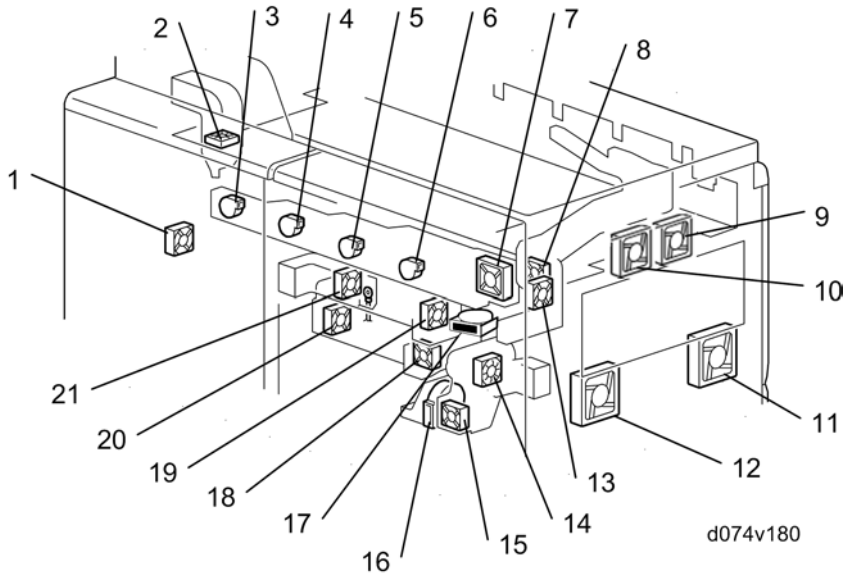

1	ITB Intake Fan	12	Duplex Exhaust Fan - Rear
2	Used Toner Intake Fan	13	Drive Exhaust Fan
3	Ozone Exhaust Fan (K)	14	Paper Cooling Intake Fan
4	Ozone Exhaust Fan (C)	15	Paper Cooling Exhaust Fan
5	Ozone Exhaust Fan (M)	16	Fusing Unit Transport Exhaust Fan
6	Ozone Exhaust Fan (Y)	17	Fusing Exit Exhaust Fan
7	Ozone Collection Fan	18	Used Toner Exhaust Fan
8	Toner Supply Cooling Fan	19	Heat Sink Exhaust Fan
9	Paper Exit Exhaust Fan - Front	20	Belt Cleaning Exhaust Fan
10	Paper Exit Exhaust Fan - Rear	21	Heat Sink Intake Fan
11	Duplex Exhaust Fan - Front		

Controller Box, Cooling Box

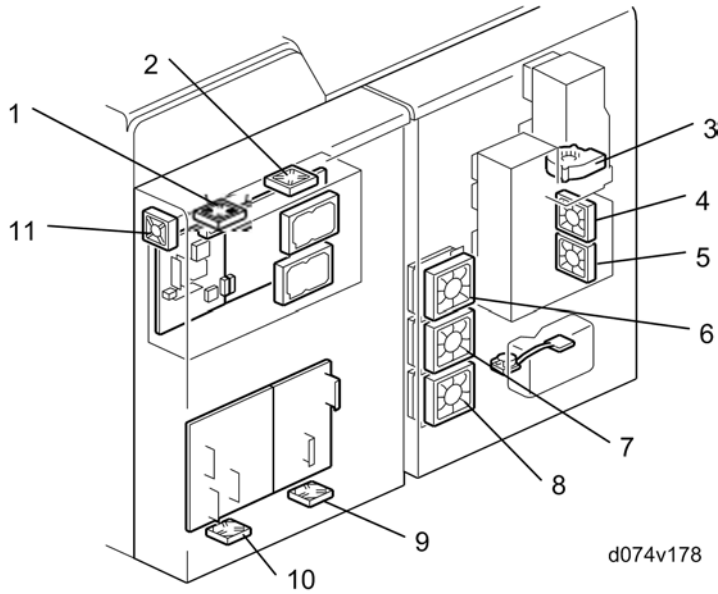

1	Controller Box Exhaust Fan 1	7	Development Unit Cooling Fan 2
2	Controller Box Exhaust Fan 2	8	Development Unit Cooling Fan 3
3	Cooling Box Ozone Exhaust Fan	9	Controller Box Intake Fan 2
4	Cooling Box Emission Exhaust Fan	10	Controller Box Intake Fan 1
5	Cooling Box Heat Fan	11	Controller Box Exhaust Fan
6	Development Unit Cooling Fan 1		

Ducts and Fans Back of Main Machine

The removal procedures for the following fans are described in this section.

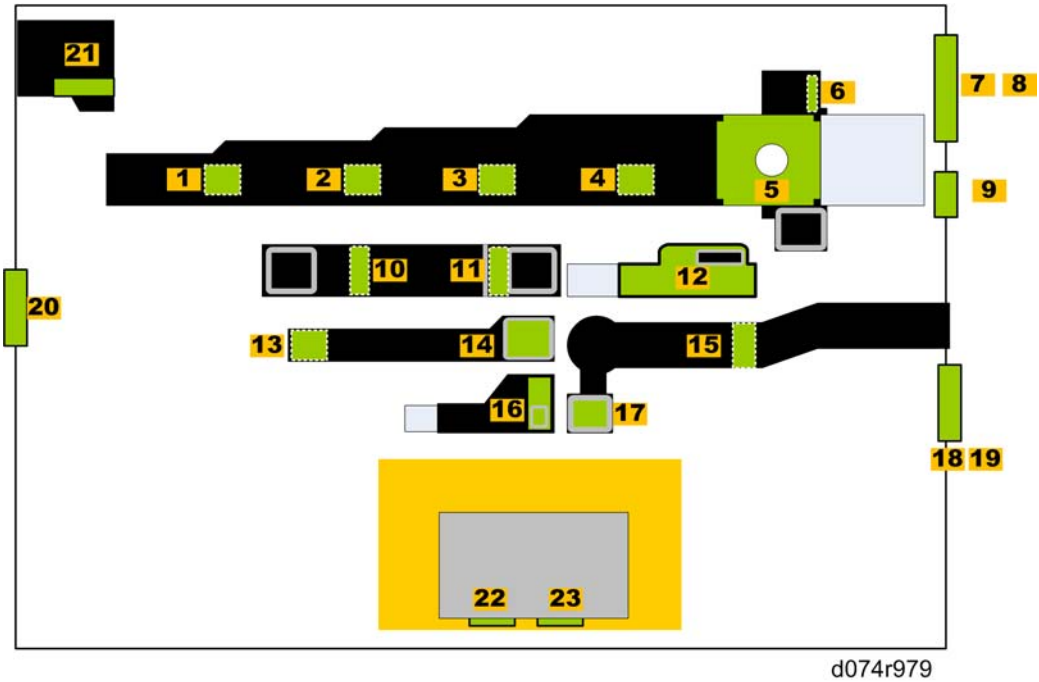

This drawing illustrates the back of the machine with the right and left covers removed and the rear boxes open. Most of these fans are not visible because they are inside the ducts.

1	Ozone Exhaust Fan (K)	13	Belt Cleaning Exhaust Fan
2	Ozone Exhaust Fan (C)	14	Used Toner Exhaust Fan
3	Ozone Exhaust Fan (M)	15	Paper Cooling Intake Fan
4	Ozone Exhaust Fan (Y)	16	Fusing Unit Transport Exhaust Fan
5	Ozone Collection Fan	17	Paper Cooling Exhaust Fan
6	Toner Supply Cooling Fan	18	Duplex Exhaust Fan - Front
7	Paper Exit Exhaust Fan - Front	19	Duplex Exhaust Fan - Rear
8	Paper Exit Exhaust Fan - Rear	20	ITB Intake Fan
9	Drive Exhaust Fan	21	Used Toner Exhaust Fan
10	Heat Sink Intake Fan	22	PSU 2 Cooling Fan 1
11	Heat Sink Exhaust Fan	23	PSU 2 Cooling Fan 2
12	Fusing Exit Exhaust Fan		

Ducts: Cooling Box Fans

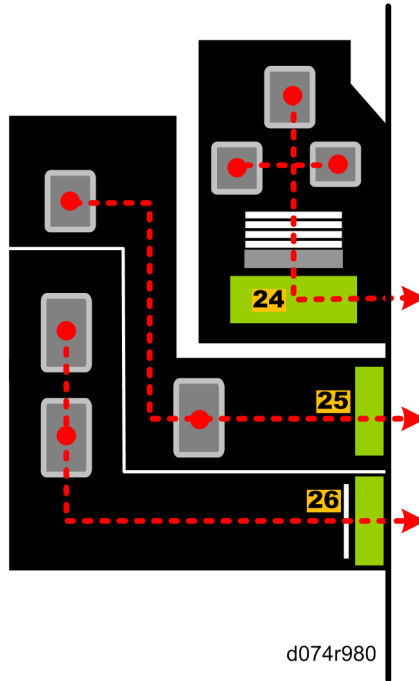



d074r980

This drawing illustrates the fans inside the cooling box with all covers removed.

24	Cooling Box Ozone Exhaust Fan
25	Cooling Box Emission Exhaust Fan
26	Cooling Box Heat Fan

Ozone Exhaust Fans (YMCK), Ozone Collection Fan

1. Open the rear boxes ( x3) ( p.400)
2. Remove the center stay ( x3).

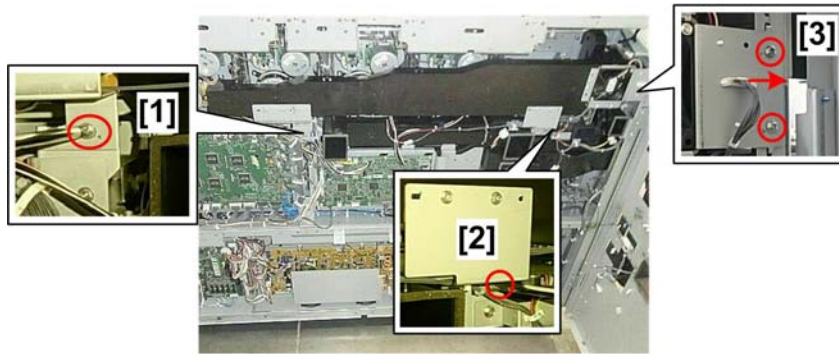

d074r831

3. Disconnect the horizontal duct:

[1] Left (🔩 x1)

[2] Center (🔩 x1)

[3] Right (🔩 x1, 🔩 x2)

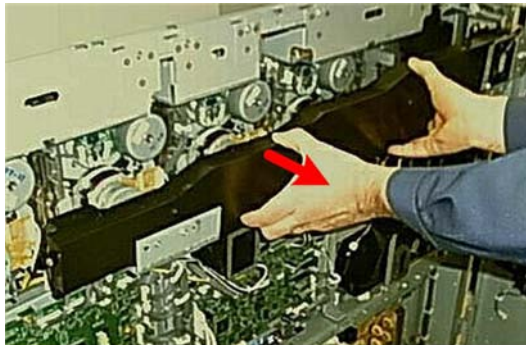

d074r832

4. Remove the duct and lay it on a flat surface.

Ozone Exhaust Fans

⚠ Note

- The following procedure is the same for all four ozone exhaust fans (YMCK) mounted inside the duct.

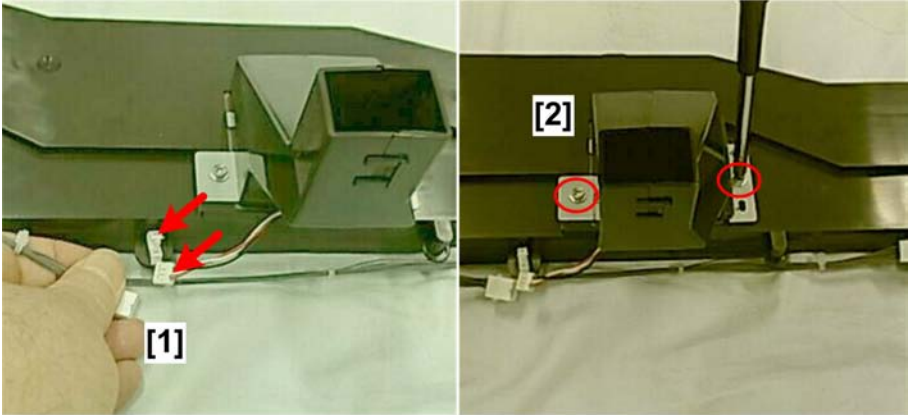

d074r833

4

1. Disconnect the fan [1] (🔌 x1, 📡 x1).
2. Disconnect the fan bracket [2] (🔩 x2).

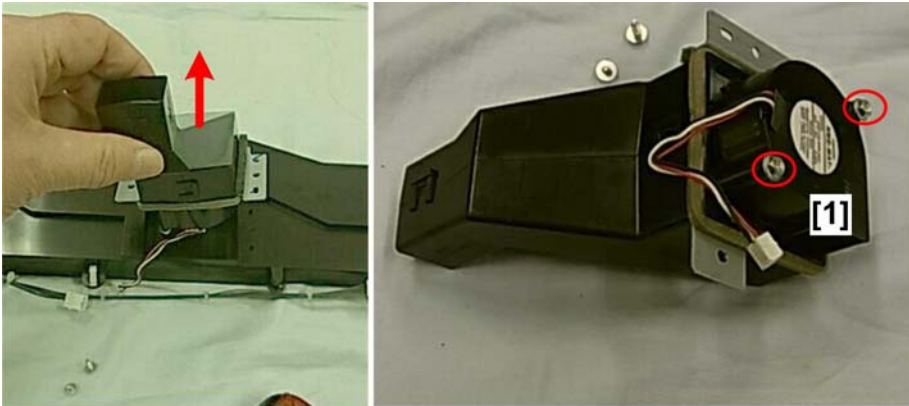

d074r834

3. Remove the fan [1] from the bracket (🔩 x2).



d074r835

4. Remove the ozone exhaust fan.

Ozone Collection Fan

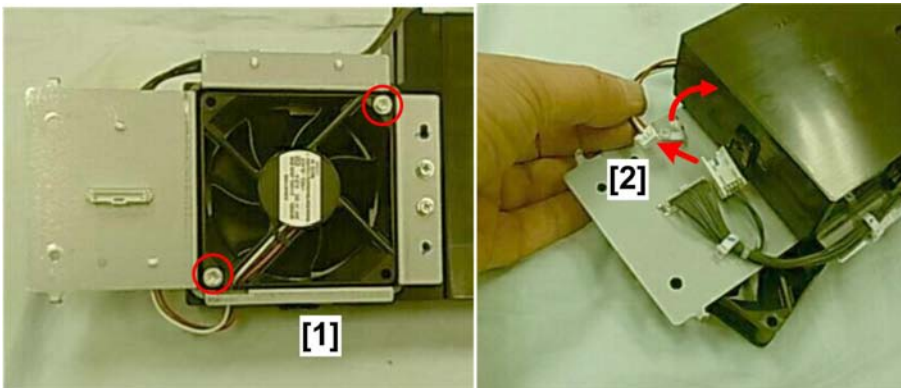

d074r836

1. On the end of the duct, disconnect the fan bracket [1] (🔩 x2).
2. Turn over the duct and disconnect harness [2] (🔌 x1, 📦 x1).

4

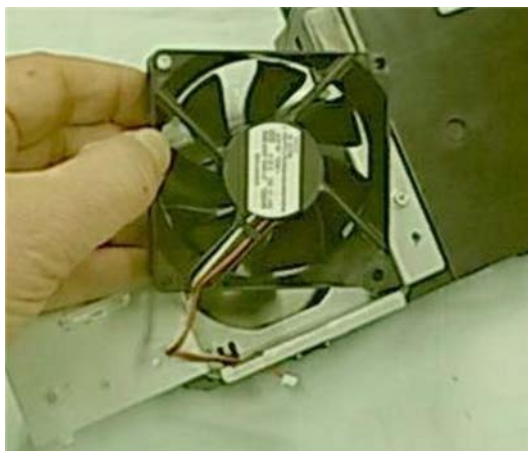

d074r837

3. Remove the fan.

Toner Supply Cooling Fan

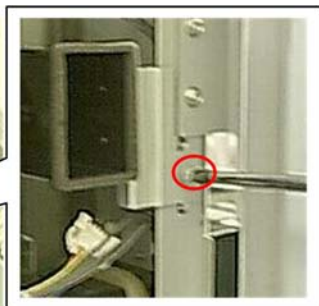
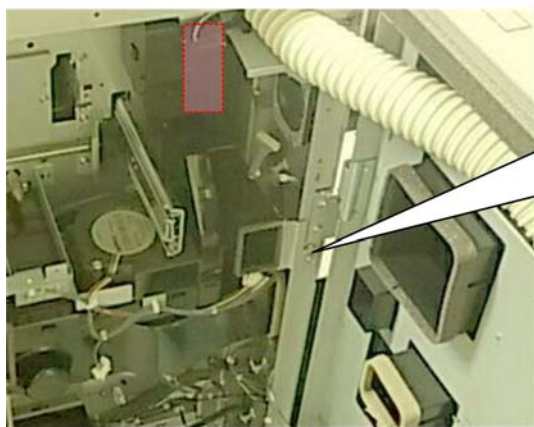

d074r838

1. Open the cooling box (■ p.400)
2. Disconnect the duct bracket (🔧 x1).

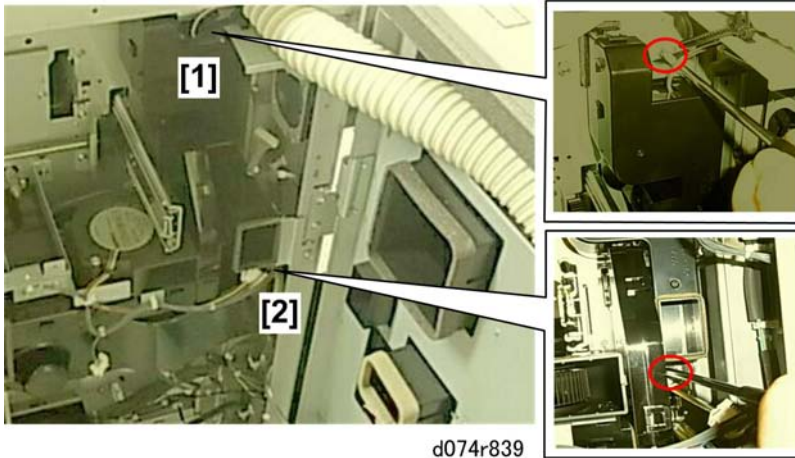

d074r839

3. Disconnect the duct at the top [1] and bottom [2] ( x2).

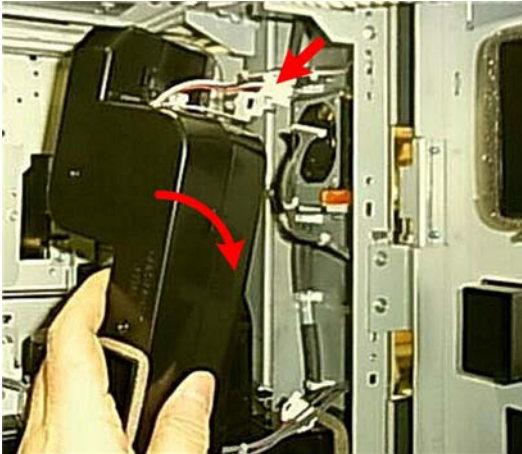

d074r840

4. Disconnect the fan and remove the duct ( x1).

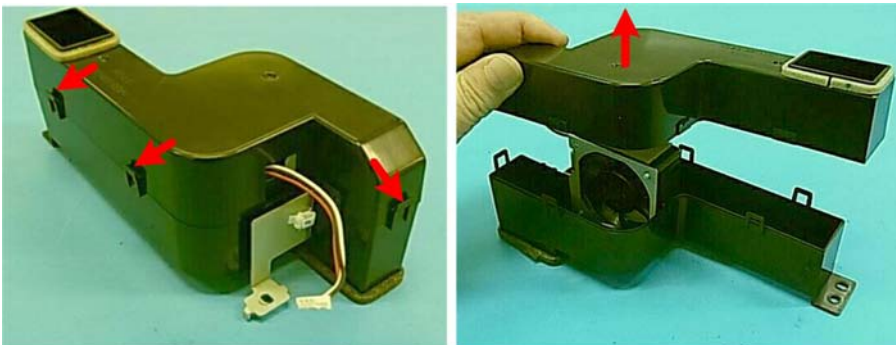

d074r841

5. Release all the lock tabs around the seam where the top and bottom of the duct are connected.

6. Separate the top and bottom.

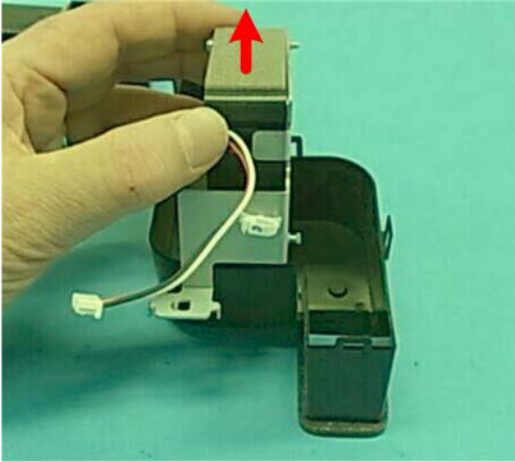

d074r842

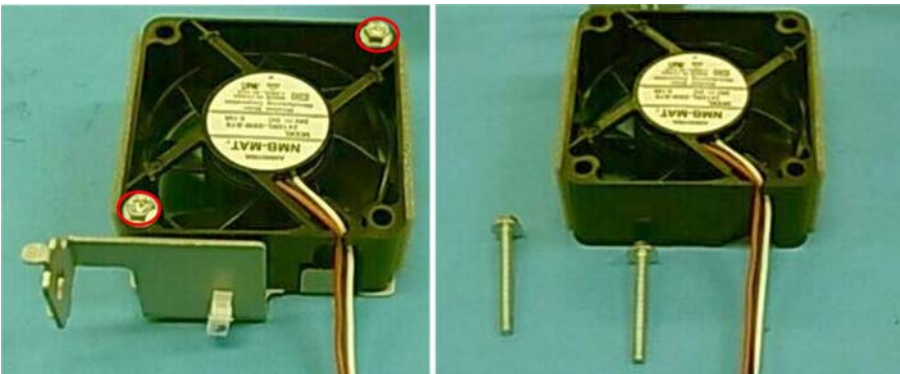

7. Remove the fan and bracket.



d074r843

8. Remove the fan ( x2).

Heat Sink Intake Fan

1. Open the rear boxes ( x3) ( p.400)
2. Remove the center stay ( x3).

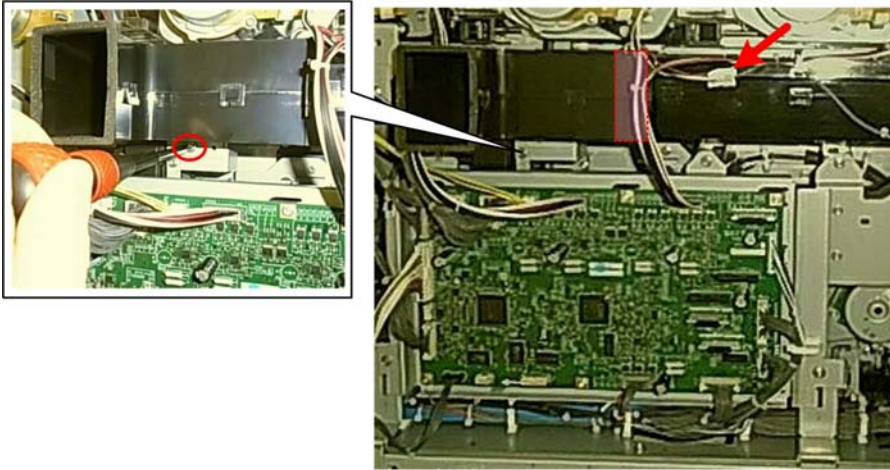

d074r844

3. Disconnect the duct bracket and disconnect the fan ( x1,  x1).

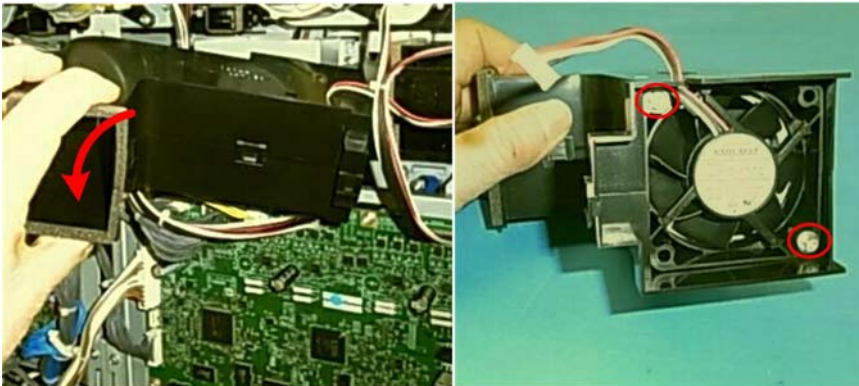

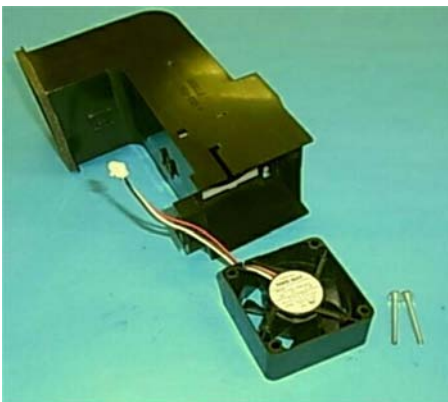

d074r845

4. Remove the duct and then remove the fan ( x2).





d074r846

Heat Sink Exhaust Fan

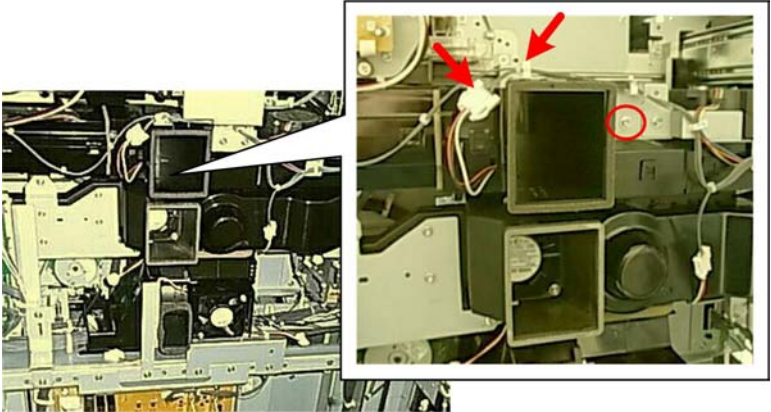
1. Open the rear boxes ( x3) ( p.400)
2. Remove the center stay ( x3).



d074r847

3. Disconnect the duct, fan harness, and fan ( x1,  x1,  x1).

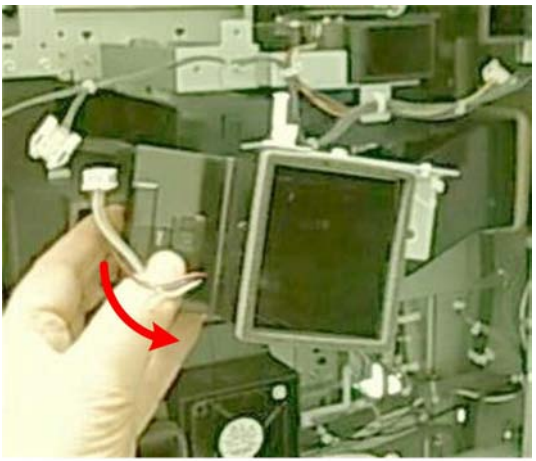

d074r848

4. Remove the duct and lay it on a flat surface.

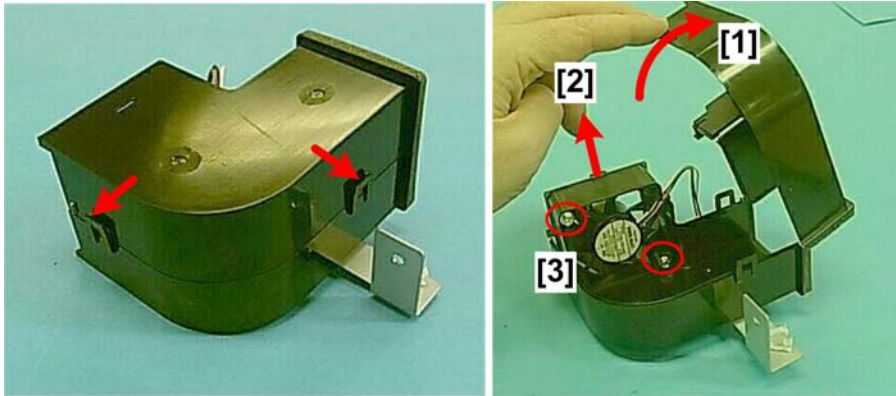

d074r849

5. Release all the lock tabs around the seam where the top and bottom of the duct are connected.
6. Raise the top of the duct [1].
7. Remove the fan and bracket assembly [2] and then disconnect the fan [3] ( x2).

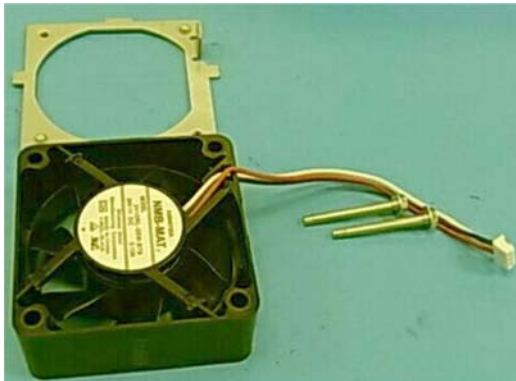

d074r850

Fusing Exit Exhaust Fan

1. Open the rear boxes ( x3) ( p.400)

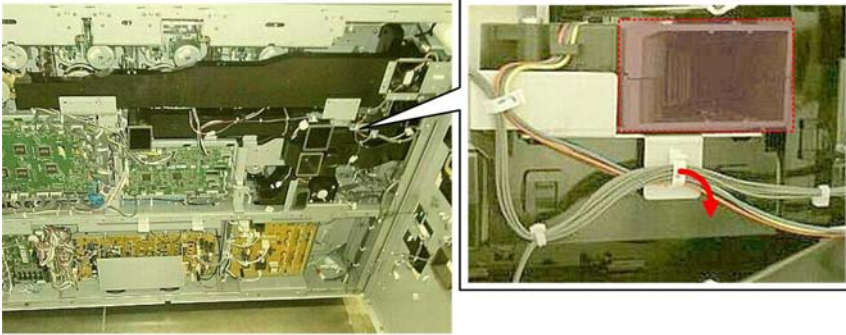

d074r851

2. Free the harnesses (🔧x1).

4

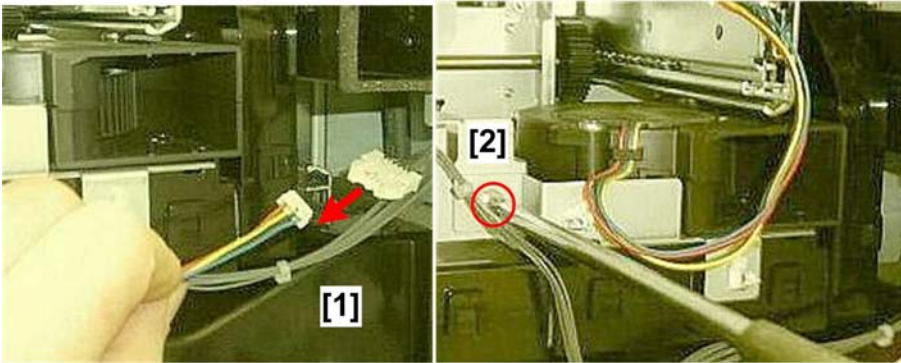

d074r852

3. Disconnect the fan [1] (🔧x1).
4. Disconnect the fan bracket [2] (🔧x1).

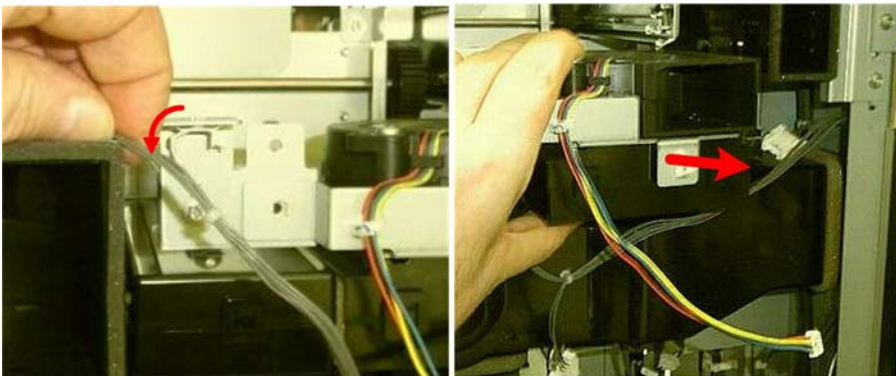

d074r853

5. Free the harness at the left (🔧x1).
6. Pull the fan and bracket assembly straight out to remove it.

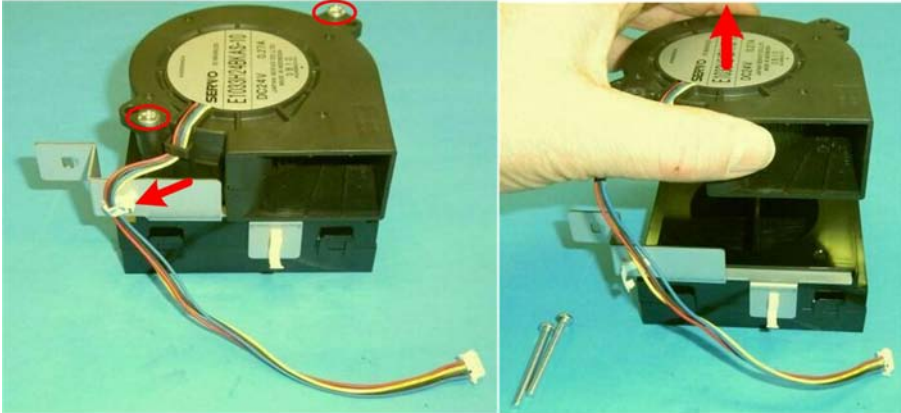

d074r854

7. Remove the fan from the bracket ( x2).





d074r855

Drive Exhaust Fan

4



d074r856

1. Remove the left cover of the main machine ( x7).
2. Open the cooling box. ( p.400)



d074r857

3. Behind the cooling box, disconnect the fan ( x1).



d074r858

4. Remove the fan ( x2).

4





d074r859

Belt Cleaning Exhaust Fan

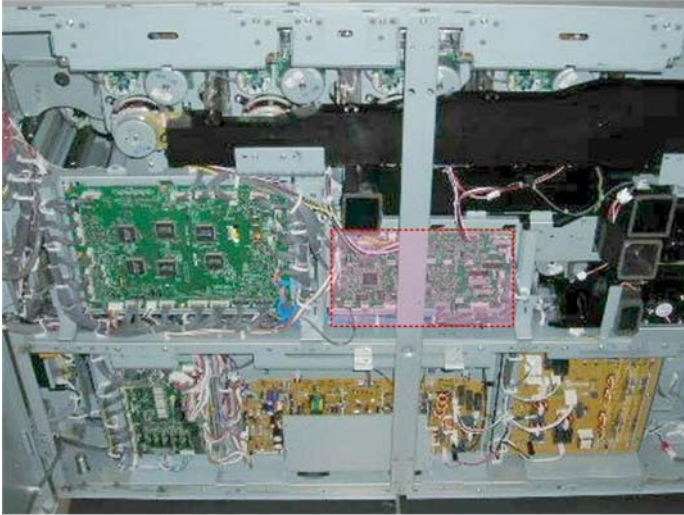
4



d074r860

1. Open the rear boxes ( x3) ( p.400)
2. Remove the center stay ( x3).

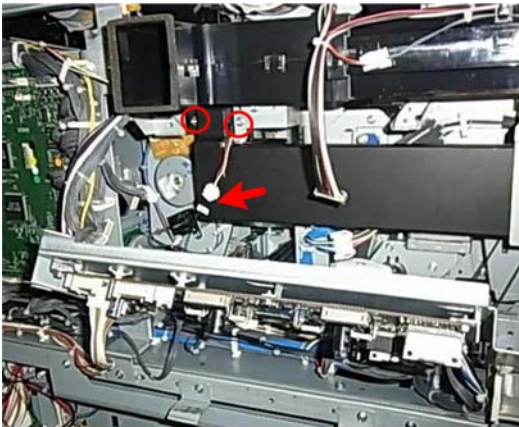

d074r861

3. On the left, disconnect the duct bracket and fan ( x2,  x1).

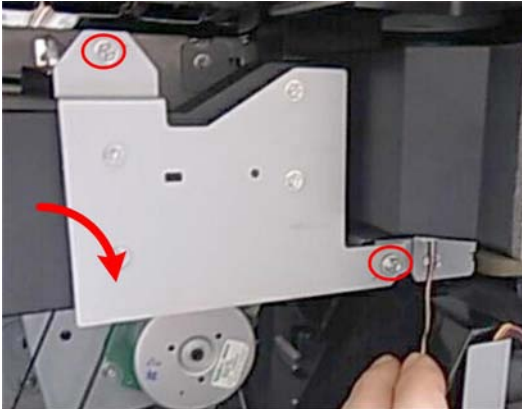

d074r862

4. On the right, disconnect the duct bracket and remove the duct ( x2).

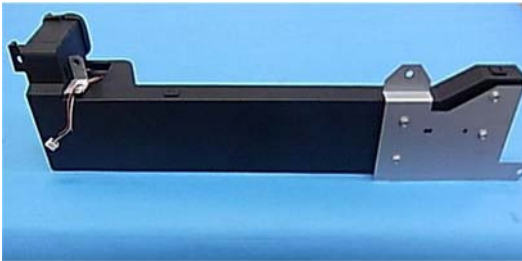

d074r863

5. Lay the duct on a flat surface.

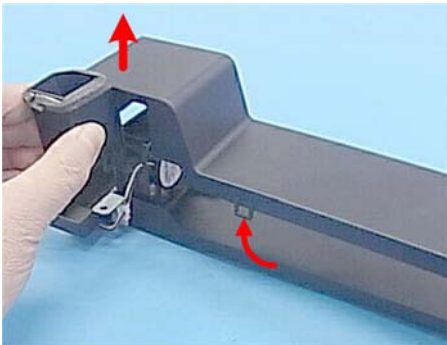

d074r864

6. Release all the lock tabs around the seam where the top and bottom of the duct are connected.
7. Separate the top and bottom.

4

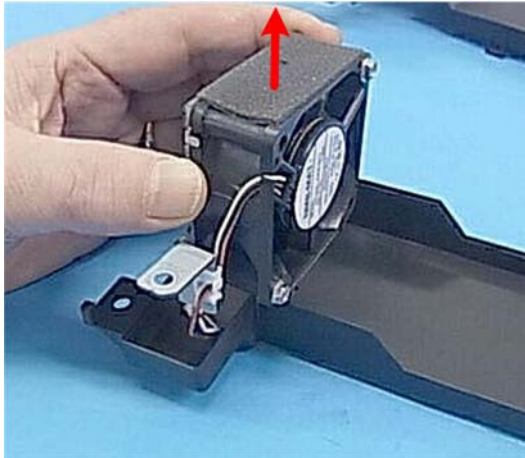

d074r865

8. Remove the fan bracket and fan.

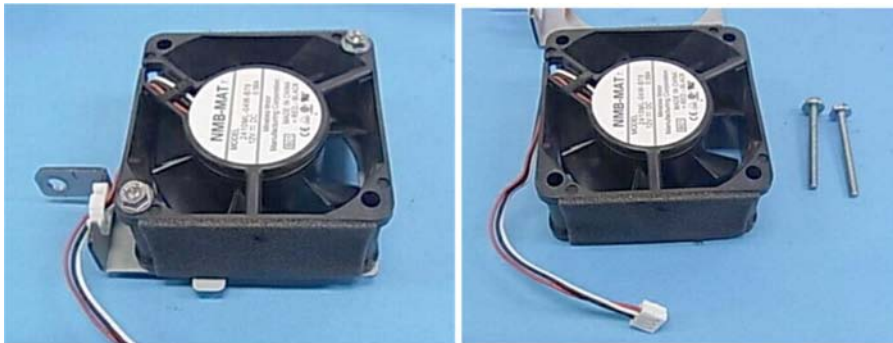

d074r866

9. Remove the fan ( x2).

Stray Toner Exhaust Fan

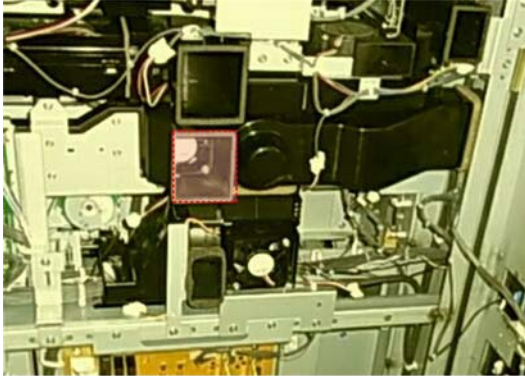

d074r867

1. Open the cooling box (🔧 p.400)



d074r868

2. Disconnect the fan and duct bracket (🔧 x1, 🔧 x1).

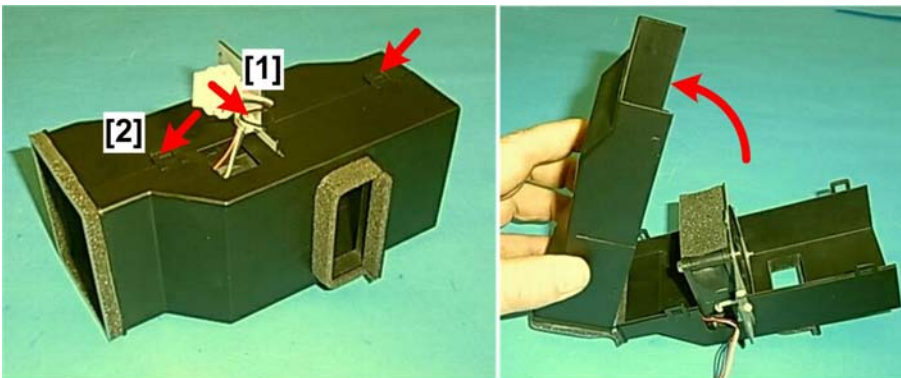

d074r869

3. Free harness [1] (🔧 x1).

4. Release all the lock tabs [2] around the seam where the top and bottom of the duct are connected.
5. Open the duct.

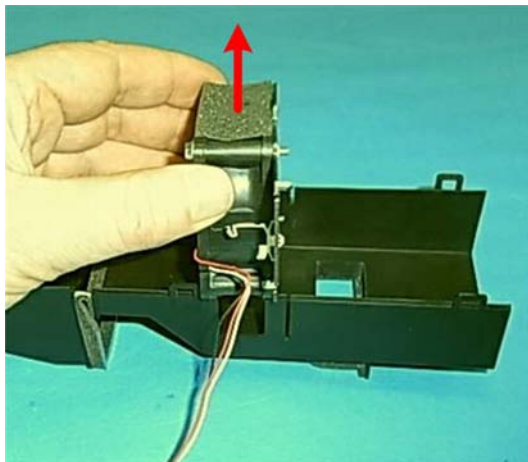

d074r870

6. Remove the bracket and fan.

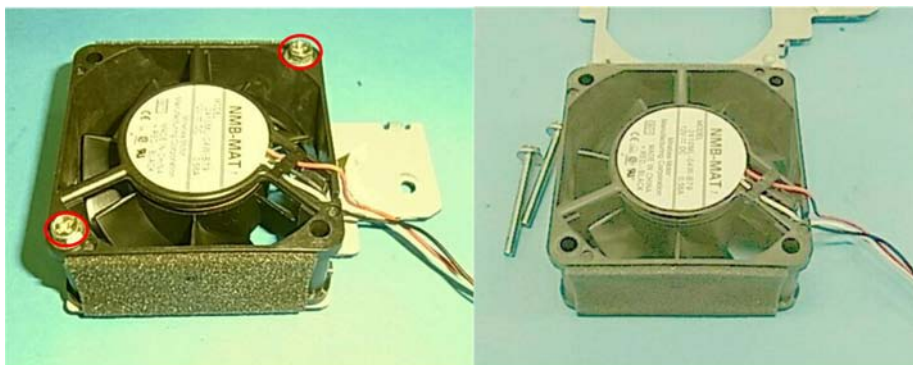

d074r871

7. Remove the fan ( x2).

Paper Cooling Intake Fan

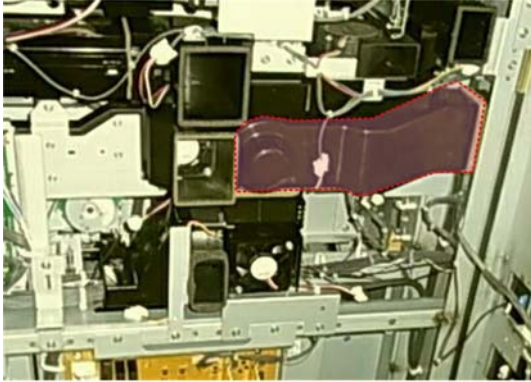

d074r872

1. Open the cooling box (▶ p.400).

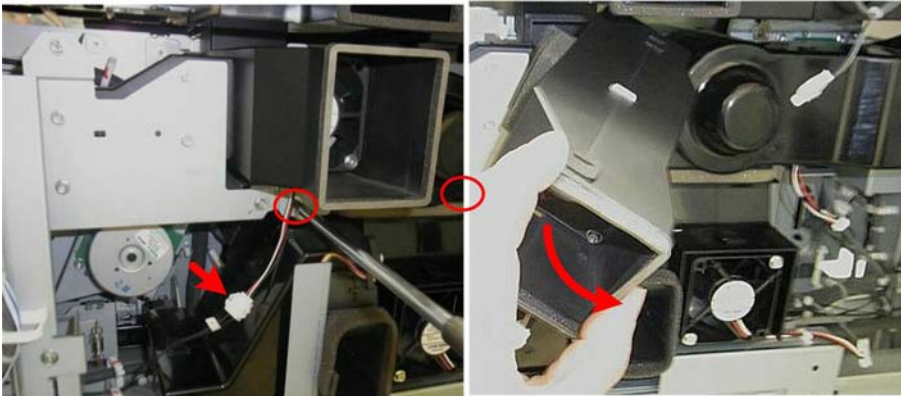

d074r873

2. Disconnect the fan and duct, and then remove the duct (🔧 x1, 🛠️ x2).

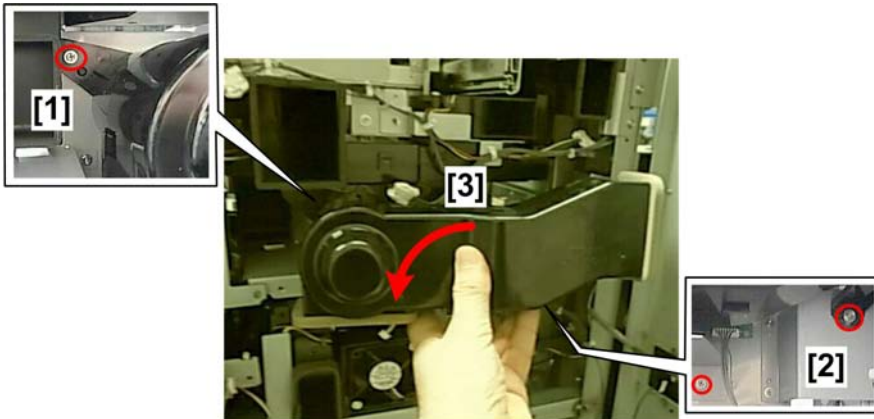

d074r874

3. Remove:

[1] Left ( x1)

[2] Right ( x2).

[3] Duct

4

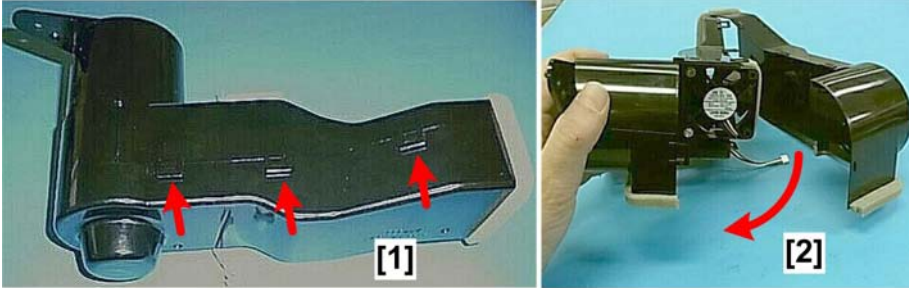

d074r875

4. Release all the lock tabs [1] around the seam where the top and bottom of the duct are connected.

5. Open the duct [2].

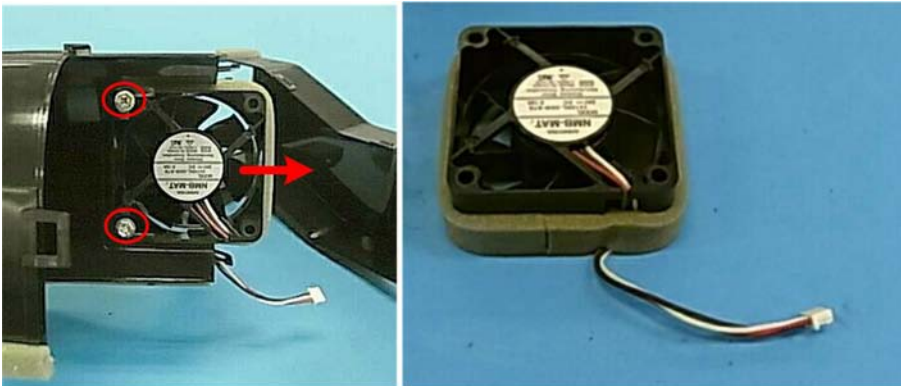

d074r876

6. Remove the bracket and fan, and then remove the fan ( x2).

Paper Cooling Exhaust Fan

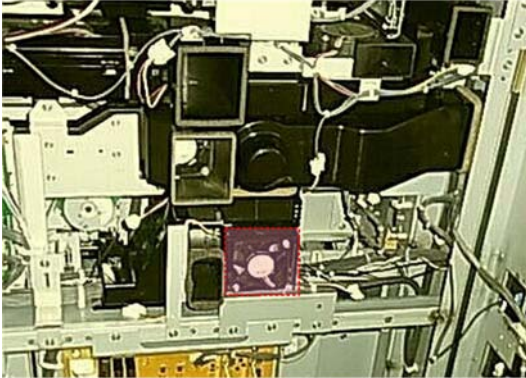

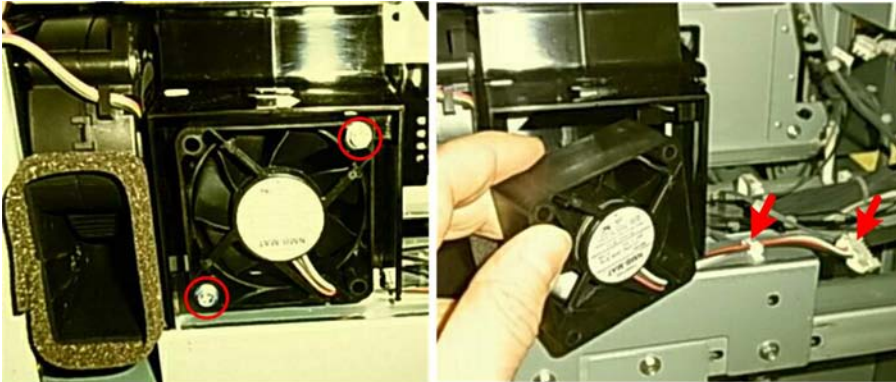

d074r877

1. Open the cooling box (p.400).



d074r878

2. Disconnect and remove the fan ( x2,  x1,  x1)

Fusing Unit Transport Exhaust Fan

4

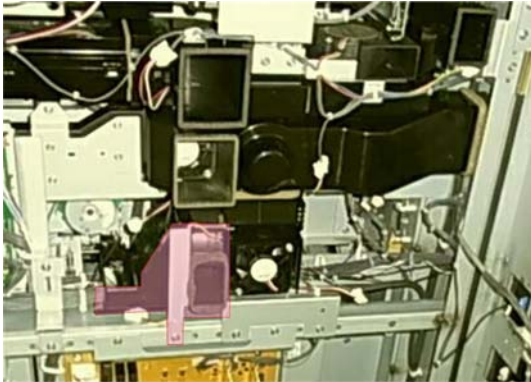

d074r879

1. Open the cooling box (🔧 p.400).

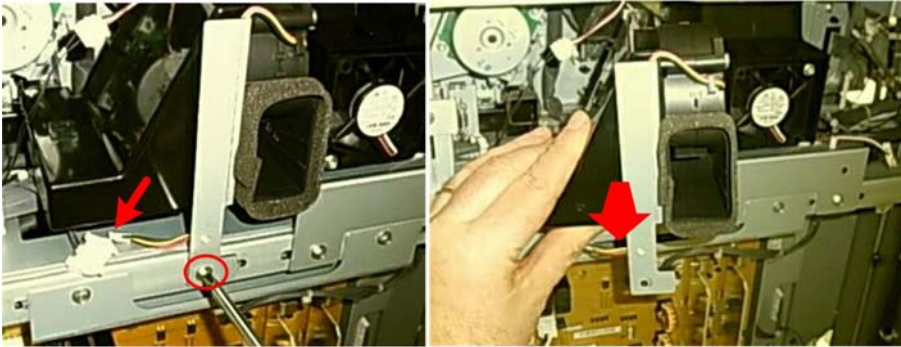

d074r880

2. Disconnect the fan and bracket, and then remove the bracket (🔧 x1, 🔩 x1).



d074r881

- Free the harness and then remove the fan (🔧 x1, 🔩 x2).



d074r882

4

Duplex Exhaust Fans

Duplex Exhaust Fan - Rear

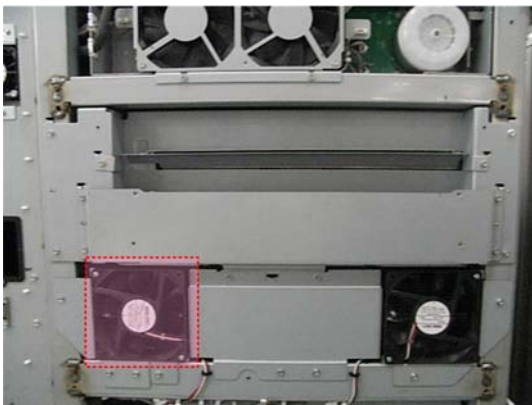

d074r883

- Open the cooling box (🔧 p.400).
- Remove the left cover of the main machine (🔩 x7).

4

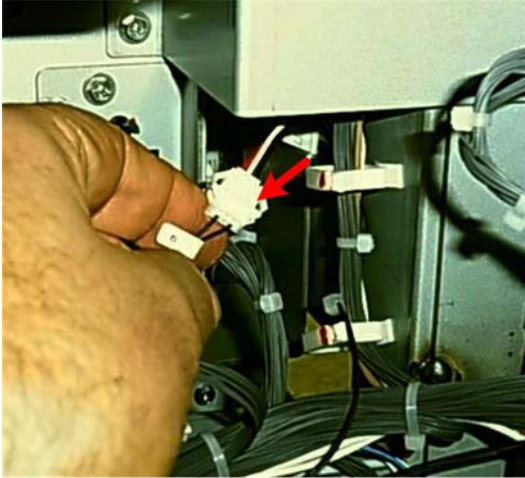

d074r884

3. Behind the cooling box, disconnect the fan (🔧 x1).

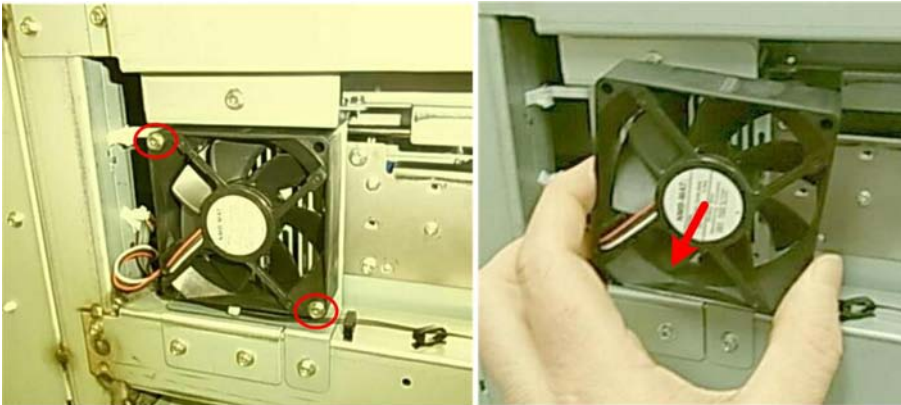

d074r885

4. Remove the fan (🔧 x2).



d074r886

Duplex Exhaust Fan - Front

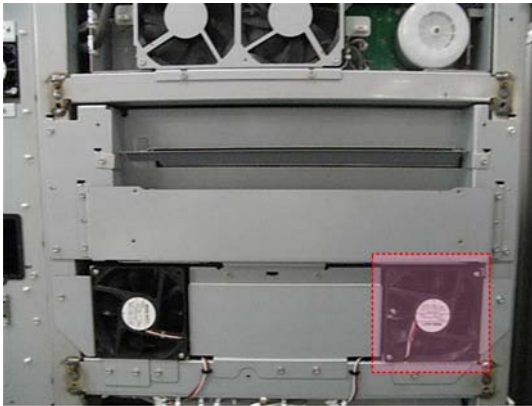

d074r887

1. Remove the left cover of the main machine (🔧 x7).

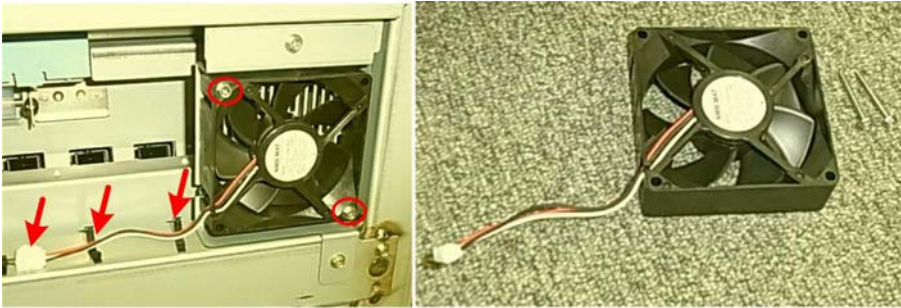

d074r888

2. Disconnect and remove the fan (🔧 x1, 🛠️ x2, 🔧 x2).

Used Toner Intake Fan



d074r890

1. Right cover ( Right Cover)

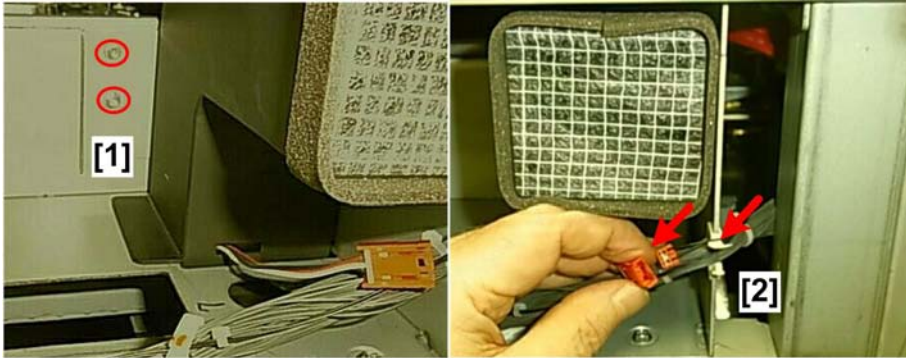

d074r891

4

2. Disconnect the duct bracket [1] ( x2).

3. Disconnect the fan [2] ( x1,  x1).

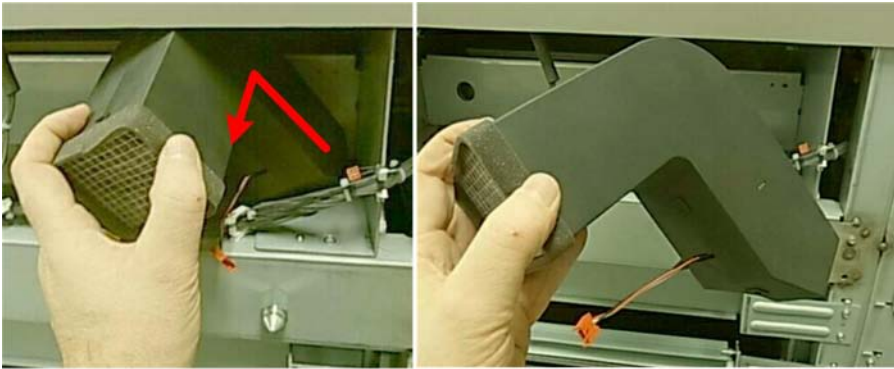

d074r892

4. Remove the duct.

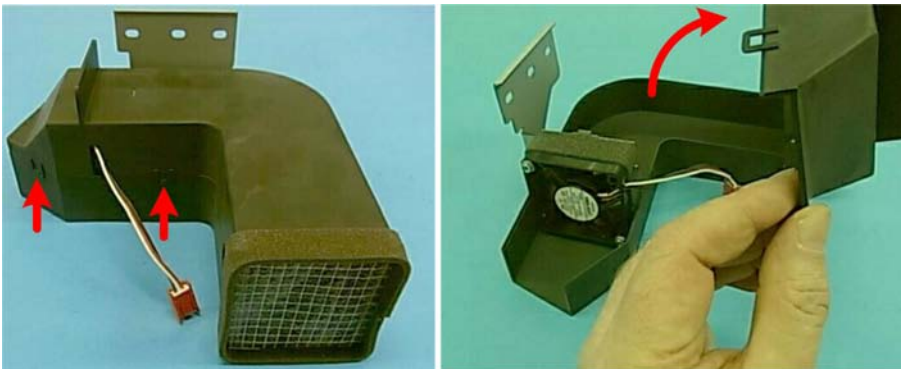

d074r893

5. Release all the lock tabs around the seam where the top and bottom of the duct are connected and open the duct.

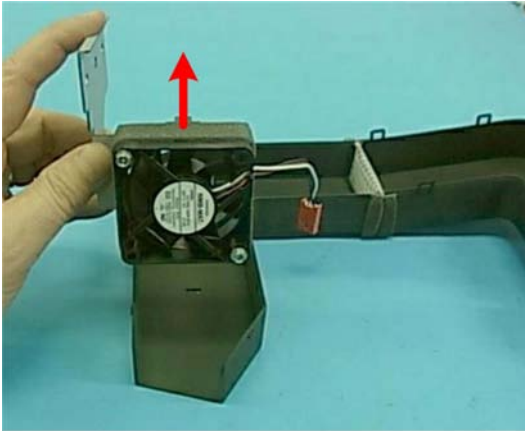

d074r894

6. Remove the bracket and fan.

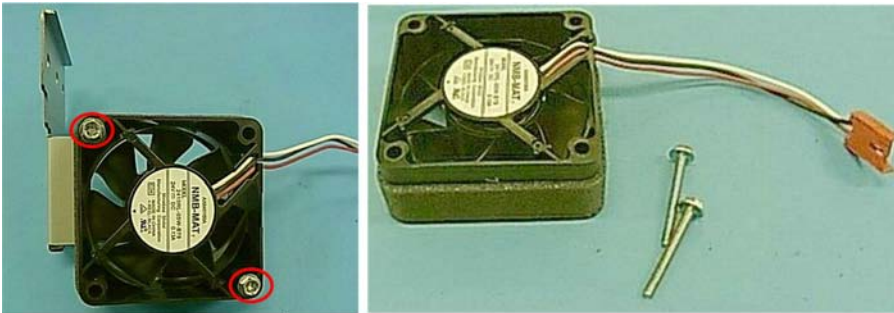

d074r895

7. Remove the fan ( x2).

ITB Intake Fan



d074r896

1. Right cover (🔧 p.406)
2. Open the controller box. (🔧 p.400)



d074r897

4

3. Lower the IOB [1] (🔧 p.830).
4. Disconnect the fan [2] (🔧 x1).

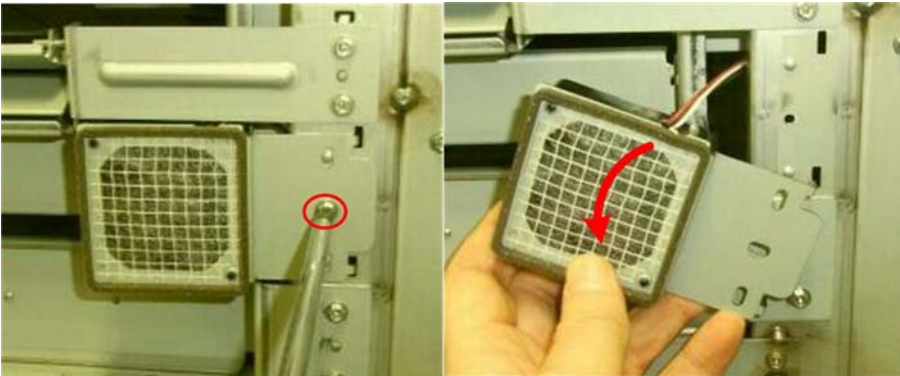

d074r898

5. On the right side of the machine, disconnect and remove the fan bracket (🔧 x1).

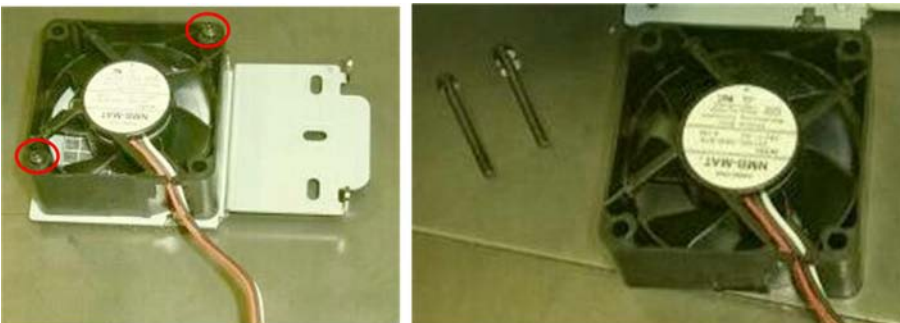

d074r899

6. Remove the fan (🔧 x2).

Cooling Box Fans

Preparation



d074r900

Remove the cooling box covers. (▶ p.402)

1. Remove the collar (🔩 x4).



d074r901

4

2. Remove the left panel of the cooling box ( x10).

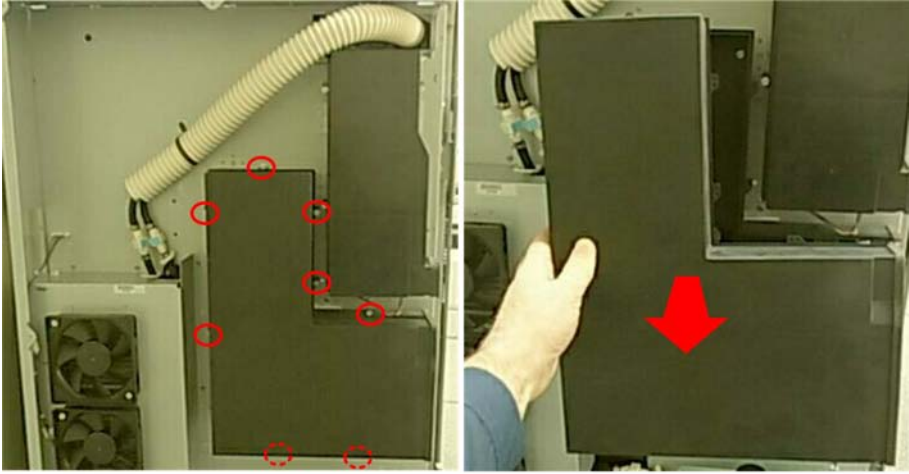

d074r902

3. Remove the lower fan cover ( x8).

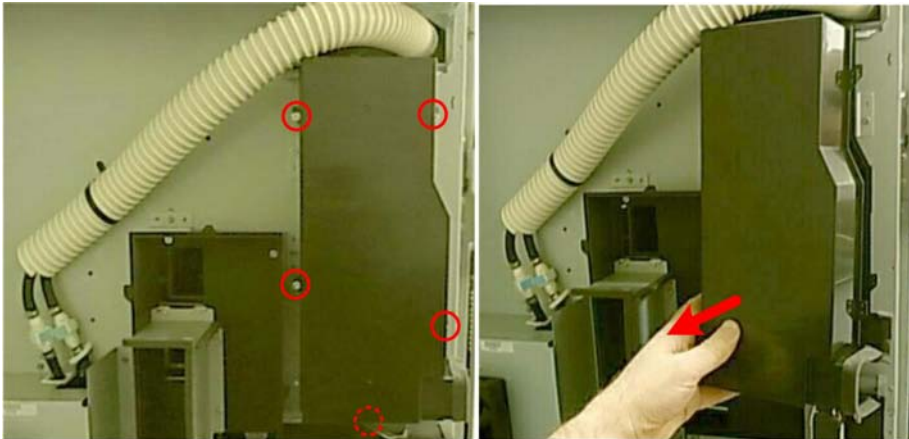

d074r903

4. Remove the upper fan cover ( x5).

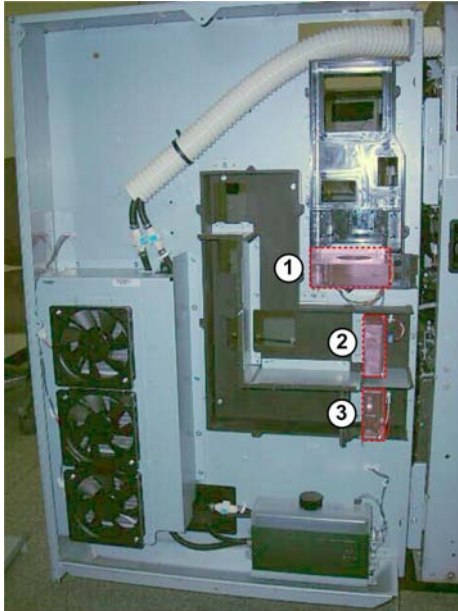

d074r903a

There are three duct fans in the cooling box.

①	Cooling Box Ozone Exhaust Fan
②	Cooling Box Emission Exhaust Fan
③	Cooling Box Heat Fan

Cooling Box Emission Exhaust Fan

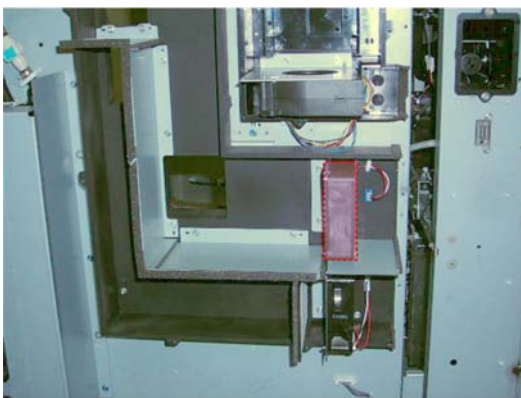

d074r903b

1. The fan is behind the bottom "L" cover.

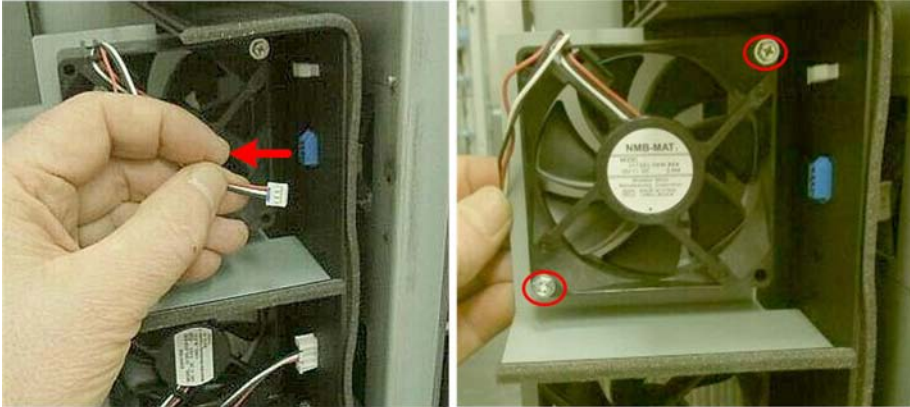

d074r904

4

- 2. Disconnect and remove the fan (🔌 x1, 🔩 x2).



d074r905

Cooling Box Heat Fan

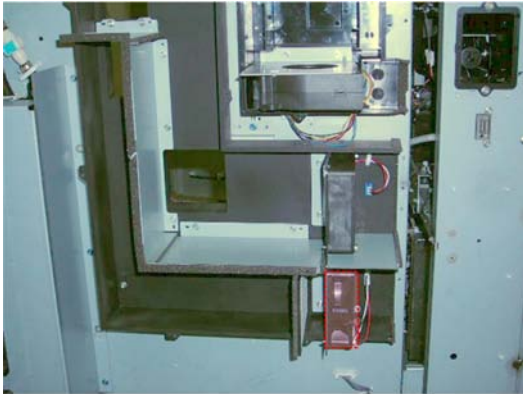

d074r903c

1. The fan is behind the bottom "L" cover.

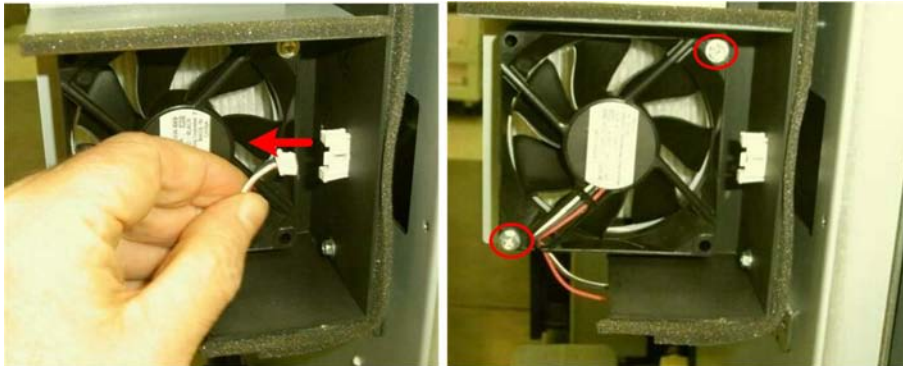

d074r906

2. Disconnect and remove the fan (🔌 x1, 🔩 x2).



d074r907

Cooling Box Ozone Exhaust Fan

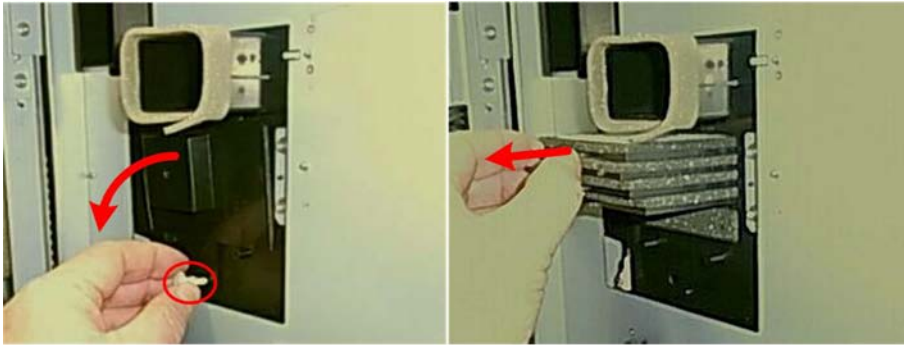

d074r910

4

1. Remove the cover lock screw and remove the cover.
2. Remove the filters and ozone filter.

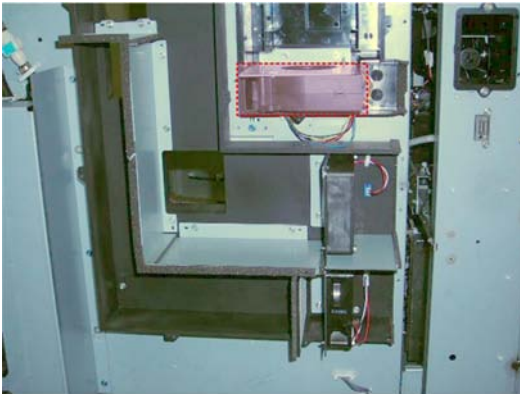

d074r903d

3. The fan is behind the top cover.

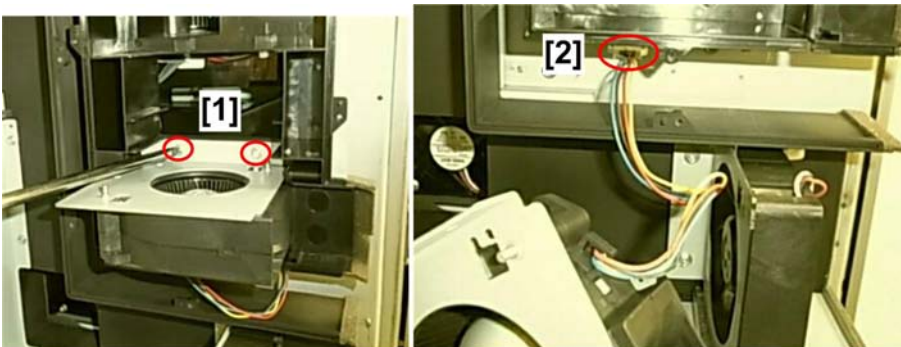

d074r908

4. Disconnect the fan bracket [1] (⚙️ x2).
5. Disconnect the fan [2] (🔌 x1).



d074r909

4

Ozone Filter, Air Filters

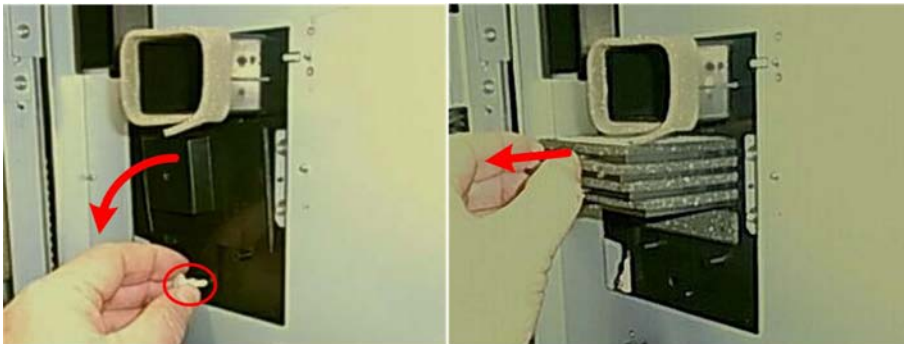

d074r910

1. Open the cooling box (p.400).
2. Remove the cover lock screw and remove the cover.
3. Remove the four air filters.

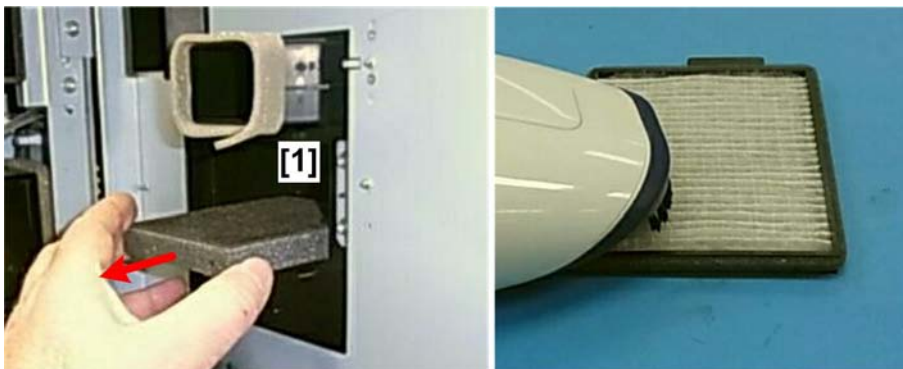

d074r911

4. Remove the ozone filter [1].

5. Vacuum clean the air filters.

Air Filter

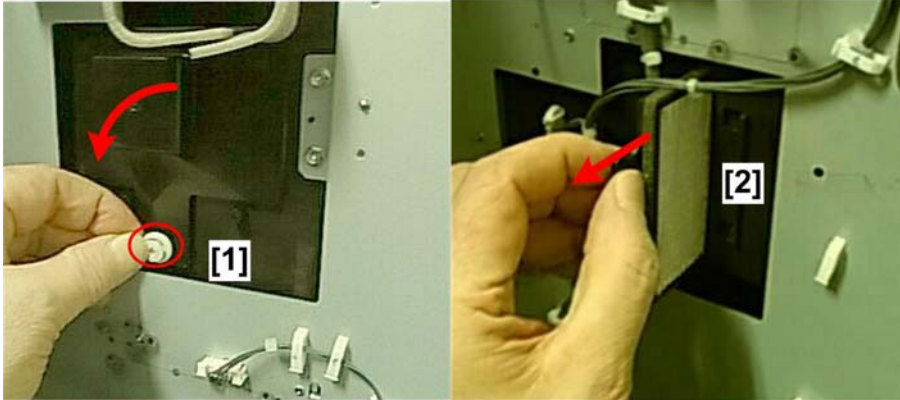

d074r912

1. Open the cooling box (p.400).
2. Remove the cover lock screw and remove the cover [1].
3. Remove the filter [2].
4. Vacuum clean the filter.

Control Box Filter

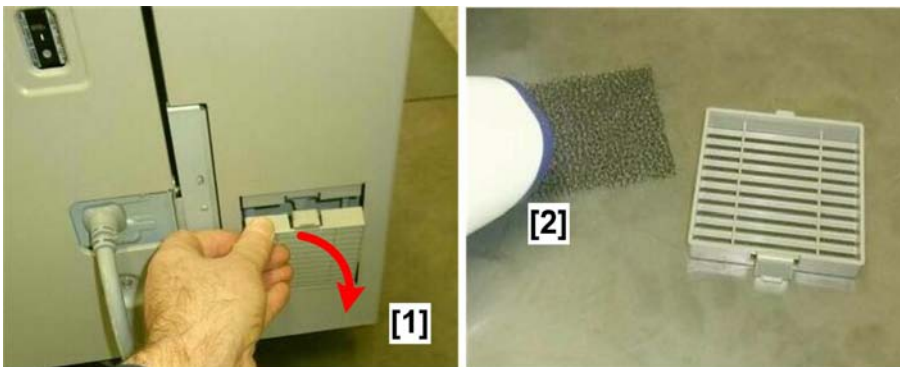

d074r913

1. At the right bottom corner of the controller box, remove the intake filter cover [1].
2. Vacuum clean the filter [2].

ITB Area Filters

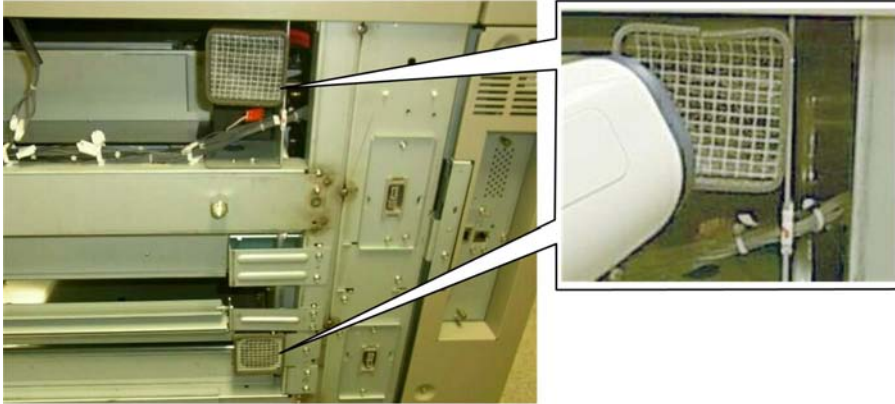

d074r889

1. Right cover (p.406)
2. Vacuum clean both filters.

Paper Exit Fans

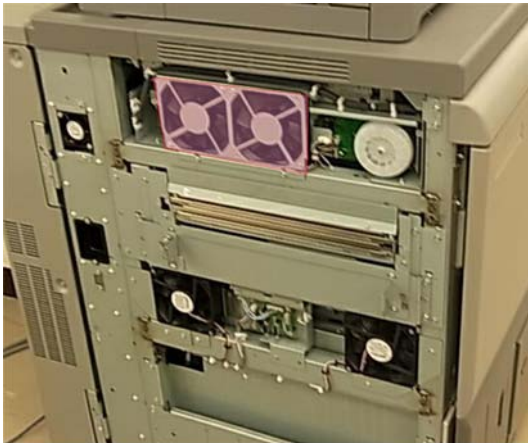

d074r938

1. Left cover (p.402)

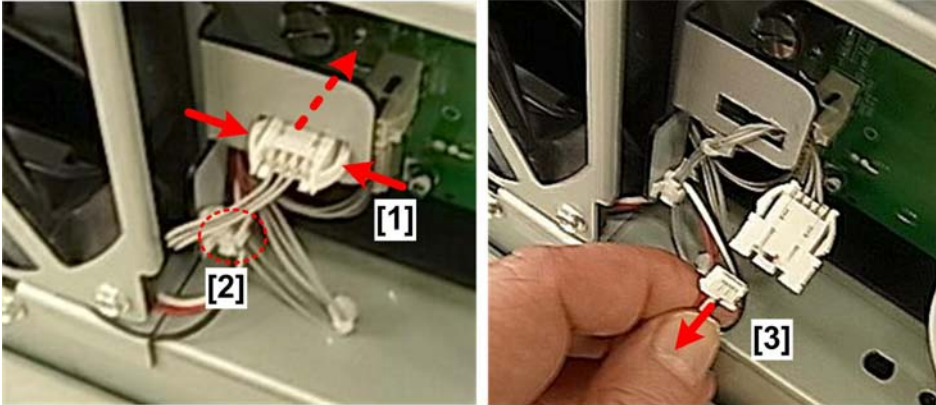

d0074r935

4

2. On **both sides** of the fan plate:

- Depress the sides of the connector [1] and push it back through the plate.
- Disconnect harness [2] (🔌x1).
- Disconnect fan harness [3] (🔌x1).

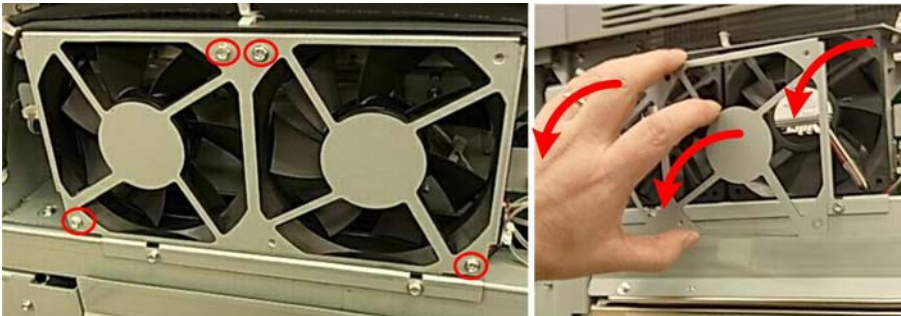

d0074r936

3. Disconnect the fan plate (🔧x4).

4. Remove the plate and fans together.



d0074r937

Firmware Update

Before You Begin...

Always obey these rules when handling and using SD cards:

- Never connect or remove an SD card with the machine on.
- Never turn the power off while the machine is downloading data from an SD card.
- The SD card is a precision item. Use it carefully. Do not keep the card in a location where there is high temperature, high humidity, or light from the sun.
- Handle SD cards carefully to avoid bending, scratching, or dropping them.
- If a power failure occurs during the firmware update, turn the machine power off/on without removing the SD card. The firmware update procedure should start again.

4

Firmware Update Procedure

1. Obtain the System SD card.
2. Disconnect the network cable and other interface cables. This prevents outside interference caused by data transfers to the machine while the software is being uploaded.
3. Turn off the machine.

↓ Note

- Shut down the Fiery controller first.

4. Remove the SD card slot cover ( x 1).
5. Insert the SD card into Slot 2 (lower slot).
6. Turn on the main switch.

You will see "Please Wait" then "Preparing to start firmware update."

The first screen appears after about 90 sec.

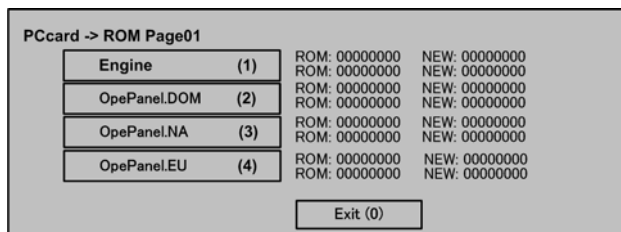

d014r912

7. Check the notations to the right.
 - "ROM" tells you the module number and version of the currently installed software.

- "NEW" tells you the module number and version of software on the SD card in Slot 2.
8. Touch "Engine" or "OpePanel.xxx". The item that you select changes to dark gray.

Note

- You can select "Engine" and one "OpePanel" selection if you want to update both.
9. Touch [Update] or push [#] on the 10-key pad to start the update.

While the Update Is in Progress

- Remain with the machine. Do not leave it unattended.
- The [Start] key flashes RED during firmware update, and then lights GREEN when the update is finished.
- When the [Start] key LED starts flashing rapidly, this means the update is almost finished.
- Never switch the machine off while the [Start] key is flashing RED.
- If the machine is switched off or accidentally unplugged before the update is finished, do not remove the SD card. Just switch the machine on again. The firmware update should restart automatically. If the firmware update does not recover, obtain a new System SD card.

The following screen sequence appears after selecting one "OpePanel" selected for update.

4

Operation Panel Update

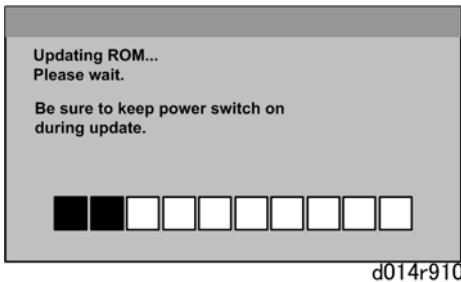

- The blocks of the progress bar fill as the update is done.
- The update requires about 9 to 10 minutes.

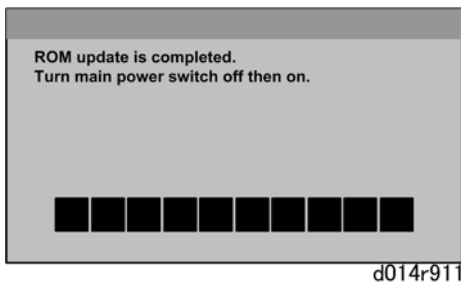

- When you see the 'update completed' message, the firmware update is complete.

Engine Update

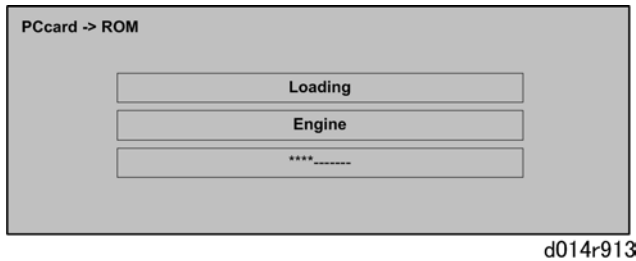

- The middle bar tells you the name of the item that you are updating.
- The bottom bar shows the progress of the update procedure.

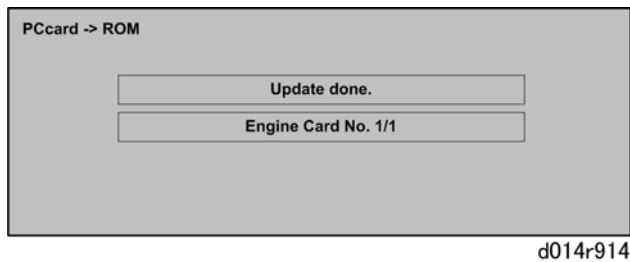

- The update is complete when you see the "Update done" message.
 - The update requires about xx minutes.
1. When you see the update completed message, turn the machine off.
 2. Remove the SD card from the SD card slot.
 3. Switch the machine on.
 4. This completes the update procedure.

Verifying the Firmware Update

This "Verify" procedure is not necessary but is strongly recommended.

1. With the System SD card in Slot 2, turn the main power switch on. You see "Please Wait". The first screen appears after about 10 sec.
2. Touch "Firmware".
3. Select the items that you updated, and then push the [Verify] button.
4. If there are no errors the machine displays the "Verify done" message for each updated item. Go to the next step.

-or-

If you see "Verify Error" in the first bar on the screen, then you must do the procedure again for the module shown in the bottom bar. For more details, see "Errors During Firmware Update" below.

5. After the firmware is correctly updated, turn the main power switch off.
6. Push the System SD card in a small distance to release it, then pull it out of the slot.
7. Turn the main power switch on, and confirm that the machine operates correctly.

Errors During Firmware Update

If an error occurs during a download, an error message will be shown in the first line. The error code consists of the letter "E" and a number ("E20", for example).

Error Message Table

No.	Meaning	Solution
20	Cannot map logical address	Make sure the SD card is installed correctly, or use a different SD card.
21	Cannot access memory	HDD connection not correct, or replace hard disk.
22	Cannot decompress compressed data	The ROM data on the SD card is not correct, or data is damaged.
23	Error occurred when ROM update program started	Controller program defective. If the second attempt fails, replace the controller board.
24	SD card access error	Make sure the SD card is installed correctly, or use a different SD card.
30	No HDD available for stamp data download	HDD connection not correct or replace hard disks.
31	Data incorrect for continuous download	Install the SD card with the remaining data necessary for the download, then re-start the procedure.
32	Data incorrect after download interrupted	Do the recovery procedure for the module, then repeat the installation procedure.
33	Incorrect SD card version	The ROM data on the SD card is not correct, or data is damaged.
34	Module mismatch - Correct module is not on the SD card	The data on the SD is not correct. Get the correct data (Japan, Overseas, OEM, etc.) then install again.
35	Module mismatch – Module on SD card is not for this machine	SD update data is not correct. The data on the SD card is for a different machine. Get the correct data then install again.

No.	Meaning	Solution
36	Cannot write module – Cause other than E34, E35	SD update data is not correct. The data on the SD card is for a different machine. Get the correct data then install again.
40	Engine module download failed	Replace the data for the module on the SD card and try again, or replace the BCU board.
42	Operation panel module download failed	Replace the data for the module on the SD card and try again, or replace the LCDC.
43	Stamp data module download failed	Replace the data for the module on the SD card and try again, or replace the hard disk.
44	Controller module download failed	Replace the data for the module on the SD card and try again, or replace the controller board.
50	Electronic confirmation check failed	SD update data is not correct. The data on the SD card is for a different machine. Get the correct data then install again.

Fiery Controller System Update

Fiery System Installation

System and user software are provided on the following media:

- System Software DVD
- User Software DVD

The System and User Software DVDs include the system software, fonts, and user software.

You install system and user software when you:

- Remedy an error.
- Replace the HDD.
- Upgrade to a more recent version of the software.

Software installation takes approximately one hour (not including the time required to configure or restore Setup).

To Install System and User Software

★ Important

- **Notify the network administrator at the customer site that some archived jobs may no longer print after you install an updated version of system software.**

1. If you have not yet done so, consider backing up configuration settings. The settings are deleted when you install system and user software (see "Backing up and restoring the Fiery Setup Configuration" in the "Installation and Service Guide").
2. Allow the network administrator the opportunity to print the Job Log. Also, print the following (if possible):
 - Configuration page—lists any installed options and records the customer's current Setup configuration.
 - Font List—lists the fonts currently on the HDD. In addition to the fonts provided in system software, the customer may have installed other fonts.
3. Remove all USB storage devices and dongles (if any) that may be connected to any Fiery controller USB ports.

★ Important

- **The system will hang up if USB storage devices or dongles are connected to Fiery controller USB ports during software installation.**

4. Insert the System Software DVD into the DVD/CD-RW drive.

↓ Note

- If you installed a new HDD, power on the system, insert the System Software DVD, allow the system to boot, and then proceed to step 6.

5. From the Fiery Control Panel or the copier/printer display panel (or the Start menu, if a monitor is connected), reboot the Fiery controller.

Allow the system to shut down and reboot. Do not push any buttons during this time.

6. At the message "All data will be deleted?", select Yes.
7. When prompted, select a language.

Wait as messages display describing the installation process.

↓ Note

- This installation segment takes approximately 12 minutes.

8. At the message "System Software is copied to the system. Remove media and select OK to reboot," remove the System Software DVD, and then select OK.

The Fiery controller reboots several times and status messages display as the installation process continues.

↓ Note

- This installation segment takes approximately 12 minutes.

9. At the message "Please insert User Software to continue installation", insert the User Software DVD into the DVD/CD-RW drive.

↓ **Note**

- If a monitor is connected (FACI), click OK to continue.

During this process, the following installations are performed:

- The entire contents of the System Software DVD are copied to a shared folder on the Fiery controller HDD, in e:\efi\user_sw.

After installation, when the Fiery controller is connected to the customer's network, users can access the user software in the shared folder and install it onto client computers.

The message "Copying User Software to Fiery shared folder. Please wait" and other messages display describing the user software installation process.

↓ **Note**

- This installation segment takes approximately 30 minutes.

10. At the message "Setup finished. Remove CD/DVD. Press OK to reboot," remove the User Software DVD and select OK.

If the User Software DVD does not eject automatically, wait for the system to boot completely and the following logo screen to display on the Fiery controller Control Panel, then access the Functions menu on the Fiery controller Control Panel and select Eject CD/DVD to remove the User Software DVD.

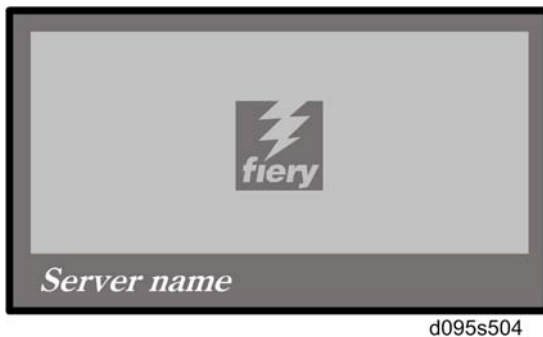

The drawing above indicates that the Fiery controller is idle.

↓ **Note**

- This installation segment takes approximately 5 minutes.

11. If user documentation was previously resident on the Fiery controller, remind the site administrator that user documentation files may be reinstalled to the Fiery controller shared folder from the User Documentation CD as follows:

- If the Fiery controller is equipped with FACI:
 - Insert the User Documentation CD in the Fiery controller DVD drive.
 - Browse to the desired language folder on the CD.
 - Select and copy the files you want to place in the shared folder on the Fiery controller.

- Browse to the shared file location: e:\efi\user_software\Documentation and paste the documentation files.
- From a client computer on the same network as the Fiery controller (assumes that the Fiery controller is powered on, has an IP address, and is accessible on the customer's network):
 - Insert the User Documentation CD in the CD drive of the client computer.
 - Browse to the desired language folder on the CD.
 - Open a web browser and type two back-slashes followed by the Fiery controller IP address.

For example: \\xx.xx.xx.x, where xx.xx.xx.x is the IP address of the Fiery controller.
 - Open the User-Docs folder.
 - Copy and paste the documentation files into the folder.

12. Use the System Updates feature to install required software updates that may be available for the Fiery controller that would have been deleted when you installed system software (see "Updating the Fiery Controller" described below).
13. Reconnect any USB storage devices or dongles that you may have removed earlier.
14. Input the settings from the Configuration page that you printed earlier, or restore settings if they were backed up prior to system software installation.

If a backup file of the configuration settings exists, restore it after the network configuration is completed (see "Backing up and restoring the Fiery Setup Configuration" in the "Installation and Service Guide").

Bypass any settings that are not included on the Configuration page if it is more appropriate for the network administrator to set them. For more information, see Configuration and Setup on the User Documentation CD.

15. Reinstall fonts or custom simulations that may have been deleted when you installed software.

Updating the Fiery Controller

Patch installation instructions

1. Make sure the Fiery controller is idle.
2. Execute "_exe" and follow the instructions in the Fiery Patch Downloader.
3. Notes about the Fiery Patch Downloader
 - a) Login must be admin. This is fixed and cannot be modified.
 - b) Password is the Fiery administrator login password.
 - c) Hostname can be either the IP address or the Fiery server name.
4. After the patch is downloaded, and when prompted by the Fiery Patch Downloader, choose Reboot. (If you choose to Restart later, make sure that you manually reboot the server for changes to take effect.)

5. Wait until the Fiery controller comes to Idle and print the configuration page.
6. Verify that the System Updates Log section contains the patch number "*****"

5. System Maintenance

Service Program Mode

See Appendices about Service Program Mode.

6. Troubleshooting

SC Table Key

SC Code Table Key

Level	Definition	Reset Procedure
A	Fusing unit SC codes shown on the operation panel. The machine is disabled. The operator cannot reset the machine.	The machine requires immediate servicing by a service technician.
B	These SC codes disable only the features that use the defective item. Normally, the user does not see these SC codes, but the SC code is displayed on the operation panel when the defective feature is used.	Cycle the machine off/on with the main power switch..
C	These are SC codes are not shown on the operation panel. They are logged internally.	Recorded only. Do SP**** to display the SC error log.
D	These SC codes are shown on the operation panel.	To reset machine, cycle the machine off/on. The SC codes are displayed again if the error occurs again.

6

Preliminary Instructions

- After a Level A SC code is issued, the machine is disabled and cannot be used until it has been serviced by a qualified technician. Execute SP5810 to release the machine for servicing.
- If the problem is in an electrical circuit board, disconnect then connect the board connectors again before you replace the PCB.
- When a Level A or Level B SC error occurs while the machine is in the SP mode, the SC number will not be shown. If this occurs, check the SC number after the machine goes out of the SP mode.
- Many SC codes contain more than one level (SC303-1, SC303-2, SC303-3, and others). Some SC codes may display a "-1", even if there is only one level.

The following abbreviations are used in these SC tables:

- (F) means "Front"
- (R) means "Rear"
- "GW" means "GW controller"; there is a problem with the controller.

 **CAUTION**

- At job end or when the machine is switched off, both sides of the ITB unit are lowered and separated from the drums.
- However, after a power failure or accidental disconnection of the power cord, or after a machine issues an SC code after a malfunction, both or one side of the ITB may remain up against the drums.
- To avoid damage to the ITB, both sides of the ITB must be checked and lowered before the ITB unit can be pulled out of the unit. (▶ p.410)

SC Tables

SC100: Scanning 1

SC101	D	Exposure Lamp Error	D074/D075
		<p>The white level peak did not reach the prescribed threshold when the white plate was scanned.</p> <ul style="list-style-type: none"> • Condensation in scanner unit • Dirty lenses, mirrors dirty or positioned incorrectly • White plate dirty or installed incorrectly • Harness between lamp and lamp stabilizer disconnected or defective • Exposure lamp defective • Lamp stabilizer defective • High voltage line leak • SIOB defective • SBU defective 	
SC120	D	Scanner Home Position Error 1	D074/D075
		<p>The scanner home position sensor did not detect the home position (did not go OFF) after the scanner moved forward 20 mm..</p> <ul style="list-style-type: none"> • Scanner motor defective • Scanner HP sensor defective • Harness between scanner motor and SIOB disconnected or defective. • SIOB defective 	
SC121	D	Scanner Home Position Error 2	D074/D075

		<p>The scanner home position sensor did not go ON after the scanner moved forward 6 mm and the feeler dropped into the HP sensor.</p> <ul style="list-style-type: none"> • Scanner motor harness disconnected or defective • Scanner motor defective • Scanner HP sensor disconnected or defective • HP sensor feeler (actuator) not positioned correctly • SIOB defective
--	--	---

SC141	D	Black Level Detection Error	D074/D075
		<p>The black level value did not reach ± 3 of the prescribed value for AGC (Automatic Gain Control) that executed immediately after the scanner unit powered on.</p> <ul style="list-style-type: none"> • Cycle the machine off/on • Harness between SBU and IPU disconnected or defective • SBU defective • IPU defective • BCU defective 	

SC142	D	White Level Detection Error	D074/D075
		<p>The 2nd white level value did not reach the target range (-7 to 0) for AGC (Automatic Gain Control) that executed immediately after the scanner unit powered on.</p> <ul style="list-style-type: none"> • Cycle the machine off/on • Condensation in the scanner unit • Dirty exposure glass, optics • White plate dirty, or set incorrectly • Harness between SBU-IPU disconnected or defective • Exposure lamp defective • SBU defective • IPU defective • BCU defective 	

SC144	D	SBU Communication Error	D074/D075
-------	---	-------------------------	-----------

		<p>When the machine was switched on, or when the machine returned to full operation from the energy save mode, the machine could not access the SBU register, or the SBU register values are abnormal.</p> <p>Note: The ASIC IDs read during automatic adjustment of the SBU can be displayed with SP4600 (SBU Version Display).</p>
		<p>SBU-BCU harness loose, disconnected, defective</p> <p>SBU board defective</p> <p>SIOB board defective</p> <p>BCU board defective</p>

SC161	D	IPU Errors	D074/D075
SC161-1	D	IPU Error 1: LSYNC	
		<p>An error occurred during the self-diagnostic test performed every time the machine is powered on, or returns to full operation from energy save mode.</p> <ul style="list-style-type: none"> • Harness between IPU and SBU disconnected or defective • Defective BCU board • Defective IPU board 	
SC161-2	D	IPU Error 2: Ri No Response	
		<p>The machine detected an error during Ri access</p> <ul style="list-style-type: none"> • IPU board defective • BCU board defective • Controller board defective 	

SC180	D	Scanner Unit Exhaust Fan Lock	D074/D075
		<p>The scanner unit exhaust fan did not switch on within 10 sec. after the CPU issued the ON signal.</p> <ul style="list-style-type: none"> • Foreign object interfering with operation of fan • Fan motor harness disconnected or defective • Fan defective • SIOB board defective • SBU board defective 	

SC181	D	Lamp Regulator Cooling Fan	D074/D075
		<p>The fan next to the lamp regulator board did not switch on within 10 sec. after the CPU issued the ON signal.</p> <ul style="list-style-type: none"> • Fan motor harness disconnected or defective • SBU harness disconnected or defective • SIOB harness disconnected or defective • Fan defective • SBU board defective • SIOB board defective 	

SC182	D	Scanner Unit Exhaust Fan Lock	D074/D075
		<p>The scanner unit exhaust fan did not switch on within 10 sec. after the CPU issued the ON signal.</p> <ul style="list-style-type: none"> • Fan motor harness disconnected or defective • SBU harness disconnected or defective • SIOB harness disconnected or defective • Fan defective • SBU board defective • SIOB board defective 	

SC195	D	Machine serial number error	
		<p>The 11-digit number registered for the machine serial number does not match.</p> <ul style="list-style-type: none"> • NVRAM defective • BCU replaced without original NVRAM • Check the serial number with SP5-811-002. • If the stored serial number is incorrect, contact your supervisor. 	

SC200: Image Writing

SC202	D	Polygon Motor 1: ON Timeout Error	
-------	---	-----------------------------------	--

		<p>After the C K polygon motor turned on, or within 10 sec. after the rpm's changed, the motor did not enter READY status.</p> <ul style="list-style-type: none"> • Cycle the machine off/on • IPU harness loose, disconnected, broken, defective • Polygon motor defective (replace laser unit) • IPU defective
SC203	D	<p>Polygon Motor 1: OFF Timeout Error</p> <p>The C, K polygon motor lock signal (XSCRDY signal) failed to unlock (go HIGH) within 3 sec. after the C, K polygon motor went OFF.</p> <ul style="list-style-type: none"> • Cycle the machine off/on • IPU harness loose, disconnected, broken, defective • Polygon motor defective (replace laser unit) • IPU defective
SC204	D	<p>Polygon Motor 1: XCRDY Signal Error</p> <p>The C, K polygon motor left the lock status once the motor achieved normal rotation speed.</p> <ul style="list-style-type: none"> • Cycle the machine off/on • IPU harness loose, disconnected, broken, defective • Polygon motor defective (replace laser unit) • IPU defective
SC206	D	<p>Polygon Motor 2: ON Timeout Error</p> <p>After the Y,M polygon motor turned on, or within 10 sec. after the rpm's changed, the motor did not achieve motor lock (READY) status.</p> <ul style="list-style-type: none"> • Cycle the machine off/on • IPU harness loose, disconnected, broken, defective • Polygon motor defective (replace laser unit) • IPU defective
SC207	D	<p>Polygon Motor 2: OFF Timeout Error</p>

		<p>The Y, M motor lock signal (XSCRDY signal) failed to unlock (go HIGH) within 3 sec. after the Y, M polygon motor went OFF.</p> <ul style="list-style-type: none"> • Cycle the machine off/on • IPU harness loose, disconnected, broken, defective • Polygon motor defective (replace laser unit) • IPU defective
--	--	---

SC208	D	Polygon Motor 2: XCRDY Signal Error
		<p>The Y,M polygon motor left the lock status once after the motor achieved regular rotation speed.</p> <ul style="list-style-type: none"> • Cycle the machine off/on • IPU harness loose, disconnected, broken, defective • Polygon motor defective (replace laser unit) • IPU defective

SC210	C	Trailing Edge Beam Error (K)
		<p>One of the following occurred:</p> <ul style="list-style-type: none"> • When the K main scan magnification rate was measured, there was no output for the trailing edge beam detection signal • The K magnification rate could not be detected • The detected K magnification rate was not within specification. <ul style="list-style-type: none"> • Cycle the machine off/on • CK Laser unit defective

SC211	C	Trailing Edge Beam Error (C)
		<ul style="list-style-type: none"> • When the C main scan magnification rate was measured, there was no output for the trailing edge beam detection signal • The C magnification rate could not be detected • The detected C magnification rate was not within specification. <ul style="list-style-type: none"> • Cycle the machine off/on • CK laser unit defective

SC212	C	Trailing Edge Beam Error (M)
		<ul style="list-style-type: none"> • When the M main scan magnification rate was measured, there was no output for the trailing edge beam detection signal • The M magnification rate could not be detected • The detected M magnification rate was not within specification.
		<ul style="list-style-type: none"> • Cycle the machine off/on • YM laser unit defective
SC213	C	Trailing Edge Beam Error (Y)
		<ul style="list-style-type: none"> • When the Y main scan magnification rate was measured, there was no output for the trailing edge beam detection signal • The Y magnification rate could not be detected • The detected Y magnification rate was not within specification.
		<ul style="list-style-type: none"> • Cycle the machine off/on • YM laser unit defective
SC220	D	TE LD1 Laser Synchronization Detection Error (K)
		A signal was not output from the K LSDB after more than 100 ms (100 ms x2) after the LD fired.
		<ul style="list-style-type: none"> • Cycle the machine off/on • CK Laser unit defective
SC222	D	TE LD1 Laser Synchronization Detection Error (C)
		A signal was not output from the C LSDB after more than 100 ms (100 ms x2) after the LD fired.
		<ul style="list-style-type: none"> • Cycle the machine off/on • CK laser unit defective
SC224	D	TE LD1 Laser Synchronization Detection Error (M)

		A signal was not output from the M LSDB after more than 100 ms (100 ms x2) after the LD fired.
		<ul style="list-style-type: none"> • Cycle the machine off/on • YM laser unit defective

SC226	D	TE LD1 Laser Synchronization Detection Error (Y)
		A signal was not output from the Y LSDB after more than 100 ms (100 ms x2) after the LD fired.
		<ul style="list-style-type: none"> • Cycle the machine off/on • YM Laser unit defective

SC230	D	K FGATE Failed to go ON
		The K FGATE signal did not go ON within the prescribed time after printing started and the STTRIG single went ON.
		<ul style="list-style-type: none"> • Cycle the machine off/on • IPU harness loose, disconnected, broken, defective • IPU defective • CK Laser unit defective

SC231	D	K FGATE Failed to go OFF
		After the K FGATE signal went on, it failed to go OFF within the prescribed time.
		<ul style="list-style-type: none"> • Cycle the machine off/on • IPU harness loose, disconnected, broken, defective • IPU defective • CK Laser unit defective

SC232	D	C FGATE Failed to go ON
-------	---	-------------------------

		<p>The C FGATE signal did not go ON within the prescribed time after printing started and the STTRIG signal went ON.</p> <ul style="list-style-type: none"> • Cycle the machine off/on • IPU harness loose, disconnected, broken, defective • IPU defective • CK Laser unit defective
SC233	D	C FGATE Failed to go OFF
		<p>After the C FGATE signal went on, it failed to go OFF within the prescribed time.</p> <ul style="list-style-type: none"> • Cycle the machine off/on • IPU harness loose, disconnected, broken, defective • IPU defective • CK Laser unit defective
SC234	D	M FGATE Failed to go ON
		<p>The M FGATE signal did not go ON within the prescribed time after printing started and the STTRIG signal went ON.</p> <ul style="list-style-type: none"> • Cycle the machine off/on • IPU harness loose, disconnected, broken, defective • IPU defective • YM laser unit defective
SC235	D	M_FGATE Failed to go OFF
		<p>After the M FGATE signal went on, it failed to go OFF within the prescribed time.</p> <ul style="list-style-type: none"> • Cycle the machine off/on • IPU harness loose, disconnected, broken, defective • IPU defective • YM laser unit defective
SC236	D	Y FGATE Failed to go ON

		The Y FGATE signal did not go ON within the prescribed time after printing started and the STTRIG single went ON.
		<ul style="list-style-type: none"> • Cycle the machine off/on • IPU harness loose, disconnected, broken, defective • IPU defective • YM laser unit defective

SC237	D	Y FGATE Failed to go OFF
		After the Y FGATE signal went on, it failed to go OFF within the prescribed time.
		<ul style="list-style-type: none"> • Cycle the machine off/on • IPU harness loose, disconnected, broken, defective • IPU defective • YM laser unit defective

SC240	D	LD Error (K)
		The LD current exceeded the prescribed limit when the K LD fired.
		<ul style="list-style-type: none"> • Cycle the machine off/on • CK laser unit defective

SC241	D	LD Error (C)
		The LD current exceeded the prescribed limit when the C LD fired.
		<ul style="list-style-type: none"> • Cycle the machine off/on • CK laser unit defective

SC242	D	LD Error (M)
		The LD current exceeded the prescribed limit when the M LD fired.
		<ul style="list-style-type: none"> • Cycle the machine off/on • YM laser unit defective

SC243	D	LD Error (Y)
-------	---	--------------

		<p>The LD current exceeded the prescribed limit when the Y LD fired.</p> <ul style="list-style-type: none"> • Cycle the machine off/on • YM laser unit defective
SC260	C	Laser Thermistor Error (CK)
SC262	C	Laser Thermistor Error (YM)
		<p>One of the following occurred:</p> <ul style="list-style-type: none"> • The reading of the thermistor in the CK or YM laser unit was less than 10°C (50°F), indicating that the thermistor has disconnected. • The reading of the thermistor in the CK or YM laser unit was more than 80°C (176°F), indicating that the thermistor has shorted out. <ul style="list-style-type: none"> • Cycle the machine off/on • IOB harness loose, disconnected, broken, defective • CK or YM laser unit defective • IOB defective
SC263	C	Laser Thermistor (Y) Error
		<p>The laser thermistor in the YM laser unit is not functioning properly because it is disconnected or shorted out.</p> <ul style="list-style-type: none"> • Replace the YM laser unit.
SC265	C	Skew Control: Out of Range Error (C)
		<p>The C skew control pulse total (SP2104-7) is not within range.</p> <ul style="list-style-type: none"> • Cycle the machine off/on • CK laser unit defective
SC266	C	Skew Control: Out of Range Error (M)
		<p>The M skew control pulse total (SP2104-8) is not within range.</p> <ul style="list-style-type: none"> • Cycle the machine off/on • YM laser unit defective

SC267	C	Skew Control: Out of Range Error (Y)
		The Y skew control pulse total (SP2104-9) is not within range.
		<ul style="list-style-type: none"> • Cycle the machine off/on • YM laser unit defective
SC270	D	Image Transfer Error (K)
		The image data that the K LDB received generated a fatal error.
		<ul style="list-style-type: none"> • Cycle the machine off/on • IPU harness loose, disconnected, broken, defective • IPU defective • CK laser unit defective
SC271	D	Image Transfer Error (C)
		The image data that the C LDB received generated a fatal error.
		<ul style="list-style-type: none"> • Cycle the machine off/on • IPU harness loose, disconnected, broken, defective • IPU defective • CK laser unit defective
SC272	D	Image Transfer Error (M)
		The image data that the M LDB received generated a fatal error.
		<ul style="list-style-type: none"> • Cycle the machine off/on • IPU harness loose, disconnected, broken, defective • IPU defective • YM laser unit defective
SC273	D	Image Transfer Error (Y)

		<p>The image data that the Y LDB received generated a fatal error.</p> <ul style="list-style-type: none"> • Cycle the machine off/on • IPU harness loose, disconnected, broken, defective • IPU defective • YM laser unit defective
SC275	D	PC Communication Error (K)
		<p>The K LDB is not functioning normally.</p> <ul style="list-style-type: none"> • Cycle the machine off/on • CK laser unit defective
SC276	D	PC Communication Error (C)
		<p>The C LDB is not functioning normally.</p> <ul style="list-style-type: none"> • Cycle the machine off/on • CK laser unit defective
SC277	D	PC Communication Error (M)
		<p>The M LDB is not functioning normally.</p> <ul style="list-style-type: none"> • Cycle the machine off/on • YM laser unit defective
SC278	D	PC Communication Error (Y)
		<p>The Y LDB is not functioning normally.</p> <ul style="list-style-type: none"> • Cycle the machine off/on • YM laser unit defective
SC280	D	IPU Image Transfer Error

		An error occurred during data sending between components (GRIFFON, LEO) on the IPU board.
		<ul style="list-style-type: none"> • Cycle the machine off/on • If the problem persists, replace the IPU

SC285	D	MUSIC Error
		The results of MUSIC pattern reading failed 4 times (SC496 issued 4 times).
		<ul style="list-style-type: none"> • A PCDU is set incorrectly • ITB is set incorrectly • Execute manual process control with SP3011-2 (Density Adjustment) • MUSIC sensor harness loose, disconnected, broken, defective • MUSIC sensor defective • ITB damaged • Laser unit defective

6

SC300: Development

Charge, Development

SC300	D	Charge Roller Power Pack Output Error (K)
SC301	D	Charge Roller Power Pack Output Error (C)
SC302	D	Charge Roller Power Pack Output Error (M)
SC303	D	Charge Roller Power Pack Output Error (Y)

		<p>The interrupt that checks the status of the PCU power pack every 10 ms detected a short at the high-voltage harness or charge leak at the charge roller. The high-voltage harness could be broken or defective, or the charge roller could be dirty.</p> <ul style="list-style-type: none"> • Disconnect the high voltage cable from Terminal C of the power pack. • Attach a voltmeter to the terminal. • If there is no output from the terminal, replace the power pack. <p>-or-</p> <ul style="list-style-type: none"> • If there is output from the terminal, test the resistance between the high voltage cable and the ground. • If resistance is nearly "0", check the high-voltage harness for defects and replace it if necessary. • Test the conductivity between the PCU and the ground. If there is no conductivity between the PCU and ground, replace the PCU. • If there is no charge PWM signal, replace the harness and/or BCU.
--	--	---

SC310	D	Charge FB Voltage Error (K)
SC311	D	Charge FB Voltage Error (C)
SC312	D	Charge FB Voltage Error (M)
SC313	D	Charge FB Voltage Error (Y)
		<p>Just before beginning to print, the charge FB (feed-back) voltage was detected less than 0.3V for 50 consecutive readings within 400 ms.</p> <ul style="list-style-type: none"> • High-voltage harness disconnected or broken • Charge roller not installed correctly • Drum not installed correctly

SC320	D	Separation Power Pack Output Error (K)
SC321	D	Separation Power Pack Output Error (C)
SC322	D	Separation Power Pack Output Error (M)
SC323	D	Separation Power Pack Output Error (Y)

		<p>The BCU detected an electrical short during development charge output for K,C,M, or Y. Possible causes for this are:</p> <ul style="list-style-type: none"> • IOB harness disconnected or defective • High-voltage cable defective • Power pack defective • Development unit defective • IOB defective
		<ol style="list-style-type: none"> 1. Disconnect the high voltage cable from Terminal B of the development power pack. 2. Attach a voltmeter to the terminal. 3. If there is no output from the terminal, replace the power pack. <p>-or-</p> <ol style="list-style-type: none"> 1. If there is output from the terminal, test the resistance between the high-voltage cable and the ground. 2. If resistance is "0" or nearly "0", check the high-voltage harness for defects and replace it if necessary. 3. If replacing the harness does not solve the problem, test the resistance between the development unit terminal and the ground. 4. If there is no resistance (0 ohms) between the development unit and the ground, replace the PCU. 5. If there is no development PWM signal, replace the IOB harness and/or IOB.

SC325	D	Development Motor Error (K)
SC326	D	Development Motor Error (C)
SC327	D	Development Motor Error (M)
SC328	D	Development Motor Error (Y)
		<p>The development motor failed to start within the prescribed time or failed during normal operation.</p> <ul style="list-style-type: none"> • Motor harness disconnected or defective • Motor shaft locked, blocked by obstruction • Motor defective

SC330	D	Toner Supply Bottle Motor Error (K)
SC331	D	Toner Supply Bottle Motor Error (C)
SC332	D	Toner Supply Bottle Motor Error (M)
SC333	D	Toner Supply Bottle Motor Error (Y)
SC334	D	Toner Supply Bottle Motor Error (S)
		<p>The machine detected that the toner supply motor was not operating.</p> <ul style="list-style-type: none"> • Toner bottle installed incorrectly • Toner bottle rotation blocked by an obstruction • Toner bottle damaged • Toner supply bottle motor defective
SC335	D	Developer Set Error (K)
SC336	D	Developer Set Error (C)
SC337	D	Developer Set Error (M)
SC338	D	Developer Set Error (Y)
		<p>Before the TD sensor control voltage ($V_{cnt} = 4.75V$) is adjusted when the TD sensor is initialized (SP3-030), the development unit is always checked for the presence of developer. The check revealed that the K, C, M, or Y development unit did not have a sufficient amount of toner. V_t (the TD sensor output) was less than 0.7V</p> <ul style="list-style-type: none"> • Replace the developer
SC345	D	Toner Supply Pump Motor Error (K, M, C, Y)

		<p>The toner supply pump motor failed to start within the prescribed time or failed during normal operation.</p> <ul style="list-style-type: none"> • Motor harness disconnected or broken • Toner pump unit harness disconnected or broken • Toner pump unit panel mount connector broken • Check each toner supply unit (K, M, C, Y) for any obstructions that could be blocking operation of a pump or sub hopper • Toner supply pump motor defective
SC355	D	Toner Supply Error (K)
		<ul style="list-style-type: none"> • Amount of toner on the ID sensor pattern printed and read between sheets less than 0.100 (SP3300-1). • Accumulated toner clutch ON time in the K sub hopper of the toner supply unit greater than 5000 (SP3301-41)
SC356	D	Toner Supply Error (C)
		<ul style="list-style-type: none"> • Amount of toner on the ID sensor pattern printed and read between sheets less than 0.200 (SP3300-3). • Accumulated toner clutch ON time in the C sub hopper of the toner supply unit greater than 5000 (SP3301-43)
SC357	D	Toner Supply Error (M)
		<ul style="list-style-type: none"> • Amount of toner on the ID sensor pattern printed and read between sheets less than 0.200 (SP3300-3). • Accumulated toner clutch ON time in the M sub hopper of the toner supply unit greater than 5000 (SP3301-43)
SC358	D	Toner Supply Error (Y)
		<ul style="list-style-type: none"> • Amount of toner on the ID sensor pattern printed and read between sheets less than 0.200 (SP3300-4). • Accumulated toner clutch ON time in the Y sub hopper of the toner supply unit greater than 5000 (SP3301-43)

		A small rectangular wire attached to the shaft of an augur in each toner supply unit scrapes the surface of the toner end sensor with each rotation of the augur. The cleaning wire may be bent or the toner end sensor is defective. If the toner end sensor is damaged or out of position, the toner end sensor will cease to function normally.
		<ul style="list-style-type: none"> • Replace the affected toner supply unit.

SC360	D	TD Sensor (Vt High) Error (K)
		The TD sensor output for the K development unit was greater than 4.7V (SP3210-1)
SC361	D	TD Sensor (Vt High) Error (C)
		The TD sensor output for the C development unit was greater than 4.7V (SP3210-2)
SC362	D	TD Sensor (Vt High) Error (M)
		The TD sensor output for the M development unit was greater than 4.7V (SP3210-3)
SC363	D	TD Sensor (Vt High) Error (Y)
		The TD sensor output for the C development unit was greater than 4.7V (SP3210-4)
		These SC codes are issued if the TD sensor output is greater than 4.7V after 20 consecutive readings.
		<ul style="list-style-type: none"> • TD sensor harness of the affected unit defective, disconnected, or broken. Replace the TD sensor. • TD sensor defective on the affected development unit

SC365	D	TD Sensor (Vt Low) Error (K)
		The TD sensor output for the K development unit was less than 0.5V (SP3210-1)
SC366	D	TD Sensor (Vt Low) Error (C)
		The TD sensor output for the C development unit was less than 0.5V (SP3210-2)
SC367	D	TD Sensor (Vt Low) Error (M)
		The TD sensor output for the M development unit was less than 0.5V (SP3210-3)

SC368	D	TD Sensor (Vt Low) Error (Y)
		The TD sensor output for the Y development unit was less than 0.5V (SP3210-4)
		These SC codes are issued if the TD sensor output is less than 0.5V after 10 consecutive readings.
		<ul style="list-style-type: none"> • TD sensor harness of the affected unit defective, disconnected, or broken. Replace the TD sensor. • Replace development unit

SC370	D	TD Sensor Initialization Error (K)
SC371	D	TD Sensor Initialization Error (C)
SC372	D	TD Sensor Initialization Error (M)
SC373	D	TD Sensor Initialization Error (Y)
		The TD sensor of the affected development unit could not be initialized within $2.9 \pm 0.2V$.
		<ul style="list-style-type: none"> • TD sensor harness of the affected unit defective, disconnected, or broken. Replace the TD sensor. • Replace development unit

SC375	D	ID Sensor Calibration Error
		The voltage reading during process control for Vsg_reg was not within the correct range ($4.0 \pm 0.5V$). Vsg_reg is the voltage reading of the light reflected directly from the bare surface of the ITB.
		<ul style="list-style-type: none"> • ID sensor harness disconnected or broken • ID sensor dirty. Check sensor window and clean with clean cloth moistened with alcohol. Do not use a dry cloth. • ID sensor defective • ITB deformed or out of position (replace damaged ITB) <p>Note:</p> <ul style="list-style-type: none"> • This error can occur as a result of cleaning the sensors with a dry cloth, which can cause a static charge to build up on the sensor and attract particles of paper dust. • Always clean the ID sensor with a clean cloth moistened with alcohol.

SC377	D	LED Error During Vsg Adjustment
		<p>ID sensor (PWM) value is greater than the threshold value (Ifsg > 27 mA) set by SP3320-15 (Default: 0) This can be caused by one or more of these conditions:</p> <ul style="list-style-type: none"> • ID sensor dirty • ID sensor defective • ITB dirty
		<ul style="list-style-type: none"> • Clean the window of the ID sensor with a clean cloth moistened with alcohol. Do not use a dry cloth. • ITB belt dirty • ITB out of position • ID sensor defective <p>Note:</p> <ul style="list-style-type: none"> • This error can occur as a result of cleaning the sensors with a dry cloth, which can cause a static charge to build up on the sensor and attract particles of paper dust. • Always clean these with a clean cloth moistened with alcohol.

SC380	D	ID Sensor Pattern Density High Error (K)
		The density of the Black reading in the ID sensor patterns created between pages (SP3300-1) is greater than the threshold value set by SP3301-21.
SC381	D	ID Sensor Pattern Density High Error (C)
		The density of the Cyan reading in the ID sensor patterns created between pages (SP3300-2) is greater than the threshold value set by SP3301-22.
SC382	D	ID Sensor Pattern Density High Error (M)
		The density of the Magenta reading in the ID sensor patterns created between pages (SP3300-3) is greater than the threshold value set by SP3301-22.
SC383	D	ID Sensor Pattern Density High Error (Y)
		<p>The density of the Yellow reading in the ID sensor patterns created between pages (SP3300-4) is greater than the threshold value set by SP3301-22.</p> <p>-or-</p> <p>The ID sensor reading for the affected color was probably due to excessive toner.</p>
		<ul style="list-style-type: none"> • Replace the toner supply unit

SC385	D	ID Sensor Pattern Density Low Error (K)
		The density of the Black reading in the ID sensor patterns created between pages (SP3300-1) is less than the threshold value set by SP3301-23.
SC386	D	ID Sensor Pattern Density Low Error (C)
		The density of the Cyan reading in the ID sensor patterns created between pages (SP3300-2) is less than the threshold value set by SP3301-24.
SC387	D	ID Sensor Pattern Density Low Error (M)
		The density of the Magenta reading in the ID sensor patterns created between pages (SP3300-3) is less than the threshold value set by SP3301-24.
SC388	D	ID Sensor Pattern Density Low Error (Y)
		The density of the Yellow reading in the ID sensor patterns created between pages (SP3300-4) is less than the threshold value set by SP3301-24.
		<ul style="list-style-type: none"> • Dust shield glass dirty • Insufficient application of development bias • Check the ITB unit

SC390	D	Drum Motor (K) Error
SC391	D	Drum Motor (C) Error
SC392	D	Drum Motor (M) Error
SC393	D	Drum Motor (Y) Error
		An error was detected at power on, when the affected motor started up, or during normal rotation of the motor. Excessive torque was detected on the motor, possibly caused by a jammed drum cleaning blade. A LOCK signal could not be detected after 1 sec.
		<ul style="list-style-type: none"> • Disassemble the PCDU and inspect the drum and cleaning blade for damage. Replace is necessary. • Execute SP7988 for whichever unit was affected. • Reset the counter with 7987 for whichever unit was affected.

SC395	D	Drum Motor Error (K)
SC396	D	Drum Motor Error (C)

SC397	D	Drum Motor Error (M)
SC398	D	Drum Motor Error (Y)
		<p>A lock signal could not be detected within one sec. after the motor start signal was sent, or the LOCK signal was lost during normal operation of the motor.</p> <ul style="list-style-type: none"> • Motor harness disconnected or broken • Obstruction is blocking operation of the drum or motor • TDCU defective • Drum motor defective

SC400: Around the Drum

SC400	D	Development Gamma Error (K)
SC401	D	Development Gamma Error (C)
SC402	D	Development Gamma Error (M)
SC403	D	Development Gamma Error (Y)
		<p>Development gamma for the affected color is not within range: $0.3 < \text{Development Gamma} < 6.0$</p> <p>One of the following problems (identified by a process control error code) has occurred during the potential control phase of process control (ACC gamma correction);</p> <ul style="list-style-type: none"> • Code 55, 56. Development gamma was not in the range 0.3 to 6.0. Process control halts and a process control code is issued: 55, 56. • Code 59. Development gamma calculation point error. • Code 61. LD did not fire and data array has all negative values. <p>Note: To display the 2-digit process control error codes, do SP3012.</p>

		<ul style="list-style-type: none"> • Dust shield glass is dirty • ITB unit transfer power pack defective • LD unit inside laser unit defective <p>If SP3012 returned a process control error code:</p> <ul style="list-style-type: none"> • Code 55, 59. Replace developer. • Code 56. Clean the toner shield glass, or replace transfer power pack. • Code 61. Replace laser unit.
--	--	--

SC405	D	Development Start Voltage (Vk) Error (K)
SC406	D	Development Start Voltage (Vk) Error (C)
SC407	D	Development Start Voltage (Vk) Error (M)
SC408	D	Development Start Voltage (Vk) Error (Y)
		<p>The detected development start voltage was not within the range of $\pm 150V$. Process control error codes: 57, 58 (displayed with SP3012).</p> <ul style="list-style-type: none"> • Potential sensor dirty or defective (Process control error code 58) • Developer requires replacement (Process control error: 57, 58)

SC410	D	Potential Sensor Vd Error (K)
SC411	D	Potential Sensor Vd Error (C)
SC412	D	Potential Sensor Vd Error (M)
SC413	D	Potential Sensor Vd Error (Y)

		<p>The reading of the potential sensor above the drum of the affected color is incorrect. Specifically, Vd was out of range:</p> $500 \leq Vd (700) \leq -800$ <p>Process control error codes: 15, 16 (displayed with SP3012)</p> <p>Note: Vd is the potential sensor reading of the unexposed surface of the OPC drum (no laser applied to the drum). This is read during the potential process control self-check.</p>
		<p>Error Code 15</p> <ul style="list-style-type: none"> • Potential sensor probe dirty. • Clean area around potential sensor with a blower brush • Potential sensor defective <p>Error Code 16</p> <ul style="list-style-type: none"> • Potential sensor board defective

SC415	C	Potential Sensor Vd Adjustment Error (K)
SC416	C	Potential Sensor Vd Adjustment Error (C)
SC417	C	Potential Sensor Vd Adjustment Error (M)
SC418	C	Potential Sensor Vd Adjustment Error (Y)
		<p>The DC bias charge could not be adjusted to the target voltage $Vd \pm 8V$</p> <p>Process control error code: 63 (displayed with SP3012).</p> <p>Note: Vd is the potential sensor reading of the unexposed surface of the OPC drum (no laser applied to this area of the drum). This is read during the potential process control self-check. Vd is adjusted with the charge roller.</p>
		<p>Error Code 63</p> <ul style="list-style-type: none"> • Charge roller dirty • Charge roller defective

SC420	C	Potential Sensor VI Adjustment Error (K)
SC421	C	Potential Sensor VI Adjustment Error (C)
SC422	C	Potential Sensor VI Adjustment Error (M)
SC423	C	Potential Sensor VI Adjustment Error (Y)

		<p>The LD power could not be adjusted to the target for $V_p \pm 5V$. Process control error code: 64 (displayed with SP3012).</p> <p>Note:</p> <ul style="list-style-type: none"> • V_l is the OPC drum potential after maximum laser exposure. The potential sensor measures V_l by reading the white patches of the potential sensor pattern. • To change V_l, the machine adjusts the input current (V_{pl}) of the laser diode.
		<p>Error Code 64</p> <ul style="list-style-type: none"> • Charge roller dirty • Charge roller defective • OPC drum is worn and needs to be replaced

6

SC430	C	Potential Sensor Vr Adjustment Error (K)
SC431	C	Potential Sensor Vr Adjustment Error (C)
SC432	C	Potential Sensor Vr Adjustment Error (M)
SC433	C	Potential Sensor Vr Adjustment Error (Y)
		<p>Potential sensor adjustment was out of range: $V_r > -200V$.</p> <p>Process control error code: 62 (displayed with SP3012).</p> <p>Note: V_r is residual voltage, the slight trace of voltage that remains after the QL neutralizes the surface of the drum. There is always some residual voltage after quenching, even on a new drum. V_r can cause dirty backgrounds on copies. The only way to compensate for V_r is to increase development bias.</p>
		<p>Error Code 62:</p> <ul style="list-style-type: none"> • OPC drum is worn, needs replacement

SC440	D	Image Transfer Power Pack Voltage Leak (K)
SC441	D	Image Transfer Power Pack Voltage Leak (C)
SC442	D	Image Transfer Power Pack Voltage Leak (M)
SC443	D	Image Transfer Power Pack Voltage Leak (Y)

		<p>The machine detected a problem with the image transfer power pack. An interrupt checks the status of the power pack every 10 ms. This SC is issued if a problem exists with 50 consecutive samplings (500 ms).</p> <ul style="list-style-type: none"> • Power pack high-voltage harness disconnected or broken • IOB defective • Image transfer power pack defective • ITB defective • PCU charge roller defective
SC446	D	Transfer Belt Drive Motor
		<p>The transfer belt drive motor failed to start within the prescribed time or failed during normal operation.</p> <ul style="list-style-type: none"> • Motor harness disconnected or broken • Physical obstruction is blocking operation of the ITB unit • Motor or motor drive board defective
SC447	D	1st Lift Motor Sensor (YCM) Error
		<p>The 1st lift motor (YCM) was operating but the 1st lift motor sensor failed to detect the position of the sensor feeler within the prescribed time.</p> <ul style="list-style-type: none"> • Sensor dirty • Sensor harness disconnected or broken • Sensor defective • Motor defective
SC448	D	ITB Unit Set Error (K)
		<p>After the front door was closed, the ITB lift sensor (K) failed to detect the ITB at the correct position.</p> <ul style="list-style-type: none"> • Operator forgot to set lever before closing front cover • 2nd lift motor sensor (K) 1 or 2 dirty • Sensor harness disconnected or broken • Sensor defective

SC449	D	ITB Tray Lift (K) Error
		<p>The 2nd lift motor (K) was operating but 2nd lift motor sensor 1 or 2 failed to detect the position of the sensor feeler for the 2nd lift tray (K) within the prescribed time.</p> <p>Note: There are two lift sensors for the 2nd lift tray below the K_PCDU. Sensor 1 is above the 2nd lift motor near the front of the ITB unit. Sensor 2 is at the rear left corner of the ITB unit below the ITB.</p>
		<ul style="list-style-type: none"> • Sensor 1 or 2 dirty • Sensor harness disconnected or broken • Sensor 1 or 2 defective • 2nd lift motor (K) defective

SC452	D	ITB Unit Transfer Power Pack Low Voltage Error (K)
SC453	D	ITB Unit Transfer Power Pack Low Voltage Error (C)
SC454	D	I ITB Unit Transfer Power Pack Low Voltage Error (M)
SC455	D	ITB Unit Transfer Power Pack Low Voltage Error (Y)
		<p>The machine detected a power pack voltage output at less than 0.1 kV due to a problem with the power pack power supply.</p>
		<ul style="list-style-type: none"> • Power pack power supply harness disconnected or broken • Replace the power pack

SC457	D	ITB Cleaning Unit Motor Error
		<p>The ITB cleaning unit motor failed to start within the prescribed time or failed during normal operation.</p>
		<ul style="list-style-type: none"> • Motor harness disconnected or broken • Physical obstruction is blocking the operation of the ITB cleaning unit • ITB cleaning unit motor defective

SC458	C	Image Transfer Roller Error (K)
SC459	C	Image Transfer Roller Error (C)
SC460	C	Image Transfer Roller Error (M)

SC461	C	Image Transfer Roller Error (Y)
		<p>The machine detected that the electrical resistance of the roller exceeded the allowed limit, indicating that the service life of the roller has expired or there could be a problem with the transfer power pack.</p> <ul style="list-style-type: none"> • High-voltage harness disconnected or broken • Connection point at the roller broken • Image transfer roller worn out, needs replacement • Image transfer power pack defective
SC464	D	ITB Unit Transfer Power Pack Leak Error
		<p>The machine detected a voltage leak at the paper transfer power pack</p> <ul style="list-style-type: none"> • Harness between power pack and IOB disconnected or broken • High-voltage harness defective • Power pack defective • IOB defective • ITB defective • PTR defective
SC465	D	PTR Motor Error
		<p>The PTR motor failed to start within the prescribed time or failed during normal operation.</p> <ul style="list-style-type: none"> • PTR motor harness disconnected or broken • Physical obstruction blocking operation of the PTR unit • Motor or motor drive board defective
SC466	D	PTR Separation Motor Error

		<p>The PTR separation motor was operating but the PTR separation sensor failed to detect the feeler that triggers detection of the PTR separation sensor.</p> <ul style="list-style-type: none"> • Sensor dirty • Motor harness disconnected or broken • Sensor defective • Motor defective
SC468	D	ITB Unit Power Pack Error: Low Output
		<p>During the execution of bias feedback control, the machine detected that the output of the paper transfer power pack was less than 0.1 kV.</p> <ul style="list-style-type: none"> • High-voltage harness disconnected or broken • Paper transfer power pack defective
SC469	C	ITB Bias Roller Service Expired
		<p>The machine detected that the electrical resistance of the roller exceeded the allowed limit, indicating that the service life of the roller has expired or there could be a problem with the paper transfer power pack.</p> <ul style="list-style-type: none"> • High-voltage harness disconnected or broken • Connection point at the roller broken • ITB bias roller worn out, needs replacement • Paper transfer power pack defective
SC470	D	ITB Unit Power Pack Leak Error
		<p>The machine detected a voltage leak at the separation power pack</p> <ul style="list-style-type: none"> • Harness between power pack and IOB disconnected or broken • High-voltage harness defective • Power pack defective • IOB defective • ITB defective • ITB bias roller defective
SC471	D	Belt Position Ready Timeout

		<p>The machine could not center the belt correctly with 400 sec. after the ITB motor starting rotating the ITB.</p> <ul style="list-style-type: none"> • Belt centering roller out of position • ITB encoder sensor defective • Belt centering roller sensor defective • Belt centering roller motor defective
		<ol style="list-style-type: none"> 1. Do the procedure to clear SC471 (p.1020) 2. Replace ITB motor rotation sensor 3. Replace belt centering roller sensor 4. Replace belt centering roller motor
SC472	D	Belt Centering Roller HP Error
		<p>The belt centering roller sensor did not detect the belt centering roller at HP during initialization, or the belt centering roller sensor still detected the belt centering roller at HP after the belt centering roller motor switched on</p>
		<ul style="list-style-type: none"> • Belt centering roller sensor defective • Belt centering roller motor defective
SC474	D	ITB Position Error 1
		<p>The belt centering sensor detected the ITB out of position.</p> <ul style="list-style-type: none"> • ITB not set correctly, re-set ITB. • Belt centering roller out of home position • ITB encoder sensor defective • Belt centering roller sensor defective • Belt centering roller motor defective
		<ol style="list-style-type: none"> 1. Re-set ITB correctly. 2. Do the procedure to clear SC474 (p.1020) 3. Replace ITB motor rotation sensor 4. Replace belt centering roller sensor. 5. Replace belt centering roller motor.
SC475	D	ITB Position Error 2

		<p>The front belt overrun sensor detected an ITB position error.</p> <ul style="list-style-type: none"> • Front belt overrun sensor defective • ITB defective or worn • Belt centering roller out of home position • ITB motor rotation sensor defective • Belt centering roller sensor defective • Belt centering roller motor defective
		<ol style="list-style-type: none"> 1. Replace the belt overrun sensor (front). 2. Do the procedure to clear SC475 (p.1020) 3. Replace ITB motor encoder 4. Replace belt centering roller sensor 5. Replace belt centering roller motor

6

SC476	D	ITB Position Error 3
		<p>The rear belt overrun sensor detected an ITB position error.</p> <ul style="list-style-type: none"> • Rear belt overrun sensor defective • ITB defective or worn • Belt centering roller out of home position • ITB motor rotation sensor defective • Belt centering roller sensor defective • Belt centering roller motor defective
		<ol style="list-style-type: none"> 1. Replace the belt overrun sensor (front). 2. Do the procedure to clear SC476 (p.1020) 3. Replace ITB motor encoder 4. Replace belt centering roller sensor 5. Replace belt centering roller motor

SC477	D	Belt Centering Sensor Error
		<p>The readings of the belt centering sensor dropped below one volt after 62 samples.</p> <ul style="list-style-type: none"> • Belt centering sensor connector loose, broken, defective • Belt centering sensor defective

SC480	D	Drum Cleaning Motor Error (K)
SC481	D	Drum Cleaning Motor Error (C)
SC482	D	Drum Cleaning Motor Error (M)
SC483	D	Drum Cleaning Motor Error (Y)
		The drum cleaning motor failed to start within the prescribed time or failed during normal operation.
		<ul style="list-style-type: none"> • Physical obstruction is blocking normal motor operation • Motor harness disconnected or broken • Motor defective
SC485	D	Used Toner Transport Motor Error
		The used toner transport motor failed to start within the prescribed time or failed during normal operation.
		<ul style="list-style-type: none"> • Physical obstruction is blocking motor or used toner transport path • Motor harness disconnected or broken • Motor defective
SC486	D	Used Toner Bottle Motor Error
		The used toner bottle motor failed to start within the prescribed time or failed during normal operation.
		<ul style="list-style-type: none"> • Physical obstruction is blocking motor or interfering with rotation of used toner bottle • Motor harness disconnected or broken • Used toner bottle motor defective
SC488	D	Used Toner Transport Blockage
		Used toner is not being moved to the used toner bottle.
		<ul style="list-style-type: none"> • Blockage in the used toner transport path • Used toner motor (main machine) harness disconnected or broken • Used toner transport motor sensor defective • Used toner motor (main machine) defective

SC490	C	Impending Failure Detection: Code 01
SC491	C	Impending Failure Detection: Code 02
SC492	C	Impending Failure Detection: Code 03
SC493	C	Impending Failure Detection: Code 04
SC494	C	Impending Failure Detection: Code 05
SC495	C	Impending Failure Detection: Code 99
		<p>The TDCU (Transfer Drive Control Board) monitors the mechanisms. If the TDCU detects an impending failure in a system, it will notify the engine of the problem with an ASAP command. The main cause of such impending failures are:</p> <ul style="list-style-type: none"> • Expiration of service life of components • Dirty sensors <hr/> <ul style="list-style-type: none"> • Clean the part • Replace the part

SC496	C	MUSIC Sensor Error
		<p>This SC is issued if one or more of the following occurred:</p> <ul style="list-style-type: none"> • MUSIC sensor sampling abnormal • Sensor LED adjustment abnormal • Number of patches abnormal • ITB scratched • Main scan registration abnormal • Sub scan registration abnormal • Main scan magnification abnormal • Main scan magnification error diffusion abnormal • Lens refraction abnormal

		<ul style="list-style-type: none"> • A PCDU is set incorrectly • ITB is set incorrectly • Execute process control density adjustment • MUSIC sensor harness loose, disconnected, broken, defective • ITB damaged • PCDU defective • Laser unit defective
SC497	C	<p>Temperature/Humidity Sensor Error (PCU)</p> <p>The machine detected one of these problems with the temperature/humidity sensor located under the rear end of the K PCDU:</p> <ul style="list-style-type: none"> • The temperature sensor output was less than 0.5V or more than 2.8V three times in one minute, indicating a problem with the temperature detection. • The humidity sensor output was more than 2.4V for three times in one minute, indicating a problem with humidity detection. <ul style="list-style-type: none"> • Sensor harness disconnected or broken • Sensor has slipped out of position • Sensor defective
SC498	C	<p>Temperature/Humidity Sensor Error (Main)</p> <p>The machine detected one of these problems with the temperature/humidity sensor located under the rear end of the K PCDU:</p> <ul style="list-style-type: none"> • The temperature sensor output was less than 0.5V or more than 2.8V three times in one minute, indicating a problem with the temperature detection. • The humidity sensor output was more than 2.4V for three times in one minute, indicating a problem with humidity detection. <ul style="list-style-type: none"> • Sensor harness disconnected or broken • Sensor has slipped out of position • Sensor defective
SC499	C	Paper Transfer Control Error

		<p>The ITB sensor that reads the encoded film strip on the edge of the image transfer belt was not operating correctly. (The TDCU constantly monitors operation of the ITB with transfer feed-back control.)</p>
		<ul style="list-style-type: none"> • ITB encoder sensor dirty • Sensor harness disconnected or damaged • Encoded scale on the edge of the ITB is damaged or dirty • ITB installed incorrectly • TDCU harness disconnected or broken • TDCU defective

SC500: Paper Feed, Transport, Duplexing

6

SC501	B	1st Tray (Tandem Tray) Feed Error
SC502	B	2nd Tray (Universal Cassette) Feed Error
		<p>One of the following occurred at the start of the job:</p> <ul style="list-style-type: none"> • The tray 1 lift sensor does not switch on 10 s after the tray lift motor switches on and starts lifting the bottom plate. • The tray lift sensor was on before the pick-up solenoid switched on. • When the tray lowered, the tray lift sensor did not go off within 1.5 sec. • The paper end sensor of the tandem tray did not detect the lower limit within 10 sec. <p>Note: Another paper tray cannot be used until the problem is resolved.</p> <ul style="list-style-type: none"> • Remove and reset the paper tray • Tray lift motor harness disconnected or broken • Paper or other obstacle trapped between tray and motor • Pick-up solenoid disconnected or broken • Paper or other obstacle blocking operation of pick-up solenoid

SC503	B	3rd Tray Feed Error	LCIT top tray
SC504	B	4th Tray Feed Error	LCIT middle tray
SC505	B	5th Tray Feed Error	LCIT bottom tray

		The tray lift motor, pick-up solenoid, or lift sensor did not operate correctly.	
		<ul style="list-style-type: none"> • Tray lift motor harness disconnected or broken • Pick-up solenoid harness disconnected or broken • Tray lift sensor harness disconnected or broken • Tray lift motor defective • Pick-up solenoid defective • Tray lift sensor defective 	
SC506	B	6th Tray Feed Error	Bypass tray on top of LCIT
		The tray lift motor, pick-up solenoid, lift sensor, or lower limit sensor did not operate correctly.	
		<ul style="list-style-type: none"> • Tray lift motor harness disconnected or broken • Pick-up solenoid harness disconnected or broken • Tray lift sensor harness disconnected or broken • Lower limit sensor disconnected or broken • Tray lift motor defective • Pick-up solenoid defective • Tray lift sensor defective • Lower limit sensor defective 	
SC507	B	Tandem Tray Rear Fence Motor Error (1st Tray)	

		<p>One of the following occurred:</p> <ul style="list-style-type: none"> • The return sensor does not switch on within 10 sec. after the rear fence motor switches on. • The HP sensor does not switch on 10 sec. after the rear fence motor switches on. • The HP sensor and return sensor switch on at the same time.
		<ul style="list-style-type: none"> • Rear fence motor harness disconnected or broken • Paper or other obstacle interfering with operation of the sensors • Paper or other obstacle trapped between tray and motor • Motor mechanical overload due to obstruction • Return sensor or HP sensor harness disconnected or broken • Return sensor or HP sensor dirty • Rear fence motor defective • Return sensor or HP sensor defective

SC511	B	LCIT Exit Roller Lift Motor Error
		<p>The exit roller lift motor of lift motor sensor is not operating.</p> <ul style="list-style-type: none"> • Motor harness disconnected or broken • Sensor harness disconnected or broken • Motor defective • Sensor defective

SC513	D	Registration Gate Position Error
-------	---	----------------------------------

		<p>The registration gate could not be detected on or off within the prescribed time. Specifically:</p> <ul style="list-style-type: none"> • The registration gate HP sensor did not switch off within 500 ms after the gate retract motor switched on. • After the registration HP sensor switched off, the HP sensor did not switch on within 500 ms.
		<ul style="list-style-type: none"> • Gate retract motor harness disconnected or broken • Gate HP sensor harness disconnected or broken • Physical obstacle (paper, etc.) is blocking operation of the motor • Gate HP sensor actuator bent, broken, or out of position • Gate HP sensor defective • Gate retract motor or motor drive board defective

SC514	D	Registration Shift Position Error
		<p>The HP sensor did not go on or off within the prescribed time. Specifically:</p> <ul style="list-style-type: none"> • During normal homing operation, before the unit shift motor starting rotating clockwise, the unit was detected at the HP (on). Or, after the unit shift motor had rotated clockwise for 20 pulses, the unit could not be detected at the HP (on). • During homing operation with the unit out of HP, The unit could not be detected off or on within 1068 ms after the unit shift motor started rotating count-clockwise and the cam shaft had rotated twice.
		<ul style="list-style-type: none"> • Shift motor harness disconnected or broken • Physical obstruction is blocking operation of the motor • HP sensor harness disconnected or broken • Sensor actuator bent, broken, or out of position • Motor or motor drive board defective

SC515	D	CIS Cleaning Fan Error
		<p>The CIS cleaning fan motor in the right drawer failed to start within the prescribed time or failed during normal operation.</p>
		<ul style="list-style-type: none"> • Fan motor harness disconnected or broken • Physical obstruction is blocking operation of the fan

SC516	D	Transport Belt Drive Motor Error
		A LOW motor LOCK signal was not detected after the motor switched off after 10 consecutive attempts.
		<ul style="list-style-type: none"> • Motor connector loose, broken, defective • Motor or motor drive board defective

SC520	D	Fusing Motor Error
		The fusing motor failed to start within the prescribed time or failed during normal operation.
		<ul style="list-style-type: none"> • Fusing motor harness disconnected or broken • Physical obstruction is blocking the operation of the 1st fusing processing unit • Fusing motor defective • Blown fused on PSU 2 on the back of the main machine

SC521	D	Exit Motor Error
		The exit motor failed to start within the prescribed time or failed during normal operation.
		<ul style="list-style-type: none"> • Exit motor harness disconnected or defective • Exit motor shaft locked, blocked by obstruction • Exit motor defective

SC525	D	Cooling Unit Transport Motor 1 Error
SC526	D	Cooling Unit Transport Motor 2 Error
		A transport motor of the optional cooling unit failed to switch on within the prescribed time after startup.
		<ul style="list-style-type: none"> • Motor harness disconnected or broken • Motor defective

SC527-001	D	Cooling Fan Alarm 1 (Buffer Pass Unit D548)
SC527-002	D	Cooling Fan Alarm 2 (Buffer Pass Unit D548)
SC527-003	D	Cooling Fan Alarm 3 (Buffer Pass Unit D548)

SC527-004	D	Cooling Fan Alarm 4 (Buffer Pass Unit D548)
		The fan stopped during operation. This alarm is issued if the fan lock sensor detects that the fan has been off for 10 sec.
		<ul style="list-style-type: none"> • Fan motor harness disconnected or broken • Fan motor defective

SC527-005	D	Exhaust Fan Alarm 1 (Buffer Pass Unit D548)
SC527-006	D	Exhaust Fan Alarm 2 (Buffer Pass Unit D548)
SC527-007	D	Exhaust Fan Alarm 3 (Buffer Pass Unit D548)
SC527-008	D	Exhaust Fan Alarm 4 (Buffer Pass Unit D548)
		The fan stopped during operation. This alarm is issued if the fan lock sensor detects that the fan has been off for 10 sec.
		<ul style="list-style-type: none"> • Fan motor harness disconnected or broken • Fan motor defective

SC530	D	Heat Sink Intake Fan Error
		The one of the fans in the heat sink duct stopped during operation. This alarm is issued if the fan lock sensor detects that the fan has been off for 5 sec.
		<ul style="list-style-type: none"> • Fan motor harness disconnected or broken • Fan motor defective

SC531	D	Paper Cooling Fan Error
		One of the fans in the paper cooling duct stopped during operation. This alarm is issued if the fan lock sensor detects that the fan has been off for 5 sec. The paper cooling duct surrounds the circular baffle at the back of the left drawer.
		<ul style="list-style-type: none"> • Fan motor harness disconnected or broken • Fan motor defective

SC532-01	B	3rd Tray Front Blower Fan Error	LCIT Top Tray: Front
SC532-02	B	3rd Tray Rear Blower Fan Error	LCIT Top Tray: Rear

SC533-01	B	4th Tray Front Blower Fan Error	LCIT Middle Tray: Front
SC533-02	B	4th Tray Rear Blower Fan Error	LCIT Middle Tray: Rear
SC534-01	B	5th Tray Front Blower Fan Error	LCIT Bottom Tray: Front
SC534-02	B	5th Tray Rear Blower Fan Error	LCIT Bottom Tray: Rear
		<p>The fan motor failed to start within the prescribed time or stopped during normal operation.</p> <ul style="list-style-type: none"> • Fan motor harness disconnected or broken • Fan motor defective 	

SC535	D	ITB Belt Cleaning Cooling Fan Error	
		<p>This is the small fan to the left or the large pressure roller fan on the front of the left drawer.</p> <ul style="list-style-type: none"> • Fan motor harness disconnected or broken • Fan motor defective 	

SC536	D	Drive Exhaust Fan Error	
		<p>The fan motor failed to start within the prescribed time or stopped during normal operation. The drive exhaust fan is located near the upper left corner of the machine at the rear.</p> <ul style="list-style-type: none"> • Fan motor harness disconnected or broken • Fan motor defective 	

SC537	D	Toner Supply Cooling Fan Error	
		<p>The fan motor failed to start within the prescribed time or stopped during normal operation. The toner supply cooling fan is inside the duct at the upper right corner at the rear of the machine. It is inside the duct that runs past the YM laser unit and connects behind the toner supply units.</p> <ul style="list-style-type: none"> • Fan motor harness disconnected or broken • Fan motor defective 	

SC538	D	Controller Box Intake Fan Error	
-------	---	---------------------------------	--

		<p>One of the fans at the bottom edge of the controller box failed to start within the prescribed time or stopped during normal operation.</p> <ul style="list-style-type: none"> • Fan motor harness disconnected or broken • Fan motor defective
SC539	D	Development Unit Cooling Fan Error
		<p>One of the three large fans that cool the liquid coolant through the radiator failed to start within the prescribed time or stopped during normal operation. These fans are located in the cooling box at the back of the machine.</p> <ul style="list-style-type: none"> • Fan motor harness disconnected or broken • Fan motor defective
SC541	A	Heating Roller Thermistor Error: Poor Connection
		<p>Temperature (t1) detected at less than 0°C.</p> <p>Note: This is the contact thermistor at the front of the fusing unit that touches the core shaft of the hot roller.</p> <ul style="list-style-type: none"> • Do SP5810 to cancel the fatal error • Harness disconnected or broken • Poor contact with surface of hot roller • Thermistor defective
SC542	A	Heating Roller Thermistor Error: Warm-up Temperature
		<p>Fusing temperature control failed to achieve the warm-up temperature.</p> <ul style="list-style-type: none"> • Do SP5810 to cancel the fatal error • Thermistor deformed • Thermistor floating free, not in contact with hot roller surface • Input voltage incorrect • Fusing lamp disconnected
SC543	A	Heating Roller Thermistor Error: Software Error
SC544	A	Thermistor 1 Error: Hardware Error

		<p>Temperature incorrect due to a TRIAC short or other problem with IOB or AC drive board</p> <ul style="list-style-type: none"> • Do SP5810 to cancel the fatal error • IOB harness disconnected or broken • AC drive board harness disconnected or broken • AC drive board defective • IOB defective
SC547	D	<p>Zero Cross Error</p> <p>Zero cross signals, generated from the AC power supply, are used to generate trigger pulses to control the applied power accurately. When the main switch is turned on, the machine checks how many zero-cross signals are generated within a prescribed time. This SC code is issued if the number of zero-cross signals detected is not within specification.</p> <ul style="list-style-type: none"> • Do SP5810 to cancel the fatal error • A fuse has blown on the AC drive board • Electrical noise on the power supply line • Fusing relay damaged, replace AC drive board.
SC551	A	<p>Pressure Roller Thermistor Error: Poor Connection</p> <p>Temperature detected at less than 0°C.</p> <ul style="list-style-type: none"> • Do SP5810 to cancel the fatal error • Harness disconnected or broken • Poor contact with surface of pressure roller • Thermistor defective
SC552	A	<p>Pressure Roller Thermistor Error: Warm-up Temperature</p>

		<p>Fusing temperature control failed to achieve the warm-up temperature.</p> <ul style="list-style-type: none"> • Do SP5810 to cancel the fatal error • Thermistor deformed • Thermistor floating free, not in contact with pressure roller surface • Input voltage incorrect • Fusing lamp disconnected
SC553	A	Pressure Roller Thermistor Error: Software Error
SC554	A	Pressure Roller Thermistor Error: Hardware Error
		<p>Temperature incorrect due to a TRIAC short or other problem with IOB or AC drive board</p> <ul style="list-style-type: none"> • Do SP5810 to cancel the fatal error • IOB harness disconnected or broken • AC drive board harness disconnected or broken • AC drive board defective • IOB defective
SC555	A	Pressure Roller Fusing Lamp Error
		<p>The fusing lamp reached the warm-up temperature and then attained fusing temperature (full power), but remained on after paper passed through the fusing unit (hot roller was not rotating)..</p> <ul style="list-style-type: none"> • Do SP5810 to cancel the fatal error • Thermistor damaged, or out of position • Fusing lamp disconnected, broken
SC557	C	Zero Cross Over Error
		<p>At power-on the machine detected that the main power supply was unstable, probably due to electrical noise on the line.</p> <ul style="list-style-type: none"> • Logged SP, no action
SC558	A	Fusing Lamp 4 Error

		<p>The fusing lamp reached the warm-up temperature and then attained fusing temperature (full power), but remained on after paper passed through the fusing unit (hot roller was not rotating).</p> <p>Note: Fusing lamp 4 is in the heating roller.</p>
		<ul style="list-style-type: none"> • Do SP5810 to cancel the fatal error • Thermistor damaged, or out of position • Fusing lamp disconnected, broken

SC559	A	Three consecutive fusing jams
		<p>This SC only occurs if SP1142 is on (Default: OFF), and paper jams occurred in the fusing unit for three consecutive feeds. With SP1142 set to "1" the machine operation can be restored only by the service technician after three consecutive jams occur.</p>
		<ul style="list-style-type: none"> • Remove jammed paper • Check inside the fusing unit for paper scraps • Make sure the paper path is clean and free

SC561	A	Heating Roller Thermistor Error: Poor Connection
		<p>Temperature detected at less than 0°C.</p> <p>Note: These are the two NC sensors on the side of the fusing unit.</p>
		<ul style="list-style-type: none"> • Do SP5810 to cancel the fatal error • Harness disconnected or broken • Poor contact with surface of heating roller • Thermistor defective

SC562	A	Heating Roller Thermistor Error: Warm-up Temperature
-------	---	--

		<p>Fusing temperature control failed to achieve the warm-up temperature.</p> <p>Note: These are the two NC sensors on the side of the fusing unit.</p> <ul style="list-style-type: none"> • Do SP5810 to cancel the fatal error • Thermistor deformed • Thermistor floating free, not in contact with heating roller surface • Input voltage incorrect • Fusing lamp disconnected
SC563	A	Heating Roller Thermistor Error: Software Error
SC564	A	Pressure Roller Thermistor Error: Hardware Error
		<p>Temperature incorrect due to a TRIAC short or other problem with IOB or AC drive board</p> <ul style="list-style-type: none"> • Do SP5810 to cancel the fatal error • IOB harness disconnected or broken • AC drive board harness disconnected or broken • AC drive board defective • IOB defective
SC566	A	Thermistor 4 Error: Poor Connection
		<p>Temperature detected at less than 0°C.</p> <p>Note: This is the contact thermistor at the top rear of the fusing unit.</p> <ul style="list-style-type: none"> • Do SP5810 to cancel the fatal error • Harness disconnected or broken • Poor contact with surface of heating roller • Thermistor defective
SC567	A	Thermistor 4 Error: Software Error
SC568	A	Thermistor 4 Error: Hardware Error

		<p>Temperature incorrect due to a TRIAC short or other problem with IOB or AC drive board</p> <ul style="list-style-type: none"> • Do SP5810 to cancel the fatal error • IOB harness disconnected or broken • AC drive board harness disconnected or broken • AC drive board defective • IOB defective
SC569	D	<p>Pressure Roller Lift Error</p> <p>Pressure roller lift motor not operating correctly. No signal to indicate completion of operation.</p> <ul style="list-style-type: none"> • Pressure roller lift sensor harness disconnected or broken • Pressure roller lift sensor dirty • Pressure roller lift harness disconnected or broken • Pressure roller lift motor blocked by an obstruction • Pressure roller lift motor defective
SC570	D	<p>Ozone Collection Fan Error</p> <p>The ozone collection fan is the large fan on the right end of the upper horizontal duct across the back of the machine.</p> <ul style="list-style-type: none"> • Fan harness disconnected or broken • Fan overload due to physical obstruction • Fan motor defective
SC571	A	<p>Thermistor 6 Error: Poor Connection</p> <p>Temperature detected at less than 0°C.</p> <p>Note: This is the contact thermistor under the pressure roller at the front of the fusing unit.</p> <ul style="list-style-type: none"> • Do SP5810 to cancel the fatal error • Harness disconnected or broken • Poor contact with surface of pressure roller • Thermistor defective

SC572	A	Thermistor 6 Error: Warm-up Temperature
		Fusing temperature control failed to achieve the warm-up temperature.
		<ul style="list-style-type: none"> • Do SP5810 to cancel the fatal error • Thermistor deformed • Thermistor floating free • Input voltage incorrect • Fusing lamp disconnected
SC573	A	Thermistor 6 Error: Software Error
SC574	A	Thermistor 6 Error: Hardware Error
		Temperature incorrect due to a TRIAC short or other problem with IOB or AC drive board
		<ul style="list-style-type: none"> • Do SP5810 to cancel the fatal error • IOB harness disconnected or broken • AC drive board harness disconnected or broken • AC drive board defective • IOB defective
SC575	A	Fusing Lamp 6 Error
		The fusing lamp in the pressure roller reached the warm-up temperature and then attained fusing temperature (full power), but remained on after paper passed through the fusing unit (hot roller was not rotating)..
		<ul style="list-style-type: none"> • Do SP5810 to cancel the fatal error • Thermistor damaged, or out of position • Fusing lamp disconnected, broken
SC576	A	Hot Roller NC Sensor (Sensor 7) Poor Connection

		<p>The hot roller NC sensor (infrared thermistor) on top of the fusing unit detected temperature less than 0C for 75 sec.</p> <ul style="list-style-type: none"> • Do SP51810 to cancel the fatal error • Sensor disconnected • Sensor connector harness or connector broken or defective
SC577	A	Thermistor 7 Error: Software Error
SC578	A	Thermistor 7 Error: Hardware Error
		<p>Temperature incorrect due to a TRIAC short or other problem with IOB or AC drive board</p> <ul style="list-style-type: none"> • Do SP5810 to cancel the fatal error • IOB harness disconnected or broken • AC drive board harness disconnected or broken • AC drive board defective • IOB defective
SC579	A	Thermistor 8 Error: Poor Connection
		<p>Temperature detected at less than 0°C.</p> <p>Note: This is the contact thermistor at the front of the fusing unit that touches the shaft of the hot roller.</p> <ul style="list-style-type: none"> • Do SP5810 to cancel the fatal error • Harness disconnected or broken • Poor contact with surface of hot roller shaft (thermistor blade out of position) • Thermistor defective
SC580	A	Thermistor 8 Error: Warm-up Temperature

		<p>Fusing temperature control failed to achieve the warm-up temperature.</p> <ul style="list-style-type: none"> • Do SP5810 to cancel the fatal error • Thermistor deformed • Thermistor floating free, not in contact with the hot roller shaft surface. • Input voltage incorrect • Fusing lamp disconnected
SC581	D	<p>Fusing Exit Exhaust Fan Error</p> <p>The fan motor failed to start within the prescribed time or stopped and remained off for one sec. This motor is the blower fan mounted flat on the rear side of the machine on the right.</p> <ul style="list-style-type: none"> • Fan motor harness disconnected or broken • Fan defective
SC582	D	<p>Cooling Box Emission Exhaust, Cooling Box Heat Fan Error</p> <p>One of these fan motors failed to start within the prescribed time or stopped and remained off for one sec. These fans are inside the cooling box below the blower fan on the right.</p> <ul style="list-style-type: none"> • Fan motor harness disconnected or broken • Fan defective
SC583	D	<p>Fusing Unit Transport Exhaust Fan</p> <p>The fan motor failed to start within the prescribed time or stopped and remained off for one sec. This is the lower blower fan mounted at a right angle on the rear of the machine behind the cooling box.</p> <ul style="list-style-type: none"> • Fan motor harness disconnected or broken • Fan defective
SC584	D	<p>Cooling Box Ozone Exhaust Fan</p>

		<p>The fan motor failed to start within the prescribed time or stopped and remained off for one sec. This is the blower fan inside the "L" duct inside the cooling box and below the air and ozone filters.</p> <ul style="list-style-type: none"> • Fan motor harness disconnected or broken • Fan defective
SC585	D	<p>Stray Toner Exhaust Fan Error</p> <p>The fan motor failed to start within the prescribed time or stopped and remained off for one sec. This is the small fan on the right end of the third duct from the top at the rear side of the machine behind the cooling box.</p> <ul style="list-style-type: none"> • Fan motor harness disconnected or broken • Fan defective
SC586	D	<p>ITB Intake Fan, Stray Toner Intake Fan Error</p> <p>One of these fan motors failed to start within the prescribed time or stopped and remained off for one sec. These are the two motors visible on the right side of the machine with the right cover removed.</p> <ul style="list-style-type: none"> • Fan motor harness disconnected or broken • Fan defective
SC587	C	<p>YM Thermistor Error</p> <p>The YM thermistor is inside the YM laser unit. One of the following occurred:</p> <ul style="list-style-type: none"> • The YM thermistor registered a reading of less than -10°C, indicating a disconnection. • The YM thermistor registered a reading of more than 80°C, indicating an electrical short circuit <ul style="list-style-type: none"> • Thermistor harness disconnected or broken • Thermistor defective
SC588	D	<p>Duplex Exhaust Fan, Exit Paper Exhaust Fan Error</p>

		One of these fan motors failed to start within the prescribed time or stopped and remained off for one sec. These are the four large fans visible on the left side of the machine with the left cover removed.
		<ul style="list-style-type: none"> • Fan motor harness disconnected or broken • Fan blocked by an obstruction • Fan defective

SC589	D	Drive Exhaust Fan Error
		The fan motor failed to start within the prescribed time or stopped and remained off for one sec. This is the small fan located at the upper rear corner on the left side of the machine.
		<ul style="list-style-type: none"> • Fan motor harness disconnected or broken • Fan blocked by an obstruction • Fan defective

SC590-1	D	Stepper Motor Error 1
		A stepper motor controlled by the Relay Board (RYB) has failed.
SC590-2		Stepper Motor Error 2
		A stepper motor controlled by the DRB in the right drawer has failed.
SC590-3		Stepper Motor Error 3
		A stepper motor controlled by the TDCU on the back of the machine has failed.
SC590-4		Stepper Motor Error 4
		A stepper motor controlled by the DDRB in the decurler unit has failed.

		<ul style="list-style-type: none"> • Motor connector loose, broken, defective • Motor drive board overheated • Motor shorted out • Motor or drive board defective <p>Note:</p> <ul style="list-style-type: none"> • Look at the Point-to-Point diagram to determine which motors the referenced board controls. • Go into the SP mode and use SP5804 to test the operation of the motors to determine which motor is not operating.
--	--	--

6

SC591	C	Double-Feed Sensor Error
		<p>The strength of the double-feed sensor LED light could not be calibrated within the prescribed range after three attempts.</p> <ul style="list-style-type: none"> • Sensor harness disconnected or broken • Physical obstruction (paper scrap) between the sensor pair (emitter/receiver) • One or both of the sensors are dirty (paper dust)

SC593	D	Decurler Unit Over Limit Error
		<p>The over-limit sensor went on because the decurler unit has moved farther than the allowed distance (± 13.85 mm).</p> <ul style="list-style-type: none"> • Adjust the distance • Cycle the machine off/on

SC594	D	Decurler Unit HP Error
		<p>The decurler unit was not detected at its home position within 6 sec.</p> <ul style="list-style-type: none"> • HP sensor disconnected or broken • Sensor defective

SC595	D	TDCU Hardware Error
-------	---	---------------------

		<p>A command was received from the TDCU due to a stepper motor error, FPGA configuration error, or FPGA power source error.</p> <ul style="list-style-type: none"> • TDCU harness disconnected or broken • TDCU board defective • Stepper motor(s) defective <p>Note: The stepper motors directly controlled by the TDCU include: fusing motor, drum cleaning motor, development motor, drum motor, PTR motor, transfer timing motor.</p>
--	--	---

SC599	D	Paper Height Sensor Error
		<p>One or more of the four paper height sensors in Tray 1 of the main machine is not functioning correctly.</p> <ul style="list-style-type: none"> • Condensation on one or more of the sensors • Sensor harness damaged, defective • Sensor connector loose, broken, defective • IOB defective

SC600: Communications

SC620	D	ADF Communication Error
		<p>No response from the ADF after connection to the main machine or an error occurred after connection.</p> <ul style="list-style-type: none"> • ADF I/F cable disconnected or loose • Electrical noise on the line (noise filter required) • ADF defective • IPU board defective

SC621	D	Peripheral Communication Error
-------	---	--------------------------------

		The UART generated an error when the finisher was connected.
		<ul style="list-style-type: none"> • Peripheral I/F cable disconnected or broken • Peripheral main board disconnected or defective • BCU defective • IOB defective

SC622	D	Paper Bank Communication Error
		The UART generated an error.
		<ul style="list-style-type: none"> • Poor bank drawer connection • BCU harness disconnected or broken • IOB harness disconnected or broken • BCU defective • IOB defective

6

SC625	D	TDCU Master Communication Error
SC626	D	TDCU Slave Communication Error
		An error was generated by ASAP protocol. ASAP (Aggregate Server Access Protocol) provides the high-availability data transfer mechanism over IP networks.
		<ul style="list-style-type: none"> • TDCU harness disconnected or broken • IOB harness disconnected or broken • TDCU defective • IOB defective

SC641	D	Engine-Controller Communication Error: No Response	GW
		There was no response to a frame sent from The Controller Board To the engine.	
		<ul style="list-style-type: none"> • Cycle the machine off/on. 	

SC652	B	@Remote Service ID2 Mismatch Error 1	GW
-------	---	--------------------------------------	----

		<p>One of the following problems occurred with ID2 stored in NVRAM:</p> <ul style="list-style-type: none"> • A control board from another machine where Cumin was set up was installed in this machine. • NVRAM was replaced with the NVRAM from another machine.
		<ul style="list-style-type: none"> • If Cumin has already been installed, confirm that the NVRAM is compatible for use with Cumin. • If Cumin has just been installed, confirm that the NVRAM is compatible for use with Cumin, clear the Cumin setting, set the common authentication, then try again.

SC653	D	@Remote Service ID2 Mismatch Error 2	GW
		<p>One of the following problems exist with the ID2 stored in NVRAM:</p> <ul style="list-style-type: none"> • ID2 has less than 17 digits • A non-printable character exists in ID2 • ID2 is all spaces • ID2 is NULL 	
		<ul style="list-style-type: none"> • Replace NVRAM. • Clear the Cumin setting, set the common authentication, then try again. 	

SC669	D	EEPROM Communication Error	
		<p>After three re-tries there was still no response from the EEPROM on the BCU.</p>	
		<ul style="list-style-type: none"> • Electrical noise • Cycle machine off/on • If problem persists, install a noise filter 	

SC670	D	Engine start failure	GW
		<p>The engine did not respond within 30s after power on, or the engine went down suddenly at power on or during warm up because a communication reset occurred between the BCU and the controller.</p>	
		<ul style="list-style-type: none"> • A fused has blown on PSU 1 • BCU installed incorrectly • BCU defective 	

SC671	D	Incorrect board detected	GW
		An illegal engine board was detected at power on.	
		<ul style="list-style-type: none"> • Replace BICU 	

SC678-01	D	Transport Cooling Unit CTB+24V Power Supply Error	
SC678-02	D	Transport Cooling Unit CTB+24VINT Power Supply Error	
		The control board of the transport cooling unit detected that the power supply was off and not functioning.	
		<ul style="list-style-type: none"> • Unit PSU harness disconnected or broken • Unit main board harness disconnected or broken • Motor harness disconnected or broken • Fan harness disconnected or broken • Unit PSU defective • Main unit control board defective • Motor defective • Fan motor defective 	

6

SC681	D	Toner Cartridge RFID Communication Error	
		A communication error occurred when the RFID tried to communicate with the RFID receptor on the toner cartridge. This SC was issued after the third attempt to communicate failed.	
		<ul style="list-style-type: none"> • RFID reader/writer defective • ASAP I/F disconnected • No ID chip on toner cartridge (replace toner cartridge) • Electrical noise 	

SC682	D	RFID ID Chip Communication Error: PCU	
-------	---	---------------------------------------	--

		RFID made three unsuccessful attempts to communicate with the ID chip on the PCU.
		<ul style="list-style-type: none"> • ID chip data corrupted • ID chip installed incorrectly • ID chip missing • Electrical noise • Replace RFID controller board • Replace PCU
SC683	C	Toner Cartridge RFID Unit Check Error
		The RFID unit communication check failed regardless of whether toner cartridges have been installed or not.
		<ul style="list-style-type: none"> • Electrical noise • Cycle the machine off/on
SC684	D	Fusing Unit ID Chip Error
		The machine made three unsuccessful attempts to communicate with the fusing unit ID chip.
		<ul style="list-style-type: none"> • ID chip missing • ID chip data corrupted • ID chip disconnected or broken • Electrical noise
SC685	C	Power Supply Error 1
		PSU 2 failure.
		<ul style="list-style-type: none"> • PSU 2 harness disconnected or broken • PSU 2 defective • Interlock relay board defective
SC686	C	Power Supply Error 2

		<p>PSU 2 failure. A fuse has blown on PSU 2 on the back of the main machine.</p> <ul style="list-style-type: none"> • PSU 2 harness disconnected or broken • PSU 2 defective • Interlock relay board defective
SC687	D	<p>Memory Address (PER) Command Error</p> <p>The BICU did not receive a memory address command from the controller within the prescribed time after the paper reached the registration sensor.</p> <ul style="list-style-type: none"> • BICU harness disconnected or broken • Controller board harness disconnected or broken • BICU defective • Controller board defective
SC690	D	<p>GAVD Transmission Error (K)</p> <p>The machine cannot communicate (data read/write) normally with the K LDB (laser control ASIC).</p> <ul style="list-style-type: none"> • Cycle the machine off/on • Replace BCU harness or BCU • Laser unit defective
SC691	D	<p>GAVD Transmission Error (C)</p> <p>The machine cannot communicate (data read/write) normally with the C LDB (laser control ASIC).</p> <ul style="list-style-type: none"> • Cycle the machine off/on • Replace BCU harness or BCU • Laser unit defective
SC692	D	<p>GAVD Transmission Error (M)</p>

		The machine cannot communicate (data read/write) normally with the M LDB (laser control ASIC).
		<ul style="list-style-type: none"> • Cycle the machine off/on • Replace BCU harness or BCU • Laser unit defective

SC693	D	GAVD Transmission Error (Y)
		The machine cannot communicate (data read/write) normally with the Y LDB (laser control ASIC).
		<ul style="list-style-type: none"> • Cycle the machine off/on • Replace BCU harness or BCU • Laser unit defective

SC700: Peripherals

6

SC701	D	ADF original pickup operation error
		Even though the pickup motor is rotating clock-wise, the pickup roller home position sensor cannot detect the position of the pickup roller.
		<ul style="list-style-type: none"> • Pickup roller HP sensor harness loose, disconnected, defective • Pickup roller HP sensor defective • Pickup motor harness loose, disconnected, defective • Pickup motor defective • ADF control board defective

SC705	D	ADF bottom plate lift motor
		The bottom plate HP sensor did not detect the home position of the bottom plate after the bottom plate lift motor switches on and lowers the bottom plate.
		The bottom plate position sensor does not detect the position of the plate after the lift motor switches on and raises the bottom plate.
		<ul style="list-style-type: none"> • ADF feed motor disconnected, defective • Bottom plate HP sensor disconnected, defective • ADF main board defective

SC719-1	D	Downstream CIT Communication Error
		<p>The downstream Cover Interposer Tray (CIT) failed to respond to three attempts by the main machine to communicate.</p> <ul style="list-style-type: none"> • CIT I/F cable disconnected, loose, or broken • CIT main board harness disconnected or broken • Main machine controller harness disconnected or broken • CIT main board defective • Main machine controller board defective
SC719-2	D	Downstream MFU Communication Error
		<p>The downstream Multi Folding Unit (MFU) failed to respond to communication from the main machine.</p> <ul style="list-style-type: none"> • MFU I/F cable disconnected, loose, or broken • MFU main board harness disconnected or broken • Main machine controller harness disconnected or broken • MFU main board defective • Main machine controller board defective
SC719-3	D	Downstream HCS Communication Error
		<p>The unit installed immediately to the left of the HCS failed to respond.</p> <ul style="list-style-type: none"> • HCS I/F cable disconnected, loose, or broken • HCS main board harness disconnected or broken • Main machine controller harness disconnected or broken • HCS main board defective • Main machine controller board defective
SC719-5	D	Downstream FIN Communication Error

		The downstream Finisher (FIN) failed to respond to communication from the main machine.
		<ul style="list-style-type: none"> • FIN I/F cable disconnected, loose, or broken • FIN main board harness disconnected or broken • Main machine controller harness disconnected or broken • FIN main board defective • Main machine controller board defective

SC719-6	D	Downstream RB Communication Error
		The downstream Ring Binder (RB) failed to respond to communication from the main machine.
		<ul style="list-style-type: none"> • RB I/F cable disconnected, loose, or broken • RB main board harness disconnected or broken • Main machine controller harness disconnected or broken • RB main board defective • Main machine controller board defective

SC720-1	D	Entrance roller motor error	Booklet Finisher (D512)
		Motor stopped operating, due to a physical obstruction or another problem.	
		<ul style="list-style-type: none"> • Check for and remove any physical obstructions around the motor and timing belts • Motor harness or connector disconnected or defective • Motor defective 	

SC720-2	D	Junction gate motor error	Booklet Finisher (D512)
---------	---	---------------------------	-------------------------

		One or both motors at the junction gates (stapler junction gate motor, proof tray junction gate motor) stopped operating, due to a physical obstruction or another problem.
		<ul style="list-style-type: none"> • Check for and remove any physical obstructions around the motor and timing belt • Motor harness or connector disconnected or defective • Motor defective • Finisher main board defective

SC720-3	D	Punch roller motor (rear) error	Booklet Finisher (D512)
		Motor stopped operating, due to a physical obstruction or another problem.	
		<ul style="list-style-type: none"> • Check for and remove any physical obstructions around the motor and timing belts • Motor harness or connector disconnected or defective • Motor defective • Finisher main board defective 	

SC720-4	D	Registration motor error	Booklet Finisher (D512)
		Motor stopped operating, due to a physical obstruction or another problem.	
		<ul style="list-style-type: none"> • Check for and remove any physical obstructions around the motor and timing belts • Motor harness or connector disconnected or defective • Motor defective • Finisher main board defective 	

SC721-1	D	Front jogger fence motor	Booklet Finisher (D512)
---------	---	--------------------------	-------------------------

		<p>The system did not detect the front jogger fence at its home position (or out of its home position) within the prescribed time. The 1st occurrence causes a jam, and the 2nd occurrence causes this SC code.</p> <ul style="list-style-type: none"> • Check for and remove any obstructions around the jogger fence • Motor harness or connector disconnected or defective • Front jogger fence HP sensor dirty • Front jogger fence HP sensor harness or connector disconnected or defective • Front jogger fence HP sensor defective • Front jogger fence motor defective • Finisher main board defective
--	--	---

SC721-2	D	Rear jogger fence motor	Booklet Finisher (D512)
		<p>The system did not detect the rear jogger fence at its home position (or out of its home position) within the prescribed time. The 1st occurrence causes a jam, and the 2nd occurrence causes this SC code.</p> <ul style="list-style-type: none"> • Check for and remove any obstructions around the jogger fence • Motor harness or connector disconnected or defective • Rear jogger fence HP sensor dirty • Rear jogger fence HP sensor harness or connector disconnected or defective • Rear jogger fence HP sensor defective • Rear jogger fence motor defective • Finisher main board defective 	

SC723	B	Positioning roller rotation motor error	Finishers (D512/D513)
-------	---	---	-----------------------

		<p>The motor that drives the rotation of the positioning sponge roller is not operating.</p> <ul style="list-style-type: none"> • Cycle the machine off/on • Check for and remove any obstruction that blocks the operation of the roller or roller arm • Motor harness loose, defective • Positioning roller HP sensor dirty • Positioning roller HP sensor harness or connector disconnected or defective • Motor defective • Sensor defective • Finisher main board defective
--	--	--

SC724	B	Positioning roller motor	Finishers (D512/D513)
		<p>The motor that lowers and raises the positioning roller above the stapling tray not operating.</p> <ul style="list-style-type: none"> • Cycle the machine off/on • Check for and remove any obstruction that blocks the operation of the roller arm • Motor harness loose, defective • Positioning roller HP sensor dirty • Positioning roller HP sensor harness or connector disconnected or defective • Motor defective • Sensor defective • Finisher main board defective 	

SC725	B	Exit guide motor error	Finishers (D512/D513)
-------	---	------------------------	-----------------------

		<p>The motor that opens and closes the exit guide at the shift tray exit is not operating correctly.</p> <ul style="list-style-type: none"> • Motor harness or connector disconnected or defective • Check for and remove any obstruction that interferes with the operation of the exit guide • Exit guide plate HP sensor dirty • Exit guide plate HP sensor harness or connector disconnected or defective • Motor defective • Sensor defective • Finisher main board defective
--	--	---

SC726	B	Shift jogger retraction motor error 1	Finishers (D512/D513)
		<p>The drag roller arm with the sponge roller did not return to its home position within the prescribed time.</p> <ul style="list-style-type: none"> • Arm blocked by an obstruction • Motor harness disconnected or defective • HP sensor harness disconnected or defective • Motor defective • HP sensor defective 	

SC728	B	Shift jogger retraction motor error 2	Finishers (D512/D513)
		<p>The side fences at the exit of the finisher did not leave (or arrive at) their home positions within the prescribed time. The 1st occurrence causes a jam, and the 2nd occurrence causes this SC code.</p> <p>If the motor is rotating, positioning roller HP sensor disconnected or defective -or- If the motor is not rotating:</p> <ul style="list-style-type: none"> • Remove any obstruction blocking movement • Positioning roller motor overloaded due to obstruction • Positioning roller motor disconnected, defective • Main board connectors disconnected or defective • Finisher main board defective 	

SC731	D	Proof (upper) tray exit motor error	Finishers (D512/D513)
		<p>Motor drive board output abnormal, or short circuit detected on the board. The 1st failure issues this SC code.</p> <ul style="list-style-type: none"> • Motor disconnected, defective • Finisher connection to motor loose, defective • Motor blocked by an obstruction • Motor defective 	
SC732	D	Shift tray exit motor error	Finishers (D512/D513)
		<p>The shift tray exit motor is not operating.</p> <ul style="list-style-type: none"> • Motor harness disconnected or defective • Motor is blocked by an obstruction • Motor defective • Finisher main board defective 	
SC733	D	Stapler exit motor error	Finishers (D512/D513)
		<p>The stapler exit motor is not operating.</p> <ul style="list-style-type: none"> • Motor harness disconnected or defective • Motor is blocked by an obstruction • Motor defective • Finisher main board defective 	
SC734	D	Proof tray junction gate motor error	Finishers (D512/D513)
		<p>The proof tray JG HP sensor did not detect the junction gate at (or out of) its home position within 2 s.</p> <ul style="list-style-type: none"> • Proof junction gate HP sensor dirty • Sensor harness or connector disconnected or defective • Proof junction gate motor harness or connector disconnected or defective • Sensor defective • Motor defective • Finisher main board defective 	

SC735	D	Stapler junction gate motor error	Finishers (D512/D513)
		<p>The stapler JG HP sensor did not detect the stapler junction gate at (or out of) its home position within the prescribed time. The 1st occurrence causes a jam, and the 2nd occurrence causes this SC code.</p> <ul style="list-style-type: none"> • Stapler junction gate HP sensor dirty • Sensor harness or connector disconnected or defective • Stapler junction gate motor harness or connector disconnected or defective • Sensor defective • Motor defective • Finisher main board defective 	

SC737	B	Pre-stack motor error	Finishers (D512/D513)
		<p>The pre-stack motor that moves the pre-stack roller is not operating.</p> <ul style="list-style-type: none"> • Motor harness disconnected or defective • Motor is blocked by an obstruction • Pre-stack roller HP sensor dirty • Pre-stack roller HP sensor harness or connector disconnected or defective • Motor defective • Sensor defective • Finisher main board defective 	

SC738	B	Pre-stack jg motor error	Finishers (D512/D513)
		<p>The pre-stack JG motor that operates the pre-stack junction gate is not operating. The pre-stack junction gate sensor did not detect the junction gate in (or out of) its home position within the prescribed time.</p> <ul style="list-style-type: none"> • Pre-stack JG motor harness or connector disconnected or defective • Pre-stack JG HP sensor dirty • Sensor harness or connector disconnected or defective • Motor defective • Sensor defective • Finisher main board defective 	

SC740	B	Finisher corner stapler motor error	Finishers (D512/D513)
		<p>The stapler motor did not switch off within the prescribed time. The 1st detection failure issues a jam error, and the 2nd failure issues this SC code.</p> <ul style="list-style-type: none"> • Number of sheets in the stack exceeded the limit for stapling • If error occurred during stapling, stapler rotation sensor 1 defective (replace stapler) • If error did not occur during stapling: staple jam: <ol style="list-style-type: none"> 1. Motor blocked by an obstruction 2. Stapler motor harness disconnected or defective 3. Corner stapler motor defective 4. Finisher main board defective 	

6

SC741	B	Finisher Corner Stapler Rotation Motor Error	Finishers (D512/D513)
		<p>The stapler did not return to its home position (or did not leave its home position) within the specified time. The 1st occurrence causes a jam, and the 2nd occurrence causes this SC code.</p> <ul style="list-style-type: none"> • If the motor is running, <ol style="list-style-type: none"> 1. Stapler rotation home position sensor harnesses are broken, loose, or defective 2. Stapler rotation home position sensors are defective • If the motor is not running: <ol style="list-style-type: none"> 1. Motor is blocked by an obstruction 2. Motor harness is disconnected or defective 3. Motor is defective 	

SC742	B	Corner stapler movement motor error	Finishers (D512/D513)
-------	---	-------------------------------------	-----------------------

		<p>The stapler did not return to its home position (or leave its home position) within the specified time after stapling. The 1st occurrence causes a jam, and the 2nd occurrence causes this SC code.</p> <ul style="list-style-type: none"> • If the motor is running, <ol style="list-style-type: none"> 1. Stapler home position sensor harness is broken, loose, or defective 2. Stapler home position sensor is defective • If the motor is not running: <ol style="list-style-type: none"> 1. Motor is blocked by an obstruction 2. Motor harness is disconnected or defective 3. Motor is defective
--	--	--

SC743	D	Booklet Stapler Motor Error	Booklet Finisher (D512)
		<p>The booklet stapler motor did not start stapling within the prescribed time. The 1st occurrence causes a jam, and the 2nd occurrence causes this SC code.</p> <ul style="list-style-type: none"> • Front motor harness disconnected or defective • Front motor overloaded due to obstruction • Front motor defective • Finisher main board defective 	

SC745	B	Feed-out belt motor error	Finishers (D512/D513)
		<p>The stack feed-out belt HP sensor did not activate within the specified time after the stack feed-out belt motor turned on. The 1st occurrence causes a jam, and the 2nd occurrence causes this SC code.</p> <ul style="list-style-type: none"> • If the motor is operating <ol style="list-style-type: none"> 1. Stack feed-out belt HP sensor harness disconnected or defective 2. Sensor defective • If the motor is not operating: <ol style="list-style-type: none"> 1. Feed-out belt motor blocked by an obstruction 2. Motor harness disconnected or defective 3. Motor defective 4. Finisher main board defective 	

SC746	B	Stack plate motor error 1: front motor	Finishers (D512/D513)
-------	---	--	-----------------------

		<p>The stack plate HP sensor (front) did not activate within the prescribed time after the motor turned on. The 1st occurrence causes a jam, and the 2nd occurrence causes this SC code.</p> <ul style="list-style-type: none"> • If the motor is operating <ol style="list-style-type: none"> 1. Front stack plate HP sensor harness disconnected or defective 2. Front stack plate HP sensor defective • If the motor is not operating: <ol style="list-style-type: none"> 1. Motor blocked by an obstruction 2. Motor harness disconnected or defective 3. Motor defective 4. Booklet finisher main board defective
--	--	--

6

SC747	B	Stack plate motor error 2: center motor	Finishers (D512/D513)
		<p>The stack plate HP sensor (center) did not activate within the prescribed time after the motor turned on. The 1st occurrence causes a jam, and the 2nd occurrence causes this SC code.</p> <ul style="list-style-type: none"> • If the motor is operating <ol style="list-style-type: none"> 1. Center stack plate HP sensor harness disconnected or defective 2. Center stack plate HP sensor defective • If the motor is not operating: <ol style="list-style-type: none"> 1. Motor blocked by an obstruction 2. Motor harness disconnected or defective 3. Motor defective 4. Booklet finisher main board defective 	

SC748	B	Stack plate motor error 3: rear motor	Finishers (D512/D513)
-------	---	---------------------------------------	-----------------------

		<p>The stack plate HP sensor (rear) did not activate within the prescribed time after the motor turned on. The 1st occurrence causes a jam, and the 2nd occurrence causes this SC code.</p>
		<ul style="list-style-type: none"> • If the motor is operating <ol style="list-style-type: none"> 1. Rear stack plate HP sensor harness disconnected or defective 2. Rear stack plate HP sensor defective • If the motor is not operating: <ol style="list-style-type: none"> 1. Motor blocked by an obstruction 2. Motor harness disconnected or defective 3. Motor defective 4. Booklet finisher main board defective

SC750	B	Proof tray lift motor error	Finishers (D512/D513)
		<p>The shift tray paper height sensor did not change its status within the prescribed time after the tray was raised or lowered. The 1st occurrence causes a jam, and the 2nd occurrence causes this SC code.</p>	
		<ul style="list-style-type: none"> • Lift motor disconnected, defective • Paper height sensor disconnected, defective • Finisher main board connection to motor loose • Finisher main board defective 	

SC753	D	Drag drive motor error	Finishers (D512/D513)
		<p>The drag roller HP sensor did not detect the drag roller in (or out of) its home position within the prescribed time. (The drag drive motor drives the timing belt that rotates the drag roller at the shift tray exit.)</p>	
		<ul style="list-style-type: none"> • If the motor is operating <ol style="list-style-type: none"> 1. Drag roller HP sensor harness disconnected or defective 2. Drag roller HP sensor defective • If the motor is not operating: <ol style="list-style-type: none"> 1. Motor blocked by an obstruction 2. Motor harness disconnected or defective 3. Motor defective 4. Finisher main board defective 	

SC754	B	Drag roller motor error	Finishers (D512/D513)
		<p>The drag roller motor did not turn on. (The drag roller motor drives the shaft that moves the drag roller left and right at the shift tray exit.)</p> <ul style="list-style-type: none"> • Motor harness disconnected or defective • Motor defective • Finisher control board defective 	

SC755	D	Shift motor error	Finishers (D512/D513)
		<p>The shift tray HP sensors did not detect the shift tray in (or out of) its home position within the prescribed times. The 1st occurrence causes a jam, and the 2nd occurrence causes this SC code.</p> <p>Note: In the Finisher SR5000 (B830), these sensors are the "half-turn" sensors.</p> <ul style="list-style-type: none"> • If the motor is operating <ol style="list-style-type: none"> 1. HP sensor harnesses disconnected or defective 2. HP sensor defective • If the motor is not operating: <ol style="list-style-type: none"> 1. Motor blocked by an obstruction 2. Motor harness disconnected or defective 3. Motor defective 4. Finisher main board defective 	

SC760	B	Punch motor error	Finishers (D512/D513)
-------	---	-------------------	-----------------------

		<p>The punch HP sensor did not detect the punch movement motor in (or out) of its home position within the prescribed time. The 1st occurrence causes a jam, and the 2nd occurrence causes this SC code.</p>
		<ul style="list-style-type: none"> • If the motor is operating: <ol style="list-style-type: none"> 1. Punch HP sensor disconnected or defective 2. Punch HP sensor defective • If the motor is not operating: <ol style="list-style-type: none"> 1. Motor blocked by an obstruction 2. Motor harness disconnected or defective 3. Motor defective 4. Finisher main board defective

SC761	D	Fold plate motor error	Booklet Finisher (D512)
		<p>The fold plate moves but: The fold plate HP sensor did not detect it at the home position within the specified time. -or- The plate remained at the home position longer than the specified time. The 1st occurrence causes a jam, and the 2nd occurrence causes this SC code.</p>	
		<ul style="list-style-type: none"> • If the motor is operating: <ol style="list-style-type: none"> 1. Fold plate HP sensor dirty 2. Fold plate HP sensor harness or connector disconnected or defective 3. Fold plate HP sensor defective • If the motor is not operating: <ol style="list-style-type: none"> 1. Fold plate motor blocked by an obstruction 2. Motor harness disconnected or defective 3. Motor defective 4. Finisher main board defective 	

SC762	D	Punch switch motor error	Booklet Finisher (D512)
-------	---	--------------------------	-------------------------

		<p>The punch switch motor failed to turn on within the specified time.</p> <ul style="list-style-type: none"> • Check for and remove obstruction blocking the motor • Motor harness or connector disconnected or defective • Motor defective 	
--	--	---	--

SC763	B	Punch movement motor error	Booklet Finisher (D512)
		<p>The punch movement HP sensor did not detect the punch at its home position (or out of its home position) within the prescribed time. The 1st occurrence causes a jam, and the 2nd occurrence causes this SC code.</p> <ul style="list-style-type: none"> • Check for and remove any obstructions that block the movement of the punch unit • Punch movement HP sensor dirty • Sensor harness or connector disconnected or defective • Sensor defective • Motor defective 	

SC764	D	Punch registration (CIS) error	Booklet Finisher (D512)
		<p>The system detected an error at the CIS (Contact Image Sensor) inside the punch unit during paper registration for paper punching.</p> <ul style="list-style-type: none"> • Check for and remove any obstructions that block the movement of the punch unit • Punch CIS unit harness or connectors disconnected or defective • CIS unit defective • Punch movement motor defective 	

SC765	B	Bottom fence lift motor error	Booklet Finisher (D512)
-------	---	-------------------------------	-------------------------

		<p>The bottom fence in the booklet fold unit did not return to the home position within the specified time.</p> <ul style="list-style-type: none"> • Bottom fence mechanism overloaded due to an obstruction • Bottom fence HP sensor connector disconnected or defective • Bottom fence HP sensor defective • Bottom fence lift motor connector disconnected or defective • Bottom fence lift motor defective • Main board defective 	
SC766	B	Clamp roller retraction motor	Booklet Finisher (D512)
		<p>The clamp roller did not return to the home position within the specified time.</p> <ul style="list-style-type: none"> • Clamp roller mechanism overloaded due to an obstruction • Clamp roller HP sensor connector disconnected or defective • Clamp roller HP sensor defective • Clamp roller retraction motor connector disconnected or defective • Clamp roller retraction motor defective • Main board defective 	
SC767-1	D	Stack JG motor	Booklet Finisher (D512)
		<p>The stack junction gate motor did not return to the home position within the prescribed time.</p> <ul style="list-style-type: none"> • Check junction gate for obstruction and remove it • Stack JG HP sensor connector disconnected or defective • Sensor defective • Stack JG motor connector disconnected or defective • Motor defective • Finisher main board defective 	
SC767-2	B	Stack transport unit motor	Finishers D434

		<p>The stack transport unit HP sensor did not detect the stack transport unit at (or out of) its home position within the prescribed time. The 1st occurrence causes a jam, and the 2nd occurrence causes this SC code.</p> <ul style="list-style-type: none"> • Check for any obstruction around the motor and remove it • Stack transport unit motor harness or connector disconnected or defective • Stack transport unit HP sensor dirty • Sensor harness connector disconnected or defective • Sensor defective • Motor defective • Finisher main board defective
--	--	---

6

SC770	B	Cover interposer lift motor 1 error	CIT D518
		<p>In the first tray:</p> <ul style="list-style-type: none"> • The upper limit sensor did not detect the bottom plate within the specified time after the lift motor switched on to lift the bottom plate. • The lower limit sensor did not direct the bottom plate within the specified time after the lift motor switched on to lower the bottom plate. <p>Note: In both cases, 1 error count indicates a jam, 2 error counts issue this SC code.</p> <ul style="list-style-type: none"> • Lift motor, upper limit sensor, lower limit sensor harnesses, connectors disconnected or defective • Lift motor defective • Upper limit sensor defective • Lower limit sensor defective 	

SC771	B	Cover interposer lift motor 2 error	CIT D518
-------	---	-------------------------------------	----------

		<p>In the second tray:</p> <ul style="list-style-type: none"> • The upper limit sensor did not detect the bottom plate within the specified time after the lift motor switched on to lift the bottom plate. • The lower limit sensor did not direct the bottom plate within the specified time after the lift motor switched on to lower the bottom plate. <p>Note: In both cases, 1 error count indicates a jam, 2 error counts issue this SC code.</p>
		<ul style="list-style-type: none"> • Lift motor, upper limit sensor, lower limit sensor harnesses, connectors disconnected or defective • Lift motor defective • Upper limit sensor defective • Lower limit sensor defective

SC772	B	Cover interposer pickup motor 1 error	CIT D518
		<p>In the first tray:</p> <ul style="list-style-type: none"> • While the pick-up roller motor was on, the pick-up roller HP sensor did not detect the pick-up roller at the home position within the specified number of pulses. • While the pick-up roller motor was on, the pick-up roller HP sensor did not detect the pick-up roller at the home position above the specified number of pulses. <p>Note: In both cases, 1 error count indicates a jam, 2 error counts issue this SC code.</p>	
		<ul style="list-style-type: none"> • The pick-up motor, pick-up roller HP sensor harnesses, connectors were disconnected or defective • Pick-up motor overload due to an obstruction • Pick-up motor defective • Pick-up roller HP sensor defective 	

SC773	D	Cover interposer pickup motor 2 error	CIT D518
-------	---	---------------------------------------	----------

		<p>In the second tray:</p> <ul style="list-style-type: none"> • While the pick-up roller motor was on, the pick-up roller HP sensor did not detect the pick-up roller at the home position within the specified number of pulses. • While the pick-up roller motor was on, the pick-up roller HP sensor did not detect the pick-up roller at the home position above the specified number of pulses. <p>Note: In both cases, 1 error count indicates a jam, 2 error counts issue this SC code.</p>
		<ul style="list-style-type: none"> • The pick-up motor, pick-up roller HP sensor harnesses, connectors were disconnected or defective • Pick-up motor overload due to an obstruction • Pick-up motor defective • Pick-up roller HP sensor defective

SC775	B	Top Fence Motor Error	Finishers D512/D513
		<p>The top fence HP sensor did not detect the top fence at (or out of) the home position within the prescribed time. The 1st occurrence causes a jam, and the 2nd occurrence causes this SC code.</p> <ul style="list-style-type: none"> • If the top fence motor is operating: <ol style="list-style-type: none"> 1. Top fence HP sensor dirty 2. Sensor harness disconnected or defective 3. Sensor defective • If the jogger top fence motor is not operating: <ol style="list-style-type: none"> 1. Top fence motor blocked by an obstruction 2. Motor harness disconnected or defective 3. Motor defective 4. Finisher main board defective 	

SC776	B	Bottom Fence Motor Error	Finishers D512/D513
-------	---	--------------------------	---------------------

		<p>The bottom fence HP sensor did not detect the bottom fence at (or out of) the home position within the prescribed time. The 1st occurrence causes a jam, and the 2nd occurrence causes this SC code.</p>	
		<ul style="list-style-type: none"> • If the bottom fence motor is operating: <ol style="list-style-type: none"> 1. Bottom fence HP sensor dirty 2. Sensor harness disconnected or defective 3. Sensor defective • If the bottom fence motor is not operating: <ol style="list-style-type: none"> 1. Bottom fence motor blocked by an obstruction 2. Motor harness disconnected or defective 3. Motor defective 4. Finisher main board defective 	

SC778-1	D	Horizontal transport motor error	Multi Folding Unit (D521)
		<p>The motor drive PCB detected an error at the motor.</p> <ul style="list-style-type: none"> • Motor harness or connector disconnected or defective • Motor or motor drive board defective 	

SC778-2	D	Top tray exit motor	Multi Folding Unit (D521)
		<p>The motor drive PCB detected an error at the motor.</p> <ul style="list-style-type: none"> • Motor harness or connector disconnected or defective • Motor or motor drive board defective 	

SC778-3	D	Top tray jg motor	Multi Folding Unit (D521)
		<p>The top tray JG HP sensor did not detect the top tray junction gate at (or out of) its home position. The 1st occurrence causes a jam, and the 2nd occurrence causes this SC code.</p> <ul style="list-style-type: none"> • Top tray JG HP sensor dirty • Sensor harness or connector disconnected or defective • Top tray JG motor harness or connector disconnected or defective • Sensor defective • Motor or motor drive board defective 	

SC778-4	D	Entrance jg motor	Multi Folding Unit (D521)
		<p>The entrance junction gate HP sensor did not detect the entrance junction gate at (or out of) its home position. The 1st occurrence causes a jam, and the 2nd occurrence causes this SC code.</p> <ul style="list-style-type: none"> • Entrance JG HP sensor dirty • Sensor harness or connector disconnected or defective • Entrance JG motor harness or connector disconnected or defective • Sensor defective • Motor or motor drive board defective 	

SC779	B	1st Stopper motor error	Multi Folding Unit (D521)
		<p>The 1st stopper HP sensor did not detect the 1st stopper in (or out of) its home position within the prescribed time. The 1st occurrence causes a jam, and the 2nd occurrence causes this SC code.</p> <ul style="list-style-type: none"> • 1st stopper HP sensor dirty • Sensor harness or connector disconnected or defective • 1st stopper motor harness or connector disconnected or defective • Sensor defective • Motor or motor drive board defective 	

SC783-1	B	2nd Stopper motor error	Multi Folding Unit (D521)
		<p>The 2nd stopper HP sensor did not detect the 2nd stopper in (or out of) its home position within the prescribed time. The 1st occurrence causes a jam, and the 2nd occurrence causes this SC code.</p> <ul style="list-style-type: none"> • 2nd stopper HP sensor dirty • Sensor harness or connector disconnected or defective • 2nd stopper motor harness or connector disconnected or defective • Sensor defective • Motor or motor drive board defective 	

SC783-2	B	3rd Stopper motor error	Multi Folding Unit (D521)
---------	---	-------------------------	---------------------------

		<p>The 3rd stopper HP sensor did not detect the 3rd stopper in (or out of) its home position within the prescribed time. The 1st occurrence causes a jam, and the 2nd occurrence causes this SC code.</p> <ul style="list-style-type: none"> • 3rd stopper HP sensor dirty • Sensor harness or connector disconnected or defective • 3rd stopper motor harness or connector disconnected or defective • Sensor defective • Motor or motor drive board defective 	
SC783-3	B	1st Fold motor error	Multi Folding Unit (D521)
		<p>The motor drive PCB detected an error at the motor.</p> <ul style="list-style-type: none"> • Motor harness or connector disconnected or defective • Motor or motor drive board defective 	
SC783-4	B	2nd Fold motor error	Multi Folding Unit (D521)
		<p>The motor drive PCB detected an error at the motor.</p> <ul style="list-style-type: none"> • Motor harness or connector disconnected or defective • Motor or motor drive board defective 	
SC783-5	B	Crease motor error	Multi Folding Unit (D521)
		<p>The motor drive PCB detected an error at the motor.</p> <ul style="list-style-type: none"> • Motor harness or connector disconnected or defective • Motor or motor drive board defective 	
SC783-6	B	Dynamic roller transport motor error	Multi Folding Unit (D521)
		<p>The motor drive PCB detected an error at the motor.</p> <ul style="list-style-type: none"> • Motor harness or connector disconnected or defective • Motor or motor drive board defective 	
SC783-7	B	Reg. roller transport motor error	Multi Folding Unit (D521)

		The motor drive PCB detected an error at the motor.
		<ul style="list-style-type: none"> • Motor harness or connector disconnected or defective • Motor or motor drive board defective

SC783-8	B	Dynamic roller lift motor error	Multi Folding Unit (D521)
		The dynamic roller HP sensor did not detect the dynamic roller in (or out of) its home position within the prescribed time. The 1st occurrence causes a jam, and the 2nd occurrence causes this SC code.	
		<ul style="list-style-type: none"> • Dynamic roller HP sensor dirty • Sensor harness or connector disconnected or defective • Dynamic roller lift motor harness or connector disconnected or defective • Sensor defective • Motor or motor drive board defective 	

6

SC783-9	B	Registration roller release motor error	Multi Folding Unit (D521)
		The registration roller HP sensor did not detect the registration roller in (or out of) its home position within the prescribed time. The 1st occurrence causes a jam, and the 2nd occurrence causes this SC code.	
		<ul style="list-style-type: none"> • Registration roller HP sensor dirty • Sensor harness or connector disconnected or defective • Registration roller release motor harness or connector disconnected or defective • Sensor defective • Motor or motor drive board defective 	

SC783-10	B	Fold plate motor error	Multi Folding Unit (D521)
----------	---	------------------------	---------------------------

		<p>The fold plate HP sensor did not detect the fold plate in (or out of) its home position within the prescribed time. The 1st occurrence causes a jam, and the 2nd occurrence causes this SC code.</p> <ul style="list-style-type: none"> • Fold plate HP sensor dirty • Sensor harness or connector disconnected or defective • Fold plate motor harness or connector disconnected or defective • Sensor defective • Motor or motor drive board defective
--	--	--

SC783-11	B	Jogger Fence Motor	Multi Folding Unit (D521)
		<p>The jogger fence HP sensor did not detect the jogger fence in (or out of) its home position within the prescribed time. The 1st occurrence causes a jam, and the 2nd occurrence causes this SC code.</p> <ul style="list-style-type: none"> • Jogger fence HP sensor dirty • Sensor harness or connector disconnected or defective • Jogger fence motor harness or connector disconnected or defective • Sensor defective • Motor or motor drive board defective 	

SC783-12	B	Positioning Roller Motor Error	Multi Folding Unit (D521)
		<p>The positioning roller HP sensor did not detect the positioning roller in (or out of) its home position within the prescribed time. The 1st occurrence causes a jam, and the 2nd occurrence causes this SC code.</p> <ul style="list-style-type: none"> • Positioning roller HP sensor dirty • Sensor harness or connector disconnected or defective • Positioning roller motor harness or connector disconnected or defective • Sensor defective • Motor or motor drive board defective 	

SC783-13	B	FM2 Direct-send JG motor	Multi Folding Unit (D521)
----------	---	--------------------------	---------------------------

		<p>The direct-send JG HP sensor did not detect the direct-send JG in (or out of) its home position within the prescribed time. The 1st occurrence causes a jam, and the 2nd occurrence causes this SC code.</p> <ul style="list-style-type: none"> • FM2 direct-send JG HP sensor dirty • Sensor harness or connector disconnected or defective • FM2 direct-send JG motor harness or connector disconnected or defective • Sensor defective • Motor or motor drive board defective
--	--	--

SC783-14	B	FM6 Pawl motor	Multi Folding Unit (D521)
		<p>The FM6 pawl HP sensor did not detect the FM6 pawl in (or out of) its home position. The 1st occurrence causes a jam, and the 2nd occurrence causes this SC code.</p> <ul style="list-style-type: none"> • FM6 pawl HP sensor dirty • Sensor harness or connector disconnected or defective • FM6 pawl motor harness or connector disconnected or defective • Sensor defective • Motor or motor drive board defective 	

SC786-10	D	Path junction gate error	Ring Binder (D519)
		<p>The path junction gate that directs paper to the punch unit below is not operating correctly.</p> <ul style="list-style-type: none"> • Physical obstruction interfering with the smooth operation of the path junction gate. • Path junction gate HP sensor dirty, disconnected, damaged, or out of position. • Path junction gate motor connection harness loose, disconnected, damaged • Path junction gate motor defective 	

SC787-1	D	Entrance motor error	Stacker (D515)
---------	---	----------------------	----------------

		The motor drive PCB detected an error at the motor.	
		<ul style="list-style-type: none"> • Motor harness or connector disconnected or defective • Motor or motor drive board defective 	
SC787-2	D	Shift JG Motor Error	Stacker (D515)
		The shift tray JG HP sensor did not detect the shift junction gate in (or out of) its home position. The 1st occurrence causes a jam, and the 2nd occurrence causes this SC code..	
		<ul style="list-style-type: none"> • Shift tray JG HP sensor dirty • Sensor harness or connector disconnected or defective • Shift tray JG motor harness or connector disconnected or defective • Sensor defective • Motor or motor drive board defective 	
SC787-3	B	Transport motor error	Stacker (D515)
		The motor drive PCB detected an error at the motor.	
		<ul style="list-style-type: none"> • Motor harness or connector disconnected or defective • Motor or motor drive board defective 	
SC787-4	D	Proof tray JG motor	Stacker (D515)
		The proof tray JG HP sensor did not detect the proof tray junction gate in (or out of) its home position within the prescribed time. The 1st occurrence causes a jam, and the 2nd occurrence causes this SC code.	
		<ul style="list-style-type: none"> • Proof tray JG HP sensor dirty • Sensor harness or connector disconnected or defective • Proof tray JG motor harness or connector disconnected or defective • Sensor defective • Motor or motor drive board defective 	
SC787-5	D	Proof tray exit motor error	Stacker (D515)

		<p>The motor drive PCB detected an error at the motor.</p> <ul style="list-style-type: none"> • Motor harness or connector disconnected or defective • Motor or motor drive board defective 	
SC789	B	Proof tray exit motor error	Multi Folding Unit (D521)
		<p>The motor drive PCB detected an error at the motor due to overload, overheating. Paper cannot exit at proof tray.</p> <ul style="list-style-type: none"> • Motor, motor drive board defective 	
SC790	D	Booklet stapler jogger motor error	Booklet Finisher (D512)
		<p>The jogger fence HP sensor failed to detect the jogger fence at the home position within the specified time.</p> <ul style="list-style-type: none"> • If the booklet stapler jogger motor is operating: <ol style="list-style-type: none"> 1. Jogger fence HP sensor harness disconnected or defective 2. Jogger fence HP sensor defective • If the jogger bottom fence motor is not operating: <ol style="list-style-type: none"> 1. Motor blocked by an obstruction 2. Motor harness disconnected or defective 3. Motor defective 4. Finisher main board defective 	
SC791	B	Booklet stapler bottom fence motor	Booklet Finisher (D512)
		<p>The bottom fence failed to return to home position or failed to leave the home position within the prescribed time.</p> <ul style="list-style-type: none"> • An obstruction is blocking the movement of the bottom fence • Motor harness disconnected or defective • Bottom fence HP sensor disconnected or defective • Motor defective • Sensor defective 	
SC792-1	D	Junction gate error	Ring Binder (D519)

		<p>Detected at HP after the time prescribed to leave the HP had elapsed (more than 36 pulses) (1 detection, jam, twice detected, SC error)</p> <p>-or-</p> <p>Not detected at HP after the time prescribed to arrive at the HP had elapsed (more than 22 pulses) (1 detection, jam, twice detected, SC error)</p>
		<ul style="list-style-type: none"> • Path JG motor (M201) defective • Motor connector disconnected or defective • Motor overload • Path JG sensor (S203) connector disconnected or defective • Sensor (S203) defective

SC792-2	B	Pre-punch side fence HP error	Ring Binder (D519)
		<p>Detected at HP after the time prescribed to leave the HP had elapsed (more than 400 pulses) (1st detection, jam, 2nd detection, SC error)</p> <p>-or-</p> <p>Not detected at HP after the time prescribed to arrive at the HP had elapsed (more than 600 pulses) (1st detection, jam, 2nd detection, SC error)</p>	
		<ul style="list-style-type: none"> • Side jogger motor (M302) connector disconnected or defective • Motor overload • Motor defective • Pre-punch jogger HP sensor (S301) connector disconnected or defective • Sensor (S301) defective 	

SC792-3	D	Pre-punch jogger roller HP error	Ring Binder (D519)
---------	---	----------------------------------	--------------------

		<p>Detected at HP after the time prescribed to leave the HP had elapsed (more than 36 pulses) (1st detection, jam, 2nd detection, SC error)</p> <p>-or-</p> <p>Not detected at HP after the time prescribed to arrive at the HP had elapsed (more than 22 pulses) (1st detection, jam, 2nd detection, SC error)</p>
		<ul style="list-style-type: none"> • Jog roller lift motor (M305) connector disconnected or defective • Motor overload • Motor defective • Jog roller lift HP sensor (S309) connector disconnected or defective • Sensor defective

6

SC792-4	B	Ring binder punch defective	Ring Binder (D519)
		<p>One or more of the following occurred:</p> <p>Punch unit not detected at initialization.</p> <p>No motor rotation detected at HP at 30 ms after the DC motor turned on</p> <p>No encoder pulse detected at HP at 5 ms after the DC motor turned on</p> <p>Not detected at HP at 400 ms after the DC motor turned on</p>	
		<ul style="list-style-type: none"> • Punch motor (M304) connector disconnected or defective • Motor overload • Motor defective • Punch HP sensor (S302) connector disconnected or defective, or sensor defective • Punch encoder sensor (S303) connector disconnected or defective, or sensor defective 	

SC792-5	B	Paddle roller HP error	Ring Binder (D519)
---------	---	------------------------	--------------------

		<p>Not detected at HP after the time prescribed to arrive at the HP had elapsed (more than 400 ms) (1st detection, jam, 2nd detection, SC error)</p> <p>-or-</p> <p>Detected at HP after the time prescribed to leave the HP had elapsed (more than 400 ms) (1st detection, jam, 2nd detection, SC error)</p>
		<ul style="list-style-type: none"> • Paddle roller lift motor (M603) connector disconnected or defective • Motor overload • Motor defective • Paddle roller HP sensor (S602) connector disconnected or defective • Sensor defective

SC792-6	B	Jogger fence 1 error	Ring Binder (D519)
		<p>Not detected at HP after the time prescribed to arrive at the HP had elapsed (more than 400 ms) (1st detection, jam, 2nd detection, SC error)</p> <p>-or-</p> <p>Detected at HP after the time prescribed to leave the HP had elapsed (more than 400 ms) (1st detection, jam, 2nd detection, SC error)</p>	
		<ul style="list-style-type: none"> • Jogger fence 1 motor (M604) connector, disconnected or defective • Motor defective • Motor overload • Side fence 1 HP sensor (S601) connector, disconnected or defective • Sensor defective 	

SC792-7	B	Jogger fence 2 error	Ring Binder (D519)
---------	---	----------------------	--------------------

		<p>Not detected at HP after the time prescribed to arrive at the HP had elapsed (more than 400 ms) (1st detection, jam, 2nd detection, SC error)</p> <p>-or-</p> <p>Detected at HP after the time prescribed to leave the HP had elapsed (more than 400 ms) (1st detection, jam, 2nd detection, SC error)</p>
		<ul style="list-style-type: none"> • Jogger fence 2 motor (M606) connector, disconnected or defective • Motor defective • Motor overload • Side fence HP sensor 1 (S611) connector disconnected or defective • Sensor defective

SC792-8	B	Stack tamper HP error	Ring Binder (D519)
		<p>Not detected at HP after the time prescribed to arrive at the HP had elapsed (more than 400 ms) (1st detection, jam, 2nd detection, SC error)</p> <p>-or-</p> <p>Detected at HP after the time prescribed to leave the HP had elapsed (more than 400 ms) (1st detection, jam, 2nd detection, SC error)</p>	
		<ul style="list-style-type: none"> • Stack tamper motor (M607) connector, disconnected or defective • Motor defective • Motor overload • Stack tamper HP sensor (S612) connector disconnected or defective • Sensor defective 	

SC792-9	B	Pre-bind jogger clamp HP error	Ring Binder (D519)
---------	---	--------------------------------	--------------------

		<p>Not detected at HP after the time prescribed to arrive at the HP had elapsed (more than 400 ms) (1st detection, jam, 2nd detection, SC error)</p> <p>-or-</p> <p>Detected at HP after the time prescribed to leave the HP had elapsed (more than 400 ms) (1st detection, jam, 2nd detection, SC error)</p>
		<ul style="list-style-type: none"> • Spine clamp motor (M605) connector disconnected or defective • Motor defective • Motor overload • Clamp HP sensor (S603) connector disconnected or defective • Sensor defective

SC792-10	B	Binder unit run-out error	Ring Binder (D519)
		<p>Not detected at HP after the time prescribed to arrive at the HP had elapsed (more than 400 ms) (1st detection, jam, 2nd detection, SC error)</p> <p>-or-</p> <p>Detected at HP after the time prescribed to leave the HP had elapsed (more than 400 ms) (1st detection, jam, 2nd detection, SC error)</p>	
		<ul style="list-style-type: none"> • Run-out press roller motor (M610) connector disconnected or defective • Motor defective • Motor overload • Run-out roller HP sensor (S614) connector disconnected or defective • Sensor defective 	

SC792-11	B	Clamp thickness error	Ring Binder (D519)
		<p>50-sheet detection sensor (S606) went OFF during pre-bind jogging when a 100-sheet thickness was detected. (1st detection jam, 2nd detection SC error)</p> <p>-or-</p> <p>50-sheet detection sensor went OFF at initialization when the clamp moved to the open position.</p>	
		<ul style="list-style-type: none"> • 50-sheet detection sensor (S606) connector disconnected or defective • Sensor defective 	

SC792-12	B	Alignment pin error	Ring Binder (D519)
		<p>Not detected at HP after the time prescribed to arrive at the HP had elapsed (more than 400 ms) (1st detection, jam, 2nd detection, SC error)</p> <p>-or-</p> <p>Detected at HP after the time prescribed to leave the HP had elapsed (more than 400 ms) (1st detection, jam, 2nd detection, SC error)</p>	
		<ul style="list-style-type: none"> • Alignment pin motor (M602) connector disconnected or defective • Motor overload • Motor defective • Alignment pin HP sensor (S604) connector disconnected or defective • Sensor defective 	

SC792-13	B	Pre-bind jogger shutter error	Ring Binder (D519)
		<p>Not detected at HP after the time prescribed to arrive at the HP had elapsed (more than 400 ms) (1st detection, jam, 2nd detection, SC error)</p> <p>-or-</p> <p>Detected at HP after the time prescribed to leave the HP had elapsed (more than 400 ms) (1st detection, jam, 2nd detection, SC error)</p>	
		<ul style="list-style-type: none"> • Shutter motor (M608) connector disconnected or defective • Motor overload • Motor defective • Shutter HP sensor (S605) connector disconnected or defective • Sensor defective 	

SC792-14	B	50/100 clamp adjustment error	Ring Binder (D519)
----------	---	-------------------------------	--------------------

		<p>Not detected at HP after the time prescribed to arrive at the HP had elapsed (more than 400 ms) (1st detection, jam, 2nd detection, SC error)</p> <p>-or-</p> <p>Detected at HP after the time prescribed to leave the HP had elapsed (more than 400 ms) (1st detection, jam, 2nd detection, SC error)</p>
		<ul style="list-style-type: none"> • 50/100 adjustment motor (M702) connector disconnected or defective • Motor overload • Motor defective • Ring switch HP sensor (S706) connector disconnected or defective, or sensor defective • Ring switch timing sensor (S707) connector disconnected or defective, or sensor defective

SC792-15	B	Timing sensor interval error	Ring Binder (D519)
		<p>The bind timing sensor (S702) remained ON or OFF longer than the prescribed time (1500 ms) during initialization or ring binding (1st detection: jam, 2nd detection: SC error)</p>	
		<ul style="list-style-type: none"> • Clamp unit motor (M701) connector disconnected or defective • Motor overload • Motor defective • Bind timing sensor (S702) connector disconnected or defective • Sensor defective 	

SC792-16	B	Clamp unit HP error	Ring Binder (D519)
----------	---	---------------------	--------------------

		<p>At initialization or during ring binding, did not arrive at the home position within the prescribed time (1500 ms) (1st detection: jam, 2nd detection: SC error)</p> <p>-or-</p> <p>Detected at HP after the time prescribed to leave the HP had elapsed (more than 1500 ms) (1st detection, jam, 2nd detection, SC error)</p>
		<ul style="list-style-type: none"> • Clamp unit motor (M701) connector disconnected or defective • Motor overload • Motor defective • Clamp unit HP sensor (S701) connector disconnected or defective • Sensor defective

6

SC792-17	B	Spine alignment error	Ring Binder (D519)
		<p>During pin alignment operation, the pin did not reach the up position or return to the home position within the prescribed time (400 ms), and one retry failed within the same time limit.</p>	
		<ul style="list-style-type: none"> • Alignment pin motor (M602) connector disconnected or defective • Motor overload • Motor defective • Alignment pin HP sensor (S604) connector disconnected or defective, or sensor defective • Alignment pin up sensor (S610) connector disconnected or defective, or sensor defective • Stack not jogged correctly, or not punched correctly 	

SC792-18	B	Binder unit not detected	Ring Binder (D519)
		<p>The binder unit could not be detected at initialization.</p>	
		<ul style="list-style-type: none"> • Drawer connector disconnected or defective • Drawer connector defective 	

SC792-19	B	Output belt unit rotation error	Ring Binder (D519)
----------	---	---------------------------------	--------------------

		<p>Detected at HP after the time prescribed to leave the HP had elapsed (more than 800 pulses) (1st detection, jam, 2nd detection, SC error)</p> <p>-or-</p> <p>Not detected at HP after the time prescribed to arrive at the HP had elapsed (more than 2300 pulses) (1st detection, jam, 2nd detection, SC error)</p>
		<ul style="list-style-type: none"> • Output belt rotation motor (M403) connector disconnected or defective • Motor overload • Motor defective • Output belt rotation HP sensor (S403) connector disconnected or defective • Sensor defective

SC792-20	B	Output belt 1 HP error	Ring Binder (D519)
		<p>Detected at HP after the time prescribed to leave the HP had elapsed (more than 200 pulses) (1st detection, jam, 2nd detection, SC error)</p> <p>-or-</p> <p>Not detected at HP after the time prescribed to arrive at the HP had elapsed (more than 2125 pulses) (1st detection, jam, 2nd detection, SC error)</p>	
		<ul style="list-style-type: none"> • Output belt 1 motor (M401) connector disconnected or defective • Motor overload • Motor defective • Output belt 1 HP sensor (S401) connector disconnected or defective • Sensor defective 	

SC792-21	B	Output belt 2 HP error	Ring Binder (D519)
----------	---	------------------------	--------------------

		<p>Detected at HP after the time prescribed to leave the HP had elapsed (more than 200 pulses) (1st detection, jam, 2nd detection, SC error)</p> <p>-or-</p> <p>Not detected at HP after the time prescribed to arrive at the HP had elapsed (more than 3130 pulses) (1st detection, jam, 2nd detection, SC error)</p>
		<ul style="list-style-type: none"> • Output belt 2 motor (M402) connector disconnected or defective • Motor overload • Motor defective • Output belt 2 HP sensor (S402) connector disconnected or defective • Sensor defective

SC792-22	B	Stack height error	Ring Binder (D519)
		<p>Stack height sensor remained ON while moving toward the top.</p> <p>-or-</p> <p>The sensor did not go ON within 6 sec. after the motor turned on.</p>	
		<ul style="list-style-type: none"> • Stacker motor (M501) connector disconnected or defective • Motor overload • Stack height sensor (S502) connector disconnected or defective • Sensor defective 	

SC792-23	B	Stacker error	Ring Binder (D519)
----------	---	---------------	--------------------

		<p>Although the stacker was full at the start and end of stacker operation with the stacker full (stacker sensors ON together), no documents were detected (also when documents were leaning)</p> <p>-or-</p> <p>Although the stacker was detected full with the stacker stopped, no documents were detected within 2 sec. (1st detection jam, 2nd detection SC error)</p>
		<ul style="list-style-type: none"> Stacker HP sensor (S501) connector disconnected or defective, or sensor defective Stacker height HP sensor (S502) connector disconnected or defective, or sensor defective Stacker detect sensor (S504) disconnected or defective, or sensor defective

SC793-1	B	Shift motor error	Stacker (D515)
		<p>The shift roller HP sensor did not detect the shift roller at (or out of) its home position within the prescribed time. The 1st occurrence causes a jam, and the 2nd occurrence causes this SC code.</p>	
		<ul style="list-style-type: none"> Shift roller HP sensor dirty Sensor harness or connector disconnected or defective Check for and remove any obstructions that interfere with the operation of the motor Shift motor harness or connector disconnected or defective Sensor defective Motor or motor drive board defective 	

SC793-2	B	Front Jogger Fence Motor Error	Stacker (D515)
---------	---	--------------------------------	----------------

		<p>The front jogger fence HP sensor did not detect the front jogger fence at (or out of) its home position within the prescribed time. The 1st occurrence causes a jam, and the 2nd occurrence causes this SC code.</p>
		<ul style="list-style-type: none"> • Front jogger fence HP sensor dirty • Sensor harness or connector disconnected or defective • Check for and remove any obstructions that interfere with the operation of the motor • Motor harness or connector disconnected or defective • Sensor defective • Motor or shift motor drive board defective

SC793-3	B	Rear Jogger Fence Motor Error	Stacker (D515)
		<p>The rear jogger fence HP sensor did not detect the rear jogger fence at (or out of) its home position within the prescribed time. The 1st occurrence causes a jam, and the 2nd occurrence causes this SC code.</p>	
		<ul style="list-style-type: none"> • Rear jogger fence HP sensor dirty • Sensor harness or connector disconnected or defective • Check for and remove any obstructions that interfere with the operation of the motor • Motor harness or connector disconnected or defective • Sensor defective • Motor or shift motor drive board defective 	

SC793-4	B	Jogger fence retraction motor error	Stacker (D515)
---------	---	-------------------------------------	----------------

		<p>The jogger fence retraction HP sensor did not detect the jogger fences at (or out of) their home position within the prescribed time. The 1st occurrence causes a jam, and the 2nd occurrence causes this SC code.</p>
		<ul style="list-style-type: none"> • Jogger fence retraction HP sensor dirty • Sensor harness or connector disconnected or defective • Check for and remove any obstructions that interfere with the operation of the motor • Motor harness or connector disconnected or defective • Sensor defective • Motor or shift motor drive board defective

SC793-5	B	Sub jogger motor error	Stacker (D515)
		<p>The sub jogger HP sensor did not detect the sub jogger fence at (or out of) its home position within the prescribed time. The 1st occurrence causes a jam, and the 2nd occurrence causes this SC code.</p>	
		<ul style="list-style-type: none"> • Sub jogger fence HP sensor dirty • Sensor harness or connector disconnected or defective • Check for and remove any obstructions that interfere with the operation of the motor • Motor harness or connector disconnected or defective • Sensor defective • Motor or shift motor drive board defective 	

SC793-6	B	LE Stopper Motor Error	Stacker (D515)
---------	---	------------------------	----------------

		<p>The LE stopper HP sensor did not detect the leading edge stopper at (or out of) its home position within the prescribed time. The 1st occurrence causes a jam, and the 2nd occurrence causes this SC code.</p> <ul style="list-style-type: none"> • LE stopper HP sensor dirty • Sensor harness or connector disconnected or defective • Check for and remove any obstructions that interfere with the operation of the motor • Motor harness or connector disconnected or defective • Sensor defective • Motor or shift motor drive board defective
--	--	---

SC793-7	B	Tray lift motor error	Stacker (D515)
		<p>When the tray was ascending (or descending), the state of the paper height sensor did not change at the prescribed time to detect the height of the stack and adjust the height of the tray. The 1st occurrence causes a jam, and the 2nd occurrence causes this SC code.</p> <ul style="list-style-type: none"> • Check for and remove any obstructions that interfere with the operation of the tray lift motor or paper height sensor actuator • Sensor actuator loose or broken • Sensor harness or connector disconnected or defective • Motor harness or connector disconnected or defective • Sensor defective • Motor defective 	

SC793-8	D	Shift tray exit motor error	Stacker (D515)
		<p>The motor drive PCB detected an error at the motor.</p> <ul style="list-style-type: none"> • Motor harness or connector disconnected or defective • Motor or motor drive board defective 	

SC799-1	D	Trimming blade motor error	Trimmer (D520)
---------	---	----------------------------	----------------

		<p>The trimming blade HP sensor did not detect the blade at (or out of) its home position within the prescribed time during trimming. The 1st detection causes a jam signal if the error occurred during cutting. The 2nd detection causes this SC code if the error occurred at the start or end of cutting.</p>
		<ul style="list-style-type: none"> • Check for and remove any obstacles (jammed paper scraps) around the blade, motor, or sensor • Trimming blade HP sensor dirty • Sensor harness or connector disconnected or defective • Trimming blade motor harness or connector disconnected or defective • Motor defective • Trimming unit main board defective

SC799-2	B	Press roller motor error	Trimmer (D520)
		<p>The press roller HP sensor did not detect the press roller at (or out of) its home position within the prescribed time. The 1st occurrence causes a jam, and the 2nd occurrence causes this SC code.</p>	
		<ul style="list-style-type: none"> • Check for and remove any obstacles around the motor and sensor • Press roller motor HP sensor dirty • Sensor harness or connector disconnected or defective • Press roller motor harness or connector disconnected or defective • Motor defective • Trimming unit main board defective 	

SC799-3	B	Cut Position Motor Error	Trimmer (D520)
		<p>The cut position HP sensor did not detect the cut position stopper at (or out of) its home position within the prescribed time. The 1st occurrence causes a jam, and the 2nd occurrence causes this SC code.</p>	
		<ul style="list-style-type: none"> • Check for and remove any obstacles around the motor and sensor • Cut position HP sensor dirty • Sensor harness or connector disconnected or defective • Cut position motor harness or connector disconnected or defective • Motor defective • Trimming unit main board defective 	

SC799-4	B	Press stopper motor error	Trimmer (D520)
		<p>The press stopper HP sensor did not detect the press stopper at (or out of) its home position within the prescribed time. The 1st occurrence causes a jam, and the 2nd occurrence causes this SC code.</p> <ul style="list-style-type: none"> • Check for and remove any obstacles around the motor and sensor • Press stopper HP sensor dirty • Sensor harness or connector disconnected or defective • Press stopper motor harness or connector disconnected or defective • Motor defective • Trimming unit main board defective 	

SC 800: Firmware

6

SC816	D	Energy save I/O subsystem error	GW
		<p>An error was detected in the signal from the ASIC (controller board) which controls the STR (Suspend to RAM) function.</p> <p>Note: STR is a feature of this machine that minimizes energy consumption while the machine is in the energy saver mode.</p>	
		<ul style="list-style-type: none"> • Reboot the machine. • Replace the controller board. 	
			SCS
		SC816-5	Machine attempted to enter STR mode before engine was OFF.
		SC816-39	Sub System
			Error occurred during system start up.
		SC816-50	Hardware
			Printer version only. Not used for this machine.

			NCS (Network Control Service)
		SC816-67	An error occurred in the access control port list: <ul style="list-style-type: none"> • Number of registrations exceeded 125 • Data notifications exceeded 12 • Data extension incorrect
		SC816-79	Sub System
			Message mismatch.
		SC816-90	Hardware/System
			A forced system reset (WDOG) occurred.

SC819	D	Fatal kernel error	GW
		Due to a control error, a RAM overflow occurred during system processing. One of the following messages was displayed on the operation panel.	
		<ul style="list-style-type: none"> • System program defective • Controller board defective • Optional board defective • Replace controller firmware 	
		0x5032	HAIC-P2 decompression error
			Error occurred in the compression/decompression module of ASIC Veena in HAIC-P2. If EFI (Fiery Controller) is connected, refer to the EFI manual. If EFI is not connected: <ul style="list-style-type: none"> • HDD defective • System memory defective
		0x6261	HDD Defective
			There was no response from HDD. The power supply to the HDD may have been interrupted suddenly. <ul style="list-style-type: none"> • Re-format HDD. • Replace HDD

		554C	USB loader defect
			USB loader was detected as defective.
		<p>Note: For more details about these SC code errors, execute SP5990 to print an SMC report so you can read the error code list. The error code is not displayed on the operation panel.</p>	

SC820	D	Self-diagnostic Error: CPU: ASIC Interrupt Error	GW
0612		<p>One of the following occurred:</p> <ul style="list-style-type: none"> • System program defective • Controller board defective • Optional board defective • Replace controller firmware <p>Note: For more details about these SC code errors, execute SP5990 to print an SMC report so you can read the error code. The error code is not displayed on the operation panel.</p>	

SC833	D	Self-diagnostic error: Engine I/F ASIC	GW
0F30		ASIC (Mandolin) for system control could not be detected. After the PCI configuration, the device ID for the ASIC could not be checked.	
0F31		ASIC (Mandolin) for system control could not be detected. After the PCI configuration, the device ID for the ASIC could not be checked.	
0F41		The read/write check done for resident RAM on the mother board could not be done correctly.	
50B1		Could not initialize or read the bus connection.	
50B2		Value of the SSCG register is incorrect.	
		<ul style="list-style-type: none"> • One or more MB (Motherboard) connections loose, damaged, defective • MB defective 	

SC842	B	NAND-Flash Update Verify Error Detected.	GW
-------	---	--	----

		<p>This SC can occur when the remote ROM and ROM is updated. SCS detected a verify error when a module was written into NAND-Flash. After the second attempt, the machine returns SC819 (Kernel Error).</p> <p>Note: SCS is the "System Control Service" or Service Resource Manager that performs processing between applications/ECS and the engine. It receives and delivers information about the engine, engine status, and job processing. It also exercises exclusive control of the operation panel and engine resources.</p>	
		<ul style="list-style-type: none"> • Cycle the machine off/on. 	
SC851	B	IEEE 1394 I/F Error	GW
		<p>Driver setting incorrect and cannot be used by the 1394 I/F.</p>	
		<ul style="list-style-type: none"> • NIB (PHY), LINK module defective; change the Interface Board • Controller board defective 	
SC853	B	Wireless LAN Error 1	GW
		<p>During machine start-up, the machine can access the board that holds the wireless LAN (Bluetooth), but not access the wireless LAN card.</p>	
		<ul style="list-style-type: none"> • Wireless LAN card missing (was removed) 	
SC854	B	Wireless LAN Error 2	GW
		<p>The board that holds the wireless LAN card (Bluetooth) could be accessed, but the wireless LAN card could not be accessed while the machine was operating.</p>	
		<ul style="list-style-type: none"> • Wireless LAN card has been removed. 	
SC855	B	Wireless LAN Error 3	GW
		<p>An error was detected for the wireless LAN card (802.11b or Bluetooth).</p>	
		<ul style="list-style-type: none"> • Wireless card not installed correctly. • Wireless LAN card defective 	
SC856	B	Wireless LAN Error 4	GW
		<p>An error was detected for the wireless LAN board (Bluetooth).</p>	

		<ul style="list-style-type: none"> • Wireless LAN card board defective. • PCI connector disconnected or defective.
--	--	--

SC857	B	USB I/F Error	GW
		The USB driver is unstable and generated an error.	
		<ul style="list-style-type: none"> • USB board defective • Controller board defective 	

SC858	A	Data Encryption Error 1	GW
		These are errors of the HDD Data Encryption Option D377.	
	0	Key Acquisition	
		Key could be acquired.	
		<ul style="list-style-type: none"> • Replace the controller board 	
	1	HDD Key Setting Error	
		The key was acquired but the HDD could not be set.	
		<ul style="list-style-type: none"> • Turn the machine power off/on several times. • Replace the controller board. 	
	2	NVRAM Read Error	
		NVRAM data conversion failed (mismatch with nvram.conf)	
		<ul style="list-style-type: none"> • Replace the NVRAM 	
	30	NVRAM Before Replace Error	
		DFU. May occur during development.	
		<ul style="list-style-type: none"> • Turn the machine power off/on several times. • Replace the controller board. 	
	31	Other Error	
		An unexpected error occurred while data was being converted. This error is the same as SC991. See SC991 below.	

SC859	B	Data Encryption Error 2	GW
		These are errors of the HDD Data Encryption Option D377.	
	8	HDD Check Error	
		Data conversion was attempted with no HDD unit present. <ul style="list-style-type: none"> • Confirm that HDD unit installed correctly • Initialize HDD with SP5832-1 Note: After installation, a new HDD should be formatted with SP5832-1	
	9	Power Loss During Data Conversion	
		Data conversion stopped before NVRAM/HDD data was converted. Format HDD with SP5832-1	
	10	Data Read Command Error	
		More than two illegal DMAC communications were returned. <ul style="list-style-type: none"> • HDD defective • Format HDD with SP5832-1 Replace HDD	

SC860	B	HDD startup error at power on	GW
		HDD is connected but a driver error is detected, or the driver did not respond with the status of the HDD within 30 s. <ul style="list-style-type: none"> • HDD is not initialized • Level data is corrupted • HDD is defective (attempt to initialize the HDD with SP5832-001) 	

SC861	D	HDD re-try failure	GW
		At power on with the HDD detected, power supply to the HDD is interrupted, after the HDD is awakened from the sleep mode, the HDD is not ready within 30 s. <ul style="list-style-type: none"> • Harness between HDD and board disconnected, defective • HDD power connector disconnected • HDD defective • Controller board defective 	

SC863	D	HDD data read failure	GW
		<p>The data written to the HDD cannot be read normally, due to bad sectors generated during operation.</p> <ul style="list-style-type: none"> HDD defective <p>Note: If the bad sectors are generated at the image partition, the bad sector information is written to NVRAM, and the next time the HDD is accessed, these bad sectors will not be accessed for read/write operation.</p>	
SC864	D	HDD data CRC error	GW
		<p>During HDD operation, the HDD cannot respond to an CRC error query. Data transfer did not execute normally while data was being written to the HDD.</p> <ul style="list-style-type: none"> HDD defective 	
SC865	D	HDD access error	GW
		<p>HDD responded to an error during operation for a condition other than those for SC863, 864.</p> <ul style="list-style-type: none"> HDD defective. 	
SC866	B	SD card error 1: Confirmation	GW
		<p>The machine detected an electronic license error in the application on the SD card in the controller slot immediately after the machine was turned on.</p> <p>Note:</p> <ul style="list-style-type: none"> The program on the SD card contains electronic confirmation license data. If the program does not contain this license data, or if the result of the check shows that the license data in the program on the SD card is incorrect, then the checked program cannot execute and this SC code is displayed. 	
		<ul style="list-style-type: none"> Program missing from the SD card Download the correct program for the machine to the SD card 	
SC867	D	SD card error 2: SD card removed	GW

		The SD card was removed while the machine is on.
		<ul style="list-style-type: none"> • Insert the SD card. • Turn the machine off and on.

SC868	D	SD card error 3: SD card access	GW
		An error occurred while an SD card was in use.	
		<ul style="list-style-type: none"> • SD card not inserted correctly • SD card defective • Controller board defective <p>Note: You can try to reformat the SD with the SD Formatter Ver. 1.1</p>	

SC870	B	Address book data error	GW
		The address book data cannot be read from the HDD or SD card where it is stored, or the data read from the media is defective.	
		<ul style="list-style-type: none"> • Cycle the machine off/on. • Software defective. • Replace controller firmware. • HDD defective. 	
		<p>More Details</p> <ul style="list-style-type: none"> • Do SP5846-50 to reset all address book data. • Reset the user information with SP5832-6. • Replace the HDDs. 	

SC872	B	HDD mail receive data error	GW
		An HDD error was detected immediately after power on, or the machine detected that the HDD was not operating correctly (data read or write) while receiving mail. The HDD may be defective or the machine was accidentally powered off while the HDD was being accessed.	
		<ul style="list-style-type: none"> • Reformat the mail RX data on the HDD with SP5832-7 • Replace the HDD 	

SC873	B	HDD mail send data error	GW
		An error was detected on the HDD immediately after the machine was turned on, or power was turned of while the machine was using the HDD.	
		<ul style="list-style-type: none"> • Do SP5832-007 (Format HDD – Mail TX Data) to initialize the HDD. • Replace the HDD. 	

SC874	D	Delete All error 1: HDD	GW
		A data error was detected for the HDD/NVRAM after the Delete All option was used. Note: The source of this error is the Data Overwrite Security Unit running from an SD card.	
		<ul style="list-style-type: none"> • Turn the main switch off/on and try the operation again. • Install the Data Overwrite Security Unit again.. • HDD defective 	

SC875	D	Delete All error 2: Data area	GW
		An error occurred while the machine deleted data from the HDD. Note: The source of this error is the Data Overwrite Security Unit D377 running from an SD card.	
		<ul style="list-style-type: none"> • Cycle the machine off/on. • Try the operation again. 	

SC876	D	Log data errors	GW
		876-1	Log data error 1
			An error was detected in the handling of the log data at power on or during machine operation. This can be caused by switching the machine off while it is operating.
			<ul style="list-style-type: none"> • Initialize the HDD with SP5832-4
		876-2	Log data error 2
			HDD encryption unit not installed.
			<ul style="list-style-type: none"> • Install the HDD encryption unit.

		876-3	Log data error 3
			Invalid log encryption key due to defective NVRAM data.
			<ul style="list-style-type: none"> Initialize the HDD with SP5832-4 Request customer's system administrator to disable HDD encryption with the User Tool.
		876-4	Log data error 4
			Erratic HDD encryption due to defective NVRAM data.
			<ul style="list-style-type: none"> Initialize HDD with SP5832-4
		876-5	Log data error 5
			<ul style="list-style-type: none"> Re-install the previous NVRAM or HDD. Initialize the HDD with SP5832-4.
		876-99	Log data error 6
			An error other than Log Data Errors 1 to 5 occurred.
			<ul style="list-style-type: none"> Request assistance from your supervisor.

SC877	B	Data Overwrite Security SD card error	GW
		An error occurred, preventing successful execution of the Data Overwrite Security function, even though it has been set up and enabled.	
		<ul style="list-style-type: none"> DOS card is not inserted completely into the SD card slot DOS card has been removed from the SD card slot. DOS card is damaged. <p>Note:</p> <ul style="list-style-type: none"> If the SD card has been removed (or was not installed correctly), switch the machine off, insert the SD card, then switch on the machine again. If the SD card has been damaged, procure a new SD card, replace the NVRAM, then do the DOS option installation. 	

SC878	D	TPM authentication error	GW
		The system firmware could not be authenticated by the TPM security chip.	

		<ul style="list-style-type: none"> • System firmware updated incorrectly. • Flash ROM on controller board defective. • Replace controller board.
--	--	---

Trusted Platform Module. In computing, Trusted Platform Module (TPM) is both the name of a published specification detailing a secure cryptoprocessor that can store cryptographic keys that protect information, as well as the general name of implementations of that specification, often called the "TPM chip" or "TPM Security Device" (as designated in certain Dell BIOS settings).

SC881	D	Management area error	GW
		This is a software error than can occur: <ul style="list-style-type: none"> • At login • When a print job was received • When WEB browser was opened 	
		<ul style="list-style-type: none"> • Cycle the machine off/on. 	

6

SC899	D	Software error	GW
		A software error occurred in the GW controller.	
		<ul style="list-style-type: none"> • Cycle the machine off/on • Update controller firmware • Controller board defective 	

SC900: Other

SC900	D	Electrical total counter error	GW
		The total counter contains data that is not a number.	
		<ul style="list-style-type: none"> • NVRAM incorrect type • NVRAM defective or corrupted • Unexpected error from external source 	

SC910	B	External controller error 1	GW
SC 911	B	External controller error 2	GW

SC 912	B	External controller error 3	GW
SC 913	B	External controller error 4	GW
SC 914	B	External controller error 5	GW
		The external controller alerted the machine about an error.	
		<ul style="list-style-type: none"> Refer to the instructions for the external controller 	

SC 919	D	External controller error 6	GW
		While EAC (External Application Converter), the conversion module, was operating normally, the receipt of a power line interrupt signal from the FLUTE serial driver was detected, or BREAK signal from the other station was detected.	
		<ul style="list-style-type: none"> Controller power outage Controller rebooted Connection to controller loose 	

SC920	B	Printer Error 1	GW
		An internal application error was detected and operation cannot continue.	
		<ul style="list-style-type: none"> Software defective, switch off/on, or change the controller firmware Insufficient memory 	

SC921	D	Printer Error 2: Font error	GW
		When the printer application started, the specified font could not be found on the SD card.	
		<ul style="list-style-type: none"> The specified font is not on the SD card SD card data corrupted 	

SC925	B	Net File function error	GW
-------	---	-------------------------	----

		<p>The NetFile file management on the HDD cannot be used, or a NetFile management file is corrupted and operation cannot continue. The HDDs are defective and they cannot be debugged or partitioned, so the Scan Router functions (delivery of received faxes, document capture, etc.), Web services, and other network functions cannot be used.</p> <p>HDD status codes are displayed below the SC code:</p>
		<ul style="list-style-type: none"> Refer to the four procedures below (Recovery from SC 925).

Here is a list of HDD status codes:

Display	Meaning
(-1)	HDD not connected
(-2)	HDD not ready
(-3)	No label
(-4)	Partition type incorrect
(-5)	Error returned during label read or check
(-6)	Error returned during label read or check
(-7)	"filesystem" repair failed
(-8)	"filesystem" mount failed
(-9)	Drive does not answer command
(-10)	Internal kernel error
(-11)	Size of drive is too small
(-12)	Specified partition does not exist
(-13)	Device file does not exist

Recovery from SC 925

Procedure 1

If the machine shows SC codes for HDD errors (SC860 to SC865) with SC 925, do the recovery procedures for SC860 to SC865.

Procedure 2

1. If the machine does not show one of the five HDD errors (SC860 to SC865), turn the machine power off and on.
2. If this is not the solution for the problem, then initialize the NetFile partition on the HDD with SP5832-11 (HDD Formatting – Ridoc I/F).

NetFiles: These are jobs printed from the document server using a PC and DeskTopBinder. Before you initialize the NetFile partition on the HDD, tell the customer:

- Received faxes on the delivery server will be erased
 - All captured documents will be erased
 - Desk Top Binder/Print Job Manager/Desk Top Editor job history will be erased
 - Documents on the document server, and scanned documents, will not be erased.
 - The first time that the network gets access to the machine, the management information must be configured again (this will use a lot of time).
3. Before you initialize the Netfile partition with SP5832-11, do these steps:
 4. Go into the User Tools mode and do "Delivery Settings" to print all received fax documents that are scheduled for delivery. Then erase them.
 5. In the User Tools mode, do Document Management> Batch Delete Transfer Documents.
 6. Do SP5832-11, and turn the machine off and on.

Procedure 3

1. If "Procedure 2" is not the solution for the problem, do SP5832-1 (HDD Formatting – All)
2. Cycle the machine off/on.

★ Important

- SP5832-001 erases all document and address book data on the hard disks. Consult with the customer before you do this SP code.

Procedure 4

If "Procedure 3" does not solve the problem, replace the HDD.

SC990	D	Software error 1	GW
		An unexpected operation was encountered by the software.	

		<ul style="list-style-type: none"> • Software crash, reboot the machine • If the HDDs have just been replaced, be sure to download the stamp data (SP 5853). • With SP5990 004(SMC Report – Logging Data), print the most recent information for SC990. • The SC990 information displays the file name, line number, and value. Report this information to your technical supervisor. For example: Function.c LINE: 123 VAL: 0
--	--	---

SC991	C	Software Error 2	GW
		The software performed an unexpected function and the program cannot continue. Recovery processing allows the program to continue.	
		<ul style="list-style-type: none"> • Software defective, re-boot 	

6

In order to get more details about SC991:

1. Execute SP7403 or print an SMC Report (SP5990) to read the history of the 10 most recent logged errors.
2. If you press the zero key on the operation panel with the SP selection menu displayed, you will see detailed information about the recently logged SC991, including the software file name, line number, and so on. Of these two methods, 1) is the recommended method, because another SC could write over the information for the previous SC.

SC992	D	Undefined Error (No SC Code)	GW
		An error not controlled by the system occurred (the error does not come under any other SC code).	
		<ul style="list-style-type: none"> • Software defective • Turn the machine power off and on. The machine cannot be used until this error is corrected. • Re-install firmware 	

SC994	C	Operation Panel Management Records Exceeded	GW
-------	---	---	----

		An error occurred because the number of records exceeded the limit for images managed in the service layer of the firmware. This can occur if there are too many application screens open on the operation panel.
		<ul style="list-style-type: none"> No action required because this SC does not interfere with operation of the machine.

SC997	B	Application selection error 1	GW
		An application did not start after pressing the appropriate key on the operation panel.	
		<ul style="list-style-type: none"> Software bug (change the firmware for the application that failed) A RAM or DIMM option required by the application is not installed or not installed correctly. 	

SC998	D	Application selection error 2	GW
		Register processing did not execute for an application within 60 sec. after the machine was switched on. No applications start correctly, and all end abnormally.	
		<ul style="list-style-type: none"> Software bug (change the firmware for the application that failed) A RAM or DIMM option required by the application is not installed or not installed correctly. 	

Special Troubleshooting Procedures

Clearing SC471, SC475 or SC476

The machine issues SC471, SC475, or SC476 when the ITB is out of position. If the countermeasures for these SC codes described in the SC tables do not correct the problem, the ITB is too far out of position for the machine to correct the problem automatically. Physical adjustment of the ITB is required.

Cam Position Check

1. First, do **SP2920-1** to check the belt centering cam position.
2. If the cam position (number of steps) is within ± 20 steps, physical adjustment is not necessary.
-or-
If the cam position is out of range, follow the procedure in the next section to do the physical adjustment.

6

Physical Adjustment

1. Open the left and right front door.



d074r790

2. Remove the left ITB unit front cover ( x 2).
3. Calculate how many notches on the scale to adjust, and check the adjustment direction (+/-) with the following formula:
 - Checked cam position (Steps)/18 = necessary number of adjustment notches.
 - For example, if the checked cam position is -27, the necessary adjustment is -1.5 notches (-27 / 18 = -1.5).

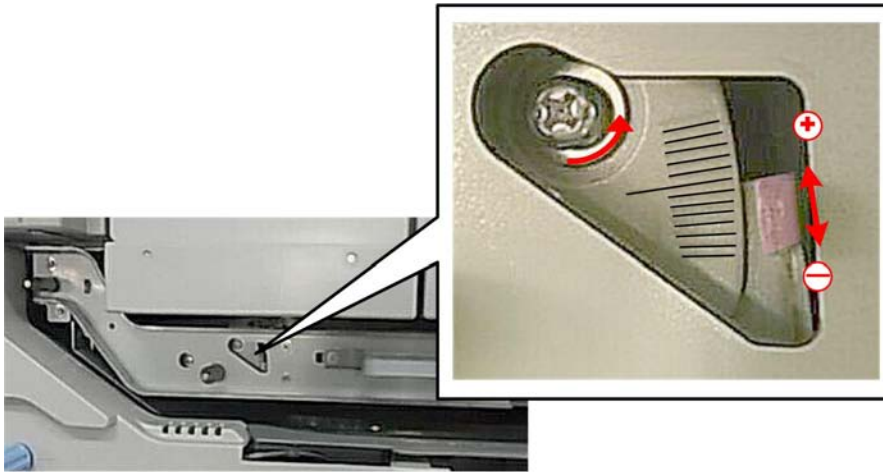

d074r791

4. Loosen the screw.
5. Push the adjuster arm up or down for the number of notches calculated in the previous step.
 - Move the arm up if the result of the calculation is positive, down if the result is negative.
 - Each line on the scale marks one notch.
6. Tighten the screw.
7. Reassemble the machine.

ITB Condition Check

An ITB condition check is required after installing a new ITB or after doing the physical adjustment described in the previous section. After the check, the detection time is stored in SP codes SP112-15, -16, -17.

1. Turn the machine on.
2. Enter the SP mode and do SP3011-001 (Manual Procon: Exe) to execute manual process control.
3. Do SP2112-001 to scan the surface of the belt with all three sensors to check for damage to the surface of the belt.
4. Do the following three SP codes to check the results of the belt scan
 - SP2112-015 (Error Code: Front)
 - SP2112-016 (Error Code: Center)
 - SP2112-017 (Error Code: Rear)
5. If the results of the three SP executions are all "0" the condition of the belt is satisfactory.

-or-

 If any of these SP codes return any value other than "0", repeat Steps 2 and 3.

6. If any SP returns an error other than "0", the belt is damaged and must be replaced.

SP3812 001 (Development Fill) Errors

After **SP3025-1** executes normally, you should see four 1s:

1111

Reading from left to right, each "1" indicates the status of the PCDUs: YMCK.

If you see any number other than a "1", this indicates an error.

SP3025-1 Error Codes

Code	Error	Comments
0	No execution	Default
1	Success	Operation succeeded
2	No developer flow	TD sensor output > 1.5V before developer installed (developer detected)
3	No developer installed	TD sensor output < 1.5V after developer installed (no developer detected)
4	Used toner bottle full	Used toner bottle detected full
5	Development motor lock	Development motor lock detected
6	Used toner bottle motor lock	Used toner transport motor or used toner bottle development motor lock detected
9	Force end	Operation end because door open or power off

Process Control Troubleshooting

Summary of Process Control SC Codes

This is a list of SC codes that may occur during process control. For more, please refer to the process control tables on the following pages.

Pre-Processing Check

SC316 to SC319	Vpp is not within the normal range (Vpp: the AC current applied to the charge roller to compensate for changes in the ambient temperature and humidity). Insufficient charge causes white spotting and too much charge causes toner to film on the surface of the drum. Vpp must be > 2.8 kV.
SC400	ID sensor could not be calibrated. An abnormal ID sensor condition is detected when before calibration begins, Vsg < 0.5V or after calibration, Vsg cannot be adjusted to 4.0±0.2V.
SC418	Correct current could not be supplied to the ID sensor.
SC436 to SC439	A problem is detected with a potential sensor during calibration.
Potential Control	
SC410 to SC413	The development gamma is out of range (not between 0.3 and 6.0) for a color.
SC414 to SC417	Vk is out of range (not within ±150V) for a color. If the development potential is less than Vk, toner is not applied to the drum.
SC420 to SC423	Vd cannot be adjusted to the target voltage for a drum.
SC424 to SC427	The potential sensor detects that Vpl is not ±10V of the target Vpl after exposure of the ID sensor patterns.
SC432 to SC435	The residual voltage on a drum is greater than -200V.
TD Sensor Output Calibration	
SC360 to SC367	An abnormal condition is detected when output of one of the TD sensors fails to fall within the range of 0.5V to 4.5V.
Process Control Gamma Correction	
SC410 to SC413	The development gamma for black, magenta, cyan, or yellow is not within range (0.3 to 6.0).
SC414 to SC417	The development start voltage (Vk) for black, magenta, cyan, or yellow PCDU is not within range (±150V)

Process Control Self-Check: SP3012

After the process control self-check is executed manually with SP3012-1 to 9, you can execute SP3012 to check the results of the self-check. The possible error codes are listed in the "Displayed Code" column in the table below.

When you do SP3012, the normal display (no errors) will look like this:

10101010

Reading from left to right each "10" represents a color: YMCK.

If a problem occurs, the code will appear in the column for the color PCDU where the error has occurred. For example, If a Vdhome error (Code 15) (see table below) occurs in the M PCDU, the display will look like this:

10151010

Or if an ID sensor error (Code 21) (see table below) occurs in the Y PCDU:

10101021

"99" displays while SP3821 executes.

★ Important

- Noise and static electricity can damage the many sensors that are used during the process control self-check. Because of this, always turn the machine off before doing any procedure described below that requires disassembly.

Normal

Displayed Code	Item	Major Cause
10	Successful	---

Potential Sensors

Displayed Code	Item	Major Cause
15	VdHome Error 1	<p>VdHome (SP3641) above $-800V$.</p> <ul style="list-style-type: none"> The window of the potential sensor probe fouled with toner Potential sensor damaged
	<p>Action:</p> <ul style="list-style-type: none"> Do SP3070 to check the function of the potential sensor. Do SP3071 to check the Voffset readings. If Voffset is over 1V, the potential sensor might be dirty due to scattered toner. Remove the PCDU. Use a blower brush to clean the window of the potential sensor probe, then check the sensor again with SP3070. If normal operation cannot be restored, replace the potential sensor probe. 	
16	VdHome Error 2	<p>VdHome (SP3772) below $-500V$.</p> <ul style="list-style-type: none"> Potential sensor relay board damaged Drum abnormal Drum motor not operating
	<p>Action:</p> <ul style="list-style-type: none"> Do SP3070 to check the function of the potential sensor. Do SP3017 to check the Vd reading.. Remove the malfunctioning PCDU with a functioning PCDU, turn the machine off then on, then do the potential sensor check again. If the replaced PCDU does not function normally, then the problem is on the machine side, or the potential sensor relay board is malfunctioning. If the replaced PCDU functions normally, then there may be a problem with the drum or the charge unit. Replace the PCDU. 	

ID Sensors

Displayed Code	Item	Major Cause
21	ID Sensor Vsg Adjust Error	<p>Vsg_reg (SP3321) is out of range (not within $4.0 \pm 0.2V$).</p> <ul style="list-style-type: none"> • ID sensor fouled with dust, toner • ITB undulating or out of position
	<p>Action:</p> <ul style="list-style-type: none"> • Remove the ITB unit. • Make sure the belt is mounted correctly. • Clean the windows of the ID sensors with a cloth moistened with alcohol. • Be sure to wipe the sensor apertures with a wet cloth. A dry cloth may generate static which can attract dust. 	
22	ID Sensor LED Current Error	<p>LED PWM (SP3322) greater than 27 mA.</p> <ul style="list-style-type: none"> • ID sensor fouled with dust, toner • ID sensor deteriorated
	<p>Action:</p> <ul style="list-style-type: none"> • Remove the ITB unit and check the ID sensors. • Clean the windows of the ID sensors with alcohol and a clean cloth. • Be sure to wipe the sensor apertures with a wet cloth. A dry cloth may generate static which can attract dust. • If the apertures are clean, then the LED of an ID sensor may have deteriorated. Replace the ID sensor plate. 	

Displayed Code	Item	Major Cause
23	ID Sensor Output Error	<p>Vsg_reg (SP3321) less than 0.5V.</p> <ul style="list-style-type: none"> • ID sensor harness loose, disconnected, damaged • ID sensor damaged <p>Note: Vsg_reg refers to the reading of the ITB surface done with the direct reflection sensors in both the color and black ID sensors.</p>
	Action:	<ul style="list-style-type: none"> • Remove the ITB unit. • Check the ID sensor harness connections and make sure that they are tight. • Check the harnesses for breaks. • If the harnesses are undamaged and tightening the connections does not solve the problem, replace the ID sensor plate.

TD Sensor (MUSIC)

Displayed Code	Item	Major Cause
41	TD Sensor Output Exceeded Upper Range	$V_t > 4.7V$
42	TD Sensor Output Below Lower Range	$V_t < 0.5V$
43	TD Sensor Malfunction: Upper Range	<p>Development gamma not within range:</p> $0.5V \leq \text{Dev Gamma} \leq 2.0V$ or $V_t > 4.7V$
44	TD Sensor Malfunction: Lower Range	<p>Development gamma not within range:</p> $0.5V \leq \text{Dev Gamma} \leq 2.0V$ or $V_t < 0.5V$

ID Sensor Pattern Detection

Displayed Code	Item	Major Cause
55	Development Gamma Error 1 SP400 to SC403	Development gamma (SP3561) greater than 6.0 (mg/cm ² /-kV).
	Action: <ul style="list-style-type: none"> • Switch the machine off and on then do SP3011. • Do SP3630 to confirm that development gamma is within the target range (-0.1 to +0.1) • If not within the target range, do the procedure again. 	
56	Development Gamma Error 2 SP400 to SC403	Development gamma (SP3630) less than 0.3 (mg/cm ² /-kV) <ul style="list-style-type: none"> • Toner shield glass dirty
Action: <ol style="list-style-type: none"> 1. Do SP2109-002 and select Pattern "12". 2. Do SP2109-005 to 008 and change the settings of these SP codes from "15 (default)" to "0". 3. Return to the print window and do the test print 1 pattern. 4. Check the pattern to determine whether the image density is extremely light. 5. Turn the machine off. 6. Open the toner hopper door, remove the toner bottles and check the toner shield glass for dirt. 7. Remove the face plate, replace the malfunctioning PCDU with a functioning PCDU, then turn the machine on and repeat Steps 1 to 3 to print the coverage test pattern. 8. If normal operation cannot be recovered: 		

Displayed Code	Item	Major Cause
		<ul style="list-style-type: none"> • Replace the image transfer power pack. • Open the development unit to see if there is too much or too little developer. • If the developer supply is normal, remove the toner end sensor to see if there is toner in the sub hopper. • If the sub hopper is empty, the powder pump is defective. Replace the toner supply unit. • If the sub hopper is full, the toner end sensor is defective. Replace the toner supply unit. • If the level of developer is either too high or too low, replace the developer.
57	Vk Error 1	Vk (development start voltage) greater than 150V.
	Action: Replace the developer.	
58	Vk Error 2	Vk (development start voltage) less than -150V. <ul style="list-style-type: none"> • The window of the potential sensor probe is covered with toner. • Potential sensor damaged
	Action: <ol style="list-style-type: none"> 1. Do SP3070 to check the function of the potential sensor. 2. Do SP3071 to check the Voffset readings. If Voffset is over 1V, the potential sensor might be dirty due to scattered toner. 3. Remove the PCPU. Use a blower brush to clean the window of the potential sensor probe, then check the sensor again with SP3070. 4. If normal operation cannot be recovered, replace the potential sensor probe. 5. If the Voffset reading is normal, replace the developer. 	
59	Insufficient Active Data	Not enough active data to calculate development gamma (only "0" or "1").
	Action: Do the "Action" procedure for code "55" described above.	

Potential Adjustment

Displayed Code	Item	Major Cause
61	LD Failure	<p>A laser diode failed to fire and write the ID sensor pattern.</p> <ul style="list-style-type: none"> • Toner shield glass dirty • PCDU set incorrectly • Laser diode defective
	<p>Action:</p> <ol style="list-style-type: none"> 1. Print the color test pattern to determine which color is abnormal. 2. Turn the machine off. 3. Check the toner shield glass for the laser unit. (p.495) > "Toner Shield Glass" 4. Reassemble the machine, switch the machine on, then do SP3011. <p>Notes:</p> <ul style="list-style-type: none"> • The probes of the potential sensors of each PCDU are located at different positions. This failure can be caused by installing a potential sensor at the incorrect position. However, you can eliminate this as a cause if a new PCDU is installed. (A guide ensures prevents a PCDU from being installed at the wrong location.) • If the machine fails to return SC240 to SC243, you can eliminate a defective LD as the cause of the problem. 	
62	Vr Error	<p>Vr (residual voltage) greater than $-200V$.</p> <ul style="list-style-type: none"> • Drum deteriorated • Toner shield glass dirty
	<p>Action:</p> <ul style="list-style-type: none"> • Open the front door, remove the toner supply unit, and check the toner shield glass for dirt. • Clean the glass then do SP3011. • If this does not solve the problem, replace the drum. 	
63	Vd Adjust Error	<p>Vd could not be adjusted within $\pm 8V$.</p> <ul style="list-style-type: none"> • Drum defective
	<p>Action:</p> <ul style="list-style-type: none"> • Replace the drum. 	

Displayed Code	Item	Major Cause
64	Vpl Adjust Error	Vpl could not be adjusted within $\pm 5V$. <ul style="list-style-type: none"> • Drum deteriorated due to filming
	Action: <ul style="list-style-type: none"> • Replace the drum. 	

Abnormal End

Displayed Code	Item	Major Cause
99	Forced Termination	Door open, power off, or other problem interfering with process control self-check.
	Action: <ul style="list-style-type: none"> • Make sure the machine is turned on. • Make sure the front door is closed completely. 	

MUSIC Adjustment Result

SP2-194-010 to -012 (MUSIC Execution Result M/C/Y Error)

This SP shows the number as a MUSIC result on the LCD. It shows which color has an error (M, Y or C).

No.	Result	Description
0	Not done	MUSIC has not been done.
1	Completed successfully	MUSIC has been done correctly.
2	Cannot detect patterns	ID sensors have not detected the patterns for MUSIC.
3	Fewer lines on the pattern than the target	The patterns detected by the ID sensors are not complete enough for MUSIC.
5	Out of the adjustment range	ID sensors have correctly detected the patterns for MUSIC, but the position of the patterns is too far away from the adjustable range.
6	Belt damage	Accurate detection is not possible due to damage to the ITB.

Troubleshooting for Image Quality Problems

This section describes some common image quality problems and explains how to resolve them.

Note

- The dark arrow in each illustration indicates the direction of paper feed.

Development-related Troubleshooting

Vertical White Line

Problem:

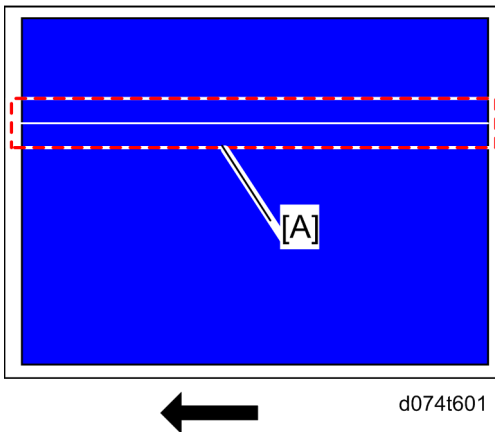

Vertical white line [A] appears on the output when a solid single color image is output.

Cause:

- Dust or dirt under the PCDU
- Laser path interruption between the laser unit and the drum unit due to dust or dirt on the toner shield glass
- Uneven developer supply due to a foreign substance stuck in the doctor gap in the development unit

Solution:

- Print three full-page, solid-fill (SP2-109-003: "26") A3 or DLT sheets and 1 dot halftone (SP2-109-003: "11") A3 or DLT sheets for each of black, cyan, magenta, and green.

To make a full-green coverage page

- Select No.26 (Full Dot Pattern) with SP2-109-003.
- Select "1" (Full Color) with SP2-109-5.

- Open SP2-109-6 and change Density K from "15" to "0".
- Open SP2-109-8 and change Density M from "15" to "0".
- Open SP2-109-7 and -9 and make sure that Density C and Density Y are both set "15" (default settings).

2. Does the problem vertical white line appear at the same place on some color's outputs?

Yes Go to "Recovery of dust or dirt under the PCDU".

No Clean the toner shield glass for the affected color.

3. Print the problem image. Does this eliminate the problem?

Yes Finished!

No Clean the doctor gap at the development unit.

- Cut an OHP sheet [A] or plastic material as shown below.
- Clean the doctor gap with this sheet and vacuum developer.



d074t708

4. Print the problem image. Does this eliminate the problem?

Yes Finished!

No Replace the affected drum unit.

5. Print the problem image. Does this eliminate the problem?

Yes Finished!

No Contact your supervisor.

Recovery of dust or dirt under the PCDU

1. Check the color which causes a vertical line.

- The PCDU's stations are placed as follows from the right; K (black), C (cyan), M (magenta) and Y (yellow). For example, check the magenta PCDU if yellow and magenta has a vertical line problem.

2. Does dust or dirt adhere under the affected PCDU?

Yes Pull out the affected PCDU, and then clean the bottom area [A] of the affected PCDU with a cloth and alcohol.



d074t709

No Contact your supervisor.

3. Print the image. Is the problem resolved?

Yes Finished!

No Contact your supervisor.

Color Toner Spotting/Staining

Paper Is Spotted with Toner

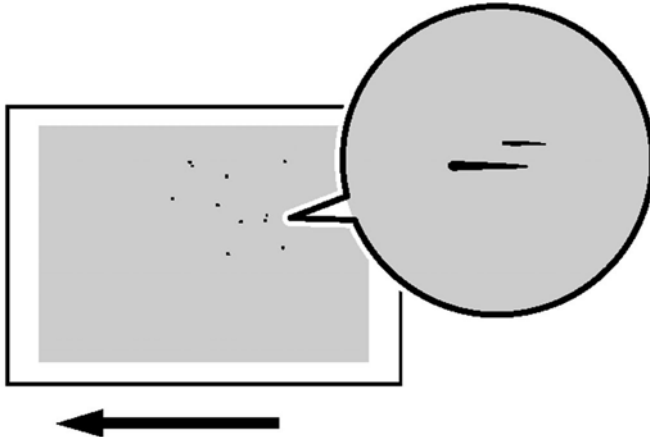

d074t602

6

Paper has toner spots of 0.5–1 mm (0.02–0.04 inches) in diameter.

Cause:

Toner fragments have slipped through the cleaning web.

This may occur in any of the following cases:

Duplex printing, printing on uncoated (especially rough-textured) paper, halftone printing, printing another job after halftone printing, or printing another job after printing on many small-size sheets

↓ Note

- To adjust the following settings, pre-register the type of paper in use as a custom paper. For details about registering custom papers, see "Registering a Custom Paper", Paper Settings Reference.

Solution:

1. Increase the temperature by 5 °C in [44: Fusing Heat Roller Temperature Adj] in [Advanced Settings] or with SP1-984.
2. Print 20 sheets of the image, then another 10. Does this eliminate the problem?
Yes Finished!
No Go to the next step.
3. Increase the temperature by an additional 5°C in [44: Fusing Heat Roller Temperature Adj] or with SP1-984.
4. Print 20 sheets of the image, then another 10. Does this eliminate the problem?
Yes Finished!

No Go to the next step.

5. Has changing the setting caused glossy lines to appear or paper to misfeed?

Yes Decrease the temperature by 10°C, and then go to the next step.

No Go to the next step.

6. Set [50: Adjust Cleaning Web Motor Interval] to -30% in [Advanced Settings] or with SP1-992 for the custom paper in use

7. Print 20 sheets of the image, then another 10. Does this eliminate the problem?

Yes Finished!

No Go to the next step.

8. Set [50: Adjust Cleaning Web Motor Interval] to -60% in [Advanced Settings] or with SP1-992 for the custom paper in use.

9. Print 20 sheets of the image, then another 10. Does this eliminate the problem?

Yes Finished!

No Go to the next step.

10. Set [50: Adjust Cleaning Web Motor Interval] to -75% in [Advanced Settings] or with SP1-992 for the custom paper in use.

11. If the problem persists, contact your supervisor.

Note

- Decreasing the value in [50: Adjust Cleaning Web Motor Interval] will shorten the replacement cycle of the cleaning unit for the fusing unit.

Colored Spots

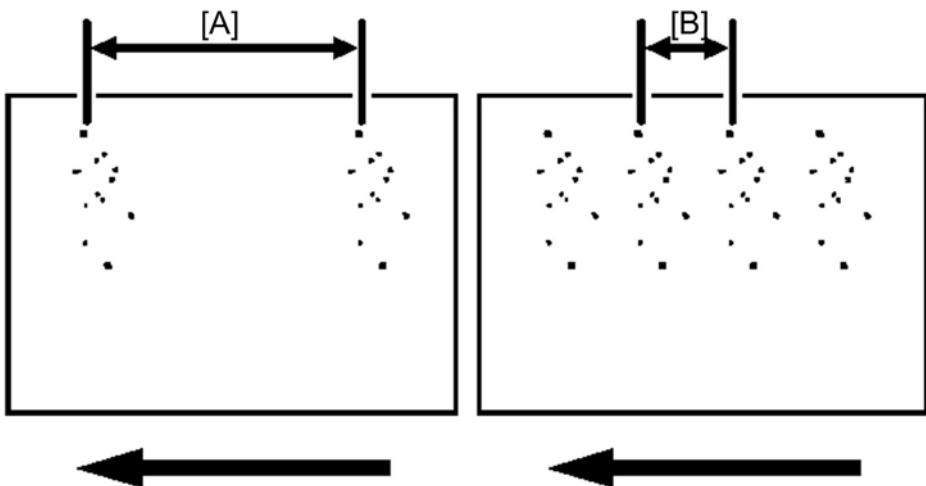

d074t603

- [A]: 189 mm (7.5 in.)
- [B]: 40 mm (1.6 in.)

Colored spots appear at 189 mm or 40 mm (7.5 inch or 1.6 inch) intervals.

Cause:

- (a) Colored spots appear at 189 mm (7.5 inch) intervals. The drum is scratched or stained.
- (b) Colored spots appear at 40 mm (1.6 inch) intervals. The charge roller is scratched or stained.

Solution:

The solution depends on the interval at which the colored spots appear. If they appear every 189 mm (7.5 inches), follow Procedure (a) on the following page; if they appear every 40 mm (1.6 inches), follow Procedure (b) on the following page.

(a) Colored spots at 189 mm (7.5 inch) intervals

1. To identify the affected color, print three full-page, solid-fill (SP2-109-003: "26") A3 or DLT sheets for each of white and black, and three full-page, halftone (SP2-109-003: "12") A3 or DLT sheets for each of cyan, magenta, and yellow.
2. Detach the drum unit of the affected color and check the drum surface. Is the surface scratched?

Yes Replace the drum unit. (▶ p.553)

No Wipe the drum surface with a well-wrung-out damp cloth, wipe it with a dry rag until no moisture remains, and then reattach the drum unit.

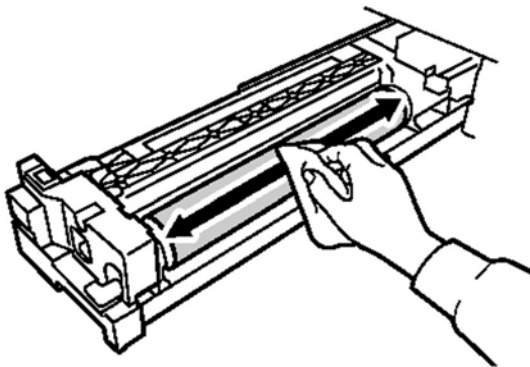

d074t604

Note

- Do not use ethanol or any other organic solvent to clean the drum. Otherwise it may cause damage to the drum.
 - After cleaning the surface of the drum, dust the surface of the drum completely with Drum Powder B1329700.
3. If the problem persists, contact your supervisor.

(b) Colored spots at 40 mm (1.6 inch) intervals

1. To identify the affected color, print three full-page, solid-fill (SP2-109-003: "26") A3 or DLT sheets for each of white and black, and three full-page, halftone (SP2-109-003: "12") A3 or DLT sheets for each of cyan, magenta, and yellow.
2. Detach the charge roller of the affected color and check its surface. Is the surface scratched?

Yes Replace the charge roller. (▶ p.551)

No Wipe the charge roller surface with a well-wrung-out damp cloth, wipe it with a dry rag until no moisture remains, and then reattach the roller.

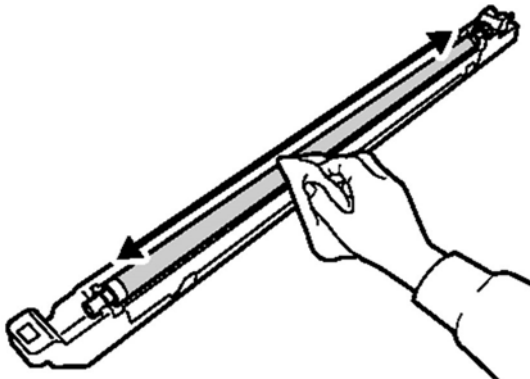

d074t605

↓ **Note**

- Do not use ethanol or any other organic solvent to clean the charge roller. Otherwise it may cause damage to the charge roller.
3. If the problem persists, contact your supervisor.

Colored Streaks (1)



d074t606

Colored streaks parallel to the paper feed direction appear.

Cause:

- The charge roller is stained.
- The cleaning unit for PCU has worn out.
- The drum surface is scratched.

Solution:

1. To identify the affected color, print three full-page, solid-fill (SP2-109-003: "26") A3 or DLT sheets for white, and three full-page, halftone (SP2-109-003: "12") A3 or DLT sheets for each of cyan, magenta, and yellow.
2. Detach the charge roller of the affected color and check its surface. Is the surface stained?
Yes Wipe the charge roller with a dry rag to remove the stain. If the stain cannot be removed, **replace the drum charge unit.** (▶ p.551)
 Go to the next step.
No Go to the next step.
3. Detach the drum unit of the affected color and check the drum surface. Is the surface stained or scratched?
Stained: Replace the drum cleaning unit. (▶ p.552)
Scratched: Replace the drum unit. (▶ p.553)
Neither: Contact your supervisor.
4. If the problem persists even if you replace the cleaning unit for PCU or drum unit, contact your supervisor.

Colored Streaks (2)

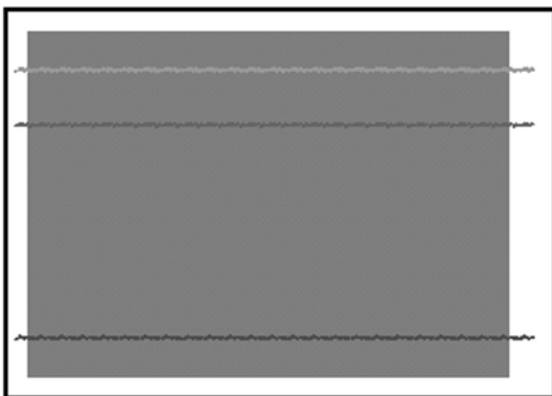

d074t607

Extended, blurred colored streaks parallel to the paper feed direction appear. The streaks also appear randomly in the margins.

Cause:

If the temperature or humidity is low, remaining toner might be missed by the cleaning blade of the cleaning unit for the transfer belt or transfer unit, causing streaks to appear sporadically.

Solution:

1. To identify the affected color, print three full-page, solid-fill (SP2-109-003: "26") A3 or DLT sheets for each of cyan, yellow, magenta, and black.
2. Which side is affected by the problem?
Printed side (1st side): Proceed to Step 6.
No image side (2nd side): Replace the PTR cleaning blade or lubrication bar. (📄 p.708)
3. Print the image. Is the problem resolved?
Yes Finished!
No Go to the next step.
4. **Replace the paper transfer roller.** (📄 p.708)
5. Print the image. Is the problem resolved?
Yes Finished!
No Check and clean other units (fusing unit or paper path).
6. **Replace the cleaning unit for the transfer belt or one of the following** (📄 p.430)
 - ITB Cleaning Blade
 - ITB Lubrication Roller
 - ITB Lubrication Bar
 - ITB Lubrication Blade
7. Print the image. Is the problem resolved?
Yes Finished!
No Go to the next step.
8. **Replace the transfer belt.** (📄 p.599)
9. Print the image. Is the problem resolved?
Yes Finished!
No Go to the next step.
10. If the problem persists even if you replace the cleaning unit for the transfer belt, contact your supervisor.

Colored Streaks (3)

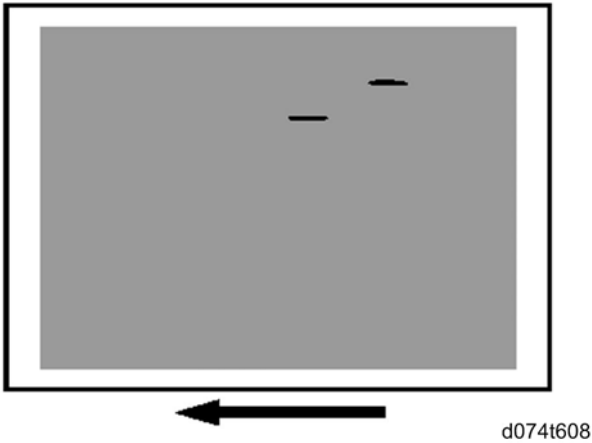

Colored streaks appear in solid-filled areas.

Cause:

If the toner contains small clumps, they disintegrate in the development unit, producing colored streaks.

This problem may occur if the machine is left unattended for a long period or the toner bottle is kept out of its moisture-proof bag for a long period.

Solution:

1. To identify the affected color, print three full-page, solid-fill (SP2-109-003: "26") A3 or DLT sheets for each of cyan, yellow, magenta, and black. The color affected by colored streaks is the cause of the problem.
2. Print 200 full-page, solid-fill (SP2-109-003: "26") A3 or DLT sheets in the affected color.
3. Print the image. Is the problem resolved?

Yes Finished!

No Replace the toner bottle for the affected color.

4. Print 200 full-page, solid-fill (SP2-109-003: "26") A3 or DLT sheets in the affected color.
5. Print the image. Is the problem resolved?

Yes Finished!

No Replace the toner supply unit for the affected color. (p.518)

6. Print 200 full-page, solid-fill (SP2-109-003: "26") A3 or DLT sheets in the affected color.
7. Print the image. Is the problem resolved?

Yes Finished!

No Replace the development unit and developer for the affected color. (p.558 or p.559)

1. Print 200 full-page, solid-fill (SP2-109-003: "26") A3 or DLT sheets in the affected color.

2. Print the image. Is the problem resolved?

Yes Finished!

No Contact your supervisor.

Stained Paper Edges

Solution:

1. If the paper edges are stained, carry out the procedure on p.1074 "Insufficient Toner Fusing".

Stained Background

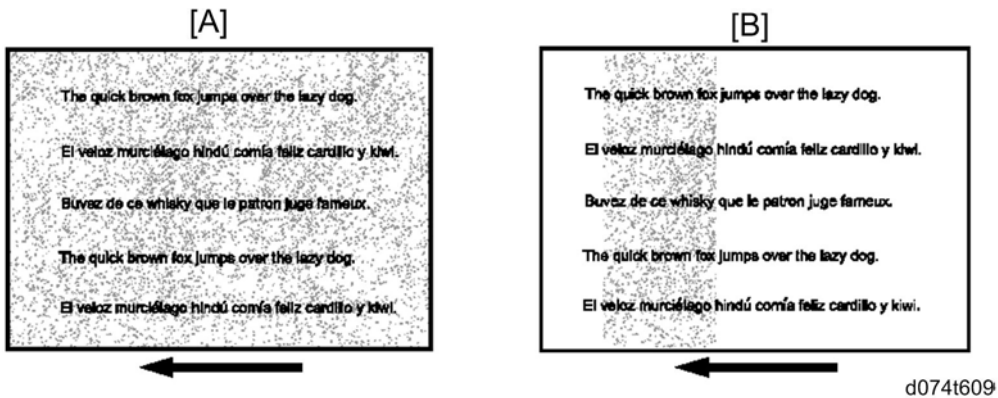

d074t609

- [A]: Completely stained background
- [B]: Partially stained background

Random "powdered" dots appear, creating a dirty background.

The background may be partially or completely stained.

Cause:

This may occur because of wearing of the developer and drum unit or staining of the charge roller.

Solution:

1. If a message prompting replacement of a unit has appeared, **replace the unit.**
 - Developer (p.559)
 - Drum unit (p.553)
 - Drum charge unit (p.551)
2. In the [Adjustment Settings for Skilled Operators] menu, execute [0201: Adjust Image Density] or SP3-011-002.
3. Print the image. Is the problem resolved?

Yes Finished!

No In the [Adjustment Settings for Skilled Operators] menu, execute [0302: Execute Process Initial Setting] or execute SP3-020-1 in the SP mode.

4. **Replace one of the following units, even if the service life of these parts has not reached the PM life.**
 - Developer (p.559)
 - Development unit (p.558)
 - Drum unit (p.553)
 - Drum charge unit (p.551)
5. If the problem persists, contact your supervisor.

Toner Scatter

Area Scatter



d074t610

Toner is scattered around a solid-fill print.

Cause:

This may occur if printed at low temperature or humidity.

Note

- To adjust the following settings, pre-register the type of paper in use as a custom paper.
- For details about how to register Custom Paper settings, see "Registering a Custom Paper" in the Paper Settings Reference.

Solution:

1. Check both sides of the paper for the problem. If it appears only on side 2 of the paper, skip to Step 3.

- Adjust the setting for side 1 of the paper. Configure the following settings in [Advanced Settings] for the custom paper in use.

<Printing in black and white>

Increase the absolute value of the negative current by 5% in [31: Paper Transfer Current: B&W] or with SP2-970.

Example: If the present current is $-40 \mu\text{A}$, change it to $-42 \mu\text{A}$.

<Printing in full color>

Increase the absolute value of the negative current by 5% in [32: Paper Transfer Current: FC] or with SP2-971.

Example: If the present current is $-70 \mu\text{A}$, change it to $-73 \mu\text{A}$.

- Adjust the setting for side 2 of the paper. Configure the following settings in [Advanced Settings] for the custom paper in use.

<Printing in black and white>

Increase the scaling factor by 5 percentage points in [33: Paper Transfer Current; Side 2: B&W] or with SP2-995.

Example: If the present value is 100%, change it to 105%

<Printing in full color>

Increase the scaling factor by 5 percentage points in [34: Paper Transfer Current; Side 2: FC] or with SP2-996.

Example: If the present value is 100%, change it to 105%

- Print the image. Is the problem resolved?

Yes Finished!

No Repeat Steps 1 to 3. If the problem persists, contact your supervisor.

Line Scatter

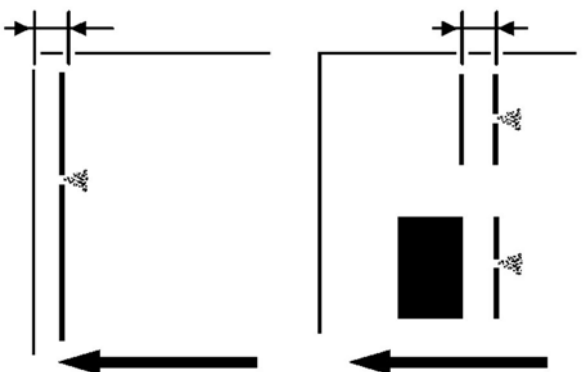

d074t611

Parts of a line exhibit splatter. This may occur in a line 5 mm or less from the leading edge, or in a line 1.5 to 5 mm from an image element on the side of the element facing the trailing edge.

[A]: 5 mm (0.2 in.), [B]: 1.5 - 5 mm (0.06 - 0.2 in.)

Cause:

This may occur when printing lines on coated or other slippery paper.

Note

- To adjust the following settings, pre-register the type of paper in use as a custom paper.
- For details about how to register Custom Paper settings, see "Registering a Custom Paper" in the Paper Settings Reference.

Solution:

The solution depends on the area in which the line splatter occurs. If the splatter occurs 5 mm (0.2 inches) or less from the leading edge, follow Procedure (a) below; otherwise, follow Procedure (b) below.

a) Line splatter that is 5 mm (0.2 inches) or less from the leading edge

Increase the leading edge margin to more than 5 mm (0.2 inches) using one of the following procedures:

1. Adjusting the shift image

In [Advanced Settings] for the custom paper in use, specify [08: Adj Image

Position of Side1 With Feed] for the side 1 of the paper and [09: Adj Image Position of Side2 With Feed] for the side 2.

2. Adjusting the mask width at the leading edge

In [Advanced Settings] for the custom paper in use, specify [13: Adjust Erase Margin of Leading Edge].

3. Adjusting the file's leading edge margin

Increase the leading edge margin in the print settings for the image to be printed.

For details about adjusting the shift image and adjusting the mask width at the leading edge, see "Adjustment Item Menu Guide".

If you cannot increase the leading edge margin to more than 5 mm (0.2 inches), use another type of paper.

b) Line splatter that is in an area more than 5 mm (0.2 inches) from the leading edge

1. Configure the following settings in [Advanced Settings] for the custom paper in use.

<Printing in black and white>

Increase the absolute value of the current by 10 μ A in [26: Image Transfer Current: B&W] or with SP2-990.

<Printing in full color>

Increase the absolute value of the current by 10 μ A in [27: Image Transfer Current: FC: Black] or with SP2-991.

2. Print the image. Is the problem resolved?

Yes Finished!

No Increase the value by 10 μ A.

3. Repeat Step 2. If the problem persists even though you have set the current to 70 μ A (maximum), use another type of paper.

Color Loss

Colorless Spots

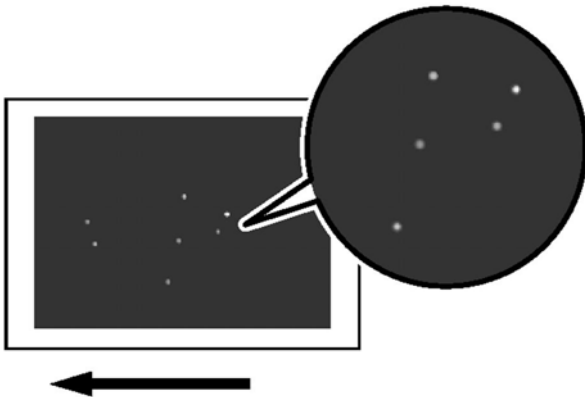

d074t612

Colorless spots appear in solid-filled areas.

Cause:

If the toner contains small clots, they fail to be transferred, producing colorless spots.

This problem may occur if the machine is left unattended for a long period or the toner bottle is taken out of its moisture-proof bag for a long period of time.

Solution:

If colorless spots appear in color printing, carry out the procedure on p.1041 "Colored Streaks (3)".

White Dots/Lines

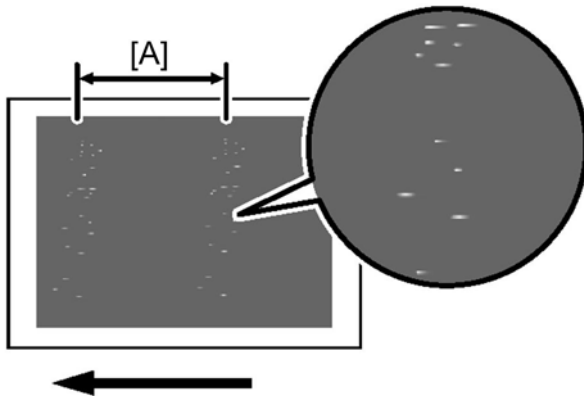

d074t613

White dots or small lines appear, spaced at 189 mm (7.5 inch) [A] intervals in the direction of the paper feed.

Cause:

The drum is stained.

Solution:

1. To identify the affected color, print three full-page, solid-fill (SP2-109-003: "26") A3 or DLT sheets or each of cyan, magenta, black, and green.

Because it is difficult to identify white spots on yellow, green is used instead of yellow.

2. Detach the drum unit of the affected color and check the drum surface. Is the drum surface stained?

Yes Carry out all of the following:

- (1) Wipe the drum surface with a clean, dry cloth to remove the stain.
- (2) After cleaning the surface of the drum, dust the surface of the drum completely with Drum Powder B1329700.
- (3) Replace the cleaning unit for PCU. (▶ p.552)
- (4) In the [Adjustment Settings for Skilled Operators] menu, set [0208: Photoconductor Special Mode] to [Special Mode] or set SP2-225-12 to 15 to "1: ON".

No Replace the drum unit. (▶ p.553)

3. If the problem persists, contact your supervisor.

Vertical White Streaks

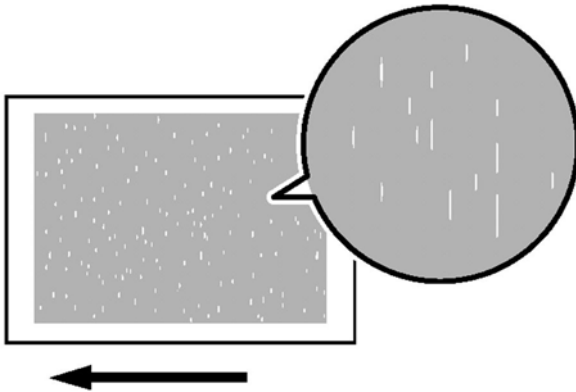

d074t614

White streaks 1 to 8 mm long perpendicular to the paper feed direction appear.

Cause:

One of the charge rollers is dirty.

Note

- If white streaks appear at 189- or 40-mm intervals, carry out the procedure on p.1036 "Colored Spots".

Solution:

1. To identify the affected color, print three full-page, halftone (SP2-109-003: "12") A3 or DLT sheets for each of cyan, magenta, yellow, and black.
2. Detach the charge roller of the affected color, wipe its surface with a well wrung-out damp cloth, wipe it with a dry cloth until no moisture remains, and then reattach the roller.

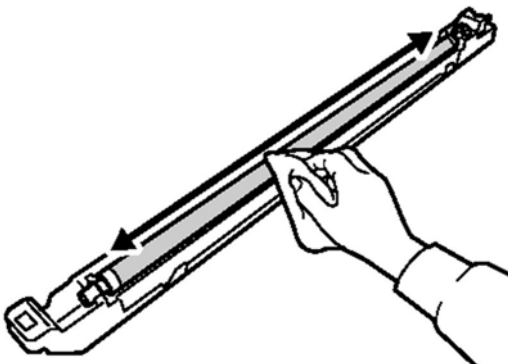

d074t615

Note

- Do not use ethanol or any other organic solvent to clean the charge roller. Otherwise it may cause damage to the charge roller.
3. If the problem persists, contact your supervisor.

White Spots

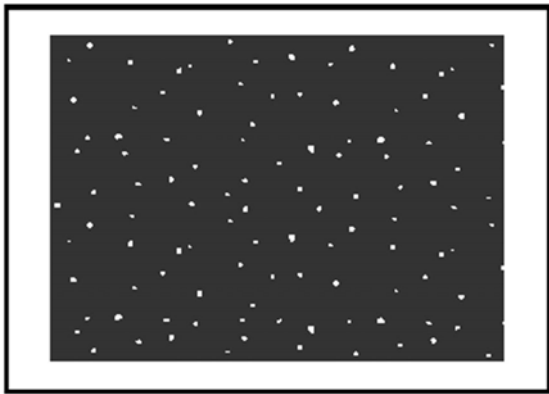

d074t616

6

White spots of 0.2–0.3 mm (0.008–0.01 inches) in diameter appear.

Cause:

This may occur if printed at low temperature or humidity.

Note

- To adjust the following settings, pre-register the type of paper in use as a custom paper.
- For details about how to register Custom Paper settings, see "Registering a Custom Paper" in the Paper Settings Reference.

Solution:

1. Check both sides of the paper for the problem. If it appears only on side 2 of the paper, skip to Step 3.
2. Adjust the setting for side 1 of the paper. Configure the following settings in [Advanced Settings] for the custom paper in use.

<Printing in black and white>

Decrease the absolute value of the negative current by 5% in [31: Paper Transfer Current: B&W] or with SP2-970.

Example: If the present current is -40 μ A, change it to -38 μ A.

<Printing in full color>

Decrease the absolute value of the negative current by 5% in [32: Paper Transfer Current: FC] or with SP2-971.

Example: If the present current is $-70 \mu\text{A}$, change it to $-67 \mu\text{A}$.

3. Adjust the setting for side 2 of the paper. Make the following settings in [Advanced Settings] for the custom paper in use.

<Printing in black and white>

Decrease the scaling factor by 5 percentage points in [33: Paper Transfer Current; Side 2: B&W] or with SP2-995.

Example: If the present value is 100%, change it to 95%.

<Printing in full color>

Decrease the scaling factor by 5 percentage points in [34: Paper Transfer Current; Side 2: FC] or with SP2-996.

Example: If the present value is 100%, change it to 95%.

4. Print the image. Is the problem resolved?

Yes Finished!

No Repeat Steps 1 to 4. If the problem persists, contact your supervisor.

Blister-like White Spots

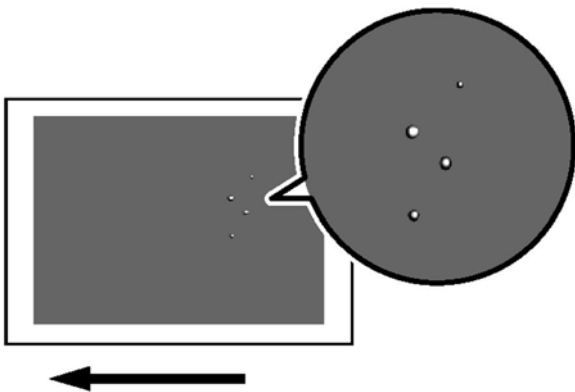

d074t617

White spots 0.3–0.5 mm in diameter surrounded by denser spots (blister-like white spots) appear.

Cause:

This may occur if a solid image is printed on coated paper, if a solid image is printed during duplex printing, or if printing is done at low temperature.

Solution:

If blister-like white spots appear, carry out the procedure on p.1074 "Insufficient Toner Fusing".

Mottling

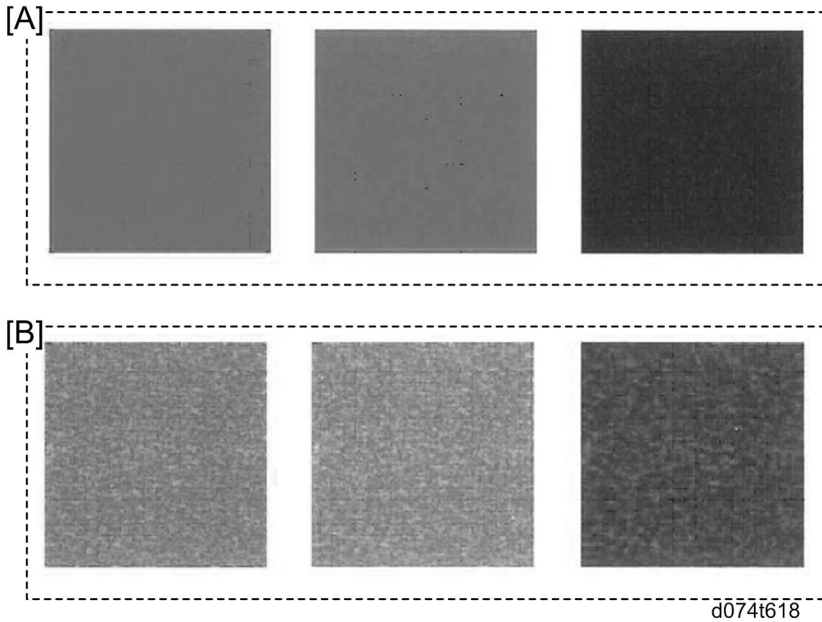

- [A]: Normal
- [B]: Mottled

Mottling occurs in solid-filled areas.

Cause:

This may occur if:

- Using paper with a rough surface
- Continuously printing solid fills covering small areas
- Printing in a low humidity environment
- Printing in a high humidity environment

Note

- If the problem occurs only if black is used when printing in full-color mode, carry out the procedure on p.1067 "Color (1): Black Faint During Full Color Printing".

Solution:

1. If a message prompting replacement of a unit has appeared, **replace the unit**.
2. To identify the affected color, print three full-page, solid-fill (SP2-109-003: "26") A3 or DLT sheets for each of cyan, yellow, magenta, and black.
3. In the [Adjustment Settings for Skilled Operators] menu, execute [0201: Adjust Image Density] or with SP3-011-002.

4. Print the image. Is the problem resolved?

Yes Check if the customer executes multiple prints job with low coverage. If so, increase the setting of SP3-820-001 to -004 for affected color. If not, contact your supervisor.

No Print 100 full-page, solid-fill (SP2-109-003: "26") A3 or DLT sheets in the affected color.

5. Print the image. Is the problem resolved?

Yes Finished!

No Reload with new paper.

6. Print the image. Is the problem resolved?

Yes Finished!

No Replace the paper with smoother paper.

7. Is any SC is issued?

Yes Do the countermeasure for the issued SC. If this does not solve the problem, contact your supervisor.

No Increase the value by 1 for all colors in [0203: Adjust Maximum Image Density] or use SP3-620-011 to 014. If this does not solve the problem, contact your supervisor.

Density Problems

Uneven Image Density

The density is uneven.

Solution:

The solution depends on the type of unevenness.

Carry out the appropriate procedure from those in the following table:

(A) The density is uneven across the entire image.

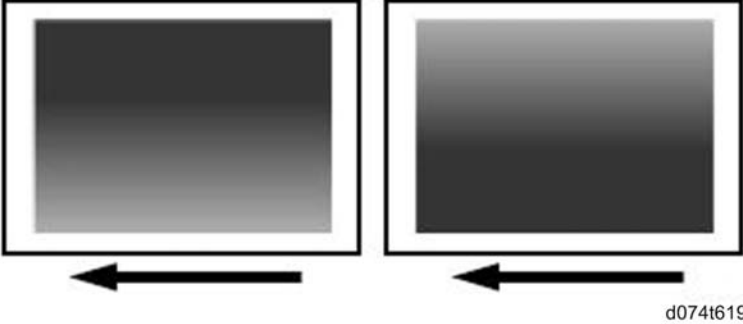
Affected area
 <p style="text-align: right; margin-right: 50px;">d074t619</p>
<p>The density from top to bottom is uneven.</p>
Solution
<ol style="list-style-type: none"> 1. Is there any part in the machine with its PM life ended? Yes Replace the unit. If the problem persists, go to the next step. No Go to the next step. 2. In the [Adjustment Settings for Skilled Operators] menu, execute [0201: Adjust Image Density] or SP3-011-002. 3. Print the image. Is the problem resolved? Yes Finished! No Go to the next step. 4. See "Uneven Density within 90 mm (3.5 in.) of the Trailing Edge" or replace one of the following units: <ul style="list-style-type: none"> • Drum unit (p.553) • Drum charge unit (p.551) • Development unit (p.558) 5. Print the image. Is the problem resolved? Yes Finished! No Check the ITB roller lift mechanism or PTR roller contact mechanism.

Affected area

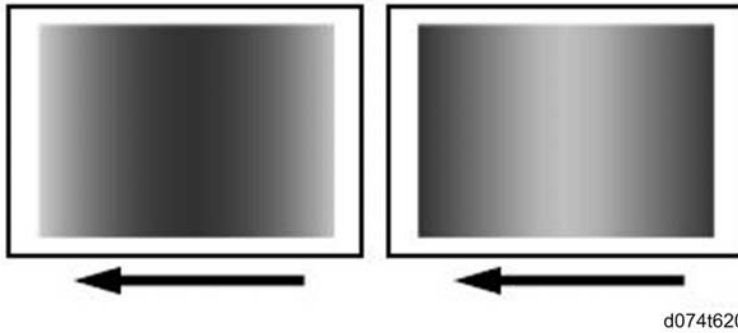

The sides are fainter or denser.

Solution

1. Is there any part in the machine with its PM life ended?
Yes Replace the unit. If the problem persists, go to the next step.
No Go to the next step.
1. In the [Adjustment Settings for Skilled Operators] menu, execute [0201: Adjust Image Density] or SP3-01 1-002.
2. Print the image. Is the problem resolved?
Yes Finished!
No Go to the next step.
3. Replace the development unit. (p.558)
4. Print the image. Is the problem resolved?
Yes Finished!
No Check the ITB roller lift mechanism or PTR roller contact mechanism.

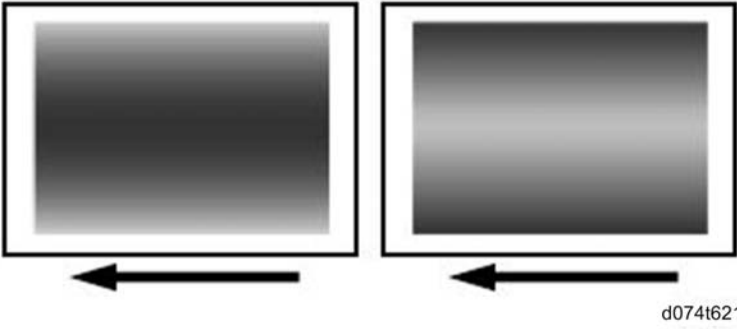
Affected area
 <p style="text-align: right; margin-right: 50px;">d074t621</p>
<p>The top and bottom are fainter or denser.</p>
Solution
<ol style="list-style-type: none"> 1. Is there any part in the machine with its PM life ended? Yes Replace the unit. If the problem persists, go to the next step. No Go to the next step. 1. In the [Adjustment Settings for Skilled Operators] menu, execute [0201: Adjust Image Density] or SP3-011-002. 2. Print the image. Is the problem resolved? Yes Finished! No Go to the next step. 3. Replace the development unit. (p.558) 4. Print the image. Is the problem resolved? Yes Finished! No Check the ITB roller lift mechanism or PTR roller contact mechanism.

(B) The density is uneven in a part of the image.

Affected area

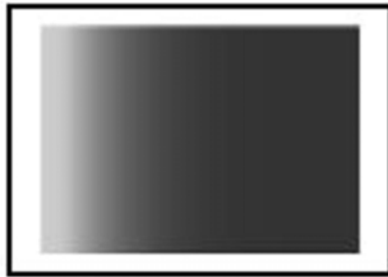

d074t622

The leading edge is fainter.

Solution

1. Is there any part in the machine with its PM life ended?
Yes Replace the unit. If the problem persists, go to the next step.
No Go to the next step.
2. In the [Adjustment Settings for Skilled Operators] menu, execute [0201: Adjust Image Density] or SP3-011-002.
3. Print the image. Is the problem resolved?
Yes Finished!
No If the problem persists, see p.1061 "Fainter Leading Edge".

Affected area



d074t623

The trailing edge is fainter.

Solution

1. Is there any part in the machine with its PM life ended?

Yes Replace the unit. If the problem persists, go to the next step.

No Go to the next step.

1. In the [Adjustment Settings for Skilled Operators] menu, execute [0201: Adjust Image Density] or SP3-01 1-002.

2. Print the image. Is the problem resolved?

Yes Finished!

No If the problem persists, see p.1061 "Fainter Leading Edge"..

Affected area

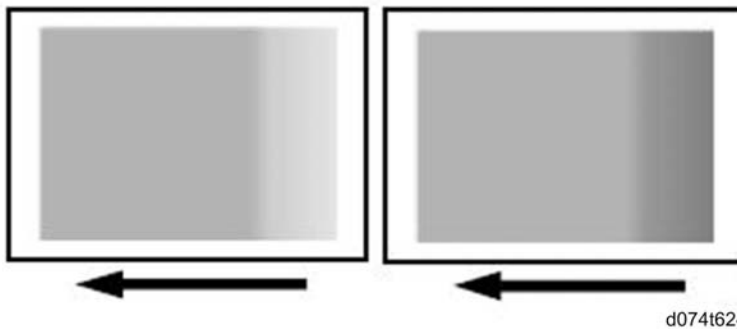

The area within 90 mm (3.5 inches) of the trailing edge is fainter or denser.

Solution

1. Is there any part in the machine with its PM life ended?

Yes Replace the unit. If the problem persists, go to the next step.

No Go to the next step.

2. In the [Adjustment Settings for Skilled Operators] menu, execute [0201: Adjust Image Density] or SP3-01 1-002.

3. Print the image. Is the problem resolved?

Yes Finished!

No If the problem persists, see p.1064 "Uneven Density within 90 mm (3.5 in.) of the Trailing Edge".

Affected area

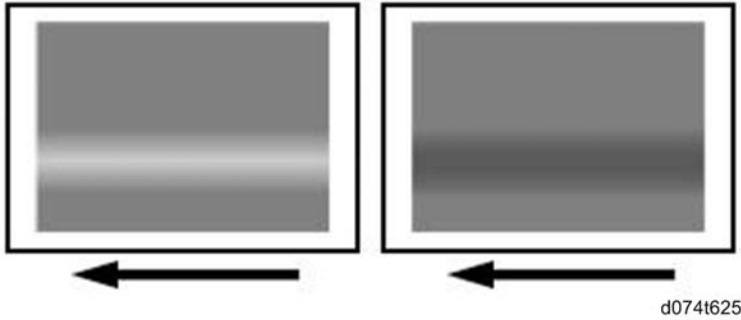

The centre is fainter or denser.

Solution

1. Is there any part in the machine with its PM life ended?
Yes Replace the unit. If the problem persists, go to the next step.
No Go to the next step.
2. In the [Adjustment Settings for Skilled Operators] menu, execute [0201: Adjust Image Density] or SP3-011-002.
3. Print the image. Is the problem resolved?
Yes Finished!
No If the problem persists, replace the development unit. (p.558)

Affected area

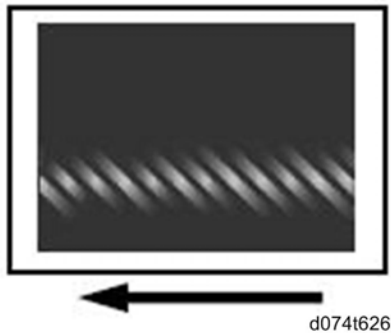

Wavy unevenness

Solution

1. Is there any part in the machine with its PM life ended?
Yes Replace the unit. If the problem persists, go to the next step.
No Go to the next step.
2. In the [Adjustment Settings for Skilled Operators] menu, execute [0201: Adjust Image Density] or SP3-011-002.
3. Print the image. Is the problem resolved?
Yes Finished!
4. **No** If the problem persists, replace the development unit or developer. (p.558) or (p.559)

(C) The vertical density fluctuates periodically

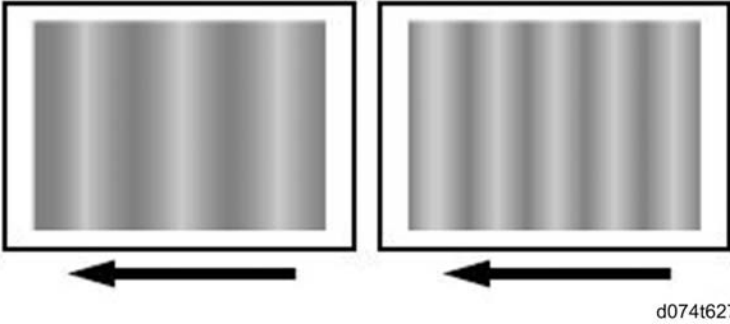
<p>Affected area</p>  <p style="text-align: right; margin-right: 50px;">d074t627</p> <p style="text-align: center;">Periodic vertical density fluctuation</p>
Solution
<ol style="list-style-type: none"> 1. In the [Adjustment Settings for Skilled Operators] menu, execute [0201: Adjust Image Density] or execute SP3-011-002 in the SP mode. 2. If the problem persists, see p.1066 "Periodic Density Fluctuation".

Uneven Density from Top to Bottom

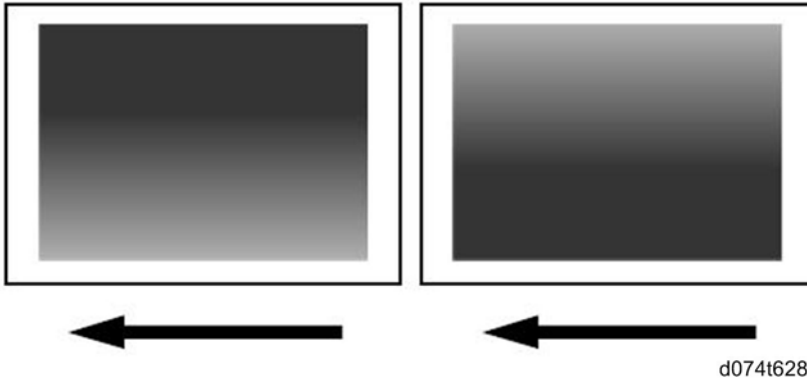

The density is uneven from top to bottom.

★ Important

- You can adjust the density of halftone images, but not that of solid fills.

Cause:

This may occur at high temperature or humidity.

Solution:

1. To identify the affected color, print three full-page, halftone (SP2-109-003: "12") A3 or DLT sheets for each of cyan, yellow, magenta, and black.
2. In the [Adjustment Settings for Skilled Operators] menu, select [0205: Adjust Density Difference Across Feed Direction] or use SP2-113-001 to 004.

Decreasing the value for the affected color makes the area above the centre denser and the area below fainter.

Increasing the value for the affected color makes the area above the centre fainter and the area below denser.

3. Turn off the power and the main power switch, and then turn the main power switch back on.

The setting specified in step 2 takes effect.

4. Print the image. Is the problem resolved?

Yes Finished!

No Go to the next step.

5. Replace one of the following units:

- Development unit (p.558)
- Drum unit (p.553)
- Drum charge unit (p.551)
- PTR unit (p.432)

- ITB roller (p.631)

6. Print the image. Is the problem resolved?

Yes Finished!

No Contact your supervisor.

Fainter Leading Edge

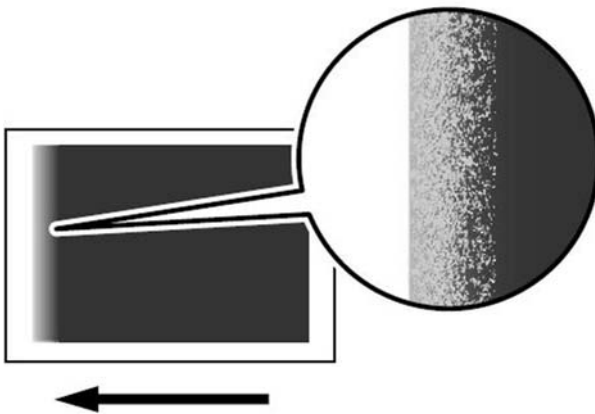

d074t629

The leading edge is fainter.

Cause:

At low temperature or when using thin coated paper, this may occur if the paper transfer current is insufficient.

At high temperature, this may occur if the paper transfer current is excessive.

Note

- To adjust the following settings, pre-register the type of paper in use as a custom paper.
- For details about how to register Custom Paper settings, see "Registering a Custom Paper" in the Paper Settings Reference.

Important

- This solution only works when the thickness of the paper is equivalent to Paper Weight 4 or above.
- If the leading edge coefficient is set too high, this could cause paper separation after image transfer to deteriorate and lead to paper jams. This is particularly true with thickness settings of 3 or lower.

Solution:

1. Make a note of the present value in the following setting in [Advanced Settings] for the custom paper in use.

<Printing in black and white>

[35: Paper Transfer Current; Lead Edge: B&W] or SP2-972.

<Printing in full color>

[36: Paper Transfer Current; Lead Edge: FC] or SP2-973.

2. Increase the scaling factor in the above setting by 10 percentage points.
3. Print the image. Is the problem resolved?

Yes Finished!

No Increase the scaling factor by 10 percentage points.

4. Repeat Step 3. If the problem persists even though you have increased the scaling factor by 50 percentage points, restore the value noted in Step 1 and go to the next step.
5. Decrease the scaling factor in the above setting by 10 percentage points.
6. Print the image. Is the problem resolved?

Yes Finished!

No Decrease the scaling factor by 10 percentage points.

7. Repeat Step 6. If the problem persists even though you have decreased the scaling factor by 50 percentage points, restore the value noted in Step 1 and contact your supervisor.

6

Fainter Trailing Edge

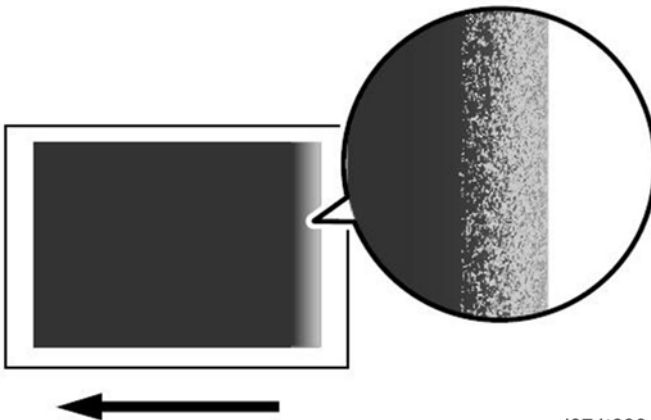

d074t630

The trailing edge is fainter.

Cause:

This may occur because of insufficient or excessive paper transfer current when using paper weighing approximately 160 g/m² (60 lb. Cover) or heavier at low temperature.

Note

- To adjust the following settings, pre-register the type of paper in use as a custom paper.
- For details about how to register Custom Paper settings, see "Registering a Custom Paper" in the Paper Settings Reference.

Solution:

1. Measure in millimeters how far the fainter area extends from the trailing edge.
2. Configure the following settings in [Advanced Settings] for the custom paper in use.

<Printing in black and white>

In [41: Ppr Transfer Current Trail Edg Dist: BW] or SP2-978, enter the value you measured in Step 1 plus an additional 10 mm.

<Printing in full color>

In [42: Ppr Transfer Current Trail Edg Dist: FC] or SP2-979, enter the value you measured in Step 1 plus an additional 10 mm.

3. Make a note of the present value in the following setting in [Advanced Settings] for the custom paper in use.

<Printing in black and white>

[39: Paper Transfer Current; Trail Edge: B&W] or SP2-2-977

<Printing in full color>

[40: Paper Transfer Current; Trail Edge: FC] or SP2-977

4. Increase the scaling factor in the above setting by 10 percentage points.
5. Check test print. Printing recovered?
 - Yes.** Succeeded, go to 6
 - No.** Failed. Restore original setting, and then lower the trailing edge correction coefficient. Go to 9.
6. Trailing edge margin satisfactory?
 - Yes.** Success. End
 - No.** Go to 7.
7. Raise the value another 5%.
8. Do a test print and check results. Image satisfactory?
 - Yes.** Succeeded, to 7 (as long as image is satisfactory, you can keep adding 5%).
 - No.** Failed. Restore original setting before it was raised 5%. No further adjustment is possible.
9. Lower the setting 10% below its original value.
10. Do a test print, check the results. Printing satisfactory?
 - Yes.** Succeeded, go to 11.
 - No.** Failed. Restore original setting. No further adjustment is possible.

11. Problem with trailing edge margin solved?

Yes. End.

No. Go to 12.

12. Reduce the setting another 5%.

13. Do a test print, check the results. Printing recovered?

Yes. Succeeded, go to 12. (as long as image is satisfactory, you can keep adding 5%).

No. Failed. Restore original setting before it was raised 5%. No further adjustment is possible.

Uneven Density within 90 mm (3.5 in.) of the Trailing Edge

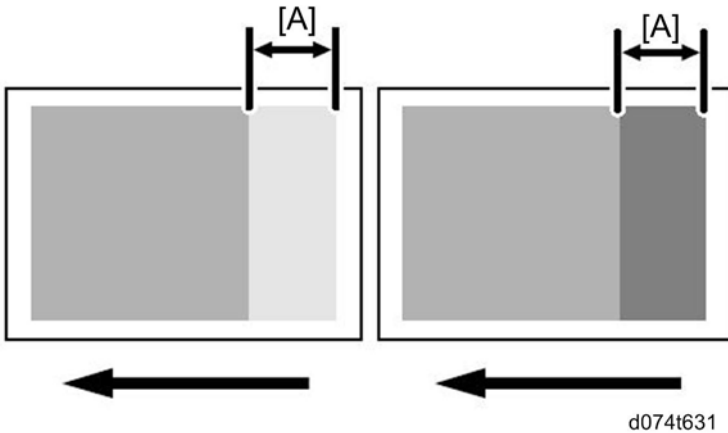

- [A]: 90 mm (3.5 in.)

Printing in the area extending approximately 90 mm (3.5 inches) from the trailing edge is fainter or denser when the temperature or humidity is low.

↓ Note

- To adjust the following settings, pre-register the type of paper in use as a custom paper.
- For details about how to register Custom Paper settings, see "Registering a Custom Paper" in the Paper Settings Reference.

Solution:

The solution depends on whether the area within 90 mm (3.5 inches) of the trailing edge is denser or fainter.

<If the area within 90 mm (3.5 inches) of the trailing edge is fainter>

1. In [Advanced Settings] for the custom paper in use, select [20: Transfer Timing Roller Feed Speed Adj] or SP1-963.
2. Check the present value. Is it higher than +0.5%?

Yes Use another type of paper.

No Increase the value by 0.1 percentage point.

3. Print the image. Is the problem resolved?

Yes Finished!

No Repeat Steps 1 to 3. If the problem persists even if you increase the value to +0.5%, contact your supervisor.

<If the area within 90 mm (3.5 inches) of the trailing edge is denser>

1. In [Advanced Settings] for the custom paper in use, select [20: Transfer Timing Roller Feed Speed Adj] or SP1-963.

2. Check the present value. Is it lower than -0.5%?

Yes Use another type of paper.

No Decrease the value by 0.1 percentage point.

3. Print the image. Is the problem resolved?

Yes Finished!

No Repeat Steps 1 to 3. If the problem persists even if you decrease the value to -0.5%, contact your supervisor.

<If you fail to solve the problem>

Follow this procedure to adjust the speed of the transfer timing roller.

1. Check the type and thickness of the paper in use.
2. Paper not registered?

No. Register the paper, or adjust the speed of the time roller with SP1-006.

Yes, In [Advanced Settings] for the custom paper in use, select [20: Transfer Timing Roller Feed Speed Adj] and adjust or use SP1-963.

3. Trailing edge margin dark?

Yes. Adjust the speed of the transfer timing roller down -0.1% from its present setting. Go to 4.

No. Adjust the speed of the transfer timing roller up +0.1% from its present setting. Go to 4

4. Operator satisfied with the results?

Yes. Finished.

No. Repeat 3

5. Operator satisfied with the results?

Yes. Finished.

No. Repeat 4.

Periodic Density Fluctuation

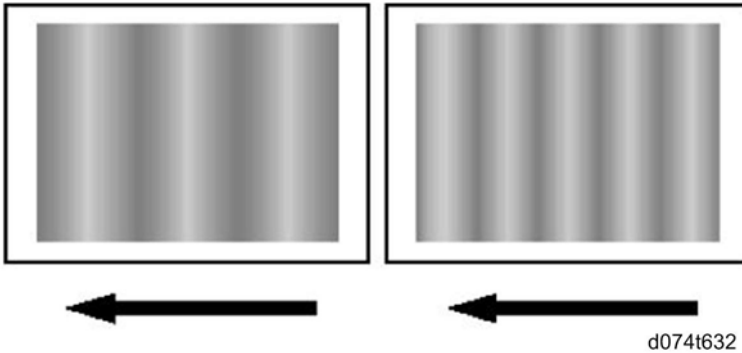

The vertical density fluctuates periodically.

Solution:

The solution depends on the interval.

6

Interval	Solution
Approximately 12-18 mm (0.5-0.7 inches)	Replace the development unit. If the problem persists, contact your supervisor.
Approximately 50 mm (2 inches)	Replace the charge roller. If the problem persists, contact your supervisor.
Approximately 60 mm (2.4 inches)	Replace the transfer unit. If the problem persists, contact your supervisor.
Approximately 95 mm (3.7 inches)	Replace the ITB drive roller. If the problem persists, contact your supervisor.
Approximately 190 mm (7.5 inches)	Replace the drum unit. If the problem persists, contact your supervisor.

Color (1): Black Faint During Full Color Printing

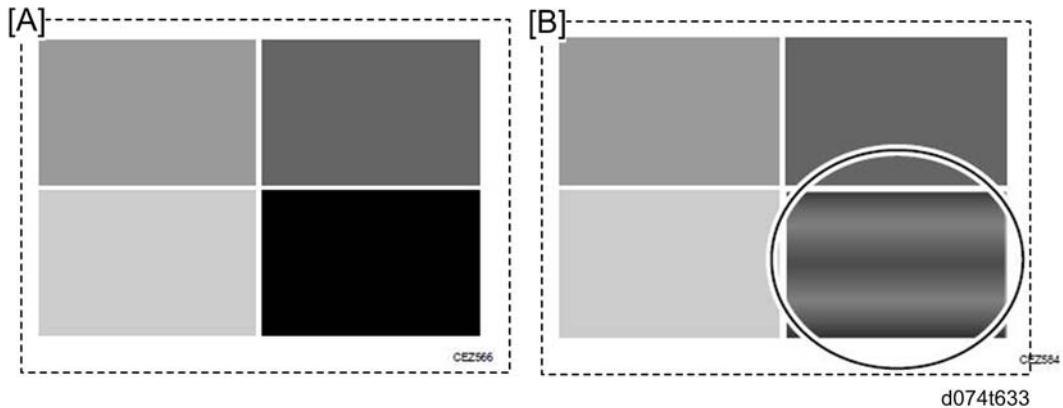

- [A]: Normal
- [B]: Black is fainter.

Black is fainter than normal during full color printing.

Cause:

If black is used when printing in full color mode with black toner only, the printing may become faint.

Note

- To adjust the following settings, pre-register the type of paper in use as a custom paper.
- For details about how to register Custom Paper settings, see "Registering a Custom Paper" in the Paper Settings Reference.

Solution:

Carry out the following sequence of procedures. Terminate the sequence as soon as the problem is resolved.

Procedure 1: Increasing the image transfer current for black in full color mode

1. In [Advanced Settings] for the custom paper in use, select [27: Image Transfer Current: FC: Black] or SP2-991.
2. Increase the value by 10 μ A.
3. Print the image. Is the problem resolved?
 - Yes** Finished!
 - No** Increase the value by 5 μ A.
4. Repeat Step 3. If doing this adversely affects colors other than black, reduce the value by 5 μ A and carry out Procedure 2, "Executing image processing".

Procedure 2: Executing image processing

Do the following on the Command WorkStation (CWS).

1. Select "Properties..." for the image.
2. Click the "Color" tab.
3. In "Color mode", select "Expert Settings...".
4. If "CMYK/Grayscale" is set to "Colorwise OFF", change it to an appropriate image process.
5. If an appropriate image process has already been selected but the problem persists, carry out Procedure 3, "Printing black using four colors (YMCK) in full-color mode".

Procedure 3: Printing black using four colors (YMCK) in full-color mode

Do the following on the Command WorkStation (CWS).

1. Select "Properties..." for the image.
2. Click the "Color" tab.
3. In "Color mode", select "Expert Settings...".
4. Click the "Gray & Black processing" tab.
5. Set "Black text graphics" to "Normal".

Black is printed with 4 colors (YMCK).

Note

- If "Black text graphics" is set to "Pure Black On", black is printed with only black toner.
6. If the problem persists, contact your supervisor.

Color (2): Entire Image Faint



d074t634

The entire image is fainter than normal.

Cause:

This may occur if:

- Continuously printing an image that consumes little toner
- The machine has not been used for a long time

- The machine is located somewhere very humid and has not been used for a while

Solution:

1. In the [Adjustment Settings for Skilled Operators] menu, execute [0201: Adjust Image Density] or execute SP3-011-002 in the SP mode.
2. Print the image. Is the problem resolved?
Yes Finished!
No Go to the next step.
3. Increase/decrease the value by 1 for all colors in [0203: Adjust Maximum Image Density] or with SP3-620-011 to 014..
4. Execute [0201: Adjust Image Density] or execute SP3-011-002 in the SP mode.
5. Print the image. Is the problem resolved?
Yes Finished!
No Repeat Steps 3 to 5. If the problem persists even if you increase the value to 5, go to the next step.
6. Execute the ACC (Automatic Color Calibration) Adjustment.

Note

 - "ACC" is machine calibration for copier jobs.
 - For printer jobs, execute Fiery calibration.
7. Print the image. Is the problem resolved?
Yes Finished!
No Go to the next step.
8. Is there any defective part, SC issued, or a part with the PM life ended?
Yes Replace the necessary part. If this does not solve the problem, contact your supervisor.
No Contact your supervisor.

Color is Too Dense

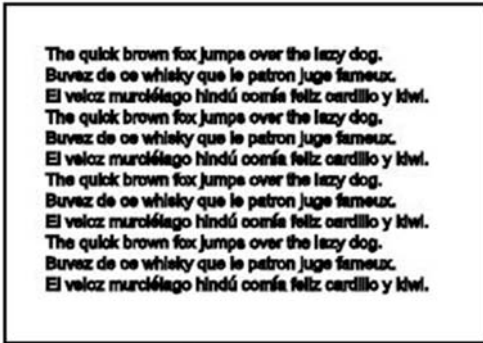

d074t635

The entire image is denser than normal.

Cause:

This may occur if:

6

- Continuously printing an image that consumes much toner
- The machine has not been used for a long time
- The machine is located somewhere very humid and has not been used for a while

Solution:

1. In the [Adjustment Settings for Skilled Operators] menu, execute [0201: Adjust Image Density] or execute SP3-011-002 in the SP mode.
2. Print the image. Is the problem resolved?
Yes Finished!
No Go to the next step.
3. Increase/decrease the value by 1 for all colors in [0203: Adjust Maximum Image Density] or with SP3-620-011 to 014.
4. Execute [0201: Adjust Image Density] or execute SP3-011-002 in the SP mode.
5. Print the image. Is the problem resolved?
Yes Finished!
No Repeat Steps 3 to 5. If the problem persists even if you decrease the value to -5, go to the next step.
6. Execute the ACC (Automatic Color Calibration) Adjustment

Note

- "ACC" is machine calibration for copier jobs.
- For printer jobs, execute Fiery calibration.

7. Print the image. Is the problem resolved?

Yes Finished!

No Go to the next step.

8. Is there any defective part, SC issued, or a part with the PM life ended?

Yes Replace the necessary part. If this does not solve the problem, contact your supervisor.

No Contact your supervisor.

Broken Thin Lines

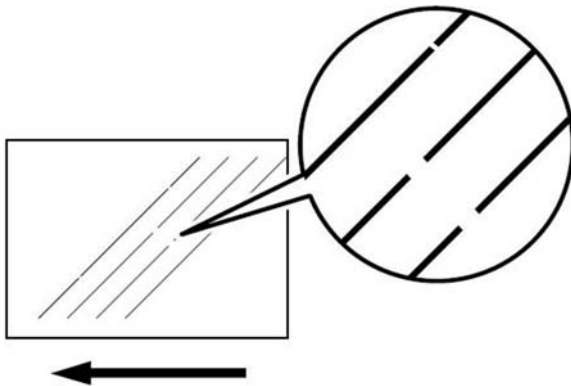

d074t636

Thin lines (1 dot lines in 1200 dpi images) break.

Cause:

Oblique (approximately 45°) thin lines or thin lines printed in faint colors are likely to contain breaks.

Solution:

1. In the [Adjustment Settings for Skilled Operators] menu, execute [0201: Adjust Image Density] or execute SP3-011-002 in the SP mode.

2. Print the image. Is the problem resolved?

Yes Finished!

No Go to the next step.

3. Increase/decrease the value by 1 for all colors in [0204: Adjust Line Width] or with SP3-623-061 to 064.

4. Execute [0201: Adjust Image Density] or execute SP3-011-002 in the SP mode.

5. Print the image. Is the problem resolved?

Yes Finished! However, execute the ACC adjustment for the copier or printer if the current color output is different from the previous color output.

No Repeat Steps 3 to 5. If the problem persists even if you increase the value to 5, contact your supervisor.

Gloss Problems

Glossy Lines

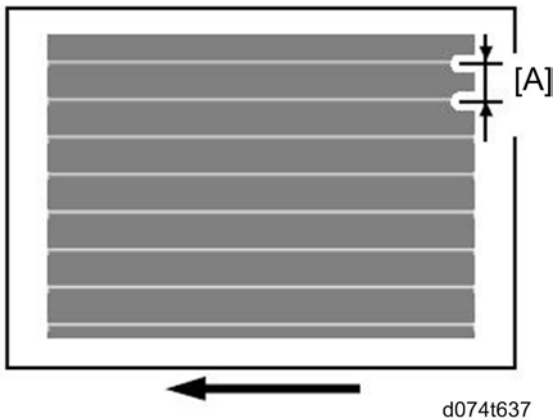

- [A]: 20 mm or 26.5 mm (0.8 or 1.0 in.)

Glossy lines appear every 20 or 26.5 mm (0.8 or 1.0 inches).

Cause:

This may occur if coated or thin paper is used.

↓ Note

- To adjust the following settings, pre-register the type of paper in use as a custom paper.
- For details about how to register Custom Paper settings, see "Registering a Custom Paper" in the Paper Settings Reference.

↓ Note

- If the glossy lines appear at irregular intervals, you cannot resolve the problem with this procedure. Contact your supervisor.
- Decreasing the temperature may cause unsatisfactory fusing.

Solution:

1. In [Advanced Settings] for the custom paper in use, select [44: Fusing Heat Roller Temperature Adj] or select SP1-984 in the SP mode.
2. Decrease the value by 10 °C. If the gloss of the entire image drops after this, decrease the value only by 5 °C instead of 10 °C.
3. If the problem persists, contact your supervisor.

Vertical Glossy Lines

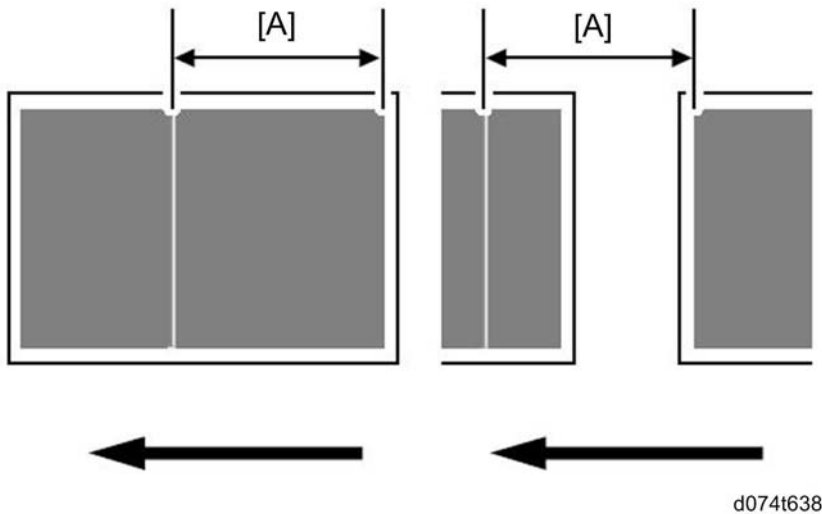

- [A]: 251 mm (10 inches)

Glossy lines parallel to the paper feed direction appear.

Cause:

Glossy lines parallel to the paper feed direction may appear 251 mm from the boundary of the margin and solid image (in the direction opposite to the paper feed direction).

Solution:

If vertical glossy lines appear, carry out the procedure in "Glossy Lines".

Insufficient Gloss

The image is not glossy enough.

Solution:

If the gloss of the image is not glossy enough, carry out the procedures in Procedure 1 and Procedure 4 on p.1074 "Insufficient Toner Fusing".

Fusing-related Troubleshooting

Optimizing Productivity for Mixed Paper Stocks

Problem

The fusing temperature is normally adjusted for each paper type. As a result, down time of the machine may be longer if the machine gets a sequence of jobs in which the paper type changes between jobs. If

a customer considers that the productivity of the machine has more priority than print quality, do the procedure below.

Solution

1. Change the setting of SP1-131-001 from "0" to "1".

This solution may get good results in the following cases:

- Small difference in the target fusing temperature between two jobs
- Same line speed between two jobs

Side Effects

- If paper weight is changed from light to heavy; a fusing problem may occur for several prints just after paper weight has been changed due to insufficient fusing temperature.
- If paper weight is changed from heavy to light; a fusing problem (glossy lines) may occur for several prints just after paper weight has been changed due to too much fusing temperature.
- Some troubleshooting by adjusting the heating roller temperature may not be effective after selecting the setting of SP1-131-001 to "1".

6

Insufficient Toner Fusing

This section explains how to resolve the problem of insufficient toner fusing on printed copies.

↓ Note

- To adjust the following settings, pre-register the type of paper in use as a custom paper.
- For details about how to register Custom Paper settings, see "Registering a Custom Paper" in the Paper Settings Reference.

Solution:

Carry out the following sequence of procedures. Terminate the sequence as soon as the problem is resolved.

Procedure 1: Changing the fusing temperature

1. In [Advanced Settings] for the custom paper in use, select [44: Fusing Heat Roller Temperature Adj] or select SP1-984 in the SP mode, and then make a note of the currently selected temperature.
2. Increase the temperature by 5 °C.
3. Print the image and check toner fusion. Is the problem resolved?

Yes Finished!

No Increase the temperature another 5 °C.

4. Repeat Step 3.

If the problem persists even if you increase the temperature to 180 °C, return the temperature to the one you noted in Step 1, and then carry out Procedure 2, "Image processing 1".

Procedure 2: Image processing 1

Do the following on the Command WorkStation (CWS).

1. Select "Properties..." for the image.
2. Click the "Color" tab.
3. In "Color mode", select "Expert Settings...".
4. If "CMYK/Grayscale" is set to "Colorwise OFF", change it to "Colorwise ON". If not, carry out Procedure 3, "Image processing 2".
5. Print the image and check toner fusion. Is the problem resolved?

Yes Finished!

No Carry out Procedure 3, "Image processing 2".

Procedure 3: Image processing 2

1. Are the images printed in one or two colors?
Yes Carry out Procedure 4, "Changing the process speed".
No (three-color printing or unknown): In the printer driver setting, select toner reduction mode.
2. Print the image and check toner fusion. Is the problem resolved?

Yes Finished!

No Carry out Procedure 4, "Changing the process speed".

Procedure 4: Changing the process speed

This will slow down the printing to give the toner more time to fuse. However, because of this, throughput will be reduced.

Example when printing on A4/LT paper:

<D074>

If the process speed is changed from [High] to [Middle]: 65 cpm → 45 cpm

If the process speed is changed from [Middle] to [Low]: 45 cpm → 32 cpm

<D075>

If the process speed is changed from [High] to [Middle]: 75 cpm → 52 cpm

If the process speed is changed from [Middle] to [Low]: 52 cpm → 37 cpm

1. In [Advanced Settings] for the custom paper in use, select [19: Process Speed Setting] or select SP1-986 in the SP mode.

The settings for the Advanced Settings and the SP settings correspond to one another as shown in the table below.

Advance Settings	SP Code Settings
High	0: Target Speed
Middle	1: Medium Speed

Advance Settings	SP Code Settings
Low	2: Low Speed

2. Decrease the value by one level.

If the present value is [High], select [Middle]. If it is [Middle], select [Low].

3. Print the image and check toner fusion. Is the problem resolved?

Yes Finished!

No If the problem persists, the machine may be faulty or the paper unsupported. Contact your supervisor.

Troubleshooting for Paper Delivery Problems

Frequent Paper Misfeeds

Coated or another type of unsupported paper is loaded in the machine's tray.

Load paper not supported by the machine's paper tray (Trays 1 and 2) in the wide LCT (Trays 3-5) or another paper tray supporting the paper. For details about the size and type of paper that can be loaded in the paper trays, see "Recommended Paper Sizes and Types", About This Machine.

The side fences in the paper tray are too close together.

If the distance between the side fences is less than the paper width, it may interfere with paper transfer and so cause paper misfeeds.

Adjust the side fences to match the paper width.

For details about loading paper, see "Loading Paper", About This Machine.

The side fences in the paper tray are too far apart.

If the side fences are too far apart, paper misfeeds may occur due to wrong paper size detection.

Adjust the side fences to match the paper width.

For details about loading paper, see "Loading Paper", About This Machine.

The paper size/orientation is not specified correctly.

In tray paper settings, specify the size and orientation of the paper in use.

For details about tray paper settings, see "Changing Tray Paper Settings", Paper Settings Reference.

Too many sheets of paper are loaded in the paper tray.

When loading paper, do not exceed the limit.

For details about how many sheets can be loaded in the paper trays, see "Recommended Paper Sizes and Types".

The edges of the sheets are rough.

Turn the sheets the other way up or smooth the edges before loading.

Sheets are curled or wavy.

- Flatten curls and waviness before loading paper.
- Turn the sheets the other way up or smooth the edges before loading.

Sheets absorbed moisture and became limp.

Sheets that will not be used for a long time should be protected from moisture by, for example, storing them in a sealed bag.

If you switch the anti-humidity heater on, the heater is inside the paper tray will operate to prevent sheets from absorbing moisture even when the main power is off.

For details about operating the anti-humidity heater, see "Anti-humidity Heater Switch", About This Machine.

When using thick paper or slippery paper.

Enable the Pickup Assist setting.

<If custom paper is used>

1. In [Advanced Settings] for the custom paper in use, set [03: Pickup Assist Setting] to [On] or set SP1-977 to "1: ON".

<If custom paper is not used>

1. In the [Adjustment Settings for Skilled Operators] menu, set [0115: Pickup Assist Setting] to [On] or by setting SP1-923-001 to 006 to "1: FORCE ON".

The paper feed sensor is stained with paper dust.

Clean the part of the paper feed sensor where the paper misfeed is detected.

For details about cleaning the paper feed sensor, see the Replacement Guide.

The paper feed performance is less sufficient because the paper transport roller is soiled with toner.

Clean the part of the paper transport roller where the paper misfeed is detected.

For details about cleaning the paper transport roller, see the Replacement Guide.

Frequent jam (J031 or J080 detected by the transfer timing sensor/ J028, J029 or J078 detected by the registration timing sensor) occurs due to the wrong operation of the transfer timing motor.

1. Check the following points:
 - The harness of the transfer timing motor is correctly connected.
 - The encoder of the transfer timing roller is correctly installed.
 - No obstruction on the transfer timing roller exists.
2. Replace the transfer timing motor.

Messages Reporting Paper Misfeeds

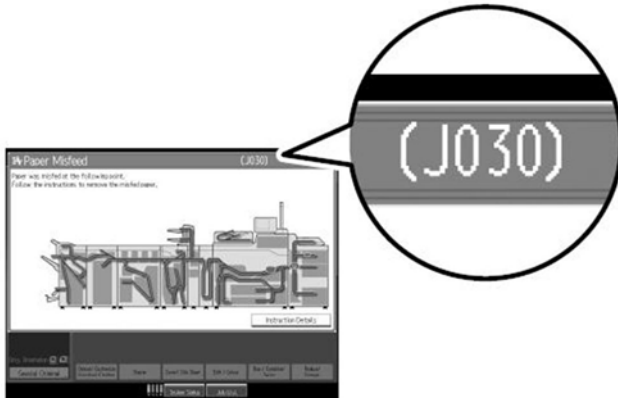

d074t639

Paper misfeeds are reported by messages prefixed with problem codes.

Resolve the problem according to the code.

This section only lists the codes for problems that can be resolved by the user.

If a problem code not listed in this section appears, contact your supervisor.

6

If (J032) Appears

Cause:

The edge of a sheet is jammed in the transfer belt or paper transfer roller.

Floppy paper is likely to cause paper misfeeding because it tends to stick to the intermediate transfer belt and paper transfer roller.

Note

- To adjust the following settings, pre-register the type of paper in use as a custom paper.
- For details about how to register Custom Paper settings, see "Registering a Custom Paper" in the Paper Settings Reference.

Solution:

<Color printing>

1. In [Advanced Settings] for the custom paper in use, set [36: Paper Transfer Current; Lead Edge: FC] to "100%" or set SP2-973 to "100%".
2. Print 25 sheets of the image. Is the problem resolved?

Yes Finished!

No Go to the next step.

3. Set [36: Paper Transfer Current; Lead Edge: FC] to "80%" or set SP2-973 to "80%".
4. Print 25 sheets of the image.
 - If paper misfeeding no longer occurs, the problem has been solved.
 - If the leading edge of the printed image becomes faint as a result of this, go to the next step.
 - If the paper misfeeding persists, skip to step 7.
5. Set [38: Ppr Transfer Current Lead Edg Dist: FC] or set SP2-975 to "5 mm".
6. Print 25 sheets of the image. Is the problem resolved?
Yes Finished!
No Contact your supervisor.
7. Ask a customer to increase the leading edge margin in the print settings (10 mm) for the image to be printed.
8. Set [36: Paper Transfer Current; Lead Edge: FC] to "0%" or set SP2-973 to "0%".
9. Print 25 sheets of the image. Is the problem resolved?
Yes Finished!
No Contact your supervisor.

6

<Black-and-white printing>

1. In [Advanced Settings] for the custom paper in use, set [35: Paper Transfer Current; Lead Edge: B&W] to "100%" or set SP2-972 to "100%".
2. Print 25 sheets of the image. Is the problem resolved?
Yes Finished!
No Go to the next step.
3. Set [35: Paper Transfer Current; Lead Edge: B&W] to "80%" or set SP2-972 to "80%".
4. Print 25 sheets of the image.
 - If paper misfeeding no longer occurs, the problem has been solved.
 - If the leading edge of the printed image becomes faint as a result of this, go to the next step.
 - If the paper misfeeding persists, skip to step 7.
5. Set [37: Ppr Transfer Current Lead Edg Dist: BW] to "5 mm" or set SP2-975 to "5 mm".
6. Print the image. Is the problem resolved?
Yes Finished!
No Contact your supervisor.
7. Ask a customer to increase the leading edge margin in the print settings (10 mm) for the image to be printed.
8. Set [35: Paper Transfer Current; Lead Edge: B&W] to "0%" or set SP2-972 to "0%".
9. Print 25 sheets of the image. Is the problem resolved?

Yes Finished!

No Contact your supervisor.

Note

- If you cannot change the leading edge margin, paper misfeeding may be eliminated by reorienting the loaded paper according to its grain. For details about paper grain and orientation, see "Loading Paper", About This Machine.

If (J080) Appears

Cause:

The correct paper feed speed is not being maintained.

When using slippery paper, traction may be lost, reducing paper feed speed.

Solution:

1. In [Advanced Settings] for the custom paper in use, set [07: Regist Jam Detection with Feed Dir] to [Off] or set SP1-958 to [Off].
2. When you set this to [Off], the printed image may become misaligned at the leading edge.
Print the image. Is the problem resolved?

Yes Finished!

No Contact your supervisor.

If (J033) or (J083) Appears

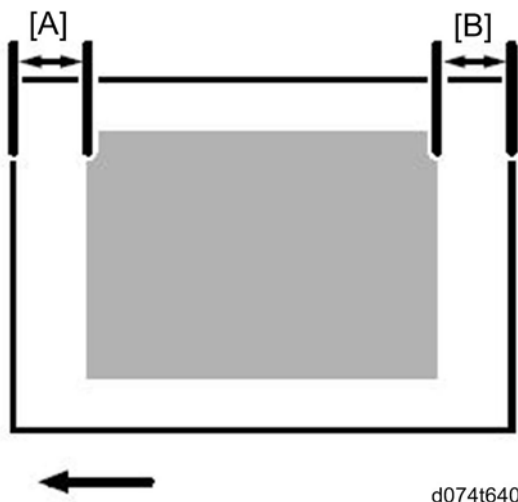

- [A]: Leading edge margin
- [B]: Trailing edge margin

At installation the service technician executes machine position adjustment using. If the sub scan registration adjustment exceeds ± 0.3 mm, the service technician should inform the operator about the amount of adjustment and then guide the operator through the user adjustment settings. The relevant settings are:

- Side 1 image position adjustment: Direction of paper feed
- Side 2 image adjustment: Direction of paper feed

Cause:

Paper is jammed in the fusing belt stripper plate.

This is likely to occur if:

- Thin or coated paper is used
- A solid image that consumes a lot of toner is printed at the leading edge
- The leading/trailing edge margin is too narrow

Paper feed direction

Leading-edge margin Trailing-edge margin

Solution:

Increase the leading/trailing edge margin.

By increasing the margin, paper can separate more easily from the fusing belt stripper plate.

When printing on one side only

<If it is acceptable for the image to be incompletely printed at its edge>

Trim the image at its leading edge to increase the margin.

1. In [Advanced Settings] for the custom paper in use, select [13: Adjust Erase Margin of Leading Edge] or select SP2-122.
2. Increase the value by 0.5 mm.
3. Print the image. Is the problem resolved?

Yes Finished!

No Keep increasing the value by 0.5 mm until the problem is resolved.

If the problem persists even though the setting has reached its maximum value, contact your supervisor.

<If it is not acceptable for the image to be incompletely printed at its edge>

1. In [Advanced Settings] for the custom paper in use, select [08: Adj Image Position of Side1 With Feed] or select SP1-950.
2. Increase the value by 0.5 mm.
3. Print the image. Is the problem resolved?

Yes Finished!

No Keep increasing the value by 0.5 mm until the problem is resolved.

If the problem persists even though the setting has reached its maximum value, contact your supervisor.

When printing on both sides

<If it is acceptable for the image to be incompletely printed at its edge>

1. In [Advanced Settings] for the custom paper in use, select [14: Adjust Erase Margin of Trailing Edge] or select SP2-123.
2. Increase the value by 0.5 mm.
3. Print the image. Is the problem resolved?

Yes Finished!

No Keep increasing the value by 0.5 mm until the problem is resolved.

If the problem persists even though the setting has reached its maximum value, contact your supervisor.

<If it is not acceptable for the image to be incompletely printed at its edge>

1. In [Advanced Settings] for the custom paper in use, select [08: Adj Image Position of Side1 With Feed] or select SP1-950.
2. Increase the value by 0.5 mm.
3. Select [09: Adj Image Position of Side2 With Feed] or select SP1-951.
4. Decrease the value by 0.5 mm.
5. Print the image. Is the problem resolved?

Yes Finished!

No Keep increasing/decreasing the value by 0.5 mm until the problem is resolved.

If the problem persists even though the setting has reached its maximum/minimum value, contact your supervisor.

If (J097) Appears

Cause:

Paper is skewed.

Solution:

Depending on the cause of the problem, do one the following:

The side fences in the paper trays are not positioned correctly.

Adjust the side fences to match the paper width.

For details about loading paper, see "Loading Paper", About This Machine.

The paper size/orientation/type is not specified correctly.

In tray paper settings, specify the size, orientation, and type of the paper in use.

For details about tray paper settings, see "Changing Tray Paper Settings", Paper Settings Reference.

Sheets of mixed type, thickness, or color are loaded in the paper tray.

Load identical sheets in the paper tray. When printing from a tray containing sheets of mixed color, you can prevent paper mis-feeding by specifying the following settings.

<If custom paper is used>

1. In [Advanced Settings] for the custom paper in use, set [12: Deactivate Image Position Adjustment Across Feed Dir] to [On] or set the setting of SP1-957 to [1].
2. In [Advanced Settings] for the custom paper in use, set [05: Skew Detection] to [Off] or set SP1-955 to [0].

<If custom paper is not used>

1. In the [Adjustment Settings for Skilled Operators] menu, set [0107: Deactivate Image Position Adjustment Across Feed Dir] to [On] or set the setting of SP1-917-001 to -007 to [1].
2. Set [0108: Skew Detection] to [Off] or SP1-021-001- to -007 to [0].

An envelope is used.

If an envelope with a beveled flap is fed with the flap open, the machine may detect it as a skew. Disable the skew detection function.

<If custom paper is used>

1. In [Advanced Settings] for the custom paper in use, set [05: Skew Detection] to [Off] or set SP1-955 to [0].

<If custom paper is not used>

1. In the [Adjustment Settings for Skilled Operators] menu, set [0108: Skew Detection] to [Off] or set SP1-021-001 to -007 to [0].

The skew detection level is too high.

The skew detection level may be too high.

<If custom paper is used>

1. In [Advanced Settings] for the custom paper in use, set [05: Skew Detection] to [Off] or set SP1-955 to [0].

<If custom paper is not used>

1. Set [0108: Skew Detection] to [Off] or SP1-021-001- to -007 to [0].

↓ Note

- If the skew detection level is reduced or the skew detection function is disabled, no misfeed report will be displayed. However, this may result in paper skew feeding. If you do not want this result, contact your supervisor.
- If the machine wrongly detects skew, see p.1088 "Wrong Detection of Skew".

If (J098) Appears

Cause:

Sheets cannot be positioned properly by image position adjustment.

Solution:

Depending on the cause of the problem, do one of the following:

The side fences in the paper trays are not positioned correctly.

Adjust the side fences to match the paper width.

For details about loading paper, see "Loading Paper", About This Machine.

The paper size/orientation/type is not specified correctly.

In tray paper settings, specify the size, orientation, and type of the paper in use.

For details about tray paper settings, see "Changing Tray Paper Settings", Paper Settings Reference.

Sheets of mixed type, thickness, or color are loaded in the paper tray.

Load identical sheets in the paper tray.

When printing from a tray containing sheets of mixed color, you can prevent paper misfeeding by specifying the following settings:

1. In the [Adjustment Settings for Skilled Operators] menu, set [0107: Deactivate Image Position Adjustment Across Feed Dir] to [On] or set the setting of SP1-917-001 to -007 to [On].
2. Set [0108: Skew Detection] or SP1-021-001- to -007 to [Off].

Colored paper or transparencies are loaded in the paper tray.

Paper edges may not have been detected correctly.

Adjust the color paper edge detection.

1. Make a note of the present value in [06: Colour Paper Edge Detection Adjustment] in [Advanced Settings] or a note of the present value in SP1-962 in the SP mode for the custom paper in use.
2. Increase the value in [06: Colour Paper Edge Detection Adjustment] or SP1-962.
3. Print the image. Is the problem resolved?

Yes Finished!

No Keep increasing the value until the problem is resolved.

If the problem persists even though the setting has reached its maximum value, restore the value noted in step 1 and go to the next step.

4. Decrease the value in [06: Colour Paper Edge Detection Adjustment] or SP1-962.
5. Print the image. Is the problem resolved?

Yes Finished!

No Keep decreasing the value until the problem is resolved.

If the problem persists even though the setting has reached its minimum value, restore the value noted in step 1 and go to the next step.

6. Set [12: Deactivate Image Position Adjustment] to [Activate] or set the setting of SP1-957 to [Active].
7. Print the image. Is the problem resolved?

Yes Finished!

No Contact your supervisor.

If (J099) Appears

Cause:

Double feeding has occurred.

Solution:

Depending on the cause of the problem, do one of the following:

Coated or another type of unsupported paper is loaded in the machine's tray.

Load paper not supported by the machine's paper tray (Trays 1 and 2) in the wide LCT (Trays 3–5) or another paper tray that supports the paper.

For details about the size and type of paper that can be loaded in the paper trays, see "Recommended Paper Sizes and Types", About This Machine.

Sheets are stuck to each other.

Fan the paper before loading it to loosen the sheets.

For details about fanning the paper, see "Fanning the Paper", About This Machine.

The edges of the sheets are rough.

Turn the sheets the other way up or smooth the edges before loading the paper.

Wrong detection of double feeding

The machine may have wrongly detected a double feed.

For details, see p.1090 "Wrong Detection of Double Feeding".

Paper Skew

The side fences in the paper tray are too far apart.

If the side fences are too far apart, the paper may misfeed.

Adjust the side fences to match the paper width.

For details about loading paper, see "Loading Paper", About This Machine.

A scrap of paper or some other small fragment is jammed in the paper feed path.

Remove the fragment.

For details about cleaning the paper feed path, see the Replacement Guide.

The correct degree of paper arching has not been specified.

Adjust the degree of paper arching at the registration gate.

<If using paper of Paper Weight 1 to 4>

1. Make a note of the present value in [0103: Adjust Registration Paper Buckle] in the [Adjustment Settings for Skilled Operators] menu or a note of the present value in SP1-004-001 to -003 in the SP mode for the custom paper in use.
2. Increase the value in [0103: Adjust Registration Paper Buckle] or SP1-004-001 to -003.
3. Print the image. Is the problem resolved?

Yes Finished!

No Keep increasing the value until the problem is resolved.

If the problem persists even though the setting has reached its maximum value, restore the value noted in step 1 and go to the next step.

4. Decrease the value in [0103: Adjust Registration Paper Buckle] or SP1-004-001 to -003.
5. Print the image. Is the problem resolved?

Yes Finished!

No Keep decreasing the value until the problem is resolved.

If the problem persists even though the setting has reached its minimum value, adjust the registration gate position. (p.324)

<If using paper of Paper Weight 5 to 7>

1. Make a note of the present value in [0104: Adjust Registration Paper Buckle (Thick Paper)] in the [Adjustment Settings for Skilled Operators] menu or a note of the present value in SP1-005-001 to -003 in the SP mode for the custom paper in use.
2. Increase the value in [0104: Adjust Registration Paper Buckle (Thick Paper)] or SP1-005-001 to -003.
3. Print the image. Is the problem resolved?

Yes Finished!

No Keep increasing the value until the problem is resolved.

If the problem persists even though the setting has reached its maximum value, restore the value noted in step 1 and go to the next step.

4. Decrease the value in [0104: Adjust Registration Paper Buckle (Thick Paper)] or SP1-005-001 to -003.
5. Print the image. Is the problem resolved?

Yes Finished!

No Keep decreasing the value until the problem is resolved.

If the problem persists even though the setting has reached its minimum value, adjust the registration gate position. (▶ p.324)

The skew detection level is too low.

Increase the skew detection level.

1. In [Adjustment Settings for Skilled Operators], select [0109: Skew Detection Level] and reduce the value or select SP1-116-001 to -007 and reduce the value.

Reduce the value to decrease the detection level.

This will allow the machine to continue printing even for a slight skew.

However, if you set the detection level too high, a paper misfeeding message (J097) will be appear frequently.

2. Print the image. Is the problem resolved?

Yes Finished!

No Adjust the registration gate position. (▶ p.324)

6

Wrong Detection of Skew

An envelope is used.

If an envelope with its flap's edges cut at a bevel is fed, the machine may detect it as a skew.

<If custom paper is used>

1. In [Advanced Settings] for the custom paper in use, set [05: Skew Detection |] to [Off] or set SP1-995 to [0].

<If custom paper is not used>

1. In the [Adjustment Settings for Skilled Operators] menu, set [0108: Skew Detection] to [Off] or set the setting of SP1-021-001 to -007 to [0].

Note

- Disabling the skew detection function will allow skewed printing. If this is not acceptable, contact your supervisor.

Double Feeding

Is the paper feed roller covered with paper dust?

Paper dust may decrease the traction of the paper feed roller and result in double feeding due to paper slippage or insufficient separation.

Cleaning the paper feed roller will restore traction and so prevent double feeding.

For details about cleaning the paper feed roller of each of the machine's trays (Trays 1 and 2), see the Replacement Guide.

For details about cleaning the paper feed roller of the multi bypass tray (Tray 6), see p.1110 "Cleaning the Paper Feed Path in the Multi Bypass Tray (Tray 6)".

For details about cleaning the paper feed roller of the interposer, see p.1113 "Cleaning the Paper Feed Rollers and Paper Feed Belt in the Interposer".

Have you ruffled the paper sufficiently?

Double feeding may result if the paper is not ruffled properly.

Remove the paper, ruffle it, and reload it.

For details about ruffling the paper, see "Fanning the Paper", About This Machine.

Is the paper feed roller covered with paper dust?

Paper dust or the surface of coated paper may decrease the traction of the paper feed roller and result in double feeding due to paper slippage or insufficient separation.

Cleaning the paper feed roller will restore traction and prevent double feeding.

For details about cleaning the paper feed roller of each of the machine's trays (Trays 1 and 2), see the Replacement Guide.

For details about cleaning the paper feed roller of the wide LCT (Trays 3-5), see p.1107 "Cleaning the Paper Feed Path in the Wide LCT (Trays 3-5)".

For details about cleaning the paper feed roller of the multi bypass tray (Tray 6), see p.1110 "Cleaning the Paper Feed Path in the Multi Bypass Tray (Tray 6)".

For details about cleaning the paper feed roller of the interposer, see p.1113 "Cleaning the Paper Feed Rollers and Paper Feed Belt in the Interposer"..

Is the Pickup Assist setting enabled?

If the Pickup Assist function operates too much, it may cause double feeding with coated paper.

By disabling the Pickup Assist setting, you can prevent double feeding.

<If custom paper is used>

1. In [Advanced Settings] for the custom paper in use, set [03: Pickup Assist Setting] to [Off] or set the setting of SP1-977 to [0: OFF].

<If custom paper is not used>

1. In the [Adjustment Settings for Skilled Operators] menu, set [0115: Pickup Assist Setting] to [Off], or set SP1-923-001 to 006 to [2: FORCE OFF].

Special or coated paper is used.

- Is the airflow strong enough?

The factory-set airflow of the wide LCT may not be strong enough to separate the sheets. Increase the airflow.

<If custom paper is used>

1. In [Advanced Settings] for the custom paper in use, increase the value in [02: Adjust Wide LCT Fan Level] or with SP1-975.

<If custom paper is not used>

1. In the [Adjustment Settings for Skilled Operators] menu, increase the value in [0113: Adjust Wide LCT Fan Level] or with SP1-920-001 to 003.
- Is the tab sheet holder attached?

By attaching the tab sheet holder, you can prevent air from leaking at the trailing edge of the paper and improve separation. See p.1105 "Attaching the Tab Sheet Holder".

Wrong Detection of Double Feeding

Preprinted paper is used.

If the sensor detects the printed part of preprinted paper, it may wrongly detect it as double feeding.

Disable the double feeding detection function.

<If custom paper is used>

1. In [Advanced Settings] for the custom paper in use, set [04: Double Feed Detect] to [Off] or set the setting of SP1-956 to [0: Off].

<If custom paper is not used>

1. In the [Adjustment Settings for Skilled Operators] menu, set [0105: Double Feed Detect] to [Off], or set SP1302-001 to 006 to [0: Off].

↓ Note

- Disabling double feed detection may reduce print image quality or cause blank sheets to be delivered.

An envelope is being used.

The seams of envelopes may cause double feeds to be erroneously detected.

Disable the double feed detection.

<If custom paper is used>

1. In [Advanced Settings] for the custom paper in use, set [04: Double Feed Detect] to [Off] or set the setting of SP1-956 to [0: Off].

<If custom paper is not used>

1. In the [Adjustment Settings for Skilled Operators] menu, set [0105: Double Feed Detect] to [Off] or set SP1-302-001 to 006 to [0: Off].

↓ Note

- Disabling double feed detection may reduce print image quality or cause blank sheets to be delivered.

The double feed detection sensor is soiled.

If the double feed detection sensor is soiled with paper dust or other fragments, it may wrongly detect double feeding.

Clean the double feed detection sensor.

For details about cleaning the double feed detection sensor, see the Replacement Guide.

Transparency rate of paper in use is not same.

Adjust the transparency rate for customer paper settings with SP1-304-001, -002 and -003.

Note

- Changing one of these settings will affects other settings. Adjust all customer paper settings which a customer usually uses.

Paper Misfeeding

Have you ruffled the paper properly?

Not ruffling the paper properly may cause paper misfeeding.

Remove the paper, ruffle it, and reload it.

For details about ruffling paper, see "Fanning the Paper", About This Machine.

The side fences in the paper tray are too close together.

If the distance between the side fences is less than the paper width, it may interfere with paper transfer and so cause paper misfeeds.

Adjust the paper guides to match the paper width.

For details about loading paper, see "Loading Paper", About This Machine.

Special or coated paper is used.

- Is the airflow powerful enough?

The factory-set airflow of the wide LCT may not be strong enough to separate the sheets. Increase the airflow.

<If custom paper is used>

1. In [Advanced Settings] for the custom paper in use, increase the value in [02: Adjust Wide LCT Fan Level] or increase the value in SP1-975.

<If custom paper is not used>

1. In the [Adjustment Settings for Skilled Operators] menu, increase the value in [0113: Adjust Wide LCT Fan Level] or with SP-1920-001 to 003.

- Is the tab sheet holder attached?

By attaching the tab sheet holder, you can prevent air from escaping at the trailing edge of the paper and so improve separation. See p.1105 "Attaching the Tab Sheet Holder"..

- Is the paper feed roller covered with paper dust?

Paper dust or the surface of coated paper may reduce the traction of the paper feed roller and cause paper misfeeding due to paper slippage or insufficient separation.

By cleaning the paper feed roller, the frictional force can be restored so that double feeding will not occur.

For details about cleaning the paper feed roller of the wide LCT (Trays 3-5), see p. 1107 "Cleaning the Paper Feed Path in the Wide LCT (Trays 3-5)".

An envelope is used.

Depending on the type of envelope, air trapped inside may be squeezed out when the paper feed roller picks up the envelope and cause slippage leading to a misfeed.

- Is the wide LCT fan disabled?

In [Advanced Settings] for the custom paper in use, set [01: Wide LCT Fan Setting] to [Off] or set the setting of SP1-976.

- Have you flattened the envelope?

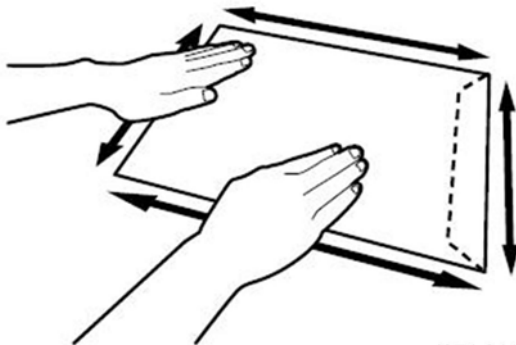

d074t641

Flatten the envelope and all its edges to eliminate air before loading. If the envelope is curled, decurl it before loading.

Paper Feed Problems Affecting Image Quality

The Image Is Positioned Incorrectly

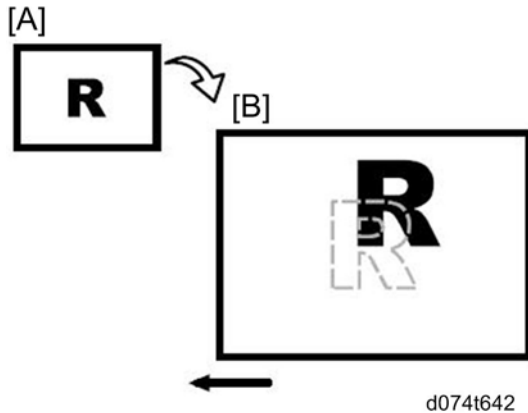

- [A]: Original
- [B]: Output

Cause:

Depending on the paper thickness, floppiness, edge roughness, and curl, the image may become positioned incorrectly.

Solution:

Adjust the image position.

<If custom paper is used>

1. In [Advanced Settings] or SP mode for the custom paper in use, adjust the image position.

The side 1 of paper

- To adjust the position horizontally, change the value in [08: Adj Image Position of Side1 With Feed] or change the value in SP1-950.
- To adjust the position vertically, change the value in [10: Adj Image Position of Side1 Across Feed] or change the value in SP1-952.

The side 2 of paper

- To adjust the position horizontally, change the value in [09: Adj Image Position of Side2 With Feed] or change the value in SP1-951.
- To adjust the position vertically, change the value in [11: Adj Image Position of Side2 Across Feed] or change the value in SP1-953.

<If custom paper is not used>

1. In the [Adjustment Settings for Skilled Operators] menu, adjust the image position.

The side 1 and side 2 of paper

- To adjust the position horizontally, change the value in [0101: Adjust Image Position With Feed Direction] or change the value of SP1-001-001 to 007.
- To adjust the position vertically, change the value in [0102: Adjust Image Position Across Feed Direction] or change the value of SP1-003-001 to 007.

If the problem persists even though you have adjusted the setting to its maximum and minimum values, contact your supervisor.

↓ Note

- For details about specifying settings in the [Adjustment Settings for Skilled Operators] menu, see the Adjustment Item Menu Guide.

Image Scaling Error on the Side 1 of Paper

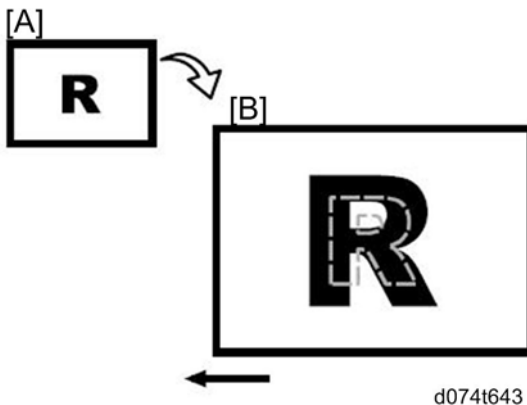

- [A]: Original
- [B]: Output

Cause:

An image scaling error may occur because of expansion or contraction of the paper.

Solution:

Adjust the image scaling.

1. In [Advanced Settings] for the custom paper in use, adjust the image scaling.
 - To adjust the horizontal scaling, change the value in [15: Adj Magnification of Side 1 Across Feed] or change the value in SP2-950.
 - To adjust the vertical scaling, change the value in [16: Adj Magnification of Side 1 With Feed] or change the value in SP2-951.

Press [+] to increase the scaling and [-] to decrease it.

2. Print the image. Is the problem resolved?

Yes Finished!

No Contact your supervisor.

Image Scaling Error on the Side 2 of Paper

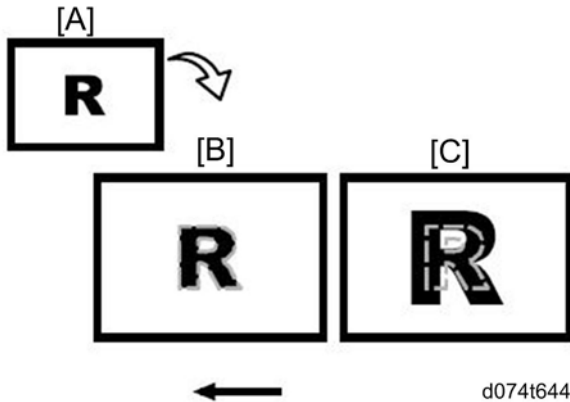

- [A]: Original
- [B]: Output side 1
- [C]: Output side 2

Cause:

An image scaling error on the side 2 of the paper may occur because the paper expands or contracts after the image on the side 1 of the paper has been fused.

Solution:

Adjust the scaling for the side 2 of the paper and minimize the difference in print size between the side 1 and the side 2.

1. In [Advanced Settings] for the custom paper in use, adjust the image scaling.
 - To adjust the horizontal scaling, change the value in [17: Adj Magnification of Side2 Across Feed] or change the value in SP2-952.
 - To adjust the vertical scaling, change the value in [18: Adj Magnification of Side2 With Feed] or change the value in SP2-953.

Press [+] to increase and [-] to decrease the scaling.

2. Print the image. Is the problem resolved?

Yes Finished!

No Contact your supervisor.

Image Skewing

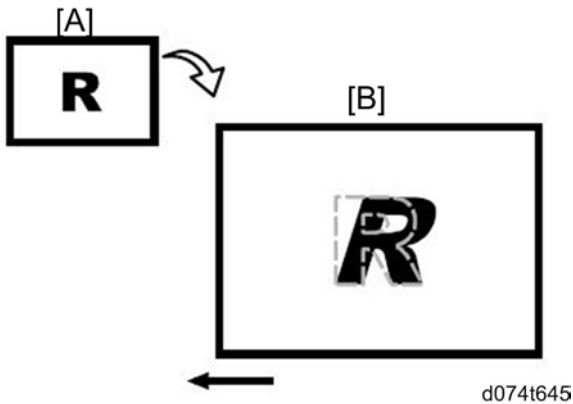

- [A]: Original
- [B]: Output

Cause:

Depending on the machine's operating environment (levelness and temperature), the printed image may become vertically skewed.

Solution:

Adjust image skew.

1. Print the image in black and white.
2. Check the direction of the skew.
3. In the [Adjustment Settings for Skilled Operators] menu, adjust the value in [0117: Perpendicularity Adjustment] or SP2-104-040.

You can adjust the skew in steps of 16.5 μm .

Press [+] to skew the image counterclockwise or [-] to skew it clockwise.

4. Print the image in black and white.

Gradually increase the value and check the printed image.

- If the problem is resolved, go to the next step.
- If the problem persists even though the setting has reached its maximum value, contact your supervisor.

5. Execute color registration.

In executing color registration, the black adjustment will also be applied to cyan, magenta, and yellow.

For details about color registration, see "Adjusting the Color Registration" in the Troubleshooting guide supplied with the machine.

Note

- You cannot skew paper with [0117: Perpendicularity Adjustment]. For details about adjusting paper skew, see p.1086 "Paper Skew".

White Spots

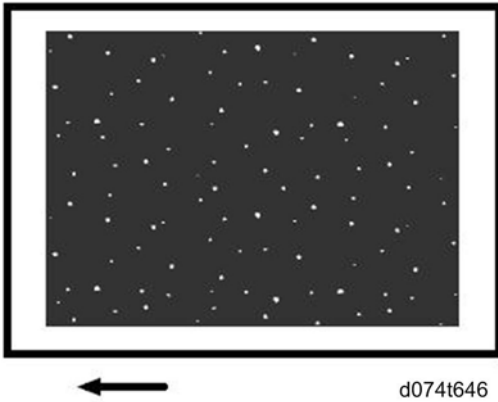

Cause:

Paper dust on the guide board and transfer timing roller may stick to the paper and produce white spots. Some types of paper, such as recycled paper, roughly cut paper, and high-friction coated paper produce a lot of paper dust, which will likely stick to the paper.

Solution:

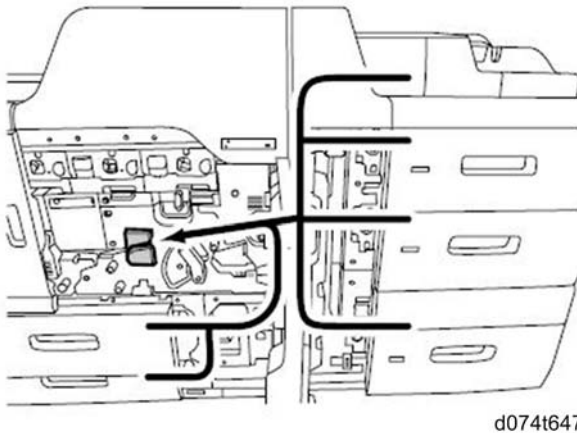

Clean the paper feed path (dust catcher, transfer timing roller, guide board, and paper feed roller) between the paper tray in use and the transfer unit's nip (where the images are transferred from the intermediate transfer belt to the paper).

The paper feed paths between each paper tray and the nip are as follows:

- For details about cleaning the dust catcher, transfer timing roller, and the machine's paper trays (Trays 1 and 2), see the Replacement Guide.
- For details about cleaning the paper feed roller of the wide LCT (Trays 3-5), see p. 1107 "Cleaning the Paper Feed Path in the Wide LCT (Trays 3-5)".
- For details about cleaning the paper feed roller of the multi bypass tray (Tray 6), see p. 1110 "Cleaning the Paper Feed Path in the Multi Bypass Tray (Tray 6)".
- For details about periodic cleaning of the machine, see the Replacement Guide.

Paper Edges Are Soiled

Cause:

The paper feed rollers or anti-static brushes are soiled.

Solution:

Depending on the cause of the problem, do one of the following:

<The surface of the paper is dirty>

1. In [Advanced Settings] for the custom paper in use, select [20: Transfer Timing Roller Feed Speed Adj] and decrease the value by 0.5% or decrease the value by 0.5% in SP1-963.
2. Print the image. Is the problem resolved?

Yes Finished!

No Keep decreasing the value by 0.5% until the problem is resolved.

If the problem persists even though you have decreased the value by 0.5%, contact your supervisor.

<The paper transport rollers are soiled.>

Clean the paper transport rollers in the machine's left drawer.

For details about cleaning the paper transport roller, see the Replacement Guide.

<The anti-static brushes are soiled.>

Clean the anti-static brushes in the exit transport and inverter transport of the machine's left drawer.

Clean the anti-static brushes with a blower brush.

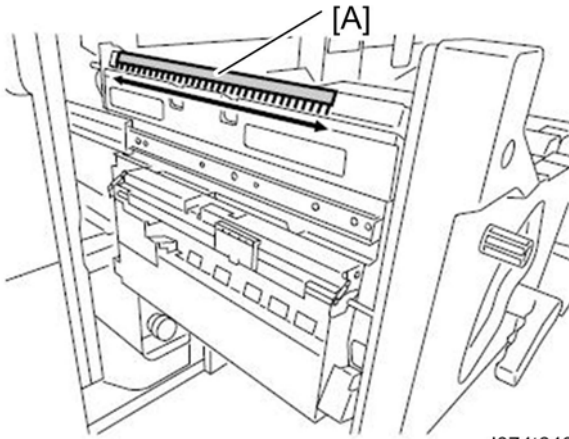

d074t648

- The anti-static brush [A] in the exit transport

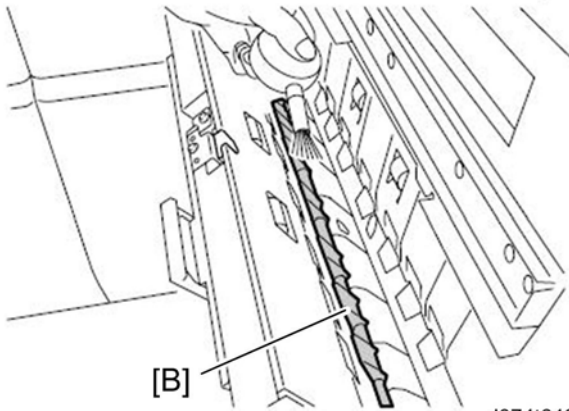

d074t649

- The anti-static brush [B] in the inverter transport

Expansion and Contraction (1)

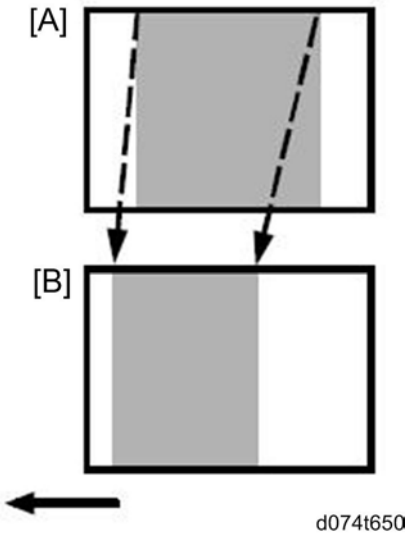

6

- [A]: Original
- [B]: Output

The leading edge margin is too narrow and the image has shrunk lengthwise.

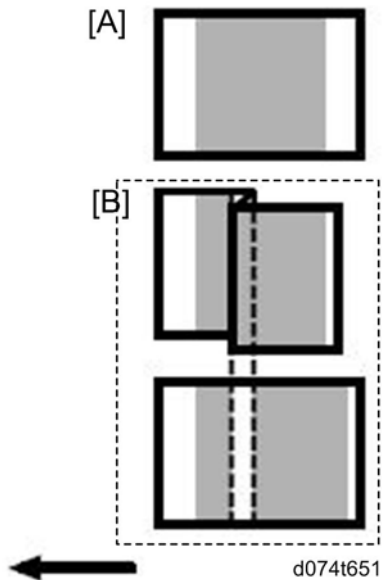

- [A]: Original
- [B]: Output

The paper has creased and no print appears where the crease has occurred.

Cause:

The paper feed speed of the transfer timing roller is too high.

Solution:

Decrease the feed speed of the transfer timing roller.

1. In [Advanced Settings] for the custom paper in use, select [20: Transfer Timing Roller Feed Speed Adj] and decrease the value by 0.5% or decrease the value by 0.5% in SP1-963.
2. Print the image. Is the problem resolved?

Yes Finished!

No Keep decreasing the value by 0.5% until the problem is resolved.

If the problem persists even though you have decreased the value by 0.5%, contact your supervisor.

Expansion and Contraction (2)

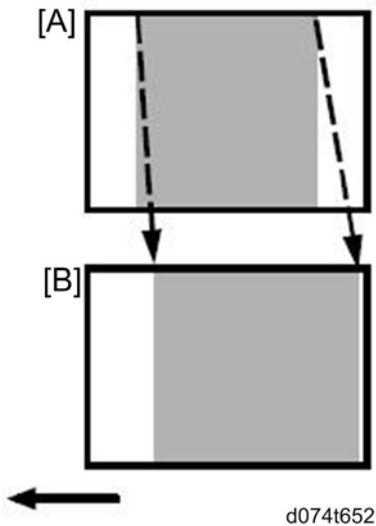

- [A]: Original
- [B]: Output

The leading edge margin is too wide and the image has stretched lengthwise.

Cause:

The paper feed speed of the transfer timing roller is too high.

Solution:

Increase the feed speed of the transfer timing roller.

1. In [Advanced Settings] for the custom paper in use, select [20: Transfer Timing Roller Feed Speed Adj] and increase the value by 0.1% or increase the value by 0.1% in SP1-963.

2. Print the image. Is the problem resolved?

Yes Finished!

No Keep increasing the value by 0.1% until the problem is resolved.

If the problem persists even though you have increased the value by 1.0%, contact your supervisor.

Scratches, Streaks, or Vertical Creases Appear on the Image Cause:

The paper feed speed of the exit motor, switchback entrance, or switchback exit is too high or too low.

Solution:

<If scratches or streaks appear on the side 2 of the paper>

1. You can lessen the problem by decreasing the paper feed speed.

In [Advanced Settings] for the custom paper in use, adjust the paper feed speed for delivery.

Depending on the type of printing, specify one of the following:

- For one-sided printing, decrease the value in [23: Exit Motor Feed Speed Adjustment] by 0.1% or decrease the value by 0.1% in SP1-964.
- For duplex printing, reduce the value in [24: Switchback Entrance Feed Speed Adj] by 0.1% or decrease the value by 0.1% in SP1-965.
- For one-sided printing (delivery of inverted paper), reduce the value in [25: Switchback Exit Feed Speed Adj] by 0.1% or decrease the value by 0.1% in SP1-966.

2. Print the image. Is the problem resolved?

Yes Finished!

No Keep decreasing the value by 0.1% until the problem is resolved.

If the problem persists even though you have decreased the value by 1.0%, contact your supervisor.

<If scratches or streaks appear on the side 1 of the paper>

You can lessen the problem by increasing the paper feed speed.

1. In [Advanced Settings] for the custom paper in use, adjust the paper feed speed for delivery.

Depending on the type of printing, specify one of the following:

- For one-sided printing, increase the value in [23: Exit Motor Feed Speed Adjustment] by 0.1% or increase the value by 0.1% in SP1-964.
- For duplex printing, increase the value in [24: Switchback Entrance Feed Speed Adj] by 0.1% or increase the value by 0.1% in SP1-965.
- For one-sided printing (delivery of inverted paper), decrease the value in [25: Switchback Exit Feed Speed Adj] by 0.1% or increase the value by 0.1% in SP1-966.

2. Print the image. Is the problem resolved?

Yes Finished!

No Keep increasing the value by 0.1% until the problem is resolved.

If the problem persists even though you have increased the value by 1.0%, contact your supervisor.

Decurling Results in Scratches, Streaks, or Creases

Cause:

The paper feed speed of the decurler unit is too high or too low.

Solution:

<If scratches or streaks appear on the side 2 of the paper or continuous noise results>

You can lessen the problem by decreasing the paper feed speed of the decurler unit.

1. In the [Adjustment Settings for Skilled Operators] menu, check the present degree of decurling (Off, Weak, or Strong) in [0116: Adjust Paper Curl].
2. In [Advanced Settings] for the custom paper in use, adjust the paper feed speed of the decurler unit.
 - If the degree of decurling is set to "Off", reduce the value in [51: Decurler Feed Speed Adj: Curl Adj Off] by 0.5% or reduce the setting of SP1-959 by 0.5%.
 - If the degree of decurling is set to "Weak", reduce the value in [52: Decurler Feed Speed Adj: Curl Adj Weak] by 0.5% or reduce the setting of SP1-960 by 0.5%.
 - If the degree of decurling is set to "Strong", reduce the value in [53: Decurler Feed Speed Adj: Curl Adj Strg] by 0.5% or reduce the setting of SP1-961 by 0.5%.
3. Print the image. Is the problem resolved?

Yes Finished!

No Keep decreasing the value by 0.5% until the problem is resolved.

If the problem persists even though the setting has reached its minimum value, contact your supervisor.

<If scratches, streaks, or creases appear on the side 1 of the paper>

You can lessen the problem by increasing the paper feed speed of the decurler unit.

1. In the [Adjustment Settings for Skilled Operators] menu, check the present degree of decurling (Off, Weak, or Strong) in [0116: Adjust Paper Curl].
2. In [Advanced Settings] for the custom paper in use, adjust the paper feed speed of the decurler unit.
 - If the degree of decurling is set to "Off", increase the value in [51: Decurler Feed Speed Adj: Curl Adj Off] by 0.5% or increase the value by 0.5% in SP1-959.
 - If the degree of decurling is set to "Weak", increase the value in [52: Decurler Feed Speed Adj: Curl Adj Weak] by 0.5% or increase the value by 0.5% in SP1-960.

- If the degree of decurling is set to "Strong", increase the value in [53: Decurler Feed Speed Adj: Curl Adj Strg] by 0.5% or increase the value by 0.5% in SP1-961.

3. Print the image. Is the problem resolved?

Yes Finished!

No Keep increasing the value by 0.5 mm until the problem is resolved.

If the problem persists even though the value has reached its maximum value, contact your supervisor.

Leading/Trailing Edge Margin Is Long

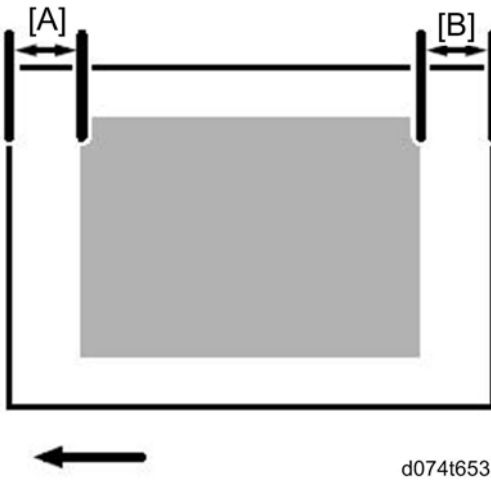

- [A]: Leading-edge margin
- [B]: Trailing-edge margin

Cause:

In some custom paper presets, the leading/trailing edge margins are set very long to prevent paper jamming.

Solution:

Adjust the leading/trailing edge margins.

1. In [Advanced Settings] for the custom paper in use, decrease the value by 0.5 mm in [13: Adjust Erase Margin of Leading Edge] or decrease the value by 0.5 mm in SP2-122.
This will decrease the leading edge margin by 0.5 mm.
2. Decrease the value by 0.5 mm in [14: Adjust Erase Margin of Trailing Edge] or decrease the value by 0.5 mm in SP2-123.
This will decrease the trailing edge margin by 0.5 mm.
3. Print the image. Is the problem resolved?

Yes Finished!

No If this causes a paper jam in duplex printing, restore the previous setting.

↓ Note

- The adjusted margin cannot be applied to masked images that are solid-filled or contain ruled lines at the leading/trailing edges.
- Decreasing the leading/trailing edge margin may cause paper to jam in the fusing belt stripper plate.

Curling

To reduce curling without using the decurler unit, reduce the heat roller temperature.

Decreasing the temperature can cause the following side effects:

- Unsatisfactory fusing
 - Reduced glossiness
 - A tendency for halftone images on uncoated paper to smear
1. In [Advanced Settings] for the custom paper in use, select [44: Fusing Heat Roller Temperature Adj] and decrease the value by 5°C or decrease the value by 5°C in SP1-984.
 2. Print a full-page solid-fill image (SP2109-011: "11"). Is the problem resolved?

Yes Finished!

No Keep decreasing the value by 5°C until the problem is solved.

If the problem persists, contact your supervisor.

↓ Note

- Decreasing the temperature may cause unsatisfactory fusing.
- To use the decurler unit, specify [0116: Adjust Paper Curl] in the [Adjustment Settings for Skilled Operators] menu.

Attaching the Tab Sheet Holder

By attaching the tab sheet holder, you can prevent air from escaping at the trailing edge of the paper and so improve separation.

This will prevent double feeding and misfeeding of special or coated paper loaded in the wide LCT (Trays 3–5).

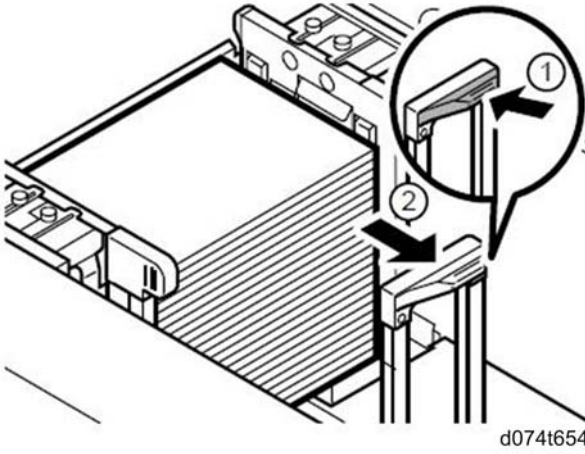

1. Unlock the end fence, and then slide it away from the paper.

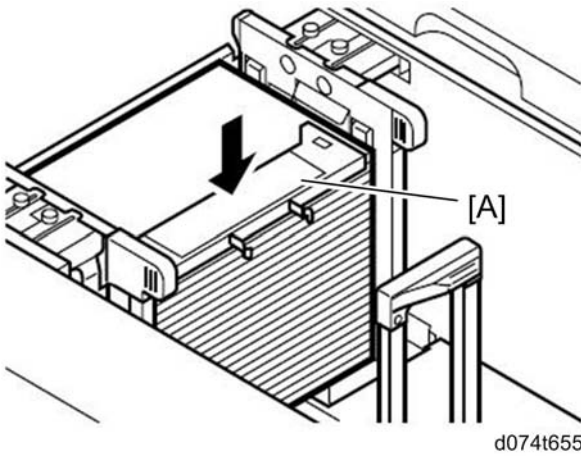

2. Place the tab sheet holder [A] on the paper.

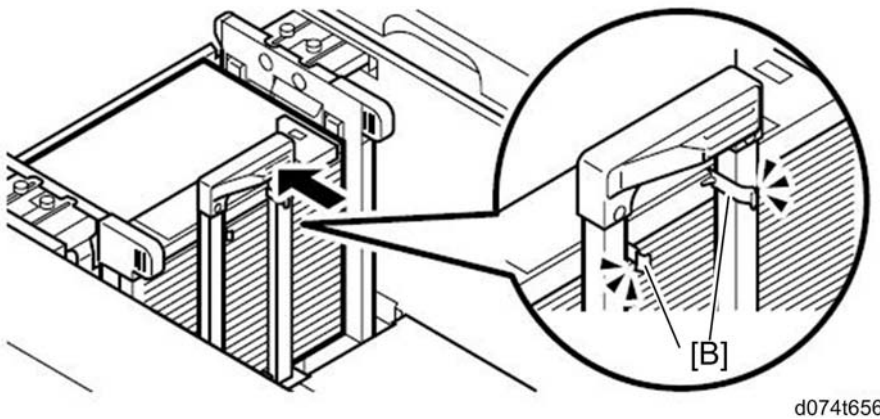

- Slide the end fence against the paper so that the tab sheet holder's clips [B] pass through the fence and click into place.

Note

- You can use the tab sheet holder for paper of the following sizes:
- Paper with a width of 288.0–330.2 mm (11.34–13.00 inches) and a length of 182.0–487.7 mm (7.17–19.20 inches).
- Paper with a width of 139.7–287.9 mm (5.50–11.33 inches) and a length of 335.5–487.7 mm (13.21–19.20 inches).

Cleaning the Paper Feed Path

Clean the paper feed path if white spots appear because of paper dust sticking to the paper, or if paper misfeeding or double feeding occurs.

Guide Board

Wipe the guide board with a well-wrung-out damp cloth. To reach the inmost recesses, the cloth should be the size of your palm.

Paper Feed Roller

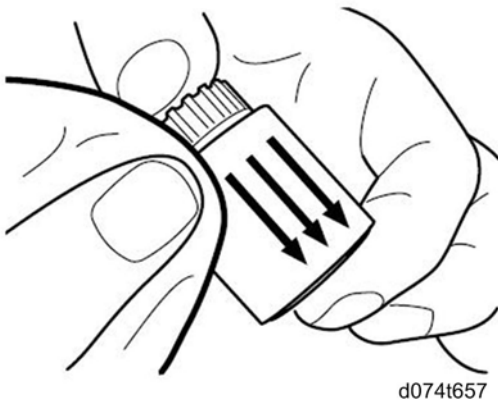

Wipe the entire surface of the paper feed roller lengthwise with a well-wrung-out damp cloth, and then with a dry, unused, lint-free cloth until no moisture remains.

Cleaning the Paper Feed Path in the Wide LCT (Trays 3-5)

Clean the guide board and paper feed rollers in the wide LCT.

The procedure is explained using Tray 3 as an example.

The procedure is the same for Trays 4 and 5.

- Open the wide LCT front cover.

2. Pull open the top tray (Tray 3) until it stops. If there is any paper in the tray, remove it.

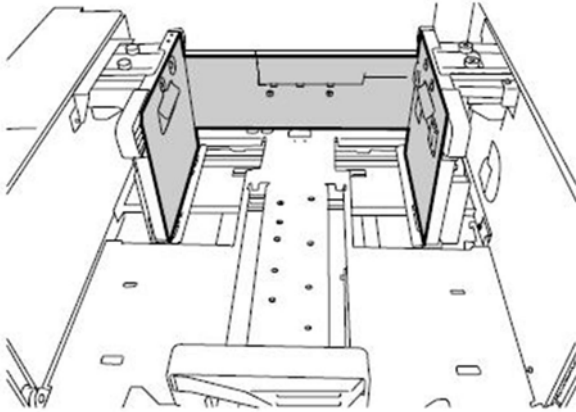

d074t658

3. Clean the side fences and front guide.

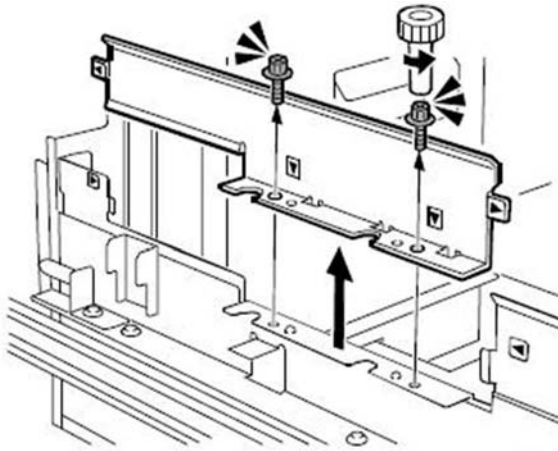

d074t659

4. Remove the two black screws on the side plate, and then remove the plate.

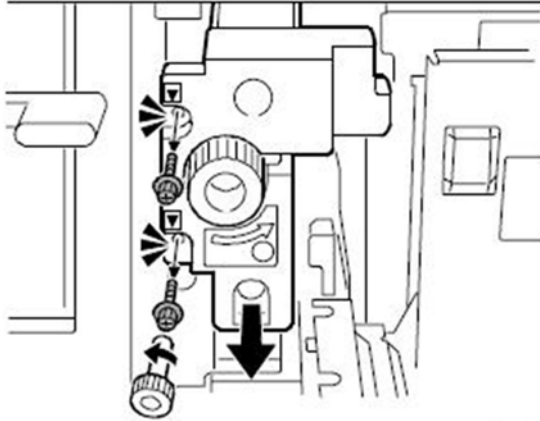

d074t660

5. Remove the two black screws on the paper feed unit U2, and then pull out the paper feed unit U2 until it stops.
6. Clean the paper feed rollers.
For details about detaching and reattaching the paper feed rollers, see the Replacement Guide.

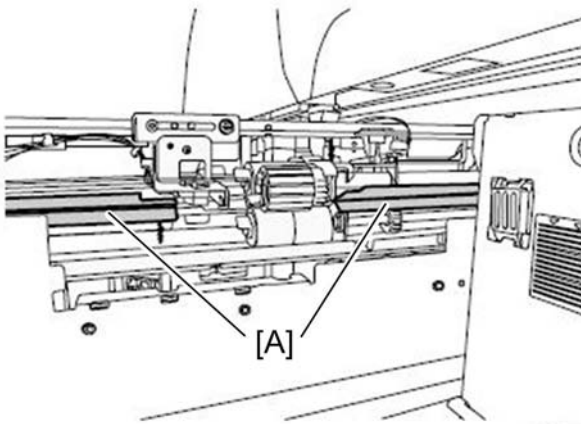

d074t661

7. Clean the guide board [A] of the paper feed unit.

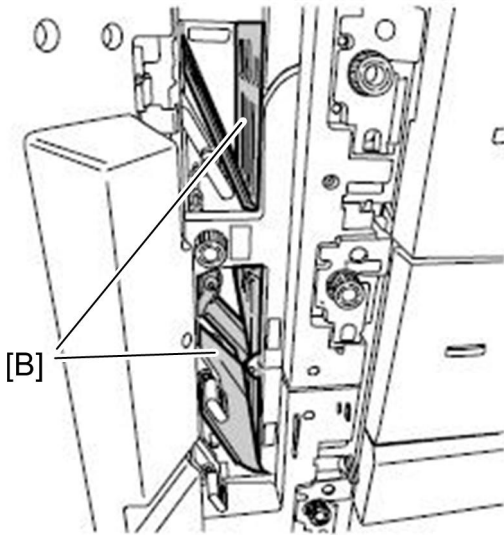

d074t662

8. Open the guide board (U1), (U3), and (U5), and then clean the guide board interior [B].
9. After cleaning, restore the machine to its operational state.

Note

- For details about the general and periodic cleaning of the machine, see the Replacement Guide.

Cleaning the Paper Feed Path in the Multi Bypass Tray (Tray 6)

Clean the guide board and paper feed rollers in the multi bypass tray (Tray 6).

Wipe the guide board with a well-wrung-out damp cloth. To reach the inmost recesses, the cloth should be the size of your palm.

1. Remove the loaded paper.

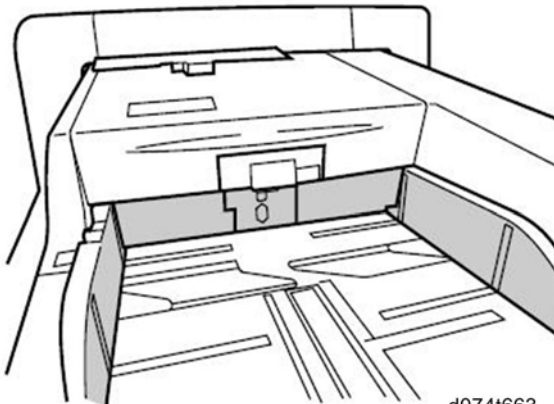

d074t663

2. Clean the side fences and front guide.

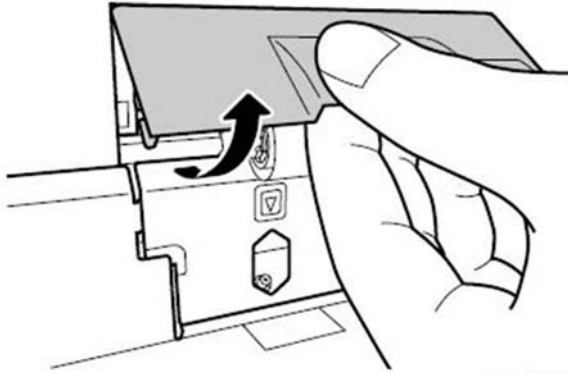

d074t664

3. Pull off the snap-off cover.

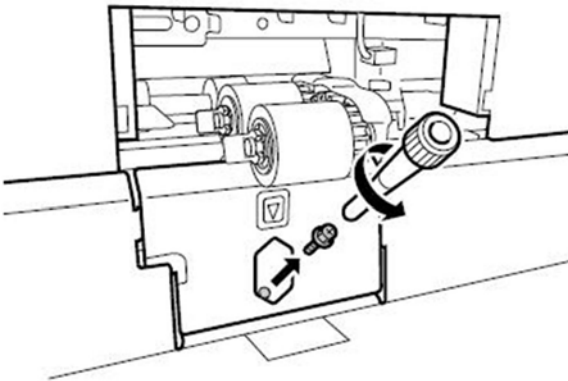

d074t665

4. Remove black screw.

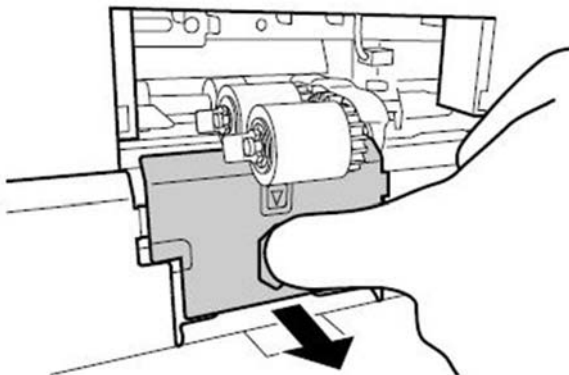

d074t666

5. Remove the plate.

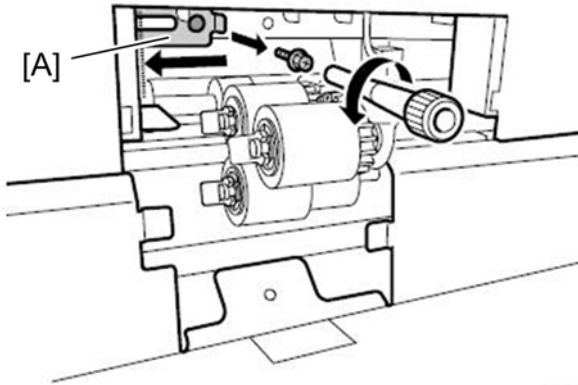

d074t667

1. Remove the black screw on the sensor positioning plate [A].
2. Push the sensor positioning plate [A] to the left.
If this plate is not pushed to the left, you will not be able to remove the feed roller.
3. Clean the paper feed rollers.

6

For details about detaching and reattaching the paper feed rollers, see the Replacement Guide.

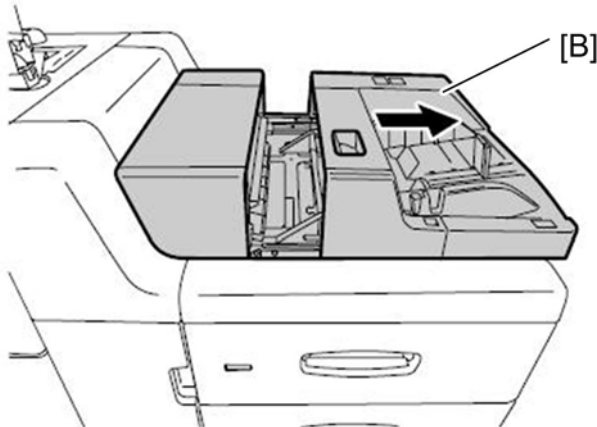

d074t668

4. Slide the paper tray [B] to the right.

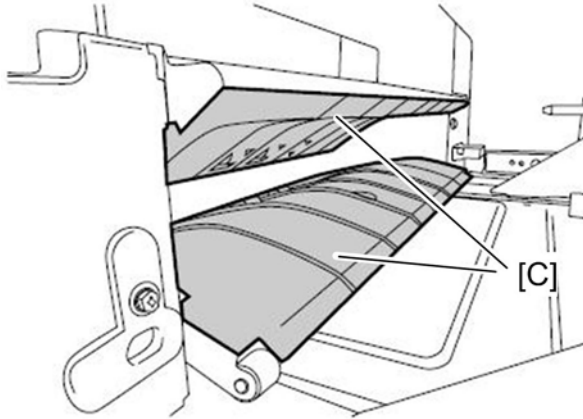

d074t669

5. Clean the guide board [C].
6. After cleaning, restore the machine to its operational state.

Note

- For details about the general and periodic cleaning of the machine, see the Replacement Guide.

Cleaning the Paper Feed Rollers and Paper Feed Belt in the Interposer

Clean the paper feed belt and paper feed rollers in the interposer.

The procedure is explained using the interposer upper tray. The procedure is the same for the lower tray.

1. Remove the loaded paper.

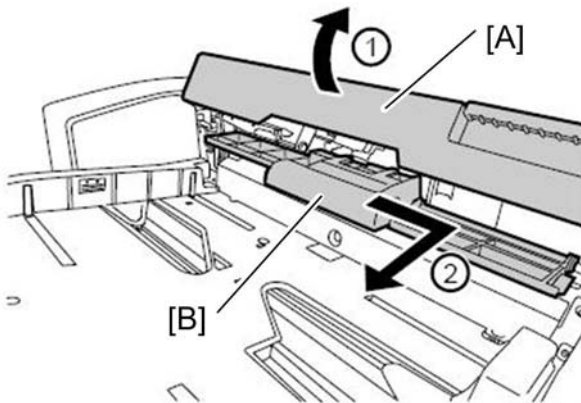

d074t670

2. Open the upper cover [A], and then detach the paper feed unit [B].
Pull out the paper feed unit slightly, release the metal shaft, and then detach it.

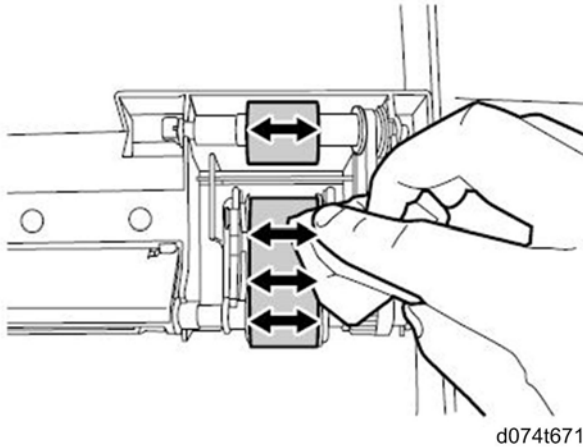

3. Clean the paper feed belt and pick-up roller in the detached paper feed unit.
4. After cleaning, restore the machine to its operational state.

6

No Error Message at Initializing of the Double Feed Sensors

After SC591 (Double-Feed Sensor Error) has occurred, the machine automatically disables the function of the double feed sensors to continue operating. However, a customer cannot notice that the machine has disabled the double feed sensors because no message is displayed on the LCD.

If a customer wants to display the message for disabling the double feed sensors, change the setting of SP1-310-001 from "0" to "1".

Efficient SP for Paper Jam Analyzing

This machine has the paper jam purge system to purge jammed paper in the paper path if possible. However, this may disturb the paper jam analyzing correctly because you are not sure where jammed paper is stuck.

If you want to know where jammed paper is stuck, change the setting of SP1-909-001 from "1" to "0" (no paper purge).

Troubleshooting for Options

Finisher SR5030/ Booklet Finisher SR5040

Delivered Sheets Are Not Stacked Properly

Solution:

Depending on the cause of the problem, do one of the following:

Coated paper is being used.

If coated paper is being used, attach the auxiliary tray for thin coated paper.



For details about attaching the auxiliary tray for thin coated paper, see "When Coated Paper Is Not Properly Aligned" in the Troubleshooting supplied with the machine.

There is a draft in the room.

Minimize drafts. For instance, turn the air conditioner off.

Printed sheets are curled.

<If the decurler unit is attached>

- In the [Adjustment Settings for Skilled Operators] menu, adjust the degree of decurling in [0116: Adjust Paper Curl].
To correct curls facing up, specify "Adjust  Curl".
To correct curls facing down, specify "Adjust  Curl".
Select "Strong" or "Weak" as the degree of decurling as required.

<If the decurler unit is not attached>

- Load the sheets the other way up.

There are too many stacked sheets.

To keep the number of stacked sheets within reason, pause printing once in a while, remove the sheets and resume printing.

For details about pausing printing, see "Pausing Print When Using Finisher SR5030 or Booklet Finisher SR5040" in the Troubleshooting supplied with the machine.

Large Delivered Sheets Are Not Stacked Properly

Cause:

When using large-size or coated paper that produces considerable inter-sheet friction, problems such as one sheet pushing out another or a sheet becoming kinked occur.

This is likely to occur if:

- B4 SEF, 8" x 14" SEF, or larger paper is used.
- Paper that produces considerable inter-sheet friction is used.
- The temperature or humidity is high.

Sheet bending

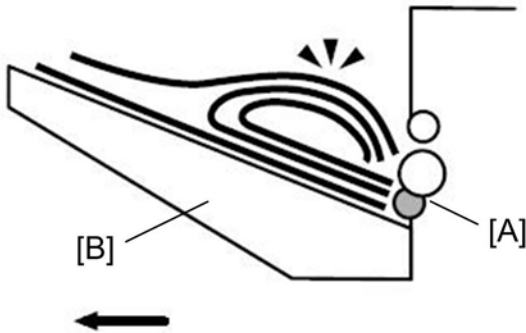

d074t672

6

- [A]: Paper exit
- [B]: Output tray

The leading edge of the delivered sheet bends upward and back.

One sheet pushing out another

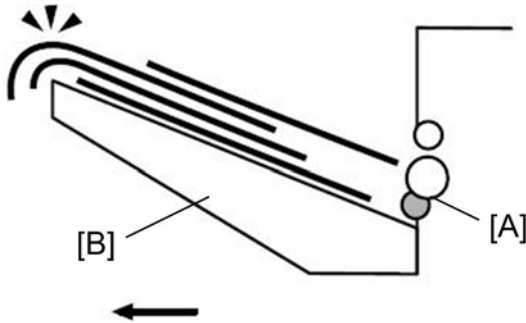

d074t673

- [A]: Paper exit
- [B]: Output tray

The sheet being delivered gets stuck to the top sheet of the stack and pushes the top sheet out.

Sheet becoming kinked

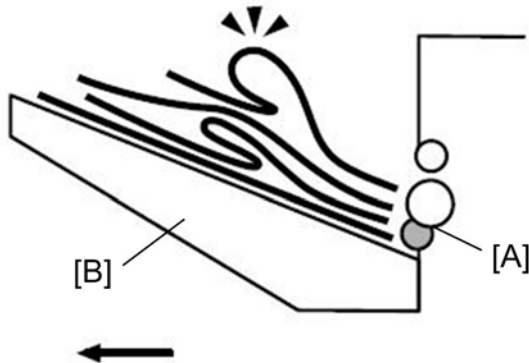

d074t674

- [A]: Paper exit
- [B]: Output tray

The sheet being delivered gets stuck to the top of the stack by its leading edge, arches up, and becomes kinked.

Solution:

Depending on the cause of the problem, do one of the following:

<Sheet bending>

The auxiliary tray is not attached.

- If using paper of Paper Weight 3 or below, attach the auxiliary tray for thin coated paper.
For details about attaching the auxiliary tray for thin coated paper, see "Using Thin Coated Paper" in the Troubleshooting supplied with the machine.
- If using paper of Paper Weight 4 or above, attach the auxiliary paper tray.
For details about attaching the auxiliary paper tray, see "Using Thick Coated Paper" in the Troubleshooting supplied with the machine.

There is a draft in the room.

Minimize drafts. For instance, turn the air conditioner off.

Sheets are curled upward.

<If the decurler unit is attached>

1. In the [Adjustment Settings for Skilled Operators] menu, set [01 16: Adjust Paper Curl] to "Adjust Curl".
As the degree of decurling, select "Weak" if the present setting is "Off" or "Strong" if the present value is "Weak".

<If the decurler unit is not attached>

1. Load the sheets the other way up.

<One sheet pushing out another or a sheet becoming kinked>

The auxiliary tray is not attached.

- If using paper of Paper Weight 3 or below, attach the auxiliary tray for thin coated paper.
For details about attaching the auxiliary tray for thin coated paper, see "Using Thin Coated Paper" in the Troubleshooting supplied with the machine.
- If using paper of Paper Weight 4 or above, attach the auxiliary paper tray.
For details about attaching the auxiliary paper tray, see "Using Thick Coated Paper" in the Troubleshooting supplied with the machine.

Sheets are curled downward.**<If the decurler unit is attached>**

1. In the [Adjustment Settings for Skilled Operators] menu, set [01 16: Adjust Paper Curl] to "Adjust [⤴] Curl".
As the degree of decurling, select "Weak" if the present setting is "Off" or "Strong" if the present value is "Weak".

<If the decurler unit is not attached>

1. Load the sheets the other way up.

↓ Note

- If the sheets cannot be stacked properly even by the abovementioned solution, the problem may be reduced by attaching the auxiliary tray for thin coated paper when using paper of Paper Weight 4 or above and attaching the auxiliary paper tray when using paper of Paper Weight 3 or below.
- If the auxiliary tray is attached, the number of sheets that can be stacked is reduced.
- If the auxiliary tray for thin coated paper is attached, the misalignment of the last sheet of each print job may exceed ± 2 mm when using the Shift Collate function.

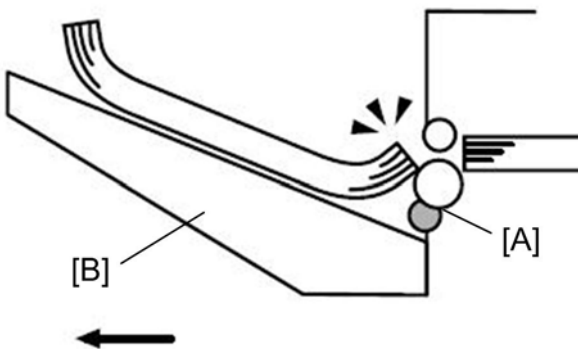
Trailing Edge of Stapled Sheets Too Near Paper Exit

d074t675

- [A]: Paper exit
- [B]: Output tray

Cause:

If there is a tight curl on a delivered set of stapled sheets or if the sheets are limp, the trailing edge of the set may be left too near the paper exit when the set is stacked.

If this happens, the next set of stapled sheets to be delivered may collide with the stacked set, resulting in paper bending or misfeeding.

This is likely to occur if:

- There is a tight curl on a delivered set of stapled sheets.
- Limp paper, such as thin or recycled paper, is used.

Solution:

1. Attach the Z-fold support tray.
2. Print the image. Is the problem resolved?

Yes Finished!

No Go to the next step.

To carry out the following steps, the decurler unit must be attached.

3. In the [Adjustment Settings for Skilled Operators] menu, set [0116: Adjust Paper Curl] to "Adjust  Curl".

Select "Strong" or "Weak" as the degree of decurling as required.

4. Print the image. Is the problem resolved?

Yes Finished!

No Contact your supervisor.

Note

- For details about attaching the Z-fold support tray, see "When Z-folded Paper Is Not Properly Aligned" in the Troubleshooting supplied with the machine.
- If the Z-fold support tray is attached, the problem of the trailing edge being too near the paper exit can be reduced, but the stapled sheets may not be stacked properly.

Sheets Cannot Be Stapled Properly**Cause:**

When the sheets are fed to the staple unit inside the finisher, they may be overlaid, resulting in their becoming misaligned by ± 5 mm relative to each other after stapling.

When using coated or other paper producing considerable inter-sheet friction, the paper edge stop may fail to ensure correct positioning, resulting in misaligned stapling.

This is likely to occur if:

- Coated or other paper producing considerable inter-sheet friction is used.
- Thin or other limp paper is used.

Solution:

Reduce the number of sheets sent in bulk to the stapler unit.

1. In the [Adjustment Settings for Skilled Operators] menu, select [0416: Number of Sheet Align for Stapling] and reduce the number of sheets from the present value.
2. Print the image. Is the problem resolved?

Yes Finished!

No If the problem persists even though the setting has reached its minimum value, contact your supervisor.

Note

- Reducing the number of sheets causes the machine to take longer for sheet alignment, reducing throughput.

6

Creases on Stapled Paper Stack

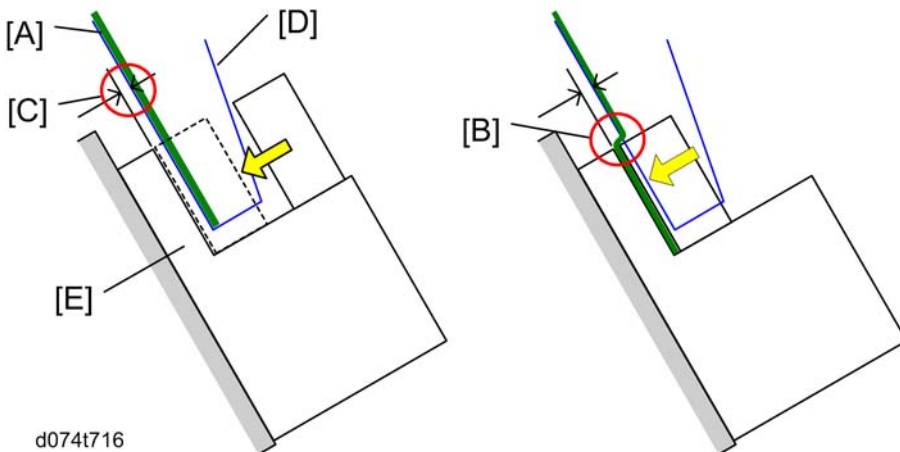

When a few sheets [A] of paper are stapled, creases [B] may occur on the stapled paper stack. This is because the gap [C] between the bottom fence [D] and corner stapler unit [E] causes creases on the paper stack. To prevent this problem, follow the procedure below.

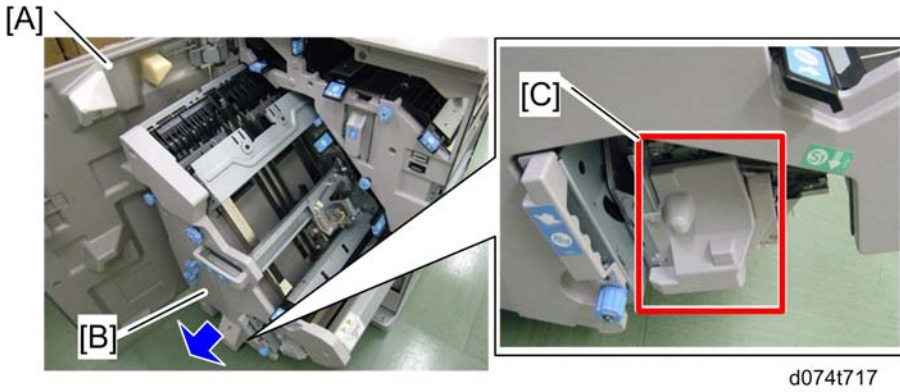

1. Open the front door [A].
2. Pull out the stack/stapler unit [B].
 - Corner stapler unit [C]

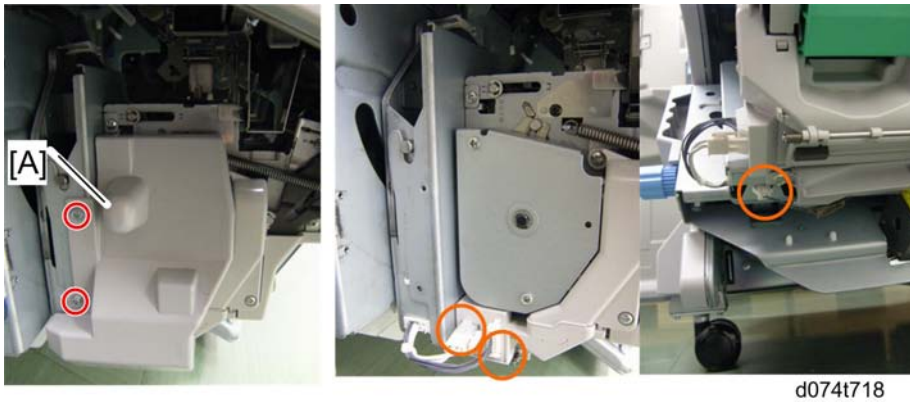

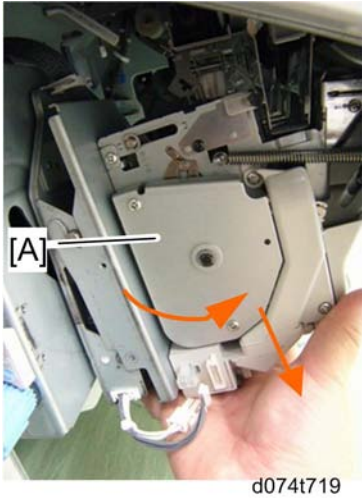

3. Remove the corner stapler cover [A] ( x2).
4. Disconnect three harnesses.

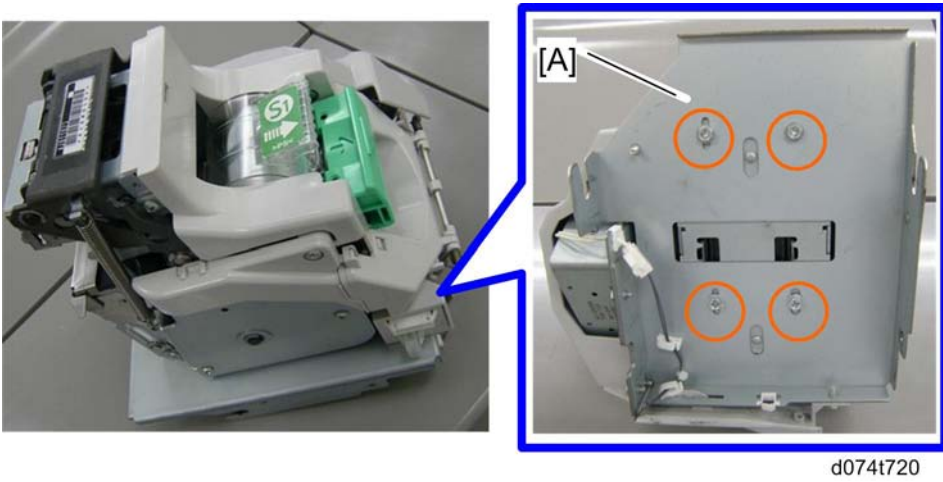

5. Turn the corner stapler unit [A] counterclockwise, and then remove it.

6



6. Remove the corner stapler base [A] from the corner stapler unit ( x4).

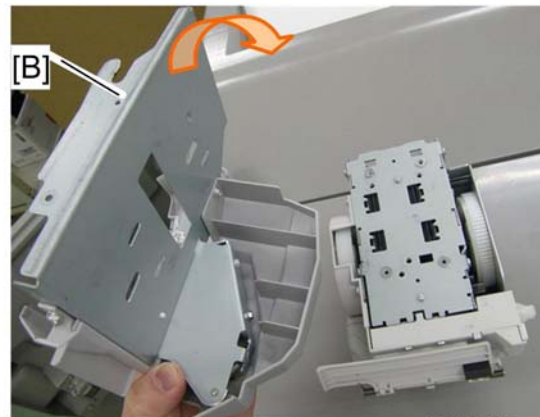
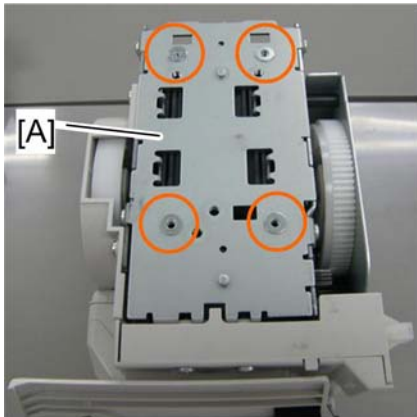

d074t721

7. Attach washers at the screw holes on the bottom of the corner stapler unit [A].
 - Measure the gap between the bottom fence and corner stapler unit, and then calculate how many washers are necessary (adjustable limit: 2.0 mm or less). The thickness of each washer is 0.5 mm.
8. Reattach the corner stapler base [B] to the corner stapler unit (⚙ x4).
9. Reinstall the corner stapler unit in the finisher.
10. Reassemble the finisher.

Staple Position is Too Close to Paper Edge

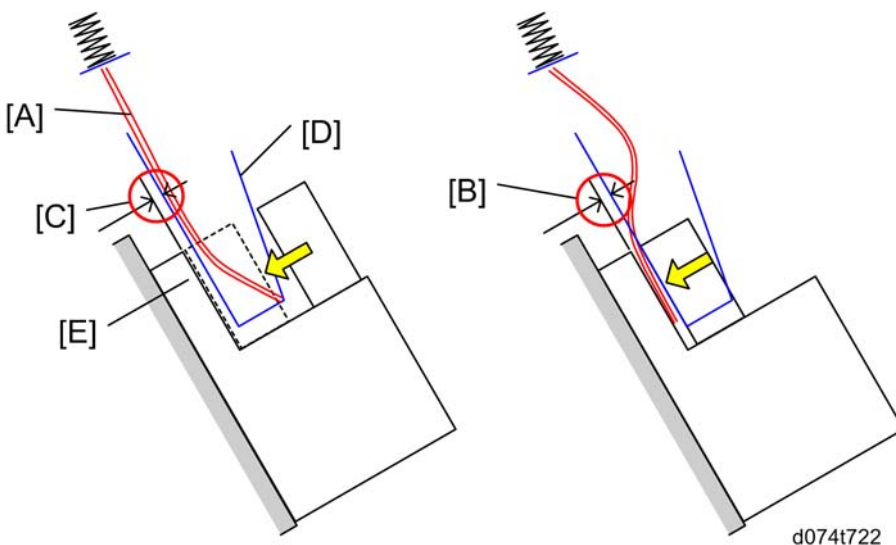

d074t722

When a few sheets [A] of paper are stapled, miss-stapling may occur on the stapled paper stack. This is because the gap [B] between the bottom fence [C] and corner stapler unit [D] makes paper buckle on the paper stack which causes the miss-stapling. To prevent this problem, follow the procedure below.

1. Remove the corner stapler unit (see "Creases on Stapled Paper Stack").
2. Attach washers on the bottom of the corner stapler unit.
 - Refer to the "Creases on Stapled Paper Stack" described above.
3. Go to next step if attaching washers does not solve the problem.
4. Mark the current position between corner stapler base and corner stapler unit.

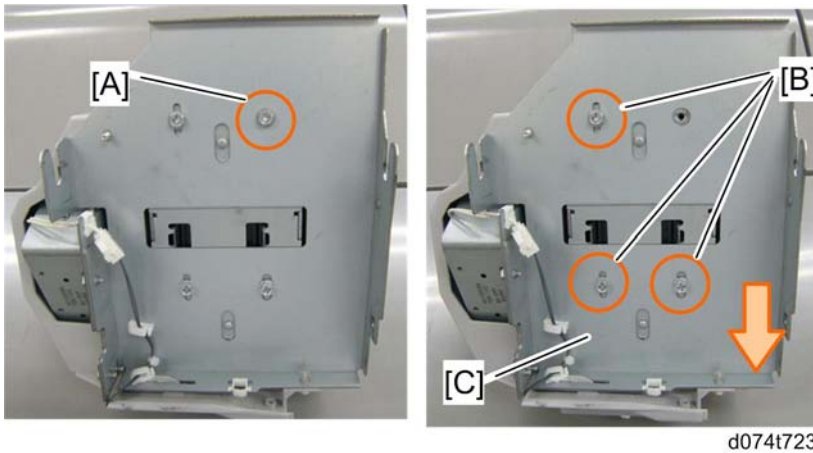

5. Remove the positioning screw [A].
6. Remove other three screws [B].
7. Slide the corner stapler base [C] down (relatively corner stapler unit up).

★ Important

- Do not slide either of the corner stapler base beyond 2.0 mm. Otherwise, corner stapler unit may interrupt other parts when the corner stapler unit moves.

8. Secure the two units ( x3).
9. Reinstall the corner stapler unit in the finisher.
10. Reassemble the finisher.

Booklet Stack Feed Out Error

When some conditions are met, booklet stack is not properly fed out to the booklet tray.

- 10 sheets or more to be stapled
- High coverage image
- Plain paper or recycle paper

This is because the friction coefficient between sheets of paper is low.

To prevent this problem, follow the procedure below.

1. Remove the booklet unit (see "Field Service Manual" for the Finisher D512/D513).

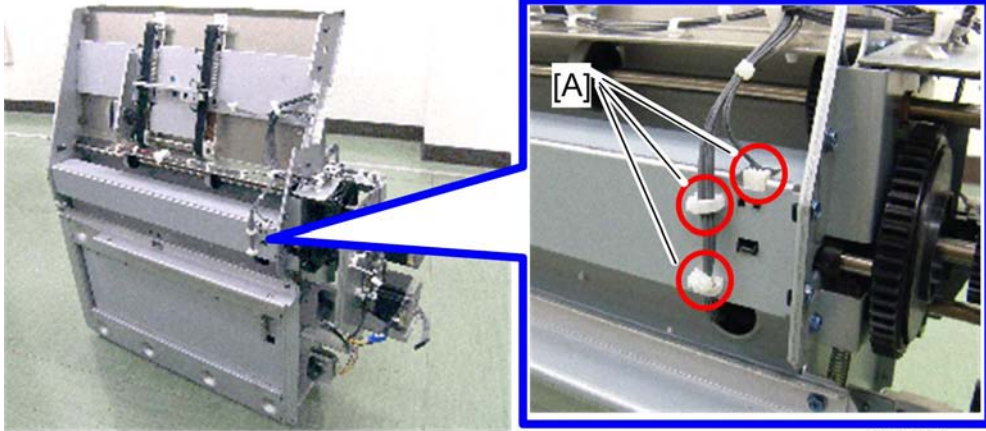

d074t724

2. Release three clamps [A].

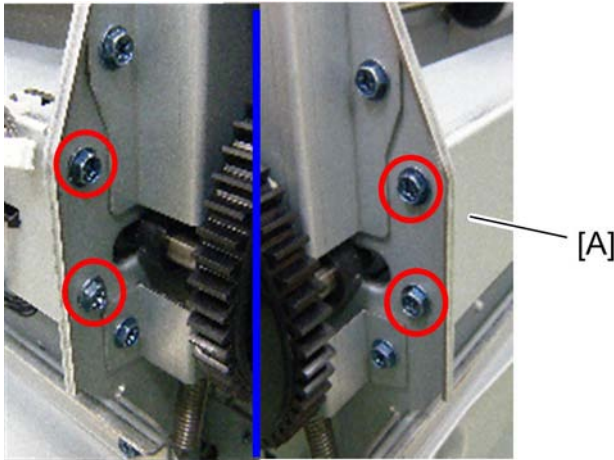

d074t725

3. Remove the upper stay [A] on the booklet unit ( x4).

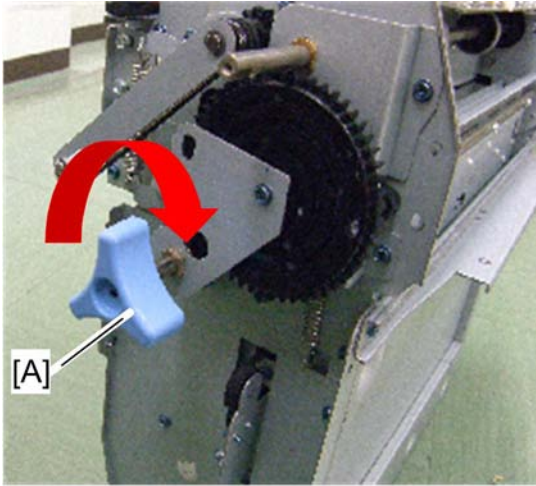

d074t726

4. Rotate the jam removal knob [A] clockwise until it stops.

6

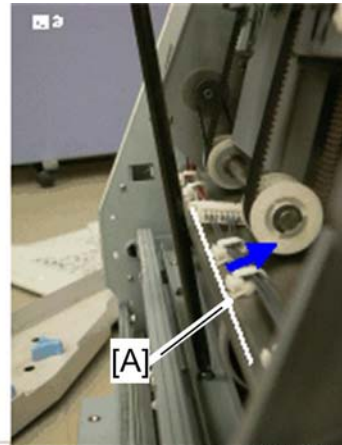

d074t727

5. Remove four screws on the both sides of the booklet unit, and then move the guide plate [A] to the arrow direction.
6. Remove the fold plate holder [A] ( x3).
7. The fold plate [B] is removed.
8. Install a new modified fold plate.
 - Ask your supervisor about the new modified fold plate.
9. Reassemble the finisher.

Multi-Folding Unit

Out-of-True Folding (Folding Deviation)

Cause:

Depending on how floppy the paper is, folds may shift out of true. This is referred to as folding deviation.

Solution:

Adjust the folding position by adjusting the position of the paper edge stopper for folding.

- For multi-sheet folding, adjust the folding position by means of the following settings:
 - 0601: Half Fold Position (Multi-sheet Fold)
 - 0602: Letter Fold-out Position 1 (Multi-sheet Fold)
 - 0603: Letter Fold-out Position 2 (Multi-sheet Fold)
 - 0604: Letter Fold-in Position 1 (Multi-sheet Fold)
 - 0605: Letter Fold-in Position 2 (Multi-sheet Fold)
- For single-sheet folding, adjust the folding position by means of the following settings:
 - 54: Adjust Z-fold Position 1
 - 55: Adjust Z-fold Position 2
 - 56: Half Fold Position: Single-sheet Fold
 - 57: Letter Fold-out Posn 1: Single-sheet Fld
 - 58: Letter Fold-out Posn 2: Single-sheet Fld
 - 59: Letter Fold-in Position 1: Single-sheet Fold
 - 60: Letter Fold-in Position 2: Single-sheet Fold
 - 61: Double Parallel Fold Position 1
 - 62: Double Parallel Fold Position 2
 - 63: Adjust Gate Fold Position 1
 - 64: Adjust Gate Fold Position 2
 - 65: Adjust Gate Fold Position 3

↓ Note

- For details about specifying settings in the [Adjustment Settings for Skilled Operators] menu, see the Adjustment Item Menu Guide.

Folding Deviation

Cause:

Depending on the paper floppiness, folding deviation (skewed folding) may occur.

Deviation refers to the difference in edge dimension of the parts between folds.

For example, in the following illustration, the dimensional difference between the top (L2[2]) and bottom (L2[1]) edges is the deviation.

<Folding deviation sample of L2 for Z-fold>

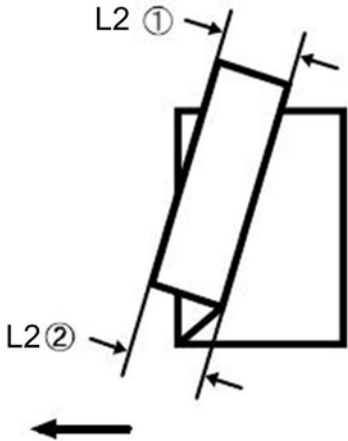

d074t676

6

Solution:

Adjust the deviation.

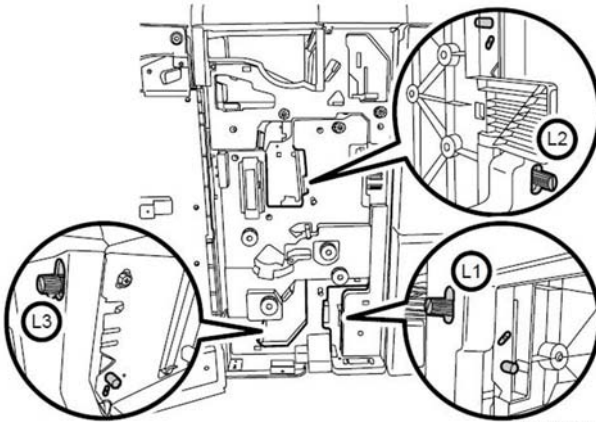

d074t677

The multi-folding unit has three adjusting screws (L1, L2, and L3) with which to adjust deviation.

L1

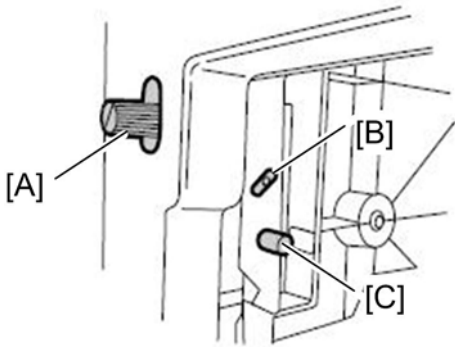

d074t678

- [A]: Adjusting screw
- [B]: Mounting screw
- [C]: Adjusting screw hole

L2

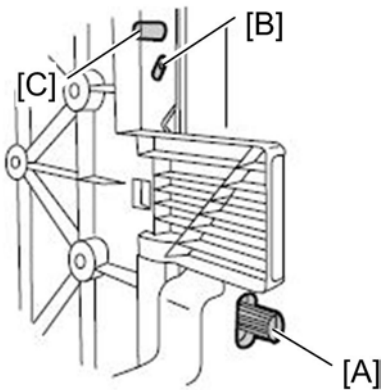

d074t679

- [A]: Adjusting screw
- [B]: Mounting screw
- [C]: Adjusting screw hole

L3

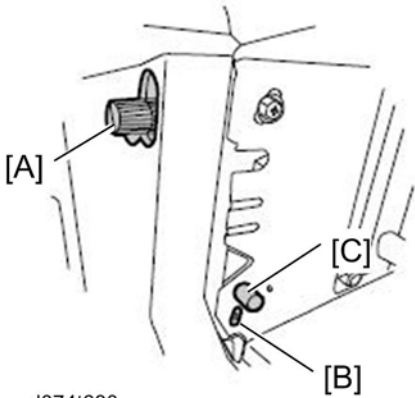

d074t680

- [A]: Adjusting screw
- [B]: Mounting screw
- [C]: Adjusting screw hole

The screws adjust the deviation of the following parts:

6

Note

- The mark ○ indicates the leading edge (relative to the paper feed direction), and the mark ● indicates the trailing edge.

Z-fold

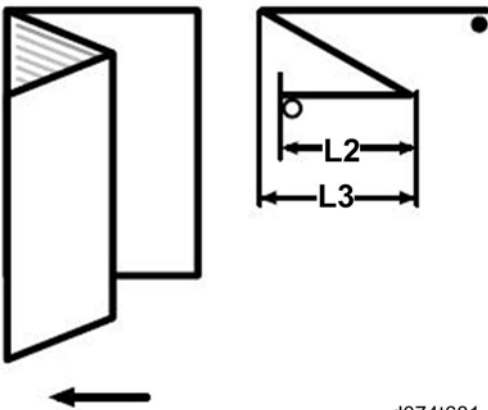

d074t681

Half Fold



d074t682

Letter Fold-in

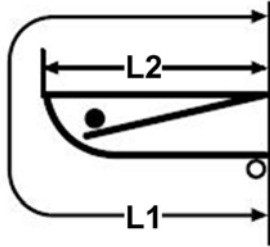
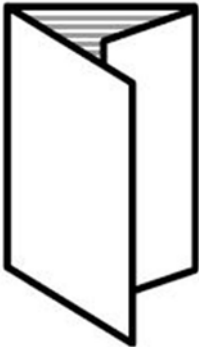

d074t683

Letter Fold-out

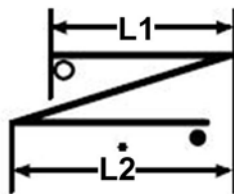
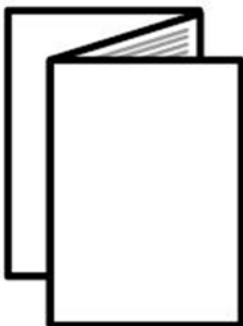

d074t684

Double Parallel

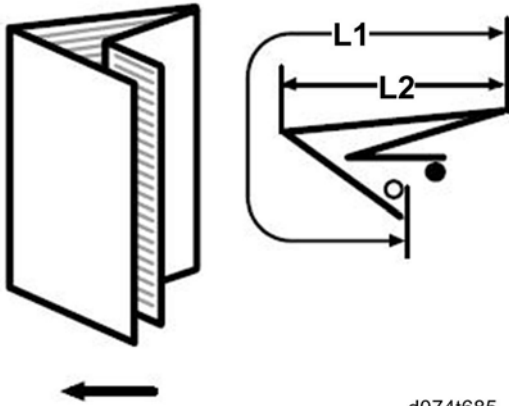

d074t685

Gate Fold

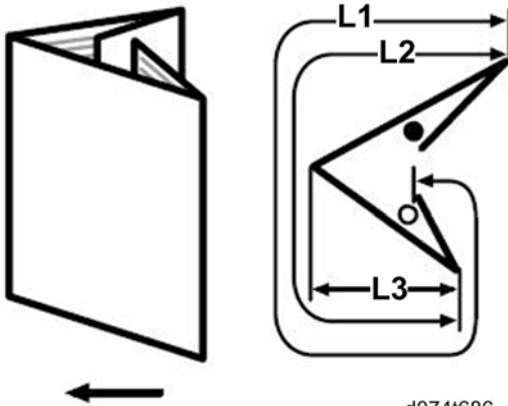

d074t686

<How to adjust the folding deviation>

This procedure is the same for L1, L2, and L3.

1. Open the front cover of the multi-folding unit.
2. Remove the mounting screw.

If the mounting screw is attached to the adjusting screw hole, unfasten it.

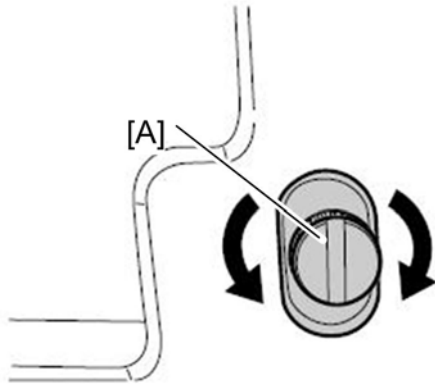

d074t687

3. Turn the adjusting screw [A] to adjust the deviation.
 - To increase the length at the bottom part of paper, turn the screw clockwise.
 - To decrease the length at the bottom part of paper, turn the screw counterclockwise.
4. Attach the mounting screw to fasten the adjusting screw.
5. If the mounting screw is attached to the adjusting screw hole, fasten it.
6. Close the front cover of the multi-folding unit.

Note

- For multi-sheet folding, the folding deviation of the sheet in the center is adjusted.
- If the deviation is large, the paper may be skewed. In that case, see Paper Skew.

Folds Soiled by Multi-Sheet Folding

Cause:

If multi-sheet folding is performed after a large number of z-folds have been performed, the tip of the blade used for the multi-sheet folding may be soiled, in turn soiling the paper.

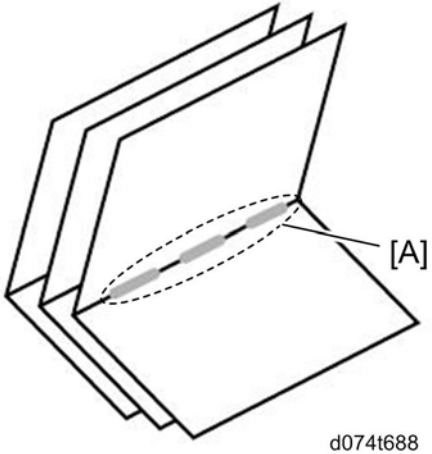

d074t688

This will produce soiling 1-3 cm (0.4-1.2 inches) in width (equal to the width of the blade) in the fold [A] of the center sheet.

Solution:

Clean the blade.

6

1. Open the front cover of the multi-folding unit.

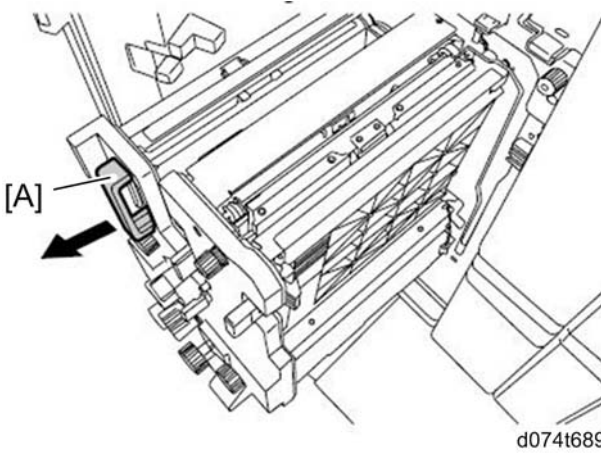

d074t689

2. Pull the multi-folding unit [A] out.

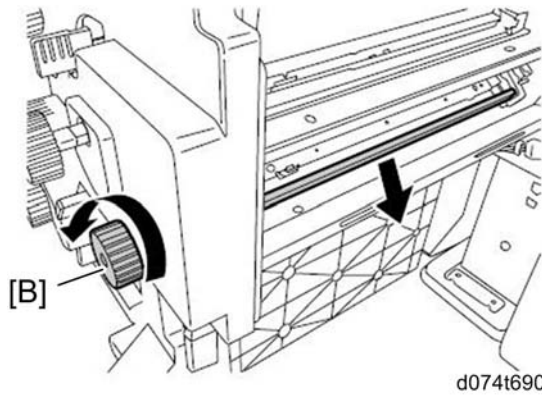

3. Turn the N11 dial [B] counterclockwise until the blade appears.
The blade is located in the right part of the multi-folding unit.

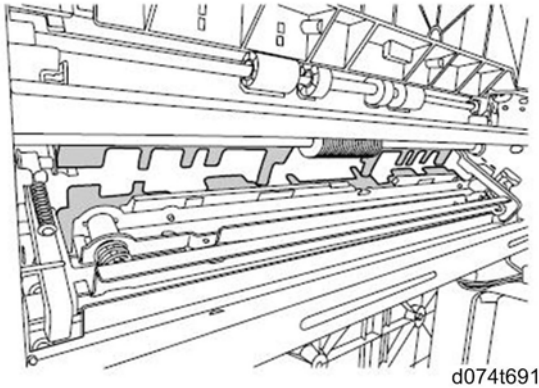

4. Wipe the tip and top of the blade with a soft dry cloth.
Be careful not to damage the blade.
5. After cleaning, restore the machine to its operational state.
The soiling will be removed by printing between three and five copies with multi-sheet fold.

Edge of Multi-Sheet Letter Fold Bent

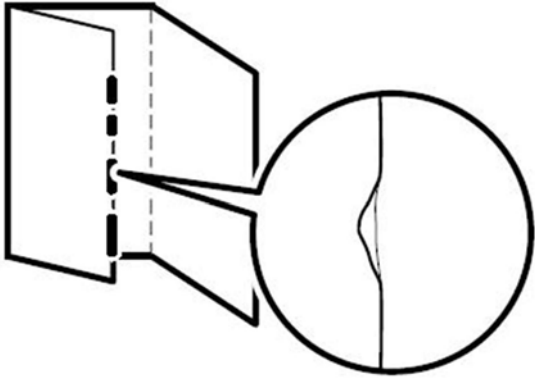

d074t692

When letter folding multiple sheets, the edge of the inner flap may become bent.

Solution:

1. Load the paper the other side up.
2. Print the image. Is the problem resolved?
Yes Finished!
No Go to the next step.
3. In the [Adjustment Settings for Skilled Operators] menu, set [0604: Letter Fold-in Position 1 (Multi-sheet Fold)] to "0.0 mm".
4. In [General Features] in [System Settings], set [Letter Fold-in Position] to "7 mm".
5. Print the image. Is the problem resolved?
Yes Finished!
No Contact your supervisor.

Z-Folding is Not Performed Properly



d074t693

- Upward curl (radius 4 cm [1.6 in.] or less) [A] at leading edge of delivered paper.

Cause:

Because the paper is curled, its leading edge catches on the guide board, leaving it in the wrong position to be folded properly.

Solution:

1. Load the sheets the other way up.
2. Print the image. Is the problem resolved?

Yes Finished!

No Move to the next step.

To carry out the following steps, the decurler unit must be attached.

3. In the [Adjustment Settings for Skilled Operators] menu, set [0116: Adjust Paper Curl] to [Adjust Curl: Weak].
4. Print the image. Is the problem resolved?

Yes Finished!

No Contact your supervisor.

Note

- This folding error will not occur when using uncurled sheets or sheets that curl downward.

Folded Sheets Are Not Stacked Properly

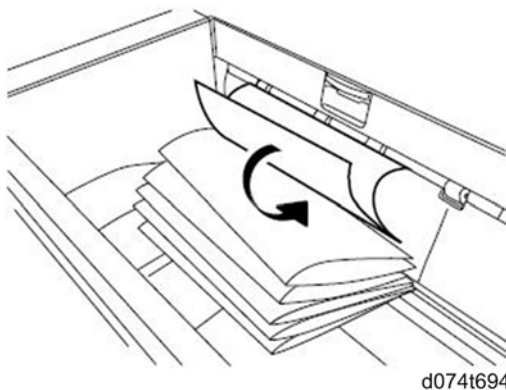

Cause:

If a large number of half-folded multi-sheet bundles have been delivered, the spines of the delivered bundles form a bulge. If a subsequently delivered bundle catches on this bulge, it may flip over in the output tray.

This is likely to occur if:

- Thick, relatively stiff paper is used.

As a bundle is delivered, its folded edge droops and catches on the stacked bundles, causing the delivered bundle to flip over.

Solution:

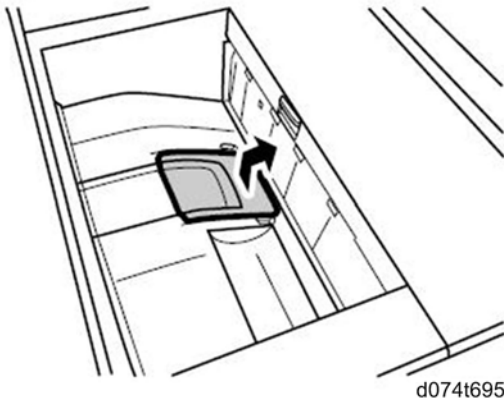

Use the Z-fold support tray for multi-folding unit.

This will reduce the angle of stacked bundles and prevent bundles flipping over as they are delivered.

For details about attaching the Z-fold support tray for multi-folding unit, see "When Z-folded Paper Is Not Properly Aligned" in the Troubleshooting supplied with the machine.

6

Note

- The flipping over of delivered sheets during other types of folding operations (such as letter-fold and gate-fold) cannot be prevented by the Z-fold support tray for the multi-folding unit.

Buffer Pass Unit

The Fan Is Noisy

You can change the buffer pass unit fan activation setting according to the type of paper and ambient temperature.

1. In the [Adjustment Settings for Skilled Operators] menu, change the value in [0118: Buffer Pass Unit Fan Activation Setting].

Note

- Depending on the setting, blocking (heat and pressure causing toner particles on stacked copies to form clumps which then detach) may occur.

High Capacity Stacker

Delivered Sheets Are Severely Curled

Cause:

Sheets with downward curls rub too much at their leading edges. This can cause a sheet to stop short with its trailing edge still in the paper exit.

Subsequently delivered sheets may become bent as they slip under the trailing edge of the partially delivered sheet.

This is likely to occur if:

- A4 or larger coated paper weighing up to 135 g/m² (50 lb. Cover) is used.

<How the problem occurs>

- (1) Downward curled paper is delivered to the stacker tray.

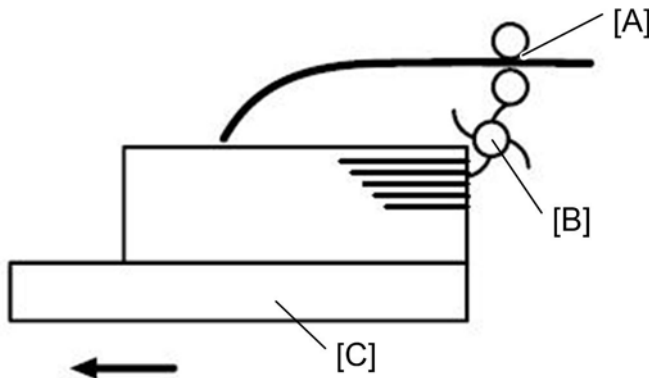

d074t696

- [A]: Paper exit
- [B]: Paddle
- [C]: Stacker shift tray
- (2) The leading edge of the sheet being delivered rubs against the top sheet of the stack, there being no air gap between the sheets, and the sheet being delivered gets stuck.

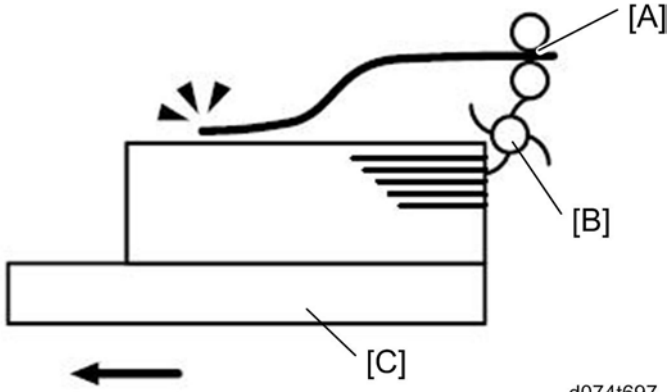

d074t697

- [A]: Paper exit
- [B]: Paddle
- [C]: Stacker shift tray
- (3) The trailing edge of the sheet being delivered is left in the paper exit.

6

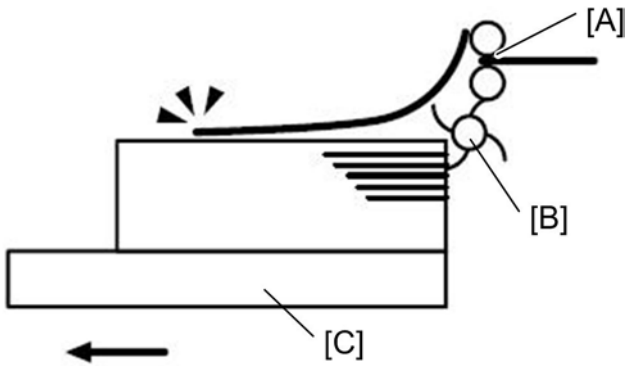

d074t698

- [A]: Paper exit
- [B]: Paddle
- [C]: Stacker shift tray
- (4) The next sheet to be delivered slips under the sheet still in the paper exit and bends back.

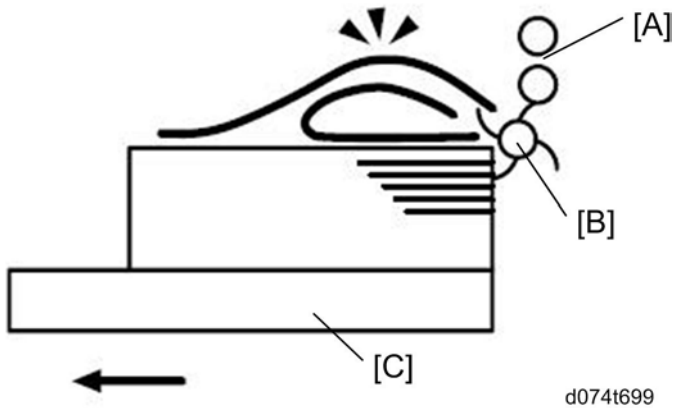

d074t699

- [A]: Paper exit
- [B]: Paddle
- [C]: Stacker shift tray

Solution:

Straighten out the paper by decurling it upward.

1. Load the sheets the other way up.
2. Print the image. Is the problem resolved?

Yes Finished!

No Move to the next step.

To carry out the following steps, the decurler unit must be attached.

3. In the [Adjustment Settings for Skilled Operators] menu, set [01 16: Adjust Paper Curl] to [Adjust [^] Curl: Weak].

4. Print the image. Is the problem resolved?

Yes Finished!

No Go to the next step.

5. Set [01 16: Adjust Paper Curl] to [Adjust [^] Curl: Strong].

6. Print the image. Is the problem resolved?

Yes Finished!

No Contact your supervisor.

Delivered Sheets Are Not Aligned

Cause:

When delivering sheets to the stacker tray, because of the friction between the sheets, the paddle fails to drag the trailing edge back into the front guide, resulting in misalignment.

The paper edge stopper also fails to push back the protruding leading edge.

This is likely to occur if:

- Thick (280 g/m² [105 lb. Cover] or heavier), uncurled A3 or larger paper is used.

<How the problem occurs>

- (1) An uncurled sheet is delivered to the stacker shift tray.

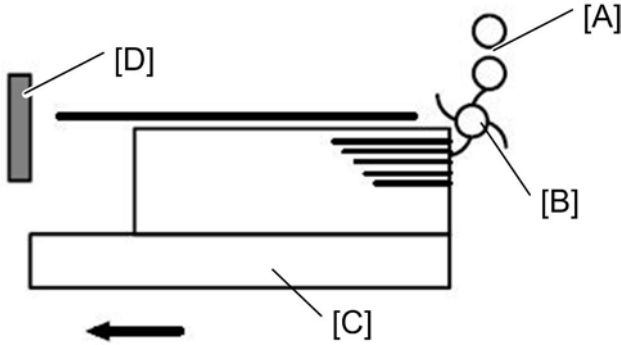

d074t700

6

- [A]: Paper exit
- [B]: Paddle
- [C]: Stacker shift tray
- [D]: Paper edge stopper

- (2) The friction at the trailing edge is too great for the paddle to drag the sheet back and align the edges of the sheet with the edges of the stack.

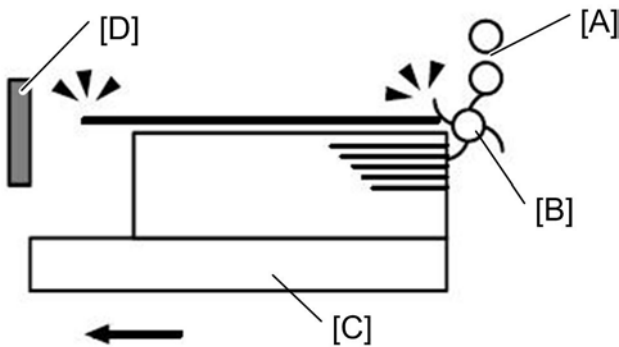

d074t701

- [A]: Paper exit
- [B]: Paddle
- [C]: Stacker shift tray
- [D]: Paper edge stopper

- (3) The paper edge stopper fails to push back the protruding leading edge and align the sheet that way.

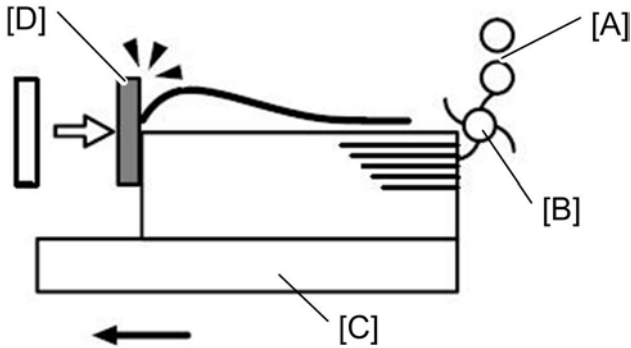

d074t702

- [A]: Paper exit
 - [B]: Paddle
 - [C]: Stacker shift tray
 - [D]: Paper edge stopper
- (4) Stacked sheets are not aligned properly.

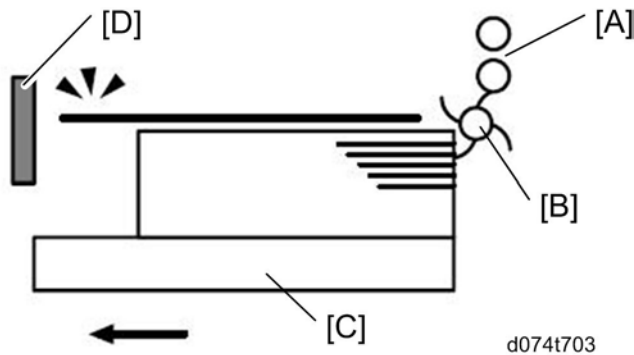

d074t703

- [A]: Paper exit
- [B]: Paddle
- [C]: Stacker shift tray
- [D]: Paper edge stopper

Solution:

Curl the paper upward.

To do this, the decurler unit must be attached.

1. In the [Adjustment Settings for Skilled Operators] menu, set [0116: Adjust Paper Curl] to [Adjust Curl: Weak].

2. Print the image. Is the problem resolved?

Yes Finished!

No Go to the next step.

3. Set [0116: Adjust Paper Curl] to [Adjust  Curl: Strong].

4. Print the image. Is the problem resolved?

Yes Finished! (Sheets are aligned to an accuracy of 7 mm [0.27 inches].)

No Contact your supervisor.

LCIT RT5060

Misfeeding due to the Paper Character

Misfeeding from the LCT tray may occur on the paper which has strong resistance against bending strength.

6

Installing the tray heater for the LCT

1. Install the tray heater for the LCT. For details, refer to the installation procedure for "LCIT (D516) Tray Heaters" in A3/DLT LCIT (D516).
2. If the tray heater does not solve the problem, go to "Changing the upper limit of the paper stack in the LCT tray" described below.

Changing the upper limit of the paper stack in the LCT tray



Changing the upper limit of the paper stack in the LCT tray can prevent paper misfeeding for the paper which has strong resistance against bending strength.

Note

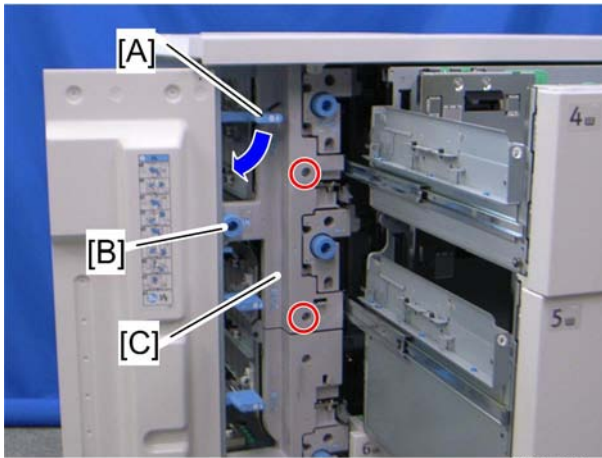
- For the paper feed unit in the top tray or middle tray, remove the inner upper cover.
 - For the paper feed unit in the bottom tray, remove the inner lower cover.
1. Pull out the top, middle or bottom tray.
 1. Open the front door.
 2. Pull out the top and middle trays.



d453r501

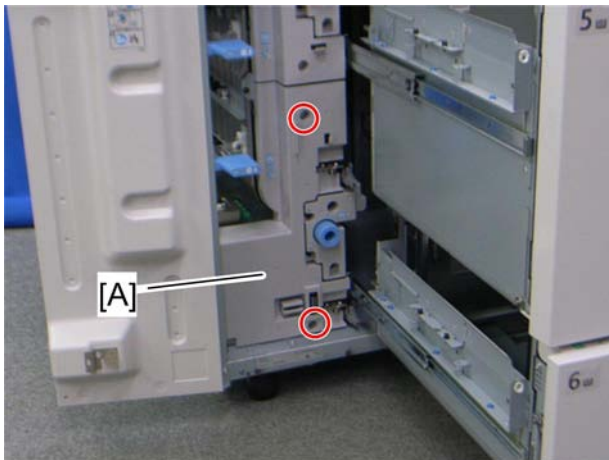

3. Pull down the U1 lever [A].
4. Remove:
 - [B] Knob ( x1)
 - [C] Inner upper cover ( x2)
5. Pull out the middle and bottom trays.

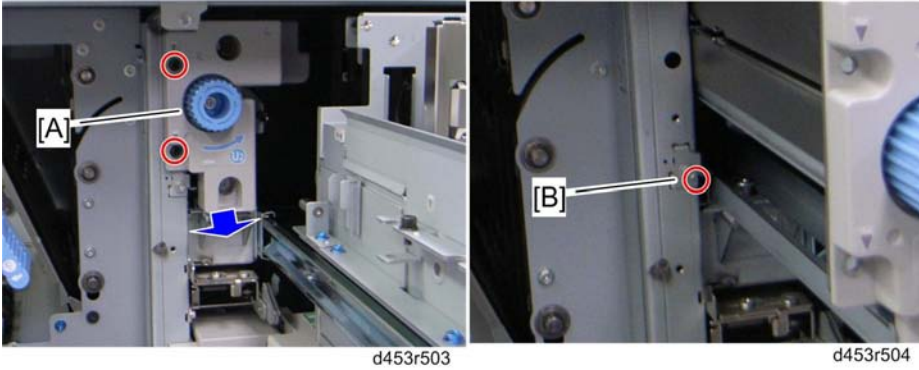

d453r502

6. Inner lower cover [A] ( x2)



7. Pull the paper feed unit [A] ( x 2).
8. Stopper bracket [B] ( x 1)

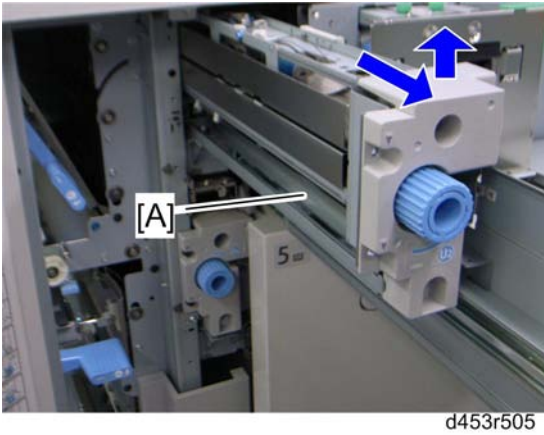

9. Pull out the paper feed unit [A] fully, and then lift it.

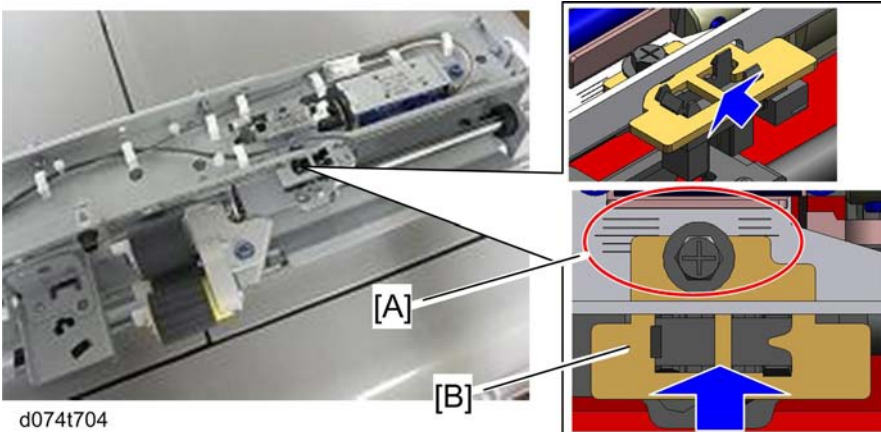

10. Note the default position of the paper lift sensor bracket by referring to the scale [A] on the frame.
 - The scale on the frame is divided into units of 1 mm.

11. Loosen the screw on the paper lift sensor bracket [B].
12. Move the bracket 0.5 mm in the arrow direction as shown above.
13. Tighten the screw on the paper lift sensor bracket [B].

Note

- To return the upper limit position to the default position, move the paper lift sensor bracket 0.5 mm to the opposite side.
- Return the upper limit position to the default if a paper jam occurs at the paper feed sensor in the LCT.

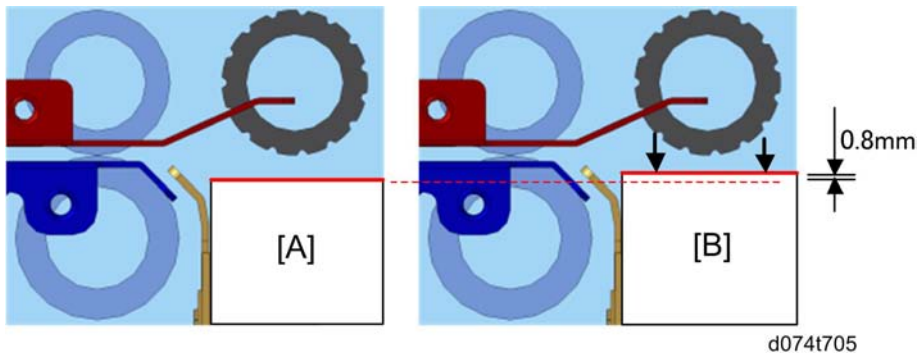

14. This adjustment raises the upper limit position by 0.8 mm.
 - [A]: Paper stack before adjustment
 - [B]: Paper stack after adjustment

Double Feeding or Misfeeding from the LCT

Changing the upper limit of the paper stack in the LCT tray

Changing the upper limit of the paper stack in the LCT tray can prevent paper double feeding or misfeeding from the LCT tray.

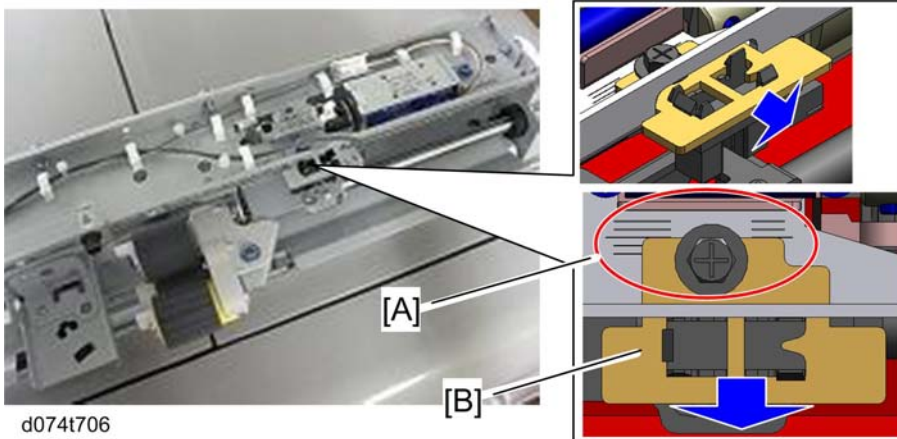

d074t706

1. Pull the paper feed unit of the LCT unit (see "Misfeeding due to the Paper Character").
2. Note the default position of the paper lift sensor bracket by referring to the scale [A] on the frame.
 - The scale on the frame is divided into units of 1 mm.
3. Loosen the screw on the paper lift sensor bracket [B].
4. Move the bracket 0.5 mm in the arrow direction as shown above.
5. Tighten the screw on the paper lift sensor bracket [B].

Note

- To return the upper limit position to the default position, move the paper lift sensor bracket 0.5 mm to the opposite side.
- Return the upper limit position to the default if a paper jam occurs at the paper feed sensor in the LCT.

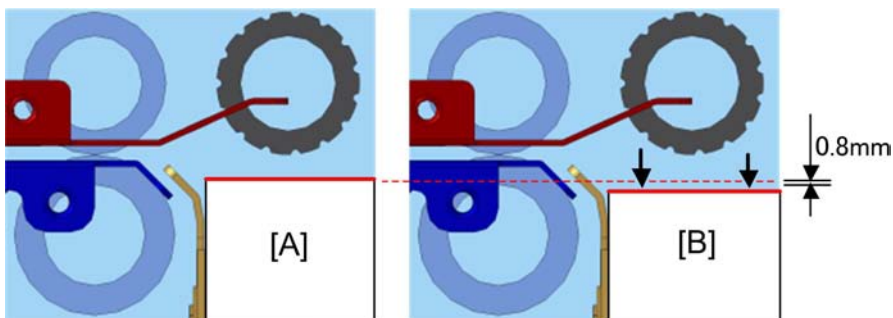

d074t707

6. This adjustment lowers the upper limit position by 0.8 mm.
 - [A]: Paper stack before adjustment
 - [B]: Paper stack after adjustment

Cover Interposer Tray CI5020

Paper Misfeeding due to Non-supported Paper Use

Cause:

- Paper in use is not supported for this unit.
- Paper in use is low friction coefficient.

Solution:

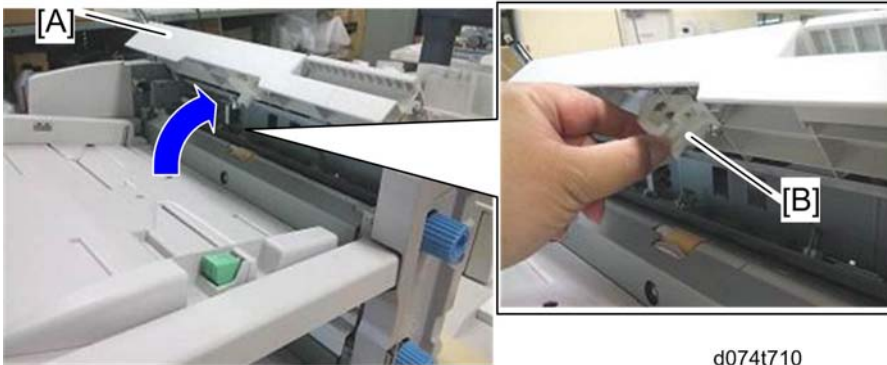

d074t710

1. Open the top cover [A].
2. Remove the pressure block [B] (spring x 1, hooks).

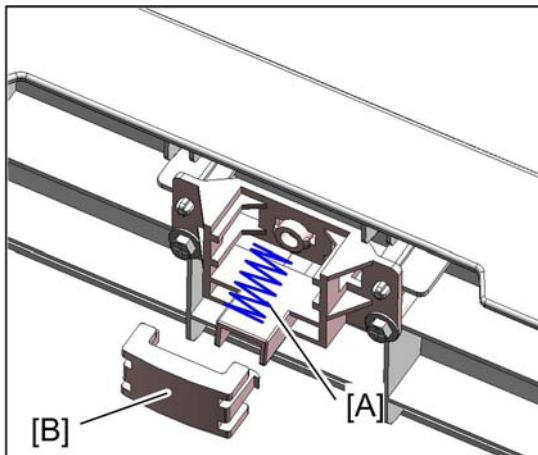

d074t711

3. Install the spring [A].
4. Reinstall the pressure block [B].

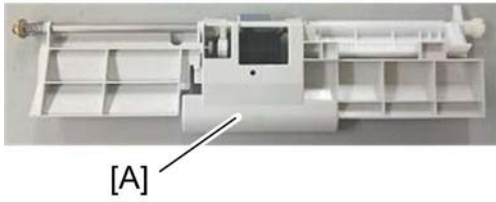

d074t712

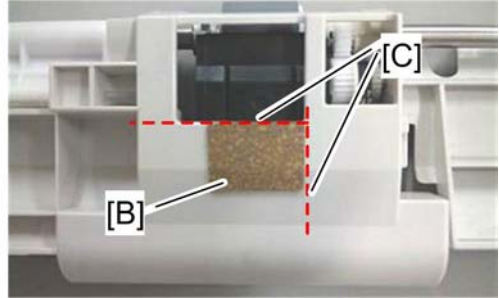

5. Remove the feed belt unit [A].
6. Align the cork pad [B] to two lines [C], and then attach it on the feed belt unit.

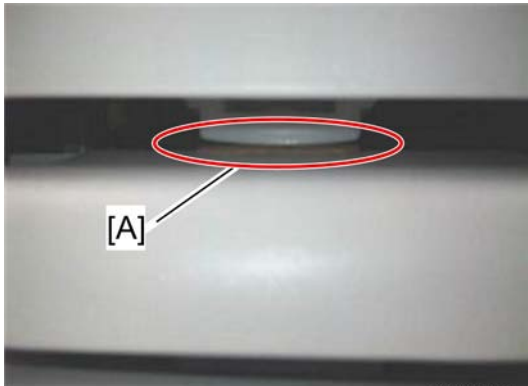

d074t713

7. Check if no gap [A] between the pressure block and cork pad after the top of the stack in the tray pushes up the feed belt unit.

Multi Bypass Tray BY5010

Paper Misfeeding due to Paper Character

Misfeeding from the bypass tray may occur on the coated paper which has strong smoothness in the low temperature and low humidity condition.

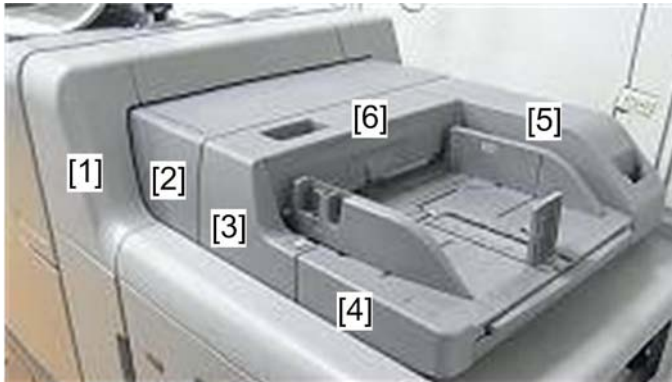

d074t714

1. Remove six covers.

- For details about removing these covers, refer to the Filed Service Manual for the Multi Bypass Tray BY5010.



d074t715

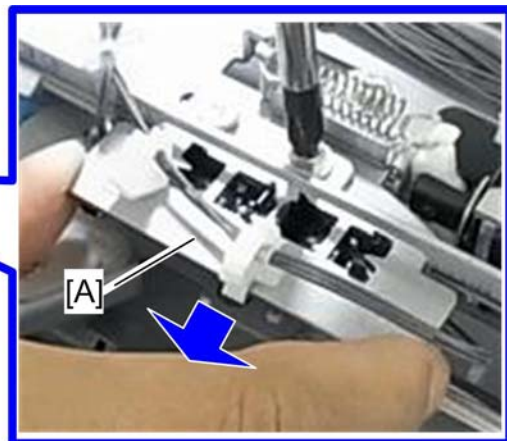

2. Note the default position of the paper lift sensor bracket [A] by referring to the scale on the frame.

- The scale on the frame is divided into units of 1 mm.

3. Loosen the screw on the paper lift sensor bracket [A].

4. Move the bracket 0.5 mm in the arrow direction as shown above.

5. Tighten the screw on the paper lift sensor bracket [B].

Note

- To return the upper limit position to the default position, move the paper lift sensor bracket 0.5 mm to the opposite side.
- Return the upper limit position to the default if a paper jam occurs at the paper feed sensor in the Multi Bypass Unit.

Troubleshooting for Throughput

Reducing the Waiting Time Prior to Printing

After receiving a print job, the machine usually stops to let the fusing temperature reach an appropriate level for printing.

The waiting time for the fusing unit to cool down may be quite long, especially before printing on thin paper. By decreasing the fusing temperature during standby, you can reduce the waiting time.

1. In the [Adjustment Settings for Skilled Operators] menu, decrease the temperature by 10°C in [0206: Adjust Fusing Temperature on Standby] or decrease the settings of SP1-107-001, 003, and 007.

Decrease the value in "Temperature on Standby Mode", "Temperature on Panel Off Mode", and "Temperature Before Performing a Process" by 10°C.

Note

- When printing on paper other than thin paper, we recommend leaving the above settings unchanged.

6

Throughput When Printing on Paper with a Thickness Equivalent to Paper Weight 6 or 7

When printing on paper with a thickness equivalent to Paper Weight 6 or 7, the machine's copy/print speed must be reduced to 70% of full speed so that the degree of toner fixation can be enhanced.

However, depending on the type of paper in use and printed image, you can have the machine print at full copy/print speed.

The following are requirements for improving throughput when using paper with a thickness equivalent to Paper Weight 6 or 7:

- Uncoated paper
 - Printing in black-and-white mode
 - Room temperature
1. In [Advanced Settings] for the custom paper in use, increase the value in [19: Process Speed Setting] by one step or increase the value of SP1-986 by 1 step.

The settings for the Advanced Settings and the SP settings correspond to one another as shown in the table below.

Advance Settings	SP Code Settings
High	0: Target Speed

Advance Settings	SP Code Settings
Middle	1: Medium Speed
Low	2: Low Speed

- If it is presently set to [Low], change it to [Middle].
 - If it is presently set to [Middle], change it to [High].
2. Set [44: Fusing Heat Roller Temperature Adj] to "180°C".
 3. Print the image. Does it exhibit any fusing problem?
 - Yes** You cannot improve throughput under the present condition. Restore the previous setting.
 - No** You can operate the machine using this setting.

Note:

The following list shows the copy/print speed for each item in [19: Process Speed Setting]:

<D074>

- High: 65 cpm (full speed)
- Middle: 45 cpm (70% of full speed)
- Low: 32 cpm (50% of full speed)

<D075/M044>

- High: 75 cpm (full speed)
- Middle: 52 cpm (70% of full speed)
- Low: 37 cpm (50% of full speed)

Throughput when Printing Black-and-White Jobs and Color Jobs

When printing intermixed black-and-white and color print jobs, switching from full-color mode to black-and-white mode takes time, causing loss of throughput each time the mode is switched.

When the machine prints a full-color print job followed by a black-and-white job, you can improve throughput by adjusting the number of black-and-white sheets the machine prints in full-color mode before switching to black-and-white mode.

1. In the [Adjustment Settings for Skilled Operators] menu, change the value in [0207: Auto Colour Selection Setting] or change the value in SP2-907-001.

Specify the appropriate number of sheets for your operating environment.

Value	Machine Operation
1 (Minimum)	<p>The machine will switch to the black-and-white mode for all black-and-white printing.</p> <p>This does not improve throughput, but prevents the cyan, magenta, and yellow development units from working when printing black-and-white sheets.</p>
10 (Maximum)	<p>When the machine prints a full-color print job followed by a black-and-white job, it will switch from full-color to black-and-white mode after printing 10 black-and-white sheets.</p>

Note

- If you print black-and-white sheets in full-color mode, the cyan, magenta, and yellow development units will work during the black-and-white printing, resulting in a shorter replacement cycle for the drum unit.
- When the machine prints a black-and-white print job followed by a full-color job, it will always switch to full-color mode, as color printing is impossible in black-and-white mode.

Fuses

Blown Fuse Conditions

AC Fuses

AC drive board

Fuse	Rating	Symptom at Power On
	200V - 240V	
FU101	10A	The machine stops during warming-up and SC547 is issued.
FU102	10A	The machine stops during warming-up and SC547 is issued.

PSU 2 AZ240166 200V

Fuse	Rating	Symptom at Power On
	200V - 240V	
FU101	8A	The machine stops during warming-up and SC547 is issued.

6

DC Fuses

PSU 2 AZ240166 200V

Fuse	Rating	Symptom at Power On
	200V - 240V	
FU102	6.3A	The machine normal during operation and SC686 or other SC is issued.
FU1	10A	The machine stops during normal operation, and an SC code related to scanner optics, paper transport, or SC686 is issued.
FU2	10A	The machine stops during normal operation, and an SC code related to the paper bank unit of the main machine, paper transport, or SC686 is issued.

Fuse	Rating	Symptom at Power On
	200V - 240V	
FU3	10A	The machine stops during normal operation, and an SC code related to the Decurler Unit, SC520, or SC686 is issued.
FU4	10A	Not Used
FU5	2A	Not Used
FU6	5A	Not Used
FU7	5A	Not Used
FU8	2A	The machine stops and a jam related to the paper transport unit is issued.

PSU 1 AZ250041

6

Fuse	Rating	Symptom at Power On
	200V - 240V	
FUS001	8A	The machine stops and SC670 or "Please Wait" is issued.

Jam Codes

These are lists of jam codes for the main machine and peripheral devices. Please note:

- **Late jam.** The paper has failed to arrive within the prescribed time due to a jam that has occurred upstream of the referenced sensor.
- **Lag jam.** The paper has failed to leave the location of the referenced sensor within the prescribed time due to a jam downstream of the referenced sensor.

Paper Late Jams: Main Machine

Code No..	Meaning
J001	Standby Jam (Initial)
J003	1st Paper Feed Sensor
J004	2nd Paper Feed Sensor
J005	1st Paper Feed Sensor (LCT)
J006	2nd Paper Feed Sensor (LCT)
J007	3rd Paper Feed Sensor (LCT)
J008	4th Paper Feed Sensor (LCT)
J009	1st Transport Sensor
J010	2nd Transport Sensor
J011	1st Transport Sensor (LCT)
J012	2nd Transport Sensor (LCT)
J013	3rd Transport Sensor (LCT)
J014	4th Transport Sensor (LCT)
J015	Vertical Transport Sensor
J016	Bank Exit Sensor (Simplex)
J017	Bank Exit Sensor (Duplex)
J018	Main Relay Sensor 1

Code No..	Meaning
J019	Main Relay Sensor 2
J020	Main Relay Sensor 3
J021	1st Relay Sensor: Lower (LCT)
J022	1st Relay Sensor: Upper (LCT)
J023	2nd Transport Sensor (LCT)
J024	3rd Transport Sensor (LCT)
J025	Exit Sensor (LCT)
J026	Relay Sensor 1 (LCT)
J027	Relay Sensor 2 (LCT)
J028	Registration Sensor (Main)
J029	Registration Sensor (LCT)
J030	Paper Late Jam
J031	Transfer Timing Sensor
J032	Transport Thermistor
J033	Fusing Exit Sensor
J034	Feed-out Entrance Sensor
J035	Exit JG Sensor
J036	Exit Sensor
J037	-
J038	Exit Relay Sensor (2nd Pass)
J039	Exit Relay Sensor (Duplex)
J040	Duplex Invert Sensor (1st Pass)
J041	Duplex Invert Sensor (2nd Pass)
J042	Duplex Transport Sensor 1
J043	Duplex Transport Sensor 2

Code No..	Meaning
J044	Duplex Transport Sensor 3
J045	Duplex Transport Sensor 6
J046	Duplex Transport Sensor 7

Paper Lag Jams: Main Machine

Code No..	Meaning
J053	1st Paper Feed Sensor
J054	2nd Paper Feed Sensor
J055	1st Paper Feed Sensor (LCT)
J056	2nd Paper Feed Sensor (LCT)
J057	3rd Paper Feed Sensor (LCT)
J058	4th Paper Feed Sensor (LCT)
J059	1st Transport Sensor
J060	2nd Transport Sensor
J061	1st Transport Sensor (LCT)
J062	2nd Transport Sensor (LCT)
J063	3rd Transport Sensor (LCT)
J064	4th Transport Sensor (LCT)
J065	Vertical Transport Sensor
J066	Bank Exit Sensor
J067	-
J068	Main Relay Sensor 1
J069	Main Relay Sensor 2
J070	Main Relay Sensor 3

Code No..	Meaning
J071	1st Relay Sensor: Lower (LCT)
J072	1st Relay Sensor: Upper (LCT)
J073	2nd Transport Sensor (LCT)
J074	3rd Transport Sensor (LCT)
J075	Exit Sensor (LCT)
J076	Relay Sensor 1 (LCT)
J077	Relay Sensor 2 (LCT)
J078	Registration Sensor
J080	Sub Scan Registration Correction
J081	Transfer Timing Sensor
J082	Transport Thermistor
J083	Fusing Exit Sensor
J084	Feed-out Entrance Sensor
J085	Exit JG Sensor
J086	Exit Sensor
J087	Exit Relay Sensor (1st Pass)
J089	Exit Relay Sensor (Duplex)
J090	Duplex Invert Sensor (1st Pass)
J091	Duplex Invert Sensor (2nd Pass)
J092	Duplex Transport Sensor 1
J093	Duplex Transport Sensor 2
J094	Duplex Transport Sensor 3
J095	Duplex Transport Sensor 6
J096	Duplex Transport Sensor 7
J097	Over Skew

Code No..	Meaning
J098	Over Shift
J099	Double-Feed

Finisher Jams (D512/D513) Jam Code Table

Code No.	Meaning
J101	Entrance: Late Jam
J102	Entrance: Lag Jam
J103	Proof Tray Exit: Late Jam
J104	Proof Tray Exit: Lag Jam
J105	Proof Tray Exit: Late Jam
J106	Shift Tray Exit: Lag Jam
J107	Stapler Exit: Late Jam
J108	Stapler Exit: Lag Jam
J109	Pre-stack Tray: Late Jam
J110	Pre-Stack Tray: Lag Jam
J111	Output
J112	Booklet Stapler: Late Jam
J113	Booklet Stapler: Lag Jam
J114	Booklet Stapler Exit: Late Jam
J115	Booklet Stapler Exit: Lag Jam
J116	Paper Transport Path
J117	Shift Tray Operation Mechanism
J118	Jogger Operation Mechanism
J119	Shift Tray Drive Mechanism

Code No.	Meaning
J120	Stapler Drive Mechanism
J121	Output Drive Mechanism
J122	Punch Drive Mechanism
J123	Jogger Fences
J124	Pre-stack Drive Mechanism
J125	Stacking Mechanism
J126	Booklet Stapling Mechanism
J127	Booklet Folding Mechanism
J128	For Debugging (Error cause unknown)
J129	Main Machine Data Corrupt

Cover Interposer Tray CI5020 (D518) Jam Code Table

Code No.	Meaning
J150	1st Feed Sensor: Late Jam
J151	1st Feed Sensor: Lag Jam
J152	2nd Feed Sensor: Late Jam
J153	2nd Feed Sensor: Lag Jam
J154	1st Transport Sensor: Late Jam
J155	1st Transport Sensor: Lag Jam
J156	2nd Transport Sensor: Late Jam
J157	2nd Transport Sensor: Lag Jam
J158	1st Tray Transport Sensor: Late Jam
J159	1st Transport Sensor: Lag Error
J160	2nd Tray Transport Sensor: Late Jam

Code No.	Meaning
J161	2nd Transport Sensor: Lag Error
J162	Vertical Exit Sensor: Late Jam
J163	Vertical Exit Sensor: Lag Error
J164	Entrance Sensor: Late Error
J165	Entrance Sensor: Lag Error
J166	Exit Sensor: Late Error
J167	Exit Sensor: Lag Error
J168	1st Lift Motor Drive Mechanism
J169	2nd Lift Motor Drive Mechanism
J170	1st Pick-up Motor Drive Mechanism
J171	2nd Pick-up Motor Drive Mechanism

Trimmer Unit TR5040 (D520) Jam Code Table

Code No.	Meaning
J200	Entrance Sensor: Late Jam
J201	Entrance Sensor: Lag Jam
J202	Skew Sensor: Late Jam
J203	Skew Sensor: Lag Jam
J204	Exit Sensor: Late Jam
J205	Exit Sensor: Lag Jam
J206	Trimming Blade Motor Lock
J207	Cut Position Motor
J208	Press Roller
J209	Press/Stopper Roller

Code No.	Meaning
J210	Tray Motor

Multi Folding Unit FD5010 (D521) Jam Code Table

Code No.	Meaning
J250	Entrance Sensor: Late Jam
J251	Entrance Sensor: Lag Jam
J252	Top Tray Exit: Lag Jam
J253	Top Tray Exit: Lag Jam
J254	Horizontal Path Exit: Late Jam
J255	Horizontal Path Exit: Lag Jam
J256	1st Stopper: Late Jam
J257	1st Stopper: Lag Jam
J258	2nd Stopper: Late Jam
J259	2nd Stopper: Lag Jam
J260	3rd Stopper: Late Jam
J261	3rd Stopper: Lag Jam
J262	Skew Correction Jam
J263	Top Tray Path Jam
J264	Entrance/Top Tray JG Motor Jam
J265	Entrance/Fold JG Motor Jam
J266	1st Stopper Motor Jam
J267	2nd Stopper Motor Jam
J268	3rd Stopper Motor Jam
J269	Dynamic Roller Lift Motor Jam

Code No.	Meaning
J270	Registration Roller Release Motor Jam
J271	Fold Blade Drive Motor Jam
J272	Jogger Fence Motor Jam
J273	Positioning Roller Motor Jam
J274	FM2 Direct Send Motor Error
J275	FM6 Pawl Motor
J276	Main Machine Data Corrupt

High Capacity Stacker SK5020 (D515) Jam Code Table

Code No..	Meaning
J300	Entrance: Late Jam
J301	Entrance: Lag Jam
J302	Proof Tray Exit: Late Jam
J303	Proof Tray Exit: Lag Jam
J304	Stack Tray Exit: Late Jam
J305	Stack Tray Exit: Lag Jam
J306	Relay Path: Late Jam
J307	Relay Path: Lag Jam
J308	Straight-through Paper Path Exit: Late Error
J309	Straight-through Paper Path Exit: Lag Jam
J310	Shift JG Motor
J311	Proof Tray JG Motor
J312	Shift Motor
J313	Front Jogger Fence Motor

Code No..	Meaning
J314	Rear Jogger Fence Motor
J315	Main Jogger Fence Retraction Motor
J316	Main Jogger Rear Fence Retraction Motor
J317	Sub Jogger Motor
J318	LE Stopper Motor
J319	Tray Lift Motor
J320	Main Machine Data Corrupt

Ring Binder RB5010 (D519) Jam Code Table

Code No..	Meaning
J350	Entrance: Late Jam
J351	Entrance: Lag Jam
J352	Central Transport Path: Late Jam
J353	Central Transport Path: Lag Jam
J354	Transport Exit: Late Jam
J355	Transport Exit: Lag Jam
J356	Before Pre-punch Unit Jam
J357	After Pre-punch Unit Jam
J358	Binder Unit TE Jam
J359	Binder Unit LE Jam
J360	Ring Jam: Wrong Ring Type
J361	Binder Unit Jam
J362	Output Belt 1 Jam
J363	Output Belt 2 Jam

Code No..	Meaning
J364	Stacker Jam
J365	Punch Motor Jam
J366	Shutter Motor Jam
J367	Alignment Pin Motor Jam
J368	Pre-Punch Jogger Jam
J369	Alignment Pin Jam
J370	Clamp Motor Jam
J371	50/100 Clamp Adjust Motor Jam
J372	Output Belt Rotation Motor Jam
J373	Main Machine Data Corrupt

Buffer Pass Unit Type (5010 D548) Jam Code Table

Code No..	Meaning
J400	Transport Sensor 1: Late Jam
J401	Transport Sensor 1: Lag Jam
J402	Transport Sensor 2: Late Jam
J403	Transport Sensor 2: Lag Jam
J404	Transport Sensor 3: Late Jam
J405	Transport Sensor 3: Lag Jam
J406	Transport Sensor 4: Late Jam
J407	Transport Sensor 4: Lag Jam
J408	Transport Sensor 5: Late Jam
J409	Transport Sensor 5: Lag Jam
J410	Transport Sensor 6: Late Jam

Code No..	Meaning
J411	Transport Sensor 6: Lag Jam
J412	Transport Sensor 7: Late Jam
J413	Transport Sensor 7: Lag Jam
J414	Transport Sensor 8: Late Jam
J415	Transport Sensor 8: Lag Jam
J416	Main Machine Data Corrupt
J500	Finisher No-Response Error After Exit

ARDF Jam Code Table

Code No..	Meaning
000	Jam Release
001	Standby Jam (Initial)
002	Reserved
003 to 007	Paper Late Jams: Main Machine
003	Separation Sensor
004	Skew Correction Sensor
005	Interval Sensor
006	Registration Sensor
007	Exit Sensor
008	Invert/Switchback Sensor
009	Lower Invert Sensor
053 to 057	Paper Lag Jams: Main Machine
053	Separation Sensor
054	Skew Correction Sensor

Code No..	Meaning
055	Interval Sensor
056	Registration Sensor
057	Exit Sensor
058	Invert/Switchback Sensor
059	Lower Invert Sensor

D074/D075, M044 Jam Displays

Code No.,	Meaning
A	1st Paper Feed Sensor
A	2nd Paper Feed Sensor
A	1st Transport Sensor
A	2nd Transport Sensor
A	Vertical Transport Sensor
A	Bank Exit Sensor
A	Main Relay Sensor 1
B	Main Relay Sensor 3
B	Relay Sensor 1 (LCT)
B	Relay Sensor 2 (LCT)
B	Registration Sensor
B1	Main Relay Sensor 2
B6	Transfer Timing Sensor
C	Transport Thermistor
D2/D3	Fusing Exit Sensor
D2/D3	Feed-out Entrance Sensor

Code No.,	Meaning
D4	Exit JG Sensor
D4	Exit Sensor
D5	Paper Exit Relay Sensor
D5,E	Duplex Invert Sensor
E	Purge Relay Sensor
E	Purged Paper Sensor
U	1st Transport Sensor (LCT)
U	2nd Transport Sensor (LCT)
U	3rd Transport Sensor (LCT)
U	1st Relay Sensor: Lower (LCT)
U	1st Relay Sensor: Upper (LCT)
U	2nd Transport Sensor (LCT)
U	3rd Transport Sensor (LCT)
U	Exit Sensor (LCT)
U,V	4th Transport Sensor (LCT)
U2	1st Paper Feed Sensor (LCT)
U4	2nd Paper Feed Sensor (LCT)
U6	3rd Paper Feed Sensor (LCT)
V	4th Paper Feed Sensor (LCT)
Z3	Duplex Transport Sensor 1
Z3	Duplex Transport Sensor 2
Z3	Duplex Transport Sensor 3
Z4	Duplex Transport Sensor 6
Z4	Duplex Transport Sensor 7

Code No.,	Meaning
Kc1 to 9	Transport Sensor 1: Late Jam
Kc1 to 9	Transport Sensor 1: Lag Jam
Kc1 to 9	Transport Sensor 2: Late Jam
Kc1 to 9	Transport Sensor 2: Lag Jam
Kc1 to 9	Transport Sensor 3: Late Jam
Kc1 to 9	Transport Sensor 3: Lag Jam
Kc1 to 9	Transport Sensor 4: Late Jam
Kc1 to 9	Transport Sensor 4: Lag Jam
Kc1 to 9	Transport Sensor 5: Late Jam
Kc1 to 9	Transport Sensor 5: Lag Jam
Kc1 to 9	Transport Sensor 6: Late Jam
Kc1 to 9	Transport Sensor 6: Lag Jam
Kc1 to 9	Transport Sensor 7: Late Jam
Kc1 to 9	Transport Sensor 7: Lag Jam
Kc1 to 9	Transport Sensor 8: Late Jam
Kc1 to 9	Transport Sensor 8: Lag Jam
Kc1 to 9	Main Machine Data Corrupt
L1 to 5	Entrance: Late Jam
L1 to 5	Entrance: Lag Jam
L1 to 5	Proof Tray Exit: Late Jam
L1 to 5	Proof Tray Exit: Lag Jam
L1 to 5	Relay Path: Late Jam
L1 to 5	Relay Path: Lag Jam
L1 to 5	Straight-through Paper Path Exit: Late Error
L1 to 5	Straight-through Paper Path Exit: Lag Jam

Code No.,	Meaning
L6	Stack Tray Exit: Late Jam
L6	Stack Tray Exit: Lag Jam
L6	Shift JG Motor
L6	Proof Tray JG Motor
L6	Shift Motor
L6	Front Jogger Fence Motor
L6	Rear Jogger Fence Motor
L6	Main Jogger Fence Retraction Motor
L6	Main Jogger Rear Fence Retraction Motor
L6	Sub Jogger Motor
L6	LE Stopper Motor
L6	Tray Lift Motor
L6	Main Machine Data Corrupt
Mc1 to 2	Entrance: Late Jam
Mc1 to 2	Entrance: Lag Jam
Mc1 to 2	Main Machine Data Corrupt
Mc10	Stacker Jam
Mc3 to 4	Central Transport Path: Late Jam
Mc3 to 4	Central Transport Path: Lag Jam
Mc3 to 4	Transport Exit: Late Jam
Mc3 to 4	Transport Exit: Lag Jam
Mc5	Before Pre-punch Unit Jam
Mc5	Punch Motor Jam
Mc5 to 6	Binder Unit TE Jam
Mc6	After Pre-punch Unit Jam

Code No.,	Meaning
Mc7 to 8	Binder Unit LE Jam
Mc7 to 8	Ring Jam: Wrong Ring Type
Mc7 to 8	Binder Unit Jam
Mc7 to 8	Shutter Motor Jam
Mc7 to 8	Alignment Pin Motor Jam
Mc7 to 8	Pre-Punch Jogger Jam
Mc7 to 8	Alignment Pin Jam
Mc7 to 8	Clamp Motor Jam
Mc7 to 8	50/100 Clamp Adjust Motor Jam
Mc9	Output Belt 1 Jam
Mc9	Output Belt 2 Jam
Mc9	Output Belt Rotation Motor Jam
N1 to 5	Entrance Sensor: Late Jam
N1 to 5	Entrance Sensor: Lag Jam
N1 to 5	Top Tray Exit: Lag Jam
N1 to 5	Top Tray Exit: Lag Jam
N1 to 5	Horizontal Path Exit: Late Jam
N1 to 5	Horizontal Path Exit: Lag Jam
N1 to 5	Top Tray Path Jam
N1 to 5	Entrance/Top Tray JG Motor Jam
N1 to 5	Entrance/Fold JG Motor Jam
N1 to 5	Main Machine Data Corrupt
N6 to 22	1st Stopper: Late Jam
N6 to 22	1st Stopper: Lage Jam
N6 to 22	2nd Stopper: Late Jam

Code No.,	Meaning
N6 to 22	2nd Stopper: Lag Jam
N6 to 22	3rd Stopper: Late Jam
N6 to 22	3rd Stopper: Lag Jam
N6 to 22	Skew Correction Jam
N6 to 22	1st Stopper Motor Jam
N6 to 22	2nd Stopper Motor Jam
N6 to 22	3rd Stopper Motor Jam
N6 to 22	Dynamic Roller Lift Motor Jam
N6 to 22	Registration Roller Release Motor Jam
N6 to 22	Fold Plate Motor Jam
N6 to 22	Jogger Fence Motor Jam
N6 to 22	Positioning Roller Motor Jam
N6 to 22	FM2 Direct Send Motor Error
N6 to 22	FM6 Pawl Motor
Q1	1st Feed Sensor: Late Jam
Q1	1st Feed Sensor: Lag Jam
Q1	1st Lift Motor Drive Mechanism
Q1	1st Pick-up Motor Drive Mechanism
Q2	2nd Feed Sensor: Late Jam
Q2	2nd Feed Sensor: Lag Jam
Q2	2nd Lift Motor Drive Mechanism
Q2	2nd Pick-up Motor Drive Mechanism
Q3 to 4	1st Transport Sensor: Late Jam
Q3 to 4	1st Transport Sensor: Lag Jam
Q3 to 4	2nd Transport Sensor: Late Jam

Code No.,	Meaning
Q3 to 4	2nd Transport Sensor: Lag Jam
Q3 to 4	1st Tray Transport Sensor: Late Jam
Q3 to 4	1st Transport Sensor: Lag Error
Q3 to 4	2nd Tray Transport Sensor: Late Jam
Q3 to 4	2nd Transport Sensor: Lag Error
Q3 to 4	Vertical Exit Sensor: Late Jam
Q3 to 4	Vertical Exit Sensor: Lag Error
Q3 to 4	Entrance Sensor: Late Error
Q3 to 4	Entrance Sensor: Lag Error
Q3 to 4	Exit Sensor: Late Error
Q3 to 4	Exit Sensor: Lag Error
Rb1 to 5	Entrance: Late Jam
Rb1 to 5	Entrance: Lag Jam
Rb1 to 5	Proof Tray Exit: Late Jam
Rb1 to 5	Proof Tray Exit: Lag Jam
Rb1 to 5	Shift Tray Exit: Late Jam
Rb1 to 5	Shift Tray Exit: Lag Jam
Rb1 to 5	Paper Transport Path
Rb1 to 5	Shift Tray Operation Mechanism
Rb1 to 5	Shift Tray Drive Mechanism
Rb1 to 5	Punch Drive Mechanism
Rb1 to 5	For Debugging (Error cause unknown)
Rb1 to 5	Main Machine Data Corrupt
Rb10 to 17	Stapler Exit: Lag Jam
Rb10 to 17	Output

Code No.,	Meaning
Rb10 to 17	Booklet Stapler: Late Jam
Rb10 to 17	Booklet Stapler: Lag Jam
Rb10 to 17	Booklet Stapler Exit: Late Jam
Rb10 to 17	Booklet Stapler Exit: Lag Jam
Rb10 to 17	Jogger Operation Mechanism
Rb10 to 17	Stapler Drive Mechanism
Rb10 to 17	Output Drive Mechanism
Rb10 to 17	Jogger Fences
Rb10 to 17	Stacking Mechanism
Rb10 to 17	Booklet Stapling Mechanism
Rb10 to 17	Booklet Folding Mechanism
Rb6 to 9	Stapler Exit: Late Jam
Rb6 to 9	Pre-stack Tray: Late Jam
Rb6 to 9	Pre-Stack Tray: Lag Jam
Rb6 to 9	Pre-stack Drive Mechanism
Rt1 to 2	Entrance Sensor: Late Jam
Rt1 to 2	Entrance Sensor: Lag Jam
Rt1 to 2	Skew Sensor: Late Jam
Rt1 to 2	Skew Sensor: Lag Jam
Rt1 to 2	Exit Sensor: Late Jam
Rt1 to 2	Exit Sensor: Lag Jam
Rt1 to 2	Trimming Blade Motor Lock
Rt1 to 2	Cut Position Motor
Rt1 to 2	Press Roller
Rt1 to 2	Press/Stopper Roller

Code No.,	Meaning
Rt1 to 2	Tray Motor

MEMO

**Pro C651EX/Pro C751EX/Pro C751
Machine Code: D074/D075/M044**

Appendices

August 2011

TABLE OF CONTENTS

1. Appendix: Specifications

Main Specifications.....	3
General Specifications: Copier and Printer.....	3
Weight Distribution.....	7
Copy Specifications.....	8
Scanner Specifications (D074/D075).....	10
Local Storage Specifications.....	13
Main Unit.....	13
System Function Specifications.....	15
ARDF.....	23
Main Machine Options.....	24
Peripheral Specifications.....	25
LCIT RT5060 (D516).....	25
Multi-Bypass Tray BY5010 (D517).....	26
Decurler Unit DU5000 Unit (D544).....	27
Multi-Folding Unit FD5010 (D521).....	28
Booklet Finisher SR5040/5030 (D512/D513).....	35

2. Appendix: Service Program Mode Tables

Group 1000.....	41
Group 2000.....	77
Group 3000.....	136
Group 4000.....	166
Group 5000.....	180
Group 6000.....	293
Group 7000.....	335
Group 8000.....	373



1. Appendix: Specifications

Main Specifications

General Specifications: Copier and Printer

Configuration	Console
Image Writing System	Laser
Color Copy Process	4-drum dry, electrostatic transfer with transfer belt
Engine Speed	Calculated for A4/LT LEF (uncoated). See below.

Machine	Thickness	Range (g/m ²)	ppm	
			B/W	FC
D074	Thick 1	52.3 to 63.0	65	65
	Thick 2	63.1 to 80.0	65	65
	Thick 3	80.1 to 105.0	65	65
	Thick 4	105.1 to 163.0	65	65
	Thick 5	163.1 to 220.0	65	65
	Thick 6	220.1 to 256.0	45	45
	Thick 7	256.1 to 300.0	45	45
D075/M044	Thick 1	52.3 to 63.0	75	75
	Thick 2	63.1 to 80.0	75	75
	Thick 3	80.1 to 105.0	75	75
	Thick 4	105.1 to 163.0	75	75
	Thick 5	163.1 to 220.0	75	75
	Thick 6	220.1 to 256.0	52	52
	Thick 7	256.1 to 300.0	52	52

First Print	B/W	Less than 11 sec. (A4/LT LEF)	
	FC	Less than 11 sec. (A4/LT LEF)	
Resolution	Reading	600 dpi	
	Writing	1200 x 4800 dpi (Main Scan x Sub Scan)	
Gradation	Reading	256 Steps	
	Writing	1200 dpi/2bit (Copy Printing) 1200 dpi/2-bit, 600 dpi/4-bit (Print Jobs)	
Warm-up Time	Less than 300 sec.		
Max. Printable Area (W x L)	323 x 480 mm (12.7 x 18.9 in.)		
Paper Capacity (80 g/m ²)	Feed Station	Sheets/Tray	Total
	Main 1st Tray	1000 + 1000	2000
	Main 2nd Tray	500	500
	LCIT 1st Tray	1000	1000
	LCIT 2nd Tray	2000	2000
	LCIT 3rd Tray	1000	1000
	Bypass (on LCIT)	500	500
		Total (80 g/m²)	7,000
Paper	Refer to "Paper Type, Size, Thickness Table" below.		

Paper Thickness/Type	Thickness	Type
Main 1st Tray	52.3 – 300 g/m ² 14 lb. Bond – 110 lb. Cover	Normal, Recycled, Used, Letterhead, Punched
Main 2nd Tray	52.3 – 256 g/m ² 14 lb. Bond – 95 lb. Cover	Normal, Recycled, Used, Letterhead, Punched, Index
LCIT 1st Tray	52.3 – 256 g/m ² 14 lb. Bond – 95 lb. Cover	Normal, Recycled, Used, Letterhead, Punched, Gloss, Matte, Index, OHP, Trace, Envelopes

LCIT 2nd Tray	52.3 – 300 g/m ² 14 lb. Bond – 110 lb. Cover	Normal, Recycled, Used, Letterhead, Punched, Gloss, Matte, Labels, Index, OHP, Trace, Envelopes
LCIT 3rd Tray	52.3 – 256 g/m ² 14 lb. Bond – 95 lb. Cover	Normal, Recycled, Used, Letterhead, Punched, Gloss, Matte, Index, OHP, Trace, Envelopes
Bypass	52.3 – 216 g/m ² 14 lb. Bond – 81 lb. Cover	Normal, Recycled, Used, Letterhead, Punched, Index, OHP, Trace
Main (Duplex)	60 – 256 g/m ² 16 lb. Bond – 95 lb. Cover	

Paper Size		
Main 1st Tray (Tandem)	A4 LEF, LT LEF (Fixed)	
Main 1st Tray (Tandem – A3 Kit)	Std.	A3 SEF, B4 SEF, A4 SEF/LEF, DLT SEF, LG SEF, LT SEF/LEF
	Custom	Min.: 210 x 210mm Max.: 305 x 439mm
Main 2nd Tray	Std.	13"x 18" SEF; SRA3 SEF, 12 x 18" SEF, SRA4 SEF/LEF; A3 SEF, A4 SEF/LEF, A5 SEF/LEF, B4 SEF, B5 SEF/LEF; DLT SEF, LG SEF, 8.5"x13" SEF, LT SEF/LEF, 8.25 x 14" SEF, 8.25 x 13" SEF, 8 x 13" SEF, Executive SEF/LEF, HLT SEF/LEF, Line Slider 1 LEF, Line Slider 2 SEF; 8-Kai SEF, 16-Kai SEF/LEF; 11"x15" SEF, 11"x14" SEF, 10"x15" SEF
	Custom	Width: 139.7 to 330.2mm Length: 139.7 to 487.7 mm

LCIT	Std.	13"x19.2" SEF, 13"x19"SEF, 12.6"x19.2"SEF, 12.6"x18.5" SEF, 13"x 18" SEF, SRA3 SEF, 12"x18" SEF, SRA4 SEF/LEF A3 SEF, A4 SEF/LEF, A5 SEF/LEF, A6 SEF, B4 SEF, B5 SEF/LEF, B6 SEF DLT SEF, LG SEF, 8.5"x13" SEF, LT SEF/LEF, 8.25"x14" SEF, 8.25"x 13" SEF, 8" x 13" SEF, 8"x10.5" LT SEF/LEF, 8"x10" SEF/LEF, Executive SEF/LEF, HLT SEF/LEF, Line Slider 1 SEF/LEF, Line Slider 2 SEF 8-Kai SEF, 16-Kai SEF/LEF, 11"x15" SEF, 11"x14" SEF, 10"x"15" SEF, 10x 14" SEF
	Custom	Width: 100 to 330.2mm Length: 139.7 to 487.7mm
Bypass (on LCIT)	Std.	Same as LCIT
	Custom	Width: 100 to 330.2mm Length: 139.7 to 630mm
Duplex Paper Sizes	A5 SEF, HLT SEF to 13"x19.2"	
Paper Size Adjustment		
Main 1st Tray (Tandem)	Fixed (A4 LEF or LT LEF)	
Main 2nd Tray	Universal Tray	
LCIT	Universal Tray	
Bypass (on LCIT)	Universal Tray	
Paper Output Capacity		
Finisher D512 (Booklet-Stapler)	Shift Tray	2500 Sheets
	Proof Tray	250 Sheets
Finisher D513 (Corner Stapler)	Shift Tray	3000 Sheets
	Proof Tray	250 Sheets
High Capacity Stacker (D515)	Stacker	5000 Sheets

	Proof Tray	250 Sheets
Ring Binder (D519)	11 Booklets (100 pages each)	
Multi Folding Unit (D521)	Varies with folding method	
Trimmer Unit (D520)	25 Booklets (A3/DLT 20 pages each)	
Power Source	North America	208V to 240V, 16A, 50/60 Hz
	Europe/Asia	220 to 240V 16A, 50/60 Hz
Power Consumption (Max.)	Less than 4000W	
Energy Star	Compliant	
Sleep Mode	Less than 30W	
Memory		
D074/D075	2.5 GB (2 GB + 512 MB)	
M044	1.5 GB (1 GB + 512 MB)	
HDD	320 GB	
Dimensions		
D074/D075	1320 x 910 x 1230 mm (52 x 35.8 x 48.4 in.) *1	
M044	1320 x 910 x 1218 mm (52 x 35.8 x 47.9 in.) *1	
Weight		
D074/D075	Less than 580 kg (1,276 lb.)	
M044	Less than 550 kg (1,210 lb.)	

*1: The rear boxes can be removed. With the controller box and cooling box removed, the main body will fit through a space (narrow door or elevator door) about 750 mm (30 in.) wide.

Weight Distribution

The main machine is heavy. Apply these numbers as reference points because the distribution of weight will differ, depending on how the machine is leveled at the four corners (a, b, c, d) in the illustration below.

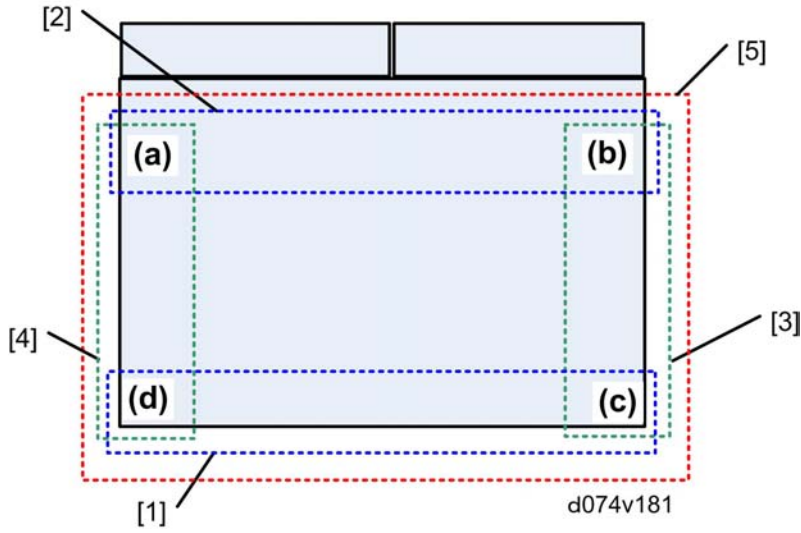

Location	Weight (kg)
a: Rear Left	144.3
b: Rear Right	155.0
c: Front Right	134.7
d: Front Left	127.2

No.	Location	Weight (kg)
1	d+c	261.9
2	a+b	299.3
3	b+c	289.7
4	a+d	271.5
5	a+b+c+d	561.2

Copy Specifications

Original Scan Method	Horizontal flatbed, ADF
Original Orientation	Left rear corner

Original Size (Max.)	12" x 17"			
Maximum Weight (Exposure Glass)	5 kg (2.3 lb.)			
Original Scales	Left Scale	EU/AP		NA
		SEF	LEF	Inch
		A3	A4	11
		B4	B5	10
		A4	A5	8.5
		B5	---	8
		A5	---	5.5
	Rear Scale	EU/AP		NA
		SEF	LEF	Inch
		A3	A4	17
		B4	B5	14
		---	---	11
		A4	A5	10
		B5	---	8.5
		A5	---	8
		---	---	5.5
Original Type	Book, Sheet, Object			
Paper Size Detection				
Main	12 x 18" SEF, A3 SEF, B4 SEF, A4 SEF/LEF, A5 SEF/LEF, DLT SEF, LT SEF/LEF, F (8 x 13")SEF, HLT SEF/LEF, B5 SEF/LEF			
LCIT	12 x 18" SEF, A3 SEF, B4 SEF, A4 SEF/LEF, A5 SEF/LEF, DLT SEF, LT SEF/LEF, F (8 x 13")SEF, HLT SEF/LEF, B5 SEF/LEF			

Bypass (on LCIT)	12 x 18" SEF, A3 SEF, B4 SEF, A4 SEF/LEF, A5 SEF/LEF, DLT SEF, LT SEF/LEF, F (8 x 13")SEF, HLT SEF/LEF, B5 SEF/LEF	
Paper Counter	1 to 9999 Sheets	
Enlarge/Reduction Rates		
NA	Enlarge	1 : 1, 1.21, 1.29, 1.55, 2.00, 4.00
	Reduce	1 : 0.93, 0.85, 0.78, 0.73, 0.65, 0.50, 0.25
EU/AP	Enlarge	1 : 1, 1.15, 1.22, 1.41, 2.00, 4.00
	Reduce	1 : 0.93, 0.82, 0.75, 0.71, 0.65, 0.50, 0.25
Zoom Rate	25% to 40% (1% steps)	

Scanner Specifications (D074/D075)

General

Scanning Method	Flatbed	
Scan Direction	Main Scan Surface	
Scan Range	Same as copy specification	
Gradation	256 Levels	
Compatible Interfaces	Ethernet (100Bases-TX/10Base-T), USB 2.0 Type A, SD Memory Card Slot	
RAM	2.5GB	
Magnification Range	Copy	600 dpi 25 – 400%
	Scan-to-file	100 – 600 dpi 600 – 1200 dpi
Scanning Color Modes	B/W, FC, Auto Color selectable	
Multiple Output	B/W	1-bit/8-bit

	FC	RGB for each color (sRGB)
Max. Area	Main Scan	297 mm (11.7 in.)
	Sub Scan	432 mm (17 in.)
Drop-out Color	Supported (Selectable)	

TWAIN

Scan Area	Main Scan (Width)	297 mm (11.7 in.)
	Sub Scan (Length)	432 mm (17 in.)
Resolution	Main: 600 dpi (100 – 1200 dpi/1 dpi specified)	
Supported Interfaces	Ethernet (100Base-TX/10Base-T)	
Drivers	Network TWAIN, WIA	
Image Memory Area	Not provided	
TWAIN Compatible OS	Windows 2000, Windows XP, Windows Server 2003, Windows Vista, Windows Server 2008, Windows 7	
TWAIN First Read Function	Supported	

Scan-to-Document

Scan Area	Main Scan (Width)	297 mm (11.7 in.)
	Sub Scan (Length)	432 mm (17 in.)
Resolution	600 dpi (Base), 400, 300, 200, 150 dpi	
Supported Interfaces	Ethernet (100Base-TX/10Base-T)	
ADF Throughput	B/W	More than 75 sheets/min. at 200 dpi (A4 LEF with MH Compression)
	FC	More than 75 sheets/min. at 200 dpi (A4 LEF with JPEG compression)

Performance	B/W	More than 77 sheets/min. at 200 dpi (A4 LEF with MH Compression)
	FC	More than 77 sheets/min. at 200 dpi (A4 LEF with JPEG compression)
Mixed Original	Supported	
Scan-to-PC	SMB, FTP, NCP Sending	
Scan-to-Email	POP before SMTP/SMTP with Authentication, S/MIME	
Distribution Addresses	2000 (LDAP compatible)	
Mail Protocol	POP, SMTP, IMAP4	
Blank Original Detection	Supported	

EFI Fiery Scanner

Scan Area	Main Scan (Width)	297 mm (11.7 in.)
	Sub Scan (Length)	432 mm (17 in.)
Resolution	600 dpi	
Grayscale	B/W: 1-bit/8-bit Selectable	
ADF Throughput	B/W	More than 75 sheets/min. at 200 dpi (1-bit A4 LEF, MH Compression)
	FC	More than 75 sheets/min. at 200 dpi (24-bit A4 LEF JPEG Compression)
Interfaces	10/100/Gigabit Ethernet	
File Formats	TIFF (Multi/Single), JPEG, PDF (Multi/Single)	
Scanning Adjustment	Supported	
Brightness Adjustment	Supported	
Original Type	Selectable	
Scan Operation	From MFP operation panel	
TWAIN Driver	Network TWAIN, EFI supported drivers	

Supported Functions	Scan-to-EFI Controller HDD, Scan-to-Email, Scan-to-Mailbox, Scan-to-Hold Queue, Scan-to-FTP, Scan-to-PC (SMB)
Blank Original Detection	Supported

Local Storage Specifications

Documents	Scanned Original Data, Print Data, Copy Data, Document Backup for Each Type
Document Handling	Paper Output (Includes Test Output, Password Output, File Merge Output), Client PC Sending
Interfaces	10/100/Gigabit Ethernet
Storage Capacity	15000 Pages or 3000 Documents (Copy Application Only) Note: <ul style="list-style-type: none"> Storage capacity can be adjusted with and SP code setting to released unused areas on the HDD. Document size is limited to 5000 pages for the Copy application and 3000 pages for other applications.

Main Unit

Engine

Configuration	Console Type with Dry Toner Fusing
Exposure	3-Line CCD Elements, 4 Lens Groups, Xenon Lamp and Reflection Plate, 600 dpi
Image Writing	Laser Raster System, 1200 x 4800 dpi, PWM, 1/48 dot
Drive System	
Drum	Traction Motor + Serration Linkage
Development	Gear and Belt Reduction + Tribol and Coupling Linkage
Drum Cleaning	Gear & Belt Reduction + Coupling Linkage

Image Transfer	Large Aperture Gear Reduction
Paper Transfer/ITB Cleaning	Reduction Gear + Coupling
Fusing	Reduction Gear + Coupling
Paper Exit	Reduction Gear + Coupling
Used Toner Collection	Gear and Belt Reduction + Coupling
Quenching Around Drums	
Method	4 Drums (YCMK)
Quenching Method	NC Roller
Drum Drive	Traction Reduction Motor + Perforated Shaft
Drums	60 mm dia.
Drum Cleaning Method	Counter-Blade
Assist Functions	Dry Drum Lubrication, Quenching Assist with PCL (Photoconductor Lamp)
Development	Circulating Dry Toner
Transfer & Separation	
Image Transfer	Belt Transfer System with Roller-Driven ITB
Paper Transfer	PTR Bias Transfer (Image from ITB to Paper)
Paper Separation Method	AC Charge
Paper Transport	Belt Assisted by Suction Fans
ITB Cleaning	Counter-Blade, Lubricant Brush Roller (Zinc Stearate Lubricant)
PTR Cleaning	Counter-Blade, Lubricant Brush Roller (Zinc Stearate Lubricant)
Paper Feed, Transport, Exit	
Feed and Separation	FRR System
1st Tray	Tandem (Fixed Size)
2nd Tray	Universal Tray
Paper Registration System	

Main Scan	Paper shift based on CIS readings
Sub Scan	Registration roller buckle adjustment with registration gate, transfer timing roller speed timing adjustment
Invert/Duplex	
Duplexing Method	Interleave
Cooling System	Heat Sink Roller
Fusing	
Fusing Method	Dry Belt (Oil-less)
Temperature Control	Non-contact Sensors, Contact Thermistors
Cleaning Method	Cleaning Web
Fusing Unit Configuration	Fusing/Exit Unit, Removable
Toner Supply	Dry Toner Pump + Sub Hopper Augur
Operation Panel	LCD with Touch Panel
Engine Control	Dual CPU
Process Control	Potential Sensors, ID Sensors, TD Sensors

System Function Specifications

Printer/Scanner

Paper Capacity Detection	
1st Tray	5-Step (including Near-End)
2nd Tray	5-Step (including Near-End)
LCIT Trays (1, 2, 3)	5-Step (including Near-End)
Bypass (on LCIT)	4-Step (including Near-End)
Limitless Paper Supply	Supported
Tray Overflow Detection	All Trays

Duplexing	
Paper Size	A5 SEF/HLT SEF to 13"x19.2"
Paper Weight	60.0 to 256 g/m ² (16 lb. Bond to 95 lb. Cover)
Paper Type	Normal, Recycled, Coated Paper
Double-Feed Detection	Provided
Stapling (Finisher D512/D513)	
Stack Thickness	2 to 100 Sheets
Paper Size	B5 to A3/DLT
Paper Thickness	64 to 90 g/m ² (2 to 100 Sheets)
Paper Type	Normal, Recycled, Coated,
Staple Positions (D512)	Corner Stapling: Rear, Rear Diagonal, Front Flat Staples: 2 Locations Booklet Staples: 2 Locations
Staple Positions (D513)	Corner Stapling: Rear, Rear Diagonal, Front Flat Stapling: 2 Locations Note: Finisher D513 does not support booklet stapling.
Staple Out Detection	Yes
Paper Thickness Settings (g/m ²)	Thick 1 52.3 to 63.0
	Thick 2 63.1 to 80.0
	Thick 3 80.1 to 105.0
	Thick 4 105.1 to 163.0
	Thick 5 163.1 to 220.0
	Thick 6 220.1 to 256.0
	Thick 7 256.1 to 300.0
	Note: Only Thick 1, 4, 5 are available for the Bypass Unit (on top of the LCIT). One can be selected with a key on the Bypass Unit.

Paper Remaining Display	Yes
Original on Exposure Glass Alert	Yes
User Code Settings	500 for registration (8 alphanumeric characters)
Energy Save	
Auto Energy Save Mode	Yes
Auto Power Save	Yes
Auto Off	Yes
Weekly Timer	Yes
Counter	Electronic Counter, Mechanical Counter
Anti-Condensation Heaters	<ul style="list-style-type: none"> • Scanner Unit (Service Option) • Transfer Unit (Switch) • Paper Bank (Switch)
@Remote Function	Supported (Basil, Cumin-N, UZ-A1)
GW SDK	Applications Available
ID Chip for Parts	Toner Bottle, Fusing Unit
Utilities	<ul style="list-style-type: none"> • Windsor • Acacia • @Remote • Email Detection for TX/RX

Copying

ACS (Auto Color Selection)	Provided
Full Color Mode	Yes
Black & White Mode	Yes
Single Color Mode	Main machine colors: 12 Colors + B&W Registered colors: 15 (displayed in SP mode only)

2-Color Mode	Black + Mono Colors Note: Display switch with SP code.		
ADF Originals	Mixed Sizes Allowed		
	Thin Paper Not Allowed		
	Allows Single/Double-Sided Originals in same Batch		
	B/W, Color in Same Stack Allowed		
	Blank Originals Not Detected		
	Non-Standard Original Sizes Allowed		
	APS Detection		
	Copy Modes (Selectable)	Text	
Photo			
Generation			
Pale			
Map			
Highlight Pen			
Inkjet Output			
Density			
Enlarge/Reduction Rates			
		NA	Enlarge
		Reduce	1 : 0.93, 0.85, 0.78, 0.73, 0.65, 0.50, 0.25
	EU/AP	Enlarge	1 : 1, 1.15, 1.22, 1.41, 2.00, 4.00
	Reduce	1 : 0.93, 0.82, 0.75, 0.71, 0.65, 0.50, 0.25	
Zoom Rate	25% to 400% (1% Steps)		
Stamp	Fixed (Provided)	8 (One Color)	
	User Defined	5 (One Color)	

Finisher (D512/D513)

Paper Punch	
NA	3-Hole, 2-Hole for LG (Switchable)
EU/AP	2-Hole, 4-Hole for Northern Europe (Switchable)
Scandinavia	4-Hole

Multi Folding Unit (D521)

Folds	
FM1: Z-Folding	1 Sheet
FM2: Half Fold	3 Sheets Allowed (64 to 80 g/m ²)
FM3: Letter Fold-out	
FM4: Letter Fold-in	
FM5: Double Parallel Fold	Only 1 sheet allowed
FM6: Gate Fold	

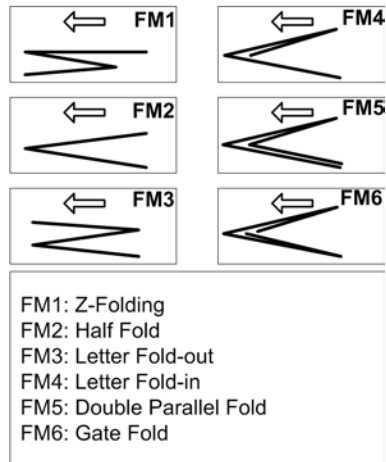

d454v900

Original Size Detection

Paper/Size		NA		EU/AP	
Paper	Size	Book Mode	ADF	Book Mode	ADF
A3 SEF	297x420 mm	X	○	○	○
B4 SEF	257x364 mm	X	X	○	○
A4 SEF	210x297 mm	X	○	○	○
A4 LEF	297x210 mm	X	○	○	○
B5 SEF	182x257 mm	X	X	○	○
B5 LEF	257x182 mm	X	X	○	○
A5 SEF	148x210 mm	X	X	△	○
A5 LEF	210x148 mm	X	X	X	○
B6 SEF	128x182 mm	X	X	X	○
B6 LEF	182x128 mm	X	X	X	○
DLT SEF	11"x17"	○	○○①	X	○○⑤
LG SEF	8.5"x14"	○	○○②	X	X
LT SEF	8.5"x11"	○	○○③	X	○○⑥
LT LEF	11"x8.5"	○	○○④	X	○○⑦
HLT SEF	5.5"x8.5"	X	○	X	X
HLT LEF	8.5"x5.5"	X	○	X	X
F SEF	8"x13"	X	X	▲	▲
Foolscap SEF	8.5"x13"	X	●②	▲	▲
Folio SEF	8.25"x13"	X	X	▲	▲
Folio SEF	11"x15"	X	●①	X	X
Folio SEF	10"x14"	X	○	X	X

Paper/Size		NA		EU/AP	
Paper	Size	Book Mode	ADF	Book Mode	ADF
Folio SEF	10"x8"	X	●③	X	X
8-Kai SEF	267x390 mm	X	X	○	●⑤
16-Kai SEF	195x267 mm	X	X	○	●⑥
16-Kai LEF	267x195 mm	X	X	○	●⑦
US EXE SEF	7.25"x10.5"	X	○	X	X
US EXE LEF	10.5"x7.25W	X	●④	X	X

Key

○ and ●	Sizes can be switched between the two settings where you see matching numbers. The default is ○.
▲	Detected as one size: F SEF 8"x13".
△	For sizes smaller than B5, one of two SP values for SP4303 can be selected: "A5" and "Unknown Document Size". Default: "Unknown Document Size"
X	Size cannot be detected.

Size Detection Switching with SP4303

4303	Min Size for APS
	<p>Sets the minimum size of the original that the will be detected by APS (Auto Paper Select – with original width sensors) of the exposure glass of the flatbed scanner.</p> <p>[0 to 2/1]</p> <p>[*0: Unknown Document Size]</p> <p>[1 A5-Lengthwise (HLT Lengthwise)]</p> <p>[2 A5 Sideways HLT Sideways]</p>

Size Detection Switching with SP4305

Note: For Europe, Asia, and Oceania, original size detection in book mode the "A B" system and SP mode setting are used for the "Kai" sizes.

8-Kai SEF	Switch to A3, B4 SEF
-----------	----------------------

16-Kai SEF	Switch to A4, A5, B5 SEF
16-Kai LEF	Switch to A4, A5, B5 LEF (However, no switching for individual sizes)

4305	8K/16K Detection
	<p>This SP enables the machine to recognize 8K/16K size paper automatically.</p> <p>[*0: Normal]</p> <p>[1: A4-Sideways LT-Lengthways]</p> <p>[2: A4-Lengthwise LT-Sideways]</p> <p>[3: 8KAI, 16 KAI]</p> <ul style="list-style-type: none"> • A3, B4: 8-Kai SEF • A4, B4, A5 SEF: 16-Kai SEF • A4, B4, A5 LEF: 16-Kai LEF

GW Controller

CPU Device	LV Dothan Pentium M 1.4 GHz	
Chip Set	GMCH, ICH6-M	
ASIC	Veena, Whistle	
Main Memory		
	Capacity	2.5 GB
	Configuration	2 GB DIMM + 0.5 GB DIMM
BIOS ROM	1 MB	
NAND Flash Memory	128 MB	
EEPROM	1 KB	
NVRAM	512 KB	
TPM	Trusted Platform Mode	
RTC	Real Time Clock	
SD Card I/F	SD Card Slots 1, 2	

HDD I/F	SATA I/F Connectors x2 HDD Power Connector x1
Network	RJ45 I/F Connector x1, 10Base-T/100Base-TX

ARDF

Original Size	Simplex: A3/11" x 17" – B6/5.5" x 8.5" Duplex: A3/11" x 17" – B5/5.5" x 8.5"
Original Weight	Simplex: 40 to 128 g/m ² (11 to 34 lb.) Duplex: 52 to 128 g/m ² (14 to 34 lb.)
Table Capacity (A4 SEF, LT SEF)	500 sheets: 69g/m ² (150 sheets: 80g/m ² , 20 lb. Bond)
Speed	426.5 mm/s
Original Standard Position	Rear left corner
Separation	Feed belt and separation roller
Original Transport	Roller transport
Original Feed Order	From top original
Reproduction Range	66 to 400%
Power Source	DC 24 V from the main machine
Power Consumption	Less than 65 W
Rated Voltage of Output Connector	Max. DC 24 V
Permissible voltage fluctuation	±10%
Dimensions (w x d x h)	680 x 565 x 180 mm (26.8" x 22.3" x 7.1")
Weight	19.5 kg (43.0 lb.)

Main Machine Options

1

A3/DLT Tray Kit B331 (Option)

Paper Size	A3 SEF, B4 SEF, 11"x17" SEF, 8½"x14" SEF, A4 SEF, A4 LEF, 8½"x11" SEF, 11"x8½" LEF, 305 mm x 439 mm
Paper Weight	52.3 to 300 g/m ²
Tray Capacity	1,000 sheets
Paper Level Detection	5-Step: 100%, 75%, 50%, 25%, End

Peripheral Specifications

LCIT RT5060 (D516)

1

Operating Environment	Ranges of temperature and humidity: Same as main machine.		
Service Life	Expected: 5 Years or 55,000K sheets		
Speed	Paper Feed	550 mm/s	
	Standard	352.8 mm/s	
	70%	246.96 mm/s	
	50%	176.4 mm/s	
Paper Feed System:	Tray 3, 4, 5	FRR-CF	
Air Assist	Air assist fans for separation, all trays		
Tray Capacity:	Tray 3, 5	1,000 sheets (Thickness: 0.11 mm)	
	Tray 4	2,000 sheets (Thickness: 0.11 mm)	
Paper Level Detection:	Tray 3, 5	5 Step: 900, 625, 375, 75, tray end	
	Tray 4	5 Step: 1750, 1250, 750, 75, tray end	
	Accuracy	±30 sheets (Tray 3, 4, 5)	
Bypass Tray (Option)	The Multi-Bypass Tray (B833) can be installed on this LCIT (D516).		
Paper Weight	Tray 3	52.3 to 256 g/m ²	
	Tray 4	52.3 to 300 g/m ²	
	Tray 5	52.3 to 256 g/m ²	
Paper Size	Tray 3,4,5	A5 (LEF) HLT (LEF) to 13 x 19.2 in.	
	Range	Length	139.7 to 487.7 mm
		Width	100 to 330.2 mm
Paper Size Switching	Side fence, end fence adjustment.		
Paper Size Detection	Automatic		

Heater (Option)	Anti-condensation heaters: 36W (18W x 2)				
Size (w x d x h)	865 x 730 x 1218mm (34 x 29 x 48 in.)				
Level	Less than 5 mm deviation at front/back, left/right				
Weight	Less than 180 kg (396 lb.)				
Power Source	DC 24 V \pm 10% (from main machine) AC 200V to 240V (from main machine)				
Power Consumption:	Less than 150 W				
I/F Connection	Serial connection to main frame				
Tab Sheet	Feed possible from all Tray. Requires installation of tab sheet fence.				
	Note: Only A4 LEF, 8½" x 11" LEF tab sheets can be fed.				
Option	The Multi-Bypass Tray (D517)				
Noise Level	Mode	Stand-alone	System		
			A	B	C
	Operation	< 73 dB	< 78 dB	< 80 dB	< 83 dB
	Standby		< 64 dB	< 70 dB	< 78 dB

Multi-Bypass Tray BY5010 (D517)

This option is installed on top of the LCIT (D516).

Operating Environment	Temperature and humidity ranges: Same as main machine.	
Service Life	Expected: 5 Years or 60,000K sheets	
Speed	Paper Feed	550 mm/s
	Standard	352.8 mm/s
	70%	246.96 mm/s
	50%	176.4 mm/s
Paper Feed System	FRR-CF	
Tray Capacity	500 sheets (Paper thickness: 0.11 mm)	

Paper Weight	52.3 to 216 g/m ²				
Paper Size	A5 (LEF) HLT (LEF) to 13 x 19.2 in.				
	Range	Length	139.7 to 630 mm		
		Width	100 to 330.2 mm		
Paper Size Switching	Operator adjustable side fences accommodate different paper sizes				
Paper Size Detection	Automatic (standard sizes only)				
Heater	None				
Paper Level Detection	4-Step: 500, 250, 50, paper end				
	Accuracy	±50 sheets			
Weight	Less than 18 kg (39.6 lb)				
Power Source	24V±10 DC (from main machine)				
Power Consumption	Less than 50 W				
Size (w x d x h)	685 x 561 x 209 mm (27 x 22 x 8.2 in.)				
Tab Sheets	A4 LEF, 8½" x 11" LEF (requires attachment of tab fence)				
Noise Level	Mode	Alone	System		
			A	B	C
	Operation	< 73 dB	< 78 dB	< 80 dB	< 83 dB
	Standby		< 64 dB	< 70 dB	< 78 dB

Decurler Unit DU5000 Unit (D544)

General

Curl Correction	Front curl, back curl (switching possible)
Speed	160 to 380 mm/s
Operating Environment	Temperature and humidity ranges: Same as main machine.
Service Life	Expected: 5 Years or 60,000K sheets

Paper Weight	52.0 g/m ² to 300g/m ²
Paper Size	100 x 139.7 to 330.2 x 630 mm
Paper Types	Normal (includes color paper), recycled paper, cloth paper, matte paper, letterhead, coarse paper, tab sheets, labels, envelopes, film, OHP, trace paper, punched paper
Power Supply	Main machine
Power Consumption	Less than 30 W
Size (w x d x h)	54.5 x 482.7 x 188.7 mm (2 x 19 x 7.5 in.)
Weight	4.8 kg (10.5 lb.)

Multi-Folding Unit FD5010 (D521)

General

Operating Environment	Temperature and humidity ranges: Same as main machine.	
Service Life	Expected: 5 years or 60,000 K (A4 LEF)	
Paper Weight	40 to 300 g/m ²	
Speed	Straight-Through	100 to 700 mm/s
	Folding	169 to 700 mm/s
Straight-Through Feed	Size	Postcard to 13x19.2"
	Type	Used paper: A3, A4, B4, B5 OHP: A4, B5 Tap paper: A4 LEF, LT LEF
Folding Methods	6 methods (FM1 to FM6)	

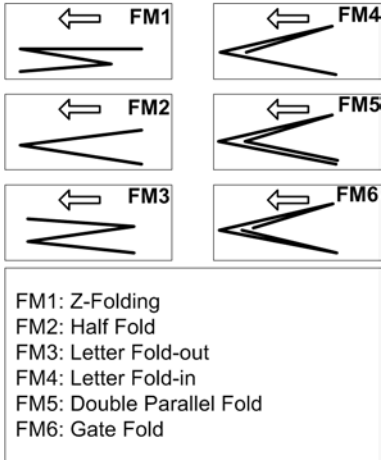

d454v900

Paper Sizes (Straight Through)	---	Postcard to 13 x 19.2 in.
Paper Sizes & Weight (Folding)	FM1	A3, B4, DLT, LG, A4, LT, 12x18", 8-kai
	FM2	A3, B4, DLT, LG, A4, B5, LT 12x18", 12.6x18.5", 12.6x19.2", 13x18", 13x19", 13x19.2", 226x310 mm, 310x432 mm, SRA3, SRA4, 8-kai (64 to 105 g/m²)
	FM3	(64 to 80 g/m²)
	FM4	
	FM5	
	FM6	
Multiple Folding	FM1	Not allowed
	FM2	Max. 3 (64 to 80 g/m ² only)
	FM3	Max. 3 (64 to 80 g/m ² only)
	FM4	Max. 3 (64 to 80 g/m ² , B4, A4, LT, B5 only)
	FM5	Not allowed
	FM6	
Line Speed (Only FM1 Z-Folded paper can exit downstream)		

1

No Fold	350 mm/sec. to top tray To downstream: Same as main machine.		
FM1	700 mm/sec. to top tray (paper < 355.6 mm long) 450 mm/sec. to top tray (paper < 355.6 mm long) To downstream: Same as main machine.		
FM2	1 Sheet: Same as main machine 2-3 Sheets: 454 mm/sec. 700 mm/sec. to top tray (paper <355.6 mm long) 350 mm/sec. to top tray (paper < 279.4 <355.6 mm long) 250 mm/sec. to top tray (paper < 279.4 mm long)		
FM3 FM4	1 Sheet: Same as main machine 2-3 Sheets: 454 mm/sec. to top tray 350 mm/sec. to top tray (paper < 420 mm long) 250 mm/sec. to top tray (paper < 420 mm long)		
FM5	1 Sheet: Same as main machine 350 mm/sec. to top tray (paper < 420 mm long) 250 mm/sec. to top tray (paper < 420 mm long)		
FM6	1 Sheet: Same as main machine as far as 3rd Stopper. At 3rd stopper feeds 50 mm at 100 mm/sec. 350 mm/sec. to top tray (paper < 420 mm long) 250 mm/sec. to top tray (paper < 420 mm long)		
Power Supply	NA	AC 120V 60 Hz, 2.0A	
	EU	AC 220 to 240V, 50/60 Hz 1.2A	
Power Consumption	270 W		
Size (w x d x h)	470 x 1000 x 730 mm (18.5 x 39.4 x 28.7 in.)		
Level	Less than 5 mm deviation at front/back, left/right		
Weight	92 kg (203 lb)		
Noise Level (dB A)	Mode	Alone	System
	No Folding	< 72 dB	---

	Folding	< 72 dB	< 76 dB
--	---------	---------	---------

Tray Capacity

The capacity of the tray on top of the unit for folded paper is determined by these variables:

- Folding Methods (FM1 to FM6)
- Paper size
- Paper weight

Folding Mode FM1

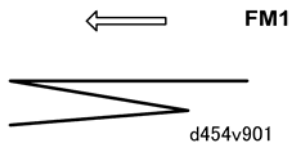

Size	Weight (Standard) 64 to 80 g/m ²	Weight (Heavy) 64 to 80 g/m ²
8-kai	35	20
12x18"	35	20
A3 SEF	35	20
DLT	35	20
B4 SEF	35	20
LG SEF	35	20
A4 SEF	30	20
LT SEF	30	20

Folding Mode FM2



1

Size	Weight (Standard) 64 to 80 g/m ²	Weight (Heavy) 64 to 80 g/m ²
13x19.2"	40	25
13x19"	40	25
12.6x19.2"	40	25
12.6x18.5"	40	25
13x18"	40	25
SRA3 (320x450 mm)	40	25
SRA4 (225x320 mm)	40	25
226x310 mm	40	25
310x432 mm	40	25
8-kai	40	25
12x18"	40	25
A3 SEF	40	25
DLT	40	25
B4 SEF	40	25
LG SEF	40	25
A4 SEF	50	50
LT SEF	50	50
B5 SEF	50	50

Folding Mode FM3

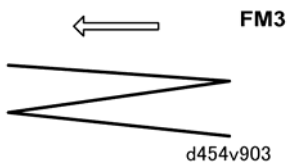

Size	Weight (Standard) 64 to 80 g/m ²	Weight (Heavy) 64 to 80 g/m ²
8-kai	30	20
12x18"	30	20
A3 SEF	30	20
DLT	30	20
B4 SEF	30	20
LG SEF	30	20
A4 SEF	40	30
LT SEF	40	30
B5 SEF	40	30

Folding Mode FM4

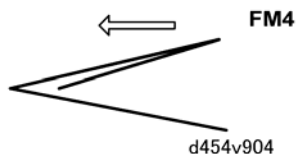

Size	Weight (Standard) 64 to 80 g/m ²	Weight (Heavy) 64 to 80 g/m ²
8-kai	40	20
12x18"	40	20
A3 SEF	40	20
DLT	40	20
B4 SEF	40	20
LG SEF	40	20
A4 SEF	50	40
LT SEF	50	40

1

Size	Weight (Standard) 64 to 80 g/m ²	Weight (Heavy) 64 to 80 g/m ²
B5 SEF	50	40

Folding Mode FM5

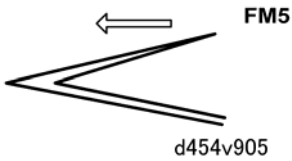

Size	Weight (Standard) 64 to 80 g/m ²	Weight (Heavy) 64 to 80 g/m ²
8-kai	30	20
12x18"	30	20
A3 SEF	30	20
DLT	30	20
B4 SEF	30	20
LG SEF	30	20
A4 SEF	30	30
LT SEF	30	30
B5 SEF	30	30

Folding Mode FM6

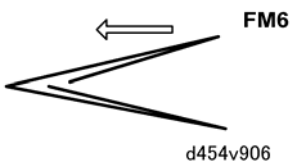

Size	Weight (Standard) 64 to 80 g/m ²	Weight (Heavy) 64 to 80 g/m ²
8-kai	50	20
12x18"	50	20
A3 SEF	50	20
DLT	50	20
B4 SEF	50	20
LG SEF	50	20
A4 SEF	30	30
LT SEF	30	30
B5 SEF	30	30

Booklet Finisher SR5040/5030 (D512/D513)

General

Operating Environment	Temperature and humidity ranges: Same as main machine.		
Service Life	Expected: Five years or 60,000K		
Size (w x h x d)	996 x 730 x 1125 mm (39.2 x 28.7 x 44.3 in.)		
Weight	Finisher D512 (Booklet Stapling)		130 kg (286 ib.)
	Finisher D513 (Corner Stapling Only)		112 kg (246.4 lb.)
Power Supply	NA	AC 120V 50/60 Hz, 2.5A	
	EU	AC 220 to 240V, 50/60 Hz 1.2A	
Power Consumption	250 W		
Level	Less than 5 mm deviation at front/back, left/right		
Noise Level (dB A)	Mode	Alone	System
	Shift	< 76 dB	---

	Staple	< 78 dB	< 83 dB
--	--------	---------	---------

1

Shift Tray

Capacity	Unfolded Paper	3000	D513: A4 LEF, B5 LEF, LT LEF
		2500	D512: A4 LEF, B5 LEF, LT LEF
		1500	A3, A4 SEF, B4, B5 SEF, LT, LG, LT SEF, SRA4, 226x310 mm
		1000	12x18", SRA3, 13x18", 12.6x1.5", 12.6x19.2", 13x19", 13x19.2", 310x432 mm
		500	A5 LEF, HLT LEF
		100	A5 SEF, HLT SEF
	Z-Folded Paper	30	
Paper Size	Unfolded Paper	A5 to 13x19.2"	
	Z-Folded Paper	A3, B4, A4 SEF, DLT, LG LT SEF, 12x18", 8-kai	
Paper Weight	Unfolded Paper	40 to 300 g/m ²	
	Z-Folded Paper	64 to 105 g/m ²	

Proof Tray

Capacity	Unfolded Paper	250	A4, LT or smaller
		50	B4, LG or larger
	Z-Folded Paper	20	A4, LT or smaller
		30	B4, LG or larger
Paper Size	Unfolded Paper	A6 SEF to 13x19.2", Postcard SEF	
	Z-Folded Paper	A3, B4, A4 SEF, DLT, LG, LT SEF, 12x18", 8-kai	
Paper Weight	Unfolded Paper	52 to 216 g/m ²	

	Z-Folded Paper	64 to 105 g/m ²
--	----------------	----------------------------

Corner Stapling

1

Stack Size (80 g/m ²)	Unfolded Paper	2 to 100	A4, B5, LT (80g/m ²)	
		2 to 50	A3, B4, DLT, LG	
	Z-Folded Paper	10		
		Combined Stack		
		Z-Folded	Unfolded	
		1	1 to 90	
		2	0 to 80	
		3	0 to 70	
		4	0 to 60	
		5	0 to 50	
		6	0 to 40	
		7	0 to 30	
		8	0 to 20	
		9	0 to 10	
10	0			
Paper Size	Unfolded Paper	B5 to A3, DLT to LT		
	Z-Folded Paper	A3, B4, DLT		
Paper Weight	Unfolded Paper	64 to 80 g/m ²		
	Z-Folded Paper	64 to 105 g/m ²		
Stapling Positions	1 Staple: Rear, Rear diagonal, or Front 2 Staples: Front/Rear			
Staple Supply	Cartridge with 5000-staple capacity			
Tray Capacity After Stapling				

	Pages	Stacks	Size
No Folding	20 to 100	125 to 25*1	A4 LEF, B5 LEF, LT LEF
	20 to 100	50 to 30*2	
	10 to 19	200 to 105	
	2 to 9	150	
	10 to 100	150 to 15	A4 SEF, B5 SEF, LT SEF
	2 to 9	150	
	10 to 50	150 to 30	A3, B4, DLT, LG
	2 to 9	150	

*1: D512

*2: D513

No Folding, Mixed Sizes	Pages	Stacks	Size
	2 to 50	30	A3/A4 LEF B4/B5 LEF DLT/LT LEF 8-Kai/16-Kai
Z-Folded, Mixed with Unfolded	Pages	Stacks	Size
	1 to 10	30 to 3	A3 Z-fold/A4 B4 Z-fold/B5 DLT Z-fold/LT 8-Kai/16-Kai
Staple Trimming	Hopper Capacity		15,000 staples
	Hopper Full Alert		Photo-sensor
	Trimming Disposal		Alert, operator

Booklet Stapling

Stack Size	20	64 to 80 g/m ²	
	15	80 to 90 g/m ²	
Paper Size	13x19.2", 13x19", 12.6x19.2", 12.6x18.5", 13x18", SRA3 (320x450 mm), 12x18", A3, B4, SRA4 (320 x 225 mm), 226x310 mm, 310 x 432 mm, A4, B5, DLT, LG, LT		
Paper Weight	64 to 90 g/m ²		
Stapling Positions	2 staples, 2 fixed locations		
Staple Supply	2 cartridges, 5000 staples each		
Tray Capacity After Stapling	Pages	Stacks	Size
	2 to 5	30	All sizes
	6 to 10	15	
	11 to 15	10	
	16 to 20	5	

Punch Unit PU5000 (D449) (Option)

This punch unit is not pre-installed in the finisher. The punch unit must be installed.

Punching	NA	2/3 hole selectable
	EU/AP	2/4 hole selectable
	Scandinavia	4 hole
Skew Correction	Yes	
Paper Registration	Yes	

Paper Size	Holes	Edge	Size
	2 Holes	SEF	A6 to A3, HLT to DLT
		LEF	A5 to A4, HLT to LT
	NA 2 Holes	SEF	A6 to A3, HLT to DLT
		LEF	A5 to A4, HLT to LT
	3 Holes	SEF	A3, B4, DLT
		LEF	A4, B5, LT
	EU 4 Holes	SEF	A3, B4, DLT
		LEF	A4, B5, LT
	Scn 4 Holes	SEF	B6 to A3, HLT to DLT
		LEF	A5 to A4, HLT to LT
	Paper Weight	Holes	Weight
2 Holes		52 to 209 g/m ²	
NA 2 Holes			
3 Holes			
EU 4 Holes		52 to 209 g/m ²	
Scn 4 Holes			

2. Appendix: Service Program Mode Tables

Group 1000

1001	Lead Edge Reg		
	Adjusts the printing leading edge registration using the trimming area pattern SP2109-3 (Pattern No. 14)		
	Setting	Weight	Default
1	Thick 1	52.3 - 63.0 g/m ²	[-3 to 3/0/0.1 mm]
2	Thick 2	63.1 - 80.0 g/m ²	
3	Thick 3	80.1 - 105.0 g/m ²	
4	Thick 4	105.1 - 163.0 g/m ²	
5	Thick 5	163.1 - 220.0 g/m ²	
6	Thick 6	220.1 - 256.0 g/m ²	
7	Thick 7	256.1 - 300.0 g/m ²	

1002	Fine Adj LEdge		
	Fine adjusts leading edge registration for thick paper trace paper and thick paper (Thick 2, Thick 3)		
	Setting	Weight	Default
1	Trace	---	[-9 to 0/0/0.1 mm]
2	Thick 2	63.1 - 80.0 g/m ²	
3	Thick 3	80.1 - 105.0 g/m ²	

1003	Side-to-Side Reg		
	Adjusts printing side-to-side registration for each feed station, using the test pattern printed with SP2109-3 (Pattern No. 14) These SP's should be adjusted after replacing the laser synchronization detector or the laser optical unit.		

1	Tray1	[-3 to +3/0/0.1 mm]
2	Tray2	
3	Dupx Tray	
4	A3LCT Tray3	
5	A3LCT Tray4	
6	A3LCT Tray5	
7	Bypass Tray	

1004	Reg Buckle Adj	
	Adjusts the registration motor timing. This timing determines the amount of paper buckle at registration. (A higher setting causes more buckling.)	
1	Tray1 & Tray2	[-5to+5/0/1 mm]
2	Dupx Tray	
3	A3LCT & Bypass Tray	

1005	Reg Buckle Adj(Thick)		
	Adjusts the registration motor timing for thick paper only. This timing determines the amount of paper buckle at registration. (A higher setting causes more buckling.)		
	Setting	Weight	Default
1	Thick 5	163.1 - 220.0 g/m ²	[-5 to +5/1/1 mm]
2	Thick 6	220.1 - 256.0 g/m ²	
3	Thick 7	256.1 - 300.0 g/m ²	

1006	Fine Adj Transfer Tmg Roller Spd
	<p>Fine adjusts the speed of the transfer timing roller for the paper type and weight. The transfer timing roller drives the transfer timing rollers that feed paper from the registration unit to the PTR unit.</p> <ul style="list-style-type: none"> • If the paper is late, the machine speeds the rollers up. • If the paper is early, the machine slows the rollers down.

	Thickness	Weight (g/m ²)	
	1	52.3 - 63.0 g/m ²	
	2	63.1 - 80.0 g/m ²	
	3	80.1 - 105.0 g/m ²	
	4	105.1 - 163.0 g/m ²	
	5	163.1 - 220.0 g/m ²	
	6	220.1 - 256.0 g/m ²	
	7	256.1 - 300.0 g/m ²	
1 to 7	Plain: Weight 1 to 7		[-3 to +3/* /0.1%]
8 to 13	Matte: Weight 2 to 7		The default settings (*) are displayed to the right of "Initial" on the screen.
14 to 19	Glossy: Weight 2 to 7		
20 to 22	Envelope: Weight 5 to 7		
23	OHP		

1007	Fine Adj Invert Ent Roller Spd		
	Changes the speed of the exit relay motor to adjust the speed of the invert entrance rollers. The invert entrance rollers are the first rollers in the paper path below the exit junction where paper is fed into the vertical path in the left drawer for inverting and duplexing.		
	Thickness	Weight (g/m ²)	
	1	52.3 - 63.0 g/m ²	
	2	63.1 - 80.0 g/m ²	
	3	80.1 - 105.0 g/m ²	
	4	105.1 - 163.0 g/m ²	
	5	163.1 - 220.0 g/m ²	
	6	220.1 - 256.0 g/m ²	
	7	256.1 - 300.0 g/m ²	

1 to 7	Plain: Weight 1 to 7	[-3 to +3/* /0.1%] The default settings (*) are displayed to the right of "Initial" on the screen.
8 to 13	Matte: Weight 2 to 7	
14 to 19	Glossy: Weight 2 to 7	

2

1008	Fine Adj Exit/Invert Roll Spd	
	Changes the speed of the invert/exit motor to adjust the speed of the first pair of invert exit rollers. The invert exit rollers are the first rollers in the vertical paper path above the invert junction gate on the far side of the left drawer where paper starts to exit the machine.	
	Thickness	Weight (g/m²)
	1	52.3 - 63.0 g/m ²
	2	63.1 - 80.0 g/m ²
	3	80.1 - 105.0 g/m ²
	4	105.1 - 163.0 g/m ²
	5	163.1 - 220.0 g/m ²
	6	220.1 - 256.0 g/m ²
	7	256.1 - 300.0 g/m ²
1 to 7	Plain: Weight 1 to 7	[-3 to +3/* /0.1%] The default settings (*) are displayed to the right of "Initial" on the screen.
8 to 13	Matte: Weight 2 to 7	
14 to 19	Glossy: Weight 2 to 7	

1009	Fine Adj Duplex/Invert Roll Spd	
	Changes the speed of the duplex/invert motor to adjust the speed of the duplex invert rollers. The duplex invert rollers feed the paper up into the first set of rollers in the duplex tray.	
	Thickness	Weight (g/m²)
	1	52.3 - 63.0 g/m ²
	2	63.1 - 80.0 g/m ²
	3	80.1 - 105.0 g/m ²

	4	105.1 - 163.0 g/m ²	
	5	163.1 - 220.0 g/m ²	
	6	220.1 - 256.0 g/m ²	
	7	256.1 - 300.0 g/m ²	
1 to 7	Plain:Weight 1 to 7		[-3 to +3/* /0.1%] The default settings (*) are displayed to the right of "Initial" on the screen.
8 to 13	Matte:Weight 2 to 7		
14 to 19	Glossy:Weight 2 7		

1010	Fine Adj Mtr Speed: High		
	Fine adjusts the speed of the motors for high speed mode (352.8 mm/s).		
1 to 4	K, C, M, Y Drum Motor		[-3 to +3/0/0.1%]
5 to 8	K, C, M, Y Dev Motor		
9 to 012	K, C, M, Y Drum CL(leaning) Mtr		
13	ITB Motor		
15	PTR Motor		[-5 to +5/0/0.1%]
29	Fusing Motor		
43	Paper Ejection Motor		
56	Paper Feed Motor		[-5 to +5/0.5/0.1%]

1011	Fine Adj Mtr Speed: Middle		
	Fine adjusts the speed of the motors for middle speed mode (246.96 mm/s).		
1 to 4	K, C, M, Y Drum Motor		[-3 to +3/0/0.1%]
5 to 8	K, C, M, Y Dev Motor		
9 to 012	K, C, M, Y Drum CL(leaning)		
13	ITB Motor		
15	PTR Motor		[-5 to +5/0/0.1%]
29	Fusing Motor		

43	Paper Ejection Motor	
56	Paper Feed Motor	[-5 to +5/0.5/0.1%]

1012	Fine Adj Mtr Speed: Low	
	Fine adjusts the speed of the motors for low speed mode (246.96 mm/s).	
1 to 4	K, C, M, Y Drum Motor	[-3 to +3/0.2/0.1%]
5 to 8	K, C, M, Y Dev Motor	
9 to 012	K, C, M, Y Drum CL Mtr	
13	ITB Motor	
15	PTR Motor	[-5 to +5/0/0.1%]
29	Fusing Motor	
43	Paper Ejection Motor	
56	Paper Feed Motor	[-5 to +5/0.5/0.1%]

1013	Fine Adj Exit Motor Speed		
	Fine adjusts the speed of exit motor for the type of weight of the paper. The exit motor drives the drives the rollers in the paper cooling unit, the second pair of invert exit rollers, and the exit rollers.		
	Thickness	Weight (g/m²)	
	1	52.3 - 63.0 g/m ²	
	2	63.1 - 80.0 g/m ²	
	3	80.1 - 105.0 g/m ²	
	4	105.1 - 163.0 g/m ²	
	5	163.1 - 220.0 g/m ²	
	6	220.1 - 256.0 g/m ²	
	7	256.1 - 300.0 g/m ²	
1 to 7	Plain:Weight 1 to 7		[-5 to +5/0/0.1%]

8 to 13	Matte: Weight 2 to 7	
14 to 19	Glossy: Weight 2 to 7	
20 to 22	Envelope: Weight 5 to 7	
23	OHP	

1020	Adjust Air DUTY	
	Adjusts the strength of the air flow of the fans in the LCIT. The side and front fans are used to assist paper separation by blowing air across the surface of the first sheet in the stack of paper in the tray.	
1	Suction Air	[0 to 100/100/5%]
2	Side Air	
3	Front Air	

1021	Skew Detect	
	This SP switches skew detection off/on for each paper feed station in the system and the duplex tray.	
1	Tray1	[0 to 1/1/1] 1: ON, 0: OFF
2	Tray2	
3	Dupx Tray	
4	A3LCT Tray3	
5	A3LCT Tray4	
6	A3LCT Tray5	
7	Bypass Tray	

1022	PTR Trans Lift Timing	
	Sets the timing for opening and closing the nip of the bias roller and PTR (Paper Transfer Roller). When thick paper is fed the PTR separation motor raises the bias roller away from the PTR so the paper can feed easily into the gap between the rollers. This operation minimizes the "shock jitter" effect with thick paper sizes.	

1	Contact	[-30 to +30/0/1 ms]
2	Separate	[-150 to +20/-70/1 ms]

1023	Shock Jitter Canceling Mode	
	Switches the shock jitter mode off and on. When the machine is in shock-jitter mode, the PTR separation motor opens the nip between the bias roller above the paper and the paper transfer roller below to allow thick paper to feed between these rollers.	
	[0 to 1/1/1]	
	1: ON, 0: OFF	

1101	Reload Permit Setting	
	Sets the temperature where the fusing motor starts to rotate.	
1	Pre-rotation Start Temp.	[0 to 200/0/1 deg]
2	Reload Target Temp.:Center	[0 to 200/165/1 deg]
3	Reload Target Temp.:Press	[0 to 200/90/1 deg]
4	Temp.:Delta:Cold:Center	[0 to 200/5/1 deg]
5	Temp.:Delta:Cold:End	[0 to 200/5/1 deg]
6	Temp.:Delta:Cold:Press:Center	[0 to 200/20/1 deg]
7	Rotation Time:Cold	[0 to 500/280/1 deg]
8	Temp.:Delta:Warm:Center	[0 to 200/5/1 deg]
9	Temp.:Delta:Warm:End	[0 to 200/5/1 deg]
10	Temp.:Delta:Warm:Press:Center	[0 to 200/10/1 deg]
11	Rotation Time:Warm	[0 to 200/15/1 deg]
12	Temp.:Delta:Hot:Center	[0 to 200/5/1 deg]
13	Temp.:Delta:Hot:End	[0 to 200/5/1 deg]
14	Temp.:Delta:Hot:Press:Center	[0 to 200/20/1 deg]
15	Rotation Time:Hot	[0 to 100/0/1 deg]
16	Temp Diff at Press Roller Ends: Cool	[0 to 200/20/1 deg]

17	Temp Diff at Press Roller Ends: Warm	[0 to 200/20/1 deg]
18	Temp Diff at Press Roller Ends: Hot	[0 to 200/20/1 deg]
20	Roll Core Temp Judgment	
	[0 to 1/1/1] 0: Metal Core Temp Detection On 1: Metal Core Temp Detection Off	
21	Roll Core Temp	[0 to 120/30/1 deg]

1102	Feed Permit Setting	
	Adjusts the start timing of paper feed. Once the machine grants permission for the start timing, it checks the temperature once again to determine the actual start timing.	
19	Feed Permit Time	[0 to 500/180/1 sec]
101	Temp Diff Heating Roller: Lower 1	[0 to 60/15/1 deg]
102	Temp Diff Heating Roller: Upper 1	[0 to 60/60/1 deg]
103	Temp Diff Press Roller: Lower 1	[0 to 60/15/1 deg]
104	Temp Diff Press Roller: Upper 1	[0 to 60/20/1 deg]
105	Rotation Time Before Judgment:1	[0 to 100/0/1 sec]
106	Temp Diff Heating Roller: Lower 2	[0 to 60/10/1 deg]
107	Temp Diff Heating Roller: Upper 2	[0 to 60/60/1 deg]
108	Temp Diff Press Roller: Lower 2	[0 to 60/10/1 deg]
109	Temp Diff Press Roller: Upper 2	[0 to 60/15/1 deg]
110	Rotation Time Before Judgment:2	[0 to 100/3/1 sec]
111	Temp Diff Heating Roller: Lower 3	[0 to 60/5/1 deg]
112	Temp Diff Heating Roller: Upper 3	[0 to 60/60/1 deg]
113	Temp Diff Press Roller: Lower 3	[0 to 60/10/1 deg]
114	Temp Diff Press Roller: Upper 3	[0 to 60/10/1 deg]

115	Rotation Time Before Judgment:3		[0 to 100/4/1 sec]
116	Temp Diff Heating Roller: Lower 4		[0 to 60/20/1 deg]
117	Temp Diff Heating Roller: Upper 4		[0 to 60/20/1 deg]
118	Temp Diff Press Roller: Lower 4		[0 to 60/20/1 deg]
119	Temp Diff Press Roller: Upper 4		[0 to 60/60/1 deg]
120	Rotation Time Before Judgment:4		[0 to 100/0/1 sec]
121	Temp Diff Heating Roller: Lower 5		[0 to 60/15/1 deg]
122	Temp Diff Heating Roller: Upper 5		
123	Temp Diff Press Roller: Lower 5		[0 to 60/20/1 deg]
124	Temp Diff Press Roller: Upper 5		[0 to 60/60/1 deg]
125	Rotation Time Before Judgment:5		[0 to 100/0/1 sec]
126	Temp Diff Heating Roller: Lower 6		[0 to 60/5/1 deg]
127	Temp Diff Heating Roller: Upper 6		[0 to 60/10/1 deg]
128	Temp Diff Press Roller: Lower 6		[0 to 60/10/1 deg]
129	Temp Diff Press Roller: Upper 6		[0 to 60/60/1 deg]
130	Rotation Time Before Judgment:6		[0 to 100/5/1 sec]
	Thickness	Weight (g/m²)	
	1	52.3 - 63.0 g/m ²	
	2	63.1 - 80.0 g/m ²	
	3	80.1 - 105.0 g/m ²	
	4	105.1 - 163.0 g/m ²	
	5	163.1 - 220.0 g/m ²	
	6	220.1 - 256.0 g/m ²	
	7	256.1 - 300.0 g/m ²	
150	Normal: Full Size: Category 1		[0 to 100/50/ 1 deg]
151	Normal: Full Size: Category 2		[0 to 100/50/ 1 deg]

152	Normal: Full Size: Category 3	[0 to 100/25/ 1 deg]
153	Normal: Full Size: Category 4	[0 to 100/25/ 1 deg]
154	Normal: Full Size: Category 5	[0 to 100/30/ 1 deg]
155	Normal: Full Size: Category 1	
156	Normal: Full Size: Category 2	
157	Normal: Full Size: Category 3	
158	Normal: Full Size: Category 4	
159	Normal: Full Size: Category 5	
160	Output Priority: Full Size: Category 1	[0 to 200/50/1 deg]
161	Output Priority: Full Size: Category 2	[0 to 200/50 deg]
162	Output Priority: Full Size: Category 3	[0 to 200/35 deg]
163	Output Priority: Full Size: Category 4	[0 to 200/30/ deg]
164	Output Priority: Full Size: Category 5	
165	Output Priority: Full Size: Category 1	
166	Output Priority: Full Size: Category 2	
167	Output Priority: Full Size: Category 3	
168	Output Priority: Full Size: Category 4	
169	Output Priority: Full Size: Category 5	
201 to 207	Normal: Uncoated Thick 1 to 7	[1 to 6/*/1 step] The default settings are displayed to the right of "Initial" on the screen.
209 to 214	Normal: Matte Thick 2 to 7	
216 to 221	Normal: Glossy Thick 2 to 7	
222 to 228	Output Priority: Uncoated Thick 1 to 5	
230 to 235	Output Priority: Matte Thick 2 to 7	
237 to 242	Output Priority: Glossy Thick 2 to 5	

1106	Fusing Temp. Display
------	----------------------

	Displays the present fusing temperature at different locations on the heating roller, pressure roller, hot roller, and hot roller core.	
1	Heating Roller Center	
2	Heating Roller Ends	
4	Heating Roller Rear	
5	Pressure Roller Center	
6	Pressure Roller Ends	
7	Hot Roller	
8	Hot Roller Core	

1107	Standby Target Temp. Setting	
	Sets the target standby temperature for the modes listed below.	
1	Standby: Center	[0 to 200/175/1 deg]
2	Standby: Press	[0 to 200/90/1 deg]
3	Preheat: Center	[0 to 200/175/1 deg]
4	Preheat: Press	[0 to 200/90/1 deg]
5	Low Power: Center	[0 to 200/100/1 deg]
6	Low Power: Press	[0 to 200/90/1 deg]
7	Print Ready: Center	[0 to 200/165/1 deg]
8	Print Ready: Press	[0 to 200/90/1 deg]

1108	After Reload/Job Target Temp.	
	Sets the target temperature for immediately after reload temperature has been achieved or paper has been fed. "Center" is the center of the heating roller, and "Press" is the pressure roller.	
1	Center	[0 to 200/165/1 deg]
2	Press	[0 to 200/90/1 deg]

1111	Environment Correction: Fusing	
	Sets the threshold for fusing temperature correction to compensate for ambient conditions.	
1	Temp.: Threshold: Low	[0 to 100/17/1 deg]
2	Temp.: Threshold: High	[0 to 100/30/1 deg]
3	Low Temp. Correction	[0 to 100/10/1 deg]
4	High Temp. Correction	[0 to 100/5/1 deg]
5	Job Low Temp. Correction	[0 to 100/15/0.1 deg]
6	Job High Temp. Correction	[0 to 100/0/0.1 deg]
7	Job Low Temp. Correction: Sp.	[0 to 100/15/0.1 deg]
8	Job High Temp. Correction: Sp.	[0 to 100/0/0.1 deg]

1114	Heat Storage Status	
	Sets the threshold for fusing temperature correction to compensate for heat accumulated on the pressure roller.	
1	Temp.: Threshold: Press	[0 to 200/60/1 deg]
2	Temp.: Threshold: Atmosphere	[0 to 200/60/1 deg]

1115	Target Temp. Correction	
	Corrects the temperature based on the difference in the target temperatures of the center and end of the hot roller.	
1	Temp.: Delta: Heat: End	[-100 to +100/5/1 deg]
2	Temp.: Delta: Press: End	[-100 to +100/0/1 deg]
3	Temp.: Delta Sub	[0 to +100/3/1 deg]
5	Temp.: Delta Heat End: Reload	[-100 to +100/5/1 deg]
6	Temp.: Delta Heat End: Prefeed	[-100 to +100/5/1 deg]
7	Temp.: Delta Heat Full Size: Reload	[-100 to +100/-10/1 deg]
8	Temp.: Delta Heat Full Size: Prefeed	[-100 to +100/-15/1 deg]

1116	Skew Correction Level Setting	
	Sets the amount of skew correction for paper fed from each paper source.	
1	Tray1	[1.6 to 7.5/3/0.1 mm]
2	Tray2	
3	Dupx Tray	
4	A3LCT Tray3	
5	A3LCT Tray4	
6	A3LCT Tray5	
7	Bypass Tray	

1117	Time Control	
	Adjust the amount of time for timeout.	
1	Control Time1	[0 to 1000/100/1 sec]
2	Control Time2	[0 to 1000/400/1 sec]
3	Temp:A:Center1	[-20 to 20/0/1 deg]
4	Temp: A: End 1	
5	Temp:A:Center2	
6	Temp: A: End 3	
7	Temp:B:Center1	
8	Temp: B: End 1	
9	Temp:B:Center2	
10	Temp: B: End 2	[-20 to +29/-5/1 deg]
11	Temp.: C: Center 1	[-20 to +29/0/1 deg]
12	Temp.: C: End 1	[-20 to +29/-5/1 deg]
13	Temp.: C: Center 2	[-20 to +29/0/1 deg]
14	Temp.: C: End 1	[-20 to +29/-5/1 deg]

15	Temp.: D: Center 1	[-20 to +29/0/1 deg]
16	Temp.: D: End 1	
17	Temp.: D: Center 2	
18	Temp.: D: End 2	[-20 to +29/-3/1 deg]
101 to 107	Category 1: Weight 1 to 7	[1 to 4/*/1 step]
111 to 117	Category 2: Weight 1 to 7	The default settings are displayed to the right of "Initial" on the screen.
121 to 127	Category 3: Weight 1 to 7	
131 to 137	Category 4: Weight 1 to 7	
141 to 147	Category 5: Weight 1 to 7	

1118	Norm Paper: Init Temp Calc	
	Adjusts the start timing from the standard trigger time for operation mode and paper type.	
1	Start Time: Normal Speed	[0 to 5/0/0.1 sec]
2	Start Time: Medium Speed	[0 to 5/1/0.1 sec]
3	Start Time: Low Speed	[0 to 5/3.5/0.1 sec]
4	Continuous Time: Normal Speed	[0 to 50/10/0/1 sec]
5	Continuous Time: Medium Speed	
6	Continuous Time: Low Speed	
	Thickness	Weight (g/m²)
	1	52.3 - 63.0 g/m ²
	2	63.1 - 80.0 g/m ²
	3	80.1 - 105.0 g/m ²
	4	105.1 - 163.0 g/m ²
	5	163.1 - 220.0 g/m ²
	6	220.1 - 256.0 g/m ²

	7	256.1 - 300.0 g/m ²	
11	Added Temp: Thickness 1		[0 to 30/5/1 deg]
12	Added Temp: Thickness 2		[0 to 30/5/1 deg]
13	Added Temp: Thickness 3		[0 to 30/10/1 deg]
14	Added Temp: Thickness 4		[0 to 30/10/1 deg]
15	Added Temp: Thickness 5		[0 to 30/15/1 deg]
16	Added Temp: Thickness 6		
17	Added Temp: Thickness 7		

1119	Norm Paper: Init Temp: Calc2		
	Adjusts fusing temperature for the core temperature of the hot roller.		
1	Continuous Time: Normal: Spd		[0 to 50/10/1 sec]
2	Continuous Time: Medium: Spd		[0 to 50/11/1 sec]
3	Continuous Time: Low: Spd		[0 to 50/13.5/1 sec]
11	Added Temp: Thickness 1		[0 to 30/10/1 deg]
12	Added Temp: Thickness 2		
13	Added Temp: Thickness 3		
14	Added Temp: Thickness 4		
15	Added Temp: Thickness 5		[0 to 30/20/1 deg]
16	Added Temp: Thickness 6		
17	Added Temp: Thickness 7		

1121	Switch: Rotation Start/Stop		
	Sets the time interval for the shift from reload temperature to standby temperature.		
1	Time:After Reload		[0 to 999/300/1 sec]
2	Time:After Recovery		[0 to 100/10/1 sec]
3	Time:After Job		[0 to 100/30/1 sec]

4	Press Temp.:After Reload	[0 to 160/160/1 deg]
5	End Uniform Start Temp.:B4	[0 to 250/210/1 deg]
6	End Uniform Start Temp.:A4	
7	End Uniform Start Temp.:A5	
8	Overshoot Prevent Temp.	[0 to 250/215/1 deg]
9	Overshoot Prevent Time	[0 to 100/20/1 sec]

1122	Standby Rotation Setting	
	Sets the interval between fusing roller idle rotations during standby. Idling the rollers helps to maintain and even fusing temperature.	
1	Rotation Interval	[0 to 240/0/1 min]
2	Rotation Time	[0 to 60/0/0.1 sec]

1123	Rotation Speed Setting	
	Sets the speed for the rotation fusing rollers during idling before paper starts to feed.	
	Rotation Speed	[0 to 1/1/1]

1124	CPM Down Setting	
	Sets the temperature differential used to calculate CPM down for low and high temperatures. Also, sets the interval for temperature checks for CPM down.	
1	Low: Down Temp.	[-50 to 0/-8/1 deg]
2	Low: Up Temp.	[-50 to 0/-6/1 deg]
3	Low :1st CPM	[10 to 100/70/5%]
4	Low :2nd CPM	[10 to 100/50/5%]
5	Low :3rd CPM	[10 to 100/30/5%]
6	High: 1st CPM	[10 to 100/75/5%]
7	High:2nd CPM	[10 to 100/50/5%]
8	High:3rd CPM	[10 to 100/25/5%]

12	High:1st CPM Down Temp.:A4	[100 to 250/210/1deg]
13	High:2nd CPM Down Temp.:A4	[100 to 250/215/1deg]
14	High:3rd CPM Down Temp.:A4	[100 to 250/220/1deg]
15	High:1st CPM Down Temp.:A5	[100 to 250/220/1deg]
16	High:2nd CPM Down Temp.:A5	[100 to 250/215/1deg]
17	High:3rd CPM Down Temp.:A5	[100 to 250/220/1deg]
18	Judging Interval	[1 to 250/10/1sec]
20	Judging Interval: Normal Speed	[0 to 200/15/1sec]
21	Judging Interval: Medium Speed	
22	Judging Interval: Low Speed	
101	High: 1st CPM Down Timing: Category 1	[100 to 250/215/1
102	High: 2nd CPM Down Timing: Category 2	[100 to 250/217/1
103	High: 3rd CPM Down Timing: Category 3	[100 to 250/225/1
111	High: 1st CPM Down Timing: Category 1	[100 to 250/215/1
112	High: 2nd CPM Down Timing: Category 2	[100 to 250/217/1
113	High: 3rd CPM Down Timing: Category 3	[100 to 250/225/1
121	High: 1st CPM Down Timing: Category 1	[100 to 250/215/1
122	High: 2nd CPM Down Timing: Category 2	[100 to 250/217/1
123	High: 3rd CPM Down Timing: Category 3	[100 to 250/225/1
131	High: 1st CPM Down Timing: Category 1	[100 to 250/215/1
132	High: 2nd CPM Down Timing: Category 2	[100 to 250/217/1
133	High: 3rd CPM Down Timing: Category 3	[100 to 250/225/1
141	High: 1st CPM Down Timing: Category 1	[100 to 250/215/1
142	High: 2nd CPM Down Timing: Category 2	[100 to 250/217/1
143	High: 3rd CPM Down Timing: Category 3	[100 to 250/225/1

1131	Continuous Print Mode Switch
	Sets the permission for paper to feed.
	Feed Permit Condition [0 to 1/0/1 Step 0: Fusing Quality Mode 1: Productivity Mode

1132	Maximum Duty Switch	
	Switches maximum fixed duty level and power control.	
1	Control Method Switch	
	[0 to 1/1/1 step] 0: Fixed Duty 1: Power Control	
3	Manual Offset	
	[0 to 4/4/1 step] 0: -400 W 1: -300 W 2: -200 W 3: -100 W 4: 0	
11	AC Voltage Value	[0 to 300/0/ 1]
12	Judgment Voltage	

1141	Fusing SC Issue Time Info	
	Displays the time when an SC code was issued.	
1	SC Number	[0 to 999/0/1 Step]
2	SC Cause	[0 to 9/0/1 Step]
101	Htg Roller: Ctr Varied Op Temp. 1	[-5 to 280/0/1 deg]
103	Htg Roller: Ctr Compensate Temp. 1	
104	Htg Roller: Ends Varied Op Temp. 1	
106	Htg Roller: Ends Compensate Temp. 1	
107	Htg Roller Rear Temp. 1	

108	Press Roller: Ctr Varied Op Temp. 1	
110	Press Roller: Ctr Compensate Temp. 1	
111	Press Roller: Ends Temp. 1	
112	Hot Roller: Surface Varied Op Temp. 1	
114	Hot Roller: Surface Compensate Temp. 1	
115	Hot Roller: Roll Core Temp. 1	
151	Htg Roller: Ctr Varied Op Temp. 2	
153	Htg Roller: Ctr Compensate Temp. 2	
154	Htg Roller: Ends Varied Op Temp. 2	
156	Htg Roller: Ends Compensate Temp. 2	
157	Htg Roller Rear Temp. 2	
158	Press Roller: Ctr Varied Op Temp. 2	
160	Press Roller: Ctr Compensate Temp. 2	
161	Press Roller: Ends Temp. 2	
162	Hot Roller: Surface Varied Op Temp. 2	
164	Hot Roller: Surface Compensate Temp. 2	
165	Hot Roller: Roll Core Temp. 2	
201	Htg Roller: Ctr Varied Op Temp. 3	
202	Htg Roller: Ctr Detect Temp. 3	
203	Htg Roller: Ctr Compensate Temp. 3	
204	Htg Roller: Ends Varied Op Temp. 3	
206	Htg Roller: Ends Compensate Temp. 3	
207	Htg Roller Rear Temp. 3	
208	Press Roller: Ctr Varied Op Temp. 3	
210	Press Roller: Ctr Compensate Temp. 3	
211	Press Roller: Ends Temp. 3	

212	Hot Roller: Surface Varied Op Temp. 3	
214	Hot Roller: Surface Compensate Temp. 3	
215	Hot Roller: Roll Core Temp. 3	

1142	Fusing Jam Detection
	This SP displays the SC code that was issued if a fusing unit jam error occurs three times in succession. This is a fatal SC error. The machine is shut down and cannot be used until the problem has been corrected.
	SC Display [0 to 1/0/1 Step] 0: OFF 1: On

1151	Pressure Setting	
	Switches on the mode that adjusts the length of time pressure is increased on the fusing roller by the pressure roller. The setting is adjusted with the "position" settings that determine the length of time that the pressure is increased (the longer the time the more pressure).	
1	Pressure Change ON/OFF	[0 to 1/1410/1 Step]
11	Pressure Position 1	[0 to 1000/1410/10 ms]
12	Pressure Position 2	[0 to 1000/0/10 ms]
13	Pressure Position 3	[0 to 1000/30/10 ms]

1152	Fusing Nip Band Check
	Checks and adjusts the nip of the hot roller and pressure roller.
1	Execute

	Use a sheet of OHP to execute this SP. Feed the sheet through fusing unit and between the hot roller and pressure roller. The sheet will stop and remain between the rollers for 30 s and is then feed out. Use a scale to measure the width of the band on the sheet. [0 to 1/1/1] 0: ON 1: OFF	
2	Pre-idling Time	[0 to 999/30/1 sec]
3	Stop Time	[0 to 255/120/1 sec]
4	Pressure Position	[0 to 3/2/1]
10	Target Temp: Center	[0 to 200/160/1 deg]
11	Target Temp: Press Roller	[0 to 200/100/1 deg]

1153	Press Roller Cooling Fan	
	Sets the temperature at which the pressure roller cooling fan starts to operate. The pressure roller cooling fan is the large blower fan at the front of the left drawer under the fusing unit.	
001	Startup Difference	[-50 to +50/5/1 deg]
002	Paper Difference	
003	After Paper Difference	

1154	Standby Rotation	
	Sets the start time and duration of hot roller rotation in the standby (Ready) mode.	
1	Rotation Start Temp	[0 to 150/120/1 deg]
2	Rotation Time	[0 to 255/30/1 sec]

1155	Job Cancel	
	Sets the temperature to trigger "Job cancel" during a job.	
1	Press Roller Temp	[100 to 200/200/1 deg]

1161	Fusing Cleaning Web	
------	---------------------	--

	Determines the operation cycles of the take-up roller which pulls fabric off the web supply roller in the fusing belt cleaning unit.
	Duplex Take up Cycle Adj. [-75 to 0/0/10 %]

1190	Manual New Unit Set	
	Sets the machine to access the fusing unit ID chip information for PM parts management.	
1	Fusing Belt	[0 to 1/1/0]
2	Hot Roller	
3	Pressure Roller	
4	Pressure Roller Bearings	

1206	Paper Shift Setting	
	Selects edge shift operation.	
	Shift Mode Selection [0 to 2/1/1] 0: Shift 1: Shift Off (Folding Mode) 2: Shift: Off	

1302	Dbl-Feed Detect	
1	Tray 1	[0 to 1 / 1 / 1] 0:OFF 1:ON
2	Tray 2	
3	A3LCT Tray3	
4	A3LCT Tray4	
5	A3LCT Tray5	
6	Bypass Tray	

1303	After Dbl-Feed Det Op Set	
------	---------------------------	--

1	Tray 1	[0 to 1 / 1 / 1] 0:JAM 1:Purge Tray
2	Tray 2	
3	A3LCT Tray3	
4	A3LCT Tray4	
5	A3LCT Tray5	
6	Bypass Tray	

1304	Dbl-Feed Detect Threshold Adj	
	Adjusts the threshold for the translucence of the paper to trigger a double-feed detection based on the type of paper.	
1	Plain	[0 to 100/30/1 %]
2	Translucent	
3	OHP	[0 to 100/5/1 %]

1305	Dbl-Feed Comp Std Value	
	Displays the threshold values for paper that triggered a double-feed detection by paper feed station for the past 5 feeds.	
1 to 5	Tray1:LAST1 to 5	
6 to 9	Tray2:LAST to 5	
11 to 15	A3LCT Tray3:LAST to 5	
16 to 20	A3LCT Tray4:LAST to 5	
21 to 25	A3LCT Tray5:LAST to 5	
26 to 30	Bypass Tray:LAST to 5	

1306	Dbl-Feed Det Light Adj Result	
	Adjusts the strength of the light emitted from the double-feed sensor LED. The double feed sensors are a pair. The sensor below emits an LED, and the sensor above receives the light.	
1	Normal Paper	[0 to 94/0/1 mA]

2	Translucent	
3	OHP	

1310	Dbl-Feed Detect Function	
	Toggles double-feed detection alert on and off.	
1	Disabled Display (0:Off 1:On)	[0 to 1/0/1]

1401	Paper Pass Time 1:Custom Paper	
1402	Paper Pass Time 1:Average	
1	Fusing Unit	[0 to 999/0/1 ms]
2	Fusing Unit	
3	Fusing Unit	
4	Tray1	
5	Tray1	
6	Tray1	
7	Tray2	
8	Tray2	
9	Tray2	
10	A3LCT Tray3	
11	A3LCT Tray3	
12	A3LCT Tray3	
13	A3LCT Tray4	
14	A3LCT Tray4	
15	A3LCT Tray4	
16	A3LCT Tray5	
17	A3LCT Tray5	
18	A3LCT Tray5	

19	Bypass Tray	
20	Bypass Tray	
21	Bypass Tray	

2

1403	Paper Pass Time 1:Max/Min Diff	
1	Fusing Unit	[0 to 999/0/1 ms]
2	Fusing Unit	
3	Fusing Unit	

1404	Paper Pass Time 1:Target Var	
1	Tray1	[0 to 999/0/1 ms]
2	Tray1	
3	Tray1	
4	Tray2	
5	Tray2	
6	Tray2	
7	A3LCT Tray3	
8	A3LCT Tray3	
9	A3LCT Tray3	
10	A3LCT Tray4	
11	A3LCT Tray4	
12	A3LCT Tray4	
13	A3LCT Tray5	
14	A3LCT Tray5	
15	A3LCT Tray5	
16	Bypass Tray	
17	Bypass Tray	

18	Bypass Tray	
----	-------------	--

1902	Cleaning Web Setting	
	This SP controls the operation of the fusing cleaning unit inside the fusing unit. The cleaning unit employs a web suspended between a supply roller and take-up roller. Between these rollers, a web contact roller keeps the web pressed against the fusing belt to take-up paper dust, toner, etc. from the surface of the belt.	
1	Web Consumption	[0 to 107/0/1]
2	Fusing Web Motor Operation Time	[3.6 to 130/16.2/0.1 sec]
	Changes the amount of time that the web motor operates to pull fresh fabric from the supply roller.	
3	Web Motor Rotation Time	[0.3 to 3.5/2.8/0.1 sec]
4	Web Near End Setting	[50 to 100/81/1%]
	Changes the web consumption ratio at which web near end is displayed.	
5	Web End Recording	[0 to 1/0/1]
6	Web Near End/End Clear	[Execute]
7	Correction Coeff. DFU	[0 to 2/1.19/0.01]
8	Take up Rotations After Jam	[0 to 30/10/1]
10	Sequence for Each Reload	[0 to 30/3.5/0.1 sec]
11	Rotations After Cold Start	[0 to 30/10/1]
12	Fixed Operation Time 1	[40 to 70/48/1%]
13	Fixed Operation Time 2	[71 to 120/62/1%]
14	Operation Intervals: Med Speed	[3.6 to 130/23.1/0.1 sec]
15	Operation Intervals: Low Speed	[3.6 to 130/32.4/0.1 sec]
16	Operation Frequency	[1 to 1000/250/1]
19	Web Counter Clear Recording	[0 to 1/0/1]
1903	Web Drive Time	

	Records and stores for display information about fusing cleaning unit web consumption.	
1	Web: Total Page Counter	[0 to 999 999 999/0/1sec]
2	Web: Total Motor Rotation Time	[0 to 25.5/0/0.1sec]
3	Operation Interval Count	[0 to 130/0/0.1sec]
4	Total Operation Rotations	[0 to 999 999 999/3/1Cycle]

1906	De-curler Setting	
	Selects the paper path in the decurl unit (upper or lower) for the paper depending on the paper feed source.	
1	Tray1: Paper Path Selection	[0 to 5/3/1]
2	Tray2: Paper Path Selection	0: Lower Pass Def
3	A3LCT Tray3: Paper Path Selection	1: Lower Pass 1
4	A3LCT Tray4: Paper Path Selection	2: Lower Pass 2
5	A3LCT Tray5: Paper Path Selection	3: Upper Pass Def
6	Bypass Tray: Paper Path Selection	4: Upper Pass 1
		5: Upper Pass 2

1909	Force Send to Purge Tray	
	Forces paper to drop into the purged paper path. Used for testing.	
1	Purge 1 (0: Off, 1: On)	[0 to 1/1/1]

1910	Paper Bank Temp/Humidity	
	Displays the current temperature and humidity readings for the paper trays inside the main machine.	
1	Temperature Reading	
2	Humidity Reading	

1912	CIS LED Power Adjustment	
------	--------------------------	--

	Adjust the power level of the CIS that is used to adjust paper registration in the paper registration unit inside the right drawer. [EXECUTE]
--	--

1913	CIS LED Adj. Result Display DFU	
	Displays the result of the adjustment to adjust the level of the CIS LED power (done with SP1912).	
	PWM Duty	

1914	CIS P Pass Pixel Display DFU	
------	-------------------------------------	--

1916	CIS LED Power Magnification	
1	Variable Magnification	[1 to 5/1.52/0.01]
2	Variable Magnification	[1 to 5/2.01/0.01]
3	Variable Magnification	[1 to 5/3.53/0.01]

1917	Side-to-Side Reg Disable	
	Used to disable side-to-side registration in the paper registration unit for a selected paper feed source.	
1	Tray1	[0 to 1/0/1]
2	Tray2	
3	Dupx Tray	
4	A3 LCT Tray3	
5	A3 LCT Tray4	
6	A3 LCT Tray5	
7	Bypass Tray	

1920	LCT Tray Fan Duty Adjustment	
	These SP codes adjust the force of the air blown by the fans during paper separation in the LCIT trays.	

1	A3LCT Tray3	[10 to 100/70/10%]
2	A3LCT Tray4	
3	A3LCT Tray5	

2

1921	LCT Fan Start Time Setting	
	These SP codes adjust the start timing of the fans during paper separation with the LCIT.	
1	A3LCT Tray3	[1 to 10/3/1 sec]
2	A3LCT Tray4	
3	A3LCT Tray5	

1922	LCT Tray Fan ON/OFF	
	These SP codes adjust the start timing of the fans used for paper separation in the LCIT trays.	
1	A3LCT Tray3	[0 to 2/0/1]
2	A3LCT Tray4	0: Auto Select 1: Force ON 2: Force OFF
3	A3LCT Tray5	

1923	LCT Pickup Assist ON/OFF	
	These SP codes switch the air assist function in the LCIT paper trays off/on.	
1	Tray1	[0 to 2/0/1]
2	Tray2	0 : AUTO
3	A3LCT Tray3	1 : ON
4	A3LCT Tray4	2 : OFF
5	A3LCT Tray5	
6	Tray6	

1927	De-curl Default: Lower Path	
------	-----------------------------	--

	Selects the default position of the decurl roller for the lower path. [-3 to 3/0/0.1 mm]	
1928	De-curl Default: Upper Path	
	Selects the default position of the decurl roller for the upper path. [-3 to 3/0/0.1 mm]	
1929	De-curl Line Speed Adj: Default	
	[-2.5 to +12.5/1/0.5%]	
1930	De-curl Line Speed Adjust:Pos.1	
	[-2.5 to +12.5/4/0.5%]	
1931	De-curl Line Speed Adj:Pos.2	
	[-2.5 to +12.5/5/0.5%]	
1932	Buffer Pass Unit	
	Sets the length of time for the fans to operate in the unit after the unit returns to standby mode.	
1	Stand-by Setting	[0 to 60/1/1 min]
2	Fan drive Setting	[0 to 4/2/1] 0: Fan On for All Paper Weights 1: Fan On from Paper Weight 3 2: Fan On from Paper Weight 4 3: Fan On from Paper Weight 5 4: Fan Off from All Paper Weights
1945	Set Cooling Operation	
1	Low Noise Op Switch Temp	[0 to 50/20/1]
2	Normal Op Switch Temp	[0 to 50/35/1]

3	High Temp Op Switch Temp	[0 to 50/38/1]
4	Fan Low Temp Op Temp	[5 to 35/22/1]
5	Pump Low Temp Op Temp	
6	Fan Op Off: Y Thermistor	[30 to 50/43/1]
7	Fan Op Off Time	[0 to 60/10/1]
8	Duplex Exhaust Fan: Front: HS	[0 to 100/45/1]
9	Duplex Exhaust Fan: Front: NS	[0 to 100/90/1]
10	Duplex Exhaust Fan: Rear: HS	[0 to 100/45/1]
11	Duplex Exhaust Fan: Rear: NS	[0 to 100/90/1]
12	Machine Stop Counter	[0 to 999 999/0/1]
13	Pressure Roller Fan Strength	[0 to 1/1/1] 0: Half Speed 1: Normal Speed
14	Stop Temperature	
15	Recovery Temperature	

1950	Image Pos: Sub: Side 1	
1951	Image Pos: Sub: Side 2	
1952	Image Pos: Main: Side 1	
1953	Image Pos: Main: Side 2	
1 to 100	Custom Paper 001 to 100	[-3 to 3/0/0.1 mm]

1955	Skew Detect	
1 to 100	Custom Paper 001 to 100	[0 to 1/1/1] 0: OFF 1: ON

1956	Dbl-Feed Detect	
1 to 100	Custom Paper 001 to 100	[0 to 1/1/1] 0: OFF 1: ON

1957	Side-to-Side Reg Disable	
------	--------------------------	--

1 to 100	Custom Paper 001 to 100	[0 to 1/1/1] 0: OFF 1: ON
1958	Sub Scan Reg Correction Setting	
1 to 100	Custom Paper 001 to 100	[0 to 1/1/1] 0: OFF 1: ON
1959	Line Speed Adjust: Default Pos	
1 to 100	Custom Paper 001 to 100	[-2.5 to +12.5/1/0.5%]
1960	Line Speed Adjust:Pos.1	
1 to 100	Custom Paper 1 to 100	[-2.5 to +12.5/4/0.5%]
1961	Line Speed Adjust:Pos.2	
1 to 100	Custom Paper 001 to 100	[-2.5 to +12.5/5/0.5%]
1962	Color Paper Adjustment	
1 to 100	Custom Paper 001 to 100	[1 to 5 / 1.52 / 0.01]
1963	Trans Timing Roll Spd:Fine Adj	
1 to 100	Custom Paper 001 to 100	[-3 to 3 / 0 / 0.1%]
1964	Exit Motor Spd:Fine Adj	
1 to 100	Custom Paper 001 to 100	[-5 to 5 / 0 / 0.1 %]
1965	Invert Entrance Spd:Fine Adj	
1 to 100	Custom Paper 001 to 100	[-3 to 3 / 0 / 0.1 %]
1966	Invert Exit Spd:Fine Adj	
1 to 100	Custom Paper 001 to 100	[-3 to 3 / 0 / 0.1 %]
1975	LCT Tray Fan Duty Adjustment	

1 to 100	Custom Paper 001 to 100	[10 to 100 / 70 / 10%]
1976	LCT Tray Fan ON/OFF	
1 to 100	Custom Paper 001 to 100	[0 to 1 / 0 / 1] 0:OFF 1:ON
1977	LCT Pickup Assist ON/OFF	
1 to 100	Custom Paper 001 to 100	[0 to 1 / 0 / 1] 0:OFF 1:ON
1984	Htg Roller Temp Setting	
		[100 to 200/* /1 deg] The default settings are displayed to the right of "Initial" on the screen.
101 to 125	Custom Paper 001 to 100	
1985	Press Roller Temp Setting	
		[50 to 200/* /1 deg] The default settings are displayed to the right of "Initial" on the screen.
101 to 125	Custom Paper 001 to 100	
1986	Process Speed	
		[0 to 2/* /1] The default settings are displayed to the right of "Initial" on the screen.
101 to 125	Custom Paper 001 to 100	
1987	Fusing Mtr Rotation Correct	
101 to 125	Custom Paper 001 to 100	

	[-10 to +10/*/0.1%] The default settings (*) are displayed to the right of "Initial" on the screen.
--	--

1988	CPM Adjustment
101 to 125	Custom Paper 001 to 100
	[1 to 100/*/1%] The default settings (*) are displayed to the right of "Initial" on the screen.

1989	Nip Width Setting
101 to 125	Custom Paper 001 to 100
	[1 to 3/2/1] The default settings (*) are displayed to the right of "Initial" on the screen.

1991	Over N-Temp:CPM Down	
	These SP codes set the threshold for triggering CPM down mode based on media and weight.	
	Thickness	Weight (g/m²)
	1	52.3 - 63.0 g/m ²
	2	63.1 - 80.0 g/m ²
	3	80.1 - 105.0 g/m ²
	4	105.1 - 163.0 g/m ²
	5	163.1 - 220.0 g/m ²
	6	220.1 - 256.0 g/m ²
	7	256.1 - 300.0 g/m ²
101 to 107	Plain: Weight 1 to 7	[0 to 3/0/1 step]
109 to 114	Matte: Weight 2 to 7	0: No CPM Down
016 to 021	Glossy: Weight 2 to 7	1: CPM Down 1
122 to 124	Envelope: Weight 5 to 7	2: CPM Down 2

125	OHP	3: CPM Down 3
-----	-----	---------------

1992	Web Feed Interval	
	This SP sets the web feed intervals for different types of paper and weight.	
	Thickness	Weight (g/m²)
	1	52.3 - 63.0 g/m ²
	2	63.1 - 80.0 g/m ²
	3	80.1 - 105.0 g/m ²
	4	105.1 - 163.0 g/m ²
	5	163.1 - 220.0 g/m ²
	6	220.1 - 256.0 g/m ²
	7	256.1 - 300.0 g/m ²
101 to 107	Plain: Weight 1 to 7	[-3 to +3/* /0.1%]
109 to 114	Matte: Weight 2 to 7	The default settings (*) are displayed to the right of "Initial" on the screen.
016 to 021	Glossy: Weight 2 to 7	
122 to 124	Envelope: Weight 5 to 7	
125	OHP	

Group 2000

2101	Reg Col Interval	
	These SPs are used to adjust main registration (RGATE).	
1 to 4	Main Scan Dot: K, C, M, Y	[-512 to 511/0/1 dot]
6 to 9	Main/Sub Scan: K, C, M, Y	[-47 to 47/0/1 sub-dot]
11	Main phase initial value: K	[0 to 1000/0/1 us]
12	Main phase initial value: C	
13	Main phase initial value: M	
14	Main phase initial value: Y	
21	Main beam pitch adj: K	[1107 to 1620/1438/1 um]
22	Main beam pitch adj: C	
23	Main beam pitch adj: M	
24	Main beam pitch adj: Y	
36 to 39	SubScan Line: K, C, M, Y	[-4096 to 4095/0/1 line]
41	Main cor revision dot: C	[-512 to 511/0/1 dot]
42	Main cor revision dot: M	
43	Main cor revision dot: Y	
45	Main cor revision subdot: C	[-47 to 47/0/1 sub-dot]
46	Main cor revision subdot: M	
47	Main cor revision subdot: Y	
49	Sub cor revision line: C	[-4096 to 4095/0/1 line]
50	Sub cor revision line: M	
51	Sub cor revision line: Y	
60	Main Left Mag.: Subdot: C	
61	Main Right Mag.: Subdot: C	

62	Main Left Mag.: Subdot: M	
63	Main Right Mag.: Subdot: M	
64	Main Left Mag.: Subdot: Y	
65	Main Right Mag.: Subdot: Y	

2102	Print Magnification Adjustment	
	Adjusts the value for the standard speed of the rate of magnification for K in the main scan direction.	
1	Main Mag.: K	[0 to 255/132/1]
4	Main Mag.: C	
7	Main Mag.: M	
10	Main Mag.: Y	
16	Main Mag.: subdot: K	[-15264 to 15264/0/1 sub-dot]
19	Main Mag.: subdot: C	
22	Main Mag.: subdot: M	
25	Main Mag.: subdot: Y	
31	Main Paper Int. Mag: Subdot: K	
32	Main Paper Int. Mag: Subdot: C	
33	Main Paper Int. Mag: Subdot: M	
34	Main Paper Int. Mag: Subdot: Y	
40	Mag setting & Adjustment	[-1 to 1/0/0.001%]
41	Face Main Mag set & Adj	[-0.8 to 0.8/00.025%]
42	Face Sub Mag set & Adj	
43	Verso Main Mag set & Adj	
44	Verso Sub Mag set & Adj	

2103	Erase Margin Adjustment	
------	-------------------------	--

	Adjusts the white space at the leading and trailing edge, left and right edge of the paper.	
1	Lead Edge Width	[0 to 9/4/0.1 mm]
2	Trail. Edge Width	
3	Left	[0 to 9/2/0.1 mm]
4	Right	

2104	Skew Adjustment	
	These SPs adjust skew.	
2	Manual C	[-50 to 50/0/1 pulse]
3	Manual M	
4	Manual Y	
6	Accumulation present value K	
7	Accumulation present value C	
8	Accumulation present value M	
9	Accumulation present value Y	
11	Accumulation MUSIC value C	
12	Accumulation MUSIC value M	
13	Accumulation MUSIC value Y	
20	Phase pattern K	[1 to 4/1/1]
21	Phase pattern C	
22	Phase pattern M	
23	Phase pattern Y	
30	Clear Revision K	[0 to 1/0/1]
31	Clear Revision C	
32	Clear Revision M	
33	Clear Revision Y	

40	Manual K CE	[-10 to 10/0/1 pulse]
41	Manual K User	

2105	Main Beam Pitch Adj	
	Adjusts the value of the beam pitch adjustment for black in the main scan direction.	
1 to 160	Revision <Color> <No.>ch(annel) [-10 to 10/*/0.1 um]	The default settings (*) are displayed to the right of "Initial" on the screen.

2106	Trapezoid Adj	
	Trapezoid adjustment for black.	
1 to 160	Revision <Color KCMY> <no.>ch(annel) [-48 to 48/* / subdot]	The default settings (*) are displayed to the right of "Initial" on the screen.

2107	Image Parameter	
	These SP codes adjust image parameters.	
1	Shading Correction Flag	[0 to 1/1/1]
2	Image Gamma Flag	
3	Jaggy Revision	[0 to 1/0/1]
4	Fatten slanted line	
5	Dot Stabilize Revision	
6	Bow Skew Revision	[0 to 1/1/1]
7	Sub Mag Adj Revision K1	
8	Sub Mag Adj Revision K2	
9	Sub Mag Adj Revision W1	
10	Sub Mag Adj Revision W2	
11	Sub Mag Adj Rev 600dpi W1	[0 to 1/0/1]

12	trapezoid Adj ON/OFF	[0 to 1/1/1]
13	Sub Mag Adj Mirror K	[0 to 1/0/1]
14	Sub Mag Adj Mirror C	
15	Sub Mag Adj Mirror M	
16	Sub Mag Adj Mirror Y	
18	Sub Mag Adj Revision K3	
19	Sub Mag Adj Revision Gray	
20	Sub Scan Revision 1 spl	
21	Sub Mag Adj Parameter Change	
22	PWM Phase Selection	[0 to 2/1/1]

2108	Image Parameter	
1	K/C Writing Unit	[0 to 1/0/1]
2	Y/M Writing Unit	

2109	Test Pattern	
	Allows you to select a test pattern.	
3	Pattern Selection	
	Allows you to select 1 of 27 patterns to print [0 to 27/0/1]	
	0:Copy Image Data	14: Trimming Area
	1:Vertical Line 1 dot	15: Hound's Tooth Check 1 Vertical
	2:Vertical Line 2 dot	16: Hound's Tooth Check 2 Vertical
	3:Horizontal Line 1 dot	17:Band Horizontal
	4:Horizontal Line 2 dot	18:Band Vertical
	5:Grid Vertical Line	19:Checker Flag Pattern
	6:Grid Horizontal Linie	20:Grayscale Vertical Margin

	7:Grid Pattern Small	21:Grayscale Horizontal Margin
	8:Grid Pattern Large	22:Step Pattern 1 dot
	9:Argyle Pattern Small	23:Step Pattern 2dot
	10:Argyle Pattern Large	24:Stripe Pattern 1 dot
	11:Independent Pattern 1 dot	25:Stripe Pattern 2dot
	12:Independent Pattern 2dot	26:Full Dot Pattern
	13:Independent Pattern 4dot	27:None
5	Color Selection	[1 to 5/1/1 step] 1: Full Color 2: Cyan 3: Magenta 4: Yellow 5: Black
6	Density: K	[0 to 15/15/1 step]
7	Density: C	
8	Density: M	
9	Density: Y	

2111	Forced Line Position Adj	
	Executes forced color matching for Mode a, b, c, d	
1	Mode a	[0 to 1/0/1]
2	Mode b	
3	Mode c	
4	Mode d	

2112	TM/P-Sensor Test	
	These SP codes are used to test the TM sensors (Toner Mark or MUSIC sensors) and P-sensor (ID sensor), and check for damage on the surface of the image transfer belt (ITB).	

1	Execute	[0 to 1/0/1]
10	General	[0 to 9999/0/1]
11	Error Code: P	[0 to 999999/0/1]
15	Error Code: Front	
16	Error Code: Center	
17	Error Code: Rear	
20	Threshold Setting	[0 to 5.5/1.9/0.01 V]
21	Judge Val: Min 2	[0 to 5.5/2.5/0.01 V]
22	Judge Val: Output Chg Amplitude High	[0 to 5.5/1/0.01 V]
23	Judge Val: Output Chg Amplitude Low	
24	Judge Val: Ave Chg Amplitude High	[0 to 5.5/0.5/0.01 V]
25	Judge Val: Ave Chg Amplitude Low	

2113	Adjust LR Density Difference	
	Adjusts in the main scan direction the amount of laser light to create the image for each color so the density is uniform on the left and right sides of the image.	
1	K	[-5 to +5/0/1]
2	C	
3	M	
4	Y	

2121	Erase Margin Adj	
1	Leading Edge	[0 to 6 / 0 / 0.1 mm]
2	Trailing Edge	[0 to 6 / 0 / 0.1 mm]

2122	Erase Margin Adj Leading Edge	
	Adjusts and enlarges margin at the trailing edge. A user setting.	

1 to 100	Custom Paper 001 to 100	[-3 to 6 / 0 / 0.1 mm]
101	Plain: Weight 1	[-3 to 6 / 0.5 / 0.1 mm]
102 to 107	Plain: Weight 2 to 7	[-3 to 6 / 0 / 0.1 mm]
109 to 114	Glossy: Weight 2 to 7	
116 to 121	Matte: Weight 2 to 7	
122 to 124	Envelope: Weight 5 to 7	
125	OHP	

2123	Erase Margin Adj Trailing Edge	
	Adjusts and enlarges margin at the trailing edge. A user setting.	
1 to 100	Custom Paper 001 to 100	[-3 to +6/0/0.1 mm]
101 to 107	Plain: Weight 1 to 7	
109 to 114	Glossy: Weight 2 to 7	
116 to 121	Matte: Weight 2 to 7	
122 to 124	Envelope: Weight 5 to 7	
125	OHP	

2130	Sub Mag Adj Parameter K	
2131	Sub Mag Adj Parameter C	
2132	Sub Mag Adj Parameter M	
2133	Sub Mag Adj Parameter Y	
	These SP modes adjust the magnification parameters in the sub scan direction for each color.	
1	Interval:0.025 Percent	[0 to 255/19/1]
2	Mag Reciprocal:0.025 Percent	[0 to 8191/3990/1]
3	Interval:0.05 Percent	[0 to 255/53/1]
4	Mag Reciprocal:0.05 Percent	[0 to 8191/1961/1]

5	Interval:0.075 Percent	[0 to 255/19/1]
6	Mag Reciprocal:0.075 Percent	[0 to 8191/1349/1]
7	Interval:0.1 Percent	[0 to 255/53/1]
8	Mag Reciprocal:0.1 Percent	[0 to 8191/1007/1]
9	Interval:0.125 Percent	[0 to 255/47/1]
10	Mag Reciprocal:0.125 Percent	[0 to 8191/799/1]
11	Interval:0.15 Percent	[0 to 255/29/1]
12	Mag Reciprocal:0.15 Percent	[0 to 8191/667/1]
13	Interval:0.175 Percent	[0 to 255/13/1]
14	Mag Reciprocal:0.175 Percent	[0 to 8191/572/1]
15	Interval:0.2 Percent	[0 to 255/29/1]
16	Mag Reciprocal:0.2 Percent	[0 to 8191/493/1]
17	Interval:0.225 Percent	[0 to 255/23/1]
18	Mag Reciprocal:0.225 Percent	[0 to 8191/437/1]
19	Interval:0.25 Percent	[0 to 255/19/1]
20	Mag Reciprocal:0.25 Percent	[0 to 8191/3991/1]
21	Interval:0.275 Percent	[0 to 255/19/1]
22	Mag Reciprocal:0.275 Percent	[0 to 8191/361/1]
23	Interval:0.3 Percent	[0 to 255/19/1]
24	Mag Reciprocal:0.3 Percent	[0 to 8191/323/1]
25	Interval:0.325 Percent	[0 to 255/17/1]
26	Mag Reciprocal:0.325 Percent	[0 to 8191/306/1]
27	Interval:0.35 Percent	[0 to 255/17/1]
28	Mag Reciprocal:0.35 Percent	[0 to 8191/289/1]
29	Interval:0.375 Percent	[0 to 255/14/1]
30	Mag Reciprocal:0.375 Percent	[0 to 8191/266/1]

31	Interval:0.4 Percent	[0 to 255/11/1]
32	Mag Reciprocal:0.4 Percent	[0 to 8191/253/1]
33	Interval:0.425 Percent	[0 to 255/21/1]
34	Mag Reciprocal:0.425 Percent	[0 to 8191/231/1]
35	Interval:0.45 Percent	[0 to 255/22/1]
36	Mag Reciprocal:0.45 Percent	[0 to 8191/220/1]
37	Interval:0.475 Percent	[0 to 255/21/1]
38	Mag Reciprocal:0.475 Percent	[0 to 8191/210/1]
39	Interval:0.5 Percent	[0 to 255/18/1]
40	Mag Reciprocal:0.5 Percent	[0 to 8191/198/1]
41	Interval:0.525 Percent	[0 to 255/19/1]
42	Mag Reciprocal:0.525 Percent	[0 to 8191/190/1]
43	Interval:0.55 Percent	[0 to 255/13/1]
44	Mag Reciprocal:0.55 Percent	[0 to 8191/182/1]
45	Interval:0.575 Percent	[0 to 255/11/1]
46	Mag Reciprocal:0.575 Percent	[0 to 8191/176/1]
47	Interval:0.6 Percent	[0 to 255/15/1]
48	Mag Reciprocal:0.6 Percent	[0 to 8191/165/1]
49	Interval:0.625 Percent	[0 to 255/16/1]
50	Mag Reciprocal:0.625 Percent	[0 to 8191/160/1]
51	Interval:0.65 Percent	[0 to 255/14/1]
52	Mag Reciprocal:0.65 Percent	[0 to 8191/154/1]
53	Interval:0.675 Percent	[0 to 255/15/1]
54	Mag Reciprocal:0.675 Percent	[0 to 8191/150/1]
55	Interval:0.7 Percent	[0 to 255/13/1]
56	Mag Reciprocal:0.7 Percent	[0 to 8191/143/1]

57	Interval:0.725 Percent	[0 to 255/14/1]
58	Mag Reciprocal:0.725 Percent	[0 to 8191/140/1]
59	Interval:0.75 Percent	[0 to 255/7/1]
60	Mag Reciprocal:0.75 Percent	[0 to 8191/133/1]
61	Interval:0.775 Percent	[0 to 255/13/1]
62	Mag Reciprocal:0.775 Percent	[0 to 8191/130/1]
63	Interval:0.8 Percent	[0 to 255/14/1]
64	Mag Reciprocal:0.8 Percent	[0 to 8191/126/1]

2141	P-Sensor Test (Average)	
	These SP codes test the belt background data, ID sensor, reflectivity of the belt and averages them for different areas of the image transfer belt. (The "P-sensor" is the ID sensor.)	
1	Average	[0 to 5.5/0/0.01V]
5	Average: Front	
6	Average: Center	
7	Average: Rear	

2142	P-Sensor Test (Maximum)	
	These SP codes test the belt background data, ID sensor, reflectivity of the belt and determine the maximum value at different areas of the image transfer belt. (The "P-sensor" is the ID sensor.)	
1	Maximum	[0 to 5.5/0/0.01V]
5	Maximum: Front	
6	Maximum :Center	
7	Maximum: Rear	

2143	P-Sensor Test (Minimum)	
------	-------------------------	--

	These SP codes test the belt background data, ID sensor, reflectivity of the belt and determine the minimum value at different areas of the image transfer belt. (The "P-sensor" is the ID sensor.)	
1	Minimum	[0 to 5.5/0/0.01V]
5	Minimum: Front	
6	Minimum: Center	
7	Minimum: Rear	

2144	P-Sensor Test (Maximum 2)	
	These SP codes test the belt background data, ID sensor, reflectivity of the belt and determine the simple maximum value at different areas of the image transfer belt. (The "P-sensor" is the ID sensor.)	
1	Maximum 2	[0 to 5.5/0/0.01V]
5	Maximum 2: Front	
6	Maximum 2: Center	
7	Maximum 2: Rear	

2145	Sensor Test (Minimum 2)	
	These SP codes test the belt background data, ID sensor, reflectivity of the belt and determine the simple minimum value at different areas of the image transfer belt. (The "P-sensor" is the ID sensor.)	
1	Minimum 2	[0 to 5.5/0/0.01V]
5	Minimum 2:Front	
6	Minimum 2:Center	
7	Minimum 2:Rear	

2146	TM Sensor Test	
	This SP sets the number of tests done to check the belt background data, TM sensor, and front edge of the belt. ("TM sensor" means "MUSIC sensor". Here, it refers to the front MUSIC sensor.)	

5	Number of Edge Detection: Front	[0 to 16/0/0.1]
6	Number of Edge Detection: Center	
7	Number of Edge Detection: Rear	

2150	Area Mag. Correction	
	Fine adjusts the image color (YMCK) in the main scan direction. Adjustment is done in units of 1/48 dots.	
001 to 056	Area <No.> <Color>	[-4095 to +4095/0/1 Subdot]
	<No.> 0 to 13 <Color> Bk, C, M, Y	

2151	Bow Skew Setting	
	Defines the initial setting for each area of the MUSIC pattern for Bow Skew testing and adjustment.	
1	Initial Setting Area 0 K	[0 to 24/0/1]
2 to 11	Initial Setting Area <Range>K	[0 to 65535/0/1]
12	Initial Setting Area 81 to 85 K	[0 to 1023/0/1]
13	Initial Setting Area 0C	[0 to 24/0/1]
14 to 23	Initial Setting Area <Range> C	[0 to 65535/0/1]
24	Initial Setting Area 81 to 85 C	[0 to 1023/0/1]
25	Initial Setting Area 0 M	[0 to 24/0/1]
26 to 35	Initial Setting Area <Range>M	[0 to 65535/0/1]
36	Initial Setting Area 81 to 85 M	[0 to 1023/0/1]
37	Initial Setting Area 0 Y	[0 to 24/0/1]
38 to 47	Initial Setting Area <Range>Y	[0 to 65535/0/1]
48	Initial Setting Area 81 to 85 Y	[0 to 1023/0/1]
61	Initial Setting Area 0 C	[0 to 24/0/1]
62 to 71	Initial Setting Area <Range>C	[0 to 65535/0/1]

72	Initial Setting Area 81 to 85 C	[0 to 1023/0/1]
73	Initial Setting Area 0 M	[0 to 24/0/1]
74 to 83	Initial Setting Area <Range>M	[0 to 65535/0/1]
84	Initial Setting Area 81 to 85 M	[0 to 1023/0/1]
85	Initial Setting Area 0 Y	[0 to 24/0/1]
86 to 95	Initial Setting Area <Range>Y	[0 to 65535/0/1]
96	Initial Setting Area 81 to 85 Y	[0 to 1023/0/1]

2152	Shading Coeff	
	Sets the adjust coefficient for exposure shading for each color in each area of the MUSIC pattern.	
1 to 128	<Area> <Front No. 0 to 30><Color KCMY>	[0.875 to 1.165/1/0.001]

2153	MUSIC Settings	
	These SP codes set up the MUSIC settings.	
1	Auto Execute	[0 to 1/1/1]
2	During ProCon	0: OFF, 1: ON
3	Initialization	
4	During Data In	
5	Writing	
6	MUSIC Temp Intervals	[0 to 1/0/1]
24	Assign Page Interval	[10 to 999/100/1 page]
29	MUSIC Density Lvl	[0 to 15/15/1]
30	Clear Main Slip	[0 to 1/0/1]
31	Clear Sub Slip	
40	Decision Temp: Change K	[0 to 99.9/1.5/0.1 deg]
41	Decision Temp: Change K2	[0 to 99.9/3/0.1 deg]

44	Decision Temp: Change M	[0 to 99.9/1.5/ 0.1deg]
45	Decision Temp: Change M2	[0 to 99.9/3/0.1 deg]
50	Decision Temp: Change Y	[0 to 99.9/1.5/0.1 deg]
51	Decision Temp: Change Y2	[0 to 99.9/3/0.1 deg]
52	Decision Temp: ITB FB Sensor	[0 to 99.9/1.5/0.1 deg]
53	Decision Temp: ITB FB Sensor2	[0 to 99.9/3/0.1 deg]

2154	MUSIC Setting:2	
	Feeds back the MUSIC setting adjustments.	
	Feed Back mode	[0 to 1 /1/1]

2155	MUSIC Setting: 3	
	Filter QF for the MUSIC settings.	
13	Filter QF	[0 to 3 /3/1]
20	BeforeFilter:a 1	[-131071 to 131071/125869/1]
21	BeforeFilter:a2	[-131071 to 131071/-60488/1]
22	BeforeFilter:b0	[-131071 to 131071/39/1]
23	BeforeFilter:b 1	[-131071 to 131071/77/1]
24	BeforeFilter:b2	[-131071 to 131071/39/1]
25	AfterFilter:a 1	[-131071 to 131071/128596/1]
26	AfterFilter:a2	[-131071 to 131071/-63398/1]
27	AfterFilter:b0	[-131071 to 131071/84/1]
28	AfterFilter:b 1	[-131071 to 131071/168/1]
29	AfterFilter:b2	[-131071 to 131071/84/1]
50	Main Offset Left: C	[-2000 to 2000/0/0.1um]
51	Main Offset Center: C	
52	Main Offset Right: C	

53	Main Offset Left: M	
54	Main Offset Center: M	
55	Main Offset Right: M	
56	Main Offset Left: Y	
57	Main Offset Center: Y	
58	Main Offset Right: Y	
62	Sub Offset Left: C	
63	Sub Offset Center: C	
64	Sub Offset Right: C	
65	Sub Offset Left: M	
66	Sub Offset Center: M	
67	Sub Offset Right: M	
68	Sub Offset Left: Y	
69	Sub Offset Center: Y	
70	Sub Offset Right: Y	
80	Skew Remainder Std Speed: C	[-2000 to 2000/0/0.001um]
81	Skew Remainder Mid Speed: C	[-2000 to 2000/32.657/0.001um]
82	Skew Remainder Low Speed: C	[-2000 to 2000/54.429/0.001um]
83	Skew Remainder Std Speed: Y	[-2000 to 2000/0/0.001um]
84	Skew Remainder Mid Speed: Y	[-2000 to 2000/32.657/0.001um]
85	Skew Remainder Low Speed: Y	[-2000 to 2000/54.429/0.001um]
90	Bow Skew Upper Limit	[0 to 24/24/1 line]
91	Bow Skew Lower Limit	[0 to 24/1/1 line]

2156	MUSIC Threshold Setting	
1	ch 0: 1st	[0.5 to 3/1.5/0.1 V]

2	ch 0: 2nd	
3	ch 0: 3rd	
4	ch 0: 4th	
5	ch 1: 1st	
6	ch 1: 2nd	
7	ch 1: 3rd	
8	ch 1: 4th	
9	ch 2: 1st	
10	ch 2: 2nd	
11	ch 2: 3rd	
12	ch 2: 4th	

2180	MUSIC Monitor	
	Lens temperature monitor.	
1	Lens Temp: K	[0 to 99.9/0/0.1 deg]
3	Lens Temp: M	
10	Previous Temp: K	
12	Previous Temp: M	
15	Previous Temp: Main Y	
16	Previous Temp: ITB FB Sensor	

2181	Alignment Result	
	These SP codes report the results of color registration alignment.	
1	General	[0 to 9999999/0/1]
2	Difference Main Left: C	[-2000 to 2000/0/0.001 um]
3	Difference Main Center: C	
4	Difference Main Right: C	

5	Difference Main Left: M	
6	Difference Main Center: M	
7	Difference Main Right: M	
8	Difference Main Left: Y	
9	Difference Main Center: Y	
10	Difference Main Right: Y	
14	Difference Sub Left: C	
15	Difference Sub Center: C	
16	Difference Sub Right: C	
17	Difference Sub Left: M	
18	Difference Sub Center: M	
19	Difference Sub Right: M	
20	Difference Sub Left: Y	
21	Difference Sub Center: Y	
22	Difference Sub Right: Y	
26	MUSIC Sub Scan Revision: C	[-4096 to 4095/0/1 line]
27	MUSIC Sub Scan Revision: M	
28	MUSIC Sub Scan Revision: Y	
30	BowSkew Revision Left: C	[-2000 to 2000/0/0.001 um]
31	BowSkew Revision Center: C	
32	BowSkew Revision Right: C	
33	BowSkew Revision Left: M	
34	BowSkew Revision Center: M	
35	BowSkew Revision Right: M	
36	BowSkew Revision Left: Y	
37	BowSkew Revision Center: Y	

38	BowSkew Revision Right: Y	
42	Skew Amt: C	
43	Skew Amt: M	
44	Skew Amt: Y	

2

2183	Main Scan Length Detection	
	These SP codes set and execute the standard speed of 2-dot measurement for each color.	
1	Execute : K	[0 to 1/0/1]
4	Execute : C	
7	Execute : M	
10	Execute : Y	

2184	Main Scan Length Target	
	These SP codes retrieve the results of 2-dot measurement for each color and display the counts.	
1	Execute: K	[0 to 1/0/1]
2	Execute: C	
3	Execute: M	
4	Execute: Y	
6	Count Value: K	[0 to 300000/266835/1]
7	Count Value: C	
8	Count Value: M	
9	Count Value: Y	

2185	Main Scan Length Detection	
	This SP selects 2-point measurement.	
1	Mode Selection	[0 to 2/2/1]

		0: OFF 1:ON 2:ALL ON
--	--	----------------------

2

2190	Line Position Adj. Setting	
	This SP selects the amount of magnification in the main scan direction for the color registration method.	
1	Partial Mag: K	[0 to 1/1/1]
2	Partial Mag: C	
3	Partial Mag: M	
4	Partial Mag: Y	
6	Left Right Mag: C	
7	Left Right Mag: M	
8	Left Right Mag: Y	
12	SnSErr Range	[-3500 to 3500/200/1 um]

2191	Polygon Mirror Face Detection	
	Selects polygon mirror facet measurement method.	
1	Mode Selection	[0 to 1/1/1] 0:OFF 1:ON

2192	LD Control	
1	LD On : K	[0 to 40 / 0 / 1] K : LD1 to 40 : ON/OFF
2	LD On : C	[0 to 40 / 0 / 1] C : LD1 to 40 : ON/OFF
3	LD On : M	[0 to 40 / 0 / 1] M : LD1 to 40 : ON/OFF
4	LD On : Y	[0 to 40 / 0 / 1] Y : LD1 to 40 : ON/OFF

2193	PD Control	
------	------------	--

1	Monitor PD Output: K	[0 to 1023 / - / 1]
2	Monitor PD Output: C	[0 to 1023 / - / 1]
3	Monitor PD Output: M	[0 to 1023 / - / 1]
4	Monitor PD Output: Y	[0 to 1023 / - / 1]

2194	MUSIC Execution Result	
7	Execution Result	[0 to 1/0/1]
8	Number of Execution	[0 to 999999/0/1times]
9	Number of Failure	
10	Error Result: M	[0 to 9/0/1]
11	Error Result: C	
12	Error Result: Y	

2197	MUSIC Start Time	
1	MUSIC Start Time (EDT)	[10 to 40/20/10 ms]
2	TM Sensor Position	[50 to 500/155/0.1 mm]

2198	Music A/D Interval	
	ADC Trigger Counter	[7.5 to 20/10/0.1 us]

2199	Music Error Time Setting	
	Error Detection Counter	[0.1 to 9.9/2.5/0.1 sec]

2201	Set DC Charge	
	These SP codes set the DC bias. However, these settings are enabled only when SP3-600-001 is selected and enabled as the method to control process control electrical potential.	
1	K	[-999 to -250/-560/1 V\
2	C	

3	M	
4	Y	

2

2202	Set AC (Fixed) Charge	
	This SP setting determines the fixed electrical potential setting when AC electrical potential adjustment is off.	
1	AC Bias :K	[0 to 3/2.2/0.01 kV]
2	AC Bias :C	
3	AC Bias :M	
4	AC Bias :Y	

2204	Set AC Environ Corr	
	Sets the target value for the AC electrical potential charge adjustment.	
1 to 4	Norm:LL:Target:K, C, M, Y	[2.5 to 3.5/2.15/0.01 mA]
6 to 9	Norm:ML:Target: K, C, M, Y	[1.5 to 2.1/3/0.01 mA]
11 to 14	Norm:MM:Target:K, C, M, Y	[1.5 to 3/2.05/0.01 mA]
16 to 19	Norm:MH:Target: K, C, M, Y	
21 to 24	Norm:HH:Target:K, C, M, Y	
26 to 29	Mid:LL:Target:K, C, M, Y	[1.2 to 2.8/1.78/ 0.01 mA]
31 to 34	Mid:ML:Target:K, C, M, Y	[1.2 to 2.8/1.74/ 0.01 mA]
36 to 39	Mid:MM:Target:K, C, M, Y	[1.2 to 2.8/1.7/ 0.01 mA]
41 to 44	Mid:MH:Target:K, C	
46 to 47	Mid:HH:Target: M, Y	
48 to 49	Mid:HH:Target:M, Y	
51 to 54	Low:LL:Target:K, C, M, Y	[1 to 2.5/1.56/ 0.01 mA]
56 to 59	Low:ML:Target:K, C, M, Y	[1 to 2.5/1.53/ 0.01 mA]
61 to 64	Low:MM:Target:K, C, M, Y	[1 to 2.5/1.5/0.01 mA]

66 to 69	Low:MH:Target:K, C, M, Y	
71 to 72	Low:HH:Target:K, C	
73 to 74	Low:HH:Target:M, Y	

2205	Adj/Display AC Charge	
	Switches the AC electrical potential setting on/off.	
1	Select	[0 to 1/0/1]
2	Temp Threshold 1	[0 to 50/3/1 deg]
3	Temp Threshold 2	[0 to 50/1/1 deg]
4	Execution Interval	[0 to 200/10/5]
5	Previous Temp:BW	[0 to 50/0/1 deg]
6	Previous Temp:Col	

2208	Chg AC Adj.: Execute	
	Touch [EXECUTE] to force execute the AC electrical potential adjustment.	
1	Execute AC Reduction	[EXECUTE]

2209	Chg AC Adj: Result	
	Displays the result of the AC electrical potential adjustment.	
1	Chg AC Adj:Result	[0 to 9999/100/1] [1111] denotes successful adjustment.

2211	Set LD Power	
	These SP codes set the LD power level for each laser unit. These settings take effect only when SP3600-001 is selected and set to "0" (ON).	
1	K	[80 to 170/100/1 %]
2	C	
3	M	

4	Y	
---	---	--

2212	Set Dev DC	
	These SP codes set the DC bias for each color. These settings take effect only when SP3600-001 is selected and set to "0" (ON).	
1	K	[-900 to 0/-450/1 V]
2	C	
3	M	
4	Y	

2220	Chg Roll Cleaning Timing	
	This SP sets the operation timing of the charge roller cleaning roller.	
	Execution Timing	[0 to 2/2/1] 0: No Operation 1: Power On & Distance 2: Distance

2221	Chg Roll Cleaning Timing	
	These SP codes set up the parameters for the operation of the charge roller cleaning roller.	
1	Execution Interval: K	[0 to 999 999/100 000/100 cm]
2	Execution Interval: C	
3	Execution Interval: M	
4	Execution Interval: Y	
5	Distance: K	[0 to 999 999/0/1 cm]
6	Distance: C	
7	Distance: M	
8	Distance: Y	
9	Delay at Power On: K	[0 to 999 999/5000/100 cm]

10	Delay at Power On: C	
11	Delay at Power On: M	
12	Delay at Power On: Y	
13	Delay at Power On: Y	

2222	Chg Roll Cleaning Execute	
	This SP triggers forced manual cleaning of the charge roller with the charge roller cleaning roller. Cleaning can be done for charge roller independently or all at once together.	
1	All	[EXECUTE]
2	K	
3	C	
4	M	
5	Y	

2224	Set QL Power	
	Sets the power level of the quenching lamps which eliminate residual charge on the drums.	
1	Norm Image	[0 to 100/80/1%]
2	Norm Margin	
3	Mid Image	[0 to 100/56/1%]
4	Mid Margin	
5	Low Image	[0 to 100/40/1%]
6	Low Margin	

2225	Cleaning Speed: Col	
	These SP codes adjust the speed of the cleaning brush rollers relative to the speed of the drums.	
1	Norm	0.1 to 1/0.38/0.01]
2	Mid	[0.1 to 1/0.56/0.01]

3	Low	[0.1 to 1/0.54/0.01]
4	Period of Revs 1	[0 to 150 000/5000/1 m]
5	Period of Temp	[0 to 50/34/1 deg]
6	Distance Coefficient1	[0.5 to 2/0.9/0.1]
7	Post Switching Coefficient	[0.5 to 2/1.25/0.1]
8	Period of Revs2	[0 to 150000/15000/1 m]
9	Period of Revs3	[0 to 150000/40000/1 m]
10	Distance Coefficient2	[0.5 to 2/1/0.1]
11	Distance Coefficient3	
12	Special Mode Selection: K	[0 to 1/0/1]
13	Special Mode Selection: C	
14	Special Mode Selection: M	
15	Special Mode Selection: Y	
16	Special Mode Coefficient1	[0.5 to 2/0.9/0.1]
17	Special Mode Coefficient2	[0.5 to 2/1.2/0.1]
18	Special Mode Coefficient3	

2301	Current Value: FC	
1	Side1:ITB K	[0 to 70/0/0.1 uA]
2	Side1:ITB C	
3	Side1:ITB M	
4	Side1:ITB Y	
7	Side1:PTR	[-400 to 0/0/1 uA]
8	Side1:SepDC	[0 to 10/0/0.1 uA]
9	Side1:SepAC	[8 to 12/10/0.1 uA]
11	Side2:ITB K	[0 to 70/0/0.1 uA]

12	Side2:ITB C	
13	Side2:ITB M	
14	Side2:ITB Y	
17	Side2:PTR	[-400 to 0/0/1 uA]
18	Side2:SepDC	[0 to 10/0/0.1 uA]
19	Side2:SepAC	[8 to 12/10/0.1 kV]

2302	Current Value: BK	
1	Side1:ITB K	[0 to 70/0/0.1uA]
7	Side1:PTR	[-400 to 0/0/1uA]
8	Side1:SepDC	[0 to 10/0/0.1uA]
9	Side1:SepAC	[8 to 12/10/0.1kV]
11	Side2:ITB K	[0 to 70/0/0.1uA]
17	Side2:PTR	[-400 to 0/0/1uA]
18	Side2:SepDC	[0 to 10/0/0.1uA]
19	Side2:SepAC	[8 to 12/10/0.1kV]

2310	Force Apply Lubricant	
	These SP codes control the forced application of lubricant to the ITB and display the histories of executed cleanings.	
1	Belt Cleaning	[0 to 1/0/1]
2	Operation Time Setting	[0 to 600/300/10sec]
3	Success App Date: History 1	[0 to 991 231/0/1]
4	Success App Date: History 2	
5	Success App Date: History 3	
6	Success App Date: History 4	
7	Success App Date: History 5	

2311	Current R Division	
11	ITB K	[0 to 6/3/1]
12	ITB C	
13	ITB M	
14	ITB Y	
17	PTR	

2312	Measured Voltage	
1	ITB K	[0 to 7/0/0.01 kV]
2	ITB C	
3	ITB M	
4	ITB Y	
7	PTR	[0 to 12/0/0.01 kV]
13	Meas ITB	[0 to 6/3/0.01 kV]
14	Meas PTR	

2313	Execute Vltg Meas	
1	FC	[EXECUTE] then displays "Completed".
2	BW	

2315	Set:Int Vltg Meas	
1	Execute Interval	[0 to 20000/200/1 Sheet]
2	Counter:FC	[0 to 20000/0/1 Sheet]
3	Counter:BW	

2321	Set:R Thresh:LLL	
1	R Thresh1:ITB	[0 to 10/0.8/0.01 kV]

2	R Thresh2:ITB	[0 to 10/1.15/0.01 kV]
3	R Thresh3:ITB	[0 to 10/1.5/0.01 kV]
4	R Thresh4:ITB	[0 to 10/3/0.01 kV]
5	R Thresh5:ITB	[0 to 10/6.5/0.01 kV]
6	R Thresh1:PTR	[0 to 10/1.8/0.01 kV]
7	R Thresh2:PTR	[0 to 10/2.48/0.01 kV]
8	R Thresh3:PTR	[0 to 10/3.5/0.01 kV]
9	R Thresh4:PTR	[0 to 10/4.8/0.01 kV]
10	R Thresh5:PTR	[0 to 10/7/0.01 kV]

2322	Set:R Thresh:LL	
1	R Thresh1:ITB	[0 to 10/0.8/0.01 kV]
2	R Thresh2:ITB	[0 to 10/1.15/0.01 kV]
3	R Thresh3:ITB	[0 to 10/1.5/0.01 kV]
4	R Thresh4:ITB	[0 to 10/3/0.01 kV]
5	R Thresh5:ITB	[0 to 10/6.5/0.01 kV]
6	R Thresh1:PTR	[0 to 10/1.5/0.01 kV]
7	R Thresh2:PTR	[0 to 10/1.95/0.01 kV]
8	R Thresh3:PTR	[0 to 10/2.65/0.01 kV]
9	R Thresh4:PTR	[0 to 10/3.8/0.01 kV]
10	R Thresh5:PTR	[0 to 10/6/0.01 kV]

2323	Set:R Thresh:ML	
1	R Thresh1:ITB	[0 to 10/0.8/0.01 kV]
2	R Thresh2:ITB	[0 to 10/1.15/0.01 kV]
3	R Thresh3:ITB	[0 to 10/1.5/0.01 kV]
4	R Thresh4:ITB	[0 to 10/3/0.01 kV]

5	R Thresh5:ITB	[0 to 10/6.5/0.01 kV]
6	R Thresh1:PTR	[0 to 10/1.2/0.01 kV]
7	R Thresh2:PTR	[0 to 10/1.55/0.01 kV]
8	R Thresh3:PTR	[0 to 10/2.05/0.01 kV]
9	R Thresh4:PTR	[0 to 10/2.9/0.01 kV]
10	R Thresh5:PTR	[0 to 10/5/0.01 kV]

2324	Set:R Thresh:MM	
1	R Thresh1:ITB	[0 to 10/0.8/0.01 kV]
2	R Thresh2:ITB	[0 to 10/1.15/0.01 kV]
3	R Thresh3:ITB	[0 to 10/1.5/0.01 kV]
4	R Thresh4:ITB	[0 to 10/3/0.01 kV]
5	R Thresh5:ITB	[0 to 10/6.5/0.01 kV]
6	R Thresh1:PTR	[0 to 10/0.9/0.01 kV]
7	R Thresh2:PTR	[0 to 10/0.65/0.01 kV]
8	R Thresh3:PTR	[0 to 10/1.45/0.01 kV]
9	R Thresh4:PTR	[0 to 10/2/0.01 kV]
10	R Thresh5:PTR	[0 to 10/4/0.01 kV]

2325	Set:R Thresh:MH	
1	R Thresh1:ITB	[0 to 10/0.8/0.01 kV]
2	R Thresh2:ITB	[0 to 10/1.15/0.01 kV]
3	R Thresh3:ITB	[0 to 10/1.5/0.01 kV]
4	R Thresh4:ITB	[0 to 10/3/0.01 kV]
5	R Thresh5:ITB	[0 to 10/6.5/0.01 kV]
6	R Thresh1:PTR	[0 to 10/0.5/0.01 kV]
7	R Thresh2:PTR	[0 to 10/6.5/0.01 kV]

8	R Thresh3:PTR	[0 to 10/0.8/0.01 kV]
9	R Thresh4:PTR	[0 to 10/1.2/0.01 kV]
10	R Thresh5:PTR	[0 to 10/2.5/0.01 kV]

2326	Set:R Thresh:HH	
1	R Thresh1:ITB	[0 to 10/0.8/0.01 kV]
2	R Thresh2:ITB	[0 to 10/1.15/0.01 kV]
3	R Thresh3:ITB	[0 to 10/1.5/0.01 kV]
4	R Thresh4:ITB	[0 to 10/3/0.01 kV]
5	R Thresh5:ITB	[0 to 10/6.5/0.01 kV]
6	R Thresh1:PTR	[0 to 10/0.4/0.01 kV]
7	R Thresh2:PTR	[0 to 10/0.52/0.01 kV]
8	R Thresh3:PTR	[0 to 10/0.65/0.01 kV]
9	R Thresh4:PTR	[0 to 10/0.95/0.01 kV]
10	R Thresh5:PTR	[0 to 10/2.4/0.01 kV]

2401	Set: ITB K: Standard	
5	FC	[0 to 70/33/0.1 uA]
15	BK	[0 to 70/34/0.1 uA]
21	Non Image	[0 to 70/5/0.1 uA]

2411	Set:ITB K:Eng Spd Coeff (100%)	
5	100%:FC	[10 to 200/100/1 %]
15	100%:BK	
21	100%:Non Image	

2412	Set:ITB K:Eng Spd Coeff (70%)	
------	-------------------------------	--

5	70%:FC	[10 to 200/70/1%]
15	70%:BK	
21	70%:Non Image	

2

2413	Set:ITB K:Eng Spd Coeff (50%)	
5	50%:FC	[10 to 200/50/1%]
15	50%:BK	
21	50%:Non Image	

2427	Set:ITB K:Env Coeff	
1	LLL:Bk:Side 1	[10 to 200/100/1%\
2	LLL:Bk:Side2	
3	LLL:FC:Side 1	
4	LLL:FC:Side2	
5	LLL:Non Image	
11	LL:Bk:Side 1	
12	LL:Bk:Side2	
13	LL:FC:Side 1	
14	LL:FC:Side2	
15	LL:Non Image	
21	ML:Bk:Side 1	
22	ML:Bk:Side2	
23	ML:FC:Side 1	
24	ML:FC:Side2	
25	ML:Non Image	
31	MM:Bk:Side 1	
32	MM:Bk:Side2	

33	MM:FC:Side1	
34	MM:FC:Side2	
35	MM:Non Image	
41	MH:Bk:Side1	
42	MH:Bk:Side2	
43	MH:FC:Side1	
44	MH:FC:Side2	
45	MH:Non Image	
51	HH:Bk:Side1	
52	HH:Bk:Side2	
53	HH:FC:Side1	
54	HH:FC:Side2	
55	HH:Non Image	

2428	Set:ITB K:Env Coeff	
1	LLL:FC:Side1	[10 to 200/100/1%]
2	LLL:FC:Side2	
3	LLL:Non Image	
11	LL:FC:Side1	
12	LL:FC:Side2	
13	LL:Non Image	
21	ML:FC:Side1	
22	ML:FC:Side2	
23	ML:Non Image	
31	MM:FC:Side1	
32	MM:FC:Side2	

33	MM:Non Image	
41	MH:FC:Side1	
42	MH:FC:Side2	
43	MH:Non Image	
51	HH:FC:Side1	
52	HH:FC:Side2	
53	HH:Non Image	

2431	Set:ITB K:R Coeff	
	R-2	[50 to 250/170/1 %]

2432	Set:ITB K:R Coeff	
	R-1	[50 to 250/152/1%]

2433	Set:ITB K:R Coeff	
	R0	[50 to 250/136/1%]

2434	Set:ITB K:R Coeff	
	R+1	[50 to 250/124/1%]

2435	Set:ITB K:R Coeff	
	R+2	[50 to 250/116/1%]

2436	Set:ITB K:R Coeff	
	R+3	[50 to 250/136/51%]

2451	Set:ITB C:Standard	
5	FC	[0 to 70/34/0.1uA]
21	Non Image	[0 to 70/5/0.1uA]

2501	Set:ITB M:Standard	
5	FC	[0 to 70/36/0.1 uA]
21	Non Image	[0 to 70/5/0.1 uA]

2551	Set:ITB Y:Standard	
5	FC	[0 to 70/38/0.1 uA]
21	Non Image	[0 to 70/5/0.1 uA]

2661	Set:ITB Col:Eng Spd Coeff	
5	100%:FC	[10 to 200/100/1 %]
21	100%:Non Image	

2662	Set:ITB Col:Eng Spd Coeff	
5	70%:FC	[10 to 200/70/1 %]
21	70%:Non Image	

2663	Set:ITB Col:Eng Spd Coeff	
5	50%:FC	[10 to 200/50/1 %]
21	50%:Non Image	

2665	Set:SepDC:Standard	
21	Non Image	[0 to 10/1/0.1 uA]

2666	Set:SepDC:Eng Spd Coeff	
1	100%	[10 to 200/100/1 %]
2	70%	[10 to 200/70/1 %]
3	50%	[10 to 200/50/1 %]

2667	Set:SepAC:Standard	
------	--------------------	--

	Non Image	[8 to 12/8.4/0.1 kV]
--	-----------	----------------------

2668	Set:SepAC:Eng Spd Coeff	
1	:100%	[10 to 200/100/1%]
2	:70%	[10 to 200/93/1%]
3	:50%	[10 to 200/88/1%]

2669	Set:SepDC:Env Coeff	
1	LLL:Bk:Side1	[10 to 200/100/1%]
2	LLL:Bk:Side2	
3	LLL:FC:Side1	
4	LLL:FC:Side2	
11	LL:Bk:Side1	
12	LL:Bk:Side2	
13	LL:FC:Side1	
14	LL:FC:Side2	
21	ML:Bk:Side1	
22	ML:Bk:Side2	
23	ML:FC:Side1	
24	ML:FC:Side2	
31	MM:Bk:Side1	
32	MM:Bk:Side2	
33	MM:FC:Side1	
34	MM:FC:Side2	
41	MH:Bk:Side1	
42	MH:Bk:Side2	
43	MH:FC:Side1	

44	MH:FC:Side2	
51	HH:Bk:Side1	
52	HH:Bk:Side2	
53	HH:FC:Side1	
54	HH:FC:Side2	

2

2670	Set:SepAC:Env Coeff	
1	LLL:Bk:Side1	[10 to 200/100/1%]
2	LLL:Bk:Side2	
3	LLL:FC:Side1	
4	LLL:FC:Side2	
11	LL:Bk:Side1	
12	LL:Bk:Side2	
13	LL:FC:Side1	
14	LL:FC:Side2	
21	ML:Bk:Side1	
22	ML:Bk:Side2	
23	ML:FC:Side1	
24	ML:FC:Side2	
31	MM:Bk:Side1	
32	MM:Bk:Side2	
33	MM:FC:Side1	
34	MM:FC:Side2	
41	MH:Bk:Side1	
42	MH:Bk:Side2	
43	MH:FC:Side1	

44	MH:FC:Side2	
51	HH:Bk:Side1	
52	HH:Bk:Side2	
53	HH:FC:Side1	
54	HH:FC:Side2	

2677	Set:Sep:L Edge Length	
1	Side1	[-10 to 30/5/1 mm]
2	Side2	

2678	Set:Sep:T Edge Length	
1	Side1	[-10 to +30/0/1 mm]
2	Side2	

2681	Set:ITB Col:R Coeff	
	R-2	[50 to 250/170/1%]

2682	Set:ITB Col:R Coeff	
	R-1	[50 to 250/152/1%]

2683	Set:ITB Col:R Coeff	
	RO	[50 to 250/136/1%]

2684	Set:ITB Col:R Coeff	
	RO	[50 to 250/124/1%]

2685	Set:ITB Col:R Coeff	
	R+2	[50 to 250/116/1%]

2686	Set:ITB Col:R Coeff	
	R+3	[50 to 250/106/1%]

2690	Set:PTR:Standard	
	Non Image	[0 to /0.83/1%]

2691	Set:PTR:R Coeff	
1	R-2	[50 to 300/225/1]
2	R-1	[50 to 300/185/1]
3	R0	[50 to 300/160/1]
4	R+1	[50 to 300/140/1]
5	R+2	[50 to 300/125/1]
6	R+3	[50 to 300/115/1]

2692	Set:RTR:Eng Spd Coeff	
1	100%	[10 to 200/100/1%]
2	70%	[10 to 200/70/1%]
3	50%	[10 to 200/50/1%]

2693	Set:PTR:Env Coeff	
1	LLL:Bk:Side1	[10 to 200/110/1 %]
2	LLL:Bk:Side2	[10 to 200/115/1 %]
3	LLL:FC:Side1	[10 to 200/110/1 %]
4	LLL:FC:Side2	[10 to 200/115/1 %]
5	LLL:Non Image	[10 to 200/110/1 %]
11	LL:Bk:Side1	[10 to 200/107/1 %]
12	LL:Bk:Side2	[10 to 200/112/1 %]

13	LL:FC:Side1	[10 to 200/107/1 %]
14	LL:FC:Side2	[10 to 200/112/1 %]
15	LL:Non Image	[10 to 200/107/1 %]
21	ML:Bk:Side1	[10 to 200/105/1 %]
22	ML:Bk:Side2	[10 to 200/110/1 %]
23	ML:FC:Side1	[10 to 200/105/1 %]
24	ML:FC:Side2	[10 to 200/110/1 %]
25	ML:Non Image	[10 to 200/105/1 %]
31	MM:Bk:Side1	[10 to 200/100/1 %]
32	MM:Bk:Side2	[10 to 200/105/1 %]
33	MM:FC:Side1	[10 to 200/100/1 %]
34	MM:FC:Side2	[10 to 200/105/1 %]
35	MM:Non Image	[10 to 200/100/1 %]
41	MH:Bk:Side1	[10 to 200/90/1 %]
42	MH:Bk:Side2	[10 to 200/95/1 %]
43	MH:FC:Side1	[10 to 200/90/1 %]
44	MH:FC:Side2	[10 to 200/95/1 %]
45	MH:Non Image	[10 to 200/90/1 %]
51	HH:Bk:Side1	[10 to 200/85/1 %]
52	HH:Bk:Side2	[10 to 200/90/1 %]
53	HH:FC:Side1	[10 to 200/85/1 %]
54	HH:FC:Side2	[10 to 200/90/1 %]
55	HH:Non Image	[10 to 200/85/1 %]

2757	Paper Size:Coeff	
1	Weight 1:1 st	[50 to 600/105/1]

2	Weight 2:1st	[50 to 600/110/1]
3	Weight 3:1st	[50 to 600/120/1]
4	Weight 4:1st	[50 to 600/135/1]
5	Weight 5:1st	[50 to 600/155/1]
6	Weight 6:1st	[50 to 600/190/1]
7	Weight 7:1st	[50 to 600/240/1]
11	Weight 1:2nd	[50 to 600/110/1]
12	Weight 2:2nd	[50 to 600/120/1]
13	Weight 3:2nd	[50 to 600/135/1]
14	Weight 4:2nd	[50 to 600/155/1]
15	Weight 5:2nd	[50 to 600/190/1]
16	Weight 6:2nd	[50 to 600/240/1]
17	Weight 7:2nd	[50 to 600/290/1]

2800	Set Paper Texture Mode	
1	Custom Paper 001	[0 to 1/0/1 Step]

2801	PTR AC Bias: Bk: 1st	
2802	PTR AC Bias: Bk: 2nd	
2803	PTR AC Bias: FC: 1st	
2804	PTR AC Bias: FC: 2nd	
1 to 100	Custom Paper 001 to 100	[0 to 12/8/0.1 kV]

2805	PTR Bias	
1	AC	[0 to 12/8/0.1 kV]
2	DC	[-100 to -10/-25/0.1 kV]

2806	Set: PTR AC: Env Coeff	
1	LLL:Bk: Side 1	[10 to 200/110/1 %]
2	LLL:Bk:Side2	[10 to 200/105/1 %]
3	LLL:FC:Side1	[10 to 200/110/1 %]
4	LLL:FC:Side2	[10 to 200/115/1 %]
5	LLL:Non Image	[10 to 200/115/1 %]
11	LL:Bk:Side1	[10 to 200/107/1 %]
12	LL:Bk:Side2	[10 to 200/112/1 %]
13	LL:FC:Side 1	[10 to 200/107/1 %]
14	LL:FC:Side2	[10 to 200/112/1 %]
15	LL:Non Image	[10 to 200/115/1 %]
21	ML:Bk:Side1	[10 to 200/105/1 %]
22	ML:Bk:Side2	[10 to 200/110/1 %]
23	ML:FC:Side1	[10 to 200/105/1 %]
24	ML:FC:Side2	[10 to 200/110/1 %]
25	ML:Non Image	[10 to 200/105/1 %]
31	MM:Bk:Side1	[10 to 200/100/1 %]
32	MM:Bk:Side2	[10 to 200/105/1 %]
33	MM:FC:Side1	[10 to 200/100/1 %]
34	MM:FC:Side2	[10 to 200/105/1 %]
35	MM:Non Image	[10 to 200/110/1 %]
41	MH:Bk:Side1	[10 to 200/90/1 %]
42	MH:Bk:Side2	[10 to 200/95/1 %]
43	MH:FC:Side1	[10 to 200/90/1 %]
44	MH:FC:Side2	[10 to 200/90/1 %]
45	MH:Non Image	[10 to 200/115/1 %]

51	HH:Bk:Side1	[10 to 200/85/1 %]
52	HH:Bk:Side2	[10 to 200/90/1 %]
53	HH:FC:Side1	[10 to 200/85/1 %]
54	HH:FC:Side2	[10 to 200/90/1 %]
55	HH:Non Image	[10 to 200/115/1 %]

2807	Set: PTR AC: Eng Spd Coeff	
1	100%	[10 to 200/100/1%]
2	70%	[10 to 200/70/1%]
3	50%	[10 to 200/50/1%]

2808	AC Size Coeff	
1	Thresh1	[100 to 330 / 297 / 1 mm]
2	Thresh2	[100 to 330 / 257 / 1 mm]
3	Thresh3	[100 to 330 / 210 / 1 mm]
4	Thresh4	[100 to 330 / 129 / 1 mm]

2809	AC Size Coeff : R-2	
------	---------------------	--

1 to 7	Size1 : Side1 : Weight1 to 7	[50 to 300 / 100 / 1 %]
11 to 17	Size1 : Side2 : Weight1 to 7	
21 to 27	Size2 : Side1 : Weight1 to 7	
31 to 37	Size2 : Side2 : Weight1 to 7	
41 to 47	Size3 : Side1 : Weight1 to 7	
51 to 57	Size3 : Side2 : Weight1 to 7	
61 to 67	Size4 : Side1 : Weight1 to 7	
71 to 77	Size4 : Side2 : Weight1 to 7	
81 to 87	Size5 : Side1 : Weight1 to 7	
91 to 97	Size5 : Side2 : Weight1 to 7	

2810	AC Size Coeff : R-1	
1 to 7	Size1 : Side1 : Weight1 to 7	[50 to 300 / 100 / 1 %]
11 to 17	Size1 : Side2 : Weight1 to 7	
21 to 27	Size2 : Side1 : Weight1 to 7	
31 to 37	Size2 : Side2 : Weight1 to 7	
41 to 47	Size3 : Side1 : Weight1 to 7	
51 to 57	Size3 : Side2 : Weight1 to 7	
61 to 67	Size4 : Side1 : Weight1 to 7	
71 to 77	Size4 : Side2 : Weight1 to 7	
81 to 87	Size5 : Side1 : Weight1 to 7	
91 to 97	Size5 : Side2 : Weight1 to 7	

2811	AC Size Coeff : R-0	
------	---------------------	--

1 to 7	Size1 : Side1 : Weight1 to 7	[50 to 300 / 100 / 1 %]
11 to 17	Size1 : Side2 : Weight1 to 7	
21 to 27	Size2 : Side1 : Weight1 to 7	
31 to 37	Size2 : Side2 : Weight1 to 7	
41 to 47	Size3 : Side1 : Weight1 to 7	
51 to 57	Size3 : Side2 : Weight1 to 7	
61 to 67	Size4 : Side1 : Weight1 to 7	
71 to 77	Size4 : Side2 : Weight1 to 7	
81 to 87	Size5 : Side1 : Weight1 to 7	
91 to 97	Size5 : Side2 : Weight1 to 7	

2812	AC Size Coeff : R + 1	
1 to 7	Size1 : Side1 : Weight1 to 7	[50 to 300 / 100 / 1 %]
11 to 17	Size1 : Side2 : Weight1 to 7	
21 to 27	Size2 : Side1 : Weight1 to 7	
31 to 37	Size2 : Side2 : Weight1 to 7	
41 to 47	Size3 : Side1 : Weight1 to 7	
51 to 57	Size3 : Side2 : Weight1 to 7	
61 to 67	Size4 : Side1 : Weight1 to 7	
71 to 77	Size4 : Side2 : Weight1 to 7	
81 to 87	Size5 : Side1 : Weight1 to 7	
91 to 97	Size5 : Side2 : Weight1 to 7	

2813	AC Size Coeff : R + 2	
------	-----------------------	--

2

1 to 7	Size1 : Side1 : Weight1 to 7	[50 to 300 / 100 / 1 %]
11 to 17	Size1 : Side2 : Weight1 to 7	
21 to 27	Size2 : Side1 : Weight1 to 7	
31 to 37	Size2 : Side2 : Weight1 to 7	
41 to 47	Size3 : Side1 : Weight1 to 7	
51 to 57	Size3 : Side2 : Weight1 to 7	
61 to 67	Size4 : Side1 : Weight1 to 7	
71 to 77	Size4 : Side2 : Weight1 to 7	
81 to 87	Size5 : Side1 : Weight1 to 7	
91 to 97	Size5 : Side2 : Weight1 to 7	

2814	AC Size Coeff : R + 3	
1 to 7	Size1 : Side1 : Weight1 to 7	[50 to 300 / 100 / 1 %]
11 to 17	Size1 : Side2 : Weight1 to 7	
21 to 27	Size2 : Side1 : Weight1 to 7	
31 to 37	Size2 : Side2 : Weight1 to 7	
41 to 47	Size3 : Side1 : Weight1 to 7	
51 to 57	Size3 : Side2 : Weight1 to 7	
61 to 67	Size4 : Side1 : Weight1 to 7	
71 to 77	Size4 : Side2 : Weight1 to 7	
81 to 87	Size5 : Side1 : Weight1 to 7	
91 to 97	Size5 : Side2 : Weight1 to 7	

2815	LEdge Coeff AC: Bk	
1 to 100	Custom Paper 001 to 100	[0 to 250/100/1%]

2816	LEdge Coeff AC: FC	
------	--------------------	--

1 to 100	Custom Paper 001 to 100	[0 to 250/100/1%]
----------	-------------------------	-------------------

2817	LEdge Length AC: BK	
1 to 100	Custom Paper 001 to 100	[0 to 30/5/1 mm]

2818	LEdge Length AC: FC	
1 to 100	Custom Paper 001 to 100	[0 to 30/5/1 mm]

2819	TEdge Coeff AC: Bk	
1 to 100	Custom Paper 001 to 100	[0 to 250/100/1 %]

2820	TEdge Coeff AC: FC	
1 to 100	Custom Paper 001 to 100	[0 to 250/100/1 %]

2821	TEdge Length AC: Bk	
1 to 100	Custom Paper 001 to 100	[0 to 100/8/1 mm]

2822	TEdge Length AC: FC	
1 to 100	Custom Paper 001 to 100	[0 to 100/8/1 mm]

2823	AC PT: Sep AC 1st			
1	Weight 1	[8 to 12/8/1 0.01 kV]	1	52.3 - 63.0 g/m ²
2	Weight 2		2	63.1 - 80.0 g/m ²
3	Weight 3		3	80.1 - 105.0 g/m ²
4	Weight 4		4	105.1 - 163.0 g/m ²
5	Weight 5		5	163.1 - 220.0 g/m ²
6	Weight 6		6	220.1 - 256.0 g/m ²
7	Weight 7		7	256.1 - 300.0 g/m ²

2824	AC PT: Sep AC 2nd			
1	Weight 1	[8 to 12/8/1 0.01 kV]	1	52.3 - 63.0 g/m ²
2	Weight 2		2	63.1 - 80.0 g/m ²
3	Weight 3		3	80.1 - 105.0 g/m ²
4	Weight 4		4	105.1 - 163.0 g/m ²
5	Weight 5		5	163.1 - 220.0 g/m ²
6	Weight 6		6	220.1 - 256.0 g/m ²
7	Weight 7		7	256.1 - 300.0 g/m ²

2830	AC Transcription Power Pack		
	AC Transcription Power Pack	[0 to 1/0/1 step] 0:OFF 1:ON	

2840	SepDC:1st		
2841	SepDC:2nd		
2842	SepAC: 1st		
2843	SepAC: 2nd		
1 to 77	<Paper Type>: Weight<No.>	[0 to 10/*/0.1 uA] The default settings (*) are displayed to the right of "Initial" on the screen.	
	Paper Type:	Plain, Glossy, Matte, Transparency, Translucent, Envelope	
	Weight (g/m ²):	1	52.3 - 63.0
		2	63.1 - 80.0
		3	80.1 - 105.0
		4	105.1 - 163.0
		5	163.1 - 220.0
		6	220.1 - 256.0
		7	256.1 - 300.0

2844	SepDC:LEdge:Coeff		
2845	SepDC:TEdge:Coeff		
2846	SepAC:LEdge:Coeff		
2847	SepAC:TEdge:Coeff		
1 to 77	<Paper Type>: Weight<No.>	[50 to 200/* /1%] The default settings (*) are displayed to the right of "Initial" on the screen.	
	Paper Type:	Plain, Glossy, Matte, Transparency, Translucent, Envelope	
	Weight (g/m ²):	1	52.3 - 63.0
		2	63.1 - 80.0
		3	80.1 - 105.0
		4	105.1 - 163.0
		5	163.1 - 220.0
		6	220.1 - 256.0
		7	256.1 - 300.0

2850	PTR Bias:Bk		
1 to 77	<Paper Type>: Weight<No.>	[-400 to 0/-40/1 uA]	
	Paper Type:	Plain, Glossy, Matte, Transparency, Translucent, Envelope	
	Weight (g/m ²):	1	52.3 - 63.0
		2	63.1 - 80.0
		3	80.1 - 105.0
		4	105.1 - 163.0
		5	163.1 - 220.0
		6	220.1 - 256.0

		7	256.1 - 300.0
--	--	---	---------------

2851	PTR Bias: FC		
1 to 77	<Paper Type>: Weight<No.>	[-400 to 0/-70/1 uA]	
	Paper Type:	Plain, Glossy, Matte, Transparency, Translucent, Envelope	
	Weight (g/m ²):	1	52.3 - 63.0
		2	63.1 - 80.0
		3	80.1 - 105.0
		4	105.1 - 163.0
		5	163.1 - 220.0
		6	220.1 - 256.0
		7	256.1 - 300.0

2852	LEdge Coeff:Bk		
2853	LEdge Coeff:FC		
1 to 77	<Paper Type>: Weight<No.>	[5 to 300/* /1%] The default settings (*) are displayed to the right of "Initial" on the screen.	
	Paper Type:	Plain, Glossy, Matte, Transparency, Translucent, Envelope	
	Weight (g/m ²):	1	52.3 - 63.0
		2	63.1 - 80.0
		3	80.1 - 105.0
		4	105.1 - 163.0
		5	163.1 - 220.0
		6	220.1 - 256.0
		7	256.1 - 300.0

2854	LEdge Length:Bk		
2855	LEdge Length:FC		
1 to 77	<Paper Type>: Weight<No.>	[0 to 30/* /1 mm] The default settings (*) are displayed to the right of "Initial" on the screen.	
	Paper Type:	Plain, Glossy, Matte, Transparency, Translucent, Envelope	
	Weight (g/m ²):	1	52.3 - 63.0
		2	63.1 - 80.0
		3	80.1 - 105.0
		4	105.1 - 163.0
		5	163.1 - 220.0
		6	220.1 - 256.0
		7	256.1 - 300.0

2856	TEdge Coeff:Bk		
2857	TEdge Coeff:FC		
1 to 77	<Paper Type>: Weight<No.>	[5 to 300/100/1%]	
	Paper Type:	Plain, Glossy, Matte, Transparency, Translucent, Envelope	
	Weight (g/m ²):	1	52.3 - 63.0
		2	63.1 - 80.0
		3	80.1 - 105.0
		4	105.1 - 163.0
		5	163.1 - 220.0
		6	220.1 - 256.0
		7	256.1 - 300.0

2858	TEdge Length:Bk		
2859	TEdge Length:FC		
1 to 77	<Paper Type>: Weight<No.>	[0 to 100/8/1 mm]	
	Paper Type:	Plain, Glossy, Matte, Transparency, Translucent, Envelope	
	Weight (g/m ²):	1	52.3 - 63.0
		2	63.1 - 80.0
		3	80.1 - 105.0
		4	105.1 - 163.0
		5	163.1 - 220.0
		6	220.1 - 256.0
		7	256.1 - 300.0

2880	PTR Speed Control:100%		
2881	PTR Speed Control:70%		
2882	PTR Speed Control:50%		
	Weight (g/m ²):	1	52.3 - 63.0
		2	63.1 - 80.0
		3	80.1 - 105.0
		4	105.1 - 163.0
		5	163.1 - 220.0
		6	220.1 - 256.0
		7	256.1 - 300.0
1	Plain: Weight 1	[-0.5 to 0.5/0/0.1 %]	
2	Plain: Weight 2	[-0.5 to 0.5/-0.1/0.1 %]	
3	Plain: Weight 3	[-0.5 to 0.5/-0.2/0.1 %]	

4	Plain: Weight 4	[-0.5 to 0.5/-0.3/0.1 %]
5	Plain: Weight 5	[-0.5 to 0.5/-0.4/0.1 %]
6	Plain: Weight 6	[-0.5 to 0.5/-0.5/0.1 %]
7	Plain: Weight 7	[-0.5 to 0.5/-0.5/0.1 %]
12	Glossy: Weight 2	[-0.5 to 0.5/-0.3/0.1 %]
13	Glossy: Weight 3	[-0.5 to 0.5/-0.3/0.1 %]
14	Glossy: Weight 4	[-0.5 to 0.5/-0.3/0.1 %]
15	Glossy: Weight 5	[-0.5 to 0.5/-0.4/0.1 %]
16	Glossy: Weight 6	[-0.5 to 0.5/-0.5/0.1 %]
17	Glossy: Weight 7	[-0.5 to 0.5/-0.5/0.1 %]

2883	PTR Speed Control	
1	Env Coeff: LLL	[-0.5 to 0.5/0.2/0.1%]
2	Env Coeff: LL	[-0.5 to 0.5/0.1/0.1%]
3	Env Coeff: ML	[-0.5 to 0.5/0/0.1%]
4	Env Coeff: MM	[-0.5 to 0.5/0/0.1%]
5	Env Coeff: MH	[-0.5 to 0.5/-0.1/0.1%]
6	Env Coeff: HH	[-0.5 to 0.5/-0.2/0.1%]

2904	Prevent Blade Bending	
	Do this SP to create a pattern on the drum at prescribed intervals to prevent the cleaning blade from bending.	
1	Pattern Create Interval	[0 to 200/0/1 Page]
2	Pattern Light Intensity	[0 to 15/5/1]
3	Op Pg Count Display	[0 to 200/0/1 Page]
4	Set Operation Temp	[0 to 50/40/1 deg]

2905	Non-stop Used Tnr Bottle Replacement	
	Do this SP to set the upper limit for level of used toner in the used toner bottle to trigger a bottle full alert.	
1	Savings Time Threshold Value	[0 to 999/300/1 sec.]
2	Discharge Time Threshold Value	[0 to 999/180/1 sec.]
3	Savings Time Count	[0 to 999/0/1 sec.]
4	Discharge Time Count	

2906	Stop Time Reverse Ctrl	
	The SP code sets the stop/reverse action of the ITB driver motor.	
1	Set Rev Execute: ImgTrans	[0 to 1/0/1]
2	Set Rev Execute: PaperTrans	0:OFF 1:ON
3	Set Rev Execute Interval	[1 to 500/30/1 m]
4	Assign Execution	[0 to 1/0/1] 0:OFF 1:ON
5	Set Execute Interval	[1 to 500/250/1 m]
6	Op Time Setting: ImgTrans	[10 to 500/30/10 msec]
7	Op Time Setting: PaperTrans	

2907	ACS Switch Set	
	This SP sets the threshold for the number of continuous black prints to ACS switching.	
	Bk image count	[0 to 10/5/1 sheet]

2909	ITB Lift	
	This SP affects the operation of ITB Lift Motor 2, the motor that lifts the right end of the ITB against the bottom of the K drum.	
	Lift ITB	[0 to 1/0/1] 0: ON Lift operation on, 1: OFF no lift.

2912	Encoder Sn:Adj Light	
------	----------------------	--

	This SP adjusts the strength of the LED beam of the ITB feed-back sensors (main sensor and sub sensor).	
1	Adj Light Amt	[0 to 1/0/1]
2	Light Amt Adj: Pass/Fail	[0 to 9/0/1]
3	Vref_Disp: Main Setting	[0 to 2.45/0/0.01 V]
4	Vref_Disp: Sub Setting	
5	Analog Out: Main: After F Adj	[0 to 5/0/0.01 V]
6	Analog Out: Sub: After F Adj	

2913	Encoder Sn:Output Disp	
	This SP displays the averaged values for the analog output from the ITB feed-back sensors.	
1	Analog: Ave: Main	[0 to 255/0/0.01 V\
2	Analog: Max: Main	
3	Analog: Min: Main	
4	Analog: Ave: Sub	
5	Analog: Max: Sub	
6	Analog: Min: Sub	

2914	Encoder Sn:Get 1stPhase	
	These SP codes reset and initialize the ITB feed-back sensors.	
1	Get Phases: Execute All	[EXECUTE]
2	352.80 Line Speed: Execute	
3	246.96 Line Speed: Execute	
4	176.40 Line Speed: Execute	
5	352.80 Phase Disp/Set	[0 to 65 535/0/1]
6	246.96 Phase Disp/Set	
8	176.40 Phase Disp/Set	

2915	Encoder Sn Ctrl Condition	
	These SP codes enables the scaled feed-back control and displays information about SC499. SC499 is issued when the ITB sensor that reads the encoded film strip on the front edge of the image transfer belt does not operate correctly. (The TDCU constantly monitors operation of the ITB with transfer feed-back control.)	
1	Scale FB Control Enable	[0 to 1/1/1]
2	SC499 Occurrences	[0 to 3/0/1]
3	MUSIC Executions After SC499	[0 to 1/0/1]

2916	Fail Predict Banner Disp	
	This SP switches the banner display on the operation panel for the for the failure prediction feature. Default: Off	
1	Code 01	[0 to 1/0/1]
2	Code 02	*0: Banner Disable (Code No.)
3	Code 03	1: Banner Enable (Code No.)
4	Code 04	Where No. = 01, 02, 03, 04, 05, 99
5	Code 05	
6	Code 99	

2920	Steering Control Roller	
	This SP must be executed after replacing the ITB. This SP initializes the position of the new belt on the rollers.	
1	Initialize Belt Position	[0 to 1/0/1]
2	Stable Position of Steering Roller	[-200 to 200/0/1 step]
3	Control ON/OFF	[0 to 1/1/1]
4	MUSIC Belt Init: On/Off	[0 to 1/1/1]
5	LED PWM of Belt Position Sensor	[0 to 80/70/0.1%]
6	Threshold for Control Rock	[0 to 1000/30/1]
7	Threshold for Sensor Error	[0 to 1/0.1/0.01 V]

8	Threshold for PWM Control	[0 to 2/0.3/0.01 V]
9	Sum of Sensor Output	[0 to 10/0/0.01 V]
10	Ratio of Sensor Output	[-1 to 1/0/0.001]

2949	Process Interval	
	This SP codes extends the time between the end of a job and when the machine shifts to energy save mode.	
	Additional Time	[0 to 10/0/1 sec]

2950	Face Main Mag set & Adj	
2951	Face Sub Mag set & Adj	
2952	Verso Main Mag set & Adj	
2953	Verso Sub Mag set & Adj	
	These SP codes set or adjust the magnification rate for Face (Recto right or odd numbered pages) and Verso (reverse or left pages even numbered pages) in the main scan and sub scan directions.	
1 to 100	Custom Paper 001 to 100	[-08 to 0.8/0/0.025%]

2970	PTR Bias:Bk	
1 to 100	Custom Paper 001 to 100	[-400 to 0/-34/1 uA]

2971	PTR Bias:FC	
1 to 100	Custom Paper 001 to 100	[-400 to 0/-52/1 uA]

2972	LEdge Coeff:Bk	
2973	LEdge Coeff:FC	
1 to 100	Custom Paper 001 to 100	[50 to 300/100/1%]

2974	LEdge Length:Bk	
2975	LEdge Length:FC	

1 to 100	Custom Paper 001 to 100	[0 to 30/5/1 mm]
2976	TEdge Coeff:Bk	
2977	TEdge Coeff:FC	
1 to 100	Custom Paper 001 to 100	[5 to 300/100/1%]
2978	TEdge Length:Bk	
2979	TEdge Length:FC	
1 to 100	Custom Paper 001 to 100	[0 to 100/8/1 mm]
2981	PTR Speed Control	
1 to 100	Custom Paper 001 to 100	[-1 to +1/0/0.1 %]
2988	PT Gap Adjustment	
1 to 100	Custom Paper 001 to 100	[0 to 3/0/1] 0:Auto 1:No 2:Weak 3:Strong
2990	ITB Bias:K:BK	
1 to 100	Custom Paper 001 to 100	[0 to 70/34/0.1 uA]
2991	ITB Bias:K:FC	
1 to 100	Custom Paper 001 to 100	[0 to 70/33/0.1 uA]
2992	ITB Bias:C:FC	
1 to 100	Custom Paper 001 to 100	[0 to 70/34/0.1 uA]
2993	ITB Bias:M:FC	
1 to 100	Custom Paper 001 to 100	[0 to 70/36/0.1 uA]
2994	ITB Bias:Y:FC	

1 to 100	Custom Paper 001 to 100	[0 to 70/38/0.1 μ A]
2995	2nd Bias Coeff: BK	
2996	2nd Bias Coeff: FC	
1 to 100	Custom Paper 001 to 100	[50 to 150/100/1%]

Group 3000

2

3011	Manual ProCon :Exe	
	Executes process control.	
1	Normal ProCon	[0 to 1/0/1]
2	Density Adjustment	
3	ACC RunTime ProCon	
4	Full MUSIC	
5	Normal MUSIC	

3012	ProCon OK?	
	Confirms that the previous execution manual process control ended successfully,.	
1	History:Last	[0 to 999 99 999/0/1
2	History:Last 2	
3	History:Last 3	
4	History:Last 4	
5	History:Last 5	
6	History:Last 6	
7	History:Last 7	
8	History:Last 8	
9	History:Last 9	
10	History:Last 10	

3020	Process Setup :Exe	
	Execute this SP at installation after all the PCDU units, toner bottles, and developer for each unit have been installed. This SP code confirms that developer/toner is in the PCDU, initializes drum cleaning, initializes the TD sensor, and executes process control to initialize toner density for each color.	

	Execute: ALL	[0 to 1/0/1]
--	--------------	--------------

3024	Developer Fill :Exe	
	Fills the PCDU with developer/toner from the developer pack. This SP must be executed at installation for all PCDU units and after developer has been replaced in a PCDU.	
1	Execute: K	[0 to 1/0/1]
2	Execute: C	
3	Execute: M	
4	Execute: Y	
11	Drive Time Upper Limit	[0 to 255/30/1 sec]

3025	Dev Fill OK?	
	Displays the results of developer/toner filling executed with SP3024.	
	From Left: YMCK	[0 to 9999/0/1] Successful return: "1111"

3030	Init TD Sensor :Exe	
	These SP codes initialize the TD sensors mounted on the side of each PCDU. Adjustment of the Vt target settings is also possible. (Vt is the current output of the TD sensor.)	
1	Execute: ALL	[0 to 1/0/1]
2	Execute: COL	
3	Execute: K	
4	Execute: C	
5	Execute: M	
6	Execute: Y	
20	Agitation Time	[3 to 20/30/1]sec
21	Initial TC	[1 to 15/7/0.1 wt%]
31	Vt Target:K	[0 to 5/2.7/0.01 V]

2

32	Vt Target:C	
33	Vt Target:M	
34	Vt Target:Y	

3031	TD Sens Init OK?	
	Displays the results of TD sensor initialization with SP3030.	
	From Left: YMCK	[0 to 9 999/0/1] Successful return: "1111"

3032	Cleaning Setup :Exe	
	Execute this SP at installation and after replacement of the cleaning unit.	
1	Execute: ALL	[0 to 1/0/1]
2	Execute: COL	
3	Execute: K	
4	Execute: C	
5	Execute: M	
6	Execute: Y	
21	A3 Page Cover	[0 to 100/6/1 Sheet]

3050	Force Tnr Supply :Exe	
	Force supplies toner to the sub hoppers of the selected color. You can also specify the amount of toner to be supplied.	
1	Execute: ALL	[0 to 1/0/1]
2	Execute: COL	
3	Execute: K	
4	Execute: C	
5	Execute: M	
6	Execute: Y	

21	Supply Quantity: K	[0 to 5/1/0.1 wt%]
22	Supply Quantity: C	
23	Supply Quantity: M	
24	Supply Quantity: Y	

3051	Manual Toner Fill :Exe	
	Executes toner filling of all sub hoppers.	
	Execute:ALL	[0 to 1/0/1]

3070	M Pot.Sens Check :Exe	
	This SP checks the condition of each of the four potential sensors after installation at the factory. Use in the field to check the condition of the sensors.	
	All Colors	[EXECUTE]

3071	Pot.Sens Chk :Disp	
	Displays the results of the potential sensor check executed with SP3070. <ul style="list-style-type: none"> • Vd is the reading of the unexposed surface of the drum by the potential sensor • Vr is residual voltage, the slight trace of voltage that remains on the drum after the QL quenches the surface of the drum. 	
1	Vd:K	[0 to 999/0/1 V]
2	Vd:C	
3	Vd:M	
4	Vd:Y	
11	Vr:K	
12	Vr:C	
13	Vr:M	
14	Vr:Y	
21	Voffset:K	

2

22	Voffset:C	
23	Voffset:M	
24	Voffset:Y	

3072	TD. Sens Check :Exe	
	Checks the condition of the TD sensors attached to the side of each PCDU. Executed at the factory after assembly. Use in the field to check the condition of the TD sensors.	
1	All Colors	[EXECUTE]

3073	TD.Sens Chk :Disp	
	Displays the results of the TD sensor check executed with SP3072.	
1	Vt:K	[0 to 1/0/0.01 V]
2	Vt:C	[0 to 5/0/0.01 V]
3	Vt:M	
4	Vt:Y	

3100	TE Detect :Set	
	This SP switches the operation of the TE sensor off and on.	
	ON/OFF	[0 to 1/0/1]

3101	Toner Status :Disp	
	Displays the amount of toner remaining for each color. Uses a descending 10-step scale: 10: Full, 2: Almost near-toner end, 1: Almost toner-end, 0: Toner end	
1	K	[0 to 10/10/1]
2	C	
3	M	
4	Y	

3102	Toner Remains :Disp	
------	---------------------	--

	Sets the toner remain display to show the amount toner remaining as a percentage.	
1	% Remains:K	[0 to 100/0/1 %]
2	% Remains:C	
3	% Remains:M	
4	% Remains:Y	
11	mg Remains:K	[0 to 999 999/0/0.1 mg]
12	mg Remains:C	
13	mg Remains:M	
14	mg Remains:Y	
21	Tnr mg(NewBtl):K	[100 to 999 999/1 386 000/0.1 mg]
22	Tnr mg(NewBtl):C	
23	Tnr mg(NewBtl):M	
24	Tnr mg(NewBtl):Y	
31	ImgArea:K	[0 to 999 999/0/1 cm ²]
32	ImgArea:C	
33	ImgArea:M	
34	ImgArea:Y	
41	TnrRemainsCoef:K	[0 to 2.55/1.1/0.1]
42	TnrRemainsCoef:C	[0 to 2.55/1.13/0.1]
43	TnrRemainsCoef:M	[0 to 2.55/1.05/0.1]
44	TnrRemainsCoef:Y	[0 to 2.55/1.06/0.1]
51	Feed Counter:K	[0 to 999 999/0/1 msec]
52	Feed Counter:C	
53	Feed Counter:M	
54	Feed Counter:Y	

3110	TNE Detect (Lvl1) Set	
	This setting determines whether Step 1 for toner near-end is displayed, and allows you to select the percentage to trigger the display.	
1	OFF/ON	[0 to 1/10/1]
11	Disp Timing:K	[10 to 100/10/1%]
12	Disp Timing:C	
13	Disp Timing:M	
14	Disp Timing:Y	

3120	TNE Detect(Lvl2) :Set	
	This setting determines whether Step 2 for toner near-end is displayed, and allows you to select the percentage to trigger the display.	
1	Set Cnt	[0 to 255/30/1 Counts]
11	Cnt:K	[0 to 255/0/1 Counts]
12	Cnt:C	
13	Cnt:M	
14	Cnt:Y	

3130	TE Detect :Set	
	This SP code allows you to set how long the machine can continue to operated after the toner near-end alert appears. This can be set to limit the number of prints by number of sheets, pixel count, or paper feed count.	
1	Set Sheets(Min)	[0 to 50/10/1 sheets]
2	Set Sheets(Max)	[0 to 5000/1000/1 sheets]
11	Page Cnt:K	[0 to 5000/0/1 sheets]
12	Page Cnt:C	
13	Page Cnt:M	
14	Page Cnt:Y	

21	Set Pxl Cnt	[0 to 1 000 000/15000/1 cm ²]
31	Pxl Cnt:K	[0 to 1 000 000/0/1 cm ²]
32	Pxl Cnt:C	
33	Pxl Cnt:M	
34	Pxl Cnt:Y	
41	Set Feed Cnt	[0 to 99 999 999/0/1 msec]
51	Feed Cnt:K	
52	Feed Cnt:C	
53	Feed Cnt:M	
54	Feed Cnt:Y	

3150	TE Sensor :Set	
	This SP sets up how the machine samples for toner-end sensor readings.	
1	Sampling Count	[4 to 20/10/1 Count]
2	Judge: P	[0.2 to 0.8/0.6/0.1]

3152	Toner Pump CL :Set	
	This SP setting sets up on the toner pump clutch operates. (The toner pump clutch engages the toner pump to pump toner into the sub hopper.)	
1	On Time	[0 to 5000/400/1 msec]
2	Off Time	
3	Recovery Times (Upper Limit)	[0 to 255/140/1 counts]
10	Stop Timing :Set	[0 to 2000/0/1 counts]
11	Cnt:K	
12	Cnt:C	
13	Cnt:M	
14	Cnt:Y	

3200	Tnr Density	
	Displays the toner density by wt% for each color.	
1	K	[0 to 25.5/0/0.1 wt%]
2	C	
3	M	
4	Y	

3201	Tnr Density	
	This SP sets the upper limit and lower limit of the range (wt%) for toner density control.	
1	Upper TC	[1 to 15/9.5/0.1 wt%]
2	Lower TC	[1 to 15/4/0.1 wt%]

3210	TD.Sens:Vt :Disp	
	This SP code displays the TD sensor outputs for all the items below.	
1-4	Current: K, C, M, Y	[0 to 5.5/0/0.01 V]
2	Current: C	
3	Current: M	
4	Current: Y	

3220	Vtcnt: Disp/Set	
	These SP codes display and allow setting of the current electrical potential of the TD sensors for each color. Vcnt is the gain value is calculated during TD sensor initialization. It is used to adjust the TD sensor output (Vt). A large gain increases Vt, and a small gain decreases Vt. Vcnt is also used to calibrate the TD sensor output (Vt) during TD sensor initialization.	
1	Current: K	[2 to 5/3.72/0.01V]
2	Current: C	
3	Current: M	
4	Current: Y	

11	Initial: K	
12	Initial: C	
13	Initial: M	
14	Initial: Y	

3230	Vtref :Disp/Set	
	These SP codes display and allow settings of the target reference voltage of the TD sensor. (Vtref is the control reference voltage.)	
1	Current: K	[0 to 5/2.7/0.01V]
2	Current: C	
3	Current: M	
4	Current: Y	
11	Initial: K	[0 to 5/0/0.01V]
12	Initial: C	
13	Initial: M	
14	Initial: Y	

3231	Vtref Limits :Set	
	This SP sets the upper limit for the target voltage of Vtref (control reference voltage).	
1	Upper:K	[0 to 5/4/0.01V]
2	Upper:C	
3	Upper:M	
4	Upper:Y	
11	Lower:K	[0 to 5/2/0.01V]
12	Lower:C	
13	Lower:M	
14	Lower:Y	

3250	ImgArea :Disp	
	Displays the amount of image surface area of the most recent page for the selected color.	
1	ImgArea:K	[0 to 9 999/0/1 cm ²]
2	ImgArea:C	
3	ImgArea:M	
4	ImgArea:Y	

3251	Dot Coverage : Disp	
	These SP codes display the percentage of the total area on the sheet used by the image for the most recent print, DC average, and total page information.	
1	DotCoverage:K	[0 to 100/0/0.01%]
2	DotCoverage:C	
3	DotCoverage:M	
4	DotCoverage:Y	
11	DC Avg.:S:K	[0 to 100/5/0.01%]
12	DC Avg.:S:C	
13	DC Avg.:S:M	
14	DC Avg.:S:Y	
21	DC Avg.:M:K	
22	DC Avg.:M:C	
23	DC Avg.:M:M	
24	DC Avg.:M:Y	
31	DC Avg.:L:K	
32	DC Avg.:L:C	
33	DC Avg.:L:M	
34	DC Avg.:L:Y	

41	TotalPage:S:Set	[1 to 255/50/1 sheets]
42	TotalPage:M:Set	[1 to 65 535/100/1 sheets]
43	TotalPage:L:Set	[1 to 65 535/1/1 sheets]

3260	Temp/Humid (PCU)	
	These SP codes display the temperature and humidity readings for the present conditions around the PCDUs.	
1	Temperature	[0 to 100/0/1 deg]
2	Relative Humidity	[0 to 100/0/1 %RH]
3	Absolute Humidity	[0 to 63/0/0.01 g/m ³]
4	Environ:Recent	[0 to 9/0/1]

3261	Temp/Humid(Body)	
	These SP codes display the temperature and humidity readings for the present conditions in the main machine.	
1	Temperature	[0 to 100/0/1 deg]
2	Relative Humidity	[0 to 100/0/1 %rH]
3	Absolute Humidity	[0 to 63/0/0.01 g/m ³]
4	Environ: Recent	[0 to 9/0/1]

3262	Env Set: PCU	
	Force executes an immediate reading of temperature/humidity conditions around the PCDUs.	
1	Force Settings	[0 to 6/0/1] 0:Sensor Detect 1:LLL 2:LL 3:ML 4:MM 5:MH 6:HH

3263	Env Set:Body	
------	--------------	--

	Force executes an immediate reading of temperature/humidity conditions inside the machine.	
1	Force Settings	[0 to 6/0/1] 0:Sensor Detect 1:LLL 2:LL 3:ML 4:MM 5:MH 6:HH

3264	Env Thresh:PCU	
	These SP codes set the thresholds for humidity readings around the PCDUs.	
1	Abs Humid:1	[0 to 100/0/0.01 g/m3]
2	Abs Humid:2	[0 to 100/5/0.01 g/m3]
3	Abs Humid:3	[0 to 100/10/0.01 g/m3]
4	Abs Humid:4	[0 to 100/18/0.01 g/m3]
5	Abs Humid:5	[0 to 100/25/0.01 g/m3]

3265	Env Thresh:Body	
	These SP codes set the thresholds for humidity readings inside the main machine.	
1	Abs Humid:1	[0 to 100/2.5/0.01 g/m3]
2	Abs Humid:2	[0 to 100/5/0.01 g/m3]
3	Abs Humid:3	[0 to 100/8.4/0.01 g/m3]
4	Abs Humid:4	[0 to 100/15/0.01 g/m3]
5	Abs Humid:5	[0 to 100/25/0.01 g/m3]

3300	ID Pattern :Disp	
	Displays the amount of toner on the drum at the ID sensor pattern created between sheets. M/A is the mass per area, or mass/unit area (mg/cm ²). This is calculated based on the ID sensor output value (Vsp). M/A is calculated for each grade of color.	
1	M/A(Latest):K	[0 to 1/0/0.001 mg/cm2]
2	M/A(Latest):C	
3	M/A(Latest):M	

4	M/A(Latest):Y	
11	M/A(Target):K	[0 to 1/0.229/0.001 mg/cm ²]
12	M/A(Target):C	[0 to 1/0.472/0.001 mg/cm ²]
13	M/A(Target):M	[0 to 1/0.52/0.001 mg/cm ²]
14	M/A(Target):Y	[0 to 1/0.472/0.001 mg/cm ²]

3301	ID Pattern :Set	
	These SP codes set up how ID sensor patterns are created on the drum between sheets of paper. As shown below, the intervals can be set up as prints, page counts, fluctuations in M/A, feed counts, and so on.	
1	Create Intrvl:K	[0 to 200/10/1 pages]
2	Create Intrvl:C	
3	Create Intrvl:M	
4	Create Intrvl:Y	
11	Page Cnt:K	[0 to 200/0/1 pages]
12	Page Cnt:C	
13	Page Cnt:M	
14	Page Cnt:Y	
21	M/A UppErr:K	[0 to 1/0.4/ mg/cm ²]
22	M/A UppErr:Col	[0 to 2/0.80/0.001 mg/cm ²]
23	M/A LowErr:K	[0 to 1/0.1/0.001 mg/cm ²]
24	M/A LowErr:Col	[0 to 1/0.2/0.10 mg/cm ²]
31	Feed Cnt :Set	[0 to 9 999 999/5000/1 msec]
41	Feed Cnt :K	[0 to 9 999 999/3330/1 msec]
42	Feed Cnt :C	[0 to 9 999 999/261/1 msec]
43	Feed Cnt :M	[0 to 9 999 999/1594/1 msec]
44	Feed Cnt :Y	[0 to 9 999 999/637/1 msec]

51	Vsg Detect Intrvl	[0 to 200/10/1 pages]
61	Vsg Page Cnt	[0 to 200/0/1 pages]
70	Voffset reg	[0 to 99/3/ 1 times\
71	Voffset dif	[0 to 99/0/ 1 times\
72	Voffset TM(Front)	
73	Voffset TM(Center)	
74	Voffset TM(Rear)	

3310	ID Sens: Offset	
	Displays the amount of voltage used to light the ID sensor LED to create the ID sensor pattern on the drum.	
1	Offset Reg	[0 to 5.5/0/0.01V]
11	V_Offset Dif	
21	V_Offset TM Front	
22	V_Offset TM Center	
23	V_Offset TM Rear	

3311	ID.Sens :Vmin	
	Displays the Vmin output for black used in the gradation pattern.	
	Vmin_K	[0 to 5/0/0.01 V]

3320	Vsg Adj: Execute	
	ALL	[0 to 1/1/1]

3321	Adjusted Vsg	
------	--------------	--

	Adjusts Vsg for B&W and the TM sensors. Vsg is the voltage measurement of the reflectivity of the bare transfer belt (ITB). There are three TM sensors mounted on the sensor array above the ITB. The front and rear sensors are MUSIC sensors. The middle sensor is also a MUSIC sensor but it also functions as the ID sensor. Throughout the service manuals these sensors are referred to as the rear MUSIC sensor, (middle) ID/MUSIC sensor, and front MUSIC sensor.	
1	Vsg reg	[0 to 5.5/3.84/0.01 V]
11	Vsg dif	[0 to 5.5/0/0.01 V]
41	Vsg TM(Front)	[0 to 5.5/3.83/0.01 V]
42	Vsg TM(Center)	[0 to 5.5/3.84/0.01 V]
43	Vsg TM(Rear)	[0 to 5.5/3,82/0.01 V]

3322	Adjusted Ifsg	
	Displays the reading of the ID sensor LED where the current was adjusted.	
1	Adjusted Ifsg	[0 to 50/7.2/0.1 mA]
11	Adjusted Ifsg	[0 to 50/6.4/0.1 mA]
21	Adjusted Ifsg	[0 to 50/6.2/0.1 mA]
22	Adjusted Ifsg	[0 to 50/7.2/0.1 mA]
23	Adjusted Ifsg	[0 to 50/6.6/0.1 mA]

3323	Vsg Adj OK?	
	These SP display a history of the results of Vsg adjustments.	
1	Latest	[0 to 999/0/1]
2	Latest 1	
3	Latest 2	
4	Latest 3	
5	Latest 4	
6	Latest 5	
7	Latest 6	

8	Latest 7	
9	Latest 8	
10	Latest 9	

3330	ID.Sens Coef :Disp	
1	K2(Latest)	[0 to 5/3.24/0.0001]
2	K5(Latest)	[0 to 5/2.56/0.0001]

3400	Toner Supply Type	
	<p>These SP codes set the method of toner supply.</p> <p>0: Fixed method</p> <p>3: DANC (with Vtref correction)</p> <p>4: DANC (without Vtref correction)</p> <p>Note: DANC (Divided Area Noise Control)</p>	
1	K	0:FIXED 3:DANC (Vt_ref Fixed) 4:DANC (Vt_ref Control) Default: 4
2	C	
3	M	
4	Y	

3440	Fixed Supply Mode	
	This SP sets the toner supply rate for the Fixed Supply Mode.	
1	Fixed Rate : K	[0 to 100 / 5 / 1 %]
2	Fixed Rate : C	
3	Fixed Rate : M	
4	Fixed Rate : Y	

3500	ImgQltyAdj :ON/OFF	
	These SP codes switch off and on the process control and MUSIC functions.	

1	ALL	[0 to 1/0/1]
2	ProCon	
3	MUSIC	
4	Init TD Sensor	

3520	ImgQltyAdj :Interval	
	This SP determines the interval for quality adjustment..	
1	During Job	[0 to 100/30/1 Pages]
2	During Stand-by	[0 to 100/10/1 min.]

3521	Drum Stop Time :Disp	
	These SP codes display the last time the drums were used.	
1	Year	[0 to 99/0/1 year]
2	Month	[1 to 12/1/1 month]
3	Day	[1 to 31/1/1 day]
4	Hour	[0 to 23/0/1 hour]
5	Minute	[0 to 59/0/1 minute]

3522	Drum Stop Environ :Disp	
	These SP codes display the temperature and humidity around the drum when last used.	
1	Temperature	[-1280 to 1270/0/0.1 deg]
2	Rel Humidity	[0 to 1000/0/0.1 %RH]
3	Abs Humidity	[0 to 1000/0/0.1 g/m3]

3529	ProCon Interval Control :Set	
	These SP codes are used to determine when process control executes automatically.	
1	Gamma Corr	[0 to 1/1/1] 0:ON 1:OFF

2	Environ Corr	
3	Abs Hum Threshold	[0 to 99/4.3/0.1 g/m3]
4	Max Cnt Threshold	[0 to 99/2/1 counts]
5	Exe Cnt	[0 to 255/0/1 counts]
6	Page Cnt: BW	[0 to 5000/0/1 sheets]
7	Page Cnt: FC	[0 to 5000/0/1 sheets]

3530	Power ON ProCon :Set	
	These SP codes set the conditions that trigger automatic execution of process control when the machine is switched on for a cold start.	
1	Non-use Time Setting	[0 to 1440/360/1 minute]
2	Temperature Range	[0 to 99/10/1 deg]
3	Relative Humidity Range	[0 to 99/50/1 %RH]
4	Absolute Humidity Range	[0 to 99/6/1 g/m3]
5	Interval:BW	[0 to 5000/0/1 sheets]
6	Interval:FC	
7	Page Cnt:BW	
8	Page Cnt:FC	

3531	Non-useTime Procon :Set	
	These SP codes set the conditions that trigger automatic execution of process control while the machine remains idle in standby mode.	
1	Non-use Time Setting	[0 to 1440/360/1 minute]
2	Temperature Range	[0 to 99/10/1 deg]
3	Relative Humidity Range	[0 to 99/50/1 %RH]
4	Absolute Humidity Range	[0 to 99/6/1 g/m3]
5	Maximum Execution Number	[0 to 99/10/1 times]

3532	JobIn Procon :Set	
	These SP codes set the conditions that trigger automatic execution of process control when the machine receives a new job.	
1	Non-use Time Setting	[0 to 1440/60/1 minute]
2	Temperature Range	[0 to 99/3/1 deg]
3	Relative Humidity Range	[0 to 99/10/1 %RH]
4	Absolute Humidity Range	[0 to 99/3/1 g/m3]

3533	Interrupt ProCon :Set	
	These SP codes set the conditions that trigger automatic execution of process control while the machine is printing.	
1	Interval: Set: BW	[0 to 5000/500/1 sheets]
2	Interval: Disp: BW	[0 to 5000/0/1 sheets]
3	Corr(Short): BW	[0 to 1/0/5/0.01]
4	Corr(Mid): BW	[0 to 1/1/0.01]
11	Interval: Set: FC	[0 to 5000/500/1 sheets]
12	Interval: Disp: FC	[0 to 5000/0/1 sheets]
13	Corr(Short): FC	[0 to 1/0.5/0.01]
14	Corr(Mid): FC	[0 to 1/1/0.01]

3534	JobEnd ProCon :Set	
	These SP codes set the conditions that trigger automatic execution of process control at job end.	
1	Interval: Set: BW	[0 to 5000/1000/1 sheets]
2	Interval: Disp: BW	[0 to 5000/0/1 sheets]
3	Corr(Short): BW	[0 to 1/0.75/0.01]
4	Corr(Mid): BW	[0 to 1/1/0.01]
11	Interval: Set: FC	[0 to 1000/1000/1 sheets]

2

12	Interval: Disp: FC	[0 to 5000/0/1 sheets]
13	Corr(Short): FC	[0 to 1/0.75/0.01]
14	Corr(Mid): FC	[0 to 1/1/0.01]

3539	Dev Agitating Time :Set	
	These SP codes set up the parameters that determine how the developer/toner is agitated in the development units.	
1	Time	[0 to 3000/0/1 sec]
10	ON/OFF(by RelHum)	[0 to 1/1/1] 0:ON 1:OFF
30	ON/OFF(by Non-use Time)	[0 to 1/0/1] 0:ON 1:OFF
50	ON/OFF(by Non-use Time)	[0 to 1/1/1] 0:ON 1:OFF

3554	Set Expel Dev Mode	
	These SP codes set the parameters for the expel toner function.	
1	Set Expel Dev Mode	[0 to 1/0/1] 0:ON 1:OFF
2	Execution Threshold Value: Run	[0 to 255/75/1 sec]
3	Execution Threshold Value: End	[0 to 255/15/1 sec]
4	Calculated Value: Half-Speed	[0 to 655.35/0.67/0.01 sec]
11	Required Expel Time: K	[0 to 655.35/0.00/0.01 sec]
12	Required Expel Time: C	
13	Required Expel Time: M	
14	Required Expel Time: Y	

3600	Select ProCon	
	These SP codes select the potential control method.	
1	Potential Control	[0 to 1/1/1] 0:FIXED 1:CONTROL
2	LD Control	

3	TC Adj. Mode	[0 to 3/2/1]
		0:Do Not Execute 1: 1st Power On 2: 1st Power On & Job End
4	ACC Before ProCon	[0 to 3/2/1]
		0:Not Execute 1:Process Control 2:TC Control
5	TC Adj. Times	[1 to 10/5/1]
10	Active Potential Control	[0 to 1/1/1] 0:ON 1:OFF
20	Exe. Mode Select	[0 to 9/3/1]

3610	Chrg AC Control	
	These SP codes the AC control value that has been selected for potential AC control.	
1	Std Speed: K	[0 to 3/2.2/0.01 kV]
2	Std Speed: C	
3	Std Speed: M	
4	Std Speed: Y	

3611	Chrg DC Control		
	These SP codes display the DC drum charge bias determined for process control for the color and speed.		
		Mode	Speed
		Med.	246.96 mm/s
		Low	176.4 mm/s
		Std.	352.8 mm/s
1	Std Speed: K	[300 to 1000/450/1 -V]	
2	Std Speed: C		

3	Std Speed: M	[300 to 1000/550/1 -V]
4	Std Speed: Y	
11	Mid Speed: K	[300 to 1000/450/1 -V]
12	Mid Speed: C	
13	Mid Speed: M	[300 to 1000/550/1 -V]
14	Mid Speed: Y	
21	Low Speed: K	[300 to 1000/450/1 -V]
22	Low Speed: C	
23	Low Speed: M	[300 to 1000/550/1 -V]
24	Low Speed: Y	

3612	Dev DC Control	
	These SP codes display the DC development charge bias determined for process control for the color and speed	
	Mode	Speed
	Med.	246.96 mm/s
	Low	176.4 mm/s
	Std.	352.8 mm/s
1	Std Speed: K	[200 to 800/350/1 -V]
2	Std Speed: C	
3	Std Speed: M	[300 to 1000/450/1 -V]
4	Std Speed: Y	
11	Mid Speed: K	[300 to 1000/350/1 -V]
12	Mid Speed: C	
13	Mid Speed: M	[300 to 1000/450/1 -V]
14	Mid Speed: Y	

21	Low Speed: K	[300 to 1000/350/1 -V]
22	Low Speed: C	
23	Low Speed: M	[300 to 1000/450/1 -V]
24	Low Speed: Y	

3613	LD Power Control	
	These SP codes display the LD power determined for process control for standard speed (352.8 mm/s),	
1	Std Speed: K	[60 to 180/107/1 %]
2	Std Speed: C	[60 to 180/88/1 %]
3	Std Speed: M	[60 to 180/110/1 %]
4	Std Speed: Y	[60 to 180/107/1 %]

3620	ProCon Target M/A	
	These SP codes set Beta Coverage for each color.	
1	Maximum M/A:K	[0.25 to 0.75/0.45/0.001 mg/cm ²]
2	Maximum M/A:C	
3	Maximum M/A:M	
4	Maximum M/A:Y	
11	Maximum M/A Adj.:K	[-5 to 5/0/1]
12	Maximum M/A Adj.:C	
13	Maximum M/A Adj.:M	
14	Maximum M/A Adj.:Y	
21	Maximum M/A Corr:K	[-0.15 to 0.15/0.000/0.001 mg/cm ²]
22	Maximum M/A Corr:C	[-0.15 to 0.15/0.012/0.001 mg/cm ²]
23	Maximum M/A Corr:M	
24	Maximum M/A Corr:Y	

3622	Dev Pot :Set	
	These SP codes display the background potential.	
1	K	[0 to 800/0/1 V]
2	C	
3	M	
4	Y	
51	UpperLimit:K	[400 to 800/625/1 V]
52	UpperLimit:C	
53	UpperLimit:M	
54	UpperLimit:Y	
61	LowerLimit (K)	[0 to 400/200/1 V]
62	LowerLimit (C)	
63	LowerLimit (M)	
64	LowerLimit (Y)	

3623	LD Power Set	
	These SP codes set background potential for the four colors. The default is 100 V. If this setting is set too large, the carrier will not adhere.	
51	Line Width Adj.:K	[20 to 120/60/1 um]
52	Line Width Adj.:C	
53	Line Width Adj.:M	
54	Line Width Adj.:Y	
61	Line Width Adj.:K	[-5 to 5/0/1]-
62	Line Width Adj.:C	
63	Line Width Adj.:M	
64	Line Width Adj.:Y	

3624	TC Adj. Mode	
	These SP codes set the parameters for the range (upper and lower limits) for target gamma adjustment for process control toner density adjustment.	
1	Target(Upp Limit)	[0 to 1/0.15/0.01 mg/cm2/-kV]
2	Target(Lwr Limit)	[-1 to 0/-0.1/0.01 mg/cm2/-kV]
3	Maximum Counts	[1 to 50/5/1]
5	Force Consume Threshold	[1 to 6/1.9/0.01 mg/cm2/-kV]
6	Consume Pattern Area	[10 to 2550/250/10 cm2]
7	Consume(Upp Limit)	[0 to 16/8/1 times]
8	Force Supply Threshold	[0 to 1/1/0.65/0.01 mg/cm2/-kV]
9	Supply(Upp Limit)	[1 to 50/5/1 g]
10	Supply(Lwr Limit)	[1 to 50/1/1 g]

3630	Dev gamma :Disp/Set	
	These SP codes display information about the most recent development gamma settings.	
1	Current:K	[0.1 to 6/0.1/0.1 mg/cm2/-kV]
2	Current:C	
3	Current:M	
4	Current:Y	
11	Target:K	[0.5 to 2.55/0.5/.5 mg/cm2/-kV]
12	Target:C	
13	Target:M	
14	Target:Y	
21	Initial:K	[0.5 to 2.55/1.25/0.01 mg/cm2/-kV]
22	Initial:C	
23	Initial:M	

24	Initial:Y	
31	Env Cor.(ON/OFF)	[0 to 1/0/1]
32	TC Cor.(ON/OFF)	
41	Environ Corr:K	[-1 to 1/1/0.01 mg/cm2/-kV]
42	Environ Corr:Col	
51	TnrDensity Corr:K	[-1 to 1/0/0.01 mg/cm2/-kV]
52	TnrDensity Corr:C	
53	TnrDensity Corr:M	
54	TnrDensity Corr:Y	
61	TnrDensity:K	[0 to 25.5/0/0.1 wt%]
62	TnrDensity:C	
63	TnrDensity:M	
64	TnrDensity:Y	
71	Environ Corr1:K	[-1 to 1/-0.10/0.01 mg/cm2/-kV]
72	Environ Corr2:K	[-1 to 1/-0.05/0.01 mg/cm2/-kV]
73	Environ Corr3:K	[-1 to 1/0/0.01 mg/cm2/-kV]
74	Environ Corr4:K	[-1 to 1/0.05/0.01 mg/cm2/-kV]
75	Environ Corr5:K	[-1 to 1/0.1/0.01 mg/cm2/-kV]
76	Environ Corr6:K	[-1 to 1/0.15/0.01 mg/cm2/-kV]
77	Environ Corr7:K	[-1 to 1/0.1/0.01 mg/cm2/-kV]
78	Environ Corr8:K	
81	Environ Corr1:Col	[-1 to 1/-0.10/0.01 mg/cm2/-kV]
82	Environ Corr2:Col	[-1 to 1/-0.05/0.01 mg/cm2/-kV]
83	Environ Corr3:Col	[-1 to 1/0/0.01 mg/cm2/-kV]
84	Environ Corr4:Col	[-1 to 1/0.05/0.01 mg/cm2/-kV]
85	Environ Corr5:Col	[-1 to 1/0.10/0.01 mg/cm2/-kV]

86	Environ Corr6:Col	[-1 to 1/0.15/0.01 mg/cm2/-kV]
87	Environ Corr7:Col	[-1 to 1/0/0.01 mg/cm2/-kV]
88	Environ Corr8:Col	[-1 to 1/0/0.01 mg/cm2/-kV]
90	TC-Gamma	[0.1 to 0.25/0.12/0.01]
91	TC Corr Threshold:K	[7 to 12/9/0.1 wt%]
92	TC Corr Threshold:C	
93	TC Corr Threshold:M	
94	TC Corr Threshold:Y	

3631	Vk :Disp	
	These SP codes display the most recent development start voltages. Vk is the development start voltage. (One for each color.)	
1	K	[-300 to +300/0/1 -V]
2	C	
3	M	
4	Y	

3641	Vd(700) :Disp	
	These SP codes display the values for OPC drum charge potential around the drum for: <ul style="list-style-type: none"> • Averaged values for each color (with offset exposure) • Maximum and minimum values • Correction coefficients 	
1	Average:K	[0 to 999/0/1 -V]
2	Average:C	
3	Average:M	
4	Average:Y	
11	Max:K	
12	Max:C	

13	Max:M	
14	Max:Y	
21	Min:K	
22	Min:C	
23	Min:M	
24	Min:Y	
31	Corr Coef:K	[0.8 to 1.2/0.97/0.01]
32	Corr Coef:C	
33	Corr Coef:M	
34	Corr Coef:Y	

3642	Vr :Disp DFU	
	These SP codes display the residual potential for each drum. (Vr is the residual voltage, the slight trace of voltage that may remain after the drum is quenched by the QL.)	
1	K	[0 to 999/0/1]
2	C	
3	M	
4	Y	

3649	Pattern Pot: VI Disp	
	These SP codes display the value of the drum potential after maximum laser exposure by reading the white patches of the potential sensor patterns of KCMY.	
1	VI (P5): K	
2	VI (P5): C	
3	VI (P5): M	
4	VI (P5): Y	

3650	APC Set	
------	---------	--

1	Interval	[0 to 200/50/1 pages]
---	----------	-----------------------

3820	Tnr Refresh Mode	
	These SP modes set the parameters for operation of the toner refresh mode: <ul style="list-style-type: none"> • Image area threshold value. • Amount of coverage • Maximum between patterns • Maximum job end pattern 	
1	Img Area Thresh:K	[0 to 25.5/2/0.1 %]
2	Img Area Thresh:C	
3	Img Area Thresh:M	
4	Img Area Thresh:Y	
11	K Amount	[0 to 65535/0/1 mm]
12	C Amount	
13	M Amount	
14	Y Amount	
21	Max Between Pattern	[0 to 255/40/1 mm]
22	Max Job End Pattern	[0 to 1000/100/1 mm]

Group 4000

★ Important

- These SP codes are for the D074/D075 only. They are unavailable for the M044.

2

4008	Sub Scan Magnification Adj	
	Adjusts the sub-scan magnification by changing the scanner motor speed.	
	[-1 to +1/0/0.1%]	

4010	Sub Scan Registration Adj	
	Adjusts the leading edge registration by changing the scanning start timing in the sub-scan direction.	
	[-3 to +3/0/0.1 mm]	

4011	Main Scan Reg	
	Adjusts the side-to-side registration by changing the scanning start timing in the main scan direction. Note: This adjustment is done for the ADF with SP6006 (ADF Reg. Adj.).	
	[-25 to +2.5/0/0.1 mm]	

4012	Set Scale Mask	
	These settings adjust the margins (erase margins) of the scanned area on the sheet. The leading, trailing, right, and left margins can be set independently.	
1	Book:Sub LEdge	[0 to 3/0/0.1 mm]
2	Book:Sub TEdge	
3	Book:Main:LEdge	
4	Book:Main:TEdge	
5	ADF:Sub:LEdge	
7	ADF:Main:LEdge	
8	ADF:Main:TEdge	

4013	Scanner Free run	
	Performs the scanner free run with the exposure lamp on or off for full-color, full size (A3 or DLT).	
1	Book mode :Lamp Off	[0 to 1/0/1]
2	Book mode :Lamp On	

4014	Scan DFU	
	Touch [Execute] to execute one scanning operation with the scanner at the home position.	
	[0 to 1/4/1]	

4020	Dust Check	
	This feature checks the ADF exposure glass for dust that can cause black lines in copies. If dust is detected, a message is displayed, but the process does not stop.	
1	Dust Detect:On/Off	[0 to 1/0/1]
	<p>Issues a warning if there is dust on the narrow scanning glass of the ADF when the original size is detected before a job starts. This function can detect dust on the white plate above the scanning glass, as well as dust on the glass. Sensitivity of the level of detection is adjusted with SP4020-002.</p> <p>Note: Always clean the ADF scanning glass and the white plate above the scanning glass before you switch this setting on.</p>	
2	Dust Detect:Lvl	[0 to 8/4/1]
	<p>Adjusts the sensitivity for dust detection on the ADF scanning glass. This SP is available only after SP4020-001 is switched on.</p> <p>0: Off. No dust warning.</p> <p>0 > 4: Lower > Normal sensitivity</p> <p>4 > 8: Normal > High sensitivity</p> <ul style="list-style-type: none"> • If you see black streaks in copies when no warning has been issued, raise the setting to increase the level of sensitivity. • If warnings are issued when you see no black streaks in copies, lower the setting. • Dust that triggers a warning could move be removed from the glass by the originals in the feed path. If the dust is removed by passing originals, this is not detected and the warning remains on. 	

3	Dust Reject:Lvl	[0 to 4/0/1]
	<p>Sets the level for vertical line correction (the black vertical lines caused by dust on the ADF exposure glass).</p> <p>0: No vertical line correction.</p> <p>1-4: Enables and sets the level for vertical line correction.</p> <p>If you select a higher number, this can decrease unwanted lines caused by dust but can also erase thin vertical lines of the original.</p>	

4301	Operation Check APS Sensor	
	[0 to 255/0/1]	

4303	Min Size for APS	
	<p>Sets the minimum size of the original that the will be detected by APS (Auto Paper Select – with original width sensors) of the exposure glass of the flatbed scanner.</p> <p>[0 to 2/0/1]</p> <p>0: Unknown Document Size</p> <p>1: A5 SEF (HLT SEF)</p> <p>2: A5 LEF (HLT LEF)</p>	

4305	8K/16K Detection	
	<p>This SP enables the machine to recognize 8K/16K size paper automatically.</p> <p>[0 to 3/0/1]</p> <p>[0: Normal</p> <p>1: A4 for LEF, LT for SEF</p> <p>2: LT for LEF, A4 for SEF</p> <p>3: 8KAI, 16 KAI</p>	

4400	Org Edge Mask	
	<p>This SP sets the mask area to remove shadows when scanning originals from the exposure glass in Book mode.</p> <p>Note: "LE" denotes "leading edge" and "TE" denotes "trailing edge".</p>	
1	Book:Sub:LEdge	[0 to 3/0/0.1 mm]

2	Book:Sub:TEdge	
3	Book:Main:LEdge	
4	Book:Main:Tedge	
5	ADF:Sub:LEdge	
7	ADF:Main:LEdge	
8	ADF:Main:TEdge	

4417	IPU Test Pattern		
	Use this SP to select the IPU test pattern to print.		
	Test Pattern [0 to 24/0/1]		
0	Scanned Image	13	Grid Pattern CMYK
1	Gradation Main Scan A	14	Color Patch CMYK
2	Gradation Main Scan B	15	Gray Pattern (1)
3	Gradation Main Scan C	16	Gray Pattern (2)
4	Gradation Main Scan D	17	Gray Pattern (3)
5	Gradation Sub Scan 1	18	Shading Pattern
6	Grid Pattern	19	Thin Line Pattern
7	Slant Grid Pattern	20	Scanned + Grid Pattern
8	Gradation RGBCMYK	21	Scanned + Grayscale
9	UCR Pattern	22	Scanned + Color Patch
10	Color Patch 16 (1)	23	Scanned + Slant Grid C
11	Color Patch 16 (2)	24	Scanned + Slant Grid D
12	Color Patch 16 64		

4450	Scan Image Pass Selection	
	These SP codes switch the operation of black reduction and shading correction off/on.	
1	Black Subtraction ON/OFF	[0 to 1/1/1]

2

	Switches the black reduction function in scanner data off/on.	
2	SH ON/OFF	[0 to 1/1/1]
	Switches shading reduction function in scanner data off/on.	

4460	Digital AE DFU	
	These SP codes set parameters for the AE function.	
1	Low Limit Value	[0 to 1023/364/1]
	This setting determines the lower limit for level of background to be skipped for the AE function. The higher the setting, the more background will be ignored.	
2	Background level	[512 to 1535/972/1]
	This setting determines the level of background to be output for the AE function.	

4490	FL Correction ON/OFF	
1	RED	[0 to 1/0/1]
2	GREEN	
3	BLUE	

4501	ACC Target Den Not Used	
	This SP sets the target density for the ACC adjustment for machines connected with the Copier Connection Kit.	
1	Copy:K:Text	[0 to 10/5/1]
2	Copy:C:Text	
3	Copy:M:Text	
4	Copy:Y:Text	
5	Copy:K:Photo	
6	Copy:C:Photo	
7	Copy:M:Photo	

8	Copy:Y:Photo	
---	--------------	--

4505	ACC Cor:Bright Not Used	
	Sets correction for bright areas for ACC correction.	
1	Master:K	[-128 to +127/0/1]
2	Master:C	
3	Master:M	
4	Master:Y	
5	Slave:K	
6	Slave:C	
7	Slave:M	
8	Slave:Y	

4506	ACC Cor:Dark Not Used	
	Sets correction for dark areas for ACC correction.	
1	Master:K	[-128 to +127/0/1]
2	Master:C	
3	Master:M	
4	Master:Y	
5	Slave:K	
6	Slave:C	
7	Slave:M	
8	Slave:Y	

4540	Print Coverage	
	This SP corrects printer coverage of 12 hues (RY, YR, YG, etc. x 4 Colors (K, C, M, Y) for a total of 48 parameters.	

1st	<x>Phase<y>	[0 to 255/0/1]
2nd	<x>Phase<y>	[-256 to +255/0/1]
3rd	<x>Phase<y>	
4th	<x>Phase<y>	
055	BLACK G	[-256 to +255/8/1]
056	BLACK B	[-256 to +255/4/1]

4550	Scan Apli:Txt/Print	
4551	Scan Apli:Txt	
4552	Scan Apli:Txt Dropout	
4553	Scan Apli:Txt/Photo	
4554	Scan Apli:Photo	
4565	Scan Apli:GrayScale	
4570	Scan Apli:Col Txt/Photo	
4571	MTF: 0(Off) 1-15 (Weak-Strong)	
4572	Scan Apli:AutoCol	
	These SP code share common parameters (see below).	
5	MTF: 0(Off) 1-15 (Weak-Strong)	[0 to 15/8/1]
	Sets the MTF level (Modulation Transfer Function) designed to improve image contrast. Set higher for stronger effect, lower for weaker effect.	
6	Smoothing: 0(x1) 1-7 (Weak-Strong)	[0 to 7/4/1]
	Use to remove "jaggies" if they appear. Set higher for smoother.	
7	Brightness: 1-255	[1 to 255/128/1]
	Set higher for darker, set lower for lighter.	
8	Contrast: 1-255	[1 to 255/128/1]
	Set higher for more contrast, set lower for less contrast.	

9	Ind Dot Erase: 0(Off) 1-7 (Weak-Strong)	[0 to 7/0/1]
	Use to remove individual dots in the background if they appear. Set higher for removal of more background.	

4600	SBU Version Display	
	These SP codes display the readings of four ID codes read during automatic adjustment of the SBU every time the machine is turned on. An incorrect ID reading issues SC144.	
1	SBU_ID	[0 to 255/0/1]
	Displays the ID code (1-byte hexadecimal) read for the SBU.	
2	GASBU-N_ID	[0 to 255/0/1]
	Displays the ID code (1-byte hexadecimal) read for the GASBU-N.	
3	VSP_F_ID	[0 to 255/0/1]
	Displays the ID code (1-byte hexadecimal) read for the VSP5100_F.	
4	VSP_L_ID	[0 to 255/0/1]
	Displays the ID code (1-byte hexadecimal) read for the VSP5100_.	

4602	Scanner Memory Access DFU	
------	----------------------------------	--

4609	Gray Balance Adj Value R DFU	
4610	Gray Balance Adj Value G DFU	
4611	Gray Balance Adj Value B DFU	
	These SP codes display the reference voltages stored in NVRAM at the factory for Red, Green, and Blue before the machine was shipped. The SBU acquires these settings every time the machine is switched on.	
1	Book Scan	[0 to 1023 / 512 / 1 Step]
2	DF Scan	[0 to 255 / 97 / 1 Step]

4623	Black Level Adj Value DFU
4624	Black Level Adj Value DFU
4625	Black Level Adj Value DFU

4628	Analog Gain Adj Value DFU
4629	Analog Gain Adj Value DFU
4630	Analog Gain Adj Value DFU

4631	Digital Gain Adj Value DFU
	When switched on, this SP displays the current range for the E (EVEN) or O (ODD) in the ASCI on the SBU after white level adjustment every time the machine is switched on.

4632	Digital Gain Adj Value DFU
	When switched on, this SP displays the current range for E (EVEN) or O (ODD) gain of GREEN or B/W in the ASCI on the SBU after white level adjustment every time the machine is switched on.

4633	Digital Gain Adj Value DFU
	When switched on, this SP displays the current range for E (EVEN) or O (ODD) gain of GREEN or B/W in the ASCI on the SBU after white level adjustment every time the machine is switched on.

4635	SSCG Noise Cancel DFU	
	Switches SSCG noise cancellation on/off. 0: Off, 1: On	
1	Correction ON/OFF	[0 to 1/1/1]
2	Adj ON/OFF	

4636	SSCG Correction DFU
4637	SSCG Correction Adj Value DFU
4638	SSCG Correction Adj Value DFU

4639	SSCG Correction Adj Value DFU
4640	SSCG Noise Size DFU
4646	Scan Adjust Error DFU
4647	Scanner Hardware Error DFU
4654	Black Level Adj Value DFU
4655	Black Level Adj Value DFU
4656	Black Level Adj Value DFU
4658	Analog Gain Adj Value DFU
4659	Analog Gain Adj Value DFU
4660	Analog Gain Adj Value DFU
4661	Digital Gain Adj Value DFU
4662	Digital Gain Adj Value DFU
4663	Digital Gain Adj Value DFU
4673	Black Level Adj Value DFU
4674	Black Level Adj Value DFU
4675	Black Level Adj Value DFU
4677	Analog Gain Adj Value DFU

4678	Analog Gain Adj Value DFU
------	----------------------------------

4679	Analog Gain Adj Value DFU
------	----------------------------------

4680	Digital Gain Adj Value DFU
4681	Digital Gain Adj Value DFU
4682	Digital Gain Adj Value DFU
	When switched on, these SP codes display the settings done at the factory for Red (Green, Blue) O (ODD) and E (EVEN) gain in the ASIC on the SBU after white level adjustment every time the machine is switched on.

4690	White Level Peak Data R: FE DFU
4691	White Level Peak Data: G: FE DFU
4692	White Level Peak Data: B: FE DFU
	When switched on, these SP codes display E (EVEN) or O (ODD) for the white level peak Red (Green, Blue) data after white level detection (AGC) after the machine is switched on.

4693	Black Level Data R: FE DFU
4694	Black Level Data G: FE DFU
4695	Black Level Data B: FE DFU
	When switched on, these SP codes display E (EVEN) or O (ODD) for the black level check done in the SBU for RED after the machine is switched on.

4699	SBU Test Pattern: F	
	Selects the scan test pattern.	
1	Select Test Pattern	[0 to 4 / 0 / 1]
	0	Normal Image Output
	1	Fixed Value Output
	2	Main Scan Gradation
	3	Sub Scan Gradation

	4	Grid Pattern	
2	Set Output Level		[0 to 1023/ 682 / 1]
3	Select Test Pattern		[0 to 4 / 0 / 1]
	0	Normal Image Output	
	1	Fixed Value Output	
	2	Main Scan Gradation	
	3	Sub Scan Gradation	
	4	Grid Pattern	
4	Set Output Level		[0 to 1023/ 682 / 1]

4802	Scanner Free run		
	This SP sets the scanner in the free run mode for testing. The free run can be set with the exposure lamp off or on.		
1	DF mode :Lamp Off	[0 to 1/0/1]	
2	DF mode :Lamp On		

4804	Home Position Operation	[0 to 1/0/1]	
	Touch [Execute] to do the home position operation once.		

4805	Scanner Carriage Retraction Operation		
	[0 to 1/0/1]		

4901	Background Erase Settings		
20	Org Density High Mode (Light)	[-128 to 127/0/1 step]	
22	Org Density High Mode (Light)		
22	Org Density High Mode (Light)		

4902	Disp ACC Data		
------	---------------	--	--

	This SP outputs the final data read at the end of ACC execution. A zero is returned if there was an error reading the data.		
1	R_DATA1	Photo C Patch Level 1 (8-bit)	[0 to 255/0/1]
2	G_DATA1	Photo M Patch Level 1 (8-bit)	
3	B_DATA1	Photo Y Patch Level 1 (8-bit)	
4	R_DATA2	Photo C Patch Level 17 (8-bit)	
5	G_DATA2	Photo M Patch Level 17 (8-bit)	
6	B_DATA2	Photo Y Patch Level 17 (8-bit)	

4905	Select Gradation Level		
	This SP changes the threshold parameters of error diffusion. [0 to 255/0/1]		

4918	Man Gamma Adj DFU		
1	Offset:Highlight		[0 to 30/15/1]
2	Offset:Middle		
3	Offset:Shadow		
4	Offset:IDmax		
5	Option:Highlight		[0 to 255/0/1]
6	Option:Middle		[0 to 12/0/1]
7	Option:Shadow		[0 to 255/0/1]
8	Option:IDmax		

4954	Read/Restore Std DFU		
	Use this SP to calibrate the scanner gamma on each machine connected with the Copier Connection Kit.		
1	Read New Chart		[0 to 1/0/1]
2	Recall Prev Chart		

3	Read Std Chart	
4	Set Std Chart	

4991	IPU Image Path Selection	
	Use this SP to use the 10-key pad to enter the number to determine the image path.	
	IPU	[0 to 11/2/1]
	0	DFID input RGB images (upper 8 bits)
	1	Synchronous RGB images in DFID
	2	Data with shading correction on
	3	Data with shading correction off
	4	Data before black offset correction
	5	Data after black offset correction
	6	Shading data
	7	Test pattern data (grayscale)
	8	RGB image after line interval correction
	9	RGB image after dot correction and pre-gamma
	10	RGB image after vertiial line correction
	11	RGB image after scanner gamma correction

4993	High Light Correction DFU
------	----------------------------------

4994	Adj Txt/Photo Recognition Level DFU
------	--

4996	White Paper Detection Level DFU
------	--

Group 5000

2

5024	mm/inch Display Selection	CTL
	[0 to 1/0/1] 0: Europe/Asia (mm) 1: North America (inch)	

5051	Refill Toner Panel Display	CTL
	Switches refill toner display off and on. [0 to 1/0/1] 0:ON 1:OFF	

5045	Accounting Counter	CTL
	Selects the counting method. Note: When the A3/DLT double count function is switched on with SP5104, 1 A3/DLT page is counted as 2.. When SP5104-1 is switched ON, the "5 Developer" and "6 Prints" items below cannot be set.	
1	Counter method [0 to 6/ * / -] Note: <ul style="list-style-type: none"> For the D074/D075 the default is "0 Developments" For M044 the default is 1: Prints 	
	0: Developments	
	1: Prints	
	2: Coverage There are 5 counters for this selection: (1) Color Total, (2) Color 1, (3) Color 2, (4) Color 3, (5) B&W Total. <ul style="list-style-type: none"> Color 1, 2, 3 total the counts for KCMY. Color 1 totals 0 to 5% coverage, Color 2 5% to 20% coverage, Color 3 more than 20% coverage. Color 1 and Color 2 can be adjusted with SP7855. 	
	3: Not used	
	4: Not used	

	<p>5: Developer (A3/DLT & Larger)</p> <p>There are four counters for this selection: (1) Color (YMC) Development, (2) Black Development, (3) Color (YMC) (A3/DLT&Larger), (4) Black Development (A3/ DLT&Larger).</p> <ul style="list-style-type: none"> • The number of prints for the colors used are counted. • When four colors are used for four-color printing, the count is done "Color (YMC) Development: +3", and "Black Development: +1" • The A3/DLT&Larger counts are done only for paper larger than A3 (wider than 420 mm)
	6: Prints (A3/DLT & Larger)

	Display IP Address	CTL
5055	<p>Switches the banner display of the IP address off and on. (Default: * Off)</p> <p>[OFF] ON</p> <p>For example, if this SP is switched on, the IP address will be displayed below "Ready" while the printer is in standby mode:</p> <p>Ready</p> <p>169.254.187.055</p>	

	Coverage Counter Display	CTL
5056	<p>This SP switches the counter list for the system administrator on/off.</p> <p>[0 to 1/0/1] 0: On 1: Off</p>	

5062	Parts Replacement Banner	CTL
1 to 118	<p>[0 to 1/0/1] 0: Display Off, 1: Display On</p> <p>This SP codes switches the replacement parts banner on and off. Default: Display OFF.</p> <p>Notes:</p> <ul style="list-style-type: none"> • This selection has no effect on the system alarm warnings. • Switching this SP on enables SP7624. • The setting of SP5066 affects what is displayed in the banner. • Related SP codes are SP5066-1, SP7624, and SP5067 	

5066	PM Parts Display [0 to 1/0/1] 0:No Display 1:Display	CTL
5067	Switching of Print Application 1 to 118 [0 to 1/0/1]	CTL
5071	Set Bypass Paper Size Display This SP determines whether long paper can be fed from the bypass tray. Even if "1" is selected only paper up to 432 mm can be used. [0 to 1 / 0 / 1] 0: Disable 1: Enable	CTL
5104	A3/DLT Double Count : SSP Specifies whether the counter is double clicked for A3/DLT size prints. When you have to change this SP, ask your supervisor. Note: This SP cannot be changed if "5" or "6" is selected for SP5045. 1 [0 to 2 / 0 / 1 /step] 0: NO (Normal count) 1: YES (Double count) 2: YES except By-pass (Normal count for unknown size)	CTL
5113	Optional Counter Type Japan Only	CTL

1	Default Optional Counter Type
	<p>[0 to 12/0/1]</p> <p>Selects the type of counter:</p> <p>0: None</p> <p>1: Key Card (RK3, 4) Japan Only</p> <p>2: Key Card Down</p> <p>3: Pre-paid Card</p> <p>4: Coin Rack</p> <p>5: MF Key Card</p> <p>11: Exp Key Card (Add)</p> <p>12: Exp Key Card (Deduct)</p>
2	External Optional Counter Type
	<p>Enables the SDK application. This lets you select a number for the external device for user access control.</p> <p>Note: "SDK" refers to software on an SD card.</p> <p>[0 to 3/0/1]</p> <p>0: None</p> <p>1: Expansion Device 1</p> <p>2: Expansion Device 2</p> <p>3: Expansion Device 3</p>

5114	Optional Card IF	CTL
	<p>This SP code enables the interface for an optional counting device.</p> <p>[0 to 8/0/1] Only settings that can be enabled for machines outside Japan are listed here.</p> <p>0: Disabled</p> <p>1: Key Cards (RK2, 3, 4)</p> <p>2: Decrementing keycard</p> <p>11: Incrementing key cards for use outside Japan</p> <p>12: Decrementing key cards for use outside Japan</p>	

5118	Disable Copying	CTL
	Temporarily denies access to the machine. [0 to 1/0/1] 0: Release for normal operation 1: Prohibit access to machine	
5120	Mode Clear Count Removal	CTL
For a machine that has a counting device, this SP sets the next action when a copy job stops because the card is removed, the card is expired, or if the paper supply runs out. Japan Only [0 to 2/0/1 step] 0: Yes 1: Stand-by 2: No		
5121	Counter Up Timing	CTL
Determines whether the optional key counter counts up at paper feed-in or at paper exit. [0 to 1/1/1] 0: Feed count 1: No feed count		
5126	Set F-size Document	
[0 to 2/0/1] 0:Foolscap 8.5x13 1:Folio 8.25x13 3:F 8 x 13		
5127	APS Off Mode	CTL
This SP can be used to switch APS (Auto Paper Select) off while a coin lock or pre-paid key card device is connected to the machine. [0 to 1/0/1] 0: On 1: Off		
5128	Code Mode With Key/Card Option Japan Only	CTL
5131	Paper Size Type Selection	

	<p>Selects the paper size type (for originals and copy paper). (Only needs to be adjusted if the optional printer controller is installed)</p> <p>[0 to 2/1]</p> <p>0: DOM (Japan)</p> <p>1: NA (North America)</p> <p>2: EU (Europe)</p> <p>After changing the value, turn the main power switch off and on.</p>
--	---

5150	Bypass Length setting	CTL
1	<p>[0 to 1 / 0 / 1 / -]</p> <p>0: OFF: Enables up to the standard 480mm</p> <p>1: ON: Enables up to 630mm</p> <ul style="list-style-type: none"> • Purpose. To switch the paper feeding control for paper sizes larger than the often used standard paper sizes(487.7mm in sub-scan direction) • Basic Control. <Target Paper Size(sub-scan direction)> Paper sizes (Lp) of 487.7mm - 630mm. <Target Feed Tray> Multi By-pass Tray ONLY <p>Notes:</p> <ul style="list-style-type: none"> • Paper must be set one sheet at a time on the feed tray because the end-fence can not support these paper sizes. • Automatic duplexing must be disabled • Only face-up stacking is possible • The purge function for jams will be disabled • Side-to-side registration correction will be disabled 	

5162	App. Switch Method	CTL
	<p>Determines if the application screen changes with a hardware switch or a software switch.</p> <p>[0 to 1/0/1] 0: Soft Key Set 1: Hard Key Set</p>	

5169	CE Login	CTL
------	----------	-----

	<p>This SP enables and disables the CE log in mode. With this SP enabled, the machine is in the CE (Customer Engineer/Service Technician) login mode.</p> <p>In the CE login mode:</p> <ul style="list-style-type: none"> • The machine power can be turned off and on in the SP mode, and it will remain in the SP mode after power is restored. • This SP is automatically reset to "0" (disabled) after the service technician closes the SP mode with the [Exit] soft button or after the log out timer expires. <p>Note: The Auto Logout Timer is in the "System Settings" of User Tools.</p> <p>[0 to 1/0/1] 0: Disable, 1: Enable 0: CE login mode disabled. 1: CE login mode enabled.</p>	
5185	TCRU: Set Machine	
	<p>This SP code sets up the machine for the TCRU program. Default: OFF [0 to 1/0/1] 0:OFF 1:ON</p> <p>Note: The machine must be cycled on after changing this SP setting.</p>	
5186	RK4	
	<p>This setting determines whether jam removal operation is enabled or disabled for RK4. [0 to 1/0/1] 0: Disable 1: Enable</p>	
5188	Copy NV Version DFU	CTL
	<p>This SP displays the NVRAM version to determine whether the NVRAM has been initialized. Used during debugging.</p>	
5190	Unit Life Target Change	CTL
	<p>This SP determines whether counter reference values for the PM counter are set in the operator adjust mode or super operator adjust mode. The settings are used for display. [0 to 1/0/1] 0:Enable 1:Disable</p>	
5193	External Controller Information Setting	CTL

	<p>This SP selects the controller type. This setting needs to be done if an external controller is installed in the machine.</p> <p>[0 to 6/0/1]</p> <p>0: No external controller installed</p> <p>1: EFI controller</p> <p>2: Ratio controller</p> <p>3: Egret controller</p> <p>4: GJ</p> <p>5: Creo</p> <p>6: QX-100</p>	
5195	Limitless Switch	CTL
	<p>This SP selects the paper feed mode by switching between "productivity priority" (0) and "tray priority" (1). This SP operates only if the operator has selected "Auto Paper Select".</p> <p>[0 to 1 / 0 / 1]</p> <p>0: Productivity priority. Switches from the current feed tray to the priority tray as soon as the machine detects the priority tray, even if paper still remains in the current feed tray.</p> <p>1: Tray priority. Switches the feed tray only after the paper in the tray current tray runs out of paper.</p>	
5199	Paper Exit After Staple End	CTL
	<p>This SP determines whether a machine that normally cannot continue to output paper if staple supply runs can continue to operate.</p> <p>[0 to 1 / 0 / 1]</p> <p>0: OFF. Paper cannot exit if no staples are available.</p> <p>1: ON. Paper can exit with no staples.</p>	
5212	Page Numbering	CTL
	<p>This program adjusts the position of the second side page numbers.</p> <ul style="list-style-type: none"> • A "-" value" moves the page number positions to the left edge or leading edge (high position). • A "+" value" moves the page number positions to the right edge or trailing edge (low position). 	

3	Duplex Printout Right/Left Position
	[-10 to +10/0/1 mm] -10 (left, +10 (right)
4	Duplex Printout High/Low Position
	[-10 to +10/0/1 mm] -10 (left, +10 (right)

5227	Page Numbering	CTL
220	Change Page No. Display	
	<p>This SP code switches the job page number entry display on/off so you can enter a starting page number.</p> <p>[0 to 1/0/1] 0: Disable 1: Enable</p>	
221	Allow Page No. Entry	
	<p>This SP code restricts the number of digits that can be entered in the job page number entry display. The default is 9 digits.</p> <p>[2 to 9/9/1]</p>	
222	Zero Surplus Setting	
	<p>This SP code determines whether initial zeros are displayed for one and two digit numbers.</p> <p>[0 to 1/0/1]</p> <p>0: Do not suppress "0"</p> <p>1: Suppress "0"</p>	

5302	Set Time	CTL
	<p>Sets the time clock for the local time. This setting is done at the factory before delivery. The setting is GMT expressed in minutes.</p> <p>[-1440 to 1440/1 min.]</p> <p>AS: +480 (Hong Kong)</p> <p>CH: +480 (Peking)</p> <p>EU: +60 (Paris)</p> <p>JA: +540 (Tokyo)</p> <p>KO: +540 (Korea)</p> <p>NA: -300 (NY)</p> <p>TW: +480 (Taipei)</p>	

5307	Summer Time	CTL
<p>Lets you set the machine to adjust its date and time automatically with the change to Daylight Savings time in the spring, and back to normal time in the fall. This SP lets you set these items:</p> <ul style="list-style-type: none"> • Day and time to go forward automatically in April • Day and time to go back automatically in October • Set the length of time to go forward and back automatically • The settings for 2 and 3 are done with 8-digit numbers 		
	Digits	Meaning
	1st, 2nd	Month. 4: April, 10: October (for months 1 to 9, the first digit of 0 cannot be input, so the eight-digit setting for 2 or 3 becomes a seven-digit setting)
	3rd	Day of the week. 0: Sunday, 1: Monday
	4th	The number of the week for the day selected at the 3rd digit. If "0" is selected for "Sunday", for example, and the selected Sunday is the start of the 2nd week, then input a "2" for this digit.
	5th, 6th	The time when the change occurs (24-hour as hex code). Example: 00:00 (Midnight) = 00, 01:00 (1 a.m.) = 01, and so on.
	7th	The number of hours to change the time. 1 hour: 1

	8th	If the time change is not a whole number (1.5 hours for example), digit 8 should be 3 (30 minutes).
	1	Setting
		Enables/disables the settings for 2 and 3. 0: Disable 1: Enable
	3	Rule Set (Start)
		The start of summer time.
	4	Rule Set (End)
		The end of summer time.

5401	Access Control DFU	CTL
	These SP's store settings that limit uses access to SDK (Software Development Kit) application data.	
103	Default Document ACL	
104	Authentication Time	
	This SP sets the length of time allowed for authentication. [1 to 255 / 0 / 1] (0 = 60 sec. standard)	
162	Extend Certification Detail	
200	SDK1 Unique ID	"SDK" is the "Software Development Kit". This data can be converted from SAS (VAS) when installed or uninstalled. DFU
201	SDK1 Certification Method	
210	SDK2 Unique ID	
211	SDK2 Certification Method	
220	SDK3 Unique ID	
221	SDK3 Certification Method	
230	SDK Certification Device	
240	Detail Option	

5404	User Code Count Clear	CTL
	Clears the counts for the user codes assigned by the key operator to restrict the use of the machine. Press [Execute] to clear.	

5411	LDAP Certification	CTL
	This SP sets up LDAP certification.	
4	Easy Certification	
	When set to "1" does easy authentication according to the SP setting. [0 to 1 / 1 / 1]	
5	Password Null Not Permit	
	This SP is referenced only when SP5411-4 is set to "1" (On). [0 to 1/1/1] 0: Password NULL not permitted. 1: Password NULL permitted	
6	Detail Options	
	(7) 0000 0000 (0)	

5413	Lockout Setting	CTL
1	Lockout On/Off	
	Switches on/off the lock on the local address book account. [0 to 1/0/1] 0: Off 1: On	
2	Lockout Threshold	
	Sets a limit on the frequency of lockouts for account lockouts. [1 to 10/5/1]	

3	<p>Cancellation On/Off</p> <p>Determines whether the system waits the prescribed time for input of a correct user ID and password after an account lockout has occurred.</p> <p>[0 to 1/0/1]</p> <p>0: Off (no wait time, lockout not cancelled)</p> <p>1: On (system waits, cancels lockout if correct user ID and password are entered.)</p>
4	<p>Cancellation Time</p> <p>Determines the length of time that the system waits for correct input of the user ID and password after a lockout has occurred. This setting is used only if SP5413-3 is set to "1" (on).</p> <p>[1 to 999/60/1 min.]</p>

5414	Access Mitigation	CTL
1	Mitigation On/Off	
	<p>Switches on/off masking of continuously used IDs and passwords that are identical.</p> <p>[0 to 1/0/1]</p> <p>0: Off</p> <p>1: On</p>	
2	Mitigation Time	
	<p>Sets the length of time for excluding continuous access for identical user IDs and passwords.</p> <p>[0 to 60/15/1 min.]</p>	

5415	Password Attack	CTL
1	Permissible Number	
	<p>Sets the number of attempts to attack the system with random passwords to gain illegal access to the system.</p> <p>[0 to 100/30/1 attempt]</p>	
2	Detect Time	
	<p>Sets the time limit to stop a password attack once such an attack has been detected.</p> <p>[1 to 10/5/1 sec.]</p>	

5416	Access Information	CTL
1	Access User Max Number	
	Limits the number of users used by the access exclusion and password attack detection functions. [50 to 200/200/1 users]	
2	Access Password Max Number	
	Limits the number of passwords used by the access exclusion and password attack detection functions. [50 to 200/200/1 passwords]	
3	Monitor Interval	
	Sets the processing time interval for referencing user ID and password information. [1 to 10/3/1 sec.]	

5417	Access Attack	CTL
1	Access Permissible Number	
	Sets a limit on access attempts when an excessive number of attempts are detected for MFP features. [0 to 500/100/1]	
2	Attack Detect Time	
	Sets the length of time for monitoring the frequency of access to MFP features. [10 to 30/10/1 sec.]	
3	Productivity Fall Wait	
	Sets the wait time to slow down the speed of certification when an excessive number of access attempts have been detected. [0 to 9/3/1 sec.]	
4	Attack Max Number	
	Sets a limit on the number of requests received for certification in order to slow down the certification speed when an excessive number of access attempts have been detected. [50 to 200/200/1 attempt]	

2

5420	User Authentication				CTL
<p>These settings should be done with the System Administrator.</p> <p>Note: These functions are enabled only after the user access feature has been enabled.</p>					
1	Copy				
<p>Determines whether certification is required before a user can use the copy applications.</p> <p>[0 to 1/0/1]</p> <p>0: On</p> <p>1: Off</p> <p>2: Color Security Setting</p>					
2	Color Security Setting				
<p>Color applications refer to this SP setting to limit the colors used.</p>					
	Bit	Mode	Bit	Mode	
	0	B&W Mode	4	Auto Color	
	1	Single Color	5	---	
	2	2-Color	6	---	
	3	Full Color	7	---	
11	<p>Document Server</p> <p>Determines whether certification is required before a user can use the document server.</p> <p>[0 to 1/0/1]</p> <p>0: On</p> <p>1: Off</p>				
31	<p>Scanner</p> <p>Determines whether certification is required before a user can use the scan applications.</p> <p>[0 to 1/0/1]</p> <p>0: On</p> <p>1: Off</p>				

41	Printer	Determines whether certification is required before a user can use the printer applications. [0 to 1/0/1] 0: On 1: Off
51	SDK1	[0 or 1/ 0 / 1] 0: ON. 1: OFF Determines whether certification is required before a user can use the SDK application.
61	SDK2	
71	SDK3	

5430	Auth Dialog Message Change	CTL
1	Message Change On/Off	
	[0 to 1 / 0 / 1]	
2	Message Text Download	
	Touch [EXECUTE].	
3	Message Text ID	

5431	External Auth User Preset	CTL
10	Tag	
11	Entry	
12	Group	
20	Mail	
32	Folder	
33	Protect Code	
34	SMTP Auth	
35	LDAP Auth	
36	SMB FTP Folder Auth	
37	Acnt Acl	

38	Document Acl
40	Cert Crypt

5481	Authentication Error Code	CTL
	These SP codes determine how the authentication failures are displayed.	
1	System Log Disp	
	<p>Determines whether an error code appears in the system log after a user authentication failure occurs.</p> <p>[0 to 1/0/1]</p> <p>0: Off</p> <p>1: On</p>	
2	Panel Disp	
	<p>Determines whether an error code appears on the operation panel after a user authentication failure occurs.</p> <p>[0 to 1/1/1]</p> <p>1: On</p> <p>0: Off</p>	

5490	MF Keycard Japan Only	CTL
1	Job Permit Setting	
	<p>Sets up operation of the machine with a keycard.</p> <p>[0 to 1/0/1]</p> <p>0: Disabled. Cancels operation if no code is input.</p> <p>1: Enabled. Allows operation if another code is input and decrements the counter once for use of the entered code.</p>	
2	Count Mode Setting	

5501	PM Alarm	CTL
1	PM Alarm Level	

	[0 to 9999 / 0 / 1 step] 0: Alarm off 1 to 9999: Alarm goes off when Value (1 to 9999) > PM counter	
2	Original Count Alarm	
	[0 to 1/0/1] 0: No alarm sounds 1: Alarm sounds after the number of originals passing through the ARDF > 10,000	
5504	Jam Alarm	CTL
	Sets the alarm to sound for the specified jam level (document misfeeds are not included). [0 to 3 / 3 / 1 step] 0: Zero (Off) 1: Low (2.5K jams) 2: Medium (3K jams) 3: High (6K jams)	
5505	Error Alarm	CTL
	Sets the error alarm level. [0 to 255 / 35 / 1 Step] (1 Step is 100 m)	
5507	Supply Alarm	CTL
1	Paper Supply Alarm	
	Switches the control call on/off for the paper supply. [0 to 1/0/1] 0: Off, 1: On 0: No alarm. 1: Sets the alarm to sound for the specified number transfer sheets for each paper size (A3, A4, B4, B5, DLT, LG, LT, HLT)	
2	Staple Supply Alarm	

	<p>This SP determines whether the machine issues a supply alarm when the finisher runs out of staples. [0 to 1/0/1]</p>	
3	<p>Toner Supply Alarm</p>	
	<p>Switches the control call on/off for the toner end. [0 to 1/0/1] 0: Off, 1: On If you select "1" the alarm will sound when the main machine detects toner end.</p>	
6	<p>Waste Toner Bottle Supply Alarm</p>	
	<p>This SP determines whether the machine issues a supply alarm when the toner bottle is full. [0 to 1/0/0] 0: No, 1: Yes</p>	
080	<p>Toner Call Timing</p>	
	<p>This SP switches the toner supply call for @Remote. [0 to 1 / 0 / 1] 0: Toner replacement. Triggers the alarm when toner should be replaced with new toner. 1: Toner near-end. The alarm triggers at toner-end or toner near-end.</p>	
	<p>Note: The "Interval nn" SP's below specify the paper control call interval for the referenced paper sizes.</p>	
132	Interval: A3	[250 to 10000/1000/1 Step]
133	Interval: A4	
134	Interval: A5	
141	Interval: B4	
142	Interval: B5	
160	Interval: DLT	
164	Interval: LG	
166	Interval: LT	
172	Interval: HLT	
5508	CC Call	CTL

1	Jam Remains	Enables/disables initiating a call.
2	Continuous Jams	[0 to 1/1/1] 0: Disable, 1: Enable
3	Continuous Door Open	
11	Jam Detection: Time Length	
	Sets the length of time to determine the length of an unattended paper jam. [3 to 30/10/1] This setting is enabled only when SP5508-4 is enabled (set to 1).	
12	Jam Detection: Continuous Count	
	Sets the number of continuous paper jams required to initiate a call. [2 to 10/5/1] This setting is enabled only when SP5508-4 is enabled (set to 1).	
13	Door Open: Time Length	
	Sets the length of time the remains opens to determine when to initiate a call. [3 to 30/10/1] This setting is enabled only when SP5508-4 is enabled (set to 1).	

5513	Parts Alarm Level Count	CTL
	This SP sets the level for the alarm to sound for the PM parts listed under SP7617-1.	
1	Normal	[1 to 9 999/300/1 step]
2	DF	

5514	Parts Alarm Level	CTL
	These SP codes determine how the parts alarm operates.	
1	Normal	
	Turns on or off the parts replacement alarm for the number of paper. [0 or 1 / 1 / -] 0: OFF, 1: ON	
2	DF	

	Turns on or off the parts replacement alarm for the number of scanned originals. [0 or 1 / 0 / -] 0: OFF, 1: ON
--	--

2

5515	SC/Alarm Setting	CTL
	Determines whether an SC call is issued when an SC error occurs while either CSS (Japan) or @Remote is enabled: [0 to 1/1/1] 1: An SC call is issued when an SC error occurs. 0: An SC call is not issued when an SC error occurs.	
1	SC Call	
	Determines whether an SC call is issued when an SC error occurs while either CSS or @Remote is enabled: [0 to 1/1/1] 1: An SC call is issued when an SC error occurs. 0: An SC call is not issued when an SC error occurs.	
2	Service Parts Near End Call	
3	Service Parts End Call	
4	User Call	
6	Communication Test Call	
7	Machine Information Notice	
8	Alarm Notice	
10	Supply Automatic Ordering Call	
11	Supply Management Report Call	
12	Jam/Door Open Call	

5516	Individual PM Part Alarm Call	CTL
1	Disable/Enable Setting (0:Not Sound 1:Send)	[0 to 1/0/1]
4	Percent Yield for Triggering	[1 to 255/75/1]

5517	Failure Prediction	CTL
	An imminent failure warning is issued whenever the machine issues a report at the number of printed pages prescribed by SP8581-1 (Total Counter). The number of pages can also be set with SP5517-2 below.	
1	Alarm On/Off Setting	
	Enables or disables the notification alarm for the @Remote. [0 or 1 / 0 / 1] 0: Off, 1: On	
2	Alarm Interval	
	Specifies the alarm interval for the @Remote. [0 to 1000 / 10 / 100 sheets/step]	

5610	Base Gamma Ctrl Pt:Execute	CTL
4	Get Factory Default	[0 to 1/0/1]
5	Set Factory Default	[0 to 1/100/1]
6	Restore Original Value	

5611	Toner Color in 2C	CTL
1	B-C	[0 to 128/100/1]
2	B-M	
3	G-C	
4	G-Y	
5	R-M	[0 to 128/0/1]
6	R-Y	

5618	Color Mode Display Selection	
------	------------------------------	--

	<p>This SP switches the color display for the operation panel LCD.</p> <p>[0 or 1 / 1 / -]</p> <p>0: Domestic Japan</p> <p>1: Overseas (Outside Japan)</p>
--	--

2

5711	Custom Setting Paper: Data Set	CTL
	<p>The Paper Library must be installed when the machine is installed. These files (library.mqp and user.mqp) are available from the Firmware Download Center. A new function has been added to allow customers to backup the Saved Paper Library data onto an SD card with DOS (Data Overwrite Security). The files are located in the MQP folder and copied to the /mnt/usb3/mqp folder in flash memory.</p>	
1	Standard Paper Data Upload	
	Basic paper data upload from SD card to main machine.	
2	Custom Paper Data Upload	
	Custom paper data upload from SD card to main machine.	
102	Custom Paper Data Download	
	Custom paper data download from main machine to SD card.	
201	Standard Paper Data Ver. (Flash)	
	This SP displays the version of Library.mqp (Paper Library) on the Flash ROM	
202	Standard Paper Data Ver. (SD Card)	
	This SP displays the version of Library.mqp (Paper Library) on the SD card.	

5715	Custom Paper: Thick	CTL
5716	Custom Paper: Thin	CTL
	<p>This SP checks the type of machine to determine whether these paper sizes are supported. (These SP codes may appear even if the machine does not support these paper types.)</p>	
1 to 100	ID1 to ID100	

5717	Custom Paper UP/Web Info. 1: P-Type	CTL
------	-------------------------------------	-----

5718	Custom Paper UP/Web Info. 2: Coated	CTL
5719	Custom Paper UP/Web Info. 3: Punch	CTL
5720	Custom Paper UP/Web Info. 4: Color	CTL
	This SP checks the type of machine to determine whether these paper sizes are supported. (These SP codes may appear even if the machine does not support these paper types.)	
1 to 100	ID1 to ID100	

5721	Custom Paper: Size Code	CTL
5722	Custom Paper: Width (M-Scan 0.1 mm)	CTL
5723	Custom Paper: (S-Scan 0.1 mm)	CTL
5724	Custom Paper: MQP Version	CTL
5725	Custom Paper: Data Type	CTL
	This SP checks the type of machine to determine whether these paper sizes are supported. (These SP codes may appear even if the machine does not support these paper types.)	
001 to 100	ID1 to ID100	

5731	Counter Effect Japan Only	CTL
	Change MK1 Cnt (Paper -> Combine)	

5789	Custom Paper Value Initialize	
	This SP clears the user paper settings selected by the user. 0: Clears all user paper settings. 1: Clears user paper settings 1	
1	Custom Paper	[0 to 100/0/1]

5792	MCS Debug SW DFU	
------	-------------------------	--

5793	ECS Debug SW DFU	
------	-------------------------	--

5801	Memory Clear
	Resets NVRAM data to the default settings. Before executing any of these SP's, print an SMC Report.
1	All Clear
	Initializes items 2 to 22 below.
2	Engine
	Initializes all registration settings for the engine and copy process settings.
3	SCS/SRM
	Initializes default system settings, SCS (System Control Service) settings, operation display coordinates, and ROM update information.
4	IMH Memory Clr
	Initializes the image file system. (IMH: Image Memory Handler)
5	MCS
	Initializes the automatic delete time setting for stored documents. (MCS: Memory Control Service)
6	Copier Application
	Initializes all main machine application settings.
8	Printer Application
	Initializes the printer defaults, programs registered, the printer SP bit switches, and the printer CSS counter.
9	Scanner Application
	Initializes the defaults for the scanner and all the scanner SP modes.
10	Web Service
	Deletes the Netfile (NFA) management files and thumbnails, and initializes the Job login ID. Netfiles: Jobs to be printed from the document server using a PC and the Desk Top Binder software
11	NCS

	Initializes the system defaults and intersection settings (IP addresses also), the Smart Net Monitor for Admin settings, Web Status Monitor settings, and the TELNET settings. (NCS: Network Control Service)
14	Clear DCS Setting
	Initializes the DCS (Delivery Control Service) settings.
15	Clear UCS Setting
	Initializes the UCS (User Information Control Service) settings.
16	MIRS Setting
	Initializes the MIRS (Machine Information Report Service) settings.
17	CCS
	Initializes the CCS (Certification and Charge-control Service) settings.
18	SRM Memory Clr
	Initializes information in non-volatile RAM.
19	LCS Memory Clr
	Initializes information in non-volatile RAM.
20	Web Uapli
	Initializes the web user application settings.
21	ECS
	Initializes the ECS settings.

5803	Input Check			
5803-1	Trio2 s1 PB		Reading	
	Bit	Component	0	1

Paper Feed 1	0	Not Used	---	---
	1	Mechanical Counter	Unconnected	
	2	Paper Set SW	Set	Not Set
	3	Width Sensor SW5	ON	OFF
	4	Width Sensor SW4	ON	OFF
	5	Width Sensor SW3	ON	OFF
	6	Width Sensor SW2	ON	OFF
	7	Width Sensor SW1	ON	OFF

5803-2	Trio2 s1 PC		Reading	
	Bit	Component	0	1
Paper Feed 2	0	2nd Tray Upper Limit Sensor	Normal	Overload
	1	1st Tray Upper Limit Sensor	Normal	Overload
	2	2nd Tray Feed Sensor	Paper Present	Paper Out
	3	2nd Tray Transport Sensor	Paper Present	Paper Out
	4	1st Tray Feed Sensor	Paper Present	Paper Out
	5	1st Tray Transport Sensor	Paper Present	Paper Out
	6	Vertical Transport Sensor	Paper Present	Paper Out
	7	Main Relay Sensor 1	Paper Present	Paper Out

5803-3	Trio2 s1 PD		Reading	
	Bit	Component	0	1

Paper Feed 3	0	Purged Paper Sensor	No Paper	Paper Present
	1	2nd Tray Paper End Sensor	Paper Present	No Paper
	2	1st Tray Paper End Sensor	Paper Present	No Paper
	3	Lower Limit Sensor	Home Position	Down
	4	Paper Height Sensor 4	LOW	HIGH
	5	Paper Height Sensor 3	LOW	HIGH
	6	Paper Height Sensor 2	LOW	HIGH
	7	Paper Height Sensor 1	LOW	HIGH

5803-4	Trio2 s1 PH		Reading	
	Bit	Component	0	1
Paper Feed 4	0	Not Used	---	---
	1	Left Tandem Set Sensor	Set	Not Set
	2	Left Tray Paper Sensor	Paper Present	No Paper
	3	Not Used	---	---
	4	Right Tandem Set Sensor	Set	Not Set
	5	Right Tray Paper Sensor	No Paper	Paper Present
	6	Fusing Lamps ON2 Detect	OFF	ON
	7	Fusing Relays ON2 Detect	OFF	ON

5803-5	Trio2 s1 PI		Reading	
	Bit	Component	0	1

Paper Feed 5	0	2nd Tray Lift Motor Paper Height Sensor 1	ON	OFF
	1	2nd Tray Lift Motor Paper Height Sensor 2	ON	OFF
	2	Rear Side Fence Closed Sensor	LOW	HIGH
	3	Rear Side Fence Open Sensor	LOW	HIGH
	4	Front Side Fence Closed Sensor	LOW	HIGH
	5	Front Side Fence Open Sensor	LOW	HIGH
	6	Rear Fence Return Sensor	Out	In
	7	Rear Fence HP Sensor	Not Home	Home

5803-6	Trio2 s2 PD		Reading	
	Bit	Component	0	1
Paper Feed 6	0	Duplex Trans Sensor 1	Paper Present	No Paper
	1	Duplex Trans Sensor 2	Paper Present	
	2	Duplex Trans Sensor 3	Paper Present	
	3	Duplex Trans Sensor 6	Paper Present	
	4	Duplex Trans Sensor 7	Paper Present	
	5	Not Used		
	6	Not Used		
	7	Not Used		

5803-7	Trio2 s2 PF		Reading	
	Bit	Component	0	1

Paper Feed 7	0	LCT Relay Sensor 2	Paper Present	No Paper
	1	LCT Relay Sensor 1	Paper Present	No Paper
	2	Main Relays Sensor 3	Paper Present	No Paper
	3	Main Relay Sensor 2	Paper Present	No Paper
	4	Bank Exit Sensor	Paper Present	No Paper
	5	Reg. Timing Sensor	Paper Present	No Paper
	6	Shift Unit HP Sensor	Not HP	At HP
	7	Gate Retract HP Sensor	Not HP	At HP

5803-8	Trio2 s3 PB		Reading	
	Bit	Component	0	1
Paper Feed 8	0	Transfer Timing Sensor	Paper Present	No Paper
	1	PTB Sensor	Paper Present	No Paper
	2	Fusing Belt Paper Sensor	Paper Present	No Paper
	3	Hot Roller Paper Sensor	Paper Present	No Paper
	4	Fusing Exit Sensor	Paper Present	No Paper
	5	Exit Unit Entrance Sensor	Paper Present	No Paper
	6	Exit JG Sensor	Paper Present	No Paper
	7	Exit Relay Sensor	Paper Present	No Paper

5803-9	Trio2 s3 PC		Reading	
	Bit	Component	0	1

Paper Feed 9	0	Exit Sensor	Paper Present	No Paper
	1	Invert/Duplex Sensor	Paper Present	No Paper
	2	Purge Relay Sensor	Paper Present	No Paper
	3	Pressure Roller Cam Position Sensor B	OFF	Malfunction
	4	Pressure Roller Cam Position Sensor A	UP	HP
	5	Web End Sensor	Normal	End
	6	Decurler Limit Sensor	Normal	Over Limit
	7	Decurler HP Sensor	At HP	Not HP

5803-11	Trio2 s1 PF		Reading	
	Bit	Component	0	1
Motor Error Detect 1	0	Not Used	---	---
	1	2nd Tray Lift Motor	Normal	Error
	2	Bank Exit Motor	Normal	Error
	3	Vertical Transport Motor	Normal	Error
	4	2nd Grip Motor	Normal	Error
	5	1st Tray Transport Motor	Normal	Error
	6	2nd Paper Feed Motor	Normal	Error
	7	1st Tray Feed Motor	Normal	Error

5803-12	Trio2 s2 PG		Reading	
	Bit	Component	0	1

Motor Error Detect 2	0	Not Used	---	---
	1	Not Used	---	---
	2	Registration Timing Motor	Normal	Error
	3	Shift Roller Motor	Normal	Error
	4	Shift Unit Motor	Normal	Error
	5	Registration Gate Motor	Normal	Error
	6	Registration Entrance Motor	Normal	Error
	7	Duplex Transport Motor 3	Normal	Error

5803-13	Trio2 s3 PH		Reading	
	Bit	Component	0	1
Motor Error Detect 3	0	Decurl Motor	Normal	Error
	1	Decurler Paper Transport Motor	Normal	Error
	2	Fusing Motor: Lock	Normal	Error
	3	Pressure Roller Lift Motor	Normal	Error
	4	Invert/Duplex Motor	Normal	Error
	5	Invert/Exit Motor	Normal	Error
	6	Exit Relay Motor	Normal	Error
	7	Duplex Transport Motor 1	Normal	Error

5803-14	Trio2 m1 PA		Reading	
	Bit	Component	0	1

Motor Error Detect 4	0	Not Used	---	---
	1	Paper Cooling Intake Fan: Lock	Error	Normal
	2	Not Used	---	---
	3	Toner Supply Cooling Fan	Error	Normal
	4	Ozone Exhaust Fan (Y): Lock	Error	Normal
	5	Ozone Exhaust Fan (M): Lock	Error	Normal
	6	Ozone Exhaust Fan (C): Lock	Error	Normal
	7	Ozone Exhaust Fan (K): Lock	Error	Normal

5803-15	Trio2 m1 P2		Reading	
	Bit	Component	0	1
Motor Error Detect 5	0	Exit Exhaust Fan: Front: Lock	Error	Normal
	1	CIS Cleaning Fan: Lock	Error	Normal
	2	Exit Exhaust Fan: Rear: Lock	Error	Normal
	3	Duplex Exhaust Fan: Rear: Lock	Error	Normal
	4	Duplex Exhaust Fan: Front: Lock	Error	Normal
	5	Fusing Unit Exhaust Fan: Lock	Error	Normal
	6	Cooling Box Emission Exhaust Fan: Lock	Error	Normal
	7	Fusing Unit Transport Exhaust Fan: Lock	Error	Normal

5803-16	Trio2 m2 P1		Reading	
	Bit	Component	0	1

Motor Error Detect 6	0	Pressure Roller Fan: Lock	Error	Normal
	1	ITB Cleaning Fan: Lock	Error	Normal
	2	Not Used	---	---
	3	ITB Intake Fan: Lock	Error	
	4	Controller Box Intake Fan 2: Lock	Error	Normal
	5	Controller Box Intake Fan 1: Lock	Error	Normal
	6	Cooling Box Heat Fan: Lock	Error	Normal
	7	Cooling Box Ozone Exhaust Fan: Lock	Error	Normal

5803-17	Trio2 m2 P3		Reading	
	Bit	Component	0	1
Motor Error Detect 7	0	ITB Intake Fan: Lock	Normal	Error
	1	Ozone Collection Fan	Error	Error
	2	Fusing Exit Exhaust Fan	Error	Error
	3	Development Unit Cooling Fan 3: Lock	Error	Error
	4	Development Unit Cooling Fan 2: Lock	Error	Error
	5	Development Unit Cooling Fan 1: Lock	Error	Error
	6	Heat Sink Exhaust Fan: Lock	Error	Error
	7	Heat Sink Intake Fan: Lock	Error	Error

5803-18	Trio2 m3 PA		Reading	
	Bit	Component	0	1

Motor Error Detect 8	0	Transfer Timing Motor: Lock	Normal	Error
	1	PTR/ITB Cleaning Motor: Lock	Normal	Error
	2	PTR Separation Motor: Lock	Normal	Error
	3	Not Used	---	---
	4	Drum Motor (Y): Lock	Normal	Error
	5	Drum Motor (M): Lock	Normal	Error
	6	Drum Motor (C): Lock	Normal	Error
	7	Drum Motor (K): Lock	Normal	Error

5803-19	Trio2 m3 PB		Reading	
	Bit	Component	0	1
Motor Error Detect 9	0	Development Motor (Y): Lock	Normal	Error
	1	Development Motor (M): Lock	Normal	Error
	2	Development Motor (C): Lock	Normal	Error
	3	Development Motor (K): Lock	Normal	Error
	4	Drum Cleaning Motor (Y): Lock	Normal	Error
	5	Drum Cleaning Motor (M): Lock	Normal	Error
	6	Drum Cleaning Motor (C): Lock	Normal	Error
	7	Drum Cleaning Motor (K): Lock	Normal	Error

5803-20	Trio2 m3 PC		Reading	
	Bit	Component	0	1

Motor Error Detect 10	0	Belt Cleaning Exhaust Fan: Lock	Error	Normal
	1	Not Used	---	---
	2	ITB AC Detection: Lock	Normal	Error
	3	Drive Exhaust Fan: Lock	Error	Normal
	4	Used Toner Bottle Motor: Lock	Normal	Error
	5	Toner Supply Motor: Lock	Normal	Error
	6	Used Toner Transport Motor: Lock	Normal	Error
	7	Stray Toner Intake Fan: Lock	Error	Normal

5803-21	Trio2 m1 PB		Reading	
	Bit	Component	0	1
Toner Supply System	0	Toner Bottle Detection Sensor (Y)	Unlock	Lock
	1	Toner Bottle Detection Sensor (M)	Unlock	Lock
	2	Toner Bottle Detection Sensor (C)	Unlock	Lock
	3	Toner Bottle Detection Sensor (K)	Unlock	Lock
	4	Toner End Sensor (Y)	No Toner	Toner
	5	Toner End Sensor (M)	No Toner	Toner
	6	Toner End Sensor (C)	No Toner	Toner
	7	Toner End Sensor (K)	No Toner	Toner

5803-22	Trio2 m1 PH		Reading	
	Bit	Component	0	1

High Voltage Error 1	0	CB Power Pack (Y/M): Y	Normal	Error
	1	CB Power Pack (Y/M): M	Normal	Error
	2	CB Power Pack (C/K): C	Normal	Error
	3	CB Power Pack (C/K): K	Normal	Error
	4	Dev. Bias Check: Y	Normal	Error
	5	Dev. Bias Check: M	Normal	Error
	6	Dev. Bias Check: C	Normal	Error
	7	Dev. Bias Check: K	Normal	Error

5803-23	Trio2 m2 PA		Reading	
	Bit	Component	0	1
High Voltage Error 2	0	Fusing Lamps ON 1 Check	OFF	ON
	1	Fusing Relays ON 1 Check	OFF	ON
	2	Separation Power Pack	Error	Normal
	3	AC Transfer Power Pack	Error	Normal
	4	CB Power Pack (Y/M): Y	Error	Normal
	5	CB Power Pack (Y/M): M	Error	Normal
	6	CB Power Pack (C/K): C	Error	Normal
	7	CB Power Pack (C/K): K	Error	Normal

5803-24	Trio2 s2 PI		Reading	
	Bit	Component	0	1

Fusing Error Detection	0	Not Used	---	---
	1	Not Used	---	---
	2	Pressure Roller Thermistor: Front	Error	Normal
	3	Heating Roller Thermistor: Rear	Error	Normal
	4	Hot Roller NC Sensor	Error	Normal
	5	Pressure Roller NC Sensor	Error	Normal
	6	Heating Roller NC Sensor: End	Error	Normal
	7	Heating Roller NC Sensor: Center	Error	Normal

5803-25	Trio2 m2 PF		Reading	
	Bit	Component	0	1
Used Toner System	0	Used Toner Exhaust Fan: Lock	Error	Normal
	1	Cooling Box Drive Exhaust Fan: Lock	Error	Normal
	2	2nd Lift Sensor 1 (K) Sensor	Up	Down
	3	2nd Lift Sensor 2 (K) Sensor	Down	Up
	4	Used Toner Bottle Full Sensor	OFF	ON
	5	Used Toner Bottle Near-Full Sensor	OFF	ON
	6	Used Toner Bottle Door Sensor	Closed	Open
	7	Used Toner Bottle Set Sensor	Set	Not Set

5803-26	Trio2 m2 PG		Reading	
	Bit	Component	0	1

Set Detect 1	0	Not Used	---	---
	1	Web Unit Set Sensor	Set	Not Set
	2	Right Drawer Set Sensor: Left	Set	Not Set
	3	Right Drawer Set Sensor: Right	Set	Not Set
	4	Left Drawer Set Sensor 1	Set	Not Set
	5	Left Drawer Set Sensor 2	Set	Not Set
	6	Belt Cleaning Unit Set Switch	Set	Not Set
	7	Belt Cleaning Unit Cover Set Switch	Set	Not Set

5803-27	Trio2 s2 PH		Reading	
	Bit	Component	0	1
Set Detect 2	0	Key Counter Feedback	Not Present	Present
	1	Key Counter Set	Set	Not Set
	2	Key Card Set	Set	Not Set
	3	Decurler Unit Set Switch	Set	Not Set
	4	Exit Motor: Lock	Normal	Error
	5	Not Used	---	---
	6	Not Used	---	---
	7	Transfer Timing Motor: Lock	Normal	Error

5803-28	Trio2 m2 P8		Reading	
	Bit	Component	0	1

Set Detect 3	0	Not Used	---	---
	1	Not Used	---	---
	2	Not Used	---	---
	3	Cleaning Unit Set SW (Y)	IN	OUT
	4	Cleaning Unit Set SW (M)	IN	OUT
	5	Cleaning Unit Set SW (C)	IN	OUT
	6	Cleaning Unit Set SW (K)	IN	OUT
	7	Not Used	---	---

5803-29	Trio2 m2 PC		Reading	
	Bit	Component	0	1
Power Supply	0	24V Line Check: Fusing Motor, Decurler Motors)	Normal	Error
	1	24V Line Check: IOB	Normal	Error
	2	12V Line Check: IOB	Normal	Error
	3	24V Interlock Check: IOB	Normal	Error
	4	24V Line Check: DRB, LDB	Normal	Error
	5	24V Line Check: Paper Bank Motors	Normal	Error
	6	5V Line Check: DRB	Normal	Error
	7	VS_Door Open Check	Closed	Open

5803-30	AD Value Display
Dbl-Feed Receptor	0 to FFFFh

5803-31	Count Display
CIS (Detect)	0 to FFFFh

5803-32	Count Display
---------	---------------

Used Toner Lock Sensor (Main)	0 to FFFFh (Cycles)
-------------------------------	---------------------

5803-33	Count Display
Used Toner Bottle Lock Sensor	0 to FFFFh (Cycles)

5803-34	TDCU Command Data Display		Reading	
	Bit	Component	0	1
Image Transfer Unit	0	ITB Unit Set Switch	Set	Not Set
	1	Belt Centering Roller HP Sensor	LOW	HIGH
	2	1st Lift Motor Sensor	LOW	HIGH
	3	PTR Separation Sensor	LOW	HIGH
	4	Rear Overrun Sensor	Error	Normal
	5	Front Overrun Sensor	Error	Normal
	6	Not Used	---	---
	7	Not Used	---	---

5803-35	TDCU Command Data Temperature Display
ITB Thermistor	0 to FFFFh Temp.: Hexadecimal Data Example: Hex. Data/100 = C°

5803-82	LCT-CPU-Port1		Reading	
	Bit	Component	0	1

LCT	0	Not Used	---	---
	1	Not Used	---	---
	2	Not Used	---	---
	3	Not Used	---	---
	4	Not Used	---	---
	5	Not Used	---	---
	6	Not Used	---	---
	7	LCT Exit Roller HP Sensor	Not Detected	Detected

5803-83	LCT-CPU-Port7		Reading	
	Bit	Component	0	1
LCT	0	Not Used	---	---
	1	Not Used	---	---
	2	Not Used	---	---
	3	Not Used	---	---
	4	Not Used	---	---
	5	Not Used	---	---
	6	LCT Front Door SW	Closed	Open
	7	Not Used	---	

5803-84	LCT-CPU-Port9		Reading	
	Bit	Component	0	1

LCT	0	SW002-1	ON	OFF
	1	SW002-2	ON	OFF
	2	SW002-3	ON	OFF
	3	SW002-4	ON	OFF
	4	SW002-5	ON	OFF
	5	SW002-6	ON	OFF
	6	SW002-7	ON	OFF
	7	SW002-8	ON	OFF

5803-85	LCT-eIO1-PortB		Reading	
	Bit	Component	0	1
LCT	0	3rd Tray Paper Height Sensor 1	Not Detected	Detected
	1	3rd Tray Paper Height Sensor 2	Not Detected	Detected
	2	3rd Tray Paper Height Sensor 3	Not Detected	Detected
	3	3rd Tray Paper Height Sensor 4	Not Detected	Detected
	4	3rd Tray Paper Size Sensor 1	Not Detected	Detected
	5	3rd Tray Paper Size Sensor 2	Not Detected	Detected
	6	3rd Tray Paper Size Sensor 3	Not Detected	Detected
	7	3rd Tray Paper Length Sensor	Not Detected	Detected

5803-86	LCT-eIO1-PortC		Reading	
	Bit	Component	0	1

LCT	0	3rd Tray Unit Set SW	Set	Not Set
	1	3rd Tray Paper End Sensor	Paper Present	No Paper
	2	3rd Tray Upper Limit Sensor	At Limit	Not Limit
	3	3rd Tray Feed Sensor	Paper Present	No Paper
	4	Not Used	---	---
	5	Not Used	---	---
	6	Not Used	---	---
	7	3rd Tray Set SW	Set	Not Set

5803-87	LCT-eIO1-PortD		Reading	
	Bit	Component	0	1
LCT	0	Not Used	---	---
	1	Not Used	---	---
	2	Not Used	---	---
	3	Not Used	---	---
	4	LCT Exit Sensor	Paper Present	No Paper
	5	3rd Tray Vertical Transport Sensor 2	Paper Present	No Paper
	6	3rd Tray Vertical Transport Sensor 1	Paper Present	No Paper
	7	3rd Tray Transport Sensor	Paper Present	No Paper

5803-88	LCT-eIO2-PortB		Reading	
	Bit	Component	0	1

LCT	0	4th Tray Paper Height Sensor 1	Not Detected	Detected
	1	4th Tray Paper Height Sensor 2	Not Detected	Detected
	2	4th Tray Paper Height Sensor 3	Not Detected	Detected
	3	4th Tray Paper Height Sensor 4	Not Detected	Detected
	4	4th Tray Paper Size Sensor 1	Not Detected	Detected
	5	4th Tray Paper Size Sensor 2	Not Detected	Detected
	6	4th Tray Paper Size Sensor 3	Not Detected	Detected
	7	4th Tray Paper Length Sensor	Not Detected	Detected

5803-89	LCT-eIO2-PortC		Reading	
	Bit	Component	0	1
LCT	0	4th Tray Unit Set SW	Set	Not Set
	1	4th Tray Paper End Sensor	Paper Present	No Paper
	2	4th Tray Upper Limit Sensor	At Limit	Not Limit
	3	4th Tray Feed Sensor	Paper Present	No Paper
	4	Not Used	---	---
	5	Not Used	---	---
	6	Not Used	---	---
	7	4th Tray Set SW	Set	Not Set

5803-90	**		Reading	
	Bit	Component	0	1

LCT	0	Not Used	---	---
	1	Not Used	---	---
	2	Not Used	---	---
	3	Not Used	---	---
	4	Not Used	---	---
	5	Not Used	---	---
	6	4th Tray Vertical Transport Sensor	Paper Present	No Paper
	7	4th Tray Transport Sensor	Paper Present	No Paper

5803-91	LCT-eIO3-PortB		Reading	
	Bit	Component	0	1
LCT	0	5th Tray Paper Height Sensor 1	Not Detected	Detected
	1	5th Tray Paper Height Sensor 2	Not Detected	Detected
	2	5th Tray Paper Height Sensor 3	Not Detected	Detected
	3	5th Tray Paper Height Sensor 4	Not Detected	Detected
	4	5th Tray Paper Size Sensor 1	Not Detected	Detected
	5	5th Tray Paper Size Sensor 2	Not Detected	Detected
	6	5th Tray Paper Size Sensor 3	Not Detected	Detected
	7	5th Tray Paper Length Sensor	Not Detected	Detected

5803-92	LCT-eIO3-PortC		Reading	
	Bit	Component	0	1

LCT	0	6th Tray Unit Set SW	Set	Not Set
	1	6th Tray Paper End Sensor	Paper Present	No Paper
	2	6th Tray Upper Limit Sensor	At Limit	Not Limit
	3	6th Tray Feed Sensor	Paper Present	No Paper
	4	Not Used	---	---
	5	Not Used	---	---
	6	Not Used	---	---
	7	6th Tray Set SW	Set	Not Set

5803-93	**		Reading	
	Bit	Component	0	1
**	0	Not Used	---	---
	1	Not Used	---	---
	2	Not Used	---	---
	3	Not Used	---	---
	4	Not Used	---	---
	5	Not Used	---	---
	6	6th Tray Vertical Transport Sensor	Paper Present	No Paper
	7	6th Tray Transport Sensor	Paper Present	No Paper

5803-94	LCT-eIO4-PortB		Reading	
	Bit	Component	0	1

LCT	0	7th Tray Paper Height Sensor 1	Not Detect	Detect
	1	7th Tray Paper Height Sensor 2	Not Detect	Detect
	2	7th Tray Paper Size Sensor 1	Detect	Not Detect
	3	7th Tray Paper Size Sensor 2	Detect	Not Detect
	4	7th Tray Paper Size Sensor 3	Detect	Not Detect
	5	7th Tray Paper Size Sensor 4	Detect	Not Detect
	6	7th Tray Paper Size Sensor 5	Detect	Not Detect
	7	7th Tray Paper Length Sensor	Detect	Not Detect

5803-95	LCT-eIO4-PortC		Reading	
	Bit	Component	0	1
LCT	0	7th Tray Lower Limit Sensor	At Low Limit	Not Low Limit
	1	7th Tray Paper End Sensor	Paper Present	No Paper
	2	7th Tray Upper Limit Sensor 1	At Upper Limit	Not Upper Limit
	3	7th Tray Feed Sensor	Paper Present	No Paper
	4	Not Used	---	---
	5	7th Tray Lift SW	ON	OFF
	6	Bypass Slide Sensor	Closed	Open
	7	Bypass Set Sensor	Set	Not Set

5803-96	**		Reading	
	Bit	Component	0	1

**	0	Not Used	---	---
	1	Not Used	---	---
	2	Not Used	---	---
	3	7th Tray Upper Limit Sensor 2	At Upper Limit	Not Upper Limit
	4	Not Used	---	---
	5	Not Used	---	---
	6	Not Used	---	---
	7	7th Tray Transport Sensor 7	Paper Present	No Paper

5803-140	CTB_H8S-PORT9		Reading	
	Bit	Component	0	1
Buffer Pass Unit	0	Not Used	---	---
	1	Not Used	---	---
	2	Exhaust Fan 4	Normal (Drive)	Error (Stop)
	3	Exhaust Fan 3	Normal (Drive)	Error (Stop)
	4	Not Used	---	---
	5	Not Used	---	---
	6	Intake Fan 4	Normal (Drive)	Error (Stop)
	7	Intake Fan 3	Normal (Drive)	Error (Stop)

5803-141	**		Reading	
	Bit	Component	0	1

Buffer Pass Unit	0	Front Door Interlock SW	Closed	Open
	1	Not Used	---	---
	2	Not Used	---	---
	3	Not Used	---	---
	4	Not Used	---	---
	5	Not Used	---	---
	6	Not Used	---	---
	7	Not Used	---	---

5803-142	**		Reading	
	Bit	Component	0	1
Buffer Pass Unit	0	Transport Motor 2	Normal (Drive)	Error (Stop)
	1	Transport Motor 1	Normal (Drive)	Error (Stop)
	2	Not Used	---	---
	3	Not Used	---	---
	4	Not Used	---	---
	5	Not Used	---	---
	6	Not Used	---	---
	7	Not Used	---	---

5803-143	**		Reading	
	Bit	Component	0	1

Buffer Pass Unit	0	Not Used	---	---
	1	Not Used	---	---
	2	Exhaust Fan 2	Normal (Drive)	Error (Stop)
	3	Exhaust Fan 1	Normal (Drive)	Error (Stop)
	4	Not Used	---	---
	5	Not Used	---	---
	6	Intake Fan 2	Normal (Drive)	Error (Stop)
	7	Intake Fan 1	Normal (Drive)	Error (Stop)

5803-144	**		Reading	
	Bit	Component	0	1
Buffer Pass Unit	0	Transport Sensor 6	Paper Present	No Paper
	1	Transport Sensor 3	Paper Present	No Paper
	2	Transport Sensor 7	Paper Present	No Paper
	3	Transport Sensor 2	Paper Present	No Paper
	4	Transport Sensor 8	Paper Present	No Paper
	5	Transport Sensor 1	Paper Present	No Paper
	6	Not Used	---	---
	7	Not Used	---	---

5803-145	**		Reading	
	Bit	Component	0	1

Buffer Pass Unit	0	Not Used	---	---
	1	Not Used	---	---
	2	24V Line Check	24V ON	24V OFF
	3	24V_INT Line Check	24V_INT ON	24V_INT OFF
	4	Transport Unit (Drawer)	Set	Not Set
	5	Not Used	---	---
	6	Transport Sensor 5	Paper Present	No Paper
	7	Transport Sensor 4	Paper Present	No Paper

5803-200	HP Sensor		Reading	
	Bit	Component	0	1
HP Sensor	0	Scanner HP Sensor	Home	Not Home
	1	Not Used	---	---
	2	Not Used	---	---
	3	Not Used	---	---
	4	Not Used	---	---
	5	Not Used	---	---
	6	Not Used	---	---
	7	Not Used	---	---

5803-202	**		Reading	
	Bit	Component	0	1

Scan Fan Lock Signal	0	Scanner Exhaust Fan	Normal (Drive)	Error (Stop)
	1	Lamp Regulator Cooling Fan	Normal (Drive)	Error (Stop)
	2	Not Used	---	---
	3	Not Used	---	---
	4	Not Used	---	---
	5	Not Used	---	---
	6	Not Used	---	---
	7	Not Used	---	---

5804	Output Check		
1	Feed Mtr 1 (Std Speed)		
2	Feed Mtr 1 (Med Speed)		
3	Feed Mtr 1 (Low Speed)		
4	Feed Mtr 2 (Std Speed)		
5	Feed Mtr 2 (Med Speed)		
6	Feed Mtr 2 (Low Speed)		
7	Bypass Grip Mtr 1 (Std Speed)		
8	Bypass Grip Mtr 1 (Med Speed)		
9	Bypass Grip Mtr 1 (Low Speed)		
10	Bypass Grip Mtr 2 (Std Speed)		
11	Bypass Grip Mtr 2 (Med Speed)		
12	Bypass Grip Mtr 2 (Low Speed)		
13	Bypass V-Transport (Std Speed)		
14	Bypass V-Transport (Med Speed)		
15	Bypass V-Transport (Low Speed)		
16	Bank Exit Mtr (Hi1:Std Speed)		

17	Bank Exit Mtr (Hi1:Med Speed)	
18	Bank Exit Mtr (Hi1:Low Speed)	
19	Bank Exit Mtr (Nor:Std Speed)	
20	Bank Exit Mtr (Nor:Med Speed)	
21	Bank Exit Mtr (Nor:Low Speed)	
22	Bank Exit Mtr (Slow Down:Std Speed)	
23	Bank Exit Mtr (Slow Down:Med Speed)	
24	Bank Exit Mtr (Slow Down:Low Speed)	
25	Registration Entrance Mtr (Hi1:Std Speed)	
26	Registration Entrance Mtr (Hi1:Med Speed)	
27	Registration Entrance Mtr (Hi1:Low Speed)	
28	Registration Entrance Mtr (Nor:Std Speed)	
29	Registration Entrance Mtr (Nor:Med Speed)	
30	Registration Entrance Mtr (Nor:Low Speed)	
31	Registration Entrance Mtr (Slow Down:Std Speed)	
32	Registration Entrance Mtr (Slow Down:Med Speed)	
33	Registration Entrance Mtr (Slow Down:Low Speed)	
34	Registration Timing Mtr (Hi1:Std Speed)	
35	Registration Timing Mtr (Hi1:Med Speed)	
36	Registration Timing Mtr (Hi1:Low Speed)	
37	Registration Timing Mtr (Nor:Std Speed)	
38	Registration Timing Mtr (Nor:Med Speed)	
39	Registration Timing Mtr (Nor:Low Speed)	
40	Reg Tmg Mtr (Slow Dn:Std Spd)	
41	Reg Tmg Mtr (Slow Dn:Med Spd)	
42	Reg Tmg Mtr (Slow Dn:Low Spd)	

43	Shift Roller Motor (Std Speed)	
44	Shift Roller Motor (Med Speed)	
45	Shift Roller Motor (Low Speed)	
46	Unit Shift Motor (HP)	
47	Unit Shift Motor (Drive)	
48	Gate Retract Motor (HP)	
49	Gate Retract Motor (Drive)	
50	1st Tray: Bottom Plate (Lift: Drive)	
51	1st Tray: Bottom Plate (Lift: HP)	
52	2nd Tray: Bottom Plate (Lift: Drive)	
53	2nd Tray: Bottom Plate (Lift: HP)	
54	Rear Fence Motor (Fws: 1 s)	
55	Rear Fence Motor (Rev: 1 s)	
58	CIS Cleaning Fan	
59	Paper Exit Cooling Fan 4	
60	Paper Exit Cooling Fan 5	
61	Paper Exit Cooling Fan 6	
62	Paper Exit Cooling Fan 6	
63	1st Tray: Pickup SOL	
64	1st Tray: Rev SOL	
65	2nd Tray: Pickup SOL	
66	2nd Tray: Rev SOL	
67	Relay SOL 1	
68	Relay SOL 1	
69	LCT Relay SOL	
70	Exit JG SOL	

71	Inverter JG SOL	
72	Exit/Inverter JG SOL	
73	Lock SOL	
74	Connect SOL	
75	Rear Side Fence SOL	
76	Front Side Fence SOL	
77	Bank LED: 1st Tray	
78	Bank LED: 2nd Tray	
80	Polygon Motor: KC	
81	Polygon Motor: MY	
90	Used Toner Bottle Motor	
91	Toner Supply Motor	
100	Bk DrumMotor: HighSpeed	
101	C DrumMotor: HighSpeed	
102	M DrumMotor: HighSpeed	
103	Y DrumMotor: HighSpeed	
104	Bk DevelopmentMotor: HighSpeed	
105	C DevelopmentMotor: HighSpeed	
106	M DevelopmentMotor: HighSpeed	
107	Y DevelopmentMotor: HighSpeed	
108	Bk CleaningMotor: HighSpeed	
109	C CleaningMotor: HighSpeed	
110	M CleaningMotor: HighSpeed	
111	Y CleaningMotor: HighSpeed	
112	ITB Motor: HighSpeed	
113	PRT Motor: HighSpeed	

114	Fusing Motor: HighSpeed	
115	Paper Ejection Motor: HighSpeed	
116	Bk DrumMotor: MiddleSpeed	
117	C DrumMotor: MiddleSpeed	
118	M DrumMotor: MiddleSpeed	
119	Y DrumMotor: MiddleSpeed	
120	Bk DevelopmentMotor: MiddleSpeed	
121	C DevelopmentMotor: MiddleSpeed	
122	M DevelopmentMotor: MiddleSpeed	
123	Y DevelopmentMotor: MiddleSpeed	
124	Bk CleaningMotor: MiddleSpeed	
125	C CleaningMotor: MiddleSpeed	
126	M CleaningMotor: MiddleSpeed	
127	Y CleaningMotor: MiddleSpeed	
128	ITB Motor: MiddleSpeed	
129	PRT Motor: MiddleSpeed	
130	Fusing Motor: MiddleSpeed	
131	Paper Ejection Motor: MiddleSpeed	
132	Bk DrumMotor: LowSpeed	
133	C DrumMotor: LowSpeed	
134	M DrumMotor: LowSpeed	
135	Y DrumMotor: LowSpeed	
136	Bk DevelopmentMotor: LowSpeed	
137	C DevelopmentMotor: LowSpeed	
138	M DevelopmentMotor: LowSpeed	
139	Y DevelopmentMotor: LowSpeed	

140	Bk CleaningMotor: LowSpeed	
141	C CleaningMotor: LowSpeed	
142	M CleaningMotor: LowSpeed	
143	Y CleaningMotor: LowSpeed	
144	ITB Motor: LowSpeed	
145	PRT Motor: LowSpeed	
146	Fusing Motor: LowSpeed	
147	Paper Ejection Motor: LowSpeed	
148	Toner Discharge Motor	
149	Transfer Timing Motor (Std Speed)	
150	Transfer Timing Motor (Med Speed)	
151	Transfer Timing Motor (Low Speed)	
161	Exit/Relay Mtr (Hi2: Std Speed)	
162	Exit/Relay Mtr (Hi2: Med Speed)	
163	Exit/Relay Mtr (Hi2: Low Speed)	
164	Exit/Relay Mtr (Nor: Std Speed)	
165	Exit/Relay Mtr (Nor: Med Speed)	
166	Exit/Relay Mtr (Nor: Low Speed)	
167	Exit/Inverter Mtr (Fwd: Hi2: Std Speed)	
168	Exit/Inverter Mtr (Fwd: Hi2: Med Speed)	
169	Exit/Inverter Mtr (Fwd:Hi2:Low Speed)	
170	Exit/Inverter Mtr (Fwd:Nor:Std Speed)	
171	Exit/Inverter Mtr (Fwd:Nor:Med Speed)	
172	Exit/Inverter Mtr (Fwd:Nor:Low Speed)	
173	Exit/Inverter Mtr (Rev:Hi2:Std Speed)	
174	Exit/Inverter Mtr (Rev:Hi2:Med Speed)	

175	Exit/Inverter Mtr (Rev:Hi2:Low Speed)	
176	Exit/Inverter Mtr (Rev:Nor:Std Speed)	
177	Exit/Inverter Mtr (Rev:Nor:Med Speed)	
178	Exit/Inverter Mtr (Rev:Nor:Low Speed)	
179	Duplex/Inverter Mtr (Fwd:Hi2:Std Speed)	
180	Duplex/Inverter Mtr (Fwd:Hi2:Med Speed)	
181	Duplex/Inverter Mtr (Fwd:Hi2:Low Speed)	
182	Duplex/Inverter Mtr (Fwd:Nor:Std Speed)	
183	Duplex/Inverter Mtr (Fwd:Nor:Med Speed)	
184	Duplex/Inverter Mtr (Fwd:Nor:Low Speed)	
185	Duplex/Inverter Mtr (Rev:Hi1:Std Speed)	
186	Duplex/Inverter Mtr (Rev:Hi1:Med Speed)	
187	Duplex/Inverter Mtr (Rev:Hi1:Low Speed)	
188	Dup Trans Mtr1 (Std Speed)	
189	Dup Trans Mtr1 (Med Speed)	
190	Dup Trans Mtr1 (Low Speed)	
194	Dup Trans Mtr3 (Std Speed)	
195	Dup Trans Mtr3 (Med Speed)	
196	Dup Trans Mtr3 (Low Speed)	
200	Scananer fanmotor	
202	Scananer Lamp	
203	Scanner Motor	
209	De-curler Unit Move: Lower Default	
210	De-curler Unit Move: Upper Default	
211	De-curl Trans Mtr (Std Speed)	
212	De-curl Trans Mtr (Med Speed)	

213	De-curl Trans Mtr (Low Speed)	
214	De-curl Trans Mtr (Reverse)	
217	A3 LCT 3rd Tray: Pickup SOL	
218	A3 LCT 4th Tray: Pickup SOL	
219	A3 LCT 5th Tray: Pickup SOL	
220	Bypass Pickup SOL	
221	A3 LCT: 3rd Tray Feed Mtr (Std Speed)	
222	A3 LCT: 3rd Tray Feed Mtr (Med Speed)	
223	A3 LCT: 4th Tray Feed Mtr (Std Speed)	
224	A3 LCT: 4th Tray Feed Mtr (Med Speed)	
225	A3 LCT: 5th Tray Feed Mtr (Std Speed)	
226	A3 LCT: 5th Tray Feed Mtr (Med Speed)	
227	Bypass: Feed Mtr (Std Speed)	
228	Bypass: Feed Mtr (Med Speed)	
229	A3 LCT: 3rd Tray Grip Mtr (Std Speed)	
230	A3 LCT: 3rd Tray Grip Mtr (Med Speed)	
231	A3 LCT: 4th Tray Grip Mtr (Std Speed)	
232	A3 LCT: 4th Tray Grip Mtr (Med Speed)	
233	A3 LCT: 5th Tray Grip Mtr (Std Speed)	
234	A3 LCT: 5th Tray Grip Mtr (Med Speed)	
235	Bypass: Transport Mtr (Std Speed)	
236	Bypass: Transport Mtr (Med Speed)	
237	A3 LCT: 3rd Transport Mtr (Std Speed)	
238	A3 LCT: 3rd Transport Mtr (Med Speed)	
239	A3 LCT: 4th Transport Mtr (Std Speed)	
240	A3 LCT: 4th Transport Mtr (Med Speed)	

241	A3 LCT: 5th Transport Mtr (Std Speed)	
242	A3 LCT: 5th Transport Mtr (Med Speed)	
243	Bypass: Transport Mtr (Std Speed)	
244	Bypass: Transport Mtr (Med Speed)	
245	A3 LCT: Exit Mtr (Std Speed)	
246	A3 LCT: Exit Mtr (Med Speed)	
247	A3 LCT: Exit Roller Retract Mtr	
248	A3 LCT: 3rd Tray Front Fan	
249	A3 LCT: 3rd Tray Rear Fan	
250	A3 LCT: 4th Tray Front Fan	
251	A3 LCT: 4th Tray Rear Fan	
252	A3 LCT: 5th Tray Front Fan	
253	A3 LCT: 5th Tray Rear Fan	

5805	Output Check	
4	Heat Sink Suction Fan NS	
5	Heat Sink Suction Fan HS	
6	Heat Sink Exhaust Fan NS	
7	Heat Sink Exhaust Fan HS	
8	Paper Fan NS	
9	Paper Fan HS	
10	Fuse Exit Fan NS	
11	Fuse Exit Fan HS	
12	Back box Fan NS	
13	Back Box Fan HS	
14	Trans. Fuse Fan	

15	Belt Cleaning Fan NS	
16	Belt Cleaning Fan HS	
17	Press Roller Fan	
18	Press Roller Suction Fan NS	
19	Opt. Suction Fan HS	
22	PCB Box Suction Fan1 NS	
24	PCB Box Suction Fan2 NS	
25	PCB Box Suction Fan2 HS	
27	PCB Box Exhaust Fan 1	
28	PCB Box Exhaust Fan2	
29	Ozone Fan: Y	
30	Ozone Fan: M	
31	Ozone Fan: C	
32	Ozone Fan:K	
33	Ozone Collection Fan	
34	Back Box Ozone Fan NS	
35	Back Box Ozone Fan HS	
37	P-sensor Fan	
38	PT Fan: Front	
39	PT Fan: Center	
40	PT Fan: Rear	
41	Developer Liquid Cooling Fan 1 NS	
43	Developer Liquid Cooling Fan NS	
45	Developer Liquid Cooling Fan 3 NS	
47	Developer Liquid Cooling Pump NS	
48	PSU Fan	

50	Buffer Pass Unit:Feed Motor 1	
51	Buffer Pass Unit:Feed Motor 2	
52	Buffer Pass Unit:Cool Fan 1-2	
53	Buffer Pass Unit:Exhaust Fan 1-2	
54	Buffer Pass Unit:Cool Fan 3-4	
55	Buffer Pass Unit:Exhaust Fan 3-4	
60	Toner Bottle Motor (K)	
61	Toner Bottle Motor (C)	
62	Toner Bottle Motor (M)	
63	Toner Bottle Motor (Y)	
65	Toner Pump CL (K)	
66	Toner Pump CL (C)	
67	Toner Pump CL (M)	
68	Toner Pump CL (Y)	
70	Toner Supply Clutch (K)	
71	Toner Supply Clutch (C)	
72	Toner Supply Clutch (M)	
73	Toner Supply Clutch (Y)	
75	Charge Roller Cleaner Lift SOL (K)	
76	Charge Roller Cleaner Lift SOL (C)	
77	Charge Roller Cleaner Lift SOL (M)	
78	Charge Roller Cleaner Lift SOL (Y)	
80	QL (K)	
81	QL (C)	
82	QL (M)	
83	QL (Y)	

90	ITB Lift Motor (K)	
91	ITB Lift Motor (YMC)	
92	PTR Lift Motor (Fwd: 1 sec.)	
93	PTR Lift Motor (Rev: 1 sec.)	
94	Steering Motor (HP)	
100	Web Motor	
101	Press Roller Lift Motor (HP)	
102	Press Roller Lift Motor (Up)	
110	Dbl-Feed Sensor (Emitter)	
111	CIS LED (Duty 50% Fixed)	
120	Charge DC Voltage (K)	
121	Charge DC Voltage (C)	
122	Charge DC Voltage (M)	
123	Charge DC Voltage (Y)	
124	Charge AC Voltage (K)	
125	Charge AC Voltage (C)	
126	Charge AC Voltage (M)	
127	Charge AC Voltage (Y)	
128	Development Bias (K)	
129	Development Bias (C)	
130	Development Bias (M)	
131	Development Bias (Y)	
132	Primary Transfer (K)	
133	Primary Transfer (C)	
134	Primary Transfer (M)	
135	Primary Transfer (Y)	

136	Secondary Transfer (+)	
137	Secondary Transfer (-)	
138	Secondary Transfer (AC)	
139	Secondary Transfer (DC)	
140	Separation AC	
141	Separation DC	
150	RFID ON/OFF:K	
151	RFID ON/OFF:C	
152	RFID ON/OFF:M	
153	RFID ON/OFF:Y	
154	RFID COM ON/OFF:K	
155	RFID COM ON/OFF:C	
156	RFID COM ON/OFF:M	
157	RFID COM ON/OFF:Y	
158	Dup Exhaust Fan Front NS	
159	Dup Exhaust Fan Front HS	
160	Dup Exhaust Fan Rear NS	
161	Dup Exhaust Fan Rear HS	
162	Exit Exhaust Fan Front NS	
163	Exit Exhaust Fan Front HS	
164	Exit Exhaust Fan Rear NS	
165	Exit Exhaust Fan Rear HS	

5806	RFID CONT.READING
	This SP is used for validation and testing of the RFIDs. After one of these SP codes is switched ON, a communication count will run until switched OFF.

1	TIMES	[0 to 65535/0/1times]
2	NOT 0	[0 to 65535/0/1times]
3	RET.	[0 to 65535/0/1times]
4	EXE.ALL	[0 to 1/0/1]
5	EXE.K	[0 to 1/0/1]
6	EXE.M	[0 to 1/0/1]
7	EXE.C	[0 to 1/1/1]
8	EXE.Y	[0 to 1/0/1]

5807	Area Selection DFU
	<p>Sets the machine for the geographical area where it will be used.</p> <p>[1 to 3/2/1] 1:DOM (Japan) 2:NA 3:EU</p>

5810	SC Reset
	<p>When the machine issues a "Level A" SC code, this indicates a serious problem in the fusing unit (SC542 to SC546, for example).</p> <ul style="list-style-type: none"> • As soon as the Level A SC code is issued, the machine is disabled immediately. • The operator cannot reset the SC because the machine requires servicing immediately. • The machine cannot be used until the machine has been service. <p>Touch [EXECUTE] to release the machine for servicing.</p>

5811	Machine Serial DFU	
	<p>This SP presents the screen used to enter the 11-digit number of the machine. The allowed entries are "A" to "Z" and "0" to "9". The setting is done at the factory, and should not be changed in the field.</p>	
2	Display	
4	Set: BCU	[0 to 255/1/1]
5	Set: Novita	[0 to 255/0/1]

	Service Tel. No. Setting		CTL
5812	<p>Use these SP modes to input service and support telephone numbers. Enter the number and press</p> <p>Press the [./*] key to input a pause. Press the "Clear modes" key to delete the telephone number.</p>		
1	Service	Service representative telephone number.	
2	Facsimile	Fax number of service representative	
3	Supply	Supplier of consumables	
4	Operation	Operation support	

5816	Remote Service		CTL
	I/F Setting		
1	<p>Turns the remote diagnostics off and on.</p> <p>[0 to 2/2/1]</p> <p>0: Remote diagnostics off.</p> <p>1: Serial (CSS or @Remote) remote diagnostics on.</p> <p>2: Network remote diagnostics on for @Remote</p>		
2	<p>CE Call</p> <p>Lets the operator engineer start or end of the remote machine check with CSS or @Remote; to do this, push the center report key</p>		
3	<p>Function Flag</p> <p>Enables and disables remote diagnosis over the @Remote network.</p> <p>[0 to 1/0/1]</p> <p>0: Disables remote diagnosis over the network.</p> <p>1: Enables remote diagnosis over the network.</p>		
4	<p>Communication Test Call</p> <p>This SP issues a test call from a GW machine to determine whether it can communicate successfully with the call center after it has been set up for NRS. Successful return will be in the range 0 to 99.</p>		

5	Device Information Call
	<p>Controls if the item for initial setting of the screen for the NRS device-information notification-call is shown.</p> <p>[0 to 1/1]</p> <p>0: Enabled. Item initial setting not shown.</p> <p>1: Disable. Item for initial setting shown.</p>
7	SSL Disable
	<p>Controls if RCG (Remote Communication Gate) confirmation is done by SSL during an RCG send for the @Remote over a network intersection.</p> <p>[0 to 1/0/1]</p> <p>0: Yes. SSL not used.</p> <p>1: No. SSL used.</p>
8	RCG Connect Timeout
	<p>Sets the length of time (seconds) for the time-out when the RCG (Remote Communication Gate) connects during a call via the @Remote network.</p> <p>[1 to 90/30/1 sec.]</p>
9	RCG Write to Timeout
	<p>Sets the length of time (seconds) for the time-out when sent data is written to the RCG during a call over the @Remote network.</p> <p>[0 to 100/60/1 sec.]</p>
10	RCG Read Timeout
	<p>Sets the length of time (seconds) for the timeout when sent data is written from the RCG during a call over the @Remote network.</p> <p>[0 to 100/60/1 sec.]</p>
11	Port 80 Enable
	<p>Controls if permission is given to get access to the SOAP method over Port 80 on the @Remote network.</p> <p>[0 to 1/0/1]</p> <p>0: No. Access denied</p> <p>1: Yes. Access granted.</p>

13	RFU Timing
	<p>This SP determines how the machine receives forum (RFU: @Remote Forum Updates) updates.</p> <p>[0 to 1 / 1/ 1]</p> <p>0: All forum updates 1: Energy status update only</p>
21	RCG – C Registered
	<p>This SP displays the Embedded RC Gate installation end flag.</p> <p>1: Installation completed 2: Installation not completed</p>
23	Connect Type (N/M)
	<p>This SP displays and selects the Embedded RC Gate connection method.</p> <p>0: Internet connection 1: Dial-up connection</p>
61	Cert. Expire Timing DFU
	Proximity of the expiration of the certification.
62	Use Proxy
	This SP setting determines if the proxy server is used when the machine communicates with the service center.
63	Proxy Host
	This is the address of the HTTP proxy server used to effect communication between Embedded RC Gate-M and the Gateway. The length of the address is limited to 127 characters (characters beyond the 127th character are ignored).
64	Proxy Port Number
	<p>This is the port number of the HTTP proxy used to effect communication between Embedded RC Gate-N and the Gateway.</p> <p>[0 to 0xffff/0/1]</p>
65	Proxy User name
	This is the user name used for certification of the HTTP proxy. The length of the name is limited to 31 characters (characters beyond the 31st character are ignored).

66	Proxy Password
	This is the certification password of the HTTP proxy. The length of the password is limited to 31 characters (characters beyond the 31st character are ignored).

Note: The proxy number, user name, and password comprise proprietary operator information required by the service technician to do the necessary settings for Embedded RC Gate-N. To prevent unauthorized access this information, these SP settings do not appear in the SMC report.

	CERT: Up State
	Displays the state of the certification update used for Embedded RC Gate. If Embedded RC Gate has not been set up, These SP settings are done automatically as soon as Embedded RC Gate is set up.
	0 The certification used by Embedded RC Gate is set correctly.
	1 The certification request (SetAuthKey) for update has been received from the CTL URL and certification is presently being updated.
	2 The certification update is completed and the CTL URL is being notified of the successful update.
	3 The certification update failed, and the CTL URL is being notified of the failed update.
	4 The period of the certification has expired and new request for an update is being sent to the CTL URL.
	11 A rescue update for certification has been issued and a rescue certification setting is in progress for the rescue CTL connection.
67	12 The rescue certification setting is completed and the CTL URL is being notified of the certification update request.
	13 The notification of the request for certification update has completed successfully, and the system is waiting for the certification update request from the rescue CTL URL.
	14 The notification of the certification request has been received from the rescue CTL URL, and the certification is being stored.
	15 The certification has been stored, and the CTL URL is being notified of the successful completion of this event.
	16 The storing of the certification has failed, and the CTL URL is being notified of the failure of this event.
	17 The certification update request has been received from the CTL URL, the CTL URL was notified of the results of the update after it was completed, but a certification error has been received, and the rescue certification is being recorded.
	18 The rescue certification of No. 17 has been recorded, and the CTL URL is being notified of the failure of the certification update.

68	CERT: Error	
	Displays a number code that describes the reason for the notification requesting the certification update.	
	0	Normal. No request for certification update in progress.
	1	Certification update in progress due to expiration of certification.
	2	SSL error has been issued after the certification has expired.
	3	There has been a shift from a common to individual certification.
	4	There has been a common certification without ID2.
	5	No certification has been issued.
69	CERT: Up ID	
	The ID of the request for certification.	
83	Firm Up Status	
	Displays the status of the firmware update.	
85	Firm Up User Check	
	This SP setting determines if the operator can check the previous version of the firmware before the firmware update execution. If the option to check the previous version is selected, a notification is sent to the system manager and the firmware update is done with the firmware files from the URL.	
86	Firmware Size	
	Allows the service technician to check the size of the firmware data files during the firmware update execution.	
87	CERT: Macro Version	
	Displays the macro version of the @Remote certification	
88	CERT: PAC Version	
	Displays the PAC version of the @Remote certification.	

89	CERT: ID2 Code
	Displays ID2 for the @Remote certification. Spaces are displayed as underscores (_). Asterisks (****) indicate that no @Remote certification exists.
90	CERT: Subject
	Displays the common name of the @Remote certification subject. CN = the following 17 bytes. Spaces are displayed as underscores (_). Asterisks (****) indicate that no DESS exists.
91	CERT: Serial No.
	Displays serial number for the @Remote certification. Asterisks (****) indicate that no DESS exists.
92	CERT: Issuer
	Displays the common name of the issuer of the @Remote certification. CN = the following 30 bytes. Asterisks (****) indicate that no DESS exists.
93	CERT: Valid Start
	Displays the start time of the period for which the current @Remote certification is enabled.
94	CERT: Valid End
	Displays the end time of the period for which the current @Remote certification is enabled.
95	Server CN Check DFU
	This is a design debugging tool. Not used.
96	GW Host DFU
	This is a design debugging tool. Not used.
97	GW URL Path DFU
	This is a design debugging tool. Not used.
99	Debug Rescue G/WURL DFU
	This is a design debugging tool. Not used.

100	Specific Gateway Host DFU	
	This is a design debugging tool. Not used.	
101	Specific Gateway URL Path DFU	
	This is a design debugging tool. Not used.	
150	Selection Country DFU	
	<p>Used only for Embedded RC Gate-M to select a country name. Once the number/country is selected, the following settings are checked:</p> <ul style="list-style-type: none"> • Access point telephone number • Dial-up user name • Modem parameters set for the country <p>[0 to 10/*/*1] *: 0: Japan, 1: USA, 3: UK 0:Japan, 1:USA, 2:Canada, 3:UK, 4:Germany, 5:France, 6:Italy, 7:Netherlands, 8:Belgium, 9:Luxembourg, 10:Spain</p>	
151	Line Type Automatic Judgement DFU	
	<p>Used only for Embedded RC Gate-M to determine whether the dial-up line is for manual rotary or push-button tone dialing.</p> <ul style="list-style-type: none"> • The status of the execution of this SP (dialing in progress, success, failure) is written to SP5816-152. • If the check succeeds, the number (dial or push number) written to SP5816-153 can be used • If the check succeeds, the number of the carrier line written to SP816-154 can be used. 	
152	Line Type Judgement Result DFU	
	Used only for Embedded RC Gate-M to display the status of the execution of SP5816-151 identify the type of line.	
	0	Success
	1	Currently dialing
	2	Line abnormal
	3	Could not confirm external line carrier with automatic detection.

	4	Line disconnected
	5	Power supply insufficient
	6	Line determination not supported
	7	Error due to fax transmission in progress.
	8	Other error
	9	Line type identification still in progress. Please wait.
153	Selection Dial/Push DFU	
	Used only for Embedded RC Gate-M to set the telephone number of the dial-up access point of the line checked with SP5816-151. If a number is entered, use that number. If a number is not displayed, use the pre-set value for that country.	
154	Outside Line Outgoing Number DFU	
	Used only for Embedded RC Gate-M to set the number of the PSTN number to dial out where Embedded RC Gate-M is used with a PBX system. If a number is set here, the number will be replaced by the number returned by the successful execution of SP5816-151.	
156	Dial Up User Name DFU	
	This is the user name for dialing at the access point where Embedded RC Gate-M is used. Note: Numbers with spaces or # marks appear enclosed with quotation marks in the user name.	
157	Dial Up Password DFU	
	This is the password for dialing at the access point where Embedded RC Gate-M is used. Note: Numbers with spaces or # marks appear enclosed with quotation marks in the user name.	
161	Local Phone Number DFU	
	This is the number of the local line where Embedded RC Gate-M is connected. This is the line used to communicate with the Call Center.	

162	Connection Timing Adjustment Incoming DFU
	<p>When the Call Center calls out to the access point where Embedded RC Gate-M is used, the ID tone (*#1#) is sent repeatedly. This SP sets the amount of time to elapse for ID tone output.</p> <p>[0 to 24/1/1 pause count]</p> <p>1 pause count = 2 sec.</p>
163	Access Point DFU
	<p>This is the dial-up telephone line number of the access point connected to Embedded RC Gate-M. If a number is entered here that number is used. If no number is entered here then the pre-set country setting is used.</p>
164	Line Connecting DFU
	<p>This SP code should be set for the customer using Embedded RC Gate-M, depending on the line usage (whether line is shared with a fax or not).</p> <p>[0 to 1/0/1]</p> <p>0: Line shared with facsimile</p> <p>1: Line not shared with facsimile</p>
173	Modem Serial No. DFU
	<p>This SP code displays the serial number of the Embedded RC Gate-M (modem).</p>
174	Retransmission Limit DFU
	<p>Use this SP to manually send a registration update request to Embedded RC Gate-M.</p>
187	FAX TX Priority DFU
	<p>This SP is used with SP5816-164 for users who are using a line shared with a facsimile unit.</p> <p>[0 to 1/0/1]</p> <p>0: Disabled. Embedded RC Gate-M continues to operate if a fax transmission starts on the same line.</p> <p>1: Enabled. Fax transmissions have priority. Embedded RC Gate-M will shut down when a fax transmission begins.</p>

200	Manual Polling	
	Executes manual polling. Embedded RC Gate periodically polls the @Remote Gateway by HTTPS. This is called "center polling". Use this SP at any time to poll the @Remote supply center.	
201	Regist: Status	
	Displays a number that indicates the status of the @Remote service device.	
	0	Neither the @Remote device nor Embedded RC Gate device are set.
	1	The Embedded RC Gate device is being set. Only Box registration is completed. In this status the Basil unit cannot answer a polling request.
	2	The Embedded RC Gate device is set. In this status the Basil unit cannot answer a polling request.
	3	The @Remote device is being set. In this status the Embedded RC Gate device cannot be set.
202	Letter Number	
	Allows entry of the number of the request needed for the Embedded RC Gate device.	
203	Confirm Execute	
	Executes the inquiry request to the @Remote CTL URL.	

204	Confirm Result	
	Displays a number that indicates the result of the inquiry executed with SP5816203.	
	0	Succeeded
	1	Inquiry number error
	2	Registration in progress
	3	Proxy error (proxy enabled)
	4	Proxy error (proxy disabled)
	5	Proxy error (Illegal user name or password)
	6	Communication error
	7	Certification update error
	8	Other error
	9	Inquiry executing
205	Confirm Place	
	Displays the result of the notification sent to the device from the CTL URL in answer to the inquiry request. Displayed only when the result is registered at the CTL URL.	
206	Register Execute	
	Executes Embedded RC Gate Registration.	

207	Register Result	
	Displays a number that indicates the registration result.	
	0	Succeeded
	2	Registration in progress
	3	Proxy error (proxy enabled)
	4	Proxy error (proxy disabled)
	5	Proxy error (Illegal user name or password)
	6	Communication error
	7	Certification update error
	8	Other error
	9	Registration executing

208	Error Code		
	Displays a number that describes the error code that was issued when either SP5816 204 or SP5816 207 was executed.		
	Cause	Code	Meaning
	Illegal Modem Parameter	-11001	Chat parameter error
		-11002	Chat execution error
		-11003	Unexpected error
	Operation Error, Incorrect Setting	-12002	Inquiry, registration attempted without acquiring device status.
		-12003	Attempted registration without execution of an inquiry and no previous registration.
		-12004	Attempted setting with illegal entries for certification and ID2.
	Error Caused by Response from CTL URL	-2385	Attempted dial up overseas without the correct international prefix for the telephone number.
		-2387	Not supported at the Service Center
		-2389	Database out of service
		-2390	Program out of service
		-2391	Two registrations for same device
		-2392	Parameter error
		-2393	Basil not managed
		-2394	Device not managed
		-2395	Box ID for Basil is illegal
		-2396	Device ID for Basil is illegal
-2397		Incorrect ID2 format	
-2398	Incorrect request number format		
209	Instl Clear		

2

	Releases a machine from its embedded RCG setup.
250	CommLog Print
	Prints the communication log.

5821	Remote Service Address	CTL
	This SP sets the IP address for RCG (Remote Communication Gate) for processing calls to the @Remote service center.	

	NVRAM Data Upload	CTL
5824	<p>Uploads the UP and SP mode data (except for counters and the serial number) from NVRAM on the control board to an SD card inserted in Slot 2.</p> <ol style="list-style-type: none"> 1. Remove the SD card slot cover on the back of the machine. 2. Insert a blank SD card in Slot 2. 3. Open this SP and touch [EXECUTE]. 4. When you see "Completed", remove the SD card from Slot 2. 	

	NVRAM Data Download	CTL
5825	<p>Downloads the content of an SD card in Slot 2 to the NVRAM on the control board.</p> <ul style="list-style-type: none"> • Remove the SD card slot cover on the back of the machine. • Insert a blank SD card in Slot 2. • Open this SP and touch [EXECUTE]. • When you see "Completed", remove the SD card from Slot 2. 	

5828	Network Setting	CTL
1	IPv4 Address (Ethernet/IEEE 802.11)	
	This SP allows you to check and reset the IPv4 address for Ethernet and wireless LAN (802.11): aaa.bbb.ccc.ddd	
2	IPv4 Subnet Mask (Ethernet/IEEE 802.11)	
	This SP allows you to check and reset the IPv4 subnet mask for Ethernet and wireless LAN (802.11): aaa.bbb.ccc.ddd	
3	IPv4 default Gateway (Ethernet/IEEE 802.11)	

	This SP allows you to check and reset the IPv4 default gateway used by the network for Ethernet and wireless LAN (802.11): aaa.bbb.ccc.ddd
6	DHCP (Ethernet/IEEE 802.11)
	This SP code allows you check and change the setting that determines whether the IP address is used with DHCP on an Ethernet or wireless (802.11) LAN network. [0 to 1 / 1 / 1] 0: Not used (manual setting) 1: Used
21	Active IPv4 Address
	This SP allows you to check the IPv4 address that was used when the machine started up with DHCP.
22	Active IPv4 Subnet Mask
	This SP allows you to check the IPv4 subnet mask setting that was used when the machine started up with DHCP.
23	Active IPv4 Gateway Address
	This SP allows you to check the IPv4 default gateway setting that was used when the machine started up with DHCP.
50	1284 Compatibility (Centro)
	Enables and disables bi-directional communication on the parallel connection between the machine and a computer. [0 to 1 / 1 / 1] 0:Off, 1: On
52	ECP (Centro)
	Disables and enables the ECP feature (1284 Mode) for data transfer. [0 to 1 / 1 / 1] 0: Disabled, 1: Enabled
65	Job Spool
	Switches job spooling on and off. [0 to 1/0/1] 0: No spooling 1: Spooling enabled

66	Job Spool Clear: Start Time		
	<p>This SP determines whether the job interrupted at power off is resumed at the next power on. This SP operates only when SP5828065 is set to 1.</p> <p>[0 to 1/1/1]</p> <p>1: Resumes printing spooled job. 0: Clears spooled job.</p>		
69	Spooling (Protocol)		
	<p>This SP determines whether job spooling is enabled or disabled for each pro to col. This is a 8-bit setting.</p>		
	0	LPR	4 BMLinks (Japan Only)
	1	FTP (Not Used)	5 DIPRINT
	2	IPP	6 Reserved (Not Used)
	3	SMB	7 Reserved (Not Used)
90	TELNET (0:OFF 1:ON)		
	<p>Disables or enables Telnet operation. If this SP is disabled, the Telnet port is closed.</p> <p>[0 to 1/1/1]</p> <p>0: Disable 1: Enable</p>		
91	Web (0:OFF 1:ON)		
	<p>Disables or enables the Web operation.</p> <p>[0 to 1/1/1]</p> <p>0: Disable 1: Enable</p>		
145	Active IPv6 Link Local Address		
	<p>This is the IPv6 local address referenced on the Ethernet or wireless LAN (802.11b) in the format:</p> <p>"Link-Local address" + "Prefix Length"</p> <p>The IPv6 address consists of a total 128 bits configured in 8 blocks of 16 bits each. These notations can be abbreviated. See "Note: IPV6 Addresses " below this table.</p>		
147	Active IPv6 Stateless Address 1		

149	Active IPv6 Stateless Address 2
151	Active IPv6 Stateless Address 3
153	Active IPv6 Stateless Address 4
155	Active IPv6 Stateless Address 5
	<p>SP codes 147 to 155 are the IPv6 stateless addresses (1 to 5) referenced on the Ethernet or wireless LAN (802.11b) in the format:</p> <p>"Stateless Address" + "Prefix Length"</p> <p>The IPv6 address consists of a total 128 bits configured in 8 blocks of 16 bits each.</p>
156	IPv6 Manual Address
	<p>This SP is the IPv6 manually set address referenced on the Ethernet or wireless LAN (802.11b) in the format:</p> <p>"Manual Set Address" + "Prefix Length"</p> <p>The IPv6 address consists of a total 128 bits configured in 8 blocks of 16 bits each. These notations can be abbreviated. See "Note: IPV6 Addresses" below this table.</p>
158	IPv6 Gateway Address
	<p>This SP is the IPv6 gateway address referenced on the Ethernet or wireless LAN (802.11b). The IPv6 address consists of a total 128 bits configured in 8 blocks of 16 bits each. These notations can be abbreviated. See "Note: IPV6 Addresses" below this table.</p>
161	IPv6 Stateless Auto Setting
	<p>Sets the machine to reference the stateless auto setting for Ethernet and wireless LAN operation.</p> <p>[0 to 1 / 1 / 1]</p> <p>0: Disable</p> <p>1: Enable</p>

Ethernet and the Wireless LAN (802.11b) reference the IPV6 "Link-Local address + Prefix Length". The IPV6 address consists of 128 bits divided into 8 blocks of 16 bits:

aaaa:bbbb:cccc:ddd:eeee:ffff:gggg:hhhh:

The prefix length is inserted at the 17th byte (Prefix Range: 0x0 to 0x80). The initial setting is 0x40(64).

For example, the data:

2001123456789012abcdef012345678940h

is expressed:

2001:1234:5678:9012:abcd:ef01:2345:6789: prefixlen 64

However, the actual IPV6 address display is abbreviated according to the following rules.

Rules for Abbreviating IPV6 Addresses

1. The IPV6 address is expressed in hexadecimal delimited by colons (:) with the following characters:

0123456789abcdefABCDEF

2. A colon is inserted as a delimiter every 4th hexadecimal character.

fe80:0000:0000:0000:0207:40ff:0000:340e

3. The notations can be abbreviated by eliminating zeros where the MSB and digits following the MSB are zero. The example in "2" above, then, becomes:

fe80:0:0:0207:40ff:0:340e

4. Sections where only zeros exist can be abbreviated with double colons (::). This abbreviation can be done also where succeeding sections contain only zeros (but this can be done only at one point in the address). The example in "2" and "3" above then becomes: fe80::207:40ff:0:340e (only the first null sets zero digits are abbreviated as "::")

-or-

fe80:0:0:0:207:40ff::340e (only the last null set before "340e" is abbreviated as "::")

236	Web Item visible
	Displays or does not display the Web system items. [0 x 0000 to 0 x ffff / 0 x ffff] 0: Not displayed, 1: Displayed bit0: Net RICOH bit1: Consumable Supplier bit2-15: Reserved (all)
237	Web shopping link visible
	Displays or does not display the link to Net RICOH on the top page and link page of the web system. [0 to 1 / 1 / 1] 0: Not display, 1:Display

238	Web supplies Link visible	
	Displays or does not display the link to Consumable Supplier on the top page and link page of the web system. [0 to 1 / 1 / 1] 0: Not display, 1:Display	
239	Web Link1 Name	
	This SP confirms or changes the URL1 name on the link page of the web system. The maximum characters for the URL name are 31 characters.	
240	Web Link1 URL	
	This SP confirms or changes the link to URL1 on the link page of the web system. The maximum characters for the URL are 127 characters.	
241	Web Link1 Visible	
	Displays or does not display the link to URL1 on the top page of the web system. [0 to 1 / 1 / 1] 0: Not display, 1:Display	
242	Web Link2 Name	Same as "-239"
243	Web Link2 URL	Same as "-240"
244	Web Link2 visible	Same as "-241"

5831	Initial Setting Clear	
	This SP clears all the User Tools settings and restores them to their factory default settings.	

5832	HDD	CTL
	Enter the SP number for the partition to initialize, then press #. When the execution ends, turn the machine power off and on.	
1	HDD Formatting (All)	
2	HDD Formatting (IMH)	
3	HDD Formatting (Thumbnail)	

4	HDD Formatting (Job Log)
5	HDD Formatting (Printer Fonts)
6	HDD Formatting (User Info)
7	Mail RX Data
8	Mail TX Data
9	HDD Formatting (Data for Design)
10	HDD Formatting (Log)
11	HDD Formatting (Ridoc I/F) (for Ridoc DesktopBinder)

5840	IEEE 802.11	CTL													
6	Channel MAX														
	Sets the maximum range of the bandwidth for the wireless LAN. This bandwidth setting varies for different countries. [1 to 14/14/1]														
7	Channel MIN														
	Sets the minimum range of the bandwidth for operation of the wireless LAN. This bandwidth setting varies for different countries. [1 to 14/1/1]														
8	Transmission Speed														
	<table border="0"> <tr> <td>0 x FF to Auto [Default]</td> <td>0 x 0A – 6M Fix</td> </tr> <tr> <td>0 x 11 – 55M Fix</td> <td>0 x 07 – 11M Fix</td> </tr> <tr> <td>0 x 10 – 48M Fix</td> <td>0 x 05 – 5.5M Fix</td> </tr> <tr> <td>0 x 0F – 36M Fix</td> <td>0 x 08 – 1M Fix</td> </tr> <tr> <td>0 x 0E – 18M Fix</td> <td>0 x 13 – 0 x FE (reserved)</td> </tr> <tr> <td>0 x 0D – 12M Fix</td> <td>0 x 12 – 72M (reserved)</td> </tr> <tr> <td>0 x 0B – 9M Fix</td> <td>0 x 09 – 22M (reserved)</td> </tr> </table>	0 x FF to Auto [Default]	0 x 0A – 6M Fix	0 x 11 – 55M Fix	0 x 07 – 11M Fix	0 x 10 – 48M Fix	0 x 05 – 5.5M Fix	0 x 0F – 36M Fix	0 x 08 – 1M Fix	0 x 0E – 18M Fix	0 x 13 – 0 x FE (reserved)	0 x 0D – 12M Fix	0 x 12 – 72M (reserved)	0 x 0B – 9M Fix	0 x 09 – 22M (reserved)
0 x FF to Auto [Default]	0 x 0A – 6M Fix														
0 x 11 – 55M Fix	0 x 07 – 11M Fix														
0 x 10 – 48M Fix	0 x 05 – 5.5M Fix														
0 x 0F – 36M Fix	0 x 08 – 1M Fix														
0 x 0E – 18M Fix	0 x 13 – 0 x FE (reserved)														
0 x 0D – 12M Fix	0 x 12 – 72M (reserved)														
0 x 0B – 9M Fix	0 x 09 – 22M (reserved)														

	WEP Key Select	
11	<p>Determines how the initiator (SBP-2) handles subsequent login requests. [00 to 11/00/1]</p> <p>Note: There are four settings (binary numbers): 00, 01, 10, 11. These settings are possible only after the wireless LAN card has been installed.</p> <p>00: 1st key. If the initiator receives another login request while logging in, the request is refused.</p> <p>01, 10, 11: 2nd, 3rd, 4th keys are "Reserved".</p>	
42	Fragment Thresh	
	<p>Adjusts the fragment threshold for the IEEE802.11 card. [256 to 2346 / 2346 / 1]</p> <p>This SP is displayed only when the IEEE802.11 card is installed.</p>	
43	11g CTS to Self	
	<p>Determines whether the CTS self function is turned on or off. [0 to 1 / 1 / 1] 0: Off, 1: On</p> <p>This SP is displayed only when the IEEE802.11 card is installed.</p>	
44	11g Slot Time	
	<p>Selects the slot time for IEEE802.11. [0 to 1 / 0 / 1] 0: 20 μm, 1: 9 μm</p> <p>This SP is displayed only when the IEEE802.11 card is installed.</p>	
45	WPA Debug Lvl	
	<p>Selects the debug level for WPA authentication application. [1 to 3 / 3 / 1] 1: Info, 2: warning, 3: error</p> <p>This SP is displayed only when the IEEE802.11 card is installed.</p>	
5841	Supply Name Setting	CTL
	Use the soft keyboard of this SP to enter the names and numbers of consumables. These are the names that appear on the display when [Inquiry] is pressed on the User Tools screen.	
5842	GWWS Analysis DFU	CTL

1	Setting 1	Bit	Groups
	<p>This is a debugging tool. It sets the debugging output mode of each Net File process.</p> <p>Bit SW 0011 1111</p>	0	System & other groups (LSB)
		1	Capture related
		2	Certification related
		3	Address book related
		4	Machine management related
		5	Output related (printing, delivery)
		6	Repository related
		Setting 2	Bit
2	<p>This SP codes sets the optional setting for message log time stamp.</p> <p>Bit 7 is the 5682 message log where the following are set:</p>	0-6	Not Used
		7	<p>Message log</p> <p>1: mm:ss:ms</p> <p>0: mm:ss (time)</p>

5844	USB	CTL
1	Transfer Rate	
	<p>Sets the speed for USB data transmission.</p> <p>[Full Speed], [Auto Change]</p>	
2	Vendor ID DFU	
	<p>Sets the vendor ID:</p> <p>Initial Setting: 0x05A Ricoh Company</p> <p>[0x0000 to 0xFFFF/1]</p>	
3	Product ID DFU	
	<p>Sets the product ID.</p> <p>[0x0000 to 0xFFFF/1]</p>	
4	Device Release Number DFU	

	<p>Sets the device release number of the BCD (binary coded decimal) display. [0000 to 9999/100/1]</p> <p>Enter as a decimal number. NCS converts the number to hexadecimal number recognized as the BCD.</p>
5	Fixed USB Port
	<p>This SP standardizes for common use the model name and serial number for USB PnP (Plug & Play). It determines whether the driver requires re-installation. [0 to 2 / 0 / 4]</p> <p>0: Off 1: Level 1 2: Level 2</p>
6	PnP Model Name
	<p>This SP sets the model name to be used by the USB PnP when "Function Enable (Level 2) is set so the USB Serial No. can have a common name (SP5844-5). Default: Laser Printer (up to 20 characters allowed).</p>
7	PnP Serial Number
	<p>This SP sets the serial number to be used by the USB PnP when "Function Enable (Level 2) is set so the USB Serial No. can have a common name (SP5844-5). Default: None (up to 12 characters allowed for entry).</p> <ul style="list-style-type: none"> • Make sure that this entry is the same as the serial number in use. • At initialization the serial number generated from the model name is used, not the setting of this SP code. • At times other than initialization, the value set for this SP code is used.
100	Notify Unsupport

	<p>This SP determines whether an alert message appears on the control panel when a USB device (unsupported device) that cannot use an A-connector is connected.</p> <p>[0 to 1/1/1]</p> <p>0: Function enable</p> <p>1: Function disable</p> <ul style="list-style-type: none"> • An unsupported device is a device that cannot use the functions of the USB device. For example, a USB mouse cannot be used even if it connected. • If the PictBridge option is not mounted, even if a digital camera is connected it cannot be used because it is an unsupported device.
--	--

5845	Delivery Server Setting	CTL
	Provides items for delivery server settings.	
1	FTP Port No.	[0 to 65535 / 3670 / 1]
	Sets the FTP port number used when image files are sent to the Scan Router Server.	
2	IP Address (Primary)	Range: 000.000.000.000 to 255.255.255.255
	Use this SP to set the Scan Router Server address. The IP address under the transfer tab can be referenced by the initial system setting.	
6	Delivery Error Display Time	[0 to 999 / 300 / 1]
	Use this setting to determine the length of time the prompt message is displayed when a test error occurs during document transfer with the NetFile application and an external device.	
8	IP Address (Secondary)	Range: 000.000.000.000 to 255.255.255.255
	Specifies the IP address assigned to the computer designated to function as the secondary delivery server of Scan Router. This SP allows only the setting of the IP address without reference to the DNS setting.	
9	Delivery Server Model	[0 to 4/ 0 / 1]
	<p>Allows changing the model of the delivery server registered by the I/O device.</p> <p>0: Unknown</p> <p>1: SG1 Provided</p> <p>2: SG1 Package</p> <p>3: SG2 Provided</p> <p>4: SG2 Package</p>	

	Delivery Svr Capability	
	Changes the capability of the registered that the I/O device registered. [0 to 255 / 0 / 1] (7) [0000 0000] (1)	
10	Bit7 = 1 Comment information exists	
	Bit6 = 1 Direct specification of mail address possible	
	Bit5 = 1 Mail RX confirmation setting possible	
	Bit4 = 1 Address book automatic update function exists	
	Bit3 = 1 Fax RX delivery function exists	
	Bit2 = 1 Sender password function exists	
	Bit1 = 1 Function to link MK-1 user and Sender exists	
	Bit0 = 1 Sender specification required (if set to 1, Bit6 is set to "0")	
	11	Delivery Svr.Capability (Ext) These settings are for future use. They will let you increase the number of registered devices (in addition to those registered for SP5845-10). There are eight bits (Bit 0 to Bit 7). All are unused at this time.
	13	Server Scheme (Primary)
14	Server Port Number (Primary)	
15	Server URL Path (Primary)	
16	Server Scheme (Secondary)	
17	Server Port Number (Secondary)	
18	Server URL Path (Secondary)	
22	Rapid Sending Control	

	<p>Switches instant transmission off/on. [0 to 1/1/1]</p> <p>0: Off. Instant transmission not possible with network setting errors. 1: On. Instant transmission possible with network setting errors.</p> <p>Note:</p> <ul style="list-style-type: none"> • The machine will continue to transmit over the network, even if the network settings are incorrect. (This causes multiple errors, of course.) • With this SP off, the machine will stop communicating with the network if the settings are wrong. This reduces the amount of spurious network traffic caused by errors due to incorrect settings.
--	--

5846	UCS Setting	CTL
	UCS (User Control Service) is the software that manages user codes and the address books for scan-to-email and scan-to-folder.	
	Machine ID (for Delivery Server)	
	Displays the unique device ID in use by the delivery server directory. The value is only displayed and cannot be changed. This ID is created from the NIC MAC or IEEE 1394 EUI.	
1	The ID is displayed as either 6-byte or 8-byte binary. 6-byte %02X.%02X.%02X.%02X.%02X.%02X 8-byte %02X.%02X.%02X.%02X.%02X.%02X.%02X.%02X	
	Machine ID Clear (Delivery Server)	
2	Clears the unique ID of the device used as the name in the file transfer directory. Execute this SP if the connection of the device to the delivery server is unstable. After clearing the ID, the ID will be established again automatically by cycling the machine off and on.	
	Maximum Entries	
3	Changes the maximum number of entries that UCS can handle. [2000 to 20000/2000/1] If a value smaller than the present value is set, the UCS managed data is cleared, and the data (excluding user code information) is displayed.	

6	Delivery Server Retry Timer
	<p>Sets the interval for retry attempts when the delivery server fails to acquire the delivery server address book.</p> <p>[0 to 255/0/1 sec.]</p> <p>0: No retries</p>
7	Delivery Server Retry Times
	<p>Sets the number of retry attempts when the delivery server fails to acquire the delivery server address book.</p> <p>[0 to 255/0/1]</p>
8	Delivery Server Maximum Entries
	<p>Lets you set the maximum number of account entries and information about the users of the delivery server controlled by UCS.</p> <p>[2000 to 20000/2000/1]</p>
10	LDAP Search Timeout
	<p>Sets the length of the time-out for the search of the LDAP server.</p> <p>[1 to 255/60/1]</p>
20	WSD Maximum Entries
	<p>WSD (Web Services on Devices) is the Microsoft standard for connectivity to web-service enabled devices.</p> <p>[50 to 250/250/1]</p> <p>Default: 250</p>
21	Folder Auth Change
	<p>This SP determines whether the user login information (Login User name and Password) or address (destination setting in the address book for Scan-to-SMB) is used to permit folder access. The machine must be cycled off/on for this setting to take effect if it is changed.</p> <p>[0 to 1 / 0 / 1]</p> <p>0: Uses operator login information (initial value of main machine)</p> <p>1: Uses address authorization information</p>

<p>40</p>	<p>Addr Book Migration (SD -> HDD)</p> <p>This SP moves the address book data from an SD card to the HDD. You must turn the machine power off and on after executing this SP.</p> <ol style="list-style-type: none"> 1. Turn the machine off. 2. Install the HDD. 3. Insert the SD card with the address book data in SD card Slot C3. 4. Turn the machine on. 5. Do SP5846-40. 6. Turn the machine off. 7. Remove the SD card from SD card Slot C3. 8. Turn the machine on. <p>Notes:</p> <ul style="list-style-type: none"> • Executing this SP overwrites any address book data already on the HDD with the data from the SD card. • We recommend that you back up all directory information to an SD card with SP5846-51 before you execute this SP. • After the address book data is copied to HDD, all the address book data is deleted from the source SD card. If the operation fails, the data is not erased from the SD card.
<p>41</p>	<p>Fill Addr Acl Info.</p> <p>This SP must be executed immediately after installation of an HDD unit in a basic machine that previously had no HDD. The first time the machine is powered on with the new HDD installed, the system automatically takes the address book from the NVRAM and writes it to the new HDD. However, the new address book on the HDD can be accessed only by the system administrator at this stage. Executing this SP by the service technician immediately after power on grants full address book access to all users.</p> <p>Procedure</p> <ol style="list-style-type: none"> 1. Turn the machine off. 2. Install the new HDD. 3. Turn the machine on. 4. The address book and its initial data are created on the HDD automatically. However, at this point the address book can be accessed by only the system administrator or key operator. 5. Enter the SP mode and do SP5846-41. After this SP executes successfully, any user can access the address book.

43	Addr Book Media
	<p>This SP displays the media where the address book currently in use is stored.</p> <p>[0 to 30 / 0 / 1]</p> <p>0: Unconfirmed</p> <p>1: SD Slot 1</p> <p>2: SD Slot 2</p> <p>4: USB Flash ROM</p> <p>20: HDD</p> <p>30: Nothing</p>
46	Initialize All Settings & Address Book
	Initializes all settings and the address book.
47	Initialize Local Addr Book
	Clears all of the address information from the local address book of a machine managed with UCS.
48	Initialize Delivery Addr Book
	Push [Execute] to delete all items (this does not include user codes) in the delivery address book that is controlled by UCS.
49	Initialize LDAP Addr Book
	Push [Execute] to delete all items (this does not include user codes) in the LDAP address book that is controlled by UCS.
50	Initialize All Addr Book
	Clears everything (including user codes) in the directory information managed by UCS. However, the accounts and passwords of the system administrators are not deleted.
51	Backup All Addr Book
	Uploads all directory information to the SD card.
52	Restore All Addr Book
	Downloads all directory information from the SD card.

53	Clear Backup Info.	
	<p>Deletes the address book uploaded from the SD card in the slot. Deletes only the files uploaded for that machine. This feature does not work if the card is write-protected.</p> <p>Note: After you do this SP, go out of the SP mode, turn the power off. Do not remove the SD card until the Power LED stops flashing.</p>	
60	Search Option	
	This SP uses bit switches to set up the fuzzy search options for the UCS local address book.	
	Bit	Meaning
	0	Checks both upper/lower case characters
	1	Japan Only
	2	
	3	
	4	--- Not Used ---
	5	--- Not Used ---
	6	--- Not Used ---
7	--- Not Used ---	
62	Complexity Option 1	
	<p>Use this SP to set the conditions for password entry to access the local address book. Specifically, this SP limits the password entry to upper case and sets the length of the password.</p> <p>[0 to 32/0/1]</p> <p>Note:</p> <p>This SP does not normally require adjustment.</p> <p>This SP is enabled only after the system administrator has set up a group password policy to control access to the address book.</p>	

63	<p>Complexity Option 2</p> <p>Use this SP to set the conditions for password entry to access the local address book. Specifically, this SP limits the password entry to lower case and defines the length of the password.</p> <p>[0 to 32/0/1]</p> <p>Note:</p> <p>This SP does not normally require adjustment.</p> <p>This SP is enabled only after the system administrator has set up a group password policy to control access to the address book.</p>
64	<p>Complexity Option 3</p> <p>Use this SP to set the conditions for password entry to access the local address book. Specifically, this SP limits the password entry to numbers and defines the length of the password.</p> <p>[0 to 32/0/1]</p> <p>Note:</p> <p>This SP does not normally require adjustment.</p> <p>This SP is enabled only after the system administrator has set up a group password policy to control access to the address book.</p>
65	<p>Complexity Option 4</p> <p>Use this SP to set the conditions for password entry to access the local address book. Specifically, this SP limits the password entry to symbols and defines the length of the password.</p> <p>[0 to 32/0/1]</p> <p>Note:</p> <p>This SP does not normally require adjustment.</p> <p>This SP is enabled only after the system administrator has set up a group password policy to control access to the address book.</p>
91	<p>FTP Auth. Port Settings</p> <p>Sets the FTP port to get the delivery server address book that is used in the individual authorization mode.</p> <p>[0 to 65535/3671/1]</p>

94	Encryption Stat
	Shows the status of the encryption function of the address book on the LDAP server.

5847	Rep. Resolution Reduction		CTL	
	These SP's change the default settings of image data sent externally by the Net File page reference function. [0 to 2/1]			
	Note:			
	<ul style="list-style-type: none"> • "NetFile" refers to jobs to be printed from the document server with a PC and the DeskTopBinder software. • This SP is available only after the File Format Converter (B609) has been installed. 			
	1	Rate for Copy Color	[0 to 5/2/1]	0: 1x
	2	Rate for Copy B&W Text	[0 to 6/0/1]	1: 1/2x
	3	Rate for Copy B&W Other	[0 to 5/2/1]	2: 1/3x
	4	Rate for Printer Color		3: 1/4x
5	Rate for Printer B&W		4: 1/6x	
7	Rate for Printer B&W 1200 dpi	[0 to 32/1/1]	5: 1/8x	
	Note: "6:" above (2/3x) applies to 3, 5, 6 only.			
21	Network Quality Default for JPEG			
	Sets the default value for the quality of JPEG images sent as NetFile pages. This function is available only with the MLB (Media Link Board) option installed. [5 to 95/50/1]			

5848	Web Service		CTL
	5847 2 sets the 4-bit switch assignment for the access control setting. Setting of 5848 1 has no effect on access and delivery from Scan Router. 5847 100 sets the maximum size of images that can be downloaded. The default is equal to 1 gigabyte.		
2	Acc. Ctrl.: Repository (only Lower 4 Bits)	0000: No access control 0001: Denies access to DeskTop Binder.	

3	Acc. Ctrl.: Doc. Svr. Print (Lower 4 Bits)	Switches access control on and off. 0000: OFF, 0001: ON
4	Acc. Ctrl.: User Directory (Lower 4 Bits)	
9	Acc. Ctrl.: Job Control (Lower 4 Bits)	
11	Acc. Ctrl: Device Management (Lower 4 Bits)	
21	Acc. Ctrl: Delivery (Lower 4 Bits)	
22	Acc. Ctrl: User Administration (Lower 4 Bits)	
99	Repository: Download Image Setting DFU	
	<p>This is a bit-switch setting. Only the lower 4 bits are enabled/disabled. Set to "0" (disabled) or "1" (enabled) as needed for image download.</p> <p>(1) Mac OS (2) Windows OS (3) OS other than Mac or Windows</p> <p>Note: This SP is used primarily by designers.</p>	
100	Repository: Download Image Max. Size	[1 to 2048 /2048 /1 K]

210	Setting: Log Type: Job 1 DFU	Note: These SP's are for display only; they cannot be changed.
	[0 to 0xFFFFFFFF/0/1]	
211	Setting: Log Type: Job 2 DFU	
	[0 to 0xFFFFFFFF/0/1]	
212	Setting: Log Type: Access DFU	
	[0 to 0xFFFFFFFF/0/1]	
213	Setting: Primary Srv DFU	
214	Setting: Secondary Srv DFU	
215	Setting: Start Time DFU	
	[0 to 0xFFFFFFFF/0/1]	
216	Setting: Interval Time DFU	
	[1 to 100/1/1]	
217	Setting: Timing DFU	
	[0 to 2/0/1]	
	0: Transmission off	
	1: Transmission 1 by 1 2: Periodic transmission	

5849	Installation Date	CTL
	Displays or prints the installation date of the machine.	
1	Display	
	Displays the installation date. The installation date is set automatically after test copies are done at the installation site.	

2	Switch to Print
	<p>Determines whether the installation date or total count is printed on the total counter printout.</p> <p>[0 to 1/0/1]</p> <p>0: Off. No Print</p> <p>1: On. Print</p>
3	Total Counter
	Displays the total count starting from the installation date (SP5849-1).

5851	Bluetooth Not Used
	<p>Sets the operation mode for the Bluetooth Unit. Press either key.</p> <p>[0 to 1/0/1]</p> <p>[0:Public] [1: Private]</p>

5853	Stamp Data Download	CTL
	<p>Push [Execute] to download the fixed stamp data from the machine ROM onto the hard disk so that these stamps can be used by the system. The customer will not be able to use these stamps ("Confidential", "Secret", etc.) until this SP has been executed.</p> <p>Note:</p> <ul style="list-style-type: none"> • This SP must always be executed after the HDD has been reformatted or replaced. • Always switch the machine off and on after executing this SP. 	

5856	Remote ROM Update	CTL
	<p>When set to "1" allows reception of firmware data via the local port (IEEE 1284) during a remote ROM update. This setting is reset to zero after the machine is cycled off and on.</p> <p>[0 to 1 / 0 / 1]</p> <p>0: Not allowed</p> <p>1: Allowed</p>	

5857	Save Debug Log	CTL
------	----------------	-----

1	On/Off (1:ON 0:OFF)
	<p>Switches on the debug log feature. The debug log cannot be captured until this feature is switched on.</p> <p>[0 to 1/0/1]</p> <p>0: OFF</p> <p>1: ON</p>
2	Target (2: HDD 3: SD Card)
	<p>Selects the destination where the debugging information generated by the event selected by SP5858 will be saved if an error is generated</p> <p>[2 to 3 /2/1]</p> <p>2: HDD</p> <p>3: SD Card</p>
5	Save to HDD
	Specifies the decimal key number of the log to be written to the hard disk.
6	Save to SD Card
	Specifies the decimal key number of the log to be written to the SD Card.
9	Copy HDD to SD Card (Latest 4 MB)
	Takes the most recent 4 MB of the log written to the hard disk and copies them to the SD Card. A unique file name is generated to avoid overwriting existing file names on the SD Card. Up to 4MB can be copied to an SD Card. 4 MB segments can be copied one by one to each SD Card.
10	Copy HDD to SD Card Latest 4 MB Any Key)
	Takes the log of the specified key from the log on the hard disk and copies it to the SD Card. A unique file name is generated to avoid overwriting existing file names on the SD Card. Up to 4 MB can be copied to an SD Card. 4 MB segments can be copied one by one to each SD Card. This SP does not execute if there is no log on the HDD with no key specified.
11	Erase HDD Debug Data
	Erases all debug logs on the HDD

	Erase SD Card Debug Data
12	Erases all debug logs on the SD Card. If the card contains only debugging files generated by an event specified by SP5858, the files are erased when SP5857-10 or -11 is executed. to enable this SP, the machine must be cycled off and on.
	Free Space on SD Card
13	Displays the amount of space available on the SD card.
	Copy SD to SD (Latest 4MB)
14	Copies the last 4MB of the log (written directly to the card from shared memory) on to an SD card.
	Copy SD to SD (Latest 4MB Any Key)
15	This SP copies the log on an SD card (the file that contains the information written directly from shared memory) to a log specified by key number.
	Make HDD Debug
16	This SP creates a 32 MB file to store a log on the HDD.
	Make SD Debug
17	This SP creates a 4 MB file to store a log on an SD card.

	Debug Save When	CTL
5858	These SP's select the content of the debugging information to be saved to the destination selected by SP5857-2. SP58583 stores one SC error specified by number.	
	Engine SC Error (0:OFF 1:ON)	
1	Stores SC codes generated by main machine engine errors. [0 to 1/0/1]	
	Controller SC Error (0:OFF 1:ON)	
2	Stores SC codes generated by CTL controller errors. [0 to 1/0/1]	
	Any SC Error	
3	0:OFF 1:ON	

4	Jam (0:OFF 1:ON
	Stores jam errors. [0 to 1/0/1]

5859	Debug Save Key No.	CTL
	These SP's allow you to set up to 10 keys for log files for functions that use common memory on the controller board. [-99999999 to 99999999 / 0 / 1]	
1 to 10	Key 1 to Key 10	

5860	SMTP/POP3/IMAP4	CTL
20	Partial Mail Receive Timeout	
	[1 to 168/72/1] Sets the amount of time to wait before saving a mail that breaks up during reception. The received mail is discarded if the remaining portion of the mail is not received during this prescribed time.	
21	MDN Response RFC2298Compliance	
	Determines whether RFC2298 compliance is switched on for MDN reply mail. [0 to 1/1/1] 0: No 1: Yes	
22	SMTP Auth. From Field Replacement	
	Determines whether the FROM item of the mail header is switched to the validated account after the SMTP server is validated. [0 to 1/0/1] 0: No. "From" item not switched. 1: Yes. "From" item switched.	

25	SMTP Auth Direct Sending	
	<p>Occasionally, all SMTP certifications may fail with SP5860-6 set to "2" to enable encryption during SMTP certification for the SMTP server. This can occur if the SMTP server does not meet RFC standards. In such cases you can use this SP to set the SMTP certification method directly. However, this SP can be used only after SP5860-3 has been set to "1" (On).</p> <p>Bit0: LOGIN Bit1: PLAIN Bit2: CRAM_MD5 Bit3: DIGEST_MD5 Bit4 to Bit 7: Not Used</p>	
26	S/MIME:MIME Header Specification	
	<p>This SP determines the standard type of header for e-mails sent with S/MIME.</p> <p>[0 to 1 / 0 / 1] 0: Microsoft Outlook Express 1: Internet Draft 2: RFC</p>	
5866	Email Report	CTL
1	Report Validity	
	<p>Disables and re-enables the email notification feature.</p> <p>[0 to 1/0/1] 0: Enable 1: Disable</p>	
5	Add Date Field	
	<p>This SP adds the current date to the date field of an email alert that informs the operator that an error has occurred.</p> <p>[0 to 1/0/1] 0: Date not added 1: Date added</p>	

5870	Common Key Info Writing		CTL
	Writes to flash ROM the common proof for validating the device for @Remote specifications.		
1	Writing	Note: These SP's are for future use and currently are not used.	
3	Initialize		

5873	SD Card Appli Move		CTL
	Moves an application from one SD card to another..		
1	Move Exec	Executes the move from one SD card to another.	
2	Undo Exec	This is an undo function. It cancels the previous execution.	

5875	SC Auto Reboot		CTL
1	Reboot Setting		
	<p>Determines whether the machine reboots automatically when an SC error occurs. [0 to 1/0/1]</p> <p>1: The machine does not reboot when an SC error occurs. However, the reboot does not occur for Type "A" SC codes.</p> <p>0: The machine reboots automatically when the machine issues an SC error and logs the SC error code. If the same SC occurs again, the machine does not reboot.</p>		
2	Reboot Type		
	<p>Selects the reboot method after an SC error occurs. [0 to 1/0/1]</p> <p>0: Manual reboot by operator or technician</p> <p>1: Automatic reboot</p>		

5878	Option Setup		CTL
	Press [Execute] to initialize the Data Overwrite Security and HDD Encryption option. Both options are available on SD cards.		
1	Data Overwrite Security		

	<p>This SP enables the Data Overwrite Security option.</p> <p>Note:</p> <ul style="list-style-type: none"> • Before execution the SD card must be in SD Card Slot 1 (option slot). • The SD card must reside in Slot 1 after execution.
2	HDD Encryption
	<p>This SP enables the HDD Encryption option.</p> <p>Note:</p> <ul style="list-style-type: none"> • Before execution the SD card must be in SD Card Slot 1 (option slot). • The SD card can be removed after execution.

5881	Fixed Phrase Block Erasing	CTL
	Press [EXECUTE] to erase fixed phrases supplied by SKB.	

5885	Set WIM Function	CTL	
	This SP determines how access to the Web Image Monitor document server is controlled. These are bit settings where "1" enables and "0" disables.		
20	DocSvr Acc Ctrl		
	Allows or disallows the functions of web image monitor. 0: OFF, 1: ON		
		(7) 0000 0000 (0)	
	LSB	0bit	Denies all access to document server
		1bit	Denies all access to User Tools
		2bit	Denies access to printing
		3bit	Denies access to fax
		4bit	Denis access to scan-to-email
		5bit	Denies access data downloading functions
		6bit	Denies access to data delete functions
	MSB	7bit	Forbid guest user

50	DocSvr Format	
	<p>Selects the display type for the document box list.</p> <p>[0 to 2 / 0 / 1]</p> <p>0: Thumbnail, 1: Icon, 2: Details</p>	
51	DocSvr Trans	
	<p>Sets the number of documents to be displayed in the document box list.</p> <p>[5 to 20 / 10 / 1]</p>	
100	Set Signature	
	<p>This SP determines whether a signature is attached to scanned documents queued for sending with Web Image Monitor.</p> <p>[0 to 2 / 0 / 1]</p> <p>0: Set individually</p> <p>Operator selects signature on the send screen when documents are sent via email.</p> <p>Operator has the option of selecting or not selecting a signature.</p> <p>1: Signature required. A signature must be selected for sending.</p> <p>2: No signature. No signature required.</p>	
101	Set Encryption	
	<p>Determines whether the scanned documents with the WIM are encrypted when they are transmitted by an e-mail.</p> <p>[0 to 1 / 0 / 1]</p> <p>0: Not encrypted, 1:Encryption</p>	
200	Detect Mem Leak	
	<p>This SP determines how Web Image Monitor memory leaks are handled. A "1" setting enables the function.</p>	
		(7) 0000 0000 (0)
	Bit 0	Displays memory status at session timeouts.
	Bit 1	Displays memory status at the start/end of PF handler only.
	Bit2-7	Not used
201	DocSvr Timeout	

	This SP sets the length of time for session timeout. The default is 30 min. The time can be reduced to shorten the time between memory leak detections. [1 to 255 / 30 / 1 min.]	
5887	SD Get Counter	CTL
	<p>After you touch [EXECUTE] this SP sends a text file to an SD card inserted in SD card Slot 2. The file is stored in a folder created in the root directory of the SD card called SD_COUNTER. The file is saved as a text file (*.txt) prefixed with the number of the machine.</p> <ul style="list-style-type: none"> • Insert the SD card in SD card Slot 1 (lower slot). • Select SP5887 then touch [EXECUTE]. • Touch [EXECUTE] in the message when you are prompted. 	
5888	Personal Information Protect	CTL
	<p>Selects the protection level for logs. [0 to 1 / 0 / 1] 0: No authentication, No protection for logs 1: No authentication, Protected logs (only an administrator can see the logs)</p>	
	SDK Application Counter	CTL
5893	<p>The machine stores up to six registered names in the SDK application.</p> <ul style="list-style-type: none"> • This SP has been implemented for all machines using Engine O8S and later. • This SP is not needed if there are no SDK applications loaded. 	
1 to 6	SDK1 to SDK-6	
5894	External Mech Count Setting	
	This SP switches the operation mode of the external counter.	
	Mech Counter Switch Setting	[0 to 2/22/1]
5898	HDD Pages	

2

	[0 to 2/0/1] 0: Standard 1: Extension A 2: Extension B
--	---

5907	Plug & Play Maker/Model Name	CTL
	<p>Selects the brand name and the production name for Windows Plug & Play. This information is stored in the NVRAM. If the NVRAM is defective, these names should be registered again.</p> <ul style="list-style-type: none"> • After selecting, press the "Original Type" key and "#" key at the same time. • When the setting is completed, the beeper sounds five times. 	

5913	Switchover Permission Time
	<p>Sets the length of time to elapse before allowing another application to take control of the display when the application currently controlling the display is not operating because a key has not been pressed.</p> <p>[3 to 30/3/1 s]</p>

5959	Paper Size
	Tray 1 (tandem tray) and the LCT do not have automatic paper size detection. Use these SP codes to set the paper size for Tray 1 and the optional LCT when it is installed.
1	1st Tray (Tandem)
	<p>The following paper sizes can be set. If the A3 DLT kit is not installed, you can only use settings 0 and 1</p> <p>[0 to 1/0/1] 0: A4 1: 8.5x11</p>

	1st Tray (A3 Kit)	
	The 1st Tray accepts the paper sizes below after the A3 Kit has been installed.	
2	0: A4	5: 11x17
	1: 8.5x11	6: 8.5x14 SEF
	2: A3 SEF	7: 8.5x11 SEF
	3: B4 SEF	8: Custom
	4:A4 SEF	

5960	A3 Tray Custom Paper Size Set	
	Sets the custom paper size for the A3/DLT option installed in Tray 1.	
1	Width (Main Scan)	[210 to 305/297/0.1]
2	Length (Sub Scan)	[210 to 439/210/0.1]

5965	Dehum-Heat on	
	Sets the anti-condensation heaters to remain on at all times. Normally, the heaters switch on only after the machine has been switched off. [0 to 1/0/1] 0:OFF/1:ON	

5967	Copy Server: Set Function	CTL
	Disables and enables the document server. This is a security measure that prevents image data from being left in the temporary file sector of the HDD. After changing this setting, switch the main switch off and on to enable the new setting. [0 to 1/0/1] 0: Enable 1: Disable	

5974	Cherry Server	CTL
	Selects which version of the Scan Router application program, "Light" or "Full (Professional)", is installed. [0 to 1 / 0 / 1 /step] 0: Light version 1: Full version	

5985	Device Setting	CTL
	<p>The NIC and USB support features are built into the CTL controller. Use this SP to enable and disable these features. In order to use the NIC and USB functions built into the controller board, these SP's must be set to "1".</p> <p>[0 to 2/0/1]</p> <p>0: Disable 1: Enable 2: Enable for @Remote</p>	
001	On Board NIC	
002	On Board USB	

5987	Mech. Counter
	<p>This SP switches the mechanical counter on and off.</p> <p>0: OFF / 1: ON</p>

5990	SP Print Mode (SMC Printout)	CTL
1	All (Data List)	<p>Prints all of the system parameter lists for the item selected.</p> <p>Input the number for the item that you want to print, and then press [1]: "Execute" on the touch panel.</p>
2	SP (Mode Data List)	
3	User Program	
4	Logging Data	
5	Diagnostic Report	
6	Non-Default	
7	NIB Summary	
8	Capture Log	
21	Copier User Program	
22	Scanner SP	
23	Scanner User Program	
24	SDK/J Summary	
25	SDK/J Application Info.	

Group 6000

6006	ADF Reg Adj	D0704/D075
1	ADF Main Reg Adj:Front	[-3 to 3/0/0.1 mm]
	Adjusts the side-to-side registration for the front in ADF mode.	
2	ADF Main Reg Adj:Rear	[-4 to 4/0/0.1 mm]
	Adjusts the side-to-side registration for the back in ADF mode.	
3	ADF Sub Reg Adj	[-29 to 29/0/1 step]
	Adjusts the vertical registration for the front in ADF mode.	
5	ADF Buckle Adj: Front	[-16 to 23/0/1 step]
	Adjusts the roller timing at the skew correction sensor/entrance roller. A higher setting causes more buckling.	
6	ADF Buckle Adj: Rear	[-20 to 20/0/1 step]
	These settings adjust the erase margin for the trailing edges for the rear.	
7	Rear Edge Rail Width (0.5mm/step)	[-20 to 20/-3/1 step]
	This SP is used to eliminate shadows that may appear at the trailing edge of copies.	

6007	ADF Input Check	D0704/D075
1	ADF Group 1	[0 to 0xFF/0]
2	ADF Group 2	
3	ADF Group 3	
	<p>Open SP mode SP6007.</p> <ol style="list-style-type: none"> Select the SP number that corresponds to the component you wish to check. (Refer to the table below.) Press On then press Off to test the selected item. You cannot exit and close this display until you click Off to switch off the output check currently executing. 	
	Description	Reading
		0 1

1	Original Tray B5 Detect Sensor	No paper	Paper detected
2	Original Tray A4 Detect Sensor	No paper	Paper detected
3	Original Tray LG Detect Sensor	No paper	Paper detected
4	Original Width Sensor 1	No paper	Paper detected
5	Original Width Sensor 2	No paper	Paper detected
6	Original Width Sensor 3	No paper	Paper detected
7	Original Width Sensor 4	No paper	Paper detected
8	Original Width Sensor 5	No paper	Paper detected
9	Original Set Sensor	No paper	Paper detected
10	Separation Sensor	No paper	Paper detected
11	Skew Correction Sensor	No paper	Paper detected
12	Entrance Sensor	No paper	Paper detected
13	Registration Sensor	No paper	Paper detected
14	Exit Sensor	No paper	Paper detected
15	Cover Sensor	Open	Close
16	ADF Position Sensor	Open	Close
18	Pick-up Roller HP Sensor	Not HP	HP
20	APS Start Sensor	Not Start	Start
21	Bottom Plate HP Sensor	Not HP	HP
22	Bottom Plate Position Sensor	Incorrect Position	Correct Position

6008	Output Check	D0704/D075	
	Turns on the selected ARDF motor (forward or reverse) or solenoid. You will hear a motor running, or you will a solenoid click. This confirms that the motor or solenoid is operating correctly.		
1	ADF Feed Motor (Fwd)	[0 to 1/0/1]	
2	ADF Feed Motor (Rev)		

3	ADF Transport Motor (Fwd)	
4	ADF Exit Motor (Fwd)	
5	ADF Upper Inverter Motor (Fwd)	
6	ADF Upper Inverter Motor (Rev)	
7	ADF Lower Inverter Motor (Fwd)	
8	ADF Lower Inverter Motor (Rev)	
9	ADF Pick-up Motor (Fwd)	
10	ADF Bottom Plate Lift Motor (Fwd)	
11	ADF Upper Inverter SOL	
12	ADF Lower Inverter SOL	

6009	ADF Free Run	D0704/D075
	This SP does an ADF free run in duplex original mode.	
1	Simplex	[0 to 1/0/1]
2	Duplex	

6016	ADF Priority Org Size Setting	D0704/D075
	ADF Original Size Detection Priority. Allows selection of alternate settings for automatic original size detection.	
	[0 to 255/0/1]	

6017	ADF Adjust	D0704/D075
	Adjusts magnification for the ARDF by changing scanning speed.	
	[-1 to 1/0/0.1%]	

6020	ADF Adjust	D0704/D075
------	------------	------------

	<p>If the original is small (B6, A5, HLT), the delay sensor detects the leading edge of the sheet and delays the original at the entrance roller for the prescribed number of pulses to buckle the leading edge and correct skew.</p> <p>[0 to 1/1]</p> <p>0: Delay skew correction only for small originals</p> <p>1: Delay skew correction for all originals, regardless of size. (May reduce the scanning speed of the ADF)</p>
	[0 to 1/0/1] 0:Buckle Correction OFF 1:Buckle Correction ON

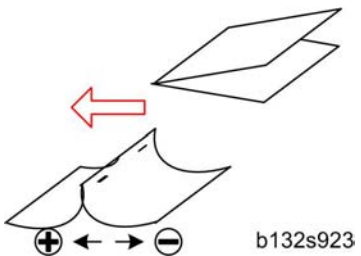
6200	Adjust Booklet Staple Position	
	This SP corrects the stapling position of the booklet stapler when paper is staple and folded by the Booklet Finisher (D513)..	
1	A3 SEF	[-2 to 2/0/0.2 mm]
2	B4 SEF	
3	A4 SEF	
4	B5 SEF	
5	12x18	
6	13x19	
7	DLT SEF	
8	LG SEF	
9	LT SEF	
11	Other	

6201	Adjust Booklet Fold Position	
	This SP corrects the folding position when paper is stapled and folded by the Booklet Finisher (D513)	
1	A3 SEF	<p>[-2 to 2/0/0.2 mm]</p> <p>+ : Shifts staple position toward crease</p> <p>- : Shifts staple position away from crease.</p>

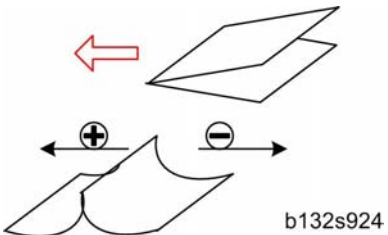
2	B4 SEF	
3	A4 SEF	
4	B5 SEF	
5	12x18	
6	13x19	
7	DLT SEF	
8	LG SEF	
9	LT SEF	
11	Other	

2

6202	Fine Adj Booklet Jogger Fence Position	
	This SP adjusts the distance between the jogger fences and the sides of the stack on the finisher stapling tray in the Booklet Finisher. The adjustment is done perpendicular to the direction of paper feed.	
1	A3 SEF	[-0.5 to 0.5/0/0.1 mm] + : Shifts staple position toward crease - : Shifts staple position away from crease.
2	B4 SEF	
3	A4 SEF	
4	B5 SEF	
5	12x18	
6	13x19	
7	DLT SEF	
8	LG SEF	
9	LT SEF	
11	Other	

6203	Set Number of Folds for Book
------	------------------------------

	<p>This SP sets the number of times the folding rollers are driven forward and reverse to sharpen the crease of a folded booklet before it exits the folding unit. When set at the default (0):</p> <ul style="list-style-type: none"> • The folding blade pushes the center of the stack into the nip of the folding roller. • The folding rollers rotated ccw to crease the booklet, reverse cw, then rotate ccw again crease the booklet fold twice before feeding to the folding unit exit rollers.
	[-1 to 9/0/ step]

6205	Booklet Stapler Jog Pawl Adjust	
1	A3 SEF	[-3 to 3/0/0.2 mm]
2	B4 SEF	
3	A4 SEF	
4	B5 SEF	
5	12x18	
6	13x19	
7	DLT SEF	
8	LG SEF	
9	LT SEF	
11	Other	

6208	Staple Position Adjustment	
1	A3 SEF	[-1 to 1/0/0.5 mm] + : Shifts staple position toward crease - : Shifts staple position away from crease.
2	B4 SEF	
3	A4 SEF	
4	A4 LEF	
5	B5 SEF	
6	B5 LEF	

7	DLT SEF	
8	LG SEF	
9	LT SEF	
10	LT LEF	
11	8-Kai SEF	
12	16-Kai SEF	
13	16-Kai LEF	
14	Other	

6209	Punch Position Adjustment : Sub Scan	
	Adjusts the punch hole positions in the direction of paper feed.	
1	2-Hole EU/JPN	[-3.5 to 3.5/0/0.5 mm]
2	3-Hole NA	
3	4-Hole EU	
4	4-Hole Scandinavia	
5	2-Hole Scandinavia	

6210	Punch Position Adjustment : Main Scan	
	This SP adjusts the punch position (front-to-back) in the main scan direction.	
1	2-Hole EU/JPN	[-3 to 3/0/0.5 mm]
2	3-Hole NA	
3	4-Hole EU	
4	4-Hole Scandinavia	
5	2-Hole NA	

6211	End Bind Jogger Adjustment	
1	A3 SEF	[-1 to 1/0/0.5 mm]

2	B4 SEF	
3	A4 SEF	
4	A4 LEF	
5	B5 SEF	
6	B5 LEF	
7	DLT SEF	
8	LG SEF	
9	LT SEF	
10	LT LEF	
11	8-Kai SEF	
12	16-Kai SEF	
13	16-Kai LEF	
14	Other	

6212	Adjust Output Jog Position	
	This SP corrects the distance between the output jogger fences and the sides of the stack when the output jogger unit attached to the side of the machine jogs sheets as they exit the finisher.	
1	A3 SEF	[0 to 2/2/0.1 mm]
2	B4 SEF	
3	A4 SEF	[0 to 5/5/0.1 mm]
4	A4 LEF	
5	A5 SEF	
6	A5 LEF	
7	B5 SEF	[0 to 2/2/0.1 mm]
8	B5 LEF	
9	DLT SEF	[0 to 5/5/0.1 mm]

10	LG SEF	
11	LT SEF	[0 to 2/2/0.1 mm]
12	LT LEF	[0 to 5/5/0.1 mm]
13	HLT SEF	
14	HLT LEF	

6213	Pre Stack Adjustment	
	<p>This SP sets the number of sheets sent to the pre-stack tray. With this SP set to the default: Normally with standard paper sizes 5 sheets are sent to the pre-stack tray. When the 6th sheet feeds, the 6th sheet and 5 sheets from the pre-stack tray are sent to the stapling tray together.</p> <p>Note:</p> <ul style="list-style-type: none"> You may need to adjust this setting or switch it off when feeding thick or slick paper. In the settings below "mai" means "sheets". 	
1	A3 SEF	[0 to 2/2/1 mai]
2	B4 SEF	
3	A4 SEF	[0 to 5/5/1 mai]
4	A4 LEF	
5	B5 SEF	
6	B5 LEF	
7	DLT SEF	[0 to 2/2/1 mai]
8	LG SEF	
9	LT SEF	[0 to 5/5/1 mai]
10	LT LEF	
11	8-Kai SEF	[0 to 2/2/1 mai]
12	16-Kai SEF	[0 to 5/5/1 mai]
13	16-Kai LEF	
14	Other	

6214	Adj Leading Edge Stopper Press	
1	A3 SEF	[-2.5 to 2.5/0/0.5 mm]
2	B4 SEF	
3	A4 SEF	
4	A4 LEF	
5	B5 SEF	
6	B5 LEF	
7	DLT SEF	
8	LG SEF	
9	LT SEF	
10	LT LEF	
11	8-Kai SEF	
12	16-Kai SEF	
13	16-Kai LEF	
15	Other	

6215	Staple Jogging Repeat Setting	
	Touch [1:+1 Time] to have the jogger fences press against the sides of the stack on the staple tray one more time to align the stack for corner stapling. [0:Default] [1:+1 Time]	

6216	Staple Tray Jog Off/On	
	[0 to 6/0/1] 0:Yes, 1:No, 2:-10, 3:-5, 4:+5, 5:+10	

6218	Finisher Input Check	
	[0 to 1/0/1]	
1	Finisher Entrance Sensor	

2	Pre-stack Paper Sensor
3	Pre-stack Roller HP Sensor
4	Proof Tray JG HP Sensor
5	Stack JG HP Sensor
6	Proof Tray Exit Sensor
7	Proof Tray Full Sensor
8	Punch Vertical Registration Sn
9	Punch Side-to-Side Regist Sn
10	Punch Blade HP Sensor
11	Punch Unit HP Sensor
12	Punch Switch
13	Punch Hopper Full Sensor
14	Punch Set Sensor
15	Stack Plate HP Sensor: Front
16	Stack Plate HP Sensor: Center
17	Stack Plate HP Sensor: Rear
18	Corner Stapler HP Sensor
19	Stapler Rotation HP Sn: Front
20	Stapler Rotation HP Sn: Rear
21	Bottom Fence HP Sensor
22	Jogger Fence HP Sensor: Front
23	Jogger Fence HP Sensor: Rear
24	Positioning Roller HP Sensor
25	Top Fence HP Sensor
26	Stack Feed-out Belt HP Sensor
27	Stapling Tray Paper Sensor

28	Corner Stapler HP Sensor
29	Staple End Sensor
30	Self-Limit Sensor
31	Stpl Trimmings Hopper Set Sn
32	Stpl Trimmings Hopper Full Sn
33	Stapling Tray Entrance Sensor
34	Stack Transport Unit HP Sensor
35	Stack JG HP Sensor
36	Bklet Top Fence HP Sensor
37	Bklet Stplr Clamp Roller HP Sn
38	Fold Plate Cam HP Sensor
39	Fold Plate HP Sensor
40	Bklet Side Fence HP Sn: Front
41	Bklet Side Fence HP Sn: Rear
42	Bklet Stplr Bottom Fence HP Sn
43	Fold Unit Entrance Sensor
44	Bklet Stapler Exit Sensor
45	Bklet Stapler HP Sensor
46	Bklet Stplr Stpl End Sn: Front
47	Bklet Stplr Stpl End Sn: Rear
48	Bklet Tray Full Sensor Upper
49	Bklet Tray Full Sensor Lower
50	Shift Tray Exit Sensor: Long
51	Shift Tray Exit Sensor: Short
52	Exit Guide HP Sensor
53	Drag Roller HP Sensor

54	Shift Tray Upper Limit Switch
55	Shift Tray HP Sensor: Front
56	Shift Tray HP Sensor: Rear
57	Paper Height Sensor: Staple
58	Paper Height Sensor: Shift
59	Paper Height Sensor: Z-Fold
60	Paper Height Sensor: TE
61	Shift Tray Full Sensor: 2500
62	Shift Tray Full Sensor: 1500
63	Shift Tray Full Sensor: 1000
64	Shift Tray Full Sensor: 500
65	Shift Tray Emergency Stop Sw
66	Shift Tray Jogger HP Sensor
67	Shift Jog Fence Retract HP Sn
68	Shift Tray Jogger HP Sensor
69	Front Door Switch
70	Punch Type 1
71	Punch Type 2
72	Staple Tray Set Sensor
73	Sub Board Set Sensor
74	Reserved

6219	Finisher Output Check
	[0 to 1/0/1]
1	Entrance Motor
2	Registration Motor

3	Proof Tray Vertical Trans Mt	
4	Pre-stack Release Motor	
5	Pre-stack Motor	
6	Shift JG Motor	
7	Stapler JG Motor	
8	Proof Tray Exit Motor	
9	Horizontal Transport Motor	
10	Punch Movement Motor	
11	Punch Switch Motor	
12	Punch Drive Motor	
13	Stapling Tray Entrance Motor	
14	Stack Plate Motor: Front	
15	Stack Plate Motor: Center	
16	Stack Plate Motor: Rear	
17	Punch S-to-S Regist: CIS Lamp	
18	Stapler Rotation Motor	
19	Stapler Movement Motor	
20	Bottom Fence Lift Motor	
21	Front Jogger Fence Motor	
22	Rear Jogger Fence Motor	
23	Positioning Roller Rotation Mt	
24	Positioning Roller Motor	
25	Stack Feed-out Belt Motor	
26	Top Fence Motor	
27	Shutter Solenoid	
28	Booklet Stapler Motor	

29	Stack Transport Motor	
30	Stack JG Motor	
31	Stack Transport Motor	
32	Reserved	
33	Bklet Stplr Clamp Roller Motor	
34	Bklet Stplr Bottom Fence Motor	
35	Bklet Stplr Side Fence Motor	
36	Bklet Stplr Top Fence Motor	
37	Bklet Stplr Mt	
38	Fold Roller Motor	
39	Fold Plate Motor	
40	Shift Tray Exit Motor	
41	Shift Motor	
42	Drag Drive Motor	
43	Drag Roller Motor	
44	Exit Guide Motor	
45	Shift Tray Lift Motor	
46	Shift Tray Jogger Fence Motor	
47	Shift Tray Jog Fence Retra Mt	

6220	Finisher Free Run 1	
	Packing Mode	[0 to 1/0/1]

6221	Punch Skew Correction	
	Skew Correction(0:On, 1:Off)	[0 to 1/0/1]

6222	Registration Buckle Adjustment	
------	--------------------------------	--

1	A4 LEF	[-2 to 2/0/0.5 mm]
2	A5 SEF	
3	A5 LEF	
4	B5 LEF	
5	LT LEF	
6	HLT SEF	
7	HLT LEF	
8	Other	

6223	Exit Guide Plate Close Timing Adj
	[0 to 1/0/1] 0:Default 1:Thin Paper

6224	Exit Paper Tray Lowering Adj
	[0 to 2/0/1] 0: Default 1: Thin Paper 2: Thick Paper

6309	Input Check: Folder	
1	Entrance Sensor	[0 to 1/0/1]
2	Entrance JG HP Sensor	
4	Registration Sensor	
5	Dynamic Roller HP Sensor	
6	Registration Roller HP Sensor	
7	Fold Plate HP Sensor	
8	Jogger Fence HP Sensor	
10	1st Stopper Paper Sensor	
11	1st Stopper HP Sensor	

12	2nd Stopper Paper Sensor	
13	2nd Stopper HP Sensor	
14	3rd Stopper Paper Sensor	
15	3rd Stopper HP Sensor	
16	Direct-Send JG HP Sensor	
17	FM6 Pawl HP Sensor	
18	Top Tray Paper Path Sensor	
19	Top Tray Exit Sensor	
20	Horizontal Path Exit Sensor	
21	Top Tray Full Sensor (E)	
23	Front Door Switch (SW1)	
24	Horizontal Path Paper Sensor	
25	Vertical Path Paper Sensor	
26	Bypass Entrance Paper Sensor	
27	Bypass Exit Paper Sensor	

6310	Output Check: Folder	
1	Horizontal Transport Motor	[0 to 1/0/1]
2	Top Tray Transport Motor	
3	Top Tray Exit Motor	
4	Dynamic Roller Transport Motor	
5	Registration Roller Transport Motor	
7	Entrance JG Motor	
8	1st Stopper Motor	
9	2nd Stopper Motor	
10	3rd Stopper Motor	

11	Dynamic Roller Lift Motor	
12	Registration Roller Release Motor	
13	Fold Plate Motor	
14	Jogger Fence Motor	
16	Direct-Send JG Motor	
17	FM6 Pawl Motor	
18	1st Fold Motor	
19	2nd Fold Motor	
20	Crease Motor	
21	Bypass JG Solenoid	
22	Exit JG Solenoid	
23	Top Tray JG Solenoid	
24	LE Stop Pawl Solenoid	
25	Reverse JG Solenoid	
26	Horizontal Exit Motor	

6311	Folder Free Run (D521)	
1	Free Run 1	
		System free run. A4 LEF at 90 ppm, with simulated staple mode.
2	Free Run 2	
		Free run for durability testing. All motors and solenoids operate to simulate full staple mode run for durability testing.
3	Free Run 3	
		Shipping free run. Simulates standby conditions during shipping.
4	Free Run 4	
		Shift free run. A4 LEF at 90 ppm with simulated output jogging with the shift jogger unit mounted on the side of the finisher.

6324	Jogger Fence Position Adjust (D521)	
1	A3 SEF	[-2 to 2/0/0.5 mm]
2	B4 SEF	
3	A4 SEF	
4	DLT SEF	
5	LG SEF	
6	LT SEF	
7	12x18	
8	8-Kai	
9	B5T	
19	Other	

6325	Registration Buckle Adjust (D521)	
1	A3 SEF	[-4 to 2/0/1 mm]
2	B4 SEF	
3	A4 SEF	
4	DLT SEF	
5	LG SEF	
6	LT SEF	
7	12x18	
8	8-Kai	
9	B5T	
19	Other	

6326	Registration Buckle Adjust Select (D521)	
------	--	--

	[0 to 1/0/1] 0: Buckle Control ON 1: Buckle Control OFF
--	---

2

6400	Cvr Inserter Input Check	
1	1st Paper Feed Sensor	[0 to 1/0/1]
2	2nd Paper Feed Sensor	
3	1st Transport Roller	
4	2nd Transport Roller	
5	1st Vertical Transport Sensor	
6	2nd Vertical Transport Sensor	
7	Output Sensor	
8	Entrance Sensor	
9	Exit Sensor	
10	1st Pick-up Roller HP Sensor	
11	2nd Pick-up Roller HP Sensor	
12	1st Upper Limit Sensor	
13	2nd Upper Limit Sensor	
14	1st Lower Limit Sensor	
15	2nd Lower Limit Sensor	
16	1st Paper Near End Sensor	
17	2nd Paper Near End Sensor	
18	1st Paper End Sensor	
19	2nd Paper End Sensor	
20	1st Paper Length Sensor	
21	2nd Paper Length Sensor	

22	1st Paper Width Sensor 1	
23	1st Paper Width Sensor 2	
24	1st Paper Width Sensor 3	
25	1st Paper Width Sensor 4	
26	1st Paper Width Sensor 5	
27	2nd Paper Width Sensor 1	
28	2nd Paper Width Sensor 2	
29	2nd Paper Width Sensor 3	
30	2nd Paper Width Sensor 4	
31	2nd Paper Width Sensor 5	
32	1st Feed Cover Sensor	
33	2nd Feed Cover Sensor	
34	Cover Vertical Transport Switch	
35	Front Door Open Switch	

6401	Cvr Inserter Output Check	
1	OFF (Stop)	[0 to 1/0/1]
2	1st Pick-up Motor	
3	2nd Pick-up Motor	
4	1st Paper Feed Motor	
5	2nd Paper Feed Motor	
6	1st Transport Motor	
7	2nd Transport Motor	
8	Vertical Transport Motor	
9	Horizontal Transport Motor	

6500	Punch Adjustment	
------	------------------	--

1	A4 LEF	[-2 to 2/0/0.1 mm]
2	LT LEF	

6501	Paddle Pos Adjustment (D519)	
	[-3 to 3/0/0.1 mm]	

6502	Adj Binding Position 1 (D519)	
1	A4 LEF	[-2 to 2/0/0.1 mm]
2	LT LEF	

6503	Adj Binding Position 2 (D519)	
1	A4 LEF	[-2 to 2/0/0.1 mm]
2	LT LEF	

6504	Adj Jog: Punching (D519)	
1	A4 LEF	[-4 to 4/0/0.1 mm]
2	LT LEF	

6505	Adj Jog: Paddle (D519)	
	[-3 to 3/0/0.1 mm]	

6506	Adj Jog: Binding 1 (D519)	
1	A4 LEF	[-2 to 2/0/0.1mm]
2	LT LEF	

6507	Adj Jog: Binding 2 (D519)	
1	A4 LEF	[-2 to 2/0/0.1mm]
2	LT LEF	

6508	Input Check: Ring Binder (D519)	
1	Entrance Sensor	[0 to 1/0/1]
2	Transport Sensor	
3	Exit Sensor	
4	Punch Process Reference Sensor	
5	Binder Delivery Base Sensor	
6	Path JG HP Sensor	
7	Paper Jog HP Sensor	
8	Jog Roller Lift HP Sensor	
9	Punch HP Sensor	
10	Punch Encoder Sensor	
11	Unit Detect Sensor	
12	Punch Size A4/LT Sensor	
13	Punch Type Sensor	
14	Full Sensor	
15	Punchout Box Sensor	
16	Output Belt 1 HP Sensor	
17	Output Belt 2 HP Sensor	
18	Output Belt Rotation HP Sensor	
19	Output Unit Entrance Sensor	
20	Booklet Pass Sensor	
21	Stack HP Sensor	
22	Stack Height Sensor 1	
24	Stacker Paper Detect Sensor	
25	Tray Detect Sensor	
26	Obstacle Detect Sensor	

27	Book Position Sensor	
28	Binder Unit Sensor	
29	Width Align HP Sensor 1	
30	Paddle Roller HP Sensor	
31	Clamp HP Sensor	
32	Alignment Pin HP Sensor	
33	Shutter HP Sensor	
34	50-Sheet Detect Sensor	
35	Paper Thickness Sensor	
37	Paper LE Detect Sensor	
38	Alignment Pin Top Edge Sensor	
39	Width Align HP Sensor 2	
40	De-curler Motor HP Sensor	
41	Shutter Motor HP Sensor	
42	Roller Lift Motor HP Sensor	
43	Binder HP Sensor	
44	Bind Timing Sensor	
45	Ring Replace HP Sensor	
46	Ring Replace Timing Sensor	
47	Ring Supply Detect Sensor	
48	Cartridge Reversed Sensor	
49	Ring Near-End Sensor	
50	Ring 50/100 Sensor	
51	Ring A4/LT Sensor	

6509	Output Check: Ring Binder (D519)
------	----------------------------------

1	Entrance Motor	[0 to 1/0/1]
2	Transport Motor	
3	Exit Motor	
4	Path JG Motor	
5	Jog Roller Motor	
6	Side Jogger Motor	
7	After-Punch Output Motor	
8	Jog Roller Lift Motor	
9	Hole Clear Motor	
10	Top Fence SOL	
11	Output Belt 1 Motor	
12	Output Belt 2 Motor	
13	Output Belt Rotation Motor	
14	Output Tray Lift Motor	
15	De-curler Motor	
16	Shutter Motor	
17	Paddle Roller Motor	
18	Alignment Pin Motor	
19	Paddle Roller Lift Motor	
20	Width Align Motor 1	
21	Clamp Motor	
22	Width Align Motor 2	
23	Roller Motor	
24	Roller Lift Motor	
25	Main Lift Motor	
26	50/100 Adjustment Motor	

6600	Stacker Input Check (D515)	
1	Entrance Sensor	[0 to 1/0/1]
2	Shift Tray Exit Sensor	
3	Proof Tray Exit Sensor	
4	Exit Sensor	
5	Transport Sensor	
6	Proof Tray Full Sensor	
7	Shift Tray JG HP Sensor	
8	Proof Tray JG HP Sensor	
9	Shift Roller HP Sensor	
11	Front Jogger Fence HP Sensor	
12	Rear Jogger Fence HP Sensor	
13	Jog Fence Retraction HP Sensor	
14	LE Stopper HP Sensor	
15	Paper Height Sensor	
16	Shift Tray Paper Sensor	
17	Tray Full Sensor 1: 25%	
18	Tray Full Sensor 2: 50%	
19	Tray Full Sensor 3: 75%	
20	Tray Full Sensor 4: 100%	
21	Tray Low Limit Sensor	
22	Roll Away Cart Set SW	
23	Tray Guard Sensor 1	
24	Tray Guard Sensor 2	
25	Sub Jogger HP Sensor	
26	Down Button	

27	Jam Button	
28	Top Door SW	
29	Front Door SW	

6601	Stacker Output Check (D515)	
1	Stop	[0 to 1/0/1]
2	Entrance Motor	
3	Proof Tray Exit Motor	
4	Shift Exit Motor	
5	Transport Motor	
6	Shift JG Motor	
7	Proof Tray JG Motor	
8	Shift Motor	
9	Front Jogger Fence Motor	
10	Rear Jogger Fence Motor	
11	Jogger Fence Retraction Motor	
13	LE Stopper Motor	
14	Sub Jogger Motor	
15	Tray Lift Motor	
16	Front Door Lock SOL	
17	Fan Motor	
18	Tray Full LED	
19	Jog In Progress LED	
20	Tray Lift LED	
21	Error LED	

6602	Jog Fence Adjust: Stacker (D515)	
------	----------------------------------	--

1	A3 SEF	[-2 to 2/0/0.1 mm]
2	B4 SEF	
3	A4 SEF	
4	A4 LEF	
5	A5 SEF	
6	A5 LEF	
7	B5 SEF	
8	B5 LEF	
9	DLT SEF	
10	LG SEF	
11	LT SEF	
12	LT LEF	
13	HLT SEF	
14	HLT LEF	
15	Other	

6603	LE Stopper Adjust: Stacker (D515)	
1	A3 SEF	[-2 to 2/0/0.1 mm]
2	B4 SEF	
3	A4 SEF	
4	A4 LEF	
5	A5 SEF	
6	A5 LEF	
7	B5 SEF	
8	B5 LEF	
9	DLT SEF	

10	LG SEF	
11	LT SEF	
12	LT LEF	
13	HLT SEF	
14	HLT LEF	
15	Other	

6604	SubJog Fence Adjust: Stacker (D515)	
1	A3 SEF	[-2 to 2/0/0.1 mm]
2	B4 SEF	
9	DLT SEF	
10	LG SEF	
15	Other	

6612	Stacker Fan Setting	
	[0 to 1/0/1] 0:ON 1:OFF	

6650	SHINJIKO Input Check	Trimmer Unit TR5040 (D520)
1	Entrance Sensor	[0 to 1/0/1]
2	Stopper Sensor	
3	Exit Sensor	
4	Booklet Sensor 1	
5	Booklet Sensor 2	
6	Booklet Sensor 3	
7	Trimming Blade HP Sensor	
8	Cut Posion HP Sensor	
9	Press Roller HP Sensor	

10	Press Stopper HP Sensor	
11	Scrap Hopper Full HP Sensor	
12	Scrap Hopper HP Sensor	
13	Door Switch	

6651	SHINJIKO Output Check	Trimmer Unit TR5040 (D520)
1	Entrance Motor	[0 to 1/0/1]
2	Exit Motor	
3	Press Roller Motor	
4	Cut Position Motor	
5	Press Stopper Motor	
6	Tray Motor	
7	Trimming Blade Motor	

6721	Adjust Booklet Staple Position (D512)	
1	A3 SEF	[-1 to 1 / 0 / 0.2 mm]
2	B4 SEF	
3	A4 SEF	
4	B5 SEF	
5	12x18	
6	13x19	
7	DLT	
8	LG	
9	LT SEF	
10	Other	

6722	Adjust Booklet Fold Position (D512)	
------	-------------------------------------	--

1	A3 SEF	[-1 to 1 / 0 / 0.2 mm]
2	B4 SEF	
3	A4 SEF	
4	B5 SEF	
5	12x18	
6	13x19	
7	DLT	
8	LG	
9	LT SEF	
10	Other	

6723	Adjust Staple Position (D512/D513)	
1	A3 SEF	[-1 to 1 / 0 / 0.5 mm]
2	B4 SEF	
3	A4 SEF	
4	A4 LEF	
5	B5 SEF	
6	B5 LEF	
7	DLT	
8	LG	
9	LT SEF	
10	LT LEF	
11	8kai SEF	
12	16kai SEF	
13	16kai LEF	
14	Other	

6724	Adj Punch Posi Sub Scan (D512/D513)	
1	2-Hole EU/JPN	[-4 to 4 / 0 / 0.5 mm]
2	3-Hole NA	
3	4-Hole EU	
4	4-Hole Scandinavia	
5	2-Hole NA	

6725	Adj Punch Posi Main Scan (D512/D513)	
1	2-Hole EU/JPN	[-2 to 2 / 0 / 0.5 mm]
2	3-Hole NA	
3	4-Hole EU	
4	4-Hole Scandinavia	
5	2-Hole NA	

6726	Fine Adj Booklet Jogger Fence Position (D512)	
1	A3 SEF	[-0.5 to 0.5 / 0 / 0.1 mm]
2	B4 SEF	
3	A4 SEF	
4	B5 SEF	
5	12x18	
6	13x19	
7	DLT	
8	LG	
9	LT SEF	
10	Other	

6728	Booklet Stapler Jog Pawl Adjust (D512)	
------	--	--

1	A3 SEF	[-2 to 2 / 0 / 0.2 mm]
2	B4 SEF	
3	A4 SEF	
4	B5 SEF	
5	12x18	
6	13x19	
7	DLT	
8	LG	
9	LT SEF	
10	Other	

6729	End Bin Jogger Adjustment (D512/D513)	
1	A3 SEF	[-1 to 1 / 0 / 0.5 mm]
2	B4 SEF	
3	A4 SEF	
4	A4 LEF	
5	B5 SEF	
6	B5 LEF	
7	DLT	
8	LG	
9	LT SEF	
10	LT LEF	
11	8kai SEF	
12	16kai SEF	
13	16kai LEF	
14	Other	

6730	Adjust Output Jog Position (D512/D513)	
1	A3 SEF	[-1 to 1 / 0 / 0.1 mm]
2	B4 SEF	
3	A4 SEF	
4	A4 LEF	
5	A5 SEF	
6	A5 LEF	
7	B5 SEF	
8	B5 LEF	
9	DLT	
10	LG	
11	LT SEF	
12	LT LEF	
13	HLT SEF	
14	HLT LEF	
15	Other	
6731	Adj Leading Edge Stopper Press (D512/D513)	

1	A3 SEF	[-2.5 to 2.5 / 0 / 0.5 mm]
2	B4 SEF	
3	A4 SEF	
4	A4 LEF	
5	B5 SEF	
6	B5 LEF	
7	DLT	
8	LG	
9	LT SEF	
10	LT LEF	
11	8kai SEF	
12	16kai SEF	
13	16kai LEF	
14	Other	

6733	Registration Buckle Adjustment (D512/D513)	
1	A4 LEF	[-1 to 1 / 0 / 0.5 mm]
2	A5 SEF	
3	A5 LEF	
4	B5 LEF	
5	LT LEF	
6	HLT SEF	
7	HLT LEF	
8	Other	

6740	Jog Position Adjust Stacker (D515)	
------	------------------------------------	--

2

1	A3 SEF	[-1 to 1 / 0 / 0.1 mm]
2	B4 SEF	
3	A4 SEF	
4	A4 LEF	
5	A5 SEF	
6	A5 LEF	
7	B5 SEF	
8	B5 LEF	
9	DLT	
10	LG	
11	LT SEF	
12	LT LEF	
13	HLT SEF	
14	HLT LEF	
15	Other	

6741	LE Stopper Adjust Stacker (D515)
------	----------------------------------

1	A3 SEF	[-1 to 1 / 0 / 0.1 mm]
2	B4 SEF	
3	A4 SEF	
4	A4 LEF	
5	A5 SEF	
6	A5 LEF	
7	B5 SEF	
8	B5 LEF	
9	DLT	
10	LG	
11	LT SEF	
12	LT LEF	
13	HLT SEF	
14	HLT LEF	
15	Other	

6742	Sub Jog Adjust Stacker (D515)	
1	A3 SEF	[-1 to 1 / 0 / 0.1 mm]
2	B4 SEF	
9	DLT	
10	LG	
15	Other	

6746	Stack Full Setting (D515)	
------	---------------------------	--

1	-	[0 to 3 / 0 / 1] 0:100% 1:75% 2:50% 3:25%
---	---	---

6752	FM2 Equal 1/2:FineAdjFld(D521)	
1 to 100	Custom Paper 001 to 100	[-4 to 4 / 0 / 0.2 mm]
101	A3 SEF	
102	B4 SEF	
103	A4 SEF	
104	DLT SEF	
105	LG SEF	
106	LT SEF	
107	12x18	
108	8kai	
109	B5 SEF	
110	13x19	
111	Other	

6753	FM3 Equal 3rds:Fine Adj 1st (D521)
------	------------------------------------

1 to 100	Custom Paper 001 to 100	[-4 to 4 / 0 / 0.2 mm]
101	B4 SEF	
102	A4 SEF	
103	LG SEF	
104	LT SEF	
107	B5 SEF	
108	Other	

6754	FM3 Equal 3rds:Fine Adj 2nd (D521)	
1 to 100	Custom Paper 001 to 100	[-4 to 4 / 0 / 0.2 mm]
101	B4 SEF	
102	A4 SEF	
103	LG SEF	
104	LT SEF	
107	B5 SEF	
108	Other	

6755	FM4 3rds 1 Flap:Fine Adj 1st (D521)	
------	-------------------------------------	--

1 to 100	Custom Paper 001 to 100	[-4 to 4 / 0 / 0.2 mm]
101	A3 SEF	
102	B4 SEF	
103	A4 SEF	
104	DLT SEF	
105	LG SEF	
106	LT SEF	
107	12x18	
108	8kai	
109	B5 SEF	
110	Other	

6756	FM4 3rds 1 Flap:Fine Adj 2nd (D521)	
1 to 100	Custom Paper 001 to 100	[-4 to 4 / 0 / 0.2 mm]
101	A3 SEF	
102	B4 SEF	
103	A4 SEF	
104	DLT SEF	
105	LG SEF	
106	LT SEF	
107	12x18	
108	8kai	
109	B5 SEF	
110	Other	

6762	Top Tray Full Set: Enable	
	[0 to 1 / 0 / 1]	

6763	Top Tray Full Set: Limit Output
	[0 to 250/0/1]

6800	Sheet Conversion DFU	CTL
	[1 to 3/3/1]	
	<p>This SP code enables punch operation in Z-fold mode. Normally punch operation is disabled in Z-fold mode, but this feature can be enabled by the service technician. The machine calculates one sheet of paper as three sheets of plain paper by default.</p> <p>[1 to 3 / 3 / 1]</p> <p>1: 1 sheet 2: 2 sheets 3: 3 sheets</p>	

6810	Ring Binding Thick Paper DFU	CTL
	<p>Selects the count type for binding the thick paper. The machine calculates one sheet of thick paper as three sheets of plain paper by default.</p> <p>[1 to 3 / 3 / 1]</p> <p>1: 1 sheet 2: 2 sheets 3: 3 sheets</p>	

6830	Extra Staples DFU	CTL
	<p>More than the standard number of corner staples can be loaded. This SP recognizes the maximum number of staples (This Setting + Standard Number).</p> <ul style="list-style-type: none"> • If the number of the maximum for staples is increased, and the mechanical warranty of the unit can be guaranteed, then the setting can take effect without changing the controller software. • However, assurance that mechanical performance can be guaranteed is required before changing the setting to increase the staple load for more than the maximum in the feed/exit specifications. Raising this setting without quality assurance could damage the machine. 	
1	<p>0 to 50 (Initial: 0) [0 to 50 / 0 / 1]</p>	

2	0 to 50 (Initial: 0) [0 to 50 / 0 / 1]
---	---

6890	Punch Function Enabled (Z-Fold)	CTL
	<p>Permission for punching thick (tab) paper is forbidden and it is up to the service technician to pass this on to the customer.</p> <p>[0 or 1 / 0 / -]</p> <p>0: Simultaneous use forbidden</p> <p>1: Simultaneous use allowed</p>	

6900	ADF Bottom Plate Lift Setting	D0704/D075
	<p>This SP setting determines whether the bottom plate lift motor of the of the ADF switches on when the original is set in the ADF original tray, or when the [Start] key is pressed.</p> <p>The ADF bottom plate lift motor raises the bottom plate that pushes up the original tray and raises it to the optimum feed position.</p> <p>[0 to 1 / 0 / 1]</p> <p>0: At Original Set</p> <p>1: At Start</p>	

Group 7000

7001	Engine Drive Distance Counter	
	[0 to 99 999 999/0/1 m]	

7401	Total SC Counter	CTL
	Displays the total number of SCs logged.	

7403	SC History	CTL
	Displays the latest 10 SC codes.	
1 to 10	Latest to Latest 9th	

7404	SC991 History	CTL
	Displays the most recent occurrences of SC991.	
1 to 10	Latest to Latest 9th	

7502	Total Paper Jam Counter	CTL
	Displays the total number of copy jams.	

7503	Total Original Jam Counter	CTL
	Displays the total number of copy jams.	

7504	Paper Jam Total by Location	CTL
1	At Power On	
3	1st Paper Feed Sensor: Late Error	
4	2nd Paper Feed Sensor: Late Error	
5	3rd Paper Feed Sensor: Late Error	
6	4th Paper Feed Sensor: Late Error	

7	5th Paper Feed Sensor: Late Error
8	6th Paper Feed Sensor: Late Error
9	1st Transport Sensor: Late Error
10	2nd Transport Sensor: Late Error
11	3rd Transport Sensor: Late Error
12	4th Transport Sensor: Late Error
13	5th Transport Sensor: Late Error
14	6th Transport Sensor: Late Error
15	Vertical Transport Sensor: Late Error
16	Bank Exit Sensor (Simplex): Late Error
17	Bank Exit Sensor (Duplex): Late Error
18	Main Relay Sensor 1: Late Error
19	Main Relay Sensor 2: Late Error
20	Main Relay Sensor 3: Late Error
21	3rd Vertical Trans Sn (Upper): Late Error
22	3rd Vertical Trans Sn (Lower): Late Error
23	4th Vertical Trans Sn: Late Error
24	5th Vertical Trans Sn: Late Error
25	LCT Exit Sensor: Late Error
26	LCT Relay Sensor 1: Late Error
27	LCT Relay Sensor 2: Late Error
28	Registration Sensor (Main): Late Error
29	Registration Sensor (LCT): Late Error
30	Paper Late Jam
31	Transfer Timing Sensor: Late Error
32	PTB Jam Sensor: Late Error

33	Fusing Exit Sensor: Late Error
34	Feed-out Entrance Sensor: Late Error
35	Exit Junction Gate Sensor: Late Error
36	Exit Sensor: Late Error
38	Exit Relay Sensor (2nd Pass) : Late Error
39	Exit Relay Sensor (Duplex) : Late Error
40	Duplex Invert Sn (1st Pass) : Late Error
41	Duplex Invert Sensor (2nd Pass): Late Error
42	Duplex Transport Sensor 1: Late Error
43	Duplex Transport Sensor 2: Late Error
44	Duplex Transport Sensor 3: Late Error
45	Duplex Transport Sensor 6: Late Error
46	Duplex Transport Sensor 7: Late Error
53	1st Paper Feed Sensor
54	2nd Paper Feed Sensor
55	4th Paper Feed Sensor
56	5th Paper Feed Sensor
57	6th Paper Feed Sensor
58	7th Paper Feed Sensor (LCT)
59	1st Transport Sensor: Lag Error
60	2nd Transport Sensor: Lag Error
61	3rd Transport Sensor: Lag Error
62	4th Transport Sensor: Lag Error
63	5th Transport Sensor: Lag Error
64	6th Transport Sensor: Lag Error
65	Vertical Transport Sensor: Lag Error

66	Bank Exit Sensor: Lag Error
68	Main Relay Sensor 1: Lag Error
69	Main Relay Sensor 2: Lag Error
70	Main Relay Sensor 3: Lag Error
71	3rd Vertical Trans Sn (Upper) : Lag Error
72	3rd Vertical Trans Sn (Lower) : Lag Error
73	4th Vertical Trans Sn: Lag Error
74	5th Vertical Trans Sn: Lag Error
75	LCT Exit Sensor: Lag Error
76	LCT Relay Sensor 1: Lag Error
77	LCT Relay Sensor 2: Lag Error
78	Registration Sensor: Lag Error
80	Sub Scan Registration Correction: Lag Error
81	Transfer Timing Sensor: Lag Error
82	PTB Jam Sensor: Lag Error
83	Fusing Exit Sensor: Lag Error
84	Feed-out Entrance Sensor: Lag Error
85	Exit Junction Gate Sensor: Lag Error
86	Exit Sensor: Lag Error
87	Exit Relay Sensor (1st Pass) : Lag Error
89	Exit Relay Sensor (Duplex) : Lag Error
90	Duplex Invert Sn (1st Pass): Lag Error
91	Duplex Invert Sn (2nd Pass): Lag Error
92	Duplex Transport Sensor 1: Lag Error
93	Duplex Transport Sensor 2: Lag Error
94	Duplex Transport Sensor 3: Lag Error

95	Duplex Transport Sensor 6: Lag Error
96	Duplex Transport Sensor 7: Lag Error
97	Over Skew
98	Over Shift
99	Double-Feed
101	Entrance: Late Error (D512/D513)
102	Entrance: Lag Error (D512/D513)
103	Proof Tray Exit: Late Error (D512/D513)
104	Proof Tray Exit: Lag Error (D512/D513)
105	Shift Tray Exit: Late Error (D512/D513)
106	Shift Tray Exit: Lag Error (D512/D513)
107	Staple Tray Exit: Late Error (D512/D513)
108	Staple Tray Exit: Lag Error (D512/D513)
109	Pre-Stack: Tray Late Error (D512/D513)
110	Pre-Stack: Tray Lag Error (D512/D513)
111	Output (D512/D513)
112	Booklet Stapler: Late Error (D512/D513)
113	Booklet Stapler: Lag Error (D512/D513)
114	Booklet Stapler Exit: Late Error (D512/D513)
115	Booklet Stapler Exit: Lag Error (D512/D513)
116	Paper Path (D512/D513)
117	Shift Tray Lift Drive Train (D512/D513)
118	Jogger Fence Drive Train (D512/D513)
119	Shift Drive Train (D512/D513)
120	Stapler Drive Train (D512/D513)
121	Stack Output Drive Train (D512/D513)

122	Punch Drive Train (D512/D513)
123	Jogger System (D512/D513)
124	Pre-Stacker Drive Train (D512/D513)
125	Booklet Path (D512/D513)
126	Booklet Stapling System (D512/D513)
127	Folding System (D512/D513)
128	For Debugging: Cause Unknown) (D512/D513)
129	Main Machine Setting Incorrect (D512/D513)
150	1st Feed Sensor: Late Error (D518)
151	1st Feed Sensor: Lag Error (D518)
152	2nd Feed Sensor: Late Error (D518)
153	2nd Feed Sensor: Lag Error (D518)
154	1st Transport Sensor: Late Error (D518)
155	1st Transport Sensor: Lag Error (D518)
156	2nd Transport Sensor: Late Error (D518)
157	2nd Transport Sensor: Lag Error (D518)
158	1st Ver. Transport Sn: Late Error (D518)
159	1st Ver. Transport Sn: Lag Error (D518)
160	2nd Ver. Transport Sn: Late Error (D518)
161	2nd Ver. Transport Sn: Lag Error (D518)
162	Vertical Exit Sensor: Late Error (D518)
163	Vertical Exit Sensor: Lag Error (D518)
164	Entrance Sensor: Late Error (D518)
165	Entrance Sensor: Lag Error (D518)
166	Interposer Exit Sensor: Late Error (D518)
167	Interposer Exit Sensor: Lag Error (D518)

168	1st Lift Motor Drive Train (D518)	
169	2nd Lift Motor Drive Train (D518)	
170	1st Pick-up Motor Drive Train (D518)	
171	2nd Pick-up Motor Drive Train (D518)	
198	Plockmatic Jam	
199	GBC Punch Unit Jam	
200	Entrance Sensor: Late Error (D520)	
201	Entrance Sensor: Lag Error (D520)	
202	Skew Sensor: Late Error (D520)	
203	Skew Sensor: Lag Error (D520)	
204	Exit Sensor: Late Error (D520)	
205	Exit Sensor: Lag Error (D520)	
206	Trimming Blade Motor Lock (D520)	
207	Cut Position Motor (D520)	
208	Press Roller (D520)	
209	Stopper/Press Roller (D520)	
210	Tray Motor (D520)	
250	Entrance: Late Jam (D521)	
251	Entrance: Lag Jam (D521)	
252	Top Tray Exit: Late Jam (D521)	
253	Top Tray Exit: Lag Jam (D521)	
254	Straight-Through Exit: Late Jam (D521)	
255	Straight-Through Exit: Lag Jam (D521)	
7505	Original Jam Total By Location	CTL
1	At Power On	

3	Separation Sn: Late
4	Skew Correction Sn: Late
5	Interval Sn: Late
6	Registration Sn: Lag
7	Exit Sn: Lag
8	Inverter Switch Sn: Lag
9	Low Inverter Sn: Lag
53	Separation Sn: Lag
54	Skew Correction Sn: Lag
55	Interval Sn: Lag
56	Registration Sn: Late
57	Exit Sn: Late
58	Inverter Switch Sn: Late
59	Low Inverter Sn: Late

7506	Jam Count by Paper Size	CTL
Displays the total number of jams by paper size.		
5	A4 LEF	
6	A5 LEF	
14	B5 LEF	
38	LT LEF	
44	HLT LEF	
132	A3 SEF	
133	A4 SEF	
134	A5 SEF	
141	B4 SEF	

142	B5 SEF	
160	DLT SEF	
164	LG SEF	
166	LT SEF	
172	HLT SEF	
255	Others	

7507	Plotter Jam History	
1	Latest	<p>Displays the following items for the last 10 copy paper jams:</p> <ol style="list-style-type: none"> 1) Jam code 2) Paper size 3) Total count when jam occurred 4) Date of jam. <p>The "jam codes" are listed in the SMC report under SP7504.</p>
2	Latest 1	
3	Latest 2	
4	Latest 3	
5	Latest 4	
6	Latest 5	
7	Latest 6	
8	Latest 7	
9	Latest 8	
10	Latest 9	

7508	Original Jam History	
------	----------------------	--

1	Original Latest	<p>Displays the following items for the Latest 10 original jams:</p> <p>1) Jam code</p> <p>2) Paper size</p> <p>3) Total count when jam occurred</p> <p>4) Date of jam.</p> <p>The "jam codes" are listed in the SMC report under SP7504.</p>
2	Latest 1	
3	Latest 2	
4	Latest 3	
5	Latest 4	
6	Latest 5	
7	Latest 6	
8	Latest 7	
9	Latest 8	
10	Latest 9	

7509	Paper Jam Total By Location
1	1st Stopper: Late Jam (D521)
2	1st Stopper: Lag Jam (D521)
3	2nd Stopper: Late Jam (D521)
4	2nd Stopper: Lag Jam (D521)
5	3rd Stopper: Late Jam (D521)
6	3rd Stopper: Lag Jam (D521)
7	Skew Correction Jam (D521)
8	Top Tray Transport Jam(D521)
9	Entrance/Top Tray JG Motor Error (D521)
10	Entrance/Fold JG Motor Error (D521)
11	1st Stopper Motor Error (D521)
12	2nd Stopper Motor Error (D521)
13	3rd Stopper Motor Error (D521)
14	Dynamic Roller Transport Motor Error (D521)

15	Registration Roller Release Motor Error (D521)
16	Fold Plate Motor Error (D521)
17	Jogger Fence Motor Jam (D521)
18	Positioning Roller Motor Jam (D521)
19	FM2 Direct Send JG Motor Jam (D521)
20	FM6 Pawl Motor (D521)
21	Main Machine Setting Incorrect for D521
45	Entrance Sensor: Late Error (D515)
46	Entrance Sensor: Lag Error (D515)
47	Proof Tray Exit: Late Error (D515)
48	Proof Tray Exit: Lag Error (D515)
49	Stack Tray Exit: Late Error (D515)
50	Stack Tray Exit Sensor: Lag Error (D515)
51	Transport Sensor: Lag Error (D515)
52	Transport Sensor: Late Error (D515)
53	Exit Sensor: Late Error (D515)
54	Exit Sensor: Lag Error (D515)
55	Shift JG Motor (D515)
56	Proof Tray JG Motor (D515)
57	Shift Roller Motor (D515)
58	Main Jogger Front Motor (D515)
59	Main Jogger Rear Motor (D515)
60	Main Jogger Fence Retraction (D515)
61	Main Jogger Fence Retraction (D515)
62	Sub Jogger Motor (D515)
63	LE Stopper Motor (D515)

64	Tray Lift Motor (D515)
65	Main Machine Setting Incorrect for D515
95	Entrance: Late Jam (D519)
96	Entrance: Lag Jam (D519)
97	Relay: Late Jam (D519)
98	Relay: Lag Jam (D519)
99	Exit: Late Error (D519)
100	Exit: Lag Error (D519)
101	Pre-punch Unit Jam (D519)
102	After Punch Unit Jam (D519)
103	Binder Unit TE Jam (D519)
104	Binder Unit LE Jam (D519)
105	Ring Jam: Wrong Ring Type (D519)
106	Binder Unit Jam (D519)
107	Output Belt 1 HP Jam (D519)
108	Output Belt 2 HP Jam (D519)
109	Stacker Jam (D519)
110	Punch Motor Jam (D519)
111	Shutter Motor Jam (D519)
112	Alignment Pin Motor Jam (D519)
113	Pre-Punch Jogger Jam (D519)
114	Alignment Pin Jam (D519)
115	Clamp Motor Jam (D519)
116	50/100 Clamp Adjust Motor Jam (D519)
117	Output Belt Rotation Motor Jam (D519)
118	Main Machine Setting Incorrect for D519

145	Relay Sensor 1: Late Error (D548)
146	Relay Sensor 1: Lag Error (D548)
147	Relay Sensor 2: Late Error (D548)
148	Relay Sensor 2: Lag Error (D548)
149	Relay Sensor 3: Late Error (D548)
150	Relay Sensor 3: Lag Error (D548)
151	Relay Sensor 4: Late Error (D548)
152	Relay Sensor 4: Lag Error (D548)
153	Relay Sensor 5: Late Error (D548)
154	Relay Sensor 5: Lag Error (D548)
155	Relay Sensor 6: Late Error (D548)
156	Relay Sensor 6: Lag Error (D548)
157	Relay Sensor 7: Late Error (D548)
158	Relay Sensor 7: Lag Error (D548)
159	Relay Sensor 8: Late Error (D548)
160	Relay Sensor 8: Lag Error (D548)
161	Main Machine Setting Incorrect for Fan Option
245	Finisher No Exiting Response

7617	Parts PM Counter Display	CTL
1	Normal	Japan Only
2	DF	Japan Only

7618	PM Parts Counter Reset (Japan Only)	CTL
1	Normal	
	Push [Execute] to clear the parts replacement alarm counter for the main machine.	
2	DF	

	Push [Execute] to clear the parts replacement alarm counter for the ADF.
--	--

2

7621	PM Counter
7622	Reset
7623	Standard Value
7624	Part Replacement Operation ON/OFF
1	#K_Development Unit
2	K_Developer
3	K_Dev Filter
4	#C_Development Unit
5	C_Developer
6	C_Dev Filter
7	#M_Development Unit
8	M_Developer
9	M_Dev Filter
10	#Y_Development Unit
11	Y_Developer
12	Y_Dev Filter
13	#K_Drum Cleaning Unit
14	K_Cleaning Blade
15	K_Lubricant Brush
16	K_Lubricant Bar
17	K_Lubricant Blade
18	K_Joint
19	K_Gears
20	#C_Drum Cleaning Unit

21	C_Cleaning Blade	
22	C_Lubricant Brush	
23	C_Lubricant Bar	
24	C_Lubricant Blade	
25	C_Joint	
26	C_Gears	
27	#M_Drum Cleaning Unit	
28	M_Cleaning Blade	
29	M_Lubricant Brush	
30	M_Lubricant Bar	
31	M_Lubricant Blade	
32	M_Joint	
33	M_Gears	
34	#Y_Drum Cleaning Unit	
35	Y_Cleaning Blade	
36	Y_Lubricant Brush	
37	Y_Lubricant Bar	
38	Y_Lubricant Blade	
39	Y_Joint	
40	Y_Gears	
41	#K_Charge Unit	
42	#C_Charge Unit	
43	#M_Charge Unit	
44	#Y_Charge Unit	
45	#K_Drum Unit	
46	K_Drum	

47	#C_Drum Unit	
48	C_Drum	
49	#M_Drum Unit	
50	M_Drum	
51	#Y_Drum Unit	
52	Y_Drum	
53	#Image Transfer Unit	
54	ITB	
55	#ITB Cleaning Unit	
56	ITB Cleaning Blade	
57	ITB Brush Roller	
58	ITB Lubricant Bar	
59	ITB Lubricant Blade	
60	#Paper Transfer Unit	
61	PTU Cleaning Blade	
62	PTU Lubricant Bar	
63	Separation PP	
64	PTR	
65	#Fusing Unit	
66	Fusing Belt	
67	Hot Roller	
68	Pressure Roller	
69	Pressure Roller Bearings	
70	#Fusing Cleaning Unit	
71	Cleaning Web	
72	Web Pressure Roller	

73	Web Roller Stopper	
74	#Main Unit Filters	
75	Dust Filter: Rear Upper Right	
76	Dust Filter: Rear Upper Left	
77	Dust Filter: Rear Lower Right	
78	Dust Filter: Rear Lower Left	
79	Dust Filter: Controller Box	
80	Ozone Filter 1	
81	Ozone Filter 2	
82	#ADF	
83	ADF Transport Belt	
84	ADF Feed Belt	
85	ADF Separation Roller	
86	ADF Pick-up Roller	
87	#1st Feed Rollers	
88	1st Pick-up Roller	
89	1st Feed Roller	
90	1st Separation Roller	
91	#2nd Feed Rollers	
92	2nd Pick-up Roller	
93	2nd Feed Roller	
94	2nd Separation Roller	
95	#3rd Feed Rollers	
96	3rd Pick-up Roller (D516)	
97	3rd Feed Roller (D516)	
98	3rd Separation Roller (D516)	

99	#4th Feed Rollers	
100	4th Pick-up Roller (D516)	
101	4th Feed Roller (D516)	
102	4th Separation Roller (D516)	
103	#5th Feed Rollers	
104	5th Pick-up Roller (D516)	
105	5th Feed Roller (D516)	
106	5th Separation Roller (D516)	
107	#6th Feed Rollers	
108	Bypass Pick-up Roller	
109	Bypass Feed Roller	
110	Bypass Reverse Roller	
111	#{D518) 1st Feed Rollers	
112	1st Pick-up Roller (D518)	
113	1st Feed Belt (D518)	
114	1st Reverse Roller (D518)	
115	#{D518) 2nd Feed Rollers	
116	2nd Pick-up Roller (D518)	
117	2nd Feed Belt (D518)	
118	2nd Reverse Roller (D518)	

7625	Pg Count History:Latest 1	
7626	Pg Count History: Latest 2	
1	#K_Development Unit	[0 to 99 999 999/0/1]
2	K_Developer	
3	K_Dev Filter	

4	#C_Development Unit	
5	C_Developer	
6	C_Dev Filter	
7	#M_Development Unit	
8	M_Developer	
9	M_Dev Filter	
10	#Y_Development Unit	
11	Y_Developer	
12	Y_Dev Filter	
13	#K_Drum Cleaning Unit	
14	K_Cleaning Blade	
15	K_Lubricant Brush	
16	K_Lubricant Bar	
17	K_Lubricant Blade	
18	K_Joint	
19	K_Gears	
20	#C_Drum Cleaning Unit	
21	C_Cleaning Blade	
22	C_Lubricant Brush	
23	C_Lubricant Bar	
24	C_Lubricant Blade	
25	C_Joint	
26	C_Gears	
27	#M_Drum Cleaning Unit	
28	M_Cleaning Blade	
29	M_Lubricant Brush	

30	M_Lubricant Bar	
31	M_Lubricant Blade	
32	M_Joint	
33	M_Gears	
34	#Y_Drum Cleaning Unit	
35	Y_Cleaning Blade	
36	Y_Lubricant Brush	
37	Y_Lubricant Bar	
38	Y_Lubricant Blade	
39	Y_Joint	
40	Y_Gears	
41	#K_Charge Unit	
42	#C_Charge Unit	
43	#M_Charge Unit	
44	#Y_Charge Unit	
45	#K_Drum Unit	
46	K_Drum	
47	#C_Drum Unit	
48	C_Drum	
49	#M_Drum Unit	
50	M_Drum	
51	#Y_Drum Unit	
52	Y_Drum	
53	#Image Transfer Unit	
54	ITB	
55	#ITB Cleaning Unit	

56	ITB Cleaning Blade	
57	ITB Brush Roller	
58	ITB Lubricant Bar	
59	ITB Lubricant Blade	
60	#Paper Transfer Unit	
61	PTU Cleaning Blade	
62	PTU Lubricant Bar	
63	Separation PP	
64	PTR	
65	#Fusing Unit	
66	Fusing Belt	
67	Hot Roller	
68	Pressure Roller	
69	Pressure Roller Bearings	
70	#Fusing Cleaning Unit	
71	Cleaning Web	
72	Web Pressure Roller	
73	Web Roller Stopper	
74	#Main Unit Filters	
75	Dust Filter: Rear Upper Right	
76	Dust Filter: Rear Upper Left	
77	Dust Filter: Rear Lower Right	
78	Dust Filter: Rear Lower Left	
79	Dust Filter: Controller Box	
80	Ozone Filter 1	
81	Ozone Filter 2	

82	#ADF	
83	ADF Transport Belt	
84	ADF Feed Belt	
85	ADF Separation Roller	
86	ADF Pick-up Roller	
87	#1st Feed Rollers	
88	1st Pick-up Roller	
89	1st Feed Roller	
90	1st Separation Roller	
91	#2nd Feed Rollers	
92	2nd Pick-up Roller	
93	2nd Feed Roller	
94	2nd Separation Roller	
95	#3rd Feed Rollers	
96	3rd Pick-up Roller (D516)	
97	3rd Feed Roller (D516)	
98	3rd Separation Roller (D516)	
99	#4th Feed Rollers	
100	4th Pick-up Roller (D516)	
101	4th Feed Roller (D516)	
102	4th Separation Roller (D516)	
103	#5th Feed Rollers	
104	5th Pick-up Roller (D516)	
105	5th Feed Roller (D516)	
106	5th Separation Roller (D516)	
107	#6th Feed Rollers	

108	Bypass Pick-up Roller	
109	Bypass Feed Roller	
110	Bypass Reverse Roller	
111	#(D518) 1st Feed Rollers	
112	1st Pick-up Roller (D518)	
113	1st Feed Belt (D518)	
114	1st Reverse Roller (D518)	
115	#(D518) 2nd Feed Rollers	
116	2nd Pick-up Roller (D518)	
117	2nd Feed Belt (D518)	
118	2nd Reverse Roller (D518)	

7628	Clear PM Counter	
	Clears PM Counters.	
1	Clear Exceeded Counts	
	Do this SP to clear all PM counts that have exceeded their limits.	
2	Reset All Counts	
	Do this SP to clear all PM counts, including those that have not exceeded their limits.	

7801	ROM No./Firmware Version	
	Displays the serial number and the ROM version for each unit or peripheral.	

7803	PM Counter Display	CTL
	Displays the PM count since the last PM.	

7804	PM Counter Reset	CTL
	Touch [EXECUTE] to reset the PM count.	

7807	SC/Jam Counter Reset	CTL
	Touch [EXECUTE] to reset the SC and jam counters.	

7826	MF Error Counter (Japan Only)	CTL
	Displays the number of counts requested of the card/key counter.	
1	Error Total	
	A request for the count total failed at power on. This error will occur if the device is installed but disconnected.	
2	Error Staple	
	The request for a staple count failed at power on. This error will occur if the device is installed but disconnected.	

7827	MF Error Counter Clear (Japan Only)	CTL
	Press Execute to reset to 0 the values of SP7826.	

7832	Self-Diagnostic Result Display	CTL
	Push [#] to display a list of error codes. Nothing is displayed if no errors have occurred.	

7835	ACC Counter	CTL
	No information is available at this time.	
1	Copy ACC	
2	Printer ACC	

7836	Total Memory Size	CTL
	Displays the contents of the memory on the controller board.	

7852	ADF Exposure Glass	
------	--------------------	--

	Displays the count for the number of times the machine has detected dust on the ARDF scanning glass at the beginning of copy jobs. This SP operates only after SP4020 1 has been turned on	
1	Dust Counter	[0 to 65 535/0/1]
2	Clear Counter	

7855	Coverage Range DFU	
1	Coverage Range 1	[1 to 200/5/1%]
2	Coverage Range 2	[1 to 200/20/1%]
	Note: <ul style="list-style-type: none"> • If Coverage Range 1 is less than Coverage Range 2, coverage is controlled by the firmware. • If Coverage Range 1 is greater than or equal to Range 2, the value cannot be entered. 	

7901	Assert Info. DFU	CTL
1	File Name	Used for debugging.
002	Number of Lines	
003	Locations	

7931	Toner Bottle Bk	
7932	Toner Bottle M	
7933	Toner Bottle C	
7934	Toner Bottle Y	
1	Machine Serial ID	[0 to 255/0/1]
2	Cartridge Ver	[0 to 255/0/1]
3	Brand ID	[0 to 255/0/1]
4	Area ID	[0 to 255/0/1]
5	Product ID	[0 to 255/0/1]

6	Color ID	[0 to 255/0/1]
7	Maintenance ID	[0 to 255/0/1]
8	New Product Information	[0 to 255/0/1]
9	Recycle Counter	[0 to 255/0/1]
10	Date	[0 to 1/100/1]
11	SerialNo.	[0 to 1/0/1]
12	Toner Remaining	[0 to 100/0/1]
13	EDP Code	[0 to 1/0/1]
14	End History	[0 to 1/0/1]
15	Refill Information	[0 to 1/0/1]
16	Attachment: Total Counter	[0 to 99999999/0/1]
17	Attachment: Color Counter	[0 to 99999999/0/1]
18	End: Total Counter	[0 to 99999999/0/1]
19	End: Color Counter	[0 to 99999999/0/1]
20	Attachment Date	[0 to 1/0/1]
21	End Date	[0 to 1/0/1]

7935	Toner Bottle Log 1: Bk	
7936	Toner Bottle Log 1: M	
7937	Toner Bottle Log 1: C	
7938	Toner Bottle Log 1: Y	
1	SerialNo.	[0 to 1/0/1]
2	Attachment Date	[0 to 1/0/1]
3	Attachment: Total Counter	[0 to 99999999/0/1]
4	Refill Information	[0 to 1/0/1]
11	SerialNo.	[0 to 1/0/1]

12	Attachment Date	[0 to 1/0/1]
13	Attachment: Total Counter	[0 to 99999999/0/1]
14	Refill Information	[0 to 1/0/1]
21	SerialNo.	[0 to 1/0/1]
22	Attachment Date	[0 to 1/0/1]
23	Attachment: Total Counter	[0 to 99999999/0/1]
24	Refill Information	[0 to 1/0/1]
31	SerialNo.	[0 to 1/0/1]
32	Attachment Date	[0 to 1/0/1]
33	Attachment: Total Counter	[0 to 99999999/0/1]
34	Refill Information	[0 to 1/0/1]
41	SerialNo.	[0 to 1/0/1]
42	Attachment Date	[0 to 1/0/1]
43	Attachment: Total Counter	[0 to 99999999/0/1]
44	Refill Information	[0 to 1/0/1]

7940	Drive Distance: End Std Value	
7942	Drive Distance % Counter	
7944	Drive Distance Counter	
1	#K_Development Unit	[0 to 99 999 999/99 999 999/1 m]
2	K_Developer	
3	K_Dev Filter	
4	#C_Development Unit	
5	C_Developer	
6	C_Dev Filter	
7	#M_Development Unit	

8	M_Developer	
9	M_Dev Filter	
10	#Y_Development Unit	
11	Y_Developer	
12	Y_Dev Filter	
13	#K_Drum Cleaning Unit	
14	K_Cleaning Blade	
15	K_Lubricant Brush	
16	K_Lubricant Bar	
17	K_Lubricant Blade	
18	K_Joint	
19	K_Gears	
20	#C_Drum Cleaning Unit	
21	C_Cleaning Blade	
22	C_Lubricant Brush	
23	C_Lubricant Bar	
24	C_Lubricant Blade	
25	C_Joint	
26	C_Gears	
27	#M_Drum Cleaning Unit	
28	M_Cleaning Blade	
29	M_Lubricant Brush	
30	M_Lubricant Bar	
31	M_Lubricant Blade	
32	M_Joint	
33	M_Gears	

34	#Y_Drum Cleaning Unit	
35	Y_Cleaning Blade	
36	Y_Lubricant Brush	
37	Y_Lubricant Bar	
38	Y_Lubricant Blade	
39	Y_Joint	
40	Y_Gears	
41	#K_Charge Unit	
42	#C_Charge Unit	
43	#M_Charge Unit	
44	#Y_Charge Unit	
45	#K_Drum Unit	
46	K_Drum	
47	#C_Drum Unit	
48	C_Drum	
49	#M_Drum Unit	
50	M_Drum	
51	#Y_Drum Unit	
52	Y_Drum	
53	#Image Transfer Unit	
54	ITB	
55	#ITB Cleaning Unit	
56	ITB Cleaning Blade	
57	ITB Brush Roller	
58	ITB Lubricant Bar	
59	ITB Lubricant Blade	

60	#Paper Transfer Unit	
61	PTU Cleaning Blade	
62	PTU Lubricant Bar	
63	Separation PP	
64	PTR	
65	#Fusing Unit	
66	Fusing Belt	
67	Hot Roller	
68	Pressure Roller	
69	Pressure Roller Bearings	
70	#Fusing Cleaning Unit	
71	Cleaning Web	
72	Web Pressure Roller	
73	Web Roller Stopper	

7954	Pg Counter(%)	
	This SP displays the current usage (listed as percent of usage) of the components listed below: Current Usage/Standard Usage Service Life x 100	
1	#K_Development Unit	[0 to 255/0/1]
2	K_Developer	
3	K_Dev Filter	
4	#C_Development Unit	
5	C_Developer	
6	C_Dev Filter	
7	#M_Development Unit	
8	M_Developer	

9	M_Dev Filter	
10	#Y_Development Unit	
11	Y_Developer	
12	Y_Dev Filter	
13	#K_Drum Cleaning Unit	
14	K_Cleaning Blade	
15	K_Lubricant Brush	
16	K_Lubricant Bar	
17	K_Lubricant Blade	
18	K_Joint	
19	K_Gears	
20	#C_Drum Cleaning Unit	
21	C_Cleaning Blade	
22	C_Lubricant Brush	
23	C_Lubricant Bar	
24	C_Lubricant Blade	
25	C_Joint	
26	C_Gears	
27	#M_Drum Cleaning Unit	
28	M_Cleaning Blade	
29	M_Lubricant Brush	
30	M_Lubricant Bar	
31	M_Lubricant Blade	
32	M_Joint	
33	M_Gears	
34	#Y_Drum Cleaning Unit	

35	Y_Cleaning Blade	
36	Y_Lubricant Brush	
37	Y_Lubricant Bar	
38	Y_Lubricant Blade	
39	Y_Joint	
40	Y_Gears	
41	#K_Charge Unit	
42	#C_Charge Unit	
43	#M_Charge Unit	
44	#Y_Charge Unit	
45	#K_Drum Unit	
46	K_Drum	
47	#C_Drum Unit	
48	C_Drum	
49	#M_Drum Unit	
50	M_Drum	
51	#Y_Drum Unit	
52	Y_Drum	
53	#Image Transfer Unit	
54	ITB	
55	#ITB Cleaning Unit	
56	ITB Cleaning Blade	
57	ITB Brush Roller	
58	ITB Lubricant Bar	
59	ITB Lubricant Blade	
60	#Paper Transfer Unit	

61	PTU Cleaning Blade	
62	PTU Lubricant Bar	
63	Separation PP	
64	PTR	
65	#Fusing Unit	
66	Fusing Belt	
67	Hot Roller	
68	Pressure Roller	
69	Pressure Roller Bearings	
70	#Fusing Cleaning Unit	
71	Cleaning Web	
72	Web Pressure Roller	
73	Web Roller Stopper	
74	#Main Unit Filters	
75	Dust Filter: Rear Upper Right	
76	Dust Filter: Rear Upper Left	
77	Dust Filter: Rear Lower Right	
78	Dust Filter: Rear Lower Left	
79	Dust Filter: Controller Box	
80	Ozone Filter 1	
81	Ozone Filter 2	
82	#ADF	
83	ADF Transport Belt	
84	ADF Feed Belt	
85	ADF Separation Roller	
86	ADF Pick-up Roller	

87	#1st Feed Rollers	
88	1st Pick-up Roller	
89	1st Feed Roller	
90	1st Separation Roller	
91	#2nd Feed Rollers	
92	2nd Pick-up Roller	
93	2nd Feed Roller	
94	2nd Separation Roller	
95	#3rd Feed Rollers	
96	3rd Pick-up Roller (D516)	
97	3rd Feed Roller (D516)	
98	3rd Separation Roller (D516)	
99	#4th Feed Rollers	
100	4th Pick-up Roller (D516)	
101	4th Feed Roller (D516)	
102	4th Separation Roller (D516)	
103	#5th Feed Rollers	
104	5th Pick-up Roller (D516)	
105	5th Feed Roller (D516)	
106	5th Separation Roller (D516)	
107	#6th Feed Rollers	
108	Bypass Pick-up Roller	
109	Bypass Feed Roller	
110	Bypass Reverse Roller	
111	#(D518) 1st Feed Rollers	
112	1st Pick-up Roller (D518)	

113	1st Feed Belt (D518)	
114	1st Reverse Roller (D518)	
115	#(D518) 2nd Feed Rollers	
116	2nd Pick-up Roller (D518)	
117	2nd Feed Belt (D518)	
118	2nd Reverse Roller (D518)	

7960	Motor Drive Information	
1	K_Drum Ave. Torque	[0 to 65 535/0/1]
2	K_Drum Max. Torque	
3	K_Drum Min. Torque	
4	C_Drum Ave. Torque	
5	C_Drum Max. Torque	
6	C_Drum Min. Torque	
7	M_Drum Ave. Torque	
8	M_Drum Max. Torque	
9	M_Drum Min. Torque	
10	Y_Drum Ave. Torque	
11	Y_Drum Max. Torque	
12	Y_Drum Min. Torque	
13	ITB Drive Ave. Torque	
14	ITB Drive Max. Torque	
15	ITB Drive Min. Torque	
16	PTR Drive Ave. Torque	
17	PTR Drive Max. Torque	
18	PTR Drive Min. Torque	

19	Transfer Timing Ave. Torque	
20	Transfer Timing Max. Torque	
21	Transfer Timing Min. Torque	
22	Fusing Drive Ave. Torque	
23	Fusing Drive Max. Torque	
24	Fusing Drive Min. Torque	
25	K_Drum Ave. Revolutions	
26	C_Drum Ave. Revolutions	
27	M_Drum Ave. Revolutions	
28	Y_Drum Ave. Revolutions	
29	ITB Mtr Ave. Revolutions	
30	PTR Mtr Ave. Revolutions	
31	ITB Timing Mtr Ave. Revolutions	
32	ITU FB Sensor: Main Ave.	
33	ITU FB Sensor: Sub Ave.	

7963	Operation Env. Log: PCU: Bk	
	This SP displays the distance traveled by the K PCDU drum so the engine can acclimate operation for the ambient temperature and humidity.	
1	Temp<=5: 0<=Hum<30	[0 to 99 999 999/0/1 m]
2	Temp<=5: 30<=Hum<55	
3	Temp<=5: 55<=Hum<80	
4	Temp<=5: 80<=Hum<100	
5	5<Temp<=15: 0<=Hum<30	
6	5<Temp<=15: 30<=Hum<55	
7	5<Temp<=15: 55<=Hum<80	

8	5<=Temp<=15: 80<=Hum<100	
9	15<=Temp<25: 0<=Hum<30	
10	15<=Temp<25: 30<=Hum<55	
11	15<=Temp<25: 55<=Hum<80	
12	15<=Temp<25: 80<=Hum<100	
13	25<=Temp<30: 0<=Hum<30	
14	25<=Temp<30: 30<=Hum<55	
15	25<=Temp<30: 55<=Hum<80	
16	25<=Temp<30: 80<=Hum<100	
17	30<=Temp: 0<=Hum<30	
18	30<=Temp: 30<=Hum<55	
19	30<=Temp: 55<=Hum<80	
20	30<=Temp: 80<=Hum<100	

7964	Operation Env. Log Clear
	Touch [EXECUTE\ to clear the ambient temperature log.

7987	Drum Motor Error Counter
	Drum motor lock condition counts for the four drum motors.
1	Drum Motor K [0 to 3/ 0 / 1]
2	Drum Motor C
3	Drum Motor M
4	Drum Motor Y

7988	Drum Motor Error Counter Clear
	Clears the motor lock condition counts for the four drum motors.
1	Drum Motor K

2	Drum Motor C
3	Drum Motor M
4	Drum Motor Y

2

7989	Trimmer Unit Counter
	Displays the count for the number of cuts performed by the trimmer unit cutting blade.
	[0 to 99 999 999/100/1

Group 8000

These new SP counters are provided for MFP, LP, and Wide Format machines that employ GW Architecture. These SP codes have been created in response to requests by customers, sales personnel and customer engineers, and R&D staff for a standardized set of counters that can be used to log more detailed information about machine operation.

These SP codes are absolutely essential to provide more detailed counters and job logs to match similar features that are being developed by competitors.

Current Status of the SP8xxx Counters

Many of these counters are provided for features that are currently not available, such as sending color faxes, and so on. However, here are some Group 8 codes that when used in combination with others, can provide useful information.

SP Numbers	What They Do
SP8211 to SP8216	The number of pages scanned to the document server.
SP8401 to SP8406	The number of pages printed from the document server
SP8691 to SP8696	The number of pages sent from the document server

Specifically, the following questions can be answered:

- How is the document server actually being used?
- What application is using the document server most frequently?
- What data in the document server is being reused?

Group 8 Service Table Keys

Many of the SPs in this group are prefixed with a letter that indicates the mode of operation (the mode of operation is referred to as an 'application'). Before reading the Group 8 Service Table, make sure that you understand what these prefixes mean.

Prefixes	Meaning	
T:	Total: (Grand Total).	Grand total of items counted for all applications (C, F, P, etc.).
C:	Copy application.	Totals (pages, jobs, etc.) executed for each application when the job was not stored on the document server
P:	Print application.	
S:	Scan application.	

Prefixes	Meaning	
L:	Local storage (document server)	Totals (jobs, pages, etc.) for the document server. The L: counters work differently case by case. Sometimes, they count jobs/pages stored on the document server; this can be in document server mode (from the document server window), or from another mode, such as from a printer driver or by pressing the Store File button in the Copy mode window. Sometimes, they include occasions when the user uses a file that is already on the document server. Each counter will be discussed case by case.
O:	Other applications (external network applications, for example)	Refers to network applications such as Web Image Monitor. Utilities developed with the SDK (Software Development Kit) will also be counted with this group in the future.

The Group 8 SP codes are limited to 17 characters, forced by the necessity of displaying them on the small LCDs of printers and faxes that also use these SPs.

★ Important

- The C (Copy application) and S (Scan application) functions appear in the SP code displays for the D074/D075 only. They do not appear in the M044 SP code displays.

Read over the list of abbreviations below and refer to it again if you see the name of an SP that you do not understand.

Abbreviation	What It Means
/	"By", e.g. "T:Jobs/Apl" = Total Jobs "by" Application
>	More (2> "2 or more", 4> "4 or more")
AddBook	Address Book
Apl	Application
B/W	Black & White
Bk	Black
C	Cyan
ColCr	Color Create
ColMode	Color Mode

Abbreviation	What It Means
Comb	Combine
Comp	Compression
Deliv	Delivery
DesApl	Designated Application. The application (Copy, Fax, Scan, Print) used to store the job on the document server, for example.
Dev Counter	Development Count, no. of pages developed.
Dup, Duplex	Duplex, printing on both sides
Emul	Emulation
FC	Full Color
FIN	Post-print processing, i.e. finishing (punching, stapling, etc.)
Full Bleed	No Margins
GenCopy	Generation Copy Mode
GPC	Get Print Counter. For jobs 10 pages or less, this counter does not count up. For jobs larger than 10 pages, this counter counts up by the number that is in excess of 10 (e.g., for an 11-page job, the counter counts up $11-10=1$)
IFax	Internet Fax
ImgEdt	Image Edit performed on the original with the copier GUI, e.g. border removal, adding stamps, page numbers, etc.
K	Black (YMCK)
LS	Local Storage. Refers to the document server.
LSize	Large (paper) Size
Mag	Magnification
MC	One color (monochrome)
NRS	New Remote Service, which allows a service center to monitor machines remotely. "NRS" is used overseas, "CSS" is used in Japan.
Org	Original for scanning
OrgJam	Original Jam

Abbreviation	What It Means
Palm 2	Print Job Manager/Desk Top Editor: A pair of utilities that allows print jobs to be distributed evenly among the printers on the network, and allows files to be moved around, combined, and converted to different formats.
PC	Personal Computer
PGS	Pages. A page is the total scanned surface of the original. Duplex pages count as two pages, and A3 simplex count as two pages if the A3/DLT counter SP is switched ON.
PJob	Print Jobs
Ppr	Paper
PrtJam	Printer (plotter) Jam
PrtPGS	Print Pages
R	Red (Toner Remaining). Applies to the wide format model A2 only. This machine is under development and currently not available.
Rez	Resolution
SC	Service Code (Error SC code displayed)
Scn	Scan
Sim, Simplex	Simplex, printing on 1 side.
S-to-Email	Scan-to-E-mail
SMC	SMC report printed with SP5990. All of the Group 8 counters are recorded in the SMC report.
Svr	Server
TonEnd	Toner End
TonSave	Toner Save
TXJob	Send, Transmission
YMC	Yellow, Magenta, Cyan
YMCK	Yellow, Magenta, Cyan, Black

Note: All of the Group 8 SPs are reset with SP5801 1 Memory All Clear, or the Counter Reset SP7808.

8001	T:Total Jobs	<p>These SPs count the number of times each application is used to do a job.</p> <p>[0 to 9999999/ 1]</p> <p>Note: The L: counter is the total number of times the other applications are used to send a job to the document server, plus the number of times a file already on the document server is used.</p>
8002	C:Total Jobs	
8004	P:Total Jobs	
8005	S:Total Jobs	
8006	L:Total Jobs	

These SPs reveal the number of times an application is used, not the number of pages processed.

- When an application is opened for image input or output, this counts as one job.
- Interrupted jobs (paper jams, etc.) are counted, even though they do not finish.
- Only jobs executed by the customer are counted. Jobs executed by the customer engineer using the SP modes are not counted.
- When using secure printing (when a password is required to start the print job), the job is counted at the time when either "Delete Data" or "Specify Output" is specified.
- When a copy job on the document server is printed, SP8022 also increments, and when a print job stored on the document server is printed, SP8024 also increments.
- When an original is both copied and stored on the document server, the C: and L: counters both increment.
- When a print job is stored on the document server, only the L: counter increments.
- When the user presses the Document Server button to store the job on the document server, only the L: counter increments.
- When the user enters document server mode and prints data stored on the document server, only the L: counter increments.
- When an image received from Palm 2 is received and stored, the L: counter increments.

8011	T:Jobs/LS	<p>These SPs count the number of jobs stored to the document server by each application, to reveal how local storage is being used for input.</p> <p>[0to9999999/ 1]</p> <p>The L: counter counts the number of jobs stored from within the document server mode screen at the operation panel.</p>
8012	C:Jobs/LS	
8014	P:Jobs/LS	
8015	S:Jobs/LS	
8016	L:Jobs/LS	
8017	O:Jobs/LS	

- When a scan job is sent to the document server, the S: counter increments. When you enter document server mode and then scan an original, the L: counter increments.

- When a print job is sent to the document server, the P: counter increments.
- When a network application sends data to the document server, the O: counter increments.
- When an image from Palm 2 is stored on the document server, the O: counter increments.

8021	T:Pjob/LS	<p>These SPs reveal how files printed from the document server were stored on the document server originally. [0 to 99999999 / 1]</p> <p>The L: counter counts the number of jobs stored from within the document server mode screen at the operation panel.</p>
8022	C:Pjob/LS	
8024	P:Pjob/LS	
8025	S:Pjob/LS	
8026	L:Pjob/LS	
8027	O:Pjob/LS	

- When a copy job stored on the document server is printed with another application, the C: counter increments.
- When an application like DeskTopBinder merges a copy job that was stored on the document server with a print job that was stored on the document server, the C: and P: counters both increment.
- When a job already on the document server is printed with another application, the L: counter increments.
- When a scanner job stored on the document server is printed with another application, the S: counter increments. If the original was scanned from within document server mode, then the L: counter increments.
- When images stored on the document server by a network application (including Palm 2), are printed with another application, the O: counter increments.
- When a copy job stored on the document server is printed with a network application (Web Image Monitor, for example), the C: counter increments.

8031	T:Pjob/DesApl	<p>These SPs reveal what applications were used to output documents from the document server. [0 to 99999999 / 1]</p> <p>The L: counter counts the number of jobs printed from within the document server mode screen at the operation panel.</p>
8032	C:Pjob/DesApl	
8034	P:Pjob/DesApl	
8035	S:Pjob/DesApl	
8036	L:Pjob/DesApl	
8037	O:Pjob/DesApl	

- When documents already stored on the document server are printed, the count for the application that started the print job is incremented.
- When the print job is started from a network application (Desk Top Binder, Web Image Monitor, etc.) the L: counter increments.

8041	T:TX Jobs/LS	<p>These SPs count the applications that stored files on the document server that were later accessed for transmission over the telephone line or over a network (attached to an e-mail, or as a fax image by I-Fax).</p> <p>[0 to 9999999 / 1]</p> <p>Note: Jobs merged for sending are counted separately.</p> <p>The L: counter counts the number of jobs scanned from within the document server mode screen at the operation panel.</p>
8042	C:TX Jobs/LS	
8044	P:TX Jobs/LS	
8045	S:TX Jobs/LS	
8046	L:TX Jobs/LS	
8047	O:TX Jobs/LS	

- When a stored copy job is sent from the document server, the C: counter increments.
- When images stored on the document server by a network application or Palm2 are sent as an e-mail, the O: counter increments.

8051	T:TX Jobs/DesApl	<p>These SPs count the applications used to send files from the document server over the telephone line or over a network (attached to an e-mail, or as a fax image by I-Fax). Jobs merged for sending are counted separately.</p> <p>[0 to 9999999 / 1]</p> <p>The L: counter counts the number of jobs sent from within the document server mode screen at the operation panel.</p>
8052	C:TX Jobs/DesApl	
8054	P:TX Jobs/DesApl	
8055	S:TX Jobs/DesApl	
8056	L:TX Jobs/DesApl	
8057	O:TX Jobs/DesApl	

- If the send is started from Desk Top Binder or Web Image Monitor, for example, then the O: counter increments.

8061	T:FIN Jobs	[0 to 9999999 / 1]
	These SPs total the finishing methods. The finishing method is specified by the application.	
8062	C:FIN Jobs	[0 to 9999999 / 1]
	These SPs total finishing methods for copy jobs only. The finishing method is specified by the application.	

8064	P:FIN Jobs	[0 to 9999999/ 1]
	These SPs total finishing methods for print jobs only. The finishing method is specified by the application.	
8065	S:FIN Jobs	[0 to 9999999/ 1]
	These SPs total finishing methods for scan jobs only. The finishing method is specified by the application. Note: Finishing features for scan jobs are not available at this time.	
8066	L:FIN Jobs	[0 to 9999999/ 1]
	These SPs total finishing methods for jobs output from within the document server mode screen at the operation panel. The finishing method is specified from the print window within document server mode.	
8067	O:FIN Jobs	[0 to 9999999/ 1]
	These SPs total finishing methods for jobs executed by an external application, over the network. The finishing method is specified by the application.	
806x 1	Sort	Number of jobs started in Sort mode. When a stored copy job is set for Sort and then stored on the document server, the L: counter increments. (See SP8066 1)
806x 2	Stack	Number of jobs started out of Sort mode.
806x 3	Staple	Number of jobs started in Staple mode.
806x 4	Booklet	Number of jobs started in Booklet mode. If the machine is in staple mode, the Staple counter also increments.
806x 5	Z-Fold	Number of jobs started in any mode other than the Booklet mode and set for Z-folding. (Multi Fold Unit)
806x 6	Punch	Number of jobs started in Punch mode. When Punch is set for a print job, the P: counter increments. (See SP8064 6.)
806x 7	Other	Reserved. Not used.
806x 8	Inside Fold	Half-Fold (FM2) (Multi Fold Unit)
806x 9	Three-IN-Fold	Letter Fold-in (FM4) (Multi Fold Unit)
806x 10	Three-OUT-Fold	Letter Fold-out (FM3) (Multi Fold Unit)
806x 11	Four Fold	Double Parallel Fold (FM5) (Multi Fold Unit)

806x 12	KANNON-Fold	Gate Fold (FM6) (Multi Fold Unit D394)
806x 13	Perfect-Bind	Perfect Binder Not Used
806x 14	Ring-Bind	Ring Binder

8071	T:Jobs/PGS	[0 to 9999999/ 1]	
	These SPs count the number of jobs broken down by the number of pages in the job, regardless of which application was used.		
8072	C:Jobs/PGS	[0 to 9999999/ 1]	
	These SPs count and calculate the number of copy jobs by size based on the number of pages in the job.		
8074	P:Jobs/PGS	[0 to 9999999/ 1]	
	These SPs count and calculate the number of print jobs by size based on the number of pages in the job.		
8075	S:Jobs/PGS	[0 to 9999999/ 1]	
	These SPs count and calculate the number of scan jobs by size based on the number of pages in the job.		
8076	L:Jobs/PGS	[0 to 9999999/ 1]	
	These SPs count and calculate the number of jobs printed from within the document server mode window at the operation panel, by the number of pages in the job.		
8077	O:Jobs/PGS	[0 to 9999999/ 1]	
	These SPs count and calculate the number of "Other" application jobs (Web Image Monitor, Palm 2, etc.) by size based on the number of pages in the job.		
807x 1	1 Page	807x 8	21 to 50 Pages
807x 2	2 Pages	807x 9	51 to 100 Pages
807x 3	3 Pages	807x 10	101 to 300 Pages
807x 4	4 Pages	807x 11	301 to 500 Pages
807x 5	5 Pages	807x 12	501 to 700 Pages
807x 6	6 to 10 Pages	807x 13	701 to 1000 Pages

807x 7	11 to 20 Pages	807x 14	1001 to Pages
--------	----------------	---------	---------------

- For example: When a copy job stored on the document server is printed in document server mode, the appropriate L: counter (SP8076 0xx) increments.
- Interrupted jobs (paper jam, etc.) are counted, even though they do not finish.
- If a job is paused and re-started, it counts as one job.
- If the finisher runs out of staples during a print and staple job, then the job is counted at the time the error occurs.
- For copy jobs (SP 8072) and scan jobs (SP 8075), the total is calculated by multiplying the number of sets of copies by the number of pages scanned. (One duplex page counts as 2.)
- The first test print and subsequent test prints to adjust settings are added to the number of pages of the copy job (SP 8072).
- When printing the first page of a job from within the document server screen, the page is counted.

8131	T:S-to-Email Jobs	[0 to 99999999/ 1]
	These SPs count the total number of jobs scanned and attached to an e-mail, regardless of whether the document server was used or not.	
8135	S:S-to-Email Jobs	
	These SPs count the number of jobs scanned and attached to an e-mail, without storing the original on the document server.	
1	B/W	Count for the number of jobs with black-and-white.
2	Color	Count for the number of jobs with color.
3	ACS	Count for the number of jobs using ACS mode.

- These counters count jobs, not pages.
- If the job is stored on the document server, after the job is stored it is determined to be color or black-and-white then counted.
- If the job is cancelled during scanning, or if the job is cancelled while the document is waiting to be sent, the job is not counted.
- If the job is cancelled during sending, it may or may not be counted, depending on what stage of the process had been reached when the job was cancelled.
- If several jobs are combined for sending to the Scan Router, Scan-to-Email, or Scan-to-PC, or if one job is sent to more than one destination. each send is counted separately. For example, if the same document is sent by Scan-to-Email as well as Scan-to-PC, then it is counted twice (once for Scan-to-Email and once for Scan-to-PC).

8141	T:Deliv Jobs/Svr		[0 to 9999999/ 1]
	These SPs count the total number of jobs scanned and sent to a Scan Router server.		
1	B/W	Count for the number of jobs with black-and-white.	
2	Color	Count for the number of jobs with color.	
3	ACS	Count for the number of jobs using ACS mode.	
8145	S:Deliv Jobs/Svr		
	These SPs count the number of jobs scanned in scanner mode and sent to a Scan Router server.		
1	B/W	Count for the number of jobs with black-and-white.	
2	Color	Count for the number of jobs with color.	
3	ACS	Count for the number of jobs using ACS mode.	

- These counters count jobs, not pages.
- The jobs are counted even though the arrival and reception of the jobs at the Scan Router server cannot be confirmed.
- If even one color image is mixed with black-and-white images, then the job is counted as a "Color" job.
- If the job is cancelled during scanning, or if the job is cancelled while the document is waiting to be delivered, the job is not counted.
- If the job is cancelled during sending, it may or may not be counted, depending on what stage of the process had been reached when the job was cancelled.
- Even if several files are combined for sending, the transmission counts as one job.

8151	T:Deliv Jobs/PC		[0 to 9999999/ 1]
	These SPs count the total number of jobs scanned and sent to a folder on a PC (Scan-to-PC). Note: At the present time, 8151 and 8155 perform identical counts.		
1	B/W	Count for the number of jobs with black-and-white.	
2	Color	Count for the number of jobs with color.	
3	ACS	Count for the number of jobs using ACS mode.	

8155	S:Deliv Jobs/PC	
	These SPs count the total number of jobs scanned and sent with Scan-to-PC.	
1	B/W	Count for the number of jobs with black-and-white.
2	Color	Count for the number of jobs with color.
3	ACS	Count for the number of jobs using ACS mode.

- These counters count jobs, not pages.
- If the job is cancelled during scanning, it is not counted.
- If the job is cancelled while it is waiting to be sent, the job is not counted.
- If the job is cancelled during sending, it may or may not be counted, depending on what stage of the process had been reached when the job was cancelled.
- Even if several files are combined for sending, the transmission counts as one job.

8171	T: Deliv Jobs/WSD	
8175	S: Deliv Jobs/WSD	
8181	T: Scan to Media Jobs	
8185	S: Scan to Media Jobs	
1	B/W	
2	Color	
3	ACS	

8191	T:Total Scan PGS	These SPs count the pages scanned by each application that uses the scanner to scan images. [0 to 9999999/ 1]
8192	C:Total Scan PGS	
8195	S:Total Scan PGS	
8196	L:Total Scan PGS	

- SP 8191 to 8196 count the number of scanned sides of pages, not the number of physical pages.
- These counters do not count reading user stamp data, or reading color charts to adjust color.
- Previews done with a scanner driver are not counted.
- A count is done only after all images of a job have been scanned.
- Scans made in SP mode are not counted.

Examples

- If 3 B5 pages and 1 A3 page are scanned with the scanner application but not stored, the S: count is 4.
- If both sides of 3 A4 sheets are copied and stored to the document server using the Store File button in the Copy mode window, the C: count is 6 and the L: count is 6.
- If both sides of 3 A4 sheets are copied but not stored, the C: count is 6.
- If you enter document server mode then scan 6 pages, the L: count is 6.

8201	T:LSize Scan PGS	[0 to 9999999/ 1]
	This SP counts the total number of large pages input with the scanner for scan and copy jobs. Note: These counters are displayed in the SMC Report, and in the User Tools display.	
8205	S:LSize Scan PGS	[0 to 9999999/ 1]
	This SP counts the total number of large pages input with the scanner for scan jobs only Note: These counters are displayed in the SMC Report, and in the User Tools display..	

8211	T:Scan PGS/LS	These SPs count the number of pages scanned into the document server . [0 to 9999999/ 1] The L: counter counts the number of pages stored from within the document server mode screen at the operation panel, and with the Store File button from within the Copy mode screen
8212	C:Scan PGS/LS	
8215	S:Scan PGS/LS	
8216	L:Scan PGS/LS	

- Reading user stamp data is not counted.
- If a job is cancelled, the pages output as far as the cancellation are counted.
- If the scanner application scans and stores 3 B5 sheets and 1 A4 sheet, the S: count is 4.
- If pages are copied but not stored on the document server, these counters do not change.
- If both sides of 3 A4 sheets are copied and stored to the document server, the C: count is 6 and the L: count is 6.
- If you enter document server mode then scan 6 pages, the L: count is 6.

8221	ADF Org Feeds
	[0 to 9999999/ 0 / 1] These SPs count the number of pages fed through the ADF for front and back side scanning.

1	Front	<p>Number of front sides fed for scanning:</p> <p>With an ADF that can scan both sides simultaneously, the Front side count is the same as the number of pages fed for either simplex or duplex scanning.</p> <p>With an ADF that cannot scan both sides simultaneously, the Front side count is the same as the number of pages fed for duplex front side scanning. (The front side is determined by which side the user loads face up.)</p>
2	Back	<p>Number of rear sides fed for scanning:</p> <p>With an ADF that can scan both sides simultaneously, the Back count is the same as the number of pages fed for duplex scanning.</p> <p>With an ADF that cannot scan both sides simultaneously, the Back count is the same as the number of pages fed for duplex rear-side scanning.</p>

- When 1 sheet is fed for duplex scanning the Front count is 1 and the Back count is 1.
- If a jam occurs during the job, recovery processing is not counted to avoid double counting. Also, the pages are not counted if the jam occurs before the first sheet is output.

8231	Scan PGS/Mode	
	[0 to 9999999 / 0 / 1]	
These SPs count the number of pages scanned by each ADF mode to determine the work load on the ADF.		
1	Large Volume	Selectable. Large copy jobs that cannot be loaded in the ADF at one time.
2	SADF	Selectable. Feeding pages one by one through the ADF.
3	Mixed Size	Selectable. Select "Mixed Sizes" on the operation panel.
4	Custom Size	Selectable. Originals of non-standard size.
5	Platen	Book mode. Raising the ADF and placing the original directly on the platen.
6	Mixed 1side/2side	

- If the scan mode is changed during the job, for example, if the user switches from ADF to Platen mode, the count is done for the last selected mode.
- If the user selects "Mixed Sizes" for copying in the platen mode, the Mixed Size count is enabled.
- In the SADF mode if the user copies 1 page in platen mode and then copies 2 pages with SADF, the Platen count is 1 and the SADF count is 3.

8241	T:Scan PGS/Org	[0 to 9999999/ 1]			
	These SPs count the total number of scanned pages by original type for all jobs, regardless of which application was used.				
8242	C:Scan PGS/Org	[0 to 9999999/ 1]			
	These SPs count the number of pages scanned by original type for Copy jobs.				
8245	S:Scan PGS/Org	[0 to 9999999/ 1]			
	These SPs count the number of pages scanned by original type for Scan jobs.				
8246	L:Scan PGS/Org	[0 to 9999999/ 1]			
	These SPs count the number of pages scanned and stored from within the document server mode screen at the operation panel, and with the Store File button from within the Copy mode screen				
		8241	8242	8245	8246
824x 1: Text		Yes	Yes	Yes	Yes
824x 2: Text/Photo		Yes	Yes	Yes	Yes
824x 3: Photo		Yes	Yes	Yes	Yes
824x 4: GenCopy, Pale		Yes	Yes	Yes	Yes
824x 5: Map		Yes	Yes	Yes	Yes

- If the scan mode is changed during the job, for example, if the user switches from ADF to Platen mode, the count is done for the last selected mode.

8251	T:Scan PGS/ImgEdt	<p>These SPs show how many times Image Edit features have been selected at the operation panel for each application. Some examples of these editing features are:</p> <p>Erase> Border</p> <p>Erase> Center</p> <p>Image Repeat</p> <p>Centering</p> <p>Positive/Negative</p> <p>[0 to 9999999/ 1]</p> <p>Note: The count totals the number of times the edit features have been used. A detailed breakdown of exactly which features have been used is not given.</p>
8252	C:Scan PGS/ImgEdt	
8255	S:Scan PGS/ImgEdt	
8256	L:Scan PGS/ImgEdt	
8257	O:Scan PGS/ImgEdt	

- The L: counter counts the number of pages stored from within the document server mode screen at the operation panel, and with the Store File button from within the Copy mode screen.

8261	T:Scn PGS/ColCr	[0 to 9999999/ 1]
	These SPs count the total number of scanned pages by the color processing mode used.	
8262	C:Scn PGS/ColCr	[0 to 9999999/ 1]
	These SPs count the number of pages by the color processing mode used for Copy jobs only.	
8265	S: Scn PGS/ColCr	[0 to 9999999/ 1]
8266	L: Scn PGS/TWAIN	[0 to 9999999/ 1]
8261 1	Color Conversion	
8261 2	Color Erase	
8261 3	Background	
8261 4	Other	

- These counters are enabled only for MFP machines that support color. The wide format machines do not support the "Background" or "Other" counters.

8281	T:Scan PGS/TWAIN	These SPs count the number of pages scanned using a TWAIN driver. These counters reveal how the TWAIN driver is used for delivery functions. [0 to 9999999/ 1] Note: At the present time, these counters perform identical counts.
8285	S:Scan PGS/TWAIN	

8291	T:Scan PGS/Stamp	These SPs count the number of pages stamped with the stamp in the ADF unit. [0 to 9999999/ 1] The L: counter counts the number of pages stored from within the document server mode screen at the operation panel, and with the Store File button from within the Copy mode screen
8295	S:Scan PGS/Stamp	

8301	T:Scan PGS/Size	[0 to 9999999/ 1]
	These SPs count by size the total number of pages scanned by all applications. Use these totals to compare original page size (scanning) and output (printing) page size [SP 8-441].	
8302	C:Scan PGS/Size	[0 to 9999999/ 1]
	These SPs count by size the total number of pages scanned by the Copy application. Use these totals to compare original page size (scanning) and output (printing) page size [SP 8-442].	
8305	S:Scan PGS/Size	[0 to 9999999/ 1]
	These SPs count by size the total number of pages scanned by the Scan application. Use these totals to compare original page size (scanning) and output page size [SP 8-445].	
8306	L:Scan PGS/Size	[0 to 9999999/ 1]
	These SPs count by size the total number of pages scanned and stored from within the document server mode screen at the operation panel, and with the Store File button from within the Copy mode screen. Use these totals to compare original page size (scanning) and output page size [SP 8-446].	

830x 1	A3	
830x 2	A4	
830x 3	A5	
830x 4	B4	
830x 5	B5	
830x 6	DLT	
830x 7	LG	
830x 8	LT	
830x 9	HLT	
830x 10	Full Bleed	
830x 254	Other (Standard)	
830x 255	Other (Custom)	

8311	T:Scan PGS/Rez	[0 to 9999999/ 1]
	These SPs count by resolution setting the total number of pages scanned by applications that can specify resolution settings.	
8315	S:Scan PGS/Rez	[0 to 9999999/ 1]
	These SPs count by resolution setting the total number of pages scanned by applications that can specify resolution settings. Note: At the present time, 8311 and 8315 perform identical counts.	
831x 1	1200dpi to 599dpi	
831x 2	600dpi to 1199dpi	
831x 3	400dpi to 599dpi	
831x 4	200dpi to 399dpi	
831x 5	to 199dpi	

- Copy resolution settings are fixed so they are not counted.
- The Fax application does not allow finely-adjusted resolution settings so no count is done for the Fax application.

8381	T:Total PrtPGS	<p>These SPs count the number of pages printed by the customer. The counter for the application used for storing the pages increments.</p> <p>[0 to 9999999/ 1]</p> <p>The L: counter counts the number of pages stored from within the document server mode screen at the operation panel. Pages stored with the Store File button from within the Copy mode screen go to the C: counter.</p>
8382	C:Total PrtPGS	
8384	P:Total PrtPGS	
8385	S:Total PrtPGS	
8386	L:Total PrtPGS	
8387	O:Total PrtPGS	

- When the A3/DLT double count function is switched on with SP5104, 1 A3/DLT page is counted as 2.
- When several documents are merged for a print job, the number of pages stored are counted for the application that stored them.
- These counters are used primarily to calculate charges on use of the machine, so the following pages are not counted as printed pages:
 - Blank pages in a duplex printing job.
 - Blank pages inserted as document covers, chapter title sheets, and slip sheets.
 - Reports printed to confirm counts.
 - All reports done in the service mode (service summaries, engine maintenance reports, etc.)
 - Test prints for machine image adjustment.
 - Error notification reports.
 - Partially printed pages as the result of a copier jam.

8391	LSize PrtPGS	[0 to 9999999/ 1]
	<p>These SPs count pages printed on paper sizes A3/DLT and larger.</p> <p>Note: In addition to being displayed in the SMC Report, these counters are also displayed in the User Tools display on the copy machine.</p>	

8401	T:PrtPGS/LS	<p>These SPs count the number of pages printed from the document server. The counter for the application used to print the pages is incremented.</p> <p>The L: counter counts the number of jobs stored from within the document server mode screen at the operation panel.</p> <p>[0 to 9999999/ 1]</p>
8402	C:PrtPGS/LS	
8404	P:PrtPGS/LS	
8405	S:PrtPGS/LS	
8406	L:PrtPGS/LS	

- Print jobs done with Web Image Monitor and Desk Top Binder are added to the L: count.

8411	Prints/Duplex	This SP counts the amount of paper (front/back counted as 1 page) used for duplex printing. Last pages printed only on one side are not counted. [0 to 9999999/ 1]
------	---------------	---

2

8421	T:PrtPGS/Dup Comb	[0 to 9999999/ 1]
	These SPs count by binding and combine, and n-Up settings the number of pages processed for printing. This is the total for all applications.	
8422	C:PrtPGS/Dup Comb	[0 to 9999999/ 1]
	These SPs count by binding and combine, and n-Up settings the number of pages processed for printing by the copier application.	
8424	P:PrtPGS/Dup Comb	[0 to 9999999/ 1]
	These SPs count by binding and combine, and n-Up settings the number of pages processed for printing by the printer application.	
8425	S:PrtPGS/Dup Comb	[0 to 9999999/ 1]
	These SPs count by binding and combine, and n-Up settings the number of pages processed for printing by the scanner application.	
8426	L:PrtPGS/Dup Comb	[0 to 9999999/ 1]
	These SPs count by binding and combine, and n-Up settings the number of pages processed for printing from within the document server mode window at the operation panel.	
8427	O:PrtPGS/Dup Comb	[0 to 9999999/ 1]
	These SPs count by binding and combine, and n-Up settings the number of pages processed for printing by Other applications	
842x 1	Simplex> Duplex	
842x 2	Duplex> Duplex	
842x 3	Book> Duplex	
842x 4	Simplex Combine	
842x 5	Duplex Combine	

842x 6	2>	2 pages on 1 side (2-Up)
842x 7	4>	4 pages on 1 side (4-Up)
842x 8	6>	6 pages on 1 side (6-Up)
842x 9	8>	8 pages on 1 side (8-Up)
842x 10	9>	9 pages on 1 side (9-Up)
842x 11	16>	16 pages on 1 side (16-Up)
842x 12	Booklet	
842x 13	Magazine	

- These counts (SP8421 to SP8427) are especially useful for customers who need to improve their compliance with ISO standards for the reduction of paper consumption.
- Pages that are only partially printed with the n-Up functions are counted as 1 page.
- Here is a summary of how the counters work for Booklet and Magazine modes:

Booklet		Magazine	
Original Pages	Count	Original Pages	Count
1	1	1	1
2	2	2	2
3	2	3	2
4	2	4	2
5	3	5	4
6	4	6	4
7	4	7	4
8	4	8	4

8431	T:PrtPGS/ImgEdt	[0 to 9999999/ 1]
	These SPs count the total number of pages output with the three features below, regardless of which application was used.	

8432	C:PrtPGS/ImgEdt	[0 to 9999999/ 1]
	These SPs count the total number of pages output with the three features below with the copy application.	
8434	P:PrtPGS/ImgEdt	[0 to 9999999/ 1]
	These SPs count the total number of pages output with the three features below with the print application.	
8436	L:PrtPGS/ImgEdt	[0 to 9999999/ 1]
	These SPs count the total number of pages output from within the document server mode window t the operation panel with the three features below.	
8437	O:PrtPGS/ImgEdt	[0 to 9999999/ 1]
	These SPs count the total number of pages output with the three features below with Other applications.	
843x 1	Cover/Slip Sheet	Total number of covers or slip sheets inserted. The count for a cover printed on both sides counts 2.
843x 2	Series/Book	The number of pages printed in series (one side) or printed as a book with booklet right/left pagination.
843x 3	User Stamp	The number of pages printed where stamps were applied, including page numbering and date stamping.

8441	T:PrtPGS/Ppr Size	[0 to 9999999/ 1]
	These SPs count by print paper size the number of pages printed by all applications.	
8442	C:PrtPGS/Ppr Size	[0 to 9999999/ 1]
	These SPs count by print paper size the number of pages printed by the copy application.	
8444	P:PrtPGS/Ppr Size	[0 to 9999999/ 1]
	These SPs count by print paper size the number of pages printed by the printer application.	
8445	S:PrtPGS/Ppr Size	[0 to 9999999/ 1]
	These SPs count by print paper size the number of pages printed by the scanner application.	

8446	L:PrtPGS/Ppr Size		[0 to 9999999/ 1]
	These SPs count by print paper size the number of pages printed from within the document server mode window at the operation panel.		
8447	O:PrtPGS/Ppr Size		[0 to 9999999/ 1]
	These SPs count by print paper size the number of pages printed by Other applications.		
844x 1	A3		
844x 2	A4		
844x 3	A5		
844x 4	B4		
844x 5	B5		
844x 6	DLT		
844x 7	LG		
844x 8	LT		
844x 9	HLT		
844x 10	Full Bleed		
844x 254	Other (Standard)		
844x 255	Other (Custom)		

- These counters do not distinguish between LEF and SEF.

8451	PrtPGS/Ppr Tray		[0 to 9999999/ 1]
	These SPs count the number of sheets fed from each paper feed station.		
1	Bypass	Bypass Tray	
2	Tray 1	Copier	
3	Tray 2	Copier	
4	Tray 3	Paper Tray Unit (Option)	
5	Tray 4	Paper Tray Unit (Option)	

6	Tray 5	LCT (Option)
7	Tray 6	Currently not used.
8	Tray 7	Currently not used.
9	Tray 8	
10	Tray 9	
11	Tray 10	
12	Tray 11	
13	Tray 12	
14	Tray 13	
15	Tray 14	
16	Tray 15	

8461	T:PrtPGS/Ppr Type	[0 to 9999999/ 1]
	<p>These SPs count by paper type the number pages printed by all applications. These counters are not the same as the PM counter. The PM counter is based on feed timing to accurately measure the service life of the feed rollers. However, these counts are based on output timing.</p> <p>Blank sheets (covers, chapter covers, slip sheets) are also counted.</p> <p>During duplex printing, pages printed on both sides count as 1, and a page printed on one side counts as 1.</p>	
8462	C:PrtPGS/Ppr Type	[0 to 9999999/ 1]
	<p>These SPs count by paper type the number pages printed by the copy application.</p>	
8464	P:PrtPGS/Ppr Type	[0 to 9999999/ 1]
	<p>These SPs count by paper type the number pages printed by the printer application.</p>	
8466	L:PrtPGS/Ppr Type	[0 to 9999999/ 1]
	<p>These SPs count by paper type the number pages printed from within the document server mode window at the operation panel.</p>	
846x 1	Normal	

846x 2	Recycled
846x 3	Special
846x 4	Thick
846x 5	Normal (Back)
846x 6	Thick (Back)
846x 7	OHP
846x 8	Other

8471	PrtPGS/Mag	[0 to 9999999/ 1]
	These SPs count by magnification rate the number of pages printed.	
1	to 49%	
2	50% to 99%	
3	100%	
4	101% to 200%	
5	201% to	

- Counts are done for magnification adjusted for pages, not only on the operation panel but performed remotely with an external network application capable of performing magnification adjustment as well.
- Magnification adjustments done with printer drivers with PC applications such as Excel are also counted.
- Magnification adjustments done for adjustments after they have been stored on the document server are not counted.
- Magnification adjustments performed automatically during Auto Reduce/Enlarge copying are counted.
- The magnification rates of blank cover sheets, slip sheets, etc. are automatically assigned a rate of 100%.

8481	T:PrtPGS/TonSave	These SPs count the number of pages printed with the Toner Save feature switched on. Note: These SPs return the same results as this SP is limited to the Print application. [0 to 9999999/ 1]
8484	P:PrtPGS/TonSave	

8491	T:PrtPGS/Col Mode	[0 to 9999999/ 1]
	These SPs count by color mode the total number of pages output by the Copy, document server, and Fax applications.	
8492	C:PrtPGS/Col Mode	[0 to 9999999/ 1]
	These SPs count by color mode the total output by the Copy application only	
8496	L:PrtPGS/Col Mode	[0 to 9999999/ 1]
	These SPs count by color mode the total output from within the document server mode window at the operation panel.	
8497	O:PrtPGS/Col Mode	[0 to 9999999/ 1]
849x 1	B/W	
849x 2	Single Color	Color MFP/2-color MFP machines only.
849x 3	Two Color	Color MFP/2-color MFP machines only.
849x 4	Full Color	Color MFP machines only

Notes for SP8491 to SP8496

- These SPs apply to the Copy, document server, and Fax applications only. They do not apply to the Print application.
- When the ACS feature is used to select the color settings automatically, the results of the ACS execute is used to increment the appropriate counter.
- If a color stamp is selected for printing on a monochrome document, the count is for B/W.
- If the output is black and white even if color print mode was selected, the pages count as Full Color.
- The color mode selected for a document stored on the document server is counted. (The color selection cannot be changed once the document is stored on the document server.)

8501	T:PrtPGS/Col Mode	[0 to 99999999/ 1]
	These SPs count by color mode the total number of pages printed.	
8504	P:PrtPGS/Col Mode	[0 to 99999999/ 1]
	These SPs count by color mode the number of pages printed with the Print application.	
8507	O:PrtPGS/Col Mode	[0 to 99999999/ 1]
These SPs count by color mode the number of pages printed with the other applications.		
1	B/W	
2	Mono Color	Color MFP and 2-Color MFP machines only.
3	Full Color	Color MFP and Color LP machines only.
4	Single Color	B081/D082 only
5	Two Color	B081/D082 only

- At the present time, 8501 and 8504 perform identical counts, because they are both limited to the Print application.

8511	T:PrtPGS/Emul	[0 to 99999999/ 1]
	These SPs count by printer emulation mode the total number of pages printed.	
8514	P:PrtPGS/Emul	[0 to 99999999/ 1]
	These SPs count by printer emulation mode the total number of pages printed.	

2

851x 1	RPCS	
851x 2	RPDL	
851x 3	PS3	
851x 4	R98	
851x 5	R16	
851x 6	GL/GL2	
851x 7	R55	
851x 8	RTIFF	
851x 9	PDF	
851x 10	PCL5e/5c	
851x 11	PCL XL	
851x 12	IPDL-C	
851x 13	BM-Links	Japan Only
851x 14	Other	
851x 15	IPDS	

- SP8511 and SP8514 return the same results as they are both limited to the Print application.
- Print jobs output to the document server are not counted.

8521	T:PrtPGS/FIN	[0 to 9999999/ 1]
	These SPs count by finishing mode the total number of pages printed by all applications.	
8522	C:PrtPGS/FIN	[0 to 9999999/ 1]
	These SPs count by finishing mode the total number of pages printed by the Copy application.	
8524	P:PrtPGS/FIN	[0 to 9999999/ 1]
	These SPs count by finishing mode the total number of pages printed by the Print application.	

8525	S:PrtPGS/FIN	[0 to 99999999/ 1]
	These SPs count by finishing mode the total number of pages printed by the Scanner application.	
8526	L:PrtPGS/FIN	[0 to 99999999/ 1]
	These SPs count by finishing mode the total number of pages printed from within the document server mode window at the operation panel.	
852x 1	Sort	
852x 2	Stack	
852x 3	Staple	
852x 4	Booklet	
852x 5	Z-Fold	
852x 6	Punch	
852x 7	Other	
806x 8	Inside Fold	Half-Fold (FM2) (Multi Fold Unit)
806x 9	Three-IN-Fold	Letter Fold-in (FM4) (Multi Fold Unit)
806x 10	Three-OUT-Fold	Letter Fold-out (FM3) (Multi Fold Unit)
806x 11	Four Fold	Double Parallel Fold (FM5) (Multi Fold Unit)
806x 12	KANNON-Fold	Gate Fold (FM6) (Multi Fold Unit)
806x 13	Perfect-Bind	Perfect Binder Not Used
806x 14	Ring-Bind	Ring Binder

Note:

- If stapling is selected for finishing and the stack is too large for stapling, the unstapled pages are still counted.
- The counts for staple finishing are based on output to the staple tray, so jam recoveries are counted.

8531	Staples	This SP counts the amount of staples used by the machine. [0 to 99999999/ 1]
------	---------	---

8551	T: PrtBooks/FIN	
8552	O: PrtBooks/FIN	
8554	P: PrtBooks/FIN	
8556	L: PrtBooks/FIN	
1	Perfect-Bind	Not Used
2	Ring-Bind	

8581	T:Counter	[0 to 9999999/ 1]
	<p>These SPs count the total output broken down by color output, regardless of the application used. In addition to being displayed in the SMC Report, these counters are also displayed in the User Tools display on the copy machine.</p> <p>Note: These SPs are supported by color MFP and LP machines only.</p>	
1	Total	
2	Total: Full Color	
3	B&W/Single Color	
4	Development: CMY	
5	Development: K	
6	Copy: Color	
7	Copy: B/W	
8	Print: Color	
9	Print: B/W	
10	Total: Color	
11	Total: B/W	
12	Full Color: A3	
13	Full Color: B4 JIS or smaller	
14	Full Color Print	
15	Mono Color Print	

16	Full Color GPC
17	Twin Color Mode Print
18	Full Color Print (Twin)
19	Mono Color Print (Twin)
20	Full Color Total (CV)
21	Mono Color Total (CV)
22	Full Color Print (CV)
28	Development: CMY (A3)
29	Development: K (A3)
30	Total: Color (A3)
31	Total: B/W (A3)

8582	C:Counter	[0 to 9999999/ 1]	
	These SPs count the total output broken down by color output for the Copy application only.		
	Note: These SPs are supported by color copy MFP machines only.		
	These counters are displayed in the SMC Report, and in the User Tools display on the copy machine.		
	1	B/W	
2	Single Color		
3	Two Color		
4	Full Color		

8584	P:Counter	[0 to 9999999/ 1]	
	These SPs count the total output broken down by color output for the Print application only. These counters are displayed in the SMC Report, and in the User Tools display on the copy machine.		
Note: These SPs are supported by color MFP and LP machines only.			
1	B/W		

2	Mono Color	
3	Full Color	
4	Single Color	
5	Two Color	

8586	L:Counter	[0 to 99999999/ 1]	
	<p>These SPs count the total output broken down by color for output from within the document server mode window at the operation panel. These counters are displayed in the SMC Report, and in the User Tools display on the copy machine.</p> <p>Note: These SPs are supported only by color copy MFP machines only with the fax application installed.</p>		
		MFP Color	Replaced:
1	B/W	Yes	---
2	Single Color	Yes	---
3	Two Color	Yes	---
4	Single Color	Yes	---

8591	O:Counter	[0 to 99999999/ 1]	
	<p>These SPs count the totals for A3/DLT paper use, number of duplex pages printed, and the number of staples used. These totals are for Other (O:) applications only.</p>		
1	A3/DLT		
2	Duplex		

8601	Coverage Counter	
1	B/W	
2	Color	
11	B/W Printing Pages	
12	Color Printing Pages	
21	Coverage Counter 1	

22	Coverage Counter 2	
23	Coverage Counter 3	

8617	SDK Apli Counter	
1	SDK-1	
2	SDK-2	
3	SDK-3	
4	SDK-4	
5	SDK-5	
6	SDK-6	

8621	Func Use Counter DFU	
1 to 64	Function 001 to Function 064	

8651	T:S-to-Email PGS	[0 to 9999999/ 1]
	These SPs count by color mode the total number of pages attached to an e-mail for both the Scan and document server applications.	
1	B/W	
2	Color	Supported by Color MFP machines only.
8655	S:S-to-Email PGS	[0 to 9999999/ 1]
	These SPs count by color mode the total number of pages attached to an e-mail for the Scan application only.	
1	B/W	
2	Color	Supported by Color MFP machines only.

Notes

- The count for B/W and Color pages is done after the document is stored on the HDD. If the job is cancelled before it is stored, the pages are not counted.
- If Scan-to-Email is used to send a 10-page document to 5 addresses, the count is 10 (the pages are sent to the same SMTP server together).

- If Scan-to-PC is used to send a 10-page document to 5 folders, the count is 50 (the document is sent to each destination of the SMB/FTP server).
- Due to restrictions on some devices, if Scan-to-Email is used to send a 10-page document to a large number of destinations, the count may be divided and counted separately. For example, if a 10-page document is sent to 200 addresses, the count is 10 for the first 100 destinations and the count is also 10 for the second 100 destinations, for a total of 20.

8661	T:Deliv PGS/Svr		[0 to 9999999/ 1]
	These SPs count by color mode the total number of pages sent to a Scan Router server by both Scan and LS applications.		
1	B/W		
2	Color	Supported by Color MFP machines only.	
8665	S:Deliv PGS/Svr		[0 to 9999999/ 1]
	These SPs count by color mode the total number of pages sent to a Scan Router server by the Scan application.		
1	B/W		
2	Color	Supported by Color MFP machines only.	

Notes

- The B/W and Color counts are done after the document is stored on the HDD of the Scan Router server.
- If the job is canceled before storage on the Scan Router server finishes, the counts are not done.
- The count is executed even if regardless of confirmation of the arrival at the Scan Router server.

8671	T:Deliv PGS/PC		[0 to 9999999/ 1]
	These SPs count by color mode the total number of pages sent to a folder on a PC (Scan-to-PC) with the Scan and LS applications.		
1	B/W		
2	Color	Supported by Color MFP machines only.	
8675	S:Deliv PGS/PC		[0 to 9999999/ 1]
	These SPs count by color mode the total number of pages sent with Scan-to-PC with the Scan application.		
1	B/W		

2	Color	Supported by Color MFP machines only.
---	-------	---------------------------------------

8691	T:TX PGS/LS	<p>These SPs count the number of pages sent from the document server. The counter for the application that was used to store the pages is incremented.</p> <p>[0 to 9999999/ 1]</p> <p>The L: counter counts the number of pages stored from within the document server mode screen at the operation panel. Pages stored with the Store File button from within the Copy mode screen go to the C: counter.</p>
8692	C:TX PGS/LS	
8694	P:TX PGS/LS	
8695	S:TX PGS/LS	
8696	L:TX PGS/LS	

2

Notes

- Print jobs done with Web Image Monitor and Desk Top Binder are added to the count.
- If several documents are merged for sending, the number of pages stored are counted for the application that stored them

8701	TX PGS/Port	[0 to 9999999/ 1]
	These SPs count the number of pages sent by the physical port used to send them. For example, if a 3-page original is sent to 4 destinations via ISDN G4, the count for ISDN (G3, G4) is 12.	
1	PSTN-1	
2	PSTN-2	
3	PSTN-3	
4	ISDN (G3,G4)	
5	Network	

8711	T:Scan PGS/Comp	[0 to 9999999/ 1]
	These SPs count the number of compressed pages scanned into the document server, counted by the formats listed below.	
1	JPEG/JPEG2000	
2	TIFF (Multi/Single)	
3	PDF	
4	Other	

5	PDF/Comp	
---	----------	--

8715	S:Scan PGS/Comp	[0 to 9999999/ 1]
	These SPs count the number of compressed pages scanned by the scan application, counted by the formats slisted below.	
1	JPEG/JPEG2000	
2	TIFF (Multi/Single)	
3	PDF	
4	Other	
5	PDF/Comp	

8721	T: Deliv PGS/WSD	
8725	S: Deliv PGS/WSD	
8731	T: Scan PGS/Media	
8735	S: Scan PGS/Media	
1	B/W	
2	Color	

8741	RX PGS/Port	[0 to 99999999/ 1]
	These SPs count the number of pages received by the physical port used to receive them.	
1	PSTN-1	
2	PSTN-2	
3	PSTN-3	
4	ISDN (G3,G4)	
5	Network	

8771	Dev Counter		[0 to 99999999/ 1]
	<p>These SPs count the frequency of use (number of rotations of the development rollers) for black and other color toners.</p> <p>Note: For machines that do not support color, the Black toner count is the same as the Total count.</p>		
1	Total	All toners (YMCK)	
2	K	Black toner	
3	Y	Yellow toner	
4	M	Magenta toner	
5	C	Cyan toner	
6	R	Red toner (Wide Format A2 machines only)	

8781	Toner Use Count: Color		[0 to 65 535]
	<p>These SPs count the frequency of use (number of rotations of the development rollers) for black and other color toners.</p>		
1	BK	Black toner	
2	Y	Yellow toner	
3	M	Magenta toner	
4	C	Cyan toner	

8791	LS Memory Remain		
<p>This SP displays the percent of space available on the document server for storing documents.</p> <p>[0 to 100/ 1]</p>			

8801	Toner Remain		[0 to 100/ 1]
	<p>This SP displays the percent of toner remaining for each color. This SP allows the user to check the toner supply at any time.</p> <p>Note: This precise method of measuring remaining toner supply (1% steps) is better than other machines in the market that can only measure in increments of 10 (10% steps).</p>		
1	K	Black.	Supported by B/W, Color, Wide Format A2, Wide Format Roll machines.
2	Y	Yellow	Color machines only.
3	M	Magenta	
4	C	Cyan	

8851	Toner Coverage 0-10%		[0 to 65 535]
	These SPs count the percentage of dot coverage for black other color toners.		
11	0-2%: BK		
12	0-2%: Y		
13	0-2%: M		
14	0-2%: C		
21	3-4%: BK		
22	3-4%: Y		
23	3-4%: M		
24	3-4%: C		
31	5-7%: BK		
32	5-7%: Y		
33	5-7%: M		
34	5-7%: C		
41	8-10%: BK		
42	8-10%: Y		

43	8-10%: M	
44	8-10%: C	

8861	Toner Coverage 11-20%	[0 to 65 535]
	These SPs count the percentage of dot coverage for black other color toners.	
8871	Toner Coverage 21-30%	[0 to 65 535]
	These SPs count the percentage of dot coverage for black other color toners.	
8881	Toner Coverage 31 -%	[0 to 65 535]
	These SPs count the percentage of dot coverage for black other color toners.	
8891	Pages: Current Toner	[0 to 65 535]
	These SPs count the number of pages for the current set toner.	
8901	Page/Toner_Prev1 DFU	
8911	Page/Toner_Prev2 DFU	
1	BK	Black toner
2	Y	Yellow toner
3	M	Magenta toner
4	C	Cyan toner

8921	Cvr Cnt/Total	
1	Coverage (%): BK	
2	Coverage (%): Y	
3	Coverage (%): M	
4	Coverage (%): C	
11	Coverage/P: BK	
12	Coverage/P: Y	
13	Coverage/P: M	
14	Coverage/P: C	

8941	Machine Status	[0 to 9999999/ 1]
	These SPs count the amount of time the machine spends in each operation mode. These SPs are useful for customers who need to investigate machine operation for improvement in their compliance with ISO Standards.	
1	Operation Time	Engine operation time. Does not include time while controller is saving data to HDD (while engine is not operating).
2	Standby Time	Engine not operating. Includes time while controller saves data to HDD. Does not include time spent in Energy Save, Low Power, or Off modes.
3	Energy Save Time	Includes time while the machine is performing background printing.
4	Low Power Time	Includes time in Energy Save mode with Engine on. Includes time while machine is performing background printing.
5	Off Mode Time	Includes time while machine is performing background printing. Does not include time machine remains powered off with the power switches.
6	SC	Total down time due to SC errors.
7	PrtJam	Total down time due to paper jams during printing.
8	OrgJam	Total down time due to original jams during scanning.
9	Supply PM Unit End	Total down time due to toner end.
8951	AddBook Register	
	These SPs count the number of events when the machine manages data registration.	

1	User Code	User code registrations.	[0 to 99999999 / 1]
2	Mail Address	Mail address registrations.	
3	Fax Destination	Fax destination registrations.	
4	Group	Group destination registrations.	
5	Transfer Request	Fax relay destination registrations for relay TX.	
6	F-Code	F-Code box registrations.	
7	Copy Program	Copy application registrations with the Program (job settings) feature.	[0 to 255 / 255]
8	Fax Program	Fax application registrations with the Program (job settings) feature.	
9	Printer Program	Printer application registrations with the Program (job settings) feature.	
10	Scanner Program	Scanner application registrations with the Program (job settings) feature.	

8999	Admin Counter List	
1	Total	
2	Copy: Full Color	
3	Copy: BW	
4	Copy: Single Color	
5	Copy: Two Color	
6	Printer: Full Color	
7	Printer: BW	
8	Printer: Single Color	
9	Printer: Two Color	
10	Fax Print: BW	

11	Fax Print: Single Color	
12	A3/DLT	
13	Duplex	
14	Coverage: Color (%)	
15	Coverage: BW (%)	
16	Coverage: Color Print Page	
17	Coverage: BW Print Page	
20	Full Color: GPC	
101	Transmission Total: Color	
102	Transmission Total: BW	
103	Fax Transmission	
104	Scanner Transmission: Color	
105	Scanner Transmission: BW	

MEMO

MEMO