

MP CW2201

**Machine Code:
D262**

Field Service Manual

March, 2016

Important Safety Notices

Warnings, Cautions, Notes

In this manual, the following important symbols and notations are used.

WARNING

- A Warning indicates a potentially hazardous situation. Failure to obey a Warning could result in death or serious injury.

CAUTION

- A Caution indicates a potentially hazardous situation. Failure to obey a Caution could result in minor or moderate injury or damage to the machine or other property.

Important

- Obey these guidelines to avoid problems such as misfeeds, damage to originals, loss of valuable data and to prevent damage to the machine.

Note

- This information provides tips and advice about how to best service the machine.

General Safety Instructions

For your safety, please read this manual carefully before you use this product. Keep this manual handy for future reference.

Safety Information

Always obey the following safety precautions when using this product.

Safety During Operation

In this manual, the following important symbols and notations are used.



[A]: ON

[B]: OFF

[C]: Push ON/Push OFF

[D]: Standby

Switches and Symbols

Where symbols are used on or near switches on machines for Europe and other areas, the meaning of each symbol conforms with IEC60417.

Safety

Prevention of Physical Injury

1. Before disassembling or assembling parts of the machine and peripherals, make sure that the machine and peripheral power cords are unplugged.
2. The plug should be near the machine and easily accessible.
3. Note that some components of the machine and the paper tray unit are supplied with electrical voltage even if the main power switch is turned off.
4. Always unplug the power cord from the power source before you move the product. Before you move the machine, arrange the power cord so it will not fall under the machine.
5. Disconnect all peripheral units (finisher, LCT, etc.) from the mainframe before you move the machine.
6. If any adjustment or operation check has to be made with exterior covers off or open while the main switch is turned on, keep hands away from electrified or mechanically driven components.
7. The machine drives some of its components when it completes the warm-up period. Be careful to keep hands away from the mechanical and electrical components as the machine starts operation.
8. The inside and the metal parts of the fusing unit become extremely hot while the machine is operating. Be careful to avoid touching those components with your bare hands.
9. To prevent a fire or explosion, keep the machine away from flammable liquids, gases, and aerosols.
10. Do not use flammable sprays or solvent in the vicinity of the machine. Also, avoid placing these items in the vicinity of the machine. Doing so could result in fire or electric shock.
11. To avoid fire or explosion, never use an organic cleaner near any part that generates heat.
12. Never remove any safety device unless it requires replacement. Always replace safety devices immediately.
13. Never do any procedure that defeats the function of any safety device.
14. Modification or removal of a safety device (fuse, switch, etc.) could lead to a fire and personal injury. Always test the operation of the machine to ensure that it is operating normally and safely after removal and replacement of any safety device.
15. For replacements use only the correct fuses or circuit breakers rated for use with the machine. Using replacement devices not designed for use with the machine could lead to a fire and personal injuries.

-
16. When using a vacuum cleaner around the machine, keep others away from the cleaner, especially small children.

Observance of Electrical Safety Standards

1. The machine and its peripherals must be installed and maintained by a customer service representative who has completed the training course on those models with exceptions on some machines where the installation can be handled by the user.

Safety and Ecological Notes for Disposal

1. Dispose of replaced parts in accordance with local regulations.
2. When keeping used lithium batteries in order to dispose of them later, do not put more than 100 batteries per sealed box. Storing larger numbers or not sealing them apart may lead to chemical reactions and heat build-up.
3. The danger of explosion exists if a battery of this type is incorrectly replaced. Replace only with the same or an equivalent type recommended by the manufacturer. Discard used batteries in accordance with the manufacturer's instructions.

Safety Instructions for Ink Cartridges

Accidental Exposure To Ink

CAUTION

1. If ink gets on the skin, wash the affected area immediately with soap and cold running water.
2. If ink gets into the eyes, immediately flush the eyes with cold running water. If there are signs of irritation or other problems, seek medical attention.
3. If ink is swallowed, drink a strong solution of cold water and table salt to induce vomiting. Seek medical attention immediately.
4. Ink is difficult to remove from fabric. Work carefully to avoid staining clothing when perfo

Handling and Storing Ink Cartridges

WARNING

- Ink is flammable. Never store ink cartridges in a location where they will be exposed to high temperature or an open flame.

CAUTION

1. Always store ink cartridges out of the reach of children.
2. Always store ink cartridges in a cool, dry location that is not exposed to direct sunlight.



















Ink Cartridge Disposal

CAUTION

1. Attach the caps to empty ink containers for temporary storage to avoid accidental spillage.
2. Return empty ink cartridges to a local dealer who can accept such items for collection and recycling or disposal.
3. If the customer decides to dispose of empty ink cartridges, make sure that they are disposed of in accordance with local laws and regulations.

Symbols and Trademarks

Symbols

Symbol	What it means
	Bushing
	C-ring
	Connector
	E-ring
	FFC (Flexible Film Cable)
	Gear
	Harness clamp
	Hex head screw
	Hook (or tab release)
	Knob screw (black)
	Knob screw (sliver)
	Pivot screw
	Screw (common screw)
	Shoulder screw
	Spring  x2
	Standoff
	Stud screw
	Timing belt

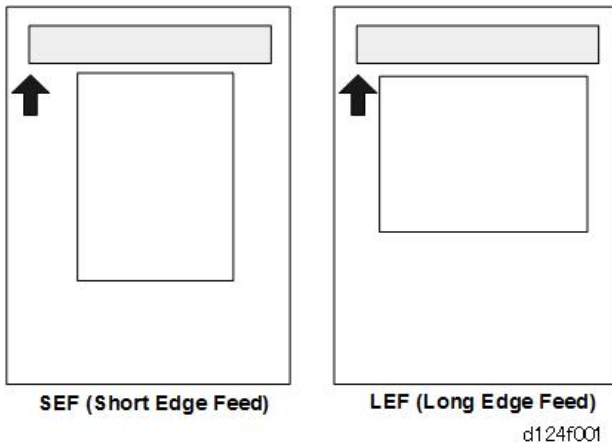

- The notations "SEF" and "LEF" describe how paper is fed from the bypass tray, short edge first or long edge first.
- "Main Scan" means "horizontal direction", the left to right and right to left movement of the carriage.
- "Sub Scan" means the "vertical direction", the direction of paper feed.

Trademarks

Adobe is either registered trademarks or trademarks of Adobe Systems Incorporated in the United States and/or other countries.

Firefox is a registered trademark of the Mozilla Foundation.

Google and Chrome are trademarks of Google Inc.

Microsoft, Windows, and Internet Explorer are either registered trademarks or trademarks of Microsoft Corporation in the United States and/or other countries.

Safari is a trademark of Apple Inc., registered in the United States and other countries.

The SD is a trademark of SD-3C, LLC.

The proper names of Internet Explorer 8, 9, 10 and 11 are as follows:

- Windows® Internet Explorer® 8
- Windows® Internet Explorer® 9
- Internet Explorer® 10
- Internet Explorer® 11

Other product names used herein are for identification purposes only and might be trademarks of their respective companies. We disclaim any and all rights to those marks.

TABLE OF CONTENTS

Symbols and Trademarks..... 1

- Symbols..... 1
- Trademarks..... 2

1. Product Information

Specifications..... 25

Main Machine, Peripherals, Options..... 26

- Model Numbers and Names..... 26
- Configuration..... 27

Guidance for Those Who Are Familiar with Predecessor Products..... 29

- Comparison to MP CW2201..... 29

Overview..... 30

- New Features..... 30
 - Auto Nozzle Check..... 30
 - Carriage Unit..... 31
 - Ink Supply Motors..... 32
 - Carriage LED Lamp..... 33
 - New Bypass Feed..... 33
 - Manual Cut..... 33
 - Configuration..... 34
 - Locations of Major Electrical Components..... 35
 - Smart Operation Panel..... 36
 - Roll Paper Setting..... 38
- Acronyms and Important Terms..... 39
- Around the Machine..... 40
- Main Sections..... 50
- Main Components..... 52
- Drive Layout..... 54
- Original Path, Paper Paths..... 56

2. Installation

Preparation..... 59

- Environment..... 59
- Minimum Space Requirements..... 60
- Configuration..... 61

Machine Level.....	61
Power Source.....	61
Installation Overview.....	62
Installation Flow.....	62
Main Machine Installation.....	64
Before You Begin.....	64
Accessory Boxes.....	64
What You Need.....	65
Accessory List in Box [3].....	65
Accessory List in Box [5].....	67
Main Unit Stand.....	67
Accessories: Main Unit Stand.....	67
Installing the Main Unit Stand.....	68
Mounting the Main Unit.....	70
Assembling the Scanner Stand.....	75
Accessories: Scanner Stand.....	75
Installing the Scanner Stand.....	76
Mounting the Scanner Unit.....	78
Roll Unit 1 (Standard).....	81
Accessories: Roll Unit 1.....	81
Installing Roll Unit 1.....	82
Wiring Roll Unit 1.....	88
Roll Unit 2 (Option).....	91
Accessories.....	92
Installing Roll Unit 2.....	93
Wiring Roll Unit 2.....	96
Controller Options.....	103
Connecting the Scanner and Main Unit.....	103
Parts to be Used.....	103
Connecting the Harnesses.....	104
Wiring the Scanner Cable.....	106
Clamping the Power Cord.....	111
Removing Tapes and Shipping Materials.....	113

Original Stacker, Guides.....	115
Installing the Original Stacker, Guides.....	115
Ink Collector Tank Storage Shelf.....	117
Installing the Ink Collector Tank Storage Shelf.....	117
Exit Stacker.....	119
Accessories: Exit Stacker.....	119
Installing the Exit Stacker.....	119
Changing the mode of the Paper Exit Stacker.....	125
Ink Filling.....	126
Draining and Filling Procedure.....	126
If Draining Fails to Start.....	129
Setting Roll Paper.....	130
Setting the Paper Spool to Roll Paper.....	130
Setting the Paper Roll to the Machine.....	132
Connecting to the Gigabit Ethernet Interface.....	135
Check Printing.....	137
Nozzle Check Pattern.....	137
When an Unbroken Nozzle Check Pattern Cannot be Produced.....	139
Halftone Check.....	139
Final Adjustments.....	140
Caster Lock.....	140
Level Adjustment.....	141
Manual Adjust Head Position.....	142
Adjust Paper Feed.....	144
Adjust Print Position.....	145
Final Settings.....	146
After Installation.....	147
Moving the Machine.....	147
Controller Options.....	148
Overview.....	148
Slots.....	148
Standard Controller Features.....	149
SD Card Appli Move.....	149

Overview.....	149
Move Exec.....	149
Undo Exec.....	150
IEEE 802.11 a/g/n Interface Unit Type M19.....	151
Included Parts.....	152
Installation.....	152
Attaching Antennas.....	153
Checking the Wireless LAN Interface Connection.....	158
OCR Unit Type M13.....	159
Recovery Procedure.....	162
File Format Converter Type M23 (MLB).....	163
Included Parts.....	163
Installation of MLB.....	163
Data Overwrite Security Unit Type M19.....	165
Overview.....	165
Before You Begin the Procedure.....	165
Seal Check and Removal.....	166
Installation Procedure.....	166
R/W NFC Personal Authentication IC Card	168
Included Parts.....	168
Installation Guide.....	169
Check All Connections.....	175
Security Setting.....	176
Security Function Installation.....	176
Data Overwrite Security.....	177
Before You Begin the Procedure.....	177
Using Auto Erase Memory.....	177
HDD Encryption.....	179
Before You Begin the Procedure:.....	179
Enable Encryption Setting.....	179
Backing Up the Encryption Key.....	182
Encryption Key Restoration.....	182
@Remote Setting.....	185

Settings Relevant to the Service Contract.....	185
Settings for @Remote Service.....	185

3. Preventive Maintenance

Preventive Maintenance Tables.....	191
PM Cleaning Points.....	192
PM Table.....	192
Scanner Unit.....	192
Horizontal Unit.....	195
Waste Ink Collection.....	199
Other Items for Cleaning.....	203
External Covers.....	203
Scanner Unit.....	204
Horizontal Unit.....	206
Paper Feed.....	206
Roll Units.....	208

4. Replacement and Adjustment

Notes on the Main Power Switch.....	213
Push Switch.....	213
Characteristics of the Push Switch (DC Switch).....	213
Shutdown Method.....	214
Forced Shutdown	216
General Precautions.....	217
External Covers.....	217
Original Transport.....	217
Paper.....	219
Copy Quality.....	219
CIS.....	220
Electrical Components.....	220
Adjustments at Machine Installation.....	220
Other Precautions.....	220
Service Precautions.....	221
Scanner Unit Rollers.....	221
Main Frame Screws.....	222

Right Plate Screws.....	222
Maintenance Unit Base Screws.....	223
Solenoid Bracket Screw.....	224
Main Carriage Screws.....	225
Temperature/Humidity Sensor Bracket.....	225
Notes on Operation of the Paper Holding Lever.....	226
Common Procedures.....	228
Before You Begin.....	228
Before Servicing the Machine.....	229
Rear Output Guides.....	229
Original Guides.....	230
Original Stacker.....	230
Ink Collector Tank.....	232
Paper Rolls.....	232
Main Covers.....	233
Left Cover.....	234
Right Cover.....	239
Right Upper Cover.....	241
Ink Cartridge Cover.....	243
Top Cover.....	245
Right Rear Cover.....	247
Left Rear Cover.....	248
Front Cover.....	249
Paper Exit Guide.....	251
Scanner Unit.....	254
Raise the Scanner Unit Fully.....	254
Scanner Upper Cover.....	255
Scanner Rear Cover.....	260
Scanner Left Cover, Scanner Right Cover.....	260
Original Table.....	261
Raise the Left Side of the Scanner Unit.....	262
Raise the Right Side of the Scanner Unit.....	264
Moving the Carriage Unit.....	267

Before You Begin.....	267
Move the Carriage Unit with SP2-102-4.....	267
Uncapping the Print Heads and Moving the Carriage Unit Manually.....	269
Capping the Print Heads Manually.....	273
Disconnecting the Main Unit from the Scanner Unit.....	274
Disconnecting the Scanner Cable.....	275
Separating the Main Unit from the Scanner Unit	278
Operation Panel.....	279
Remove.....	279
Precaution.....	281
Scanner.....	284
Before You Begin.....	284
Safety Switch Diagram.....	284
Original Width Sensors, Original Set Sensor.....	285
Safety Switch.....	288
Original Registration Sensor.....	289
Scanner Motor.....	290
SIB (Scanner I/F Board).....	292
Remove.....	292
Precaution.....	293
Original Feed Roller.....	294
Remove.....	294
Adjustment.....	298
Exposure Glass.....	299
Remove.....	299
Precaution.....	300
CIS Unit.....	301
Remove.....	301
Precaution.....	303
Adjustment.....	305
Original Exit Sensor.....	305
Original Exit Roller.....	306
Remove.....	306

Adjustment.....	310
White Plate Bracket.....	310
Original Stop Switch.....	311
Roll Units.....	314
Roll Unit 1.....	314
Remove.....	314
Precaution.....	320
Roll Unit 2 (Option).....	322
Remove.....	322
Precaution.....	327
Rewind Switch.....	329
Remove.....	329
Precaution.....	330
Left Outer Cover, Left Inner Cover.....	330
Remove.....	330
Precaution.....	331
Encoder Sensors.....	332
Remove.....	332
Cleaning.....	333
Roll Paper Feed Motor.....	334
Roll Paper Feed Clutch.....	336
Remove.....	336
Precaution.....	340
Paper Release Sensor.....	342
Remove.....	342
Cleaning.....	343
Precaution.....	344
Feed Roller Housing.....	344
Separate the Feed Roller Housing (Roller Unit 1).....	345
Separate the Feed Roller Housing (Roller Unit 2).....	348
Paper Entrance Sensors, Exit Sensor.....	352
Remove.....	352
Cleaning.....	355

Feed Roller.....	355
Remove.....	355
Precaution.....	358
Roll End Sensor.....	358
Paper Transport.....	361
Bypass Sensor.....	361
Pre-Registration Sensor.....	362
Registration End Sensor.....	363
Paper Transport Fan Motor.....	364
Paper Exit.....	366
Cutter.....	366
Exit Guide.....	367
Remove.....	367
Precaution.....	368
Cutter Unit.....	369
Cutter Switch (Right).....	372
Cutter Switch (Left).....	373
Cutter Motor.....	374
Motor Timing Belt, Cutter Belt.....	375
Remove.....	375
Precaution.....	378
Paper Exit Sensor.....	379
Guide Plate Safety Sensor.....	380
Main Scan.....	382
Horizontal Encoder Sensor.....	382
Remove.....	382
Precaution.....	384
Horizontal Encoder Sheet.....	385
Remove.....	385
Cleaning.....	388
Precaution.....	388
Horizontal Motor.....	389
Horizontal Timing Belt.....	391

Sub Scan.....	393
Vertical Encoder Sensor.....	393
Precaution.....	394
Vertical Encoder Wheel, Timing Belt.....	394
Vertical Encoder HP Sensor.....	397
Vertical Motor.....	399
Bypass Stopper Clutch Sensor.....	400
Bypass Stopper Clutch.....	402
Carriage Unit.....	406
Before You Begin.....	406
DRESS Sensor.....	407
Remove.....	408
Cleaning.....	410
Adjustment.....	411
LED.....	414
Remove.....	414
HRB (Head Relay Board).....	416
Remove.....	416
Precaution.....	423
Head Lift Motor.....	423
Print Head Unit.....	425
Black Print Head Unit Accessories.....	426
Color Print Head Unit Accessories.....	427
Carriage Unit Cover Removal.....	427
Black Print Head Unit Removal.....	429
New Black Print Head Unit Installation.....	437
Color Print Head Unit Removal.....	446
New Color Print Head Unit Installation.....	454
After the Print Head Unit Replacement.....	462
Carriage Unit.....	465
Remove Ink Supply Unit.....	466
Free the Harness on the Right Side of the Main Unit.....	469
Main Ink Level Sensor Bracket Removal.....	474

Ink Tube Rail Removal.....	476
Horizontal Encoder Sheet Removal.....	477
Tension Bracket Removal.....	479
Right Plate Removal.....	481
Carriage Unit Removal.....	486
Precaution.....	498
Ink Supply.....	504
Ink Supply Unit.....	504
Ink Supply Unit Accessories.....	504
Before You Begin.....	505
Ink Supply Unit Replacement.....	505
Carriage Disconnection.....	506
Ink Supply Unit Removal.....	514
New Ink Supply Unit Installation.....	514
Ink Tube Attachment to the Print Head Unit.....	516
Air Release Solenoid.....	521
Ink Level Sensor and Temperature/Humidity Sensor.....	525
Maintenance Unit, Waste Ink Collection.....	530
Left Ink Sump.....	530
Ink Collector Unit.....	531
Ink Collector Unit Contact Switch.....	532
Right Ink Sump.....	533
Maintenance Unit.....	534
Auto-Nozzle Check.....	538
Auto-Nozzle Check Upper Unit.....	538
Auto-Nozzle Check Unit.....	540
After Replacement.....	542
Electrical Components.....	544
Rear Cover.....	544
PCB Box.....	545
Controller Board.....	553
Remove.....	553
Replacing the NVRAM and Memory.....	555

RFDB (Roll Feeder Drive Board).....	556
Remove.....	556
IOB (Input/Output Board).....	558
Remove.....	558
HDD.....	560
Remove.....	560
Settings.....	561
BiCU (Base image Control Unit).....	562
Remove.....	563
EEPROM Replacement.....	564
NVRAM.....	566
NVRAM on the controller board.....	566
NVRAM (EEPROM) on the BiCU.....	568
PSU (Power Supply Unit).....	570
Remove.....	571
Precaution.....	572
Sensors, Switches.....	573
Ink Collector Tank Cover Switch.....	573
Ink-cartridge Cover Switch.....	573
Front Cover Safety Switches.....	574
Front Cover Switch.....	575
Remove.....	575
Precaution.....	577
Special Adjustments.....	578
Image Adjustment with SP Modes.....	578
Step 1: Magnification for Paper Type: Plain.....	578
Step 2: Copy/Main Scan Magnification.....	579
Step 3: Copy/Print Sub Scan Magnification.....	579
Step 4: Scanner Mask Setting.....	580
Step 5: Erase Margins.....	581
Step 6: Printer: Leading Edge, Side-to-Side Registration.....	581
Step 7: Scanner Mask Setting.....	582
Step 8: Erase Margins.....	583

Step 9: Scanner Registration.....	583
Step 10: Printer: Cut Length.....	584
Step 11: Synchro Cut (Trailing Edge Registration).....	585
CIS Adjustment with SP Modes.....	586
To Print the CIS Adjustment Pattern.....	586
To Adjust the Image at the CIS Joints.....	587
To Adjust the Scan Speed Switching.....	588

5. System Maintenance Reference

Service Program Mode.....	591
Firmware Update.....	592
Overview.....	592
Firmware Type.....	592
Procedure.....	594
Update procedure.....	594
Error Screens During Updating.....	599
RFU Updating the Firmware.....	606
RFU Performable Condition.....	606
Package Firmware Update.....	607
Overview.....	607
Immediate Update.....	608
Update at the Next Visit (Reserve).....	611
How to Set the Machine to Download Firmware Later (RESERVE).....	611
How to Check if the Firmware Downloaded with RESERVE.....	613
How to Install Firmware Downloaded with RESERVE.....	615
Update via SD card.....	618
Updating JavaVM.....	621
Creating an SD Card for Updating.....	621
Updating Procedure.....	621
List of Error Messages.....	622
Capturing the Debug Logs.....	624
Overview.....	624
Security of the Operation Log.....	626
Retrieving the Debug Logs.....	626

Procedure for Retrieving the Debug Log with SD Card.....	626
Reboot/System Setting Reset.....	628
System Settings and Copy Setting Reset.....	628
System Setting Reset.....	628
Copier Setting Reset.....	628
NVRAM Data Upload/Download.....	630
Uploading Content of NVRAM to an SD card.....	630
Downloading an SD Card to NVRAM.....	631
Address Book Upload/Download.....	633
Information List.....	633
Download.....	633
Upload.....	635
SMC List Card Save Function.....	636
Overview.....	636
SMC List Card Save.....	636
Procedure.....	636
File Names of the Saved SMC Lists.....	638
Error Messages.....	639
UP/SP Data Import/Export.....	640
Overview.....	640
Import/export conditions.....	640
UP Data Import/Export.....	640
Data that can be imported and exported.....	640
Data that cannot be imported or exported.....	640
Exporting Device Information.....	641
Importing Device Information.....	643
SP Data Import/Export.....	644
Data that can be imported and exported.....	644
Exporting Device Information.....	644
Importing Device Information.....	645
Possible solutions for import/export problems.....	646
Test Pattern Printing.....	649
Card Save Function.....	650

Overview.....	650
Card Save:.....	650
Procedure.....	650
Error Messages.....	653

6. Troubleshooting

Service Call Conditions.....	655
SC100: Scanning.....	656
SC200: Image Writing.....	661
SC300: Not Used.....	679
SC400: Not Used.....	680
SC500: Paper Feed, Transport.....	681
SC600: Communication.....	690
SC700: Not Used.....	706
SC800: Firmware.....	707
SC900: Software.....	718
Printing Problems.....	722
Before You Begin.....	722
White Lines, Horizontal Banding.....	722
Print heads clogged.....	722
Other Measures.....	723
Horizontal Lines In Margins.....	723
White, Color Vertical Banding.....	724
Print Head Out of Position, Horizontal Encoder Strip Problem.....	724
Overall Poor Image Quality.....	724
Gap Adjustment.....	725
Print heads clogged.....	725
Paper Feed Faulty.....	725
Horizontal Encoder Strip.....	725
Text Shifted Out of Position.....	726
Obstructed, Faulty Paper Feed.....	726
Ink Scatter.....	727
Gap Adjustment.....	727
Print heads clogged.....	727

Faulty Maintenance Unit, Carriage Unit.....	728
Mixed Colors.....	728
Print heads clogged.....	728
Faulty Maintenance Unit.....	729
Image Abraded, Paper Torn, Ink Running.....	729
Gap Adjustment.....	729
Paper Feed Obstruction.....	729
Faulty Carriage Unit.....	730
Color Density Too Light.....	730
Printer Driver Settings.....	730
Part of Image Missing, Text Misaligned.....	730
Printer Driver Settings.....	731
Faulty Controller.....	731
Image Skewed on Paper.....	731
Obstructed Paper Feed.....	731
Bolded Text Does Not Appear Bold in Printout.....	731
Printer Driver Settings.....	732
Scanning Problems.....	733
Flow Chart.....	733
Scanning Troubleshooting.....	733
Jam Code Tables.....	738
Overview.....	738
Scanner Original Jams.....	739
Printer Paper Jams.....	740
Electrical Components.....	744
Scanner Unit.....	744
Main Unit Sensors, Motors.....	745
Roll Units.....	748
Ink Supply.....	750
Carriage Unit.....	751
Around the Carriage Unit.....	754
Maintenance Unit.....	755
Boards.....	757

Fuses.....	759
Scanner Unit.....	759
Operation Panel.....	759
SIB (Scanner I/F Board).....	759
Main Boards (PCB Box).....	760
Controller Board.....	760
IOB (Input/Output Board).....	762
BiCU (Base image Control Unit).....	764
PSU (Power Supply Unit).....	767
Carriage Unit.....	768
HRB.....	768

7. Detailed Description

Overview.....	771
General Operation Sequence.....	771
1 Power ON.....	771
2 Paper Exit and Job End.....	772
Scanner Unit.....	773
Scanner Layout.....	773
Side View.....	773
Front View.....	774
Original Width Detection.....	775
Scanning.....	777
Original Feed, Exit Sequence.....	777
Auto Image Density Correction.....	778
Scanning Area.....	779
Scan Magnification Correction.....	779
Original Drive Mechanism.....	780
Scanning Motor, Rollers.....	780
Original Feed Speed.....	781
Scanning Mechanism.....	782
CIS Structure.....	782
Printed Image.....	783
Long Original or Special Original with Carrier Sheet.....	783

Related SPs.....	784
Image Processing.....	785
Features for Printing.....	785
Image Flow.....	786
Copy Job Image Data Flow.....	786
Scan Job Image Data Flow.....	787
Print Job Image Data Flow.....	788
Copy Mode Image Processing.....	788
Print Mode Image Processing.....	789
Copy Resolution: Copy Jobs and Print Jobs.....	789
Copy Jobs.....	790
Print Jobs.....	791
Image Troubleshooting.....	794
Paper Feed and Exit.....	797
Overview.....	797
Roll Unit Operation.....	798
General Operation of Roll Unit.....	798
Roll Feed Mechanism.....	799
Initializing the First Paper Roll.....	800
Initializing the Second Paper Roll.....	804
Roll Rewinding for Removal.....	804
Roll End.....	807
Main Unit Paper Feed.....	808
Registration Roller.....	808
Vertical Feed Mechanism.....	809
Remaining Paper Detection.....	811
Paper Transport Fan.....	814
General Operation.....	814
Transport Fan Duty Adjustment.....	815
Normal Paper, Recycled Paper.....	816
Translucent Paper.....	817
Front Cover Switches.....	818
Detailed Description of Paper Feed Sequence.....	819

Paper Feed Layout.....	819
Operation Sequence When the First Roll is Set.....	820
Operation Sequence When the Second Roll is Set.....	822
Cutting.....	822
Manual Cut.....	823
Bypass Feed.....	824
Related SPs.....	826
Ink Supply.....	827
Overview.....	827
Ink Cartridge.....	829
Ink Supply Mechanism.....	831
Controlling Ink Supply to the Sub Tanks.....	833
The OCFS System.....	833
Controlling Ink Supply During Printing.....	835
Air Detection and Air Purging.....	835
Air Purge Mechanism.....	836
After Air Purging.....	837
Emergency Print.....	837
Printable Conditions.....	838
Printing.....	838
Conditions for Function End.....	838
Number of Printable sheets.....	838
Operation of Emergency Print.....	839
Printing.....	840
Printing Drive Mechanism.....	840
Carriage Unit.....	841
Print Head Unit.....	845
Print Head.....	846
DRESS Sensor.....	847
Temperature Monitoring.....	850
Print Head Height Adjustment.....	851
Height Adjustment Mechanism.....	852
Raising and Lowering the Print Heads.....	853

Maintenance Unit.....	854
Overview.....	854
Capping/Uncapping.....	855
Print Head Cleaning Cycle.....	857
Manual Print Head Cleaning and Flushing.....	861
Automatic Downtime Cleaning.....	862
Automatic Mist Cleaning.....	863
Auto-Nozzle Check Module.....	864
Overview.....	864
Timing for Detection.....	865
Detection.....	865
Wiping an Electrode Plate.....	866
When Ink Deficiency is Detected.....	868
Operating Life.....	870
Waste Ink Collection.....	870
Ink Collector Tank.....	871
Right Ink Sump.....	872
Left Ink Sump.....	873
Related SPs.....	874
Print Head Cleaning and Adjustment.....	876
Nozzle Check Pattern Print.....	876
Clean Print Heads.....	877
Flush Print Heads.....	878
Adjust Head Position.....	879
Automatic Adjust Head Position.....	879
Manual Adjust Head Position.....	880
Adjust Paper Feed.....	881
Adjust Print Position.....	883
Prevent Paper Abrasion.....	885
Electrical Components.....	887
Boards.....	887
Block Diagram.....	887
Parts Layout.....	888

SIB (Scanner I/F Board).....	888
Controller Board.....	889
IOB (Input/Output Board).....	891
HDD.....	891
BiCU (Base image Control Unit).....	892
PSU (Power Supply Unit).....	893
Option.....	894
File Format Converter Type M23 (MLB).....	894
Energy Save.....	896
Energy Save Mode.....	896
Specification.....	897



1. Product Information

Specifications

1

See Appendices. for the following information:

- General Specifications
- Printer Specifications
- Scanning Specifications
- Option Specifications

Main Machine, Peripherals, Options

1

Model Numbers and Names

Model Number	Name	
D262-17	Ricoh	MP CW2201 SP
	Gestetner	MP CW2201
	Savin	MP CW2201
	Lanier	MP CW2201
D262-21	Ricoh	MP CW2201 SP
D262-27	Ricoh	MP CW2201 SP
	NRG	MP CW2201 SP

Configuration



Main Machines and Peripherals

No.	Item	Machine Code
1	Main Machine and Stand	D262
2	Scanning Unit and Stand	Standard
3	Roll Unit	Standard
4	Exit Stacker	Standard
5	Roll Unit RU6550	D3CR (Option)

Other Options

Option	No.	Slot
Data Overwrite Security Type M19	D3BS	SD Card Slot 1
OCR Unit Type M13	D3AC	SD Card Slot 1

Option	No.	Slot
File Format Converter Type M23	D3CX	Board A
IEEE 802.11 a/g/n Interface Unit Type M19	D3BR	Board B
NFC Card Reader Type M23	D3DG	USB

Guidance for Those Who Are Familiar with Predecessor Products

Comparison to MP CW2201

The MP CW2201 is a wide-format inkjet printer that incorporates the design of the MP CW2200. Here is a brief summary of the features of the MP CW2201 and MP CW2200.

MP CW2201 and MP CW2200 Compared

Item	MP CW2201	MP CW2200
Output speed (A1 LEF, high speed mode)	<ul style="list-style-type: none"> • 3.8 ppm (black-and-white), 2.0 ppm (color) • 5 sheets A1 LEF in 101 s (black-and-white), 175 s (color) • 5 sheets D LEF in 104 s (black-and-white), 169 s (color) 	<ul style="list-style-type: none"> • 3.4 ppm (black-and-white), 1.1 ppm (color) • 5 sheets A1 LEF in 109 s (black-and-white), 293 s (color) • 5 sheets D LEF in 116 s (black-and-white), 318 s (color)
1st Copy Time	<ul style="list-style-type: none"> • BK: 29sec • FC: 53sec 	<ul style="list-style-type: none"> • BK: 29sec • FC: 84sec
JOB Cancellation During Printing	Will be improved from MP CW2200	Limited Support
Manual Cut	Will be supported	Not Support
Force Print	PS Driver, HDI Driver	PS Driver
Printer Driver UI	Will be improved from MP CW2200	-
Setting Roll Paper	Will be improved from MP CW2200	-
Stacker	Will be improved from MP CW2200	-
Operation Panel	Smart Operation Panel	Conventional Panel
Auto-Nozzle Detection	Will be supported	Not Support

Overview

1

New Features

Auto Nozzle Check

The auto-nozzle check function detects whether the nozzle drops ink correctly. It checks the change in electrical charge caused by the ink dropped to the electrode plate at constant intervals. If ink is not dropped well but the effect is not so severe, the adjacent nozzles drop larger dots for printing to minimize the effect. If the effect is severe, the nozzles are cleaned automatically.

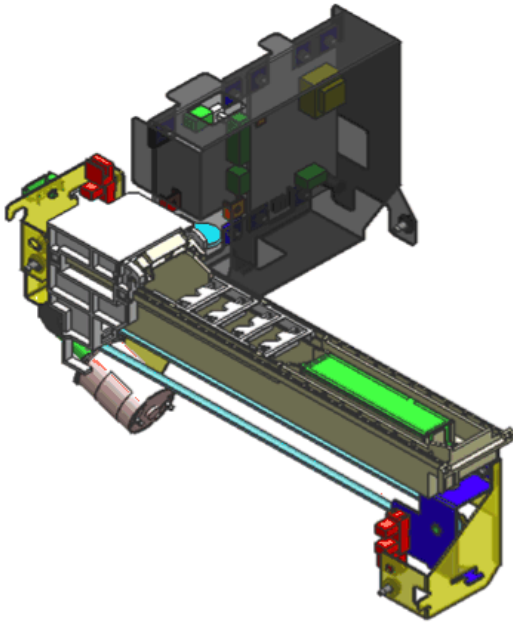

d262k1539

Carriage Unit

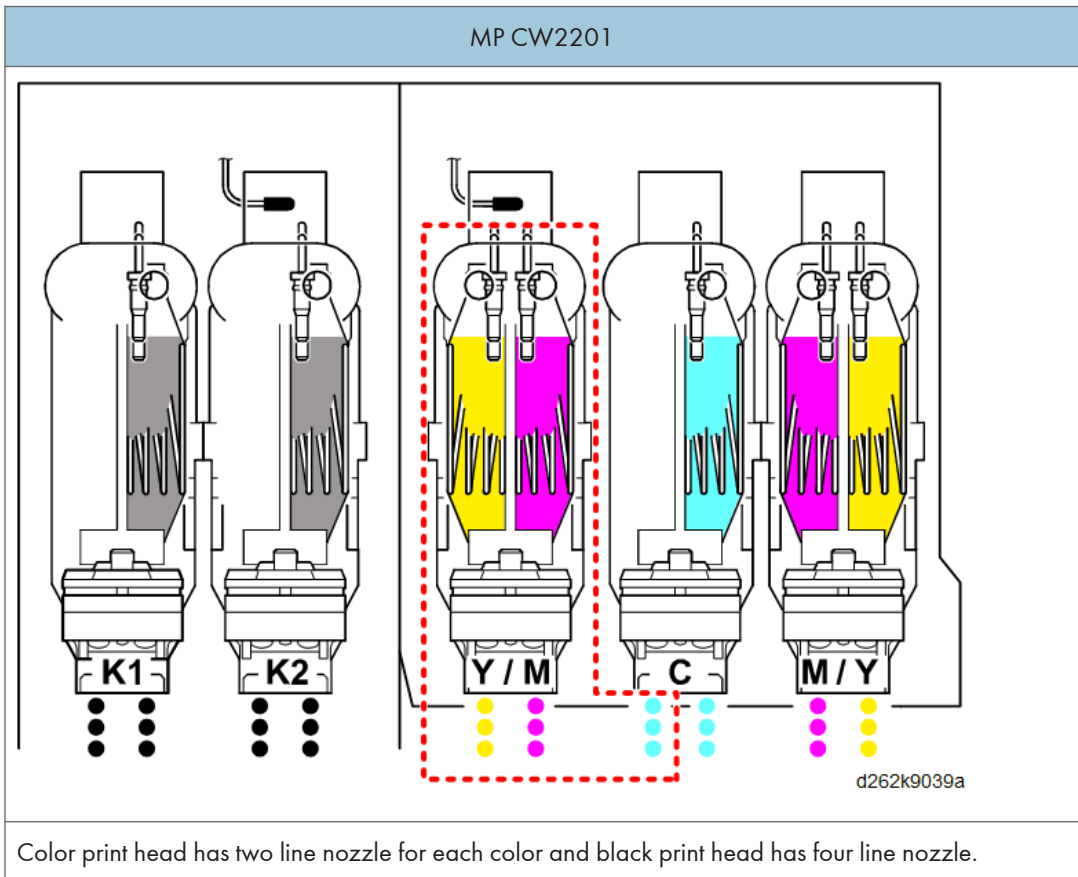

MP CW2200

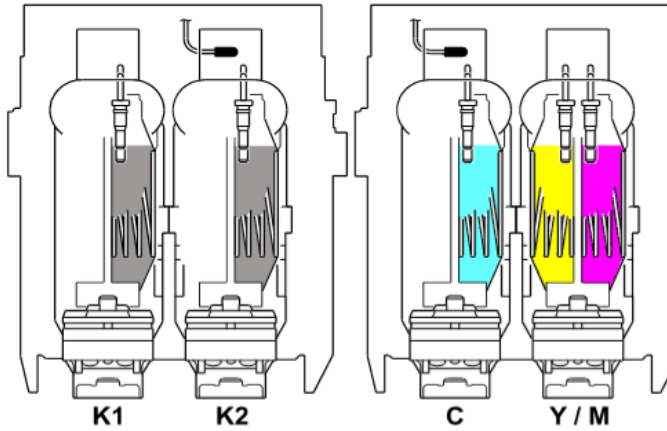

d262k1540

Color print head has one line nozzle for each color and black print head has four line nozzle.

Ink Supply Motors

Two ink supply motors are added for color print head addition.

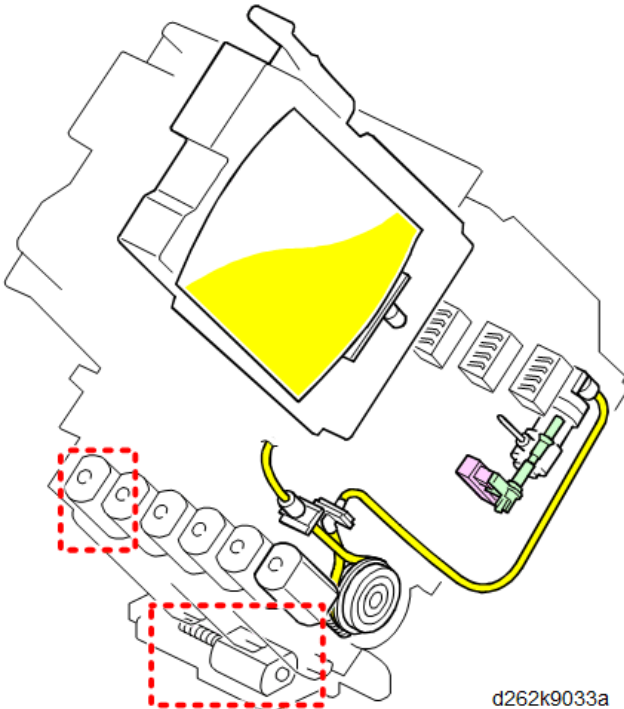

d262k9033a

Carriage LED Lamp

An LED on the carriage lights during operation to prevent users from opening the front cover by mistake.



d262k1542

1

New Bypass Feed

For bypass feed, the user manually feeds a sheet of paper into the front of the machine until the paper edge contacts the stopper [1].

When the bypass sensor [2] detects the paper, the machine grabs the paper and feeds it through the machine. On this time, the bypass stopper clutch [3] is ON and then the stopper opens in coordination with the vertical motor [4].

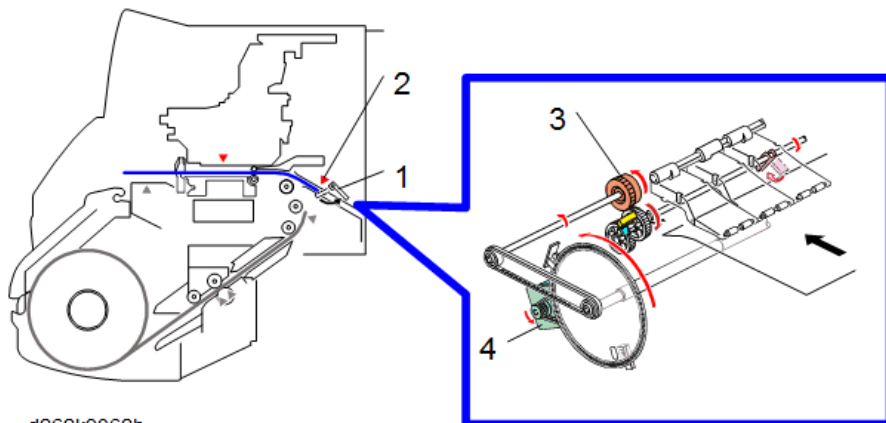

d262k9062b

Manual Cut

Manual Cut is to feed and discard paper that is damaged by moisture or paper jam.

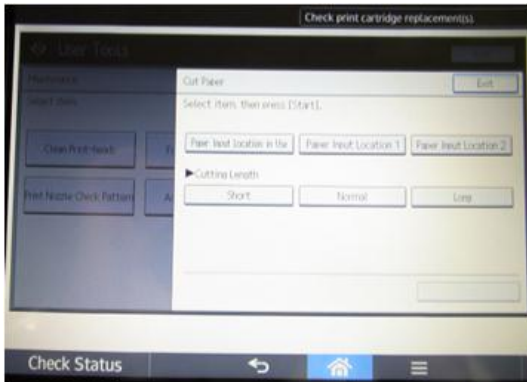

d262k1537

Configuration

Scanner harness falls down from center back of scanner unit into the PCB box.



d262k0100

MP CW2200's scanner harness falls down from left back of scanner unit.

Locations of Major Electrical Components

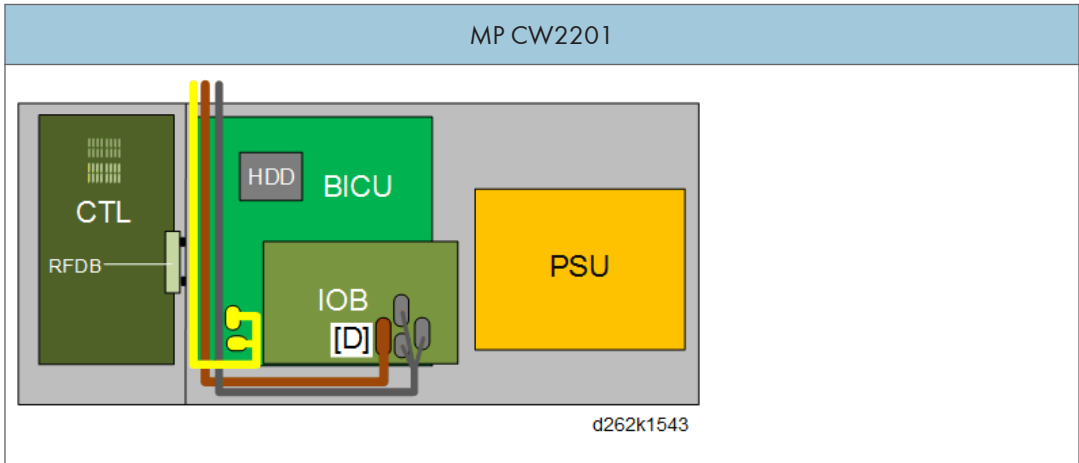

1

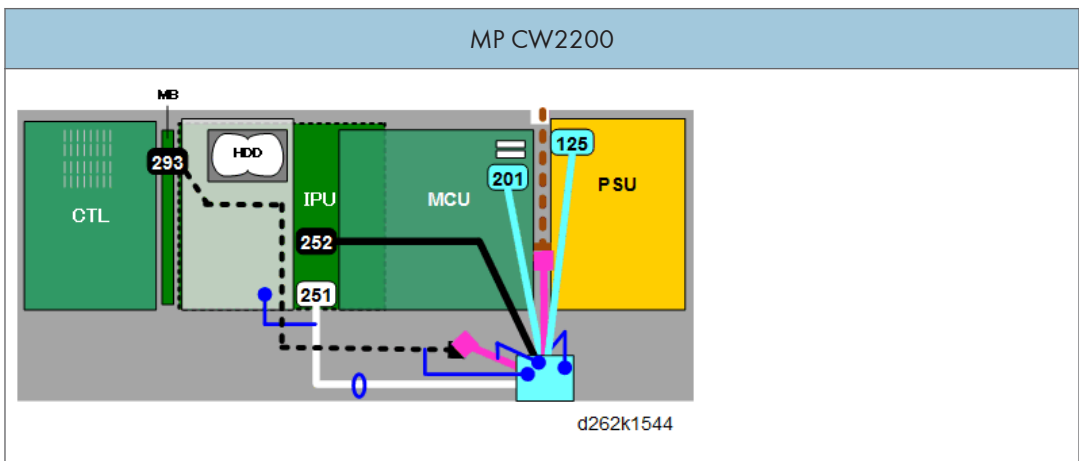

Smart Operation Panel

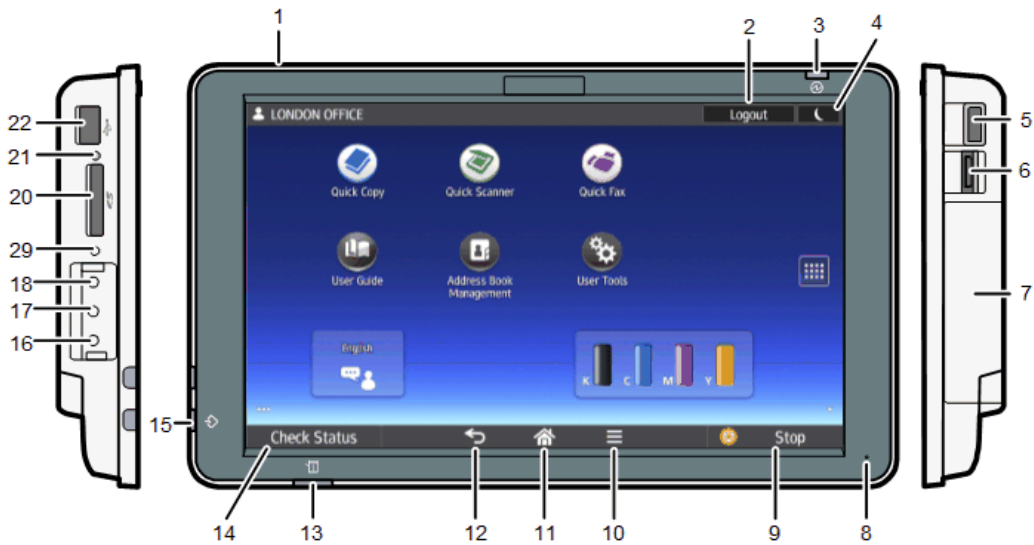

d262k1545

No.	Name	No.	Name
1	Speaker	12	[Back] key
2	[Login/Logout] key	13	[Check Status] indicator
3	Main power indicator	14	[Check Status] key
4	[Energy Saver] key	15	Data In indicator (facsimile and printer modes)
5	USB slot for digital cameras	16	Extended Feature key (EX3)
6	HDMI slot	17	Extended Feature key (EX2)
7	USB slot for NFC card readers	18	Extended Feature key (EX1)
8	Microphone	19	Control panel reboot key
9	[Stop] key	20	SD card slot
10	[Menu] key	21	Media access lamp
11	[Home] key	22	USB slot

Tilting the operation panel easily

Change the angle freely from 0° to 55° on panel



d262k1517

1

New smart UI and classic UI are ready

Smart UI Copy

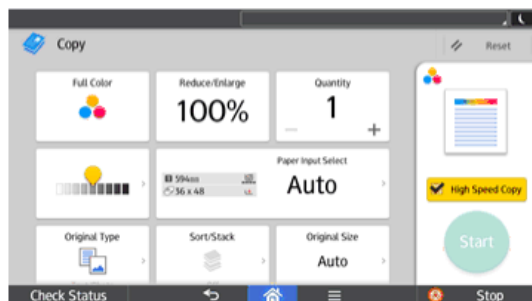

d262k1546

Smart UI Scan

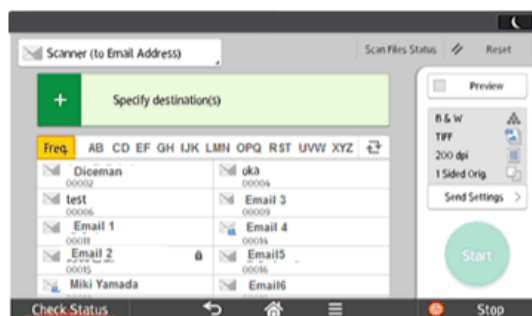

d262k1547

Classic UI

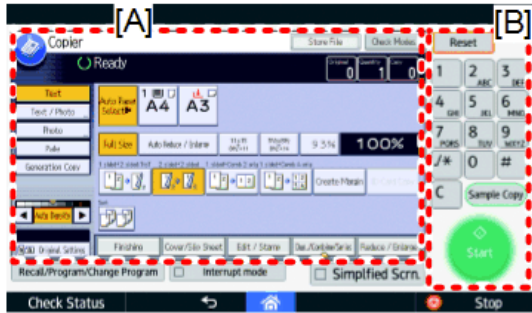

d262k1548

A:Classic UI area is same as MP CW2200's operation panel display.

B:Numeric key area is integrated into touch display.

Roll Paper Setting

Roll Paper Setting Position

Roll paper setting position of MP CW2201 changes by 40mm forward and 20mm low compared to MP CW2200. It can be set the roll paper without having to bend over too much.

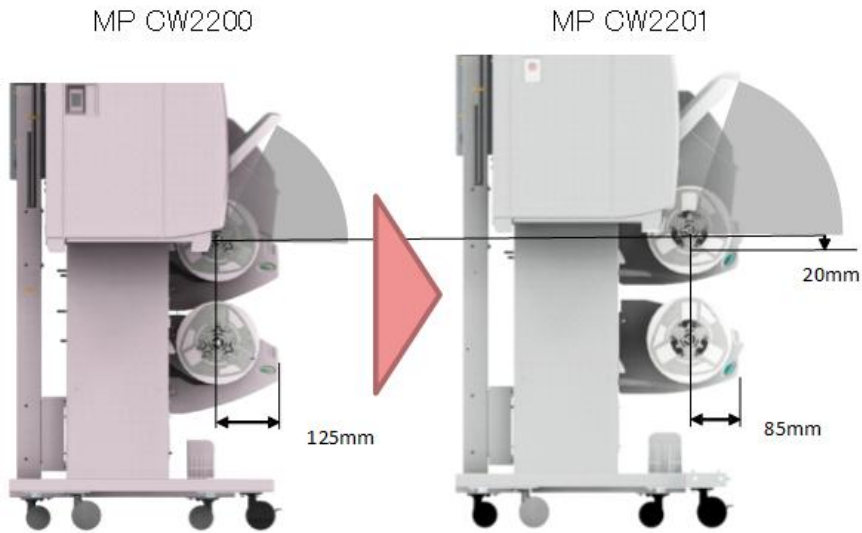

d262k1551

New Paper Spool

The levers do not have to be lowered for 2-inch core. The procedure is same for 2-inch core and 3-inch core paper rolls.

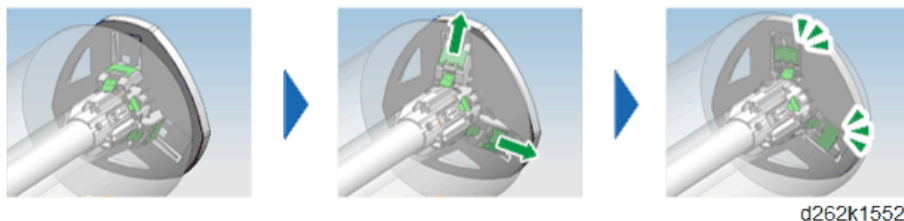

Acronyms and Important Terms

Here are some commonly used acronyms and standard terms you should know.

- **DRESS.** Direct Realization Edge Scanning Sensor. The DRESS sensor is mounted on the left, lower edge of the carriage unit. It detects skew correction, performs paper registration and does color registration.
- **OCFS.** On Carriage Filling Sensor. There are five of these sensors (one for each color) mounted on the carriage unit. A feeler arm attached to the flexible side of each color tank swings in and out of the sensor gap as the ink supply in the tank goes low and high. These sensors are used to monitor the level of the ink in the tanks.
- **Sub Scan.** This means the vertical direction. It is used in reference to printing, scanning, and paper feed.
- **Main Scan.** This means the horizontal direction. It is used in reference to printing, scanning, and paper feed.

Around the Machine

Front

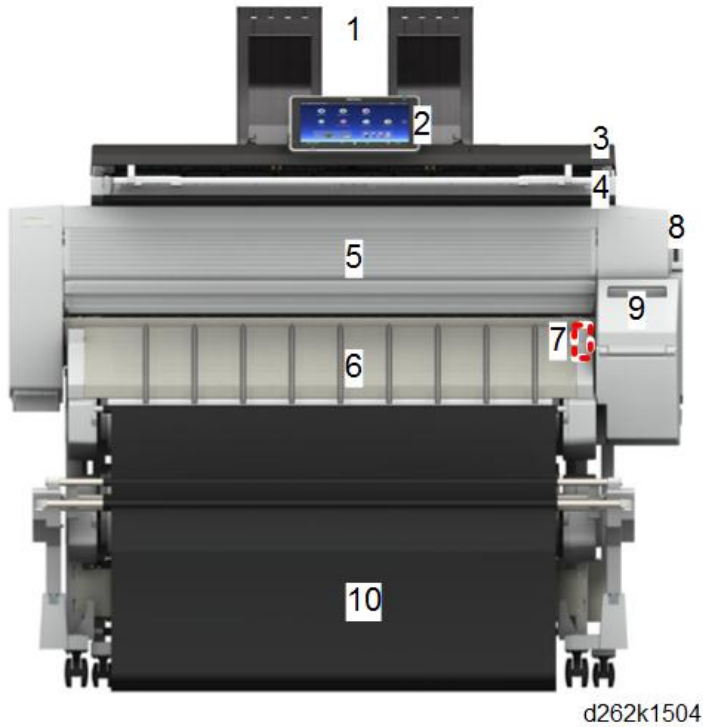

1	Original Stacker	6	Paper Exit Guide
2	Operation Panel	7	Auto-Nozzle Check Unit
3	Scanner Unit Cover	8	Paper Holding Lever
4	Original Table	9	Ink Cartridge Cover
5	Front Cover	10	Exit Stacker

Original Tray

As each original is scanned, the original guide (1) guides it to the original stacker (2) on top of the machine.

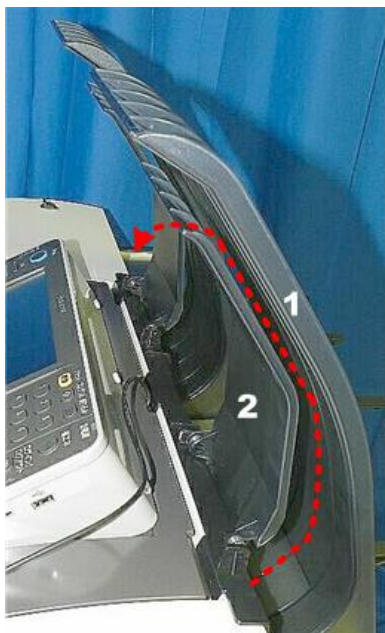

d124f004

Scanner Unit Cover

The scanner unit opens easily for removal of paper jams (1), and can be opened to the full vertical position (2) for servicing (this requires disconnect of the arms on the left and right).



d124f008

Original Table

The plates on the original table of the scanner unit can be adjusted to accept originals up to 914.4 mm (36 in.) for scanning. Original length is limited to 1.5 m (49 ft.)



d124f009

Front Cover

The front cover is easily raised and lowered to expose the platen for cleaning and paper jam removal. The front cover locks in place and remains open after it has been raised. Two sensors (micro-switches) on either end of the front cover detect when the cover is opened and closed.

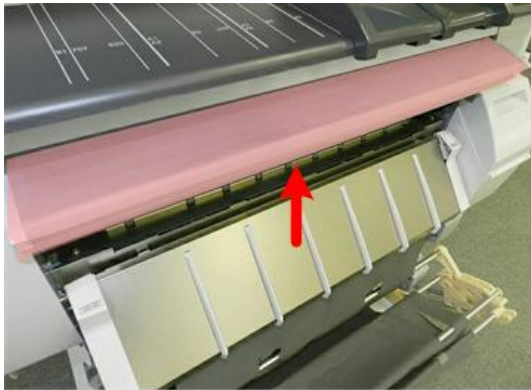

d124f010

When the pin on the left of the front cover is inserted correctly into its track [A], it slides down and pushes a micro-switch [B] to the rear. This signals that the front cover is installed correctly. The open switch signals a cover open error if the front cover is down but not correctly set in the track.



d1241029

Paper Exit Guide

The paper exit guide guides printed paper from the machine into the exit stacker attached to the front of the machine.

- Two lock magnets on either end of the guide hold it in place when it is open.
- A micro-switch on the right detects when the guide is opened and closed.



d124f011

A torque limiter on the right hinge of the paper exit guide acts as a damper to slow the descent of the guide after it is separated from the lock magnet above. This prevents the guide from falling abruptly.



d1241030

Paper Holding Lever

There is no bypass feed tray, but paper can be fed manually for bypass printing.

Raising the paper holding lever [1] lifts the registration rollers [2] so that cut-sheet paper can be loaded on the right side of the platen. Lowering the lever [3] clamps the paper in place for paper feed.

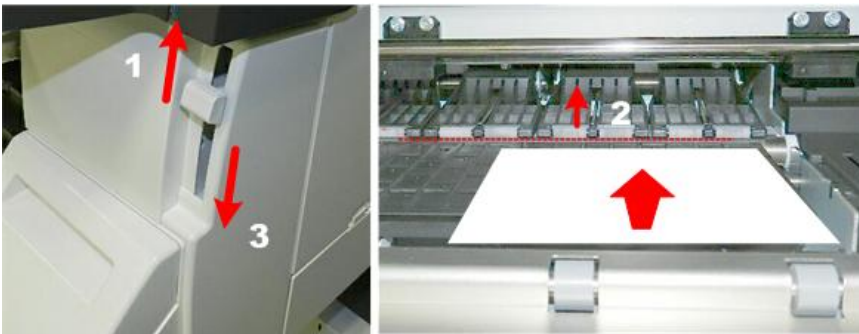

d124f012

Ink Cartridge Cover

The ink cartridge cover can be opened and closed for the insertion and removal of the four ink cartridges. A small sensor (micro-switch) detects when this cover is opened and closed.

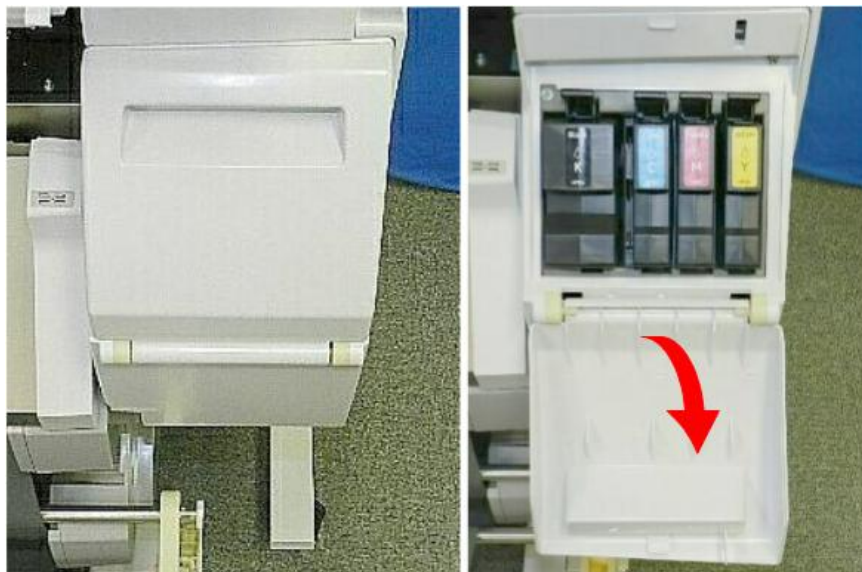

d262k8525

Exit Stacker

The exit stacker, attached to the front of the machine, can be adjusted for output: Basket mode and Stack mode

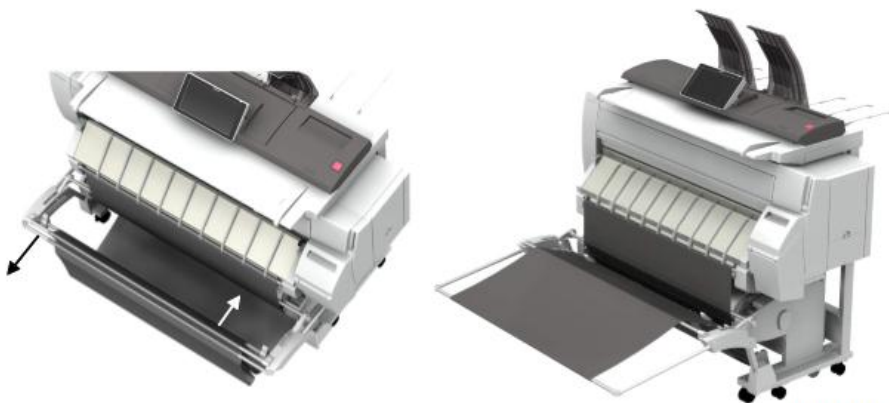

d262k1518

- **Basket Mode.** For standard size paper. The exit stacker is shortened so that it is rounded and deep to hold paper in a small well.
- **Stack Mode (for A0 SEF/A1 LEF).** The exit stacker is extended to the front until it is flat. It can hold up to 10 stacked sheets.
- **Wire guide mode (for A1 SEF/A2 LEF).** Two wire guides can be attached to the rear rod.

★ Important

- After configuring the exit stacker for one of these modes, always check the ends of the rods to confirm that they are set correctly.

1

Easy Installation of Exit Stacker

The exit stacker is assembled as below at shipping from the factory.

Exit stacker installation is easier than MP CW2200.

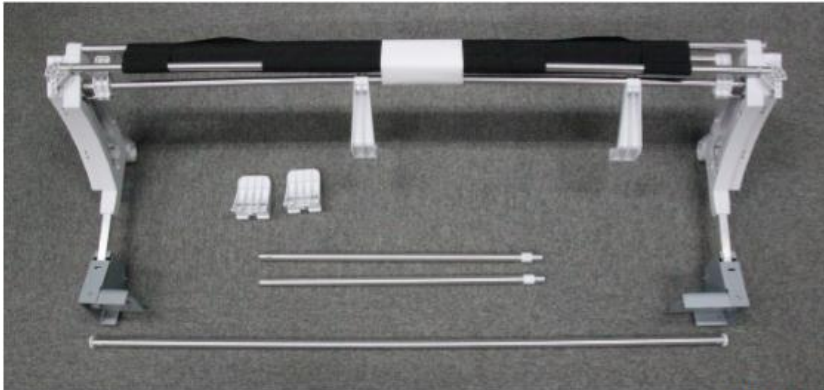

d262k1550

Right Side

The optical cloth holder [1] attached to the right side of the scanner unit holds the accessory optical cloth [2], which can be used to clean the exposure glass. The scanner stand [3] holds the scanner unit above the main unit. The ink collector tank cover [4] can be opened and closed for insertion and removal of the ink collector tank [5].

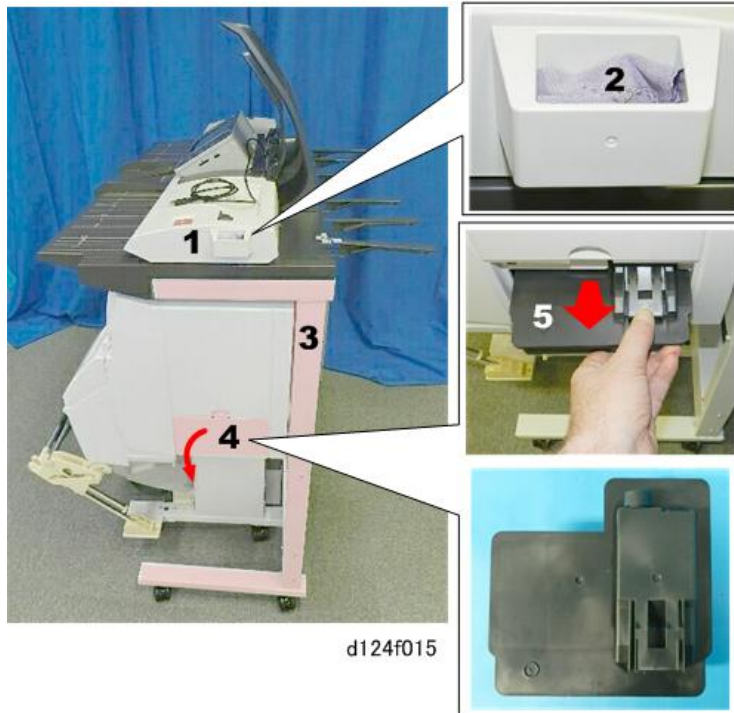

1	Optical Cloth Holder
2	Optical Cloth
3	Scanner Stand
4	Ink Collector Tank Cover
5	Ink Collector Tank

Left Side

The power cord [1], power switch [2], and manual pocket [3] are on the left side of the machine. There is only one power switch on this machine that can cycle the machine off and on.



d124f016

1	Power Cord
2	Power Switch
3	Manual Pocket

Back

Four rear output guides [1] can be attached to the back of the machine to hold originals that exit the back of the machine. The PCB box cover [2] covers the area where the controller board and all other PCBs are mounted on the back of the machine. Four braided ground harnesses are connected with screws to the back of the scanner unit and the PCB box cover.



d262k1549

1	Original Output Guides (x4)
2	Rear Cover

Main Sections

1

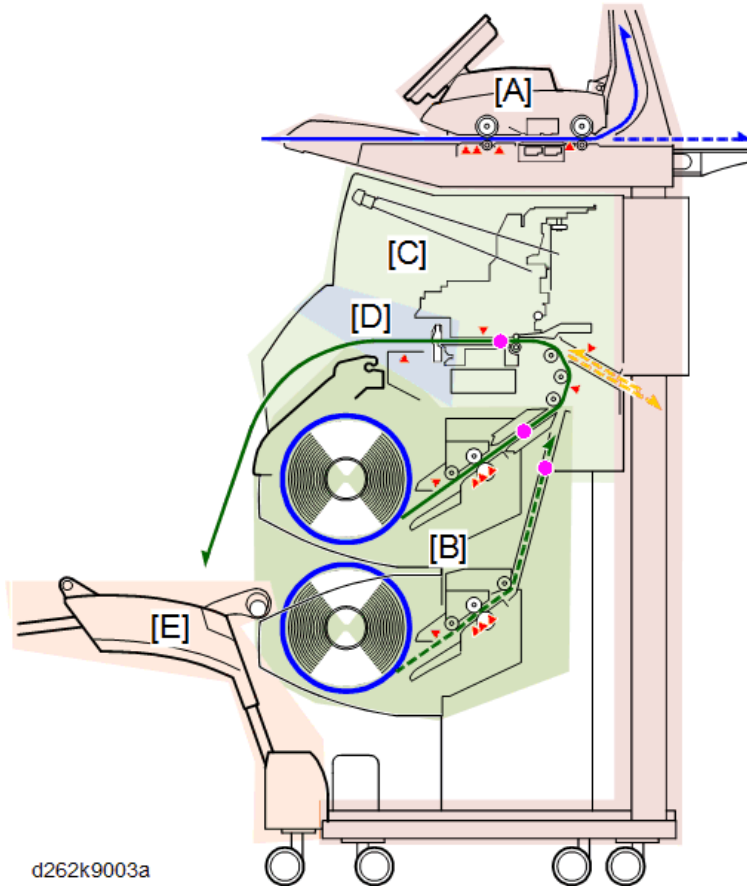

d262k9003a

The machine is comprised of five main sections.

[A]	Scanner. Five staggered CIS units above the original path scan images from the original.
	<ul style="list-style-type: none"> • An independent scanner stand supports the scanner. The scanner stand is docked to the back of the main unit and fastened with four screws to the base of the main unit. • Originals fed from the original feed tray exit at the top. If the original guides are removed, the originals will exit the rear. • The scanner also holds the operation panel.
[B]	Paper Feed. The main unit stand supports both the main unit and holds the paper feed rollers.

	<ul style="list-style-type: none"> • Paper is supplied from one roll unit, provided with the main unit. • Suction from one fan below the platen holds the paper in position during feeding and printing. • One additional roll unit can be installed as an option. Printed sheets from both rolls exit the machine at the front. • The stoppers of the paper rolls can be easily adjusted to accommodate either 2-in. or 3-in. roll cores.
[C]	Main Unit. This is the main body of the unit.
	<ul style="list-style-type: none"> • Carriage Unit. The carriage unit holds the print heads and head ink tanks. The carrier moves horizontally and prints at 64.7 mm/s on one pass. • Print heads. The replaceable print heads contain small sub tanks that can hold 6 cc of ink. There are two K print heads and one head each for Y1M1, C and Y2M2. The print heads can be replaced on site. • Main scan unit. Refers to the horizontal motor and horizontal encoder that move the carriage unit and print heads from left to right during printing. • Sub scan unit. Refers to the vertical motor and vertical encoder wheel and sensors that control operation of the urethane-coated paper feed roller driven by the vertical motor and controlled by a vertical encoder wheel. • Ink supply unit. Ink is supplied through a tube pumping system. The ink supply pumps are controlled by feedback provided by feeler sensors attached to the sides of the ink cartridges above the print heads. • Print head maintenance. The maintenance unit has four head caps and one cleaning cap. The one cleaning cap (a suction cap) performs head maintenance for all the heads. • Waste ink collection. Three receptacles hold waste ink. The ink collector tank, easily removed from the right side of the main unit. The right ink sump is located behind the ink collector tank on the right side of the main unit. The left ink sump is on the left side of the machine.
[D]	Paper exit and cutter. Each sheet of roll paper is cut as it exits the front of the machine.
	<ul style="list-style-type: none"> • A small cutter set on a track and driven by a small motor cuts each sheet of paper from right to left. • The paper exits the machine from the front into the stacker.
[E]	Exit Stacker. A cloth frame stacker that holds prints as they are output from the machine.

- The stacker can hold many different sizes of paper. Capacity: 10 sheets.
- The printed sheets are stored in the well of the stacker as each exits the machine. Or, the stacker frame can be extended to hold each printed sheet straight after it exits.

Main Components

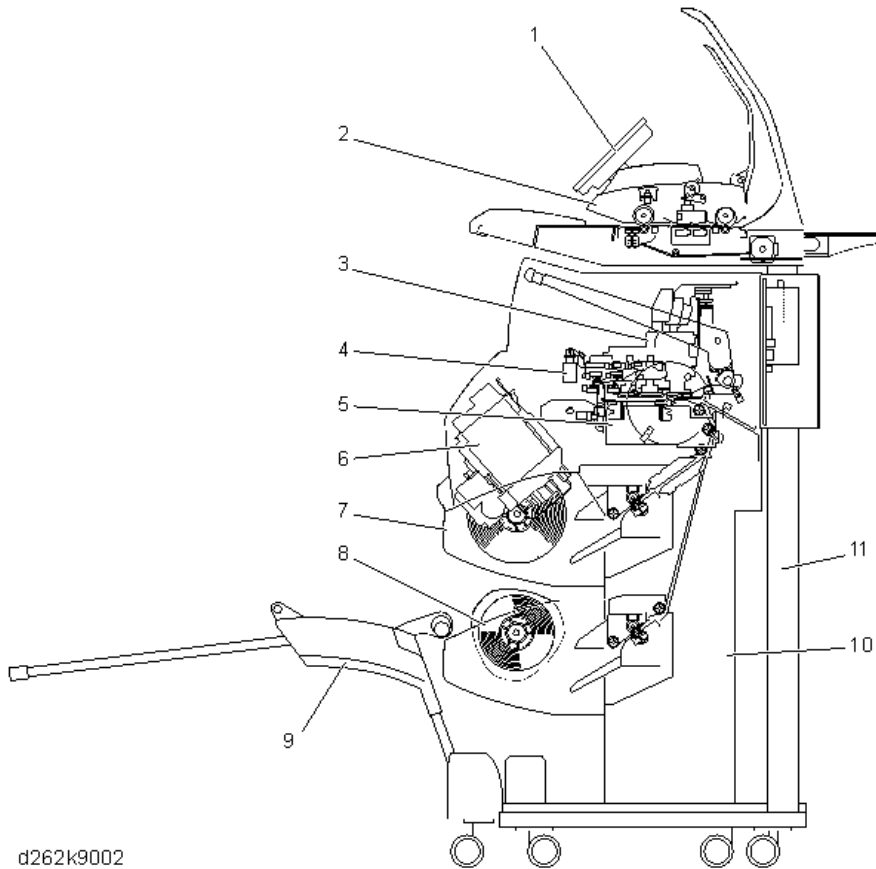

d262k9002

No.	Item
1	Operation panel
2	Scanner unit
3	Carriage unit

No.	Item
4	Air release solenoid
5	Maintenance unit
6	Ink supply unit
7	Roll Unit 1 (Std.)
8	Roll Unit 2 (Option)
9	Exit stacker
10	Main unit stand
11	Scanner stand

Drive Layout

1

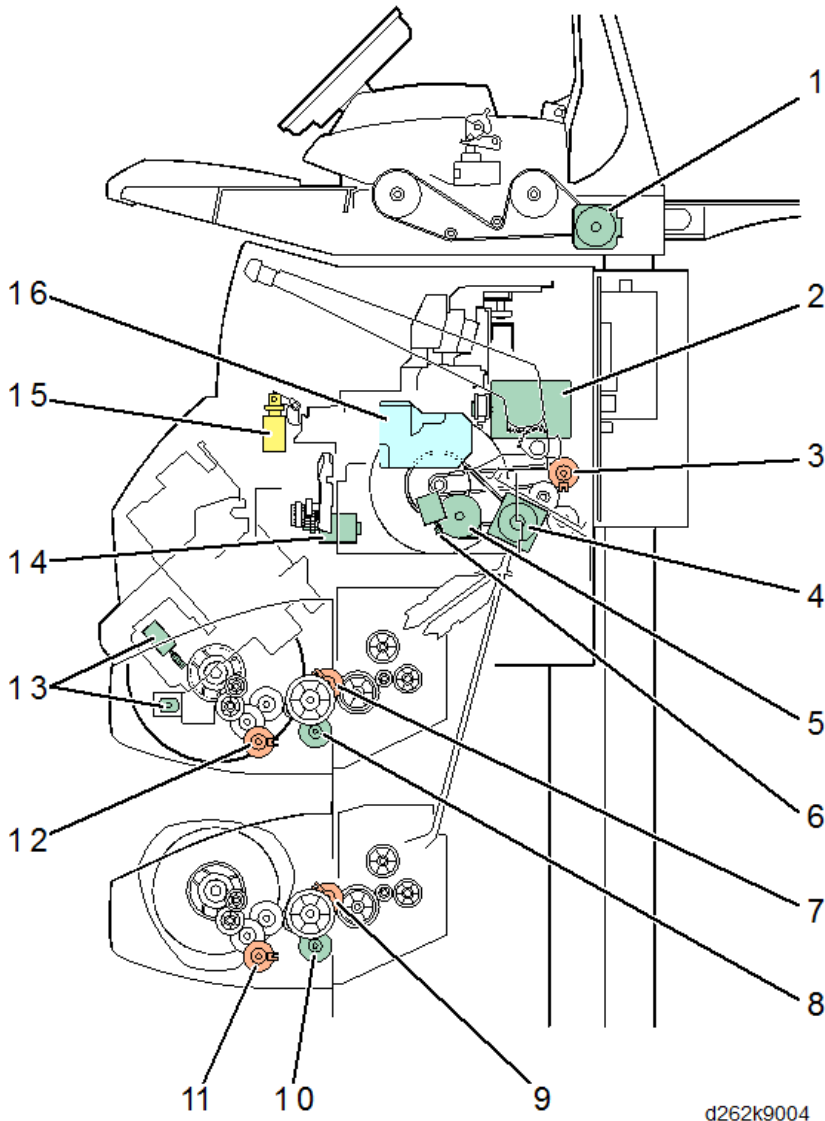

No.	Item
1	Scanner motor
2	Horizontal motor
3	Bypass clutch
4	Vertical motor

No.	Item
5	Maintenance motor
6	Maintenance lift motor
7	Roll paper feed clutch (Roll Unit 1)
8	Roll paper feed motor (Roll Unit 1)
9	Roll paper feed clutch (Roll Unit 2)
10	Roll paper feed motor (Roll Unit 2)
11	Pre-skew correction clutch 2 (Not-functional)
12	Pre-skew correction clutch 1 (Not-functional)
13	Ink pump motors (seven)
14	Cutter motor
15	Air release solenoid
16	Head lift motor

Original Path, Paper Paths

1

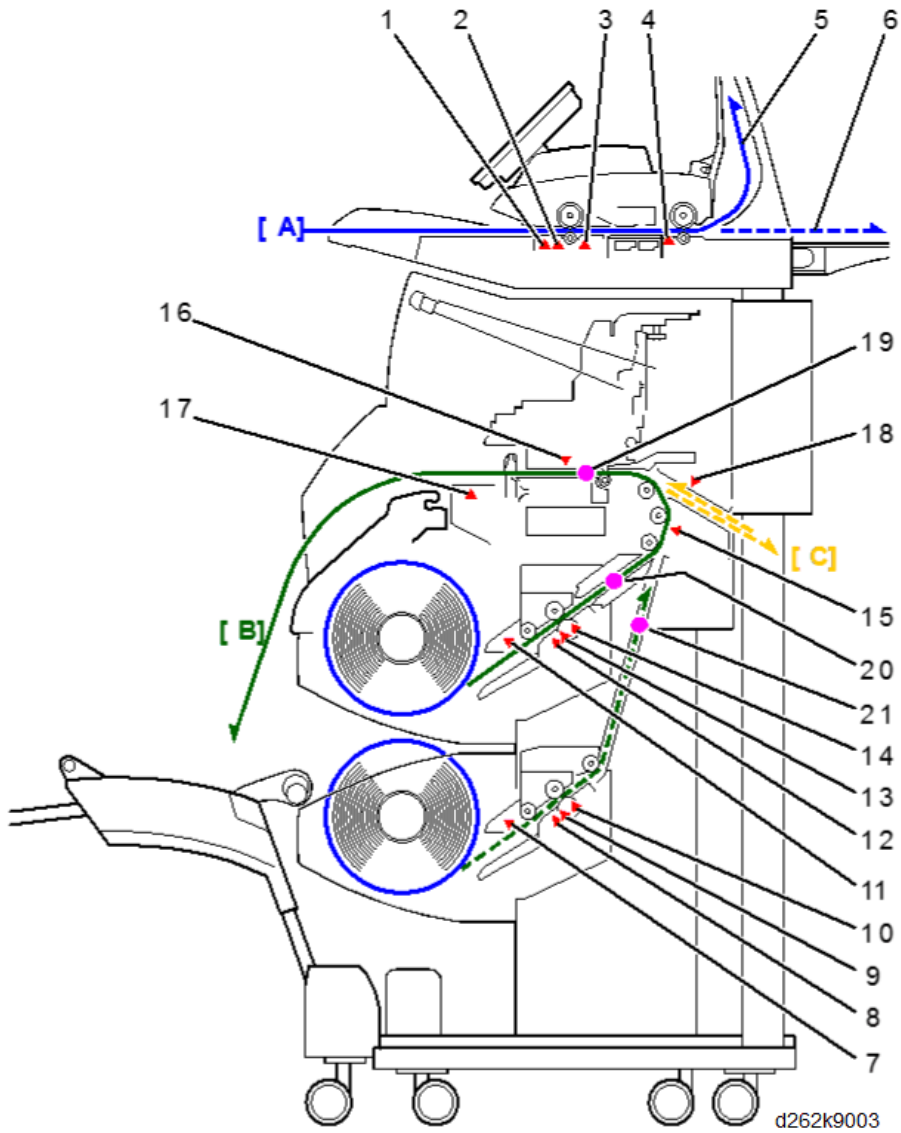

No.	Item
[A]	Original path
1	Original width sensors
2	Original set sensor
3	Original registration sensor

No.	Item
4	Original exit sensor
5	Original exit (top)
6	Original exit (rear)
[B]	Roll paper paths
7	Roll end sensor (Roll Unit 2)
8	Paper entrance sensor (Right, Roll Unit 2)
9	Paper entrance sensor (Center, Roll Unit 2)
10	Exit sensor (Roll Unit 2)
11	Roll end sensor (Roll Unit 1)
12	Paper entrance sensor (Right, Roll Unit 1)
13	Paper entrance sensor (Center, Roll Unit 1)
14	Exit sensor (Roll Unit 1)
15	Pre-registration sensor
16	DRESS sensor
17	Exit sensor
[C]	Bypass paper path
18	Bypass sensor
19	Registration standby position
20	Paper standby position (Roll 1)
21	Paper standby position (Roll 2)

2. Installation

Preparation

Environment

The shaded square in the illustration above is the environment recommended for an office.

1. Temperature Range: 10 °C to 27°C (50 °F to 81 °F)
2. Humidity Range: 15% to 80% Rh

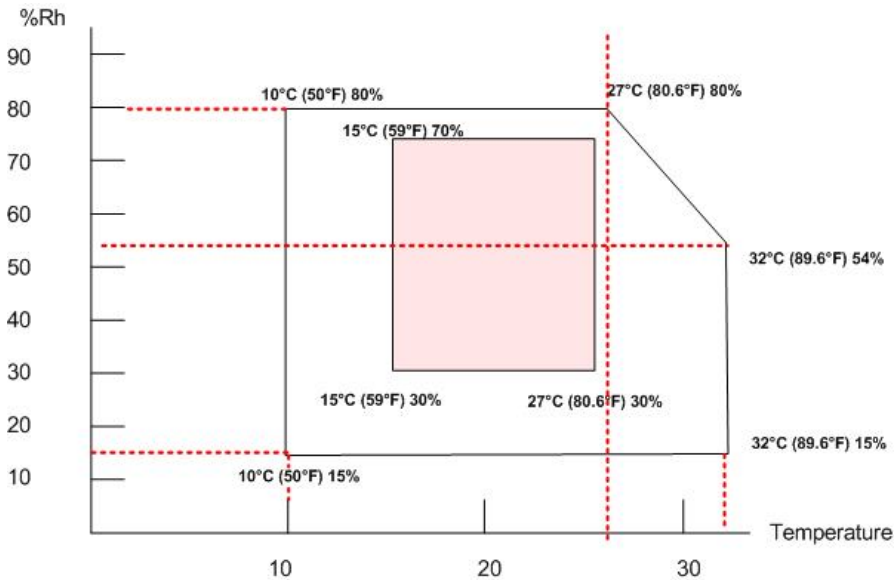

d124:900

3. Ambient Illumination: Less than 1,500 Lux.

★ Important

- Never expose the machine to direct sunlight.
 - If the scanning unit on top of the machine is exposed to direct sunlight, this could cause vertical black and white lines in scanned images.
 - If the machine is near a window, turn it around so the back of the machine is not facing the window and install blinds to block sunlight.
4. Ventilation: More than 30 m³/hr/person in the work area, more than three times per hour.
 5. Ambient Dust: Less than 0.075 mg/m³
 6. If the installation area has air-conditioners or heaters, put the machine in a location where:
 - There are no sudden temperature changes from low to high, or high to low.

- The machine will not be directly exposed to cool air from an air conditioner in the summer.
- The machine will not be directly exposed to reflected heat from a space heater in the winter.

7. Do not install the machine in an area filled with gases that can cause corrosion.

★ Important

- **Never set up the machine where it will be exposed to ammonia fumes.**
- **Ammonia in the surrounding area can cause poor reproduction of filled areas in images.**

8. Do not install the machine in areas higher than 2,000 m (6,600 ft) above sea level.

9. Put the machine on a strong and level surface.

★ Important

- **The floor of a residence must be able to support 1800 N/m² or more.**
- **The floor of an office must be able to support 2900 N/m² or more..**

10. Do not install the machine in an area where there are frequent strong vibrations.

Minimum Space Requirements

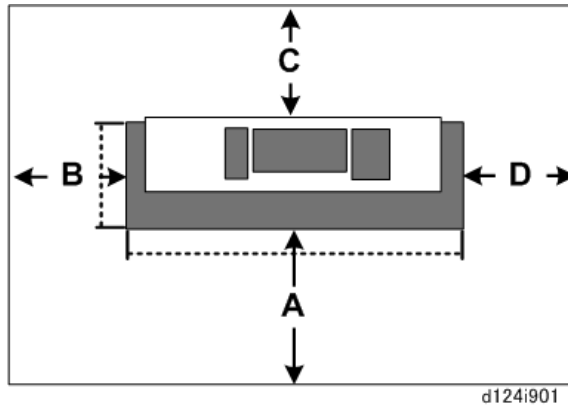

	Side	mm	m	in.	ft.
A	Front	2,000	2.0	78.8	6.5
B	Left	600	0.6	23.6	2.0
C	Back	600	0.6	23.6	2.0
D	Right	600	0.6	23.6	5

Configuration

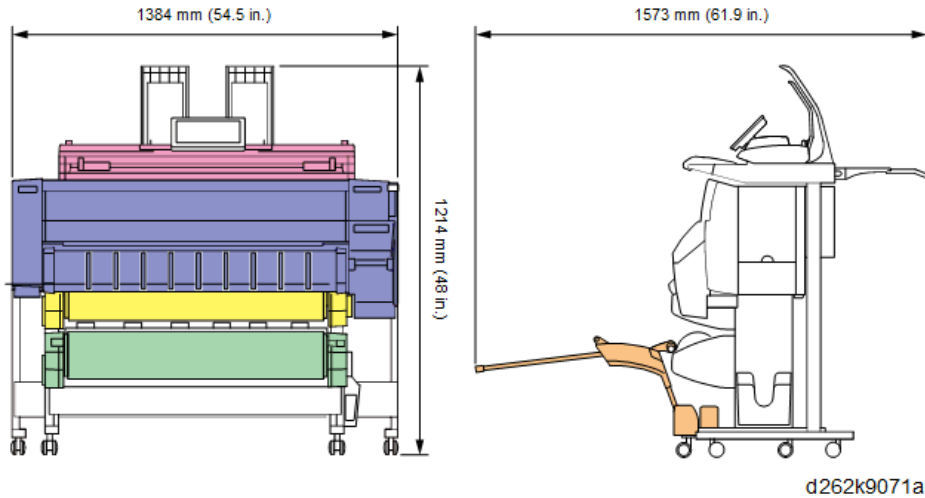

2

Machine Level

1. Front to back: Not more than 5 mm from level
2. Right to left: Not more than 0.15/1000 mm from level.

Power Source

1. Input Voltage Level:
 - North America: 110-120V 3.6 A or more 60 Hz
 - Europe, Asia, China: 220-240V 1.5A or more 50/60 Hz
2. Permissible Voltage Fluctuation: $\pm 10\%$
3. Do not set objects on the power cord.

★ Important

- Make sure the plug is firmly inserted in the outlet.
- Do not connect the machine to a power source that is shared with other equipment.
- To prevent damage to the breaker switch, installation of a voltage stabilizer (constant voltage transformer) is recommended for work sites where there is fluctuation in the AC power source.
- To protect the HDD, always switch the machine off with the operation switch on the operation panel, wait for the power switch LED to stop flashing, then switch off the main switch on the side of the machine.

Installation Overview

Installation Flow

Here is a summary of the sequence recommended for installation of all options.

2

Step	Procedure
1	Main Unit Stand
2	Mounting the Main Unit
3	Assembling the Scanner Stand
4	Mounting Scanner Unit
5	Roll Unit 1 (Standard)
6	Roll Unit 2 (Option)
7	Controller Options
8	Connecting Scanner and Main Unit
	<ul style="list-style-type: none"> • Connecting the Harnesses • Wiring the Scanner Cable • Clamping the Power Cord
9	Removing Tapes and Shipping Materials
10	Original Stacker, Guides
11	Installing the Original Stacker, Guides
12	Ink Collector Tank Storage Shelf
13	Exit Stacker
14	Ink Filling
15	Set Roll Paper
16	Check Printing
17	Final Adjustments
18	Final Settings

Step	Procedure
19	After Installation

Main Machine Installation

Before You Begin

⚠ CAUTION

- To avoid serious injury or damage to the machine, do not plug the machine into a power source until you are instructed to do so in these installation procedures.

Accessory Boxes

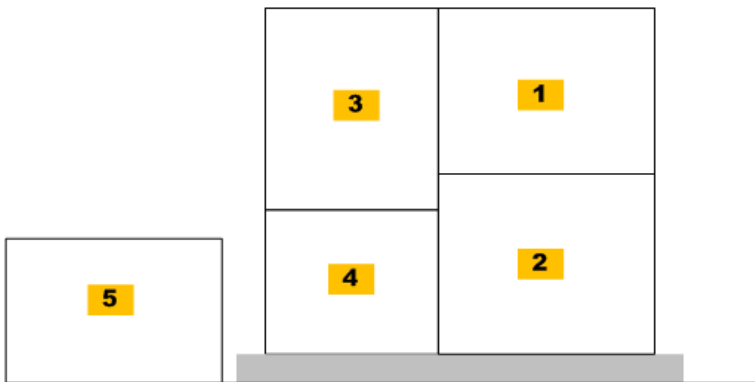

d124i902

Box	Content
[1]	<ul style="list-style-type: none"> Scanner Unit
[2]	<ul style="list-style-type: none"> Main Unit
[3]	<ul style="list-style-type: none"> Accessories Exit Stacker
[4]	<ul style="list-style-type: none"> Roll Unit 1
[5]	<ul style="list-style-type: none"> Scanner Stand Main Unit Stand Hex-bolts for Stands Allen Key

What You Need

Here is a list of tools required for this installation.

- Allen key (2.5 mm)
One is provided but you may need extra keys if two or more people are working on the installation.
- Driver 300 cm (12 in.) or longer
- Stubby driver
- Flashlight
- Small scale or ruler
- Adjustable wrench

Accessory List in Box [3]

No.	Item	Q'ty
-	Joint Bracket	2
-	Paper Transport Guide Plate (Semi-Transparent)	1
-	Stacker Assembly	1
-	Lower Rod Guide	2
-	Side Pipe	2
-	Front Rod	1
-	Roll Spool with Stoppers	1
-	Optical Cloth	1
-	Starter Ink Cartridge K	1
-	Starter Ink Cartridge C	1
-	Starter Ink Cartridge M	1
-	Starter Ink Cartridge Y	1
-	Drain Cartridge K	1
-	Drain Cartridge C	1
-	Drain Cartridge M	1

No.	Item	Q'ty
-	Drain Cartridge Y	1
-	Rear Output Guide	4
-	Original Guide	2
-	Original Stacker	1
-	Ferrite Core for LAN Cable	1
-	Power Cord	1
-	Optical Cloth Pocket	1
-	Manual Pocket	1
-	Rivet (Manual Pocket)	2
-	Harness Clamp for Roll Unit 1	2
-	Harness Clamp for Power Cord	3
-	Screws M3x8 for Side Pipe	2
-	Screws M4x8 for Stacker	6
-	Screws M4x8 for Connecting the Scanner Unit and Main Unit	8
-	Screws M3x8 with Spring Washer for Roll Unit	4
-	Screws M3x6 for Paper Transport Guide	2
-	Screws M3x6 for Scanner Ground harnesses	3
-	Ink Collector Tank Storage Shelf	1
-	Screw M4x8 for Storage Shelf	2
-	Leveling Mount	4
-	Brand Plate for Main Unit (NA/EU Only)	1
-	Model No. Plate (NA/EU Only)	1
-	Brand Plate for Operation Panel (NA/EU Only)	1
-	NFC Tag	1

Accessory List in Box [5]

No.	Item	Q'ty
-	Stay for Main Unit Stand	2
-	Left Support for Main Unit Stand	1
-	Right Support for Main Unit Stand	1
-	Left Support for Scanner Stand	1
-	Right Support for Scanner Stand	1
-	Center Stay for Scanner Stand	2
-	Hex Socket Bolt M4x8	32
-	Lock washer	32
-	Allen key	1

Main Unit Stand

Accessories: Main Unit Stand

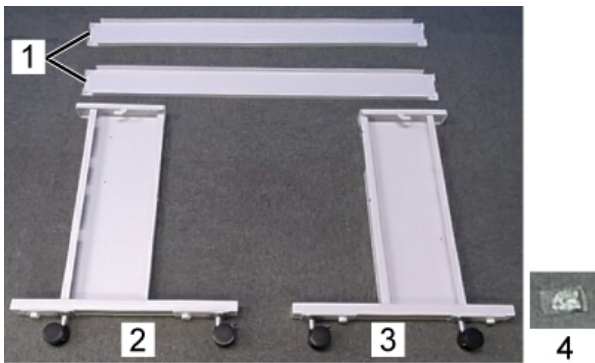

d1241481b

No.	Item	Q'ty
1.	Stay	2
2.	Left Support	1
3.	Right Support	1

No.	Item	Q'ty
4.	Hex Socket Bolt* ¹	8
4.	lock washers	8
4.	Allen key	1

*¹ An Allen key is provided for the hex bolts. One lock washer is provided for each socket bolt.

Installing the Main Unit Stand

★ Important

- Be sure to attach one lock washer to each hex socket bolt before you fasten the bolt.



d124i303

1. While holding the right support, latch a stay to the rear of the base of the support.

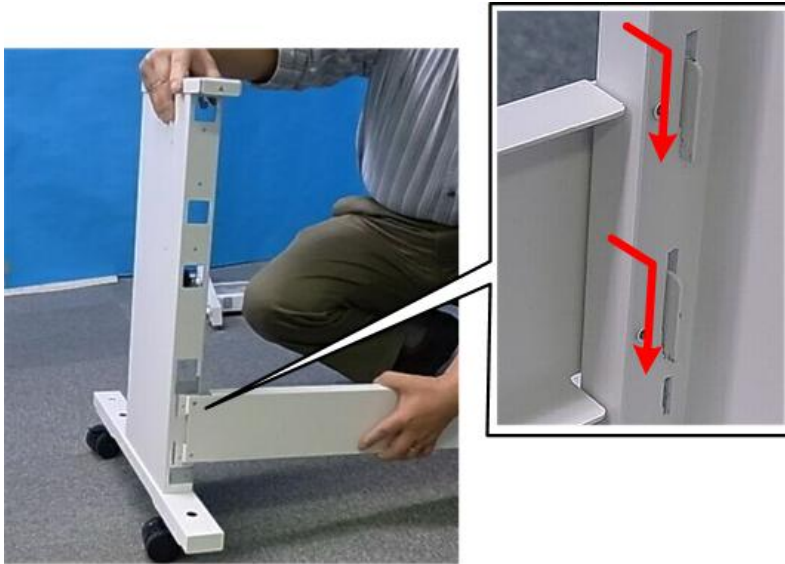

d124i009

2. Attach the other end of the stay to the rear of the base of the left support so the supports can stand upright by themselves.



d124i010

3. Latch the other stay to the front of the bases of the left and right supports.

4. Push down the front and rear stays to lock them in place.

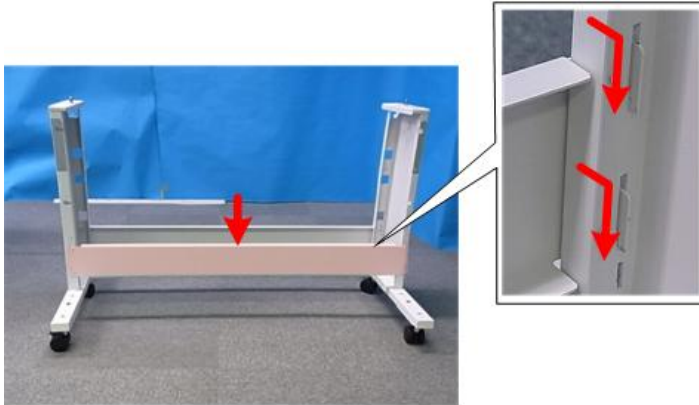

d124i011

5. Fasten the front stay [A] and rear stay [B] to the supports (🔩 x4 each). You will need the Allen key to attach the hex socket bolts.

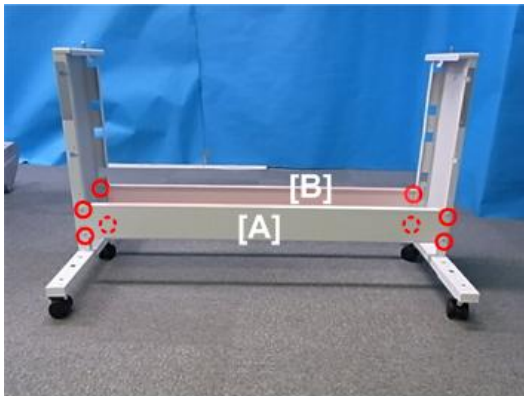

d124i012

Mounting the Main Unit

★ Important

- Mount the main unit immediately after you have removed the box from the pallet and opened the box.
- To avoid damage to the bottom of the main unit, do not set the main unit on the floor.

Parts to be Used

No.	Item	Q'ty
-	Hex Socket Bolt*1	3

No.	Item	Q'ty
-	lock washers	3
-	Allen key	1

*1 An Allen key is provided for the hex bolts. One lock washer is provided for each socket bolt.

★ Important

- Be sure to attach one lock washer to each hex socket bolt before you fasten the bolt.



d124i303

1. Locate the vertical positioning pins at the top of both sides of the main unit stand.



d124i019

2. Locate the handles on the right side of the main unit.



3. Locate the handles on the left side of the main unit.



4. With two people holding the left end [A] and right end [B] (their hands positioned as shown below) lift the main unit and hold it over the top the main unit stand.



d124i020

5. Position the main unit over the top of the stand so that the triangle marks at the rear are aligned (**X**).



d124i021

6. With the marks aligned (▲), lower the main unit so that the positioning pins on either end of the stand fit into the holes at the bottom of the main unit frame.



d124i022

7. Fit each screw with a lock washer.

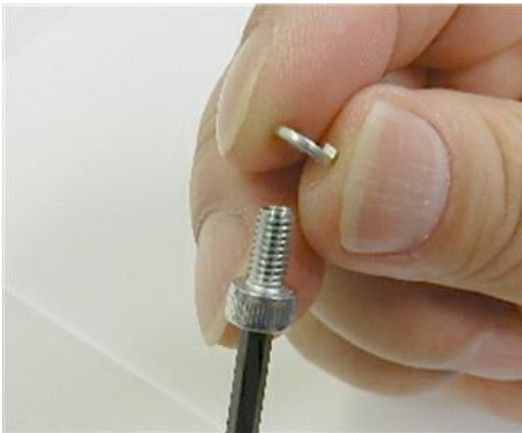

d124i303

8. Use an Allen key to fasten the left and right sides of the stand to the bottom of the main unit with the hex-head screws and lock washers (🔩 x3 hex socket bolt)

★ Important

- Make sure that each screw is tightly fastened.

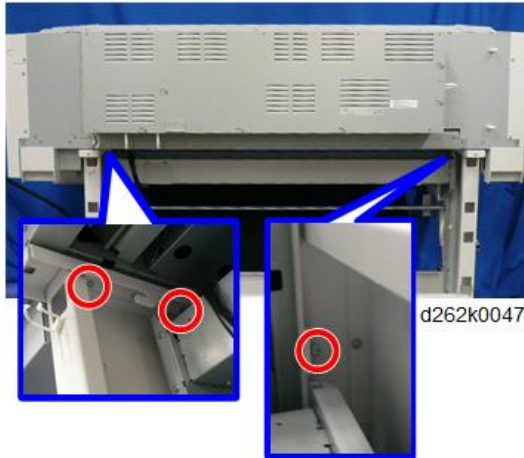

Assembling the Scanner Stand

Accessories: Scanner Stand

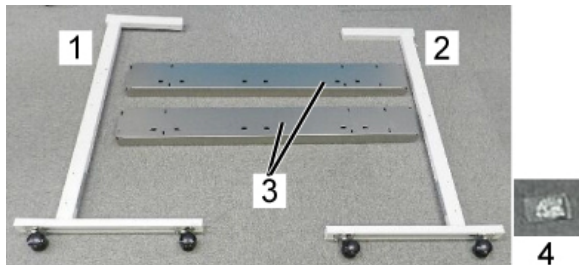

d1241481a

No.	Item	Q'ty
1.	Left Support	1
2.	Right Support	1
3.	Center Stay	2
4.	Hex Socket Bolt M4x8*1	16
4.	Lock washer	16
4.	Allen key	1

* 1 For the scanner stand assembly and connection of scanner stand to main unit with these bolts, you will need an Allen key. One lock washer is provided for each socket bolt.

Installing the Scanner Stand

★ Important

- Be sure to attach one lock washer to each hex socket bolt before you fasten the bolt.

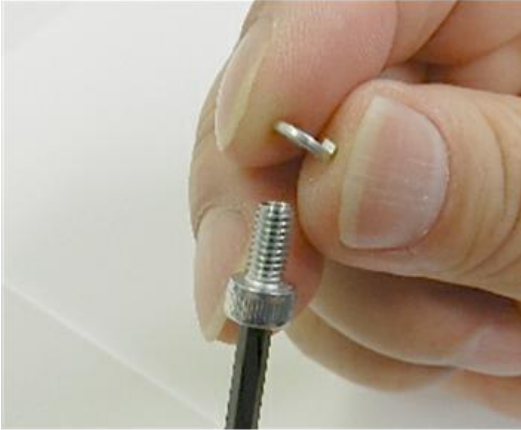

d124i303

1. Position the left and right supports of the scanner stand as shown below.





d124i003

2. Set the two center stays between the left and right supports.
3. Make sure that the pattern of clustered cutouts [A] are down.

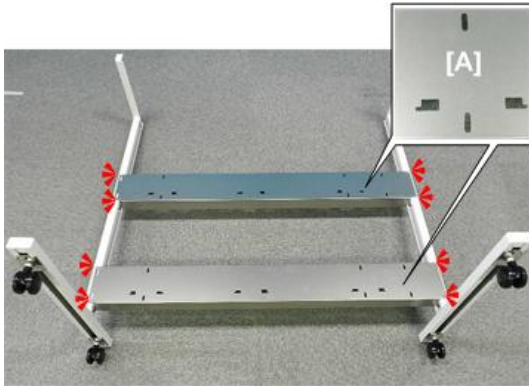
- Engage the ends of the stays on the ends of both stays.



d124i004

- Insert the ends of each stay to the left and right supports and tighten by hand ( x16 hex socket bolt). (Do not tighten the hex-head bolts until all have been inserted.)
- After all the bolts have been inserted and slightly tightened, use the Allen key to tighten all the bolts. ( x16)

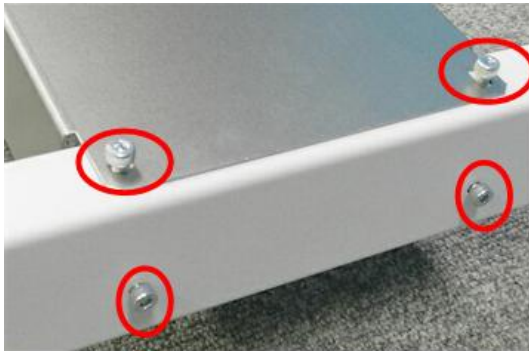

d124i005

7. Set the assembled stand upright.



d124i007

Mounting the Scanner Unit

★ Important

- Mount the main unit immediately after you have removed the box from the pallet and opened the box.
- Do not grip the scanner unit by the front end. The front end is made of plastic only and break easily.



d262k8510

Parts to be Used

No.	Item	Q'ty
-	Hex Socket Bolt* 1	4
-	Lock washers	4

No.	Item	Q'ty
-	Allen key	1

*1 An Allen key is provided for the hex bolts. One lock washer is provided for each socket bolt.

★ Important

- Be sure to attach one lock washer to each hex socket bolt before you fasten the bolt.

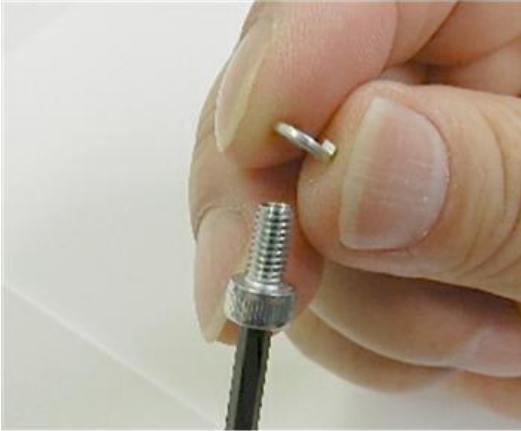

d124i303

1. Locate the vertical positioning pins at the top of both sides of the assembled scanner stand.



d124i013

2. Remove the orange tape [A], [B] from both ends of the scanner unit.

3. Arrange the harness [C] in front as shown below.

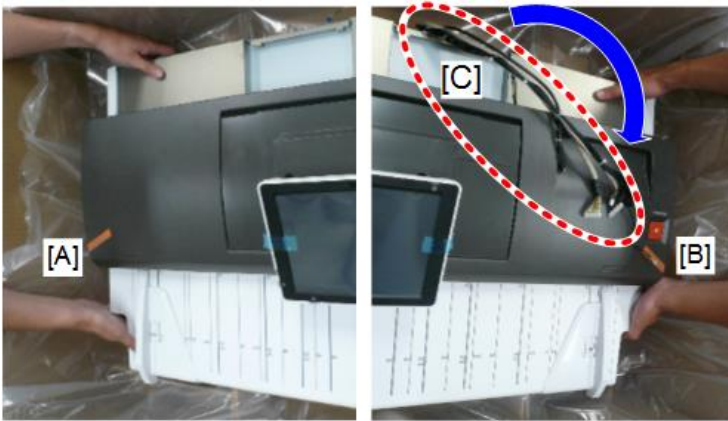

d262k0001

4. With two people holding both ends of the scanner unit (with their hands positioned as shown below [A] to [D]), set the scanner unit [E] on top of the scanner stand.

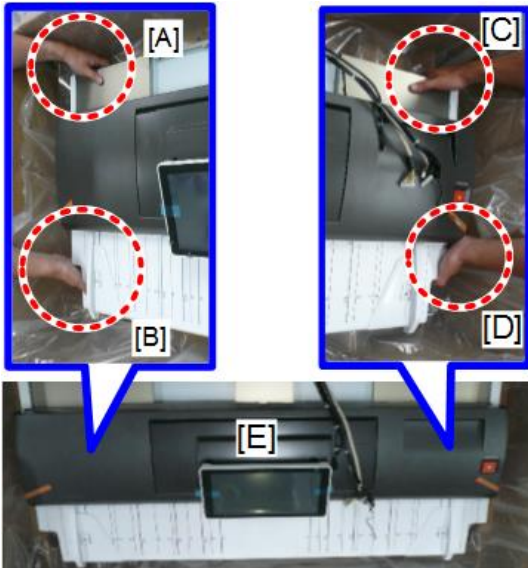

d262k0002

- Align the cut-outs in the frame of the scanner unit with the positioning pins on either end of the scanner stand.

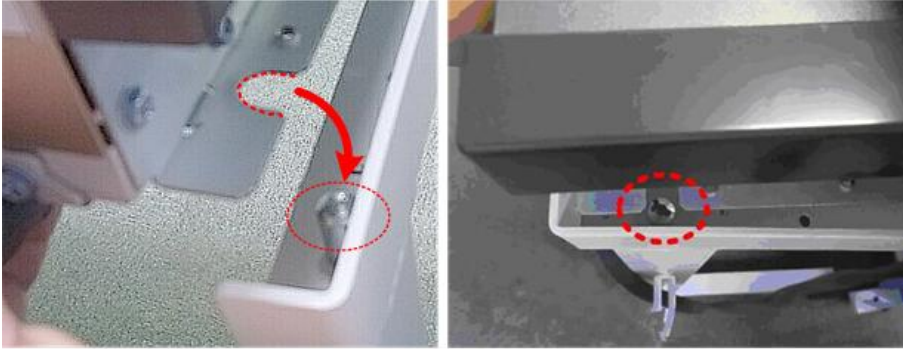

d124i015

- Set the scanner unit on the positioning pins, then fasten the unit to the stand ( x4 hex socket bolt).



d124i016

Roll Unit 1 (Standard)

Accessories: Roll Unit 1

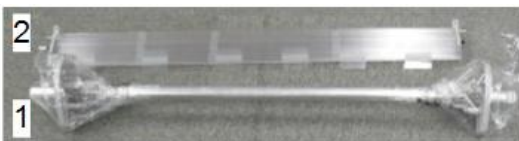

d262k8103

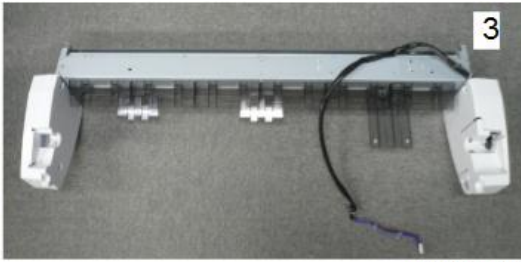

d262k8102

No.	Item	Q'ty
1.	Roll Spool with Stoppers	1
2.	Paper Transport Guide Plate (Semi-Transparent)	1
3.	Roll Unit 1	1
-	Screw M3x8 with Spring Washer (for Roll Unit)	4
-	Screw M3x6 (for Paper Transport Guide)	2
-	Clamp	2

Installing Roll Unit 1

1. Raise the paper exit guide [A].

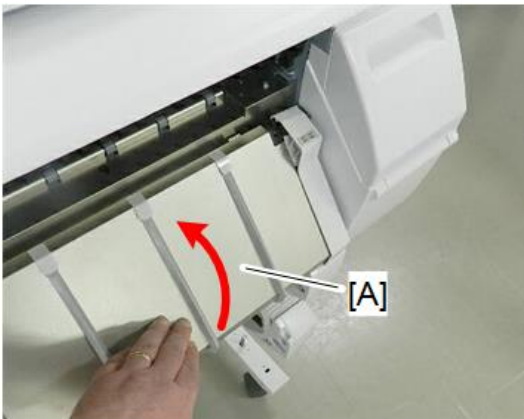

d262k2001

2. Locate the positioning pins on the left [A] and right [B] ends of the roll unit.

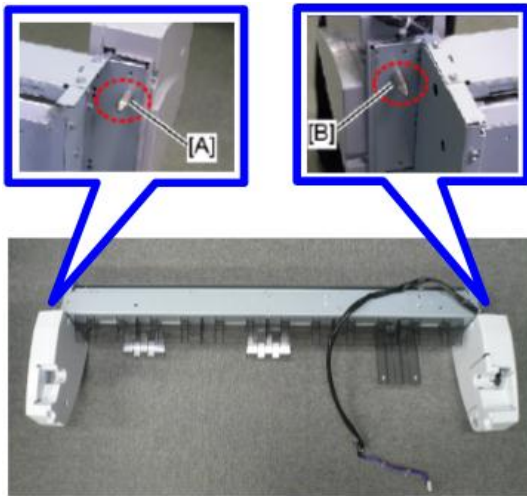

d262k8104

3. Locate the cut-outs in the left and right supports of the main unit stand.

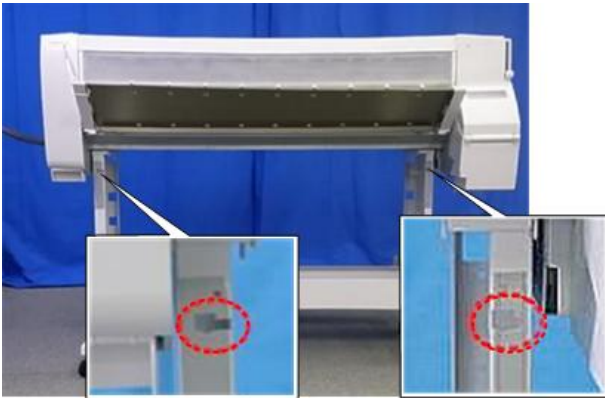

d124i028

4. To install the roll unit 1, place the harness backward.

↓ **Note**

- If the roll unit 1 is installed with the harness placing the front side, the harness cannot be arranged to the backward.



d262k8520

5. While holding the unit with both hands:

- Set the positioning pins on the left and right ends of the roll unit into the cut-outs in the supports
- Push the roll unit in.
- Slide it slightly to the right to lock the unit in place.



d124i030

6. Behind the stand on both sides, make sure that the holes of the roll unit and the stand frame are aligned.
7. Insert the tip of a long screwdriver (30 cm: 12 in.) through each pair of holes to make sure that they are aligned.

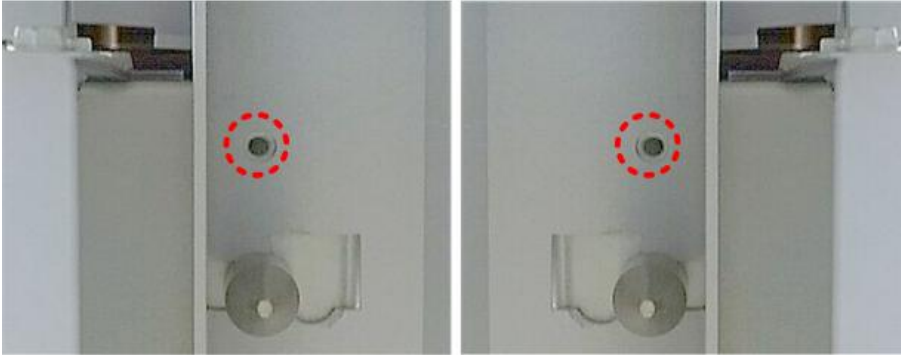

d124i031

8. Pull the harness over the top of the roll unit to the rear.
9. Fasten the roll unit to the stand (✎ x4 M3x8 with washer). (Be sure to use the screws with the washers attached.)



d124i032

Note

- There are two pegs on each end of the paper transport guide.



d124i033

10. While holding the paper transport guide with both hands as shown below, insert the pegs on either end of the guide into the cut-outs in the stand on the left [A] and right [B]. The guide should slide into position and fit tightly after correct alignment.

↓ **Note**

- Make sure that the pegs are tight in the cut-outs: [A] (black) on the left, and [B] (white) on the right.



d124i034

11. Fasten the guide to the frame on the right [C] and left [D] ( x2 M3x6).

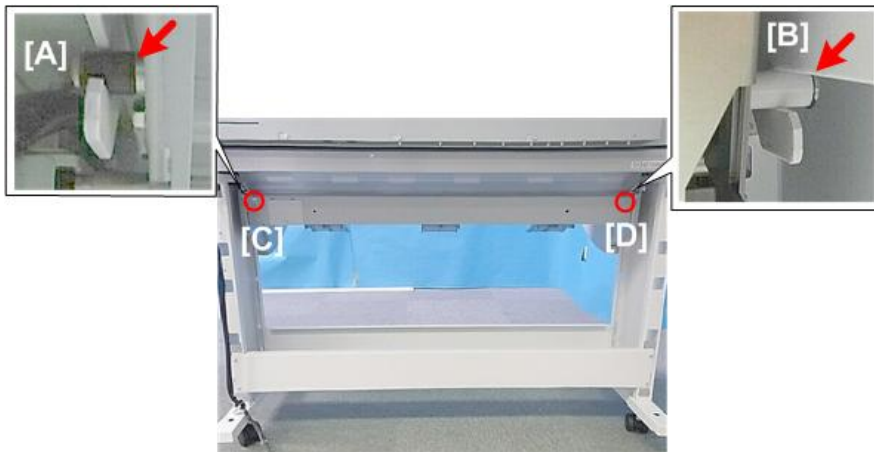

d124i035

12. Use a thin edge (like the end of a metal scale) to push the tongues of the guide film sheet up and behind the plate. There are six film sheet tongues.

★ Important

- Paper will not feed from the roll correctly if these film sheets are not pushed behind the plate.

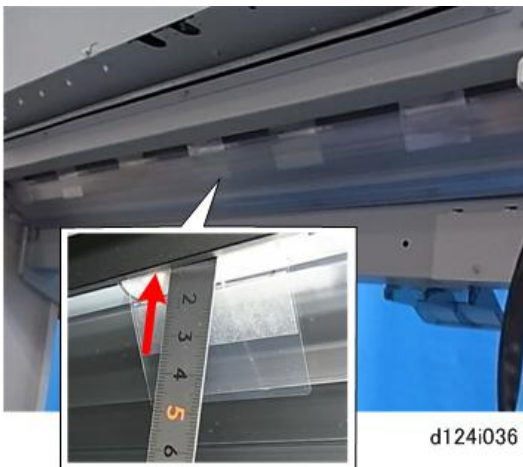

d124i036

13. Attach the clamps, route the harness, and then close the clamps (🔧x2).

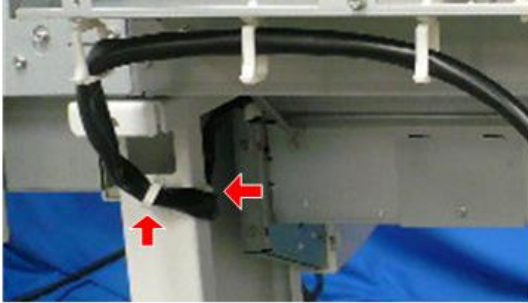

d262k0004

Wiring Roll Unit 1

Connect Roll Unit 1 to the machine. The figure below shows the wiring example.

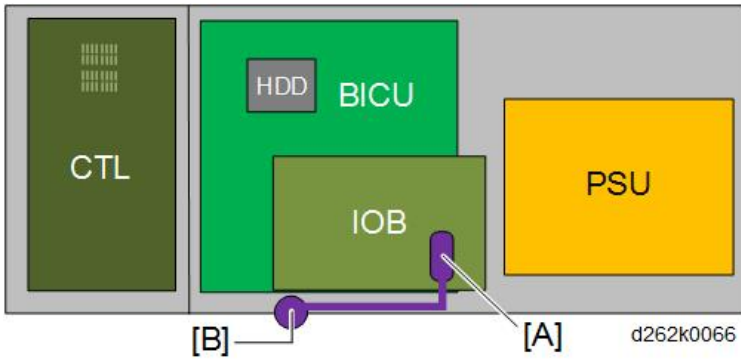

[A]	IOB CN254
[B]	Harness bracket of Roll Unit 1

1. Remove screws on the left cover of the rear of the machine ( x3).



d262k0005

2. Remove the screws circled in red ( x3).
3. Loosen (do not remove) the screws indicated by the red arrows ( x10).



d262k0006

4. Slide the cover to the right and remove it.

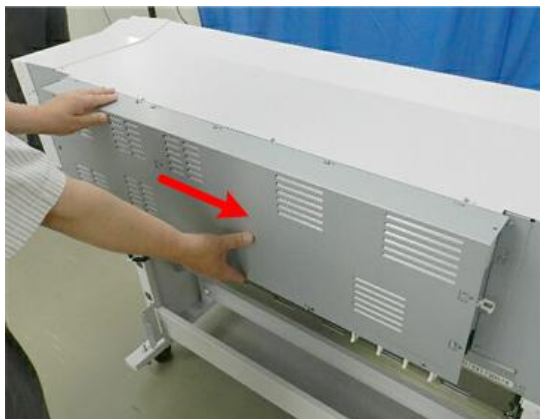

d124i043

5. Attach the harness bracket [A] (2 M3x6).

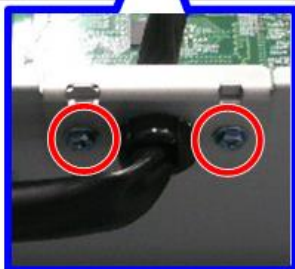
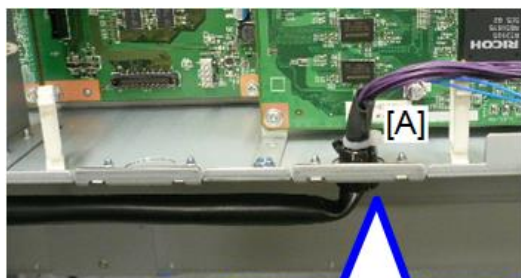

d262k0007

6. Connect the connector of the harness of Roll Unit 1 to IOB [A], and then clamp it (🔧 x2, 📌 x1).

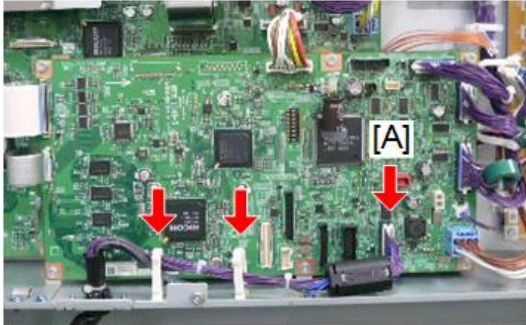

d262k0008

7. Check that the clamps beneath the machine are closed and the harness is connected securely.

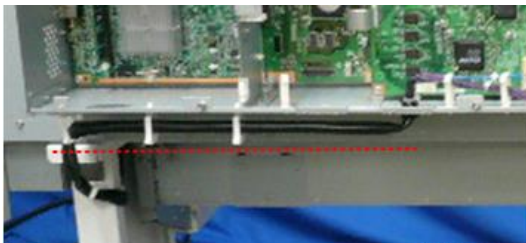

d262k0009

⬇️ Note

- The harnesses must be flat against the bottom of the PCB box to prevent them from interfering with paper in the bypass feed path.
- During bypass feed, the trailing edge of the paper will come out from the back of the machine, and then reverse feed back into the machine.

Roll Unit 2 (Option)

One additional roll unit can be installed: Roll Unit RU6520

Attach Roll Unit 2 after attaching Roll Unit 1.

Accessories

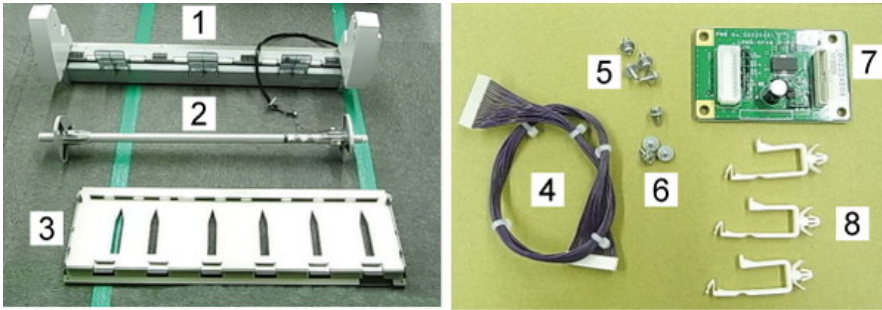

d1241404

No.	Item	Q'ty
1	Roll Unit 2	1
2	Roll Spool with Stoppers	1
3	Paper Transport Guide Plate	1
4	Harness	1
5	Screw M3x10 with Spring Washer	4
6	Screw M3x6	4
7	RFDB	1
8	Clamp	3

Note

- Remove the protection sheet [A] from the paper transport guide plate.

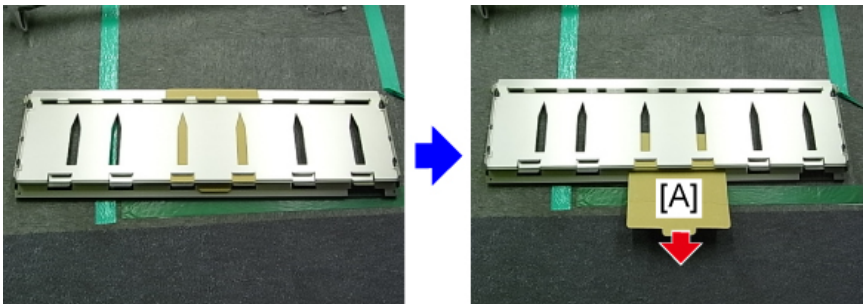

d1241405

Installing Roll Unit 2

1. Unpack the roll unit. Locate the positioning pins on the left [A] and right [B] ends.

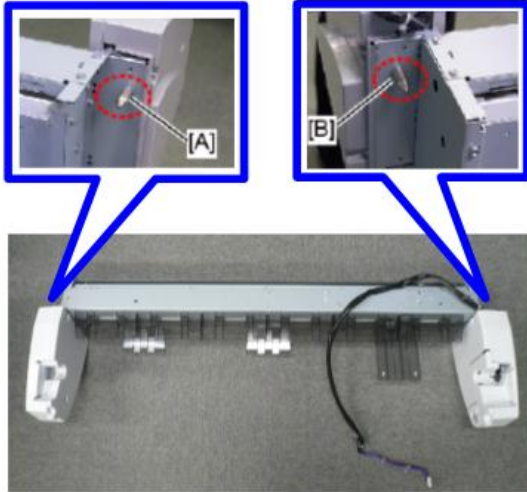

d262k8104

2. Locate the cut-outs in the left and right supports of the main unit stand.



d124i028a

3. To install the roll unit 2, place the harness backward.

Note

- If the roll unit 2 is installed with the harness placing the front side, the harness cannot be arranged to the backward.

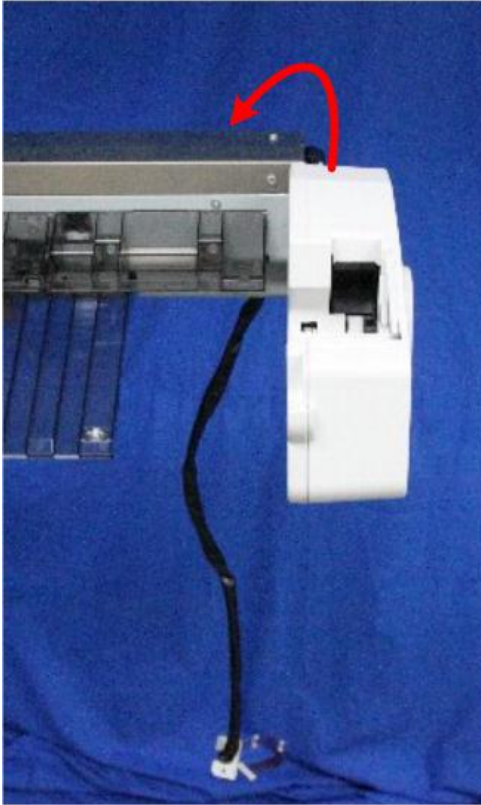

d262k8521

4. While holding the unit with both hands:

- Set the positioning pins on the left and right end of the roll unit into the cut-outs in the supports
- Push the roll unit in.
- Slide it slightly to the right to lock the unit in place.

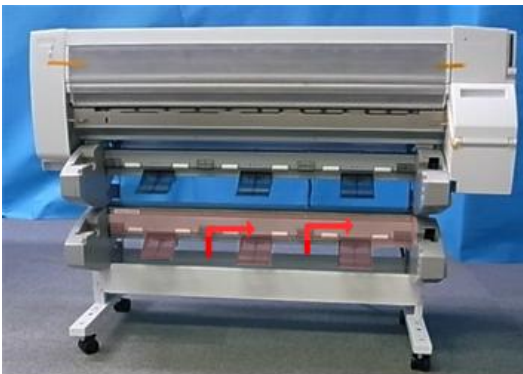

d124i038

5. Insert a long screwdriver (30 cm: 12 in.) into each pair of holes to make sure that they are aligned.
6. Fasten the roll unit to the stand (⚙️ x4 M3x8 with washer). Be sure to use the screws with the washers attached.



d124i039

7. Attach the harness clamps and then close the clamps around the harness (🔧x2).

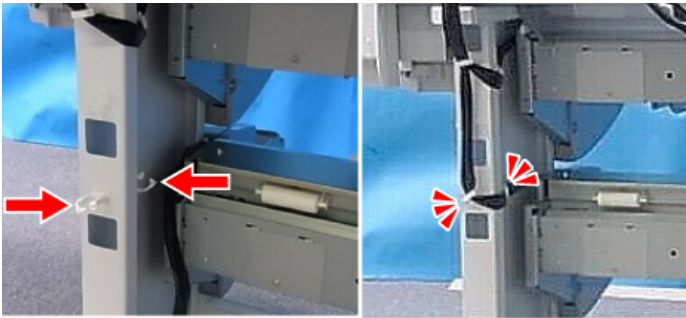

d124i040b

8. Fasten the harness with the same clamps as for Roll Unit 1.

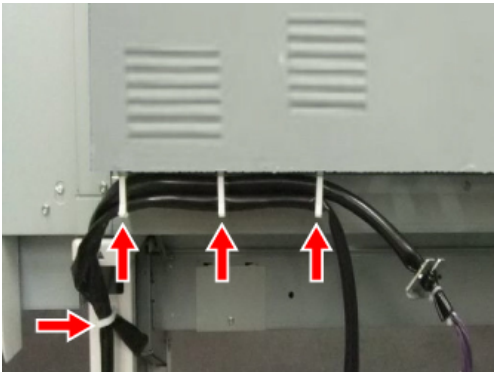

d1241406

Wiring Roll Unit 2

Connect Roll Unit 2 to the machine. The figure below shows the wiring example.

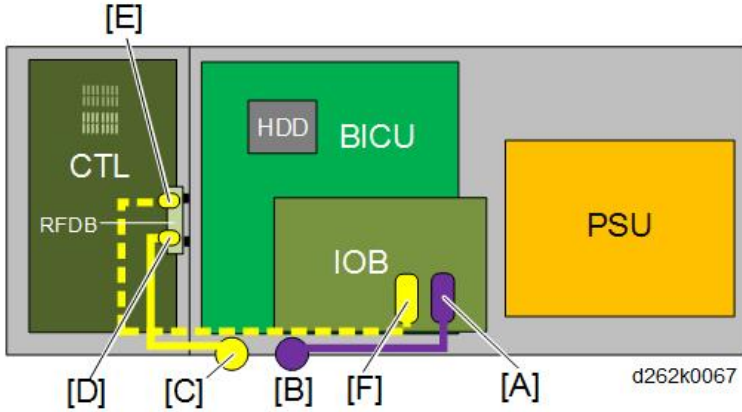

[A]	IOB CN254
[B]	Harness bracket of Roll Unit 1
[C]	Harness bracket of Roll Unit 2
[D]	RFDB CN301
[E]	RFDB CN300
[F]	IOB CN255

1. Remove the screws on the left cover of the rear of the machine ( x3).



d262k0005

2. Remove the screws circled in red ( x3).

3. Loosen (do not remove) the screws indicated by the arrows ( x10).

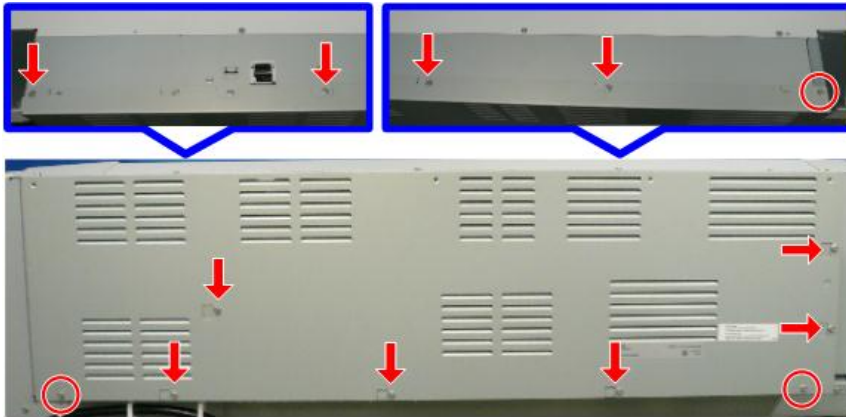

d262k0006

4. Slide the cover to the right and remove it.

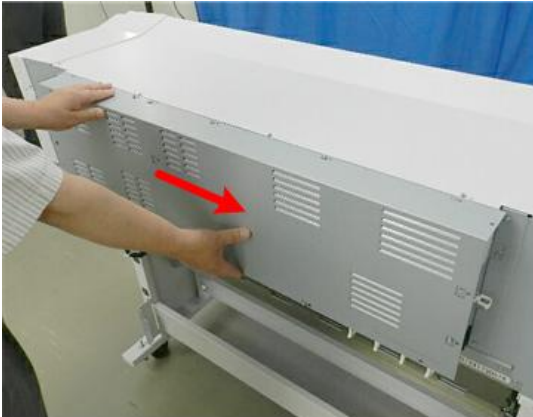

d124i043

5. Attach the RFBD ( x2,  x2).

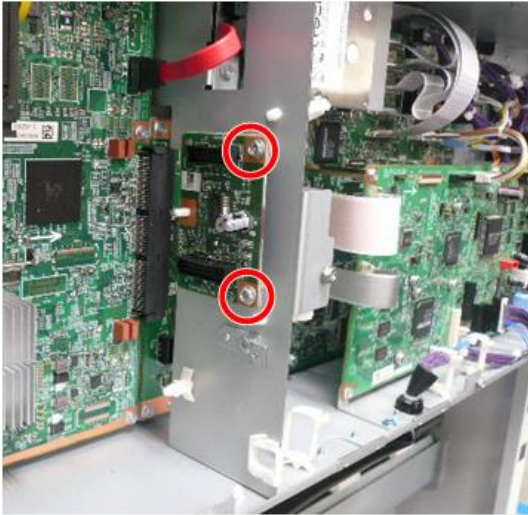

d262k0010

6. Remove the harness bracket [A] ( x2).

 **Note**

- Keep the removed screws. They are to be used in the next step.
- The removed harness will not be used anymore.



d262k0007

7. Attach the harness bracket of Roll Unit 2 [A] with the screws removed in the previous step ( x2).

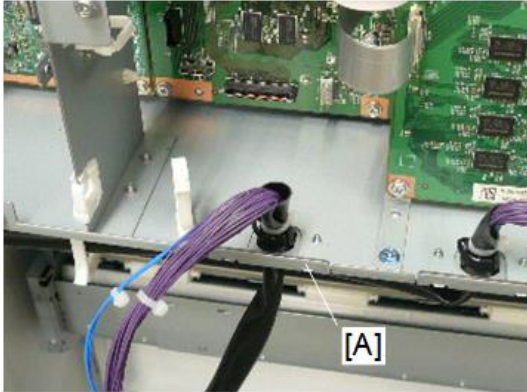

d262k0012

8. Connect the connector of the harness of Roll Unit 2 to RFDB [A] ( x1).

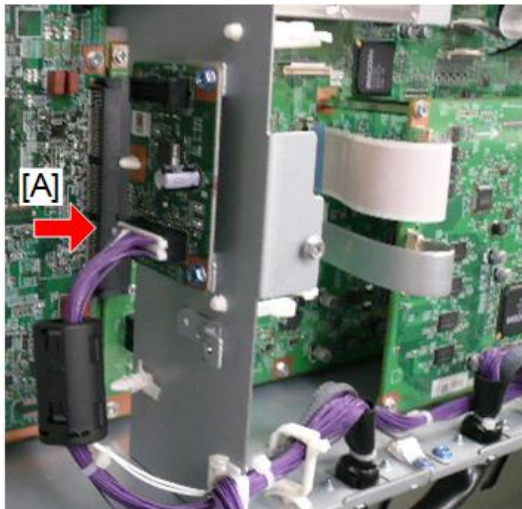

d262k0013

9. Connect the connectors of the harness to RFDB [A] and IOB [B].



d262k0014

10. Clamp the harness connected in Step 8 and Step 9.

Wiring of Roll Unit 2 is completed.

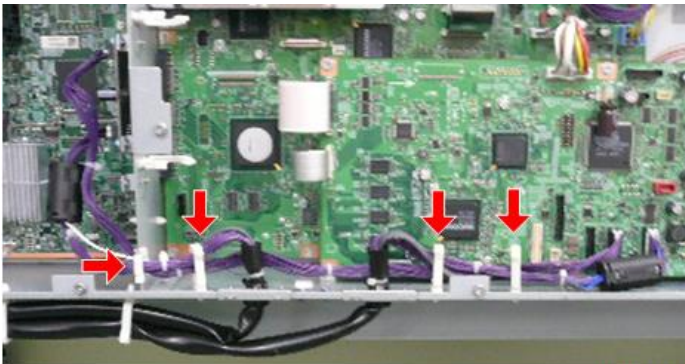

d262k0015

11. Behind the machine, hold the guide plate as shown below, and then set the cut-outs on the left and right over the pegs.

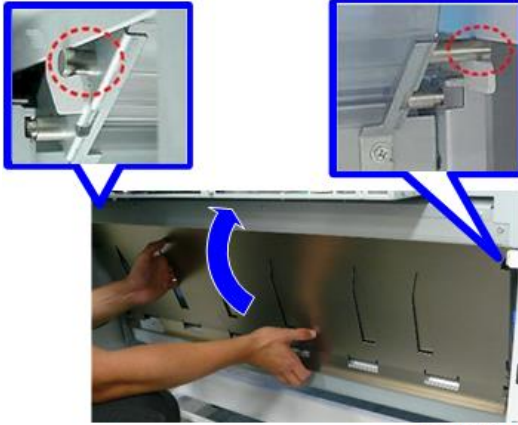

d262k0016

12. Lift the guide slightly, and then insert the bottom pegs into the cut-outs at the lower left and lower right corners.



d262k0017

13. Check the top of the plate and make sure that it is parallel with the edge of the machine.

14. Check each corner of the plate to be sure that each peg is tight in its cut-out.

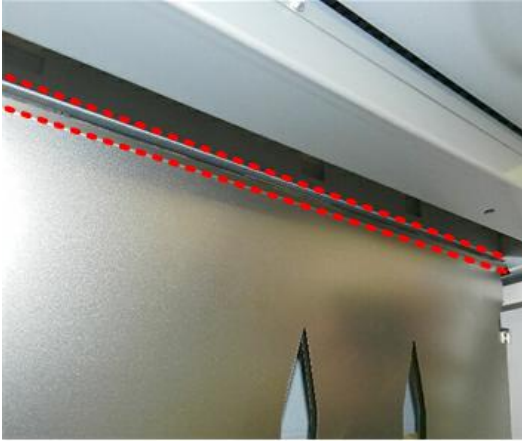

d124i201

15. Fasten the plate (tapping  x2 - M3x6).

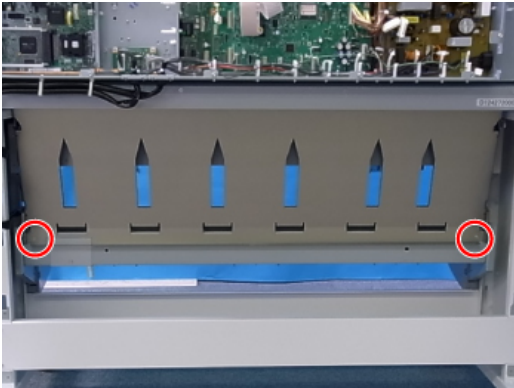

d1241052a

16. Make sure that the clamps are closed and that there is absolutely no slack in the harnesses.

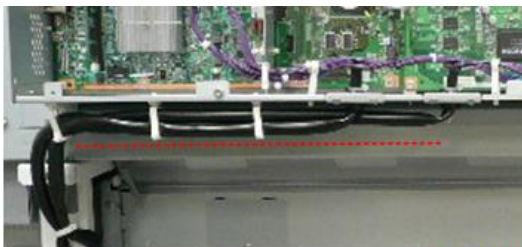

d262k0018

 **Note**

- The harnesses must be flat against the bottom of the PCB box to prevent them from interfering with paper in the bypass feed path.

- During bypass feed, the trailing edge of the paper will come out from the back of the machine, and then reverse feed back into the machine.

Controller Options

If you intend to install one or more of the following options which require the installation of boards, do so before you re-attach the rear cover.

- File Format Converter (MLB)
- IEEE 802.11 a/g/n Interface Unit

2

Connecting the Scanner and Main Unit

Connect the scanner unit and main unit with the scanner cable and fix them with the joint brackets.

Parts to be Used

No.	Item	Q'ty
-	Joint Bracket	2
-	Harness Clamp	3
-	Power Cord	1
-	Tapping Screw M4x8	8

Connecting the Harnesses

1. At the rear, attach a joint bracket to each side [A] [B] of the stand ( x4 M4x8).

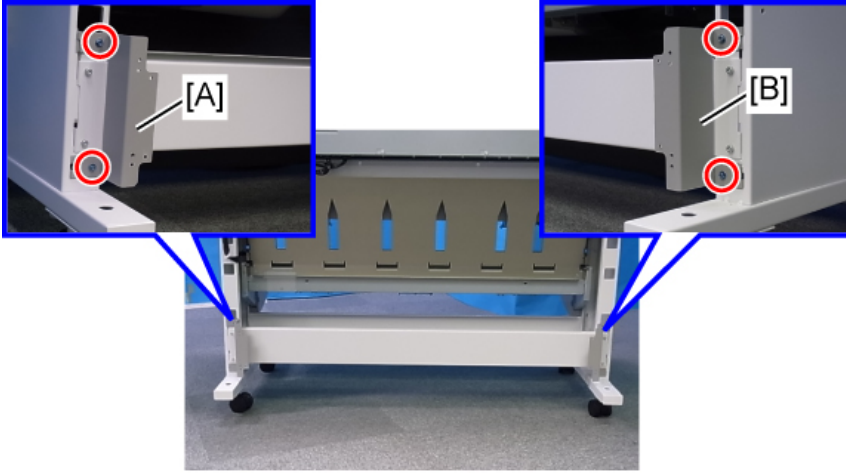

d1241062

2. Bring the scanner unit and main unit close together.

 **Note**

- Dock the left side of the scanner unit to the back of the main unit.
- Lower the four bolts on the main-unit stand so that the stand does not touch the scanner unit.

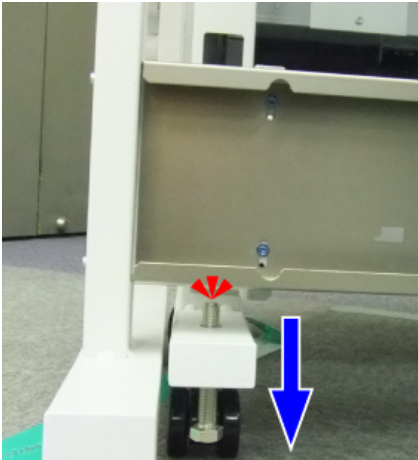

d1241421

3. Fasten the scanner stand to the main-unit bracket on the left [A] and right [B] ( x4 M4x8).



Connected Machine

Rear:

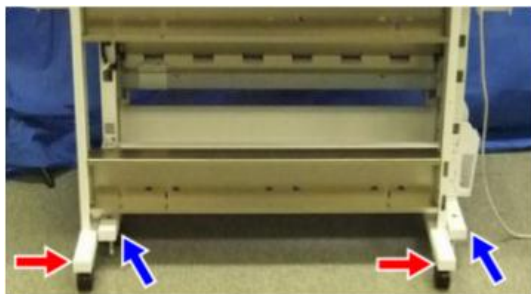

Front:

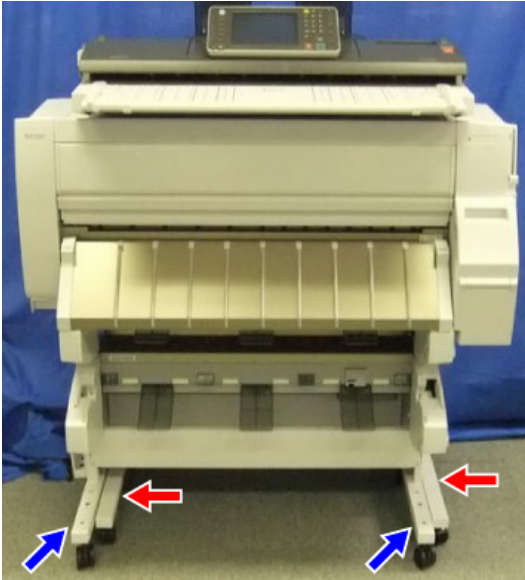

d1241491

Wiring the Scanner Cable

Connect the scanner cable of the scanner unit to the machine. The figure below shows the wiring example.

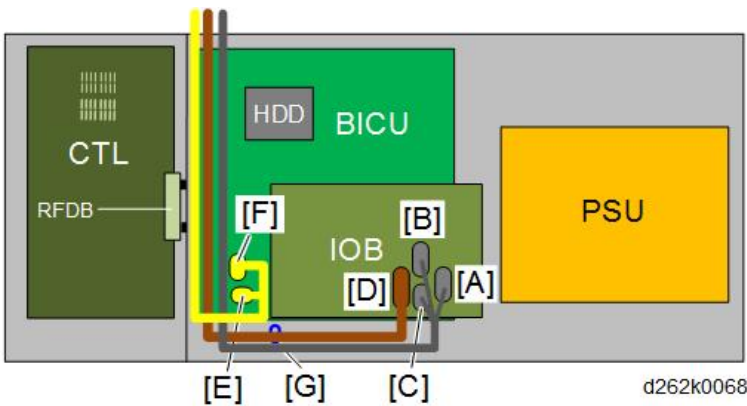

[A]	IOB CN258
[B]	IOB CN259
[C]	IOB CN256
[D]	IOB CN257

[E]	BICU CN216
[F]	BICU CN215
[G]	Ground Clamp

1. Place the scanner unit [A] and main unit [B] as shown below.

⚠ CAUTION

- The scanner unit is top heavy and unstable. It can fall over easily. Grip the supports below the scanner unit and push it slowly when you move it.

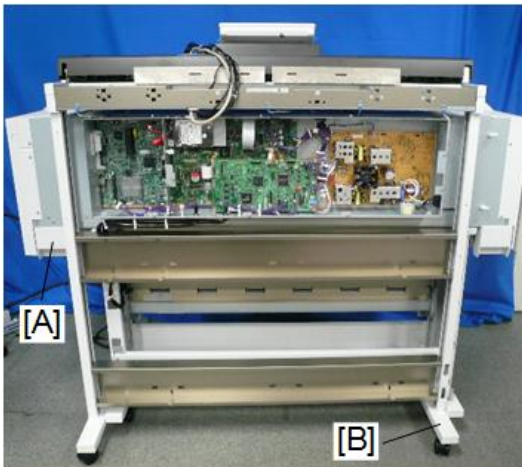

d262k0019

2. Clamp the scanner cable to the machine.

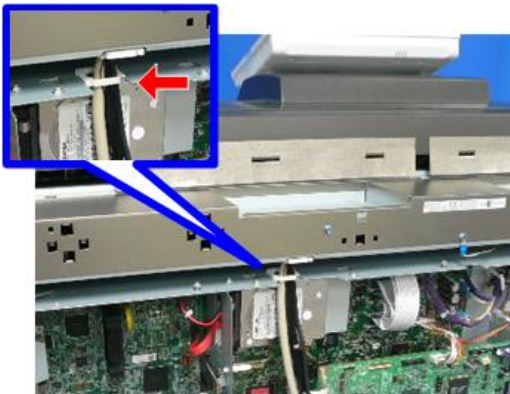

d262k0020

3. Remove the ground plate ( x1 - M3x8).



d262k0277

4. Connect the connectors of the scanner cable [A], [B], [C], and [D] to the IOB.

5. Connect the USB cable [F] and connector [E] to BiCU.

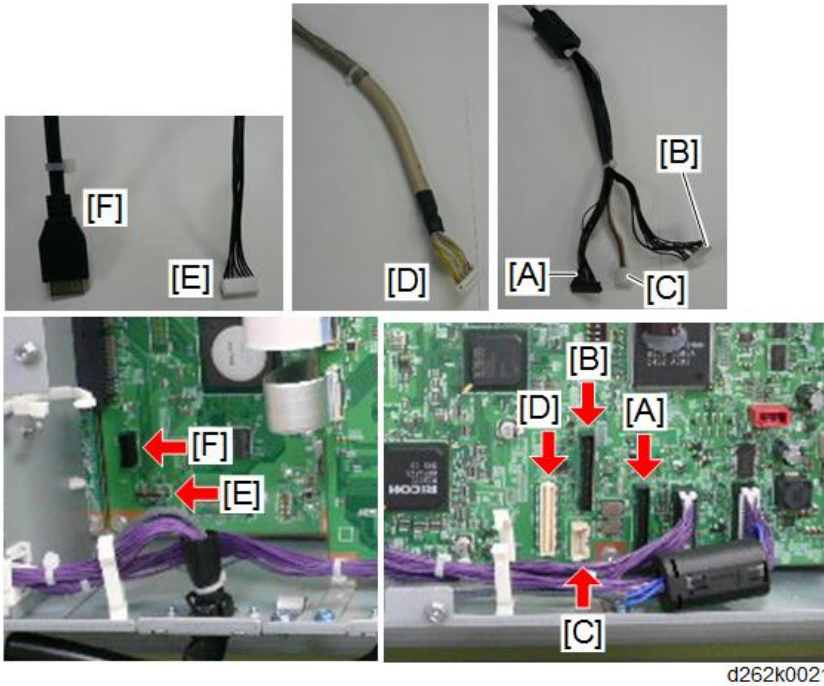

6. Attach the ground clamp to the shielded cable [A] and fasten it to the machine with the screw ( x1 - M3x8).

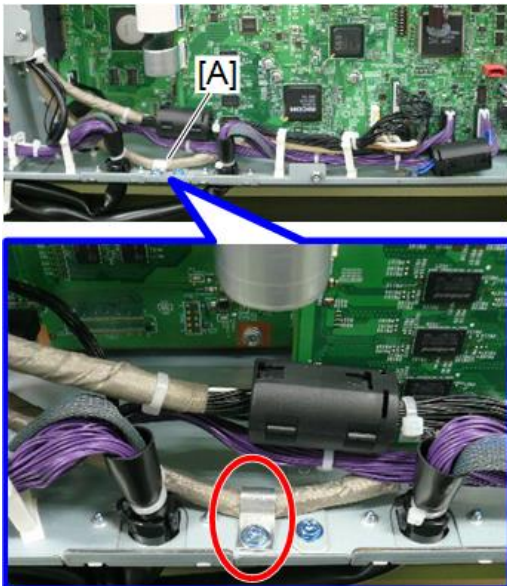

7. When wiring ends, clamp the scanner cable (🔧x5).

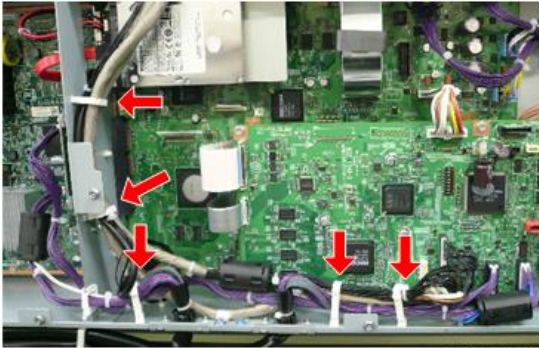

d262k0022

8. Slide the cover onto the back to re-attach the cover. Make sure all the attached screws are tight in their cut-outs.



d262k8522

9. Re-attach the removed screws circled in red (🔧x3).

10. Tighten the screws indicated by the arrows ( x10).

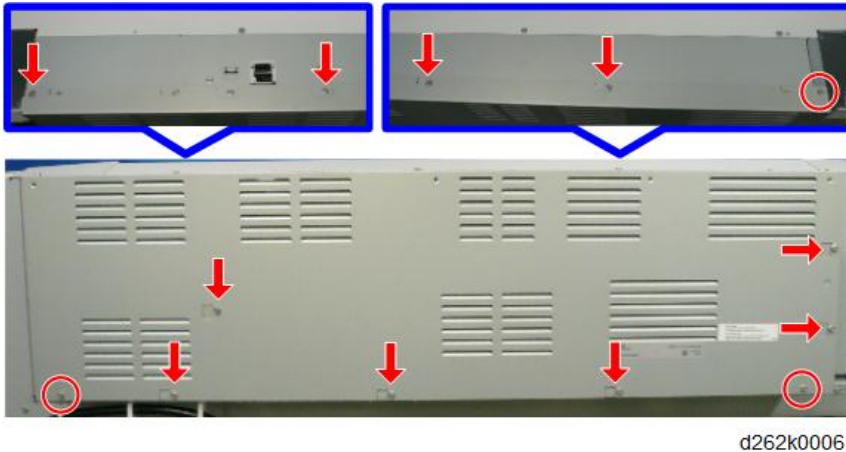

11. Fasten the removed screws on the left of the machine ( x3).



Clamping the Power Cord

1. Make sure that the power cord is not connected to the power source.
2. Attach the medium-size clamp, connect the power cord [A], and then close the clamp ( x3).

CAUTION

- Do not connect the power cable to the power source at this time.

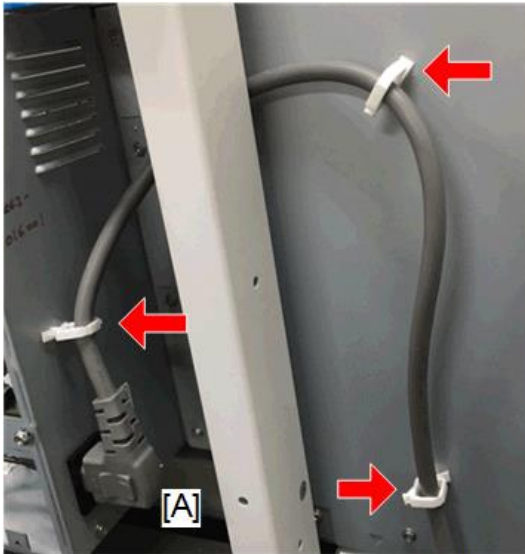

d262k0023

3. Remove the filament tape.

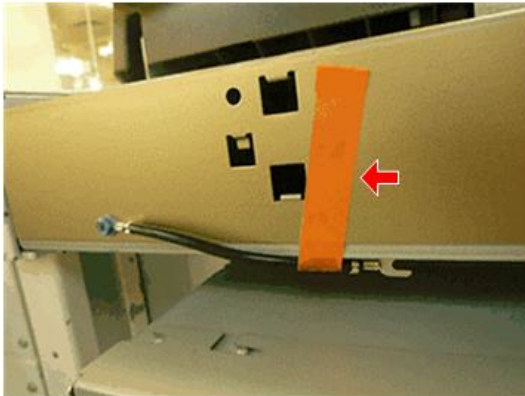

d262k3109

4. Connect the ground harnesses of the scanner unit to the back of the machine ( x3 M3x6).

Note

- Be sure to connect the ground harnesses securely. Otherwise the normal image may not be obtained on copying or scanning.

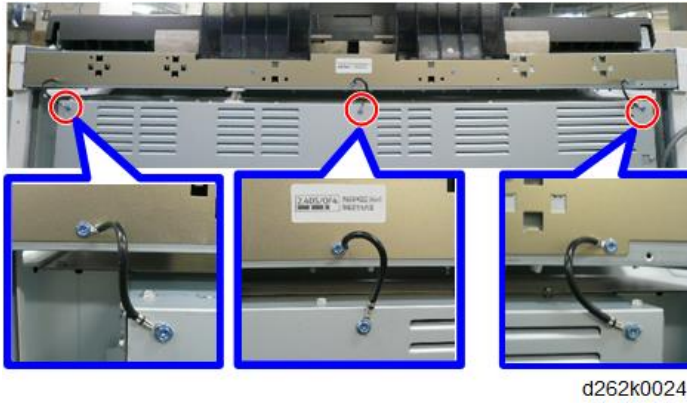

Removing Tapes and Shipping Materials

1. Open the scanner unit and remove the vinyl and filament tape.
2. Remove all the external tape and other materials attached to the machine.

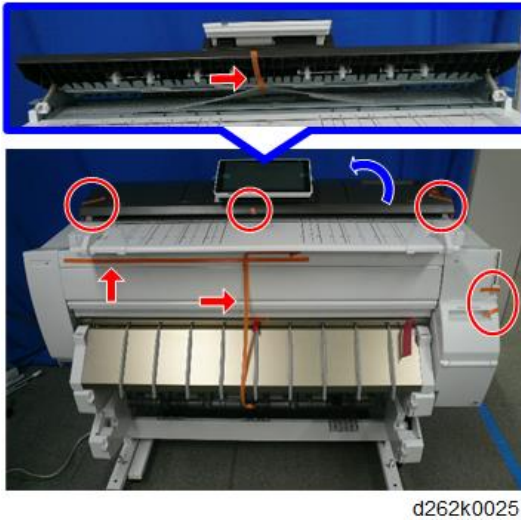

3. Lift the front cover, and remove the filament tape.

Fold the bottom of the cover into the machine so that it locks and remains open.



d262k0325

4. Remove the tape and other materials attached to the inside of the machine. Remove the tape [A], tape [B], film sheet [C], tape [D], and GAP protective material [E] in this order.

↓ Note

- When removing the tapes, never touch the horizontal encoder sheet.
- Never pull out the red tag. If it is pulled out forcibly, the carriage left cover is removed that causes the damage to the carriage unit.

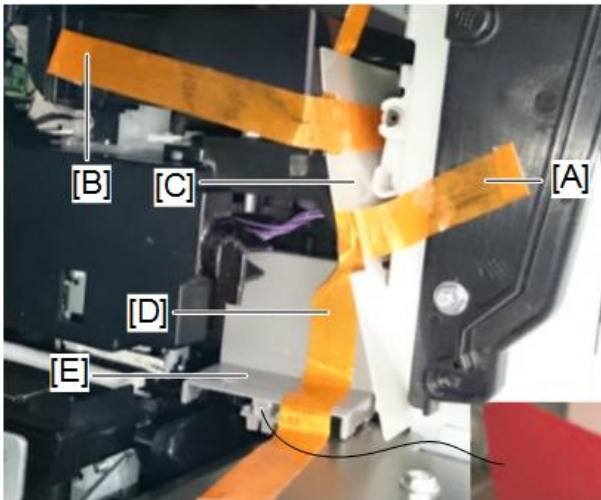

d262k0324

Remove the tape [A] with protective material [B] for ink tubes.

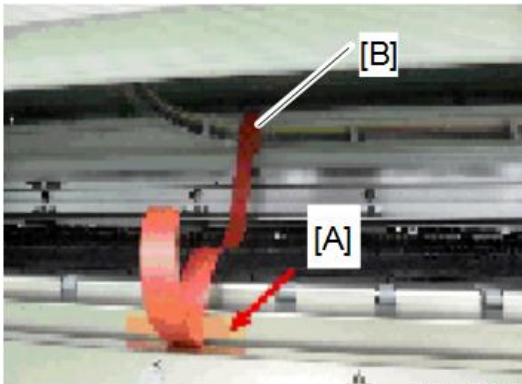

d262k1538

5. Close the front cover. Push it in and make sure that it locks.

Original Stacker, Guides

Installing the Original Stacker, Guides

1. Insert the hooks on the bottom of the original stacker [A] into the holes.
2. Push down the four tabs [B] to attach.



d124i065

3. Attach the original guides [A] to the back of the stacker.

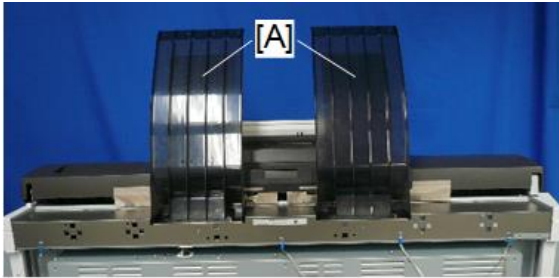

d262k0027

4. Attach the four rear guides [A].

↓ Note

- There are six connection slots for the guides. However, attach the guides to the inner four points (leave both outer slots empty).

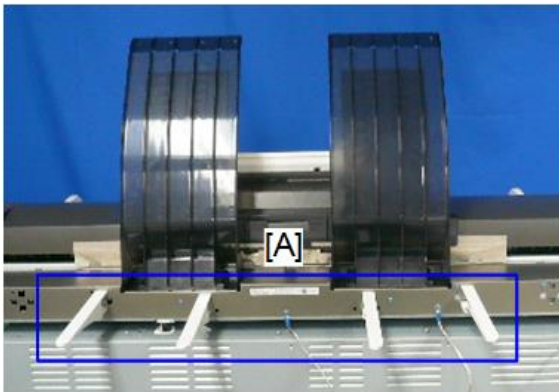

d262k0028

5. Use the rivets to attach the manual pocket [A] to the right side of the main unit stand (✎ x2).

↓ Note

- To set a rivet, align the rivet with its hole, and then push it in.

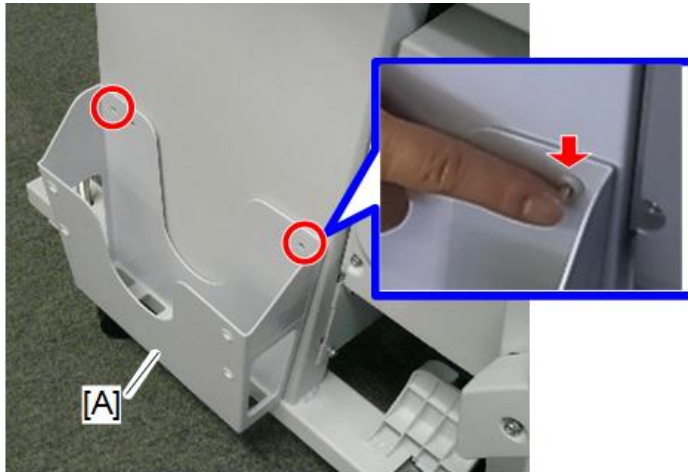

d262k3110

6. Attach the optical cloth pocket at the location shown below.

- First, dampen a clean cloth with a small amount of water or alcohol, and then wipe the surface where the optical cloth pocket will be attached.
- Remove the tape from the back of the pocket, and then attach it as shown below.

7. Place the optical cloth in the pocket.

d1241073a

Ink Collector Tank Storage Shelf

Installing the Ink Collector Tank Storage Shelf

The ink collector tank storage shelf [A] is attached to the bottom stay [B] of the scanner stand [B].

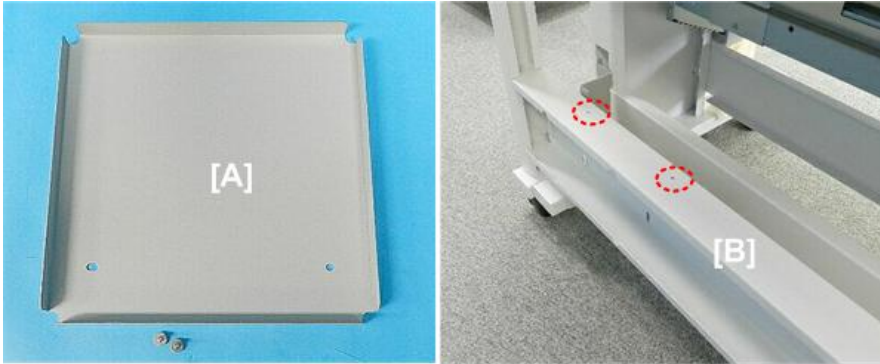

d124i160

1. Fasten the shelf [A] to the stay ( x2 M4x8).

2. Set the extra ink collector tank [B] on the shelf.

- When the ink collector tank becomes full, the machine will stop.
- The operator can remove the full tank and replace it with the empty tank.
- At the next PM visit, the service technician can swap the full tank with another empty tank (a service part, not a consumable).

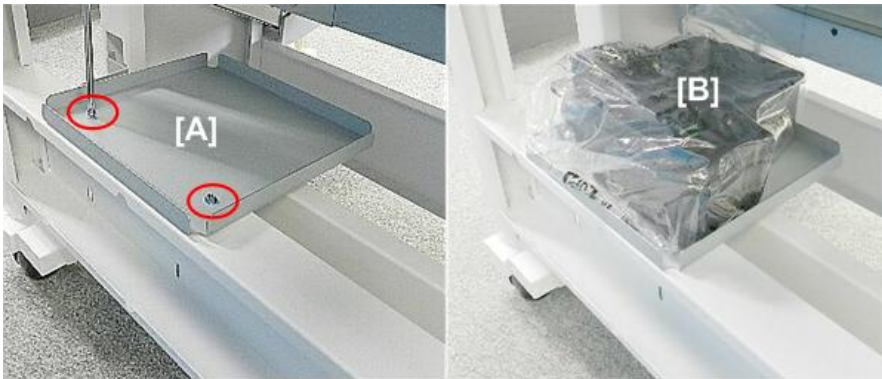

d124i161

Exit Stacker

Accessories: Exit Stacker

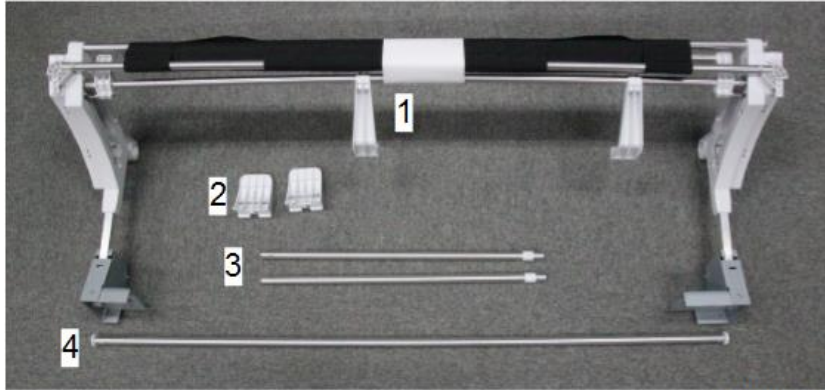

d262k0326

No.	Item	Q'ty
1	Stacker Assembly	1
2	Guide: Rod: Lower (Guide Rod)	2
3	Pipe: Stacker: Side: Front	2
4	Rod: Stacker: Middle: Assembly	1
-	Tapping Hexagonal Screws: 3x8	2
-	Tapping Hexagonal Screws: 4x8	6

Installing the Exit Stacker

⚠ Note

- To fasten the screws of the exit stacker, a stubby is necessary.

1. Raise the paper exit guide [A].



d262k0327

2. If the bolt is protruding from the main unit stand, turn it clockwise until flush.



d262k0328

3. Attach the guide rod to the right foot of the main unit stand. ( x1 M4x8)

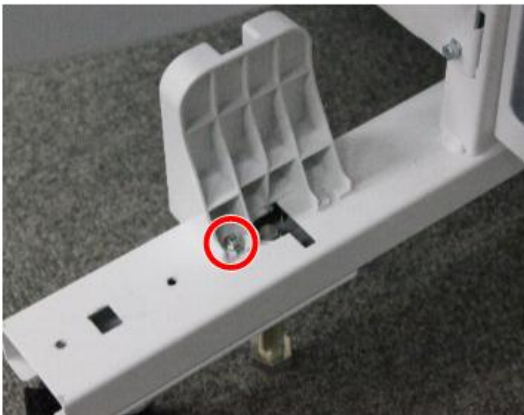

d262k0329

4. Attach the guide rod to the left foot of the main unit stand. ( x1 M4x8)



d262k0330

5. Attach the paper exit stacker [A] to the feet of the main unit stand. ( x4 M4x8)

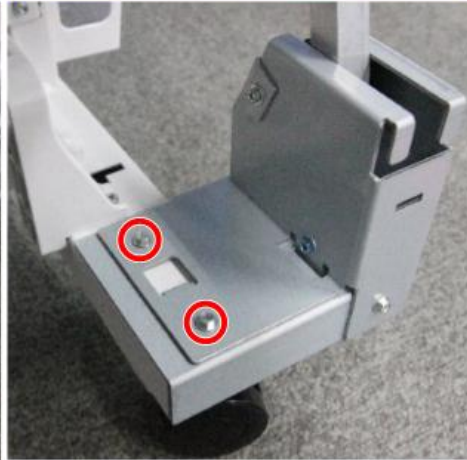
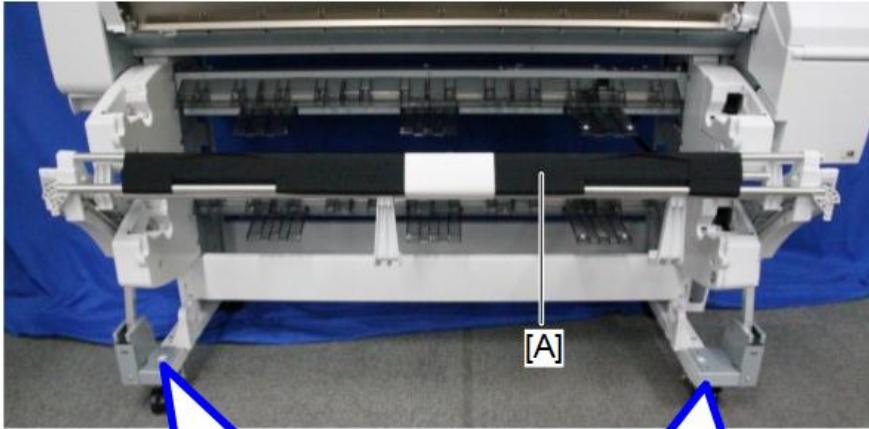

d262k0331

6. Pass the side pipes through the sliders on both sides of the stacker then attach them to the connector block. ( x2 M3x8)

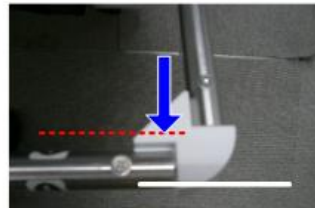
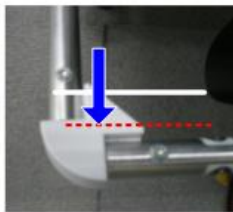
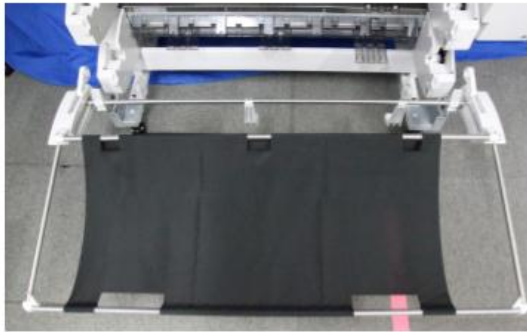
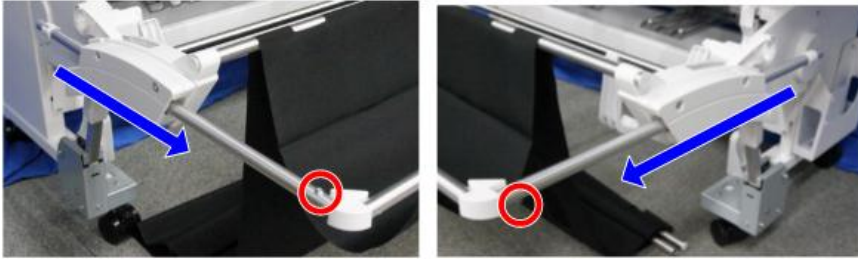

d262k0332

 **Note**

- Be sure to insert the pipe fully into the connector block. Otherwise other parts cannot be attached.

7. Attach the rods [A] and [B] to the slots of the guide rods, as shown below.

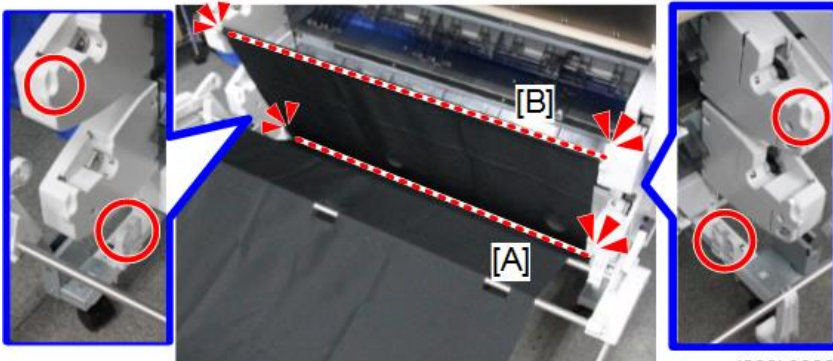
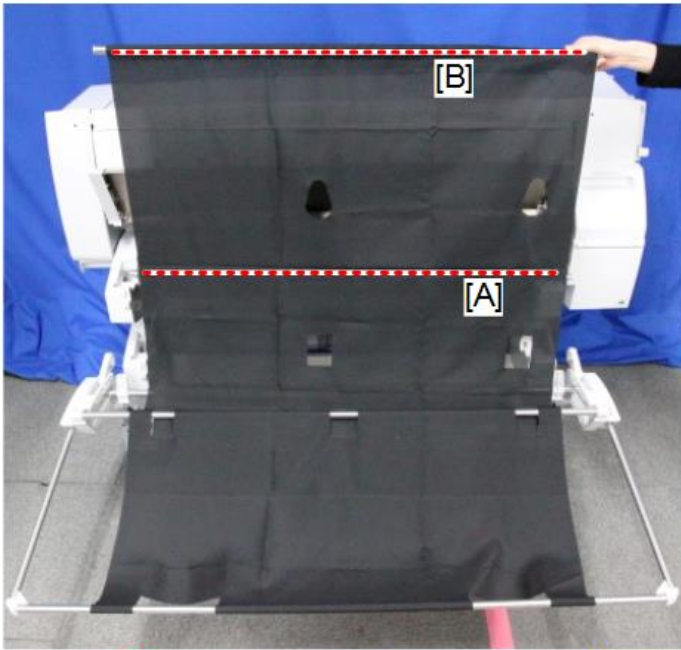

d262k0333

8. Pass the middle rod [A] rear of the sheet and insert it into the left and right holes.



d262k0334

Attached Paper Exit Stacker



d262k0335

Changing the mode of the Paper Exit Stacker

The mode of the paper exit stacker can be changed according to the purpose.

- Standard Mode
For normal printing
- A1T/A2Y Stack Mode
Used for exiting of A1T/A2Y plain paper.
- A0T/A1Y Stack Mode
Used for exiting of A0T/A2Y plain paper.

For making settings for each mode, refer to user guide.

Ink Filling

Before a machine leaves the factory, the ink supply tubes, sub tanks, and print heads are filled with priming fluid. This fluid prevents the seams of the joints and connections of the ink supply system from drying out during shipping and storage.

- The priming fluid must be drained completely from the ink supply tubes, ink tanks, and print heads at installation before they are filled with ink.
- Special cartridges, the same shape as ink cartridges, are loaded into the ink supply unit. The ink pumps rotate in reverse to draw the priming fluid out of the print head units and ink supply tubes.

★ Important

- Never turn the power OFF or try to use the operation panel during the following procedure.
- Do not touch the machine while it is draining.

Draining and Filling Procedure

1. Remove the drain cartridges [1] and starter ink cartridges [2] from their packing material.



d262k8105

2. Insert the power cord into a power source.
3. Open the ink cartridge cover.
4. Load the primer fluid drain cartridges into the ink supply unit, and then close the cover.

★ Important

- Load the cartridge securely until the lever clicks. Otherwise the fluid may spill inside the machine.

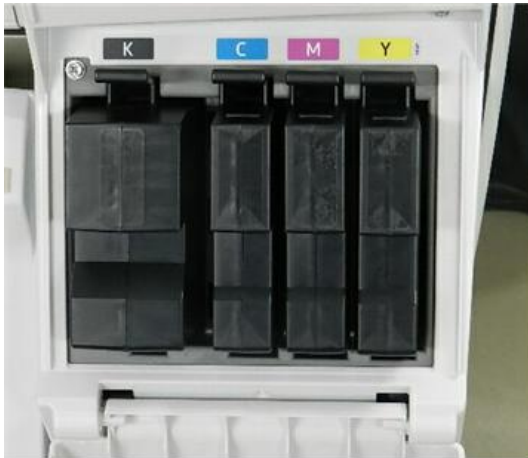

d1241003

5. Turn the power ON.
6. Wait for the machine to beep twice.
7. Enter the SP mode and select SP2-012-001 (Initial Operation Setting). Make sure that it is set to "9".

↓ **Note**

- SP2-012-001
- This SP code is used to modify the initial ink filling sequence at installation and after one or more print heads have been replaced. Every time the machine is turned on, the machine checks the ink level in each sub tank. If ink is low, then the machine switches on
- the ink pump motor(s) to fill the tank(s).

8. Next, set SP2-100-004 (Special Maintenance: Extract Filling Liquid) to "31" and then touch [#] and [EXECUTE].

↓ **Note**

- SP2-100-004
- Press [EXECUTE] to drain the primer fluid from the print heads, print head sub tanks, and ink supply tubing. This is done at installation before the ink cartridges are installed.
 - Special cartridges are provided to hold the drained fluid.
 - This SP is used only at installation before the print heads are filled with ink.
- The ink pumps start operating in reverse to draw the fluid out of the print head units and the tubes.
- Draining the fluid requires about 7 min. and 48 sec.

The procedure is finished when a message tells you the procedure has completed. The machine disables the cartridges so that they can no longer be used.

↓ **Note**

- To check for completion of an operation with SP, specify SP2-030-001 (Extract Filling Liq Prog Mng: Completed State Flag). If the operation is completed, "00011111" will be displayed for that SP.

↓ **Note**

- If the draining operation does not start, go to the next section below for more about an alternative procedure.

9. Turn the power OFF.

10. Remove the primer fluid drain cartridges and replace them with the starter ink cartridges.

★ **Important**

- Load the cartridge securely until the lever clicks. Otherwise the fluid may spill inside the machine.



d1241004

11. Close the cartridge cover.

12. Turn the power ON.

- The ink filling sequence will start automatically.
- The ink filling requires about 13 min and 42 sec.
- After filling, the machine may display the pre-near end alert for one or more of the color ink cartridges. This is normal.
- If you do not see a message that tells you filling has started, cycle the power OFF/ON and try again.

13. After the procedure is completed, open SP2-012-001 (Initial Operation Setting) and confirm that it displays "0".

↓ **Note**

- SP2-012-001

- This SP code is used to modify the initial ink filling sequence at installation and after one or more print heads have been replaced. Every time the machine is turned on, the machine checks the ink level in each sub tank. If ink is low, then the machine switches on the ink pump motor(s) to fill the tank(s).
- This SP should always be set to "0" unless there are specific instructions that it should be reset temporarily.

14. Discard the filled primer fluid drain cartridges.

★ Important

- Obey the local laws and regulations regarding the disposal of items such as the primer fluid drain cartridges.

If Draining Fails to Start

If one or more of the ID chips on the drain cartridges is damaged, the operation may not start. Even if you set **SP2-100-004** (Special Maintenance: Extract Filling Liquid) to "31", the fluid will not drain from the tubes, ink sub tanks, and print heads.

↓ Note

- SP2-100-004
 - Press [EXECUTE] to drain the primer fluid from the print heads, print head sub tanks, and ink supply tubing. This is done at installation before the ink cartridges are installed.
 - Special cartridges are provided to hold the drained fluid.
 - This SP is used only at installation before the print heads are filled with ink.
1. Open **SP2-012-001** (Initial Operation Setting) and set it to "3".

↓ Note

- SP2-012-001
 - This SP code is used to modify the initial ink filling sequence at installation and after one or more print heads have been replaced. Every time the machine is turned on, the machine checks the ink level in each sub tank. If ink is low, then the machine switches on the ink pump motor(s) to fill the tank(s).
 - This SP should always be set to "0" unless there are specific instructions that it should be reset temporarily.
2. Turn the power OFF.
 3. Remove the drain cartridges, and then replace them with the ink starter cartridges.
 4. Close the ink cartridge cover.
 5. Turn the power ON.
 - Ink filling starts.

- The ink and primer fluid drain from the tubes, ink sub tanks and the print heads into the ink collector tank.
6. After the operation is completed, flush all the print heads three times. ([User Tools> Maintenance> Flush Print Heads> Select all]).

Note

- At the end of filling and draining of ink and fluid into the ink collector tank, **SP2-012-001** resets automatically to "0"

Setting Roll Paper

Note

- Roll paper can be set to Roll Unit 1 and Roll Unit 2. Setting method is the same for both units. This section describes the method to set the paper to Roll Unit 1.
- Roll paper cannot be set to Roll Unit 1 and Roll Unit 2 simultaneously.
- To set the paper spool to the roll paper, put the roll paper on the flat surface and set the paper spool.
- To set the paper spool to the roll paper, avoid to apply strong power to the roll paper by falling down the roll paper or inserting the paper spool forcibly.

Setting the Paper Spool to Roll Paper

1. Raise the lock lever [B] of the left flange [A] to release the lock and remove the flange from the spool [C].

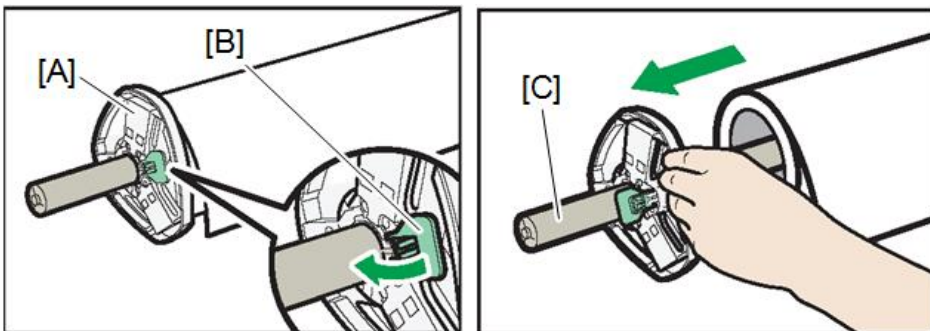

d262k0052

2. Remove both the right flange and spool from the paper roll.

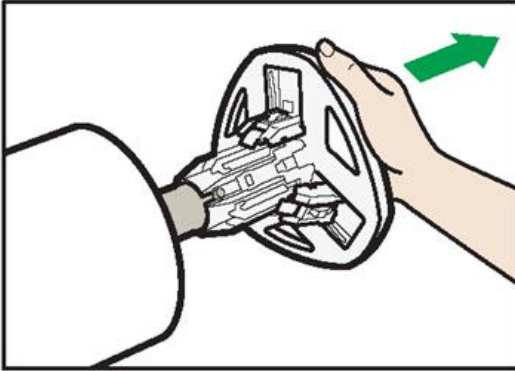

d262k0060

3. Insert a spooling flange to touch the paper roll from the right of it.

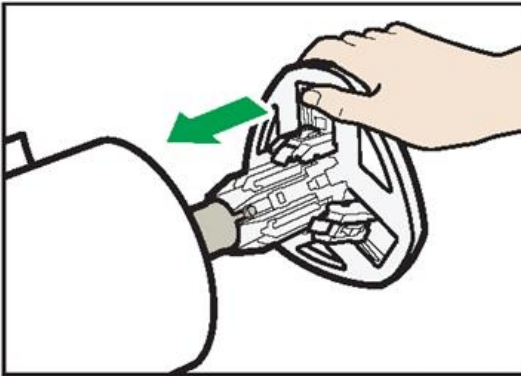

d262k3113

↓ **Note**

- When loading the paper roll to the paper spool and machine, make sure that the edge of the paper feeds from top of the roll toward the front.

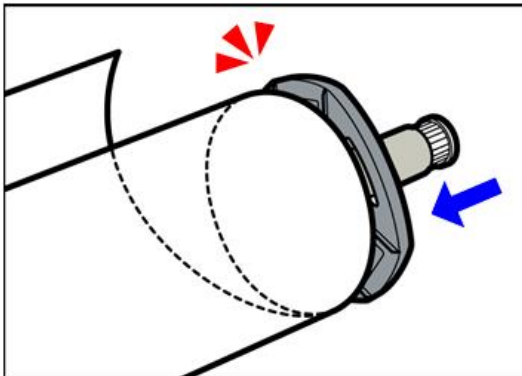

d262k0054

4. Insert the spool into the left flange.
5. Lower the lock lever of the left flange to lock the flange.

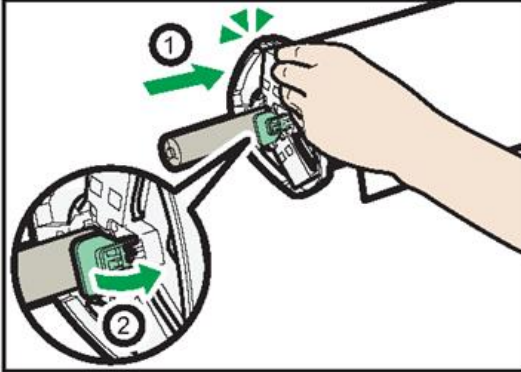

d262k0056

Setting the Paper Roll to the Machine

↓ Note

- Be sure to turn the power ON.
- Make sure that the output basket is set to standard mode before setting.

1. Lift up the paper input location cover [A] until it clicks.

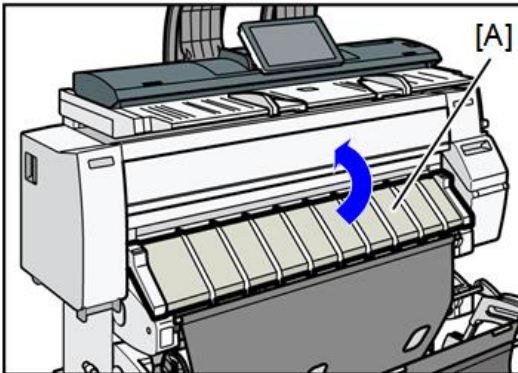

d262k0058

2. Remove bar [A], and then hook it in front of the output basket.

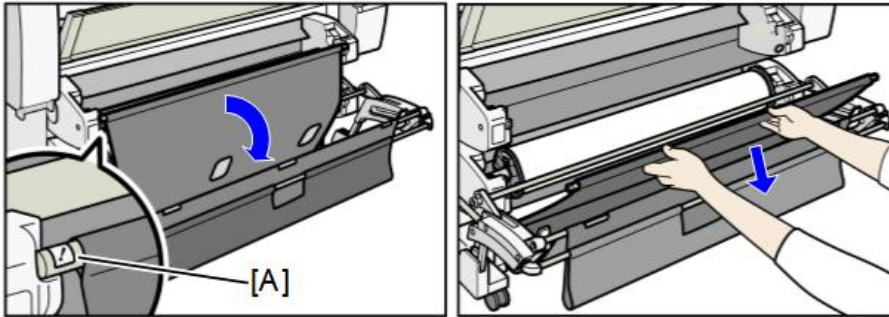

d262k0059

3. If the roll unit 2 is attached, pull down the exit stacker rod [A] attached to the front of the roll unit 2 toward you.

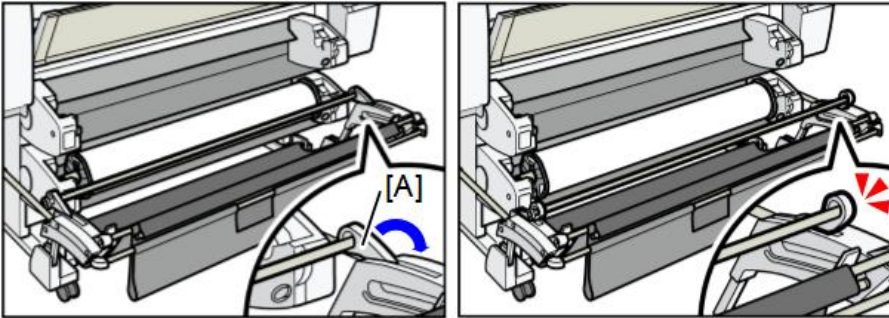

d262k0061

4. Hold both flanges and place the paper roll on the paper input location.

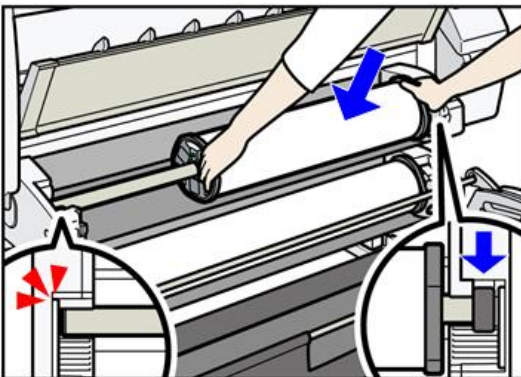

d262k0062

↓ Note

- Be sure to place the spool so that its right edge is covered by the black shutter.

5. Hold the paper roll beneath and feed the paper edge into the guides behind the paper roll.

When set correctly, the paper is pulled into the machine and the beeper sounds.

6. Return the bar [B] of the output basket.

Push bar [A] into the machine, and then lift bar up and hook it.

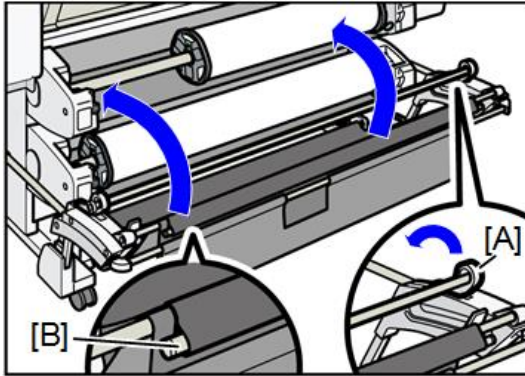

d262k0064

7. Lower the paper input location cover [A].

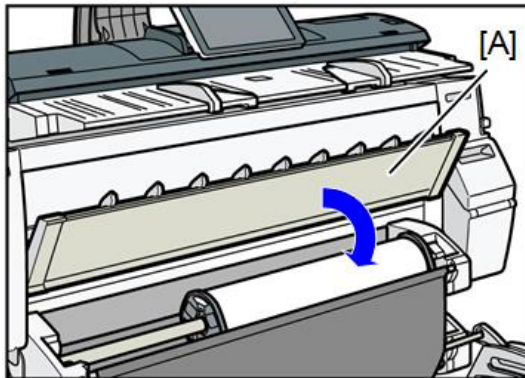

d262k0065

8. Select whether or not to cut off the edge of the paper roll on the screen.

Note

- Select [Cut] when the edge of the paper is cut manually, such as with scissors, or the paper is damp.

9. Follow the on-screen instructions to specify the paper type and thickness of the paper roll.

Touch [Matches] if the paper type and thickness of paper roll you loaded are the same as those displayed on the screen.

If the paper type and thickness are different from those displayed, touch [Does not Match]. Select the proper items according to the paper type and thickness you want to use, and then touch [OK].

10. Make sure that the size of paper roll you loaded is displayed correctly on the screen.

↓ Note

- When [Film (Matte)] is specified for Paper Type or when Prevent Paper Abrasion is specified, touch [Exit] on the screen after lowering the paper input location cover. You can change the Prevent Paper Abrasion setting in System Settings if necessary. However, if you specify [Film (Matte)] for Paper Type, the Prevent Paper Abrasion setting is automatically selected, and you cannot change it. For details about Prevent Paper Abrasion, refer to the user guide.
- When the settings in step 9 are finished, the machine pulls the paper inside, and paper is output about one meter (40 inches) from the paper output location. Then the machine rewinds the paper to the prescribed position. Do not touch the output paper until the machine stops moving. If you select [Cut] in step 8, the edge of the paper is cut off.
- If you insert a roll of paper into the machine at an angle or if there is space between the paper and the flanges, the paper may not be pulled into the inside of the machine. If that happens, return to step 1 and start again.
- When you load two paper rolls into Paper Input Locations 1 and 2 in succession, make sure that the paper size you loaded first is displayed on the screen correctly, and then load the other paper roll into the other paper input location.
- When the [Notification Sound] is set to [No Sound], it will not sound if you insert paper into the paper input location. For details about [Notification Sound], refer to the user guide.
- You can specify the types of paper you load in the paper input location in advance. For details, refer to the user guide.
- For details about the settings for the paper thickness and types, refer to the user guide.
- For details about how to store the paper roll, refer to the user guide.

Connecting to the Gigabit Ethernet Interface

This section describes how to connect an Ethernet interface cable to the Gigabit Ethernet port.

If you use an Ethernet interface cable that supports 1000BASE-T, set [Ethernet Speed] to [Auto Select: Enable 1Gbps] in [Interface Settings] in [System Settings].

⚠ CAUTION

- Properly shielded and grounded cables and connectors must be used for connections to a host computer (and/or peripheral) in order to meet emission limits.

★ Important

- If the main power switch is on, turn it off.
- Use the following Ethernet cables.
 - When using 100BASE-TX/10BASE-T:

Unshielded Twisted Pair Cable (UTP) or Shielded Twisted Pair Cable (STP) and Category type 5 or more

- When using 1000BASE-T:
Unshielded Twisted Pair Cable (UTP) or Shielded Twisted Pair Cable (STP) and Category type 5e or more

1. Make loops 3 cm (1.2 inch) [A] from the end of each Ethernet cable and attach included ferrite cores to each loop as shown.

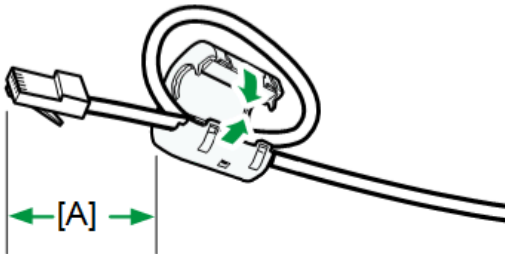

d262k1001

2. Make sure the main power switch is turned off.
3. Connect the Ethernet interface cable to the Gigabit Ethernet port.

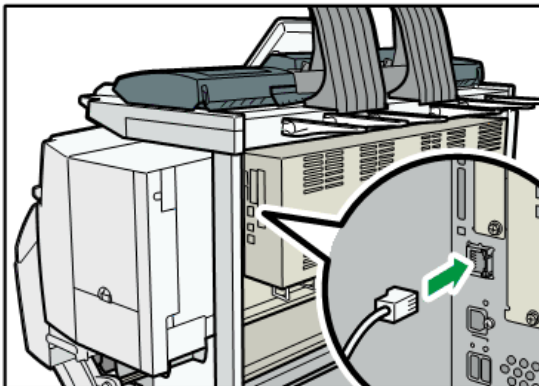

d262k1002

4. Connect the other end of the Ethernet interface cable to a network connection device such as a hub.

5. Turn on the main power switch of the machine.

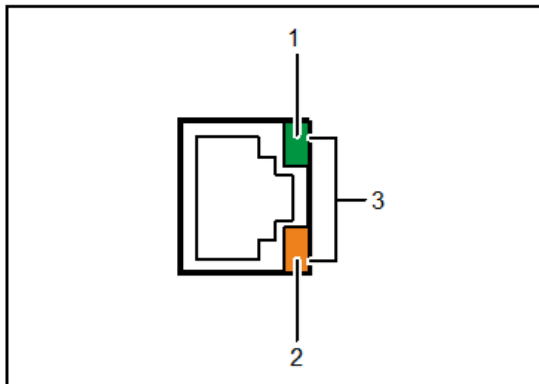

d262k1003

1. Indicator (green)
When 10BASE-T is operating, the LED is lit green.
2. Indicator (orange)
When 100BASE-TX is operating, the LED is lit orange.
3. Indicators (both orange and green)
When 1000BASE-T is operating, both LEDs are lit.

↓ Note

- The Gigabit Ethernet interface LED is not lit during power saving.

Check Printing

Nozzle Check Pattern

1. Touch [Home] at the bottom of the screen in the center.
2. Flick the screen to the left, and then touch the User Tools icon.
3. Touch [Machine Features].
4. Touch [Maintenance].
5. Touch [Print Nozzle Check Pattern].

6. Select the paper feed location and touch [OK].

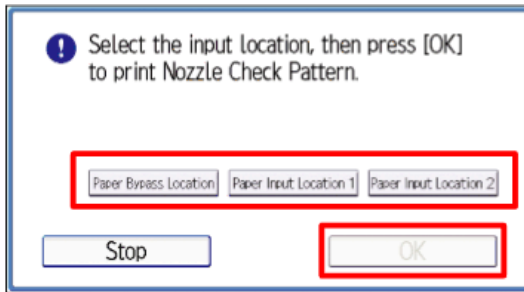

d262k1507

7. Follow the prompts to start printing the pattern.

8. Use a loupe or magnifying glass to check the condition of the pattern.

- If the pattern shows no broken lines, the machine is ready for operation.

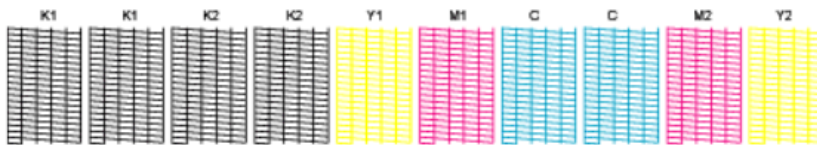

d262k1064

- If any of the lines are broken, identify the patterns where the broken lines exist, and then clean the print heads. (See below.)

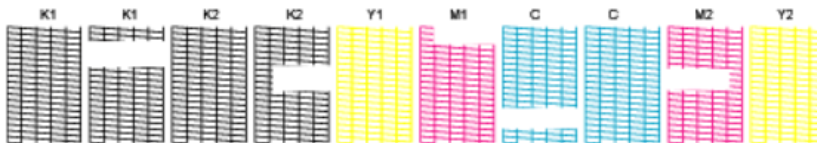

d262k1065

9. Touch [Clean Print-heads]

10. Select the print head(s) to clean then touch [Start], and then follow the prompts to complete the cleaning.

11. Print another Nozzle Check Pattern, and then check the results.

- If the patterns have no broken lines, the procedure is completed.
- If there are still broken lines in one or more of the patterns, clean the print heads again, and then print another Nozzle Check Pattern.
- If lines still exist after the third cleaning and Nozzle Check Pattern printing, touch [Exit], and then flush the print heads.

★ Important

- Flushing the print heads consumes a large amount of ink.

- **Never execute print head flushing until you have executed print head cleaning at least 3 times.**

12. Touch [Flush Print-heads].

13. Follow the prompts to complete print head flushing.

14. Print another Nozzle Check Pattern.

- If the patterns have no broken lines, you have finished.
- If there are still broken lines in the patterns, go to the next section.

2

When an Unbroken Nozzle Check Pattern Cannot be Produced

Do this procedure if three cleanings and one flushing have failed to produce an unbroken Nozzle Check Pattern.

1. Make sure that the ambient temperature and humidity are within the acceptable range:

- Temperature Range: 10°C to 27°C (50 °F to 81 °F)
- Humidity Range: 15% to 80% Rh

2. Clean the print heads again, and then print another Nozzle Check Pattern.

3. If the Nozzle Check Pattern is still abnormal, let the machine remain idle for 10 minutes.

4. Execute two more cleanings and one flushing.

- Be sure to print a Nozzle Check Pattern after each cleaning and flushing.
- If you have produced an unbroken Nozzle Check Pattern, you can stop.

5. After the flushing, if the Nozzle Check Pattern is still not perfect, let the machine remain idle for 8 hours.

6. Execute three more cleanings and one flushing.

- Be sure to print a Nozzle Check Pattern after each cleaning and the flushing.
- When you have produced an unbroken Nozzle Check Pattern, you can stop.

Halftone Check

Leftover priming fluid can cause streaking in halftone areas. Do this check to confirm that all of the primer fluid has been drained from the ink sub tanks and ink supply tubes.

- 1. Touch [Home] at the bottom of the screen in the center.**
- 2. Flick the screen to the left, and then touch the User Tools icon.**
- 3. Touch [Machine Features].**
- 4. Touch [Maintenance] > [Printer Features].**

5. On the Printer Features screen, under the List/Test Prints tab, touch [Color Sample].

The color sample prints about 240 palette samples. This is a very large sample and may require a minute or so to finish printing.

6. Check several of the sample blocks.

- The left side [A] shows a normal, half-tone pattern with no streaks.
- If the primer fluid did not drain completely, this can cause light streaks to appear in half-tone areas [B].

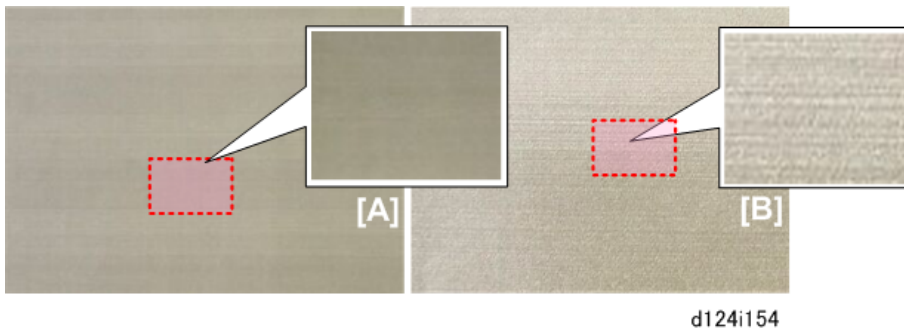
**7. If you detect any streaking, flush the print head of the color where you see the problem.**

- Touch User Tools icon on the operation panel.
- Touch [Maintenance] > [Flush Print-heads]
- When the message tells you flushing is completed, repeat the procedure.
- Flush the print heads three times.

Final Adjustments

Caster Lock

Lower the caster locks on the left and right front casters to keep the machine from moving.



d124i162

Level Adjustment

Adjust the level of the machine if it is on an uneven surface.

1. Place a leveling mount under the bolt at each corner of the machine.
2. Turn each bolt to lower it onto the leveling mount until it is tight.



d124i163

3. Open the front cover.

4. Place a leveling instrument on the cross-piece in front of the platen.

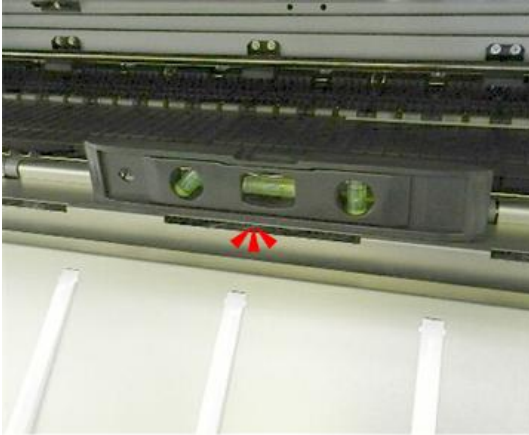

d124i164

5. Use a wrench to adjust the height of each bolt to level the machine.

Note

- Make sure that the machine angle is not more than 0.15/1000 mm from level.



d124i165

Manual Adjust Head Position

1. Touch [Home] at the bottom of the screen in the center.
2. Flick the screen to the left, and then touch the User Tools icon.
3. Touch [Machine Features].
4. Touch [Maintenance].
5. Touch [Manual Adjust Print Head Position].

6. Select the target location and resolution, and then touch [Start Printing].

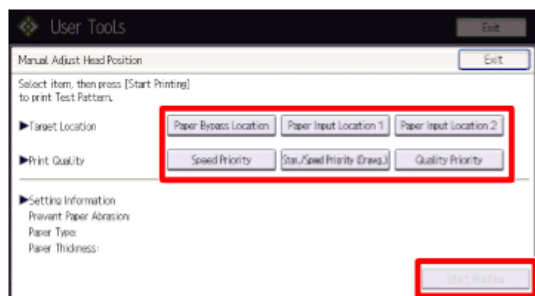

d262k1510

2

Target Location (Paper Source)

Paper Bypass Location	Bypass paper feed
Paper Input Location 1	Roll Unit 1
Paper Input Location 2	Roll Unit 2

Print Quality

Speed Priority	Draft (pattern A - G)
Stan. / Speed Priority (Drawg.)	Standard quality (pattern A - J)
Quality Priority	High quality (pattern A - J)

7. Check the test pattern.

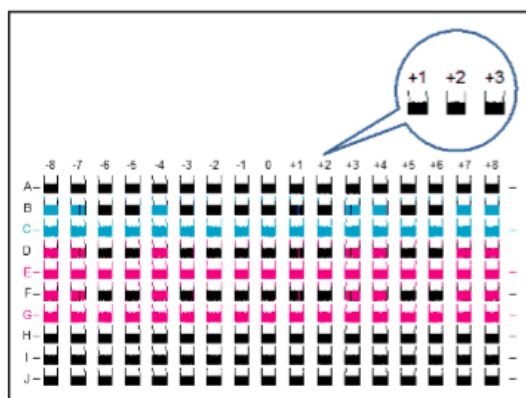

d262k1071

To determine the adjustment value:

- Identify the number of the column where the square is faintest, or select the square where the internal lines overlap to form a solid color.

- The number above the square is the adjustment value.
- If you cannot determine the adjustment value, select the square that is between the straightest vertical lines.
- Write down these values (A4, B2, etc.) for use later in the procedure.

8. When printing is completed, touch [Adjustment].

9. Enter the values for each row. (touch the plus or minus button; the numbers will appear automatically.)

10. Print another test pattern.

11. Make sure that the numbers you entered correspond to the results in the new test pattern.

Adjust Paper Feed

Adjust paper feed if you see these problems in the prints:

- Broken horizontal lines
- Patchy images (uneven filled areas)
- White lines at regular intervals

1. Touch [Home] at the bottom of the screen in the center.
2. Flick the screen to the left, and then touch the User Tools icon.
3. Touch [Machine Features].
4. Touch [Maintenance].
5. Touch [Adjust Paper Feed].
6. Select [Print Test Pattern] for the paper feed source.

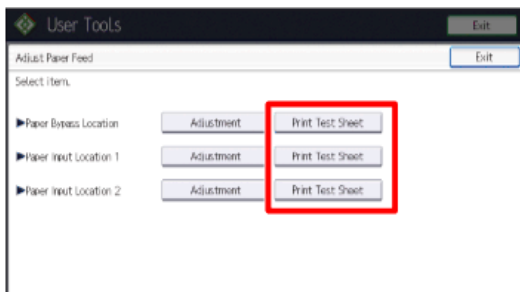

d262k1512

Paper Bypass Location	Bypass paper feed
Paper Input Location 1	Roll Unit 1
Paper Input Location 2	Roll Unit 2

7. When you are prompted, touch [Start Printing].
8. The adjustment value appears to the left of the lightest gray square with straight horizontal lines on both sides.

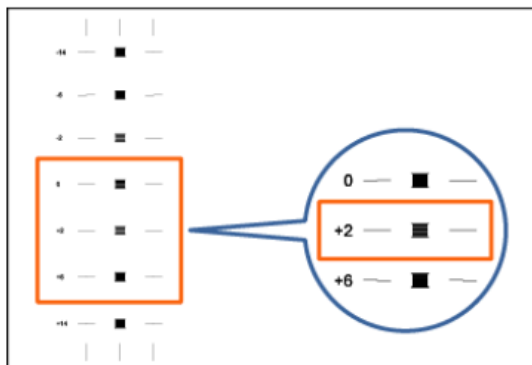

d262k1073

9. Touch [Adjustment].

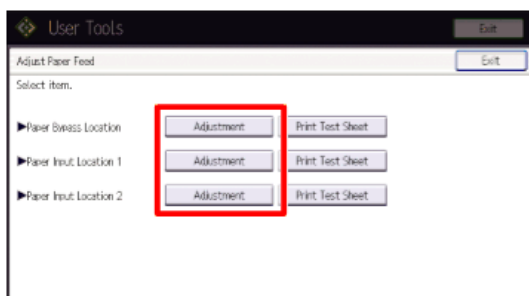

d262k1513

10. Enter the adjustment values, and then touch [OK].
 - Touch [↑] and [↓] to enter the adjustment value of "Top Margin".
 - Touch [←] and [→] to enter the adjustment value of "Left Margin".

Adjust Print Position

This procedure checks and allows you to adjust the print start position at the upper left corner of each sheet.

1. Touch [Home] at the bottom of the screen in the center.
2. Flick the screen to the left, and then touch the User Tools icon.
3. Touch [Machine Features].
4. Touch [Maintenance].
5. Touch [Adjust Print Position].

6. Select [Print Test Sheet] for the paper feed source.

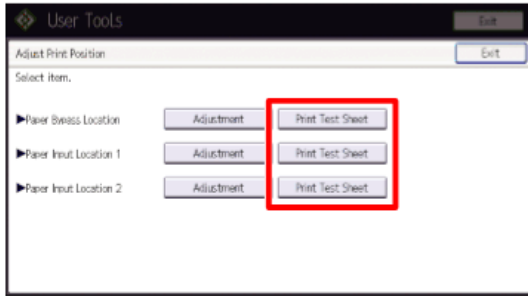

d262k1511

Paper Bypass Location	Bypass paper feed
Paper Input Location 1	Roll Unit 1
Paper Input Location 2	Roll Unit 2

7. When you are prompted, touch [Start Printing].
8. The black arrow indicates the direction of paper feed.
9. Rotate the test sheet 180 degrees. [A] is the top margin and [B] is the left margin.

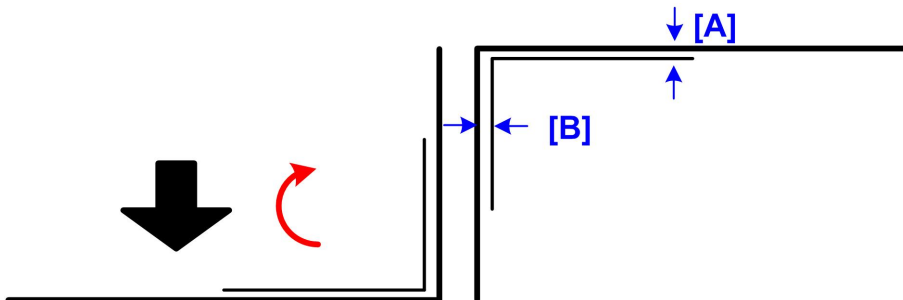

d124r696

10. Touch the arrow keys to adjust the margins.

Note

- Increasing the value for the top and left margin moves the print position down and to the right. You will see the blue square move as you change the settings, so you can confirm the effect of the changes.

Final Settings

Check and adjust the date and time settings: User Tool > System Settings > Timer Settings > Set Date, Set Time.

After Installation

Do these tasks after installation is completed.

1. Perform the SMC List Card Save (SP Text Mode) function to save the SMC list as CSV files to the SD-card inserted into the operation panel SD-card slot. (p.636)
2. Upload the NVRAM contents to an SD card.
 - Insert an SD card into SD card Slot 2 of the machine.
 - Do **SP5-824** (NVRAM Data Upload) to upload the contents of the NVRAM to the SD card.
 - Keep the SD card in a safe place.

Note

- **SP5-824**
- Touch [EXECUTE] to upload the UP and SP mode data (except for counters and the serial number) from NVRAM on the control board to an SD card.
- Note: While using this SP mode, always keep the front cover open. This prevents a software module accessing the NVRAM during the upload.

Moving the Machine

Important

- **The scanner stand and scanner unit assembly is extremely top heavy and can tip over easily. Never attempt to move the machine with the scanner stand detached from the main unit.**

Observe the following precautions when moving the machine to another location in the same room or in the same building:

- Two people are required to push and move the machine to a new location.
- To prevent ink spillage, never tilt the machine. A new machine with no ink in it can be tilted 70° from the horizontal to load it onto a truck or into an elevator. However, a used machine with ink in it should never be tilted more than 45° from the horizontal.
- Make sure that the four screws that connect the scanner stand to the main unit stand are attached and securely fastened.
- Make sure that the four casters of the main unit stand and scanner stand are unlocked before you try to move the machine.
- It is not necessary to remove the ink cartridges.
- Position your hands at the base of the main unit and then push it slowly to the new location.
- Before shipping the main unit, pack and tape some shipping material against the carriage to prevent the carriage from slipping out of position.
- Make sure that the main unit is packed level and strapped securely.

Controller Options

Overview

2

Slots

There are three slots for boards (A, B) and two SD card slots (1, 2) for SD cards on the faceplate of the controller box. Each board or SD card must be inserted into its assigned slot. The slot assignments of boards and SD cards are written on a decal on the controller box cover as shown below.

★ Important

- Always touch a grounded surface to discharge static electricity from your hands before you handle SD cards, printed circuit boards, or memory boards.

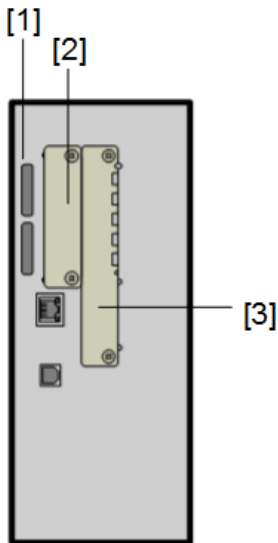

d262k8519

No.	Slots	Options
[1]	SD card slot 1, 2	<ul style="list-style-type: none"> • Slot 1 (upper): Option slot • Slot 2 (lower): Service slot
[2]	Slot A	Slot A : IEEE 802.11 a/g/n Interface Unit Type M19
[3]	Slot B	Slot B File Format Converter Type M23

Standard Controller Features

- Option SD cards must go into slot 1. If more than one card is used, the modules must be merged onto one SD card.
- The Network function, USB Host Function are built in and enabled before the machine leaves the factory.
- Data Overwrite Security, HDD Encryption
 - These features are built into the machine for all models.
There is no Security SD Card in the DOS version that is not for CC certification.
 - These features must be activated by customer or technician after installation.

SD Card Appli Move

Overview

The service program "SD Card Appli Move" (SP5-873) allows you to move application programs from one SD card to another SD card.

If more than one application is required, the applications must be moved to one SD card with SP5873-1.

Be very careful when you do the SD Card Appli Move procedure:

- The data necessary for authentication is transferred with the application program from an SD card to another SD card. Authentication fails if you try to use the SD card after you move the application program from one card to another card.
- Do not use the SD card if it has been used before for other purposes. Normal operation is not guaranteed when such an SD card is used.
- The original application SD card should be stored using the following procedure.

Move Exec

The menu "Move Exec" (SP5-873-001) lets you move application programs from the original SD card to another SD card.

★ Important

- Do not turn ON the write protect switch of the system SD card or application SD card on the machine. If the write protect switch is turned ON, a download error (e.g. Error Code 44) occurs during a firmware update or application merge.

1. Turn OFF the main power.

2. Remove the SD card slot cover [A] ( x2).

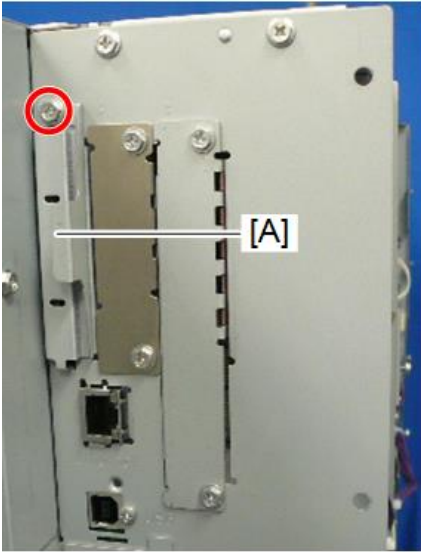

d262k2005

3. Make sure that a target SD card is in SD Card Slot 1 (upper). The application program is moved to this SD card.
4. Insert the source SD card with the application program in SD Card Slot 2 (lower). The application program is copied from this source SD card.
5. Turn ON the main power.
6. Enter the SP mode.
7. Select SP5-873-001 "Move Exec".
8. Follow the messages shown on the operation panel.
9. Turn OFF the main power.
10. Remove the source SD card from SD Card Slot 2 (right).
11. Attach the slot cover.
12. Turn ON the main power.
13. Check that the application programs run properly.

Undo Exec

"Undo Exec" (SP5-873-002) lets you move back application programs from an SD card in SD Card Slot 1 (upper) to the original SD card in SD Card Slot 2 (lower). You can use this program when, for example, you have mistakenly copied some programs by using Move Exec (SP5-873-001).

★ Important

- Do not turn ON the write protect switch of the system SD card or application SD card on the machine. If the write protect switch is ON, a download error (e.g. Error Code 44) occurs during a firmware upgrade or application merge.
1. Turn OFF the main power.
 2. Insert the original SD card in SD Card Slot 2 (lower). The application program is copied back into this card.
 3. Insert the SD card with the application program in SD Card Slot 1 (upper).The application program is copied back from this SD card.
 4. Turn ON the main power.
 5. Start the SP mode.
 6. Select SP5-873-002 "Undo Exec."
 7. Follow the messages shown on the operation panel.
 8. Turn OFF the main power.
 9. Remove the SD card from SD Card Slot 2 (right).
 10. Turn ON the main power.
 11. Check that the application programs run normally.
 12. Make sure that the machine can recognize the option.

IEEE 802.11 a/g/n Interface Unit Type M19

Installation Procedure

1. Install the board.
2. Attach the antenna.

Included Parts

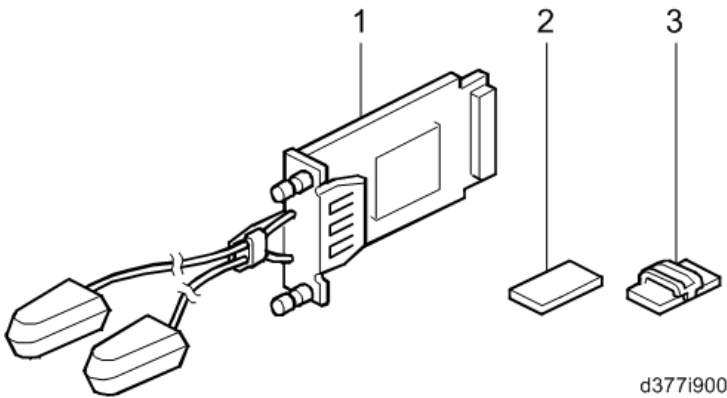

No.	Item	Q'ty
1	IEEE 802.11 a/g/n Interface Unit Type M19	1
2	Hook and loop fastener Patch	2
3	Cable Sticker	8
-	Caution Sheet	1
-	Caution Sheet	1

Installation

⚠ WARNING

- Set the main power switch to OFF and disconnect the power plug from the power outlet before performing the procedure below. Working with power supplied may cause electrical shock or defects.

⚠ CAUTION

- Do not put your hands in the controller box. It may cause trouble or injury.
- Before installing, touch the metal to eliminate static electricity. Otherwise the wireless LAN board may be defected with static electricity

1. Remove the cover for Slot A [A] ( x2).

2. Insert the wireless LAN board [B] into Slot A ( x2).

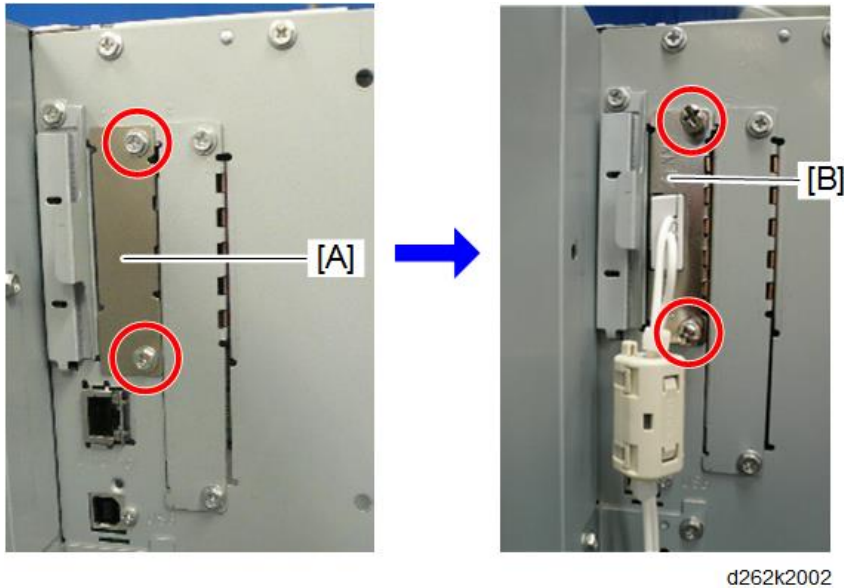

Note

- Insert the board fully to the back to connect it firmly.
- The removed cover will not be used. The customer should keep it.

Attaching Antennas

⚠ WARNING

- Set the main power switch to OFF and disconnect the power plug from the power outlet before performing the procedure below. Working with power supplied may cause electrical shock or defects.

⚠ CAUTION

- Do not put your hands in the controller box. It may cause trouble or injury.
- Before installing, touch the metal to eliminate static electricity. Otherwise Wireless LAN Board may be defected with static electricity.

1. Check the antennas of the wireless LAN board [A] and place it to the right of the main unit.

2. Use a damp cloth to clean the area [B] on the rear cover.

↓ Note

- Hook and loop fastener patches and clamps are to be attached to area [B] to clamp the antenna cables. To avoid Hook and loop fastener patches and clamps being removed, clean the area.

2

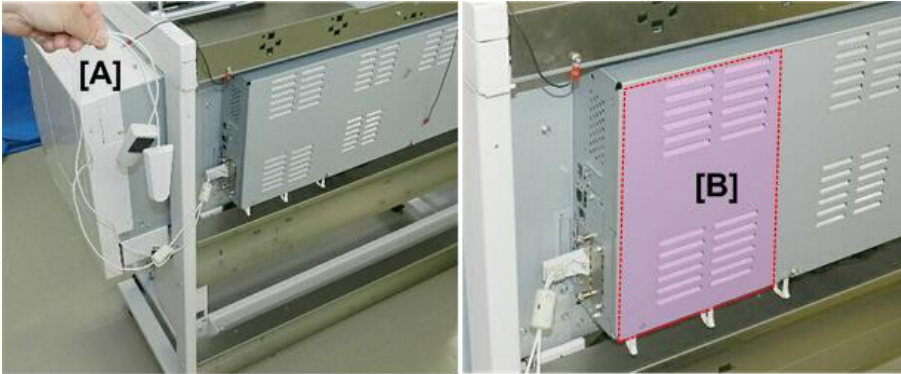

d124i124

3. Peel the tape from the back of a Hook and loop fastener patch [1].

4. Attach the Hook and loop fastener patch at the upper part of the PCB box [2].

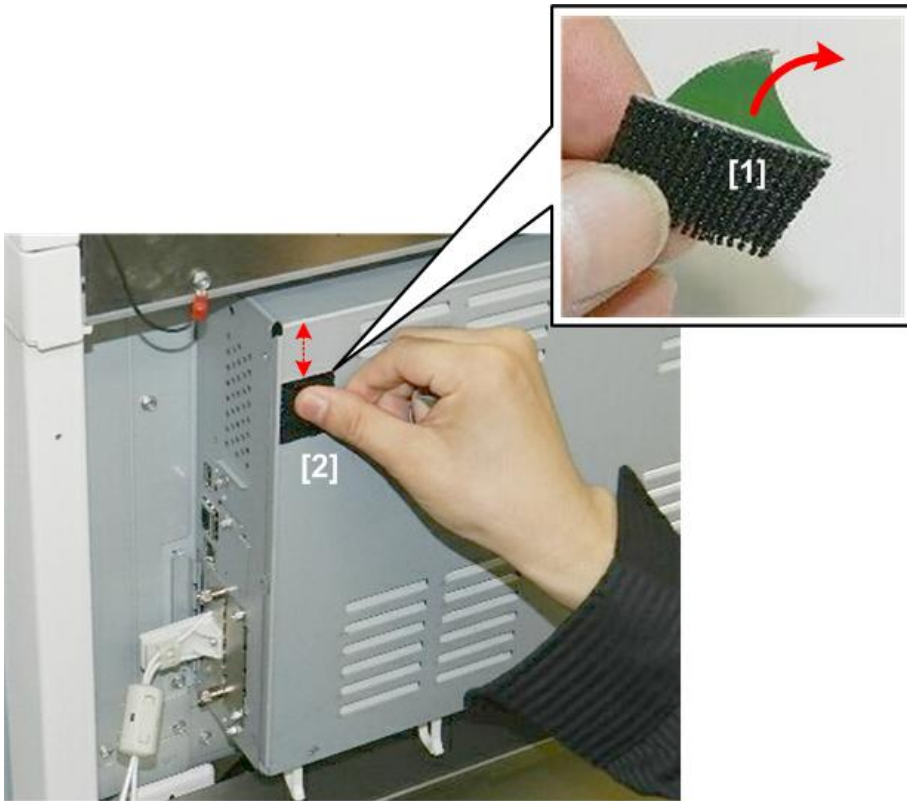

d124i125

5. Peel the tape from the back of the other Hook and loop fastener patch [1].
6. Attach the Hook and loop fastener patch at the lower part of the PCB box [2].

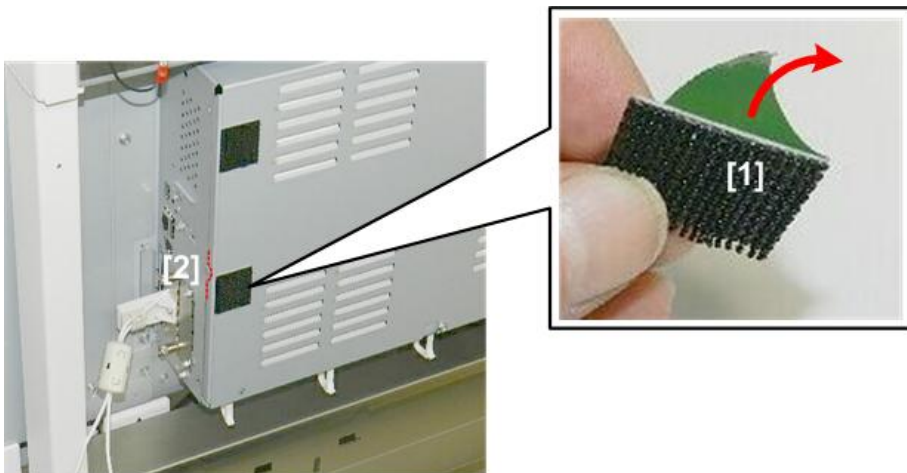

d124i126

7. Attach the antenna 1 to the upper patch.



d124i127

8. Attach the antenna 2 to the lower patch.



d124i128

9. Attach a clamp between Antennas 1 and 2 and clamp the antenna cables (🔗x1).



d124i133

10. Attach a clamp below Antenna 2 and clamp the antenna cable (🔗x1).



d124i134

11. Open the clamp attached in Step 9 and clamp Antenna cable (🔗x1).

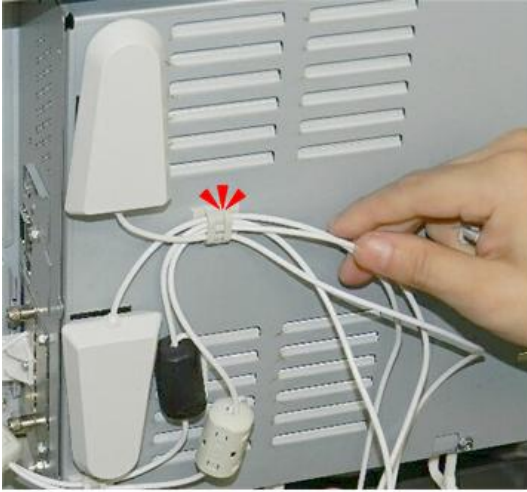

d124i135

12. Attach a clamp as shown and clamp the antenna cable (🔗x1).



d124i136

13. Output the system setup list and check that the system configuration recognizes the option correctly.

Checking the Wireless LAN Interface Connection

1. Check the settings of the IPv4 address and subnet mask or IPv6 address.
2. Select Machine Features/Counter.
3. Touch [System Settings].
4. Select Wireless LAN for Interface Settings.

5. Touch [Exit].

Flow of the Setup

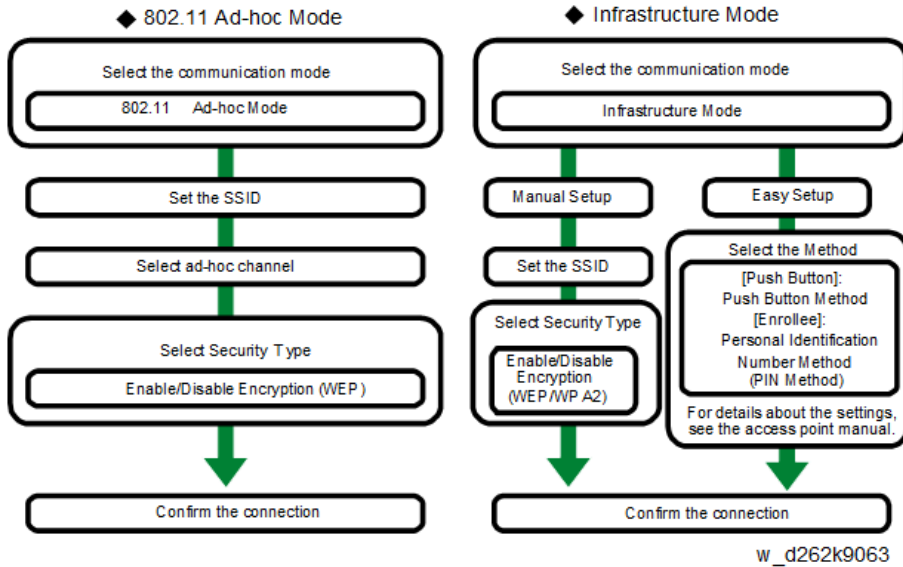

Note

- For details, refer to the user guide.
- If the wireless LAN board does not function correctly, refer to the slip included in the option box.

OCR Unit Type M13

1. Turn OFF the main power.

2. Remove the SD card slot cover [A]. ( × 1)

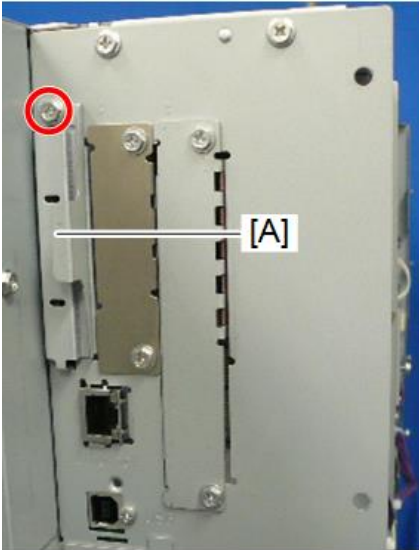

d262k2005

3. Insert the SD card into SD slot 1 or 2 with its label facing [A] the rear of the machine.

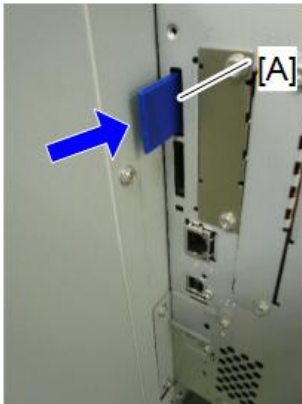

d262k0072

4. Turn ON the main power.
5. Touch [EXECUTE] in SP5-878-004 (Option Setup: OCR Dictionary).

The SD card ID is saved in the NVRAM, and the ID of the MFP is saved on the SD card. The MFP and SD card are thereby linked.

6. When "operation complete" is displayed, touch [CLOSE].

 **Note**

- If installation fails, "Failed" is displayed.
- If installation fails, perform the following steps.

1. Check whether it is a used SD card.
2. Turn the main power OFF, and repeat steps 1-5.

7. Turn the main power OFF/ON.

8. Press [EXECUTE] in SP5-878-004 (Option Setup: OCR Dictionary).

Dictionary data is copied to the HDD.

Note

- On the first run, SP5-878-004 links the SD card, and on the second run, copies dictionary data.

9. Turn the main power OFF, and remove the SD card from the SD card slot.

Note

- Keep the SD card in the SD card storage location of the MFP. The original SD card is needed in the event of a HDD malfunction.

10. Return the SD card slot cover to the original position.

11. Turn the main power ON.

12. Press [Send File Type / Name] on the [Scanner] screen.

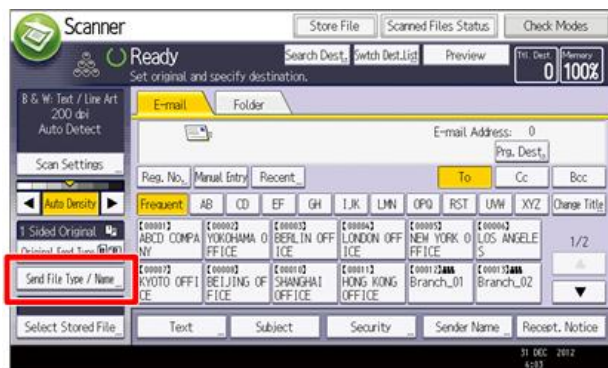

w_d1351739

13. Check if [OCR Settings] is displayed on the [Send File Type / Name] screen.

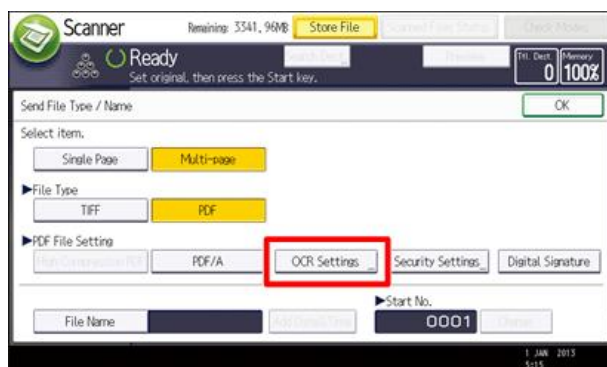

w_d1351740

Note

- After installation, the OCR setting can be changed on the "OCR setting" screen.
- When setting OCR, set [OCR setting] to [Yes]. (Default setting: [No])

Recovery Procedure

2

When this option is installed, a function is saved on the HDD, and ID information on the SD card is saved in the NVRAM. Therefore, when replacing the HDD and/or NVRAM, this option must be reinstalled.

When storing the original SD card and;

- When only the HDD is replaced;
Reinstall using the original SD card.
- When only the NVRAM is replaced;
When performing upload/download of NVRAM data, reinstall using the original SD card.
When not performing upload/download of NVRAM data, order and reinstall a new SD card (service part).
- When the HDD and NVRAM are replaced simultaneously;
Reinstall using the original SD card.

If the original SD card is lost;

Order and reinstall a new SD card (service part).

Note

- Perform reinstallation in the same way as installation.

File Format Converter Type M23 (MLB)

Included Parts



d262k2003

No.	Item	Q'ty
1	PCB	1
2	Screws	2

Installation of MLB

⚠ WARNING

- Set the main power switch to OFF and disconnect the power plug from the power outlet before performing the procedure below. Working with power supplied may cause electrical shock or defects.

⚠ CAUTION

- Do not put your hands in the controller box. It may cause trouble or injury.
- Before installing, touch the metal to eliminate static electricity. Otherwise the data converter board may be defected with static electricity.

1. Remove the cover for Slot B [A] ( x2).

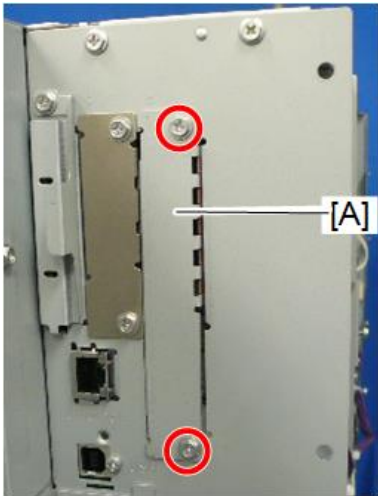

d262k2004

2. Attach the cover [B] to the MLB [A] ( x2).

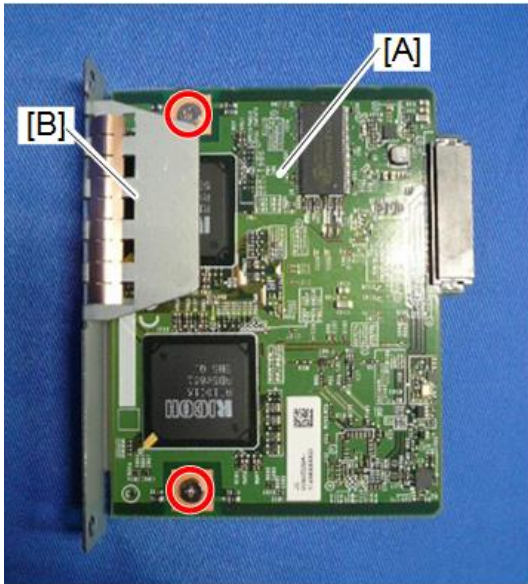

d262k2008

3. Insert the MLB with the cover attached to Slot A.
4. Tighten the screws ( x2).
5. Connect the power plug to a wall outlet and set the main power switch to ON.
6. Output the system setup list and check that the system configuration recognizes the option correctly.

Data Overwrite Security Unit Type M19

Overview

This option should be installed only for the customer who requires the **CC certified Data Overwrite Security function**.

The function of this option is completely the same as the Data Overwrite Security in Security Functions, which is standard on this machine.

2

Before You Begin the Procedure

1. Confirm that the Data Overwrite Security unit SD card is the correct type for the machine. The correct type for this machine is "Type M19".

★ Important

- If you install any version other than "Type M19", you have to replace the NVRAM and do this installation procedure again.
2. Make sure that the following settings are not at their factory default values:
 - Supervisor login password
 - Administrator login name
 - Administrator login password

If any of these settings is at a factory default value, tell the customer these settings must be changed before you do the installation procedure.

3. Make sure that "Admin. Authentication" is ON.

[System Settings] – [Administrator Tools] – [Administrator Authentication Management] - [Admin. Authentication]

If this setting is OFF, tell the customer this setting must be ON before you do the installation procedure.

4. Make sure that "Administrator Tools" is enabled (selected).

[System Settings] – [Administrator Tools] – [Administrator Authentication Management] - [Available Settings]

If this setting is disabled (not selected), tell the customer this setting must be enabled (selected) before you do the installation procedure.

Seal Check and Removal

★ Important

- You must check the box seals to make sure that they are not removed after the items have been sealed in the box at the factory before you do the installation.

2

1. Check the box seals [A] on each corner of the box.
 - Make sure that a tape is attached to each corner.
 - The surfaces of the tapes must be blank. If you see “VOID” on the tapes, do not install the components in the box.
2. If the surfaces of the tapes do not show “VOID”, remove them from the corners of the box.
3. You can see the “VOID” marks [B] when you remove each seal. In this condition, they cannot be attached to the box again.

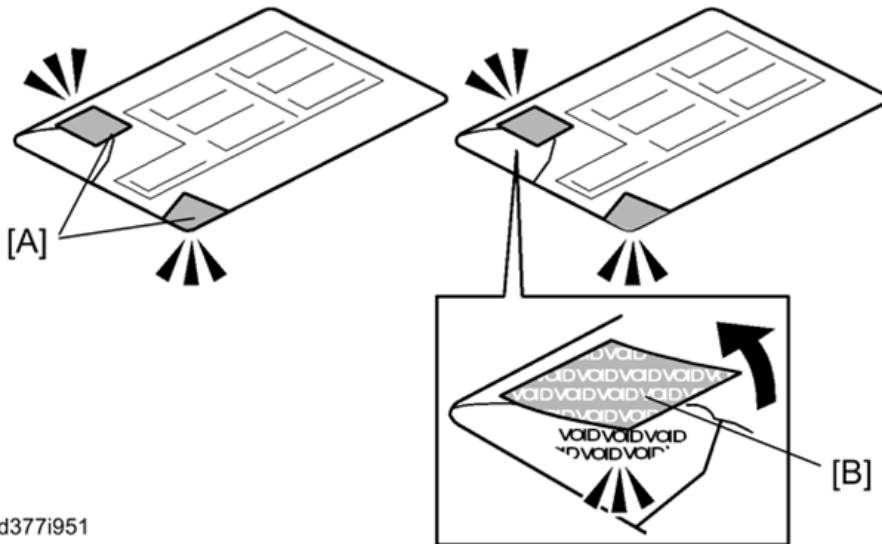

Installation Procedure

1. Turn the main power OFF.

2. Remove the SD card slot cover [A]. ( × 1)



d262k0071

3. Insert the SD card (Data Overwrite Security Unit) in SD slot 1 (upper) [A] with its label face towards the front of the machine. Then push it slowly into SD slot 1 (upper) until you hear a click.

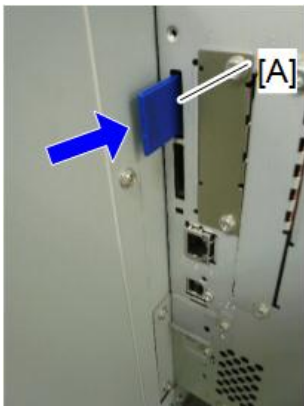

d262k0072

4. Install the application using SP5-878-001.

 **Note**

- If this option is installed afterward, execute SP 1 to 3 listed below then SP of Step 4.
- If the HDD is changed to a new one, execute SP 1 only. If you opt to use the existing HDD, data stored in the old HDD will not be guaranteed. It is recommended that you use a new HDD.
 1. SP5-801-014 (Clear DCS Setting)
 2. SP5-832-001 (HDD Formatting (All))
 3. SP5-832-002 (HDD Formatting (IMH))

Note

- SP5-878-001
- Enables the Data Overwrite Security unit. Touch [EXECUTE] on the operation panel. Then cycle the machine off/on.
- SP5-801-014
- Initializes the DCS (Delivery Control Service) settings.
- SP5-832-001
- HDD Formatting (All)
- SP5-832-002
- HDD Formatting (IMH)

R/W NFC Personal Authentication IC Card

Included Parts



d262k2020

No.	Item	Q7ty
1	IC card: R/W: Assembly	1
2	USB cable	1
3	Plastic plate	1
4	Cable clamp	8
5	Screw M3x8	1



No.	Item	Qty
6	Plastic screw	4
7	Ferrite core	2
8	Decal: Card reader	1
-	Fastener: R/W	2

Installation Guide

⚠ WARNING

- Set the main power switch to OFF and disconnect the power plug from the power outlet before performing the procedure below. Working with power supplied may cause electrical shock or defects.

Removing the operation cover

1. Remove the screws on the operation cover ( x2).
2. Release the hooks ( x3).



d262k2010

3. Push the operation cover in the direction indicated by the arrows and remove it.

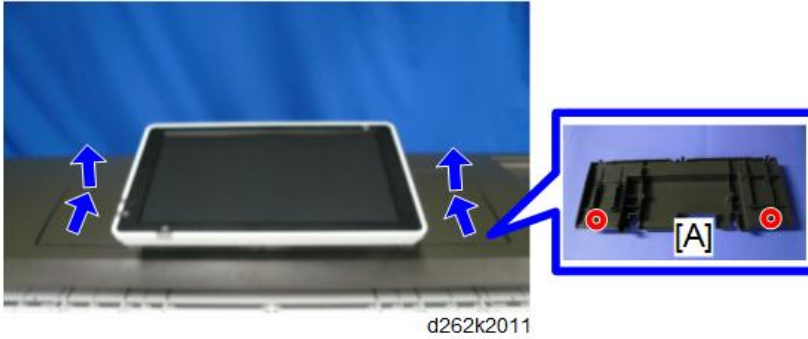

Note

- Move the hooks on the rear of the operation cover [A] to the wide end of the mounting holes, and pull up the cover to remove.

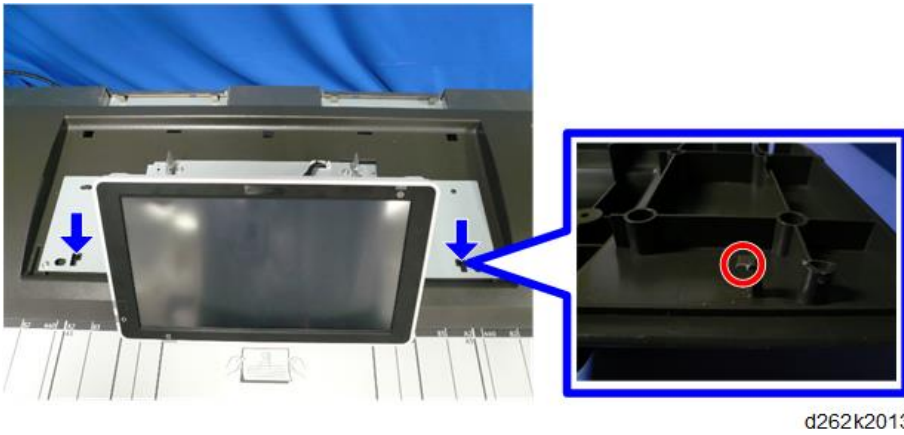

Fixing the IC card

1. Thread the two mounting holes with the metal screw [A].

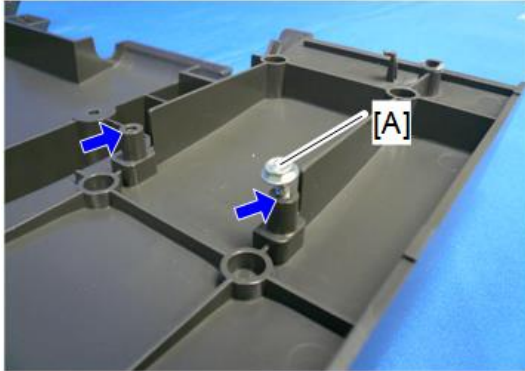

d262k2014

2. Fix the IC card [A] to the plastic plate [B] using the fastener [C].
3. Fix the plastic plate to the cover ( x2).

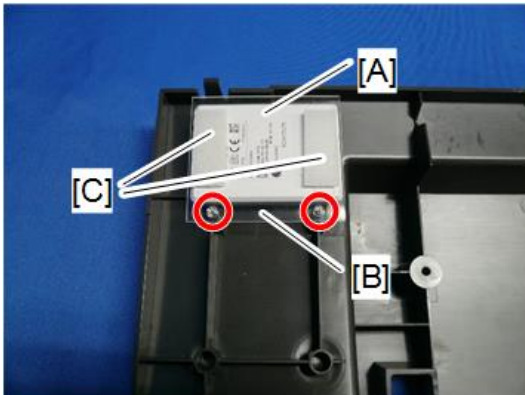

d262k2015

4. Screws on the right bracket of the operation panel ( x2).



d262k2021

5. Right cover [A] of the operation panel.

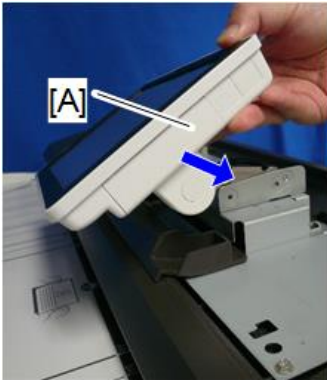

d262k2022

6. Center part of the removed cover.



d262k2023

7. Attach the ferrite core [A] to the USB cable.

Loop the cable around the core once.



d262k2024

8. Connect the USB connector [A] to the IC card.

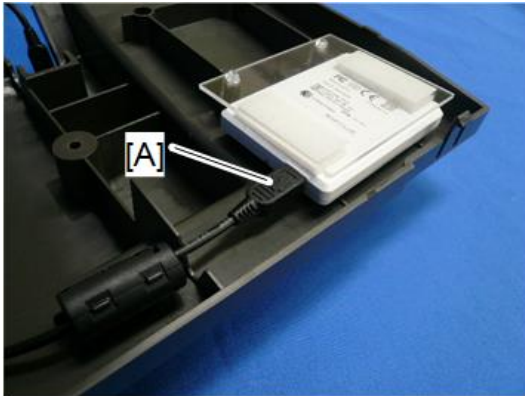

d262k2025

9. Secure the cable with the clamp [A] and dress it as shown.

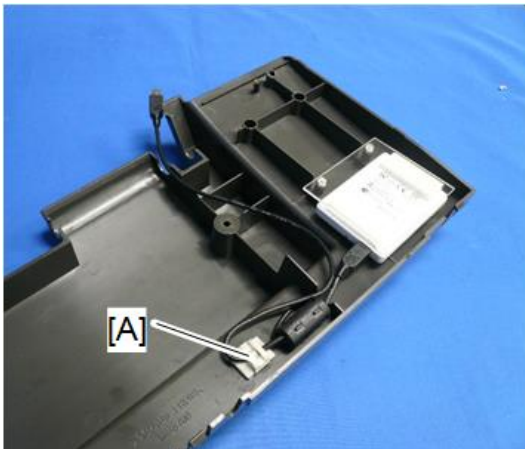

d262k2026

10. Align the hooks on the rear of the operation cover with the wide end of the mounting holes and pull the cover toward you ( x2).



d262k2012

11. Hook the rear of the operation cover. ( x3)

12. Tighten the screws ( x2).



d262k2010

13. Pass the cable through the center hole of the right cover [A], and connect the USB connector to the operation panel.



d262k2027

14. Attach the right cover [A].



d262k2028

15. Attach the right bracket to the operation panel and secure it with screws ( x2).



d262k2029

Check All Connections

1. Plug in the power cord. Then turn ON the main power.
2. Enter the printer user mode. Then print the configuration page.

User Tools → Machine Features → Printer Features → List Test Print → Configuration Page

All installed options are shown in the "System Reference" column.

Security Setting

Security Function Installation

2

The machine contains the Security functions (Data Overwrite Security and HDD Encryption unit) in the controller board.

If you are installing a new machine, it is recommended to activate the Data Overwrite Security and HDD Encryption by selecting "Format All Data" from "System Settings" on the operation panel.

↓ Note

- This method is recommended because there is no user data on the hard drive yet (Address Book data, image data, etc.).

If the customer wishes to activate the Data Overwrite Security and HDD Encryption unit on a machine that is already running, it is recommended to activate the unit by selecting "All Data" from "System Settings" on the operation panel.

★ Important

- **Selecting "All Data" will preserve the data that has already been saved to the HDD. (If "Format All Data" is selected, all user data saved to the HDD up to that point will be erased).**

Immediately after encryption is enabled, the encryption setting process will take several minutes to complete before you can begin using the machine.

↓ Note

- If encryption is enabled after data has been stored on the HDD, or if the encryption key is changed, this process can take up to three and a half hours or more.

The machine cannot be operated while data is being encrypted.

Once the encryption process begins, it cannot be stopped.

Make sure that the machine's main power is not turned OFF while the encryption process is in progress.

If the machine's main power is turned off while the encryption process is in progress, the HDD will be damaged and all data on it will be unusable.

Print the encryption key and keep the encryption key (which is printed as a paper sheet).

Keep the encryption key in a safe place. If the encryption key is lost and is needed, the controller board, HDD and NVRAM must all be replaced at the same time.

↓ Note

- "NVRAM" mentioned in here means the NVRAM on the Controller Board.
- "NVRAM" or EEPROM on the BCU has nothing to do with this.

Please use the following procedures when the Data Overwrite Security and HDD Encryption must be reinstalled.

Data Overwrite Security

Before You Begin the Procedure

1. Make sure that the following settings (1) to (3) are not at their factory default values.

- (1) Supervisor login password
- (2) Administrator login name
- (3) Administrator login password

If any of these settings is at a factory default value, tell the customer these settings must be changed before you do the installation procedure.

2. Make sure that "Admin. Authentication" is on.

[User Tools] -> [Machine Features] -> [System Settings] -> [Administrator Tools] -> [Administrator Authentication Management] -> [Admin. Authentication]

If this setting is off, tell the customer this setting must be on before you do the installation procedure.

3. Make sure that "Administrator Tools" is enabled (selected).

[User Tools] -> [Machine Features] -> [System Settings] -> [Administrator Tools] -> [Administrator Authentication Management] -> [Available Settings]

If this setting is disabled (not selected), tell the customer this setting must be enabled (selected) before you do the installation procedure.

Using Auto Erase Memory

The Auto Erase Memory function can be enabled by the following procedure.

1. Log in as the machine administrator from the control panel.
2. Press [User Tools].
3. Press [Machine Features].
4. Press [System Settings].
5. Press [Administrator Tools].
6. Press [Next] three times.

7. Press [Auto Erase Memory Setting].

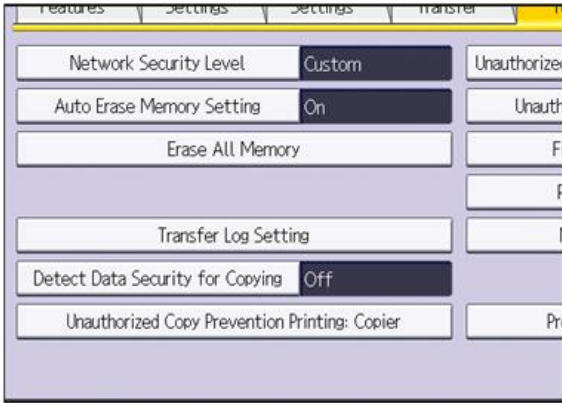

w_d1822517

8. Press [On].

9. Select the method of overwriting.

If you select [NSA] or [DoD], proceed to step 10.

If you select [Random Numbers], proceed to step 12.

10. Press [Change].

11. Enter the number of times that you want to overwrite using the number keys, and then press [#].

12. Press [OK]. Auto Erase Memory is set.

13. Log out.

14. Check the display and make sure that the overwrite erase icon appears.



15. Check the overwrite erase icon.

The icon [1] is lit when there is temporary data to be overwritten, and blinks during overwriting.

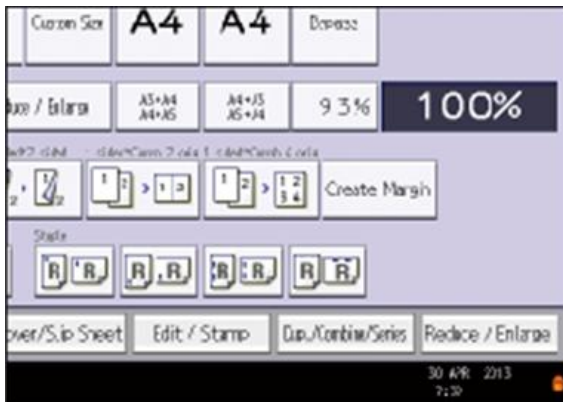
The icon [2] is lit when there is no temporary data to be overwritten.



w_d1822516

	Icon [1]	This icon is lit when there is temporary data to be overwritten, and blinks during overwriting.
	Icon [2]	This icon is lit when there is no temporary data to be overwritten.

HDD Encryption

Before You Begin the Procedure:

1. Make sure that the following settings (1) to (3) are not at the factory default settings.

- (1) Supervisor login password
- (2) Administrator login name
- (3) Administrator login password

If any of these settings is at a factory default value, tell the customer these settings must be changed before you do the installation procedure.

2. Confirm that "Admin. Authentication" is on: [User Tools] -> [Machine Features] - [System Settings] - [Administrator Tools] - [Administrator Authentication Management] - [Admin. Authentication] - [On]

If this setting is off, tell the customer that this setting must be on before you can do the installation procedure.

3. Confirm that "Administrator Tools" is selected and enabled.

[User Tools] -> [Machine Features] - [System Settings] - [Administrator Tools] - [Administrator Authentication Management] - [Available Settings]

"Available Settings" is not displayed until step 2 is done.

If this setting is not selected, tell the customer that this setting must be selected before you can do the installation procedure.

Enable Encryption Setting

Machine Data Encryption Settings can be enabled by the following procedure.

Setting Up Encryption

★ Important

- When setting up encryption, specify whether to start encryption after deleting data (initialize) or encrypt and retain existing data. If data is retained, it may take some time to encrypt it.

1. Turn ON the main power.
2. Log in as the machine administrator from the control panel.
3. Press [User Tools].
4. Press [Machine Features].
5. Press [System Settings].
6. Press [Administrator Tools].
7. Press [Next] three times.
8. Press [Machine Data Encryption Settings].

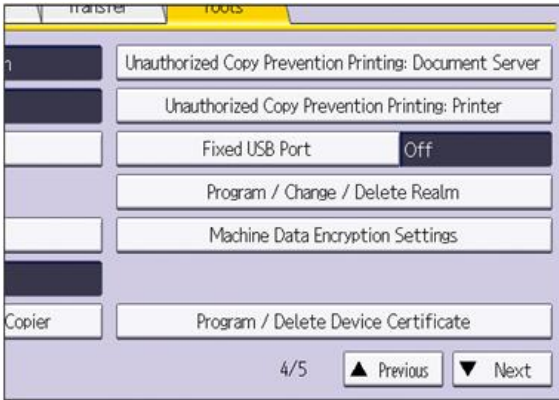

w_d1822518

9. Press [Encrypt].

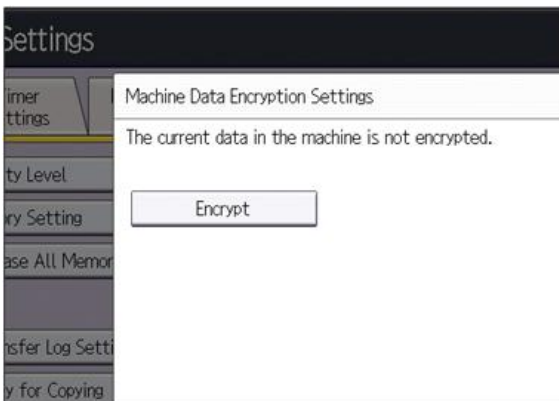

w_d1822519

10. Select the data to be carried over to the HDD and not be reset.

To carry all of the data over to the HDD, select [All Data].

To carry over only the machine settings data, select [File System Data Only].

To reset all of the data, select [Format All Data].

11. Select the backup method.

If you have selected [Save to SD Card], load an SD card into the media slot on the side of the control panel and press [OK] to back up the machine's data encryption key.

If you have selected [Print on Paper], press the [Start] key. Print out the machine's data encryption key.

12. Press [OK].**13. Press [Exit].****14. Press [Exit].****15. Log out.****16. Turn OFF the main power, and then turn the main power back ON.**

The machine will start to convert the data on the memory after you turn on the machine. Wait until the message "Memory conversion complete. Turn the main power switch off." appears, and then turn the main power OFF again.

Check the Encryption Settings

1. Press [User Tools].
2. Press [Machine Features].
3. Press [System Settings].
4. Press [Administrator Tools].
5. Press [Machine Data Encryption Settings].
6. Confirm whether the encryption has been completed or not on this display.

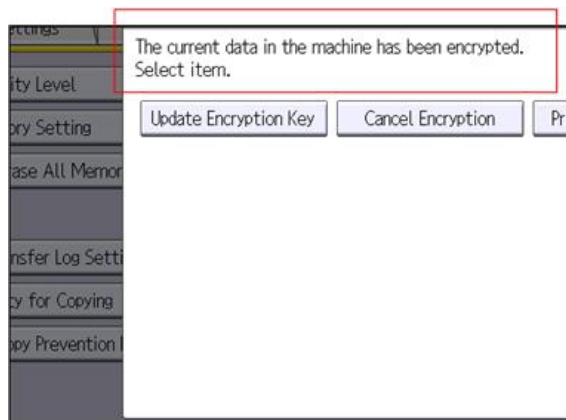

w_d1822520

Backing Up the Encryption Key

The encryption key can be backed up. Select whether to save it to an SD card or to print it.

★ Important

- The encryption key is required for data recovery if the machine malfunctions. Be sure to store the encryption key safely for retrieving backup data.

1. Log in as the machine administrator from the control panel.
2. Press [User Tools].
3. Press [Machine Features].
4. Press [System Settings].
5. Press [Administrator Tools].
6. Press [Next] three times.
7. Press [Machine Data Encryption Settings].
8. Press [Print Encryption Key].

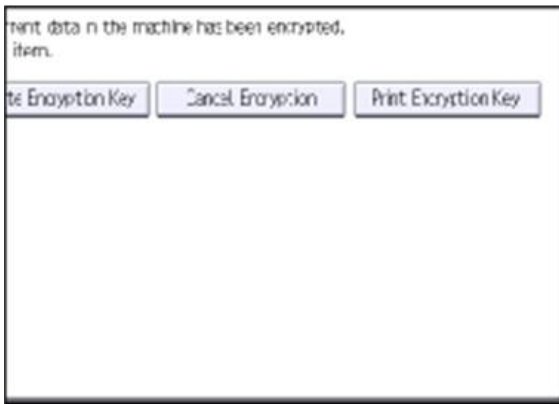

w_d1822515

9. Select the backup method.

If you have selected [Save to SD Card], load an SD card into the media slot on the side of the control panel and press [OK]. After the machine's data encryption key is backed up, press [Exit].

If you have selected [Print on Paper], press the [Start] key. Print out the machine's data encryption key.

10. Press [Exit].
11. Log out.

Encryption Key Restoration

How to restore the old encryption key to the machine

The following message appears after the controller board is replaced. In such a case, it is necessary to restore the encryption key to the new controller board.

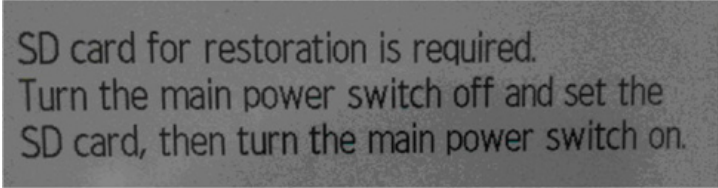

SD card for restoration is required.
Turn the main power switch off and set the
SD card, then turn the main power switch on.

d1420101

2

To do this, follow the procedure below.

1. Prepare an SD card that has been initialized in FAT16 format.
2. Using a PC, create a folder in the SD card and name it "restore_key".
3. Create a folder in the "restore_key" folder and name it the same as machine's serial number, "xxxxxxxxxxx" (11 digits).
4. Create a text file called "key_xxxxxxxxxxxx.txt" and save it in the "xxxxxxxxxxx" folder. Write the encryption key in the text file.

/restore_key/xxxxxxxxxxx/key_xxxxxxxxxxxx.txt

Note

- Ask an Administrator to enter the encryption key. The key has already been printed out by the user and may have been saved in the "key_xxxxxxxxxxxx.txt" file.

5. Turn ON the machine's main power.
6. Confirm that a message is displayed on the LCD telling to insert the SD card that contains the encryption key.
7. Turn OFF the main power.
8. Insert the SD card that contains the encryption key into SD card slot 2 (the lower slot).
9. Turn ON the main power.

Note

- The machine will automatically restore the encryption key to the flash memory on the controller board.

10. Turn OFF the main power when the machine has returned to normal status.

11. Remove the SD card from SD card slot 2.

How to do a forced start up with no encryption key

If the encryption key back-up has been lost, follow the procedure below to do a forced start-up.

Important

- The HDD will be formatted after the forced start-up.
- Encrypted data will be deleted.

- User settings will be cleared.

1. Prepare an SD card.
2. Create a directory named "restore_key" inside the root directory of the SD card. Then, save the "nvram_key.txt" file using the following name:

/restore_key/nvram_key.txt

3. Create a text file and write "nvclear".

★ Important

- Write this string at the head of the file.
 - Use all lower-case letters.
 - Do not use quotation marks or blank spaces.
 - It is judged that a forced start has been selected when the content of "nvclear" is executed and the machine shifts to the alternate system (forced start).
4. Confirm that a message is displayed on the LCD telling to insert the SD card that contains the encryption key.
 5. Turn OFF the main power.
 6. Insert the SD card that contains the encryption key into SD card slot 2 (the lower slot).
 7. Turn ON the main power and the machine automatically clears the HDD encryption.
 8. Turn OFF the main power when the machine has returned to normal status.
 9. Remove the SD card from SD card Slot 2.
 10. Turn ON the main power.
 11. Memory clear SP5-801-xx (Exclude SP-5-801-001: All Clear and SP-5-801-002: Engine), and clear SP5-846-046: address book.

↓ Note

- SP5-801-XXX
 - Resets NVRAM data to the default settings. Before executing any of these SP codes, print an SMC Report.
 - SP5-801-001
 - Initializes items.
 - SP5-801-002
 - Initializes all registration settings for the engine and copy process settings.
 - SP5-846-046
 - Displays the slot number where an address book data is in.
12. Set necessary user settings with the User Tools screen.

@Remote Setting

Settings Relevant to the Service Contract

Change the necessary settings for the following SP modes if the customer has entered a service contract.

Note

- You must select one of the counter methods (developments/prints) in accordance with the contract (SP5-045-001).

Counting method		
SP No.	Function	Default
SP5-045-001	Specifies if the counting method used in meter charge mode is based on developments or prints.	"1": Prints
Service Tel. No. Setting		
SP No.	Function	Default
SP5-812-001 through 004	SP5-812-002 programs the service station fax number. The number is printed on the counter list when the meter charge mode is selected. This lets the user fax the counter data to the service station.	

Settings for @Remote Service

Note

- Prepare and check the following check points before visiting the customer site. For details, ask the @Remote key person.

Check points before making @Remote settings

- The setting of SP5-816-201 (Remote Service: Regist: Status) in the mainframe must be "0".
- Print the SMC with SP5-990-002 (SP Print Mode: SP (Mode Data List)) and then check if a device ID2 (SP5-811-003) must be correctly programmed.
 - 6 spaces must be put between the 3-digit prefix and the following 8-digit number (e.g. xxx____xxx).
 - ID2 (SP5-811-003) and the serial number on the machine serial decal pasted at the rear must be the same (e.g. ID2: A01____23456789 = serial No. A0123456789)

3. The following settings must be correctly programmed.

- Proxy server IP address (SP5-816-063)
- Proxy server Port number (SP5-816-064)
- Proxy User ID (SP5-816-065)
- Proxy Password (SP5-816-066)

4. Get a Request Number.

Execute the @Remote Settings

1. Enter the SP mode.
2. Input the Request number which you have obtained from @Remote Center GUI, and then enter [OK] with SP5-816-202 (Remote Service: Letter Number).
3. Confirm the Request number, and then click [EXECUTE] with SP5-816-203 (Remote Service: Confirm Execute).
4. Check the confirmation result with SP5-816-204 (Remote Service: Confirm Result).

Value	Meaning	Solution/ Workaround
0	Succeeded	-
1	Request number error	Check the request number again.
3	Communication error (proxy enabled)	Check the network condition.
4	Communication error (proxy disabled)	Check the network condition.
5	Proxy error (Illegal user name or password)	Check Proxy user name and password.
6	Communication error	Check the network condition.
8	Other error	See "SP5-816-208 Error Codes" below this.
9	Request number confirmation executing	Processing... Please wait.

5. Make sure that the screen displays the Location Information with SP5-816-205 (Remote Service: Confirm Place) only when it has been input at the Center GUI.
6. Click [EXECUTE] to execute the registration with SP5-816-206 (Remote Service: Register Execute).

7. Check the registration result with SP5-816-207 (Remote Service: Register Result).

Value	Meaning	Solution/ Workaround
0	Succeeded	-
1	Request number error	Check the request number again.
2	Already registered	Check the registration status.
3	Communication error (proxy enabled)	Check the network condition.
4	Communication error (proxy disabled)	Check the network condition.
5	Proxy error (Illegal user name or password)	Check Proxy user name and password.
8	Other error	See "SP5-816-208 Error Codes" below this.
9	Request number confirmation executing	Processing... Please wait.

8. Exit the SP mode.

SP5-816-208 Error Codes

Cause	Code	Meaning	Solution/ Workaround
Operation Error, Incorrect Setting	-12002	Inquiry, registration attempted without acquiring Request No.	Obtain a Request Number before attempting the Inquiry or Registration.
	-12003	Attempted registration without execution of a confirmation and no previous registration.	Perform Confirmation before attempting the Registration.
	-12004	Attempted setting with illegal entries for certification and ID2.	Check ID2 of the mainframe.
	-12005	@Remote communication is prohibited. The device has an Embedded RC gate-related problem.	Make sure that "Remote Service" in User Tools is set to "Do not prohibit".
	-12006	A confirmation request was made after the confirmation had been already completed.	Execute registration.
	-12007	The request number used at registration was different from the one used at confirmation.	Check Request No.
	-12008	Update certification failed because mainframe was in use.	Check the mainframe condition. If the mainframe is in use, try again later.
	-12009	The ID2 in the NVRAM does not match the ID2 in the individual certification.	Check ID2 of the mainframe.
	-12010	The certification area is not initialized.	Initialize the certification area.

Cause	Code	Meaning	Solution/ Workaround
Error Caused by Response from GW URL	-2385	Other error	
	-2387	Not supported at the Service Center	
	-2389	Database out of service	
	-2390	Program out of service	
	-2391	Two registrations for the same mainframe	Check the registration condition of the mainframe
	-2392	Parameter error	
	-2393	External RCG not managed	
	-2394	Mainframe not managed	
	-2395	Box ID for external RCG is illegal.	
	-2396	Mainframe ID for external RCG is illegal.	
	-2397	Incorrect ID2 format	Check the ID2 of the mainframe.
	-2398	Incorrect request number format	Check the Request No.

3. Preventive Maintenance

Preventive Maintenance Tables

See "Appendices" for the following information:

- Preventive Maintenance Tables

PM Cleaning Points

PM Table

The following points are referenced by number in the PM table.

3

Scanner Unit

Exposure Glass

- Optical glass cleaner cloth, water damp cloth.
1. Raise the scanner unit.
 2. Clean the surface of the glass.

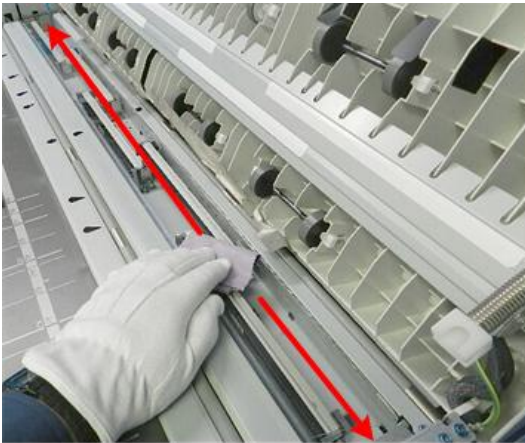

d124p012

Original Width Sensors, Original Set Sensor

- Blower brush
1. Raise the scanner unit.
 2. Clean with a blower brush.

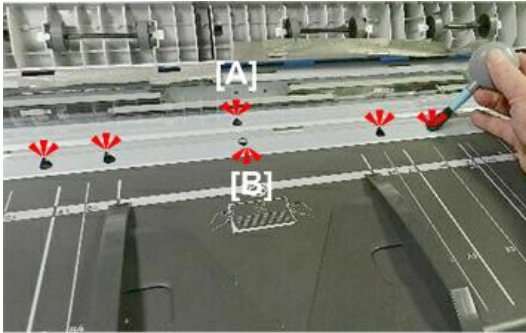

d124p013

3. Remove the original width sensor cover plate (🛠️ x2) (p.285) .
4. Clean each sensor with the blower brush.



d124p014

Original Feed Roller

- Alcohol, damp cloth, dry cloth
1. Remove the registration sensor cover plate (🛠️ x2) (p.289).
 2. Wipe the original feed roller [B] while turning the gear [A].

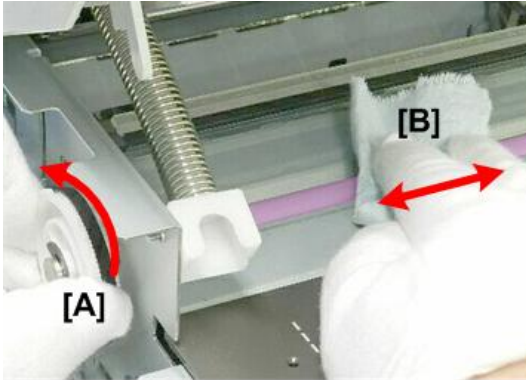

d124p015

Original Exit Roller

- Alcohol, damp cloth, dry cloth.
1. Remove the top of the scanner unit (p.254).
 2. On the left side of the machine, turn the drive gear [A] as you wipe the surface of the roller [B] with the cloth.

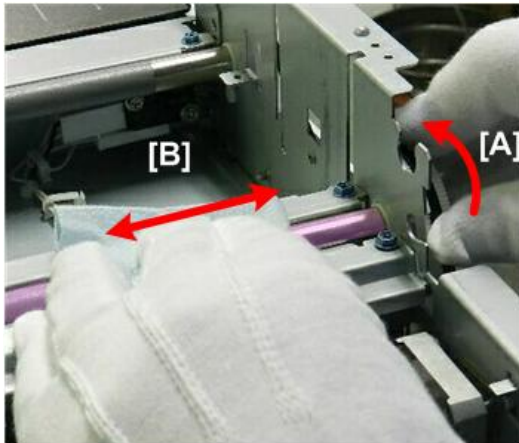

d124p016

White Plate

- Alcohol, damp cloth, dry cloth.
1. Raise the scanner unit.
 2. Clean the 5 plates.

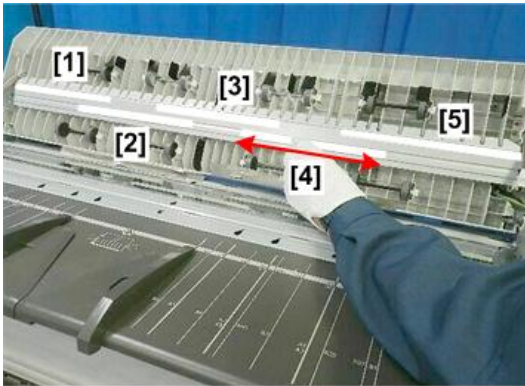

d124p017

CIS Lens

- Lens paper, or clean cloth dampened with alcohol.
1. Raise the scanner unit.
 2. Clean the surfaces of the 5 lenses.



d124p018

Horizontal Unit

Black Print Head Unit

The black print head units can be replaced separately or together (p.425).

Color Print Head Unit

The black print head units can be replaced separately or together (p.425).

Horizontal Encoder

- Clean cloth dampened with alcohol, dry cloth.

★ Important

- Never touch or handle the surface of the encoder strip with bare hands. Smudges and fingerprints can interfere with the sensor readings of the encoder strip.
1. Move the carriage unit to the center (p.267).
 2. Remove the top cover (p.245).
 3. Push the carriage to the right.



d124p008

4. Loosen the screws on both sides of the ink tube rail. Do not remove the screws. ( x2)

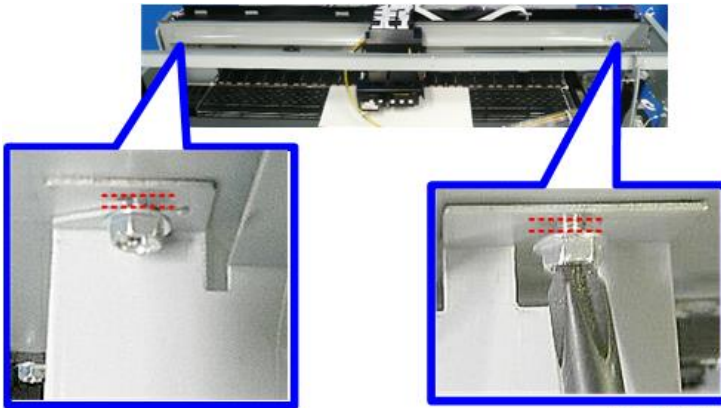

d262k3104

5. Remove the plate.

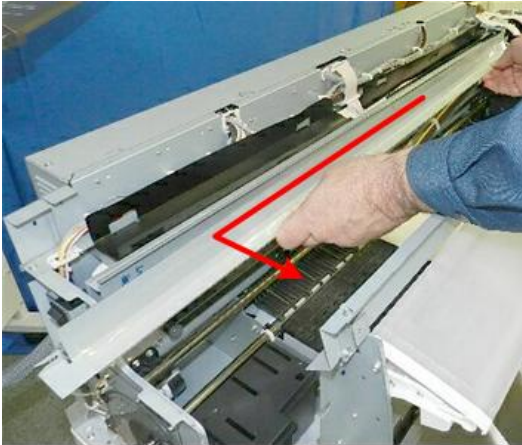

d124p009

6. Prepare a piece of clean linen cloth dampened with alcohol.
7. Wipe both sides of the encoder strip with the cloth.
8. Clean the strip as far as the carriage on the right, move the carriage to the left, and then clean the other end of the strip.

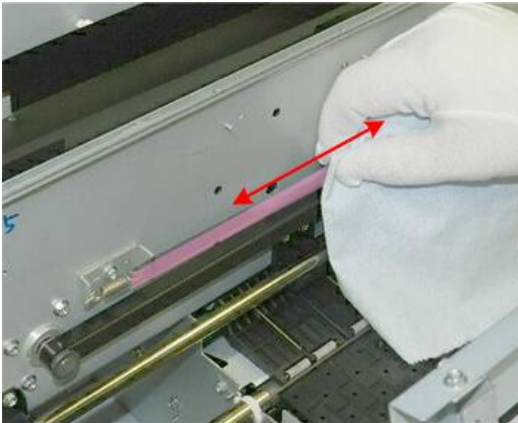

d124p010

DRESS Sensor

- Cleaning cloth

The recommended cleaning interval is 10Km. However, if the operator is frequently printing with tracing paper or print Quality mode, cleaning every 5Km is recommended.

1. Remove the DRESS Sensor (p.407).
2. Clean the DRESS sensor with a cleaning cloth.
 - Always use the cleaning cloth, never use a cotton swab or tissue paper.
 - Cleaning the DRESS sensor prevents errors when it reads the reflectivity of the surfaces of glossy paper and tracing paper.

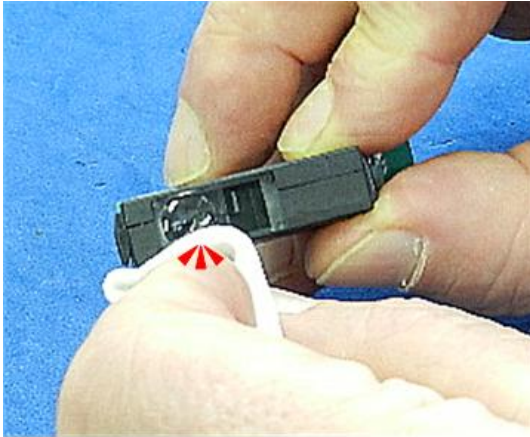

d124r539

Maintenance Unit

- Dry linen cloth.

★ Important

- After replacing the ink collector unit, always remove ink that has hardened around the wiper blade, suction cap, and three print head caps.

1. Move the carriage unit to the center (p.267).
2. Remove the top cover (p.245).
3. Use a tightly wrapped linen cloth dampened with water to clean:

[A] Wiper and blade

[B] Suction cap

[C] Print head caps

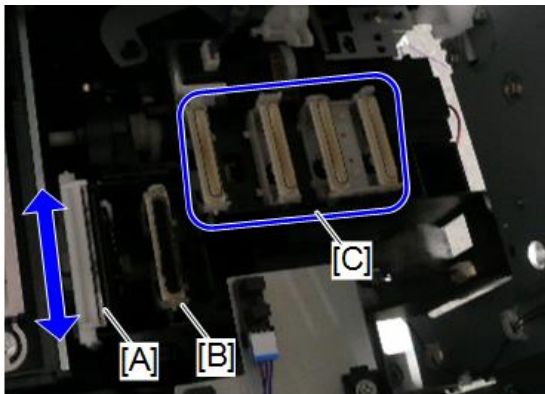

d262k0133

Waste Ink Collection

Ink Collector Tank

1. Open the ink collector cover on the right side of the machine.
2. Depress the release [A], and then pull the tank straight out of the machine.
3. Lay the tank on a flat surface with the port [B] facing up.



d124r543

★ Important

- The port at [B] is open and will leak ink if the tank is turned on its side or turned upside down. Tape the port to prevent leakage.

Right Ink Sump

Replace the right ink sump when a message alerts you that the tank is full.

1. Remove the ink collector unit on the right side of the machine.
2. Remove the ink collector cover and right cover (p.239).
3. Disconnect the sump and pull it out slowly ( x1).

★ Important

- To avoid spilling ink, do not tilt the sump as you remove it.

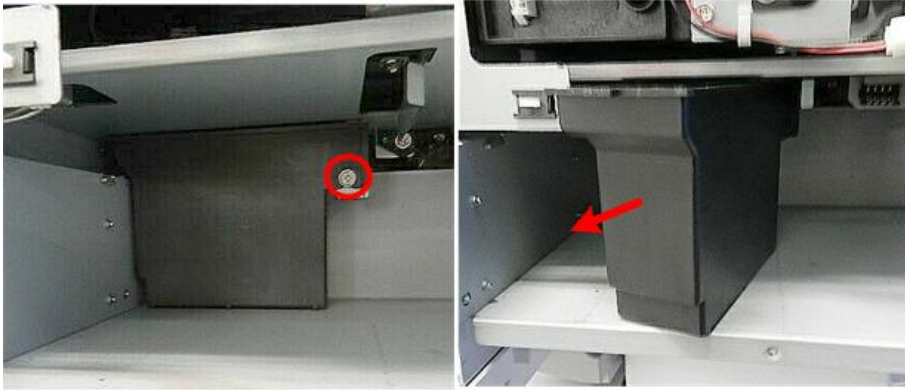

d124p027

4. Cover the top of the tank with some paper and tape, and then discard it.

★ Important

- Follow the local laws and regulations regarding the disposal of this item.
- Never attempt to empty the right ink sump and re-use it.

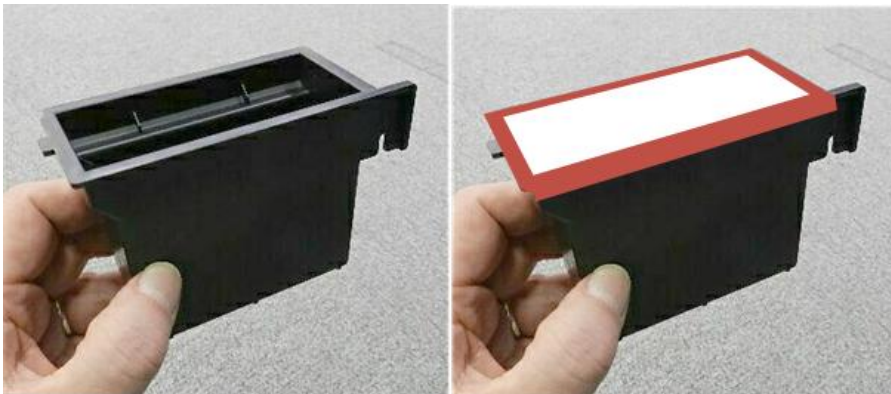

d124p028

5. After installing the new right ink sump, open SP2-505-002 (Reset Waste Ink Counter: Waste Ink: Right C/R) and touch [EXECUTE] to clear the counter for the new sump.

↓ Note

- A software count triggers a prompt to tell the operator when the right ink sump is near-full, and then finally full and in need of replacement.

Left Ink Sump

- Dry linen cloth

After replacing the collector unit, always remove ink that has hardened around the gate.

Use a dry linen cloth to clean the gate of the sump. You may need to use the tip of a small screwdriver to remove hardened ink.

1. Remove the left cover (p.234).
2. Use a dry cloth wrapped around the tip of a small screwdriver to clean around the openings of the gate.

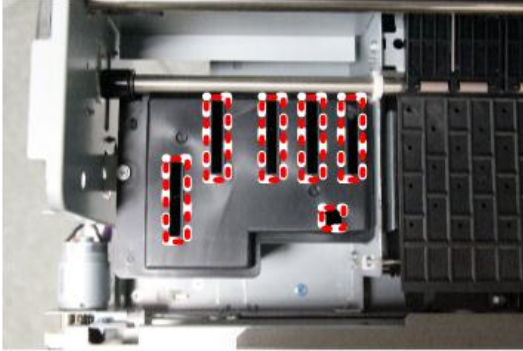

d262k8086

3. Use the bare tip of a small screwdriver to remove hardened ink that cannot be removed by wiping with the cloth.

Note

- Replace the left sump when a message alerts you that the tank is full (p.530).

Ink Tube Guide

- Damp cloth.
1. Remove the top cover (p.245).
 2. Use the damp cloth to clean the back of the guide where it rubs against the frame during normal operation [A].

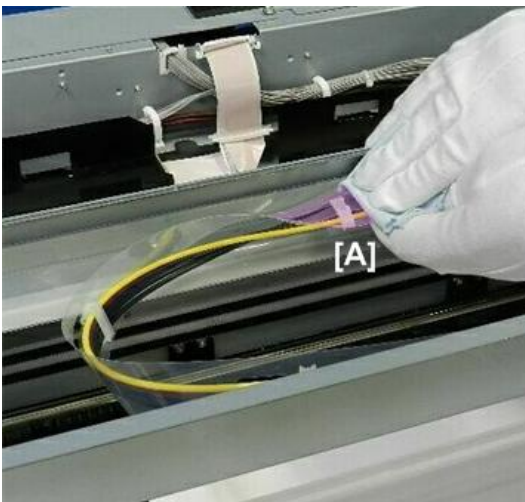

d124p029

Platen

- Linen cloth dampened with alcohol, blower brush.
1. Open the front cover.
 2. Dampen a clean linen cloth with water.
 3. Wipe the platen [A] with the damp cloth, and then wipe with a dry cloth.

★ Important

- To avoid damage or discoloration of the platen, never use an organic solvent like alcohol, benzene, acetone, etc. to clean it.
4. Use a blower brush [B] to remove paper dust from the holes in the platen plates.

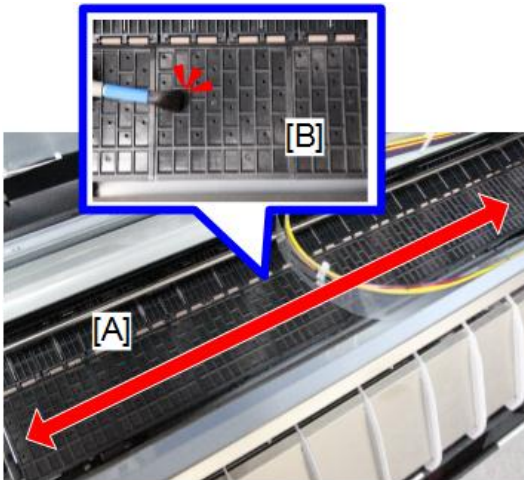

d262k8087

Vertical Encoder

- Linen cloth dampened with alcohol

★ Important

- Never touch or handle the surface of the encoder wheel with bare hands. Smudges and fingerprints can interfere with the sensor readings of the encoder edge.
 - Handle the wheel carefully to avoid bending it.
1. Remove the left cover (p.234).
 2. Prepare a piece of clean linen cloth dampened with alcohol.
 3. While turning gear and the wheel, clean the edge of the wheel with the cloth.

★ Important

- Never use a cotton swab or cotton ball, tissue paper, or any other material that could shed and leave fibers on the edge of the encoder wheel.

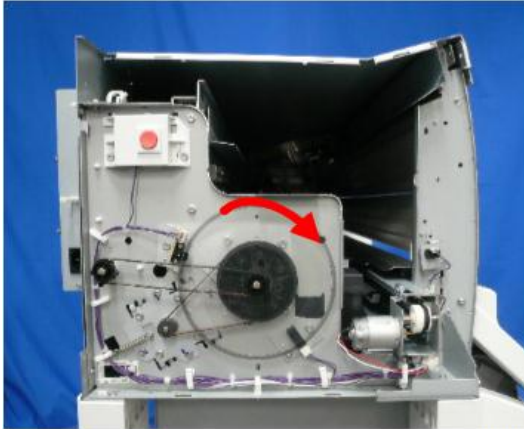

d262k8093

Other Items for Cleaning

These items are not included in the PM table but they should be cleaned during the course of replacement and adjustment procedures.

External Covers

- Linen cloth, dampened with water
1. Clean the covers with a clean cloth dampened with water.

★ Important

- To avoid damage or discoloration, never use an organic solvent like benzene, acetone, etc. to clean the surfaces of the covers.



d124p001

Scanner Unit

Original Set Sensor

- Blower brush
1. Raise the scanner unit.
 2. Clean with a blower brush with the original sensor cover attached.

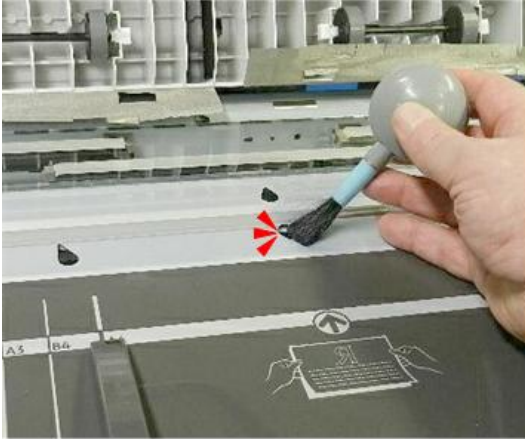

d124p019

3. Raise the scanner unit.
4. Remove the original width sensor cover plate ( x2) (p.285).
5. Use a blower brush to clean the sensor.



d124p020

Original Registration Sensor

- Blower brush
1. Raise the scanner unit.

2. Clean with a blower brush [A].
- or-
3. Remove the original registration sensor cover plate, and then clean with the blower brush [B]. ( x2) (p.289).

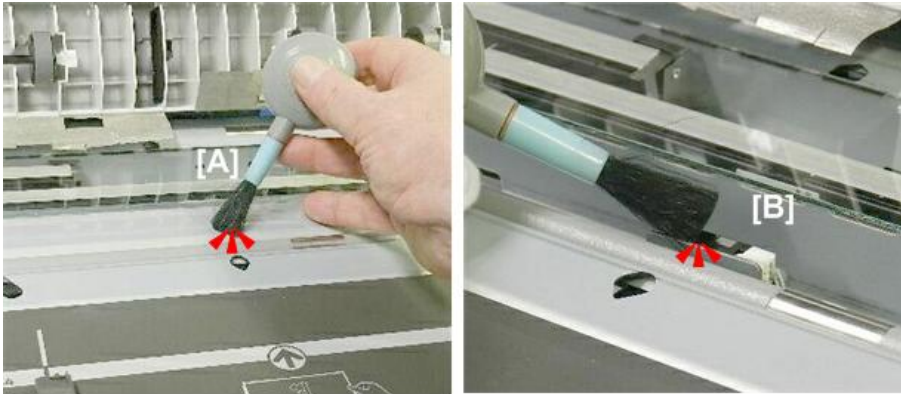

d124p023

Original Exit Sensor

- Blower brush

1. Remove the scanner unit (p.254).
2. Clean with a blower brush [A]
- or-
3. Remove the scanner unit, remove the original exit sensor cover plate and then clean the sensor with the blower brush [B]. ( x2).

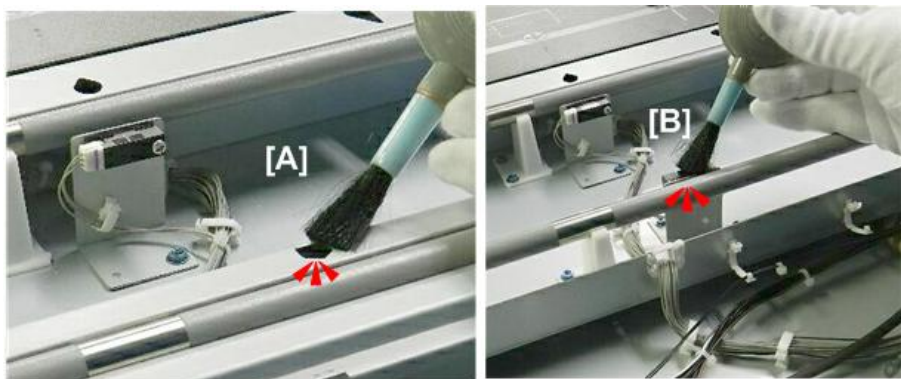

d124p021

Horizontal Unit

Ink Level Sensors

- Blower brush
1. Move the carriage unit to the center (p.267).
 2. Remove right cover (p.239).
 3. Remove right upper cover (p.241).
 4. Clean FS1 (Feeler Sensor 1 [A]) with a blower brush.
 5. Clean FS2 (Feeler Sensor 2 [B]) with a blower brush.

3

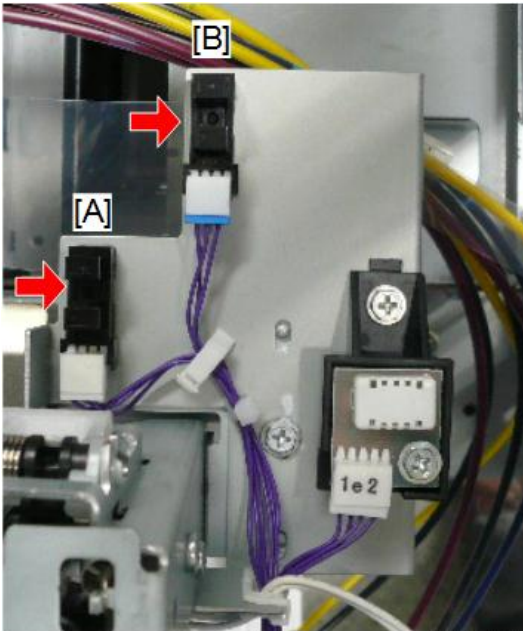

d262k8098

Paper Feed

Bypass Sensor, Pre-registration Sensor

1. Remove the right cover (p.239).
2. Remove the right upper cover (p.241).

3. Remove the right rear metal plate ( x4).

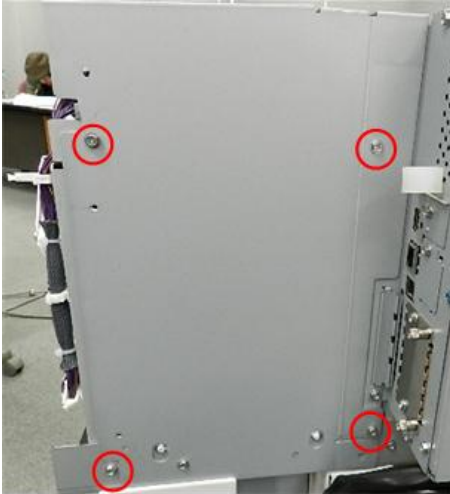

d124i206

4. Use a blower brush to clean the upper bypass sensor [A].
5. Clean the lower pre-registration sensor [B].



d124i207

Paper Exit Sensor

- Blower brush
1. Raise the paper exit guide.
 2. Use the blower brush to clean the exit sensor [A].
 - or-
 3. Remove the feed roller cover and clean the exit sensor [B] (p.367).

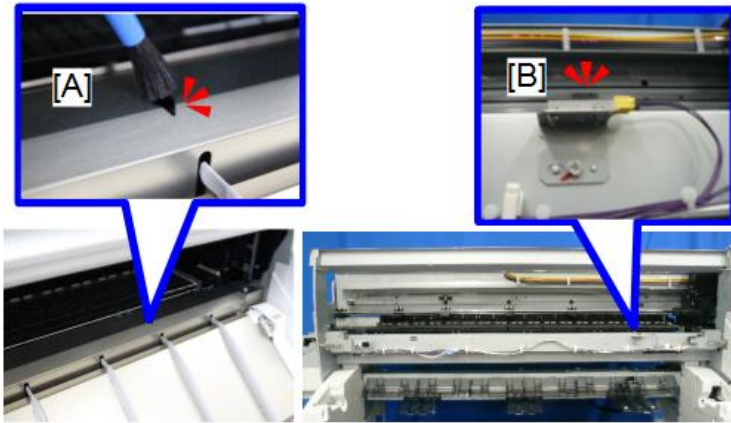

d262k8088

Roll Units

Roll End Sensor

- Blower brush

This procedure is the same for both roll end sensors [A] [B].

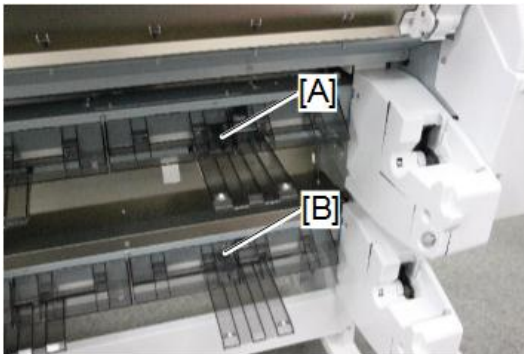

d262k8089

1. The roll end sensors are located on the back of Roll Unit 1 and Roll Unit 2.
2. Remove the sensor cover plate [A] ( x2).

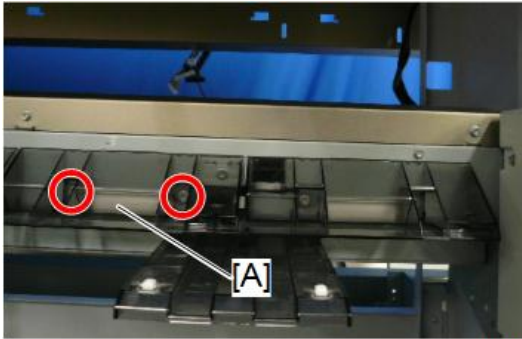

d262k8090

3

3. Clean the exposed sensor with a blower brush.

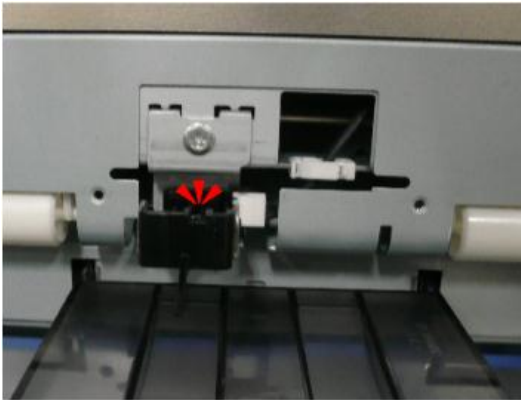

d262k8091

Roll Unit Paper Release Sensor

This procedure is the same for both roll units.

1. Remove the sensor plate ( x1).



d124r246

2. Remove the sensor ( x4).

3

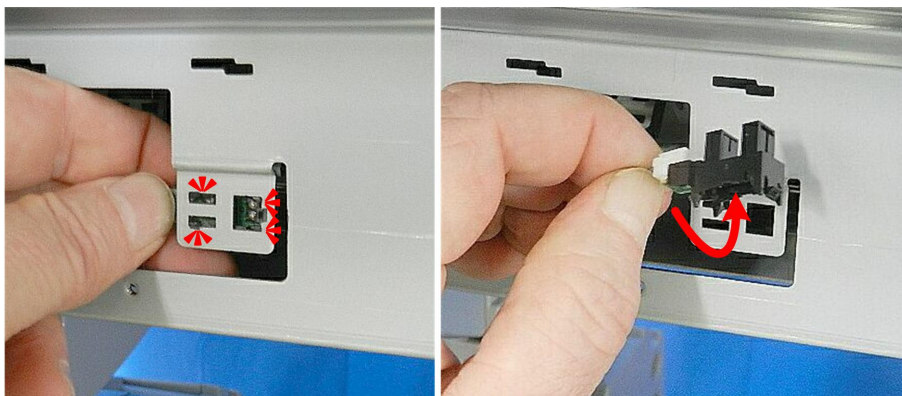

d124r247

3. Clean the sensor with a blower brush.

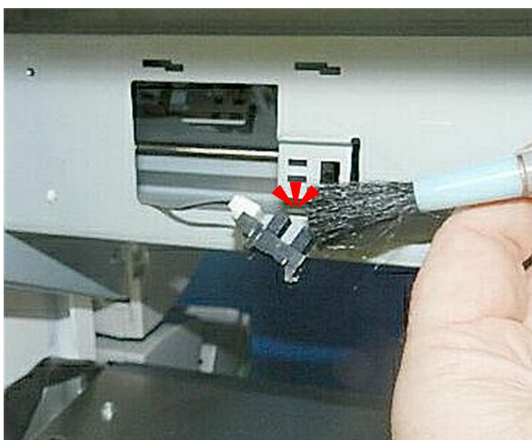

d124r249

4. Set the wide hooks first, then the smaller hooks to re-install.

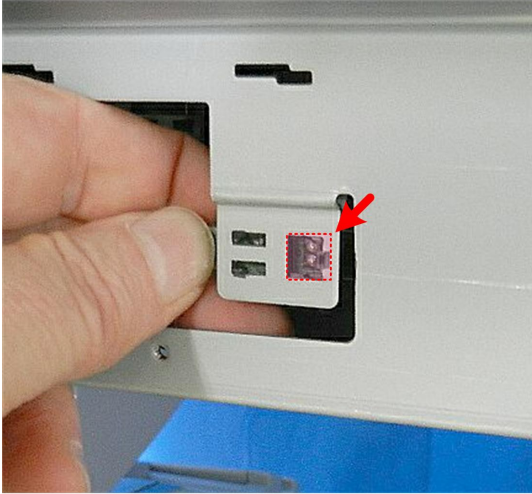

d124r250

Roll Feed Roller

1. Remove the roll unit (p.314, p.322).
2. Feed roller housing (p.345, p.348).
3. Clean the roller with a dry, clean cloth to remove paper dust.

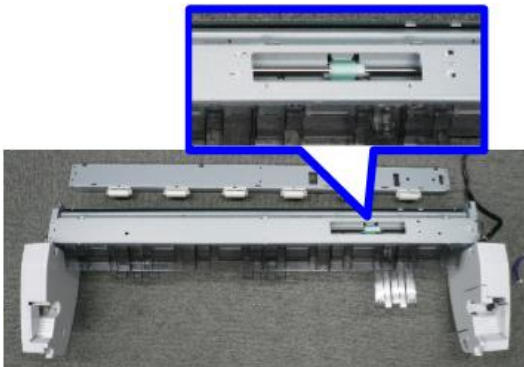

d262k8092

4. Replacement and Adjustment

Notes on the Main Power Switch

Push Switch

The main power button of this machine has been changed to a push-button switch from the conventional rocker switch. The push switch has characteristics and specifications different from the rocker switch. Care must be taken when replacing and adjusting parts.

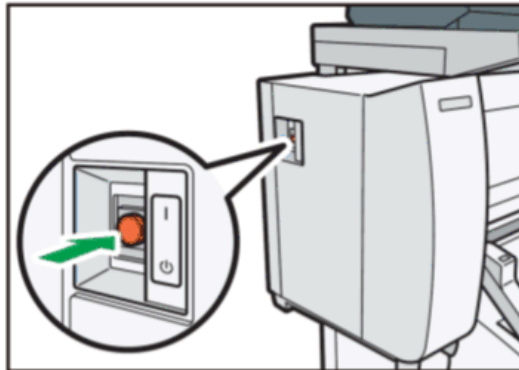

d262k1541

Characteristics of the Push Switch (DC Switch)

Power is supplied to the machine even when the main power switch is turned OFF.

The push switch in this machine uses DC (direct current). Therefore, if the AC power cord is connected to an electrical outlet, power is supplied to the controller board, the operation unit and other modules even when the main power is turned OFF. When replacing the controller board and the operation unit in this state, not only these boards, it will damage other electrical components.

In 100V models, only one of the AC lines for the fusing unit is shut off when you turn off the main power; the other line carries current even when you turn off the main power switch.

So, when performing maintenance work such as replacing parts, in addition to turning off the main power with the push switch, always unplug the AC power cord.

When you disconnect the power cord from the AC outlet, inside the machine there is still residual charge.

When you disconnect the power cord from the AC wall outlet, inside the machine for a while there is still residual charge. Therefore, if you remove boards in this state, it can cause a blown fuse or memory failure.

- How to remove the residual charge inside the machine

After you unplug the power cord from the AC wall outlet, in order to remove the residual charge from inside the machine, be sure to press the main power switch. Thus, the charge remaining in the machine is released, and it is possible to remove boards.

When you reconnect the AC power cord into an AC wall outlet, the machine will start automatically.

In order to remove the residual charge, push the main power switch while you disconnect the AC power cord. At that time, the power ON flag inside the machine is set. Therefore, after you finish work on the machine and reconnect the power cord to the AC, even if you do not press the main power switch, the machine will start automatically and the moving parts will begin to move. **When working on moving parts, be careful that fingers or clothes do not get caught.**

Note

- Automatic restart deals with cases when you accidentally unplugged the AC power cord or unexpected power outages. By keeping the power flag ON, after the resumption of power, the machine will start up automatically.

In rare cases, when you reconnect the AC power cord to a power outlet, the machine does not start automatically. In this case, the machine has not failed. The cause is due to the timing of releasing the residual charge. If you press the main power switch while the residual charge was already released, the power ON flag will not be set. At this time, start the machine manually by pressing the main power switch.

Shutdown Method

1. Press the main power switch on the front of the machine.

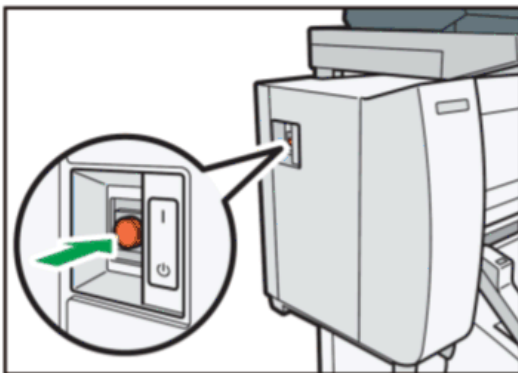

d262k1541

CAUTION

- Before you disconnect any of the cables, make sure that the LEDs on the BICU have turned off completely.

- In this model, note that the LEDs are not as close to the USB cable as usual.

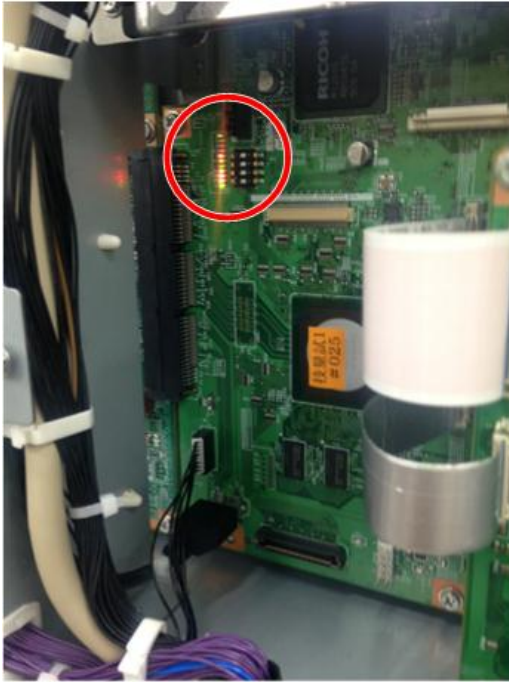

d262k8523

2. Disconnect the power cord
3. Wait 3 minutes. This is the time required if you intend to remove the rear cover and service parts in the machine, like removal of the controller board, for example).

↓ Note

- If some LEDs on any of the boards are blinking or lit, current is still flowing.
- After the shutdown process, the main power is turned off automatically.

When the shutdown is complete

Main power LED: Off

Operation panel LED: Off

↓ Note

- How to start from shutdown
- To start the machine, press the main power switch. However, if you press the main power switch between the beginning and the end of a shutdown, the machine will not start.

Forced Shutdown

In case normal shutdown does not complete for some reason, the machine has a forced shutdown function.

To make a forced shutdown, press and hold the main power switch for 6 seconds.

In general, do not use the forced shutdown.

Note

- Forced shutdown may damage the hard disk and memory, and can cause damage to the machine. Use a forced shutdown only if it is unavoidable.

General Precautions

External Covers

1. To avoid personal injury or damage to the machine during operation, operators and service technicians must always obey the instructions in the manuals and decals attached to the machine.
2. The moving parts and drive mechanisms inside the machine are dangerous. Never wedge a piece of paper or the tip of a tool into an interlock safety switch so that the machine can continue to operate with covers open.
3. Do not lay anything on top of the machine, and never block air ventilation louvers on the covers. Blocked louvers could interfere with the airflow and cause the machine to overheat and cause a fire.
4. Open the scanner cover only after the original has exited the original path. If you open the scanner cover while an original is being scanned, the interlock safety switches will stop the machine and this will cause a jam. In an emergency if you must stop a scan in progress, press the Original Stop button (🛑) on the right side of the scanner cover.
5. Open the front cover only after all scanning and print jobs have finished and the last print or original has exited. Opening the front cover while the machine is operating will activate the interlock safety switches and cause the machine to jam.
6. To prevent personal injury or damage to the machine, never lean on the machine, and never place heavy objects on the original tray or paper exit stacker.

4

Original Transport

1. Never attempt to feed originals that are not within the specifications. Doing so could cause the machine to jam, result in poor print quality, damage a valuable original, or damage the machine. Obey the following guidelines before you scan an original, and inspect each original for:
 - (1) Dirty surfaces, the originals must be clean
 - (2) Stacking, originals must be fed one by one
 - (3) Folding, originals must be flat
 - (4) Glue, adhesive tape that could foul the feed path
 - (5) Holes, no paper with punched edges
 - (6) Folded corners
 - (7) Wrinkles and tears
 - (8) Rippled surfaces (caused by high humidity)
 - (9) Sheets taped together

- (10) Crooked leading edge
- (11) Thick paper pasted at the leading edge
- (12) Clips, staples
- (13) Wet ink, wet correction fluid originals
- (14) Carbon paper
- (15) An film original not within specification
- (16) Excessive curling
- (17) Sticky surfaces that could stick to the exposure glass

 **Note**

- You may be able to feed originals with some of the defects listed above if you use a document carrier.

4

2. Insert an original only after the machine prompts you to do so after the machine is ready for copying.
3. To set the original, lay it face down and align the right side guide with the right edge of the original. Aligning the right guide with the right edge of the original prevents skewing during scanning.
4. Push the leading edge into the scanner. Release it as soon as the machine grabs the leading edge and feeds it partially. To avoid skewing or damaging the original, never attempt to push or pull on the original during this initial feeding.
5. If you see a problem at the beginning of scanning, press the original stop button () to stop original feed, and then open the scanner unit and remove the original.
6. Periodically clean the original table and the surface of the feed roller with a water dampened cloth. Clean the exposure glass with the optical cloth provided with the machine. Cleaning prevents poor feeding, dirt or dust transfer to the original, and poor copy image quality. To prevent damage to the machine, the cleaning cloth should be only slightly damp; make sure no liquid drips into the machine.
7. To ensure good print quality and to prevent jams, always remove a thick or long original from the original stacker as soon as it exits.
8. Thick or especially long originals may not feed correctly. While feeding a thick or long original, you can gently push the sides with both hands during scanning of the first half. You can guide the sides with both hands as the second half scans.
9. When you open the scanner cover, always use both hands, placed on either side of it, as shown on the decal and described in the operating instructions. To avoid personal injury or damage to the machine, never open or close the scanner cover with one hand.
10. The weight limit of the original table is 5 kg (11 lb.). To avoid damaging the original table, never lean on the original table and never place anything on the original table when you are working around the machine.

11. To avoid damage to the exposure glass below the cover or the white plates attached to the underside of the cover, always check the original path before you close the scanner cover.
12. If anything falls into the machine that the operators cannot recover, they must call for service. Foreign objects in the machine could cause a short (which can lead to a fire), or could cause feed problems.
13. During feeding of a thick original (90 g/m²), the side guides could skew the image and cause parts of the image to disappear at the points where the CIS elements join. In such a case, use the white lines on the original table to guide the original during feeding.
14. When feeding a thick original (180 g/m²), do not push the original after it strikes the original feed roller and starts to feed. The original feed roller has a one-way feed clutch. If the original is pushed in the direction of the leading edge, this could buckle the original and cause it to jam at the original registration sensor.
15. Originals up to 135 g/m² can exit to the original stacker on top of the machine. Thicker originals must feed straight through and exit the back of the machine. Removal of the original exit guide on top of the machine allows the originals to exit straight out the back.
16. Also, use straight-through original feed for thin or flimsy originals. For example, tracing paper (80 g/m² or less), or normal paper (52.3 g/m² or less). Buckling of thin or flimsy paper can lead to accordion jams and damage the original.

Paper

1. Always set the roll (or start paper feed) from the bottom of the roll, not the top. Feeding paper from the top of the roll places an excessive load on the paper feed rollers and could cause problems with paper feed and cutting. Also, feeding the paper from the top sets the paper against the direction of paper curl, which causes the paper to lift and rub against the print heads leading to poor copy quality and damage to the print heads.
2. If the machine is to remain idle for a long period where the temperature and humidity are high or low, remove the paper rolls from the machine and store them (in their original packing if possible). If the rolls cannot be removed and stored, then before the machine is used again, feed the leading edge of the roll about 1,000 mm (39 in.), and then cut it off.

Copy Quality

1. Photo images that have areas filled with dithering or fine lines frequently exhibit moiré.
2. Even for images where moiré does not stand out with 1:1 copying, changing the rate of magnification could cause moiré to appear.
3. In cases where 0.5 mm bands occur in halftone areas of uneven density, switch to Photo/Text mode (or Text mode) so banding does not stand out. Inconsistencies in the optical properties across the CIS can cause slight unevenness in image density.

4. The thickness of fine lines (0.1 mm or less), or the lines in enlarged copies of originals previously reduced, may look different in the copies compared with the originals. This is because of a phenomenon unique to digital copiers: the position of the elements in the CIS unit and position of the fine lines in the original may not be consistent.
5. If a dirty background still appears in a copy using the Auto Density setting, adjust the notch to a lighter setting.

CIS

1. Always handle the CIS unit carefully during its removal to prevent it from shock and vibration.
2. Never touch the CIS lenses with bare hands or fingers.
3. Use only lens paper to clean the lenses.
4. Never attempt to disconnect the signal or power connectors from the CIS unit. This could damage the CIS unit or throw it out of adjustment. When connecting the CIS unit, connect the FFCs at the SIB.

4

Electrical Components

1. Make sure that all terminal connections are grounded. The ground wire on the terminal of the electrical power cord must be properly grounded.
2. All of the ground harnesses that are connected to the back of the scanner unit and the PCB box should remain connected while the machine is operating.

Adjustments at Machine Installation

1. Avoid placing the machine near a window to prevent sunlight from entering the machine and causing problems in images like uneven density.
2. The back of the scanner unit should never be exposed to strong light.
3. If the windows near the machine are provided with blinds or curtains, close them.

Other Precautions

1. The CIS unit has five separate elements, and sometimes image density may appear uneven at the joints where these elements connect. When this problem occurs, try scanning in the Photo Mode. The scanning level may be affected by the original floating away from the exposure glass during scanning. This can also cause inconsistencies in the wavelengths of the CIS unit with color originals and lead to slightly uneven density in the copied image. If you see white areas in dithered images,

switch the machine to the Photo Mode. If you see fine lines that appear as scratches, change the setting of the density notch adjustment.

2. Because the CIS unit has 5 separate elements, pixels may become misaligned at the joints of these elements.
 - Normal paper original: 2 pixels
 - Normal paper with curl: 3 to 4 pixels
 - Thick original (1 mm): 3 to 6 pixels

Note

- In order to compensate for the differences in Generation Copy Mode, try reversing the direction of the original when you insert it, or swap the orientation between LEF and SEF.
3. Problems can occur with a pasted up original. When using a pasted up original, try Text Mode or Photo Mode. Shadows can appear in copies because the CIS light source comes from one direction where there are edges (steps) on the pasted up document.
 4. After printing, if the machine is to remain idle for a long period, remove the paper rolls from the machine and store them in their protective bags. Paper exposed to a high or low temperature or high humidity can absorb or lose moisture causing it to curl and ripple, wrinkle, or fold.

Service Precautions

Scanner Unit Rollers

The surfaces of the main rollers (original feed roller, original exit roller, registration roller, and exit roller) are covered with a soft urethane coating. This coating is soft and can be damaged quite easily (even with a fingernail).

- Never touch the surface of these rollers with bare hands.
- Always hold the rollers by the bare ends where they are not coated.
- Never use any type of strong organic solvent to clean the surface of these rollers. Use only an alcohol or water dampened cloth to clean the rollers.



d1241036

4

Main Frame Screws

There are paint-locked screws across the top of the machine (under the top cover). These screws are positioned and adjusted at the factory. Never loosen or attempt to adjust these screws.

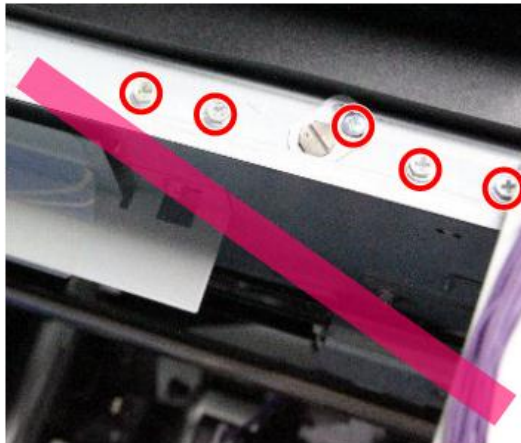

d262k8502

Right Plate Screws

You can see the heads of four paint-locked screws around the top of the maintenance unit. These screws hold a re-enforcement plate. Never loosen or remove any of these screws.

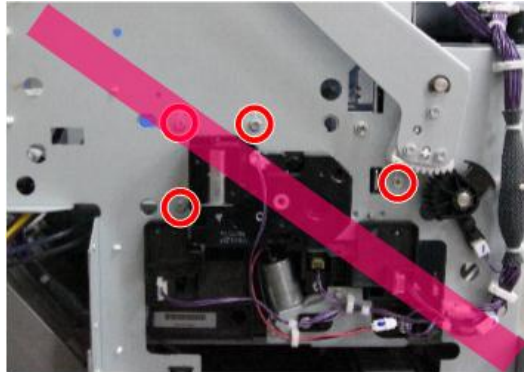

d262k8503

Maintenance Unit Base Screws

The maintenance unit base plate supports the maintenance unit. These screws hold the base plate under the maintenance unit, which must always remain in the same position below the carriage print heads.

The two base plate screws at the back on the right rear panel should never be loosened or removed.

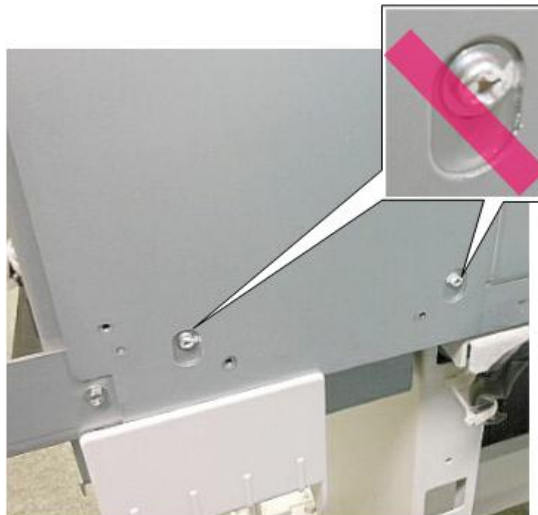

d262k8505

There are also two paint-locked screws at the front. One screw is at the front below the switch bracket [A] on the right. The other screw [B] is to the right of the temperature/humidity sensor above the ink supply unit.

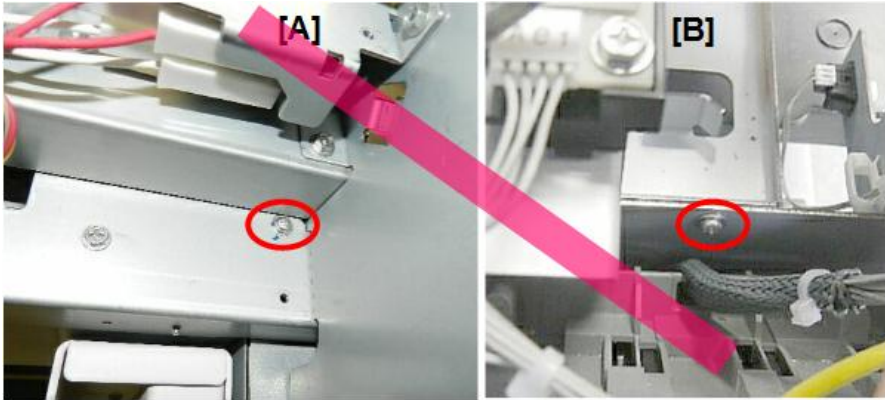

d262k8506

4

Solenoid Bracket Screw

The position of the air solenoid bracket is adjusted at the factory. This screw is also paint-locked to remind you that it should not be removed.

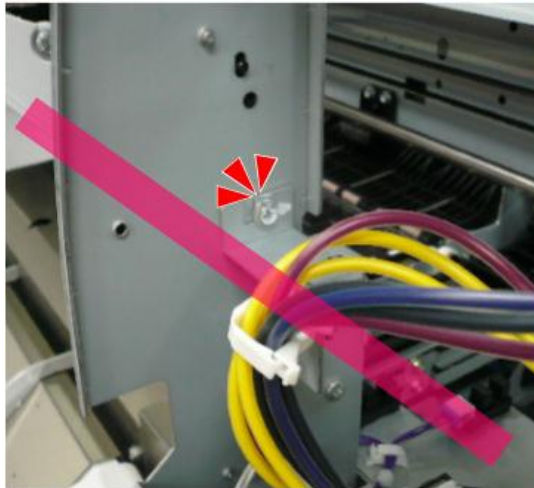

d262k8504

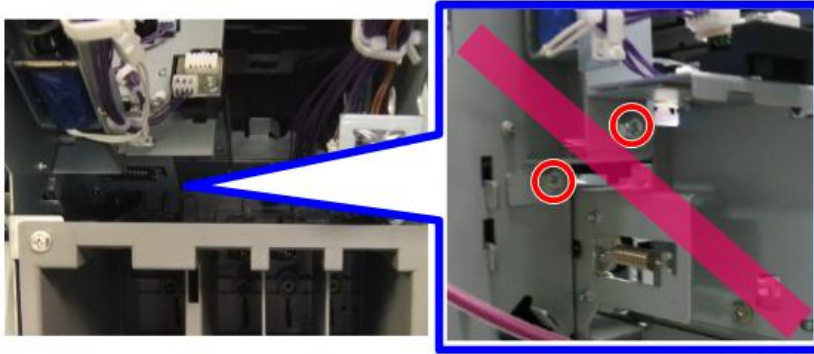

d262k8507

4

Main Carriage Screws

The illustration above shows the left cover of the carriage unit removed. It is extremely important you never loosen or remove these screws. Tampering with these screws could cause the carriage unit to fall out of alignment or onto the platen plates.

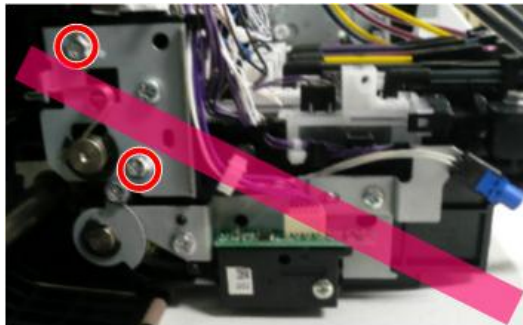

d262k8508

Temperature/Humidity Sensor Bracket

This screw is paint locked. However, this bracket must be removed in order to remove the carriage unit. The bracket must be reinstalled at exactly the same position so the sensors are positioned correctly (p.465).

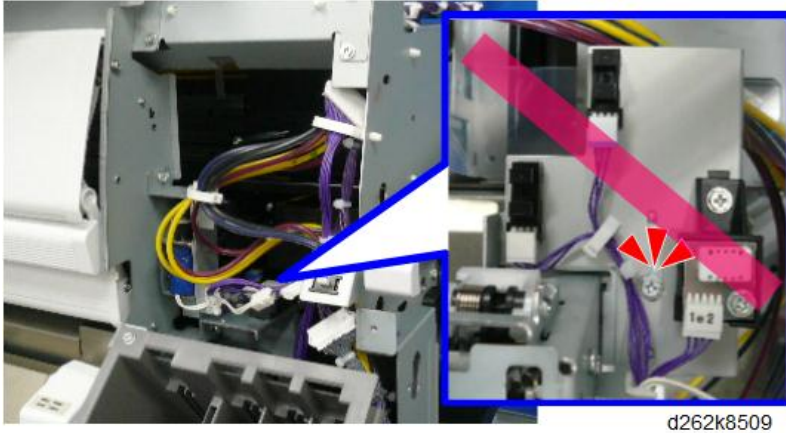

4

Notes on Operation of the Paper Holding Lever

To operate the paper holding lever [A], do not pull up the paper holding lever too much. If the lever is pulled up too much, it may be removed from the black gear (the figure below is with the upper right cover removed).

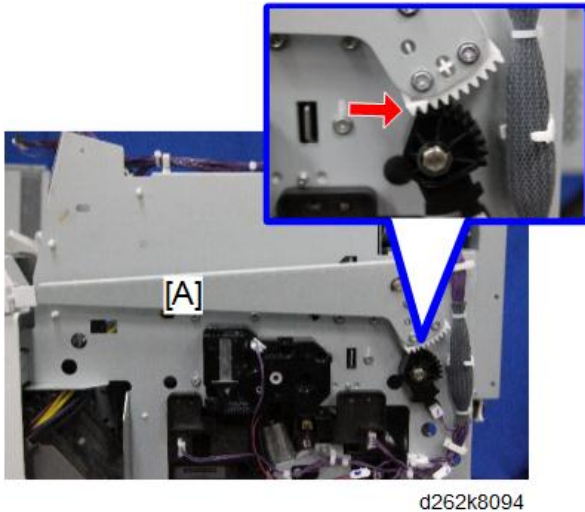

If the lever is removed from the gear, set the gear so that the gear and the first gear teeth of the paper holding lever are aligned.

↓ Note

- If necessary, the paper holding lever can be removed (remove the E-ring of the paper holding lever). However, do not remove the gear.
- When the paper holding lever is removed and re-attached, check the followings:
[1] The paper holding lever is horizontal.

[2] The gear and the first gear teeth of the paper holding lever are aligned.

Common Procedures

Before You Begin

This section describes procedures commonly used to service the machine.

★ Important

- The service technician must be familiar with all procedures in this section before servicing the machine, as described in other sections of this service manual.

What You Need

Tool	Needed For:
Alcohol, clean linen cloths	Cleaning surfaces and rollers
Allen key (2.5 mm)	Removing and attaching hex bolts.
Blower brush	Cleaning sensors
Clean rags	Wiping up ink, covering disconnected ink tubes
Clean waste paper	To place under the maintenance unit and other parts that can leak ink, in order to protect tables and other surfaces
Flashlight (small)	Checking the position of the suction cap and print head caps of the maintenance unit.
Gloves	Handling encoder strips and wheels, and urethane-coated rollers
Lens paper	Cleaning the CIS elements
Metal scale	Inserting sheets into narrow gaps.
Phillips driver – long	At least 300 mm (12") to reach screws inside the machine.
Phillips driver – small	Removing small screws
Radio pliers	Attaching, reattaching e-rings

Before Servicing the Machine

WARNING

- Before doing any procedure, always turn off the power switch and unplug the machine from its power source.



d124r001

To prevent damage to these parts, and to prevent interference with raising and lowering the top of the scanner unit, always remove them before servicing the machine:

- [A] Original guides (x2)
- [B] Original stacker (x2)
- [C] Rear output guides (x4)

Rear Output Guides

1. At the back of the machine, for each guide press down on the top of the guide [1].
2. Lower it away from the plate [2].

3. Unhook it at the bottom [3].

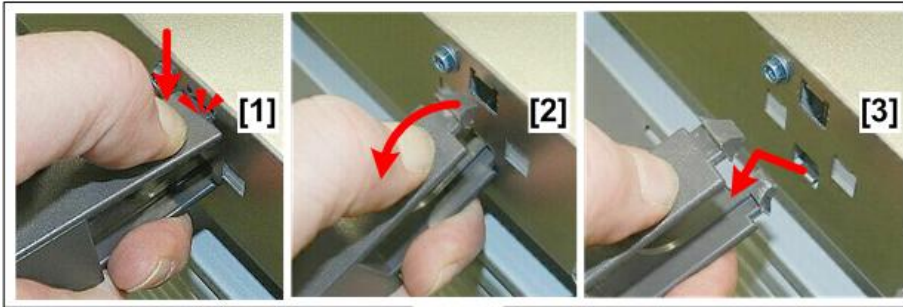

d124r002

4

Original Guides

1. Rotate each guide away from the machine and remove it.

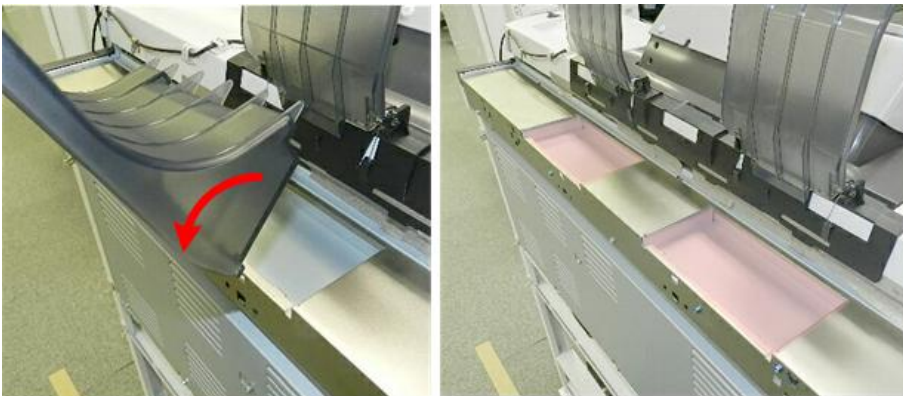

d124r003

Original Stacker

1. First, separate the tabs at the base (▼ x4).

2. Rotate the original stacker away from the machine to remove it.



d124r004

Reinstallation

4

1. To reinstall the original stacker, first connect it at the base, and then rotate the tray up.



d124r005

2. Pull out the light shield and confirm that the gap at the top of the scanner unit is completely covered.

★ Important

- This light shield prevents light from entering the scanner unit.
- If this gap is not covered, strong light could enter the back of the scanner unit and cause image distortion during scanning.



d124r006

Ink Collector Tank

1. Open the ink collector cover.
2. Depress the lever on the top of the ink collector to unlock it, and then remove it.

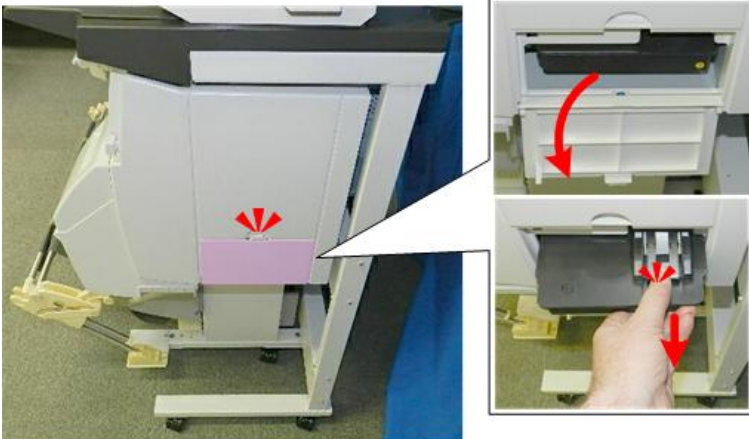

d124r010

Paper Rolls

1. Make sure that the machine is switched on.
2. Raise the paper exit guide [A].

3. Press button [B] and hold it for at least 2 seconds to rewind the paper.

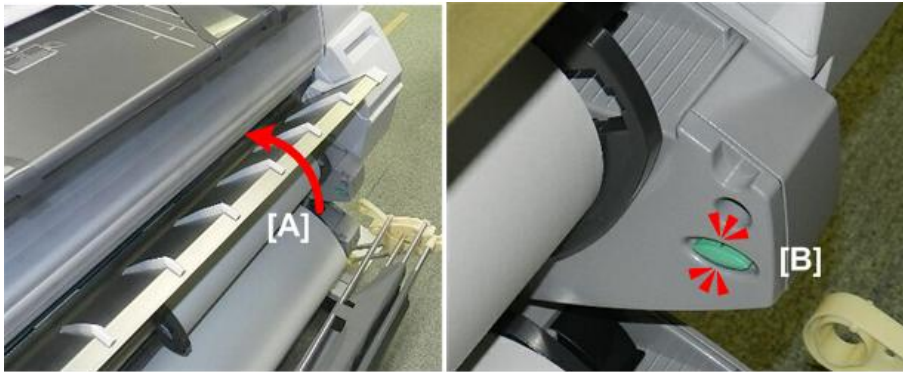

d124r011

4

4. Avoid touching the paper with your hands. Grip the roll at the plastic holders on both ends, and then lift the paper roll out of the machine.



d124r012

5. Lay the roll horizontally on a flat clean surface.

Main Covers

In order to service some parts inside the machine, covers must be removed on the right side in this order:

- Right Cover (p.239) > Right Upper Cover (p.241) > Ink Cartridge Cover (p.243)

To remove the top cover, the covers must be removed in this order:

- Right Cover (p.239) > Right Upper Cover (p.241) > Ink Cartridge Cover (p.243) > Left Cover (p.234) > Top Cover (p.245)

Note

- Use only a water dampened cloth to clean the covers. To protect the finish of the covers, never use an organic solvent to clean them.

Left Cover

1. Raise the paper exit guide.



d1241006

2. Below the open guide, remove the screw ( x1).



d124r028

3. Lower the paper exit guide.



d1241006a

4

4. Push in the bottom of the front cover, and then raise it until it locks.

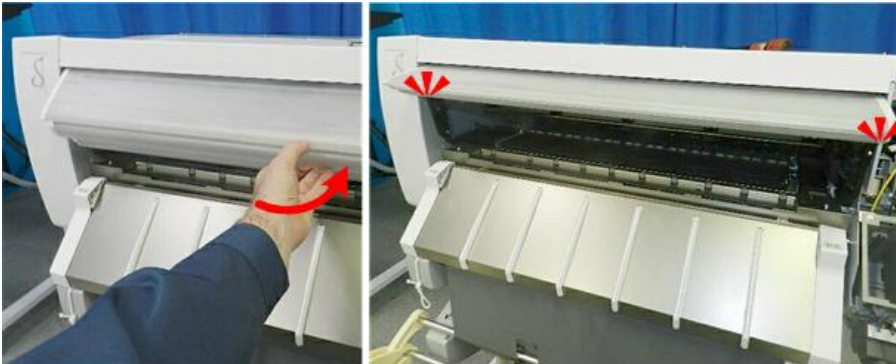

d124r030

5. Below the cover, remove the screw ( x1).



d124r031

6. Lower the front cover.



d124r032

7. At the back, disconnect the left cover ( x2).

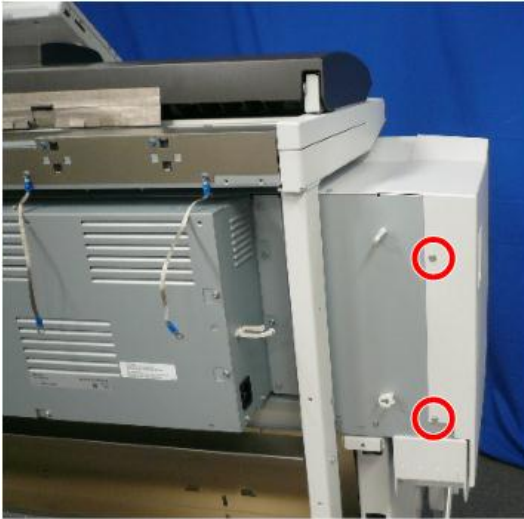

d262k1027

8. Lift the cover straight up and remove it.



d124r034

Reinstallation

1. Set the bottom hooks [A] into the holes in the frame.
2. Raise the cover so that the middle hook [B] fits into its hole.

3. Insert the tabs [C] on the top edge of the cover into their holes.

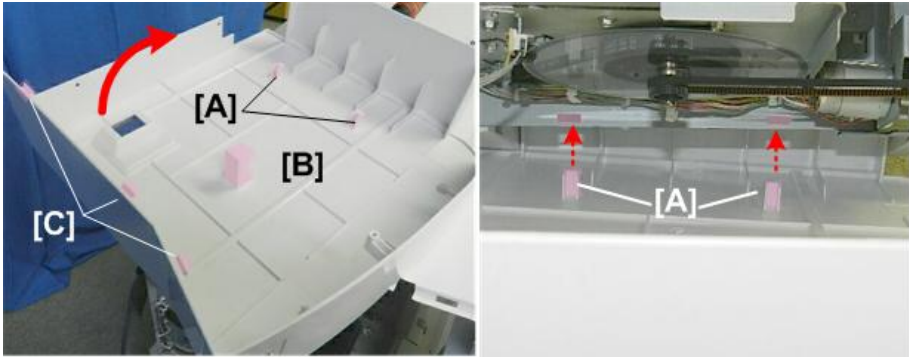

d124r035

4. Lower the cover so that the hooks and tabs engage the machine frame.

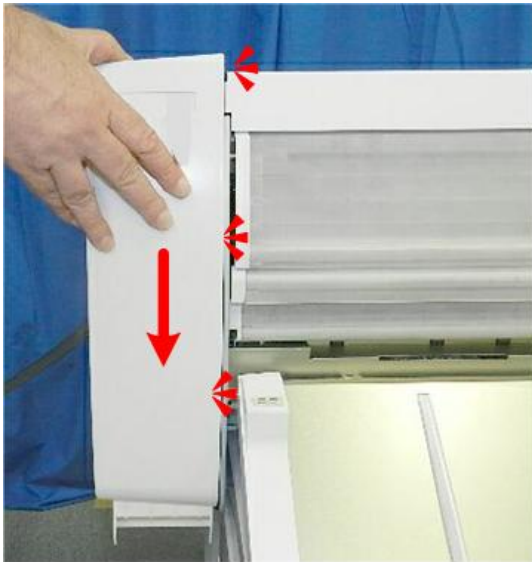

d124r036

Right Cover

1. Open the ink collector cover.

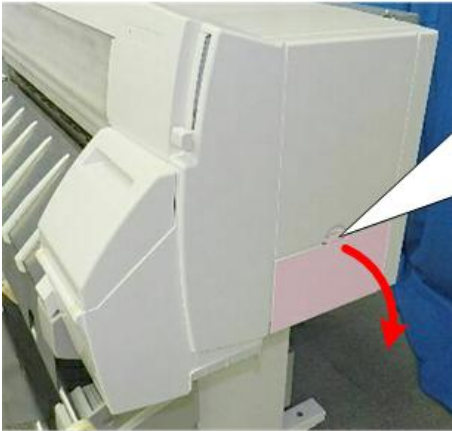

d124r015

2. Disconnect the hinges on both ends of the cover and remove it.

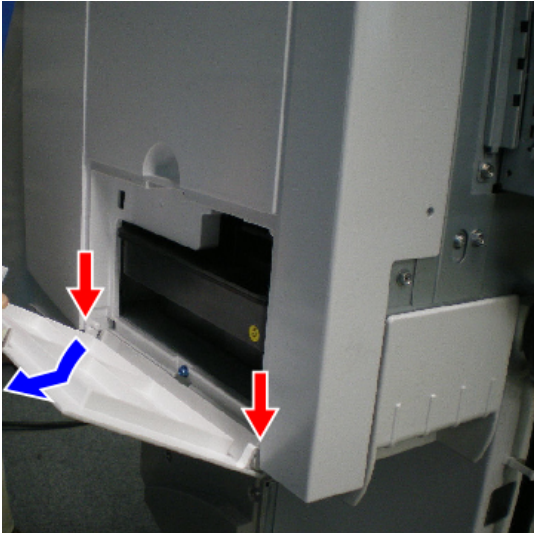

d1241100

3. Disconnect the bottom of the cover ( x1).



d1241101

4

4. At the back of the machine, disconnect the right cover ( x2).



d262k1028

5. Lift the cover straight up and remove it.

 **Note**

- Raise the right cover [A] and pull it toward you to remove.
- To raise the paper holding lever [B] for removing the right cover, do not raise the lever too much, which might disengage it from the gear.

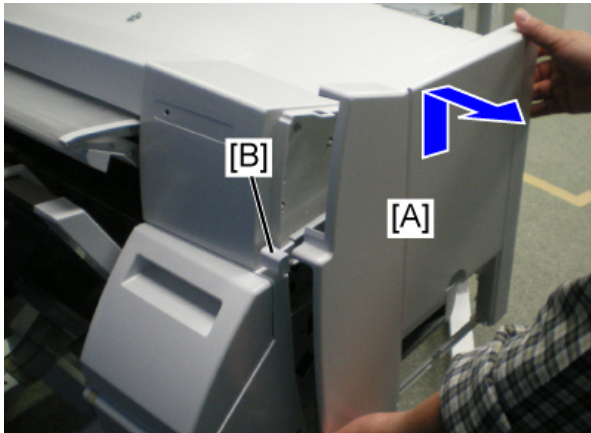

d1241102

Reinstallation

- Align the tabs inside the right cover with the cutouts of the main unit and attach the cover.
- To raise the paper holding lever for attaching the right cover, do not raise the lever too much, which might disengage it from the gear.

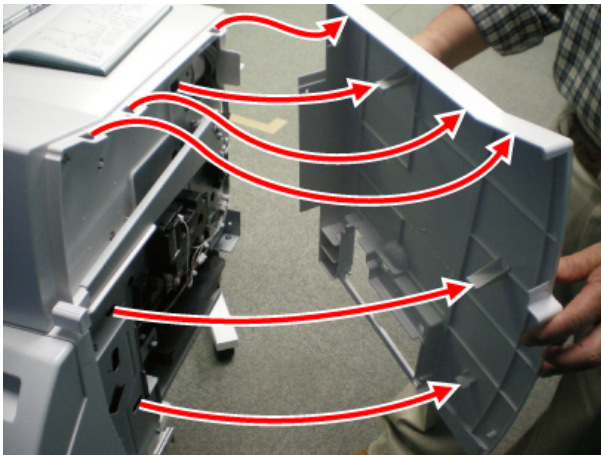

d1241103

Right Upper Cover

Remove

1. Right cover (p.239).
2. Disconnect the cover at the top [A] ( x1).
3. Raise the paper holding lever [B].

4. Disconnect the cover at [C] ( x1).

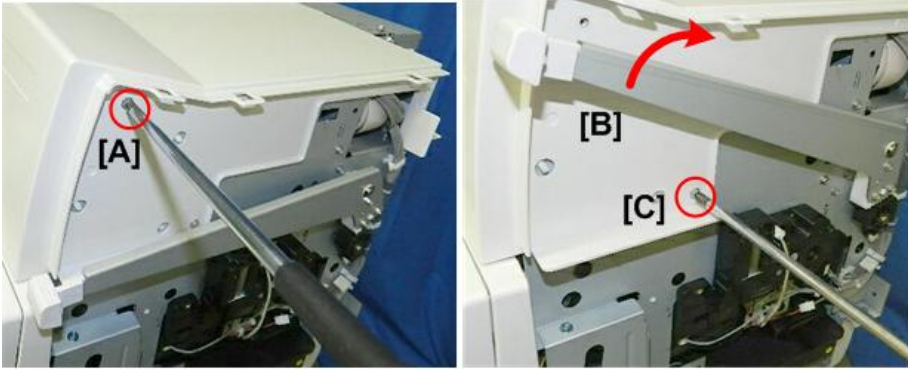

d124r020

5. Disconnect the cover at the rear [A] ( x1).
6. Pull the lever [B] slightly away from the machine.
7. Lift the cover [C] to remove it.



d124r021

Reinstallation

1. Insert the three tabs on the top edge of the cover [A] into the holes [B].

2. Insert and slide the hooks [C] into the holes on the top edge of the ink cartridge cover [D].

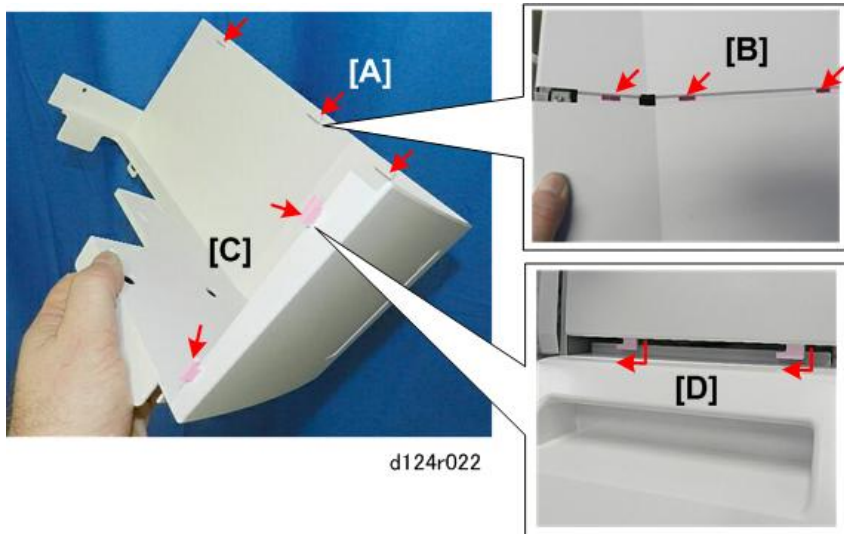

Ink Cartridge Cover

Remove

1. Right cover (p.239).
2. Right upper cover (p.241).
3. Open the ink cartridge cover.

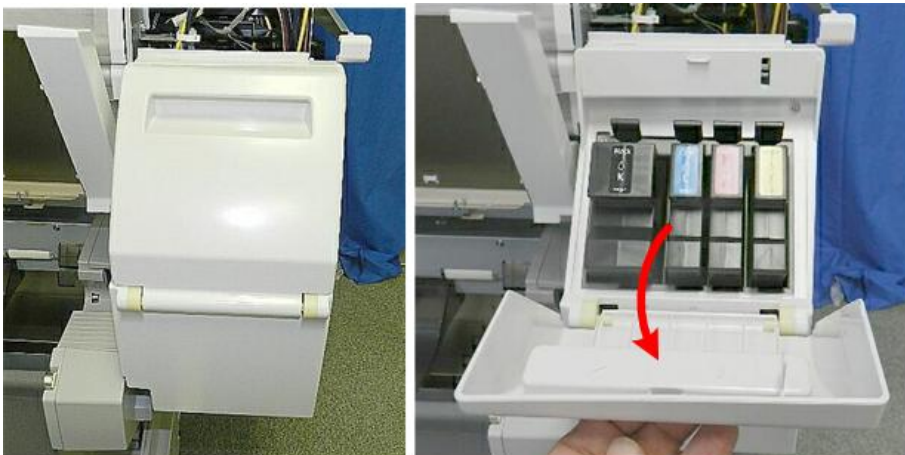

4. Depress the tab of each ink cartridge and remove it.



d124r024

5. Disconnect the top of the cover ( x1).



d124r025

6. Raise the paper exit guide.



d1241006

7. Disconnect the side of the cover [A] ( x1).
8. Rotate the cover [B] forward slightly and then remove it.

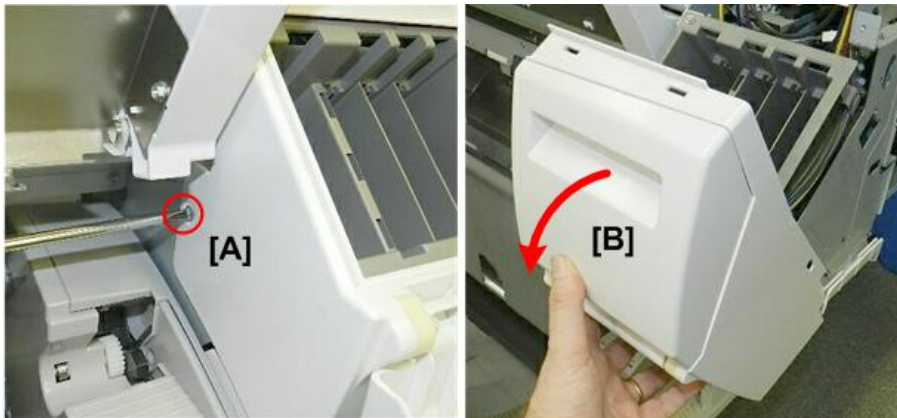

d124r027

Top Cover

Remove

1. Right cover (p.239).
2. Right upper cover (p.241).
3. Left cover (p.234).

4. Disconnect the top cover ( x7).



5. Lift the cover and remove it.

★ Important

- Do not attempt to print with the top cover removed. Light striking the exit sensor with the cover removed will cause paper to jam.



d124r038

Reinstallation

1. Before fastening the screws, make sure that the bosses fit into the holes in the rear edge of the top cover.



d124r039

Right Rear Cover.

Remove

1. Remove the top cover (p.245).
2. Remove the right rear cover. (⚙️ x4)



d262k1029

★ Important

- Never loosen nor remove the two screws in the slots at the lower part of the right rear cover.

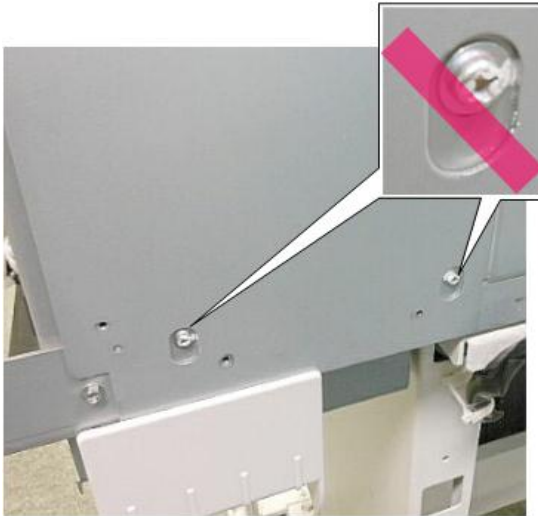

d262k8505

Precaution

- Hook the right rear cover to the cutout of the frame. [A]
- Insert the bottom of the right rear cover inside the plastic plate of the frame (handle of the main unit). [B]

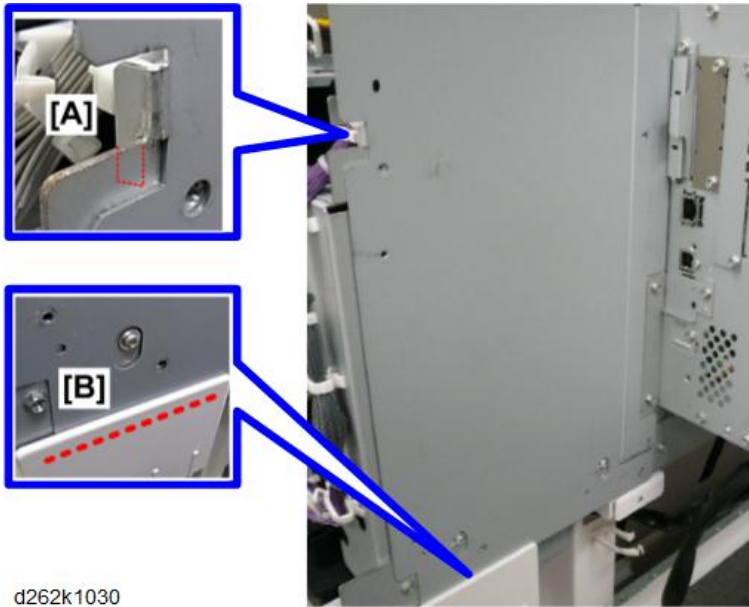

Left Rear Cover

Remove

1. Remove the top cover (p.245).
2. Remove the left rear cover. (🔧 x5)



Precaution

- Hook the left rear cover to the cutout of the frame. [A]
- Insert the bottom of the left rear cover inside the plastic plate of the frame (handle of the main unit). [B]

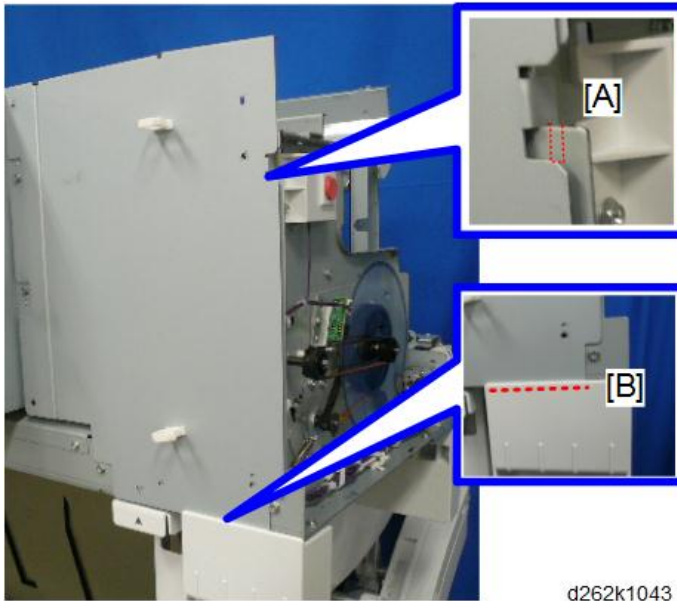

Front Cover

Remove:

1. Remove the top cover (p.245).
2. Raise the top cover to the angle shown above.

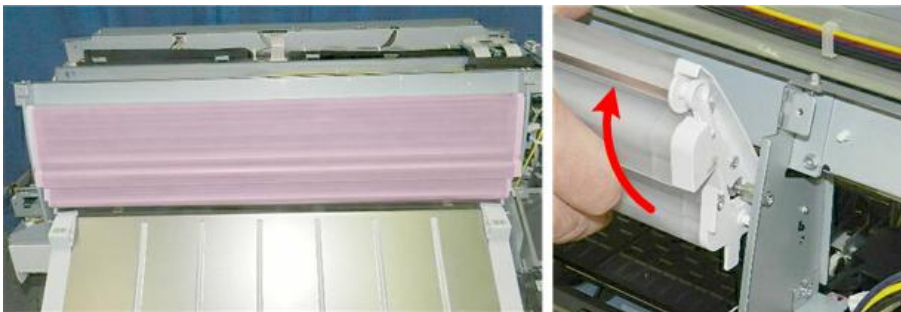

3. Disconnect the peg on the left [A] and the peg on the right [B].

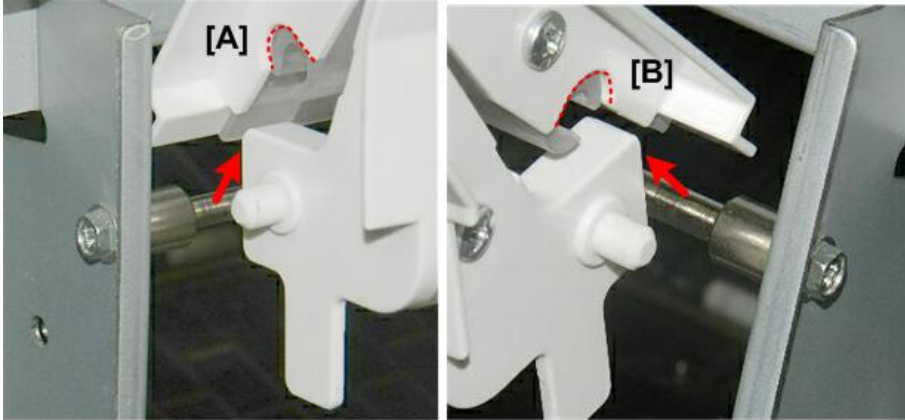

d124r041

4. Remove the front cover.



d124r042

Reinstallation

1. Make sure that the left and right pegs are inserted into the left and right guides.

2. Raise and lower the front cover to confirm that it operates smoothly.

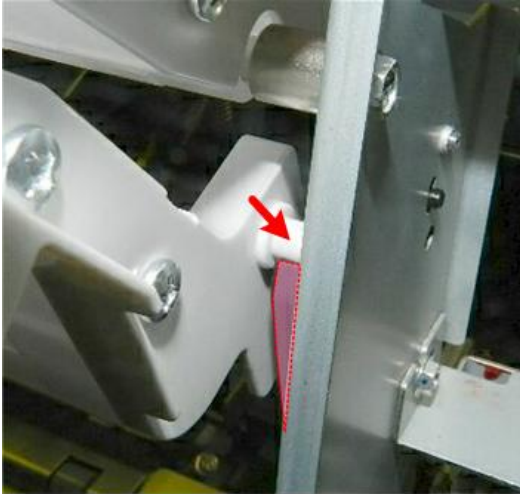

d124r043

Paper Exit Guide

1. Raise the paper exit guide until it stops.



d1241006

2. On the right, disconnect the torque limiter plate (⌚x2).



d1241007

3. Remove the plate.



d1241008

4. Remove the gear.



d1241009

5. Raise the guide to the angle shown above ①, shift it slightly to the left, and then lift it straight up ②, and then remove it.



d1241011

Reinstallation

1. When you set the gear, turn it until you feel the coupling on the back of the gear engage with the shaft pin.
2. Push in on the gear slightly so that it snaps into place.

3. The tip of the shaft should be visible as shown above. If the gear is not inserted far enough, you will not be able to re-attach the cover.

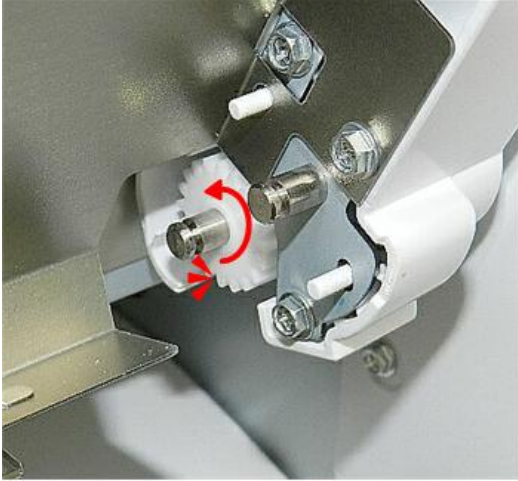

d1241012

4

Scanner Unit

Raise the Scanner Unit Fully

1. Open the top of scanner unit.
2. Remove the screws on the left and right bases of the scanner unit arms. ( x2)

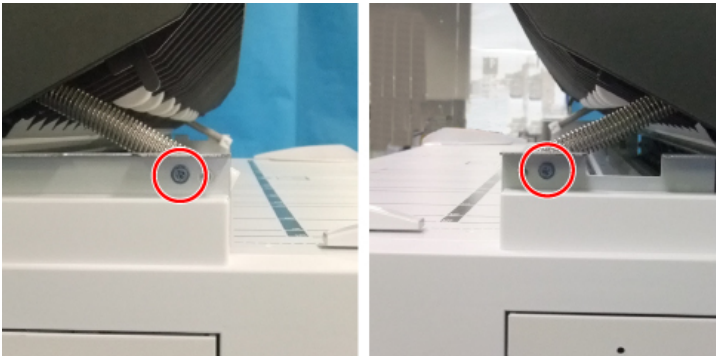

d1241576

3. Disconnect the hinges from the post screws. Do not remove the screws.

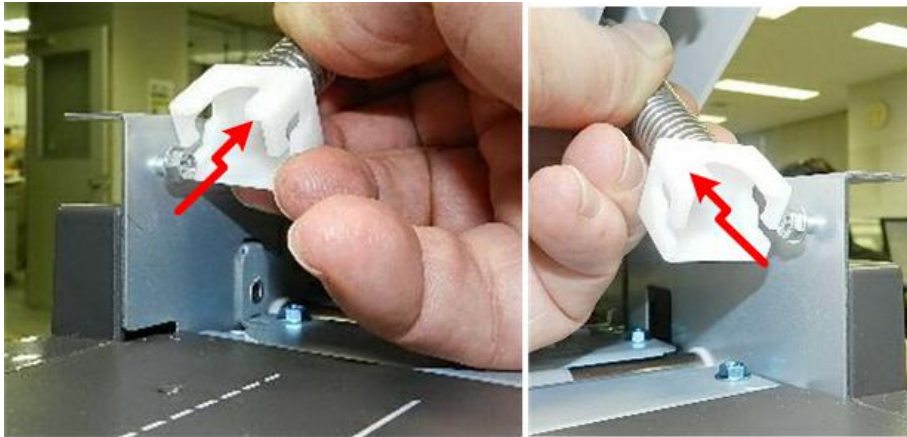

d124r086

4. Raise the scanner to the full upright position.

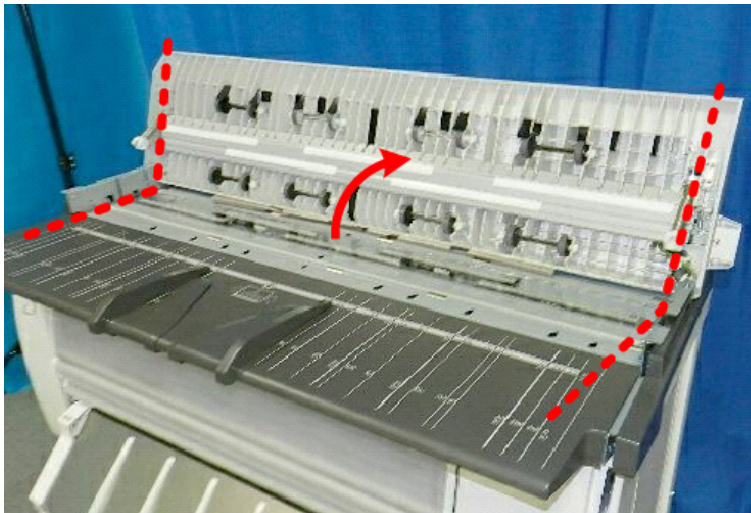

d124r087a

Scanner Upper Cover

1. Remove the scanner rear cover (p.260).
2. Remove the scanner left cover and scanner right cover (p.260).
3. Raise the scanner unit to the full upright position (p.254).

4. Remove the USB cable [A] and USB power supply harness [B]. (🔍x1)

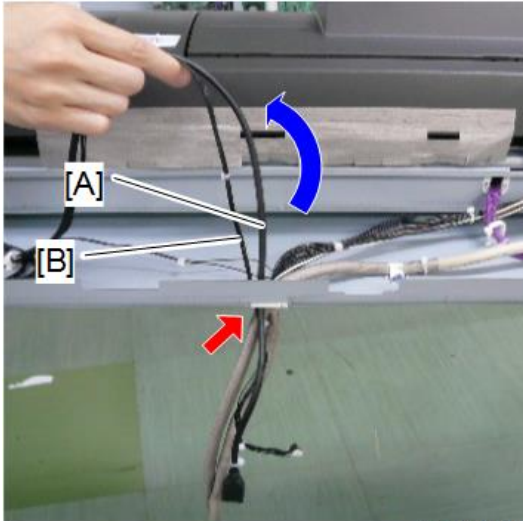

d262k1032

↓ Note

- Release the clamp and pass the cable beneath the bracket.

5. Remove the ferrite core.



d262k0323

6. Remove the clamps and connector, and pull away the harnesses. (🔍x1, 🔄x3)

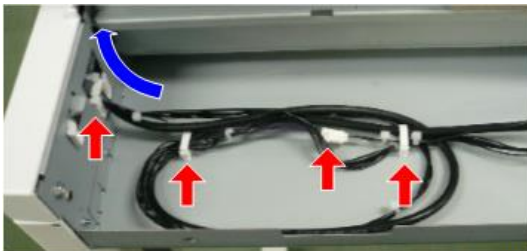

d262k1033

7. Pull out the harness from the cutout of the right bracket of the main unit.

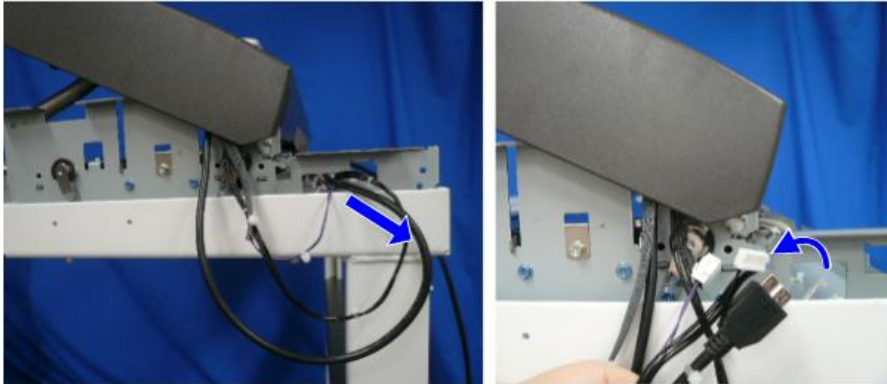

d262k1034

4

8. Remove the ground wire from the right hinge of the top of scanner unit. ( x2,  x2)

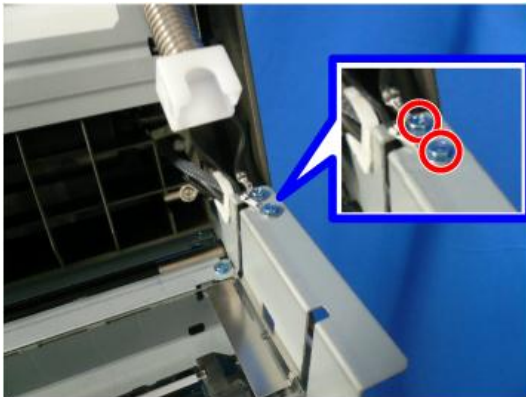

d262k1035

9. Remove the ground wire from the right hinge of the top of scanner unit, release the clamp, and pull away the harness. ( x1)

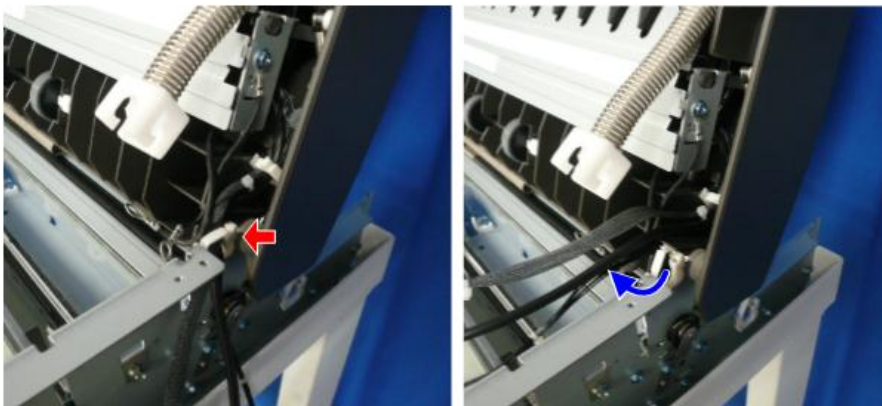

d262k1036

10. Remove the ground wire [A] and bracket [B] from the left hinge of the top of scanner unit.
( x2)

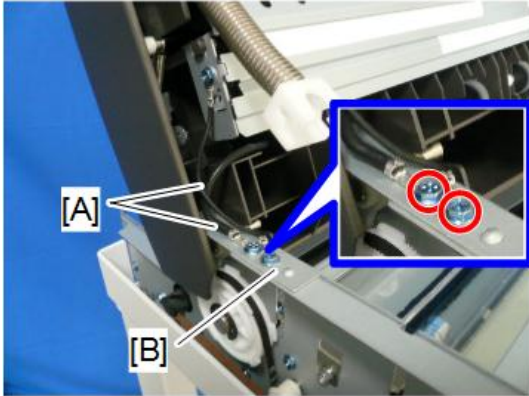

d262k1037

11. Release the boss of the right latch of the top of scanner unit on the rear of the main unit and pull the latch up.

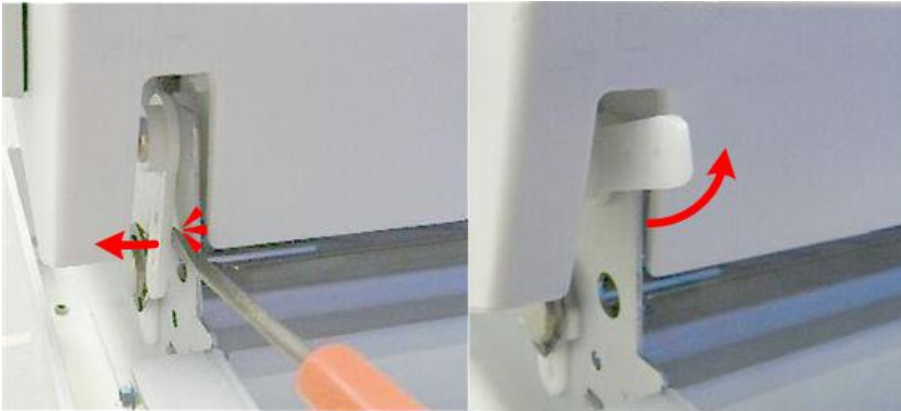

d124r170

12. Release the boss of the left latch of the top of scanner unit on the rear of the main unit and pull the latch up.

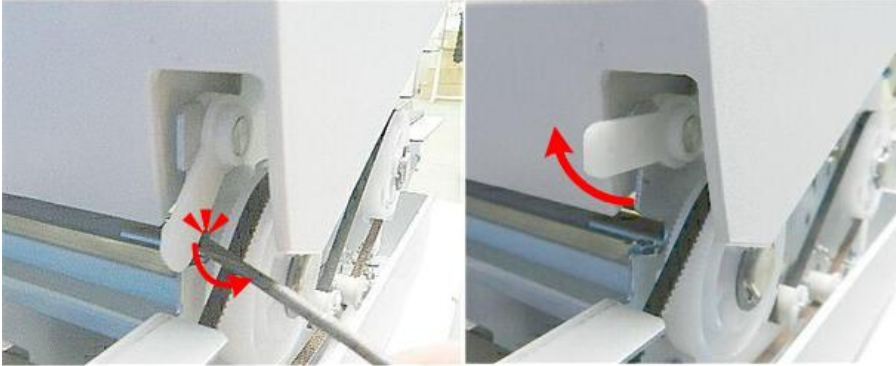

d124r169

4

13. While holding the left and right latches pushed, slightly tilt the top of scanner unit and pull it up to remove.



d124r171



d262k1044

★ Important

- The left and right latches easily come off the top of scanner unit. Check that the latches are attached on the top of scanner unit soon after removing it.

Scanner Rear Cover

Remove

1. Remove the screws of the three ground wires connected to the PCB box and remove the scanner rear cover. ( x3)



d262k1038

Precaution

Set the three guides of the scanner rear cover to the cutout on the rear of the scanner unit.

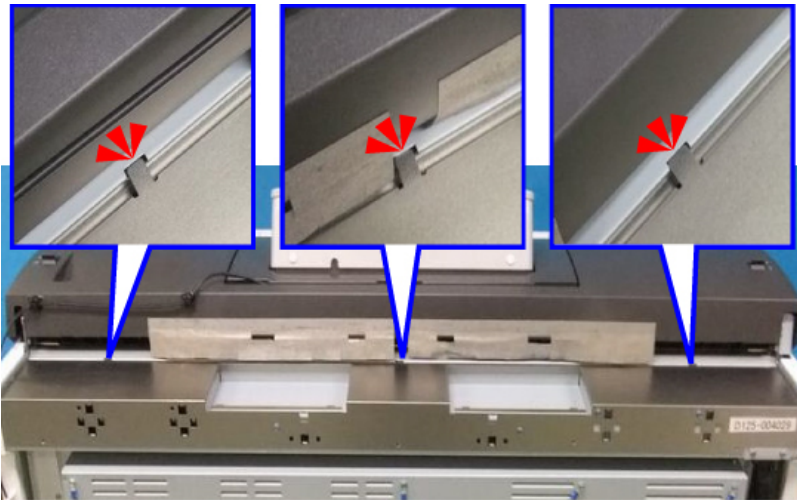

d1241468

Scanner Left Cover, Scanner Right Cover

1. Remove the scanner rear cover. (Scanner Rear Cover)
2. Open the top of scanner unit [A].

3. Remove the scanner left cover [B]. ( x1)

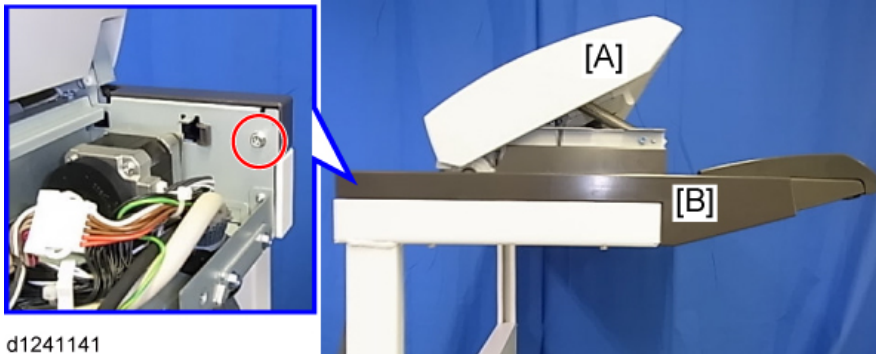

d1241141

4. Remove the scanner right cover [A]. ( x1)

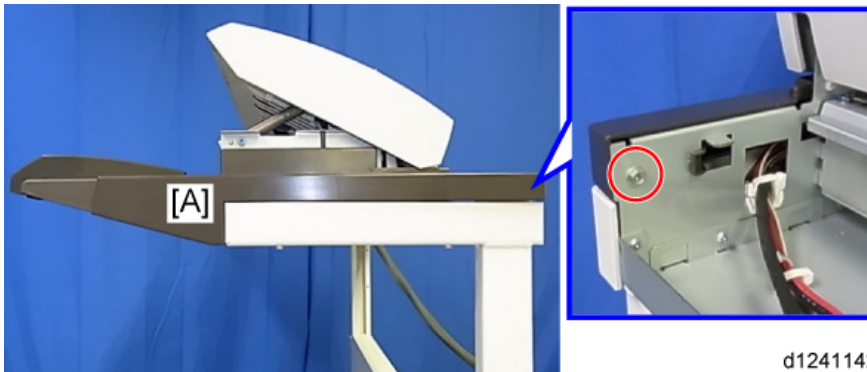



d1241142

4

Original Table

1. Raise the scanner unit to the full upright position (p.254).
2. Remove the scanner left cover and scanner right cover (p.260).
3. Remove the screw [B] on the left of the original table [A]. ( x1: M4x10)

 **Note**

 - To attach the original table, be sure to mount this screw on the left side.
4. Remove the tapping screw [D] on the right of the original table [C]. ( x1)

 **Note**

 - To attach the original table, be sure to mount this screw on the right side.



5. Remove the original table.

4



Raise the Left Side of the Scanner Unit.

To remove the screw behind the edge of the scanner rack without removing the rack from the scanner unit, place the scanner unit above the edge of the scanner rack.



1. Separate the scanner unit and the main unit (p.274).
2. Remove the scanner rear cover (p.260).
3. Remove the scanner left cover and scanner right cover (p.260).

4. Loosen the bolt with a hexagonal wrench from the lower right of the scanner rack. ( x2)

 **Note**

- Never remove this bolt.



d124r095

5. Remove the bolt with a hexagonal wrench from the lower left of the scanner rack. ( x2)

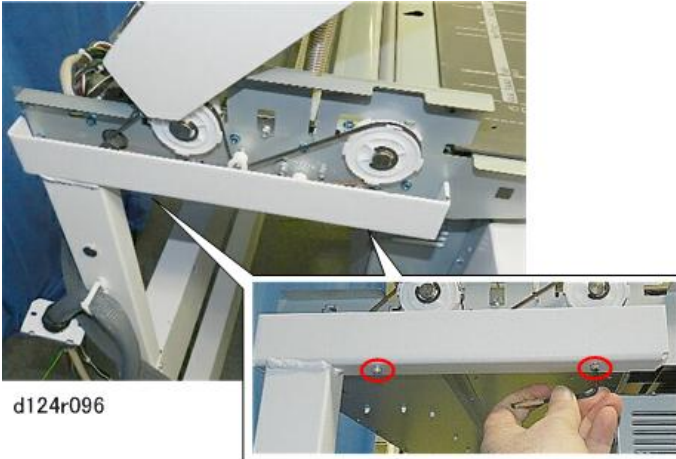

d124r096

6. Slowly move the scanner unit so that the main unit is placed under the scanner unit.

 **Note**

- Placing of the main unit under the scanner unit prevents the scanner unit from falling to the floor.



d262k1039

7. Slowly raise the left side of the scanner unit to put it on the left rear edge of the scanner rack [A].
8. Insert the cardboard between the left front of the bottom of the scanner unit and the scanner rack [B].

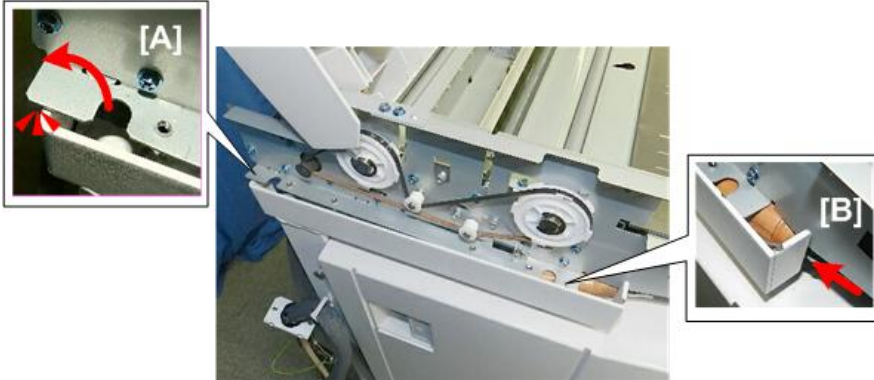

d124r099

Note

- The size of the sheet of cardboard inserted between the scanner unit and scanner rack is 10 cm long and 2 cm thick.

Raise the Right Side of the Scanner Unit.

To remove the screw behind the edge of the scanner rack without removing the rack from the scanner unit, place the scanner unit above the edge of the scanner rack.



d262k1040

1. Separate the scanner unit and the main unit (p.274).
2. Remove the scanner rear cover (p.260).
3. Remove the scanner left cover and scanner right cover (p.260).
4. Loosen the bolt with a hexagonal wrench from the lower left of the scanner rack. ( x2)

 **Note**

- Never remove this bolt.

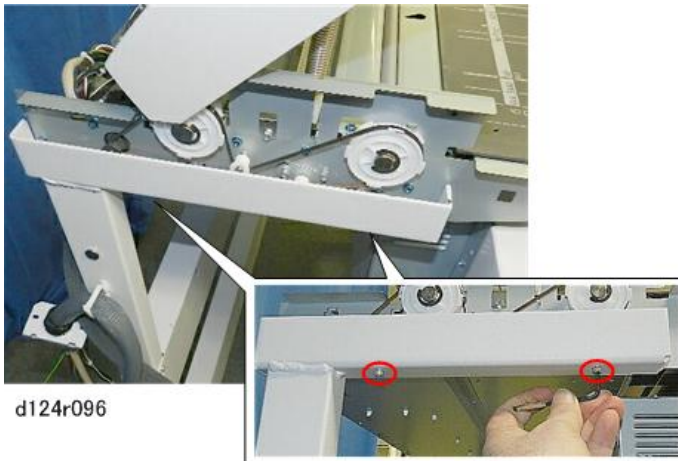

d124r096

5. Remove the bolt with a hexagonal wrench from the lower right of the scanner rack. ( x2)



d124r095

6. Slowly move the scanner unit so that the main unit is placed under the scanner unit.

 **Note**

- Placing of the main unit under the scanner unit prevents the scanner unit from falling to the floor.



d262k1039

7. Slowly raise the right side of the scanner unit to put it on the right rear edge of the scanner rack [A].

8. Insert the cardboard between the right front of the bottom of the scanner unit and the scanner rack [B].



↓ **Note**

- The size of the sheet of cardboard inserted between the scanner unit and scanner rack is 10 cm long and 2 cm thick.

Moving the Carriage Unit

Before You Begin

While the machine is idle, the carriage unit always resides on the right side of the machine where the maintenance unit caps cover the print heads to prevent them from drying out. However, some maintenance procedures require uncapping the print heads and then moving the carriage unit to the center of the platen, or to the far left side of the platen.

Using **SP2-102-004** (Maintenance Unit Exchange: Decapping) is the best way to move the carriage unit, but you can also uncap the print heads and move the carriage unit manually. For example, you may need to move the carriage out of the home position manually when you already have the machine partially disassembled and realize that you must move the carriage unit.

There may be occasions when you need to return the maintenance unit to the home position manually to prevent the print heads from drying out.

- If the machine is partially disassembled at the end of the work day, the print heads should be capped manually before leaving the machine to sit for more than an hour.
- If the machine was operating when a power outage occurred, leaving the carriage unit out of the home position, you will need to cap the print heads if power cannot be restored within a short time.

Move the Carriage Unit with SP2-102-4

Before you turn the machine off for a service procedure that requires that the carriage be out of the home position.

1. Go into the System SP mode.
2. Open SP2-102-4 (Maintenance Unit Exchange: Decapping).
3. Select the setting for the procedure you need.

2-102-4	Maintenance Unit Exchange Reset – Decapping
1	Lowest the maintenance unit ink caps and uncaps the print heads. The carriage does not move.
2	Uncaps the print heads and moves the carriage to the left of the platen.
3	Uncaps the print heads and moves the carriage to the center of the platen. This is the most often used procedure during servicing.

4

4. Turn the machine off.
5. Always slide a sheet of paper under the carriage unit after it has been moved to the center. This protects the platen from ink that could drip from the uncapped print heads.

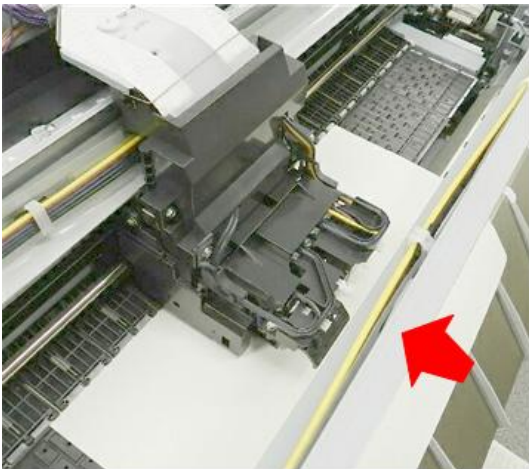

d124i208

6. Before you turn on the power switch to return the carriage unit to its home position on the right, check the position of the horizontal encoder strip on the left.
 - If the encoder strip is up on the bracket as shown at [A], pull it forward and down so that it is in front of the bracket as shown at [B].
 - If the machine is turned on with the strip positioned as shown at [A], the movement of the carriage unit may scratch the surface of the encoder strip.

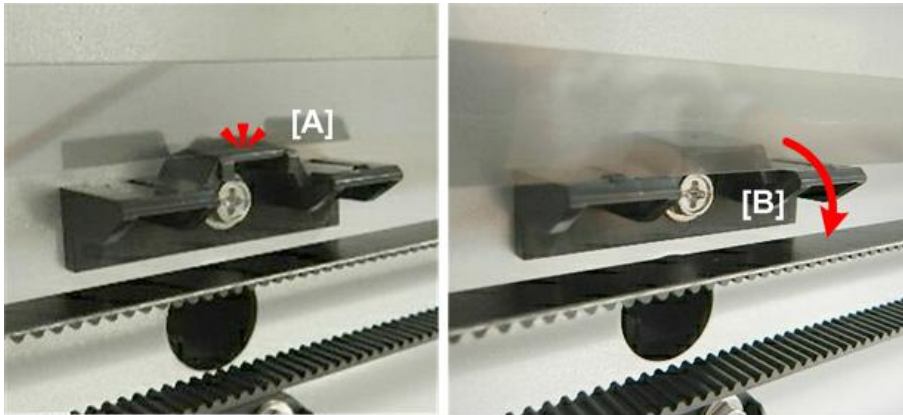

d124i209

7. After you reassemble the machine, turn the machine on. The carriage will return to the right side (home position), where the maintenance unit will cap the print heads automatically.

4

Uncapping the Print Heads and Moving the Carriage Unit Manually

1st Point: Suction Cap (K1)

- Rotating the hex socket at [A] raises and lowers suction cap [B] which covers the K1 print head.
- Normally the suction cap is up and engaged with the black print head of the carriage unit to keep it from drying out.
- The suction cap must be lowered before the carriage can be moved away from the right side of the machine.

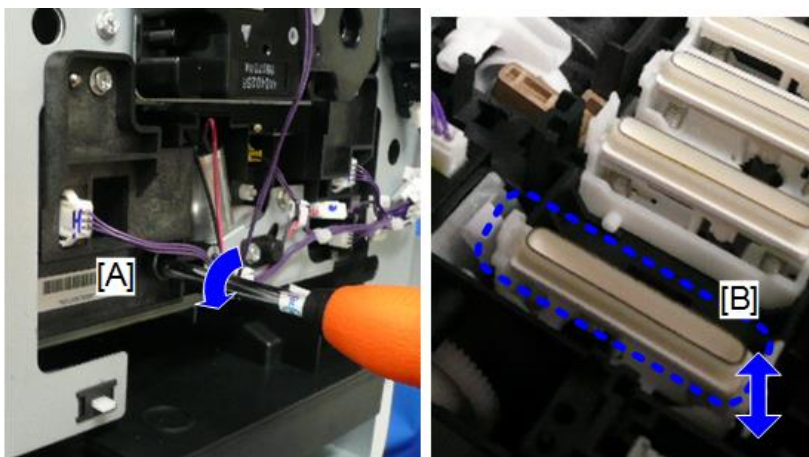

d262k0123

2nd Point: Print Caps (K2, M1Y1, C, M2Y2)

- Rotating the hex socket at [A] raises and lowers print head caps [B] which cover the K2, M1Y1, C, and M2Y2 print heads.
- Normally, these print head caps are up and engaged with the K2, M1Y1, C, and M2Y2 print heads of the carriage unit to keep them from drying out.
- The print head caps must be lowered before the carriage can be moved away from the right side of the machine.

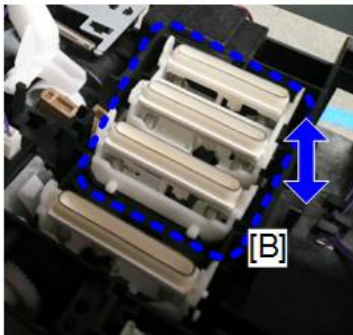
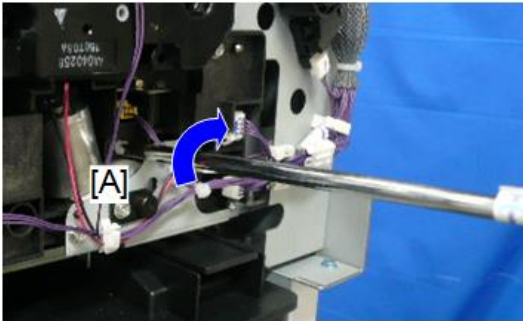

d262k0124

Procedure

1. Raise the front cover (p.249).
2. Raise the paper holding lever [A].
3. Side a sheet of paper [B] into the machine as far as the gap between the raised rollers and the platen.
4. Lower the paper holding lever [C] to hold the paper in place.

Note

- This paper protects the platen from ink that may leak from the carriage unit after it is moved away from the right side of the machine.

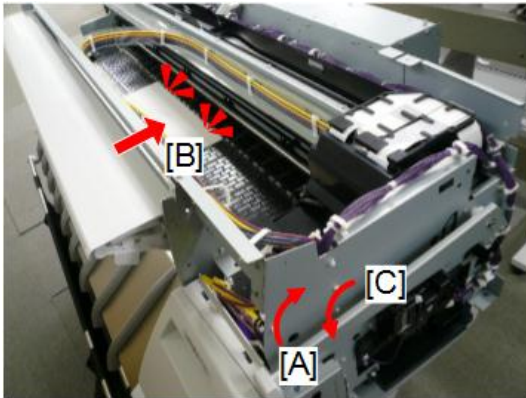

d262k8112

4

5. Check the gap on the right side of the maintenance unit.

- There will be no gap if the cleaning unit is forward and the suction cap is up. Go to the next step to lower the suction cap. Normally, the suction cap will be up.
- There will be a gap if the suction cap is already down. **Go to Step 7.**

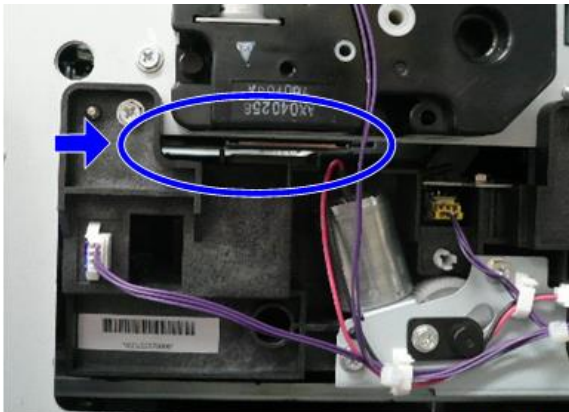

d262k0125

- 6. Set a screwdriver in hole [A] and rotate it counter-clockwise to lower the suction cap. Use a flashlight to confirm that the suction cap is down.**

7. Set a screwdriver in hole [B] and rotate it clockwise to lower the K2 and color print head caps. Use a flashlight to confirm that the print head caps are down.

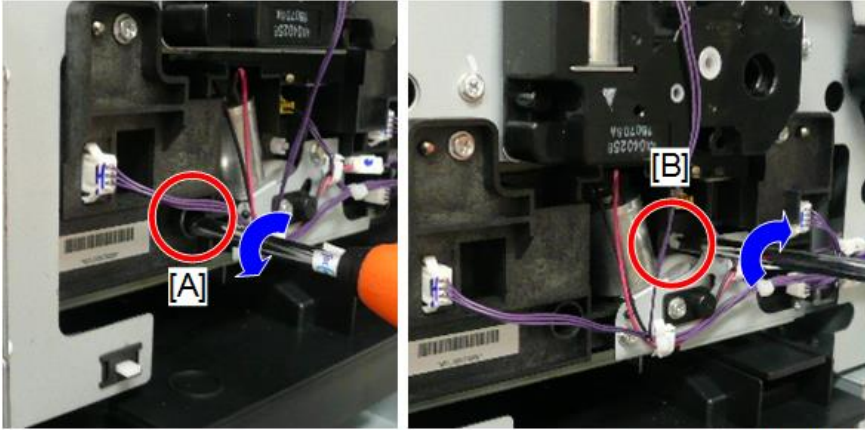

d262k0126

8. Once again check the gaps.
 - Both the suction cap and K2/color print head caps should be down.
 - Your view should not be blocked by either the suction cap or K2/color print head caps.

⚠ CAUTION

- To prevent damaging the caps, you must confirm that both the suction cap and K2/color print caps are down before you push the carriage unit away from the home position.

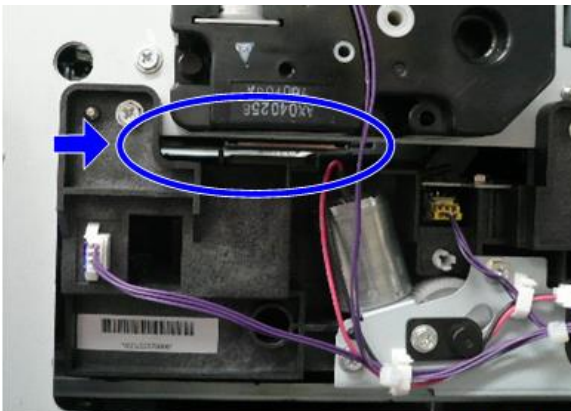

d262k0125

9. Push the carriage unit away from the right side of the machine so that it is over the paper.

Capping the Print Heads Manually

★ Important

- Do this procedure only when it is absolutely necessary and the print heads cannot be capped automatically by switching the machine on.
- Slowly, push the carriage unit to the right side of the machine until it stops. The carriage should be over the maintenance unit.

★ Important

- In order to prevent damage to the wipers and edges of the print head caps, the print heads must be positioned directly above the print head caps within ± 0.8 mm.
- Use a flashlight to look through the hole and check the position of the hex socket.
 - If the hex socket is visible [A], the cleaning unit is forward and no adjustment is necessary. **Go to the next Step.**
 - If the hex socket is only partially visible or not visible at all [B] and [C], then set a screwdriver at [D] and rotate it counter-clockwise to move the cleaning mechanism until you see the hex socket [A]. This moves the cleaning unit forward so that you can raise the suction cap.

★ Important

- The cleaning unit may be out of position (to the rear) only if the machine was interrupted during the print head cleaning cycle as a result of a power outage.

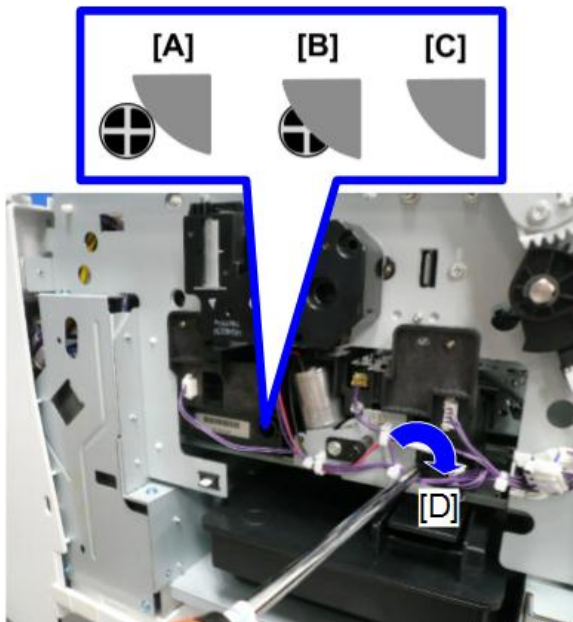

- Set a screwdriver in hole [A] and rotate it counter-clockwise to raise the suction cap. Use a flashlight to confirm that the suction cap is up.

4. Set a screwdriver in hole [B] and rotate it clockwise to raise the K2 and color print head caps. Use a flashlight to confirm that the print head caps are up.

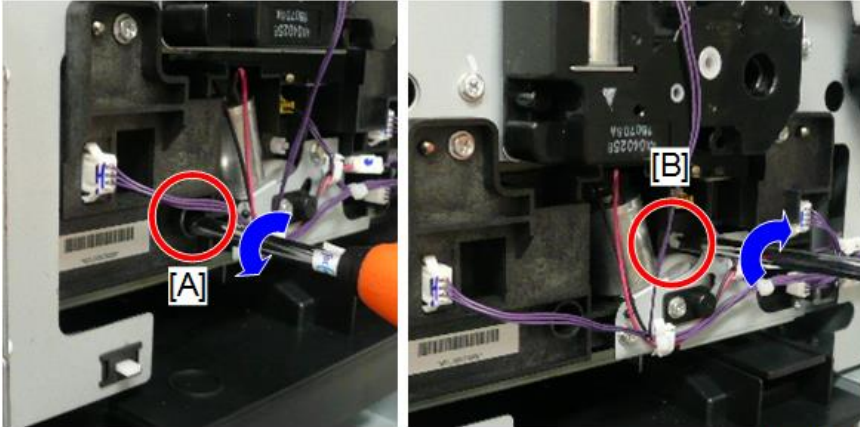

d262k0126

5. Once again check the gaps. Both the suction cap and K2/color print head caps should be up.
6. At the resumption of servicing, be sure to uncap the print heads before you move the carriage unit manually.

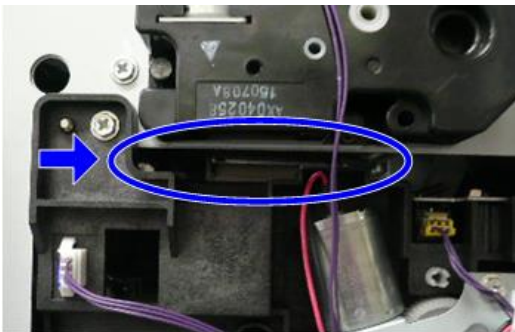

d262k0128

Disconnecting the Main Unit from the Scanner Unit

⚠ WARNING

- Before doing any procedure, always turn off the power switch and unplug the machine from its power source. Or electric shock or defect may be caused.

⚠ CAUTION

- Before you disconnect any of the cables, make sure that the LEDs on the BICU have turned off completely.

- In this model, note that the LEDs are not as close to the USB cable as usual.



d262k8523

4

Disconnecting the Scanner Cable

Disconnect the scanner cable from the main unit.

The figure below shows the wiring pattern in the main unit.

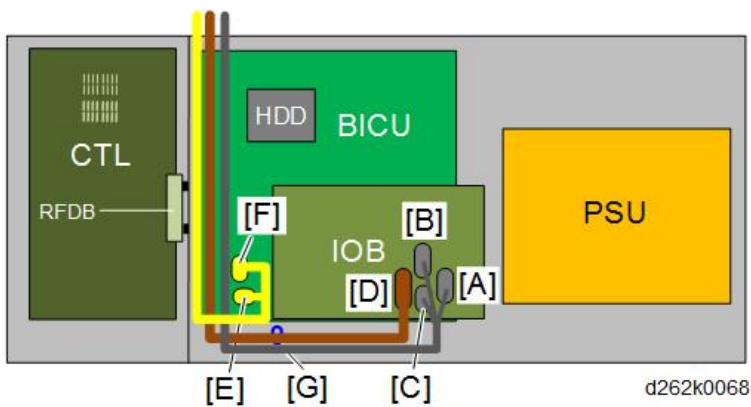

d262k0068

[A]	IOB CN258
[B]	IOB CN259

[C]	IOB CN256
[D]	IOB CN257
[E]	BICU CN216
[F]	BICU CN215
[G]	Ground clamp

1. Release the clamps in the main unit. Separate the power cord and disconnect the connector [A] of the power cord.

4

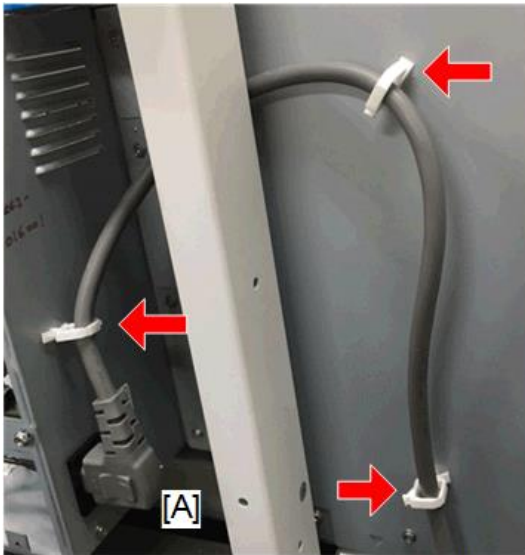

d262k0023

2. Disconnect the ground wires from the main unit ( x3: 3x6).

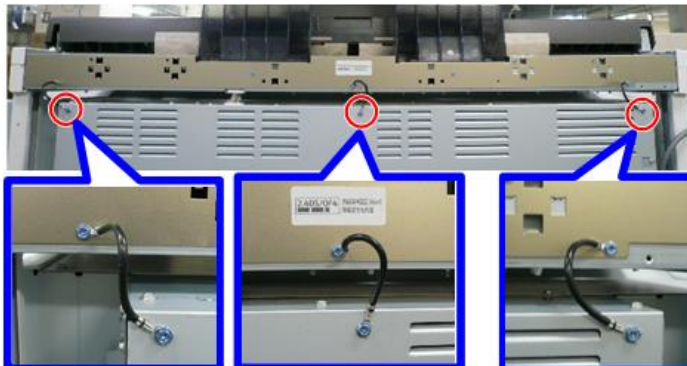

d262k0024

3. Remove the rear cover (p.544).

4. Remove the ground plate [A] ( x1 - M3x8)..



d262k0070

5. Remove all clamps in the figure below.

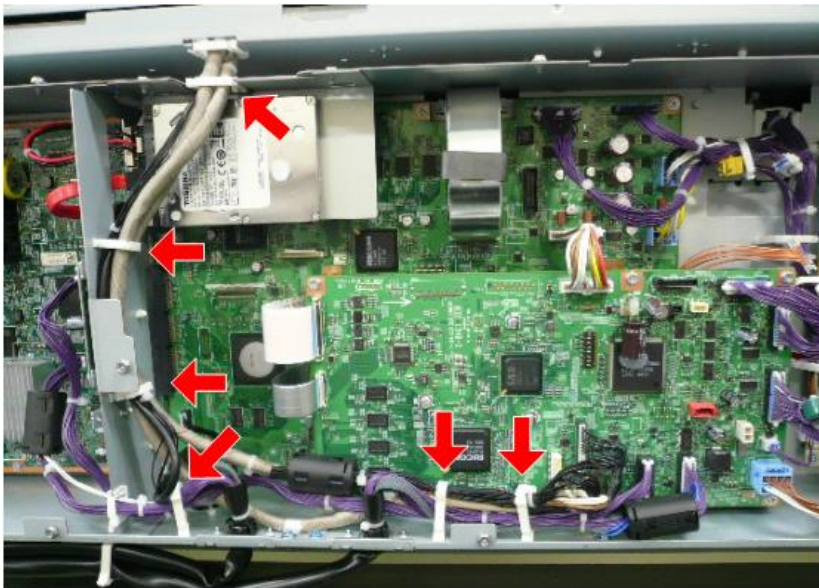

d262k0321

6. Disconnect all the connectors from CN258 [A], CN259 [B], CN256 [C], and CN257 [D] on IOB and CN216 [E] and cn215 [F] on BiCU

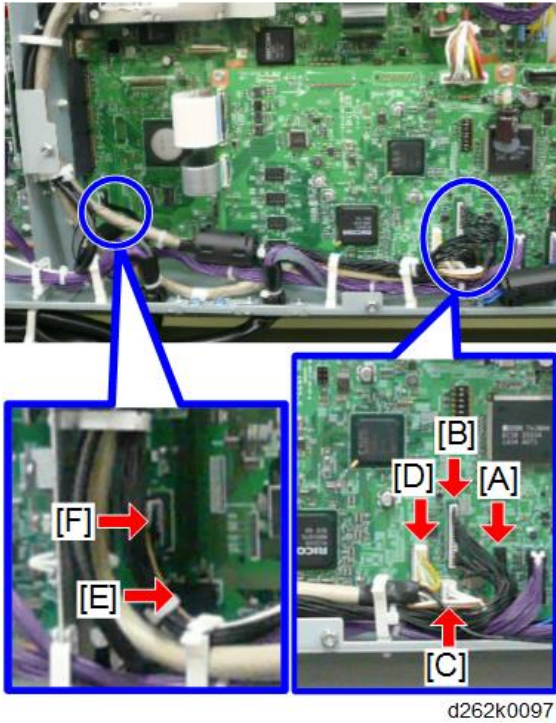

Separating the Main Unit from the Scanner Unit

Separate the main unit from the scanner unit completely.

1. Disconnect the scanner unit from the bracket [A] [B] ( x4: 4x6).

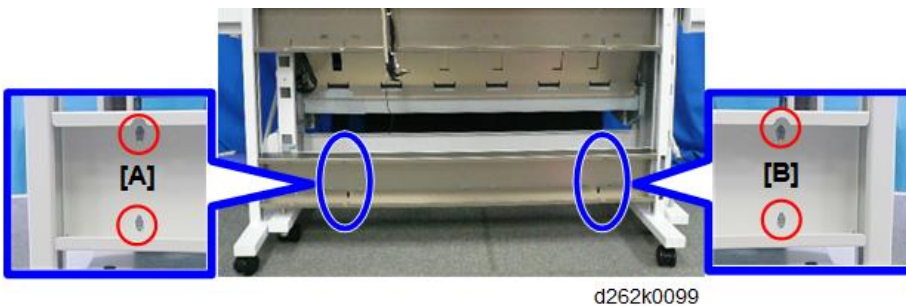

2. Slowly, pull the scanner stand away from the back of the main unit.

★ Important

- To avoid scratching or breaking the original table, never lay anything on the original table while you are working.

- Move the scanner unit and stand assembly carefully. It is top heavy and can tip over easily.





d262k0100

4

Operation Panel

The work other than removing of the operation panel, refer to the service manual for Smart Operation Panel.

Remove

1. Remove the screws on the operation cover. ( x2)
2. Release the hooks. ( x3)

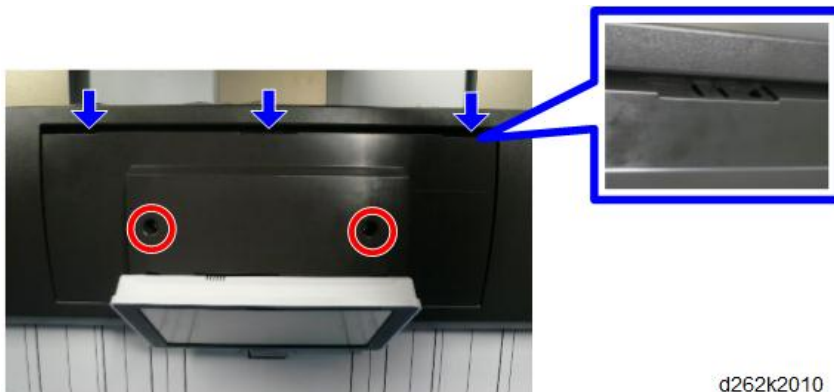

d262k2010

3. Push the operation cover in the direction indicated by the arrows and remove it.

Note

- Two hooks are on the back of the cover [A].

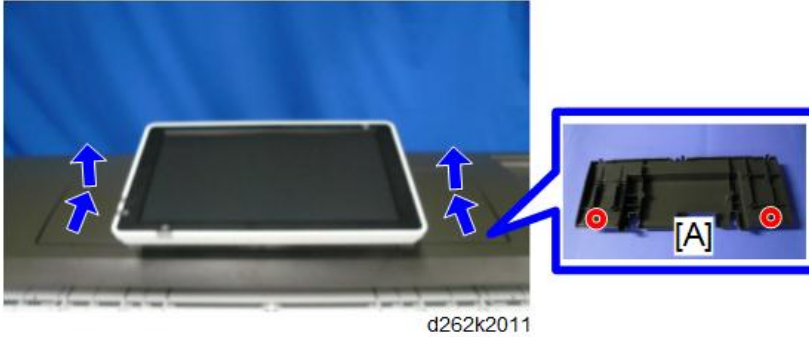

4

4. Remove the clamp and screws. (🔧 x1, 🔩 x5)

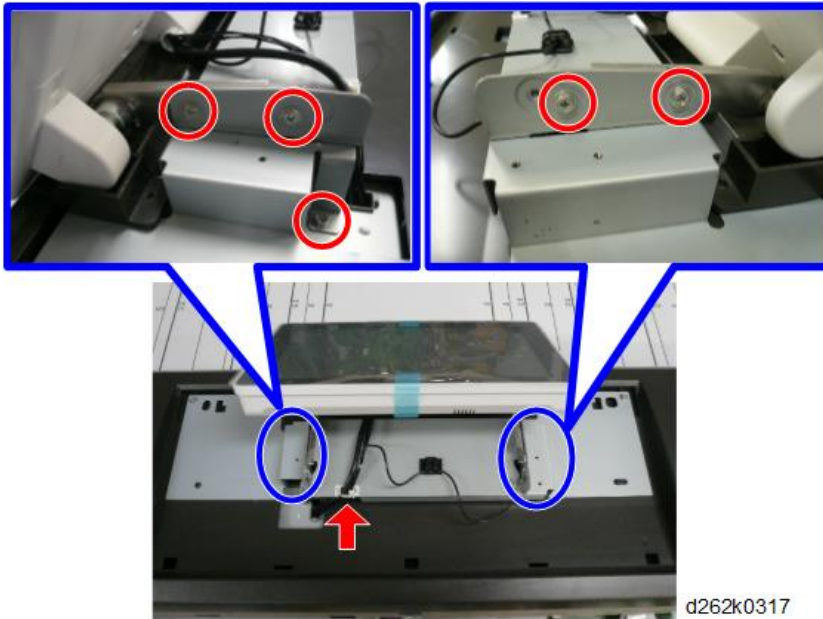

5. Remove the operation panel.

6. Remove the screws on the rear cover of the operation panel and remove the cover. (🔧 x3)

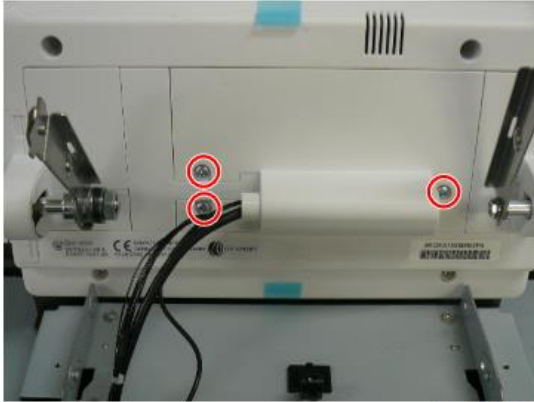

d262k0318

7. Remove the connectors and clamp. (🔧 x2, 🗑️ x1)

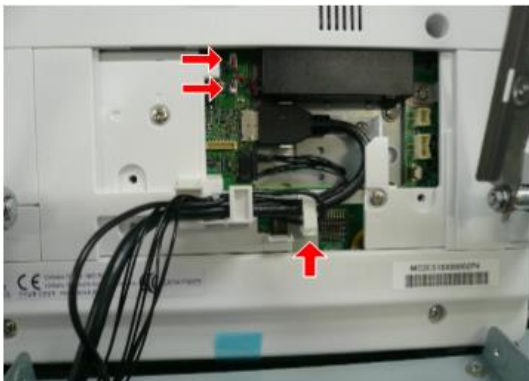

d262k0319

Precaution

Place the left and right supports of the operation panel at the L-shaped corners, move them in the direction indicated by the arrows, and seat them in the cutouts.

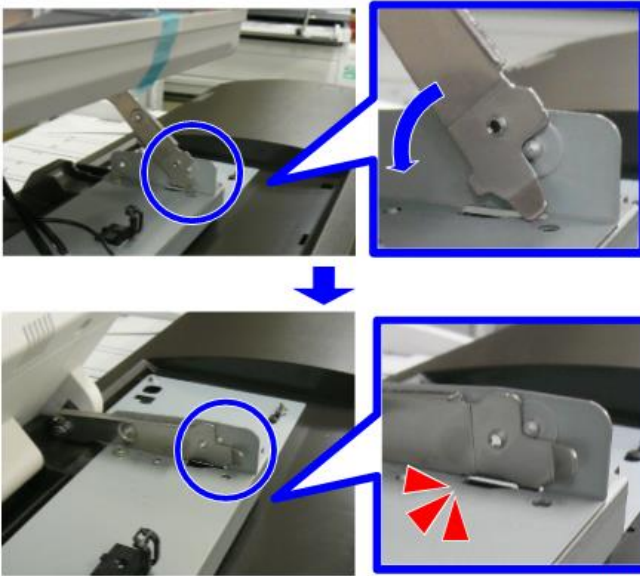

d262k0320

4

Mounting the Operation Cover

1. Align the hooks on the rear of the operation cover with the wide end of the mounting holes and pull the cover toward you. (▼ x2)



d262k2012

2. Hook the cover onto the rear of the operation cover. (▼ x3)

3. Tighten the screws. ( x2)

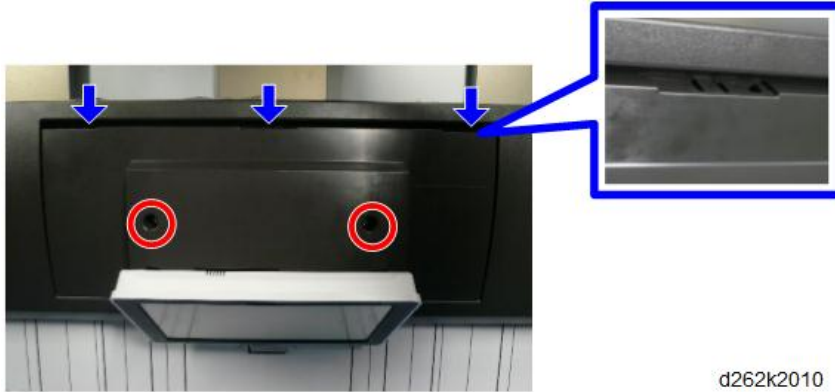

d262k2010

Scanner

Before You Begin

Safety Switch Diagram

To ensure the safety of everyone working around the machine, two switches inside the scanner section prevent the LED radiation from switching on accidentally.

- When the original feed unit is opened and the switches open, a +24V line connecting each LED driver on the SIF board is disconnected.
- When the original feed unit is closed and the switches close, the +24V line is re-connected.

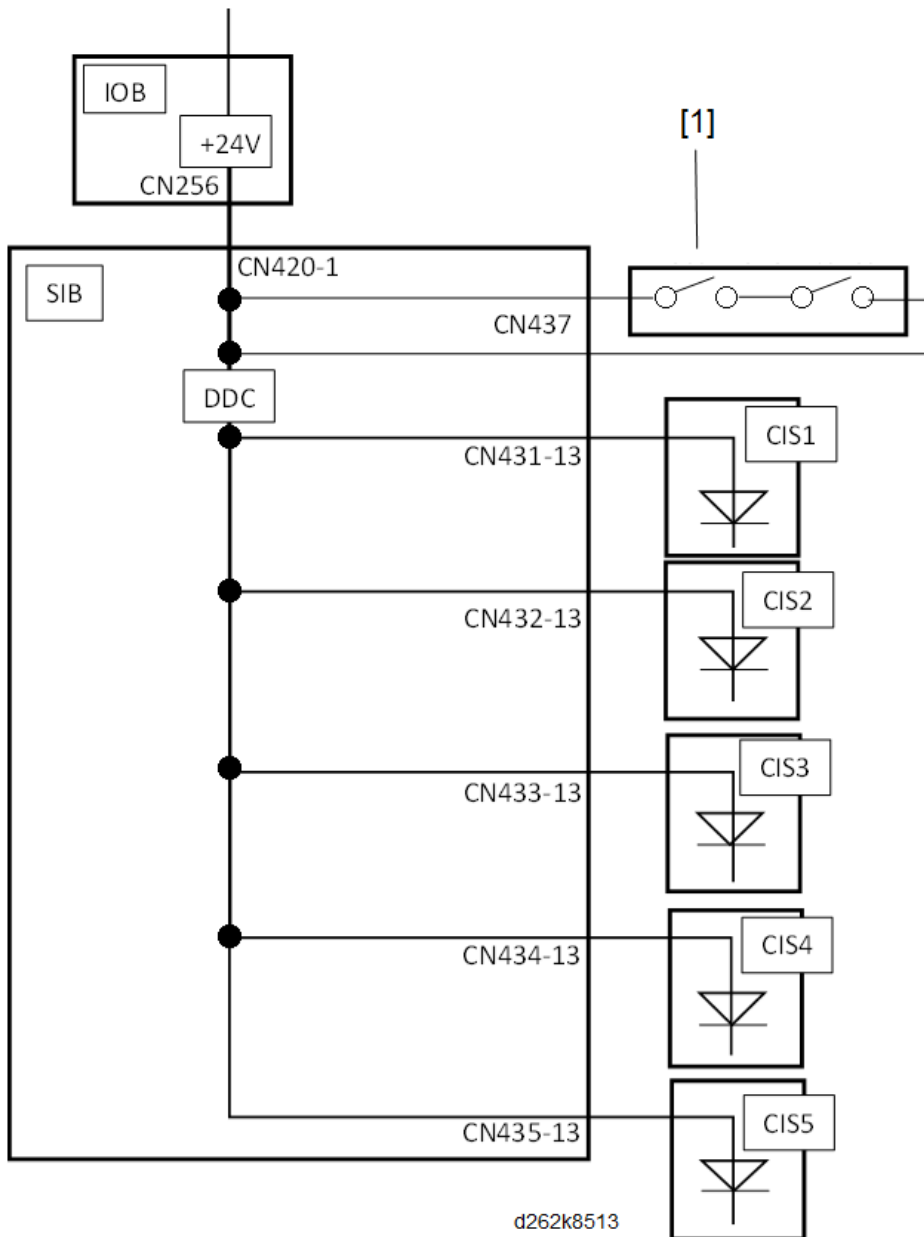

[1]: Scanner Switches

Original Width Sensors, Original Set Sensor

1. Remove the scanner rear cover (p.260).
2. Remove the scanner left cover and scanner right cover (p.260).

3. Raise the top of scanner unit to the full upright position (p.254).
4. Remove the original table (p.261).
5. Remove the sensor cover. ( x2)



d262k1017

6. Remove the screws of the sensor bracket and turn the bracket over. ( x3)

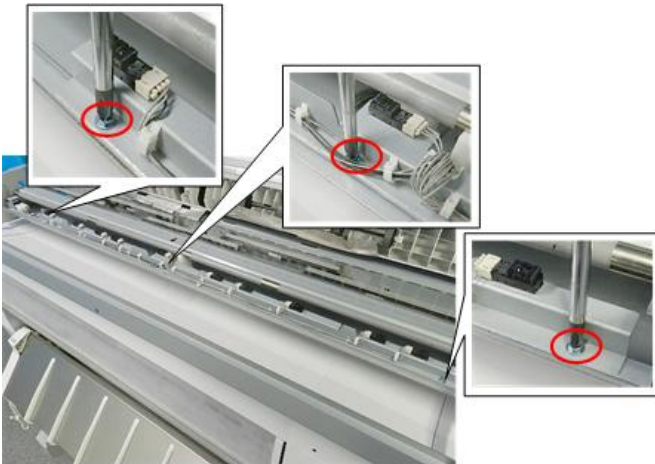

d124r121

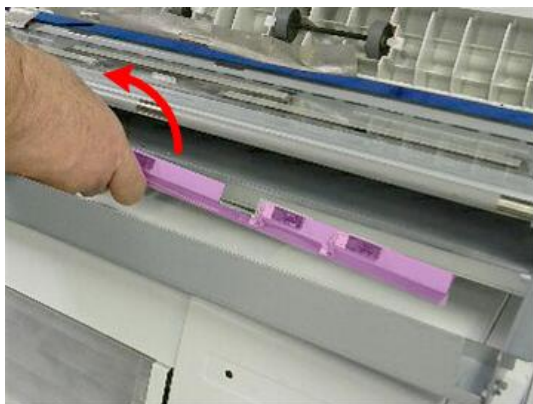

d124r122

7. In the center of the bracket, disconnect and remove the original set sensor. (🔧 x1, 🔪 x4, 📏 x1)

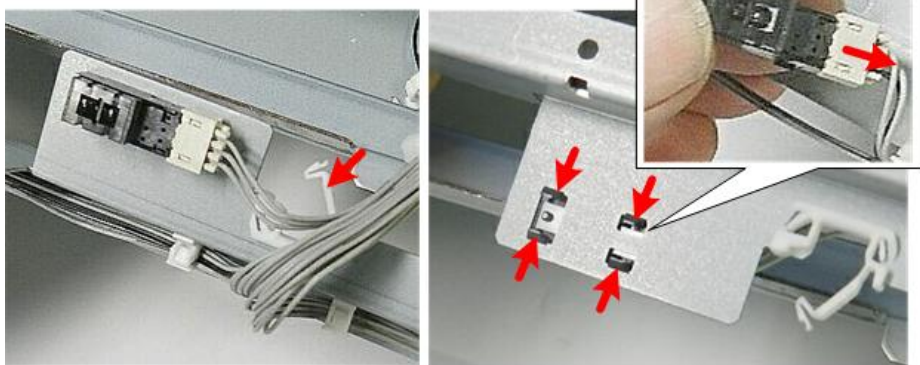

d124r123

8. Remove the other nine original width sensors. (🔧 x1, 🔪 x4, 📏 x1)

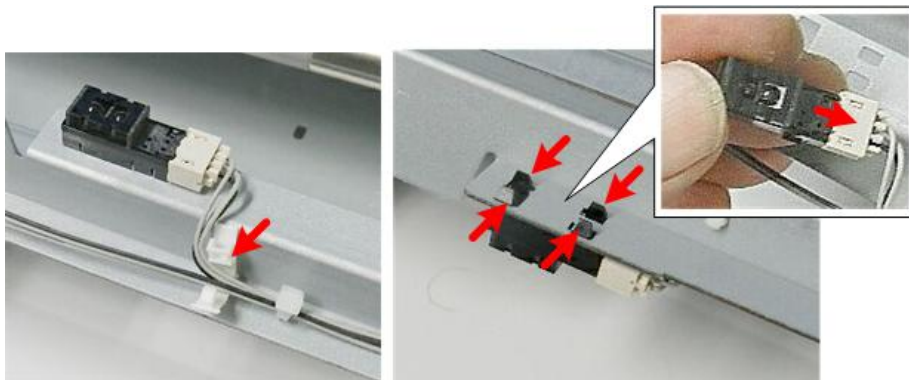

d124r124

Safety Switch

1. Remove the scanner rear cover (p.260).
2. Remove the scanner left cover and scanner right cover (p.260).
3. Raise the top of scanner unit to the full upright position (p.254).
4. Remove the original table (p.261).
5. Remove the sensor cover. ( x2)

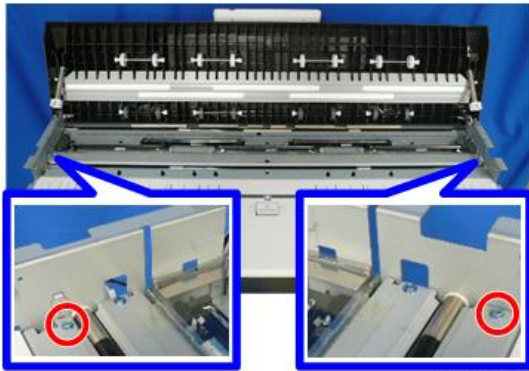

d262k1017

6. Remove the safety switch with the bracket [A]. ( x1)

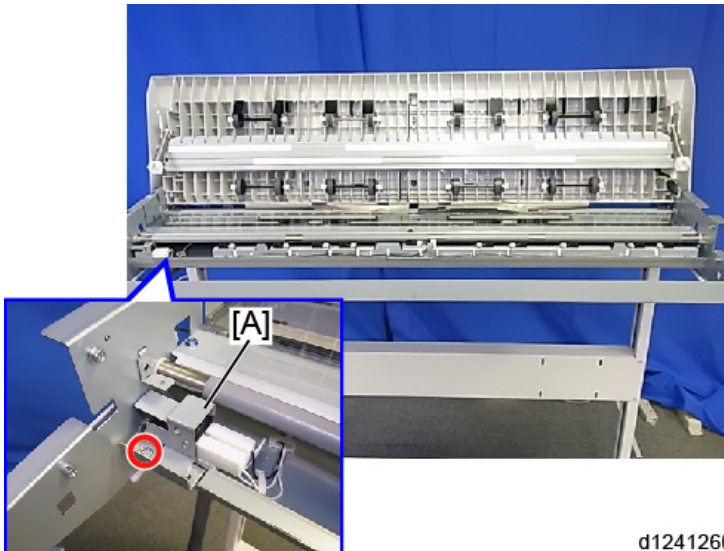

d1241260

7. Separate the bracket and the safety switch [A]. ( x2,  x2)

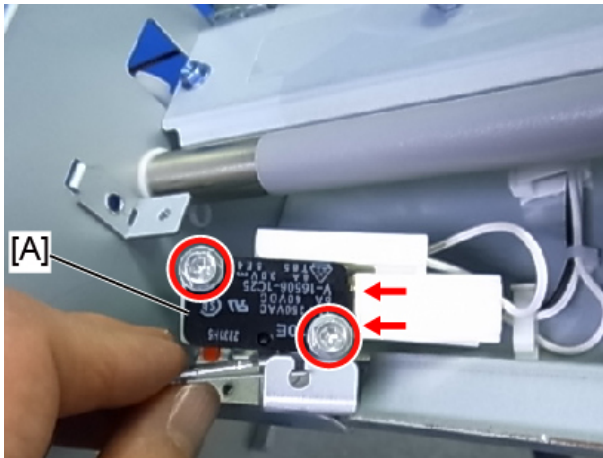

d1241261

4

Original Registration Sensor

1. Raise the top of scanner unit to the full upright position (p.254).
2. Remove the guide plate [A]. ( x2)

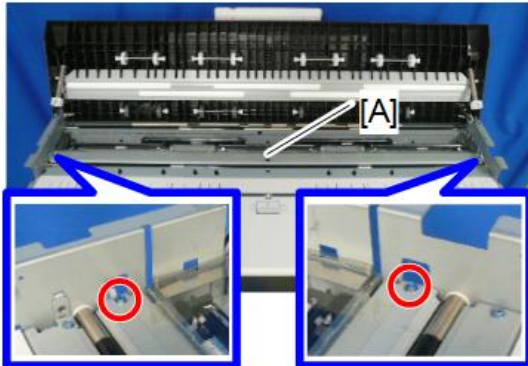

d262k1009

3. Remove the original registration sensor with the bracket [A]. ( x1,  x1,  x1)

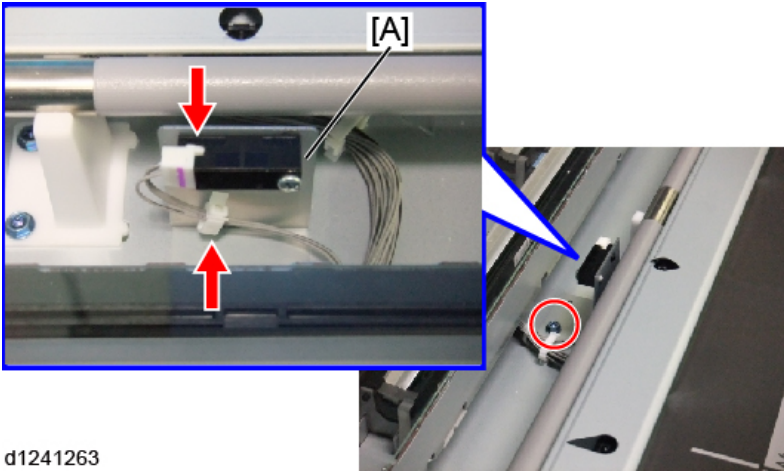

d1241263

4. Separate the bracket and the original registration sensor [A]. ( x1)

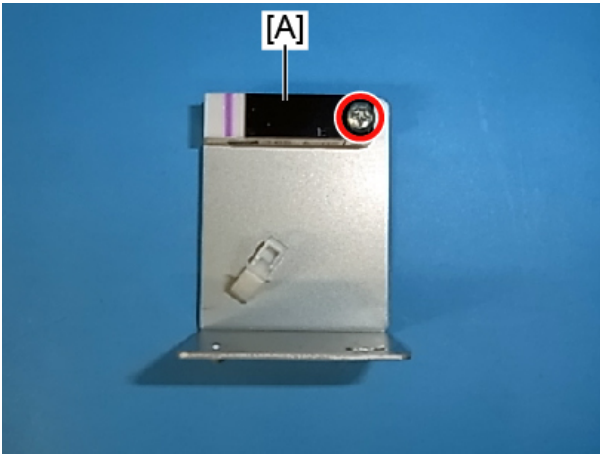

d1241264

Scanner Motor

1. Remove the scanner rear cover (p.260).
2. Remove the scanner left cover and scanner right cover (p.260).
3. Raise the left side of the scanner unit (p.262).

- Loosen the screw of the tension bracket [A], and then remove the spring [B] to loosen the tension of the timing belt. (🔧 x1)

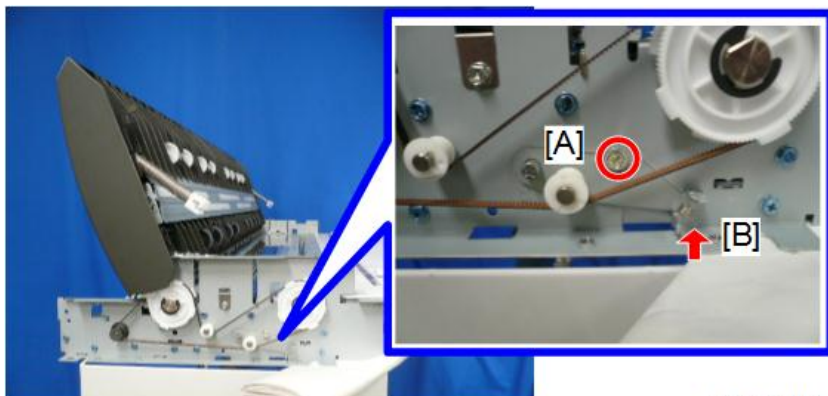

d262k1004

- Remove the timing belt [B] from the scanner motor [A].
- Remove the scanner motor [C]. (🔧 x2, 🛠️ x1)

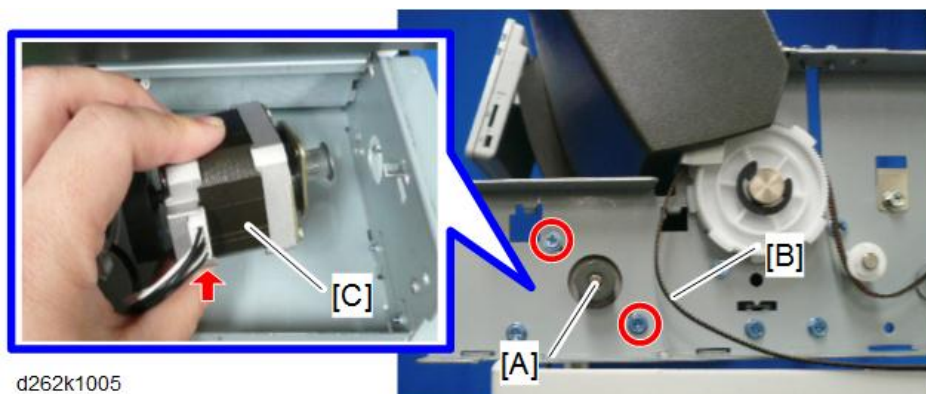

d262k1005

Scanner Motor



d1241347

4

SIB (Scanner I/F Board)

Remove

1. Remove the scanner rear cover (p.260).
2. Disconnect all the connectors connected to the SIB. (E⁺ x8, E⁻ x1)



d262k1006

3. Release the FFCs from the guide. (x5)

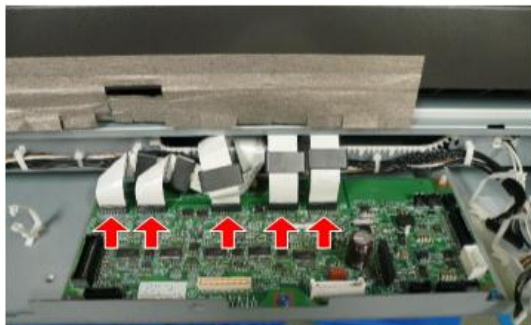

d262k1007

↓ Note

- Each FFC is numbered with the number of the CIS unit it is connected to.

4. Remove the SIB. (x3, x3)

↓ Note

- Use a pair of radio pliers to disconnect the front edge of the board.



d262k1008

Precaution

Each FFC connector slot is marked with the number of CIS element that it connects to. The example below shows "CIS 5".

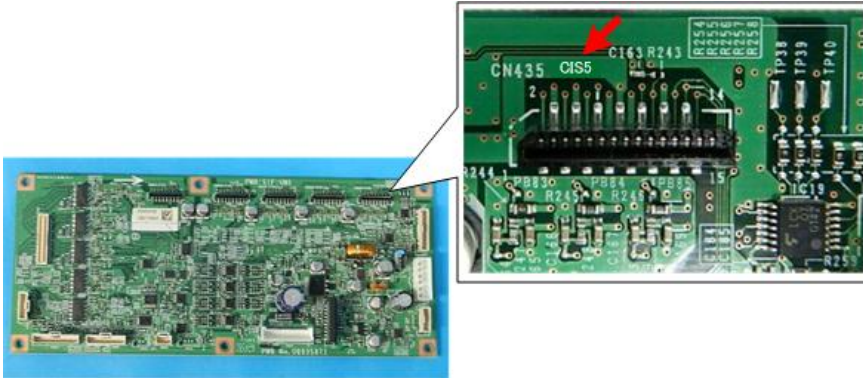

d124r106a

4

Connect the FFC with the same number as the number of the SIB connector to the SIB.

Note

- If the tip of the FFC curls, flatten it and make the connection.
- If the FFC is connected with its tip curled, SC may be displayed or the picture cannot be copied or scanned properly.

Original Feed Roller

Remove

1. Remove the scanner rear cover (p.260).
2. Remove the scanner left cover and scanner right cover (p.260).
3. Raise the top of scanner unit to the full upright position (p.254).
4. Remove the guide plate [A]. ( x2)

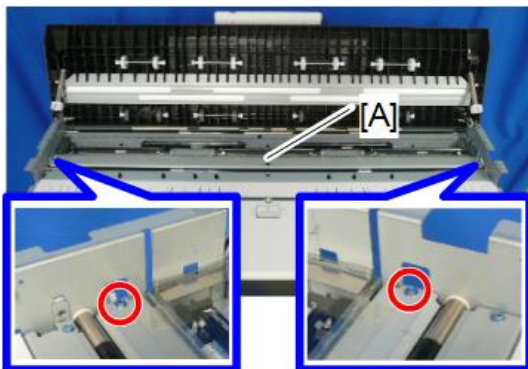

d262k1009

5. Raise the left side of the scanner unit (p.262).

6. Loosen the screw of the tension bracket [A], and then remove the spring [B] to loosen the tension of the timing belt. (🔧 x1)

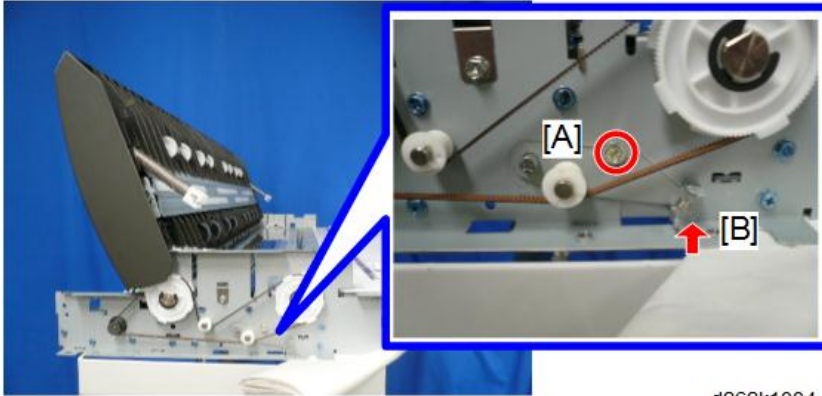

d262k1004

4

7. Remove the timing belt from the original feed roller drive gear

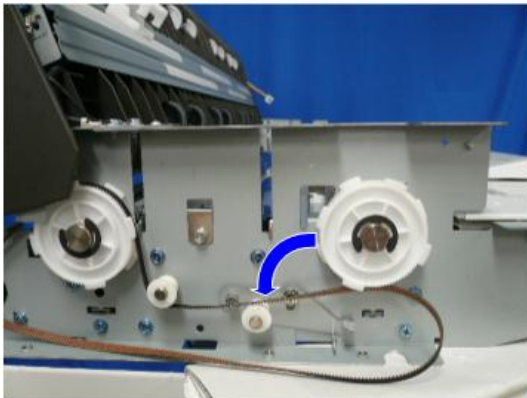

d262k1010

8. Remove the gear and shaft. (🔧 x1)

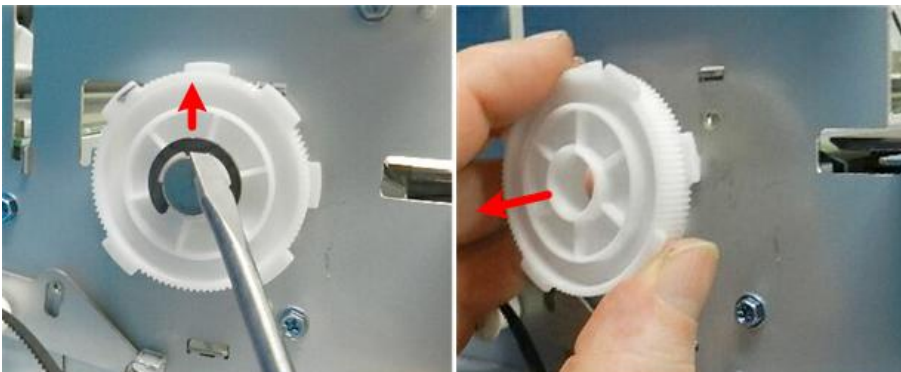

d124r152

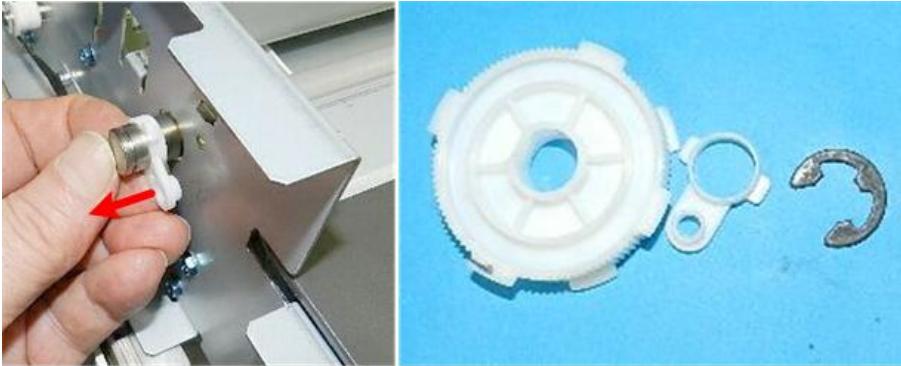

d124r154

4

Note

- Attach the gear with the face of the gear [A] inserted against the frame so that it can fit over the flat side of the shaft [B].

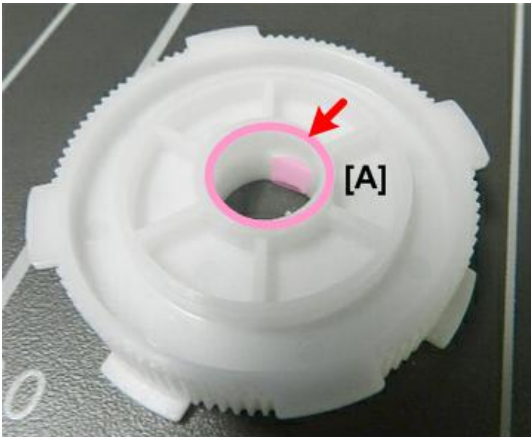

d124r153

9. Lower the left side of the scanner unit.
10. Raise the right side of the scanner unit (p.264).
11. On the right, remove the ground plate [A] from the shaft. ( x1)

Note

- Conductive grease is applied to the shaft and ground plate. Avoid to attach it around.

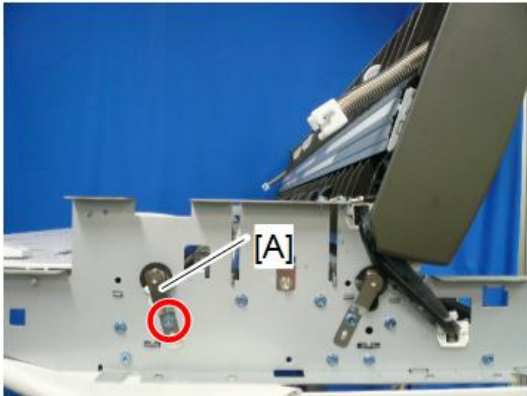

d262k1011

12. Remove the shaft. (Ⓒ x1, wave washer x1, washer x1)

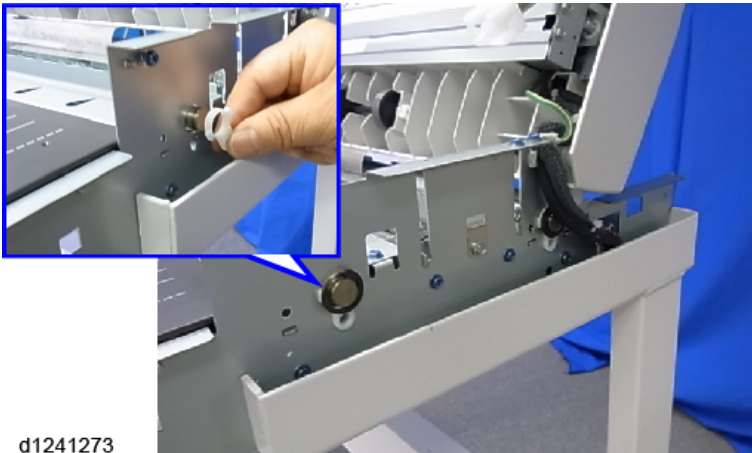

d1241273

13. Slide the original feed roller [A] to the left until you see the coated surface close to the hole in the frame [B] and remove the right end of the roller from the hole of the right frame.

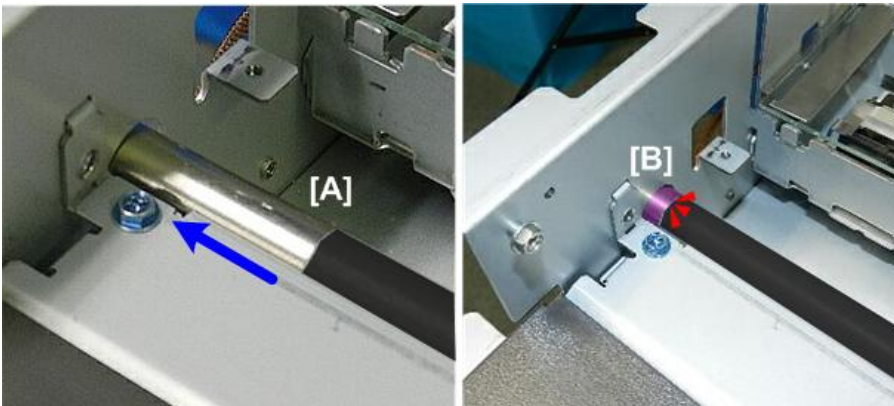

d124r157

4

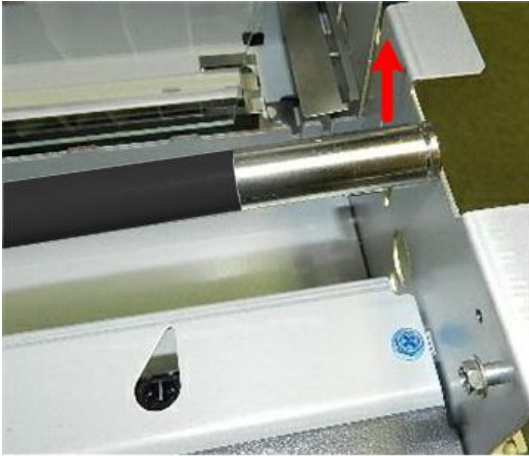

d124r158

14. Slide the original feed roller to the right, and remove the left end of the roller from the hole of the left frame to remove the roller from the main unit.

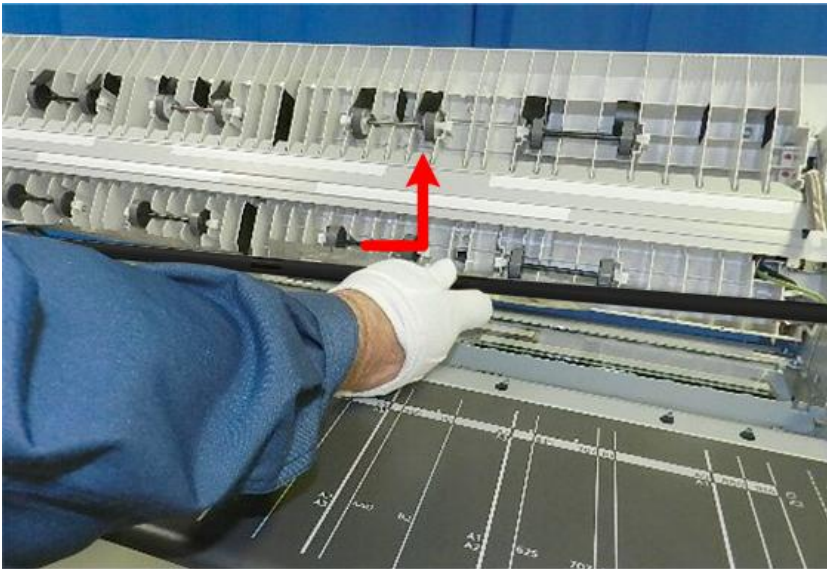

d124r159

Adjustment

After changing the original feed roller, perform the CIS adjustment (p.586).

Exposure Glass

Remove

⚠ CAUTION

- The exposure glass is very long and thin. It is very easy to break. Handle it carefully.

1. Remove the scanner rear cover (p.260).
2. Remove the scanner left cover and scanner right cover (p.260).
3. Raise the top of scanner unit to the full upright position (p.254).
4. Remove the guide plate [A]. ( x2)

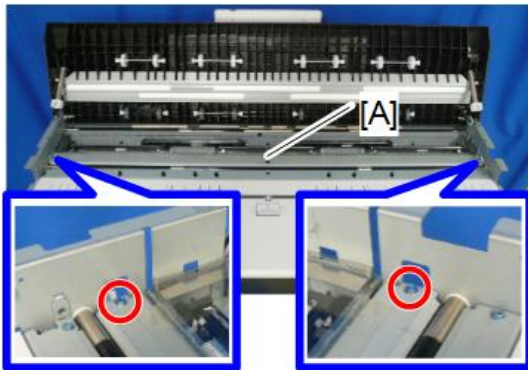

d262k1009

5. Remove the screw on the right side [A] and the leaf spring [B] on the right of the exposure glass. ( x1 with washer)

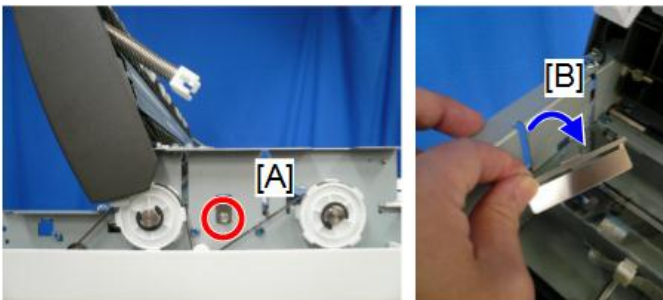

d262k1012

6. Remove the screw on the left side [A] and the leaf spring [B] on the left of the exposure glass. ( x1 with washer)

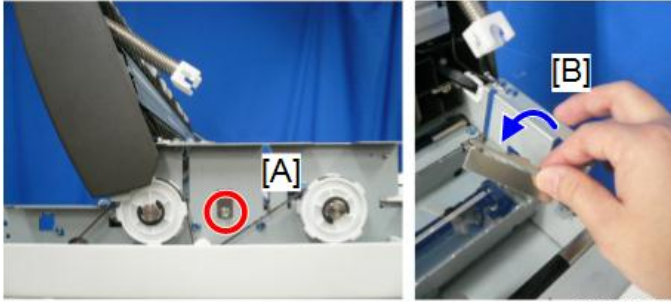

d262k1013

4

7. Remove the exposure glass.

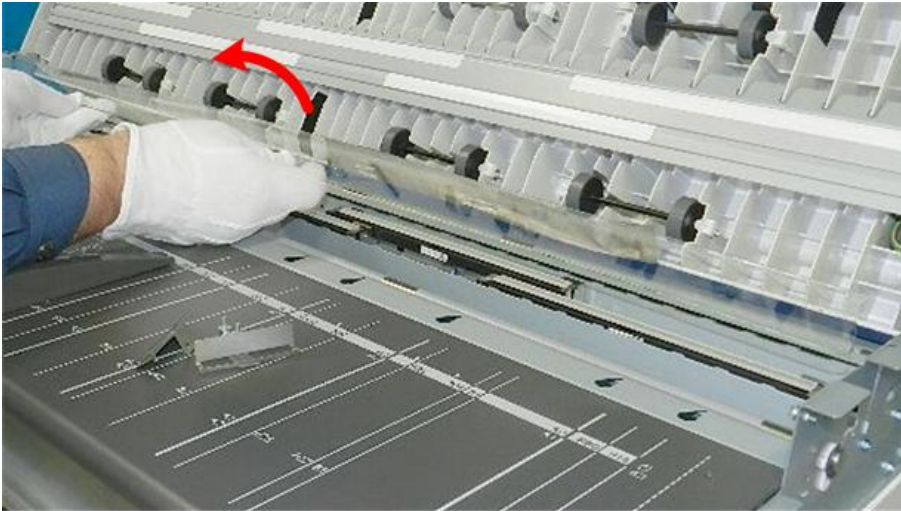

d124r132

Precaution

When you reinstall the exposure glass, set the glass so that the blue dot on the side of the glass is placed at the front side of the main unit.

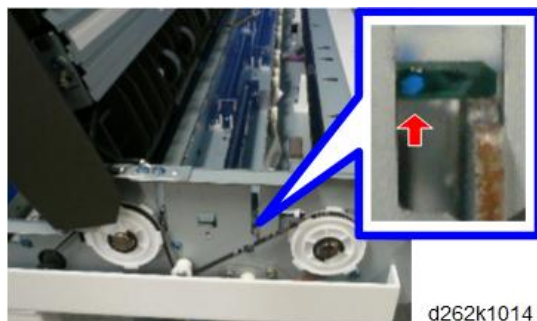

CIS Unit

4

Remove

⚠ CAUTION

- For changing or adjusting, be sure to turn the main power off. Otherwise the LED emission may damage your eyes.
- Follow these cautions when changing the CIS unit. Otherwise the CIS may be damaged or print quality may be deteriorated.
 - Handle the CIS unit carefully to protect it from sudden shock and vibration.
 - Never touch the CIS lenses.
 - Clean the CIS lens cover with lens paper only. Never use tissues paper or cloth that could leave lint or other particles on the lenses.
 - Never disconnect the signal or power supply harnesses from the CIS unit.

1. Remove the scanner rear cover (p.260).
2. Remove the scanner left cover and scanner right cover (p.260).
3. Raise the top of scanner unit to the full upright position (p.254).
4. Remove the exposure glass (p.299).

5. Release the FFCs, and push them in the opening [A]. ( x5)

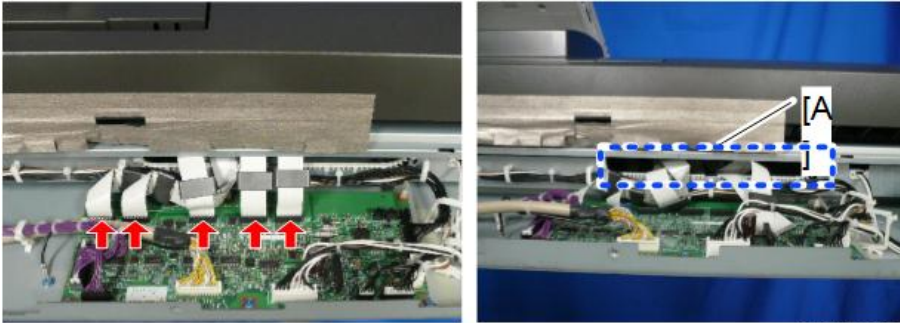

d262k1015

4

6. Remove the screws from the left [A] and right [B] sides of the CIS frame. ( x4)

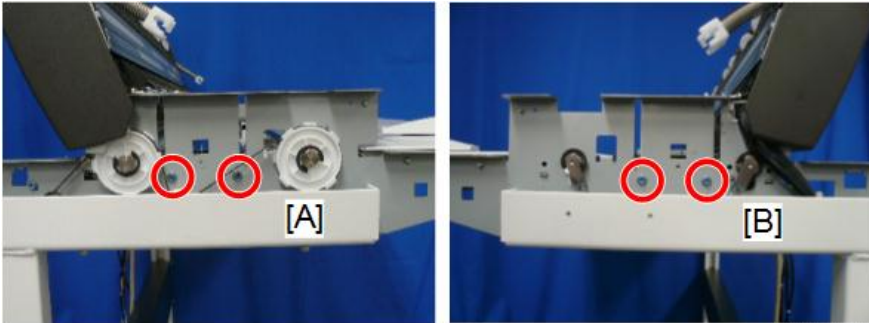

d262k1016

7. Remove the CIS unit [A].

 Note

- Lift the right side of the CIS unit and move it to the right to remove.
- Never touch the CIS lenses.
- Handle the CIS unit carefully to protect it from sudden shock and vibration.

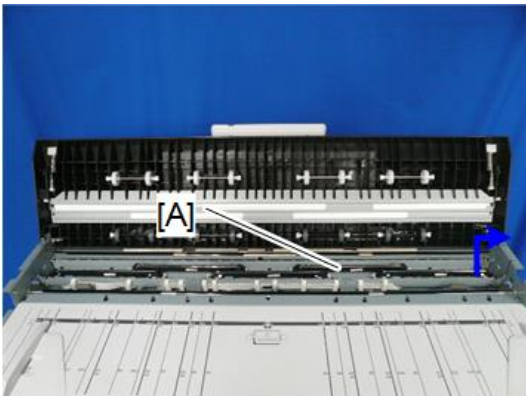

d262k1024

Precaution

1. Never touch the CIS lenses.

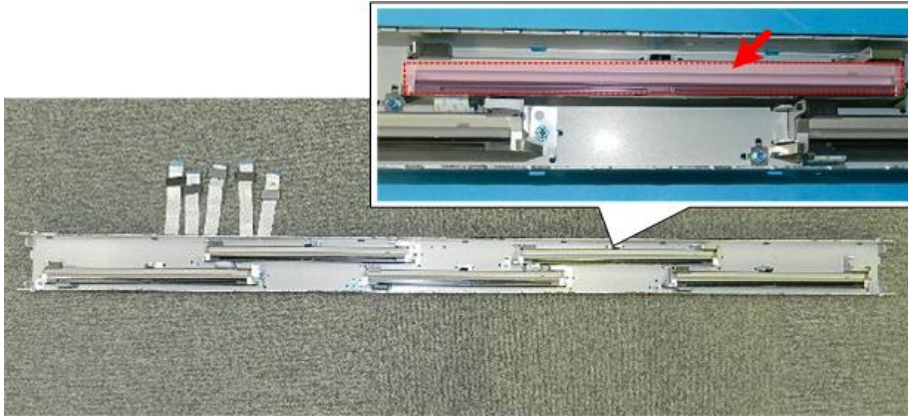

2. Clean away smudges or dirt with lens paper.
3. At the rear, locate the slot rimmed with white plastic [A]. This is where the FFCs will be re-inserted.

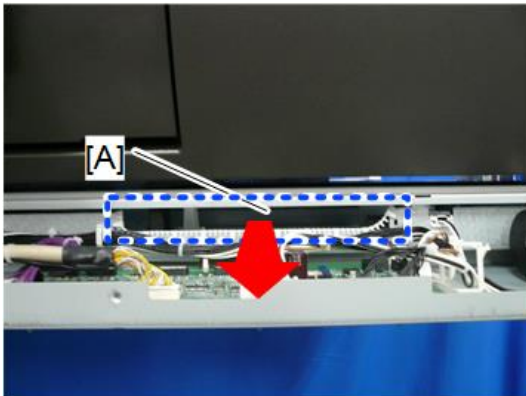

d262k1025

4. Insert the CIS units to the slits on the left [A] and right [B].

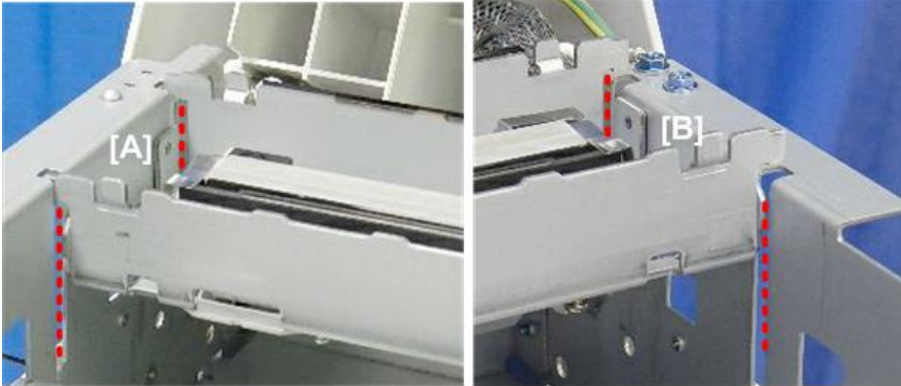

d124r141

4

↓ Note

- To attach the CIS unit, fully insert the frames on the both sides to the slits of the main unit and fasten it with screws.
- Check that there is no dust or dirt on the CIS lenses or exposure glass.

5. At the rear, pull each FFC through the slot using the Allen key.

6. Connect the FFCs to the SIB. ( x5)

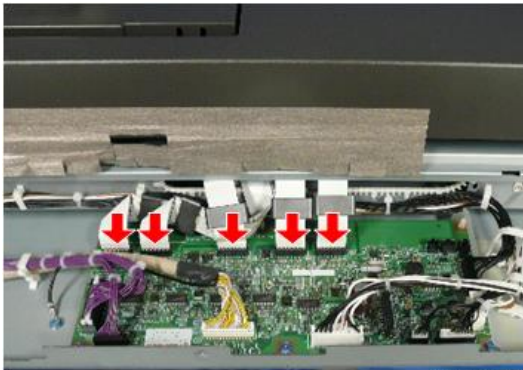

d262k1026

↓ Note

- Each FFC connector slot of the SIB is marked with the number of CIS element that it connects to. The example below shows "CIS 5".
- Connect the FFC with the same number as the number of the SIB connector to the SIB.

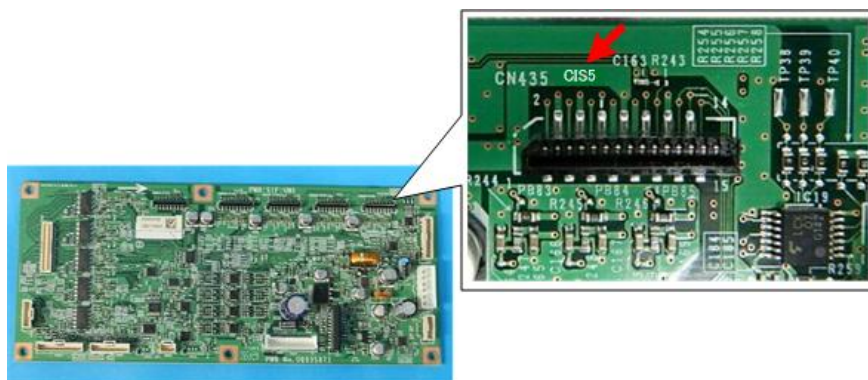

d124r106a

↓ Note

- If the tip of the FFC curls, flatten it and make the connection.
- If the FFC is connected with its tip curled, SC may be displayed or the picture cannot be copied or scanned properly.

4

Adjustment

After changing the CIS Unit, perform the CIS adjustment (p.586).

Original Exit Sensor

1. Remove the top of scanner unit (p.255).
2. Remove the CIS unit (p.301).
3. Remove the brackets on both sides of the original exit roller. ( x4)

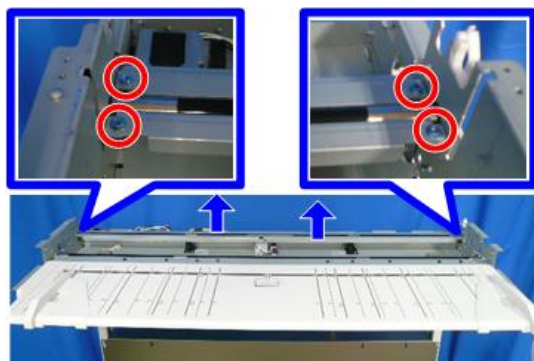

d262k1020

4. Remove the original exit sensor. (🔧x1, 🛠️x1, 🗑️x1)

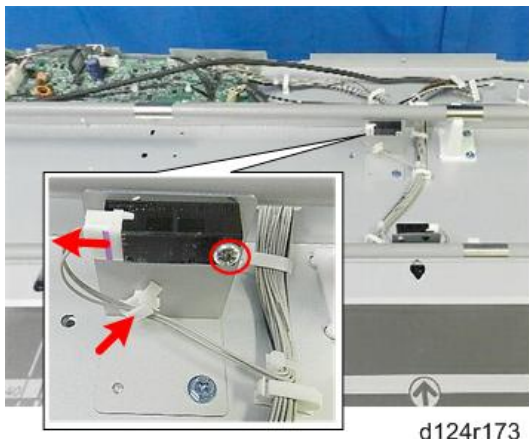

4

Original Exit Roller

Remove

1. Remove the top of scanner unit (p.255).
2. Remove the CIS unit (p.301).
3. Remove the brackets on both sides of the original exit roller. (🔧x4)

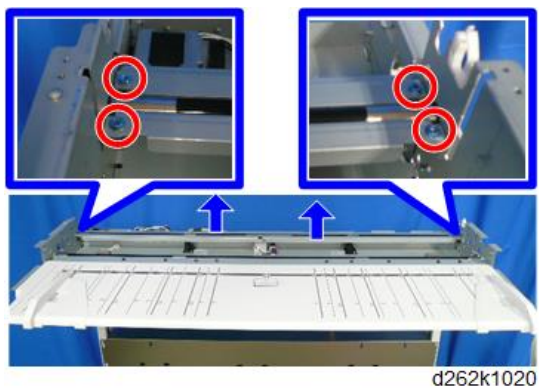

4. Raise the left side of the scanner unit (p.262).

5. Loosen the screw of the tension bracket [A], and then remove the spring [B] to loosen the tension of the timing belt. (🔧 x1)

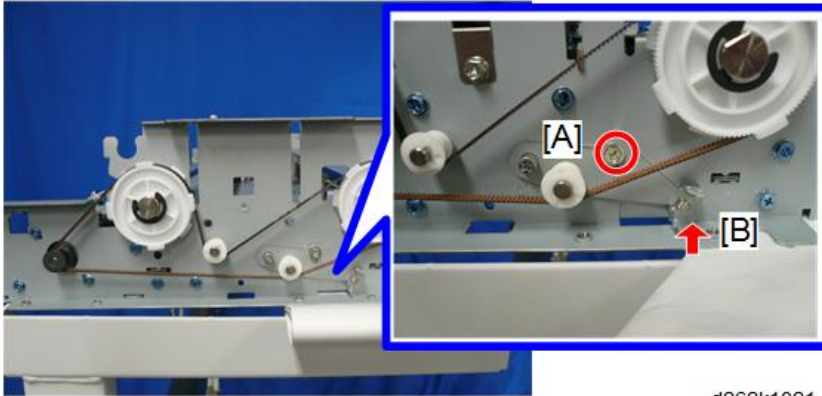

d262k1021

4

6. Remove the timing belt from the original feed roller drive gear.

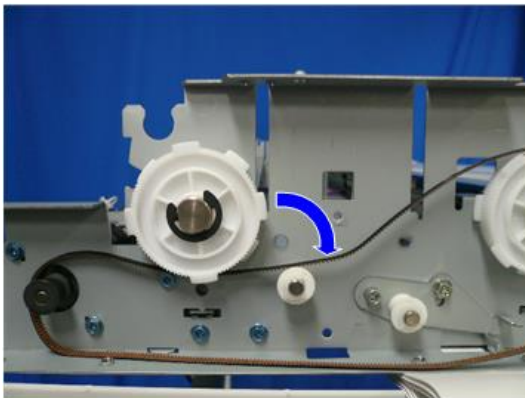

d262k1022

7. Remove the gear and shaft. (🔧 x1)

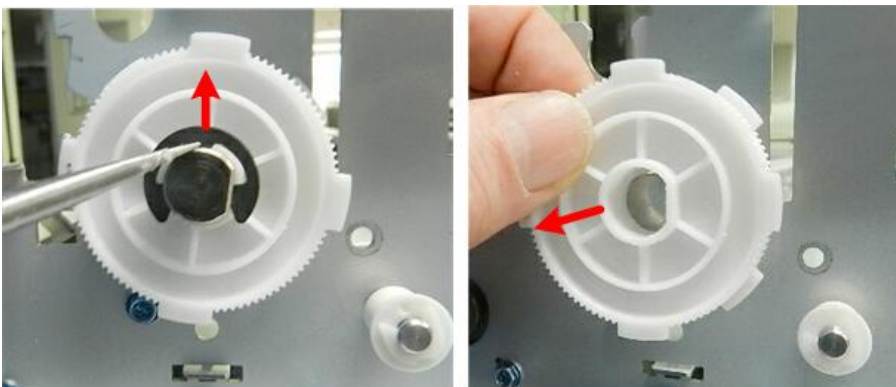

d124r176

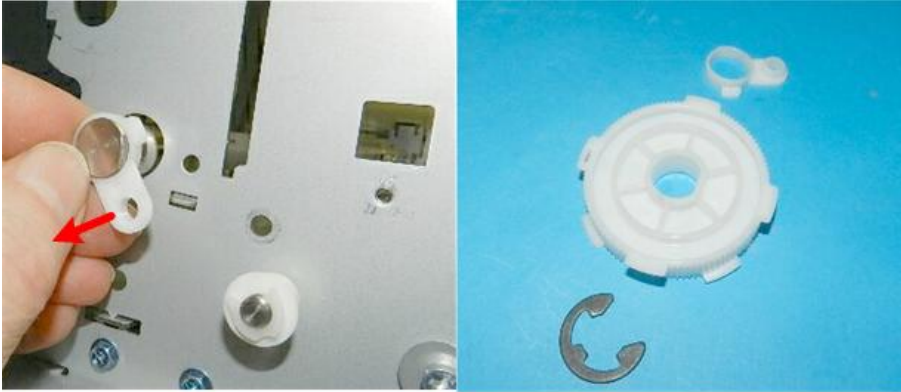

d124r177

4

Note

- Attach the gear with the face of the gear [A] inserted against the frame so that it can fit over the flat side of the shaft [B].

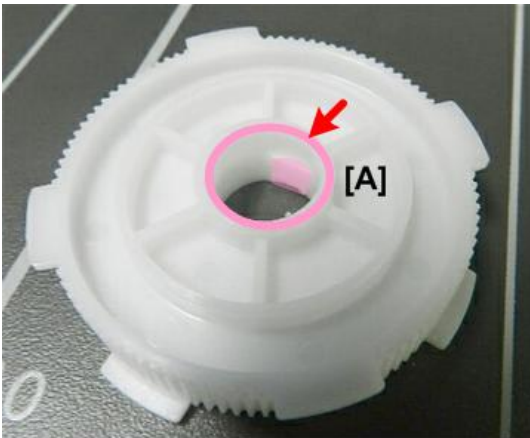

d124r153

8. Lower the left side of the scanner unit.
9. Raise the right side of the scanner unit (p.264).
10. On the right, remove the ground plate [A] from the shaft. ( x1)

Note

- Conductive grease is applied to the shaft and ground plate. Avoid to attach it around.

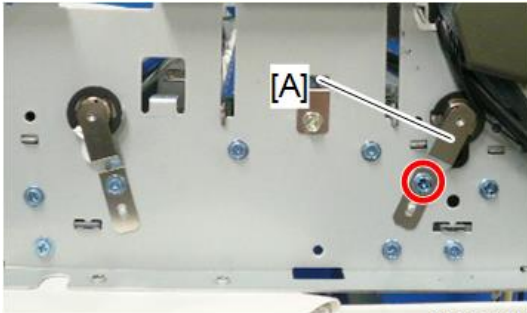

d262k1023

11. Remove the right shaft of the original exit roller. (⊗ x1 [A], wave washer x1 [B], washer x1 [C])

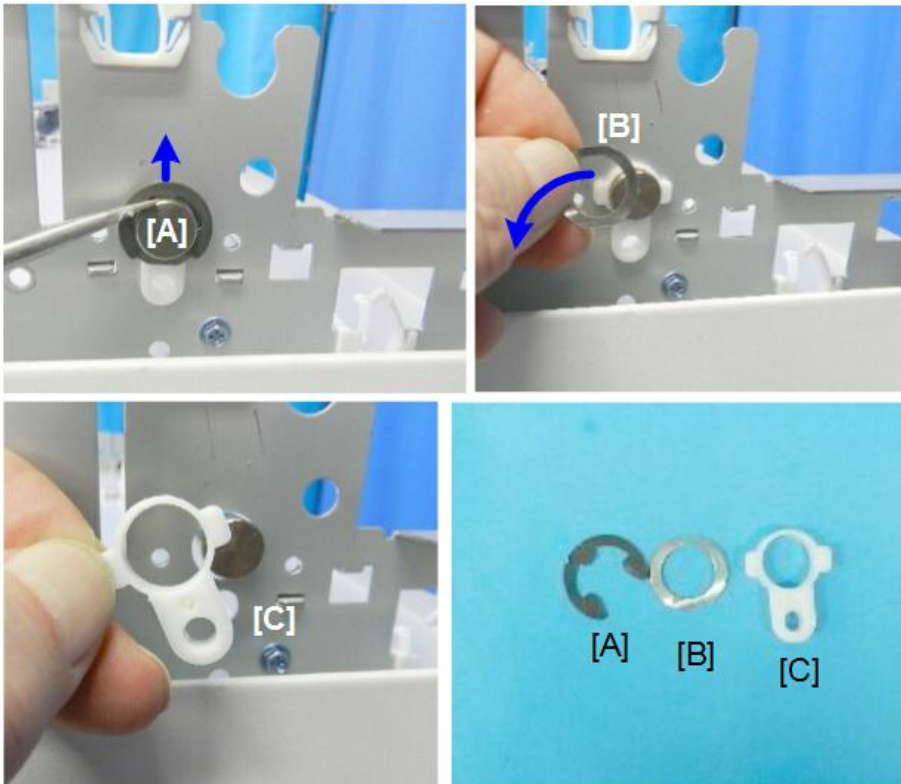

d262k8526

12. Slide the original exit roller to the left until you see the coated surface [A] close to the hole in the frame and remove the right end of the roller from the hole of the right frame [B].

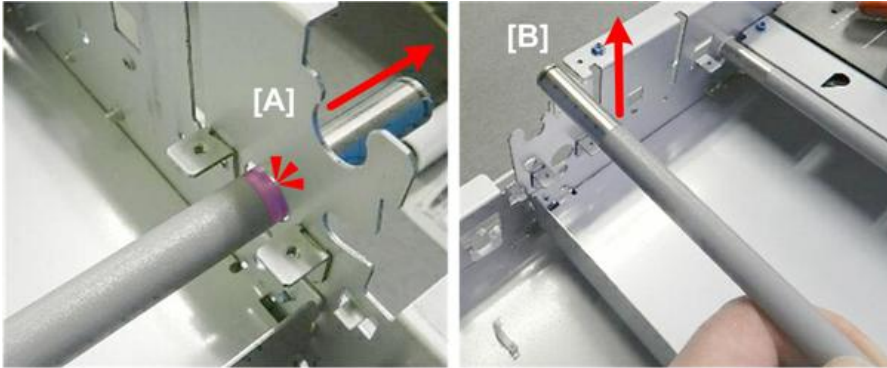

d124r180



d124r181

Adjustment

After changing the original exit roller, perform the CIS adjustment (p.586).

White Plate Bracket

1. Raise the top of scanner unit to the full upright position (p.254).

2. Remove the ground wire connected to the white plate bracket. ( x2)

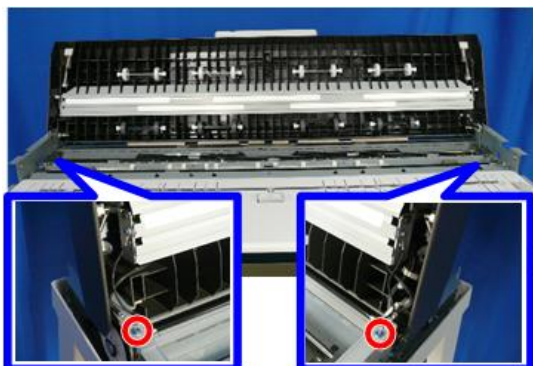

d262k1018

3. While holding the right and left white objects pressed, pull the white plate bracket [A] toward you to remove it.

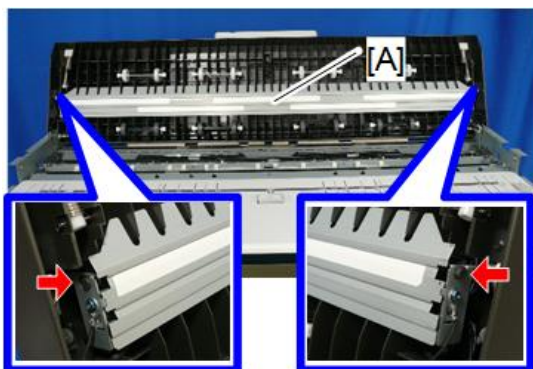

d262k1019

Original Stop Switch

1. Raise the top of scanner unit to the full upright position (p.254).
2. The switch cover is fastened by four hooks under the top of scanner unit on the right side.
Use the tip of a small screwdriver to release the hooks [A] of the switch cover and remove the switch cover on top of the scanner cover [B]. ( x4)

4

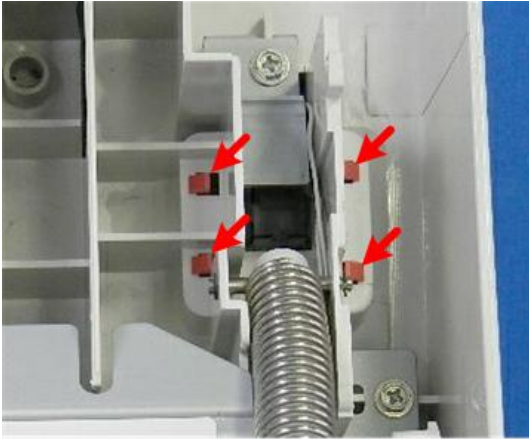

d124r701

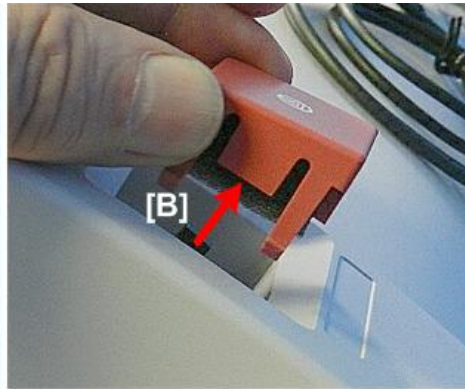
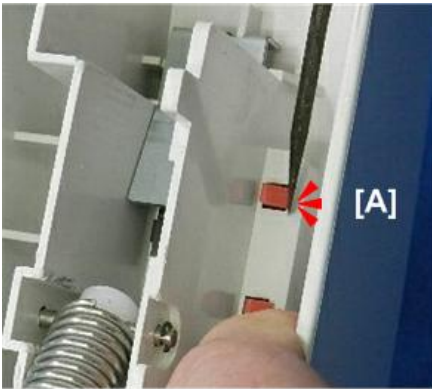

d124r702

3. Remove the switch cover plate of the original stop switch. ( x1)

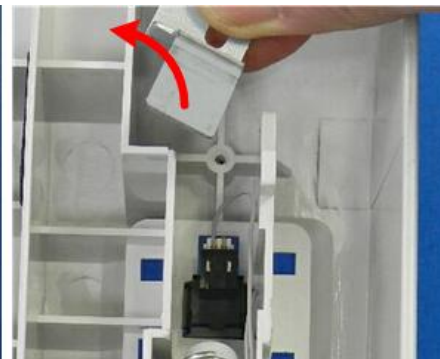

d124r703

4. Use the tip of a small screwdriver to release both sides of the original stop switch [A] and remove the connector [B]. (🔧 x1)

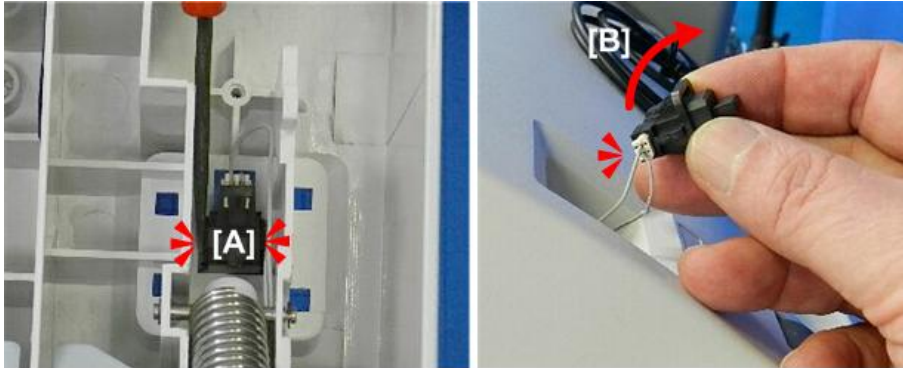

d124r704

4

Original Stop Switch

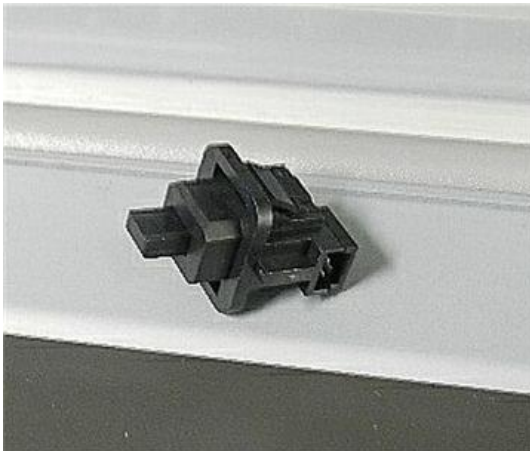

d124r705

Roll Units

Note

- Set the main power switch to OFF and disconnect the power plug from the power outlet before the procedure below. Operation with the power being supplied may cause electrical shock or defects.

Note

- For roll unit 1 and 2, the replacement procedure is a little different, but the parts can be replaced with the same procedure.

4

Roll Unit 1

Remove

1. Remove the roll unit 1.
2. Remove the rear cover (p.544).
3. Release the lower clamps of IOB (🔧x4).
4. Remove the clamps and connector from CN254 of the IOB [A] (🔧x1).

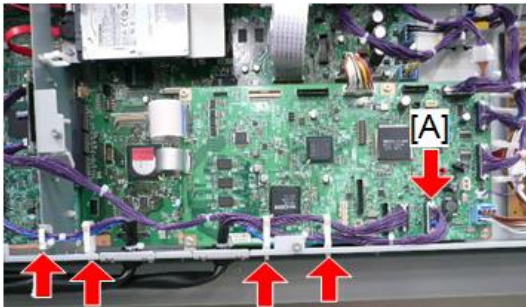

d262k0177

5. Remove the harness bracket of the roll unit 1 (🔧 x2).



d262k0178

4

6. Release the clamps and pull away the harness of the roll unit 1 (🔧 x4).



d262k0179

If only the roll unit 1 is mounted, go to step 8.

7. If the roll unit 2 is attached, remove the guide plate ( x2).

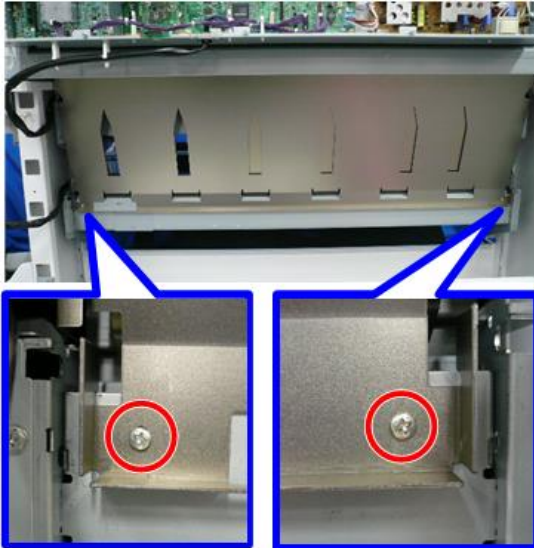

d262k0180

 **Note**

- Release the cutouts of the guide plate from the pins on both ends of the main unit.

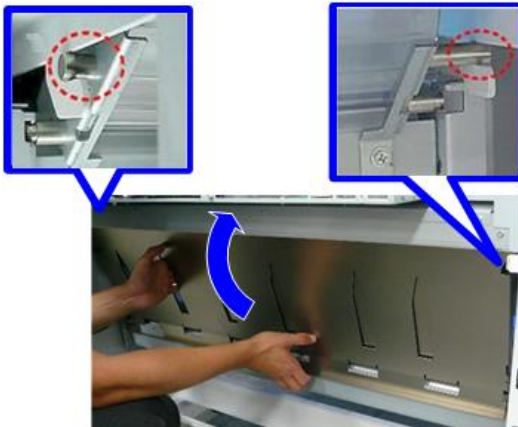

d262k0016

8. Remove the guide plate ( x2).

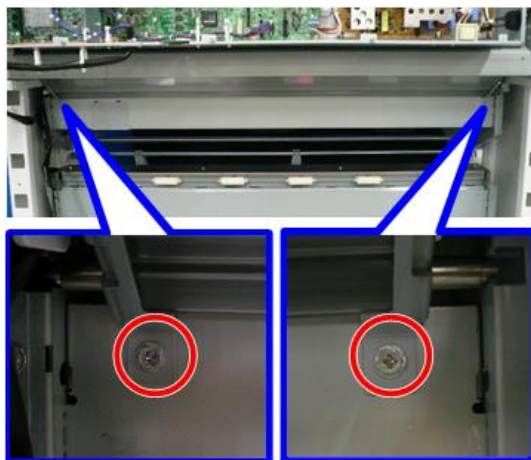

d262k0181

 **Note**

- Pull the guide plate toward you slightly, and then remove it.



d262k0182

9. The roll unit 1 is fastened with four screws, two on the left and two on the right.

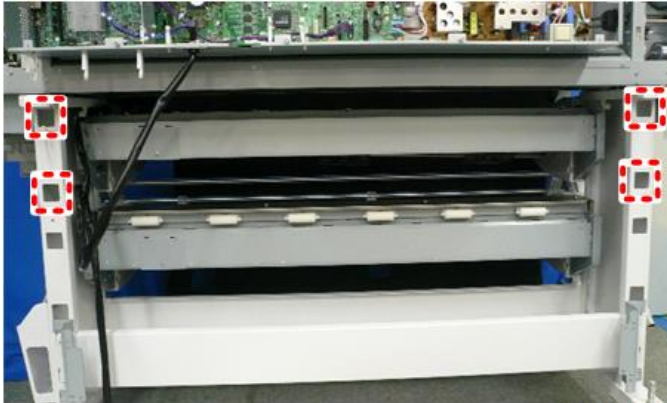

d262k0183

↓ Note

- To remove the screws, use a long screwdriver of 25 cm or longer.

10. From the left of the roll unit 1, remove the upper [A] and lower screws [B] ( x2).

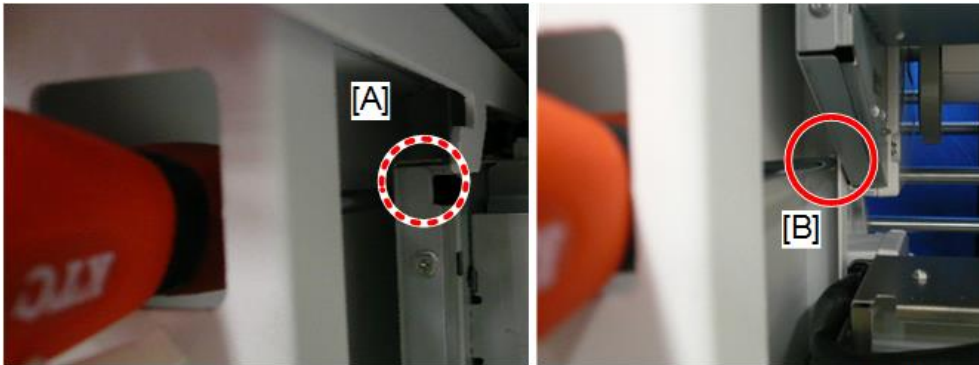

d262k0184

11. From the right of the roll unit 1, remove the upper [A] and lower screws [B] ( x2).

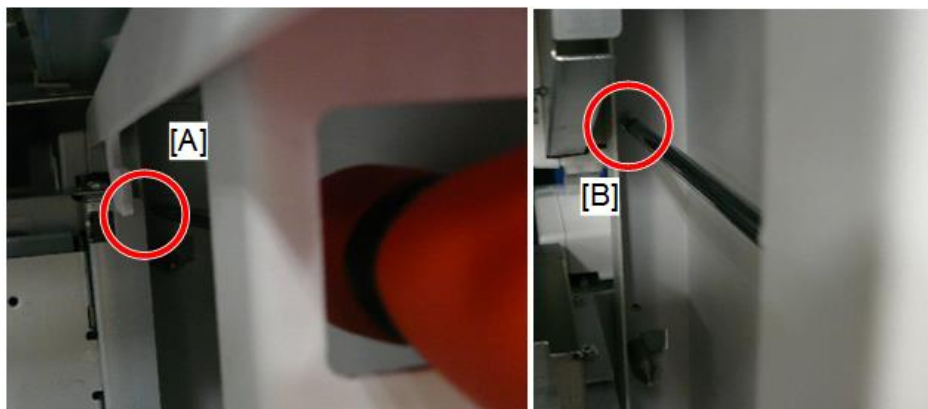

d262k0185

4

12. On the front of the main unit, raise the paper exit guide [A] and push the harness of the roll unit 1 [B] to the front over the top of the roll unit 1.

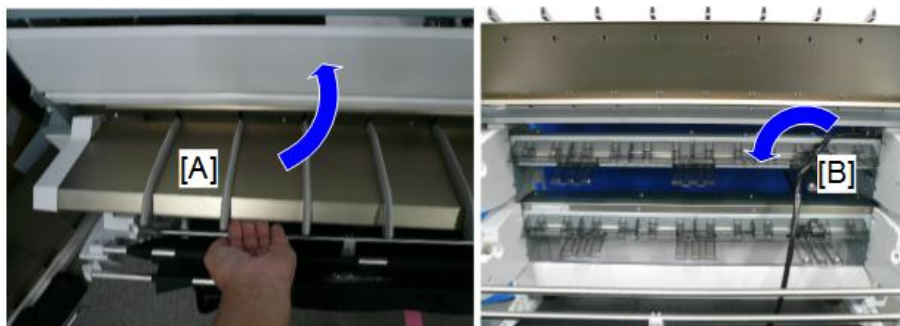

d262k0186

13. From the front of the machine, push the roll unit 1 slightly to the left [1], and then remove it [2].

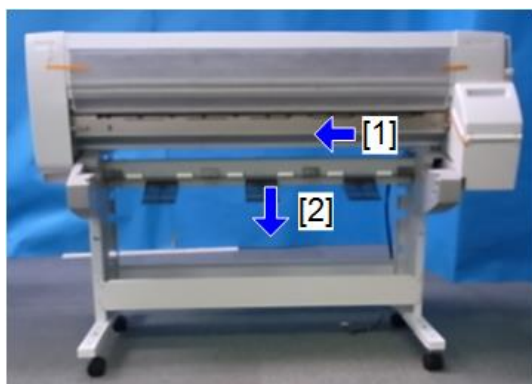

d262k0187

Roll Unit 1

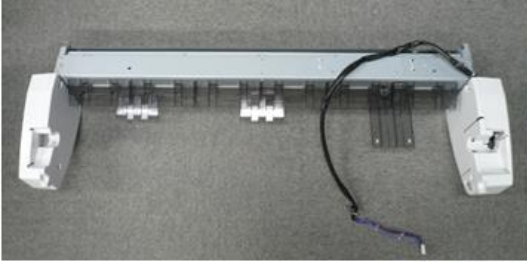

d262k0188

4

Precaution

1. To install the roll unit 1 at the front, push it to the right so that it locks into place.
2. At the rear, push the roll unit [A] to the left to make sure that it is locked in place.
3. Use a flashlight to check hole [B] on the right and left to make sure that the holes are aligned correctly.

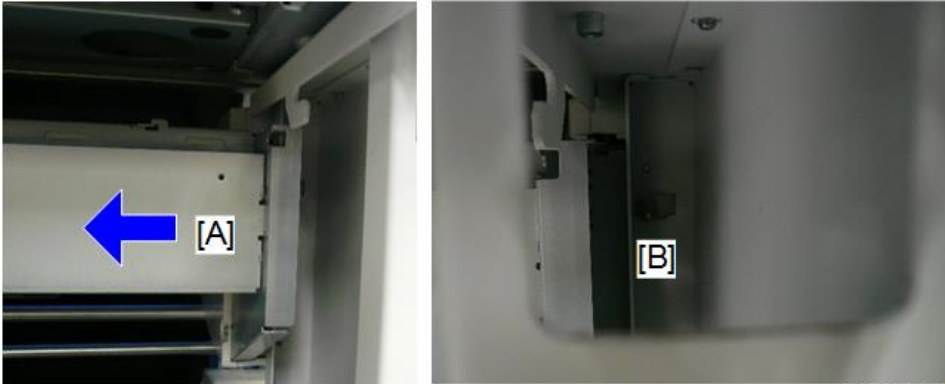

d262k0189

4. To install the guide plate of roll unit 1, make sure that the two pins on the left [A] and right [B] are seated correctly on the cutouts.



5. Use the end of a scale or ruler to push the film sheets behind the guide plate of the roll unit 1.

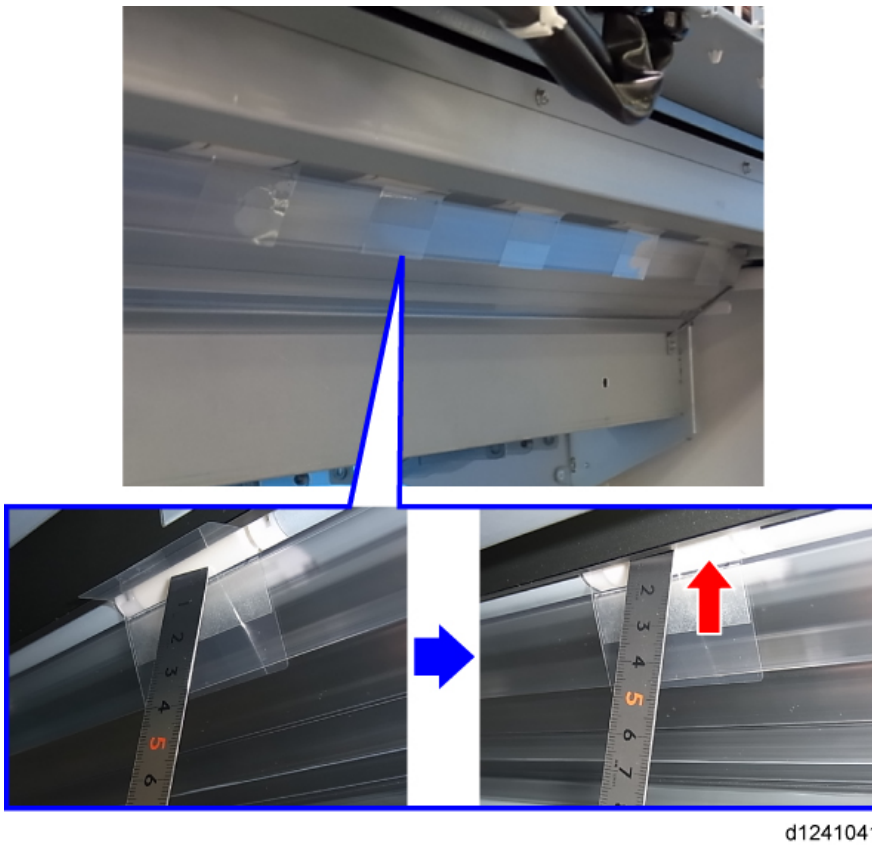

6. Make sure that the roll unit harness are tight against the bottom of the PCB box.

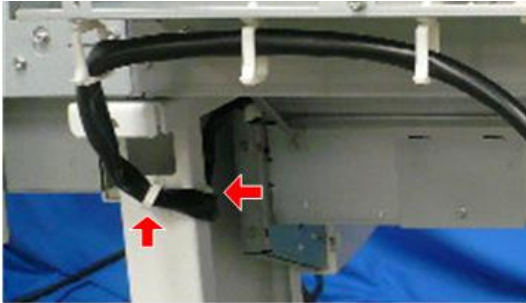

d262k0004

Note

- During bypass paper feed, the trailing edge of the paper comes out of the machine briefly and then feeds back into the machine. If the harnesses of the roll unit are hanging down, they could interfere with paper in the bypass paper feed path.

Roll Unit 2 (Option)

Remove

1. Remove the roll unit 2.

Note

- The roll unit 2 can be removed with the same procedure as the roll unit 1.

2. Remove the rear cover (p.544).
3. Release the clamps at the lower part of the PCB box. (x4).

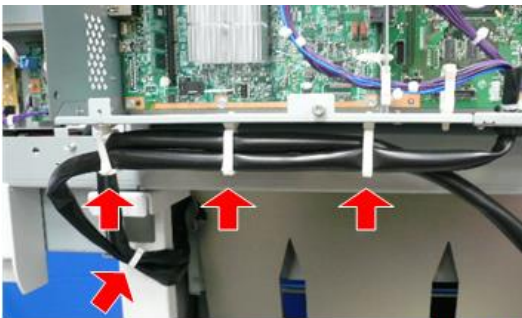

d262k0191

4. Remove the connector [A] from CN300 of the RFDB and CN255 [B] from IOB.

5. Remove the connector [C] from CN301 of the RFDB and harness bracket [D] (E⁺ x1,  x2).

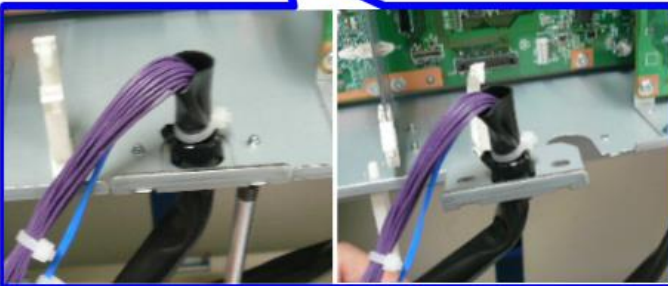
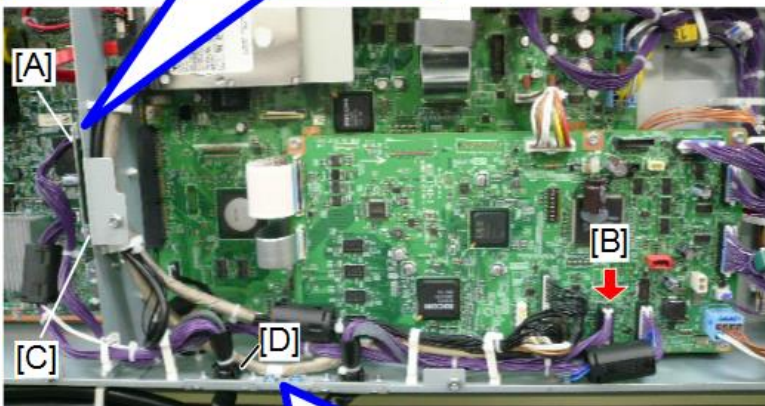
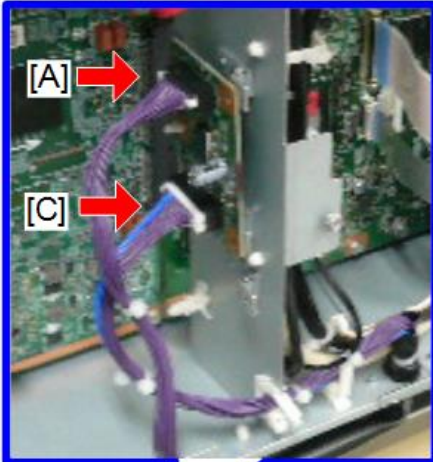

d262k0192

6. Pull away the harness of the roll unit 2.



d262k0193

7. Remove the guide plate ( x2).

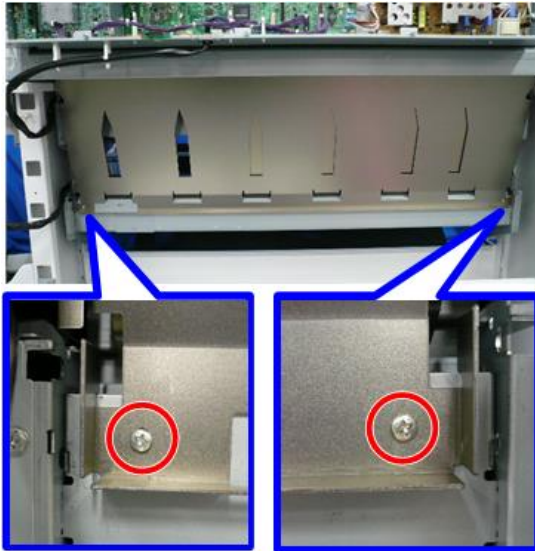

d262k0180

 **Note**

- Release the cutouts of the guide plate from the pins on the both ends of the main unit.

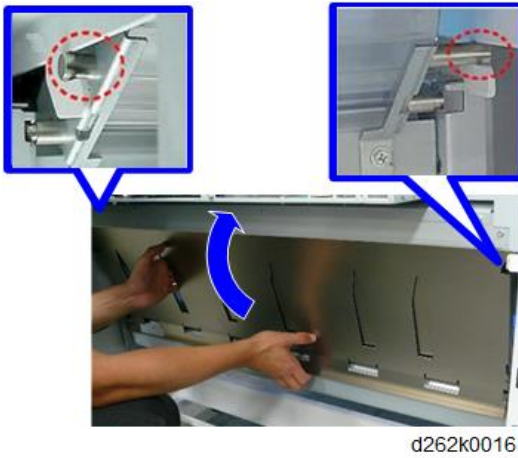

8. The roll unit 2 is fastened with four screws, two on the left and two on the right.

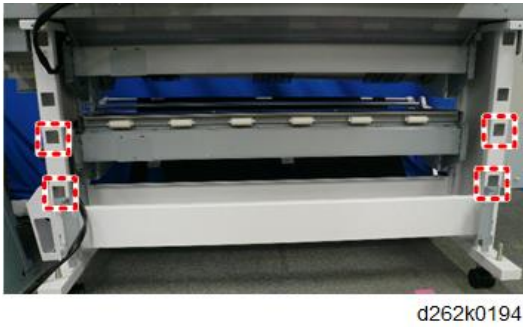

↓ **Note**

- To remove the screws, use a long screwdriver of 25 cm or longer.

9. From the left of the roll unit 2, remove the upper [A] and lower screws [B] ( x2).

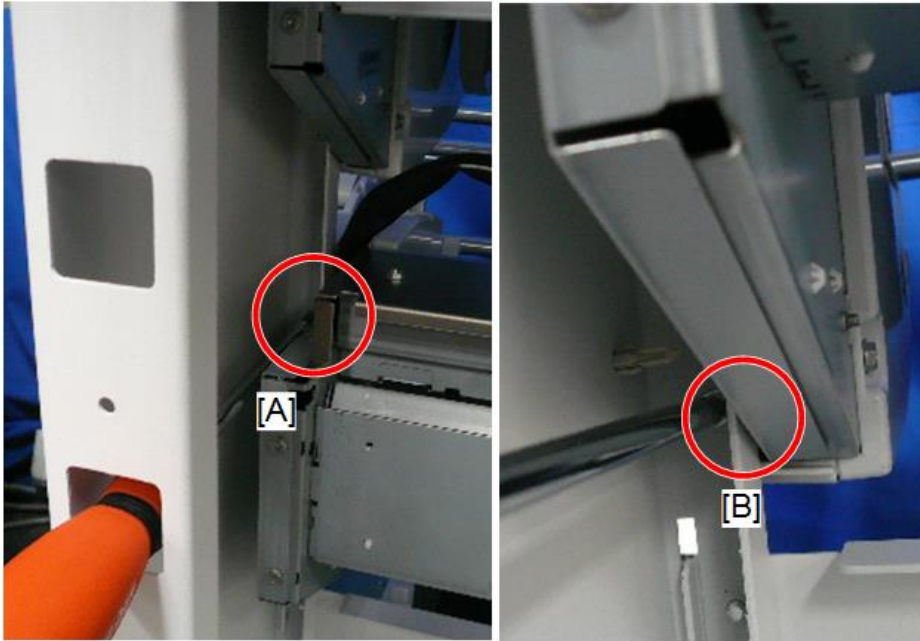

d262k0195

10. From the right of the roll unit 2, remove the upper [A] and lower screws [B] ( x2).

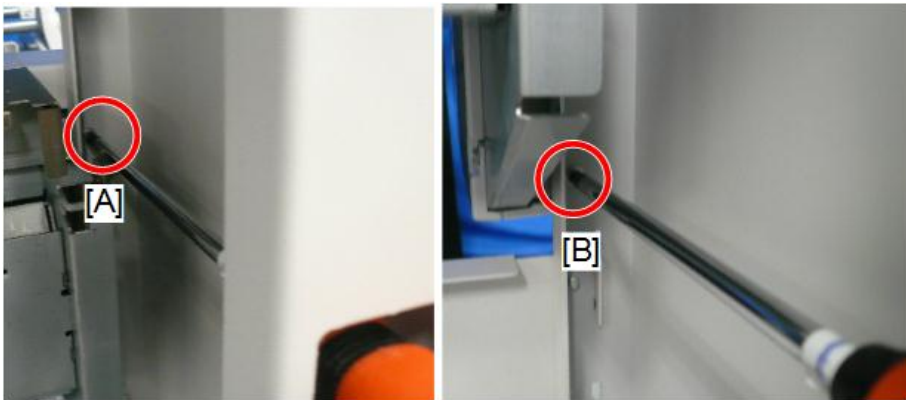

d262k0196

11. Push the roll unit 2 [A] slightly to the left [1], and then remove it [2].

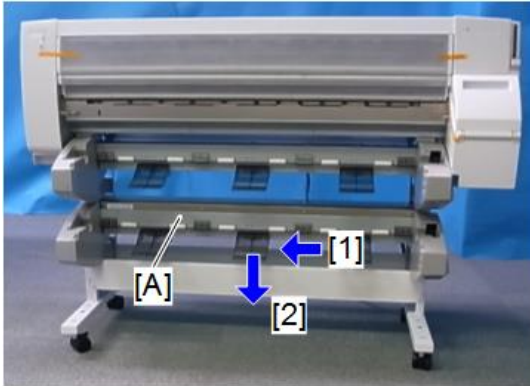

d262k0197

Roll Unit 2



d262k0198

Precaution

1. To install the roll unit 2 at the front, push it to the right so that it locks into place.
2. At the rear, push the roll unit 2 [A] to the left to make sure that it is locked in place.
3. Use a flashlight to check hole [B] on the right and left to make sure that the holes are aligned correctly.

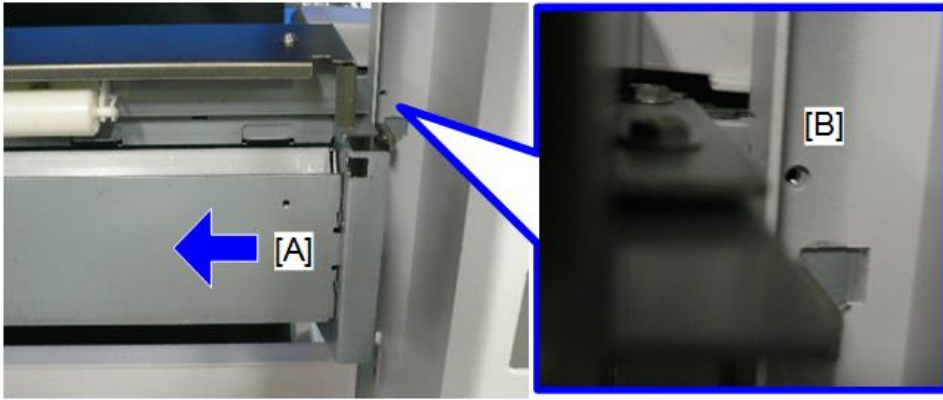

d262k0199

4

4. To install the guide plate of the roll unit 2, make sure that the hooks of the guide plate are placed correctly on the left and right pins.

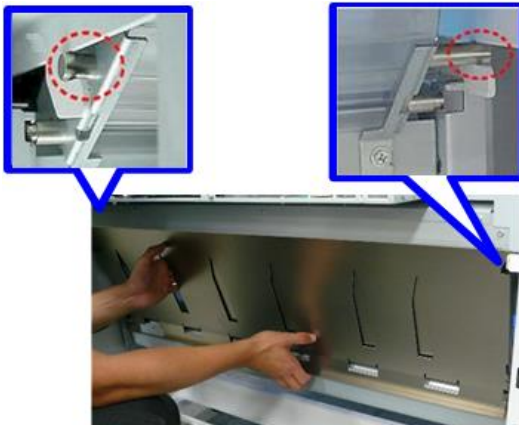

d262k0200

5. Make sure that the roll unit harness are tight against the bottom of the PCB box.

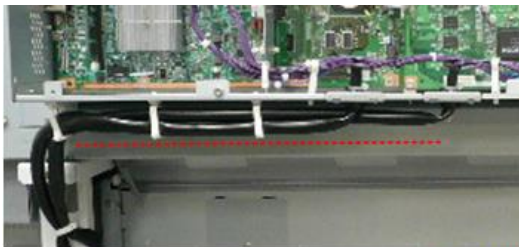

d262k0018

Note

- During bypass paper feed, the trailing edge of the paper comes out of the machine briefly and then feeds back into the machine. If the harnesses of the roll unit are hanging down, they could interfere with paper in the bypass paper feed path.

Rewind Switch

Remove

1. Remove the roll unit (p.314, p.322).
2. Remove the right outer cover [A] ( x3).

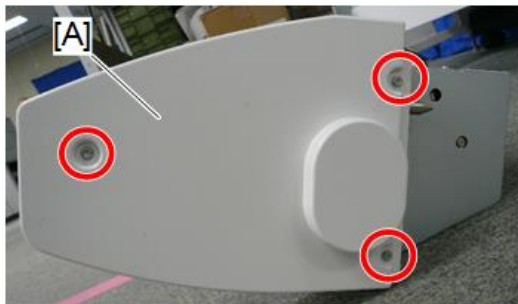

d262k0201

3. Remove the right outer cover [A] and switch cover [B] ( x3).

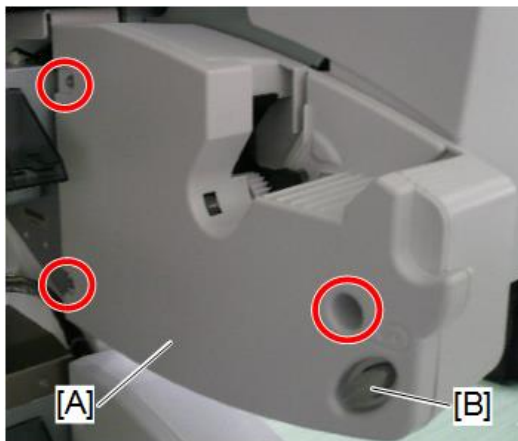

d262k0202

4. Remove the rewind switch [A] (🔌 x1)

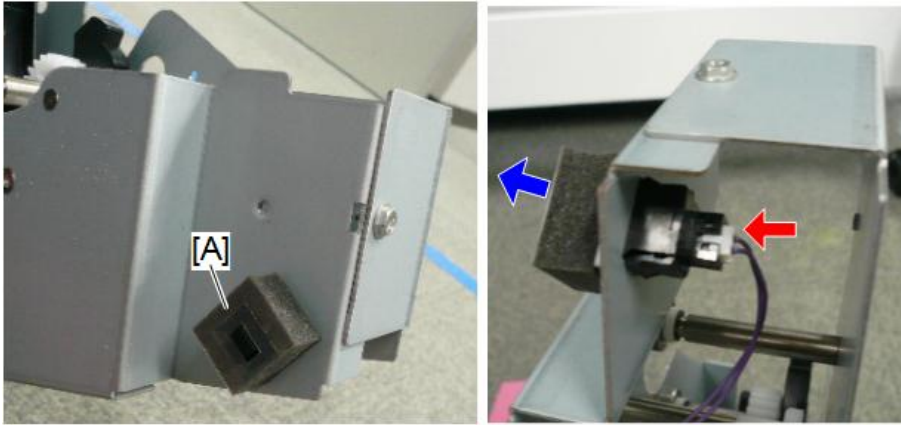

d262k0203

Precaution

- To install the right outer cover, pull the latch forward slightly.



- After attaching the cover, pull the latch forward and then release it so that it flips back to the rear.

Left Outer Cover, Left Inner Cover

Remove

1. Remove the roll unit (p.314, p.322).

2. Remove the left outer cover ( x3).



d262k0205

3. Remove the left inner cover ( x3).



d262k0206

4

Precaution



To install the left inner cover, make sure the leaf spring is not pinched between the covers.



d262k0207

Encoder Sensors

Remove

1. Remove the roll unit (p.314, p.322).
2. Remove the right outer cover, right inner cover, and switch cover (p.342).
3. Disconnect the sensor bracket and pull away the harness ( x1,  x1).

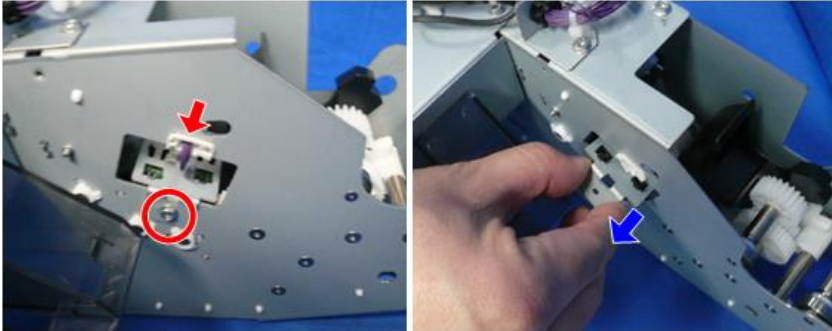

d262k0208

4. Slide the latch and pull out the sensor bracket.

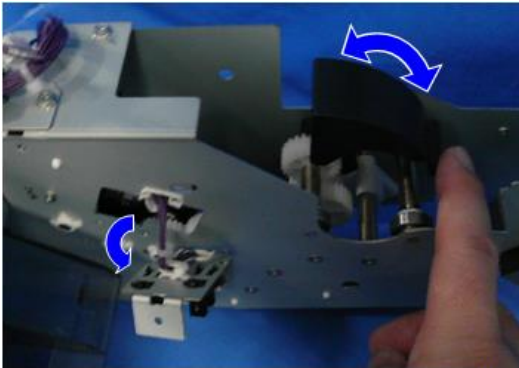

d262k0209

5. Release the clamp of the sensor bracket and pull away the harness (🔧x2).

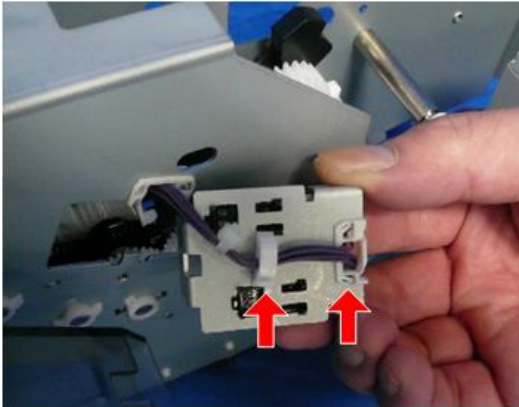

d262k0210

6. Remove the encoder sensor [A] (🔧 (white) x1, 🔧 x3).
7. Remove the encoder sensor [B] (🔧 (black) x1, 🔧 x3).

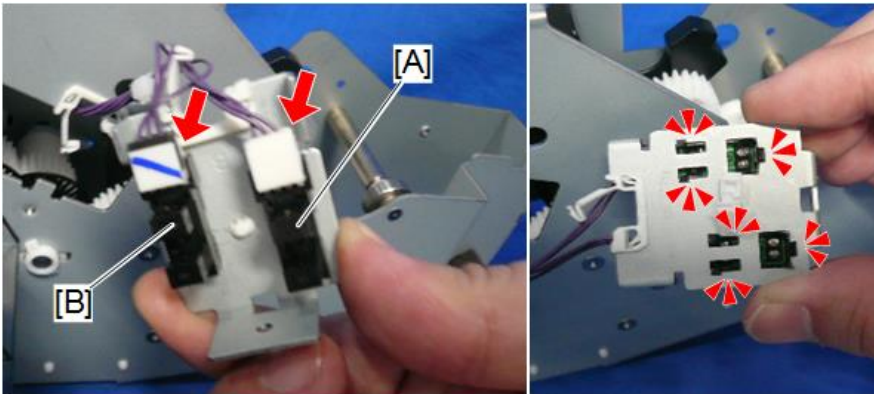

d262k0211

Cleaning

Clean the sensors with a blower brush.



d124r263

Roll Paper Feed Motor

1. Remove the roll unit (p.314, p.322).
2. Remove the right outer cover, right inner cover, and switch cover (p.342).

The roll paper feed motor [A] is placed at the lower right of the roll unit.

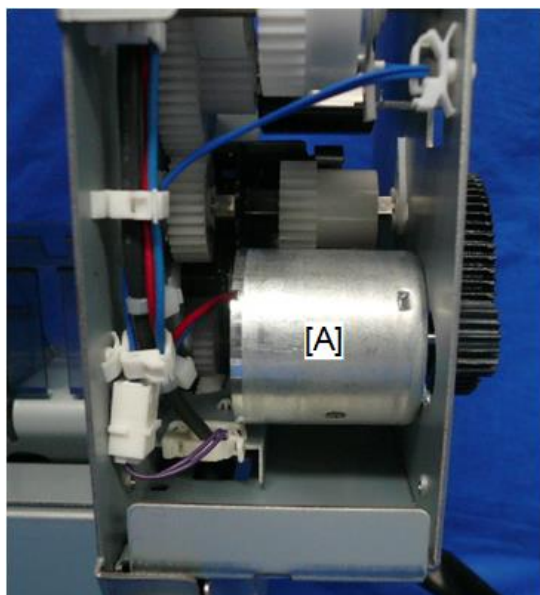

d262k0212

3. Remove the roll paper feed motor from the frame ( x2).

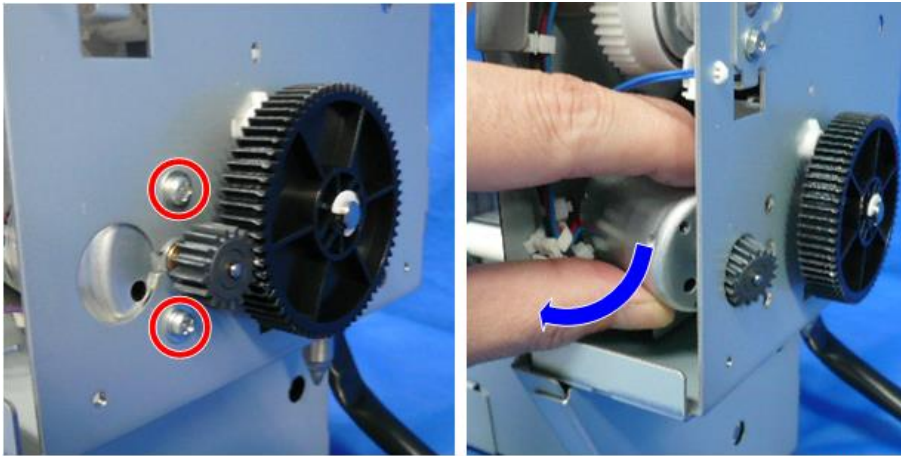

d262k0213

4

4. Release the clamps, pull away the harness, and remove the motor ( x4,  x1).

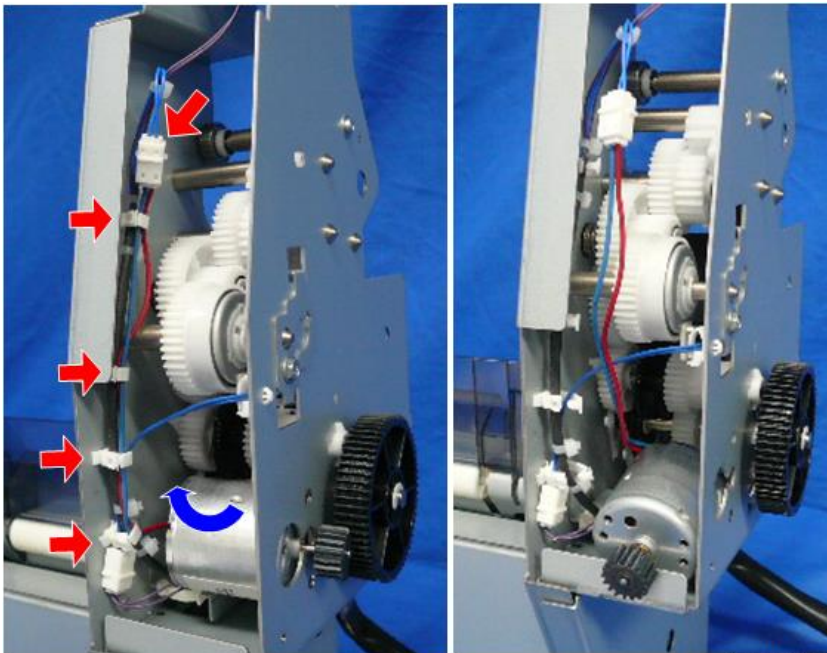

d262k0214

Roll Paper Feed Clutch

Remove

1. Separate the scanner unit and the main unit (p.274).
2. Remove the roll unit (p.314, p.322).
3. Remove the right outer cover, right inner cover, and switch cover (p.342).
4. Remove the right back bracket ( x2).

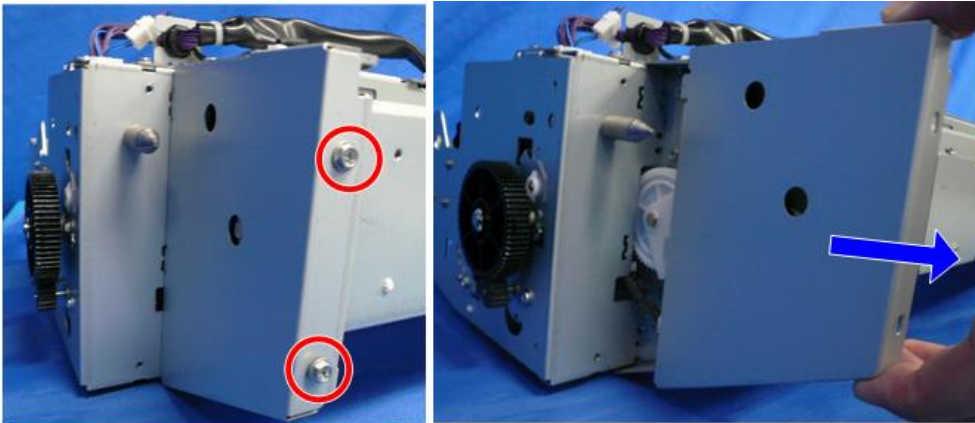

d262k0215

5. Remove the screws ( x4).

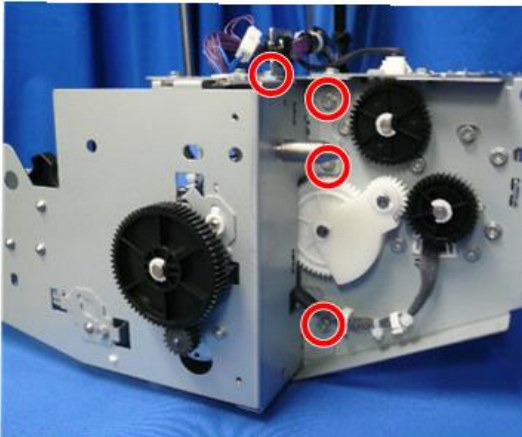

d262k0216

6. Remove the screw [A] and snap ring of the gear [B] ( x1, snap ring x1).

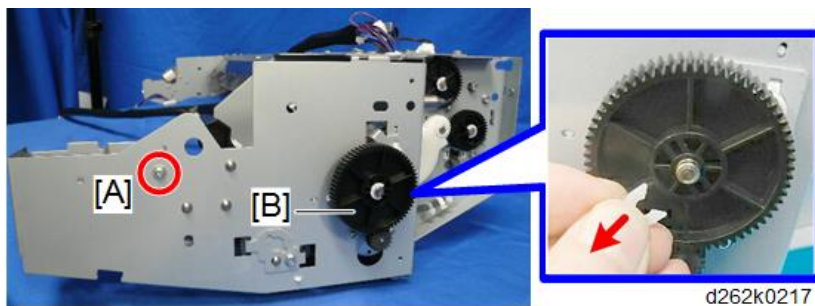

7. Turn the gear until the alignment mark [A] is horizontal.

8. Remove the gear [B] and alignment pin [C].

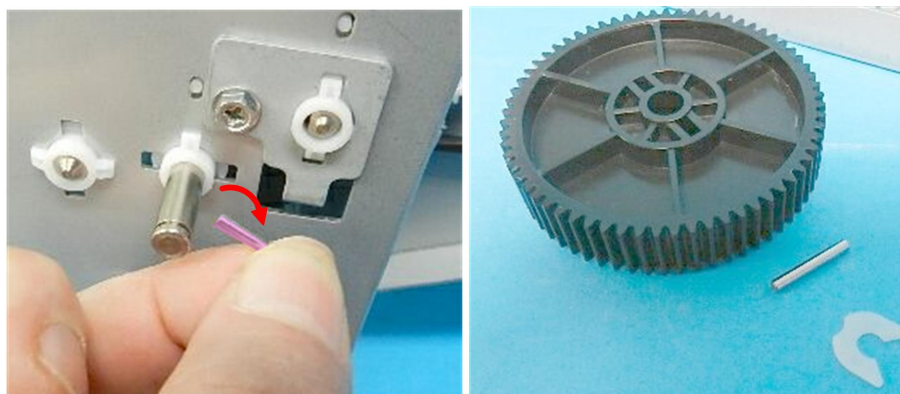
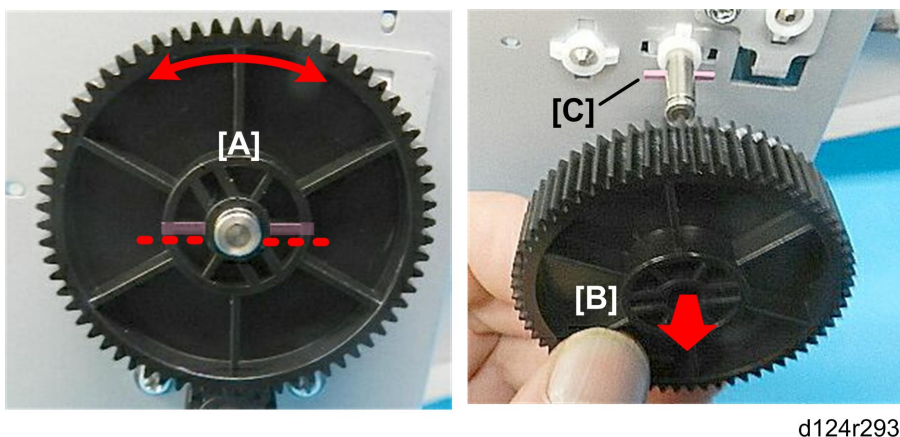

9. Remove the screw at the right back of the roll unit ( x1).

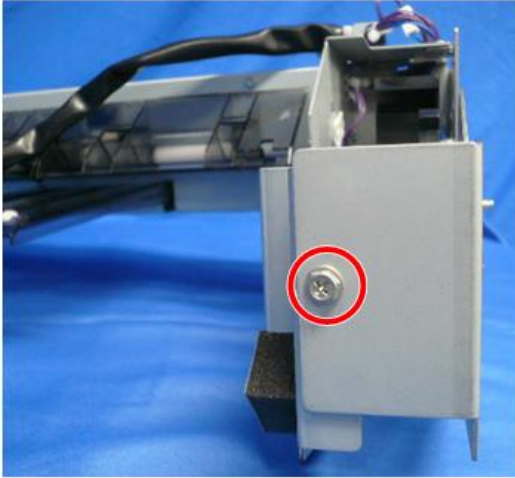

d262k0218

10. Disconnect the motor ( x5,  x1).

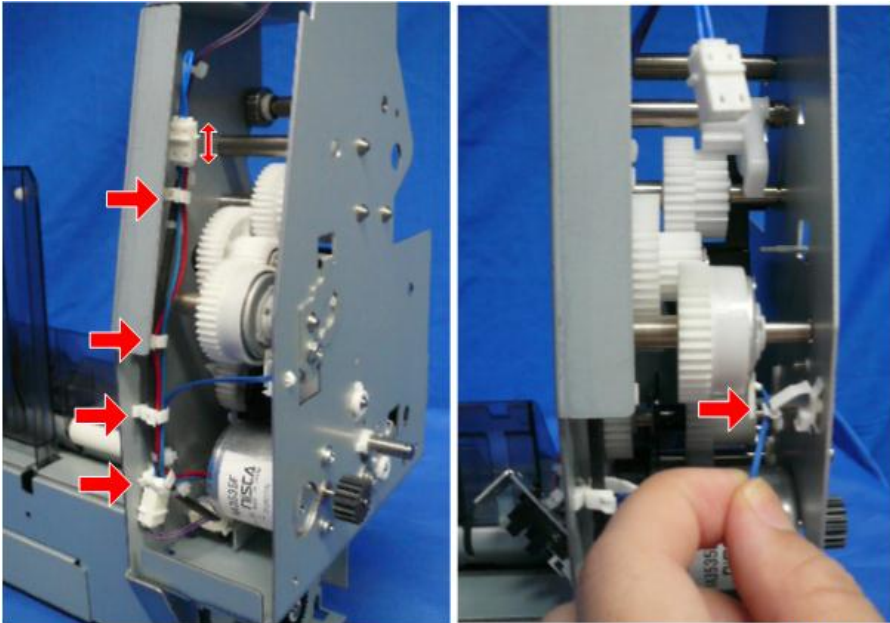

d262k0219

11. Remove the screw [A] ( x2).

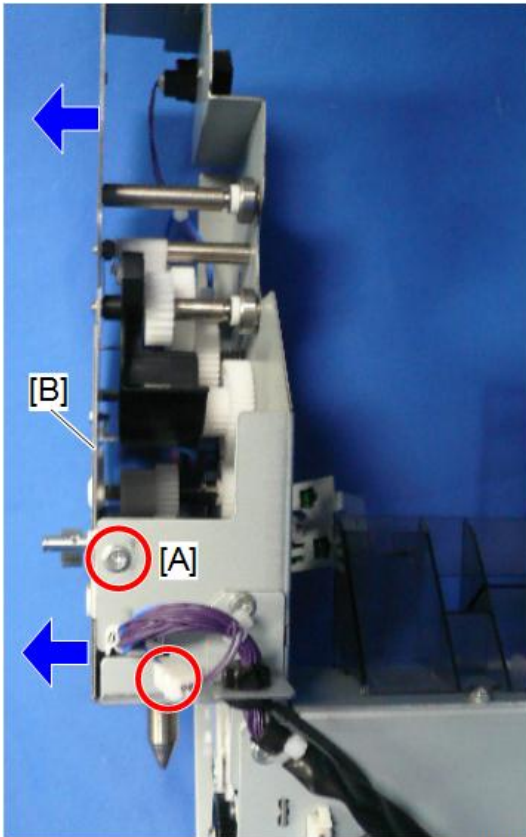
12. Remove the bracket [B].

d262k0220

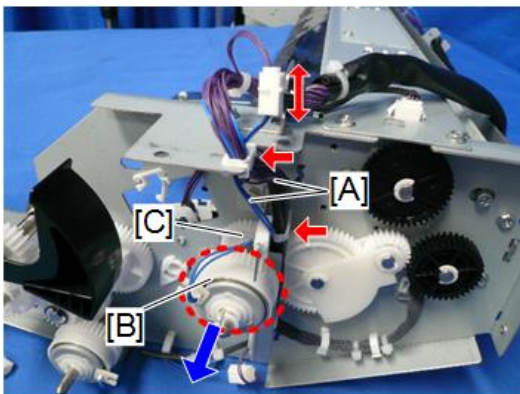
13. Remove the clamps and connector, and pull away the harnesses [A] (x3).**14. Remove the roll paper feed clutch [B] and gear [C].**

d262k0221

Precaution

1. Rotate the roll paper feed clutch so that the clutch arms [A] and [B] are placed as shown below.

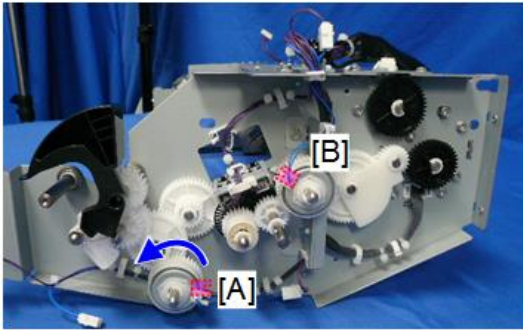

d262k0222

Note

- Because the shaft of the roll paper feed clutch is D-shaped, insert the shaft into the hole in the gear carefully.

2. Rotate the clutch so that the clutch arm [A] is vertical. Attach the bracket [B] (1 x1).

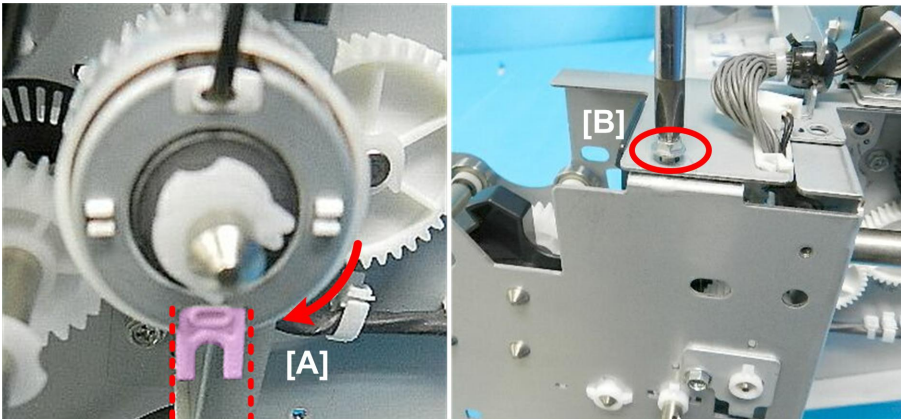

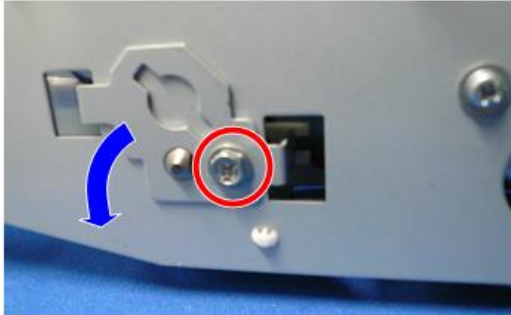

d124r302

3. If the tip of the pawl is not within the gap of the clutch arm, remove the clutch pawl plate ( x1).



d262k0223

4. Using the tip of a small screwdriver, set the clutch arm so that it is perfectly vertical..
5. Set the clutch pawl plate so that the tip of the pawl is between the gap of the clutch arm.
6. Attach the clutch pawl plate ( x1).
7. If the tip of the pawl is not between the gap of the clutch arm, remove the clutch pawl plate ( x1).



d262k0224

8. Insert the alignment pin [A] into the shaft so that it is horizontal.
9. Set the gear on the end of the shaft, and then rotate it so that the alignment mark [B] is horizontal.

10. Push the gear [C] onto the shaft so that the pin locks into the groove on the back of the gear.

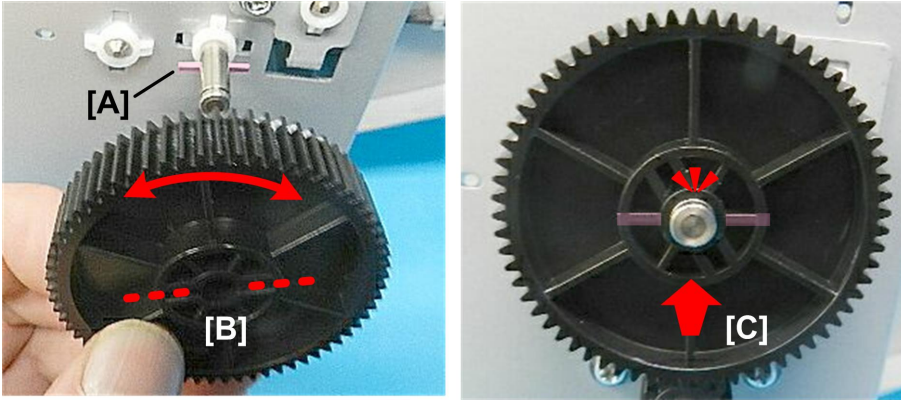

d124r305

Paper Release Sensor

Remove

1. Remove the sensor cover ( x1).



d124r246

2. Remove the roll end sensor (▼ x4, ⏏ x1).

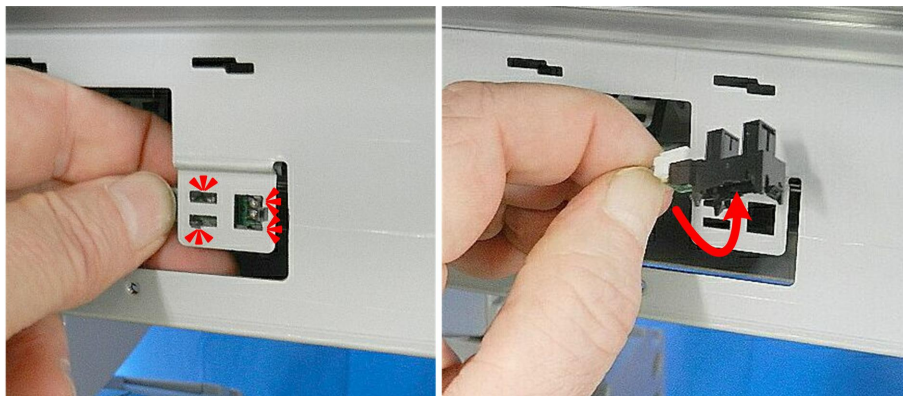

d124r247

4



d124r248

Cleaning

Clean the roll end sensor with a blower brush.



d124r249

4

Precaution

To install the roll end sensor, attach the claw first.



d124r250

Feed Roller Housing

The feed roller housing must be separated from the roll feed unit when removing the paper entrance sensors, exit sensor, and roll feed roller.

The procedure to separate the roller housing is slightly different between roll unit 1 and roll unit 2. Roll unit 1 [A] has no top cover while roll unit 2 [B] has a top cover.

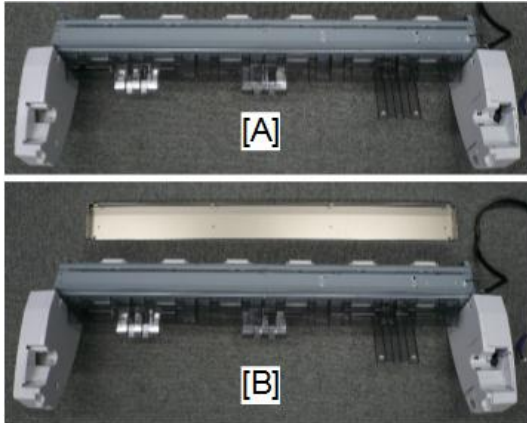

d262k0225

Separate the Feed Roller Housing (Roller Unit 1)

1. Remove the roll unit 1 (p.314).



d262k0226

2. Disconnect the roll end sensor (E x1).

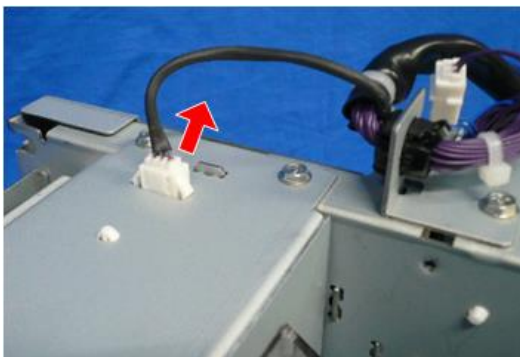

d262k0227

3. Remove the gear train cover ( x2).

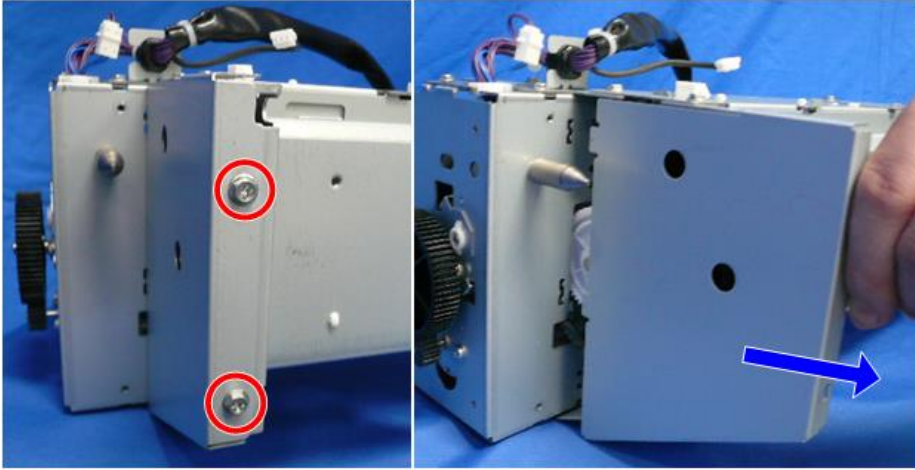

d262k0228

4. Remove the clip and gear (clip x1, gear x1).

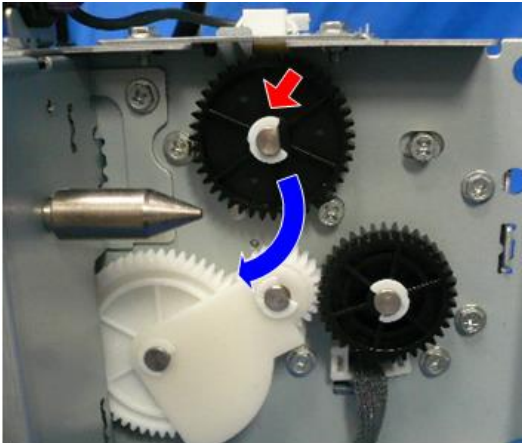

d262k0229

5. Raise the tip of the latch [1] out of its hole, rotate it to vertical [2], and then remove it [3].

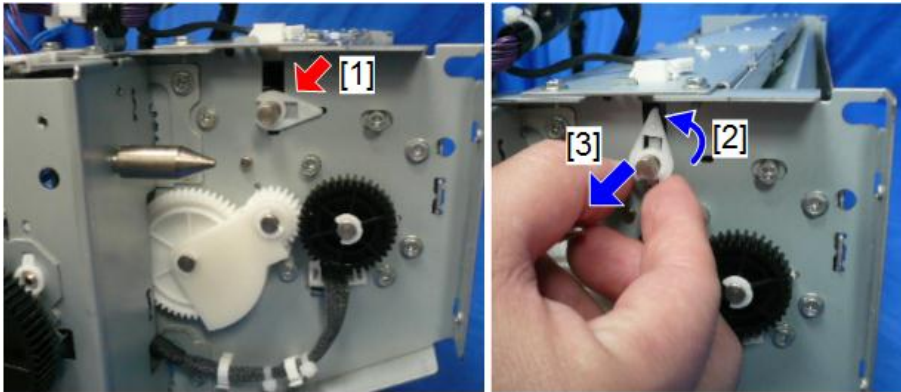

d262k0230

4

6. Remove the screw [A] on the left of the feed roller housing (1 x1).
7. Remove the screw [B] on the right of the feed roller housing (1 x1).

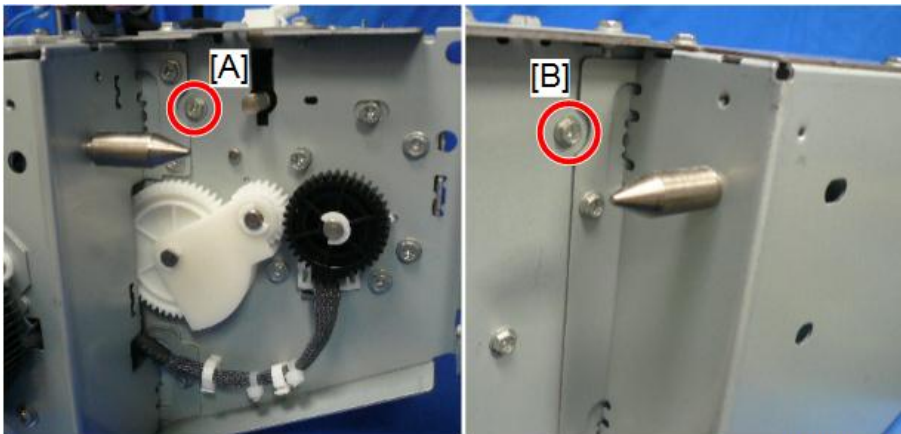

d262k0231

8. Remove the feed roller housing ( x4).



d262k0232



d262k0233

Separate the Feed Roller Housing (Roller Unit 2)

1. Remove the roll unit 2 (p.322).
2. Remove the upper part of the top cover and remove the screws on the back ( x8).

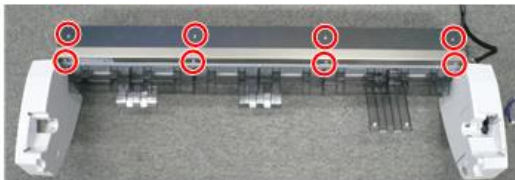

d262k0234

3. Remove the top cover.

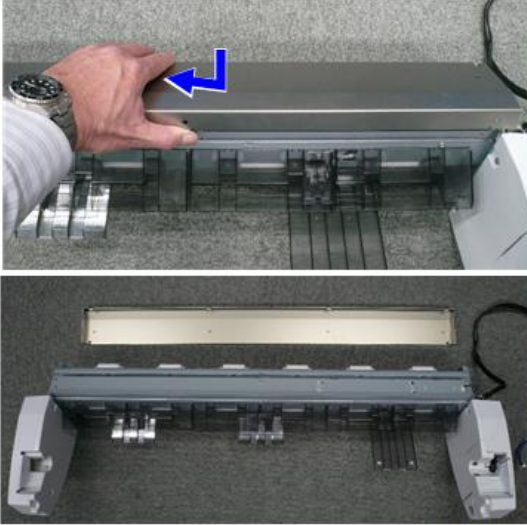

d262k0235

4. Disconnect the roll end sensor (E x1).



d262k0236

5. Disconnect the plate to which the idle rollers are attached ( x6).

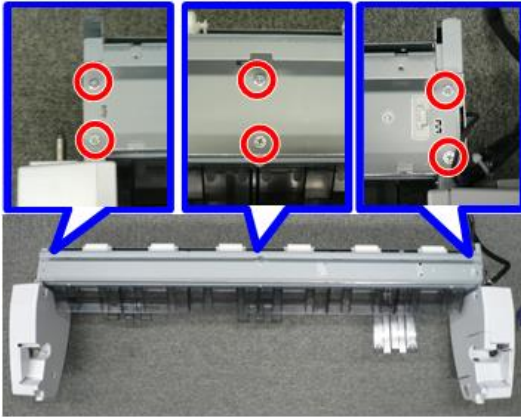

d262k0237



d262k0238

6. Remove the gear train cover ( x2).

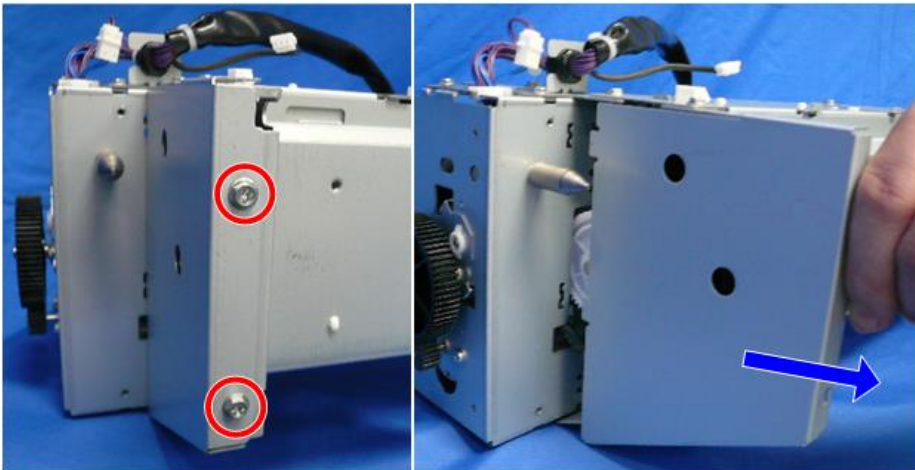

d262k0228

7. Remove the clip and gear (clip x1, gear x1).

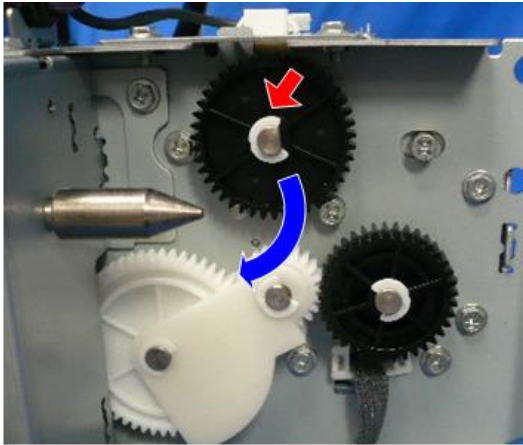

d262k0229

8. Raise the tip of the latch [1] out of its hole, rotate it to the vertical [2], and then remove it [3].

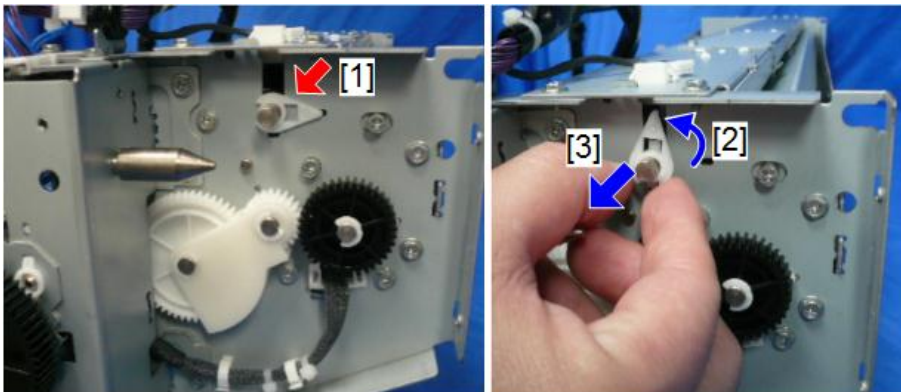

d262k0230

9. Remove the screw [A] on the left of the feed roller housing ( x1).

10. Remove the screw [B] on the right of the feed roller housing ( x1).

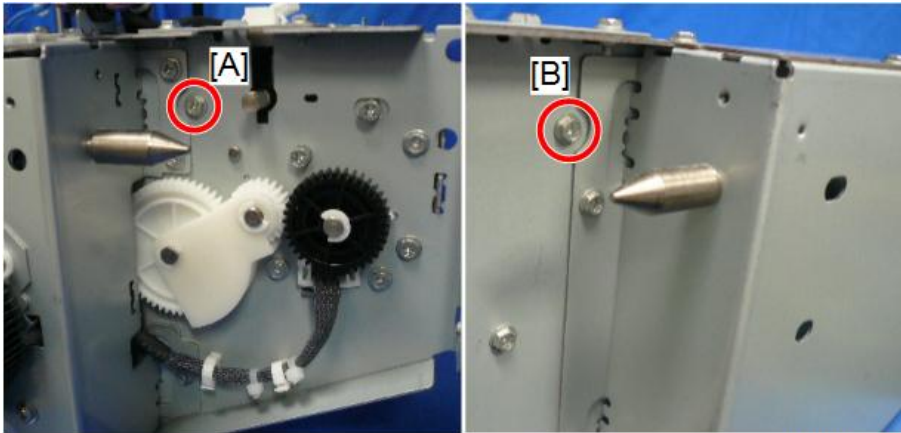

d262k0231

11. Remove the feed roller housing.



d262k0239

Paper Entrance Sensors, Exit Sensor

Remove

1. Separate the feed roller housing (p.345, p.348).

2. Remove the sensor bracket [A] ( x1).

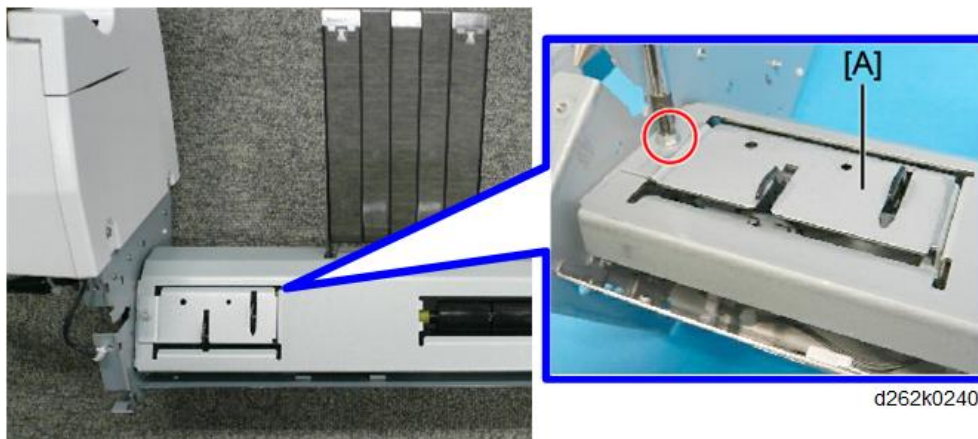

4

3. Pull out the sensor bracket [A] release the clamp [B], and pull away the harness. ( x1).

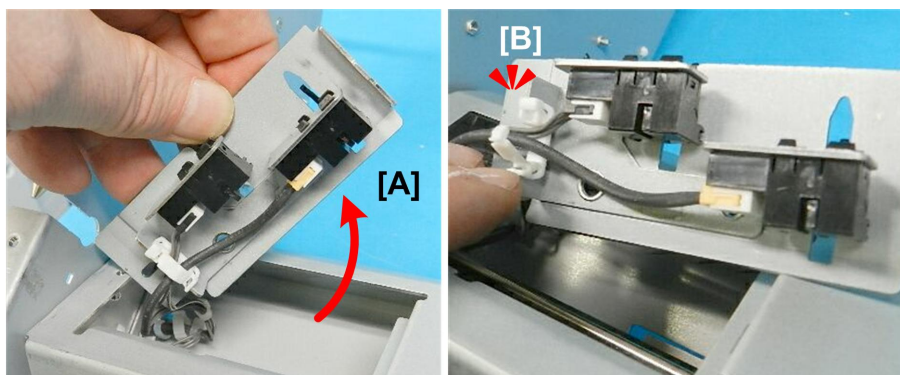

4. Disconnect the paper entrance sensor (Right) [A] ( x1,  x4).

5. Remove the exit sensor [B] ( x1,  x4).

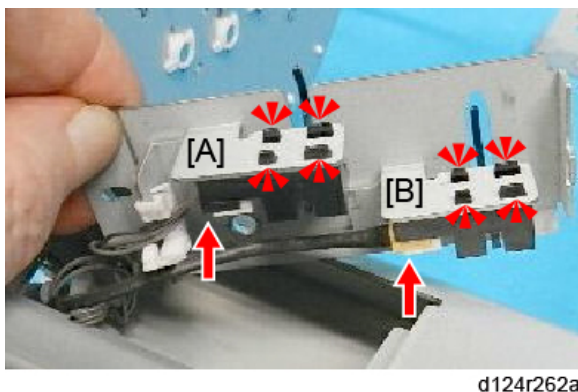

6. Remove the screws of the sensor bracket [A].

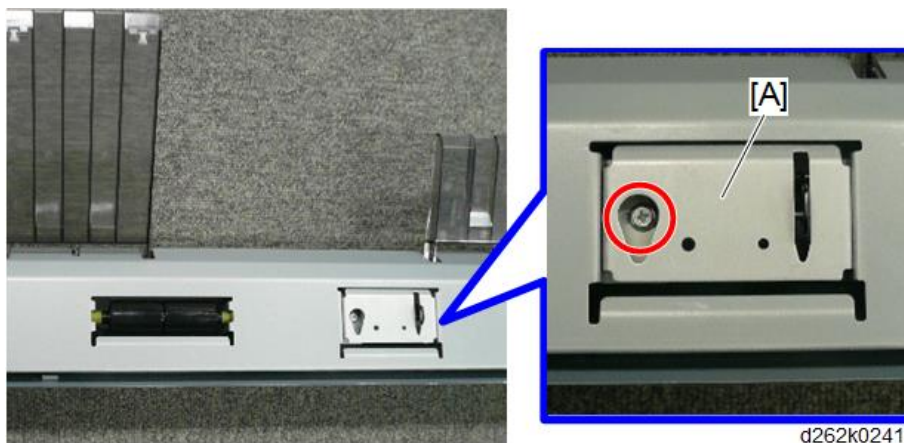

7. Pull out the sensor bracket [A].

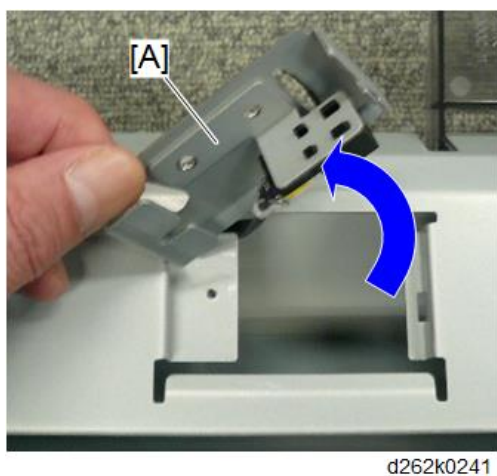

8. Disconnect the paper entrance sensor (Center) (E x1).

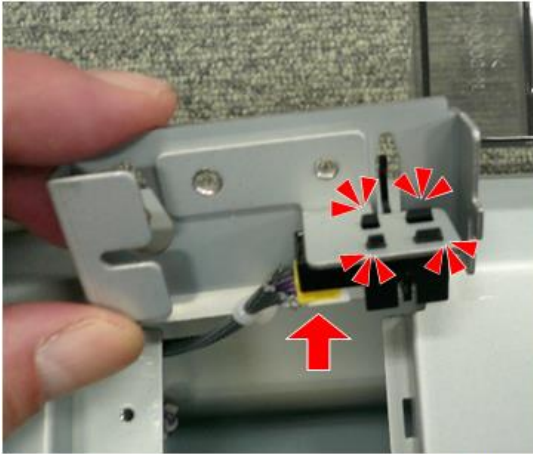

d262k0242

4

Cleaning

Clean the sensors with a blower brush.

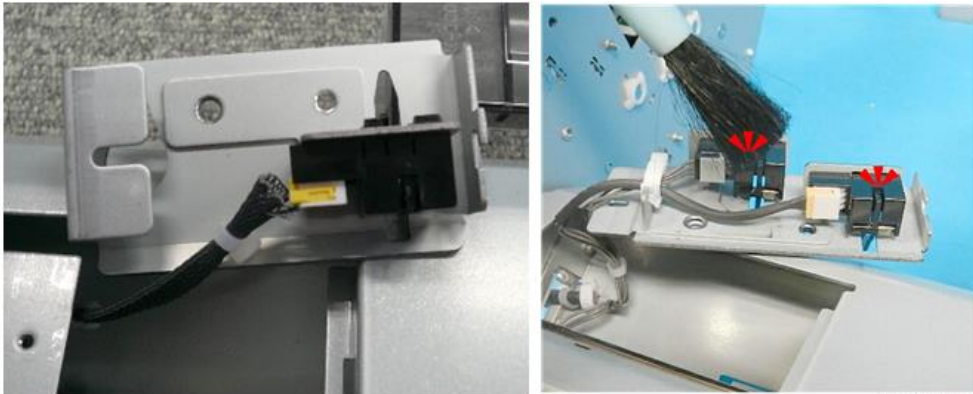

d262k0244

Feed Roller

Remove

1. Separate the feed roller housing (p.345, p.348).

2. Remove the cover the feed roller housing ( x3).

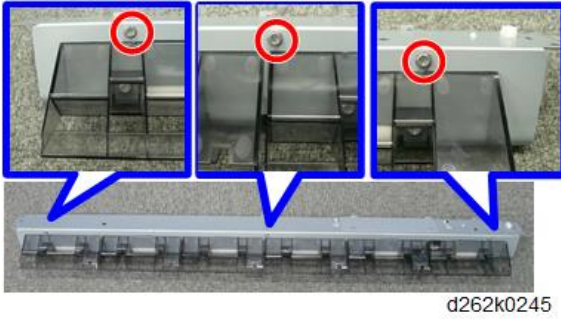

 **Note**

- Slide the feed roller housing and cover plate in the opposite direction to free the bosses from their notches, and then separate them.

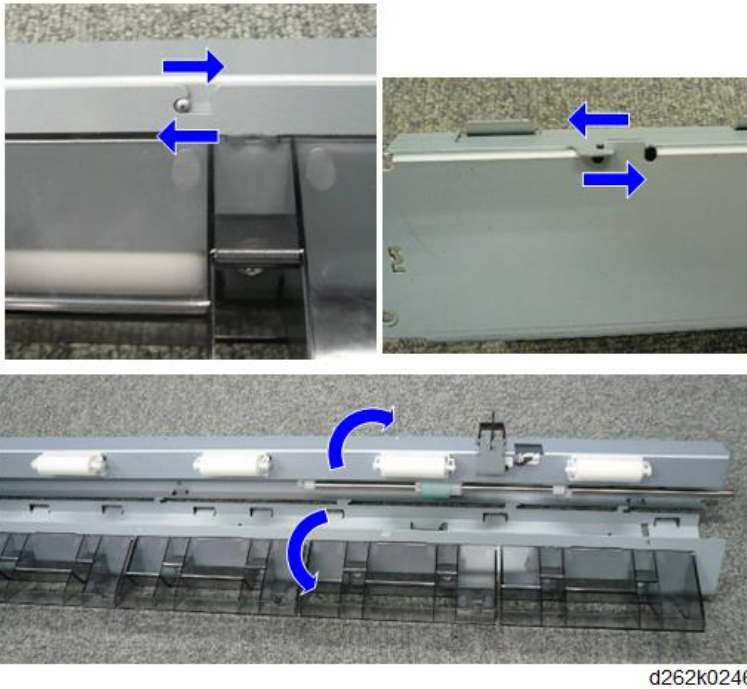

You can see the feed roller [A].

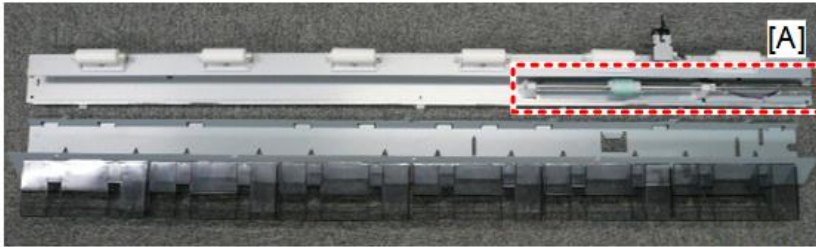

d262k0247

3. Push the feed roller with the shaft to the right (clip x2).

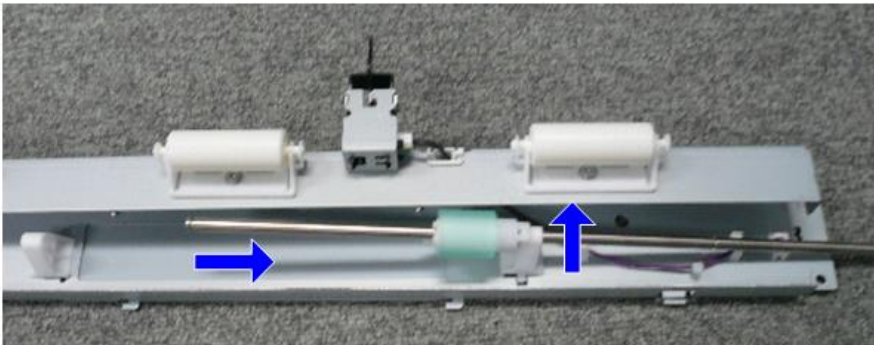

d262k0249

4. Remove the feed roller from the shaft (clip x2).

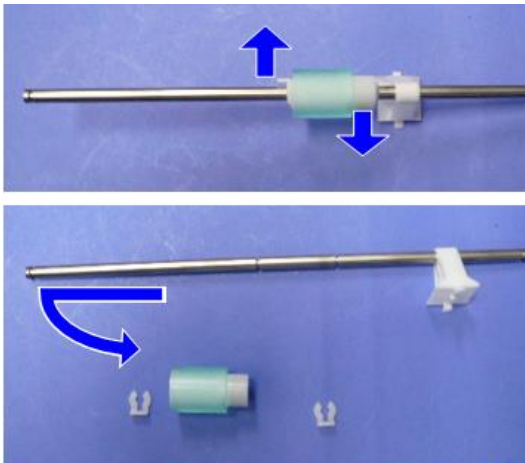

d262k0250

5. Remove the idle rollers by opening a support on either side.

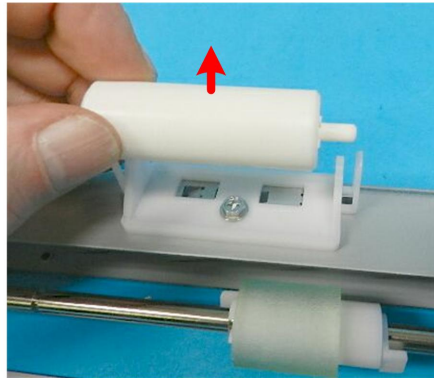
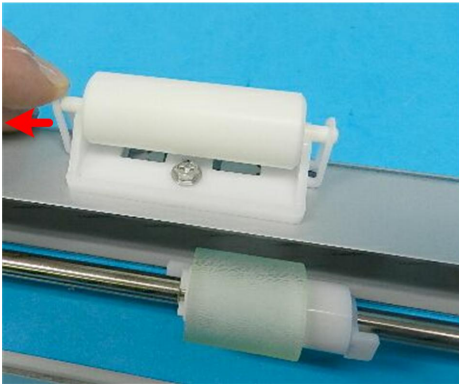

d124r272

4

Precaution

- To re-assemble the feed roller housing and cover plate, match the hooks [A] and bosses [B] with their contact points, and then press the halves in the opposite direction [C].

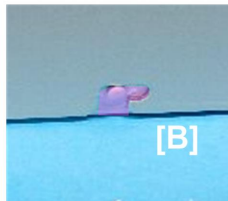
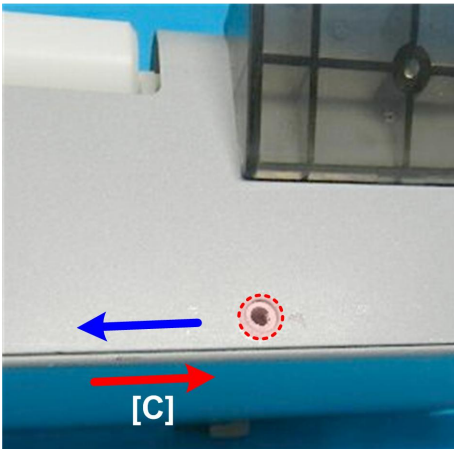

d124r273

- The holes align when the halves are locked correctly.

Roll End Sensor

1. The roll end sensors are located on the roll unit 1 [A] and roll unit 2 [B].

To remove the roll end sensor on the roll unit 1, raise the paper exit guide.

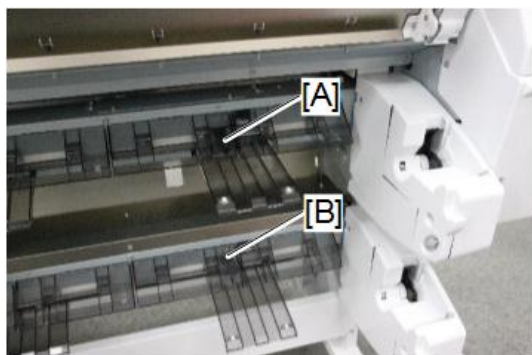

d262k8089

2. Remove the two roll guides [A] ( x4).

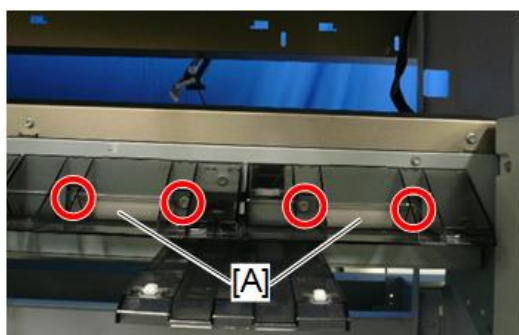

d262k0251

3. Remove the sensor bracket ( x1,  x1).

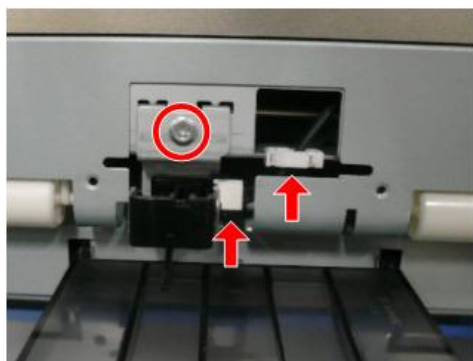

d262k0252

4. Remove the sensor [A] from the bracket (▼ x3).

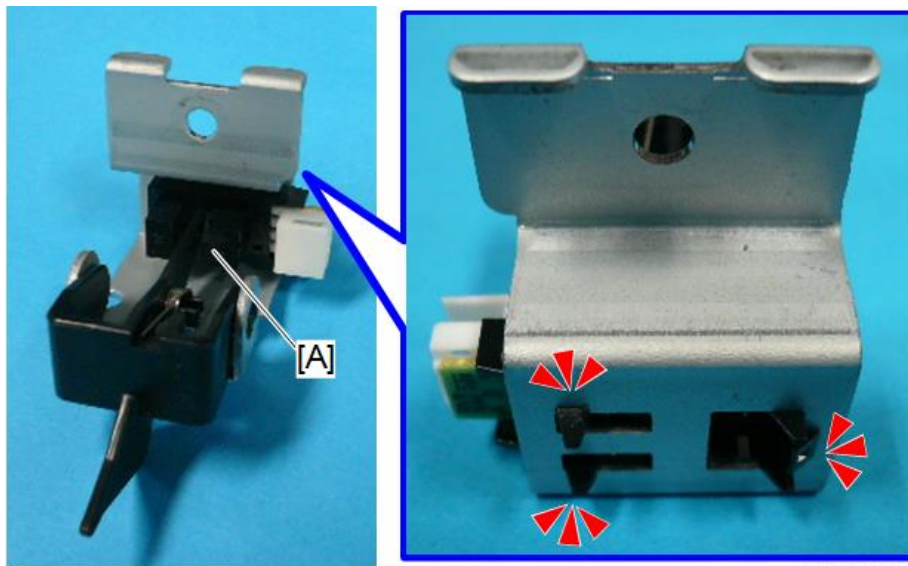

d262k0253

Paper Transport

⚠ WARNING

- Set the main power switch to OFF and disconnect the power plug from the power outlet before the procedure below. Operation with the power being supplied may cause electrical shock or defects.

Bypass Sensor

1. Remove the right rear cover (p.247).
2. Remove the auto-nozzle check unit (p.540).
3. Disconnect the harness of the bypass sensor and push it into the hole in the bracket [A] (🔧 x1).

★ Important

- Do not release the clamp [B]. This is to prevent the harness from falling inside the bracket.

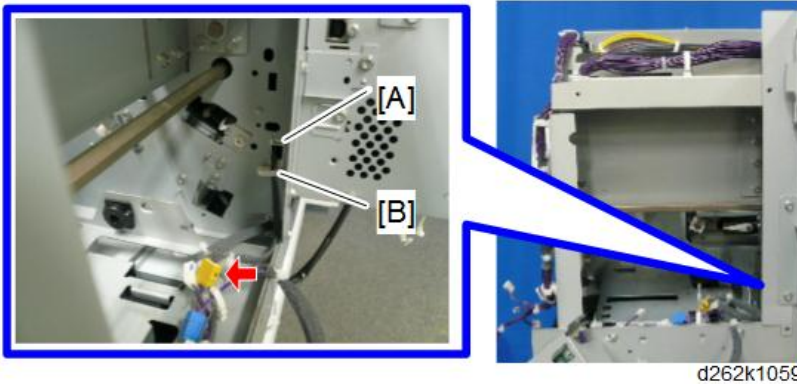

4. Pull away the feeler from the slit using a thin screwdriver, and disconnect the bypass sensor from the bracket [A] (🔧 x1).

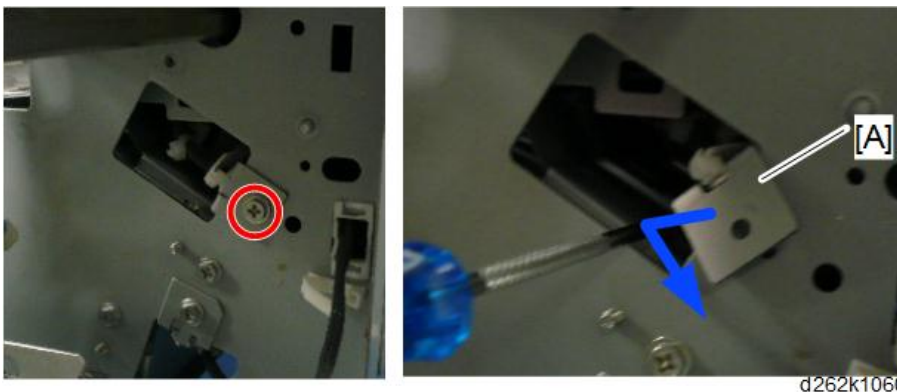

5. Remove the bypass sensor (🔧 x1, 🛠️ x1, ▼ x4)

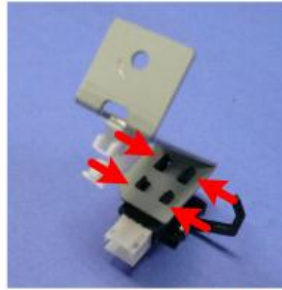

d262k8108

4

Pre-Registration Sensor

1. Remove the right rear cover (p.247).
2. Remove the auto-nozzle check unit (p.540).
3. Disconnect the pre-registration sensor with the bracket [A] and push it into the hole in the bracket [B] (🔧 x1, 🛠️ x1).

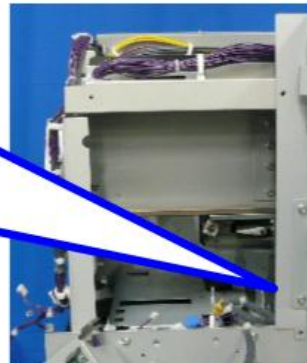
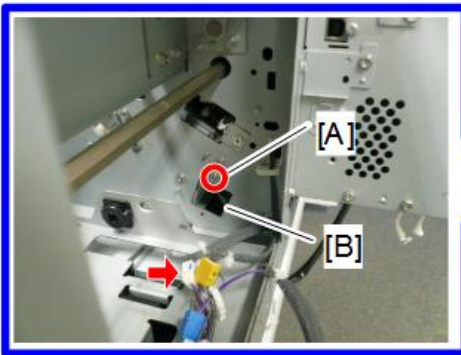

d262k1061

4. Pull out the pre-registration sensor bracket [A] from under the PCB box.

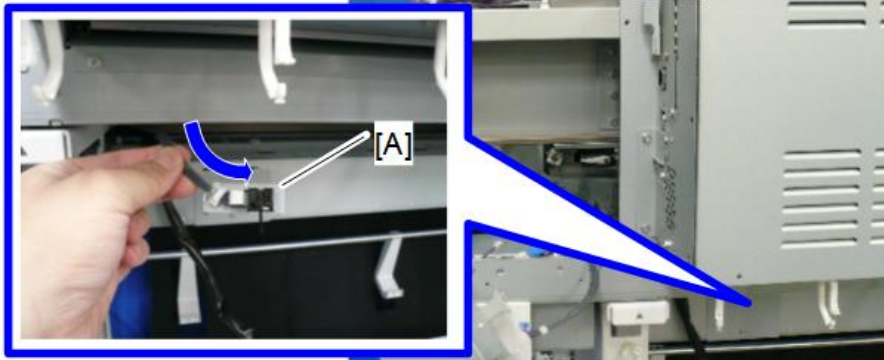

d262k1062

5. Remove the pre-registration sensor (🖨️ x1, 📄 x1, ▼ x4)

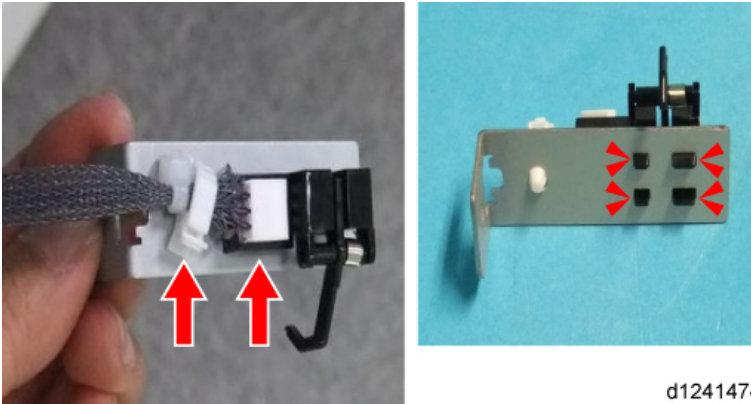

d1241474

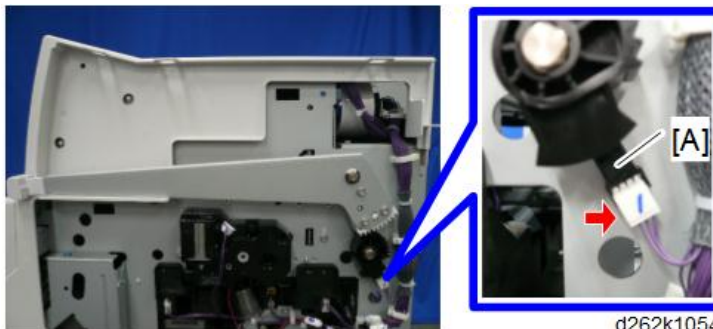

Registration End Sensor

1. Remove the right cover (p.247).
2. Remove the registration end sensor [A] (📄 x1).



d262k1054

Paper Transport Fan Motor

1. Remove the cutter unit (p.369).
2. Disconnect the paper transport fan assembly [A] ( x2,  x2).

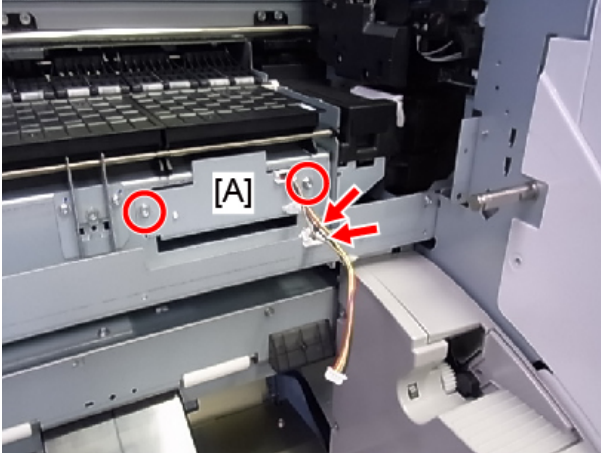

d1241237

 **Note**

- The bracket is sealed with the sponge squashed, so pull it out forcibly.

3. Remove the paper transport fan motor from the bracket ( x2,  x3).

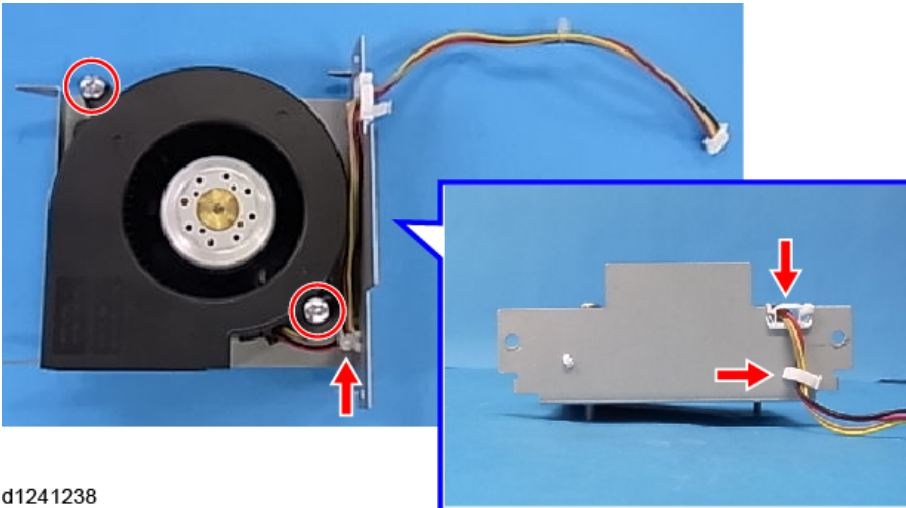

d1241238

 **Note**

- To reinstall the paper transport fan motor, align the bosses with the cutout of the main unit and push it in.

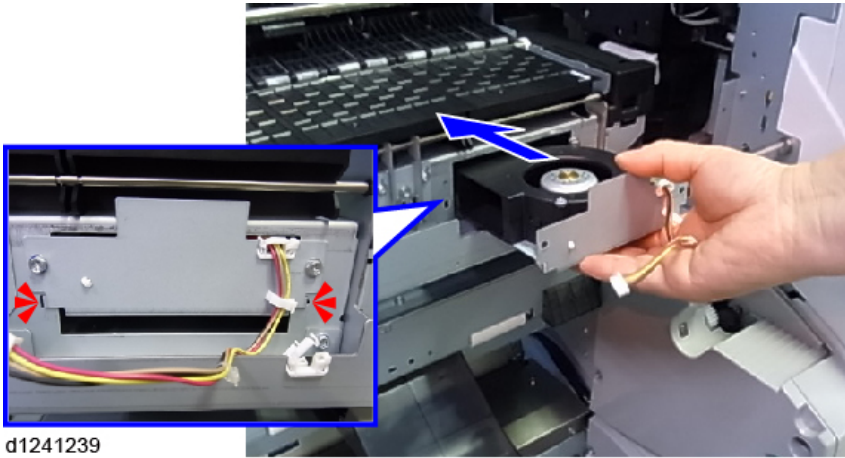

d1241239

Paper Exit

⚠ WARNING

- Set the main power switch to OFF and disconnect the power plug from the power outlet before the procedure below. Operation with the power being supplied may cause electrical shock or defects.

Cutter

1. Open the front cover (p.249).
2. Left cover (p.234).
3. Raise the cutter on the right [A] of the main unit and push it to the left until it stops at [B].

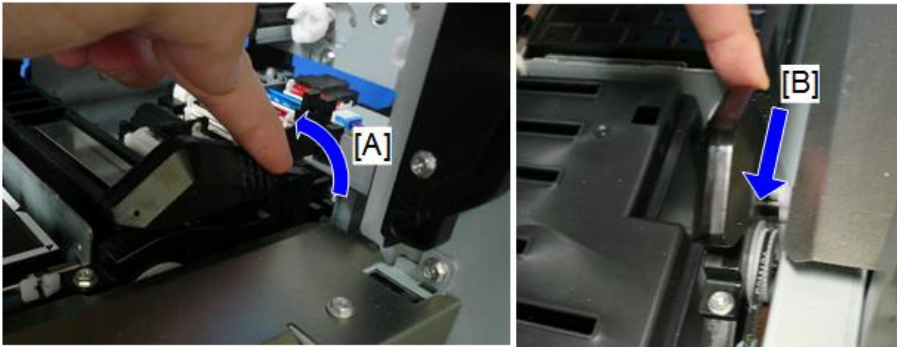

d262k0259

4. Cutter ( x1).

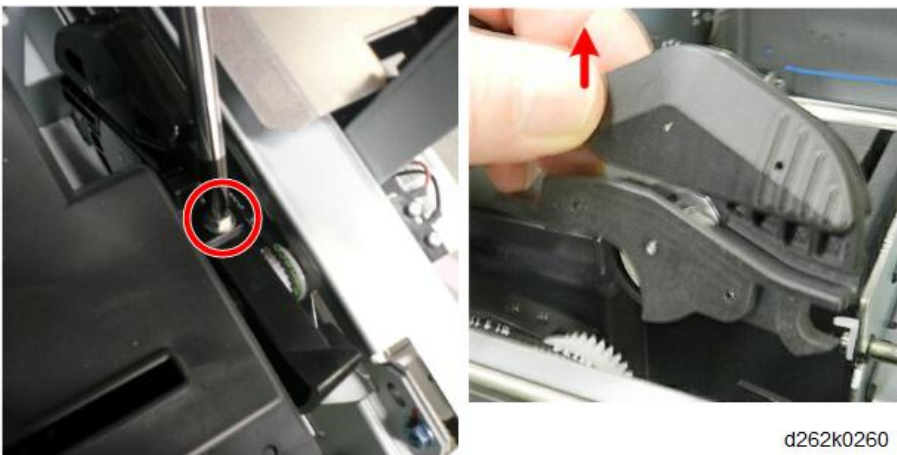

d262k0260

Cutter



d124r342

4

Exit Guide

Remove

1. Top cover (p.245).
2. Ink-cartridge cover (p.243).
3. Front cover (p.249).
4. Paper Exit Guide plate (p.251).
5. Guide rails [A] and [B] on both sides ( x2 for each).

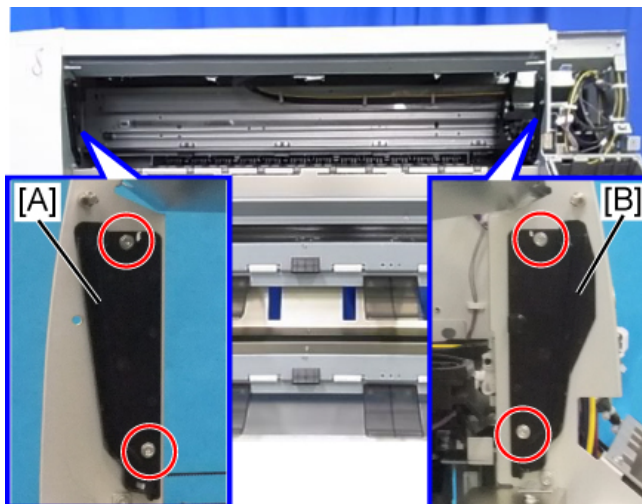

d1241242

6. Exit guide ( x9).

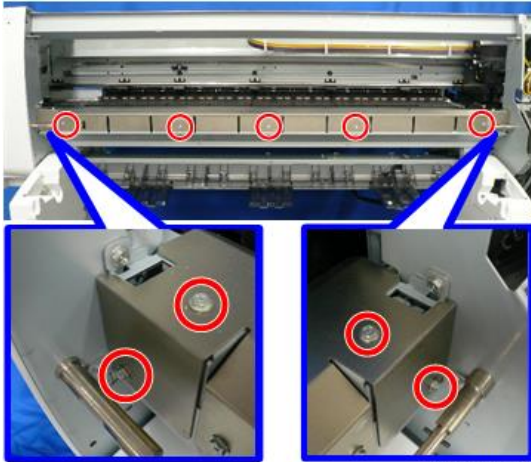

d262k0261

Precaution

To install the left guide rail, make sure that the shaft of the guide rail is in the bracket hole of the front cover switch.



d262k0262

Cutter Unit

1. Raise the cutter on the right [A] of the main unit and push it to the left until it stops at [B].

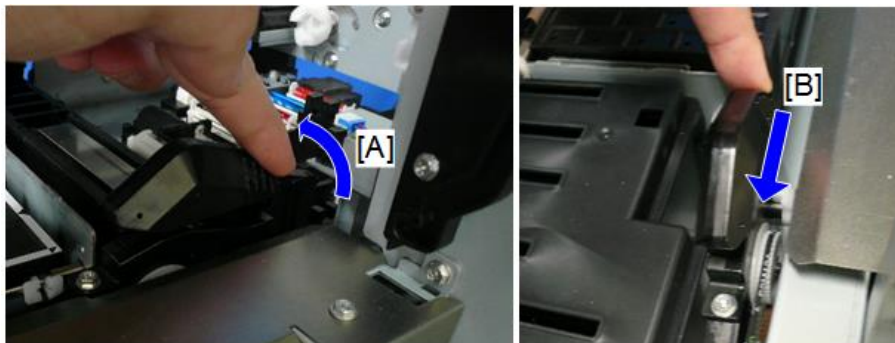

d262k0259

2. Exit guide (p.367).
3. Left cover (p.234).
4. Lower guide plate [A] ( x4).

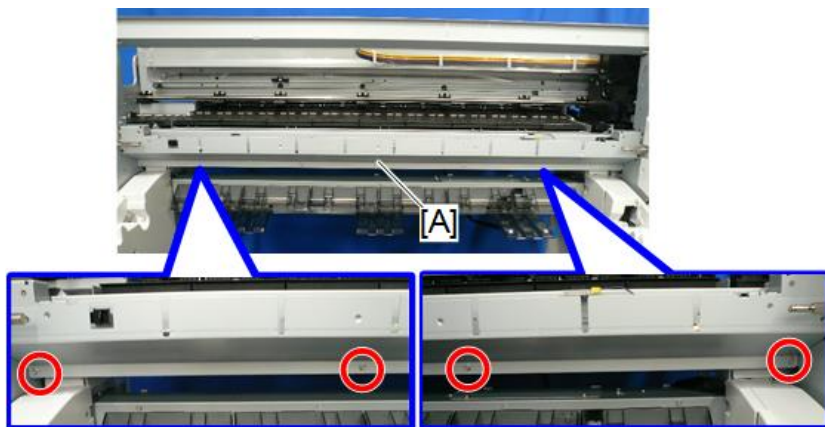

d262k0256

5. Connector and clamp of the cutter motor (🔌 x1, 🛠️ x1).

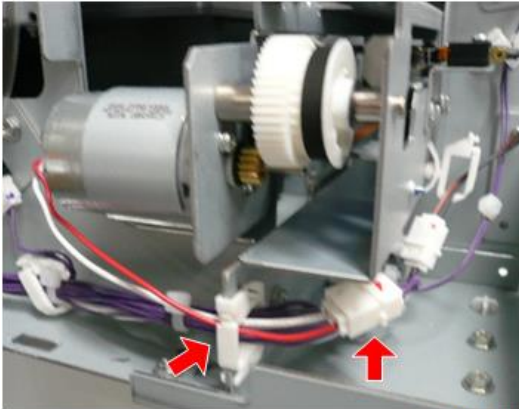

d262k0263

6. Disconnect the left cutter switch (🛠️ x1, 🔌 x1).

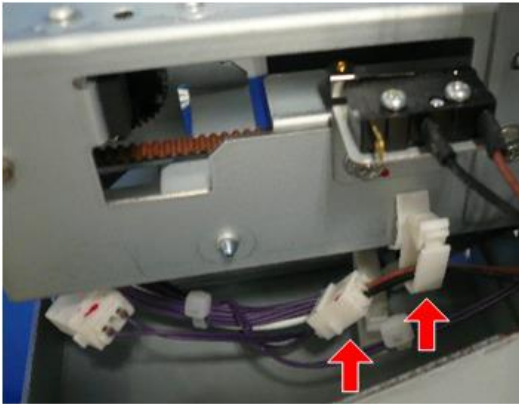

d262k0264

7. Sensor bracket on the left of the main unit (🔌 x1, 🛠️ x2).

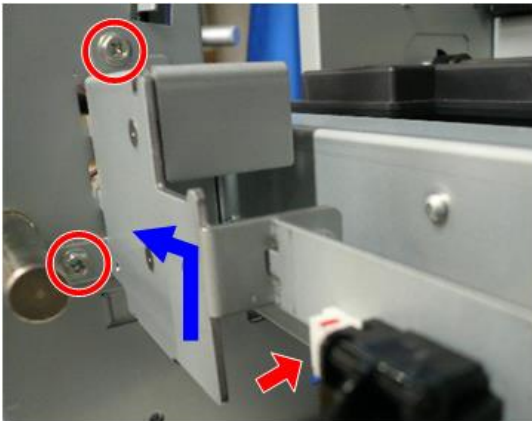

d262k0265

8. Remove the bracket of the right front cover safety switch on the right of the main unit ( x2).

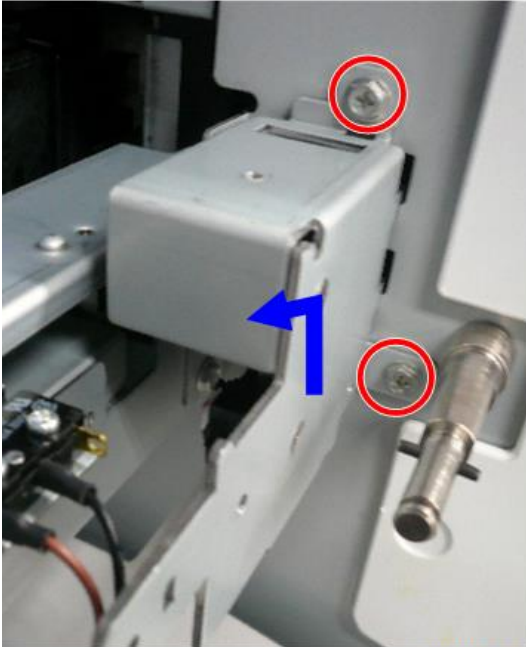

d262k0266

9. Remove the three connectors, release the clamps, and pull away the harness ( x3,  x7).

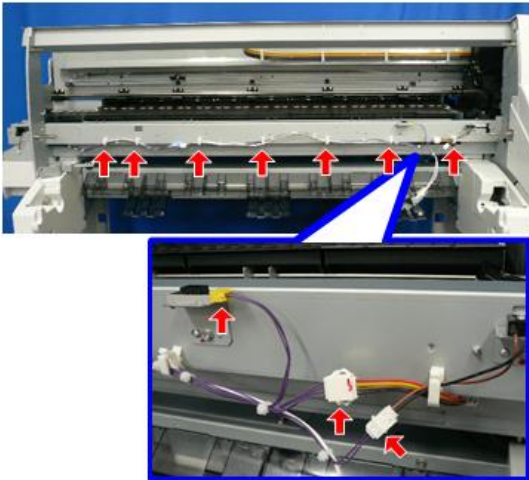

d262k0267

10. Remove the screws on the left [A] and right [B] of the main unit and take out the cutter unit [C] ( x2).

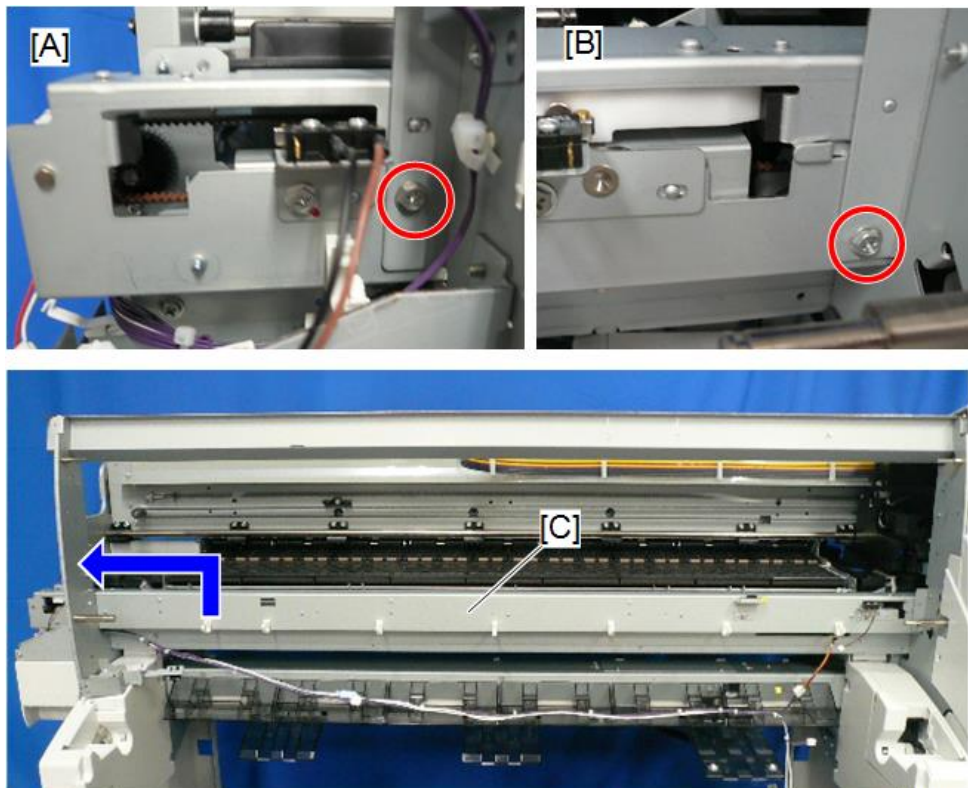

d262k0268

Cutter Switch (Right)

1. Exit guide (p.367).

2. Lower guide plate [A] ( x4).

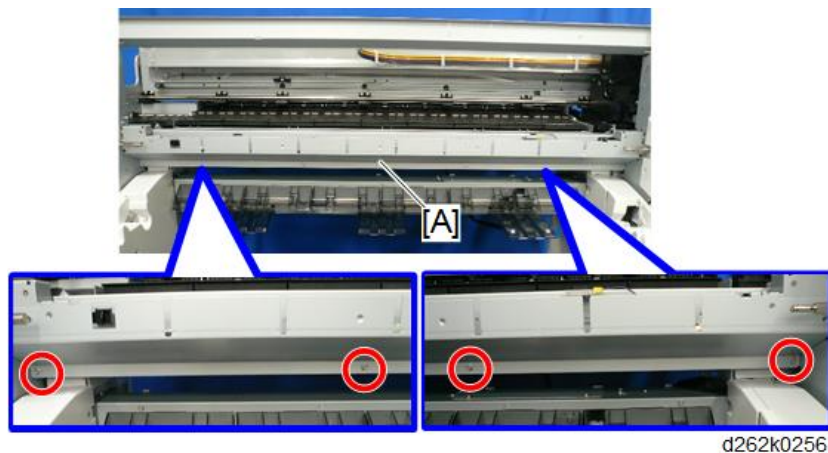

3. Cutter switch (right) ( x1,  x1,  x2).

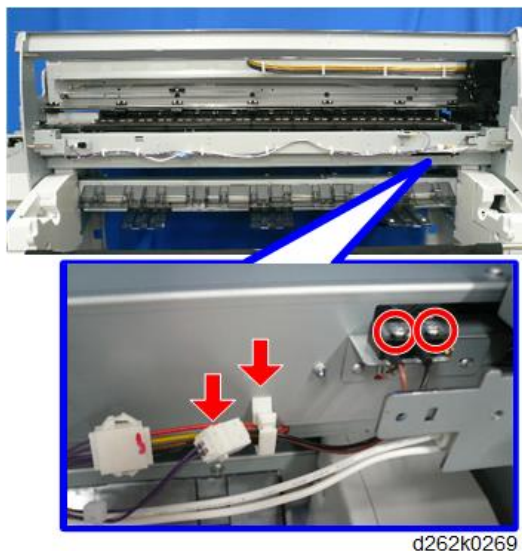

Cutter Switch (Left)

1. Left cover (p.234).

2. Cutter switch (left) (🔌 x1, 🛠️ x1, 🛠️ x2).

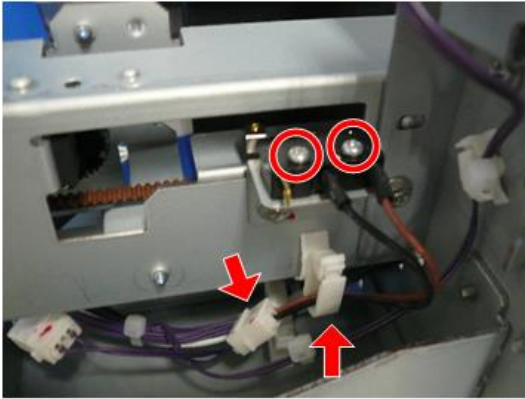

d262k0270

4

Cutter Motor

1. Cutter unit (p.369).
2. Loosen the two screws of the cutter unit to release the tension of the timing belt [A].
3. Spring [B] (🔧 x1).

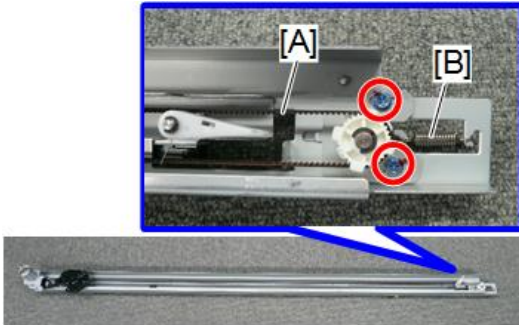

d262k0271

4. Cutter motor assembly [A] (x2).

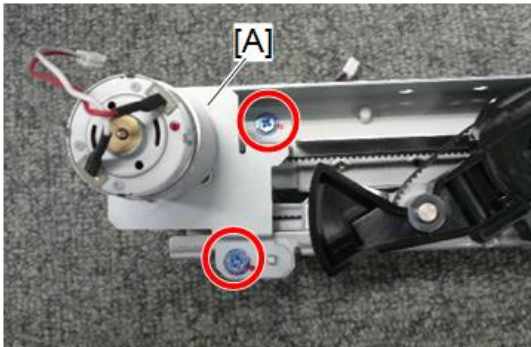

d262k0272

5. Cutter motor (x1, gear x1, x2)

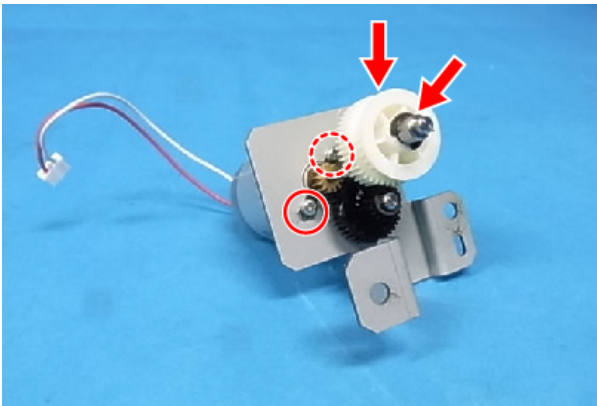

d1241253

4

Motor Timing Belt, Cutter Belt

Remove

1. Cutter unit (p.369).
2. Cutter motor (p.374).

3. Disengage the timing belt from the flapper of the cutter unit.

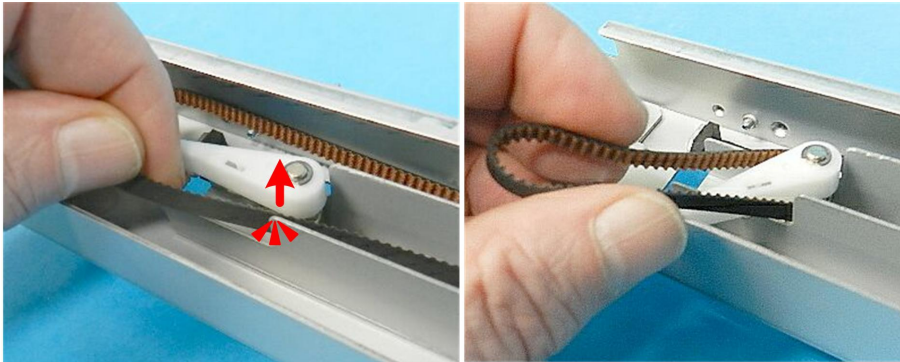

d124r349

4

4. Disconnect the race from the cutter unit bracket ( x5).

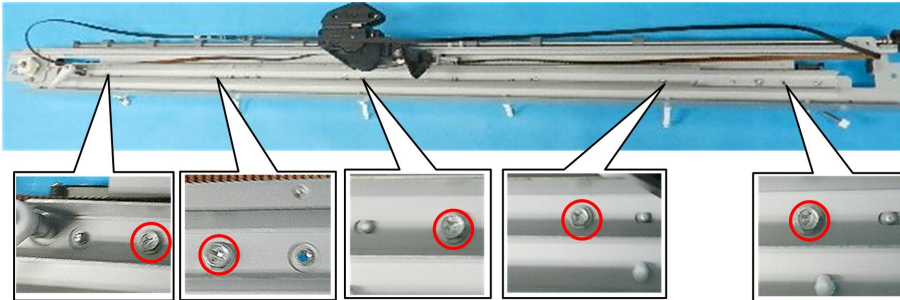

d124r350

5. Push the cutter [A] all the way to the right, pull the rail [B] up slightly, and then remove the cutter.

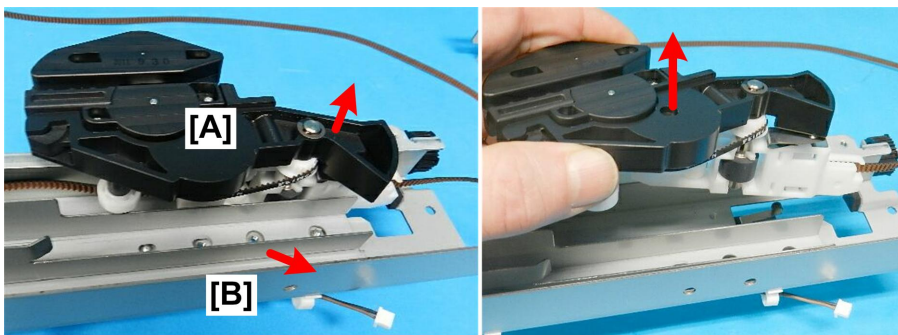

d124r351

6. Disconnect each end of the timing belt [A] and [B] from the cutter.

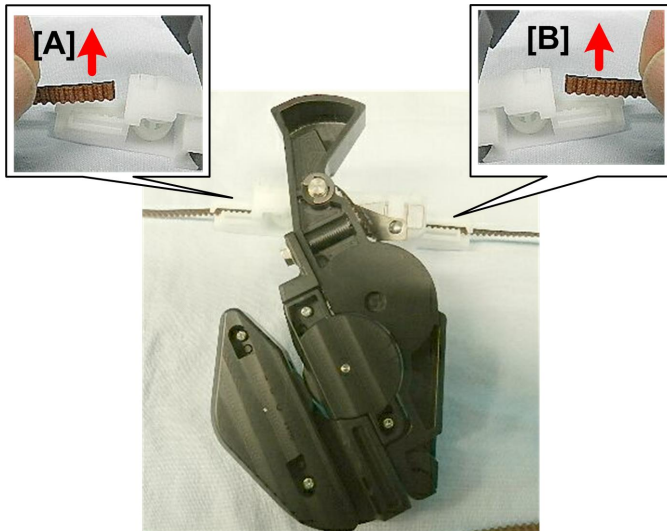

d124r352

7. Cutter from the cutter belt drive gear (Ⓒ x1, spacer x1).

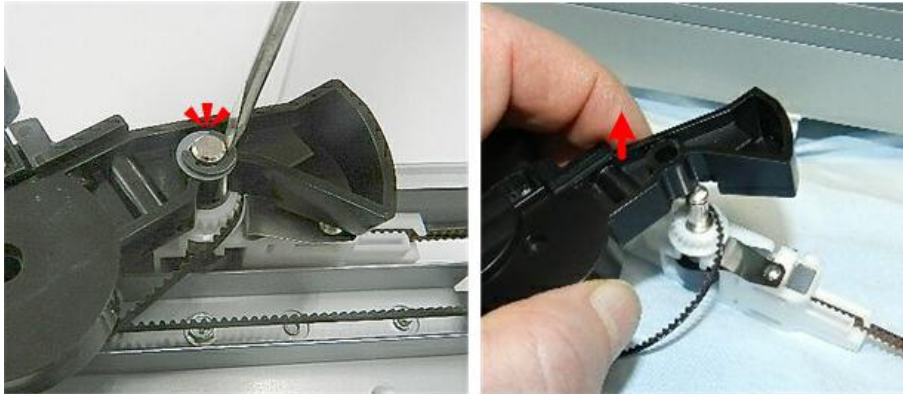

d124r353



d124r354

Precaution

- On the right end, place the timing belt on the top rail [A], the lower rail [B], and then behind the flapper [C].

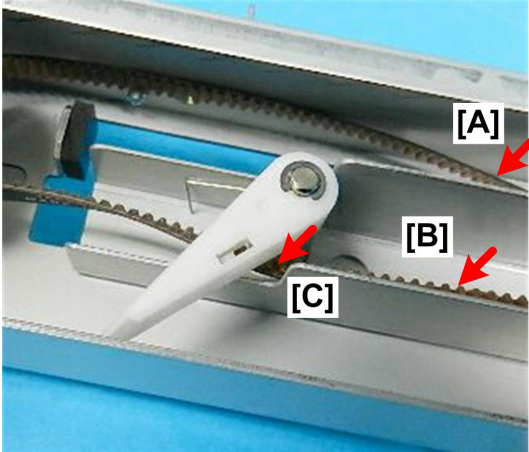

d124r355

- Position the belt below the cutter as shown below.

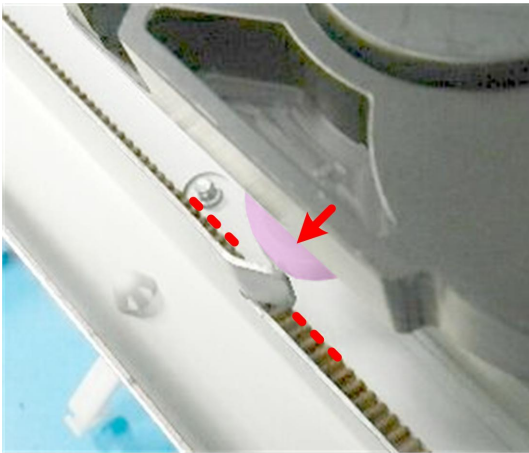

d124r356

- Before reattaching the motor, make sure that the belt is positioned in the upper rail [A] and on the lower rail [B].

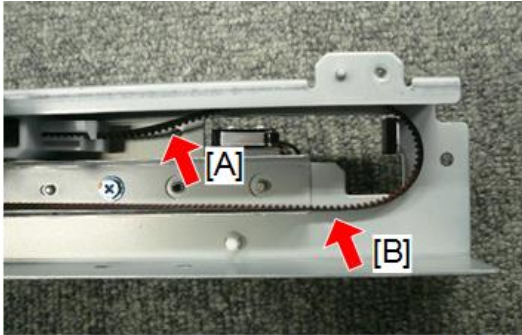

d262k0273

- Tighten the screws so that there is tension on the belt.

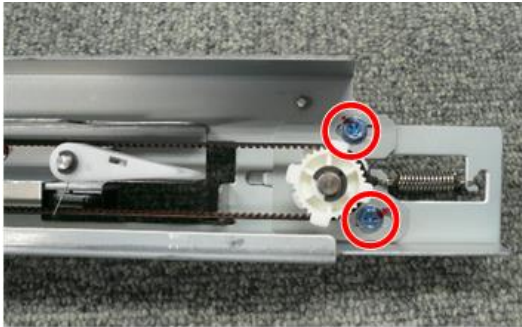

d262k0274

Paper Exit Sensor

1. Exit guide (p.367).
2. Lower guide plate [A] ( x4).

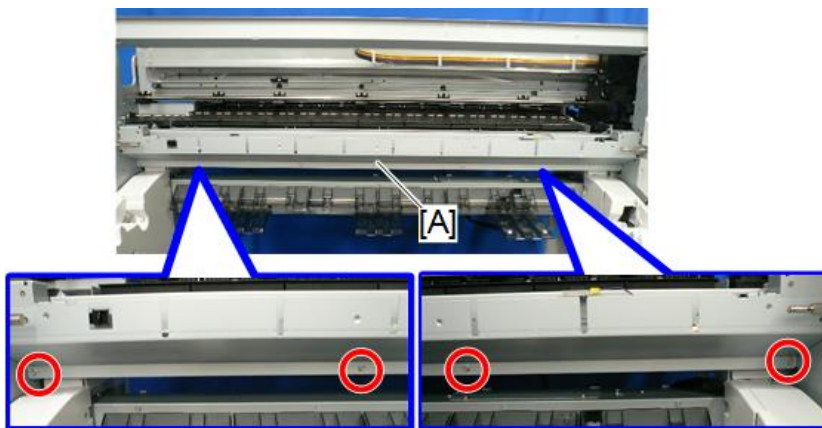

d262k0256

3. Exit sensor [A] (☞ x1, ▼ x4).

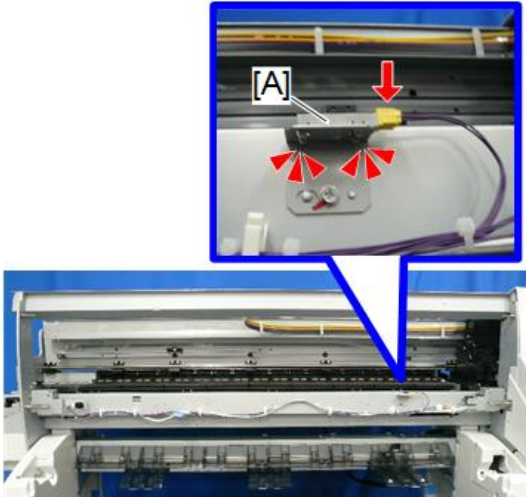

d262k0275

Guide Plate Safety Sensor

- 1. Exit guide (p.367).
- 2. Lower guide plate [A] (☞ x4).

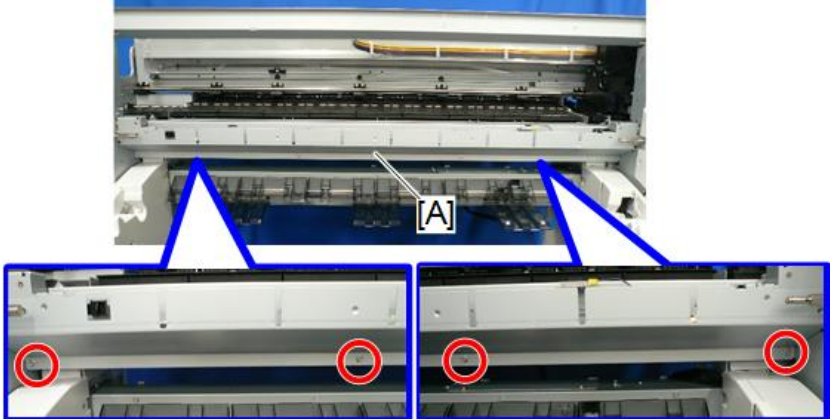

d262k0256

3. Guide plate safety sensor [A]  x1,  x4).

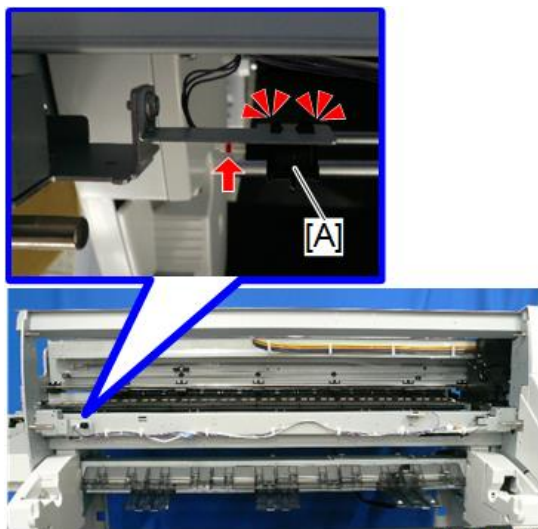

d262k0276

Main Scan

⚠ WARNING

- Set the main power switch to OFF and disconnect the power plug from the power outlet before performing the procedure below. Working with power supplied may cause electrical shock or defects.

Horizontal Encoder Sensor

4

Remove

1. Decap the print head and move the carriage unit to the center of the main unit. (p.267)

↓ Note

- When the carriage unit is moved, ink may spill out from the print head on to the platen. To move the carriage unit, place a sheet of regular paper under the carriage unit to protect the platen.
- The sheet under the carriage unit should be flat, with no paper wrinkling, which could scratch the nozzle face or cause clogging of the nozzle.
- Do not place any film under the carriage unit.
- To place the regular paper, do not pull up the paper holding lever too much (p.226).

2. Remove the top cover (p.245).

3. Loosen the screws on both sides of the ink tube rail. Do not remove the screws. (🔧 x2)

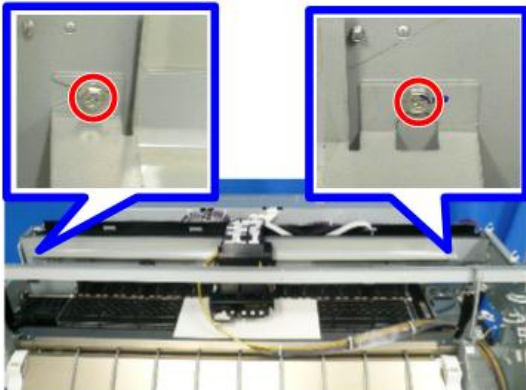

d262k1055

- Slide the rail off the screws, [A] on the right of the rail and [B] on the left.

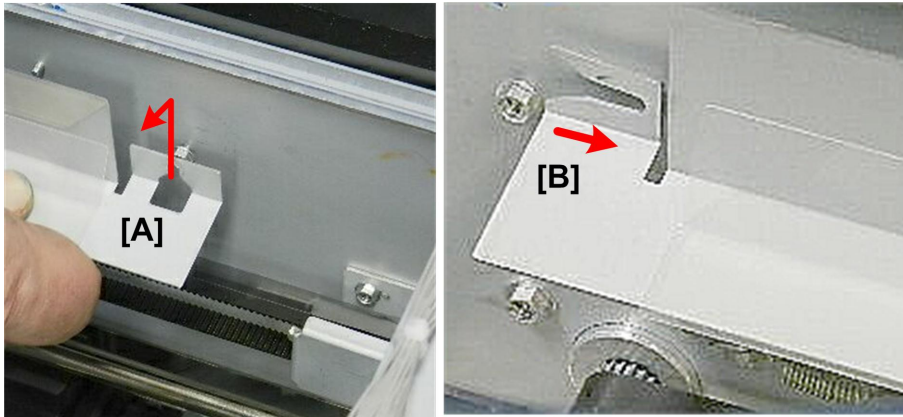

d124r458

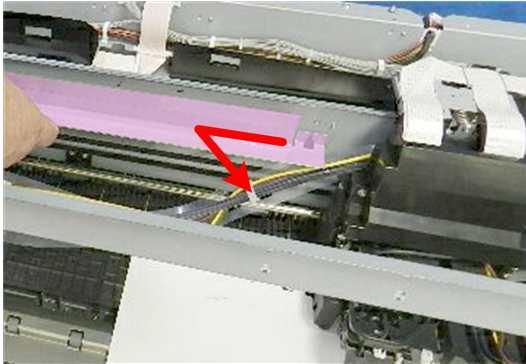

d124r459

- Remove the carriage top covers that secure the ink tube at both left and right of the carriage unit ( x2).

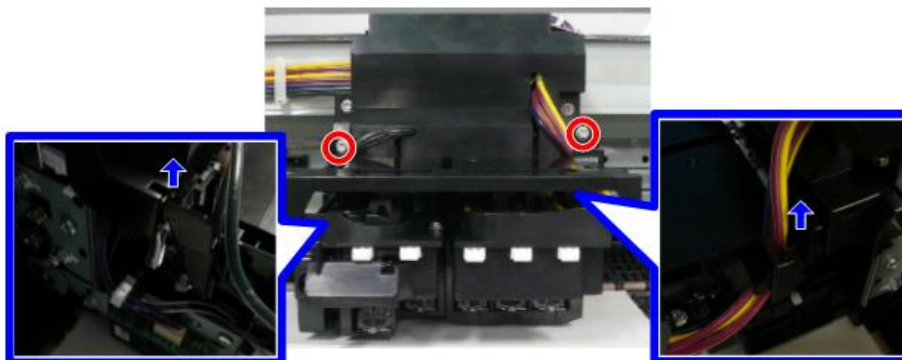

d262k3024

6. Remove the carriage front cover [A]. ( x2)

 **Note**

- To remove the carriage front cover, remove the ink tube from the groove.

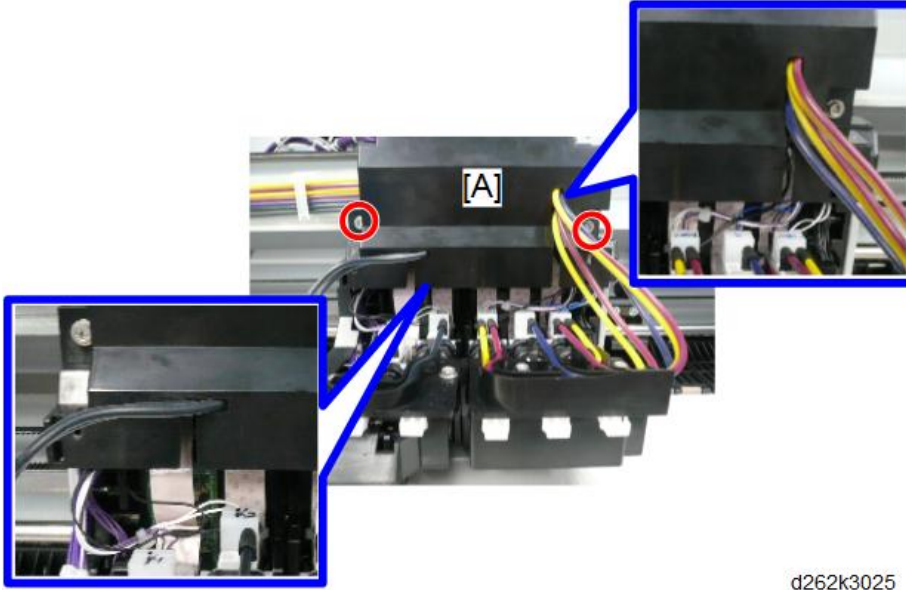

d262k3025

7. Remove the horizontal encoder sensor from the right rear of the carriage unit. ( x1,  x1)

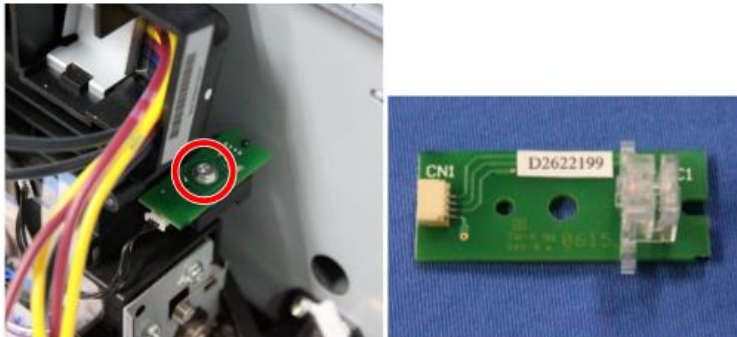

d262k0309

Precaution

Check that the upper end of the horizontal encoder sheet is caught by the cutout at the lower part of the horizontal encoder sensor.

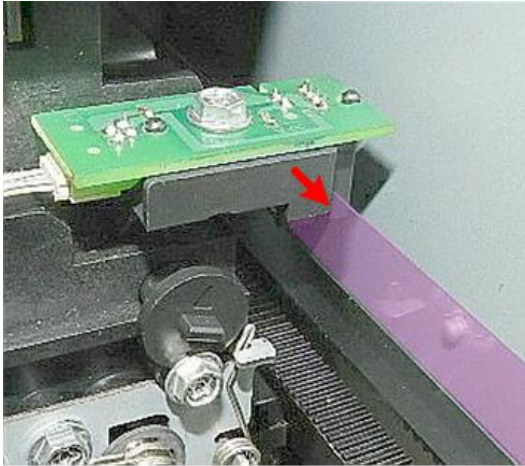

d124r535

Horizontal Encoder Sheet

Remove

↓ Note

- Do not touch the horizontal encoder sheet with bare hands.
1. Remove the top cover (p.245).
 2. Loosen the screws on both sides of the ink tube rail. Do not remove the screws. (🔧 x2)

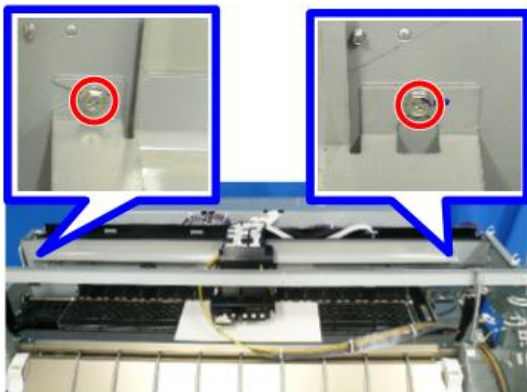

d262k1055

3. Remove the rail from the screws [A] on the right of the rail and [B] on the left.

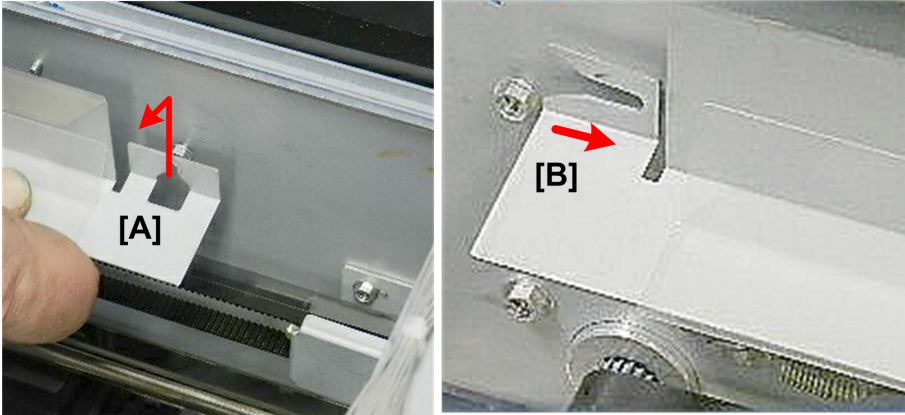

d124r458

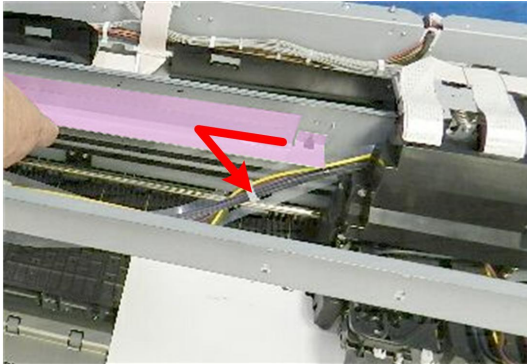

d124r459

4. The horizontal encoder sheet [A] covers the main unit from left to right. The upper end of the horizontal encoder sheet [B] is caught by the cutout of the horizontal encoder sensor.

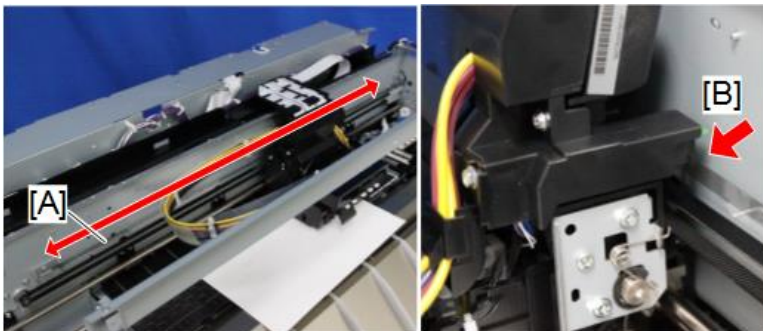

d262k0310

5. Pull the right end of the horizontal encoder sheet [1] to the right and unhook the sheet [2].

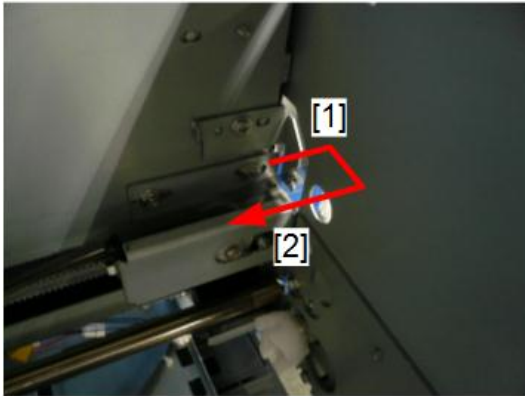

d262k1056

4

6. Remove the left end of the horizontal encoder sheet from the spring [A] and remove the spring [B]. (Spring x1)

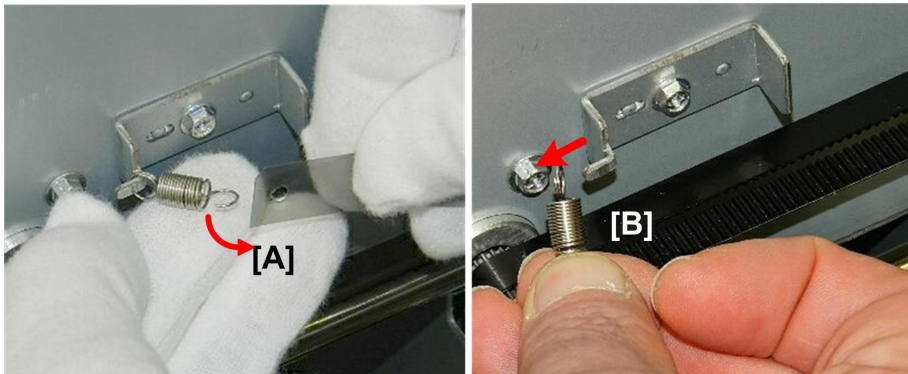

d124r375

7. Take out the horizontal encoder sheet.

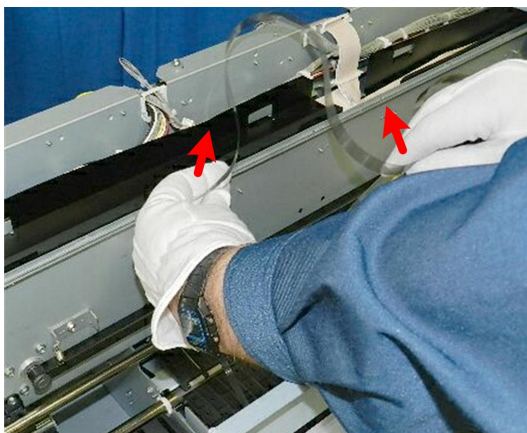

d124r376

Cleaning

If the horizontal encoder sheet is dirty, wipe it with a cloth dampened with alcohol then with a dry cloth before attaching.

★ Important

- Do not use a cotton swab or tissues whose fibers may adhere on the horizontal encoder sheet.

Precaution

- To attach the left end of the horizontal encoder sheet, place it so that the cutout [A] is placed at the upper left.
- Slide the horizontal encoder sheet to the cutout [B] of the horizontal encoder sensor.

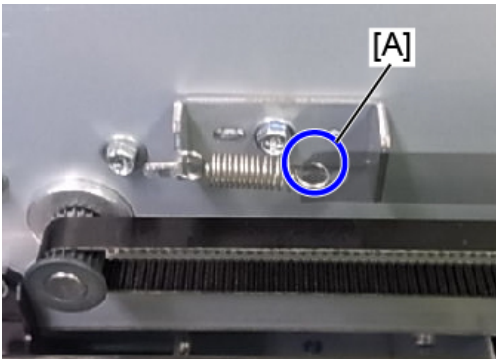

d1241311

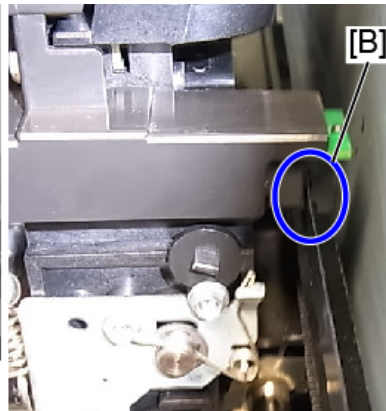

A transparent sheet is attached to the service part of the horizontal encoder sheet for protecting the part. Peel off the protective sheet before attaching the part.



d1249700

- Before you turn the machine on, check the position of the horizontal encoder strip on the left.
 - If the encoder strip is up on the bracket as shown at [A], pull it forward and down so it is in front of the bracket as shown at [B].

- If the machine is turned on with the strip positioned as shown at [A], the movement of the carriage unit may scratch the surface of the encoder strip.

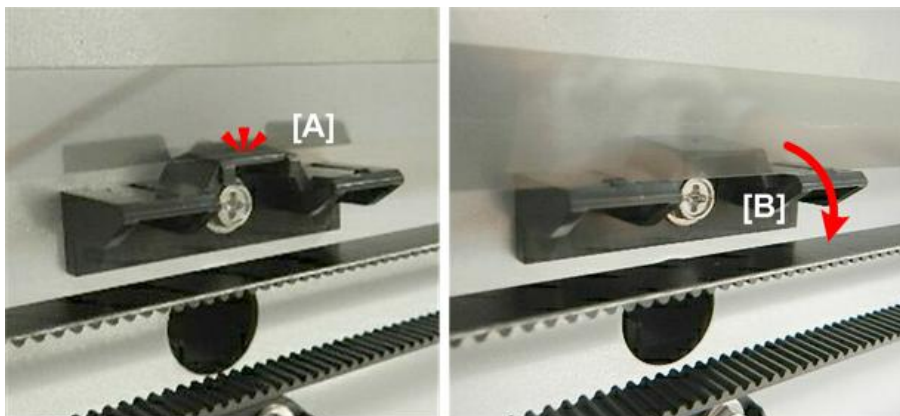

d124i209

Horizontal Motor

1. Remove the top cover (p.245).
2. Remove the left rear cover (p.248).
3. On the right of the main unit, loosen the tension screw [A] hidden behind the paper holding lever until the horizontal timing belt is loosened with the timing belt pressure bracket [B] moving to the left.

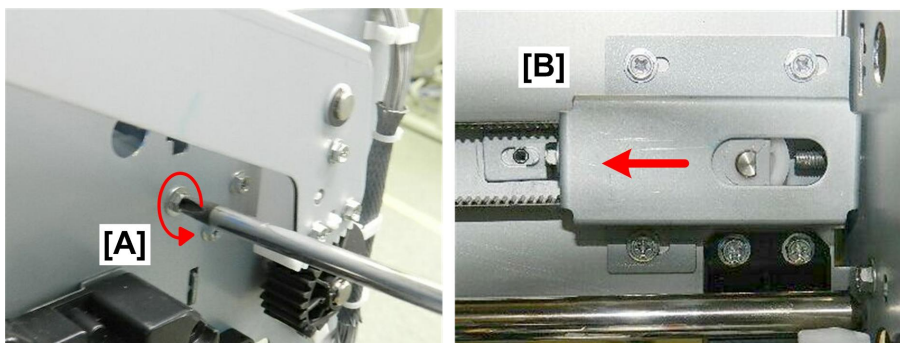

d124r414

4. On the right of the main unit, remove the screw [A] and loosen the other three screws. ( x1)

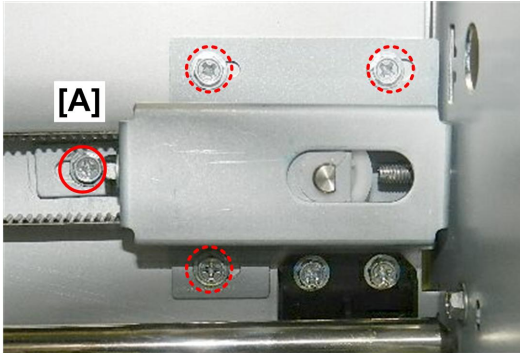

d124r413

5. On the left of the main unit, remove the screws of the horizontal motor [A]. ( x3)

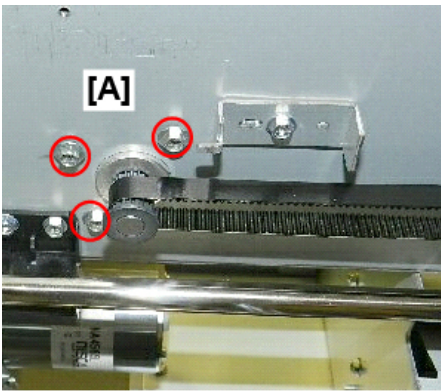

d124r412a

6. On the left of the main unit, remove the horizontal timing belt from the motor drive gear [A].

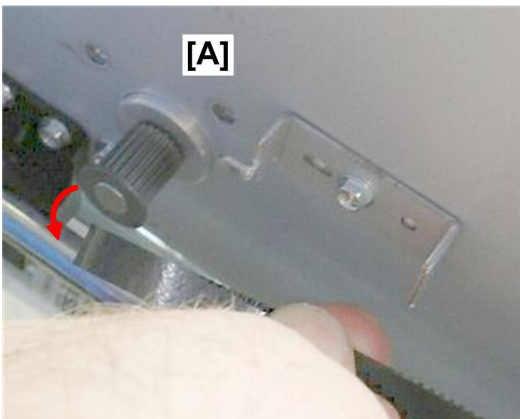

d124r415

7. Remove the horizontal motor. (📎 x1)

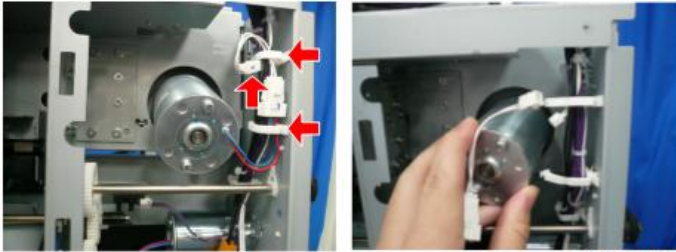

d262k1057

Horizontal Motor



d262k1058

4

Horizontal Timing Belt

The horizontal timing belt is located behind the carriage unit. Before changing the horizontal timing belt, remove the carriage unit (frame).

1. Remove the carriage unit (p.465).

2. Remove the plate from the carriage unit [A] [B]. ( x1)

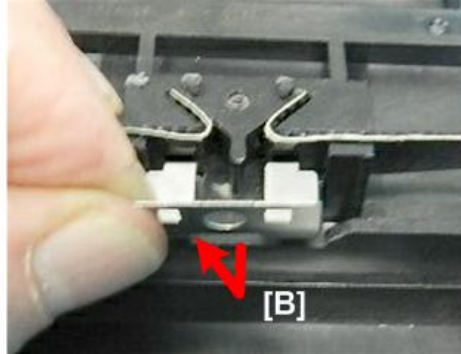
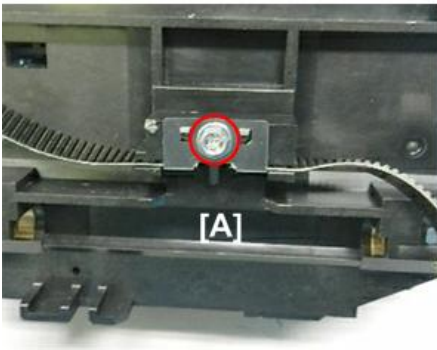

d124r499

4

3. Remove both ends of the horizontal timing belt from the grip.

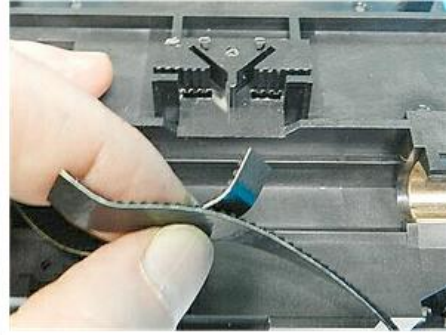
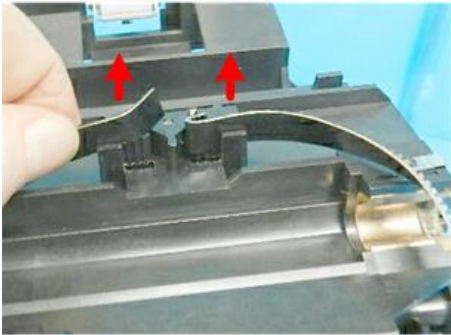

d124r500

Sub Scan

Vertical Encoder Sensor

Preparation

Remove:

- Left cover (p.234)

1. Disconnect the sensor bracket [A] ( x1,  x1).

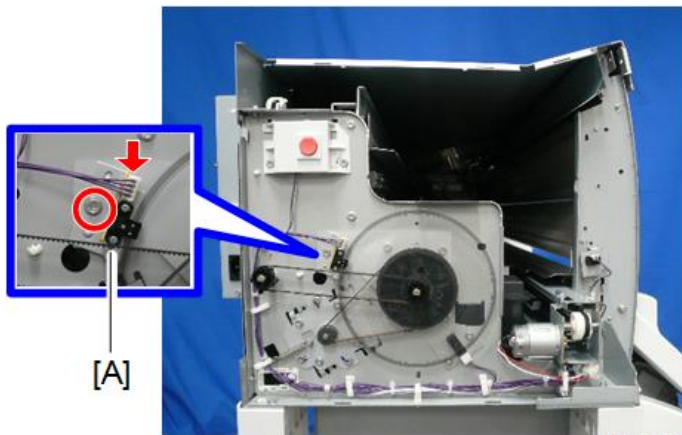

d262k3000

2. Separate the sensor and bracket ( x2).



d124r421

Reinstallation

1. Clean the sensor with a blower brush.

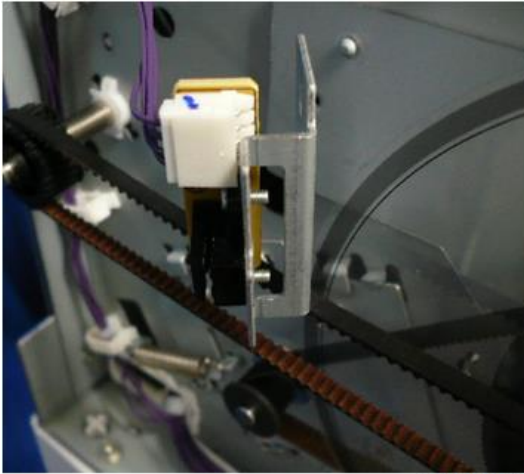

d262k3001

Precaution

To attach the sub-scan encoder sensor, catch the sub-scan encoder sheet by the sensor cutout [A].

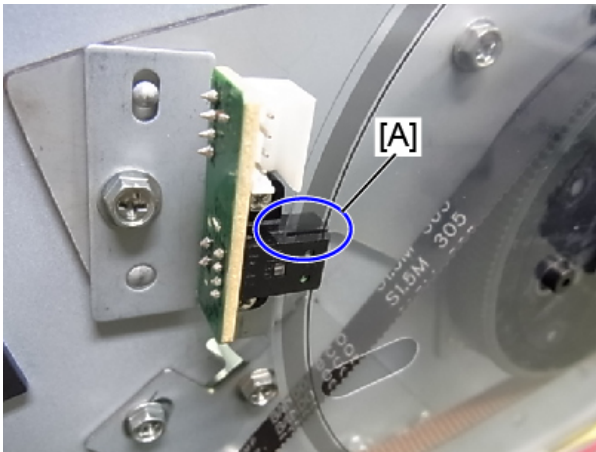

d1241401

Vertical Encoder Wheel, Timing Belt

The edge of the encoder wheel [A] is marked with coded patterns that are read by the encoder sensor [B].

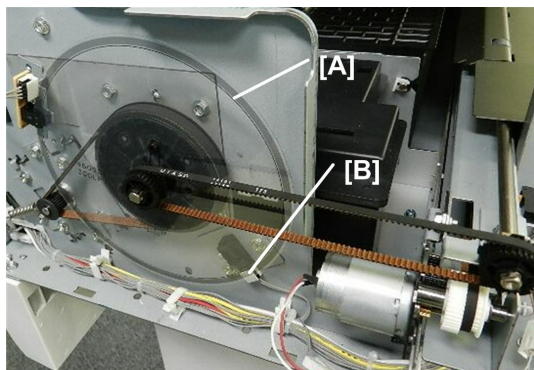

d124r423

★ Important

- Handle the encoder wheel by its hub. Never touch the edges of the vertical encoder wheel with bare hands.
- To clean the edges of the encoder wheel, wipe it with a clean linen cloth dampened with alcohol to remove dust, ink, or fingerprints.
- Never use a cotton swab, tissue, or any other kind of material that could shred and leave fibers on the surface of the encoder.

Preparation

Remove:

- Left cover (p.234)
- Vertical encoder sensor (p.393)

1. Disconnect the roller gear [A] and remove it, with the timing belt [B] (▼ x1, ⚙ x1, ⚙ x1).

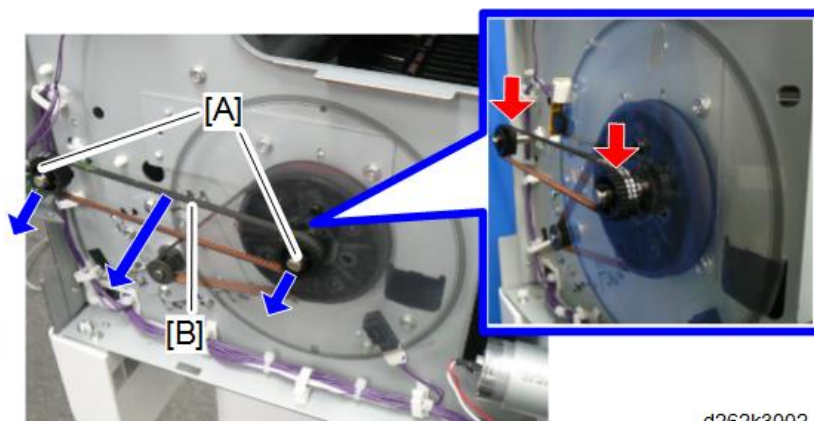

d262k3002

2. Remove the tension spring [A] (🔧 x1).

3. Remove the screws on the vertical motor bracket [B] and loosen the timing belt [C] ( x3).

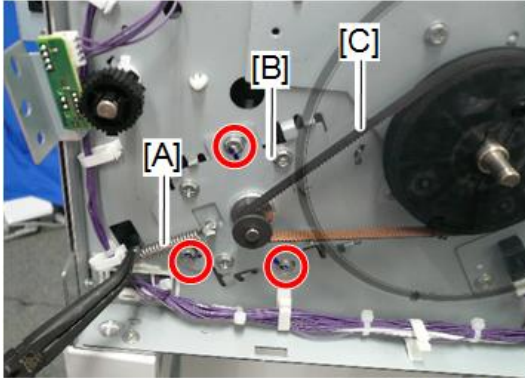

d262k3003

4. Push the bracket [A] to the right, and then separate the timing belt [B] from the motor drive gear.

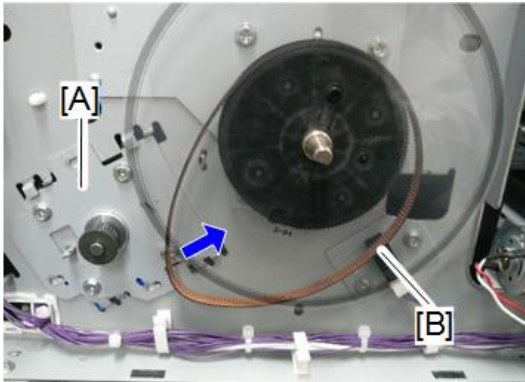

d262k3004

5. Use the head of a small screwdriver to apply slight pressure to the back of the wheel [A], and then remove the wheel with the timing belt.

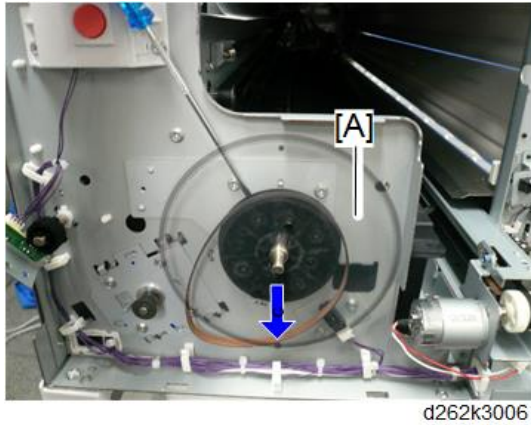

4

Vertical Encoder Wheel

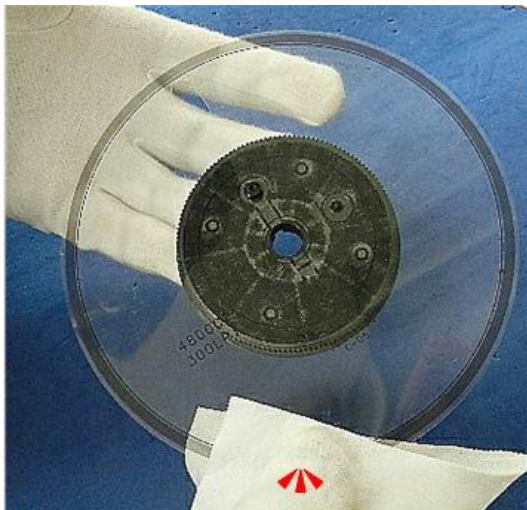

d124r431

Vertical Encoder HP Sensor

Preparation

Remove:

- Left cover (p.234)
- Vertical encoder sensor (p.393)
- Vertical encoder wheel (p.394)

1. Remove the sensor with the sensor bracket [A] ( x2,  x1).

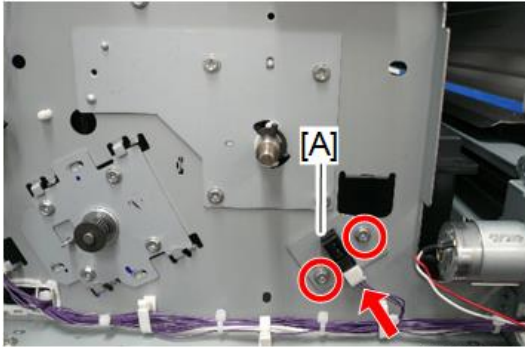

d262k3007

4

2. Separate the bracket and sensor [A] ( x4).

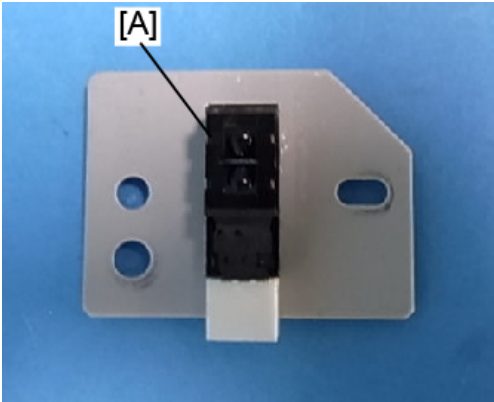

d1421191

Reinstallation

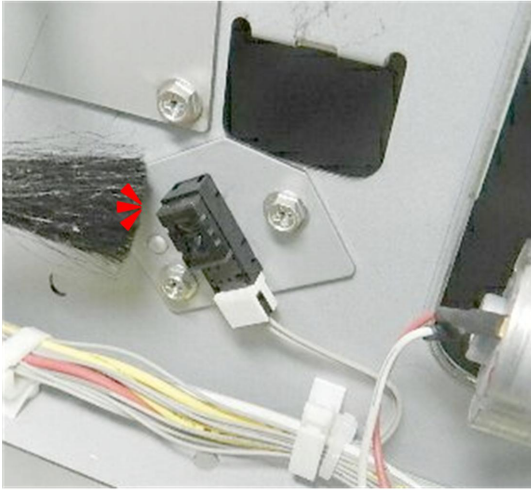
1. Clean the sensor with a blower brush.

d124r435

Vertical Motor

Preparation

Remove:

- Left cover (p.234)
- Left rear cover (p.248)
- Vertical encoder sensor (p.393)
- Vertical encoder wheel (p.394)

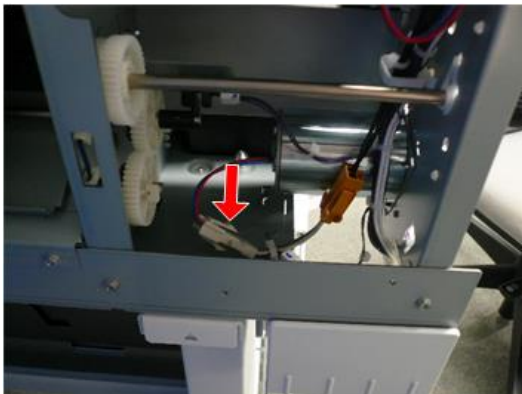
1. Disconnect the connector of the motor bracket. (E x1)

d262k3008

2. Slide and remove the motor bracket [A].

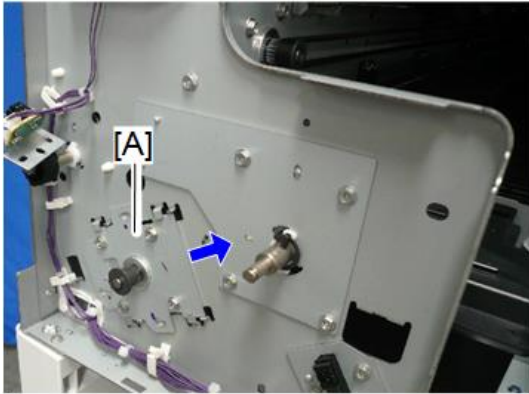

d262k3009

4

3. Separate the motor and bracket [A] ( x4).

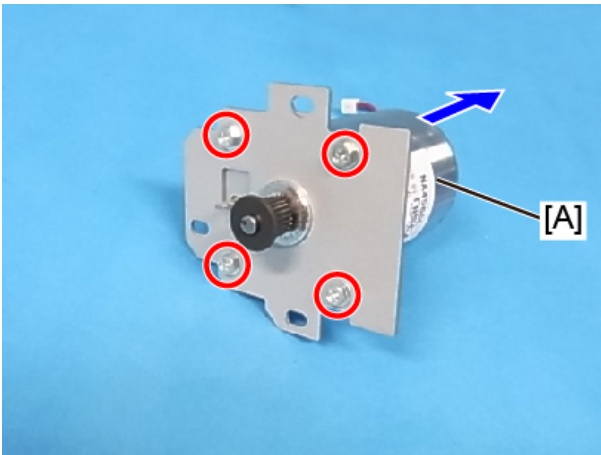

d1241118

Bypass Stopper Clutch Sensor

Preparations

Remove:

- Left cover (p.234)
- Left rear cover (p.248)

1. Turn the gear [A] counterclockwise and separate the sensor filler [B] from the bypass stopper clutch sensor [C].

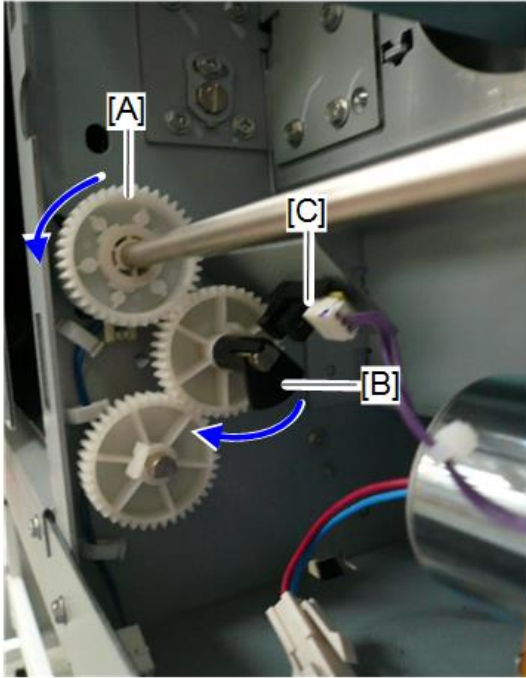

d262k3010

2. Bypass stopper clutch sensor bracket [A] ( x2,  x1).

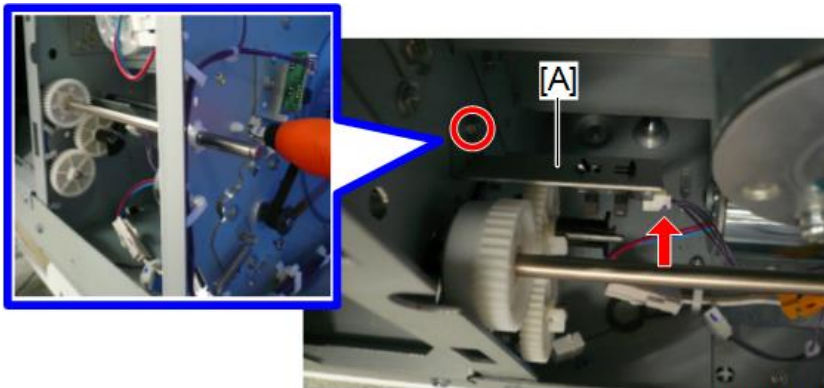

d262k3011

3. Remove the bypass stopper clutch sensor from the bracket (▼ x2).

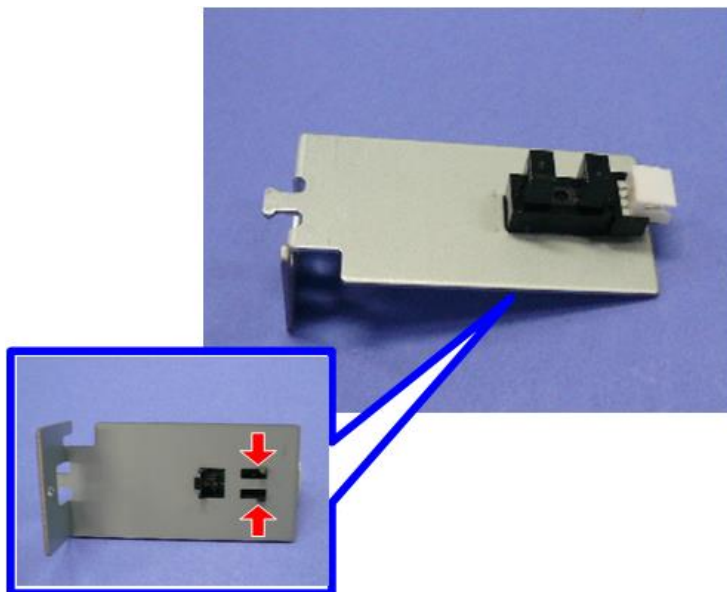

d262k3012

Bypass Stopper Clutch

Preparations

Remove:

- Bypass stopper clutch sensor (p.400)

1. Sensor filler [A] (▼ x1).

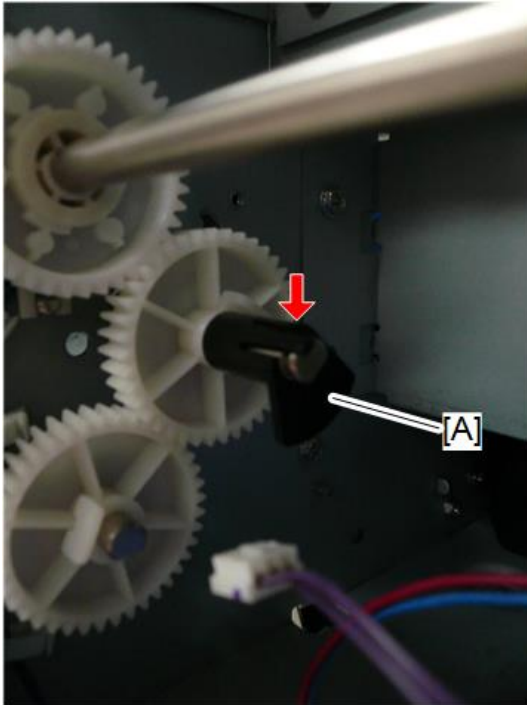

d262k3013

2. Gear [A] (▼ x1).

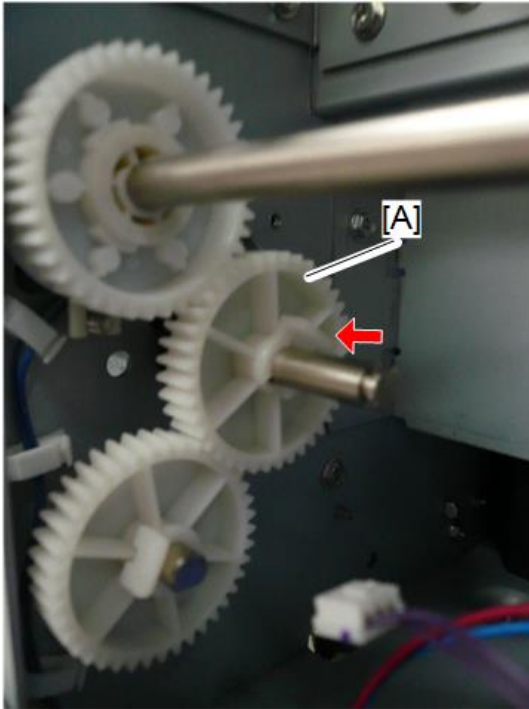

d262k3014

↓ Note

- If the clutch plate is detached from the gear, place the gear with the clutch side [A] up and attach it to the gear.

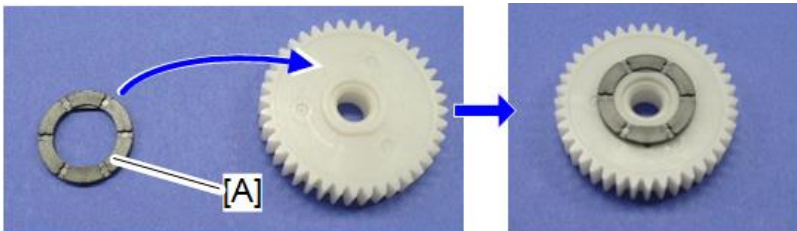

d262k3015

- Take care that the clutch plate is attached correctly with the clutch side.

3. Slide the gear [A] to the outside of the main unit. (🔧 x1, 📦 x3, 🛠️ x1)

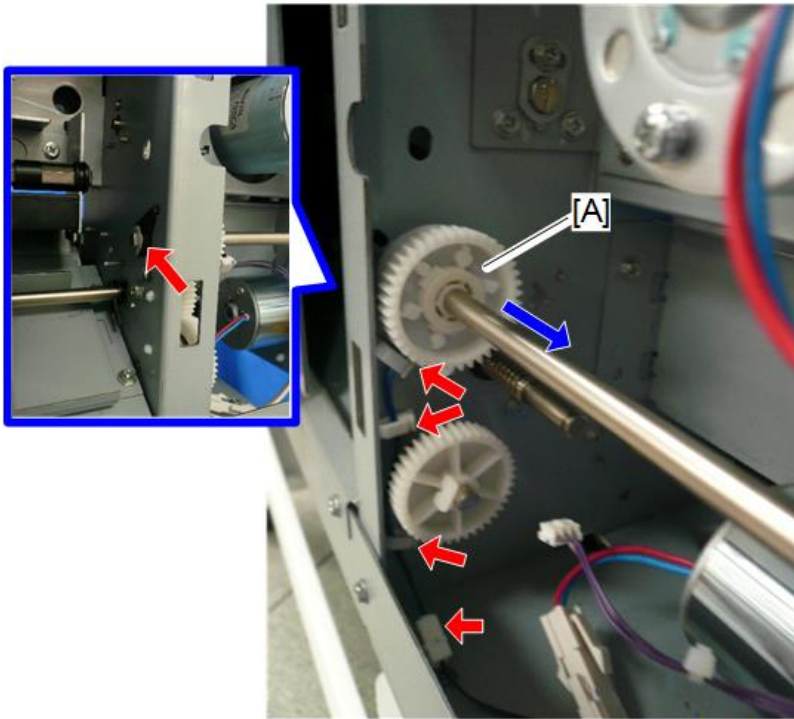

d262k3016

4. Bypass stopper clutch [A]. (🛠️ x1)

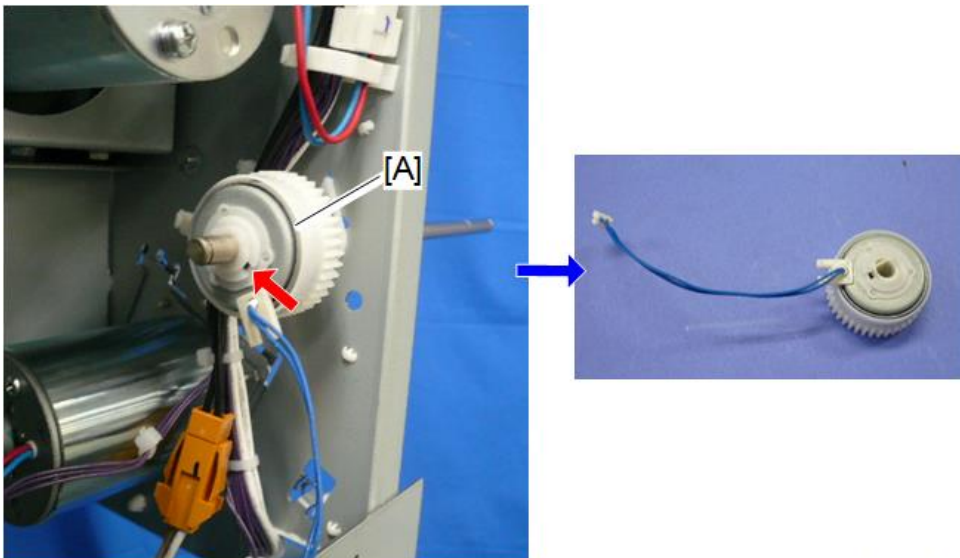

d262k3017

Carriage Unit

Before You Begin

WARNING

- Set the main power switch to OFF and disconnect the power plug from the power outlet before performing the procedure below. Working with power supplied may cause electrical shock or defects.

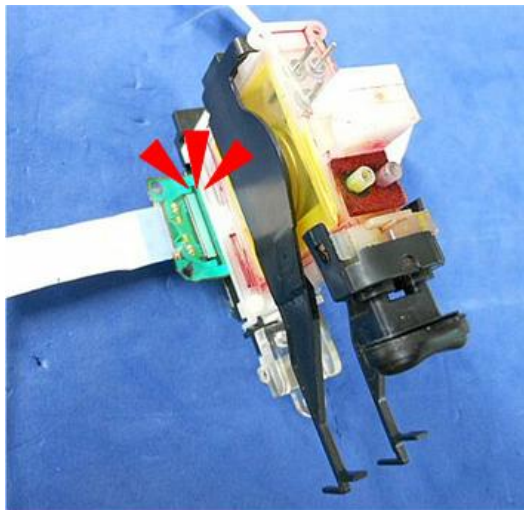

d124r729

Important

- Always follow instructions and work carefully to avoid spilling ink from the ink tubes and the tops of the ink sub tanks.
 - If ink spills onto a printed circuit board at the base of the FFC, the print head unit will become unusable and require replacement.
1. Horizontal line on both the left and right margins.
 - The width of the left and right margins must be the same.
 - The width of the left and right margins must be in the range: 2.5 to 3.0 mm.
 2. If the left and right margins are the same size and within the range 2.5 to 3.0 mm, no adjustment is necessary.
-or-
If the margins need adjustment, do the following steps.

3. Use **SP2-104-001** (Paper Edge Detection Delay Adj: Normal Paper Right Edge) and **SP2-104-002** (Paper Edge Detection Delay Adj: Normal Paper Left Edge) to adjust the left and right margins. Here are some sample measurements and correction entries.

Margin	Measured (mm)	SP	Enter +/-	Target
Right	1	2104-001	+2	3
Right	4.5	2104-001	-1.5	3
Left	1.0	2104-002	-2.0	3
Left	4.5	2104-002	+1.5	3

4. Print another test pattern with **SP4-417** (IPU Test Pattern Setting - Pattern Selection) Pattern 3 Grid Pattern A and check the results.

Note

- SP4-417
 - Enter the number for the desired test pattern, switch the display to the "Copy Window" then press the [Start] button.
5. Repeat the adjustment procedure until both measurements are equal and within range.
6. After completing the adjustment, open **SP2-104-031** (Paper Edge Detection Delay Adj: Automatic Conversion) and touch [EXECUTE].
- This saves the adjusted settings.
 - These adjusted settings are applied not only to Normal Paper but all other types of paper included under this SP code.
7. Open **SP4-012** (Scanner Edge Margin).
- Touch **SP4-012-007** (DF: Left Edge), and then restore the original setting noted in Step 8.
 - Touch **SP4-012-008** (DF: Right Edge), and then restore the original setting noted in Step 8.

Note

- SP4-012
- These SP's define borders around the image area output by the scanner. Each edge can be set independent of the others.

DRESS Sensor

Important

- To remove the DRESS sensor, never loosen nor remove the two screws shown below (the figure below shows the main unit with the carriage left cover removed).

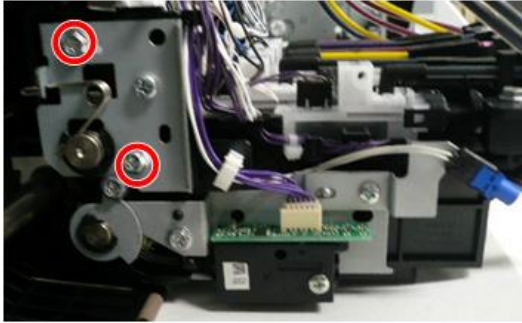

d262k3018

4

Remove

1. Uncap the print head and move the carriage unit to the left of the main unit (p.267) .

Note

- When the carriage unit is moved, ink may spill out from the print head onto the platen. To move the carriage unit, place a sheet of plain paper under the carriage unit to protect the platen.
- The sheet under the carriage unit should be flat, with no paper wrinkling, which could scratch the nozzle face or cause clogging of the nozzle.
- Do not place any film under the carriage unit.
- To place the plain paper, do not pull up the paper holding lever too much (p.226).

2. Remove the left cover (p.234).
3. Open the front cover.

4. Place a sheet of paper at the left end of the platen and move the carriage unit above the paper manually.

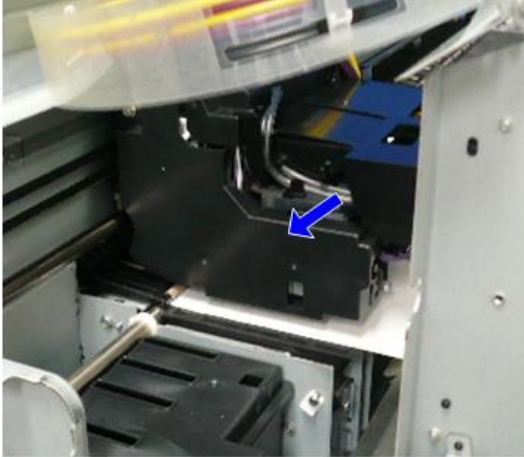

d262k3019

5. Remove the carriage left cover. ( x1)

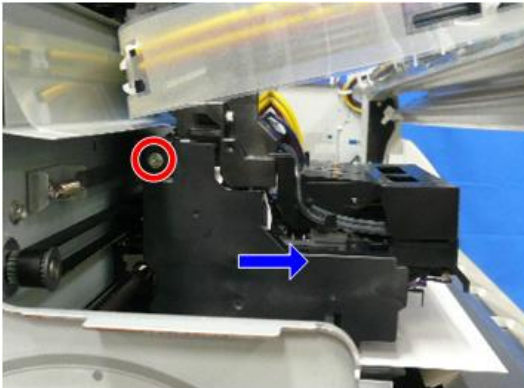

d262k3020

6. Remove the DRESS sensor. (🔧 x1, 📏 x1, 🖋️ x1)

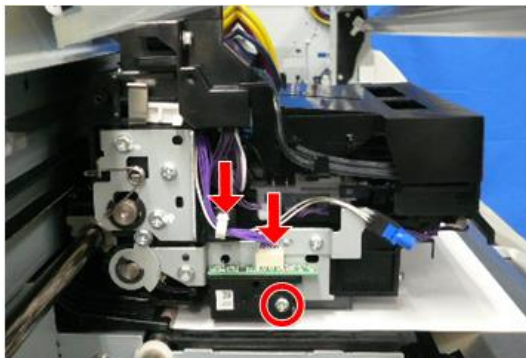

d262k3021

4

DRESS Sensor

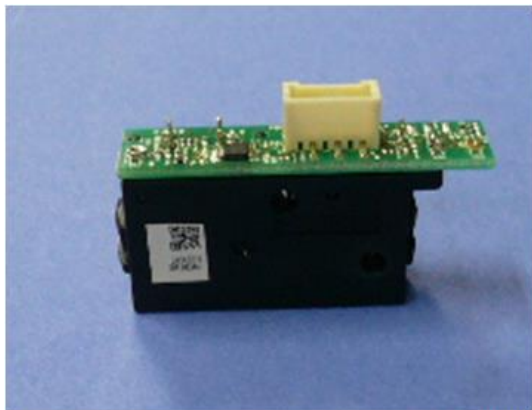

d262k3022

Cleaning

Remove the paper dust on the sensor with a blower brush. If the ink-mist is attached, remove it with non-woven fabric or a cotton swab.

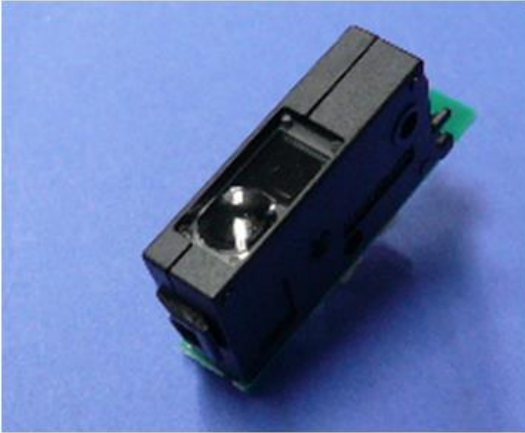

d262k3023

Adjustment

After replacing the DRESS sensor, adjust the paper edge detection delay, following the procedure below.

Paper Edge Detection Delay Adjustment

1. In system settings, make settings for the roll unit 1 as follows:

Paper size: 914 mm (36 inches)

Paper type: Not displayed (plain paper)

2. Set the roll unit (plain paper) whose size is different from the setting, with this setting retained.
3. Enter SP mode and make the settings described below.

SP	Settings
SP4-417-001 (IPU Test Pattern Setting: test pattern select)	3: Grid Pattern A
SP4-012-007 (Scanner Edge Margin: DF: left)	0 (Retrieves the original value after adjustment)
SP4-012-008 (Scanner Edge Margin: DF: right)	0 (Retrieves the original value after adjustment)
SP2-103-003 (Printing Erase Margin: left edge)	3.0 mm
SP2-103-004 (Printing Erase Margin: right edge)	3.0 mm

SP	Settings
SP2-104-001 (Paper Edge Detection Delay Adjustment: plain paper: right edge)	+3.0 mm
SP2-104-002 (Paper Edge Detection Delay Adjustment: plain paper: left edge)	-3.0 mm

4. Move to Copy mode of SP mode and make settings and preparations as described below.

Item	Settings/Preparations
Original size	Width: 594 mm or more, Length: approx. 210 mm
Paper size	Synchro-cut
Print mode	Monochrome High-Speed mode

5. Place the right original side guide as follows.

- 914 mm

6. Place the original in alignment with the right original side guide and copy it.

Note

- A pattern may be printed on the platen, depending on the sensitivity of the DRESS sensor. In such a case, clean the platen after adjustment. (Paper Feed System)

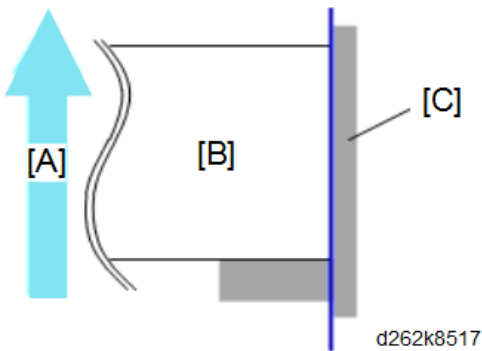

[A]:Direction for paper feeding

[B]:Original

[C]:Side guide

7. Check the left and right margins of the printed grid pattern.

Left and right margins of the grid pattern	Solutions
Within 2.5 to 3.0 mm	Retrieve the settings for SP4-012-007/008 (Scanner Edge Margin: DF: left/right) to the values before adjustment. This completes adjustment.
Outside 2.5 to 3.0 mm	Adjust the margin as described below.

Margin Adjustments

1. Set SP2-104 (paper edge detection delay adjustment) as described below in SP mode.

Right edge adjustment: Set SP2-104-001 (right edge of plain paper) as described in the table below.

To increase the margin	Add the value so that the margin becomes 3.0 mm. Example: If the current margin is 1.0 mm, enter +2.0 mm as the current value.
To decrease the margin	Subtract the value so that the margin becomes 3.0 mm Example: If the current margin is 4.5 mm, enter -1.5 mm as the current value.

Left edge adjustment: Set SP2-104-002 (left edge of plain paper) as described in the table below.

To increase the margin	Subtract the value so that the margin becomes 3.0 mm. Example: If the current margin is 1.0 mm, enter -2.0 mm as the current value.
To decrease the margin	Add the value so that the margin becomes 3.0 mm. Example: If the current margin is 4.5 mm, enter +1.5 mm as the current value.

2. Print the grid pattern again and check the right and left margins.

If the margin is between 2.5 and 3.0 mm, go to the next step.

3. Do SP2-104-031 (Paper Edge Detection Delay Adj: Automatic Conversion).

When the SP is done, the expected value based on the adjustment of the plain paper will be reflected on the other type of paper.

4. Return the settings for the following SPs to the default.

- SP4-012-007 (Scanner Edge Margin: DF: left)
- SP4-012-008 (Scanner Edge Margin: DF: right)

LED

★ Important

- To remove the LED, never loosen nor remove the two screws shown below (the figure below shows the main unit with the carriage left cover removed).

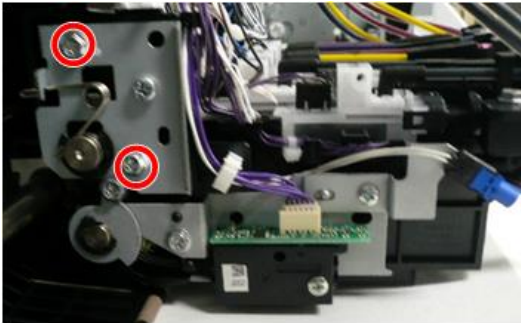

d262k3018

Remove

1. Uncap the print head and move the carriage unit to the left of the main unit (p.267).

↓ Note

- When the carriage unit is moved, ink may spill out from the print head onto the platen. To move the carriage unit, place a sheet of plain paper under the carriage unit to protect the platen.
- The sheet under the carriage unit should be flat, with no paper wrinkling, which could scratch the nozzle face or cause clogging of the nozzle.
- Do not place any film under the carriage unit.
- To place the plain paper, do not pull up the paper holding lever too much (p.226).

2. Remove the left cover (p.234).

3. Open the front cover.

4. Place a sheet of paper at the left end of the platen and move the carriage unit above the paper manually.

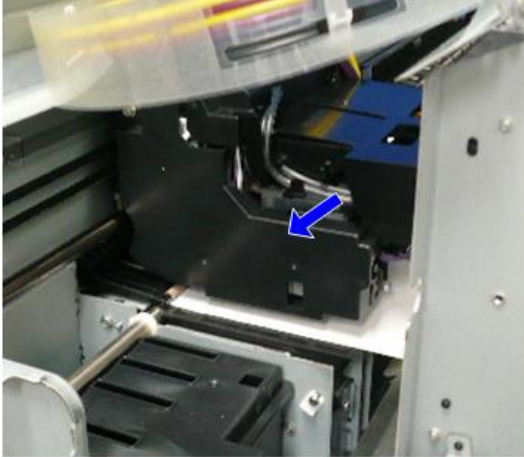

d262k3019

5. Remove the carriage left cover. ( x1)

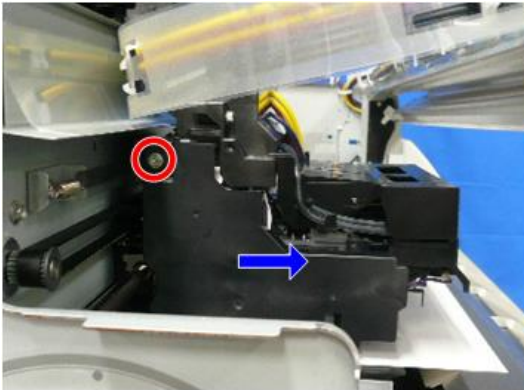

d262k3020

6. Remove the LED.

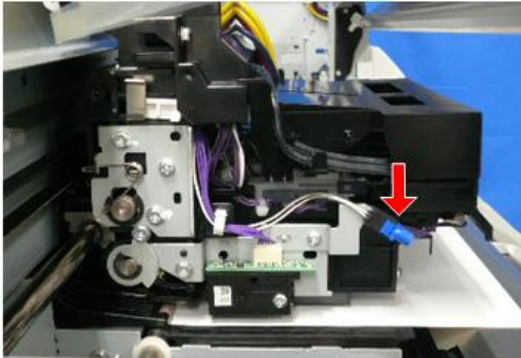

d262k3080

HRB (Head Relay Board)

Remove

1. Uncap the print head and move the carriage unit to the center of the main unit (p.267).

Note

- When the carriage unit is moved, ink may spill out from the print head onto the platen. To move the carriage unit, place a sheet of plain paper under the carriage unit to protect the platen.
- The sheet under the carriage unit should be flat, with no paper wrinkling, which could scratch the nozzle face or cause clogging of the nozzle.
- Do not place any film under the carriage unit.
- To place the plain paper, do not pull up the paper holding lever too much (p.226).

2. Remove the top cover (p.245).
3. Remove the front cover (p.249).

4. Remove the carriage left cover. ( x1)

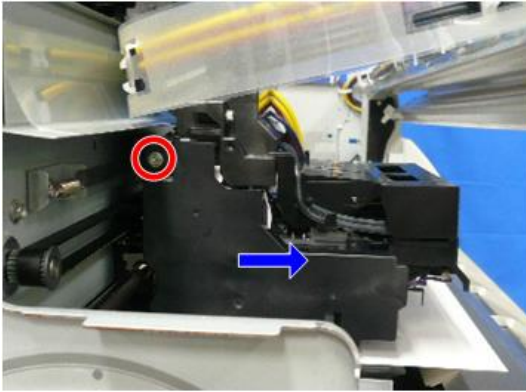

d262k3020

4

5. Remove the carriage upper cover that hold the ink tubes on both sides of the carriage unit. ( x2)

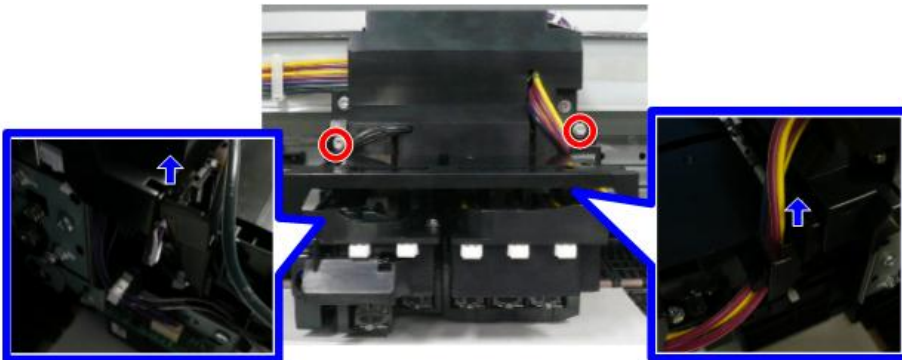

d262k3024

6. Remove the carriage front cover [A]. ( x2)

 **Note**

- To remove the carriage front cover, remove the ink tubes from the groove.

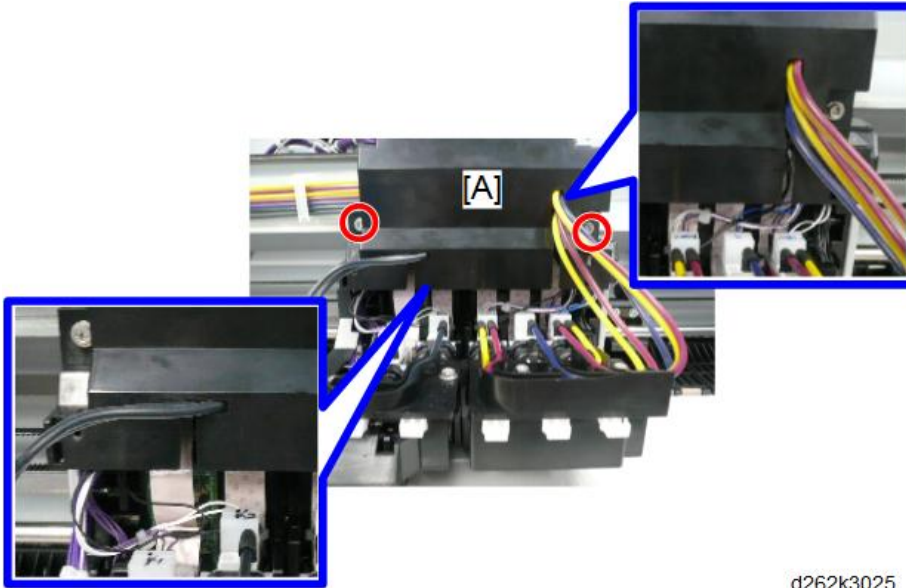

d262k3025

7. Release the FFCs from the left of the HRB. ( x2)

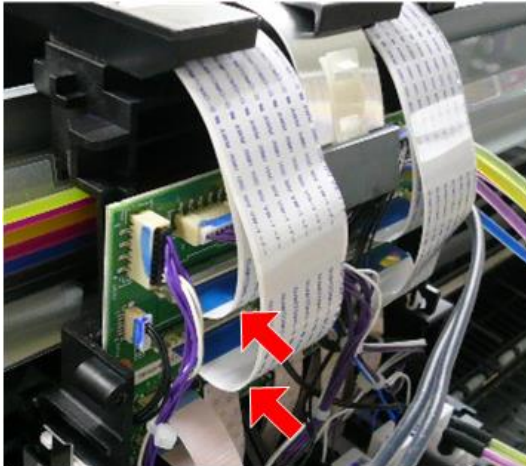

d262k0280

 **Note**

- To release the FFCs, push the plate [A] to the HRB.

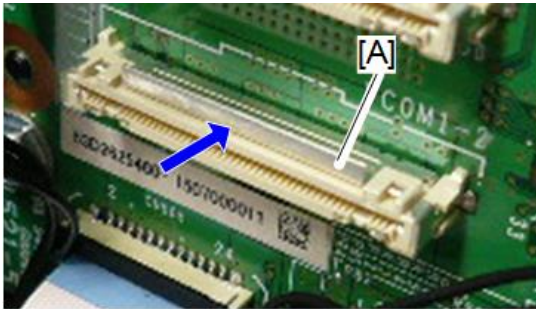

d262k3085

8. Release the FFCs from the right of the HRB. ( x2)

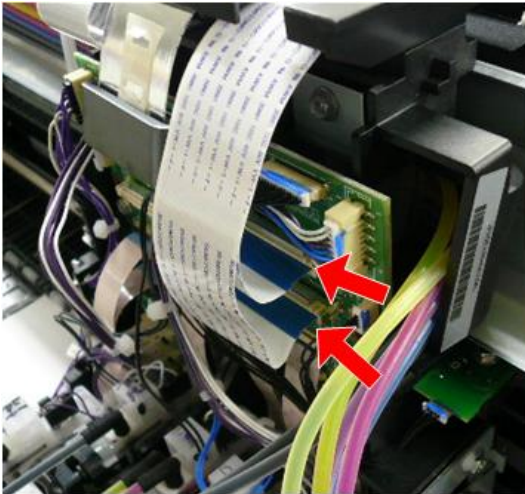

d262k0281

9. Release the FFC from the center of the HRB. ( x1)

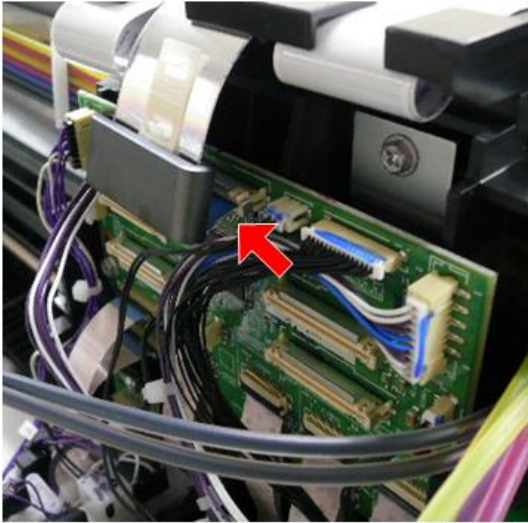

d262k0282

 **Note**

- Pack the FFCs on the FFC guide as shown below.

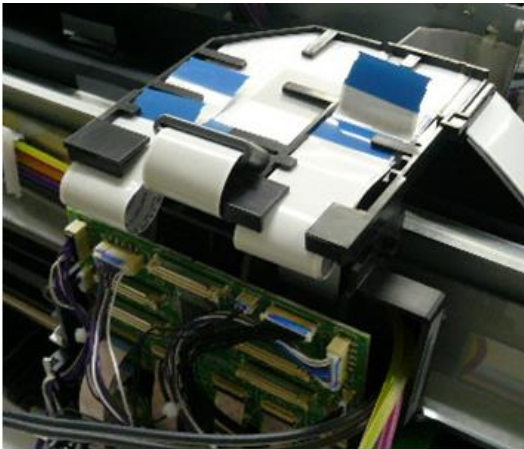

d262k0283

10. Remove the connector from the HRB. (🔌 x7)

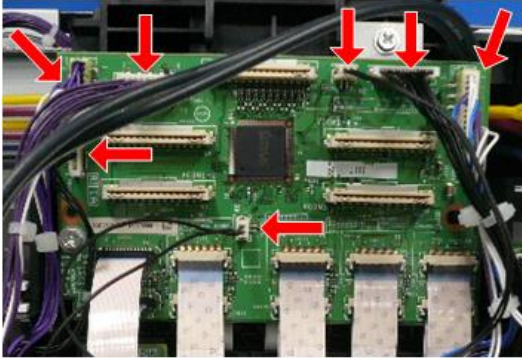

d262k3030

11. Release the FFCs (front side) from the bottom of the HRB. (📄 x5)

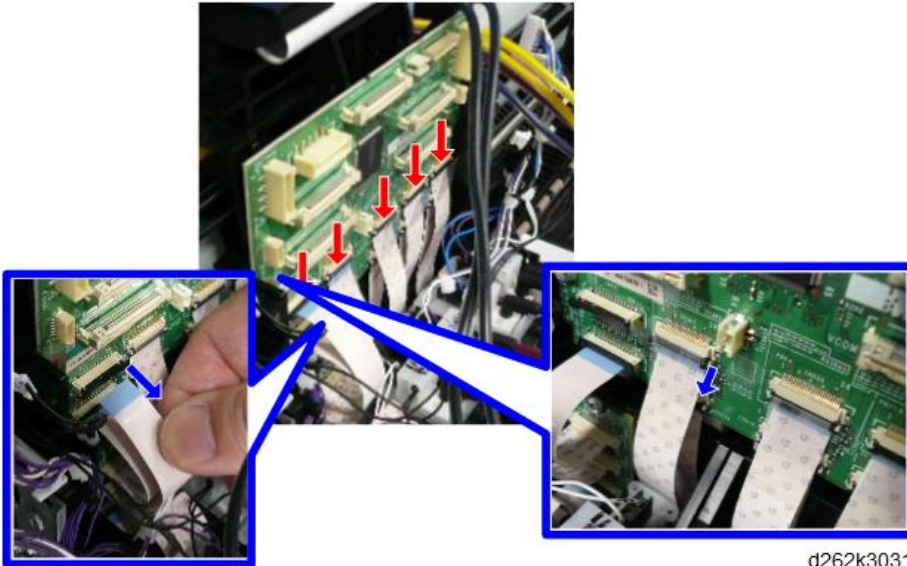

d262k3031

⬇️ **Note**

- To release the FFCs, be sure you understand of the directions of the locks.
- To release the FFCs [A], pull the lock toward you.
- To release the FFCs [B], push up the lock.

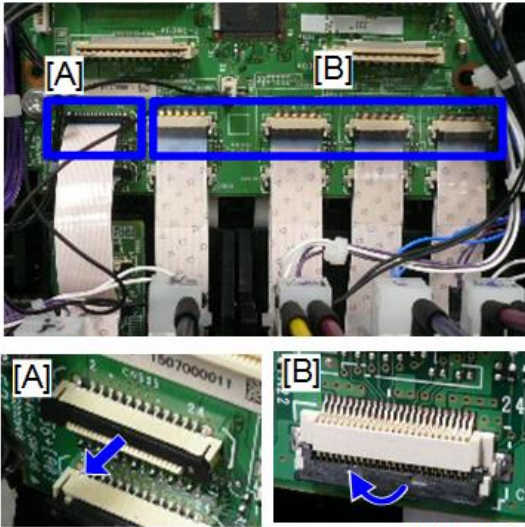

d262k3086

12. Release the FFCs (backward) from the bottom of the HRB. ( x5)

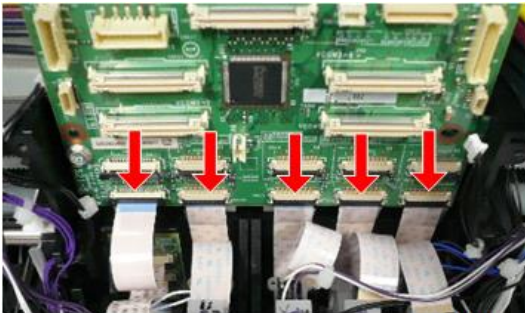

d262k3032

13. Remove the HRB. ( x1)



d262k3033

Precaution

The sheets are attached to the eight FFCs at the lower part of the HRB. To attach the FFCs to the HRB, connect the FFCs by holding the sheets.

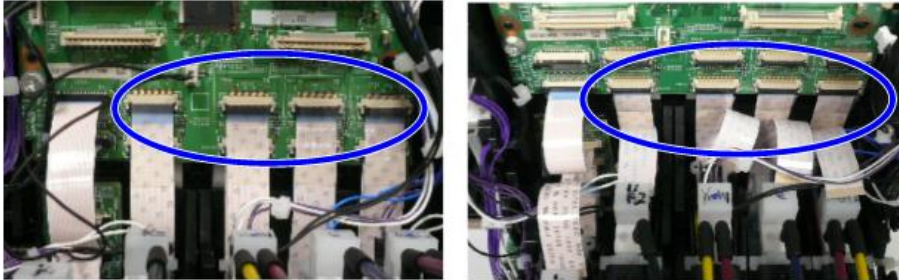

d262k3034

4

Head Lift Motor

★ Important

- To remove the head lift motor, never loosen nor remove the four screws shown below (the figure below shows the main unit with the right cover removed).

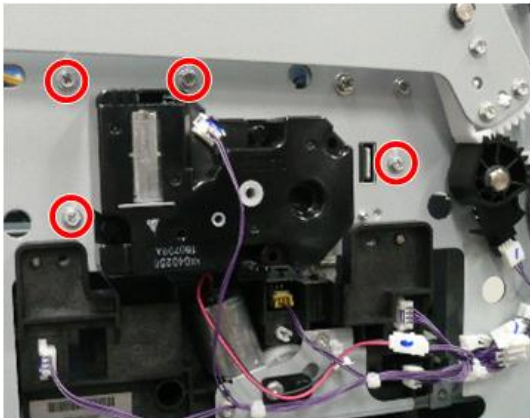

d262k3035

1. Uncap the print head and move the carriage unit to the center of the main unit (p.267).

↓ Note

- When the carriage unit is moved, ink may spill out from the print head onto the platen. To move the carriage unit, place a sheet of plain paper under the carriage unit to protect the platen.
- The sheet under the carriage unit should be flat, with no paper wrinkling, which could scratch the nozzle face or cause clogging of the nozzle.

- Do not place any film under the carriage unit.
- To place the plain paper, do not pull up the paper holding lever too much (p.226).

2. Remove the top cover (p.245).

3. Remove the head lift motor [A]. (⚙️ x1, 🔧 x3)

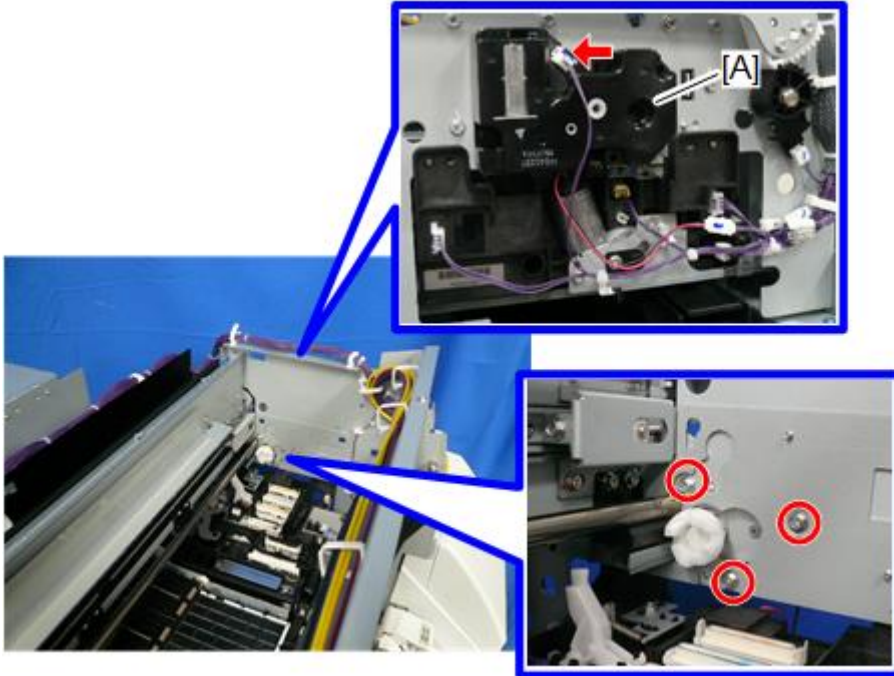

d262k3036

Head Lift Motor



d1241302

Print Head Unit

CAUTION

- Before starting the task of changing the print head unit, set the main power switch to OFF and back ON to terminate the maintenance operation of the print head unit to be changed. Then the maintenance operation for the old print head unit will be prevented from being performed for the new print head unit.

The unit on the left is the black print head unit ([A] in the figure below). It includes print heads and head tanks for K1 and K2.

The unit on the right is the color print head unit ([B] in the figure below). It includes print heads and head tanks for Y1, M1, C, M2, and Y2.

The print head and head tank cannot be replaced separately. To change the print head and head tank, change the print head unit.

The black and color print head units [A] and [B] can be replaced separately or simultaneously.

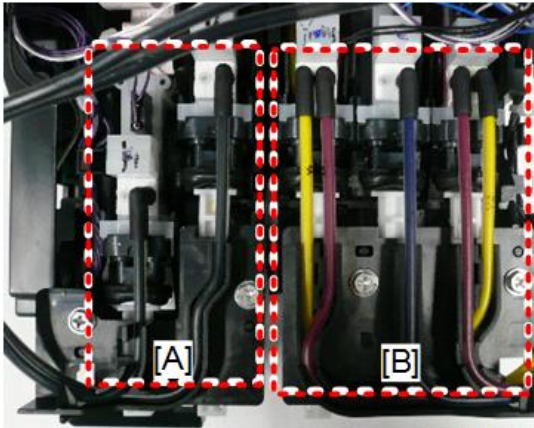

d262k3037

Black Print Head Unit Accessories

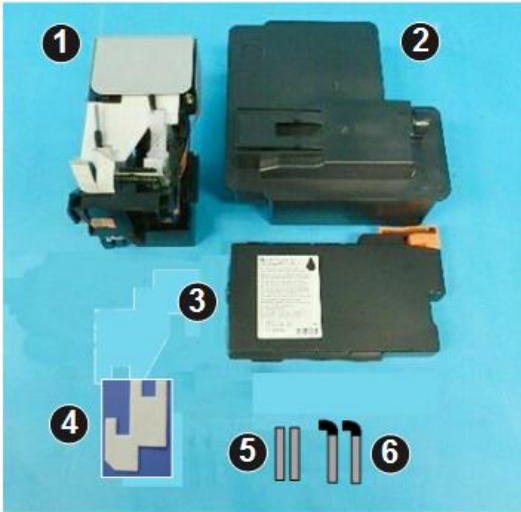

d262k3038

No.	Item	Q'ty
1	Black Print Head Unit	1
2	Ink Collector Tank	1
3	Ink Cartridge (Black: K)	1
4	Protective Sheet	1
5	Plug (Uncapped)	2
6	Plug (Capped)	2

Color Print Head Unit Accessories



d262k3039

No.	Item	Q'ty
1	Color Print Head Unit	1
2	Ink Collector Tank	1
3	Ink Cartridge (Color: C, Y, M)	3
4	Protective Sheet	1
5	Plug (Uncapped)	5
6	Plug (Capped)	5

Carriage Unit Cover Removal

1. Set the main power switch to OFF and back ON to terminate the maintenance operation of the print head unit to be changed.
2. Uncap the print head and move the carriage unit to the center of the main unit (p.267).

↓ Note

- When the carriage unit is moved, ink may spill out from the print head onto the platen. To move the carriage unit, place a sheet of plain paper under the carriage unit to protect the platen.

- The sheet under the carriage unit should be flat, with no paper wrinkling, which could scratch the nozzle face or cause clogging of the nozzle.
- Do not place any film under the carriage unit.
- To place the plain paper, do not pull up the paper holding lever too much (p.226).

3. Remove the top cover (p.245).

4. Remove the front cover (p.249).

5. Open the ink collector tank cover and remove the customer's ink collector tank [A].

6. Attach the new ink collector tank [B] and close the cover.



d124r707

7. Remove the carriage left cover.

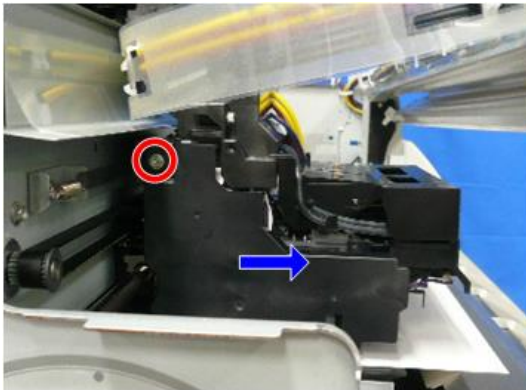

d262k3020

8. Remove the carriage unit upper cover that hold the ink tubes on both sides of the carriage unit. ( x2)

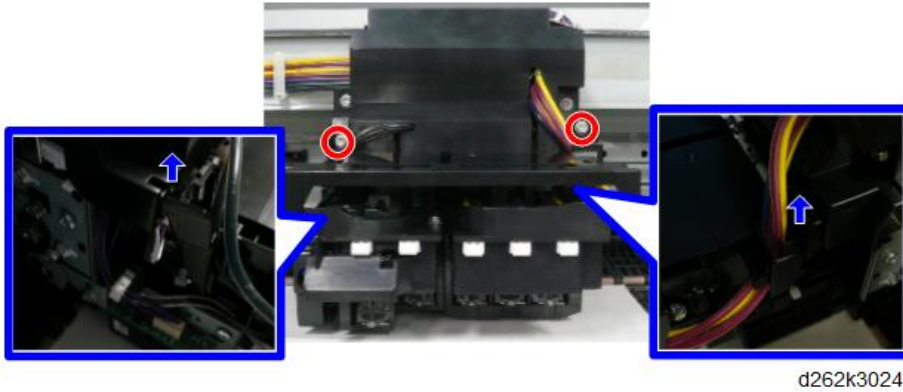

9. Remove the carriage front cover [A]. ( x2)

 **Note**

- To remove the carriage front cover, remove the ink tubes from the groove.

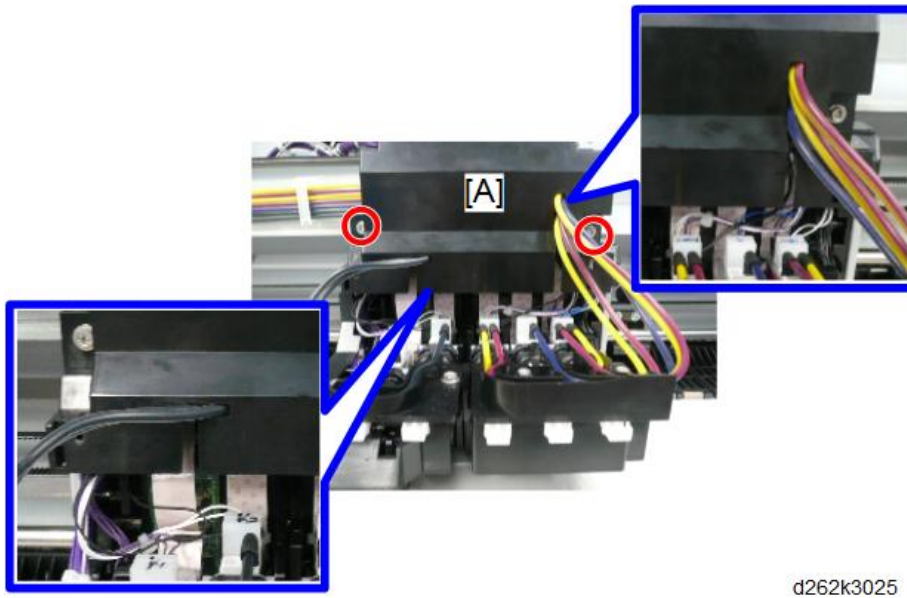

Black Print Head Unit Removal

CAUTION

- When replacing a print head, never touch the main ink level sensor feeler. Doing so applies compression to the head tank that will cause ink to spill.

- The black print heads have two main ink level sensor feelers [A], and the color print heads have five [B].

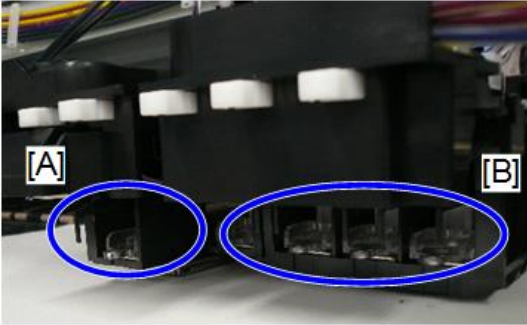

d262k3040

4

1. Remove the carriage unit covers (p.427).
2. Remove the thermistor from the head tank (K2) of the print head unit.

↓ Note

- Unbend the tip of the harness then remove.

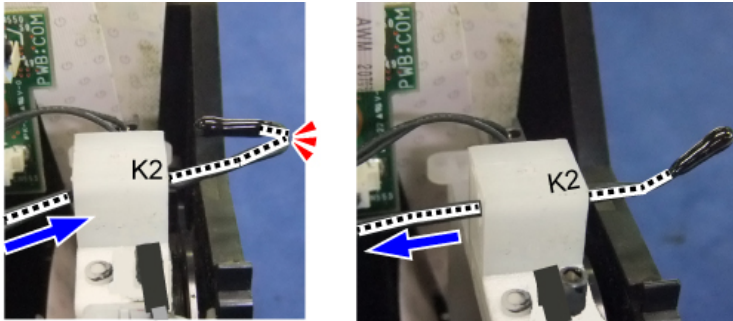

d1241597

3. Release the FFCs from the left of the HRB (📄 x2)

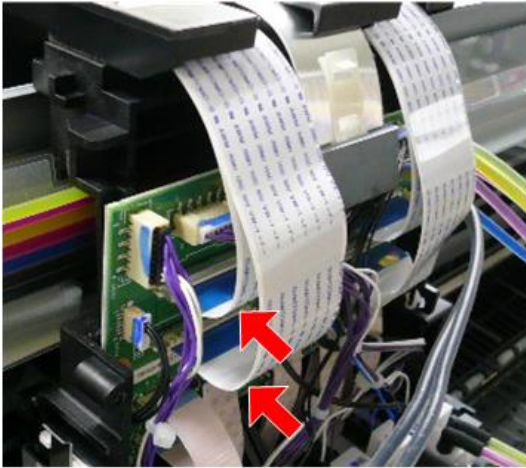

d262k0280

↓ Note

- To release the FFCs, push the plate [A] to the HRB.

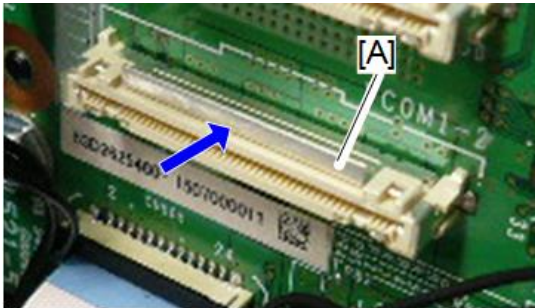

d262k3085

4. Remove the connector from the HRB. (📄 x1)

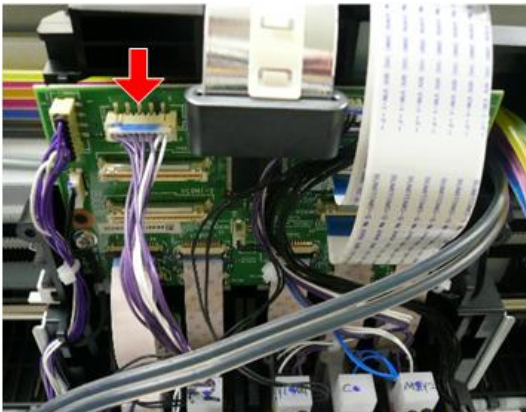

d262k0284

5. Release the FFCs (front side) from the bottom of the HRB. ( x2)

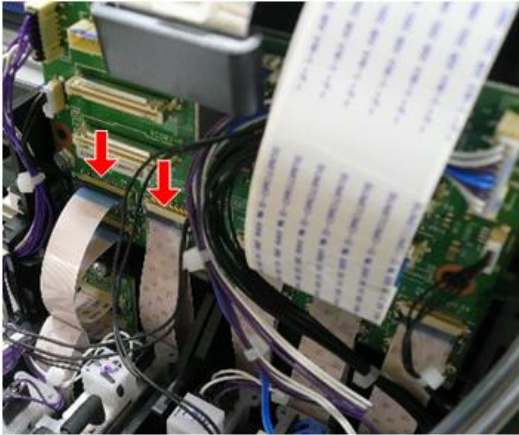

d262k0285

 **Note**

- To release the FFCs, be sure you understand of the directions of the locks.
- To release the FFCs [A], pull the lock toward you.
- To release the FFCs [B], push up the lock.

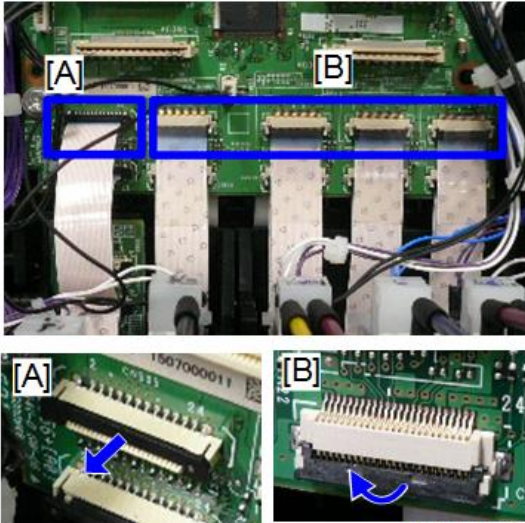

d262k3086

6. Release the FFCs (backward) from the bottom of the HRB. ( x2)

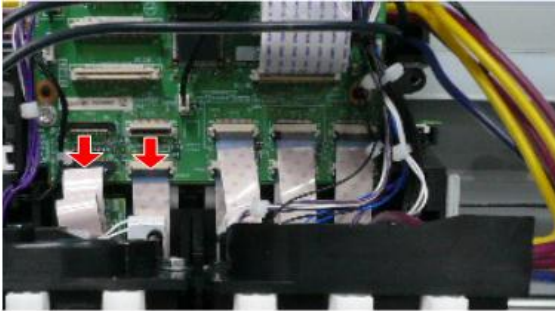

d262k8099

7. Take two caps of the accessories of the new print head.



d1241070

8. Push the two white projections of the black print head to release the air from the head tanks (K1) and (K2).

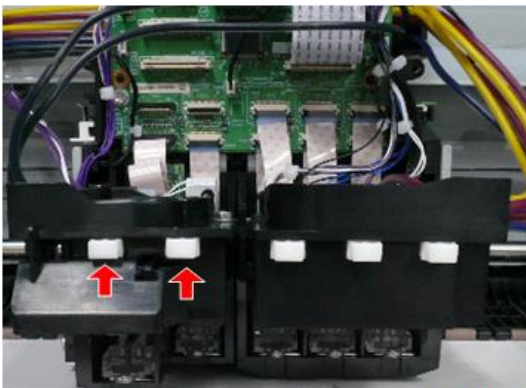

d262k3044

9. Attach the protective sheet enclosed in the new print head unit to the print head to be removed.

Note

- The protective sheet shields the main unit and its surroundings from ink spills.

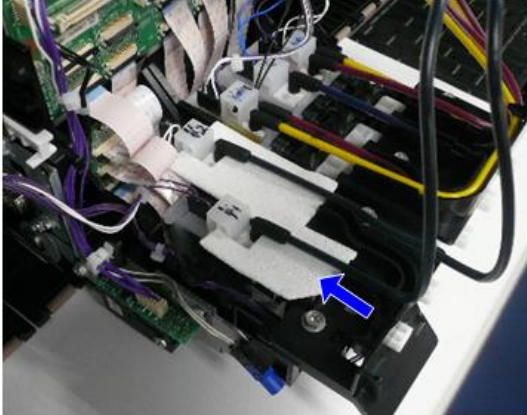

d262k3045

10. Remove the ink tube (K1) from the ink supply port of the print head [A] and attach the plug to the joint of the ink tube (K1) [B].

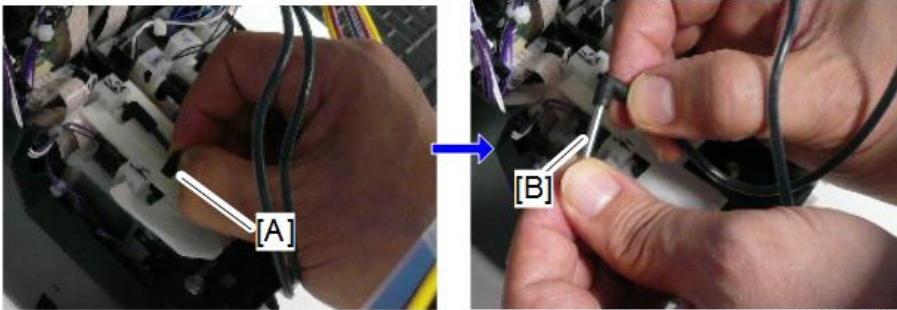

d262k3046

11. Take two plugs (capped) of the accessories of the new print head unit.



d1241154_e

4

12. Attach the plug (capped) [A] to the ink supply port of the print head to be removed.

↓ Note

- The cap prevents the ink leakage from the ink supply port.

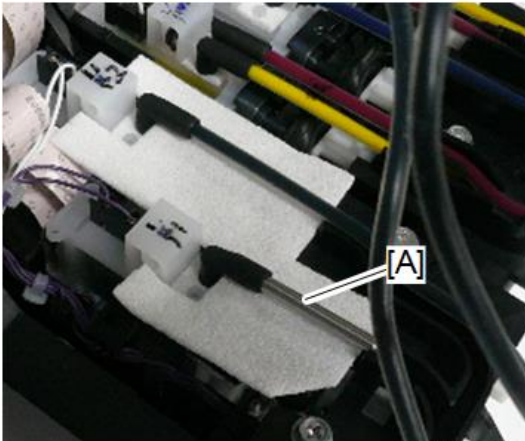

d262k3047

13. Remove the ink tube (K2) from the ink supply port of the print head and attach the plug to the joint and the plug (capped) to the ink supply port of the removed ink tube (K2).

14. Slightly pull up the black print head to be removed to release it from the guide rod backward. Then place it on several sheets of paper.

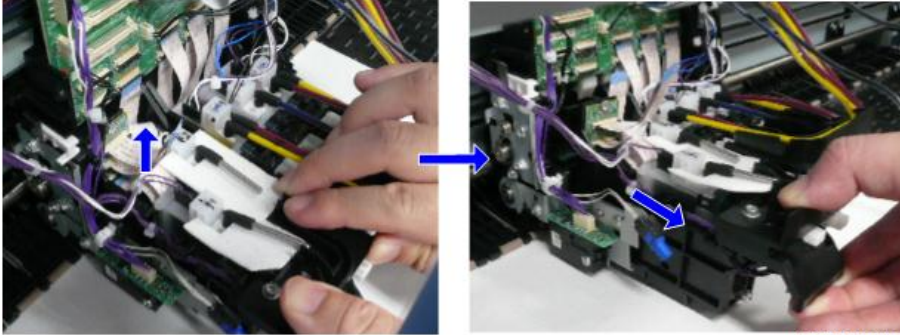

d262k3048

4

15. Check that the ink does not spill on the paper beneath the removed print head. If it spills, change the paper.
16. Release the FFCs from the removed print head.

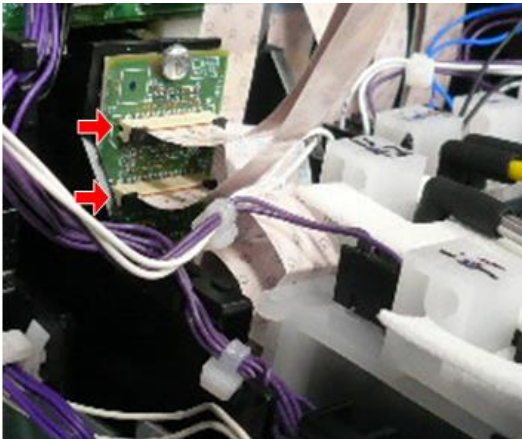

d262k3049

Note

- Attach the released FFCs to the new print head.

New Black Print Head Unit Installation

1. Remove the orange tape [A] and bracket [B] from the new print head.

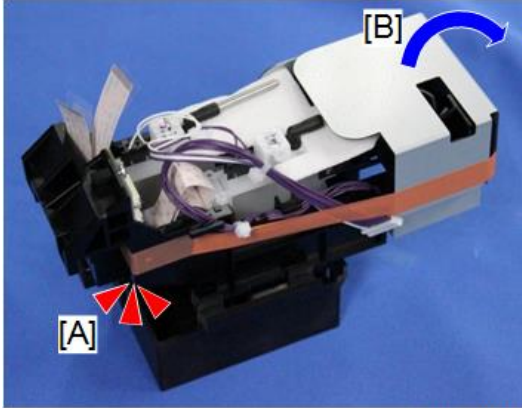

d262k0287

2. Attach the released FFCs to the new print head.

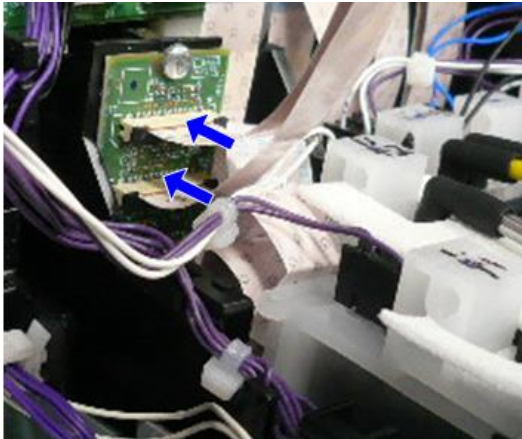

d262k3050

3. Remove the cradle [A] from the new print head.

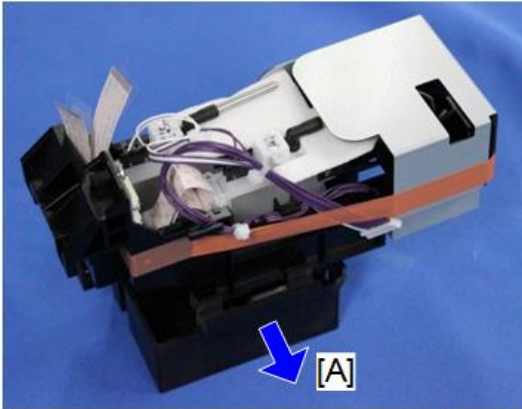

d262k0288

↓ Note

- Put the old print head on the cradle, wrap them in paper to avoid ink leakage, and put them in a plastic bag to bring them back.

4. Attach the print head to the guide rod.

↓ Note

- Do not apply excessive force when attaching the print head to the guide rod. Or the deviation may occur upon print head installation.

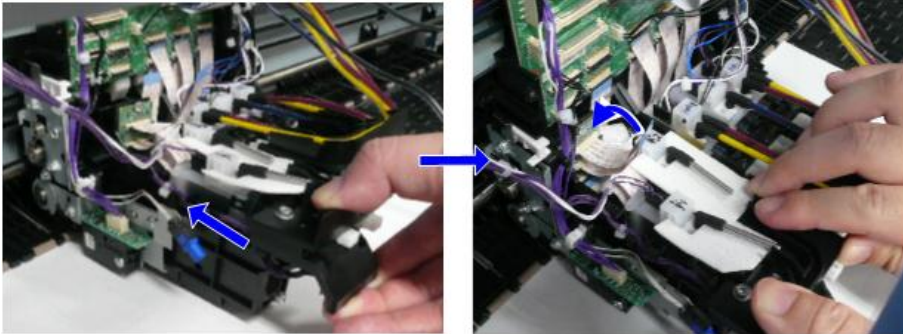

d262k3051

5. Push the two white projections on the print head to release the air.

↓ Note

- Releasing of the air removes the negative pressure and avoid bubbles.

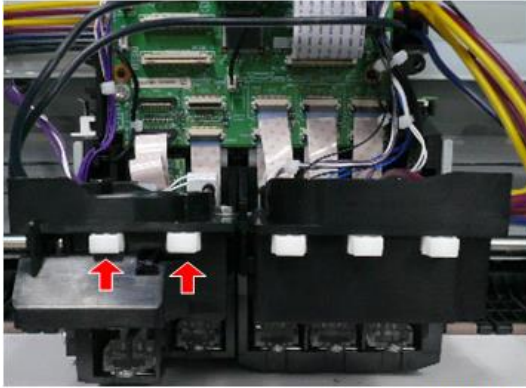

d262k3044

6. Remove the two plugs (capped) from the ink supply ports of the print head.
7. Remove the plugs [A] from two ink tubes and attach them to the ink supply ports [B].

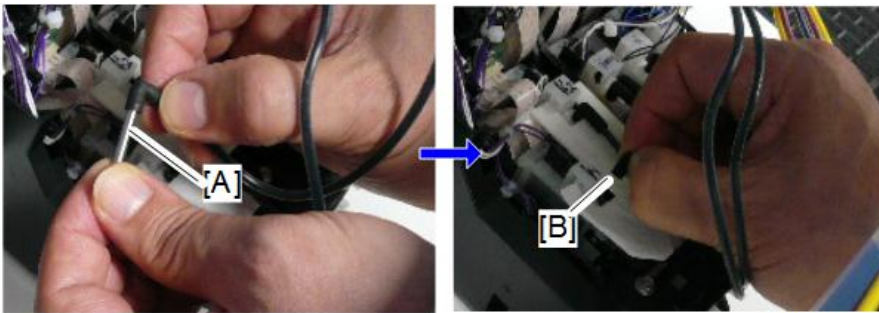

d262k3052

8. Remove the protective sheet from the print head and discard it.

Note

- When removing the protective sheet, do not pull up the ink tube too much. Or you might accidentally remove the ink tube.

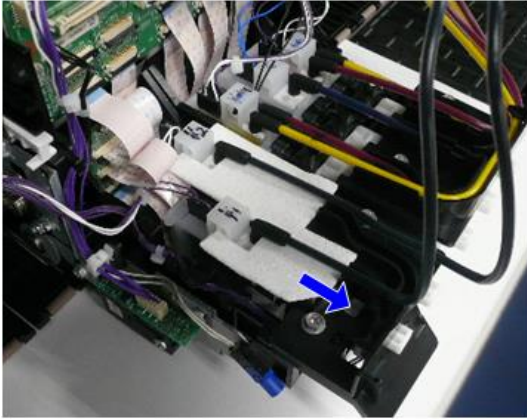

d262k3053

4

9. Connect the FFCs (back side) to the lower connectors at the lower part of the HRB. ( x2)

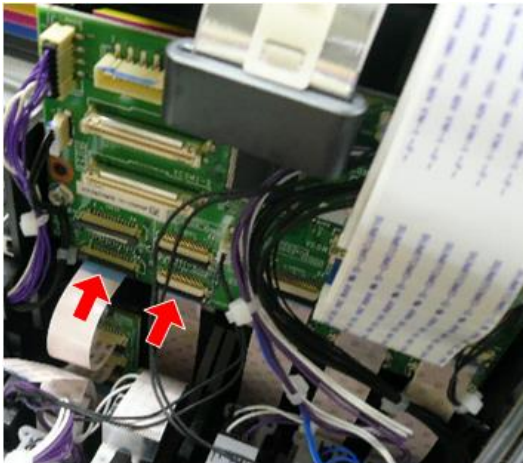

d262k3054

 **Note**

- To connect the FFCs, be sure you understand the directions of the locks of the connectors.
- To connect the FFCs [A], push in the lock.
- To connect the FFCs [B], push down the lock.

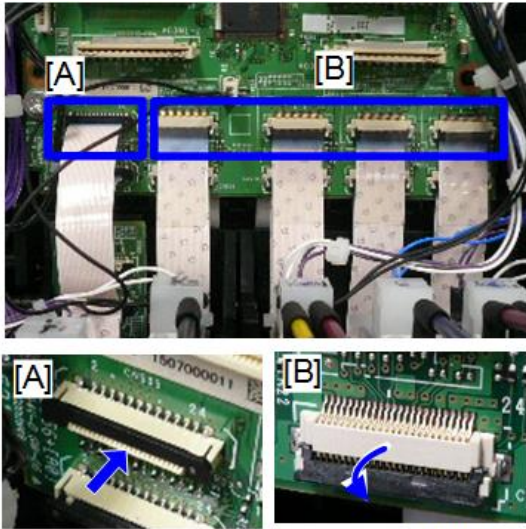

d262k3087

10. Connect the FFCs (front side) to the upper connectors at the lower part of the HRB. ( x2)

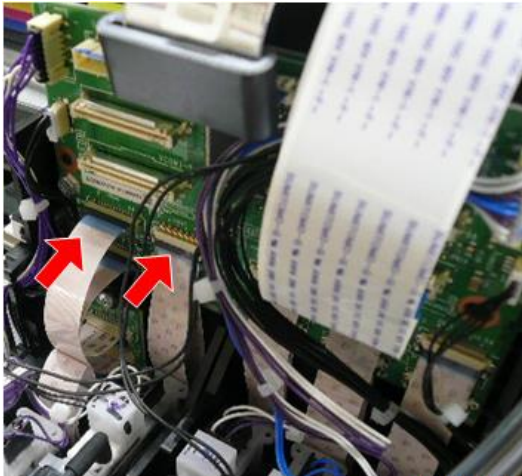

d262k3055

⬇ Note

- If the FFC is pulled after connecting to the HRB, it may be hooked into the OCFS actuator. Then the FFC becomes longer than the required length to the connector and the deflected part may push the OCFS actuator. In this case, release the FFC and release the hooked part. Then connect it to the HRB again.

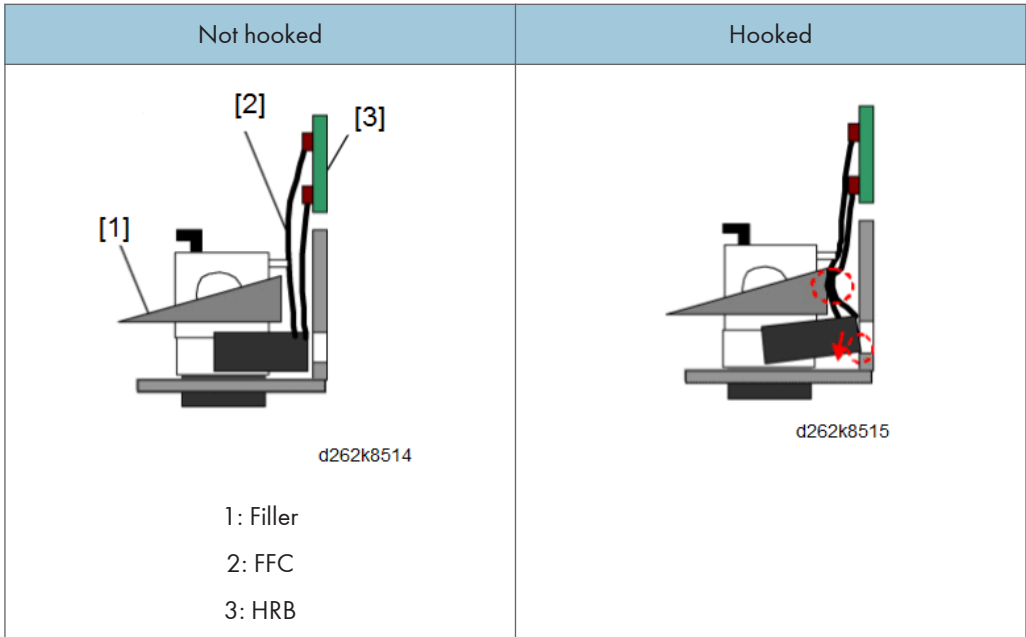

11. Connect the connector to the HRB. (E x1)

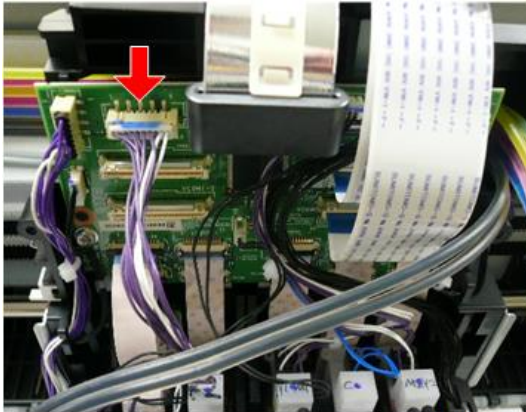

d262k0284

12. Connect the FFCs to the HRB. ( x2)

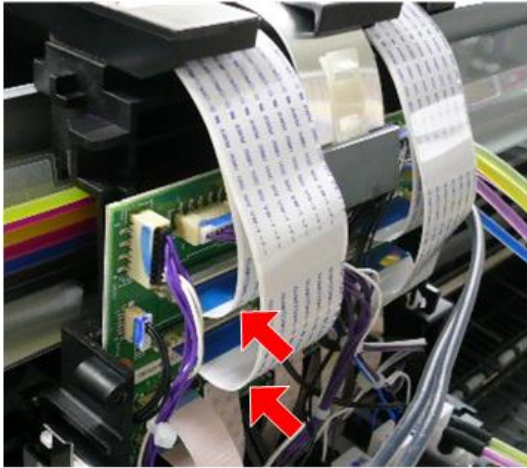

d262k0280

4

13. Attach the thermistor to the head tank (K2) of the print head unit.

 Note

- Insert the thermistor into the hole of the head tank from left to right, fold back the tip of the harness, then feed the thermistor back into the hole.
- Insert the sensor head [A] so that it placed above the harness [B] in the hole of the head tank.

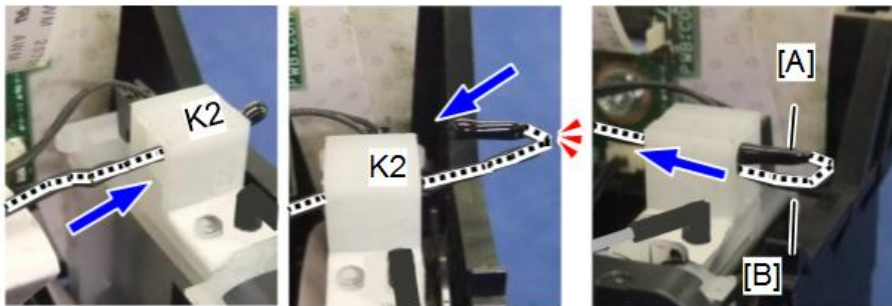

d262k8518

14. Place the ink tubes on the path of the print head, from right to left in order of K2 and K1.

- Place the ink tube (K2) [A] on the path of the print head first.
- Then place the ink tube (K1) [B] upon the ink tube (K1) on the path of the print head.

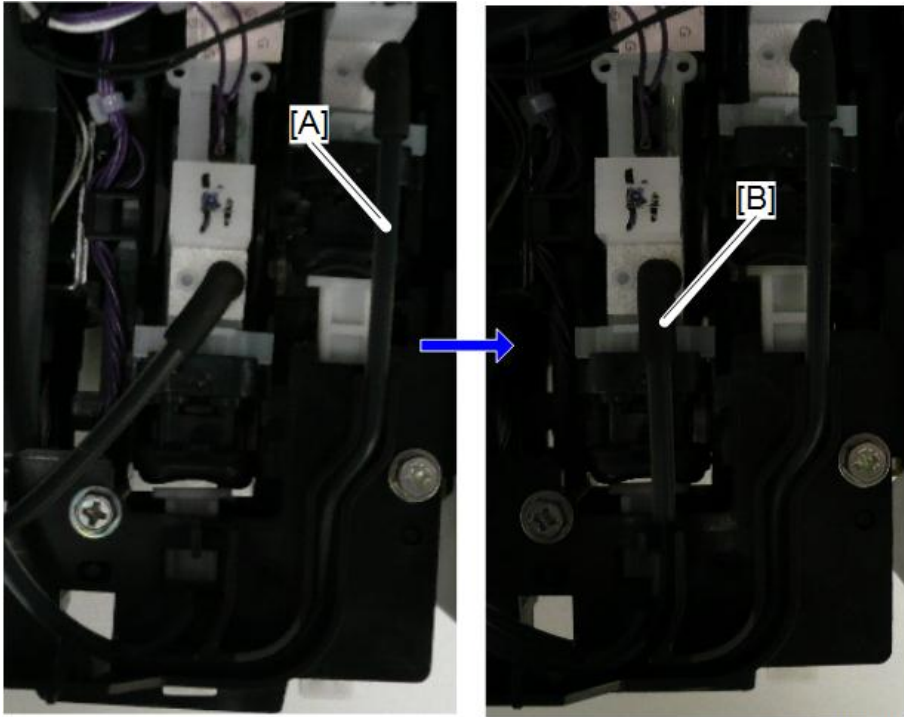

D262k3088

15. Attach the carriage unit cover.

For attaching the carriage unit cover, perform the procedure for removing in reverse order. (Print Head Unit)

Note

- To attach the carriage upper cover, move the harness to the HRB so that no pressure is applied to the ink tube.

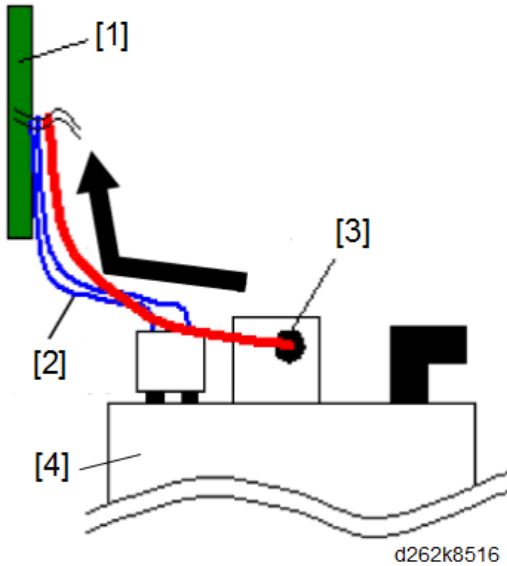

- 1: HRB
- 2: Electrode pin harness
- 3: Thermistor
- 4: Head tank

↓ **Note**

- Keep extra length of the thermistor harness above the carriage front cover line as shown in the illustration below.

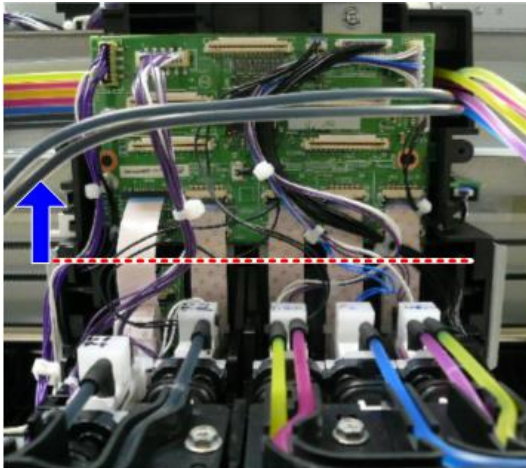

Note

- Fold the electrode pin harness to the left above the carriage front cover line as shown in the illustration below.

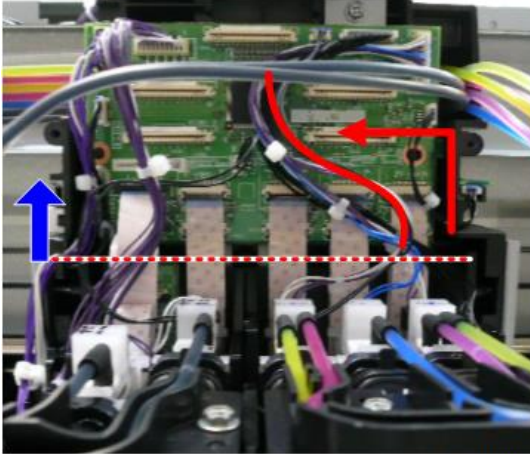

d262k0289

16. When the black print head replacement ends, reset the counter and perform the initial filling sequence. (Print Head Unit)

Color Print Head Unit Removal

CAUTION

- When replacing a print head, never touch the main ink level sensor feeler. Doing so applies compression to the head tank that will cause ink to spill.
- The black print heads have two main ink level sensor feelers [A], and the color print heads have five [B].

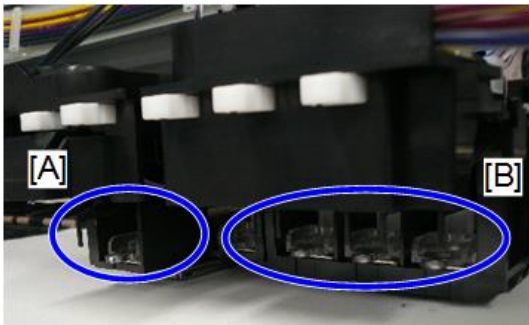

d262k3040

1. Remove the carriage unit covers (p.427).

2. Remove the thermistor from the head tank (Y1/M1) of the print head unit.

↓ Note

- Unbend the tip of the harness [A] then remove.

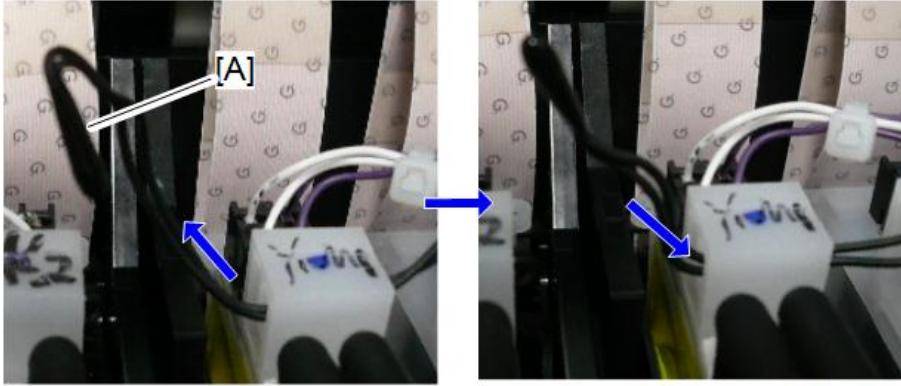

D262k3089

3. Release the FFCs from the right of the HRB. (x2)

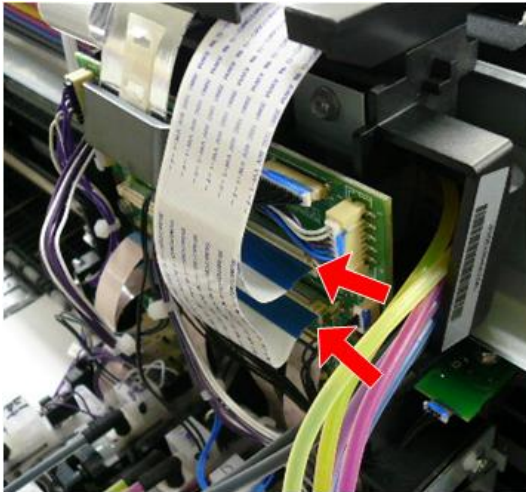

d262k0281

↓ Note

- To release the FFCs, push the plate [A] to the HRB.

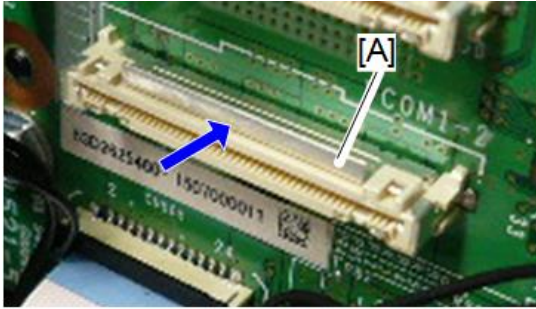

d262k3085

4. Release the FFC from the center of the HRB. ( x1)

4

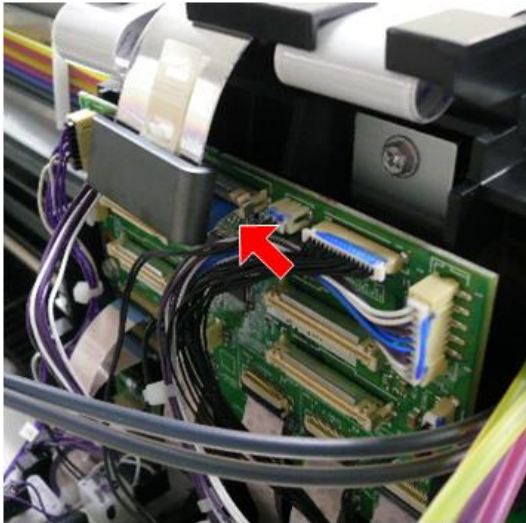

d262k0282

5. Remove the connectors from the HRB. ( x2)

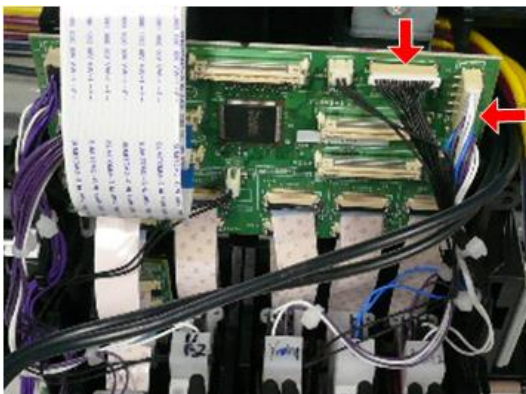

d262k3060

6. Release the FFCs (front side) from the bottom of the HRB. ( x3)

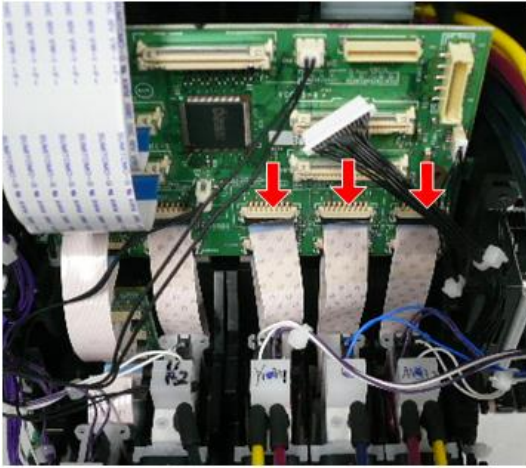

d262k3061

Note

- To release the FFCs, be sure you understand of the directions of the locks.
- To release the FFCs [A], pull the lock toward you.
- To release the FFCs [B], push up the lock.

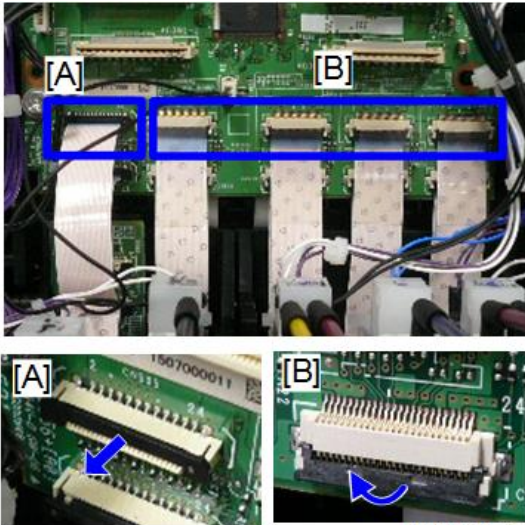

d262k3086

7. Release the FFCs (backward) from the lower part of the HRB. ( x3)

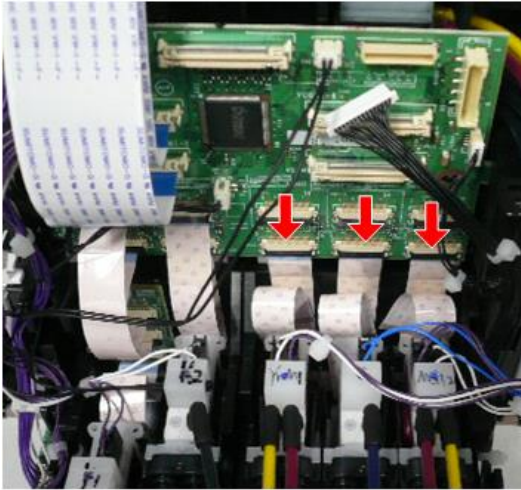

d262k3062

8. Take five plugs of the accessories of the new print head.



d1241158

9. Push the three white projections of the color print head to release the air from the head tanks (Y1, M1), (C), and (M2, Y2).

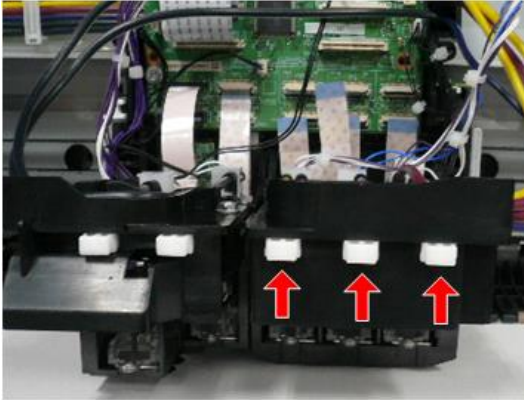

d262k3063

10. Attach the protective sheet enclosed in the new print head unit to the print head to be removed.

Note

- The protective sheet shields the main unit and its surroundings from ink spills.

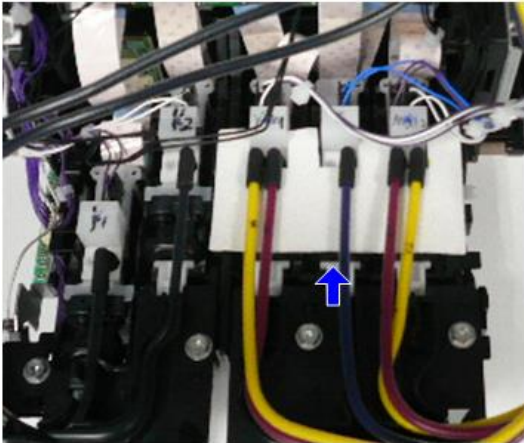

d262k3064

11. Remove the ink tube (M2) [A] from the ink supply port of the print head, and attach the plug to the ink tube joint (M2) [B].

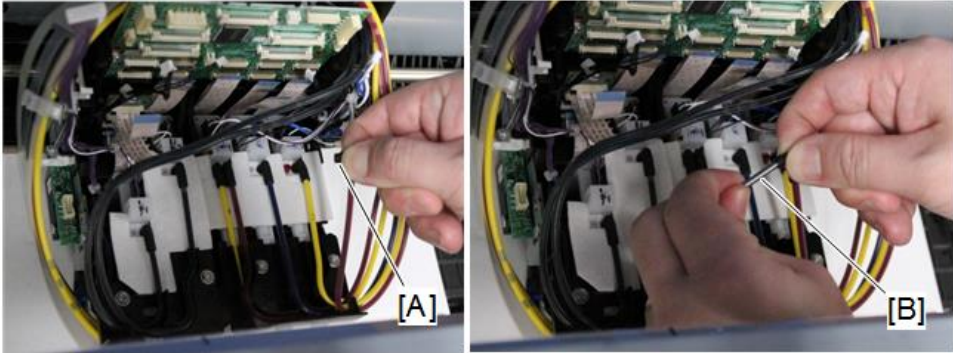

d262k0291

4

12. Take five plugs (capped) of the accessories of the new print head unit.



d262k0292

13. Attach the plug (capped) [A] to the ink supply port of the print head to be removed.

Note

- The cap prevents the ink leakage from the ink supply port.

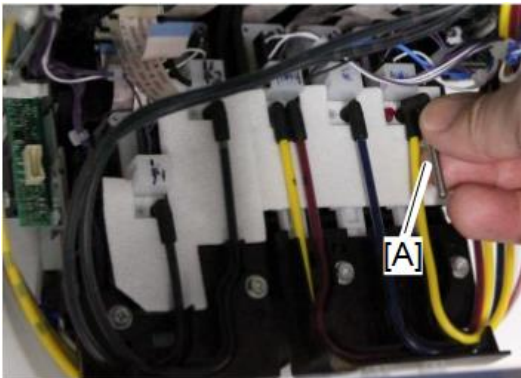

d262k3066

14. Remove the ink tubes (Y2, C, M1, Y1) from the ink supply ports of the print heads and attach the plugs to the joints and the plugs (capped) to the ink supply ports of the removed ink tubes.
15. Slightly pull up the color print head to be removed to release it from the guide lock backward. Then place it on several sheets of paper.

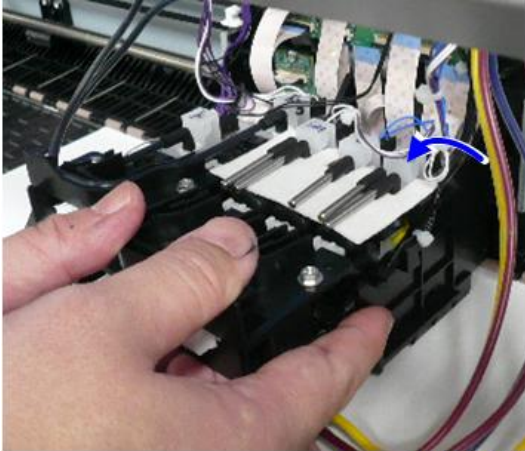

d262k3067

16. Check that the ink does not spill on the paper beneath the removed print head. If it spills, change the paper.

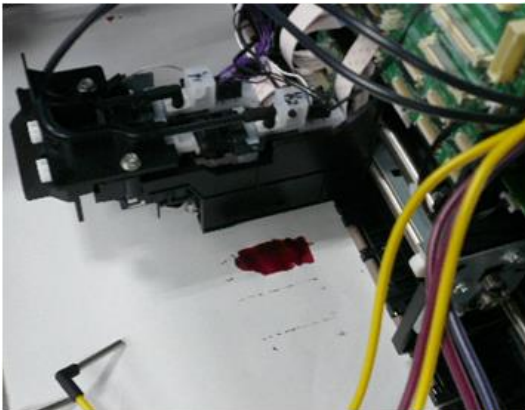

d262k3068

New Color Print Head Unit Installation

1. Remove the orange tape and bracket from the new print head unit.

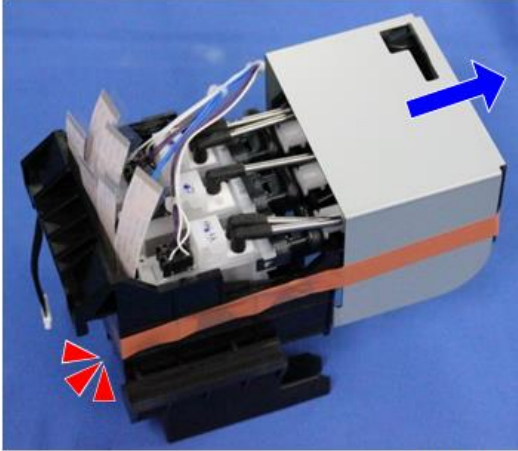

d262k0293

2. Remove the cradle [A] from the new print head.

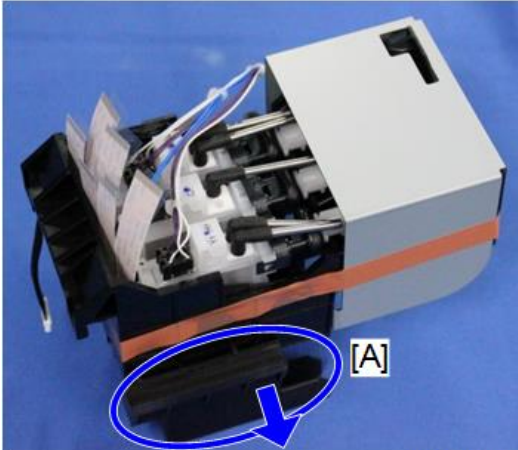

d262k0294

↓ Note

- Put the old print head on the cradle, wrap them in paper to avoid ink leakage, and put them in a plastic bag to bring them back.

3. Attach the print head to the guide rod.

↓ Note

- Do not apply excessive force when attaching the print head to the guide rod. Or the deviation may occur upon print head installation.

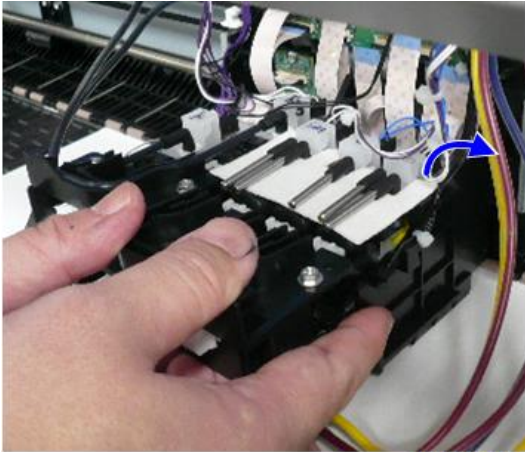

d262k3069

4

4. Push the three white projections on the print head to release the air.

Note

- Releasing of the air removes the negative pressure and avoid bubbles.

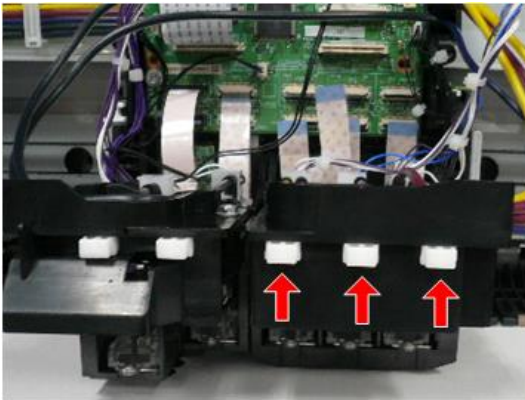

d262k3063

5. Remove the five plugs (capped) from the ink supply ports of the print heads.

6. Remove the plugs [A] from five ink tubes and attach them to the ink supply ports [B].

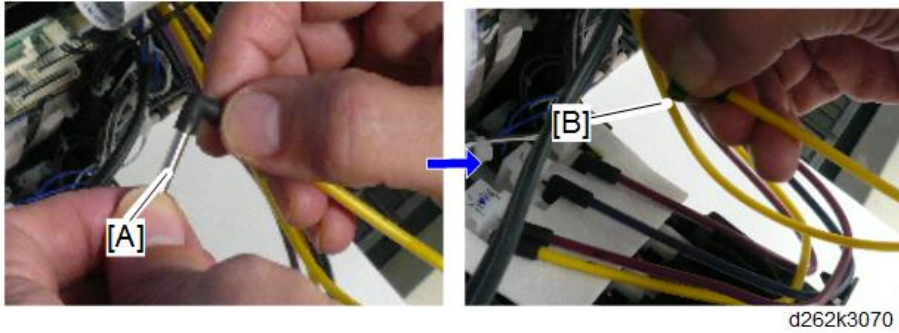

4

7. Remove the protective sheet from the print head and discard it.

↓ Note

- When removing the protective sheet, do not pull up the ink tube too much. Or you might accidentally remove the ink tube.



8. Connect the FFCs (back side) to the lower connectors at the lower part of the HRB. ( x3)

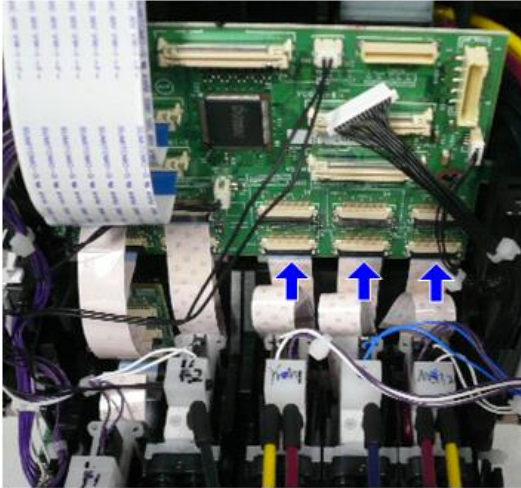

d262k3072

↓ **Note**

- To connect the FFCs, be sure you understand the directions of the locks of the connectors.
- To connect the FFCs [A], push in the lock.
- To connect the FFCs [B], push down the lock

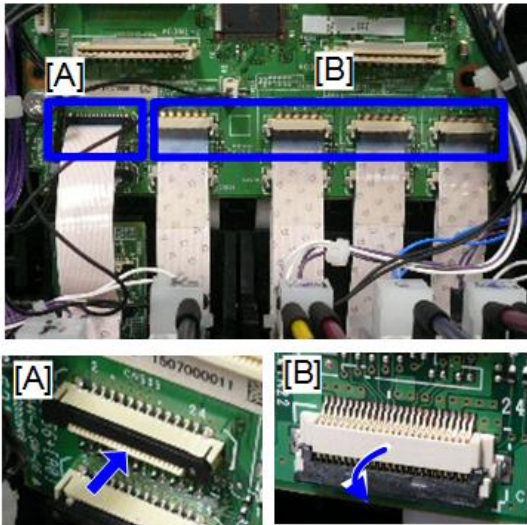

d262k3087

9. Connect the FFCs (front side) to the upper connectors at the lower part of the HRB. ( x3)

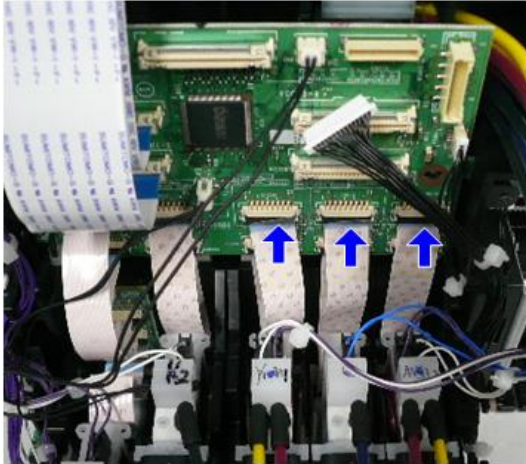

d262k3073

Note

- If the FFC is pulled after connecting to the HRB, it may be hooked into the OCFS actuator. Then the FFC becomes longer than the required length to the connector and the deflected part may push the OCFS actuator. In this case, release the FFC and release the hooked part. Then connect it to the HRB again.

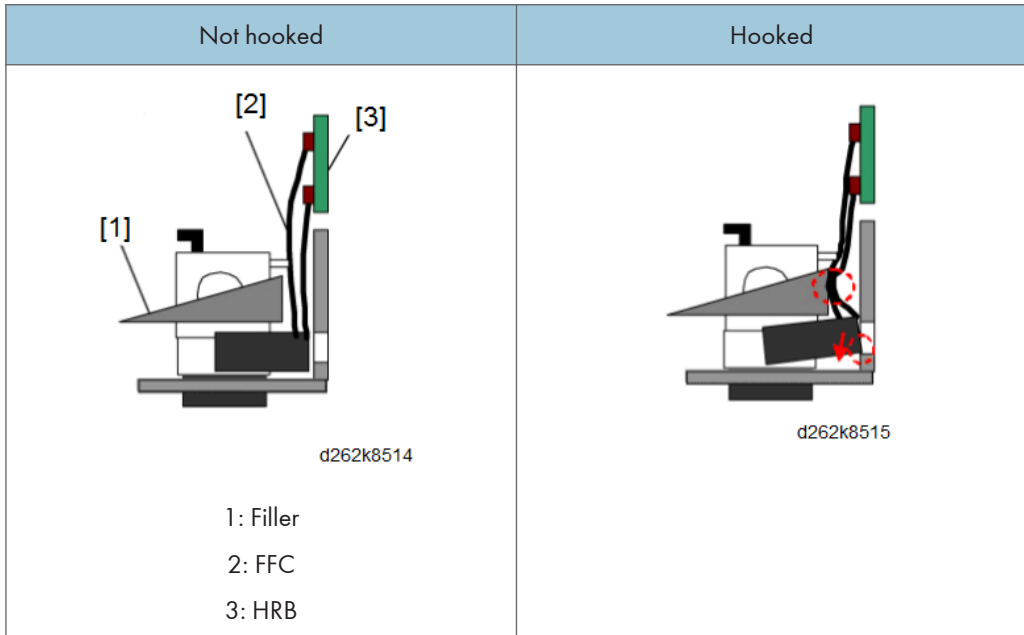

10. Connect the connector to the HRB. (E² x2)

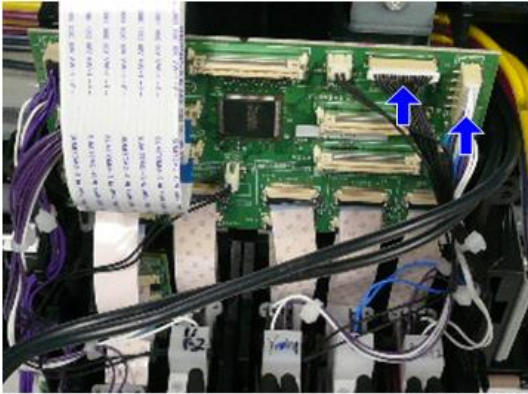

d262k3074

11. Connect the FFC to the center connector of the HRB. (E¹ x1)

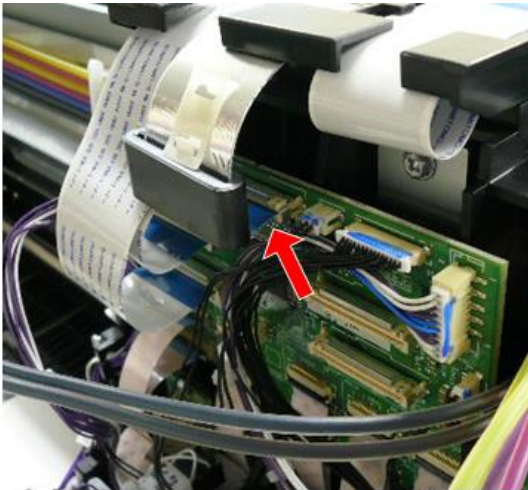

d262k0295

12. Connect the FFCs to the right connectors of the HRB. ( x2)

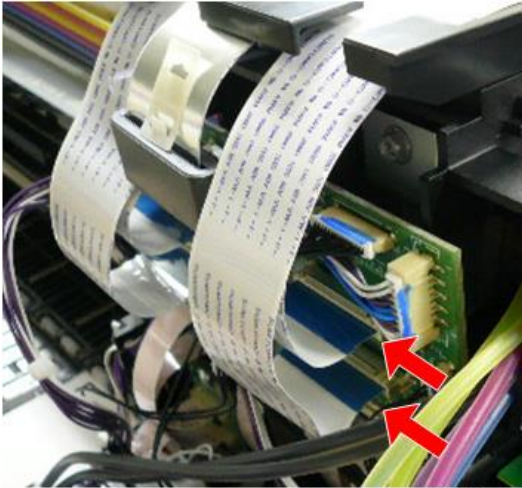

d262k0296

13. Attach the thermistor to the head tanks (Y1/M1) of the print head units.

 **Note**

- Insert the thermistor into the hole of the head tank from right to left, fold back the tip of the harness [A], then feed the thermistor back into the hole.
- Insert the sensor head so that it placed above the harness in the hole of the head tank.

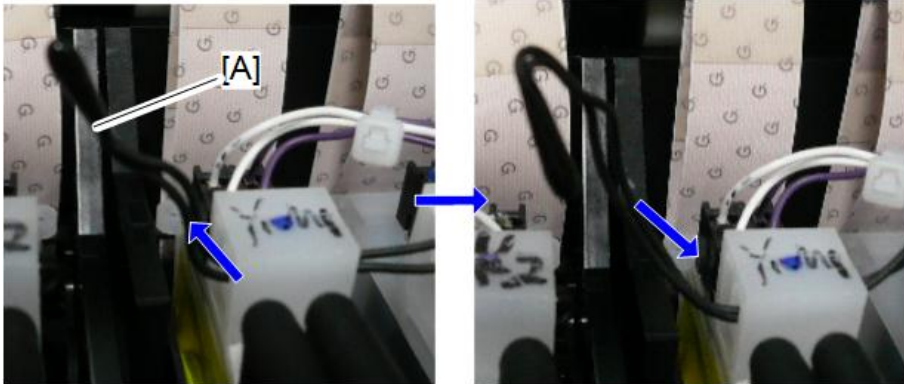

D262k3090

14. Place the ink tubes on the path of the print head, from right to left in order of Y1, M1, C, Y2, and M2.

- Place the ink tube (Y1) on the path of the print head first. [A]
- Then place the ink tube (M1) upon the ink tube (Y1) on the path of the print head. [B]
- Then place the ink tube (C) upon the ink tube (M1) [C] and the ink tube (Y2) upon the ink tube (C) on the path of the print head. [D]

- Last of all, place the ink tube (M2) upon the ink tube (Y2) on the path of the print head. [E]

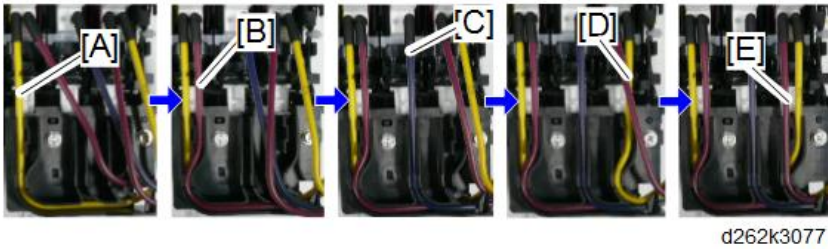

15. Attach the carriage unit cover.

For attaching the carriage unit cover, perform the procedure for removing in reverse order. (Print Head Unit)

↓ Note

- To attach the carriage upper cover, move the harness to the HRB so that no pressure is applied to the ink tube.

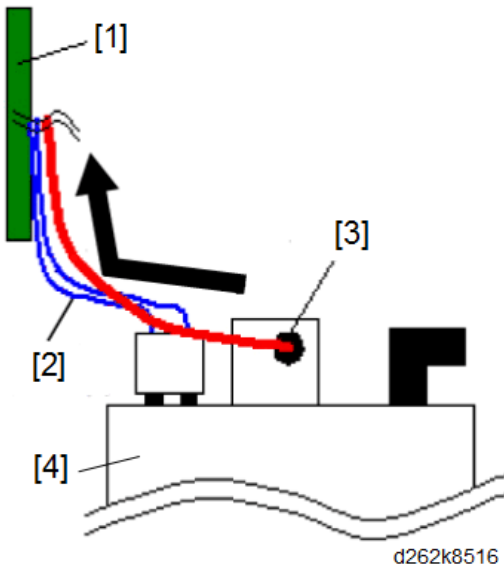

- 1: HRB
- 2: Electrode pin harness
- 3: Thermistor
- 4: Head tank

↓ Note

- Keep extra length of the thermistor harness above the carriage front cover line as shown in the illustration below.

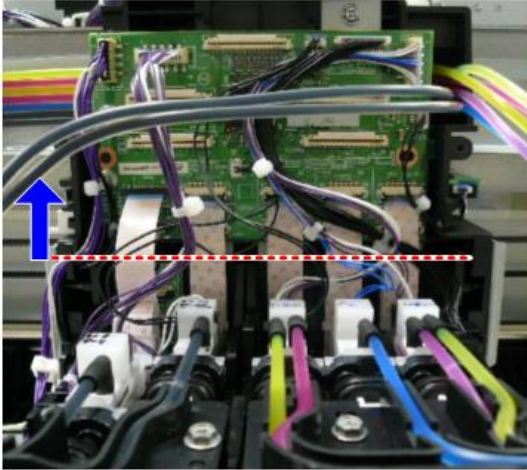

d262k0290

Note

- Fold the electrode pin harness to the left above the carriage front cover line as shown in the illustration below.

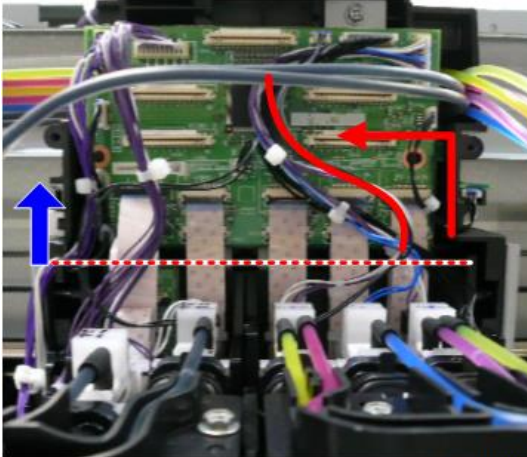

d262k0289

16. When the color print head replacement terminates, reset the counter and perform the initial filling sequence. (Print Head Unit)

After the Print Head Unit Replacement

When the print head unit replacement terminates, reset the counter with SP and fill the ink. When the black print head is replaced, adjust the density.

Then adjust the head position.

Counter Reset/Ink Filling

1. Check that the new ink collector tank is attached.
2. Open the ink cartridge cover, remove the customer's ink cartridge, and attach the new ink cartridge.

Note

- Keep the ink-cartridge cover open.

3. Set the main power switch to ON. If an error is displayed on the operation panel, ignore it.

CAUTION

- If SC282-XX (air detection frequency error) is displayed, ignore it.

4. Enter SP mode
5. Select SP2-400-001 (Carriage Unit Replacement NV Clear), set the values shown below depending on the replaced print head unit, and execute the SP.

For	Enter
Black and color print heads	0
Black print head only	1
Color print head only	2

6. Exit SP mode and set the main power switch to OFF.
7. Close the ink-cartridge cover.
8. Set the main power switch to ON (the initial filling sequence will begin automatically).

Note

- The initial filling sequence requires about 15 minutes.
- When the initial filling sequence ends, the machine beeps.
- Do not use the operation panel nor open the cover during the initial filling sequence.

9. When the initial filling sequence completes, print the nozzle check pattern and check that every nozzle is firing. (Nozzle Check Pattern Print)

Note

- If the print head unit is uncapped during replacing, some nozzle may not be firing. In such a case, recover it by cleaning or flushing the print heads. (Clean Print Heads, Flush Print Heads)

Density Check (Black Print Head Only)

1. Enter SP mode
2. Select SP2-902-001 (internal test pattern selection: R120 (MtoP) internal pattern), and use "10", "11", or "12", as required.

The thickness of the pattern decreases in the order of 10, 11, and 12.

3. Check the density of head 1 and of head 2 referring the printed pattern.

Printing from the tip to between about 96 and 128 mm is for print head 1.

Printing from the tip to between about 128 and 160 mm is for print head 2.

4. If a difference is detected, adjust with SP3-132-001/002 (circuit corrected value).

SP3-132-001: For print head 1

SP3-132-002: For print head 2

↓ Note

- Increasing the value makes printing darker.
- Adjust it to between 94% and 97%.

5. Exit SP mode.

Head Position Adjustment

1. Check that there is no error on the nozzle check pattern print, and adjust the head position for the roll unit 1 with the four methods described below. (Head Position Adjustment)

(1) "Normal (Plain)", "Prevent Paper Abrasion: Strong (Head Height High)", "Standard"

(2) "Coated Paper", "Prevent Paper Abrasion: Off (Head Height Standard)", "Quality Priority"

(3) "Coated Paper", "Prevent Paper Abrasion: Off (Head Height Standard)", "Speed Priority"

(4) "Normal (Plain)", "Prevent Paper Abrasion: Strong (Head Height Standard)", "Standard"

↓ Note

- For the coated paper mode, plain paper can be used but the setting should be "Coated Paper".
- Head position can be adjusted automatically or manually.

2. Enter SP mode and do SP5-884-003 (Factory setting: Head Gap Backup).

↓ Note

- Then the adjusted results will be applied to another paper type and mode. However, adjust the head position for each paper type and mode if necessary.

3. Exit SP mode.

Ink Cartridge and Ink Collector Tank Replacement

1. Open the ink-cartridge cover, and remove the ink cartridge.
2. Attach the customer's ink cartridge and close the ink-cartridge cover.
3. Open the ink collector tank cover and remove the ink collector tank.
4. Attach the customer's ink collector tank and close the cover.

Carriage Unit

★ Important

- The screws shown below are adjusted their position at the factory. Never loosen nor remove them for changing or adjusting.

Forty screws on the backward frame of the main unit (the figure is with the upper cover removed)

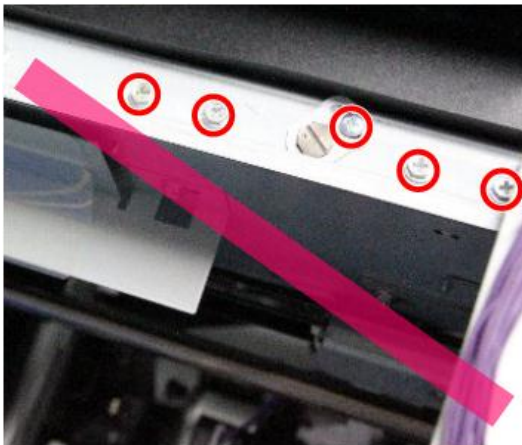

d262k8502

Four screws beneath the paper holding lever (the figure below is with the right cover removed)

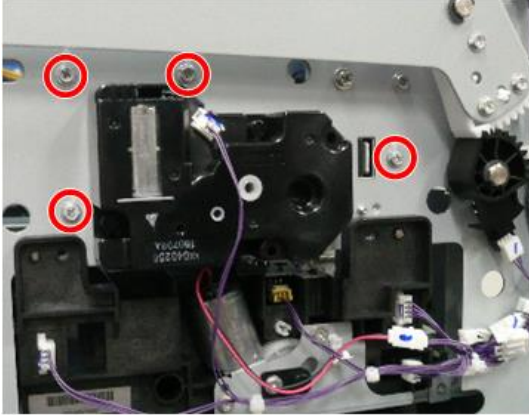

d262k3035

4

Remove Ink Supply Unit

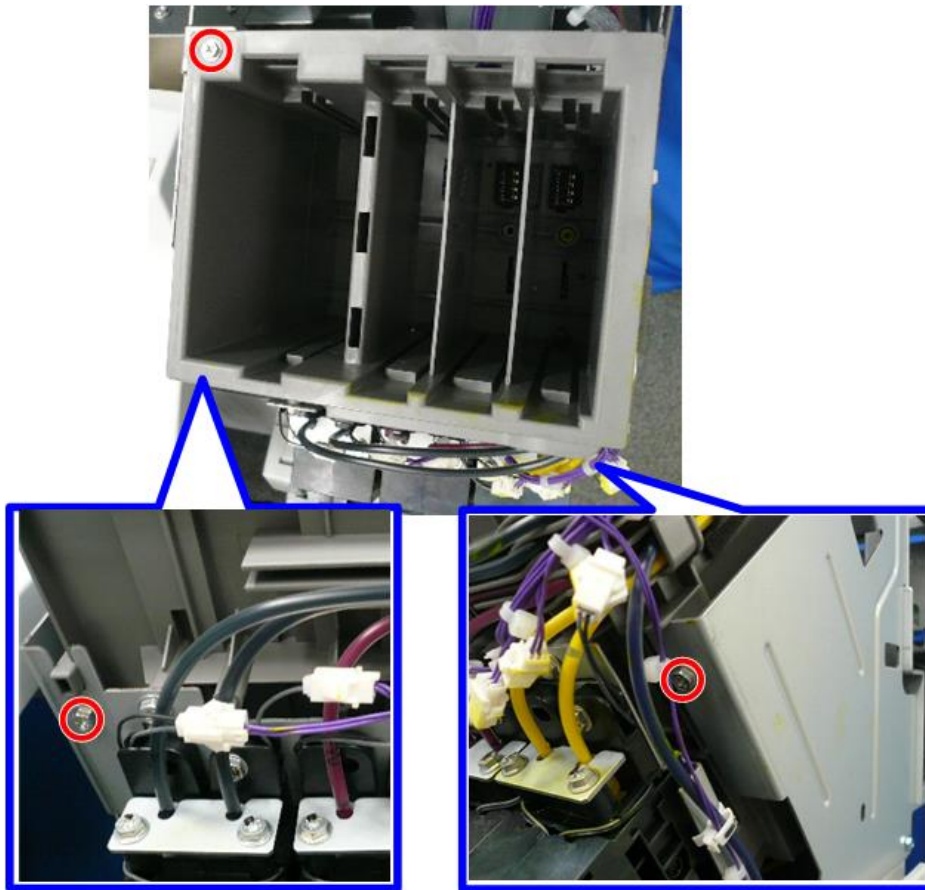

1. Remove the maintenance unit (p.534).
2. Remove the top cover (p.245).
3. Remove the ink collector tank (p.531).
4. Remove the ink cartridge cover (p.243).
5. Remove the front cover (p.249).
6. Remove the paper exit guide (p.251).

7. Remove the screws around the ink supply unit. ( x3)



d262k3101

8. Release the clamps, free the ink tubes, and remove the connectors [A] and [B] of the ink supply unit.

( x2,  x2)

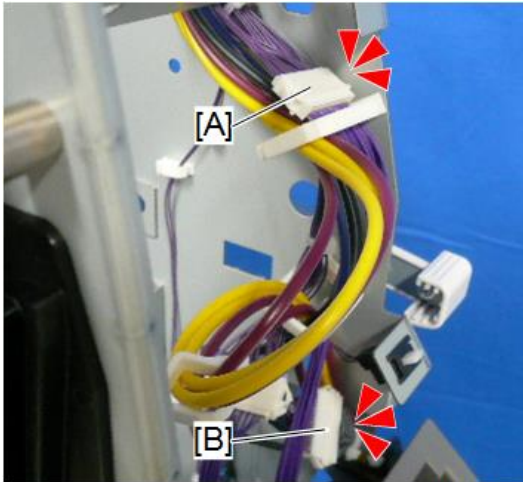

d262k0165

9. Release the clamps inside the frame on the right front of the main unit and free the ink tubes. (🔧x3)

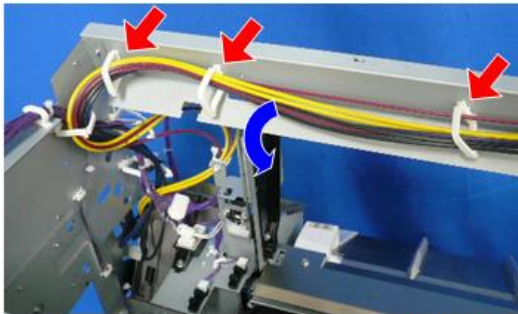

d262k0166

10. Release the clamps inside the frame at the center of the main unit and free the ink tubes. (🔧x2)

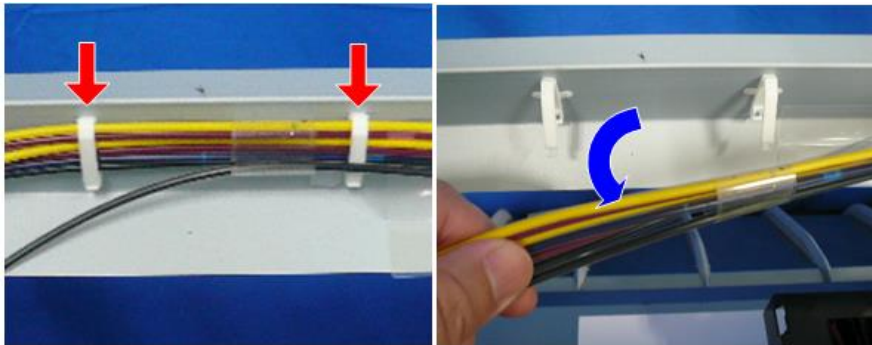

d262k0167

11. Remove the ink supply unit.

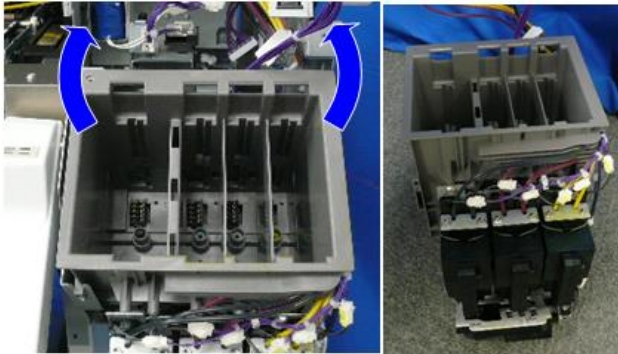

d262k0168

Free the Harness on the Right Side of the Main Unit

1. Release the clamps on the right top of the main unit and free the harness. (🖨️x3)

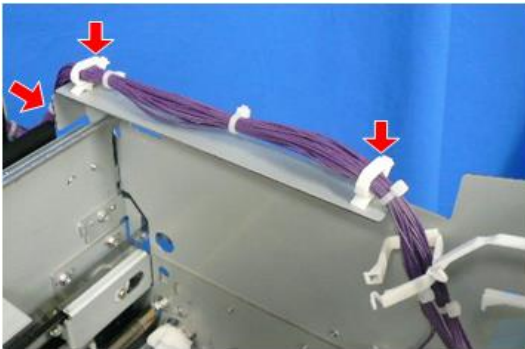

D262k3092

2. Remove the connector [A] of the ink collector tank cover sensor inside the right panel, release the clamps, and free the sensor harness. (🔧 x1, 🗑️ x4)

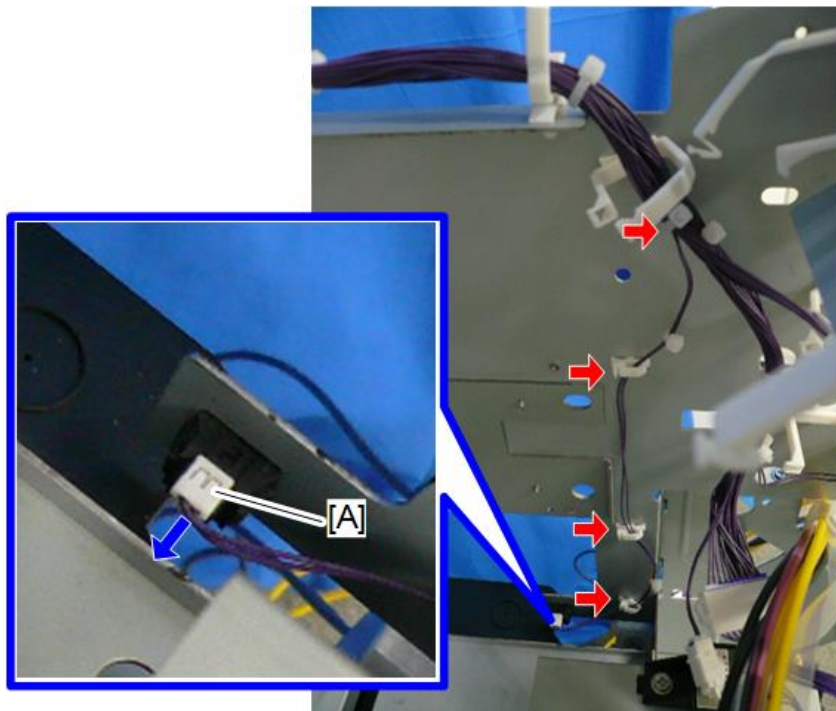

D262k3093

3. Remove the connector of the ink cartridge cover sensor [A] inside the front of the main unit. (🔧 x1)

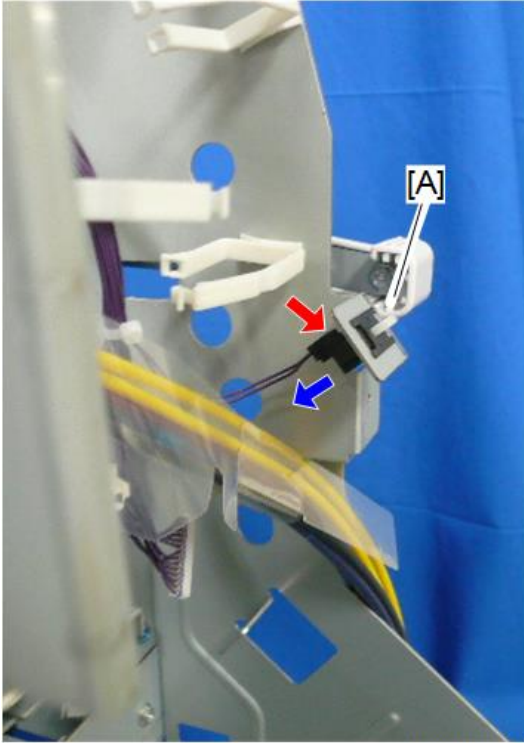

d262k3094

4. Remove the connector [A] of the ink supply unit. (🔧 x2)

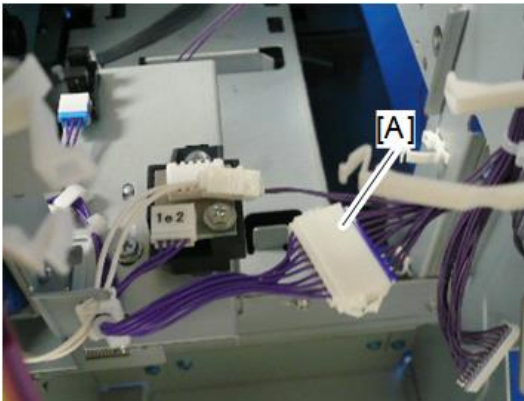

d262k3095

5. Take out the harnesses from the main unit and move them to the back of the main unit.

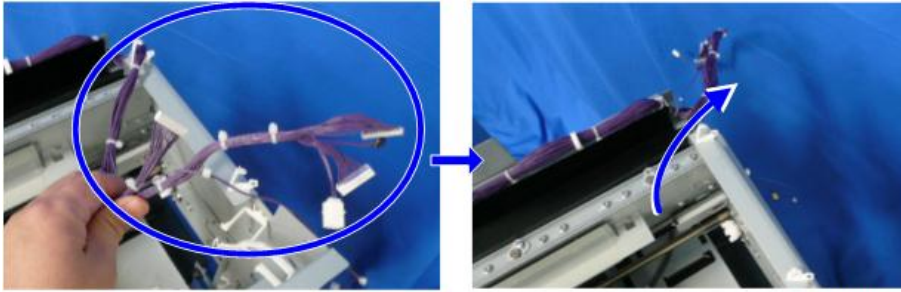

d262k3096

4

6. Release the clamps [A] and remove the connectors [B] on the right back of the main unit, and free the harness. (🔧 x4, 🛠️ x2)

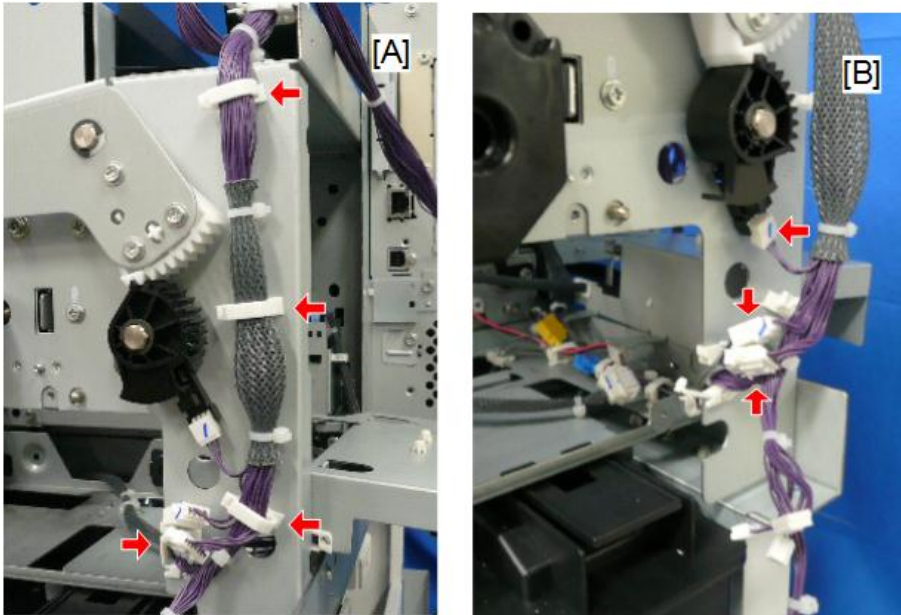

d262k3097

7. Free the auto-nozzle check unit (p.540).

8. Release the clamps inside the right of the main unit. (🖨️ x4)

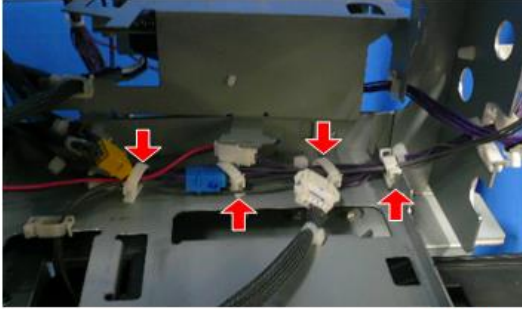

d262k3098

9. Remove the connectors, and free the harnesses. (🖨️ x4)

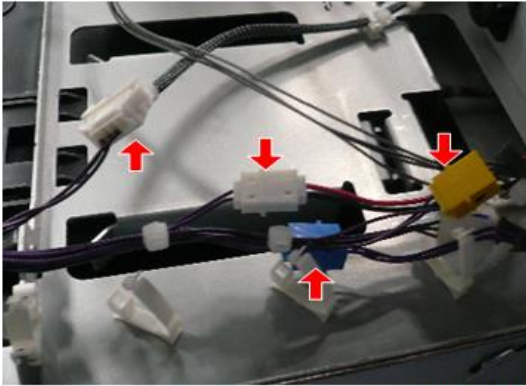

d262k3099

10. Take out the harnesses from the main unit.

11. Move the harnesses to the back of the main unit.

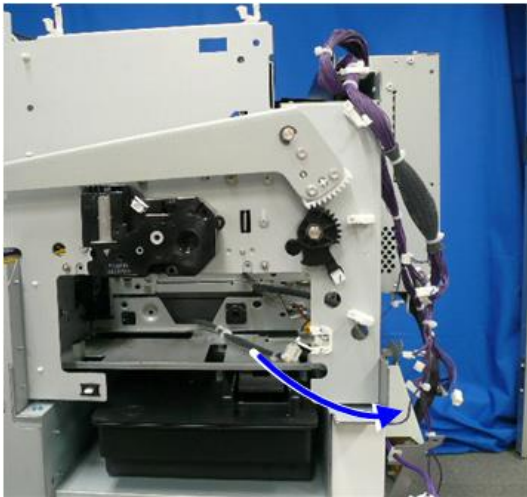

d262k3100

4

Main Ink Level Sensor Bracket Removal

★ Important

- The screws shown below are adjusted their position at the factory. Never loosen nor remove them for changing or adjusting.
- A screw at the upper part of the air release solenoid bracket.

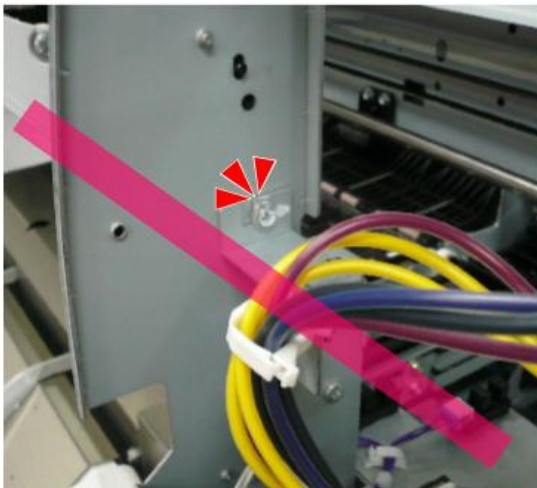

d262k8504

- Two screws at the lower part of the air release solenoid and main ink level sensor bracket.

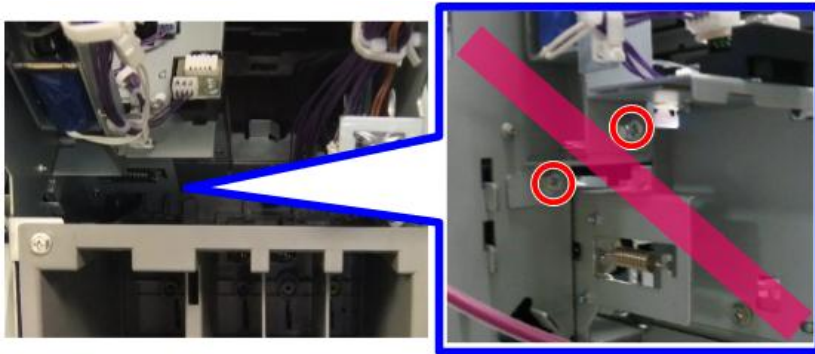

d262k8507

1. Mark the point of the boss of the main ink level sensor bracket (a red line in the illustration below).

4

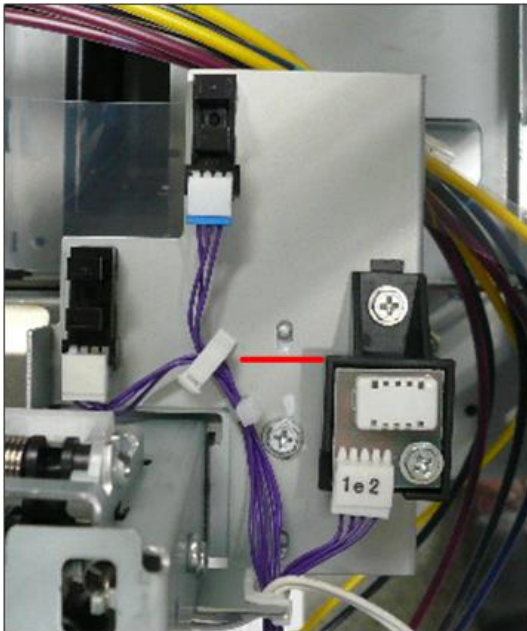

D262k3091

↓ Note

- When the main ink level sensor bracket is to be attached, be sure to place the OCFS actuator at the center of the OCFS actuator sensor. For details, see "Attach the main ink level sensor bracket in the procedure below" in "Precautions" for attaching the carriage unit.

2. Remove the main ink level sensor bracket on the right front of the main unit. (🔧x2, 🪛x1)

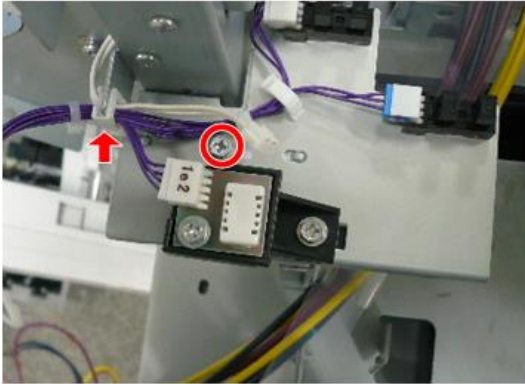

d262k3102

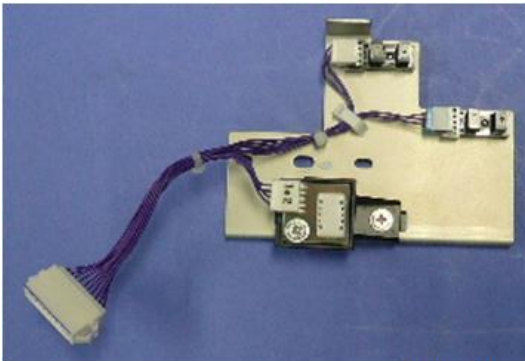

d262k3103

Ink Tube Rail Removal

1. Loosen the right and left screws on the ink tube rail. (🪛x2)

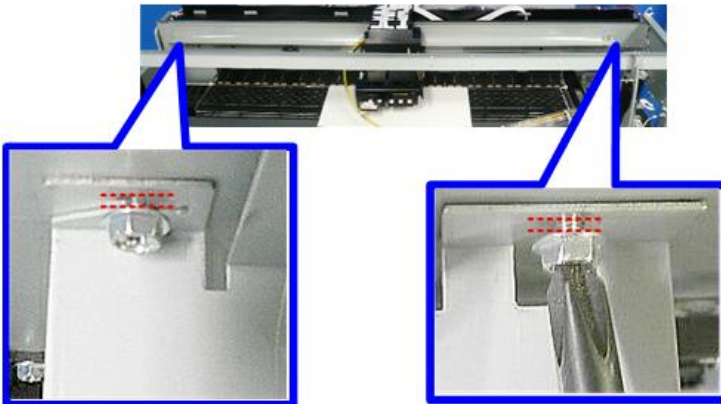

d262k3104

2. Remove the rail from the loosened screws [A] and [B].

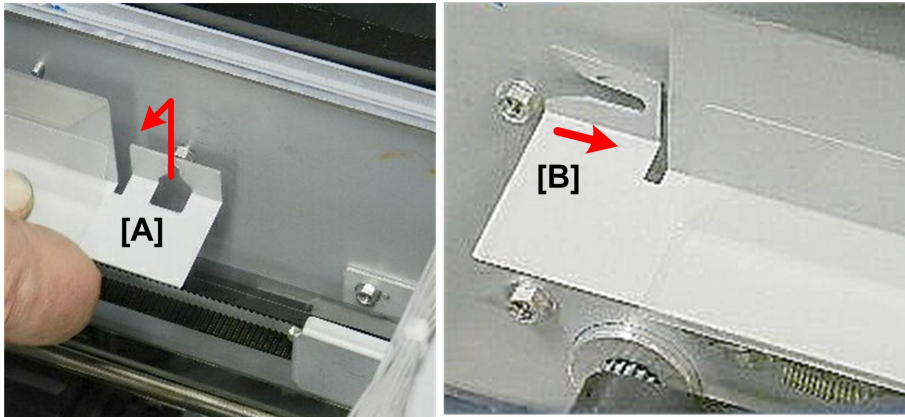

d124r458

4

3. Move the rail to the left and pull it out from the rear of the carriage unit to take it out from the main unit.

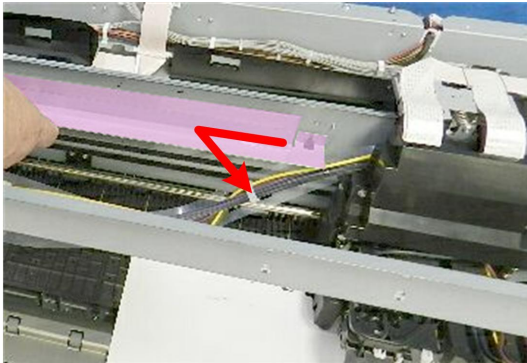

d124r459

Horizontal Encoder Sheet Removal

↓ Note

- Do not touch the horizontal encoder sheet with bare hands.

1. Release and remove the spring on the left of the main unit. ( x1)

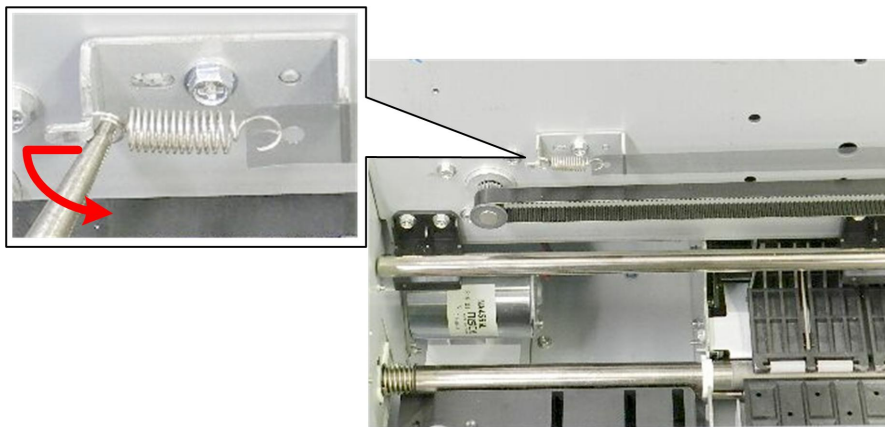

d124r460

2. On the right of the main unit, remove the right end of the horizontal encoder sheet from the screw.

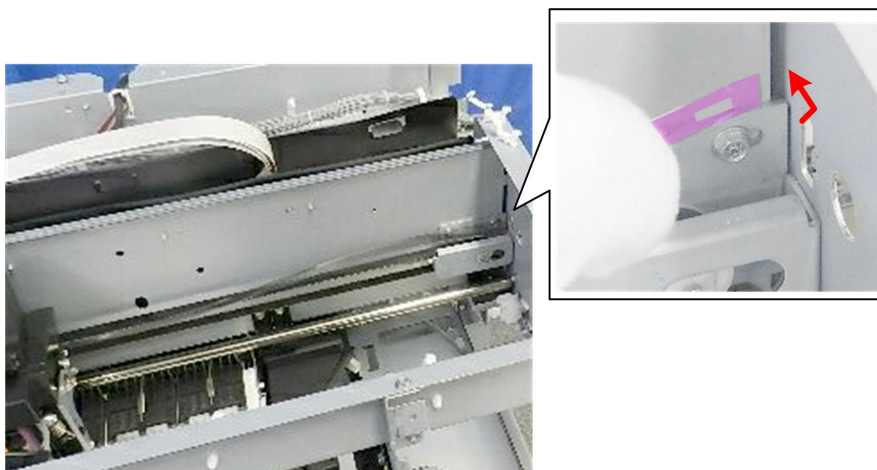

d124r461

3. Pull out the horizontal encoder sheet from the back of the carriage unit [A] to take it out from the main unit [B].

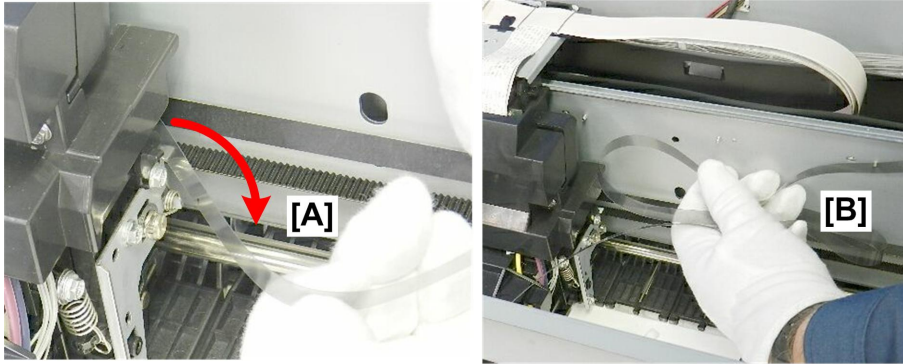

d124r462

4

Tension Bracket Removal

1. Remove the screws of the tension bracket [A] inside the right of the main unit. ( x3)

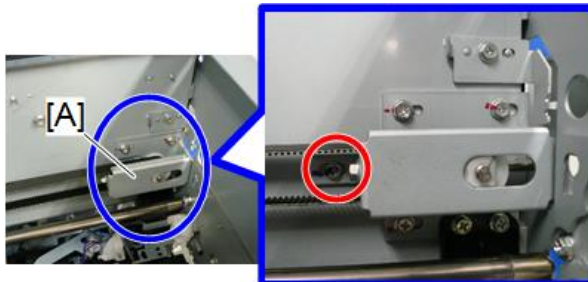

d262k0148

2. On the right of the main unit, remove the tension screw hidden behind the paper holding lever and the tension bracket is removed. ( x1)

↓ Note

- When removing the outside screw, hold the bracket to prevent the spring, that is not fixed to the bracket, from falling.

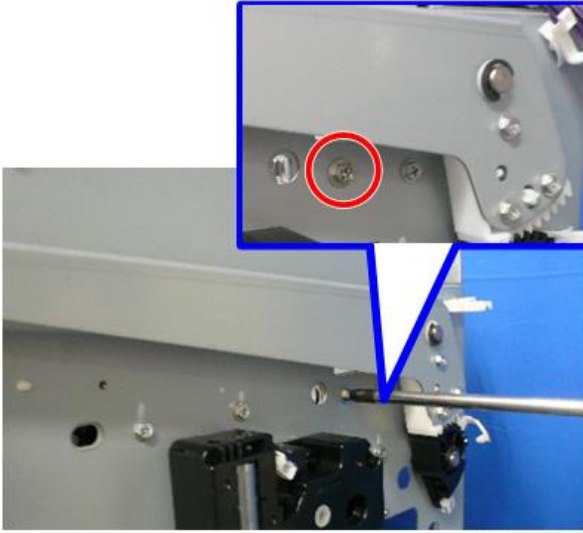

d262k0149



d262k0150

3. Remove the plate of the tension bracket together with the horizontal timing belt. ( x3)

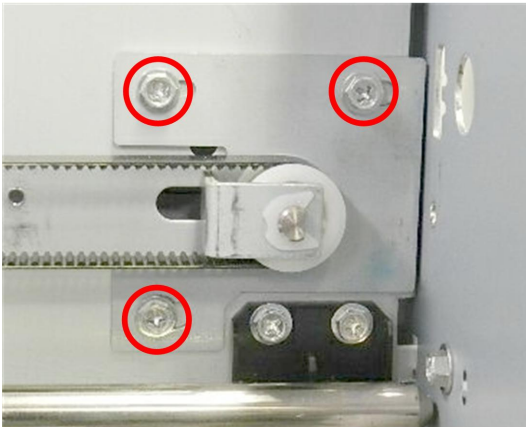

d124r466

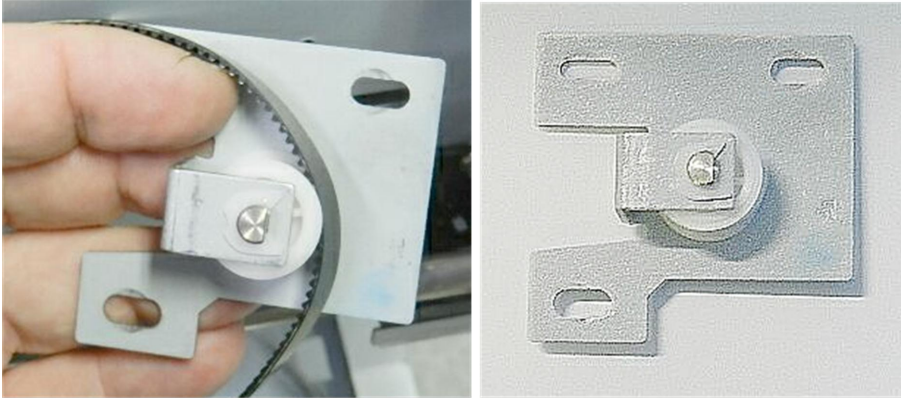

d124r467

4

Right Plate Removal

1. Remove the actuator [A] beneath the paper holding lever. (Ⓒ x1)

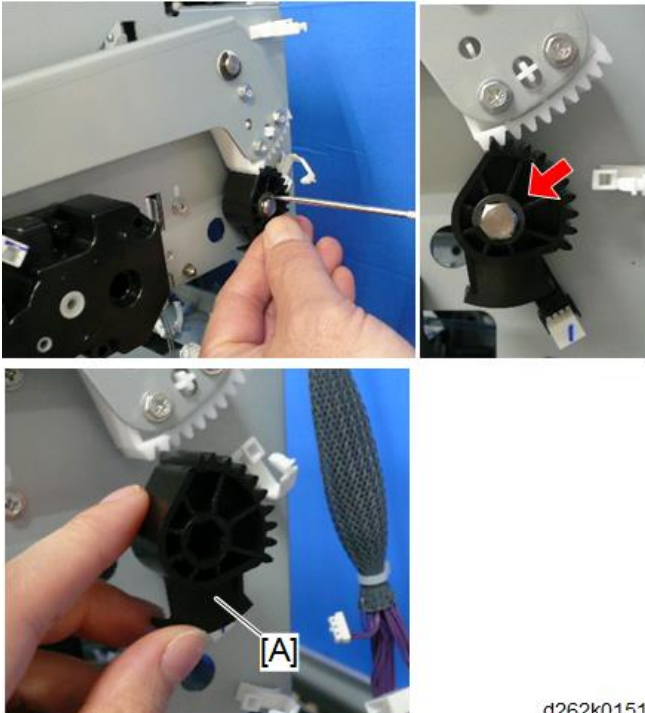

d262k0151

2. Remove the paper holding lever. (Ⓒ x1)



d262k0152

3. Remove the blue screws on the right front plate. ( x7)

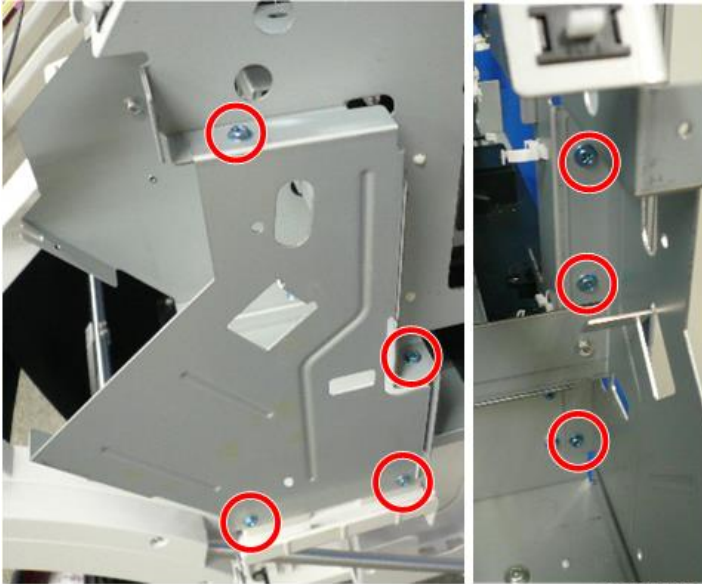

d262k0153

4. Remove the right front plate.

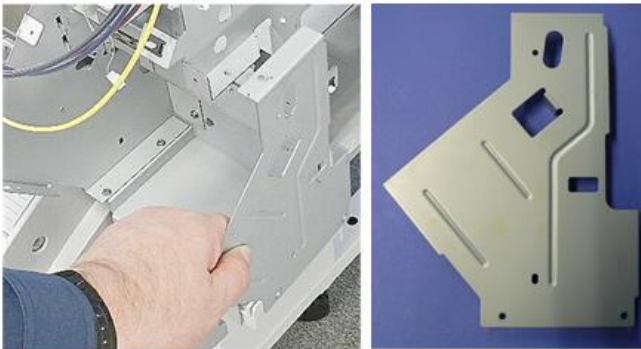

d262k0154

5. Release the clamps on the right back of the main unit, free the harnesses, and move them to the back of the main unit. (🔧x2)

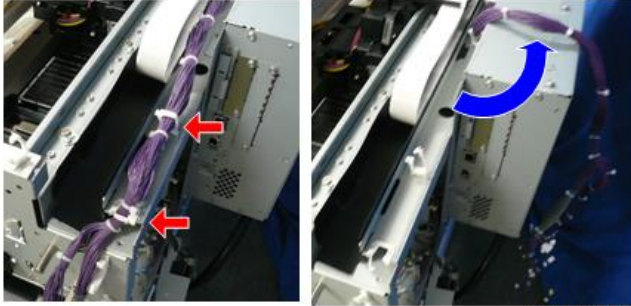

d262k0155

4

6. Remove the right panel.

1. Remove the screws on the right back of the main unit. (🔧x6)

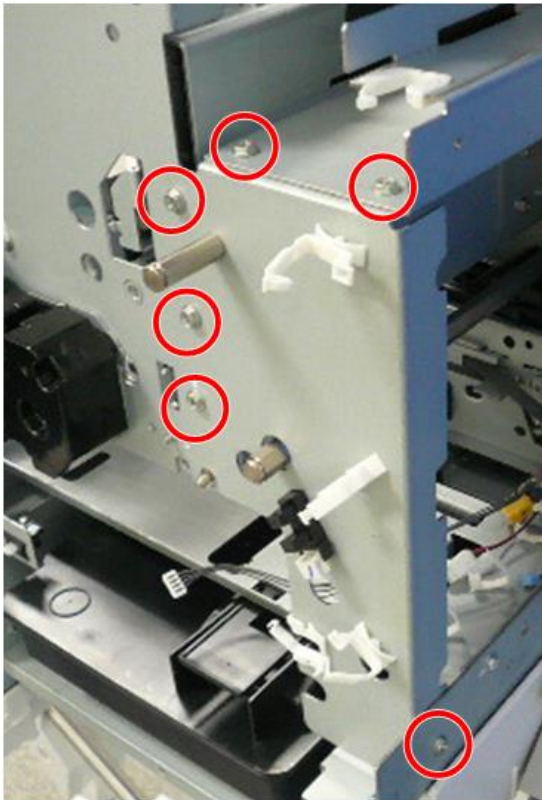

d262k0156

2. Remove the screws on the front. (🔧x3)

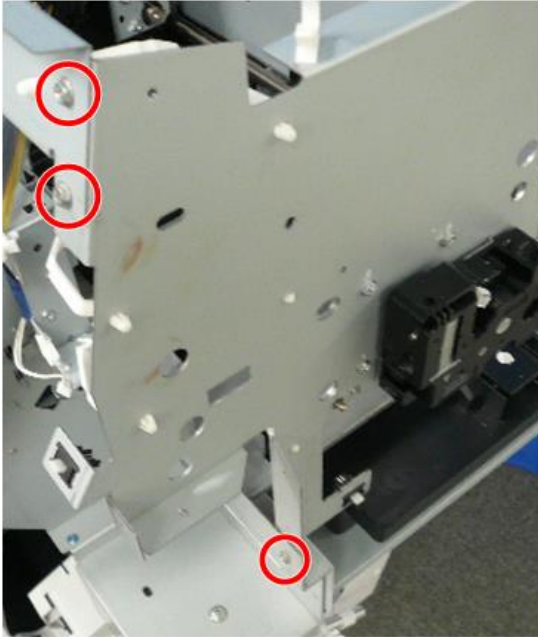

d262k0157

3. Remove the plate [A] inside the right panel. ( x1)



d262k0159

4. Remove the right panel.

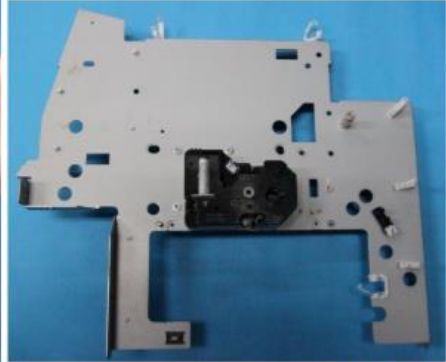
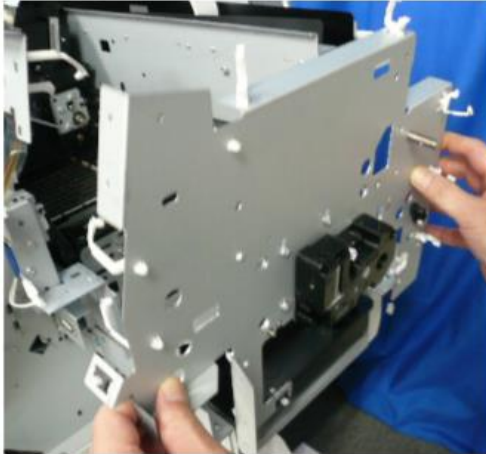

d262k0158

Carriage Unit Removal

1. Remove the carriage left cover. ( x1)

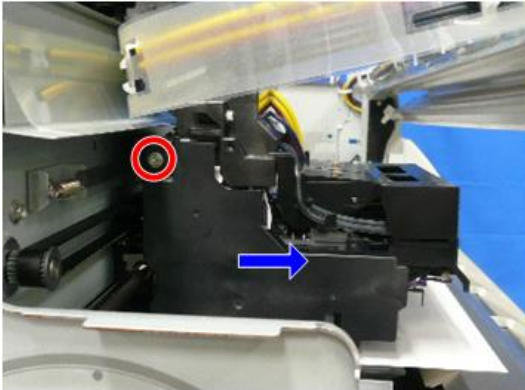

d262k3020

2. Remove the carriage upper cover that hold the ink tubes on both sides of the carriage unit. ( x2)

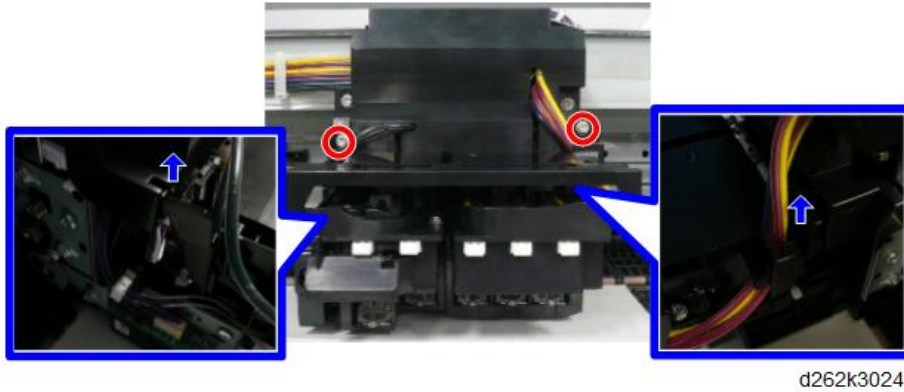

3. Remove the carriage front cover [A]. ( x2)

 **Note**

- To remove the carriage front cover, remove the ink tubes from the groove.

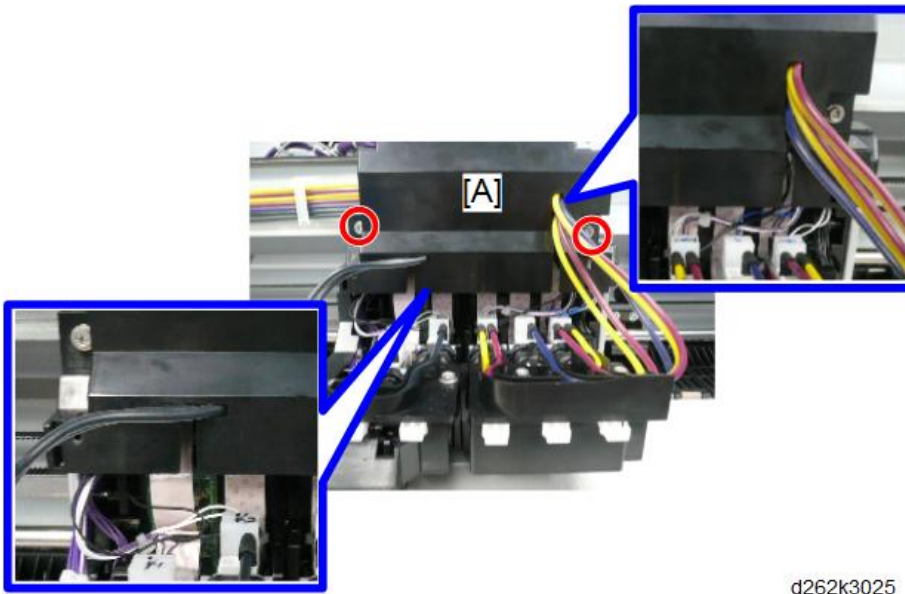

4. Release the FFCs from the left of the HRB. ( x2)

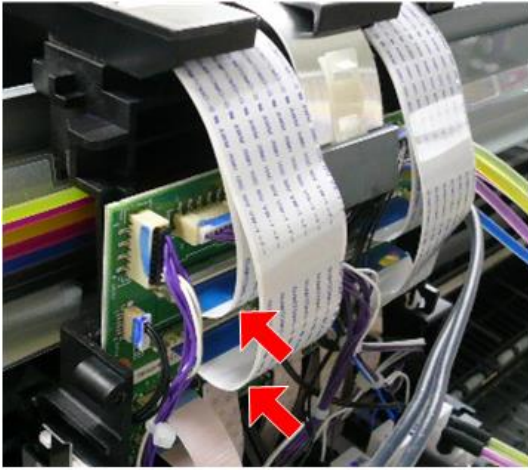

d262k0280

 **Note**

- To release the FFCs, push the plate [A] to the HRB.

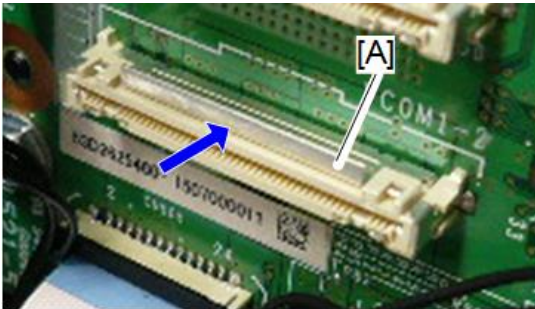

d262k3085

5. Release the FFCs from the right of the HRB. ( x2)

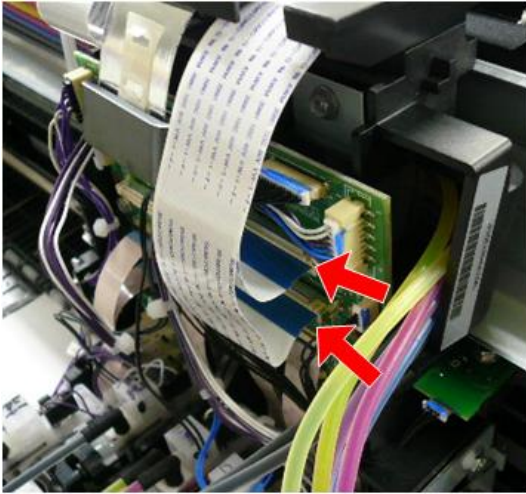

d262k0281

6. Release the FFC from the center of the HRB. ( x1)

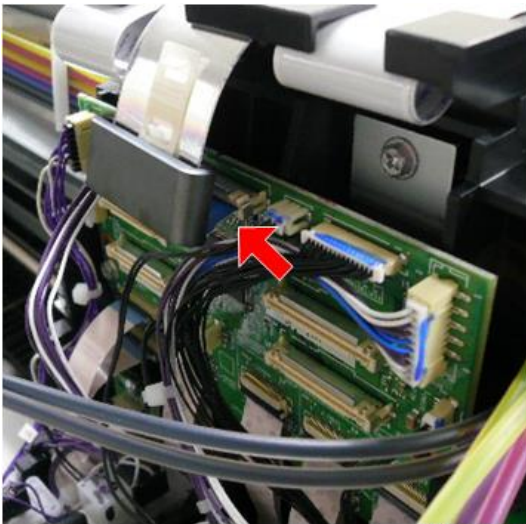

d262k0282

7. Remove the connector from the HRB. (E₁ x7)

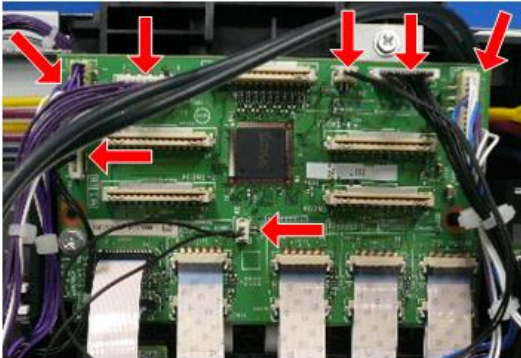

d262k3030

4

8. Release the FFCs (front side) from the lower part of the HRB. (E₁ x5)

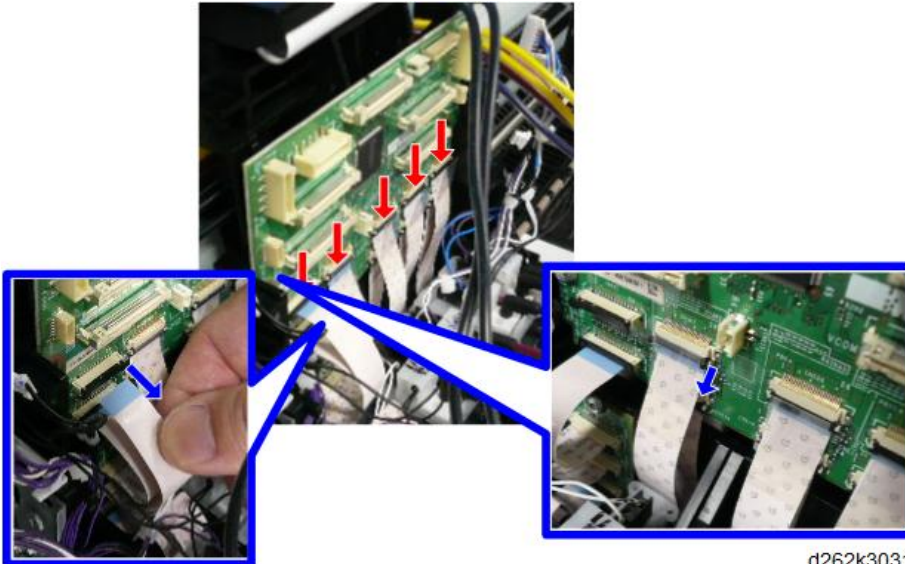

d262k3031

↓ Note

- To release the FFCs, be sure you understand of the directions of the locks.
- To release the FFCs [A], pull the lock toward you.
- To release the FFCs [B], push up the lock.

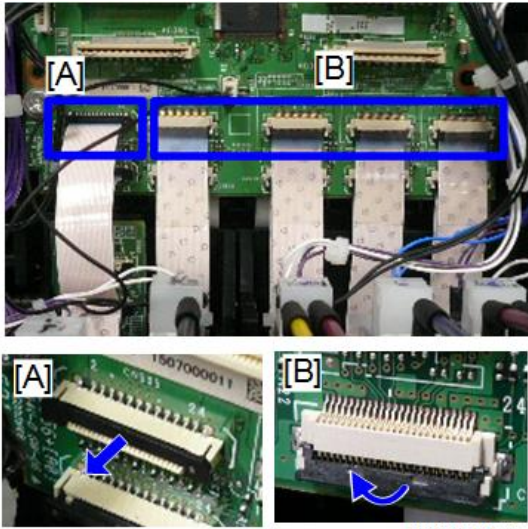

d262k3086

9. Release the FFCs (backward) from the lower part of the HRB. ( x5)

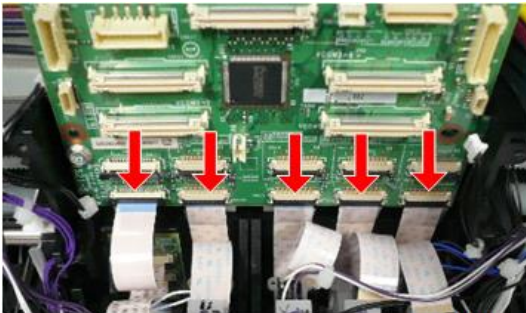

d262k3032

10. Slide the wire retainer on the right top of the FFC guide plate to the left while holding it pushed and remove it from the cutout.

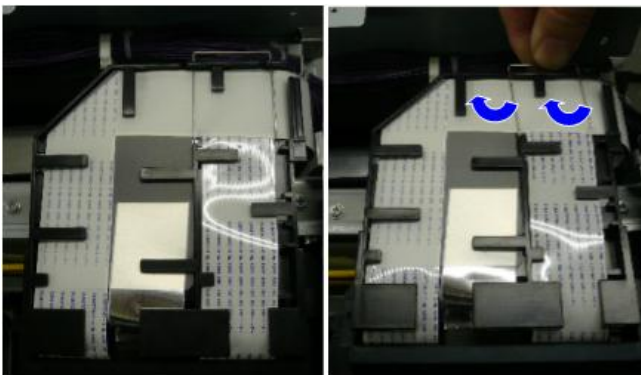

d262k0160

11. Remove the sheet from the FFC guide plate.

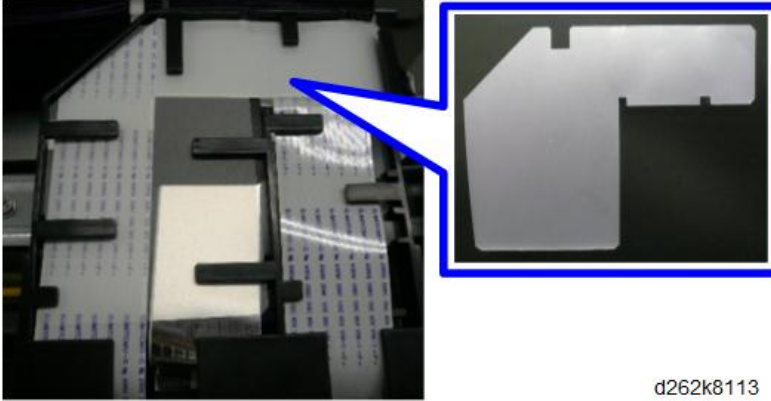

4

12. Release the FFCs from the guide

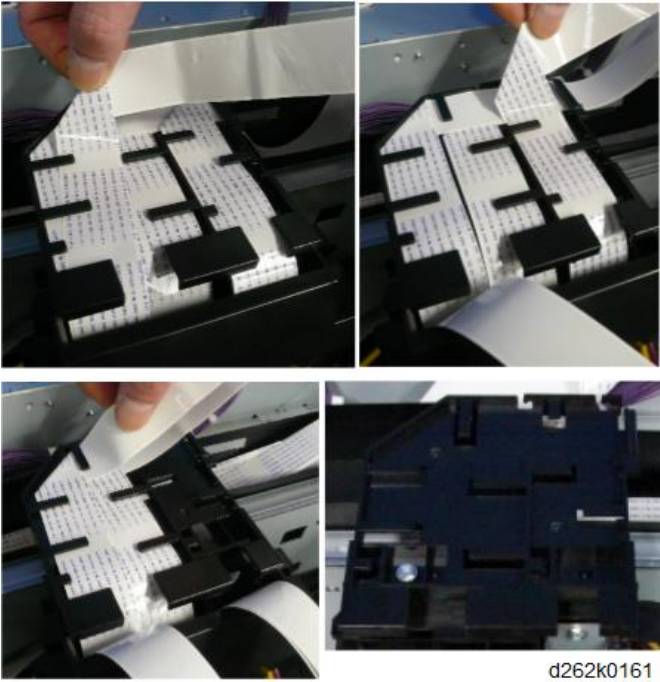

13. Take the plugs for attaching to the ink tubes and plugs (capped) for attaching to the ink supply ports of the print head unit as they are disconnected, to prevent ink leakage. Two plugs for black print head and five plugs for color print head are necessary.



d262k0298

14. Place a large sheet of paper under the carriage unit. (This prevents the platen from being dirty caused by ink leakage as the ink tube is removed.)
15. Push the right and left white projections of the black and color print heads to release the air from the head tanks.

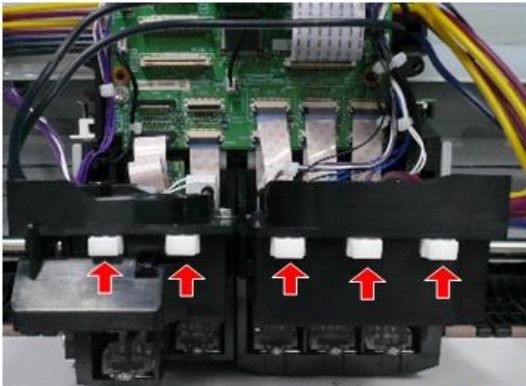

d262k3079

16. Attach the protective sheet [A] to the new print head.



d262k0299

4

17. Remove the ink tube (M2) [A] from the ink supply port of the print head, and attach the plug [B] to the ink tube port.

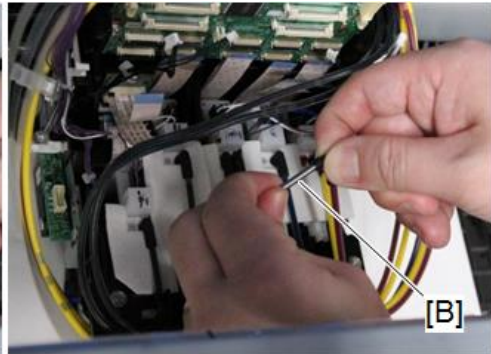
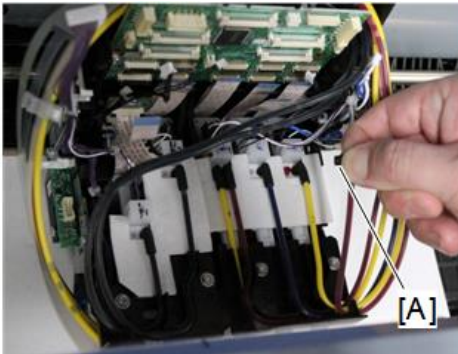

d262k0291

18. Attach the plug (capped) [A] to the ink supply port from which the ink tube (M2) was removed.

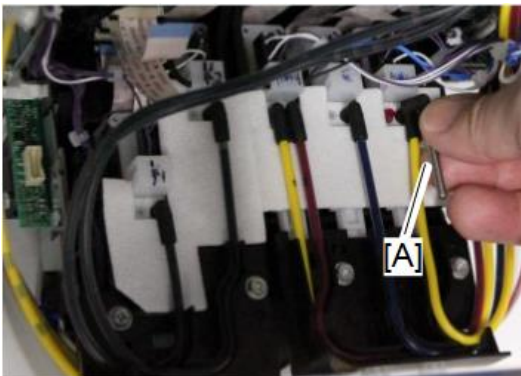

d262k3066

19. Repeat steps 16 and 17 for ink tubes (Y2), (C), (M1), (Y1), (K2), and (K1) in this order.

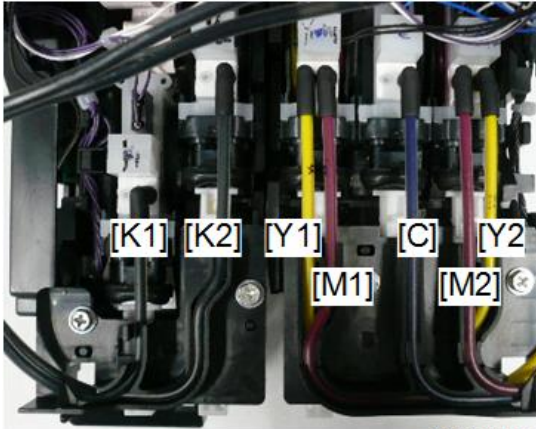

d262k3078

20. Remove the HRB. (🔧 x1)



d262k3033

21. Attach the plugs of all seven ink tubes and seven ink supply ports, then remove the bracket that secures the ink tubes. (🔧 x1)

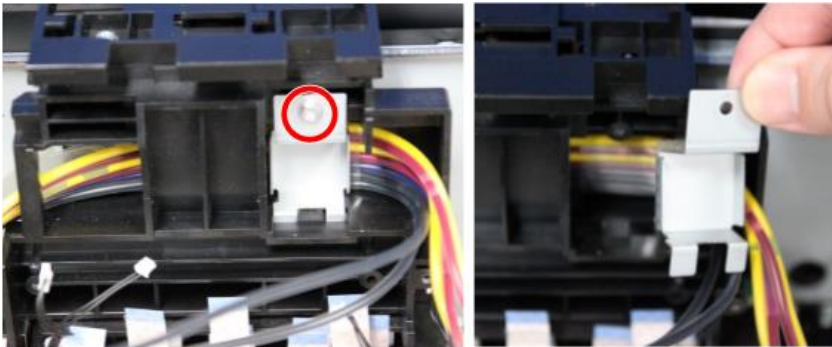

d262k0300

22. Remove the ink tubes from the carriage unit.

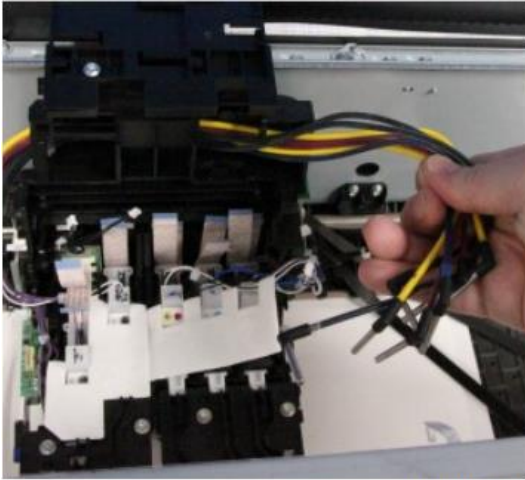

d262k0301

23. On the left of the main unit, remove the horizontal timing belt [A] from the motor drive gear.

24. Move the carriage unit to the right end of the main unit [C] while pulling up the horizontal timing belt [B] (to prevent the belt from fouling at the back of the carriage unit).

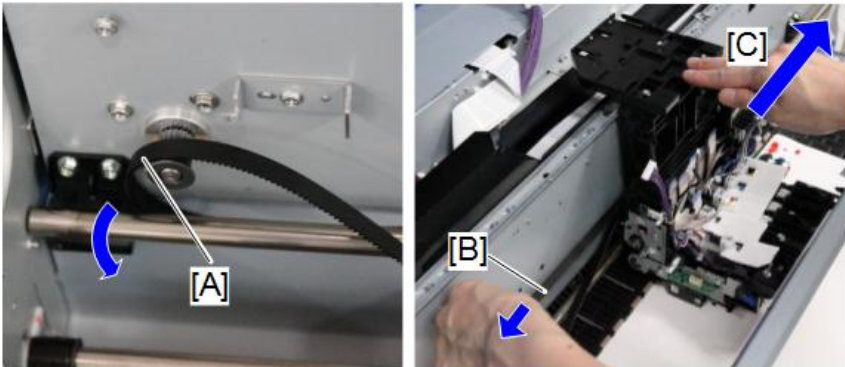

d262k0302

25. Hold the carriage unit with both hands and remove it from the guide rod.

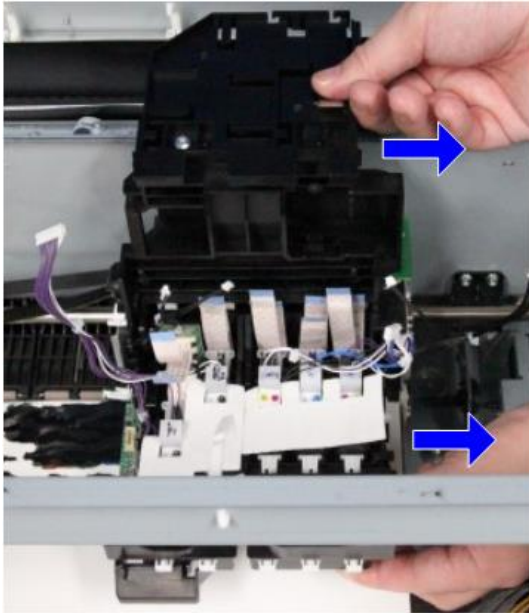

d262k0303

Note

- Place the removed carriage unit on the flat place.
- Place the carriage unit with the nozzles facing down on a flat paper.

Carriage Unit

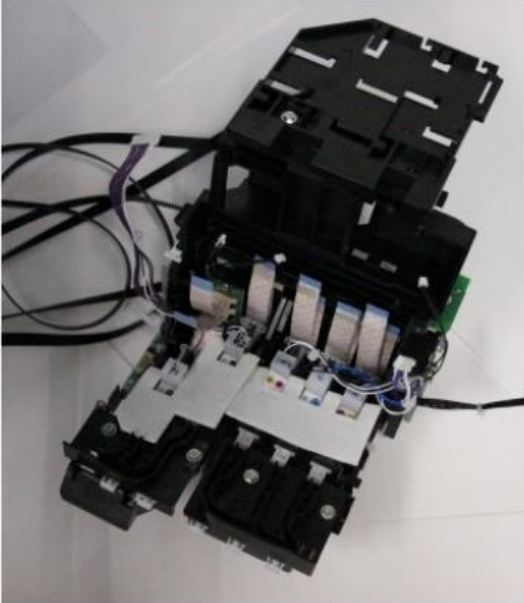

d262k0304

4

Precaution

Check the position of the carriage unit after attaching it to the guide rod.

1. The shaft [A] at the lower part of the carriage unit is inserted in the guide rod.
2. The slider [B] at the upper part of the carriage unit contacts with the rail as shown below.

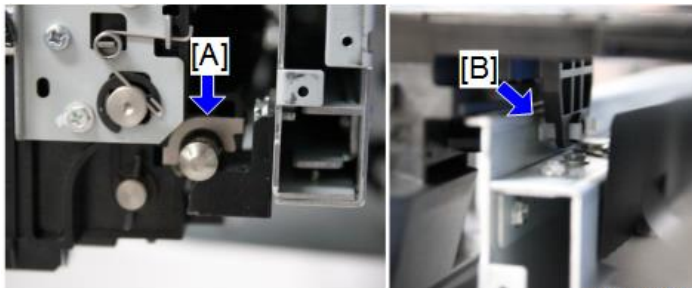

d262k0305

Before attaching the bracket to secure the ink tubes, check that the ink tubes are lined correctly as shown below.

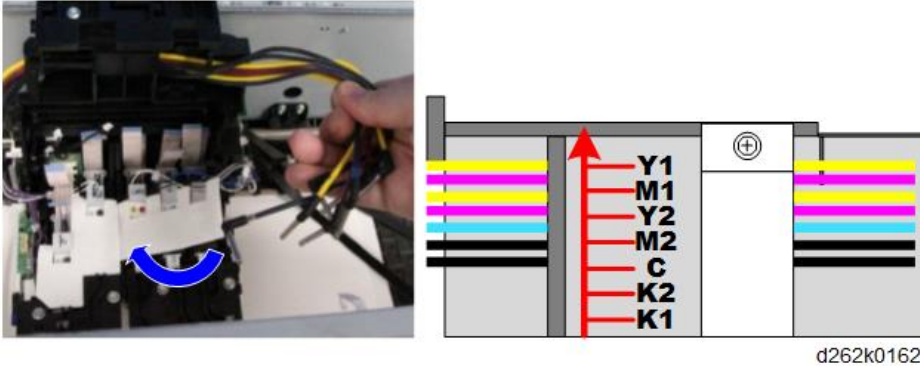

1. Pass the ink tubes, K2, K1, Y1, M1, C, Y2, and M2 in this order one by one through the upper part of the carriage unit.
2. Pass the ink tubes from left side to the right side of the carriage unit in the order described above.

Note

- Then the tubes are prevented from crossing inside the carriage unit.
 - If the ink tubes are crossed, the bracket to secure the ink tubes may not be attached correctly.
3. If the plugged ink tube is hard to pass the upper part of the carriage unit, pull it out using the longnose pliers.

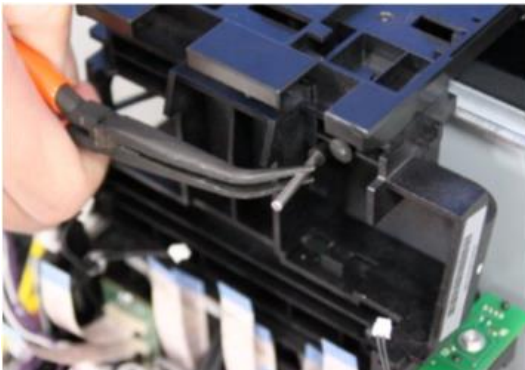

d262k0308

Place the ink tubes on the print head in the procedure below.

1. Remove the plugs of the ink tubes (K1) and (K2) and the ink supply ports of the print head.
2. Attach the ink tubes (K1) and (K2) to the ink supply ports and place them on the path of the print head in the order of K2 and K1.

Place the ink tube (K2) [A] on the path of the print head first.

Then place the ink tube (K1) [B] upon the ink tube (K2) on the path of the print head.

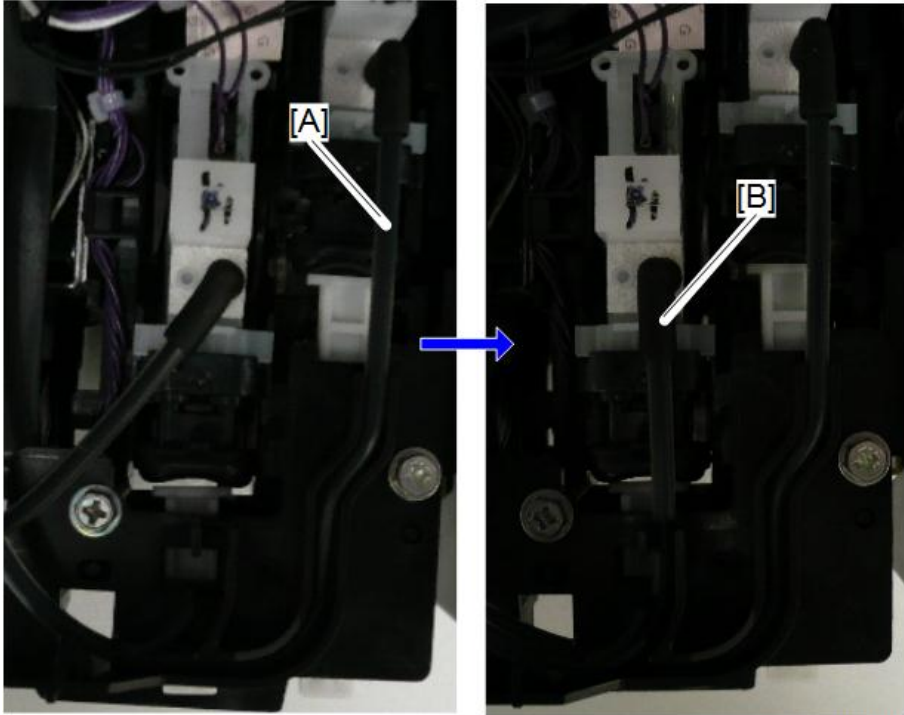

D262k3088

3. Remove the plugs from the ports of the ink tubes (Y1), (M1), (C), (M2), and (Y2) and the ink supply ports of the print heads.
4. Place the ink tubes on the path of the print head, from right to left in order of Y1, M1, C, Y2, and M2.
 - Place the ink tube (Y1) on the path of the print head first. [A]
 - Then place the ink tube (M1) upon the ink tube (Y1) on the path of the print head. [B]
 - Then place the ink tube (C) upon the ink tube (M1) [C] and the ink tube (Y2) upon the ink tube (C) on the path of the print head. [D]
 - Last of all, place the ink tube (M2) upon the ink tube (Y2) on the path of the print head. [E]

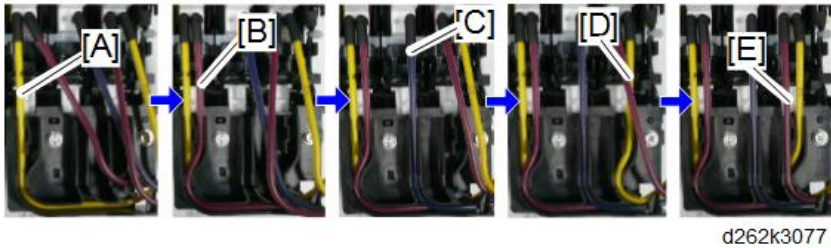

Before attaching the bracket to secure the ink tubes, check the followings:

- Place the ink tube so that the cutout of the ink tube guide is placed 1 to 4 mm apart from the side of the carriage unit.
- Check that there is the space between the ink tube guide and the carriage unit.

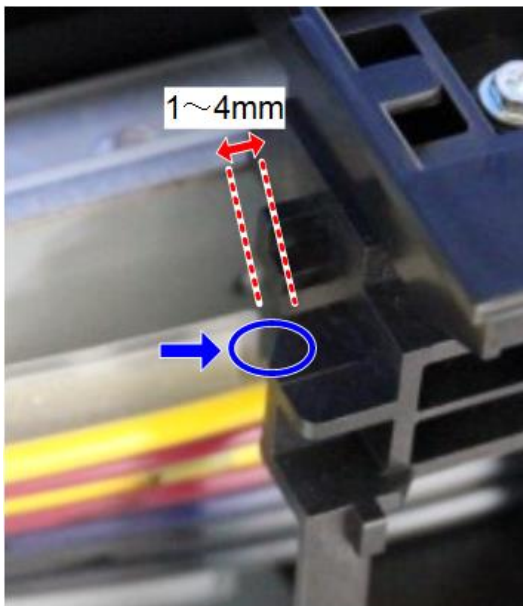

d262k0306

To attach the bracket to secure the ink tubes, insert the two projections under the bracket to the holes of the carriage unit.

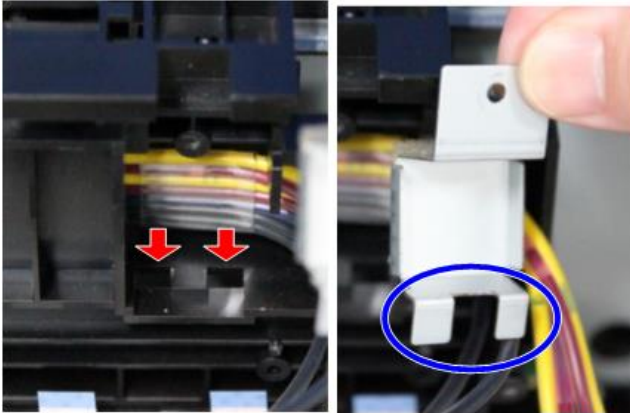

d262k0307

When the carriage unit installation completes, move the unit right and left to check that it does not fall down from the rail.

Note

- If the ink tube falls down, the ink tube is loosely attached on the left of the carriage unit. Remove the bracket to secure the ink tubes and pull the ink tube from the left of the carriage unit as possible to remove the looseness.

When the paper holding lever is attached, check the followings:

- [1] The paper holding lever is horizontal.
- [2] The gear and the first gear teeth of the paper holding lever are aligned.
- [3] The actuator for the gear is in the gap of the registration release sensor.

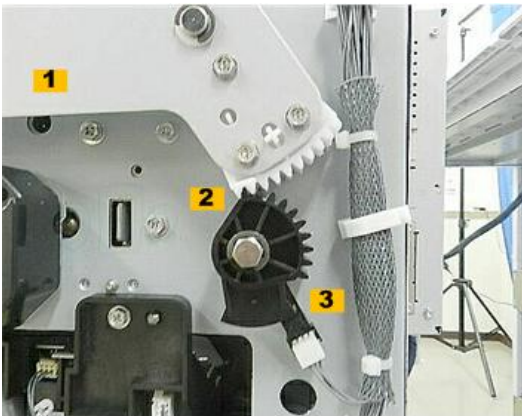

d1241091

Attach the main ink level sensor bracket in the procedure below.

1. Loosen the screw of the bracket to move the bracket back and forth.

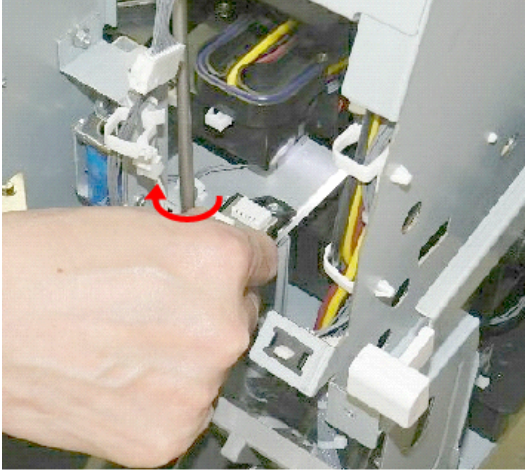

d1241092_e

2. Check that the feeler is placed at the center of the feeler sensor [1] [2]. If it is not placed at the center, adjust the position by moving the bracket back and forth.

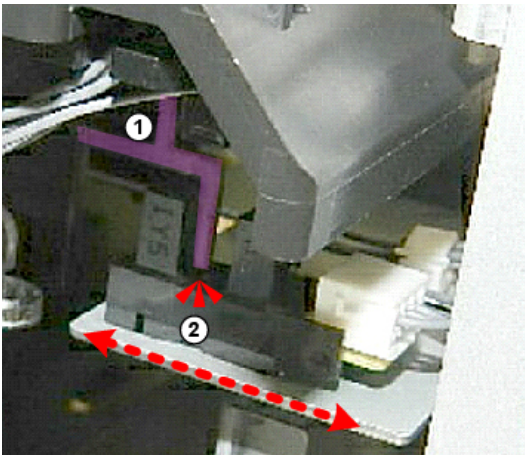

d1241093_e

3. Tighten the screw of the bracket.

Ink Supply

Ink Supply Unit

This section describes how to replace the ink supply unit.

Ink Supply Unit Accessories

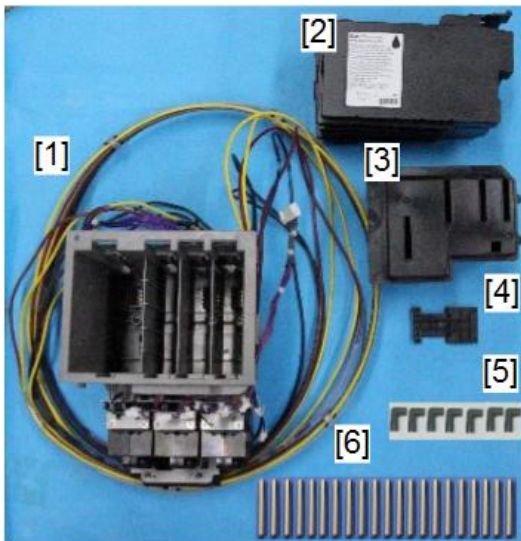

d262k8501

No.	Item	Q'ty
1.	Ink Supply Unit (ink tubes attached)	1
2.	Ink Cartridges (K, C, Y, M)	4
3.	Ink Sump	1
4.	Ink Sump Cap	1
5.	Rubber Caps	7
6.	Plugs	21

Before You Begin

★ Important

- Always follow instructions and work carefully to avoid spilling ink from the ink tubes and the tops of the ink sub tanks. If ink spills onto a printed circuit board at the base of the FFC, the print head unit will become unusable and require replacement.

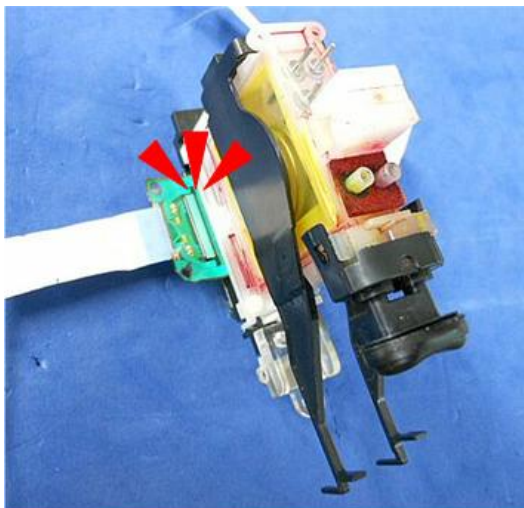

d124r729

Ink Supply Unit Replacement

1. Do SP2090-1 to clear the NVRAM setting for the ink supply unit.
2. Move the Carriage Unit with SP2102-4 (p.267).
3. Turn the machine off and disconnect the power cord from the power source.
4. Separate the Main Unit from the Scanner Unit (p.274).
5. Remove the top cover (p.245).

Carriage Disconnection

1. Remove the left cover of the carriage unit ( x1).

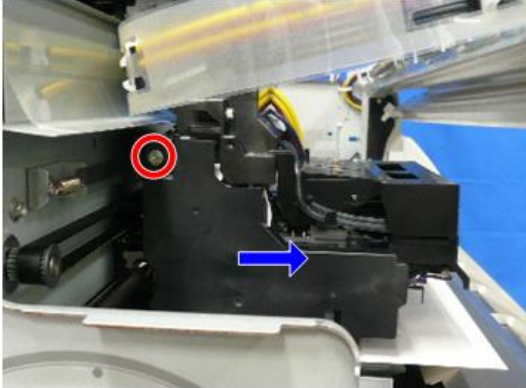

d262k3020

2. Remove the carriage top covers that secure the ink tube at both left and right of the carriage unit ( x2).

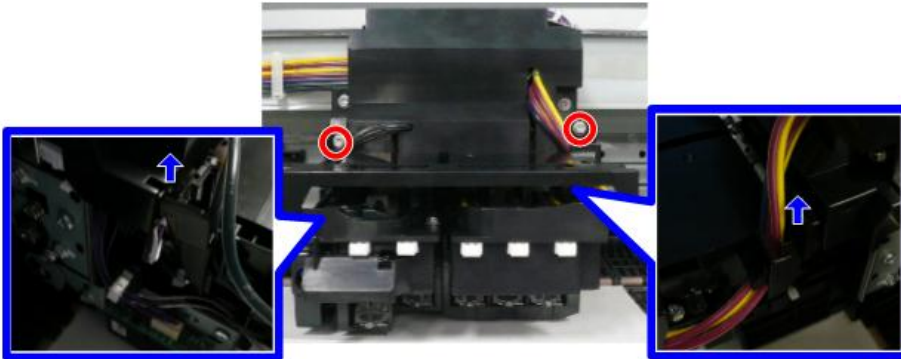

d262k3024

3. Remove the carriage front cover [A] ( x2).

 **Note**

- When the carriage front cover is to be removed, pull the ink tube out from the groove.

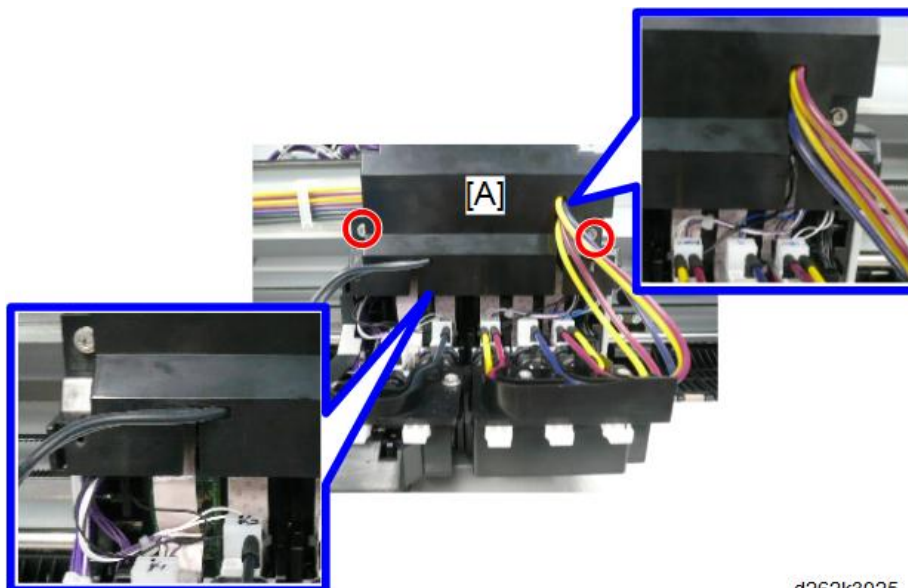

d262k3025

4. Release the FFCs on the left of the HRB ( x2).

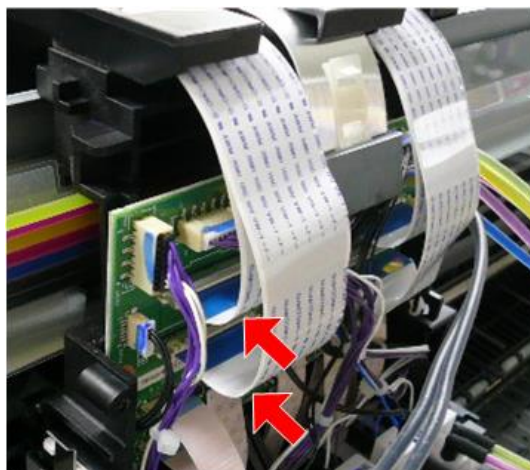

d262k0280

 **Note**

- To remove the FFCs, push the bracket [A] to the HRB.

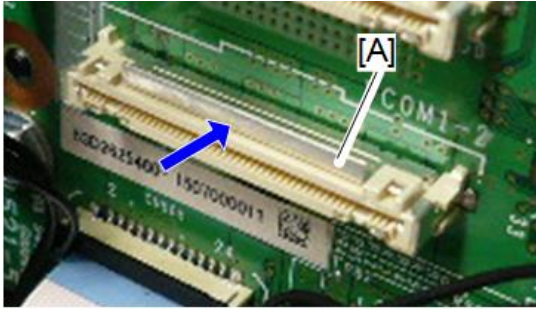

d262k3085

5. Release the FFCs on the right of the HRB ( x2).

4

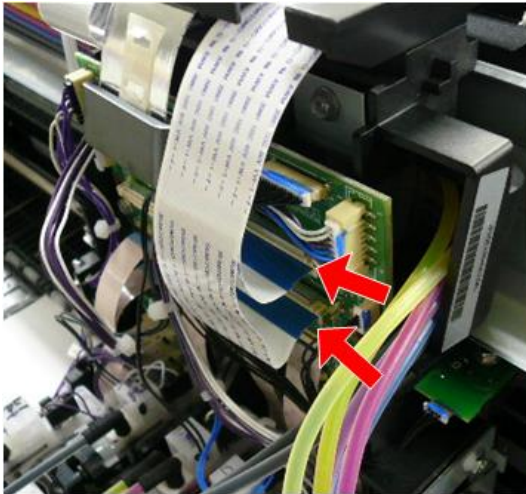

d262k0281

6. Release the FFC at the center of the HRB ( x1).

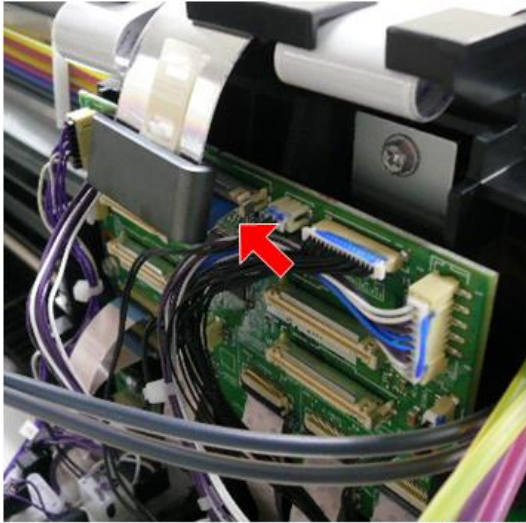

d262k0282

7. Press and pull the wire retainer to the left on the upper right of the flat cable guide plate to remove it from the cutout.

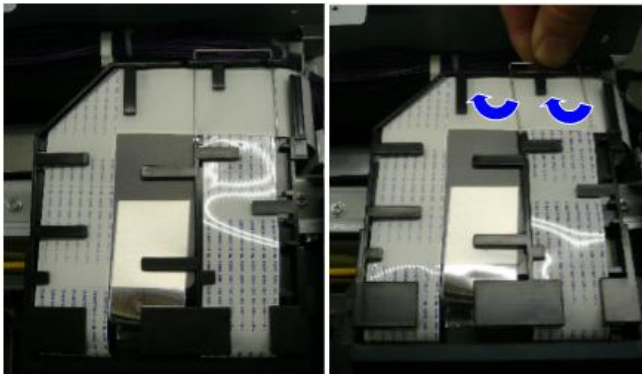

d262k0160

8. Remove the film sheet on the FFC guide plate.

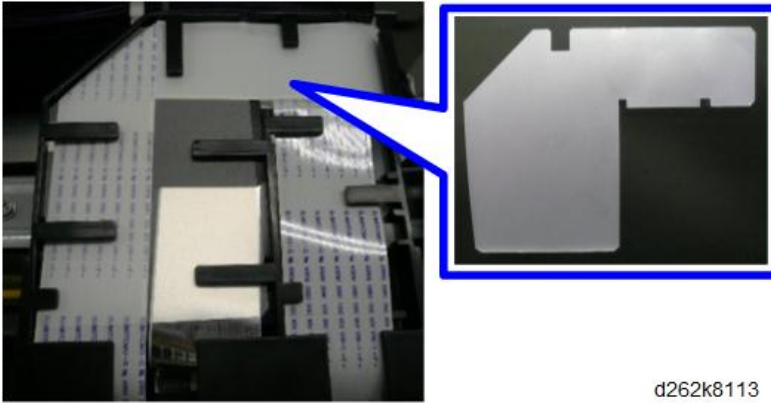

4

9. Take off the flat cable from the guide.

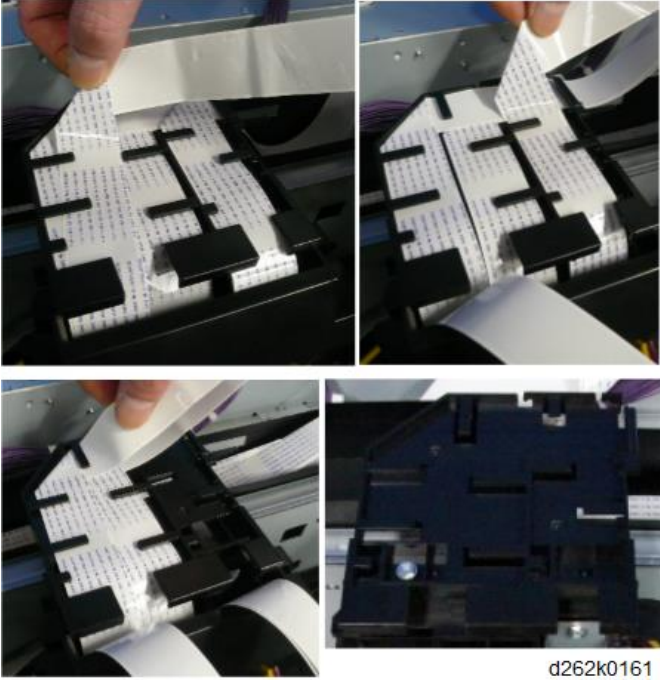

10. You will need the uncapped/capped plugs to plug each ink supply tube and ink supply port as they are disconnected, to prevent ink leakage. For the head carriage (black), two

pairs of uncapped/capped plugs and for the head carriage (color), five pairs are required.



d262k0298

4

11. Place a large sheet of paper under the carriage unit.
12. Before disconnecting the tubes, press the white plungers to purge air from the ink sub tanks.

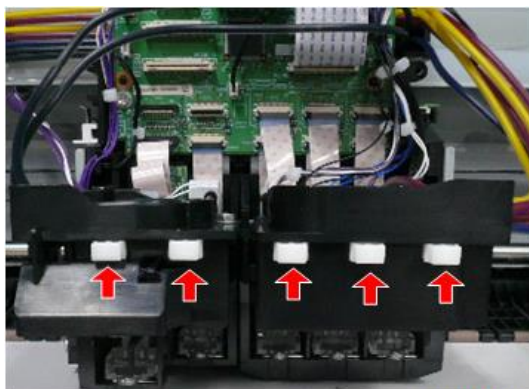

d262k3079

13. Attach the protective sheet [A] to the new head carriage.



d262k0299

4

14. Remove the ink tube (M2) [A] from the ink supply port of the head carriage, and plug the uncapped plug [B] into the port of the tube.

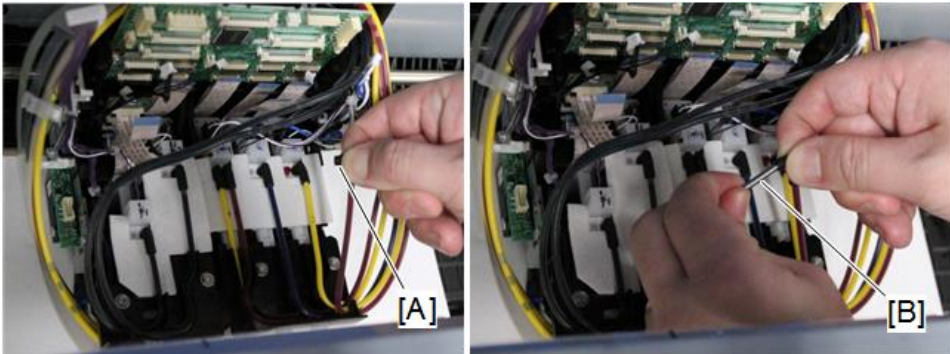

d262k0291

15. Plug the capped plug [A] into the ink supply port from which the ink tube (M2) was removed.

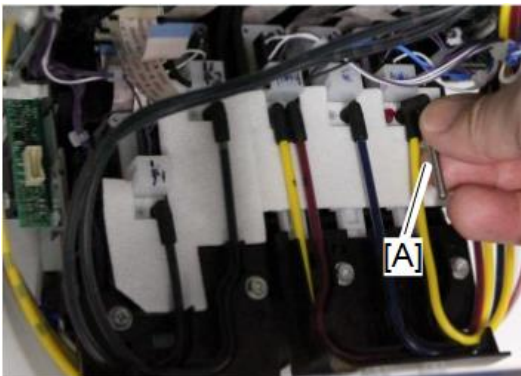

d262k3066

16. Now, following the same steps to disconnect the ink tube (M2), disconnect and cap the other ink supply tubes and ink ports in this order: Y2 > C > M1 > Y1 > K2 > K1

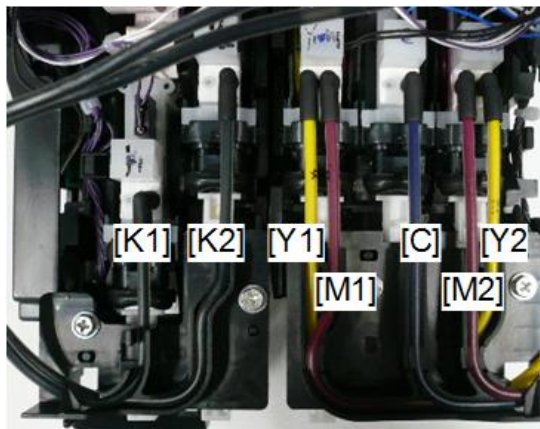

d262k3078

17. Seven ink supply tubes and seven ink ports must be disconnected and plugged.
18. The ports of the ink supply tanks and ink supply tubes should now be plugged.
19. Remove the tube pressure plate ( x1).

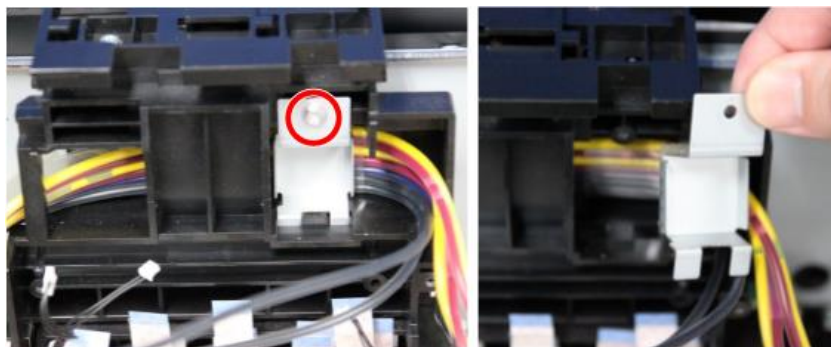

d262k0300

20. Push the tubes up and then pull them out of the carriage unit.

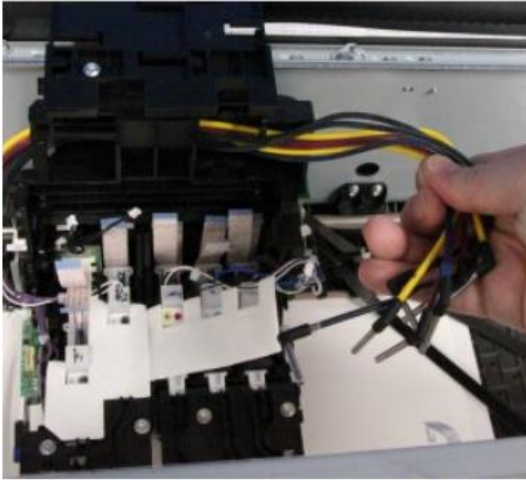

d262k0301

4

Ink Supply Unit Removal

Perform "Ink Supply Unit" in "Carriage Unit (Frame)" (p.466).

New Ink Supply Unit Installation

1. Cap the tip of each new tube with a rubber nozzle.



d262k1083

2. Follow in reverse order the removal procedure for the ink supply unit described above, until you are ready to connect the ink supply tubes.

3. The ink cartridge cover on the front and the ink collector tank cover on the right side must be reinstalled to prevent their sensors from returning an error when the machine is turned on.
4. Reattach the ink cartridge cover.
5. Reconnect the FFCs ( x4) to the carriage unit.
6. Close the front cover if it is up.
7. Make sure that the paper exit guide is down.
8. Set the service ink cartridges in the new ink supply unit.
9. The dummy tank [A] is provided with a nozzle plate [B].

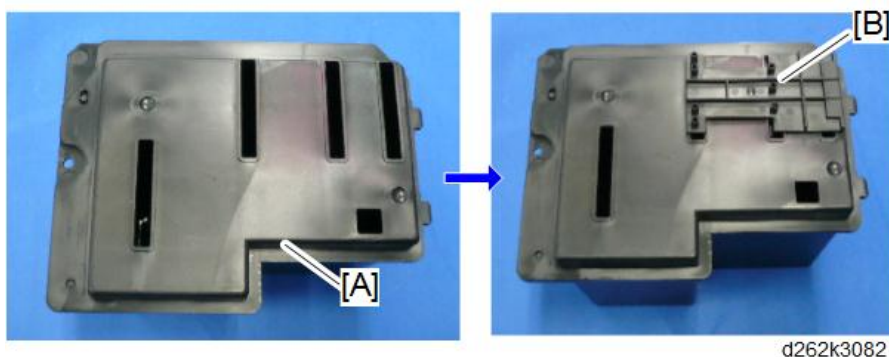

10. Snap the nozzle plate onto the top of the dummy tank.
11. Set the dummy tank on the platen.

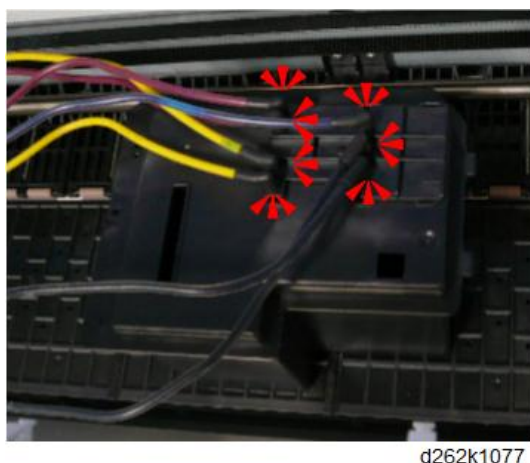

12. Connect each tube to the top of the box. The order of connection is not important.
13. Before going to the next step, check:
 - FFCs on the carriage unit must be connected to prevent an error.

- **Front cover** must be down so that the cover sensor detects the front cover closed.
- **Paper exit guide** must be down so that the guide sensor detects that the guide down.
- **Right covers** must be attached so that the ink collector sensor detects that the cover is closed.
- **Ink cartridge cover** must be attached.

14. Open the ink cartridge cover and leave it open.

★ Important

- The ink cartridge cover must be open so that you can complete this procedure.
- If the machine is powered on with the cover closed, the machine will start the initial filling sequence and try to move the carriage unit to the home position for capping.

15. Turn on the machine.

16. Ignore the error.

17. Go into the SP mode and do SP2012-1. If the value of this SP code does not read "9", then enter "9".

18. Confirm that all seven ink supply tubes are connected securely to the dummy tank.

19. Open SP2100-5, and then enter "31".

- The ink starts pumping from the ink cartridges, through the tubes and into the ink sump.
- When you see "Completed" the pumping operation is finished.

20. Turn the machine off.

21. Disconnect the ink supply tubes from the dummy tank.

22. Insert a metal plug into the end of each tube to prevent ink leakage.

Ink Tube Attachment to the Print Head Unit

Before attaching the bracket to secure the ink tubes, check that the ink tubes are lined correctly as shown below.

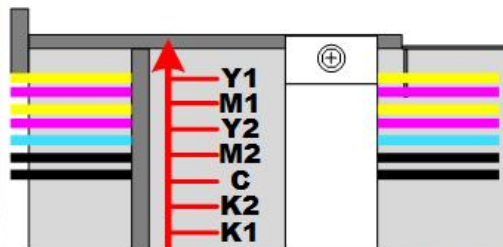
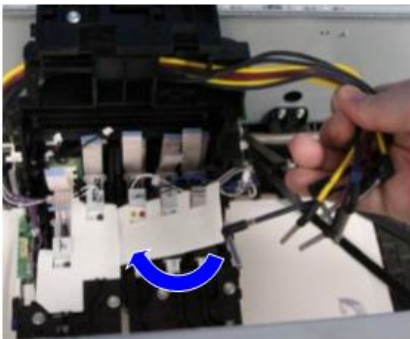

d262k0162

1. Pass the ink tubes, K2, K1, Y1, M1, C, Y2, and M2 in this order one by one through the upper part of the carriage unit.
2. Pass the ink tubes from left side to the right side of the carriage unit in the order described above.

Note

- Then the tubes are prevented from crossing inside the carriage unit.
 - If the ink tubes are crossed, the bracket to secure the ink tubes may not be attached correctly.
3. If the plugged ink tube is hard to pass the upper part of the carriage unit, pull it out using the longnose pliers.

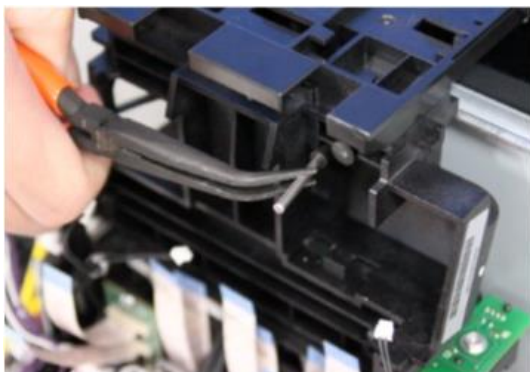

d262k0308

Place the ink tubes on the print head in the procedure below.

1. Remove the plugs of the ink tubes (K1) and (K2) and the ink supply ports of the print head.
2. Attach the ink tubes (K1) and (K2) to the ink supply ports and place them on the path of the print head in the order of K2 and K1.

Place the ink tube (K2) [A] on the path of the print head first.

Then place the ink tube (K1) [B] upon the ink tube (K2) on the path of the print head.

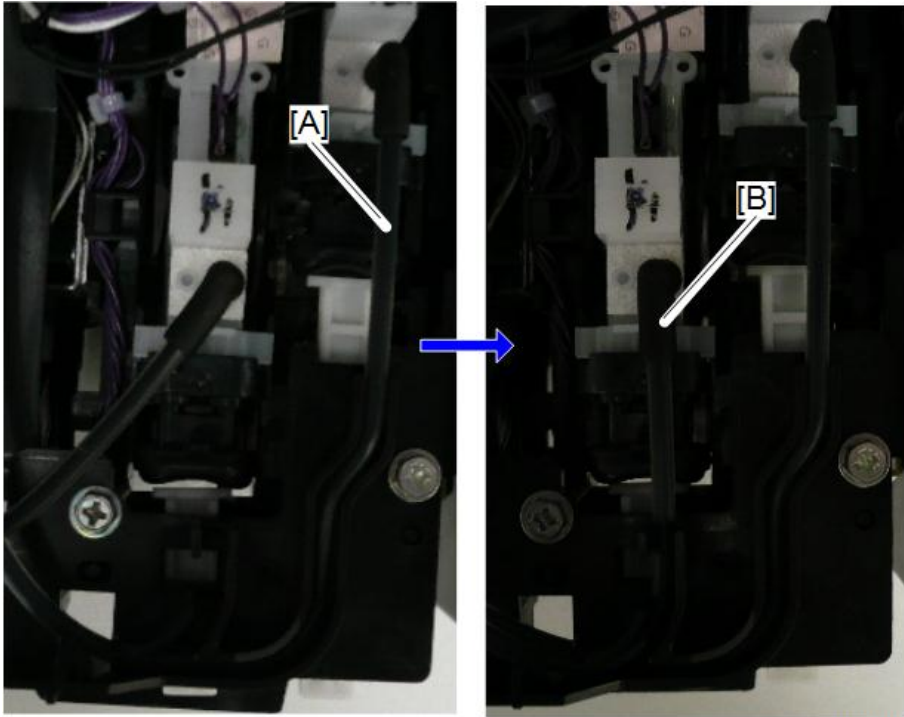

D262k3088

3. Remove the plugs from the ports of the ink tubes (Y1), (M1), (C), (M2), and (Y2) and the ink supply ports of the print heads.
4. Place the ink tubes on the path of the print head, from right to left in order of Y1, M1, C, Y2, and M2.
 - Place the ink tube (Y1) on the path of the print head first. [A]
 - Then place the ink tube (M1) upon the ink tube (Y1) on the path of the print head. [B]
 - Then place the ink tube (C) upon the ink tube (M1) [C] and the ink tube (Y2) upon the ink tube (C) on the path of the print head. [D]
 - Last of all, place the ink tube (M2) upon the ink tube (Y2) on the path of the print head. [E]

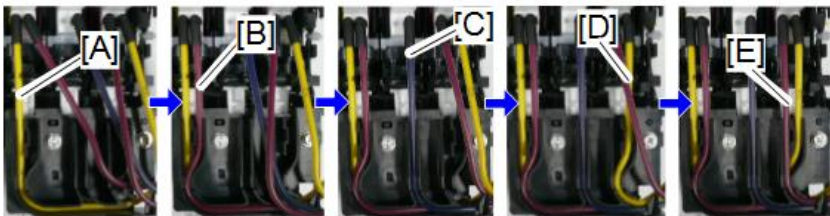

d262k3077

Before attaching the bracket to secure the ink tubes, check the followings:

- Place the ink tube so that the cutout of the ink tube guide is placed 1 to 4 mm apart from the side of the carriage unit.
- Check that there is the space between the ink tube guide and the carriage unit.

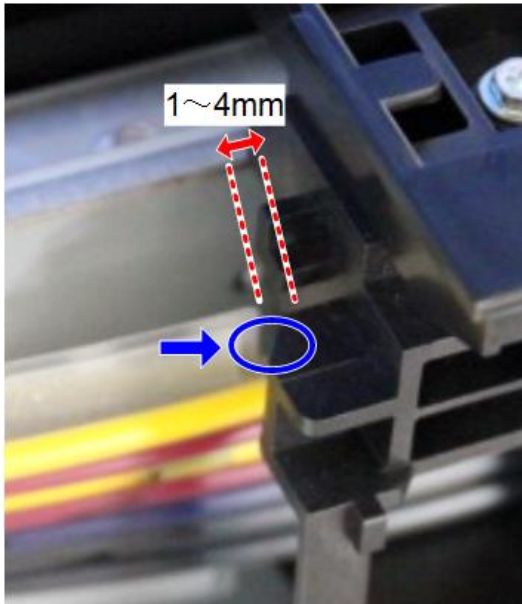

d262k0306

To attach the bracket to secure the ink tubes, insert the two projections under the bracket to the holes of the carriage unit.

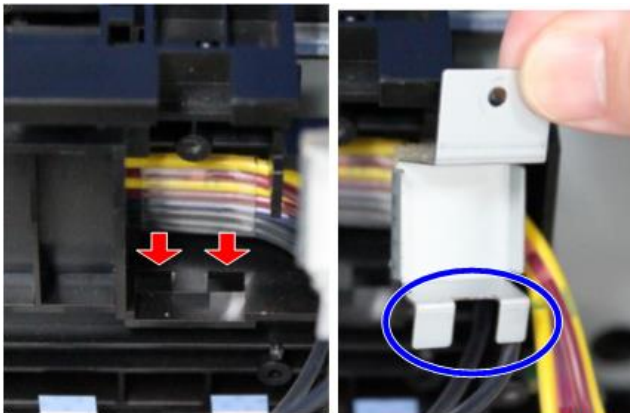

d262k0307

When the carriage unit installation completes, move the unit right and left to check that it does not fall down from the rail.

Note

- If the ink tube falls down, the ink tube is loosely attached on the left of the carriage unit. Remove the bracket to secure the ink tubes and pull the ink tube from the left of the carriage unit as possible to remove the looseness.

Before you turn the machine on, check the position of the horizontal encoder strip on the left.

- If the encoder strip is up on the bracket as shown at [A], pull it forward and down so it is in front of the bracket as shown at [B].
- If the machine is turned on with the strip positioned as shown at [A], the movement of the carriage unit may scratch the surface of the encoder strip.

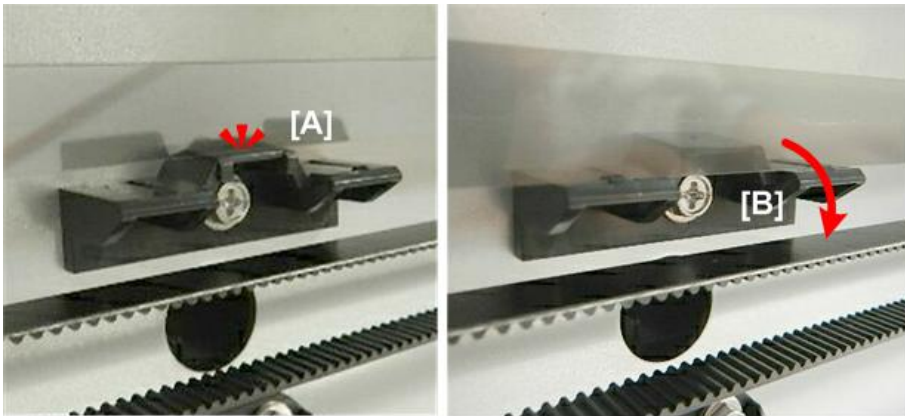

d124i209

After attaching the ink supply unit, perform the operations described below.

1. Attach the carriage front cover, upper cover, and left cover to the carriage unit.
2. Open the ink-cartridge cover, and remove the customer's ink cartridge.
3. Attach the service ink cartridge to the ink supply unit and close the ink-cartridge cover.
4. Turn the machine on.
5. Flush the print heads (p.878).
6. Set SP2-012-001 to "0".
7. Open the ink cartridge cover and remove the service ink cartridges in the ink supply unit.
8. Attach the customer's cartridges and close the ink cartridge cover.
9. Turn the main power switch OFF and back ON.
10. Print a Nozzle Check Pattern and check the condition of the print heads. (Nozzle Check Pattern Print)
11. Obey the local laws when you dispose of the ink sump holding the drained ink.

- Before disposal, cover the slots on top of the sump with the covers provided.
- If the covers are not available, cover the slots with some strong tape to prevent the ink from spilling out of the sump.

Air Release Solenoid

Preparation

- Move the Carriage Unit with SP2102-4 (p.267)
- Separate the Main Unit from the Scanner Unit (p.274)

Remove:

- Top cover (p.245)
- Ink cartridge cover (p.243)
- Front cover (p.249)
- Paper exit guide (p.251)

1. The air release solenoid is encased by a bracket.
2. Release the clamp and disconnect the solenoid (🔌x1, 🛠x1).

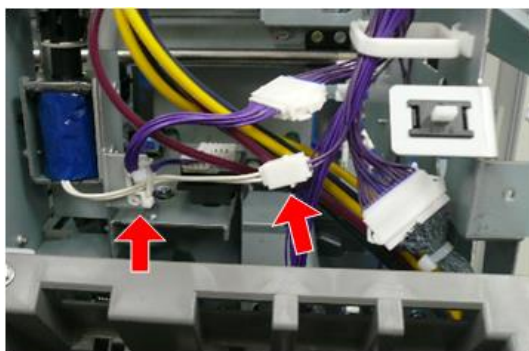

d262k0175

3. Disconnect the ink supply unit frame ( x3).

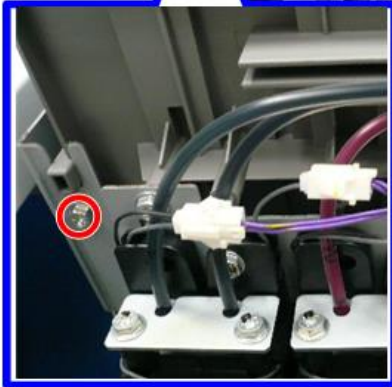
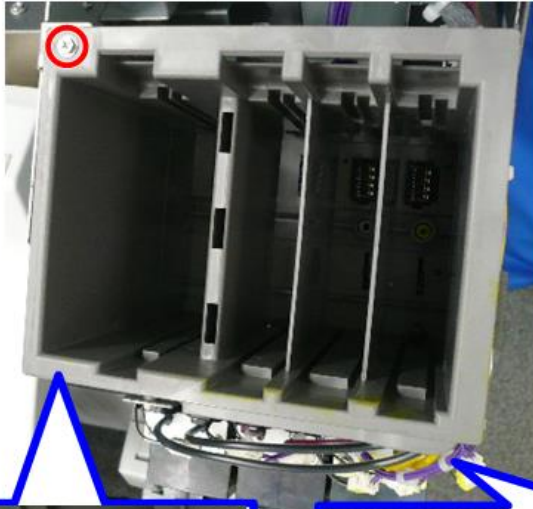

d262k3101

- Free the ink supply tubes and disconnect the ink supply unit at [A] and [B] (🔌 x2, 🖨️ x2).

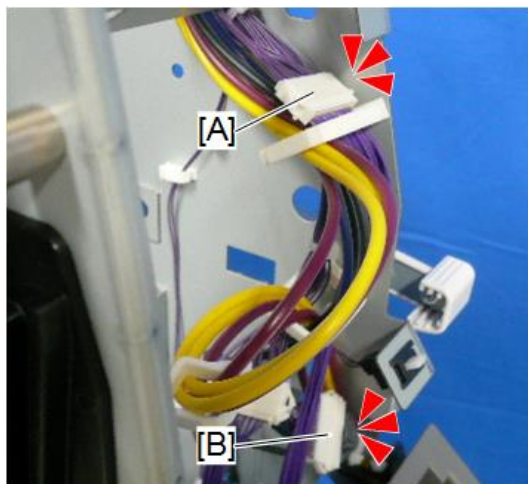

d262k0165

- On the right side of the back of the front support of the machine, free the ink supply tubes (🔌 x3).

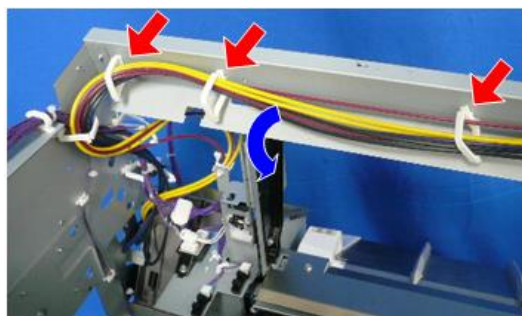

d262k0166

- Near the center of the front support, free the ink supply tubes (🔌 x2).

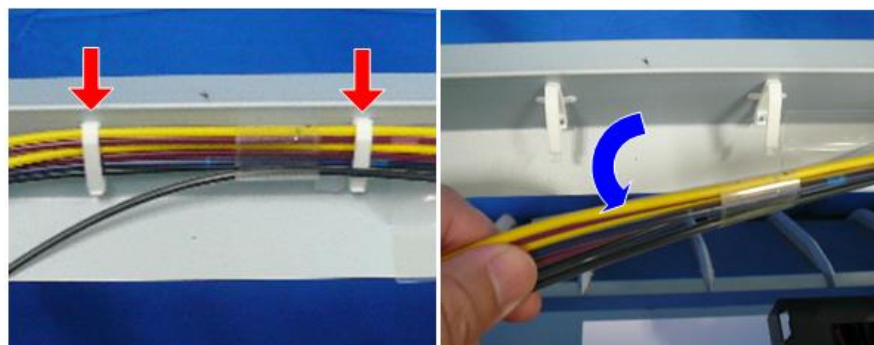

d262k0167

7. Remove the ink supply unit and set it on the stool or box.

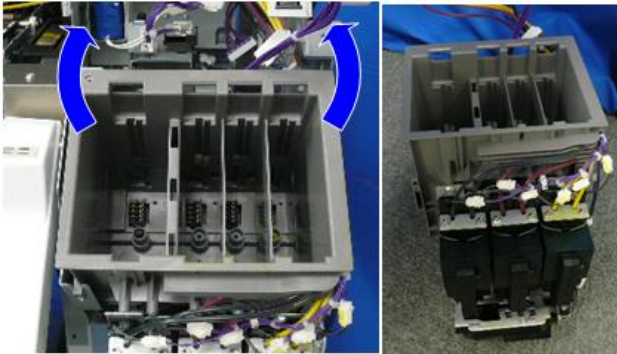

d262k0168

4

8. Remove the side of the bracket and take out the air release solenoid ( x2).

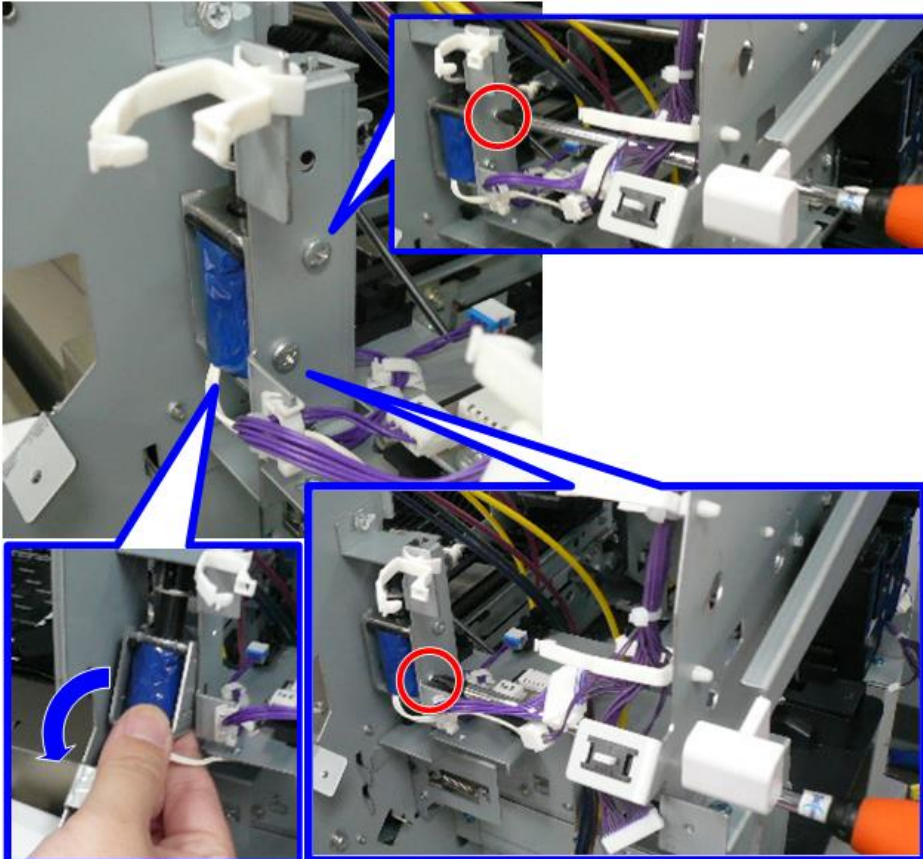

d262k0169

Air Release Solenoid



d124r522

4

Ink Level Sensor and Temperature/Humidity Sensor

★ Important

- Positions of the screws shown below are adjusted at the factory. Do not loosen or remove them when replacing and adjusting the sensors.
- The screw on the ink level sensor bracket

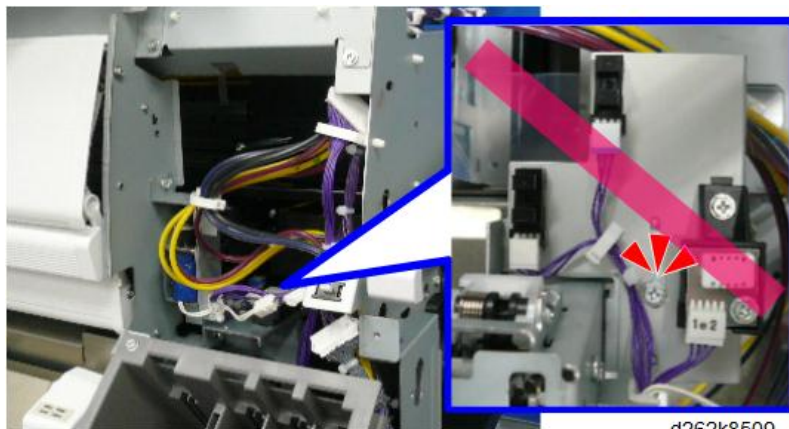

d262k8509

- The screw at the upper part of the air release solenoid bracket

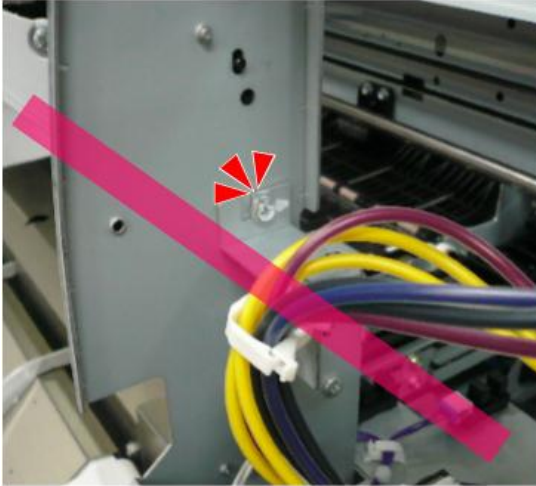

d262k8504

- The two screws at the lower part of the air release solenoid bracket

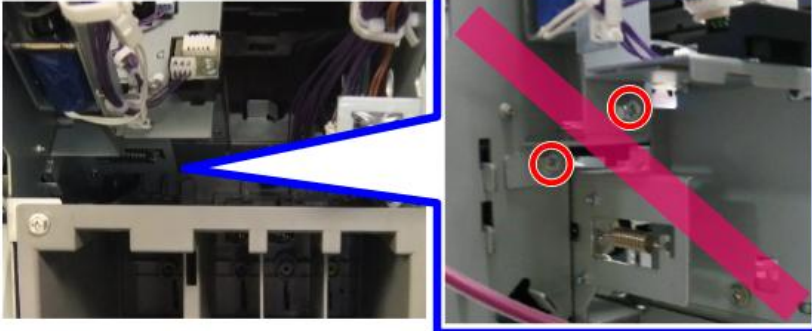

d262k8507

Preparation

- Separate the Main Unit from the Scanner Unit (p.274)
- Move the Carriage Unit with SP2102-4 (p.267)

↓ Note

- When the carriage unit is moved, ink may spill out from the print head onto the platen. To move the carriage unit, place a sheet of regular paper under the carriage unit to protect the platen.
- The sheet under the carriage unit should be flat, with no paper crinkling, which could scratch the nozzle face or cause clogging the nozzle.
- Do not place any film under the carriage unit.
- To place the regular paper, do not pull up the paper holding lever too much (p.226).

Remove:

- Top cover (p.245)

- Right cover (p.239)
- Right upper cover (p.241)
- Ink cartridge cover (p.243)

To remove the temperature/humidity sensor, go to step 1.

To remove the ink level sensor, go to step 2.

1. Remove the temperature/humidity sensor [A] (🔧 x1, 🛠️ x1).

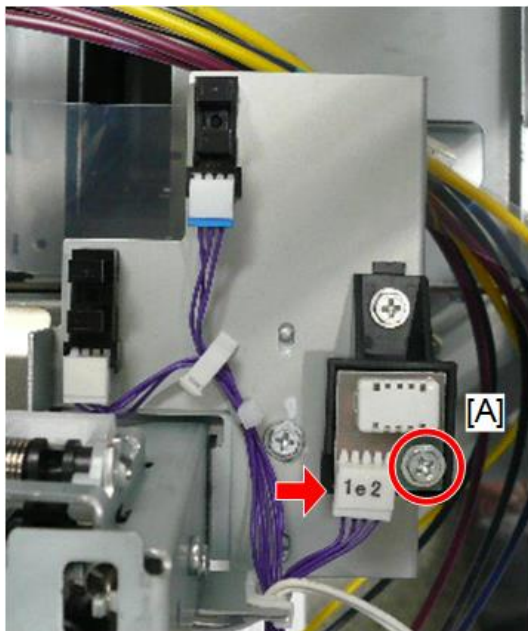

d262k0172

2. Remove the ink level sensor (M1, Y1, C, M2, Y2, K2) [A] (⚠ x3, 🛠 x1).

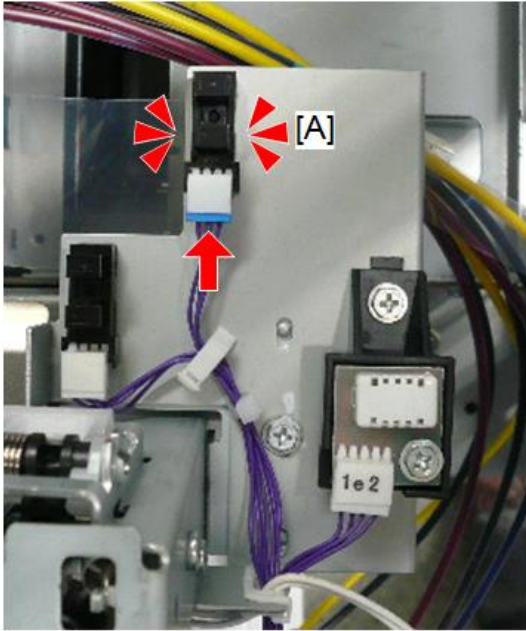

d262k0173

3. Remove the ink level sensor (K1) [A] (⚠ x3, 🛠 x1).

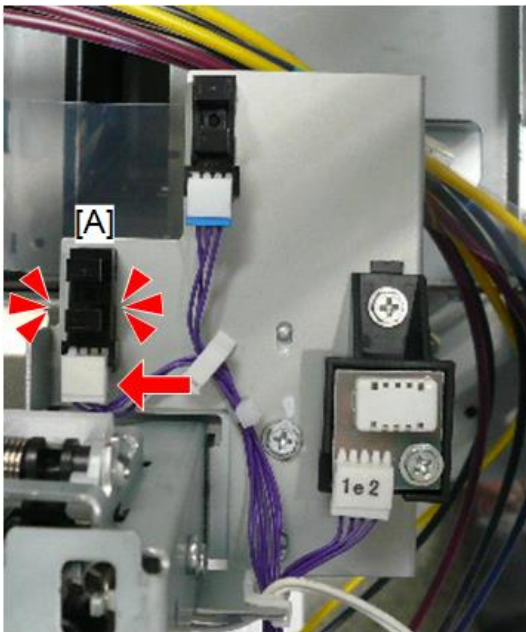

d262k0174

Note

- The color of the connector of ink level sensor, Y1, M1, C, M2, Y2, is blue and that of K1 is white.

Maintenance Unit, Waste Ink Collection

Left Ink Sump

The service life of the left ink sump is about 5 years, or until it becomes full. Capacity: 500 cc.

Preparation

- Separate the Main Unit from the Scanner Unit (p.274)

Remove:

- Left cover (p.234)

4

1. Disconnect the left side ( x1).

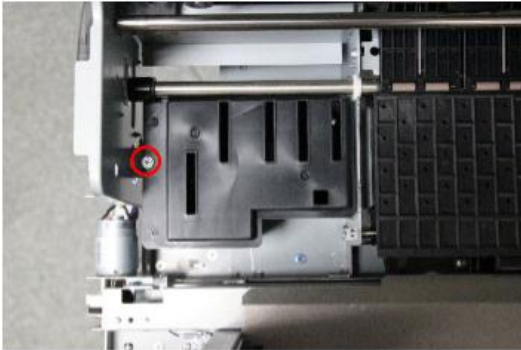

d262k8109

2. Unhook the right side and remove the sump.

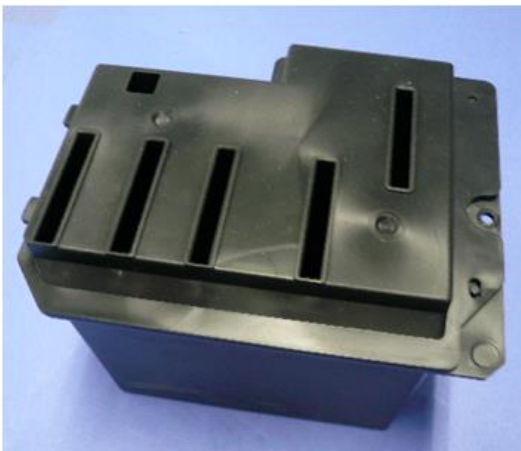

d262k3081

3. Set the sump on a flat surface.

4. If the left sump is being replaced:

- After installing the new left ink sump, turn on the machine and go into the SP mode.
- Open **SP2505-001** and touch [EXECUTE] to clear the counter for the left ink sump.
- Cover the slits on top of the left ink sump with the covers provided with the new unit.

★ Important

- Obey the local laws and regulations regarding disposal of items such as waste ink tanks that contain waste ink.

Ink Collector Unit

Open the ink collector cover on the right side of the machine [A]. Push the lever [B] and pull out the ink collector tank [C] from the main unit.

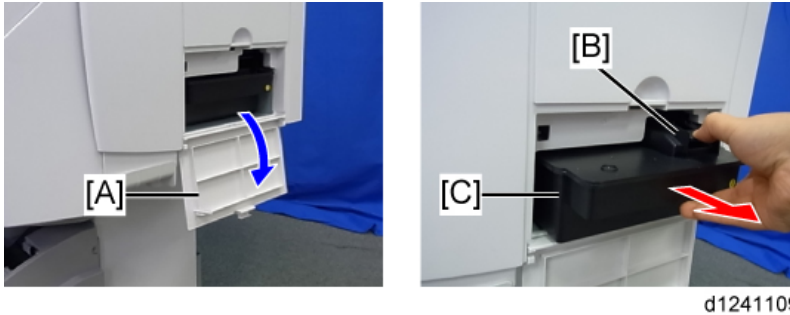

1. Depress the release [A], and then pull the tank straight out of the machine.
2. Lay the tank on a flat surface with the port [B] facing up.

★ Important

- The port at [B] is open and will leak ink if the tank is turned on its side or turned upside down.

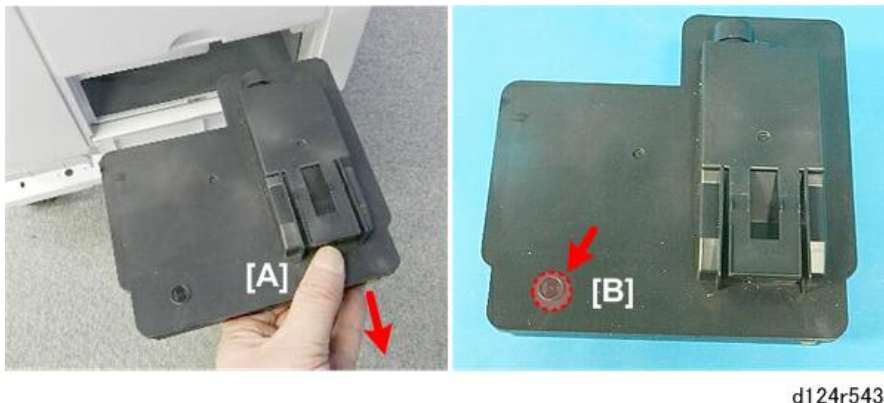

Ink Collector Unit Contact Switch

Preparation

- Open the ink collector cover (p.243) and remove the ink collector tank (p.531)
- Remove the maintenance unit (p.534)

1. The sensor is located at [A].
2. Use the tip of a small screwdriver to release both sides of the sensor [B].

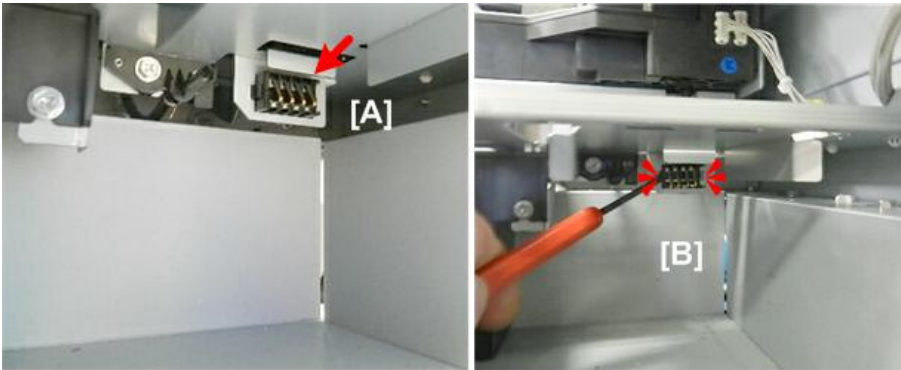

d124r567

3. Pull the harness and sensor through hole [A].
4. Free the harness [B] (⚙️ x6).
5. Disconnect and remove the sensor [C] (🔪 x1).

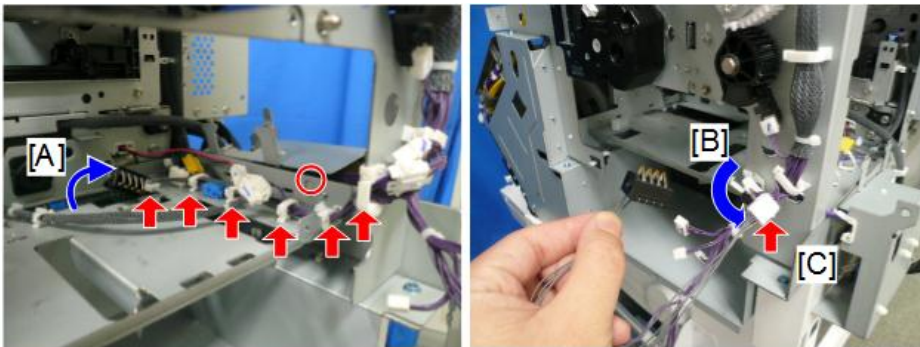

d262k1046

Reinstallation

1. When you position the sensor for reinstallation, make sure that the sensor is positioned so the bend in the tines is down.

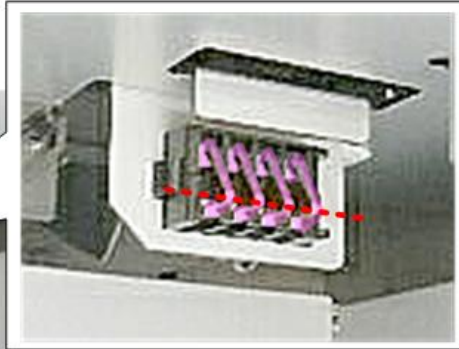

d124r570

4

Right Ink Sump

The service life of the right ink sump is about 5 years, or until it becomes full. Capacity: 147 cc.

1. On the right side of the machine, remove the ink collector unit (p.531).
2. Remove the right cover (p.239).
3. Remove the right upper cover (p.241).
4. Disconnect the sump and pull it out slowly ( x1).

★ Important

- To avoid spilling ink, do not tilt the sump while you remove it.

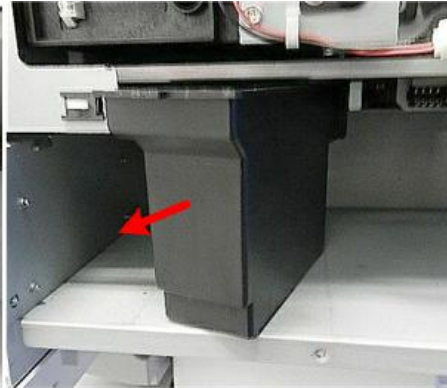

d124p027

5. Cover the top of the tank with some paper and tape, and then discard it.

★ Important

- Follow the local laws and regulations regarding the disposal of this item.
- Never attempt to empty the right ink sump and re-use it.

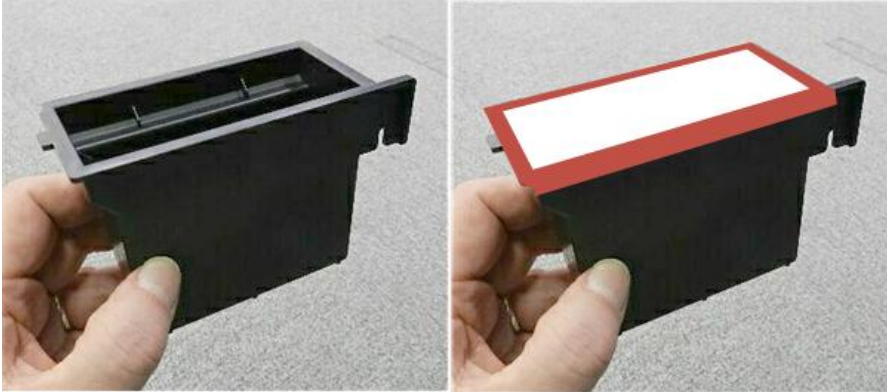

d124p028

6. After installing the new right ink sump, open SP2505-002 (Clear Counter) and touch [EXECUTE] to clear the counter for the new sump.

Maintenance Unit

You can check the status of the maintenance unit with two counters:

- **SP2-231-003** (PM Counter Indication - Maintenance Unit). Displays the status of the maintenance unit as the amount of usage remaining (a percent).
- **SP2-231-008** (PM Counter Indication - PM Counter Maintenance Unit). Displays the status of the maintenance unit as the distance (mm) of paper fed

Preparation

- Move the Carriage Unit with SP2102-4 (p.267)
- Separate the Main Unit from the Scanner Unit (p.274)

Remove:

- Ink collector tank (p.531)
- Right cover (p.239)
- Right upper cover (p.241)
- Ink cartridge cover (p.243)

1. Uncap the print head and move the carriage unit to the center of the main unit (p.267).

↓ Note

- When the carriage unit is moved, ink may spill out from the print head onto the platen. To move the carriage unit, place a sheet of regular paper under the carriage unit to protect the platen.
- The sheet under the carriage unit should be flat, with no paper crinkling, which could scratch the nozzle face or cause clogging of the nozzle.
- Do not place any film under the carriage unit.
- To place the regular paper, do not pull up the paper holding lever too much. (p.226)

2. Set several sheets of clean paper on a flat surface to hold the maintenance unit after it is removed.

★ Important

- The bottom edges of the maintenance unit are covered with ink and will stain any surface where it is placed.
- Always set the maintenance unit on a surface covered with paper that will absorb ink and can be discarded later.

3. Turn down the maintenance lock lever [A].

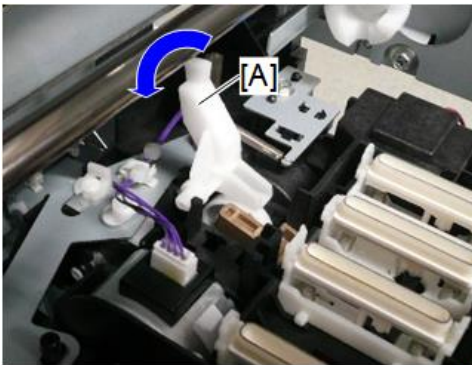

d262k0130

4. Slowly, pull the maintenance unit [A] out of the machine (☞ x6, 🗑️ x2, 🗑️ x2).

5. Lay it down in the location prepared at Step 1.

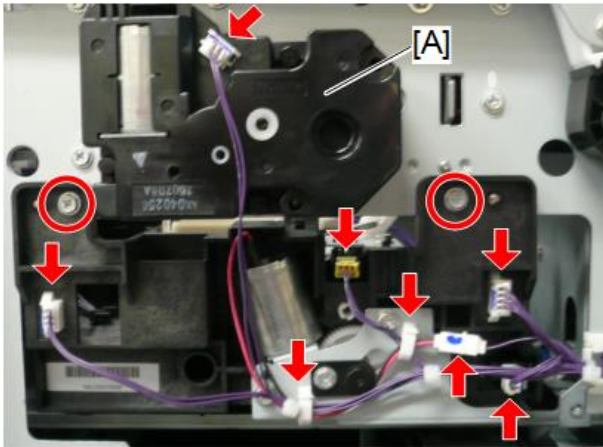

d262k0129

Note

- Do not clear the PM counter.

Reinstallation

The maintenance unit should be cleaned after the ink collector unit,

1. Use a linen cloth, dampened very slightly with water and tightly wrapped around the end of a small screwdriver, to remove any ink that has hardened at the following locations:

★ Important

- Make sure the cloth is only slightly damp. Do not allow any water near the protective caps [C]. Water on the caps could seep onto the print head nozzles and dilute the ink.

[A] Wiper and blade

[B] Suction cap

[C] Print head caps (x4)

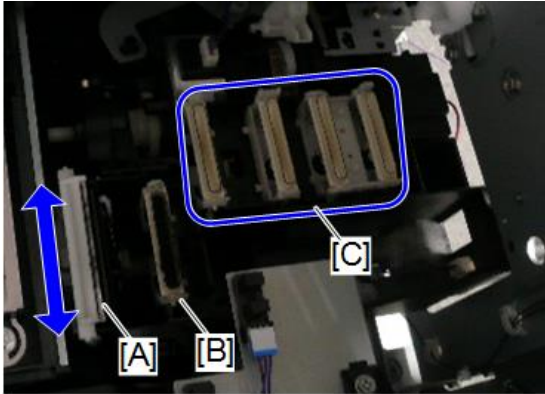

d262k0133

2. Check the other print head caps and clean if necessary.

★ Important

- Never use cotton, tissue, or any other material that could shred and leave fibers around the suction cap or the print head caps.

3. Check that the maintenance lock lever is pressed down [A]. Then insert the unit slowly, to avoid damaging the print-head caps and suction-cap wipers [B], and turn the maintenance lock lever [A] upward as you set the unit in the machine.

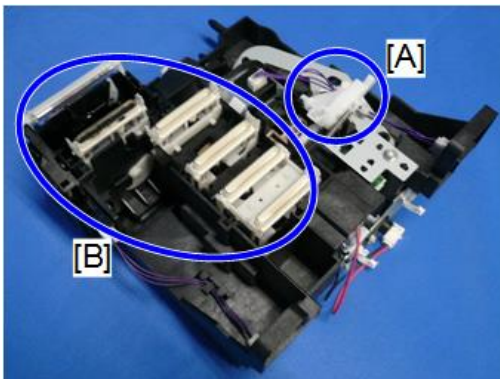

d262k0132

4. After replacing the maintenance unit with a new one, open SP2102-001 and then touch [EXECUTE] to reset the maintenance unit counter.

Auto-Nozzle Check

Auto-Nozzle Check Upper Unit

The procedure below is supposed that SP shown in the table below can be performed correctly.

SP	Contents
SP2-024-001	Move the carriage.
SP2-024-002	Move the cutter.
SP2-024-003	Move the wiper of the electrode plate.

4

If SP shown above cannot be performed, perform the procedure in Auto-Nozzle Check Unit.

1. Move the head carriage, cutter, and wiper of the electrode plate to the specified position with the SP2-024-001, SP2-024-002, and SP2-024-003.

2. Turn off the power.

WARNING

- Before doing any procedure, always turn off the power switch and unplug the machine from its power source. Or electric shock or defect may be caused.

3. Separate the scanner unit and main unit (p.274).

4. Open the front cover (p.249).

5. Remove the right cover (p.239)

6. Remove the right rear cover (p.247).

7. Remove the maintenance unit (p.534).

8. Remove the harness [A] from the auto-nozzle check board (🔧 x1, 📏 x1).

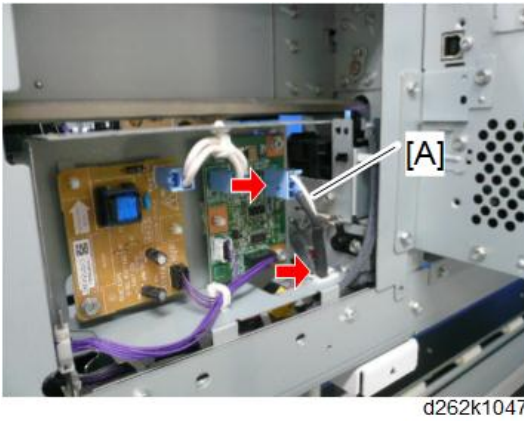

9. Move the auto-nozzle check board block [A] to the right (🔧 x1).

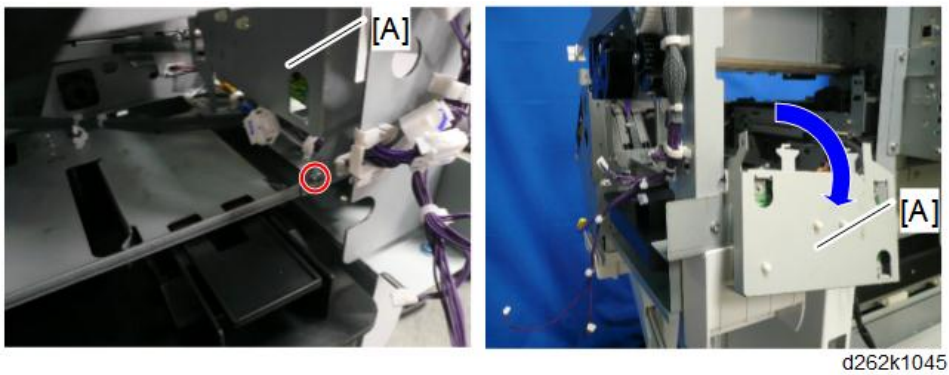

10. Remove the harness cover [A] and three screws (🔧 x3).

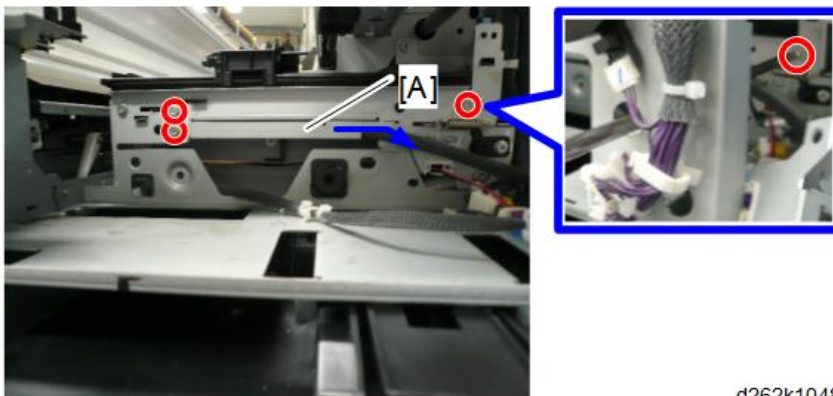

11. Move the harness [A] to the left and remove the timing belt [C] from the wiper slider [B].

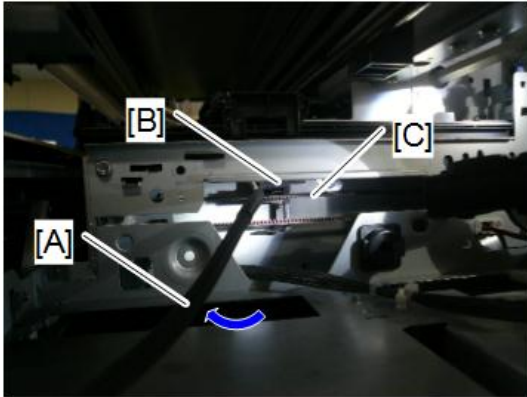

d262k1049

12. Move the hook [A] of the auto-nozzle check upper unit.

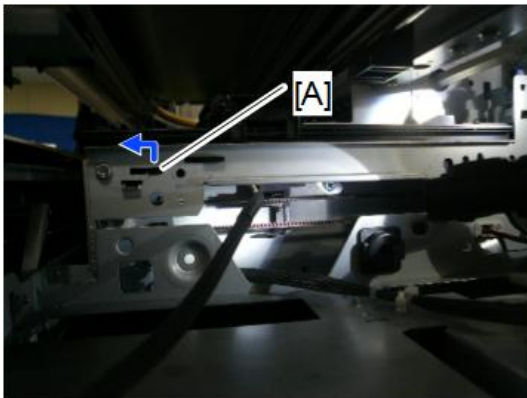

d262k1050

13. Push up the auto-nozzle check upper unit and remove it from the opening of the front cover.

Auto-Nozzle Check Unit

If the auto-nozzle check SP cannot be performed and the head carriage, cutter, and electrode plate cannot be moved to the specified position, change the Auto-Nozzle Check Unit including the auto-nozzle module bracket.

1. Separate the scanner unit and main unit (p.274).
2. Open the front cover (p.249).
3. Remove the right cover (p.239)
4. Remove the right rear cover (p.247).

5. Remove the maintenance unit (p.534).
6. Remove the harness [A] from the auto-nozzle check board (🔧 x1, 🖱️ x1).

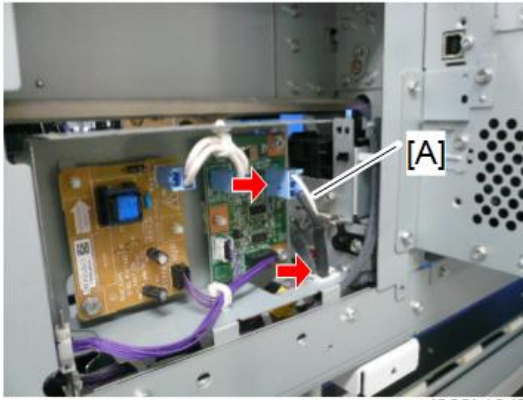

d262k1047

4

7. Move the auto-nozzle check board block [A] to the right (🔧 x1).

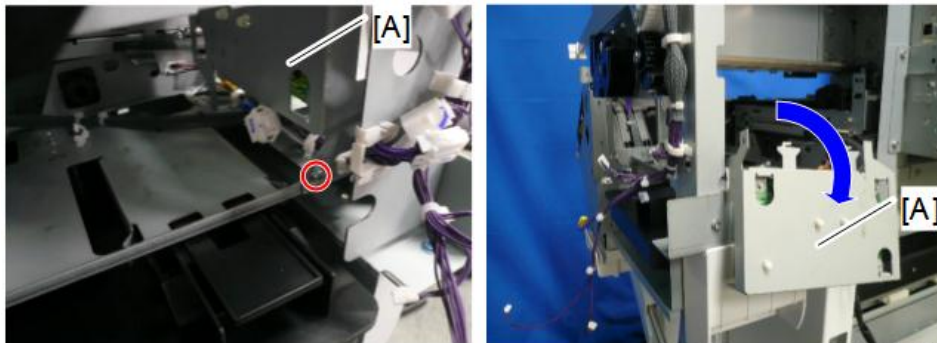

d262k1045

8. Remove the two auto-nozzle check position sensor harnesses [A] (🔧 x1, 🖱️ x1).

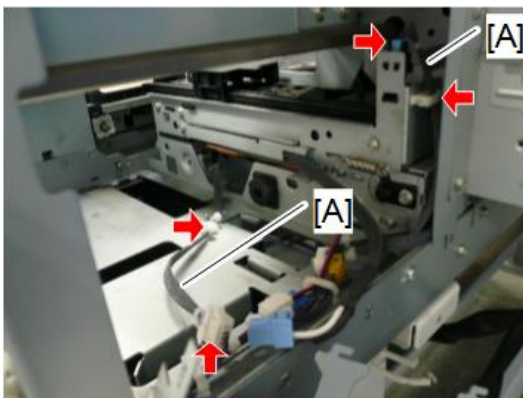

d262k1052

9. Remove the two screws fixing the auto-nozzle check bracket ( x2).

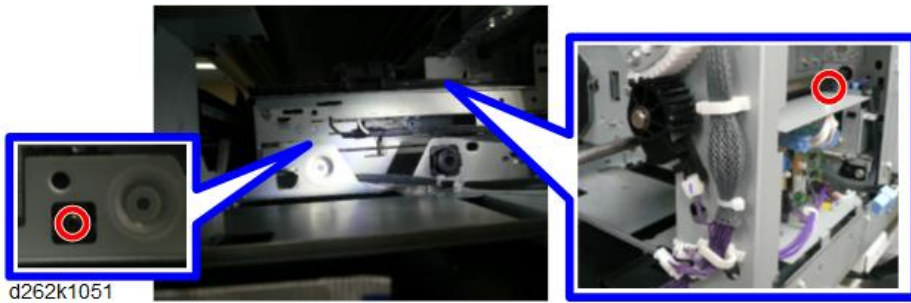

10. Turn the auto-nozzle check unit [B] forward while releasing the hook [A] of the auto-nozzle check bracket, and pull it out from the opening of the right back of the main unit.

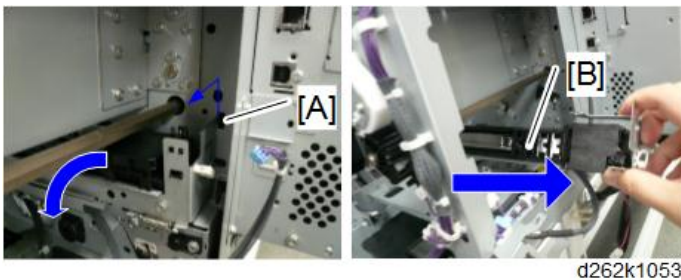

After Replacement

After changing the auto-nozzle check upper unit or auto-nozzle check unit, perform the procedures below.

1. Perform SP2-024-004 to reset the counters.

The counters shown below will be reset.

SP	Contents
SP7-761-011 to 019	Auto-nozzle checking time
SP7-767-011 to 020	Accumulated value of no-purging
SP7-768-011 to 020	Accumulated value of no-purging lines
SP7-761-020	Electrode-plate wiping time
SP2-021-011	Flag for operating life of the auto-nozzle check

2. Perform SP2-024-005 to wipe the electrode plate.**↓ Note**

- When the SP is performed, the check operation after changing the auto-nozzle check unit will be done.

3. Perform SP2-020-001 with the argument 31 to check purging.**↓ Note**

- When the SP is performed, the auto-nozzle check operation will be done in the unit of the specified number of rows of the nozzles.

Electrical Components

⚠ WARNING

- Set the main power switch to OFF and disconnect the power plug from the power outlet before performing the procedure below. Working with power supplied may cause electrical shock or defects.



Rear Cover

4

Preparation

- Separate the Main Unit from the Scanner Unit (p.274)

↓ Note

- The rear cover is held in place by many screws but only six screws need to be removed (the others can just be loosened).
1. Remove the screws circled in red ( x6).
 2. Loosen (do not remove) the screws marked by the red arrows ( x10).



d262k0005

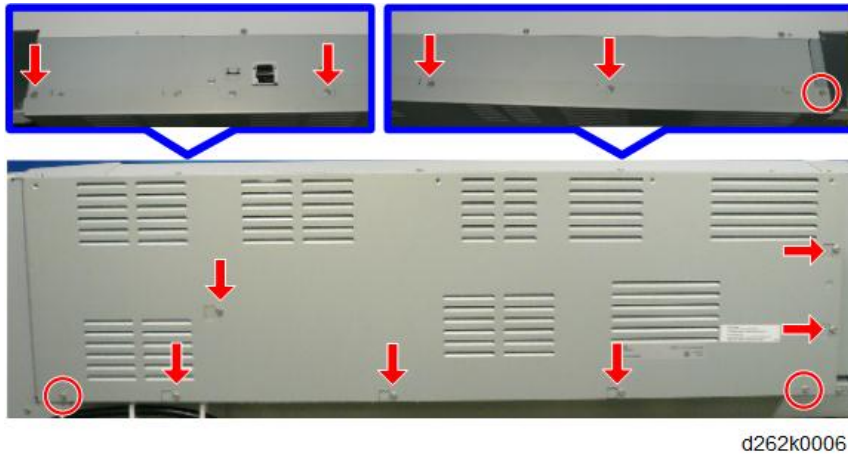

3. Slide the cover to the right and remove it.



PCB Box

★ Important

- To remove the PCB box, never loosen nor remove the two screws shown below. (The figure shown below is the left side viewing from the rear.)

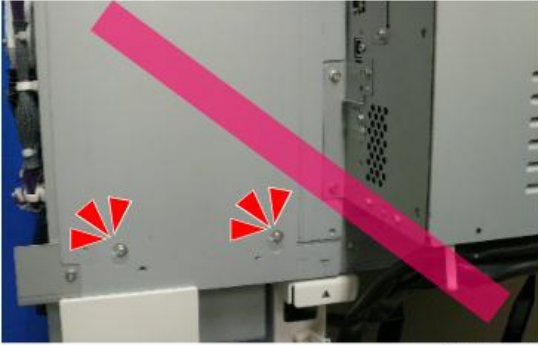

d262k8511

4

1. Scanner cable (p.274).
2. Top cover (p.245).
3. Rear cover (p.239).
4. Left rear cover (p.248).
5. Right rear cover (p.247).
6. Release the clamps (🔧x7).

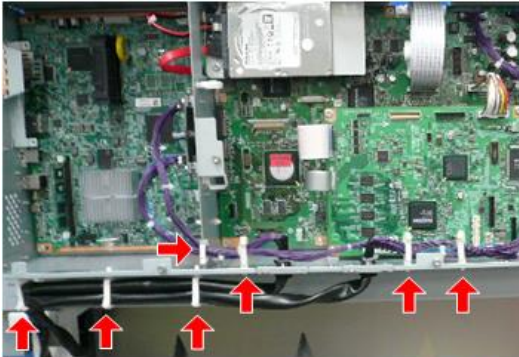

d262k0135

7. Disconnect the connector from CN254 of the IOB and pull away the harness of the roll unit 1 (🔧 x1).



d262k0136

8. Remove the harness bracket of the roll unit 1 (🔧 x2).

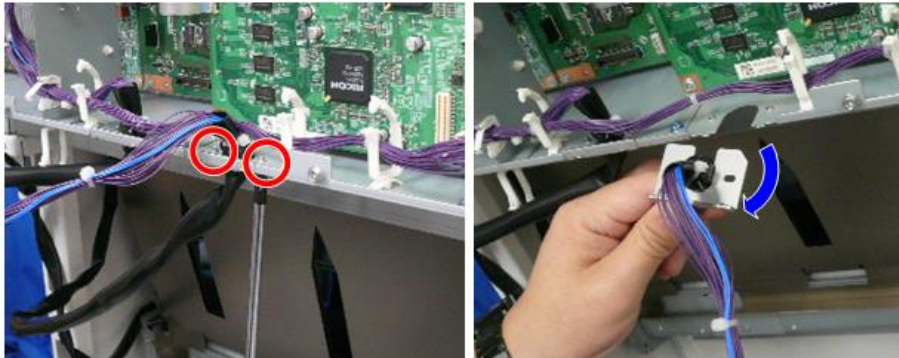

d262k0137

If the roll unit 2 is mounted, go to step 9.

If only the roll unit 1 is mounted, go to step 10.

9. Release the connector [A] from CN301 of the RFDB and harness bracket [B] of the roll unit 2 (🔧 x1, 🛠️ x2).

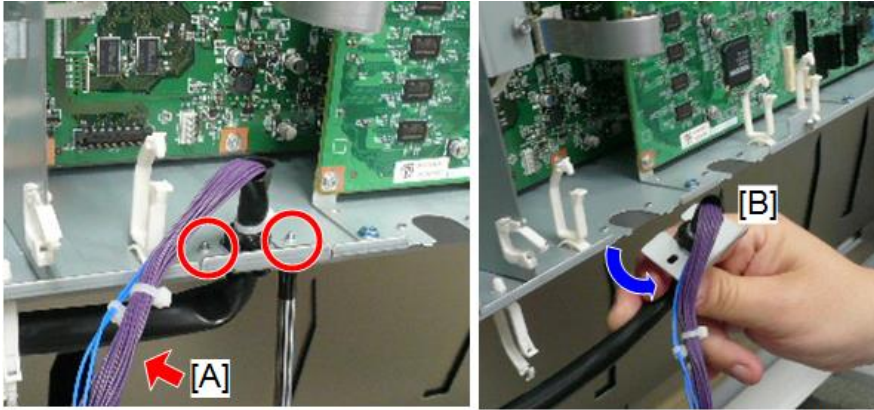

d262k0138

10. Release the FFCs [A] on the BiCU, release the clamp [B] at the upper part of the PCB box, and pull away the FFC (🔧 x5, 🛠️ x1)

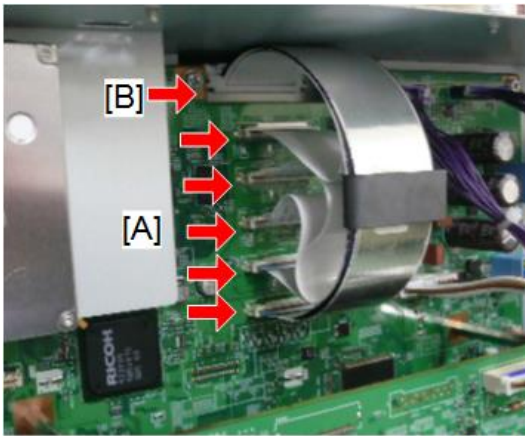

d262k0139

↓ Note

- Remove the clamp [A] of the FFC by pushing it towards the BiCU.

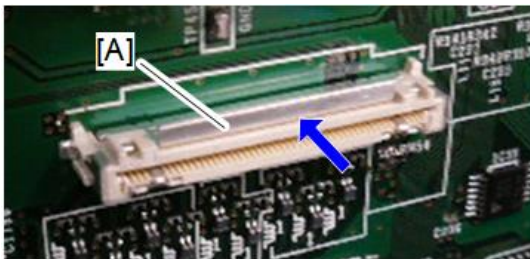

d262k3084

11. Remove the connector and clamps shown in the figure below (🔧 x1, 🗑️ x6).

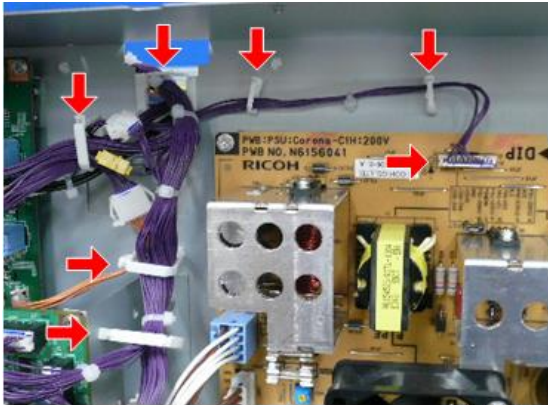

d262k0140

12. Disconnect the connectors of the IOB (🔧 x7).

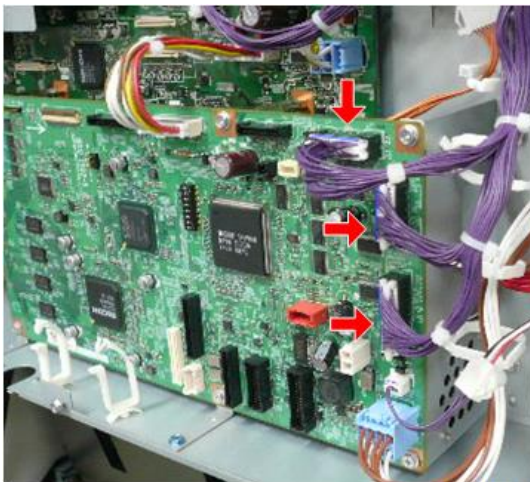

d262k0141

13. Disconnect the connectors of the BiCU (📷 x4).

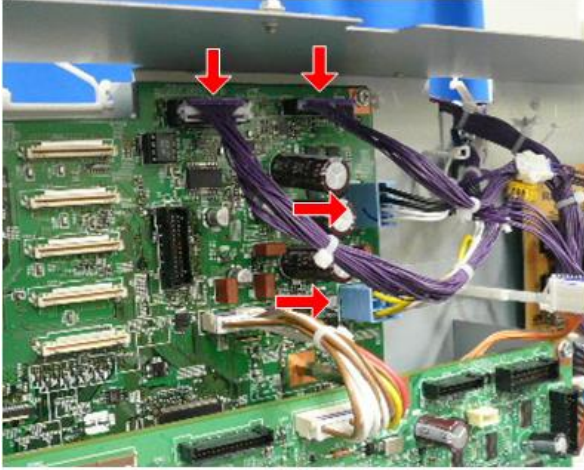

d262k0142

14. Disconnect the relay connectors shown in the figure below (📷 x3).

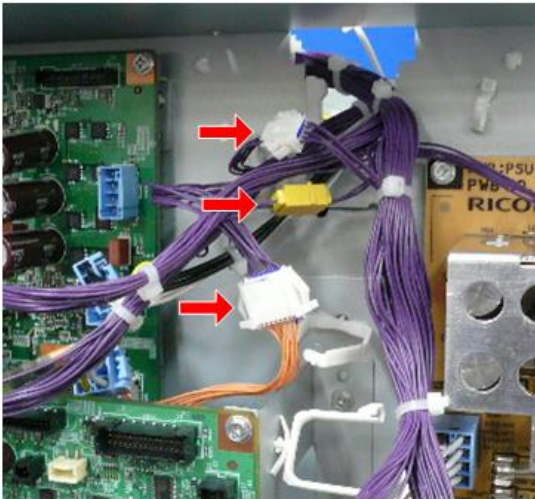

d262k0143

15. Release the clamps at the center back of the upper part of the PCB box.

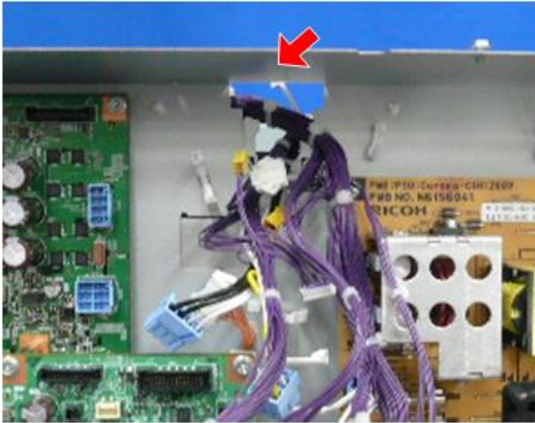

d262k0147

16. Release the three clamps at the upper part of the PCB box and pull away the three cables and FFC to the back.

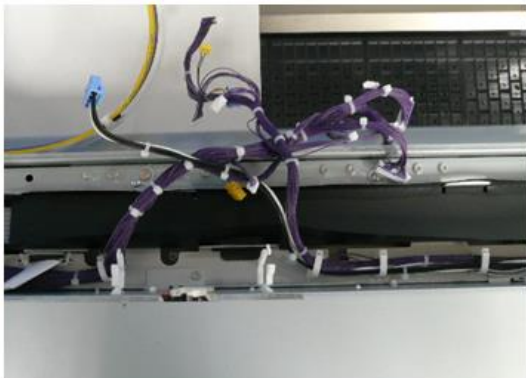
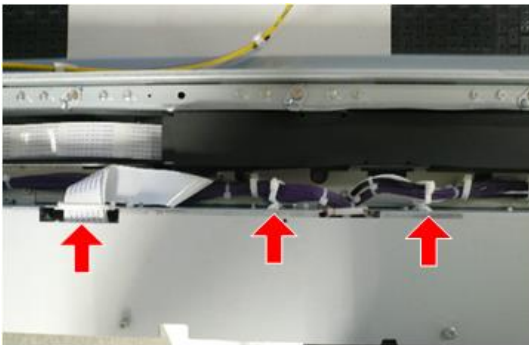

d262k0145

17. PCB box ( x5).

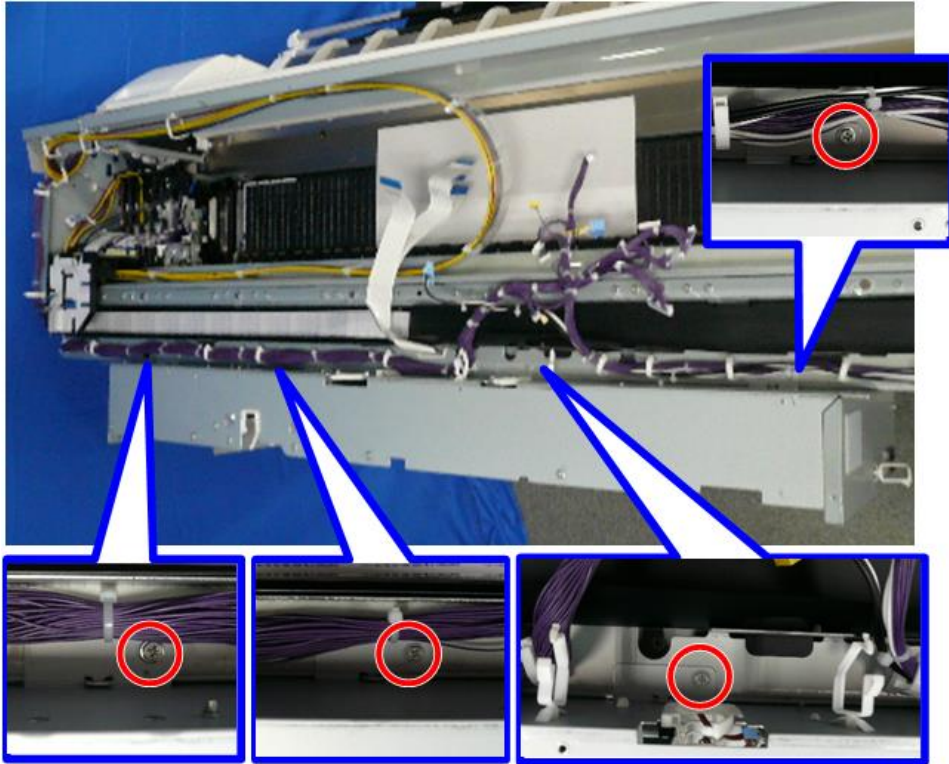

d262k0144

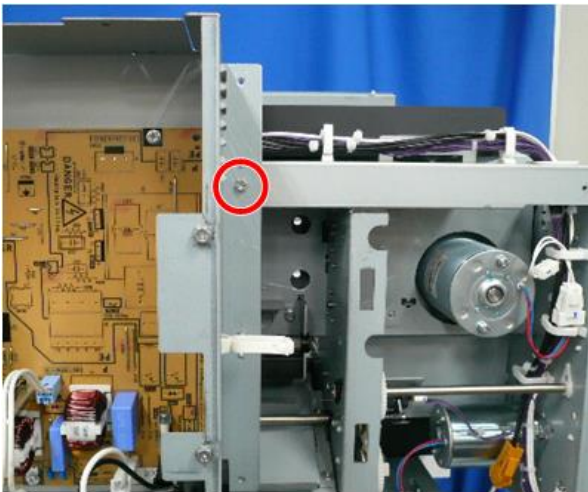

d262k0146

Controller Board

The blue frame shows the location of the controller board.

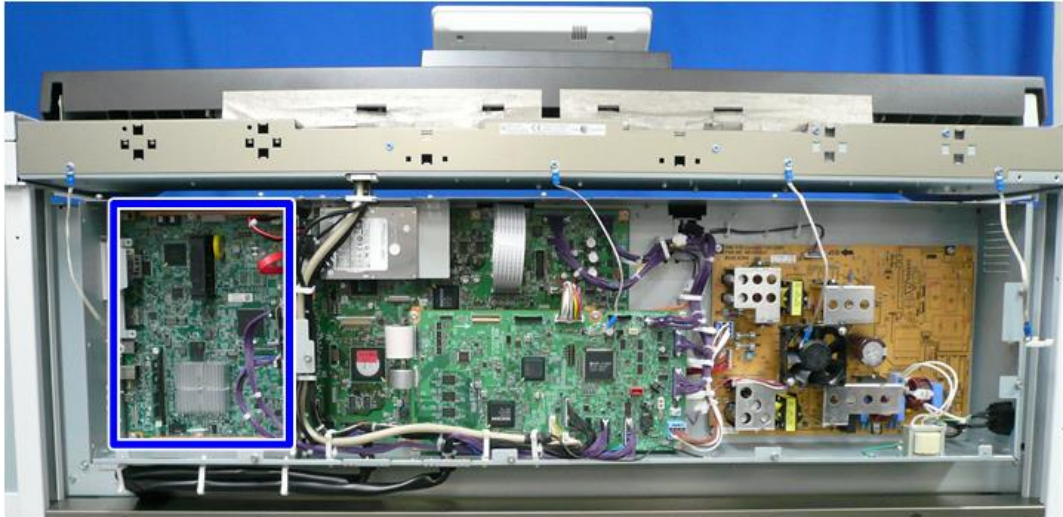

d262k0101

4

Remove

1. Rear cover (p.544) .

2. Left cover of the PCB box ( x7).

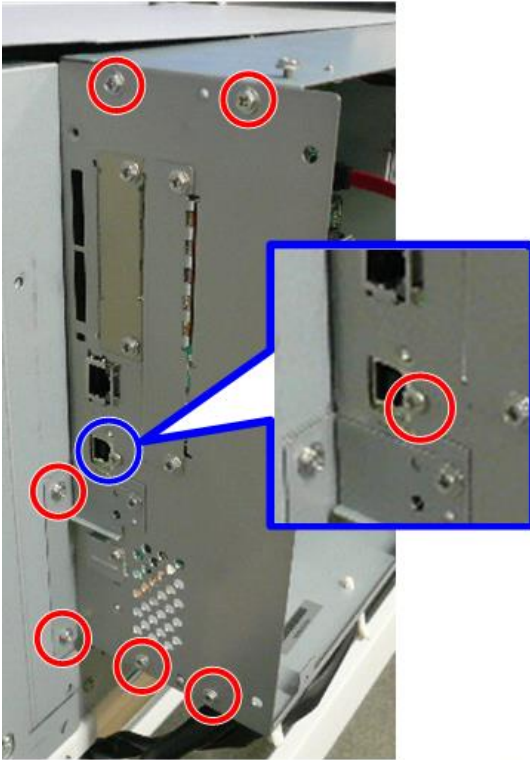

d262k0102

3. Controller board (x7).

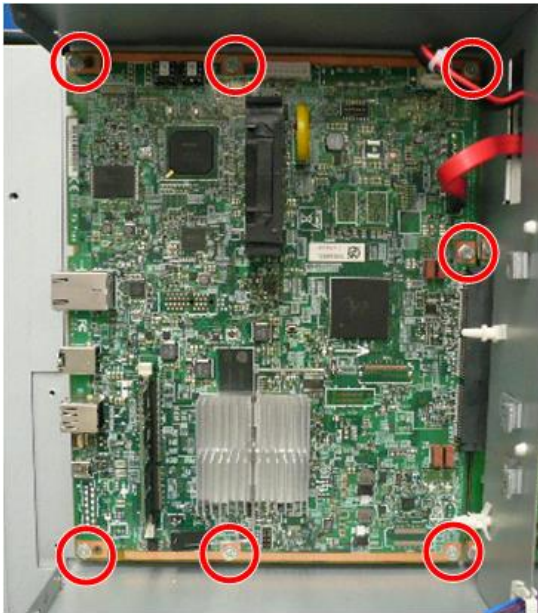

d262k0103

4

Replacing the NVRAM and Memory

If you are going to replace the controller board, remove the NV-RAM [A] from the old controller board and mount it on the new controller board.

Also mount the memory [B] on the new controller board.

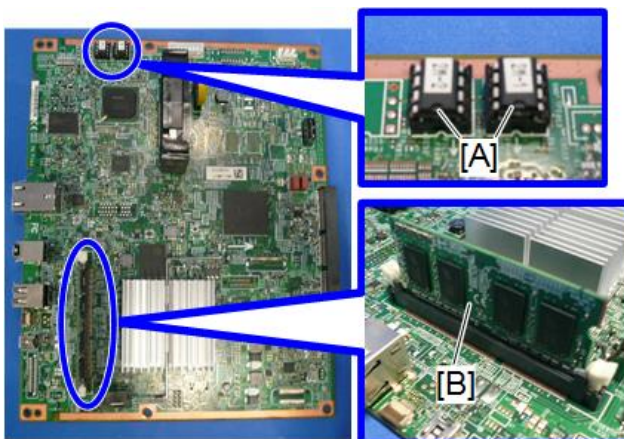

d262k0104

RFDB (Roll Feeder Drive Board)

The RFDB is mounted only when the roll unit 2 (option) is attached, and it is placed in the POB box as shown below.



d262k0105

Remove

1. Rear cover (p.544).

2. Disconnect the connectors shown in the figure below (E x2).

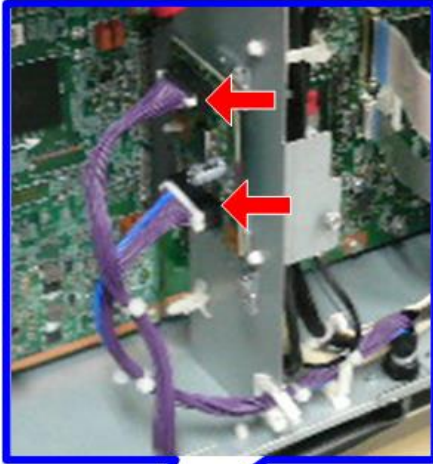

d262k0106

3. RFDB ( x2).

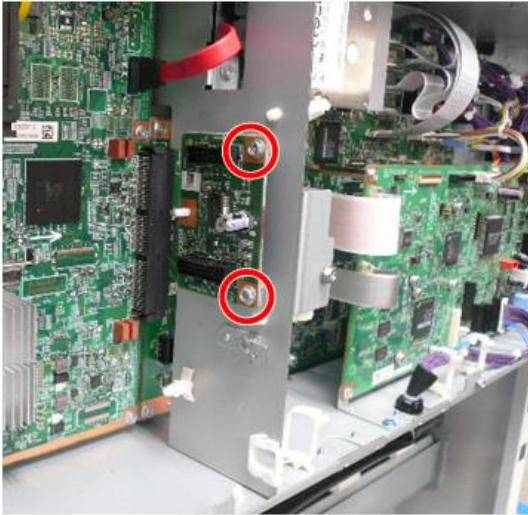

d262k0010

IOB (Input/Output Board)

The blue frame shows the location of the IOB.

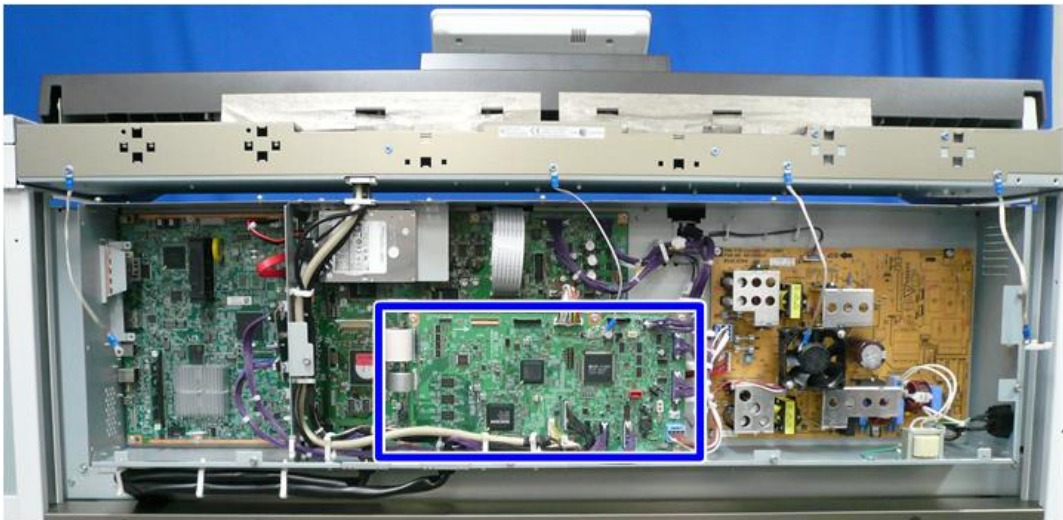

d262k0107

Remove

1. Rear cover (p.544).

2. Disconnect the connectors shown in the figure below (EFC x8, FFC x2).

↓ Note

- To disconnect the FFCs, unlock the connectors and release the FFCs as shown below.

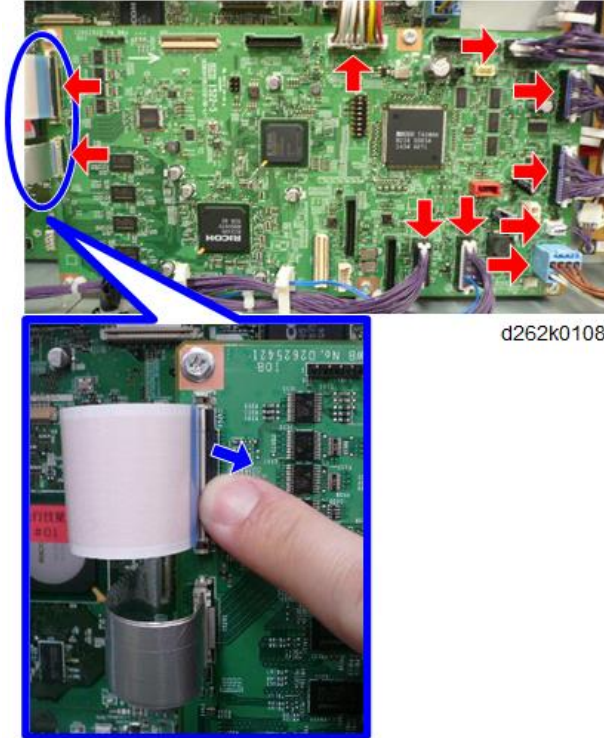

3. Remove the IOB (IOB x6).

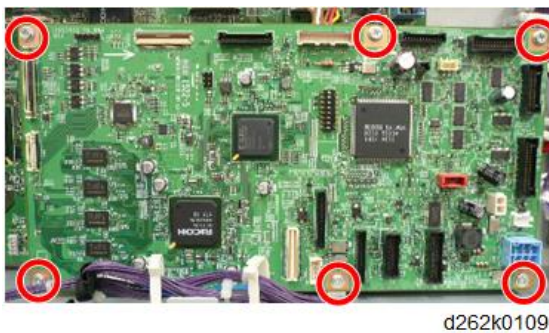

HDD

Note

- For replacing the HDD, the information of the customer is treated. Confirm the HDD replacement procedure with the customer.

The blue frame shows the location of the HDD.

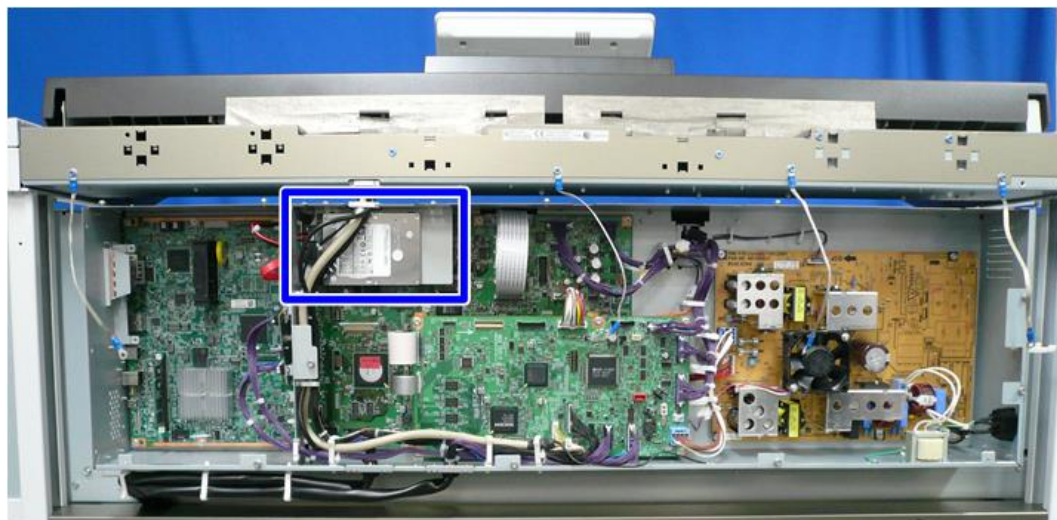

d262k0110

Remove

1. Rear cover (p.544).

2. Disconnect the connector of the HDD from the controller board.

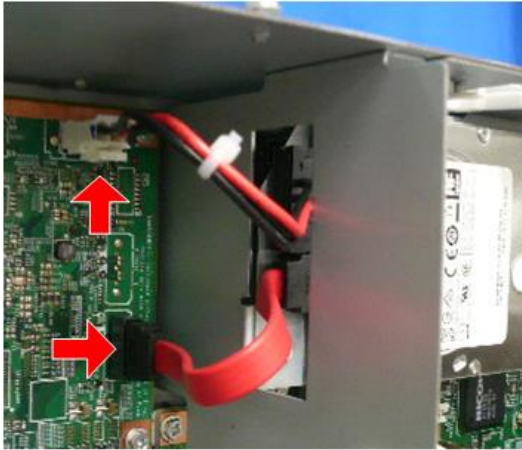

d262k0111

3. HDD with the bracket ( x3).



d262k0112

4. Turn the bracket over and remove the HDD ( x4).

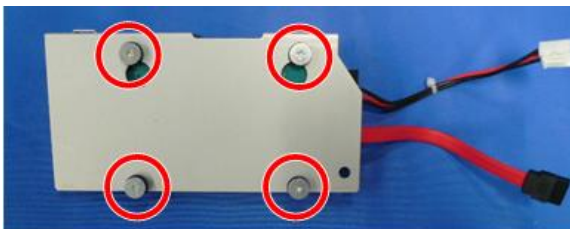

d262k0113

Settings

- After replacement, hand over the removed HDD to the customer or damage the HDD and bring it back (non-free).

- Notice to the customer that the document box data and address data will be deleted when an HDD is replaced so that the re-registration is required if the data are necessary.
- If the IC-card personal authentication has been set, the settings will be cleared and resetting is necessary when the HDD is replaced.
- Format the new HDD with SP shown below and download the fixed stamp data to the HDD.

1. Set the main power switch to ON and enter the SP mode using the operation panel.
2. Do SP5-832-001 to format the HDD.
3. Do SP5-853-001 to download the fixed stamp data.
4. Finish the SP mode and set the main power switch off and on again.

4

BiCU (Base image Control Unit)

Note

- To attach the BiCU, loosen the screws on the controller board, attach the BiCU, and then tighten the screws on the controller board and BiCU.

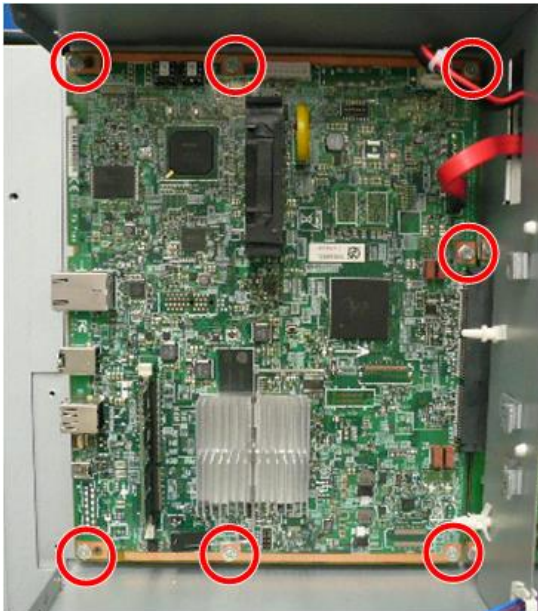

d262k0103

The blue frame shows the location of the BiCU in the POB box (back of the IOB [A] and HDD bracket [B]).

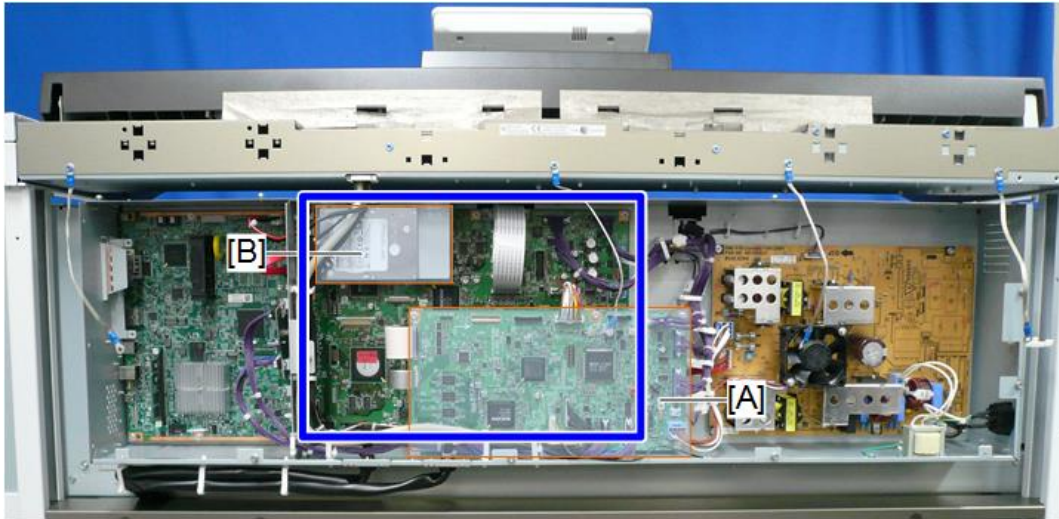

d262k0114

4

Remove

1. Rear cover (p.544).
2. Remove the IOB (p.558).
3. Remove the HDD (p.560).
4. Disconnect the connectors shown in the figure below (🔌 x7, 📏 x5).

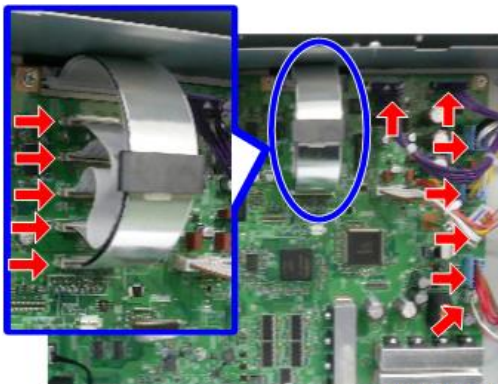

d262k0115

↓ Note

- Remove the clamp [A] of the FFC by pushing it towards the BiCU.

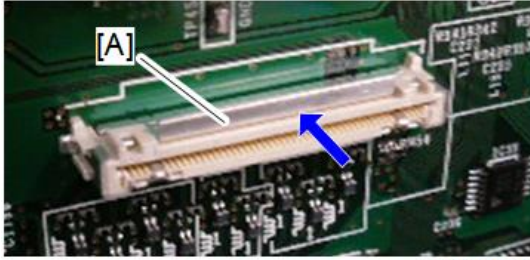

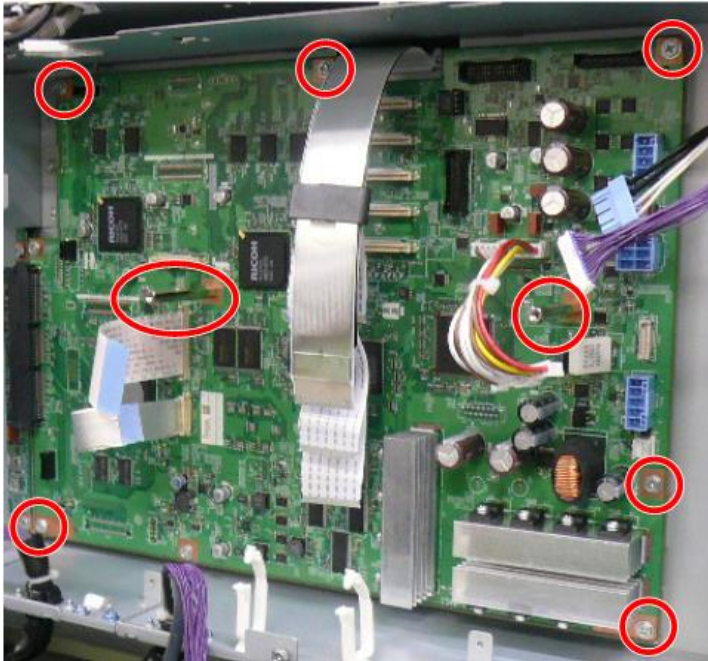

d262k3084

5. BiCU ( x8,  x2).



d262k0116

EEPROM Replacement

When the BiCU is replaced, remove the film cables [A] ( x2), connector [B] ( x1), and EEPROM [C] and connect them to the new BiCU.

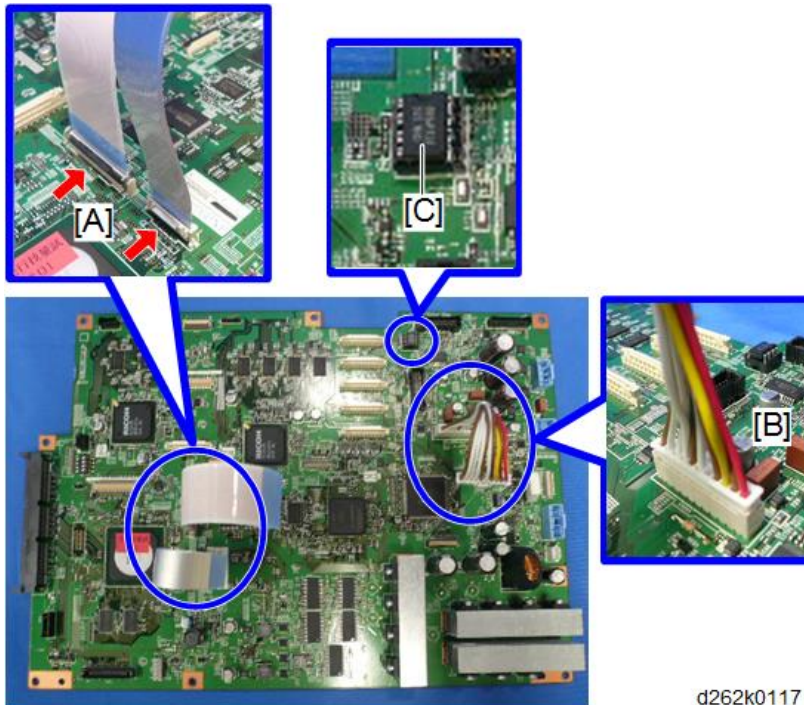

d262k0117

↓ **Note**

- The pins of the EEPROM are soft and easy to bend. Work carefully when you remove it.
1. Use the tip of a small screwdriver to alternately raise the top [1] and bottom [2] of the EEPROM slightly.
 2. When the EEPROM is loose, remove it [3].

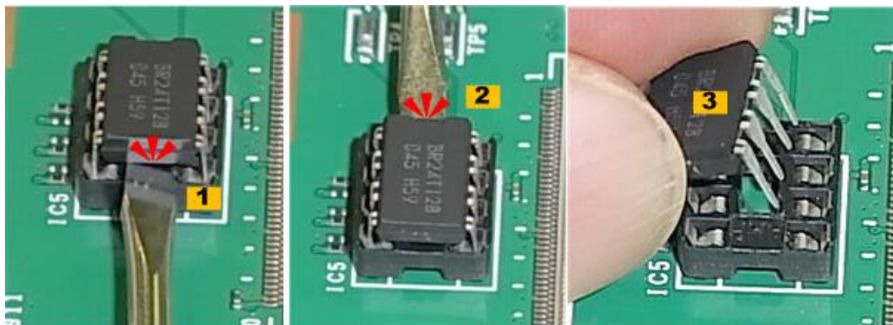

d1241113

3. Position the EEPROM on the new BiCU socket so that the semi-circular indentation is pointing up.



d262k0119

4. Make sure each pin is matched with a hole, and then press down to insert the EEPROM.

NVRAM

NVRAM on the controller board

CAUTION

- SC195 (Machine serial number error) will be displayed if you forget to attach the NVRAM.
- If you mounted the NVRAM in the wrong direction, each component needs to be replaced because a short circuit was caused in the controller board and the NVRAM.
- Installing a new NVRAM initializes SPs and issues an SC. Reset the SC with the procedure below.

1. Make sure that you have the SMC report (factory settings). This report comes with the machine.
2. Output the SMC log using one of the following methods:
To save SMC log data to an SD card, execute SP5-992-001 (p.636).
3. Turn off the main power switch.
4. Insert a blank SD card in the SD slot 2, and then turn on the main power switch.
5. Use SP5-824-001 to upload the NVRAM data from the controller board.
6. Make sure the customer has a backup of their address book data. If not, obtain the backup by referring to SP5-846-051.

Important

- The address data stored in the machine will be discarded later during this procedure. So be sure to obtain a backup of the customer's address book data.

- Note that the counters for the user will be reset when doing the backup/restore of the address book data.
- If they have a backup of the address book data, use their own backup data for restoring. This is because there is a risk that the data cannot be backed up properly depending on the NV-RAM condition.

7. Turn the main power OFF and unplug the power supply cord.
8. Push the main power switch ON again to discharge the residual charge.
9. Replace the NV-RAM with a new one.
10. Turn the power ON.

★ Important

- Appears at start-up, but this is normal behavior.
1. Change the SP settings for the operation panel.
 - SP5-748-201: (OpePanel Setting: Cheetah Panel Connect Setting): Change the value from "0" to "1".

11. Cycle the main power OFF/ON with the SD card where the NV-RAM data has been uploaded in SD slot 2.

★ Important

- SC992 appears at start-up, but this is normal behavior. This is because information written to the NV-RAM and on the hard disk do not match due to replacement of the NV-RAM. Go to Step 12.

12. Download the NV-RAM data stored in the SD card to the brand-new NV-RAM using SP5-825-001 (NV-RAM Data Download).

↓ Note

- The download will take a couple of minutes.

13. Turn the main power OFF and remove the SD card from SD slot 2.

14. Turn the main power ON.

15. Restore the original settings of the following SPs, referring to the SMC data obtained in step 2.

↓ Note

- SP5-825-001 does not download the following SP data to the new NV-RAM. So you must set them manually.

- a. SP5-985-001 (Device Setting: On Board NIC)
- b. SP5-985-002 (Device Setting: On Board USB)

16. If the security functions (HDD Encryption and HDD Data Overwrite Security) were applied, set the functions again.

17. Ask the customer to restore their address book. Or restore the address book data using SP5-846-052 (UCS Setting: Restore All Addr Book), and ask the customer to ensure the address book data has been restored properly.

★ Important

- If you have obtained the backup of the customer's address book data, delete the backup immediately after the NV-RAM replacement to avoid accidentally taking out the customer's data.

18. Output the SMC log using one of the following methods:

To print SMC log data, execute SP5-990-001.

To save SMC log data to an SD card, execute SP5-992-001 (p.636).

↓ Note

- Check that the counters are reset.

19. Make sure that the list output in step 7-1 through step 7-3 matches the destination information in step 7-4. If not, set it to the setting before replacement.

★ Important

- Try all the items below if NVRAM upload (SP5-824-001) or download (SP5-825-001) cannot be done.
 - Check the SP values that changed on the SMC you printed out in step 2. Adjust the values manually. Make sure that the values of SP5-045-001 and SP5-302-002 are the same as before replacing.
 - Replace all PM parts because all PM counters will be reset.

↓ Note

- If a message tells you need an SD card to restore displays after the NVRAM replacement, create a "SD card for restoration" and restore with the SD card.

NVRAM (EEPROM) on the BiCU

⚠ CAUTION

- Keep NVRAMs away from any objects that can cause static electricity. Static electricity can damage data in the NVRAM.
1. Make sure that you have the SMC report (factory settings). This report comes with the machine.
 2. Output the SMC log using one of the following methods:
 - To print SMC log data, execute SP5-990-001 ([SP Print Mode]-[All (Data List)]).
 - To save SMC log data to an SD card, execute SP5-992-001 ([SP Text Mode]-[All (Data List)]).
 3. Turn OFF the main power.

4. Insert a blank SD card in SD slot #2, and then turn ON the main power.
5. Upload the NVRAM data from the BiCU using SP5-824-001.
6. Turn OFF the main power and disconnect the power plug.
7. Replace the NVRAM on the BiCU with a new one.

Note

- Make sure the NVRAM [A] is installed at the correct mounting location and orientation. Install the NVRAM so that the indentation on the NVRAM corresponds with the mark [B] on the BiCU.
- Incorrect installation of the NVRAM will damage both the BiCU and the NVRAM

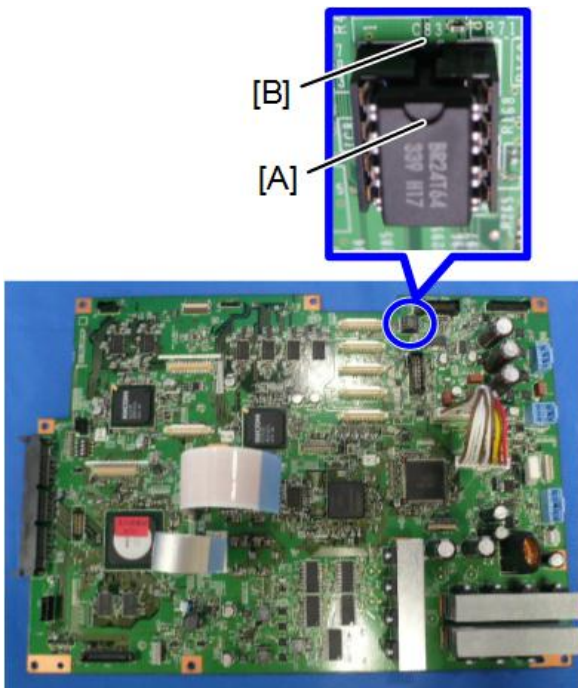

d262k8529

8. Connect the power plug and turn ON the main power.
9. Set SP5-811-001 ([Machine Serial Number]-[Set]), SP5-807-001 ([Area/Model Selection DFU - JPN: 1, NA: 2, EU/AA: 3, CHN: 6]) and SP5-907-001 ([Plug & Play Maker/Model Name]).

Note

- For information on how to configure the machine serial number and area selection, contact the supervisor in your branch.
- SC995 will appear until the machine serial number and area selection are programmed correctly.

10. Turn OFF then ON the main power.
11. Do SP5-801-002 to clear the all SP settings for the engine data in NVRAM.
12. Turn OFF then ON the main power.
13. From the SD card where you saved the NVRAM data in step 5, download the NVRAM data with SP5-825-001.
14. Turn OFF the main power.
15. Remove the SD card from slot #2.
16. Turn ON the main power.
17. Check the factory setting sheet and the SMC data printout from step2, and set the user tool and SP settings so that they are the same as before replacement.

PSU (Power Supply Unit)

⚠ WARNING

- When replacing the PSU, do not touch the shaded area shown below.

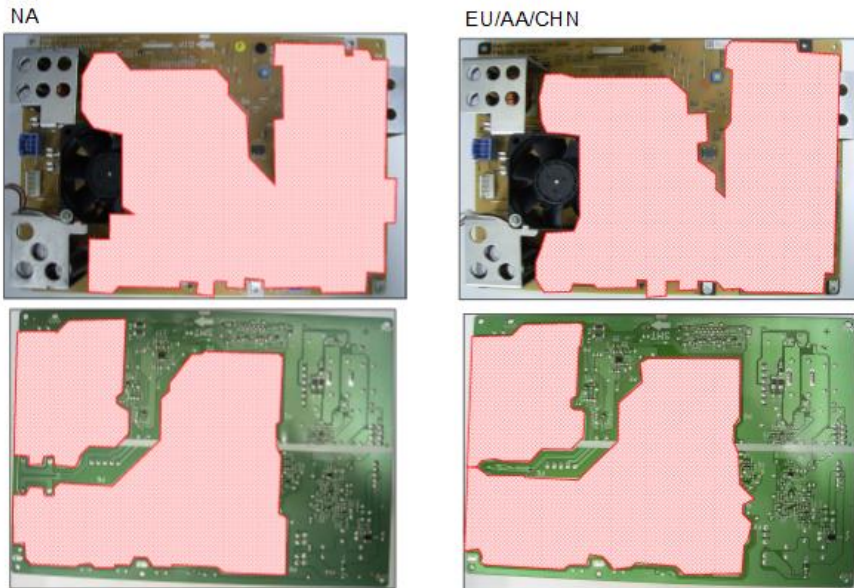

d262k8530

The blue frame shows the location of the PSU



d262k0118

Remove

1. Rear cover (p.544).
2. Cables (🔌 x5).

4

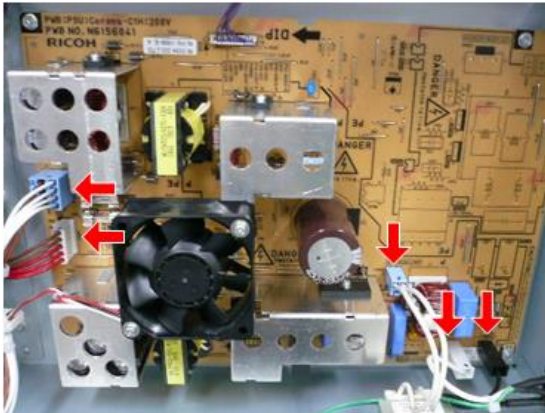

d262k0120

3. PSU ( x5).

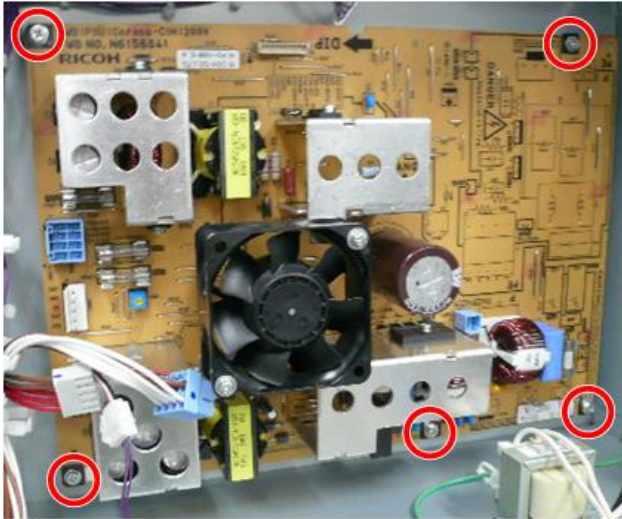

d262k0121

Precaution

To attach the PSU, connect the white connector of the relay connector [A] to the left and the black connector to the right.

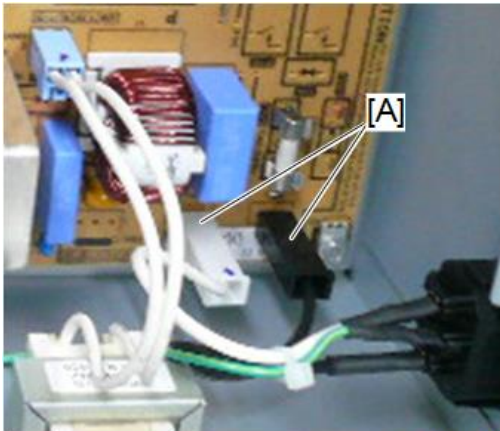

d262k0122

Sensors, Switches

⚠ WARNING

- Set the main power switch to OFF and disconnect the power plug from the power outlet before performing the procedure below. Working with power supplied may cause electrical shock or defects.

Ink Collector Tank Cover Switch

1. Right cover (p.239).
2. Ink collector tank cover switch [A] (E x1).

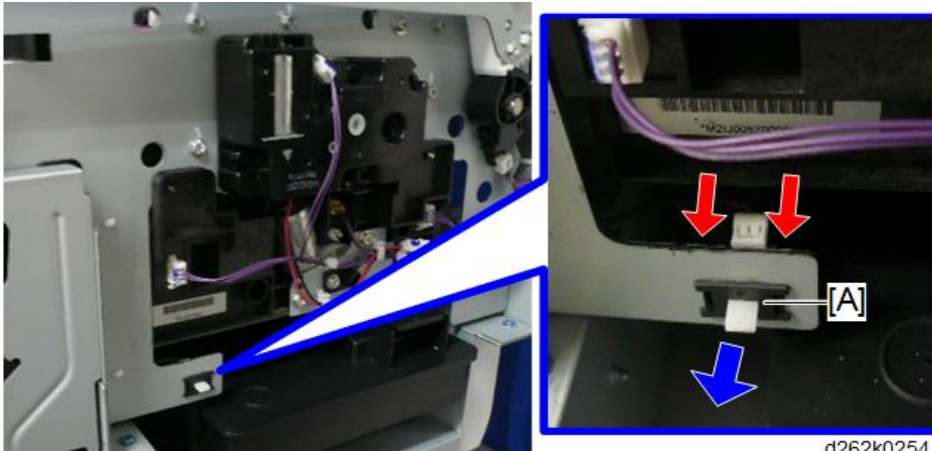

Ink-cartridge Cover Switch

1. Right cover (p.239).
2. Right upper cover (p.241).
3. Ink-cartridge cover (p.243).

4. Ink-cartridge cover switch [A] (🔧 x1).

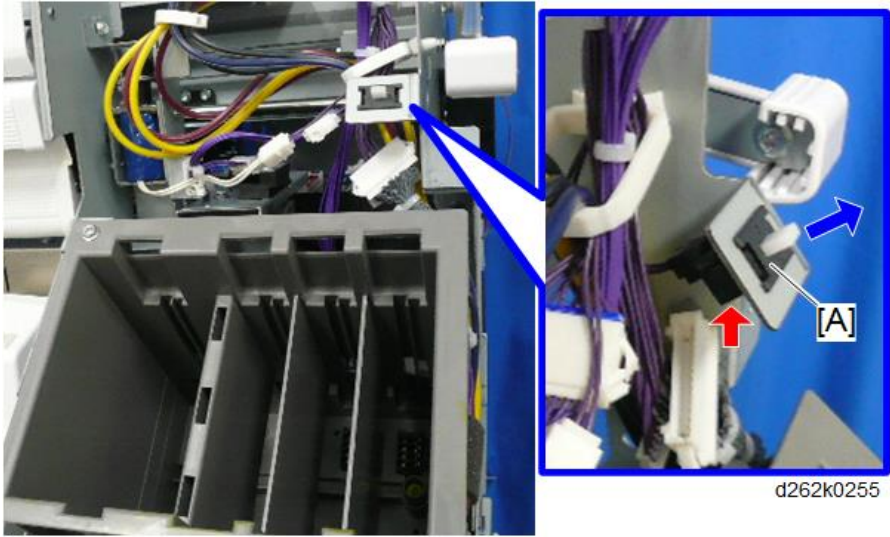

Front Cover Safety Switches

- 1. Paper Exit guide (p.251).
- 2. Lower guide plate [A] (🔧 x4).

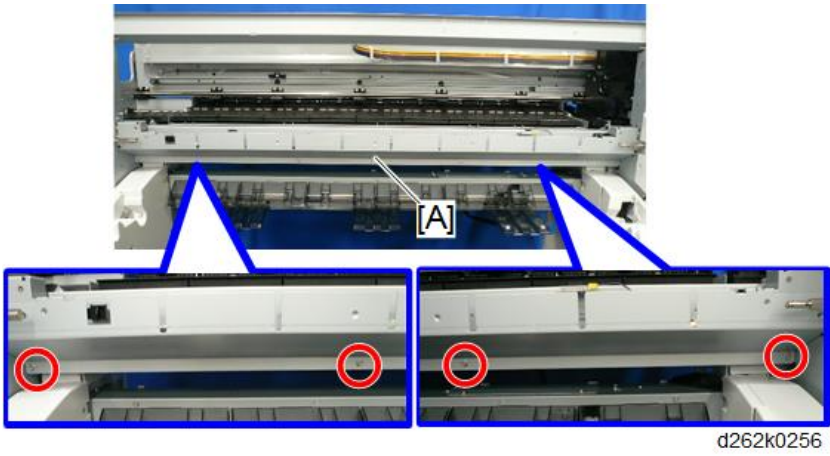

3. Front cover safety switch assembly (right) [A] ( x2).

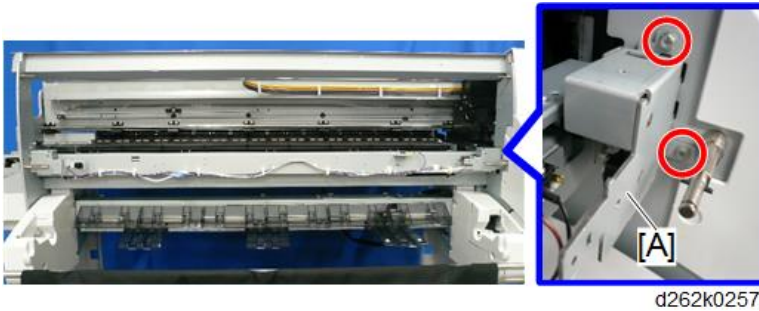

4. Front cover safety switch (right) [A] ( x2, snap ring x1).

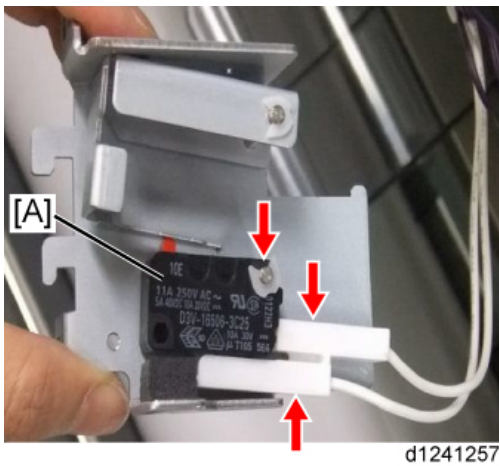

Front Cover Switch

Remove

1. Left cover (p.234).
2. Open the front cover.
3. The front cover switch is placed on the left of the main unit and outside of the support.

4. Switch bracket (🔧 x1, 🛠️ x1).



d262k0312

5. Lever from the switch bracket.

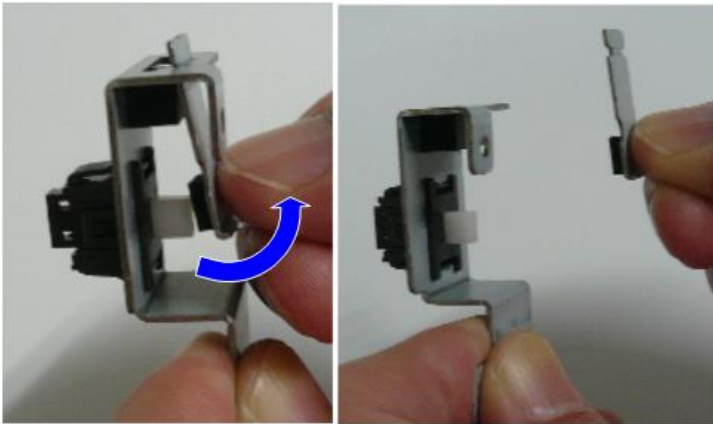

d262k0313

6. Front cover switch from the switch bracket (▼ x2).

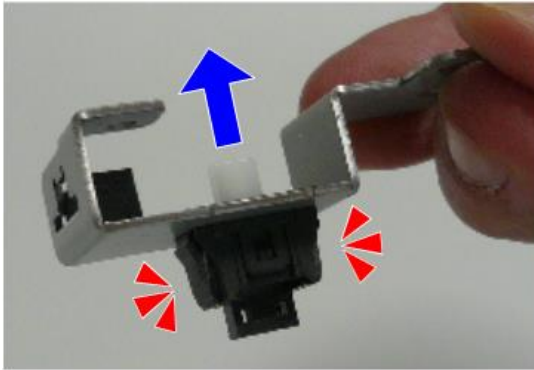

d262k0314

4

Precaution

Support the bracket with the front cover switch attached as shown below, and insert the top of the lever into the hole on the back of the rubber.

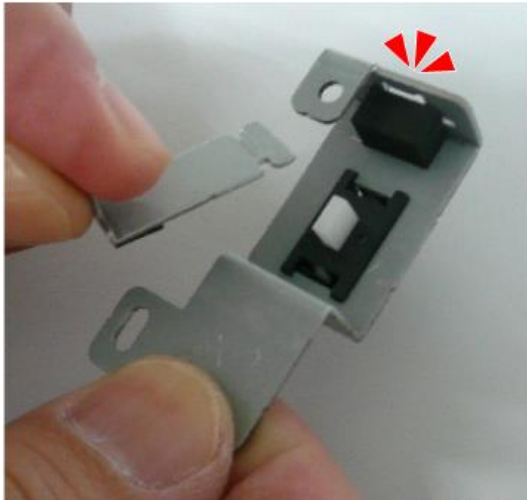

d262k0315

Special Adjustments

Image Adjustment with SP Modes

Do these adjustments if output is unsatisfactory. Before you start measurements and adjustments, let the test print cool for five minutes.

Note

- Do each adjustment in the order described below. Be sure to turn the machine off/on after each SP adjustment to enable the new setting.

4

Step 1: Magnification for Paper Type: Plain

- Go into the SP mode.
- Do **SP4-417**, select Pattern 3, and then touch [OK].
- Touch [COPY Window] at the top of the screen.
- Select the paper size.
- Set a blank sheet of A1 SEF paper on the original tray.
- Touch [Start] to print the test pattern.
- Print two more test patterns (you need three grid pattern prints).
- Refer to the diagram and instruction table below to do the SP magnification corrections if they are needed. The example below illustrates the adjustments for "Normal/Recycled" paper.

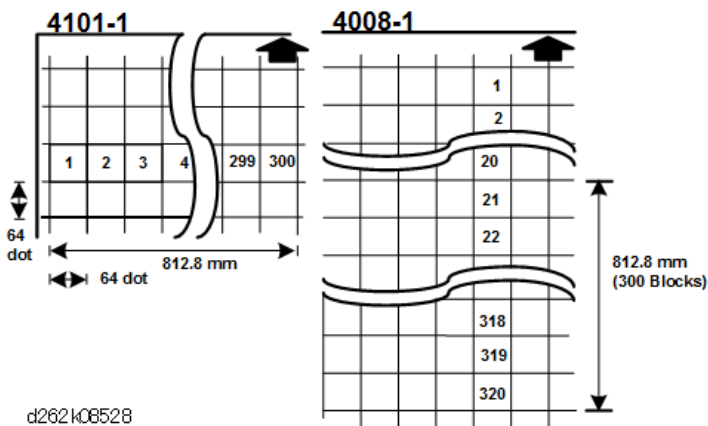

d262k08528

Resolution = 600 dpi

1 inch = 25.4 mm

SP	Comments
4-101-1	On each grid test pattern, measure the width from block 1 to block 300 (300 blocks) then average the three measurements. The width must be 812.8 mm. If the average measured width is not 812.8 mm, adjust this SP until the width is 812.8 mm.
4-008-1	On each grid test pattern, measure the length from block 21 to block 320 (300 blocks) then average the three measurements. The length must be 812.8 mm. If the measured length is not 812.8 mm, adjust this SP until the length is 812.8 mm.

Step 2: Copy/Main Scan Magnification

1. Make a 1:1 copy of the AO SEF Magnification Chart with plain roll paper.

Note

- You can use a different test chart but only if it has lines 1000 mm long in the sub-scan direction and 700 mm long in the main-scan direction.
2. Measure the length and width of the image on the original and the copy.
 3. If the measurements are not within "Standard", adjust these SPs in the order shown in the table below.

SP	Paper Type	Standard
SP2-117-001	Normal Recycled	Less than ± 0.5
SP2-117-002	IJ Normal	
SP2-117-003	Translucent	
SP2-117-004	Coated (CAD)	
SP2-117-005	Coated	
SP2-117-006	Matte Film	
SP2-117-007	Special	

Step 3: Copy/Print Sub Scan Magnification

1. Make a 1:1 copy of the AO SEF Magnification Chart.

Note

- You can use a different test chart but only if it has lines 1000 mm long in the sub-scan direction and 700 mm long in the main-scan direction.

2. Measure the length and width of the images on the original and the copy.
3. Do the same measurements that you did for "Step 1: Magnification for Paper Type: Plain".
4. If the measurements are not within "Standard", adjust these SPs in the order shown in the table below.

Copy

SP	Paper Type	Standard
SP2-116-001	Normal/Recycled Paper	Less than ± 0.5
SP2-116-002	IJ Normal Paper	
SP2-116-003	Translucent	
SP2-116-004	Coated Paper (CAD)	
SP2-116-005	Coated Paper	
SP2-116-006	Matte Film	
SP2-116-007	Special Paper	

Print

SP	Paper Type	Standard
SP2-116-011	Normal/Recycled Paper	Less than ± 0.5
SP2-116-012	IJ Normal Paper	
SP2-116-013	Translucent	
SP2-116-014	Coated Paper (CAD)	
SP2-116-015	Coated Paper	
SP2-116-016	Matte Film	
SP2-116-017	Special Paper	

Step 4: Scanner Mask Setting

SP	Set To:	Comments
4-012-005	0	Scanner Erase Margin - DF: Leading Edge

SP	Set To:	Comments
4-012-006	0	Scanner Erase Margin - DF: Trailing Edge
4-012-007	0	Scanner Erase Margin - DF: Left Edge
4-012-008	0	Scanner Erase Margin - DF: Right Edge

Step 5: Erase Margins

Set these SPs to "5" to make measurement easier:

SP	Set To:	Comments
2-103-001	5	Print Erase Margin – Leading Edge
2-103-002	5	Print Erase Margin – Trailing Edge
2-103-003	5	Print Erase Margin – Left Edge
2-103-004	5	Print Erase Margin – Right Edge

4

Step 6: Printer: Leading Edge, Side-to-Side Registration

- Use a sheet of blank plain paper to print the IPU Printing test pattern (SP4-417 Pattern 3) for each paper feed station installed on the machine:
 - Paper Input 1
 - Paper Input 2
 - Bypass
- Measure the gaps for the leading edge and side-to-side registration.

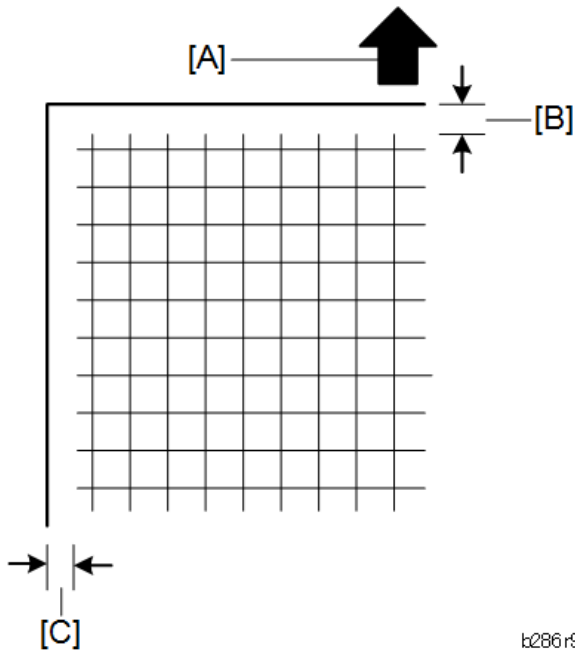

k286r907

[A]: Direction of Paper Feed

[B]: Sub Scan: 5 ± 0.5 mm

[C]: Main Scan: 5 ± 0.5 mm

3. Touch "SP Mode" at the top of the screen, and then adjust these SPs if a measurement is not within "Standard".

SP	Standard:	Comments
1-001-001	5 ± 0.5 mm	Print Position Adj (Top Edge) - Bypass Feed
1-001-002		Print Position Adj (Top Edge) - Paper Input 1
1-001-003		Print Position Adj (Top Edge) - Paper Input 2
1-002-001		Print Position Adj (Left Edge) - Bypass Feed
1-002-002		Print Position Adj (Left Edge) - Paper Input 1
1-002-003		Print Position Adj (Left Edge) - Paper Input 2

Step 7: Scanner Mask Setting

Do these SPs to replace the "0" settings done in Step 5.

SP	Set To:	Comments
4-012-005	1.5	Scanner Edge Margin - DF: Leading Edge
4-012-006		Scanner Edge Margin - DF: Trailing Edge
4-012-700		Scanner Edge Margin - DF: Left Edge
4-012-008	0.5	Scanner Edge Margin - DF: Right Edge

Step 8: Erase Margins

Do these SPs to replace the settings done in Step 6.

SP	Set To:	Comments
2-103-001	2	Printing Erase Margin – Leading Edge
2-103-002		Printing Erase Margin – Trailing Edge
2-103-003		Printing Erase Margin – Left Edge
2-103-004	0.5	Printing Erase Margin – Right Edge

Step 9: Scanner Registration

1. Use the A1 LEF Test Chart to make a 1:1 copy on plain A1 LEF paper.
2. On the copy, measure the gap between the chart image at the leading edge and at the left edge.
3. Adjust these SPs if necessary.

SP	Standard	Comments
4-010-001	±3 mm	Scanner Sub Scan - Leading Edge Reg Adjustment
4-010-002	±2.8 mm	Scanner Main Scan - Trailing Edge Reg Adjustment
4-011	±2.8 mm	Scanner Main Scan - Registration

Step 10: Printer: Cut Length

1-921	Cut Length Adjustment - Cutting Position Adjustment
	This SP adjusts the distance between the DRESS sensor (image registration sensor) and the first cut position. This setting is no longer used after the 2nd cut during continuous printing. Cuts once to test the new setting, then once to do the actual cut.
	<p>[-10 to 10/0/0.1 mm]</p> <p>Example</p> <ul style="list-style-type: none"> To set a length of 297 mm, with the machine cutting at 300 mm, you need to move the cutting position 3 mm upstream with a value of -3 mm. To set a length of 295 mm, with the machine cutting at 297 mm, you need to move the cutting position downstream with a value of +2 mm

4

↓ Note

- The cut length adjustment is done for all paper sizes after these settings are done.
 - After these settings are done you may still need to do fine adjustments for each paper size.
- Use the Preset Cut feature to make standard cuts of plain paper for these sizes:

Size	Orientation
A3	Sideways
A1	Lengthways
A0	Lengthways
A	Sideways (Eng. 11")
B	Sideways (Eng. 17")
D	Lengthways (Eng. 34")
E	Lengthways (Eng. 44")

- Measure the cuts and check them against the standards of this table.

Cut Length (mm)	Cut Tolerance (mm)
Less than 297	±3
420 to 1219	±5
to 2000	±6

Cut Length (mm)	Cut Tolerance (mm)
to 3000	±11
to 3600	±14
to 15,000	±150

Step 11: Synchro Cut (Trailing Edge Registration)

The following SPs are used in this step:

- SP4-961-001 (Document Length Adjustment – Input Tolerance 210 mm)
- SP4-961-002 (Document Length Adjustment – Input Tolerance 1000 mm)
- SP4-961-003 (Document Length Adjustment – Check Document Length)

1. Prepare two originals
 - 1 original 210 mm long (A4 LEF)
 - 1 original 1000 mm long (measure and cut)
2. Go into the SP mode and do **SP4-961-001**.
3. Touch [COPY Window] and copy the 210 mm sheet that you prepared in Step 1.
4. Touch [SP Mode] to go back to the SP mode.
5. Do **SP4-961-003** to check the original scan length.
6. If the display is different, adjust with **SP4-961-001**.
7. Do **SP4-961-002**.
8. Touch [COPY Window] and scan the 1000 mm sheet that you prepared in Step 1.
9. Touch [SP Mode] to go back to the SP mode.
10. Do **SP4-961-003** to check the scan length.
11. If the display is different, adjust with SP4-961-002.

Cut Length (mm)	Cut Tolerance (mm)
Less than 297	±4.50
to 594	±5.00
to 841	±6.00
to 1219	±8.50
to 2000	±18.0

Cut Length (mm)	Cut Tolerance (mm)
to 3000	±27.0
to 3600	±33.0
to 15,000	±150

CIS Adjustment with SP Modes

4

To Print the CIS Adjustment Pattern

1. Enter the SP mode.
2. Open **SP4-417** Pattern 3, and touch [OK].
3. Touch [COPY Window] to go to the main screen.
4. On the operation panel, select one of the rolls for paper feed.
5. Put the blank sheet of paper on the original feed tray and feed it into the original feed unit. Pattern 6 (a grid pattern) prints.
6. Touch [SP Mode] to return to the SP mode.
7. Open **SP4-973**, push [0] on the operation panel to change the setting from "2" to "0", then push [#].
8. Touch [Exit] twice to leave the SP mode.
9. Select the paper input size, and then copy the grid pattern that you printed in Step 7 above.

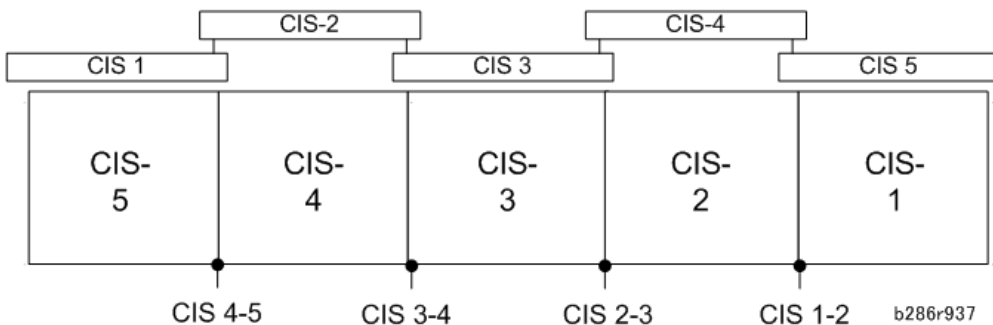

↓ Note

- When you look at the printed pattern, the number sequence of the CIS joints is reversed, with CIS-5 on the left through CIS-1 on the right as shown in the diagram above.

↓ Note

- After completing the CIS adjustments, be sure to reset **SP4-973** to "2".

To Adjust the Image at the CIS Joints

1. Check the printed pattern to determine if the dots are aligned at CIS 1-2.
2. If they are aligned correctly, no adjustment is necessary.

-or-

If they are not aligned correctly, do the next step. Here are two samples where the outputs are not aligned correctly.

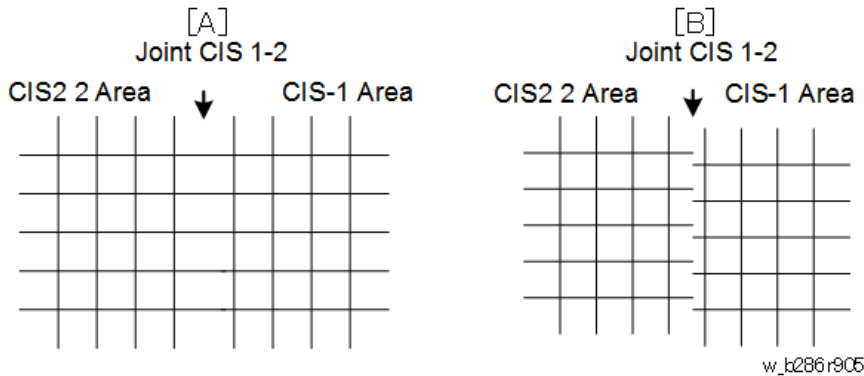

- [A]: Distance between the lines at CIS 1-2 is wider than usual (as shown above). If the distance between these lines is wider or narrower than the other lines, adjust the main scan offset at CIS 1-2 with **SP4-972-001** (CIS Joint Adjustment – CIS 1-2 Main Scan) as described below.
- [B]: The lines at CIS 1-2 are broken. If the output from CIS 1 is lower (as shown above) or higher, adjust the sub scan offset at CIS 1-2 with **SP4-972-006** (CIS Joint Adjustment – CIS 1-2 Sub Scan) as described below.

To adjust the main scan offset for Example [A]

Problem: Output from CIS 1 is too far to the right.

1. Do **SP4-972-001** and adjust the setting.
 - Adjust the position of CIS 1. The position of CIS 2 does not move.
 - If the area at the joint is too wide, set a smaller value.
 - If the area at the joint is too narrow, set a larger value.
 - In the example [A], you must set a smaller value.

To adjust the sub scan offset for Example [B]

Problem: Output from CIS 1 is lower than the output from CIS 2.

1. Do **SP4-972-006** and adjust the setting.
 - Adjust the position of CIS 1. The position of CIS 2 does not move.
 - If the CIS 1 area is higher than the CIS 2 area, set a larger value.

- If the CIS 1 area is lower than the CIS 2 area, set a smaller value.
- In the example shown [B], you must decrease the value for CIS 1.

After adjusting

1. Print one more pattern and check CIS 1-2.
2. Repeat these procedures until the image at CIS 1-2 is correct.
3. Do these procedures for the other joints (CIS 2-3, CIS 3-4, CIS 4-5)

Note

- The "Effect" column in the table below tells you which area moves with the adjustment, and which area does not move.

SP4-972	CIS Main/Sub Scan Offset Adjustment [0 to 2047/638/1]		
	Problem	Joint	Effect
001	Main Scan Interval 1-2	CIS 1-2	CIS 1 moves. CIS 2 does not move.
003	Main Scan Interval 2-3	CIS 2-3	CIS 3 moves. CIS 2 does not move.
004	Main Scan Interval 3-4	CIS 3-4	CIS 4 moves. CIS 3 does not move.
005	Main Scan Interval 4-5	CIS 4-5	CIS 5 moves. CIS 4 does not move.
006	Sub Scan Interval 1-2	CIS 1-2	CIS 1 moves. CIS 2 does not move.
008	Sub Scan Interval 2-3	CIS 2-3	CIS 3 moves. CIS 2 does not move.
009	Sub Scan Interval 3-4	CIS 3-4	CIS 4 moves. CIS 3 does not move.
010	Sub Scan Interval 4-5	CIS 4-5	CIS 5 moves. CIS 4 does not move.

Note

- After completing the CIS adjustments, be sure to reset SP4-973 to "2."

To Adjust the Scan Speed Switching

If some problem is found with the distance between the original feed roller (rear) and the original feed roller (front) in the CIS adjustment pattern, do the adjustment described below.

1. Enter SP mode and select the appropriate SP number in the table below.

SP4-965	Problem	Effect
1	Leading edge	The original feeding is interrupted at the position where the original is fed by the distance of the original exit roller (112.2 mm) from where the original registration sensor detects the leading edge of the original. Then the scan speed is lowered by the set value.
2	Position	To adjust the starting position of SP4-965-001 (Scan Speed Adjustment: Leading Edge).
3	Trailing edge	The scan speed is changed to the value set for SP4-965 14.5 mm after the original set sensor detects the original trailing edge.

2. Enter the value and touch [Set].
3. Touch [Exit] once.
4. Repeat steps 1 to 3.

5. System Maintenance Reference

Service Program Mode

See "Appendices" for Service Program Mode.

Firmware Update

Overview

In order to update the firmware of this machine, it is necessary to download the latest version of firmware on a SD card.

Insert the SD card in SD card slot 2 beside the left rear of the controller box.

Firmware Type

Main unit

Firmware type	Firmware position	Message display
System/Copy	Controller Board	System/Copy
Engine	BICU	Engine
NetworkSupport	Controller Board	NetworkSupport
Data Erase Onb	Controller Board	HDD Format Option
RPCS	Controller Board	RPCS
PDF	Controller Board	PS PDF
Option MSIS	Controller Board	RPGL MISIS
Option RTIFF	Controller Board	RTIFF
PDF	Controller Board	PDF
Printer	Controller Board	Printer MediaPrint:JPEG MediaPrint:TIF
Font EXP	Controller Board	FONT
PS3	Controller Board	MOC2e_prt_PS3
PS3 Font	Controller Board	FONT2

Firmware type	Firmware position	Message display
RPGL Font	Controller Board	FONT5
NetworkDocBox	Controller Board	NetworkDocBox
Scanner	Controller Board	Scanner
Websupport	Controller Board	Websupport
WebUapl	Controller Board	WebUapl
animation	Controller Board	MOC2a_animat
PowerSaving Sys	Controller Board	MOCC2a_subcpu

Smart Operational Panel

Firmware type	Partation	Message display
CheetahSystem	Smart Operation Panel-CPU board	M2a_System
BluetoothService	Smart Operation Panel-CPU board	M2a_BluetoothSe
CSPF	Smart Operation Panel-CPU board	M2a_cspf
LegacyUI	Smart Operation Panel-CPU board	M2a_LegacyUI
MediaPrtScn	Smart Operation Panel-CPU board	M2a_MeidaPrtScn
PrinterInfo	Smart Operation Panel-CPU board	M2a_PrinterInfo
PrinterSJob	Smart Operation Panel-CPU board	M2a_PrinterSJob
ProgramInfoService	Smart Operation Panel-CPU board	M2a_ProgramInfo
ScanToME	Smart Operation Panel-CPU board	M2a_ScanToME

Firmware type	Partation	Message display
SimpleScan	Smart Operation Panel-CPU board	M2a_SimpleScan
SmartCopy	Smart Operation Panel-CPU board	M2a_SmartCopy
SmartScan	Smart Operation Panel-CPU board	M2a_SmartScan
LanguageWidget	Smart Operation Panel-CPU board	M2a_WLanguage

↓ Note

- Even when not using a RPCS driver, the XPS driver requires RPCS firmware.

5

Procedure

★ Important

- A SD card is a precision device, so when you handle an SD card, respect the following.
- When the power is switched ON, do not insert or remove a card.
- During installation, do not switch the power OFF.
- Since the card is manufactured to high precision, do not store it in a hot or humid location, or in direct sunlight.
- Do not bend the card, scratch it, or give it a strong shock.
- Before downloading firmware on an SD card, check whether write-protection of the SD card is canceled. If write-protection is enabled, an error code (error code 44, etc.) will be displayed during download, and the download will fail.
- Before updating firmware, remove the network cable from this machine.
- If SC818 is generated during software update, switch the power OFF -> ON, and complete the update which was interrupted.
- During software update, network cables, remove interface cables, wireless boards, etc., (so that they are not accessed during update).

Update procedure

1. First download the software to be updated to the SD card.
2. Switch the power OFF.

3. Remove the SD card slot cover [A]. ( ×1)

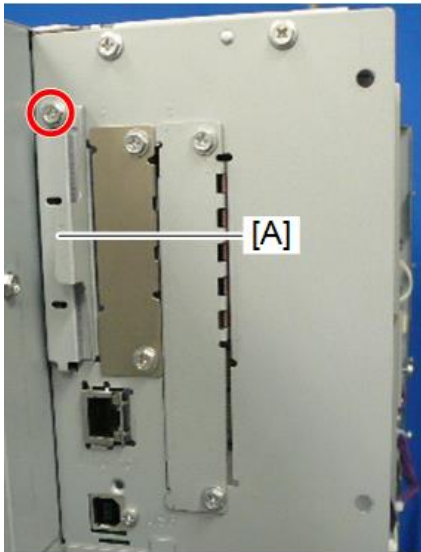

d262k2005

4. Insert the SD card [A] straight in slot 2.

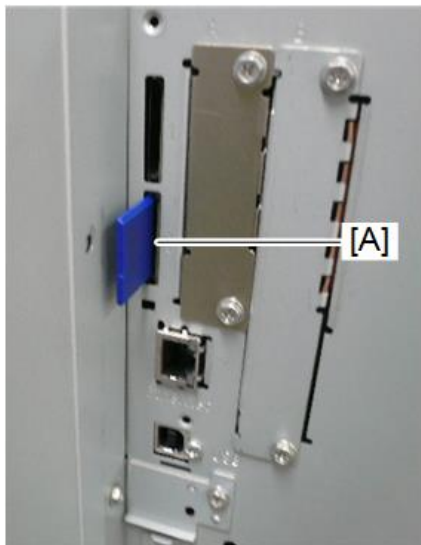

d262k2006

 **Note**

- Check whether the card is properly in the SD card slot. When a SD card is inserted, a click is heard, and it is locked.
- To remove the card, release by pressing once in the set state.

5. Switch the power ON.

6. Wait until the update screen starts (about 45 seconds).
When it appears, "Please Wait" is displayed.
7. Check whether a program installation screen is displayed. (English display) When two or more software modules are contained in the SD card, they are displayed as follows.

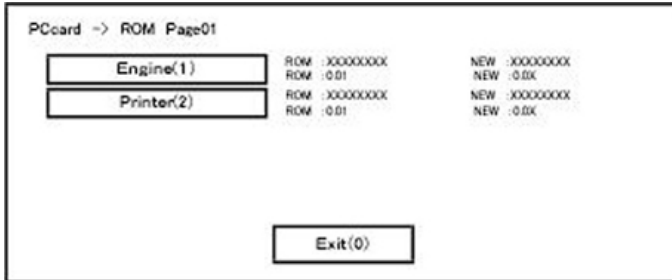

When two or more software names are displayed

1. Press the module selection button or 10 keypad [1] - [5].
2. Choose the appropriate module. (If already selected, cancel the selection)

Operation of keys or buttons

Keys or buttons to press	Contents
[Exit] or 10 key [0]	Returns to normal screen.
[Start] Key	Select all modules.
[Clear/Stop] key	Cancel all selection states.

Display contents

On the above screen, two programs, i.e., engine firmware and printer application are displayed. (The screen may change depending on the firmware or application).

The display contents are as follows:

Display	Contents
ROM:	Display installed module number / version information.
NEW:	Display module number / version information in the card.

* The upper row corresponds to the module number, the lower row corresponds to the version name.

8. Select the module with the module selection button or 10 key operation. The selected module is highlighted, and [Verify] and [Update] are displayed.

↓ Note

- Depending on the combination of update software, it may not be possible to select simultaneously.

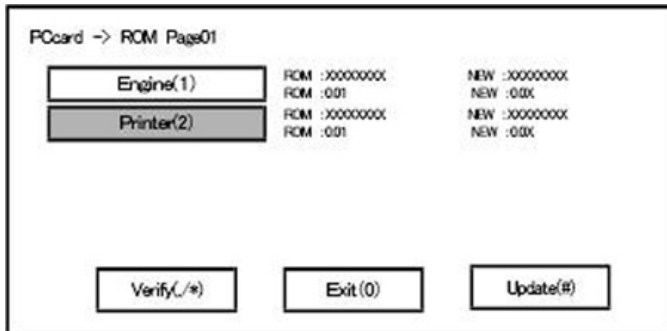

Key or button operations

Keys or buttons to press	Contents
[Update] or [#] key	Update the ROM of the selected module.
[Verify] button or [.//*] key	Perform verification of the selected module.

- Press the [Update] or [#] key, and perform software update.
- During firmware update, a "firmware update/ verification progress screen" is displayed. When firmware update is complete, a "firmware update end screen" is displayed.

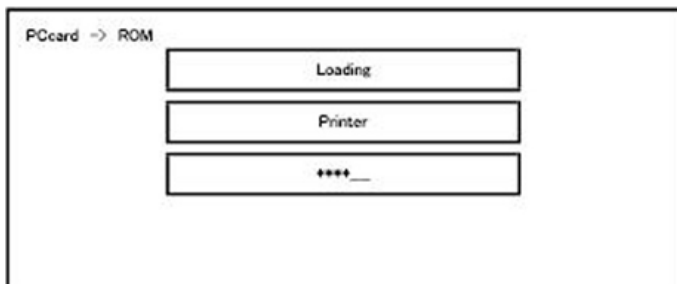

- In the middle row, the name of the module currently being updated is displayed. (in this case, the printer is being updated)
- In the lower row, a progress bar is displayed in ten steps. (The more *, the more the progress.)
- When updating the control unit program, since progress cannot be displayed on the screen, the ROM update process is determined when the LED of the [Start] key changes from red to green.

Firmware update end screen

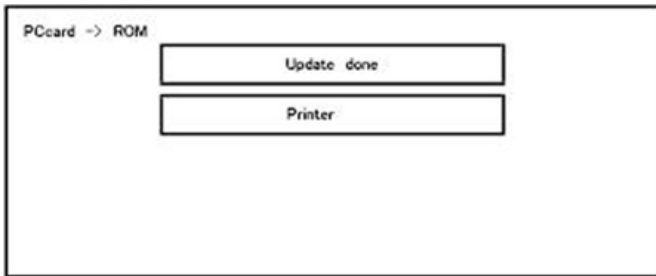

- This screen is displayed when all selected firmware modules are to be updated. "printer" in the second row shows that the module updated last is the printer. (When more than one are updated simultaneously, only what was updated last is displayed.)
- When Verify has completed normally, the Update done display of the above screen is "Verify done." If "Verify Error" is displayed, reinstall the software of the application displayed in the lower row.

5

11. After switching power OFF, remove the SD card.
12. Again, switch the power ON, and check whether the machine is operating normally.
13. Return the SD card slot cover to the original position.

↓ Note

- When the power supply is switched OFF during firmware update, update is interrupted, and the power is switched ON again, normal operation cannot be guaranteed.
- To guarantee operation, an update error continues to be displayed until update is successful.
- In this case, insert the SD card again, switch the power ON, and continue download of firmware from the SD card automatically.
- Web access card software: EXJS (EXtended Java Script) is a Type-C ESA application, and like a conventional Web access card, update using an sdk folder is required.
- The PS3 firmware program is included in the preinstalled PDF firmware.
- In the default state, although the PS3 firmware program is hidden in the disabled state, the function is enabled by installing the PS3 card.
- (The program installed in the PS3 card is a dongle (key) for enabling PS3 function).
- Due to the above specification, the self-diagnosis result report shows the ROM module number / software version of the PDF firmware at the PS location.

Error Screens During Updating

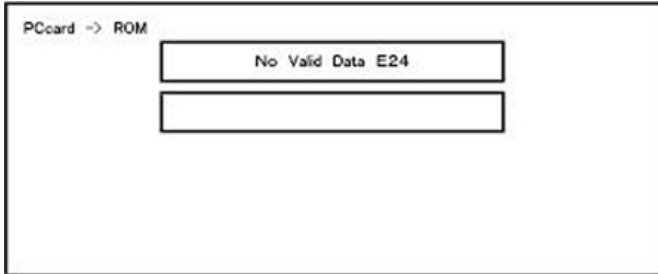

EXX shows an error code.

(This error is generated if update was performed when a printer application startup card is removed after system startup. An error indicating failure of card access is displayed on the screen.)

For error codes, refer to the following table:

Error Code List

Code	Contents	Solutions
20	Physical address mapping cannot be performed.	<ul style="list-style-type: none"> • Switch the main power supply off and on to try again. • Re-insert the SD card to reboot it. • Replace the controller board if the above solutions do not solve the problem.
21	Insufficient memory for the download	<ul style="list-style-type: none"> • Switch the main power supply off and on to try again. • Replace the controller board if the updating cannot be done by switching the power off and on.
22	Decompression of compressed data failed.	<ul style="list-style-type: none"> • Switch the main power supply off and on to try again. • Replace the SD card used for the update. • Replace the controller board if the above solutions do not solve the problem.

Code	Contents	Solutions
24	SD card access error	<ul style="list-style-type: none"> • Re-insert the SD card. • Switch the main power supply off and on to try again. • Replace the SD card used for the update. • Replace the controller board if the above solutions do not solve the problem.
32	<p>The SD card used after download suspension is incorrect.</p> <p>SD cards are different between the one which was inserted before power interruption and the one which was inserted after power interruption.</p>	<ul style="list-style-type: none"> • Insert the SD card containing the same program as when the firmware update was suspended, and then switch the main power supply off and on to try again. • There is a possibility that the SD card is damaged if the update cannot be done after the correct SD card has been inserted. In this case, try again with a different SD card. • Replace the controller board if the above solutions do not solve the problem. Replace all relevant boards if the update is done for the BCU and FCU. Replace the operation panel unit if the update is done for the operation panel.
33	<p>Card version error.</p> <p>The wrong card version is downloaded.</p>	<ul style="list-style-type: none"> • Install the correct ROM update data for each version in the SD card.
34	<p>Destination error.</p> <p>A card for the wrong destination is inserted.</p>	<ul style="list-style-type: none"> • Install the correct ROM update data for each destination (JPN/ EXP/ OEM) in the SD card.
35	<p>Model error.</p> <p>A card for the wrong model is inserted.</p>	<ul style="list-style-type: none"> • Install the correct ROM update data for each model in the SD card.

Code	Contents	Solutions
36	<p>Module error.</p> <p>The program to be downloaded does not exist on the main unit.</p> <p>The download destination specified by the card does not match up to the destination for the main unit's program.</p>	<ul style="list-style-type: none"> • Install the program to be updated in advance. • There is a possibility that the SD card containing the program to be updated has not been mounted. Check to confirm that the SD card has been correctly mounted. • The SD card is incorrect if the program to be updated has been correctly installed. In this case, insert the correct SC card.
38	<p>The version of the downloaded program has not been authorized for the update.</p>	<ul style="list-style-type: none"> • Make sure that the program to be overwritten is the specified version.
40	<p>Engine download fails.</p>	<ul style="list-style-type: none"> • Switch the main power supply off and on to try again. • If the download fails again, replace the controller board and the BCU.
41	<p>Fax download fails.</p>	<ul style="list-style-type: none"> • Switch the main power supply off and on to try again. • If the download fails again, replace the controller board and the FCU board.
42	<p>Control panel / language download fails.</p>	<ul style="list-style-type: none"> • Switch the main power supply off and on to try again. • If the download fails again, replace the controller board and the operation panel unit.
43	<p>Printing download fails.</p>	<ul style="list-style-type: none"> • Switch the main power supply off and on to try again. • The SD card media is damaged if the update fails again. Replace the SD card media.

Code	Contents	Solutions
44	The data to be overwritten cannot be accessed when controller-related programs are downloaded.	<ul style="list-style-type: none"> • Switch the main power supply off and on to try again. • Install the correct ROM update data in the SD card. • Replace the controller board if the data to be overwritten is contained on the controller board.
49	Firmware updates are currently prohibited.	<ul style="list-style-type: none"> • The setting of Update Firmware in the Administrator Tools has been set to [Prohibit] by an administrator. Amend the setting to [Do not Prohibit] and try again.
50	The results of the electronic authorization check have rejected the update data.	<ul style="list-style-type: none"> • Install the correct ROM update data in the SD card.
57	@Remote is not connected at the date/time reserved for receiving the package firmware update from the network.	<ul style="list-style-type: none"> • Check the @Remote connection.
58	Update cannot be done due to a reception route problem.	<ul style="list-style-type: none"> • Check the @Remote connection.
59	HDD is not mounted.	<ul style="list-style-type: none"> • Check the HDD connection.
60	HDD could not be used during the package firmware update.	<ul style="list-style-type: none"> • Try again. • Replace the HDD if the download fails again.
61	The module ID for the package firmware update is incorrect.	<ul style="list-style-type: none"> • Prepare the correct package files.
62	The configuration of the package firmware update files is incorrect.	<ul style="list-style-type: none"> • Prepare the correct package files.
63	Reception fails due to the power off at the reserved date/time of the remote firmware update from the network.	<ul style="list-style-type: none"> • Update is to be done automatically when the next reception time has elapsed.

Code	Contents	Solutions
64	Reception fails due to the power off at the reserved date/time of the package firmware update from the network.	<ul style="list-style-type: none"> Reset the reservation date/time for the remote update.
65	Reception fails due to the status error of the machine at the reserved date/time of the remote firmware update from the network.	<ul style="list-style-type: none"> Update is to be done automatically when the next reception time has elapsed.
66	Reception failed due to the status error of the machine at the reserved date/time of the package firmware update from the network.	<ul style="list-style-type: none"> Reset the reservation date/time for the remote update.
67	Acquisition of the latest version information from the Gateway fails at the reserved date/time of the remote firmware update from the network.	<ul style="list-style-type: none"> Check that the network is connected correctly.
68	Acquisition of the latest version information from the Gateway fails.	<ul style="list-style-type: none"> Check that the network is connected correctly.
69	Download fails at the reserved date/time of the remote firmware update from the network.	<ul style="list-style-type: none"> Check that the network is connected correctly.
70	Package firmware download from the network fails.	<ul style="list-style-type: none"> Check that the network is connected correctly.
71	Network communication error occurs at the reserved date/time of the package firmware update from the network.	<ul style="list-style-type: none"> Check that the network is connected correctly.
72	The setting of @Remote is invalid at the reserved date/time of the package firmware update from the network.	<ul style="list-style-type: none"> Set the setting of @Remote Service in the Administrator Tools to [Do not Prohibit].

Code	Contents	Solutions
57	@Remote is not connected at the date/time reserved for receiving the package firmware update from the network.	<ul style="list-style-type: none"> • Check the @Remote connection.
58	Update cannot be done due to a reception route problem.	<ul style="list-style-type: none"> • Check the @Remote connection.
59	HDD is not mounted.	<ul style="list-style-type: none"> • Check the HDD connection.
60	HDD could not be used during the package firmware update.	<ul style="list-style-type: none"> • Try again. • Replace the HDD if the download fails again.
61	The module ID for the package firmware update is incorrect.	<ul style="list-style-type: none"> • Prepare the correct package files.
62	The configuration of the package firmware update files is incorrect.	<ul style="list-style-type: none"> • Prepare the correct package files.
63	Reception fails due to the power off at the reserved date/time of the remote firmware update from the network.	<ul style="list-style-type: none"> • Update is to be done automatically when the next reception time has elapsed.
64	Reception fails due to the power off at the reserved date/time of the package firmware update from the network.	<ul style="list-style-type: none"> • Reset the reservation date/time for the remote update.
65	Reception fails due to the status error of the machine at the reserved date/time of the remote firmware update from the network.	<ul style="list-style-type: none"> • Update is to be done automatically when the next reception time has elapsed.
66	Reception failed due to the status error of the machine at the reserved date/time of the package firmware update from the network.	<ul style="list-style-type: none"> • Reset the reservation date/time for the remote update.

Code	Contents	Solutions
67	Acquisition of the latest version information from the Gateway fails at the reserved date/time of the remote firmware update from the network.	<ul style="list-style-type: none"> Check that the network is connected correctly.
68	Acquisition of the latest version information from the Gateway fails.	<ul style="list-style-type: none"> Check that the network is connected correctly.
69	Download fails at the reserved date/time of the remote firmware update from the network.	<ul style="list-style-type: none"> Check that the network is connected correctly.
70	Package firmware download from the network fails.	<ul style="list-style-type: none"> Check that the network is connected correctly.
71	Network communication error occurs at the reserved date/time of the package firmware update from the network.	<ul style="list-style-type: none"> Check that the network is connected correctly.
72	The setting of @Remote is invalid at the reserved date/time of the package firmware update from the network.	<ul style="list-style-type: none"> Set the setting of @Remote Service in the Administrator Tools to [Do not Prohibit].

↓ Note

- The PDF firmware installed as standard contains a program required to print PS3 data as default. However, this PS3 program is normally disabled.
- The PS3 firmware is a dongle (key) which enables PS3 data printing functions. When the PS3 firmware is installed, the PS3 program in the PDF firmware is enabled. Due to this specification, the self-diagnosis result report shows the ROM part number/software version of the PDF firmware contained in the PS3 program.

RFU Updating the Firmware

In this machine, software can be updated by remote control using @Remote.

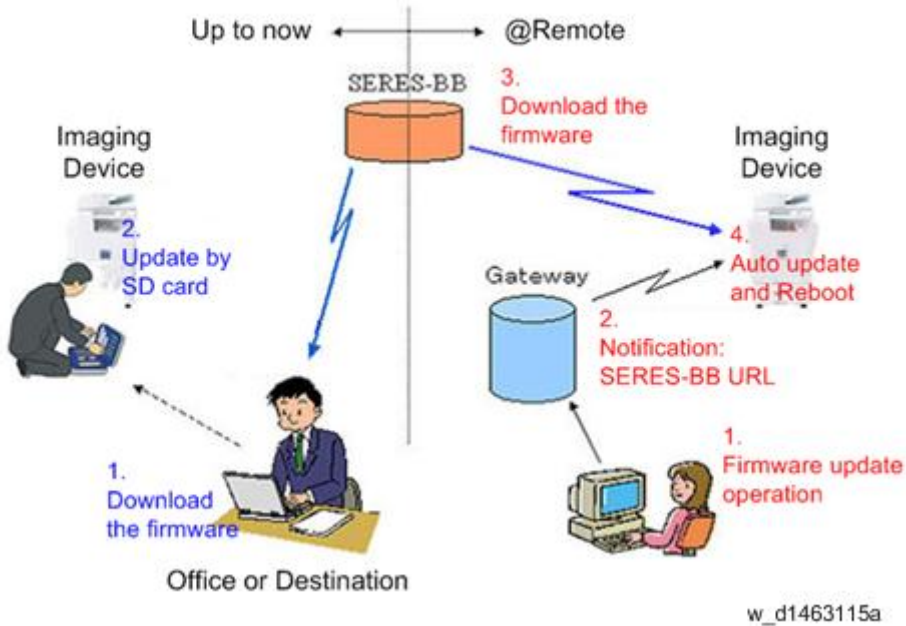

5

RFU Performable Condition

RFU is performable for a device which meets the following conditions.

1. The customer consents to the use of RFU.
2. The device is connected to a network via TCP/IP for @Remote.

Package Firmware Update

⚠ CAUTION

- The HDD unit must be installed on the machine to enable the SFU or the package firmware update via SD card.

Overview

Each firmware module (such as System/Copy, Engine, etc) used to be updated individually. However, an all-inclusive firmware package (package_ALL) is now available.

There are two ways to update using the firmware package.

- Package Firmware Update via a network: SFU (Smart Firmware Update)
- Package Firmware Update with an SD card

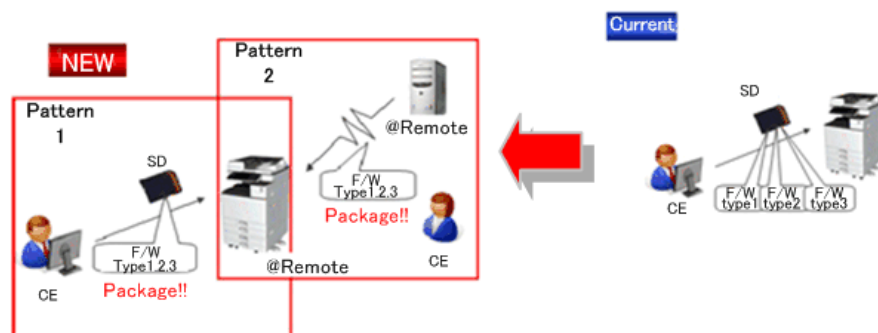

w_d176f2130

Package Firmware Update via a network: SFU (Smart Firmware Update)

- There are two methods for SFU.
 - Immediate Update: To update the firmware when visiting
 - Update at the next visit: To set the date and time for downloading. The firmware will be automatically downloaded beforehand and updated at the following visit.
- “Update at the next visit” is recommended since firmware download may take some minutes due to the network condition.

↓ Note

- SFU requires the connection to @Remote via a device which has the embedded @Remote communicating function. When a machine is connected to @Remote via an intermediate device (RC Gate), the SFU function is disabled.

Package Firmware Update via an SD Card

Package firmware update can also be performed using the conventional SD card method by writing the package firmware directly to the SD card.

Types of firmware update files, supported update methods:

	SFU	SD	RFU
Individual firmware	N/A	Available	Available
Package firmware	Available	Available	N/A

Immediate Update

Enter the [Firmware Update] menu in the SP mode and update the package firmware.

Note

- The [Firmware Update] button will appear even when a machine is connected to @Remote with a device which does not have an embedded @Remote communicating function.
- If an error code is displayed, refer to Error Screens During Updating (p.599).

1. Enter the SP mode.
2. Touch [Firmware Update].

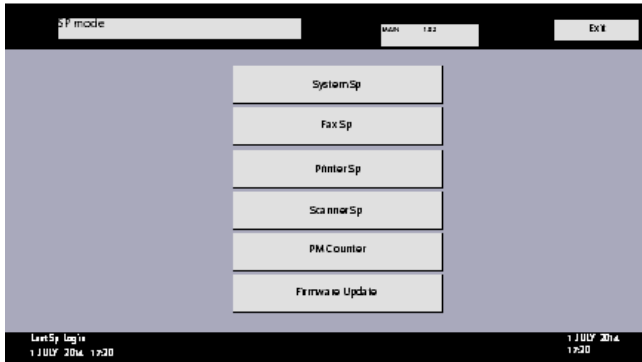

d197f0507

3. Touch [Update].

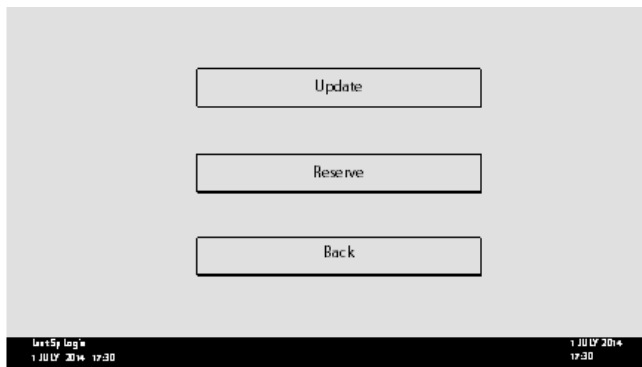

d197f0508

4. Touch [Execute Update].

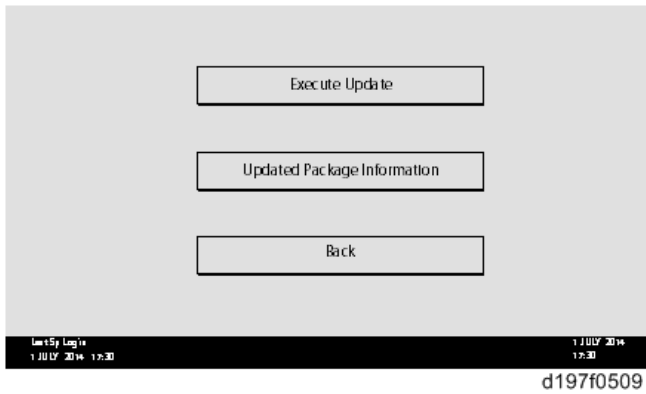

5. Touch [YES].

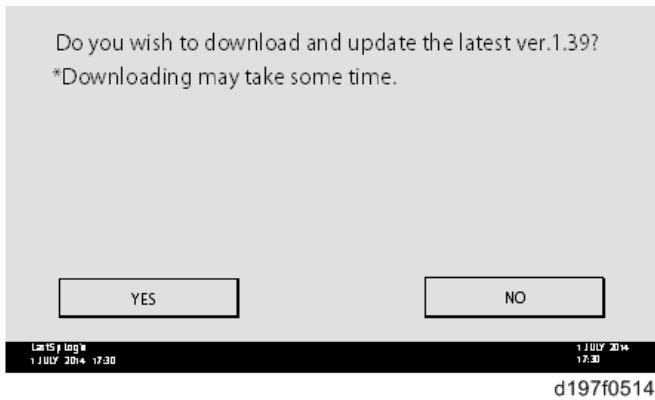

6. The following display will be displayed.

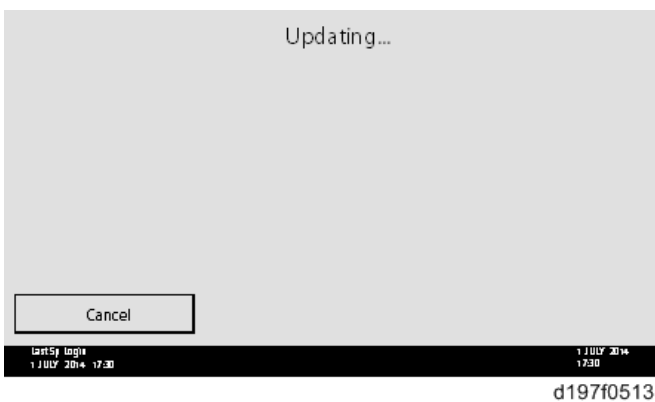

↓ Note

- If the error code E66, which indicates that the download of the firmware has failed, is displayed, implement this procedure from step 1.

- Update will be started automatically after the download is finished.
- When the machine is in the update mode, the automatic update is suspended if a print job is implemented. After the print job is finished, touch [YES] on the display shown with the following picture to restart updating.

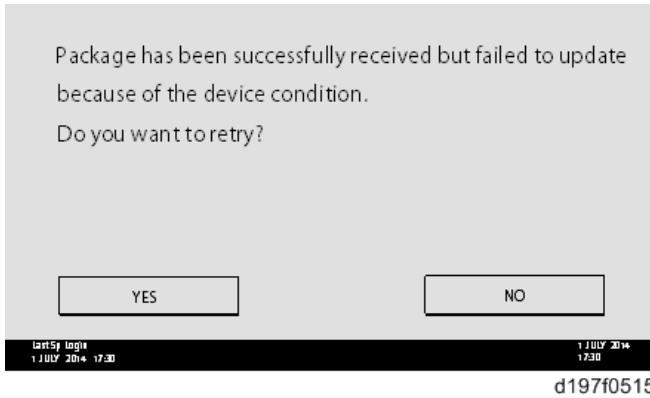

5

7. [Update done] is displayed.

- The machine will automatically reboot itself.

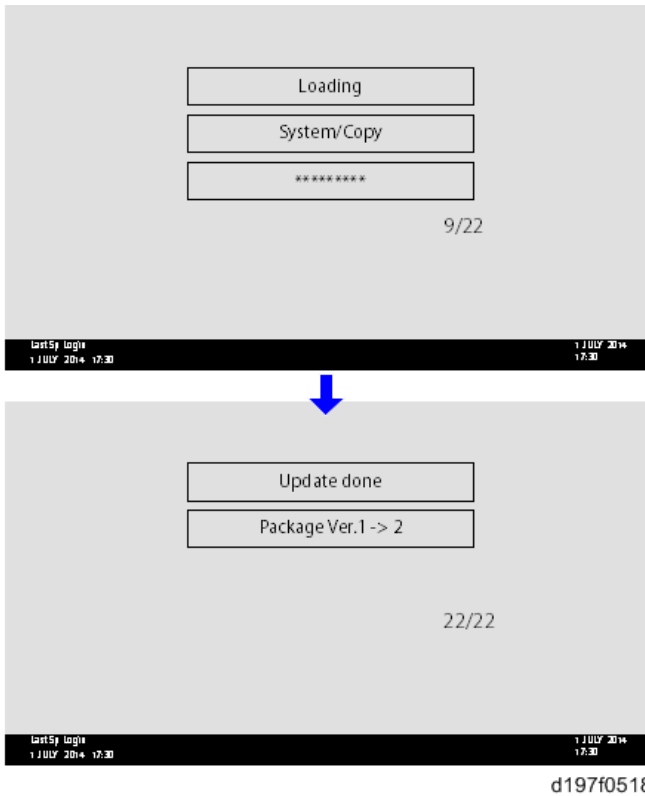

↓ Note

- The figures at the lower right of the display indicate “Number of updated items/ All items to be updated”.

Update at the Next Visit (Reserve)

It is possible to set the machine to download the package firmware which is necessary for SFU in advance, and then perform the actual installation at the next service visit. This saves waiting time for the firmware to download at the service visit.

How to Set the Machine to Download Firmware Later (RESERVE)

Enter the [Firmware Update] menu in the SP mode and update the package firmware.

↓ Note

- The [Firmware Update] button will appear even when a machine is connected to @Remote with a device which does not have an embedded @Remote communicating function. If an error code is displayed, refer to Error Screens During Updating (p.599).

1. Enter the SP mode.
2. Touch [Firmware Update].

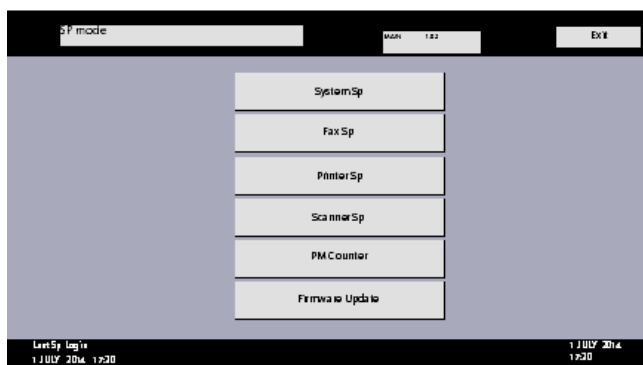

d197f0507

3. Touch [Reserve].

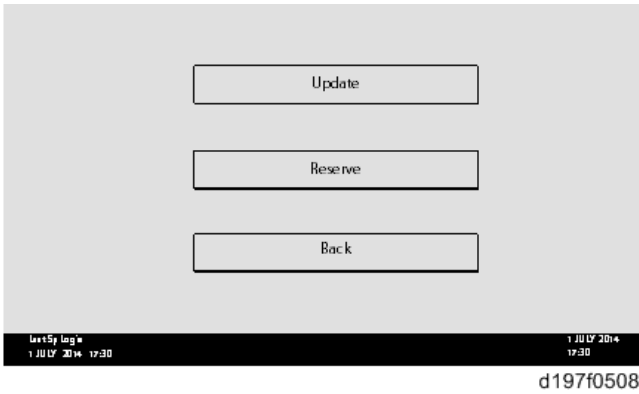

4. Touch [Reservation setting].

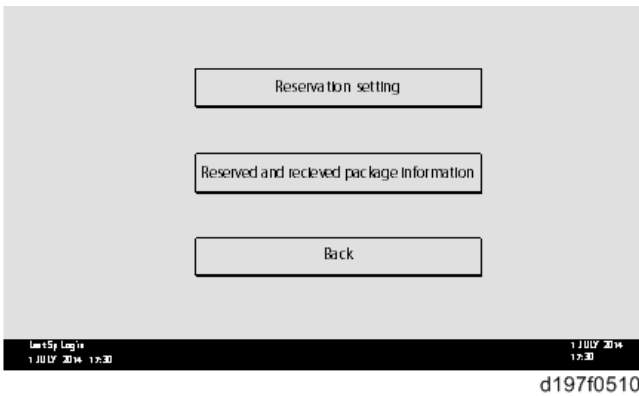

5. Enter the dates and times of next visit and start of receiving data.

- "Next time to visit this customer": The package firmware will be automatically downloaded by this time/date.
- "When to receive? (1-7)": The download of the package firmware will begin this number of days before the next visit.

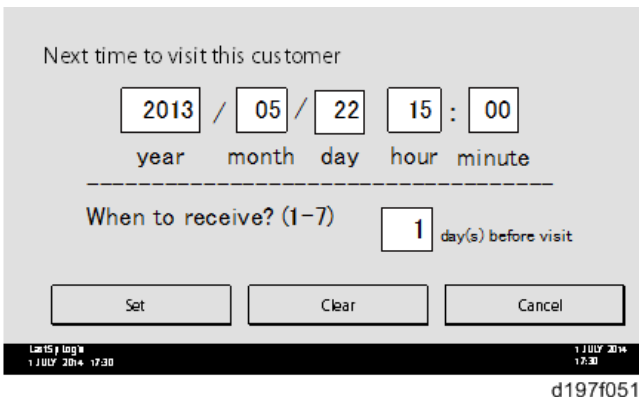

Successful Download

In the two diagrams below, the firmware is set to be downloaded by the day before the next scheduled visit. In the first diagram, the download is successful on the first try. In the second diagram, the download fails three times and is successful on the fourth try.



- If the firmware download fails or cannot be completed due to the network settings/condition, no power to the machine, or other reason, the machine will continue retrying every six hours until the scheduled deadline (up to a maximum of four tries). For example, if the download is set for the day before the next visit, the machine will attempt the download at 24 hours before the visit, and then continue trying every six hours (max. four tries total).
- The retry is only performed in cases when the firmware download has failed.
- If the machine is in Energy Saver mode when the download is scheduled to begin, the download will be performed in the background and the machine/panel will stay in Energy Saver mode.
- The download will continue uninterrupted even if the customer initiates a print job, copy job, fax receiving or other operation while the download is in progress.
- The download will be terminated if the customer turns the power off while the download is in progress.
- If the download cannot be completed successfully by the time of the next scheduled visit, the machine will stop trying to download the firmware.

How to Check if the Firmware Downloaded with RESERVE

1. Enter the SP mode.

2. Touch [Firmware Update].

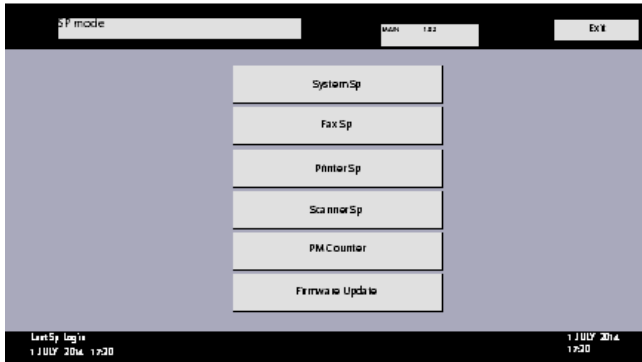

d197f0507

3. Touch [Reserve].

5

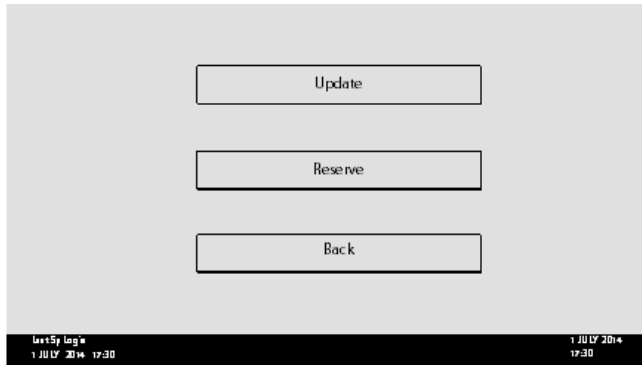

d197f0508

4. Touch [Reserve and received package information].

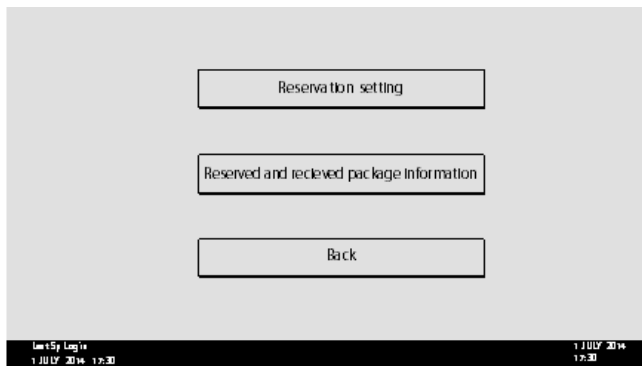

d197f0510

5. Check the information displayed.

When the package firmware is downloaded successfully, the details of the download result are displayed as the following picture shows.

Reservation reception result	Success
Part number of reserved and received package	D1234567
Version of reserved and received package	1.35
Package received date	2014/05/22
Reservation reception has succeeded. You may start the update.	Back

Lenovo Logo 1 JULY 2014 17:30 1 JULY 2014 17:30

d197f0511

↓ Note

- This information will only be displayed if the reserved firmware has already been downloaded. If not, all the data items are indicated with “-”.

5

How to Install Firmware Downloaded with RESERVE

1. Enter the SP mode.
2. Touch [Firmware Update].

The screenshot shows a menu titled "SP mode" with a "Back" button at the top left and an "Exit" button at the top right. The main menu contains the following options:

- System Sp
- Fax Sp
- Printer Sp
- Scanner Sp
- PM Counter
- Firmware Update

Lenovo Logo 1 JULY 2014 17:30 1 JULY 2014 17:30

d197f0507

3. Touch [Update].

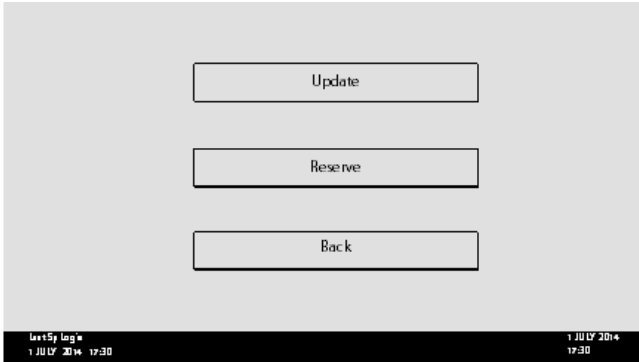

d197f0508

4. Touch [Execute Update].

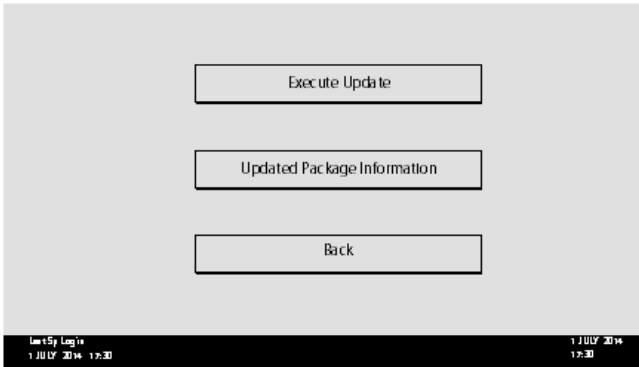

d197f0509

5. Check the version of the received package firmware, and then touch [YES].

- Update is started.

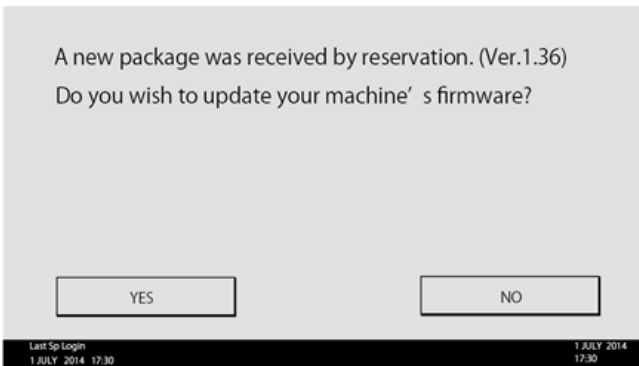

d197f0516

Note

- If the version of the reserved package in the HDD is older than the latest version, the messages shown in the following picture are displayed.

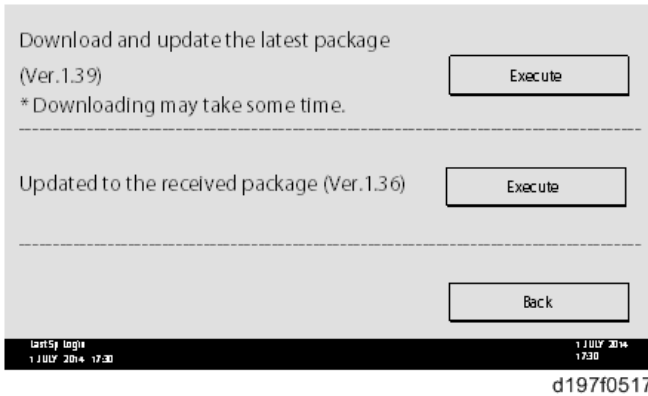

- If you wish to download the latest version, touch [Execute] beside the message “Download and update the latest package.” Then update of the package firmware will be started.
- If you wish to update using the firmware in the HDD (old version), touch [Execute] beside the message “Update to the received package.”

6. [Update done] message is displayed.

- The machine will automatically reboot itself.

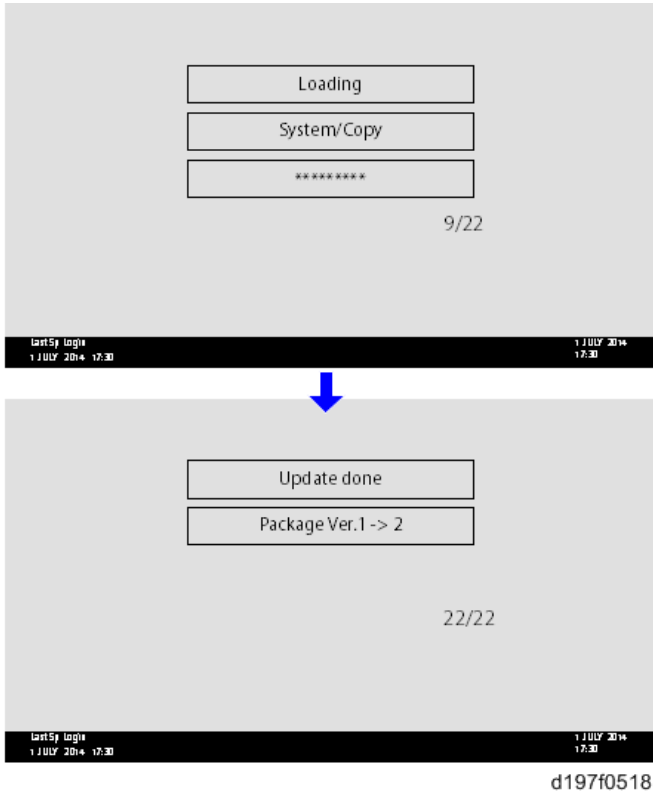

↓ Note

- The figures at the lower right of the display indicate “Number of updated items/ All items to be updated”.

Update via SD card

Update with an SD card, which is the conventional method, is available if you write the package firmware to the SD card.

↓ Note

- If an error code is displayed, refer to Error Screens During Updating (p.599).
1. Create a new folder in the SD card, and then name it “package”.

2. Copy the package firmware (xxxxxxx.pkg) to this folder.

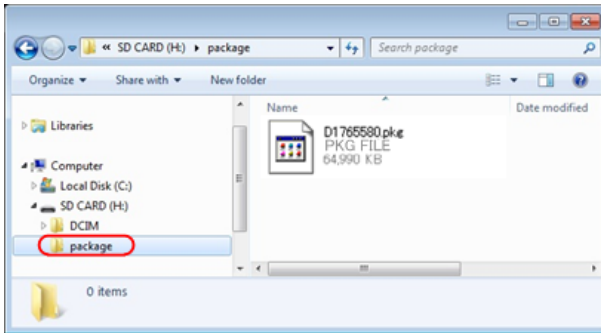

d197f0504

★ Important

- If you copy the package firmware into the conventional "romdata" folder, the update will not work.
- Only one version of the package firmware should be copied into the folder. If you copy multiple versions of package firmware to the SD card, the machine will select only one version of the firmware randomly.

3. Turn the power OFF.

4. Insert the SD card which contains the package into SD card slot 2 (for service).

5. Turn the power ON and touch [Update].

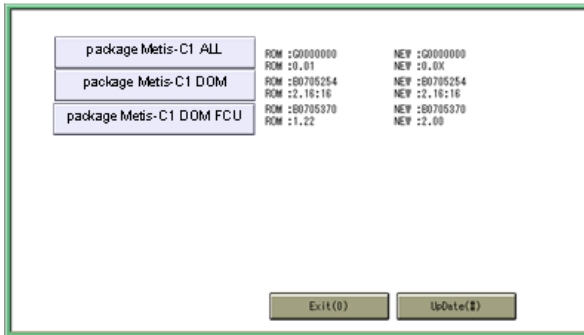

d176f2127

↓ Note

- When the SD card contains both a firmware package and one or more modules, the following display may show up. Select [Package] and touch [OK] to move to step 4 above.

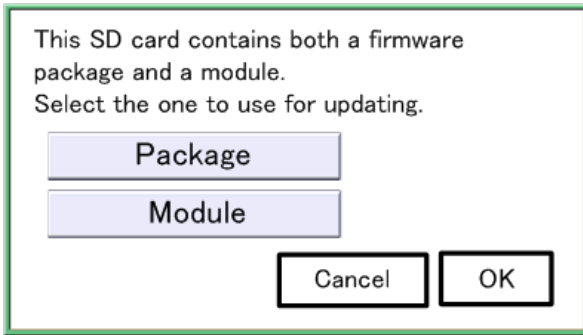

d176f2128

- Update is started automatically after the package firmware download to the HDD has been completed.
- When update is completed, "Update done" is displayed.

5

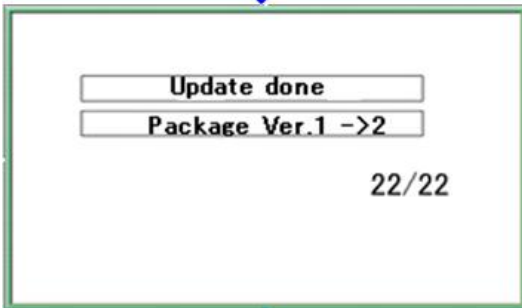
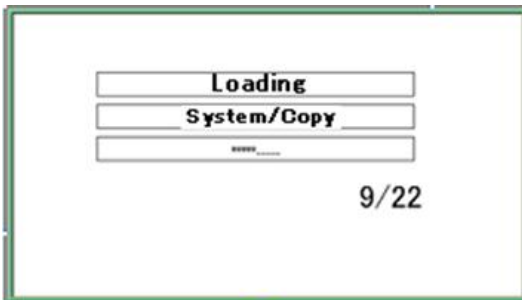

w_d177z0021a

Note

- The figures at the lower right of the display indicate "Number of updated items/ All items to be updated".

- Turn the main power switch OFF, and then pull out the SD card from SD card slot 2.
- Turn the power ON.

Updating JavaVM

Creating an SD Card for Updating

1. Download the update modules from Firmware Download Center. As one of the model modules, "Java VM v11 UpdateTool" is available for download. (The version differs depending on the model.)
2. Unzip the downloaded file. Copy the whole "sdk" folder to the root of the SD card directly below.

Note

- When unzipping the downloaded file, two subfolders ("update" and "sdk") exist in the "sdk" folder. Rather than just copying the subfolder "sdk", copy the whole folder "sdk".

Updating Procedure

CAUTION

- SD card can be inserted with the machine power off.
 - During the updating process, do not turn off the power.
 - If you turn off the power during the updating, the machine performance is not guaranteed. (There is a possibility that an SC and boot failure occurs.)
 - If you accidentally turn off the power during the updating, retry the updating procedure from the beginning. (If the update fails again, you will need to replace the controller board.)
1. If the boot priority application is set to the ESA application, switch to the copy application. ([System Settings]-[General Features]-[Function Priority])
 2. Insert the SD card you created into the service slot, and then turn ON the main power switch.
 3. Take a note of the current Heap size. ([Extended Feature Settings] – [Administrator Tools] – [Heap/Stack Size Settings])
The Heap size setting is changed to the initial setting when updating.
 4. Turn OFF the main power.
 5. Insert the SD card for update into the service slot.
 6. Turn ON the main power.
 7. After booting Java VM, update of the application is started. "Updating SDK/J" appears in the banner message of the touch panel display. (Estimated time: about 2 minutes)

8. After completing the update and starting the Java VM, "Update SDK / J done SUCCESS" appear in the banner message of the touch panel display. After turning off the power, remove the SD card from the slot.

When you fail to update, "Update SDK/J done FAIL" is displayed. You can confirm the cause of the error message below.

9. Turn ON the main power.
10. Reconfigure the Heap size. ([Extended Feature Settings]-[Administrator Tools]-[Heap/ Stack Size Settings]).

See the manual for the ESA application to know what value to set for the heap size.

11. Return to the previous setting for the boot priority application.

List of Error Messages

5

Update results are output as a text file on the SD card called "sdkjversionup.log" in the "\sdk \update" folder.

Result	File contents	Description of the output
Success	script file = /mnt/sd0/sdk/update/ bootscript 2012/08/22 17:57:47 start 2012/08/22 17:59:47 end SUCCESS	Boot script path Boot scripts processing start time End time boot script processing, the results
Failure	script file = /mnt/sd0/sdk/update/ bootscript 2012/08/22 17:57:47 start XXXX Error 2012/08/22 17:57:57 end FAIL	Boot script path Boot scripts processing start time Error message (Possibly multiple) End time boot script processing, the results

Error Message	Cause	Remedy
PIECEMARK Error,machine=XXXXX	Applied the wrong updating tool (Using the updating tool of a different model)	Use the correct updating tool for this model.
pasePut() - error : The file of the copy origin is not found Put Error!	Inadequacy with the SD card for updating (Files are missing in the updating tool)	Re-create the SD card for updating.

Error Message	Cause	Remedy
<p>paseCopy() - error : The file of the copy origin is not found.</p> <p>Copy Error!</p>	<p>Inadequacy SD card for updating</p> <p>(Files in the updating tool are missing)</p>	<p>Inadequacy SD card for updating</p> <p>(Files in the updating tool are missing)</p>
<p>[file name: XX] error, No space left on device</p> <p>pasePut() - error : The destination directory cannot be made.</p> <p>pasePut() - error : fileCopy Error.</p> <p>Put Error!</p>	<p>Writing destination is full. (The NAND flash memory on the controller board is full.)</p>	<p>Uninstall the unnecessary SDK applications.</p> <p>If you can not uninstall it, implement escalation, stating the "model name, application configuration, SMC sheet (SP5-990-006/024/025), and error file."</p>
<p>[file name: XX] error, No space left on device</p> <p>paseCopy() - error : The destination directory cannot be made.</p> <p>paseCopy() - error : fileCopy Error.</p> <p>Copy Error!</p>	<p>Writing destination is full. (The NAND flash memory on the controller board is full.)</p>	<p>Uninstall the unnecessary SDK applications.</p> <p>If you can not uninstall it, implement escalation stating the "model name, application configuration, SMC sheet (SP5-990-006/024/025), and error file."</p>
<p>Put Error! * 1</p> <p>Copy Error! * 1</p> <p>Delete Error!</p> <p>[XXXXX] is an unsupported command.</p> <p>Version Error</p>	<p>Error, not normally expected to occur</p>	<p>If you cannot uninstall it, implement escalation stating the "model name, application configuration, SMC sheet (SP5-990-006/024/025), and error file."</p> <p>* 1</p> <p>Without the foregoing error message, only "Put Error / Copy Error" will be displayed</p>

Capturing the Debug Logs

Overview

With this feature, you can save debug logs that are stored in the machine (HDD or operation panel) on an SD card. It allows the Customer Engineer to save and retrieve error information for analysis.

The Capturing Log feature saves debug logs for the following four.

- Controller debug log including operation log
- Engine debug log
- FCU debug log
- Operation panel log

★ Important

- In older models, a technician enabled the logging tool after a problem occurred. After that, when the problem had been reproduced, the technician was able to retrieve the debug log.
- However, this new feature saves the debug logs at the time that problems occur. Then you can copy the logs to an SD card.
- You can retrieve the debug logs using a SD card without a network.
- Analysis of the debug log is effective for problems caused by the software. Analysis of the debug log is not valid for the selection of defective parts or problems caused by hardware.

Types of debug logs that can be saved

Type	Storage Timing	Destination (maximum storage capacity)
Controller debug log including operation log	<ul style="list-style-type: none"> • Saved at all times 	HDD (4 GB) or SD card connected to the service slot. When the data gets over 4.0 GB, the older data is deleted.
Engine debug log	<ul style="list-style-type: none"> • When an engine SC occurs • When paper feeding/output stop by jams • When the machine doors are opened during normal operation 	HDD or SD card connected to the service slot (Up to 300 times)

Type	Storage Timing	Destination (maximum storage capacity)
FCU debug log	<ul style="list-style-type: none"> When a specified amount of FCU debug log is stored in the FCU. If fax application is unavailable (e.g. not installed), the machine does not transfer the log. 	HDD or SD card connected to the service slot
Operation panel log	<ul style="list-style-type: none"> When an error related to the operation panel occurs. 	Memory in the operation panel.

↓ **Note**

- **Debug logs are not saved in the following conditions:**
- While erasing all memory
- While data encryption equipment is installed
- While changing the firmware configuration
- Forced power OFF (accidentally disconnecting the outlet)
- Engine debug log in shutdown
- When the power supply to the HDD is off because of energy saving (engine OFF mode /STR mode)
- When one of the following SC occurs: SC672, SC816, SC819, SC878, SC899, SC859, SC860, SC861, SC863, or SC864

↓ **Note**

- **Following logs are not saved:**
- Log related to the energy saver mode (Engine-off, suspend-mode, or other cases)
- Network communication log
- Logs related to NRS
- IP-FAX log
- Access log for unauthorized user (guest)
- HTTP session timeout log
- Auto log-out log
- IC card related log
- Authorization for Fax

Security of the Operation Log

The following operation logs related to security are not saved.

- User ID
- Password
- IP address
- Telephone number
- Encryption key
- Transition to SP mode

Retrieving the Debug Logs

★ Important

- Retrieve debug logs to identify the date of occurrence of the problems and to find details of the problems
- e.g.: At around 8:00 am on March 10, an engine stall occurred. The operation panel does not respond. Turn the main power supply off / on.
- Analysis of the debug log is effective for problems caused by the software. Analysis of the debug log is not valid for the selection of defective parts or problems caused by hardware.

Procedure for Retrieving the Debug Log with SD Card

1. Insert the SD card into the slot on the side of the operation panel or the service slot.

★ Important

- It is recommended to use the SD card provided as a service part. This is because the log data can be acquired much faster than when using commercially available SD cards.

2. Enter SP mode.
3. Execute SP5-858-141 (Acquire All Debug Logs) to write the debug log to the SD card.

If the transfer is finished successfully, 'completed' is displayed on the touch panel display.

↓ Note

- The approximate time it takes to transfer the debug log is as follows. Transfer time may be affected by the type or format of the SD card. (It is recommended that you format the SD card using the Panasonic SD Formatter (freeware)).
- Controller debug log (GW debug log): 2 - 20 minutes
- Engine debug log: 2 minutes
- Operation panel debug log: 2 - 20 minutes

4. Make sure that the SD card access LED is off, then remove the SD card.

Note

- If 'failed' appears on the touch panel display, turn the power off, and then recover from step 1 again.

The debug logs are saved with the following file names.

Controller debug log (GW debug log)	/LogTrace/[Machine Serial]/watching/[yyyymmdd_hhmmss]_[UniqueID].gz
Engine debug log	/LogTrace/[Machine Serial]/engine/[yyyymmdd_hhmmss].gz
FCU debug log	/LogTrace/[Machine Serial]/fcu/[yyyymmdd_hhmmss].gz

Reboot/System Setting Reset

System Settings and Copy Setting Reset

System Setting Reset

The system settings in the UP mode can be reset to their defaults. Use the following procedure.

1. Touch [Home] at the bottom of the screen in the center.
2. Flick the screen to the left, and then touch the User Tools icon.
3. Touch [Machine Features].
4. Hold down  and then press [System Settings].

Note

- Press  first.

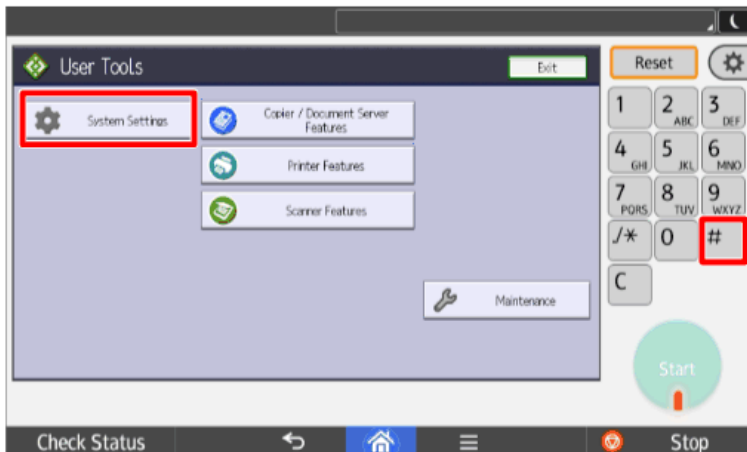

d262k8534

5. Touch "Yes" when the message prompts you to confirm that you want to reset the system settings.
6. Touch [exit] when the message tells you that the settings have been reset.

Copier Setting Reset

Use the following procedure to reset the copy settings in the UP mode to their defaults.

1. Touch [Home] at the bottom of the screen in the center.
2. Flick the screen to the left, and then touch the User Tools icon.

3. Touch [Machine Features].

4. Hold down $\#$ and then press [Copier/Document Server Features].

Note

- Press $\#$ first.

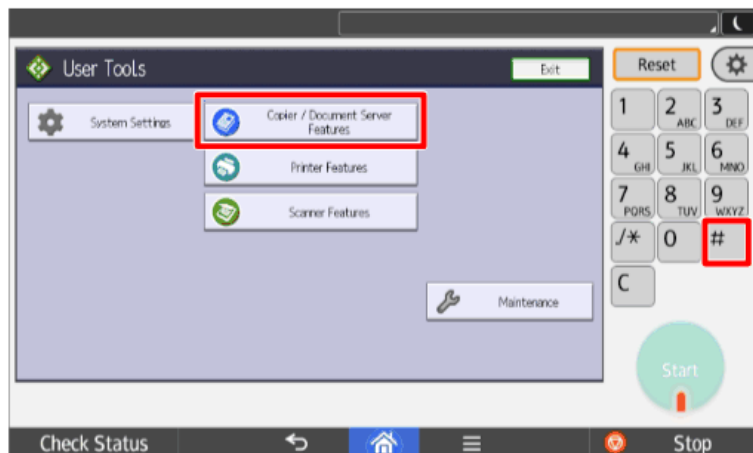

d262k8535

5. Touch [Yes] when the message prompts you to confirm that you want to reset the Copier Document Server settings.

6. Touch [exit] when the message tells you that the settings have been reset.

NVRAM Data Upload/Download

Uploading Content of NVRAM to an SD card

Do the following procedure to upload SP code settings from NVRAM to an SD card.

Note

- This data should always be uploaded to an SD card before the NVRAM is replaced.
 - Make sure that the write protection of an SD card is unlocked.
1. Do SP5-990-001 (SP Print Mode: All (Data List)) before you switch the machine off. You will need a record of the NVRAM settings if the upload fails.
 2. Switch the copier main power switch off.
 3. Remove the SD slot cover [A]. ( × 1)

5

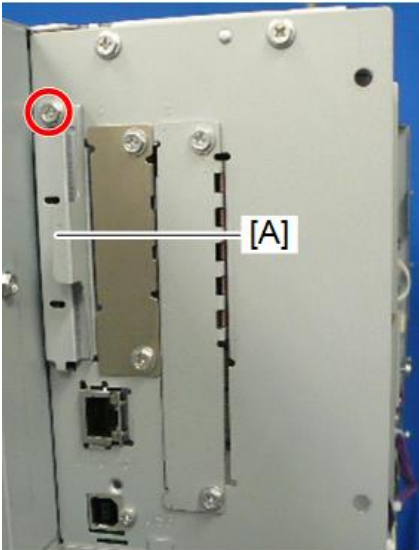

d262k2005

4. Insert the SD card into SD card slot 2 (lower) [A].

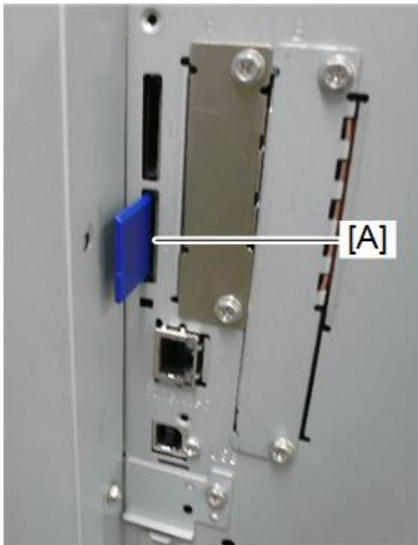

d262k2006

5

5. Switch the copier on.
6. Execute SP5-824-001 (NVRAM Data Upload) and then touch [EXECUTE].
7. The following files are copied to an NVRAM folder on the SD card when the upload procedure is finished. The file is saved to the path and the following filename:

NVRAM**<serial number>.NV**

Here is an example with Serial Number "K5000017114":

NVRAM\K5000017114.NV

8. In order to prevent an error during the download, be sure to mark the SD card that holds the uploaded data with the number of the machine from which the data was uploaded.

Note

- You can upload NVRAM data from more than one machine to the same SD card.

Downloading an SD Card to NVRAM

Do the following procedure to download SP data from an SD card to the NVRAM in the machine.

- The NVRAM data download may fail if the SD card with the NVRAM data is damaged, or if the connection between the controller and BCU is defective.
- Do the download procedure again if the download fails.
- Do the following procedure if the second attempt fails:

- Enter the NVRAM data manually using the SMC print you created before uploading the NVRAM data.
1. Switch the copier main power switch off.
 2. Remove the SD slot cover. ( × 1)
 3. Insert the SD card with the NVRAM data into SD Card Slot 2 (lower).
 4. Switch the copier main power switch on.
 5. Do SP5-825-001 (NVRAM Data Download) and touch [EXECUTE].

 **Note**

- The serial number of the file on the SD card must match the serial number of the machine for the NVRAM data to download successfully. The download fails if the serial numbers do not match.

This procedure does not download the following data to the NVRAM:

- Total Count
- C/O, P/O Count

Address Book Upload/Download

Information List

The following information is possible to be uploaded and downloaded.

Information	
<ul style="list-style-type: none"> • Registration No. • User Code • E-mail • Protection Code • Fax Destination • Fax Option • Group Name • Key Display 	<ul style="list-style-type: none"> • Select Title • Folder • Local Authentication • Folder Authentication • Account ACL • New Document Initial ACL • LDAP Authentication

Download

1. Prepare a formatted SD card.
2. Make sure that the write-protection on the SD card is off.
3. Turn off the main power switch of the main machine.

4. Remove the SD slot cover [A] at the left rear side of the machine ( × 1).

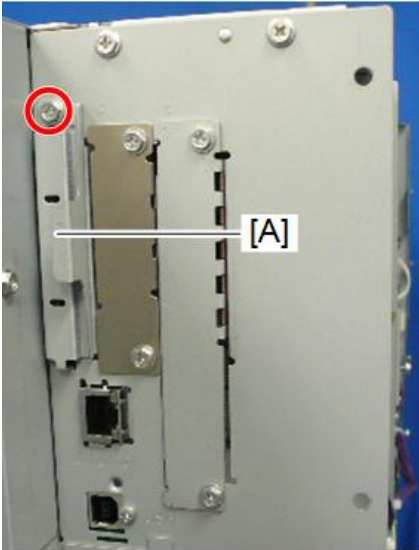

5

5. Install the SD card into the SD card slot 2 (lower) [A] (for service use).

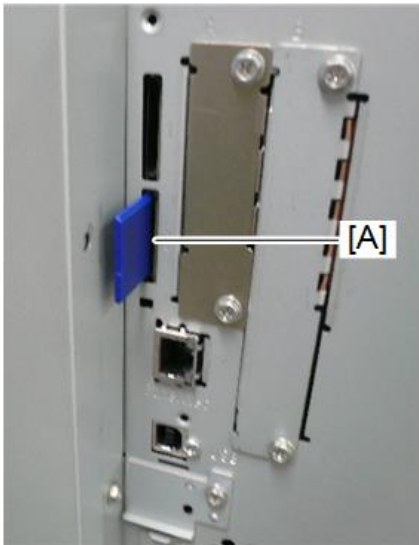

6. Turn on the main power switch.
7. Enter the SP mode.
8. Do SP5-846-051 (Backup All Addr Book).
9. Exit the SP mode, and then turn off the main power switch.
10. Remove the SD card from the SD card slot 2 (lower).

11. Install the SD slot cover.

↓ Note

- If the capacity of SD card is not enough to store the local user information, an error message is displayed.
- Carefully handle the SD card, which contains user information. Do not take it back to your location.

Upload

1. Turn off the main power switch of the main machine.
2. Remove the SD slot cover at the left rear side of the machine ( × 1).
3. Install the SD card, which has already been uploaded, into the SD card slot 2 (lower).
4. Turn on the main power switch.
5. Enter the SP mode.
6. Do SP5-846-052 (Restore All Addr Book).
7. Exit the SP mode, and then turn off the main power switch.
8. Remove the SD card from the SD card slot 2 (lower).
9. Install the SD slot cover.

↓ Note

- The counter in the user code information is initialized after uploading.
- The information of an administrator and supervisor cannot be downloaded nor uploaded.
- If there is no data of address book information in the SD card, an error message is displayed.

SMC List Card Save Function

Overview

SMC List Card Save

- The SMC List Card Save (SP Text Mode) function is used to save the SMC list as CSV files to the SD-card inserted into the operation panel SD-card slot.

Procedure

5

- Turn the main power switch OFF.
- Insert the SD card into the operation panel SD-card slot. Then turn the power ON.
- Enter SP mode.
- Select "Copy SP".

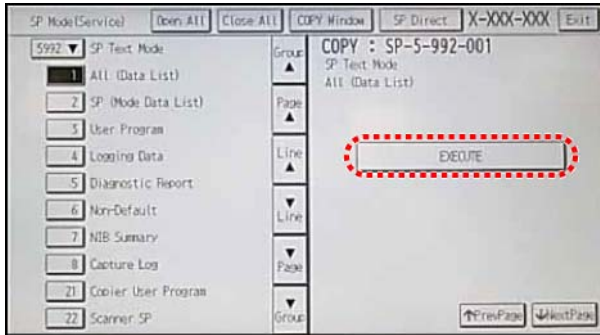

d1440127

- Select SP-5992 "SP Text Mode".
- Select a detail SP number shown below to save data on the SD card.
SP-5992-xxx (SP Text Mode)

Detail No.	SMC Categories to Save
001	All (Data List)
002	SP (Mode Data List)
003	User Program
004	Logging Data

Detail No.	SMC Categories to Save
005	Diagnostic Report
006	Non-Default
007	NIB Summary
008	Capture Log
021	Copier User Program
022	Scanner SP
023	Scanner User Program
024	SDK/J Summary
025	SDK/J Application Info
026	Printer SP

5

7. Press [EXECUTE].

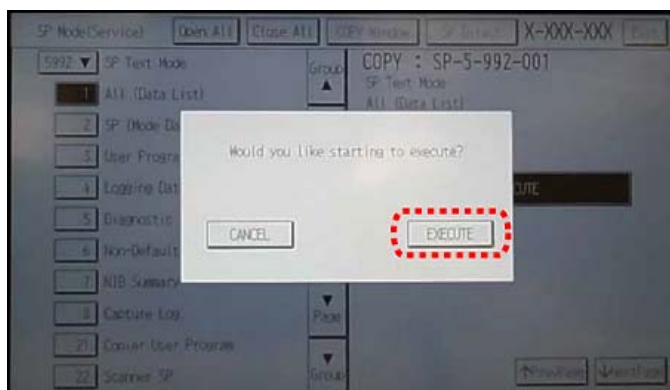

d1440128

8. Press [EXECUTE] again to start. Press [CANCEL] to cancel the saving.



d1440130

9. "It is executing it" is shown on the screen while executing.

5

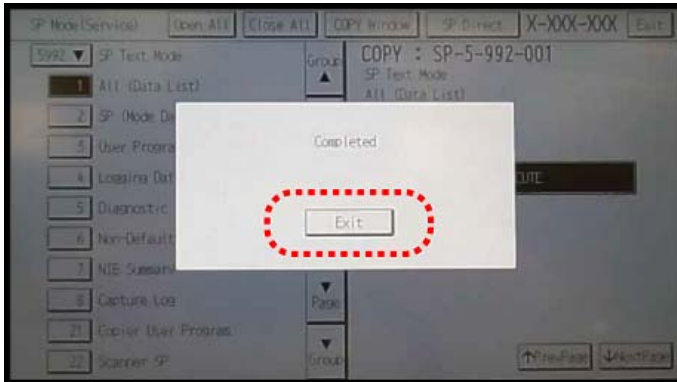

d1440129

10. Wait for 2 to 3 minutes until "Completed" is shown.

Note

- The SMC list saving may take from 2 to 3 minutes to complete.
- Press [CANCEL] to abort executing.

11. Press [Exit] to exit from SP mode.

File Names of the Saved SMC Lists

The SMC list data saved on the SD-card will be named automatically. The file naming rules are as follows.

Example:

W801P999017_59921_20111011_53954.csv



d1440131a

A:

Machine serial number (fixed for each machine)

B:

SP number saved in this file.

First four digits (5992) in this part are fixed. The other one or two digits are the detail SP number(s). In this case, it is one digit. Therefore, this file is of SP5-992-001 (All data list). See the upper SP table for the correspondence between SP detail numbers and the contents.

C:

File creation date

Year/Month/Day ("Zero" will be omitted if each is one digit.)

D:

File creation time

Hour/Minute/Second ("Zero" will be omitted if each is one digit.)

E:

File Extension CSV (Comma Separated Value)

This part is fixed.

Note

- A folder named by the machine serial number will be created on the SD card when this function is executed.
- This function can save the SMC list data only to an SD card inserted into the operation panel SD card slot.

Error Messages

SMC List Card Save error message:

- **Failed:**
FACTOR: Read-only file system, No space left on device.

If an error occurs, pressing "Exit" will cause the device to discard the job and return to the ready state.

UP/SP Data Import/Export

Overview

Import/export conditions

Import/export is possible between devices only if their model type, region of use, and the following device configurations match.

- Input Tray
- Output Tray
- ARDF
- Whether or not equipped with a hard disk
- Whether or not equipped with a finisher and the type of finisher

5

UP Data Import/Export

Data that can be imported and exported

- Copier / Document Server Features
- Printer Features
- Scanner Features
- Facsimile Features
- Browser Features
- Extended Feature Settings
- Program (Document Server)
- Program (Copier)
- Program (Scanner)
- Web Image Monitor Setting
- Web Service Settings
- System Settings

Data that cannot be imported or exported

- Some System Settings *1 *2

*1 The setting for the date, settings that require the device certificate, and settings that need to be adjusted for each machine (for example, image adjustment settings) cannot be imported or exported.

*2 Settings only for executing functions and settings only for viewing cannot be imported or exported.

- Extended Feature Settings
- Address book
- Programs (fax function)
- Programs (printer function)
- User stamp in Copier / Document Server Features
- Settings that can be specified via telnet
- @Remote-related data
- Counters
- EFI printer unit settings
- Settings that can only be specified via Web Image Monitor or Web Service (for example, Bonjour, SSDP setting)

Exporting Device Information

This can be exported / imported by an administrator with all privileges.

When exporting SP device information from the control panel, the data is saved on an SD card.

- 1. Insert an SD card into the media slot on the side of the control panel.**
- 2. Log in from the control panel as an administrator with all privileges.**
- 3. Press [System Settings].**
- 4. Press [Administrator Tools].**
- 5. Press [Next] four times.**

6. Press [Device Setting Information: Export (Memry Strge Devc)].

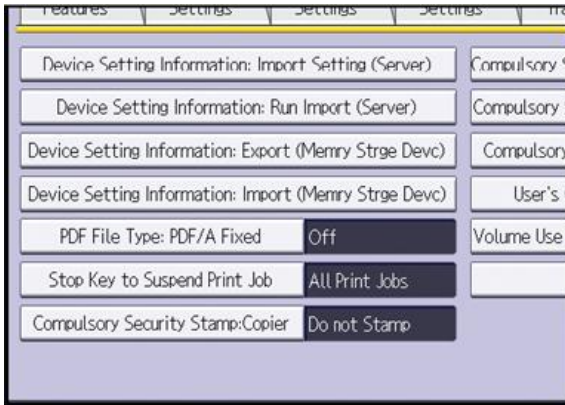

w_d1825501

7. Set the export conditions.

5

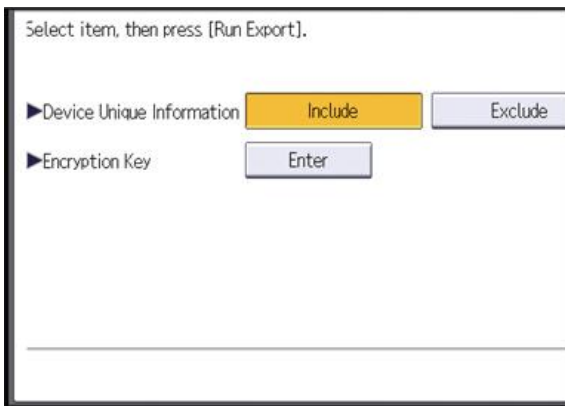

w_d1825502

- Specify whether to [Include] or [Exclude] the "Device Unique Information". "Device Unique Information" includes the IP address, host name, fax number, etc.
- Specify an encryption key.

8. Press [Run Export].

9. Press [OK].

10. Press [Exit].

11. Log out.

Note

- If data export fails, the details of the error can be viewed in the log.
- When device Information is periodically imported, it is necessary to create the device setting information file with special software and store it on the web server.

Importing Device Information

This can be exported / imported by an administrator with all privileges.

Import device information saved on an SD card.

1. Insert an SD card into the media slot on the side of the control panel.
2. Log in from the control panel as an administrator with all privileges.
3. Press [System Settings].
4. Press [Administrator Tools].
5. Press [Next] four times.
6. Press [Device Setting Information: Import (Memory Storage Device)].
7. Configure the import conditions.

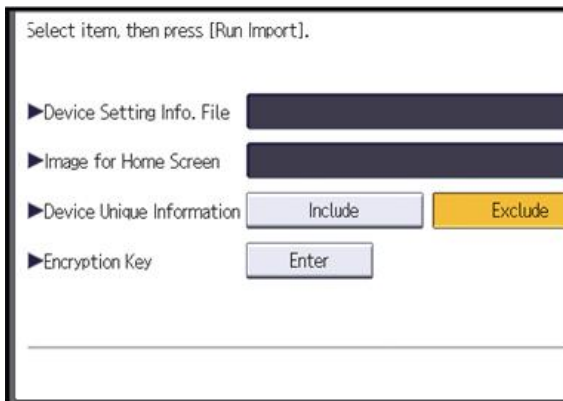

w_d1825503

- Press [Select] of the "Device Setting Info. File" to select the file(s) to import.
- When inserting a file into a home screen, press [Select] for the Image for Home screen and select the file. You cannot use this setting when using the Smart Operation Panel.
- Specify whether to [Include] or [Exclude] the "Device Unique Information". "Device Unique Information" includes the IP address, host name, fax number, etc.
- Enter the encryption key that was specified when the file was exported.

8. Press [Run Import].
9. Press [OK].
10. Press [Exit].

The machine restarts.

Note

- If data export fails, the details of the error can be viewed in the log.

SP Data Import/Export

Data that can be imported and exported

- System SP
- Printer SP
- Fax SP
- Scanner SP

Exporting Device Information

When exporting SP device information from the control panel, the data is saved on an SD card.

5

1. Insert an SD card into the media slot on the side of the control panel.
2. Enter SP mode.
3. Press SP5-749-001 (Import/Export: Export)
4. Select "Target" SP settings (System/Printer/Fax/Scanner) to be exported.
5. Select "Option" settings (Unique/Secret).

Item	Specification	Note
Unique	Unique information of the machine is included in the exported file if you select "Unique" setting.	<p>Unique information that can be updated</p> <p>#1. Items that are to be used to identify the machine. Example: Network Information/ Host name / Information related to fax number / Mail address assigned to the machine</p> <p>#2. Items for specifying the options equipped on the machine. Example: Lot number for developer</p> <p>Unique information that cannot be updated</p> <p>#1. Items that may cause a problem if imported Example: Serial number / Information related to @Remote</p> <p>#2. Items for managing the history of the machine Example: Time and date / Counter information / Installation date</p> <p>#3. Setting values for the Engine</p>

Item	Specification	Note
Secret	Secret information is exported if you select "Secret" setting.	<p>Secret information</p> <p>#1. Data that cannot be exported without being encrypted. (Exported data is encrypted.) Example: Password / Encryption key / PIN code</p> <p>#2. Confidential information for the customer Example: User name / User ID / Department code / Mail address / Phone number</p> <p>#3. Personal information Example: Document name / Image data</p> <p>#4. Sensitive information for the customer Example: MAC address / Network parameters</p>

* The IP address is exported when both 'Unique' and 'Secret' are selected.

6. Select "Crpt config" setting (Encryption).

Encryption	Select whether to encrypt or not when exporting. If you push the "Encryption" key, you can export secret information.	If the encryption function is used, setting of an encryption key is required by direct input. <ul style="list-style-type: none"> Type the arbitrary password using the soft keyboard Can enter up to 32 characters
------------	--	--

7. Press [Execute].

8. Press [OK].

↓ Note

- If data export fails, the details of the error can be viewed in the log.

Importing Device Information

Import device information saved on an SD card.

1. Insert an SD card into the media slot on the side of the control panel.
2. Enter SP mode.
3. Press SP5-749-101 (Import/Export: Import)
4. Select a unique setting.

5. Press [Encryption Key], if the encryption key was created when the file was exported.
6. Select an encryption setting.

Unique	If you want to apply the unique information to the target machine, select the "Unique" key.	Refer to the above information.
Encryption	If an encrypted file is selected as the import file, this setting is required.	

7. Press [Execute].
8. Press [OK].

Note

- If data export fails, the details of the error can be viewed in the log.

Possible solutions for import/export problems

The access log file is created when export/import is executed. The file is stored in the same location as the exported device setting information file.

If an error occurs, check the log's result code in the access log file first. Values other than 0 indicate that an error occurred.

The result code will appear in the circled area illustrated below.

- Example of a log file

```

"1.0.0"
"ExecType", "Date", "SerialNo", "PnP", "Model", "Destination", "IP", "Host", "Storage", "FileName", "FileID", "TotalItem", "NumOfOkItem", "ResultCode", "ResultName", "Identifier"
"IMPORT"
"2012-07-05T15:29:16+09:00"
"3C35-7M0014"
"Brand Name"
"Product Name"
"0"
"10"
"10.250.155.125"
"RNP00267332582D"
"SD"
"201207051519563C35-710220.csv"
"201207051519563C35-710220"
" 0"
" 2"
"*****ID REQUEST"
"TargetID", "ModuleID", "Prefix", "Item", "NgCode", "NgName"
    
```

w_d1825500

If you cannot solve the problem or do not know how to solve it after checking the code, note down the error log entry, then contact your supervisor.

Result Code	Cause	Solutions
2 (INVALID REQUEST)	A file import was attempted between different models or machines with different device configurations.	Import files exported from the same model with the same device configurations.
4 (INVALID OUTPUT DIR)	Failed to write the device information to the destination device.	Check whether the destination device is operating normally.
7 (MODULE ERROR)	An unexpected error occurred during import or export.	Switch the power off and then back on, and then try the operation again. If the error persists, contact your supervisor.
8 (DISK FULL)	The available storage space on the external medium is insufficient.	Execute the operation again after making sure there is enough storage space.
9 (DEVICE ERROR)	Failed to write or read the log file.	Check whether the path to the folder for storing the file or the folder in which the file is stored is missing.
10 (LOG ERROR)	The hard disk is faulty.	Contact your supervisor.

Result Code	Cause	Solutions
20 (PART FAILED)	Failed to import some settings.	<p>The reason for the failure is logged in "NgCode". Check the code.</p> <p>Reason for the Error (Ng-Name)</p> <p>2. INVALID VALUE The specified value exceeds the allowable range.</p> <p>3. PERMISSION ERROR The permission to edit the setting is missing.</p> <p>4. NOT EXIST The setting does not exist in the system.</p> <p>5. INTERLOCK ERROR The setting cannot be changed because of the system status or interlocking with other specified settings.</p> <p>6. OTHER ERROR The setting cannot be changed for some other reason.</p>
21 (INVALID FILE)	Failed to import the file because it is in the wrong format in the external medium.	<p>Check whether the file format is correct.</p> <p>The import file should be a CSV file.</p>
22 (INVALID KEY)	The encryption key is not valid.	Use the correct encryption key.

 **Note**

- When exporting device information from the control panel, the data can be saved only on an SD card.
- The file format for exports is CSV.

Test Pattern Printing

Printing Test pattern: SP4-417

Some of these test patterns are used for copy image adjustments but most are used primarily for design testing.

↓ Note

- Do not operate the machine until the test pattern is printed out completely. Otherwise, an SC occurs.
1. Enter the SP mode and select **SP4-417**.
 2. Enter the number for the test pattern that you want to print and press [#].

No.	Pattern
0	Scanned Image
1	Gradation Main Scan A
2	Color Patch 16
3	Grid Pattern A
4	Slant Grid Pattern B
5	Slant Grid Pattern C
6	Slant Grid Pattern D
7	Scanned + Grid Pattern C
8	Scanned + Grid Pattern D

3. Touch "Copy Window" to open the copy window, then select the settings for the test print (paper size etc.).
4. Press the "Start" key to start the test print.
5. After checking the test pattern, touch "SP Mode" on the LCD to return to the SP mode display.
6. Reset all settings to the default values.
7. Touch "Exit" twice to exit SP mode.

Card Save Function

Overview

Card Save:

- The Card Save function is used to save print jobs received by the printer on an SD card with no print output. Card Save mode is toggled using printer Bit Switch #1 bit number 4. Card Save will remain enabled until the SD card becomes full, or until all file names have been used.
- Captures are stored on the SD card in the folder /prt/cardsave. File names are assigned sequentially from PRT00000.prn to PRT99999.prn. An additional file PRT.CTL will be created. This file contains a list of all files created on the card by the card save function.
- Previously stored files on the SD card can be overwritten or left intact. Card Save SD has "Add" and "New" menu items.
 - **Card Save (Add):** Appends files to the SD Card. Does not overwrite existing files. If the card becomes full or if all file names are used, an error will be displayed on the operation panel. Subsequent jobs will not be stored.
 - **Card Save (New):** Overwrites files in the card's /prt/cardsave directory.

Limitation:

- Card Save cannot be used with PjL Status Readback commands. PjL Status Readbacks will not work. In addition they will cause the Card Save to fail.

Procedure

1. Turn the main power switch OFF.
2. Insert the SD card into slot 2 (lower). Then turn the power ON.
3. Enter SP mode.
4. Select the "Printer SP".

5. Select SP-1001 "Bit Switch".

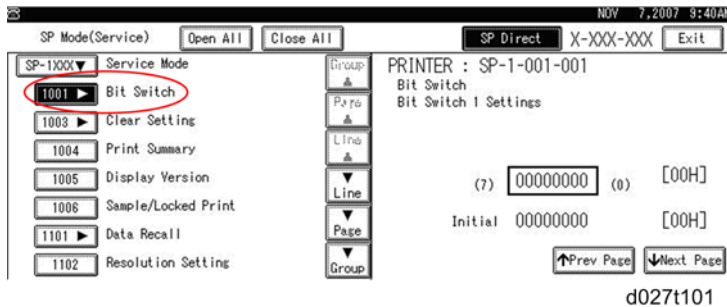

6. Select "Bit Switch 1 Settings" and use the numeric keypad to turn bit 4 ON and then press the "#" button to register the change. The result should look like: 00010000. By doing this, Card Save option will appear in the "List/Test Print" menu.

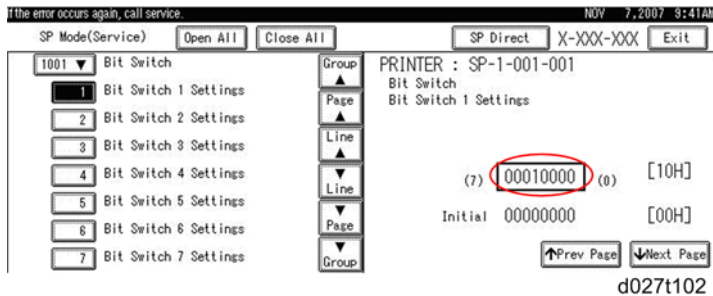

7. Press "Exit" to exit SP Mode.
8. Press the User Tools icon.
9. Press "Machine Features"
10. Select "Printer Features".

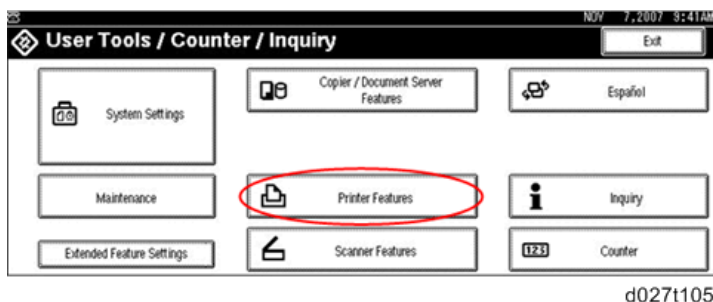

- Card Save (Add) and Card Save (New) should be displayed on the screen. Select Card Save (Add) or Card Save (New).

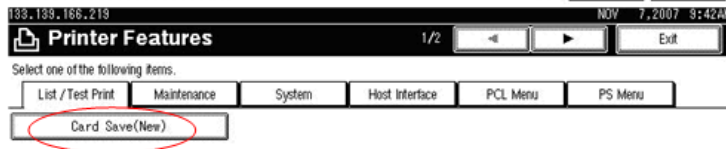
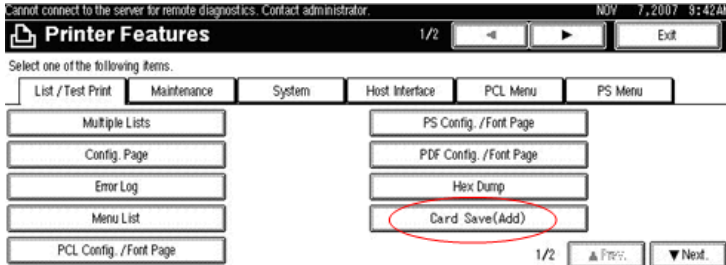

5

2/2 < > Prev. Next
d0271106

- Press "OK" and then exit the "User Tools" menu.

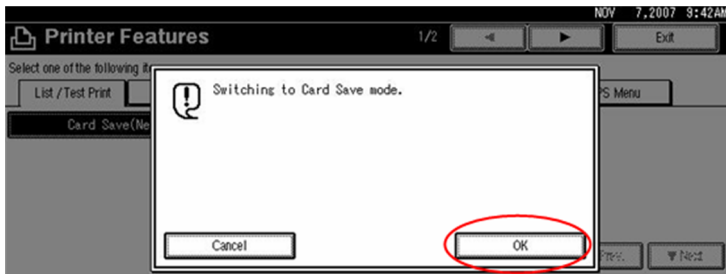

d0271107

- Press the "Printer" button.
- Card Save should be displayed in the top left of the display panel.

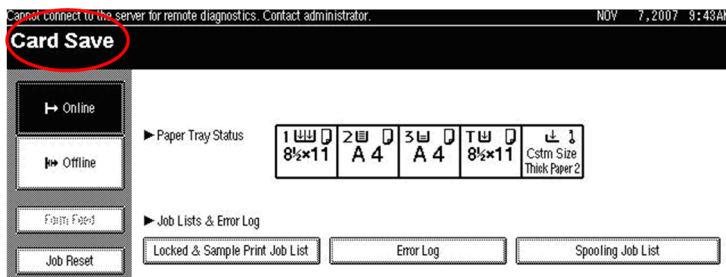

d0271109

- Send a job to the printer. The Communicating light should start blinking.

16. As soon as the printer receives the data, it will be stored on the SD card automatically with no print output. Nothing is displayed on the screen, indicating that a Card Save operation was successful.
17. Press "Stop" button to exit Card Save mode.
18. Change the Bit Switch Settings back to the default 00000000. Press the "#" button in the numeric keypad to register the changes.
19. Remove the SD card after the main power switch is turned off.

Error Messages

Card Save error messages:

- **Init error:** A card save process (e.g. card detection, change to kernel mode) failed to initialize.
- **Card not found:** Card cannot be detected in the slot.
- **No memory:** Insufficient working memory to process the job.
- **Write error:** Failed to write to the card.
- **Other error:** An unknown error occurred.

If an error occurs, pressing "OK" will cause the device to discard the job and return to the ready state.

6. Troubleshooting

Service Call Conditions

There are four levels of service call conditions.

Level	Definition	Reset Procedure
A	Fusing unit SC codes shown on the operation panel. The machine is disabled. The operator cannot reset the machine.	The machine requires immediate servicing by a service technician.
B	These SC codes disable only the features that use the defective item. The user does not see these SC codes in usual conditions. But, they are shown on the operation panel when the defective feature is used.	Cycle the machine off/on with the main power switch..
C	SC codes that are not shown on the operation panel. They are recorded internally.	Recorded only.
D	These SC codes are shown on the operation panel. To reset these SC codes, turn the operation switch or main power switch off and on. These SC codes are shown again if the error occurs again.	Set the operation switch or the main power switch to "off" then to "on" .

Preliminary Instructions

- If the problem is in an electrical circuit board, disconnect then connect the board connectors again before you replace the PCB.
- If the problem is a motor lock, check the mechanical load before you replace a motor or sensor.
- When a Level A or Level B SC occurs while the machine is in the SP mode, the SC number will not be shown. If this occurs, check the SC number after the machine goes out from the SP mode. This does not include Level B codes.
- Many SC codes contain more than one level (SC303-1, SC303-2, SC303-3, and others). Some SC codes can show a "-1", even if there is only one level.
- The following abbreviations are used in these SC tables: (F) means "Front", (R) means "Rear", "CTL" means "Controller".

SC100: Scanning

SC101	D	Scanner Lamp Error
		The peak value of the white reference image data on the automatic adjustment is lower than the specified value.
		<ul style="list-style-type: none"> • Standard white strips dirty or not platen white plate installed improperly • CIS-to-SIB harness loose, broken, defective • SIB-to-IOB harness loose, broken, defective • SIB defective • IOB defective • BiCU defective • CIS defective
		<ul style="list-style-type: none"> • Reattach/clean the white plate. • Replace CIS. • Replace SIB, IOB, or BiCU. • Check harness connections between CIS and SIB or replace harness. • Check harness connections between SIB and IOB or replace harness.

SC143	C	Scanner Automatic Adjustment Error
		The number of automatic white level adjustments exceeds a specified limit.
		<ul style="list-style-type: none"> • Standard white strips dirty or not platen white plate installed improperly • CIS-to-SIB harness loose, broken, defective • SIB-to-IOB harness loose, broken, defective • CIS defective • SIB defective • IOB defective • BiCU defective
		<ul style="list-style-type: none"> • Reattach/clean the white plate. • Replace CIS. • Replace SIB, IOB, or BiCU. • Check harness connections between CIS and SIB or replace harness. • Check harness connections between SIB and IOB or replace harness.
SC144-01	D	Scanner Communication Error (AFE Communication Error)
		On automatic adjustment, check ERRBit of the SERI_STS1 register by writing to LM98714.
		<ul style="list-style-type: none"> • SIB-to-IOB harness connector loose, broken, defective • SIB defective • IOB defective • BiCU defective
		<ul style="list-style-type: none"> • Replace SIB, IOB, or BiCU. • Check harness connections between SIB and IOB or replace harness.

SC144-02	D	Scanner Communication Error (Volans2 PLL Lock Error)
		On automatic adjustment, an error is generated when the PLL lock status at the LVDS input section of Volans2 is checked.
		<ul style="list-style-type: none"> • SIB-to-IOB harness connector loose, broken, defective • SIB defective • IOB defective • BiCU defective
		<ul style="list-style-type: none"> • Replace SIB, IOB, or BiCU. • Check harness connections between SIB and IOB or replace harness.
SC144-03	D	Scanner Communication Error (Volans2 communication error)
		On automatic adjustment, an error is generated when checking the connection with Volans2.
		<ul style="list-style-type: none"> • IOB-to-BiCU harness connector loose, broken, defective • IOB defective • BiCU defective
		<ul style="list-style-type: none"> • Replace IOB or BiCU. • Check harness connections between CIS and BIU or replace harness.
SC161-01	D	IPU Error 1: Volans2 Configuration Error
		An IPU error is generated upon communication check if FPGA configuration (Volans2) does not end with power on or recovery from Power Save mode.
		<ul style="list-style-type: none"> • Check all harness connections to the IPU for a loose, broken, defective connection • IPU defective • IOB/BiCU boards defective (connection problem between FPGA and the engine CPU) • Chip fault (FPGA defective)
		Replace the IOB/BiCU boards, or check the connection

SC161-02	D	IPU Error 2: Ri Response Error
		An IOB error (Ri response error) is generated if an error is detected in Ri access.
		<ul style="list-style-type: none"> • IPU defective • IOB board error (Ri2005 and peripheral circuit defective). • Chip fault (Ri2005 defective)
		Power reset
SC161-05	D	BICU Error: Ri2005 M-to-P Response Error
		A BICU error (RI2005_MtoP response error) is generated if an error is detected in RI2005 (MtoP) access.
		<ul style="list-style-type: none"> • BICU board defective (RI2005 operation error)
		Replace BICU board
SC161-11	D	IPU Error (Lsync Error)
		Perform IPU self-diagnosis before reading, and if an error is detected in the results, an IPU error (LSYNC error) is generated.
		<ul style="list-style-type: none"> • Connection problem of the LVDS cable between IOB and BiCU (IPU) boards • IOB board defective • BiCU (IPU) board defective (ASIC: Macaron defective)
		<ul style="list-style-type: none"> • SC auto-reboot • Main power OFF/ON • Replace the Parts • Reset the connector • Replace the cable • Replace the IOB board • Replace the BiCU (IPU) board

<p>SC161-20</p>	<p>D</p>	<p>IPU Error (DRAM Initialization Trouble)</p> <p>An IPU error (DRAM initialization trouble) is issued if DDR-PHY initialization and the Training status check result in an error with power on or recovering from Power Save mode.</p> <ul style="list-style-type: none"> • IPU board defective (Connection problem of Macaron/DRAM device) • DRAM device defective <p>• SC reproducibility check</p> <p>Reproducible</p> <p>Do the items below.</p> <ul style="list-style-type: none"> • Connection <ul style="list-style-type: none"> • Check that all connectors are connected correctly (no loose connector/not fully connected). <ul style="list-style-type: none"> • No SC is generated. <p>End</p> <ul style="list-style-type: none"> • An SC is generated. • IPU/BICU trouble • IPU/BICU trouble <ul style="list-style-type: none"> • Replace IPU/BICU <ul style="list-style-type: none"> • No SC is generated. <p>End</p> <ul style="list-style-type: none"> • An SC is generated. <p>Replace the machine/design analysis</p>
-----------------	----------	---

SC200: Image Writing

SC200-00	D	Suction Cap HP Sensor Error
		The maintenance unit slide sensor did not detect the suction cap and wiper blade assembly at home position.
		<ul style="list-style-type: none"> • HP sensor connection loose, broken, defective • Paper or other obstacle blocking movement of the mechanism • HP sensor defective
SC201-01	D	Print Head Caps Home Position Sensor Error
		The cap sensor in the maintenance unit failed to detect the left cradle at the up position or down position (home position).
		<ul style="list-style-type: none"> • HP sensor connection loose, broken, defective • Paper or other obstacle blocking movement of the mechanism • HP sensor defective
SC201-02	D	Cleaner Unit Slider Sensor Error
		The slider sensor at the back of the maintenance unit failed to detect the cleaner unit at the forward position or the rear position (home position). The left cradle, suction cap, rubber wiper blade, and wipers comprise the maintenance cleaning unit.
		<ul style="list-style-type: none"> • HP sensor connection loose, broken, defective • Paper or other obstacle blocking operation of the motor • HP sensor defective • Motor defective

SC202	D	Ink Level Detection Feeler Position Error
		<p>One of the following conditions existed:</p> <ul style="list-style-type: none"> • When air was purged one or more of the feelers could not be detected so the operation could not continue. • When the maintenance pump attempted to apply negative pressure on the print head ink tank, the feeler could not be detected at its prescribed position after the pressure was applied. • OCFS could not detect the feeler(s) after the feeler sensor performed the check after filling.
SC202-00	D	Full Tank Detection Feeler Position Error
		Interrupted during specifying the cause
SC202-01	D	Head Tank 1: Ink Level Sensor Feeler Error at Air Release
SC202-02	D	Head Tank 2: Ink Level Sensor Feeler Error at Air Release
SC202-03	D	Head Tank 3: Ink Level Sensor Feeler Error at Air Release
SC202-04	D	Head Tank 4: Ink Level Sensor Feeler Error at Air Release
SC202-05	D	Head Tank 5: Ink Level Sensor Feeler Error at Air Release
SC202-06	D	Head Tank 6: Ink Level Sensor Feeler Error at Air Release
SC202-07	D	Head Tank 7: Ink Level Sensor Feeler Error at Air Release
		Feeler cannot be detected during air release.
		<ul style="list-style-type: none"> • Feeler cannot be detected because it is out of position (loose, broken, defective, or blocked by an obstruction) • Air release solenoid blocked • Maintenance unit defective • Print head ink tank defective • Air release solenoid defective
SC202-11	D	Head Tank 1: Air Leak at Negative Pressure
SC202-12	D	Head Tank 2: Air Leak at Negative Pressure
SC202-13	D	Head Tank 3: Air Leak at Negative Pressure
SC202-14	D	Head Tank 4: Air Leak at Negative Pressure

SC202-15	D	Head Tank 5: Air Leak at Negative Pressure
SC202-16	D	Head Tank 6: Air Leak at Negative Pressure
SC202-17	D	Head Tank 7: Air Leak at Negative Pressure
SC202-18	D	Head Tanks 3 and 4: Air Leak at Negative Pressure
SC202-19	D	Head Tanks 6 and 7: Air Leak at Negative Pressure
		Air leak. Pressure applied but immediate leak and air detected.
		<ul style="list-style-type: none"> • Feeler cannot be detected because it is out of position (loose, broken, defective, or blocked by an obstruction) • Air release solenoid blocked • Maintenance unit defective • Print head ink tank defective • Air release solenoid defective
SC202-23	D	Head Tank 3: Nozzle or Filter Clogged (2HT System)
SC202-24	D	Head Tank 4: Nozzle or Filter Clogged (2HT System)
SC202-26	D	Head Tank 6: Nozzle or Filter Clogged (2HT System)
SC202-27	D	Head Tank 7: Nozzle or Filter Clogged (2HT System)
SC202-28	D	Head Tanks 3 and 4: Nozzle or Filter Clogged (2HT System)
SC202-29	D	Head Tanks 6 and 7: Nozzle or Filter Clogged (2HT System)
		Nozzle or filter clogged (one side) (2HT System). A color nozzle or filter is clogged. A color nozzle or filter is clogged
		<ul style="list-style-type: none"> • Auto-Nozzle check • Nozzle cleaning • Nozzle flushing
SC202-31	D	Head Tank 1: Insufficient suction
SC202-32	D	Head Tank 2: Insufficient suction
SC202-33	D	Head Tank 3: Insufficient suction
SC202-34	D	Head Tank 4: Insufficient suction
SC202-35	D	Head Tank 5: Insufficient suction

SC202-36	D	Head Tank 6: Insufficient suction
SC202-37	D	Head Tank 7: Insufficient suction
SC202-38	D	Head Tanks 3 and 4: Insufficient suction
SC202-39	D	Head Tanks 6 and 7: Insufficient suction
		Nozzle or filter clogged or insufficient suction (both sides) (1HT System/2HT System). <ul style="list-style-type: none"> • Nozzle or filter for some color clogged • Suction trouble
		<ul style="list-style-type: none"> • Auto-Nozzle check • Nozzle cleaning • Nozzle flushing • Maintenance unit defective
SC202-41	D	Head Tank 1: Ink Level Feeler Error 1
SC202-42	D	Head Tank 2: Ink Level Feeler Error 1
SC202-43	D	Head Tank 3: Ink Level Feeler Error 1
SC202-44	D	Head Tank 4: Ink Level Feeler Error 1
SC202-45	D	Head Tank 5: Ink Level Feeler Error 1
SC202-46	D	Head Tank Tanks 4 and 5: Ink Level Feeler Error 1
SC202-47	D	Head Tank 7: Ink Level Feeler Error 1
SC202-48	D	Head Tanks 3 and 4: Ink Level Feeler Error 1

SC202-49	D	Head Tanks 6 and 7: Ink Level Feeler Error 1
		No air release (ink entry, etc.) Feeler did not release, even when air release valve was pressed manually. Even at negative pressure, the feeler against the wall of the tank did not detect any change.
		<ul style="list-style-type: none"> • Feeler cannot be detected because it is out of position (loose, broken, defective, or blocked by an obstruction) • Air release solenoid blocked • Maintenance unit defective • Print head ink tank defective • Air release solenoid defective
SC202-51	D	Head Tank 1: Ink Level Feeler Error 2
SC202-52	D	Head Tank 2: Ink Level Feeler Error 2
SC202-53	D	Head Tank 3: Ink Level Feeler Error 2
SC202-54	D	Head Tank 4: Ink Level Feeler Error 2
SC202-55	D	Head Tank 5: Ink Level Feeler Error 2
SC202-56	D	Head Tank 6: Ink Level Feeler Error 2
SC202-57	D	Head Tank 7: Ink Level Feeler Error 2
SC202-58	D	Head Tanks 3 and 4: Ink Level Feeler Error 2
SC202-59	D	Head Tanks 6 and 7: Ink Level Feeler Error 2
		<p>While ink tank was under negative pressure, ink level sensor feeler was out of position and caused the error. Air is releasing now but not previously.</p> <ul style="list-style-type: none"> • Dirty horizontal encoder strip • Obstruction between feeler and side of the ink tank
SC202-61	D	Head Tank 1: Ink Level Feeler Error 3
SC202-62	D	Head Tank 2: Ink Level Feeler Error 3
SC202-63	D	Head Tank 3: Ink Level Feeler Error 3
SC202-64	D	Head Tank 4: Ink Level Feeler Error 3
SC202-65	D	Head Tank 5: Ink Level Feeler Error 3
SC202-66	D	Head Tank 6: Ink Level Feeler Error 3

SC202-67	D	Head Tank 7: Ink Level Feeler Error 3
		The OCFS could not detect the position of the ink level feeler.
		<ul style="list-style-type: none"> • Feeler cannot be detected because it is out of position (loose, broken, defective, or blocked by an obstruction) • Air release solenoid blocked • Maintenance unit defective • Print head ink tank defective • Air release solenoid defective
SC202-70	D	Ink Level Feeler Error 4: All Feelers
		All ink level sensor feelers were not detected.
		<ul style="list-style-type: none"> • Feeler cannot be detected because it is out of position (loose, broken, defective, or blocked by an obstruction) • Maintenance unit defective • Print head ink tank defective • Air release solenoid defective
SC203	D	Supply Pump Suction Timeout Errors
		The supply pump motor reversed to apply negative pressure, but the sensor failed to detect one or more feelers at the prescribed positions, so pressure could not be detected as normal. Problem may be cause by
		<ul style="list-style-type: none"> • An air leak • Clogged tubing between the supply pump and print head • Failure to purge air from the tank • A broken or defective feeler
SC203-00	D	Air Leak Error
		Interrupted during specifying the cause
SC203-11	D	Head Tank 1: Air Leak Error

SC203-12	D	Head Tank 2: Air Leak Error
SC203-13	D	Head Tank 3: Air Leak Error
SC203-14	D	Head Tank 4: Air Leak Error
SC203-15	D	Head Tank 5: Air Leak Error
SC203-16	D	Head Tank 6: Air Leak Error
SC203-17	D	Head Tank 7: Air Leak Error
		Air leak: Immediate air leak detected at application of negative pressure
		<ul style="list-style-type: none"> • Feeler broken, damaged, or blocked • Air release solenoid blocked • Air release solenoid defective • Ink supply pump or tube defective
SC203-21	D	Ink Pump 1 Timeout Error
SC203-22	D	Ink Pump 2 Timeout Error
SC203-23	D	Ink Pump 3 Timeout Error
SC203-24	D	Ink Pump 4 Timeout Error
SC203-25	D	Ink Pump 5 Timeout Error
SC203-26	D	Ink Pump 6 Timeout Error
SC203-27	D	Ink Pump 7 Timeout Error
		Ink supply defective, pump faulty and could not form negative pressure, but there was negative pressure at the maintenance unit.
		<ul style="list-style-type: none"> • Feeler broken, damaged, or blocked • Ink supply pump or tube defective
SC203-31	D	Head Tank 1: Purge Error
SC203-32	D	Head Tank 2: Purge Error
SC203-33	D	Head Tank 3: Purge Error
SC203-34	D	Head Tank 4: Purge Error
SC203-35	D	Head Tank 5: Purge Error

SC203-36	D	Head Tank 6: Purge Error
SC203-37	D	Head Tank 7: Purge Error
		No air release (ink entry, etc.) Feeler does not release, even when air purge valve is pressed, and the feeler that is not detecting the negative pressure is depressed and out of position.
		<ul style="list-style-type: none"> • Feeler broken, damaged, or blocked • Air release solenoid blocked • Air release solenoid defective • Ink supply pump or tube defective
SC203-51	D	Ink Supply Error: Head Tank 1
SC203-52	D	Ink Supply Error: Head Tank 2
SC203-53	D	Ink Supply Error: Head Tank 3
SC203-54	D	Ink Supply Error: Head Tank 4
SC203-55	D	Ink Supply Error: Head Tank 5
SC203-56	D	Ink Supply Error: Head Tank 6
SC203-57	D	Ink Supply Error: Head Tank 7
		<ul style="list-style-type: none"> • Feeler broken, damaged, or blocked • Air release solenoid blocked • Air release solenoid defective • Ink supply pump or tube defective
SC210	D	Carriage Horizontal Initialization Error
		The machine failed to detect the carriage unit at the start position.
		<ul style="list-style-type: none"> • Horizontal encoder installed incorrectly (not inserted into the gap of the horizontal encoder sensor) • Horizontal encoder strip dirty • Horizontal encoder strip loose, broken, defective • Horizontal encoder sensor connector loose, broken, defective • Horizontal encoder sensor defective

SC211-01	D	<p>Carriage Communication Error</p> <hr/> <p>No response from the motor control firmware</p> <hr/> <p>Communication error between the motor control firmware and engine. The machine failed to stop within the specified time and area because of the mechanical trouble.</p> <p>Communication Error</p> <ul style="list-style-type: none"> • Cycle the machine off/on • If the problem recurs, check around the HRB on the carriage unit for a loose, broken, or defective connector • Check around the MCU for a loose broken connector on a harness from the carriage unit. • Replace BICU. <p>Mechanical Trouble</p> <ul style="list-style-type: none"> • Check that there is no problem with the driving parts (guide, rod, roller, gear, belt). • If the belt is loose, tighten the belt. • If it is not recovered by turning the power OFF/ON, replace the parts.
----------	---	---

SC211-02	D	<p>Carriage Hardware Error</p> <hr/> <p>Response of hardware error from motor control</p> <hr/> <ul style="list-style-type: none"> • Horizontal motor connector loose, broken, defective • Horizontal motor blocked by an obstacle • Horizontal encoder strip dirty • Horizontal encoder strip loose, broken, defective, or installed incorrectly • Horizontal encoder sensor connector loose, broken, defective • Horizontal encoder installed incorrectly • MCU connector loose, broken, defective • Horizontal encoder sensor defective • Horizontal motor defective • MCU defective <p>Motor load error on motor (defective or broken), sensor (defective, broken, or position error), encoder sheet (broken, position error, or dirty), and others.</p> <ul style="list-style-type: none"> • Check for loose connectors of the sensor monitor, position error of the sensor encoder sheet, and dirt or scratches on the encoder sheet, and then turn the main power switch OFF and back ON. • If the carriage does not move first, replace the motor. • If the carriage moves first but is not recovered, replace the sensor. • Replace BICU.
SC211-03	D	<p>Main Scan Direction Error</p> <hr/> <p>Response of moving direction error from motor control</p> <hr/> <p>Wrong connection of harnesses on the motor or encoder.</p> <ul style="list-style-type: none"> • If the machine works correctly, check for loose connector of the sensor monitor, position error of the sensor encoder sheet, and dirt or scratches on the encoder sheet, and then turn the main power OFF and back ON. • If the error has been recovered and the motor connection was not correct, connect the harness +/- connection in reverse. • If the error has been recovered and the encoder connection was not correct, connect the harness A/B connection in reverse.

SC211-04	D	Main scan motor driver error (overcurrent)
		Response to a motor driver error (overcurrent) from motor control
		<p>This error is issued when the motor driver is in overcurrent status.</p> <ul style="list-style-type: none"> • Check that there is no problem with the driving parts (guide, rod, roller, gear, belt). • Check that there is no problem with sliding. • Replace the BICU.
SC211-05	D	Main Scan Motor Driver Error (Overheating)
		Response to a motor driver error (overheating) from motor control
		<p>This error is generated when the motor driver is in overheating status.</p> <ul style="list-style-type: none"> • Check that there is no problem with the driving parts (guide, rod, roller, gear, belt). • Check that there is no problem on sliding. • Check that there is no abnormal odor, smoke, or fire. • Replace the BICU.
SC211-06	D	Main Scan Motor Driver Error (Low Voltage)
		Response to a motor driver error (overheating) from motor control
		<p>This error is generated when the motor driver is in overheating status.</p> <p>If it is not recovered by turning the power OFF and back ON, replace the BICU.</p>

SC212-01	D	Head Lift Motor Error
		<p>The status of the head lift sensor 1 or 2 did not change when the carriage was raised. Within 25 sec.:</p> <ul style="list-style-type: none"> • At initialization, head lift sensor 1 did not go OFF and head lift sensor 2 did not go ON. • When the carriage was raised 1 mm, head lift sensor 1 did not go OFF and head lift sensor 2 did not go OFF. • When the carriage was raised 2 mm, print head sensor 1 did not go ON.
		<ul style="list-style-type: none"> • One or more sensor connector loose, broken, defective • Lift motor connector loose, broken, defective. • One or more sensor defective • Lift motor defective

SC250-01	B	High-Voltage Detection Error
		<p>A high-voltage error (SC250-01) is generated when the machine receives a high-voltage error detection signal 40 times in total with a 10 ms polling interval.</p> <ul style="list-style-type: none"> • Leak • Loose connection • Harness damaged • Unit defective • High-voltage power source trouble
		<ul style="list-style-type: none"> • Recovery with main switch ON/OFF • Set or replace the harness on the high-voltage power supply route. • Set or replace the unit. • Replace the high-voltage power source

SC250-02	B	Auto-Nozzle Check Prohibit (Electrode Wiping)
		The auto-nozzle check prohibit flag is set to ON. <ul style="list-style-type: none"> • Wiper position detection (at the far end) sensor defective • Electrode wiping motor defective
		<ul style="list-style-type: none"> • Remove any foreign matter. • Replace the wiper position detection (at the far end) sensor • Replace the electrode wiping motor • Replace the auto-nozzle check unit
SC250-03	B	Auto-Nozzle Check Life
		The auto-nozzle check unit ends its service life. <ul style="list-style-type: none"> • Do a auto-nozzle check
		<ul style="list-style-type: none"> • After replacing the auto-nozzle check unit, do SP2-020-004.
SC252-01	D	Electrode Wiping Return Position Error
		If the wipe position detection (Home position) sensor is Low before starting return <ul style="list-style-type: none"> • Wipe position detection (Home position) sensor defective
		<ul style="list-style-type: none"> • Remove the foreign matter. • Replace the wipe position detection (Home position) sensor • Replace the auto-nozzle check unit.

SC252-02	D	<p>Electrode Wiping End Position Error</p> <p>When driving the wiper for return, the wipe position detection (Home position) sensor is not set to Low until motor drive timeout.</p> <ul style="list-style-type: none"> • Foreign matter is in the auto-nozzle check route, and the wiper cannot move to the end. • Either the wipe position detection (Home position) sensor or electrode wiping motor is defective. <ul style="list-style-type: none"> • Remove the foreign matter. • Replace the wipe position detection (Home position) • Replace the auto-nozzle check unit. • Replace the electrode wiping motor
SC252-03	D	<p>Electrode Wiping Homing Error</p> <p>When detecting the electrode wiping HP, the wipe position detection (Home position) sensor is not set to Low and times out.</p> <ul style="list-style-type: none"> • Foreign matter is in the auto-nozzle check route, and the wiper cannot finish homing. • Wipe position detection (Home position) trouble <ul style="list-style-type: none"> • Remove the foreign matter. • Replace the wipe position detection (Home position) • Replace the auto-nozzle check unit. • Replace the electrode wiping motor
SC252-04	D	<p>Electrode Wiping Start Position Error</p> <p>When the wiper position detection (at the far end) sensor is Low before starting the operation</p> <ul style="list-style-type: none"> • Foreign material is found on the wiper position detection (at the far end) sensor. <ul style="list-style-type: none"> • Remove the foreign matter. • Replace the wiper position detection (at the far end) sensor • Replace the auto-nozzle check unit. • Replace the electrode wiping motor

SC280	D	Air detection sensor error
SC280-01	D	Head 1: Air detection sensor error
SC280-02	D	Head 2: Air detection sensor error
SC280-03	D	Head 3: Air detection sensor error
SC280-04	D	Head 4: Air detection sensor error
SC280-05	D	Head 5: Air detection sensor error
		A problem has occurred at the terminal pin sensor on top of one of the sub tanks, or the maintenance unit is not functioning correctly. <ul style="list-style-type: none"> Terminal pin defective Maintenance unit defective FFC broken
		<ul style="list-style-type: none"> Main power switch OFF to ON Replace the electrode pin. Replace the maintenance unit. Replace the FFC.

SC282	D	Air Detection Frequency Error
		<p>Air Detection</p> <p>Air leaks slowly from the air release section of the print head tank. SC is generated when the time of air detections exceeds the threshold within the specified period.</p>
SC282-11	D	Head 1
SC282-12	D	Head 2
SC282-13	D	Head 3
SC282-14	D	Head 4
SC282-15	D	Head 5
SC282-16	D	Multiple Heads
		<ul style="list-style-type: none"> Replace the carriage unit and reset SP.

SC283	D	Ink End Detection Error
		The mechanical ink end sensor has failed, or one of the ink supply pumps has failed.
SC283-01	D	Ink end detection error tank 1
SC283-02	D	Ink end detection error tank 2
SC283-03	D	Ink end detection error tank 3
SC283-04	D	Ink end detection error tank 4
SC283-05	D	Ink end detection error tank 5
SC283-06	D	Ink end detection error tank 6
SC283-07	D	Ink end detection error tank 7
SC283-08	D	Ink end detection error tank 3 & 4
SC283-09	D	Ink end detection error tank 6 & 7
		<ul style="list-style-type: none"> • Cycle the machine off/on • Ink end sensor defective • Replace ink supply unit
SC285-00	C	DRESS Sensor Calibration Error
		<p>Detection conditions:</p> <ol style="list-style-type: none"> 1. The reflected beams was measured less than 400 when the head gap was adjusted automatically. 2. When the sensor output is lower than 4.0 V with the magnification register ON and in Full Duty for calibration of the image registration.
		<ul style="list-style-type: none"> • DRESS sensor harness loose, broken, defective • DRESS sensor defective • Common to 1 and 2: Sensor trouble, such as sensor defective, loose connection (CN11) • Only 1: Not-recommended paper used (dark color or pattern printed)

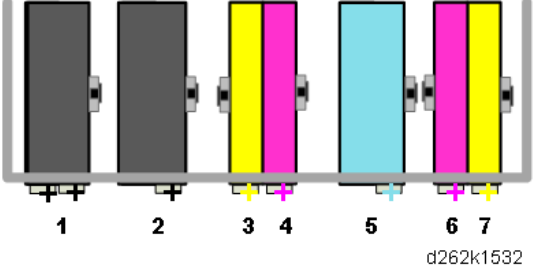
SC290	D	<p>OCFS Ink Pump Reverse Suction Error</p> <p>The OCFS could not detect when the supply pump motor reversed because a feeler was broken or out of position, or an ink supply pump could not siphon ink.</p>
SC290-01	D	Head Tank 1 (K1)
SC290-02	D	Head Tank 2 (K2)
SC290-03	D	Head Tank 3 (Y1)
SC290-04	D	Head Tank 4 (M1)
SC290-05	D	Head Tank 5 (C)
SC290-06	D	Head Tank 6 (M2)
SC290-07	D	Head Tank 7 (Y2)
		
		<ul style="list-style-type: none"> • Cycle the machine off/on • Replace print head (with new OCFS) • Replace ink supply unit
SC293	D	<p>OCFS Ink Timeout During Filling</p> <p>The OCFS feeler is out of position and cannot be read, or one of the ink supply pumps is not pumping ink</p>

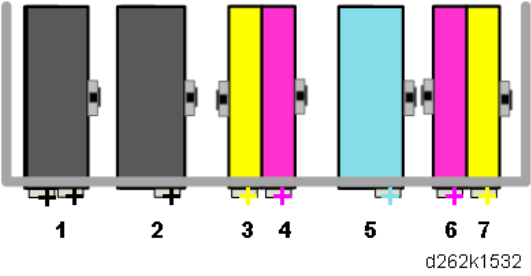
SC293-01	D	Head Tank 1 (K1)	
SC293-02	D	Head Tank 2 (K2)	
SC293-03	D	Head Tank 3 (Y1)	
SC293-04	D	Head Tank 4 (M1)	
SC293-05	D	Head Tank 5 (C)	
SC293-06	D	Head Tank 6 (M2)	
SC293-07	D	Head Tank 7 (Y2)	
		<ul style="list-style-type: none"> • Replace the ink supply unit • Replace ink end sensor 	

SC300: Not Used

There are no Group 300 service codes for this machine.

SC400: Not Used

There are no Group 400 service codes for this machine.

SC500: Paper Feed, Transport

SC503-00	B	Paper Feed Pressure Release Operation Error: Roll 1
		Within 3 sec. after the release and application of pressure in Roll Unit 1, there was no signal from the paper release sensor.
		<ul style="list-style-type: none"> • Sensor harness loose, broken, defective • Sensor defective • BiCU/IOB defective
SC504-00	B	Pressure Feed Pressure Release Operation Error: Roll 2
		Within 3 sec. after the release and application of pressure in Roll Unit 2, there was no signal from the paper release sensor.
		<ul style="list-style-type: none"> • Sensor harness loose, broken, defective • Sensor defective • RFDB defective
SC508-01	D	Cutter Sensor Error
		One or both the cutter switches (the return switch on the left and HP switch on the right) remained on during cutting, when the front cover was opened and closed, or when the machine was switched on.
		<ul style="list-style-type: none"> • Cutter left return switch harness loose, broken, defective • Cutter left return switch defective • Cutter right return switch harness loose, broken, defective • Cutter right return switch defective
SC508-02	D	Cutter Motor Error
		The cutter HP sensor on the right did not go off within 300 ms after the cutter motor was switched on. The cutter did not move from its home position.
		<ul style="list-style-type: none"> • Cutter motor harness loose, broken, defective • Something is blocking the horizontal movement of the cutter in its track • Cutter motor defective

SC508-03	D	Cutter Operation Error	
		The cutter return switch on the left end of the cutter unit did not switch on within 3 sec. after the cutter motor switched on.	
		<ul style="list-style-type: none"> • Something is blocking the cutter in its track • The cutter drive belt is jammed. (Stop driving the cutter and move it to its home position on the right.) 	
SC508-04	D	Cutter Home Position Switch Error	
		After normal cutting, the right cutter sensor is not set to ON within 3 sec. after the cutter returns to its home position.	
		<ul style="list-style-type: none"> • Something is blocking the cutter in its track • The cutter drive belt is jammed 	
6	SC520-01	D	Vertical Paper Feed Mechanism Communication Error
			No response from the motor control firmware
			Communication error between the motor control firmware and engine, or the machine failed to stop within the specified time and area because of the mechanical trouble.
			<p>Communication Error</p> <ul style="list-style-type: none"> • Cycle the machine off/on • Check the harness connections between the roll unit and the MCU, and RFDB if Roll Unit 2 is installed • MCU defective • If not recovered, replace the BICU. <p>Mechanical Trouble</p> <ul style="list-style-type: none"> • Check that there is no problem with the driving parts (registration roller and its parts, gear, roller, belt, pressure roller). • If the belt is loose, reset the motor. • If it is not recovered by setting the main power switch to OFF and back ON, replace the parts.

SC520-02	D	Vertical Paper Feed Hardware Error
		Response of hardware error from motor control
		<ul style="list-style-type: none"> • Motor (defective or broken), sensor (defective, broken, or position error), encoder sheet (broken, position error, or dirty), or other rotation load error. • Roll paper feed motor harness loose, broken, defective • Encoder sensor harness or encoder wheel loose, broken, defective • Motor defective • BICU defective
SC520-03	D	Vertical Paper Feed Operation Direction Error
		Response of moving direction error from motor control
		<ul style="list-style-type: none"> • Vertical wheel sensor connection loose, broken, defective • Vertical motor connection loose, broken, defective • Check motor to confirm that the polarity of the harness connector is correct • If the motor or an encoder error has been recovered and the motor connection was not correct, reverse the harness +/- connection. • Check the sensor to confirm that the polarity of the harness connection is correct • If the motor or an encoder error has been recovered and the encoder connection was not correct, reverse the connections of the phase A and phase B sensor harnesses.
SC520-04	D	Sub Scan Motor Driver Error (Overcurrent)
		Response to the motor driver error (overcurrent) from motor control
		<ul style="list-style-type: none"> • Check that there is no problem on the driving parts (registration roller and its parts, gear, roller, belt, and pressure roller). • Check that there is no problem on sliding. • If no problem is found above but it is not recovered by setting the main power switch to OFF and back ON, replace the BICU.

SC520-05	D	Sub Scan Motor Driver Error (Overheating)
		Response to a motor driver error (overheating) from motor control
		<ul style="list-style-type: none"> • Check that there is no problem on the driving parts (registration roller and its parts, gear, roller, belt, and pressure roller). • Check that there is no problem on sliding. • Check that there is no abnormal odor, smoke, or fire. • If no problem is found above but it is not recovered by setting the main power switch to OFF and back ON, replace BICU.
SC520-06	D	Sub Scan Motor Driver Error (Low Voltage)
		Response to the motor driver error (low voltage) from motor control
		<p>This error is generated when the motor driver is in low-voltage status.</p> <ul style="list-style-type: none"> • If it is not recovered by setting the main power switch to OFF and back ON, replace the BICU.
SC521-01	D	Roll Unit 1 Communication Error
		No response from the motor control firmware
		<p>Communication error between the motor control firmware and engine. The machine failed to stop within the specified time and area because of the mechanical trouble.</p> <p>Communication Error</p> <ul style="list-style-type: none"> • Roll Unit 1 is not connected • Cycle the machine off/on • Check the harness connections between the roll unit and the MCU • MCU defective • If not recovered, replace IOB and BICU. <p>Mechanical Trouble</p> <ul style="list-style-type: none"> • Check that there is no problem on the feed driving parts (gear, roller). • If it is not recovered by setting the main power switch to OFF and back ON, replace the parts.

SC521-02	D	<p>Roll Unit 1 Hardware Error</p> <hr/> <p>Response of hardware error from motor control</p> <hr/> <p>Motor (defective or broken), sensor (defective, broken or position error), encoder sheet (broken, position error, or dirty), and other rotation load error</p> <ul style="list-style-type: none"> • Roll paper feed motor harness loose, broken, defective • Encoder sensor harness or encoder wheel loose, broken, defective • Motor defective • If not recovered, replace IOB and BICU.
SC521-03	D	<p>Roll unit 1 motor driver defective</p> <hr/> <p>Response to the motor driver error from motor control</p> <hr/> <p>This error is generated when the motor driver is in overcurrent, heating, or low-voltage status.</p> <ul style="list-style-type: none"> • Check that there is no problem on the driving parts (roller and its parts, gear, roller, motor). • Check that there is no problem with sliding. • If no problem is found above but it is not recovered by setting the main power switch to OFF and back ON, replace IOB.
SC522-01	D	<p>Roll 2 Communication Error</p> <hr/> <p>No response from the motor control firmware</p> <hr/> <p>Communication error between the motor control firmware and engine The machine failed to stop within the specified time and area due to the mechanical trouble.</p> <p>Communication Error</p> <ul style="list-style-type: none"> • Cycle the machine off/on • Check the harness connections between the roll unit, RFDB, MCU • MCU or RFDB defective • If not repaired above, replace BICU and RFDB. <p>Mechanical Trouble</p> <ul style="list-style-type: none"> • Check that there is no problem on the feed driving parts (gear, roller). • If it is not recovered by setting the main power switch to OFF and back ON, replace the parts.

SC522-02	D	Roll 2 Hardware Error
		Response of hardware error from motor control
		<p>Motor (defective or broken), sensor (defective, broken or position error), encoder sheet (broken, position error, or dirty), and other rotation load error</p> <ul style="list-style-type: none"> • Roll paper feed motor harness loose, broken, defective • Encoder sensor harness or encoder wheel loose, broken, defective • Motor defective • If not repaired above, replace BICU and RFDB.
SC522-03	D	Roll unit 2 motor driver defective
		Response to the motor driver error from motor control
		<p>This error is issued when the motor driver is in overcurrent, heating, or low-voltage status.</p> <ul style="list-style-type: none"> • Check that there is no problem on the driving parts (roller and its parts, gear, roller, motor). • Check that there is no problem with sliding. • If no problem is found above but it is not recovered by setting the main power switch to OFF and back ON, replace IOB.
SC523-01	B	Stripper Support Sensor Error (Not Set to ON)
		When the stop position of the bypass paper stopper was being moved, the bypass stopper clutch sensor was not set to ON.
		<p>Bypass stopper clutch sensor trouble, bypass stopper clutch defective</p> <ul style="list-style-type: none"> • Main power switch OFF and back ON
SC523-02	B	Bypass Stopper Clutch Sensor Error (Not Set to OFF)
		When the refuge position of the bypass paper stopper was being moved, the bypass stopper clutch sensor was not set to OFF.
		<p>Bypass stopper clutch trouble, bypass stopper clutch defect</p> <ul style="list-style-type: none"> • Main power switch OFF and back ON

SC530-01	D	Intake Fan Error
		The fan was detected rotating at less than 100 r/min three times when checked at 0.3-sec. intervals (the fan stops for about 1 sec.).
		<ul style="list-style-type: none"> • Fan harness loose, broken, defective • Fan defective • Replace the intake fan or board, and set the main power switch OFF and back ON.
SC532-01	D	PSU Fan Error
		Check the lock sensor value every 100 msec. with the fan ON. If the lock signal is locked (abnormal) 50 times (5 sec.) consecutively, it is judged that the fan does not rotate correctly (locked).
		Board trouble, harness damage, loose connector <ul style="list-style-type: none"> • Check/replace the harness, check/replace the fan.
SC532-02	D	BiCU Fan Error
		Check the lock sensor value every 100 msec. with the fan ON. If the lock signal is locked (abnormal) 100 times (10 sec.) consecutively, it is judged that the fan does not rotate correctly (locked).
		Board trouble, harness damage, loose connector <ul style="list-style-type: none"> • Set the main power switch OFF and back ON, check/replace the board, check/replace the harness, check/replace the fan.
SC540-00	C	Vertical HP Sensor Error
		Not signal from the vertical HP sensor.
		<ul style="list-style-type: none"> • Edge of the wheel is dirty and requires cleaning • Edge of the vertical wheel not positioned in sensor gap • Sensor connection loose, broken, defective • Sensor defective

SC571-01	D	Head Temperature Sensor Error (Black)
		The head temperature sensor error is detected for the specified period of time.
		<ul style="list-style-type: none"> • Connection loose, broken, defective at CN138 • After correcting the problem, cycle the machine off/on • Loose connector, sensor error • Resolve the problem with the sensor, such as by correcting a loose connector of the sensor on HRB, or sensor disconnection on the head, or resetting the power.
SC571-02	D	Head Temperature Sensor Error (Color)
		The head temperature sensor near the color sub tanks registered a temperature that was out of range.
		<p>The head temperature sensor error is detected for the specified period of time.</p> <ul style="list-style-type: none"> • Connection loose, broken, defective at CN138 • After correcting the problem, cycle the machine off/on • Sensor defective • Loose connector, sensor error • Resolve the problem with the sensor, such as by correcting a loose connector of the sensor on HRB, or sensor disconnection on the head, or resetting the power.
SC573-01	D	Temperature/Humidity Sensor – Temperature Error
		The temperature/humidity sensor error is detected for the specified period of time.
		<ul style="list-style-type: none"> • Connection loose, broken, defective at CN263 • After correcting the problem, cycle the machine off/on • Sensor defective

SC573-02	D	Temperature/Humidity Sensor Error (Humidity)
		The temperature/humidity sensor error is detected for the specified period of time.
		<ul style="list-style-type: none">• Connection loose, broken, defective at CN263• After correcting the problem, cycle the machine off/on• Sensor defective

SC600: Communication

SC632-00	B	Counter device error 1	CTL
		After 3 attempts to send a data frame to the optional counter device via the serial communication line, no ACK signal was received within 100 ms.	
		<ul style="list-style-type: none"> Serial line between the optional counter device, the relay board and copier control board is disconnected or damaged. Make sure that SP5113 is set to enable the optional counter device. 	
		<ul style="list-style-type: none"> Check if the setting of the SP5113 is correctly set. Check the connection between the main machine and optional counter device. 	

SC633-00	B	Counter device error 2	CTL
		After communication was established, the controller receives the brake signal from the accounting device.	
		<ul style="list-style-type: none"> Serial line between the optional counter device, the relay board and copier control board is disconnected or damaged. Make sure that SP5113 is set to enable the optional counter device. 	
		<ul style="list-style-type: none"> Confirm that the setting of SP5113 is correct. Check the connection between the main machine and optional counter device. 	

SC634-00	B	Counter device error 3	CTL
		A backup RAM error was returned by the counter device.	
		<ul style="list-style-type: none"> Counter device control board defective Backup battery of counter device defective 	
		<ul style="list-style-type: none"> Replace the counter device. 	

SC635-00	B	Counter device error 4	CTL
		A backup battery error was returned by the counter device.	
		<ul style="list-style-type: none"> Counter device control board defective Backup battery of counter device defective 	
		<ul style="list-style-type: none"> Replace the counter device. 	
SC636	D	SD Card Error	CTL
01		Expanded authentication module error	
		There is no expanded authentication module in the machine. The SD card or the file of the expanded authentication module is broken. There is no DESS module in the machine.	
		<ul style="list-style-type: none"> No expanded authentication module Defective SD card Defective file in the authentication module No DESS module 	
		<ol style="list-style-type: none"> Install the expanded authentication module. Install the SD card. Install the DESS module. In the SSP mode set SP5-401-160 to 0. In the SSP mode, set SP5-401-161 to 0. Cycle the machine off/on. Execute SP5-876-1 (security all clear). If this is a mass-produced machine, replace the NV. 	
02		Version error	
		The version of the expanded authentication module is not correct.	
		<ul style="list-style-type: none"> Incorrect module version 	
		<ul style="list-style-type: none"> Install the correct file of the expanded authentication module. 	
SC637	D	Tracking information notification error	CTL

01	Tracking application error
	Tracking information was lost. The machine failed to give notice of the tracking information to the tracking SDK application.
	<ul style="list-style-type: none"> • Cycle the machine off/on
02	Management server error
	The machine failed to give notice of the tracking information to the management server. Tracking information was lost, and the machine could not count correctly.
	<ul style="list-style-type: none"> • Cycle the machine off/on

6

SC641-00	D	Engine serial communication error	CTL
		An error occurs in serial communication with engine.	
		<ul style="list-style-type: none"> • SC641-1: Timeout error • SC641-2: Retry over • SC641-3: Download error • SC641-4: UART error 	
		<ul style="list-style-type: none"> • Cycle the machine off/on 	

SC650	C	@Remote communication error (Cumin-M)	CTL
01	The authentication for the Cumin-M fails failed at a dial up connection due to one or more of the following:		
	<ul style="list-style-type: none"> • Incorrect SP settings • Disconnected telephone line • Disconnected modem board • Disconnected wireless LAN card 		
		<ul style="list-style-type: none"> • Check and set the correct user name (SP5-816-156) and password (SP5-816-157). 	

04	Communication line error
	The supplied voltage is not sufficient due to the defective communication line or defective connection.
	The authentication for the Cumin-M fails failed at a dial up connection due to one or more of the following: <ul style="list-style-type: none"> • Incorrect SP settings • Disconnected telephone line • Disconnected modem board • Disconnected wireless LAN card
	<ul style="list-style-type: none"> • Check and set the correct user name (SP5-816-156) and password (SP5-816-157).
05	No modem board
	Modem board is not installed even though the setting at Cumin-M (During the operation)
	The authentication for the Cumin-M fails failed at a dial up connection due to one or more of the following: <ul style="list-style-type: none"> • Incorrect SP settings • Disconnected telephone line • Disconnected modem board • Disconnected wireless LAN card
	<ul style="list-style-type: none"> • Check and set the correct user name (SP5-816-156) and password (SP5-816-157).
13	Modem board error 1
	Modem board not installed or the board is defective.
	<ul style="list-style-type: none"> • Install the modem board. • Check correct setting value for modem driver (SP5-816-160, SP5-816-165 to 171, SP5-816-188 and 189). • Replace the modem board.

14	Modem board error 2
	Modem board not installed or the board is defective.
	<ul style="list-style-type: none"> • Uninstall the modem board if it is installed. • Check that the wired/wireless LAN is working properly.

For more details about this SC code error, execute SP5990 to print an SMC report so you can read the error code. The error code is not displayed on the operation panel. Here is a list of error codes:

Error	Problem	Solution
1	Failure to certify dial-up	In the User Tools, check the dial-up user and dial-up password settings
4	Illegal modem setting	Check the setting of SP5816 160 to determine whether the setting for the AT command is correct. If this SP setting is correct, then the problem is a bug in the software.
5	Poor connection due to low power supply on the line.	The problem is on the external power supply line, so there is no corrective action on the machine.
11	Data in the NVRAM became corrupted when the network enable switch and Cumin-M were enabled at the same time.	Use SP5985 1 and set the NIC to "0" (Disable) to disable the network board.
12	The modem board could not enable the NIB.	Replace the modem board.

SC651	C	Incorrect dial up connection	CTL
01	-	Chat program parameter error	
02	-	Chat program execution error	
		An unexpected error occurs when the modem (Cumin-M) tries to call the center with a dial up connection.	
		<ul style="list-style-type: none"> • Caused by a software bug • No action required • This SC does not interfere with operation of the machine. 	

SC652-00	A	Remote service ID2 mismatching	
		There was an authentication mismatch between ID2 for @Remote, the controller board, and NVRAM.	
		<ul style="list-style-type: none"> • Used controller board installed • Used NVRAM installed • An unexpected error occurs when the modem (Embedded RCG-M) tries to call the center with a dial up connection. 	
		<ul style="list-style-type: none"> • Install the correct controller board or anew controller board. • Install the correct NVRAM or new NVRAM. 	
SC653-00	A	Incorrect remote service ID2	CTL
		ID2 stored in the NVRAM is incorrect.	
		<ul style="list-style-type: none"> • Used NVRAM installed • An unexpected error occured when the modem (Embedded RCG-M) tries to call the center with a dial up connection 	
		<ul style="list-style-type: none"> • Clear the ID2 in the NVRAM • Input the correct ID2. 	
SC665-01	D	FFC Connection Error (BiCU-HRB)	
		An FFC set error is detected with port read and AD value read.	
		<ul style="list-style-type: none"> • FFC harness set trouble or a break between the BiCU and HRB boards 	
		<ul style="list-style-type: none"> • Connect or replace the FFC harness. 	
SC665-02	D	FFC Connection Error (BiCU-IOB)	
		FFC set error is detected with port read and AD value read.	
		<ul style="list-style-type: none"> • FFC harness set trouble or a break between the BiCU and IOB boards 	
		<ul style="list-style-type: none"> • Connect or replace the FFC harness. 	

SC666-01	D	37 V Overcurrent Error (Power ON/Recover from Sleep)
		Power of 37 V is shut down by detecting overcurrent upon setting the main power switch to ON or in recovery from Sleep mode.
		<ul style="list-style-type: none"> • Print head defective, HRB defective, BiCU defective, harness short-circuited, air release SOL defective
		<ul style="list-style-type: none"> • Replace the print head, HRB, BiCU, harness, or air release SOL.
SC666-02	D	37 V Overcurrent Error (Operation)
		Power of 37 V is shut down by detecting overcurrent during operation.
		<ul style="list-style-type: none"> • Print head defective, HRB defective, BiCU defective, harness short-circuited, air release SOL defective
		<ul style="list-style-type: none"> • Replace the print head, HRB, BiCU, harness, or air release SOL.
SC669	D	EEPROM Communication Error
		Five attempts to communicate between the EEPROM and NVRAM failed.
		<ul style="list-style-type: none"> • Device ID data corrupted • Connection between controller board and MCU loose, broken, defective • NVRAM defective • Controller board defective • MCU defective
SC669-02	D	EEPROM1 channel error

SC669-03	D	<p data-bbox="426 250 669 280">EEPROM1 device error</p> <p data-bbox="426 309 1174 378">An error report is received from the device in EEPROM (engine NVRAM) communication and retried 3 times, but communication is not retrieved.</p> <ul data-bbox="450 407 1204 878" style="list-style-type: none"> <li data-bbox="450 407 1101 437">• Noise, loose connection, EEPROM defective, BiCU defective <li data-bbox="450 466 879 495">• Main power switch OFF and back ON <li data-bbox="450 515 707 544">• Replace the EEPROM. <li data-bbox="450 564 666 593">• Replace the BiCU. <li data-bbox="450 613 1174 682">• Check whether the EEPROM is fully connected or not. If it is not fully connected, connect it properly. <li data-bbox="450 691 1184 760">• Check whether foreign matter is attached to the EEPROM connection section or not. If so, remove it. <li data-bbox="450 780 1204 878">• If an error is generated, check for recovery by setting the main power switch to OFF and back ON. If not recovered, replace the EEPROM. If not recovered by replacing the EEPROM, replace the BiCU.
SC669-36	D	EEPROM1 Verify Error
SC669-37	D	<p data-bbox="426 966 772 995">EEPROM1 Defect Detection Error</p> <p data-bbox="426 1025 1174 1093">An error report is received from the device in EEPROM (engine NVRAM) communication and retried 2 times, but communication is not retrieved.</p> <ul data-bbox="450 1123 1204 1593" style="list-style-type: none"> <li data-bbox="450 1123 1101 1152">• Noise, loose connection, EEPROM defective, BiCU defective <li data-bbox="450 1181 879 1211">• Main power switch OFF and back ON <li data-bbox="450 1230 707 1260">• Replace the EEPROM. <li data-bbox="450 1279 666 1309">• Replace the BiCU. <li data-bbox="450 1328 1174 1397">• Check whether the EEPROM is fully connected or not. If it is not fully connected, connect it properly. <li data-bbox="450 1407 1184 1475">• Check whether foreign matter is attached to the EEPROM connection section or not. If so, remove it. <li data-bbox="450 1485 1204 1593">• If an error is generated, check for recovery by setting the main power switch to OFF and back ON. If not recovered, replace the EEPROM. If not recovered by replacing the EEPROM, replace the BiCU.

SC669-38	D	<p>EEPROM2: EEPROM for KAKA Data Error</p> <p>The values for the y1_head and y2_head of each print head (KAKA) for 3 bytes (both upper and lower) are checked, and all values are different and recovery is not available after 2 retries.</p> <ul style="list-style-type: none"> Noise, EEPROM defective, BiCU defective Main power switch OFF and back ON Replace the BiCU. If an error is generated, check recovery by setting the main power switch to OFF and back ON. If not recovered, replace the BiCU.
SC669-39	D	<p>EEPROM2 Defect Detection Error</p> <p>An error report is received from the device in EEPROM (engine NVRAM) communication and retried 2 times, but communication is not retrieved.</p> <ul style="list-style-type: none"> Noise, EEPROM defective, BiCU defective Main power switch OFF and back ON Replace the BiCU. If an error is generated, check for recovery by setting the main power switch to OFF and back ON. If not recovered, replace the BiCU.
SC669-52	D	EEPROM2 Channel Error
SC669-53	D	<p>EEPROM2 Device Error</p> <p>An error report is received from the device in EEPROM (engine NVRAM) communication and retried 3 times, but communication is not retrieved.</p> <ul style="list-style-type: none"> Noise, EEPROM defective, BiCU defective Main power switch OFF and back ON Replace the BiCU. If an error is generated, check for recovery by setting the main power switch to OFF and back ON. If not recovered, replace the BiCU.

<p>SC673-10</p>	<p>D</p>	<p>Flair Communication Disabled on the Operation Panel (Cheetah)</p>
		<p>This is generated only when a Cheetah operation panel is installed.</p> <p>Communication with the controller of the Cheetah operation panel is done with USB Ethernet communication. The Cheetah operation panel has a communication path (Flair communication) to transmit main unit information besides the communication with the GW operation section.</p> <p>The operation panel does not accept response from the main unit with this Flair communication.</p> <p>This error is generated because the CATS module does not start if SP setting (SP-5748-201) is not activated with a Cheetah operation panel installed.</p>
		<ul style="list-style-type: none"> • This error is generated when the CATS module (GW controller) cannot report a response to the report of the monitor service module (operation panel).
		<ul style="list-style-type: none"> • Main power switch OFF and back ON
<p>SC674-01 SC674-02</p>	<p>D</p>	<p>Transfer Error</p>
		<p>-</p>
		<ul style="list-style-type: none"> • Video transfer error is generated in the controller.
		<p>-</p>
<p>SC680-01</p>	<p>D</p>	<p>DSP Start Error</p>
		<p>A DSP start error occurs 3 times consecutively.</p>
		<ul style="list-style-type: none"> • KISSIN defective, BiCU defective
		<ul style="list-style-type: none"> • Cycle the machine off/on • If not repaired, replace BICU.

SC680-02	D	DSP Initialization Error
		A WDT error or communication error is generated because of DSP runaway after completion of DSP start. Communication is not established after a specified period of time after DSP start is completed.
		<ul style="list-style-type: none"> • KISSIN defective, BiCU defective
		<ul style="list-style-type: none"> • Cycle the machine off/on • If not repaired, replace BiCU.
SC680-03	D	DSP Operation Error
		A WDT error or communication error is generated because of DSP runaway on DSP operation.
		<ul style="list-style-type: none"> • KISSIN defective, BiCU defective
		<ul style="list-style-type: none"> • Cycle the machine off/on • If not recovered, replace the BiCU.
SC681-01	D	KISSIN Initialize Error
		KISSIN ID check fail
		<ul style="list-style-type: none"> • KISSIN defective, BiCU defective
		<ul style="list-style-type: none"> • Cycle the machine off/on • If not recovered, replace the BiCU.
SC685	C	Ink Collector Tank Communication Error
		The error report is received from the device in communication with the ink collector tank (ID Chip) and retried 3 times, but communication is not retrieved.
SC685-02	C	Channel Error (Path Disconnected)
		<ul style="list-style-type: none"> • Replace the BiCU

SC685-03	C	<p data-bbox="404 250 646 280">Device Error (No ACK)</p> <ul data-bbox="429 309 1201 752" style="list-style-type: none"> <li data-bbox="429 309 861 339">• Insert and remove the ink collector tank <li data-bbox="429 358 765 388">• Replace the ink collector tank. <li data-bbox="429 407 1119 472">• Check whether foreign matter is attached to the ID chip of the ink collector tank or not. If so, remove it. <li data-bbox="429 491 1185 556">• Check whether foreign matter is pinched with or attached to the ID chip terminal of the ink collector tank or not. If so, remove it. <li data-bbox="429 576 1185 640">• Check whether the ID chip terminal of the ink collector tank is defective, such as being deformed, or not. If so, replace the ID chip terminal. <li data-bbox="429 660 1201 752">• If an error is generated after removing the exterior for repairing the machine, check that the connectors are correctly connected upon repair. If some trouble is found, correct it.
SC686-12	C	<p data-bbox="404 813 996 842">Ink Cartridge (C): Channel Error (Bus Disconnection, etc.)</p> <p data-bbox="404 872 1126 936">There was an error in communication with the ID Chip on the Cyan ink cartridge. Three retries were attempted and failed.</p> <ul data-bbox="429 966 642 995" style="list-style-type: none"> <li data-bbox="429 966 642 995">• Replace the BiCU

SC686-13	C	<p data-bbox="408 250 902 282">Ink Cartridge (C): Device Error (No ACK Signal)</p> <p data-bbox="408 309 1126 380">There was an error in communication with the ID Chip on the Cyan ink cartridge. Three retries were attempted and failed.</p> <ul data-bbox="430 407 1204 1203" style="list-style-type: none"> <li data-bbox="430 407 965 439">• Ink cartridge ID data corrupted or chip damaged <li data-bbox="430 454 609 486">• Spurious noise <li data-bbox="430 501 724 533">• Cycle the machine off/on <li data-bbox="430 548 938 580">• Remove the Cyan ink cartridge and set it again <li data-bbox="430 595 691 627">• Switch the machine on <li data-bbox="430 642 1007 674">• If the problem persists, replace the Cyan ink cartridge <li data-bbox="430 689 820 721">• Insert and remove the ink-cartridge. <li data-bbox="430 736 724 768">• Replace the ink-cartridge. <li data-bbox="430 784 1122 854">• Check whether foreign matter is attached to the ID chip of the ink cartridge or not. If so, remove it. <li data-bbox="430 870 1190 964">• Check whether foreign matter is pinched with or attached to the ID chip terminal of the ink cartridge holder (insertion section on the main unit) or not. If so remove it. <li data-bbox="430 980 1190 1081">• Check whether the ID chip terminal of the ink cartridge holder (insertion section on the main unit) is defective, such as being deformed, or not. If so, replace the service part module. <li data-bbox="430 1097 1204 1203">• If an error is generated after removing the exterior for repairing the machine, check that the connectors are correctly connected upon repair. If some trouble is found, correct it.
SC686-22	C	<p data-bbox="408 1264 998 1295">Ink Cartridge (M): Channel Error (Bus Disconnection, etc.)</p> <p data-bbox="408 1323 1167 1393">There was an error in communication with the ID Chip on the Magenta ink cartridge. Three retries were attempted and failed.</p>

SC686-23	C	<p data-bbox="408 250 906 280">Ink Cartridge (M): Device Error (No ACK Signal)</p> <p data-bbox="408 309 1167 378">There was an error in communication with the ID Chip on the Magenta ink cartridge. Three retries were attempted and failed.</p> <ul data-bbox="430 407 1201 1197" style="list-style-type: none"> <li data-bbox="430 407 961 437">• Ink cartridge ID data corrupted or chip damaged <li data-bbox="430 456 609 486">• Spurious noise <li data-bbox="430 505 724 535">• Cycle the machine off/on <li data-bbox="430 554 979 584">• Remove the Magenta ink cartridge and set it again <li data-bbox="430 603 691 633">• Switch the machine on <li data-bbox="430 652 1044 682">• If the problem persists, replace the Magenta ink cartridge <li data-bbox="430 701 824 731">• Insert and remove the ink-cartridge. <li data-bbox="430 750 724 780">• Replace the ink-cartridge. <li data-bbox="430 799 1122 868">• Check whether foreign matter is attached to the ID chip of the ink cartridge or not. If so, remove it. <li data-bbox="430 887 1188 976">• Check whether foreign matter is pinched with or attached to the ID chip terminal of the ink cartridge holder (insertion section on the main unit) or not. If so, remove it. <li data-bbox="430 995 1188 1083">• Check whether the ID chip terminal of the ink cartridge holder (insertion section on the main unit) is defective, such as being deformed, or not. If so, replace the service part module. <li data-bbox="430 1103 1201 1197">• If an error is generated after removing the exterior for repairing the machine, check that the connectors are correctly connected upon repair. If some trouble is found, correct it.
SC686-32	C	<p data-bbox="408 1260 989 1289">Ink Cartridge (Y): Channel Error (Bus Disconnection, etc.)</p> <p data-bbox="408 1319 1140 1387">There was an error in communication with the ID Chip on the Yellow ink cartridge. Three retries were attempted and failed.</p>

SC686-33	C	<p data-bbox="408 250 902 280">Ink Cartridge (Y): Device Error (No ACK Signal)</p> <hr/> <p data-bbox="408 309 1140 378">There was an error in communication with the ID Chip on the Yellow ink cartridge. Three retries were attempted and failed.</p> <hr/> <ul data-bbox="430 407 1201 1197" style="list-style-type: none"> <li data-bbox="430 407 965 437">• Ink cartridge ID data corrupted or chip damaged <li data-bbox="430 456 609 486">• Spurious noise <li data-bbox="430 505 724 535">• Cycle the machine off/on <li data-bbox="430 554 954 584">• Remove the Yellow ink cartridge and set it again <li data-bbox="430 603 691 633">• Switch the machine on <li data-bbox="430 652 1020 682">• If the problem persists, replace the Yellow ink cartridge <li data-bbox="430 701 820 731">• Insert and remove the ink-cartridge. <li data-bbox="430 750 724 780">• Replace the ink-cartridge. <li data-bbox="430 799 1122 868">• Check whether foreign matter is attached to the ID chip of the ink cartridge or not. If so, remove it. <li data-bbox="430 887 1190 976">• Check whether foreign matter is pinched with or attached to the ID chip terminal of the ink cartridge holder (insertion section on the main unit) or not. If so, remove it. <li data-bbox="430 995 1190 1083">• Check whether the ID chip terminal of the ink cartridge holder (insertion section on the main unit) is defective, such as being deformed, or not. If so, replace the service part module. <li data-bbox="430 1103 1201 1197">• If an error is generated after removing the exterior for repairing the machine, check that the connectors are correctly connected upon repair. If some trouble is found, correct it.
SC686-42	C	<p data-bbox="408 1264 993 1293">Ink Cartridge (K): Channel Error (Bus Disconnection, etc.)</p> <hr/> <p data-bbox="408 1323 1126 1391">There was an error in communication with the ID Chip on the Black ink cartridge. Three retries were attempted and failed.</p>

SC686-43	C	<p data-bbox="406 250 902 280">Ink Cartridge (K): Device Error (No ACK Signal)</p> <p data-bbox="406 309 1126 374">There was an error in communication with the ID Chip on the Black ink cartridge. Three retries were attempted and failed.</p> <ul data-bbox="430 407 1201 1197" style="list-style-type: none"> <li data-bbox="430 407 965 437">• Ink cartridge ID data corrupted or chip damaged <li data-bbox="430 456 609 486">• Spurious noise <li data-bbox="430 505 724 535">• Cycle the machine off/on <li data-bbox="430 554 941 584">• Remove the Black ink cartridge and set it again <li data-bbox="430 603 691 633">• Switch the machine on <li data-bbox="430 652 1009 682">• If the problem persists, replace the Black ink cartridge <li data-bbox="430 701 824 731">• Insert and remove the ink-cartridge. <li data-bbox="430 750 724 780">• Replace the ink-cartridge. <li data-bbox="430 799 1122 864">• Check whether foreign matter is attached to the ID chip of the ink cartridge or not. If so, remove it. <li data-bbox="430 883 1188 976">• Check whether foreign matter is pinched with or attached to the ID chip terminal of the ink cartridge holder (insertion section on the main unit) or not. If so, remove it. <li data-bbox="430 995 1188 1087">• Check whether the ID chip terminal of the ink cartridge holder (insertion section on the main unit) is defective, such as being deformed, or not. If so, replace the service part module. <li data-bbox="430 1107 1201 1197">• If an error is generated after removing the exterior for repairing the machine, check that the connectors are correctly connected upon repair. If some trouble is found, correct it.
SC687-00	D	<p data-bbox="406 1264 611 1293">PER command error</p> <p data-bbox="406 1323 1098 1387">The main machine received no PER-command module from the GW controller.</p> <ul data-bbox="430 1421 1012 1450" style="list-style-type: none"> <li data-bbox="430 1421 1012 1450">• Poor communication, cycle the machine power off/on

SC700: Not Used

There are no Group 700 service codes for this machine..

SC800: Firmware

SC816	D	Energy save I/O subsystem error	
		The energy save I/O subsystem is defective or this system detected a controller board error.	
		<ul style="list-style-type: none"> • Reboot the machine. • Replace the controller board. 	
SC817	D	Monitor error	CTL
		This is a file detection and electronic file signature check error when the boot loader attempts to read the self-diagnostic module, system kernel, or root system files from the OS Flash ROM, or the items on the SD card in the controller slot are false or corrupted.	
		<ul style="list-style-type: none"> • OS Flash ROM data defective • SD card data defective 	
		<ul style="list-style-type: none"> • Change the controller firmware. • Use another SD card. 	

Error Codes

Code	Meaning
0x0000 0000	BIOS boot error
0x0000 0001	Primary boot start load error
0x0000 0002	Secondary boot load error (Boot3.Elf)
0x0000 0003	Self-diagnostic module error (Diag.Elf)
0x0000 0004	Kernel start error (Netbsd)
0x0000 0005	Root file system file read error (Rootfs)
0xffff ffff	Other error

Example: Data in the self-diagnostic module, system kernel, or root system files are corrupted or do not exist in OS flash ROM or on the SD card

Files in the self-diagnostic module, kernel, or root file system on the SD card have been falsified or altered

- Before discarding the SD card, try to update the data on the card. If the error occurs again, the card may be defective.
- Be sure to use an SD card that contains the correct electronic signature.

SC818-00	D	Watchdog Error	CTL
		A watchdog error is generated.	
		<ul style="list-style-type: none"> • During running of the system program, bus hold or interrupt program endless loop is generated and other processes cannot work. 	
		<ul style="list-style-type: none"> • Main power switch OFF to ON • Replace the system program • Replace the controller board • Replace the peripherals 	

SC819	D	Fatal kernel error	
		Due to a control error, a RAM overflow occurred during system processing. One of the following messages was displayed on the operation panel.	
		0x5032	HAIC-P2 error
		0x5245	Link-up fail
		0x5355	L2 Status Time Out
		0x696e	gwinit died
		0x766d	Vm_pageout: VM is full
		554C	USB loader defect
		Other	
		<ul style="list-style-type: none"> • System program defective • Controller board defective • Optional board defective • Replace controller firmware 	

SC840	D	EEPROM access error	CTL
		A read error occurred during I/O processing. The failure of the 3rd attempt to read caused this error.	
		<ul style="list-style-type: none"> Defective EEPROM 	
		<ul style="list-style-type: none"> Replace the EEPROM. 	
SC841	D	EEPROM read error	CTL
		Mirrored data of the EEPROM is different from the original data in EEPROM.	
		<ul style="list-style-type: none"> Data in the EEPROM was overwritten for some reason. 	
		<ul style="list-style-type: none"> Cycle the machine off/on 	
SC842-00	C	Nand-Flash updating verification error	CTL
		A write error for the module written in Nand-Flash occurred while the remote ROM and ROM were being updated.	
		<ul style="list-style-type: none"> Damaged Nand-Flash 	
		<ul style="list-style-type: none"> Cycle the machine off/on 	
SC842-01	C	Nand-Flash Bad Blocks Exceed Threshold	CTL
		When Nand-Flash status is read and the number of bad blocks exceeds the threshold upon starting or recovering from Power Save mode, SCS generates this SC error.	
		<ul style="list-style-type: none"> Nand-Flash bad blocks exceed the threshold. 	
		<ul style="list-style-type: none"> Replace the controller board. 	
SC842-02	C	Nand-Flash Block Erasing Time Exceed Threshold.	CTL
		When Nand-Flash status is read and the block erasing time exceeds the threshold upon starting or recovering from Power Save mode, SCS generates this SC error.	
		<ul style="list-style-type: none"> The maximum number of Nand-Flash blocks being erased exceeds the threshold. 	
		<ul style="list-style-type: none"> Replace the controller board. 	

SC850	D	Network I/F error	CTL
		<ul style="list-style-type: none"> • Not functional 	
		<ul style="list-style-type: none"> • Cycle the machine off/on 	

SC855	B	Hardware Problem:wireless LAN board	CTL
		The wireless LAN board can be accessed, but an error was detected.	
		<ul style="list-style-type: none"> • Loose connection • Defective wireless LAN card 	
		<ul style="list-style-type: none"> • Check wireless LAN card connection • Main power switch OFF to ON • Replace the wireless card if the problem still exists. 	

SC858	A	Data encryption conversion error	CTL
		These are errors of the HDD Data Encryption Option D377.	
00		Key Acquisition	
		Key could be acquired.	
		<ul style="list-style-type: none"> • Replace the controller board 	
01		HDD Key Setting Error	
		The key was acquired but the HDD could not be set.	
		<ul style="list-style-type: none"> • Turn the machine power off/on several times. • Replace the controller board. 	
02		NVRAM Read Error	
		NVRAM data conversion failed (mismatch with nvram.conf)	
		<ul style="list-style-type: none"> • Replace the NVRAM 	
30		NVRAM Before Replace Error DFU	
		May occur during development.	
		<ul style="list-style-type: none"> • Turn the machine power off/on several times. • Replace the controller board. 	

31		Other Error	
		An unexpected error occurred while data was being converted. This error is the same as SC991. See SC991 below.	
SC859	B	Data encryption conversion errors	CTL
		Data encryption on the HDD failed.	
01		HDD encrypted data restoration error	
		Data could not be restored after encryption.	
		<ul style="list-style-type: none"> • HDD connection loose, broken, defective • Format HDD • HDD defective 	
02		Power interrupt error	
		Power supply was interrupted during data encryption.	
		<ul style="list-style-type: none"> • Cycle the machine off/on 	
08		HDD Check Error	
		Data conversion was attempted with no HDD unit present.	
		<ul style="list-style-type: none"> • Confirm that HDD unit installed correctly • Initialize HDD with SP5832-1 <p>Note: After installation, a new HDD should be formatted with SP5832-1</p>	
09		Power Loss During Data Conversion	
		Data conversion stopped before NVRAM/HDD data was converted.	
		<ul style="list-style-type: none"> • Format HDD with SP5832-1 	
10		Data Read Command Error	
		More than two illegal DMAC communications were returned.	
		<ul style="list-style-type: none"> • HDD defective • Format HDD with SP5832-1 • Replace HDD 	

SC860	B	HDD startup error at power on	CTL
		HDD is connected but a driver error is detected. The driver did not respond with the status of the HDD within 30 sec.	
		<ul style="list-style-type: none"> • HDD is not initialized • Level data is corrupted • Initialize the HDD with SP5-832-001. • HDD is defective 	
SC862	D	Bad sector overflow	CTL
		There more 100 bad sectors in image storage area of the HDD.	
		<ul style="list-style-type: none"> • Format HDD with SP4911-2 • HDD defective 	
SC863	D	HDD data read failure	CTL
		The data written to the HDD cannot be read normally, due to bad sectors generated during operation.	
		<ul style="list-style-type: none"> • HDD defective • Controller defective 	
		<p>Note: If the bad sectors are generated at the image partition, the bad sector information is written to NVRAM, and the next time the HDD is accessed, these bad sectors will not be accessed for read/write operation.</p>	
SC864	D	HDD data CRC error	CTL
		During HDD operation, the HDD cannot respond to a CRC error query. Data transfer did not execute normally while data was being written to the HDD.	
		<ul style="list-style-type: none"> • Format HDD • HDD defective 	
SC865	D	HDD access error	CTL
		An error was detected during operation of the HDD.	
		<ul style="list-style-type: none"> • HDD defective. 	

SC866	B	SD card authentication error	CTL
		A correct license was not found in the SD card.	
		<ul style="list-style-type: none"> • Wrong type of SD card • SD card data is corrupted. 	
		<ul style="list-style-type: none"> • Used correct SD card • Replace SD card 	
SC867	B	SD card error 2: SD card removed	CTL
		The SD card in the boot slot when the machine was turned on was removed while the machine was on.	
		<ul style="list-style-type: none"> • Insert the SD card • Turn the machine's power off/on 	
SC868	D	SD card access error	CTL
		An error occurred while an SD card was used.	
		<ul style="list-style-type: none"> • SD card not inserted correctly • SD card defective • Controller board defective 	
SC872	D	HDD mail RX data error	CTL
		An HDD error was detected immediately after power on.	
		<ul style="list-style-type: none"> • The HDD may be defective or the machine was accidentally powered off while the HDD was being accessed. • Cycle the machine off/on • Reformat the HDD with SP5832-7 (Mail RX Data) • Replace the HDD 	

SC873	D	HDD mail TX error	CTL
		An error was detected on the HDD immediately after the machine was turned on, or power was turned of while the machine used the HDD.	
		<ul style="list-style-type: none"> • Do SP5832-007 to format the HDD. • HDD defective. 	

SC874			
-05	D	Batch Erase Error (Data Area Erase) Read Error	
-06	D	Batch Erase Error (Data Area Erase) Write Error	
-09	D	Batch Erase Error (Data Area Erase) No Drive Response	
-10	D	Batch Erase Error (Data Area Erase) Kernel Error	
-12	D	Batch Erase Error (Data Area Erase) Specified Partition Not Found	
-13	D	Batch Erase Error (Data Area Erase) No Device File	
-14	D	Batch Erase Error (Data Area Erase) Start Option Error	
-15	D	Batch Erase Error (Data Area Erase) Specified Sector Number Not Found	
-16	D	Batch Erase Error (Data Area Erase) hdderase Fail	
-41	D	Batch Erase Error (Data Area Erase) Other Fatal Error	
-42	D	Batch Erase Error (Data Area Erase) End with Stop Indication	
-61	D	Batch Erase Error (Data Area Erase) Recovery of Library Error	
-62	D	Batch Erase Error (Data Area Erase) Recovery of Library Error	
-63	D	Batch Erase Error (Data Area Erase) Recovery of Library Error	
-64	D	Batch Erase Error (Data Area Erase) Recovery of Library Error	
-65	D	Batch Erase Error (Data Area Erase) Recovery of Library Error	
-66	D	Batch Erase Error (Data Area Erase) Not Available	
-67	D	Batch Erase Error (Data Area Erase) Erase Not End	
-68	D	Batch Erase Error (Data Area Erase) HDD Format Fail (Normal)	
-69	D	Batch Erase Error (Data Area Erase) HDD Format Fail (Error)	

-70	D	Batch Erase Error (Data Area Erase) Wrong Recovery of Library	
-99	D	Batch Erase Error (Data Area Erase) Other Errors	
		<p>A data erase error of HDD/NVRAM is detected. Recovered after performing the batch erase option (data erase of HDD/NVRAM)</p> <ul style="list-style-type: none"> • The HDD erase program detects an error. • An error is detected by erasing the data of NVRAM. • The erase program (batch erase option) has not been set. <ul style="list-style-type: none"> • Turn the main power OFF and back ON, and then perform batch erase (HDD erase) from UP again. • If any HDD sector has problem, an error is generated after performing batch erase again. • If the batch erase option has not been set, set it. 	
SC875	D	Delete al error 2: Data area	CTL
		<p>An error occurred while the machine deleted data from the HDD</p> <p>Note: The source of this error is the Data Overwrite Security Unit running from an SD card.</p>	
		<ul style="list-style-type: none"> • Cycle the machine off/on 	
SC876	D	Log Data Error	CTL
		<p>An error was detected in the handling of the log data at power on or during machine operation. This can be caused by switching the machine off while it is operating.</p>	
01	D	Log Data Error 1	
		<ul style="list-style-type: none"> • Damaged log data file in the HDD 	
		<ul style="list-style-type: none"> • Initialize the HDD with SP5-832-004. 	

02	D	Log Data Error 2
		<ul style="list-style-type: none"> An encryption module not installed
		<ul style="list-style-type: none"> Replace or set again the encryption module. Disable the log encryption setting with SP9-730-004 ("0" is off.).
03	D	Log Data Error 3
		<ul style="list-style-type: none"> Invalid log encryption key due to defective NVRAM data
		<ul style="list-style-type: none"> Initialize the HDD with SP5-832-004. Disable the log encryption setting with SP9-730-004 ("0" is off.)
04	D	Log Data Error 4
		<ul style="list-style-type: none"> Unusual log encryption function due to defective NVRAM data
		<ul style="list-style-type: none"> Initialize the HDD with SP5-832-004.
05	D	Log Data Error 5
		<ul style="list-style-type: none"> Installed NVRAM or HDD which is used in another machine.
		<ul style="list-style-type: none"> Reinstall the previous NVRAM or HDD. Initialize the HDD with SP5-832-004.
99	D	Log Data Error 99
		<ul style="list-style-type: none"> Other than the above causes
		<ul style="list-style-type: none"> Ask your supervisor.

SC877	B	Data Overwrite Security error	CTL
		An error occurred, preventing successful execution of the Data Overwrite Security function, even though it has been enabled with SP5898.	
		<ul style="list-style-type: none"> Cycle the machine off/on Replace NVRAM 	

SC878	D	Chip errors	CTL
00	D	TPM electronic recognition error	
01	D	USB flash error	

02	D	TPM error
03	D	TCSD error
		<ul style="list-style-type: none"> • Incorrect updating for the system firmware • Incorrect operating of the USB flash • Defective flash ROM on the controller board
		<ul style="list-style-type: none"> • Replace the controller board.

SC880	D	File Format Converter Error (MLB)	CTL
		A request for access to the file format converter board (MLB) was not answered within the specified time.	
		<ul style="list-style-type: none"> • Board defective 	

SC881	D	Authentication area error	CTL
		Authentication application error is detected.	
		Error data in an authentication application reaches the management limit.	
		<ul style="list-style-type: none"> • Turn the main power switch off and on. 	

SC899	D	Software performance error	CTL
		If the processing program shows abnormal performance and the program is abnormally ended, this SC is issued.	
		<ul style="list-style-type: none"> • Controller board defective • Software defective 	
		<ul style="list-style-type: none"> • Replace the controller board. • Turn the main switch off and on. • Update the firmware on the controller. 	

SC900: Software

SC900	D	Electric counter error	CTL
		The total count contains something that is not a number.	
		<ul style="list-style-type: none"> • NVRAM incorrect type • NVRAM defective • NVRAM data scrambled • Unexpected error from external source 	
		<ul style="list-style-type: none"> • Check the connection between the NVRAM and controller. • Replace the NVRAM. • Replace the controller board. 	

6

SC920 02	B	Printer application error	CTL
		Working memory error	
		An error was detected in the printer application program and operation cannot continue.	
		<ul style="list-style-type: none"> • Defective software • Unexpected hardware resource (e.g., memory shortage) 	
		<ol style="list-style-type: none"> 1. Software err, cycle the machine off/on 2. Insufficient memory, add more memory 	

SC990	D	Software performance error	CTL
		The software makes an unexpected operation.	
		<ul style="list-style-type: none"> • Defective software • Defective controller • Software error 	
		<ul style="list-style-type: none"> • Cycle the machine off/on. • Reinstall the controller firmware • Reinstall the main firmware 	

SC991	C	Software continuity error	CTL
		The software has attempted to perform an unexpected operation. However, unlike SC 990, the object of the error is continuity of the software.	
		<ul style="list-style-type: none"> • Software program error • Internal parameter incorrect • Insufficient working memory 	
		<ul style="list-style-type: none"> • This SC is not displayed on the LCD (logging only). 	

For more details about SC991:

1. Execute SP7403 or print an SMC Report (SP5990) to read the history of the 10 most recent logged errors.
2. If you touch the zero key on the operation panel with the SP selection menu displayed, you will see detailed information about the recently logged SC991, including the software file name, line number, and so on. Of these two methods, 1) is the recommended method, because another SC could write over the information for the previous SC.

SC992	C	Undefined Error (No SC Code)	CTL
		An error not controlled by the system occurred (the error does not come under any other SC code).	
		<ul style="list-style-type: none"> • Software defective • Turn the machine power off and on. The machine cannot be used until this error is corrected. • Re-install firmware 	

SC997	B	Application function selection error	CTL
		The application selected by the operation panel key operated abnormally (No response, abnormal ending).	
		<ul style="list-style-type: none"> • Software (including the software configuration) defective • An option required by the application (RAM, DIMM, board) is not installed. • Nesting of the fax group addresses is too complicated. 	
		<ul style="list-style-type: none"> • Check the devices necessary for the application program. If necessary devices have not been installed, install them. • Check that application programs are correctly configured. • For a fax operation problem, simplify the nesting of the fax group addresses. • Take necessary countermeasures specific to the application program. If the logs can be displayed on the operation panel, see the logs. 	

SC998	D	Application start error	CTL
		No applications start within a specified time after the power is turned on.	
		<ul style="list-style-type: none"> • Loose connection of RAM-DIMM, ROM-DIMM • Defective controller • Software problem 	
		<ul style="list-style-type: none"> • Check the setting of SP5-875-001. If the setting is set to "1 (OFF)", change it to "0 (ON)". • Check if the RAM-DIMM and ROM-DIMM are correctly connected. • Reinstall the controller system firmware. • Replace the controller board. 	

Note 1

If a problem always occurs in a specific condition (for example, printer driver setting, image file), the problem may be caused by a software error. In such a case, the following data and information need to be sent back to your product specialist. Please understand that it may take some time to get a reply on how to solve the problem, because in some cases the design staff in Japan must analyze the data.

- Symptom / Possible Causes / Action taken
- Summary sheet (SP mode "Printer SP", SP1-004 [Print Summary])
- SMC - All (SP5-990-001)

- SMC - Logging (SP5-990-004)
- Printer driver settings used when the problem occurs
- All data displayed on the screen (SC code, error code, and program address where the problem is logged.)
- Image file which causes the problem, if possible

Printing Problems

Before You Begin

Before you refer to this section, make sure that you are completely familiar with the procedures described in Print Head Adjustment and Cleaning procedures (p.876).

- Clean Print-heads
- Flush Print-heads
- Auto Adjust Print Head Position
- Manual Adjust Head Position
- Print Nozzle Check Pattern
- Adjust Paper Feed
- Adjust Print Position

6

White Lines, Horizontal Banding

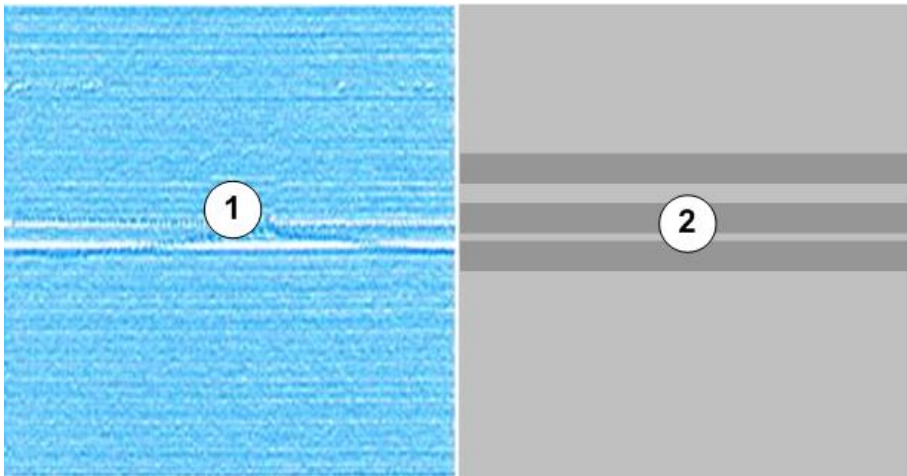

d124t001

White lines ① horizontal banding ②

Print heads clogged

Do this procedure if three cleanings and one flushing have failed to produce an unbroken Nozzle Check Pattern.

1. **Make sure that the ambient temperature and humidity are within the acceptable range:**
 - Temperature Range: 10°C to 27°C (50 °F to 81 °F)
 - Humidity Range: 15% to 80% Rh
2. **Clean the print heads again, and then print another Nozzle Check Pattern.**
3. **If the Nozzle Check Pattern is still abnormal, let the machine remain idle for 10 minutes.**
4. **Execute two more cleanings and one flushing.**
 - Be sure to print a Nozzle Check Pattern after each cleaning and the flushing.
 - If you have produced an unbroken Nozzle Check Pattern, you can stop.
5. **After the flushing, if the Nozzle Check Pattern is still not perfect, let the machine remain idle for 8 hours.**
6. **Execute three more cleanings and one flushing.**
 - Be sure to print a Nozzle Check Pattern after each cleaning and the flushing.
 - When you have produced an unbroken Nozzle Check Pattern, you can stop.

Other Measures

- Clean or replace maintenance unit.
- Inspect vertical encoder wheel for dirt or damage. Clean or replace.
- Replace the print head(s) (p.425).

Horizontal Lines In Margins



d124t002

Horizontal lines appear in the margins ① and ②.

Faulty Print Head or Carriage Unit

- Replace the print heads.
- Replace the carriage unit.

White, Color Vertical Banding

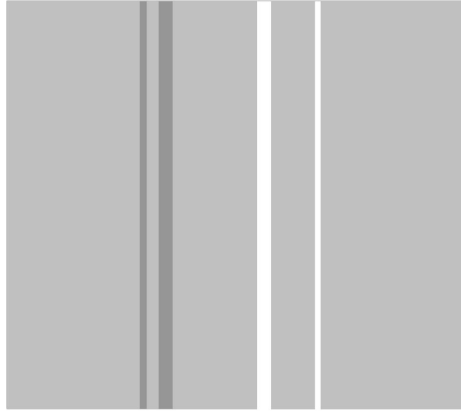

d124t003

6

Print Head Out of Position, Horizontal Encoder Strip Problem

- Do the Adjust Print Head procedure.
- Check the horizontal encoder strip and make sure that it has been installed correctly.
- Inspect the horizontal encoder strip for dirt or damage. Clean or replace it.

Overall Poor Image Quality

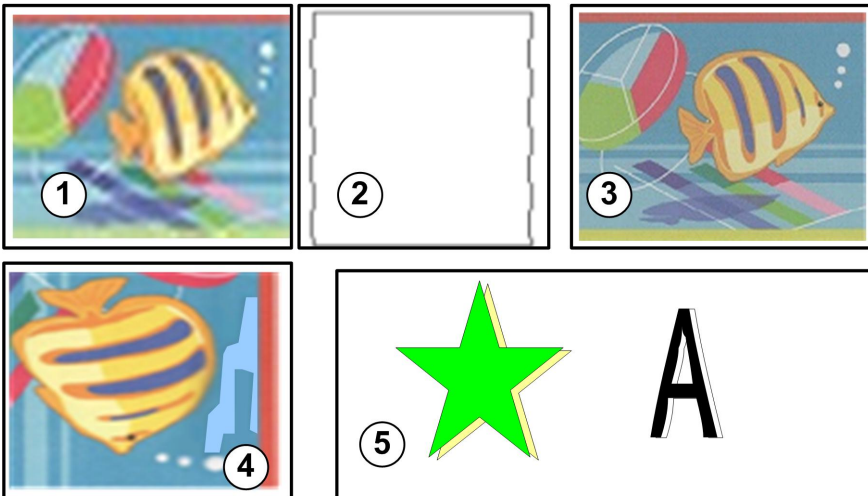

d124t004

- Image blurred ①

- Lines not straight ②
- Overall poor color quality ③
- Uneven density ④
- Double lines in graphics, text ⑤

Gap Adjustment

- Make sure that the gap between the carriage and the platen has been adjusted correctly for the type and thickness of the paper.

Print heads clogged

Do this procedure if three cleanings and one flushing have failed to produce an unbroken Nozzle Check Pattern.

- 1. Make sure that the ambient temperature and humidity are within the acceptable range:**
 - Temperature Range: 10°C to 27°C (50 °F to 81 °F)
 - Humidity Range: 15% to 80% Rh
- 2. Clean the print heads again, and then print another Nozzle Check Pattern.**
- 3. If the Nozzle Check Pattern is still abnormal, let the machine remain idle for 10 minutes.**
- 4. Execute two more cleanings and one flushing.**
 - Be sure to print a Nozzle Check Pattern after each cleaning and the flushing.
 - If you have produced an unbroken Nozzle Check Pattern, you can stop.
- 5. After the flushing, if the Nozzle Check Pattern is still not perfect, let the machine remain idle for 8 hours.**
- 6. Execute three more cleanings and one flushing.**
 - Be sure to print a Nozzle Check Pattern after each cleaning and the flushing.
 - When you have produced an unbroken Nozzle Check Pattern, you can stop.

Paper Feed Faulty

- Do the Adjust Paper Feed Procedure

Horizontal Encoder Strip

- Make sure the horizontal encoder strip has been installed correctly.
- Inspect the strip for dirt or damage. Clean or replace the strip.

Text Shifted Out of Position

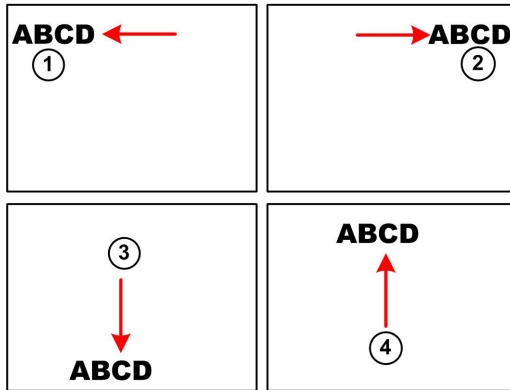

d124t005

Text misaligned, shifted too far

- Left ①
- Right ②
- Down ③
- Up ④

Obstructed, Faulty Paper Feed

- Inspect the horizontal encoder strip for dirt or damage. Clean or replace horizontal encoder strip.
- Inspect the vertical encoder wheel for dirt or damage. Clean or replace vertical encoder wheel.
- Inspect the platen for shreds of paper or other obstacles.
- Inspect the platen plates for dirt or damage. Clean or replace the platen plates.

Ink Scatter

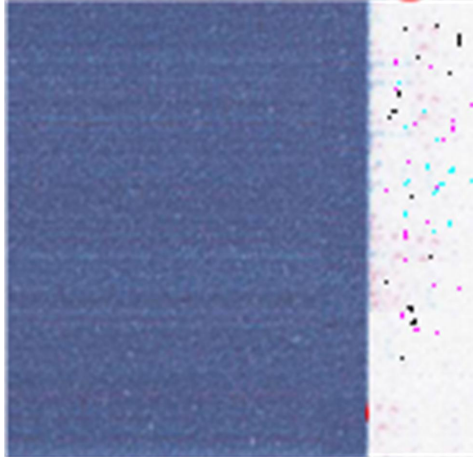

d124t006

Gap Adjustment

- Make sure that the gap between the carriage and the platen has been adjusted correctly for the type and thickness of the paper.

Print heads clogged

Do this procedure if three cleanings and one flushing have failed to produce an unbroken Nozzle Check Pattern.

- 1. Make sure that the ambient temperature and humidity are within the acceptable range:**
 - Temperature Range: 10°C to 27°C (50 °F to 81 °F)
 - Humidity Range: 15% to 80% Rh
- 2. Clean the print heads again, and then print another Nozzle Check Pattern.**
- 3. If the Nozzle Check Pattern is still abnormal, let the machine remain idle for 10 minutes.**
- 4. Execute two more cleanings and one flushing.**
 - Be sure to print a Nozzle Check Pattern after each cleaning and the flushing.
 - If you have produced an unbroken Nozzle Check Pattern, you can stop.
- 5. After the flushing, if the Nozzle Check Pattern is still not perfect, let the machine remain idle for 8 hours.**
- 6. Execute three more cleanings and one flushing.**
 - Be sure to print a Nozzle Check Pattern after each cleaning and the flushing.

- When you have produced an unbroken Nozzle Check Pattern, you can stop.

Faulty Maintenance Unit, Carriage Unit

- Clean the maintenance unit
- Replace maintenance unit.
- Replace the carriage unit.

Mixed Colors

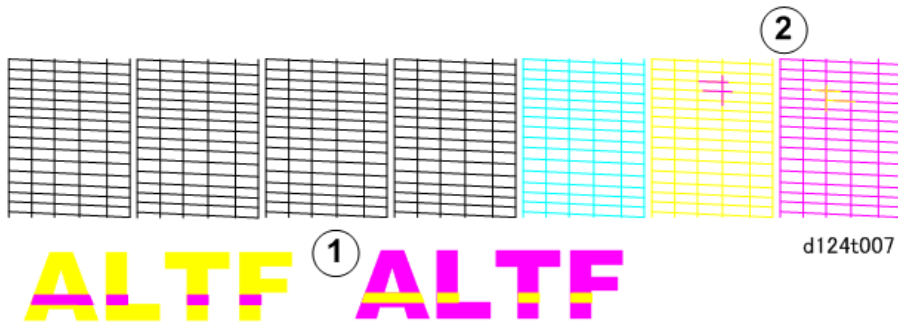

Mixed colors in printout ①, or Nozzle Check Pattern ②

Mixed colors means two ink colors and one color seeps into the track of another color. This can occur only at the YM print head because the print head is shared.

Print heads clogged

Do this procedure if three cleanings and one flushing have failed to produce an unbroken Nozzle Check Pattern.

- 1. Make sure that the ambient temperature and humidity are within the acceptable range:**
 - Temperature Range: 10°C to 27°C (50 °F to 81 °F)
 - Humidity Range: 15% to 80% Rh
- 2. Clean the print heads again, and then print another Nozzle Check Pattern.**
- 3. If the Nozzle Check Pattern is still abnormal, let the machine remain idle for 10 minutes.**
- 4. Execute two more cleanings and one flushing.**
 - Be sure to print a Nozzle Check Pattern after each cleaning and the flushing.
 - If you have produced an unbroken Nozzle Check Pattern, you can stop.

5. After the flushing, if the Nozzle Check Pattern is still not perfect, let the machine remain idle for 8 hours.
6. Execute three more cleanings and one flushing.
 - Be sure to print a Nozzle Check Pattern after each cleaning and the flushing.
 - When you have produced an unbroken Nozzle Check Pattern, you can stop.

Faulty Maintenance Unit

- Clean the maintenance unit
- Replace maintenance unit.

Image Abraded, Paper Torn, Ink Running

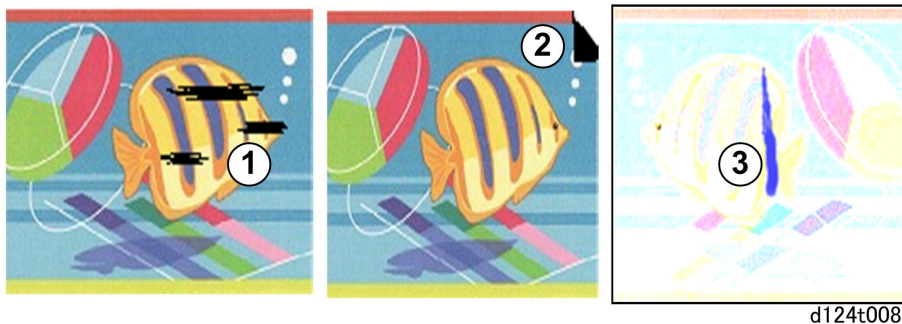

Output not clean, paper corner bent

- Print head abrasion ①
- Dog-eared corner of paper ②
- Ink run ③

Gap Adjustment

- Make sure that the gap between the carriage and the platen has been adjusted correctly for the type and thickness of the paper.

Paper Feed Obstruction

- Inspect the platen for paper fragments or dirty plates. Clean the plates.
- Check around the carriage unit for paper fragments.
- Check around the maintenance unit for paper fragments.

Faulty Carriage Unit

- Replace the carriage unit.

Color Density Too Light



d124t009

Printer Driver Settings

- Make sure the printer driver color settings are set correctly.
- Enhance the image with an image editor.

Part of Image Missing, Text Misaligned

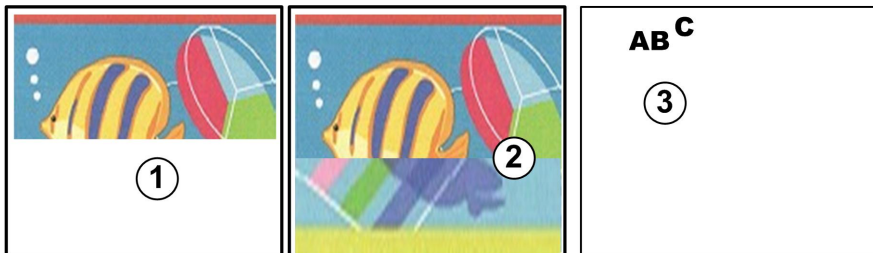

d124t010

- Image not complete ①
- Part of image missing ②
- Text misaligned ③

Printer Driver Settings

- Make sure that the printer driver settings for paper type match the type of paper loaded.
- Make sure all the print cartridges have sufficient ink.

Faulty Controller

- Replace the controller board.

Image Skewed on Paper

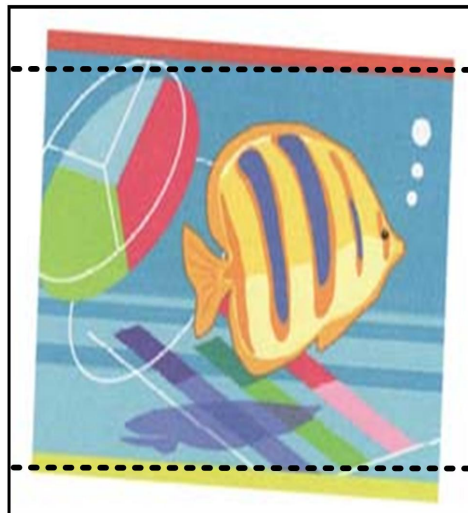

d124t011

6

Obstructed Paper Feed

- Inspect the platen, carriage unit, and maintenance unit for paper fragments.

Bolded Text Does Not Appear Bold in Printout

Print Head Array

The print head array consists of tiny ports...



Print Head Array
The print head array consists of tiny ports...

d124t012

Printer Driver Settings

- Check the Increase bold with font size checkbox.
- Make sure bold was selected in the application.

Scanning Problems

Flow Chart

Follow this flow chart to determine the cause of an image problem. Use **SP4-417** (IPU Test Pattern Setting - Pattern Selection) Pattern 3 to print the test pattern and User Tools > Maintenance functions.

Note

- Enter the number for the desired test pattern, switch the display to the "Copy Window" then press the [Start] button.

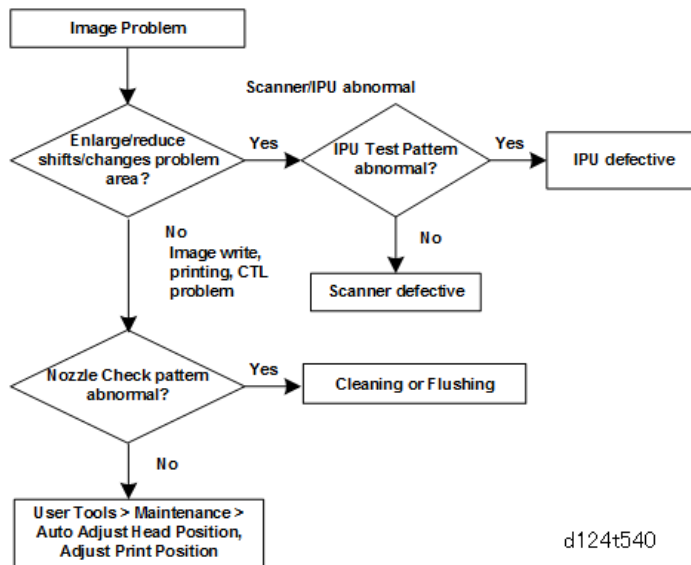

Scanning Troubleshooting

1. No image

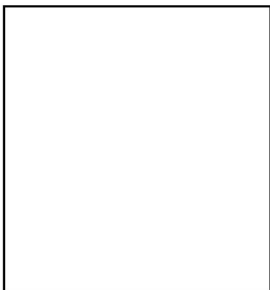

d093t541

Possible causes:

- Connection problem between CIS and IPU.
- CIS defective

2. No image (solid black copy/print, or no image with only vertical white lines on the output)



b286t542

Possible causes:

- Connection problem between CIS and IPU.
- CIS defective

3. Light image

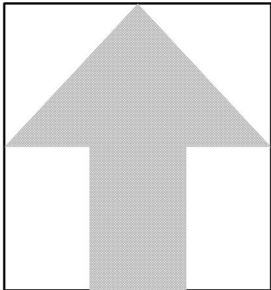

b286t543

Possible causes:

- Low CIS output
- IPU board defective

4. Vertical black lines

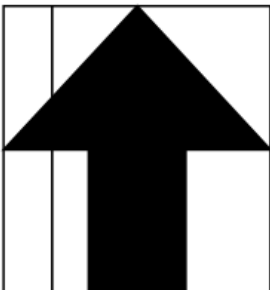

b286t544

Possible causes:

- Dirty exposure glass
- CIS defective

5. Vertical white lines

b286t545

Possible causes:

- Dirty exposure glass
- Dirt or scratches on the white plate above the CIS
- CIS defective

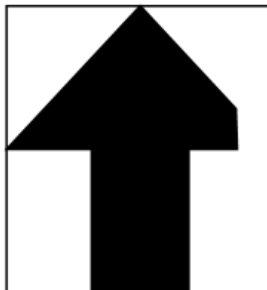
6. Black or white bands with no image-width 1/5 A0 (E) size

b286t546

Possible causes:

- Connection problem between CIS and IPU
- CIS output error
- IPU board adjustment error

7. White lines every 1mm pitch in halftone areas

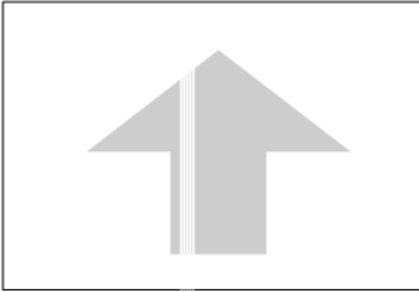

b286t547

Possible causes:

- CIS defective

Case 8: Dark image density at CIS1, CIS3, and CIS5.

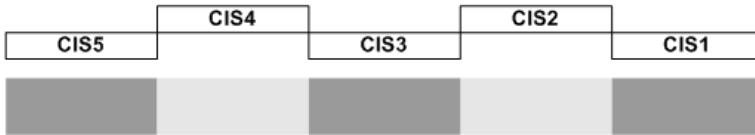

b286t574

6

Possible cause:

- The machine is near a window and sunlight is hitting the CIS unit
- The light shield have been removed or is tucked inside the machine.



d124r006

★ Important

- This light shield prevents light from entering the scanner unit.

- If this gap is not covered by the shield, strong light could enter the back of the scanner unit and cause image distortion during scanning.
- Make sure that the light shield has not been removed.
- Move the machine away from the window.
- Close the window blinds to block the sunlight.
- If closing the blinds or moving the machine is not possible (or if the light shield has been removed or damaged), cover the top of the machine with one wide sheet of paper (at least 840 mm wide) to block the sunlight.

Case 9: Dark image density at CIS2 and CIS4.

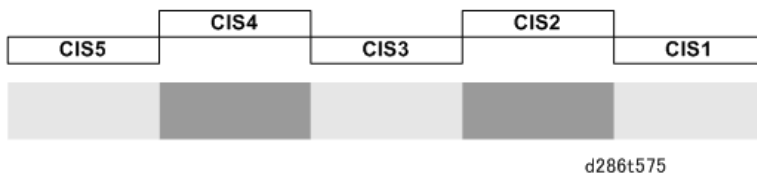

Possible causes:

- The white plate is not flat against the original.
- The original is wrinkled.

Jam Code Tables

Overview

When a jam occurs:

- The jam indicator lights.
- Dynamic graphic messages on the display panel show the location of the jam and instructions about how to correct the problem.

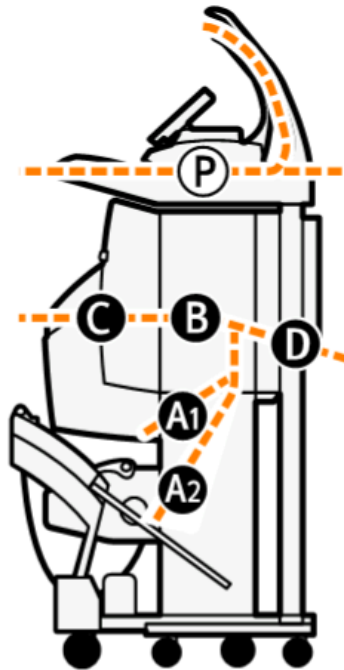

d262k1506

Code	Location
0 to 8	Scanner Jams
A1	RF 1: Roll Unit 1 (Standard)
A2	RF 2: Roll Unit 2 (Option)
B	Registration standby position
C	Paper exit (main machine)
D	Bypass paper feed path

- If the operator opens and closes the paper exit cover during copying, this is not recorded in the jam record.
- An original or paper feed jam that occurs just after the main power switch or operation switch comes on is not recorded in the jam record.

★ Important

- In the tables below "late" and "lag" have the following meanings.
- **Late.** The original or paper failed to arrive at the sensor location within the prescribed time after original feed started.
- **Lag.** The original or paper failed to leave the sensor location with the prescribed time.

Scanner Original Jams

Original Jam Names

Code/Area	Jam Name & Description
1	Initial Jam
	At power ON, or when the scanner cover was closed, one of the following sensors was ON. <ul style="list-style-type: none"> • Original set sensor • Original registration sensor • Original exit sensor • Original width sensors
2	Original registration sensor late
	Original registration sensor did not go ON within the prescribed time (after the original should have fed 15 mm).
3	Original registration sensor off jam
	The original set sensor or the original registration sensor went OFF before the exit sensor went ON. This can occur if the original is less than 132.5 mm long. -or- After the exit sensor went ON, the original registration sensor went OFF before the original set sensor went OFF.
4	Original registration sensor lag jam

Code/Area	Jam Name & Description
	After the original set sensor went OFF, the original registration sensor did not go OFF within the prescribed time (after the original should have fed 20 mm).
5	Original exit sensor lag jam
	The original exit sensor did not go off within the prescribed time (after the original should have fed 20 mm).
6	Original stop jam
	The [Original Stop] button on top of the scanner unit was pushed to remove the original so that it could be set again.
7	Original exit late jam
	After the original set sensor went ON, the exit sensor did not go ON within the prescribed time (within the time the original should have fed 20 mm).
8	Next original set jam
	<p>The next original was set on the original feed table too early.</p> <ul style="list-style-type: none"> • The original set sensor detected the trailing edge of the first original. • The paper set sensor detected the leading edge of the next original before the IPU received the scan end signal.

Printer Paper Jams

Code	Area	Name
1	All	Initial jam
2	B	Main scan HP jam
8	A1	Pre-registration sensor lag jam (Roll Unit 1)
9	A2	Pre-registration sensor lag jam (Roll Unit 2)
13	B	DRESS sensor late jam during image registration
16	C	Exit sensor lag jam
34	B	Bypass paper set jam
41	B	Main scan printing jam

Code	Area	Name
53	A1	Paper out (Roll Unit 1)
54	A2	Paper out (Roll Unit 2)
58	B	Pre-registration sensor lag jam
63	B	DRESS sensor lag jam during image registration
66	C	Exit sensor lag jam
84	B	Bypass sensor late jam

Details

Code	Details
1	<p>One or more of the following sensors detected the presence or absence of paper at a location other than the paper standby or registration standby position when the machine was turned on, when a cover was opened and then closed, or when the machine returned to normal operation from the energy save mode:</p> <ul style="list-style-type: none"> • Roll Unit 1 or 2 exit sensor (paper absent) • Pre-registration sensor (paper absent) • Bypass sensor (paper present) • Exit sensor (paper present) <p>The machine will also signal an initial jam in these cases:</p> <ul style="list-style-type: none"> • If a cover is opened during printing • If an error occurs in edge detection (paper size detection) or skew detection by the DRESS sensor during the first phase of bypass printing..
2	<p>The carriage does not return to the home position on the right side of the machine during edge detection or printing due to an obstruction (torn, wrinkled paper).</p>
8	<p>During paper feed from Roll Unit 1, the pre-registration sensor did not detect any paper:</p> <ul style="list-style-type: none"> • After paper was fed long enough to feed the paper the distance between the pre-registration sensor and the registration roller plus 100 mm • After paper was fed long enough to feed the paper the distance between the paper standby position and the pre-registration sensor plus 100 mm.

Code	Details
9	<p>During paper feed from Roll Unit 2, the pre-registration sensor did not detect any paper:</p> <ul style="list-style-type: none"> • After paper was fed long enough to feed the paper the distance between the pre-registration sensor and the registration roller plus 100 mm • After paper was fed long enough to feed the paper the distance between the paper standby position and the pre-registration sensor plus 100 mm.
13	<p>The DRESS sensor failed to detect the leading edge of the paper at the start of the print job:</p> <ul style="list-style-type: none"> • During roll paper edge detection • Within the prescribed time (enough time for the paper to feed from the paper standby position to the DRESS sensor, plus 100 mm). • Within the prescribed time (enough time for the paper to feed from the paper registration position to the DRESS sensor, plus 100 mm). • The right edge of the paper could not be detected before the start of printing.
16	<p>One of the following occurred:</p> <ul style="list-style-type: none"> • During printing, the exit sensor did not detect the leading edge of the paper within the prescribed time (enough time for the paper to feed to the exit sensor plus 100 mm). • During skew correction, the exit sensor did not detect the leading edge of the paper within the prescribed time (enough time for the paper to feed to the exit sensor plus 100 mm). • Paper was not detected by the roll exit sensor.
34	<p>During paper edge detection during the preparation for bypass printing, the DRESS sensor could not detect the right edge of the paper (returned a "0").</p>
41	<p>The machine detected an overload on the horizontal motor during printing, caused by an obstruction in the paper path (torn or wrinkled paper).</p>
53	<p>Roll end at Roll Unit 1. The roll unit exit sensor did not detect paper for 7 sec.</p>
54	<p>Roll end at Roll Unit 2. The roll unit exit sensor did not detect paper for 7 sec.</p>

Code	Details
58	<ul style="list-style-type: none">• After the rewind button on either roll unit was pressed, the pre-registration sensor did not detect the absence of paper within the prescribed time (after enough time had elapsed for the paper to reverse feed from the registration standby position to the pre-registration sensor plus 200 mm).• During skew correction forcing a paper rewind (due to excessive skew), the pre-registration sensor did not detect the absence of paper within the prescribed time (after enough time had elapsed for the paper to reverse feed from the registration standby position to the pre-registration sensor plus 200 mm).
63	During paper size detection, immediately after paper cutting, or after skew correction, the DRESS sensor detected no paper within the prescribed time (after enough time had elapsed for the paper to feed as far as the DRESS sensor plus 200 mm).
66	During paper edge detection, the exit sensor detected paper but the paper end sensor signaled paper end. (The paper stopped at the exit sensor.)
84	The bypass sensor signaled no paper present during edge detection in preparation for bypass printing.

Electrical Components

Scanner Unit

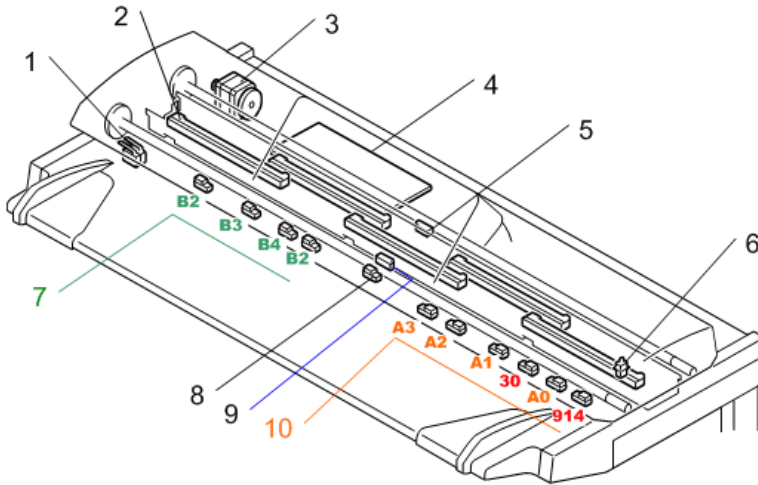

d1249006

No.	Component	Function
1	Safety switch	A push-switch that detects when the scanner cover is open and disables machine operation. This prevents the CIS from switching on while the cover is open
2	CIS unit	Five CIS elements that transfer scan image signals from CIS LEDs to the SIF
3	Scanner motor	Drives the original feed roller and original exit roller that feed the original through the scanner unit
4	SIB	Scanner Interface Board. This is the board that controls the scanner, and serves as the signal I/F board between the IPU and MCU.
5	Original Exit Sensor	Detects the leading and trailing edges of the original as it leaves the scanner unit. Signals a jam if the edges are not detected within the prescribed time.
6	Original stop switch	Halts original feed after the operator presses this on the operation panel to stop feeding because the original has skewed or wrinkled.

No.	Component	Function
7	Original width sensors (JIS)	Detect the width of the original. Architecture sizes.
8	Original set sensor	Detects the leading edge of the original. This starts the scanner motor. Also functions as an original width sensor (it detects A4 or 8.5" width paper).
9	Original registration sensor	1) Detects the leading edge of the original. Feed pauses briefly at the original feed roller, so that the operator can manually make the original straight. 2) Detects the leading and trailing edges of the original for jam detection.
10	Original width sensors (ISO)	Detect the width of the original. Engineering sizes.

Main Unit Sensors, Motors

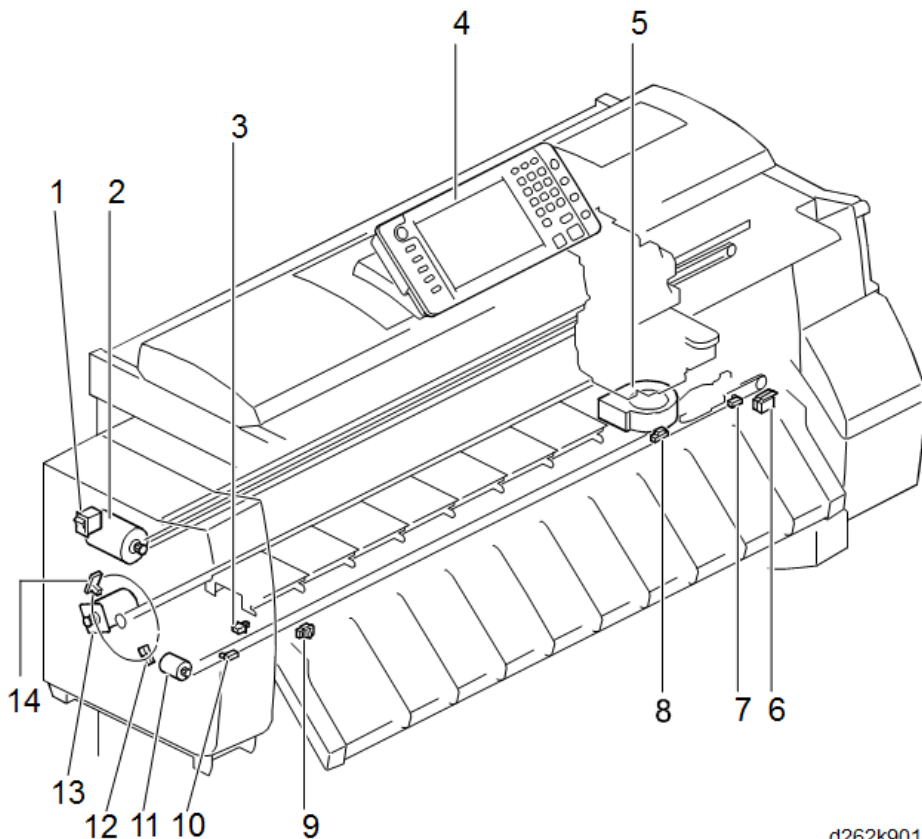

d262k9012

No.	Component	Function
1	Main Switch	Switches the machine on/off.
2	Horizontal Motor	Mounted at the left rear corner of the printer, the horizontal motor alternately runs forward and reverse to drive the timing belt that moves the carriage to the left and right during printing. The operation of the motor is controlled by the horizontal encoder strip stretched across the width of the printer and threaded through the horizontal encoder sensor on the right rear corner of the carriage unit. The sensor reads this strip as the carriage moves from side to side and uses these readings to control the operation of the motor.
3	Front Cover Track Switch	A push switch mounted on the left post of the main machine that detects when the pin on the left end of the front cover is mounted correctly in its track.
4	Operation panel	The intuitive 10.1 inch operation panel eliminate all hardware key from the panel.
5	Paper transport fan	The large fan mounted below the perforated platen plates. This fan creates the suction that holds the paper on the paper path.
6	Front Cover Switch: Right	One of two safety switches that disable the machine when the front cover is opened.
7	Cutter HP Switch	Detects when the cutter has arrived at the home position on the right and switches the cutter motor off.
8	Exit Sensor	Located at the paper exit of the main machine, detects the leading and trailing edges of the paper. Signals an error if the paper fails to arrive or leave the sensor location within the prescribed time.
9	Paper Exit Guide Switch	Detects when the exit guide plate on the front of the machine is opened and closed.
10	Cutter Return Switch	Detects when the cutter has arrived at the left side of the machine after cutting. Reverses the cutter motor, which moves the cutter back to the home position on the right side of the machine.

No.	Component	Function
11	Cutter Motor	Drives the cutter to the left and right across the paper path when cutting paper. The cutter cuts as it moves from right to left. When the cutter reaches the left side, the cutter return sensor reverses the motor. A guide lever falls into a lower track that lowers the cutter so that it passes under the paper on its return to the home position on the right.
12	Vertical Encoder HP Sensor	Mounted opposite and lower than the vertical encoder sensor on the left side of the machine, this sensor also reads the code on the rim of the vertical encoder wheel, and detects when the wheel reaches the home position and switches off the vertical motor. This sets the encoder wheel at the start position for every job.
13	Vertical Motor	The vertical motor drives the paper feed rollers and exit rollers in the main machine. The operation of this motor is controlled by the vertical encoder sensor and vertical HP sensor which read the encoded rim of the vertical encoder wheel.
14	Vertical Encoder Sensor	The rim of the vertical encoder wheel on the left side of the machine is centered in the gap of this sensor. The sensor reads the code on the rim of the vertical encoder wheel as it rotates, to control the operation of the vertical motor during paper feed.

Roll Units

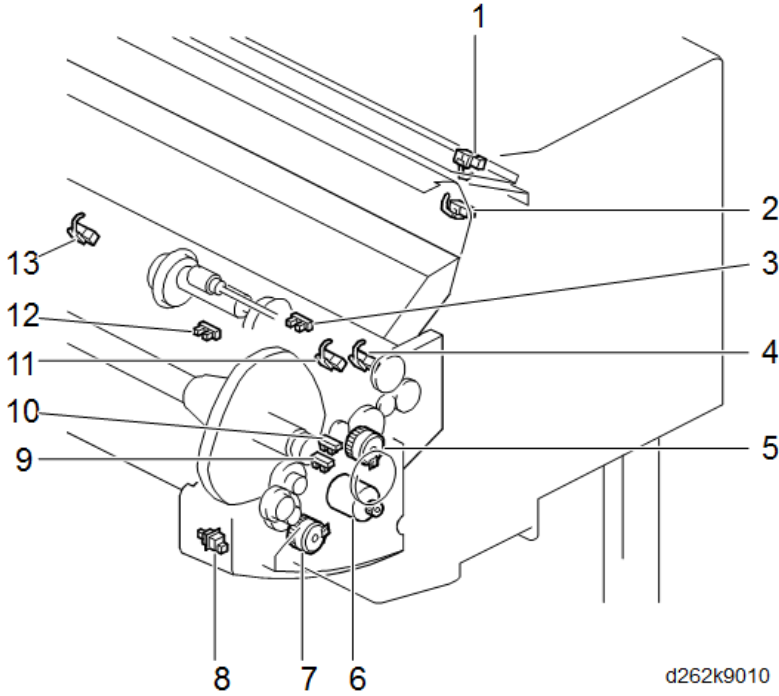

No.	Component	Function
1	Bypass Sensor	Detects the trailing edge of the cut sheet manually inserted into the main machine for bypass feed.
2	Pre-Registration Sensor	Located at the top of the vertical paper feed path in the main unit, detects the leading edge of paper roll paper.
3	Paper Release Sensor	Controls the raising and lowering of the roll feed roller idle rollers during paper feed.
4	Roll Unit Exit Sensor	Detects the leading edge of the roll paper as it leaves the roll unit.
5	Roll Paper Feed Clutch	Engages and disengages the cam shaft that raises and lowers the roll feed roller idle rollers in the roll unit. This closes and opens the nip of the roll feed roller.
6	Roll Paper Feed Motor	Drives the roll paper feed roller that feeds the roll paper from the roll unit.

No.	Component	Function
7	Pre-skew Correction Clutch	Not functional.
8	Roll Rewind Switch	Located on the inside cover of the right end of Roll Unit 1. Depressing the switch rewinds the paper onto the paper roll.
9	Encoder Sensor 2	Monitors the number of rotations of the drum core. The rotation of the core accelerates as the amount of paper on the roll diminishes. This count is used in a calculation to determine the amount of paper remaining on the roll.
10	Encoder Sensor 1	Monitors the rotations of the roll feed motor. This count is used to calculate the remaining service life of the roll feed motor.
11	Paper Entrance Sensor (Right)	Detects the edge of the roll paper when it leaves the roll unit and enters the main paper path.
12	Roll End Sensor	Detects when the paper roll runs out of paper.
13	Paper Entrance Sensor (Center)	Detects the edge of the roll paper when it leaves the roll unit and enters the main paper path.

Ink Supply

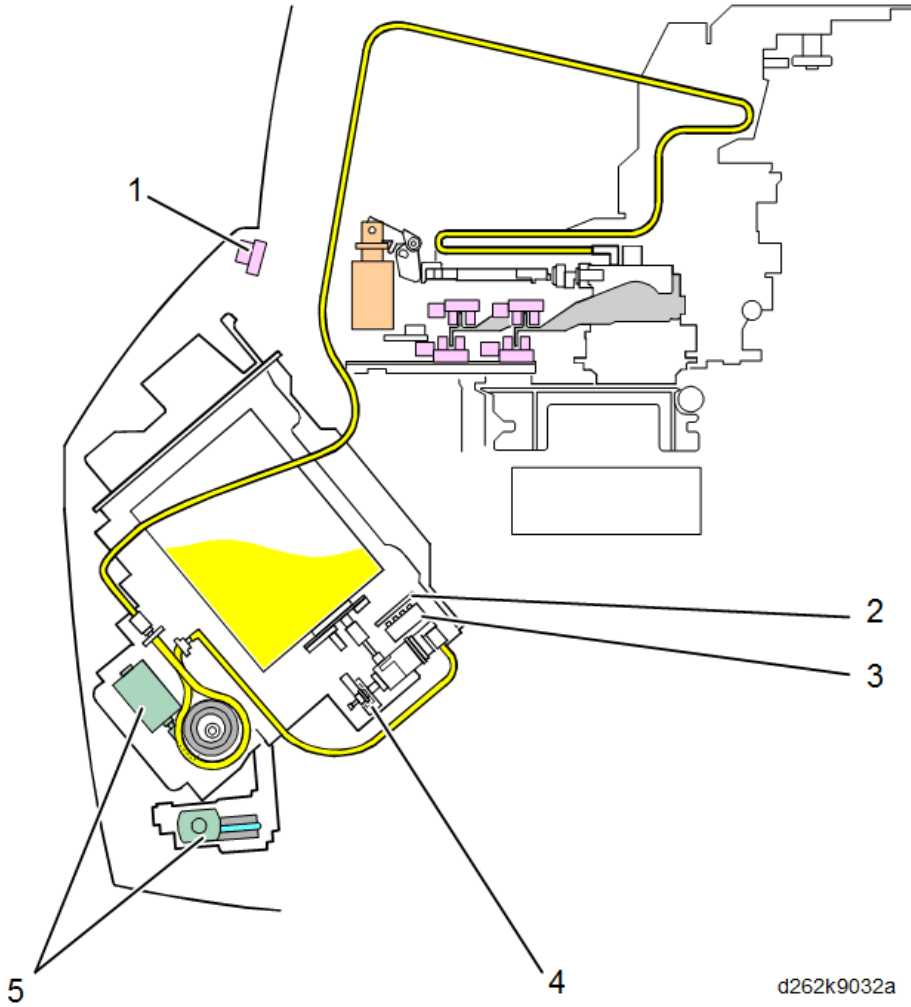

No.	Component	Function
1	Ink cartridge cover switch	Detects when the ink cartridge cover is opened and closed.
2	Ink cartridge ID chip	These ID chips identify each cartridge as the correct type for the machine.
3	CCB	Cartridge Control Board. Relays the ink cartridge ID chip signals that confirm whether the ink cartridges are installed correctly in the ink cartridge holder.

No.	Component	Function
4	Ink end sensor	Located below the supply port of each cartridge. Detects when the ink cartridge is out of ink.
5	Ink pump motor (K2)	These motors pump ink from the ink cartridges, through the supply tubes, and into the ink supply tanks of each print head.

Carriage Unit

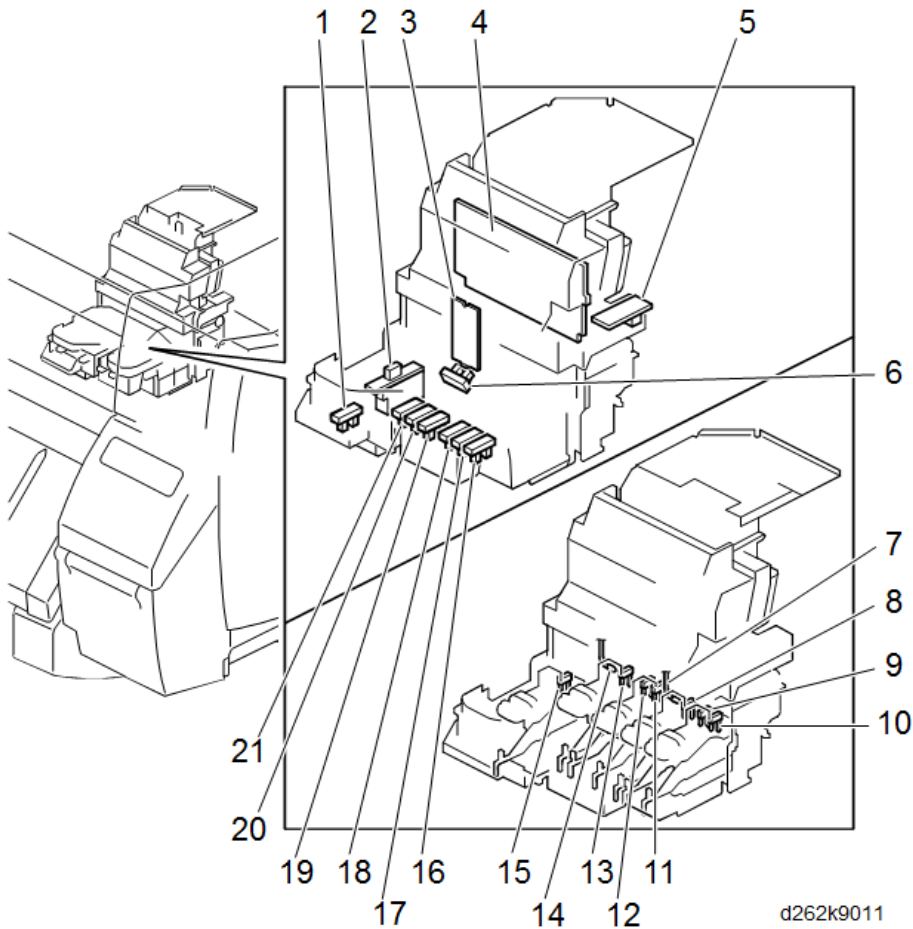

No.	Component	Function
1	OCFS 1 (K1)	On Carriage Filler Sensor K1. The on-carriage sensor that monitors the position of the feeler arm on the side of the K1 ink sub tank. This movement of this sensor is used to signal low ink in the K1 sub tank.
2	DRESS Sensor	Direct Realization Edge Scanning Sensor. The DRESS sensor is mounted on the left lower edge of the carriage unit. It performs both paper registration and image registration.
3	COM	Relays signals between the main machine and the K1 print head unit.
4	HRB	Head Relay Board. Mounted behind the print heads in the carriage. The HRB relays signals to the BiCU from the horizontal encoder sensor, DRESS sensor, color print heads and thermistors.
5	Horizontal Encoder Sensor	Detects the long encoder strip mounted behind the horizontal drive belt. Controls the operation of the horizontal motor, which drives the carriage unit during printing.
6	Head Lift Sensor	Detects the vertical print head position and controls the head lift motor.
7	Head Thermistor (Color)	Monitors the temperature of the color print head units.
8	Air Sensor: C	Detects excess air in the C ink sub tank of the C print head unit.
9	Air Sensor: M2	Detects excess air in the M2 ink sub tank of the Y2M2 print head unit.
10	Air Sensor: Y2	Detects excess air in the Y2 ink sub tank of the Y2M2 print head unit.
11	Air Sensor: M1	Detects excess air in the M1 ink sub tank of the Y1M1 print head unit.
12	Air Sensor: Y1	Detects excess air in the Y1 ink sub tank of the Y1M1 print head unit.
13	Air Sensor: K2	Detects excess air in the K2 ink sub tank of the K2 print head unit.
14	Head Thermistor (K)	Monitors the temperature of the black print head unit (K1).

No.	Component	Function
15	Air Sensor: K1	Detects excess air in the K1 ink sub tank of the K1 print head unit.
16	OCFS 7 (Y2)	On Carriage Filler Sensor Y2. The on-carriage sensor that monitors the position of the feeler arm on the side of the Y2 ink sub tank. The movement of this sensor is used to signal low ink in the Y2 sub tank.
17	OCFS 6 (M2)	On Carriage Filler Sensor M2. The on-carriage sensor that monitors the position of the feeler arm on the side of the M2 ink sub tank. The movement of this sensor is used to signal low ink in the M2 sub tank.
18	OCFS 5 (C)	On Carriage Filler Sensor C. The on-carriage sensor that monitors the position of the feeler arm on the side of the C ink sub tank. The movement of this sensor is used to signal low ink in the C sub tank.
19	OCFS 4 (M1)	On Carriage Filler Sensor M1. The on-carriage sensor that monitors the position of the feeler arm on the side of the M1 ink sub tank. The movement of this sensor is used to signal low ink in the M1 sub tank.
20	OCFS 7 (Y1)	On Carriage Filler Sensor Y1. The on-carriage sensor that monitors the position of the feeler arm on the side of the Y1 ink sub tank. The movement of this sensor is used to signal low ink in the Y1 sub tank.
21	OCFS 2 (K2)	On Carriage Filler Sensor K2 The on-carriage sensor that monitors the position of the feeler arm on the side of the K2 ink sub tank. The movement of this sensor is used to signal low ink in the K2 sub tank.

Around the Carriage Unit

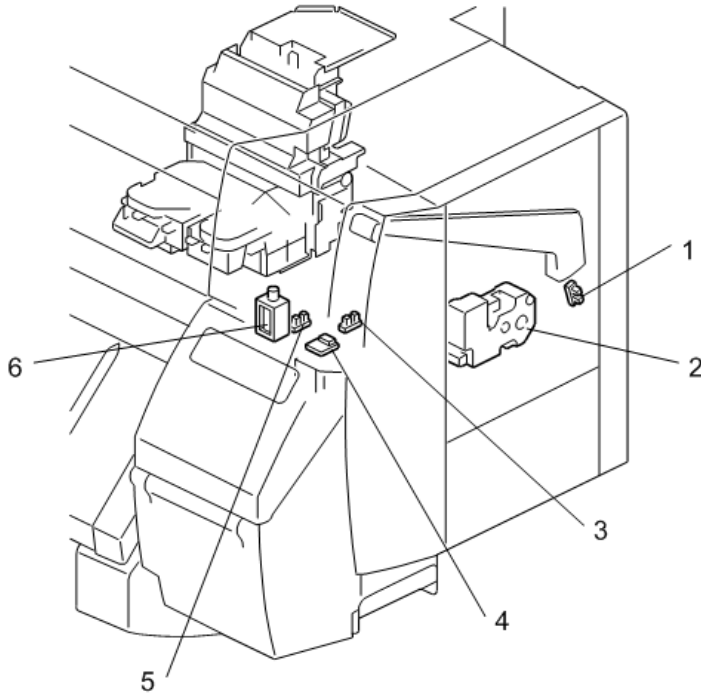

d1249360

No.	Component	Function
1	Registration Release Sensor	Detects the raising and lowering of the paper holding lever which raises and lowers the registration roller when the operator loads a cut sheet manually.
2	Head Lift Motor	Raises and lowers the carriage to adjust the gap between the print heads and the paper for different thickness of paper. The motor is controlled by head lift sensors 1 and 2.
3	Main Ink Level Sensor 2	Checks the position of the K2, C, Y, or M on-carriage filler sensor after one of the OCFS detects a problem in one of the ink sub tanks (low ink, ink end, or excess air). If the reading of main ink level sensor 2 confirms the condition, it will signal the machine to supply more ink or purge air from the tank. This sensor (also known as "FS2") services the OCFS of K2, C, Y, and M.

No.	Component	Function
4	Temperature/Humidity Sensor	Located on the right side of the machine above the ink supply unit. The temperature/humidity thermistor constantly measures temperature and humidity inside the machine. The printer uses these readings to adjust the operation of the machine.
5	Main Ink Level Sensor 1	Checks the position of the K1 on-carriage filler sensor after the OCFS of the K1 print head detects a problem in the ink sub tank (low ink, ink end, or excess air). If the reading of main ink level sensor 1 confirms the condition, it will signal the machine to supply more ink or purge air from the tank. This sensor (also known as "FS1") services only the OCFS of the K1 ink supply tank.
6	Air Release Solenoid	Located on the right side of the machine. When the air level sensors detect excess air in an ink sub tank, the system activates the plunger of the air release solenoid to purge air from the tank. The partial vacuum created by the suction pulls in the sides of the tank so that the tank can fill with more ink.

Maintenance Unit

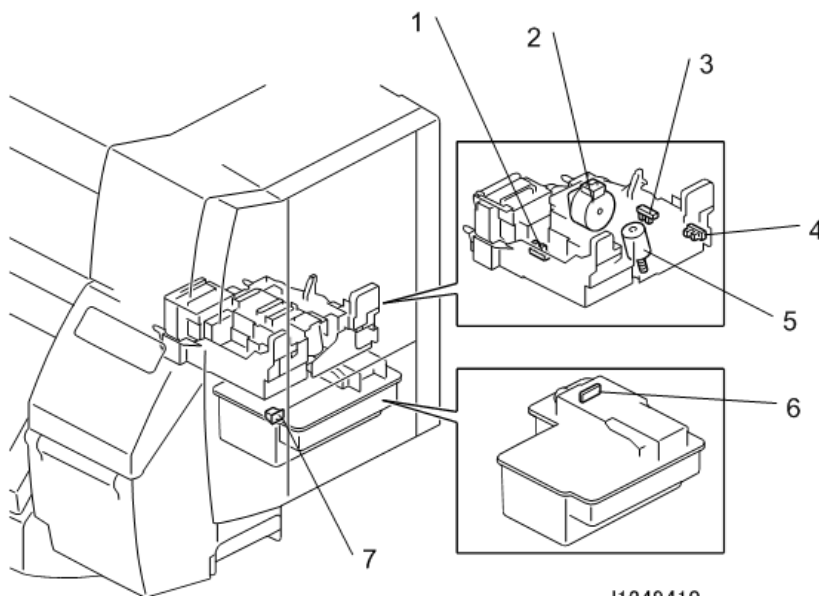

d1249410

No.	Component	Function
1	Suction Cap Sensor	This sensor switches the maintenance motor on and off when the motor raises and lowers the K1 cradle for capping during the printing cycle or during the print head cleaning cycle.
2	Maintenance Motor	The maintenance motor: 1) Raises and lowers the print head suction cap, 2) Drives the pump that sucks waste ink from the print heads through the suction cap, and 3) Drives the wiper blade and wiper in the cleaning unit.
3	Maintenance Lift Sensor	Controls the operation of the maintenance lift motor that raises and lowers the color cradle (K2, C, YM) during capping.
4	Slide Sensor	This sensor controls the operation of the maintenance motor when it slides the K1 cradle to the front (home position) or to the rear during the print head cleaning cycle.
5	Maintenance Lift Motor	Raises and lowers the color cradle (K2, C, YM caps) during capping and the print head cleaning cycle. The maintenance lift sensor controls operation of this motor during raising and lowering.
6	BOW Board	This is the ID chip holds the ID code that confirms the tank is the correct one for the machine. The machine software records a count in this chip every time the maintenance unit suction cap operates to suck waste ink from the print heads during cleaning. Once the count is exceeded this signals tank full, and the machine disables the code so that the tank can no longer be used.
7	Ink Collector Cover Switch	Detects when the ink collector tank door is opened and closed. The machine does not operate until the cover is closed.

Boards

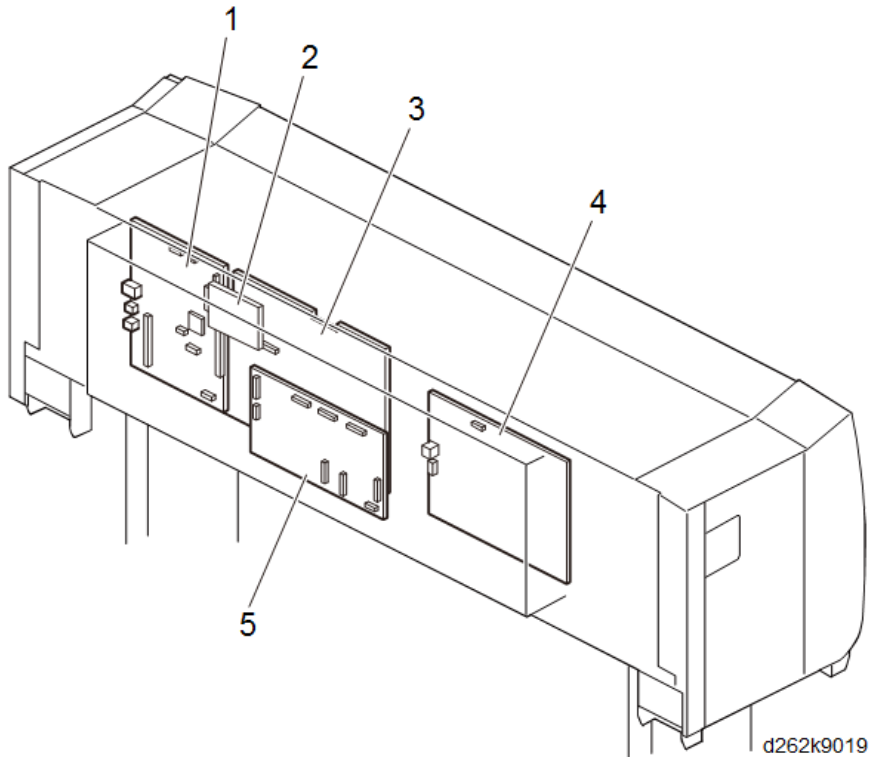

6

No.	Component	Function
1	Controller board	Controls memory and all peripheral devices.
2	HDD	320 GB Hard Disk Drive
3	BiCU	<p>Base image Control Unit. The control board controls the system, base engine, and scanner, sends the load signal of the base engine (high-voltage power supply, motors, sensors, solenoids, and clutches) and scanner (sensor and motor), and supplies power as IO.</p> <p>This also performs image processing. After processing image data sent from the CIS, this sends the processed data to the head through IOB and HRB.</p>

No.	Component	Function
4	PSU	Power Supply Unit. Connected to the external power source, provides DC current that runs the machine and all its components.
5	IOB	Input/Output Board. This functions as the interface for data transmission and power supply to the paper supply module and scanner module. This controls the driver for paper supply, head up/down, maintenance motor, ink supply, and ink drop detection.
-	RFDB	Roll Feed Drive Board. Controls the operation of Roll Unit 2. Provided with Roll Unit 2 (option).
-	MLB	Media Link Board (File Format Converter). An option. Documents saved with the copy/printer function can be received from your client computer via a network, using Desk Top Binder, for example.

Fuses

Scanner Unit

Operation Panel

Refer to Smart Operation Panel Manual.

SIB (Scanner I/F Board)

The SIB is placed at the left back of the scanner unit, controls the CIS, scanner motor, and sensors on the scanner motor, and relays the signals.

The CIS reads image data, which are then converted from analog to digital and sent to the BiCU.

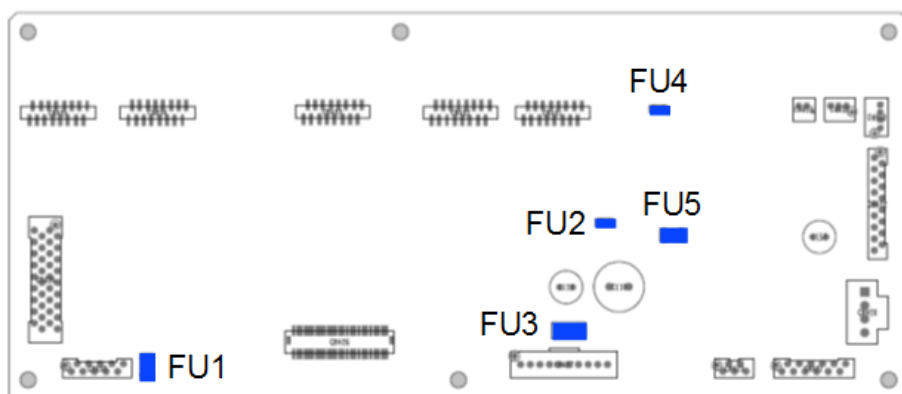

d262k1553

LED Status

LED	Color	LED Status
LED1	Green	Power ON: Lit Power OFF / Sleep mode: not lit

Fuse

Name	Output terminal	Capacity	Voltage	Type	Part No.
FU1	CN436 CN438	1.1 A 8 V DC	5 V	Sensors for scanner unit	11090007

Name	Output terminal	Capacity	Voltage	Type	Part No.
FU2	CN431 to CB435	1.5 A 6 V DC	1.1 V	CIS	11090097
FU3	CN437	2 A 250 V AC	24 V	Scanner motor	11071362
FU4	CN431 to CB435	1.5 A 6 V DC	3.3 V	CIS	11090097
FU5	CN431 to CB435	1.1 A 16 V DC	6.2 V	CIS LED	11090071

Main Boards (PCB Box)

6

Controller Board

The controller board is placed at left in the PCB box and controls the machine. This board controls the MFP system.

The built-in flash ROM stores various firmware for controlling the machine and security functions, such as encryption and certification.

The printer and scanner functions can be expanded, using the optional slots (interface/SD card).

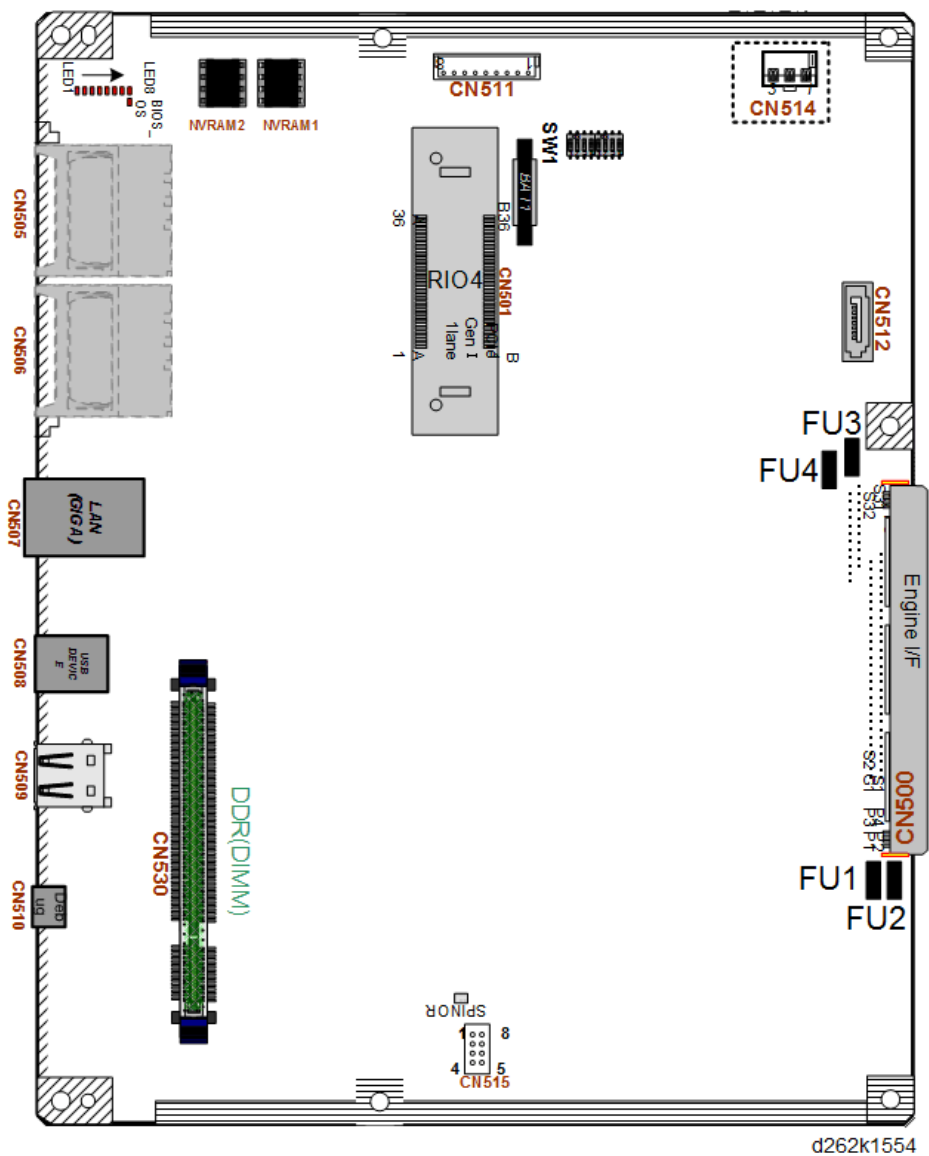

FUSE

Name	Output terminal	Capacity	Voltage	Type	Part No.
FU1	CN509, CN530	250 V, 5 A	5 V	DIMM, USB host	-

Name	Output terminal	Capacity	Voltage	Type	Part No.
FU2	CN510, CN508, CN507, CN505, CN506, CN514	250 V, 5 A	5 V	Debug port, USB, SD card slot (op, service), LAN, HDD (5 V)	-
FU3	CN509, CN530, CN501	250 V, 5 A	5 V	USB host (5 V), DIMM (5 V), RIO4 (5 V)	-
FU4	CN512, CN501	250 V, 5 A	5 V	HDD, RIO4 (3.3 V)	-

SW1

★ Important

- Do not change these switch settings.

No.	Factory Setting
1	OFF
2	OFF
3	OFF
4	OFF
5	OFF
6	OFF
7	OFF
8	OFF

IOB (Input/Output Board)

The IOB is placed at the center front of the PCB box and installed horizontally.

This functions as the interface for data transmission and power supply to the paper supply module and scanner module.

This controls the driver for paper supply, head lift, maintenance motor, ink supply and purge detection.

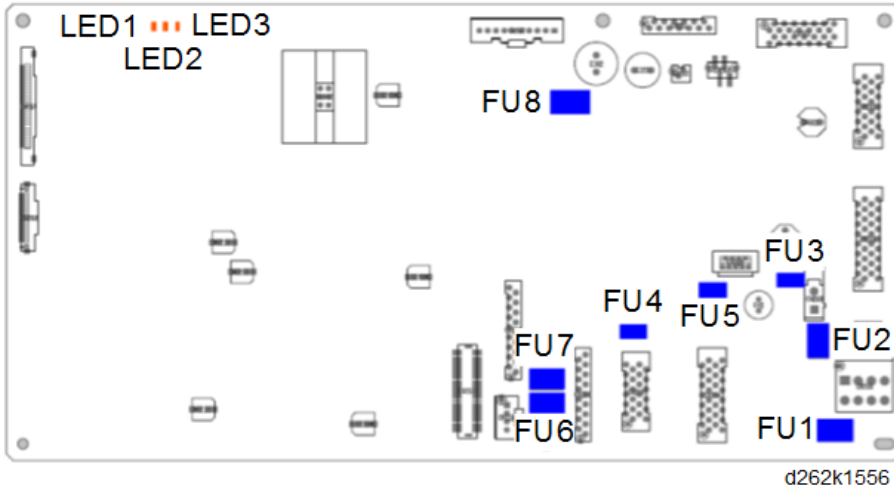

LED Status

LED	Color	LED Status
LED1	Yellow-green	Flash: Normal Not lit or Lit: Abnormal
LED2	Yellow-green	Lit: Abnormal Not lit: Normal
LED3	Orange	Not lit: Normal Lit: Abnormal

FUSE

Name	Output terminal	Capacity	Voltage	Type	Part No.
FU1	CN263, 254, 255	-	24V	Paper Feed Clutch, Paper Feed Motor	-
FU2	CN268	-	24V	IFBOX	-
FU3	CN254, 263, 265, 266	-	5V	Sensors	-
FU4	CN255	-	5V	RFDB	-
FU5	CN269	-	5V	IFBOX	-
FU6	CN256	-	24V	SIB	-

Name	Output terminal	Capacity	Voltage	Type	Part No.
FU7	CN256	-	24V	SIB	-
FU8	CN251, 252, 253	-	24V	Key Counter, Key Card	-

SW1

SW No.	Note	Settings at Installation	Note
1	-	OFF	Prohibited
2	-	OFF	Prohibited
3	-	OFF	Prohibited
4	-	OFF	Prohibited
5	-	OFF	Prohibited
6	-	OFF	Prohibited
8	Ri debug mode	OFF	OFF: Normal ON: IC20 debug mode

BiCU (Base image Control Unit)

The BiCU is placed at the back of the IOB in the PCB box.

The control board controls the system, base engine, and scanner, sends the load signal of the base engine (high-voltage power supply, motors, sensors, solenoids, and clutches) and scanner (sensor and motor), and supplies power as IO.

This also performs image processing. After processing image data sent from the CIS, this sends the processed data to the head through IOB and HRB.

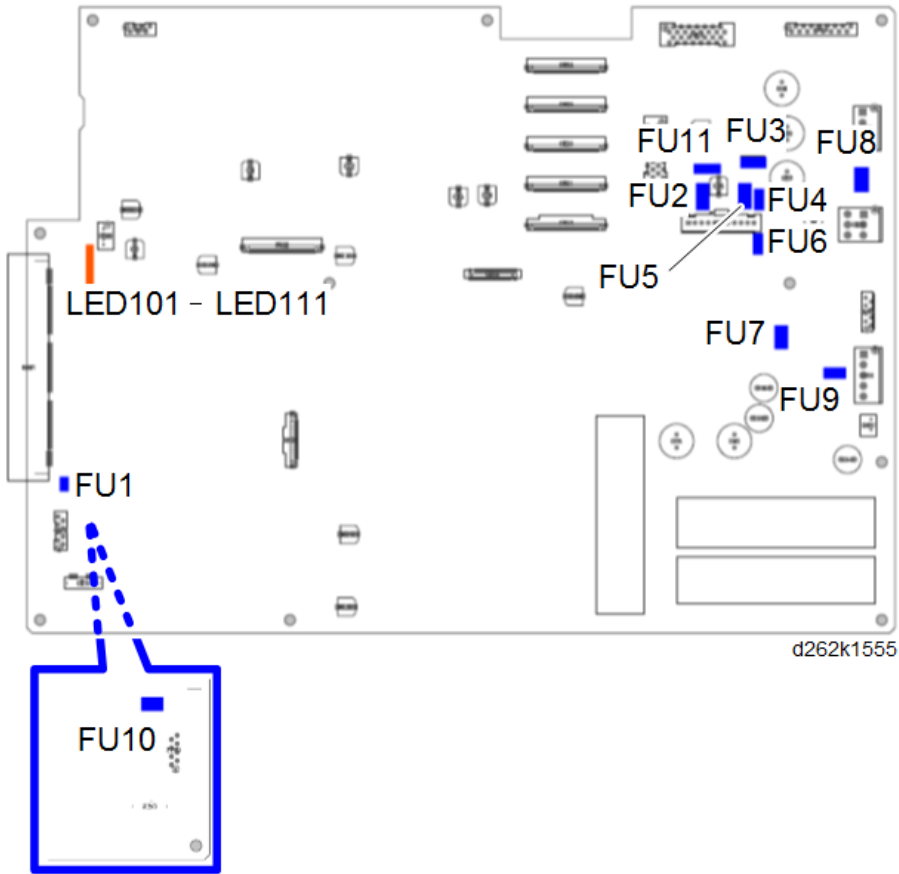

Note

- FU10 is located on the back surface of the board.

LED Status

LED	Color	LED Status
LED101	Yellow-green	Normal: Flash Abnormal: Lit or Not lit
LED102	Yellow-green	Operation: Flash Others: Not lit
LED103	Yellow-green	DSP start check
LED105	Yellow-green	Normal: Flash Abnormal: Not lit

LED	Color	LED Status
LED106	Yellow-green	Normal: Flash Abnormal: Not lit
LED107	Yellow	Standby: Flash Operation: Lit
LED108	Yellow	Standby: Flash Operation: Lit
LED109	Red	5VX input: Lit Others: Not lit
LED111	Green	3.3V input: Lit Others: Not lit

6

Fuse

Name	Output terminal	Capacity	Voltage	Type	Part No.
FU1	CN215 CN216	76V 5A	5.1V	Operation panel	11071302
FU2	-	250V T6.3A	24V	BiCU	11071374
FU3	CN203	250V T6.3A	24V	Main scan and sub scan motor	11071374
FU4	CN214	72V 0.5A	5V	NMB	11071211
FU5	-	250V T2A	5V	Sensors	11071362
FU6	-	72V 2.5A	5V	BiCU	11071219
FU7	CN208 to CN211	250V T2.5A	37V	HRB	11071226
FU8	CN214	250V T2A	24V	HVP	11071362
FU9	CN210	72V 2.5A	5.1V	HRB	11071219
FU10	CN218	76V 1.6A	5.1V	MKB	11071127
FU11	CN213	72V 4A	24V	Intake fan	11071107

PSU (Power Supply Unit)

The PSU is placed at right in the PCB box.

DC voltage is loaded to the main unit.

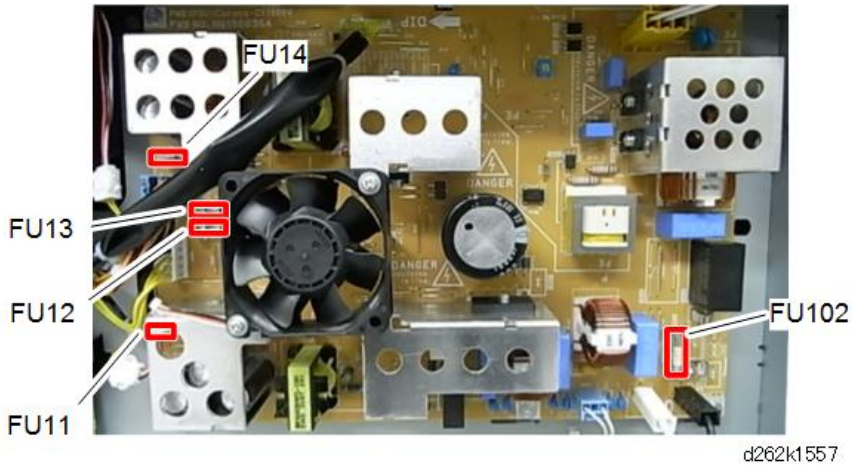

Fuse (100 V)

Name	Output terminal	Capacity	Voltage	Type	Part No.
FU102	CN904-3	T10A 250V	AC	Input protection	-
FU11	CN911-3	T5A 250V	5.1V	BiCU	-
FU12	CN912-5 CN912-6	T10A 250V	24V	IOB	-
FU13	CN912-7	T10A 250V	24V	IOB	-
FU14	CN912-8	T10A 250V	24V	IOB	-

Fuse (200V)

Name	Output terminal	Capacity	Voltage	Type	Part No.
FU102	CN904-3	T5A 250V	AC	Input protection	-

Name	Output terminal	Capacity	Voltage	Type	Part No.
FU11	CN9111-3	T5A 250V	5.1V	BiCU	-
FU12	CN912-5 CN912-6	T10A 250V	24V	IOB	-
FU13	CN912-7	T2.5A 250V	24V	IOB	-
FU14	CN912-8	T6.3A 250V	24V	IOB	-

Carriage Unit

6

HRB

The HRB behind the print heads relays signals to the control board from the horizontal encoder sensor, DRESS sensor, and thermistors.

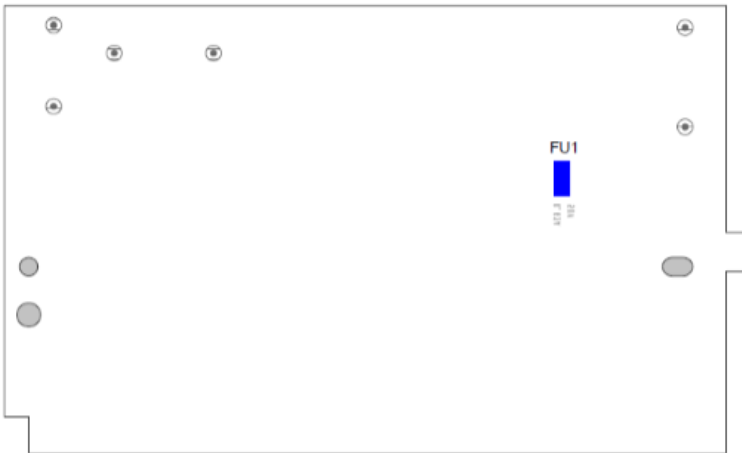

d262k1560

Note

- FU1 is located on the back surface of the board.

Name	Output terminal	Capacity	Voltage	Type	Part No.
FU1	-	0.63A 50V(DC)	3.3V	Print heads and sensors	-

7. Detailed Description

Overview

General Operation Sequence

Here is a brief summary of what happens when an original is scanned and printed with roll paper from Roll Unit 1. Every phase of this operation summary is described in detail in later sections of this document.

The general operation sequence is composed of these steps:

1 Power ON
2 Scanning
3 Paper Feed
4 Printing
5 Cutting
6 Paper Exit and Job End

1 Power ON

1. The machine checks for paper jams, and issues a jam alert if one is detected.
2. The maintenance unit print head caps are lowered to uncap the print heads.
3. The horizontal motor switches ON and moves the carriage to the start position and then back to the maintenance unit.
4. The positions of the print head OCFS feelers are checked to determine whether sufficient ink remains in each sub tank.
5. The print head sub tanks are air purged and filled as needed and then the print heads are cleaned.
6. The print heads are capped.
7. The printer beeps twice when it is ready for operation.

Note

- When the machine is powered on, especially after a cold start, the machine automatically checks temperature, ink level, and air sensors. Then it cleans and re-fills the print heads. This can require more time, depending on how long the machine has been off.

- If the machine is accidentally unplugged from the wall power socket, or if a power outage occurs during the cleaning cycle after power on, the cycle will not resume from where it was interrupted after power is restored. You must do cleaning with the user tools after power is restored.

2 Paper Exit and Job End

1. After the paper has been cut and the cutter has returned to its home position, the machine feeds the paper out of the machine.
2. When the exit sensor detects the trailing edge of the paper, this signals job end.
3. The paper transport fan switches off and the paper is reverse fed to the registration standby position.
4. The machine is ready for the next job.
5. If the machine remains idle for more than 14 min. (default), it will enter the Sleep Mode.

Scanner Unit

Scanner Layout

Side View

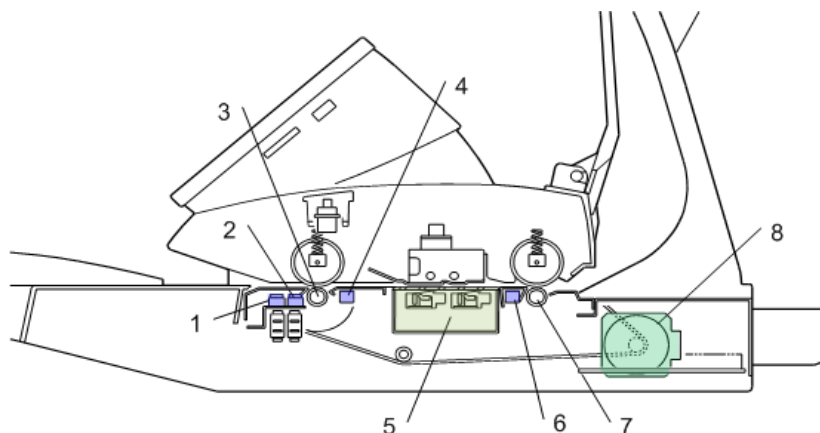

d1249101

7

No.	Item
1	Original width sensors
2	Original set sensor
3	Original entrance roller
4	Original registration sensor
5	CIS unit
6	Original exit sensor
7	Original exit roller
8	Scanner motor

- The original width sensors (1) detect the width of the original, and the original set sensor (2) detects when the original is set by the operator.

- The original entrance roller (3) feeds the original to the original registration sensor (4). The original registration sensor detects the leading edge of the original and stops long enough for the operator to align the original manually if the original is not straight.
- The CIS unit (5) under the original scans the original and sends the data to the SIB in the scanner unit.
- The original exit sensor (6) detects the leading and trailing edges of the original to check the feed timing of the original.
- The original exit roller (7) feeds the original out of the scanner unit.
- The scanner motor (8) drives the scanner entrance roller and the exit roller via a single timing belt.
- Two safety micro-switches (not shown) on the left side of the scanner unit disconnect power to the scanner unit every time the scanner unit cover is opened. This prevents the CIS unit from turning ON while the cover is open.
- Pressing the original stop key  (a push-switch on the right side of the scanner unit) interrupts scanning if a problem occurs during scanning (wrinkling, skew) so that the original can be removed.

Front View

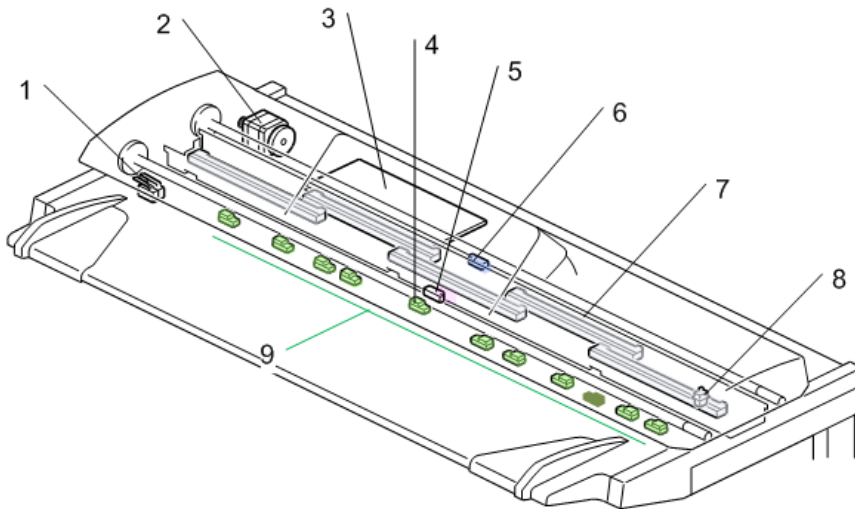

d1249005

No.	Item
1	Safety switches

No.	Item
2	Scanner motor
3	SIB
4	Original set sensor
5	Original registration sensor
6	Original exit sensor
7	CIS unit (5 elements)
8	Original stop switch
9	Original width sensors

Original Width Detection

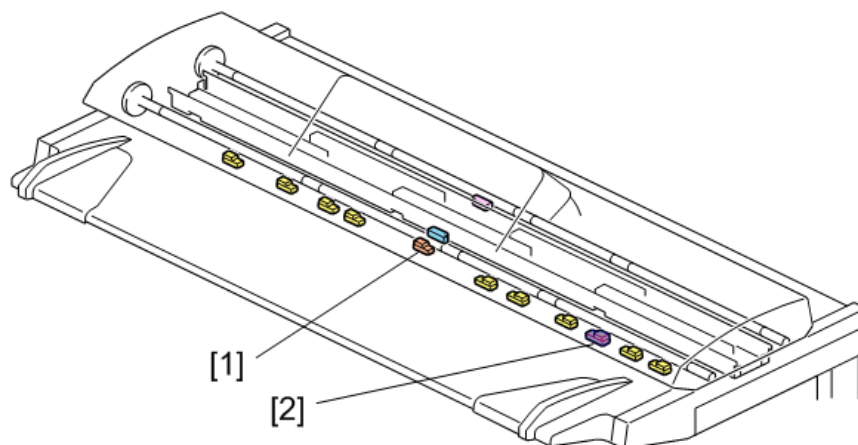

d1249103

Several sensors are used to detect the width of the original when it is set on the original table:

- **Metric**

10 sensors: 9 original width sensors plus the original set sensor [1] which also functions as a width sensor.

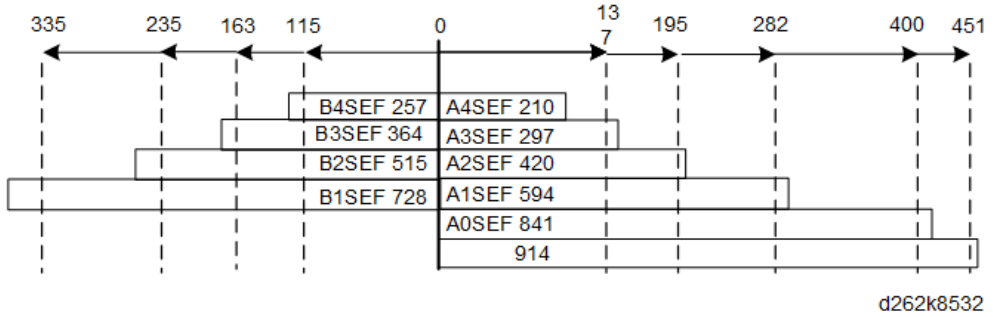

• Inch

11 sensors: 10 original width sensors and the original set sensor [1] which also functions as a width sensor. The NA machine has one additional width sensor [2] (30").

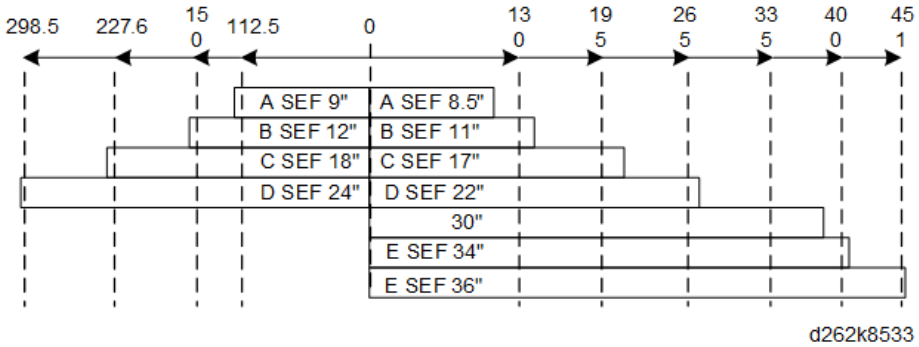

- The sensors to the left of center (set sensor position "0") detect B series (Metric) or Architecture (USA) sizes.
- The sensors to the right of center (set sensor position "0") detect A series (Metric) or Engineering (USA) sizes.
- If only one original sensor is detects a paper, the machine detects an A4 or 8 ½" "A" size SEF original.

Scanning

Original Feed, Exit Sequence

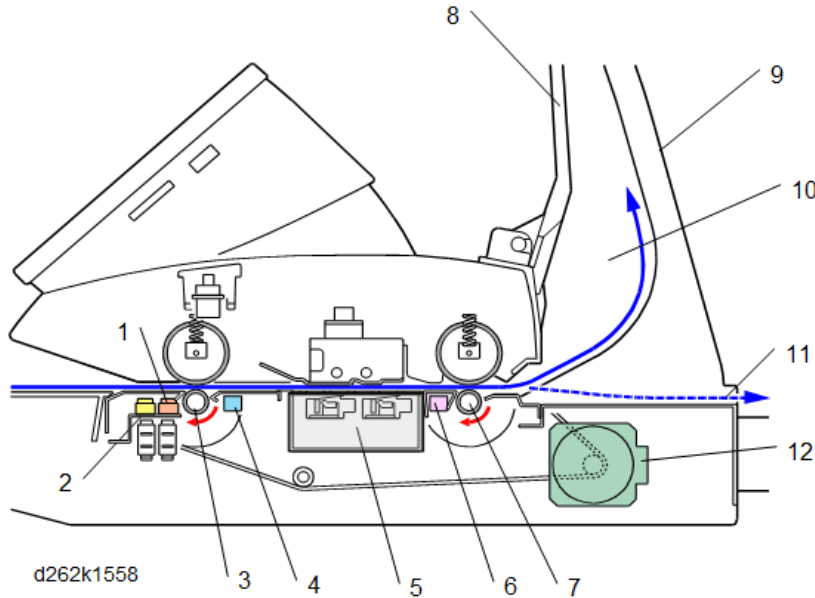

Only one original can be placed face-down on the original table.

- The original set sensor (1) detects the leading edge of the original and the original width sensors (2) detect the width of the original.
- The original entrance roller (3) grabs the leading edge, feeds it a short distance and then stops for 1 sec. This is called Delay 1. This gives the operator time to set the paper again if it is not perfectly straight.
- The original feed roller feeds the original to the original registration sensor (4).
- When the original registration sensor detects the leading edge of the original, the machine stops original feed again for 1 sec. This is called Delay 2. This gives the operator another chance to check that the original is straight.
- If the original is not straight, the user can push the original stop key (🛑) on the right side of the scanner unit, remove the original, and try again.
- The length of time for Delay 1 and Delay 2 to pause can be adjusted with User Tools > System Settings > General Features > Original Feed Delay.
- The CIS (Contact Image Sensor) (5) scans the original from below.
- The original exit sensor (6) checks the timing of the passage between the leading and trailing edges of the original to make sure that there is no jam.

- The original exit roller (7) feed the original out of the scanner unit while the scanned image is processed
- The original stacker (8) and original guide (9) comprise the upper output tray (10). The upper output tray receives the original after scanning. Long originals will curl in the tray.
- If the original guide is removed, the original feeds straight out the back of the scanner unit (11)

Note

- If the original output trays are removed, the original feeds straight out of the rear of the machine. The user should remove the original output trays when scanning thick originals.
- The scanner motor (12) drives the entrance roller and exit roller in the scanner unit via a single timing belt.

Auto Image Density Correction

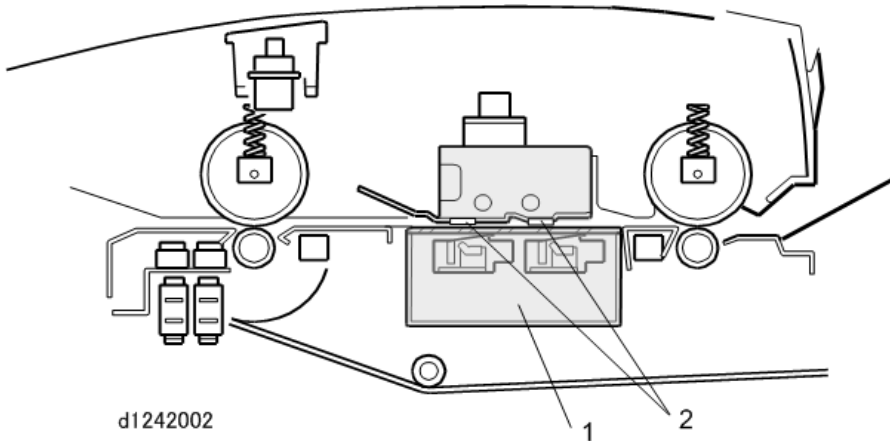

Auto Image Density Correction corrects the background density.

- First, the CIS unit (1) reads the surface of the white strips (2) on the platen plate.
- There is one white strip mounted above each section of the CIS unit. The machine uses these readings as reference points for density correction.

Scanning Area

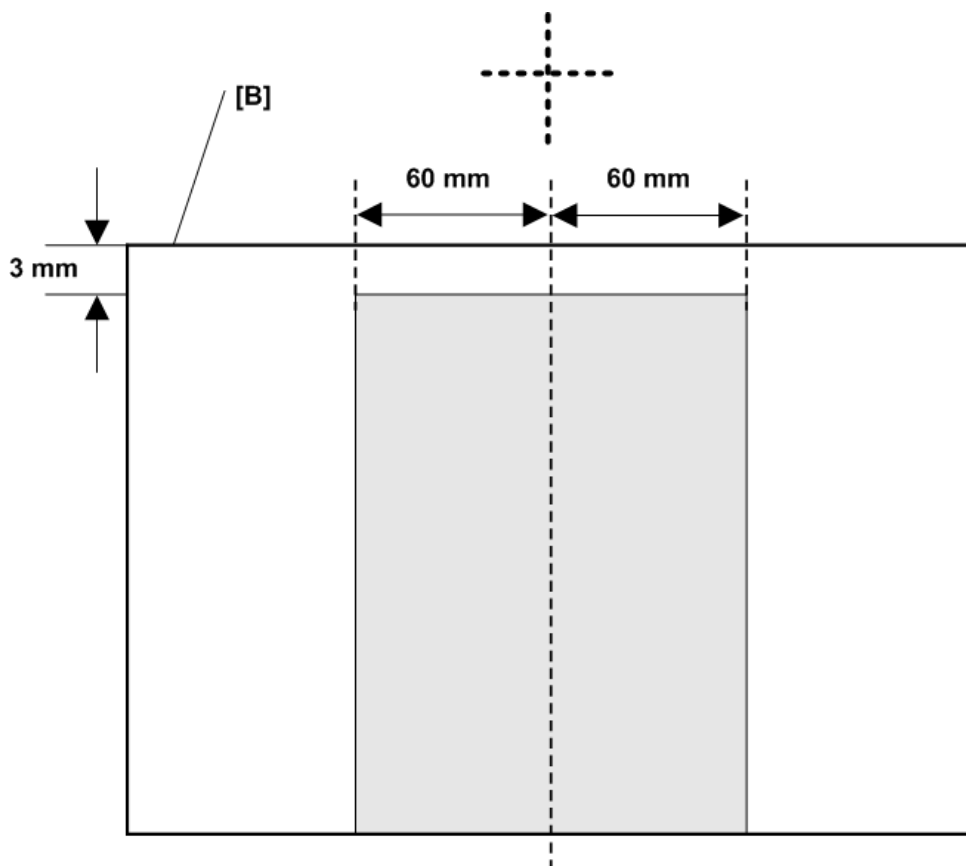

d1242003

During scanning, the CIS corrects the image density line by line. To do this, it starts 3 mm from the leading edge of the original [B], and reads 60 mm to the left and to the right of center.

These start positions can be adjusted with the following SP codes:

- SP4-901-005 Digital AE -Start Position
- SP4-901-006 Digital AE -Left Start Position
- SP4-901-007 Digital AE -Right Start Position

Scan Magnification Correction

Magnification (enlargement/reduction) correction in the sub scan (vertical) direction is done by adjusting the speed of the scanner motor with **SP2-116** (Copier Sub Scan Magnification Correct). Adjustment is done relative to the default setting "0" (100%).

- Reducing the setting increases the speed of the scanner motor, and the image is reduced when it prints.

- Increasing the setting reduces the speed of the scanner motor, and the image is enlarged when it is printed.

Original Drive Mechanism

Scanning Motor, Rollers

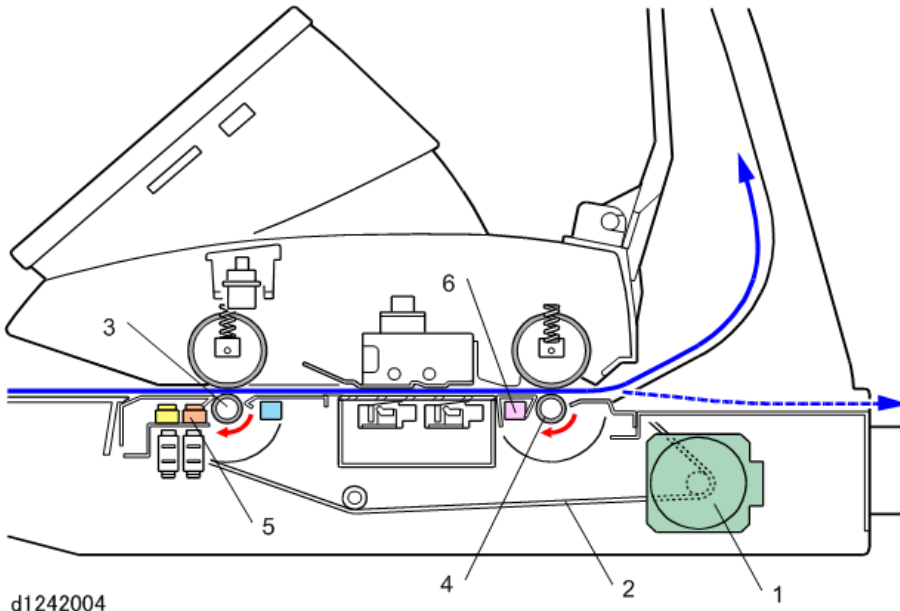

- The scanner motor (1) (a stepper motor) and timing belt (2) drive the original entrance roller (3) and original exit roller (4).
- The original set sensor (5) turns the motor on when the original is set.
- The original exit sensor (6) switches the motor off when the sensor detects the trailing edge of the original.

Original Feed Speed

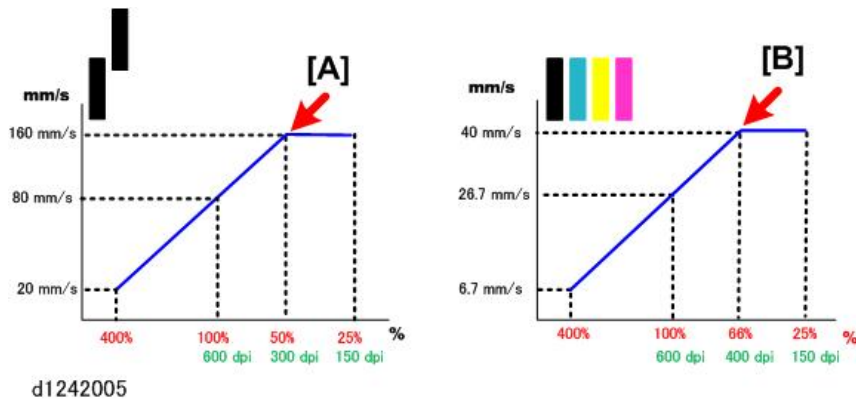

In the diagram above, the **red numbers** (%) below the horizontal axis of both graphs show the magnification steps for **copy jobs**. The **green numbers** (dpi) below the horizontal axis of both graphs show the resolution steps for **scanning jobs**.

During copying, the speed of original feed is adjusted for magnification (resolution is fixed at 600 dpi). During scanning to a file, the speed of original feed is adjusted for resolution (magnification is fixed at 100%).

The scanning speed increases as resolution or magnification lowers. But to prevent color separation caused by excessive speed, scanning speed does not increase any more when resolution (or magnification) reaches the following values, and then image processing reduces the data:

- Black-and-white: When resolution is less than 300 dpi or less, or magnification is less than 50% [A]
- Full color: When resolution is less than 400 dpi or less, or magnification is less than 66% [B]

Black-and-White Standard for Copying

- Resolution: 600 dpi (fixed). Copy resolution cannot be adjusted.
- Magnification: 100%
- Original scanning speed : 80 mm/s

Black-and-White Standard for Scan to File

- Resolution: 200 dpi
- Magnification: 100% (fixed)
- Scanning speed: 160 mm/s (with electronic magnification)

This graph shows the reciprocal relation between copy magnification and scan job resolution. For example:

- A copy reduced to 50% (one-half of an image at 100% 600 dpi) is reduced by removing half the pixels.
- This is the same as a 300 dpi copy at 100%, in other words, the same as a document scanned to a file at 300 dpi.

Scanning Mechanism

CIS Structure

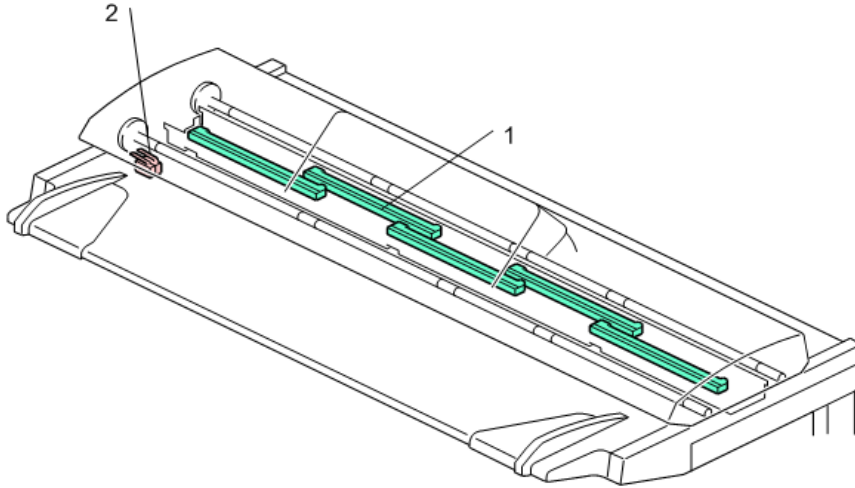

7

d1249104

This machine uses 5 contact image sensors (1) linked in a staggered configuration mounted below the original feed path. The CIS scans both black-and-white and color originals at a maximum of 926.5 mm (36 1/2 inches) wide with 600 dpi.

A pair of safety switches (2) cut off the power circuits of the CIS unit when the scanner cover is raised. This prevents the CIS unit from lighting up accidentally when the cover is open.

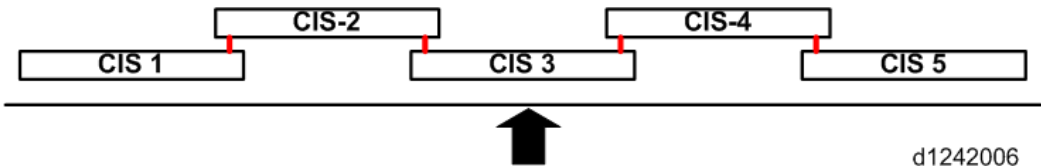

d1242006

The CIS unit is made of 5 contact image sensors connected at 4 joints. If you look from above, the CIS sections are numbered from left to right as CIS-1 to CIS-5.

Printed Image

Abc				
CIS-5	CIS-4	CIS-3	CIS-2	CIS-1

d1242007

When you look at the copy to identify the areas scanned by each section, the numbering is in the opposite sequence, with CIS-5 on the left to CIS-1 on the right.

Long Original or Special Original with Carrier Sheet

When a long original, or a special original (extremely thin or fragile) with a carrier sheet, is fed into the scanner unit, this creates a load on the scanner when the scanned portion of the original behind the scanner unit starts to sag. This can cause the original to slip in the original feed path and interfere with smooth operation of the scanner motor. To correct this, the scanning speed can be switched at a desired location in order to compensate for slippage of the special originals in the original feed path.

The scanning speed can be switched at designated points:

- Up to 15 switching points can be designated for a long original up to the maximum length of 15,000 mm (15 m or approximately 50 ft.).
- The first starting point (the reference point) is upstream of the CIS.
- The points can be entered with SP codes **SP4-993**, **SP4-994**
- The speed of the scanner motor can be set in the range of $\pm 10\%$ where it can be adjusted in fine increments ($\pm 0.1\%$)

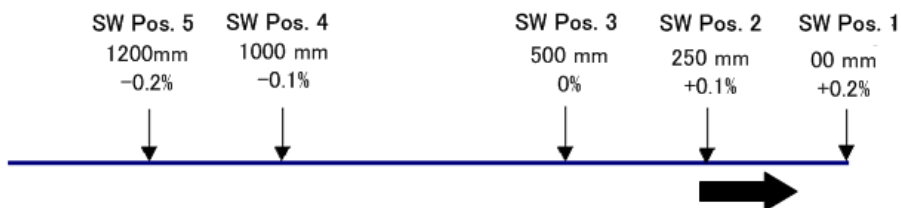

d1242008

As shown above, as more of the original feeds through the scanner unit, the speed of the scanner motor is decreased slightly.

- If the speed is set at "0" at any point, the speed will be 100% the normal speed of the scanner motor.

- If the image is to be magnified, the speed of the vertical motor is automatically adjusted to account for the changes in scanning speed, so magnification will not be affected.

The machine can also be set not to release the trailing edge of the original at the end of the scan job. This prevents the original from falling on the floor. The trailing edge is held in the nip of the exit roller until it can be removed manually. This feature can be switched on/off with **SP4-975** (Prevent Original Falling).

Related SPs

- 4-901-005 Digital [Shading Correction DFU]-[Digital AE -Start Position]:
Defines the start position for digital A/E processing of the scanned image data.
- 4-901-006 Digital [Shading Correction DFU]-[Digital AE -Left Start Position]:
This SP sets the start position for digital AE processing for scanned image data in the main scan direction (from the center of the original as a reference point), starting at the left side of the original.
- 4-901-007 Digital [Shading Correction DFU]-[:
This SP sets the start position for digital AE processing for scanned image data in the main scan direction (from the center of the original as a reference point), stopping at the right side of the original.
- 2-116-XXX [Copier Sub Scan Magnification Correct]:
Use these SP codes to correct magnification in the sub scan direction, depending on what type of paper is used. Correction is done in the range [+1.0% to -1.0%/0.0/0.1%]
- 4-993-XXX [Document Feed Speed Adjustment DFU]:
This SP sets the speed adjustments for scanning long originals, or special originals with a carrier sheet, after SP4992 has been turned on. (See detailed description below for SP4994.)
- 4-994-XXX [Document Feed Speed Adjustment]:
- 4-975-001 [Prevent Document Fall]:
This SP sets the scanner unit to hold the trailing edge of the original if it is longer than 450 mm to prevent it from falling on the floor. Use this setting for long originals fed straight out the back of the machine.

Image Processing

Features for Printing

For printing, data is written in bands in the direction of main scanning, and these bands are parallel in the sub scanning direction. The BiCU converts the data.

↓ Note

- The BiCU supports mirror, reverse, and jpeg compression and decompression.
- Writing in the margin is performed after BiCU but not CTL. An abnormal image of writing in the margin is caused with BiCU.

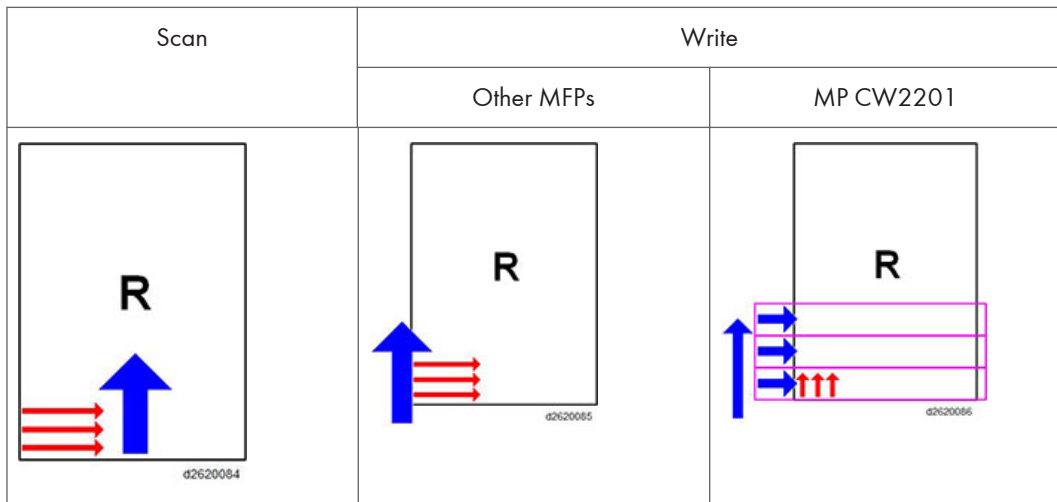
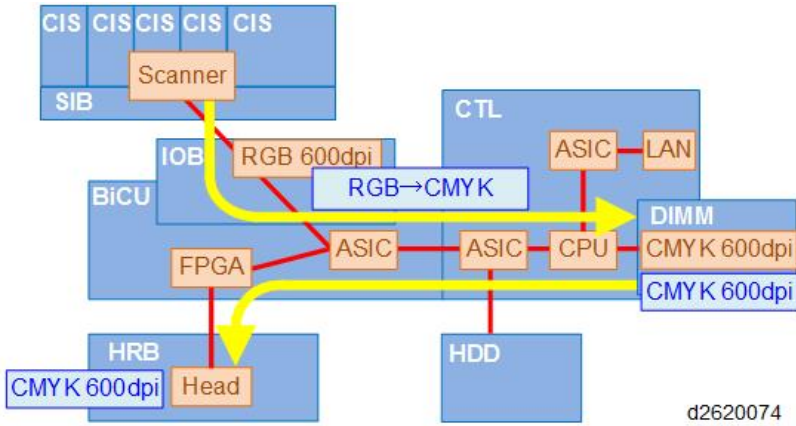

Image Flow

Copy Job Image Data Flow

For Multiple Copies of an Original of A1 or Smaller for Monochrome or A2 or Smaller for Color



d2620074

7

Note

- Data do not go to the HDD but are stored in DIMM only.
- Data is cached with FPGA for several bands, converted between horizontal and vertical for each band, and are carried out down sampling.

For Other Size or Multiple Originals

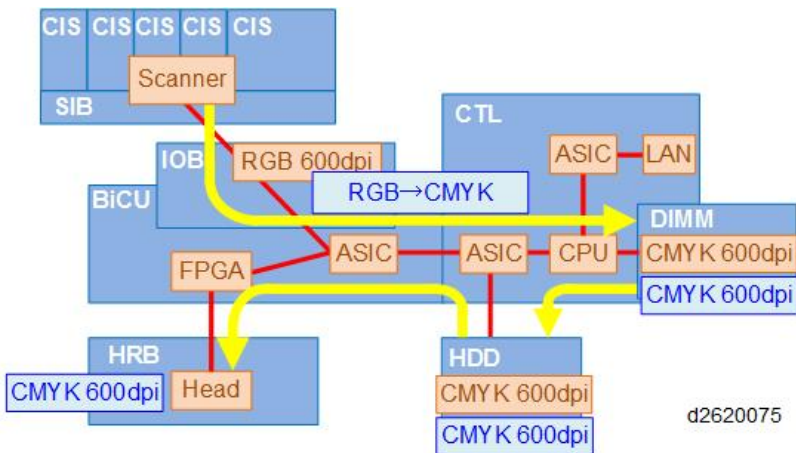

d2620075

Note

- Data is stored on the HDD.

- Data is cached with FPGA for several bands, converted between horizontal and vertical for each band, and are carried out down sampling.

Scan Job Image Data Flow

Transferring for Each Twain Page

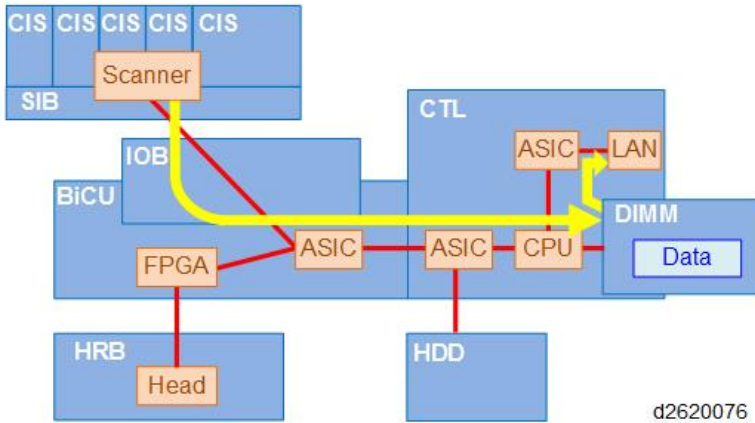

Note

- The data format depends on the settings.

Delivering Data

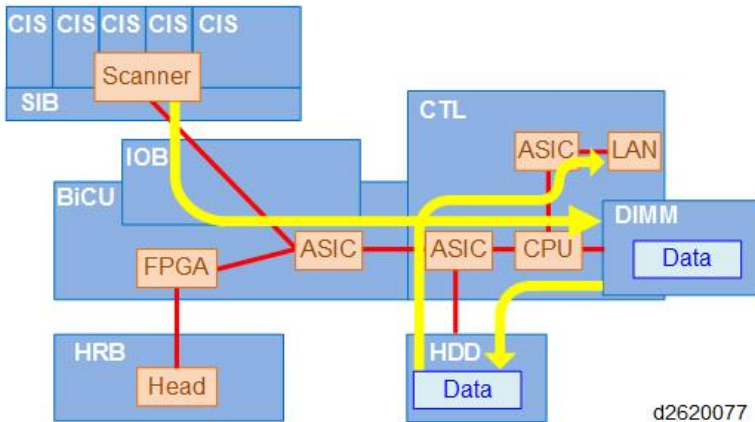

Note

- The data format depends on the settings.
- All data is temporarily stored on the HDD.
- Data is distributed through a LAN.

Print Job Image Data Flow

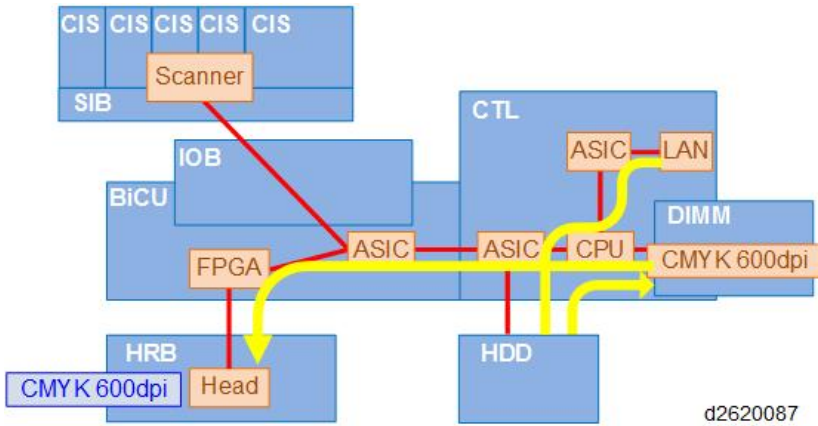

Note

- All data is temporarily stored on the HDD.
- Data is cached with FPGA for several bands, converted between horizontal and vertical for each band, and decreased in value.

Copy Mode Image Processing

The copy modes (selected from the operation on the main machine) are provided to achieve the best possible results in copying, depending on the type and quality of the original. Here is a brief summary of the copy modes as they appear in order of selection on the operation panel.

Copy Mode	For Original Type
Drawing	For line drawings with fine lines that could easily break up during copying.
Text	Mainly text with few or no illustrations.
Photo	Glossy photos, photos printed on paper, re-produced photos (generation copies).
Text/Photo	Text mixed with photos and drawings.
Glossy Photo	Photos or illustrations printed on glossy surface paper.
Printed Photo	Printed photos and artwork on magazine pages.
Copied Photo	Photos or illustrations copied onto paper and printed in color.

Copy Mode	For Original Type
Background Lines	Forces background lines of section paper, for example, to dropout. (Forcing blue to drop out may be difficult.)
Patched Original	Text, photos, drawings, pasted up on paper or boards for layout.
Generation Copy	Originals copied many times in succession with text letters starting to become distorted.
Map	Full color maps with fine lines.
Highlight Pen	Text marked with yellow highlight that you do not want to lose in a black-and-white copy.

Print Mode Image Processing

The print modes (selected with the printer driver) are provided to achieve the best possible results in print jobs.

Print Mode	What It Does
Normal (Default)	Target for color reproduction quality in printing is RGB monitor color.
Color/Black-and-White	Aims for B&W reproduction detected by the human eye.
CUD Print	Adjusts colors so they are easily distinguished by those with color blindness.
POP Optimization	Best quality of outstanding colors for POP printing.
Ink Save	Best possible print production with less ink in order to conserve toner.

Copy Resolution: Copy Jobs and Print Jobs

In the tables below:

- **Uni-Dir** means "uni-directional" printing. The print heads lay down ink in only one pass as the carriage unit moves from right to left.
- **Bi-Dir** means "bi-directional" printing. The print heads lay down ink in two passes as the carriage unit moves from right to left and then right to left.

- **Switching** "Yes/No" means that the operator can/cannot switch between uni-directional and bi-directional printing.

Copy Jobs

No.	Paper Type	Quality	Direction		Resolution (dpi)
			Bi-Dir./Uni-Dir.	Switching	
1	Normal/Monochrome	High Speed	Bi-Dir.	Yes	600x300
2		Standard	Bi-Dir.	Yes	600x600
3	Normal/Color	High Speed	Bi-Dir.	Yes	600x300
4		Standard.	Bi-Dir.	Yes	600x600
5	Recycled/Monochrome	High Speed	Bi-Dir.	Yes	600x300
6		Standard	Bi-Dir.	Yes	600x600
7	Recycled/Color	High Speed	Bi-Dir.	Yes	600x300
8		Standard	Bi-Dir.	Yes	600x600
9	IJ Normal/Monochrome	High Speed	Bi-Dir.	Yes	600x300
10		Standard	Bi-Dir.	Yes	600x600
11	IJ Normal/Color	High Speed	Bi-Dir.	Yes	600x300
12		Standard	Bi-Dir.	Yes	600x600
13	Translucent/ Monochrome	Standard	Uni-Dir.	No	600x600
14	Translucent/Color	Standard	Uni-Dir.	No	600x600
15	Matte Film/Monochrome	Standard	Uni-Dir.	No	600x600
16	Matte Film/Color	Standard	Uni-Dir.	No	600x600
17	Coated (CAD)/ Monochrome	High Speed	Bi-Dir.	Yes	600x300
18		Standard	Bi-Dir.	Yes	600x600

No.	Paper Type	Quality	Direction		Resolution (dpi)
			Bi-Dir./Uni-Dir.	Switching	
19	Coated (CAD)/Color	High Speed	Bi-Dir.	Yes	600x300
20		Standard	Bi-Dir.	Yes	600x600
21	Coated/Monochrome	Standard	Uni-Dir.	No	600x1200
22	Coated/Color	Standard	Uni-Dir.	No	600x1200
23	Special/Monochrome	Standard	Uni-Dir.	No	600x1200
24	Special/Color	Standard	Uni-Dir.	No	600x1200

Print Jobs

Paper Type	Quality	Direction		Resolution (dpi)	Scan
		Bi-Dir./Uni-Dir.	Switching		
Normal/Monochrome	High Speed (LD)	Bi-Dir.	Yes	600x300	1
	High Speed	Bi-Dir.	Yes	600x300	1
	Standard	Bi-Dir.	Yes	600x600	2
	Quality	Uni-Dir	No	600x600	4
Normal/Color	High Speed (LD)	Bi-Dir.	Yes	600x300	1
	High Speed	Bi-Dir.	Yes	600x300	1
	Standard	Bi-Dir.	Yes	600x600	2
	Quality	Uni-Dir	No	600x600	4

Paper Type	Quality	Direction		Resolution (dpi)	Scan
		Bi-Dir./Uni-Dir.	Switching		
Recycled/Monochrome	High Speed (LD)	Bi-Dir.	Yes	600x300	1
	High Speed	Bi-Dir.	Yes	600x300	1
	Standard	Bi-Dir.	Yes	600x600	2
	Quality	Uni-Dir	No	600x600	4
Recycled/Color	High Speed (LD)	Bi-Dir.	Yes	600x300	1
	High Speed	Bi-Dir.	Yes	600x300	1
	Standard	Bi-Dir.	Yes	600x600	2
	Quality	Uni-Dir	No	600x600	4
IJ Normal/Monochrome	High Speed (LD)	Bi-Dir.	Yes	600x300	1
	High Speed	Bi-Dir.	Yes	600x300	1
	Standard	Bi-Dir.	Yes	600x600	2
	Quality	Uni-Dir	No	600x600	4
IJ Normal/Color	High Speed (LD)	Bi-Dir.	Yes	600x300	1
	High Speed	Bi-Dir.	Yes	600x300	1
	Standard	Bi-Dir.	Yes	600x600	2
	Quality	Uni-Dir	No	600x600	4

Paper Type	Quality	Direction		Resolution (dpi)	Scan
		Bi-Dir./Uni-Dir.	Switching		
Translucent/ Monochrome	High Speed	Bi-Dir.	Yes	600x600	4
	Standard	Uni-Dir.	No	600x600	4
	Quality	Uni-Dir	No	600x600	8
Translucent/Color	High Speed	Bi-Dir.	Yes	600x600	4
	Standard	Uni-Dir.	No	600x600	4
	Quality	Uni-Dir	No	600x600	8
Matte Film/ Monochrome	High Speed	Uni-Dir.	No	600x600	4
	Standard	Uni-Dir.	No	600x600	4
	Quality	Uni-Dir	No	1200x1200	8
Matte Film/Color	High Speed	Uni-Dir.	No	600x600	4
	Standard	Uni-Dir.	No	600x600	4
	Quality	Uni-Dir	No	1200x1200	8
Coated (CAD)/ Monochrome	High Speed (LD)	Bi-Dir.	Yes	600x300	1
	High Speed	Bi-Dir.	Yes	600x300	1
	Standard	Bi-Dir.	Yes	600x600	2
	Quality	Uni-Dir	No	600x600	4

Paper Type	Quality	Direction		Resolution (dpi)	Scan
		Bi-Dir./Uni-Dir.	Switching		
Coated (CAD)/Color	High Speed (LD)	Bi-Dir.	Yes	600x600	2
	High Speed	Bi-Dir.	Yes	600x600	2
	Standard	Bi-Dir.	Yes	600x600	4
	Quality	Uni-Dir	No	600x600	4
Coated/Monochrome	High Speed	Uni-Dir.	No	600x600	4
	Standard	Uni-Dir.	No	600x600	8
	Quality	Uni-Dir	No	1200x1200	8
Coated/Color	High Speed	Uni-Dir.	No	600x600	4
	Standard	Uni-Dir.	No	600x600	8
	Quality	Uni-Dir	No	1200x1200	8
Special/Monochrome	High Speed	Uni-Dir.	No	600x600	4
	Standard	Uni-Dir.	No	600x600	8
	Quality	Uni-Dir	No	1200x1200	8
Special/Color	High Speed	Uni-Dir.	No	600x600	4
	Standard	Uni-Dir.	No	600x600	8
	Quality	Uni-Dir	No	1200x1200	8

Image Troubleshooting

Internal Test Patterns

2-902	Internal Test Pattern Select - RI20 (MtoP) Internal Patterns	
	Pattern	
	0	No Test Pattern Output
	1	Black Grid Pattern
	2	Cyan Grid Pattern
	3	Magenta Grid Pattern
	4	Yellow Grid Pattern
	5	Frame Pattern
	6	Black 2x2 Pattern
	7	Cyan 2x2 Pattern
	8	Magenta 2x2 Pattern
	9	Yellow 2x2 Pattern
	10	Density Pattern 1
	11	Density Pattern 2

IPU Test Patterns

4-417	IPU Test Pattern Setting - Pattern Selection	
	No.	Pattern Name
	0	Scanned Image
	1	Gradation Main Scan A
	2	Color Patch 16
	3	Grid Pattern A
	4	Slant Grid Pattern B
	5	Slant Grid Pattern C
	6	Slant Grid Pattern D
	7	Scanned + Grid Pattern C

7. Detailed Description

	8	Scanned + Grid Pattern D
--	---	--------------------------

Paper Feed and Exit

Overview

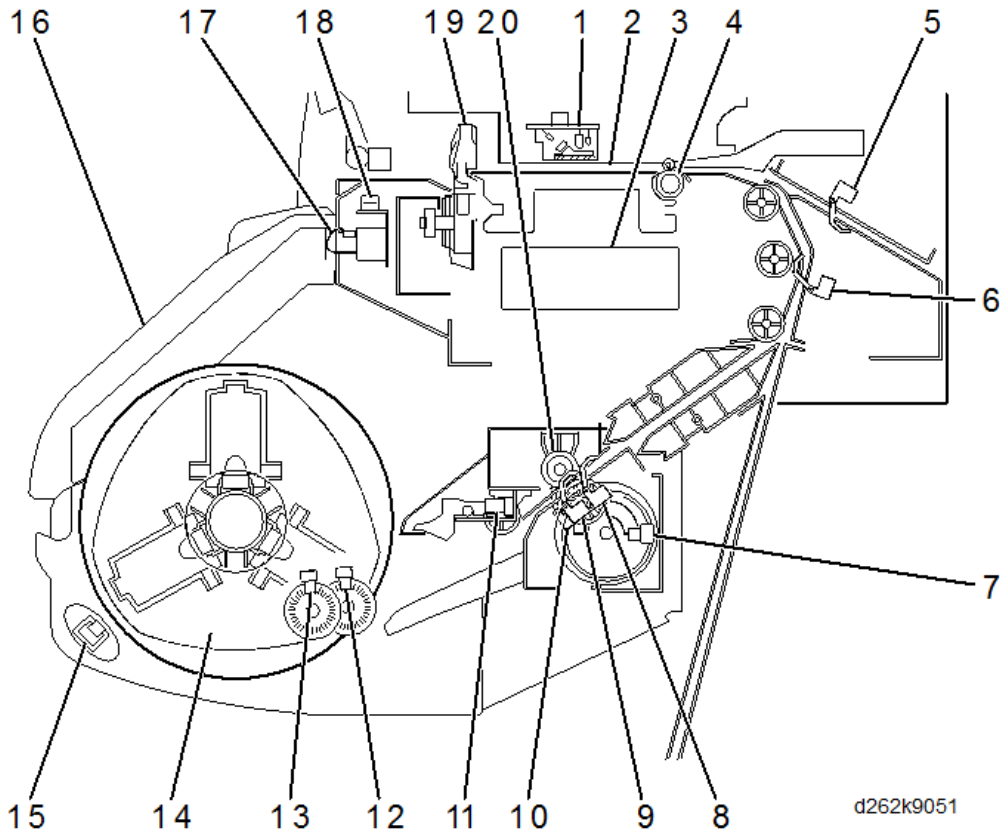

d262k9051

No.	Item	No.	Item
1	DRESS sensor	11	Roll end sensor
2	Platen	12	Encoder sensor 1 (motor)
3	Paper transport fan	13	Encoder sensor 2 (paper)
4	Registration roller	14	Spool
5	Bypass sensor	15	Roll rewind switch
6	Pre-registration sensor	16	Paper exit guide
7	Paper release sensor	17	Paper exit guide switch

No.	Item	No.	Item
8	Roll feeder exit sensor	18	Exit sensor
9	Roll feeder entrance sensor (right)	19	Cutter
10	Roll feeder entrance sensor (center)	20	Feed roller

Roll Unit Operation

General Operation of Roll Unit

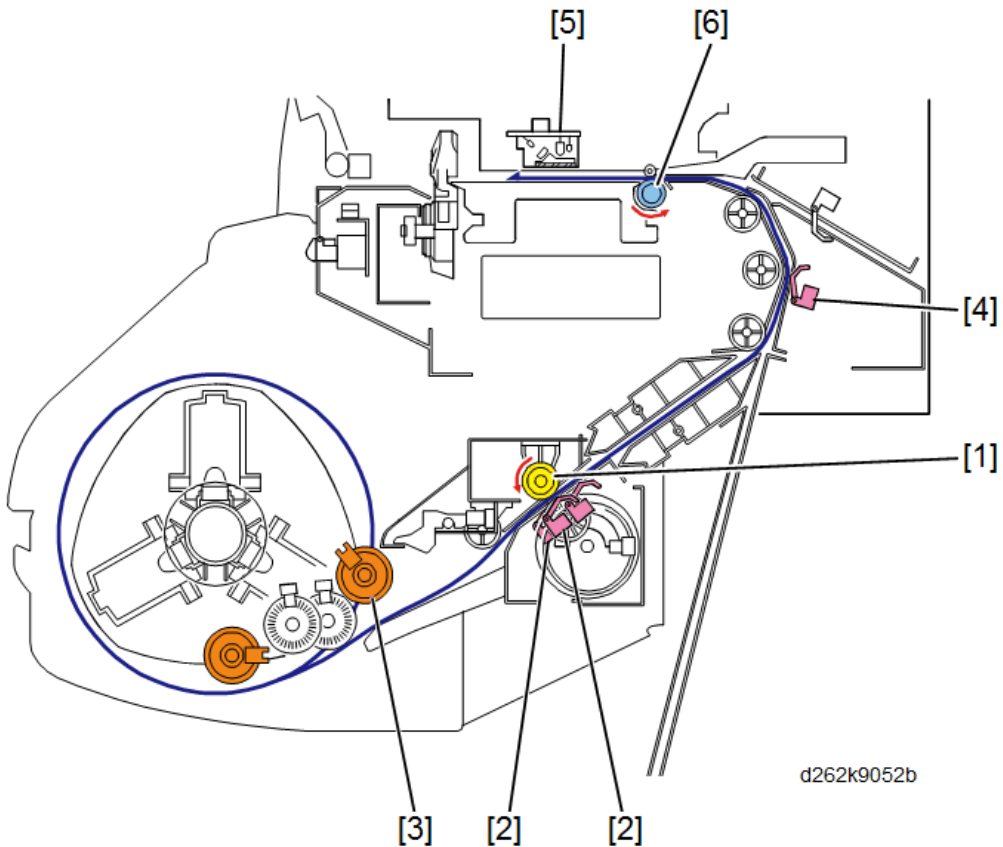

Just after the main power is turned ON, the nip between the roll feed roller [1] and its idle roller is closed. When the user installs a roll, the machine initializes the roll as follows:

- When the paper entrance sensor [2] detects the leading edge, the roll paper feed motor and roll feed clutch [3] rotate together to feed the paper until the pre-registration sensor [4] detects its leading edge.

- Next, the vertical feed motor [not shown] on the left side of the machine turns ON.
- When the DRESS sensor [5] detects the leading edge, the motors and roll feed clutch turn OFF and the machine checks for paper skew.
- Then the roll paper feed motor and roll feed clutch turn [3] ON and reverse feed.
- This process opens the nip between the roll feed roller and its idle roller.
- The registration roller [6] now has the paper and the vertical feed motor controls paper feed.
- The vertical feed motor feeds the paper to the registration standby position below the registration roller [6].
- The roll paper feed motor reverse feeds with the clutch [3] off. This rotates the roll spool in reverse to take up slack.

Roll Feed Mechanism

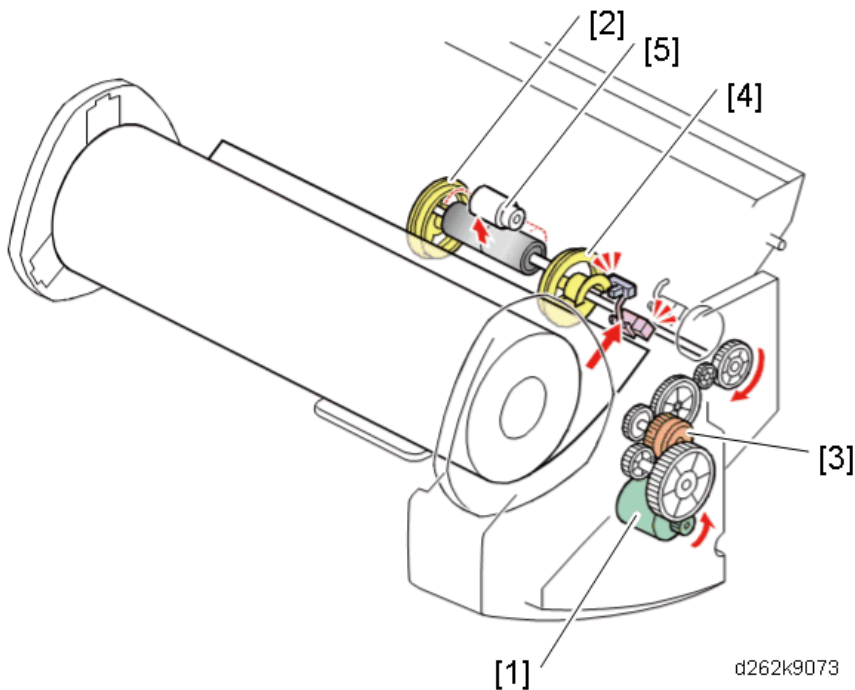

- When the roll paper feed motor [1] rotates forward, the feed roller [2] feeds the paper into the machine.
- When the roll paper feed motor rotates in reverse with the roll feed clutch [3] OFF, the spool reverses (for example, to take up slack).

- When the roll paper feed motor rotates in reverse with the roll feed clutch ON, the feed roller rotates in reverse. The cam [4] also rotates, and this moves the idle roller [5] into and out of contact with the feed roller, so the paper reverse feeds intermittently.

Initializing the First Paper Roll

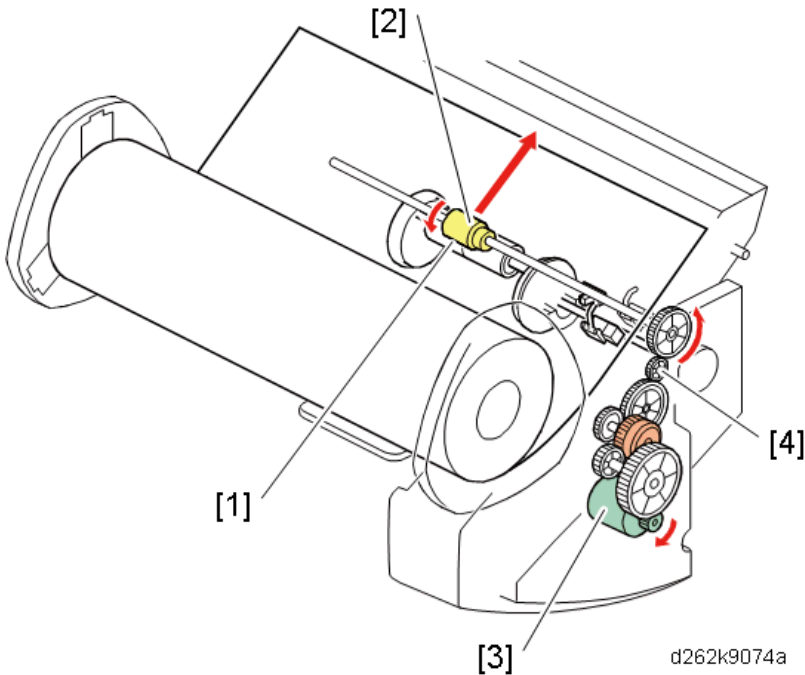

- The operator manually inserts the leading edge of the roll sheet into the paper path slot of the roll feeder as far as the closed nip [1] of the paper feed roller and idle roller.
- The roll feed roller [2] rotates briefly. This grabs the paper, and the roll paper feed motor [3] stops.
- A prompt appears on the screen and asks the user if the paper should be cut ["Cut" or "No Cut"]. The operator presses "Cut" (recommended).
- The user then selects Paper Type and Thickness.
- The roll paper feed motor [3] starts rotating clockwise. This turns the shaft of the roll feed roller [2] and feeds the paper.
- The roll paper feed motor rotates the roll feed roller via the drive gears [4].
- The paper continues to feed through the nip [1] of the roll feed roller and the idle rollers, which are still lifted into contact with the feed roller.

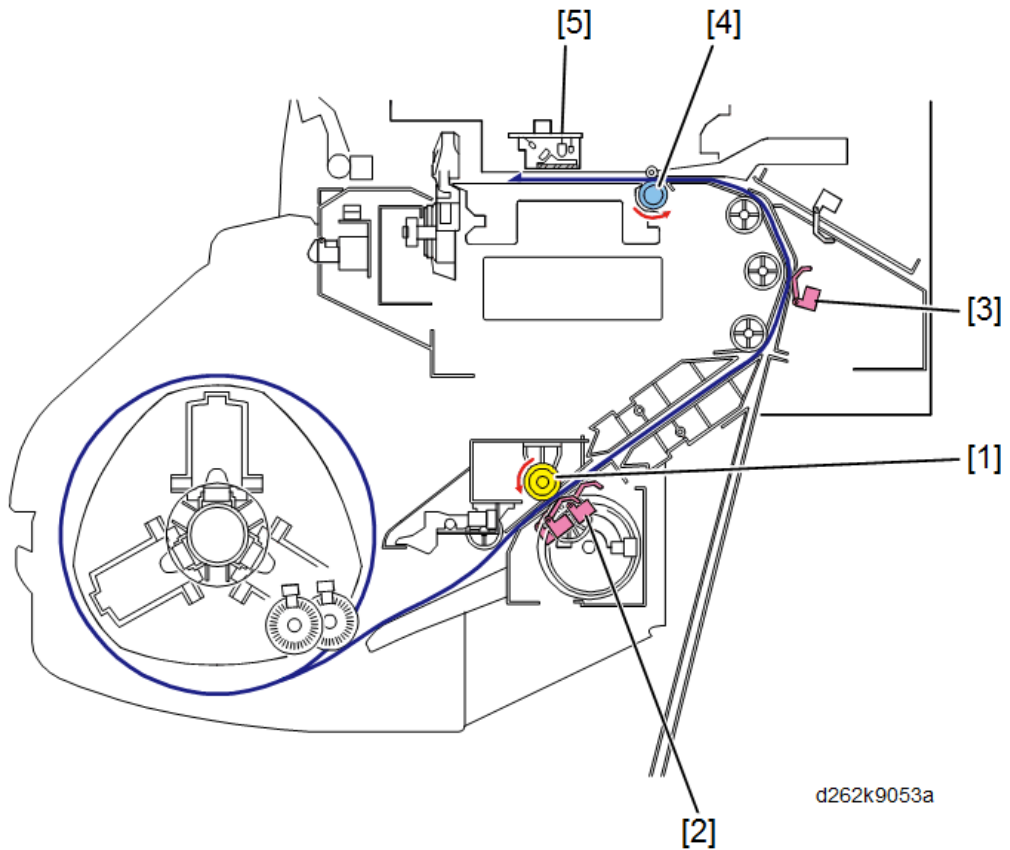

- The roll feed roller [1] feeds the paper over the feeler of the paper exit sensor [2] and out of the roll feeder into the vertical feed path of the main machine.
- When the leading edge of the paper reaches the pre-registration sensor [3], the vertical motor on the left side of the machine turns ON and rotates the registration roller [4].
- When the DRESS sensor [5] detects the leading edge of the paper, the vertical motor stops.

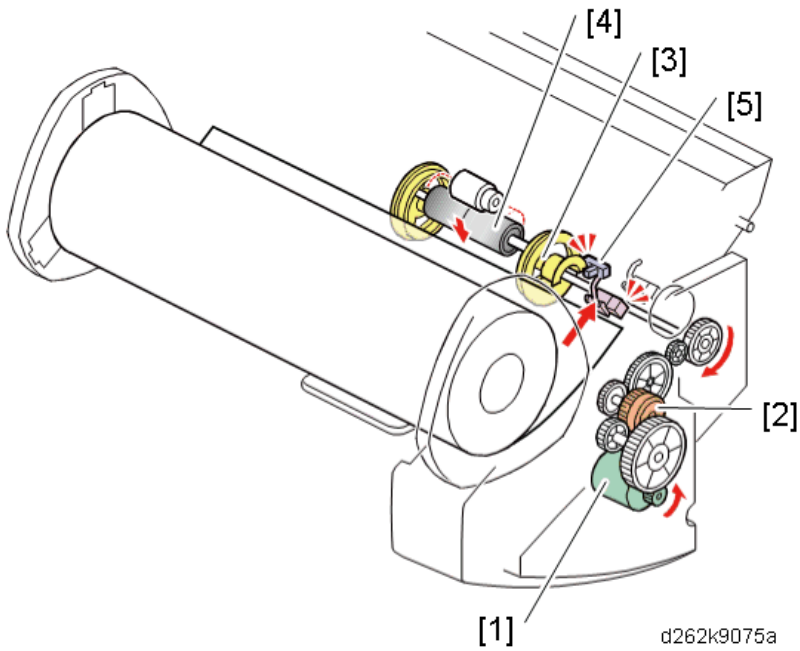

7

- At the same time, the roll paper feed motor [1] and clutch [2] also stop.
- Then the clutch turns ON again but the motor rotates counter-clockwise.
- When the motor turns in this direction, the cam shaft [3] rotates and moves the idle roller [4] down until the paper release sensor [5] turns ON.
- The feed roller and idle roller are now separated.

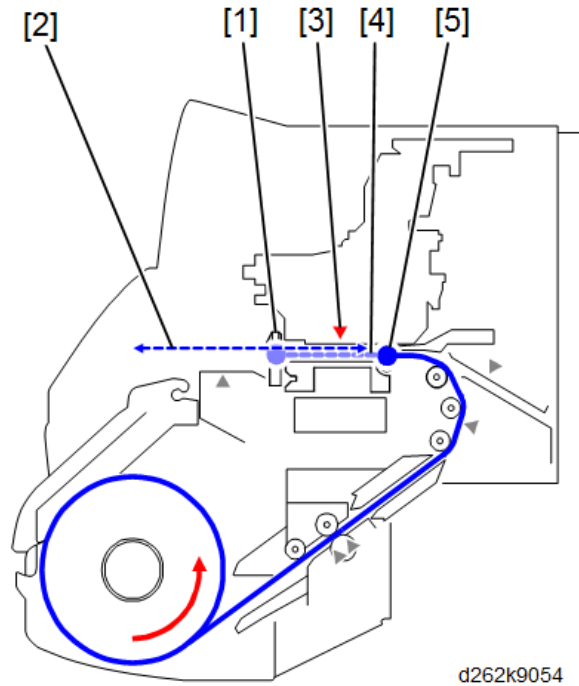

- The vertical motor turns ON again, and feeds the paper forward to the cutter [1].
- The cutter motor on the left side of the machine (not shown) turns ON and drives the cutter across the paper to cut it..
- The vertical feed motor turns ON again, feeds the paper forward out of the front of the machine a short distance [2], stops, and then reverses.
- When the DRESS sensor [3] detects the edge of the paper again, it starts a count, and then stops the paper at the registration standby position [4] above the registration roller [5].

Initializing the Second Paper Roll

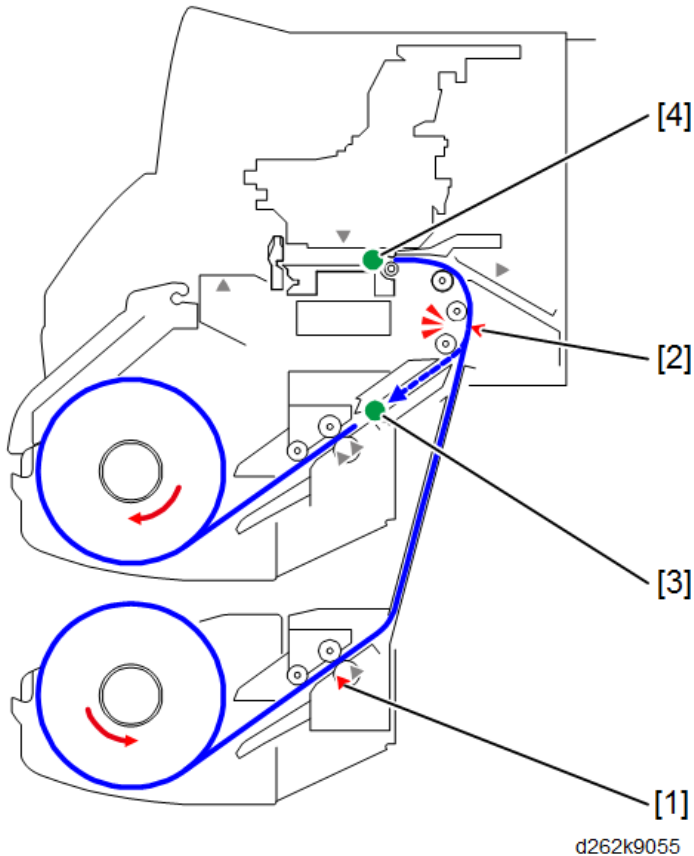

- When the user feeds the edge of a roll into Roll Unit 2, as far as the entrance sensor [1] for roll 2, the vertical feed motor and the roll paper feed motor for Roll 1 reverse feed the paper from Roll Unit 1.
- When the pre-registration sensor [2] detects the edge of the paper, the machine reverse feeds the paper to the paper standby position [3] for Roll Unit 1. Then the motors turn OFF.
- "Initializing the First Paper" (described above) is executed for the roll paper in Roll Unit 2.
- The leading edge of the Roll Unit 2 paper stops at the registration standby position at the registration roller [4].

Roll Rewinding for Removal

Before a roll can be removed, the paper must be rewound onto the roll.

To do this, the user presses the roll rewind switch on the right inner cover of the Roll Unit for at least 2 seconds and then releases it.

There are two different sequences::

- Reversing a roll from the registration standby position
- Reversing a roll from the paper standby position

From the registration standby position:

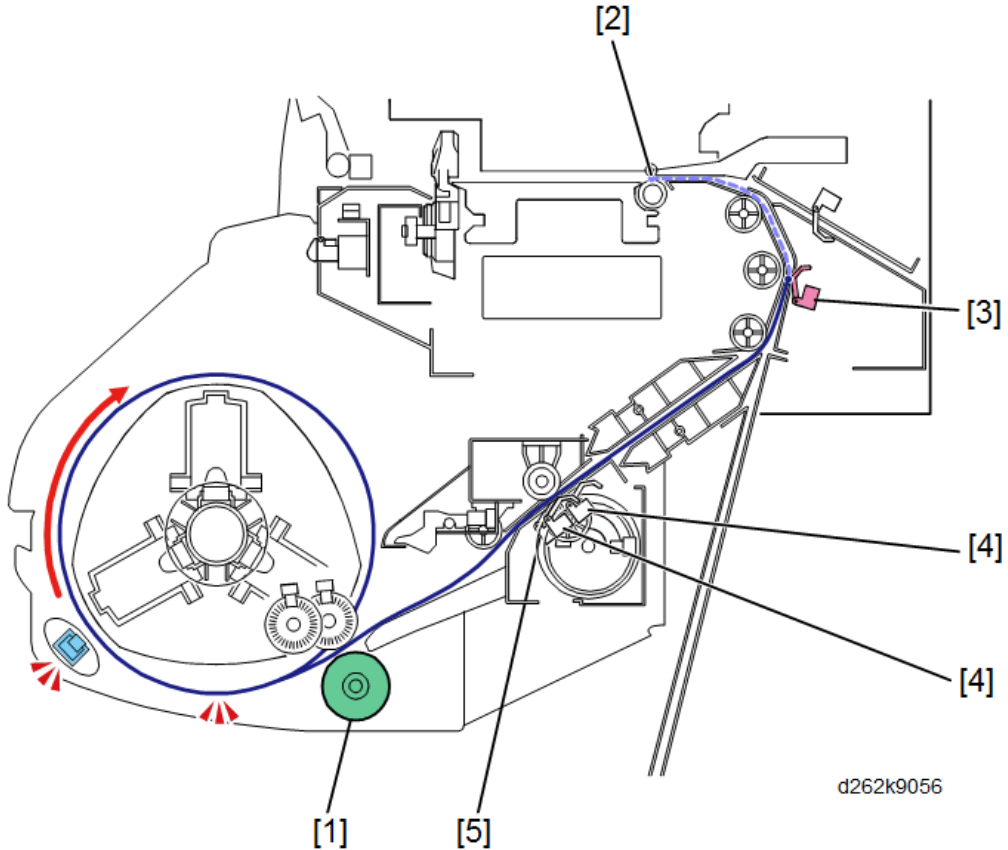

- The vertical motor and roll paper feed motor [1] reverse feed the paper from the registration standby position [2] (the roll feed clutch stays off, so only the spool is reversing the paper, and not the roll feed roller).
- When the edge of the paper passes the pre-registration sensor [3], the vertical motor stops.
- When the edge of the paper reaches the paper entrance sensor [4] [or after 5 seconds has passed, whichever is first], the roll paper feed motor also stops.
- Then, the roll paper feed motor reverses briefly with the clutch on. This closes the nip [5] between the roll feed roller and its idle roller. So the next time paper is inserted, the nip is already closed.
- The operator then turns the roll by hand until the edge of the paper comes out of the machine.

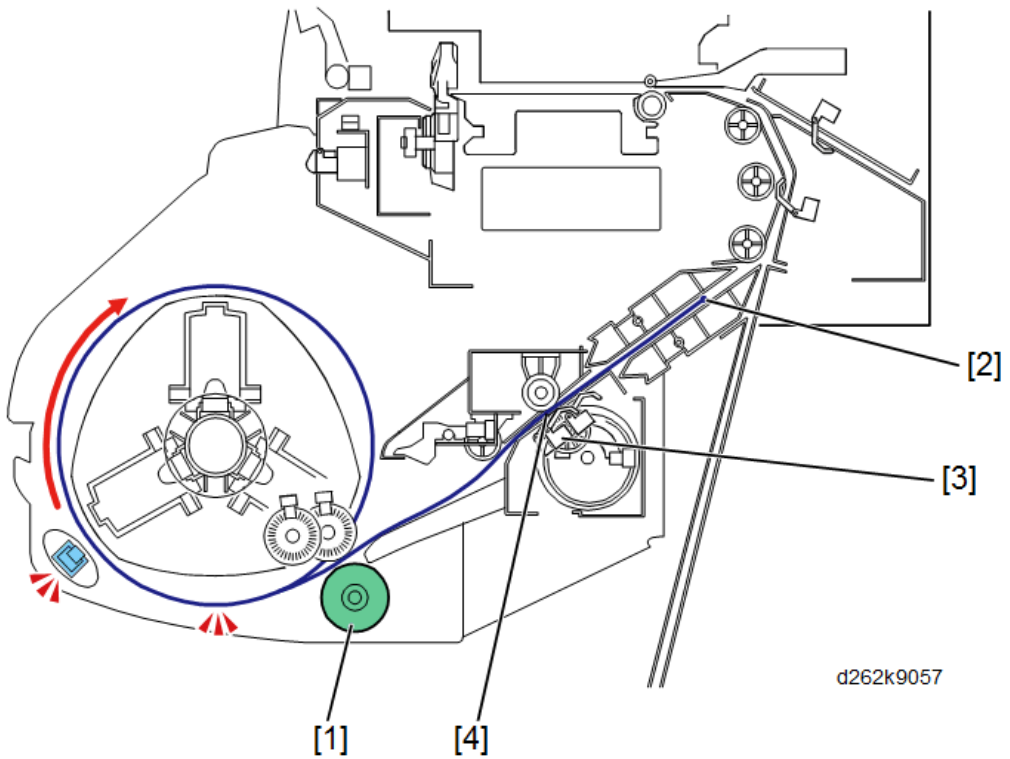

From the paper standby position:

- Only the roll paper feed motor [1] reverse feeds the paper from the paper standby position [2] (the roll feed clutch stays off, so only the spool is reversing the paper, and not the roll feed roller).
- When the edge of the paper reaches the paper entrance sensor [3] (or after 5 seconds has passed, whichever is first), the roll paper feed motor stops.
- Then, the roll paper feed motor reverses briefly with the clutch on. This closes the nip [4] between the roll feed roller and its idle roller. So the next time paper is inserted, the nip is already closed.
- The operator then turns the roll by hand until the edge of the paper comes out of the machine.

Roll End

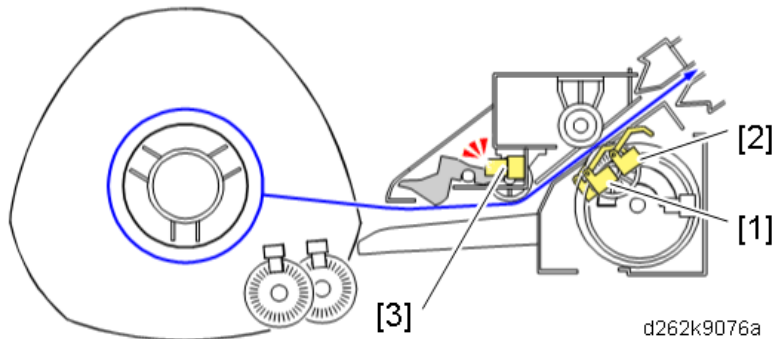

The trailing edge of the paper roll may or may not be fastened to the roll core, depending on the type of roll in use.

If the trailing edge of the paper is not attached to the roll core:

- The machine signals roll end when the trailing edge passes the roll feeder entrance sensor (1) and then the roll feeder exit sensor (2).
- Both actuators pop up once the trailing edge of the paper passes.
- This signals roll end and the machine displays a message to alert the operator that the roll needs replacement.

If the trailing edge of the paper is attached to the roll core:

- At the end of the roll, the trailing edge of the paper remains attached to the roll core, but the paper continues to feed.
- The paper is pulled taut, up against the actuator of the roll end sensor (3). This signals roll end and switches off the vertical feed motor and horizontal motor. This shuts down paper feed and printing.
- The machine displays a message to alert the operator that the roll needs replacement.

Main Unit Paper Feed

Registration Roller

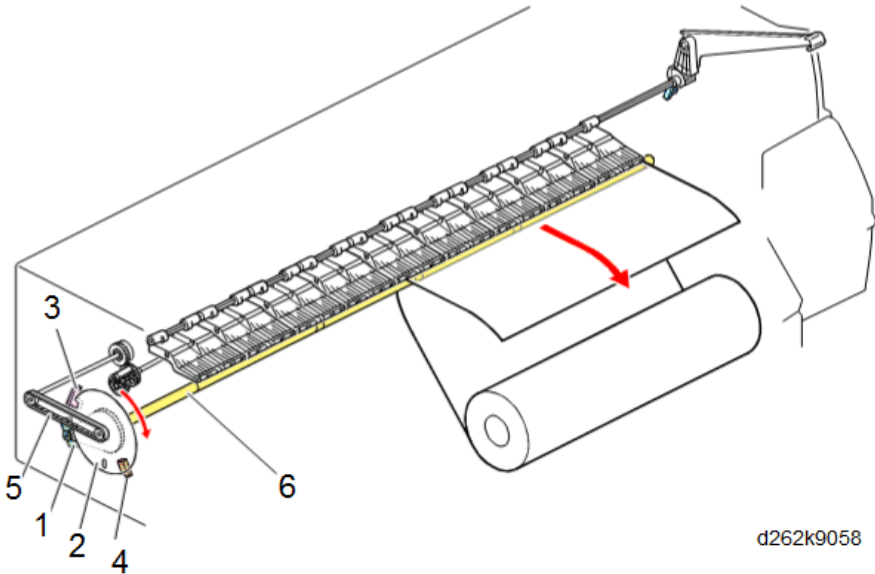

d262k9058

7

No.	Item
1	Vertical motor
2	Vertical encoder wheel
3	Vertical encoder sensor
4	Vertical encoder HP sensor
5	Timing belt
6	Registration roller

- The vertical motor (1), controlled by the vertical encoder wheel (2), vertical encoder sensor (3), and vertical encoder HP sensor (4), drives the timing belt (5) that rotates the registration roller (6).

Vertical Feed Mechanism

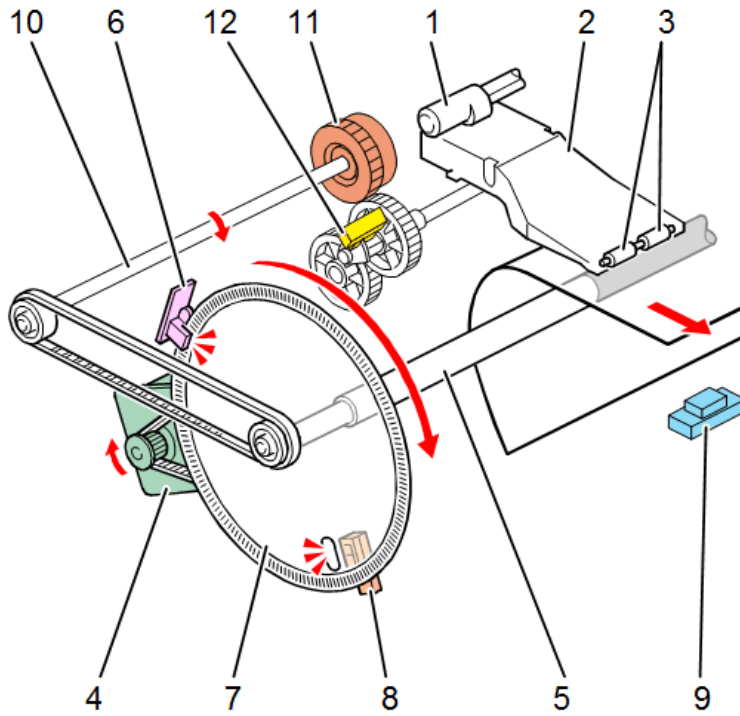

d262k9060

No.	Item
1	Paper holding lever cam
2	Pressure arm
3	Registration roller idle rollers
4	Vertical motor
5	Registration roller
6	Vertical encoder sensor
7	Vertical encoder wheel
8	Vertical encoder HP sensor
9	Exit sensor
10	Bypass stopper shaft

No.	Item
11	Bypass stopper clutch
12	Bypass stopper clutch sensor

- When the paper holding lever is down, the paper holding lever cam (1) depresses the spring-loaded pressure arm (2) that keeps downward pressure on the registration idle rollers (3). This closes the nip at the registration standby position.
- When the paper holding lever on the right side of the machine is raised, this rotates the paper holding lever cam down to raise the idle rollers and open the nip. This is done to load paper for bypass feed.
- The vertical motor (4) uses one drive belt to drive the registration roller (5).
- The vertical encoder sensor (6) reads the codes notched on the edge of the vertical encoder wheel (7) as it rotates on the end of the shaft of the registration roller. These readings are used to control vertical paper feed in the main machine.
- The vertical encoder HP sensor (8) detects the small hole in the encoder wheel, and then stops the vertical motor with the wheel at the home (start) position.
- The exit sensor (9) detects the leading edge and trailing edges of the paper as it leaves the machine.
- The bypass stopper shaft (10) has bypass stoppers, and it rotates by the vertical motor via timing belt.
- The bypass stopper clutch sensor (12) detects the bypass stopper position, it controls the bypass stopper clutch status ON or OFF.

Remaining Paper Detection

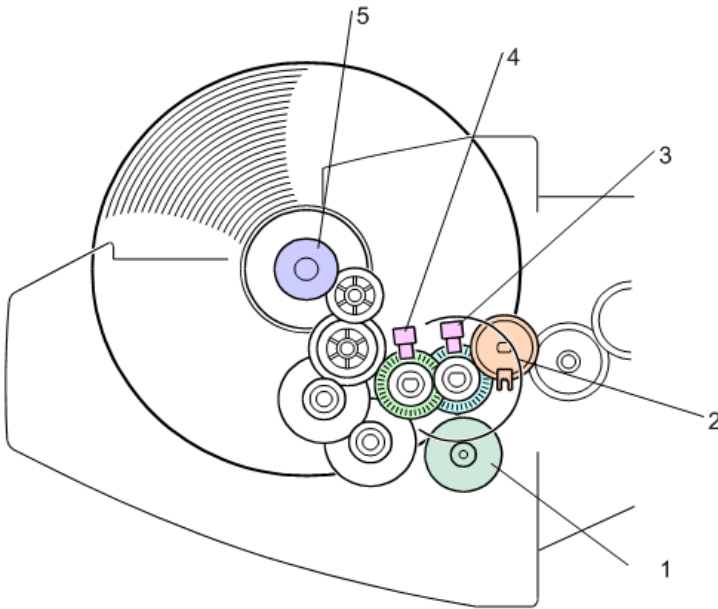

d1249206

No.	Item
1	Roll paper feed motor
2	Roll feed clutch
3	Encoder sensor 1
4	Encoder sensor 2
5	Roll core

The two encoders in the roll unit are part of the DSP (Digital Signal Processing) system used to control machine operation.

- **Encoder sensor 1 (3):** Counts rotations of the roll paper feed motor. This pulse count is used to measure the operation time of the roll paper feed motor.
- **Encoder sensor 2 (4):** Counts the rotations of the roll core which vary depending on how much paper remains on the roll. (The number of rotations increases as the diameter of the paper roll decreases) . This pulse count is used in a calculation to determine how much paper remains on the roll.

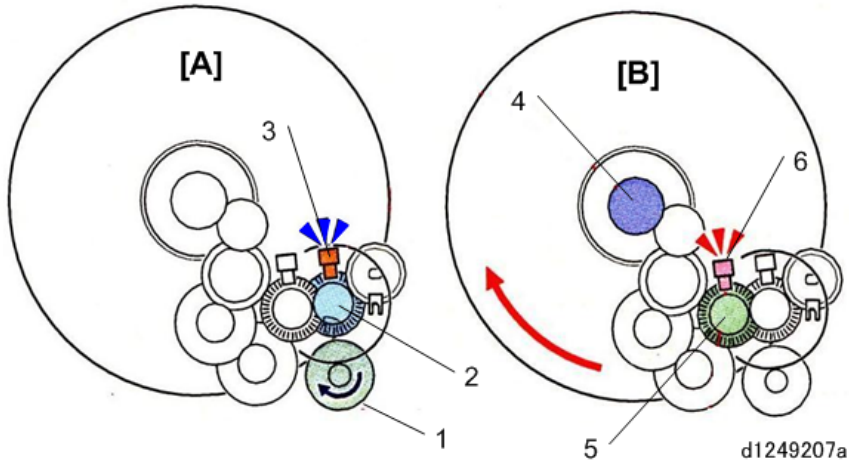

To tally a count for the operation time of the motor [A]:

- The roll paper feed motor (1) and encoder wheel 1 (2) rotate together.
- Encoder sensor 1 (3) counts the rotations of the encoder wheel.
- The encoder wheel and sensor always monitor the motor while it is operating.

To tally a count for the remaining paper calculation [B]:

- The core of the roll (4) and encoder wheel 2 (5) rotate together.
- Encoder sensor 2 (6) counts the rotations of the encoder wheel. The machine uses the pulse count to calculate how much paper remains on a paper roll.

The encoder wheel and sensor count the rotations of the roll core when the machine feeds paper out of the machine, and then reverse feeds the leading edge of the paper to the registration standby position. This is done at the following times:

- When the roll is replaced or swapped for another roll.
- When the paper is fed back to the registration standby position after the paper is cut at the end of a job.
- When the other paper roll is selected for paper feed. For example, if paper from Roll Unit 1 is at the paper registration position, and Roll Unit 2 is selected.

The machine calculates the amount of paper remaining on a roll based on the diameter of the roll and the number of rotations made by the core, and then displays the amount of paper remaining as it diminishes.

- The encoder wheel and sensor, and a small PCB in the roll unit, comprise the device that measures the amount of paper remaining on the roll.
- The residual paper detection encoder is a small wheel with 40 slits (spokes) around its center capable of generating 503 pulses with one rotation.

5-Step Operation Panel Display



d1244024

	Panel Display	Pulse Count	Remaining %	Roll Dia. (mm)
1	■ ■ ■ ■	< 130	50 to 100%	φ 123 to φ 156*1
2	■ ■ ■ □	130 to 140	30 to 50%	φ 110 to φ 123
3	■ ■ □ □	140 to 165	10 to 30%	φ 97 to φ 110
4	■ □ □ □	> 165	< 10%	< φ 97
5	□ □ □ □	---	---	---
*1	The range is wide here because the same "fuzzy logic" is applied to both 2-in. and 3-in. to compensate for the differences in diameters with these rolls.			

7

- 100 mm = 1 pulse count
- For a 2-in. roll the maximum (Normal paper 90 m φ 112 mm) the half count is at "3" above.
- Vertical Feed Amount Table (100 mm = 1 pulse count)

	% Remaining	Pulse Count	Roll Dia. (mm)
①	100	Less than 98	φ 173
②	90	99 to 107	φ 161
③	80	108 to 116	φ 149
④	70	117 to 127	φ 137
⑤	60	128 to 141	φ 125
⑥	50	142 to 158	φ 113
⑦	40	159 to 179	φ 101

	% Remaining	Pulse Count	Roll Dia. (mm)
⑧	30	180 to 207	φ 89
⑨	20	208 to 245	φ 77
⑩	10	More than 246	φ 65

Paper Transport Fan

General Operation

The transport fan below the perforated platen plates provides the suction to keep the leading edge flat during paper registration and cutting, and also keeps the paper flat against the platen during printing.

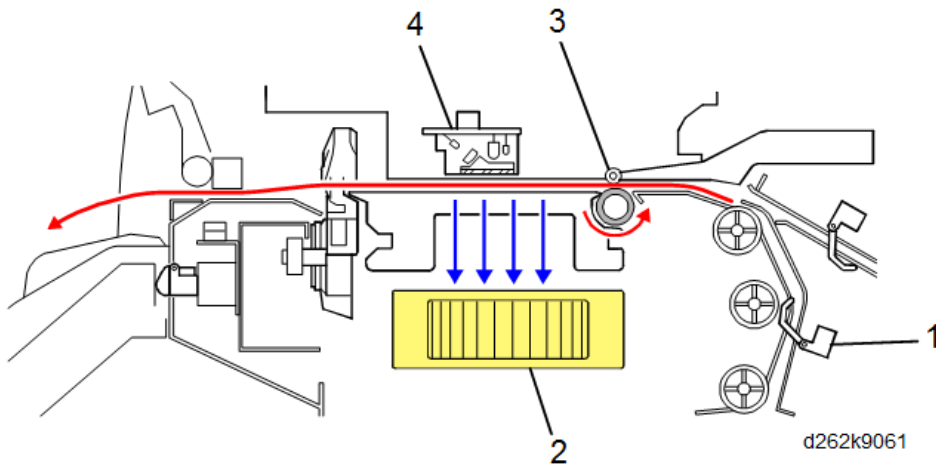

When paper is fed:

- The pre-registration sensor (1) detects the leading edge of the paper. This turns the transport fan (2) ON.
- The paper passes the registration standby position (3) above the registration roller.
- When the DRESS sensor (4) detects the leading edge of the paper, the operation of the fan is set to **Duty 1** mode. This pulls the paper down onto the perforated platen plates and keeps completely flat for cutting and printing.
- The fan remains on until the end of the job.
- The fan duty is adjusted for each phase of this operation as shown below.

Transport Fan Duty Adjustment

The transport fan below the perforated platen plates provides enough suction to keep the leading edge flat during paper registration and cutting, and also keeps the paper flat against the platen during printing. The machine adjusts the duty of the transport fan automatically for the size and type of paper selected for the job.

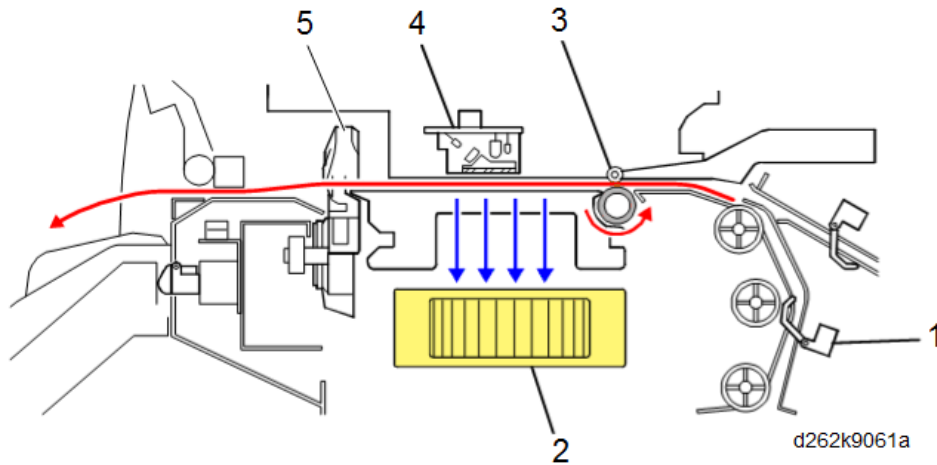

No.	Item
1	Pre-registration sensor
2	Paper transport fan
3	Registration standby position
4	DRESS sensor
5	Cutter

When paper is fed:

- The pre-registration sensor (1) detects the leading edge of the paper and turns ON the fan (2).
- The DRESS sensor (3) on the left side of the carriage goes ON when it detects the leading edge of the paper and switches operation of the fan to **Duty 1**.
- The paper transport fan remains in the **Duty 1** phase while the paper feeds **79 mm** past the registration standby position (4). This provides maximum suction to keep the leading edge of the paper flat.
- When the leading edge of the paper exceeds **79 mm** of feed, the motor enters the **Duty 2** phase.
- When the paper reaches the cutting position, the fan enters the **Duty 3** phase.

- When the cutter (5) reaches the left side of the machine after cutting the paper, the cutter return switch turns ON, and the cutter motor reverses to return the cutter to its home position on the right side of the machine.
- This switch detection of the cutter shifts the paper transport fan into **Duty 2** phase again.

This shift in the operation of the paper transport motor **Duty 1 > Duty 2 > Duty 3** and back to **Duty 2** is the same for every size and type of paper. However:

- The level of the duty, that is, the amount of suction applied by varying the speed of the motor, is different for each paper size (width) and paper type.
- As a general rule, **Duty 1** is the highest setting to ensure that the leading edge of the paper remains flat as it passes over the platen.
- The duty settings for thicker paper are much higher than those for thinner, lightweight paper.
- The duty settings are selected automatically as soon as paper size and type are selected for the job.

The duty levels are set according to paper type, width and thickness for each type of paper:

- Normal, recycled paper
- Ink jet paper
- Translucent paper
- Coated paper
- Matte film
- Special paper

For example, note the differences in the duty levels for normal paper and translucent paper, especially for wider paper.

Normal Paper, Recycled Paper

Thin	Duty[%]		
Normal	Duty[%]		
Width: mm	Duty 1	Duty 2	Duty 3
279.4 to 420	30	30	30
420 to 620	30	30	30
620 to 841	30	30	30
841 or wider	30	30	30
Width: mm	Duty 1	Duty 2	Duty 3

Thin	Duty[%]		
Normal	Duty[%]		
279.4 to 420	50	30	30
420 to 620	50	30	30
620 to 841	50	30	30
841 or wider	50	30	30

Translucent Paper

Thin	Duty[%]		
Normal	Duty[%]		
Width: mm	Duty 1	Duty 2	Duty 3
279.4 to 420	40	30	30
420 to 620	40	30	30
620 to 841	40	30	30
841 or wider	40	30	30
Width: mm	Duty 1	Duty 2	Duty 3
279.4 to 420	40	30	30
420 to 620	40	30	30
620 to 841	40	30	30
841 or wider	40	30	30

The following SP codes can be used to adjust the operation of the paper transport fan by changing the duty levels.

SP1-956-001.

- Use this SP to review the current duty settings.

SP1-955-001.

- Adjusts fan duty in the range of $\pm 20\%$ for all duty phases. The firmware checks the current fan operation setting and then uses a lookup table to fetch the specified setting (the percentage to be added to the current operation level).
- The optimum duty settings for each paper size and type are done at the factory before the machine is shipped.

SP1-955-002 to 010

- Adjusts fan duty in the range of $\pm 20\%$ for the duty phases of different types of paper. The firmware checks the current fan operation setting of the motor for the selected paper type, and then uses a lookup table to fetch the specified setting (the percentage to be added to the current operation level).
- It is important to remember that if an adjustment is done with this SP code for a particular paper type, it will be added to any change previously specified with SP1-955-001.

Front Cover Switches

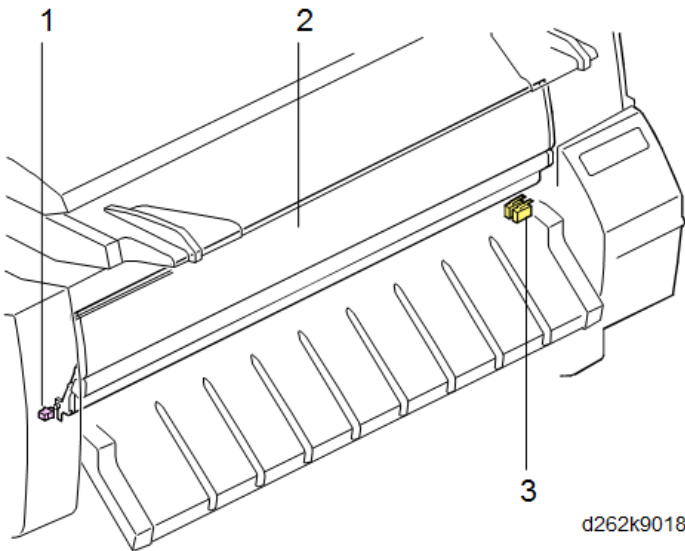

- The front cover (2) can be raised to remove paper jams and to load paper for bypass feeding.
- The right front cover switch (3) is push-switches that detect when the front cover is raised and lowered.
- The guide pins on either end of the front cover are set in tracks which guide the cover into the correct closed position. The front cover track switch (1) (a push-switch) has been added to ensure that these guide pins are inserted correctly into the left and right track.

Detailed Description of Paper Feed Sequence

Paper Feed Layout

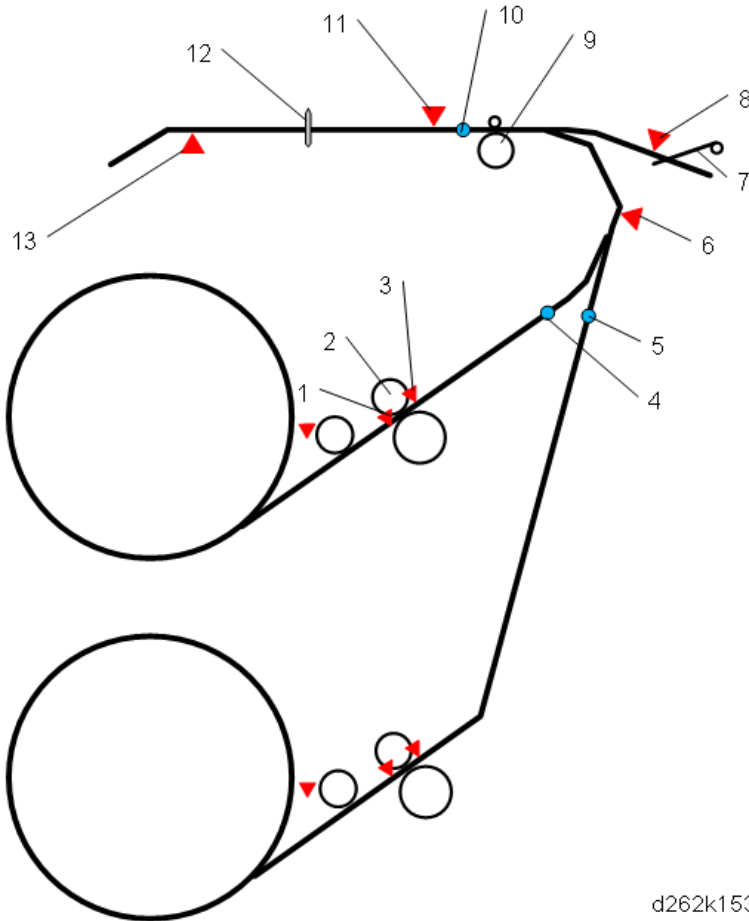

d262k1530

No.	Item	No.	Item
1	Paper entrance sensor	8	Bypass sensor
2	Paper feed roller	9	Registration roller
3	Paper exit sensor	10	Registration standby position
4	Paper standby position (RU 1)	11	DRESS sensor
5	Paper standby position (RU 2)	12	Cutter

No.	Item	No.	Item
6	Pre-registration sensor	13	Exit sensor
7	Bypass stopper		

Operation Sequence When the First Roll is Set

Here is a detailed description of what happens when the first roll is loaded (Roll Unit 1).

1. The paper entrance sensor goes ON.
2. The roll paper feed clutch > ON delays 50 ms.
3. Roll paper feed motor > ON rotating forward at 100 mm/s.
4. Roll feeder paper exit sensor > ON, roll paper feed motor ON.
5. Paper feeds 65 mm > clutch OFF > roll paper feed motor Off
6. A prompt on the operation panel asks the operator to select cutting the leading edge of the paper or not cutting the paper.
7. Roll feeder paper feed clutch > ON and delay: 50 ms.
8. Roll paper feed motor > ON and feeds paper toward the pre-registration sensor.
9. Pre-registration sensor > ON
10. Vertical motor > ON and feeds paper. The speed of the vertical motor is 3 mm/s faster than the speed of the roll paper feed motor (80 mm/s + 3 mm/s).
11. Paper transport fan below the platen > ON.
12. The DRESS sensor on the left side of the carriage detects the leading edge of the paper and switches the paper feed clutch OFF.
13. Both roll paper feed motor and vertical motor OFF.
14. Horizontal motor ON > carriage moves to the left and delays 1 sec.
15. roll paper feed motor > ON at 35 mm/s and vertical motor > ON forward at 100 mm/s
16. Paper feeds 60 mm > roll paper feed motor OFF > Vertical motor OFF.

Skew Correction

After the paper has arrived at the registration roller:

1. First, the machine does a pre-check. The DRESS sensor detects the right edge of the paper to see if the paper edge is within ± 10 mm of deviation from the right edge. (If the paper size is greater than 304.8 mm (12"), the paper edge must be within ± 6 mm).

If the amount of skew is not within range of pre-check:

- The roll paper feed motor and vertical motor both reverse and the paper is rewound back onto the paper roll.

- The leading edge of the paper must be fed manually from the roll unit and the sequence is done again.
 - The operator should check the roll to make sure that the clamps are locked and that the roll is set correctly.
2. If the amount of skew is within range of pre-check, the horizontal motor ON > Carriage moves to the leading edge detect position.
 3. The roll paper feed motor and vertical motor turns ON again.
 4. When the DRESS sensor detects the leading edge of the paper, it allows paper to feed 100 mm and turns the roll paper feed motor and vertical motors OFF.
 5. The horizontal motor turns ON and moves the carriage to the left side of the machine.
 6. The roll paper feed motor and vertical motor both turn ON and feed the paper 60 mm.
 7. Now, the roll paper feed motor reverses while the vertical motor continues to feed the paper forward. This takes up any slack in the paper to correct skew, and then both motors turn OFF.
 8. Paper transport fan remains ON.
 9. The horizontal motor turns ON and moves the carriage to the right edge and stops > DRESS sensor detects the right edge again.
 10. If the amount of deviation is within ± 5 mm, paper registration ends and the sequence continues without interruption.
If the deviation is not within ± 5 mm, the paper is released, the vertical motor and roll paper feed motors reverse feed, and the paper rewinds onto the roll.
 11. The paper feed sequence continues from Step 2 of above.

Paper Size Detection

1. The horizontal motor > ON and makes a complete pass from right to left, back to the right and stops.
2. The DRESS sensor detects the left edge of the paper on the platen.
3. The machine records the readings of the horizontal encoder for the right and left edges of the paper. This is done to confirm the paper size with the selection done with an external coin operated device if one is attached.

Paper Fan Duty is Adjusted

1. The duty of the transport fan is automatically adjusted for the size of the paper and type of paper selected for the print job.
2. The suction of this fan below the platen keeps the leading edge of the paper flat against the platen during paper registration and prevents the paper from floating free during printing.

Paper Cutting

If the operator selected paper cutting, the cutter cuts the paper.

1. Horizontal motor ON > Carriage moves to left side of the machine and stops.

2. roll paper feed motor > ON at 35 mm/s and vertical motor > ON at 100 mm/s
3. Paper feeds 200 mm past cutter > roll paper feed motor > OFF > Vertical motor OFF.
4. Cutter starts the cut.
5. Cutter completes the cut when it reaches the left side of the machine.
6. Cutter return sensor turns ON > Cutter motor drives the cutter back to its home position on the right.
7. roll paper feed motor > ON reverse feeds and stops.
8. Vertical motor > ON then stops when DRESS sensor detects the leading edge at the paper registration position.

Operation Sequence When the Second Roll is Set

Here is a description of what happens when roll paper is already loaded and the leading edge of the paper is at the registration standby position. This sequence is executed when:

- Roll Unit 2 (optional roll unit) is installed.
- Both roll units are installed, but the paper for the roll unit selected for the job is not at the registration standby position.

At the start of the job, the paper at the registration standby position must be retracted so that the paper from the other roll can be fed for printing.

1. The roll paper feed motor of the roll with paper at the registration standby position > ON **reverses** at **120 mm/s**.
2. The vertical motor > ON **reverses** at **100 mm/s**. (The difference in the motor speeds keeps the paper taut).
3. The pre-registration sensor > OFF and starts a pulse count.
4. Once the paper has fed downstream back into the roll unit paper path, the pre-registration sensor stops the reverse feed.
5. The roll unit clutch, roll paper feed motor, and paper release sensor go off and the paper stops.
6. The paper is now at the paper feed standby position **51.5 mm** downstream of the pre-registration sensor, and the path is open for paper from the other roll to feed.

Cutting

At the end of the job the cutter unit cuts from right to left. The circular cutter leaves its home position on the right, cuts the paper as it moves to the left, and then drops below the paper and returns to its home position on the right.

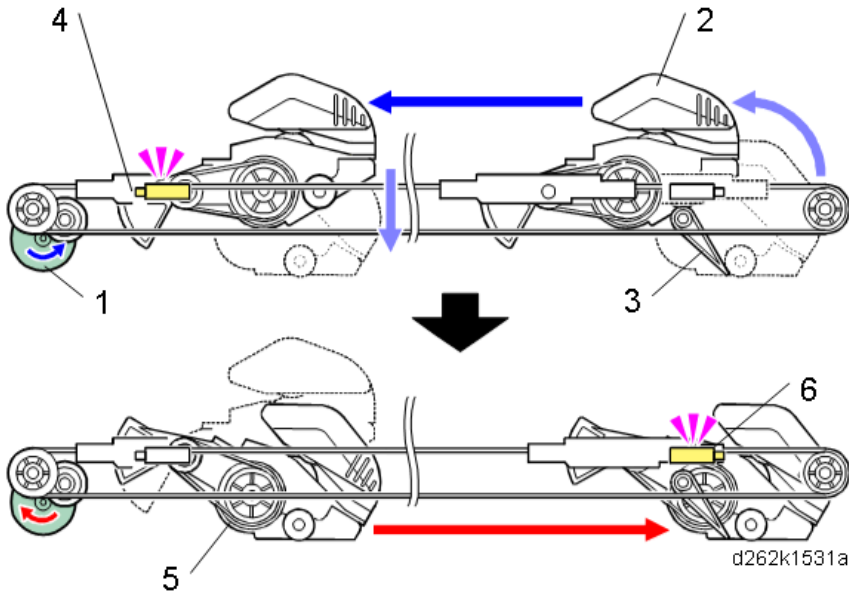

1. At the end of the job, the cutter motor (1) switches on.
2. The timing belt pulls the cutter (2) to the left as its circular blade (3) cuts the paper in its path.
3. When the cutter reaches the cutter return left switch (4) at the end of the cut, the cutter motor reverses.
4. Immediately, the cutter drops into a lower race at (5). This lowers the cutter so it is below the paper.
5. The motor and drive belt pull the cutter back to the right. When the cutter reaches the cutter HP sensor (6), the sensor signals the machine to shut down the motor and the cutter stops at its home position.

7

Manual Cut

Manual Cut is to feed and discard paper that is damaged by moisture or paper jam.

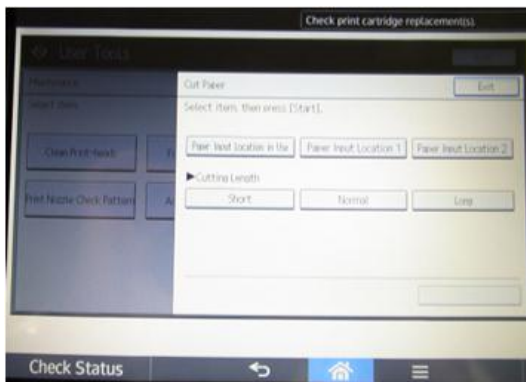

d262k1537

Three different cut lengths can be selected.

- Short: 210 mm
- Normal: 450 mm
- Long: 650 mm

Bypass Feed

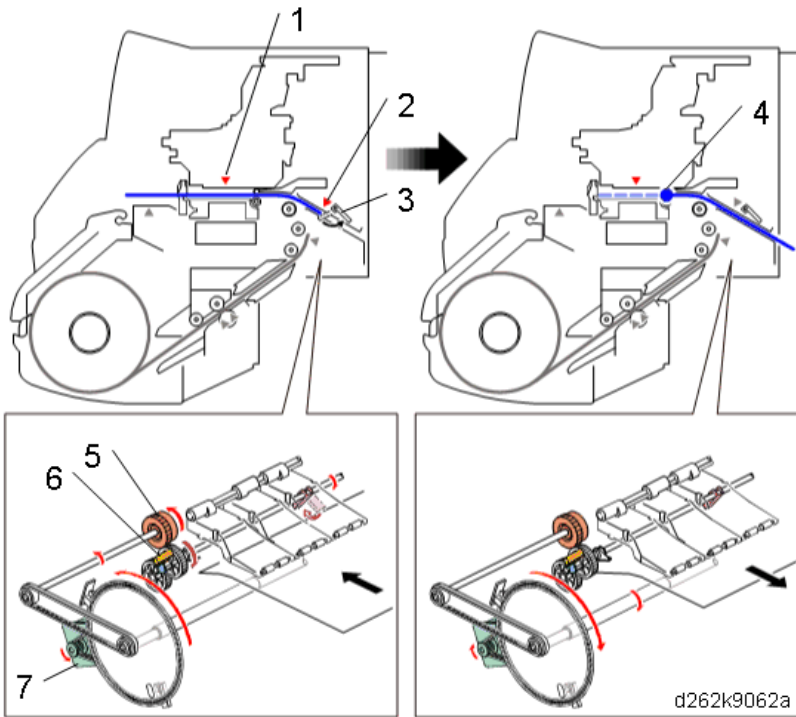

No.	Item
1	DRESS sensor
2	Bypass sensor
3	Bypass stopper
4	Bypass standby position
5	Bypass stopper clutch
6	Bypass stopper clutch sensor

No.	Item
7	Sub scan motor

Here are the steps for loading paper in the bypass paper path:

1. When there is no paper in the paper path, the registration sensor detects OFF.
2. The operator puts the paper on the bypass tray. Insert the paper [B] as far as the stopper [A] (registration sensor OFF, bypass sensor ON).

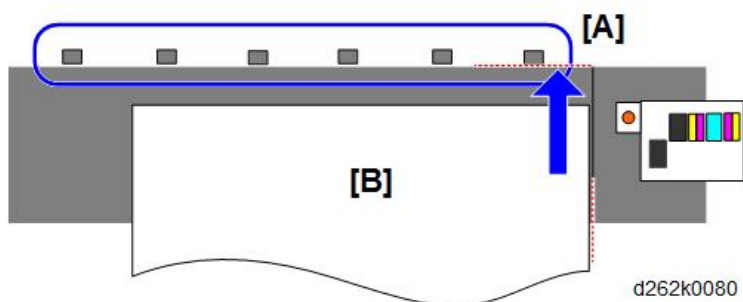

3. The operator closes the front cover and enters the settings for the paper on the operation panel. The paper transport fan turns ON and the preparation for paper feed is start.
4. The carriage unit moves to the paper detect position and the DRESS sensor detects the paper. And then, the carriage unit moves to the air purging position.
5. The bypass stopper clutch turns ON and the vertical motor rotates in the reverse direction to the position where the bypass stopper clutch sensor detects ON.
6. The bypass stopper clutch is turned OFF.
7. Skew detection is performed.
8. Paper width detection is performed.
9. The carriage unit moves to the paper leading edge detect position.
10. The vertical motor rotates in reverse to the paper length detect position (DRESS sensor OFF).
11. The carriage unit returns to the home position and the preparation for paper feed on the bypass tray is finished.

Normally, the margin at the trailing edge is 18 mm, except when printing with color in the following cases:

Media	Print Mode
Special	Standard
Special	Quality
Matte Film	Quality

Media	Print Mode
Tracing Paper	Quality

Related SPs

- 1-956-001 [Suction Fan Duty Correction - Suction Fan Duty DFU]:
This SP adjusts the amount of suction created in the Duty 2 phase of the transport fan operation cycle. This setting applied to Duty 2 only for all jobs, regardless of paper type, width, thickness, etc.
- 1-955-001 [Suction Fan Duty Correction DFU]-[Suction Fan]:
Adjusts fan Duty in the range of $\pm 20\%$ for all Duty phases (1, 2, and 3). The firmware checks the current fan operation setting and then uses a lookup table to fetch the specified setting (the percentage to added to current operation level).
- 1-955-002 [Suction Fan Duty Correction DFU]-[Normal Paper]:
Adjusts fan Duty in the range of $\pm 20\%$ for all Duty phases for Normal paper.
- 1-955-003 [Suction Fan Duty Correction DFU]-[Recycled Paper]:
Adjusts fan Duty in the range of $\pm 20\%$ for all Duty phases for Recycled paper.
- 1-955-004 [Suction Fan Duty Correction DFU]-[IJ Normal Paper]:
Adjusts fan Duty in the range of $\pm 20\%$ for all Duty phases for Ink Jet Normal paper.
- 1-955-005 [Suction Fan Duty Correction DFU]-[Translucent]:
Adjusts fan Duty in the range of $\pm 20\%$ for all Duty phases for Translucent paper.
- 1-955-006 [Suction Fan Duty Correction DFU]-[Mat Film]:
Adjusts fan Duty in the range of $\pm 20\%$ for all Duty phases for Matte Film.
- 1-955-007 [Suction Fan Duty Correction DFU]-[Coated (CAD) Paper]:
Adjusts fan Duty in the range of $\pm 20\%$ for all Duty phases for Coated/CAD Paper.
- 1-955-008 [Suction Fan Duty Correction DFU]-[Coated Paper]:
Adjusts fan Duty in the range of $\pm 20\%$ for all Duty phases for Coated Paper.
- 1-955-010 [Suction Fan Duty Correction DFU]-[Special Paper]:
Adjusts fan Duty in the range of $\pm 20\%$ for all Duty phases for Coated Paper.

Ink Supply

Overview

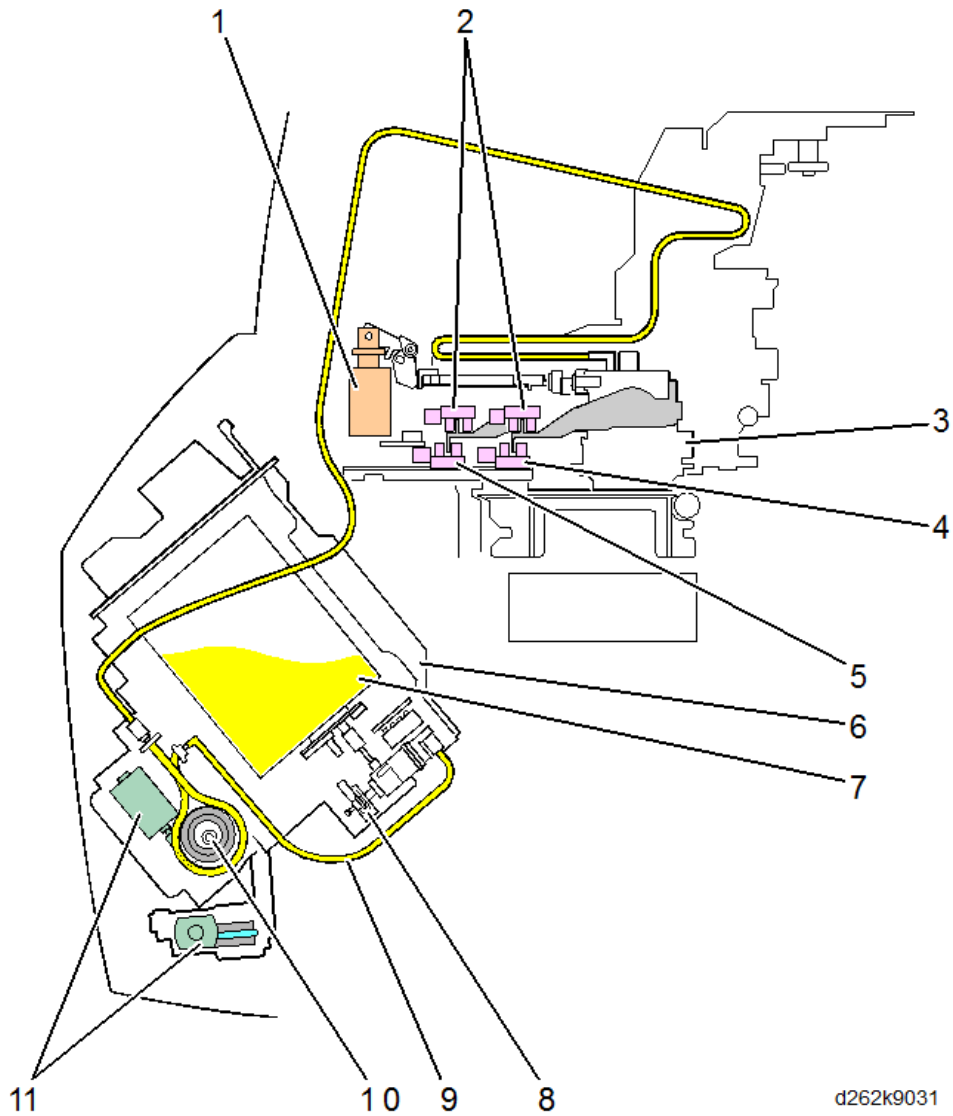

No.	Item	Qty
1	Air release solenoid	1
2	OCFS (On Carriage Fill Sensors)	7

No.	Item	Qty
3	Print head sub tanks	7
4	Main ink level sensor 1	1
5	Main ink level sensor 2	1
6	Ink supply unit	1
7	Ink cartridges	4
8	Ink end sensors	1
9	Ink supply tubes	7*1
10	Ink pump cams	7
11	Ink pump motors	7

* 1 There are four short ink supply tubes (one for each cartridge) between the ink cartridge port and the pumps. The black tube splits into two supply tubes before the pumps, one for K1 and one for K2, bringing the total of tubes to 5.

7

- The ink supply unit (6) houses the ink cartridges, the lower end of the ink supply tubes, and the ink pumps.
- The ink supply unit holds four replaceable ink cartridges (7), one for each color (K, C, Y, M). The black cartridge (K) is larger than the other three.
- The ink end sensor (8) detects when the cartridge is out of ink. This is a new component with this machine.
- The ink supply tube (9) transports ink from the ink cartridges to the print head unit in the carriage unit. The tube is flexible yet sturdy enough to prevent kinking and blocking the flow of ink.
- The ink pump cam (10), driven by the ink pump motor (11), rotates against the ink supply tube to force ink through the tube.
- The air release solenoid (1) provides pressure to push excess air out of the print head sub tanks.
- The print head sub tanks (3) (1 for C and 2 each for black, M and Y) hold the ink supplied to the print heads from the ink pumps of the ink supply unit.
- The OCFS (2) (one sensor and one feeler for each sub tank) is mounted in front of the carriage unit. The sensor is above the actuator of the feeler attached to the side of the sub tank. This feeler and actuator monitors the level of ink in each sub tank and triggers an alert when ink runs low.

Ink Cartridge

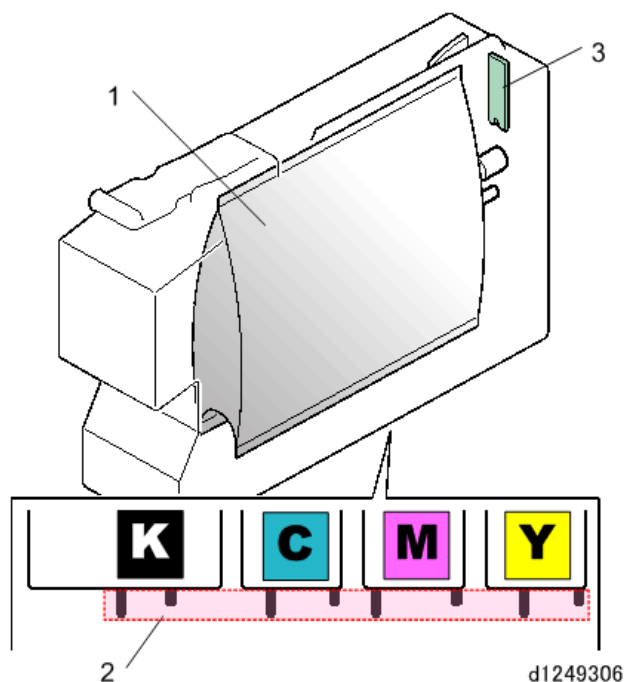

Ink inside each cartridge is enclosed in an airtight packet (1) that collapses as ink is drawn from the cartridge. The unique combination of runners and tracks on the bottoms of the cartridges (2), and slots in the ink supply unit, prevents any cartridge from being installed in the wrong position.

Each cartridge is provided with an ID chip (3). The machine monitors the ink levels (based on counts of ink pump operation) and stores this information in ID chips of the ink cartridges.

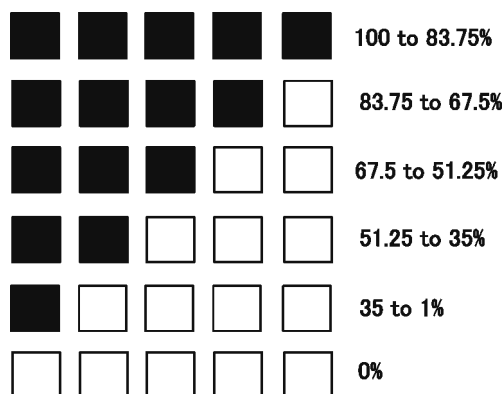

d1245019

This count data is used to create the graphic display on the operation panel that shows the amount of ink consumed, as well as the amount of ink remaining.

At the 5th level (35 to 20%):

- When the ink level is between 35% and 20%, this signals pre-near end. The machine displays a message that alerts the operator to prepare a new ink cartridge to replace the old one.
- When the ink level drops below 20%, this signals near-end. The machine displays a message that alerts the operator that ink will run out soon.
- Finally, when the ink level drops to zero (the last level of the display), this triggers the ink out alert. Printing stops and the empty ink cartridge must be replaced.
- As soon as a cartridge runs out of ink, its "end history" is written onto the cartridge ID chip to permanently disable the cartridge and prevent it from being re-used.

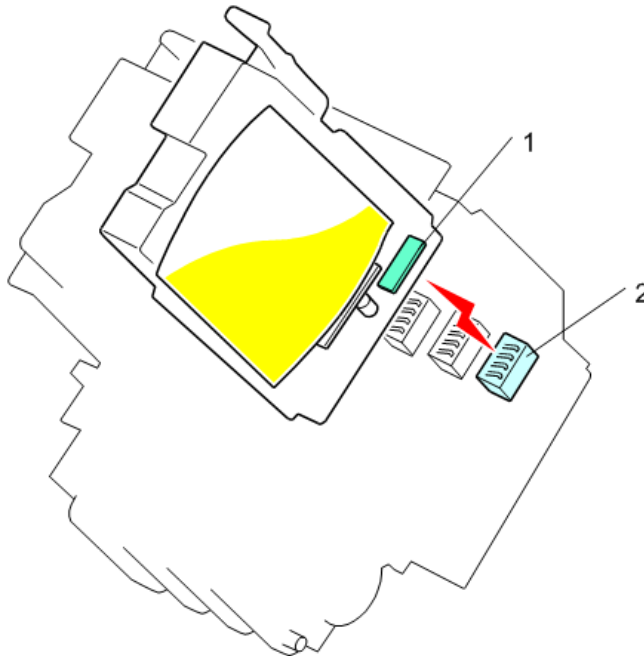

d1249302a

When an ink cartridge is inserted, the ID chip (1) contacts a CCB (Cartridge Control Board) (2) at the back of the ink supply unit slot. When the ID chip and CCB make contact, this tells the machine that the cartridge is inserted correctly. Ink usage is based on pulse counts taken during operation of the ink pump motors. The chip and CCB contact is also used to transfer the ink usage count from the main machine to the memory map of the chip.

Ink Supply Mechanism

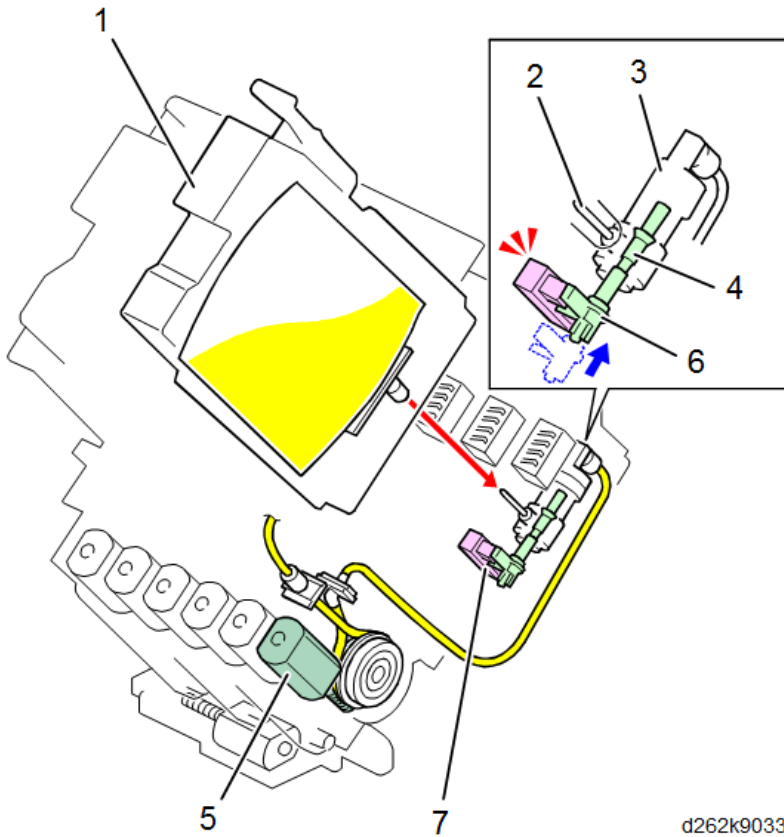

d262k9033

7

No.	Item
1	Ink cartridge
2	Ink supply needle
3	Cylinder
4	Plunger
5	Ink pump motor
6	Actuator
7	Ink end sensor

- When the ink cartridge (1) is inserted, the ink supply needle (2) is inserted and sealed into the ink supply port.

- Ink flow flows through the cylinder (3) and over the plunger (4) as the ink pump motor (5) pumps ink from the cartridge.
- While ink is flowing smoothly, the actuator (6) on the end of the plunger remains outside the gap of the ink end sensor (7).
- When the ink in a cartridge runs out, the ink pump motor continues to try to draw ink from the ink port. But with no ink, this creates a negative pressure between the pump and the ink cartridge.
- When the negative pressure (suction) becomes strong enough, it will pull the actuator on the end of the plunger into the gap of the ink end sensor. This will signal that the ink cartridge has run out of ink and trigger the ink end alert for the cartridge.

Here is a side view of the ink pump mechanism.

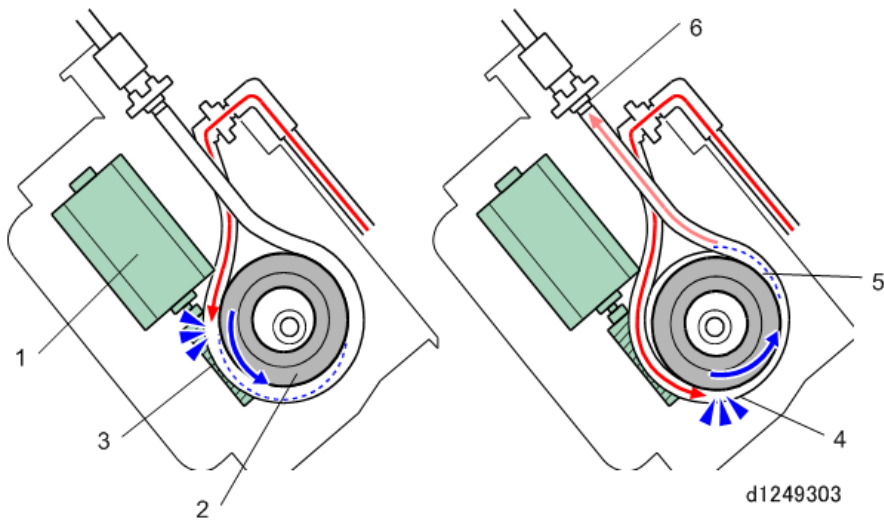

- The ink pump motor (1) drives the ink pump cam (2) counter-clockwise and compresses the ink supply tube (3).
- The pressure on the tube (4) drives the ink bolus (5) ahead of the cam and creates enough suction to pull ink through the tube behind the pressure point.
- This action of the cam alternately applying and releasing pressure against the side of the tube drives the ink out of the pump and into the tube (6) to the carriage unit and print head sub tank above.

Controlling Ink Supply to the Sub Tanks

The OCFS System

The OCFS (On Carriage Filler Sensor) system monitors the ink level of each ink sub tank in the print heads. This is a new system that constantly monitors the level of ink during printing and then signals for a re-fill whenever more ink is needed in one or more of the print heads.

- The main advantage of this system is that the sensors are inside the carriage and move with the carriage unit. This ensures that the ink level in each tank is constantly monitored.
- Printing does not have to be interrupted to move the carriage to the right to check the ink levels, as in previous ink jet models.

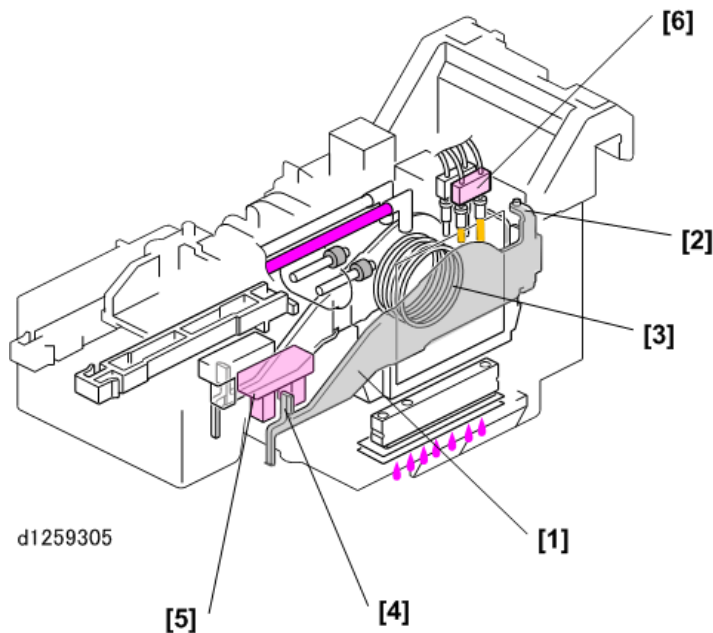

The OCFS system contains the following parts:

- An actuator arm [1] is attached to a hinge [2] at the rear.
- The center of the actuator is mounted on a weak spring [3] attached to the flexible side of the ink sub tank.
- When the sub tank is full of ink, the actuator [4] on the end of the actuator arm points straight to the front and remains in the gap of the OCFS [5].
- The air sensors [6] are a pair of vertical terminals attached to the top of the ink sub tank. These sensors detect air in the tank.

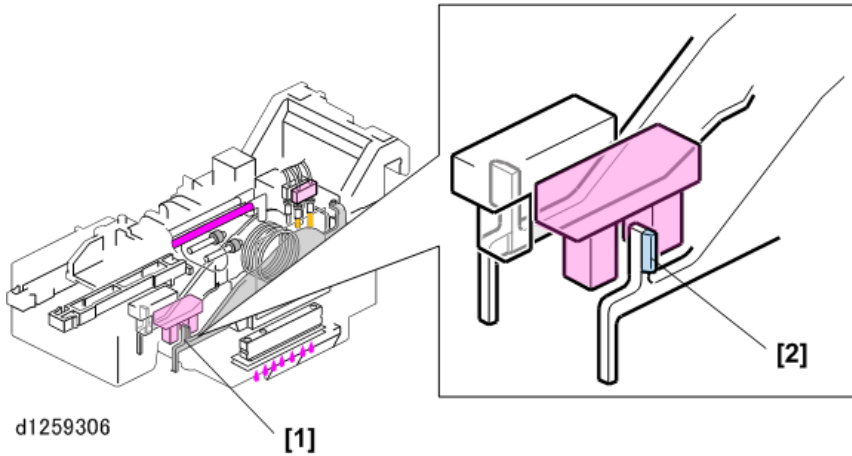

The OCFS actuator [1] on the top of the actuator arm is not symmetrical.

- The side of the actuator away from the tank has an extended wing [2] (shaded blue in the drawing) attached to it.

Because this actuator is wider than a normal actuator, it takes longer for it to move from right to left through and then out of the gap of the OCFS.

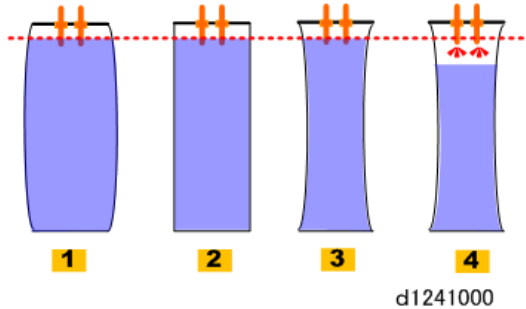

The sides of the sub tanks are flexible.

- The sides may bend out slightly when the tank is full [1], and then gradually collapse as ink is drained from the tank [2] and [3].
- The actual level of the ink does not change at [2] and [3] even though there is less ink in the tank.
- However, if air enters the tank [4], the air sensors at the top of the tank will be exposed and detect air in the tank.

Controlling Ink Supply During Printing

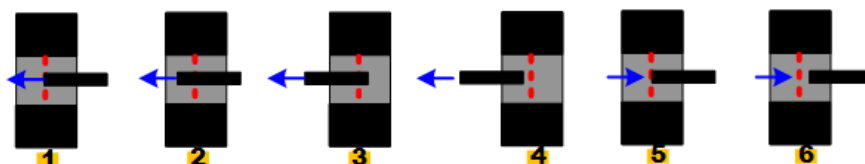

d262k8536

The illustration above shows how the actuator moves through gap of the OCFS (viewed from bottom front)..

- As ink is consumed, the side of the tank collapses, and the OCFS actuator moves through the OCFS sensor gap [1] > [2] > [3].
- When the actuator moves out of the gap at [4], the sensor turns off. This signals low ink. When this occurs, the ink pump motor in the ink supply unit pumps ink to the tank until the sensor returns to [5].
- The motor pumps a prescribed amount of ink (**Wcc**) determined by the machine's software to be enough to turn the sensor back on.
- After that, the machine continues to pump ink a very short time (**tsec**).
- This is the ink full position [6].

Air Detection and Air Purging

The air sensors on top of each ink sub tank check for the presence of air in the tanks. Air is purged from the tank after it is detected, and then the sub tank is refilled with ink. The air purge, filling, and full position 'learning' sequence is done when one of the following occurs:

- Air is detected in a tank. (The purging and filling is not done until the end of the job.)
- Before print head flushing

Air Purge Mechanism

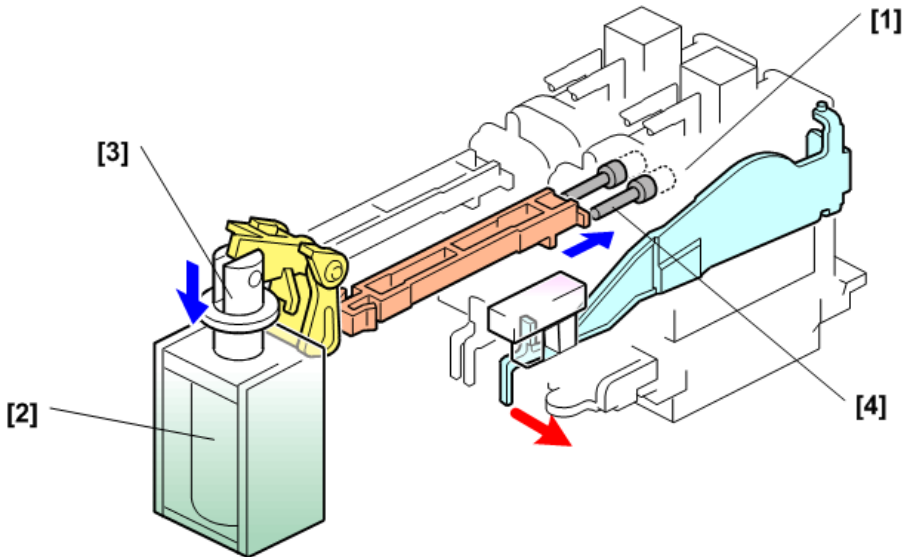

d1259356

7

When an air sensor detects air in a sub tank, the air is not purged until the job ends. At the end of the job:

- The machine moves the carriage unit to the right and stops when the tank to be purged is aligned with the air release solenoid.
- The correct position to stop is detected by monitoring the horizontal encoder strip behind the carriage unit.
- When the carriage unit has positioned the print head tank [1] behind the air release solenoid [2], the solenoid switches on and pushes the plunger [3].
- The plunger pushes in the purge valve [4] and the excess air is purged from the sub tank.
- After the air has been purged, the ink supply motor turns on to supply more ink to replace the purged air with ink.
- As more ink flows into the tank, the actuator moves in direction of the red arrow toward the full position.
- After air has been purged, ink is pumped from the cartridge up to the sub tank, and then 0.6 cc of ink is pumped out by reversing the ink pump.

After Air Purging

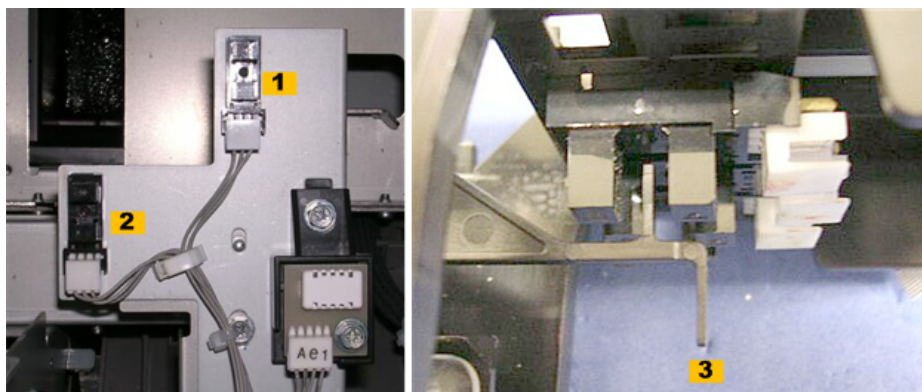

d1259359

After every air purging:

1. The carriage moves to the main ink level sensors [1] and [2].
2. The carriage stops when the lower actuator [3] on the OCFS sensor feeler enters the main ink level sensor.
 - Main ink level sensor 2 [1] detects the actuators of K2, C, Y, and M.
 - Main ink level sensor 1 [2] detects the actuator of K1 only.
 - Two main ink level sensors are required because the K1 print head is not level with the other 4 print heads.
3. The machine records how far the carriage has moved along the horizontal encoder, and stores this as the new "Tank Full Position".
4. At the end of a job, the machine moves the carriage to the main ink level sensor to compare with the most recent Tank Full Position.
 - This sequence is also done at cleaning and flushing.
 - The carriage does not move to this sensor during printing. (Ink level during printing is checked with the OCFS sensors.)

7

Emergency Print

When ink in a color cartridge runs out, only monochrome printing can be continued under certain conditions.

★ Important

- Even if only color ink runs out, monochrome printing cannot be continued under some conditions. Printing volume cannot be guaranteed. Cartridge change is strongly recommended.

Printable Conditions

- Only color ink runs out.
- During monochrome printing, ink used for air purging of an ink head for which ink has run out remains in the head tank.
- The air-mixed flag is not set for the heads, including those with ink end.
Reason: If the air-mixed flag is set, ink volume in the head tank cannot be determined correctly, in which case emergency stop of printing because ink consumption cannot be performed.
- Ink cartridges are mounted at all ink-cartridge ports.
- The ink-cartridge cover is closed.
- Color ink end is not caused by maintenance operations.

Printing

The display shown below appears during copying/printing operation.

"The color ink ends. For color printing, change the cartridges.

Monochrome printing is temporarily enabled. If there is a print job being performed, reset it. Then perform the monochrome printing."

Note

- Monochrome printing can be continued by touching [Print].
- Color printing can be continued by resetting the current print job then starting monochrome printing again.

Conditions for Function End

If the conditions below are applied, the machine exit Emergency Print mode.

- When three days have passed after entering Emergency Print mode, (SP No.: SP2-802-003 to -007)
* When emergency printing ends and the ink-end display appears, reset the corresponding SPs (SP2-802-003 to -007, SP2-801-003 to -007).
- When the specified ink has been consumed with air purging for the color whose ink ends,

If the machine judges itself to be exited Emergency Print mode, the machine stops, Emergency Print mode is canceled, and the ink-end display appears.

Printing cannot be performed until the empty ink cartridge is replaced.

Number of Printable sheets

- Room temperature and humidity: 34

[Standard], [temperature 25°C], [humidity 15%], [High-Speed mode], [A0 SEF]

- Low temperature and humidity: 6
[Standard], [temperature 10°C], [humidity 15%], [High-Speed mode], [A0 SEF]

Note

- The above values vary according to printing conditions and head status. They are not guaranteed.

Operation of Emergency Print

If the message "Color ink has run out" is displayed, emergency print is enabled. Follow the procedure below.

For continuing the current black and white print job

1. When the message is displayed, touch [Print].
2. Wait for a while, and the current black and white print job will start.

For interrupting the current black and white print job

1. When the message is displayed, touch [Delete] and the [Ready] screen is retrieved.
2. A new black and white print job will be enabled but the color print job will be disabled.

For canceling the current color print job

1. On the [Replace Print Cartridge] screen, select [Exit].
2. The normal screen is retrieved. Touch [Check Status] at the lower left.
3. Select the [Current Job] tab and touch [Cancel Reservation]
4. On the confirmation screen, touch [Delete] to cancel the current job.
5. On the home screen, select the copy application and the [Replace Print Cartridge] screen is displayed again. Touch [Exit].
6. A printable screen is displayed. A new black and white print job will be enabled but the color print job will be disabled.

Printing

Printing Drive Mechanism

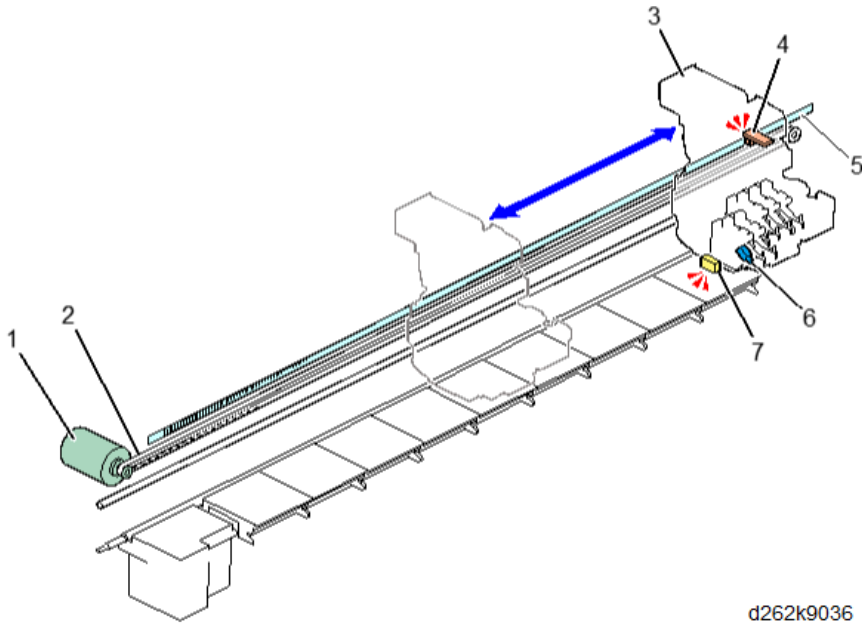

d262k9036

7

No.	Item
1	Horizontal motor
2	Drive belt
3	Carriage unit
4	Horizontal encoder sensor
5	Horizontal encoder strip
6	LED indicator
7	DRESS sensor

- The horizontal motor (1), the large motor on the back of the left side of the machine, drives the belt (2) attached to the back of the carriage unit (3). This mechanism moves the carriage unit left and right when the motor alternately rotates forward/reverse.

- The horizontal encoder sensor (4) brackets the top edge of the horizontal encoder strip (5), which stretches behind the drive belt and across the platen. The sensor reads the timing notches from the strip as the carriage is driven left and right by the horizontal motor. This controls the operation of the motor and movement of the carriage unit during printing and other operations, such as paper registration and image registration.
- LED (6) lights during operation to prevent users from opening the front cover by mistake.
- The DRESS sensor (7) performs paper registration and image registration while the carriage unit is moving during paper feed.

Carriage Unit

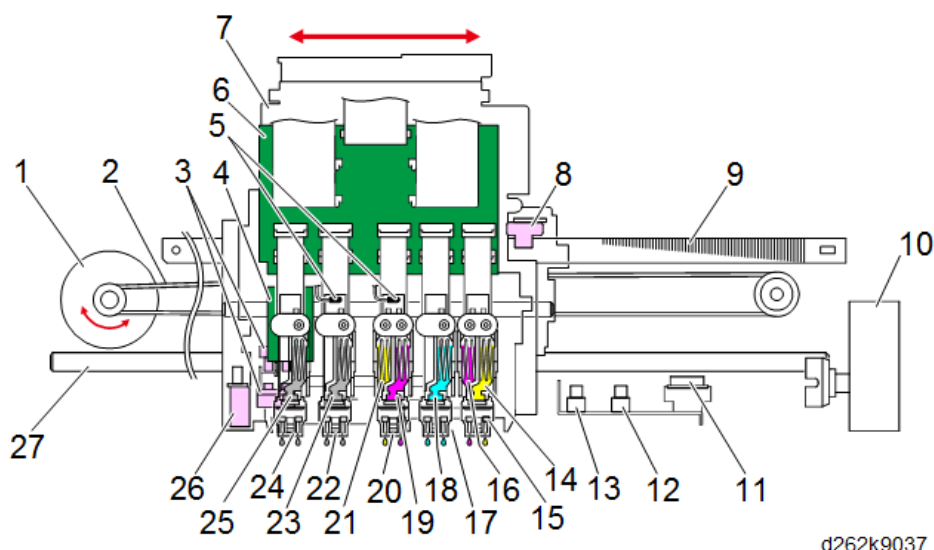

No.	Item	No.	Item
1	Horizontal motor	15	Print head (Y2M2)
2	Drive belt	16	HT6 (Head Tank M2)
3	Head lift sensors	17	Print head (C)
4	COM	18	HT5 (Head Tank C)
5	Print head thermistors	19	HT4 (Head Tank M1)
6	HRB (Head Relay Board)	20	Print head (Y1M1)
7	Carriage unit	21	HT3 (Head Tank Y1)

No.	Item	No.	Item
8	Horizontal encoder sensor	22	Print head (K2)
9	Horizontal encoder strip	23	HT2 (Head Tank K2)
10	Head lift motor	24	Print head (K1)
11	Temperature/humidity sensor	25	HT1 (Head Tank K1)
12	Ink level sensor 1	26	DRESS sensor
13	Ink level sensor 2	27	Guide rod
14	HT7 (Head Tank Y2)		

- During printing, the horizontal motor (1) and drive belt (2) drive the carriage unit (7) to the left and right on its guide rod (27) above the paper on the platen.
- The HRB (6) behind the print head units relays signals to the control board from the horizontal encoder sensor, DRESS sensor, color print heads and thermistors.
- The COM board (4) relays signals between the main machine and the K1 print head unit.
- The horizontal encoder sensor (8) on the carriage unit brackets the horizontal strip (8) and reads the codes on the top edge of the strip. This controls the operation of the horizontal motor and movement of the carriage unit.
- The thermistors (5) measure the temperature of the black (K1, K2) and color print heads (C, YM). These temperature readings are used to adjust the voltage applied to the piezoelectric elements above the nozzles that release ink during printing.

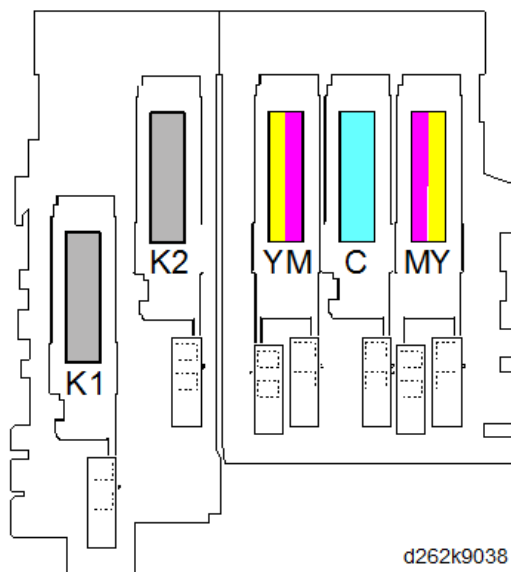

- There is one piezoelectric element for each print head: K1 (25), K2 (23), Y1M1(20), C (17), and Y2M2 (15). An electric charge applied to the element makes it expand and discharge ink through the print head nozzles and onto the paper below.
- At the beginning of a print job, the carriage moves left then back to the right, so that the DRESS sensor (26) on the side of the carriage can detect the side edges of the paper below. Based on these readings, the machine determines the image print start position.
- Ink level sensor 1 (13) checks the position of the feeler mounted on the side of the K1 ink sub tank. Ink level sensor 2 (12) measures the positions of the feelers on the sides of the K2, C, Y, and M sub tanks. The position of the feelers is used to determine how much ink needs to be supplied. While ink level sensor 1 services only the K1 print head unit, and ink level sensor 2 services the other four sub tanks.
- The temperature/humidity sensor (11) constantly measures the temperature and humidity inside the machine, and then uses these readings to adjust operation of the machine.
- The head lift motor (10) can raise the carriage unit (1 mm or 2 mm) to increase the gap between the print heads and thick paper to prevent ink abrasion. Two head lift sensors (3) control the raising and lowering of the carriage with the head lift motor.

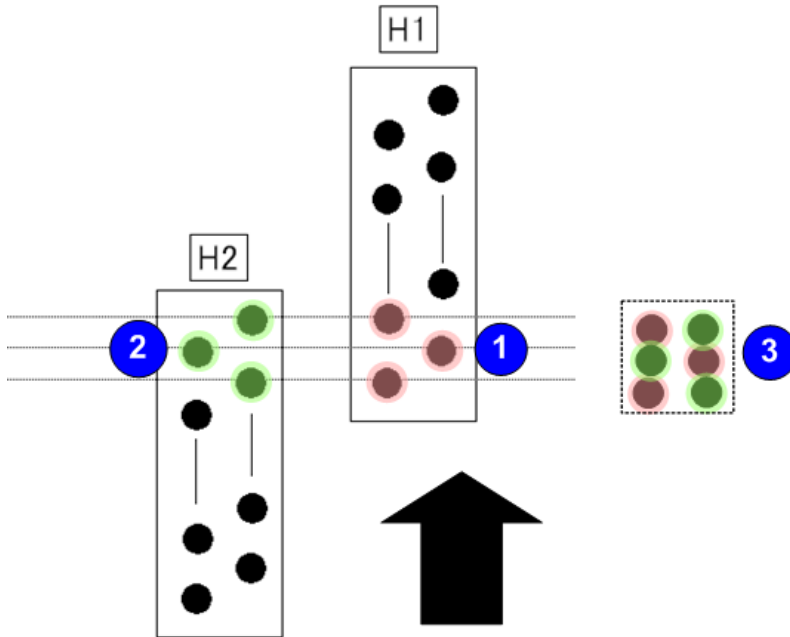

d1245024

7

The K1 print head sits forward of the K2 print head in the direction of paper feed. This allows a greater band of coverage during black-and-white printing. Three nozzles at the rear section of K1 ① and three nozzles at the front section of K2 ② overlap the same area on the paper. However, the arrangement of the nozzle ports is staggered ③ so positions of the nozzle ports complement one another when ink is put down on the paper.

Print Head Unit

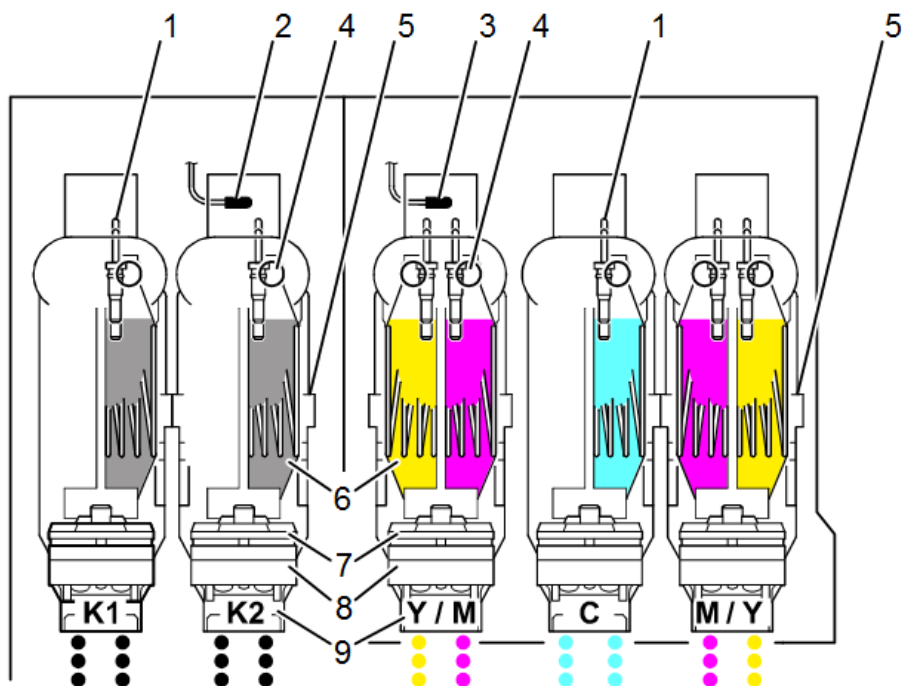

d262k9039

No.	Item	Qty
1	Air sensors pairs	7
2	Head thermistor (Black)	1
3	Head thermistor (Color)	1
4	Purge valves	7
5	Ink sub tanks (K1, K2, Y1, M1, C, Y2, M2)	7
6	Ink sub tank feelers	7
7	Filter units	7
8	Print head units (K1, K2, Y1M1, C, Y2M2)	5
9	Print heads	5

The illustration above shows carriage unit cradles. The left cradle holds the black print head units (K1, K2) and the right cradle holds the color print heads units (Y1M1, C, Y2M2).

- The black thermistor (2) monitors the head around the black print head units, and the color thermistor(3) measures the heat around the color print head units.
- A pair of air sensor terminals (1) is attached to the top of each sub tank.
- The purge valves (4) allow air to escape from the ink sub tank if an air sensor detects too much air in the tank. The valve is operated by a plunger and air release solenoid (not shown).
- The ink sub tanks (5) hold the ink pumped from the ink cartridges by the ink supply unit.
- One ink sub tank feeler (6) is attached to the side of each ink sub tank. The OCFS (On Carriage Fill Sensors) and the stationary main ink level sensors on the right side of the machine check the positions of these feelers to determine the level of ink in the sub tanks. The OCFS actuators are attached to the right sides of the K1, K2, and C tanks, but the OCFS actuators are attached to both sides of the Y1M1 and M2Y2 tanks.
- A filter unit (7) is set on top of every print head unit (8) as an extra precaution to keep the ink free of dirt, paper dust.
- The print heads (9) eject the ink onto the paper.

Print Head

7

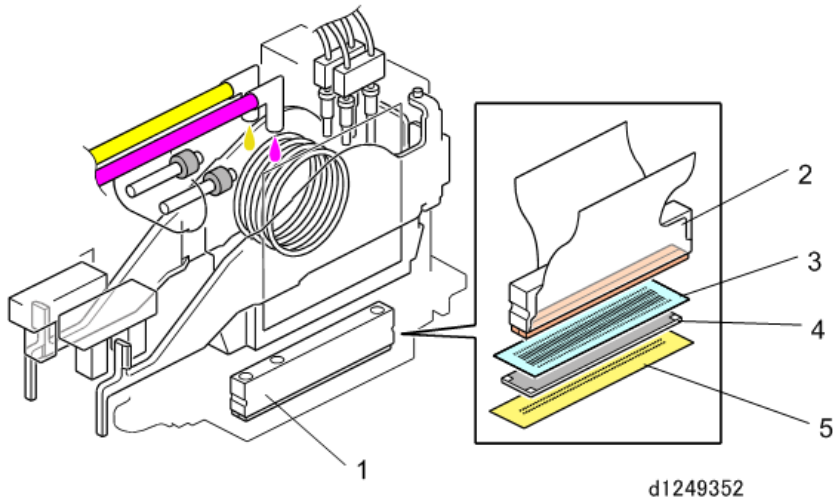

No.	Item
1	Print head
2	Piezoelectric element
3	Vibration plate

No.	Item
4	Flow plate
5	Nozzle array plate

Each print head (1) is comprised of the above parts.

- When a small electric charge is applied to the piezoelectric element (2), this causes it to expand and expel ink under pressure.
- The vibration plate (3) and flow plate (4) apply the ink evenly to the back of the nozzle array plate (5).
- The ink flows evenly through the ports of the nozzle array plate.

DRESS Sensor

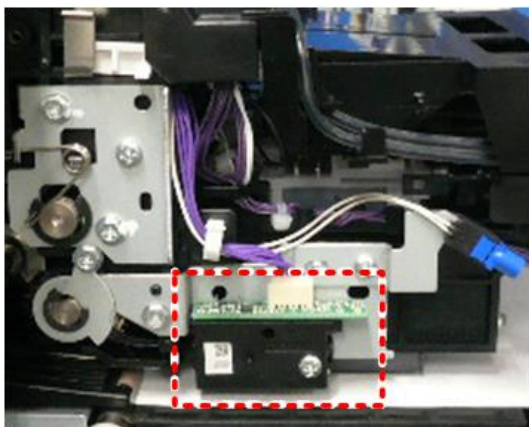

d262k1533

The DRESS (Direct Realization Edge Scanning Sensor) sensor is mounted on the left side of the carriage unit (shown above on the left cover with the carriage unit removed).

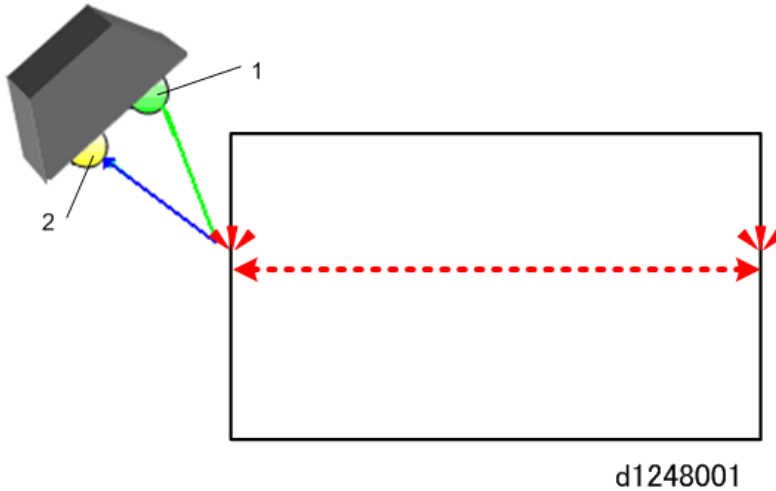

The sensor contains an LED (1) and a receptor (2). The sensor detects the edges of the paper when it detects the change in reflectivity between the paper and platen at the edges.

The DRESS sensor performs these functions:

- **Paper width detection:** The sensor checks the right and left edges of the paper on the platen to determine the size of the paper.
- **Image registration:** Detects the leading edge, right edge, and left edge of the paper so the machine can position the image on the paper.
- **Skew correction:** Checks and corrects skew at the right edge of the paper. If the edge is skewed more than ± 10 mm, the machine rewinds the paper onto the roll.
- **Dot position correction (color registration):** The carriage moves across the paper during printing, so the ink drops cannot fall vertically. The readings of the DRESS sensor are used to adjust the timing of the piezoelectric elements in the print heads that release the ink. Timing is adjusted for the height of the carriage (and print heads), paper thickness, speed of the carriage, and print mode (uni-directional or bi-directional).

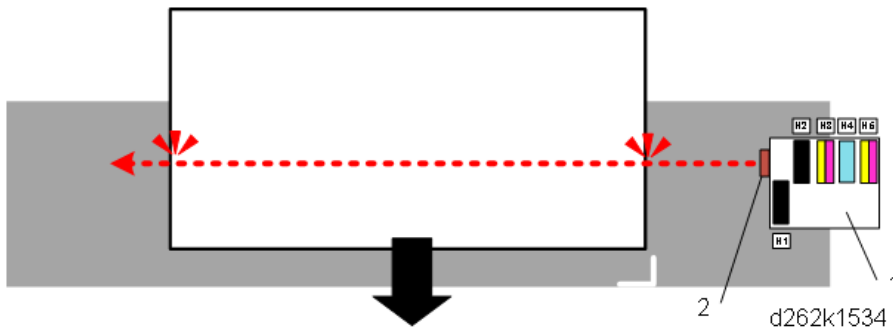

1. When a job starts, the horizontal motor switches on and moves the carriage (1) across the paper so that the DRESS sensor (2) can detect the right and left edges of the paper.

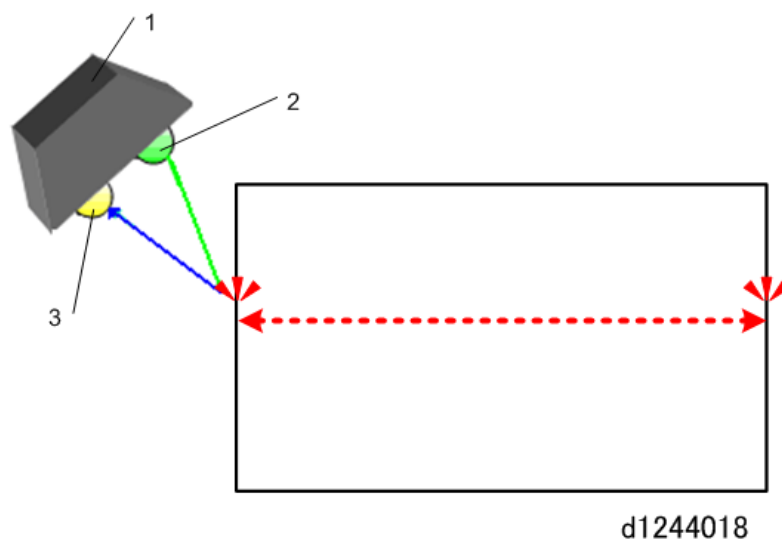

2. The DRESS sensor (1) (functioning here as an image registration sensor) is comprised of a sensor with an LED (2) and a receptor (3).
- The strength of the reflection of the light from the paper vary depending on the texture of the paper.
 - Printing problems can occur if the same threshold value of reflectivity is used for every type of paper.
 - For this reason, different threshold values of reflectivity are assigned for different types of paper to compensate for any difference in the reflectivity of their surfaces.

The readings of the DRESS sensor for the left and right margins are used to determine the horizontal placement of the image on paper. This can be adjusted with SP1-002 (Print Position Adjustment). This adjustment determines where the moving carriage starts and ends printing with every horizontal pass across the paper.

- A larger setting moves the image to create a wider left margin.
- A smaller setting moves the image to the create narrow left margin.

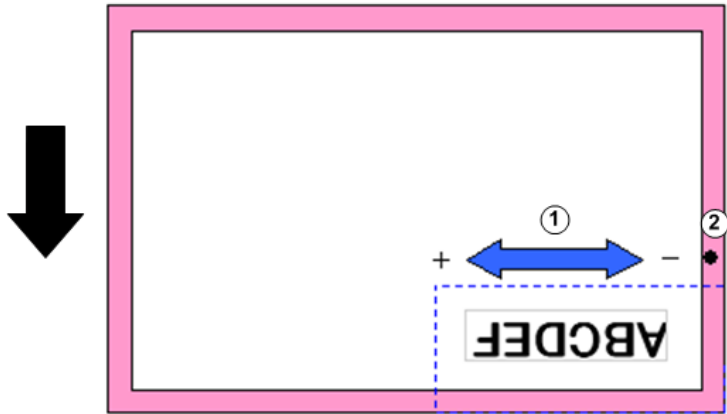

d1244019

①	Image position adjustment in the main scan (horizontal) direction
②	Margin (white space)

Temperature Monitoring

7

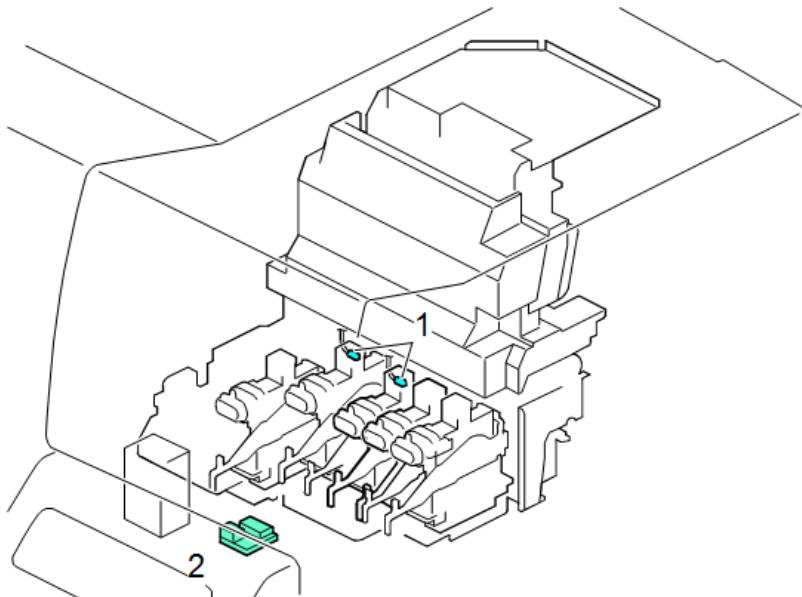

d262k9040

Print Head Thermistors

There are two thermistors [1]. One thermistor is for black ink (K1, K2) and one thermistor is for color ink (C, YM). These thermistors measure the temperature around the print head units inside the carriage. The machine uses this information to adjust the flow of ink from the print heads. Monitoring the temperature near the print heads is critical because the temperature can affect the viscosity of the ink at the ink nozzles.

- At low temperatures, the viscosity of the ink becomes high and can slow ink flow.
- At high temperatures, the viscosity of the ink becomes low and can cause ink to spill and run.
- The adjustment is done by changing the duty (strength of electrical charge) used to activate the piezoelectric elements that project ink through the ink nozzles of the print heads. (The amount of ink ejected will vary directly with the amount of charge applied to the piezoelectric element.)

Temperature/Humidity Sensor

The temperature/humidity sensor [2] is mounted on the right side of the machine above the ink supply unit. The machine uses the readings of the temperature/humidity sensor to set the duty for operation of the ink cartridge pump motors.

- Ink is pumped to the sub tanks in very small increments, and the operation of the ink pumps must be regulated to assure that the ink supply is constant.
- Adjustments must be made to compensate for the expansion and contraction of the ink tubes and other parts of the ink supply system caused by fluctuation in temperature.

The readings of the K2 print head thermistor and the temperature/humidity sensor are used together to calculate the operating temperature of the machine.

- If the machine overheats and the operating temperature exceeds the maximum temperature, the machine will shut down automatically and will not restart until it has cooled and been cycled off/on. The machine must be cycled off/on, even after it has cooled down to the operational range.
- If the temperature is too low at a cold start in the morning, for example, the machine will not start the initial cleaning cycle until the machine has warmed up. In this case, the machine does not require cycling off/on. The initial cleaning will start as soon as the machine has warmed up, and then the machine is ready for operation.

Print Head Height Adjustment

The gap between the print heads and the platen can be adjusted to accommodate thick paper. Raising the print heads and widening the gap between the print heads and the paper prevents the print heads from abrading the paper during printing.

Height Adjustment Mechanism

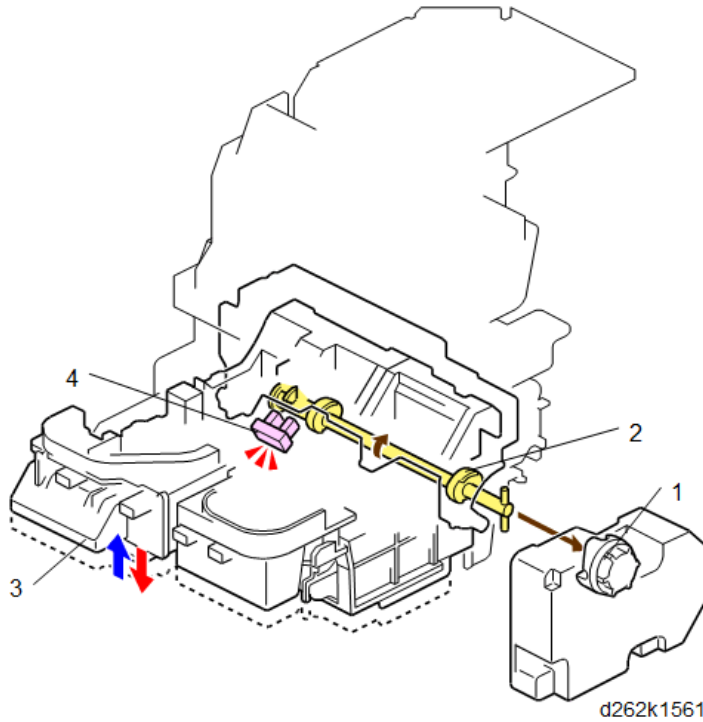

7

No.	Item
1	Head lift motor
2	Cam
3	Carriage unit
4	Head lift sensor

- When the operator selects the setting to change the height of the carriage, the carriage moves to the right, so that the coupling on the end of the shaft can engage the head lift motor (1).
- The head lift motor rotates the cam (2) and raises the carriage unit (3) with the cam pressing against the bottom of the carriage.
- Head limit sensor (4) detects the actuator when the carriage is lifted to its setting point and stops the motor.
- When the carriage unit is raised to the selected height, the cam locks in place and the carriage unit disengages from the head lift motor.

Raising and Lowering the Print Heads

The carriage unit and print heads can be raised to two high positions (1 mm, 2 mm) to eliminate smearing caused by the print heads rubbing across the surface of thick paper.

★ Important

- The Prevent Paper Abrasion setting must be done with the User Tools menu before starting the print job.

1. Touch User Tools icon on the machine operation panel.
2. Touch [System Settings], touch [Next], and then touch [Prevent Paper Abrasion].

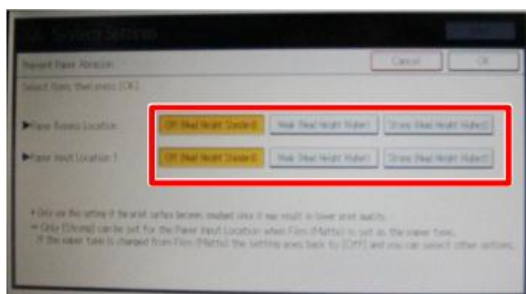

d262k1515

3. The first selection is for a bypass print job. The second and third selections are for Roll Feed 1 and Roll Feed 2, respectively.
4. Three selections are available for each feed location: Off (standard), Strong, and Weak.

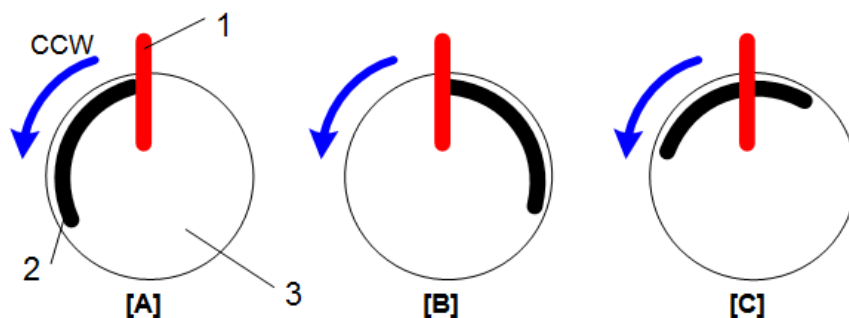

d262k1559

1: Head Lift Sensor, 2: Actuator, 3: Head Lift Cam

	User Tool	Height	Sensor	Rotate CCW (7 sec)	Rotate CCW (0.5 sec)	Rotate CW (0.15 sec)
[A]	Off	Default	ON to OFF	No	Yes	Yes

	User Tool	Height	Sensor	Rotate CCW (7 sec)	Rotate CCW (0.5 sec)	Rotate CW (0.15 sec)
[B]	Strong	2 mm	OFF to ON	No	Yes	Yes
[C]	Weak	1 mm	OFF to ON	Yes	No	Yes

Maintenance Unit

Overview

The maintenance unit performs these important functions:

- Raises the print head caps to cap the print heads, to prevent them from drying out while the machine is idle.
- Lowers the print heads at the start of a job, to uncap the print heads.
- Cleans the print heads when required.

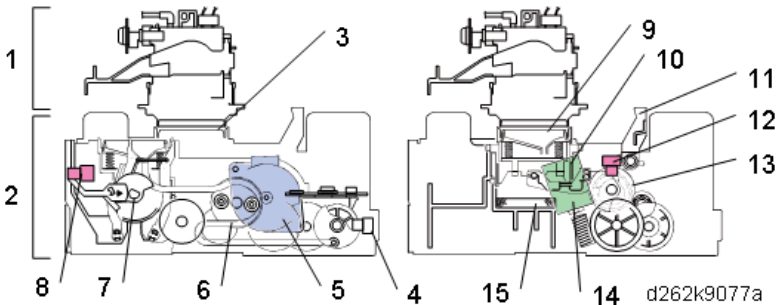

No.	Item
1	Carriage unit
2	Maintenance unit
3	Print head cap (K1)/Suction cap
4	Slide sensor
5	Maintenance motor
6	Suction pump

No.	Item
7	Suction cap actuator
8	Suction cap sensor
9	Color print head caps (K2, Y1M1, C, Y2M2)
10	Lift lever (K2, Y1M1, C, Y2M2)
11	Carriage stopper
12	Lift sensor
13	Lift sensor actuator
14	Lift motor
15	Cap pads (K2, C, YM)

Capping/Uncapping

The K1 print head and the K2, C, YM print heads are uncapped and capped at the same time.

K1 Print Head Uncapping/Capping

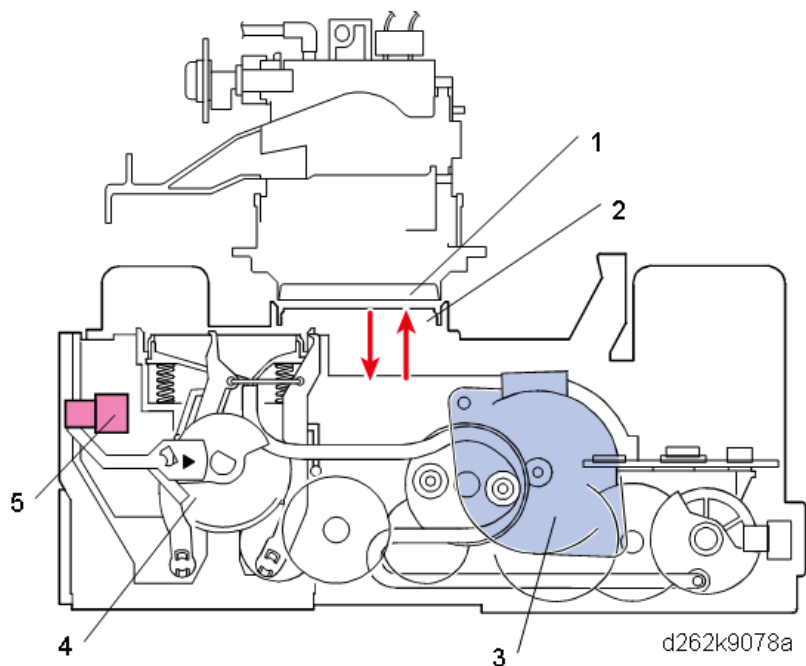

The maintenance motor uncaps and caps the K1 print head.

- While the machine is idle, the K1 print head (1) on the bottom of the carriage unit is capped and sealed by the suction cap (2) to prevent it from drying out.
- At the start of the next job, the maintenance motor (3) rotates forward and lowers the suction cap to uncap the K1 print head.
- At the end of the job, the carriage unit moves to the right and positions itself over the maintenance unit.
- The maintenance motor rotates forward again and raises the suction cap to cap the K1 print head.
- The rotating suction cap actuator (4) (mounted on a shaft with a lift cam driven by the maintenance motor) and suction cap sensor (5) control the raising and lowering of the suction cap.

K2, Y1M1, C, Y2M2 Print Head Uncapping/Capping

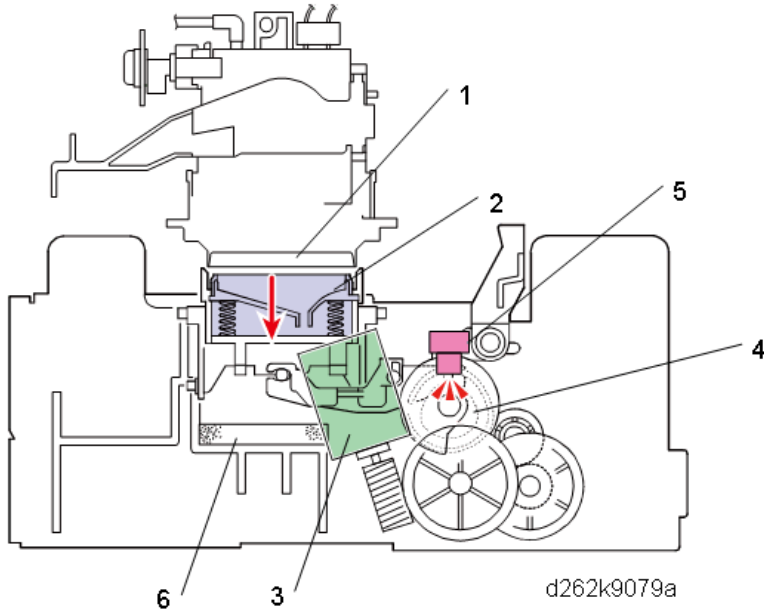

- While the machine is idle, the K2, Y1M1, C, and Y2M2 print heads (1) on the bottom of the carriage unit are capped and sealed by the print head caps (2).
- At the start of the next print job, the lift motor (3) rotates forward and lowers the K2, Y1M1, C, and Y2M2 caps to uncap the K2, Y1M1, C, Y2M2 print heads.
- The rotating lift actuator (4) (mounted on a shaft with a cam driven by the lift motor) and lift sensor (5) control the lowering of the four print caps.
- The caps rest on the absorbent cap pads (6) while they are down.

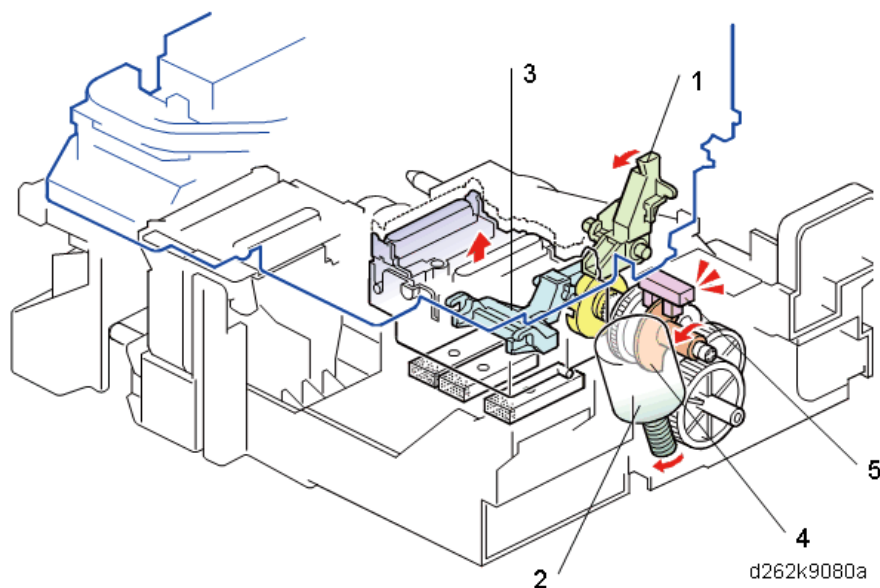

- At the end of a print job, the carriage unit moves to the right and positions itself over the maintenance unit.
- The carriage stopper (1) positions the carriage unit so that the caps and print heads are aligned.
- The maintenance lift motor (2), rotating forward, raises the K2, C, Y,M print head caps (not shown) on the lift lever (3) and covers the print heads to prevent them from drying out.
- The rotating lift actuator (4) (mounted on a shaft with a lift cam driven by the lift motor) and lift sensor (5) control the raising of the caps.

Print Head Cleaning Cycle

The four steps of the cleaning cycle are done for each print head that requires cleaning.

Step 1: Sliding the Cleaning Unit to the Rear

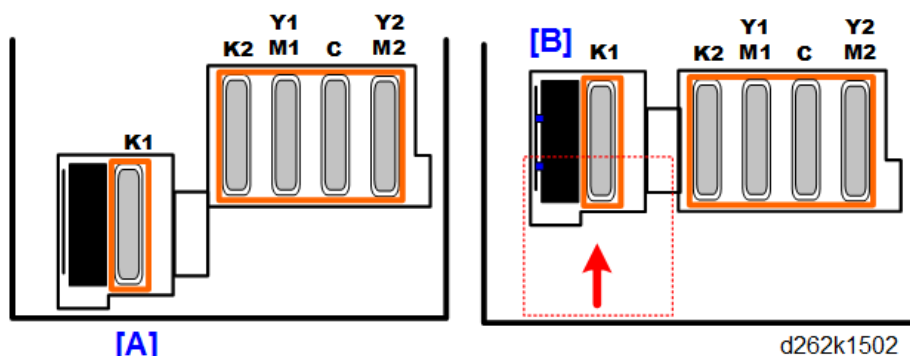

This step moves the cleaning unit from [A] to [B] in order to clean the K2, C, and YM print heads.

- This step is done for cleaning the K2, C, and YM print heads in order to position the suction cap (print head cap for K1) correctly.
- If only the K1 print head is to be cleaned, the cleaning unit is positioned to start cleaning immediately with the suction cap forward at [A].

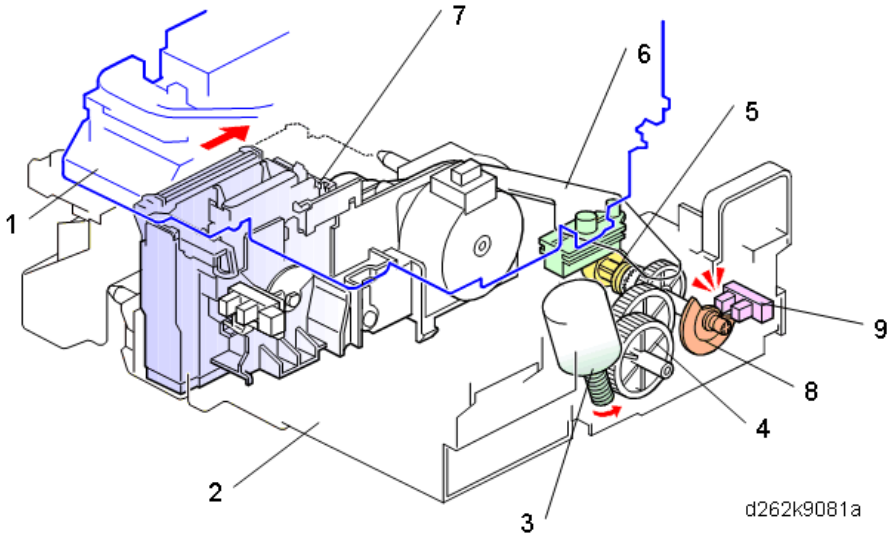

7

- At the start of the cleaning cycle, the carriage unit (1) positions itself over the maintenance unit (2).
- The lift motor (3) rotates in reverse and drives the gear train (4).
- The gears rotate a shaft with a large cam (5) between two swinging plates attached to the slide arm (6) linked to the cleaning unit (7)
- When the cam pushes the front plate forward, the slide arm and cleaning unit move to the rear.
- When the slide actuator (8) (attached to the same shaft driven by the lift motor) activates the slide sensor (9), the lift motor switches off with the cleaning unit at the rear.

Step 2: Raising the Suction Cap

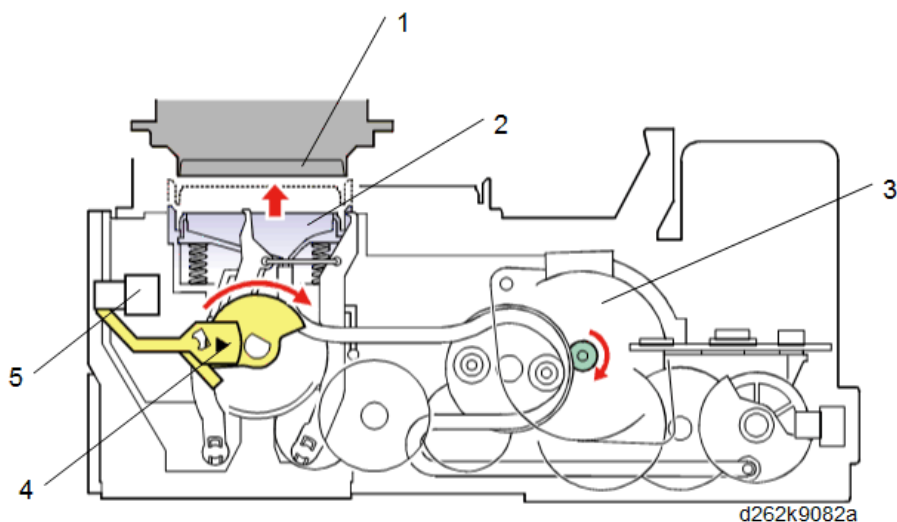

- The carriage moves to the left and stops, with the print head (1) to be cleaned directly above the suction cap (2).
- The maintenance motor (3) rotates forward and raises the suction cap.
- The suction cap actuator (4) (attached to the shaft with the cam driven by the maintenance motor to raise the suction cap) and suction cap sensor (5) signal the machine to turn off the motor when the cap is up and sealed on the print head.

Step 3: Suction

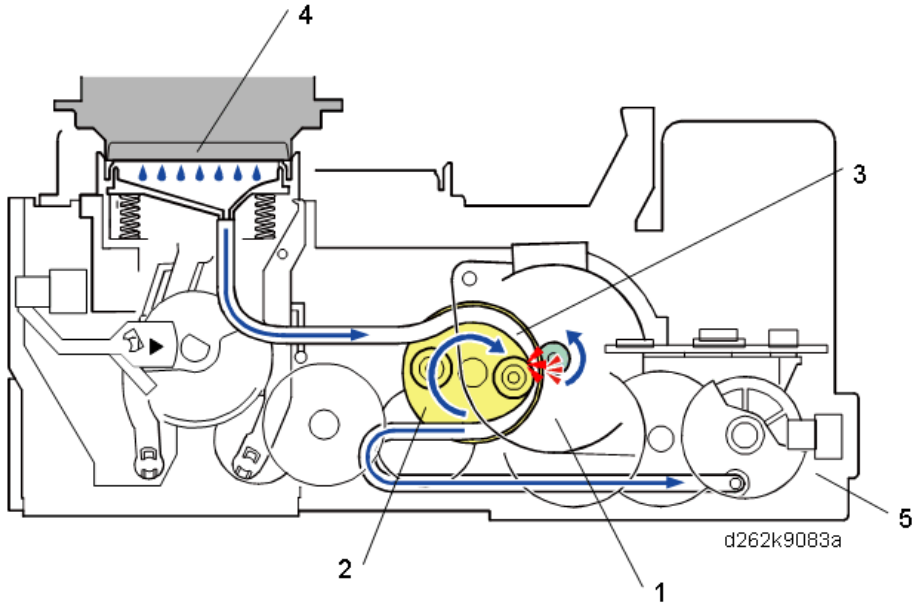

- The maintenance motor (1) reverses and rotates the cam inside the suction pump (2).
- The rotation of the cam alternately squeezes and releases the suction tube (3) to create enough pressure to draw ink from the surface of the print head (4).
- The ink is drawn through the tube which exits at the back of the maintenance unit (5) and continues down to the ink collector tank below the maintenance unit on the right side of the machine.
- The suction cap lowers away from the print head after suctioning ink for the prescribed time.

Step 4: Scraping and Wiping

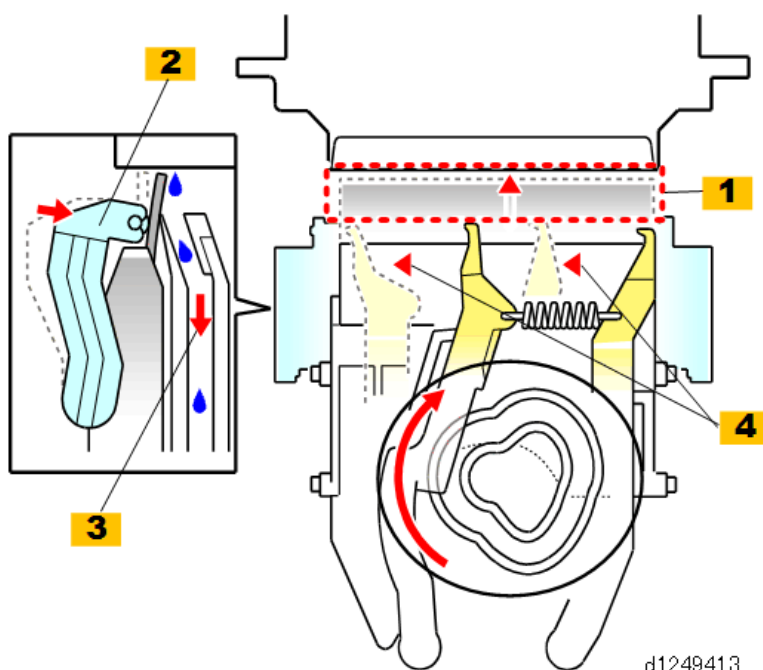

- The maintenance motor continues to rotate after lowering the suction cap, and drives the cam and linkages that complete the cleaning cycle at this step.
- The rubber scraper [1] is raised to the surface of the print head.
- The knock lever [2] taps the edge of the scraper to scrape ink from the print head. The ink falls into a vent [3] which opens over the right ink sump below the maintenance unit.
- Next, the linkage cocks the spring loaded wipers [4] to the rear, and then releases them so that they spring forward and flick any remaining ink into the vent. This is done twice.

This completes the cleaning cycle.

Manual Print Head Cleaning and Flushing

The operator can use the User Tools to clean and flush the print heads whenever a problem with printing occurs.

- Every execution of print head cleaning and flushing is recorded in NVRAM by a counter (0 to 999999).
- This is done so that the service technician can keep track of how many times the operator is cleaning and flushing the print heads with SP7-212 (User Cleaning) and SP7-213 (User Refreshing).
- Humidity can affect the number of times the print heads require cleaning and refreshing.
- For more details about manual print head cleaning and refreshing, refer to Print Head Cleaning and Adjustment (p.876).

Automatic Downtime Cleaning

Ink can thicken or dry around the nozzles if the print heads remains idle for a long time, especially at low temperatures. This can affect the quality of printing. To prevent the drying or thickening of ink around the nozzles, the machine will execute a maintenance cleaning cycle appropriate for the length of time that the print heads have remained idle. This is done automatically without intervention by the operator.

The machine monitors two phases of downtime.

- **Idle time 1:** Starts after the last sheet exits and all the print heads are capped
- **Idle time 2:** Amount of time each head has remained idle

↓ Note

- Idle (or downtime) refers to the length of time that a print head has not been used. For example, If the machine is used for extensive black-and-white copying and printing over a period of several days, a count of idle time for the color print heads (C, YM) is maintained even though the machine has not been turned off.

These idle time counts are used to execute these operations:

- Air purging (ink supply and purging, filling and cleaning, and air purging/filling together)
- Ink supply sequence
- Cleanings and flushing (refreshing) done by the operator manually
- Ink purging done after idle time

The type of maintenance operation is selected and executed automatically based on the time elapsed from the start of downtime.

Maintenance Cycles Based on Idle Time

No.	Downtime	Try to Detect Air?	If air is detected for a print head* ¹	If no air detected
1	< 10 h	No	---	---
2	> 10 and < 24 h	Yes	Ink supply, air purge/ink fill sequence	Small downtime ink purge
3	> 24 h and < 3 days	Yes	Ink supply, air purge/ink fill sequence	Large downtime ink purge
4	> 3 days, < 7 days	Yes	Ink supply, air purge/ink fill sequence	Large downtime ink purge 3 times
5	> 7 days and < 45 days	Yes	Ink supply, air purge/ink fill sequence > Downtime cleaning	Downtime cleaning

No.	Downtime	Try to Detect Air?	If air is detected for a print head* ¹	If no air detected
6	> 45 days	Yes	Ink supply, air purge/ink fill sequence > Downtime cleaning	Ink fill sequence > Downtime cleaning
* ¹ The cycle is executed for the affected print head unit only.				

The maintenance cycle could be brief or require several minutes to complete depending on ambient conditions and how long the print heads have remained idle.

Approximate Times Required for Cleaning

No.	Downtime	Approximate Time
1	< 10 h	16 sec.
2	> 10 and < 24 h	9 sec.* ¹
3	> 24 h and < 3 days	3 min.
4	> 3 days, < 7 days	3 min. or more
5	> 7 days and < 45 days	30 min.
6	> 45 days	More than 30 min.
* ¹ 9 sec. at power on, at job start possibly up to 16 sec.		

The following SP codes can be used to modify automatic cleaning after downtime:

- **SP2-513** Maintenance After Leftover Threshold
- **SP2-514** Auto Cleaning Start Threshold
- **SP2-521-001 to -003** Maintenance After Leftover Repeat
- **SP2-517** Maintenance After Leftover Information
- **SP2-520** Maintenance After Leftover Setting On/Off Switch

Automatic Mist Cleaning

The condition of the print head nozzles can deteriorate over time due to ink that starts to cling to the nozzles and accumulates inside the suction cap and the three protective caps of the maintenance unit. Paper dust can also accumulate and interfere with the operation of the nozzles.

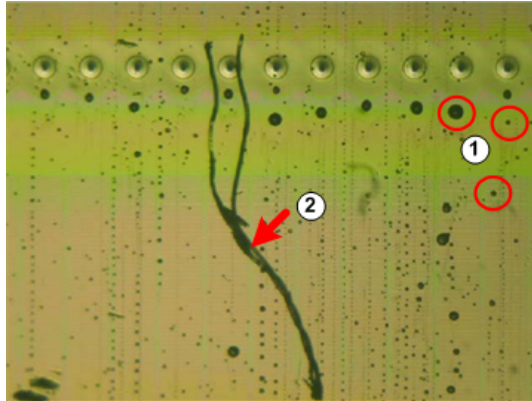

d1245021

The illustration above shows droplets of mist ① and paper fibers and dust ② that can collect near the nozzles. This undesirable condition is corrected with periodic automatic cleanings while the printer is in use, greatly extending the length of time the machine can be used without operator intervention.

- **Mist count.** A "mist count" triggers automatic cleaning. This mist count can be extended to increase the timing between automatic cleanings. The mist count, which determines the intervals between automatic cleanings, has been doubled for this machine.
- **Count adjustment.** The count is automatically adjusted for the width of the paper and total print area.
- **Paper dust count.** The paper dust count (the total number of pages printed, cutting count) is used to determine when cleaning is done for paper dust.

Auto-Nozzle Check Module

Overview

The auto-nozzle check function detects whether the nozzle drops ink correctly. It checks the change in electrical charge caused by the ink dropped to the electrode plate at constant intervals. If ink is not dropped well but the effect is not so serious, the adjacent nozzles drop larger dots for printing to minimize the effect. If the effect is serious, the print head is cleaned automatically.

The part on which the electrode plate and slider are placed is called the holder. It is made of plastic to maintain high voltage of the electrode and insulation properties of GND.

Name	Function
Electrode plate for detection	Placed facing the nozzle and charged to 500 V when detecting.
Wiper	Wipes ink from the electrode with the slider after ink drop detection process.

Name	Function
Slider	A wiper is attached. It wipes the electrode by moving back and forth, driven by the timing belt beneath the holder.
Wiper cleaner	Scrapes ink off the wiper with the cutout when the wiper returns to its home position after wiping.
Ink collector tank	Collects the ink scraped with the wiper cleaner
Wiper drive motor	Moves the slider back and forth with a timing belt.
Wiper position sensor (backward)	Detects when the slider reaches the front end. After ink drop detection process, the motor rotates in reverse to perform wiping.
Wipe position sensor (home position)	Detects the home position of the slider.
Auto-nozzle check board	Supplies high voltage to the electrode and detects the change in electrical charge.

Timing for Detection

The frequency of Auto-Nozzle Check can be set in the initial settings. The period required for one check is 25 seconds (no ink deficiency for five heads).

- Standard (default): For every maintenance cycle (automatic and manual) and before printing after 10 hours have passed after detecting ink deficiency in the previous purging detection.
- Frequent: Before printing or for automatic cleaning between pages.
- OFF: No nozzle check (the same conditions as MP CW2200)

Auto-Nozzle Check does not function at 9°C or lower or 36°C or higher, because such environments affect detection accuracy.

Detection

The print head performs air purging before printing, moves over the electrode plate charged at 500 V, and starts dropping ink. Dropping of the negatively-charged ink onto the electrode plate causes variation in the charge of the electrode plate. The auto-nozzle check board detects this charge variance and judges whether to drop ink or not.

Each print head has 192 nozzles. Each nozzle drops ink and checked one by one. They do not drop ink all at once.

For example, the 1st nozzle drops ink and is checked, then the 2nd nozzle drops ink and is checked, then the 3rd nozzle and soon until the 192nd nozzle.

After dropping ink from all nozzle, the carriage moves outside the area, where wiping is inhibited and the electrode plate is wiped.

Detection Image

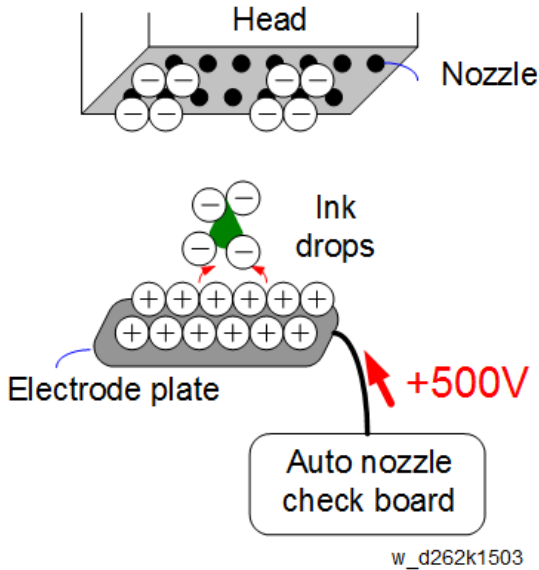

w_d262k1503

7

Electrode Plate



d2620090

Wiping an Electrode Plate

The slider moves back and forth driven by the timing belt, which is driven by a wheel rotated by the wiper drive motor.

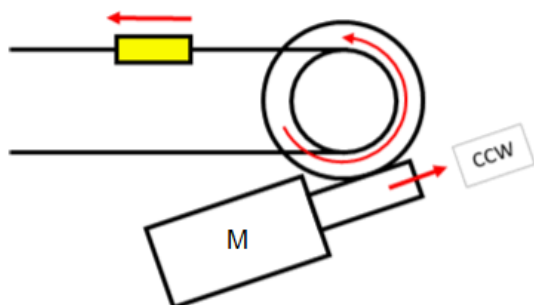

d262k8527

The timing for stopping the slider is determined with the front and back through sensors.

The sensor to stop backward wiping motion is "Wiper position detection [A] (home position)", and the sensor to stop forward wiping motion is "Wiper position detection [B] (backward)".

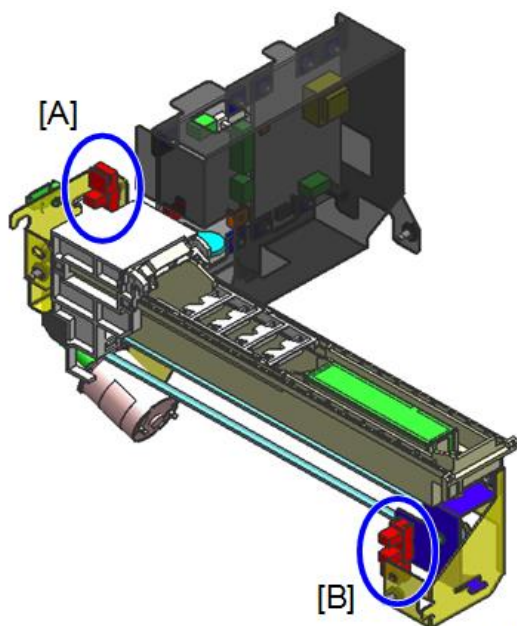

d2620092

When moving backward from the home position (① in the picture below), the slider moves from the back to the front side of the machine, with the wiper maintaining the upper position (retracted position). The wiper descends around the backward slope at the end of this motion (starting point for the reverse motion).

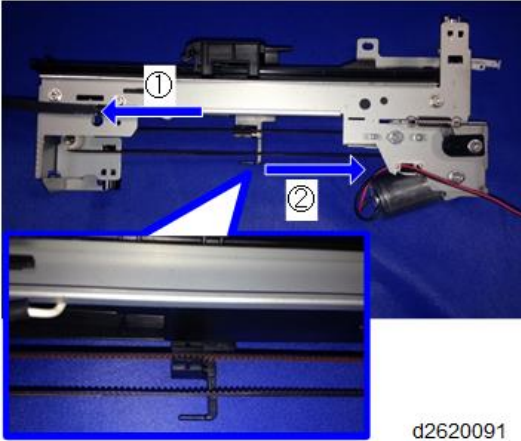

For reverse motion (② in the picture above), the motor rotates in the opposite direction to wipe from the front side to the back side of the machine, with the wiper ([A] in the picture below) maintaining the lower position (sweeping position).

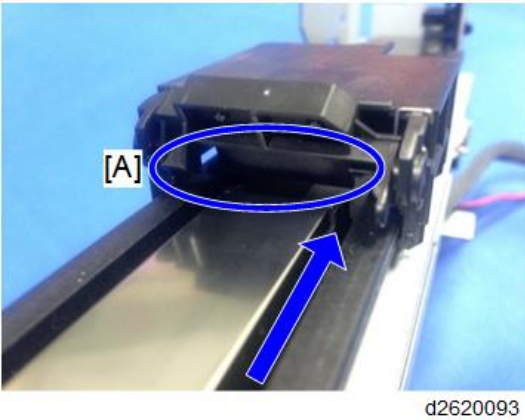

The wiper cleans the electrode plate, then the wiper cleaner cleans the wiper to remove the attached ink.

Around the slope at the back at the end of this motion (home position), the wiper ascends again.

The wiper drive motor is driven with 24 V. When positive voltage is applied to the motor, the output axis of the motor rotates counterclockwise and the slider moves from the home position to the back.

When Ink Deficiency is Detected

If ink deficiency is not so serious, printing continues by compensating with the adjacent nozzles. If ink deficiency is serious, automatic cleaning is performed.

Type of move	Purging detection results	Move
Nozzle interpolating mode	Ink deficiency (not serious)	If ink deficiency is detected but can be covered with nozzle compensation printing, printing will continue in Nozzle Compensating mode.
Recovery cleaning	Ink deficiency (serious)	If ink deficiency cannot be covered by nozzle compensation, clean the head and perform the auto-nozzle check. If the nozzle regains functionality for normal printing mode or nozzle compensating mode, the nozzle is treated as functional. If the nozzle does not regain, nozzle compensation will not be done.

Not serious

The adjacent picture elements are dropped with larger dots to compensate for the dropping no ink nozzles.

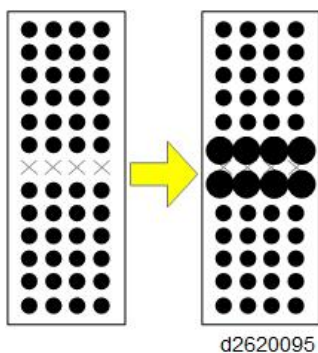

Serious

If nozzle compensation cannot solve the problem, the print head is cleaned automatically.

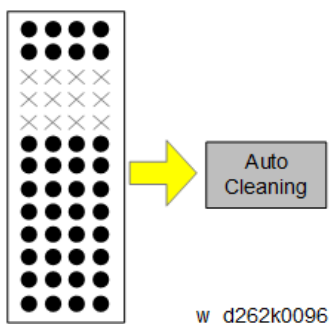

Operating Life

After 60,606 cleanings (equivalent to 30,000 m), it is recommended to replace the wiper blades. Replace the holder.

Waste Ink Collection

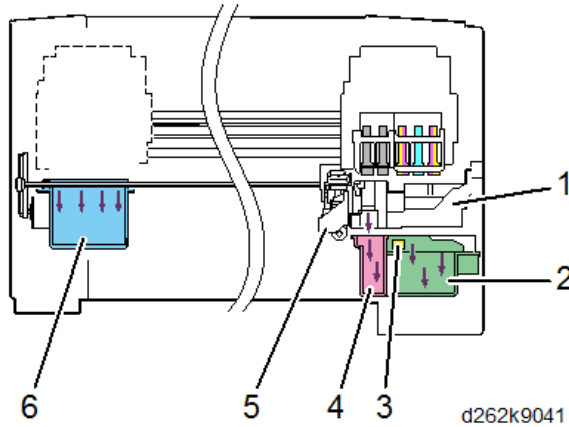

7

No.	Item
1	Maintenance unit
2	Ink collector tank
3	Ink collector tank chip
4	Right ink sump
5	Auto-nozzle check unit
6	Left ink sump

- The machine executes the print head cleaning cycle with the carriage unit positioned over the maintenance unit (1).
- The ink collector tank (2) collects the ink drawn from the print heads by the suction pump inside the maintenance unit during the print head cleaning cycle.
- The ink collector chip (3) detects when the ink collector tank is installed correctly. It will signal an error if the tank is not installed or not set correctly. Printing cannot be done unless the tank is set correctly. This sensor also detects when the ink collector tank is full.

- The right sump (4) resides behind the ink collector tank and directly below the maintenance cleaning unit. This is an open sump that collects the ink that is wiped and scraped from the print heads at the end of the cleaning cycle.
- During printing, the machine occasionally flushes ink through the print head nozzles (with a very small amount of ink) which falls into the left ink sump (6). This keeps the nozzles primed and in good working condition. This operation is controlled by the machine firmware and is not part of the print head cleaning cycle.

Ink Collector Tank

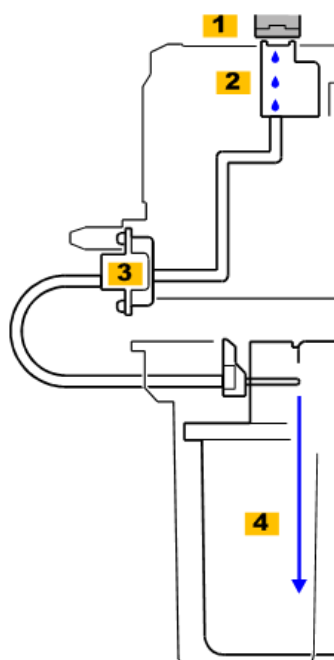

d1249414

The ink collector tank collects ink during print head cleaning. Ink is drawn from the surface of the print head [1] into the suction cap [2]. The suction pump [3] pumps the waste ink directly out the back of the maintenance unit to the ink collector tank [4].

The ink collector tank must be replaced when it becomes full.

- The ink collector tank has an ID chip that confirms when the tank was installed, and that it is the correct type of tank for the machine.
- The machine cannot operate if the tank is not installed correctly.
- Alerts inform the operator when the tank is near-full and then full. These alerts are triggered by the information stored in the ID chip of the tank.

- A software count totals the usage of the tank in the number of times the maintenance unit sucks ink from the print heads during the head maintenance cycle. The count is stored in the ID chip of the ink collector tank.
- The near full alert is triggered at 361 ml and the tank full alert is triggered at 425 ml.
- The ink collector tank must be replaced; it cannot be emptied and reused. After a tank becomes full, an "end history" setting is written into the ID chip to prevent the tank from being used again.

The tank near full and full thresholds that trigger the near-full and full alerts can be adjusted with SP2-507-001, 002.

- **Tank near full:** A prompt appears on the operation panel of the machine, and the machine will continue to operate.
- **Tank full:** A prompt appears on the operation panel of the machine. If a page is being printed, the job will finish, and then the machine will shut down and cannot be used until after the tank has been replaced.

★ Important

- Adjusting SP2-507-001 and 002 is not recommended.

Right Ink Sump

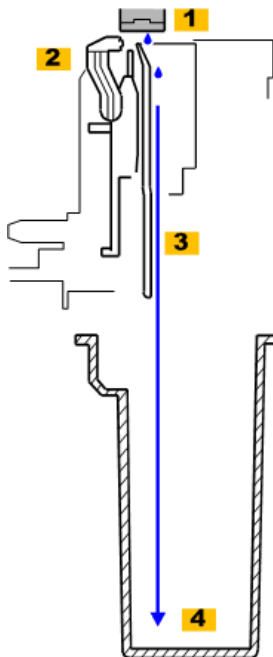

d1249415

The ink scraped and wiped from the print head [1] by the scraper and wipers [2] flows through a vent [3] through the open top of the right ink sump [4].

A software count triggers a prompt to tell the operator when this tank is near-full and then finally full and in need of replacement. The count is done by counting the usage of the wiper mechanism in the maintenance unit. The two strokes of the wiper removes ink from the cleaning plate and drops the ink down into the sump below. The wiper operation count is stored in NVRAM. The right ink sump has no ID chip.

The tank is near full at 125 ml and full at 147 ml. The estimated period of time between replacements is about 5 years.

Prompts

- **Tank near full.** A prompt appears on the operation panel of the machine, and the machine will continue to operate.
- **Tank full.** A prompt appears on the operation panel of the machine. If a page is being printed, the print will finish, and then the machine will shut down and cannot be used until after the tank has been replaced with a new tank and the counter has been reset to "0" with an **SP2-505-002**.

Left Ink Sump

Occasionally, a printing job will pause long enough for the carriage to move to the left and drain ink over the left ink sump on the left side of the machine.

A software count triggers a prompt to tell the operator when this tank is near-full and then finally full and in need of replacement. The left ink sump has no ID chip.

- Near full: 425 ml
- Tank full: 500 ml

Estimated time between replacements: about 5 years

Prompts

- **Tank near full.** A prompt appears on the operation panel of the machine, and the machine will continue to operate.
- **Tank full.** A prompt appears on the operation panel of the machine. If a page is being printed, the job will finish, and then the machine will shut down and cannot be used until after the tank has been replaced.

The count must be reset with **SP2-505-001** after the left ink sump has been replaced. There is no sensor to detect when the left ink sump is removed and inserted.

The machine refers to a lookup table to determine how to execute draining. The draining intervals and amount of ink released is determined by the ambient temperature and humidity. Settings in the lookup table are adjusted for temperature in 1 °C steps and for humidity in 3 steps.

Humidity

Steps	Range (rH%)
1	Up to 35%
2	35% to 65%
3	65% and over

- Temperature and humidity are always sampled by the temperature/humidity sensor immediately before a scheduled draining.
- Normally, draining is done in this order: Color heads Y1M1, C, Y2M2 and then Black heads K1, K2 with no delay between color and black purging.
- Draining may be slightly slower at cooler temperatures around 15°C (59°F)

Related SPs

- 1-002-XXX [Print Position Adj (Left Edge)]:
This SP adjusts the horizontal registration of the image area on paper for each paper feed station. This adjustment determines where the moving carriage starts and ends printing with every horizontal pass across the paper.
- 7-212-XXX [User Cleaning]:
This SP displays the number of print head cleanings executed manually. Print head cleaning can be done with the User Tools.
- 7-213-XXX [User Refreshing]:
This SP displays the number of print head flushings executed manually. Print head flushing (refreshing) can be done with the User Tools.
- 2-513-XXX [Mainten. after Leftover Thresh` DFU]:
Even with the print heads capped, if the machine remains idle for a long period, this can cause the ink around the nozzles to dry slightly and become too viscous to produce good quality images. To prevent this, the machine will execute a maintenance cycle appropriate for the length of time that the machine has remained idle. This is done automatically without intervention by the operator after the machine is turned on, or after a print head has not been used for a long period of time.
- 2-514-XXX [Auto Cleaning Start Threshold DFU]:
This SP code sets the threshold setting to trigger automatic cleaning, based on the mist count.
- 2-517-XXX [Mainten. after Leftover Info.]:
The machine executes a maintenance cycle at power on, and at the start of a print job after it has remained idle for a significant length of time.
- 2-520-001 [Mainten. after Leftover Setting -On/Off Switch]:

Use this SP code to switch on/off the number of times that the downtime cycles execute. The settings of SP2-521-001 to -003 allow you to set the number of times the cycles (small downtime purge, large downtime purge, and downtime) cleaning execute.

- 2-521-XXX [Mainten. after Leftover Repeat]:

These SP codes allow you to set the number of times the cleaning cycles (small downtime purge, large downtime purge, and downtime) execute. To use these settings, SP2-520 must be set.

- 2-507-001 [Waste Ink Related Threshold DFU]-[Change Waste Ink Box Full Threshold]:

This SP adjusts the threshold for the tank full alert for the ink collector tank on the right side of the machine.

- 2-507-002 [Waste Ink Related Threshold DFU]-[Change Waste Ink Box Near Full Threshold]:

This SP adjusts the threshold for the near-tank full alert for the ink collector tank on the right side of the machine.

- 2-505-002 [Reset Waste Ink Counter]-[Waste Ink: Right C/R]:

A software count triggers a prompt to tell the operator when the right ink sump is nearfull, and then finally full and in need of replacement.

- 2-505-001 [Reset Waste Ink Counter]-[Waste Ink: Right C/R]:

The firmware count triggers a prompt to tell the operator when the left ink sump tank is near-full, and then finally full and in need of replacement. The count is stored in NVRAM.

Print Head Cleaning and Adjustment

When printing repeatedly, print quality may be deteriorated because the inside of the machine gets dirty. In such a case, do maintenance using the Maintenance Menu.

Nozzle Check Pattern Print

Print the nozzle check pattern after filling the ink for the first time or for checking the clogging of the print head nozzle.

Note

- Before printing the nozzle check pattern, make sure that Prevent Paper Abrasion mode is not enabled (p.885).
1. Touch [Home] at the bottom of the screen in the center.
 2. Flick the screen to the left, and then touch the User Tools icon.
 3. Touch [Machine Features].
 4. Touch [Maintenance].
 5. Touch [Print Nozzle Check Pattern].
 6. Select the input location and touch [OK].

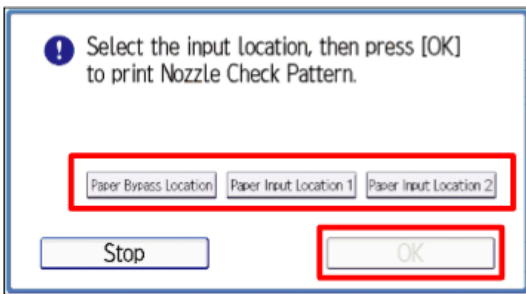

d262k1507

7. Check the print results of the test pattern.

- Normal print results:

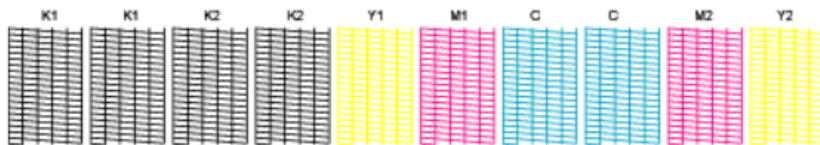

d262k1064

- If a nozzle is clogged:

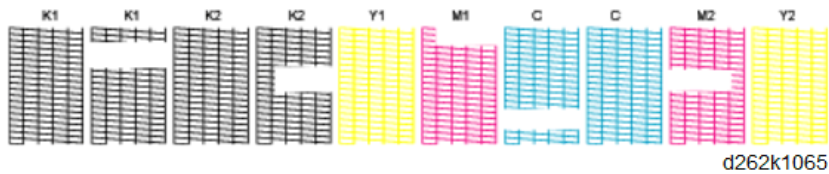

There are broken lines on the pattern. Clean the print head for the color.

The pattern corresponds to Black (K1), Black (K2), Yellow (Y1), Magenta (M1), Cyan, Magenta (M2), and Yellow (Y2) for [Clean Print-heads] and [Flush Print-heads] in [Maintenance], from left to right.

8. Touch [Exit].
9. Touch [User Tools] on the top right of the screen.
10. Touch [Home] at the bottom of the screen in the center.

↓ Note

- If a nozzle is clogged, perform the maintenance, cleaning the print head three times and flush it once. For each maintenance, check the nozzle check pattern. (p.877, p.878)

Clean Print Heads

Clean the print heads when a nozzle is clogged, a specific color is not printing, or prints out unclearly.

↓ Note

- During cleaning the print heads, do not conduct any other operations.
- During cleaning the print heads, do not open the cover.
- If the ink collector box is full, cleaning print heads cannot be performed.
- If one of the ink tanks is empty, cleaning print heads cannot be performed.
- If ink-near-end or ink-end is detected during cleaning, cleaning print heads may not be completed.
- Cleaning print heads consumes ink.

1. Touch [Home] at the bottom of the screen in the center.
2. Flick the screen to the left, and then touch the User Tools icon.
3. Touch [Machine Features].
4. Touch [Maintenance].
5. Touch [Clean Print-heads].
6. Select the color of the head for cleaning, and then touch [Start].

↓ Note

- If you touch [Start] while operating the machine, the operation is canceled (touching operation is ignored and the beep sounds).



7. Touch [Exit].
8. Touch [User Tools] on the top right of the screen.

↓ Note

- To check the results of cleaning print heads, print the test pattern again and check it.
- If all nozzles are dropping ink and colors are not mixed, cleaning ends.
- If a nozzle is clogged after cleaning print heads three times, perform flushing print heads. For each maintenance, check the nozzle check pattern.

7

Flush Print Heads

If a nozzle is clogged after repeated cleaning print heads, perform flushing print heads to clean the print heads strongly.

↓ Note

- During flushing the print heads, do not conduct any other operations.
- During flushing the print heads, do not open the cover.
- If the ink collector box is full, flushing print heads cannot be performed.
- If one of the ink tanks is empty, flushing print heads cannot be performed.
- If ink-near-end or ink-end is detected during flushing, flushing print heads may not be completed.
- As flushing print heads consumes more ink than cleaning, perform flushing only when necessary.

1. Touch [Home] at the bottom of the screen in the center.
2. Flick the screen to the left, and then touch the User Tools icon.
3. Touch [Machine Features].
4. Touch [Maintenance].
5. Touch [Flush Print-heads].
6. Select the color of the head for flushing and touch [Start].

↓ Note

- If you touch [Start] while operating the machine, the operation is canceled (touching operation is ignored and the beep sounds).



7. Touch [Exit].
8. Touch [User Tools] on the top right of the screen.
9. Touch [Home] at the bottom of the screen in the center.

↓ Note

- To check the results of flushing print heads, print the test pattern again and check it.
- If all nozzles are dropping ink and colors are not mixed, flushing ends.

Adjust Head Position

If bi-directional printing produces misaligned vertical lines or blurred colors, print the test pattern and adjust the print head position. The test pattern differs depending on the print quality.

↓ Note

- Before adjustment, make sure that Prevent Paper Abrasion mode is not enabled (p.885).
- During test pattern printing, do not conduct any other operations.
- For Film (Matte), the head position cannot be adjusted automatically. Adjust it manually.
- For the bypass paper feed location, the head position cannot be adjusted automatically. Adjust it manually.

Automatic Adjust Head Position

1. Touch [Home] at the bottom of the screen in the center.
2. Flick the screen to the left, and then touch the User Tools icon.
3. Touch [Machine Features].
4. Touch [Maintenance].

5. Touch [Auto Adjust Head Position].
6. Select the items for adjusting the head position and touch [Adjustment].

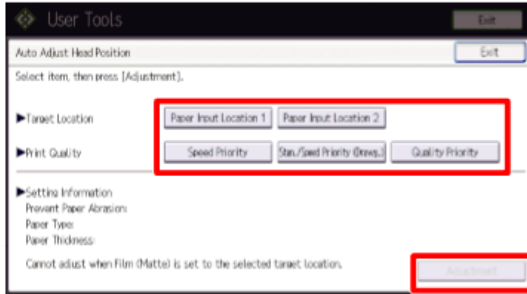

d262k1509

7. Touch [Exit].
8. Touch [User Tools] on the top right of the screen.
9. Touch [Home] at the bottom of the screen in the center.

Note

- If automatic adjustment fails, do the adjustment manually.

Manual Adjust Head Position

1. Touch [Home] at the bottom of the screen in the center.
2. Flick the screen to the left, and then touch the User Tools icon.
3. Touch [Machine Features].
4. Touch [Maintenance].
5. Touch [Manual Adjust Head Position]
6. Select the items for adjusting the head position and touch [Start Printing].

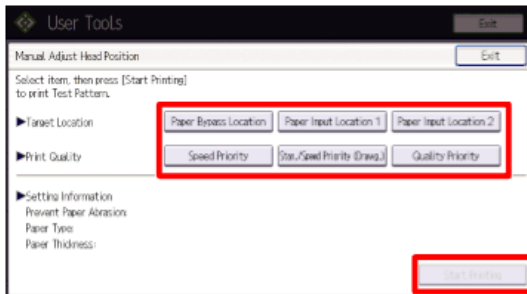

d262k1510

7. Check the test pattern.

To determine the adjustment value, the optimal adjustment value is the number above the square pattern that has the faintest color closest to gray and aligned vertical lines on both sides. If the value in column "A" is "+2", the adjustment value of "A" is "+2".

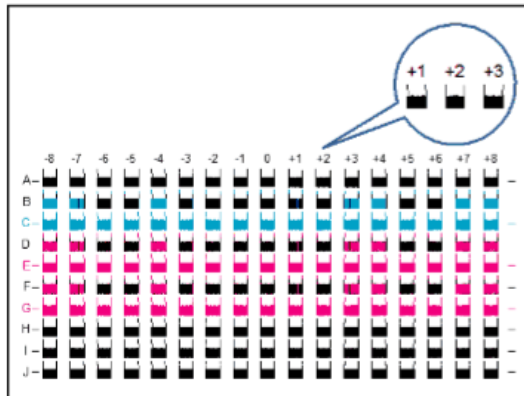

d262k1071

8. Touch [Adjustment].
9. Touch the plus or minus button to enter the value, and touch [OK].
10. Repeat steps 5 to 7 to print the test pattern, until the optimum adjustment value is "0".
11. Touch [Exit].
12. Touch [User Tools] on the top right of the screen.
13. Touch [Home] at the bottom of the screen in the center.

Adjust Paper Feed

Adjust paper feed if you see these problems in the prints:

- Broken horizontal lines
- Patchy images (uneven filled areas)
- White lines at regular intervals

★ Important

- **Before adjustment, make sure that Prevent Paper Abrasion mode is not enabled (p.885).**
- **During test sheet printing, do not conduct any other operations.**

1. Touch [Home] at the bottom of the screen in the center.
2. Flick the screen to the left, and then touch the User Tools icon.
3. Touch [Machine Features].
4. Touch [Maintenance].
5. Touch [Adjust Paper Feed].

6. Select the paper feed location for adjusting, and touch [Print Test Sheet].

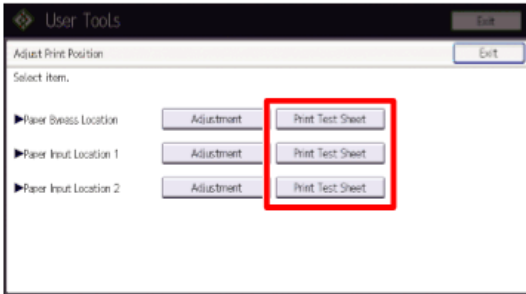

d262k1511

7. Touch [Start Printing].
8. Check the test sheet.

To determine the adjustment value, the optimal adjustment value is the number above the square pattern that has the faintest color closest to gray and aligned vertical lines on both sides. If the number appeared to the left of the lightest gray square with straight horizontal lines on both sides is "+2", the adjustment value is "+2".

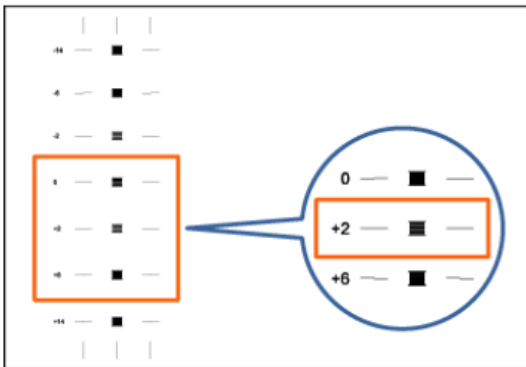

d262k1073

Note

- Even for the pattern with the lightest gray square, if the horizontal lines are not straight, select the value referring to the above or below pattern whose horizontal lines are misaligned in the opposite direction. For example, "+2" square is the faintest and the horizontals on both sides of "+6" are in the opposite direction to "+2", so the adjustment value is between "+3" and "+5" depending on the degree of misalignment. After completing the adjustment, adjust the paper feed again to check if the optimal adjustment value is set.

9. Select the paper feed location for adjusting, and touch [Adjustment].
10. Touch the plus or minus button to enter the value and touch [OK].
11. Touch [Exit].
12. Touch [User Tools] on the top right of the screen.

13. Touch [Home] at the bottom of the screen in the center.

Note

- To check the results of the adjustment, print the test sheet again.

Adjust Print Position

Print the test sheet for adjusting the print start position of paper for each paper feed location.

Important

- **Before adjustment, make sure that Prevent Paper Abrasion mode is not enabled (p.885).**
- **During test sheet printing, do not conduct any other operations.**

1. Touch [Home] at the bottom of the screen in the center.
2. Flick the screen to the left, and then touch the User Tools icon.
3. Touch [Machine Features].
4. Touch [Maintenance].
5. Touch [Adjust Print Position].
6. Select the paper feed location, and touch [Print Test Sheet].

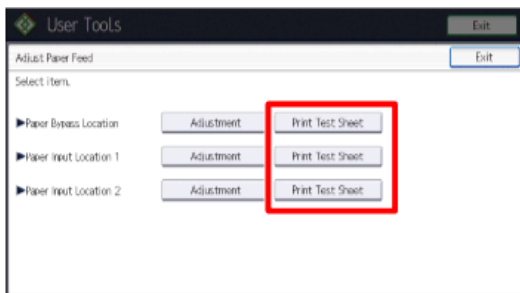

d262k1512

7. Touch [Start Printing] to print the test sheet.
8. Check the test sheet.

To determine the adjustment value, measure the margins between the center of the printed lines and the paper edges. Adjust so that the margins are 5 mm.

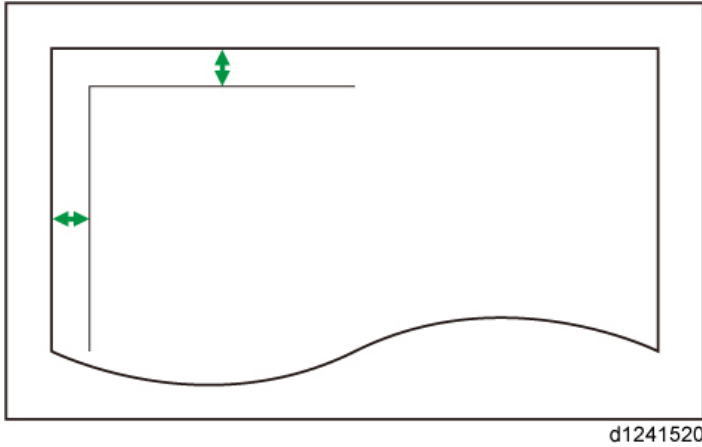

For example, if the center of the horizontal line is printed 4 mm from the top edge of the test sheet, the adjustment value of Top Margin is "1.0 mm".

In the same manner, if the center of the vertical line is printed 8 mm from the left edge of the test sheet, the adjustment value of Left Margin is "-3.0mm".

9. Select the paper feed location for adjusting, and touch [Adjustment].

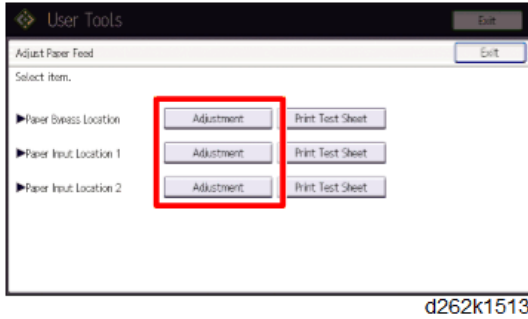

10. Enter the adjustment value, and touch [OK].

Note

- Touch the Up or Down button to adjust the Top Margin and the Left or Right button to adjust the Left Margin.

11. Touch [Exit].
12. Touch [User Tools] on the top right of the screen.
13. Touch [Home] at the bottom of the screen in the center.

Prevent Paper Abrasion

When printing on an extremely thick or thin paper, the printed image may get dirty because the paper rubs the print heads or ink blurs. To avoid this, adjust the height of the print heads for each paper supply location

- Off: Head Height Standard
- Weak: Head Height Higher
- Strong: Head Height Highest

★ Important

- As the print quality may deteriorated, this function should be enabled only when paper abrasion is distinct.

↓ Note

- If Film (Matte) is selected for the paper type, prevent paper abrasion is automatically enabled.

1. Touch [Home] at the bottom of the operation panel in the center.
2. Flick the screen to the left and touch [Initial Settings].
3. Touch [Machine Features].
4. Touch [System Settings].
5. Check that the General Features tab is selected.
6. Touch [Prevent Paper Abrasion].

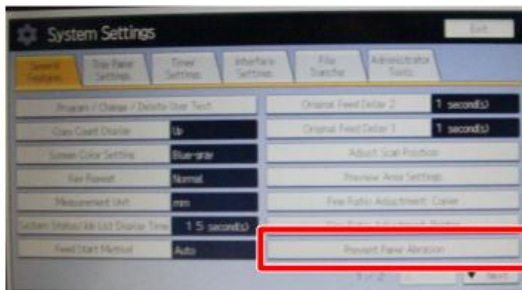

d262k1514

7. Set Prevent Paper Abrasion for the paper supply location.
8. Touch [OK].

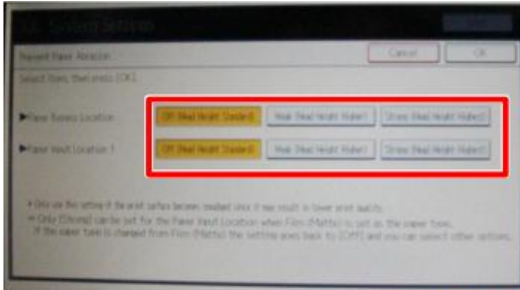

d262k1515

9. Touch [Exit].
10. Touch [User Tools] on the top right of the operation panel.
11. Touch [Home] at the bottom of the operation panel in the center.

Electrical Components

Boards

Block Diagram

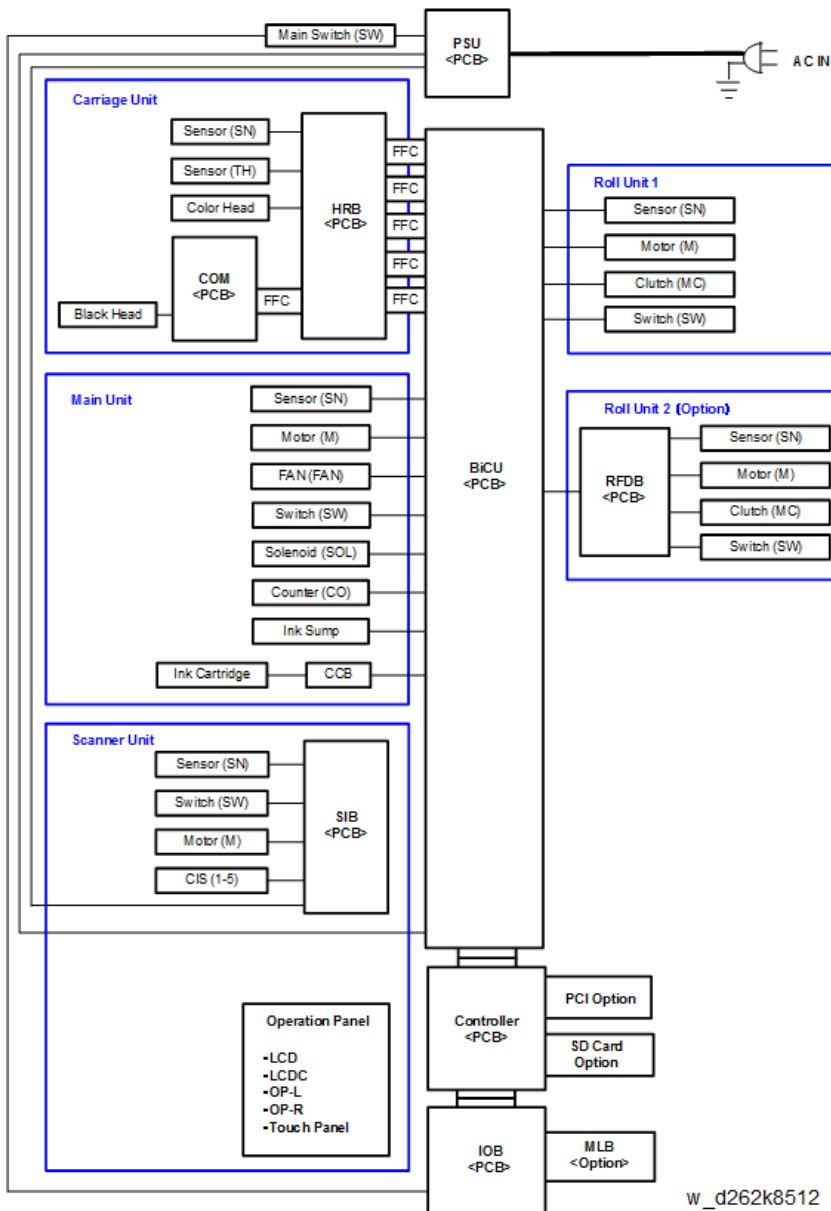

w_d262k8512

Parts Layout

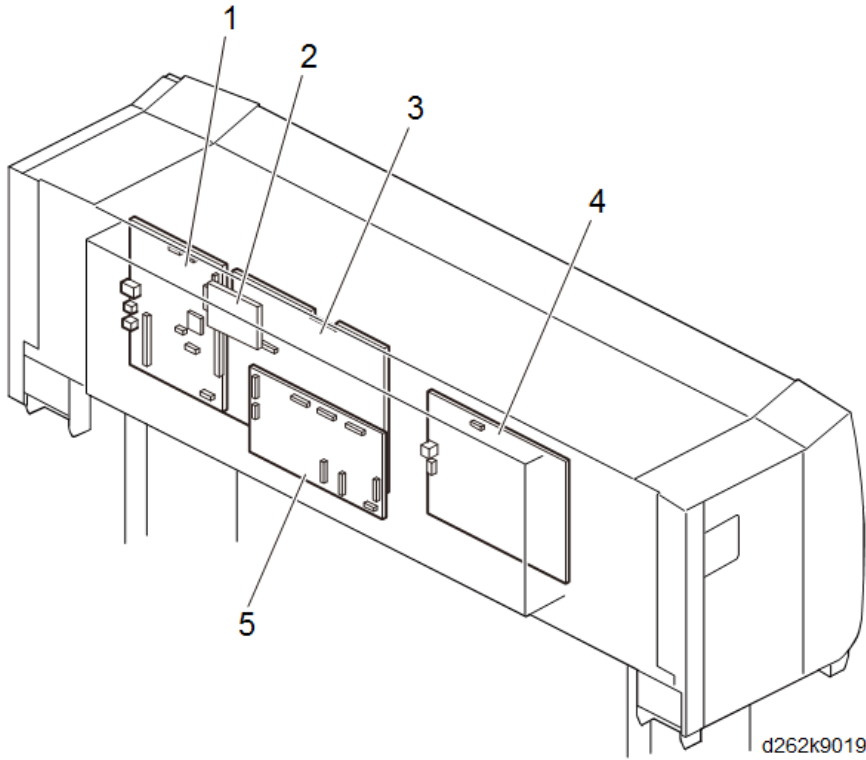

7

No.	Component	No.	Component
1	Controller Board	4	PSU
2	HDD	5	IOB
3	BiCU		

SIB (Scanner I/F Board)

The SIB is located at the left back of the scanner unit. It controls the CIS, scanner motor, and sensors on the scanner motor, and relays the signals.

The CIS reads image data, which are then converted from analog to digital and sent to the BiCU.

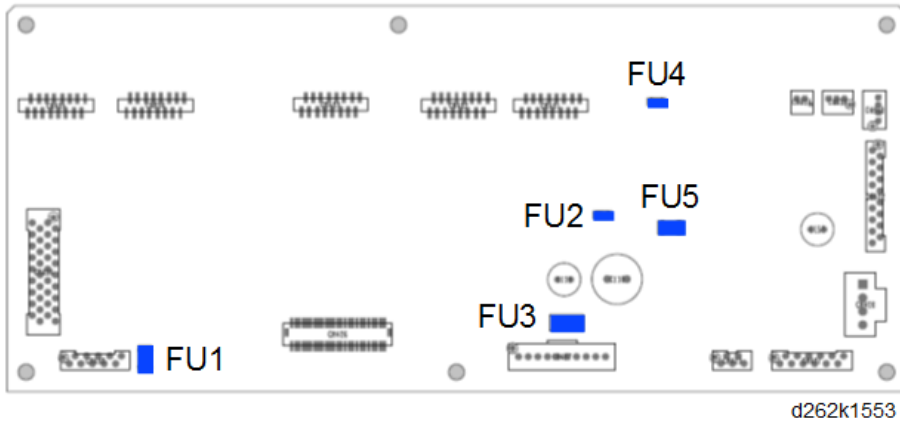

Controller Board

The controller board is located on the left in the PCB box and controls the machine. This board controls the MFP system.

The built-in flash ROM stores various firmware for controlling the machine and security functions, such as encryption and certification.

The printer and scanner functions can be expanded, using the optional slots (interface/SD card).

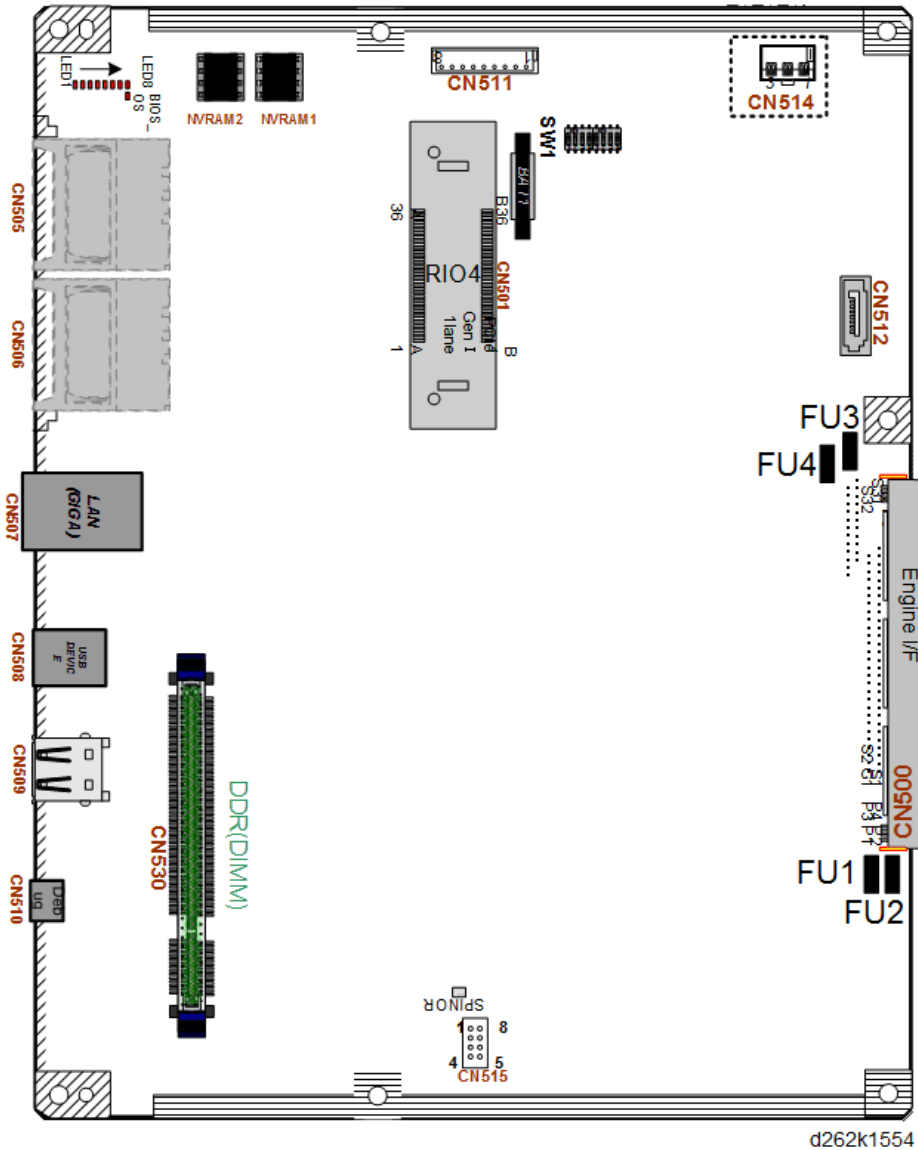

Electrical Components for the Controller

Item	Function
Memory	Functions as the program operation area for copying, printing, and SDK, and the data processing area for image processing. Capacity: 4096 MB (common for all models)
NV-RAM	Functions as the total counter. Also functions as a storage area for part of the initial settings and SP settings.

Item	Function
SD card	<p>Used for optional functions.</p> <p>There are two SD card slots.</p> <ul style="list-style-type: none"> • OCR Unit Type M13 • Data Overwrite Security Unit Type M19

IOB (Input/Output Board)

The IOB is located at the center front of the PCB box and installed horizontally.

It functions as the interface for data transmission and power supply to the paper supply module and scanner module.

It controls the driver for paper supply, head lift, maintenance motor, ink supply and ink drop detection.

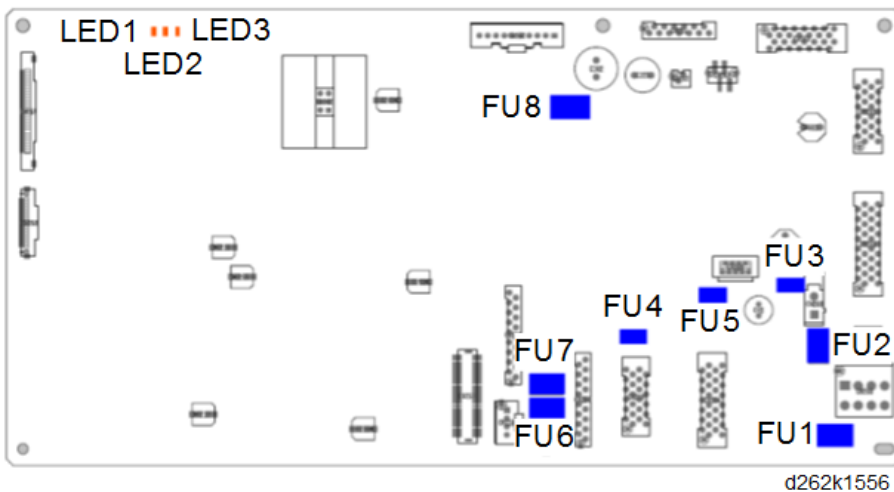

HDD

The HDD is located at the upper left front of the BiCU in the PCB box.

It is used for saving the data listed below (capacity: 320 GB).

Area	Data
Partition 1 (UNIX-FS)	<ul style="list-style-type: none"> • Thumbnail image • Address book • Debug log • TX/RX mail • Job spool save • Print data area Data stored before RIP processing Media print thumbnail images Media print preview images Media print print data (temporarily)
Partition 2 (raw)	<ul style="list-style-type: none"> • Local storage Document box images Sample/Located/Hold/Stored Print documents <ul style="list-style-type: none"> • Tentative electronic sorting for copying • Scanning area (2 GB max.) • Electric sorting for printing • Fixed stamp image, halftone pattern, storing copy data for print

BiCU (Base image Control Unit)

The BiCU is located at the back of the IOB in the PCB box.

The BiCU controls the system, base engine, and scanner, sends the load signal of the base engine (high-voltage power supply, motors, sensors, solenoids, and clutches) and scanner (sensor and motor), and supplies power as IO.

It also performs image processing. After processing image data sent from the CIS, the BiCU sends the processed data to the head through IOB and HRB.

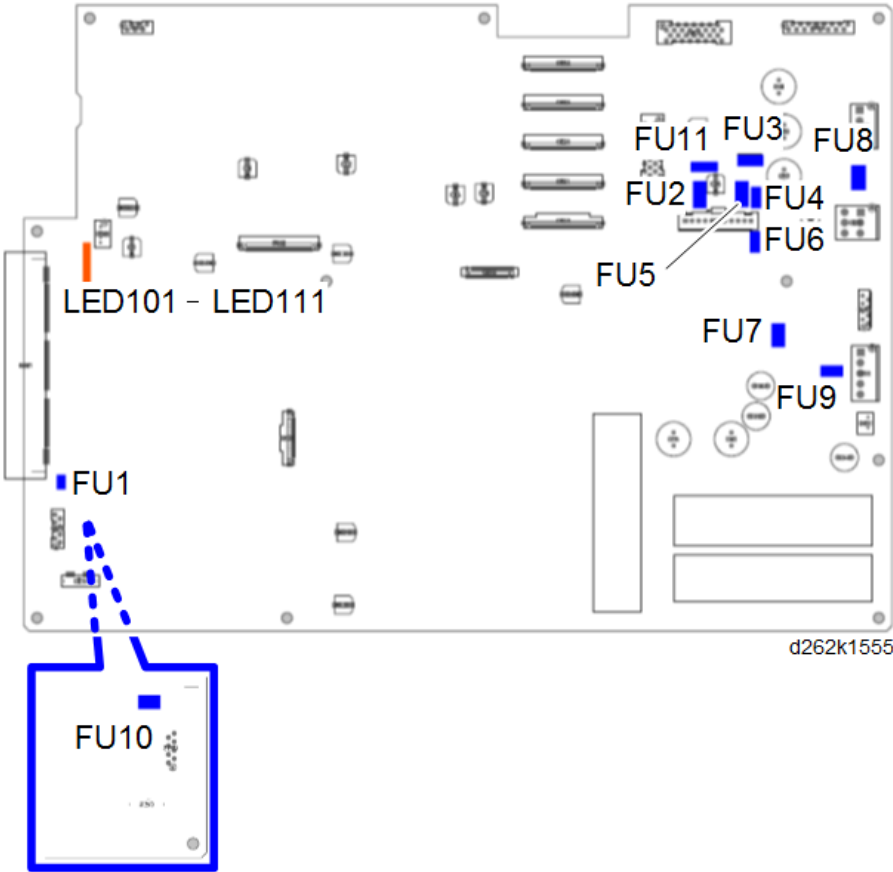

PSU (Power Supply Unit)

The PSU is located at right in the PCB box.

DC voltage is loaded to the main unit.

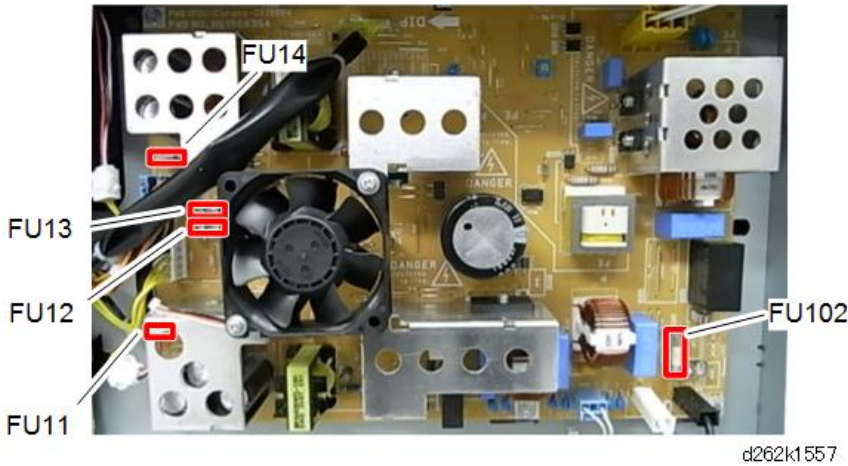

Option

File Format Converter Type M23 (MLB)

The following values apply when File format converter is installed. When Using the E-mail, Folder Sending, Storing, or Network Delivery Functions If File format converter is not installed, any size up to 2700 mm at 600 dpi can be scanned.

1. Copier, Printer related
No limitations (both color and B/W)
2. Scanner related
B/W:

	Resolution	Length	Maximum length
Not installed	600 dpi	2.7 m	2,774 mm
	400 dpi	4.1 m	4,161 mm
	300 dpi	5.5 m	5,548 mm
	200 dpi	8.3 m	8,323 mm
	150 dpi	11.0 m	11,097 mm
Installed	600 dpi	15 m	

Color: JPEG

	Resolution	Length	Maximum length
Regardless of whether installed or not installed	600 dpi	2.7 m	2,774 mm
	400 dpi	4.1 m	4,161 mm
	300 dpi	5.5 m	5,548 mm
	200 dpi	8.3 m	8,323 mm
	150 dpi	11.0 m	11,097 mm

Note

- The scanning length with PDF files is 5.08m, regardless of whether or not the File Format Converter is installed. This is due to a limitation with the PDF1.4 format itself.

3. Document Server related

B/W:

If the File Format Converter is installed, it is possible to print out stored documents using reduction/enlargement.

Note

- The maximum size to which these documents may be enlarged is A0/E (which is A4 x 400%).

The image density cannot be adjusted, regardless of whether the File Format Converter is installed.

Color:

Neither image density adjustment nor reduction/enlargement are possible, regardless of whether the File Format Converter is installed.

4. File import

When the File Format Converter is installed, it is possible to import Copier and Printer files from the Document server to a PC (color and B/W).

5. Capture related

This feature is not supported, regardless of whether or not the File Format Converter is installed.

Energy Save

Energy Save Mode

This machine has the following energy saving functions.

Low Power mode

If you do not use the machine for a certain period after an operation, the display will turn off and the machine goes into Low Power mode. The machine uses less electricity in Low Power mode.

You can change the amount of time that the machine waits before switching to Low Power mode under [Low Power Mode Timer].

You can change the machine's settings to enter Low Power mode when you press [Energy Saver].

To exit Low Power mode, touch the display panel.

Sleep mode

If the machine remains inactive for a specified period or [Energy Saver] is pressed, it enters Sleep mode to further reduce the electricity it consumes.

You can change the amount of time that the machine waits before switching to Sleep mode under [Sleep Mode Timer].

To exit Sleep mode, touch the display panel.

Note

- When a machine is in Low Power mode, the main power indicator is lit. In Sleep mode, the main power indicator flashes slowly.
- The energy saving functions will not operate in the following cases:
 - When operations are suspended during printing
 - When a warning message appears
 - When paper is jammed
 - When the Data In indicator is lit or flashing
- The machine does not enter Low Power mode or Sleep mode in the following cases:
 - During communication with external equipment
 - When the hard disk is active
 - When the service call message appears
 - When the machine's cover is opened
 - When the "Add Ink" message appears
 - When ink is being replenished
 - When one of the following screens is displayed:

- Machine Features
- Counter
- Inquiry
- Address Book Management
- Tray Paper Settings
- When data is being processed
- When a recipient is being registered in the address list
- When the sample print, locked print, hold print, or stored print screen is displayed
- When the screen of a document that was stored under the printer function appears (The machine enters Low Power mode if this happens)
- When accessing the machine using Web Image Monitor
- When the internal cooling fan is active
- When the machine's covers are open

Specification

EU

	Specification
Reduced electrical consumption in Low Power mode * 1	45.0 W
Time of switch into Low Power mode	1 minute
Time of switch out from Low Power mode * 1	1.3 seconds
Reduced electrical consumption in Sleep mode * 1	0.83 W
Time of switch into Sleep mode	14 minutes
Time of switch out from Sleep mode * 1	3.5 seconds

* 1 The time it takes to switch out from energy saving functions and electrical consumption may differ depending on the conditions and environment of the machine.

NA

	Specification
Reduced electrical consumption in Low Power mode * 1	44.4 W

	Specification
Time of switch into Low Power mode	1 minute
Time of switch out from Low Power mode * 1	1.8 seconds
Reduced electrical consumption in Sleep mode * 1	0.84 W
Time of switch into Sleep mode	14 minutes
Time of switch out from Sleep mode * 1	4.7 seconds

* 1 The time it takes to switch out from energy saving functions and electrical consumption may differ depending on the conditions and environment of the machine.

Note

- Specifications can vary depending on which options are installed on the machine.
- The machine enters sleep mode directly in the following situations:
 - Low Power Mode Timer and Sleep Mode Timer are set to the same time
 - Sleep Mode Timer is set shorter than Low Power Mode Timer
- Depending on which embedded software application is installed on it, the machine might take longer than indicated to enter Sleep mode.

MEMO

MEMO

MP CW2201

**Machine Code:
D262**

Appendices

March, 2016

TABLE OF CONTENTS

1. Specifications

Specifications.....	3
General Specifications.....	3
Printer Specifications.....	8
Scanning Specifications.....	10
Option Specifications.....	12
Roll Feed Units.....	12

2. Preventive Maintenance Tables

Maintenance Tables.....	13
Key for PM Table.....	13
PM Table: Main Machine.....	13

3. SP Mode Tables

Service Program Mode.....	17
Main SP Tables-1.....	18
SP1-XXX.....	18
Main SP Tables-2.....	26
SP2-XXX.....	26
Main SP Tables-3.....	60
SP3-XXX.....	60
Main SP Tables-4.....	74
SP4-XXX.....	74
Main SP Tables-5.....	82
SP5-XXX.....	82
Main SP Tables-6.....	133
SP6-XXX.....	133
Main SP Tables-7.....	134
SP7-XXX.....	134
Main SP Tables-8.....	193
SP8-XXX.....	193
Printer Service Mode.....	244
Printer Service Mode.....	244
Scanner Service Mode.....	260
SP-1XXX System and Others.....	260

SP2-XXX Scanning Image Quality.....	262
Input and Output Check.....	264
Input Check Table (SP5-803).....	264
Output Check Table (SP5-804).....	267

1. Specifications

Specifications

General Specifications

Configuration	Console	
Printing Method	On-demand piezo inkjet system	
Color	Monochrome, Full Color Printing	
Nozzle Numbers	192 nozzles x 2 lines = 384 nozzles Black (K): 768, Color (Y, C, M): 192 each	
Memory	4 GB	
HDD Capacity	295 GB	
Originals		
Type	Sheet	
Thickness	Recommended	0.090 to 0.2 mm (64 to 190 g/m ²)
	Possible	0.035 to 1.0 mm ^{*1}
Scan Method	Face-down, center set	
Delivery	Top stacker or straight-through ^{*2}	
Size (W x L)	Max.	914.4 x 15,000 mm (36 x 591 in.) ^{*3}
	Min.	210 x 210 mm (8.3 x 8.3 in.)
^{*1}	Quality is not guaranteed. A carrier sheet is required for paper less than 0.07 mm thick.	
^{*2}	The original guide should be removed for originals thicker than 135 g/m ² so they can exit the back of the scanner unit.	
^{*3}	<ul style="list-style-type: none">• An original up to 960 mm (37.8") wide can pass through the scanning unit but scanned width is limited to 914.4 mm (36").• Width detection of Arch, ANSI sizes possible at same time.	

Paper		
Feed Method	Roll paper, cut sheets (bypass feed only)	
Paper Type	Normal, recycled, ink jet standard, tracing paper, matte film, coated paper (CAD), coated paper, special paper	
Paper Thickness	Roll	0.068 to 0.2 mm, 51 to 200 g/m ²
	Sheet	0.068 to 0.4 mm, 51 to 220 g/m ²
Paper Rolls	Core diameter	2 in./3 in. *1
	Circumference	Less than 176 mm (7 in.)
Width *2	mm	297, 364, 420, 440, 490, 515, 594, 610, 620, 625, 660, 680, 707, 728, 800, 841, 880, 914
	in.	11, 12, 13.4, 15, 17, 18, 22, 24, 30, 34, 36 in.
Paper Size W x L	Max.	914.4 x 15,000 mm (36 x 590 in.) *3
	Min.	279.4 x 210 mm (11 x 8.3 in.)
	Bypass	Max. length: 2,000 mm (79 in.)
Image Borders	Roll	Less than 3 mm (all edges)
	Bypass	Leading edge: Less than 3 mm Trailing edge: Less than 18 mm *4 Left/right edges: Less than 3 mm
Straight Line Deviation	Vertical	Less than ±1/184 mm
	Horizontal	Less than ±2/841 mm
	Angle	Less than 1/200 mm
*1 Roll holders easy to adjust for 2-in. or 3-in. roll cores.		
*2 The machine can handle Middle Eastern paper sizes (450, 600, 900 mm) but they cannot be recognized by the firmware.		
*3 The maximum length applies to normal and recycled paper only. For other types of paper the maximum length is 3,600 mm (142 in.).		
*4 Trailing edge is less than 21 mm for the following: special paper (color/standard mode, color/quality mode), matte film (color/quality mode), tracing paper (color/quality mode).		

Resolution*¹	
Scanning	600 dpi
Copying	600 dpi
* ¹ Resolution is determined by the speed/quality selection in the printer driver. For more details, please refer to the operating instructions.	
Warm-up Time	Less than 40 sec. at 23°C (73.4°F).
Recovery	7 sec. (from Sleep Mode)
LCD Recovery	3 sec. (from Low Power Mode)

First Copy	A0 SEF	High Speed	BW: 51 sec. FC: 81 sec.
		Standard	BW: 71 sec. FC: 155 sec.
	A1 LEF	High Speed	BW: 29 sec. FC: 53 sec.
		Standard	BW: 41 sec. FC: 84 sec.

Continuous Copy Speed

	A0 SEF	High Speed	BW: 1.9 cpm FC: 1.1 cpm
		Standard	BW: 1.1 cpm FC: 0.6 cpm
	A1 LEF	High Speed	BW: 3.8 cpm FC: 2.1 cpm
		Standard	BW: 2.0 cpm FC: 1.2 cpm

Continuous Copy Speed*¹ (After Recovery)

	A1 LEF	High Speed	BW: 102 sec. FC: 183 sec.
		Standard	BW: 167 sec. FC: 288 sec.
	D Size LEF	High Speed	BW: 110 sec. FC: 189 sec.
		Standard	BW: 178 sec. FC: 313 sec.

*¹ Time (sec.) required to print 5 continuous copies after recovery from the energy save mode.

Magnification	
Fixed	

Engineering (NA)	25.0%, 32.4%, 50.0, 64.7%, 100.0%, 129.4%, 200.0%, 258.8%, 400.0%
Architecture (NA)	25.0%, 33.3%, 50.0%, 66.7%, 100.0%, 133.3%, 200.0%, 266.7%, 400.0%
Other	25.0%, 35.4%, 50.0%, 70.7%, 100.0%, 141.4%, 200.0%, 282.8%, 400.0%
Zoom	25.0% to 400.0% (0.1% Steps)
Magnification Difference	100 to 400%: less than $\pm 0.5\%$ 99.9 to 50%: less than $\pm 0.7\%$ 49.9 to 25%: less than $\pm 1.0\%$
Magnification Deviation	Less than $\pm 0.1\%$
Continuous Copies	1 to 99
Languages	
North America	English, French, Spanish, Portuguese (Brazil)
Europe/Oceania	English, German, French, Italian, Spanish, Dutch, Swedish, Norwegian, Danish, Czech, Hungarian, Finnish, Portuguese, Polish, Russian, Catalan, Turkish, Greek
China	Chinese (simplified characters), English

Paper Feed			
Paper Input	Std.	1 paper roll + bypass feed	
	Max.	2 paper rolls + bypass feed (1 roll option)	
Paper Cutting (Roll)			
		Std. Cut	Synchro Cut
		23°C, 50%	23°C, 50%
Standard	297 mm	± 2.0 mm	± 3.5 mm
	420 mm	± 3.5 mm	± 4.0 mm
	594 mm	± 3.5 mm	± 4.0 mm

	841 mm	±3.5 mm	±4.5 mm
	1219 mm	±3.5 mm	±6.0 mm
Long Size	2 m	±4.5 mm	±12.0 mm
	3 m	±9.0 mm	±18.0 mm
	3.6 m	±11.0 mm	±22.0 mm
	15 m	±150 mm	±150 mm

Ink			
Ink Type	Water-resistant pigment ink		
Supply Method	Ink cartridge, pump tube system		
Ink Cartridges	Colors	K, C, Y, M	
	Capacity	K	200 cc
		C	100 cc
		Y	100 cc
		M	100 cc
Waste Ink Collection			
Left Sump	Capacity	500 cc	
Right Sump	Capacity	147 cc	
Ink Collector	Capacity	1000 cc	

Exit Stacker (Stack Mode)			
Stack Mode	Paper	A0 SEF, A1 LEF, A2 SEF	
	Capacity	10 sheets	A0 SEF/A1 LEF
		10 sheets	A1 SEF/A2 LEF
Basket Mode	1 sheet		

Power Source Required	
------------------------------	--

North America	120-127V 15A 60 Hz
Europe/Asia/China	220-240V 8A 50/60 Hz

Power Consumption	Ave.	Less than 100W	
	Max.	Less than 180W	
Sleep Mode	Less than 1.1W		
Low Power Mode	Less than 80W	EU, Asia, China	
	Less than 70W	NA	
Dimensions (w x d x h)	1384 x 1022 x 1214 mm (54.5 x 40.2 x 48 in.)		
Weight	Less than 120 kg (264 lb.)		

Environment			
Sound Power Level	Standby	40 dB or less	
	Copying	B&W	68 dB or less
FC		66 dB or less	
Sound Pressure Level	Standby	36 dB or less	
	Copying	B&W	60 dB or less
		FC	60 dB or less
Ozone Emission	None		

Printer Specifications

Ink	Pigment based YMCK		
Interface			
Standard	Ethernet(1000BASE-T/100BASE-TX/10BASE-T), USB2.0, SD card slot		
Options	Wireless LAN (IEEE802.11a/b/g/n*1), Gigabit Ethernet		

*1 IEEE802.11a/b only in Europe, and wireless LAN not supported in China.			
Print Resolution	Determined by driver selection		
	High Speed	600 x 300 dpi (default)	
	Standard	600 x 600 dpi	
	Quality	1200 x 1200 dpi	
Print Speed		BW	Color
	A0 SEF	High Speed	1.9 ppm
		Standard	1.1 ppm
	A1 LEF	High Speed	3.8 ppm
		Standard	2.0 ppm

First Print*1			
D124 (A0)	A0 SEF	High Speed	BW: 51 sec. FC: 83 sec.
		Standard	BW: 75 sec. FC: 143 sec.
	A1 LEF	High Speed	BW: 31 sec. FC: 55 sec.
		Standard	BW: 44 sec. FC: 77 sec.
*1 Time elapsed from when the machine receives the print job start command in standby mode until the sheet is cut and stacked (roll stops rotating).			

Printer Drivers	PS3, HDI
Supported Languages	RP-GL/GL2, PS3, PDF, RTIFF
Operating Systems	Windows Vista/7/8/8.1, Windows Server 2003/2003 R2/2008/2008 R2/2012/2012 R2, OS X 10.7 or later
Protocols	TCP/IP (IPv4, IPv6)
Built-in Fonts	136 Roman fonts (standard), Euro currency compatible
Interfaces	

Standard	<ul style="list-style-type: none"> • Ethernet (1000BASE-T/100Base-TX/10Base-T) • USB2.0 • SD card slot • USB Host (built-in)
Option	<ul style="list-style-type: none"> • IEEE802.11 a/b/g/n Wireless LAN*¹ • IEEE802.11b Wireless LAN (Europe)
* ¹ Wireless LANs not compatible in China.	

Scanning Specifications

Scanning Method	Original transport under CIS sensor array	
Illumination	LED array, RGB method for full color and black-and-white scanning	
Scanning Resolution	600 dpi (150/200/300/400/600 dpi)	
RGB Support	Standard	
Gradation		
Monochrome	1-bit (2 steps)	
Grayscale	8-bit (256 steps)	
Full Color	24-bit (RGB 256 steps), 8-bit (RGB 256 steps)	
Scanning Length (at 600 dpi)		
Black-and-White	Max.	914.4 x 15,000 mm (36 x 591 in.)* ¹
	Min.	210 x 210 mm (8.3 x 8.3 in.)
Full Color	Max.	914.4 x 2,774 mm (36 x 109 in.)
	Min.	210 x 210 mm (8.3 x 8.3 in.)
* ¹ 15,000 mm (50 ft.) with File Format Converter (MLB) installed. 2,774 mm (9 ft.) without File Format Converter installed.		
Scanning Speed		
Black-and-White	Resolution	Speed

	600 dpi	80 mm/s
	200 dpi	160 mm/s
Full Color	600 dpi	26.7 mm/s
	200 dpi	40 mm/s

Interfaces	
Standard	<ul style="list-style-type: none"> • Ethernet (1000BASE-T/100Base-TX/10Base-T) • USB2.0 (SD card slot) • USB Host (built-in)
Option	<ul style="list-style-type: none"> • IEEE802.11 a/b/g/n Wireless LAN*¹ • IEEE802.11 b Wireless LAN (Europe)
* ¹ Wireless LANs not compatible in China.	

Mail TX	
Scanning Speed	150, 200, 300, 400, 600 dpi
Protocol	SMTP
Output Format	TIFF (single/multi), JPEG PDF (single/multi, high-compression)
File TX	
Scanning Speed	150, 200, 300, 400, 600 dpi
Protocol	SMB, FTP
Output Format	TIFF (single/multi), JPEG PDF (single/multi, high-compression)
Network TWAIN Scanning	
Scanning Speed	150 to 1200 dpi (adjustable in 1 dpi steps)
Protocols	TCP/IP
Operating Systems	Windows Vista/7/8/8.1, Windows Server 2003/2003 R2/2008/2008 R2/2012/2012 R2

Option Specifications

1

Roll Feed Units

These specifications for Roll Unit 1 (Standard) and Roll Unit 2 (option) are the same.

Power Source	From main machine
Dimensions (w x d x h)	1108 x 432 x 398 mm (43.6 x 17 x 15.7 lb.)
Weight	14.5 kg (32 lb.)

2. Preventive Maintenance Tables

Maintenance Tables

Key for PM Table

Item	Meaning		
A	Adjust		
C	Clean		
I	Inspect		
L	Lubricate		
R	Replace		
K	K = 1,000		
PM	Machine site visit, scheduled or as needed.		
	Meters	Feet	Sqf
5K m	5,000	16,404	45,250
10K m	10,000	32,800	90,500
20K m	20,000	65,600	181,000
30K m	30,000	98,400	271,500

PM Table: Main Machine

★ Important

- The PM intervals of parts may vary, depending on the amount of coverage in prints and the color usage ratio. The expected color ratio for this machine is 9:1 (9 black-and-white prints for every 1 color print.)

	Item	5K m	10K m	20K m	30K m	EM
Scanner Unit						

	Item	5K m	10K m	20K m	30K m	EM
1	Exposure Glass					I, C
2	Original Width Sensors				C	
3	Original Feed Roller					C
4	Original Exit Roller					C
5	White Plate					I, C
6	CIS Lens					C
Horizontal Unit						
7	Black Print Head Unit (K1, K2)					R
8	Color Print Head Unit (C, YM)					R
9	Horizontal Encoder					C
10	DRESS Sensor		C			
Maintenance Unit						
11	Maintenance Unit				R	
Waste Ink Collection						
12	Ink Collector Tank	R				
13	Right Ink Sump				I	
14	Left Ink Sump				R	
Ink Supply						
15	Ink Tube Guide		C			
Paper Feed						
16	Platen		C			C
17	Paper Feed Rollers		C			
Vertical Unit						
18	Vertical Encoder					C
Auto Nozzle Check						

	Item	5K m	10K m	20K m	30K m	EM
19	Auto Nozzle Check Unit					R
20	Electrode					C
21	Wiper					C

Notes

Refer to the next section for more details.

1	Exposure Glass. Optical glass cleaner, damp cloth.
2	Original Width Sensors. Blower brush.
3	Original Feed Roller. Alcohol, damp cloth, dry cloth.
4	Original Exit Roller. Alcohol, damp cloth, dry cloth.
5	White Plate. Alcohol, damp cloth, dry cloth.
6	CIS Lens. Lens paper, alcohol.
7	Black Print Head Unit. Replace when necessary. After replacement, do Nozzle Check pattern, head cleaning, head flushing.
8	Color Print Head Unit. Replace when necessary. After replacement, do Nozzle Check pattern, head cleaning, head flushing.
9	Horizontal Encoder. Clean cloth dampened with alcohol, dry cloth.
10	DRESS Sensor. Clean with clean white cloth. Note: The recommended cleaning interval is 10Km. However, if the operator is frequently printing on tracing paper, or frequently using Quality mode printing, cleaning every 5Km is recommended.
11	Maintenance Unit. Use a dry linen cloth to clean around the lips of the suction cup and print head caps.
12	Ink Collector Tank. Swap with new ink collector tank.
13	Right Ink Sump. Never attempt to empty it and re-use it.
14	Left Ink Sump. Use a dry linen cloth to clean the gate of the sump. You may need to use the tip of a small screwdriver to remove hardened ink.
15	Ink Tube Guide. Use a damp cloth to clean the areas where the guide is rubbing.

16	Platen. Use a linen cloth dampened slightly with water to clean the surface of the platen. Use a blower brush to clean the holes of the plates to clear any clogging.
17	Paper Feed Rollers. Use a linen cloth dampened with alcohol to clean the surfaces of the rollers.
18	Vertical Encoder. Use a linen cloth dampened with alcohol to clean the edge of the vertical encoder wheel.
19	Auto Nozzle Module. Replace when necessary.
20	Electrode. Use a damp cloth to clean.
21	Wiper. Use a damp cloth to clean.

3. SP Mode Tables

Service Program Mode

Notation	What it means
[range/default step]	Example: [-9 to +9/+3.0/0.1 mm]. <ul style="list-style-type: none">• Setting can be adjusted in the range ± 9• Default: +3.0. Value reset to default after an NVRAM reset• Value is changed in 0.1 mm steps with each key push.
DFU	"Design or Factory Use". Do not change this value. The factory default setting provides optimum performance.
CTL	Means "controller". This is used to denote SP codes related to the GW+ controller.
Not Used	These SP's appear in the SP mode menus but these codes are not used because: <ul style="list-style-type: none">• Currently the feature is not available for the main machine, or its use has been discontinued.• The SP is intended for use with a peripheral that is currently under development but not available at this time.• Executing these SP's has no effect on operation of the main machine or any peripheral device.
Japan Only	This feature or item is for Japan only. Do not change this value.

★ Important

- Always cycle the machine off/on after changing an SP setting.

Main SP Tables-1

SP1-XXX

3

1001	Print Position Adj (Top Edge)
1	By-pass Feed
	[-2 to 2/ 0.0 /0.1 mm]
2	Paper Input 1
	[-2 to 2/ 0.0 /0.1 mm]
3	Paper Input 2
	[-2 to 2/ 0.0 /0.1 mm]

1002	Print Position Adj (Left Edge)
1	By-pass Feed
	[-10 to 10/ 0.0 /0.1 mm]
2	Paper Input 1
	[-10 to 10/ 0.0 /0.1 mm]
3	Paper Input 2
	[-10 to 10/ 0.0 /0.1 mm]
7	By-pass Input (Paper Edge)
	[0 to 65535 / 0 / 1]
8	Paper Input 1 (Paper Edge)
	[0 to 65535 / 0 / 1]
9	Paper Input 2 (Paper Edge)
	[0 to 65535 / 0 / 1]

1830	Sub Scan Feed Ad (Special) - Thin
	[-400 to 400/01]
1	Applying Size 1/Rem1/Thin
2	Applying Size 1/Rem2/Thin
3	Applying Size 1/Rem3/Thin
4	Applying Size 1/Rem4/Thin
5	Applying Size 1/Rem5/Thin
6	Applying Size 1/Rem6/Thin
7	Applying Size 1/Rem7/Thin
8	Applying Size 2/Rem1/Thin
9	Applying Size 2/Rem2/Thin
10	Applying Size 2/Rem3/Thin
11	Applying Size 2/Rem4/Thin
12	Applying Size 2/Rem5/Thin
13	Applying Size 2/Rem6/Thin
14	Applying Size 2/Rem7/Thin
15	Applying Size 3/Rem1/Thin
16	Applying Size 3/Rem2/Thin
17	Applying Size 3/Rem3/Thin
18	Applying Size 3/Rem4/Thin
19	Applying Size 3/Rem5/Thin
20	Applying Size 3/Rem6/Thin
21	Applying Size 3/Rem7/Thin
22	Applying Size 4/Rem1/Thin
23	Applying Size 4/Rem2/Thin
24	Applying Size 4/Rem3/Thin

25	Applying Size 4/Rem4/Thin
26	Applying Size 4/Rem5/Thin
27	Applying Size 4/Rem6/Thin
28	Applying Size 4/Rem7/Thin

1831	Sub Scan Feed Ad (Special) - Normal
	[-400 to 400/01]
1	Applying Size 1/Rem1/Normal
2	Applying Size 1/Rem2/Normal
3	Applying Size 1/Rem3/Normal
4	Applying Size 1/Rem4/Normal
5	Applying Size 1/Rem5/Normal
6	Applying Size 1/Rem6/Normal
7	Applying Size 1/Rem7/Normal
8	Applying Size 2/Rem1/Normal
9	Applying Size 2/Rem2/Normal
10	Applying Size 2/Rem3/Normal
11	Applying Size 2/Rem4/Normal
12	Applying Size 2/Rem5/Normal
13	Applying Size 2/Rem6/Normal
14	Applying Size 2/Rem7/Normal
15	Applying Size 3/Rem1/Normal
16	Applying Size 3/Rem2/Normal
17	Applying Size 3/Rem3/Normal
18	Applying Size 3/Rem4/Normal
19	Applying Size 3/Rem5/Normal

20	Applying Size 3/Rem6/Normal
21	Applying Size 3/Rem7/Normal
22	Applying Size 4/Rem1/Normal
23	Applying Size 4/Rem2/Normal
24	Applying Size 4/Rem3/Normal
25	Applying Size 4/Rem4/Normal
26	Applying Size 4/Rem5/Normal
27	Applying Size 4/Rem6/Normal
28	Applying Size 4/Rem7/Normal

1832	Sub Scan Feed Ad (Special) - Semi Thick
	[-400 to 400/01]
1	Applying Size 1/Rem1/Semi Thick
2	Applying Size 1/Rem2/Semi Thick
3	Applying Size 1/Rem3/Semi Thick
4	Applying Size 1/Rem4/Semi Thick
5	Applying Size 1/Rem5/Semi Thick
6	Applying Size 1/Rem6/Semi Thick
7	Applying Size 1/Rem7/Semi Thick
8	Applying Size 2/Rem1/Semi Thick
9	Applying Size 2/Rem2/Semi Thick
10	Applying Size 2/Rem3/Semi Thick
11	Applying Size 2/Rem4/Semi Thick
12	Applying Size 2/Rem5/Semi Thick
13	Applying Size 2/Rem6/Semi Thick
14	Applying Size 2/Rem7/Semi Thick

15	Applying Size 3/Rem1/Semi Thick
16	Applying Size 3/Rem2/Semi Thick
17	Applying Size 3/Rem3/Semi Thick
18	Applying Size 3/Rem4/Semi Thick
19	Applying Size 3/Rem5/Semi Thick
20	Applying Size 3/Rem6/Semi Thick
21	Applying Size 3/Rem7/Semi Thick
22	Applying Size 4/Rem1/Semi Thick
23	Applying Size 4/Rem2/Semi Thick
24	Applying Size 4/Rem3/Semi Thick
25	Applying Size 4/Rem4/Semi Thick
26	Applying Size 4/Rem5/Semi Thick
27	Applying Size 4/Rem6/Semi Thick
28	Applying Size 4/Rem7/Semi Thick

1833	Sub Scan Feed Ad (Special) – Thick 1
	[-400 to 400/01]
1	Applying Size 1/Rem1/Thick 1
2	Applying Size 1/Rem2/Thick 1
3	Applying Size 1/Rem3/Thick 1
4	Applying Size 1/Rem4/Thick 1
5	Applying Size 1/Rem5/Thick 1
6	Applying Size 1/Rem6/Thick 1
7	Applying Size 1/Rem7/Thick 1
8	Applying Size 2/Rem1/Thick 1
9	Applying Size 2/Rem2/Thick 1

10	Applying Size 2/Rem3/Thick 1
11	Applying Size 2/Rem4/Thick 1
12	Applying Size 2/Rem5/Thick 1
13	Applying Size 2/Rem6/Thick 1
14	Applying Size 2/Rem7/Thick 1
15	Applying Size 3/Rem1/Thick 1
16	Applying Size 3/Rem2/Thick 1
17	Applying Size 3/Rem3/Thick 1
18	Applying Size 3/Rem4/Thick 1
19	Applying Size 3/Rem5/Thick 1
20	Applying Size 3/Rem6/Thick 1
21	Applying Size 3/Rem7/Thick 1
22	Applying Size 4/Rem1/Thick 1
23	Applying Size 4/Rem2/Thick 1
24	Applying Size 4/Rem3/Thick 1
25	Applying Size 4/Rem4/Thick 1
26	Applying Size 4/Rem5/Thick 1
27	Applying Size 4/Rem6/Thick 1
28	Applying Size 4/Rem7/Thick 1

1834	Sub Scan Feed Ad (Special) – Thick 2
	[-400 to 400/01]
1	Applying Size 1/Rem1/Thick 2
2	Applying Size 1/Rem2/Thick 2
3	Applying Size 1/Rem3/Thick 2
4	Applying Size 1/Rem4/Thick 2

5	Applying Size 1/Rem5/Thick 2
6	Applying Size 1/Rem6/Thick 2
7	Applying Size 1/Rem7/Thick 2
8	Applying Size 2/Rem1/Thick 2
9	Applying Size 2/Rem2/Thick 2
10	Applying Size 2/Rem3/Thick 2
11	Applying Size 2/Rem4/Thick 2
12	Applying Size 2/Rem5/Thick 2
13	Applying Size 2/Rem6/Thick 2
14	Applying Size 2/Rem7/Thick 2
15	Applying Size 3/Rem1/Thick 2
16	Applying Size 3/Rem2/Thick 2
17	Applying Size 3/Rem3/Thick 2
18	Applying Size 3/Rem4/Thick 2
19	Applying Size 3/Rem5/Thick 2
20	Applying Size 3/Rem6/Thick 2
21	Applying Size 3/Rem7/Thick 2
22	Applying Size 4/Rem1/Thick 2
23	Applying Size 4/Rem2/Thick 2
24	Applying Size 4/Rem3/Thick 2
25	Applying Size 4/Rem4/Thick 2
26	Applying Size 4/Rem5/Thick 2
27	Applying Size 4/Rem6/Thick 2
28	Applying Size 4/Rem7/Thick 2

1921	Cut Length Adjustment - Cutting Position Adjustment
------	---

1	[-10 to 10/0.0/0.1 mm]	
---	------------------------	--

1925	Cutter Simultaneous Drive Adj	
1	Cut Timing	[0.1 to 1.0 / 0.3 / 0.1]

1926	Carriage Updown Adjustment	
1	Updown Time	[-5.0 to 5.0 / 0.0 / 0.1]

1930	Manual Cut	
1	Active Roll	[0 to 2 / 1 / 1]
2	Roll 1	[0 to 2 / 1 / 1]
3	Roll 2	[0 to 2 / 1 / 1]
10	Jam	[0 or 1 / 0 / 1]

Main SP Tables-2

SP2-XXX

3

2010	User Maintenance	
	1	Cleaning
		[EXECUTE]
	2	Refreshing (Flushing)
		[EXECUTE]

2012	Initial Operation Setting	
	[0 to 10/0/1]	

2015	Auto Nozzle Check	
	1	Setting [0 to 2 / 0 / 1]
	2	Mode Memory Flag [0 to 10 / 0 / 1]

2016	Nozzle Compensation Mode Start	
	1	H1 [0 to 0xFFFFFFFF / 0 / 1]
	2	H2
	3	H3
	4	H4
	5	H5

2017	Nozzle Compensation Mode Release	
	1	- [0 to 168 / 10 / 1 hour]

2018	Nozzle Fracture Condition	
------	---------------------------	--

1	H1ODD 1-32	[0xFFFFFFFF to 0xFFFFFFFF / 0 / 1]
2	H1ODD 33-64	
3	H1ODD 65-96	
4	H1ODD 97-128	
5	H1ODD 129-160	
6	H1ODD 161-192	
7	H1EVEN 1-32	
8	H1EVEN 33-64	
9	H1EVEN 65-96	
10	H1EVEN 97-128	
11	H1EVEN 129-160	
12	H1EVEN 161-192	
13	H2ODD 1-32	
14	H2ODD 33-64	
15	H2ODD 65-96	
16	H2ODD 97-128	
17	H2ODD 129-160	
18	H2ODD 161-192	
19	H2EVEN 1-32	
20	H2EVEN 33-64	

21	H2EVEN 65-96	[0xFFFFFFFF to 0xFFFFFFFF / 0 / 1]
22	H2EVEN 97-128	
23	H2EVEN 129-160	
24	H2EVEN 161-192	
25	H3ODD 1-32	
26	H3ODD 33-64	
27	H3ODD 65-96	
28	H3ODD 97-128	
29	H3ODD 129-160	
30	H3ODD 161-192	
31	H3EVEN 1-32	
32	H3EVEN 33-64	
33	H3EVEN 65-96	
34	H3EVEN 97-128	
35	H3EVEN 129-160	
36	H3EVEN 161-192	
37	H4ODD 1-32	
38	H4ODD 33-64	
39	H4ODD 65-96	
40	H4ODD 97-128	

41	H4ODD 129-160	[0xFFFFFFFF to 0xFFFFFFFF / 0 / 1]
42	H4ODD 161-192	
43	H4EVEN 1-32	
44	H4EVEN 33-64	
45	H4EVEN 65-96	
46	H4EVEN 97-128	
47	H4EVEN 129-160	
48	H4EVEN 161-192	
49	H5ODD 1-32	
50	H5ODD 33-64	
51	H5ODD 65-96	
52	H5ODD 97-128	
53	H5ODD 129-160	
54	H5ODD 161-192	
55	H5EVEN 1-32	
56	H5EVEN 33-64	
57	H5EVEN 65-96	
58	H5EVEN 97-128	
59	H5EVEN 129-160	
60	H5EVEN 161-192	

2019

Retry Sensor Nozzle

1	H1ODD 1-32	[0 to 0xFFFFFFFF / 0 / 1]
2	H1ODD 33-64	
3	H1ODD 65-96	
4	H1ODD 97-128	
5	H1ODD 129-160	
6	H1ODD 161-192	
7	H1EVEN 1-32	
8	H1EVEN 33-64	
9	H1EVEN 65-96	
10	H1EVEN 97-128	
11	H1EVEN 129-160	
12	H1EVEN 161-192	
13	H2ODD 1-32	
14	H2ODD 33-64	
15	H2ODD 65-96	
16	H2ODD 97-128	
17	H2ODD 129-160	
18	H2ODD 161-192	
19	H2EVEN 1-32	
20	H2EVEN 33-64	

21	H2EVEN 65-96	[0 to 0xFFFFFFFF / 0 / 1]
22	H2EVEN 97-128	
23	H2EVEN 129-160	
24	H2EVEN 161-192	
25	H3ODD 1-32	
26	H3ODD 33-64	
27	H3ODD 65-96	
28	H3ODD 97-128	
29	H3ODD 129-160	
30	H3ODD 161-192	
31	H3EVEN 1-32	
32	H3EVEN 33-64	
33	H3EVEN 65-96	
34	H3EVEN 97-128	
35	H3EVEN 129-160	
36	H3EVEN 161-192	
37	H4ODD 1-32	
38	H4ODD 33-64	
39	H4ODD 65-96	
40	H4ODD 97-128	

41	H4ODD 129-160	[0 to 0xFFFFFFFF / 0 / 1]
42	H4ODD 161-192	
43	H4EVEN 1-32	
44	H4EVEN 33-64	
45	H4EVEN 65-96	
46	H4EVEN 97-128	
47	H4EVEN 129-160	
48	H4EVEN 161-192	
49	H5ODD 1-32	
50	H5ODD 33-64	
51	H5ODD 65-96	
52	H5ODD 97-128	
53	H5ODD 129-160	
54	H5ODD 161-192	
55	H5EVEN 1-32	
56	H5EVEN 33-64	
57	H5EVEN 65-96	
58	H5EVEN 97-128	
59	H5EVEN 129-160	
60	H5EVEN 161-192	

2020	Auto Nozzle Check	
1	Execute Detecting row by row of Nozzles	[0 to 255 / 0 / 1]
2	Exec. Auto Nozzle Check: No Plate Wiping	[0 to 255 / 0 / 1]

3	Reset:Freqcy,Accumulatn Count/Head Replacemt	[0 or 1 / 0 / 1]
4	Reset:Freqcy,Accumulatn Count/Md Replacemt	[0 or 1 / 0 / 1]

2021	Auto Nozzle Check	
10	Condition Auto Nozzle Check.DisableFlag(WiperErr)	[0 or 1 / 0 / 1]
11	Condition Auto Nozzle Check Replacement Flag	[0 or 1 / 0 / 1]
12	Condition Electrode Plate Discharge Flag	[0 or 1 / 0 / 1]
14	Condition Execute Elect. Plate Powerful Cleaning Flag	[0 or 1 / 0 / 1]
16	Condition Disable Auto Nozzle Check (Before Start)	[0xFF or 1 / 0 / 1]
17	Condition Disable Auto Nozzle Check (Midway)	[0xFF or 1 / 0 / 1]

2022	Auto Nozzle Check Setting	
11	Temperature Range Lower Limit	[0.0 to 55.0 / 10.0 / 0.1]
12	Temperature Range Upper Limit	[0.0 to 55.0 / 35.0 / 0.1]
13	Setting Humidity Range Lower Limit	[0.0 to 100.0 / 1.0 / 0.1]
14	Humidity Range Upper Limit	[0.0 to 100.0 / 80.0 / 0.1]
17	Number of Retry	[0 to 255 / 1 / 1]
18	Over Retrying Permit Setting	[0 to 192 / 192 / 1]

2023	Electrode Plate Wiping	
-------------	-------------------------------	--

1	Execute Elect. Plate Wiping Sequence	[0 or 1 / 0 / 1]
3	Execute Outward Only	[0 or 1 / 0 / 1]
4	Execute Wiping HP Detection	[0 or 1 / 0 / 1]
6	Reset Elect. Plate Wiping Count.	[0 or 1 / 0 / 1]

3

2024	Auto Nozzle Check Replacement	
1	Retract Carriage	[0 or 1 / 0 / 1]
2	Retract Cutter	[0 or 1 / 0 / 1]
3	Move Auto Nozzle Check Wiper	[0 or 1 / 0 / 1]
4	Reset:Freqcy,Accumulatn Count/Md Replacemt	[0 or 1 / 0 / 1]
5	Execute Elect. Plate Wiping Sequence	[0 or 1 / 0 / 1]

2025	Auto Nozzle Check Maintenance		
1	Recovery CL Upper Limit	ENG*	[0 to 255 / 6 / 1]
2025	Auto Nozzle Check Maintenance		
2	Recovery CL Continuous Count H1		[0 to 255 / 0 / 1]
3	Recovery CL Continuous Count H2		[0 to 255 / 0 / 1]
4	Recovery CL Continuous Count H3		[0 to 255 / 0 / 1]
5	Recovery CL Continuous Count H4		[0 to 255 / 0 / 1]
6	Recovery CL Continuous Count H5		[0 to 255 / 0 / 1]

2026	Soft Count Ink End Detection	
1	ON/OFF	[0 or 1 / 1 / 1]
2	Detection Threshold	[1.3 to 2.0 / 1.6 / 0.1]
3	No. of Detections (Black)	[0 to 65535 / 0 / 1]
4	No. of Detections (Cyan)	[0 to 65535 / 0 / 1]
5	No. of Detections (Magenta)	[0 to 65535 / 0 / 1]
6	No. of Detections (Yellow)	[0 to 65535 / 0 / 1]

3

2030	Extract Filling Liq Prog Mng	
1	Completed State Flag	
2	H1	
3	H2	
4	H3	
5	H4	
6	H5	
	0	1st sequence finished (initial)
	1	2nd sequence finished
	2	3rd sequence finished
	3	4th sequence finished
	4	5th sequence finished
	5	6th sequence finished
	6	Negative pressure formation incomplete
	7	Completed

2050	Air Detection Check	
1	Air Detection Sensor: Execute Check	
	[EXECUTE]	

2	Air Detection Sensor: Check Result			
	[0 to 127/0/1]			
		Bit	HT (Head Tank)	
		0	M	
		1	Y	
		2	C	
		3	K2	

2090	NV Clear at Supply Unit Exc. - Execute NV Value Clear		
	[EXECUTE]		
	[0 to 1/0/1]		

2100	Special Maintenance		
3	Fully Automated Cleaning		
	[EXECUTE]		
4	Extract Filling Liquid		
	[EXECUTE]		
5	Extract Air		
	[EXECUTE]		

2102	Maintenance Unit Exchange		
1	Reset		
	[EXECUTE]		
4	Decapping		
	[EXECUTE]		

2103	Printing Erase Margin		
------	-----------------------	--	--

1	Leading Edge (Roll Paper)
	[0 to 20/ 3 /0.1 mm]
2	Trailing Edge (Roll Paper)
	[0 to 20/ 3 /0.1 mm]
3	Left Edge (Roll Paper)
	[0 to 20/ 3 /0.1 mm]
4	Right Edge (Roll Paper)
	[0 to 20/ 3 /0.1 mm]
5	Leading Edge (By-pass)
	[0 to 20/ 3 /0.1 mm]
6	Trailing Edge (By-pass)
	[0 to 20/ 18 /0.1 mm]
7	Left Edge (By-pass)
	[0 to 20/ 3 /0.1 mm]
8	Right Edge (By-pass)
	[0 to 20/ 3 /0.1 mm]

2104	Paper Edge Detection Delay Adj
1	Normal Paper Right Edge
	[-20 to 20/ 4 /0.1 mm]
2	Normal Paper Left Edge
	[-20 to 20/ 0 /0.1 mm]
3	Recycled Paper Right Edge
	[-20 to 20/ 4 /0.1 mm]
4	Recycled Paper Left Edge
	[-20 to 20/ 0 /0.1 mm]

5	IJ Normal Paper Right Edge
	[-20 to 20/ 4 /0.1 mm]
6	IJ Normal Paper Left Edge
	[-20 to 20/ 0 /0.1 mm]
7	Tracing Paper Right Edge
	[-20 to 20/ 2.5 /0.1 mm]
8	Tracing Paper Left Edge
	[-20 to 20/ 1.0 /0.1 mm]
9	Mat Film Right Edge
	[-20 to 20/ 2.5 /0.1 mm]
10	Mat Film Left Edge
	[-20 to 20/ 1.0 /0.1 mm]
11	Coated Paper (CAD) Right Edge
	[-20 to 20/ 4.0 /0.1 mm]
12	Coated Paper (CAD) Left Edge
	[-20 to 20/ 0.0 /0.1 mm]
13	Coated Paper Right Edge
	[-20 to 20/ 4.0 /0.1 mm]
14	Coated Paper Left Edge
	[-20 to 20/ 0.0 /0.1 mm]
17	Special Paper Right Edge
	[-20 to 20/ 4.0 /0.1 mm]
18	Special Paper Left Edge
	[-20 to 20/ 0.0 /0.1 mm]
19	Special Paper Right Edge
	[-25.0 to 25.0 / 4.0 / 0.1 mm]

20	Special Paper Left Edge
	[-25.0 to 25.0 / -0.0 / 0.1mm]
31	Automatic Conversion
	[EXECUTE]

2116	Copier Sub Scan Magnification Correct
1	Normal/Recycled Paper
	[-1 to 1/0/0.1%]
2	IJ Normal Paper
	[-1 to 1/0/0.1%]
3	Translucent
	[-1 to 1/0/0.1%]
4	Coated Paper (CAD)
	[-1 to 1/0/0.1%]
5	Coated Paper
	[-1 to 1/0/0.1%]
6	Mat Film
	[-1 to 1/0/0.1%]
7	Special Paper
	[-1 to 1/0/0.1%]
8	Glossy Paper
	[-1 to 1/0/0.1%]
9	Reserved 1
	[-1 to 1/0/0.1%]
10	Reserved 2
	[-1 to 1/0/0.1%]

11	Normal/Recycled Paper
	[-1 to 1/0/0.1%]
12	IJ Normal Paper
	[-1 to 1/0/0.1%]
13	Translucent
	[-1 to 1/0/0.1%]
14	Coated Paper (CAD)
	[-1 to 1/0/0.1%]
15	Coated Paper
	[-1 to 1/0/0.1%]
16	Mat Film
	[-1 to 1/0/0.1%]
17	Special Paper
	[-1 to 1/0/0.1%]
18	Glossy Paper
	[-1 to 1/0/0.1%]
19	Reserved 4
	[-1 to 1/0/0.1%]
20	Reserved 5
	[-1 to 1/0/0.1%]
2117	Copier Mainscan Magnif Correct

1	Normal/Recycled Paper	[-1.0 to 1.0 / 0.0 / 0.1%]
2	IJ Normal Paper	
3	Translucent Paper	
4	Coated Paper (CAD)	
5	Coated Paper	
6	Mat Film	
7	Special Paper	
8	Glossy Paper	
9	Reserved 1	

2193	Image Regist. Calibration	
	-	
1	Paper Feed Tray1:LED PWM Setting	[0 to 4000 / 0 / 1]
2	Paper Feed Tray1:Magnifi. Ratio Regist.	[0 or 1 / 0 / 1]
3	Paper Feed Tray2:LED PWM Setting	[0 to 4000 / 0 / 1]
4	Paper Feed Tray2:Magnifi. Ratio Regist.	[0 or 1 / 0 / 1]
5	Bypass Tray:LED PWM Setting	[0 to 4000 / 0 / 1]
6	Bypass Tray:Magnifi. Ratio Regist.	[0 or 1 / 0 / 1]
20	ON/OFF	[0 or 1 / 0 / 1]

2194	DRESS Executed Result	
1	Year	[0 to 99/12/1 year]

2	Month
	[1 to 12/1/1 month]
3	Day
	[1 to 31/1/1 day]
4	Hour
	[0 to 23/0/1 hour]
5	Minute
	[0 to 59/0/1 minute]
6	Head Temperature H1
	[-100 to 100/0/1 deg]
7	Head Temperature H2
	[-100 to 100/0/1 deg]
8	Head Temperature H3
	[-100 to 100/0/1 deg]
9	Head Temperature H4
	[-100 to 100/0/1 deg]
10	Result
	[0 to 255/0/1]
11	Executed Count
	[0 to 65 535/0/1 times]
12	Reading Failure Count
	[0 to 65 535/0/1 times]
13	Calculation Failure Count
	[0 to 65 535/0/1 times]
14	Effect Recognition Failure Count
	[0 to 65 535/0/1 times]

15	Elapsed Failure Notice Count
	[0 to 65 535/0/1 times]
16	DRAMA_failure reason_notice
	[0 to 65 535/0/1 times]
17	Executed Count: Normal Paper
	[0 to 65 535/0/1 times]
18	Executed Count: Recycled Paper
	[0 to 65 535/0/1 times]
19	Executed Count: IJ Normal Paper
	[0 to 65 535/0/1 times]
20	Executed Count: Tracing Paper
	[0 to 65 535/0/1 times]
21	Executed Count: Mat Film
	[0 to 65 535/0/1 times]
22	Executed Count: Coated Paper (CAD)
	[0 to 65 535/0/1 times]
23	Executed Count: Coated Paper
	[0 to 65 535/0/1 times]
24	Executed Count: Special Paper
	[0 to 65 535/0/1 times]
25	Executed Count: Glossy Paper
	[0 to 65 535/0/1 times]
26	Failure Count: Normal Paper
	[0 to 65 535/0/1 times]
27	Failure Count: Recycled Paper
	[0 to 65 535/0/1 times]

28	Failure Count: IJ Normal Paper
	[0 to 65 535/ 0 /1 times]
29	Failure Count: Tracing Paper
	[0 to 65 535/ 0 /1 times]
30	Failure Count: Mat Film
	[0 to 65 535/ 0 /1 times]
31	Failure Count: Coated Paper (CAD)
	[0 to 65 535/ 0 /1 times]
32	Failure Count: Coated Paper
	[0 to 65 535/ 0 /1 times]
33	Failure Count: Special Paper
	[0 to 65 535/ 0 /1 times]
34	Failure Count: Glossy Paper
	[0 to 65 535/ 0 /1 times]

2211	Air Detection Freq. Check Result
1	Carriage Unit (Black)
	[EXECUTE]
2	Carriage Unit (Color)
	[EXECUTE]

2213	Air Detection Freq. Checked Date
------	----------------------------------

2214	Air Detection Freq. Check Result
1	H1
	[0 or 1/ 0 /1]

2	H2
	[0 or 1/0/1]
3	H3
	[0 or 1/0/1]
4	H4
	[0 or 1/0/1]
5	H5
	[0 or 1/0/1]

3

2215	Air Detection Freq. Check Period
	[0 to 255/10/1 day]

2217	Prev. Air Leakage Check Counter
1	H1
	[0 to 999 999/0/1]
2	H2
	[0 to 999 999/0/1]
3	H3
	[0 to 999 999/0/1]
4	H4
	[0 to 999 999/0/1]
5	H5
	[0 to 999 999/0/1]

2218	Accumulated Air Leakage Counter
1	H1
	[0 to 999 999/0/1]

2	H2
	[0 to 999 999/ 0 /1]
3	H3
	[0 to 999 999/ 0 /1]
4	H4
	[0 to 999 999/ 0 /1]
5	H5
	[0 to 999 999/ 0 /1]

2231	PM Counter Indication
1	Carriage Unit (Black)
	[0 to 500/ 0 /1 %]
2	Carriage Unit (Color)
	[0 to 500/ 0 /1 %]
3	Maintenance Unit
	[0 to 500/ 0 /1 %]
4	Waste Ink Box: Left
	[0 to 200/ 0 /1 %]
5	Waste Ink Box: Right
	[0 to 200/ 0 /1 %]
6	Carriage Unit (Black)
	[0 to 0xFFFF FFFF/ 0 /1 mm]
7	Carriage Unit (Color)
	[0 to 0xFFFF FFFF/ 0 /1 mm]
8	Maintenance Unit
	[0 to 0xFFFF FFFF/ 0 /1 mm]

2235	Temp. Rise User CL Switch	
1	ON/OFF Setting	[0 to 31 / 31 / 1]
2235	Temp. Rise User CL Switch	
2	Temperature Threshold H1	[0.0 to 55.0 / 7.0 / 0.5]
3	Temperature Threshold H2	
4	Temperature Threshold H3	
5	Temperature Threshold H4	
6	Temperature Threshold H5	

2245	Air Detection Flag	
1	H1	
		[0 to 31/ 0 /1] 0: Normal 1: Air mixing at job end 2: Air mixing after idle time 4: Air mixing after ink pumps idle
2	H2	
		[0 to 31/ 0 /1] 0: Normal 1: Air mixing at job end 2: Air mixing after idle time 4: Air mixing after ink pumps idle
3	H3	
		[0 to 31/ 0 /1] 0: Normal 1: Air mixing at job end 2: Air mixing after idle time 4: Air mixing after ink pumps idle

4	H4
	[0 to 31/0/1] 0: Normal 1: Air mixing at job end 2: Air mixing after idle time 4: Air mixing after ink pumps idle
5	H5
	[0 to 31/0/1] 0: Normal 1: Air mixing at job end 2: Air mixing after idle time 4: Air mixing after ink pumps idle

2246	Ink Supply Operation Time
1	H1
	[0xFFFF FFFF/0/1]
2	H2
	[0xFFFF FFFF/0/1]
3	H3
	[0xFFFF FFFF/0/1]
4	H4
	[0xFFFF FFFF/0/1]
5	H5
	[0xFFFF FFFF/0/1]

2247	Ink Supply Seq. Progress Control
1	H1
	[0xFFFF FFFF/0/1]

2	H2
	[0xFFFF FFFF/0/1]
3	H3
	[0xFFFF FFFF/0/1]
4	H4
	[0xFFFF FFFF/0/1]
5	H5
	[0xFFFF FFFF/0/1]

2249	Set Air Detection Flag - Flag Continued Time
	[0 to 255/6/1 hour]

2252	Air Purge Fill Feeler Position
1	HT1 OFF_ON
	[0 to 65 535/0/1 count]
2	HT2 OFF_ON
	[0 to 65 535/0/1 count]
3	HT3 OFF_ON
	[0 to 65 535/0/1 count]
4	HT4 OFF_ON
	[0 to 65 535/0/1 count]
5	HT5 OFF_ON
	[0 to 65 535/0/1 count]
6	HT6 OFF_ON
	[0 to 65 535/0/1 count]
7	HT7 OFF_ON
	[0 to 65 535/0/1 count]

8	HT1 ON_OFF
	[0 to 65 535/0/1 count]
9	HT2 ON_OFF
	[0 to 65 535/0/1 count]
10	HT3 ON_OFF
	[0 to 65 535/0/1 count]
11	HT4 ON_OFF
	[0 to 65 535/0/1 count]
12	HT5 ON_OFF
	[0 to 65 535/0/1 count]
13	HT6 ON_OFF
	[0 to 65 535/0/1 count]
14	HT7 ON_OFF
	[0 to 65 535/0/1 count]

2306	OCFS Position Check Repeat
1	H1
2	H2
3	H3
4	H4
5	H5
	[0 to 1/0/1]

2400	NV Clear at Carriage Exchange
------	-------------------------------

	[0 to 2/0/1]
	<ul style="list-style-type: none"> • 0: Clears counter for all print heads for carriage replacement if both cradles are to be replaced. • 1: Clears counters for K1, K2 if the left black print head cradle is to be replaced. • 2: Clears counters for C, Y, M if the right color cradle is to be replaced.

2438	Motor Control Log Save Setting	
1	DDR/HDD Log Save Setting	[0 to 3 / 0 / 1]

3

2505	Reset Waste Ink Counter	
1	Waste Ink: Left C/R	
	[EXECUTE]	
	[0 to 1/0/1]	
2	Waste Ink: Right C/R	
	[EXECUTE]	
	[0 to 1/0/1]	

2508	Remove Ink Setting	
1	No. of Times	[0 to 5 / 0 / 1]

2515	OCFS Filling Flag After CL(eaning)	
	[0 to 127/0/1] 0: Not executed, 1: Executed	

2516	Automatic Cleaning Off/On	
1	Automatic Mist Cleaning	[0 or 1 / 1 / 1]
2	Automatic Paper Dust Cleaning	[0 or 1 / 0 / 1]
3	Auto Cleaning for Decapping	[0 or 1 / 1 / 1]
4	Auto Cleaning for Bk Head Decapping	[0 or 1 / 1 / 1]

5	Auto Cleaning for Single Head Decapping	[0 or 1 / 0 / 1]
---	---	------------------

2517	Mainten. after Leftover Info.	
1	Printing Standby Time	
	[0 to 4294967295/0/1 sec]	
2	Last Maintenance Time H1	
	[0 to 4294967295/0/1 sec]	
3	Last Maintenance Time H2	
	[0 to 4294967295/0/1 sec]	
4	Last Maintenance Time H3	
	[0 to 4294967295/0/1 sec]	
5	Last Maintenance Time H4	
	[0 to 4294967295/0/1 sec]	
6	Last Maintenance Time H5	
	[0 to 4294967295/0/1 sec]	
7	Last Maintenance Type H1	
	[0 to 255/0/1]	
8	Last Maintenance Type H2	
	[0 to 255/0/1]	
9	Last Maintenance Type H3	
	[0 to 255/0/1]	
10	Last Maintenance Type H4	
	[0 to 255/0/1]	
11	Last Maintenance Type H5	
	[0 to 255/0/1]	

12	Temperature Leftover Began H1
	[0 to 55/0/0.5 C]
13	Temperature Leftover Began H2
	[0 to 55/0/0.5 C]
14	Temperature Leftover Began H3
	[0 to 55/0/0.5]
15	Temperature Leftover Began H4
	[0 to 55/0/0.5]
16	Temperature Leftover Began H5
	[0 to 55/0/0.5]
2518	All Channel Flushing Time
	[0 to 0xFFFFFFFF]
2520	Mainten. after Leftover Setting -On/Off Switch
	[0 to 31/0/1]
2521	Mainten. after Leftover Repeat
	1 Little Flushing
	[0 to 10/1/1]
2	Rich Flushing
	[0 to 10/1/1]
3	Cleaning after Leftover
	[0 to 10/1/1]
2600	Head Accumulated Decap Time

1	HT1	[0 to 65535 / 0 / 1]
2	HT2	
3	HT3	
4	HT4	
5	HT5	

3

2610	Bk Head Accumulated Decap Time	
1	HT1	[0 to 65535 / 0 / 1]
2	HT2	[0 to 65535 / 0 / 1]

2705	Ink on Normal Operation	
1	Consumption Counter HT1	
		[0 to 99999999 nI]
2	Consumption Counter HT2	
		[0 to 99999999 nI]
3	Consumption Counter HT3	
		[0 to 99999999 nI]
4	Consumption Counter HT4	
		[0 to 99999999/0/1 nI]
5	Consumption Counter HT5	
		[0 to 99999999 nI]
6	Consumption Counter HT6	
		[0 to 99999999 nI]
7	Consumption Counter HT7	
		[0 to 99999999 nI]

2707	OCFS Consumption Counter	
------	--------------------------	--

1	HT1
2	HT2
3	HT3
4	HT4
5	HT5
6	HT6
7	HT7
	[0 to 999999999/0/1 n]

2708	Ink After End
1	Consumption Counter K
2	Consumption Counter C
3	Consumption Counter M
4	Consumption Counter Y
	[0 to 2550000000/0/1 n]

2720	DecapCount per Head (Flushing)	
1	HT1	[0 to 65535 / 0 / 1]
2	HT2	
3	HT3	
4	HT4	
5	HT5	

2721	Decap Flushg Count Threshold	
1	-	[1 to 255 / 3 / 1]

2722	Decap Flushing Counter	
-------------	-------------------------------	--

1	HT1	[0 to 255 / 0 / 1]
2	HT2	
3	HT3	
4	HT4	
5	HT5	

3

2800	EM Print Mode Setting	
1	ON/OFF	[0 to 10 / 1 / 1]
2	Release Threshold (Ink Consumption)	[0 to 99999999 / 98960 / 1]
3	Release Threshold (Time)	[0 to 255 / 73 / 1]

2801	EM Print Mode	
3	Ink Consumption Counter HT3	[0 to 99999999 / 0 / 1]
4	Ink Consumption Counter HT4	
5	Ink Consumption Counter HT5	
6	Ink Consumption Counter HT6	
7	Ink Consumption Counter HT7	

2802	EM Print Mode Start Time	
-------------	---------------------------------	--

3	HT3	[0 to 4294967295 / 0 / 1]
4	HT4	
5	HT5	
6	HT6	
7	HT7	

2803	Ink End (EM Print)	
2	Cyan	[0 or 1 / 0 / 1]
3	Magenta	[0 or 1 / 0 / 1]
4	Yellow	[0 or 1 / 0 / 1]

2902	Internal Test Pattern Select - RI20 (MtoP) Internal Patterns	
	Pattern	
	0	No Test Pattern Output
	1	Black Grid Pattern
	2	Cyan Grid Pattern
	3	Magenta Grid Pattern
	4	Yellow Grid Pattern
	5	Frame Pattern
	6	Black 2x2 Pattern
	7	Cyan 2x2 Pattern
	8	Magenta 2x2 Pattern
	9	Yellow 2x2 Pattern
	10	Density Pattern 1
	11	Density Pattern 2
	12	Density Pattern 3

2903	KISSIN Internal Pattern	
	-	
1	Image Datamask Setting	[0 or 1 / 0 / 1]
2	Select Internal Test Pattern	[0 to 2 / 0 / 1]

2904	LVDS Test Pattern	
	-	
1	Select LVDS Test Pattern	[0 or 1 / 0 / 1]

2920	FFC Connect Error Flag	
	-	
001	-	[0 to 255 / 0 / 1]

2959	Engine Control IC ID Indication	
1	IC Name	[0 to 255/ 0 /1]
	Version	[0 to 0xFFFFFFFF/ 0 /1]

2974	KAKA1 Variation Adj.	
1	Correction Value a	[0.0501 to 0.2285 / 0.1000 / 0.0001]
2	Correction Value b	[-6.1400 to 11.9871 / 0.0000 / 0.0001]
2974	KAKA2 Variation Adj.	
3	Correction Value a	[0.0501 to 0.2285 / 0.1000 / 0.0001]
4	Correction Value b	[-6.1400 to 11.9871 / 0.0000 / 0.0001]
2974	KAKA3 Variation Adj.	
5	Correction Value a	[0.0501 to 0.2285 / 0.1000 / 0.0001]

6	Correction Value b	[-6.1400 to 11.9871 / 0.0000 / 0.0001]
2974	KAKA4 Variation Adj.	
7	Correction Value a	[0.0501 to 0.2285 / 0.1000 / 0.0001]
8	Correction Value b	[-6.1400 to 11.9871 / 0.0000 / 0.0001]
2974	KAKA5 Variation Adj.	
9	Correction Value a	[0.0501 to 0.2285 / 0.1000 / 0.0001]
10	Correction Value b	[-6.1400 to 11.9871 / 0.0000 / 0.0001]

Main SP Tables-3

SP3-XXX

3

3005	Head Gap Adjust Mj4-20KHz	
1	Adjusted Value on Fitting A	[-400 to 400 / 0 / 1 dot]
3	Adjusted Value on Fitting B	
5	Adjusted Value on Fitting C	
8	Adjusted Value on Fitting D	
51	By-pass: Normal-Thick A	[-400 to 400 / 0 / 1 dot]
53	By-pass: Normal-Thick B	
55	By-pass: Normal-Thick C	
58	By-pass: Normal-Thick D	
101	Paper Supply 1: Normal-Thick A	[-400 to 400 / 0 / 1 dot]
103	Paper Supply 1: Normal-Thick B	
105	Paper Supply 1: Normal-Thick C	
108	Paper Supply 1: Normal-Thick D	
151	Paper Supply 2: Normal-Thick A	
153	Paper Supply 2: Normal-Thick B	
155	Paper Supply 2: Normal-Thick C	
158	Paper Supply 2: Normal-Thick D	

3008 Head Gap Adjust Mj5-16kHz		
1	Adjusted Value on Fitting A	[-400 to 400 / 0 / 1 dot]
3	Adjusted Value on Fitting B	
5	Adjusted Value on Fitting C	
8	Adjusted Value on Fitting D	
51	By-pass: Normal-Thick A	[-400 to 400 / 0 / 1 dot]
53	By-pass: Normal-Thick B	
55	By-pass: Normal-Thick C	
58	By-pass: Normal-Thick D	
101	Paper Supply 1: Normal-Thick A	[-400 to 400 / 0 / 1 dot]
103	Paper Supply 1: Normal-Thick B	
105	Paper Supply 1: Normal-Thick C	
108	Paper Supply 1: Normal-Thick D	
151	Paper Supply 2: Normal-Thick A	
153	Paper Supply 2: Normal-Thick B	
155	Paper Supply 2: Normal-Thick C	
158	Paper Supply 2: Normal-Thick D	

3100 DRAMA DL Tool Connection Check		
1	-	[0 or 1 / 0 / 1]

3106 Short Paper Width Detection		
---	--	--

1	Switching Modes	[0 to 3 / 0 / 1]
2	Paper Width Detection Mask Value	[0.0 to 255.0 / 10.0 / 0.1]
3	Noise Detection Mask Value	[0.0 to 255.0 / 10.0 / 0.1]

3109	Test Pattern Output		
5	Gap Section Correction 1016 Black&White H1fH	[0 or 1 / 0 / 1]	
6	Gap Section Correction Pre		
7	Gap Section Correction 1016 H2fH2r		
8	Gap Section Correction 847 & 423 H2fH1f		
9	Gap Section Correction 847 & 423 H2fH4f		
10	Gap Section Correction 1016 H2fH1r & H2fH1f		
11	Gap Section Correction 1016 H2fH4r & H2fH4f		
12	Gap Section Correction 1016 H1fH1r		
13	Gap Section Correction 847 & 423 H1fH2f		
14	Gap Section Correction 847 & 423 H1fH4f		
15	Gap Section Correction 1016 H1fH2r & H1fH2f		
16	Gap Section Correction 1016 H1fH4r & H1fH4f		
20	Forward-Backward Adjustment Pattern Printing		[1 to 3 / 1 / 1]

21	Printing Position Adjustment	[1 to 3 / 2 / 1]
22	Transport Roller Correction	[1 to 3 / 1 / 1]
100	Nozzle Check Pattern Printing (User)	[1 to 3 / 1 / 1]
101	Paper Feed Length Adjustment	[1 to 3 / 2 / 1]
102	Nozzle Check Pattern Printing (Mj2)	[1 to 3 / 1 / 1]
103	Nozzle Check Pattern Printing (Mj4)	[1 to 3 / 1 / 1]
104	2 by 2 Pattern (High Speed)	[1 to 3 / 1 / 1]
105	2 by 2 Pattern (Standard)	[1 to 3 / 1 / 1]

3113	Pattern Notice Paper Thickness v	
1	By-pass Feed	
		[0 to 255/0/1] <ul style="list-style-type: none"> • Normal Paper: 0h • Thin Paper: 1h • Medium Thick Paper: 2h • Thick 1: 3h • Thick 2: 4h
2	Paper Input 1	
3	Paper Input 2	

3114	Avoid Head Friction	
1	By-pass Feed	
2	Paper Input 1	

3	Paper Input 2
	<p>[0 to 2/0/1]</p> <ul style="list-style-type: none"> • 0: Normal height • 1: 1 mm • 2: 2 mm

3

3115	Pattern Notice Image Mode - Image Mode
	<p>1: Standard</p> <p>2: Quality</p> <p>3: High Speed</p> <p>[0 to 255/0/1]</p>

3126	Gap Section Correction	
145	1016:color H1fA	[-100 to 100 / 0 / 1]
146	1016:color H1fB	
147	11016:color H1fC	
148	1016:color H1fD	
149	1016:color H1fE	
150	1016:color H1fF	
151	1016:color H1fG	[-100 to 100 / 0 / 1]
152	1016:color H1fH	
153	1016:color H1fI	
154	1016:color H1fJ	
155	1016:color H1fK	
156	1016:color H1fL	

157	847:H1fA	[-100 to 100 / 0 / 1]
158	847:H1fB	
159	847:H1fC	
160	847:H1fD	
161	847:H1fE	
162	847:H1fF	
163	847:H1fG	
164	847:H1fH	
165	847:H1fI	
166	847:H1fJ	
167	847:H1fK	
168	847:H1fL	
169	423:H1fA	[-100 to 100 / 0 / 1]
170	423:H1fB	
171	423:H1fC	
172	423:H1fD	
173	423:H1fE	
174	423:H1fF	
175	423:H1fG	
176	423:H1fH	
177	423:H1fI	
178	423:H1fJ	
179	423:H1fK	
180	423:H1fL	

181	1016:Black&WhiteH2fA	[-100 to 100 / 0 / 1]
182	1016:Black&WhiteH2fB	
183	1016:Black&WhiteH2fC	
184	1016:Black&WhiteH2fD	
185	1016:Black&WhiteH2fE	
186	1016:Black&WhiteH2fF	
187	1016:Black&WhiteH2fG	[-100 to 100 / 0 / 1]
188	1016:Black&WhiteH2fH	
189	1016:Black&WhiteH2fI	
190	1016:Black&WhiteH2fJ	
191	1016:Black&WhiteH2fK	
192	11016:Black&WhiteH2fL	
193	1016:ColorH2rA	[-100 to 100 / 0 / 1]
194	1016:ColorH2rB	
195	1016:ColorH2rC	
196	1016:ColorH2rD	
197	1016:ColorH2rE	
198	1016:ColorH2rF	
199	1016:ColorH2rG	[-100 to 100 / 0 / 1]
200	1016:ColorH2rH	
201	1016:ColorH2rI	
202	1016:ColorH2rJ	
203	1016:ColorH2rK	
204	1016:ColorH2rL	

205	847:H2fA	[-100 to 100 / 0 / 1]
206	847:H2fB	
207	847:H2fC	
208	847:H2fD	
209	847:H2fE	
210	847:H2fF	
211	847:H2fG	
212	847:H2fH	
213	847:H2fI	
214	847:H2fJ	
215	847:H2fK	
216	847:H2fL	
217	423:H2fA	[-100 to 100 / 0 / 1]
218	423:H2fB	
219	423:H2fC	
220	423:H2fD	
221	423:H2fE	
222	423:H2fF	
223	423:H2fG	
224	423:H2fH	
225	423:H2fI	
226	423:H2fJ	
227	423:H2fK	
228	423:H2fL	

229	423:H1fH4fA	[-100 to 100 / 0 / 1]
230	423:H1fH4fB	
231	423:H1fH4fC	
232	423:H1fH4fD	
233	423:H1fH4fE	
234	423:H1fH4fF	
235	423:H1fH4fG	
236	423:H1fH4fH	
237	423:H1fH4fI	
238	423:H1fH4fJ	
239	423:H1fH4fK	
240	423:H1fH4fL	
241	1016:H1fH4rA	[-100 to 100 / 0 / 1]
242	1016:H1fH4rB	
243	1016:H1fH4rC	
244	1016:H1fH4rD	
245	1016:H1fH4rE	
246	1016:H1fH4rF	
247	1016:H1fH4rG	
248	1016:H1fH4rH	
249	1016:H1fH4rI	
250	1016:H1fH4rJ	
251	1016:H1fH4rK	
252	1016:H1fH4rL	

3127	Gap Section Correction
-------------	-------------------------------

1	1016:Black&WhiteH2rA	[-100 to 100 / 0 / 1]
2	1016:Black&WhiteH2rB	
3	1016:Black&WhiteH2rC	
4	1016:Black&WhiteH2rD	
5	1016:Black&WhiteH2rE	
6	1016:Black&WhiteH2rF	
7	1016:Black&WhiteH2rG	
8	1016:Black&WhiteH2rH	
9	1016:Black&WhiteH2rI	
10	1016:Black&WhiteH2rJ	
11	1016:Black&WhiteH2rK	
12	1016:Black&WhiteH2rL	

3132	ECB Correction Value	
1	H1	[94 to 97/ 94 /1 %]
2	H2	[94 to 97/ 94 /1 %]
5	H5	

3140	Ink Drying Time Setting	
1	Normal Paper	[0 to 1800/ 0 /1 sec]
2	Recycled Paper	[0 to 1800/ 0 /1 sec]
3	IJ Normal Paper	[0 to 1800/ 0 /1 sec]

5	Translucent
	[0 to 1800/0/1 sec]
6	Mat Film
	[0 to 1800/15/1 sec]
7	Coated (CAD) Paper
	[0 to 1800/0/1 sec]
8	Coated Paper
	[0 to 1800/0/1 sec]
10	Special Paper
	[0 to 1800/0/1 sec]
11	Photo Gloss Paper
	[0 to 1800/0/1 sec]
106	Mat Film (Color)
	[0 to 1800/15/1 sec]

3141	Paper Feed Part Correction
	[0 to 1/0/1]

3144	Print Head Joint Amount Decr.	
001	OFF/ON	[0 or 1 / 0 / 1]

3146	Sub Scan White Area Skip
	These SP codes switch the skipping of blank areas on/off during printing and scanning.
1	Printer 0:OFF/1:ON
	[0 to 1/0/1] 0:OFF 1:ON
2	Copy 0:OFF/1:ON
	[0 to 1/0/1] 0:OFF 1:ON

3147	Resolution Conversion:Printer	
1	0: C2Process 1: C1Compatibility	[0 or 1 / 0 / 1]
3147	Resolution Conversion:Copy	
2	0: C2Process 1: C1Compatibility	[0 or 1 / 0 / 1]
3147	Resolution Conversion:Printer	
3	ContinuousExec.Count UpperLmt (600/300dpi)	[1 to 100 / 4 / 1]
3147	Resolution Conversion:Copy	
4	ContinuousExec.Count UpperLmt (600/300dpi)	[1 to 100 / 4 / 1]

3148	No Discharge Compensation	
1	Normal Paper OFF/ON	[0 or 1 / 1 / 1]
2	Translucent Paper OFF/ON	[0 or 1 / 1 / 1]
3	Mat Film OFF/ON	[0 or 1 / 1 / 1]
4	Coated (CAD) Paper OFF/ON	[0 or 1 / 1 / 1]
5	Special Paper OFF/ON	[0 or 1 / 1 / 1]
6	Photo Glossy Paper OFF/ON	[0 or 1 / 1 / 1]

3149	No Discharge: No. of Nozzles	
1	Upper Limit (Auto Nozzle Check.: Std)	[0 to 32 / 5 / 1]
2	Upper Limit (Auto Nozzle Check.: High)	[0 to 32 / 2 / 1]

3150	No Discharge Threshold	
1	Normal Paper: Speed Priority	[0 to 256 / 130 / 1]

2	Normal Paper: Standard	[0 to 256 / 256 / 1]
3	Normal Paper: Quality Priority	[0 to 256 / 224 / 1]
4	Translucent Paper: Speed Priority	[0 to 256 / 206 / 1]
5	Translucent Paper: Standard	[0 to 256 / 206 / 1]
6	Translucent Paper: Quality Priority	[0 to 256 / 256 / 1]
7	Mat Film: Speed Priority	[0 to 256 / 175 / 1]
8	Mat Film: Standard	[0 to 256 / 224 / 1]
9	Mat Film: Quality Priority	[0 to 256 / 256 / 1]
10	Special Paper: Speed Priority	[0 to 256 / 224 / 1]
11	Special Paper: Standard	[0 to 256 / 128 / 1]
12	Special Paper: Quality Priority	[0 to 256 / 256 / 1]
13	Coated Paper (CAD): Standard	[0 to 256 / 201 / 1]
14	Coated Paper (CAD) : Quality Priority	[0 to 256 / 201 / 1]
15	Photo Glossy Paper: Standard	[0 to 256 / 127 / 1]
16	Photo Glossy Paper: Quality Priority	[0 to 256 / 127 / 1]
17	Normal Paper: Speed Priority (Drawing)	[0 to 256 / 130 / 1]
18	Coated Paper (CAD): Speed Priority (Drawing)	[0 to 256 / 130 / 1]
19	Coted(CAD) Paper Speed Priority	[0 to 256 / 130 / 1]

3151	4-valued Process Parameter	
1	Translucent	[0 or 1 / 0 / 1]

3160	Carriage LED	
1	ON/OFF	[0 to 3 / 1 / 1]
2	Control High Light Level	[1 to 99 / 80 / 1]
3	Control Medium Light Level	[1 to 99 / 50 / 1]
4	Control Low Light Level	[0 of 1 / 0 / 1]

Main SP Tables-4

SP4-XXX

4008	Scanner Sub Scan - Magnification Adjustment	
	[-0.9 to 0.9/ 0.0 /0.1%]	
4010	Scanner Sub Scan	
1	Leading Edge Registration Adjustment	
	[-10 to 10/ 0.0 / 0.1 mm] <ul style="list-style-type: none"> • A higher setting "+" shifts the image down (against the sub scan direction). • A lower setting "-" shifts the image up (with the sub scan direction). 	
2	Trailing Edge Registration Adjustment	
	[-10 to 10/ 0 /0.1 mm] <ul style="list-style-type: none"> • A higher setting "+" shifts the image down (against the sub scan direction). • A lower setting "-" shifts the image up with the sub scan direction). 	
4011	Scanner Main Scan - Registration Adjustment	
	[-4 to 4/ 0.0 /0.1 mm] <ul style="list-style-type: none"> • A higher setting "+" shifts the image away from the right edge of the paper as it exits for a wider margin. • A lower setting "-" shifts the image to toward the right edge of the paper as it exits for a narrower margin. 	
4012	Scanner Edge Margin	
5	DF: Leading Edge	
	[0 to 9/ 0.0 /0.1 mm]	
6	DF: Trailing Edge	
	[0 to 9/ 0.0 /0.1 mm]	

7	DF: Left Edge
	[0 to 9/ 0.0 /0.1 mm]
8	DF: Right Edge
	[0 to 9/ 0.0 /0.1 mm]

4013	Scanner Free Run
1	Execute
	[OFF] [ON]
2	Dummy Page Interval Setting
	[0 to 25/ 0.9 /0.1 sec]
3	Dummy Document Length Setting
	[0.2 to 30/ 0.6 /0.1 m]

4101	Scanner Main Scan
1	Magnification Adjustment
	[-0.9 to 0.9/ 0 /0.1%]

4417	IPU Test Pattern Setting - Pattern Selection	
	[0 to 8/ 0 /1]	
	No.	Pattern Name
	*0	Scanned Image
	1	Gradation Main Scan A
	2	Color Patch 16
	3	Grid Pattern A
	4	Slant Grid Pattern B
	5	Slant Grid Pattern C
	6	Slant Grid Pattern D
	7	Scanned + Grid Pattern C
	8	Scanned + Grid Pattern D

4606	White Level Adjust	
1	Gain Adjustment	[0 to 1023 / 860 / 1 digit]
2	LED Adjustment	[0 to 1023 / 800 / 1 digit]
3	LED Adjustment(Gain Default)	[0 to 1023 / 450 / 1 digit]

4700	FPGA ID Indication – Volans
------	-----------------------------

4709	Gray Balance Adj Value: Current
	[-1024 to 1023/ 0 /1] <ul style="list-style-type: none"> • Display format: Hexadecimal • The values are stored after the machine is cycled off/on. • The settings are stored in the RI2005-SIB register
1 to 3	CIS1: G, R, B
4 to 6	CIS2: G, R, B
7 to 9	CIS2: G, R, B

10 to 12	CIS4: G, R, B
13 to 15	CIS5: G, R, B

4820	Lamp Defective - Lamp Error Flag	
	0: Normal 1: Abnormal	
	Bit	(7) 0000 0000 (0)
	0	CIS 1 lamp
	1	CIS 2 lamp
	2	CIS 3 lamp
	3	CIS 4 lamp
	4	CIS 5 lamp

4903	Filter Setting	
1	Ind Dot Erase: Text	
	[0 to 7/ 4/1] 0 (Weakest), 4 (Medium: Default), 7 (Strongest)	
2	Ind Dot Erase : Generation Copy	
	[0 to 7/4/1] 0 (Weakest), 4 (Medium: Default), 7 (Strongest)	
3	Ind Dot Erase : Drawing	
	[0 to 7/0/1] 0 (Weakest), 4 (Medium: Default), 7 (Strongest)	

4961	Document Length Adjustment	
1	Input Tolerance: 210mm	
	[-9.9 to +9.9/0.0/0.1 mm]	
2	Input Tolerance: 1000 mm	
	[-9.9 to +9.9/0.0/0.1 mm]	

3	Check Document Length
---	-----------------------

4965	Scan Speed Adjustment
1	Leading Edge
	[-1 to 0/ -0.9 /0.1%]
2	Position
	[0 to 200/ 112 /1 mm]
3	Trailing Edge
	[-1 to 1/ 0.3 /0.1%]

4966	Scan Speed Adjustment
	[5 to 170/ 80 /0.1 mm/s]

4972	Scan Correction
1	CIS Joint Adjustment CIS1-2 Main Scan
	[0 to 656/ 241 /1]
2	CIS Joint Adjustment CIS2 Main Scan
	[0 to 656/ 242 /1]
3	CIS Joint Adjustment CIS2-3 Main Scan
	[0 to 656/ 243 /1]
4	CIS Joint Adjustment CIS3-4 Main Scan
	[0 to 656/ 425 /1]
5	CIS Joint Adjustment CIS4-5 Main Scan
	[0 to 656/ 426 /1]
6	CIS Joint Adjustment CIS1-2 Sub Scan
	[0 to 2815/ 1860 /1]

7	CIS Joint Adjustment CIS2 Sub Scan
	[0 to 255/ 16 /1]
8	CIS Joint Adjustment CIS2-3 Sub Scan
	[0 to 2815/ 1860 /1]
9	CIS Joint Adjustment CIS3-4 Sub Scan
	[0 to 255/ 84 /1]
10	CIS Joint Adjustment CIS4-5 Sub Scan
	[0 to 2815/ 1860 /1]

4973	Scan Correction – CIS Scan Setting Difference in Grade Adj.
	[0 to 2/ 2 /1] 0: No adjustment 1: Simple adjustment at joints 2: Gradation adjustment at joint

4975	Prevent Document Fall
	[0 to 1/ 0 /1] 0: The scanner exit roller does not hold the leading edge 1: The scanner exit roller does not release the trailing edge of the original if it is longer than 450 mm. The original remains in the nip of the exit rollers until it is removed manually.

4978	Scan LED Wavelength	
	-	
1	CIS1:R	[400.0 to 700.0 / 620.0 / 0.1]
2	CIS1:G	[400.0 to 700.0 / 530.0 / 0.1 nm]
3	CIS1:B	[400.0 to 700.0 / 465.0 / 0.1 nm]
4	CIS2:R	[400.0 to 700.0 / 620.0 / 0.1]
5	CIS2:G	[400.0 to 700.0 / 530.0 / 0.1 nm]

6	CIS2:B	[400.0 to 700.0 / 465.0 / 0.1 nm]
7	CIS3:R	[400.0 to 700.0 / 620.0 / 0.1]
8	CIS3:G	[400.0 to 700.0 / 530.0 / 0.1 nm]
9	CIS3:B	[400.0 to 700.0 / 465.0 / 0.1 nm]
10	CIS4:R	[400.0 to 700.0 / 620.0 / 0.1]
11	CIS4:G	[400.0 to 700.0 / 530.0 / 0.1 nm]
12	CIS4:B	[400.0 to 700.0 / 465.0 / 0.1 nm]
13	CIS5:R	[400.0 to 700.0 / 620.0 / 0.1]
14	CIS5:G	[400.0 to 700.0 / 530.0 / 0.1 nm]
15	CIS5:B	[400.0 to 700.0 / 465.0 / 0.1 nm]

4992	Document Feed Speed Adjustment - ON/OFF
	[0 to 1/ 0 /1]

4994	Document Feed Speed Adjustment
	[0 to 15000/ 0 /1]
1	Position 1
2	Position 2
3	Position 3
4	Position 4
5	Position 5
6	Position 6
7	Position 7
8	Position 8
9	Position 9
10	Position 10
11	Position 11

12	Position 12
13	Position 13
14	Position 14
15	Position 15

Main SP Tables-5

SP5-XXX

3

5009	Add display language	
201	1-8	[1 to 255 / 0 / 1]
202	9-16	
203	17-24	
204	25-32	
205	33-40	
206	41-48	
207	49-56	

5024	mm/inch Display Selection
	Europe/Asia model: [0 = mm/1 = inch] American model: [0 = mm/1 = inch]

5045	Accounting Counter	CTL
1	Counter Method	
	[0 to 7/0/1] 0: Development counter (black prints) 1: Paper counter. Shows the total page counts	

2	Counter Unit		
	[0 to 8/0/1]		
	0	Meters	
	1	Yards	
	2	Feet	
	3	Meters ²	
	4	Yards ²	
	5	Feet ²	
	6	A3=1	Surface area count
	7	0.1 meters	Only for counting devices by user.
	8	01. yards	

5051	Toner Refill Detection Display Not Used	
	[0 to 1/0/1] [0:ON] [1:OFF]	

5055	Display IP Address	
	[0 to 1/0/1] [OFF] [ON]	

5062	Part Replacement Alert Display	
	[0 to 1/0/1] [0: No display] [1: Display] Note: This display is enabled with SP7624.	
1	Maintenance Kit	
2	Left Ink Sump	
3	Right Ink Sump	
9	Print Head Unit: Black	
10	Print Head Unit: Color	

5066	PM Parts Display
	[*0: No Display] [1: Display]

5067	Part Replacement Operation Type
	[0 to 1/ 0 /1] [0: Service] [1: User]
1	Maintenance Kit
2	Left Ink Sump
3	Right Ink Sump
9	Print Head Unit (Black)
10	Print Head Unit (Color)

5071	Set Bypass Paper Size Display
	[0 to 1/ 0 /1] 0:Disabled 1:Enabled

5075	USB Keyboard
	[0 to 1/ 0 /1] 0:Disabled 1:Enabled

5083	LED Light Switch Setting
	[0 to 1/ 0 /1] 0:OFF 1:ON

5101	Copy automatic clear timer setting
202	0:ON 1:OFF
	[0 or 1 / 0 / 1]

5113	Optional Counter Type
------	-----------------------

1	<p>Default Optional Counter Type</p> <p>[0 to 8/0/1]</p> <p>0: None</p> <p>1: Key Card (RK3, 4)</p> <p>2: Key Card Down</p> <p>3: Pre-paid Card</p> <p>4: Coin Rack</p> <p>5: MF Key Card</p> <p>8: Key Counter + Vendor</p> <p>Note: Items 1, 2, 3, 5, 5 are for Japan Only</p>
2	<p>External Optional Counter Type</p> <p>[0 to 3/0/1]</p> <ul style="list-style-type: none"> • 0: None • 1: Expansion Device 1 • 2: Expansion Device 2 • 3: Expansion Device 3
5114	<p>Optional Counter I/F</p> <p>0: OFF, 1: ON</p>
5118	<p>Disable Copying</p> <p>Temporarily denies access to the machine. Japan Only</p> <p>[0 to 1/0/1]</p> <p>0: Release for normal operation</p> <p>1: Prohibit access to machine</p>

5120	Mode Clear Opt. Counter Removal
	<p>Do not change. Japan Only</p> <p>[0 to 2/ 0/1]</p> <p>0: Yes. Normal reset</p> <p>1: Standby. Resets before job start/after completion</p> <p>2: No. Normally no reset</p>
5121	Counter Up Timing
	<p>[0 to 1/1/1]</p> <p>0: Feed count, 1: No feed count</p>
5127	APS OFF Mode
	<p>[0 to 1/0/1]</p> <p>0: On, 1: Off</p>
5128	Code Mode With Key/Card Option Japan Only
5162	App. Switch Method
	[0: Soft Key Set] [1: Hard Key Set]
5169	CE Login
	<p>[0 to 1/0/1]</p> <p>0: Off. Printer bit switches cannot be adjusted.</p> <p>1: On. Printer bit switches can be adjusted.</p>
5180	Change Count Method Japan Only
5188	Copy NV Version

5191	Mode Set	
	[0 to 1/1/0] 1: Allowed 0: Not allowed	
5195	Limitless SW Not Used	
	[0 to 1/0/1] 0: Productivity priority 1: Tray priority	
5227	Page Numbering	
201	Allow Page No. Entry	
	[2 to 9 / 9 / 1]	
202	Zero Surplus Setting	
	[0 or 1 / 0 / 1]	
5305	Auto Off Set	
	[0 to 1/0/1] 0: On (Auto Off cannot be released) 1: Off (Auto Off can be released)	
5307	Daylight Saving Time	
1	Setting	[0 to 1/0/1] 0: Disable, 1: Enable
3	Rule Set (Start)	The start of summer time.
4	Rule Set (End)	The end of summer time.
5402	Access Control Not Used	
101-170	SDJK1 Limit Settings	

5404	User Code Count Clear
	[EXECUTE]

5411	LDAP Certification
4	Simplified Authentication
	[0 or 1/1/1] 1: On, 0: Off
5	Password Null Not Permit
	[0 or 1/0/-] 0: Password NULL not permitted. 1: Password NULL permitted.
6	Detail Option
	[0 to 0xff/0/0x01] 0: Off 1:On

5412	Krb Certification
	(7) 00000000 (0)

5413	Lockout Setting
1	Lockout On/Off
	[0 or 1/0/-] 0: Off, 1: On
2	Lockout Threshold
	[1 to 10/5/1/step]
3	Cancellation On/Off
	[0 or 1/0/-] 0: Off (no wait time, lockout not cancelled) 1: On (system waits, cancels lockout if correct user ID and password are entered.)
4	Cancellation Time
	[1 to 999/60/1 min./step]

5414	Access Mitigation
1	Mitigation On/Off
	[0 or 1/ 0 /1] 0: Off, 1: On
2	Mitigation Time
	[0 to 60/ 15 /1 min./step]

5415	Password Attack
1	Permissible Number
	[0 to 100/ 30 /1 attempt/step]
2	Detect Time
	[1 to 10/ 5 /1 sec./step]

5416	Access Information
1	Access Use Max Num
	[50 to 200/ 200 /1 users/step]
2	Access Password Max Num
	[50 to 200/ 200 /1 password/step]
3	Monitor Interval
	[1 to 10/ 3 /1 sec./step]

5417	Access Attack
1	Access Permissible Number
	[0 to 500/ 100 /1/step]
2	Attack Detect Time
	[10 to 30/ 10 /1 sec./step]

3	Productivity Fall Wait
	[0 to 9/ 3 /1 sec./step]
4	Attack Max Number
	[50 to 200/ 200 /1 attempt/step]

5420	User Authentication	
1	Copy	
	[0 or 1/ 0 /1] 0: On, 1: Off	
2	Color Security Setting	
11	Document Server	
	[0 or 1/ 0 /1] 0: On, 1: Off	
31	Scanner	
	[0 or 1/ 0 /1] 0: On, 1: Off	
41	Printer	
	[0 or 1/ 0 /1] 0: On, 1: Off	
51	SDK1	[0 or 1/ 0 /1] 0: ON. 1: OFF
61	SDK2	
71	SDK3	
81	Browser	
	[0 to 1/ 0 /1] 0:Authenticate 1:Do not authenticate	

5430	Auth Dialog Message Change	
1	Message Change On/Off	

2	Message Text Download
3	Message Text ID
	[0 to 1/0/1 0: OFF 1: ON

5431	External Auth User Preset
	[0 or 1/1/1] 0: Not allowed copying, 1: Allowed copying
10	Tag
11	Entry
12	Group
20	Mail
32	Folder
33	ProtectCode
34	SmtphAuth
35	LdapAuth
36	Smb Ftp Fldr Auth
37	AcntAcl
38	Document Acl
40	CertCrypt

5481	Authentication Error Code
1	System Log Disp
	[0 or 1/0/1] 0: Off, 1: On

2	Panel Disp
	[0 or 1/ 1 /1] 0: Off, 1: On

5490	MF Key Card
1	Job Permit Setting
2	Count Mode Setting
	[0 to 1/0/1] 1: Allowed 0: Not allowed 1: Certification executes with a user code (9999 9999). Printing executes and the counter increments for the user code. 0: Certification executes without a user code but printing is cancelled.

5491	Optional Counter Not Used
------	----------------------------------

5501	PM Alarm	CTL
1	PM Alarm Level	
	[0 to 9999/0/1 step] 0: Alarm off 1 to 9999: Alarm goes off when Value (1 to 9999) > PM counter	
2	Original Count Alarm	
	[0 to 1/0/1] 0: No alarm sounds 1: Alarm sounds after the number of originals passing through the ARDF > 10,000	

5504	Jam Alarm Japan Only
	[0 to 3/ 3 /1 step] 0: Zero (Off) 1: Low (2.5K jams) 2: Medium (3K jams) 3: High (6K jams)

5507	Supply/CC Alarm
1	Power Supply Alarm
3	Toner Supply Alarm
80	Toner Call Timing
81	Toner Call Threshold
97	Interval: 841 mm
98	Interval: 594 mm
99	Interval: 420 mm
100	Interval: 297 mm
101	Interval: 210 mm
106	Interval: 728 mm
107	Interval: 515 mm
108	Interval: 364 mm
109	Interval: 257 mm
128	Interval: Other
129	Interval: A0
130	Interval:A1
132	Interval: A3
133	Interval: A4
138	Interval: B1

139	Interval: B2
141	Interval: B4
160	Interval: DLT
164	Interval: LG
165	Interval: Foolscap
166	Interval: LT
175	Interval: 12x18
225	Interval: 36 inch
227	Interval: 18 inch
226	Interval: 24 inch
228	Interval: 12 inch
229	Interval: 9 inch
234	Interval: 34 inch
235	Interval: 12 inch
236	Interval: 17 inch
237	Interval: 11 inch
238	Interval: 8.5 inch

5508	CC Call Japan Only	
1	Jam Remains	[0 to 1/1] 0: Disabled, 1: Enabled
2	Continuous Jams	
3	Continuous Door Open	
11	Jam Detection: Time Length	
	[03 to 30/1] This setting is enabled only when SP5508-4 is enabled (set to 1).	

12	Jam Detection Continuous Count
	[02 to 10/1] This setting is enabled only when SP5508-4 is enabled (set to 1).
13	Door Open: Time Length
	[03 to 30/1] This setting is enabled only when SP5508-4 is enabled (set to "1").

5515	SC/Alarm Setting
1	SC Call
2	Service Parts Near End Call
3	Service Parts End Call
4	User Call
	[0 to 1/1/1] 0: Off 1: On
6	Communication Test Call
7	Machine Information Notice
8	Alarm Notice
	[0 or 1/1/1] 0: Off 1: On
9	Non-Genuine Toner Alarm
10	Supply Automatic Ordering Call
11	Supply Management Report Call
	[0 to 1/1/1]
12	Jam/Door Open Call
	[0 to 1/1/1]
50	Timeout:Manual Call
	[1 to 255 / 5 / 1 min]

51	Timeout:Other Call
	[1 to 255 / 10 / 1 min]

5618	Color Mode Display Selection
	<p>[0 to 1/0/1] 0:EXP 1:DOM</p> <p>0: Presents 5 selections:</p> <ul style="list-style-type: none"> • Auto color select • Full color • B&W • 2-color • Single-color.

3

5728	Network Setting	
1	NAT Machine Port1	[0 to 65535 / 49101 / 1]
2	NAT UI Port1	[0 to 65535 / 55101 / 1]
3	NAT Machine Port2	[0 to 65535 / 49102 / 1]
4	NAT UI Port2	[0 to 65535 / 55102 / 1]
5	NAT Machine Port3	[0 to 65535 / 49103 / 1]
6	NAT UI Port3	[0 to 65535 / 55103 / 1]
7	NAT Machine Port4	[0 to 65535 / 49104 / 1]
8	NAT UI Port4	[0 to 65535 / 55104 / 1]
9	NAT Machine Port5	[0 to 65535 / 49105 / 1]
10	NAT UI Port5	[0 to 65535 / 55105 / 1]
11	NAT Machine Port6	[0 to 65535 / 49106 / 1]
12	NAT UI Port6	[0 to 65535 / 55106 / 1]
13	NAT Machine Port7	[0 to 65535 / 49107 / 1]
14	NAT UI Port7	[0 to 65535 / 55107 / 1]
15	NAT Machine Port8	[0 to 65535 / 49108 / 1]

16	NAT UI Port8	[0 to 65535 / 55108 / 1]
17	NAT Machine Port9	[0 to 65535 / 49109 / 1]
18	NAT UI Port9	[0 to 65535 / 55109 / 1]
19	NAT Machine Port10	[0 to 65535 / 49110 / 1]
20	NAT UI Port10	[0 to 65535 / 55110 / 1]
5728	Network Setting	
101	PacketCapture	[0 or 1 / 0 / 1]
102	PacketCapture:mode	[0 or 1 / 0 / 1]
103	PacketCapture:interface	[0 to 3 / 0 / 3]
104	PacketCapture:length	[54 to 65535 / 128 / -]
105	PacketCapture:broadcast	[0 or 1 / 0 / -]
106	PacketCapture:specify port	[0 or 1 / 0 / 1]
107	PacketCapture:portnumber	[0 to 65535 / 0 / -]
108	PacketCapture:time	[0 to 0xffffffff / 128 / 1]
5730	Extended Function Setting Not Used	
5731	Counter Effect Not Used	

5734	PDF Setting
	<p>[0 to 1 / 0 / 1] 0:Setting not fixed 1:Setting fixed</p> <ul style="list-style-type: none"> • 0: Allows setting clear write PDF, PDF/A, or encoded PDF on the application screen. • 1: PDF/A can be selected on the application screen, but PDF, Clear Write PDF, or encoded PDF are grayed-out and cannot be selected.

3

5745	DeemedPowerConsumption	
211	Controller Standby	[0 to 9999 / 0 / 1]
212	STR	
213	Main Power Off	
214	Scanning and Printing	
215	Printing	
216	Scanning	
217	Engine Standby	
218	Low Power Consumption	
219	Silent condition	
220	Heater Off	

5748	OpePanel Setting	
101	Op Type Action Setting	[0 to 255 / 0 / 1]
201	Cheetah Panel Connect Setting	[0 or 1 / 0 / 1]

5749	Import/Export
1	Export
101	Import

5751	Key Event Encryption Setting	
001	Password	[0 to 255 / 0 / -]

5752	Copy:WebAPI Setting		
001	Copy:FlairAPI Setting		[0 to 255 / 0 / 1]
	bit0	FlairAPI server start up	0: Off 1: On
	bit1	Access permission from FlairAPI external device	0: Disabled 1: Enabled
	bit2	Switching dedicated IPv6	0: IPv6 only 1: IPv4 priority
	bit3	Remote UI function	0: Disabled 1: Enabled
	bit4	Not used	
	bit5	Not used	
	bit6	Not used	
	bit7	Not used	

5755	Display Setting	
1	Disp Administrator Password Change Scrn	
2	Hide Administrator Password Change Scrn	

5758	RemoteUI Setting	
1	Authentication	[0 or 1 / 0 / 1]

5761	SmartOperationPanel Setting	
1	Restore the default Home screen	[0 to 255 / 0 / 1]

5801	Memory Clear	
1	All Clear	

2	Engine
3	SCS
4	IMH Memory Clr
5	MCS
6	Copier application
7	Fax application Not Used
8	Printer application
9	Scanner application
10	Web Service
11	NCS (Network Control Service)
14	Clear DCS Setting
15	Clear UCS Setting
16	MIRS Setting
17	CCS
18	SRM Memory Clr
19	LCS
20	Web Uapl
21	ECS
25	websys
26	PLN
27	SAS
28	Rest WebService

5802	Carriage Free Run
11	Release Paper Feed Pressure: Upper
12	Release Paper Feed Pressure: Lower

5803	Input Check
1	Paper Inlet Sensor: Upper
2	Paper Inlet Sensor: Lower
3	Paper Exit Sensor: Upper
4	Paper Exit Sensor: Lower
5	Front Register Sensor
6	By-pass Sensor
7	Output Sensor
10	Paper Feed Pressure Release Sensor: Upper
11	Paper Feed Pressure Release Sensor: Lower
12	Register Pressure Release Sensor: Lower
13	Residual Amount. Sensor Upper
14	Residual Amount. Sensor Lower
15	Residual Qty. Ratio M
16	Residual Qty. Ratio Y
17	Main Scan Encoder Sensor
18	Sub Scan Encoder Sensor
19	Roll End Sensor/Upper
20	Roll End Sensor/Lower
21	Front Cover Pre-Sensor
22	Total Counter
23	Separation claw position sensor
30	Outside Temperature
31	Outside Humidity
41	Head Rising Sensor 1
42	Head Rising Sensor 2

43	Head Temperature Sensor: Color
45	Head Temperature Sensor: Black
48	DRESS Sensor 1
49	DRESS Sensor 2
50	Front Cover Sensor Left
51	Front Cover Sensor Right
52	Cartridge Cover Sensor
53	Roll Paper Cover Sensor
54	Waste Ink Box Cover Sensor
55	Waste Ink Box Setting Sensor
60	Sub Scan HP Sensor
61	Cutter Sensor Right
62	Cutter Sensor Left
70	Maintenance Suction Unit HP Detection Sensor
71	MaintenDehumidify Unit HP Detection Sensor
72	MaintenanceCleaner Slide HP Detection Sensor
91	Ink Cartridge Sensor: Y
92	Ink Cartridge Sensor: M
93	Ink Cartridge Sensor: C
94	Ink Cartridge Sensor: K
150	MainFillerSens Front
151	MainFillerSens Rear
152	OCFS HT1
153	OCFS HT2
154	OCFS HT3
155	OCFS HT4

156	OCFS HT5
157	OCFS HT6
158	OCFS HT7
159	INKEND SENSOR K
160	INKEND SENSOR C
161	INKEND SENSOR M
162	INKEND SENSOR Y
201	Original Width Sensor:A0
202	Original Width Sensor:A1
203	Original Width Sensor:A2
204	Original Width Sensor:A3
205	Original Width Sensor:B1
206	Original Width Sensor:B2
207	Original Width Sensor:B3
208	Original Width Sensor:B4
209	Original Width Sensor:91.4mm
210	Original Width Sensor:30"
211	Original Set Sensor
212	Original Registration Sensor
213	Original Exit Sensor
214	Original Emergency Stop Sensor
215	Original Feed Unit Open Sensor
250	Auto Nozzle Check Wiper Pos Detect HP Sen
251	Auto Nozzle Check Wiper Pos Detect

5804	Output Check
------	--------------

51	Paper Feed Motor: Upper
52	Paper Feed Motor Speed: Upper
53	Paper Feed Motor: Lower
54	Paper Feed Motor Speed: Lower
55	Paper Feed Clutch: Upper
56	Paper Feed Clutch: Lower
59	Sub Scan Motor
60	Sub Scan Motor Speed
63	Move Cutter Toward Right
64	Move Cutter Toward Left
65	Start Suction Fan
66	Suction Fan Speed
67	Suction Fan Revolution
68	MCU Cooling Fan
69	PSU Cooling Fan
71	DRESS LED On
72	Manual feed clutch
100	Auto Nozzle Check LED On
110	Air Release Solenoid On/Off
111	Carriage LED On/Off
112	Carriage LED Duty Setting
201	Document
211	CIS_LED_R
212	CIS_LED_G
213	CIS_LED_B

5811	Machine Serial Number
1	Set
	[0 to 255/0/1]
2	Display
	[0 to 255/0/1]

5812	Service Tel. No. Setting
1	Service
2	Facsimile
3	Supply
4	Operation

5816	Remote Service	CTL
1	I/F Setting	
	[0 to 2/2/1 /step] 0: Remote service off 1: CSS remote service on 2: @Remote service on	
2	CE Call	
	[0 or 1/0/1 /step] 0: Start of the service 1: End of the service NOTE: This SP is activated only when SP 5816-1 is set to "2".	
3	Function Flag	
	[0 to 1/0/1 /step] 0: Disabled, 1: Enabled NOTE: This SP setting is changed to "1" after @Remote register has been completed.	

7	SSL Disable
	[0 to 1/ 0 /1 /step] 0: Uses the RCG certification 1: Does no use the RCG certification
8	RCG Connect Timeout
	[1 to 90/ 30 /1 second /step]
9	RCG Write Timeout
	[1 to 100/ 60 /1 second /step]
10	RCG Read Timeout
	[1 to 100/ 60 /1 second /step]
11	Port 80 Enable
	[0 or 1/ 0 /-] 0: Disabled, 1: Enabled
13	RFU (Remote Firmware Update) Timing
	[0 or 1/ 1 /-] <ul style="list-style-type: none"> • 0: RFU is executed whenever update request is received. • 1: RFU is executed only when the machine is in the sleep mode.
14	RCG Error Cause
	[0 to 1/ 0 /1] 0:Normal condition 1:Error <ul style="list-style-type: none"> • If "1" is displayed, this means that the authentication from client to server failed when the network re-booted. • To restore normal operation, cycle the machine off/on to return a "0" (normal condition).
21	RCG – C Registered
	0: Installation not completed 1: Installation completed

23	Connect Type (N/M/3G) [0 or 2/0/1 /step 0: Internet connection 1: Dial-up connection 2: Wirelss lan connection
62	Use Proxy
63	Proxy Host
64	Proxy Port Number
65	Proxy User Name
66	Proxy Password

67	CERT: Up State	
	0	The certification used by Embedded RC Gate is set correctly.
	1	The certification request (setAuthKey) for update has been received from the GW URL and certification is presently being updated.
	2	The certification update is completed and the GW URL is being notified of the successful update.
	3	The certification update failed, and the GW URL is being notified of the failed update.
	4	The period of the certification has expired and new request for an update is being sent to the GW URL.
	11	A rescue update for certification has been issued and a rescue certification setting is in progress for the rescue GW connection.
	12	The rescue certification setting is completed and the GW URL is being notified of the certification update request.
	13	The notification of the request for certification update has completed successfully, and the system is waiting for the certification update request from the rescue GW URL.
	14	The notification of the certification request has been received from the rescue GW controller, and the certification is being stored.
	15	The certification has been stored, and the GW URL is being notified of the successful completion of this event.
	16	The storing of the certification has failed, and the GW URL is being notified of the failure of this event.
	17	The certification update request has been received from the GW URL, the GW URL was notified of the results of the update after it was completed, but a certification error has been received, and the rescue certification is being recorded.
	18	The rescue certification of No. 17 has been recorded, and the GW URL is being notified of the failure of the certification update.

68	CERT: Error	
	0	Normal. There is no request for certification update in progress.
	1	Request for certification update in progress. The current certification has expired.
	2	An SSL error notification has been issued. Issued after the certification has expired.
	3	Notification of shift from a common authentication to an individual certification.
	4	Notification of a common certification without ID2.
	5	Notification that no certification was issued.
	6	Notification that GW URL does not exist.
69	CERT: Up ID	
83	Firmware Up Status	
85	Firm Up User Check	
86	Firmware Size	
87	CERT: Macro Ver.	
88	CERT: PAC Ver.	
	Displays the PAC version of the @Remote certification.	
89	CERT: ID2 Code	
90	CERT: Subject	
91	CERT: Serial No.	
92	CERT: Issuer	
93	CERT: Valid Start	
94	CERT: Valid End	
102	CERT: Encrypt Level	
	[1 to 2/1/1]	
103	Client Communication Method	
	[0 to 3 / 0 / 1]	

104	Client Communication Limit
	[1 to 7 / 7 / 1]
115	Network Information Waiting timer
150	Selection Country
	Not used
151	Line Type Automatic Judgment
	Not used
152	Line Type Judgment Result
	Not used
153	Selection Dial/Push
	Not used
154	Outside Line/Outgoing Number
	Not used
156	Dial Up User Name
	Not used
157	Dial Up Password
	Not used
161	Local Phone Number
	Not used
162	Connection Timing Adjustment: Incoming
	Not used
163	Access Point
	Not used
164	Line Connecting
	Not used

173	Modem Serial Number
	Not used
174	Retransmission Limit
	Not used
187	FAX TX Priorit
	Not used
190	3G DongleID
199	ppp Connect Timer
200	Manual Polling
	Not used
201	Regist: Status
	<ul style="list-style-type: none"> • 0: Neither the @Remote device nor Embedded RCG Gate is set. • 1: The Embedded RCG Gate is being set. Only Box registration is completed. In this status, @Remote device cannot communicate with this device. • 2: The Embedded RCG Gate is set. In this status, the @Remote device cannot communicate with this device. • 3: The @Remote device is being set. In this status the Embedded RCG Gate cannot be set. • 4: The @Remote module has not started.
202	Letter Number
	Allows entry of the request number needed for the Embedded RCG Gate.
203	Confirm Execute
	Executes the confirmation request to the @Remote Gateway.
204	Confirm Result

	<ul style="list-style-type: none"> 0: Succeeded 1: Confirmation number error 2: Registration in progress 3: Proxy error (proxy enabled) 4: Proxy error (proxy disabled) 5: Proxy error (Illegal user name or password) 6: Communication error 7: Certification update error 8: Other error 9: Confirmation executing
205	Confirm Place
206	Register Execute
207	<p>Register Result</p> <ul style="list-style-type: none"> 0: Succeeded 2: Registration in progress 3: Proxy error (proxy enabled) 4: Proxy error (proxy disabled) 5: Proxy error (Illegal user name or password) 6: Communication error 7: Certification update error 8: Other error 9: Registration executing

208	Error Code		
	Cause	Code	Meaning
	Illegal Modem Parameter	-11001	Chat parameter error
		-11002	Chat execution error
		-11003	Unexpected error
	Operation Error, Incorrect Setting	-12002	Inquiry, registration attempted without acquiring device status.
		-12003	Attempted registration without execution of an inquiry and no previous registration.
		-12004	Attempted setting with illegal entries for certification and ID2.
	-	-12005	@Remote communication is prohibited. The device has an Embedded RC gate-related problem.
		-12006	A confirmation request was made after the confirmation had been already completed.
		-12007	The request number used at registration was different from the one used at confirmation.
		-12008	Update certification failed because mainframe was in use.

208	Error Caused by Response from GW URL	-2385	Attempted dial up overseas without the correct international prefix for the telephone number.
		-2387	Not supported at the Service Center
		-2389	Database out of service
		-2390	Program out of service
		-2391	Two registrations for same device
		-2392	Parameter error
	-	-2393	RCG device not managed
		-2394	Device not managed
		-2395	Box ID for RCG device is illegal
		-2396	Device ID for RCG device is illegal
		-2397	Incorrect ID2 format
		-2398	Incorrect request number format
209	Instl Clear		
240	CommErrorTime		
241	CommErrorCode 1		
	[0 to 0xffffffff / 0x00000000 / 1]		
242	CommErrorCode 2		
	[0 to 0xffffffff / 0x00000000 / 1]		
243	CommErrorCode 3		
	[0 to 0xffffffff / 0x00000000 / 1]		
244	CommErrorState 1		
	[0 to 0xffff / 0x0000 / 1]		
245	CommErrorState 2		
	[0 to 0xffff / 0x0000 / 1]		

246	CommErrorState 3	
	[0 to 0xffff / 0x0000 / 1]	
247	SSL Error Count	
	[0 to 255 / 0 / 1]	
248	Other Err Count	
250	CommLog Print	Prints the communication log.

3

5821	Remote Service Address	CTL
2	RCG IP Address	
3	RCG Port	
	[0 to 65 535/443/1]	
4	RCG URL Path	
5	RCG IPv6 Address	
6	RCG IPv6 URL Path	
7	RCG Host Name	
8	RCG Host URL Path	

5824	NVRAM Data Upload	
	[EXECUTE]	

5825	NVRAM Data Download	
	[EXECUTE]	

5828	Network Setting	CTL
039	User Class	
040	Class Id	

50	1284 Compatibility (Centro)
	[0 or 1/1/1/step] 0: Disabled, 1: Enabled
52	ECP (Centro)
	[0 or 1/1/1/step] 0: Disabled, 1: Enabled Note: This SP is activated only when SP5-828-50 is set to "1".
65	Job Spooling
	[0 or 1/0/1/step] 0: Disabled, 1: Enabled
66	Job Spooling Clear: Start Time
	0: ON (Data is cleared) 1: OFF (Automatically printed)
69	Job Spooling (Protocol)
	0: Validates 1: Invalidates bit0: LPR bit1: FTP bit2: IPP bit3: SMB bit4: BMLinkS bit5: DIPRINT bit6: sftp bit7: wsprnd
87	Protocol usage
90	TELNET (0: OFF 1: ON)
	[0 or 1/1/-] 0: Disable, 1: Enable

91	Web (0: OFF 1: ON)
	[0 or 1/1/-] 0: Disable, 1: Enable
145	Active IPv6 Link Local Address
147	Active Ipv6 Stateless Address 1
149	Active Ipv6 Stateless Address 2
151	Active Ipv6 Stateless Address 3
153	Active Ipv6 Stateless Address 4
155	Active Ipv6 Stateless Address 5
156	Ipv6 Manual Address
158	Ipv6 Gateway Address
161	Ipv6 Stateless Auto Setting
	[0 or 1/1/1 /step] 0: Disable, 1: Enable
219	IPsec Aggressive Mode Setting
	-
236	Web Item Visible
	[0 x 0000 to 0 x ffff/0 x ffff] 0: Not displayed, 1: Displayed <ul style="list-style-type: none"> • bit0: Net RICOH • bit1: Consumable Supplier • bit2-15: Reserved (all)
237	Web shopping Link Visible
	[0 to 1/1/1] 0: Not display, 1:Display
238	Web Supplies Link visible
	[0 to 1/1/1] 0: Not display, 1:Display

239	Web Link 1 Name	
240	Web Link 1 URL	
241	Web Link 1 visible	
	[0 to 1/1/1] 0: Not display, 1:Display	
242	Web Link 2 Name	Same as "-239"
243	Web Link 2 URL	Same as "-240"
244	Web Link 2 visible	Same as "-241"
249	DHCPv6 DUID	

5832	HDD	
1	HDD Formatting (All)	
2	HDD Formatting (IMH)	
3	HDD Formatting (Thumbnail/OCR)	
4	HDD Formatting (Job Log)	
5	HDD Formatting (Printer Fonts)	
6	HDD Formatting (User Info)	
7	Mail RX Data	
8	Mail TX Data	
9	HDD Formatting (Data for Design)	
10	HDD Formatting (Log)	
11	HDD Formatting (Ridoc I/F) (for Ridoc Desk Top Binder)	
12	HDD Formatting (Thumbnail)	

5840	IEEE 802.11	
6	Channel MAX	
	[1 to 14/1]	

7	Channel MIN
	[1 to 14/1]
11	WEP Key Select
	[0 to 1/1] 0: If the initiator receives another login request while logging in, the request is refused. 1: If the initiator receives another login request while logging in, the request is refused and the initiator logs out. Note: Displayed only when the wireless LAN card is installed.
45	WPA Debug Lvl1
	[1 to 3/ 3 /1] 1: Info, 2: warning, 3: error This SP is displayed only when the IEEE802.11 card is installed.
46	11w
	[0 to 2 / 0 / 1]
47	PSK Set Type
	[0 or 1 / 0 / 1]

5841	Supply Name Setting
1	Toner Name Setting: Black
2	Toner Name Setting: Cyan
3	Toner Name Setting: Yellow
4	Toner Name Setting: Magenta
9	WasteTonerBottle

5844	USB
1	Transfer Rate
	[Full Speed] [Auto Change]

4	Device Release Number.
	[0000 to 9999/1] Enter as a decimal number. NCS converts the number to hexadecimal number recognized as the BCD.
5	Fixed USB Port
	[0 to 2/ 0 /1/step] 0: Disable 1: Level 1 2: Level 2
6	PnP Model Name
7	PnP Serial Number
8	Mac Supply Level
	[0 or 1 / 1 / 1]
100	Notify Unsupport
	[0 or 1/ 1 /1] 0: Not displayed,

5845	Delivery Server Setting	CTL
1	FTP Port No.	
	[0 to 65535/ 3670 /1 /step]	
2	IP Address (Primary)	
	Range: 000.000.000.000 to 255.255.255.255	
6	Delivery Error Display Time	
	[0 to 999/ 300 /1 second /step]	
8	IP Address (Secondary)	
	Range: 000.000.000.000 to 255.255.255.255	

9	Delivery Server Model	
	[0 to 4/0/1 /step] 0: Unknown 1: SG1 Provided 2: SG1 Package 3: SG2 Provided 4: SG2 Package	
10	Delivery Svr Capability	
	[0 to 255/0/1 /step]	
	Bit7 = 1 Comment information exists	
	Bit6 = 1 Direct specification of mail address possible	
	Bit5 = 1 Mail RX confirmation setting possible	
	Bit4 = 1 Address book automatic update function exists	
	Bit3 = 1 Fax RX delivery function exists	
	Bit2 = 1 Sender password function exists	
	Bit1 = 1 Function to link MK-1 user and Sender exists	
	Bit0 = 1 Sender specification required (if set to 1, Bit6 is set to "0")	
11	Delivery Svr Capability (Ext)	
	[0 to 255/0/1 /step] Bit7 = 1 Address book usage limitation (Limitation for each authorized user) Bit6 = 1 RDH authorization link Bit5 to 0: Not used	
22	Rapid Sending Control	
	[0 to 1/0/1] 0: Disable, 1: Enable	
5846	UCS Settings	CTL
1	Machine ID (For Delivery Server)	

2	Machine ID Clear (For Delivery Server)
3	Maximum Entries
	[2000 to 20000/ 2000 /1 /step]
6	Delivery Server Retry Timer
	[0 to 255/ 0 /1 /step]
7	Delivery Server Retry Times
	[0 to 255/ 0 /1 /step]
8	Delivery Server Maximum Entries
	[2000 to 50000/ 2000 /1/step]
10	LDAP Search Timeout
	[1 to 255/ 60 /1 /step]
21	Fold Auth Change
40	Addr Book Migration (SD -> HDD) Not Used
41	Fill Addr Acl Info.
	<p>This SP must be executed immediately after installation of an HDD unit in a basic machine that previously had no HDD. The first time the machine is powered on with the new HDD installed, the system automatically takes the address book from the NVRAM and writes it onto the new HDD. However, the new address book on the HDD can be accessed only by the system administrator at this stage. Executing this SP by the service technician immediately after power on grants full address book access to all users.</p> <p>Procedure</p> <ol style="list-style-type: none"> 1. Turn the machine off. 2. Install a new HDD. 3. Turn the machine on. 4. The address book and its initial data are created on the HDD automatically. However, at this point the address book can be accessed by only the system administrator or key operator. 6. Enter the SP mode and do SP5846-041 . After this SP executes successfully, any user can access the address book.

43	Addr Book Media
	<p>[0 to 30/- /1]</p> <ul style="list-style-type: none"> • 0: Unconfirmed • 1: SD Slot 1 • 2: SD Slot 2 • 4: USB Flash ROM • 20: HDD • 30: Nothing
47	Initialize Local Addr Book
48	Initialize Delivery Addr Book
49	Initialize LDAP Addr Book
50	Initialize All Addr Book
51	Backup All Addr Book
52	Restore All Addr Book
53	Clear Backup Info
60	Search Option
	<p>Bit: Meaning</p> <p>0: Checks both upper/lower case characters</p> <p>1: Japan Only</p> <p>2: Japan Only</p> <p>3: Japan Only</p> <p>4 to 7: Not Used</p>
62	Complexity Option 1
	[0 to 32/ 0 /1 /step]
91	FTP Auth Port Setting
	[0 to 65535/ 3671 /1 /step]
94	Encryption Stat

5847	Rep Resolution Reduction
1	Rate for Copy Color
	[0 to 5 / 2 / 1]
2	Rate for Copy B&W Text
	[0 to 6 / 0 / 1]
3	Rate for Copy B&W Other
	[0 to 6 / 0 / 1]
4	Rate for Printer Color
	[0 to 5 / 2 / 1]
5	Rate for Printer B&W
	[0 to 6 / 0 / 1]
6	Rate for Printer Color 1200dpi
	[0 to 5 / 4 / 1]
7	Rate for Printer B&W 1200dpi
	[0 to 6 / 1 / 1]
21	Network Quality Default for JPEG
	[5 to 95 / 50 / 1]

5848	Web Service
2	Acc. Ctrl.: Repository (only Lower 4 Bits)
	0000: No access control
	0001: Denies access to DeskTop Binder.
3	Acc. Ctrl.: Doc. Svr. Print (Lower 4 Bits)
	0000: OFF, 0001: ON
4	Acc. Ctrl.: User Directory (Lower 4 Bits)
	0000: OFF, 0001: ON

7	Access Ctrl: Comm. Log Fax (Lower 4bits)
	0000: OFF, 0001: ON
9	Acc. Ctrl.: Job Control (Lower 4 Bits)
	0000: OFF, 0001: ON
11	Acc. Ctrl: Device Management (Lower 4 Bits)
	0000: OFF, 0001: ON
21	Acc. Ctrl: Delivery (Lower 4 Bits)
	0000: OFF, 0001: ON
22	Acc. Ctrl: User Administration (Lower 4 Bits)
	0000: OFF, 0001: ON
24	Access Ctrl: Log Service (Lower 4bits)
25	Access Ctrl: Rest Webservice (Lower 4bits)
99	Repository: Download Image Setting
100	Repository: Download Image Max. Size
	[1 to 1024/1 K]
150	Log Operation Mode
	[0 to 9 / 0 / 1]
217	Setting: Timing

5849	Installation Date
1	Display
2	Switch to Print
	[0 to 1/0/1] 0: No Print, 1: Print
3	Total Counter
	[0 to 9999 9999]

5851	Bluetooth Mode
	[0: Public] [1: Private]

5853	Stamp Data Download
	[Execute]

5856	Remote ROM Update
	[0 to 1/0/1] 0: Not allowed, 1: Allowed

5858	Collect Machine Info	
1	0:OFF 1:ON	[0 or 1 / 1 / 1]
2	Save To (0:HDD 1:SD)	[0 or 1 / 0 / 1]
3	Make Log Trace Dir	[0 or 1 / 0 / 1]
101	Failure Occuring Date	[0 or 20371212 / 0 / 1]
102	Tracing Days	[1 to 180 / 2 / 1 day]
103	Acquire Fax Address(0:OFF 1:ON)	[0 or 1 / 0 / 1]
111	Acquire All Info & Logs	[0 or 1 / 0 / 1]
121	Acquire Configuration Page	[0 or 1 / 0 / 1]
122	Acquire Font Page	[0 or 1 / 0 / 1]
123	Acquire Print Setting List	[0 or 1 / 0 / 1]
124	Acquire Error Log	[0 or 1 / 0 / 1]
131	Acquire Fax Info	[0 or 1 / 0 / 1]
141	Acquire All Debug Logs	[0 or 1 / 0 / 1]
142	Acquire Controller Debug Logs Only	[0 or 1 / 0 / 1]
143	Acquire Engine Debug Logs Only	[0 or 1 / 0 / 1]
144	Acquire Opepanel Debug Logs Only	[0 or 1 / 0 / 1]

145	Acquire FCU Debug Logs Only	[0 or 1 / 0 / 1]
146	Acquire Only Network Packets	[0 or 1 / 0 / 1]

5860	SMTP/POP3/IMAP4	
20	Partial Mail Receive Timeout	
		[1 to 168/72/1]
21	MDN Response RFC2298Compliance	
		[0 to 1/1] 0: No, 1: Yes
22	SMTP Auth. From Field Replacement	
		[0 to 1/1] 0: No. "From" item not switched. 1: Yes. "From" item switched.
25	SMTP Auth Direct Sending	
		Bit0: LOGIN Bit1: PLAIN Bit2: CRAM_MD5 Bit3: DIGEST_MD5 Bit4 to Bit 7: Not Used
26	S/MIME: MIME Header Settings	
		[0 to 2/0/1] 0: Microsoft Outlook Express standard 1: Internet Draft standard 2: RFC standard
28	S/MIME: Authentication Check	
		[0 to 1/0/1] 0: No Checking 1: Checking
5866	E-Mail Report	

1	Report Validity
	[0 or 1/0/1] 0: Enable, 1: Disable
5	Add Date Field
	[0 to 1/0/1]

5870	Common Key Info Writing Not Used
1	Writing
3	Initialize
4	Writing 2048 bit

5873	SD Card Appli Move
1	Move Exec
2	Undo Exec

5875	SC Auto Reboot
1	Reboot Setting
	[0 to 1/0/1] 0: On, 1: Off On: default: 0 (Reboots automatically) The machine reboots automatically when the machine issues an SC error and logs the SC error code. If the same SC occurs again, the machine does not reboot. OFF: 1 (Does not reboot automatically. Changing this setting to "0" sets the machine to reboot automatically after an SC occurs.
2	Reboot Type
	[0 to 1/0/1] 0: Allows manual reboot, 1: Automatic reboot

5878	Option Setup
------	--------------

1	Data Overwrite Security
	[EXECUTE]
2	HDD Encryption
	[EXECUTE]
4	OCR Dictionary
	[EXECUTE]

5881	Fixed Phase Block Erasing
1	[EXECUTE]

5884	Factory Setting
1	Restore
2	Backup
3	Head Gap Backup

5886	Farm Update Setting	
100	Skip Version Check	[0 or 1 / 0 / 1]
101	Skip LR Check	[0 or 1 / 0 / 1]

5887	SD Get Counter	CTL
<p>This SP sends a text file to an SD card inserted in SD card Slot 2 (lower slot). The operation stores. The file is stored in a folder created in the root directory of the SD card called SD_COUNTER. The file is saved as a text file (*.txt) prefixed with the number of the machine.</p> <ol style="list-style-type: none"> 1. Insert the SD card in SD card Slot 2 (lower slot). 2. Select SP5887 then touch [EXECUTE]. 3. Touch [EXECUTE] in the message when you are prompted. 		

5888	Personal Information Protect	
	[0 to 1/0/1] 0: No authentication, No protection for logs 1: No authentication, Protected logs (only an administrator can see the logs)	

5895	Application invalidation	
1	Printer	[0 or 1 / 0 / 1]
2	Scanner	[0 or 1 / 0 / 1]

5900	Engine Log Upload	
1	Pattern	[0 to 4 / 0 / 1]
2	Triggerw	[0 to 3 / 0 / 1]

5907	Plug & Play Maker/Model Name	
------	------------------------------	--

5913	Switchover Permission Time	
	[0 to 1/1/1] 0: OFF 1: ON	

5967	Copy Server: Set Function	
	[0 to 1/1/1] 0: ON, 1: OFF	

5973	User Stamp Registration	
101	Frame deletion setting	[0 to 3 / 0 / 1 mm]

5985	Device Setting	
1	On Board NIC	
	[0: Disable] [1: Enable]	

2	On Board USB
	[0: Disable] [1: Enable]

5987	Counter Falsifying Guard - 0:OFF/1:ON DFU
	[0 to 1/0/1]

5990	SP Print Mode
1	All (Data List)
2	SP (Mode Data List)
3	User Program
4	Logging Data
5	Diagnostic Report
6	Non-Default (Prints only SPs set to values other than defaults.)
7	NIB Summary
21	Copier User Program
22	Scanner SP
23	Scanner User Program
24	SDK/J Summary
25	SDK/J Application Info
26	Printer SP
27	SmartOperationPanel SP
28	SmartOperationPanel UP

5992	SP Text Mode
1	All (Data List)
2	SP (Mode Data List)
3	User Program Data

4	Logging Data
5	Diagnostic Report
6	Non-Default (Prints only SPs set to values other than defaults.)
7	NIB Summary
21	Copier User Program
22	Scanner SP
23	Scanner User Program
24	SDK/J Summary
25	SDK/J Application Info
26	Printer SP
27	SmartOperationPanel SP
28	SmartOperationPanel UP

Main SP Tables-6

SP6-XXX

There are no SP codes for this group because there are no peripheral units for this machine at the present time.

Main SP Tables-7

SP7-XXX

3

7001	Operating Period Indication
	[0 to 99999999/0/1 min]
1	Main Scan Motor
2	Scanner Motor
3	Sub Scan Motor
4	Paper Feed Motor: Upper
5	Paper Feed Motor: Lower
7	Suction Fan
8	Head Rising Motor (Lift Motor)
9	MCU Cooling Fan
10	PSU Cooling Fan
11	Supply Motor P1 (Bk1)
12	Supply Motor P2 (Bk2)
13	Supply Motor P3 (C)
14	Supply Motor P4 (M1)
15	Supply Motor P5 (M2)
16	Supply Motor P6 (Y1)
17	Supply Motor P7 (Y2)

7002	GL Total Count
	[0 to 99999999/0/1 page]
1	Color (Volume)
2	Black & White (Volume)

3	Color (Converted into A4)
4	Black & White (Converted into A4)
10	Color: width \geq 841 (High Speed/Standard) [0 to 0xFFFFFFFF/0/1]
11	Color: width: \geq 841 (Fine)
12	Color: width: \geq 594 (High Speed/Standard)
13	Color: width: \geq 594 (Fine)
14	Color: width: \geq 420 (High Speed/Standard)
15	Color: width: \geq 420 (Fine)
16	Color: width: $<$ 420 (High Speed/Standard)
17	Color: width: $<$ 420 (Fine)
18	Mono: width: \geq 841 (High Speed/Standard)
19	Mono: width: \geq 841 (Fine)
20	Mono: width: \geq 594 (High Speed/Standard)
21	Mono: width: \geq 594 (Fine)
22	Mono: width: \geq 420 (High Speed/Standard)
23	Mono: width: \geq 420 (Fine)
24	Mono: width: $<$ 420 (High Speed/Standard)
25	Mono: width: $<$ 420 (Fine)

7212	User Cleaning
11	Count H1 [0 to 999 999/0/1]
12	Count H2 [0 to 999 999/0/1]

13	Count H3
	[0 to 999 999/0/1]
14	Count H4
	[0 to 999 999/0/1]
15	Count H5
	[0 to 999 999/0/1]

7213	User Refreshing
11	Count H1
	[0 to 999 999/0/1]
12	Count H2
	[0 to 999 999/0/1]
13	Count H3
	[0 to 999 999/0/1]
14	Count H4
	[0 to 999 999/0/1]
15	Count H5
	[0 to 999 999/0/1]

7214	Front Cover Open
1	Recovery Cleaning Count H1
2	Recovery Cleaning Count H2
3	Recovery Cleaning Count H3
4	Recovery Cleaning Count H4
5	Recovery Cleaning Count H5
	[0 to 999 999/0/1]

6	Open Count During Maintenance
	[0 to 3/0/1]

7215	Auto Nozzle Check Maintenance
1	Recovery Cleaning Count H1
2	Recovery Cleaning Count H2
3	Recovery Cleaning Count H3
4	Recovery Cleaning Count H4
5	Recovery Cleaning Count H5
	[0 to 999999/0/1]

7216	Temp. Rise User CL Switch	
001	Refreshing Count H1	[0 to 99999 / 0 / 1]
002	Refreshing Count H2	
003	Refreshing Count H3	
004	Refreshing Count H4	
005	Refreshing Count H5	

7217	Cleaning After Leftover
------	-------------------------

Time	Time	Power ON	Job Start	Energy Save
<10 hr	16 s	No	Yes	No
>10 hr<24	9 s (Power ON) 16 s (Job Start)	Yes	Yes	No
>24 hr.<1 week	3 min.	Yes	Yes	No
>1 week<2 weeks	3 min.	Yes	Yes	Yes
>2 weeks<45 days	30 min.	Yes	Yes	Yes

1	Count H1
	[0 to 999 999/0/1]
2	Count H2
	[0 to 999 999/0/1]
3	Count H3
	[0 to 999 999/0/1]
4	Count H4
	[0 to 999 999/0/1]
5	Count H5
	[0 to 999 999/0/1]
6	Count H1 LV2
	[0 to 20000/0/1]
7	Count H2 LV2
	[0 to 20000/0/1]
8	Count H3 LV2
	[0 to 20000/0/1]
9	Count H4 LV2
	[0 to 20000/0/1]
10	Count H5 LV2
	[0 to 20000/0/1]

7218	Ink Supply Seq. After Leftover
	Idle Time 1
1	Count H1
	[0 to 999 999/0/1]

2	Count H2
	[0 to 20000/0/1]
3	Count H3
	[0 to 20000/0/1]
4	Count H4
	[0 to 20000/0/1]
5	Count H5
	[0 to 20000/0/1]
Idle Time 2	
6	Count H1 LV2
	[0 to 20000/0/1]
7	Count H2 LV2
	[0 to 20000/0/1]
8	Count H3 LV2
	[0 to 20000/0/1]
9	Count H4 LV2
	[0 to 20000/0/1]
10	Count H5 LV2
	[0 to 20000/0/1]

7222	Electrified Mist [0 to 0xFFFFFFFF/0/1 nI]
1	Nozzle 1
2	Nozzle 2
3	Nozzle 3
4	Nozzle 4

5	Nozzle 5
6	Nozzle 6
7	Nozzle 7
8	Nozzle 8
9	Nozzle 9
10	Nozzle 10

7223	Cleaning Total
1	Count H1
	[0 to 999999/0/1]
2	Count H2
	[0 to 999999/0/1]
3	Count H3
	[0 to 999999/0/1]
4	Count H4
	[0 to 999999/0/1]
5	Count H5
	[0 to 999999/0/1]

7224	Refreshing Total
1	Count H1
	[0 to 999999/0/1]
2	Count H2
	[0 to 999999/0/1]
3	Count H3
	[0 to 999999/0/1]

4	Count H4
	[0 to 999999/0/1]
5	Count H5
	[0 to 999999/0/1]

7227	Automatic Mist Cleaning
1	Count H1
	[0 to 999999/0/1]
2	Count H2
	[0 to 999999/0/1]
3	Count H3
	[0 to 999999/0/1]
4	Count H4
	[0 to 999999/0/1]
5	Count H5
	[0 to 999999/0/1]

7228	Automatic Paper Dust Cleaning
1	Count H1
	[0 to 999999/0/1]
2	Count H2
	[0 to 999999/0/1]
3	Count H3
	[0 to 999999/0/1]
4	Count H4
	[0 to 999999/0/1]

5	Count H5
	[0 to 999999/0/1]

7229	Decap Auto Cleaning	
1	Count H1	[0 to 999999/0/1]
2	Count H2	
3	Count H3	
4	Count H4	
5	Count H5	

7230	Decap Auto Cleaning (Flushing)	
1	Count H1	[0 to 999999 / 0 / 1]
2	Count H2	
3	Count H3	
4	Count H4	
5	Count H5	

7235	Ink Removal
-------------	--------------------

1	Maintenance Count H1	[0 to 999999 / 0 / 1]
2	Maintenance Count H2	
3	Maintenance Count H3	
4	Maintenance Count H4	
5	Maintenance Count H5	

7401	Total SC Counter	CTL
1	SC Counter	
	[0 to 65 535/0]	
2	Total SC Counter	
	[0 to 65 535/0]	

7402	Feeler Position Error Count
1	HT1
	[0 to 10000/0/1]
2	HT2
	[0 to 10000/0/1]
3	HT3
	[0 to 10000/0/1]
4	HT4
	[0 to 10000/0/1]
5	HT5
	[0 to 10000/0/1]
6	HT6
	[0 to 10000/0/1]
7	HT7
	[0 to 10000/0/1]

7403	SC History	CTL
1	Latest	
2	Latest 1	
3	Latest 2	
4	Latest 3	
5	Latest 4	
6	Latest 5	
7	Latest 6	
8	Latest 7	
9	Latest 8	
10	Latest 9	

7404	SC991 History	
------	---------------	--

7405	Maintenance Motor Error SC Count	
1	ST Motor (after Replace)	
	[0 to 10000/0/1]	
2	ST Motor (Accumulated)	
	[0 to 10000/0/1]	
3	DC Motor (after Replace)	
	[0 to 10000/0/1]	
4	DC Motor (Accumulated)	
	[0 to 10000/0/1]	

7502	Total Paper Jam Counter	CTL
1	Jam Counter	
2	Total Jam Counter	

7503	Total Original Jam Counter	CTL
1	Original Jam Counter	
2	Total Original Counter	

7504	Paper Jam Loc
1	At Power On
2	1st Paper Feed SN: Late
8	2nd Paper Feed SN: Late
9	3rd Paper Feed SN: Late
13	3rd Paper Feed SN: Late
16	2nd Vertical Transport SN: Late
34	3rd Vertical Transport SN: Late
41	4th Vertical Transport SN: Late
53	Relay SN: Late
54	Registration SN: Late
58	Fusing Exit SN: Late
63	Exit Unit Entrance SN: Late
66	Duplex Transport SN 1: Late
84	Duplex Transport SN 2: Late

7505	Original Jam Detection
1	Duplex Transport SN 3: Late
2	Duplex Exit SN: Late
3	1st Paper Feed SN: Lag
4	2nd Paper Feed SN: Lag
5	LCT Paper Feed SN: Lag
6	3rd Vertical Transport SN: Lag

7	4th Vertical Transport SN: Lag
8	Relay SN: Lag

7506	Jam Count by Paper Size
97	A0T/A1
98	A1T/A2
99	A2T/A3
100	A3T/A4
101	A4T
106	B1T/B2
107	B2T/B3
108	B3T/B4
109	B4T
225	36x48T/24x36
226	24x36T/18x24
227	18x24T/12x18
228	12x18T/9x12
229	9x12T
234	34x44T/22x34
235	22x34T/17x22
236	17x22T/11x17
237	11x17T/8.5x11
238	8.5x11T
255	Other

7507	Plotter Jam History
------	---------------------

1	Last	<p>Sample Display</p> <p>CODE :103</p> <p>SIZE: :00h</p> <p>TOTAL :0000063</p> <p>DATE: Thu Aug 23 00:58:16 2012</p> <p>where:</p> <p>CODE is the SP7504-* number (see above).</p> <p>SIZE is the ASAP paper size code in hex.</p> <p>TOTAL is the total jam error count</p> <p>DATE is the date the jams occurred.</p>
2	Latest 1	
3	Latest 2	
4	Latest 3	
5	Latest 4	
6	Latest 5	
7	Latest 6	
8	Latest 7	
9	Latest 8	
10	Latest 9	

Paper Hex Codes

Size	Code	Size	Code	Size	Code
A4 (S)	05	A3 (L)	84	DLT (L)	A0
A5 (S)	06	A4 (L)	85	LG (L)	A4
B5 (S)	0E	A5 (L)	86	LT (L)	A6
LT (S)	26	B4 (L)	8D	HLT (L)	AC
HLT (S)	2C	B5 (L)	8E	Others	FF

7508	Original Jam History
------	----------------------

1	Last	<p>Sample Display:</p> <p>CODE : 002</p> <p>SIZE : aeh</p> <p>TOTAL : 00000063</p> <p>DATE : Thu Sep 20 04:51:14: 2012</p> <p>where:</p> <p>CODE is the SP7-505-* number.</p> <p>SIZE is the paper size code in hex. (See "Paper Size Hex Codes" below.)</p> <p>TOTAL is the total jam error count (SP7003)</p> <p>DATE is the date the previous jam occurred</p>
2	Latest 1	
3	Latest 2	
4	Latest 3	
5	Latest 4	
6	Latest 5	
7	Latest 6	
8	Latest 7	
9	Latest 8	
10	Latest 9	

Paper Size Hex Codes

Paper Size	Code (hex)	Paper Size	Code (hex)
A4 LEF	05	B4 SEF	8D
A5 LEF	06	B5 SEF	8E
B5 LEF	0E	DLT SEF	A0
LT LEF	26	LG SEF	A4
HLT LEF	2C	LT SEF	A6
A3 SEF	84	HLT SEF	AC
A4 SEF	85	Others	FF
A5 SEF	86		

7514	Paper Jam Count by Location
-------------	------------------------------------

1	Initial jam	[0 to 65535 / 0 / 1]
2	Main scan HP jam	
8	Pre-registration sensor lag jam (Roll Unit 1)	
9	Pre-registration sensor lag jam (Roll Unit 2)	
13	DRESS sensor late jam during image registration	
16	Exit sensor lag jam	
34	Bypass paper set jam	
41	Main scan printing jam	
53	Paper out (Roll Unit 1)	
54	Paper out (Roll Unit 2)	
58	Pre-registration sensor lag jam	
63	DRESS sensor lag jam during image registration	
66	Exit sensor lag jam	
84	Bypass sensor late jam	

7515	Original Jam Count by Detection	
1	Initial jam	[0 to 65535 / 0 / 1]
2	Original registration sensor late	
3	Original registration sensor off jam	
4	Original registration sensor lag jam	
5	Original exit sensor lag jam	
6	Original stop jam	
7	Original exit late jam	
8	Next original set jam	

7516	Paper Size Jam Count
-------------	-----------------------------

97	A0T/A1	[0 to 65535 / 0 / 1]
98	A1T/A2	
99	A2T/A3	
100	A3T/A4	
101	A4T	
106	B1T/B2	
107	B2T/B3	
108	B3T/B4	
109	B4T	
225	36×48T/24×36	
226	24×36T/18×24	
227	18×24T/12×18	
228	12×18T/9×12	
229	9×12T	
234	34×44T/22×34	
235	22×34T/17×22	
236	17×22T/11×17	
237	11×17T/8.5×11	
238	8.5×11T	
255	Others	

7520	Update Log
-------------	-------------------

1	ErrorRecord1	[0 to 255 / 0 / 1]
2	ErrorRecord2	
3	ErrorRecord3	
4	ErrorRecord4	
5	ErrorRecord5	
6	ErrorRecord6	
7	ErrorRecord7	
8	ErrorRecord8	
9	ErrorRecord9	
10	ErrorRecord10	

7624	Part Replacement Operation ON/OFF
	0 to 99999999
1	Maintenance Unit
2	Left Ink Sump
3	Right Ink Sump
9	Print Head Unit: Black
10	Print Head Unit: Color

7703	Accumulated Decapping Time
	[0 to 65535/0/1 sec]

7704	Move Carriage (Tube)
------	----------------------

7710	InternalTempMonitor: RF Switch
------	--------------------------------

1	H1	[0.0 to 55.0 / 0.0 / 0.5]
2	H2	
3	H3	
4	H4	
5	H5	

3

7713	Cartridge Empty
1	Occurrence Count: K
2	Occurrence Count: C
3	Occurrence Count: M
4	Occurrence Count: Y
	[0 to 1000/0/1]

7714	Air Purge Filling after SC202
1	H Sucking Count H1
2	H Sucking Count H2
3	H Sucking Count H3
4	H Sucking Count H4
5	H Sucking Count H5
	[0 to 999999/0/1]

7717	Air in SubTank
1	Count HT1
	[0 to 999999/0/1]
2	Count HT2
	[0 to 999999/0/1]

3	Count HT3
	[0 to 999999/0/1]
4	Count HT4
	[0 to 999999/0/1]
5	Count HT5
	[0 to 999999/0/1]
6	Count HT6
	[0 to 999999/0/1]
7	Count HT7
	[0 to 999999/0/1]

7720	Refilled Cartridge
1	Detection Count: K
	[0 to 999999/0/1]
2	Detection Count: C
3	Detection Count: M
4	Detection Count: Y

7721	Ink Supply Sequence
1	Count H1
	[0 to 999999/0/1]
2	Count H2
	[0 to 999999/0/1]
3	Count H3
	[0 to 999999/0/1]
4	Count H4
	[0 to 999999/0/1]

5	Count H5
	[0 to 999999/0/1]

7722	Under Humidity Change
1	Air Purge Filling H1
	[0 to 999999/0/1]
2	Air Purge Filling H2
	[0 to 999999/0/1]
3	Air Purge Filling H3
	[0 to 999999/0/1]
4	Air Purge Filling H4
	[0 to 999999/0/1]
5	Air Purge Filling H5
	[0 to 999999/0/1]

7723	Under Humidity Change
1	Ink Supply Sequence Count H1
	[0 to 999999/0/1]
2	Ink Supply Sequence Count H2
	[0 to 999999/0/1]
3	Ink Supply Sequence Count H3
	[0 to 999999/0/1]
4	Ink Supply Sequence Count H4
	[0 to 999999/0/1]
5	Ink Supply Sequence Count H5
	[0 to 999999/0/1]

7724	Supply After Time Out
1	Reverse Success Count HT1
	[0 to 999999/0/1]
2	Reverse Success Count HT2
	[0 to 999999/0/1]
3	Reverse Success Count HT3
	[0 to 999999/0/1]
4	Reverse Success Count HT4
	[0 to 999999/0/1]
5	Reverse Success Count HT5
	[0 to 999999/0/1]

7725	Air Purge Filling After Leftover
	Idle Time 1
1	Count H1
	[0 to 999999/0/1]
2	Count H2
	[0 to 999999/0/1]
3	Count H3
	[0 to 999999/0/1]
4	Count H4
	[0 to 999999/0/1]
5	Count H5
	[0 to 999999/0/1]
	Idle Time 2 (LV2)

6	Count H1 (LV2)
	[0 to 999999/0/1]
7	Count H2 (LV2)
	[0 to 999999/0/1]
8	Count H3 (LV2)
	[0 to 999999/0/1]
9	Count H4 (LV2)
	[0 to 999999/0/1]
10	Count H5 (LV2)
	[0 to 999999/0/1]

7726	Little Flushing After Leftover
	Idle Time 1
1	Count H1
	[0 to 999999/0/1]
2	Count H2
	[0 to 999999/0/1]
3	Count H3
	[0 to 999999/0/1]
4	Count H4
	[0 to 999999/0/1]
5	Count H5
	[0 to 999999/0/1]
	Idle Time 2
6	LV2 Count H1
	[0 to 999999/0/1]

7	LV2 Count H2
	[0 to 999999/0/1]
8	LV2 Count H3
	[0 to 999999/0/1]
9	LV2 Count H4.
	[0 to 999999/0/1]
10	LV2 Count H5.
	[0 to 999999/0/1]

3

7727	Rich Flushing After Leftover
	Idle Time 1
1	Count H1
	[0 to 999999/0/1]
2	Count H2
	[0 to 999999/0/1]
3	Count H3
	[0 to 999999/0/1]
4	Count H4
	[0 to 999999/0/1]
5	Count H5
	[0 to 999999/0/1]
	Idle Time 2
6	LV2 Count H1
	[0 to 999999/0/1]
7	LV2 Count H2
	[0 to 999999/0/1]

8	LV2 Count H3
	[0 to 999999/0/1]
9	LV2 Count H4
	[0 to 999999/0/1]
10	LV2 Count H5
	[0 to 999999/0/1]

7728	Flushing Before Printing
1	Count K
	[0 to 999999/0/1]
2	Count C
	[0 to 999999/0/1]
3	Count M
	[0 to 999999/0/1]
4	Count Y
	[0 to 999999/0/1]

7729	Before & During Printing
1	Flushing Amount K
	[0 to 999999/0/1x10 n]
2	Flushing Amount C
	[0 to 999999/0/1x10 n]
3	Flushing Amount M
	[0 to 999999/0/1x10 n]
4	Flushing Amount Y
	[0 to 999999/0/1x10 n]

7730	After Printing
1	Flushing Amount K
	[0 to 999999/0/1x10 n]
2	Flushing Amount C
	[0 to 999999/0/1x10 n]
3	Flushing Amount M
	[0 to 999999/0/1x10 n]
4	Flushing Amount Y
	[0 to 999999/0/1x10 n]

7731	User Cleaning
1	Count/ K Cartridge
	[0 to 999999/0/1]
2	Count/ C Cartridge
	[0 to 999999/0/1]
3	Count/ M Cartridge
	[0 to 999999/0/1]
4	Count/ Y Cartridge
	[0 to 999999/0/1]

7732	User Refreshing
1	Count/ K Cartridge
	[0 to 999999/0/1]
2	Count/ C Cartridge
	[0 to 999999/0/1]
3	Count/ M Cartridge
	[0 to 999999/0/1]

4	Count/ Y Cartridge
	[0 to 999999/0/1]

7733	Cleaning After Leftover
1	Count/ K Cartridge
	[0 to 20000/0/1]
2	Count/ C Cartridge
	[0 to 20000/0/1]
3	Count/ M Cartridge
	[0 to 20000/0/1]
4	Count/ Y Cartridge
	[0 to 20000/0/1]

7734	Ink Supply Seq. After Leftover
1	Count/ K Cartridge
	[0 to 20000/0/1]
2	Count/ C Cartridge
	[0 to 20000/0/1]
3	Count/ M Cartridge
	[0 to 20000/0/1]
4	Count/ Y Cartridge
	[0 to 20000/0/1]

7735	Cleaning Total
1	Count/ K Cartridge
	[0 to 999999/0/1]

2	Count/ C Cartridge
	[0 to 999999/0/1]
3	Count/ M Cartridge
	[0 to 999999/0/1]
4	Count/ Y Cartridge
	[0 to 999999/0/1]

7736	Refreshing Total
1	Count/ K Cartridge
	[0 to 999999/0/1]
2	Count/ C Cartridge
	[0 to 999999/0/1]
3	Count/ M Cartridge
	[0 to 999999/0/1]
4	Count/ Y Cartridge
	[0 to 999999/0/1]

7737	Automatic Mist Cleaning
1	Count/ K Cartridge
	[0 to 999999/0/1]
2	Count/ C Cartridge
	[0 to 999999/0/1]
3	Count/ M Cartridge
	[0 to 999999/0/1]
4	Count/ Y Cartridge
	[0 to 999999/0/1]

7738	Automatic Paper Dust Cleaning	
1	Count/ K Cartridge	[0 to 999999/0/1]
2	Count/ C Cartridge	[0 to 999999/0/1]
3	Count/ M Cartridge	[0 to 999999/0/1]
4	Count/ Y Cartridge	[0 to 999999/0/1]

7739	Decap Auto Cleaning	
1	Count/ K Cartridge	[0 to 999999/0/1]
2	Count/ C Cartridge	[0 to 999999/0/1]
3	Count/ M Cartridge	[0 to 999999/0/1]
4	Count/ Y Cartridge	[0 to 999999/0/1]

7740	Air Purge Filling After SC202	
1	H Sucking Count/ K Cartridge	[0 to 999999/0/1]
2	H Sucking Count/ C Cartridge	[0 to 999999/0/1]
3	H Sucking Count/ M Cartridge	[0 to 999999/0/1]

4	H Sucking Count/ Y Cartridge
	[0 to 999999/0/1]

7741	Front Cover Open CL Count
1	Count/K Cartridge
2	Count/C Cartridge
3	Count/M Cartridge
4	Count/Y Cartridge

7742	Air Purge Fill After Pressure Lost
1	Air Purge Filling/ K Cartridge
	[0 to 999999/0/1]
2	Air Purge Filling/ C Cartridge
	[0 to 999999/0/1]
3	Air Purge Filling/ M Cartridge
	[0 to 999999/0/1]
4	Air Purge Filling/ Y Cartridge
	[0 to 999999/0/1]

7743	Air in SubTank
1	Count/ K Cartridge
	[0 to 999999/0/1]
2	Count/ C Cartridge
	[0 to 999999/0/1]
3	Count/ M Cartridge
	[0 to 999999/0/1]

4	Count/ Y Cartridge
	[0 to 999999/0/1]

7744	Decap Auto Cleaning (Flushing)	
1	Count/ K Cartridge	[0 to 999999 / 0 / 1]
2	Count/ C Cartridge	
3	Count/ M Cartridge	
4	Count/ Y Cartridge	

7745	Auto Nozzle Check Recov. CL	
1	Count/ K Cartridge	[0 to 999999 / 0 / 1]
2	Count/ C Cartridge	
3	Count/ M Cartridge	
4	Count/ Y Cartridge	

7746	Ink Supply Sequence	
1	Count/ K Cartridge	[0 to 999999/0/1]
2	Count/ C Cartridge	[0 to 999999/0/1]
3	Count/ M Cartridge	[0 to 999999/0/1]
4	Count/ Y Cartridge	[0 to 999999/0/1]

7747	Under Humidity Change	
-------------	------------------------------	--

1	Air Purge Filling/K Cartridge
	[0 to 999999/0/1]
2	Air Purge Filling/C Cartridge
	[0 to 999999/0/1]
3	Air Purge Filling/M Cartridge
	[0 to 999999/0/1]
4	Air Purge Filling/Y Cartridge
	[0 to 999999/0/1]

7748	Under Humidity Change
1	Ink Supply Sequence Count K Cartridge
	[0 to 999999/0/1]
2	Ink Supply Sequence Count C Cartridge
	[0 to 999999/0/1]
3	Ink Supply Sequence Count M Cartridge
	[0 to 999999/0/1]
4	Ink Supply Sequence Count Y Cartridge
	[0 to 999999/0/1]

7749	Air Purge Filling After Leftover
1	Count/ K Cartridge
	[0 to 999999/0/1]
2	Count/ C Cartridge
	[0 to 999999/0/1]
3	Count/ M Cartridge
	[0 to 999999/0/1]

4	Count/ Y Cartridge
	[0 to 999999/0/1]

7750	Little Flushing After Leftover
1	Count/ K Cartridge
	[0 to 999999/0/1]
2	Count/ C Cartridge
	[0 to 999999/0/1]
3	Count/ M Cartridge
	[0 to 999999/0/1]
4	Count/ Y Cartridge
	[0 to 999999/0/1]

7751	Rich Flushing After Leftover
1	Count/ K Cartridge
	[0 to 999999/0/1]
2	Count/ C Cartridge
	[0 to 999999/0/1]
3	Count/ M Cartridge
	[0 to 999999/0/1]
4	Count/ Y Cartridge
	[0 to 999999/0/1]

7752	Flushing before Printing
1	Count/ K Cartridge
	[0 to 999999/0/1]

2	Count/ C Cartridge
	[0 to 999999/0/1]
3	Count/ M Cartridge
	[0 to 999999/0/1]
4	Count/ Y Cartridge
	[0 to 999999/0/1]

3

7753	Before & During Printing
1	Flushing Amount K
	[0 to 999999/0/1 nl]
2	Flushing Amount C
	[0 to 999999/0/1 nl]
3	Flushing Amount M
	[0 to 999999/0/1 nl]
4	Flushing Amount Y
	[0 to 999999/0/1 nl]

7754	After Printing
1	Flushing Amount K
	[0 to 999999/0/1 nl]
2	Flushing Amount C
	[0 to 999999/0/1 nl]
3	Flushing Amount M
	[0 to 999999/0/1 nl]
4	Flushing Amount Y
	[0 to 999999/0/1 nl]

7755	OCFS Check Execution Count	
1	H1	
		[0 to 999999/0/1]
2	H2	
		[0 to 999999/0/1]
3	H3	
		[0 to 999999/0/1]
4	H4	
		[0 to 999999/0/1]
5	H5	
		[0 to 999999/0/1]

7756	OCFS Filling Count per Job	
1	HT1	
		[0 to 1000/0/1]
2	HT2	
		[0 to 1000/0/1]
3	HT3	
		[0 to 1000/0/1]
4	HT4	
		[0 to 1000/0/1]
5	HT5	
		[0 to 1000/0/1]
6	HT6	
		[0 to 1000/0/1]

7	HT7
	[0 to 1000/0/1]
7760	Print Volume from Latest Cleaning
1	H1
	[0 to 99999999/0/1 page]
2	H2
	[0 to 99999999/0/1 page]
3	H3
	[0 to 99999999/0/1 page]
4	H4
	[0 to 99999999/0/1 page]
5	H5
	[0 to 99999999/0/1 page]
7761	Auto Nozzle Check Count

1	/H1(head replacement)	[0 to 999999 / 0 / 1 Page]	
2	/H2(head replacement)		
3	/H3(head replacement)		
4	/H4(head replacement)		
5	/H5(head replacement)		
8	Sequence Count(head replacement)		
9	Error Count (head replacement)		
11	/H1(Md replacement)		
12	/H2(Md replacement)		
13	/H3(Md replacement)		
14	/H4(Md replacement)		
15	/H5(Md replacement)		
18	Sequence Count (Md replacement)		
19	Error Count (Md replacement)		
20	Electrode Plate Wiping Count		
7761	Auto Nozzle Check Condition		
21	Residual Auto Nozzle Check Quantity		[0 to 100 / 100 / 1 Page]
7762	Nozzle Fracture Condition		

1	H1ODD Nozzle Undischarge Ink	[0 to 192 / 0 / 1]
2	H1EVEN Nozzle Undischarge Ink	
3	H2ODD Nozzle Undischarge Ink	
4	H2EVEN Nozzle Undischarge Ink	
5	H3ODD Nozzle Undischarge Ink	
6	H3EVEN Nozzle Undischarge Ink	
7	H4ODD Nozzle Undischarge Ink	
8	H4EVEN Nozzle Undischarge Ink	
9	H5ODD Nozzle Undischarge Ink	
10	H5EVEN Nozzle Undischarge Ink	

7763	Retry Sensor Nozzle	
1	H1ODD Retry Nozzle Number	[0 to 192 / 0 / 1]
2	H1EVEN Retry Nozzle Number)	
3	H2ODD Retry Nozzle Number	
4	H2EVEN Retry Nozzle Number	
5	H3ODD Retry Nozzle Number	
6	H3EVEN Retry Nozzle Number	
7	H4ODD Retry Nozzle Number	
8	H4EVEN Retry Nozzle Number	
9	H5ODD Retry Nozzle Number	
10	H5EVEN Retry Nozzle Number	

7764	Life Counter Display	
1	Carriage Unit (Black)	[0 to 500 / 0 / 1]
2	Carriage Unit (Color)	
3	Maintenance Kit	

4	Left Ink Sump	[0 to 200 / 0 / 1]
5	Right Ink Sump	

7765	Life Counter (Calculate	
1	Print Head Unit (Black)	[0 to 0xFFFFFFFF / 0 / 1]
2	Print Head Unit (Color)	
3	Maintenance Kit	
4	Left Ink Sump	
5	Right Ink Sump	

7766	Nozzle Compensation Mode Start	
1	Head 1	[0 to 999999 / 0 / 1]
2	Head 2	
3	Head 3	
4	Head 4	
5	Head 5	

7767	Accum. Nozzle Fracture Counts	
-------------	--------------------------------------	--

1	Nozzle1/Head Replacement	[0 to 99999999 / 0 / 1]
2	Nozzle2/Head Replacement	
3	Nozzle3/Head Replacement	
4	Nozzle4/Head Replacement	
5	Nozzle5/Head Replacement	
6	Nozzle6/Head Replacement	
7	Nozzle7/Head Replacement	
8	Nozzle8/Head Replacement	
9	Nozzle9/Head Replacement	
10	Nozzle10/Head Replacement	
11	Nozzle1/Auto Nozzle Check Unit Replacement	
12	Nozzle2/Auto Nozzle Check Unit Replacement	
13	Nozzle3/Auto Nozzle Check Unit Replacement	
14	Nozzle4/Auto Nozzle Check Unit Replacement	
15	Nozzle5/Auto Nozzle Check Unit Replacement	
16	Nozzle6/Auto Nozzle Check Unit Replacement	
17	Nozzle7/Auto Nozzle Check Unit Replacement	
18	Nozzle8/Auto Nozzle Check Unit Replacement	
19	Nozzle9/Auto Nozzle Check Unit Replacement	
20	Nozzle10/Auto Nozzle Check Unit Replacement	

7768	Accum. Nozzle Fracture Number
-------------	--------------------------------------

1	Nozzle1/Head Replacement	[0 to 99999999 / 0 / 1]
2	Nozzle2/Head Replacement	
3	Nozzle3/Head Replacement	
4	Nozzle4/Head Replacement	
5	Nozzle5/Head Replacement	
6	Nozzle6/Head Replacement	
7	Nozzle7/Head Replacement	
8	Nozzle8/Head Replacement	
9	Nozzle9/Head Replacement	
10	Nozzle10/Head Replacement	
11	Nozzle1/Auto Nozzle Check Unit Replacement	
12	Nozzle2/Auto Nozzle Check Unit Replacement	
13	Nozzle3/Auto Nozzle Check Unit Replacement	
14	Nozzle4/Auto Nozzle Check Unit Replacement	
15	Nozzle5/Auto Nozzle Check Unit Replacement	
16	Nozzle6/Auto Nozzle Check Unit Replacement	
17	Nozzle7/Auto Nozzle Check Unit Replacement	
18	Nozzle8/Auto Nozzle Check Unit Replacement	
19	Nozzle9/Auto Nozzle Check Unit Replacement	
20	Nozzle10/Auto Nozzle Check Unit Replacement	

7770	No Filling Negative Pressure	
1	Pressure/Humidity Fluctuation Count H1	[0 to 999999/0/1]
2	Pressure/Humidity Fluctuation Count H2	[0 to 999999/0/1]

3	Pressure/Humidity Fluctuation Count H3
	[0 to 999999/0/1]
4	Pressure/Humidity Fluctuation Count H4
	[0 to 999999/0/1]
5	Pressure/Humidity Fluctuation Count H5
	[0 to 999999/0/1]

3

7771	No Filling Negative Pressure	
1	Pressure/Humidity Fluctuation Count/ K Cart	
		[0 to 999999/0/1]
2	Pressure/Humidity Fluctuation Count/ C Cart	
		[0 to 999999/0/1]
3	Pressure/Humidity Fluctuation Count/ M Cart	
		[0 to 999999/0/1]
4	Pressure/Humidity Fluctuation Count/ Y Cart	
		[0 to 999999/0/1]

7772	Temp. Rise User CL Switch	
1	Refreshing Count/K	[0 to 999999 / 0 / 1]
2	Refreshing Count/C	
3	Refreshing Count/C	
4	Refreshing Count/Y	

7780	EM Print Mode Count
------	---------------------

1	Head Tank 1	[0 to 999999 / 0 / 1]
2	Head Tank 2	
3	Head Tank 3	
4	Head Tank 4	
5	Head Tank 5	
6	Head Tank 6	
7	Head Tank 7	

7781	EM Print Finish	
1	Ink Consumption Count	[0 to 999999 / 0 / 1]
2	Time Exceed Count	
3	Bk Ink End Count	
4	Air Leak Count	
5	Cartridge Replacement Count	
6	Require Maintenance Count	

7782	EM Print Quantity	
1	New Number of Sheets	[0 to 99999999 / 0 / 1]
2	New Number of Sheets (A4)	
3	Total Number of Sheets	
4	Total Number of Sheets (A4)	

7801	ROM Part Number
2	Engine
7801	ROM Version
102	Engine

7801	ROM Part Number
7803	PM Counter Display
7804	PM Counter Reset
	[EXECTUE]
7807	SC/Jam Counter Reset
	[EXECTUE]
7826	MF Error Counter Japan Only
1	Error Total
2	Error Staple
7827	MF Error Counter Clear Japan Only
	[EXECTUE]
7832	Self-Diagnose Result Display
7836	Total Memory Size
7840	ServiceSP Entry Code Chg Hist
1	Change Time :Latest
2	Change Time :Last1
101	Initialize Time :Latest
102	Initialize Time :Last1
7853	Cartridge Replace
1	Count K
	[0 to 1000/0/1]

2	Count C
	[0 to 1000/0/1]
3	Count M
	[0 to 1000/0/1]
4	Count Y
	[0 to 1000/0/1]

7854	Move Carriage (Tube)	
1	Carriage Moving Count	[0 to 4294967295 / 5 / 1]

7901	Assert Info.	
1	File Name	Module name
2	Number of Lines	Lines where error occurred.
3	Location	Component affected by error

7910	ROM No	
1	System/Copy	
2	Engine	
3	Lcdc	
15	Scanner	
18	NetworkSupport	
22	BIOS	
23	HDD Format Option	
132	NetWare	
150	RPCS	
151	PS	
155	RPGL	

157	RTIFF
160	MSIS
162	PDF
165	PJL
167	MediaPrint:JPEG
168	MediaPrint:TIFF
180	FONT
181	FONT1
182	FONT2
183	FONT3
184	FONT4
185	FONT5
200	Factory
201	Copy
202	NetworkDocBox
204	Printer
205	Scanner
210	MIB
211	Websupport
212	WebUapl
213	SDK1
214	SDK2
215	SDK3
250	Package

7911	Firmware Version
-------------	-------------------------

1	System/Copy
2	Engine
3	Lcdc
15	Scanner
18	NetworkSupport
22	BIOS
23	HDD Format Option
132	NetWare
150	RPCS
151	PS
155	RPGL
157	RTIFF
160	MSIS
162	PDF
165	PJL
167	MediaPrint:JPEG
168	MediaPrint:TIFF
180	FONT
181	FONT1
182	FONT2
183	FONT3
184	FONT4
185	FONT5
200	Factory
201	Copy
202	NetworkDocBox

204	Printer
205	Scanner
210	MIB
211	Websupport
212	WebUapl
213	SDK1
214	SDK2
215	SDK3
250	Package

7931	Cartridge: Black
7932	Cartridge: Magenta
7933	Cartridge: Cyan
7934	Cartridge: Yellow
1	Model ID
	[0 to 255/0/1]
2	Cartridge Version
3	Brand Name ID
4	Area ID
5	Type ID
6	Color ID
7	Maintenance ID
8	Brand New Information
9	Recycling Counter
10	Manufactured Date
	[0 to 1/0/1]

11	Serial No.
12	Remaining Ink
	[0 to 100/ 100 /1]
13	EDP Code
14	Empty Log
15	Refill Log
16	Fitted: Total Counter
	[0 to 99999999/ 0 /1]
17	Fitted: Color Counter
18	Empty: Total Counter
19	Empty: Color Counter
20	Fitted Date
	[0 to 1/ 0 /1]
21	Empty Date
22	Ink Consumption Volume
	[0 to 0xFFFFFFFF/ 0 /1]
23	Expiry Date
	[0 to 255/ 0 /1]
24	Initial Fill Count
25	Refreshing Count
26	Cleaning Count
27	Ink Capacity
	[0 to 0xFFFFFFFF/ 0 /1]
28	Air Purge Filling Count
	[0 to 255/ 0 /1]

29	Print Volume per Cartridge
	[0 to 16777215/0/1]
30	Machine Serial Number Log: 1 Previous
	[0 to 255/0/1]
31	Machine Serial Number Log: 2 Previous
32	Machine Serial Number Log: 3 Previous
33	Machine Serial Number Log: 4 Previous
34	Machine Serial Number Log: 5 Previous
35	Machine Counter (m)
	[0 to 4294967295 / 0 / 1]

7935	Cartridge: Black Log 1
7936	Cartridge: Magenta Log 1
7937	Cartridge: Cyan Log 1
7938	Cartridge: Yellow Log 1
1	Serial No.
	[0 to 1/0/1]
2	Fitted Date & Time
3	Fitted: Total Counter
	[0 to 99999999/0/1]
4	Refill Log
	[0 to 1/0/1]
5	Serial No.
6	Fitted Date & Time
7	Fitted: Total Counter
	[0 to 99999999/0/1]

8	Refill Log
9	Serial No.
10	Fitted Date & Time
11	Fitted: Total Counter
12	Refill Log
	[0 to 1/0/1]
13	Serial No.
14	Fitted Date & Time
15	Fitted: Total Counter
	[0 to 99999999/0/1]
16	Refill Log
	[0 to 1/0/1]
17	Serial No.
18	Fitted Date & Time
19	Fitted: Total Counter
	[0 to 99999999/0/1]
20	Refill Log

7960	Cutter Drive Count
1	Drive Count
	[0 to 99999999/0/1 times]
2	Clear Drive Count
	[EXECUTE]
3	Unit Drive Count
	[0 to 99999999/0/1 times]

4	Clear Unit Drive Count
	[EXECUTE]
7961	Waste Ink Analysis
	Right Ink Sump 001 - 004
1	Right Ink Box Amount Counter
	[0 to 999999/0/0.001]
2	Right Ink Box Near Full Date
	[0 to 0xFFFFFFFF/0/1]
3	Right Ink Box Full Date
	[0 to 0xFFFFFFFF/0/1]
4	Right Ink Box Fitting Count
	[0 to 255/0/1]
	Left Ink Sump
5	Left Ink Box Amount Counter
	[0 to 2000000/0/10.001 ul]
6	Left Ink Box Near Full Date
	[0 to 0xFFFFFFFF/0/1]
7	Left Ink Box Full Date
	[0 to 0xFFFFFFFF/0/1]
8	Left Ink Box Fitting Count
	[0 to 0xFFFFFFFF/0/1]
	Carriage Unit
9	Carriage Unit (Black) Initial Count
	[0 to 255/0/1]

10	Carriage Unit (Color) Initial Count
	[0 to 255/0/1]
11	Total Cleaning Count
	[0 to 65535/0/1]
12	Total Refreshing Count
	[0 to 65535/0/1]
13	Total Ink Supply Sequence Count
	[0 to 255/0/1]
14	Air Purge Filling Count: Total
	[0 to 65535/0/1]
15	Air Purge Filling Count: Maintenance Total
	[0 to 65535/0/1]
16	Flushing Count after Printing
	[0 to 999999/0/1]
17	Little Flushing Count after Leftover
	[0 to 65535/0/1]
18	Total Decapping Cleaning Count
	[0 to 65535/0/1]
19	Negative Pressure Recovery Count
	[0 to 9999/0/1]
20	User Cleaning Count
	[0 to 65535/0/1]
21	User Refreshing Count
	[0 to 65535/0/1]
22	Cleaning Count after Leftover
	[0 to 65535/0/1]

23	Ink Supply after Leftover Count
	[0 to 255/0/1]
24	Air Purge Filling Count: after Leftover
	[0 to 65535/0/1]
25	Total Decapping Flushing Count
	[0 to 65535 / 0 / 1]
26	Ink Supply Count
	[0 to 255/0/1]
27	Air Purge Filling Count (Pressure)
	[0 to 65535/0/1]
28	Air Purge Filling Count (Humidity)
	[0 to 65535/0/1]
29	Maintenance Count without Waste Box
	[0 to 65535/0/1]
30	Flushing Count before Printing
	[0 to 1677215/0/1]
31	Flushing Count during Printing
	[0 to 1677215/0/1]
32	Flushing Count after Printing
	[0 to 65535/0/1]
33	Feed Count Cleared Count
	[0 to 65535/0/1]
34	Mist Count Cleared Count
	[0 to 65535/0/1]
35	Wiping Count after Suction
	[0 to 1677215/0/1]

Ink Collector Unit	
36	Front Ink Box Printed Length
	[0 to 72 000 000/ 0 /1 mm]
37	Front Ink Box Amount Counter
	[0 to 3000/ 0 /0.001 ml]
38	Front Right Ink Box Amount Counter
	[0 to 999/ 0 /0.001 ml]
39	Front Right Ink Box C/R Date
	[0 to 0xFFFFFFFF/ 0 /1]
40	Front Left Ink Box Amount Counter
	[0 to 2000/ 0 /0.001 ml]
41	Front Left Ink Box C/R Date
	[0 to 0xFFFFFFFF/ 0 /1]
42	Ink Box Exchange Count
	[0 to 255/ 0 /1]
44	Front Cover Open Maintenance Count
45	Total Auto Nozzle Check Recov. CL Count
	[0 to 65535 / 0 / 1]
46	RF Count at Temperature rises
	[0 to 65535 / 0 / 1]

7962	Waste Ink Box
1	Model ID
	[0 to 255/ 0 /1]
2	Waste Ink Box Version
3	Brand Name ID

4	Area ID
5	Type ID
6	Color ID
7	Maintenance ID
8	Brand New Information
9	Recycling Counter
10	Manufactured Date
	[0 to 1/0/1]
11	Serial No.
12	Remaining Capacity
	[0 to 100/0/1%]
13	EDP Code
14	Full Log
15	Refill Log
16	Fitted: Total Counter
	[0 to 99999999/0/1]
17	Fitted: Color Counter
18	Full: Total Counter
19	Full: Color Counter
20	Fitted Date
	[0 to 1/0/1]
21	Full Date
22	Full Threshold
	[0 to 65535/0/0.1 ml]
23	Near Full Threshold
	[0 to 100/0/1]

24	Waste Volume Count
	[0 to 0xFFFFFFFF/0/1 nl]
25	Accum. Printed Length (High Speed/Standard)
	[0 to 0xFFFFFFFF/0/1 mm]
26	Accum. Printed Length (Fine)
	[0 to 0xFFFFFFFF/0/1 mm]
27	User Cleaning Count
	[0 to 0xFFFF/0/1]
28	Driven Refreshing Count in Suction
	[0 to 0xFFFF/0/1]
29	Air Purge Filling Count: Weak Pressure
	[0 to 0xFFFF/0/1]
30	Air Purge Filling Count: Humidity Change
	[0 to 0xFFFF/0/1]
31	Maintenance Count after Box Cover Open
	[0 to 255/0/1]
32	Cleaning Count
	[0 to 0xFFFFFFFF/0/1]
33	Initial Fill Count
	[0 to 255/0/1]
34	Ink Supply Sequence Count
	[0 to 255/0/1]

7963	Waste Ink Box Log 1
1	Serial No.
	[0 to 1/0/1]

2	Fitted Date & Time
3	Fitted: Total Counter (Box 1)
	[0 to 99999999/0/1]
4	Refill Log
	[0 to 1/0/1]
5	Serial No.
6	Fitted Date & Time
7	Fitted: Total Counter (Box 2)
	[0 to 99999999/0/1]
8	Refill Log
	[0 to 1/0/1]
9	Serial No.
10	Fitted Date & Time
11	Fitted: Total Counter (Box 3)
	[0 to 99999999/0/1]
12	Refill Log
	[0 to 1/0/1]
13	Serial No.
14	Fitted Date & Time
15	Fitted: Total Counter (Box 4)
	[0 to 99999999/0/1]
16	Refill Log
	[0 to 1/0/1]
17	Serial No.
18	Fitted Date & Time

19	Fitted: Total Counter (Box 5)
	[0 to 99999999/0/1]
20	Refill Log
	[0 to 1/0/1]

7972	Carriage Unit B Counter - Mono (per A4 Converted)
	[0 to 99999999/0/1 page]

7973	Carriage Unit C Counter - Color (per A4 Converted)
	[0 to 99999999/0/1 page]

Main SP Tables-8

SP8-XXX

Many of these counters are provided for features that are currently not available, such as sending color faxes, and so on. However, here are some Group 8 codes that when used in combination with others, can provide useful information.

SP Numbers	What They Do
SP8211 to SP8216	The number of pages scanned to the document server.
SP8401 to SP8406	The number of pages printed from the document server
SP8691 to SP8696	The number of pages sent from the document server

Specifically, the following questions can be answered:

- How is the document server actually being used?
- What application is using the document server most frequently?
- What data in the document server is being reused?

Most of the SPs in this group are prefixed with a letter that indicates the mode of operation (the mode of operation is referred to as an 'application'). Before reading the Group 8 Service Table, make sure that you understand what these prefixes mean.

PREFIX	WHAT IT MEANS	
T:	Total: (Grand Total).	Grand total of the items counted for all applications (C, F, P, etc.)..
C:	Copy application.	Totals (pages, jobs, etc.) executed for each application when the job was not stored on the document server.
P:	Print application.	
S:	Scan application.	

PREFIX	WHAT IT MEANS	
L:	Local storage (document server)	Totals (jobs, pages, etc.) for the document server. The L: counters work differently case by case. Sometimes, they count jobs/pages stored on the document server; this can be in document server mode (from the document server window), or from another mode, such as from a printer driver or by pressing the Store File button in the Copy mode window. Sometimes, they include occasions when the user uses a file that is already on the document server. Each counter will be discussed case by case.
O:	Other applications (external network applications, for example)	Refers to network applications such as Web Image Monitor. Utilities developed with the SDK (Software Development Kit) will also be counted with this group in the future.

The Group 8 SP codes are limited to 17 characters, forced by the necessity of displaying them on the small LCDs of printers and faxes that also use these SPs. Read over the list of abbreviations below and refer to it again if you see the name of an SP that you do not understand.

Key for Abbreviations

ABBREVIATION	WHAT IT MEANS
/	"By", e.g. "T:Jobs/Apl" = Total Jobs "by" Application
>	More (2> "2 or more", 4> "4 or more")
AddBook	Address Book
Apl	Application
B/W	Black & White
Bk	Black
C	Cyan
ColCr	Color Create
ColMode	Color Mode
Comb	Combine
Comp	Compression
Deliv	Delivery

ABBREVIATION	WHAT IT MEANS
DesApl	Designated Application. The application (Copy, Fax, Scan, Print) used to store the job on the document server, for example.
Dev Counter	Development Count, no. of pages developed.
Dup, Duplex	Duplex, printing on both sides
Emul	Emulation
FC	Full Color
FIN	Post-print processing, i.e. finishing (punching, stapling, etc.)
Full Bleed	No Margins
GenCopy	Generation Copy Mode
GPC	Get Print Counter. For jobs 10 pages or less, this counter does not count up. For jobs larger than 10 pages, this counter counts up by the number that is in excess of 10 (e.g., for an 11-page job, the counter counts up $11-10=1$)
IFax	Internet Fax
ImgEdt	Image Edit performed on the original with the copier GUI, e.g. border removal, adding stamps, page numbers, etc.
K	Black (YMCK)
LS	Local Storage. Refers to the document server.
LSize	Large (paper) Size
Mag	Magnification
MC	One color (monochrome)
NRS	New Remote Service, which allows a service center to monitor machines remotely. "NRS" is used overseas, "CSS" is used in Japan.
Org	Original for scanning
OrgJam	Original Jam
Palm 2	Print Job Manager/Desk Top Editor: A pair of utilities that allows print jobs to be distributed evenly among the printers on the network, and allows files to be moved around, combined, and converted to different formats..

ABBREVIATION	WHAT IT MEANS
PC	Personal Computer
PGS	Pages. A page is the total scanned surface of the original. Duplex pages count as two pages, and A3 simplex count as two pages if the A3/DLT counter SP is switched ON.
PJob	Print Jobs
Ppr	Paper
PrtJam	Printer (plotter) Jam
PrtPGS	Print Pages
R	Red (Toner Remaining). Applies to the wide format model A2 only. This machine is under development and currently not available.
Rez	Resolution
SC	Service Code (Error SC code displayed)
Scn	Scan
Sim, Simplex	Simplex, printing on 1 side.
S-to-Email	Scan-to-E-mail
SMC	SMC report printed with SP5990. All of the Group 8 counters are recorded in the SMC report.
Svr	Server
TonEnd	Toner End
TonSave	Toner Save
TXJob	Send, Transmission
WSD	Web Services Devices
YMC	Yellow, Magenta, Cyan
YMCK	Yellow, Magenta, Cyan, Black

Note

- All of the Group 8 SPs are reset with SP5 801 1 Memory All Clear, or the Counter Reset SP7 808.

8001	T:Total Jobs	<p>These SPs count the number of times each application is used to do a job.</p> <p>[0 to 9999999 / 0 / 1]</p> <p>Note: The L: counter is the total number of times the other applications are used to send a job to the document server, plus the number of times a file already on the document server is used.</p>
8002	C:Total Jobs	
8004	P:Total Jobs	
8005	S:Total Jobs	
8006	L:Total Jobs	

- These SPs reveal the number of times an application is used, not the number of pages processed.
- When an application is opened for image input or output, this counts as one job.
- Interrupted jobs (paper jams, etc.) are counted, even though they do not finish.
- Only jobs executed by the customer are counted. Jobs executed by the customer engineer using the SP modes are not counted.
- When using secure printing (when a password is required to start the print job), the job is counted at the time when either "Delete Data" or "Specify Output" is specified.
- When a copy job on the document server is printed, SP8022 also increments, and when a print job stored on the document server is printed, SP8024 also increments.
- When an original is both copied and stored on the document server, the C: and L: counters both increment.
- When a print job is stored on the document server, only the L: counter increments.
- When the user presses the Document Server button to store the job on the document server, only the L: counter increments.
- When the user enters document server mode and prints data stored on the document server, only the L: counter increments.
- When an image received from Palm 2 is received and stored, the L: counter increments.
- When the customer prints a report (user code list, for example), the O: counter increments.

8011	T:Jobs/LS	<p>These SPs count the number of jobs stored to the document server by each application, to reveal how local storage is being used for input.</p> <p>[0 to 9999999 / 0 / 1]</p> <p>The L: counter counts the number of jobs stored from within the document server mode screen at the operation panel.</p>
8012	C:Jobs/LS	
8014	P:Jobs/LS	
8015	S:Jobs/LS	
8016	L:Jobs/LS	
8017	O:Jobs/LS	

- When a scan job is sent to the document server, the S: counter increments. When you enter document server mode and then scan an original, the L: counter increments.
- When a print job is sent to the document server, the P: counter increments.
- When a network application sends data to the document server, the O: counter increments.
- When an image from Palm 2 is stored on the document server, the O: counter increments.

8021	T:P job/LS	These SPs reveal how files printed from the document server were stored on the document server originally. [0 to 99999999 / 0 / 1] The L: counter counts the number of jobs stored from within the document server mode screen at the operation panel.
8022	C:P job/LS	
8024	P:P job/LS	
8025	S:P job/LS	
8026	L:P job/LS	
8027	O:P job/LS	

- When a copy job stored on the document server is printed with another application, the C: counter increments.
- When an application like DeskTopBinder merges a copy job that was stored on the document server with a print job that was stored on the document server, the C: and P: counters both increment.
- When a job already on the document server is printed with another application, the L: counter increments.
- When a scanner job stored on the document server is printed with another application, the S: counter increments. If the original was scanned from within document server mode, then the L: counter increments.
- When images stored on the document server by a network application (including Palm 2), are printed with another application, the O: counter increments.
- When a copy job stored on the document server is printed with a network application (Web Image Monitor, for example), the C: counter increments.

8031	T:P job/DesApl
8032	C:P job/DesApl
8034	P:P job/DesApl
8035	S:P job/DesApl
8036	L:P job/DesApl

8037	O:Pjob/DesApl
	<p>These SPs reveal what applications were used to output documents from the document server.</p> <p>[0 to 99999999 / 0 / 1]</p> <p>The L: counter counts the number of jobs printed from within the document server mode screen at the operation panel.</p>

- When documents already stored on the document server are printed, the count for the application that started the print job is incremented.
- When the print job is started from a network application (Desk Top Binder, Web Image Monitor, etc.) the L: counter increments.

8041	T:TX Jobs/LS
8042	C:TX Jobs/LS
8044	P:TX Jobs/LS
8045	S:TX Jobs/LS
8046	L:TX Jobs/LS
8047	O:TX Jobs/LS
	<p>These SPs count the applications that stored files on the document server that were later accessed for transmission over the telephone line or over a network (attached to an e-mail).</p> <p>[0 to 99999999 / 0 / 1]</p> <p>Note: Jobs merged for sending are counted separately.</p> <p>The L: counter counts the number of jobs scanned from within the document server mode screen at the operation panel.</p>

- When a stored copy job is sent from the document server, the C: counter increments.
- When images stored on the document server by a network application or Palm2 are sent as an e-mail, the O: counter increments.

8051	T:TX Jobs/DesApl
8052	C:TX Jobs/DesApl
8054	P:TX Jobs/DesApl

8055	S:TX Jobs/DesApl
8056	L:TX Jobs/DesApl
8057	O:TX Jobs/DesApl
	<p>These SPs count the applications used to send files from the document server over the telephone line or over a network (attached to an e-mail). Jobs merged for sending are counted separately.</p> <p>[0 to 9999999 / 0 / 1]</p> <p>The L: counter counts the number of jobs sent from within the document server mode screen at the operation panel.</p>

- If the send is started from Desk Top Binder or Web Image Monitor, for example, then the O: counter increments.

8061	T:FIN Jobs
	<p>[0 to 9999999 / 0 / 1]</p> <p>These SPs total the finishing methods. The finishing method is specified by the application.</p>
8062	C:FIN Jobs
	<p>[0 to 9999999 / 0 / 1]</p> <p>These SPs total finishing methods for copy jobs only. The finishing method is specified by the application.</p>
8064	P:FIN Jobs
	<p>[0 to 9999999 / 0 / 1]</p> <p>These SPs total finishing methods for print jobs only. The finishing method is specified by the application.</p>
8065	S:FIN Jobs
	<p>[0 to 9999999 / 0 / 1]</p> <p>These SPs total finishing methods for scan jobs only. The finishing method is specified by the application.</p> <p>Note: Finishing features for scan jobs are not available at this time.</p>

8066	L:FIN Jobs	
	<p>[0 to 99999999 / 0 / 1]</p> <p>These SPs total finishing methods for jobs output from within the document server mode screen at the operation panel. The finishing method is specified from the print window within document server mode.</p>	
8067	O:FIN Jobs	
	<p>[0 to 99999999 / 0 / 1]</p> <p>These SPs total finishing methods for jobs executed by an external application, over the network. The finishing method is specified by the application.</p>	
1	Sort	Number of jobs started in Sort mode. When a stored copy job is set for Sort and then stored on the document server, the L: counter increments. (See SP8066 1)
2	Stack	Number of jobs started out of Sort mode.
3	Staple	Number of jobs started in Staple mode.
4	Booklet	Number of jobs started in Booklet mode. If the machine is in staple mode, the Staple counter also increments.
5	Z-Fold	Number of jobs started In any mode other than the Booklet mode and set for folding (Z-fold).
6	Punch	Number of jobs started in Punch mode. When Punch is set for a print job, the P: counter increments. (See SP8064 6.)
7	Other	Reserved. Not used.
8	Inside-Fold	
9	Three-in-Fold	
10	Three-Out-Fold	
11	Four-Fold	
12	Kannon-Fold	
13	Perfect Bind	
14	Ring Bind	
15	3rd Vendor	

16	eWireBinder	
----	-------------	--

8071	T:Jobs/PGS		
	[0 to 9999999/ 0 / 1] These SPs count the number of jobs broken down by the number of pages in the job, regardless of which application was used.		
8072	C:Jobs/PGS		
	[0 to 9999999/ 0 / 1] These SPs count and calculate the number of copy jobs by size based on the number of pages in the job.		
8074	P:Jobs/PGS		
	[0 to 9999999/ 0 / 1] These SPs count and calculate the number of print jobs by size based on the number of pages in the job.		
8075	S:Jobs/PGS		
	[0 to 9999999/ 0 / 1] These SPs count and calculate the number of scan jobs by size based on the number of pages in the job.		
8076	L:Jobs/PGS		
	[0 to 9999999/ 0 / 1] These SPs count and calculate the number of jobs printed from within the document server mode window at the operation panel, by the number of pages in the job.		
8077	O:Jobs/PGS		
	[0 to 9999999/ 0 / 1] These SPs count and calculate the number of "Other" application jobs (Web Image Monitor, Palm 2, etc.) by size based on the number of pages in the job.		
1	1 Page	8	21 to 50 Pages
2	2 Pages	9	51 to 100 Pages
3	3 Pages	10	101 to 300 Pages

4	4 Pages	11	301 to 500 Pages
5	5 Pages	12	501 to 700 Pages
6	6 to 10 Pages	13	701 to 1000 Pages
7	11 to 20 Pages	14	1001 to Pages

- For example: When a copy job stored on the document server is printed in document server mode, the appropriate L: counter (SP8076 0xx) increments.
- Interrupted jobs (paper jam, etc.) are counted, even though they do not finish.
- If a job is paused and re-started, it counts as one job.
- If the finisher runs out of staples during a print and staple job, then the job is counted at the time the error occurs.
- For copy jobs (SP 8072) and scan jobs (SP 8075), the total is calculated by multiplying the number of sets of copies by the number of pages scanned. (One duplex page counts as 2.)
- The first test print and subsequent test prints to adjust settings are added to the number of pages of the copy job (SP 8072).
- When printing the first page of a job from within the document server screen, the page is counted.

8131	T:S-to-Email Jobs	
	[0 to 9999999 / 0 / 1] These SPs count the total number of jobs scanned and attached to an e-mail, regardless of whether the document server was used or not.	
8135	S:S-to-Email Jobs	
	These SPs count the number of jobs scanned and attached to an e-mail, without storing the original on the document server.	
1	B/W	Count for the number of jobs with black-and-white.
2	Color	Count for the number of jobs with color.
3	ACS	Count for the number of jobs using ACS mode.

- These counters count jobs, not pages.
- If the job is stored on the document server, after the job is stored it is determined to be color or black-and-white then counted.
- If the job is cancelled during scanning, or if the job is cancelled while the document is waiting to be sent, the job is not counted.

- If the job is cancelled during sending, it may or may not be counted, depending on what stage of the process had been reached when the job was cancelled.
- If several jobs are combined for sending to the Scan Router, Scan-to-Email, or Scan-to-PC, or if one job is sent to more than one destination. each send is counted separately. For example, if the same document is sent by Scan-to-Email as well as Scan-to-PC, then it is counted twice (once for Scan-to-Email and once for Scan-to-PC).

8141	T:Deliv Jobs/Svr	
	[0 to 99999999 / 0 / 1] These SPs count the total number of jobs scanned and sent to a Scan Router server.	
8145	S:Deliv Jobs/Svr	
	These SPs count the number of jobs scanned in scanner mode and sent to a Scan Router server.	
1	B/W	Count for the number of jobs with black-and-white.
2	Color	Count for the number of jobs with color.
3	ACS	Count for the number of jobs using ACS mode.

- These counters count jobs, not pages.
- The jobs are counted even though the arrival and reception of the jobs at the Scan Router server cannot be confirmed.
- If even one color image is mixed with black-and-white images, then the job is counted as a "Color" job.
- If the job is cancelled during scanning, or if the job is cancelled while the document is waiting to be delivered, the job is not counted.
- If the job is cancelled during sending, it may or may not be counted, depending on what stage of the process had been reached when the job was cancelled.
- Even if several files are combined for sending, the transmission counts as one job.

8151	T:Deliv Jobs/PC	
	[0 to 99999999 / 0 / 1] These SPs count the total number of jobs scanned and sent to a folder on a PC (Scan-to-PC).	
8155	S:Deliv Jobs/PC	
	These SPs count the total number of jobs scanned and sent with Scan-to-PC.	

1	B/W	Count for the number of jobs with black-and-white.
2	Color	Count for the number of jobs with color.
3	ACS	Count for the number of jobs using ACS mode.

- These counters count jobs, not pages.
- If the job is cancelled during scanning, it is not counted.
- If the job is cancelled while it is waiting to be sent, the job is not counted.
- If the job is cancelled during sending, it may or may not be counted, depending on what stage of the process had been reached when the job was cancelled.
- Even if several files are combined for sending, the transmission counts as one job.

8171	T: Deliv Jobs/WSD	
	Total jobs for WSD (WS-Scanner for Web Services Devices).	
8175	S: Deliv Jobs/WSD	
8181	T: Scan to Media Jobs	
8185	S: Scan to Media Jobs	
	Total number of jobs scanned for WSD.	
	001	B/W
	002	Color
	003	ACS

8191	T:Total Scan PGS
8192	C:Total Scan PGS
8195	S:Total Scan PGS
8196	L:Total Scan PGS
	These SPs count the pages scanned by each application that uses the scanner to scan images. [0 to 99999999 / 0 / 1]

- SP 8191 to 8196 count the number of scanned sides of pages, not the number of physical pages.
- These counters do not count reading user stamp data, or reading color charts to adjust color.

- Previews done with a scanner driver are not counted.
- A count is done only after all images of a job have been scanned.
- Scans made in SP mode are not counted.

Examples:

- If 3 B5 pages and 1 A3 page are scanned with the scanner application but not stored, the S: count is 4.
- If both sides of 3 A4 sheets are copied and stored to the document server using the Store File button in the Copy mode window, the C: count is 6 and the L: count is 6.
- If both sides of 3 A4 sheets are copied but not stored, the C: count is 6.
- If you enter document server mode then scan 6 pages, the L: count is 6.

3

8211	T:Scan PGS/LS
8212	C:Scan PGS/LS
8215	S:Scan PGS/LS
8216	L:Scan PGS/LS
	<p>These SPs count the number of pages scanned into the document server. [0 to 9999999 / 0 / 1]</p> <p>The L: counter counts the number of pages stored from within the document server mode screen at the operation panel, and with the Store File button from within the Copy mode screen</p>

- Reading user stamp data is not counted.
- If a job is cancelled, the pages output as far as the cancellation are counted.
- If the scanner application scans and stores 3 B5 sheets and 1 A4 sheet, the S: count is 4.
- If pages are copied but not stored on the document server, these counters do not change.
- If both sides of 3 A4 sheets are copied and stored to the document server, the C: count is 6 and the L: count is 6.
- If you enter document server mode then scan 6 pages, the L: count is 6.

8221	ADF Org Feeds
	<p>[0 to 9999999 / 0 / 1]</p> <p>These SPs count the number of pages fed through the ADF for front and back side scanning.</p>
1	Front

	<p>Number of front sides fed for scanning:</p> <p>With an ADF that can scan both sides simultaneously, the Front side count is the same as the number of pages fed for either simplex or duplex scanning.</p> <p>With an ADF that cannot scan both sides simultaneously, the Front side count is the same as the number of pages fed for duplex front side scanning. (The front side is determined by which side the user loads face up.)</p>
2	Back
	<p>Number of rear sides fed for scanning:</p> <p>With an ADF that can scan both sides simultaneously, the Back count is the same as the number of pages fed for duplex scanning.</p> <p>With an ADF that cannot scan both sides simultaneously, the Back count is the same as the number of pages fed for duplex rear-side scanning.</p>

- When 1 sheet is fed for duplex scanning the Front count is 1 and the Back count is 1.
- If a jam occurs during the job, recovery processing is not counted to avoid double counting. Also, the pages are not counted if the jam occurs before the first sheet is output.

8231	Scan PGS/Mode
	[0 to 9999999 / 0 / 1] These SPs count the number of pages scanned by each ADF mode to determine the work load on the ADF.
1	Large Volume
	Selectable. Large copy jobs that cannot be loaded in the ADF at one time.
2	SADF
	Selectable. Feeding pages one by one through the ADF.
3	Mixed Size
	Selectable. Select "Mixed Sizes" on the operation panel.
4	Custom Size
	Selectable. Originals of non-standard size.
5	Platen
	Book mode. Raising the ADF and placing the original directly on the platen.

6	Mixed 1 Side/2 Side
	Mixed scanning jobs with one-side, 2-side originals.

- If the scan mode is changed during the job, for example, if the user switches from ADF to Platen mode, the count is done for the last selected mode.
- If the user selects "Mixed Sizes" for copying in the platen mode, the Mixed Size count is enabled.
- In the SADF mode if the user copies 1 page in platen mode and then copies 2 pages with SADF, the Platen count is 1 and the SADF count is 3.

3

8241	T:Scan PGS/Org
	[0 to 9999999/ 0 / 1] These SPs count the total number of scanned pages by original type for all jobs, regardless of which application was used.
8242	C:Scan PGS/Org
	[0 to 9999999/ 0 / 1] These SPs count the number of pages scanned by original type for Copy jobs.
8245	S:Scan PGS/Org
	[0 to 9999999/ 0 / 1] These SPs count the number of pages scanned by original type for Scan jobs.
8246	L:Scan PGS/Org
	[0 to 9999999/ 0 / 1] These SPs count the number of pages scanned and stored from within the document server mode screen at the operation panel, and with the Store File button from within the Copy mode screen

	8241	8242	8245	8246
1: Text	Yes	Yes	Yes	Yes
2: Text/Photo	Yes	Yes	Yes	Yes
3: Photo	Yes	Yes	Yes	Yes
4: GenCopy, Pale	Yes	Yes	Yes	Yes
5: Map	Yes	Yes	No	Yes

6: Normal/Detail	Yes	No	No	No
7: Fine/Super Fine	Yes	No	No	No
8: Binary	Yes	No	Yes	No
9: Grayscale	Yes	No	Yes	No
10: Color	Yes	No	Yes	No
11: Other	Yes	Yes	Yes	Yes

- If the scan mode is changed during the job, for example, if the user switches from ADF to Platen mode, the count is done for the last selected mode.

8251	T:Scan PGS/ImgEdt
8252	C:Scan PGS/ImgEdt
8255	S:Scan PGS/ImgEdt
8256	L:Scan PGS/ImgEdt
8257	O:Scan PGS/ImgEdt
	<p>These SPs show how many times Image Edit features have been selected at the operation panel for each application. Some examples of these editing features are:</p> <ul style="list-style-type: none"> • Erase> Border • Erase> Center • Image Repeat • Centering • Positive/Negative <p>[0 to 99999999 / 0 / 1]</p> <p>Note: The count totals the number of times the edit features have been used. A detailed breakdown of exactly which features have been used is not given.</p>

- The L: counter counts the number of pages stored from within the document server mode screen at the operation panel, and with the Store File button from within the Copy mode screen.

8261	T: Scn PGS/ColorCr
8262	C: Scn PGS/ColorCr
8265	S: Scn PGS/ColorCr

8266	L: Scn PGS/ColorCr
1	Color Conversion
2	Color Erase
3	Background
4	Other

8281	T:Scan PGS/TWAIN
8285	S:Scan PGS/TWAIN
	<p>These SPs count the number of pages scanned using a TWAIN driver. These counters reveal how the TWAIN driver is used for delivery functions.</p> <p>[0 to 9999999/ 0 / 1]</p> <p>Note: At the present time, these counters perform identical counts.</p>

8291	T:Scan PGS/Stamp
8295	S:Scan PGS/Stamp

8301	T:Scan PGS/Size
	<p>[0 to 9999999/ 0 / 1]</p> <p>These SPs count by size the total number of pages scanned by all applications. Use these totals to compare original page size (scanning) and output (printing) page size [SP 8-441].</p>
8302	C:Scan PGS/Size
	<p>[0 to 9999999/ 0 / 1]</p> <p>These SPs count by size the total number of pages scanned by the Copy application. Use these totals to compare original page size (scanning) and output (printing) page size [SP 8-442].</p>
8305	S:Scan PGS/Size
	<p>[0 to 9999999/ 0 / 1]</p> <p>These SPs count by size the total number of pages scanned by the Scan application. Use these totals to compare original page size (scanning) and output page size [SP 8-445].</p>

8306	L:Scan PGS/Size [0 to 9999999/ 0 / 1] These SPs count by size the total number of pages scanned and stored from within the document server mode screen at the operation panel, and with the Store File button from within the Copy mode screen. Use these totals to compare original page size (scanning) and output page size [SP 8-446].
1	A3
2	A4
4	B4
6	DLT
7	LG
8	LT
100	A2
101	B3
102	A0
103	A1
104	B1
105	B2
106	30x42
107	34x44
108	22x34
109	17x22
110	36x48
111	24x36
112	18x24
113	12x18
114	9x12

115	15x20
254	Other (Standard)
255	Other (Custom)

8311	T:Scan PGS/Rez
	[0 to 9999999 / 0 / 1] These SPs count by resolution setting the total number of pages scanned by applications that can specify resolution settings.
8315	S:Scan PGS/Rez
	[0 to 9999999 / 0 / 1] These SPs count by resolution setting the total number of pages scanned by applications that can specify resolution settings. Note: At the present time, 8311 and 8315 perform identical counts.
1	1200dpi to
2	600dpi to 1199dpi
3	400dpi to 599dpi
4	200dpi to 399dpi
5	to 199dpi

- Copy resolution settings are fixed so they are not counted.

8381	T:Total PrtPGS
8382	C:Total PrtPGS
8384	P:Total PrtPGS
8385	S:Total PrtPGS
8386	L:Total PrtPGS
8387	O:Total PrtPGS

	<p>These SPs count the number of pages printed by the customer. The counter for the application used for storing the pages increments.</p> <p>[0 to 99999999 / 0 / 1]</p> <p>The L: counter counts the number of pages stored from within the document server mode screen at the operation panel. Pages stored with the Store File button from within the Copy mode screen go to the C: counter.</p>
1	Field Number
2	Length (High)
3	Length (Low)
4	Area (High)
5	Area (Low)

- When the A3/DLT double count function is switched on with SP5104, 1 A3/DLT page is counted as 2.
- When several documents are merged for a print job, the number of pages stored are counted for the application that stored them.
- These counters are used primarily to calculate charges on use of the machine, so the following pages are not counted as printed pages:
 - Blank pages in a duplex printing job.
 - Blank pages inserted as document covers, chapter title sheets, and slip sheets.
 - Reports printed to confirm counts.
 - All reports done in the service mode (service summaries, engine maintenance reports, etc.)
 - Test prints for machine image adjustment.
 - Error notification reports.
 - Partially printed pages as the result of a copier jam.

8401	T:PrtPGS/LS
8402	C:PrtPGS/LS
8404	P:PrtPGS/LS
8405	S:PrtPGS/LS
8406	L:PrtPGS/LS

	<p>These SPs count the number of pages printed from the document server. The counter for the application used to print the pages is incremented.</p> <p>The L: counter counts the number of jobs stored from within the document server mode screen at the operation panel.</p> <p>[0 to 9999999 / 0 / 1]</p>
--	---

- Print jobs done with Web Image Monitor and Desk Top Binder are added to the L: count.

3

8421	T:PrtPGS/Dup Comb
	<p>[0 to 9999999 / 0 / 1]</p> <p>These SPs count by binding and combine, and n-Up settings the number of pages processed for printing. This is the total for all applications.</p>
8422	C:PrtPGS/Dup Comb
	<p>[0 to 9999999 / 0 / 1]</p> <p>These SPs count by binding and combine, and n-Up settings the number of pages processed for printing by the copier application.</p>
8424	P:PrtPGS/Dup Comb
	<p>[0 to 9999999 / 0 / 1]</p> <p>These SPs count by binding and combine, and n-Up settings the number of pages processed for printing by the printer application.</p>
8425	S:PrtPGS/Dup Comb
	<p>[0 to 9999999 / 0 / 1]</p> <p>These SPs count by binding and combine, and n-Up settings the number of pages processed for printing by the scanner application.</p>
8426	L:PrtPGS/Dup Comb
	<p>[0 to 9999999 / 0 / 1]</p> <p>These SPs count by binding and combine, and n-Up settings the number of pages processed for printing from within the document server mode window at the operation panel.</p>

8427	O:PrtPGS/Dup Comb	
	[0 to 99999999 / 0 / 1] These SPs count by binding and combine, and n-Up settings the number of pages processed for printing by Other applications	
1	Simplex> Duplex	
2	Duplex> Duplex	
3	Book> Duplex	
4	Simplex Combine	
5	Duplex Combine	
6	2-in-1	2 pages on 1 side (2-Up)
7	4-in-1	4 pages on 1 side (4-Up)
8	6-in-1	6 pages on 1 side (6-Up)
9	8-in-1	8 pages on 1 side (8-Up)
10	9-in-1	9 pages on 1 side (9-Up)
11	16-in-1	16 pages on 1 side (16-Up)
12	Booklet	
13	Magazine	
14	2-in-1 + Booklet	
15	4-in-1 + Booklet	
16	6-in-1 + Booklet	
17	8-in-1 + Booklet	
18	9-in-1 + Booklet	
19	2-in-1 + Magazine	
20	4-in-1 + Magazine	
21	6-in-1 + Magazine	
22	8-in-1 + Magazine	

23	9-in-1 + Magazine	
24	16-in-1 + Magazine	

- These counts (SP8421 to SP8427) are especially useful for customers who need to improve their compliance with ISO standards for the reduction of paper consumption.
- Pages that are only partially printed with the n-Up functions are counted as 1 page.

Here is a summary of how the counters work for Booklet and Magazine modes:

3

Booklet		Magazine	
Original Pages	Count	Original Pages	Count
1	1	1	1
2	2	2	2
3	2	3	2
4	2	4	2
5	3	5	4
6	4	6	4
7	4	7	4
8	4	8	4

8431	T:PrtPGS/ImgEdt
	[0 to 9999999 / 0 / 1] These SPs count the total number of pages output with the three features below, regardless of which application was used.
8432	C:PrtPGS/ImgEdt
	[0 to 9999999 / 0 / 1] These SPs count the total number of pages output with the three features below with the copy application.

8434	P:PrtPGS/ImgEdt
	[0 to 99999999 / 0 / 1] These SPs count the total number of pages output with the three features below with the print application.
8436	L:PrtPGS/ImgEdt
	[0 to 99999999 / 0 / 1] These SPs count the total number of pages output from within the document server mode window at the operation panel with the three features below.
8437	O:PrtPGS/ImgEdt
	[0 to 99999999 / 0 / 1] These SPs count the total number of pages output with the three features below with Other applications.
1	Cover/Slip Sheet
	Total number of covers or slip sheets inserted. The count for a cover printed on both sides counts 2.
2	Series/Book
	The number of pages printed in series (one side) or printed as a book with booklet right/left pagination.
3	User Stamp
	The number of pages printed where stamps were applied, including page numbering and date stamping.

8441	T:PrtPGS/Ppr Size
	[0 to 99999999 / 0 / 1] These SPs count by print paper size the number of pages printed by all applications.
8442	C:PrtPGS/Ppr Size
	[0 to 99999999 / 0 / 1] These SPs count by print paper size the number of pages printed by the copy application.

8444	P:PrtPGS/Ppr Size
	[0 to 9999999/ 0 / 1] These SPs count by print paper size the number of pages printed by the printer application.
8445	S:PrtPGS/Ppr Size
	[0 to 9999999/ 0 / 1] These SPs count by print paper size the number of pages printed by the scanner application.
8446	L:PrtPGS/Ppr Size
	[0 to 9999999/ 0 / 1] These SPs count by print paper size the number of pages printed from within the document server mode window at the operation panel.
8447	O:PrtPGS/Ppr Size
	[0 to 9999999/ 0 / 1] These SPs count by print paper size the number of pages printed by other applications.
1	A3
2	A4
4	B4
6	DLT
7	LG
8	LT
100	A2
101	B3
102	A0
103	A1
104	B1
105	B2
106	30x42

107	34x44
108	22x34
109	17x22
110	36x48
111	24x36
112	18x24
113	12x18
114	9x12
115	15x20
237	15inch Custom
238	14inch Custom
239	841 mm Custom: A0-
240	841 mm Custom: -A0
241	594 mm Custom
242	420 mm Custom
243	297 mm Custom
244	210 mm Custom
245	228 mm Custom
246	515 mm Custom
247	364 mm Custom
248	257 mm Custom
249	30/34/36 Custom
250	22/24 Custom
251	12/18 Custom
252	11/12 Custom
253	8.5/9 Custom

254	Other (Standard)
255	Other (Custom)

- These counters do not distinguish between LEF and SEF.

8451	PrtPGS/Ppr Tray	
	[0 to 99999999 / 0 / 1] These SPs count the number of sheets fed from each paper feed station.	
1	Bypass	Bypass Tray
2	Tray 1	Copier
3	Tray 2	Copier
4	Tray 3	Paper Tray Unit (Option)
5	Tray 4	Paper Tray Unit (Option)
6	Tray 5	LCT (Option)
7	Tray 6	Currently not used.
8	Tray 7	Currently not used.
9	Tray 8	Currently not used.
10	Tray 9	Currently not used.
11	Tray 10	Currently not used.
12	Tray 11	Currently not used.
13	Tray 12	Currently not used.
14	Tray 13	Currently not used.
15	Tray 14	Currently not used.
16	Tray 15	Currently not used.
101	LC Inserter	
102	3rd Vendor	

8461	T:PrtPGS/Ppr Type
	[0 to 9999999/ 0 / 1] These SPs count by paper type the number pages printed by all applications. <ul style="list-style-type: none"> • These counters are not the same as the PM counter. The PM counter is based on feed timing to accurately measure the service life of the feed rollers. However, these counts are based on output timing. • Blank sheets (covers, chapter covers, slip sheets) are also counted. • During duplex printing, pages printed on both sides count as 1, and a page printed on one side counts as 1.
8462	C:PrtPGS/Ppr Type
	[0 to 9999999/ 0 / 1] These SPs count by paper type the number pages printed by the copy application.
8464	P:PrtPGS/Ppr Type
	[0 to 9999999/ 0 / 1] These SPs count by paper type the number pages printed by the printer application.
8466	L:PrtPGS/Ppr Type
	[0 to 9999999/ 0 / 1] These SPs count by paper type the number pages printed from within the document server mode window at the operation panel.
1	Normal
2	Recycled
3	Special
4	Thick
5	Normal (Back)
6	Thick (Back)
7	OHP
8	Other

8471	PrtPGS/Mag
	[0 to 99999999 / 0 / 1] These SPs count by magnification rate the number of pages printed.
1	- 49%
2	50% to 99%
3	100%
4	101% to 200%
5	201% -

- Counts are done for magnification adjusted for pages, not only on the operation panel but performed remotely with an external network application capable of performing magnification adjustment as well.
- Magnification adjustments done with printer drivers with PC applications such as Excel are also counted.
- Magnification adjustments done for adjustments after they have been stored on the document server are not counted.
- Magnification adjustments performed automatically during Auto Reduce/Enlarge copying are counted.
- The magnification rates of blank cover sheets, slip sheets, etc. are automatically assigned a rate of 100%.

8481	T:PrtPGS/TonSave
8484	P:PrtPGS/TonSave
	These SPs count the number of pages printed with the Toner Save feature switched on. Note: These SPs return the same results as this SP is limited to the Print application. [0 to 99999999 / 0 / 1]

8491	T:PrtPGS/Col Mode
8492	C:PrtPGS/Col Mode
8496	L:PrtPGS/Col Mode
8497	O:PrtPGS/Col Mode

	These SPs count the number of pages printed for each color mode. [0 to 9999999/ 0 / 1]
1	B/W
2	Single Color
3	Two Color
4	Full Color

8501	T:PrtPGS/Col Mode
8504	P:PrtPGS/Col Mode
8507	O:PrtPGS/Col Mode
	These SPs count the number of pages printed for each color mode. [0 to 9999999/ 0 / 1]
1	B/W
2	Mono Color
3	Full Color
4	Single Color
5	Two Color

8511	T:PrtPGS/Emul
	These SPs count by printer emulation mode the total number of pages printed. [0 to 9999999/ 0 / 1]
8514	P:PrtPGS/Emul
	These SPs count by printer emulation mode the total number of pages printed. [0 to 9999999/ 0 / 1]
1	RPCS
2	RPDL
3	PS3

4	R98	
5	R16	
6	GL/GL2	
7	R55	
8	RTIFF	
9	PDF	
10	PCL5e/5c	
11	PCL XL	
12	IPDL-C	
13	BM-Links	Japan Only
14	Other	
15	IPDS	
16	XPS	

- SP8511 and SP8514 return the same results as they are both limited to the Print application.
- Print jobs output to the document server are not counted.

8521	T:PrtPGS/FIN
	These SPs count by finishing mode the total number of pages printed by all applications. [0 to 99999999 / 0 / 1]
8522	C:PrtPGS/FIN
	These SPs count by finishing mode the total number of pages printed by the Copy application. [0 to 99999999 / 0 / 1]
8524	P:PrtPGS/FIN
	These SPs count by finishing mode the total number of pages printed by the Print application. [0 to 99999999 / 0 / 1]

8525	S:PrtPGS/FIN	
	These SPs count by finishing mode the total number of pages printed by the Scanner application. [0 to 9999999 / 0 / 1]	
8526	L:PrtPGS/FIN	
	These SPs count by finishing mode the total number of pages printed from within the document server mode window at the operation panel. [0 to 9999999 / 0 / 1]	
1	Sort	
2	Stack	
3	Staple	
4	Booklet	
5	Z-Fold	
6	Punch	
7	Other	
8	Inside Fold	Half-Fold (FM2) (Multi Fold Unit)
9	Three-IN-Fold	Letter Fold-in (FM4) (Multi Fold Unit)
10	Three-OUT-Fold	Letter Fold-out (FM3) (Multi Fold Unit)
11	Four Fold	Double Parallel Fold (FM5) (Multi Fold Unit)
12	KANNON-Fold	Gate Fold (FM6) (Multi Fold Unit)
13	Perfect-Bind	Perfect Binder Not Used
14	Ring-Bind	Ring Binder Not Used
15	3rd Vendor	
16	eWireBinder	

- If stapling is selected for finishing and the stack is too large for stapling, the unstapled pages are still counted.
- The counts for staple finishing are based on output to the staple tray, so jam recoveries are counted.

8531	Staples
	This SP counts the amount of staples used by the machine. [0 to 9999999 / 0 / 1]

8551	T: PrtBooks/FIN Not Used	
8552	O: PrtBooks/FIN Not Used	
8554	P: PrtBooks/FIN Not Used	
8556	L: PrtBooks/FIN Not Used	
	1	Perfect-Bind
	2	Ring-Bind
	3	eWireBinder

8581	T:Counter	
	[0 to 9999999 / 0 / 1]	
	These SPs count the total output broken down by color output, regardless of the application used. In addition to being displayed in the SMC Report, these counters are also displayed in the User Tools display on the copy machine.	
	1	Total
	2	Total: Full Colopr
	3	B&W/Mono Color
	4	Development: CMY
	5	Development: K
	6	Copy: Color
	7	Copy: B/W
	8	Print: Color
	9	Print: B/W
	10	Total: Color
	11	Total: B/W

14	Full Color Print
15	Mono Color Print
101	Total: Full Color Length (Low)
102	Total: Full Color Length (High)
103	Total: Full Color Area (Low)
104	Total: Full Color Area (High)
105	B&W/Mono Color Length (Low)
106	B&W/Mono Color Length (High)
107	B&W/Mono Color Area (Low)
108	B&W/Mono Color Area (High)
117	Copy: Color Length (Low)
118	Copy: Color Length (High)
119	Copy: Color Area (Low)
120	Copy: Color Area (High)
121	Color: B/W Length (Low)
122	Color: B/W Length (High)
123	Color: B/W Area (Low)
124	Color: B/W Area (High)
125	Print: Color Length (Low)
126	Print: Color Length (High)
127	Print: Color Area (Low)
128	Print: Color Area (High)
129	Print: B/W Length (Low)
130	Print: B/W Length (High)
131	Print: B/W Area (Low)
132	Print: B/W Area (High)

133	Total Color: Length (Low)
134	Total Color: Length (High)
135	Total Color: Area (Low)
136	Total Color: Area (High)
137	Total B/W Length (Low)
138	Total B/W Length (High)
139	Total B/W Area (Low)
140	Total B/W Area (High)
141	Full Color Print Length (Low)
142	Full Color Print Length (High)
143	Full Color Print Area (Low)
144	Full Color Print Area (High)
145	Mono Color Print Length (Low)
146	Mono Color Print Length (High)
147	Mono Color Print Area (Low)
148	Mono Color Print Area (High)

8582	C: Counter
8584	P: Counter
8586	L: Counter
1	B/W
2	Single Color
3	Two Color
4	Full Color
101	Length (High), B/W
102	Length (Low), B/W

103	Area (High), B/W
104	Area (Low), B/W
111	Length (High), Single
112	Length (Low), Single
113	Area (High), Single
114	Area (Low), Single
121	Length (High), Twin
122	Length (Low), Twin
123	Area (High), Twin
124	Area (Low), Twin
131	Length (High), Full
132	Length (Low), Full
133	Area (High), Full
134	Area (Low), Full

8601	T: Coverage Counter
1	B/W
2	Color
11	B/W Printing Pages
12	Color Printing Pages
21	Coverage Counter 1
22	Coverage Counter 2
23	Coverage Counter 3
31	Coverage Counter 1 (YMC)
32	Coverage Counter 2 (YMC)
33	Coverage Counter 3 (YMC)

41	Cvg Counter 1 Length (High)
42	Cvg Counter 1 Length (Low)
43	Cvg Counter 2 Length (High)
44	Cvg Counter 2 Length (Low)
45	Cvg Counter 3 Length (High)
46	Cvg Counter 3 Length (Low)
51	Cvg Counter 1 (YMC) Length (High)
52	Cvg Counter 1 (YMC) Length (Low)
53	Cvg Counter 2 (YMC) Length (High)
54	Cvg Counter 2 (YMC) Length (Low)
55	Cvg Counter 3 (YMC) Length (High)
56	Cvg Counter 3 (YMC) Length (Low)
61	Cvg Counter 1 Area (High)
62	Cvg Counter 1 Area (Low)
63	Cvg Counter 2 Area (High)
65	Cvg Counter 2 Area (Low)
65	Cvg Counter 3 Area (High)
66	Cvg Counter 3 Area (Low)
71	Cvg Counter 1 (YMC) Area (High)
72	Cvg Counter 1 (YMC) Area (Low)
73	Cvg Counter 2 (YMC) Area (High)
74	Cvg Counter 2 (YMC) Area (Low)
75	Cvg Counter 3 (YMC) Area (High)
76	Cvg Counter 3 (YMC) Area (Low)

8602	D: Coverage Counter
------	---------------------

8604	P: Coverage Counter
8606	L: Coverage Counter
	Provide a breakdown about coverage.
1	B/W
2	Single Color
3	Two Color
4	Full Color

8617	SDK Apli Counter DFU
	SDK 1 to 12

8621	Func Use Counter Not Used
	001 to 064: Function 001 to 064

8651	T:S-to-Email PGS
	[0 to 9999999 / 0 / 1] These SPs count by color mode the total number of pages attached to an e-mail for both the Scan and document server applications. Note: This SP is expanded for color MFP and color LP machines. For this machine, the count is done for black only.
1	B/W
2	Color

8655	S:S-to-Email PGS
	[0 to 9999999 / 0 / 1] These SPs count by color mode the total number of pages attached to an e-mail for the Scan application only. Note: This SP is expanded for color MFP and color LP machines. For this machine, the count is done for black only.
1	B/W

2	Color	Color MFP machines only
---	-------	-------------------------

- For SP8651 and SP8655 the count for B/W and Color pages is done after the document is stored on the HDD. If the job is cancelled before it is stored, the pages are not counted.
- If Scan-to-Email is used to send a 10-page document to 5 addresses, the count is 10 (the pages are sent to the same SMTP server together).
- If Scan-to-PC is used to send a 10-page document to 5 folders, the count is 50 (the document is sent to each destination of the SMB/FTP server).
- Due to restrictions on some devices, if Scan-to-Email is used to send a 10-page document to a large number of destinations, the count may be divided and counted separately. For example, if a 10-page document is sent to 200 addresses, the count is 10 for the first 100 destinations and the count is also 10 for the second 100 destinations, for a total of 20).

8661	T:Deliv PGS/Svr
	<p>[0 to 9999999/ 0 / 1]</p> <p>These SPs count by color mode the total number of pages sent to a Scan Router server by both Scan and LS applications.</p> <p>Note: This SP is expanded for color MFP and color LP machines. For this machine, the count is done for black only.</p>
8665	S:Deliv PGS/Svr
	<p>[0 to 9999999/ 0 / 1]</p> <p>These SPs count by color mode the total number of pages sent to a Scan Router server by the Scan application.</p> <p>Note: This SP is expanded for color MFP and color LP machines. For this machine, the count is done for black only.</p>
1	B/W
2	Color

- The B/W and Color counts are done after the document is stored on the HDD of the Scan Router server.
- If the job is canceled before storage on the Scan Router server finishes, the counts are not done.
- The count is executed even if regardless of confirmation of the arrival at the Scan Router server.

8671	T:Deliv PGS/PC
	[0 to 9999999/ 0 / 1]

	<p>These SPs count by color mode the total number of pages sent to a folder on a PC (Scan-to-PC) with the Scan and LS applications.</p> <p>Note: This SP is expanded for color MFP and color LP machines. For this machine, the count is done for black only.</p>
8675	S:Deliv PGS/PC
	<p>[0 to 99999999 / 0 / 1]</p> <p>These SPs count by color mode the total number of pages sent with Scan-to-PC with the Scan application.</p> <p>Note: This SP is expanded for color MFP and color LP machines. For this machine, the count is done for black only.</p>
1	B/W
2	Color

8691	T:TX PGS/LS
8692	C:TX PGS/LS
8694	P:TX PGS/LS
8695	S:TX PGS/LS
8696	L:TX PGS/LS
	<p>These SPs count the number of pages sent from the document server. The counter for the application that was used to store the pages is incremented.</p> <p>[0 to 99999999 / 0 / 1]</p> <p>The L: counter counts the number of pages stored from within the document server mode screen at the operation panel. Pages stored with the Store File button from within the Copy mode screen go to the C: counter.</p>

- Print jobs done with Web Image Monitor and Desk Top Binder are added to the count.
- If several documents are merged for sending, the number of pages stored is counted for the application that stored them.

8701	TX PGS/Port
------	-------------

	[0 to 9999999 / 0 / 1] These SPs count the number of pages sent by the physical port used to send them. For example, if a 3-page original is sent to 4 destinations via ISDN G4, the count for ISDN (G3, G4) is 12.
1	PSTN-1
2	PSTN-2
3	PSTN-3
4	ISDN (G3,G4)
5	Network

8711	T:Scan PGS/Comp
	[0 to 9999999 / 1] These SPs count the number of compressed pages scanned into the document server, counted by the formats listed below.
1	JPEG/JPEG2000
2	TIFF (Multi/Single)
3	PDF
4	Other
5	PDF/Comp
6	PDF/A
7	PDF(OCR)
8	PDF/Comp(OCR)
9	PDF/A(OCR)

8715	S:Scan PGS/Comp
	[0 to 9999999 / 1] These SPs count the number of compressed pages scanned by the scan application, counted by the formats listed below.

1	JPEG/JPEG2000
2	TIFF (Multi/Single)
3	PDF
4	Other
5	PDF/Comp
6	PDF/A
7	PDF(OCR)
8	PDF/Comp(OCR)
9	PDF/A(OCR)

8721	T: Deliv PGS/WSD	
8725	S: Deliv PGS/WSD	
8731	T: Scan PGS/Media	
8735	S: Scan PGS/Media	
	Total number of pages sent via WSD (WS-Scanner for Web Services Devices).	
1	B/W	
2	Color	

8741	RX PGS/Port	
	[0 to 99999999 / 0 / 1] These SPs count the number of pages received by the physical port used to receive them.	
1	PSTN-1	
2	PSTN-2	
3	PSTN-3	
4	ISDN (G3,G4)	
5	Network	

8781	Ink_Botol_Info.
	This SP displays the number of toner bottles used. The count is done based on the equivalent of 1,000 pages per bottle.
1	BK
2	Y
3	M
4	C

8791	LS Memory Remain
	This SP displays the percent of space available on the document server for storing documents. [0 to 100/ 0 / 1]

8801	Ink Remain
	This SP displays the percent of ink remaining for each color. This SP allows the user to check the toner supply at any time. [0 to 100/ 0 / 1]
1	BK
2	Y
3	M
4	C

8811	Eco Counter
1	Eco Total
2	Color
3	Full Color
5	Combine
9	Combine (%)
10	Paper Cut (%)

51	Sync Eco Total
52	Sync Color
53	Sync Full Color
55	Sync Combine
56	Sync Color(%)
57	Sync Full Color(%)
59	Sync Combine(%)
60	Sync Paper Cut(%)
101	Eco Totalr:Last
102	Color: Last
103	Full Color: Last
105	Combine: Last
106	Color (%): Last
107	Full Color (%): Last
109	Combine (%): Last
110	Paper Cut (%): Last
151	Sync Eco Totalr:Last
152	Sync Color:Last
153	Sync Full Color:Last
154	Sync Combine:Last
155	Sync Color(%):Last
156	Sync Full Color(%):Last
157	Sync Combine(%):Last
159	Sync Paper Cut(%):Last
160	Sync Eco Totalr:Last

8851	Cvr Cnt: 0 - 10%
8861	Cvr Cnt: 11 - 20%
8871	Cvr Cnt: 21 - 30%
8881	Cvr Cnt: 31%
	[0 to 9999999] These SPs count the percentage of dot coverage for each color.
1	BK
2	Y
3	M
4	C

8891	Page/Ink Bottle
	Total number of pages per toner bottle.
1	BK
2	Y
3	M
4	C

8901	Page/Toner_Prev1 DFU
1	BK
2	Y
3	M
4	C

8911	Page/Toner_Prev2 DFU
1	BK
2	Y

3	M
4	C

8921	Cvr Cnt/Total
1	Coverage (%): BK
2	Coverage (%): Y
3	Coverage (%): M
4	Coverage (%): C
11	Coverage/P: BK
12	Coverage/P: Y
13	Coverage/P: M
14	Coverage/P: C
21	Ink Cons (ml): BK
22	Ink Cons (ml): Y
23	Ink Cons (ml): M
24	Ink Cons (ml): C

8941	Machine Status
	[0 to 99999999 / 0 / 1] These SPs count the amount of time the machine spends in each operation mode. These SPs are useful for customers who need to investigate machine operation for improvement in their compliance with ISO Standards.
1	Operation Time
	Engine operation time. Does not include time while controller is saving data to HDD (while engine is not operating).
2	Standby Time
	Engine not operating. Includes time while controller saves data to HDD. Does not include time spent in Energy Save, Low Power, or Off modes.

3	Energy Save Time
	Includes time while the machine is performing background printing.
4	Low Power Time
	Includes time in Energy Save mode with Engine on. Includes time while machine is performing background printing.
5	Off Mode Time
	Includes time while machine is performing background printing. Does not include time machine remains powered off with the power switches.
6	SC
	Total down time due to SC errors.
7	PrtJam
	Total down time due to paper jams during printing.
8	OrgJam
	Total down time due to original jams during scanning.
9	Supply PM Wait End
	Total down time due to toner end.

8951	AddBook Register
	These SPs count the number of events when the machine manages data registration.
1	User Code
	User code registrations. [0 to 9999999/ 0 / 1]
2	Mail Address
	Mail address registrations. [0 to 9999999/ 0 / 1]
4	Group
	Group destination registrations. [0 to 9999999/ 0 / 1]

6	F-Code
	F-Code box registrations. [0 to 9999999 / 0 / 1]
7	Copy Program
	Copy application registrations with the Program (job settings) feature. [0 to 255 / 0 / 255]
9	Printer Program
	Printer application registrations with the Program (job settings) feature. [0 to 255 / 0 / 255]
10	Scanner Program
	Scanner application registrations with the Program (job settings) feature. [0 to 255 / 0 / 255]

8961	Electricity Status	
	-	
1	Ctrl Standby Time	[0 to 99999 / - / 1]
2	STR Time	
3	Main Power Off Time	
4	Reading and Printing Time	
5	Printing Time	
6	Reading Time	
7	Eng Waiting Time	
8	Low Power State Time	
9	Silent State Time	
10	Heater Off State Time	
11	LCD on Time	

8971	Unit Control	
	-	
1	Engine Off Recovery Count	[0 to 99999 / - / 1]
2	Power Off Count	
3	Force Power Off Count	

3

8999	Admin Counter List	
	-	
1	Total	
2	Copy: Full Color	
3	Copy: BW	
4	Copy: Single Color	
5	Copy: Two Color	
6	Printer: Full Color	
7	Printer: BW	
8	Printer: Single Color	
9	Printer: Two Color	
22	Copy: Full Color (%)	
23	Copy: B/W (%)	
24	Copy: Single Color (%)	
25	Copy: Two Color (%)	
26	Printer: Full Color (%)	
27	Printer: B/W (%)	
28	Printer: Single Color (%)	
29	Printer: Two Color (%)	
101	Transmission Total: Color	

102	Transmission Total: BW
103	Fax Transmission
104	Scanner Transmission: Color
105	Scanner Transmission: BW

Printer Service Mode

Printer Service Mode

1001	Bit Switch			
001	Bit Switch 1	0	1	
	bit 0	DFU	-	
	bit 1	Responding with the hostname as the sysName	Model name (PnP name)	Hostname
	This BitSwitch can change the value of the sysName. 0 (default): Model name (PnP name) such as "MP C401SP" 1: Host name			
	bit 2	DFU	-	
	bit 3	No I/O Timeout	0:Disabled	1:Enabled
	Enables/Disables MFP I/O Timeouts. If enabled, the MFP I/O Timeout setting will have no affect. I/O Timeouts will never occur.			
	bit 4	SD Card Save Mode	0:Disabled	1:Enabled
	If this bit switch is enabled, print jobs will be saved to the GW SD slot and not output to paper.			
bit 5	[PS and PDF] Paper size error margin	±5pt	±10pt	
When a PS job is printed by using a custom paper size, the job might not be printed because of a paper size mismatch caused by a calculation error. By default, the error margin for matching to a paper size is ±5 points. By enabling this BitSwitch, the error margin for matching to a paper size can be extended to ±10 points.				

1001	Bit Switch			
bit 6	Color balance switching	0:Disabled	1:Enabled	
	This BitSwitch can be used to restore the color balance to match that of previous models. If this BitSwitch is set to "1" (Enabled), the color balance that is equivalent to Fuji-Xerox printers will be used.			
bit 7	[RPCS,PCL]: Printable area frame border	0: Disable	1: Enable	
	Prints all RPCS and PCL jobs with a border around the printable area.			

1001	Bit Switch				
002	Bit Switch 2		0	1	
	bit 0	Color balance switching	Disabled	Enabled	
		This BitSwitch can be used to restore the color balance to match that of previous models. If this BitSwitch is set to "1" (Enabled), the color balance from 09S and earlier models will be used.			
	bit 1	DFU	-	-	
	bit 2	DFU	-	-	
	bit 3	[PCL5e/c.PS]: PDL Auto Switching	0: Enable	1: Disable	
		Enables/disable the MFPs ability to change the PDL processor mid-job. Some host systems submit jobs that contain both PS and PCL5e/c. If Auto PDL switching is disabled, these jobs will not be printed properly.			
	bit 4	Color balance switching	Disabled	Enabled	
		This BitSwitch can be used to restore the color balance to match that of previous models. If this BitSwitch is set to "1" (Enabled), the color balance from 09A and Extended 09A models will be used.			
	bit 5	DFU	-	-	
bit 6	Switch dither	0: Use normal dither	1: Use alternative dither		
	See RTB#RD014018.				
bit 7	DFU	-	-		

1001		Bit Switch		
003	Bit Switch 3		0	1
	bit 0	DFU	-	-
	bit 1	DFU	-	-
	bit 2	[PCL5e/c]: Legacy HP compatibility	0:Disabled	1:Enabled
		Uses the same left margin as older HP models such as HP4000/HP8000. In other words, the left margin defined in the job (usually "<ESC>*r0A") will be changed to "<ESC>*r1A".		
bit 3 to 7	DFU	-	-	

1001		Bit Switch		
004	Bit Switch 4		0	1
	bit 0 to 7	DFU	-	-

1001	Bit Switch			
005	Bit Switch 5		0	1
	bit 0	DFU	-	-
	bit 1	Multiple copies if a paper size or type mismatch occurs	0:Disabled (Single copy)	1:Enabled (Multiple copy)
	If a paper size or type mismatch occurs during the printing of multiple copies, only a single copy is output by default. Using this bit switch, the device can be configured to print all copies even if a paper mismatch occurs.			
	bit 2	Prevent SDK applications from altering the contents of a job.	0:Disabled	1:Enabled
	Enable: SDK applications will not be able to alter print data. This is achieved by preventing SDK applications from accessing a module called the "GPS Filter". Note: The main purpose of this bit switch is for troubleshooting the effects of SDK applications on data.			
	bit 3	[PS] PS Criteria	0: Pattern3	1: Pattern 1
Change the number of PS criterion used by the PS interpreter to determine whether a job is PS data or not. Pattern3: (2 to 4): The larger the pattern number, the greater the number of criterion used. Pattern 4 includes most PS commands. Pattern1: A small number of PS tags and headers				
bit 4	Increase max. number of stored jobs.	0:Disabled (100)	1:Enabled (750)	
Changes the maximum number of jobs that can be stored on the HDD. The default (disabled) is 100. If this is enabled, the max. will be raised to 750 or 1000 depending on the model.				

1001		Bit Switch		
	bit 5	DFU	-	-
	bit 6	Method for determining the image rotation for the edge to bind on.	0:Disabled	1:Enabled
		Enable: The image rotation will be performed as they were in the specifications of older models for the binding of pages of mixed orientation jobs. The old models are below: - PCL: Pre-04A models - PS/PDF/RPCS: Pre-05S models		
	bit 7	Letterhead mode printing	0:Disabled	1:Enabled (Duplex)
		Routes all pages through the duplex unit. If this is disabled, simplex pages or the last page of an odd-paged duplex job are not routed through the duplex unit. This could result in problems with letterhead/pre-printed pages. Only affects pages specified as Letterhead paper.		

1001		Bit Switch		
006	Bit Switch 6		0	1
	bit 0	Include bypass in auto tray select	0:Disabled	1:Enabled
		If enabled, the Bypass tray tray will be included in auto tray selection.		
	bit 1 to 7	DFU	-	-

1001		Bit Switch		
007	Bit Switch 7		0	1
	bit 0 to 7	DFU	-	-

1001	Bit Switch			
008	Bit Switch 8		0	1
	bit 0 to 2	DFU	-	-
	bit 3	[PCL.PS]: Allow BW jobs to print without requiring User Code	0:Disabled	1:Enabled (allow BW jobs to print without a user code)
	BW jobs submitted without a user code will be printed even if usercode authentication is enabled. Note: Color jobs will not be printed without a valid user code.			
	bit 4 to 5	DFU	-	-
	bit 6	PCL, RPCS, PS: Forced BW print	0:Disabled	1:Enabled
		Switches whether to ignore PDL color command.		
bit 7	DFU	-	-	

1001		Bit Switch		
009	Bit Switch 9		0	1
	bit 0	PDL Auto Detection timeout of jobs submitted via USB or Parallel Port (IEEE 1284).	0:Disabled (Immediately)	1:Enabled (10 seconds)
	To be used if PDL auto-detection fails. A failure of PDL autodetection does not necessarily mean that the job can not be printed. This bit switch tells the device whether to time-out immediately (default) upon failure or to wait 10 seconds.			
	bit 1	DFU	-	-
	bit 2	Job Cancel	0:Disabled (Not cancelled)	1:Enabled (Cancelled)
	Enable: All jobs will be cancelled after a jam occurs. Note: If this bit switch is enabled, printing under the following conditions might result in problems: - Job submission via USB or parallel port - Spool printing (WIM > Configuration > Device Settings > System)			
bit 3	DFU	-	-	
bit 4	Timing of the PjL Status ReadBack (JOB END) when printing multiple collated copies.	0:Disabled	1:Enabled	
This bit switch determines the timing of the PjL USTATUS JOB END sent when multiple collated copies are being printed. Disable (=0 (default)): JOB END is sent by the device to the client after the first copy has completed printing. This causes the page counter to be incremented after the first copy and then again at the end of the job. Enable (=1): JOB END is sent by the device to the client after the last copy has finished printing. This causes the page counter to be incremented at the end of each job.				

1001	Bit Switch			
009	Bit Switch 9		0	1
	bit 5	Display UTF-8 text in the operation panel	0:Enabled	1:Disabled
	Enable (=0): Text composed of UTF-8 characters can be displayed in the operation panel. Disable (=1): UTF-8 characters cannot be displayed in the operation panel. For example, job names are sometimes stored in the MIB using UTF-8 encoded characters. When these are displayed on the operation panel, they will be garbled unless this bit switch is enabled (=0).			
	bit 6	Disable super option	0:Enabled	1:Disabled
	Switches super option disable on / off. If this is On, multiple jobs are grouped at LPR port. PJJ settings are enabled even jobs that are specified queue names are sent.			
bit 7	Enable/Disable Print from USB/SD's Preview function	0:Enabled	1:Disabled	
Determines whether print from USB/SD will have the Preview function. Enabled (=0): Print from USB/SD will have the Preview function. Disabled (=1): Print from USB/SD will not have the Preview function.				

1001		Bit Switch		
010	Bit Switch A		0	1
	bit 0 to 3	DFU	-	-
	bit 4	Not Used	-	-
	bit 5	Store and Skip Errored Job locks the queue	0: Queue is not locked after SSEJ	1: Queue locked after SSEJ
	If this is 1, then after a job is stored using Store and Skip Errored Job (SSEJ), new jobs cannot be added to the queue until the stored job has been completely printed.			
	bit 6	Allow use of Store and Skip Errored Job if connected to an external charge device.	0: Does not allow SSEJ with ECD	1: Allows SSEJ with ECD
	If this is 0, Store and Skip Errored Job (SSEJ) will be automatically disabled if an external charge device is connected. Note: We do not officially support enabling this bit switch (1). Use it at your own risk.			
bit 7	Job cancels remaining pages when the paid-for pages have been printed on an external charge device		Job does not cancel	Job cancels
	When setting 1 is enabled, after printing the paid-for pages on an external charge device, the job that includes any remaining pages will be canceled. This setting will prevent the next user from printing the unnecessary pages from the previous user's print job.			

1001		Bit Switch	
011	Bit Switch B	0	1
	bit 0 to 1	DFU	-
		Switch for enabling or disabling Limitless Paper Feeding for the Bypass Tray	0: Enable
bit 2	<p>When the Bypass Tray is the target of the Auto Tray Select and Any Size/Type is configured for the Tray Setting Priority setting of the Bypass Tray, this BitSwitch can switch the behavior whether or not Limitless Paper Feeding is applied to the Bypass Tray.* The default is Enabled (=0).</p> <p>* Limitless Paper Feeding will try a matching tray of the next highest priority if a job specified to Auto Tray Select as the tray setting is submitted and the tray runs out of paper.</p> <p>Enabled (=0: Default): Limitless Paper Feeding is applied to the Bypass Tray.</p> <p>If a tray other than the Bypass Tray matches the job's paper size and type but has run out of paper, printing will occur from the Bypass Tray.</p> <p>Disabled (=1): Limitless Paper Feeding is not applied to the Bypass Tray.</p> <p>If a tray other than the Bypass Tray matches the job's paper size and type but has run out of paper, printing will stop and an alert will appear on the LCD screen, stating that the tray has run out of paper. This prevents unexpected use of the Bypass Tray.</p> <p>Limitations when this BitSwitch is set to "1":</p> <ul style="list-style-type: none"> - The "Paper Tray Priority: Printer" setting must be configured to a tray other than the Bypass Tray. - Jobs that contain more than one paper size cannot be printed. 		

1001		Bit Switch		
011	bit 3	DFU	-	-
	bit 4	<p>Add "Apply Auto Paper Select" is the condition that decides if the device's paper size or paper type should be overwritten.</p> <p>0:Enabled 1:Disabled</p>		
		<p>If this BitSwitch is set to "1" (enabled), the "Apply Auto Paper Select" setting will decide if the paper size or paper type that is specified in the device settings should be overwritten by the job's commands when "Tray Setting Priority" is set to "Driver/Command" or "Any Type".</p> <ul style="list-style-type: none"> - Apply Auto Paper Select = OFF: Overwritten (priority is given to the job's commands) - Apply Auto Paper Select = ON: Not overwritten (priority is given to the device settings) 		
bit 5 to 7	Not Used	-	-	

1001		Bit Switch		
012	Bit Switch C		0	1
	bit 0	DFU	-	-
	bit 1 to 4	Not Used	-	-
	bit 5	<p>Change the user ID type displayed on the operation panel</p> <p>0:Enabled 1:Disabled</p>		
		<p>As of 15S models, the Login User Name can be displayed on the operation panel. The user ID type displayed on the operation panel can be changed by configuring BitSwitch # 12-5 as follows:</p> <ul style="list-style-type: none"> - 0 (default): Login User Name - 1: User ID. If this is enabled, User ID will be displayed, which is equivalent to the behavior exhibited in 14A and earlier models. 		
bit 6 to 7	Not Used	-	-	

1003	Clear setting		
------	---------------	--	--

1	Initialize Printer System Initializes the settings in the printer feature settings of UP mode.
3	Delete Program DFU
1004	Print Summary Touch [Execute] to print the printer summary sheets.
1005	Display Version. Printer Application Version Displays the version of the controller firmware.
1006	Sample/Locked Print This SP disables/enables use of the document server. [0 or 1/ 0 /1] 0: Enabled. Document server can be used. 1: Disabled. Document server cannot be used.

1101	Data Recall Not Used
	<p>The copier firmware has a test pattern with eight stepped gradation scales for each color (KCYM), including background white, for Text and Photo modes. The ACC procedure automatically calibrates the gamma curve when the user selects ACC. Generally, here is what happens:</p> <ul style="list-style-type: none"> • The operator prints the pattern. • Operator places the pattern on the exposure glass. • Copier scans 8 lines (1 for each color in text mode and one for each color in photo mode). • Machine corrects the printer gamma by comparing the ideal settings with the current image density. • Machine combines the corrected gamma curve with the High, Middle, Low ID values currently in memory. • Machine calculates the ID max (amplitude and gamma curve) based on data from the ACC scan. The correct gamma curves can be adjusted with SP4918. <p>Note: This is done only with machines that support ACC.</p>
	The SP codes below display the settings for factory, previous setting, current setting, and ACC setting.
1	Factory
2	Previous
3	Current
4	ACC

1102	Resolution Setting
	This setting matches supported resolution with a dithering mode.

1103	Test Page
1	Color Gray Scale
2	Color Pattern

SP1103-001

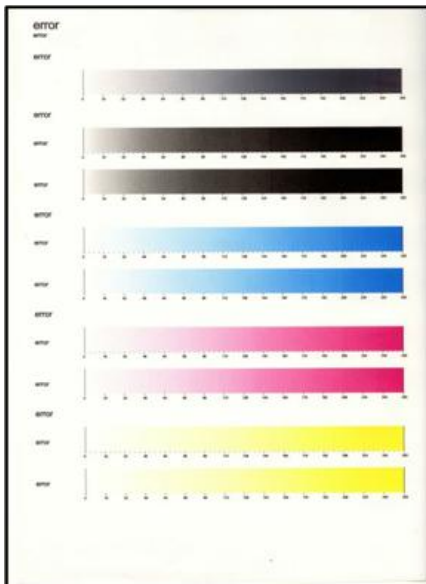

SP1103-002

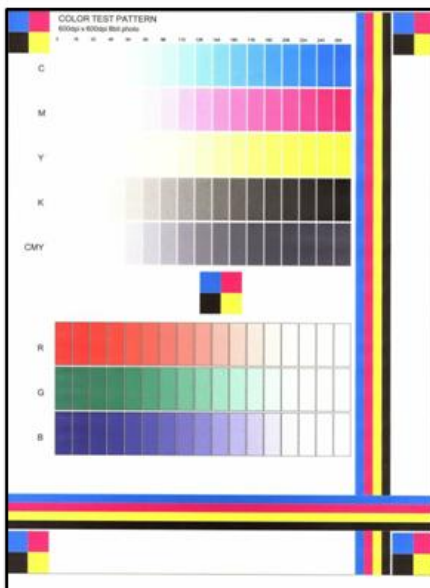

d124r746

1104	Gamma Adjustment
1 to 4	Set Black 1 to 4
21 to 24	Set Cyan 1 to 4
41 to 44	Set Magenta 1 to 4
61 to 64	Set Yellow 1 to 4

1105	Save Tone Control Value
------	-------------------------

1106	Toner Limit
	Full color: Range 0 to 400 2-Color : Range 0 to 200

1108	Ext. Ink Save	
1	Mode1:Text	[0 to 255 / 75 / 1]
2	Mode2:Text	[0 to 255 / 50 / 1]
3	Mode1:Image	[0 to 255 / 75 / 1]

4	Mode2:Image	[0 to 255 / 50 / 1]
5	Mode1:Line	[0 to 255 / 75 / 1]
6	Mode2:Line	[0 to 255 / 50 / 1]
7	Mode1:Paint	[0 to 255 / 75 / 1]
8	Mode2:Paint	[0 to 255 / 50 / 1]

1110	Media Print Device Setting
	Sets which tray given priority for paper feed
	The bypass tray is "0". [0 to 4/1/1] 0: Bypass 1:Tray 1 2:Tray 2 3:Tray 3 4:LCT

1111	All Jobs Delete Mode
	This switch determines whether all SCS jobs in progress are included in the SMC report when SP5990 is executed.
	[0 to 1/1/1] 1:Jobs included 0:Jobs not included

1400	RPGL Setting (EXP)
	These SP codes set up the print parameters for RPGL.
1	Set Thin Line Width (EXP)
	[0 to 99/ 5 /1]
2	Correct Line Width (EXP)
	[0 to 3/ 2 /1] 0:Mode 1 1:Mode 2 2:Mode 3 3:Mode 4
4	Character Density (EXP)
	[15 to 30/ 15 /1]
5	Photo Density (EXP)
	[15 to 30/ 15 /1]

6	Default Blank Space (EXP)
	[0 to 1/0/1] 0: Margin 1: No margin
7	Job Reset (EXP)
	[0 to 1/0/1] 0;Enble 1:Disable
8	Search Not Set Tray (EXP)
	[0 to 1/0/1] <ul style="list-style-type: none"> • 0: Include tray not specified in search • 1: Do not included unspecified tray in search
9	Character Total Amount (EXP)
	[99 to 400/99/1]
10	Photo Total Amount (EXP)
	[99 to 400/99/1]
11	Basis of Scale (EXP)
	[0 to 1/1/1] 0: Allow maximum size paper 1: Submenu setting

Scanner Service Mode

SP-1XXX System and Others

1001	Scan Nv Version	
5	Name_Model Name_History No.	
1005	Erase Margin (Remote Scan)	
1	[0 to 5 / 0 / 1 mm]	
1009	Remote Scan Disable	
1	[0 or 1 / 0 / 1] 0: ON (enabled) 1: OFF (disabled)	
1010	Non Display Clear Light PDF	
1	[0 or 1 / 0 / 1] 0: Display ON 1: Display OFF	
1011	Org Count Display	
1	[0 or 1 / 0 / 1] 0: OFF (no display) 1: ON (count displays)	
1012	User Info Release	
1	[0 or 1 / 1 / 1] 1: Release 0: Do not release	
1013	Scan to Media Device Setting	
2	[0 or 1 / 0 / 1] 0: Disable 1: Enable	
1014	Scan to Folder Pass Input Set	
1	0:OFF 1:ON	[0 to 1 / 0 / 1]
1041	Scan: Flair API Setting	

001	0x00 - 0xff	[0 to 255 / 0 / 1]	
This SP code enables/disables the scanner's FlairAPI function.			
bit0	FlairAPI server start up	0: Off	1: On
For setting whether to start the HTTP server for FlairAPI or not. 0: All the scanner's FlairAPI functions* are to be disabled. *Example of FlairAPI functions • Remote UI			
bit1	Access permission from FlairAPI external device	0: Disabled	1: Enabled
0: Accessible only from internal devices of the machine (the operation panel, SKD/J, MFP browser, etc.) 1: Accessible from both internal devices of the machine and external devices (a PC, remote UI, IT-BOX, etc.)			
bit2	Switching dedicated IPv6	0: IPv6 only	1: IPv4 priority
0: Accessible only by IPv6 1: Accessible by IPv4 if the IPv4 address is effective or by IPv6 if the IPv4 address is not effective. If the IPv4 address is effective, access from the Android operation panel is disabled.			
bit3	Remote UI function	0:Disabled	1:Enabled
For setting whether the remote UI (scanner function) is to be used or not 0: Remote UI is not to be used. 1: Remote UI is to be used.			
bit4	Not used		
bit5	Not used		
bit6	Not used		
bit7	Not used		

SP2-XXX Scanning Image Quality

2021	Compression Level (Grayscale)
1	Comp 1: 5-95
	[5 to 95 / 20 / 1]
2	Comp 2: 5-95
	[5 to 95 / 40 / 1]
3	Comp 3: 5-95
	[5 to 95 / 65 / 1]
4	Comp 4: 5-95
	[5 to 95 / 80 / 1]
5	Comp 5: 5-95
	[5 to 95 / 95 / 1]

2026	High Compression of PDF
1	Comp1: 5-95
	[5 to 95 / 15 / 1]
2	Comp2: 5-95
	[5 to 95 / 25 / 1]
3	Comp3: 5-95
	[5 to 95 / 40 / 1]
4	Comp4: 5-95
	[5 to 95 / 70 / 1]
5	Comp5: 5-95
	[5 to 95 / 90 / 1]

2030	OCR PDF DetectSens
------	--------------------

001	White Lumi Value:0 - 255	[0 to 255 / 250 / 1]
002	White Pix Ratio: 0 - 100	[0 to 100 / 80 / 1]
003	White Tile Ratio: 0 - 100	[0 to 100 / 80 / 1]

Input and Output Check

Input Check Table (SP5-803)

5803	Input Check
1	Paper Inlet Sensor: Upper
2	Paper Inlet Sensor: Lower
3	Paper Exit Sensor: Upper
4	Paper Exit Sensor: Lower
5	Front Register Sensor
6	By-pass Sensor
7	Output Sensor
10	Paper Feed Pressure Release Sensor: Upper
11	Paper Feed Pressure Release Sensor: Lower
12	Register Pressure Release Sensor: Lower
13	Residual Amount. Sensor Upper
14	Residual Amount. Sensor Lower
15	Residual Qty. Ratio M
16	Residual Qty. Ratio Y
17	Main Scan Encoder Sensor
18	Sub Scan Encoder Sensor
19	Roll End Sensor/Upper
20	Roll End Sensor/Lower
21	Front Cover Pre-Sensor
22	Total Counter
23	Separation claw position sensor

30	Outside Temperature
31	Outside Humidity
41	Head Rising Sensor 1
42	Head Rising Sensor 2
43	Head Temperature Sensor: Color
45	Head Temperature Sensor: Black
48	DRESS Sensor 1
49	DRESS Sensor 2
50	Front Cover Sensor Left
51	Front Cover Sensor Right
52	Cartridge Cover Sensor
53	Roll Paper Cover Sensor
54	Waste Ink Box Cover Sensor
55	Waste Ink Box Setting Sensor
60	Sub Scan HP Sensor
61	Cutter Sensor Right
62	Cutter Sensor Left
70	Maintenance Suction Unit HP Detection Sensor
71	MaintenDehumidify Unit HP Detection Sensor
72	MaintenanceCleaner Slide HP Detection Sensor
91	Ink Cartridge Sensor: Y
92	Ink Cartridge Sensor: M
93	Ink Cartridge Sensor: C
94	Ink Cartridge Sensor: K
150	MainFillerSens Front
151	MainFillerSens Rear

152	OCFS HT1
153	OCFS HT2
154	OCFS HT3
155	OCFS HT4
156	OCFS HT5
157	OCFS HT6
158	OCFS HT7
159	INKEND SENSOR K
160	INKEND SENSOR C
161	INKEND SENSOR M
162	INKEND SENSOR Y
201	Original Width Sensor:A0
202	Original Width Sensor:A1
203	Original Width Sensor:A2
204	Original Width Sensor:A3
205	Original Width Sensor:B1
206	Original Width Sensor:B2
207	Original Width Sensor:B3
208	Original Width Sensor:B4
209	Original Width Sensor:914mm
210	Original Width Sensor:30"
211	Original Set Sensor
212	Original Registration Sensor
213	Original Exit Sensor
214	Original Emergency Stop Sensor
215	Original Feed Unit Open Sensor

250	Auto Nozzle Check Wiper Pos Detect HP Sen
251	Auto Nozzle Check Wiper Pos Detect

Output Check Table (SP5-804)

5804	Output Check
	Most of these sensors present [OFF] [ON] selections. After pressing the [ON] selection, be sure to press [OFF] to switch the component off.
51	Paper Feed Motor: Upper
52	Paper Feed Motor Speed: Upper
53	Paper Feed Motor: Lower
54	Paper Feed Motor Speed: Lower
55	Paper Feed Clutch: Upper
56	Paper Feed Clutch: Lower
59	Sub Scan Motor
60	Sub Scan Motor Speed
63	Move Cutter Toward Right
64	Move Cutter Toward Left
65	Start Suction Fan
66	Suction Fan Speed
67	Suction Fan Revolution
68	MCU Cooling Fan
69	PSU Cooling Fan
71	DRESS LED On
72	Manual feed clutch
100	Auto Nozzle Check LED On
110	Air Release Solenoid On/Off

111	Carriage LED On/Off
112	Carriage LED Duty Setting
201	Document
211	CIS_LED_R
212	CIS_LED_G
213	CIS_LED_B