



RICOH UNIVERSITY

Learning ♦ Knowledge ♦ Performance



D124
SERVICE MANUAL

LANIER RICOH SAVIN

It is the reader's responsibility when discussing the information contained within this document to maintain a level of confidentiality that is in the best interest of Ricoh Americas Corporation and its member companies.

NO PART OF THIS DOCUMENT MAY BE REPRODUCED IN ANY FASHION AND DISTRIBUTED WITHOUT THE PRIOR PERMISSION OF RICOH AMERICAS CORPORATION.

All product names, domain names or product illustrations, including desktop images, used in this document are trademarks, registered trademarks or the property of their respective companies.

They are used throughout this book in an informational or editorial fashion only and for the benefit of such companies. No such use, or the use of any trade name, or web site is intended to convey endorsement or other affiliation with Ricoh products.

WARNING

The Service Manual contains information regarding service techniques, procedures, processes and spare parts of office equipment distributed by Ricoh Americas Corporation. Users of this manual should be either service trained or certified by successfully completing a Ricoh Technical Training Program.

Untrained and uncertified users utilizing information contained in this service manual to repair or modify Ricoh equipment risk personal injury, damage to property or loss of warranty protection.

Ricoh Americas Corporation

LEGEND

PRODUCT CODE	COMPANY		
	LANIER	RICOH	SAVIN
D124	MP CW2200	MP CW2200 SP	MP CW2200

DOCUMENTATION HISTORY

REV. NO.	DATE	COMMENTS
*	01/2013	Original Printing

D124

TABLE OF CONTENTS

1. NEW FEATURES	1-1
1.1 MODEL NUMBERS AND NAMES	1-1
1.2 MAIN MACHINE, PERIPHERALS, OPTIONS	1-2
Main Machines and Peripherals	1-2
Other Options.....	1-3
1.3 MAIN FEATURES.....	1-4
1.3.1 COMPARISON WITH OTHER EARLIER PRINTERS	1-4
Horizontal carriage movement during printing.....	1-4
Vertical paper feed	1-5
Maintenance unit.....	1-6
Ink supply	1-7
Waste ink collection.....	1-8
1.3.2 SOME UNIQUE FEATURES OF D124.....	1-9
Configuration	1-9
Image registration.....	1-9
Front Cover Switches	1-10
Ink level detection.....	1-10
Cutter	1-11
Paper feed control.....	1-11
Improved Productivity.....	1-12
2. PRODUCT INFORMATION.....	2-1
2.1 SPECIFICATIONS	2-1
2.2 MAIN MACHINE, PERIPHERALS, OPTIONS	2-2
Main Machines and Peripherals	2-2
Other Options.....	2-3
2.3 GUIDANCE FOR THOSE WHO ARE FAMILIAR WITH PREDECESSOR PRODUCTS.....	2-4
2.3.1 COMPARISON TO D093/D094	2-4
D124 and D093/D094 Compared	2-4
2.4 OVERVIEW.....	2-6
2.4.1 ACRONYMS AND IMPORTANT TERMS	2-6
2.4.2 AROUND THE MACHINE.....	2-7

Front.....	2-7
1 Original Tray.....	2-8
2 Operation Panel	2-9
3 USB Cable	2-10
4 Scanner Unit Cover.....	2-10
5 Original Table.....	2-11
6 Front Cover	2-11
7 Paper Exit Guide	2-12
8 Paper Holding Lever.....	2-13
9 Ink Cartridge Cover	2-13
10 Exit Stacker	2-14
Right Side.....	2-15
Left Side	2-16
Back	2-17
2.4.3 MAIN SECTIONS.....	2-18
2.4.4 MAIN COMPONENTS	2-21
2.4.5 DRIVE LAYOUT	2-22
2.4.6 ORIGINAL PATH, PAPER PATHS	2-23
3. INSTALLATION.....	3-1
3.1 PREPARATION	3-1
3.1.1 ENVIRONMENT	3-1
3.1.2 MINIMUM SPACE REQUIREMENTS.....	3-2
3.1.3 MACHINE LEVEL	3-3
3.1.4 POWER SOURCE.....	3-3
3.1.5 INSTALLATION OVERVIEW	3-4
Installation Flow.....	3-4
3.2 MAIN MACHINE INSTALLATION	3-5
3.2.1 BEFORE YOU BEGIN	3-5
Accessory Boxes.....	3-5
What You Need.....	3-6
3.2.2 ASSEMBLE SCANNER STAND.....	3-7
Accessories: Scanner Stand	3-7
Installation: Scanner Stand	3-8
3.2.3 ASSEMBLE THE MAIN UNIT STAND.....	3-10
Accessories: Main Stand.....	3-10
Installation: Main Stand.....	3-12
3.2.4 MOUNT THE SCANNER UNIT.....	3-14
3.2.5 MOUNT THE MAIN UNIT	3-16

3.2.6 ROLL UNIT 1 (STANDARD)	3-19
Accessories: Roll Unit 1	3-19
Installation: Roll Unit 1.....	3-19
3.2.7 ROLL UNIT 2 (D622) (OPTION)	3-25
Accessories	3-25
Installation	3-26
3.2.8 CONTROLLER OPTIONS	3-32
3.2.9 CONNECT THE SCANNER AND MAIN UNIT.....	3-33
Connect Harnesses.....	3-33
Connect the Host USB Cable.....	3-37
Connect and Clamp the Power Cord, Clamp the Main Harness	3-39
Dock the Scanner Stand to the Main Unit	3-39
Connect Ground Harnesses.....	3-40
3.2.10 REMOVE TAPES AND SHIPPING MATERIALS.....	3-41
3.2.11 ORIGINAL STACKER, GUIDES.....	3-42
3.2.12 INK COLLECTOR TANK STORAGE SHELF	3-45
3.2.13 ASSEMBLE AND INSTALL THE EXIT STACKER	3-46
Accessories: Exit Stacker.....	3-46
Installation: Exit Stacker	3-47
Changing Exit Stacker Mode.....	3-54
3.2.14 INK FILLING	3-57
Draining and Filling Procedure	3-57
If Draining Fails to Start.....	3-59
3.2.15 SET ROLL PAPER	3-60
3.2.16 REWINDING A ROLL.....	3-64
3.2.17 CHECK PRINTING	3-65
Nozzle Check Pattern.....	3-65
When Printing Cannot Be Restored	3-66
Halftone Check.....	3-67
3.2.18 FINAL ADJUSTMENTS	3-68
Caster Lock.....	3-68
Level Adjustment.....	3-68
Manual Adjust Head Position	3-70
Adjust Paper Feed.....	3-72
Adjust Print Position	3-75
3.2.19 FINAL SETTINGS.....	3-76
3.2.20 AFTER INSTALLATION.....	3-76
3.2.21 MOVING THE MACHINE.....	3-77

3.3 CONTROLLER OPTIONS	3-78
3.3.1 OVERVIEW	3-78
Standard Controller Features	3-78
Controller Options	3-79
3.3.2 FILE FORMAT CONVERTER (MLB)	3-80
Accessories	3-80
Installation	3-81
3.3.3 WIRELESS LAN	3-86
Accessories	3-86
Installation	3-87
3.3.4 GIGABIT ETHERNET	3-92
Accessories	3-92
Installation	3-93
3.3.5 COPY DATA SECURITY UNIT	3-95
Accessories	3-95
Installation	3-96
3.3.6 BROWSER UNIT	3-98
Accessories	3-98
Installation	3-98
4. PREVENTIVE MAINTENANCE.....	4-1
4.1 PM TABLES.....	4-1
4.1.1 KEY FOR PM TABLE	4-1
4.1.2 PM TABLE: MAIN MACHINE.....	4-2
4.2 PM CLEANING POINTS.....	4-5
4.2.1 SCANNER UNIT	4-5
1 Exposure Glass.....	4-5
2 Original Width Sensors, Original Set Sensor.....	4-6
3 Original Feed Roller	4-7
4 Original Exit Roller.....	4-7
5 White Plate.....	4-8
6 CIS Lens	4-8
4.2.2 HORIZONTAL UNIT	4-9
7 Black Print Head Unit	4-9
9 Horizontal Encoder.....	4-9
10 DRESS Sensor.....	4-11
11 Maintenance Unit	4-12
4.2.3 WASTE INK COLLECTION	4-13
12 Ink Collector Tank	4-13

13 Right Ink Sump.....	4-13
14 Left Ink Sump	4-14
15 Ink Tube Guide.....	4-15
16 Platen	4-16
17 Paper Feed Rollers	4-17
18 Vertical Encoder	4-18
4.3 OTHER ITEMS FOR CLEANING.....	4-19
4.3.1 EXTERNAL COVERS.....	4-19
4.3.2 SCANNER UNIT	4-20
Original Set Sensor	4-20
Original Registration Sensor	4-21
Original Exit Sensor.....	4-21
4.3.3 HORIZONTAL UNIT	4-22
Ink Level Sensors.....	4-22
4.3.4 PAPER FEED	4-23
Bypass Sensor, Pre-registration Sensor	4-23
Paper Exit Sensor	4-24
4.3.5 ROLL UNITS.....	4-25
Roll End Sensor	4-25
Roll Unit Paper Release Sensor.....	4-25
Roll Feed Roller.....	4-27
5. REPLACEMENT AND ADJUSTMENT	5-1
5.1 GENERAL PRECAUTIONS	5-1
5.1.1 EXTERNAL COVERS.....	5-1
5.1.2 ORIGINAL TRANSPORT.....	5-2
5.1.3 PAPER.....	5-4
5.1.4 COPY QUALITY	5-4
5.1.5 CIS.....	5-4
5.1.6 ELECTRICAL COMPONENTS	5-5
5.1.7 ADJUSTMENTS AT MACHINE INSTALLATION.....	5-5
5.1.8 OTHER PRECAUTIONS	5-5
5.1.9 SERVICE PRECAUTIONS	5-6
Scanner Unit Rollers	5-6
Main Frame Screws	5-6
Right Plate Screws.....	5-7
Maintenance Unit Base Screws	5-7
Solenoid Bracket Screw	5-8
Main Carriage Screws.....	5-9

Platen Plate Guide Rod Screws	5-9
Sensor and Temperature/Humidity Sensor Bracket	5-10
5.2 COMMON PROCEDURES	5-11
5.2.1 BEFORE YOU BEGIN	5-11
5.2.2 BEFORE SERVICING THE MACHINE	5-12
Rear Output Guides	5-13
Original Guides	5-14
Original Stacker.....	5-14
5.2.3 SEPARATE THE MAIN UNIT FROM THE SCANNER UNIT	5-16
5.2.4 INK COLLECTOR TANK	5-17
5.2.5 PAPER ROLLS	5-18
5.2.6 MAIN COVERS.....	5-19
Right Cover	5-19
Right Upper Cover.....	5-21
Ink Cartridge Cover	5-23
Left Cover.....	5-25
Top Cover	5-29
5.2.7 FRONT COVER.....	5-31
5.2.8 PAPER EXIT GUIDE	5-32
5.2.9 ROLLER COVER.....	5-35
5.2.10 MOVING THE CARRIAGE UNIT	5-37
Before You Begin	5-37
Move the Carriage Unit with SP2102-4	5-37
Uncapping the Print Heads and Moving the Carriage Unit Manually..	5-39
Capping the Print Heads Manually.....	5-42
5.2.11 REAR COVER	5-44
5.2.12 DISCONNECTING THE MAIN UNIT FROM THE SCANNER UNIT	
5-45	
5.3 SCANNER	5-48
5.3.1 BEFORE YOU BEGIN	5-48
Scanner Safety.....	5-48
Safety Switch Diagram	5-49
5.3.2 RAISE THE SCANNER UNIT	5-50
5.3.3 SCANNER COVERS	5-51
Scanner Rear Cover.....	5-51
Scanner Left Cover, Right Cover.....	5-52
5.3.4 ORIGINAL TABLE	5-53
5.3.5 SIB.....	5-54

5.3.6	SCANNER MOTOR	5-57
	Raise the Left End of the Scanner Unit	5-57
	Remove the Scanner Motor	5-59
5.3.7	SAFETY SWITCHES	5-60
5.3.8	ORIGINAL SET SENSOR, ORIGINAL WIDTH SENSORS	5-62
5.3.9	ORIGINAL REGISTRATION SENSOR.....	5-64
5.3.10	EXPOSURE GLASS.....	5-66
5.3.11	CIS UNIT	5-69
	After Installation of a New CIS	5-72
5.3.12	ORIGINAL FEED ROLLER.....	5-73
5.3.13	ORIGINAL EXIT ROLLER, ORIGINAL EXIT SENSOR	5-78
	Remove Top of Scanner Unit.....	5-78
	Original Exit Sensor.....	5-81
	Original Feed Roller	5-82
5.3.14	OPERATION PANEL.....	5-88
	Operation Panel Removal	5-88
	USB Board	5-89
	LCD and Operation Touch Panel	5-90
	OP-R Board.....	5-91
	OP-L Board	5-93
	Touch Screen Calibration.....	5-96
5.4	ROLL UNITS.....	5-98
5.4.1	ROLL UNIT REMOVAL.....	5-98
	Remove Roll Unit 1	5-98
	Remove Roll Unit 2	5-105
5.4.2	ROLL UNIT RIGHT COVERS.....	5-110
5.4.3	ROLL UNIT LEFT COVERS	5-112
5.4.4	PAPER RELEASE SENSOR.....	5-114
5.4.5	SEPARATE THE ROLLER HOUSING.....	5-116
	Separate the Roller Housing: Roll Unit 1	5-117
	Separate the Roller Housing: Roll Unit 2.....	5-120
5.4.6	ENTRANCE SENSOR, EXIT SENSOR.....	5-124
5.4.7	ROLL FEED ROLLER.....	5-125
5.4.8	ROLL FEED MOTOR.....	5-129
5.4.9	ENCODER SENSORS	5-130
5.4.10	ROLL FEED CLUTCH	5-132
5.4.11	ROLL END SENSOR.....	5-137
5.5	PAPER FEED, PAPER TRANSPORT	5-138

5.5.1 PAPER TRANSPORT FAN	5-138
5.5.2 PLATEN PLATES	5-141
5.5.3 EXIT ROLLER	5-142
5.5.4 EXIT SENSOR.....	5-144
5.5.5 BYPASS SENSOR, PRE-REGISTRATION SENSOR	5-146
5.6 CUTTER	5-150
5.6.1 CUTTER BLADE	5-150
5.6.2 CUTTER UNIT	5-152
5.6.3 CUTTER MOTOR.....	5-156
5.6.4 CUTTER BELTS.....	5-157
5.6.5 CUTTER RETURN SWITCH	5-161
5.6.6 PAGE 5-35CUTTER HP SWITCH	5-162
5.7 MAIN SCAN.....	5-163
5.7.1 HORIZONTAL ENCODER.....	5-163
5.7.2 HORIZONTAL MOTOR	5-167
5.7.3 HORIZONTAL TIMING BELT	5-169
5.8 SUB SCAN.....	5-170
5.8.1 VERTICAL ENCODER SENSOR	5-170
5.8.2 VERTICAL ENCODER WHEEL, TIMING BELT	5-171
5.8.3 VERTICAL ENCODER HP SENSOR	5-175
5.8.4 VERTICAL MOTOR.....	5-177
5.9 CARRIAGE UNIT.....	5-178
5.9.1 BEFORE YOU BEGIN	5-178
5.9.2 BLACK AND COLOR PRINT HEADS.....	5-179
Black Print Head Unit (K1, K2) Accessories.....	5-180
Color Print Head Unit (C, YM) Accessories.....	5-181
Carriage Unit Covers.....	5-182
Black Print Head Unit	5-185
New Black Print Head Unit Installation	5-189
Color Print Head Unit	5-193
New Color Print Head Unit Installation	5-197
Finishing the Installation.....	5-201
5.9.3 DRESS SENSOR	5-209
5.9.4 MAIN INK LEVEL SENSORS	5-213
5.9.5 HORIZONTAL ENCODER SENSOR.....	5-216
5.9.6 HEAD LIFT MOTOR	5-219
5.9.7 CARRIAGE UNIT.....	5-220
Before You Begin	5-220

Carriage Unit Removal	5-221
Carriage Unit Reinstallation.....	5-239
5.10 INK SUPPLY	5-243
5.10.1 AIR RELEASE SOLENOID.....	5-243
5.10.2 TEMPERATURE/HUMIDITY SENSOR	5-246
5.10.3 INK SUPPLY UNIT	5-247
Ink Supply Unit Accessories.....	5-247
Before You Begin	5-248
Ink Supply Unit Replacement	5-248
Carriage Disconnection	5-249
Ink Supply Unit Removal	5-255
New Ink Supply Unit Installation.....	5-258
5.11 MAINTENANCE UNIT, WASTE INK COLLECTION	5-265
5.11.1 LEFT INK SUMP.....	5-265
5.11.2 INK COLLECTOR UNIT.....	5-266
5.11.3 INK COLLECTOR UNIT CONTACT SWITCH.....	5-267
5.11.4 RIGHT INK SUMP	5-269
5.11.5 MAINTENANCE UNIT	5-270
5.12 BOARDS, HDD	5-273
5.12.1 PSU	5-273
5.12.2 MCU	5-278
MCU Removal.....	5-278
MCU Replacement.....	5-282
5.12.3 RFDB (OPTION).....	5-284
5.12.4 CONTROLLER BOARD, NVRAM.....	5-286
5.12.5 MOTHERBOARD	5-289
5.12.6 HDD.....	5-291
5.12.7 IPU.....	5-294
5.12.8 HRB.....	5-296
5.13 SWITCHES	5-302
5.13.1 FRONT COVER SWITCHES.....	5-302
Front Cover Switch: Left.....	5-303
Front Cover Switch: Right	5-304
Front Door Track Switch.....	5-305
5.13.2 PAPER EXIT GUIDE SWITCH.....	5-307
5.13.3 INK COLLECTOR COVER SWITCH.....	5-308
5.13.4 INK CARTRIDGE COVER SWITCH.....	5-309
5.13.5 ORIGINAL STOP SWITCH.....	5-310

5.14	PRINT HEAD CLEANING AND ADJUSTMENT	5-312
5.14.1	MAINTENANCE MENU ADJUSTMENTS	5-312
5.14.2	NOZZLE CHECK, CLEAN AND FLUSH PRINT HEADS	5-314
	Nozzle Check	5-314
	Clean Print Heads	5-316
	Flush Print Heads	5-319
	When Printing Cannot Be Restored	5-320
5.14.3	AUTO ADJUST HEAD POSITION	5-321
5.14.4	MANUAL ADJUST HEAD POSITION	5-323
5.14.5	ADJUST PAPER FEED	5-326
5.14.6	ADJUST PRINT POSITION	5-329
5.15	SPECIAL ADJUSTMENTS	5-331
5.15.1	IMAGE ADJUSTMENT WITH SP MODES	5-331
	Step 1: Magnification for Paper Type: Plain	5-331
	Step 2: Main Scan Magnification	5-332
	Step 3: Copy/Print Sub Scan Magnification	5-333
	Step 4: Scanner Mask Setting	5-334
	Step 5: Erase Margins	5-335
	Step 6: Printer: Leading Edge, Side-to-Side Registration	5-335
	Step 7: Scanner Mask Setting	5-336
	Step 8: Erase Margins	5-336
	Step 9: Scanner Registration	5-337
	Step 10: Printer: Cut Length	5-337
	Step 11: Synchro Cut (Trailing Edge Registration)	5-339
5.15.2	CIS ADJUSTMENT WITH SP MODES	5-340
	To Print the CIS Adjustment Pattern	5-340
	To Adjust the Image at the CIS Joints	5-341
6.	SYSTEM MAINTENANCE REFERENCE	6-1
6.1	SERVICE PROGRAM MODE	6-1
6.2	SYSTEM MAINTENANCE TASKS	6-2
6.2.1	ADDRESS BOOK UPLOAD/DOWNLOAD	6-3
	Address Book Data Download	6-3
	Address Book Upload	6-4
6.2.2	CONTROLLER SELF-DIAGNOSTICS	6-4
	Overview	6-4
	Running the Self-Diagnostic Program	6-4
6.2.3	DEBUG LOG	6-5
	Overview	6-5

Switching On and Setting Up Save Debug Log.....	6-5
Retrieving the Debug Log from the HDD.....	6-9
Recording Errors Manually.....	6-9
New Debug Log Codes.....	6-10
6.2.4 FIRMWARE UPDATE.....	6-11
Overview.....	6-11
Updating Firmware.....	6-11
6.2.5 INITIALIZE ALL SP SETTINGS.....	6-13
6.2.6 NVRAM DATA UPLOAD/DOWNLOAD.....	6-14
Uploading NVRAM Data to an SD Card.....	6-14
Downloading NVRAM Data from an SD Card.....	6-15
6.2.7 PRINT JOB TO SD CARD.....	6-16
Overview.....	6-16
Procedure.....	6-17
6.2.8 SD CARD APPLICATION MOVE.....	6-19
Removing the SD Card Slot Cover.....	6-19
Restrictions and Precautions on the Use of SD Cards.....	6-19
Move Execute.....	6-20
Undo Exec.....	6-21
6.2.9 SMC REPORTS.....	6-22
Printing an SMC Report.....	6-22
Printing and SMC Report to SD Card.....	6-23
How Files are Named.....	6-25
6.2.10 SOFTWARE RESET.....	6-25
6.2.11 STAMP DATA DOWNLOAD.....	6-26
6.2.12 TEST PATTERN PRINTING.....	6-27
6.3 MAIN SP MODES.....	6-28
6.3.1 INSTALLATION.....	6-28
Main Machine Installation.....	6-28
Controller Option Installation.....	6-28
6.3.2 REPLACEMENT AND ADJUSTMENT.....	6-29
Address Book.....	6-29
CIS Replacement.....	6-29
Carriage Unit: Move Carriage Unit.....	6-29
Carriage Unit: Replacement.....	6-30
Controller Board Replacement.....	6-30
Cutter Blade, Cutter Unit Replacement.....	6-30
Debug Tools.....	6-31

DRESS Sensor Replacement	6-31
HDD Replacement	6-32
Ink Supply Unit Replacement	6-32
Left Ink Sump Replacement	6-32
Machine Information.....	6-33
Maintenance Unit: Replacement	6-34
NVRAM Upload/Download	6-34
PM Part Call Alarm.....	6-35
Print Head Replacement	6-35
Right Ink Sump Replacement.....	6-36
Self Diagnostic	6-36
SMC Print Report	6-37
SMC Report Print to SD Card	6-37
Software Reset.....	6-37
Stamp Data Download	6-37
Test Patterns.....	6-38
Touch Screen Calibration.....	6-38

7. TROUBLESHOOTING..... 7-1

7.1 SERVICE CALL CONDITIONS.....	7-1
7.2 SC100: SCANNING	7-2
7.3 SC200: IMAGE WRITING	7-5
7.4 SC300: NOT USED	7-16
7.5 SC400: DRESS SENSOR.....	7-17
7.6 SC500: PAPER FEED, TRANSPORT	7-18
7.7 SC600: COMMUNICATION	7-24
7.8 SC700: NOT USED	7-40
7.9 SC800: FIRMWARE	7-41
7.10 SC900: SOFTWARE.....	7-58
7.11 PRINTING PROBLEMS	7-64
7.11.1 BEFORE YOU BEGIN	7-64
7.11.2 WHITE LINES, HORIZONTAL BANDING.....	7-64
Print heads clogged.....	7-64
Other Measures.....	7-65
7.11.3 HORIZONTAL LINES IN MARGINS	7-65
7.11.4 WHITE, COLOR VERTICAL BANDING.....	7-65
Print Head Out of Position, Horizontal Encoder Strip Problem.....	7-65
7.11.5 OVERALL POOR IMAGE QUALITY	7-66
Gap Adjustment.....	7-66

Print heads clogged.....	7-66
Paper Feed Faulty.....	7-66
Horizontal Encoder Strip	7-66
7.11.6 TEXT SHIFTED OUT OF POSITION.....	7-67
Obstructed, Faulty Paper Feed	7-67
7.11.7 INK SCATTER	7-67
Gap Adjustment.....	7-68
Print heads clogged.....	7-68
Faulty Maintenance Unit, Carriage Unit.....	7-68
7.11.8 MIXED COLORS	7-68
Print heads clogged.....	7-68
Faulty Maintenance Unit.....	7-69
7.11.9 IMAGE ABRADED, PAPER TORN, INK RUNNING	7-69
Gap Adjustment.....	7-69
Paper Feed Obstruction	7-69
Faulty Carriage Unit	7-69
7.11.10 COLOR DENSITY TOO LIGHT	7-70
Printer Driver Settings	7-70
7.11.11 PART OF IMAGE MISSING, TEXT MISALIGNED	7-70
Printer Driver Settings	7-70
Faulty Controller.....	7-70
7.11.12 IMAGE SKEWED ON PAPER	7-71
Obstructed Paper Feed.....	7-71
7.11.13 BOLDED TEXT DOES NOT APPEAR BOLD IN PRINTOUT ...	7-71
Printer Driver Settings	7-71
7.12 SCANNING PROBLEMS	7-72
7.12.1 FLOW CHART	7-72
7.12.2 SCANNING TROUBLESHOOTING.....	7-73
7.13 JAM CODE TABLES.....	7-77
7.13.1 OVERVIEW	7-77
7.13.2 SCANNER ORIGINAL JAMS.....	7-78
7.13.3 PRINTER PAPER JAMS	7-80
7.14 ELECTRICAL COMPONENTS	7-84
7.14.1 SCANNER UNIT.....	7-84
7.14.2 MAIN UNIT SENSORS, MOTORS	7-86
7.14.3 ROLL UNITS.....	7-89
7.14.4 INK SUPPLY.....	7-91
7.14.5 CARRIAGE UNIT.....	7-93

7.14.6	AROUND THE CARRIAGE UNIT	7-95
7.14.7	MAINTENANCE UNIT	7-97
7.14.8	BOARDS.....	7-99
7.15	FUSES	7-101
7.15.1	SCANNER UNIT.....	7-101
	Operation Panel	7-101
	SIB	7-101
7.15.2	MAIN BOARDS (REAR BOX).....	7-103
	GW +Controller Board.....	7-103
	Mother Board	7-105
	IPU	7-106
	MCU.....	7-108
	PSU.....	7-111
7.15.3	CARRIAGE UNIT.....	7-112
	HRB.....	7-112
8.	ENERGY AND PAPER SAVING.....	8-1
8.1	ENERGY SAVE	8-1
8.1.1	ENERGY SAVER MODES	8-1
8.1.2	TIMER SETTINGS.....	8-1
8.1.3	RETURN TO STAND-BY MODE	8-2
8.1.4	RECOMMENDATION.....	8-2
8.1.5	ENERGY SAVE EFFECTIVENESS.....	8-3

READ THIS FIRST

Safety, Symbols, Trademarks

For your safety, please read this manual carefully before you service the machine. Always keep this manual handy for future reference.

Safety Information

Always obey these safety precautions when using this product. This machine complies with the following safety standards:

- Canada: IC ES-003 Class B
- China: GB9254, GB17625.1
- Europe: EN55022 Class B
- Oceania: CISPR22
- Russia: GOST-R
- USA: FCC Part 15 Subpart B Class B

Switches and Symbols

Where symbols are used on or near switches on machines for Europe and other areas, the meaning of each symbol conforms with IEC60417.

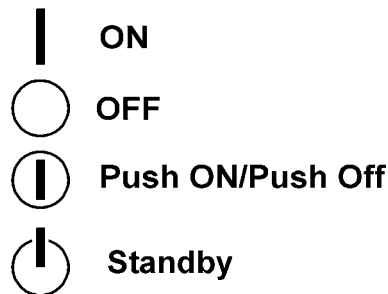

_onoff

Responsibilities of the Customer Engineer

Maintenance

Maintenance shall be done only by trained customer engineers who have completed service training for the machine and all optional devices designed for use with the machine.

Installation

The main machine and options shall be installed by the customer engineer. The customer engineer must follow the installation instructions described in the operating instructions.

Reference Material for Maintenance

Maintenance shall be done with the special tools and the procedures prescribed for maintenance of the machine described in the reference materials (service manuals, technical bulletins, operating instructions, and safety guidelines for customer engineers).

Important

- Use only consumable supplies and replacement parts designed for use with the machine.

Before Installation, Maintenance

Shipping and Moving the Machine

CAUTION

- Work carefully when lifting or moving the machine. If the machine is heavy, two or more customer engineers may be required to move the machine without causing injury (muscle strains, spinal injuries, etc.) or damage to the machine if it is dropped or tipped over.
- To avoid ink spillage, never tilt the machine when you are moving it.
- Personnel working around the machine should always wear proper clothing and footwear. Never wear loose fitting clothing or accessories (neckties, loose sweaters, bracelets, etc.) or casual footwear (slippers, sandals, etc.) when lifting or moving the machine.
- Always unplug the power cord from the power source before you move the machine. Before you move the machine, arrange the power cord so it will not fall under the machine.

Power

WARNING

- Always turn the machine off and disconnect the power plug before doing any maintenance procedure.
- After turning the machine off, power is still supplied to the main machine and other devices. To prevent electrical shock, switch the machine off, wait for a few seconds, then unplug the machine from the power source.
- Before you do any checks or adjustments after turning the machine off, work carefully to avoid injury.
- After removing covers or opening the machine to do checks or adjustments, avoid touching electrical components or moving parts (gears, timing belts, etc.).
- After turning the machine on with any cover removed, keep your hands away from electrical components and moving parts.

Installation, Disassembly, and Adjustments

CAUTION

- After installation, maintenance, or adjustment, always check the operation of the machine to make sure that it is operating normally. This ensures that all shipping materials, protective materials, wires and tags, metal brackets, etc., (attached to protect the machine during shipping), have been removed and that no tools remain inside the machine.
- Never use your fingers to check moving parts that are causing spurious noise. Never use your fingers to lubricate moving parts while the machine is operating.

Special Tools

CAUTION

- Use only standard tools approved for machine maintenance.
- For special adjustments, use only the special tools and lubricants described in the service manual. Using tools incorrectly, or using tools that could damage parts, could damage the machine or cause injuries.

During Maintenance

General

CAUTION

- Before you begin a maintenance procedure always switch the machine off.
- Disconnect the power plug from the power source.

Safety Devices

WARNING

- Never remove any safety device (a fuse, thermistor, etc.) unless it requires replacement. Always replace a safety device immediately.
- Never do any procedure that defeats the function of any safety device. Modification or removal of a safety device (fuse, thermistor, etc.) could cause a fire and personal injury. After removal and replacement of any safety device, always test the operation of the machine to ensure that it is operating normally and safely.
- For replacement parts use only the correct fuses, thermistors, circuit breakers, etc. rated for use with the machine. Using replacement devices not designed for use with the machine could cause a fire and personal injuries.

Organic Cleaners

CAUTION

- During cleaning never use any organic cleaners (alcohol, etc.) other than those described in the service manual.
- Make sure the room is well ventilated before using any organic cleaner. Always use organic solvents in small amounts to avoid breathing the fumes and becoming nauseous.
- Switch the machine off, unplug it, and allow it to cool before doing preventive maintenance.
- To avoid fire or explosion, never use an organic cleaner near any component that generates heat.
- Wash your hands thoroughly after cleaning parts with an organic cleaner to avoid contamination of food, drinks, etc.

Power Plug and Power Cord

CAUTION

- Before servicing the machine (especially when responding to a service call), always make sure that the power plug has been inserted completely into the power source. A partially inserted plug could generate heat (due to a power surge caused by high resistance) and cause a fire or other problems.
- Always check the power plug and make sure that it is free of dust and lint. Clean it if necessary. A dirty plug can generate heat and cause a fire.
- Inspect the entire length of the power cord for cuts or other damage. Replace the power cord if necessary. A frayed or otherwise damaged power cord can cause a short circuit which could lead to a fire or personal injury from electrical shock.
- Check the length of the power cord between the machine and power supply. Make sure the power cord is not coiled or wrapped around any object such as a table leg. Coiling the power cord can cause excessive heat to build up and could cause a fire.
- Make sure that the area around the power source is free of obstacles so the power cord can be removed quickly in case of an emergency.
- Make sure that the power cord is grounded (earthed) at the power source with the ground wire on the plug.
- Connect the power cord directly into the power source. Never use an extension cord.
- When you disconnect the power plug from the power source, always pull the plug, not the cable.

After Installation Servicing

Disposal of Used Items

CAUTION

- Always dispose of used items in accordance with the local laws and regulations regarding the disposal of such items.
- To protect the environment, never dispose of this product or any kind of waste from consumables at a household waste collection point. Dispose of these items at one of our dealers or at an authorized collection site.

Points to Confirm with Operators

At the end of installation or a service call, instruct the user about use of the machine. Emphasize the following points.

- Show operators how to remove jammed paper and troubleshoot other minor problems by following the procedures described in the operating instructions.
- Point out the parts inside the machine that they should not touch or attempt to remove.
- Confirm that operators know how to store and dispose of consumables such as ink cartridges, paper, etc.
- Make sure that all operators have access to an operating instruction manual for the machine.
- Confirm that operators have read and understand all the safety instructions described in the operating instructions.
- Demonstrate how to turn off the power and disconnect the power plug (by pulling the plug, not the cord) if any of the following events occur:
 1. Something has spilled into the machine.
 2. Service or repair of the machine is necessary.
 3. The machine cover has been damaged.
- Caution operators about removing paper fasteners around the machine. They should never allow paper clips, staples, or any other small metallic objects to fall into the machine.

Safety Instructions for Ink Cartridges

Accidental Exposure To Ink

CAUTION

- If ink gets on the skin, wash the affected area immediately with soap and cold running water.
- If ink gets into the eyes, immediately flush the eyes with cold running water. If there are signs of irritation or other problems, seek medical attention.
- If ink is swallowed, drink a strong solution of cold water and table salt to induce vomiting. Seek medical attention immediately.
- Ink is difficult to remove from fabric. Work carefully to avoid staining clothing when performing routine maintenance or replacing cartridges.

Handling and Storing Ink Cartridges

CAUTION

- Always store ink cartridges out of the reach of children.
- Always store ink cartridges in a cool, dry location that is not exposed to direct sunlight.

Ink Cartridge Disposal

CAUTION















- Attach the caps to empty ink containers for temporary storage to avoid accidental spillage.
- Return empty ink cartridges to a local dealer who can accept such items for collection and recycling or disposal.
- If the customer decides to dispose of empty ink cartridges, make sure that they are disposed of in accordance with local laws and regulations.

Safety Instructions for Batteries

CAUTION

- Always replace a lithium battery on a PCB with the same type of battery prescribed for use on that board.
- Replacing a lithium battery with any type other than the one prescribed for use on the board could lead to an explosion or damage to the PCB.
- Never discard used batteries by mixing them with other trash.
- Remove used batteries from the work site and dispose of them in accordance with local laws and regulations regarding the disposal of such items.

Conventions

Symbol	What it means
	Bushing
	C-ring
	Connector
	E-ring
	FFC (Flexible Film Cable)
	Gear
	Harness clamp
	Hex head screw
	Hook (or tab release)
	Knob screw (black)
	Knob screw (sliver)
	Pivot screw
	Screw (common screw)
	Shoulder screw
	Spring  x2
	Standoff
	Stud screw
	Timing belt

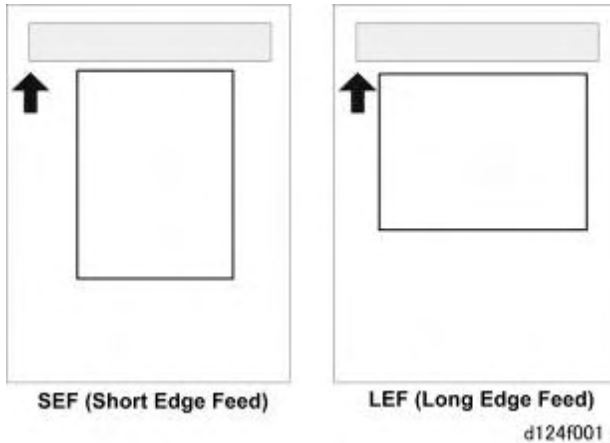

- The notations "SEF" and "LEF" describe how paper is fed from the bypass tray, short edge first or long edge first.
- "Main Scan" means "horizontal direction", the left to right and right to left movement of the carriage.
- "Sub Scan" means the "vertical direction", the direction of paper feed.

Warnings, Cautions, Notes

In this manual, the following important symbols and notations are used.

WARNING

- A Warning indicates a potentially hazardous situation. Failure to obey a Warning could result in death or serious injury.

CAUTION

- A Caution indicates a potentially hazardous situation. Failure to obey a Caution could result in minor or moderate injury or damage to the machine or other property.

Important

- **Obey these guidelines to avoid problems such as misfeeds, damage to originals, loss of valuable data and to prevent damage to the machine**

Note

- This information provides tips and advice about how to best service the machine.

Trademarks

- Microsoft[®], Windows[®], and MS-DOS[®] are registered trademarks of Microsoft Corporation in the United States and /or other countries.
- PostScript[®] is a registered trademark of Adobe Systems, Incorporated.
- PCL[®] is a registered trademark of Hewlett-Packard Company.
- Ethernet[®] is a registered trademark of Xerox Corporation.
- PowerPC[®] is a registered trademark of International Business Machines Corporation.
- Other product names used herein are for identification purposes only and may be trademarks of their respective companies. We disclaim any and all rights involved with those marks.

NEW FEATURES

REVISION HISTORY		
Page	Date	Added/Updated/New
		None

1. NEW FEATURES

1.1 MODEL NUMBERS AND NAMES

Model Number	Name	
D124-17	Ricoh	MP CW2200 SP
	Gestetner	MP CW2200
	Savin	MP CW2200
	Lanier	MP CW2200
D124-21	Ricoh	MP CW2200 SP
D124-27	Ricoh	MP CW2200 SP
	NRG	MP CW2200 SP

1.2 MAIN MACHINE, PERIPHERALS, OPTIONS



d124f022

Main Machines and Peripherals

No.	Item	Machine Code
①	Main Machine and Stand	D124
②	Scanning Unit and Stand	Standard
③	Roll Unit	Standard
④	Exit Stacker	Standard
⑤	Roll Unit RU6520	D622-01 (Option)

Other Options

Option	No.	Slot
Browser Unit Type M5	D624-02	SD Card Slot 1 or 2
Copy Data Security Unit Type F	B829-07	Board Installation
Data Overwrite Security Type H	D377-22	SD Card Slot 1 or 2
File Format Converter Type M5	D625	Board A
Gigabit Ethernet Type B	D377-21	Board C
IEEE 802.11 a/g Interface Unit Type J	D377-01	Board B (NA)
IEEE 802.11 a/g Interface Unit Type J	D377-02	Board B (EU)
IEEE 802.11 g Interface Unit Type K	D377-19	Board B (Other)

1.3 MAIN FEATURES

1.3.1 COMPARISON WITH OTHER EARLIER PRINTERS

Horizontal carriage movement during printing

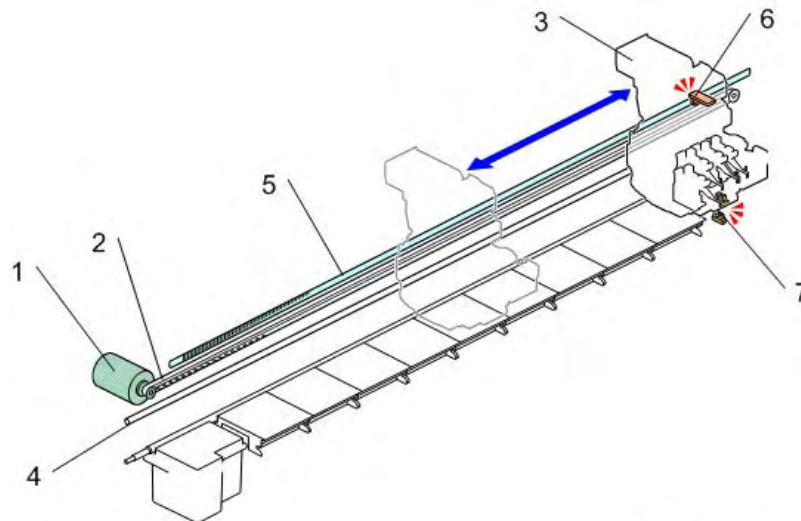

d1249353a

- A horizontal motor (1) and long drive belt drive (2) move the carriage unit (3) and print heads left and right over the surface of the paper during printing. Normally, the machine prints on the right to left pass only, but bi-directional printing (laying down ink on both passes left and right) is also possible.
- The operation of the horizontal motor is controlled by a long horizontal encoder strip (5) stretched across the width of the main unit.
- A horizontal encoder sensor (6) mounted on the back of the carriage unit reads the codes on the strip to control operation of the motor and carriage unit as the carriage unit moves left and right.

Vertical paper feed

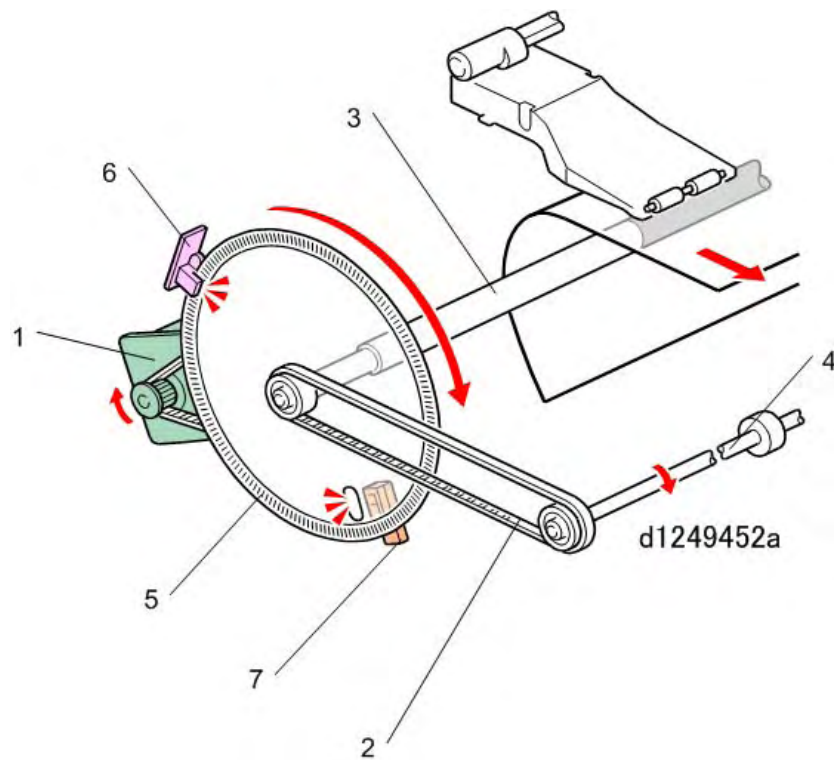

- A vertical feed motor (1) and drive belt (2) rotate the registration roller (3) and exit roller (4) to feed paper in the paper path. The diameter of the exit roller is slightly larger than the diameter of the registration roller. This keeps the paper slightly stretched to prevent buckling.
- The operation of the vertical motor is controlled by a vertical encoder wheel (5) mounted on the left side of the machine in front of the vertical feed motor.
- A vertical encoder sensor (6) brackets the edge of the vertical encoder wheel. It reads the codes on the edge of the wheel as it rotates, to control vertical paper feed.
- The vertical encoder HP sensor (7) stops the motor when the wheel reaches the home position at the end of a job.

Maintenance unit

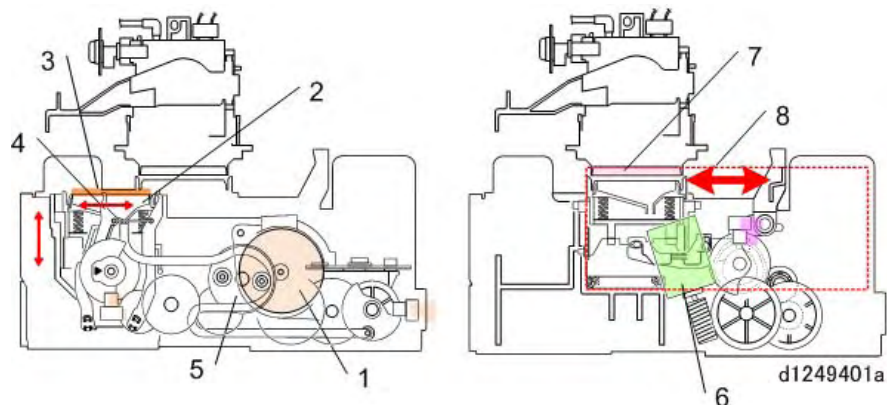

- The maintenance unit on the right side of the machine cleans the print heads.
- There are two motors in the maintenance unit: the maintenance motor and the maintenance lift motor.
- The maintenance motor (1) raises the suction cap (2) that cleans the print heads and caps the K1 print head, raises the wiper blade (3), moves the wiper (4), and drives the suction pump (5).
- The maintenance lift motor (6) raises the three print head caps (7) that protect the K2, C, M, and Y print heads from drying out, and slides the cleaning unit (8) forward and backward.
- The maintenance lift motor and the sliding cleaning unit is a new mechanism.

Ink supply

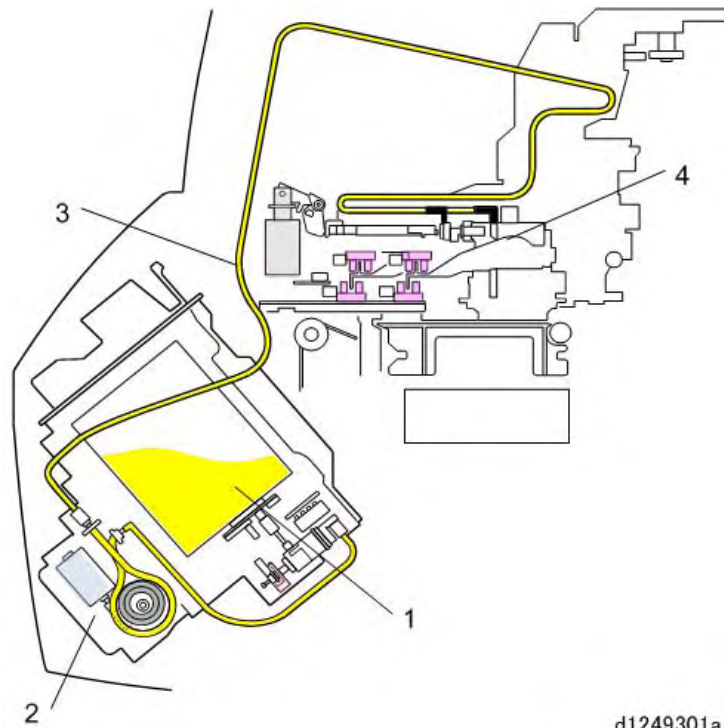

- Ink is supplied from four ink cartridges (1) mounted on the right side of the machine.
- Ink pumps (2) pump ink through ink supply tubes (3) to the ink sub tanks (4) mounted above each print head.
- Each ink cartridge has an ID chip. These chips keep an accurate count of the amount ink sent to each sub tank in the carriage unit.

Waste ink collection

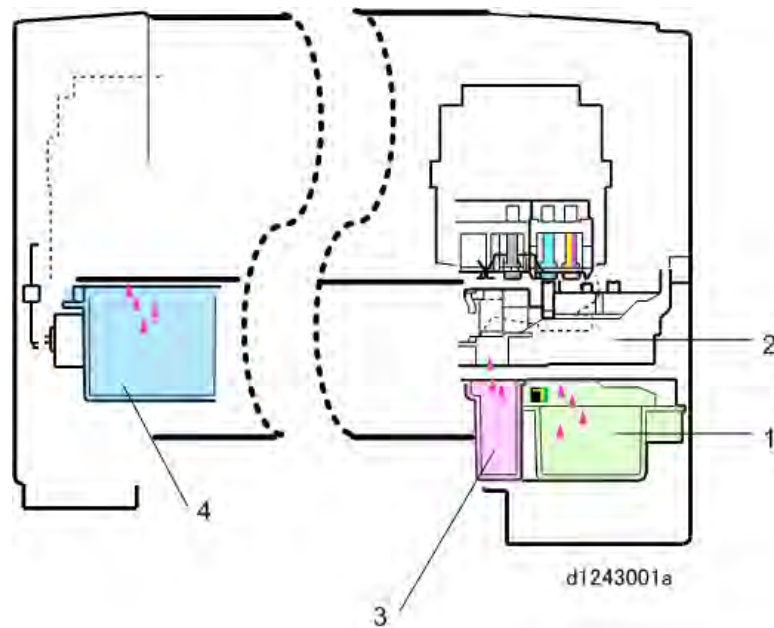

- A waste ink collector tank (1), mounted on the right side of the machine below the maintenance unit (2), collects the ink removed from the print heads by the maintenance unit during print head cleaning. The ink collector tank has an ID chip that keeps a count that will signal when the tank is full and needs to be replaced.
- A right ink sump (3), mounted behind the waste ink collector, catches waste ink that is scraped from the surfaces of the heads during print head cleaning by the maintenance unit.
- A left ink sump (4) on the left side of the machine collects ink vented from the print heads, which is done occasionally during printing to prime the print heads and prevent them from clogging.

1.3.2 SOME UNIQUE FEATURES OF D124

Here is a summary of new features.

Configuration



d124r079

- The scanner unit and main unit are mounted on separate racks.
- The units can be easily separated for servicing, or for placing the scanner on a low table or desk so it can be operated from a sitting position.

Image registration

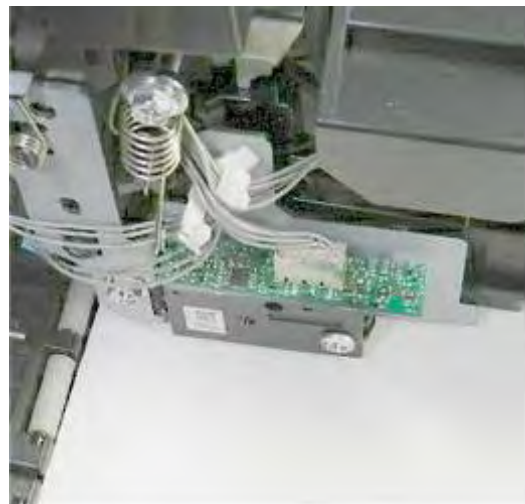

d1249416

The DRESS (Direct Realization Edge Scanning Sensor) sensor, mounted on the left side of the carriage unit, functions as a paper registration sensor and image registration sensor.

Front Cover Switches

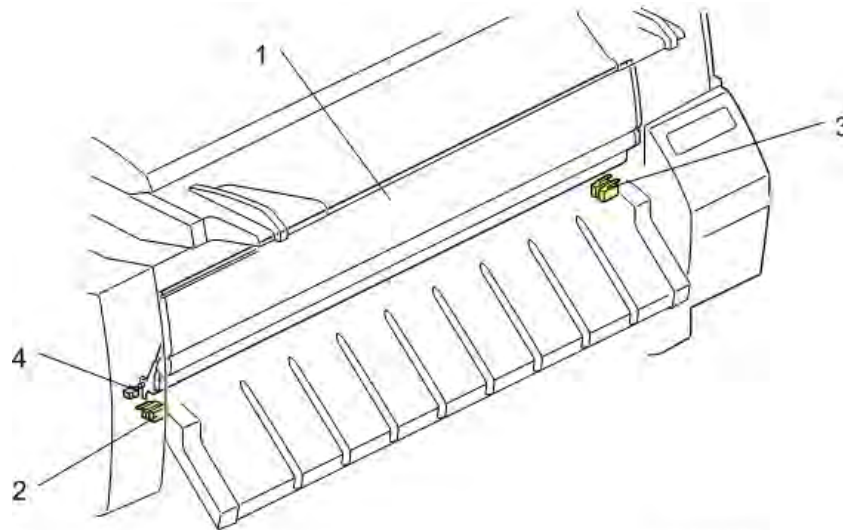

d1249502

- The front cover (1) can be raised to remove paper jams and to load paper for bypass feeding.
- The left front cover switch (2) and right front cover switch (3) are push-switches that detect when the front cover is raised and lowered.
- The guide pins on either end of the front cover are set in tracks which guide the cover into the correct closed position. The front cover track switch (4) (a push-switch) has been added to ensure that these guide pins are inserted correctly into the left and right track.
- The machine cannot operate until the front cover is down and all three of these switches are closed.

Ink level detection

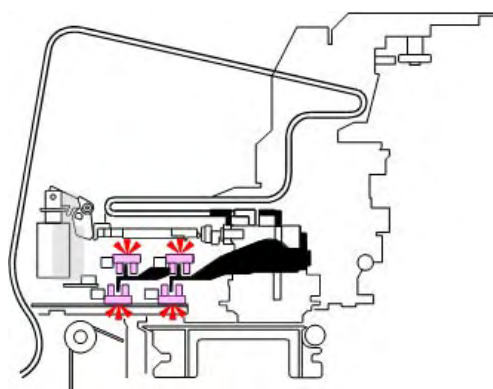

d1249417

An OCFS (On Carriage Filler Sensor) system constantly monitors the ink level of each sub tank for each color. This is described in detail in later sections.

Cutter

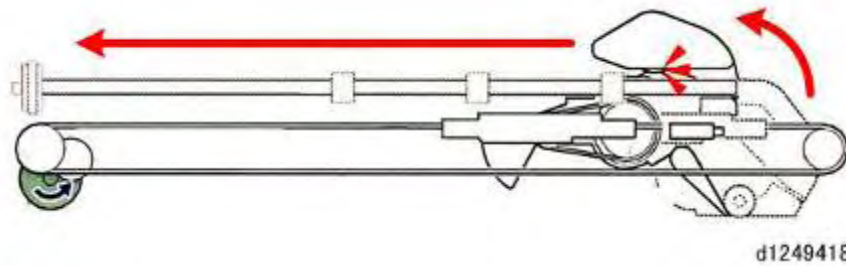

A one-direction cutter cuts roll paper from right to left and returns to the right side of the machine after cutting. It moves below the paper without interfering with paper feed.

Paper feed control

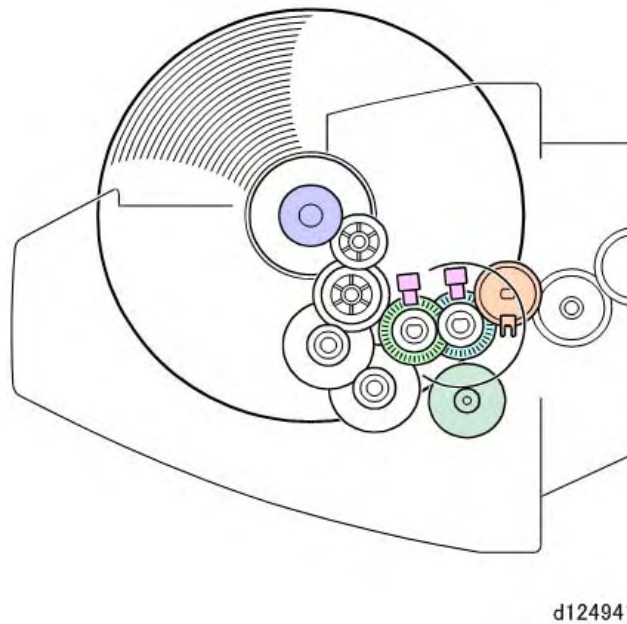

The DSP control (Digital Signal Processing) system controls paper feed with encoder wheels. It assures accurate roll paper feed and constantly monitors the amount of paper remaining on the rolls.

Improved Productivity

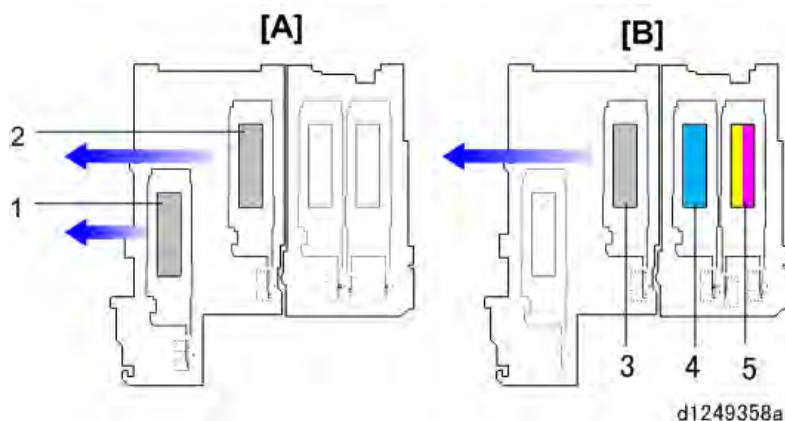

During black-and-white printing [A] only the K1 print head (1) and K2 print head (2) are used. These black print heads are offset so they can cover a wider band with black ink. This increases printing speed because a wider band can be covered with one pass in a monochrome print. During color printing [B] the K2 (3), C (4), and YM (5) print heads are used. The band is narrower because the forward sitting K1 print head is not used.

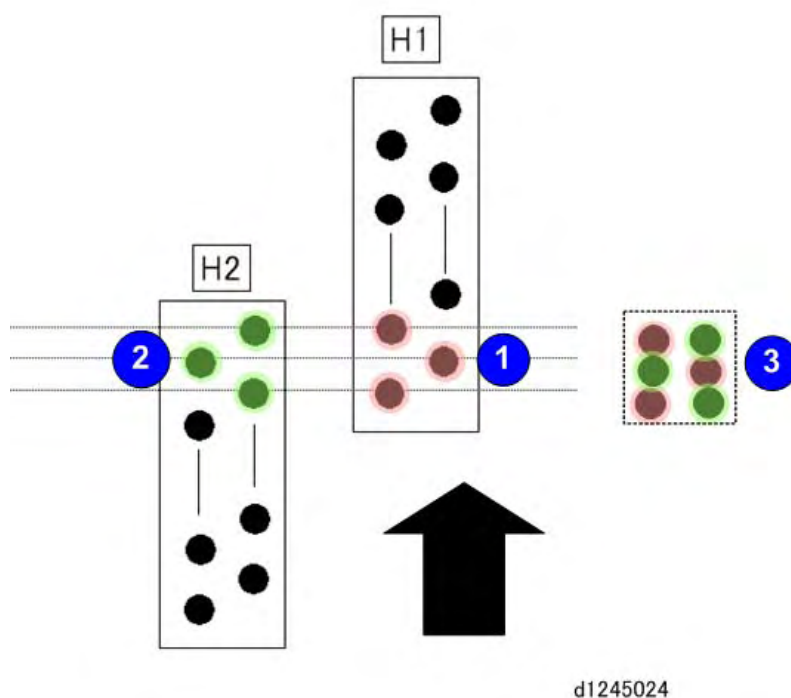

The K1 print head (H1) sits forward of the K2 print head (H2) in the direction of paper feed. This allows a greater band of coverage during monochrome printing. Three nozzles at the rear section of K1 ① and three nozzles at the front section of K2 ② overlap the same area on the paper. However, the arrangement of the nozzle ports is staggered ③ so the positions of the nozzle ports complement one another when ink is put down on the paper.

PRODUCT INFORMATION

REVISION HISTORY		
Page	Date	Added/Updated/New
		None

2. PRODUCT INFORMATION

2.1 SPECIFICATIONS

See Appendices. for the following information:

- General Specifications
- Printer Specifications
- Scanning Specifications
- Option Specifications

2.2 MAIN MACHINE, PERIPHERALS, OPTIONS



d124f022

Main Machines and Peripherals

No.	Item	Machine Code
①	Main Machine and Stand	D124
②	Scanning Unit and Stand	Standard
③	Roll Unit	Standard
④	Exit Stacker	Standard
⑤	Roll Unit RU6520	D622-01 (Option)

Other Options

Option	No.	Slot
Browser Unit Type M5	D624-02	SD Card Slot 1 or 2
Copy Data Security Unit Type F	B829-07	Board Installation
Data Overwrite Security Type H	D377-22	SD Card Slot 1 or 2
File Format Converter Type M5	D625	Board A
Gigabit Ethernet Type B	D377-21	Board C
IEEE 802.11 a/g Interface Unit Type J	D377-01	Board B (NA)
IEEE 802.11 a/g Interface Unit Type J	D377-02	Board B (EU)
IEEE 802.11 g Interface Unit Type K	D377-19	Board B (Other)

2.3 GUIDANCE FOR THOSE WHO ARE FAMILIAR WITH PREDECESSOR PRODUCTS

2.3.1 COMPARISON TO D093/D094

The D124 is a wide-format inkjet printer that incorporates the design of the D093/D094 digital wide-format machine. Here is a brief summary of the features of the D124 and D093/D094.

D124 and D093/D094 Compared

Item	D124	D093/D094
CIS	5 staggered units	5 staggered units
Color scanning	Yes	Yes
Controller	GW+	GW
Copying/printing	Inkjet Technology	Electrostatic-photo
HDD overwrite/encryption	Yes (Std.)	Yes (Std.)
Languages	20 Languages	18 Languages
Media to print	Yes (Std.)	No
Memory (Standard)	3GB + 250GB HDD	1GB + 160GB HDD (With Scanner Option) 2GB + 160GB HDD
PDF batch print	Yes	Yes
Printer function	Standard	Option
Rear original output	Yes	Yes
SDK	Yes	Yes (With Printer Option)
Scan to multimedia	Yes(Std.)	Yes (Option)
Scanning Speed (600 dpi)	80 mm/sec (B/W) 26.7 mm/sec (FC)	80 mm/sec (B/W) 26.7 mm/sec (FC)
Scanning function	Standard	Option
WSD* ¹	Yes	No

*¹ New network technology named “Web Services on Devices (WSD)”, introduced with Windows Vista, makes connecting each device much easier. AT/AP-C2 supports this new technology and enables users to enjoy the following benefits.

- Automatic driver installation of network printer
- To discover an available printer without inputting an IP address and print from it.
- Automatic notification of print job end, occurring error and when the error is fixed.

2.4 OVERVIEW

2.4.1 ACRONYMS AND IMPORTANT TERMS

Here are some commonly used acronyms and standard terms you should know.

- **DRESS.** Direct Realization Edge Scanning Sensor. The DRESS sensor is mounted on the left, lower edge of the carriage unit. It detects skew correction, performs paper registration and does color registration.
- **OCFS.** On Carriage Filling Sensor. There are five of these sensors (one for each color) mounted on the carriage unit. A feeler arm attached to the flexible side of each color tank swings in and out of the sensor gap as the ink supply in the tank goes low and high. These sensors are used to monitor the level of the ink in the tanks.
- **Sub Scan.** This means the vertical direction. It is used in reference to printing, scanning, and paper feed.
- **Main Scan.** This means the horizontal direction. It is used in reference to printing, scanning, and paper feed.

2.4.2 AROUND THE MACHINE

Front



d124f002

Product Information

1	Original Stacker	6	Front Cover
2	Operation Panel	7	Paper Exit Guide
3	USB Cable	8	Paper Holding Lever
4	Scanner Unit Cover	9	Ink Cartridge Cover
5	Original Table	10	Exit Stacker

1 Original Tray

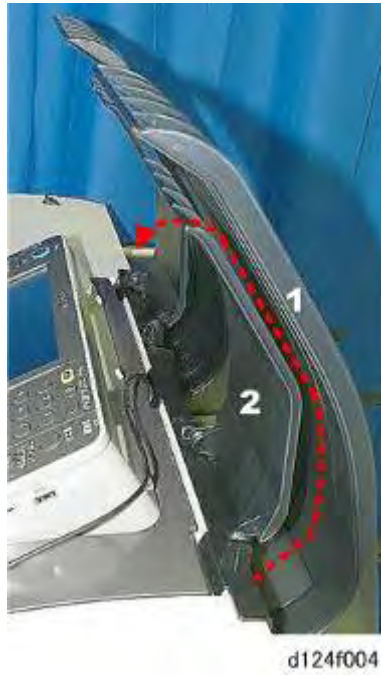

As each original is scanned, the original guide (1) guides it to the original stacker (2) on top of the machine.

2 Operation Panel



d124f005

This machine features a full operation panel.

1	Function Keys
2	Color LCD featuring an 8.4 in. WVGA and touch-panel
3	10-key pad with operation keys

Product Information

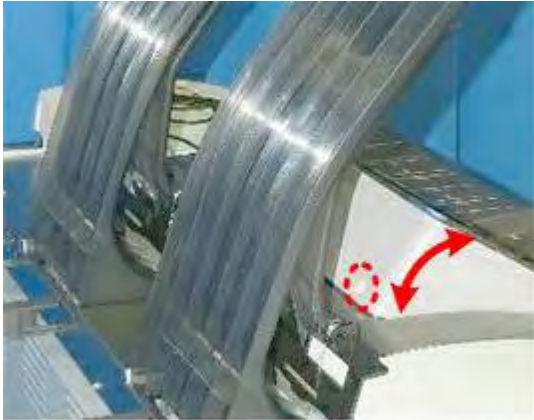

d124f006

Three plastic rivet screws hold the operation panel cover in place. These screws can be removed easily and then reinserted to change the angle of the operation panel (three different positions), to reduce glare on the operation panel LCD.

3 USB Cable

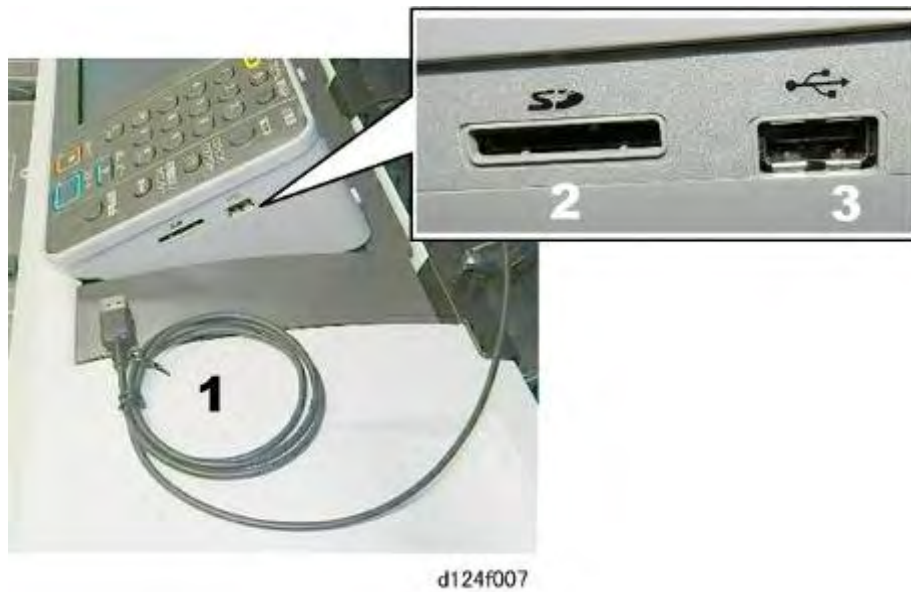

A USB cable [1] is permanently attached to the back of the operation panel. The end of this USB cable is plugged into the USB Host slot of the machine controller on the back of the machine. This cable is used for the scan-to-media feature, where scanned documents can be stored on memory devices inserted into the side of the operation panel. There are two slots, an SD card slot [2] and a USB memory device slot [3].

4 Scanner Unit Cover



The scanner unit opens easily for removal of paper jams (1), and can be opened to the full vertical position (2) for servicing (this requires disconnect of the arms on the left and right).

5 Original Table



d124f009

The plates on the original table of the scanner unit can be adjusted to accept originals up to 914.4 mm (36 in.) for scanning. Original length is limited to 15 m (49 ft.)

6 Front Cover

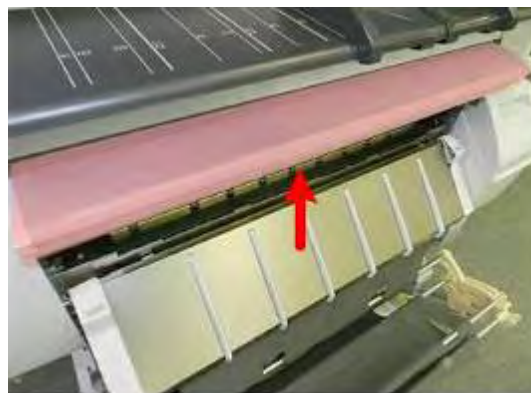

d124f010

The front cover is easily raised and lowered to expose the platen for cleaning and paper jam removal. The front cover locks in place and remains open after it has been raised. Two sensors (micro-switches) on either end of the front cover detect when the cover is opened and closed.



d1241029

When the pin on the left of the front cover is inserted correctly into its track [A], it slides down and pushes a micro-switch [B] to the rear. This signals that the front cover is installed correctly. The open switch signals a cover open error if the front cover is down but not correctly set in the track.

7 Paper Exit Guide



d124f011

The paper exit guide guides printed paper from the machine into the exit stacker attached to the front of the machine.

- Two lock magnets on either end of the guide hold it in place when it is open.
- A micro-switch on the right detects when the guide is opened and closed.



d1241030

A torque limiter on the right hinge of the paper exit guide acts as a damper to slow the descent of the guide after it is separated from the lock magnet above. This prevents the guide from falling abruptly.

8 Paper Holding Lever

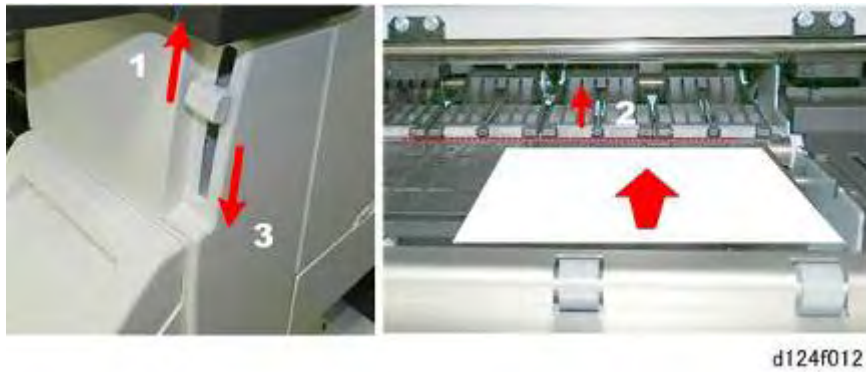

There is no bypass feed tray, but paper can be fed manually for bypass printing.

Raising the paper holding lever [1] lifts the registration rollers [2] so that cut-sheet paper can be loaded on the right side of the platen. Lowering the lever [3] clamps the paper in place for paper feed.

9 Ink Cartridge Cover

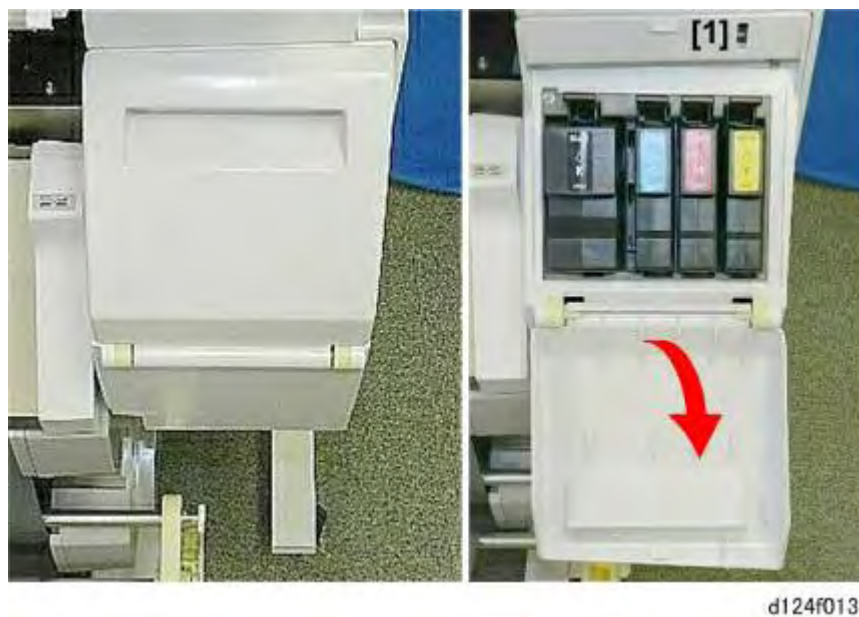

The ink cartridge cover can be opened and closed for the insertion and removal of the four ink cartridges. A small sensor (micro-switch) detects when this cover is opened and closed.

10 Exit Stacker



The exit stacker, attached to the front of the machine, can be adjusted for output: [1] Basket mode and [2] Stack mode

- **Basket Mode.** For standard size paper. The exit stacker is shortened so that it is rounded and deep to hold paper in a small well.
- **Stack Mode (for A0 SEF/A1 LEF).** The exit stacker is extended to the front until it is flat. It can hold up to 10 stacked sheets.
- **Wire guide mode (for A1 SEF/A2 LEF).** Two wire guides can be attached to the rear rod.

★ Important

- **After configuring the exit stacker for one of these modes, always check the ends of the rods to confirm that they are set correctly.**

Right Side

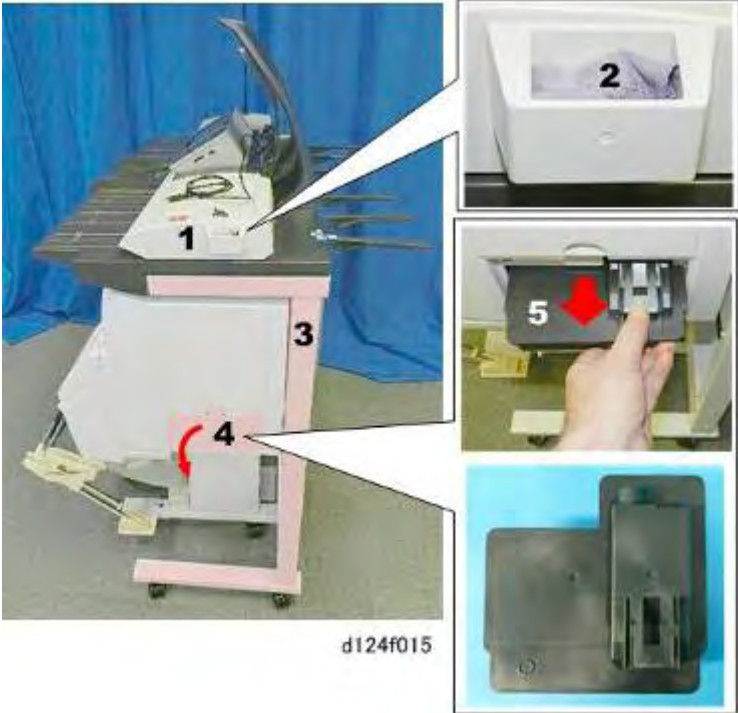

Product Information

1	Optical Cloth Holder
2	Optical Cloth
3	Scanner Stand
4	Ink Collector Tank Cover
5	Ink Collector Tank

The optical cloth holder [1] attached to the right side of the scanner unit holds the accessory optical cloth [2], which can be used to clean the exposure glass. The scanner stand [3] holds the scanner unit above the main unit. The ink collector tank cover [4] can be opened and closed for insertion and removal of the ink collector tank [5].

Overview

Left Side



1	Power Cord
2	Power Switch
3	Manual Pocket

The power cord [1], power switch [2], and manual pocket [3] are on the left side of the machine. There is only one power switch on this machine that can cycle the machine off and on.

Back



Product Information

1	Original Output Guides (x4)
2	Rear Cover

Four rear output guides [1] can be attached to the back of the machine to hold originals that exit the back of the machine. The PCB box cover [2] covers the area where the controller board and all other PCBs are mounted on the back of the machine. Four braided ground harnesses are connected with screws to the back of the scanner unit and the PCB box cover.

2.4.3 MAIN SECTIONS

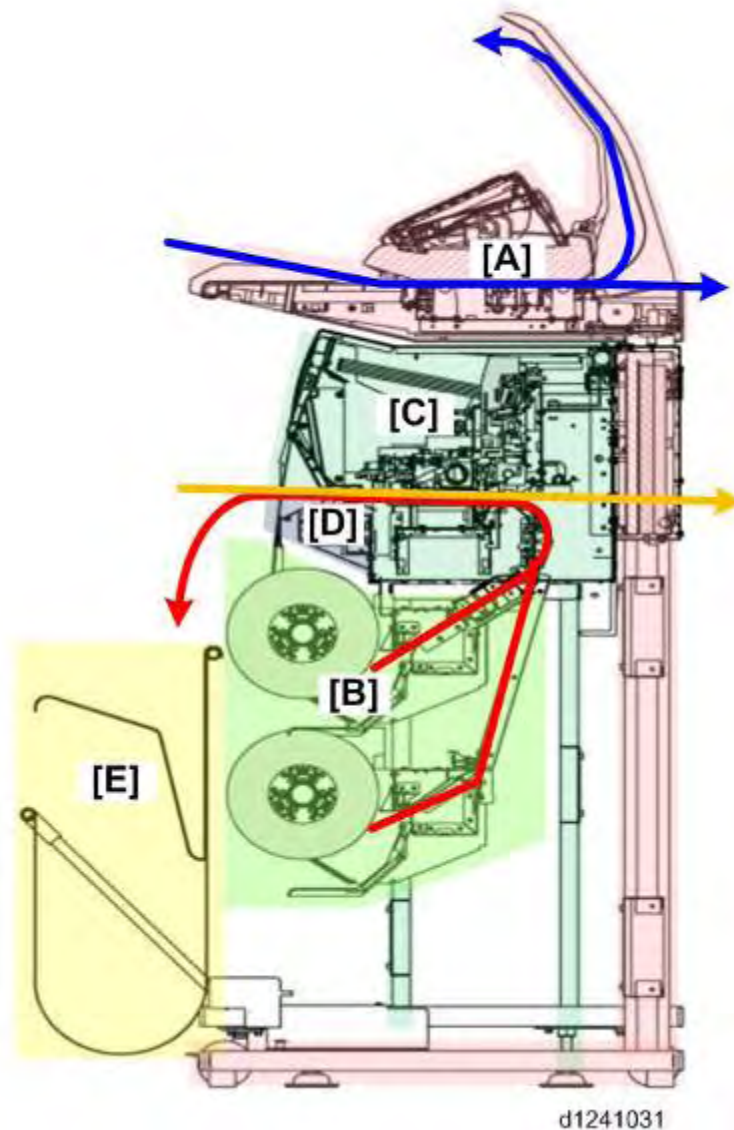

The machine is comprised of five main sections.

<p>[A]</p>	<p>Scanner. Five staggered CIS units above the original path scan images from the original.</p>
	<ul style="list-style-type: none"> ▪ An independent scanner stand supports the scanner. The scanner stand is docked to the back of the main unit and fastened with four screws to the base of the main unit. ▪ Originals fed from the original feed tray exit at the top. If the original guides are removed, the originals will exit the rear. ▪ The scanner also holds the operation panel.

[B]	Paper Feed. The main unit stand supports both the main unit and holds the paper feed rollers.
	<ul style="list-style-type: none"> ▪ Paper is supplied from one roll unit, provided with the main unit. ▪ Suction from one fan below the platen holds the paper in position during feeding and printing. ▪ One additional roll unit can be installed as an option. Printed sheets from both rolls exit the machine at the front. ▪ The stoppers of the paper rolls can be easily adjusted to accommodate either 2-in. or 3-in. roll cores.
[C]	Main Unit. This is the main body of the unit.
	<ul style="list-style-type: none"> ▪ Carriage Unit. The carriage unit holds the print heads and head ink tanks. The carrier moves horizontally and prints at 64.7 mm/s on one pass. ▪ Print heads. The replaceable print heads contain small sub tanks that can hold 6 cc of ink. There are two K print heads and one head each for Y, M, and C. The print heads can be replaced on site. ▪ Main scan unit. Refers to the horizontal motor and horizontal encoder that move the carriage unit and print heads from left to right during printing. ▪ Sub scan unit. Refers to the vertical motor and vertical encoder wheel and sensors that control operation of the urethane-coated paper feed roller driven by the vertical motor and controlled by a vertical encoder wheel. ▪ Ink supply unit. Ink is supplied through a tube pumping system. The ink supply pumps are controlled by feedback provided by feeler sensors attached to the sides of the ink cartridges above the print heads. ▪ Print head maintenance. The maintenance unit has three head caps and one cleaning cap. The one cleaning cap (a suction cap) performs head maintenance for all the heads. ▪ Waste ink collection. Three receptacles hold waste ink. The ink collector tank, easily removed from the right side of the main unit. The right ink sump is located behind the ink collector tank on the right side of the main unit. The left ink sump is on the left side of the machine.
[D]	Paper exit and cutter. Each sheet of roll paper is cut as it exits the front of the machine.

Overview

	<ul style="list-style-type: none">▪ A small cutter set on a track and driven by a small motor cuts each sheet of paper from right to left.▪ The paper exits the machine from the front into the stacker.
[E]	Exit Stacker. A cloth frame stacker that holds prints as they are output from the machine.
	<ul style="list-style-type: none">▪ The stacker can hold many different sizes of paper. Capacity: 10 sheets.▪ The printed sheets are stored in the well of the stacker as each exits the machine. Or, the stacker frame can be extended to hold each printed sheet straight after it exits.

2.4.4 MAIN COMPONENTS

Product Information

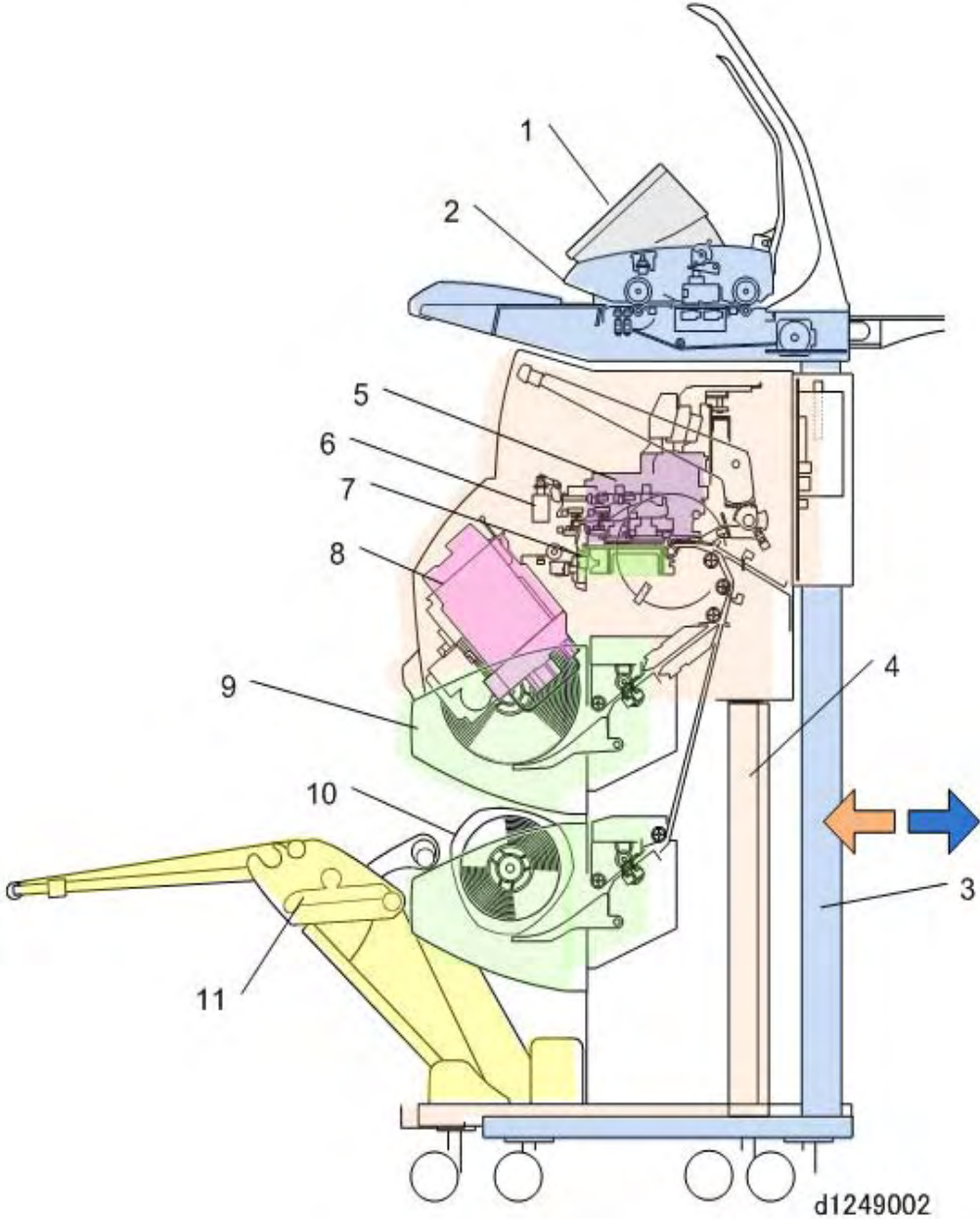

No.	Item	No.	Item
1	Operation panel	7	Maintenance unit
2	Scanner unit	8	Ink supply unit
3	Scanner stand	9	Roll Unit 1 (Std.)
4	Main unit stand	10	Roll Unit 2 (Option)
5	Carriage unit	11	Exit stacker
6	Air release solenoid		

2.4.5 DRIVE LAYOUT

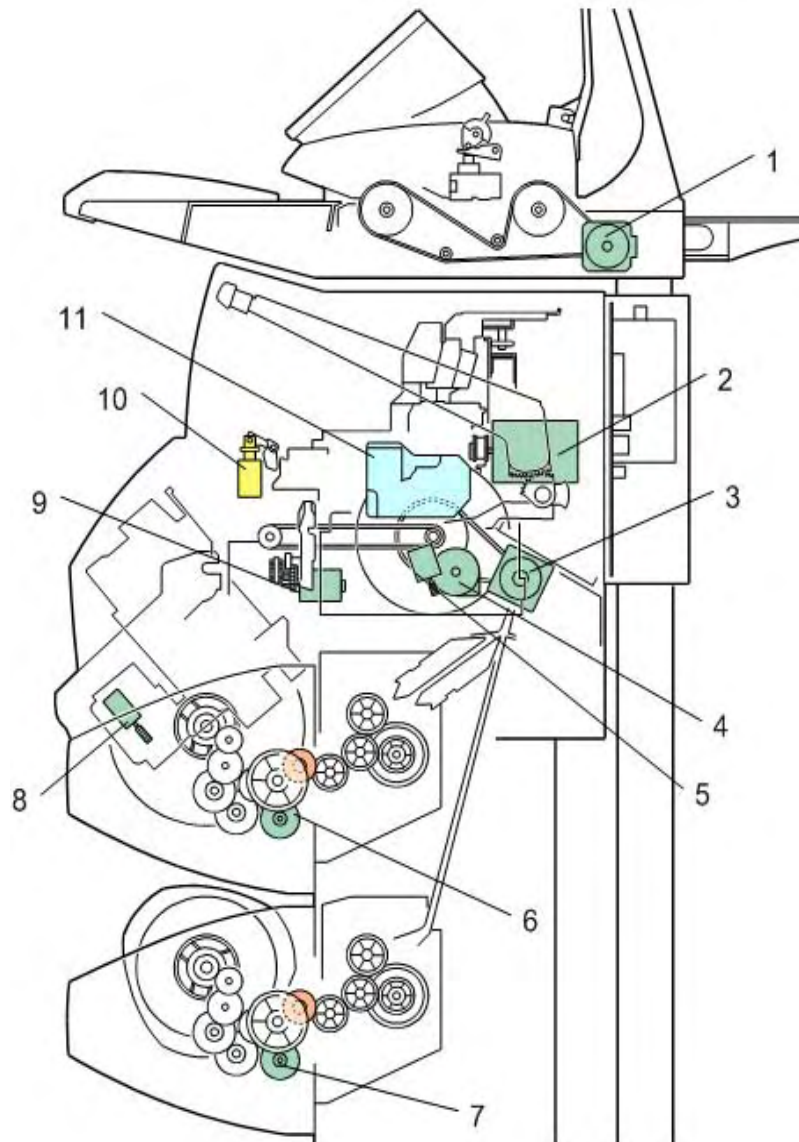

d1249004

No.	Item	No.	Item
1	Scanner motor	7	Roll paper feed motor 2
2	Horizontal motor	8	Ink pump motors (five)
3	Vertical motor	9	Cutter motor
4	Maintenance motor	10	Air release solenoid
5	Maintenance lift motor	11	Head lift motor
6	Roll paper feed motor 1		

2.4.6 ORIGINAL PATH, PAPER PATHS

Product Information

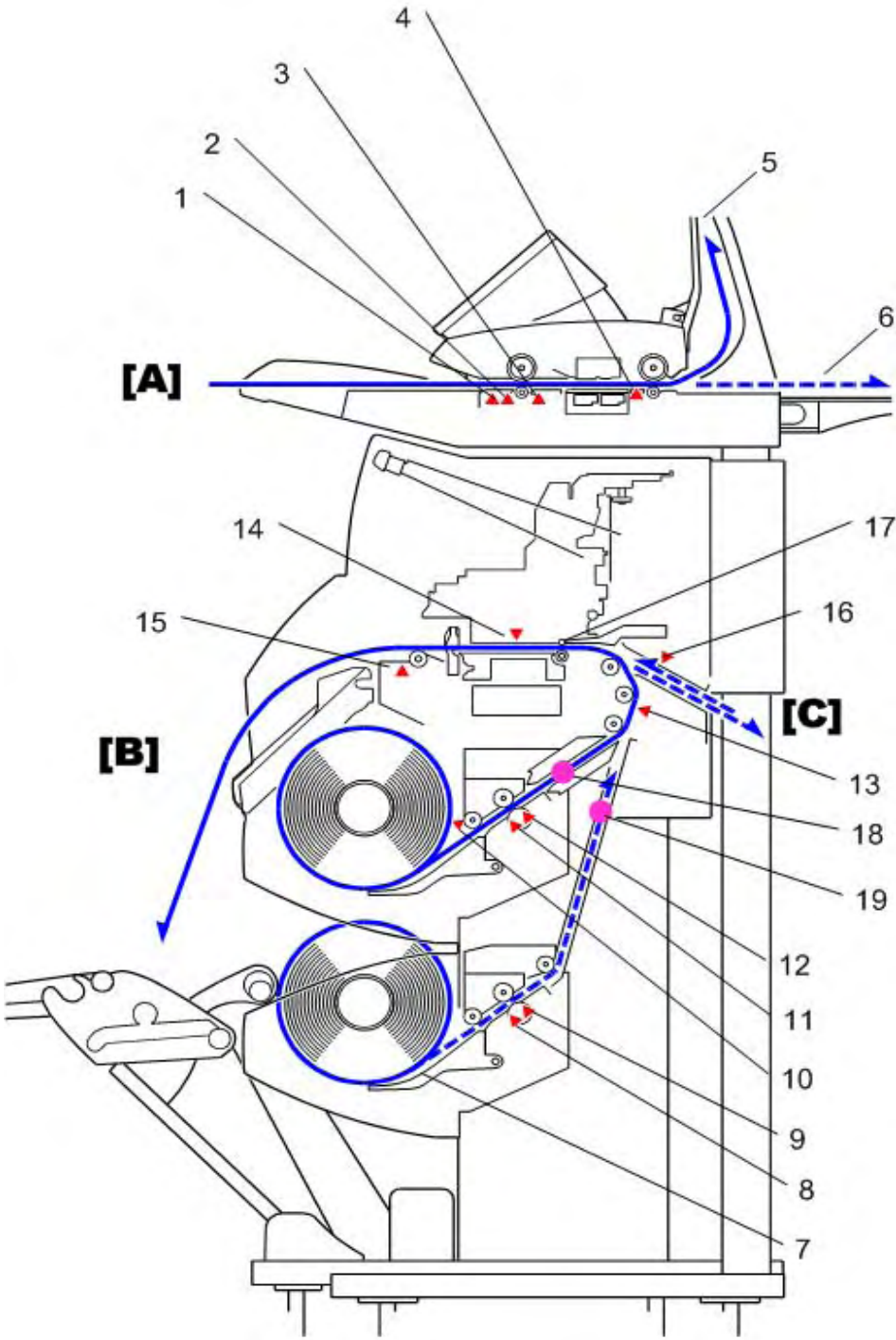

d1249003

No.	Item
[A]	Original path
1	Original width sensors
2	Original set sensor
3	Original registration sensor
4	Original exit sensor
5	Original exit (top)
6	Original exit (rear)
[B]	Roll paper paths
7	Roll end sensor (Roll Unit 2)
8	Entrance sensor (Roll Unit 2)
9	Exit sensor (Roll Unit 2)
10	Roll end sensor (Roll Unit 1)
11	Entrance sensor (Roll Unit 1)
12	Exit sensor (Roll Unit 2)
13	Pre-registration sensor
14	DRESS sensor
15	Exit sensor
[C]	Bypass paper path
16	Bypass sensor
17	Registration standby position
18	Paper standby position (Roll 1)
19	Paper standby position (Roll 2)

INSTALLATION

REVISION HISTORY		
Page	Date	Added/Updated/New
		None

3. INSTALLATION

3.1 PREPARATION

3.1.1 ENVIRONMENT

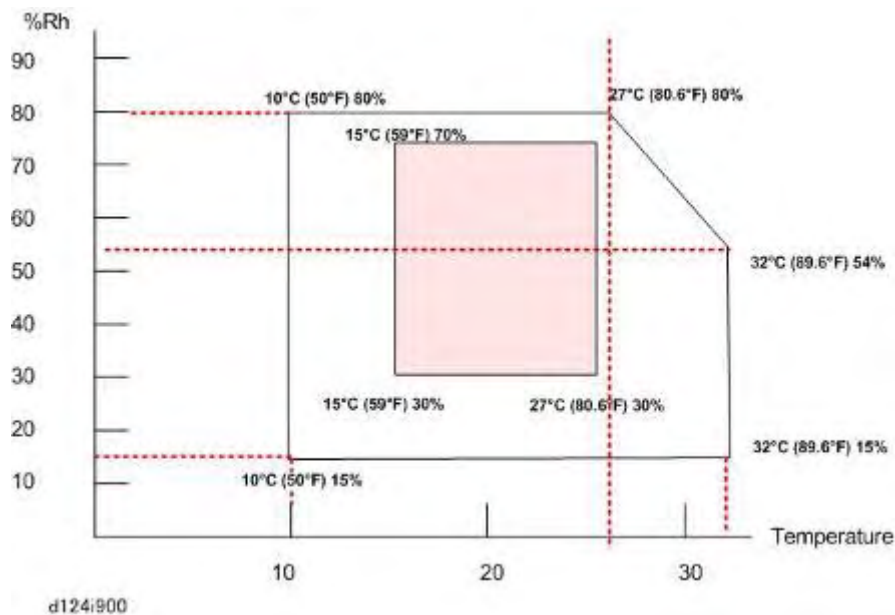

The shaded square in the illustration above is the environment recommended for an office.

1. Temperature Range: 10 °C to 27°C (50 °F to 81°F)
2. Humidity Range: 15% to 80% Rh
3. Ambient Illumination: Less than 1,500 Lux.

★ Important

- Never expose the machine to direct sunlight.
 - If the scanning unit on top of the machine is exposed to direct sunlight, this could cause vertical black and white lines in scanned images.
 - If the machine is near a window, turn it around so the back of the machine is not facing the window and install blinds to block sunlight.
4. Ventilation: More than 30 m³/hr/person in the work area, more than three times per hour.
 5. Ambient Dust: Less than 0.075 mg/m³
 6. If the installation area has air-conditioners or heaters, put the machine in a location where:
 - There are no sudden temperature changes from low to high, or high to low.
 - The machine will not be directly exposed to cool air from an air conditioner in the summer.
 - The machine will not be directly exposed to reflected heat from a space heater in the winter.

Preparation

- Do not install the machine in an area filled with gases that can cause corrosion.

★ Important

- Never set up the machine where it will be exposed to ammonia fumes.
- Ammonia in the surrounding area can cause poor reproduction of filled areas in images.

- Do not install the machine in areas higher than 2,000 m (6,600 ft) above sea level.

- Put the machine on a strong and level surface.

★ Important

- The floor of a residence must be able to support 1800 N/m² or more.
- The floor of an office must be able to support 2900 N/m² or more..

- Do not install the machine in an area where there are frequent strong vibrations.

3.1.2 MINIMUM SPACE REQUIREMENTS

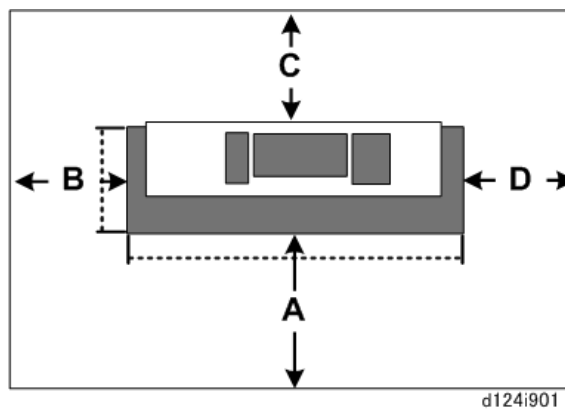

	Side	mm	m	in.	ft.
A	Front	2,000	2.0	78.8	6.5
B	Left	600	0.6	23.6	2.0
C	Back	600	0.6	23.6	2,0
D	Right	600	0.6	23.6	5

3.1.3 MACHINE LEVEL

1. Front to back: Not more than 5 mm from level
2. Right to left: Not more than 0.15/1000 mm from level.

3.1.4 POWER SOURCE

1. Input Voltage Level:
 - North America: 110-120V 3.6 A or more 60 Hz
 - Europe, Asia, China: 220-240V 1.5A or more 50/60 Hz
2. Permissible Voltage Fluctuation: $\pm 10\%$
3. Do not set objects on the power cord.

★ Important

- Make sure the plug is firmly inserted in the outlet.
- Do not connect the machine to a power source that is shared with other equipment.
- To prevent damage to the breaker switch, installation of a voltage stabilizer (constant voltage transformer) is recommended for work sites where there is fluctuation in the AC power source.
- To protect the HDD, always switch the machine off with the operation switch on the operation panel, wait for the power switch LED to stop flashing, then switch off the main switch on the side of the machine.

3.1.5 INSTALLATION OVERVIEW

Installation Flow

Here is a summary of the sequence recommended for installation of all options at installation.

Step	Procedure
1	Assemble Scanner Stand
2	Assemble Main Unit Stand
3	Mount Scanner Unit
4	Mount Main Unit
5	Roll Unit Unit 1 (Standard)
6	Roll Unit Unit 2 (Option)
7	Controller Options
8	Connect Scanner and Main Unit
	<ul style="list-style-type: none"> <li data-bbox="336 1084 639 1117">▪ Connect Harnesses
	<ul style="list-style-type: none"> <li data-bbox="336 1151 584 1184">▪ Install Brackets
	<ul style="list-style-type: none"> <li data-bbox="336 1218 711 1252">▪ Connect Host USB Cable
	<ul style="list-style-type: none"> <li data-bbox="336 1285 1075 1319">▪ Connect and Clamp Power Cord, Clamp Main Harness
9	Remove Tapes and Shipping Materials
10	Original Stacker, Guides
11	Ink Collector Tank Storage Shelf
12	Assemble and Install Exit Stacker
13	Ink Filling
14	Set Roll Paper
15	Check Printing
16	Final Adjustments
17	Final Settings
18	After Installation

3.2 MAIN MACHINE INSTALLATION

3.2.1 BEFORE YOU BEGIN

Accessory Boxes

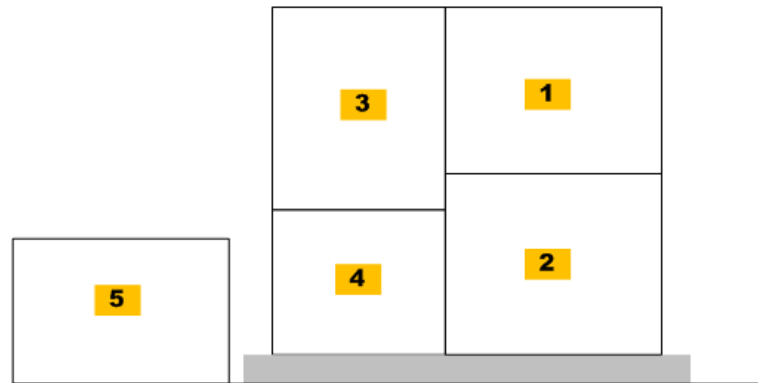

d124i902

Installation

Box	Content
[1]	<ul style="list-style-type: none"> ▪ Scanner Unit ▪ Exit Guide (Semi-transparent)
[2]	<ul style="list-style-type: none"> ▪ Main Unit
[3]	<ul style="list-style-type: none"> ▪ Accessories
[4]	<ul style="list-style-type: none"> ▪ Roll Unit 1 ▪ Roll Paper Spool x2 ▪ Transport Guide
[5]	<ul style="list-style-type: none"> ▪ Scanner Stand ▪ Main Unit Stand ▪ Hex-bolts for Stands ▪ Allen Key

The screws for each unit are packed together with the unit in the same box. Unpack the items as they are needed, to prevent mixing the screws.



No.	Items	Qty
[1]	Primer Fluid Drain Cartridges	4
[2]	Starter Cartridges	4

What You Need

Here is a list of tools required for this installation.

- Allen key (2.5 mm). One is provided but you may need extra keys if two or more people are working on the installation.
- Driver 300 cm (12 in.) or longer
- Flashlight
- Small scale or ruler
- Adjustable wrench

⚠ CAUTION

- To avoid serious injury or damage to the machine, do not plug the machine into a power source until you are instructed to do so in these installation procedures.

3.2.2 ASSEMBLE SCANNER STAND

Accessories: Scanner Stand

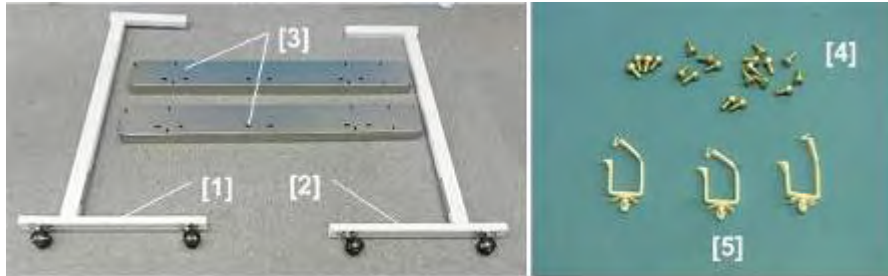

No.	Item	Q'ty
1.	Left Support	1
2.	Right Support	1
3.	Center Stay	2
4.	Hex Socket Bolt M4x8* ¹ with lock washers	20
5.	Clamp	3
*1	For the scanner stand assembly and connection of scanner stand to main unit with these bolts, you will need an Allen key. Items 4 and 5 are provided with the roll unit. One lock washer is provided for each socket bolt.	

Installation: Scanner Stand



d124i303

★ Important

- Be sure to attach one lock washer to each hex socket bolt before you fasten the bolt.



d124i003

1. Position the left and right supports of the scanner stand as shown above.





d124i004

2. Set the two center stays between the left and right supports.
3. Make sure that the pattern of clustered cutouts [A] are down.
4. Engage the ends of the stays on the ends of both stays.



d124i005

5. Insert and finger-tighten the end of each stay to the left and right supports ( x16). (Do not tighten the hex-head bolts until all have been inserted.)
6. After all the bolts have been inserted and slightly tightened, use the Allen key to tighten all the bolts. ( x16)



d124i007

7. Set the assembled stand upright. This completes assembly of the scanner stand.

Installation

3.2.3 ASSEMBLE THE MAIN UNIT STAND

Accessories: Main Stand

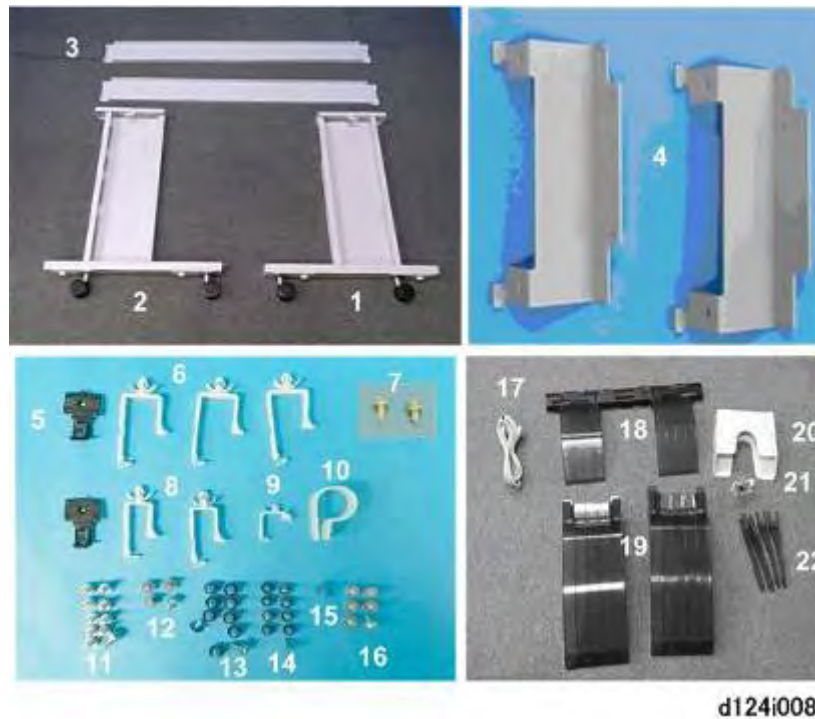

No.	Item	Q'ty
1.	Left Support	1
2.	Right Support	1
3.	Stay	2
4.	Joint Bracket	2
5.	Clamp – Velcro* ¹	2
6.	Clamp - Large	3
7.	Rivet (Manual Pocket)	2
8.	Clamp - Medium	2
9.	Clamp - Small	1
10.	Clamp - Round	1
11.	Hex Socket Bolt* ² with lock washers.	10

No.	Item	Q'ty
12.	Screw	4
13.	Screw	10
14.	Screw	9
15.	Screw	1
16.	Screw	6
17.	Power Cord	1
18.	Original Stacker	1
19.	Original Guide	2
20.	Manual Pocket	1
21.	Optical Cloth Pocket	1
22.	Rear Output Guide	4

*1	Items 5 to 16 are packed with the Roll Unit.
*2	An Allen key is provided for the hex bolts. One lock washer is provided for each socket bolt.

Installation: Main Stand



d124i303

★ Important

- Be sure to attach one lock washer to each hex socket bolt before you fasten the bolt.



d124i009

1. While supporting the right support with your hand, latch a stay to the rear base of the support.



d124i010

2. Attach the other end of the stay to the base of the left support so the supports can stand upright by themselves.

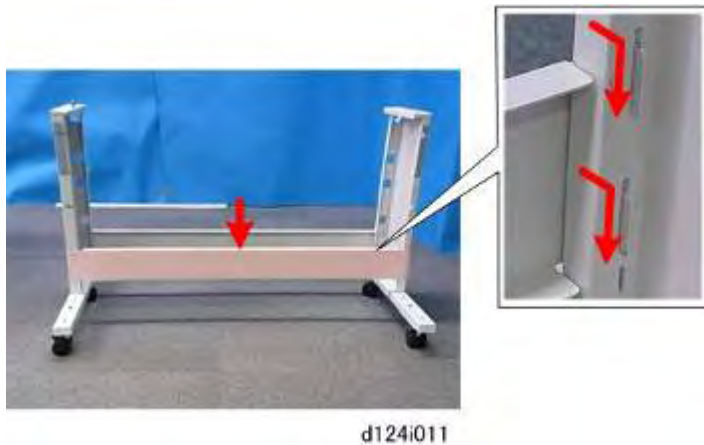

3. Latch the other stay to the base of the left and right support at the front.
4. Push down the front and rear stays to lock them in place.

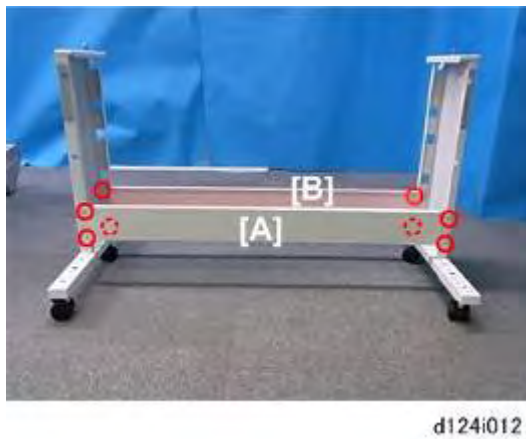

5. Fasten the front stay [A] and rear stay [B] to the supports (🔑 x4 each). You will need the Allen key to attach the hex socket bolts.

3.2.4 MOUNT THE SCANNER UNIT

⚠ CAUTION

- Mount the scanner unit immediately after you remove it from the pallet and open the box.



d124i013

1. Locate the vertical positioning pins on top of both sides of the assembled scanner stand.



d124i014

2. Remove the orange tape from both ends of the scanner unit.
3. Arrange the harness to the front as shown above.
4. With two people lifting both ends of the scanner unit, and with their hands positioned as shown above, set the scanner unit on top of the scanner stand.

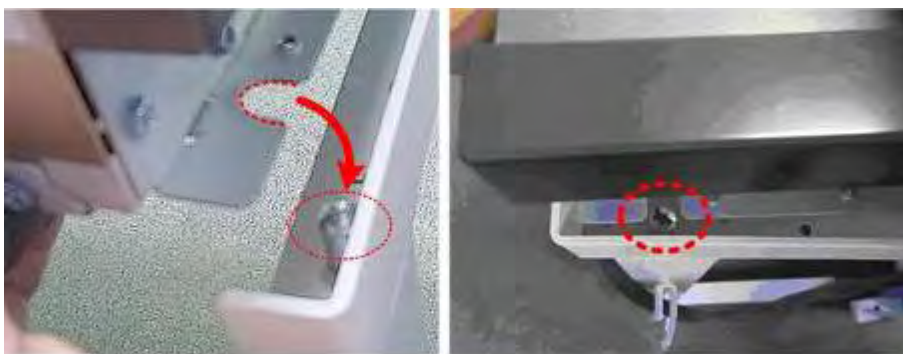

d124i015

5. Align the cut-outs in the frame of the scanner unit with the positioning pins on either end of the scanner stand.



6. Set the scanner unit down on the positioning pins, then fasten the unit to the stand ( x4 - M4x8).



7. Attach the clamps ( x3).



8. Remove the Factory Settings Sheet from under the right front end of the scanner unit.

★ Important

- Make a copy of the Factory Settings Sheet and leave the original with the machine for future reference.

3.2.5 MOUNT THE MAIN UNIT

⚠ CAUTION

- Mount the main unit immediately after you remove it from the pallet and open the box.
- To avoid damage to the bottom of the main unit, never set the main unit on the floor.



1. Locate the vertical positioning pins on the tops of both sides of the main unit stand.



2. Locate the handles on the right side of the main unit.



3. Locate the handles on the left side of the main unit.

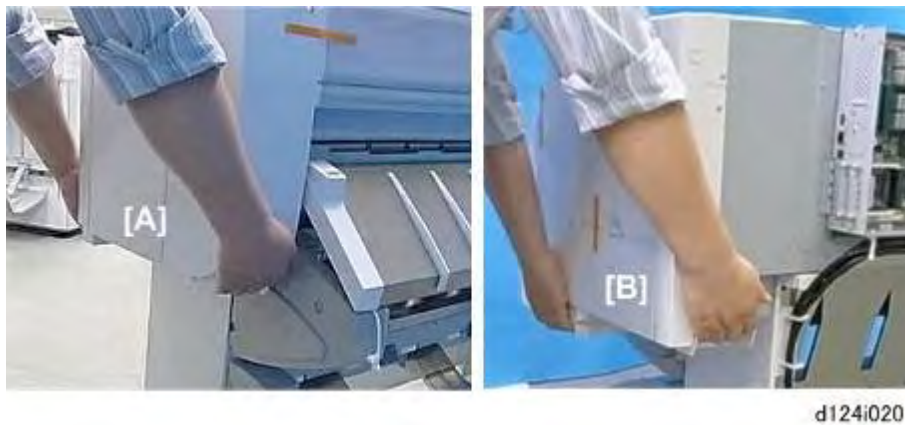

4. With two people holding the left end [A] and right end [B] with their hands positioned as shown above, lift the main unit and hold it over the top of the main unit stand.



5. Position the main unit over the top of the stand so that the triangle marks at the rear are aligned (▲).

Main Machine Installation



d124i022

6. With the marks aligned (), lower the main unit so that the positioning pins on either end of the stand insert smoothly into the holes in the bottom of the main unit frame.



d124i303

7. Fit each screw with a lock washer.



d124i023

8. Under the stand, use an Allen key to fasten the left and right sides of the stand to the bottom of the main unit with the hex-head bolts and lock washers ( x3 - M4x8)

★ Important

- Confirm that each bolt is tight.

3.2.6 ROLL UNIT 1 (STANDARD)

Accessories: Roll Unit 1



No.	Item	Q'ty
1.	Paper Transport Guide Plate (Semi-Transparent)	1
2.	Roll Unit 1	1
3.	Roll Spool with Stoppers	1
4.	Screw M3x8 with Spring Washer (for Roll Unit)	4
5.	Screw M3x6 (for Paper Transport Guide)	2
6.	Screw (for Harness Bracket)	2
7.	Clamp	3

Installation

Installation: Roll Unit 1



1. Raise the paper exit guide [A].

Main Machine Installation



2. Locate the positioning pins on the left and right ends of the roll feed unit.

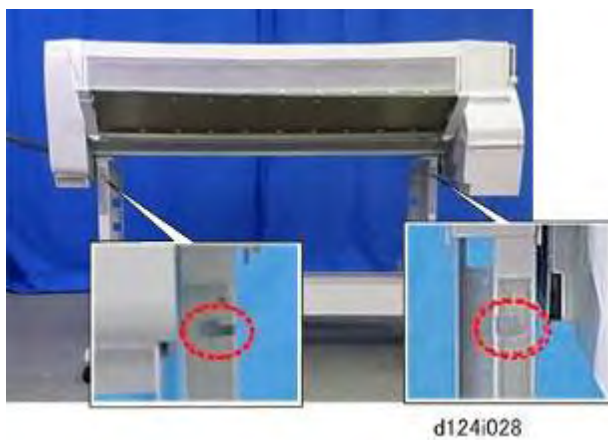

3. Locate the cut-outs in the left and right supports of the main unit stand.



4. Lay the harness away from the back of the roll feed unit as shown above, so that the harness will not interfere with installation.



d124i030

5. While holding the unit with both hands:
 - Set the positioning pins on the left and right ends of the roll feed unit into the cut-outs in the supports
 - Push the roller unit in.
 - Slide it slightly to the right to lock the unit in place.



d124i031

6. Behind the stand on both sides, make sure that the holes of the roll feed unit and the stand frame are aligned.
7. Insert the tip of a long screwdriver (30 cm: 12 in.) through each pair of holes to make sure that they are aligned.



d124i032

8. Pull the harness over the top of the roll unit to the rear.

Main Machine Installation

- Fasten the roll feed unit to the stand (4 x M3x8). (Be sure to use the screws with the washers attached.)



d124i033

- There are two pegs on each end of the paper transport guide.



d124i034

- While holding the paper transport guide with both hands as shown above, insert the pegs on either end of the guide into the cut-outs in the stand on the left [A] and right [B]. The guide should slide into position and fit snugly after correct alignment.



d124i035

12. Make sure that the pegs are snug in the cut-outs: [A] (black) on the left, and [B] (white) on the right.
13. Fasten the guide to the frame on the right [C] and left [D] ( x2).



14. Use a thin edge (like the end of a metal scale) to push the tongues of the guide mylar up and behind the plate. There are six mylar tongues.

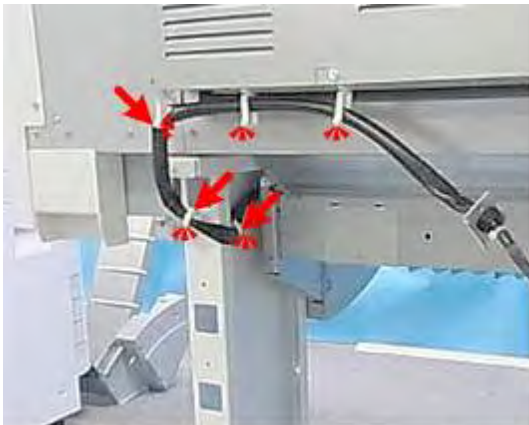

★ Important

- Paper will not feed from the roll correctly if these mylars are not pushed behind the plate.

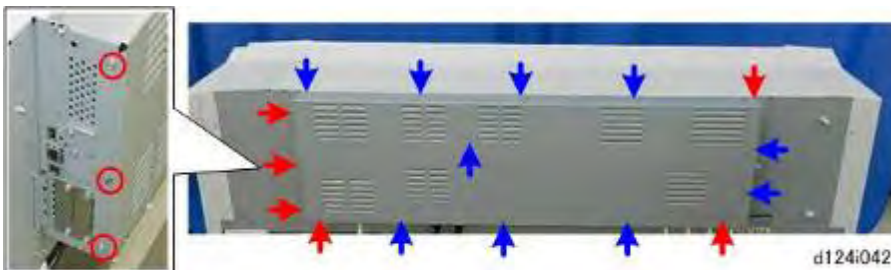

15. Attach the clamps, route the harness, and then close the clamps ( x3).



16. Remove the screws marked by red arrows ( x6).
17. Loosen (do not remove) the screws marked by the blue arrows ( x10).

Main Machine Installation



d124i043

- Slide the cover to the right and remove it.



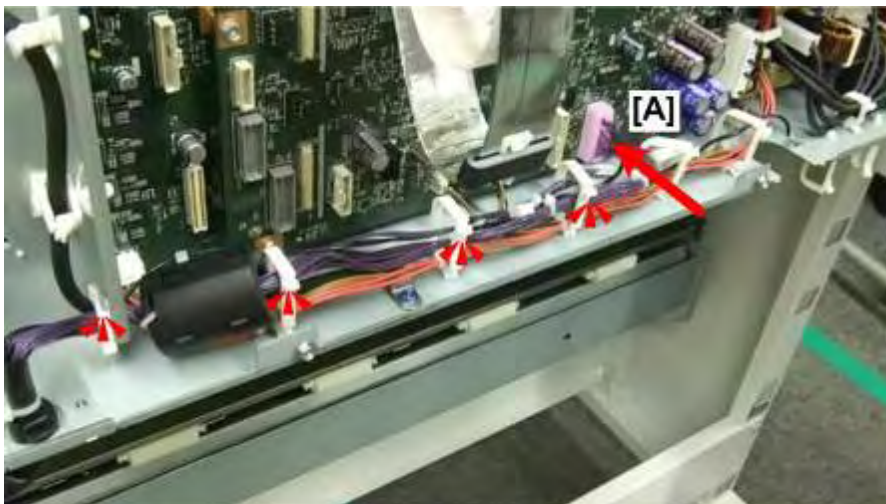

d124i166

- On the back of the machine, locate the knockout [A] on the bottom edge of the electrical component box.
- Attach the harness bracket [B] ( x2).



d124i167

- Route the harness, connect it to the MCU at [A] **CN215**, and then clamp it ( x4,  x1).

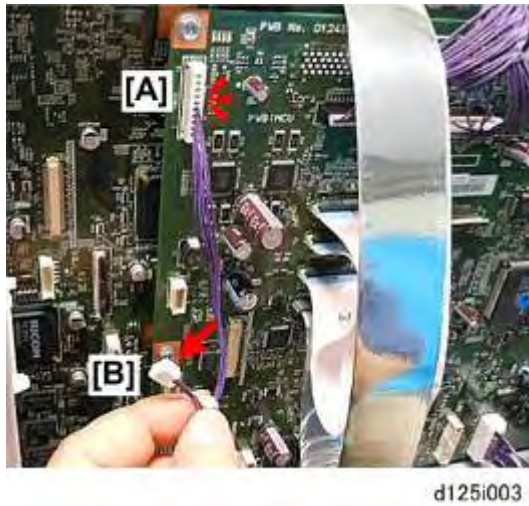

22. Connect harness [A] to the MCU at **CN910** (x1). (The open connector [B] is for Roll Unit 2).
 23. If you intend to install Roll Unit 2 (option), go to the next section.
- or-
- If you are finished, re-attach the rear cover.

Installation

3.2.7 ROLL UNIT 2 (D622) (OPTION)

One additional roll unit can be installed: Roll Unit RU6520 (D622)

Accessories



Main Machine Installation

No.	Item	Q'ty
1	Roll Unit 2	1
2	Roll Spool with Stoppers	1
3	Paper Transport Guide Plate	1
4	Clamp	3
5	Screw M3x6 (for Paper Transport Guide)	2
6	Screw M3x8 with Spring Washer (for Roll Unit)	4
7	Screw (for Harness Bracket)	2
8	Screw (for RFDB)	2
9	RFDB	1
10	Harness	1

Installation



1. Unpack the roll feed unit. Locate the positioning pins on the left and right ends.



d124i028a

2. Locate the cut-outs in the left and right supports of the main unit stand



d124i029

3. Lay the harness away from the back of the roll feed unit as shown above, so that the harness will not interfere with installation.



d124i038

4. While holding the unit with both hands:
 - Set the positioning pins on the left and right end of the roll feed unit into the cut-outs in the supports
 - Push the roll unit in.
 - Slide it slightly to the right to lock the unit in place.

Main Machine Installation





5. Insert a long screwdriver (30 cm: 12 in.) into each pair of holes to make sure that they are aligned.
6. Fasten the roll feed unit to the stand ( x4 M3x8). Be sure to use the screws with the washers attached.

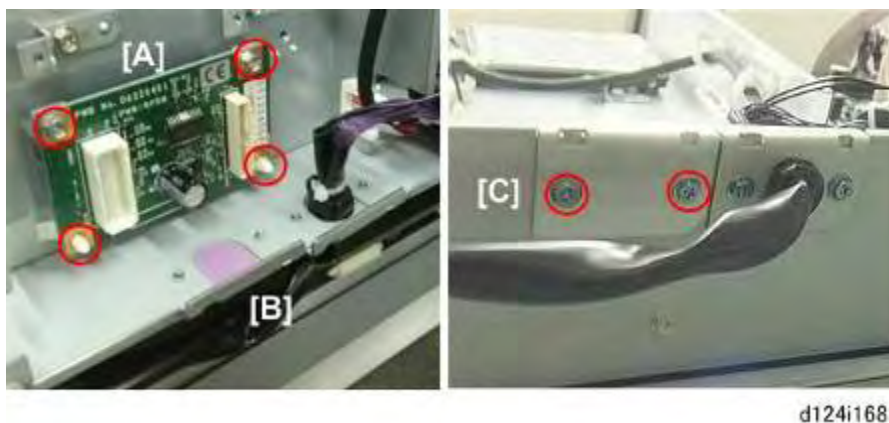

7. Attach the three harness clamps and then close the clamps around the harness ( x3).



8. Fasten the RFDB [A] to the frame ( x2,  x2).
9. The cut-out for the harness bracket is covered by a plate [B].
10. Under the edge of the box [C], unfasten the plate and discard it ( x2).



d124i169

11. Fasten the harness bracket to the bottom of the box (🔩 x2).

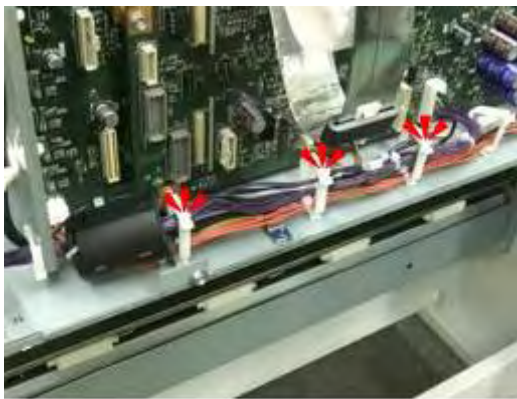

d125i002

12. Open the clamps (🔧 x3).

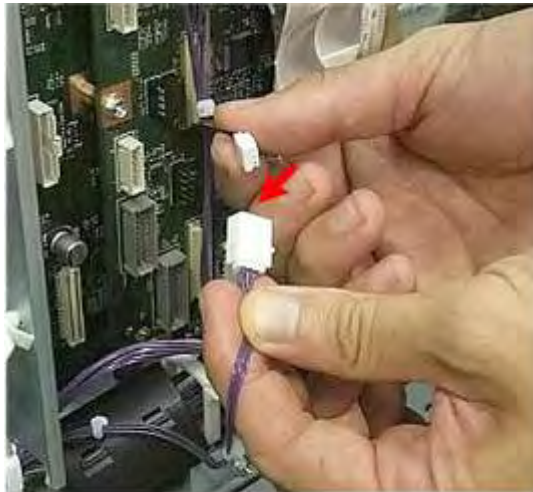

d125i001

13. Connect the small harness to the harness connected above at CN910 of the MCU above (🔧 x1).

Installation

Main Machine Installation

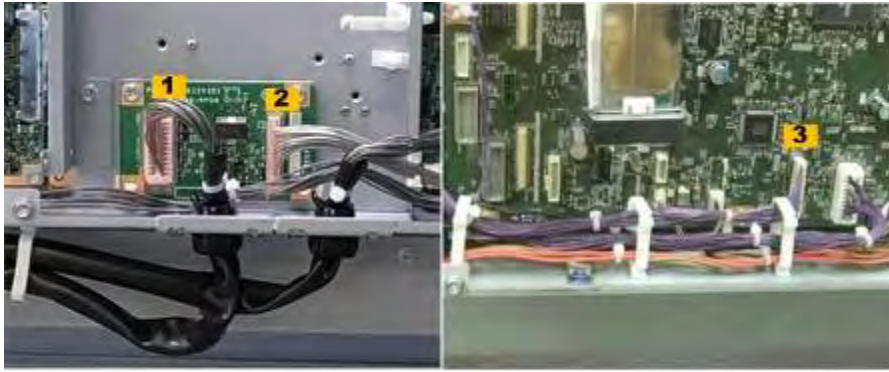

d124i046

14. Connect the harness [1] at **CN301** (🔌x1).
15. Connect one end of the accessory harness [2] to the RFDB at **CN300** (🔌x1).
16. Connect the other end of the accessory harness [3] to the MCU at **CN202** (🔌x1)



d124i304

17. Open the ferrite core, lay the harnesses into the center of the core, and then close the core.

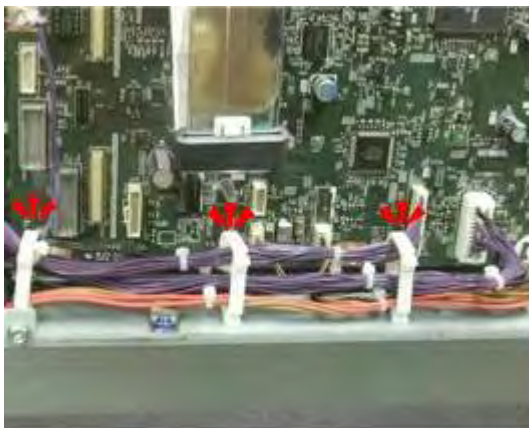

d124i305

18. Close the clamps (🔧x3).



d124i047

19. Behind the machine, hold the guide plate as shown, and then set the cut-outs on the left and right over the pegs.



d124i048

20. Lift the guide slightly, and then insert the bottom pegs into the cut-outs at the lower left and lower right corners.
21. Check each corner of the plate to be sure that each peg is snug in its cut-out.



d124i201

22. Check the top of the plate and make sure that it is parallel with the edge of the machine.



23. Fasten the plate ( x2 - M3x6).

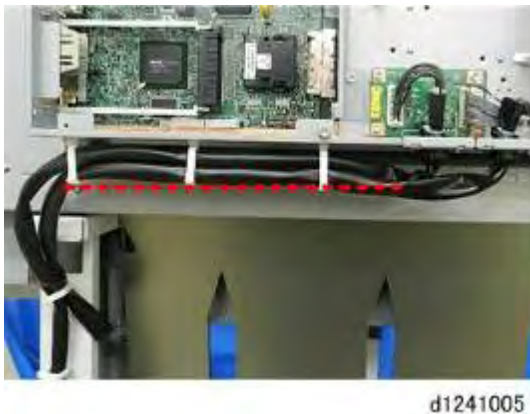



24. Check the clamps and harnesses.

- Make sure that the clamps are closed and that there is absolutely no slack in the harnesses.
- The harnesses must be flat up against the bottom of the PCB box to prevent them from interfering with paper in the bypass feed path.
- During bypass feed, the trailing edge of the paper will come out from the back of the machine, and then reverse feed back into the machine.

3.2.8 CONTROLLER OPTIONS

If you intend to install one or more of the following options which require the installation of boards, do this now before you re-attach the rear cover.

- File Format Converter (MLB)  page 3-78
- Gigabit Ethernet  page 3-78
- Copy Data Security  page 3-78

3.2.9 CONNECT THE SCANNER AND MAIN UNIT

Connect Harnesses



d124i050

1. Bring the scanner unit and main unit close together as shown above.

⚠ CAUTION

- The scanner unit is top heavy and unstable. It can fall over easily.
- Grip the supports below the scanner unit and push it slowly when you move it.



d124i306

2. Make sure that the harness is inside and behind the left support of the stand.

★ Important

- If the harness is wrapped around the outside in front of the support, the harness will be pinched between the stand and back of the machine when the scanner stand is docked to the back of the machine.

Main Machine Installation

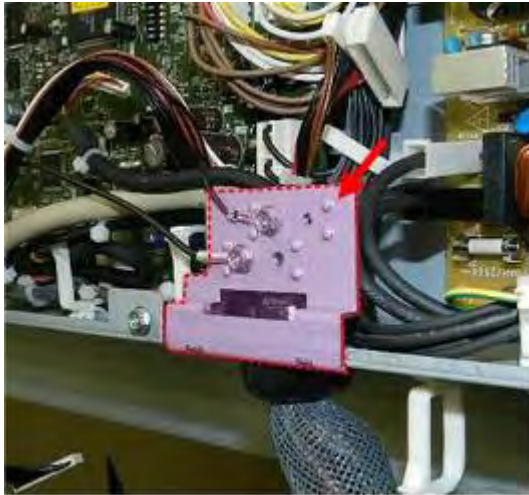

d1241021

3. Set the scanner cable bracket in the cutout in the bottom edge of the PCB box.



d1241022

4. Fasten the bottom of the scanner cable bracket to the bottom edge of the PCB box (2 - M3x6).



d1241023

5. Open the harness clamps [A] (2).
6. Connect the relay harness [B] (1).

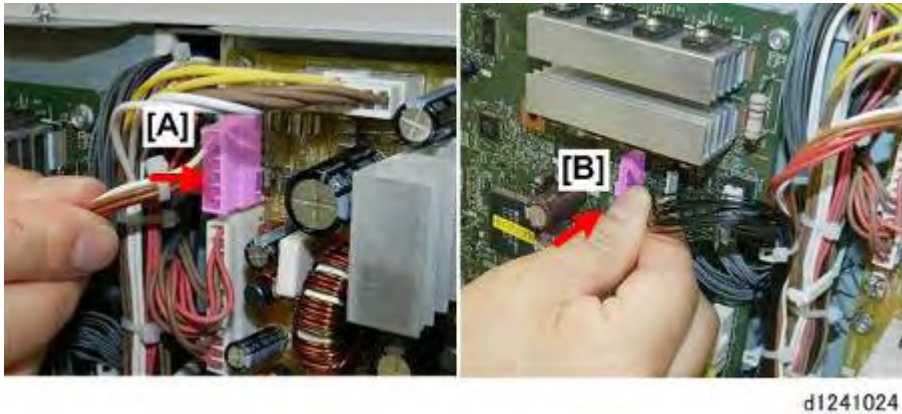

7. Insert the 6-pin connector of the harness into [A] at **CN125** on the **PSU**.
8. Insert the 19-pin connector of the harness into [B] at **CN201** on the **MCU**.
9. Close the harness clamps (🔧x2).

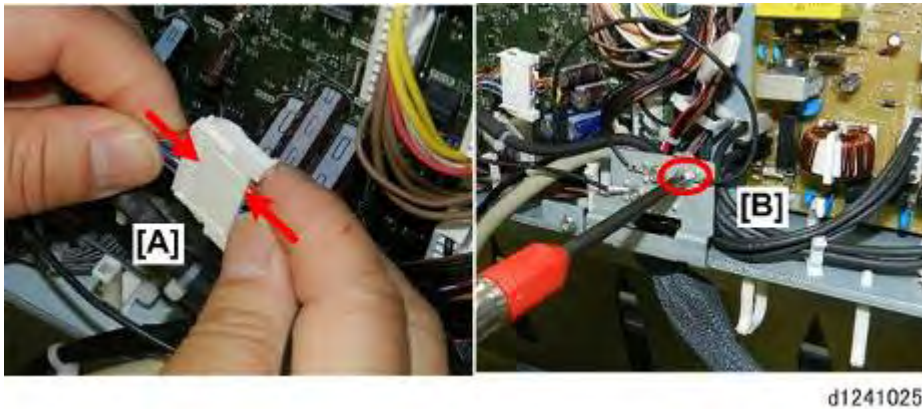

10. Connect relay harness [A] to the harness from the motherboard (🔧x1).
11. Attach ground wire [B] (🔧x1).

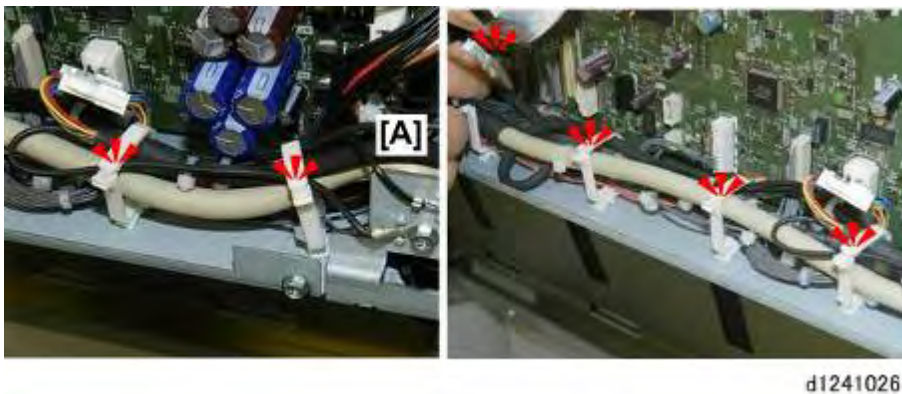

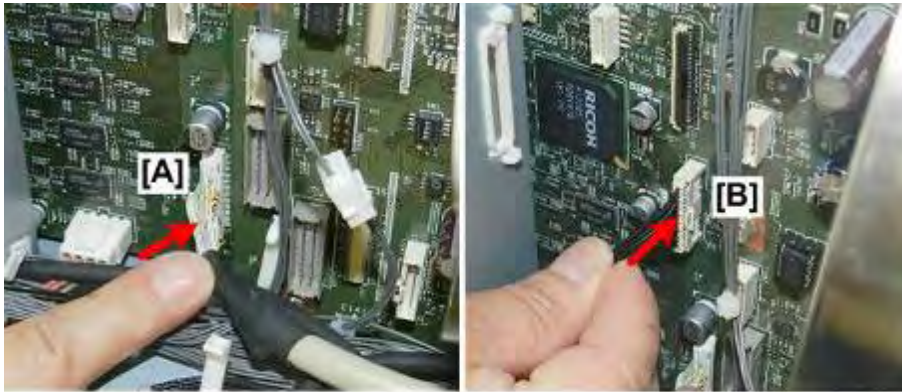

12. Starting at the I/F cable bracket [A], route and clamp the white and black harness from right to left (🔧x6).

Main Machine Installation



d1241027

13. Insert the connector of the scanner cable at [A] at **CN251** on the **IPU** ( x1).
14. Insert the 17-pin harness at [B] at **CN252** on the **IPU** ( x1).



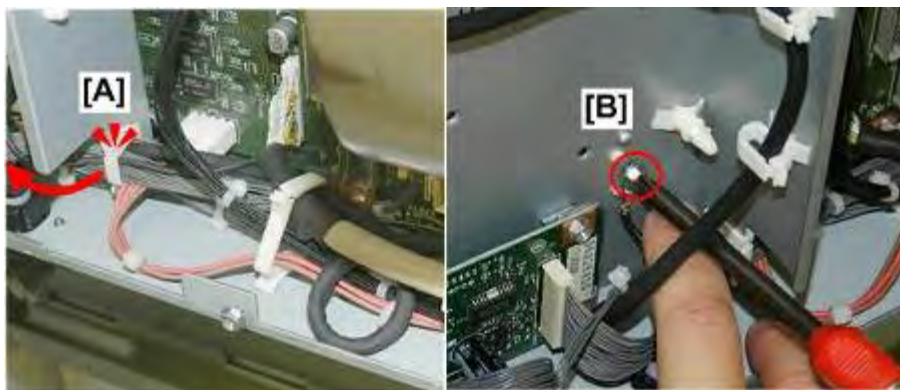

d124i307

15. Remove the shield-clamp screw, and then fasten the shielded cable with the clamp and screw ( x1).



d1241028

16. Route the black ground wire through the clamp [A] ( x1).
17. On the other side of the partition, fasten ground wire [B] ( x1 - M3x6)
18. After completing the harness and wire connections, re-attach the cover:



d124i056

- Slide the cover onto the back. Make sure all the attached screws are snug in their cut-outs.

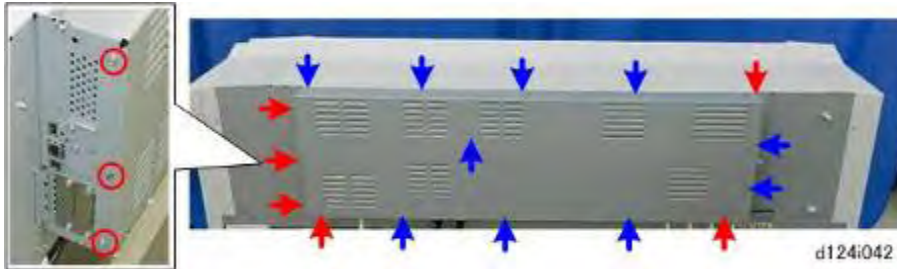

d124i042

- Re-attach the removed screws marked by the red arrows (6x6).
- Tighten the screws marked by the blue arrows (6x10).

Connect the Host USB Cable



d124i129

- The host USB cable [A] (permanently attached to the back of the operation panel) must be connected to the controller box [B] on the back of the machine.

Main Machine Installation

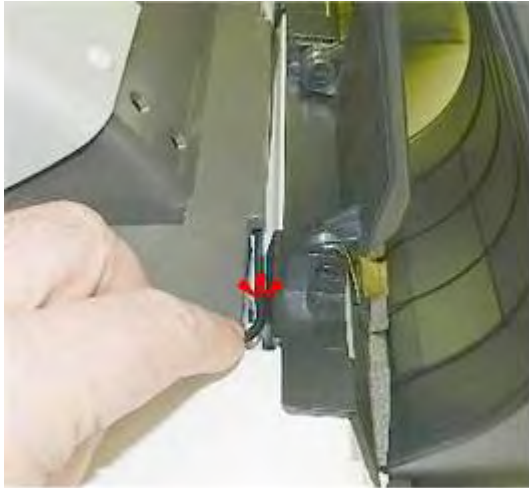

d124i130

2. Push the scanner stand close to the main unit stand.
3. At the back of the operation panel, set the cable in the groove.

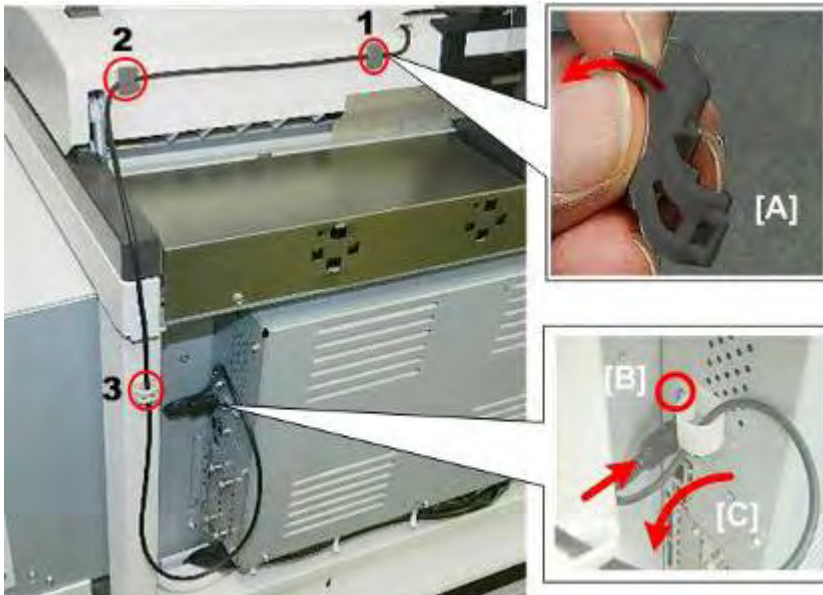

d124i131

4. Remove the tape from the back of Velcro clamps, and then set them at positions [1] and [2] shown above.
5. Attach the small clamp at [3].
6. Close and lock each clamp [A] around the cable (🔧x3).
7. Insert the cable into the controller, set the round clamp [B] around the cable and then attach the clamp to the faceplate of the controller (🔧x1 M3x8).
8. Make sure the USB cable is routed as shown.
9. Pull the cable [C] through the clamps to remove as much slack as possible.

Connect and Clamp the Power Cord, Clamp the Main Harness

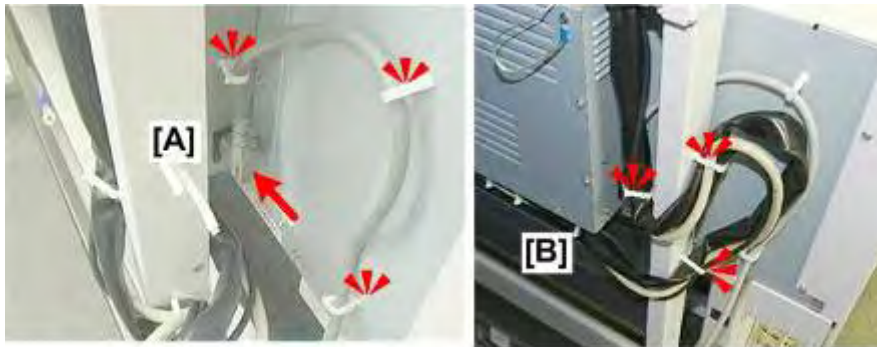

d1241032

1. Make sure that the power switch is OFF.
2. Confirm that the power cord is not connected to the power source.
3. Attach the medium-size clamps, connect the power cord [A], and then close the clamps (🔧x3).
4. Attach the large clamps, and then clamp the scanner I/F cable as shown above (🔧x3).

⚠ CAUTION

- Do not connect the power cable to the power source at this time.

Dock the Scanner Stand to the Main Unit



d124i202



1. Lower the four bolts on the base of the main unit stand.
 - You may need a wrench to loosen the bolts until you can lower them by hand.
 - Lower them until the tops are flat with the top of the stand feet but the bottoms do not touch the floor.
 - This prevents the bolts from interfering with the docking of the scanner stand and the installation of the exit stacker.

Main Machine Installation





2. At the rear, attach a joint bracket to each side of the stand ( x2 each).
3. Dock the left side of the scanner to the back of the main unit.

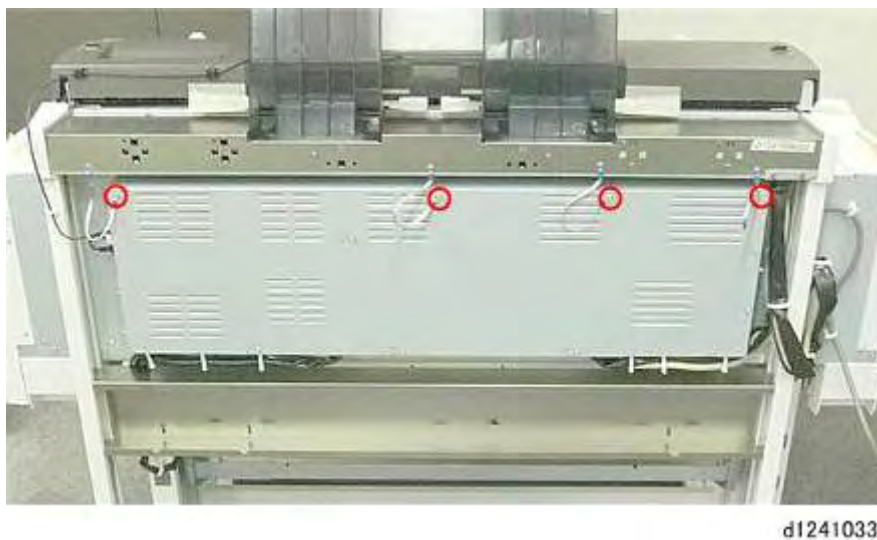

4. Fasten the scanner stand to the main unit bracket on the left [A] ( x2).
5. Fasten the scanner stand to the main unit bracket on the right [B] ( x2).
6. Connect the USB cable from the operation panel to the controller box ( x1).

Connect Ground Harnesses



1. Connect the ground harnesses to the back of the machine ( x4).

3.2.10 REMOVE TAPES AND SHIPPING MATERIALS



d124i063

1. Open the scanner unit and remove the paper sheet.
2. Remove all the external tape and other materials attached to the machine.



d124i064

3. Lift the front cover, and then fold the bottom into the machine so that it locks and remains open.

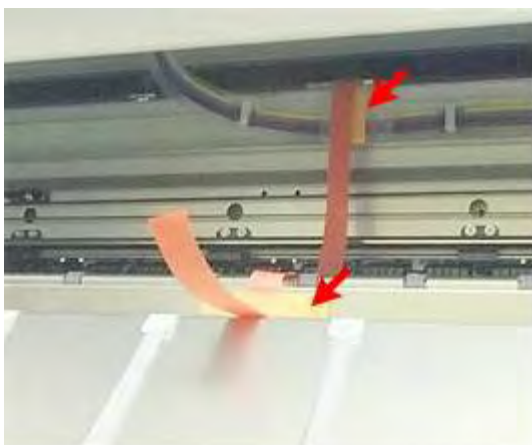

d124i064a

4. Remove the tape and cardboard.

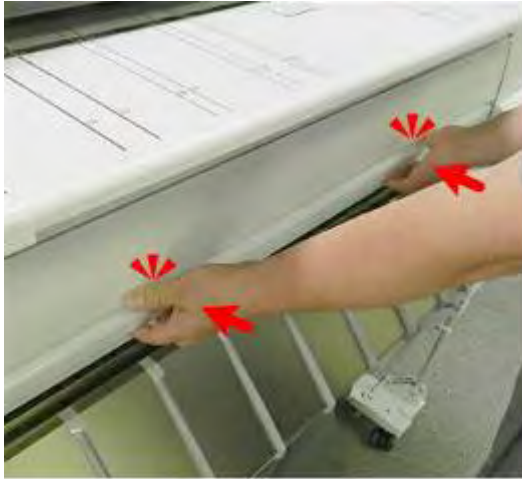

d124i308

5. Close the front cover. Push it in and make sure that it locks.

3.2.11 ORIGINAL STACKER, GUIDES



d124i065

1. Insert the projections on the bottoms of the original stacker [A] into the holes.
2. Push down the four tabs [B] to attach.



d124i066

3. Attach the original guides behind the stacker.

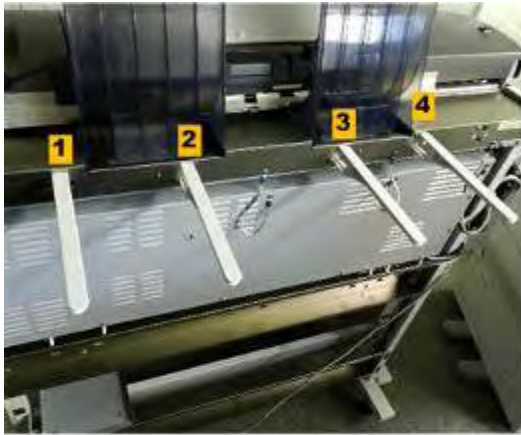

d124i067

4. Attach the four rear guides.

↓ **Note**

- There are six connection slots for the guides. However, attach the guides to the inner four points (leave both outer slots empty).



d124i068

5. Use the rivets to attach the manual pocket to the left side of the main unit stand (🔩 x2).

↓ **Note**

- To set a rivet, align the rivet with its hole, and then just push in.

Main Machine Installation



d124i069

6. Attach the optical cloth pocket at the location shown above.
 - First, dampen a clean cloth with a small amount of water or alcohol, and then wipe the surface where the optical cloth pocket will be attached.
 - Remove the tape from the back of the pocket, and then attach it as shown above.
7. Place the optical cloth in the pocket.

3.2.12 INK COLLECTOR TANK STORAGE SHELF



1. The ink collector tank storage shelf [A] is attached to the bottom cross-piece of the scanner stand.



2. Fasten the shelf to the cross-piece ( x2 M4x8).
3. Set the extra ink collector tank on the shelf.
 - When the ink collector tank becomes full, the machine will stop.
 - The operator can remove the full tank and replace it with the empty tank.
 - At the next PM visit, the service technician can swap the full tank with another empty tank (a service part, not a consumable).

3.2.13 ASSEMBLE AND INSTALL THE EXIT STACKER

Accessories: Exit Stacker

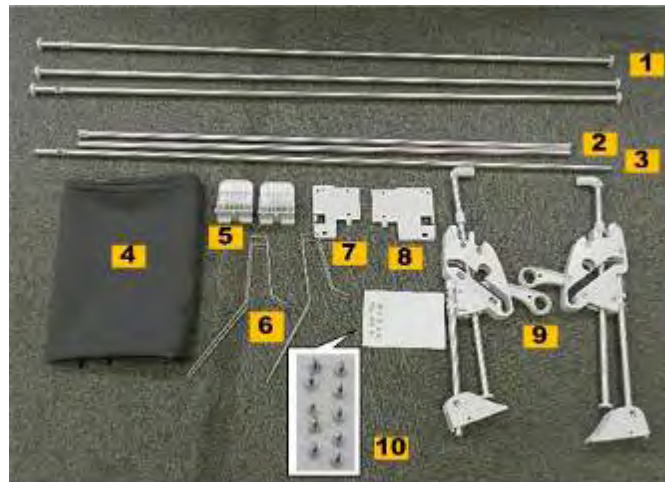

d124i070

No.	Item	Q'ty
1.	Rod: Long, capped	3
2.	Rod: Short, capped	2
3.	Rod: Long, uncapped	1
4.	Cloth	1
5.	Molded Bracket	2
6.	Wire Guide	2
7.	Plate Bracket: Small	1
8.	Plate Bracket: Large	1
9.	Side Frame	2
10.	Hex Socket Bolt M4x8*1	10

*1 You will need an Allen key to attach the hex socket bolts.



Installation: Exit Stacker

d124r733

1. If the bolts are up on the front feet of the main unit stand, lower them.



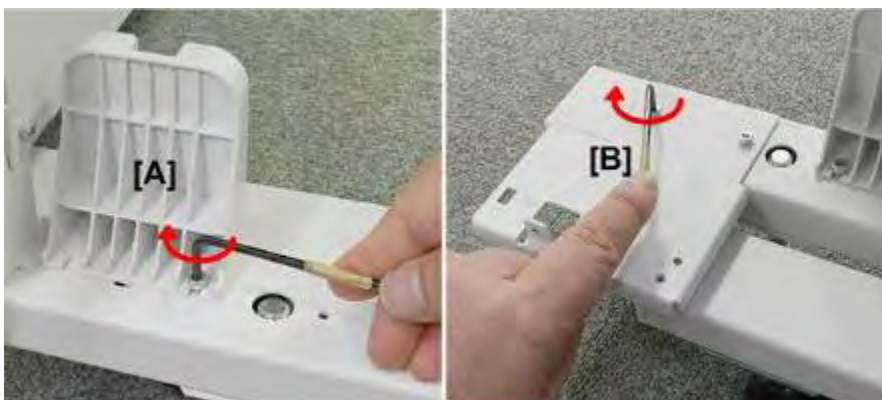

d124i309

2. On the right foot, use an Allen key to:
 - Attach molded bracket [A] ( x1).
 - Attach **large** plate bracket [B] ( x1).



d124i310

3. On the left foot, use an Allen key to:
 - Attach one molded bracket [A] ( x1).
 - Attach **small** plate bracket [B] ( x1).

Main Machine Installation

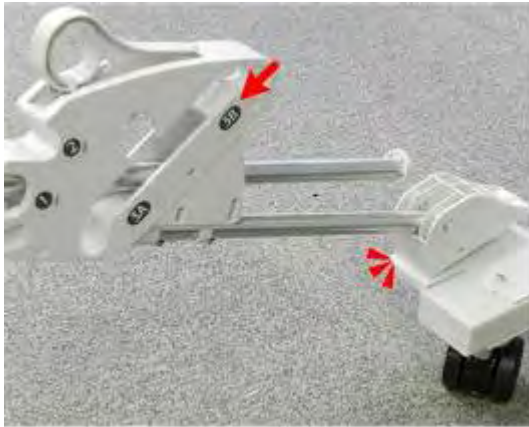

d124i311

4. Set the left side frame (the one with the number decals) on the plate bracket of the left foot.



d124i312

5. Fasten the left side arm to the left foot ( x2).

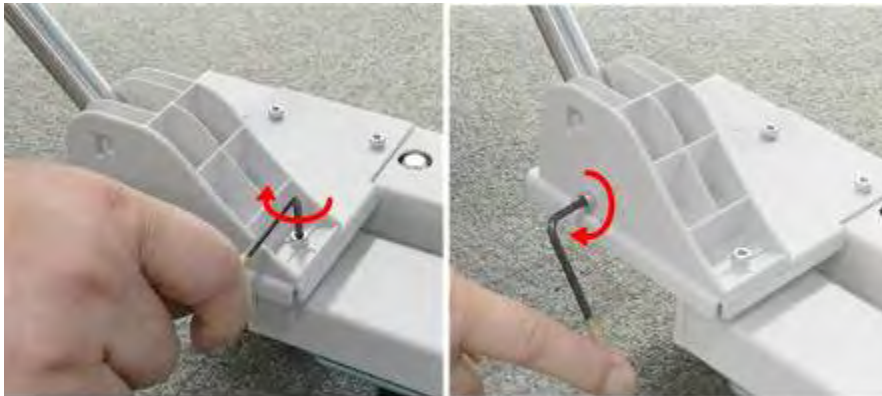

d124i313

6. Fasten the right side arm to the right foot ( x1).



7. On the **right** foot, set the shaft as shown at [A] (not [B]).

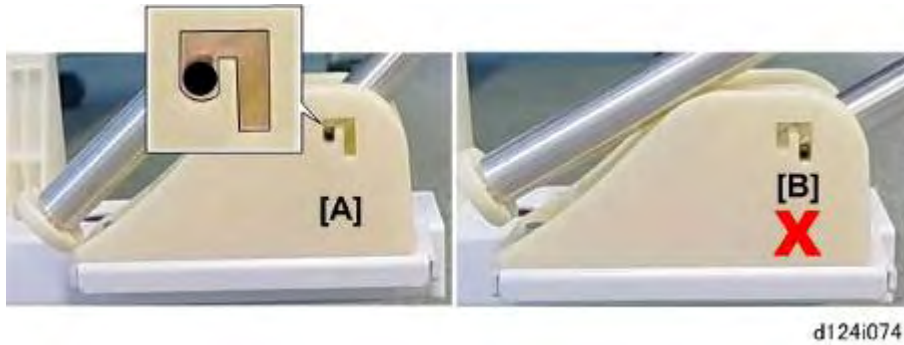

8. On the **left** foot, set the shaft as shown at [A] (not [B]).



9. Turn the cloth with the rod sleeve [A] facing down, and then spread the cloth on the floor.

Installation

Main Machine Installation

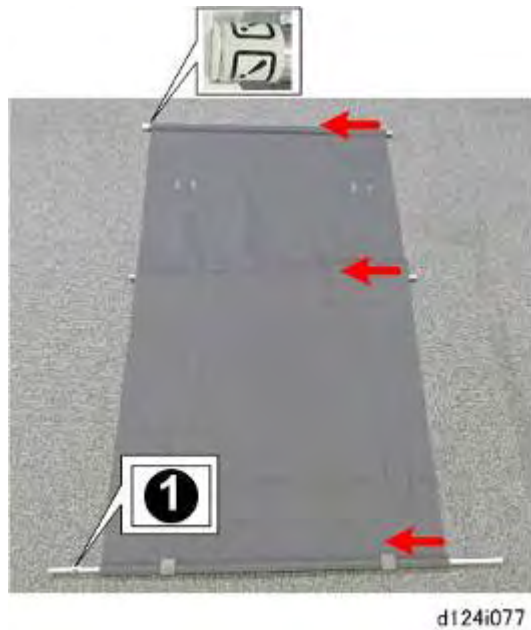

10. Insert the long cap-less rod ① through the sleeve.
11. Insert the remaining short rods through the other sleeves.
 - The rear rod is marked with an exclamation mark (!),
 - The center rod above is unmarked. It is the same length as the rod marked with the exclamation mark (!).



12. Raise the exit guide.

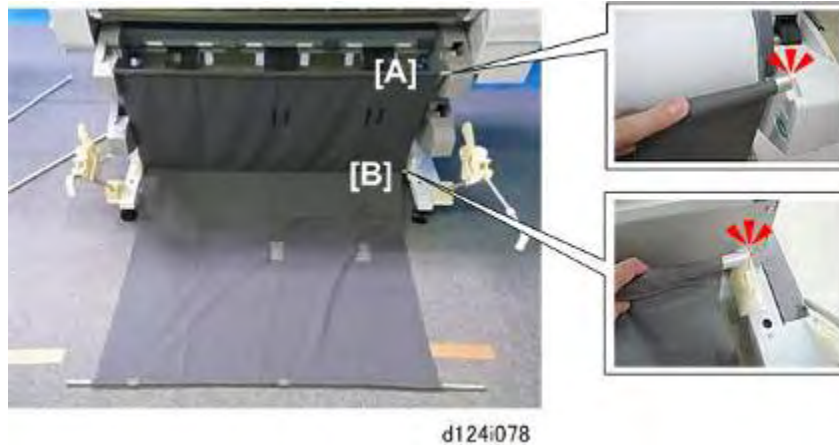

13. Set both ends of rod [A] (**marked with an exclamation mark (!)**) and inserted in the sleeve at the far edge of the cloth) into the slots in the left and right side of Roll Unit 1.
14. Set both ends of the rod [B] (**unmarked** and inserted in the sleeve at the center of the cloth) into the slots in the molded brackets on the left and right side of the frame.

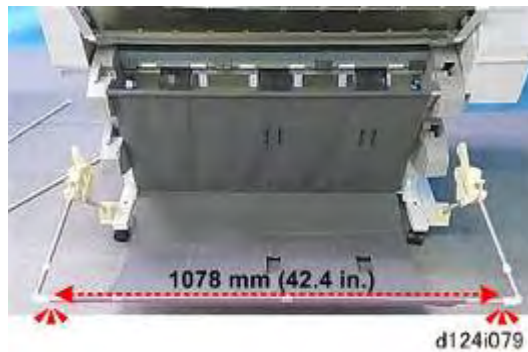

15. Set both ends of the long cap-less rod (marked "①") at the front edge of the cloth into the L-brackets on the ends of the left and right arms.
 - When you set the ends of the rods, make sure they are inserted completely.
 - If an end of the long rod at the front is not capped completely, the remaining rods will not install correctly.
 - The bare rod should measure about 1078 mm (42.4 in.) from end to end between the plastic caps when it is installed correctly.

Main Machine Installation



d124i080

16. Check the arrangement of the rods. The photo above shows the correct positions of all three rods inserted through the cloth sleeves.

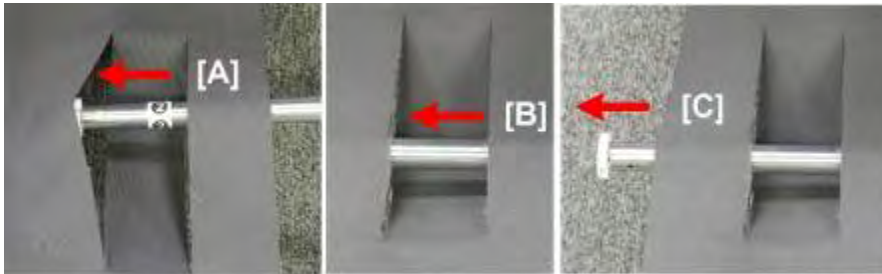

d124i314

17. At the front, pass the long rod marked ② into the left slit [A], through the center slit [B], and out of the right slit [C].



d124i315

18. Set the end of the rod [A] marked with the "2" decal on the left, in front of the "2" decal on the left side arm.
19. Set the other end of the rod [B] in the groove of the right side arm.

★ Important

- If the rod does not fit, or if one of the caps comes off, this means that the front rod is not snug in its L-joints.
- Check both ends of the front rod and make sure that the ends of the rod are inserted tightly into the L-joints.

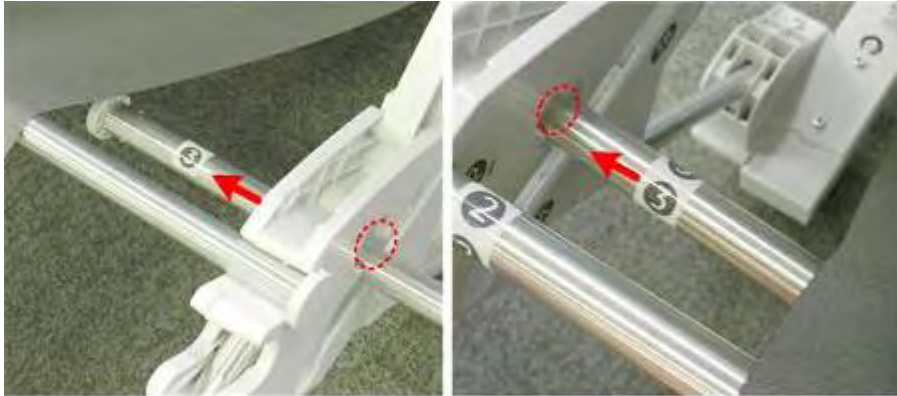

d124i316

20. Insert the end of the rod marked ③ into the round hole of the right side arm.

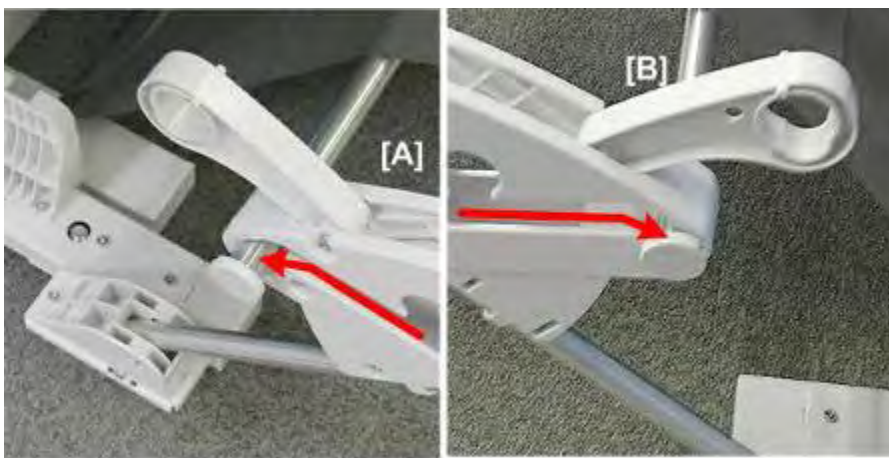

d124i317

21. Slide the ends of rod ③ to the back and down on the left [A] and the right [B].

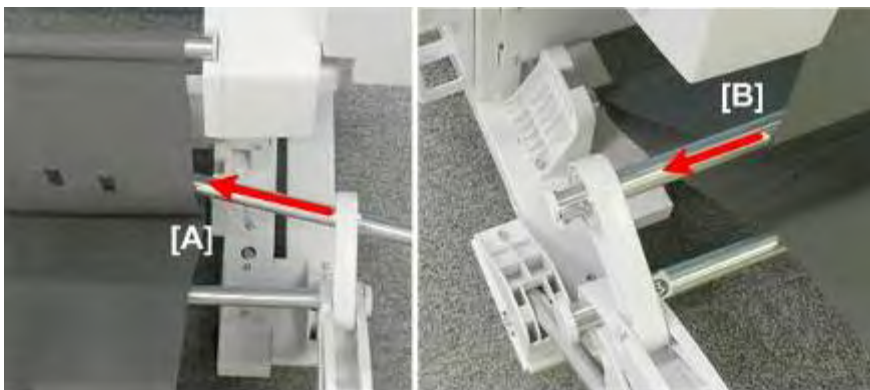

d124i318

22. Take the last rod (capped and not marked with a number), and pass it through the round hole in the arm on the right [A].
23. Push it to the left **behind** the cloth. **Do not** push it through the small slits in the cloth.
24. Push the end of the rod through the hole in the arm on the left [B].



d124i319

25. This completes the installation of the exit stacker.

Changing Exit Stacker Mode

The configuration of the exit stacker can be adjusted for two modes: Basket Mode and Stack Mode.

- **Stack Mode.** For A0 SEF/A1 LEF paper. The exit stacker is extended so that it is flat and can hold up to 10 stacked sheets.

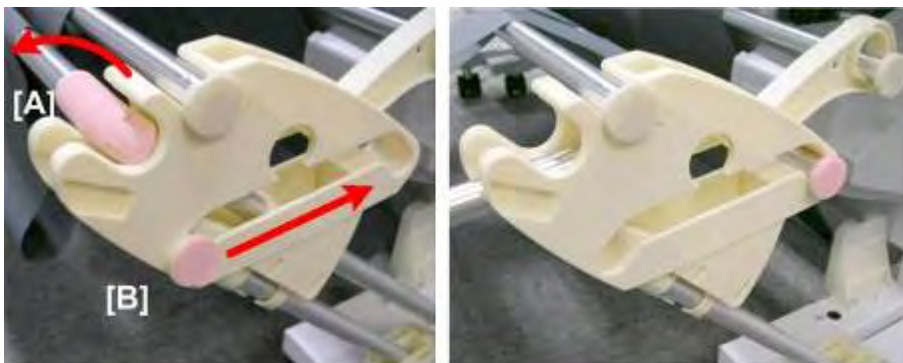

d124i087

1. Pull out and lower the extension bar [A].
2. Move rod both ends of rod [B] to the rear.



d124i088

- **Basket Mode.** For A0/A1 SEF paper. The exit stacker is shortened so that it is rounded and deep to hold paper in a small well. Holds one sheet.

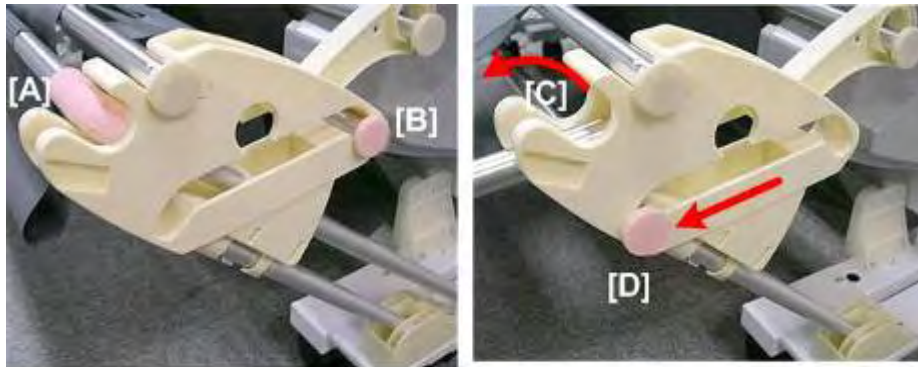

d124i084

1. In the photo on the left, the extension [A] is down and the rod [B] is at the rear.
2. Pull out the extension at [C], and then move both ends of the rod [D] forward.



d124i085

3. Push down both sides of the extension [A].



d124i086

- **Wire Guide Mode.** For A1 SEF/A2 LEF Paper. With the exit stacker set up for either the basket mode or stacker mode, two wire guides can be attached for A1 SEF or A2 LEF paper.

Main Machine Installation

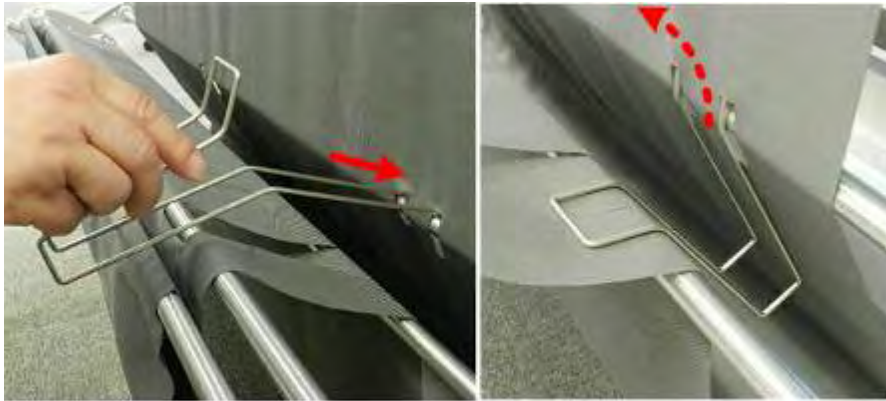

d124i320

1. Insert the prongs into the holes, on the left and right.



d124i321

3.2.14 INK FILLING

Before a machine leaves the factory, the ink supply tubes, sub tanks, and print heads are filled with fluid. This priming fluid prevents the seams of the joints and connections of the ink supply system from drying out during shipping and storage.

- The priming fluid must be drained completely from the ink supply tubes, ink tanks, and print heads at installation before they are filled with ink.
- Special cartridges, the same shape as ink cartridges, are loaded into the ink supply unit. The ink pumps rotate in reverse to draw the priming fluid out of the print head units and ink supply tubes.

⚠ CAUTION

- Never switch the machine off or try to use the operation panel during the following procedure.
- Do not touch the machine while it is draining.



d1241002

Draining and Filling Procedure

1. Remove the drain cartridges [1] and starter ink cartridges [2] from their packing material.
2. Insert the power cord into a power source.
3. Open the ink cartridge cover.

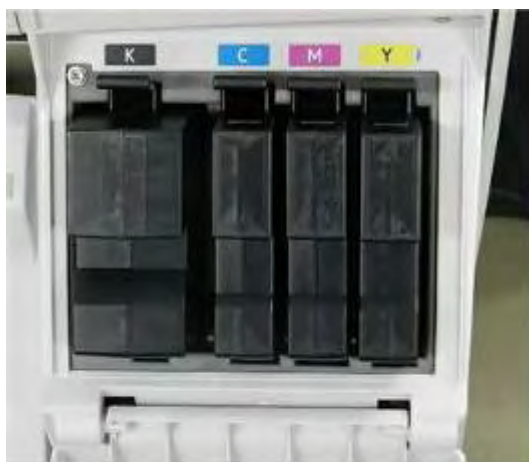

d1241003

Main Machine Installation

4. Load the Primer Fluid Drain Cartridges into the ink supply unit, and then close the cover.
5. Turn the machine on.
6. Wait for the machine to beep twice.
7. Enter the SP mode and open **SP2012-001** (Initial Operation Setting), and then make sure that it is set to "9".
8. Next, open **SP2100-004** (Special Maintenance), enter "15" and then press [#].
 - The ink pumps start operating in reverse to draw the fluid out of the print head units and the tubes.
 - Draining the fluid requires about 7 min. and 20 sec.
9. The procedure is finished when a message tells you the procedure has completed. The machine disables the cartridges so that they can no longer be used.

Important

- **If the draining operation does not start, go to the next section below for more about an alternative procedure.**
10. Turn the machine off.



d1241004

11. Remove the primer fluid drain cartridges and replace them with the starter ink cartridges.
12. Close the cartridge cover.

CAUTION

- Never switch the machine off or try to use the operation panel during ink filling.
 - Do not touch the machine during ink filling.
13. Turn the machine on.
 - The ink filling sequence will start automatically.
 - The ink filling requires about 20 min.
 - After filling, the machine may display the pre-near end alert for one or more of the color ink cartridges. This is normal.
 - If you do not see a message that tells you filling has started, cycle the machine off/on and try again.
 14. After the procedure is completed, open **SP2012-001** and confirm that it displays "0".

15. Discard the filled primer fluid drain cartridges.

★ Important

- Obey the local laws and regulations regarding the disposal of items such as the primer fluid drain cartridges.

If Draining Fails to Start

If one or more of the ID chips on the drain cartridges is damaged, the operation may not start. Even if you set **SP2100-004** to "15", the fluid will fail to drain from the tubes, ink sub tanks, and print heads.

1. Open **SP2012-001** and set it to "3".
2. Turn the machine off.
3. Remove the drain cartridges, and then replace them with the ink starter cartridges.
4. Close the ink cartridge cover.
5. Turn the machine on.
 - Ink filling starts.
 - The ink and primer fluid are purged from the tubes, ink sub tanks and the print heads into the ink collector tank.
6. After the operation is completed, flush all the print heads three times. ([User Tools> Maintenance> Flush Print Heads> Select all]).

↓ Note

- At the end of filling and purging of ink and fluid into the ink collector tank, **SP2012-001** resets automatically to "0"
7. Print a Nozzle Check Pattern to check the condition of the print heads.

3.2.15 SET ROLL PAPER

1. Select a paper type for each paper feed station: User Tool > System Settings > Tray Paper Setting > Next > Paper Type: Tray n
2. Select the paper type for each paper feed station:
 - Paper Type: Paper Bypass
 - Paper Type: Paper Input 1
 - Paper Type: Paper Input 2
3. Make sure that the machine is turned on.

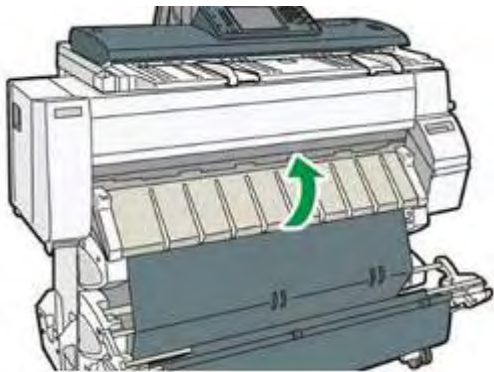

d124i091

4. Raise the paper exit guide.

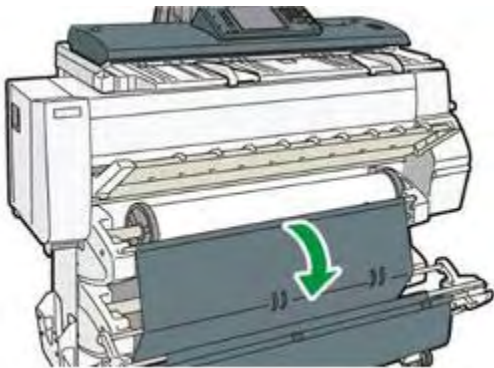

d124i092

5. Remove the exit stacker rod attached to the front of Roll Unit 1.

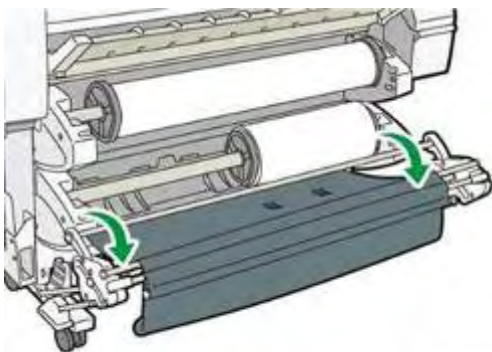

d124i093

6. Lower the exit stacker rod attached to the front of Roll Unit 2 (if it is installed).

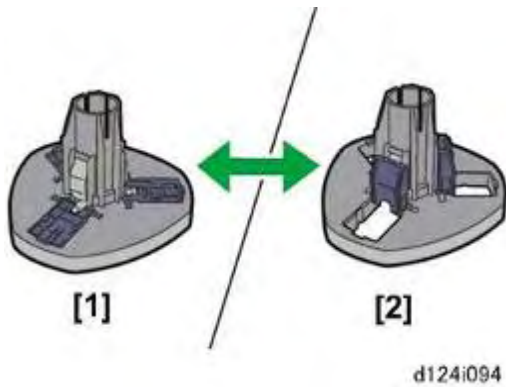

7. Set the roller stopper for the size of the roll core of the paper roll to be loaded. Moving the levers left and right adjusts for the size of the roll core. Both roller stoppers must be set identically.
- For a 2-in. core, lower the levers [1] of both stoppers so they are flat.
 - For a 3-in. core, raise the levers [2] of both stoppers.

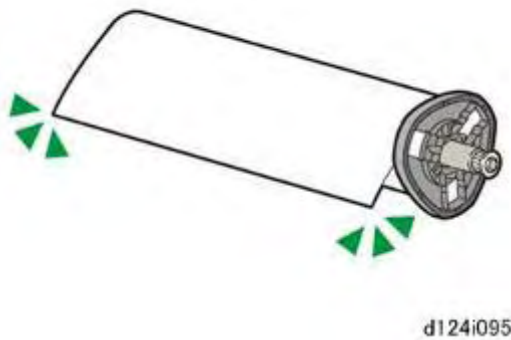

8. Set the roll on the shaft so the leading edge of the paper is pointed down.

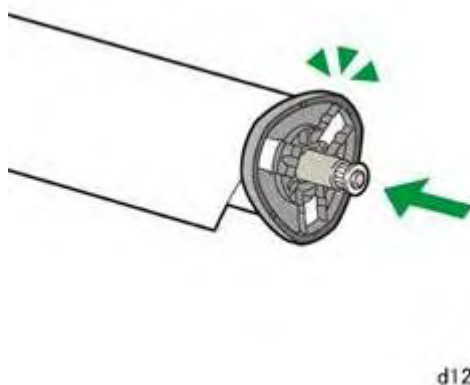

9. Push the paper roll against the stopper on the end of the shaft.

Main Machine Installation

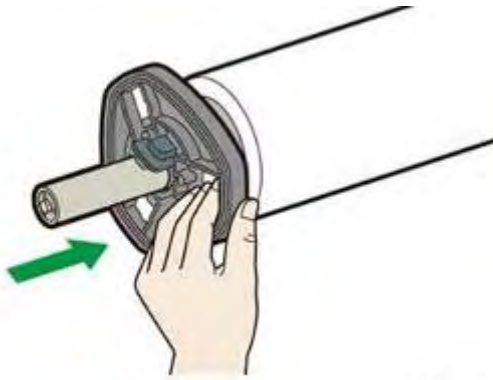

d124i097

10. Set the other paper holder on the left end of the shaft:

- While pressing in with your hand on the right end of the paper roll, press the left paper holder with your other hand until the right end of the roll is against the right paper holder.
- Lower and lock the lever of the left paper holder.

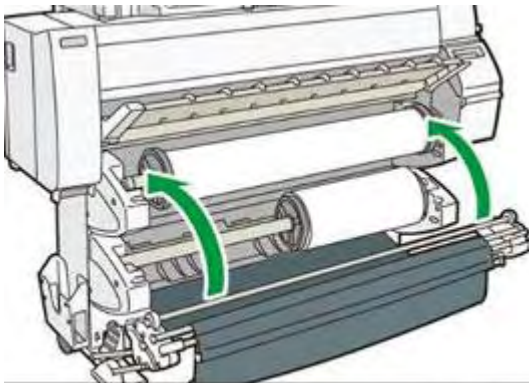

d124i098

11. Set the paper rolls in the roll units.

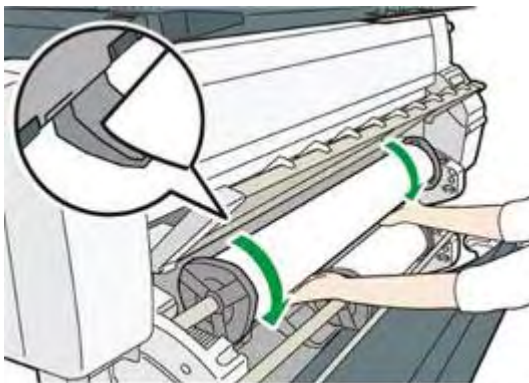

d124i099

12. Set the left and right ends of the rolls in the roll unit sockets, and then pull the leading edge of the paper slightly so that it hangs down.
13. While holding both sides of the leading edge of the paper, rotate and feed the paper up about 1/3 of the distance into the machine.
14. Make sure that the leading edge of the paper passes over the top of the paper guide inside the machine.

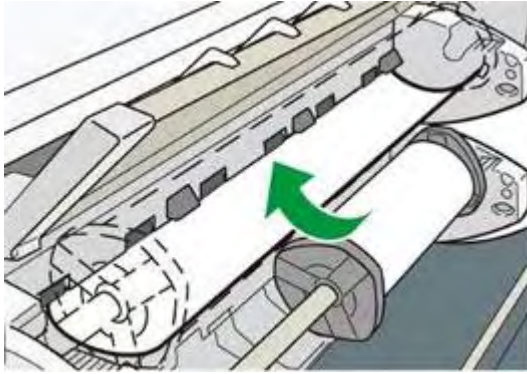

15. Insert the leading edge of the roll paper below the roller at the feed slot, and then feed the paper into the machine until the machine grabs and pulls the paper slightly. (When the machine detects the leading edge of the paper, it will grab it and then sound a buzzer.)

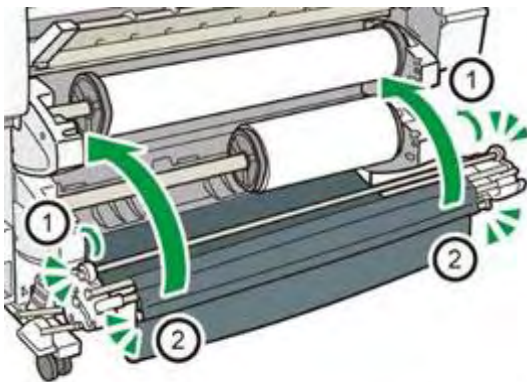

d124i101

16. Re-set the exit stacker rods to their original positions.
 17. When you see the cover open alert on the operation panel, close the exit guide.

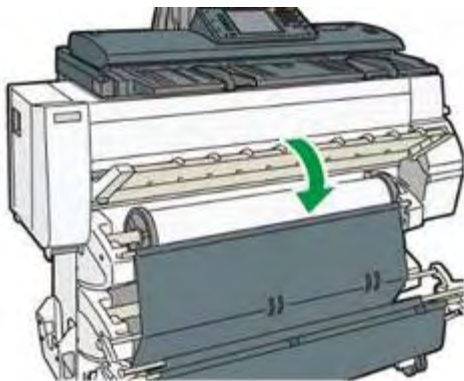

d124i102

18. Lower the paper exit guide plate.
 19. When the message on the operation panel prompts you to select cutting or no cutting:
 - Touch [Cut] to make a clean edge if the paper has been cut manually or is damp.
Selecting "Cut" is strongly recommended.
 - Touch [Do Not Cut] if you do not want a fresh cut on the leading edge of the paper.
 20. When the next message prompts you to confirm the paper type and thickness, select the correct setting for the paper type and thickness of the paper loaded in the machine.

Main Machine Installation

- Touch [Match] if the Paper Type and Paper Thickness Settings match those of the paper loaded in the machine.
 - or-
 - Touch [Does Not Match] if the Paper Type and Paper Thickness Settings do not match those of the paper loaded in the machine. Then input the correct settings.
21. The roll paper feeds into the machine.
 - Next, the paper will feed out of the machine, reverse feed, and then automatically stop at the prescribed print start position.
 - If [Cut] was selected at Step 17, then the leading edge of the paper is cut off.
 22. Check the display and make sure that correct setting for the paper size is selected.

3.2.16 REWINDING A ROLL

You need to rewind the roll before removing it for temporary storage or swapping it for another roll.

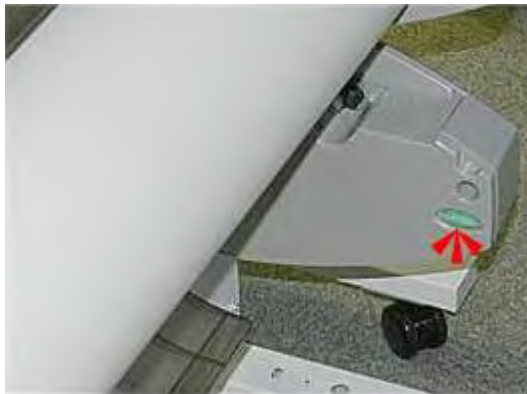

d124i204

1. Press and hold the rewind button on the right side for at least 2 seconds. You may need to depress the button longer if the paper does not come out of the machine.
2. The roll will reverse feed out of the machine onto the roll.

★ Important

- The paper rolls installed in the machine are not enclosed and remain exposed to ambient temperature and humidity.
- If the machine has remained idle for a long time, before you use the machine it is recommended that you rewind the roll, cut off the equivalent of two full roll rotations, and then reload the paper.

3.2.17 CHECK PRINTING

Nozzle Check Pattern

1. Press [User Tools] on the operation panel.
2. Touch [Maintenance] and then select "Print Nozzle Check Pattern".
3. Follow the prompts to start printing the pattern.
4. Use a loupe or magnifying glass to check the condition of the pattern.

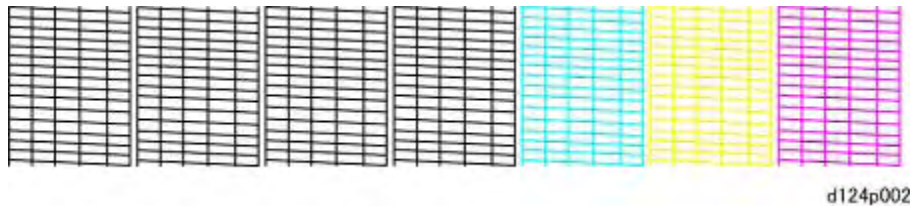

- If the pattern shows no broken lines, the machine is ready for operation.

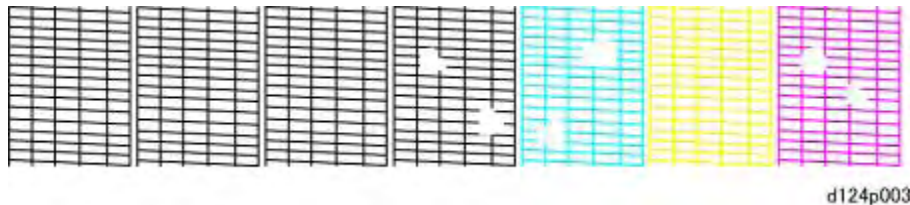

- If any of the lines are broken, identify the patterns where the broken lines exist, and then clean the print heads. (See below.)
5. Press [User Tools] on the operation panel.
 6. Touch [Maintenance] > [Clean Print-heads]
 7. Select the print head(s) to clean then touch [Start], and then follow the prompts to complete the cleaning.
 8. Print another Nozzle Check Pattern, and then check the results.
 - If the patterns have no broken lines, you have finished.
 - If there are still broken lines in one or more of the patterns, clean the print heads again, and then print another Nozzle Check Pattern.
 - If lines still exist after the third cleaning and Nozzle Check Pattern printing, touch [Exit], and then flush the print heads.

★ Important

- Flushing the print heads consumes a large amount of ink.
 - Never execute print head flushing until you have executed print head cleaning at least 3 times.
9. Touch [Flush Print-heads].
 10. Follow the prompts to complete print head flushing.
 11. Print another Nozzle Check Pattern.
 - If the patterns have no broken lines, you have finished.

- If there are still broken lines in the patterns, go to the next section.

When Printing Cannot Be Restored

Do this procedure if three cleanings and one flushing have failed to produce an unbroken Nozzle Check Pattern.

1. Make sure that the ambient temperature and humidity are within the acceptable range:
 - Temperature Range: 10°C to 27°C (50 °F to 81°F)
 - Humidity Range: 15% to 80% Rh
2. Clean the print heads again, and then print another Nozzle Check Pattern.
3. If the Nozzle Check Pattern is still abnormal, let the machine remain idle for 10 minutes.
4. Execute two more cleanings and one flushing.
 - Be sure to print a Nozzle Check Pattern after each cleaning and the flushing.
 - If you have produced an unbroken Nozzle Check Pattern, you can stop.
5. After the flushing, if the Nozzle Check Pattern is still not perfect, let the machine remain idle for 8 hours.
6. Execute three more cleanings and one flushing.
 - Be sure to print a Nozzle Check Pattern after each cleaning and the flushing.
 - When you have produced an unbroken Nozzle Check Pattern, you can stop.
7. If the Nozzle Check Pattern is still unsatisfactory:
 - Go into the SP mode and open **SP2100-002**.
 - Enter the number of the print head that is abnormal.

To Service:	Color	You Enter:
Head 1	K1 (Black)	1
Head 2	K2 (Black)	2
Head 3	C (Cyan)	4
Head 4	YM (Yellow/Magenta)	8
All	K, C, Y, M	15

- If you need to flush more than one head (but not all). add their entry numbers and then enter the sum. For example, to clean Head 2 and Head 3, add 2+ 4 and then enter "6"

Halftone Check

Leftover primer fluid can cause streaking in halftone areas. Do this check to confirm that all of the primer fluid has been drained from the from the ink sub tanks and ink supply tubes.

1. At the initial screen, press the User Tools button .
2. Touch [Printer Features].
3. On the Printer Features screen, under the List/Test Prints tab, touch [Color Sample].
The color sample prints about 240 palette samples. This is a very large sample and may require a minute or so to finish printing.

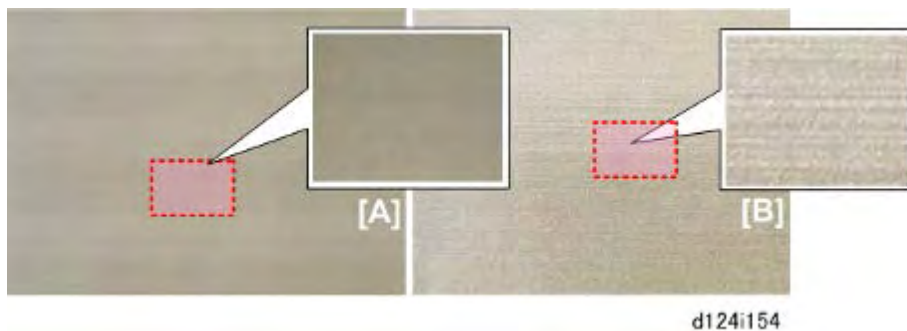

4. Check several of the sample blocks.
 - The left side [A] shows a normal, half-tone pattern with no streaks.
 - If the primer fluid did not drain completely, this can cause light streaks to appear in half-tone areas [B].
5. If you detect any streaking, flush the print head of the color where you see the problem.
 - Press [User Tools] on the operation panel.
 - Touch [Maintenance] > [Flush Print-heads]
 - When the message tells you flushing is completed, repeat the procedure.
 - Flush the print heads three times.

3.2.18 FINAL ADJUSTMENTS

Caster Lock



d124i162

1. Lower the caster locks on the left and right front casters to keep the machine from moving.

Level Adjustment

Adjust the level of the machine if it is on an uneven surface.



d124i163

1. Place a shoe under the bolt at each corner of the machine.
2. Turn each bolt to lower it onto the shoe until it is snug.



d124i164

3. Open the front cover.
4. Place a level on the cross-piece in front of the platen.



d124i165

5. Use a wrench to adjust the height of each bolt to level the machine.

Front to back:	Not more than 5 mm from level
Right to left:	Not more than 0.15/1000 mm from level.

Manual Adjust Head Position

1. Press the  button on the operation panel.
2. Touch [Maintenance].

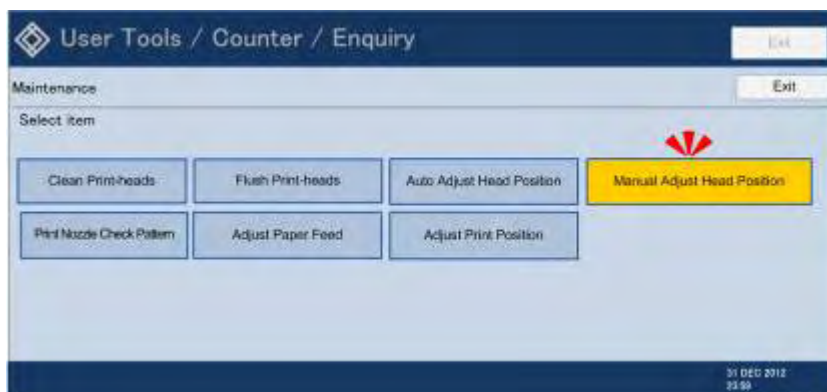

d124r674

3. Touch [Manual Adjust Print Head Position].

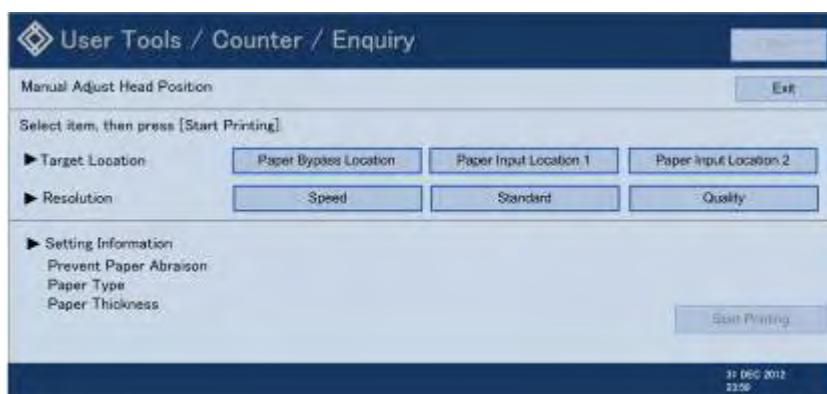

d124r675

Target Location (Paper Source)

Paper Bypass Location	Bypass paper feed
Paper Input Location 1	Roll Unit 1
Paper Input Location 2	Roll Unit 2

Resolution

Speed	Draft
Standard	Standard quality
Quality	High quality

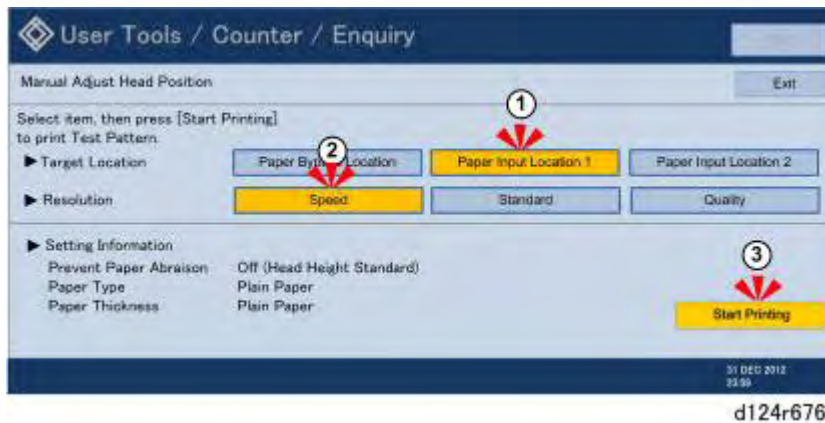

4. Select the Target Location and Resolution, and then touch [Start Printing]. A message will ask you to wait while the while the test pattern prints.

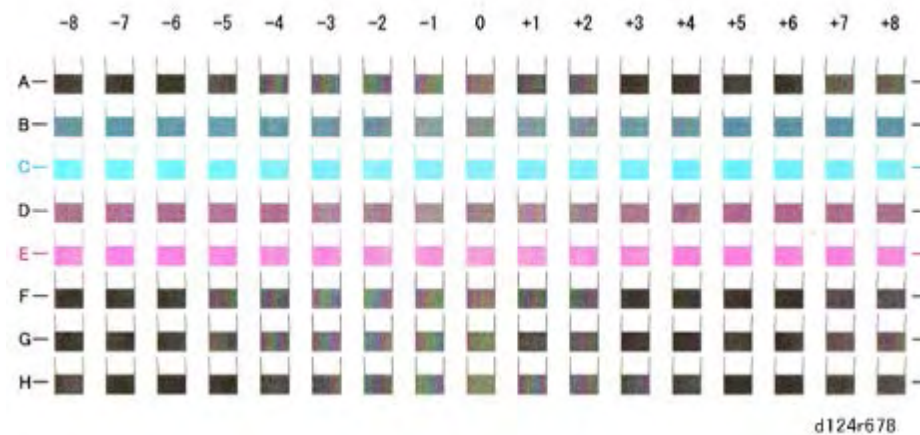

5. Look at the test pattern. To determine the adjustment value:
 - Identify the number of the column where the square is faintest, or select the square where the internal lines overlap to form a solid color.
 - The number above the square is the adjustment value.
 - If you still cannot determine the adjustment value, select the square that is between the straightest vertical lines.
 - Write down these values for use later in the procedure (A4, B2, etc.)
6. When the next message tells you that printing is completed, touch [Adjustment].

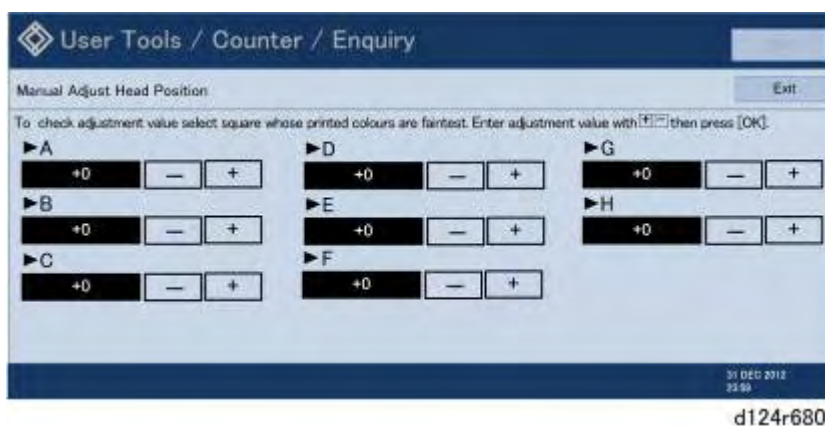

7. Enter the values for each row. (Just press the plus or minus button; the numbers will appear automatically.)

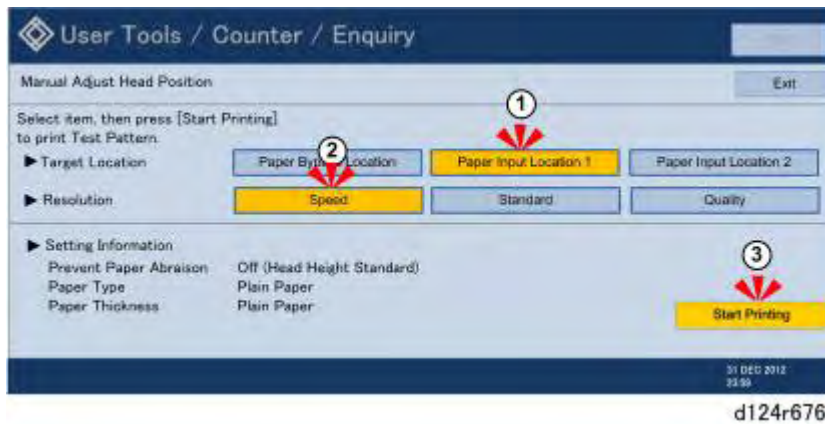

8. Print another test pattern.
9. Make sure that the numbers you entered correspond to the results in the new test pattern.

Adjust Paper Feed

Adjust paper feed if you see these problems in the prints:

- Broken horizontal lines
 - Patchy images (uneven filled areas)
 - White lines at regular intervals
1. Press the  button on the operation panel.
 2. Touch [Maintenance].

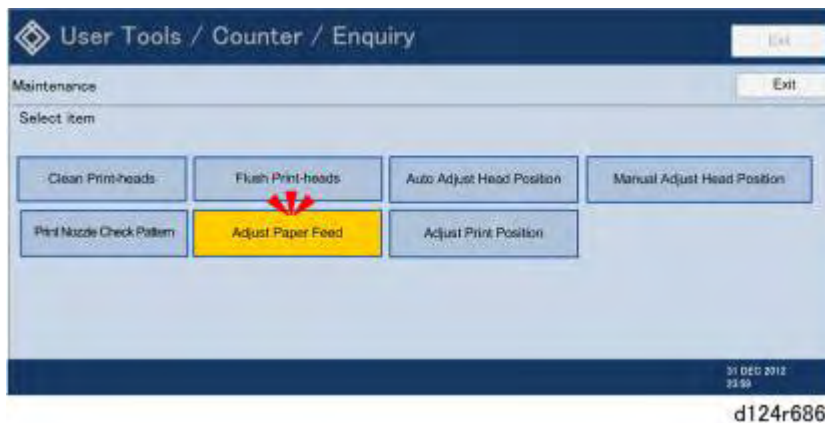

3. Touch [Adjust Paper Feed].

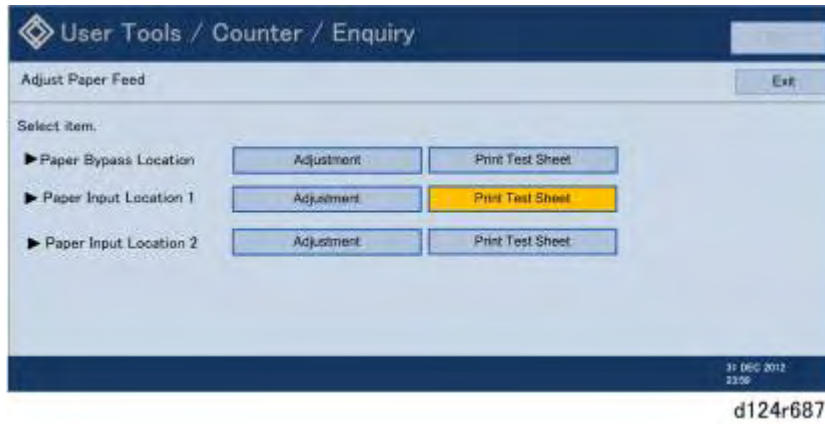

4. Select [Print Test Pattern] for the paper feed source.

Paper Bypass Location	Bypass paper feed
Paper Input Location 1	Roll Unit 1
Paper Input Location 2	Roll Unit 2

Installation

5. When you are prompted to start the print, touch [Start Printing].

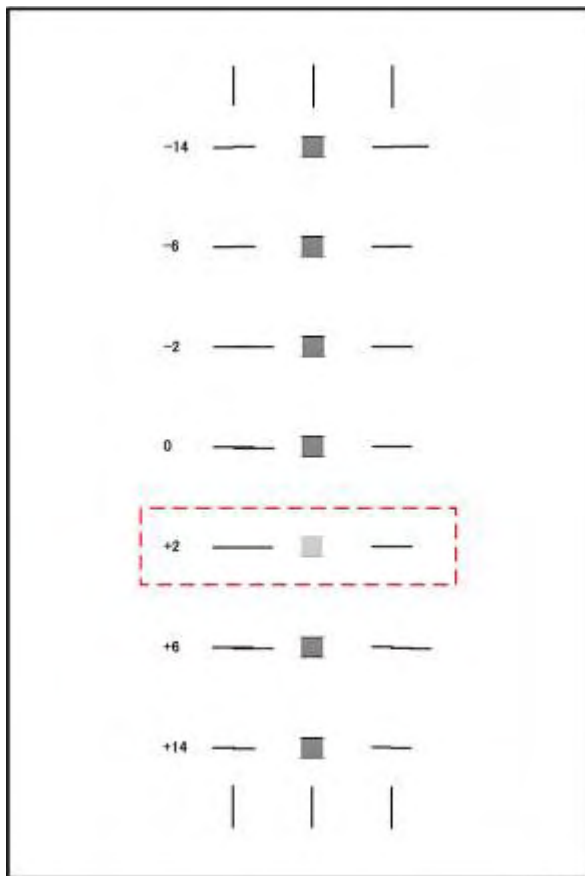

6. The adjustment value appears to the left of the lightest gray square with straight horizontal lines on both sides.

Main Machine Installation

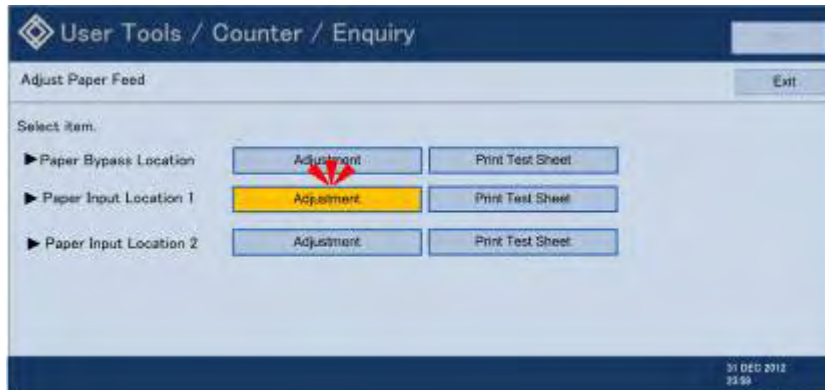

d124r690

7. Touch [Adjustment].

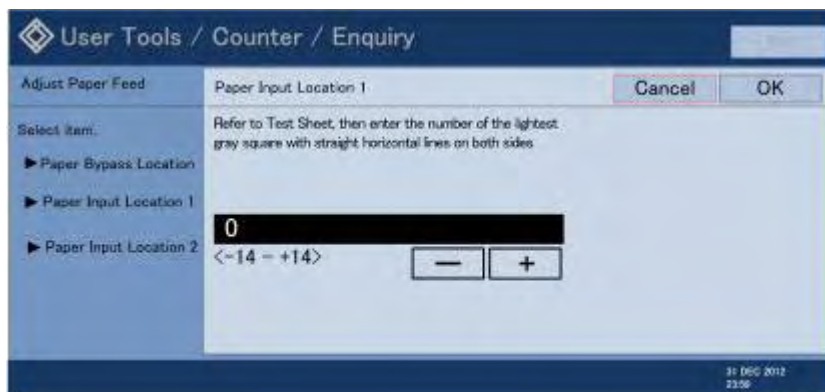

d124r697

8. Touch the plus or minus key to enter the number where you identified the correct value in the test print. (Pressing either key increments/decrements the numbers automatically.)

Adjust Print Position

This procedure checks and allows you to adjust the print start position at the upper left corner of each sheet.

1. Press the  button on the operation panel.
2. Touch [Maintenance].

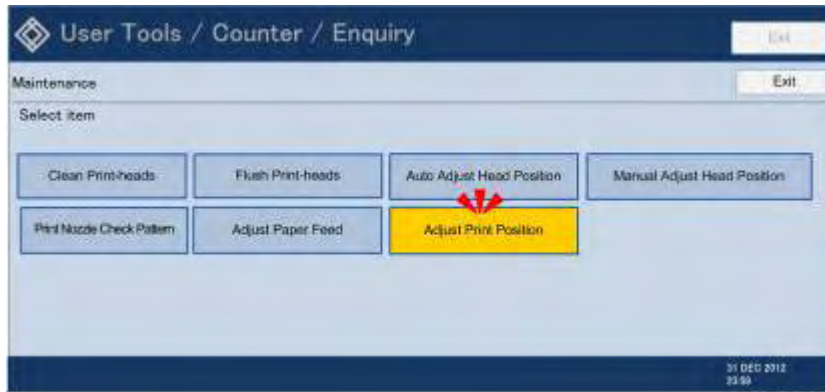

d124r692

3. Touch [Adjust Print Position].

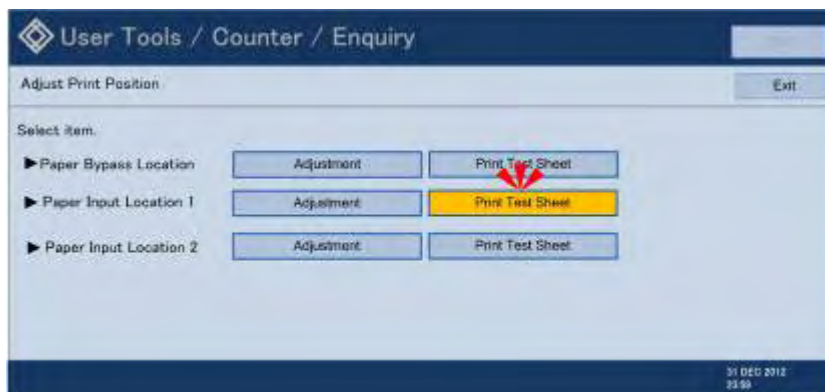

d124r693

4. Select [Print Test Sheet] for the paper feed source.

Paper Bypass Location	Bypass paper feed
Paper Input Location 1	Roll Unit 1
Paper Input Location 2	Roll Unit 2

5. When you are prompted to start the print, touch [Start Printing]. A message will ask you to wait while the test sheet is printing.

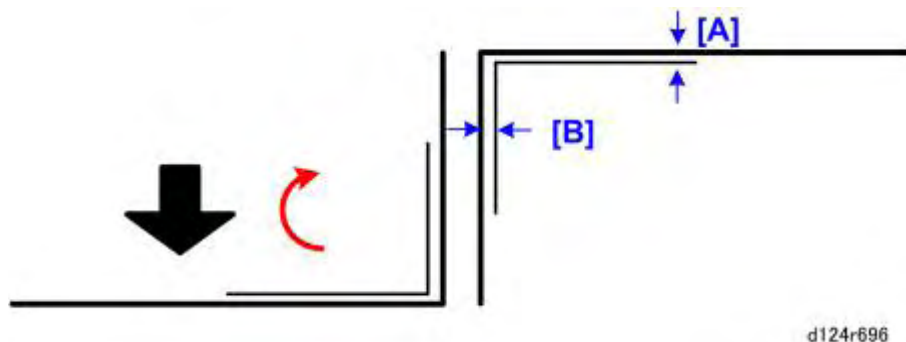

d124r696

6. The black arrow indicates the direction of paper feed.
7. Rotate the test sheet 180 degrees. [A] is the top margin and [B] is the left margin.

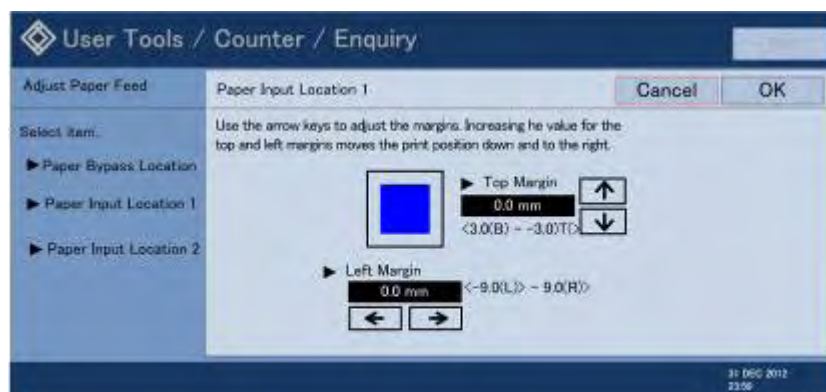

d124r691

8. Touch the arrow keys to adjust the margins.

Note

- Increasing the value for the top and left margin moves the print position down and to the right. You will see the blue square move as you change the settings, so you can confirm the effect of the changes.

3.2.19 FINAL SETTINGS

1. Check and adjust the date and time settings: User Tool > System Settings > Timer Settings > Set Date, Set Time.

3.2.20 AFTER INSTALLATION

Do these tasks after installation is completed.

1. Make a copy of the Factory Settings Sheet and store the original with the machine.
2. Upload the NVRAM contents to an SD card.
 - Insert an SD card in SD card Slot 2 of the machine.
 - Do **SP5824** to upload the contents of the NVRAM to the SD card.
 - Keep the SD card in a safe place.

3.2.21 MOVING THE MACHINE

Observe the following precautions when moving the machine to another location in the same room or in the same building:

- Two people are required to push and move the machine to a new location.
- To prevent ink spillage, never lift and tip the machine from the level position.
- Make sure that the four screws that connect the scanner stand to the main unit stand are attached and securely fastened.

★ Important

- **The scanner stand and scanner unit assembly is extremely top heavy and can tip over easily. Never attempt to move the machine with the scanner stand detached from the main unit.**
- Make sure that the four casters of the main unit stand and scanner stand are unlocked before you try to move the machine.
- It is not necessary to remove the ink cartridges.
- Position your hands at base of the main unit and then push it slowly to the new location.



d124i205

- Before shipping the main unit, pack and tape some shipping material against the carriage to prevent the carriage from slipping out of position.
- Make sure that the main unit is packed level and strapped securely.
- A new machine with no ink in it can be tilted 70° from the horizontal to load it onto a truck or into an elevator. However, a used machine with ink in it should never be tilted more than 45° from the horizontal.

3.3 CONTROLLER OPTIONS

3.3.1 OVERVIEW

There are three slots for boards (A, B, C) and two SD card slots (1, 2) for SD cards on the faceplate of the controller box. Each board or SD card must be inserted into its assigned slot. The slot assignments of boards and SD cards are written on a decal on the controller box cover as shown below.

★ Important

- Always touch a grounded surface to discharge static electricity from your hands before you handle SD cards, printed circuit boards, or memory boards.

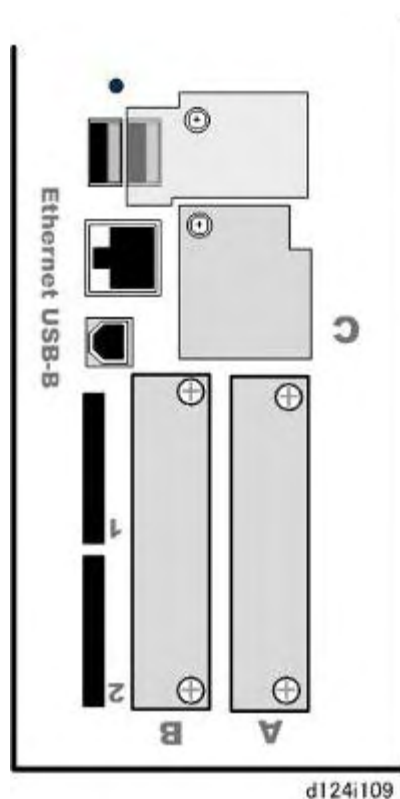

Standard Controller Features

The Printer/Scanner Unit features are provided with the machine.

- They reside on an SD card that is inserted into SD Card Slot 1 before the machine is shipped from the factory.
- This SD card (Printer/Scanner Unit Type MPCW1) must remain in SD Card Slot 1 and be removed only for special procedures like firmware download, application move/undo, etc.
- The Network function, USB Host Function are built in and enabled before the machine leaves the factory.
- Data Overwrite Security, and Data Encryption are also built into the ROM on the GW

controller board, and enabled before the machine leaves the factory.

Controller Options

The controller options available for this machine are listed in the table below.

Option	No.	Slot
Browser Unit Type M5	D624-02	SD Slot 1 or 2
Data Overwrite Security Unit Type H	D377-22	SD Slot 1 or 2
Gigabit Ethernet Type B	D377-21	Board C
IEEE 802.11 a/g Interface Unit Type J	D377-02	Board B (EU)
IEEE 802.11g Interface Unit Type K	D377-19	Board B (Other)
IEEE 802.11 a/g Interface Unit Type J	D377-01	Board B (NA)
Copy Data Security Unit Type F	B829-07	Board Installation
File Format Converter Type M5	D625	Board A

3.3.2 FILE FORMAT CONVERTER (MLB)

Accessories



No.	Item	Q'ty
1.	Mother Board	1
2.	File Format Converter	1
3.	Standoff	1
4.	Screw	1

Installation

Preparation

- Separate the main unit from the scanner unit

Remove:

- Rear cover

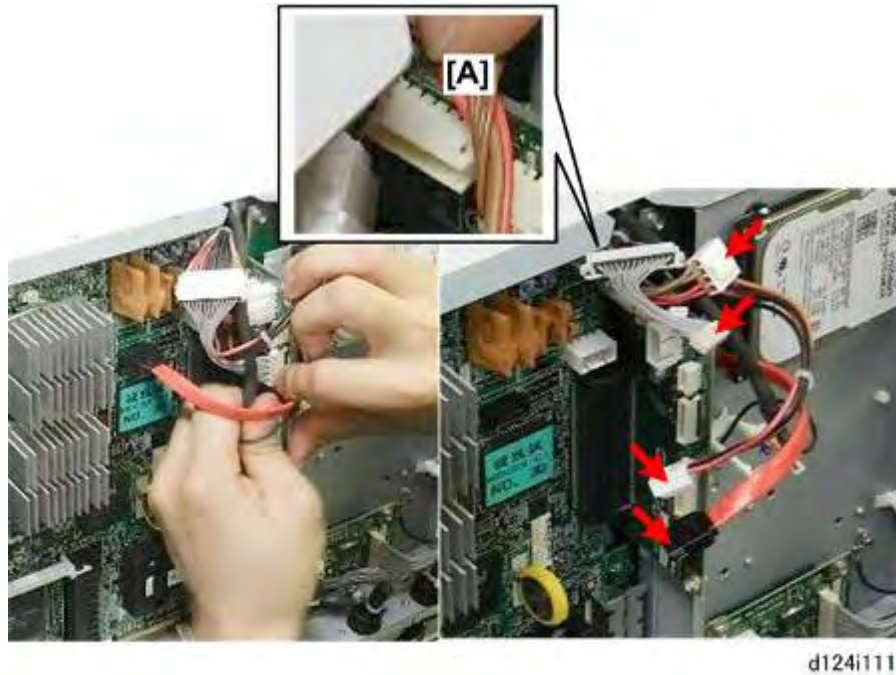

1. Disconnect the mother board and HDD from the controller board (🔧x1, 📁x6).

⬇ Note

- One connector [A] is empty. No harness is connected here.



2. Remove the SD card slot cover (🔧x1).

Controller Options

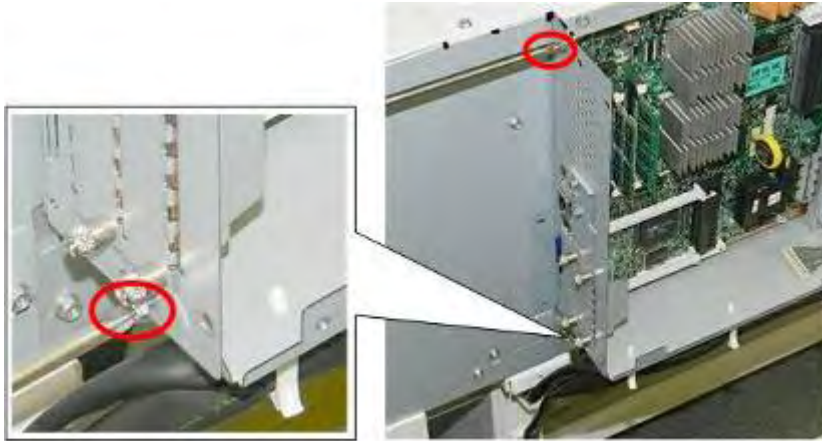



d124i112a

3. Remove the controller box faceplate ( x2).



d124i113

4. Disconnect the mother board bracket ( x3,  x1)



d124i114

5. Slide the controller board and mother board out of the machine.



d124i114a

6. Disconnect the mother board from the controller board.

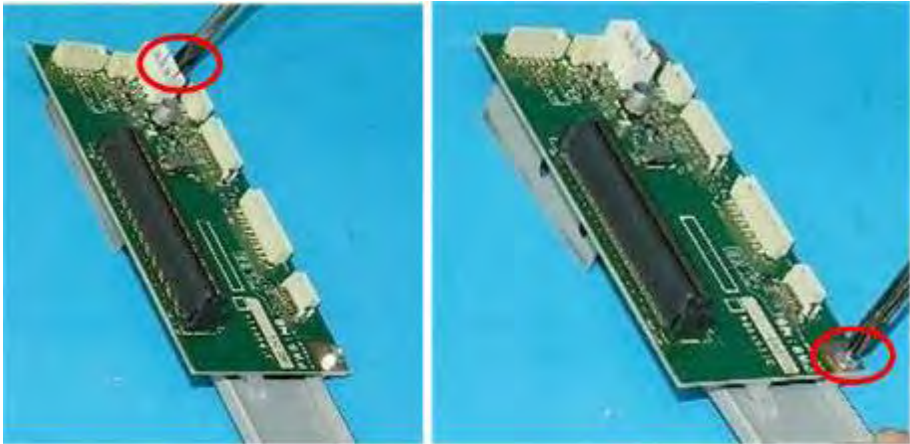

d124i115

7. Disconnect the mother board from its bracket ( x2). Keep these screws.



d124i115a

8. Fasten the standoff to the bottom of the bracket ( x1).

Installation

Controller Options

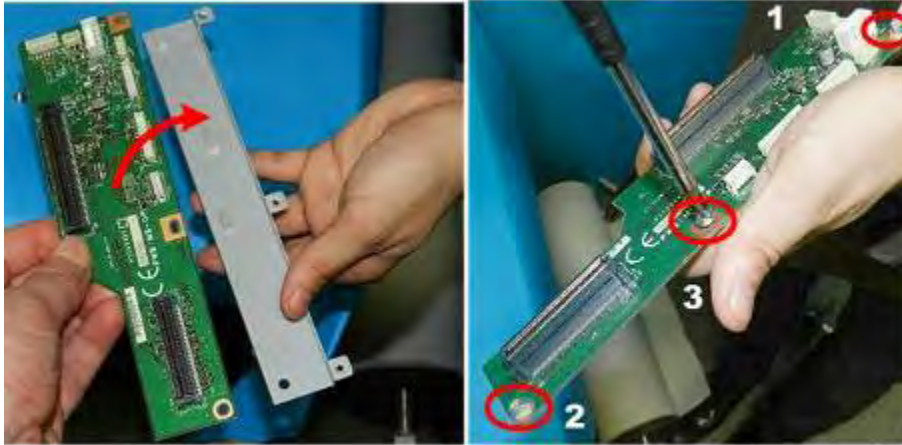

d124i116

9. Fasten the new mother board to the bracket ( x3).
10. Fasten and tighten the screws in the order 1 > 2 > 3.

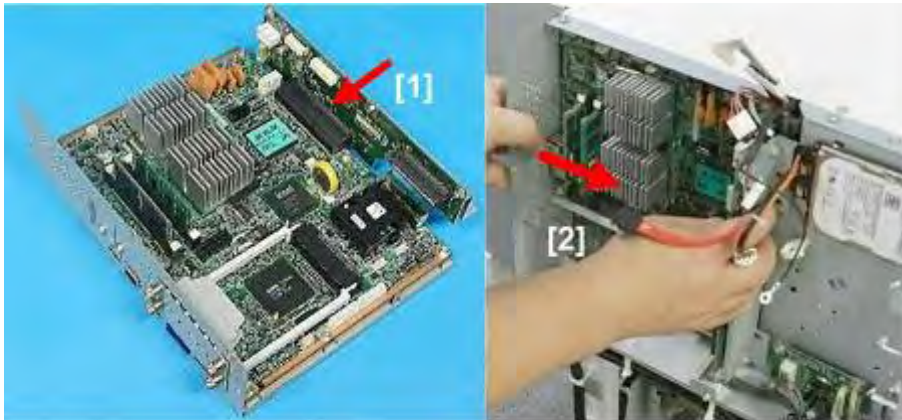

d124i117

11. Connect the mother board [1] to the back of the controller board.
12. Slide the controller board [2] into the machine.

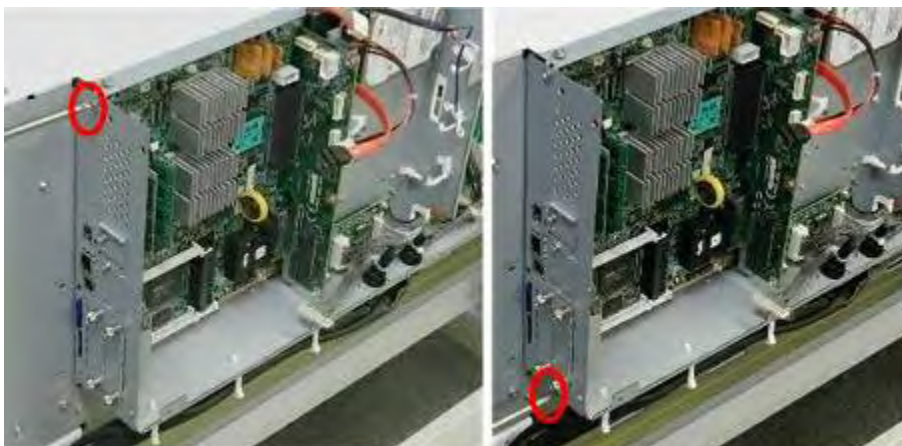



d124i118

13. Reattach the controller board faceplate ( x2).



d124i119

14. Reattach the mother board bracket at [A] ( x3,  x1).
15. Remove the cover of Slot A [B] ( x2).

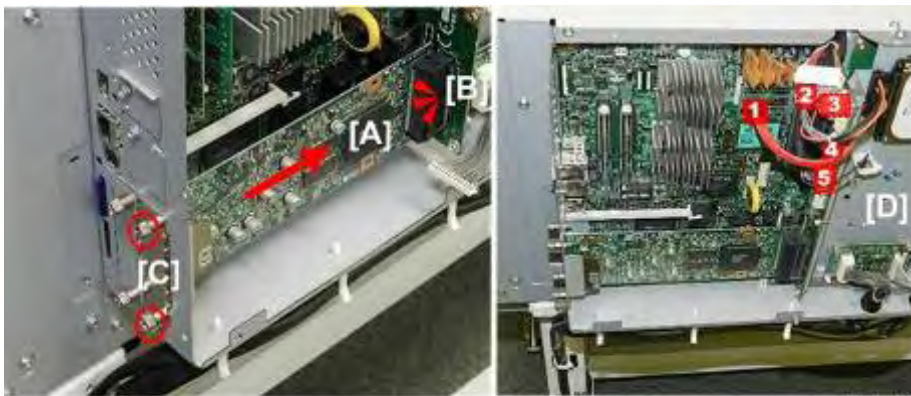

d124i120

16. Insert the file format converter board [A].
17. Make sure that the board connects completely at [B].
18. Tighten the knob screws [C] with your fingers ( x2).

★ Important

- To avoid twisting and damaging the boards, finger-tighten the knob screws.
- Do not use a screwdriver.

19. Reconnect the boards at [D] ( x4).

3.3.3 WIRELESS LAN

Accessories



No.	Item	Q'ty
1.	Clamps	8
2.	Velcro Patch	2
3.	Wireless LAN Board	1
4.	Antenna* ¹	1
<p>*¹ The wire with the black ferrite core is for TX/RX and the wire with the white ferrite core is for RX only.</p>		

Installation



d124i122

1. Remove the cover of Slot B (🔩 x2).



d124i123

2. Insert the wireless LAN board and fasten the screws with your fingers (🔩 x2).

★ Important

- To avoid twisting and damaging the boards, finger-tighten the knob screws.
- Do not use a screwdriver.

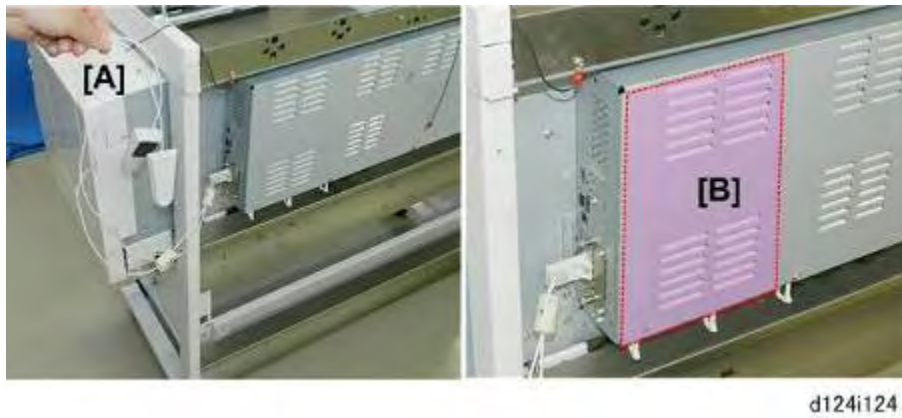

3. Set the connected antennas [A] aside.
4. Use a damp cloth to clean the area [B] where the antennas will be attached.

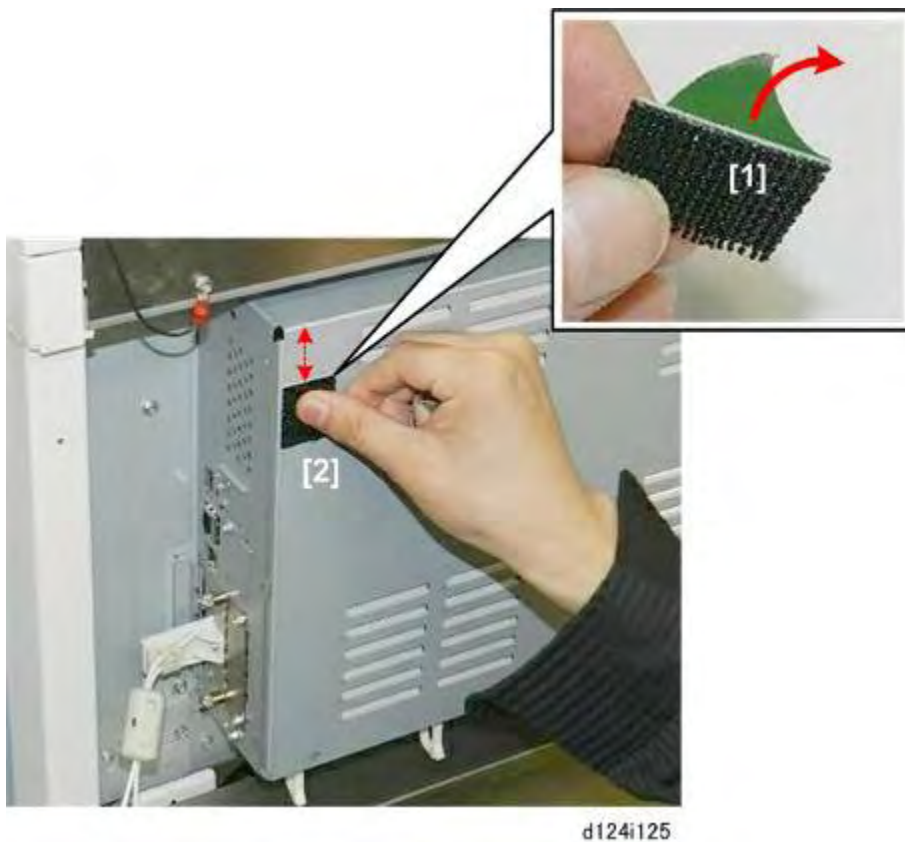

5. Peel the tape from the back of a Velcro patch [1].
6. At a distance from the top edge of the PCB box that is the same size as the patch, attach the patch [2] to the back of the box.

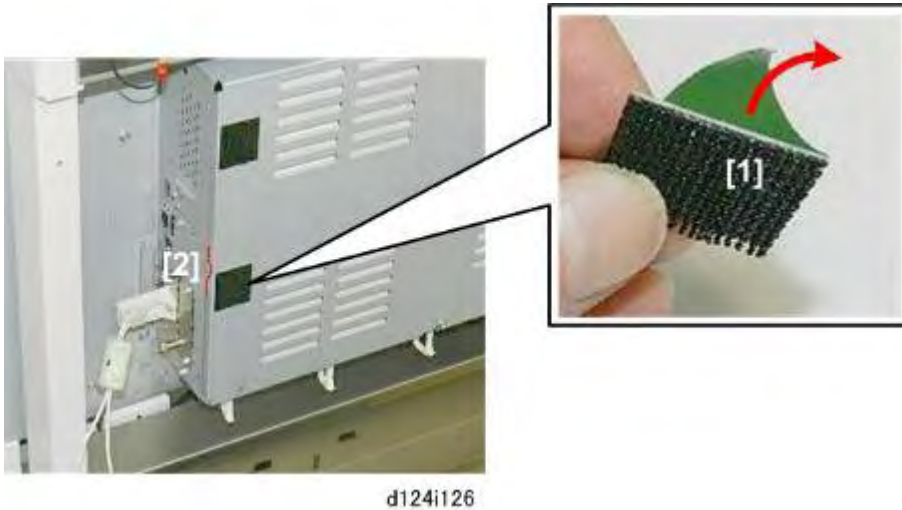

7. Peel the tape from the back of the other Velcro patch [1].
8. Attach the patch at the same height as the screw hole [2].



9. Attach the antenna with the black ferrite core to the upper patch.

★ Important

- The antenna with the black ferrite core attached to its cable is the TX/RX antenna and it must be attached to the upper patch so that it is higher for both sending and receiving.

Controller Options



d124i128

10. Attach the antenna with the white ferrite core to the lower patch.



d124i133

11. Attach a clamp between the antennas and then clamp the harnesses (🔧x1).



d124i134

12. Attach another clamp below the lower antenna, and then clamp the harness (🔧x1).



d124i135

13. Open the upper clamp and clamp the harnesses (🔗x1).



d124i136

14. Attach the last clamp and route the harnesses as shown (🔗x1).
15. For details about wireless antenna settings, please refer to the Operating Instructions.

3.3.4 GIGABIT ETHERNET

Accessories



d124i139

No.	Item	Q'ty
1.	Ferrite Core	1
2.	Screw	2
3.	Plastic Plug	1
4.	Gigabit Ethernet Board	1

Installation

Preparation

- Separate the main unit from the scanner unit

Remove:

- Rear cover



d124i140

1. Remove the cover of Slot C ( x1).

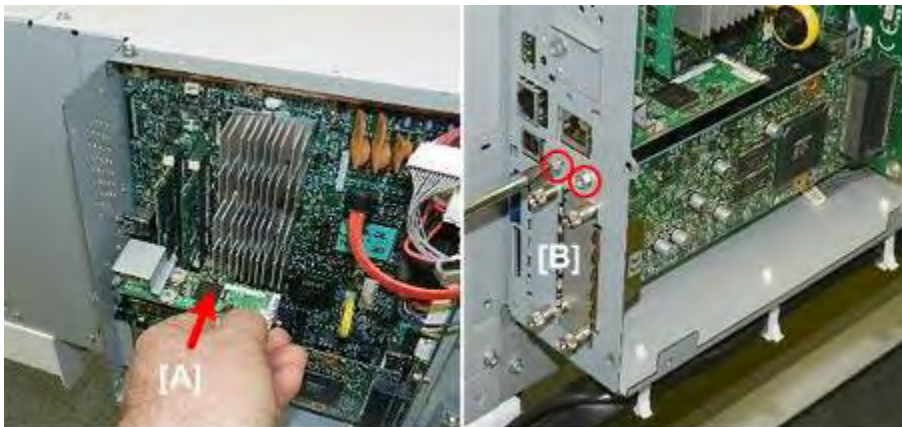

d124i141

2. Insert the Gigabit Ethernet board [A] into the controller board.
3. Fasten the board to the controller faceplate [B] ( x2).

Controller Options



4. Insert the plastic plug into the "Ethernet" connector.

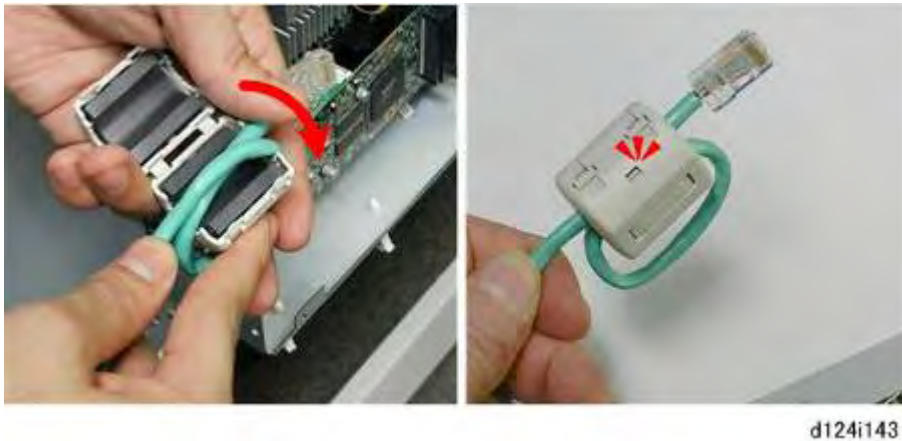

5. As close as possible to one end of the cable, loop the cable through one ferrite core and then lock the core.

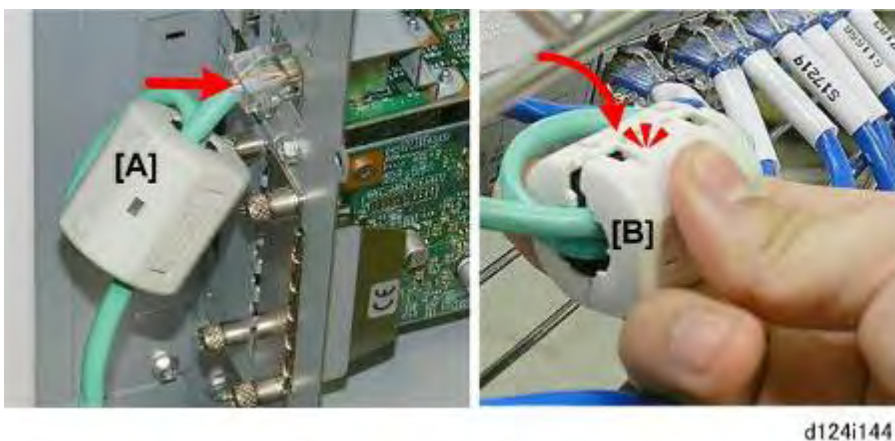

6. Connect the cable with the ferrite core to the Gigabit Ethernet Board.
7. Wrap the other end of the cable through the other ferrite core, and then connect it to the server box.

3.3.5 COPY DATA SECURITY UNIT

Accessories



No.	Item	Q'ty
1.	Cable	1
2.	Screws	2
3.	Board (ICIB-3)	1
4.	FFC	1

Installation

Installation

Preparation

- Separate the main unit from the scanner unit

Remove:

- Rear cover

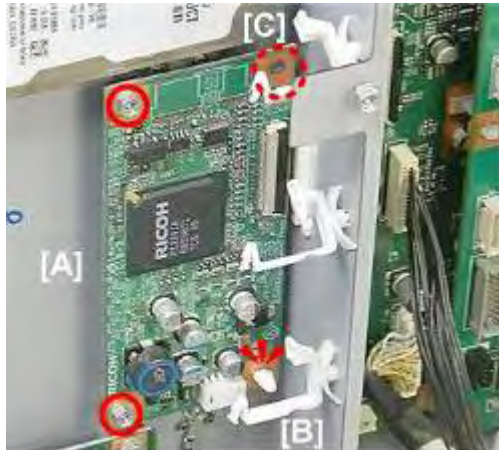

d124i151

1. Attach the board below the HDD.



[A] ( x2)

[B] ( x1)



[C] This hole remains open.

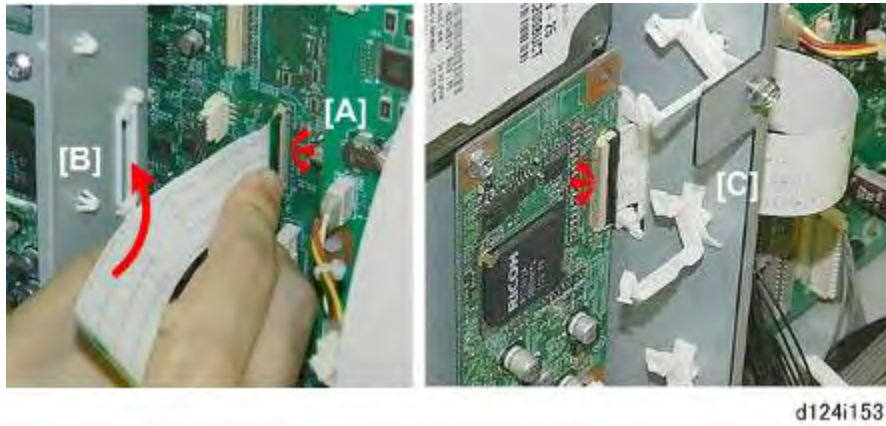

d124i152

2. Pass one end of the cable through the bracket and clamp it ( x1).
3. Connect the connector [B] to the copy data security board ( x1).
4. Connect the other end of the cable to the IPU [C] at **CN259** ( x1).



5. Connect one end of the FFC to the IPU [A] at **CN258** ( x1).
6. Pass the other end of the FFC through the plate [B].
7. On the other side of the plate [C], connect the FFC to the copy data security board ( x1).

3.3.6 BROWSER UNIT

Accessories

Check the accessories and their quantities against the table below.

No.	Description	Qt'y
1.	Browser Unit SD Card	1

Installation

CAUTION

- Before doing the procedure, turn off the main power switch and unplug the machine from its power source.
1. Remove the SD card slot cover ( x1).
 2. Insert the SD card into Slot 1.
 3. Reconnect the machine and turn it on.
 4. Push [User Tools].
 5. Touch [Extended Feature Settings].
 6. Touch [Extended Feature Settings] again.
 7. Touch [Install].
 8. Touch [SD Card].
 9. Touch the [Browser] line. (Source: SD Card Slot 2)
 10. Under "Install to:" touch [Machine HDD] then touch [Next]
 11. When you see "Ready to Install", check the information on the screen to confirm the previous selection.
 12. Touch [OK]. You will see "Installing..." then "Completed".
 13. Touch [Exit] twice to return to the copy screen.
 14. Turn the machine off and on with the card still in Slot 2.
 15. Open the Browser screen from the "Extended Feature Settings" in User Tools. A message appears if the installation was successful:
"The MFP Browser was successfully installed."

PREVENTIVE MAINTENANCE

REVISION HISTORY		
Page	Date	Added/Updated/New
		None

4. PREVENTIVE MAINTENANCE

4.1 PM TABLES

4.1.1 KEY FOR PM TABLE

Item	Meaning		
A	Adjust		
C	Clean		
I	Inspect		
L	Lubricate		
R	Replace		
K	K = 1,000		
PM	Machine site visit, scheduled or as needed.		
	Meters	Feet	Yards
8K m	8,000	26,247	8,749
10K m	10,000	32,800	10,933
20K m	20,000	65,600	21,867
30K m	30,000	98,400	32,800

4.1.2 PM TABLE: MAIN MACHINE

★ Important

- The PM intervals of parts may vary, depending on the amount of coverage in prints and the color usage ratio. The expected color ratio for this machine is 9:1 (9 black-and-white prints for every 1 color print.)

	Item	8K m	10K m	20K m	30K m
	Scanner Unit				
1	Exposure Glass		I, C		
2	Original Width Sensors				C
3	Original Feed Roller		I, C		
4	Original Exit Roller		C		
5	White Plate		I, C		
6	CIS Lens		I, C		
	Horizontal Unit				
7	Black Print Head Unit (K1, K2)			R	
8	Color Print Head Unit (C, YM)			R	
9	Horizontal Encoder		I		
10	DRESS Sensor		C		
	Maintenance Unit				
11	Maintenance Unit			R	
	Waste Ink Collection				
12	Ink Collector Tank	R			
13	Right Ink Sump				I
14	Left Ink Sump				I
	Ink Supply				

	Item	8K m	10K m	20K m	30K m
15	Ink Tube Guide		C		
	Paper Feed				
16	Platen		C		
17	Paper Feed Rollers		C		
	Vertical Unit				
18	Vertical Encoder		I		

Notes

Refer to the next section for more details.

1	Exposure Glass. Optical glass cleaner, damp cloth.
2	Original Width Sensors. Blower brush.
3	Original Feed Roller. Alcohol, damp cloth, dry cloth.
4	Original Exit Roller. Alcohol, damp cloth, dry cloth.
5	White Plate. Alcohol, damp cloth, dry cloth.
6	CIS Lens. Lens paper, alcohol.
7	Black Print Head Unit. Replace when necessary. After replacement, do Nozzle Check pattern, head cleaning, head flushing.
8	Color Print Head Unit. Replace when necessary. After replacement, do Nozzle Check pattern, head cleaning, head flushing.
9	Horizontal Encoder. Clean cloth dampened with alcohol, dry cloth.
10	DRESS Sensor. Clean with clean white cloth. Note: The recommended cleaning interval is 10Km. However, if the operator is frequently printing on tracing paper, or frequently using Quality mode printing, cleaning every 5Km is recommended.
11	Maintenance Unit. Use a dry linen cloth to clean around the lips of the suction cup and print head caps.

12	Ink Collector Tank. Swap with new ink collector tank.
13	Right Ink Sump. Never attempt to empty it and re-use it.
14	Left Ink Sump. Use a dry linen cloth to clean the gate of the sump. You may need to use the tip of a small screwdriver to remove hardened ink.
15	Ink Tube Guide. Use a damp cloth to clean the areas where the guide is rubbing.
16	Platen. Use a linen cloth dampened slightly with water to clean the surface of the platen. Use a blower brush to clean the holes of the plates to clear any clogging.
17	Paper Feed Rollers. Use a linen cloth dampened with alcohol to clean the surfaces of the rollers.
18	Vertical Encoder. Use a linen cloth dampened with alcohol to clean the edge of the vertical encoder wheel.

4.2 PM CLEANING POINTS

The following 18 points are referenced by number in the PM table.

4.2.1 SCANNER UNIT

1 *Exposure Glass*

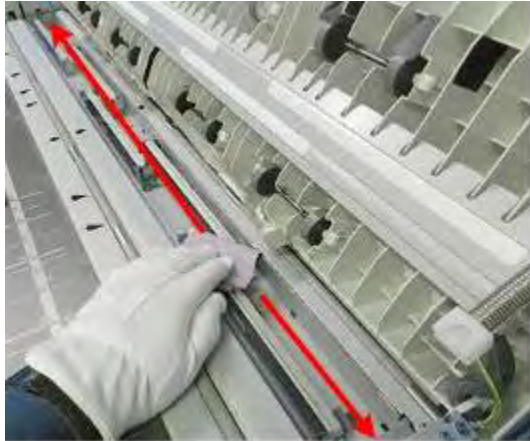

d124p012

- Optical glass cleaner cloth, water damp cloth.
- 1. Raise the scanner unit.
- 2. Clean the surface of the glass.

2 Original Width Sensors, Original Set Sensor

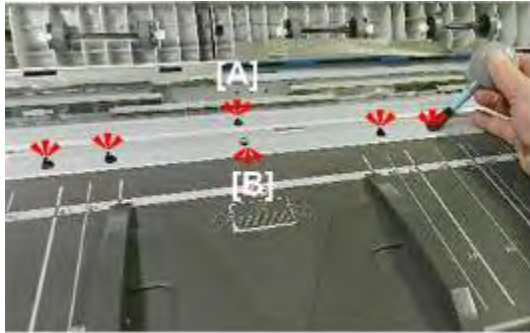



d124p013

- Blower brush
- 1. Raise the scanner unit.
- 2. Clean with a blower brush.





d124p014

- 3. Remove the original width sensor cover plate. ( x2)  page 5-62
- 4. Clean each sensor with the blower brush.

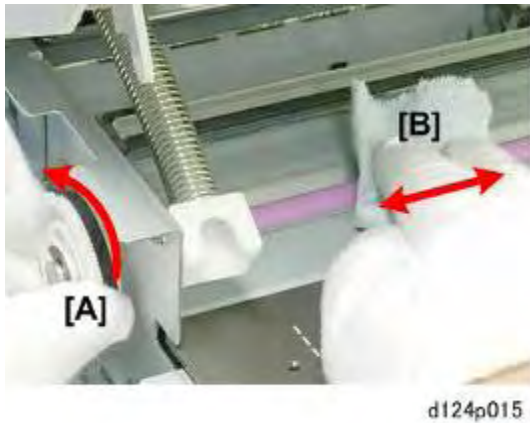
3 Original Feed Roller



- Alcohol, damp cloth, dry cloth
1. Remove the registration sensor cover plate. ( x2)  page 5-64
 2. Clean the roller.

4 Original Exit Roller

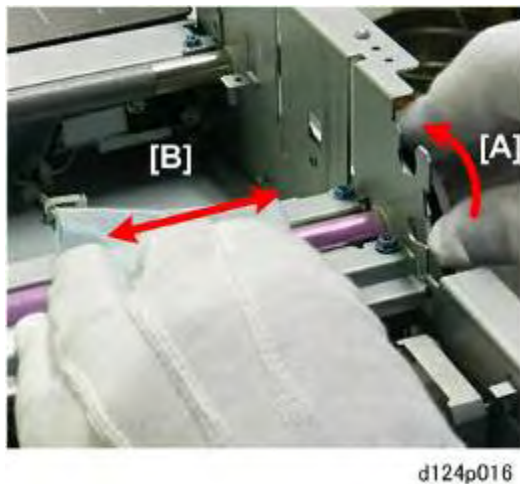

- Alcohol, damp cloth, dry cloth.
1. Remove the top of the scanner unit.  page 5-78
 2. On the left side of the machine, turn the drive gear [A] as you wipe the surface of the roller [B] with the cloth.

Preventive Maintenance

5 White Plate

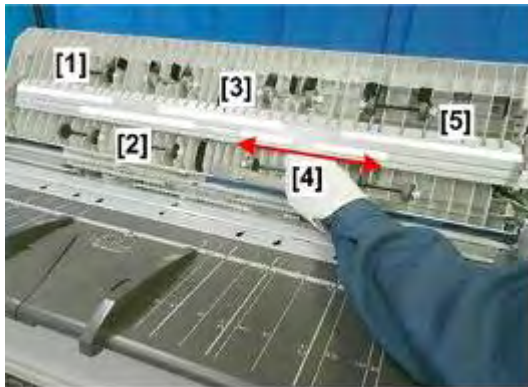

d124p017

- Alcohol, damp cloth, dry cloth.
1. Raise the scanner unit.
 2. Clean the 5 plates.

6 CIS Lens



d124p018

- Lens paper, or clean cloth dampened with alcohol.
1. Raise the scanner unit.
 2. Clean the surfaces of the 5 lenses.

4.2.2 HORIZONTAL UNIT

7 Black Print Head Unit

The black print head units can be replaced separately or together. 📖 page 5-179

8 Color Print Head Unit

The black print head units can be replaced separately or together. 📖 page 5-179

9 Horizontal Encoder



- Clean cloth dampened with alcohol, dry cloth.

★ Important

- Never touch or handle the surface of the encoder strip with bare hands. Smudges and fingerprints can interfere with the sensor readings of the encoder strip.

1. Move the carriage unit to the center. 📖 page 5-37
2. Remove the top cover. 📖 page 5-29



3. Push the carriage to the right.

PM Cleaning Points

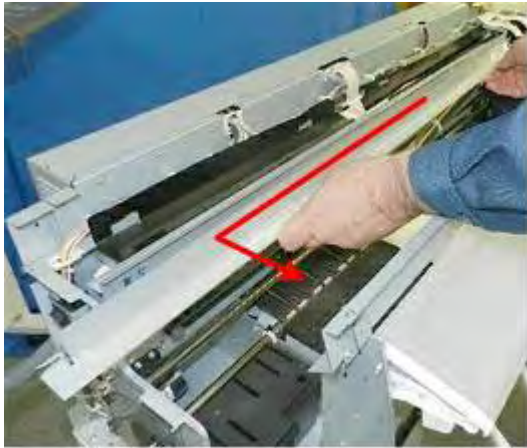

d124p009

4. Disconnect the encoder strip cover plate ( x2).
5. Remove the plate.
6. Prepare a piece of clean linen cloth dampened with alcohol.

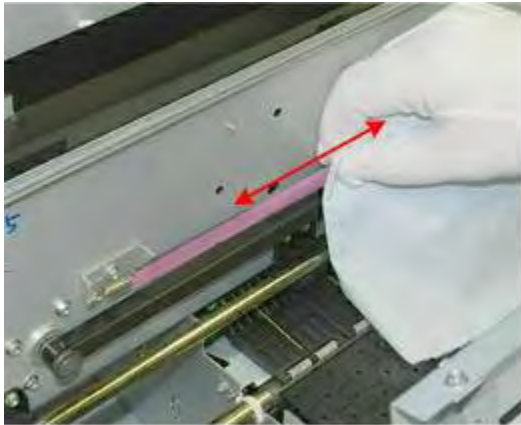

d124p010

7. Wipe both sides of the encoder strip with the cloth.
8. Clean the strip as far as the carriage on the right, move the carriage to the left, and then clean the other end of the strip.

10 DRESS Sensor



d124r539

- Cleaning cloth
 - The recommended cleaning interval is 10Km. However, if the operator is frequently printing with tracing paper or print Quality mode, cleaning every 5Km is recommended.
1. Remove the DRESS Sensor ➤ page 5-209
 2. Clean the DRESS sensor with a cleaning cloth.
 - Always use the cleaning cloth, never use a cotton swab or tissue paper.
 - Cleaning the DRESS sensor prevents errors when it reads the reflectivity of the surfaces of glossy paper and tracing paper.

11 Maintenance Unit

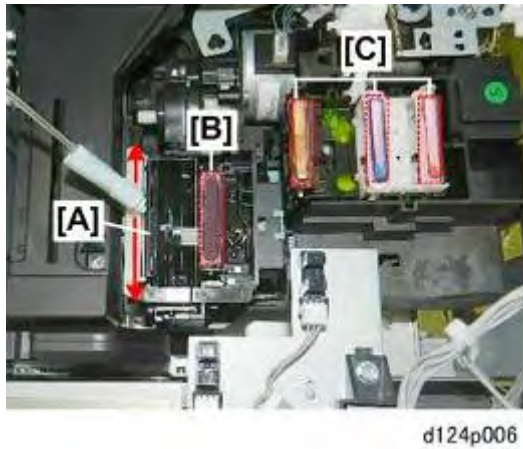

- Dry linen cloth.

★ Important

- After replacing the ink collector unit, always remove ink that has hardened around the wiper blade, suction cap, and three print head caps.
1. Move the carriage unit to the center. ➡ page 5-37
 2. Remove the top cover. ➡ page 5-29
 3. Use a tightly wrapped linen cloth dampened with water to clean:
 - [A] Wiper and blade
 - [B] Suction cap
 - [C] Print head caps (x3)

4.2.3 WASTE INK COLLECTION

12 Ink Collector Tank



1. Open the ink collector cover on the right side of the machine.
2. Depress the release [A], and then pull the tank straight out of the machine.
3. Lay the tank on a flat surface with the port [B] facing up.

★ Important

- The port at [B] is open and will leak ink if the tank is turned on its side or turned upside down. Tape the port to prevent leakage.

Preventive
Maintenance

13 Right Ink Sump



- Replace the right ink sump when a message alerts you that the tank is full.
1. Remove the ink collector unit on the right side of the machine.
 2. Remove the ink collector cover and right cover. ➤ page 5-19
 3. Disconnect the sump and pull it out slowly (⚠ x1).

★ Important

- To avoid spilling ink, do not tilt the sump as you remove it.



d124p028

4. Cover the top of the tank with some paper and tape, and then discard it.

★ Important

- Follow the local laws and regulations regarding the disposal of this item.
- Never attempt to empty the right ink sump and re-use it.

5. After installing the new right ink sump, open SP2505-002 (Clear Counter) and touch [EXECUTE] to clear the counter for the new sump.

14 Left Ink Sump



d124p005

- Dry linen cloth
 - After replacing the collector unit, always remove ink that has hardened around the gate.
 - Use a dry linen cloth to clean the gate of the sump. You may need to use the tip of a small screwdriver to remove hardened ink.
1. Remove the left cover. ➡ page 5-25
 2. Use a dry cloth wrapped around the tip of a small screwdriver to clean around the openings of the gate.
 3. Use the bare tip of a small screwdriver to remove hardened ink that cannot be removed by wiping with the cloth.

Note

- Replace the left sump when a message alerts you that the tank is full.  page 5-265

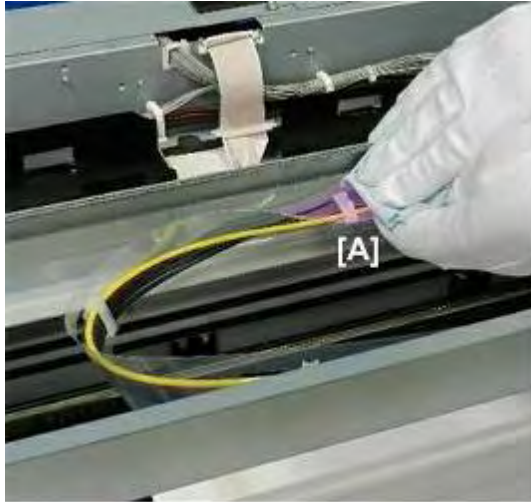
15 Ink Tube Guide

d124p029

- Damp cloth.
1. Remove the top cover.  page 5-29
 2. Use the damp cloth to clean the back of the guide where it rubs against the frame during normal operation.

16 Platen

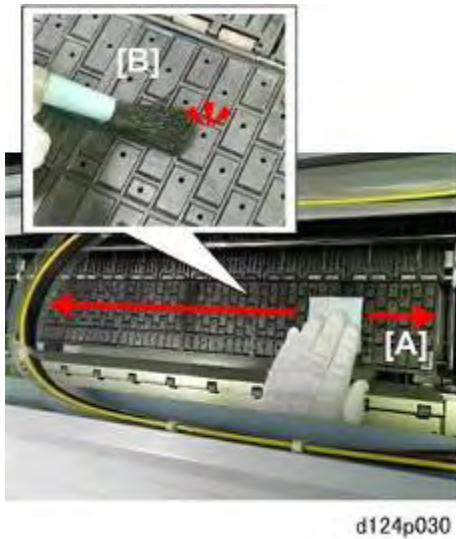

- Linen cloth dampened with alcohol, blower brush.
1. Open the front cover.
 2. Dampen a clean linen cloth with water.
 3. Wipe the platen [A] with the damp cloth, and then wipe with a dry cloth.

★ Important

- To avoid damage or discoloration of the platen, never use an organic solvent like alcohol, benzene, acetone, etc. to clean it.
4. Use a blower brush [B] to remove paper dust from the holes in the platen plates.

17 Paper Feed Rollers

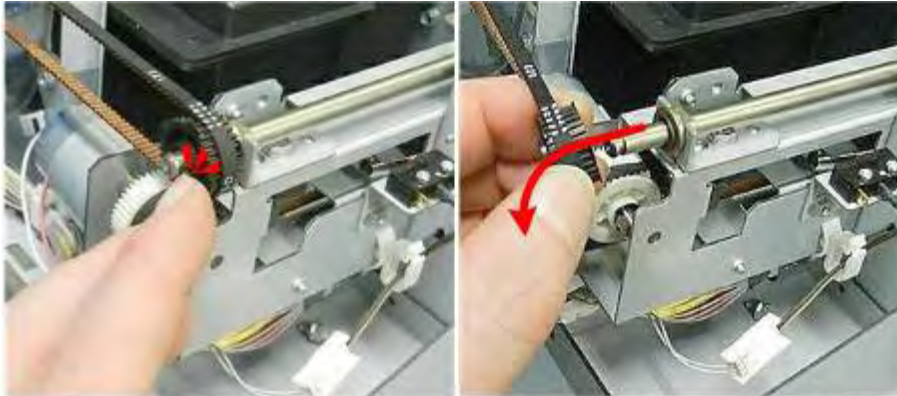

d124p032

- Linen cloth dampened with alcohol.
- 1. Remove the left cover. ➤ page 5-25
- 2. Release the drive gear and remove it with the timing belt.



d124p033

- 3. While turning the end of the shaft [A], hold the cloth against the surface of the first rotating roller [B].
- 4. Be sure to clean all the rollers where they are exposed.

Preventive
Maintenance

18 Vertical Encoder

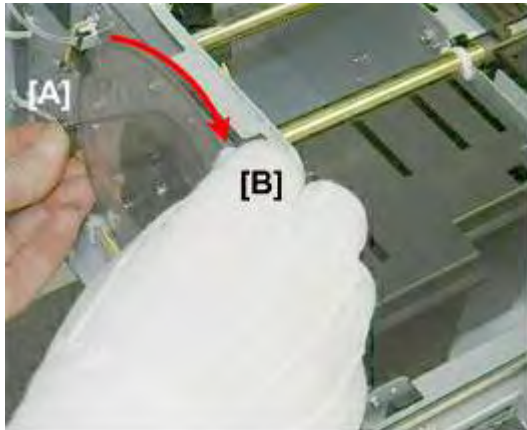

d124p011

- Linen cloth dampened with alcohol

★ Important

- Never touch or handle the surface of the encoder wheel with bare hands. Smudges and fingerprints can interfere with the sensor readings of the encoder edge.
- Handle the wheel carefully to avoid bending it.

1. Remove the left cover. ➔ page 5-25
2. Prepare a piece of clean linen cloth dampened with alcohol.
3. While turning gear [A] and the wheel, clean the edge of the wheel [B] with the cloth.

★ Important

- Never use a cotton swab or cotton ball, tissue paper, or any other material that could shed and leave fibers on the edge of the encoder wheel.

4.3 OTHER ITEMS FOR CLEANING

These items are not included in the PM table but they should be cleaned during the course of replacement and adjustment procedures.

4.3.1 EXTERNAL COVERS

- Linen cloth, dampened with water



d124p001

1. Clean the covers with a clean cloth dampened with water.

★ Important

- To avoid damage or discoloration, never use an organic solvent like benzene, acetone, etc. to clean the surfaces of the covers.

4.3.2 SCANNER UNIT

Original Set Sensor

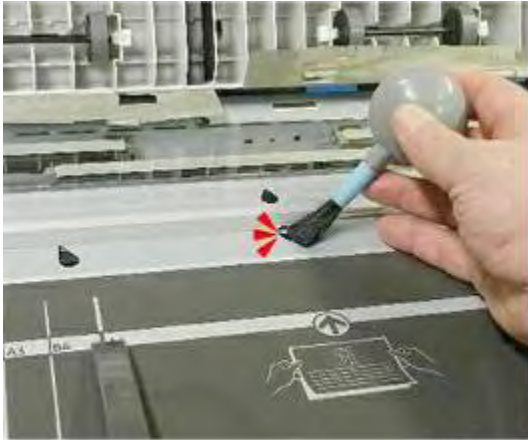

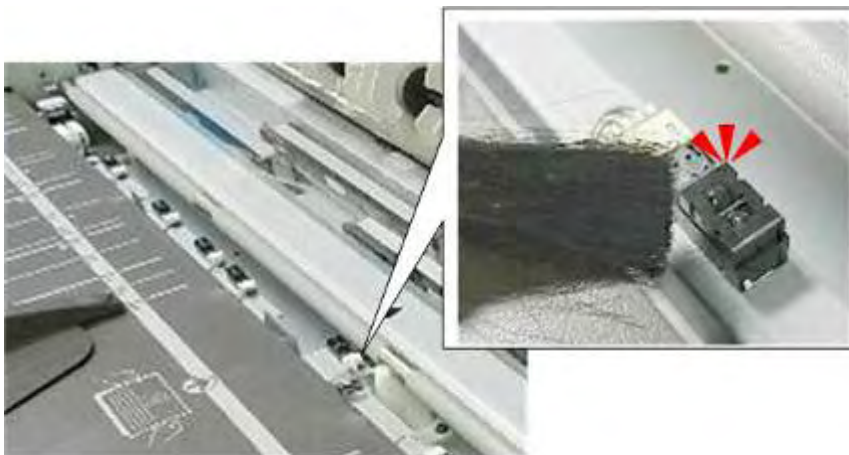

d124p019

- Blower brush
- 1. Raise the scanner unit.
- 2. Clean with a blower brush with the original sensor cover attached.





d124p020

1. Raise the scanner unit.
2. Remove the original width sensor cover plate ( x2)  page 5-62
3. Use a blower brush to clean the sensor.

Original Registration Sensor





d124p023

- Blower brush
1. Raise the scanner unit.
 2. Clean with a blower brush [A].
 - or-
 3. Remove the original registration sensor cover plate, and then clean with the blower brush [B]. ( x2).  page 5-64

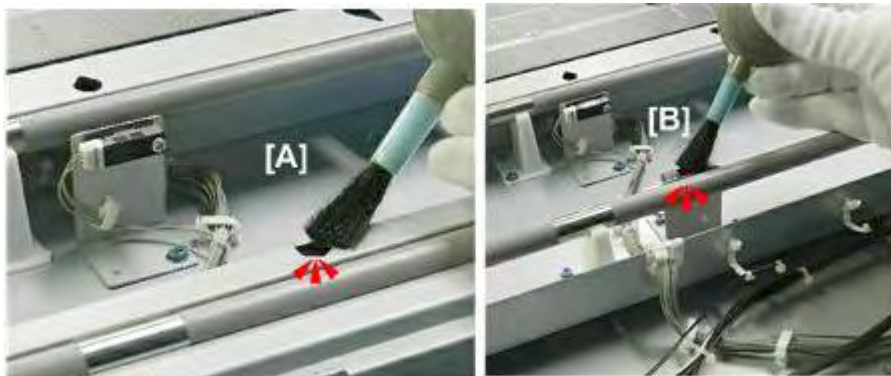
Original Exit Sensor



d124p021

- Blower brush
1. Remove the scanner unit.  page 5-78
 2. Clean with a blower brush [A]
 - or-
 3. Remove the scanner unit, remove the original exit sensor cover plate and then clean the sensor with the blower brush [B]. ( x2).

4.3.3 HORIZONTAL UNIT

Ink Level Sensors

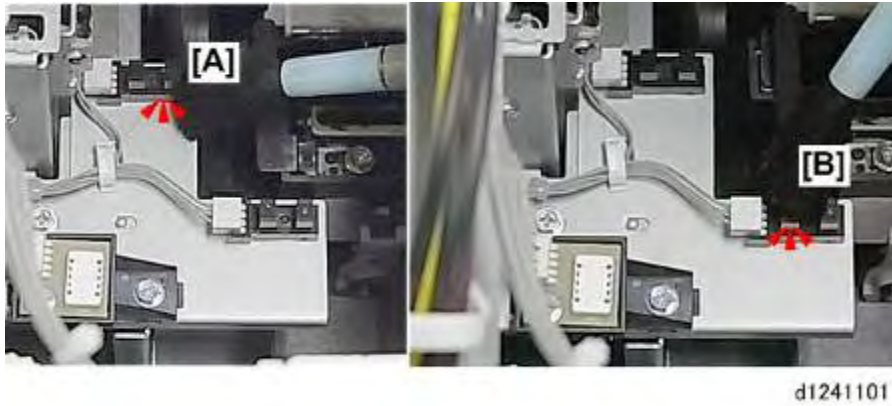

- Blower brush
1. Move the carriage unit to the center. ➤ page 5-37
 2. Remove right cover. ➤ page 5-19
 3. Remove right upper cover. ➤ page 5-21
 4. Clean FS1 (Feeler Sensor 1) with a blower brush.
 5. Clean FS2 (Feeler Sensor 2) with a blower brush..

4.3.4 PAPER FEED

Bypass Sensor, Pre-registration Sensor

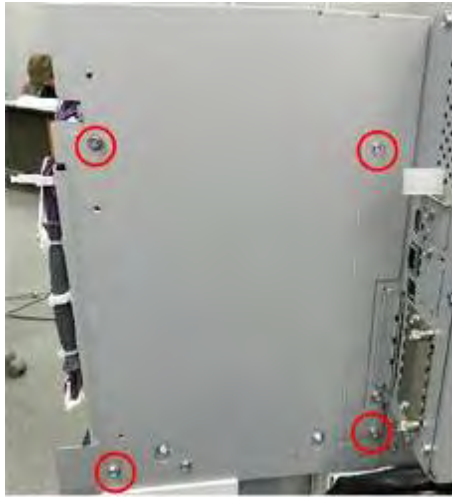

d124i206

- Right Cover
 - Right Upper Cover
1. Remove the right rear metal plate ( x4).



d124i207

2. Use a blower brush to clean the upper bypass sensor [A].
3. Clean the lower pre-registration sensor [B].

Preventive
Maintenance

Paper Exit Sensor

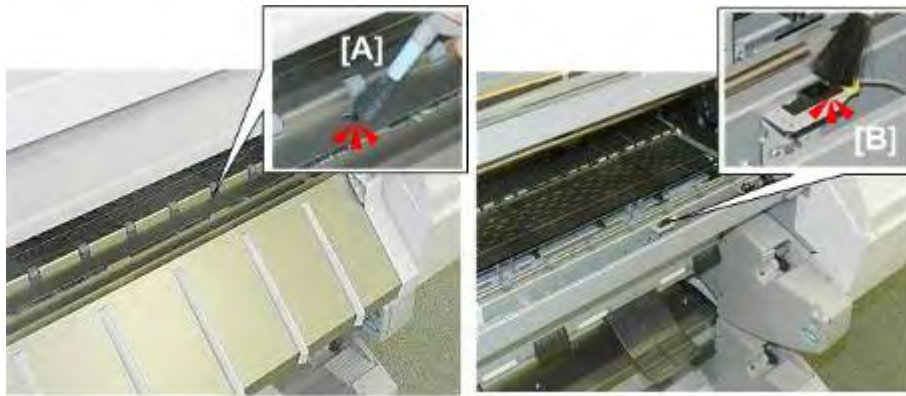

d124p034

- Blower brush
1. Raise the paper exit guide.
 2. Use the blower brush to clean the exit sensor [A].
-or-
 3. Remove the feed roller cover and clean the exit sensor [B]. ➡ page 5-35

4.3.5 ROLL UNITS

Roll End Sensor

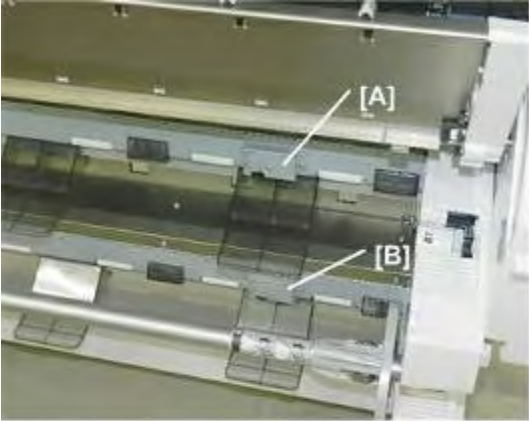

d1241034

This procedure is the same for both roll end sensors.

1. The roll end sensors are located on the back of Roll Unit 1 [A] and Roll Unit 2 [B].

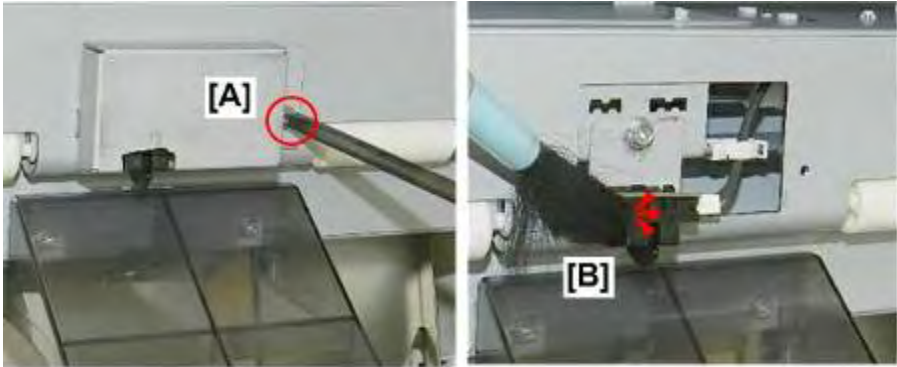

d1241035

2. Remove the sensor cover plate [A] (1 x1).
3. Clean the exposed sensor [B] with a blower brush.

Roll Unit Paper Release Sensor



d124r246

This procedure is the same for both roll units.

Preventive Maintenance

Other Items for Cleaning

1. Remove the sensor plate ( x1).



d124r247

2. Remove the sensor ( x4).



d124r249

3. Clean the sensor with a blower brush.



d124r250

4. Set the wide hooks first, then the smaller hooks to re-install.

Roll Feed Roller



d124r738

1. Remove the roll unit. ➤ page 5-98
2. For Roll Unit 2, remove the cosmetic metal cover (🔧 x6). (Roll Unit 2 does not have this cover.)
3. Remove the cover plate (🔧 x2).
4. Clean the roller with a dry, clean cloth to remove paper dust.

REPLACEMENT AND ADJUSTMENT

REVISION HISTORY		
Page	Date	Added/Updated/New
		None

5. REPLACEMENT AND ADJUSTMENT

5.1 GENERAL PRECAUTIONS

5.1.1 EXTERNAL COVERS

1. To avoid personal injury or damage to the machine during operation, operators and service technicians must always obey the instructions in the manuals and decals attached to the machine.
2. The moving parts and drive mechanisms inside the machine are dangerous. Never wedge a piece of paper or the tip of a tool into an interlock safety switch so that the machine can continue to operate with covers open.
3. Do not lay anything on top of the machine, and never block air ventilation louvers on the covers. Blocked louvers could interfere with the airflow and cause the machine to overheat and cause a fire.
4. Open the scanner cover only after the original has exited the original path. If you open the scanner cover while an original is being scanned, the interlock safety switches will stop the machine and this will cause a jam. In an emergency if you must stop a scan in progress, press the Original Stop button (🛑) on the right side of the scanner cover.
5. Open the front cover only after all scanning and print jobs have finished and the last print or original has exited. Open the front cover while the machine is operating will activate the interlock safety switches and cause the machine to jam.
6. To prevent personal injury or damage to the machine, never lean on the machine, and never place heavy objects on the original tray or paper exit stacker.

5.1.2 ORIGINAL TRANSPORT

1. Never attempt to feed originals that are not within the specifications. Doing so could cause the machine to jam, result in poor print quality, damage a valuable original, or damage the machine. Obey the following guidelines before you scan an original, and inspect each original for:

- (1) Dirty surfaces, the originals must be clean
- (2) Stacking, originals must be fed one by one
- (3) Folding, originals must be flat
- (4) Glue, adhesive tape that could foul the feed path
- (5) Holes, no paper with punched edges
- (6) Folded corners
- (7) Wrinkles and tears
- (8) Rippled surfaces (caused by high humidity)
- (9) Sheets taped together
- (10) Crooked leading edge
- (11) Thick paper pasted at the leading edge
- (12) Clips, staples
- (13) Wet ink, wet correction fluid originals
- (14) Carbon paper
- (15) An film original not within specification
- (16) Excessive curling
- (17) Sticky surfaces that could stick to the exposure glass

Note

- You may be able to feed originals with some of the defects listed above if you use a document carrier.
2. Insert an original only after the machine prompts you to do so after the machine is ready for copying.
3. To set the original, lay it face down and align the right side guide with the right edge of the original. Aligning the right guide with the right edge of the original prevents skewing during scanning.
4. Push the leading edge into the scanner. Release it as soon as the machine grabs the leading edge and feeds it partially. To avoid skewing or damaging the original, never attempt to push or pull on the original during this initial feeding.
5. If you see a problem at the beginning of scanning, press the original stop button () to stop original feed, and then open the scanner unit and remove the original.
6. Periodically clean the original table and the surface of the feed roller with a water dampened cloth. Clean the exposure glass with the optical cloth provided with the machine. Cleaning

- prevents poor feeding, dirt or dust transfer to the original, and poor copy image quality. To prevent damage to the machine, the cleaning cloth should be only slightly damp; make sure no liquid drips into the machine.
7. To ensure good print quality and to prevent jams, always remove a thick or long original from the original stacker as soon as it exits.
 8. Thick or especially long originals may not feed correctly. While feeding a thick or long original, you can gently push the sides with both hands during scanning of the first half. You can guide the sides with both hands as the second half scans.
 9. When you open the scanner cover, always use both hands, placed on either side of it, as shown on the decal and described in the operating instructions. To avoid personal injury or damage to the machine, never open or close the scanner cover with one hand.
 10. The weight limit of the original table is 5 kg (11 lb.). To avoid damaging the original table, never lean on the original table and never place anything on the original table when you are working around the machine.
 11. To avoid damage to the exposure glass below the cover or the white plates attached to the underside of the cover, always check the original path before you close the scanner cover.
 12. If anything falls into the machine that the operators cannot recover, they must call for service. Foreign objects in the machine could cause a short (which can lead to a fire), or could cause feed problems.
 13. During feeding of a thick original (90 g/m^2), the side guides could skew the image and cause parts of the image to disappear at the points where the CIS elements join. In such a case, use the white lines on the original table to guide the original during feeding.
 14. When feeding a thick original (180 g/m^2), do not push the original after it strikes the original feed roller and starts to feed. The original feed roller has a one-way feed clutch. If the original is pushed in the direction of the leading edge, this could buckle the original and cause it to jam at the original registration sensor.
 15. Originals up to 135 g/m^2 can exit to the original stacker on top of the machine. Thicker originals must feed straight through and exit the back of the machine. Removal of the original exit guide on top of the machine allows the originals to exit straight out the back.
 16. Also, use straight-through original feed for thin or flimsy originals. For example, tracing paper (80 g/m^2 or less), or normal paper (52.3 g/m^2 or less). Buckling of thin or flimsy paper can lead to accordion jams and damage the original.

5.1.3 PAPER

1. Always set the roll (or start paper feed) from the bottom of the roll, not the top. Feeding paper from the top of the roll places an excessive load on the paper feed rollers and could cause problems with paper feed and cutting. Also, feeding the paper from the top sets the paper against the direction of paper curl, which causes the paper to lift and rub against the print heads leading to poor copy quality and damage to the print heads.
2. If the machine is to remain idle for a long period where the temperature and humidity are high or low, remove the paper rolls from the machine and store them (in their original packing if possible). If the rolls cannot be removed and stored, then before the machine is used again, feed the leading edge of the roll about 1,000 mm (39 in.), and then cut it off.

5.1.4 COPY QUALITY

1. Photo images that have areas filled with dithering or fine lines frequently exhibit moiré.
2. Even for images where moiré does not stand out with 1:1 copying, changing the rate of magnification could cause moiré to appear.
3. In cases where 0.5 mm bands occur in halftone areas of uneven density, switch to Photo/Text mode (or Text mode) so banding does not stand out. Inconsistencies in the optical properties across the CIS can cause slight unevenness in image density.
4. The thickness of fine lines (0.1 mm or less), or the lines in enlarged copies of originals previously reduced, may look different in the copies compared with the originals. This is because of a phenomenon unique to digital copiers: the position of the elements in the CIS unit and position of the fine lines in the original may not be consistent.
5. If a dirty background still appears in a copy using the Auto Density setting, adjust the notch to a lighter setting.

5.1.5 CIS

1. Always handle the CIS unit carefully during its removal to prevent it from shock and vibration.
2. Never touch the CIS lenses with bare hands or fingers.
3. Use only lens paper to clean the lenses.
4. Never attempt to disconnect the signal or power connectors from the CIS unit. This could damage the CIS unit or throw it out of adjustment. When connecting the CIS unit, connect the FFCs at the SIB.

5.1.6 ELECTRICAL COMPONENTS

1. Make sure that all terminal connections are grounded. The ground wire on the terminal of the electrical power cord must be properly grounded.
2. All of the ground harnesses that are connected to the back of the scanner unit and the PCB box should remain connected while the machine is operating.

5.1.7 ADJUSTMENTS AT MACHINE INSTALLATION

1. Avoid placing the machine near a window to prevent sunlight from entering the machine and causing problems in images like uneven density.
2. The back of the scanner unit should never be exposed to strong light.
3. If the windows near the machine are provided with blinds or curtains, close them.

5.1.8 OTHER PRECAUTIONS

1. The CIS unit has five separate elements, and sometimes image density may appear uneven at the joints where these elements connect. When this problem occurs, try scanning in the Photo Mode. The scanning level may be affected by the original floating away from the exposure glass during scanning. This can also cause inconsistencies in the wavelengths of the CIS unit with color originals and lead to slightly uneven density in the copied image. If you see white areas in dithered images, switch the machine to the Photo Mode. If you see fine lines that appear as scratches, change the setting of the density notch adjustment.
2. Because the CIS unit has 5 separate elements, pixels may become misaligned at the joints of these elements.
 - Normal paper original: 2 pixels
 - Normal paper with curl: 3 to 4 pixels
 - Thick original (1 mm): 3 to 6 pixels

Note

- In order to compensate for the differences in Generation Copy Mode, try reversing the direction of the original when you insert it, or swap the orientation between LEF and SEF.
3. Problems can occur with a pasted up original. When using a pasted up original, try Text Mode or Photo Mode. Shadows can appear in copies because the CIS light source comes from one direction where there are edges (steps) on the pasted up document.
 4. After printing, if the machine is to remain idle for a long period, remove the paper rolls from the machine and store them in their protective bags. Paper exposed to a high or low temperature or high humidity can absorb or lose moisture causing it to curl and ripple, wrinkle, or fold.

5.1.9 SERVICE PRECAUTIONS

Scanner Unit Rollers



d1241036

The surfaces of the main rollers (original feed roller, original exit roller, registration roller, and exit roller) are covered with a soft urethane coating. This coating is soft and can be damaged quite easily (even with a fingernail).

- Never touch the surface of these rollers with bare hands.
- Always hold the rollers by the bare ends where they are not coated.
- Never use any type of strong organic solvent to clean the surface of these rollers. Use only an alcohol or water dampened cloth to clean the rollers.

Main Frame Screws

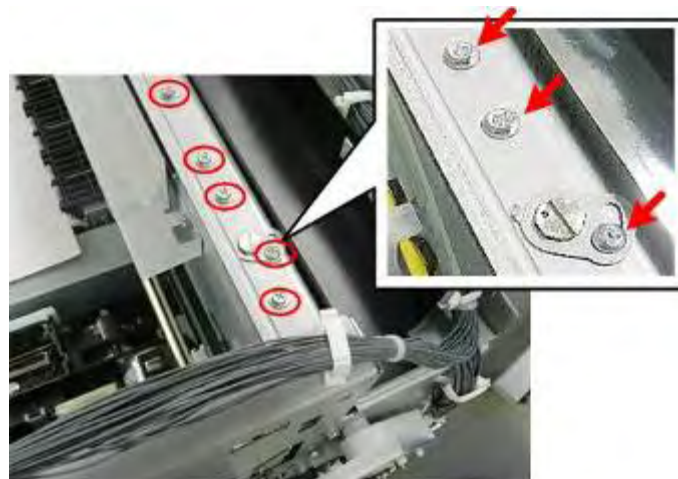

d1241037

There are paint-locked screws across the top of the machine (under the top cover). These screws are positioned and adjusted at the factory. Never loosen or attempt to adjust these screws.

Right Plate Screws

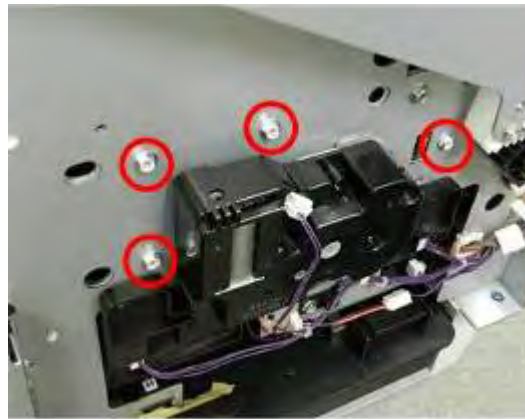

d1241038

You can see the heads of four paint-locked screws around the top of the maintenance unit. These screws hold a re-enforcement plate. Never loosen or remove any of these screws.

Maintenance Unit Base Screws

The maintenance unit base plate supports the maintenance unit. These screws hold the base plate under the maintenance unit, which must always remain in the same position below the carriage print heads.



d124r734

The two base plate screws at the back on the right rear panel should never be loosened or removed.

General Precautions

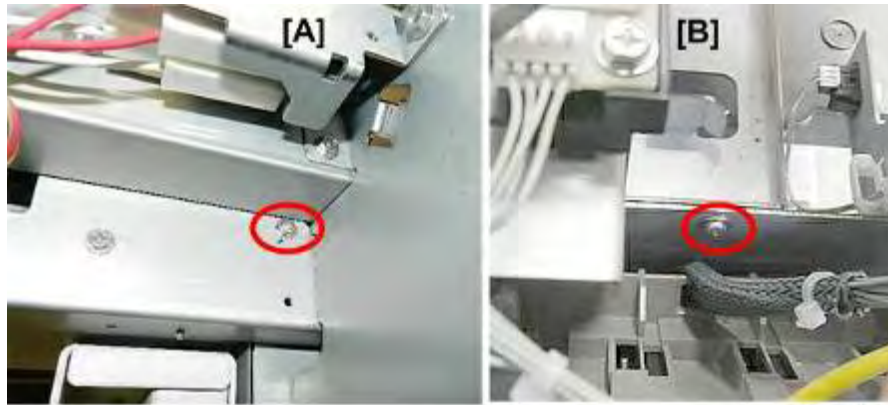

d124i322

There are also two paint-locked screws at the front. One screw is at the front below the switch bracket [A] on the right. The other screw [B] is to the right of the temperature/humidity sensor above the ink supply unit.

Solenoid Bracket Screw



d124r735

The position of the air solenoid bracket is adjusted at the factory. This screw is also paint-locked to remind you that it should not be removed.

Main Carriage Screws

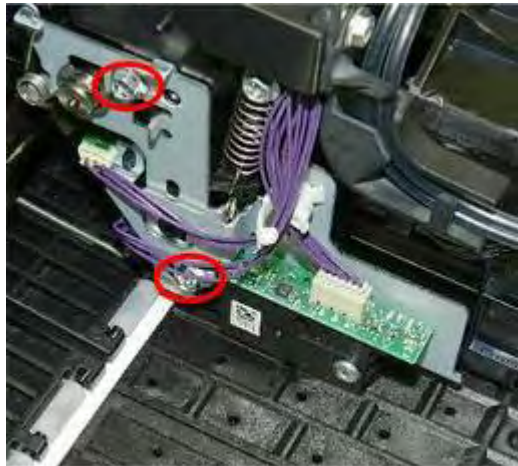

d124i323

The illustration above shows the left cover of the carriage unit removed. It is extremely important you never loosen or remove these screws. Tampering with these screws could cause the carriage unit to fall out of alignment or onto the platen plates.

Platen Plate Guide Rod Screws



d124r747

Never loosen the center screws of the brackets that hold the platen plate guide rod in place. The platen plates should never be removed.

Sensor and Temperature/Humidity Sensor Bracket

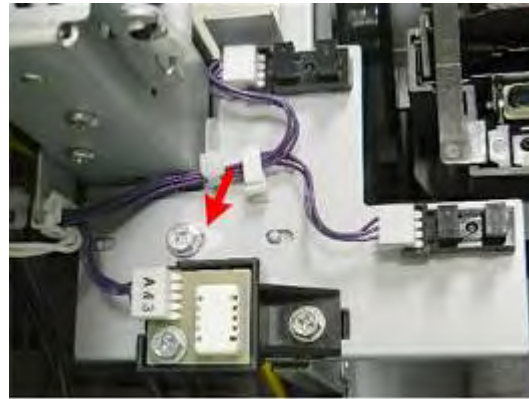

d124r774

This screw is paint locked. However, this bracket must be removed in order to remove the carriage unit. The bracket must be reinstalled at exactly the same position so the sensors are positioned correctly. ➤ page 5-239

5.2 COMMON PROCEDURES

5.2.1 BEFORE YOU BEGIN

This section describes procedures commonly used to service the machine.

★ Important

- The service technician must be familiar with all procedures in this section before servicing the machine, as described in other sections of this service manual.

What You Need

Tool	Needed For:
Alcohol, clean linen cloths	Cleaning surfaces and rollers
Allen key (2.5 mm)	Removing and attaching hex bolts.
Blower brush	Cleaning sensors
Clean rags	Wiping up ink, covering disconnected ink tubes
Clean waste paper	To place under the maintenance unit and other parts that can leak ink, in order to protect tables and other surfaces
Flashlight (small)	Checking the position of the suction cap and print head caps of the maintenance unit.
Gloves	Handling encoder strips and wheels, and urethane-coated rollers
Lens paper	Cleaning the CIS elements
Metal scale	Inserting mylars into narrow gaps.
Phillips driver – long	At least 300 mm (12") to reach screws inside the machine.
Phillips driver – small	Removing small screws
Radio pliers	Attaching, reattaching e-rings

5.2.2 BEFORE SERVICING THE MACHINE

⚠ WARNING

- Before doing any procedure, always turn off the power switch and unplug the machine from its power source.



d124r001

To prevent damage to these parts, and to prevent interference with raising and lowering the top of the scanner unit, always remove them before servicing the machine:

[A] Original guides (x2)

[B] Original stacker (x2)

[C] Rear output guides (x4)

Rear Output Guides

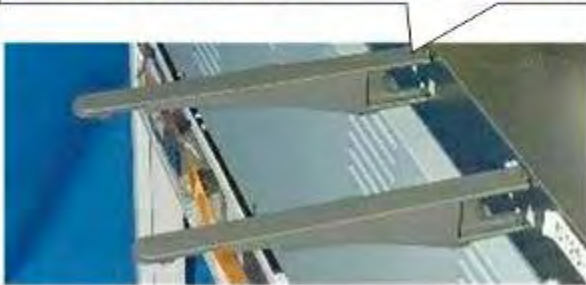
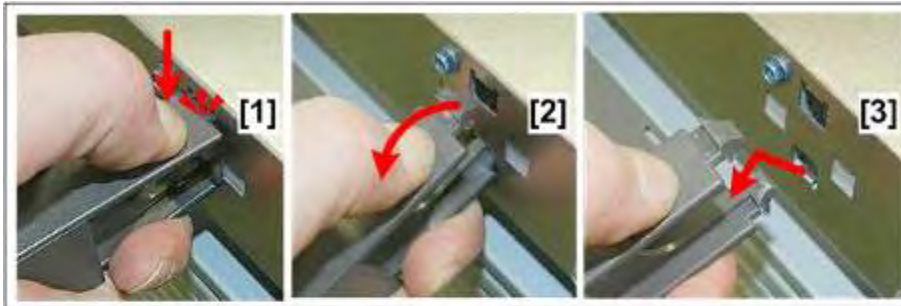

d124r002

1. At the back of the machine, for each guide press down on the top of the guide [1].
2. Lower it away from the plate [2].
3. Unhook it at the bottom [3].

Original Guides



d124r003

1. Rotate each guide away from the machine and remove it.

Original Stacker



d124r004

1. First, separate the tabs at the base (▼ x4).
2. Rotate the original stacker away from the machine to remove it.

Reinstallation



d124r005

1. To reinstall the original stacker, first connect it at the base, and then rotate the tray up.



2. Pull out the light shield and confirm that the gap at the top of the scanner unit is completely covered.

★ Important

- This light shield prevents light from entering the scanner unit.
- If this gap is not covered, strong light could enter the back of the scanner unit and cause image distortion during scanning.

5.2.3 SEPARATE THE MAIN UNIT FROM THE SCANNER UNIT

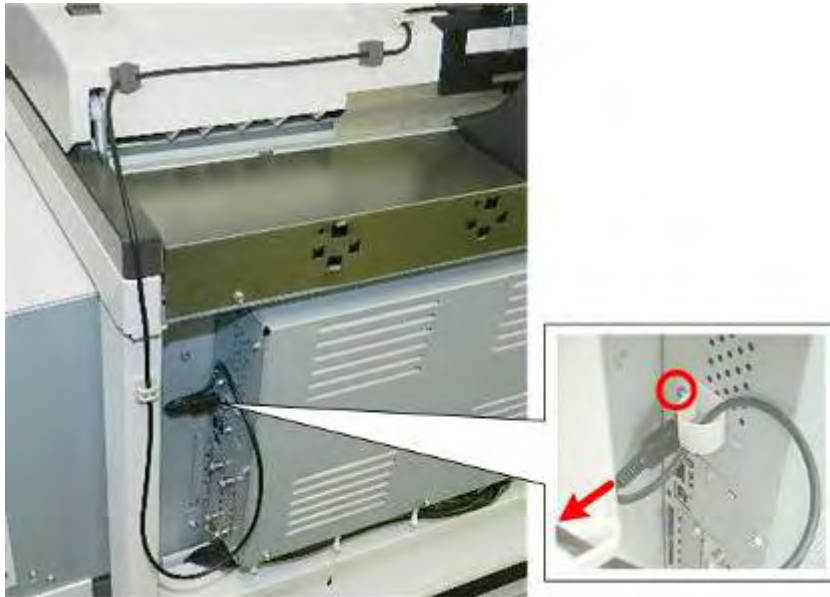

d124r088

1. Remove the round clamp (🔧 x1).
2. Disconnect the host USB cable (🔌 x1).
3. Coil the harness and set it on top of the scanner unit.

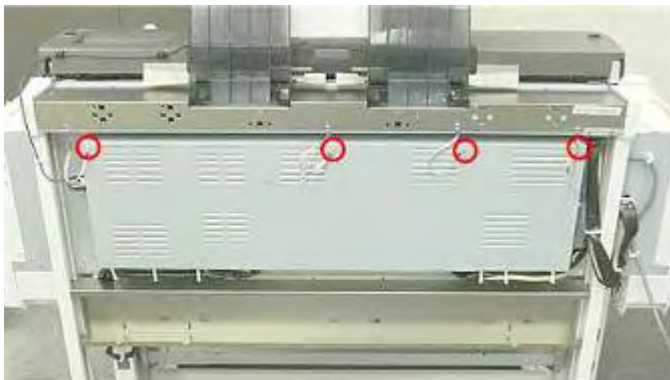

d124r069

4. Disconnect the ground harnesses from the PCB box (🔧 x4).

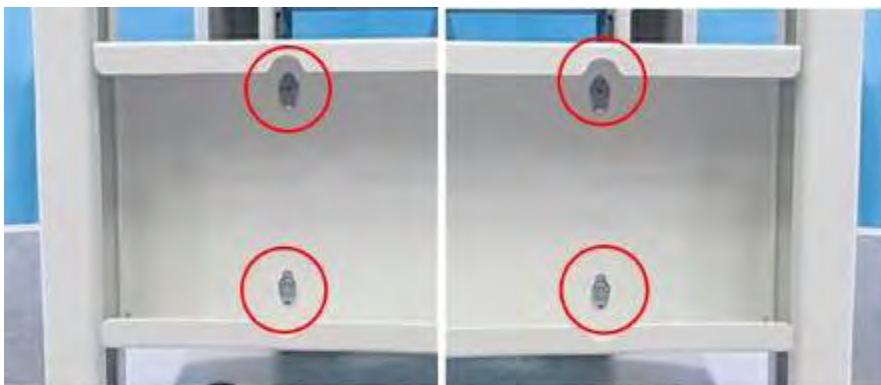

d124r069a

- Remove the base screws on the left and right( x4).



d124r079

- Slowly, pull the scanner stand away from the back of the main unit.

★ Important

- To avoid scratching or breaking the original table, never lay anything on the original table while you are working.
- Move the scanner unit and stand assembly carefully. It is top heavy and can tip over easily.

5.2.4 INK COLLECTOR TANK

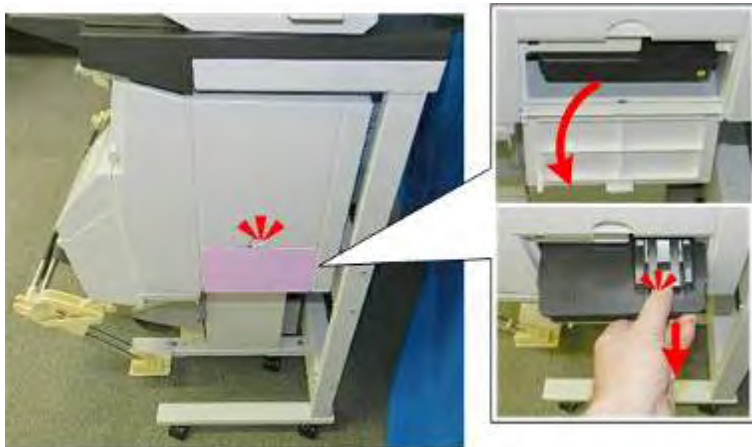

d124r010

- Open the ink collector cover.
- Depress the lever on the top of the ink collector to unlock it, and then remove it.

5.2.5 PAPER ROLLS

1. Make sure that the machine is switched on.



d124r011

2. Raise the paper exit guide [A].
3. Press button [B] and hold it for at least 2 seconds to rewind the paper.



d124r012

4. Avoid touching the paper with your hands. Grip the roll at the plastic holders on both ends, and then lift the paper roll out of the machine.
5. Lay the roll horizontally on a flat clean surface.

5.2.6 MAIN COVERS

In order to service some parts inside the machine, covers must be removed on the right side in this order:

- Right Cover > Right Upper Cover > Ink Cartridge Cover

To remove the top cover, the covers must be removed in this order:

- Right Cover > Right Upper Cover > Ink Cartridge Cover > Left Cover > Top Cover

↓ Note

- Use only a water dampened cloth to clean the covers. To protect the finish of the covers, never use an organic solvent to clean them.

Right Cover



d124r015

1. Open the ink collector cover.



d124r016

2. Disconnect the hinges on both ends of the cover and remove it.
3. Disconnect the bottom of the cover (🔩 x1).

Common Procedures



d124r017

4. At the back of the machine, disconnect the right cover ( x2).
5. Lift the cover straight up and remove it.

Reinstallation

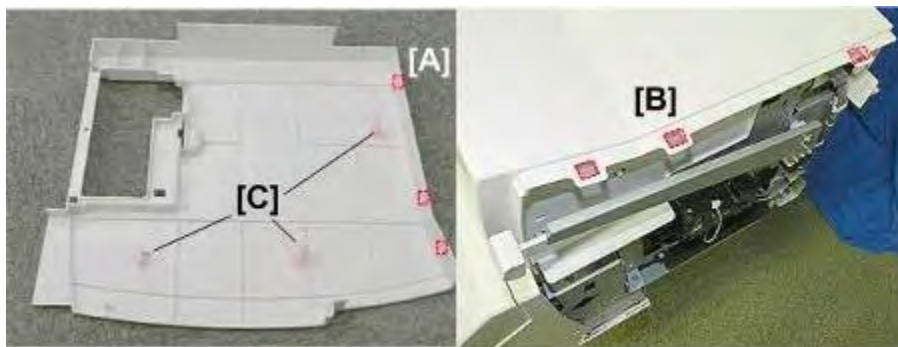

d124r018

1. There are three tabs on the top edge of the cover [A] that fit into the holes [B].
2. The three hooks [C] fit into holes in the machine frame.

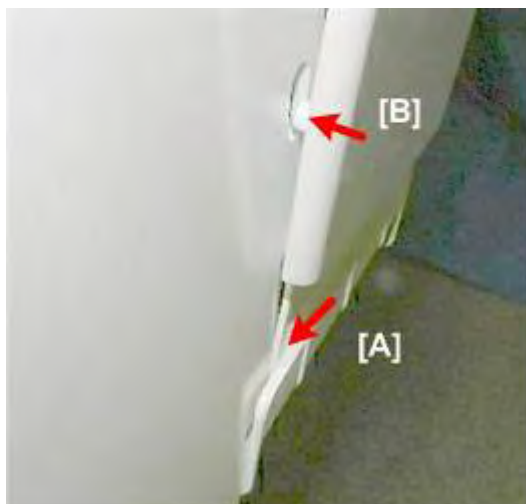

d124r019

3. After you engage the tabs and hooks, make sure that the lap of the cover is inserted into the slot [A].
4. Make sure the peg [B] is inserted into the hole.

Right Upper Cover



Preparation

Remove:

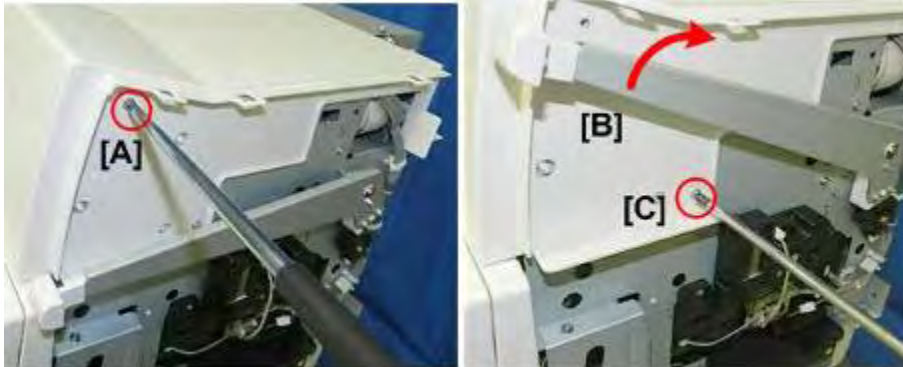
- Right cover ■ page 5-19



d124r020

1. Disconnect the cover at the top [A] ( x1).
2. Raise the paper holding lever [B].
3. Disconnect the cover at [C] ( x1).

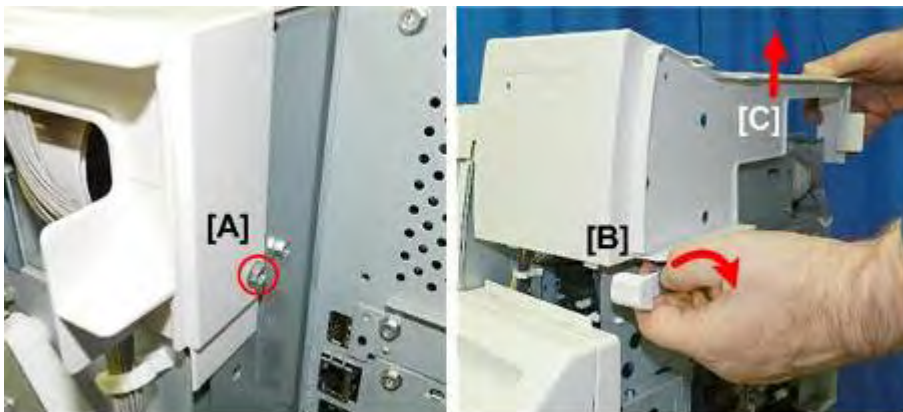

d124r021

4. Disconnect the cover at the rear [A] ( x1).
5. Pull the lever [B] slightly away from the machine.
6. Lift the cover [C] to remove it.

Reinstallation

Common Procedures

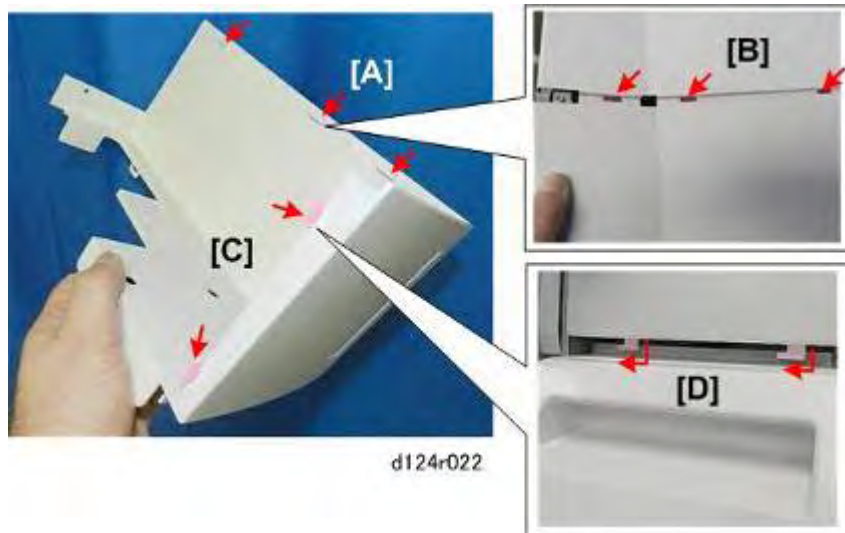



1. Insert the three tabs on the top edge of the cover [A] into the holes [B].
2. Insert and slide the hooks [C] into the holes on the top edge of the ink cartridge cover [D].

Ink Cartridge Cover

Preparation

Remove:

- Right cover  page 5-19
- Right upper cover  page 5-21



d124r023

1. Open the ink cartridge cover.



d124r024

2. Depress the tab of each ink cartridge and remove it.



d124r025

Replacement
and
Adjustment

Common Procedures

3. Disconnect the top of the cover ( x1).



d1241006

4. Raise the paper exit guide [A].

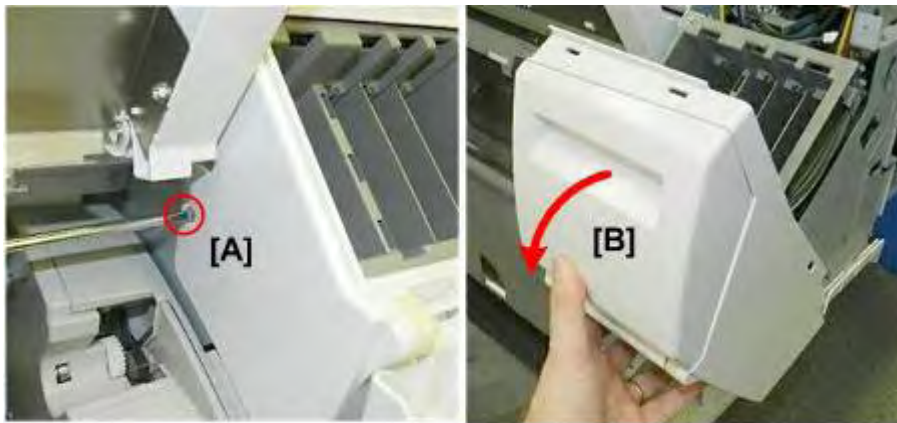

d124r027

5. Disconnect the side of the cover [A] ( x1).
6. Rotate the cover forward slightly and then remove it.

Left Cover



d1241006

1. Raise the paper exit guide [A].



d124r028

2. Below the open guide, remove the screw ( x1).



d1241006a

3. Lower the paper exit guide.

Common Procedures



4. Push in the bottom of the front cover, and then raise it until it locks.

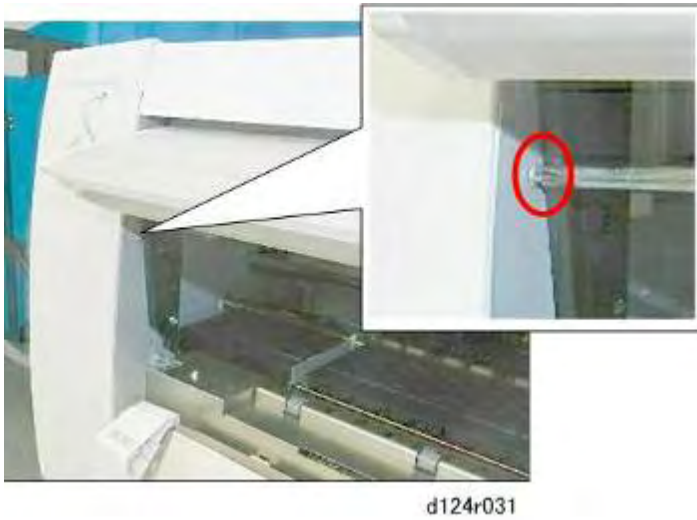

5. Below the cover, remove the screw ( x1).



6. Lower the front cover.



d124r033

7. At the back, disconnect the left cover ( x2).



d124r034

8. Lift the cover straight up and remove it.

Reinstallation

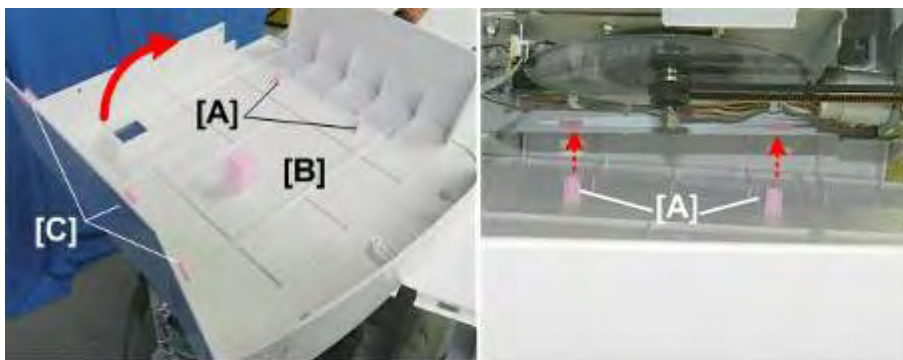

d124r035

1. Set the bottom hooks [A] into the holes in the frame.

Common Procedures

2. Raise the cover so that the middle hook [B] fits into its hole.
3. Insert the tabs [C] on the top edge of the cover into their holes.





d124r036

4. Lower the cover so that the hooks and tabs engage the machine frame.

Top Cover

Preparation

Remove:

- Right cover  page 5-19
- Right upper cover  page 5-21
- Left cover  page 5-25



1. Disconnect the top cover ( x7).



2. Lift the cover and remove it.

Important

- Do not attempt to print with the top cover removed. Light striking the exit sensor with the cover removed will cause paper to jam.

Reinstallation



1. Before fastening the screws, make sure that the bosses fit into the holes in the rear edge of the top cover.

5.2.7 FRONT COVER

Preparation

Remove:

- Top cover  page 5-29



d124r040

1. Raise the top cover to the angle shown above.

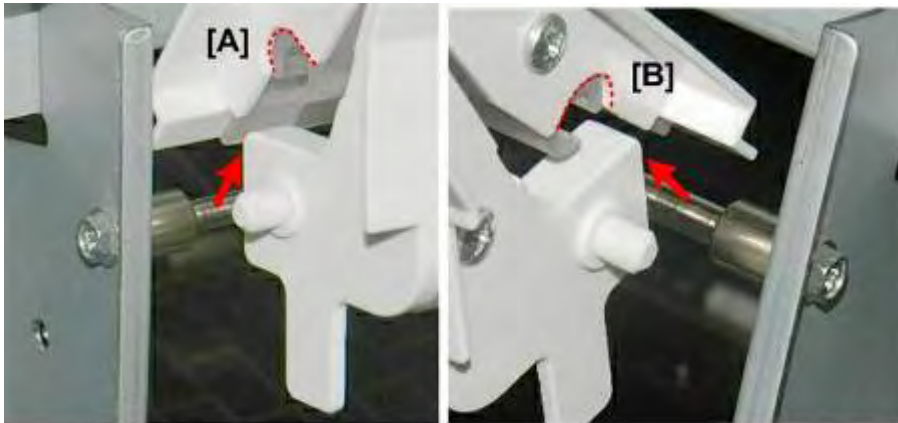

d124r041

2. Disconnect the peg on the left [A] and the peg on the right [B].



d124r042

3. Remove the front cover.

Reinstallation

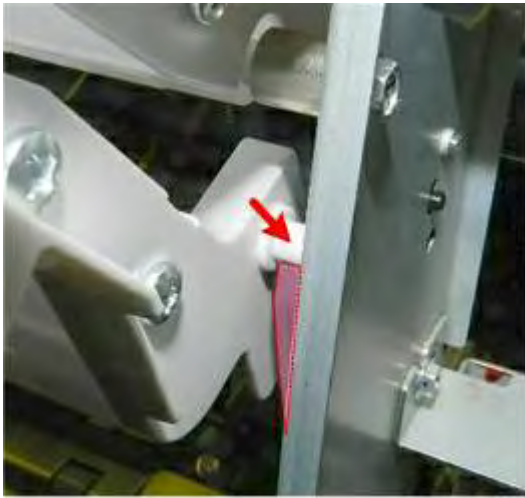

d124r043

1. Make sure that the left and right pegs are inserted into the left and right guides.
2. Raise and lower the front cover to confirm that it operates smoothly.

5.2.8 PAPER EXIT GUIDE



d1241006

1. Raise the paper exit guide until it stops.



d1241007

2. On the right, disconnect the torque limiter plate (①x2).

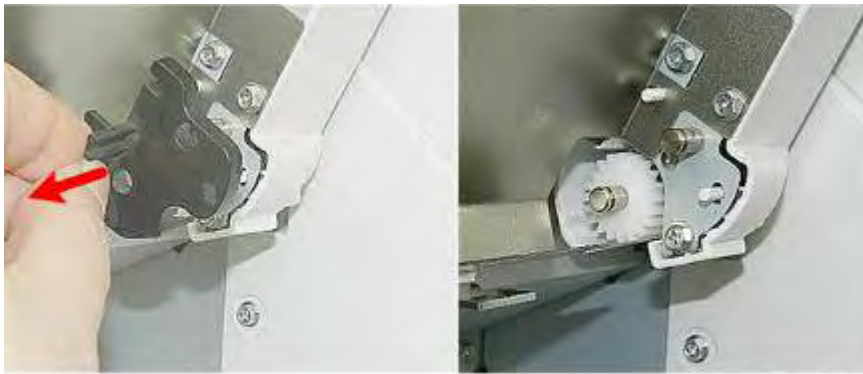

d1241008

3. Remove the plate.



d1241009

4. Remove the gear.



d1241011

5. Raise the guide to the angle shown above ①, shift it slightly to the left, and then lift it straight up ②, and then remove it.

Reinstallation

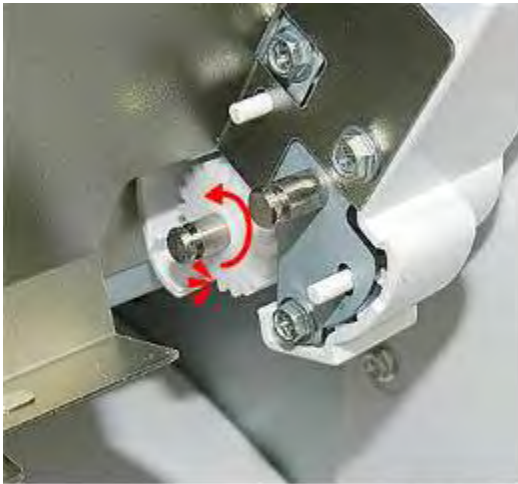





d1241012

1. When you set the gear, turn it until you feel the coupling on the back of the gear engage with the shaft pin.
2. Push in on the gear slightly so that it snaps into place.
3. The tip of the shaft should be visible as shown above. If the gear is not inserted far enough, you will not be able to re-attach the cover.

5.2.9 ROLLER COVER

Preparation

Remove:

- Top cover  page 5-29
- Front cover  page 5-31
- Paper exit guide  page 5-32
- Ink cartridge cover  page 5-23



d124r048

1. The roller cover is exposed for removal.



d124r049

2. Remove the guide for the front cover on the left ( x2).



d124r050



3. Remove the guide for the front cover on the right ( x2).

Common Procedures



d124r051

4. Disconnect:

- Left end of cover [A] ( x2)
- Right end of cover [B] ( x2)



d124r052

5. Lift the cover and remove it.

5.2.10 MOVING THE CARRIAGE UNIT

Before You Begin

While the machine is idle, the carriage unit always resides on the right side of the machine where the maintenance unit caps cover the print heads to prevent them from drying out. However, some maintenance procedures require uncapping the print heads and then moving the carriage unit to the center of the platen, or to the far left side of the platen.

Using **SP2102-004** is the best way to move the carriage unit, but you can also uncap the print heads and move the carriage unit manually. For example, you may need to move the carriage out of the home position manually when you already have the machine partially disassembled and realize that you must move the carriage unit.

There may be occasions when you need to return the maintenance unit to the home position manually to prevent the print heads from drying out.

- If the machine is partially disassembled at the end of the work day, the print heads should be capped manually before leaving the machine to sit for more than an hour.
- If the machine was operating when a power outage occurred, leaving the carriage unit out of the home position, you will need to cap the print heads if power cannot be restored within a short time.

Move the Carriage Unit with SP2102-4

Before you turn the machine off for a service procedure that requires that the carriage be out of the home position.

1. Go into the System SP mode.
2. Open **SP2102-4**
3. Select the setting for the procedure you need.

2102-4	Maintenance Unit Exchange Reset – Decapping
1	Lowers the maintenance unit ink caps and uncaps the print heads. The carriage does not move.
2	Uncaps the print heads and moves the carriage to the left of the platen.
3	Uncaps the print heads and moves the carriage to the center of the platen. This is the most often used procedure during servicing.

4. Turn the machine off.

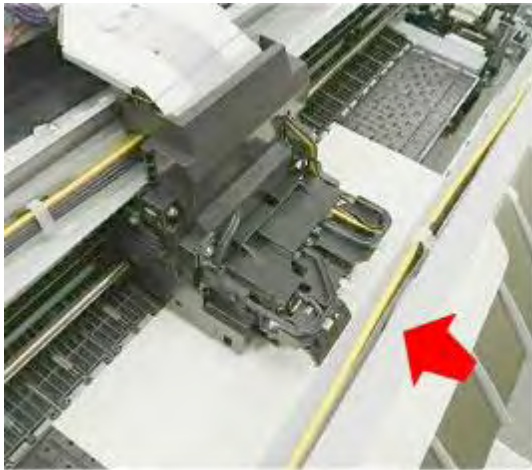

d124i208

5. Always slide a sheet of paper under the carriage unit after it has been moved to the center. This protects the platen from ink that could drip from the uncapped print heads.

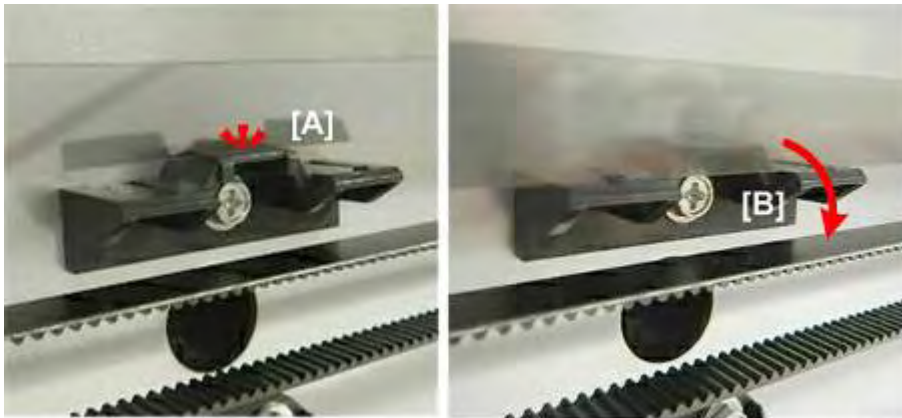

d124i209

6. Before you turn on the power switch to return the carriage unit to its home position on the right, check the position of the horizontal encoder strip on the left.
 - If the encoder strip is up on the bracket as shown at [A], pull it forward and down so that it is in front of the bracket as shown at [B].
 - If the machine is turned on with the strip positioned as shown at [A], the movement of the carriage unit may scratch the surface of the encoder strip.
7. After you reassemble the machine, turn the machine on. The carriage will return to the right side (home position), where the maintenance unit will cap the print heads automatically.

Uncapping the Print Heads and Moving the Carriage Unit Manually

1st Point: Suction Cap (K1)

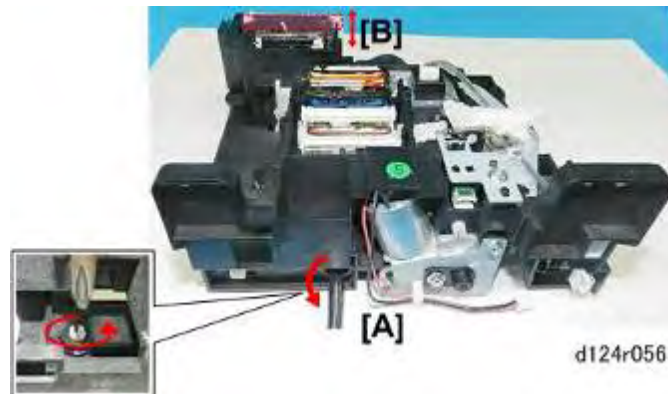

- Rotating the hex socket at [A] raises and lowers suction cap [B] which covers the K1 print head.
- Normally the suction cap is up and engaged with the black print head of the carriage unit to keep it from drying out.
- The suction cap must be lowered before the carriage can be moved away from the right side of the machine.

2nd Point: Print Caps (K2, Y, CM)

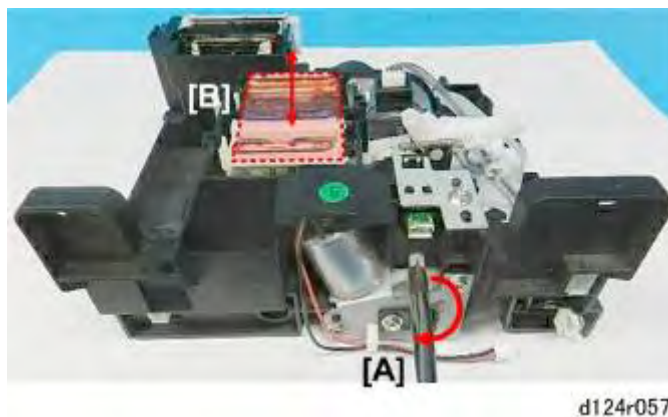

- Rotating the hex socket at [A] raises and lowers print head caps [B] which cover the K2, C, and YM print heads.
- Normally, these print head caps are up and engaged with the K2, C, and YM print heads of the carriage unit to keep them from drying out.
- The print head caps must be lowered before the carriage can be moved away from the right side of the machine.

Procedure

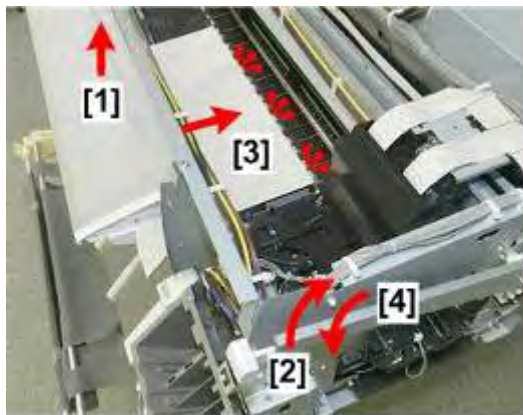

d124r062

1. Raise the front cover [1].
2. Raise the paper holding lever [2].
3. Slide a sheet of paper [3] into the machine as far as the gap between the raised rollers and the platen.
4. Lower the paper holding lever [4] to hold the paper in place.

↓ Note

- This paper protects the platen from ink that may leak from the carriage unit after it is moved away from the right side of the machine.

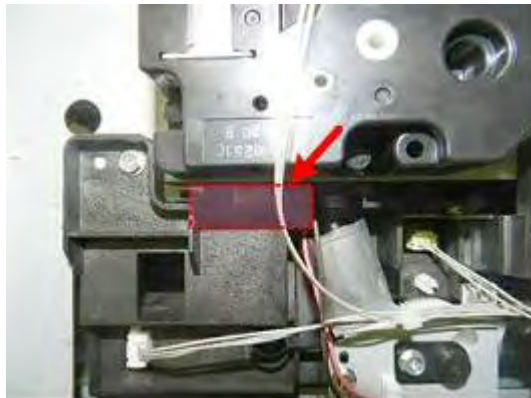

d124r060

5. Check the gap on the right side of the maintenance unit.
 - There will be no gap if the cleaning unit is forward and the suction cap is up. Go to the next step to lower the suction cup. Normally, the suction cap will be up.
 - There will be a gap if the suction cup is already down. **Go to Step 7.**



6. Set a screwdriver in hole [A] and rotate it counter-clockwise to lower the suction cap. Use a flashlight to confirm that the suction cap is down.
7. Set a screwdriver in hole [B] and rotate it clockwise to lower the K2 and color print head caps. Use a flashlight to confirm that the print head caps are down.

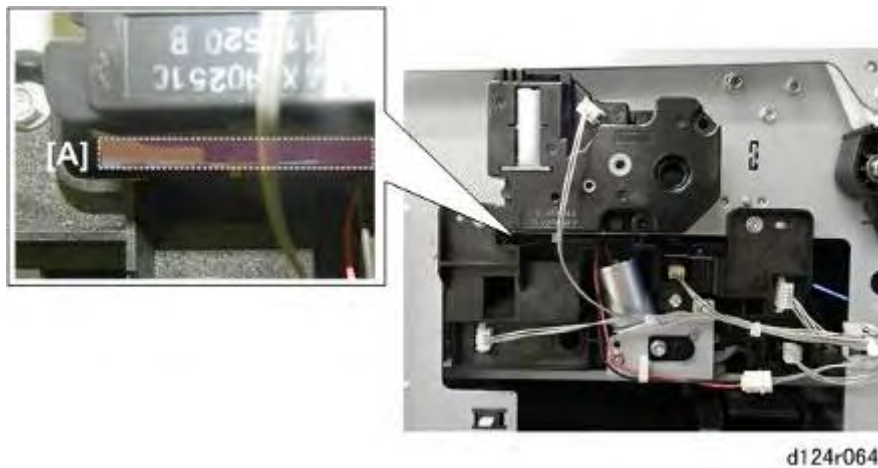

8. Once again check the gaps at [A].
 - Both the suction cap and K2/color print head caps should be down.
 - Your view should not be blocked by either the suction cap or K2/color print head caps.

⚠ CAUTION

- To prevent damaging the caps, you must confirm that both the suction cap and K2/color print caps are down before you push the carriage unit away from the home position.

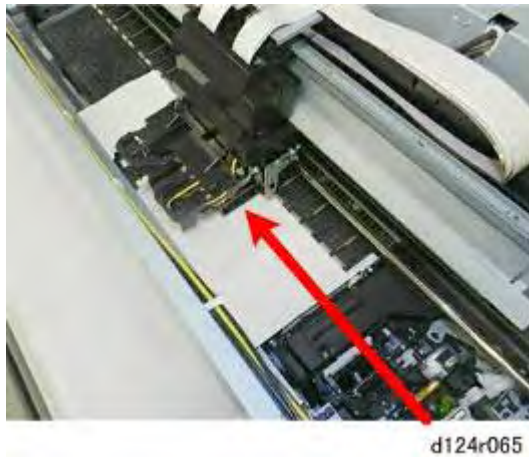

9. Push the carriage unit away from the right side of the machine so that it is over the paper.

Capping the Print Heads Manually

★ Important

- Do this procedure only when it is absolutely necessary and the print heads cannot be capped automatically by switching the machine on.
1. Slowly, push the carriage unit to the right side of the machine until it stops. The carriage should be over the maintenance unit.

★ Important

- In order to prevent damage to the wipers and edges of the print head caps, the print heads must be positioned directly above the print head caps within ± 0.8 mm.

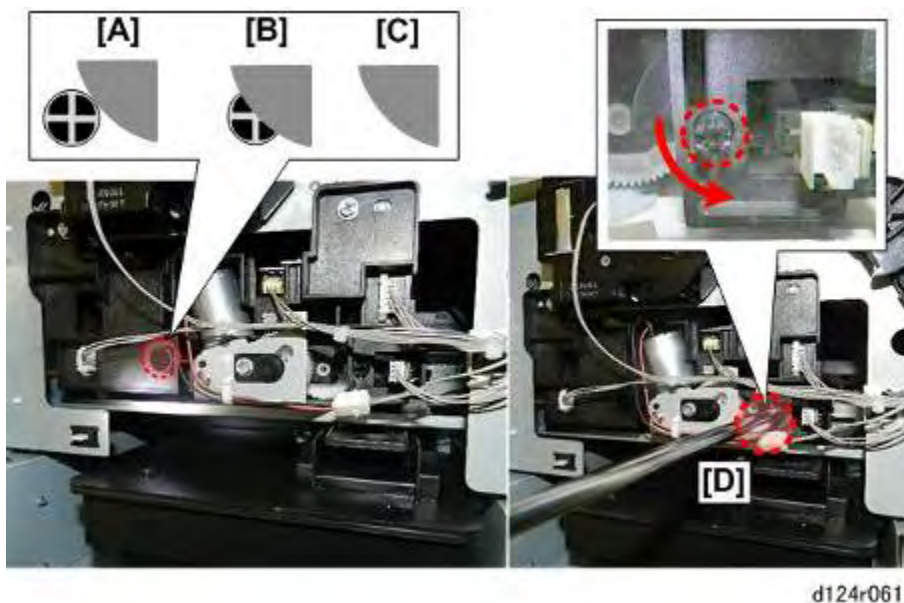

2. Use a flashlight to look through the hole and check the position of the hex socket.
 - If the hex socket is visible [A], the cleaning unit is forward and no adjustment is necessary. **Go to the next Step.**
 - If the hex socket is only partially visible or not visible at all [B] and [C], then set a

screwdriver at [D] and rotate it counter-clockwise to move the cleaning mechanism until you see the hex socket [A]. This moves the cleaning unit forward so that you can raise the suction cap.

★ Important

- The cleaning unit may be out of position (to the rear) only if the machine was interrupted during the print head cleaning cycle as a result of a power outage.



d124r063a

3. Set a screwdriver in hole [A] and rotate it counter-clockwise to raise the suction cap. Use a flashlight to confirm that the suction cap is up.
4. Set a screwdriver in hole [B] and rotate it clockwise to raise the K2 and color print head caps. Use a flashlight to confirm that the print head caps are up.

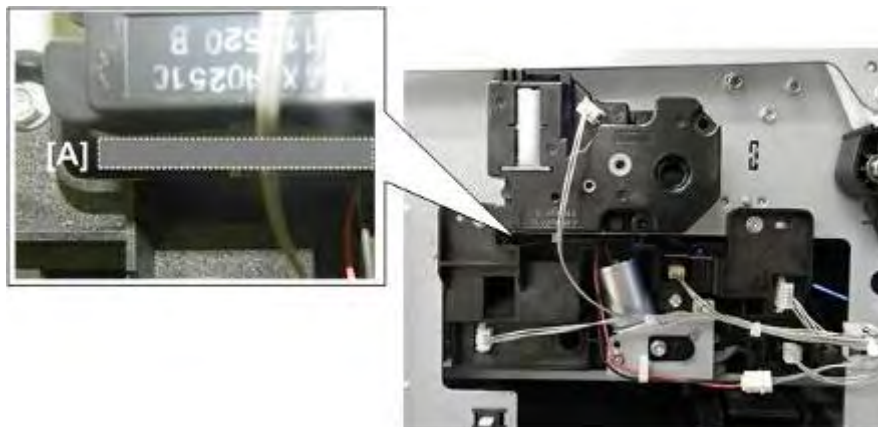

d124r064a

5. Once again check the gaps at [A]. Both the suction cap and K2/color print head caps should be up.
6. At the resumption of servicing, be sure to uncap the print heads before you move the carriage unit manually.

5.2.11 REAR COVER



Preparation

- Separate the Main Unit from the Scanner Unit  page 5-16

Note

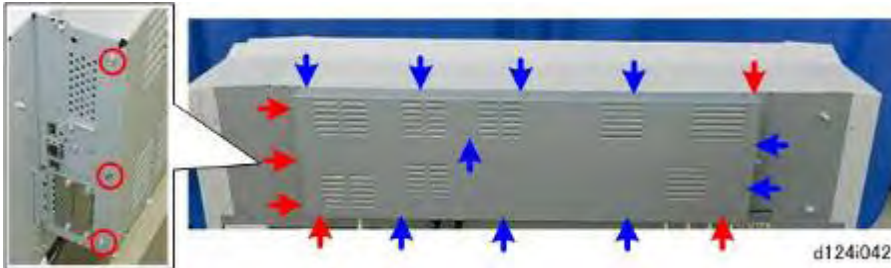
- The rear cover is held in place by many screws but only six screws need to be removed (the others can just be loosened).



1. Remove the screws marked by red arrows ( x6).
2. Loosen (do not remove) the screws marked by the blue arrows ( x10).



3. Slide the cover to the right and remove it.

5.2.12 DISCONNECTING THE MAIN UNIT FROM THE SCANNER UNIT

Preparation

- Separate the Main Unit from the Scanner Unit ➤ page 5-16

Remove

- Rear Cover ➤ page 5-44

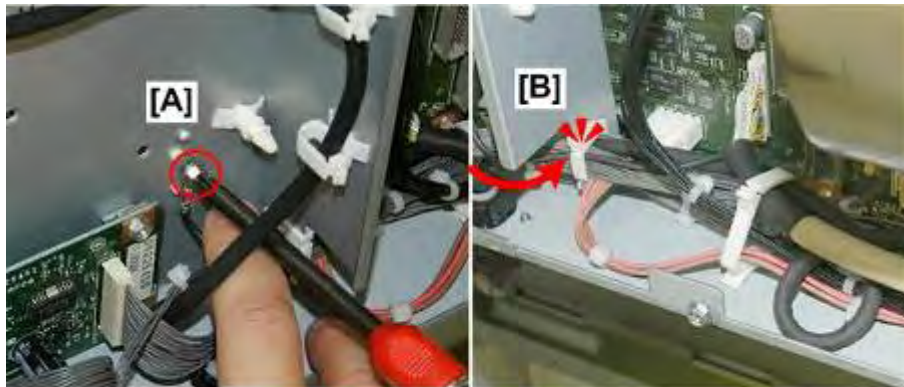

d1241028a

1. On the other side of the partition, disconnect ground wire [A] (⚙x1)
2. Route the black ground wire back through the clamp [B] (⚙x1).



d1241027a

3. Disconnect the connector of the scanner cable from **CN251** of the IPU.
4. Disconnect the 17-pin harness from **CN252** of the IPU.

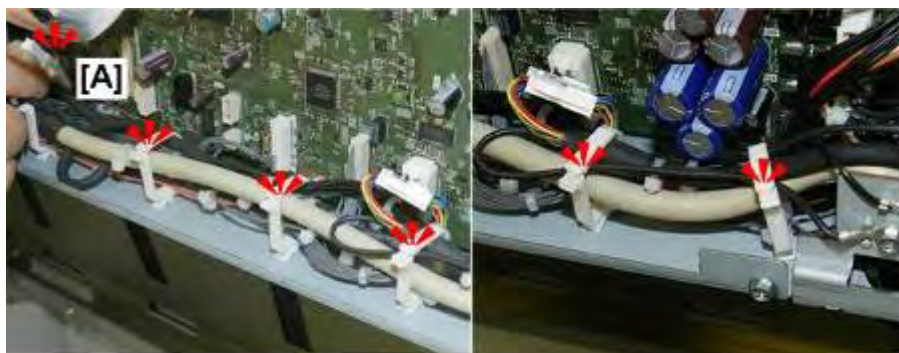

d1241026a

Common Procedures

5. Starting at the left [A], open the clamps and free the harnesses and ground wire (⚙️x6).

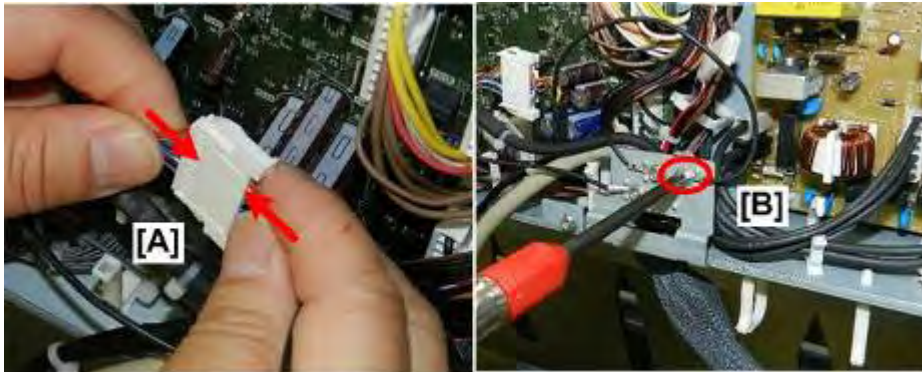

d1241025

6. Disconnect relay harness [A] (⚙️x1).
7. Unfasten ground wire [B] (⚙️x1).



d1241024a

8. Disconnect the 6-pin connector from **CN125** on the **PSU**.
9. Disconnect the 19-pin connector from **CN201** on the **MCU**.



d1241023a

10. Open the harness clamps [A] (⚙️x2).
11. Disconnect relay harness [B] (⚙️x1).
12. Free the harnesses and close the harness clamps (⚙️x2).



d1241022

13. Disconnect the bottom of the scanner cable bracket from the bottom of the PCB box ( x2).

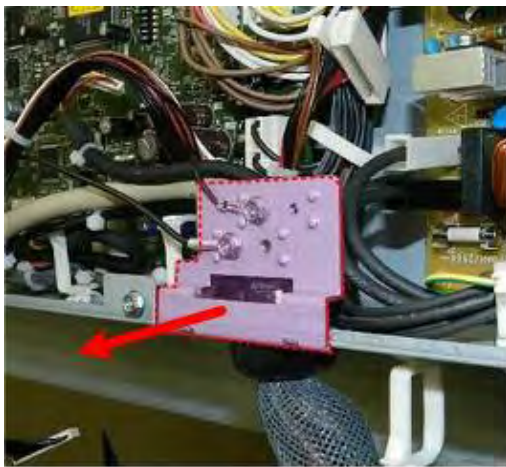

d1241021a

14. Remove the bracket and disconnected harnesses.



d1241078

15. Pull the scanner stand away from the main unit.

 **Important**

- To avoid scratching or breaking the original table, never lay anything on the original table while you are working.
- Move the scanner unit and stand assembly carefully. It is top heavy and can tip over easily.

Replacement and Adjustment

5.3 SCANNER

5.3.1 BEFORE YOU BEGIN

Scanner Safety

WARNING

- The scanner unit can emit Class 1 M LED radiation when open. Never attempt to view the CIS units with an optical instrument.

The scanner unit of this machine uses class 1M LED radiation which can seriously damage the eyes.

Blue:	Wavelength 452-463 nm and an output 6.9 mW
Green:	Wavelength 520-531 nm and an output 3.9 mW
Red:	Wavelength 629-634 nm and an output 4.8 mW

CAUTION

- Always turn off the power switch and disconnect the power plug from the power outlet before beginning any disassembly or adjustment procedure for the scanner unit.
- Never touch the safety switches (which will turn on the main power) when the original feed unit is open.
- After finishing every disassembly or adjustment of the scanner unit, always: 1) Confirm that the safety switches work correctly, 2) Confirm that the opening and closing of the original feed unit operates the safety switches.

Safety Switch Diagram

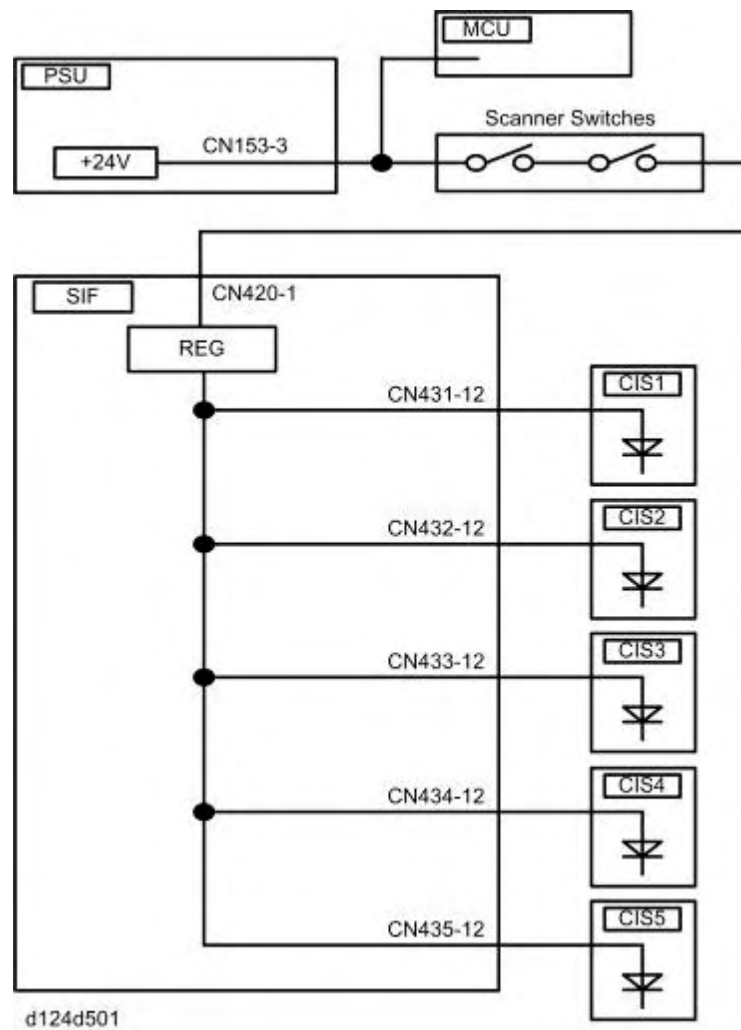

To ensure the safety of everyone working around the machine, two switches inside the scanner section prevent the LED radiation from switching on accidentally.

- When the original feed unit is opened and the switches open, a +24V line connecting each LED driver on the SIF board is disconnected.
- When the original feed unit is closed and the switches close, the +24V line is re-connected.

5.3.2 RAISE THE SCANNER UNIT

1. Open the scanner unit.



2. Remove the lock screws on the left [A] and right [B] bases of the scanner unit arms ( x2).

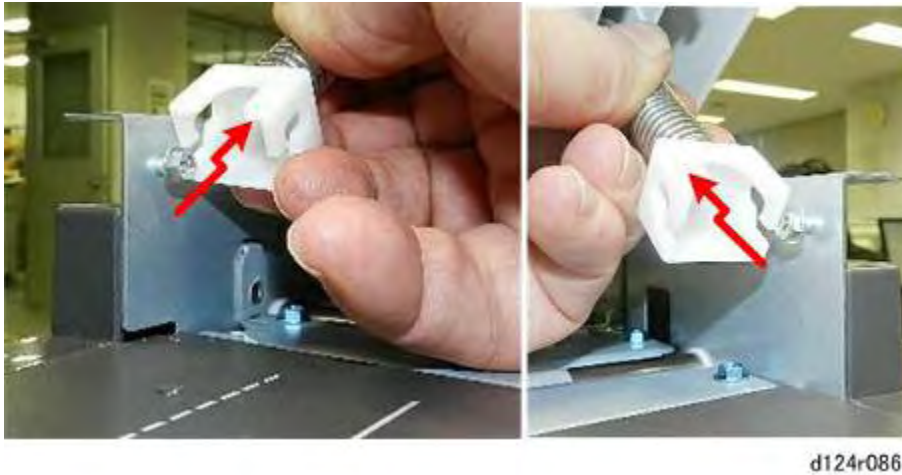

3. Disconnect the hinges from the post screws. Do not remove the screws.

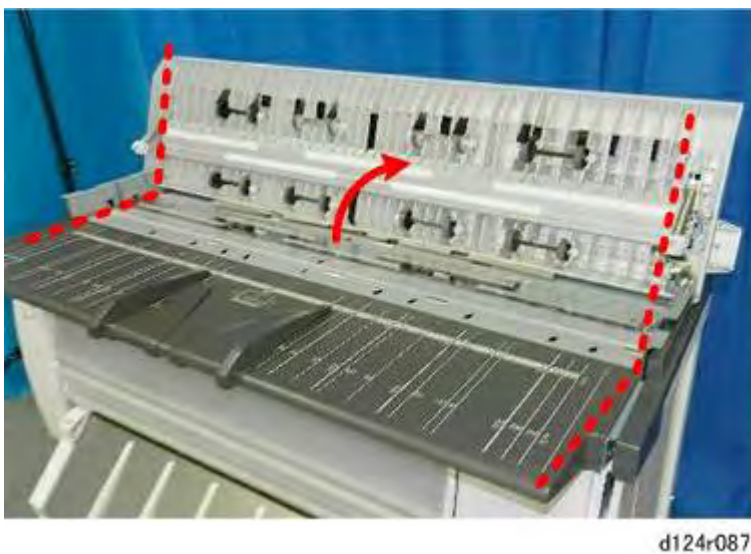

4. Raise the scanner to the full upright position.

5.3.3 SCANNER COVERS

Scanner Rear Cover

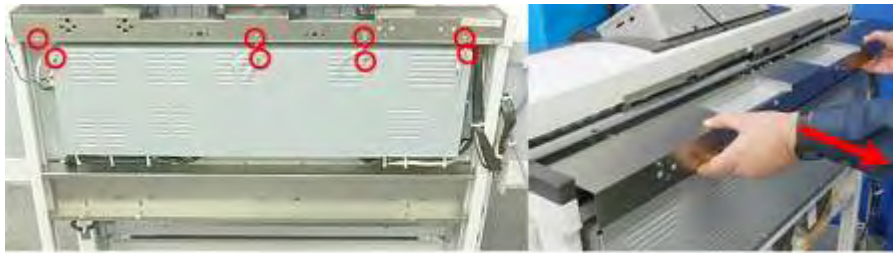

d124r090

1. Disconnect the cover ground harnesses ( x8).
2. Remove the cover.

Reinstallation

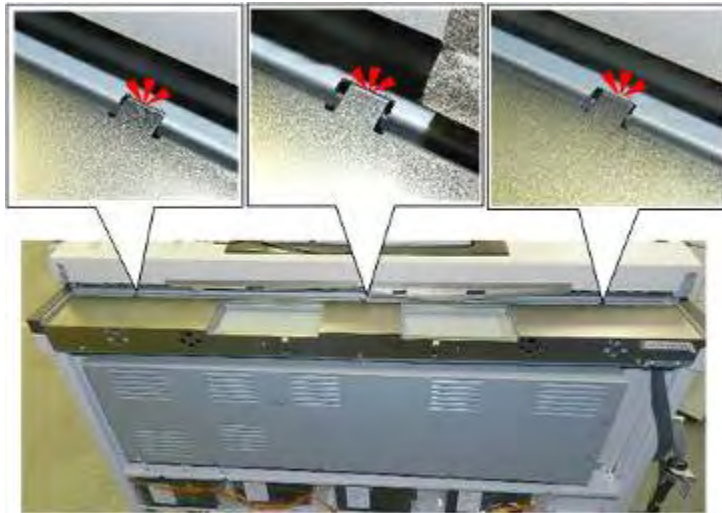

d124r090a

1. When you re-attach the cover, make sure that each of the three plate guides is inserted in its hole.

Scanner Left Cover, Right Cover

Preparation

Remove:

- Scanner rear cover



d124r091

1. Behind the unit, disconnect the left cover ( x1).
2. Slide the cover forward and remove it.



d124r092

3. Behind the unit, disconnect the right cover ( x1).
4. Slide the cover forward and remove it.

5.3.4 ORIGINAL TABLE

Preparation

- Raise the scanner unit

Remove:

- Scanner left cover, right cover



1. On the left side [A], remove pivot screw [B] (⚙️ x1).

★ Important

- This pivot screw must be reinstalled on the left end of the original table.

2. On the right side [C], remove tapping screw [D] (⚙️ x1).

★ Important

- This screw must be reinstalled on the right end of the original table.



3. Remove the original table.

5.3.5 SIB

Preparation

Remove:

- Scanner Rear Cover  page 5-51



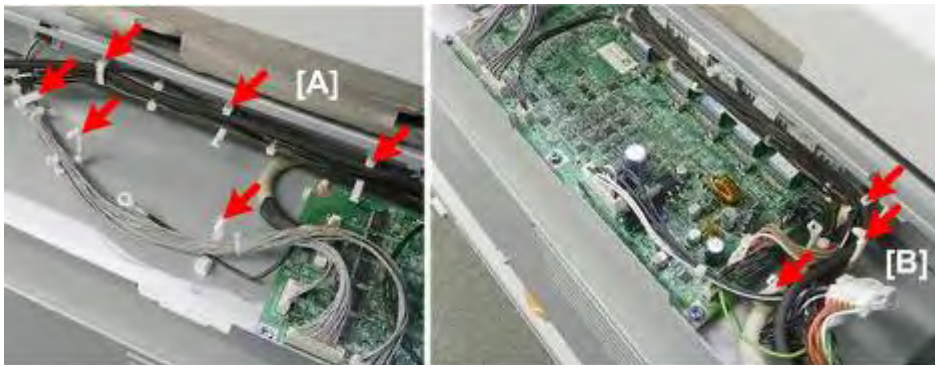

d124r100

1. The SIB is located at the left rear corner of the scanner unit.



d124r101

2. Open the harness clamps to the left [A] (x6).
3. Open the harness clamps to the right [B] (x3).



d124r102

4. Disconnect the left side of the board (x5).



d124r103

5. Disconnect the right side of the board ( x4).



d124r104



6. Pull the harnesses away from the FFCs and then disconnect the FFCs ( x5).

 **Note**

- Each FFC is numbered with the number of the CIS unit it is connected to.



d124r105

7. Disconnect the rear edge [A] of the board ( x3).
8. Use a pair or radio pliers to disconnect the front edge [B] of the board ( x3).

Scanner



d124r106

9. Remove the SIB.

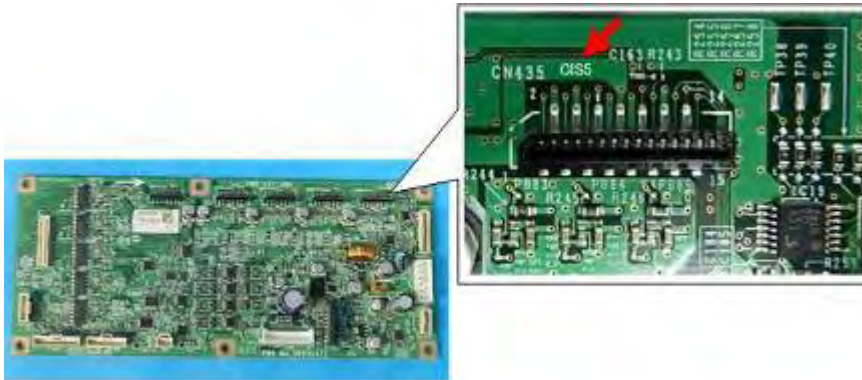



d124r106a

10. Each FFC connector slot is marked with the number of CIS element that it connects to. (The example above shows "CIS 5".)

5.3.6 SCANNER MOTOR

Preparation

Remove:

- Scanner Rear Cover  page 5-51
- Scanner Left Cover and Right Cover  page 5-52
- Separate Main Unit and Scanner Unit  page 5-16



Raise the Left End of the Scanner Unit



d124r098

Preparation

Remove:

- Separate the main unit from the scanner unit  page 5-16
- Scanner rear cover  page 5-51
- Scanner left cover, right cover  page 5-52

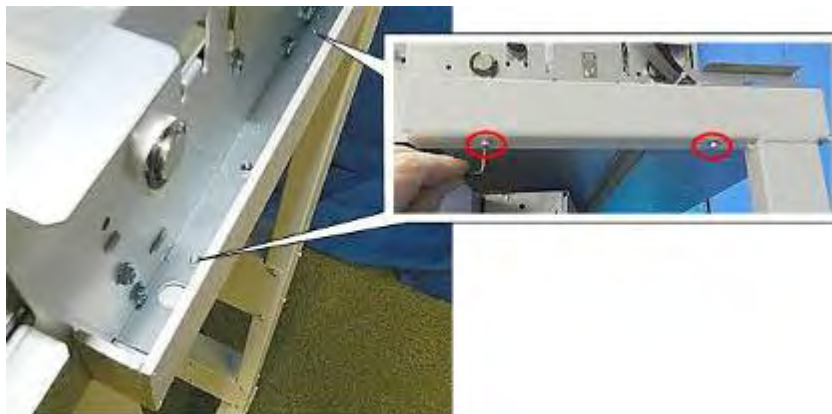

d124r095

1. On the right side, use the Allen key to loosen the hex-head bolts ( x2).

Do Not Remove These Hex Head Bolts.

Scanner



2. On the left side, use the Allen key to remove the hex-head bolts ( x2).



3. Slowly, push the scanner unit over the main unit. (This prevents the scanner unit from falling onto the floor.)



4. Slowly, lift the scanner unit and set it on top of the left rear corner of the scanner stand [A].
5. Place the square handle of a screwdriver or a block of wood or cardboard between the front left corner of the unit and the rack frame [B].

Note

- A block of wood 10 cm long and 2 cm thick (4 x 1 in.) is ideal.
- This block stabilizes the front end and prevents it from falling.

Remove the Scanner Motor

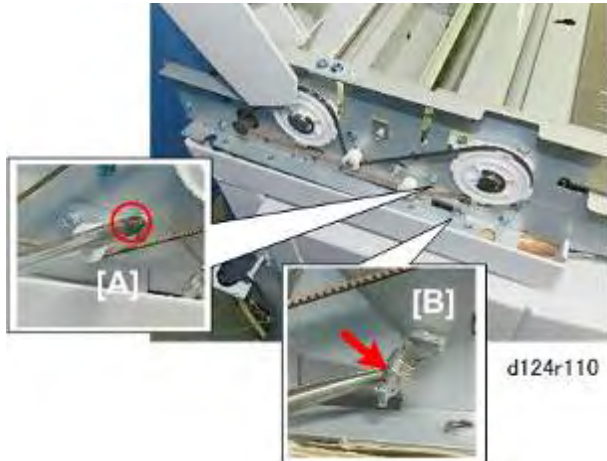

1. Loosen screw [A] (⚙️ x1).
2. Remove spring [B] (🔪 x1).

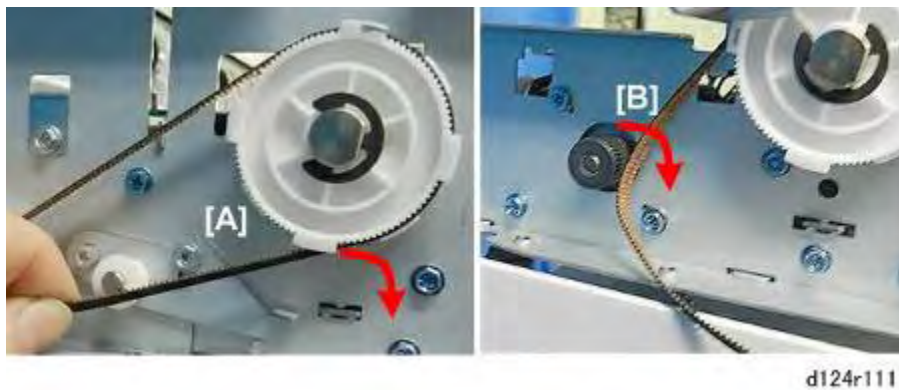

3. Disconnect the timing belt from drive gears [A] and [B] (⚙️ x1).

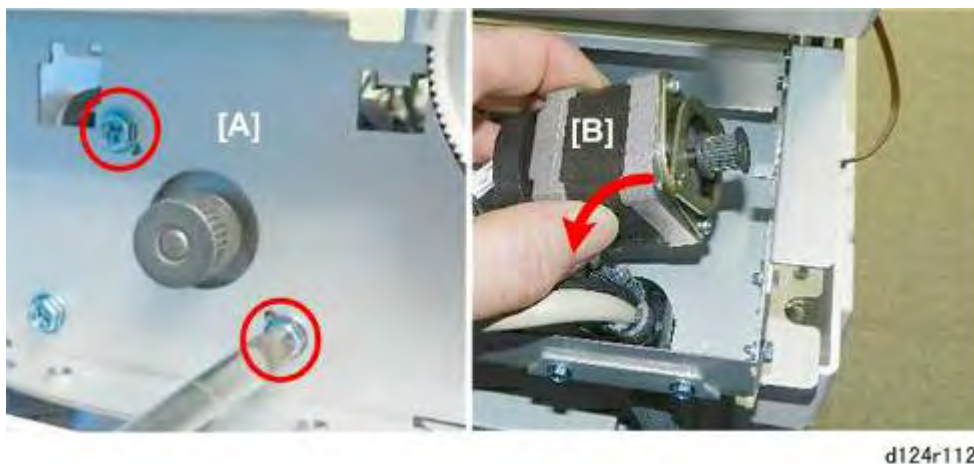

4. Disconnect the motor from frame [A] (🔩 x2).

Scanner

5. Pull the motor [B] away from the frame.



d124r113

6. Disconnect the motor.

5.3.7 SAFETY SWITCHES

Preparation

- Raise the Scanner Unit

Remove:

- Scanner Left and Right Covers ➤ page 5-52
- Original Table ➤ page 5-53

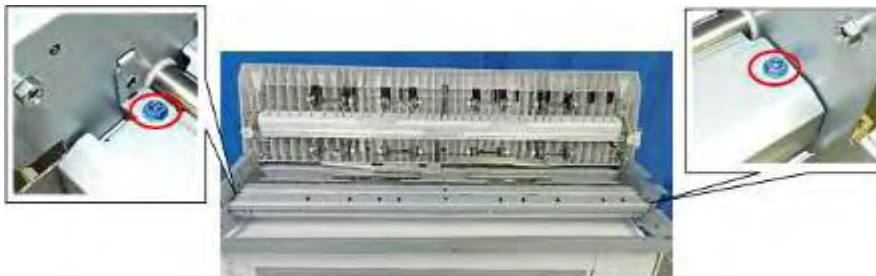

d124r115

1. Disconnect the left and right ends of the original width sensor cover plate (⚙ x2).





d124r116

2. Remove the original width sensor cover plate.



d124r117

3. Remove the mounting bracket [A] ( x1,  x1).
4. Remove the long lock screws [B] ( x2).



d124r118

5. Separate the bracket and the switches.

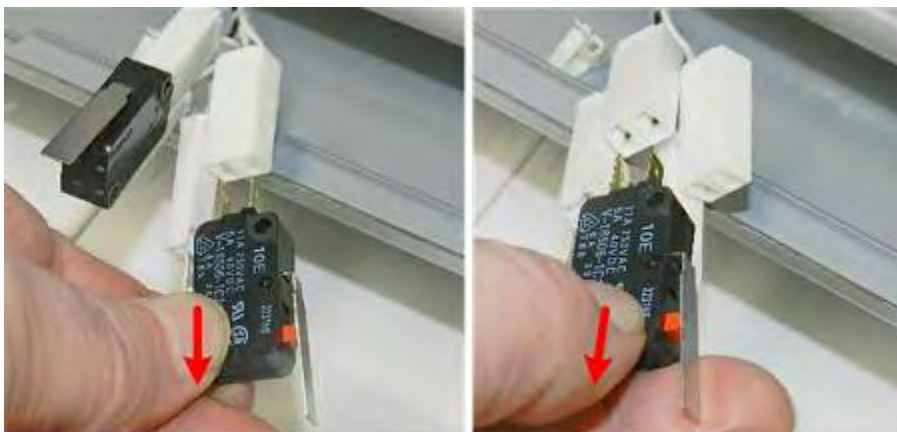

d124r119

6. Disconnect the switches ( x2).



d124r120

5.3.8 ORIGINAL SET SENSOR, ORIGINAL WIDTH SENSORS

Preparation

- Raise the Scanner Unit

Remove:

- Scanner left cover, right cover → page 5-52
- Original Table → page 5-53

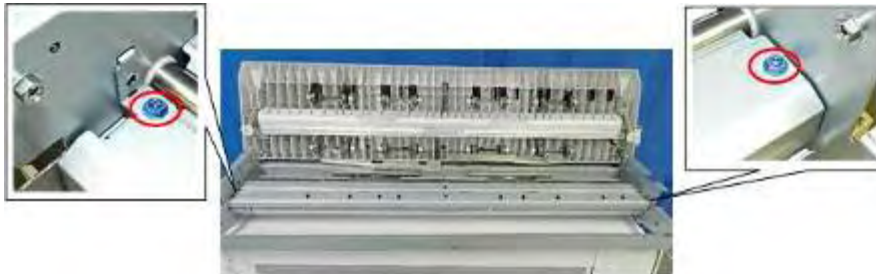

d124r115

1. Disconnect the left and right ends of the original width sensor cover plate (🔑x2).



d124r116

2. Remove the original width sensor cover plate.

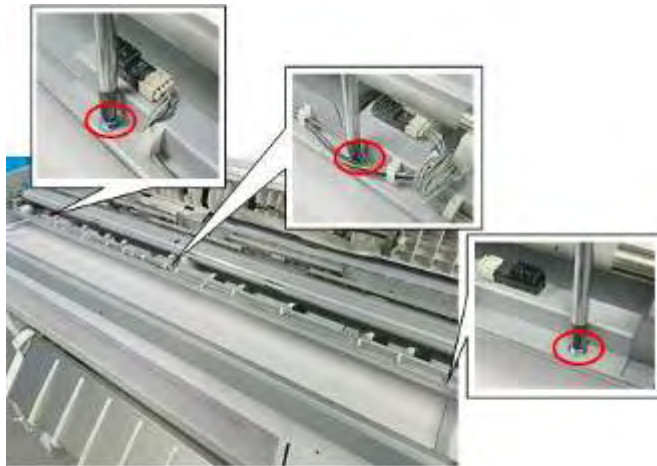

d124r121

3. Disconnect the original width sensor bracket ( x3).





d124r122

4. Turn the bracket over.



d124r123

5. In the center of the bracket, disconnect and remove the set sensor ( x1,  x4,  x1).

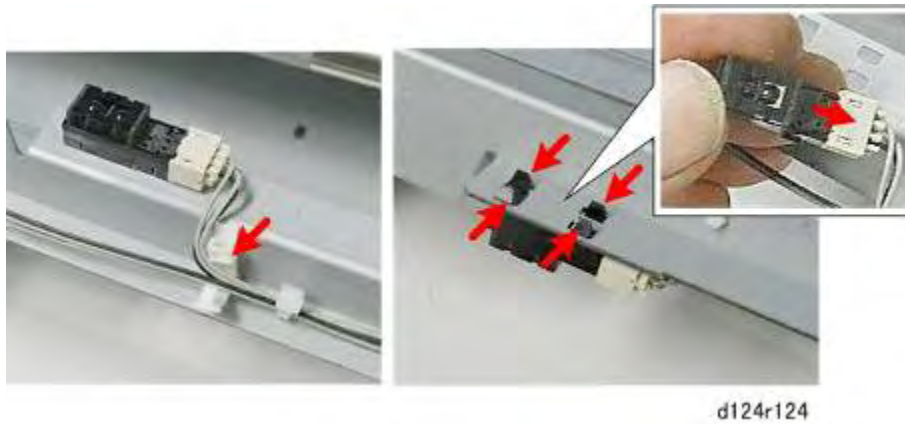

6. Remove the other width sensors (🔌x1, 🔌x4, 🔌x1).

5.3.9 ORIGINAL REGISTRATION SENSOR

Preparation

- Raise the Scanner Unit

Remove:

- Scanner Left and Right Covers 🛠️ page 5-52



1. Disconnect the left and right ends of the registration sensor cover plate (🔧 x2).



2. Remove the registration sensor cover plate.

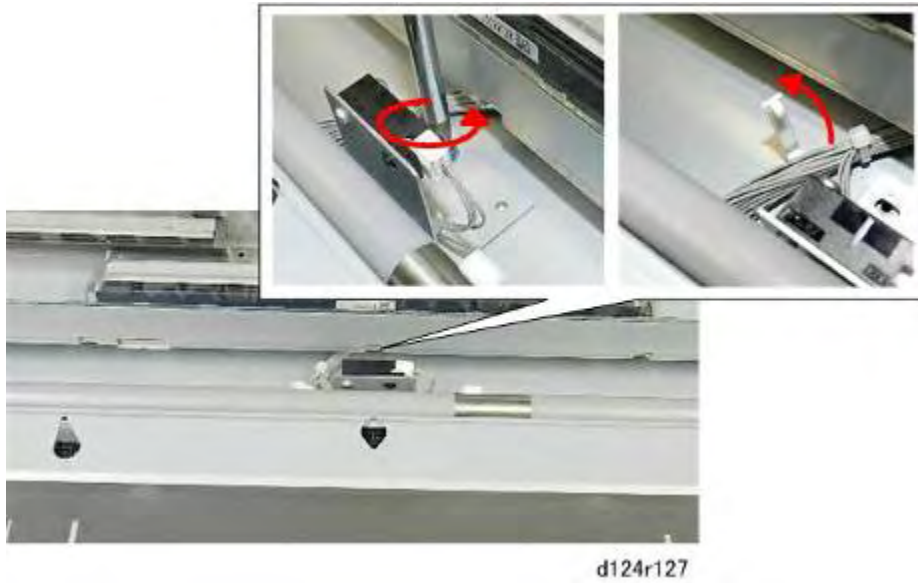

3. Disconnect the sensor bracket (🔧 x1, 📏 x1).

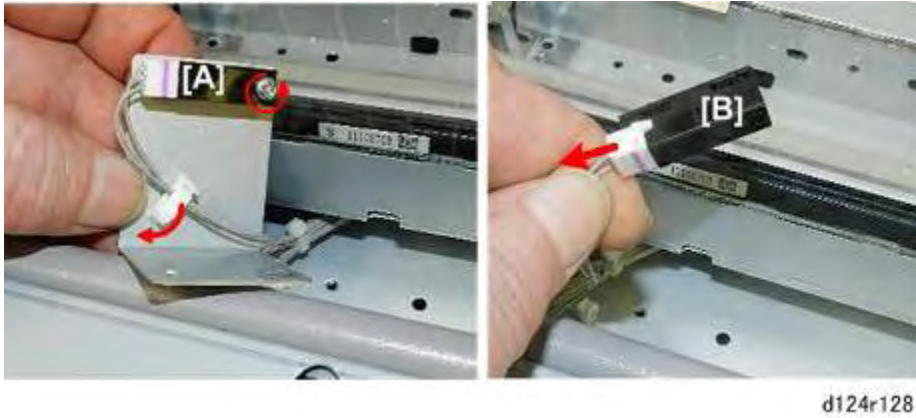

4. Disconnect sensor [A] from the bracket (🔧 x1, 📏 x1).
 5. Disconnect sensor [B] (📏 x1).

5.3.10 EXPOSURE GLASS

Preparation

- Raise the Scanner Unit

Remove:

- Scanner Left and Right Cover  page 5-52

Important

- The exposure glass is very long and thin. It is very easy to break, so handle it carefully.



d124i210

1. Remove the left screw [A] and right screw [B] from the ends of the center plate with the mylar.



d124i211

2. Remove the center plate.



d124r130

3. On the right side [A], remove leaf plate [B] (1 x1).

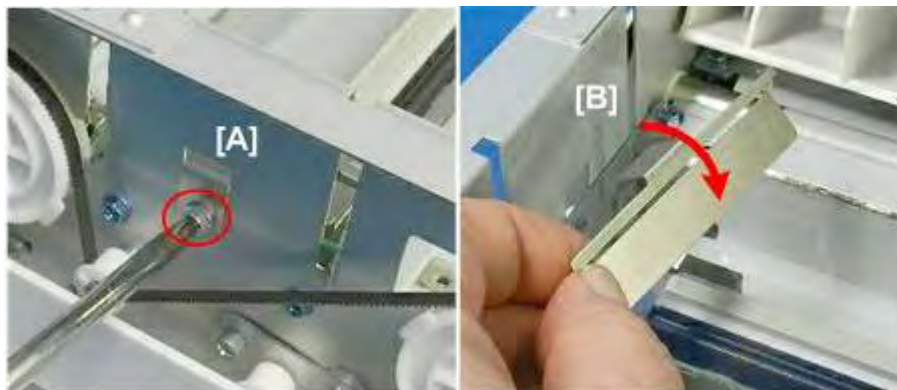

d124r131

4. On the left side [A], remove the other leaf spring [B] (1 x1).

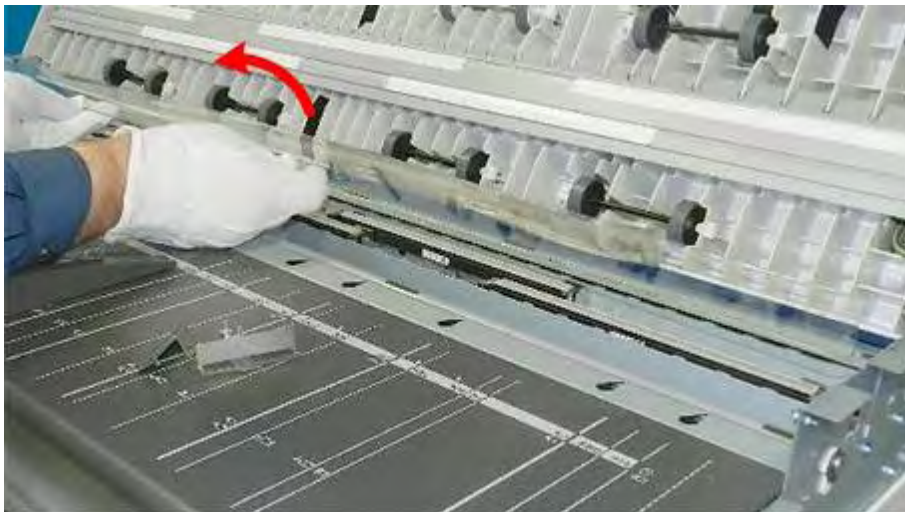

d124r132

5. Remove the exposure glass.

Reinstallation

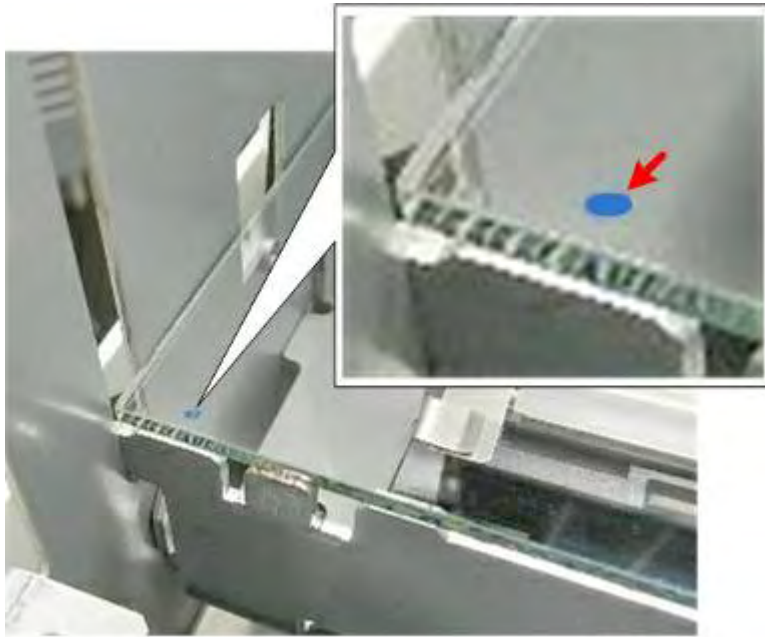

d124i212

1. When you reinstall the exposure glass, set the glass so that the blue dot is on the surface of the lower left corner of the glass.

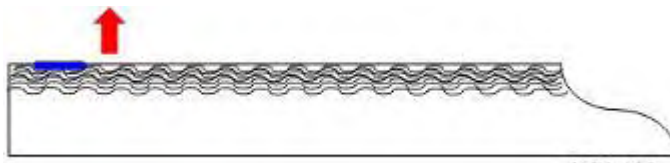

d124r133

2. The side with the blue dot is the side with the shiny, wavy patterns facing up.
3. To see these patterns, hold the edge of the glass up toward a light and move the edge from side to side.

5.3.11 CIS UNIT



Follow these cautions when removing the CIS unit:

- To preserve the alignment of its components and to prevent other damage, always handle the CIS unit carefully to protect it from sudden shock and vibration.
- To prevent finger prints and smudges, never touch the CIS lens cover with bare hands.
- Clean the CIS lens cover with lens paper only. Never use tissue paper or cloth that could leave lint or other particles on the lenses.
- To preserve the alignment of its components, always disconnect and re-connect the CIS unit at the SIB. Never disconnect the signal or power supply harnesses from the CIS unit.
- Always handle the CIS unit carefully when it is out of the machine. Protect it from shock and vibration.

Preparation



- Raise the Scanner Unit

Remove:

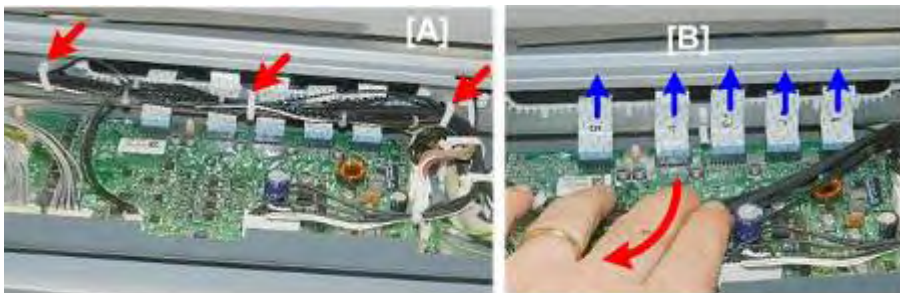
- Scanner Rear Cover  page 5-51
- Scanner Left and Right Covers  page 5-52
- Exposure Glass  page 5-66



d124r135

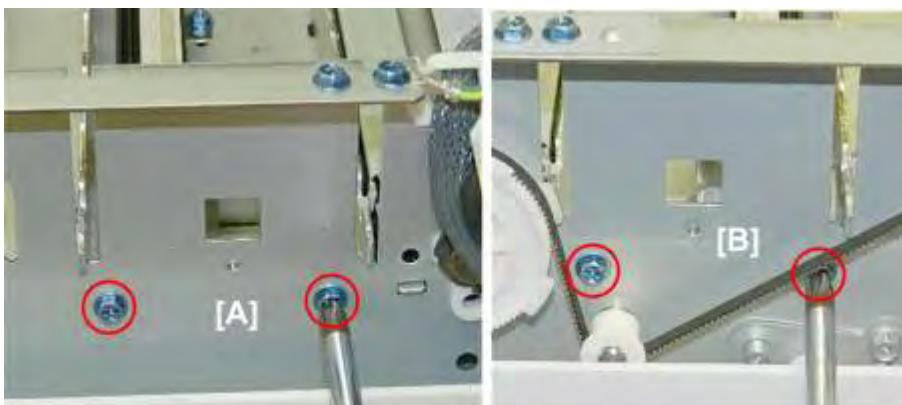

1. At the rear [A], open the clamps around the harness in front of the FFCs ( x3).
2. Pull the harness away and disconnect the FFCs ( x5).



d124r136

3. Disconnect the CIS frame:

Scanner

- Right side [A] ( x2)
- Left side [B] ( x2)

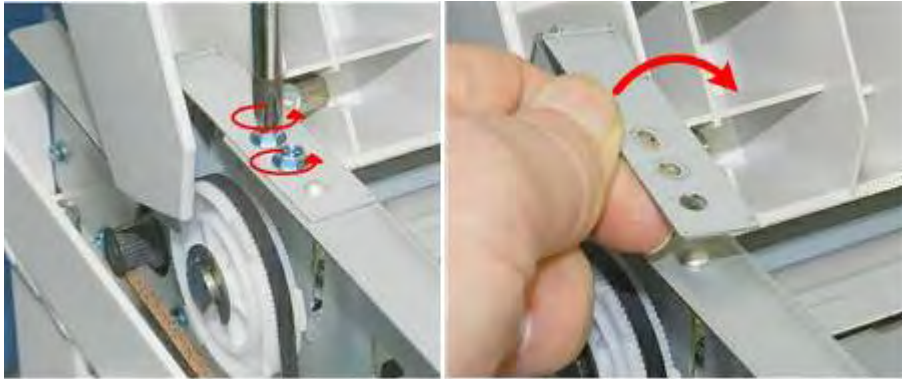

d124r137

4. On the left side, remove the bracket ( x2).



d124r138

5. Lift the CIS unit straight up and remove it.

Important

- Always handle the CIS unit carefully to prevent it from shock or vibration. Handling the CIS unit roughly could damage the alignment of its elements.

Reinstallation

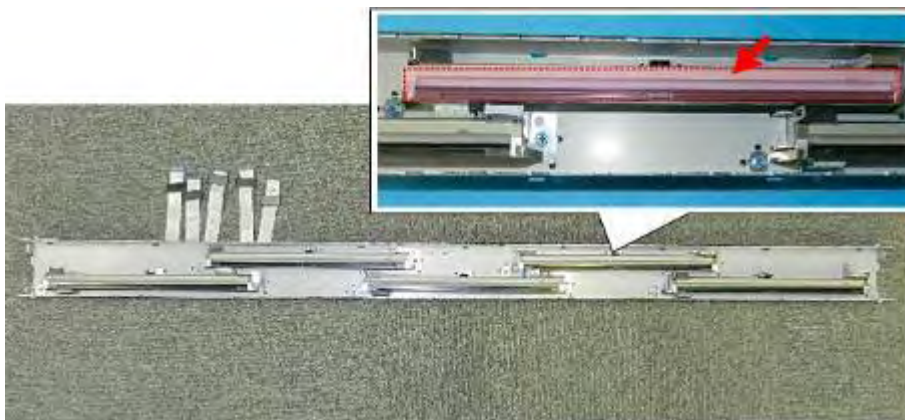

1. Do not touch the CIS lenses with bare hands.
2. Clean away smudges or dirt with lens paper.

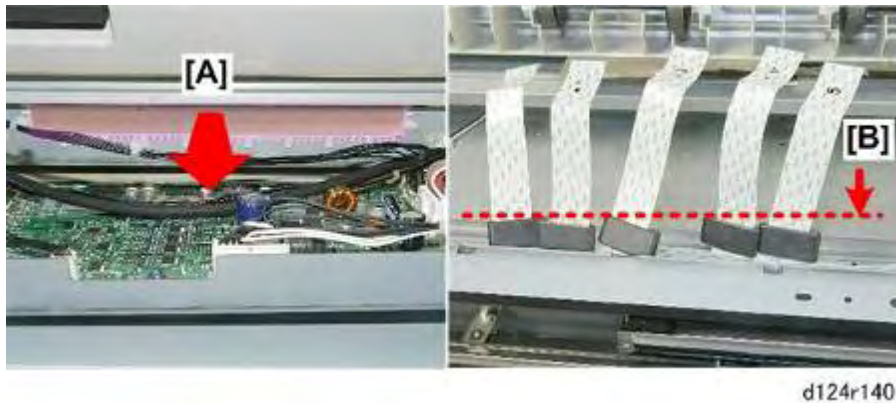

3. At the rear, locate the slot rimmed with white plastic [A]. This is where the FFCs will be re-inserted.
4. At the front, push the ferrite cores on the FFCs down and away from the edge connectors as shown at [B].



5. Raise the CIS unit, fit the tabs on the left end [A] and right end [B] into the channels in the frame, and then slowly lower the CIS unit.

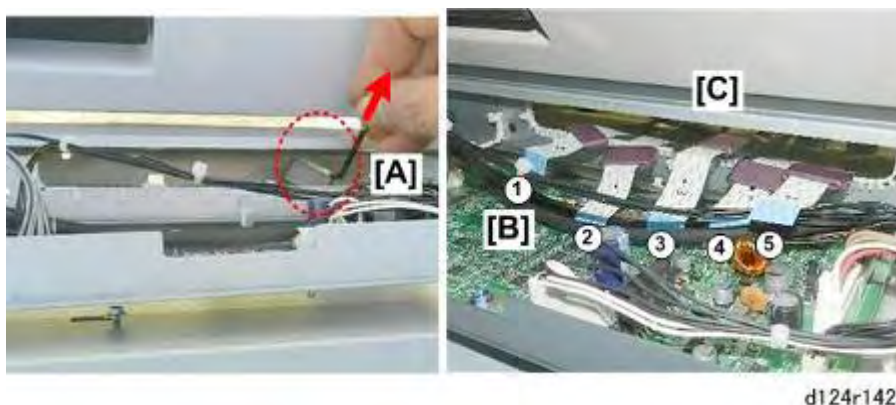

6. At the rear [A], use the short end of the Allen key to pull each FFC [B] through the slot.
7. Push each ferrite core [C] back through the slot so they are no longer visible.



8. Reconnect the FFCs and clamp the harness ( x5,  x3).

After Installation of a New CIS

1. Turn the machine on.
2. Go into the SP mode and do the following SP codes. (The SP code settings are listed on the sheet provided with the new CIS unit.)
 - SP4709-001 to 015
 - SP4972-001 to 010
 - SP4979-001 to 060
3. Cycle the machine off/on.
4. Go into the SP mode and open **SP4417**.
5. Select Pattern 8 and touch [OK].
6. At the top of the screen, touch [Copy Window].
7. Set one blank sheet of A3 LEF paper on the original table.
8. Touch the Copy key and wait for the machine to print the pattern.
9. At the top of the Copy Window, touch [SP Mode] to return to the SP mode.
10. Check the printed pattern.

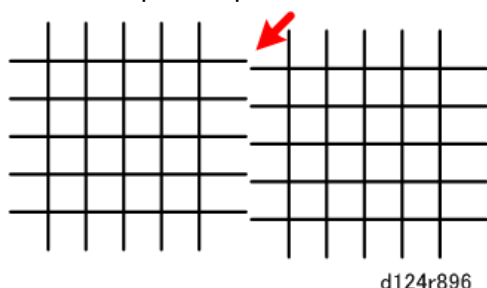

11. If you see any broken lines, do the procedure to adjust the CIS with the SP mode.

 page 5-340

5.3.12 ORIGINAL FEED ROLLER

Preparation

- Raise the Scanner Unit

Remove:

- Left and Right Covers  page 5-52



1. Disconnect the left and right ends of the registration sensor cover plate ( x2).



2. Remove the registration sensor cover plate.



3. Raise the left end of the scanner unit.

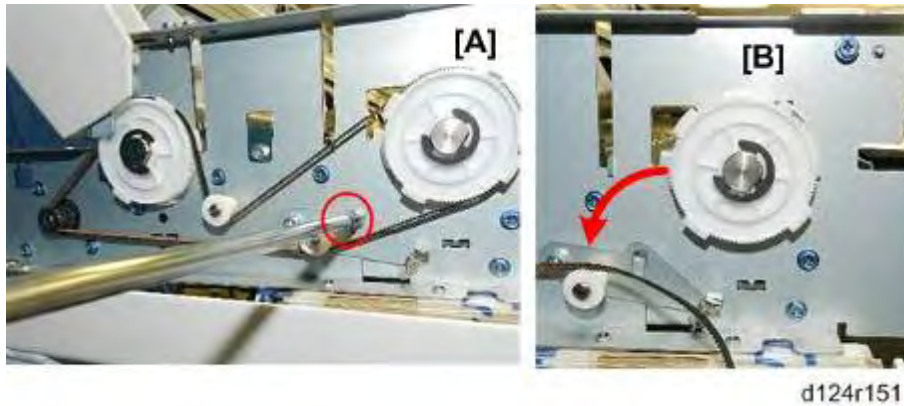

4. On the left [A], loosen the tension bracket and disconnect the timing belt from the original feed roller drive gear [B] (P x1, O x1).

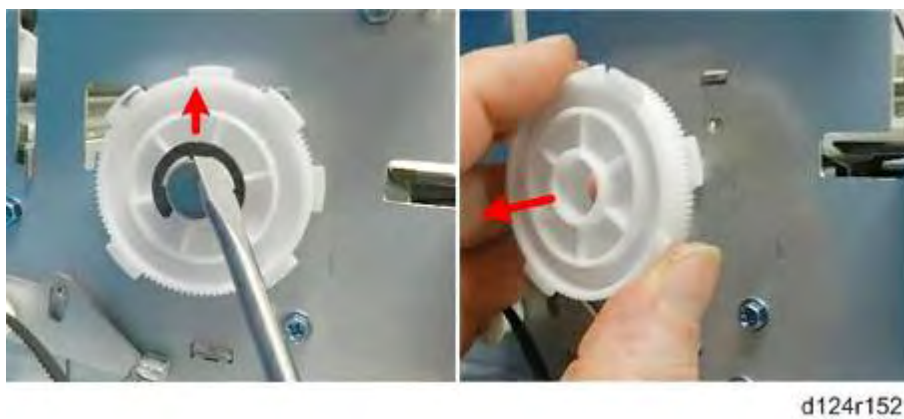

5. Remove the drive gear (C x1).

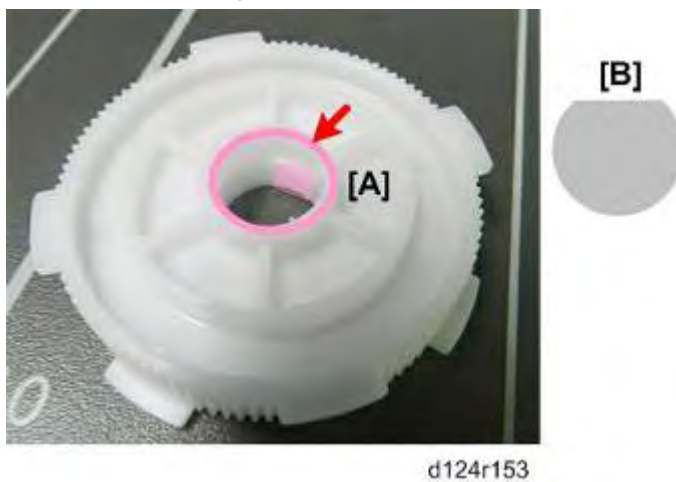

6. Note that the face of the gear [A] is re-inserted against the frame so that it can fit over the flat side of the shaft [B] when the gear is re-attached



d124r154

7. Remove the Teflon bushing.

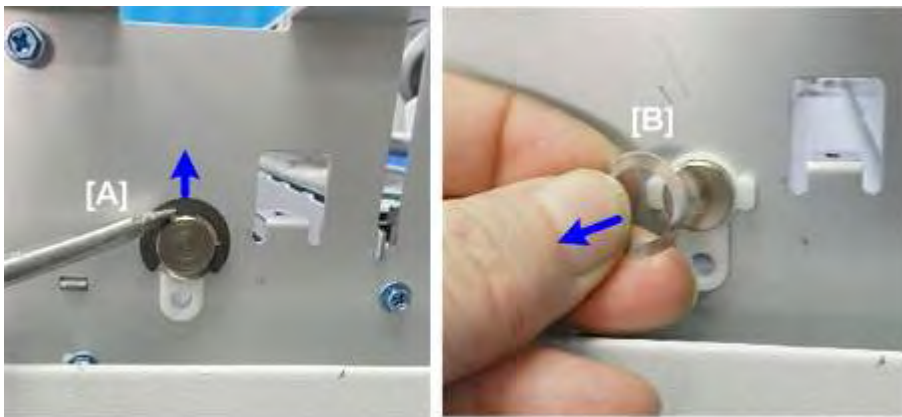

d124r155

8. On the right [A], disconnect the right end of the shaft (Ⓢx1).

9. Remove ring [B].



d124r156

10. Remove the Teflon bushing.

Replacement and Adjustment

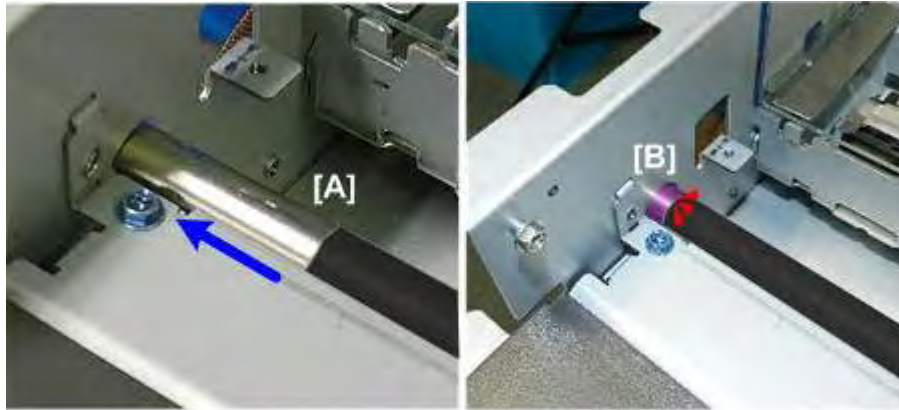

d124r157

★ Important

- The urethane-coated surface of the roller is soft. Handle the roller carefully to avoid scratching its surface.

11. Slowly, push the end of the shaft [A] to the left until you see the coated surface [B] close to the hole in the frame.

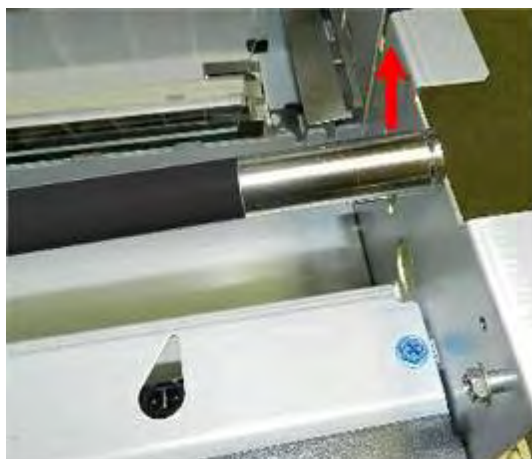

d124r158

12. Lift the right end of the roller shaft until it clears the hole on the right.

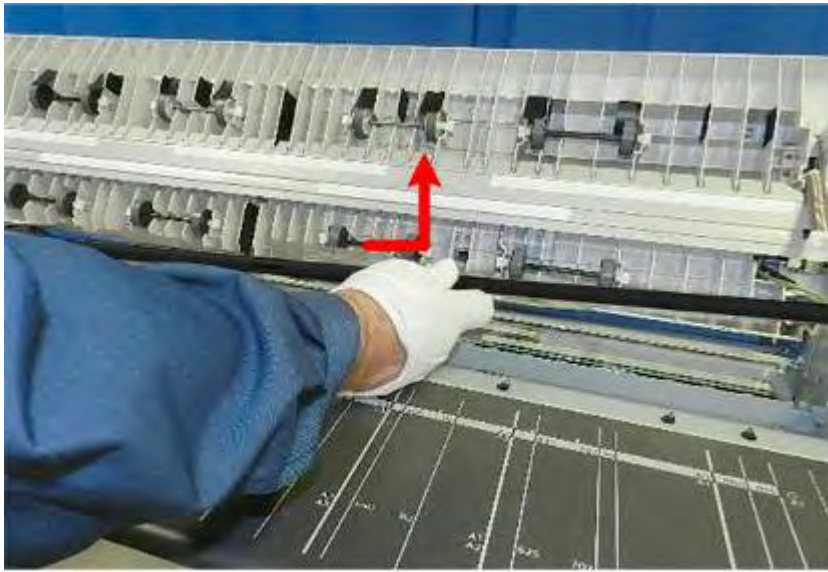

d124r159

13. Remove the roller.



d124r160

14. The urethane-coated surface of the roller [A] is soft and scratches easily. Always hold the roller by the ends [B] where the roller surface is bare.

5.3.13 ORIGINAL EXIT ROLLER, ORIGINAL EXIT SENSOR

Preparation

Remove:

- CIS Unit  page 5-69
- Top of scanner unit (see below)

Remove Top of Scanner Unit



d124r165

1. At the rear, disconnect the scanner unit ( x3).



d124r166

2. Free the harnesses ( x5).

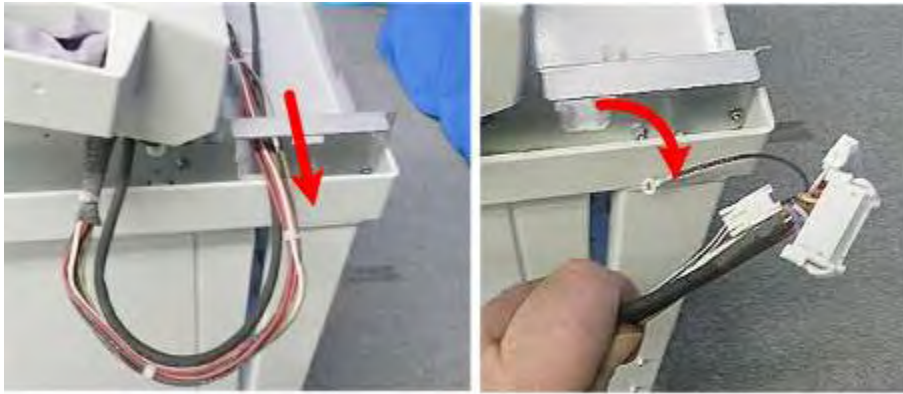



d124r167

3. At the rear corner, pull the harnesses through the hole one at a time.



d124r168

4. At the right hinge of the scanner unit, disconnect the ground wire and free the shielded harness ( x1,  x1)



d124r169

5. At the back of the machine on the left side, use the tip of a small screwdriver to free the latch.

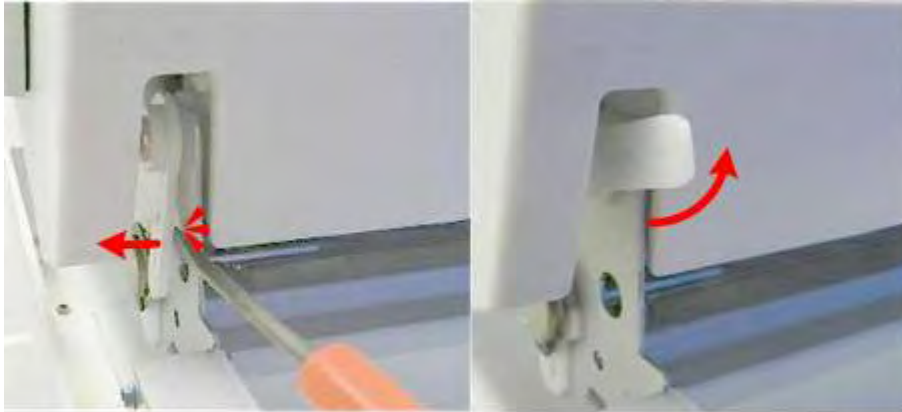

d124r170

6. At the back of the machine on the right side, use the tip of a small screwdriver to free the latch.



d124r171

7. While holding both of these latches up, lift and remove the top of the scanner unit.

★ Important



- The latches on either end can fall off easily.
- As soon as you lay the top down, confirm that both these latches are still on the shaft and have not fallen off while lifting and moving the top.

8. Lay the top on a flat surface.

Original Exit Sensor

Preparation



Remove:

- CIS  page 5-69
- Top of scanner unit  page 5-78



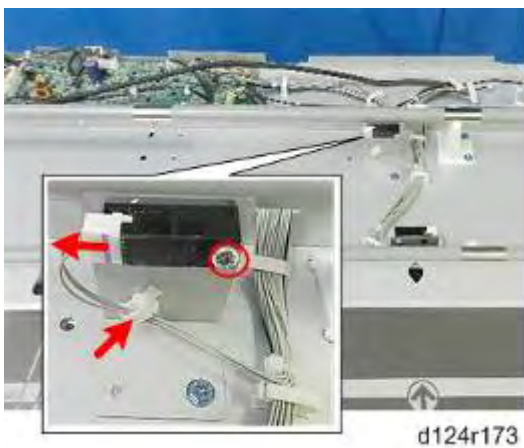

1. Remove the plates on both sides of the exit roller ( x4).



2. Remove the exit sensor ( x1,  x1,  x1)

Original Feed Roller

Remove:

- CIS  page 5-69
- Top of scanner unit  page 5-78



1. Remove the plates on both sides of the exit roller ( x4).



2. When removing the original exit roller, work carefully.

 **Important**



- The urethane-coated surface of the roller is soft and scratches easily. Handle the roller carefully to avoid scratching its surface.

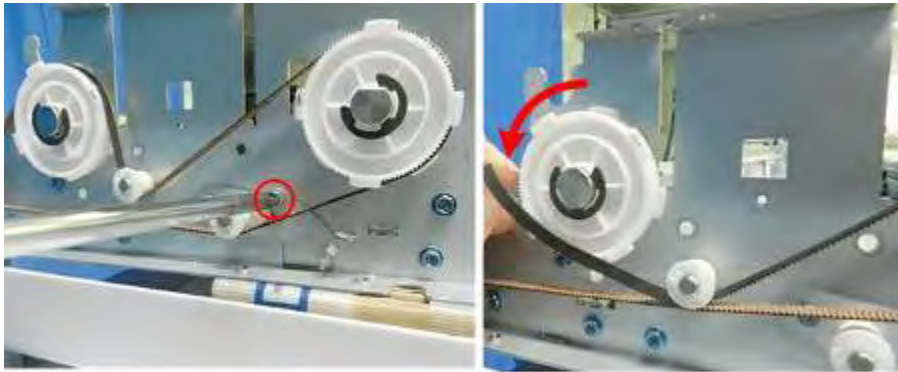

3. Raise the left end of the scanner unit.  page 5-57



d124r175

4. On the left, loosen the tension bracket and disconnect the timing belt from the original feed roller drive gear ( x1,  x1).

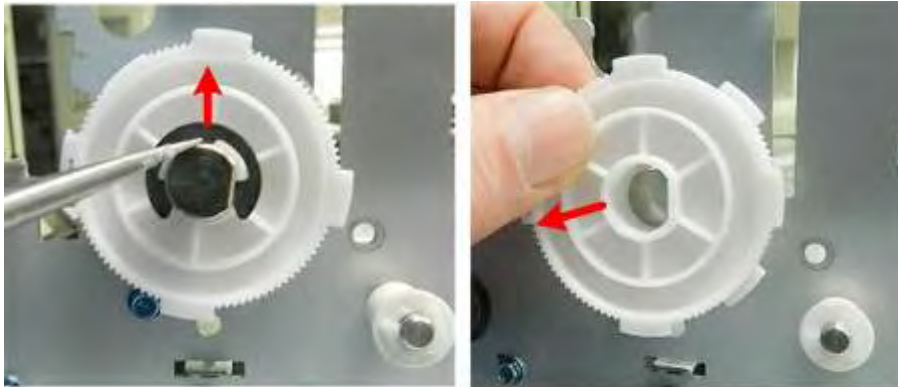

d124r176

5. Remove the drive gear ( x1).

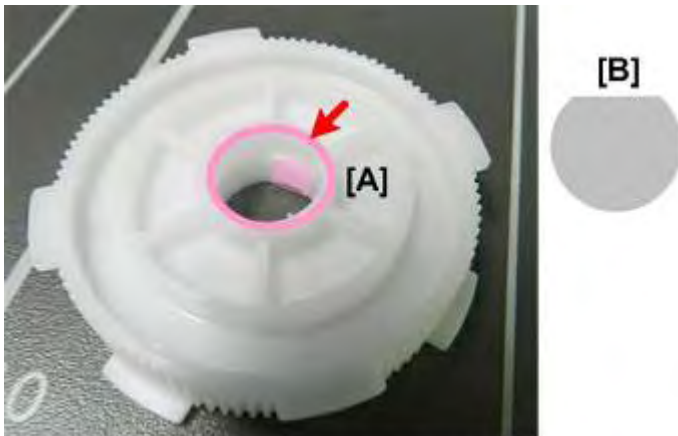

d124r153

6. Note that the face of the gear [A] is re-inserted against the frame so that it can fit over the flat side of the shaft [B] when the gear is re-attached



d124r177

7. Remove the Teflon bushing.

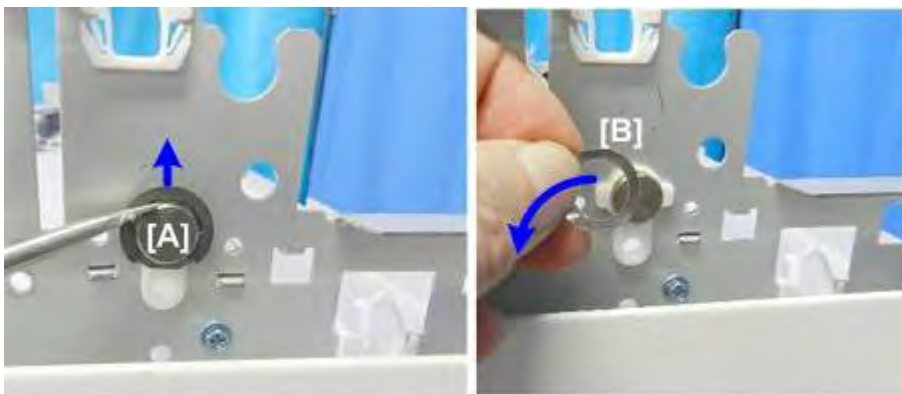

d124r178

8. On the right [A], disconnect the right end of the shaft (Ⓢx1).
9. Remove ring [B].



d124r179

10. Remove the Teflon bushing.

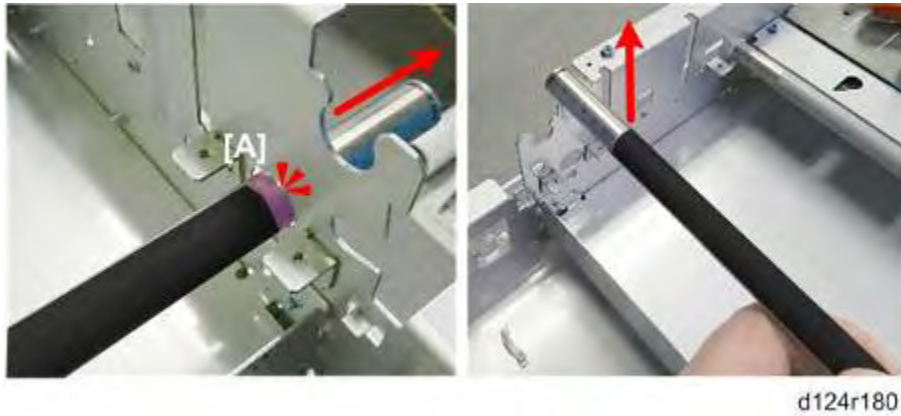

★ Important

- The urethane-coated surface of the roller is soft and scratches easily. Handle the roller carefully to avoid scratching its surface.

11. Slowly, push the end of the shaft to the until you see the coated surface [A] close to the hole in the frame, and then raise the other end of the roller.



12. Lift the other end of the roller shaft until it clears the hole on the right, and then remove it.

Reinstallation of Scanner Top Cover



1. Viewed from the rear, make sure that the right latch [A] is attached to the shaft with the large flange facing the center of the machine.



d124r183

2. Viewed from the rear, make sure that the left latch [A] is attached to the shaft with the large flange facing the center of the machine.

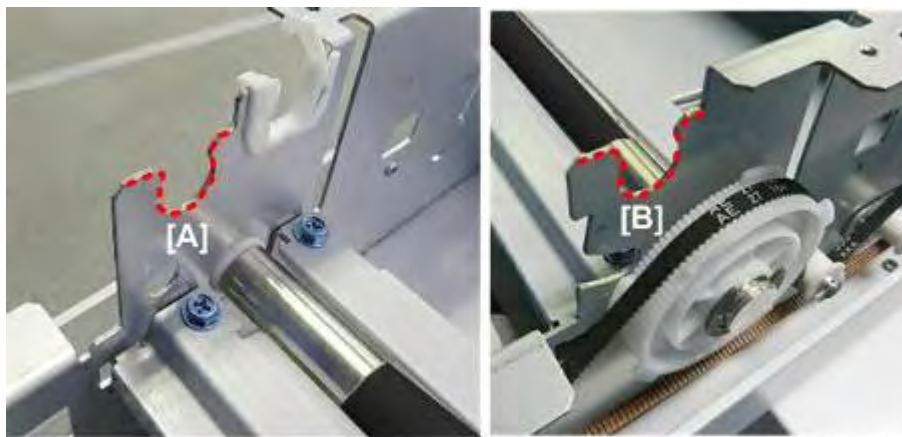

d124r185

3. Locate the saddle in the frame on the right [A] and the left [B]. The grooves of the latches will be set at these points.

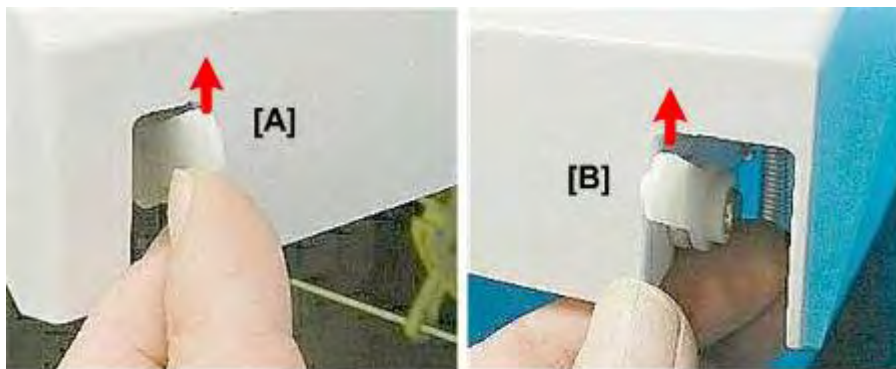

d124r184

4. Raise the right latch [A] and left latch [B].



d124r187

5. While continuing to hold both the right and left latches up, set the top on the scanner unit.



d124r188

6. On the right [A] and left [B], rotate both latches down so they lock in place.

5.3.14 OPERATION PANEL

Operation Panel Removal

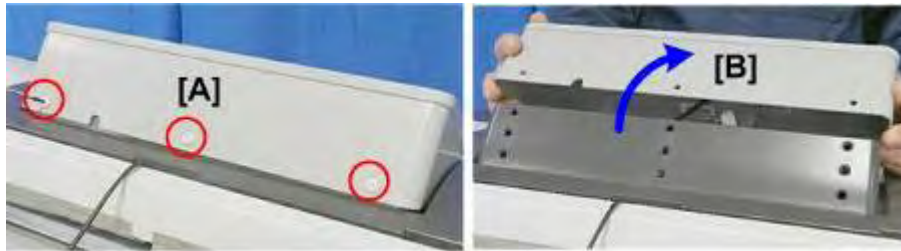

d124r190

1. From the back of the machine, remove the three rivet screws [A].
To remove a rivet screw:
 - Use a small screw driver to loosen the screw until it raises slightly.
 - Remove the rivet with your fingers.
2. From the front, raise the operation panel [B] off the base. **Do not remove!** There are connectors attached below the operation panel.



d124r191

3. At the front, disconnect the operation panel, and then lay it on a flat, clean surface (📄 x2).



d124r192

4. Remove the plastic base (🔩 x6).

USB Board

Preparation

Remove:

- Operation panel 



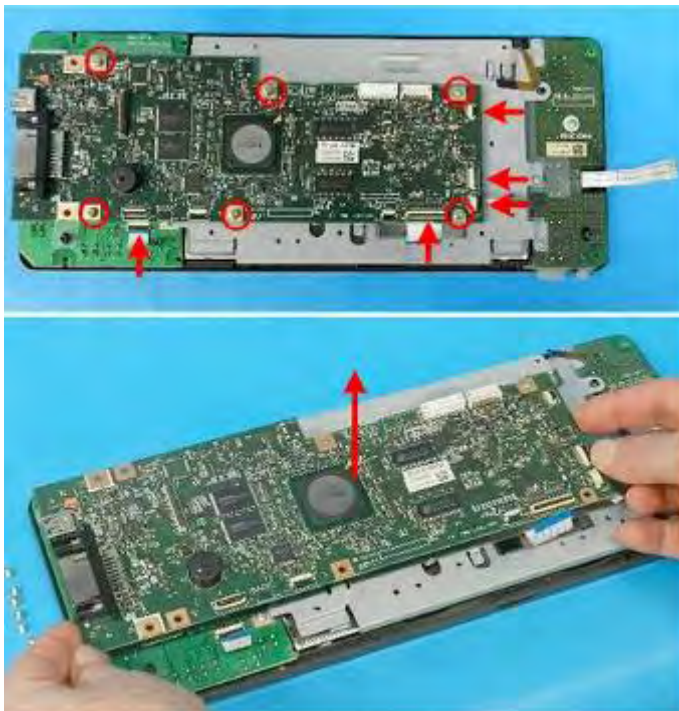

d124r193

1. Remove the metal cover plate ( x8).



d124r194

2. Disconnect the USB board ( x5,  x6)
3. Remove the board.





d124r195

LCD and Operation Touch Panel

Preparation

Remove:

- Operation panel  page 5-88
- USB Board  page 5-89



d124r196

1. Remove the mylar cover.

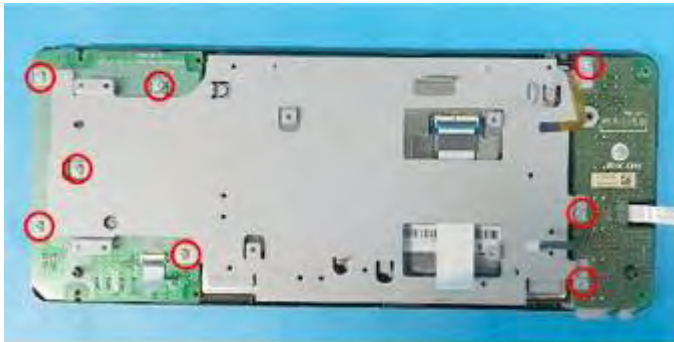

d124r197

2. Disconnect the metal cover plate ( x8)



d124r198

3. Remove the cover plate.



d124r199

4. Remove the LCD.

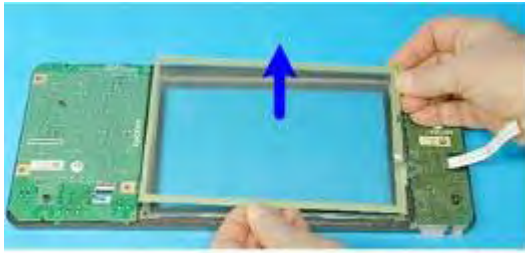



d124r200

5. Remove the touch panel.

OP-R Board

Preparation

Remove:

- Operation panel  page 5-88
- USB Board  page 5-89



d124r196

1. Remove the mylar cover.

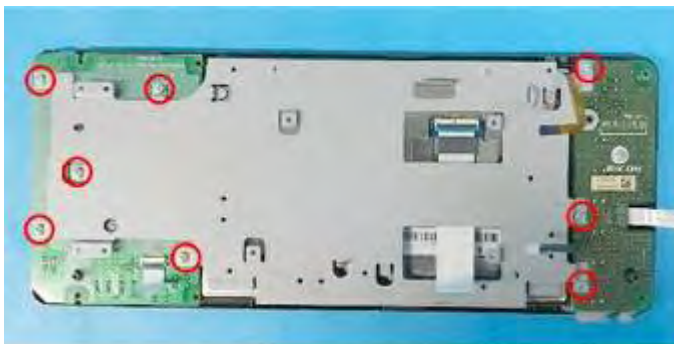

d124r197

2. Disconnect the metal cover plate ( x8)



d124r198

Scanner

3. Remove the metal plate.



d124r201

4. Disconnect the OP-R Board ( x1).



d124r202

5. Remove the OP-R Board.





d124r203

OP-L Board

Preparation

Remove:

- Operation panel  page 5-88
- USB Board  page 5-89



d124r196

1. Remove the mylar cover.

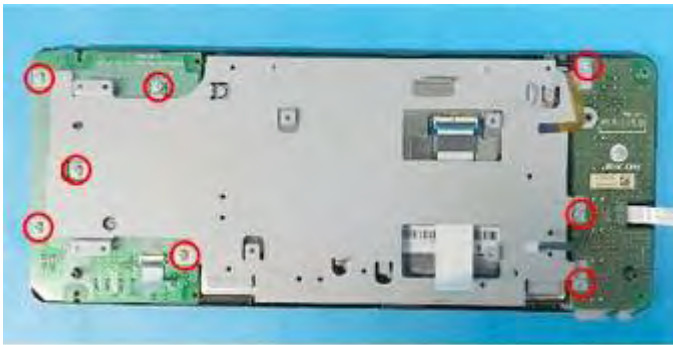

d124r197

2. Disconnect the metal cover plate ( x8)

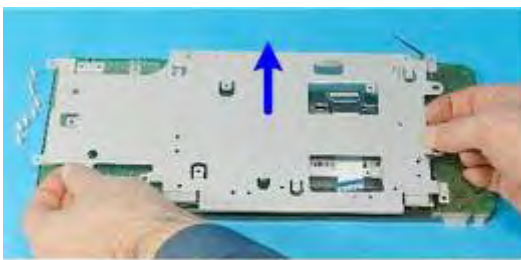

d124r198

3. Remove the metal plate.



d124r204

Scanner

4. Disconnect the OP-L Board ( x1).



d124r205

5. Remove the OP-L board.



d124r206

Reinstallation



d124r207

1. Before you fasten screws to re-attach a metal cover plate during re-assembly, always check and make sure that the five FFCs are visible and free for re-attachment to the USB board.

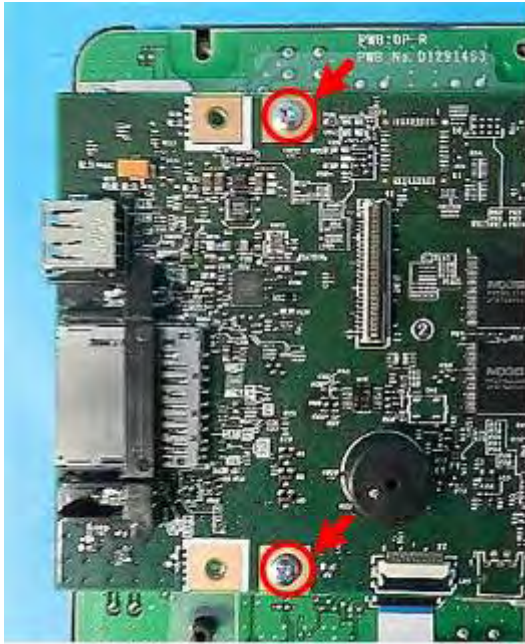

d124r208

2. When you re-attach the USB board on the left, make sure you set the screws as shown above. (The other holes are used for re-attachment of the plastic base.)

Touch Screen Calibration

Always re-calibrate the screen after servicing the operation panel.

★ Important

- Do not attempt to use other items on these menu
- Items other than "Touch Screen Adjust" are for design use only.
- To avoid errors, do not touch the [Reset] key on the operation panel during this procedure.

1. Push [C], push [1] [9] [9] [3], and then press [C] 5 times.

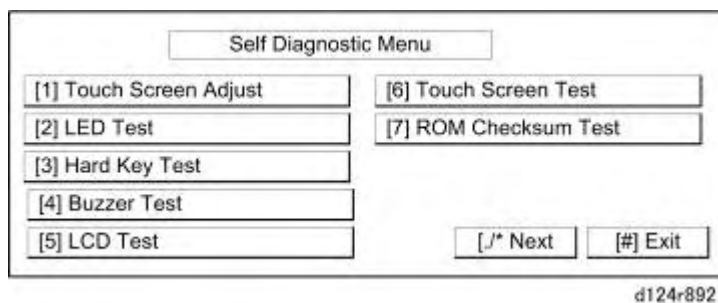



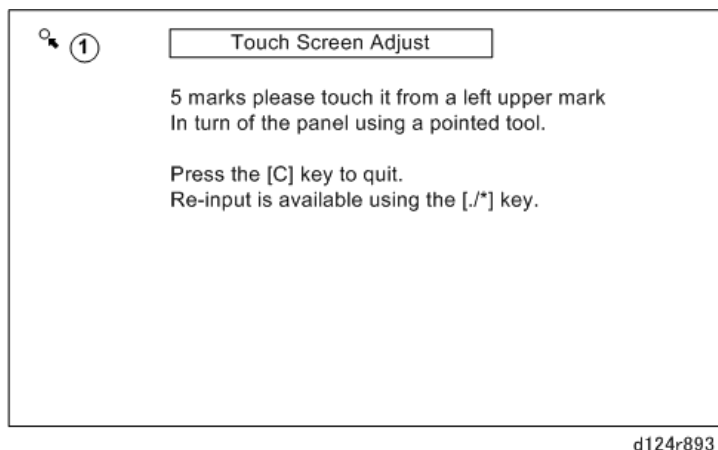

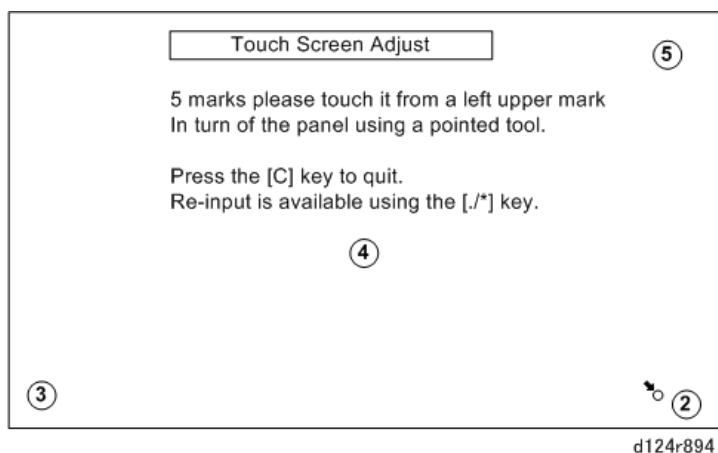

2. Touch "[1] Touch Screen Adjust" on the touch-panel or push [1] on the operation panel.



3. Use a dull, soft point to press  in the upper left corner .



4. Press the  mark in the lower right corner  after it appears, and then continue to press each  mark at   .

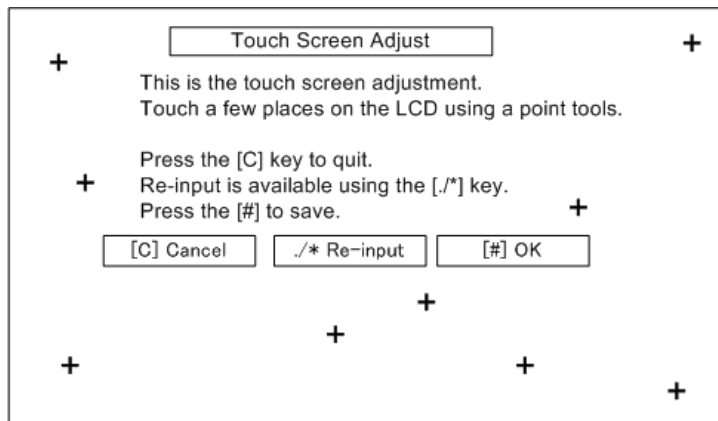

d124r895

5. Touch several random spots on the touch screen to confirm that the marker (+) appears exactly where the screen was touched.
6. If the (mark does not appear where the screen is touched, push [./* Re-input] and repeat the procedure.
7. When you are finished, touch "[#] OK" on the screen (or push [#] on the operation panel).
8. Touch [#] Exit on the screen to close the menu and save the settings.

5.4 ROLL UNITS

5.4.1 ROLL UNIT REMOVAL

Remove Roll Unit 1

Preparation

- Separate the Main Unit from the Scanner Unit  page 5-16

Remove:

- Rear cover  page 5-44

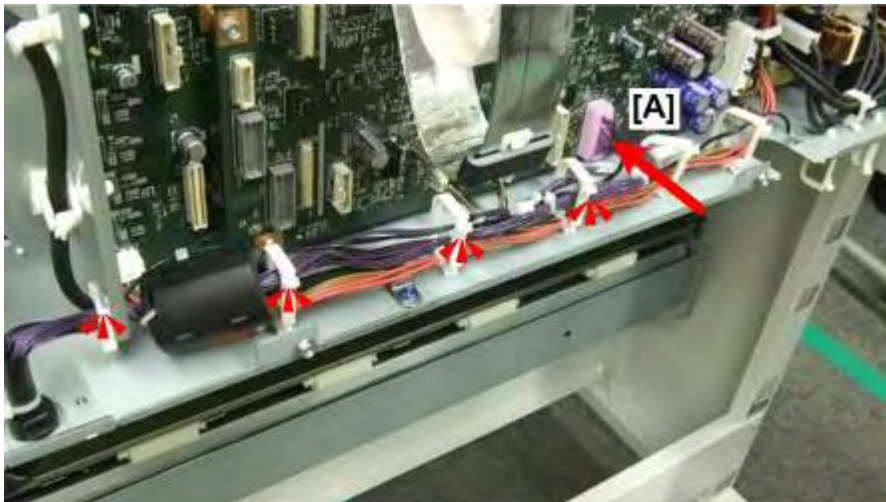

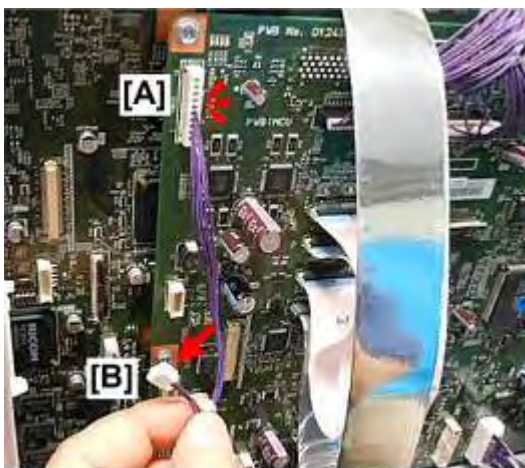

d124i167

1. Open the clamps and disconnect at [A] **CN215** (x4, x1).



d125i003

2. Disconnect the roll unit [A] **CN910** at the top right corner of the MCU (x1).
3. If Roll Unit 2 is connected, disconnect it at [B] (x1).

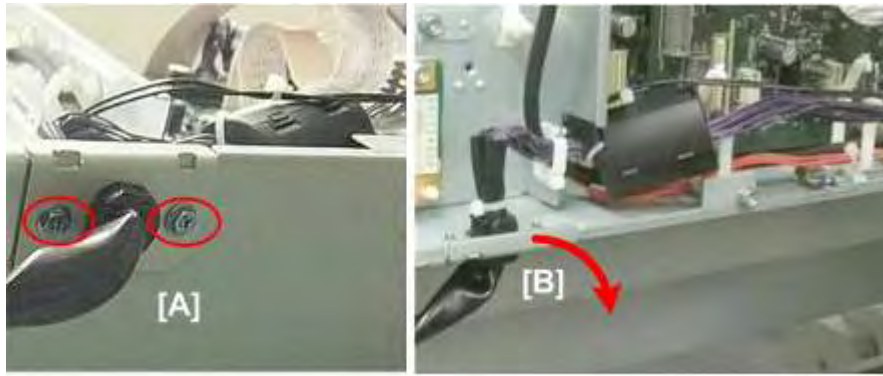

d124r213

4. Disconnect harness bracket [A] ( x2).
5. Remove harness bracket [B].



d124r214

6. Open the harness clamps and pull away the harness ( x5).



d124r215

7. Disconnect the guide plate ( x2).

 **Note**

- This plate requires removal only if Roll Unit 2 is installed.

Replacement and Adjustment

Roll Units



d124r216

8. Lift the plate slightly [1] and pull it out [2].



d124r217

9. Disconnect the semi-transparent paper guide ( x2).



d124r218

10. Pull the guide toward you slightly [1], and then remove it [2].



d124r219

11. The roll unit is fastened with four screws, two on the left [A] and two on the right [B].



12. On the left side, use a long screwdriver to remove the top screw [A] and bottom screw [B] (2).



13. On the right side, use a long screwdriver to remove the top screw [A] and bottom screw [B] (2).



14. Raise the paper exit guide [A].
 15. Push the roll unit harness [B] to the front over the top of the roll unit.

Replacement and Adjustment

Roll Units

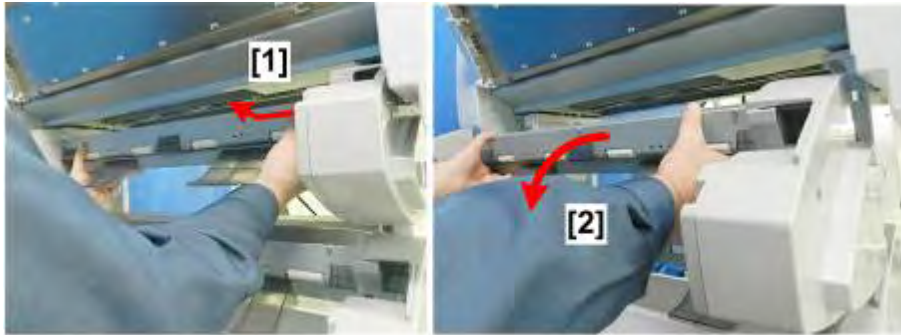

d124r223

16. From the front of the machine, push the roll unit slightly to the left [1], and then remove it [2].



d124r224

17. Lay the roll unit on a flat clean surface.

Reinstallation

1. When you install the roll unit at the front, push it to the right so that it locks into place.

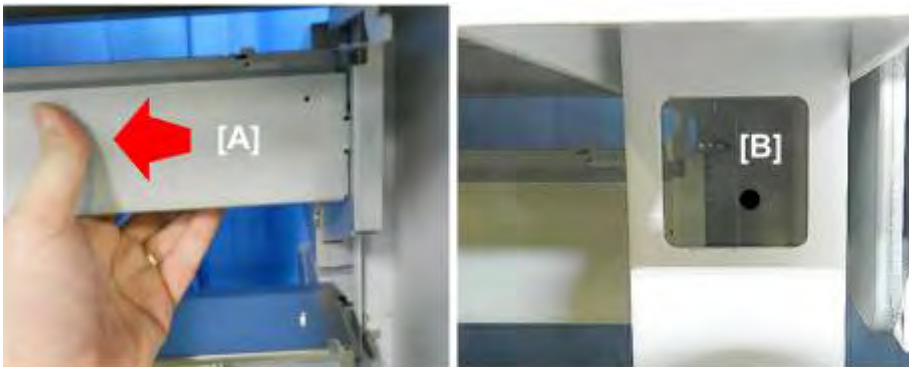

d124r225

2. At the rear, push the roll unit [A] to the left to make sure that it is locked in place.
3. Use a flashlight to check hole [B] on the right (and on the left) to make sure that the holes are aligned correctly.



d124r226

4. When you re-install the semi-transparent guide, make sure that the two pins on the left [A] and on the right [B] are seated correctly on the supports.



d124r227

5. Use the end of a scale or ruler to push the mylar behind the semi-transparent guide.



d124r228

6. At the bottom of the guide plate, make sure that the left and right corners are seated correctly.

Roll Units



d124r214a

7. At the rear, check the roll unit harnesses and make sure that they are tight against the bottom of the PCB box.
 - During bypass paper feed, the trailing edge of the paper comes out of the machine briefly and then feeds back into the machine.
 - If they are hanging down, they could interfere with paper in the bypass paper feed path.

Remove Roll Unit 2

Preparation

- Separate the Main Unit from the Scanner Unit  page 5-16

Remove:

- Rear Cover  page 5-44

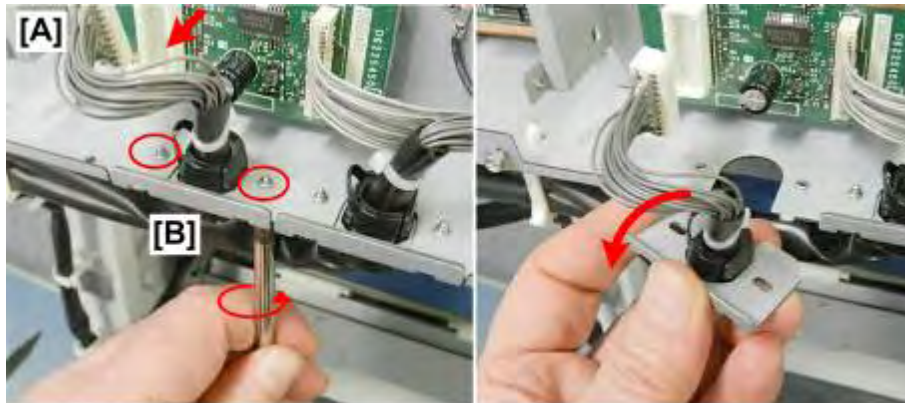

d124r231

1. Disconnect harness [A] ( x1).



d124r232

2. Free the harness for roll unit 2 ( x7).

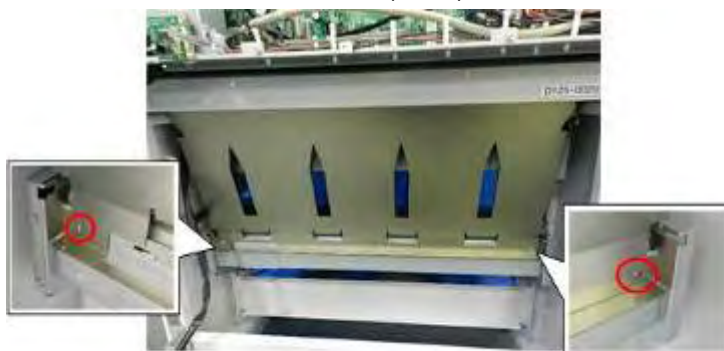

d124r215

3. Disconnect the guide plate ( x2).

Roll Units



d124r216

4. Lift the plate slightly and pull it out.



d124r233

5. The roll unit is fastened with four screws, two on the left [A] and two on the right [B].



d124r234

6. On the left side, use a long screwdriver to remove the top screw [A] and bottom screw [B] ( x2).



d124r235

- On the right side, use a long screwdriver to remove the top screw [A] and bottom screw [B] ( x2).



d1241006

- Raise the paper exit guide [A].



d124r237

- From the front of the machine, push the roll unit slightly to the left [1], and then remove it [2].



d124r238

- Lay the roll unit on a flat clean surface.

Reinstallation

- When you install the roll unit at the front, push it to the right so that it locks in place.

Roll Units

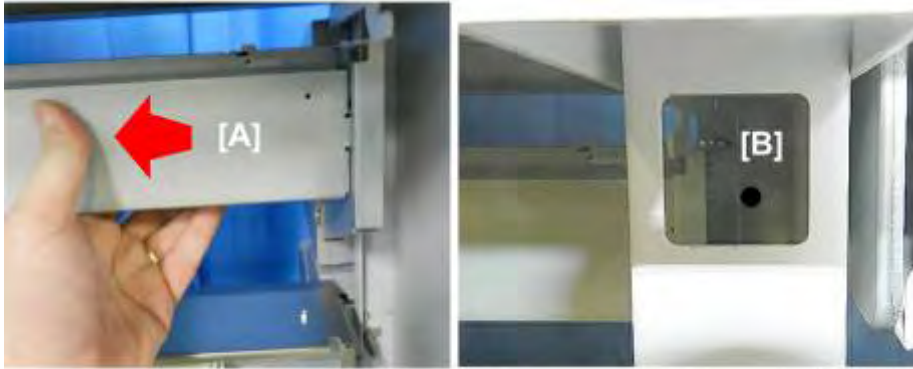

d124r225

2. At the rear, push the roll unit [A] to the left to make sure that it is locked in place.
3. Use a flashlight to check hole [B] on the right (and on the left) to make sure that the holes are aligned correctly.



d124r226

4. When you re-install the semi-transparent guide, make sure that the two pins on the left [A] and on the right [B] are seated correctly on the supports.



d124r228

5. At the bottom of the guide plate, make sure that the left and right corners are seated correctly.



d124r214a

6. At the rear, check the roll unit harnesses and make sure that they are tight against the bottom of the PCB box.
 - During bypass paper feed, the trailing edge of the paper comes out of the machine briefly and then feeds back into the machine.
 - If they are hanging down, they could interfere with paper in the bypass paper feed path.

5.4.2 ROLL UNIT RIGHT COVERS

Preparation

- Separate the Main Unit from the Scanner Unit ➤ page 5-16

Remove:

- Rear Cover ➤ page 5-44
- Roll Unit ➤ page 5-98



d124r240

1. Remove the right outer cover ( x3).



d124r241

2. Remove the right inner cover ( x3).
3. Catch the push-switch [A] as it falls free.

Reinstallation

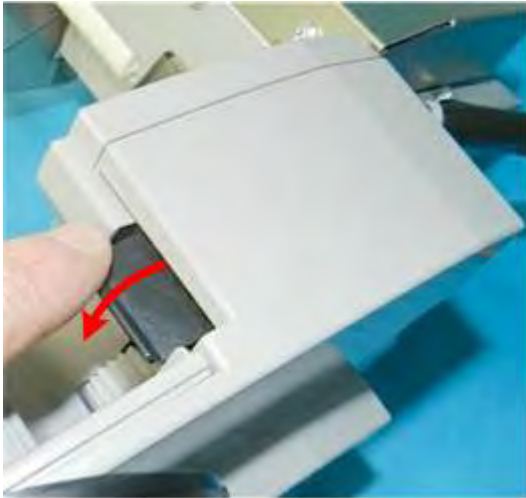

d124r245

1. Install the right inner cover first.
2. When you re-install the right outer cover, pull the latch forward slightly before you fasten the cover with screws.
3. After attaching the cover, pull the latch forward and then release it so that it flips back to the rear. Do this a few times to make sure that the cover is not blocking the latch movement.

★ Important

- If the latch does not move freely, remove the cover and re-attach it.
- The latch must move freely so that the roll can be re-installed.

5.4.3 ROLL UNIT LEFT COVERS

Preparation

- Separate the Main Unit from the Scanner Unit ➤ page 5-16

Remove:

- Rear Cover ➤ page 5-44
- Roll Unit ➤ page 5-98



d124r242

1. Remove the left outer cover (⚙ x3).



d124r736

2. Remove the leaf ground plate (⚙ x1).



d124r243

3. Remove the right inner cover ( x3).

Reinstallation



d124r244

1. When you re-attach the left inner cover, make sure the leaf spring is not pinched between the covers.

5.4.4 PAPER RELEASE SENSOR

Preparation

- Separate the Main Unit from the Scanner Unit  page 5-16

This sensor can be cleaned or replaced without removing the roll unit.



d124r246

1. Remove the sensor plate ( x1).

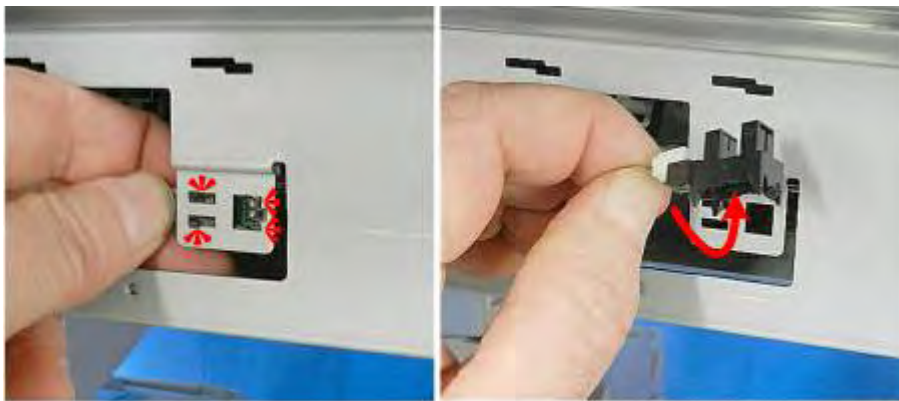

d124r247

2. Remove the sensor ( x4).



d124r248

3. Disconnect the sensor ( x1).

Reinstallation



d124r249

1. Before reinstallation, clean the sensor with a blower brush.



d124r250

2. Set the wide hooks first, then the smaller hooks.

5.4.5 SEPARATE THE ROLLER HOUSING

The feed roller housing must be separated from the roll feed unit in order to:

- Service the rollers
- Clean (or replace) the entrance or exit sensors.

The procedure to separate the roller housing is slightly different between Roll Unit 1 and Roll Unit 2.

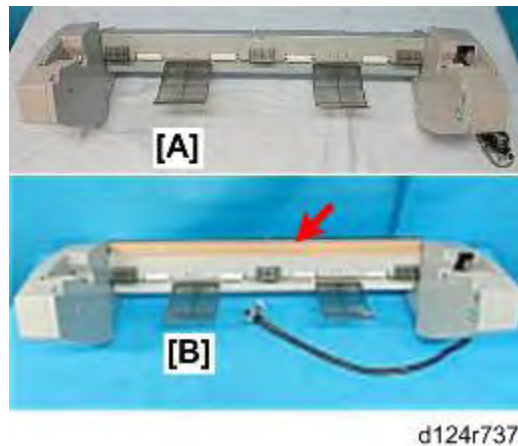

Roll Unit 1 [A] and Roll Unit 2 [B] are the same with the exception of the top covers. Roll Unit 1 has no top cover while Roll Unit [2] has a shiny metal cosmetic cover. This causes some small differences in the procedure to separate the roll unit housing from the roll unit.

Separate the Roller Housing: Roll Unit 1

Preparation

- Remove Roll Unit 1  page 5-98



d124r739

- Set the roll unit on a flat clean surface.



d124r748

- Disconnect the roll end sensor ( x1).

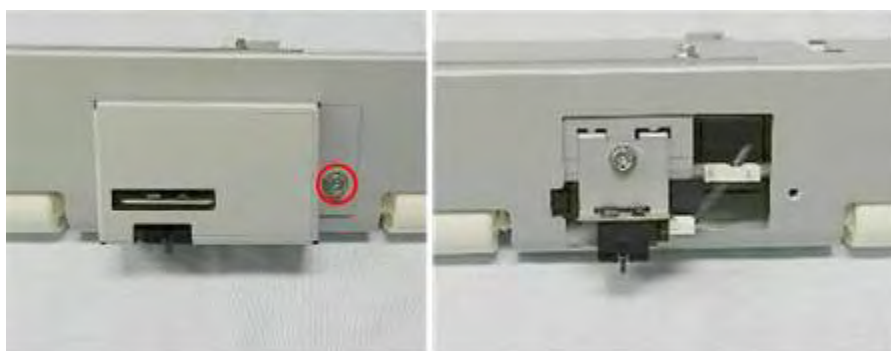

d124r749

- Remove the roll end sensor cover ( x1).

Roll Units

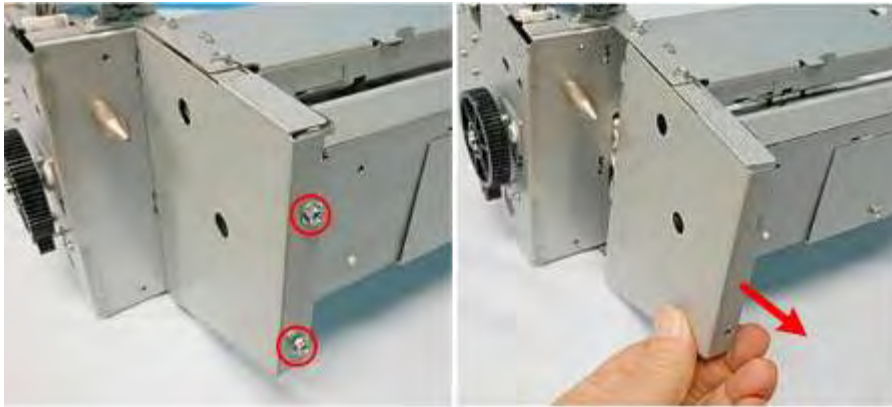



d124r740

4. Remove the gear train cover ( x2).



d124r741

5. Remove the clip and gear ( x1,  x1).

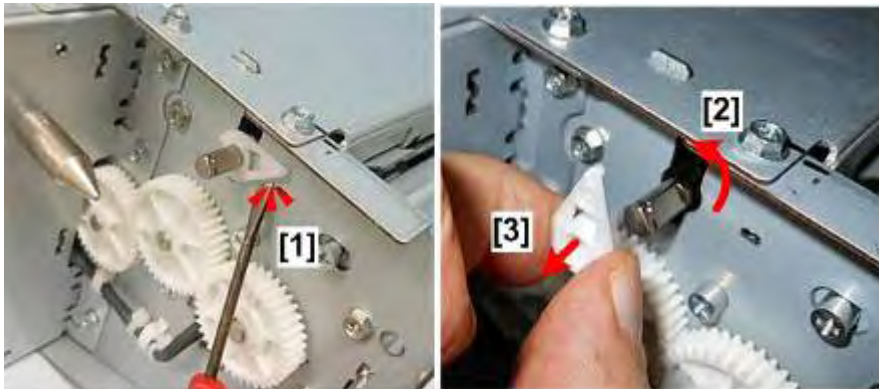

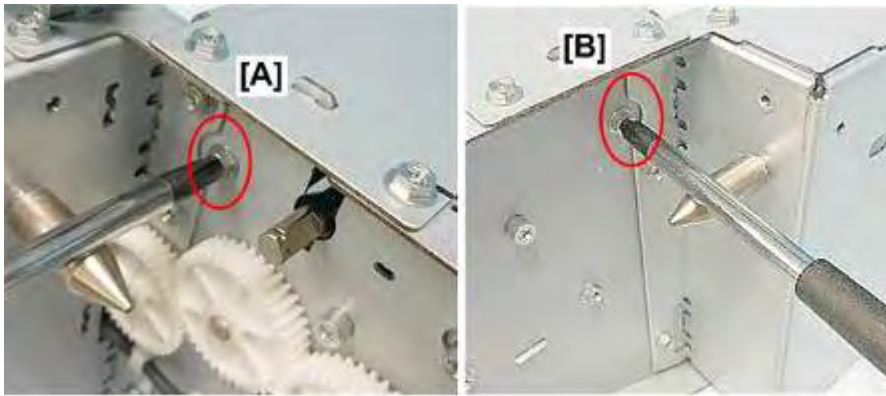

d124r742

6. Raise the tip of the latch [1] out of its hole, rotate it to the vertical [2], and then remove it.



d124r743

7. Disconnect the housing on the left [A] ( x1).
8. Disconnect the housing on the right [B] ( x1).



d124r744

9. Disconnect the top plate ( x4).



d124r745

10. Remove the roller housing.

Replacement and Adjustment

Separate the Roller Housing: Roll Unit 2

Preparation

- Remove Roll Unit 2  page 5-105

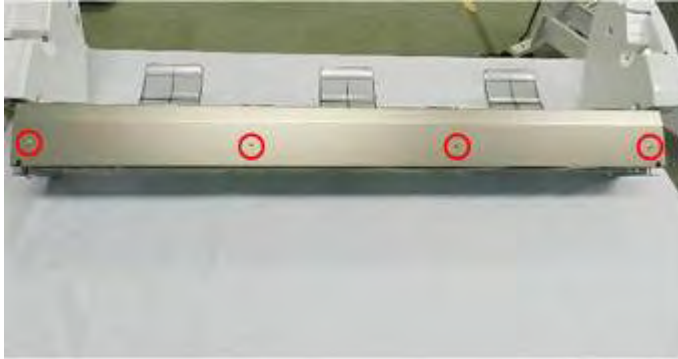

d124r750

1. Disconnect the top of the cosmetic cover plate ( x4).



d124r751

2. Disconnect the front edge of the cosmetic cover plate ( x4).



d124r252

3. Remove the plate.



d124r748

4. Disconnect the roll end sensor ( x1).



d124r749

5. Remove the roll end sensor cover ( x1).



d124r253

6. Disconnect the plate ( x6).

Roll Units



d124r254

7. Remove the flat plate with the idle rollers attached.



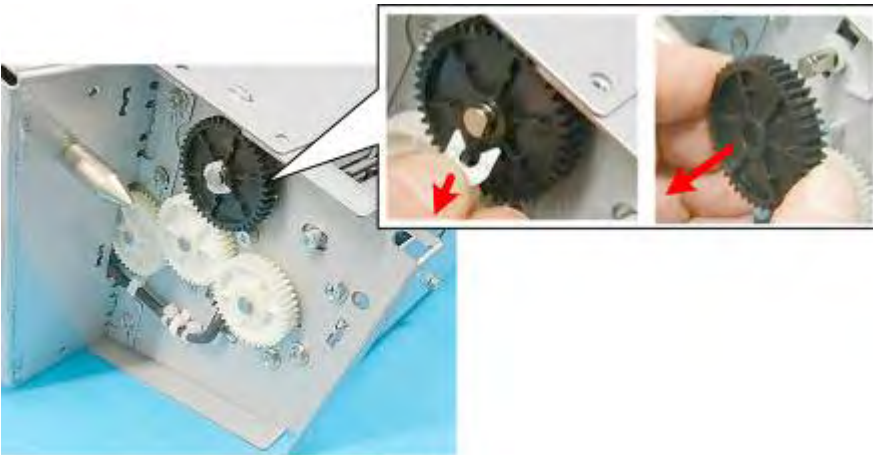

d124r255

8. Remove the gear train cover ( x2).



d124r256

9. Remove the clip and gear ( x1,  x1).



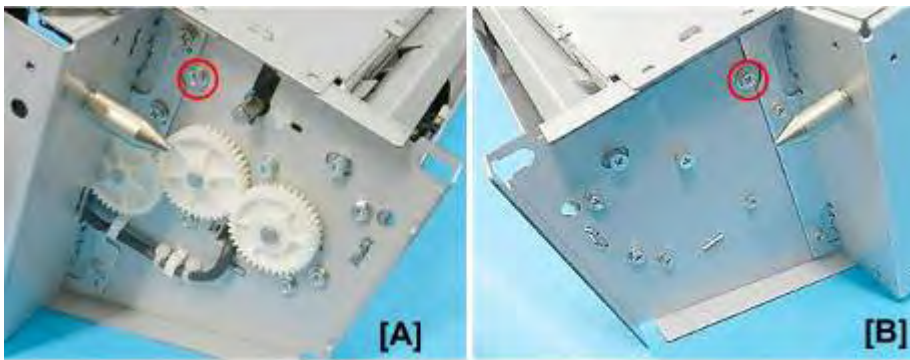

d124r257

10. Raise the tip of the latch [1] out of its hole, rotate it to the vertical [2], and then remove it.



d124r258

11. Disconnect the housing on the left [A] ( x1).
12. Disconnect the housing on the right [B] ( x1).

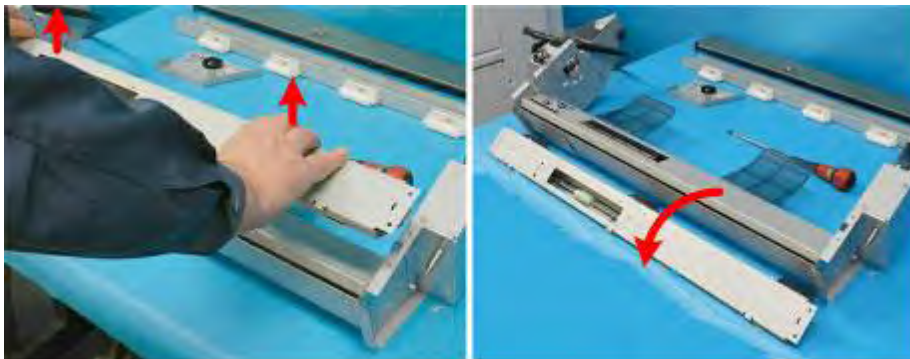

d124r259

13. Remove the roller housing.

Replacement and Adjustment

5.4.6 ENTRANCE SENSOR, EXIT SENSOR

Preparation

- Separate the Main Unit from the Scanner Unit ➤ page 5-16

Remove:

- Roll Unit 1 or 2 ➤ page 5-98
- Separate the Roller Housing



d124r260

1. Disconnect sensor cover [A] ( x1). ① is the entrance sensor, ② is the exit sensor.
2. Slide it forward slightly [B] and then remove it.

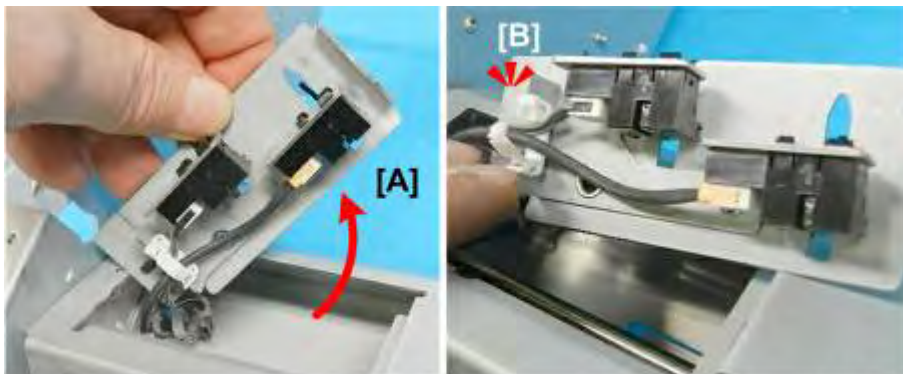

d124r261

3. Pull the sensor bracket [A] out, and then disconnect harness [B] ( x1).

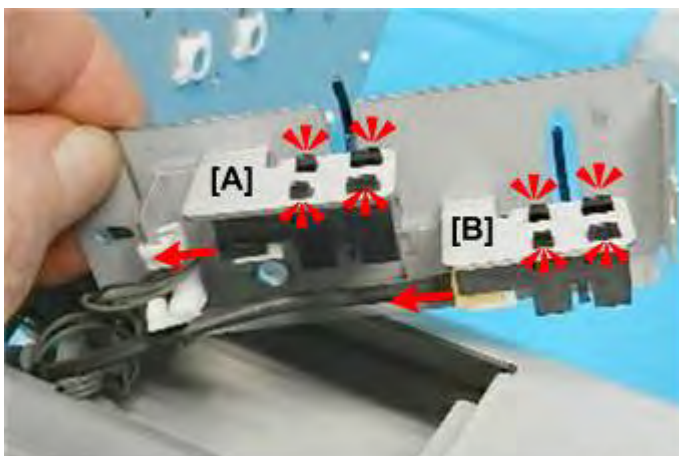

d124r262

4. Disconnect the exit sensor [A] (⚡ x4).
5. Disconnect the entrance sensor [B] (⚡ x4).

Reinstallation

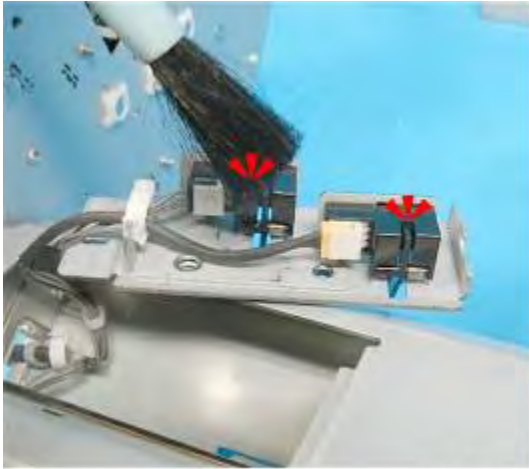

d124r263

1. Before reinstallation, clean the sensors with a blower brush.

5.4.7 ROLL FEED ROLLER

Preparation

- Separate the Main Unit from the Scanner Unit ➤ page 5-16

Remove:

- Roll Unit 1 or 2 ➤ page 5-98
- Separate the Roller Housing ➤ page 5-116



d124r265

1. Remove the roller cover (⚡ x3).

Roll Units

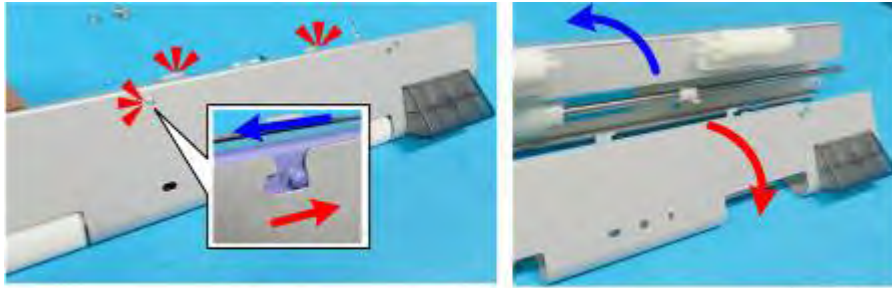

d124r266

2. Push the sides of the roller housing in the opposite direction to free the bosses from their notches, and then separate them.

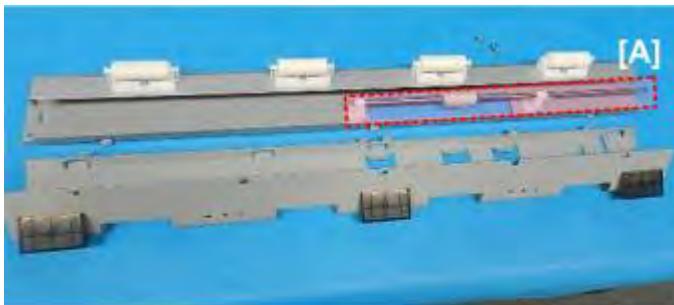

d124r267

3. With the halves separated, you can see the feed roller [A].

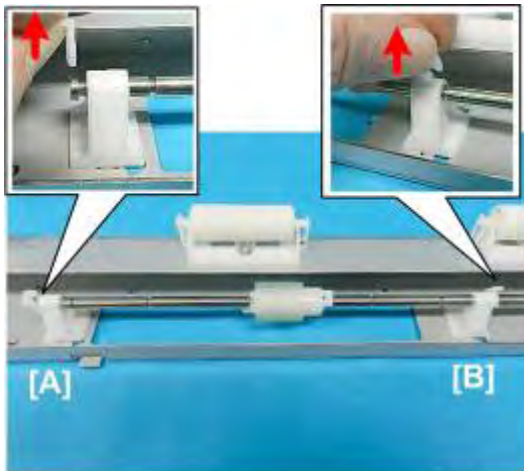

d124r268

4. Remove the clips at each stay [A] and [B] (2x).

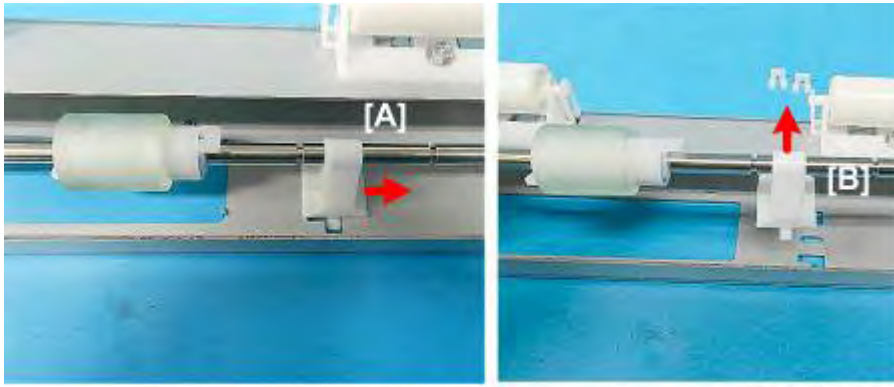

d124r269

5. Push the right stay [A] to the right and disconnect it at the base [B].

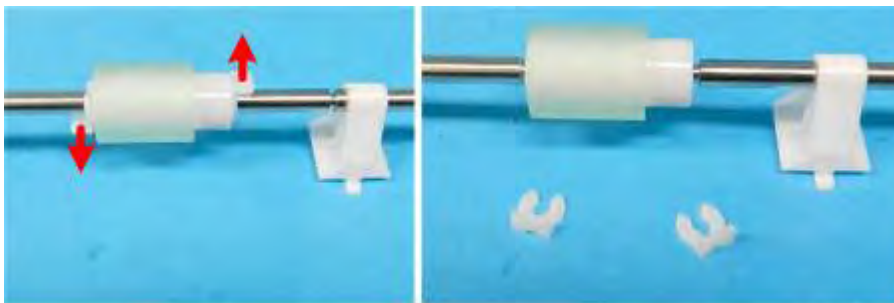

d124r270

6. Disconnect both ends of the roller (ⓐx2).

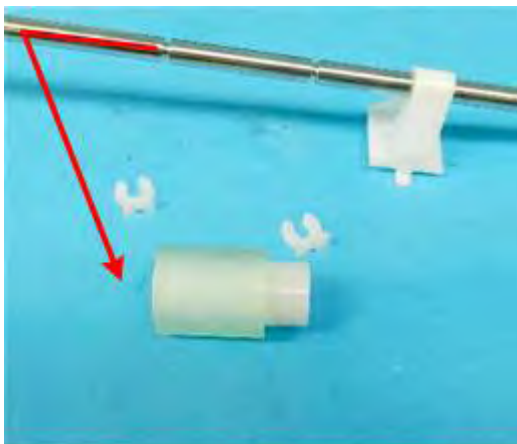

d124r271

7. Slide the roller off the shaft.

Roll Units

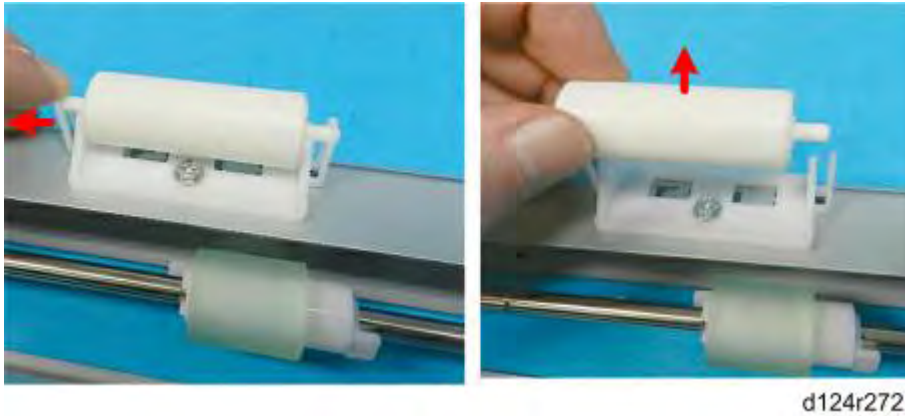

8. The idle rollers can be removed easily by opening a support on either side.

Reinstallation

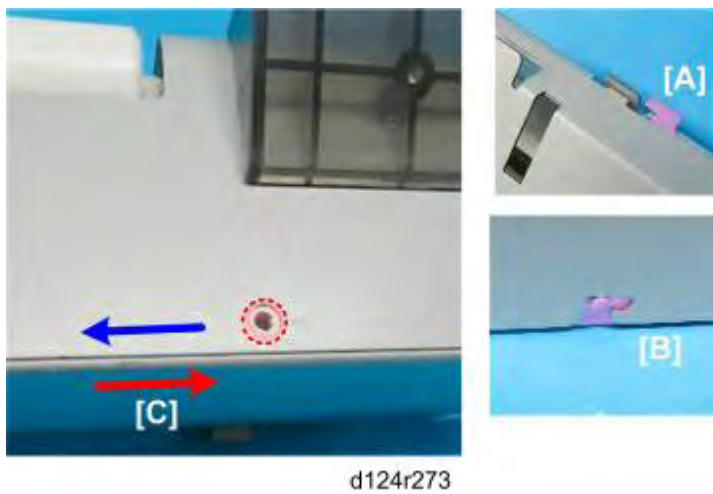

1. When you re-assemble the roller housing, match the hooks [A] and bosses [B] with their contact points, and then press the halves in the opposition direction.
2. The holes [C] align when the halves are locked correctly.

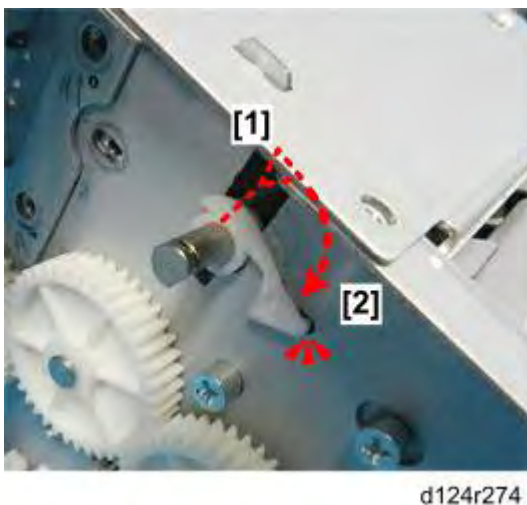

3. Slide the latch onto the shaft at the vertical [1] and then rotate it down so that its tab locks into the hole [2].

5.4.8 ROLL FEED MOTOR

Preparation

- Separate the Main Unit from the Scanner Unit ➤ page 5-16

Remove:

- Roll Unit ➤ page 5-98
- Roll Unit Right Covers ➤ page 5-110

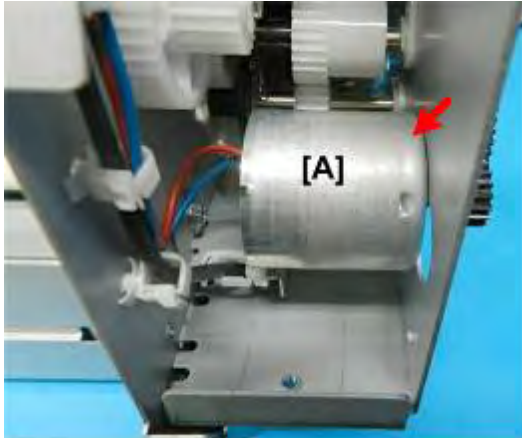

d124r275

1. Raise the bottom of the roll unit so that you can see the motor [A].



d124r276

2. Disconnect the motor and separate it from the frame (⚙️ x2).

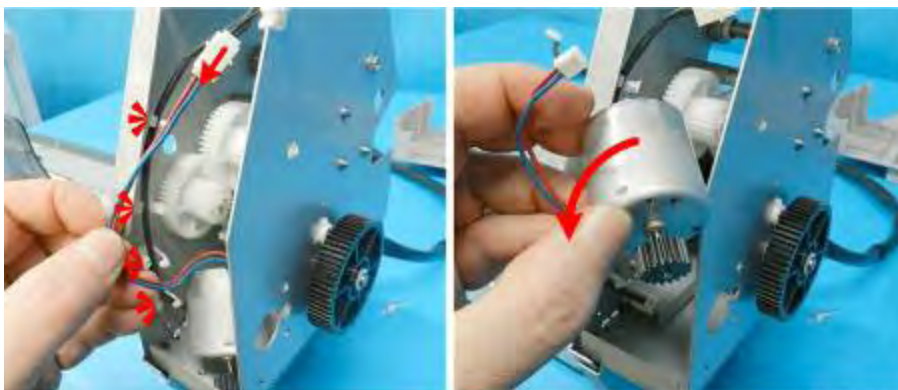

d124r277

3. Disconnect the harness and remove the motor (⚙️ x4, 📦 x1).

5.4.9 ENCODER SENSORS

Preparation

- Separate the Main Unit from the Scanner Unit ➤ page 5-16

Remove:

- Roll Unit ➤ page 5-98
- Roll Unit Right Covers ➤ page 5-110



d124r280

1. Disconnect the harness bracket and harness ( x1,  x1).

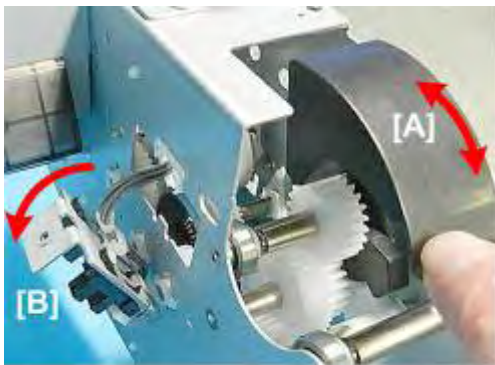

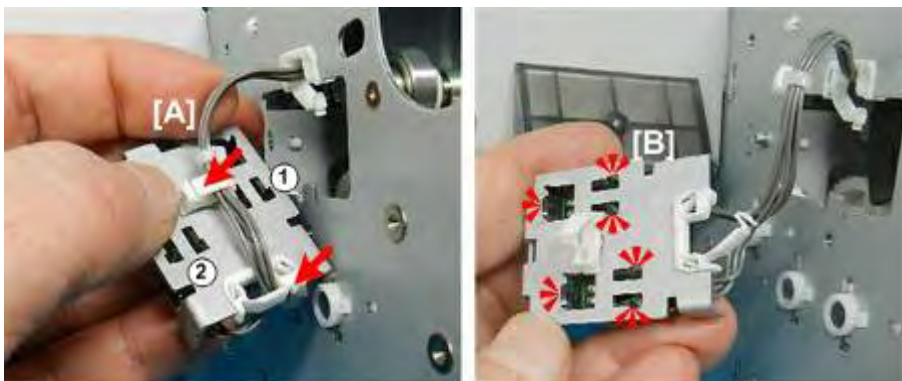

d124r281

2. Slide the latch [A] forward, and then pull out the harness bracket [B].



d124r282

3. Disconnect the harnesses [A] ( x2).
4. Disconnect the sensors [B] ( x6).
 - ① is encoder sensor 1, ② is encoder sensor 2.

Reinstallation



d124r283

1. Before reinstallation, clean the sensors with a blower brush.

5.4.10 ROLL FEED CLUTCH

Preparation

- Separate the Main Unit from the Scanner Unit ➤ page 5-16

Remove:

- Roll Unit ➤ page 5-98
- Roll Unit Right Covers ➤ page 5-110
- Roll Unit Left Covers ➤ page 5-112

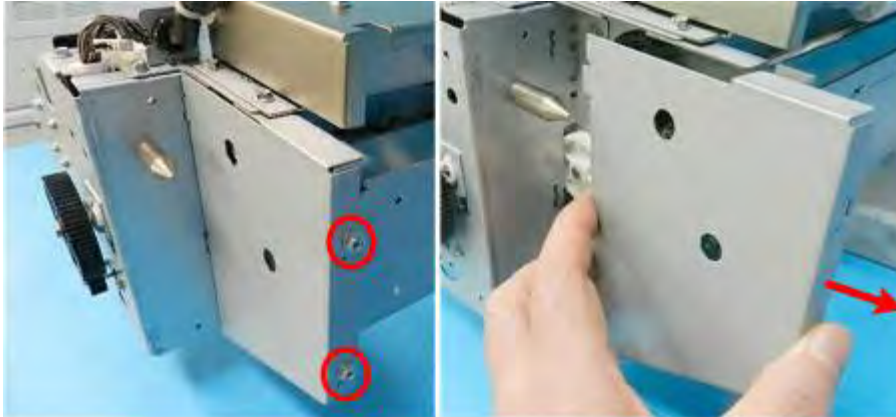

d124r290

1. Remove the gear train cover ( x2).



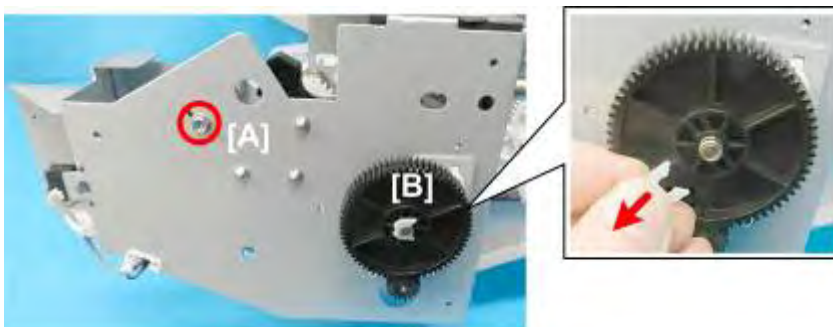

d124r291

2. Remove the screws ( x4).



d124r292

3. On the other side, remove screws [A] and disconnect the gear [B] ( x1,  x1).

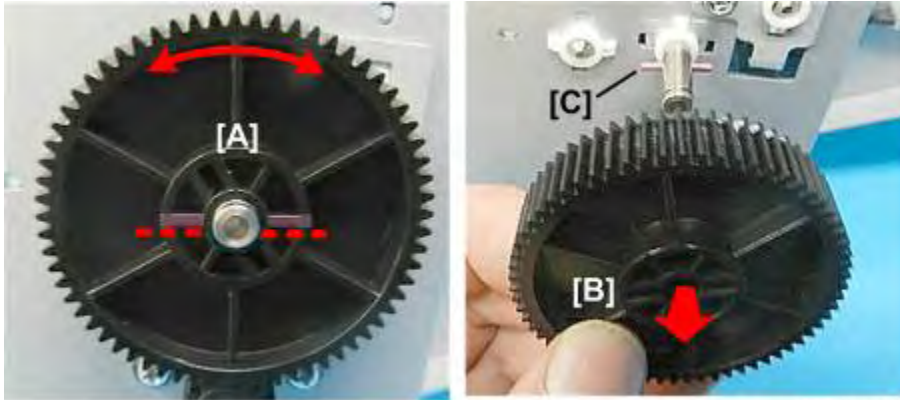

d124r293

4. Turn the gear until you see the alignment mark [A] perfectly horizontal.
5. Slowly, pull gear [B]. You will see alignment pin [C]. If it falls out, retrieve it immediately.

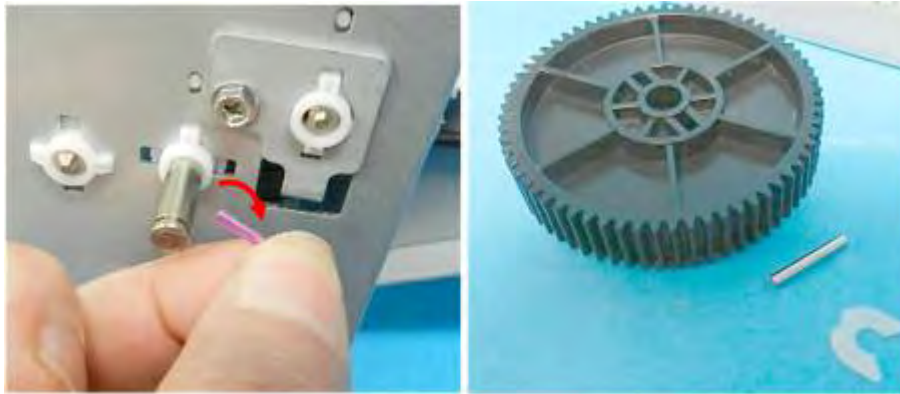

d124r294

6. Remove the alignment pin.

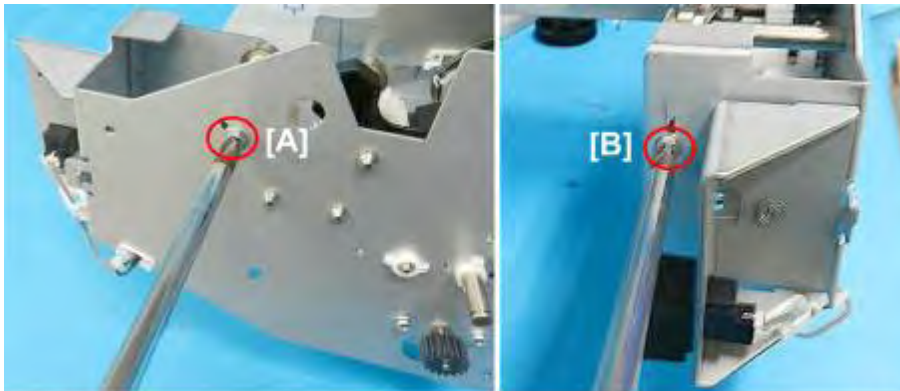

d124r295

7. Remove screws [A] and [B] on the right end of the unit ( x2).

Replacement and Adjustment

Roll Units



d124r296

8. Disconnect the switch (🔌x2, 🗑️x1).



d124r297

9. Disconnect the motor (🔌x1).

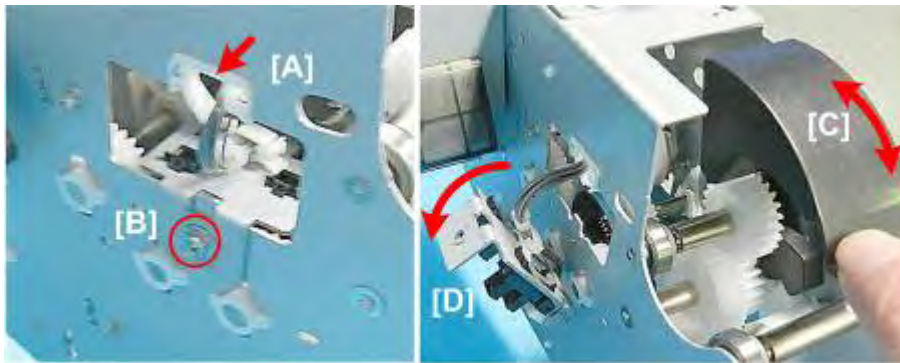

d124r298

10. Disconnect the harness [A] and harness clamp [B] (🔌x1, 🗑️x1).

11. Move latch [C] forward slightly, and then remove the harness bracket [D].



d124r299

12. Remove screw [A] ( x1).
13. While pressing in on the end of the roller shaft [B], slowly remove the plate [C].

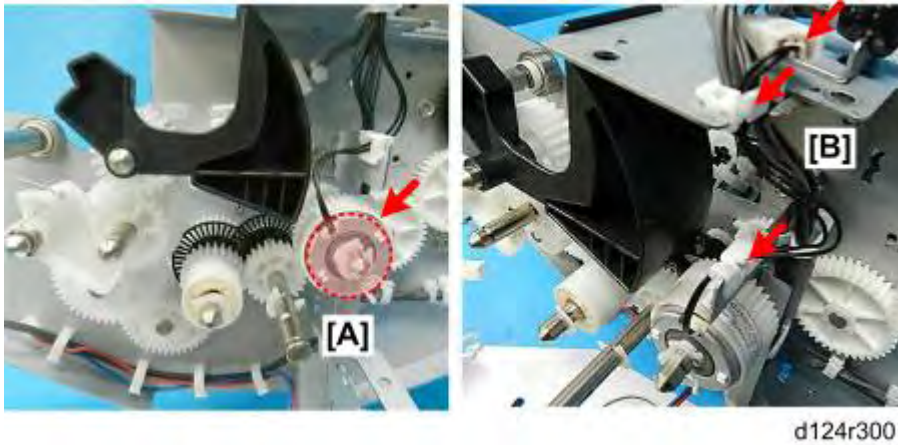

14. The clutch is located at [A].
15. Free the clutch harness [B] ( x3).



16. Remove the clutch and gear.

Reinstallation

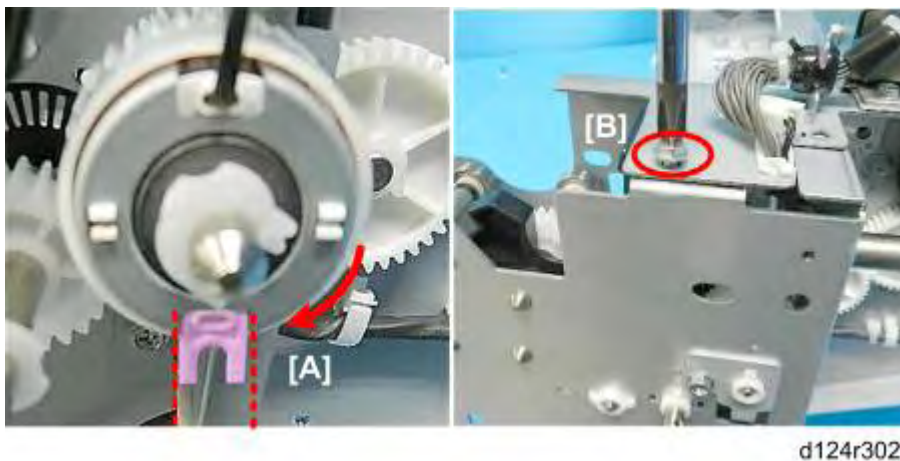

1. Rotate the clutch so that the clutch arm [A] is vertical.
2. Fasten screw [B].

Replacement and Adjustment

Roll Units



d124r303

3. Remove the clutch pawl plate (1 x1).

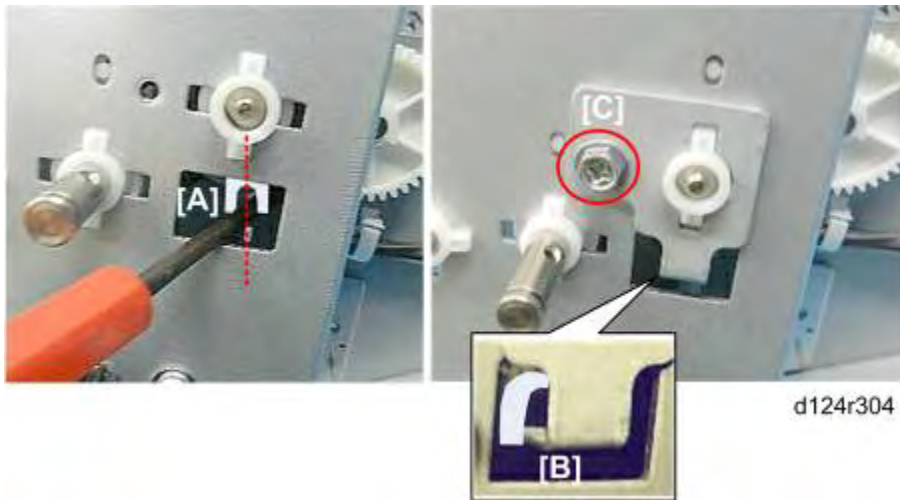

d124r304

4. Using the tip of a small screwdriver, set the clutch arm so that it is perfectly vertical.
5. Set the clutch pawl plate [B] so that the tip of the pawl is between the gap of the clutch arm [B].
6. Fasten the clutch pawl plate [C] (1 x1).

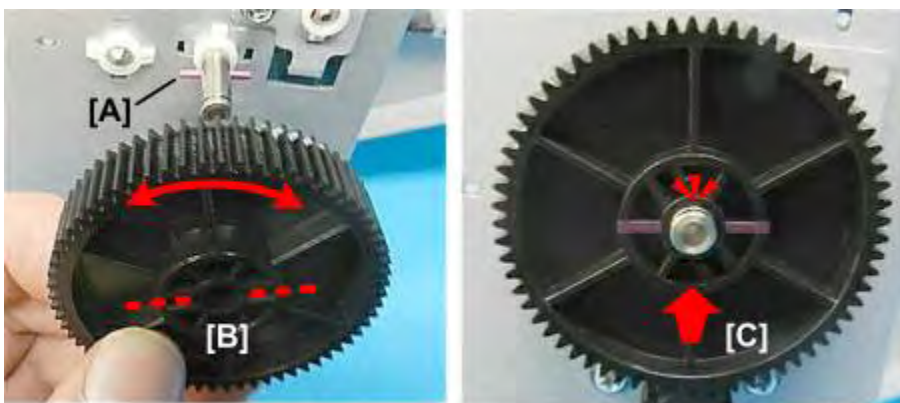

d124r305

7. Insert the alignment pin [A] into the shaft so that it is horizontal.
8. Set gear [B] on the end of the shaft, and then rotate it so that the horizontal alignment line is also horizontal.

- Slowly, push the gear [C] onto the shaft so that the pin locks into the groove on the back of the gear.

5.4.11 ROLL END SENSOR

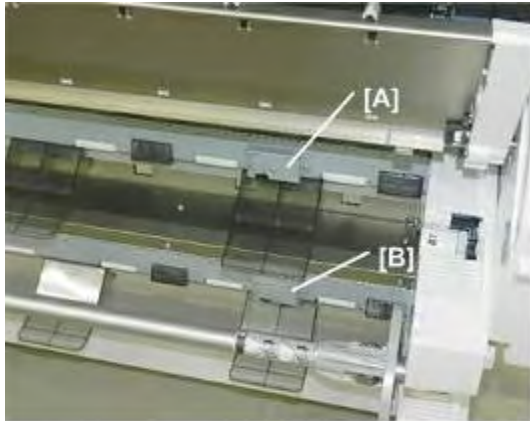

d1241034

- The roll end sensors are located on the back of Roll Unit 1 [A] and Roll Unit 2 [B].

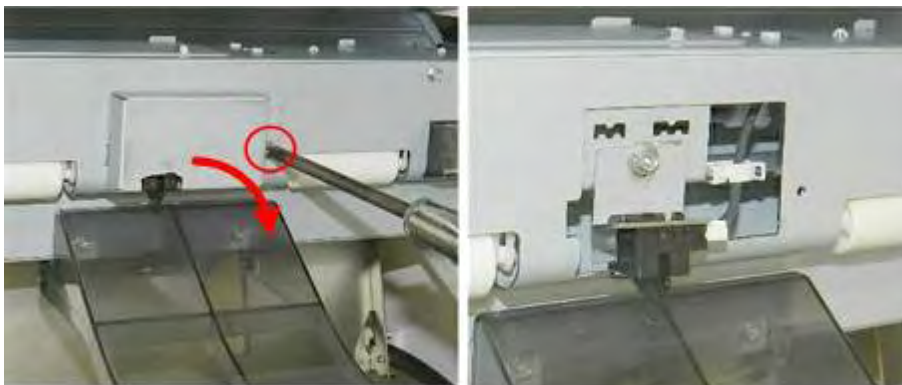

d1241039

- Remove the roll end sensor bracket cover (⚙️ x1).

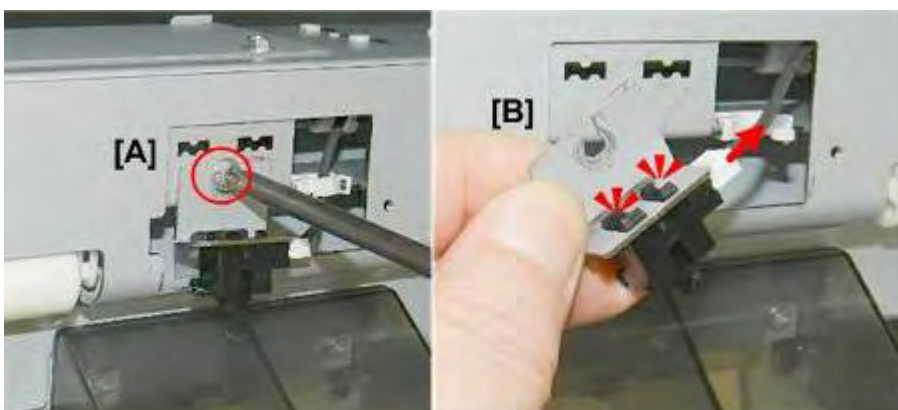

d1241040

- Disconnect the sensor bracket (⚙️ x1).
- Remove the sensor from the bracket (⚙️ x4, ⚙️ x1).

5.5 PAPER FEED, PAPER TRANSPORT

5.5.1 PAPER TRANSPORT FAN

Preparation

- Separate the Main Unit from the Scanner Unit ➤ page 5-16

Remove:

- Top cover ➤ page 5-29
- Front cover ➤ page 5-31
- Paper exit guide ➤ page 5-32
- Cutter Unit ➤ page 5-152



d124r321

1. The single paper transport fan is located on the right.



d124r322

2. Free the harness and disconnect the fan cover plate (🔧x2, 🔩x2).



d124r323

3. Remove the fan.

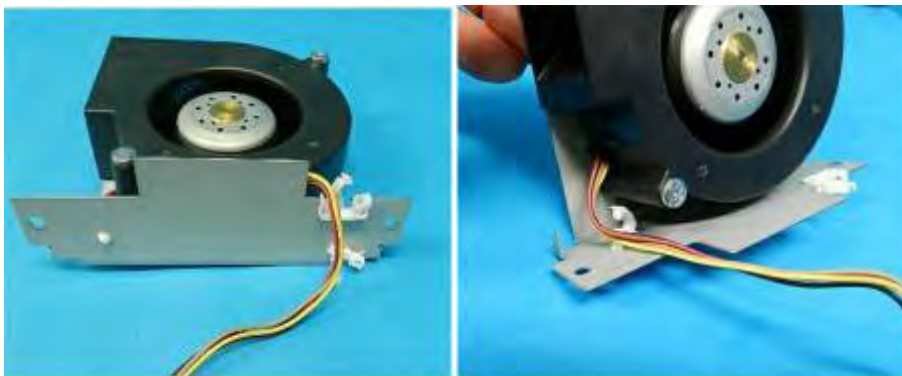

d124r324

4. Disconnect the fan harness (🔧x2).



d124r325

5. Separate the fan and bracket (🔧x1).

Replacement
and
Adjustment

Paper Feed, Paper Transport



d124r325a

Reinstallation



d124r721

1. When you reinstall the fan, make sure that its front edge does not catch on the front edge of the rubber gasket inside the machine and tear it.

5.5.2 PLATEN PLATES

⚠ CAUTION

- There are nine platen plates. As it is difficult to adjust their heights correctly after removal, the platen plates should never be removed in the field.

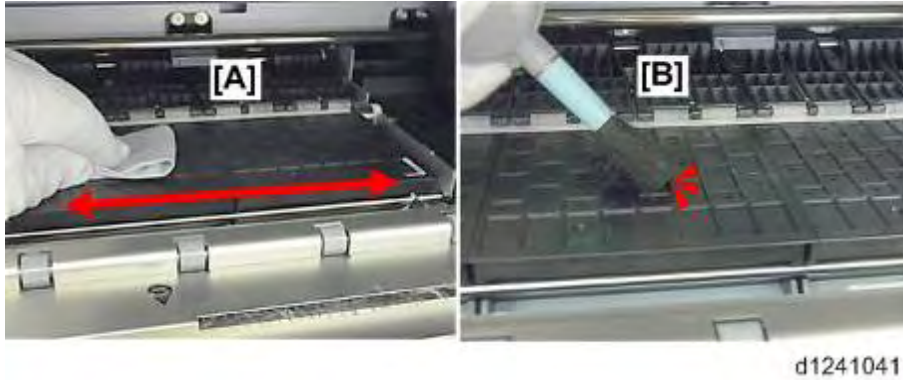

- Open the front cover.
- Use a clean cloth, slightly dampened with water, to clean the surface of the platen plates [A].
 - ★ Important**
 - To avoid damage or discoloration of the platen, never use an organic solvent like alcohol, benzene, acetone, etc. to clean it.
- Use a blower brush [B] to clean the holes in the plates.

5.5.3 EXIT ROLLER

Preparation

- Separate the Main Unit from the Scanner Unit ➤ page 5-16

Remove:

- Top cover ➤ page 5-29
- Front cover ➤ page 5-31
- Paper exit guide ➤ page 5-32

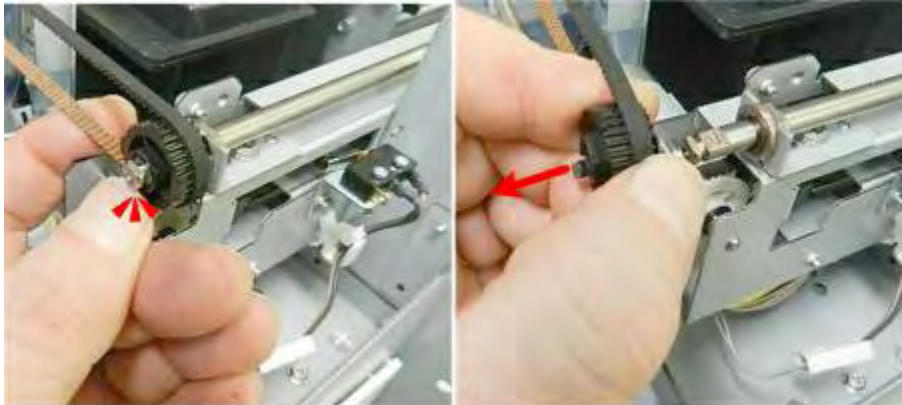

d124r363

1. Release the drive gear and remove it, with the timing belt (▼ x1, ⦿ x1).



d124r365

2. Push the roller shaft [A] to the right to disengage the right end from the bracket.
3. Lift the roller shaft [B] to remove it.



d124r366

4. Remove the bushing from the right end of the shaft (🕒x1, 🟩x1).

5.5.4 EXIT SENSOR

Preparation

- Separate the Main Unit from the Scanner Unit ➤ page 5-16

Remove:

- Top cover ➤ page 5-29
- Front cover ➤ page 5-31
- Ink cartridge cover ➤ page 5-23
- Paper exit guide ➤ page 5-32

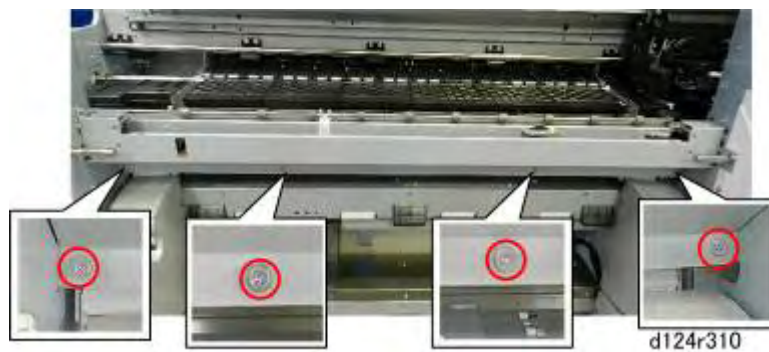

1. Disconnect the sensor cover plate ( x4).



d124r311

2. Remove the sensor cover plate.

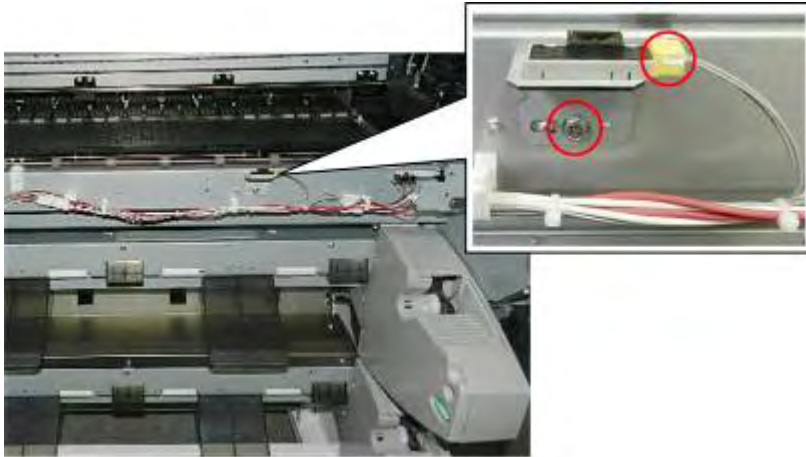

d124r336

3. Disconnect the sensor and bracket sensor bracket (⚙️ x1, 🔧 x1).



d124r337

4. Remove the bracket [A], and then disconnect the sensor [B] (⚙️ x4).

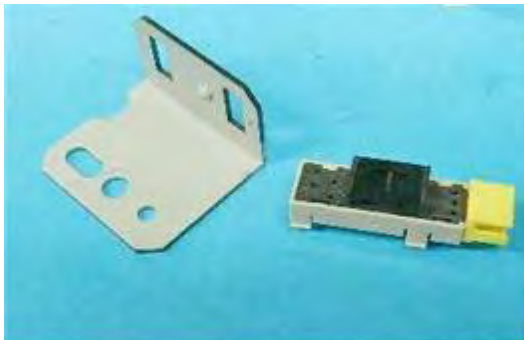

d124r338

Replacement
and
Adjustment

5.5.5 BYPASS SENSOR, PRE-REGISTRATION SENSOR

Preparation

Remove:

- Ink collector tank [page 5-17](#)
- Right cover [page 5-19](#)
- Right upper cover [page 5-21](#)
- Maintenance Unit [page 5-270](#)



d124i206

1. Remove the right rear metal plate ( x4).



d124r734

Important

- Do not loosen, and never remove the paint-locked screws near the lower edge of the plate. These are the screws that hold the maintenance unit base plate in the correct position.



d124r722

2. Disconnect the cover plate ( x2)



d124r723

3. Remove the cover plate.

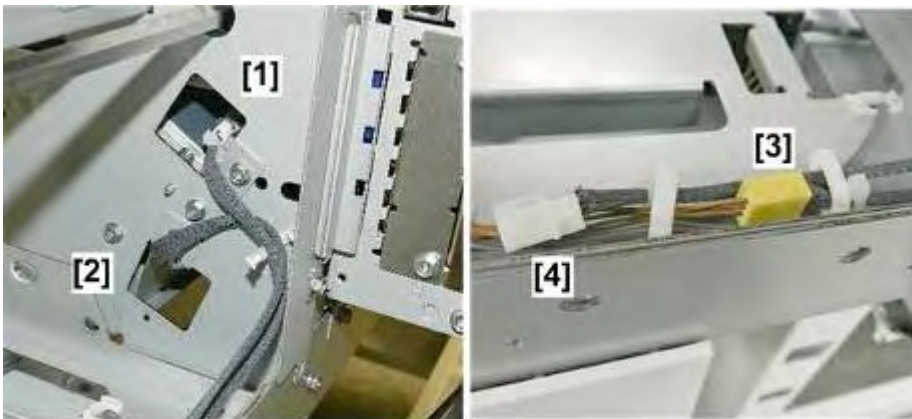

d124r724



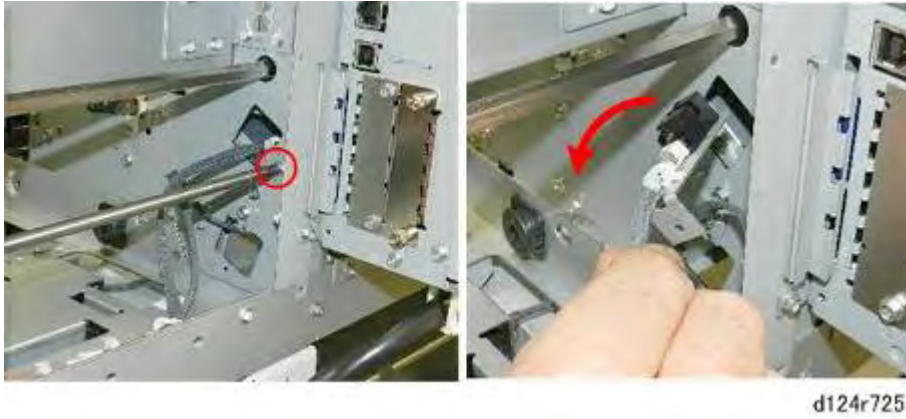

4. The upper sensor [1] is the bypass sensor, and the lower sensor [2] is the pre-registration sensor.
5. The yellow connector [3] is on the harness for the bypass sensor (the upper sensor), and the white connector [4] is on the harness for the pre-registration sensor (the lower sensor).

Paper Feed, Paper Transport



6. Remove the bypass sensor bracket ( x1).



7. Disconnect the bypass sensor ( x1,  x1,  x1,  x4)



8. Remove the pre-registration sensor bracket ( x1).



d124r728

1. Disconnect the pre-registration sensor (🔌x1, 📄x1, 🔌x1, ▼x4)

5.6 CUTTER

5.6.1 CUTTER BLADE

Preparation

- Open the front cover

Remove:

- Left cover  page 5-25

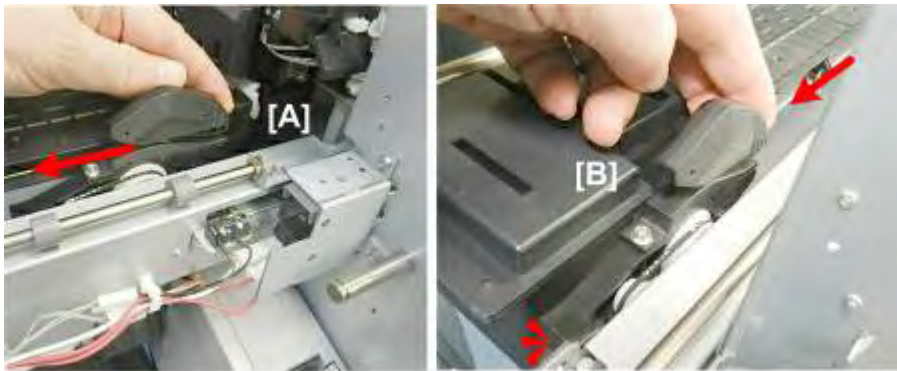

d124r340

1. On the right, raise the cutter [A].
2. Push it to the left side of the machine until it stops at [B].



d124r341

3. Disconnect the cutter and remove it ( x1).



d124r342

Reinstallation

If you are replacing only the cutter blade (not the cutter unit):

1. Go into the SP mode.
2. Open **SP7960-002** and then touch [EXECUTE] to reset the counter for the new cutter blade.

5.6.2 CUTTER UNIT

Preparation

- Separate the Main Unit from the Scanner Unit ➤ page 5-16

Remove:

- Top cover ➤ page 5-29
- Ink cartridge cover ➤ page 5-23
- Front cover ➤ page 5-31
- Paper exit guide ➤ page 5-32



d124r310a

1. Push the cutter from the right side [A] all the way over to the left side of the machine until it stops [B].

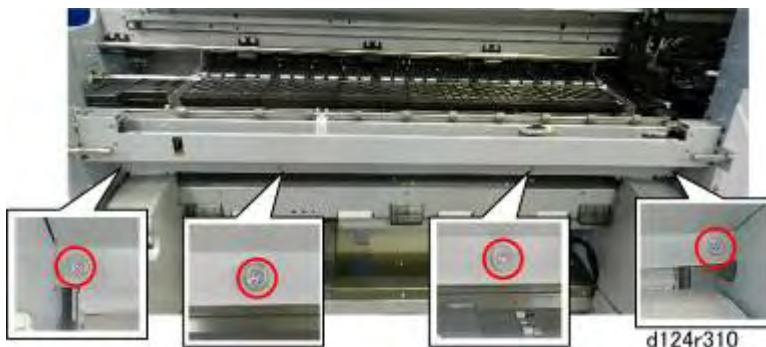

d124r310

2. Disconnect the sensor cover plate ( x4).



d124r311

3. Remove the sensor cover plate.



d124r312

4. On the left, disconnect the timing belt (ⓐx1).

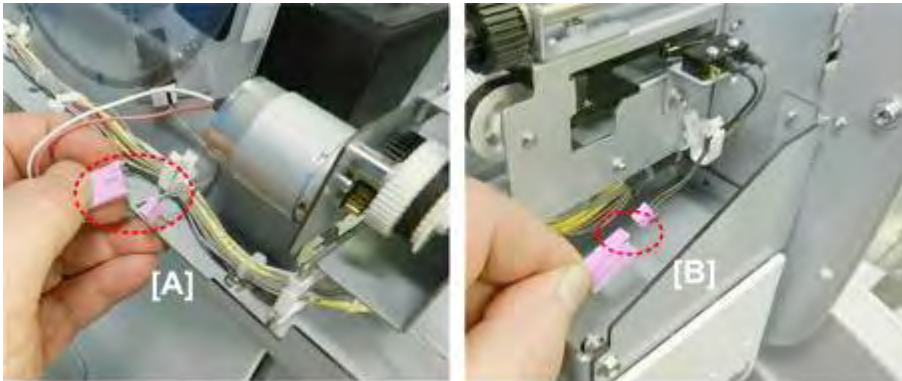

d124r313

5. Disconnect the cutter motor [A] (ⓐx1).
6. Disconnect the cutter return switch [B] (ⓐx1).

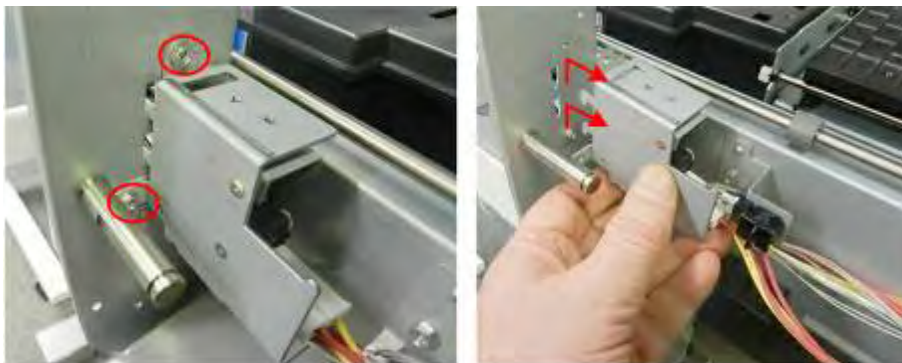

d124r314

7. On the left, disconnect the left front cover switch bracket (ⓐx2).

Cutter





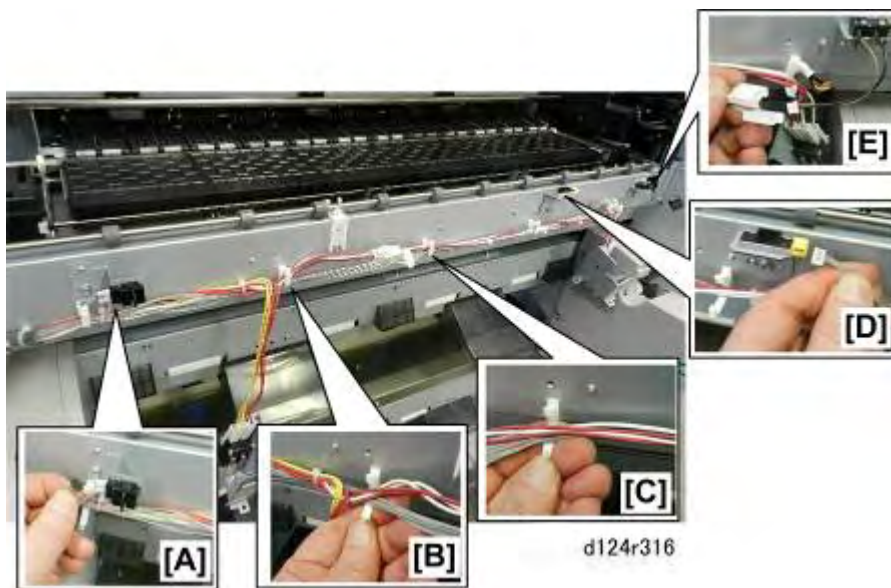

d124r315

8. On the right, disconnect the right front cover switch bracket ( x2).



d124r316

9. Disconnect the paper exit guide switch [A] ( x1).
10. Free the harness at [B] and [C] ( x2).
11. Disconnect the exit sensor [D] ( x1).
12. Free the harness at [E] ( x1).



d124r317

13. Pull the freed harnesses away from the clamps.



14. Disconnect the cutter unit on the left [A] and right [B] ( x1).



15. Remove the cutter unit.



16. Lay the cutter unit on a flat clean surface.

Reinstallation

If you are replacing the cutter unit:

1. Go into the SP mode.
2. Open **SP7960-004** and then touch [EXECUTE] to reset the counter for the new cutter unit.

5.6.3 CUTTER MOTOR

Preparation

- Separate the Main Unit from the Scanner Unit ➤ page 5-16

Remove:

- Cutter Unit ➤ page 5-152

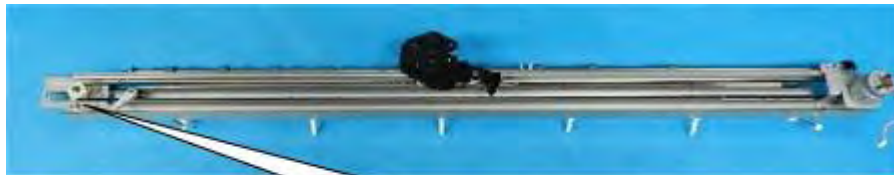

d124r345



1. On the left, disconnect the tension bracket [A] (⚙️x1).
2. Push the tension bracket [B] to the left and right to loosen it.
3. Disconnect the belt [C] (⚙️x1).

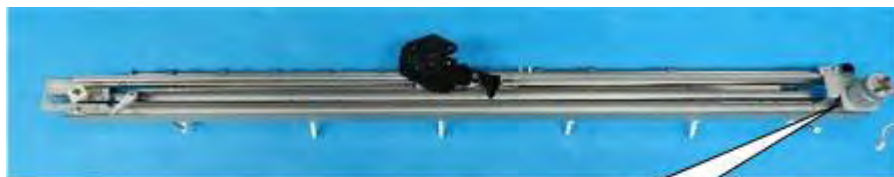

d124r346



4. Remove the motor bracket with the motor attached (⚙️x2).



d124r347

- Remove the drive gear (Ⓢx1).



d124r348

- Separate the motor and bracket (Ⓢx1).

5.6.4 CUTTER BELTS

Preparation

- Separate the Main Unit from the Scanner Unit ➤ page 5-16

Remove:

- Cutter Unit ➤ page 5-152
- Cutter Motor ➤ page 5-156

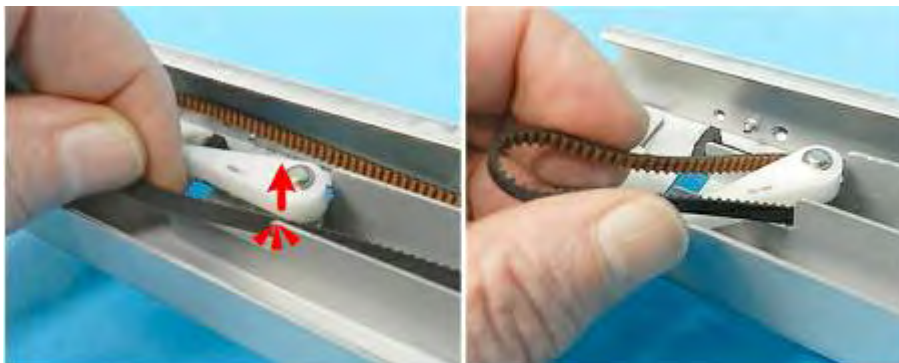

d124r349

- On the right, disengage the timing belt from the flapper (x1).

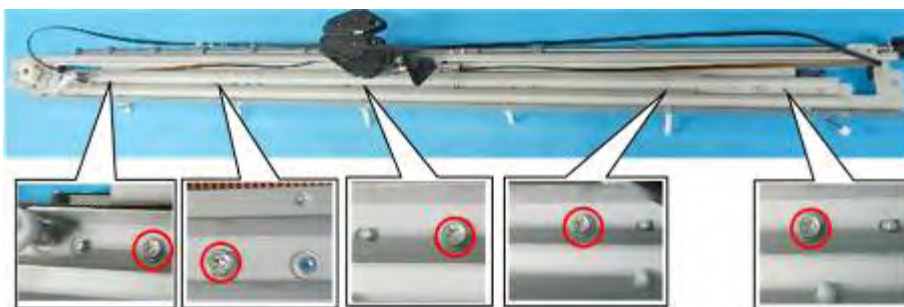

d124r350

- Disconnect the race from the cutter unit bracket (Ⓢx5).

Cutter

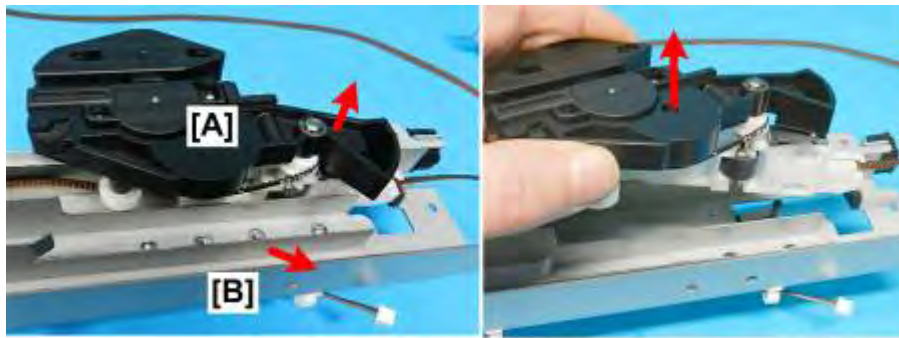

d124r351

3. Push the cutter [A] all the way to the right.
4. Pull the race [B] up slightly, and then remove the cutter.

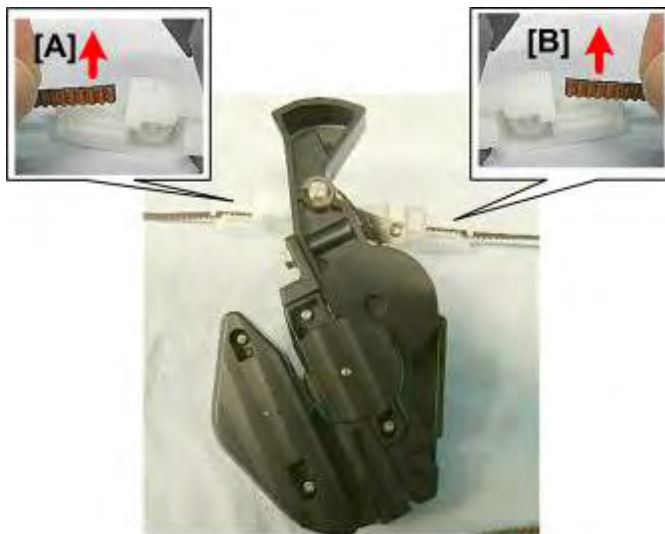

d124r352

5. Disconnect each end of the timing belt [A] and [B] from the cutter.



d124r353

6. Turn the cutter over and disconnect the cutter belt drive gear (⊗x1, ⊙x1).



d124r354

Reinstallation

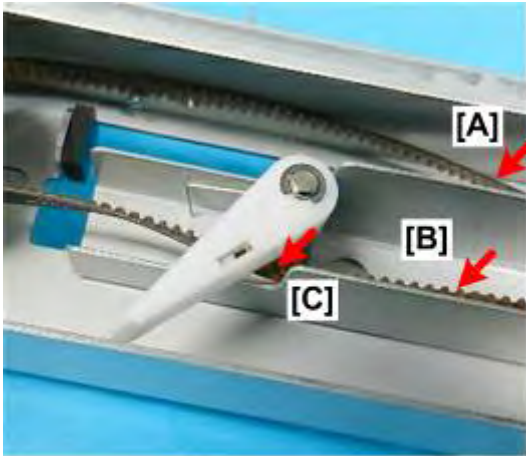

d124r355

1. On the right end, place the timing belt on the top race [A], the lower race [B], and then behind the flapper [C].



d124r356

2. Position the belt below the cutter as shown above.

Cutter

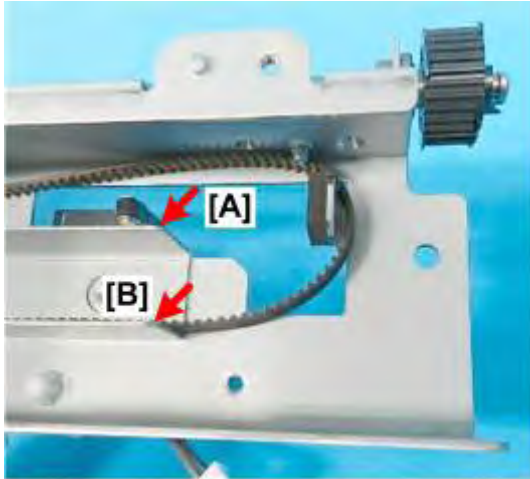

d124r357

3. Before reattaching the motor, make sure that the belt is positioned in the upper race [A] and on the lower race [B].

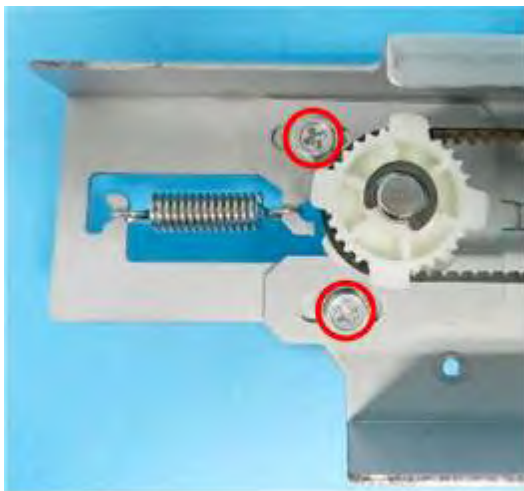

d124r358

4. Be sure to tighten the screws on the left end so that there is tension on the belt.

5.6.5 CUTTER RETURN SWITCH



Preparation

Remove:

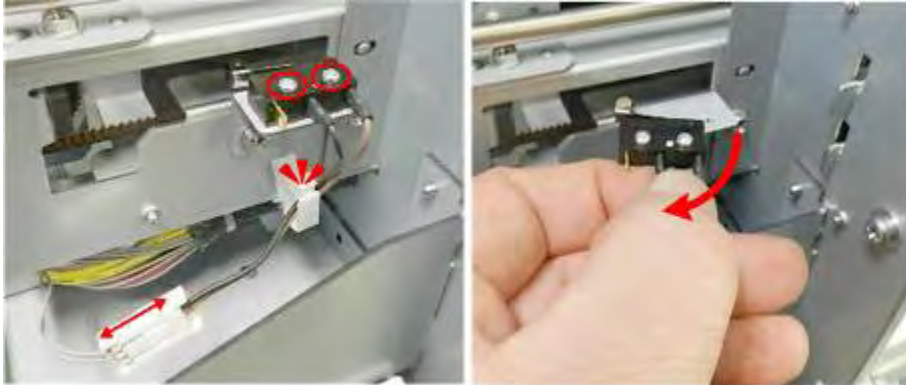
- Left cover  page 5-25



d124r359

1. Disconnect the switch ( x1,  x1).
2. Remove the switch ( x2).



d124r360

5.6.6 PAGE 5-35CUTTER HP SWITCH



Preparation

Remove:

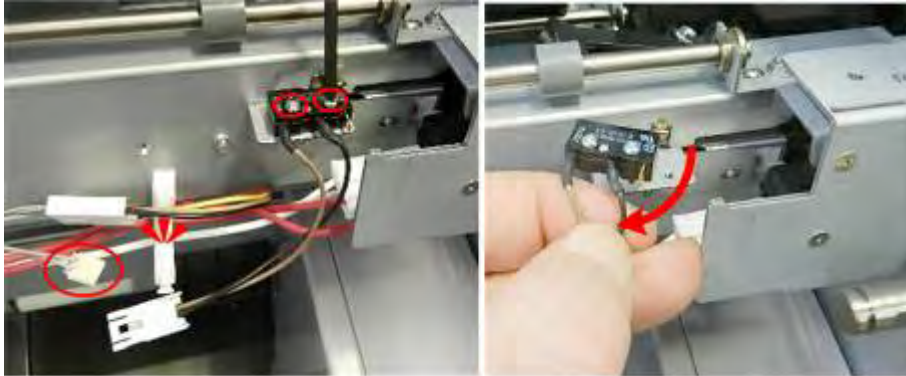
- Roller Cover  page 5-35



d124r361

1. Disconnect the switch ( x1,  x1).
2. Remove the switch ( x2).



d124r362

5.7 MAIN SCAN

5.7.1 HORIZONTAL ENCODER

- Always handle the encoder strip by its ends and edges. Wearing gloves is recommended.
- Never touch the surface of the horizontal encoder strip with bare hands.
- To clean the encoder, wipe it with a clean linen cloth dampened with alcohol to remove dust, ink, or fingerprints.
- Never use a cotton swab, tissue, or any other kind of material that could shred and leave fibers on the surface of the encoder.

Preparation

- Separate the Main Unit from the Scanner Unit ➤ page 5-16

Remove:

- Top cover ➤ page 5-29



1. On the right and left, **loosen** the screws of the ink supply tube rail (⚙️ x2).

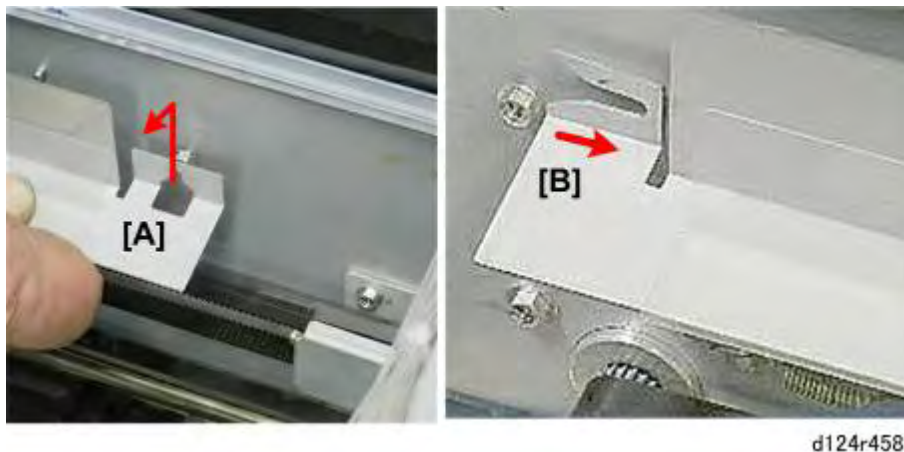

2. Lift the right end [A] of the rail off its screw, and then pull the left [B] away from its screw to disconnect both ends.

Main Scan

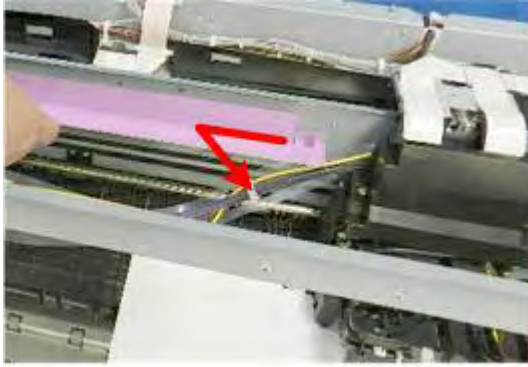

d124r459

3. Pull the rail to the left, through the back of the carriage unit.



d124r372

4. Pull the rail out of the machine.



d124r373

- The horizontal encoder [A] stretches from the left side to the right side of the machine.
- At [B], the top edge of the encoder strip passes through the gap of the horizontal encoder sensor on the back of the carriage unit.

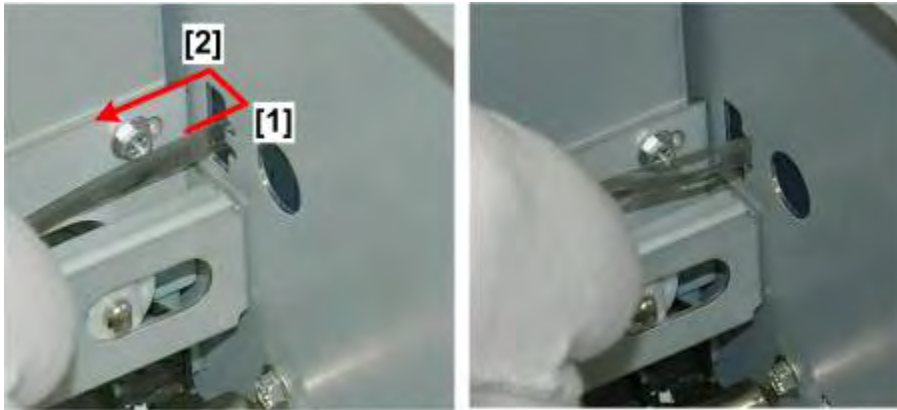

d124r374

5. On the right end, pull the end of the strip to the right [1], then lift the end of the strip off its post [2].

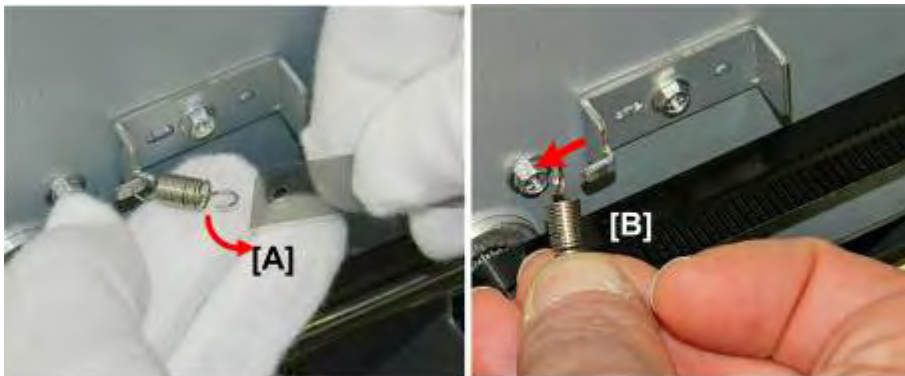

d124r375

6. On the left end, disconnect the left end of the strip [A] from the spring, and then remove the spring [B] (1 x1).



d124r376

7. Remove the strip and lay it on a flat clean surface.

Reinstallation

1. Before reinstallation, inspect the encoder strip. If it is dirty, clean it with an alcohol damp cloth, and then dry it with a dry linen cloth.

★ Important

- Never use a cotton ball, cotton swab, or tissue paper to clean the surface of the encoder strip.

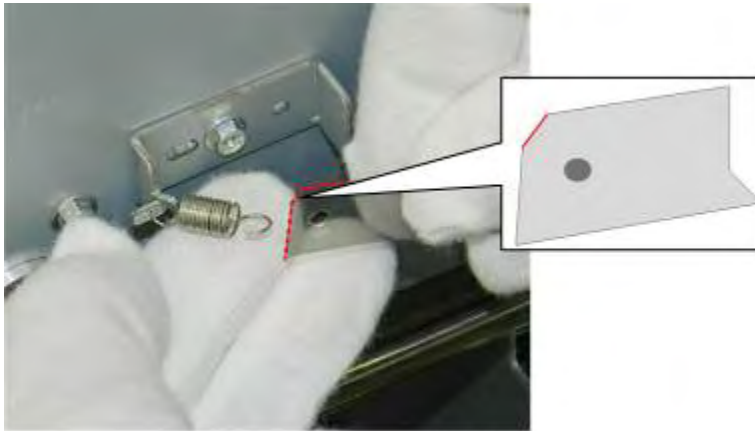

d124r377

2. Attach the left end of the strip with the beveled corner pointing up (the right end of the strip is square).

★ Important

- The machine will not operate if the encoder strip is not installed correctly.

5.7.2 HORIZONTAL MOTOR

Preparation

- Separate the Main Unit from the Scanner Unit  page 5-16

Remove:

- Top cover  page 5-29



d124r412

- At the front, on the left side, disconnect the motor ( x3).

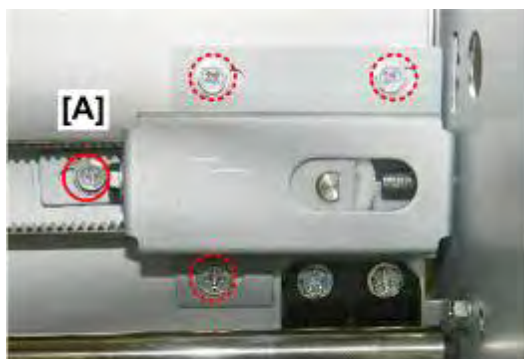

d124r413

- On the right, remove screw [A], and then loosen the other three screws ( x1).

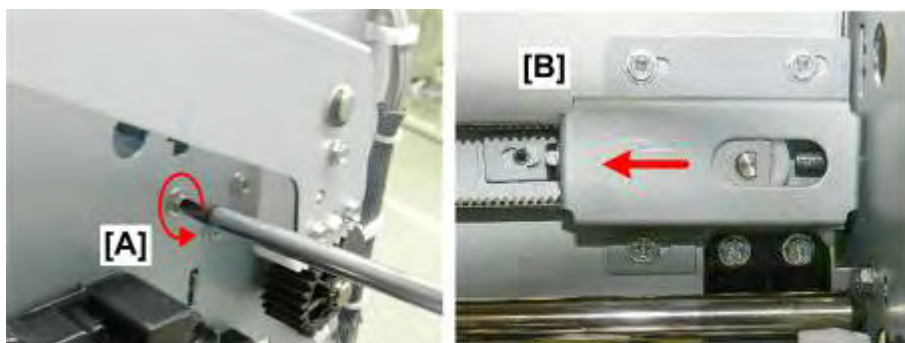

d124r414

- On the right cover of the machine, loosen screw [A] until you see the tension bracket [B] shift to the left and relax tension on the timing belt.

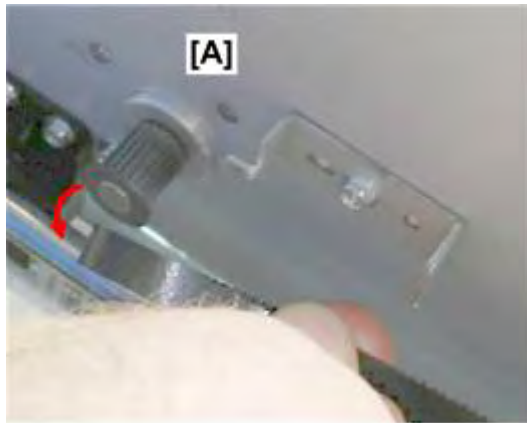

d124r415

4. On the left end of the timing belt, remove the timing belt from the motor drive gear [A].



d124r564

5. Remove the left rear panel of the machine ( x3).



d124r416

6. Disconnect the motor and remove it ( x1).



d124r417

5.7.3 HORIZONTAL TIMING BELT

The horizontal timing belt is attached to the back of the carriage unit and cannot be removed or replaced without first removing the carriage unit.  xref

Preparation

Remove:

- Carriage Unit  page 5-220

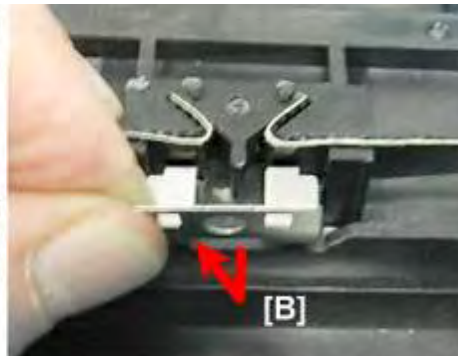

d124r499

1. Remove the lock plate from the back of the carriage unit ( x1).



d124r500

2. Remove both ends of the horizontal timing belt from the serrated grips.

5.8 SUB SCAN

5.8.1 VERTICAL ENCODER SENSOR



Preparation

Remove:

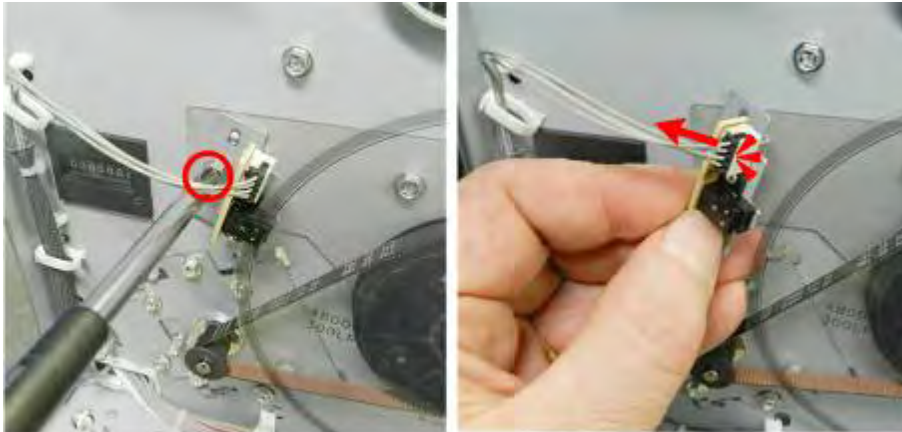
- Left cover  page 5-25



d124r420

1. Disconnect the sensor bracket ( x1,  x1).



d124r421

2. Separate the sensor and bracket ( x2).

Reinstallation



d124r422

1. Clean the sensor with a blower brush.

5.8.2 VERTICAL ENCODER WHEEL, TIMING BELT

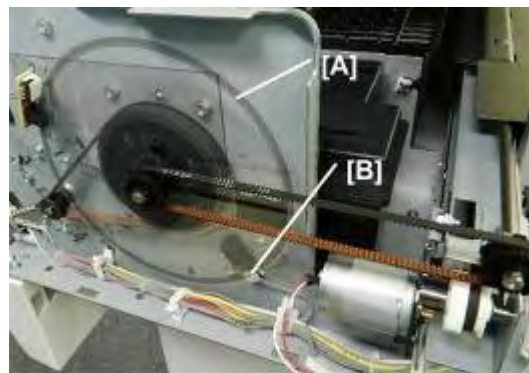

d124r423

The edge of the encoder wheel [A] is marked with coded patterns that are read by the encoder sensor [B].

★ Important

- Handle the encoder wheel by its hub. Never touch the edges of the vertical encoder wheel with bare hands.
- To clean the edges of the encoder wheel, wipe it with a clean linen cloth dampened with alcohol to remove dust, ink, or fingerprints.
- Never use a cotton swab, tissue, or any other kind of material that could shred and leave fibers on the surface of the encoder.

Preparation

Remove:

- Left cover ➤ page 5-25
- Vertical encoder sensor ➤ page 5-170



d124r424

1. Disconnect the roller gear and remove it, with the timing belt (▼ x1, ⚙ x1, ⚙ x1).

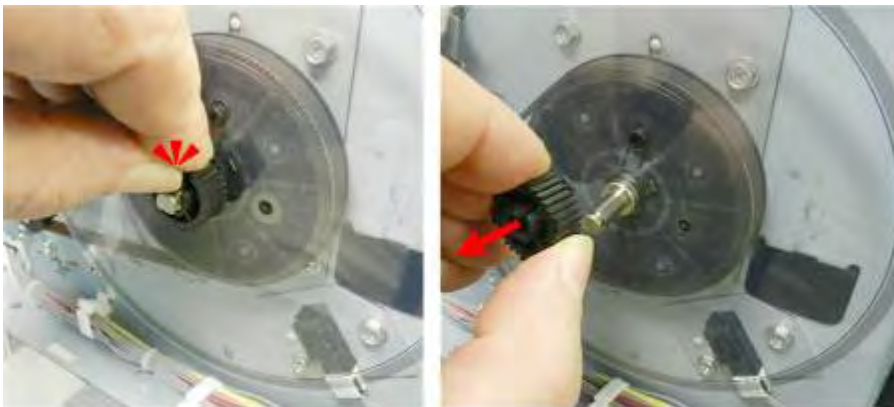

d124r425

2. Disconnect and remove the gear from the shaft of the vertical encoder wheel (▼ x1, ⚙ x1).



d124r426

3. Remove the flexible clip from the shaft of the wheel (🔗 x1).



d124r427

4. Remove the tension spring ( x1).

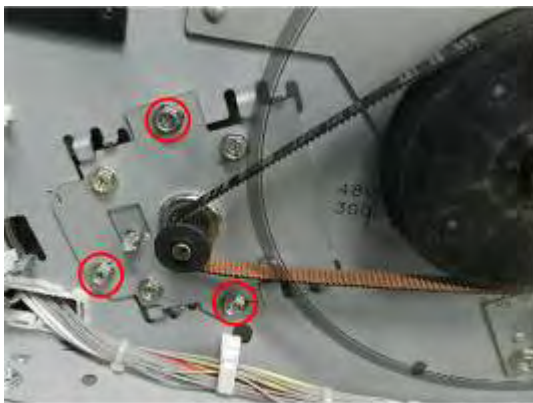

d124r428

5. Loosen the vertical motor bracket ( x3).

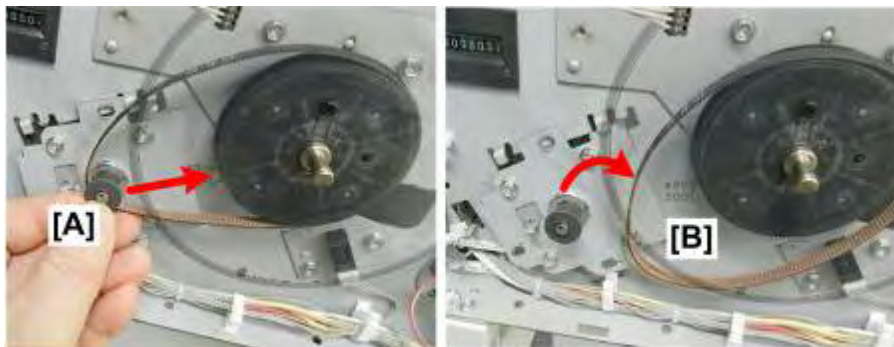

d124r429

6. Push the bracket [A] to the right, and then separate the timing belt [B] from the motor drive gear.

Replacement
and
Adjustment

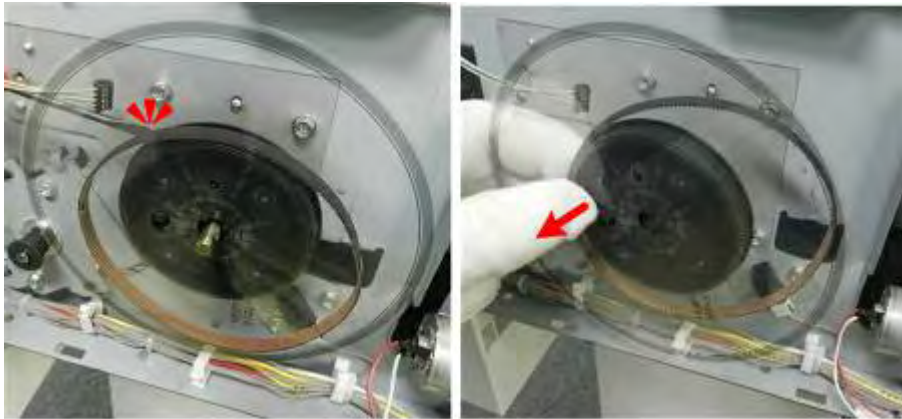

d124r430

7. Use the head of a small screwdriver to apply slight pressure to the back of the wheel, and then remove the wheel with the timing belt.

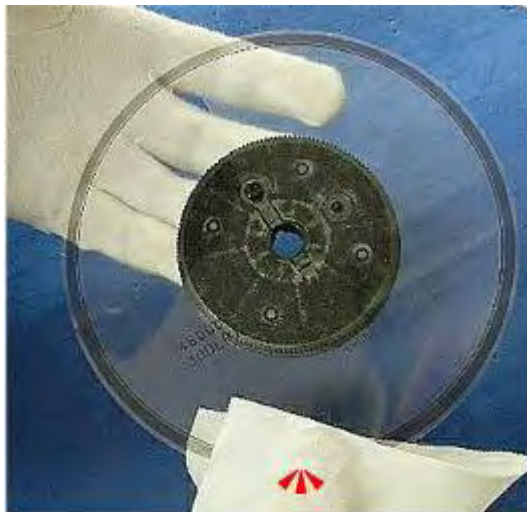

d124r431

5.8.3 VERTICAL ENCODER HP SENSOR

Preparation

Remove:

- Left cover ➤ page 5-25
- Vertical encoder wheel ➤ page 5-171

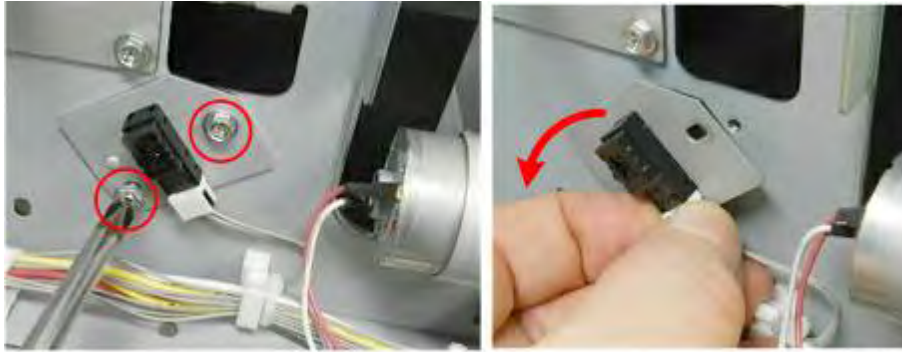

d124r432

1. Remove the sensor bracket (⚙️ x2).

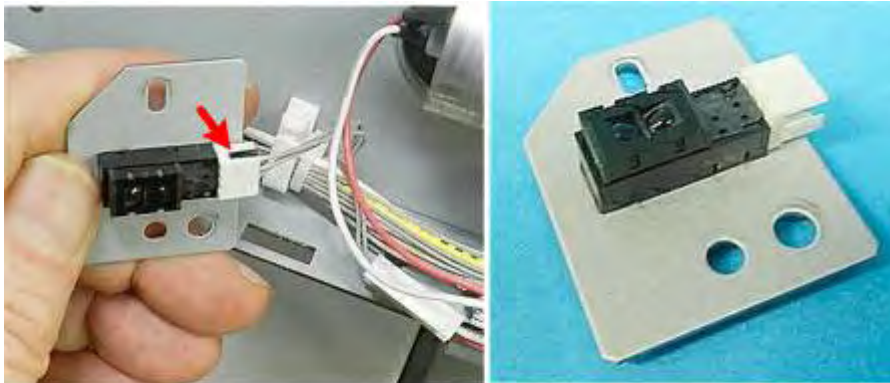

d124r433

2. Disconnect the sensor (🔌 x1).

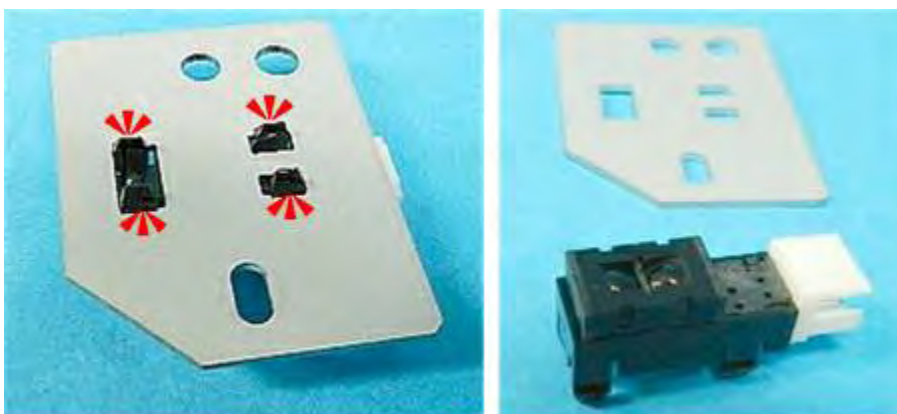

d124r434

3. Separate the bracket and sensor (🔪 x4).

Reinstallation





d124r435

1. Clean the sensor with a blower brush.

5.8.4 VERTICAL MOTOR

Preparation

Remove:

- Left cover  page 5-25
- Vertical encoder wheel  page 5-171

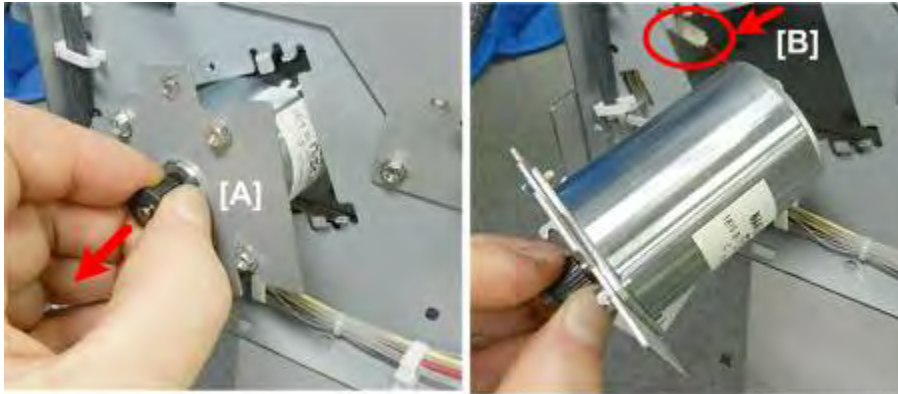

d124r436

1. Pull out the motor bracket [A] slightly.
2. Disconnect the motor [B] ( x1).



d124r437

3. Separate the motor and bracket ( x4).

5.9 CARRIAGE UNIT

5.9.1 BEFORE YOU BEGIN

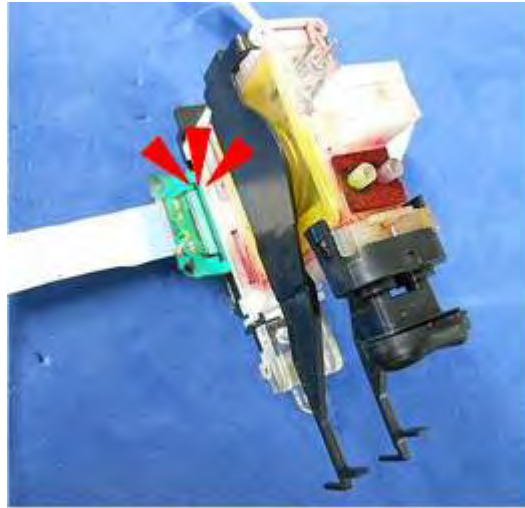

d124r729

Important

- Always follow instructions and work carefully to avoid spilling ink from the ink tubes and the tops of the ink sub tanks.
- If ink spills onto a printed circuit board at the base of the FFC, the print head unit will become unusable and require replacement.

5.9.2 BLACK AND COLOR PRINT HEADS

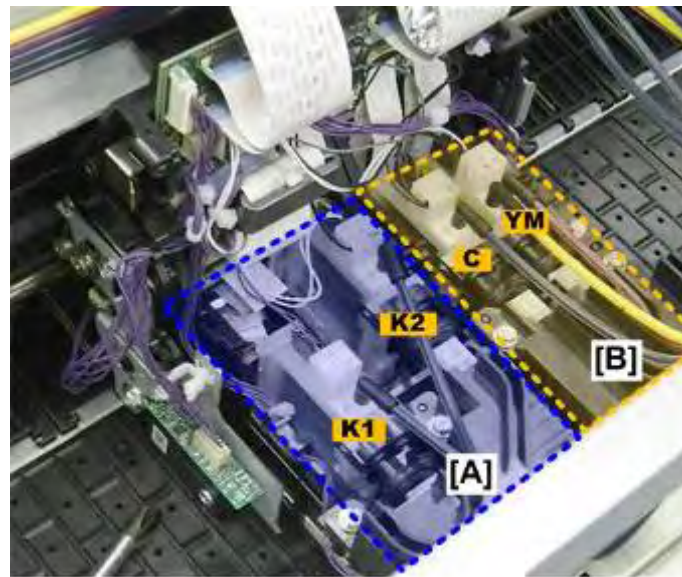

d1241153

- The unit on the left is the Black Print Head Unit (K1, K2) [A]. It holds the black print head units and sub tanks.
- The unit on the right is the Color Print Head Unit (C, YM) [B]. It holds the color print head units and sub tanks.
- A single print head (K1, K2, C, or YM) cannot be replaced individually; the entire left or right print head unit must be replaced.
- The left and right print head units {A} and [B] can be replaced separately or as a pair.

Black Print Head Unit (K1, K2) Accessories

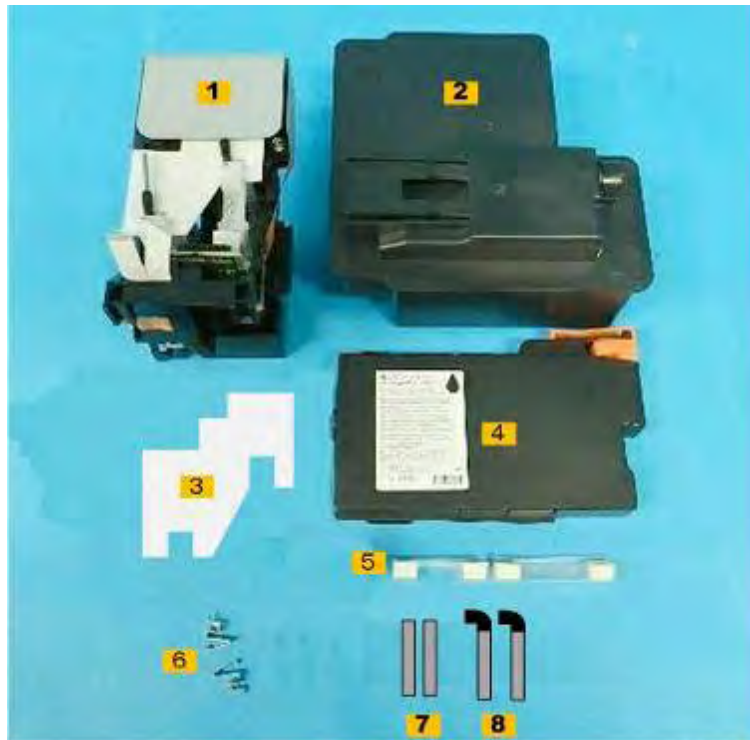

d1241151

No.	Item	Qty
1.	Black Print Head Unit	1
2.	Ink Collector Tank	1
3.	Protective Sheet	1
4.	Ink Cartridge (K)	1
5.	Rear Cushion	1
6.	Bracket	2
7.	Plug (Uncapped)	2
8.	Plug (Capped)	2

Color Print Head Unit (C, YM) Accessories



d1241152

No.	Item	Qty
1.	Black Print Head Unit	1
2.	Ink Collector Tank	1
3.	Protective Sheet	1
4.	Ink Cartridge (C, Y, M)	1
5.	Rear Cushion	1
6.	Bracket	2
7.	Plug (Uncapped)	3
8.	Plug (Capped)	3

Replacement
and
Adjustment

Carriage Unit Covers

Preparation

- Move the Carriage Unit with SP2102-4  page 5-37
- Separate the Main Unit from the Scanner Unit  page 5-16

Remove:

- Top cover  page 5-29
- Front cover  page 5-31
- Paper exit guide  page 5-32



d124r707

1. Open the cover on the right side of the machine and remove the ink collector tank [A], and then replace it with the ink collector tank provided with the accessories.

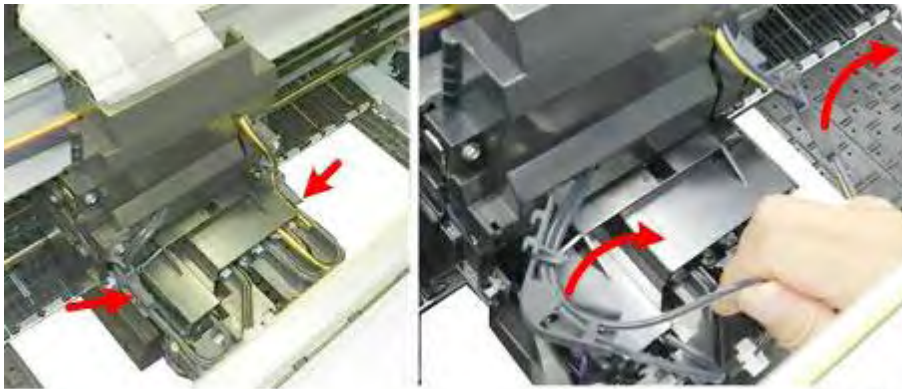

d124r706

2. Unfasten the "L" brackets from the left and right sides of the carriage unit.

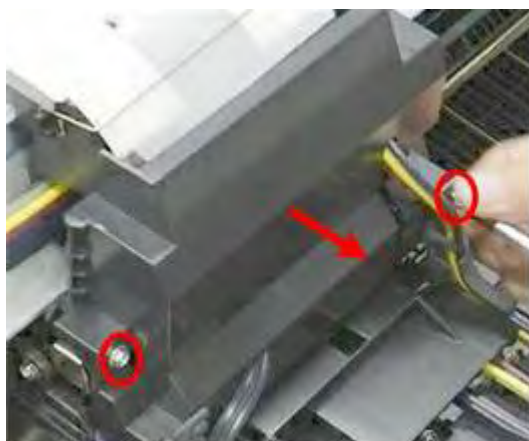

3. Remove the front cover ( x2).



4. Remove the left cover of the carriage unit ( x1).

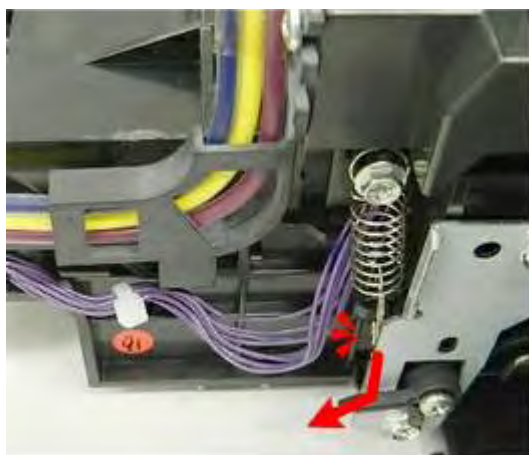

5. Release the right spring ( x1). (Do not remove the spring from the cover.)

Carriage Unit

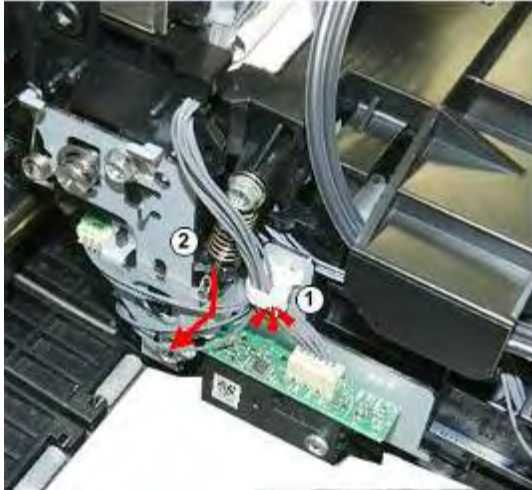

d124r484

6. Open the clamp ① and then release the spring ② (🔧x1, 🪛x1). (Do not remove the spring from the cover.)

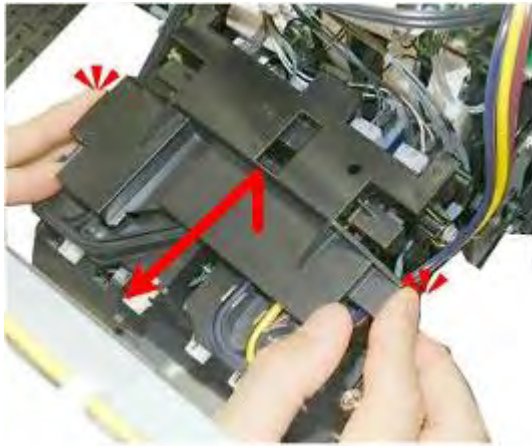

d124r485

7. Spread both sides of the top cover slightly, and then remove it.

Black Print Head Unit

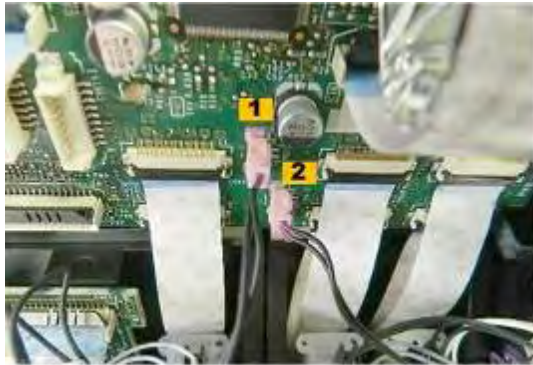

d124r753

1. Before you start disconnecting harnesses, note the position of thermistor connectors [1] and [2].
 - [1] is the thermistor connector of K2 on the left.
 - [2] is the thermistor connector of C on the right.
 - Make sure that these thermistor harnesses are reconnected correctly.

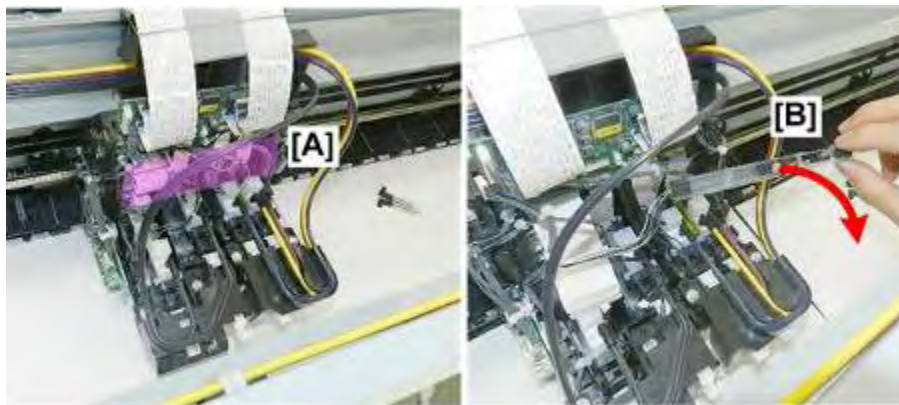

d1241071

2. Disconnect the FFCs and harnesses of **both print head units** [A].
3. Remove the rear cushion [B].

★ Important

- The OCFS sensor harnesses can be discarded. However, you must keep the air sensor harness and the thermistor harness in order to connect the new unit.

Carriage Unit

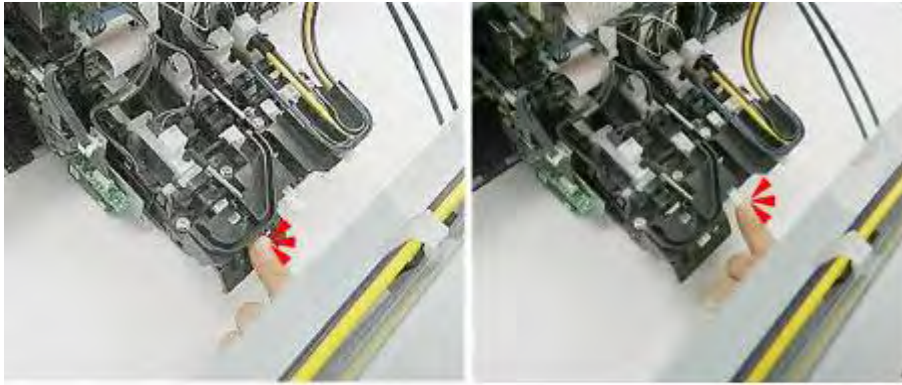

d1241080

4. Press in the left and then the right plunger to expel air from the K1 and K2 sub ink tanks.



d124r775

5. Slide the accessory protective sheet under the tubes. This prevents spilled ink from falling into the machine.



d1241070

6. Get the uncapped accessory plugs.

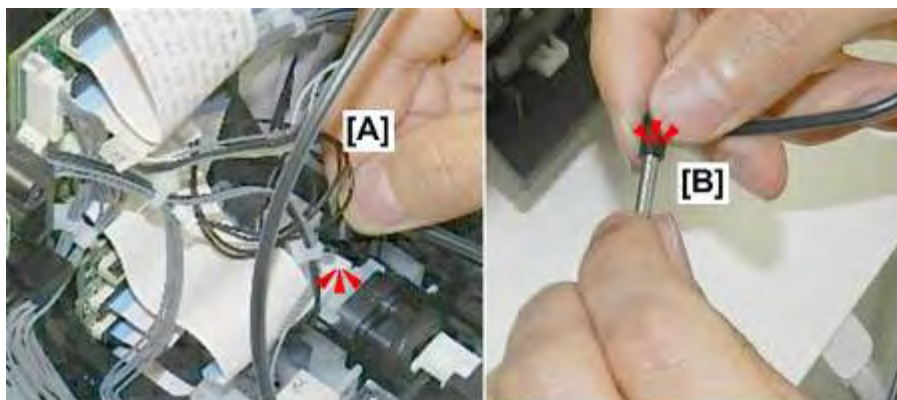

d1241073

7. Disconnect the K2 ink tube [A], and then plug the open end [B].
8. Disconnect and plug the K1 ink tube and then plug it



d124r776

9. Get the two capped accessory plugs.

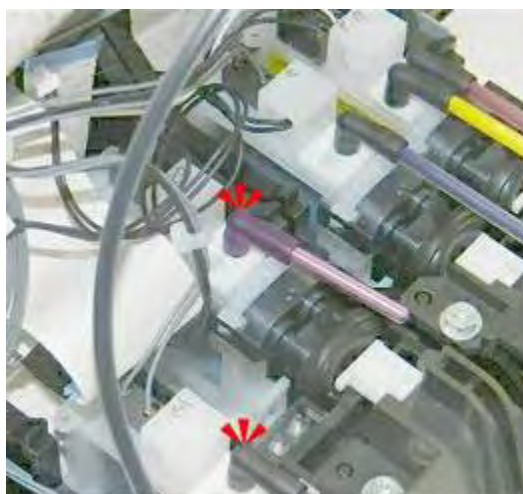

d1241074

10. Attach the plugs to the open ports on top of the tanks.

★ Important

- These plugs prevent ink from leaking from the top of the print head sub tanks.

11. Confirm that the ports on top of the two ink supply tanks (K1, K2) and the ends of both black ink supply tubes are plugged.

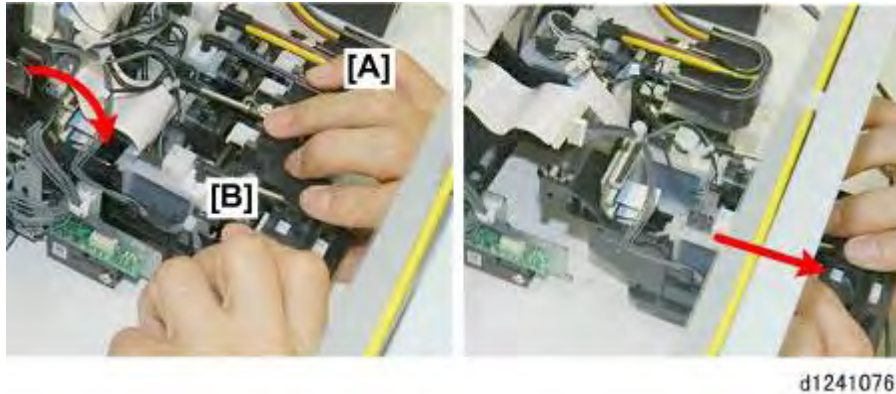

12. While holding the right print head unit [A] steady, raise the left print head unit [B], and then rock it forward slightly to remove it from the support rod at the rear.
13. Set the old print head unit down on a piece of paper.

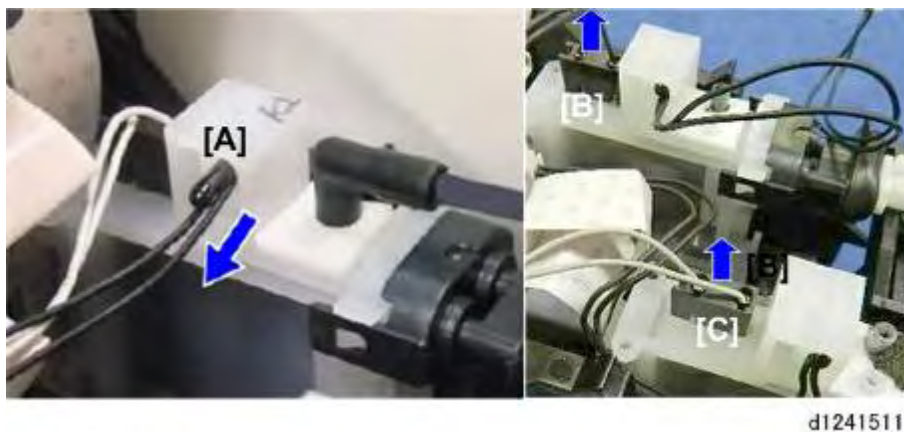

14. Disconnect the thermistor harness [A] from the old print head unit (removed from the machine) for re-connection to the new unit.
15. Disconnect the two air sensor harnesses [B] and [C] from the old print head unit (removed from the machine) for re-connection to the new unit.

★ Important

- When you discard the old unit, always obey local laws and regulations regarding the disposal of such items.

16. Check the paper under the carriage unit. If it is stained with ink remove it, and then replace it with a fresh sheet of paper.

New Black Print Head Unit Installation

Follow the removal procedure in reverse to install the new black print head unit., but please pay attention to these important points during the installation procedure.



d124r709

1. Remove the tape and protective metal cap from the new unit.

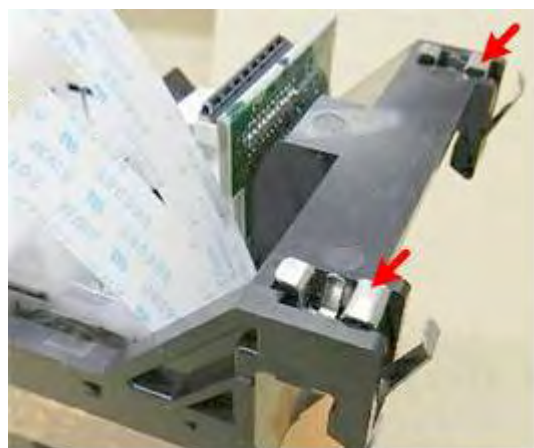

d1241156

2. Set the brackets into the holes on the back of the new unit.

Carriage Unit

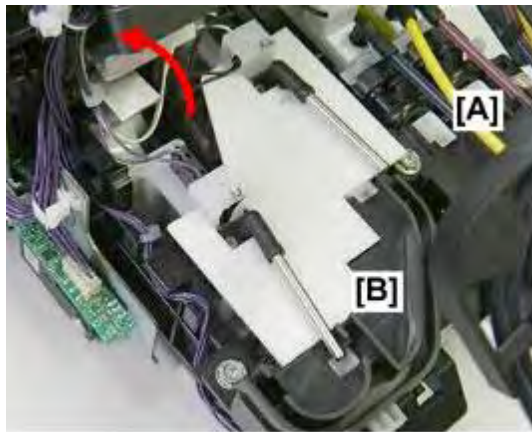

d1241078

3. Steady the right unit [A] as you hook the back of the right unit [B] over the guide rod at the rear.

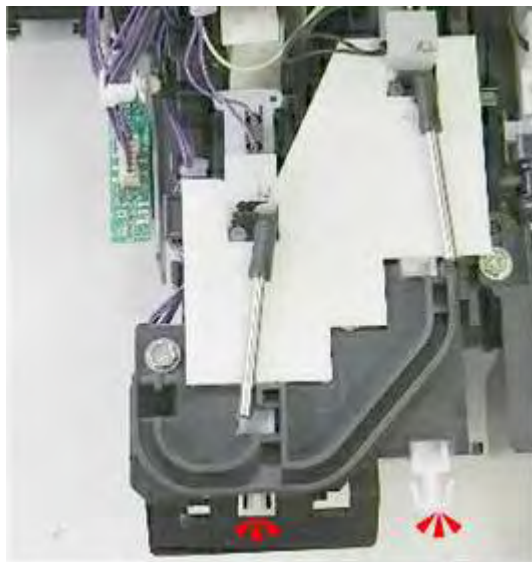

d124r777

4. Before you remove the plugs, press both plungers to expel any air that has accumulated during storing and shipping.

★ Important

- Expelling the air will reduce pressure inside the ink sub tanks and prevent ink leakage after the plugs are removed.



d124r754

5. Remove the capped plugs [A].
6. Unplug the ink tubes and reconnect them [B].

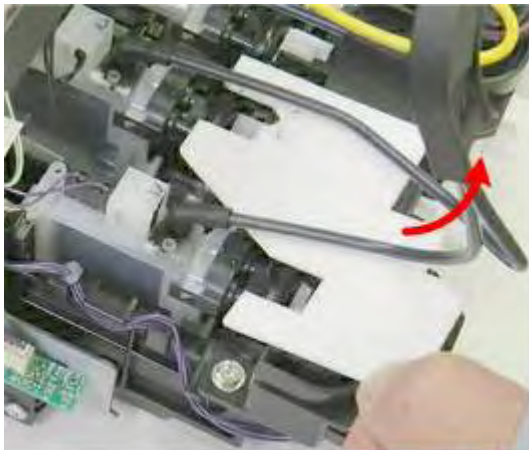

d124r755

7. Remove the protective sheet and discard it.

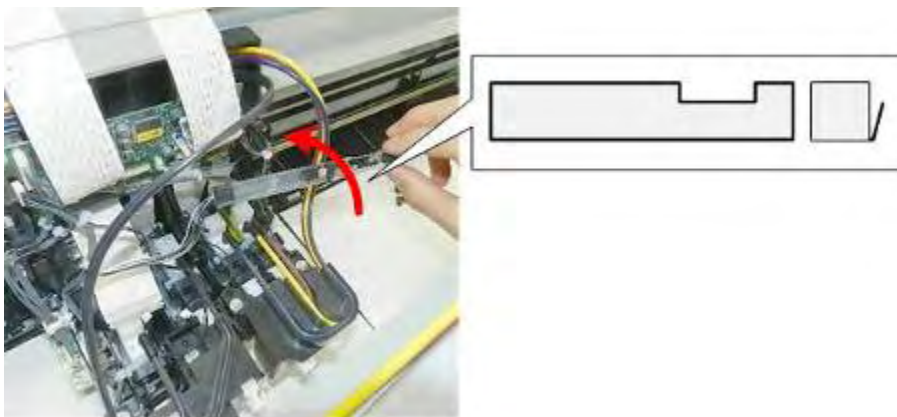

d1241079

8. Hold the new accessory rear cushion with the cut-out on the right (viewed from above) with the mylar leaf flared from the bottom.

Carriage Unit

★ Important

- The rear cushion must be installed below the HRB before the harnesses are re-connected.

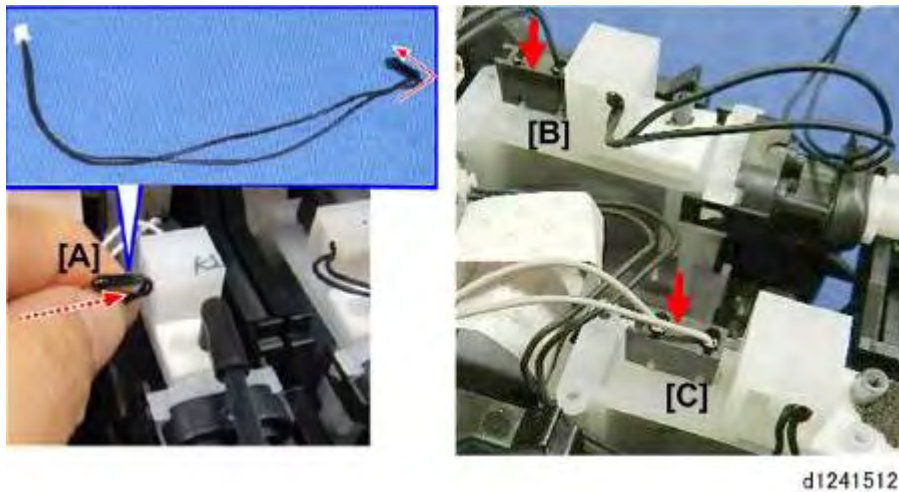

9. Connect the thermistor harness [A] (removed from the old print head unit) to the new print head unit.
10. Connect the two air sensor harnesses [B] and [C] (removed from the old print head unit) to the new print head unit.

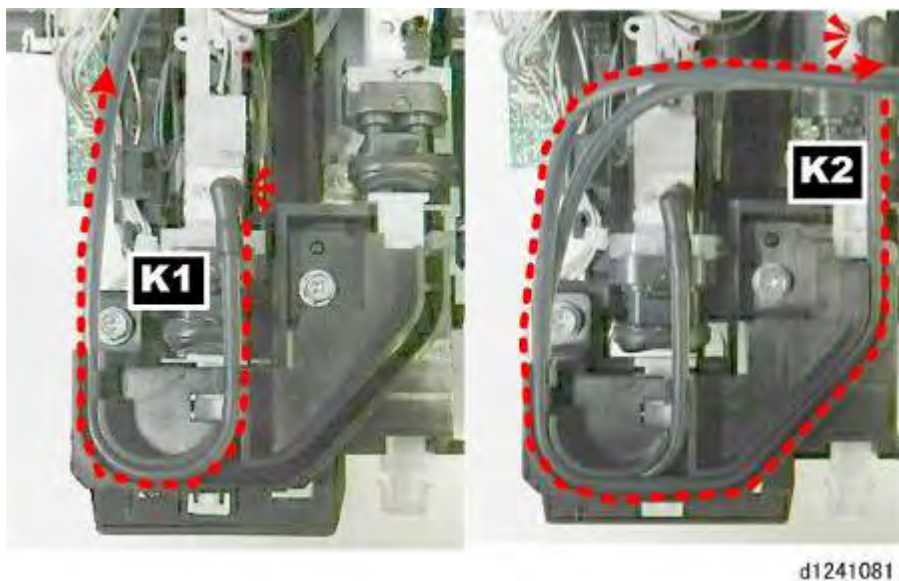

11. Connect the ink supply tubes from left to right in this order: K1 > K2.
 - K1 first
 - K2 over K1 on the left
12. Reconnect the harnesses to the HRB if you are replacing only the black print head unit
-or-
Go on to the next section if you need to replace the color print head unit.

Color Print Head Unit



d124r753

1. Before you start disconnecting harnesses, note the position of thermistor connectors [1] and [2].
 - [1] is the thermistor connector of K2 on the left.
 - [2] is the thermistor connector of C on the right.
 - Make sure that these harnesses are reconnected correctly.

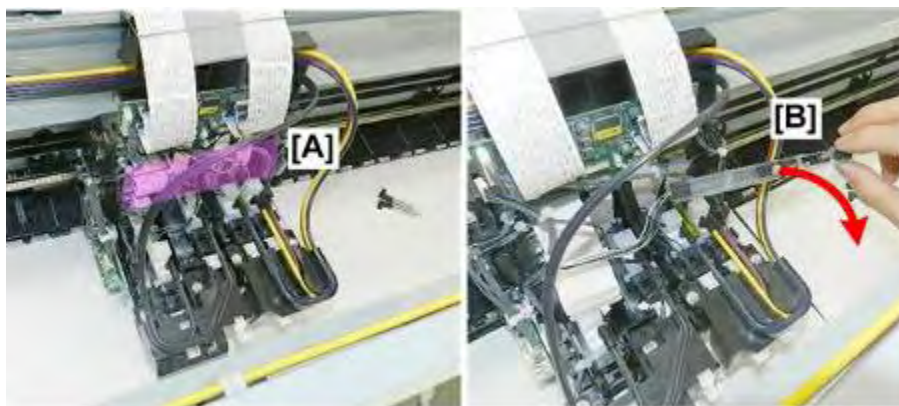

d1241071

2. Disconnect the FFCs and harnesses of **both print head units** [A].
3. Remove the rear cushion [B].

★ Important

- The OCFS sensor harnesses can be discarded. However, you must keep the air sensor harness and the thermistor harness in order to connect the new unit.



d1241066

4. Press in the left and then the right plunger to purge air from the Y and CM sub ink tanks.

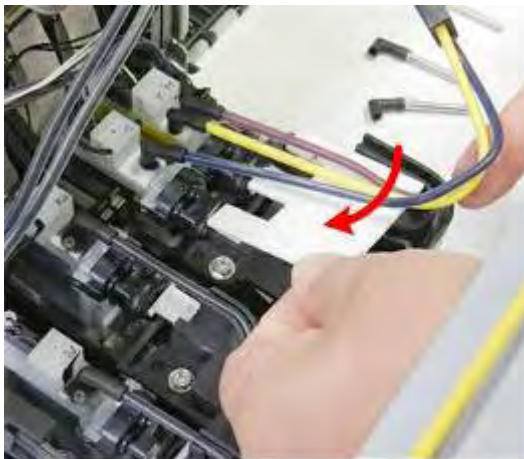

d124r778

5. Slide the accessory protective sheet under the tubes. This prevents spilled ink from falling into the machine.



d1241158

6. Get the uncapped accessory plugs.

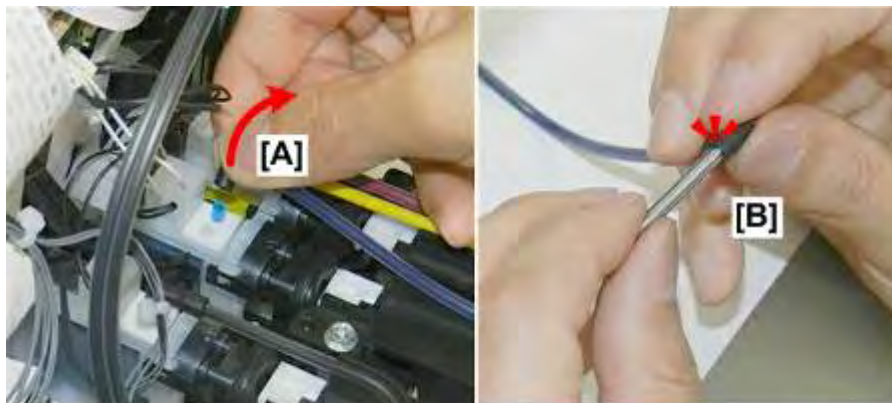

d1241055

7. Disconnect the Cyan ink tube [A], and then plug the open end [B].
8. Disconnect and plug the Yellow and Magenta ink tubes, and then plug them.



d124r779

9. Get the three capped accessory plugs.

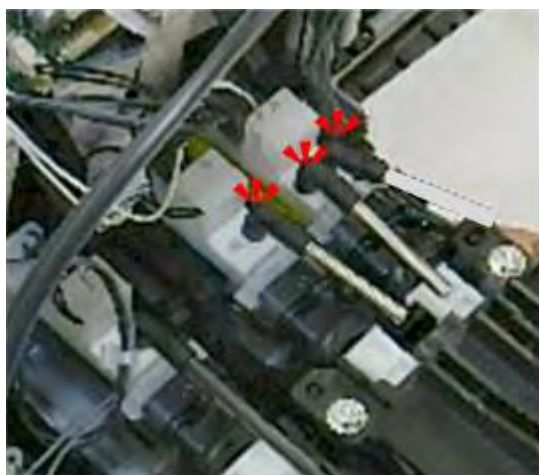

d124r713

10. Attach the plugs to the open ports on top of the tanks.

★ Important

- **These plugs prevent ink from leaking from the top of the print head sub tanks.**

11. Confirm that the ports on top of the three ink supply tanks (C, Y, M) and the ends of both black ink supply tubes are plugged.

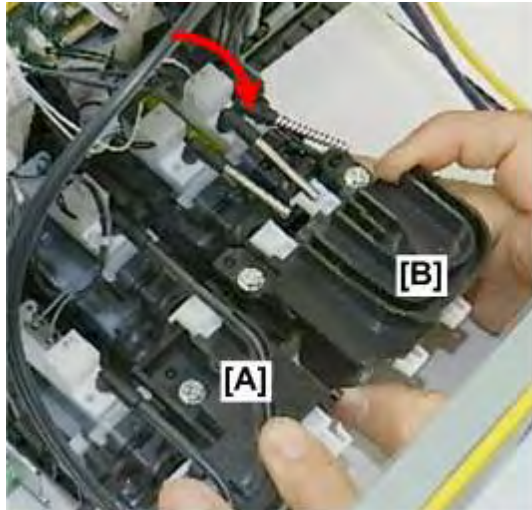

d1241060

12. While holding the left print head unit [A] steady, raise the right print head unit [B], and then rock it forward slightly to remove it from the support rod at the rear..
13. Set the old print head unit down on a piece of paper.



d1241506

14. Disconnect the thermistor harness [A] from the old unit (removed from the machine) for re-connection to the new unit.
15. Disconnect the three air sensor harnesses [B], [C] and [D] from the old print head unit (removed from the machine) for re-connection to the new unit.

★ Important

- When you discard the old unit, always obey local laws and regulations regarding the disposal of such items.

16. Check the paper under the carriage unit. If it is stained with ink remove it, and then replace it with a fresh sheet of paper.

New Color Print Head Unit Installation

Follow the removal procedure in reverse to install the new black print head unit, but please pay attention to these important points during the installation procedure.



d124r712

1. Remove the tape and protective metal cap from the new unit.

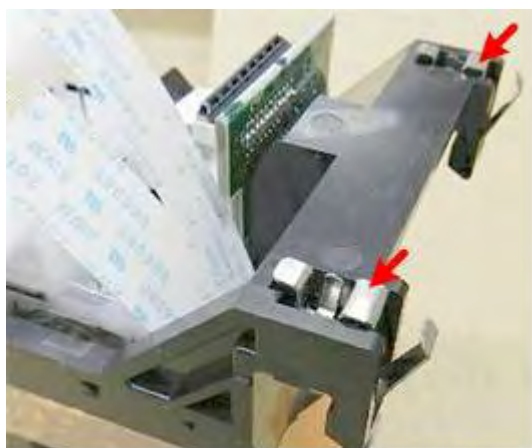

d1241156

2. Set the brackets into the holes on the back of the new unit.

Carriage Unit

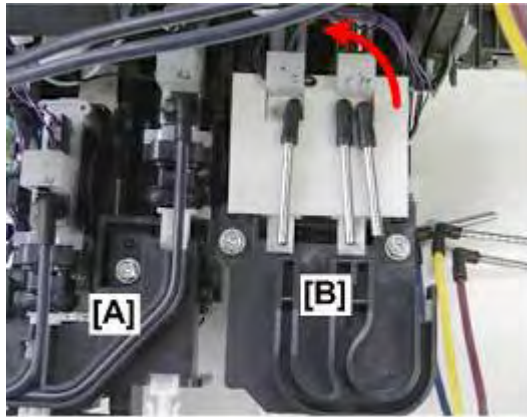

d124r757

3. Steady the left print head unit [A] as you hook the back of the right print head unit [B] over the guide rod at the rear.

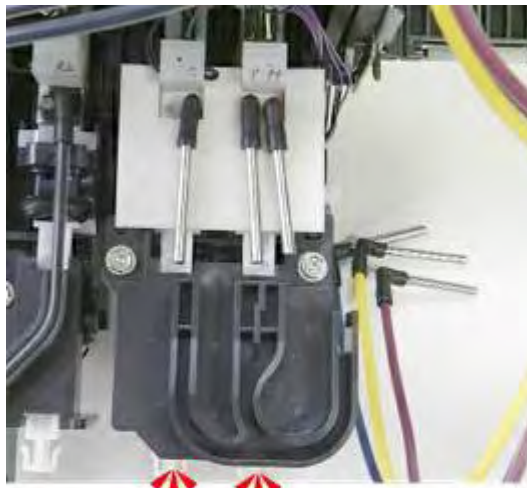

d124r780

4. Before you remove the plugs, press both plungers to expel any air that has accumulated during storing and shipping.

★ Important

- Expelling the air will reduce pressure inside the ink sub tanks and prevent ink leakage after the plugs are removed.

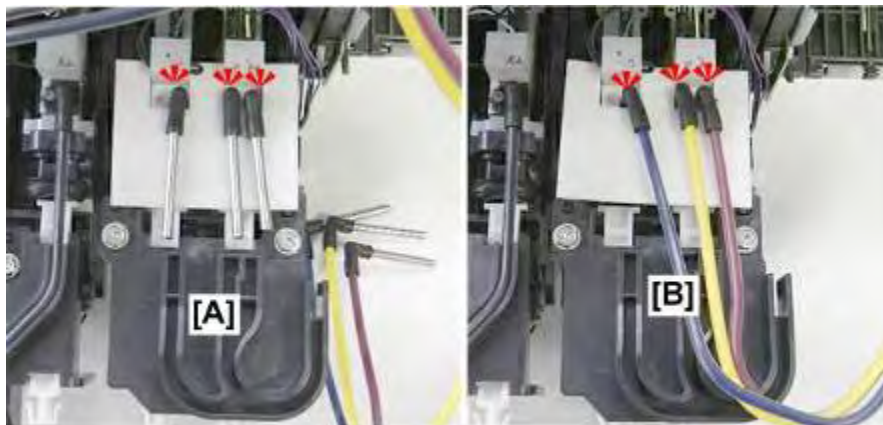

d124r758

5. Remove the capped plugs [A].
6. Unplug the ink tubes and reconnect them [B].

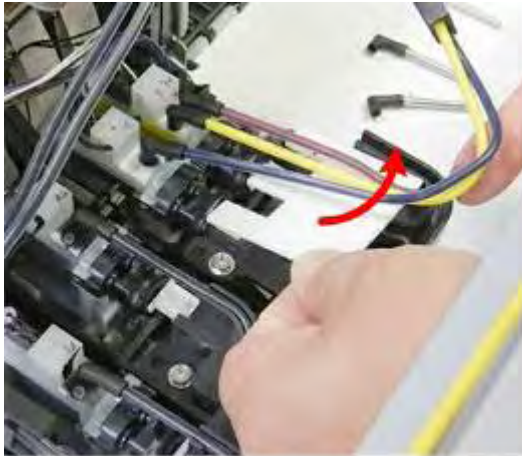

d124r759

7. Remove the protective sheet and discard it.



d1241064

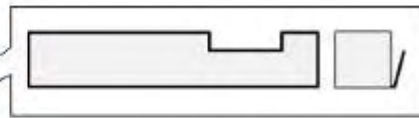

8. Hold the new accessory rear cushion with the cut-out on the right (viewed from above) with the mylar leaf flared from the bottom.

★ Important

- The rear cushion must be installed below the HRB before the harnesses are re-connected.

Carriage Unit

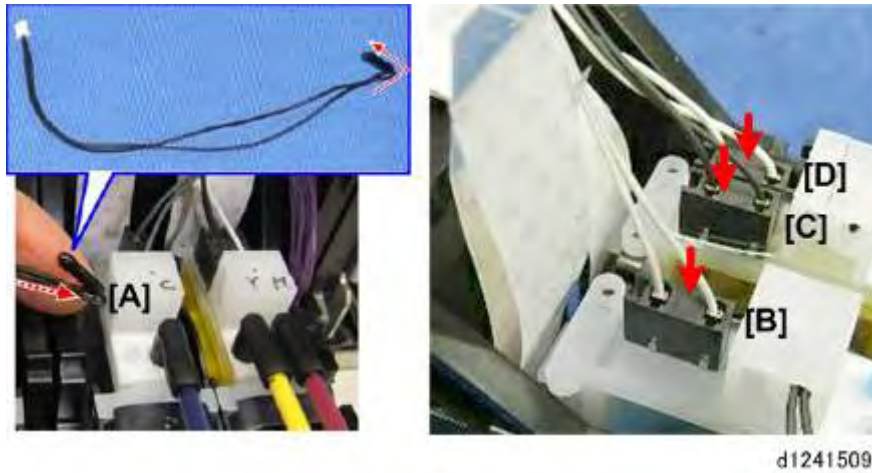

9. Connect the thermistor harness [A] (removed from the old print head unit) to the new print head unit.
10. Connect the three air sensor harnesses [B], [C] and [D] (removed from the old print head unit) to the new print head unit.

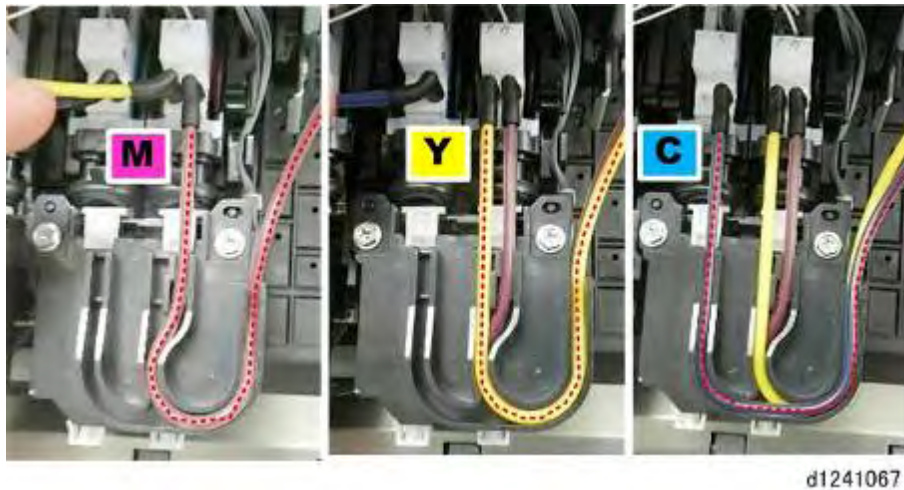

11. Connect the ink supply tubes from right to left in this order: M > Y > C.
 - M first
 - Y over M on the right
 - C over Y, M on the right

Finishing the Installation

After Replacement of the Black, Color Print Head Unit or Both

1. Make sure that the accessory ink cartridges and the accessory ink collector tank are installed.
2. Make sure that the ink cartridge cover is open.
3. Turn the machine on.
4. Ignore the error on the operation panel.
5. Open **SP2400-001**. Enter the correct number (see below), press [#], and then touch [EXECUTE]. This SP code resets the counter for the carriage print heads. Choose the correct setting for the replacement.

For	Enter
Black and color print heads	0
Black print heads only	1
Color print heads only	2

- Enter "0" if you replaced both black and color print heads.
 - Enter "1" if you replaced the black print heads only.
 - Enter "2" if you replaced the color print heads only.
6. Turn the machine off.
 7. Close the cartridge cover.
 8. Turn the machine on. The initial fill sequence will begin. The filling sequence requires about 15 minutes to complete.
 9. Wait for the machine to beep twice. This signals the end of the ink filling sequence.
 10. Print the Nozzle Check Pattern, and then check the results: [User Tools] > Maintenance > Print Nozzle Check Pattern.
 11. Clean the print heads if necessary.  page 5-314
 12. Touch [Exit] after you are finished, and then do the four adjustments described below.

Important

- The following four adjustments must be done in the order described below.
- Before you do these four adjustments, make sure that Normal (Plain) roll paper is loaded in the machine. The adjustment for coated paper (or other types of paper) can be done successfully with plain paper.

Adjustment 1

1. Touch > "System Settings" > "Input Paper Settings" tab > [Next] > "Paper Type: Paper Input 1".

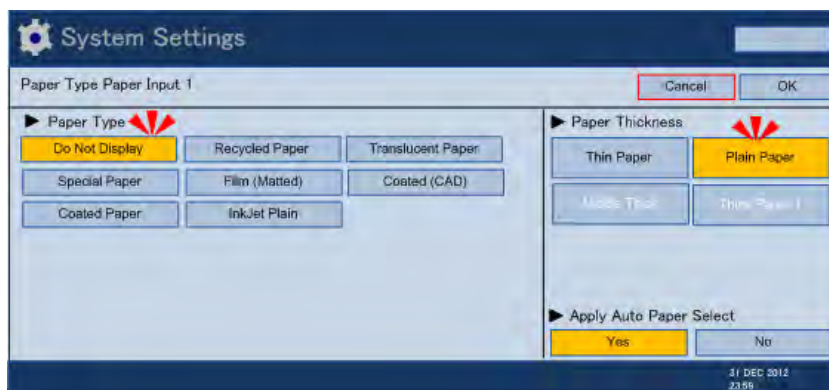

d1249921

2. Touch **"Plain Paper"** and **"Do Not Display"** and then touch [OK].
3. Touch [Previous].

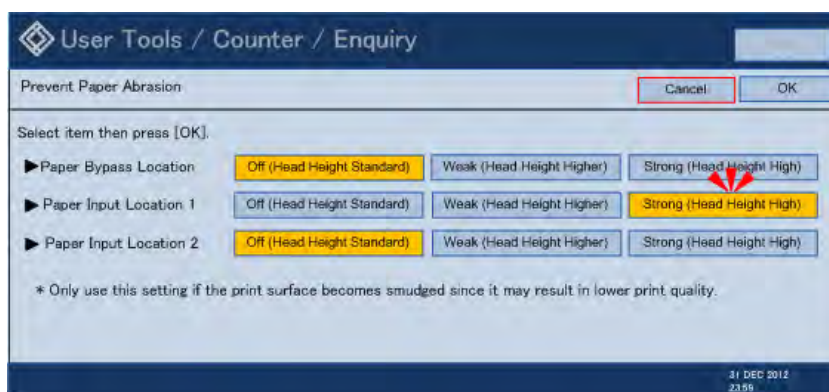

d1249922

4. Touch "General Features" tab > [Next] > "Prevent Paper Abrasion" > **"Paper Input Location 1: Strong (Head Height High)"** > [OK] > [Exit].

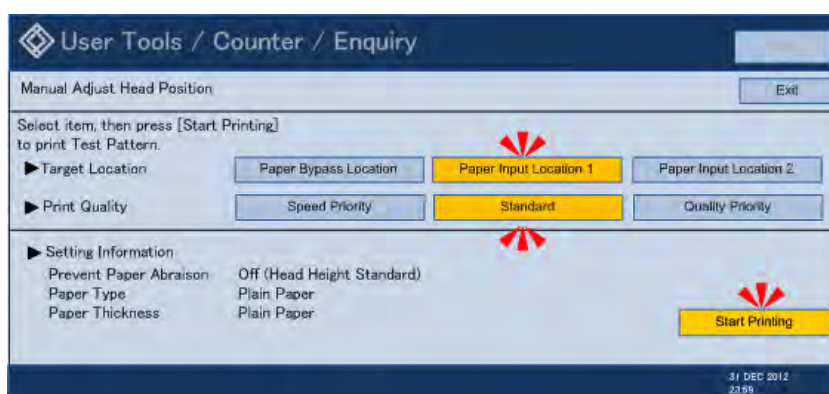

d1249923

5. Touch "Maintenance" > "Manual Adjust Print Head Position" > **"Target Location: Paper Input Location 1"** > **Print Quality: Standard** > Start Printing. The message asks you to wait while the pattern is printing.

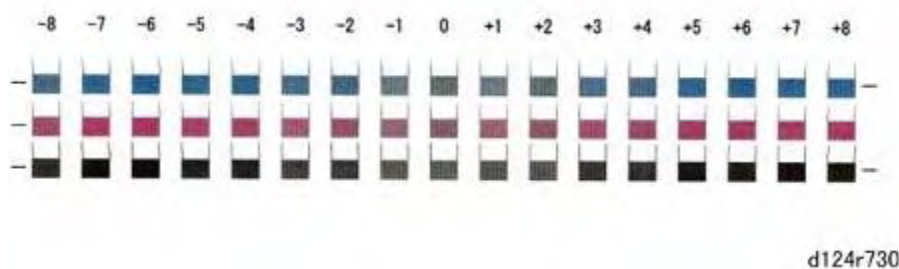

Note

- Only the first three rows of the pattern will print because the print heads are at maximum height.
6. A message prompts you to cancel or do any adjustment. Check the test pattern.
 - If the pattern is acceptable, touch [Cancel].
 - If adjustment is required touch [Adjustment] page 5-323
 7. Touch [Exit] twice and do the next adjustment.

Adjustment 2

1. Touch > "System Settings" > "Input Paper Settings" tab > [Next] > "Paper Type Paper Input 1".

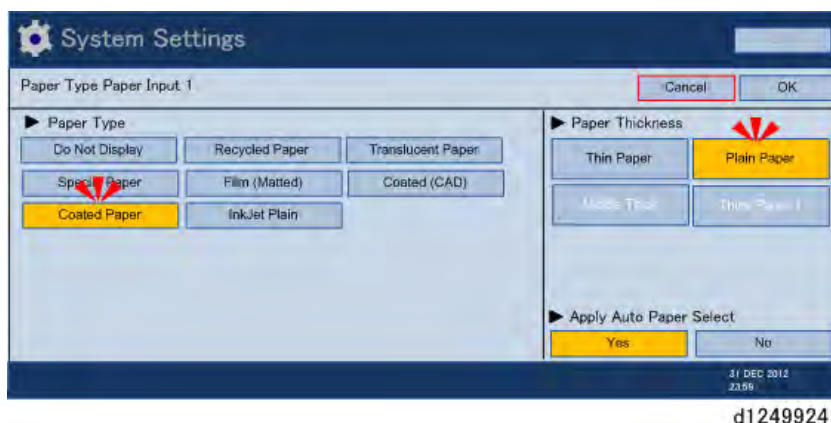

Replacement and Adjustment

2. Touch "**Coated Paper**" and "**Plain Paper**" and then touch [OK].
3. Touch [Previous].

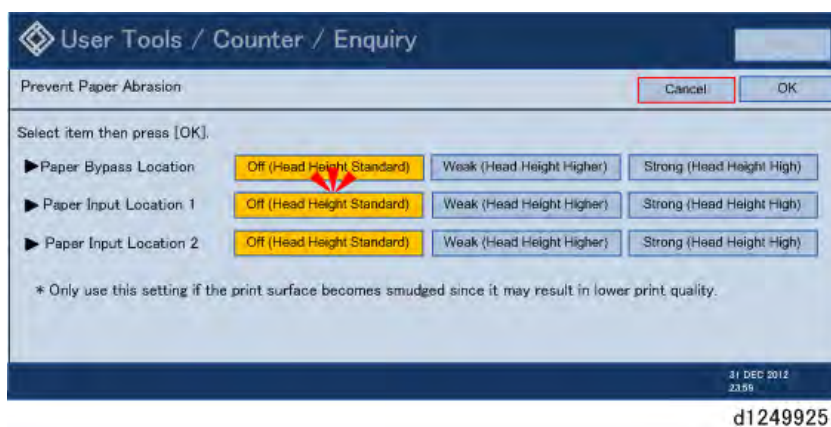

4. Touch "General Features" tab > [Next] > "Prevent Paper Abrasion" > "**Paper Input Location 1: Off (Head Height Standard)**" > [OK] > [Exit].

Carriage Unit

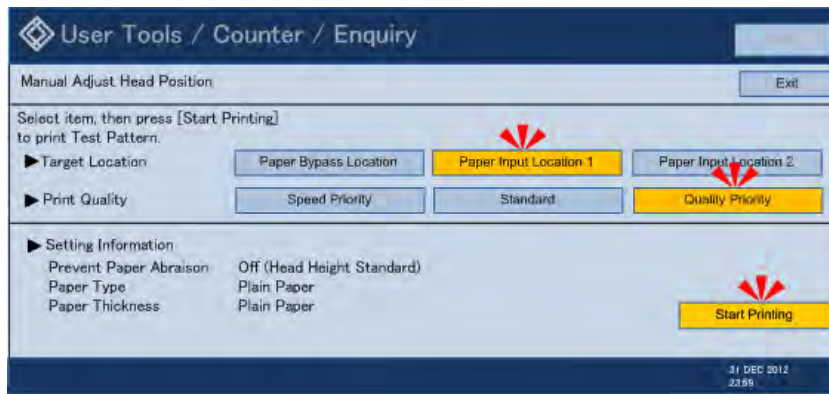

d1249926

5. Touch "Maintenance" > "Manual Adjust Print Head Position" > "**Target Location: Paper Input Location 1**" > "**Print Quality: Quality Priority**" > Start Printing. The message asks you to wait while the pattern is printing.

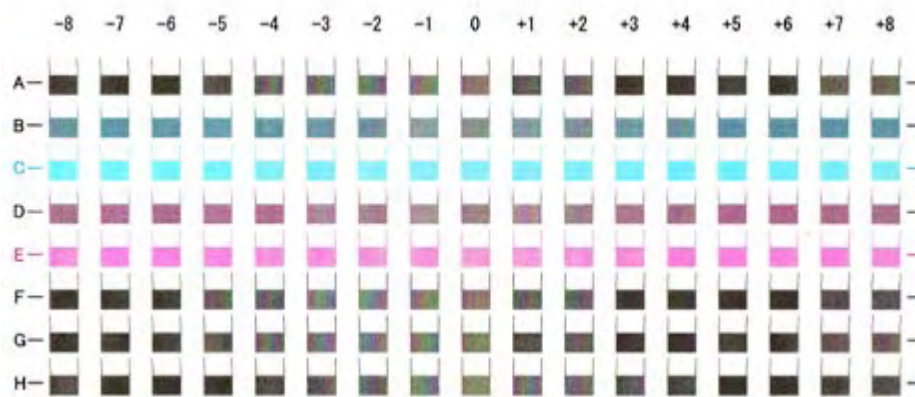

d124r678

6. A message prompts you to cancel or do any adjustment. Check the test pattern.
 - If the pattern is acceptable, touch [Cancel].
 - If adjustment is required touch [Adjustment]  page 5-323
7. Touch [Exit] twice and do the next adjustment.

Adjustment 3

1. Touch > "System Settings" > "Input Paper Settings" tab > [Next] > "Paper Type Paper Input 1".

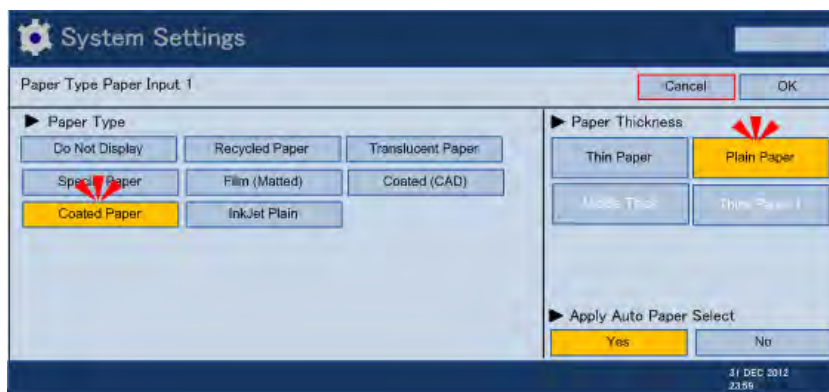

d1249924

2. Touch "Coated Paper" and "Plain Paper" and then touch [OK].
3. Touch [Previous].

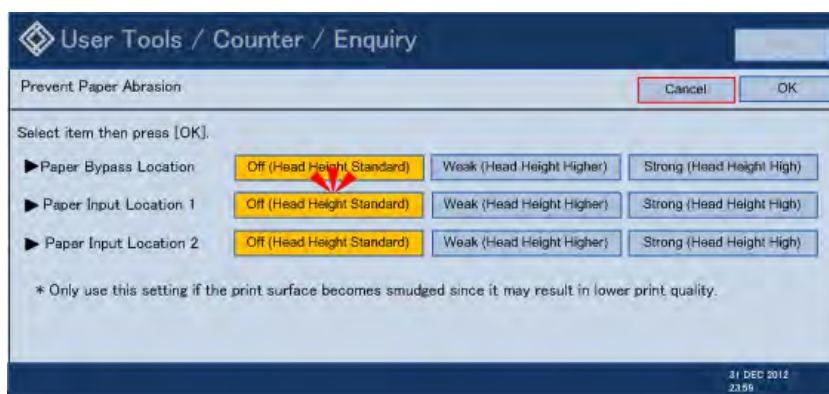

d1249925

4. Touch "General Features" tab > [Next] > "Prevent Paper Abrasion" > "Paper Input Location 1: Off (Head Height Standard)" > [OK] > [Exit].

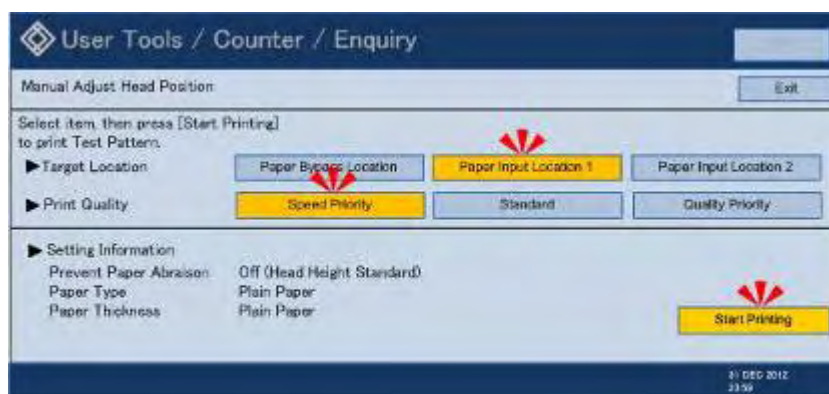

d1249927

5. Touch "Maintenance" > "Manual Adjust Print Head Position" > "Target Location: Paper Input Location 1" > "Print Quality: Speed Priority" > Start Printing. The message asks you to wait while the pattern is printing.

Carriage Unit

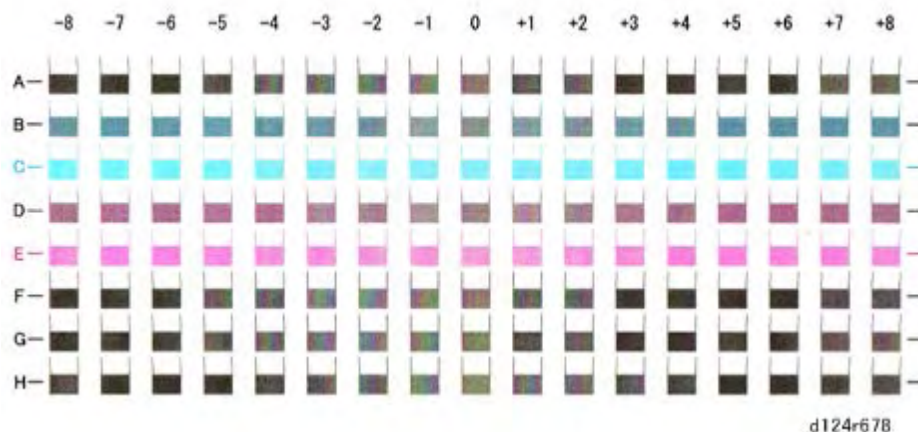

6. A message prompts you to cancel or do any adjustment. Check the test pattern.
 - If the pattern is acceptable, touch [Cancel].
 - If adjustment is required touch [Adjustment] [page 5-323](#)

Adjustment 4

1. Touch > "System Settings" > "Input Paper Settings" tab > [Next] > "Paper Type Paper Input 1".

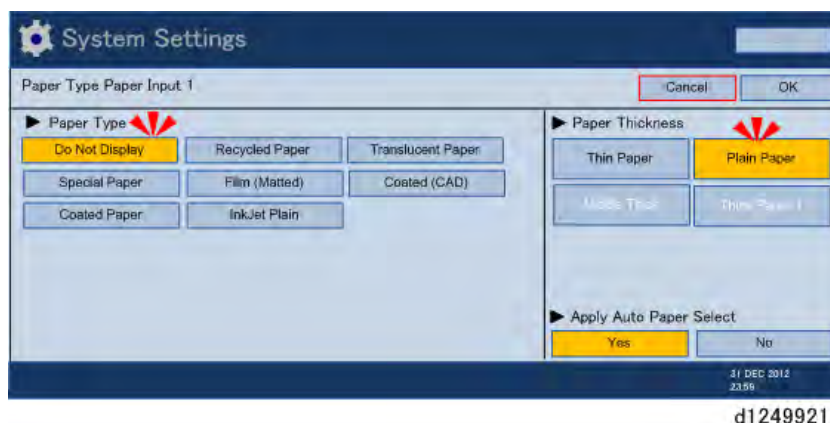

2. Touch **"Plain Paper"** and **"Do Not Display"** and then touch [OK].
3. Touch [Previous].

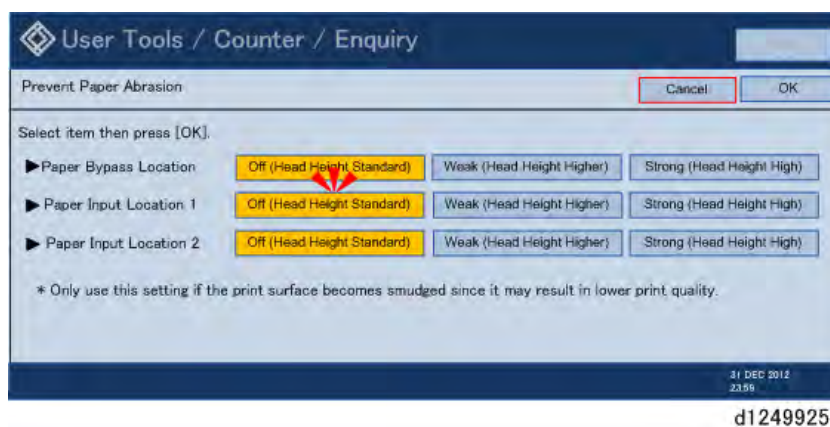

4. Touch "General Features" tab > [Next] > "Prevent Paper Abrasion" > **"Paper Input Location 1: Off (Head Height Standard)"** > [OK] > [Exit].

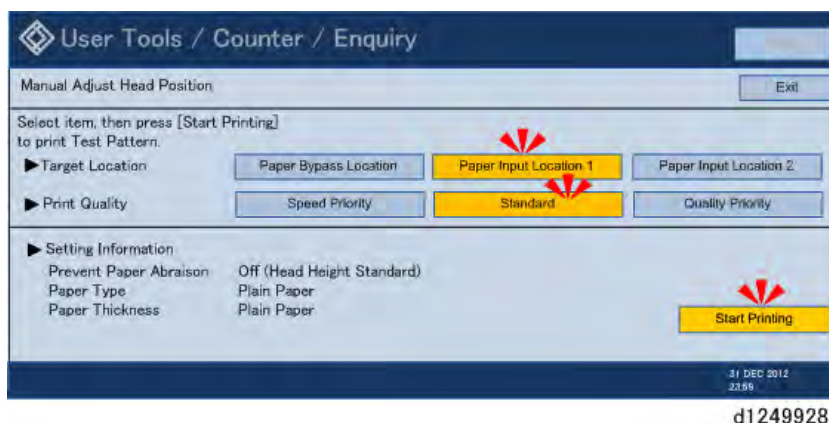

5. Touch "Maintenance" > "Manual Adjust Print Head Position" > "**Target Location: Paper Input Location 1**" > "**Print Quality: Standard**" > Start Printing. The message asks you to wait while the pattern is printing.

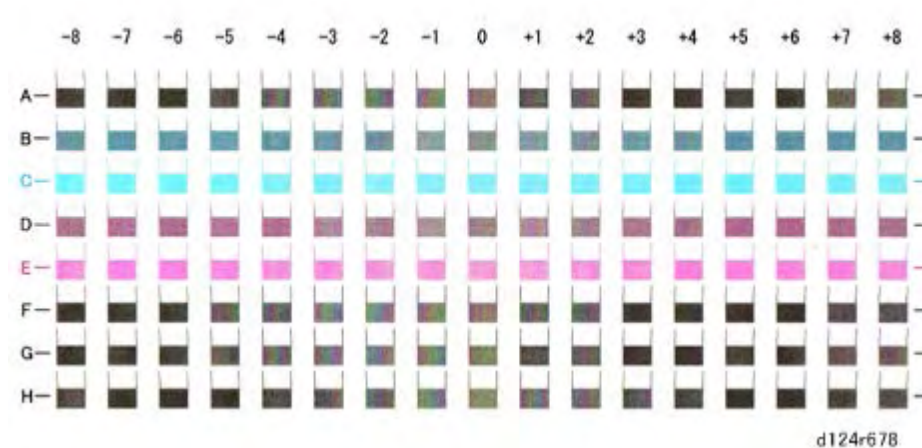

6. A message prompts you to cancel or do any adjustment. Check the test pattern.
 - If the pattern is acceptable, touch [Cancel].
 - If adjustment is required touch [Adjustment]  page 5-323
7. Exit the User Tools and execute **SP5884-003** (Factory Setting – Head Gap Backup) to save the adjusted settings.
8. Exit the SP mode.
9. Remove the accessory ink cartridges and replace them with the customer's ink cartridges.
10. Remove the accessory ink collector tank and replace it with the customer's ink collector tank.

After Replacement of the Black Print Head Unit

This procedure is done only after replacement of the black print.

1. Go into the SP mode and open **SP2902**.
2. Select Pattern **11 Density Pattern 2**, and then touch [OK].
3. At the top of the screen, touch [COPY Window].
4. On the Copy Window screen, select [High Speed Copy].
5. Touch the icon for Paper Input 1 (Roll 1).
6. Feed one sheet of A4 SEF paper into the scanner unit, and then press [Start] to print the

Carriage Unit

pattern.



7. Mark the leading edge of the pattern with a black arrow.
8. Use a ruler to mark the left edge at 65 mm, 97 mm, and 129 mm.
 - The band between 65 and 97 mm is the coverage area for H1 (the K1 print head).
 - The band between 97 mm and 129 mm is the coverage area for H2 (the K2 print head).
9. If the H1 and H2 bands are of equal density, no adjustment is necessary.
-or-
If the densities of the H1 and H2 bands are different, adjustment is required. Go to the next step.
10. At the top of the screen touch [SP Mode].
11. Open **SP3132** (ECB Correction Value), and then adjust the density of the light band to the density of the dark band.

★ Important

- The density of the lighter band is always adjusted to match the density of the darker band.

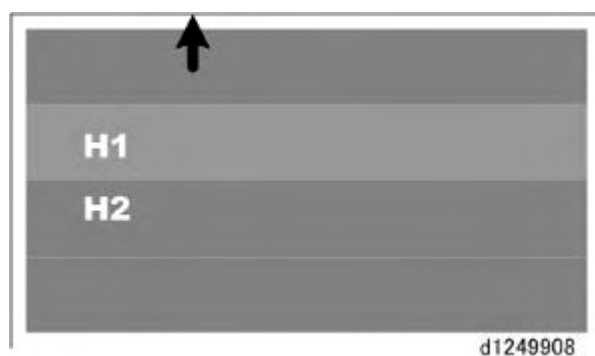

12. If the H1 band is lighter than the H2 band as shown above:
 - At **SP3132-001** touch [H1].

★ Important

- The 94% value displayed can be adjusted only in the range 94 to 97%.
- Enter a higher setting, and then touch [#].
- Repeat Steps 3 to 7 to print another pattern and check the results.

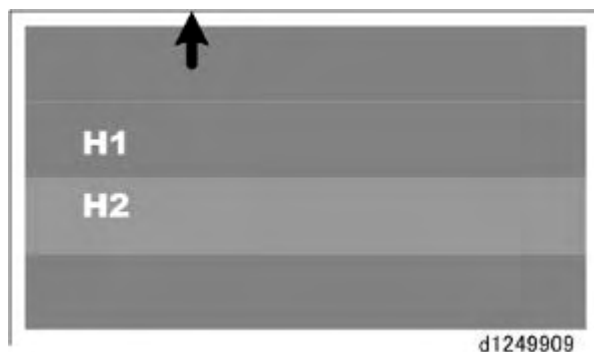

13. If the H2band is lighter than the H1band as shown above:

- At **SP3132-002** touch [H2].

★ Important

- The 94% value displayed can be adjusted only in the range 94 to 97%.
- Enter a higher setting, and then touch [#].
- Repeat Steps 3 to 7 to print another pattern and check the results.

14. Repeat the adjustment of either H1 or H2 until the bands are of equal density.

5.9.3 DRESS SENSOR

Preparation

- Move the Carriage Unit with SP2102-4 page 5-37
- Separate the Main Unit from the Scanner Unit page 5-16

Remove:

- Top cover page 5-29



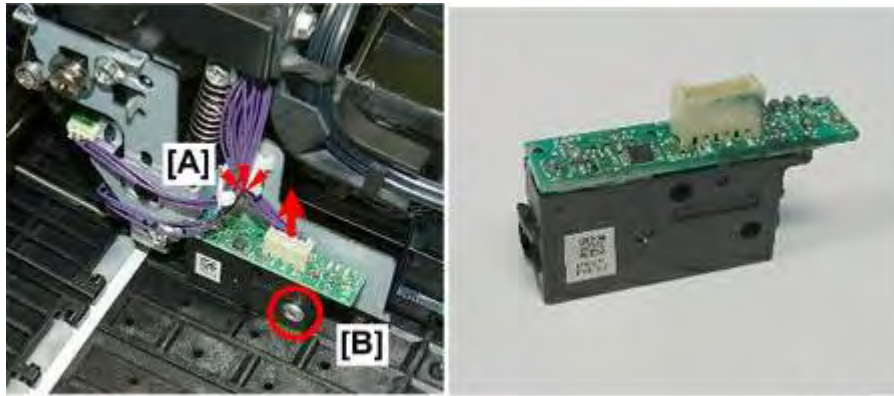

1. Remove the left cover of the carriage unit (x1).

Carriage Unit



d124r538

2. Disconnect the sensor [A] ( x1,  x1).
3. Remove the sensor [B] ( x1).
4. Set the sensor on a flat clean surface..



d124r539

5. Clean the DRESS sensor with an accessory cleaning cloth or a piece of lens paper.

★ Important

- The recommended cleaning interval is every 10Km. However, if the operator is frequently printing with tracing paper, cleaning every 5Km is recommended.

Reinstallation

Do this adjustment only if the DRESS sensor has been replaced with a new one.

★ Important

- Before you do this procedure, make sure that the width of the roll paper is in the range 594 to 841 mm (24 to 34 in.).
 - You will also need a blank sheet of paper for the original that is 594 mm (24 in.) wide and 210 mm (8.5 in.) long.
1. Touch [User Tools] on the operation panel.
 2. Touch [System Settings] > [Input Paper Settings] > [Paper Input Size 1] > [Down Arrow].
 3. Select [Architecture 36 inch/914 mm] and then touch [OK].
 4. Touch [Paper Type: Paper Input 1] > [Do Not Display] > [OK].
 5. Touch [Exit] twice to close the User Tools menu.

6. Enter the SP mode.
7. Open **SP4417**, select Pattern **8 Grid Pattern B**, and then touch [OK].
8. Open **SP4012**.
 - Touch **SP4012-007**. Note the current setting, and then set this SP to "0.0".
 - Touch **SP4012-008**. Note the current setting, and then set this SP to "0.0".

★ Important

- Both of these settings must be restored the original settings upon completion of this procedure.

9. Open **SP2103**.
 - Touch **SP2103-003** (Left Edge): Note the setting: 3.0 mm
 - Touch **SP2103-004** (Right Edge): Note the setting: 3.0 mm
10. At the top of the screen touch [COPY Window].
11. Touch the icon for Paper Input Location 1.

★ Important

- The width of the paper must be in the range 594 to 841 mm (24 to 34 in.)

12. On the Copy Window touch [Synchro Cut] > [Black & White] > [High Speed Copy].



d1249911

13. Slide the original guide all the way to the right to the 914 mm or 36 inch mark.
14. Align the right edge of a blank original with the original guide and feed it into the scanner unit.

★ Important

- The original must be at least 594 mm (24 in.) wide and 210 mm (8.5 in.) long.

15. Touch the [Start] button. The pattern prints.

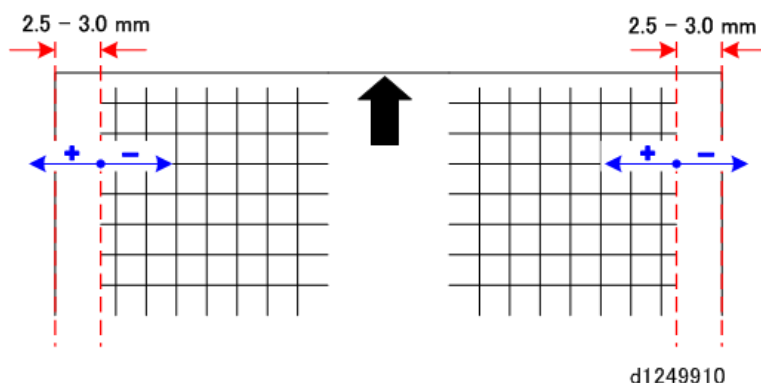

16. Mark the original with an arrow.
17. Use a scale to measure the distance from the edge of the paper to the tip of a horizontal line on both the left and right margins.
- The width of the left and right margins must be the same.
 - The width of the left and right margins must be in the range: 2.5 to 3.0 mm.
18. If the left and right margins are the same size and within the range 2.5 to 3.0 mm, no adjustment is necessary.
- or-
- If the margins need adjustment, do the following steps.
19. Use **SP2104-001** and **SP2104-002** to adjust the left and right margins. Here are some sample measurements and correction entries.

Margin	Measured (mm)	SP	Enter +/-	Target
Right	1	2104-001	+2	3
Right	4.5	2104-001	-1.5	3
Left	1.0	2104-002	-2.0	3
Left	4.5	2104-002	+1.5	3

20. Print another test pattern with **SP4417** Pattern 8 Grid Pattern B and check the results.
21. Repeat the adjustment procedure until both measurements are equal and within range.
22. After completing the adjustment, open **SP2104-031** (Automatic Conversion) and touch [EXECUTE].
- This saves the adjusted settings.
 - These adjusted settings are applied not only to Normal Paper but all other types of paper

included under this SP code.

23. Open **SP4012**.

- Touch **SP4012-007**, and then restore the original setting noted in Step 8.
- Touch **SP4012-008**, and then restore the original setting noted in Step 8.

5.9.4 MAIN INK LEVEL SENSORS

Preparation

- Move the Carriage Unit with SP2102-4 ➤ page 5-37
- Separate the Main Unit from the Scanner Unit ➤ page 5-16

Remove:

- Right cover ➤ page 5-19
- Right upper cover ➤ page 5-21
- Ink cartridge cover ➤ page 5-23

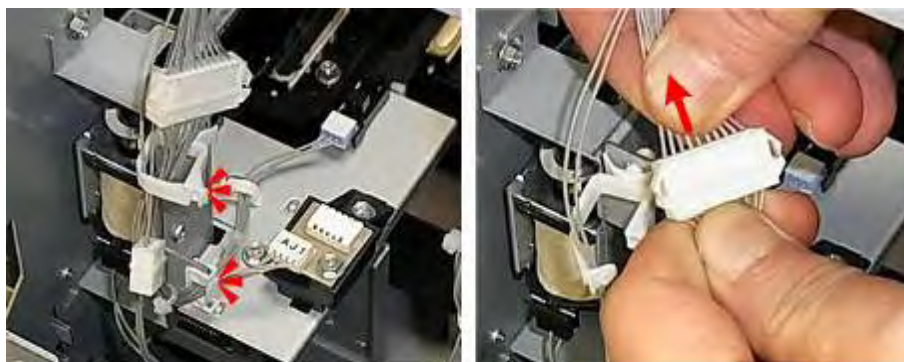

d1241102

1. Disconnect the sensor harnesses (🔌x2, 🔑x1)

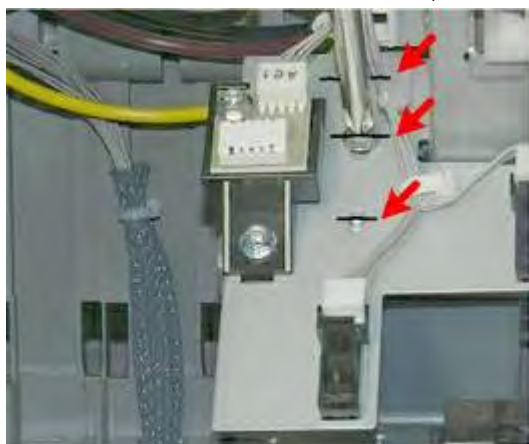

d124r773

2. Use a pencil or marker to mark the positions of the bosses and screw of the plate.

★ Important

- This plate slides forward and back. It must be aligned precisely when it is reinstalled.

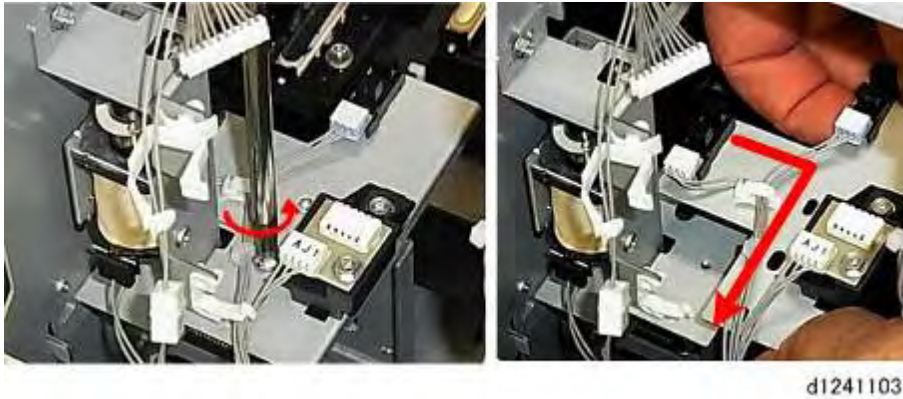

3. Disconnect and remove the sensor bracket (🔧 x1).

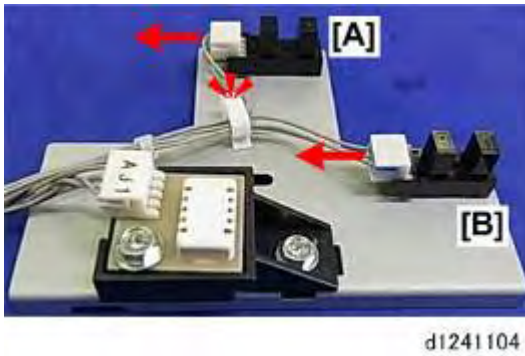

4. Disconnect main ink level sensor 1 (FS1) [A] and main ink level sensor 2 (FS2) [B] (🔧 x1, 📧 x2).

↓ Note

- You may see these sensors labeled on the bracket or the machine as "FS1" and "FS2". "FS" means "feeler sensor".



5. Disconnect the sensors from the bracket (🔧 x3 ea.).

Reinstallation

The position of the ink level sensor bracket requires adjustment.

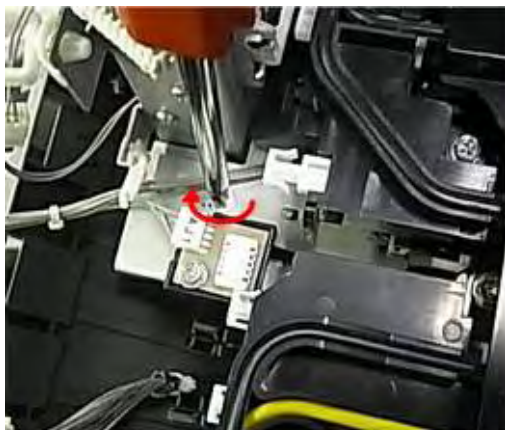

d1241106

1. Attach the sensor bracket and align it with the marks you made on the bracket before removal, but do not tighten the screw. The bracket should be loose so that it can move to the front and back (⚙️ x1).



d1241107

2. Slowly, push the carriage unit [A] to the right until you see the actuator in the gap of the first sensor [B].
3. Make sure that the actuator is centered in the gap.

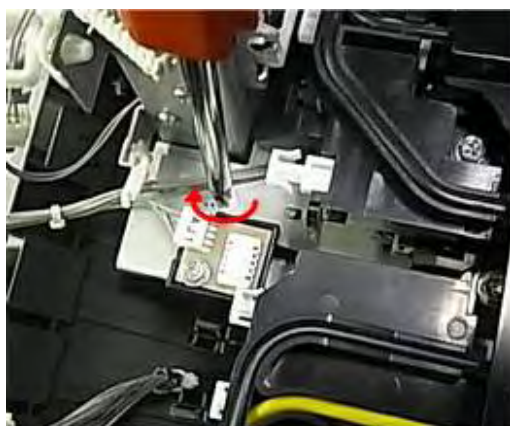



d1241106

4. Tighten the screw.

5.9.5 HORIZONTAL ENCODER SENSOR

Preparation

- Move the Carriage Unit with SP2102-4  page 5-37
- Separate the Main Unit from the Scanner Unit  page 5-16

Remove:

- Top cover  page 5-29



1. On the right and left, **loosen** the screws of the ink supply tube rail ( x2).

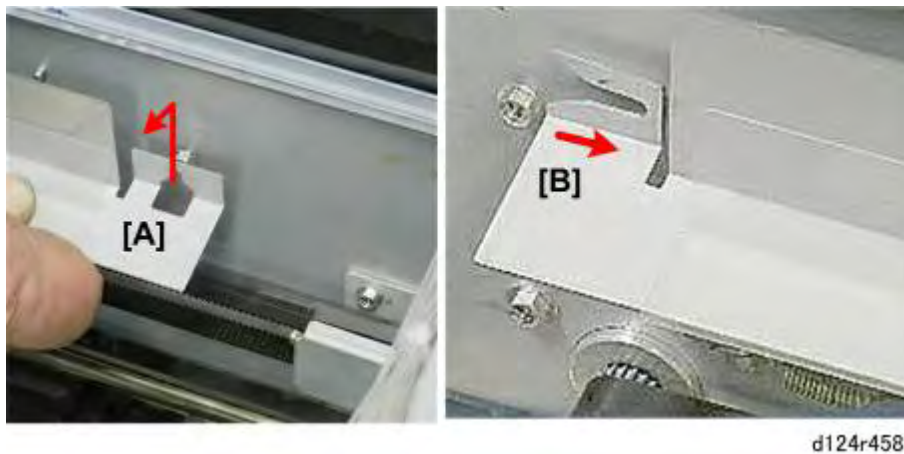

2. Lift the right end [A] of the rail off its screw, and then pull the left [B] away from its screw to disconnect both ends.

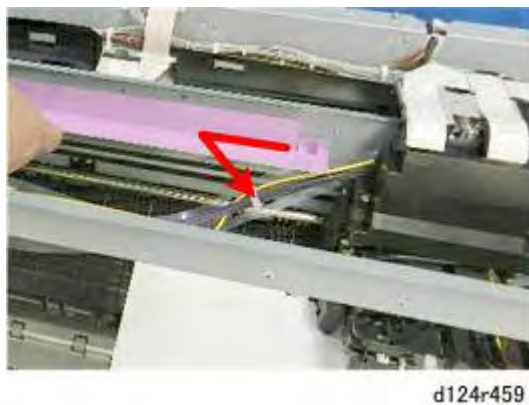

3. Pull the rail to the left, through the back of the carriage unit.



d124r372

4. Pull the rail out of the machine.

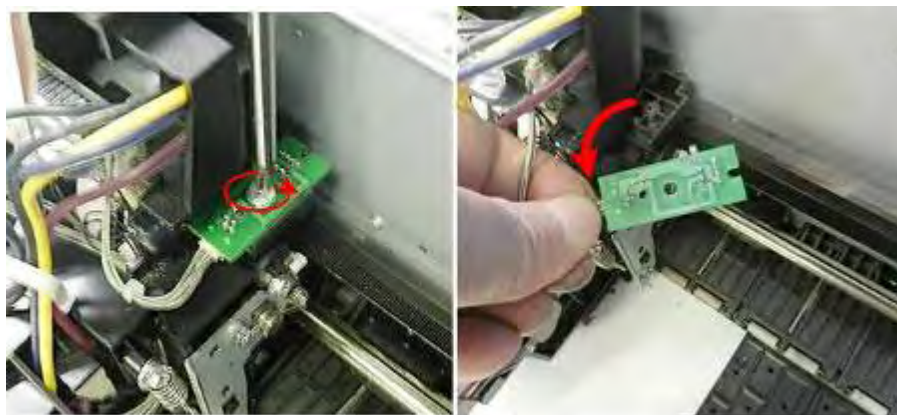

d124r533

5. At the right rear corner of the carriage unit, remove the sensor ( x1).

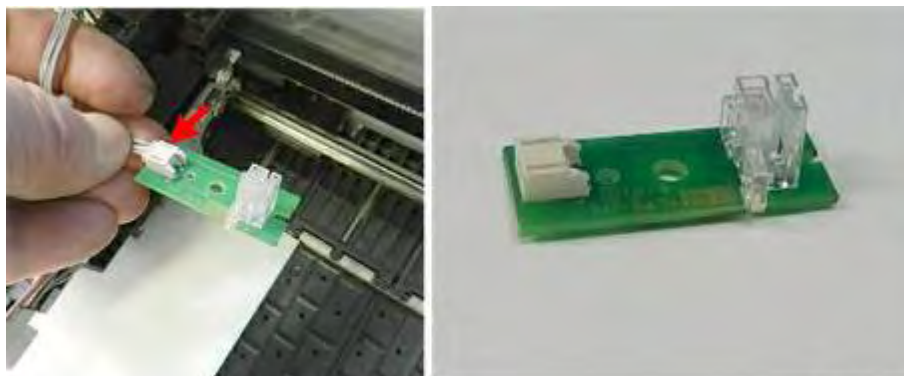

d124r534

6. Disconnect the sensor ( x1).

Replacement
and
Adjustment

Carriage Unit

Reinstallation

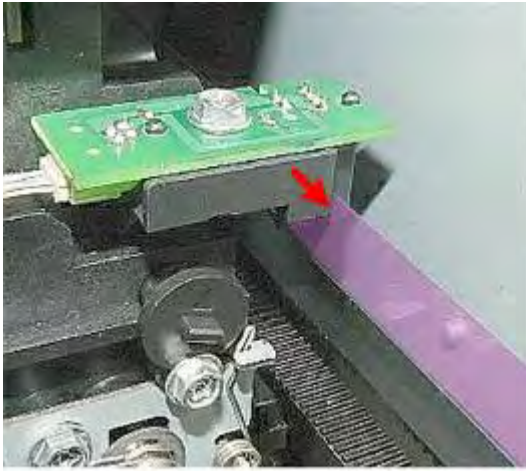



d124r535

1. Make sure the top edge of the horizontal encoder strip is inserted into the slot below the horizontal encoder sensor.

5.9.6 HEAD LIFT MOTOR

Preparation

- Move the Carriage Unit with SP2102-4  page 5-37
- Separate the Main Unit from the Scanner Unit  page 5-16

Remove:

- Top cover  page 5-29

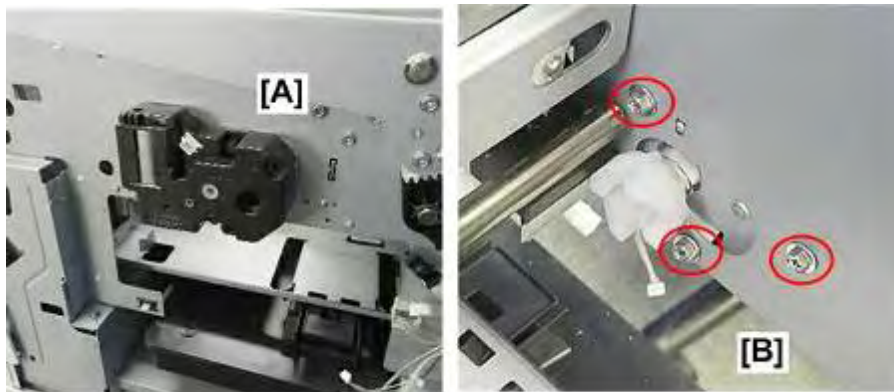

d124r536

1. The head lift motor [A] is mounted on the left side of the right frame.
2. Disconnect the motor bracket [B] ( x3).



d124r537

3. Remove the motor from the right side of the frame.

5.9.7 CARRIAGE UNIT

This section describes removal of the complete carriage unit.

Before You Begin

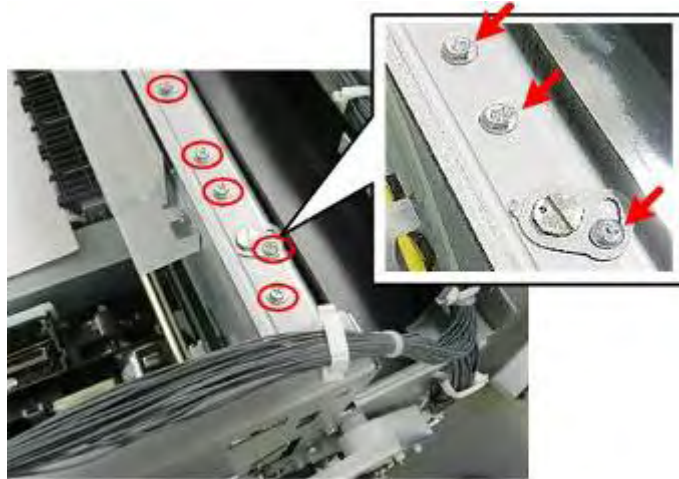

d1241037

There are paint-locked screws across the top of the machine (under the top cover). These screws are positioned and adjusted at the factory. Never loosen or attempt to adjust these screws.

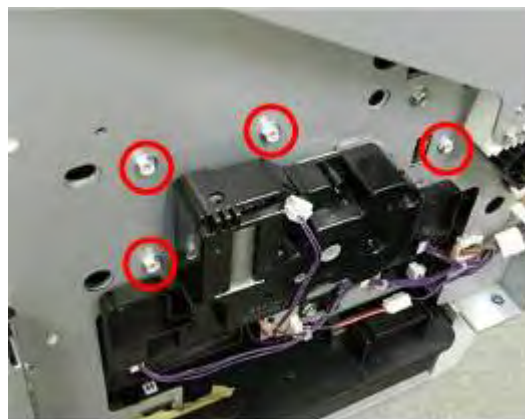



d1241038

You can see the heads of four paint-locked screws around the top of the maintenance unit. These screws hold a re-enforcement plate. Never loosen or remove any of these screws.





Carriage Unit Removal

The carriage unit must be removed to replace the horizontal timing belt.

Preparation

- Move the Carriage Unit with SP2102-4  page 5-37
- Separate the Main Unit from the Scanner Unit  page 5-16

Remove:

- Ink collector tank  page 5-17
- Top cover  page 5-29
- Ink cartridge cover  page 5-23
- Front cover  page 5-31
- Paper exit guide  page 5-32

Ink Supply Unit



d124r440

1. Place a stool or box in front of the machine to support the ink supply unit after it is removed.

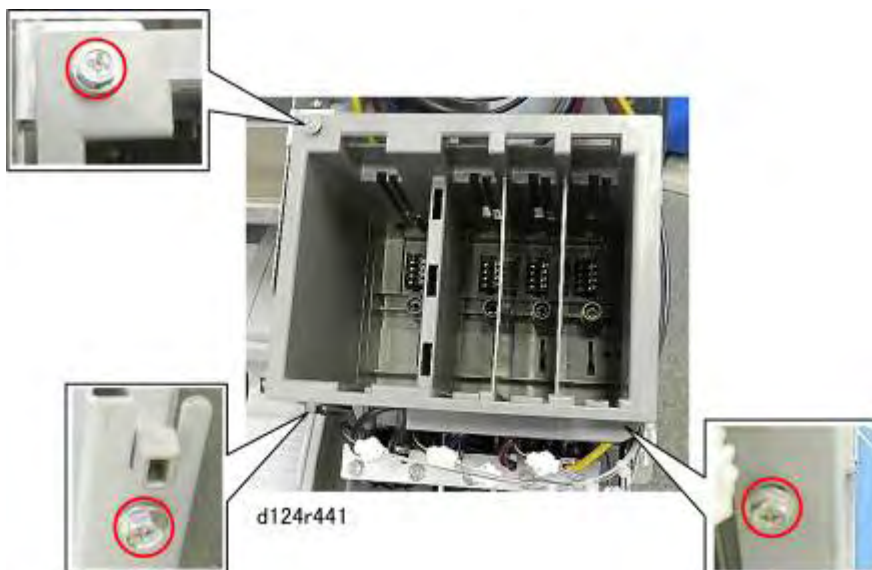

2. Disconnect the frame of the ink supply unit ( x3).

Carriage Unit

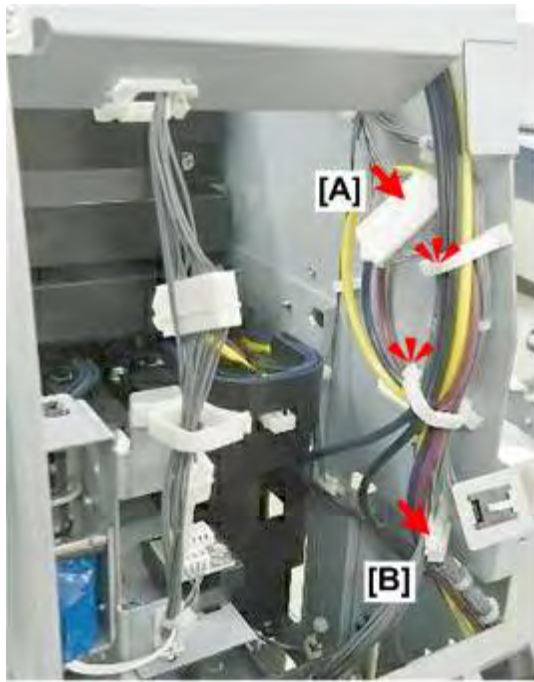

d1241082

3. Free the ink supply tubes and disconnect the ink supply unit at [A] and [B] (🖨️x2, 🖨️x2).



d124r512

4. On the right side of the back of the front support of the machine, free the ink supply tubes (🖨️x3).

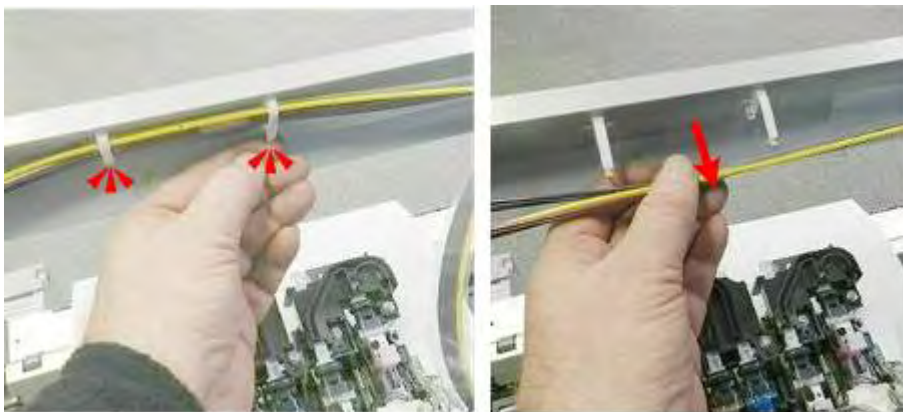

d124r513

5. Near the center of the front support, free the ink supply tubes (🖨️x2).



d124r444

6. Remove the ink supply unit and set it on the box or stool in front of the machine.

Harnesses: Right Side



d124r445

1. Free the harnesses on the top edge of the right frame (🔧x3).

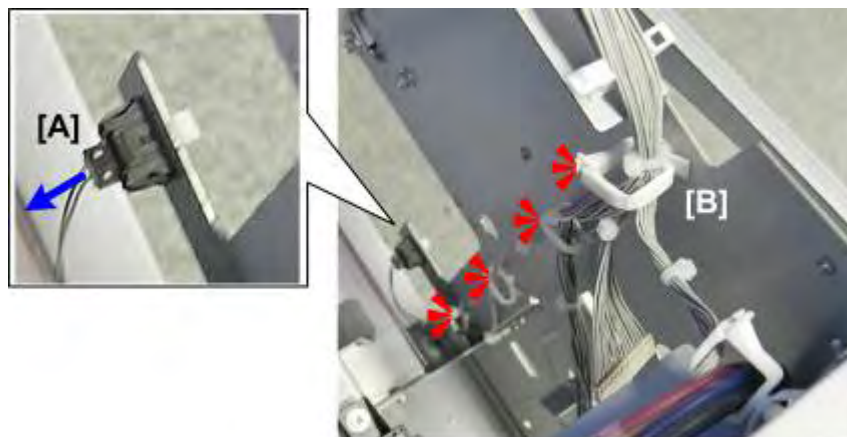

d124r446

2. On the left side of the right frame, disconnect the ink collector cover sensor [A] and free the harnesses [B] (🔧x1, 🗑️x4).

Replacement and Adjustment

Carriage Unit

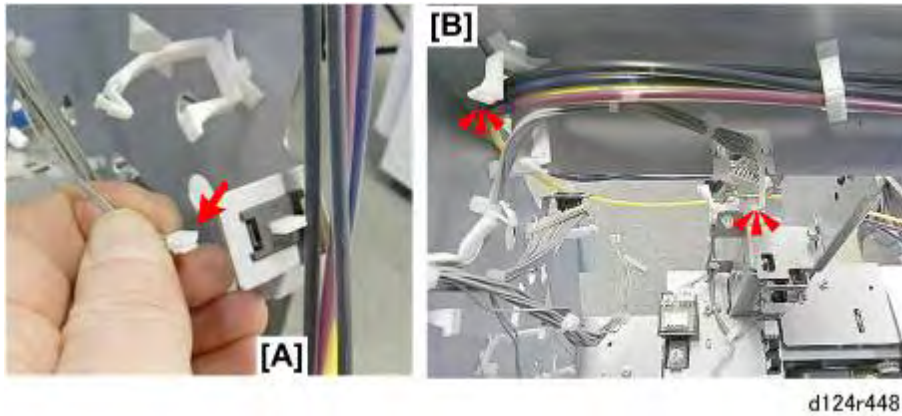

3. At the front, disconnect the ink cartridge cover sensor [A] (🔌 x1).
4. At [B], free the harnesses and ink supply tubes (🔌 x2).

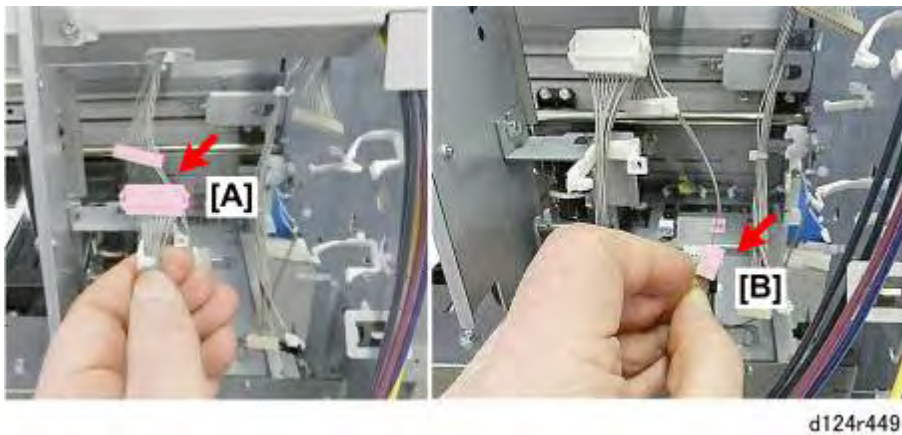

5. Disconnect the ink supply unit at [A] and [B] (🔌 x2).

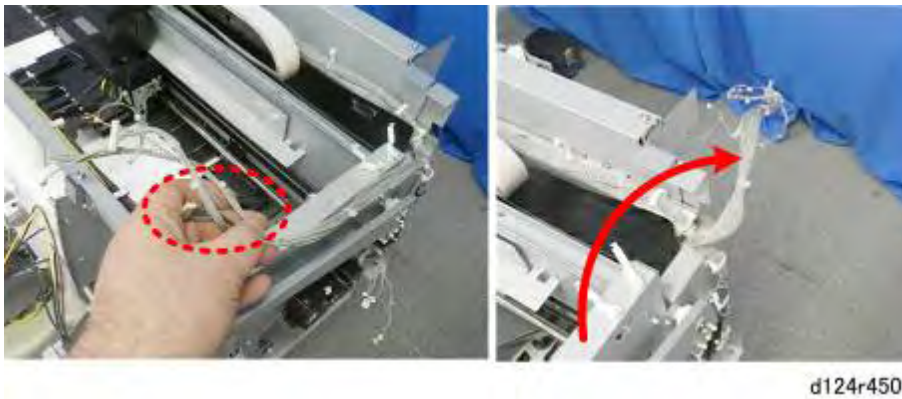

6. Take the bundled harnesses and lay them at the back of the machine.

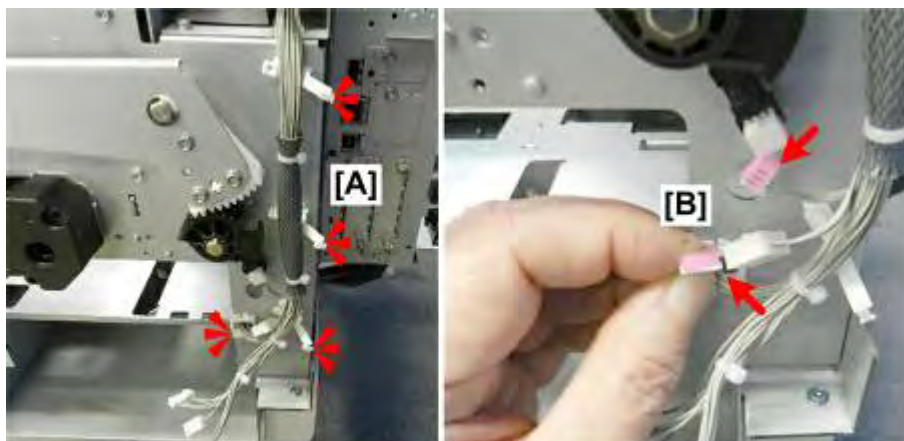

d124r451

7. At the right rear corner of the machine, free the harnesses (🔧x4).



d1241083

8. In the right side, disconnect and free the harnesses (🔧x2, 🗑️x3).
9. Pull the freed ends of the harnesses out of the machine.

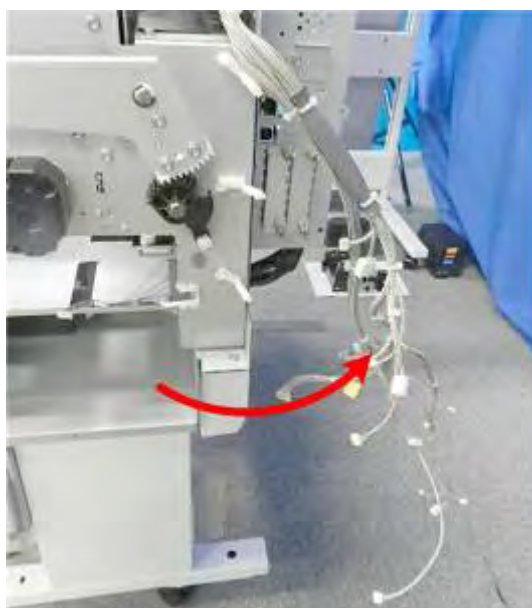

d124r454

Carriage Unit

10. Pull the bundled harnesses to the back of the machine.

Ink Supply Tube Rail



1. On the left and right, **loosen** the screws of the ink supply tube rail ( x2).

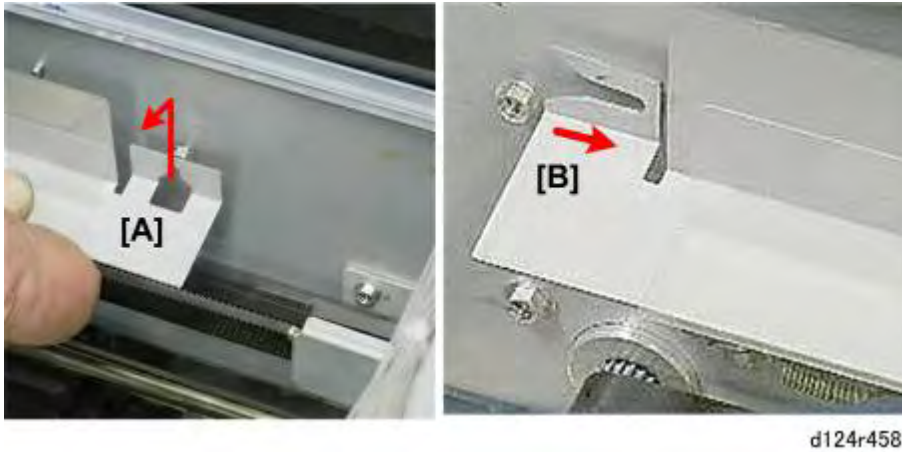

2. Lift the right end [A] of the rail off its screw, and then pull the left [B] away from its screw to disconnect both ends.

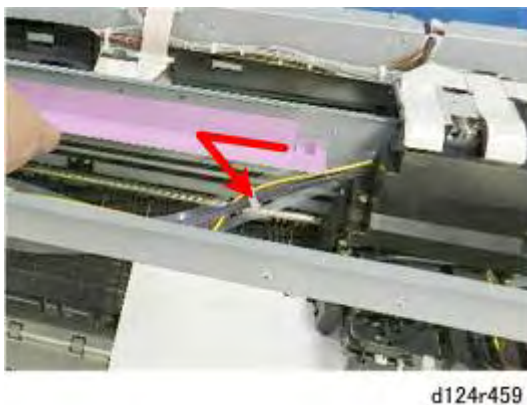

3. Pull the rail to the left, through the back of the carriage unit.



d124r372

4. Pull the rail out of the machine.

Carriage Unit

Horizontal Encoder Strip

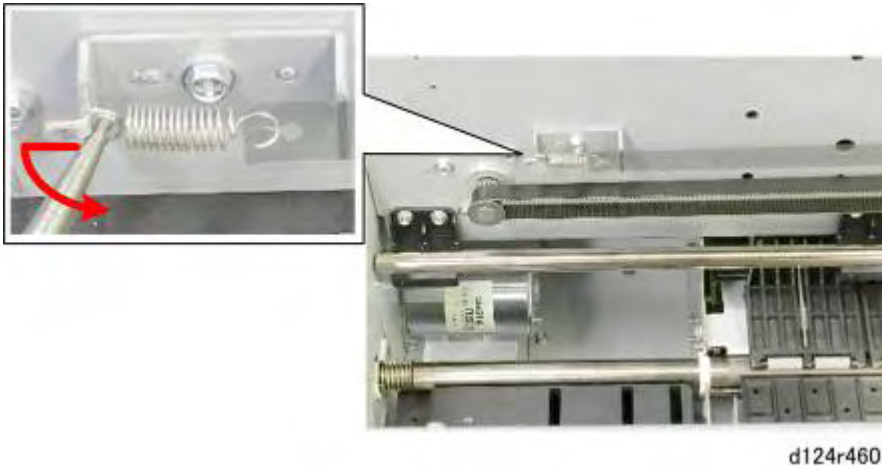

1. On the left side of the machine, disconnect and remove the spring (🔧 x1).

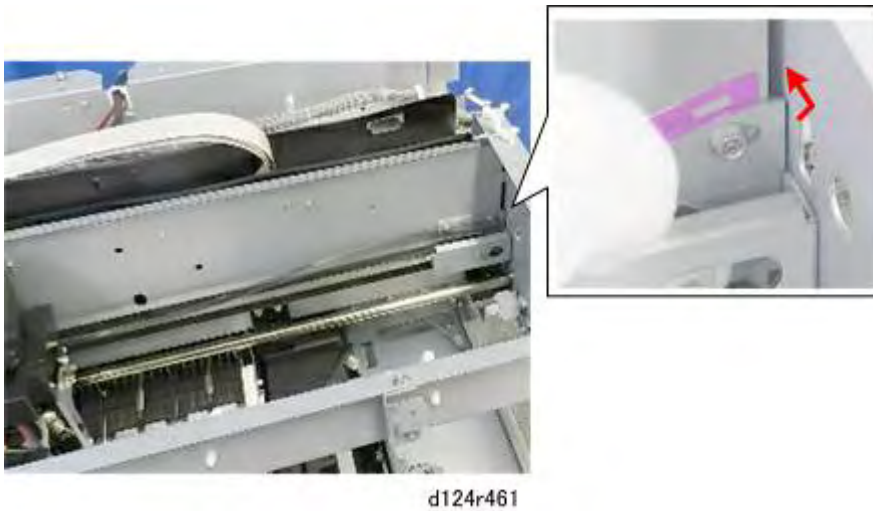

2. On the right side of the machine, disconnect the right end of the horizontal encoder strip.

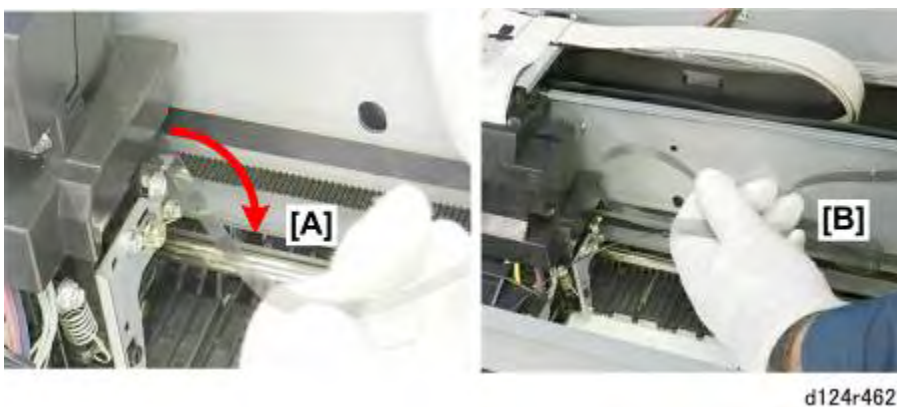

3. Slide the encoder strip out of the slot on the back of the carriage unit [A], and then remove the strip [B].

Horizontal Timing Belt, Belt Bracket

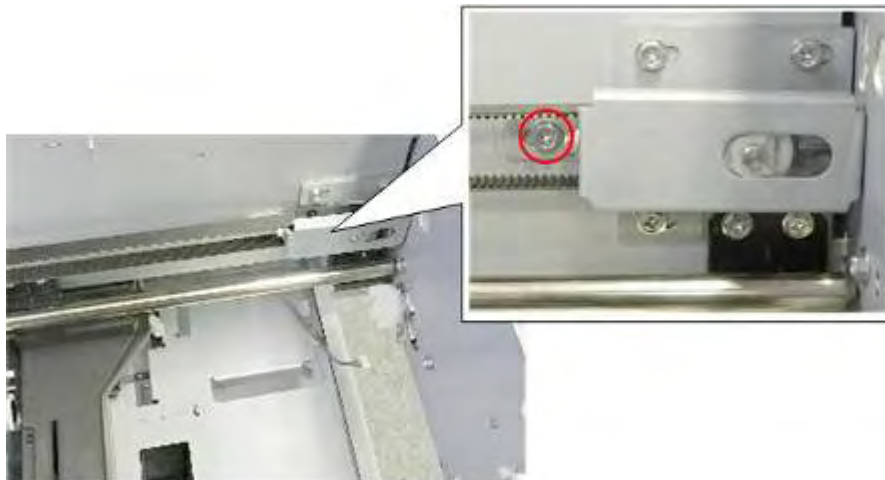

d124r463

1. The tension bracket is on the right side of the machine.
2. Remove the screw ( x1).

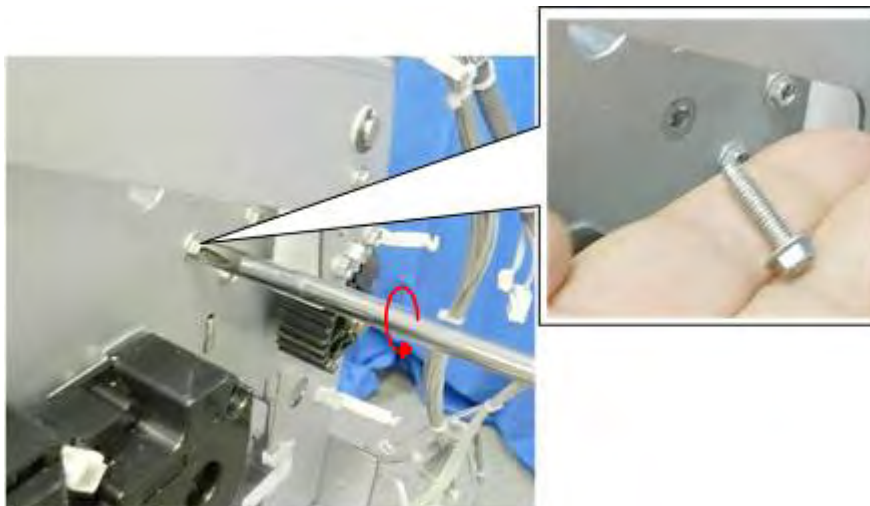

d124r464

3. On the right side of the machine, remove the long tension screw from behind the paper holding arm ( x1).



d124r465

4. Remove the tension bracket with its spring.

Carriage Unit

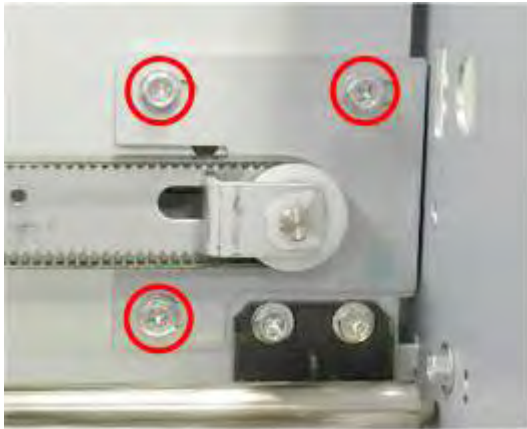

d124r466

5. Disconnect the tension bracket plate ( x3).



d124r467

6. Disconnect the horizontal timing belt and remove the bracket.

Right Plate



d124r766

1. Remove the paper holding lever (Ⓒx1).

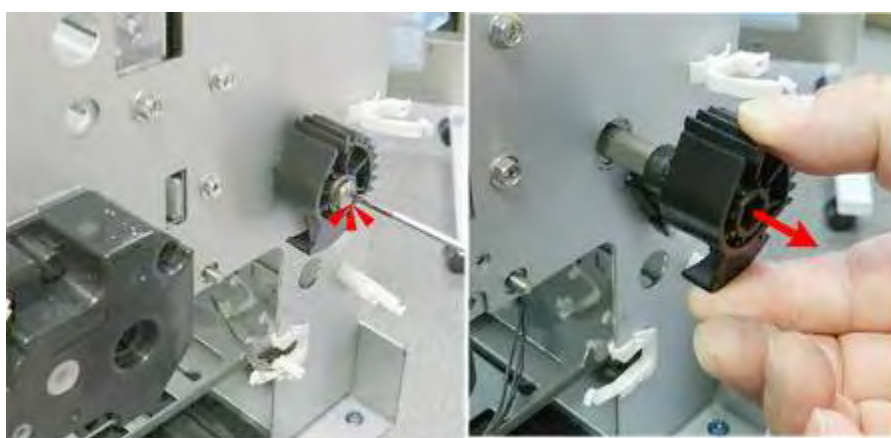

d124r767

2. Remove the actuator gear (Ⓒx1).

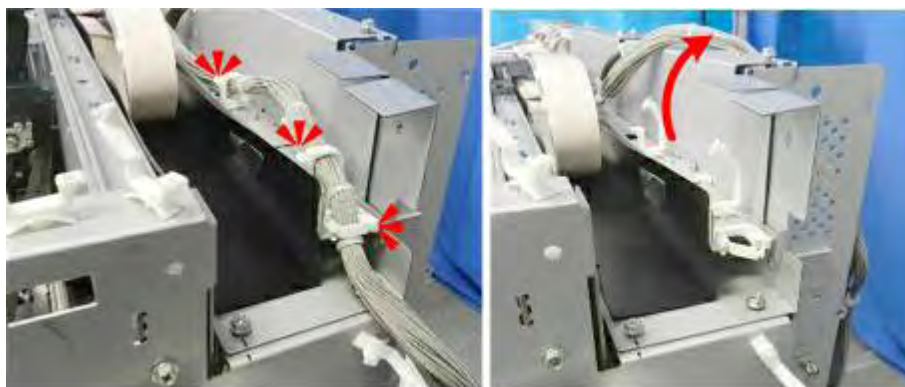

d124r472

3. At the right rear top corner of the machine, free the bundled harnesses and lay them over the back of the machine (Ⓒx3).

Replacement and Adjustment

Carriage Unit





d1241038

★ Important

- Never loosen or remove these paint-locked screws.



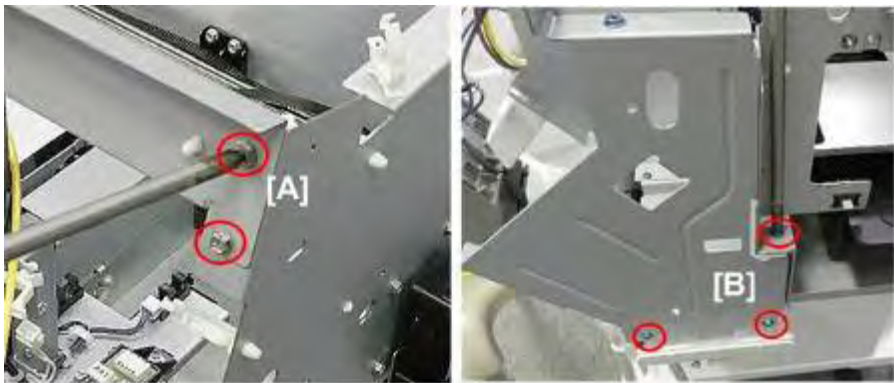

d124r768

4. Disconnect the plate screws in the ink supply well ( x1,  x1).



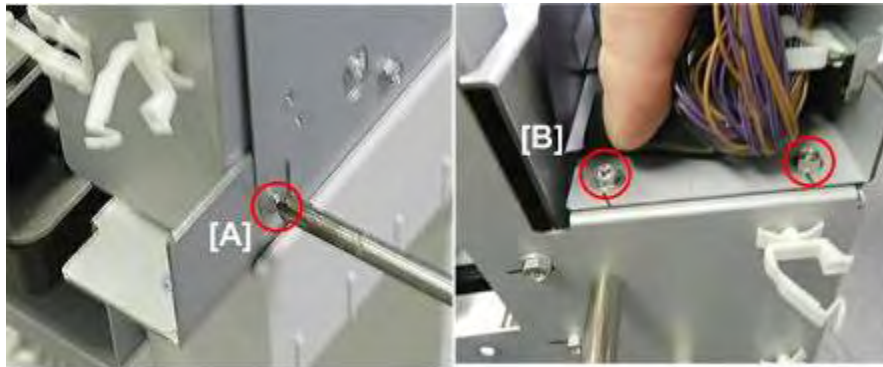

d124r769

5. Disconnect the top right corner of the plate [A] ( x2).
6. Disconnect the lower right corner of the plate [B] ( x3).



d124r770

7. At the rear, disconnect the lower right corner of the plate [A] ( x).
8. Disconnect the top right corner [B] ( x2).



d124r771

9. Remove the side screws ( x2).

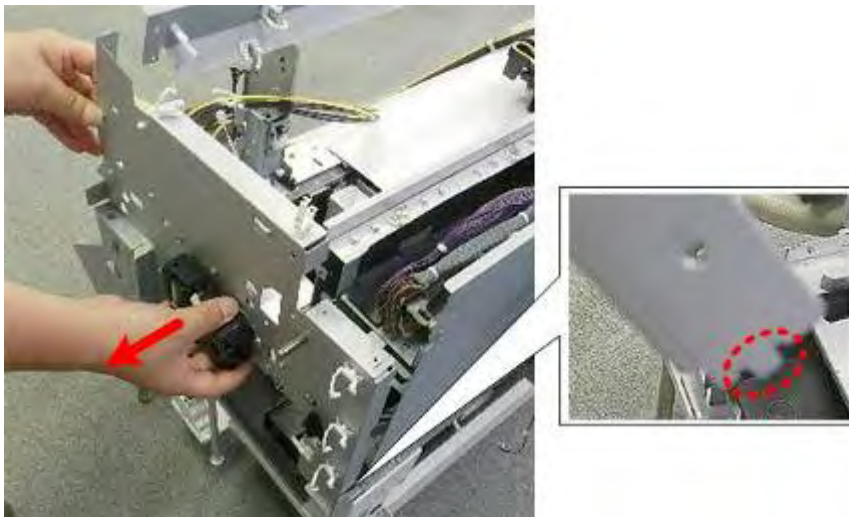

d124r772

10. Finally, disengage the lower right corner of the plate and remove it.

Carriage Unit

Carriage Disconnection

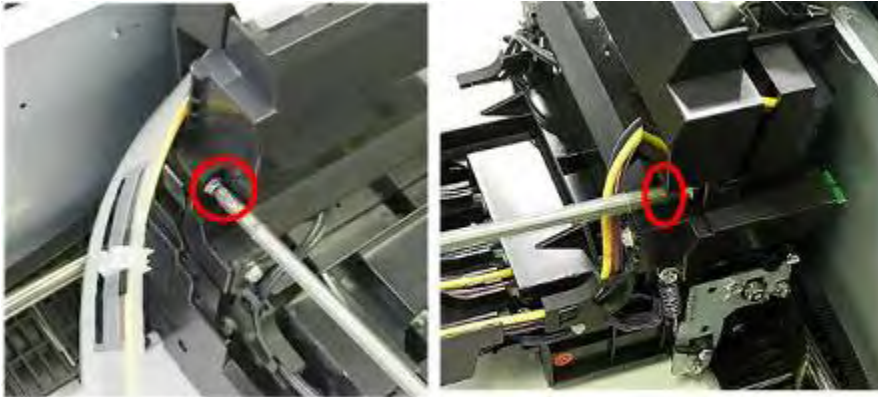

d124r760

1. Remove the upper screws ( x2).

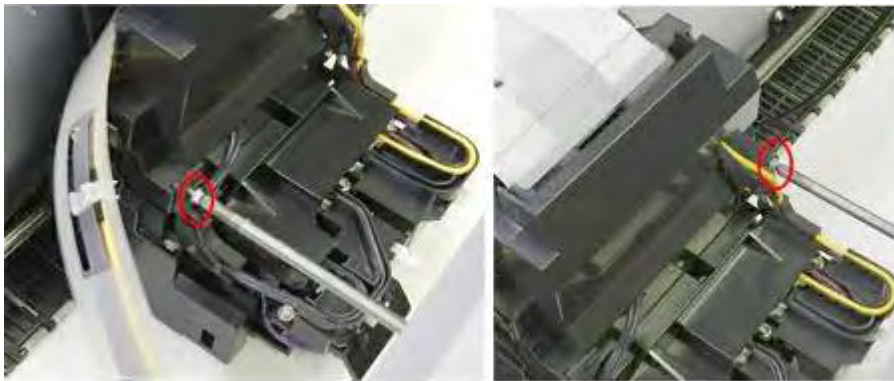

d124r761

2. Remove the lower screws ( x2).



d124r762

3. Remove the front cover.

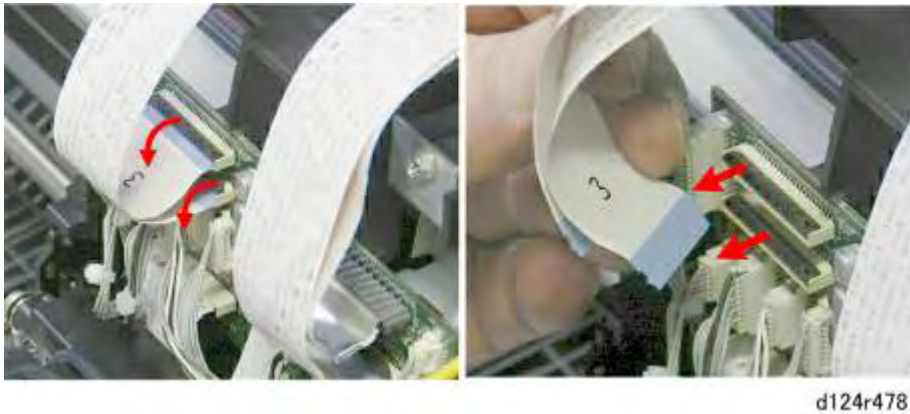

4. Disconnect the FFCs on the left ( x2).

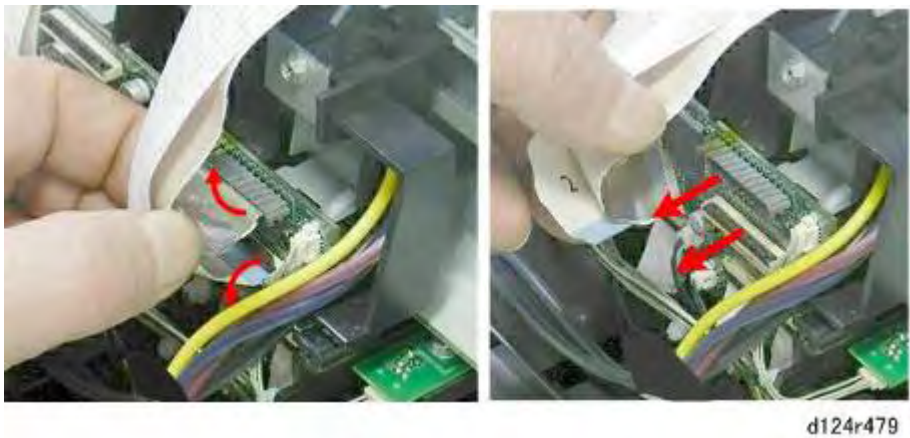

5. Disconnect the FFCs on the right ( x2).



6. Remove the front wire retainer.

Replacement
and
Adjustment

Carriage Unit

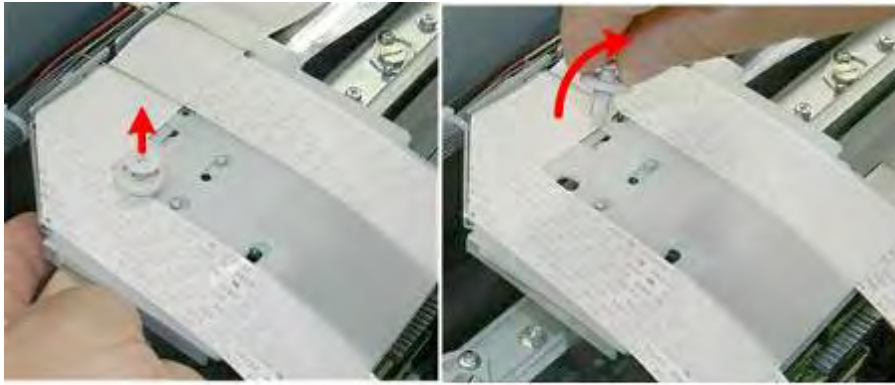

d1241086

7. From under the plate, push the plastic screw up and then remove it.

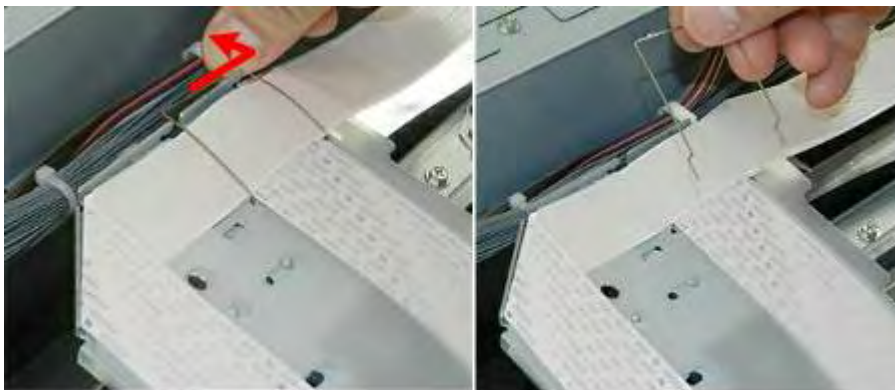

d1241087

8. Push the wire guide to the right to release it, and then remove it.

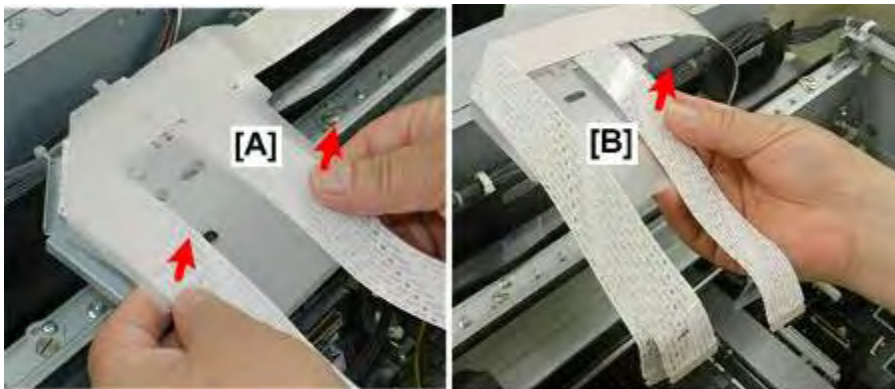

d1241088

9. Separate the semi-transparent cover sheet and the FFC guide, and then set them aside on top of the machine.

Ink Level Sensor Bracket

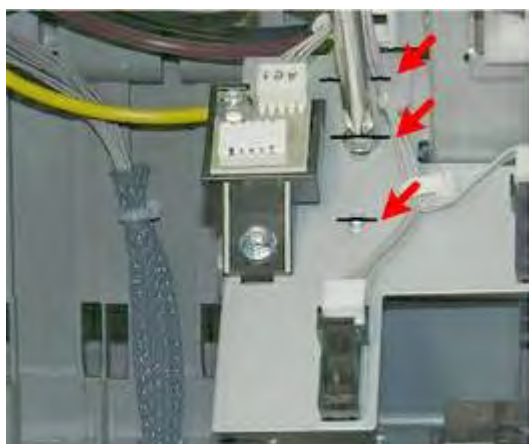

d124r773

1. First, use a pencil or marker to mark the positions of the bosses and screw of the plate.

★ Important

- This plate slides forward and back. It must be aligned precisely when it is reinstalled.

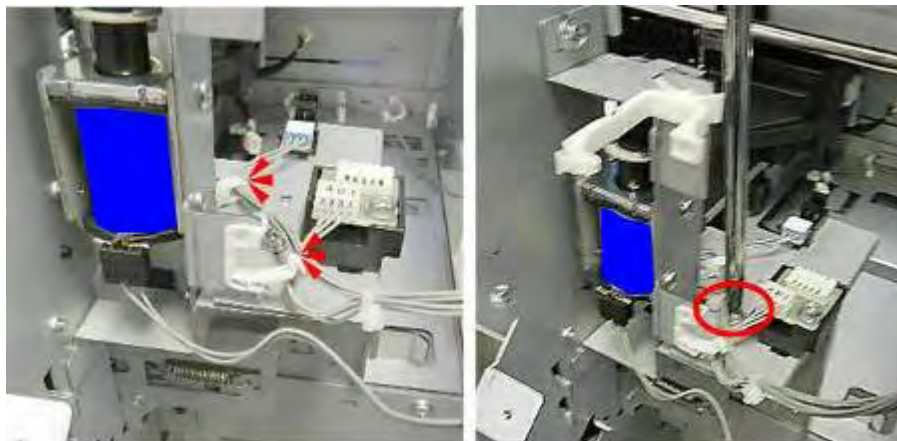

d124r455

2. At the front, disconnect the ink level sensor bracket (⚙️x2, 🔑x1).



d124r456

3. Remove the sensor bracket.

Carriage Removal

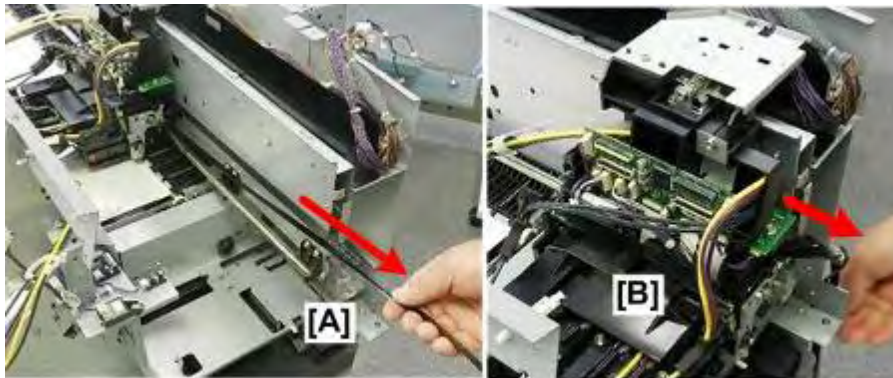

d124r763

1. Prepare a flat clean surface, such as a stool or small table covered with paper, at the right side of the machine.

★ Important

- The ink tubes are still connected to the carriage unit, so there is not much space for moving the carriage unit after it is off the guide rod. Place the table or stand as close as possible to the right side of the main unit.
 - To avoid ink leakage, always keep the carriage unit higher than the ink supply unit.
2. Pull the horizontal drive belt out of the machine [A].
 3. Pull the belt toward the right as you pull the carriage unit [B] to the right edge of the machine.

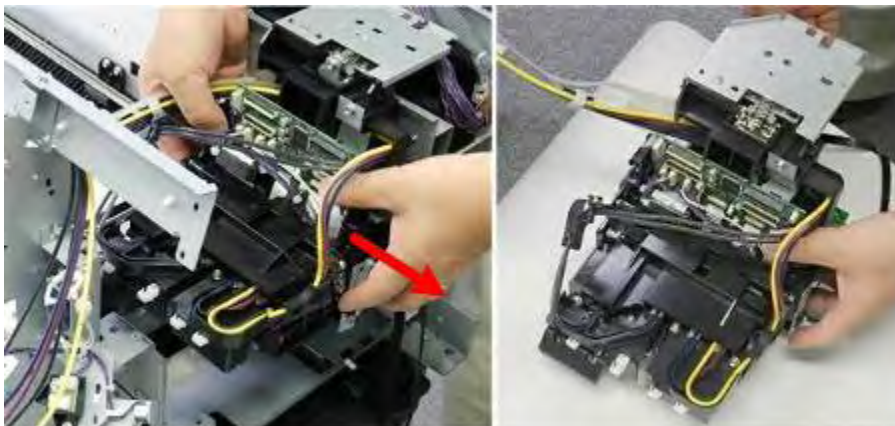

d124r764

4. Grip both sides of the carriage unit, push it off the guide rod, and then lay it down on the table or stand next to the right side of the machine.



d124r765

5. The horizontal drive belt is connected to the back of the carriage unit.

Carriage Unit Reinstallation

Pay close attention to these important points when you reinstall the carriage unit.

Mounting the Carriage

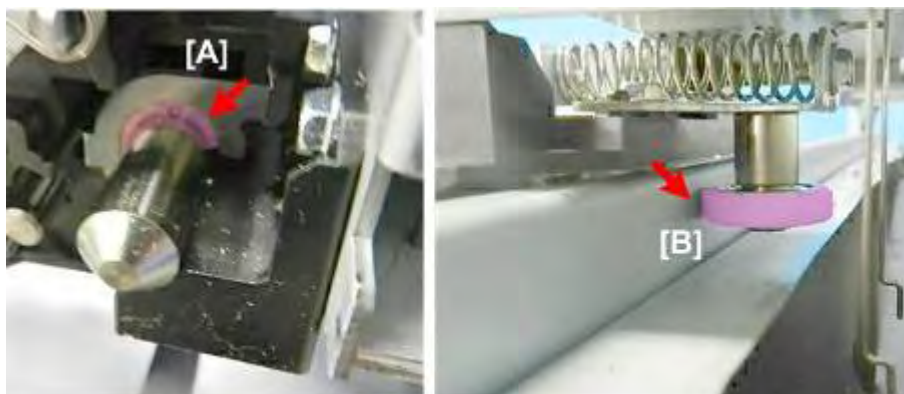

d124r496

1. After you set the carriage unit on the guide rod, check its position.
2. The felt bushing [A] should be seated snugly on the guide rod.
3. The wheel [B] at the top should be positioned on the race as shown.

Carriage Unit

Paper Holding Lever

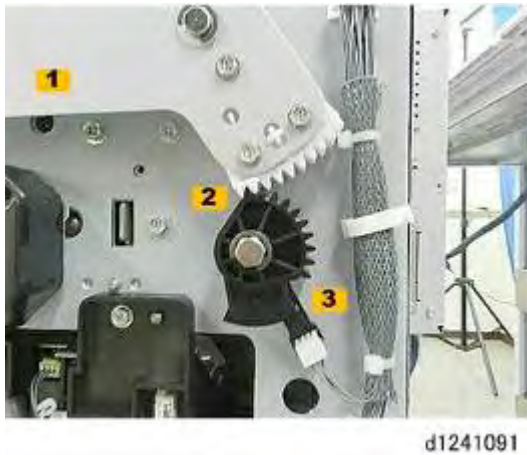

1. When you reattach the paper holding lever, confirm:
 - The paper holder lever [1] is level.
 - The first gear of each [2] is meshed.
 - Actuator [3] is down and in the gap of the registration release sensor.

FFC Pressure Plate



1. Make sure the tab is engaged and through the hole of the frame as shown, before you reattach the semi-transparent cover and wires.

Ink Level Sensor Bracket

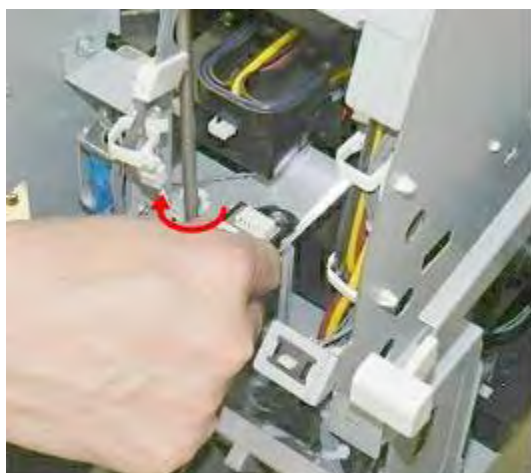

d1241092

1. Attach the ink level sensor bracket but do not tighten it.

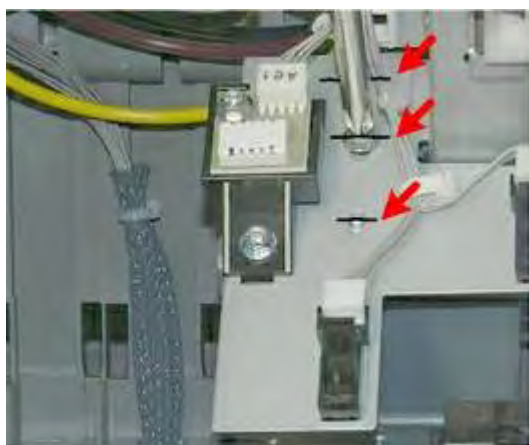

d124r773

2. Position the plate so that it is aligned with the marks that you drew when you removed it.

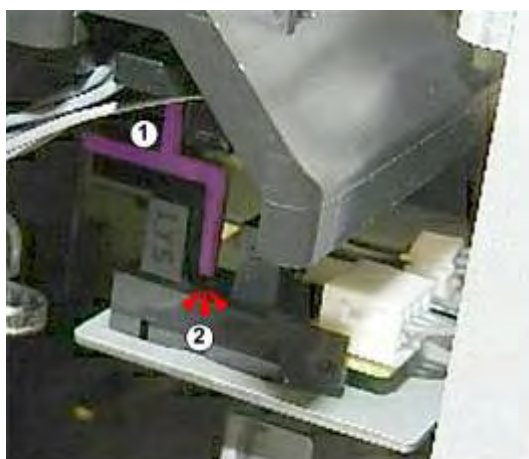

d1241093

3. Check the position of the actuators ① and ②.
4. The actuators must be centered in the gaps of the sensors above and below.
5. Tighten the bracket screw.

Horizontal Encoder Strip

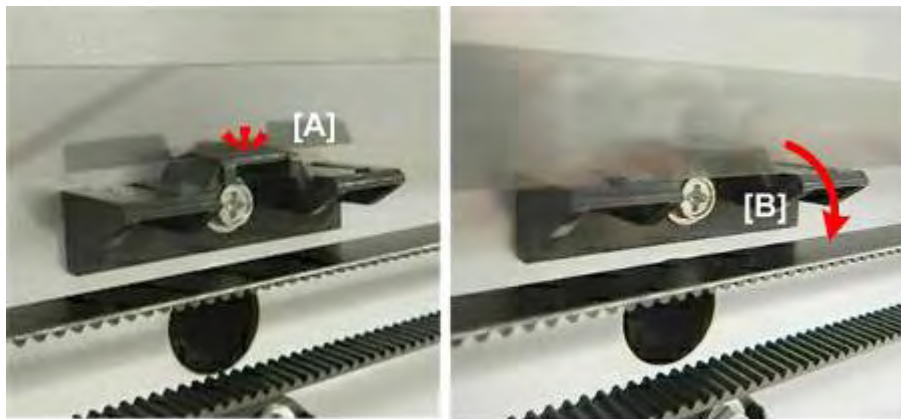



d124i209

1. Before you turn on the power switch, check the position of the horizontal encoder strip on the left.
 - If the encoder strip is up on the bracket as shown at [A], pull it forward and down so that it is in front of the bracket as shown at [B].
 - If the machine is turned on with the strip positioned as shown at [A], the movement of the carriage unit may scratch the surface of the encoder strip.
2. Do the Auto Adjust Print Head Position procedure. ➤ page 5-321
3. Open the SP mode and do **SP5884-003** Factory Setting – Head Gap Backup.





5.10 INK SUPPLY

5.10.1 AIR RELEASE SOLENOID

Preparation



- Move the Carriage Unit with SP2102-4  page 5-37
- Separate the Main Unit from the Scanner Unit  page 5-16

Remove:

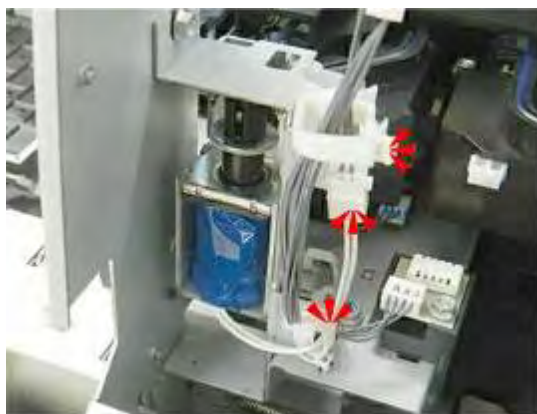
- Top cover  page 5-29
- Ink cartridge cover  page 5-23
- Front cover  page 5-31
- Paper exit guide  page 5-32



d1241095

1. The air release solenoid is encased by a bracket.
2. Disconnect the solenoid ( x3,  x1).



d124r440

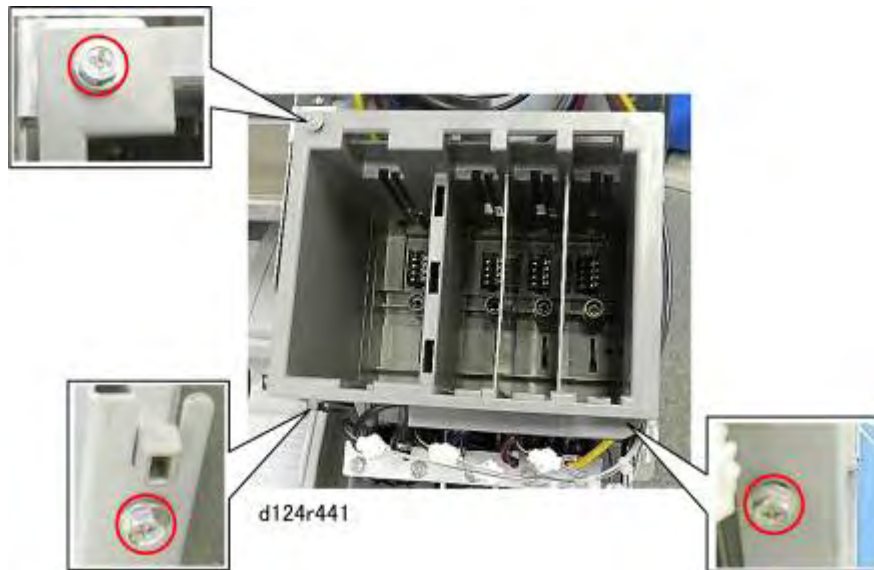

3. Set a stool or box in front of the machine to support the ink supply unit.

Ink Supply

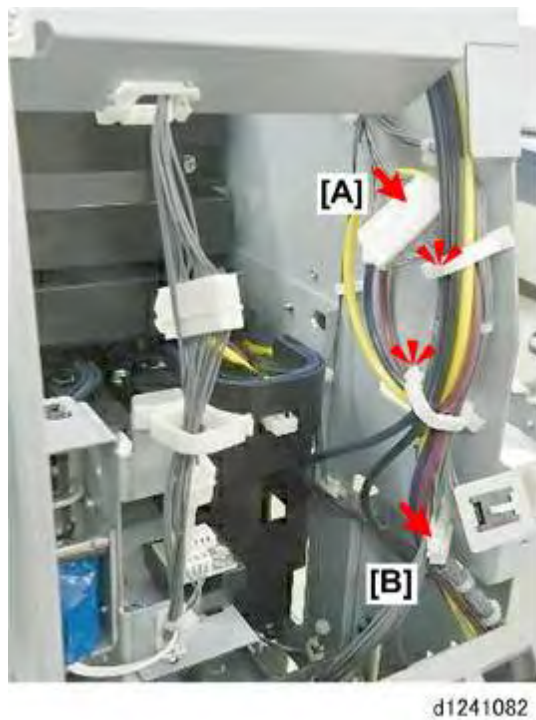

4. Disconnect the ink supply unit frame ( x3).



5. Free the ink supply tubes and disconnect the ink supply unit at [A] and [B] ( x2,  x2).

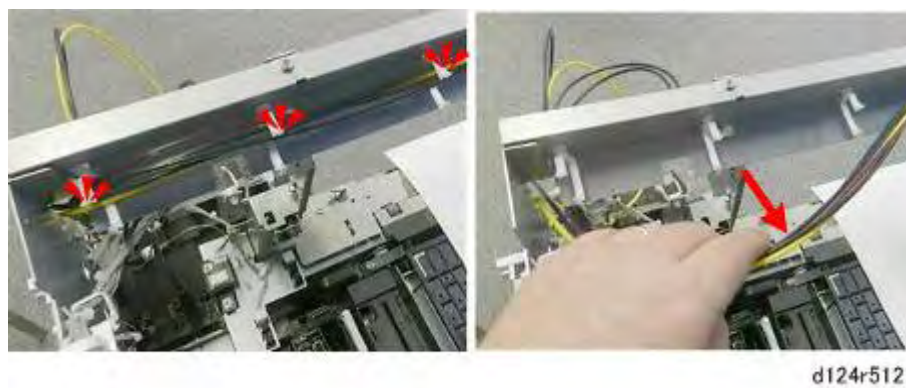

- On the right side of the back of the front support of the machine, free the ink supply tubes (🔧x3).

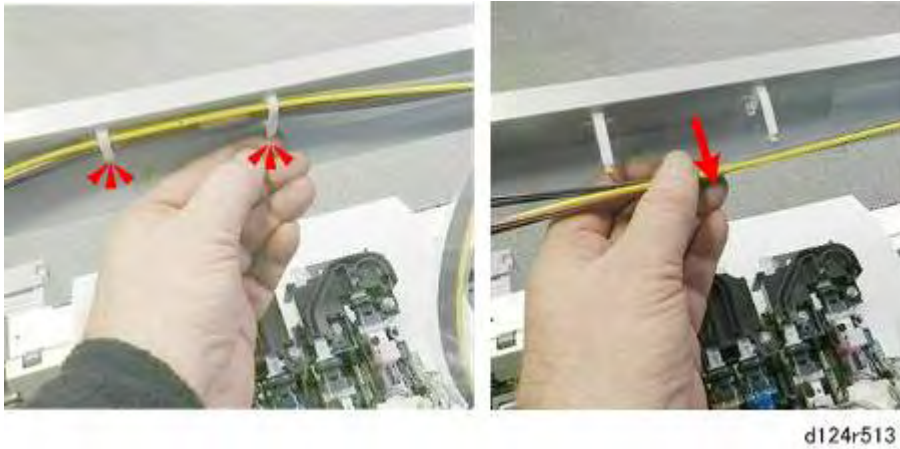

- Near the center of the front support, free the ink supply tubes (🔧x2).

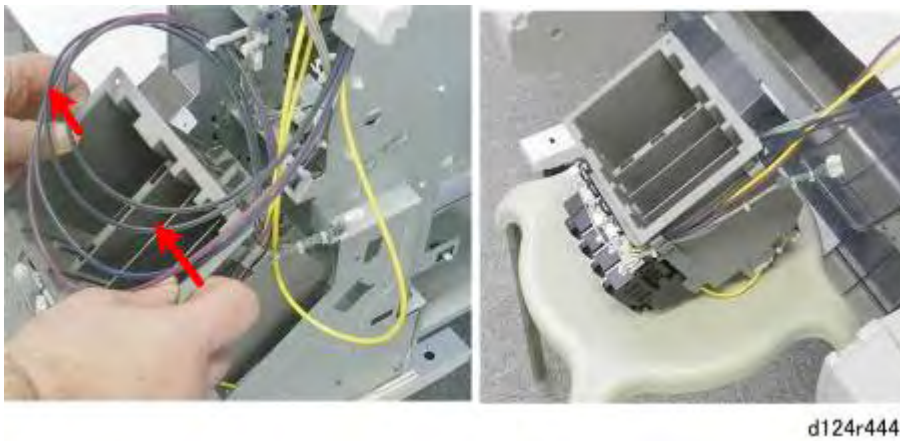

- Remove the ink supply unit and set it on the stool or box.







- Remove the side of the bracket (🔧x2).



d124r522

5.10.2 TEMPERATURE/HUMIDITY SENSOR

Preparation



- Separate the Main Unit from the Scanner Unit  page 5-16
- Move the Carriage Unit with SP2102-4  page 5-37
- Right cover  page 5-19
- Right upper cover  page 5-21

Remove:

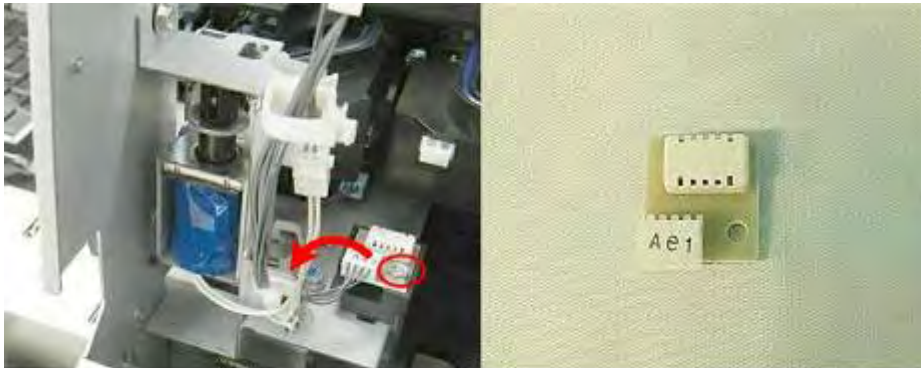
- Top cover  page 5-29



d1241096

1. Remove the sensor ( x1,  x1).

5.10.3 INK SUPPLY UNIT

This section describes how to replace the ink supply unit.

Ink Supply Unit Accessories



d124r752

No.	Item	Q'ty
1.	Ink Supply Unit (ink tubes attached)	1
2.	Ink Cartridges (K, C, Y, M)	4
3.	Ink Sump	1
4.	Ink Sump Cap	1
5.	Rubber Caps	5
6.	Plugs	15

Before You Begin

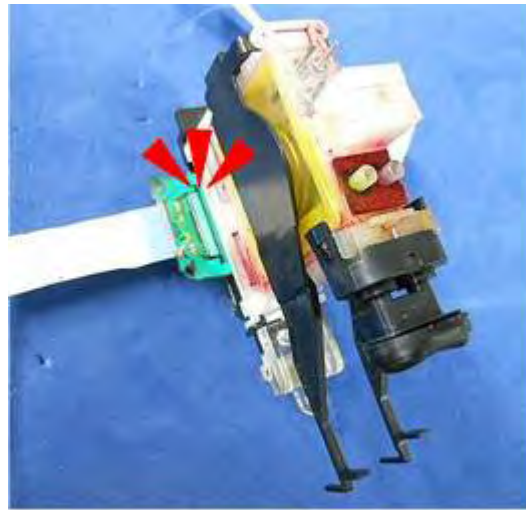

d124r729

★ Important

- Always follow instructions and work carefully to avoid spilling ink from the ink tubes and the tops of the ink sub tanks. If ink spills onto a printed circuit board at the base of the FFC, the print head unit will become unusable and require replacement.

Ink Supply Unit Replacement

1. Do **SP2090-1** to clear the NVRAM setting for the ink supply unit.
2. Move the Carriage Unit with SP2102-4 ➤ page 5-37
3. Turn the machine off.
4. Separate the Main Unit from the Scanner Unit ➤ page 5-16
5. Remove the top cover ➤ page 5-29

Carriage Disconnection



d124r476

1. Remove the left cover of the carriage unit ( x1).

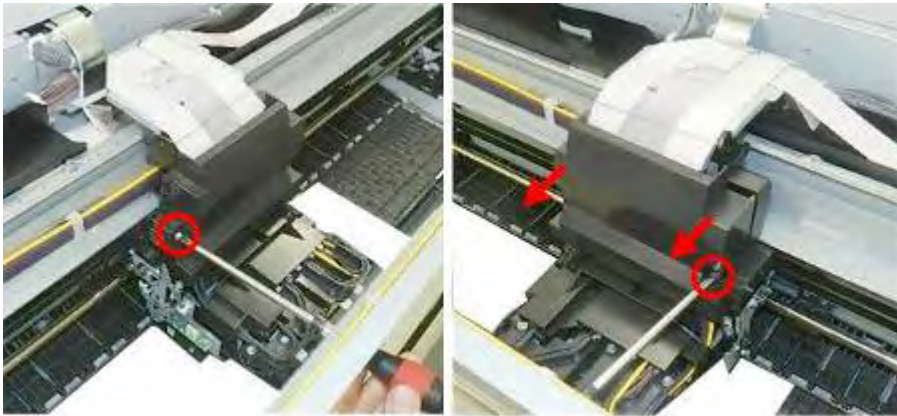

d124r477

2. Remove the front cover ( x2).



d124r478

3. Disconnect the FFCs on the left ( x2).

Ink Supply



d124r479

4. Disconnect the FFCs on the right ( x2).

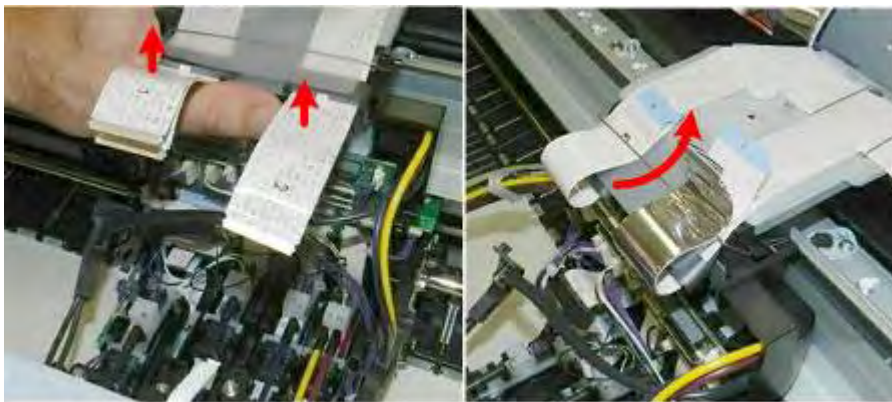

d124r732

5. Raise the connected FFCs and loop them under the wire retainer.

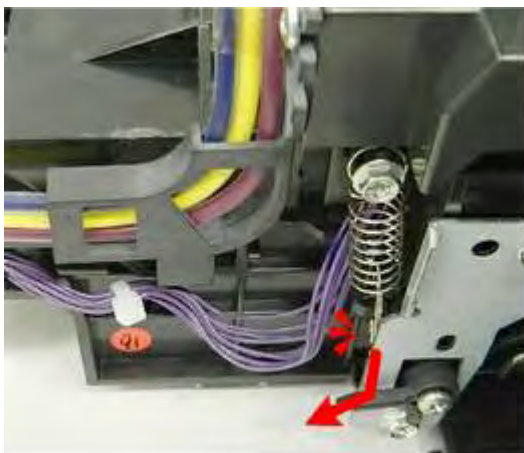

d124r483

6. At the front of the machine, release the spring on the right side of the carriage unit.

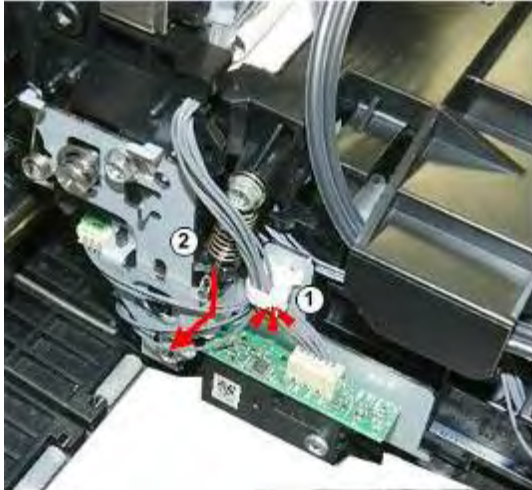

d124r484

7. Open the clamp and release the spring on the left side of the carriage unit.

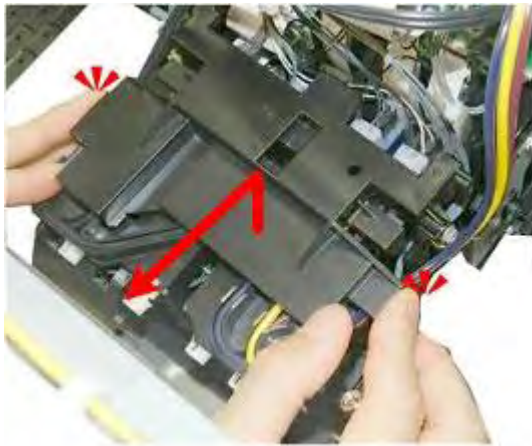

d124r485

8. Remove the top cover.

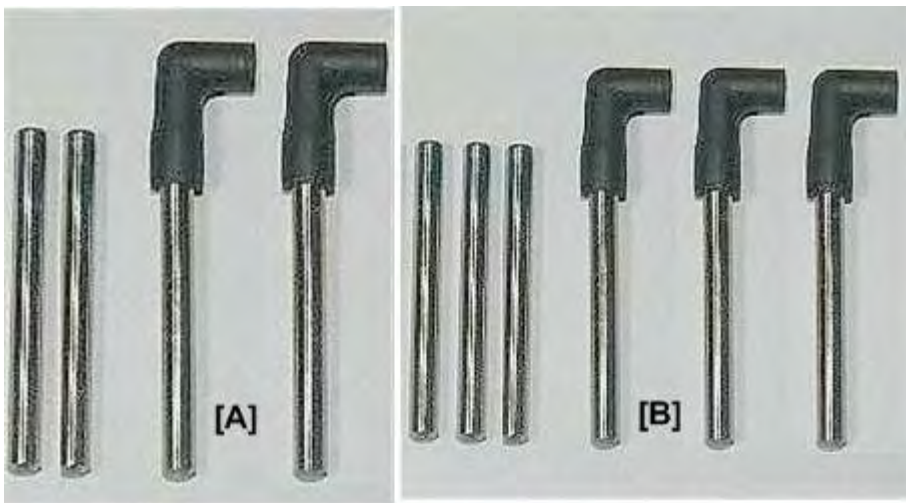

d1241089

9. You will need the uncapped/capped plugs to plug each ink supply tube and ink supply port as

Ink Supply

they are disconnected, to prevent ink leakage.

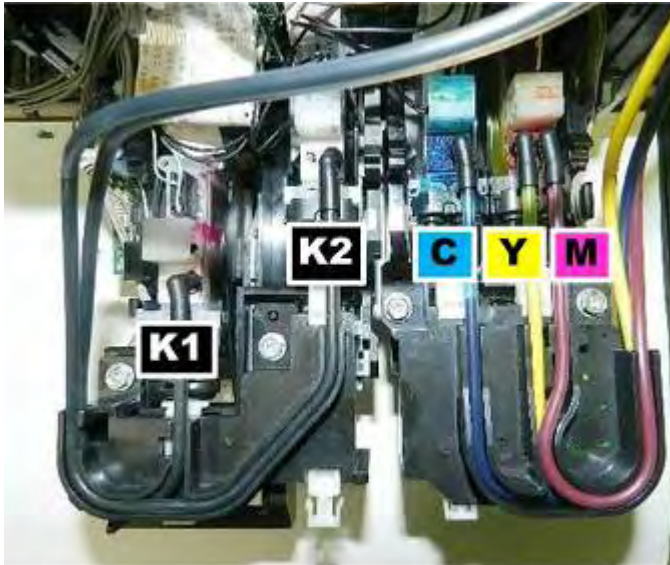

10. Five ink supply tubes and five ink ports must be disconnected and plugged in the order described below.



11. Before disconnecting the tubes, press the white plungers to purge air from the ink sub tanks.
12. Place a large sheet of paper under the carriage unit.

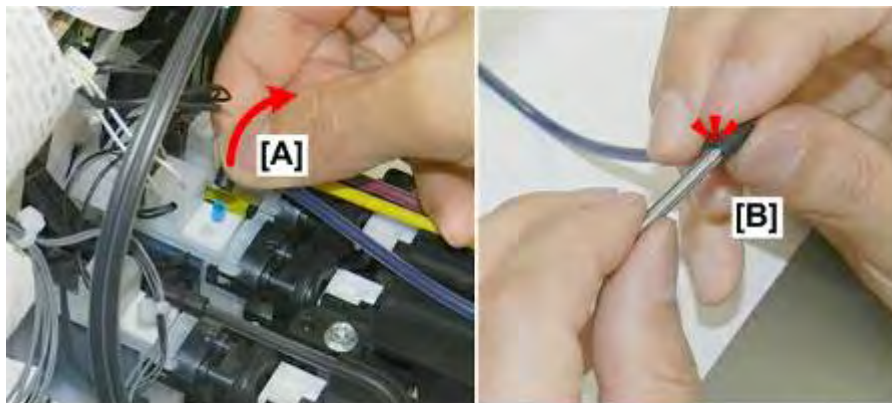

d1241055

13. Disconnect the Cyan ink tube.



d1241056

14. Use an uncapped plug to plug the open end of the ink supply tube.



d1241057

15. Use a capped plug to plug the open port on top of the ink supply tank.
16. Now, following the same steps to disconnect the Cyan tube, disconnect and cap the other ink supply tubes and ink ports in this order: **Y > M > K2 > K1**
17. The ports of the ink supply tanks and ink supply tubes should now be plugged.

Ink Supply

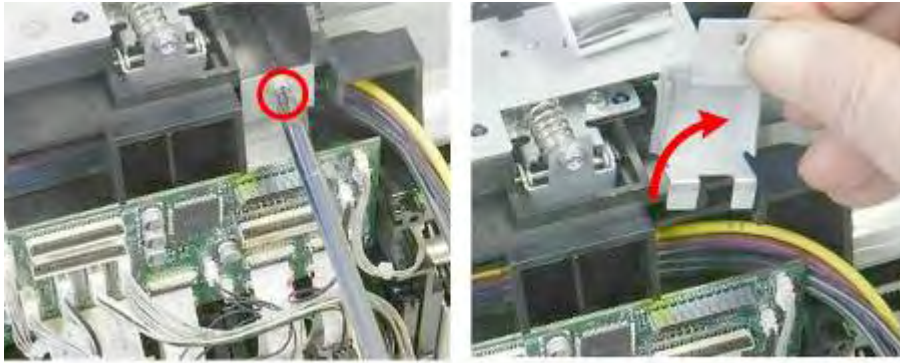

d124r493

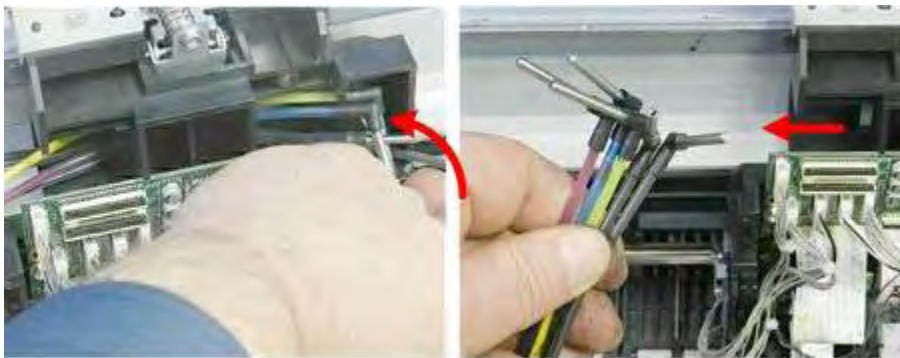

18. Remove the tube pressure plate (1 x1).



d124r494

19. Push the tubes up and then pull them out of the carriage unit.

Ink Supply Unit Removal

1. Remove the ink cartridge cover ( x2).  page 5-23



d124r511

2. Remove the ink cartridges.

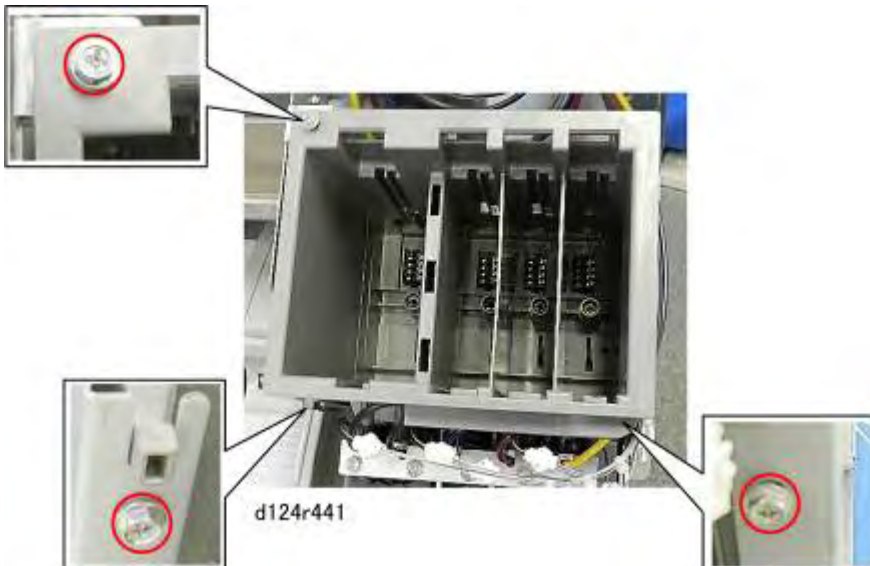

d124r441

3. Disconnect the ink supply unit frame ( x3).

Ink Supply

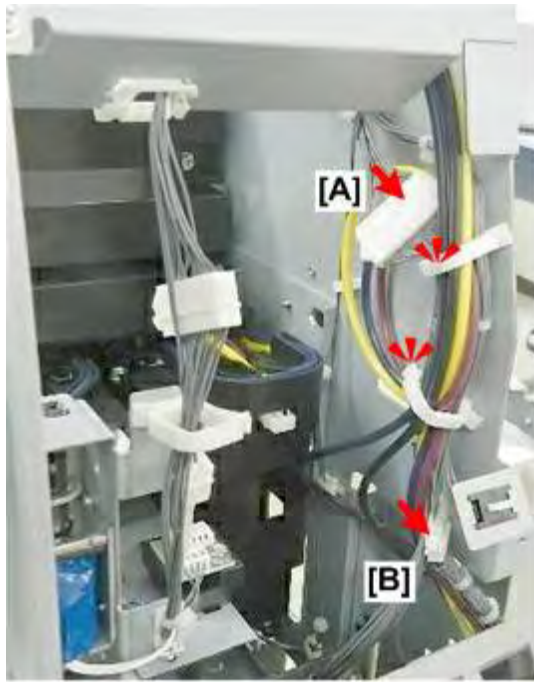

d1241082

4. Free the ink supply tubes and disconnect the ink supply unit at [A] and [B] (🔧x2, 🔧x2).

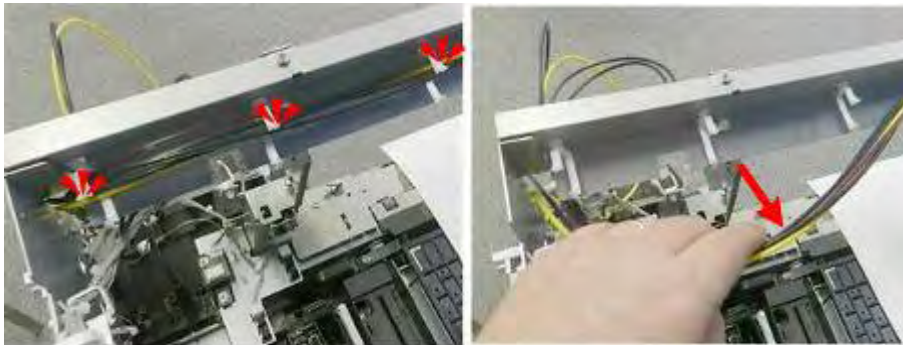

d124r512

5. On the right side of the back of the front support of the machine, free the ink supply tubes (🔧x3).

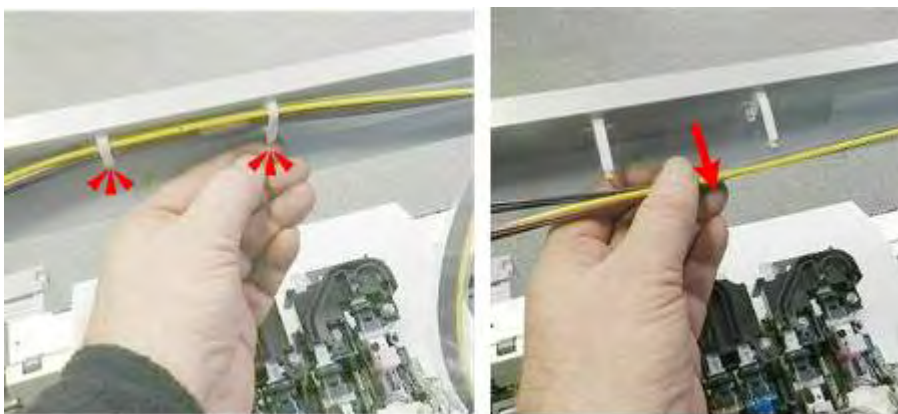

d124r513

6. Near the center of the front support, free the ink supply tubes (🔧x2).

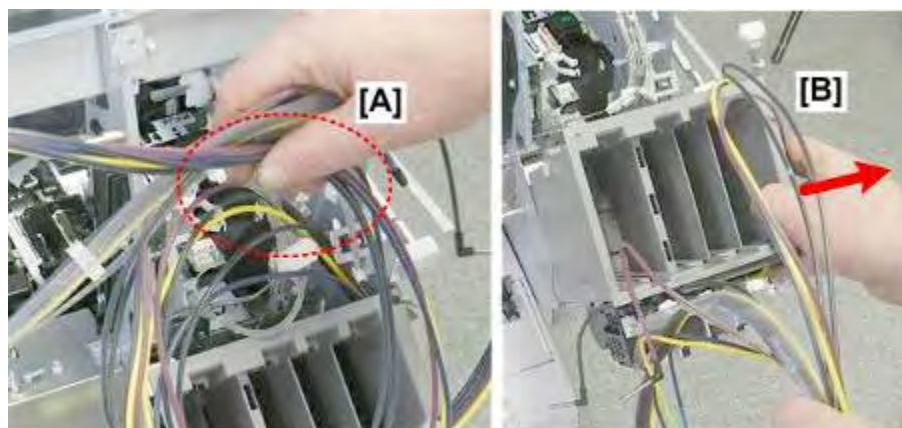

d124r514

7. Gather the ink supply tube assembly [A].
8. Remove the ink supply unit [B].

⚠ CAUTION

- To prevent an ink spill, never lift the ink supply unit higher than the carriage unit.



d124r515

9. Lay the ink supply unit on a flat clean surface.

New Ink Supply Unit Installation

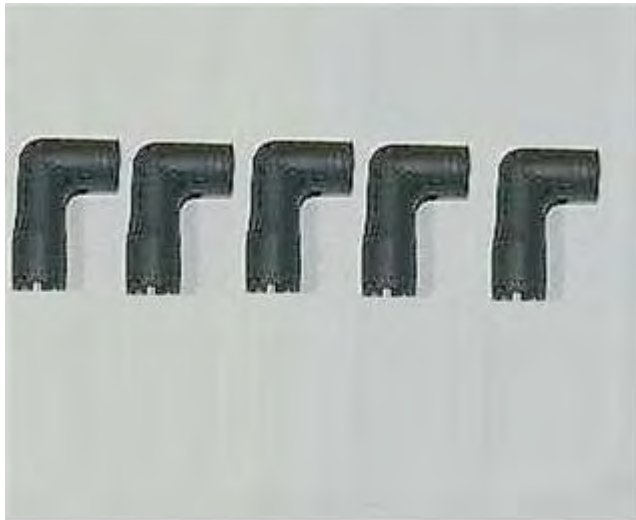

d1241097

1. Cap the tip of each new tube with a rubber nozzle.
2. Follow in reverse order the removal procedure for the ink supply unit described above, until you are ready to connect the ink supply tubes.
3. The ink cartridge cover on the front and the ink collector tank cover on the right side must be reinstalled to prevent their sensors from returning an error when the machine is turned on.
4. Reattach the ink cartridge cover.
5. Reconnect the FFCs ( x4) to the carriage unit.
6. Close the front cover if it is up.
7. Make sure that the paper exit guide is down.
8. Set the service ink cartridges in the new ink supply unit.



d1241098

9. The dummy tank [1] is provided with a nozzle plate [2].
10. Snap the nozzle plate onto the top of the dummy tank.
11. Set the dummy tank on the platen.



d1241099

12. Connect each tube to the top of the box. The order of connection is not important.
13. Before going to the next step, check:
 - **FFCs** on the carriage unit must be connected to prevent an error.
 - **Front cover** must be down so that the cover sensor detects the front cover closed.
 - **Paper exit guide** must be down so that the guide sensor detects that the guide down.
 - **Right covers** must be attached so that the ink collector sensor detects that the cover is closed.
 - **Ink cartridge cover** must be attached.
14. Open the ink cartridge cover and leave it open.

★ Important

 - The ink cartridge cover must be open so that you can complete this procedure.
 - If the machine is powered on with the cover closed, the machine will start the initial filling sequence and try to move the carriage unit to the home position for capping.
15. Turn on the machine.
16. Ignore the error.
17. Go into the SP mode and do **SP2012-1**. If the value of this SP code does not read "9", then enter "9".
18. Confirm that all five ink supply tubes are connected securely to the dummy tank.
19. Open **SP2100-5**, and then enter "31".
 - The ink starts pumping from the ink cartridges, through the tubes and into the ink sump.
 - When you see "Completed" the pumping operation is finished.
20. Turn the machine off.
21. Disconnect the ink supply tubes from the dummy tank.
22. Insert a metal plug into the end of each tube to prevent ink leakage.

Ink Supply



d124r501

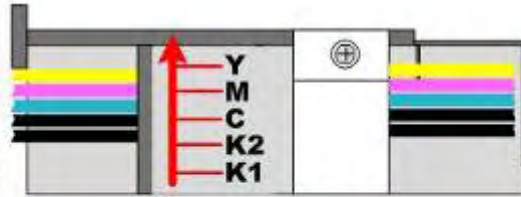

23. Make sure the ink supply tubes are flat and stacked correctly.
24. Pass each tube through the top of the carriage unit in this order: K1 > K2 > C > M > Y
25. The tubes should enter the left and leave the right side of the carriage unit in the order shown above.
 - This ensures that the tubes are not crossed inside the carriage unit.
 - If they are crossed, the tube pressure plate may not set correctly.



d124r502

26. If the plugged tubes do not pass through the top of the carriage unit easily, use a pair of thin nosed pliers to pull them through.

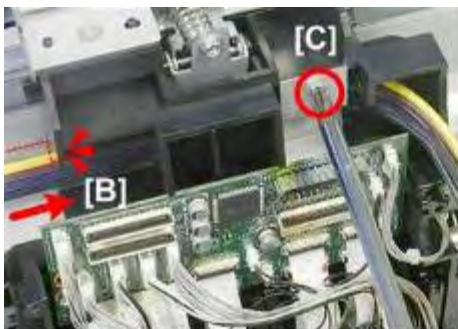

d124r507

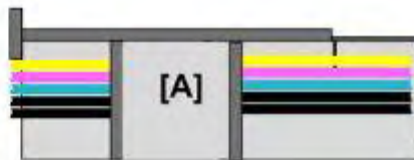

27. Make sure the tubes enter on the left and emerge on the right stacked in the same order [A].

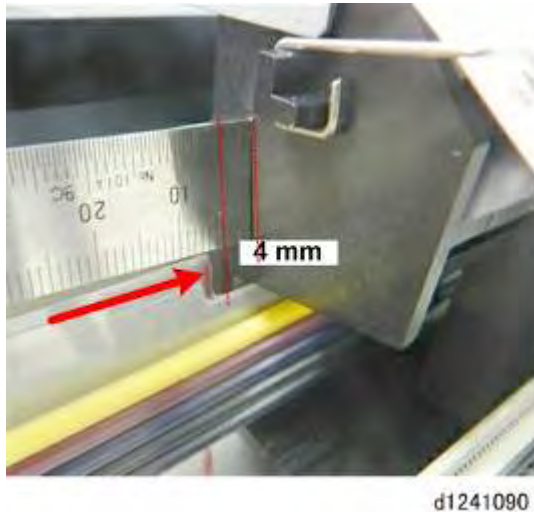

28. Before you tighten the pressure plate, push in the ink supply tube bundle until the "L" notch is 4 mm away from the side of the carriage unit.
29. Reattach the pressure plate.
30. Push the carriage unit to the left and right to make sure that the tubes do not fall off the ink supply tube rail.

Note

- If the tubes fall off the rail, there is too much slack to the left of the carriage unit. Remove the pressure plate and make sure that the tubes are pushed as far as possible against the left side of the carriage unit.

Important

- **The ink supply tubes must be reconnected and set in the order described below.**

Routing and Reconnecting the Ink Supply Tubes

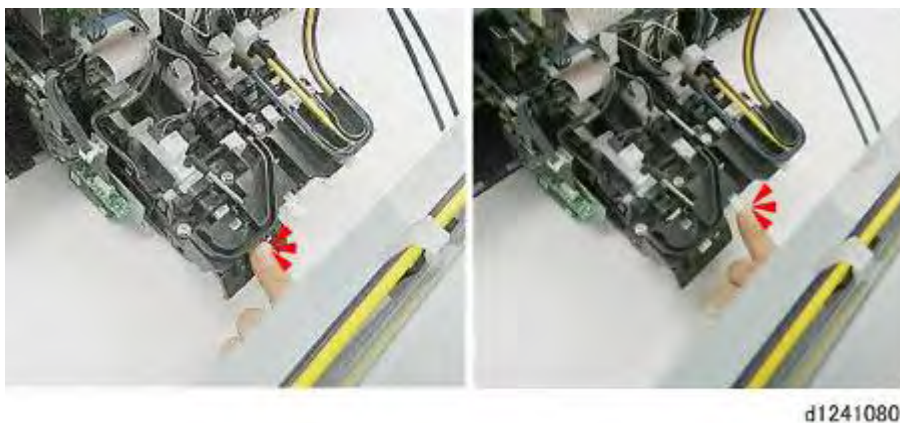

1. Press in the left and then the right plunger to purge air from the K1 and K2 sub ink tanks.

Ink Supply

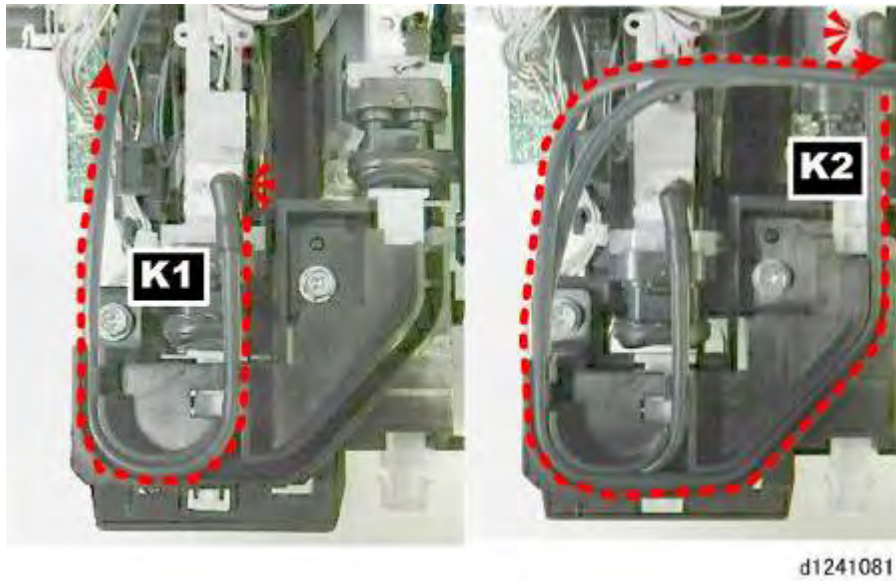

2. Remove the plugs from the end of the K1 and K2 ink supply tubes and the ink supply ports on top of the tank.
3. Connect the ink supply tubes from left to right in this order: K1 > K2.
 - K1 first
 - K2 over K1 on the left



4. Push the harnesses and FFCs to the rear so that they do not interfere with reattachment of the top cover of the carriage unit.



d1241066

5. Press in the left and then the right plunger to purge air from the Y and CM sub ink tanks.

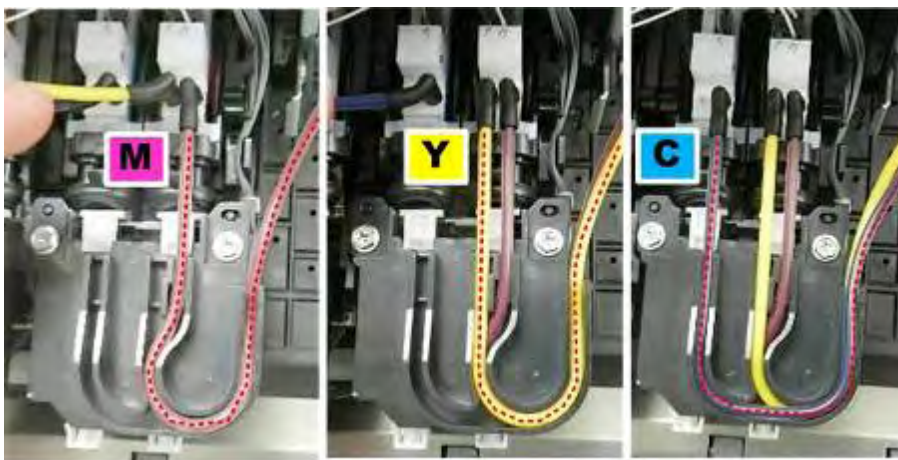

d1241067

6. Remove the plugs from the end of the color ink supply tubes and the ink supply ports on top of the tank.
7. Connect the ink supply tubes from right to left in this order: M > Y > C.
 - M first
 - Y over M on the right
 - C over Y, M on the right
8. Reinstall the top cover, front cover, and left cover of the carriage unit.
9. Close the ink cartridge cover.

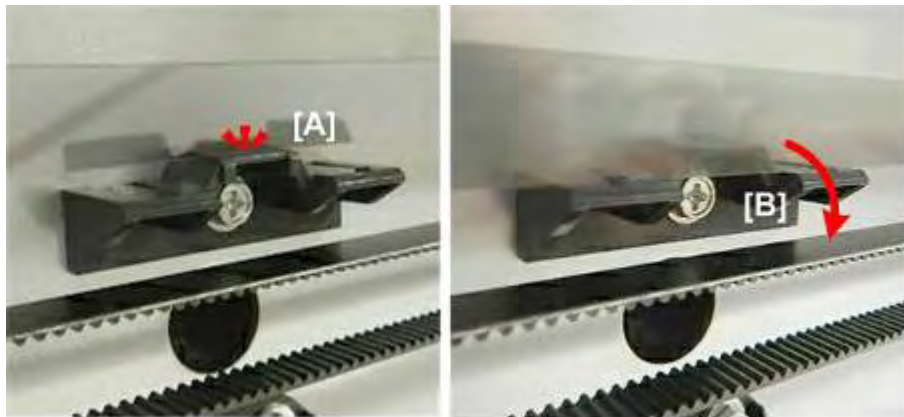

d124i209

10. Before you turn the machine on, check the position of the horizontal encoder strip on the left.
 - If the encoder strip is up on the bracket as shown at [A], pull it forward and down so it is in front of the bracket as shown at [B].
 - If the machine is turned on with the strip positioned as shown at [A], the movement of the carriage unit may scratch the surface of the encoder strip.
11. Turn the machine on. ➤ page 5-314
12. Flush the print heads. ➤ page 5-319
13. Print a Nozzle Check Pattern and check the condition of the print heads. Clean the print heads if necessary.
14. Replace the service ink cartridges in the ink supply unit with the customer's cartridges.
15. Obey the local laws when you dispose of the ink sump holding the purged ink.
 - Before disposal, cover the slots on top of the sump with the covers provided.
 - If the covers are not available, cover the slots with some strong tape to prevent the ink from spilling out of the sump.

5.11 MAINTENANCE UNIT, WASTE INK COLLECTION

5.11.1 LEFT INK SUMP

The service life of the left ink sump is about 5 years, or until it becomes full. Capacity: 500 cc.

Preparation

- Separate the Main Unit from the Scanner Unit → page 5-16

Remove:

- Left cover → page 5-25



d124r540

1. Disconnect the left side [A] ( x1).
2. Unhook the right side [B] and remove the sump.



d124r541

3. Set the sump on a flat surface.
4. If the left sump is being replaced:
 - After installing the new left ink sump, turn on the machine and go into the SP mode.
 - Open **SP2505-001** and touch [EXECUTE] to clear the counter for the left ink sump.



d124r541a

- Cover the slits on top of the left ink sump with the covers provided with the new unit.

★ Important

- Obey the local laws and regulations regarding disposal of items such as waste ink tanks that contain waste ink.

5.11.2 INK COLLECTOR UNIT

1. Open the ink collector cover on the right side of the machine.



d124r543

2. Depress the release [A], and then pull the tank straight out of the machine.
3. Lay the tank on a flat surface with the port [B] facing up.

★ Important

- The port at [B] is open and will leak ink if the tank is turned on its side or turned upside down.

5.11.3 INK COLLECTOR UNIT CONTACT SWITCH

Preparation

- Open the ink collector cover and remove the ink collector tank.
- Remove the maintenance unit.  page 5-270





d124r567

1. The sensor is located at [A].
2. Use the tip of a small screwdriver to release both sides of the sensor [B].



d124r568

3. Pull the harness and sensor through hole [A].
4. Free the harness [B] ( x6).
5. Disconnect and remove the sensor [C] ( x1).

Reinstallation



1. When you position the sensor for reinstallation, make sure that the sensor is positioned so the bend in the tines is down.

5.11.4 RIGHT INK SUMP

The service life of the right ink sump is about 5 years, or until it becomes full. Capacity: 147 cc.

1. On the right side of the machine, remove the ink collector unit.
2. Remove the right cover. ➤ page 5-19
3. Remove the right upper cover. ➤ page 5-21

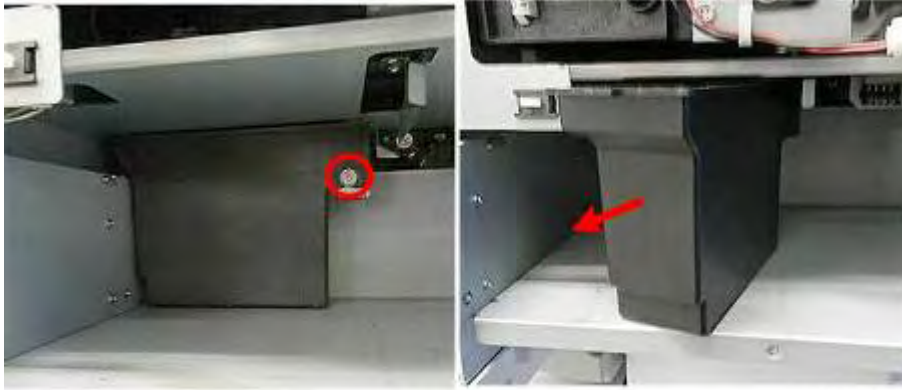

d124p027

4. Disconnect the sump and pull it out slowly (⚙️x1).

★ Important

- To avoid spilling ink, do not tilt the sump while you remove it.



d124p028

5. Cover the top of the tank with some paper and tape, and then discard it.

★ Important

- Follow the local laws and regulations regarding the disposal of this item.
- Never attempt to empty the right ink sump and re-use it.



6. After installing the new right ink sump, open **SP2505-002** (Clear Counter) and touch [EXECUTE] to clear the counter for the new sump.

5.11.5 MAINTENANCE UNIT





You can check the status of the maintenance unit with two counters:

- **SP2231-003** (PM Counter Indication - Maintenance Unit). Displays the status of the maintenance unit as the amount of usage remaining (a percent).
- **SP2231-008** (PM Counter Indication - PM Counter Maintenance Unit). Displays the status of the maintenance unit as the distance (mm) of paper fed

Preparation

- Move the Carriage Unit with SP2102-4  page 5-37
- Separate the Main Unit from the Scanner Unit  page 5-16



Remove:

- Ink collector tank  page 5-17
 - Right cover  page 5-19
 - Right upper cover  page 5-21
 - Ink cartridge cover  page 5-23
1. Set several sheets of clean paper on a flat surface to hold the maintenance unit after it is removed.

Important

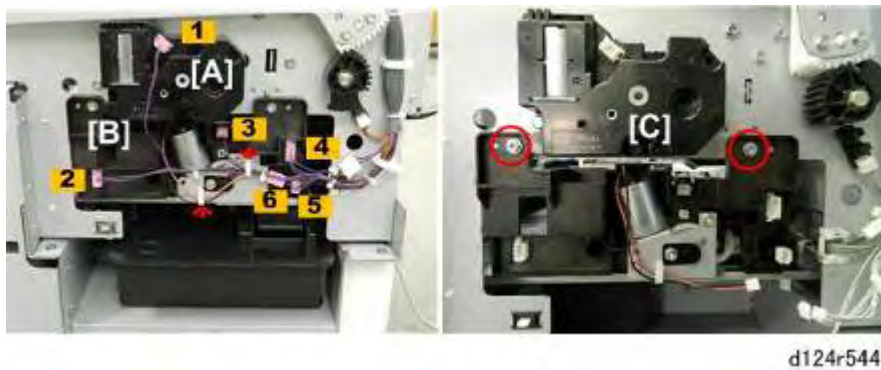
- The bottom edges of the maintenance unit are covered with ink and will stain any surface where it is placed.
- Always set the maintenance unit on a surface covered with paper that will absorb ink and can be discarded later.



2. On the right side of the machine, disconnect the lift motor [A] and the maintenance unit [B] ( x6  x2).
3. Disconnect the maintenance unit [C] ( x2).

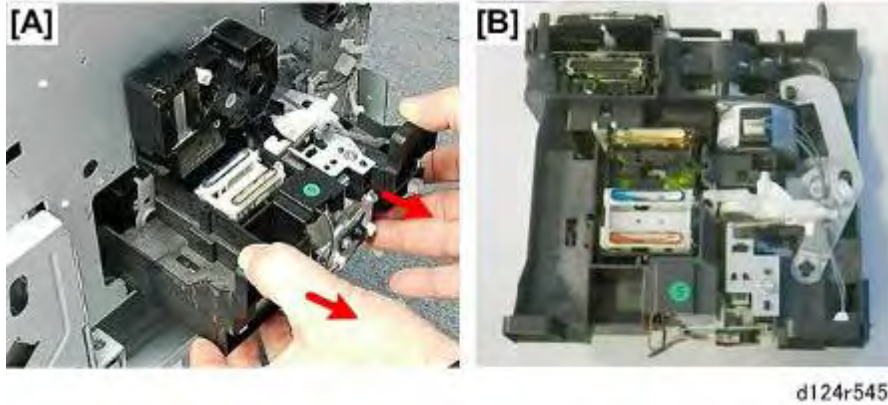

4. Slowly, pull the maintenance unit out of the machine.
5. Lay it down in the location prepared at Step 1.

Reinstallation

The maintenance unit should be cleaned after the ink collector unit,

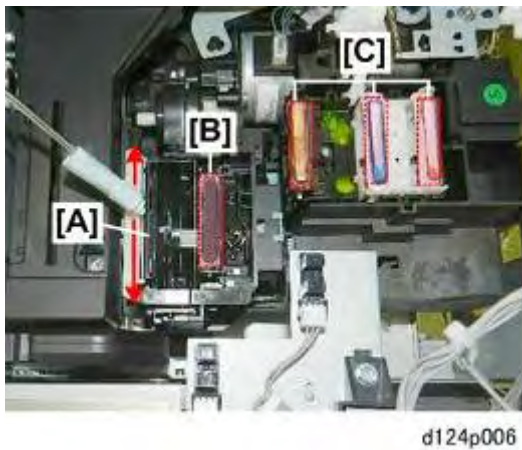

1. Use a linen cloth, dampened very slightly with water and tightly wrapped around the end of a small screwdriver, to remove any ink that has hardened at the following locations:

★ Important

- Make sure the cloth is only slightly damp. Do not allow any water near the protective caps [C]. Water on the caps could seep onto the print head nozzles and dilute the ink.

[A] Wiper and blade

[B] Suction cap

[C] Print head caps (x3)

2. Check the other print head caps and clean if necessary.

★ Important

- Never use cotton, tissue, or any other material that could shred and leave fibers around the suction cap or the print head caps.

Maintenance Unit, Waste Ink Collection

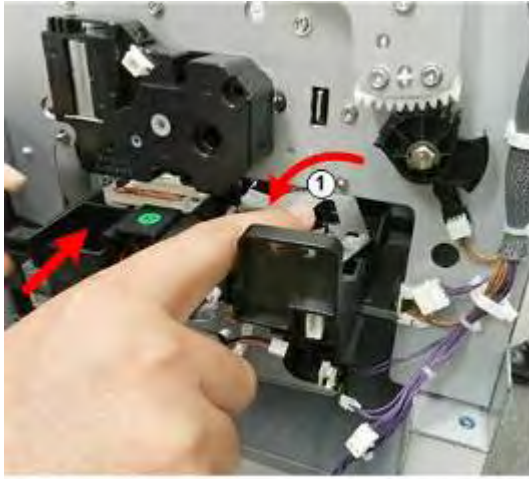

d124r546

3. Insert the unit slowly to avoid damaging the print head caps and suction cap wipers, and press the maintenance lock lever (1) down as you set the unit in the machine.
4. After replacing the maintenance unit with a new one, open **SP2102-001** and then touch [EXECUTE] to reset the maintenance unit counter.

5.12 BOARDS, HDD

5.12.1 PSU

Preparation

- Separate the Main Unit from the Scanner Unit ➤ page 5-16

Remove:

- Rear cover ➤ page 5-44



d124r580

1. The arrow shows the location of the PSU.
2. If you are removing the EU version of the PSU, remove the choke coil.

★ Important

- The choke coil is provided on EU machines only. Go to Step 6 if your machine is not an EU machine.

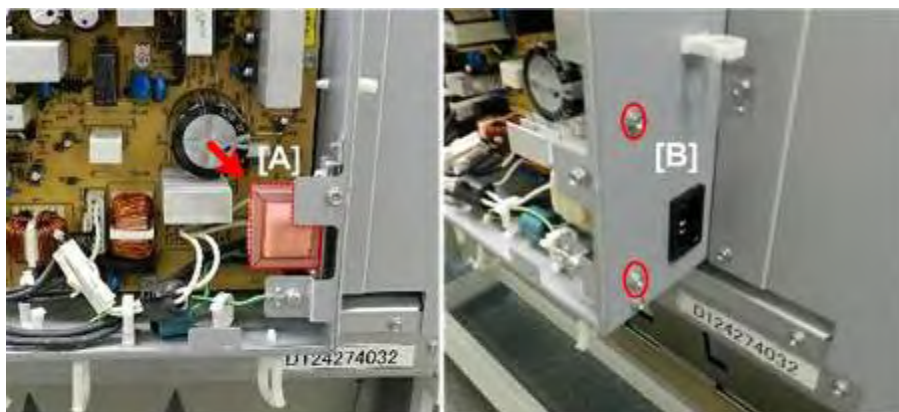

d124r523

3. The choke coil [A] is at the lower right corner of the PSU.
4. Unfasten the coil bracket [B] (⚙ x2).

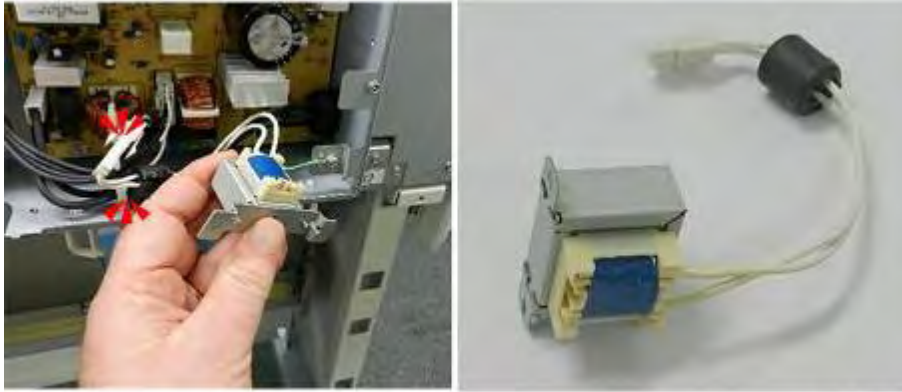

d124r897

5. Disconnect the coil harness and remove the coil (🔌x1, 🌀x1).

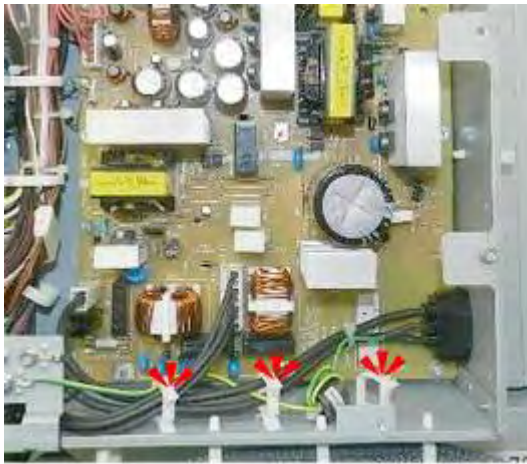

d124d581

6. At the bottom edge of the PSU, open the clamps (🔌x3)



d124r583

7. Release the power cord socket and push it out (👉x2).



d124r584

8. Disconnect the board at the upper left corner (🔌 x4).



d124r585

9. Disconnect the board at the bottom left corner (🔌 x2).

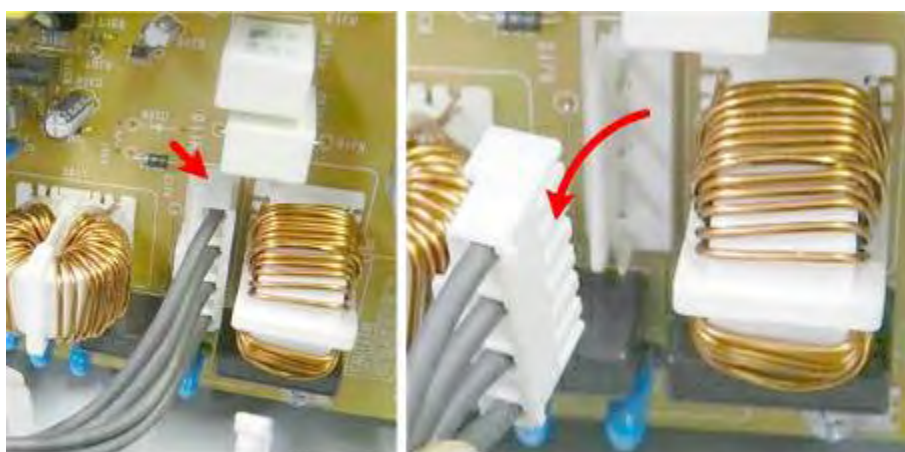

d124r586

10. Disconnect the board between the coils (🔌 x1).

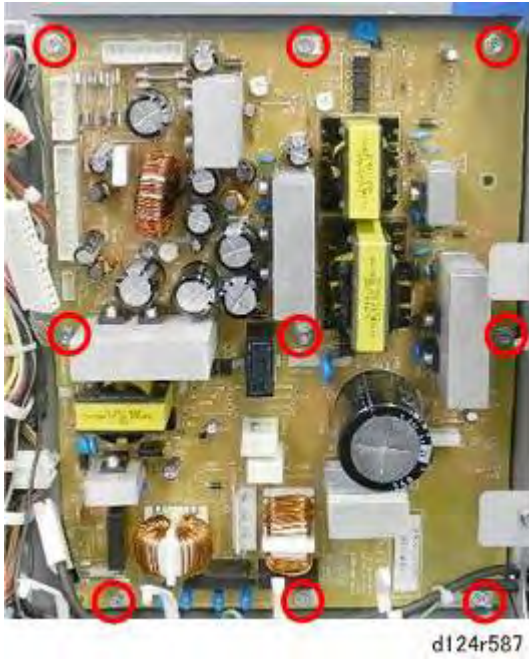

11. Disconnect the board ( x9).

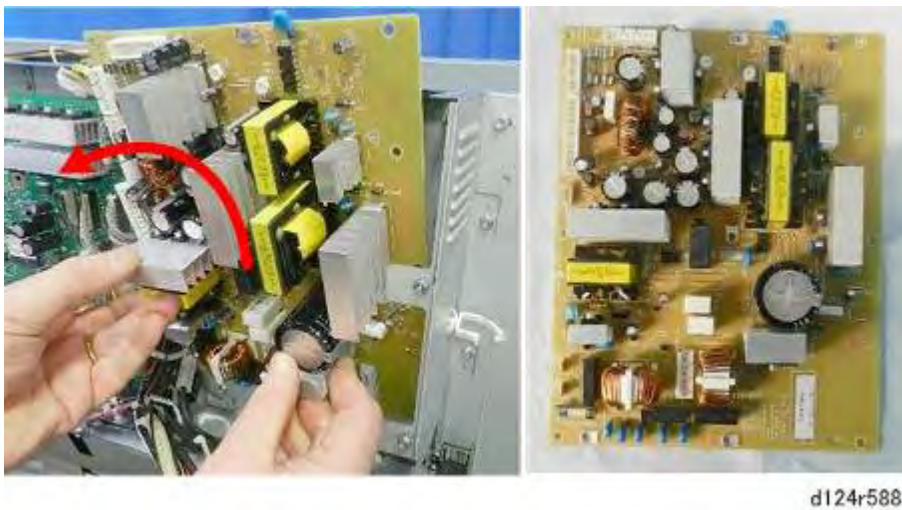

12. Remove the PSU and lay it on a flat clean surface.

Reinstallation



d124r585

1. Reconnect the bayonet connectors with the white connector over the black connector.

5.12.2 MCU

MCU Removal

Preparation

- Separate the Main Unit from the Scanner Unit  page 5-16

Remove:

- Rear cover  page 5-44



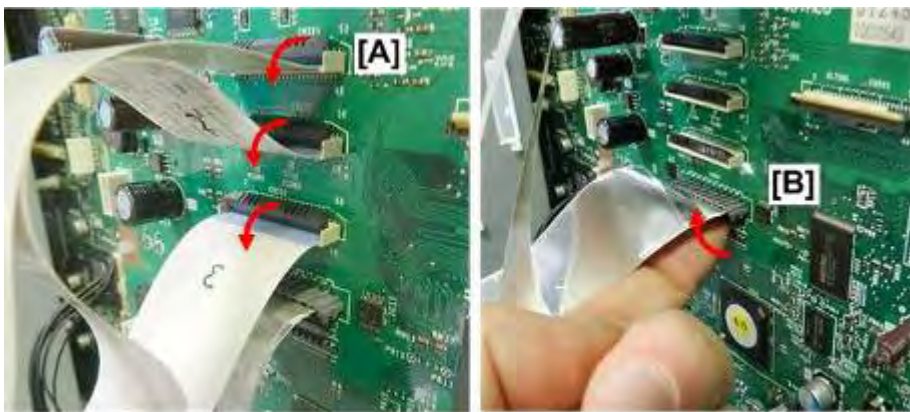

d124r590

1. The arrow shows the location of the MCU.



d124r591

2. Disconnect the first three FFCs [A] (top to bottom) ( x3).
3. Disconnect the 4th FFC [B] ( x1).

Note

- The last FFC rotates up, opposite to the direction of the top three FFCs.

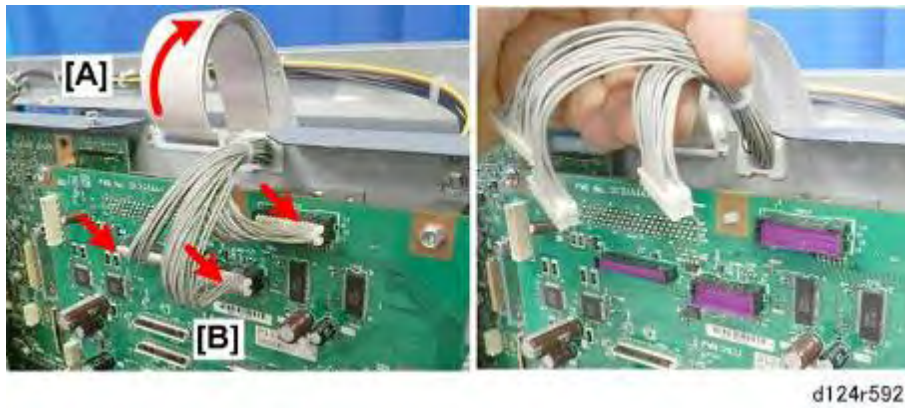

d124r592

4. Lay the disconnected FFCs [A] over the back of the machine.
5. Disconnect the top edge of the board [B] (🔌 x3).



d124r593

6. Open the clamps at the bottom edge of the board (🔧 x5).

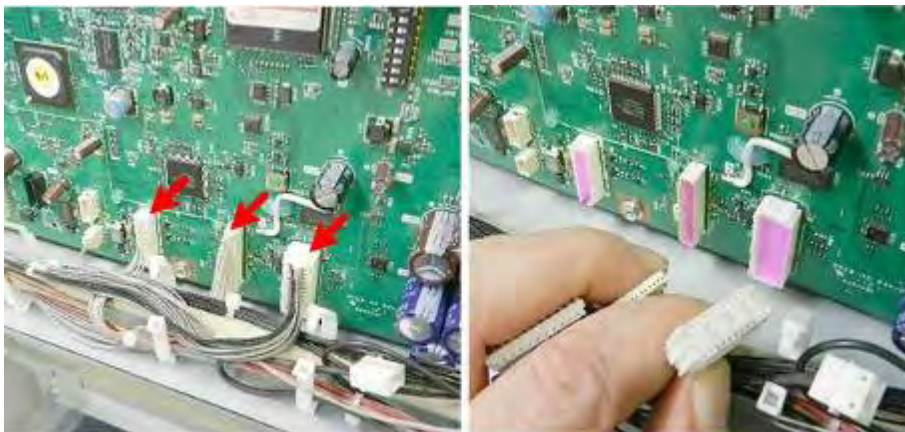

d124r594

7. Disconnect the bottom edge of the board (🔌 x3).

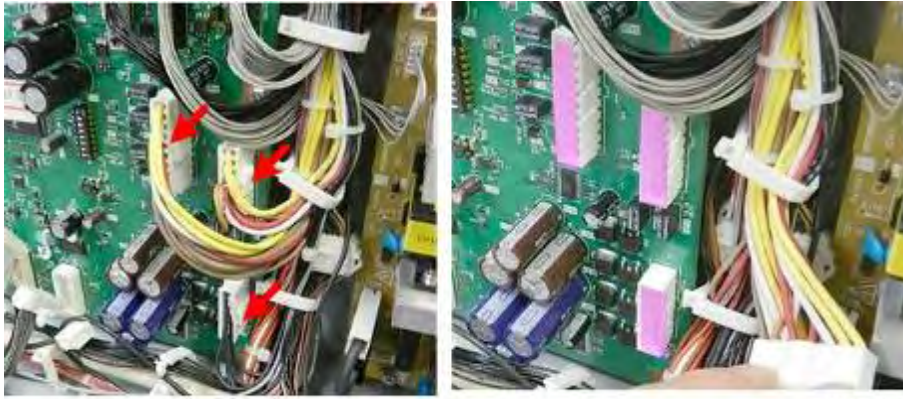

d124r595

8. Disconnect the lower right corner of the board (🔧 x3).



d124r596

9. Disconnect the right edge of the board (🔧 x3).



d1241111

10. Disconnect the scanner I/F cable bracket and push it aside so that you can reach the screw on the lower right corner of the board (🔩 x2)



d124r597

11. Remove the screws ( x8).



d124r599

12. Remove the board and place it on a flat clean surface.

MCU Replacement

If you are going to install a new MCU, you must remove the EEPROM from the old MCU and install it on the new MCU.



1. Locate the EEPROM on the lower left side of the MCU.

★ Important

- The pins of the EPROM are soft and easy to bend. Work carefully when you remove it.

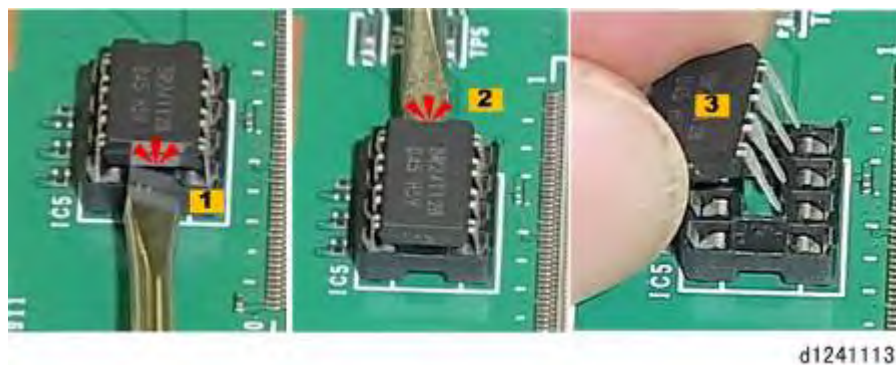

2. If you do not have a chip puller, use the tip of a small screwdriver to raise the bottom [1] of the EEPROM slightly.
3. Raise the top [2] slightly.
4. Alternately raise the bottom and top of the EEPROM slightly until you see it is loose, and then remove it [3].

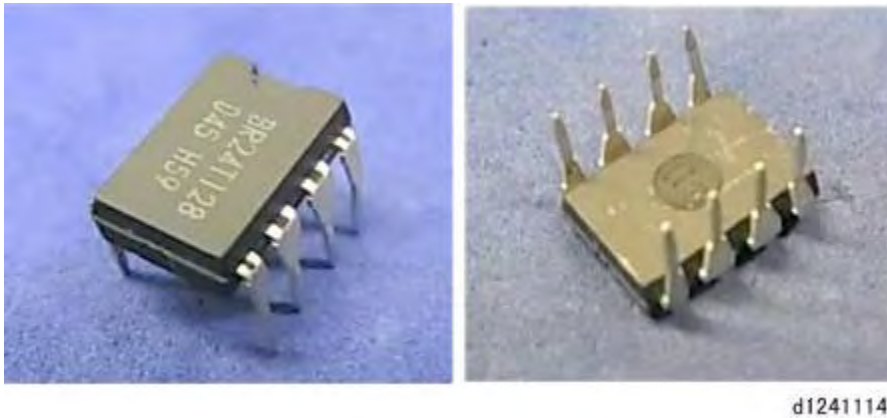

d1241114

5. Check the pins and make sure that they are not bent. Straighten them gently with a small screwdriver if they are bent.

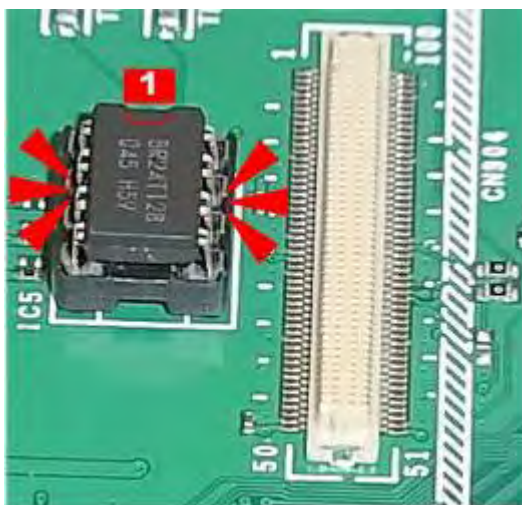

d1241115

6. Position the EEPROM on the socket of the new board so the semi-circular indentation [1] is pointing up.
7. Make sure each pin is matched with a hole, and then press down to insert the EEPROM.

5.12.3 RFDB (OPTION)

The RFDB is the board provided with Roll Unit 2 (an option).

Preparation

- Separate the Main Unit from the Scanner Unit ➤ page 5-16

Remove:

- Rear cover ➤ page 5-44



d124r600

1. The arrow shows the location of the RFDB.



d124r601

2. Disconnect the board at [A] and [B] (⚙️ x2, 🔧 x2).



d124r602

3. Release the bottom edge (🔧 x2).



d124r603

4. Remove the board and lay it on a flat clean surface.

5.12.4 CONTROLLER BOARD, NVRAM

Preparation

- If you are going to replace the controller board, be sure to upload the NVRAM data to an SD card with SP5824. [▶ page 6-14](#)
- Separate the Main Unit from the Scanner Unit [▶ page 5-16](#)

Remove:

- Rear cover [▶ page 5-44](#)



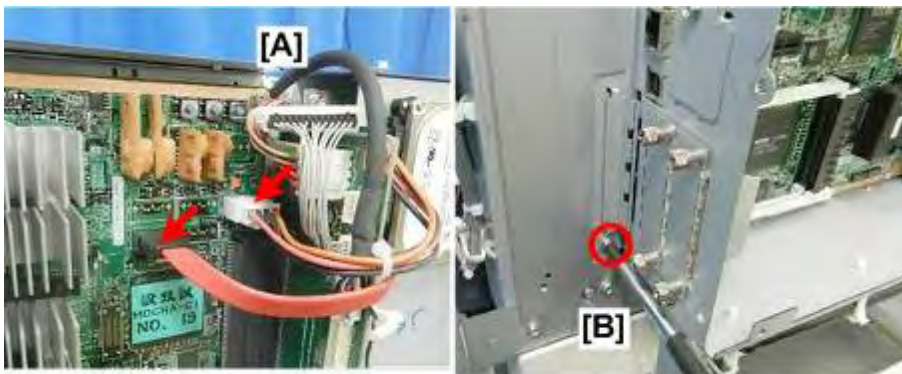

d124r604

1. The arrow shows the location of the controller board.



d124r605

2. Disconnect the right upper corner of the board [A] ( x2).
3. Disconnect the SD card slot cover [B] ( x1).



4. Remove the SD card slot cover.
5. If there are any optional boards installed, remove them now (🔧 x2). (The photo above shows no boards installed.)



6. Remove the board lock screw (🔧 x1).



7. Slowly, pull the board out and lay it on a clean flat surface, and then remove the screws (🔧 x7).

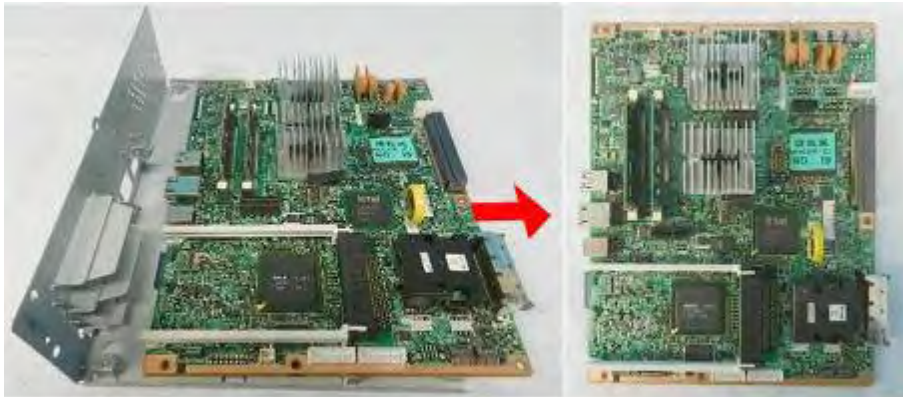

d124r609

8. Pull the board to the right to separate it from its mounting plate.

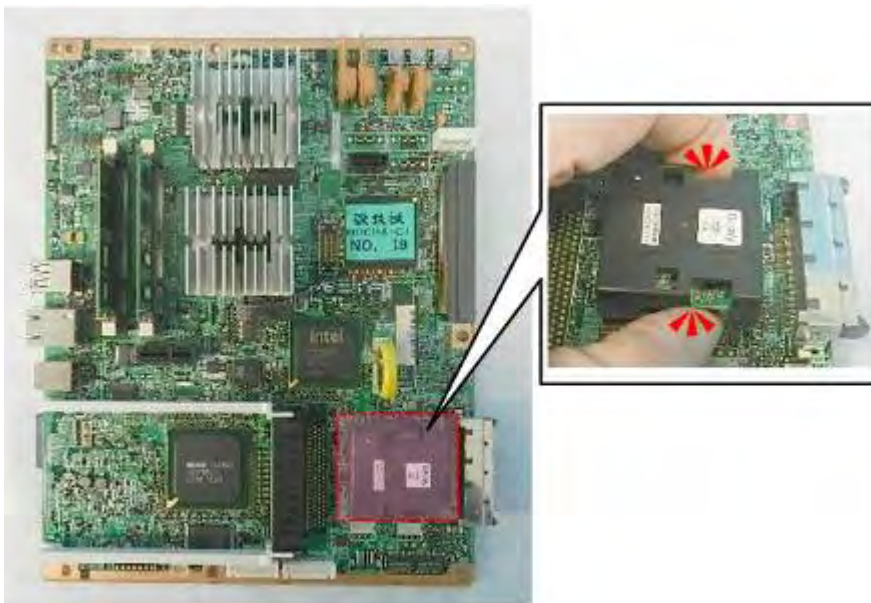

d124r610

9. Depress both sides of the NVRAM to release them.



d124r611

10. If you are installing a new controller board, attach the NVRAM from the old board to the new

controller board.

5.12.5 MOTHERBOARD

Preparation

- Separate the Main Unit from the Scanner Unit ➤ page 5-16

Remove:

- Rear cover ➤ page 5-44
- Controller Board ➤ page 5-286

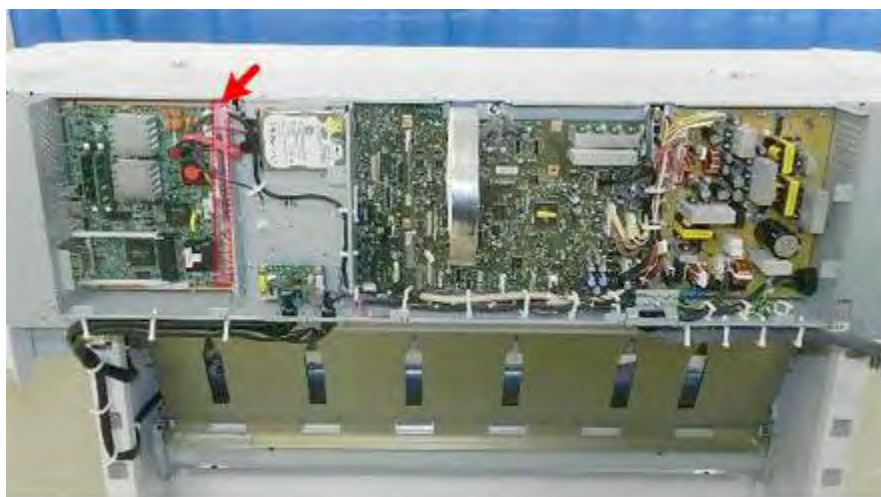

d124r612

1. The arrow shows the location of the motherboard. The motherboard is mounted sideways between the controller board and the HDD bracket, so it is difficult to see.



d124r613

2. Disconnect the mother board (⚙️ x4, 🔌 x1, 🔧 x1).



d124r614

3. Remove the motherboard bracket ( x1).



d124r615

4. Separate the motherboard and bracket ( x1).

5.12.6 HDD

Preparation

- Separate the Main Unit from the Scanner Unit ➤ page 5-16

Remove:

- Rear cover ➤ page 5-44
- Controller Board ➤ page 5-286
- Motherboard ➤ page 5-289



d124r616

1. The arrow shows the location of the HDD.

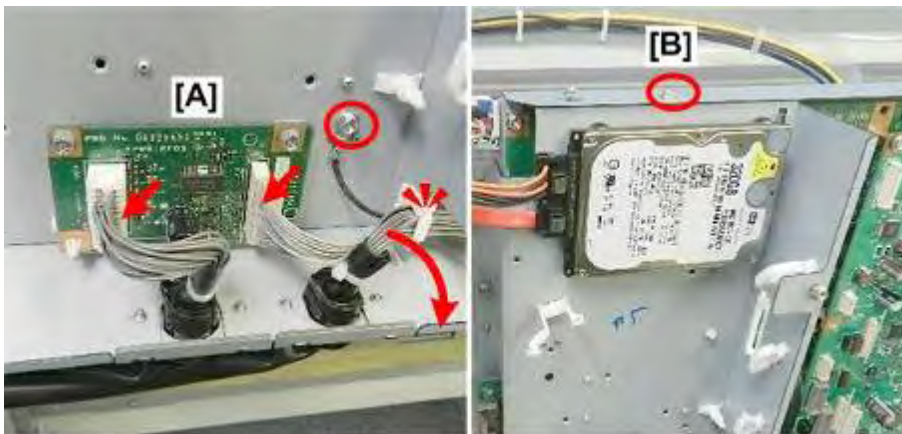

d124r616

2. Disconnect the RFDB [A] and ground wire (⚡x2, 🔧x1, 🗑️x1).
3. Disconnect the top of the HDD bracket [B] (🔧x1).

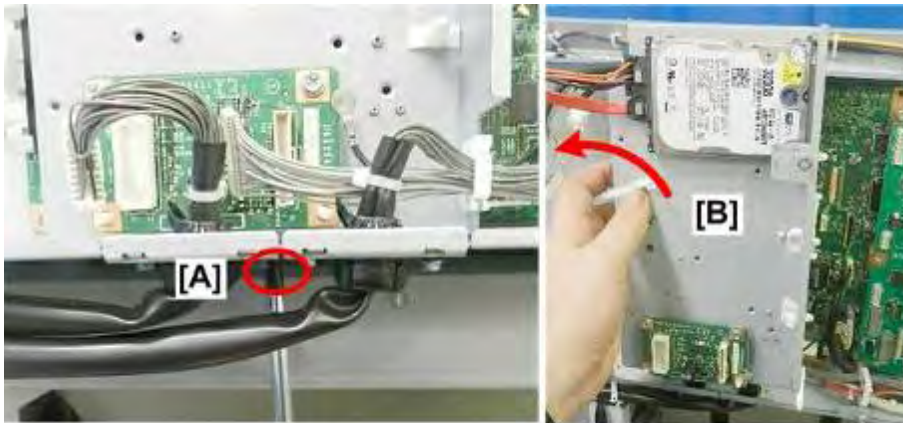

d124r618

4. Disconnect the bottom of the HDD bracket [A] ( x1).
5. Remove the bracket [B] with the HDD and RFDB attached.

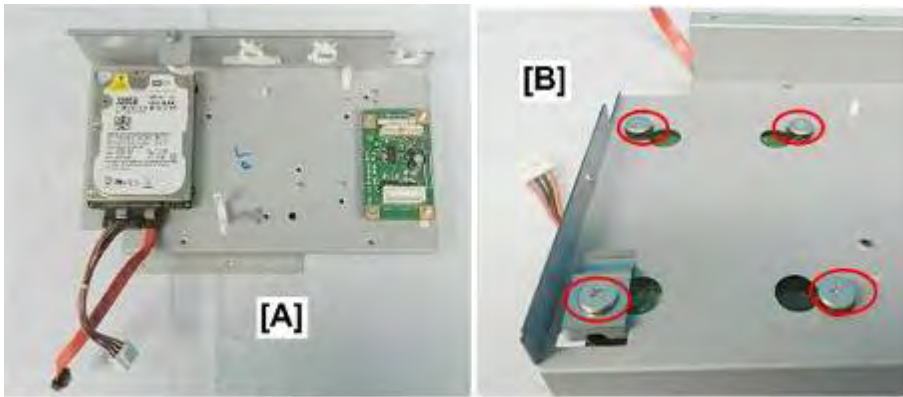

d124r619

6. Lay the HDD bracket [A] on a flat clean surface.
7. Turn it over and remove the screws [B] ( x4).



d124r620

Re-installation

★ Important

- Formatting a new hard disk with **SP5832-001** is not required but it is strongly recommended.
 - You must always execute **SP5853** after replacing or formatting the HDD to download the fixed stamp data from NVRAM. If this is not done, the operator will not have access to the fixed stamps.
 - After downloading the stamp data, you must cycle the machine off/on.
1. Turn the machine on and enter the SP mode.
 2. If you are installing a new HDD, do **SP5832-001** to format the hard disk.
 3. Open **SP5853** and then touch [EXECUTE]. A screen will display "Loading" as the stamp data is downloaded.
 4. When you see "Completed", the download is finished.
 5. Touch [Exit].
 6. Cycle the machine off/on.

5.12.7 IPU

Preparation

- Separate the Main Unit from the Scanner Unit ➤ page 5-16

Remove:

- Rear cover ➤ page 5-44
- Controller Board ➤ page 5-286
- Motherboard ➤ page 5-289

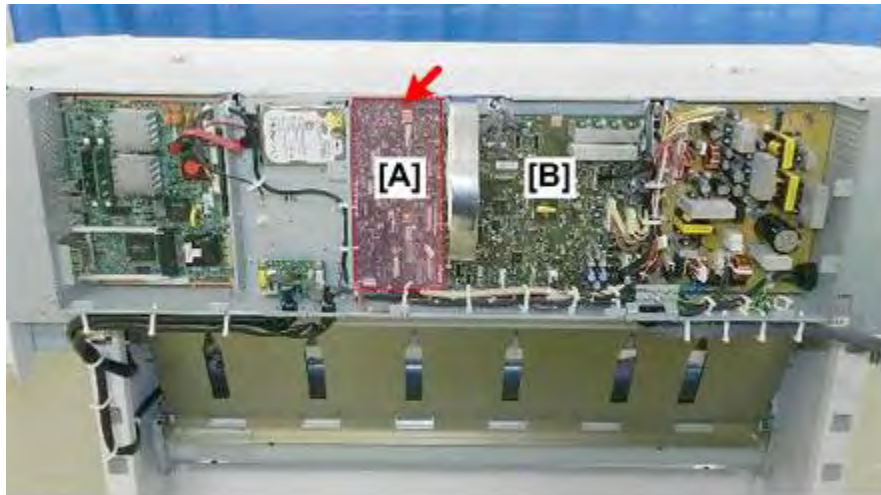

d124r621

1. The arrow shows the location of the IPU [A]. The IPU is mounted behind the MCU and the HDD bracket, so only part of it is visible.
2. First, remove the MCU [B]. ➤ page 5-278



d124r623

3. Disconnect the bottom of the IPU (Ⓜ x3).

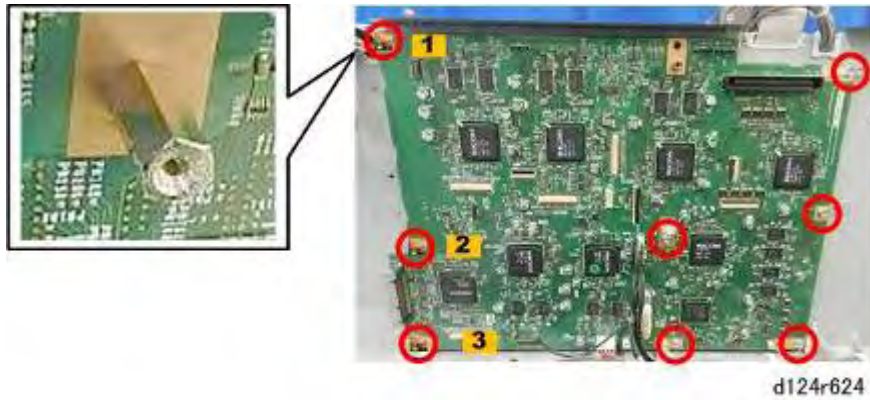



4. Disconnect the board ( x8).
 - Screws [1], [2], and [3] are post screws. Each holds one of the screws to attach the MCU in front of the IPU.
 - Remove and reattach each post screw with fingers. The screw should be finger-tight only (not tightened with a wrench).



5. Remove the IPU and lay it on a flat clean surface.

5.12.8 HRB

Preparation

- Move the Carriage Unit with SP2102-4  page 5-37
- Separate the Main Unit from the Scanner Unit  page 5-16

Remove:

- Top cover  page 5-29
- Front cover  page 5-31
- Paper exit guide  page 5-32



d124r477

1. Remove the front cover ( x2).



d124r478

2. Disconnect the FFCs on the left ( x2).



d124r479

3. Disconnect the FFCs on the right ( x2).



d1241085

4. Remove the front wire retainer.

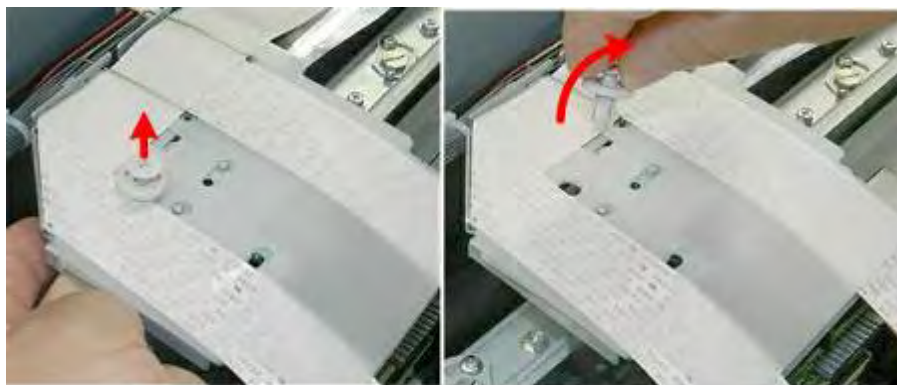

d1241086

5. From under the plate, push the plastic screw up and then remove it.

Replacement
and
Adjustment

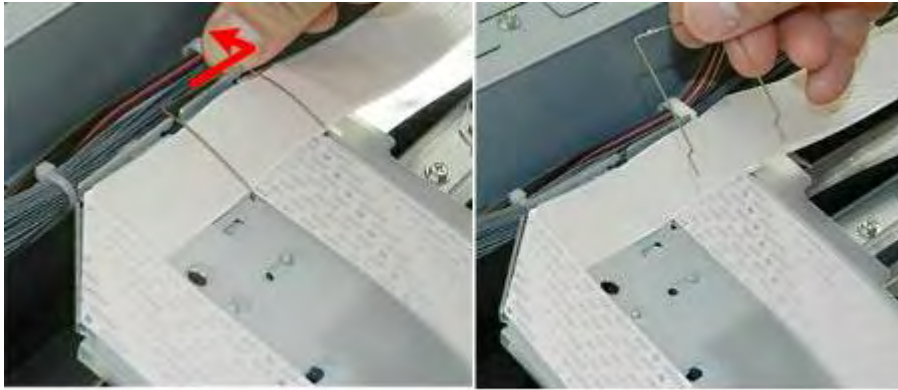

d1241087

6. Push the wire guide to the right to release it, and then remove it.

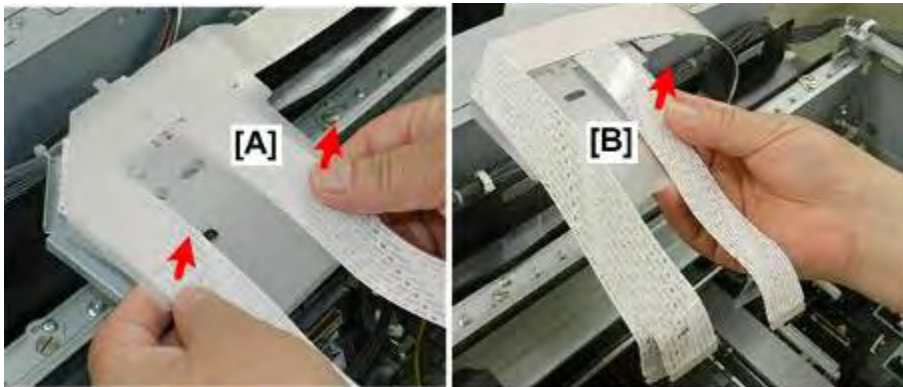

d1241088

7. Separate the semi-transparent cover sheet and the FFC guide, and then set them aside on top of the machine.

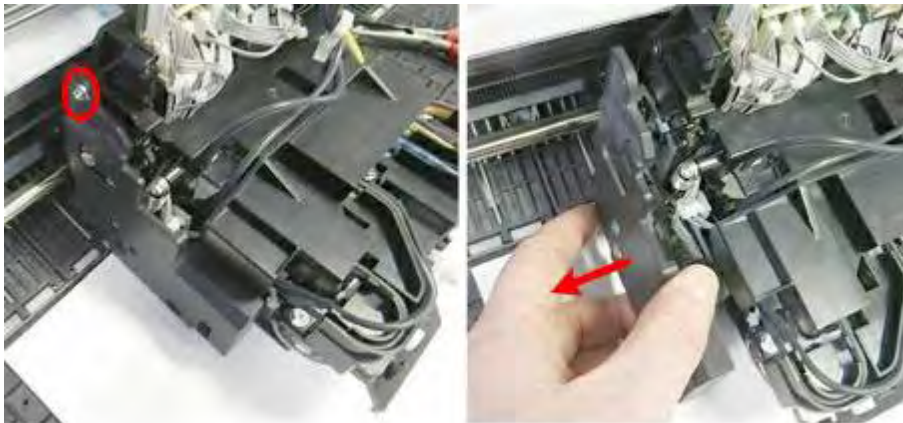

d124r629

8. Remove the left cover of the carriage unit ( x1).

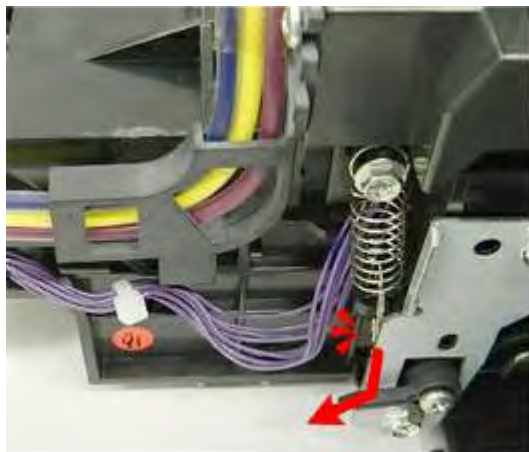

d124r483

9. At the front of the machine, release the spring on the right side of the carriage unit.

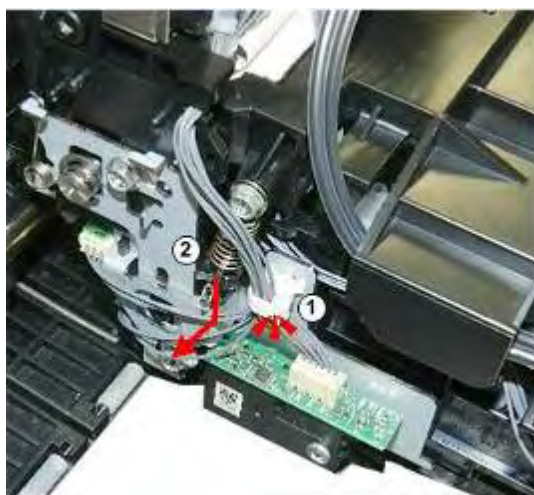

d124r484

10. Open the clamp and release the spring on the left side of the carriage unit.

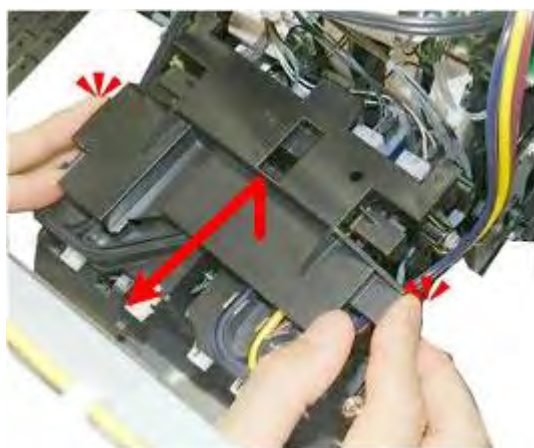

d124r485

11. Remove the top cover.

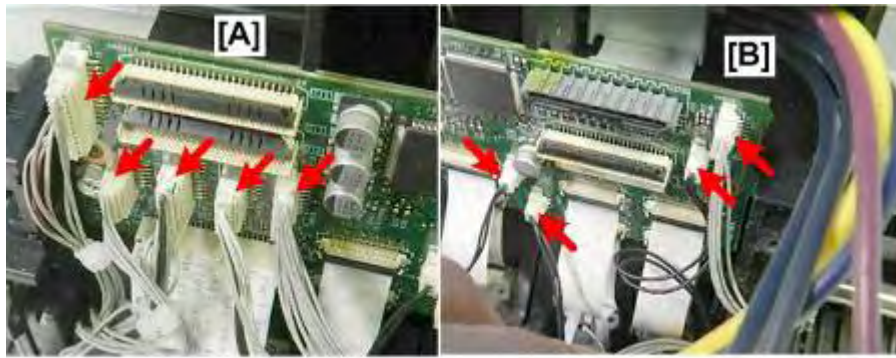

d124r633

12. Disconnect the left side of the board [A] (🔌 x5).
13. Disconnect the right side of the board [B] (🔌 x4).

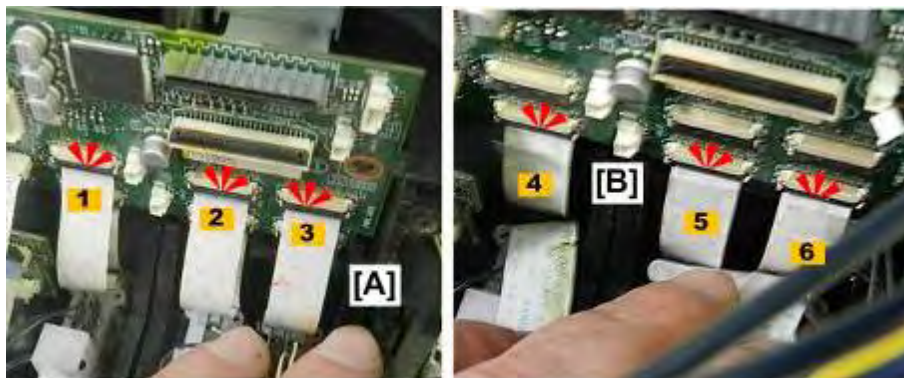

d124r634

14. Disconnect the upper set of FFCs (🔌 x3).
15. Disconnect the lower set of FFCs (🔌 x3).

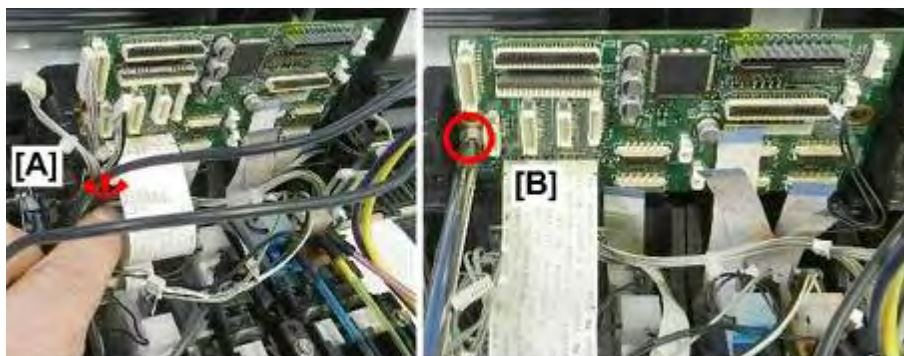

d124r635

16. Disconnect the wide FFC [A] on the left (🔌 x1).
17. Disconnect the board (🔌 x1).

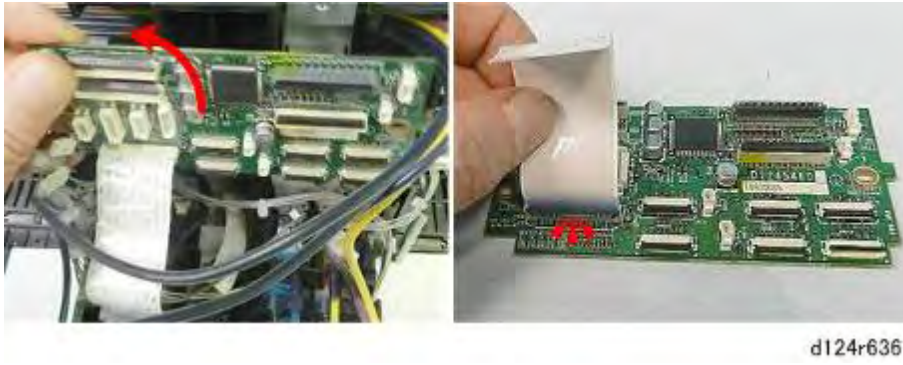

18. Remove the board, lay it on a flat clean surface, and then disconnect the FFC ( x1).









5.13 SWITCHES

5.13.1 FRONT COVER SWITCHES

Preparation

- Separate the Main Unit from the Scanner Unit  page 5-16

Remove:

- Paper rolls  page 5-18
- Top cover  page 5-29
- Front cover  page 5-31
- Ink cartridge cover  page 5-23
- Roller Cover  page 5-35
- Paper exit guide  page 5-32



d124r558

1. The arrows show the locations of the two front cover switches

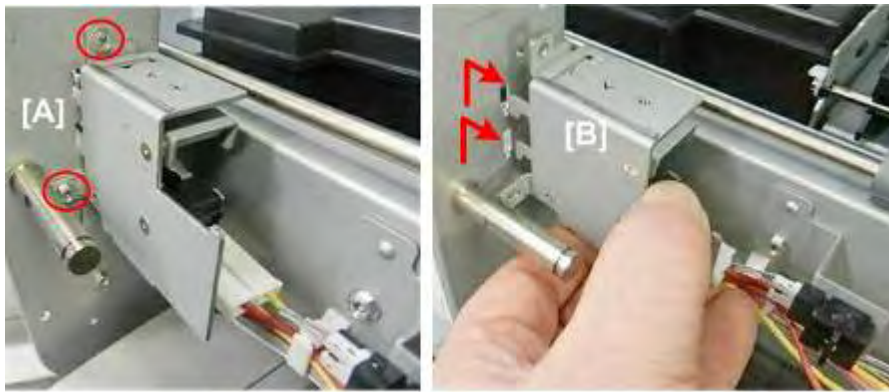

Front Cover Switch: Left

d124r550

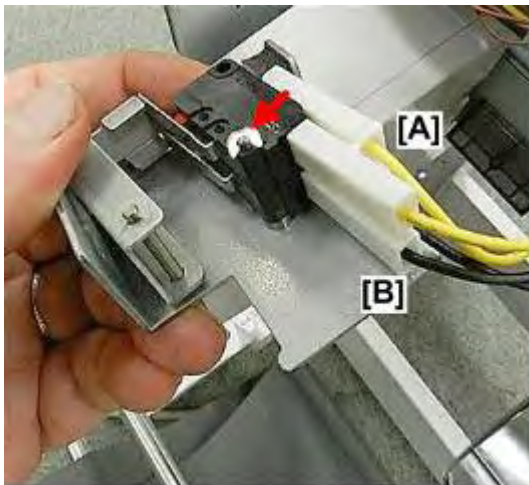
1. Disconnect the left front cover switch bracket [A] ( x2).
2. Remove the bracket [B].



d124r551

3. Disconnect the switch post ( x1)
4. Lift the switches off the post and then disconnect them:
 - [A] Front cover interlock switches ( x2: Yellow)
 - [B] Horizontal cover interlock switches ( x2: Black)

Front Cover Switch: Right

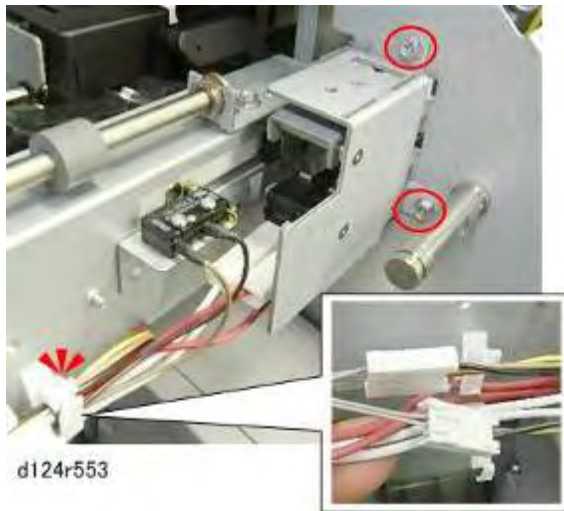

1. Disconnect the right front cover switch ( x2,  x1).

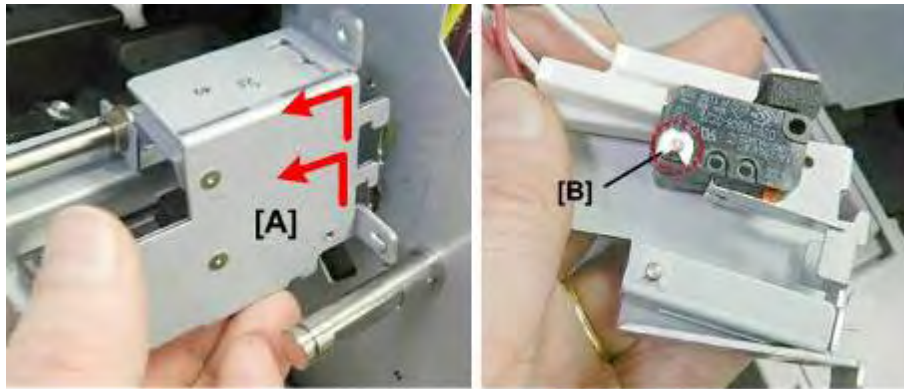

2. Remove the switch bracket [A].
3. Disconnect the switch post [B] ( x1).

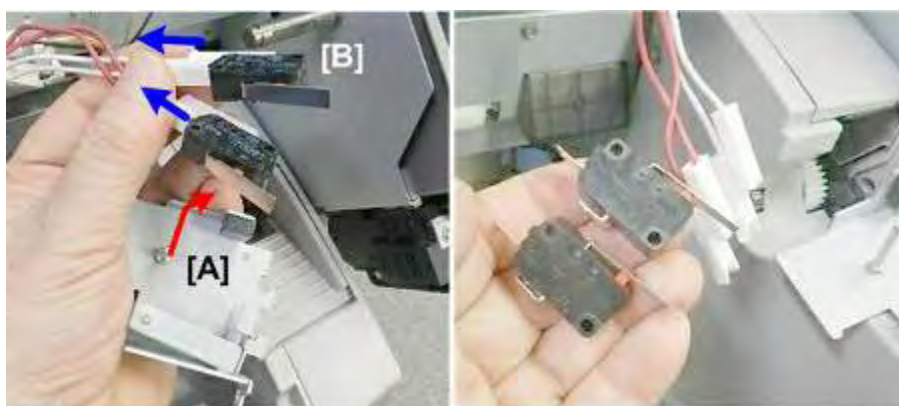

4. Lift the switches off the post [A].
5. Disconnect the switches [B] ( x2).

Front Door Track Switch

Preparation

- Left cover  page 5-25





d1241117

1. The front door track switch is located on the outer side of the left post.



d1241118

2. Raise the front cover.
3. Disconnect the switch bracket ( x1,  x1).



d1241119

4. Separate the lever and bracket.

Switches

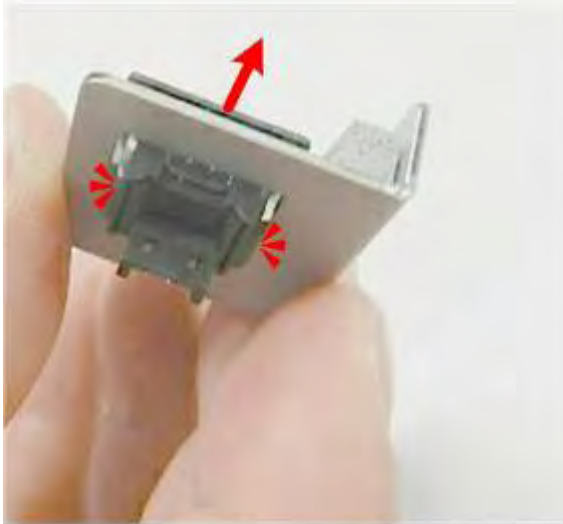

d1241120

5. Depress the releases on both sides of the switch, and then remove it.

Reinstallation



d1241121







1. Hold the reassembled bracket and switch as shown.
2. Insert the tip of the lever into the hole behind the rubber block.

5.13.2 PAPER EXIT GUIDE SWITCH

Preparation

- Separate the Main Unit from the Scanner Unit  page 5-16

Remove:

- Paper rolls  page 5-18
- Top cover  page 5-29
- Front cover  page 5-31
- Ink cartridge cover  page 5-23
- Roller Cover  page 5-35
- Paper exit guide  page 5-32

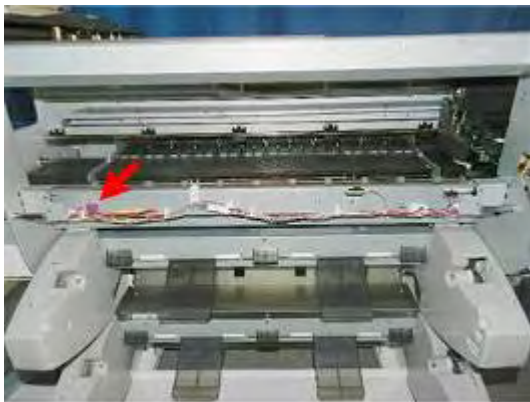

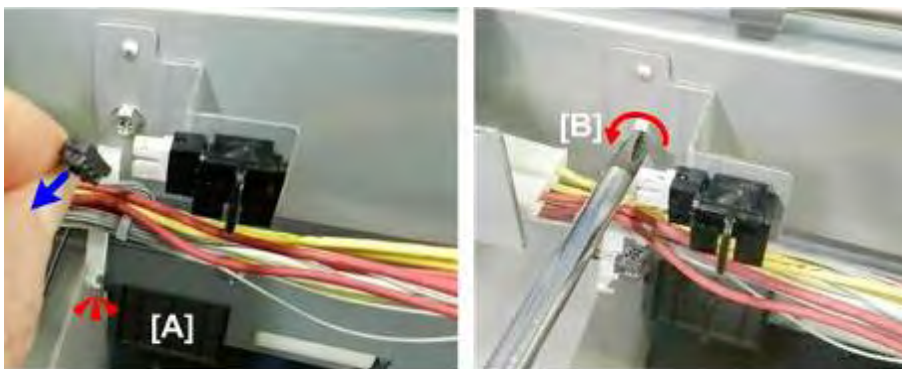

d124r559

1. The arrow shows the location of the paper exit guide switch.



d124r556

2. Disconnect the sensor [A] ( x1,  x1).
3. Remove the bracket [B] ( x1).

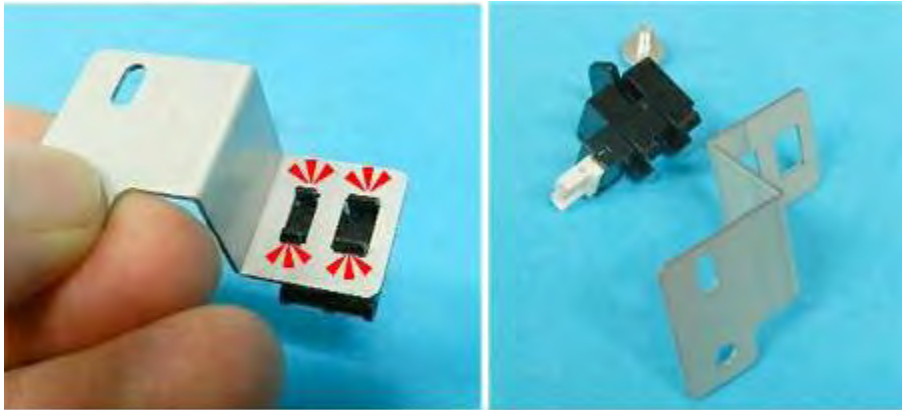

d124r557

4. Separate the sensor and bracket (🔧 x4).

5.13.3 INK COLLECTOR COVER SWITCH

Preparation

- Separate the Main Unit from the Scanner Unit 🛠 page 5-16

Remove:

- Right cover 🛠 page 5-19
- Right upper cover 🛠 page 5-21

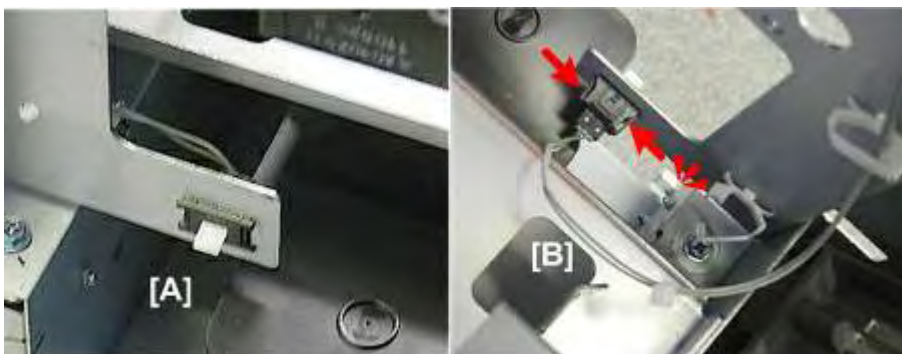

d124r560

1. Locate the switch [A] on the right side of the machine.
2. Release the harness and switch [B] (🔧 x1).



3. Pull the switch through the frame and disconnect it (🔧 x1).

5.13.4 INK CARTRIDGE COVER SWITCH

Preparation

- Separate the Main Unit from the Scanner Unit ➤ page 5-16

Remove:

- Right cover ➤ page 5-19
- Right upper cover ➤ page 5-21
- Ink cartridge cover ➤ page 5-23
- Front cover ➤ page 5-31



d124r562

1. Locate the switch [A] above the ink supply unit.
2. Disconnect the switch [B] (ⓘ x1).

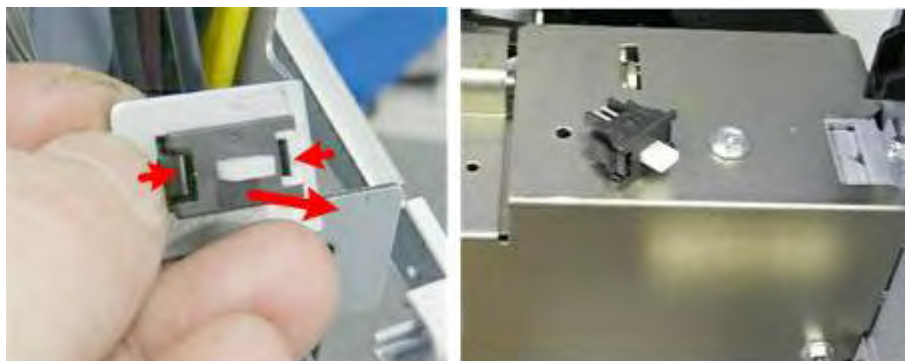

d124r563

3. Depress both sides of the switch to release it, and then push it out.

5.13.5 ORIGINAL STOP SWITCH

Preparation

- Raise the Scanner Unit



d124r701

1. The switch cover is fastened by four hooks under the scanner unit cover on the right side.

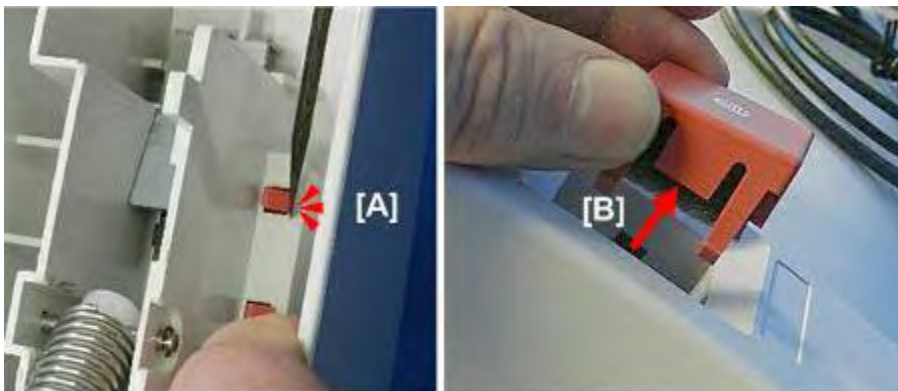

d124r702

2. Use the tip of a small screwdriver [A] to release the switch cover (▼ x4).
3. On top of the scanner cover [B], remove the switch cover.



d124r703

4. Remove the switch cover plate (🔧 x1).

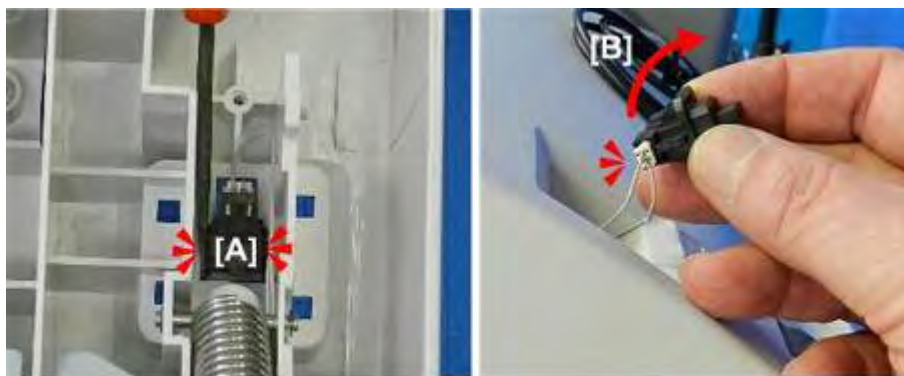

d124r704

5. Use the tip of a small screwdriver to release both sides of the switch [A].
6. On top of the scanner cover [B], remove and disconnect the switch [B] (x1).



d124r705

5.14 PRINT HEAD CLEANING AND ADJUSTMENT

5.14.1 MAINTENANCE MENU ADJUSTMENTS

There are seven important adjustments on the Maintenance Menu.

1. Press the  button on the operation panel.

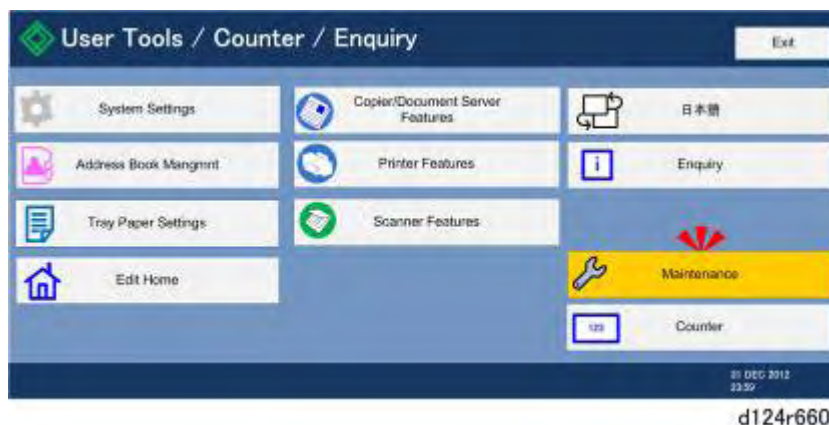

2. Touch [Maintenance] to open the Maintenance Menu.

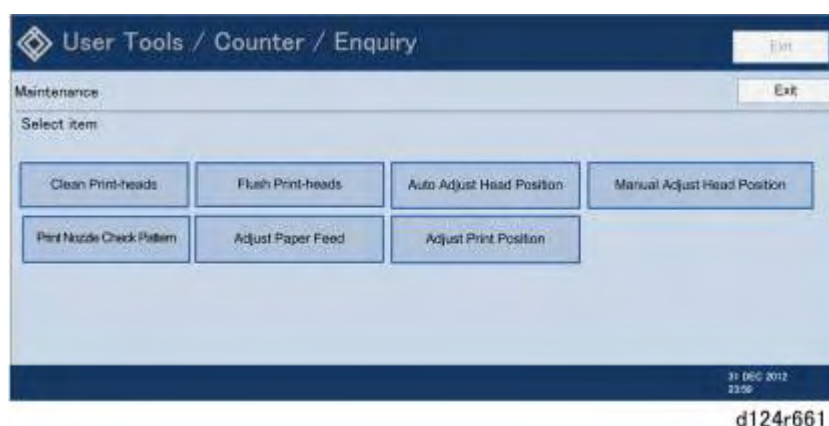

These are the seven adjustments on the Maintenance Menu.

- **Clean Print-heads.** Clean the print heads when you see broken lines or white patches in the Nozzle Check Pattern. Cleaning consumes ink. Never clean the print heads unless the Nozzle Check Pattern is abnormal.
- **Flush Print-heads.** Flush the print heads only after three consecutive cleanings and three checks of the Nozzle Check Pattern show that the problem has not been corrected.
- **Auto Adjust Print Head Position.** Do this procedure if you see broken vertical lines or blurred, smeared, or streaked colors.
- **Manual Adjust Head Position.** Do this procedure if the "Auto Adjust Print Head Position" execution fails.
- **Print Nozzle Check Pattern.** Print a Nozzle Check Pattern to detect blockages in the flow of ink from one or more of the print heads. Clean the print heads up to three times. If the third cleaning fails, flush the print heads.

- **Adjust Paper Feed.** Do this procedure if you see broken horizontal lines, patchy images, or white lines at regular intervals in your printouts.
- **Adjust Print Position.** Do this procedure to adjust the print start position at the upper left corner of each sheet where printing starts.

5.14.2 NOZZLE CHECK, CLEAN AND FLUSH PRINT HEADS

Nozzle Check

★ Important

- Always print the Nozzle Check Pattern before cleaning or flushing the print heads.

- Press the  button on the operation panel.
- Touch [Maintenance].

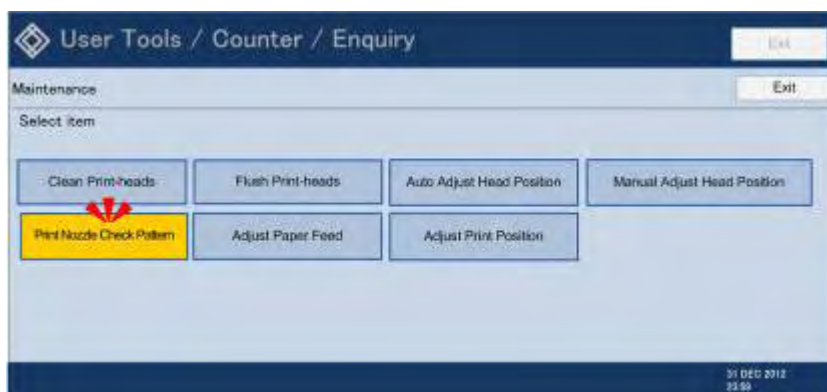

d124r682

- Touch [Print Nozzle Check Pattern].

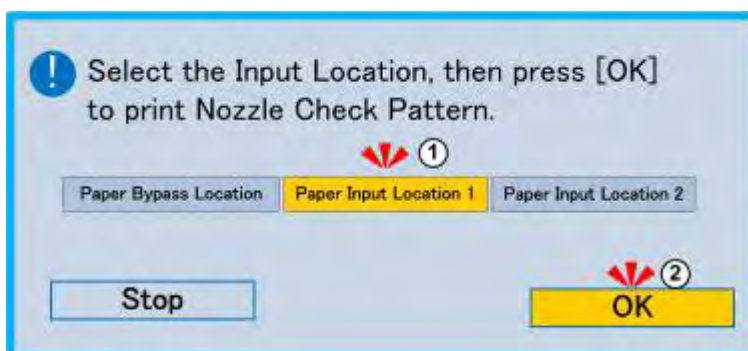

d124r683

Selection	Feed Station
Paper Bypass Location	Bypass feed
Paper Input Location 1	Roll Unit 1
Paper Input Location 2	Roll Unit 2 (Option)

- The first selection will not display if paper is not set for bypass feed.
 - The third selection will not display if Roll Unit 2 is not installed.
- Select the paper feed station and then touch [OK]. A message will ask you to wait while the pattern is printing.
 - When the message prompts you that the pattern printing has completed, touch [Exit].

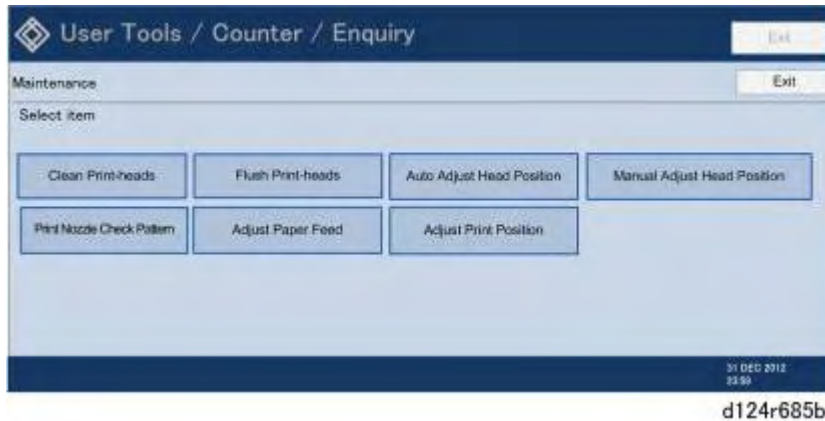

- The display loops back to the Maintenance Menu. Check the Nozzle Check Pattern.

Normal

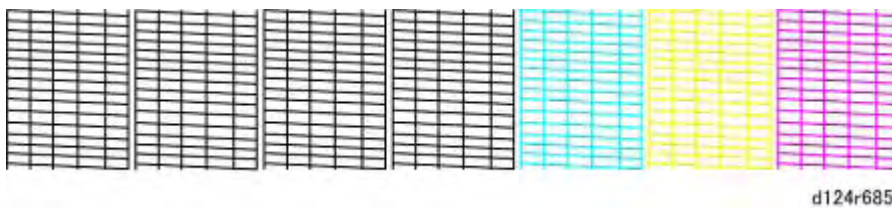

- The print heads are operating normally if none of the lines are broken.

Abnormal

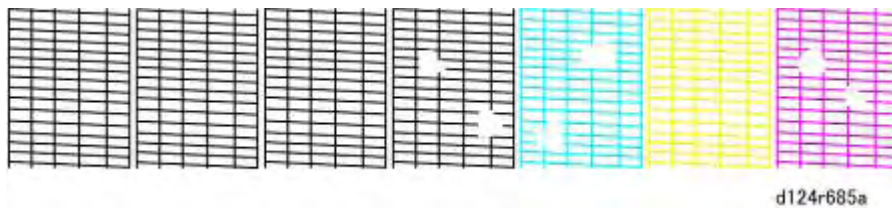

- If you see bare patches caused by broken lines, one or more print head need cleaning or flushing.

- Go to the next section to clean the print heads.

Clean Print Heads

★ Important

- Print head cleaning consumes ink. Do this procedure only after you have detected broken lines or white patches in the printed Nozzle Check Pattern.

1. First, always check the ink level indicator in the printer driver to confirm that there is ink in the cartridge.

↓ Note

- If one or more ink tanks are empty, replace the ink cartridge, and then print another Nozzle Check Pattern.

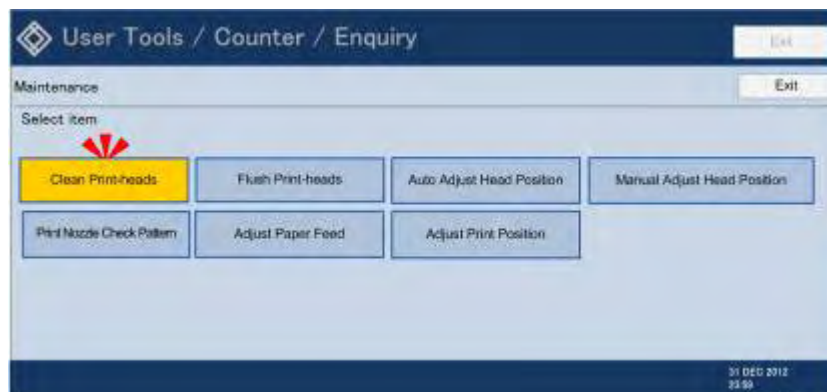

d124r662

2. Touch [Clean Print-heads].

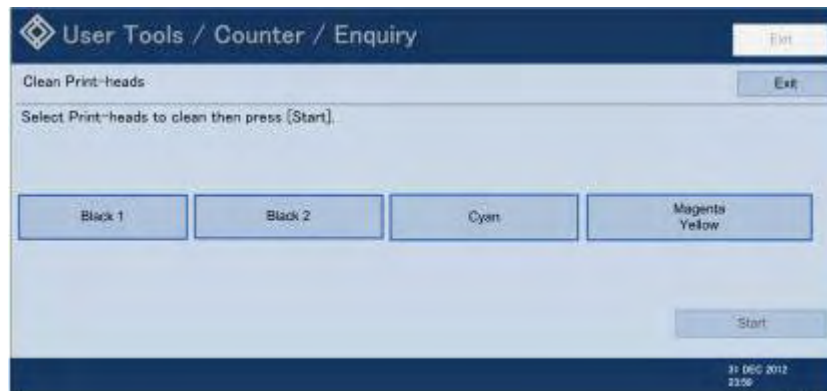

d124r663

- There is one selection for each print head unit.

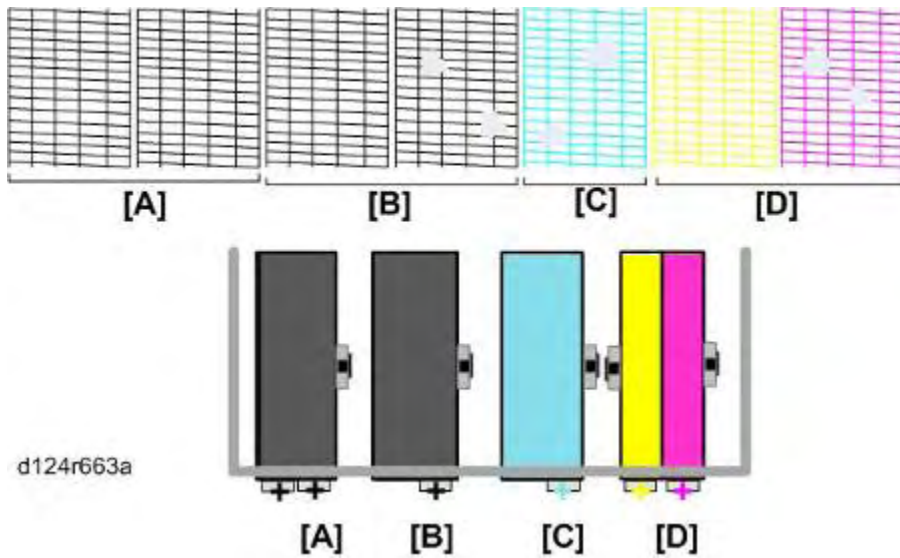

[A]	Black 1	Normal
[B]	Black 2	Abnormal
[C]	Cyan	Abnormal
[D]	Magenta, Yellow	Abnormal

- The Nozzle Check Pattern in this example shows that three print heads require cleaning.



- Touch each selection once to select the print head for cleaning, and then touch [Start]. A message will ask you to wait while the print heads are being cleaned.
 - Cleaning one print head takes about 60 sec.
 - The Magenta and Yellow print heads require about 120 sec.
- When the message tells you that print head cleaning has completed, touch [Exit].

Print Head Cleaning and Adjustment

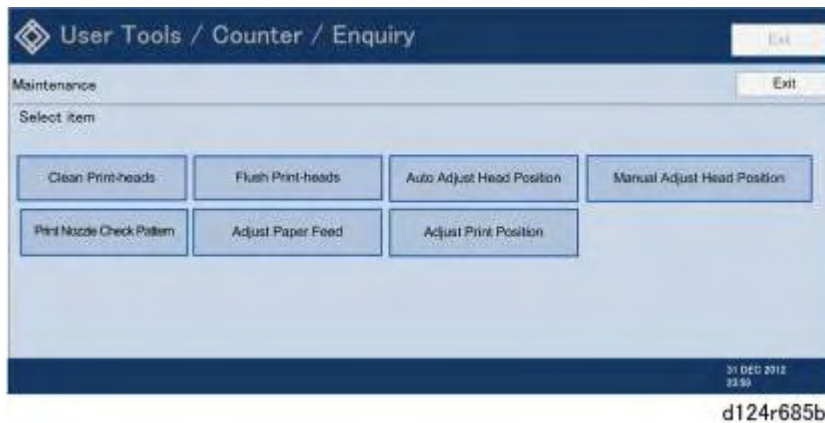

3. The display loops back to the Maintenance Menu. Print another Nozzle Check Pattern and check the results.
4. If one or more pattern is abnormal, repeat the cleaning procedure from Step 3.
5. Print another Nozzle Check Pattern and check the results.
6. If one or more pattern is abnormal, repeat the cleaning procedure from Step 3. Be sure to select only the print head where the pattern is broken.
7. After the third cleaning, if one or more of the patterns is abnormal, go to the next section and flush the print head where the pattern is abnormal.

★ Important

- Print head flushing consumes a significant amount of ink.
- Never flush the print heads until three print head cleanings have failed to solve the problem.

Flush Print Heads

★ Important

- Flushing a print head consumes ink. Never flush a print head until you have followed the procedure above to clean it at least three times.

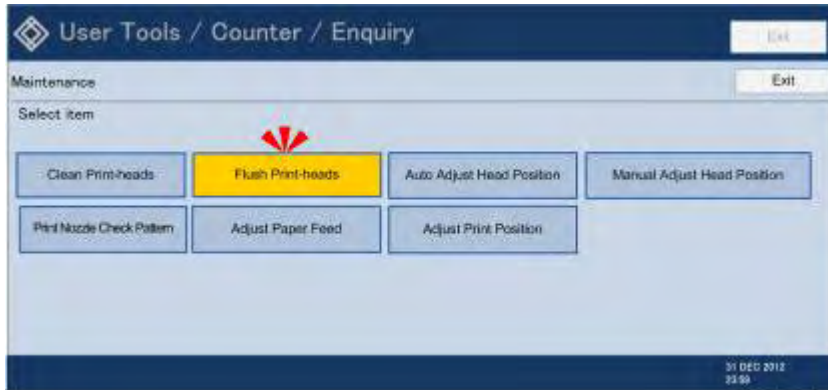

d124r665

1. Touch [Flush Print-heads].

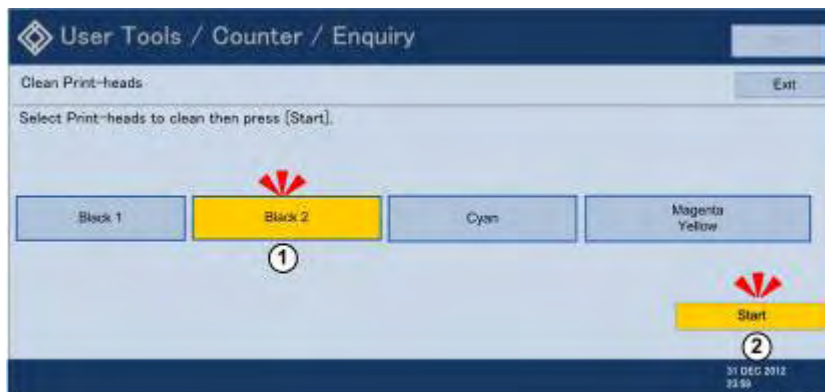

d124r666

2. Select the print head where the pattern is broken, and then touch [Start]. A message asks you to wait while the print head is flushing. Flushing a print head requires about 3 min.
3. When the message tells you that the flushing is completed, touch [Exit].

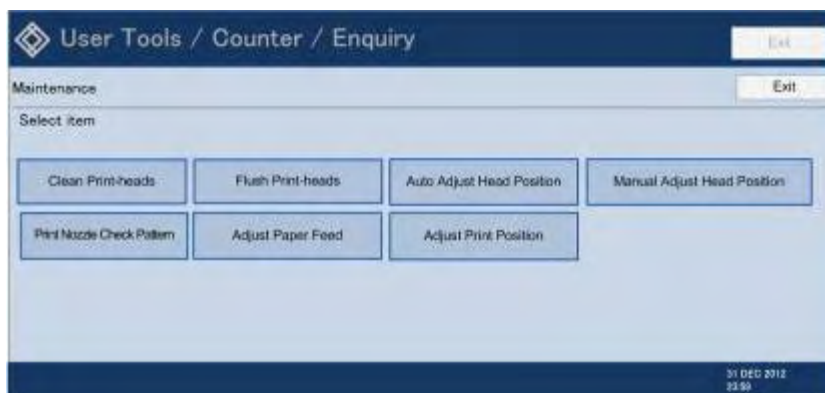

d124r685b

4. The display will loop back to the Maintenance Menu. Touch [Print Nozzle Check Pattern] to print another Nozzle Check Pattern.

Replacement and Adjustment

5. If the pattern is still broken after three cleanings and one flushing, go to the next section.

When Printing Cannot Be Restored

Do this procedure if three cleanings and one flushing have failed to produce an unbroken Nozzle Check Pattern.

1. Make sure that the ambient temperature and humidity are within the acceptable range:
 - Temperature Range: 10°C to 27°C (50 °F to 81°F)
 - Humidity Range: 15% to 80% Rh
2. Clean the print heads once, and then print a Nozzle Check Pattern.
3. If the Nozzle Check Pattern is abnormal, let the machine remain idle for 10 minutes.
4. Execute two more cleanings and one flushing.
 - Be sure to print a Nozzle Check Pattern after each cleaning and the flushing.
 - Once you have produced an unbroken Nozzle Check Pattern, you can stop.
5. After the flushing, if the Nozzle Check Pattern is still not perfect, let the machine remain idle for 8 hours.
6. Execute three more cleanings and one flushing.
 - Be sure to print a Nozzle Check Pattern after each cleaning and the flushing.
 - When you have produced an unbroken Nozzle Check Pattern, you can stop.
7. If the Nozzle Check Pattern is still unsatisfactory:
 - Go into the SP mode and open **SP2100-002**.
 - Enter the number of the print head that is abnormal.

To Service:	Color	You Enter:
Head 1	K1 (Black)	1
Head 2	K2 (Black)	2
Head 3	C (Cyan)	4
Head 4	YM (Yellow/Magenta)	8
All	K, C, Y, M	15

- If you need to flush more than one head (but not all). add their entry numbers and then enter the sum. For example, to clean Head 2 and Head 3, add 2+ 4 and then enter "6"
8. If the last flushing does not correct the problem, the defective print head must be replaced.

5.14.3 AUTO ADJUST HEAD POSITION

Adjust the print head position if you see these problems in the prints:

- Broken vertical lines
 - Blurred or streaked colors
1. Press the  button on the operation panel.
 2. Touch [Maintenance].

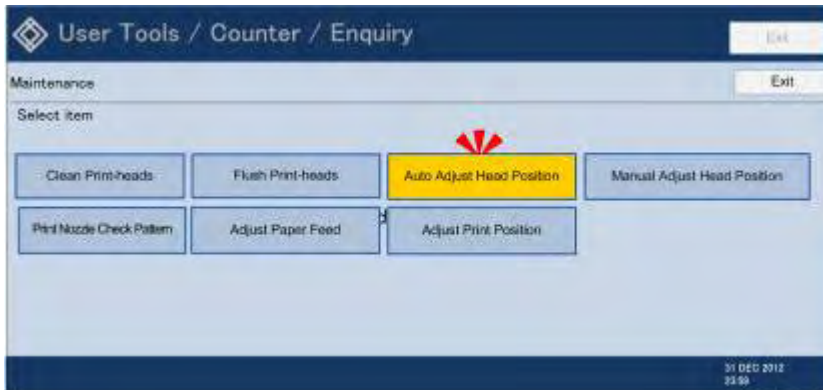

d124r668

3. Touch [Auto Adjust Print Head Position].

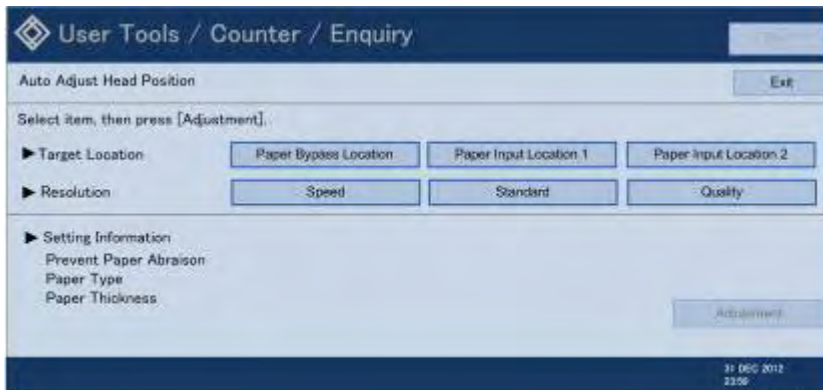

d124r669

Target Location (Paper Source)

Paper Bypass Location	Bypass paper feed
Paper Input Location 1	Roll Unit 1
Paper Input Location 2	Roll Unit 2

Replacement and Adjustment

Resolution

Speed Priority	Draft
Standard	Standard quality
Quality Priority	High quality

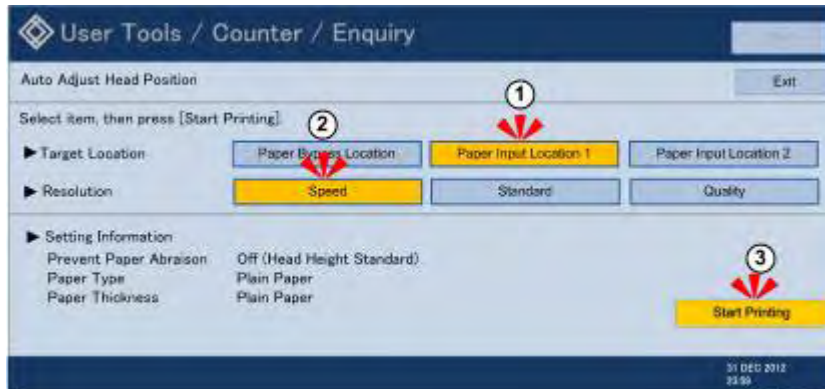

d124r670

4. Select the Target Location and Resolution, and then touch [Start Printing].
 - A message will ask you to wait while the adjustment is done and a pattern prints.



d124r673

- If the adjustment succeeded, the pattern will look like the one above. The black arrow indicates the direction of paper feed.



- If the automatic adjustment fails, a message will say "Failed to adjust" and tell you to do the adjustment manually. (See the next section.)

5.14.4 MANUAL ADJUST HEAD POSITION

Do this procedure if "Auto Print Head Adjustment" (described in the previous section) fails.

1. Press the  button on the operation panel.
2. Touch [Maintenance].



3. Touch [Manual Adjust Print Head Position].

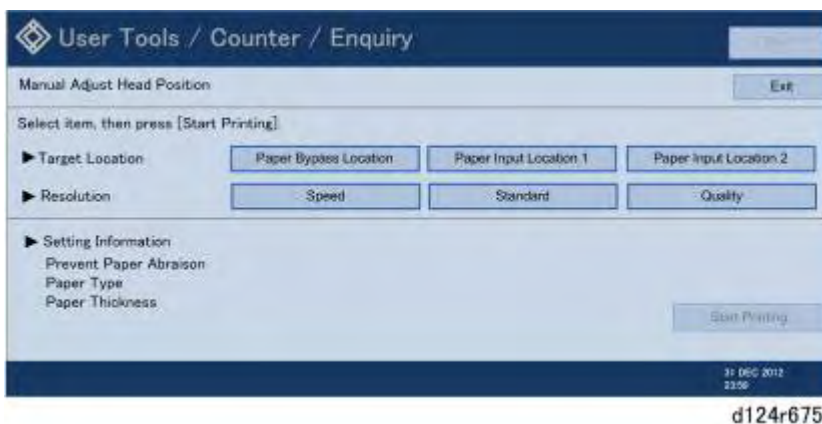

Replacement and Adjustment

Target Location (Paper Source)

Paper Bypass Location	Bypass paper feed
Paper Input Location 1	Roll Unit 1
Paper Input Location 2	Roll Unit 2

Resolution

Speed Priority	Draft
Standard	Standard quality
Quality Priority	High quality

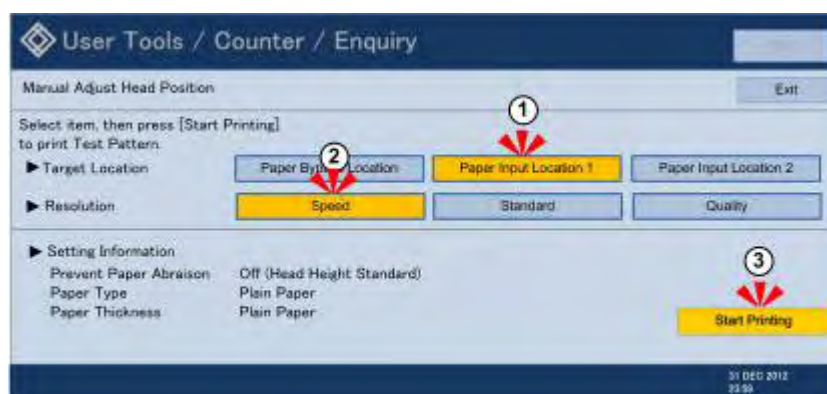

d124r676

4. Select the Target Location and Resolution, and then touch [Start Printing].
 - A message will ask you to wait while the while the test pattern prints.

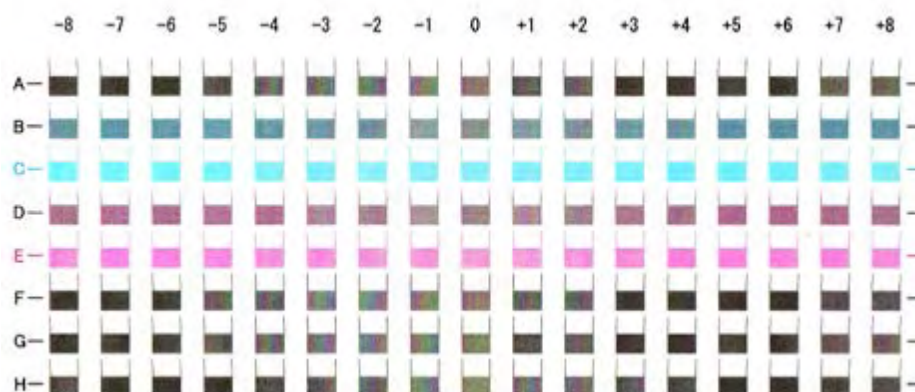

d124r678

5. Look at the test pattern. To determine the adjustment value:
 - Identify the number of the column where the square is faintest, or select the square

where the internal lines overlap to form a solid color.

- The number above the square is the adjustment value.
- If you still cannot determine the adjustment value, select the square that is between the straightest vertical lines.
- Write down these values for use later in the procedure (A4, B2, etc.)

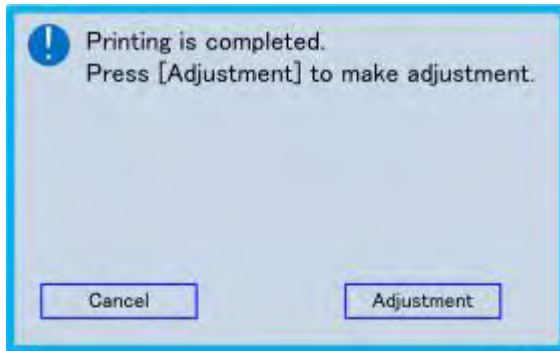

d124r679

6. Touch [Adjustment].

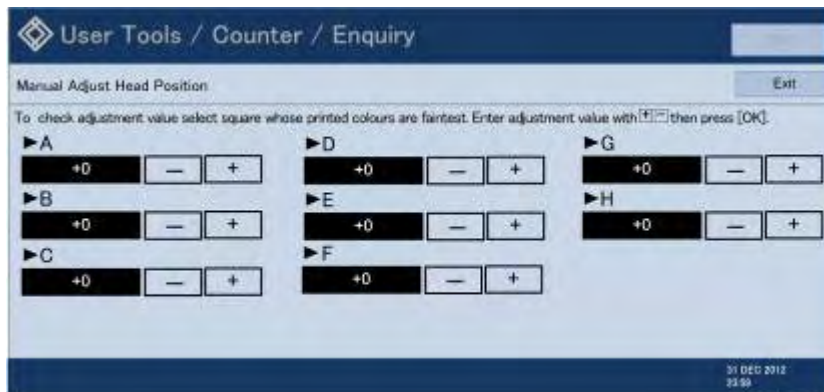

d124r680

7. Enter the values for each row. (Just press the plus or minus button; the numbers will appear automatically.)

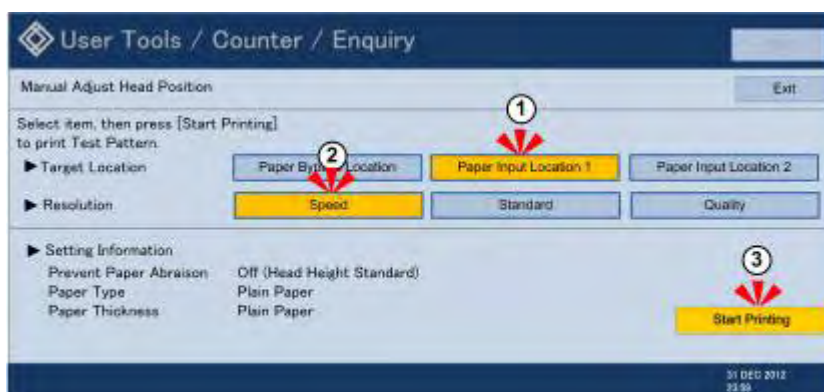

d124r676

8. Print another test pattern.
9. Make sure that the numbers you entered correspond to the results in the new test pattern.

5.14.5 ADJUST PAPER FEED

Adjust paper feed if you see these problems in the prints:

- Broken horizontal lines
 - Patchy images (uneven filled areas)
 - White lines at regular intervals
1. Press the  button on the operation panel.
 2. Touch [Maintenance].

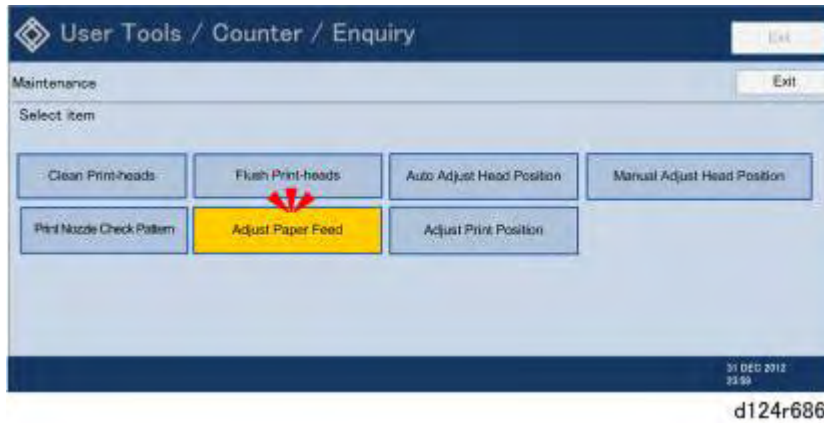

3. Touch [Adjust Paper Feed].

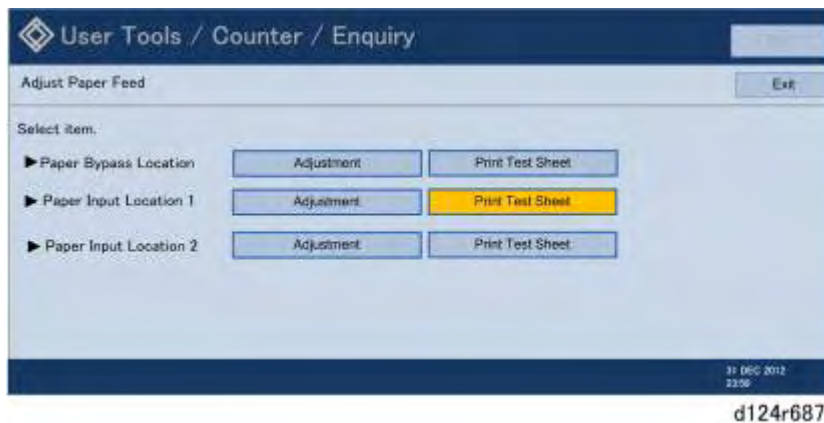

4. Select [Print Test Pattern] for the paper feed source.

Paper Bypass Location	Bypass paper feed
Paper Input Location 1	Roll Unit 1
Paper Input Location 2	Roll Unit 2

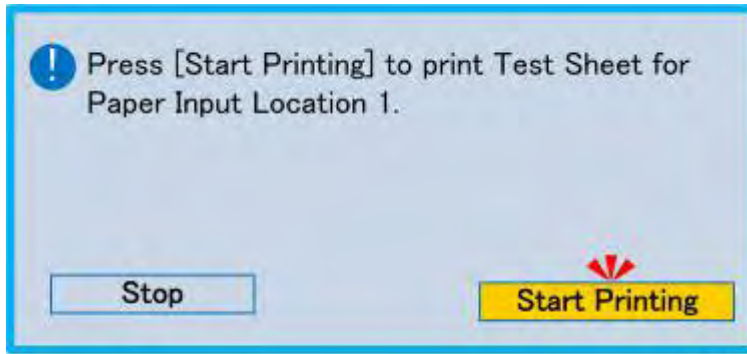

d124r688

5. Touch [Start Printing].

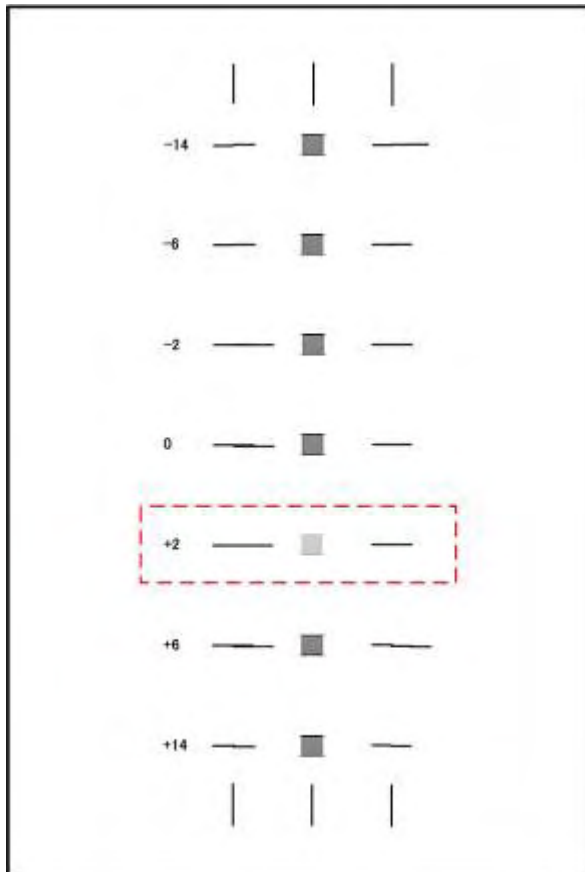

d124r689

6. The adjustment value appears to the left of the lightest gray square with straight horizontal lines on both sides.

Print Head Cleaning and Adjustment

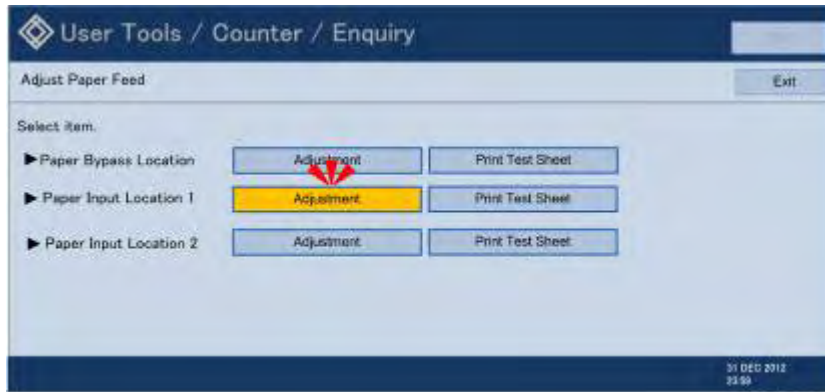

d124r690

7. Touch [Adjustment].

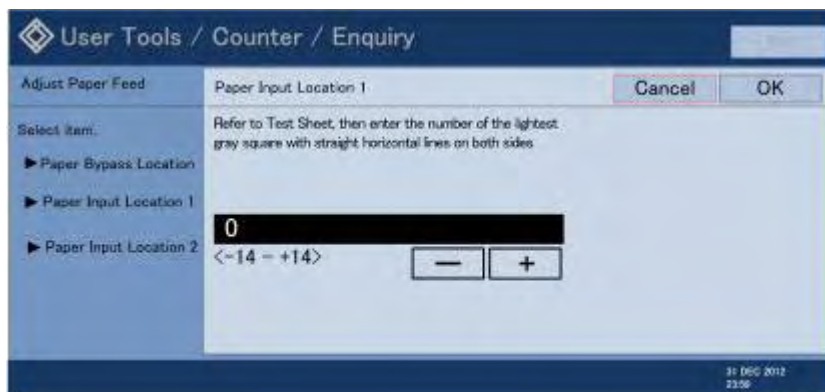

d124r697

8. Touch the plus or minus key to enter the number where you identified the correct value in the test print. (Pressing either key increments/decrements the numbers automatically.)

5.14.6 ADJUST PRINT POSITION

Do this procedure to check and adjust the print start position at the upper left corner of each sheet where printing starts.

1. Press the  button on the operation panel.
2. Touch [Maintenance].

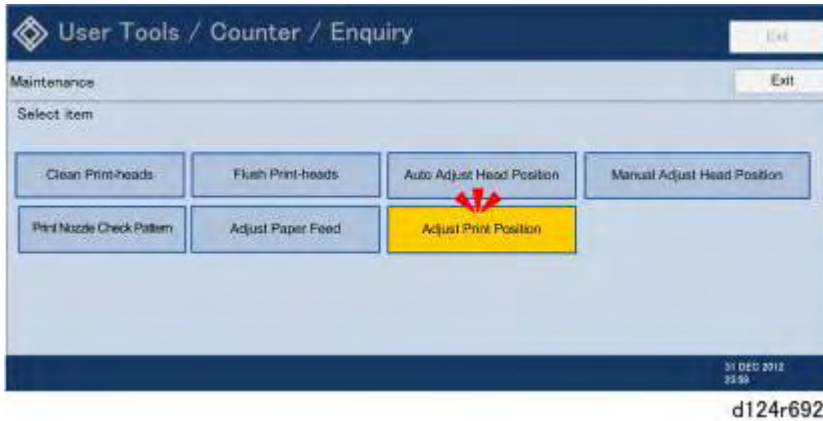

3. Touch [Adjust Print Position].

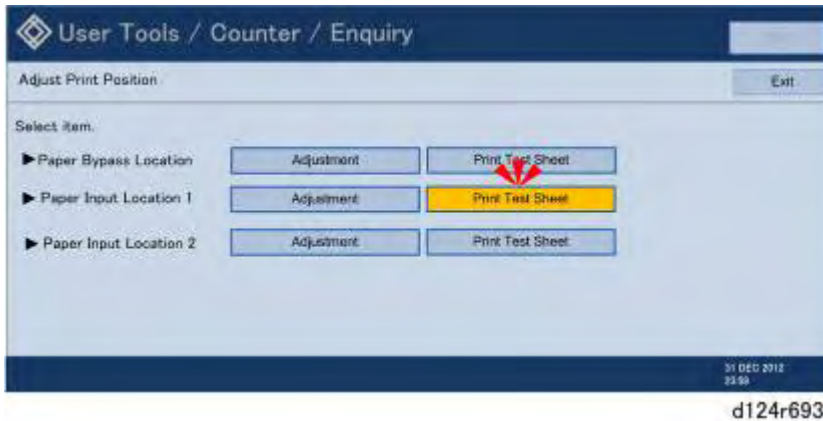

4. Select [Print Test Sheet] for the paper feed source.

Paper Bypass Location	Bypass paper feed
Paper Input Location 1	Roll Unit 1
Paper Input Location 2	Roll Unit 2

Replacement and Adjustment

Print Head Cleaning and Adjustment

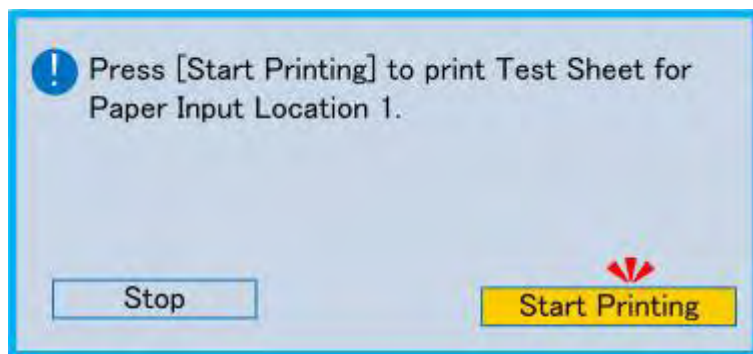

d124r694

5. Touch [Start Printing]. A message will ask you to wait while the test sheet is printing.

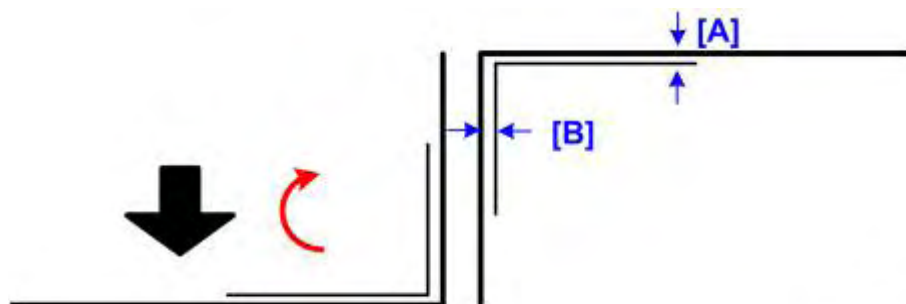

d124r696

6. The black arrow indicates the direction of paper feed.
7. Rotate the test sheet 180 degrees. [A] is the top margin and [B] is the left margin.

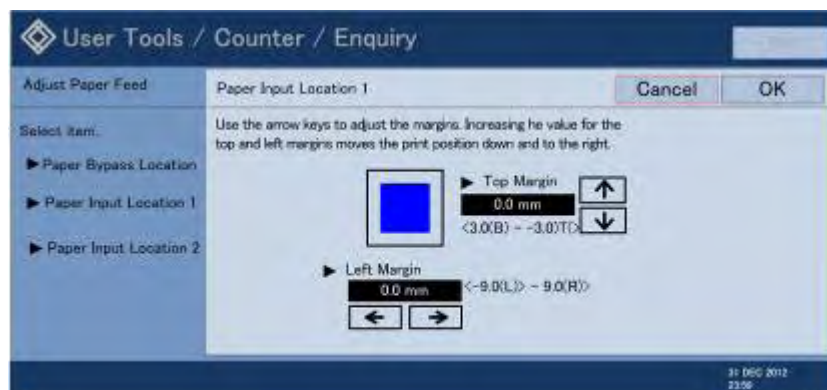

d124r691

8. Touch the arrow keys to adjust the margins.

↓ Note

- Increasing the value for the top and left margin moves the print position down and to the right. You will see the blue square move as you change the settings, so you can confirm the effect of the changes.

5.15 SPECIAL ADJUSTMENTS

5.15.1 IMAGE ADJUSTMENT WITH SP MODES

Do these adjustments if output is unsatisfactory. Before you start measurements and adjustments, let the test print cool for five minutes.

Note

- Do each adjustment in the order described below. Be sure to turn the machine off/on after each SP adjustment to enable the new setting.

Step 1: Magnification for Paper Type: Plain

- Go into the SP mode.
- Do **SP4417**, select Pattern 8, and then touch [OK].
- Touch "COPY Window" at the top of the screen.
- Select the paper size.
- Set a blank sheet of A1 SEF paper on the original tray.
- Press [Start] to print the test pattern.
- Print two more test patterns (you need three grid pattern prints).
- Refer to the diagram and instruction table below to do the SP magnification corrections if they are needed. The example below illustrates the adjustments for "Normal/Recycled" paper.

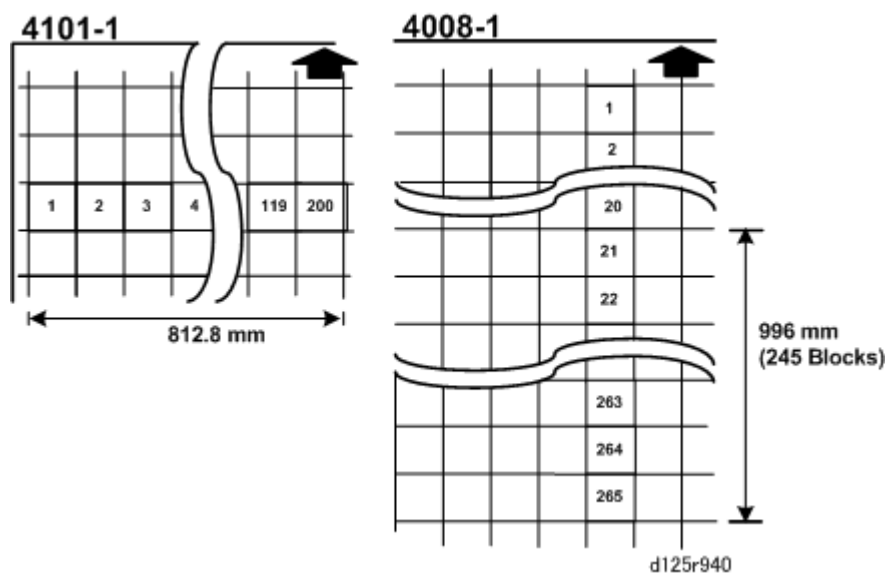

SP	Comments
4101-1	On each grid test pattern, measure the width from block 1 to block 200 (200 blocks) then average the three measurements. The width must be 812.8 mm. If the average measured width is not 812.8 mm, adjust this SP until the width is 812.8 mm.
4008-1	On each grid test pattern, measure the length from block 21 to block 265 (245 blocks) then average the three measurements. The length must be 996 mm. If the measured length is not 996 mm, adjust this SP until the length is 996 mm.

Step 2: Main Scan Magnification

1. Make a 1:1 copy of the A0 SEF Magnification Chart with plain roll paper.

Note

- You can use a different test chart but only if it has lines 1000 mm long in the sub-scan direction and 700 mm long in the main-scan direction.
2. Measure the length and width of the image on the original and the copy.
 3. If the measurements are not within "Standard", adjust these SPs in the order shown in the table below.

SP	Paper Type	Standard
SP4101-2	Normal Recycled	Less than ± 0.5
SP4101-3	IJ Normal	
SP4101-4	Translucent	
SP4101-5	Coated (CAD)	
SP4101-6	Coated	
SP4101-7	Matte Film	
SP4101-8	Special	

Step 3: Copy/Print Sub Scan Magnification

1. Make a 1:1 copy of the A0 SEF Magnification Chart with translucent paper.

Note

- You can use a different test chart but only if it has lines 1000 mm long in the sub-scan direction and 700 mm long in the main-scan direction.
2. Measure the length and width of the images on the original and the copy.
 3. Do the same measurements that you did for "Step 1: Magnification for Paper Type: Plain".
 4. If the measurements are not within "Standard", adjust these SPs in the order shown in the table below.

Copy

SP	Paper Type	Standard
SP2116-1	Normal/Recycled Paper	Less than ± 0.5
SP2116-2	IJ Normal Paper	
SP2116-3	Translucent	
SP2116-4	Coated Paper (CAD)	
SP2116-5	Coated Paper	
SP2116-6	Matte Film	
SP2116-7	Special Paper	

Special Adjustments

Print

SP	Paper Type	Standard
SP2116-11	Normal/Recycled Paper	Less than ± 0.5
SP2116-12	IJ Normal Paper	
SP2116-13	Translucent	
SP2116-14	Coated Paper (CAD)	
SP2116-15	Coated Paper	
SP2116-16	Matte Film	
SP2116-17	Special Paper	

Step 4: Scanner Mask Setting

SP	Set To:	Comments
4012-5	0	Scanner Erase Margin - DF: Leading Edge
4012-6	0	Scanner Erase Margin - DF: Trailing Edge
4012-7	0	Scanner Erase Margin - DF: Left Edge
4012-8	0	Scanner Erase Margin - DF: Right Edge

Step 5: Erase Margins

Set these SPs to "5" to make measurement easier:

SP	Set To:	Comments
2103-1	5	Print Erase Margin – Leading Edge
2103-2	5	Print Erase Margin – Trailing Edge
2103-3	5	Print Erase Margin – Left Edge
2103-4	5	Print Erase Margin – Right Edge

Step 6: Printer: Leading Edge, Side-to-Side Registration

- Use a sheet of blank plain paper to print the IPU Printing test pattern (SP4417 Pattern 8) for each paper feed station installed on the machine:
 - Paper Input 1
 - Paper Input 2
 - Bypass
- Measure the gaps for the leading edge and side-to-side registration.

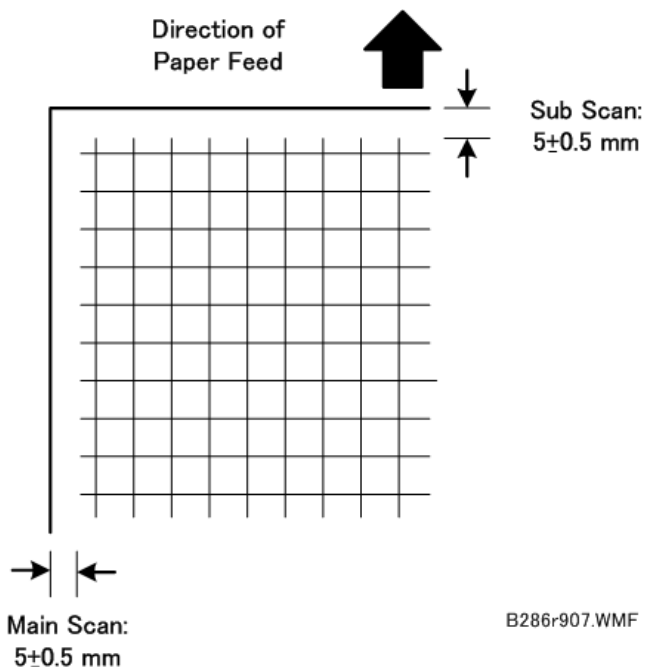

- Touch "SP Mode" at the top of the screen, and then adjust these SPs if a measurement is not within "Standard".

Special Adjustments

SP	Standard:	Comments
1001-1	5 ±0.5 mm	Print Position Adj (Top Edge) - Bypass Feed
1001-2		Print Position Adj (Top Edge) - Paper Input 1
1001-3		Print Position Adj (Top Edge) - Paper Input 2
1002-1		Print Position Adj (Left Edge) - Bypass Feed
1002-2		Print Position Adj (Left Edge) - Paper Input 1
1002-3		Print Position Adj (Left Edge) - Paper Input 2

Step 7: Scanner Mask Setting

Do these SPs to replace the “0” settings done in Step 5.

SP	Set To:	Comments
4012-5	1.5	Scanner Edge Margin - DF: Leading Edge
4012-6		Scanner Edge Margin - DF: Trailing Edge
4012-7		Scanner Edge Margin - DF: Left Edge
4012-8	0.5	Scanner Edge Margin - DF: Right Edge

Step 8: Erase Margins

Do these SPs to replace the settings done in Step 6.

SP	Set To:	Comments
2103-1	2	Printing Erase Margin – Leading Edge
2103-2		Printing Erase Margin – Trailing Edge
2103-3		Printing Erase Margin – Left Edge
2103-4	0.5	Printing Erase Margin – Right Edge

Step 9: Scanner Registration

1. Use the A1 LEF Test Chart to make a 1:1 copy on plain A1 LEF paper.
2. On the copy, measure the gap between the chart image at the leading edge and at the left edge.
3. Adjust these SPs if necessary.

SP	Standard	Comments
4010-1	±3 mm	Scanner Sub Scan - Leading Edge Reg Adjustment
4010-2	±2.8 mm	Scanner Main Scan - Trailing Edge Reg Adjustment
4011	±2.8 mm	Scanner Main Scan - Registration

Step 10: Printer: Cut Length

1921	Cut Length Adjustment - Cutting Position Adjustment
	This SP adjusts the distance between the DRESS sensor (image registration sensor) and the first cut position. This setting is no longer used after the 2nd cut during continuous printing. Cuts once to test the new setting, then once to do the actual cut.
	<p>[-10 to 10/0/0.1 mm]</p> <p>Example</p> <ul style="list-style-type: none"> ▪ To set a length of 297 mm, with the machine cutting at 300 mm, you need to move the cutting position 3 mm upstream with a value of -3 mm. ▪ To set a length of 295 mm, with the machine cutting at 297 mm, you need to move the cutting position downstream with a value of +2 mm

Note

- The cut length adjustment is done for all paper sizes after these settings are done.
 - After these settings are done you may still need to do fine adjustments for each paper size.
1. Use the Preset Cut feature to make standard cuts of plain paper for these sizes:

Special Adjustments

Size	Orientation
A3	Sideways
A1	Lengthways
A0	Lengthways
A	Sideways (Eng. 11")
B	Sideways (Eng. 17")
D	Lengthways (Eng. 34")
E	Lengthways (Eng. 44")

2. Measure the cuts and check them against the standards of this table.

Cut Length (mm)	Cut Tolerance (mm)
Less than 297	±3
420 to 1219	±5
to 2000	±6
to 3000	±11
to 3600	±14
to 15,000	±150

Step 11: Synchro Cut (Trailing Edge Registration)

The following SPs are used in this step:

- SP4961-1 (Document Length Adjustment – Input Tolerance 210 mm)
 - SP4961-2 (Document Length Adjustment – Input Tolerance 1000 mm)
 - SP4961-3 (Document Length Adjustment – Check Document Length)
1. Prepare two originals
 - 1 original 210 mm long (A4 LEF)
 - 1 original 1000 mm long (measure and cut)
 2. Go into the SP mode and do **SP4961-1**.
 3. Touch "COPY Window" and copy the 210 mm sheet that you prepared in Step 1.
 4. Touch "SP Mode" to go back to the SP mode.
 5. Do **SP4961-3** to check the original scan length.
 6. If the display is different, adjust with **SP4961-1**.
 7. Do **SP4961-2**.
 8. Touch "COPY Window" and scan the 1000 mm sheet that you prepared in Step 1.
 9. Touch "SP Mode" to go back to the SP mode.
 10. Do **SP4961-3** to check the scan length.
 11. If the display is different, adjust with SP4961-2.

Cut Length (mm)	Cut Tolerance (mm)
Less than 297	±4.50
to 594	±5.00
to 841	±6.00
to 1219	±8.50
to 2000	±18.0
to 3000	±27.0
to 3600	±33.0
to 15,000	±150

5.15.2 CIS ADJUSTMENT WITH SP MODES

To Print the CIS Adjustment Pattern

1. Open the roll unit drawer and cut off a sheet of paper from the widest roll. (Turn the manual feed knob to feed the paper, then push the cutter from side to side to cut.)
2. Close the roll unit drawer.
3. Enter the SP mode.
4. Open **SP4417** Pattern 8, and touch [OK].
5. Touch "COPY Window" to go to the main screen.
6. On the operation panel, select one of the rolls for paper feed.
7. Put the blank sheet of paper on the original feed tray and feed it into the original feed unit. Pattern 6 (a grid pattern) prints.
8. Touch "SP Mode" to return to the SP mode.
9. Open **SP4973**, push [0] on the operation panel to change the setting from "2" to "0", then push [#].
10. Touch "Exit" twice to leave the SP mode.
11. Select the paper input size, and then copy the grid pattern that you printed in Step 7 above.

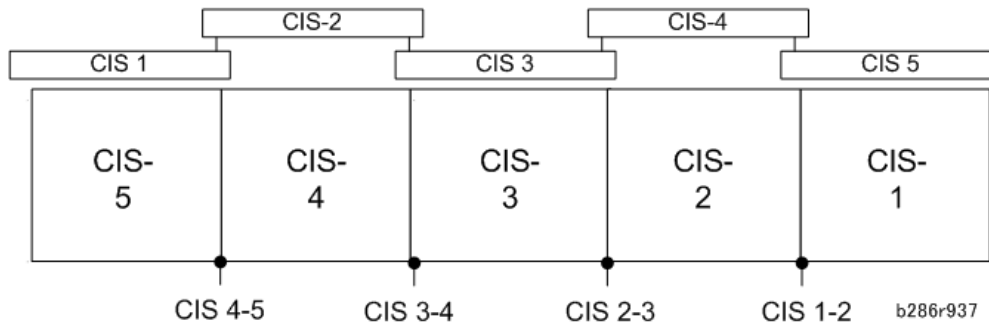

Note

- When you look at the printed pattern, the number sequence of the CIS joints is reversed, with CIS-5 on the left through CIS-1 on the right as shown in the diagram above.

Important

- After completing the CIS adjustments, be sure to reset **SP4973** to "2".

To Adjust the Image at the CIS Joints

1. Check the printed pattern to determine if the dots are aligned at CIS 1-2.
2. If they are aligned correctly, no adjustment is necessary.

-or-

If they are not aligned correctly, do the next step. Here are two samples where the outputs are not aligned correctly.

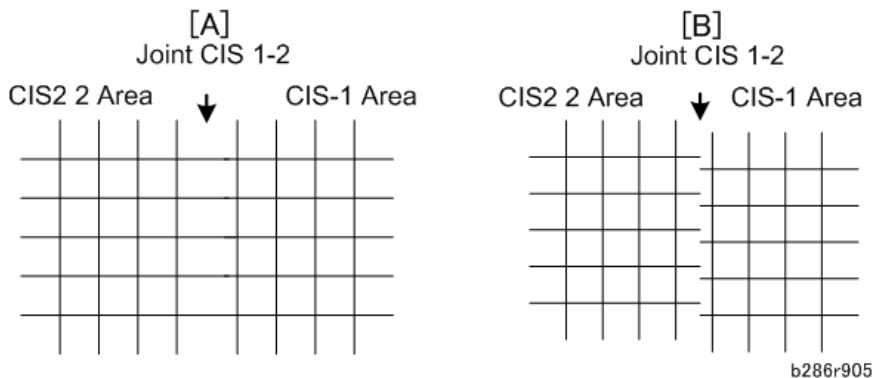

- [A]: Distance between the lines at CIS 1-2 is wider than usual (as shown above). If the distance between these lines is wider or narrower than the other lines, adjust the main scan offset at CIS 1-2 with **SP4972-1** (CIS Joint Adjustment – CIS 1-2 Main Scan) as described below.
- [B]: The lines at CIS 1-2 are broken. If the output from CIS 1 is lower (as shown above) or higher, adjust the sub scan offset at CIS 1-2 with **SP4972-6** (CIS Joint Adjustment – CIS 1-2 Sub Scan) as described below.

To adjust the main scan offset for Example [A]

Problem: Output from CIS 1 is too far to the right.

1. Do **SP4972-1** and adjust the setting.
 - Adjust the position of CIS 1. The position of CIS 2 does not move.
 - If the area at the joint is too wide, set a smaller value.
 - If the area at the joint is too narrow, set a larger value.
 - In the example [A], you must set a smaller value.

To adjust the sub scan offset for Example [B]

Problem: Output from CIS 1 is lower than the output from CIS 2.

1. Do **SP4972-6** and adjust the setting.
 - Adjust the position of CIS 1. The position of CIS 2 does not move.
 - If the CIS 1 area is higher than the CIS 2 area, set a larger value.
 - If the CIS 1 area is lower than the CIS 2 area, set a smaller value.
 - In the example shown [B], you must decrease the value for CIS 1.

After adjusting

1. Print one more pattern and check CIS 1-2.
2. Repeat these procedures until the image at CIS 1-2 is correct.
3. Do these procedures for the other joints (CIS 2-3, CIS 3-4, CIS 4-5)

Note

- The “Effect” column in the table below tells you which area moves with the adjustment, and which area does not move.

SP4972	CIS Main/Sub Scan Offset Adjustment [0 to 2047/638/1]		
	Problem	Joint	Effect
1	Main Scan Interval 1-2	CIS 1-2	CIS 1 moves. CIS 2 does not move.
3	Main Scan Interval 2-3	CIS 2-3	CIS 3 moves. CIS 2 does not move.
4	Main Scan Interval 3-4	CIS 3-4	CIS 4 moves. CIS 3 does not move.
5	Main Scan Interval 4-5	CIS 4-5	CIS 5 moves. CIS 4 does not move.
6	Sub Scan Interval 1-2	CIS 1-2	CIS 1 moves. CIS 2 does not move.
8	Sub Scan Interval 2-3	CIS 2-3	CIS 3 moves. CIS 2 does not move.
9	Sub Scan Interval 3-4	CIS 3-4	CIS 4 moves. CIS 3 does not move.
10	Sub Scan Interval 4-5	CIS 4-5	CIS 5 moves. CIS 4 does not move.

Important

- After completing the CIS adjustments, be sure to reset SP4973 to "2."

SYSTEM MAINTENANCE REFERENCE

REVISION HISTORY		
Page	Date	Added/Updated/New
		None

6. SYSTEM MAINTENANCE REFERENCE

6.1 SERVICE PROGRAM MODE

See "Appendices" for Service Program Mode.

6.2 SYSTEM MAINTENANCE TASKS

Task	What It Does
Address Book Upload/Download	Handling address book data.
Controller Self-Diagnostics	Controller self-diagnostics
Debug Log	Store error information for analysis.
Firmware Update	Updating the firmware.
Initialize All SP Settings	Restore all SP settings to factory defaults.
NVRAM Data Upload/Download	NVRAM data upload/download
Print Job to SD Card	Printing jobs to an SD card.
SD Card Application Move	Moving applications to other SD cards
SMC Reports	Printing an SMC report for reference.
Printing an SMC Report	Print report on paper
Printing an SMC Report to SD Card	Print to file on SD card
Software Reset	Same as cycling machine off/on
Stamp Data Download	Downloading stamp data
Test Pattern Printing	Print the test patterns.

6.2.1 ADDRESS BOOK UPLOAD/DOWNLOAD

The address book data must be downloaded from the machine before the controller board is replaced. This procedure can upload or download the following information for the address book:

- Registration No.
- User Code
- E-mail
- Protection Code
- Fax Destination
- Fax Option
- Group Name
- Key Display
- Select Title
- Folder
- Local Authentication
- Folder Authentication
- Account ACL
- New Document Initial ACL
- LDAP Authentication

★ Important

- This procedure does not upload or download sensitive administrator or supervisor settings. This information is protected.

Address Book Data Download

1. Prepare a formatted SD card.
2. Make sure that the write-protection on the SD card is off.
3. Turn off the main power switch of the main machine.
4. Remove the SD slot cover ( x1).
5. Install the SD card into the SD card slot 2.
6. Turn on the main power switch.
7. Enter the SP mode
8. Open **SP5846-051** (Backup All Addr Book).
9. Touch [EXECUTE].
10. When the prompt asks you to continue, touch [EXECUTE].
11. When you see "Completed", touch [EXIT].
12. Exit the SP mode, and then turn off the main power switch.
13. Remove the SD card from the SD card slot 2 and give it to the operator.
14. Install the SD slot cover.

★ Important

- The data on the SD card belongs to the customer. Never remove an SD card that contains customer address data from the work site.

15. Turn the machine on.

Address Book Upload

1. Turn off the main power switch of the main machine.
2. Remove the SD slot cover at the left rear side of the machine ( x1).
3. Install the SD card, which has already been uploaded, into the SD card slot 2.
4. Turn on the main power switch.
5. Enter the SP mode.
6. Open **SP5846-052** (Restore All Addr Book).
7. Touch [EXECUTE].
8. When the prompt asks you to continue, touch [EXECUTE].
9. When you see "Completed", touch [EXIT].
10. Exit the SP mode, and then turn off the main power switch.
11. Remove the SD card from the SD card slot 2 and give it to the operator.

★ Important

- The data on the SD card belongs to the customer. Never remove an SD card that contains customer address data from the work site.

12. Install the SD slot cover.

13. Turn the machine on.

6.2.2 CONTROLLER SELF-DIAGNOSTICS

Overview

There are two types of self-diagnostics for the controller.

- **Power-on self-diagnostics.** The machine automatically starts the self-diagnostics just after the power has been turned on.
- **SC detection.** The machine automatically detects SC conditions at power-on or during operation.

Running the Self-Diagnostic Program

1. Enter the SP mode.
2. Open **SP7832-001** (Self Diagnose Result Display).

On the right you will see "None" if there were no errors, or you will a list of errors if any occurred.

6.2.3 DEBUG LOG

Overview

This machine provides a Save Debug Log feature that allows the Customer Engineer to save error data as errors occur, and then retrieve error information for analysis.

Normally, every time an error occurs debug information is recorded in volatile memory but this information is lost when the machine is switched off and on.

After the Save Debug Log feature is turned on, it provides two performs two functions:

- After an error occurs, the error information is saved directly to the HDD for later retrieval
- The error information can be copied from the HDD to an SD card.

When a user is experiencing problems with the machine, follow the procedure below to set up the machine so the error information is saved automatically to the HDD.

Switching On and Setting Up Save Debug Log

The debug information cannot be saved until the “Save Debug Log” function has been switched on and a target has been selected.

1. Enter the SP mode.
2. Select **SP5857** and then touch [1].

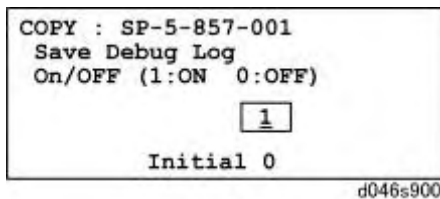

3. On the control panel keypad, press “1” then press . This switches the Save Debug Log feature on.

Note

- The default setting is “0” (OFF). This feature must be switched on in order for the debug information to be saved.

4. Next, select the target destination where the debug information will be saved.
 - Under “5857 Save Debug Log”.
 - Touch “2 Target”.
 - Enter “2” with the operation panel key to select the hard disk as the target destination, then press .

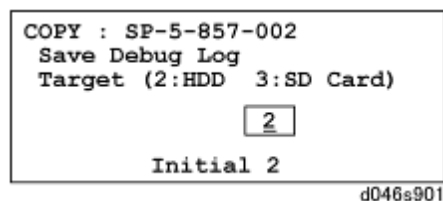

Note

- You can select “3 SD Card” to save the debug information directly to an SD card inserted in SD card Slot 2.
5. Now touch “5858”.
 6. Select the events that you want to record in the debug log. **SP5858** (Debug Save When) provides the following items for selection.

1	Engine SC Error	Saves data when an engine-related SC code is generated.
2	Controller SC Error	Saves debug data when a controller-related SC Code is generated.
3	Any SC Error	Saves data only for the SC code that you specify by entering code number.
4	Jam	Saves data for jams.

More than one event can be selected.

Example 1: To Select Items 1, 2, 4

Touch the appropriate items(s). Press “ON” for each selection. This example shows “Engine SC Error” selected.

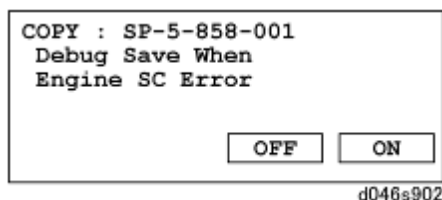

Example 2: To Specify an SC Code

Touch “3 Any SC Error”, enter the 3-digit SC code number with the control panel number keys, then press . This example shows an entry for SC670.

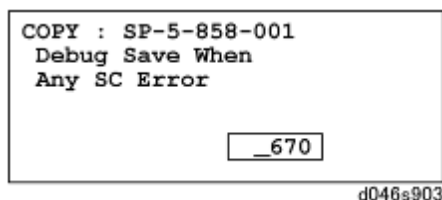

For details about SC code numbers, please refer to the SC tables in the SC tables.

7. Next, select the one or more memory modules for reading and recording debug information. Touch [5859].

- Under “5859” press the appropriate key item for the module that you want to record.
- Enter the appropriate 4-digit number, then press .
- Refer to the two tables below for the 4-digit numbers to enter for each key.
- The example below shows “Key 1” with “2222” entered.

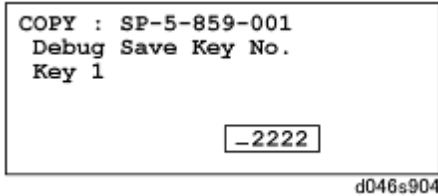

The following keys can be set with the corresponding numbers. (The initials in parentheses indicate the names of the modules.)

4-Digit Entries for Keys 1 to 10

Key No.	Copy	Printer	Scanner	Web
1	2222 (SCS)			
2	2223 (SRM)			
3	256 (IMH)			
4	1000 (ECS)			
5	1025 (MCS)			
6	4848 (COPY)	4400 (GPS)	5375 (Scan)	5682 (NFA)
7	2224 (BCU)	4500 (PDL)	5682 (NFA)	6600 (WebDB)
8		4600 (GPS-PM)	3000 (NCS)	3300 (PTS)
9		2000 (NCS)	2000 (NCS)	6666 (WebSys)
10		2224 (BCU)		2000 (NCS)

The default settings for Keys 1 to 10 are all zero (“0”).

Key to Acronyms

Acronym	Meaning	Acronym	Meaning
ECS	Engine Control Service	NFA	Net File Application
GPS	GW Print Service	PDL	Printer Design Language
GSP-PM	GW Print Service – Print Module	PTS	Print Server
IMH	Image Memory Handler	SCS	System Control Service
MCS	Memory Control Service	SRM	System Resource Management
NCS	Network Control Service	WebDB	Web Document Box (Document Server)

The machine is now set to record the debugging information automatically on the HDD (the target selected with **SP5857-002**) for the events that you selected with **SP5858** and the memory modules selected with **SP5859**.

Please keep the following important points in mind when you are doing this setting:

- Note that the number entries for Keys 1 to 5 are the same for the Copy, Printer, Scanner, and Web memory modules.
- The initial settings are all zero.
- These settings remain in effect until you change them. Be sure to check all the settings, especially the settings for Keys 6 to 10. To switch off a key setting, enter a zero for that key.
- You can select any number of keys from 1 to 10 (or all) by entering the corresponding 4-digit numbers from the table.
- You cannot mix settings for the groups (COPY, PRINTER, etc.) for 006 to 010. For example, if you want to create a PRINTER debug log you must select the settings from the 9 available selections for the “PRINTER” column only.
- One area of the disk is reserved to store the debug log. The size of this area is limited to 4 MB.

Retrieving the Debug Log from the HDD



Retrieve the debug log by copying it from the hard disk to an SD card.

1. Insert the SD card into the service slot of the copier.
2. Enter the SP mode and execute **SP5857-009** (Copy HDD to SD Card (Latest 4 MB)) to write the debugging data to the SD card.
3. After you return to the service center, use a card reader to copy the file and send it for analysis to Ricoh by email, or just send the SD card by mail.

Recording Errors Manually

Since only SC errors and jams are recorded to the debug log automatically, for any other errors that occur while the customer engineer is not on site, please instruct customers to perform the following immediately after occurrence to save the debug data. Such problems would include a controller or panel freeze.

In order to use this feature, the customer engineer must have previously switched on the Save Debug Feature (**SP5857-001**) and selected the hard disk as the save destination (**SP5857-002**).

1. When the error occurs, on the operation panel, press  (Clear Modes).
2. On the control panel, enter "01" then hold down  for at least 3 sec. until the machine beeps then release. This saves the debug log to the hard disk for later retrieval with an SD card by the service representatives.
3. Switch the machine off and on to resume operation. The debug information for the error is saved on the hard disk so the service representatives can retrieve it on their next visit by copying it from the HDD to an SD card.

New Debug Log Codes

SP5857-015: Copy SD Card-to-SD Card: Any Desired Key

This SP copies the log on an SD card (the file that contains the information written directly from shared memory) to a log specified by key number.

- The copy operation is executed in the log directory of the SD card inserted in the same slot. (This function does not copy from one slot to another.)
- Each SD card can hold up to 4 MB of file data. Unique file names are created for the data during the copy operation to prevent overwriting files of the same name. This means that log data from more than one machine can be copied onto the same SC card. This command does not execute if there is no log on the HDD for the name of the specified key.

SP5857-016: Create a File on HDD to Store a Log

This SP creates a 32 MB file to store a log on the HDD. However, this is not a completely empty file.

- The created file will hold the number “2225” as the SCS key number and other non-volatile information.
- Even if this SP is not executed, a file is created on the HDD when the first log is stored on the HDD, but this operation takes time. This creates the possibility that the machine may be switched off and on before the log can be created completely.
- If you execute this SP to create the log file beforehand, this will greatly reduce the amount of time required to acquire the log information and save onto the HDD.
- With the file already created on the HDD for the log file, the data only needs to be recorded; a new log file does not require creation.
- To create a new log file, execute **SP5857-011** to delete the debug log data from the HDD and then execute this SP (**SP5857-016**).

SP5857-017 Create a File on SD Card to Store a Log

- This SP creates a 4 MB file to store a log on an SD card. However, this is not a completely empty file.
- The created file will hold the number “2225” as the SCS key number and other non-volatile information.
- Even if this SP is not executed, a file is created on the SD card when the first log is stored on the SD card, but this operation takes time. This creates the possibility that the machine may be switched off and on before the log can be created completely.
- If you execute this SP to create the log file beforehand, this will greatly reduce the amount of time required to acquire the log information and save onto the SD card.
- With the file already created on the SD card for the log file, the data only needs to be recorded; a new log file does not require creation.
- To create a new log file, execute **SP5857-012** to delete the debug log data from the SD card

and then execute this SP (**SP5857-017**).

6.2.4 FIRMWARE UPDATE

Overview

The MCU (Main Control Unit) board flash-memory contains the software for this machine. To upgrade the software, .SD cards are necessary. The SD cards contain the SCU and ECU firmware.

★ Important

- Always turn the main power switch off before you insert or remove an SD card.
- Keep the main switch on during software installation.
- Store and handle SD cards carefully to protect them from heat, humidity, and sunlight.
- Before you handle SD cards, touch a grounded surface to discharge static electricity from your hands.

Updating Firmware

1. Turn the power switch off.
2. A message prompts you to wait at least 2 minutes. Wait for the message to go off so the machine is completely shut down.



3. Remove the SD slot cover [1] (1 x1).
4. Insert the SD card [2] with the firmware in SD card Slot 2. (If there is an SD card in Slot 2, remove it.)
5. Turn on the main power switch. "Program to start firmware update" appears on the operation panel display.

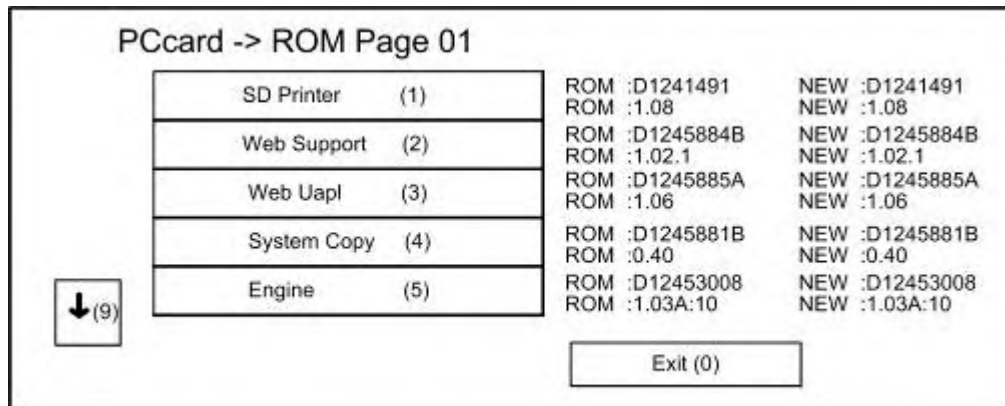

d124m941

After approximately 90 sec. the initial firmware update screen appears.

★ Important

- Only the firmware update applications on the SD card are displayed in the menu. If more than one update is to be done, the System Copy and Engine updates should always be done first.

- Look at the numbers in the right (ROM) and left (NEW) columns.
 - If the NEW number is higher than the ROM number the application needs to be updated.
 - If the numbers are the same, the application does not need to be updated.
- Press the down arrow to see the next screen.

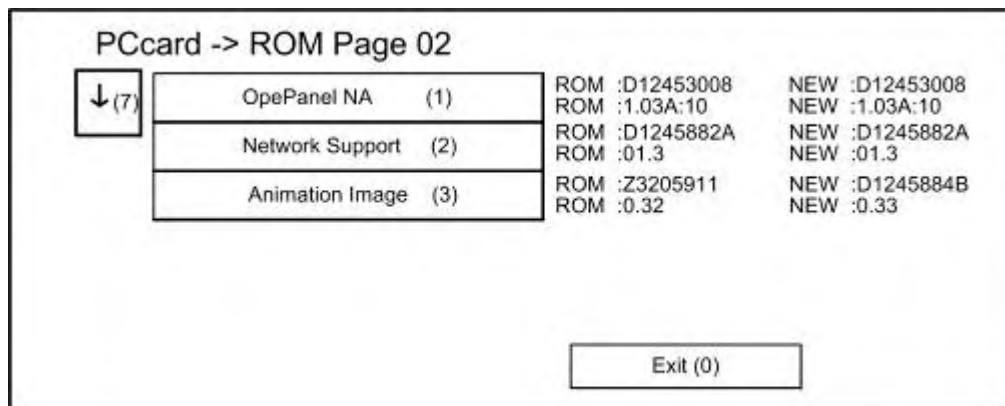

D124s942

- If no application needs to be updated, touch [Exit].
- To update an application:
 - Touch the name of the application that needs to be updated. The name of the application changes to reverse black and the [Update#] key appears at the lower right corner of the screen.
 - Touch [Update#] to start the update procedure.
 - Follow the instructions on the operation panel to complete the procedure.

★ Important

- **Never switch the machine off while a firmware update is in progress.**

10. When the update is finished:

- Switch the machine off.
- Remove the SD card from Slot 2.
- Reattach the SD card slot cover.

Note:

- More than one application can be selected for update, but there are restrictions.
- Controller applications and the operation panel update must be done separately.
- If you select a controller application and the operation panel for update, the machine will display a message: "Caution! Controller applications and Op Panel must be installed separately."

6.2.5 INITIALIZE ALL SP SETTINGS

Follow this procedure to initialize the SP settings and restore them to their factory default settings.

1. Enter the SP Mode.
2. Print an SMC list with **SP5990**.

↓ Note

- If you do not want to print the list on paper, you can use **SP5992** to write the list to an SD card inserted in Slot 2.

3. Do **SP5811-2** to display the serial number of the machine.
4. Write down the serial number of the machine. You will need to re-enter this number after initializing the settings.
5. To initialize the SP settings, do **SP5801-1**.

↓ Note

- The total counter is not cleared when RAM is cleared.

6. Use **SP5811** to re-enter the serial number of the machine.

6.2.6 NVRAM DATA UPLOAD/DOWNLOAD

Uploading NVRAM Data to an SD Card

Before you begin, please note:

- Uploading NVRAM contents to an SD card will fail if the machine serial number of the machine is not registered with **SP5811**.
 - The machine serial number is set at the factory before shipping.
 - NVRAM data can be uploaded from several machines and stored on the same SD card because a unique filename is created automatically for each machine.
1. Enter the SP mode and do **SP5990-2** to print an SMC report.
 - Always print an SMC report before uploading NVRAM data, just in case the download of the NVRAM data fails.
 - If the download fails, you can use the report to re-enter the SP and UP settings manually.
 2. Turn the machine off.
 3. Insert the SD card in Slot 2.
 4. Turn the machine on.
 5. Enter the SP mode and do **SP5824** (NVRAM Data Upload).
 6. Touch [EXECUTE] on the operation panel to start the upload.
 - Data uploaded from NVRAM is stored in a file in the NVRAM folder created on the on the card:
NVRAM folder> D1242702008.nv
where D1242702008.nv is the number of the machine entered at the factory before shipping. The number will be unique for each machine.
 - If this upload is done with the NVRAM folder and file from a previous upload is stored on the SD card, the folder and file will be overwritten. (A new directory and file are not created.)

Downloading NVRAM Data from an SD Card

Before you begin, please note:

- Downloading NVRAM data from an SD card may fail if the SD card is defective or if there is poor connection between the controller and the MCU.
- If downloading NVRAM data from an SD card fails, just repeat the procedure.
- If the second attempt to download from the SD card fails, then you must enter the SP and UP settings manually from the SMC report you printed before uploading the NVRAM data to the SD card.

1. Turn the machine off.
2. Insert the SD card that holds the NVRAM data in Slot 2.

 **Important**

- **The machine number included in the filename of the file on the SD card must match the number of the machine.**
3. Turn the machine on.
 4. Enter the SP mode and open **SP5825**.
 5. Touch [EXECUTE]. The download executes.
 6. When the prompt that tells you that the operation has completed and that the machine must be re-booted, touch [Exit].
 7. Exit the SP mode and remove the SD card.
 8. Cycle the machine off/on.

6.2.7 PRINT JOB TO SD CARD

Overview

The Card Save function prints jobs to an SD card with no print output.

- Card Save mode is toggled using printer Bit Switch #1 bit number 4.
- Card Save will remain enabled until the SD card becomes full, or until all file names have been used.
- Captures are stored on the SD card in the folder /prt/cardsave.
- File names are assigned sequentially from PRT00000.prn to PRT99999.prn.
- One additional file PRT.CTL is always created. This file contains a list of all files created on the card by the card save function.
- Previously stored files on the SD card can be overwritten or left intact.
- Card Save SD has “Add” and “New” menu items. **Card Save (Add)**: Appends files to the SD Card and does not overwrite existing files.
- If the card becomes full, or if all file names are used, an error will be displayed on the operation panel.
- After the arrow appears, subsequent jobs will not be stored. **Card Save (New)**: Overwrites files in the card's /prt/cardsave directory.
- Card Save cannot be used with PjL Status Readback commands. PjL Status Readbacks will not work. In addition they will cause the Card Save to fail.

Procedure

1. Switch the machine off..
2. Insert the SD card into slot 2.
3. Turn the power ON.
4. Enter SP mode, and then touch [Printer SP].
5. Open **SP-1001 "Bit Switch"**.

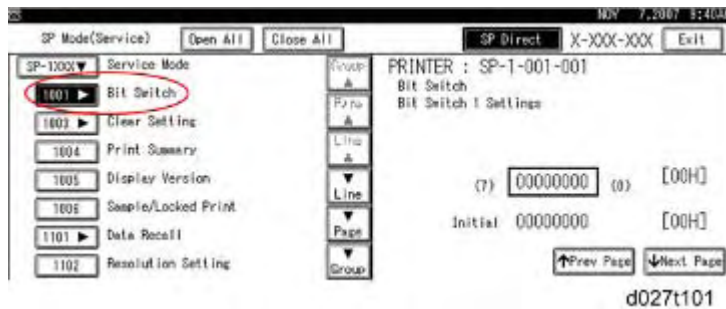

6. Touch [4] on the operation panel to toggle the switch to "1", and then press . You should see: "00010000".

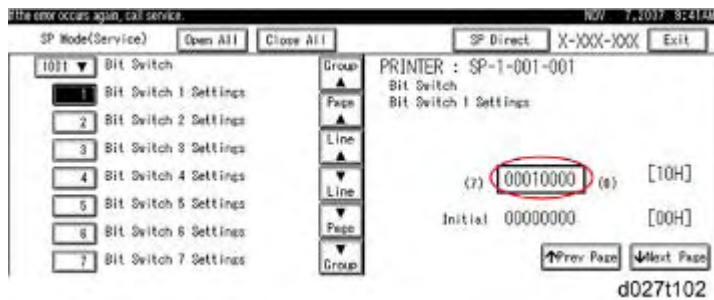

7. Press "Exit" to exit SP Mode.
8. Press the button to open the User Tools menu.
9. Touch [Printer Features].
10. Card Save (Add) and Card Save (New) should be displayed on the screen.

Note

- These Card Save features will display only after the digit 4 has been set to "1" in the Printer SP Mode (Step 6 above).

11. Touch [Card Save (Add)] or [Card Save (New)].

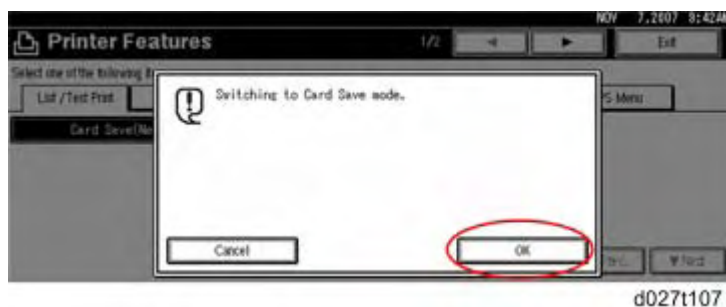

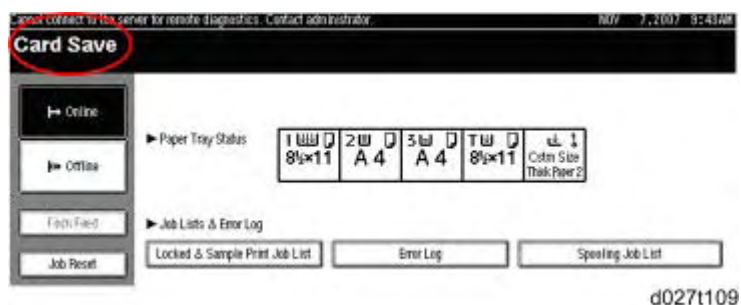

System Maintenance Tasks

12. Touch [OK].
13. Touch [Exit] to exit the “User Tools/Counter” menu.
14. Press the “Printer” button.

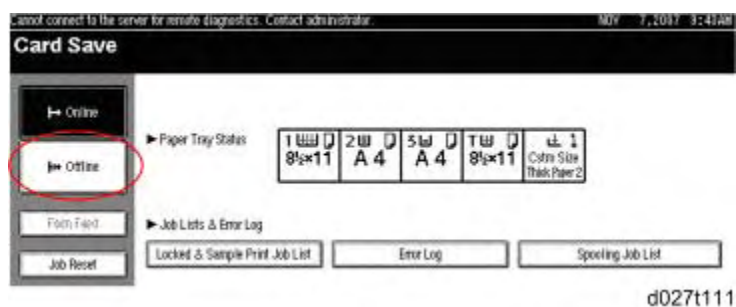

- Card Save should be displayed in the top left of the display panel.
15. Send a job to the printer. The Data In light will start flashing.
 - As soon as the printer receives the data, it will be stored on the SD card automatically with no print output.
 - Nothing is displayed on the screen, indicating that a Card Save operation was successful.



16. Touch [Offline], and then press  to exit Card Save mode.
17. Go back into the printer SP mode and set the setting back to the default (00000000). Be sure the press  to save the setting.
18. Switch the machine off and remove the SD card.

Error messages

If an error occurs, pressing "OK" will cause the device to discard the job and return to standby.

Error	Meaning
Card not found	Card cannot be detected in the slot.
Init error	A card save process (e.g. card detection, change to kernel mode) failed to initialize.
No memory	Insufficient working memory to process the job.
Other error	An unknown error occurred.
Write error	Failed to write to the card.

6.2.8 SD CARD APPLICATION MOVE

Removing the SD Card Slot Cover

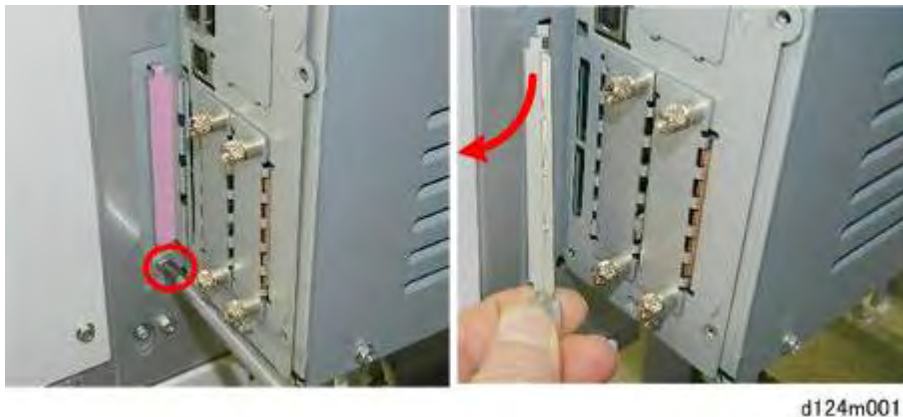

- The SD card slot cover is fastened by one screw.
- Remove this cover to insert SD cards.
- Always reattach this cover after removing or inserting SD Cards.

Restrictions and Precautions on the Use of SD Cards

- Always touch a grounded surface to discharge static electricity from your hands before you handle SD cards.
- When an application is moved from one SD card to another SD card, the authentication data is moved with the application program to the target SD card.
- Do not use an SD card if it has been used with a computer or other device. (The SD card may not operate correctly.)
- The original SD card received with purchase of the application program is the only evidence

that the customer is licensed to use the application. For this reason, the original SD card should be stored at the work site as proof of purchase by the customer. Also, the service technician may occasionally need to check the dates and version numbers SD cards during troubleshooting.

- After an SD card has been used to combine applications on one card, it cannot be used for any other purpose.
- Always make sure that the write-protect switch is OFF before uploading data to an SD card. It is very easy to accidentally turn on the write-protect switch when inserting and removing an SD card.
- To remove an SD card from its slot, push it in gently to release it then pull it out of its slot.

Move Execute

“Move Exec” (**SP5873-1**) moves one application program from the original SD card to another SD card. The application program is moved from Slot 2 to Slot 1.

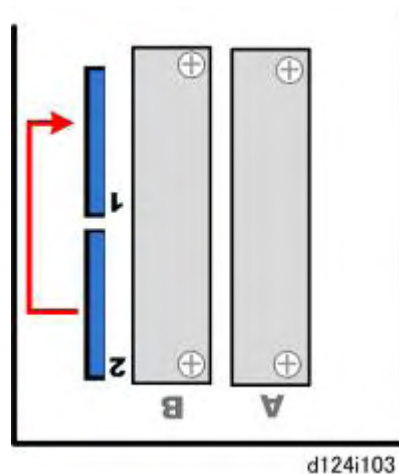



1. Turn off the machine off.
2. Remove the SD card slot cover ( x1).
3. Insert the original SD card with the application in Slot 2.
4. Insert the SD card to receive the application in Slot 1.
5. Turn on the main power switch.
6. Enter the SP mode and open **SP5873-1** “Move Exec.”
7. Touch [EXECUTE]
8. When the prompts asks you if you want to continue, touch [EXECUTE].
9. When you see the completed message, exit the SP mode.
10. Turn off the machine.
11. Remove the original SD card from Slot 2.
12. Leave the other SD card in Slot 1.
13. Turn the machine on.
14. Check that the application program runs normally.

15. Tell the customer to store the original SD card in a safe place.

Undo Exec

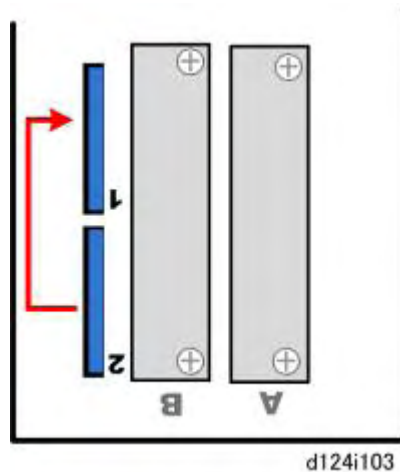
“Undo Exec” (**SP5873-2**) restores an application to its original SD card. The application is moved from Slot 2 to Slot 1.



1. Turn the machine off.
2. Remove the SD card slot cover ( x1).
3. Insert the SD card that currently holds the application in Slot 2.
4. Insert the original SD card to receive the restored application in Slot 1.
5. Turn the machine on.
6. Enter the SP mode and do **SP5873-2** “Undo Exec.”
7. Follow the messages on the operation panel to complete the procedure.
8. Exit the SP mode.
9. Turn off the main power switch.
10. Remove both SD cards.
11. Insert the SD card with the restored application in Slot 1.
12. Turn on the main power switch.
13. Check that the application operates normally.

6.2.9 SMC REPORTS

Printing an SMC Report

The machine automatically switches to ink save mode when it prints an SMC report, so the printed report will appear faint. If you need a darker printout, print the report to an SD card (next section), and then print it at normal density.

1. Enter the SP mode.
2. Touch [System SP]
3. Touch [Copy Window] at the top edge of the screen to move to the copy screen.
4. Select the paper feed station, and then touch [Start].
5. Touch [SP Window] at the top of the screen to return to the SP mode.
6. Open **SP5990** and then select a number for the desired print.

No.	What It Prints
1	All (Data List)
2	SP (Mode Data List)
3	User Program Data
4	Logging Data
5	Diagnostic Report
6	Non-Default (Prints only SPs set to values other than defaults.)
7	NIB Summary
8	Capture Log
21	Copier User Program
22	Scanner SP
23	Scanner User Program
24	SDK/J Summary
25	SDK/J Application Info
26	Printer SP

7. Touch [EXECUTE]

- When the message asks you to confirm starting, touch [EXECUTE].

Printing and SMC Report to SD Card

This function is used to save the SMC list as CSV files to the SD-card inserted into the operation panel SD-card slot.

- Turn the machine OFF.
- Insert the SD card into the SD card slot on the right edge of the operation panel.
- Turn the machine on.
- Enter the SP mode, and then touch [System SP].

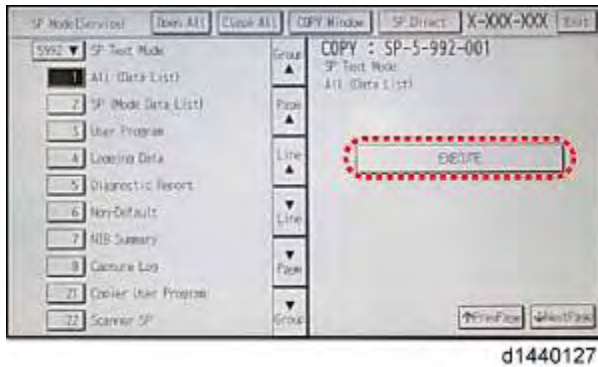

- Open **SP5992** (SP Text Mode).
- Select a detail SP number shown below to save data on the SD card.

No.	SMC Categories to Save
1	All (Data List)
2	SP (Mode Data List)
3	User Program
4	Logging Data
5	Diagnostic Report
6	Non-Default
7	NIB Summary
8	Capture Log
21	Copier User Program
22	Scanner SP
23	Scanner User Program

System Maintenance Tasks

No.	SMC Categories to Save
24	SDK/J Summary
25	SDK/J Application Info
26	Printer SP

7. Touch [EXECUTE].
8. Touch [EXECUTE] again to start. A message tells you operation is executing.
9. Wait for 2 to 3 minutes until you see the "Completed" message.
10. Touch [Exit] to exit the SP mode.

Note

- If the machine returns a "Failed" error message, there is no space remaining on the SD card. Touch [Exit] and then exit the SP mode. Try again with another SD card with sufficient space.

How Files are Named

The SMC list data saved on the SD-card are named automatically using the file naming conventions described below.



W490M000006_59921_20111011_53954.csv
 ───────────┬───┬───┬───┬───
 [A] [B] [C] [D] [E]
 d1440131

[A]	Machine serial number (fixed for each machine)
[B]	SP number saved in this file. First four digits (5992) in this part are fixed. The other one or two digits are the detail SP number(s). In this case, it is one digit. Therefore, this file is of SP5992-001 (All data list). See the upper SP table for the correspondence between SP detail numbers and the contents.
[C]	File creation date. YY/MM/DD ("0" is omitted if each is one digit.)
[D]	File creation time. HH/MM/SS (0" is omitted if each is one digit.)
[E]	File Extension CSV (Comma Separated Value). This part is fixed.

- A folder named using the machine serial number will be created on the SD card.
- This function can save the SMC list data only to an SD card inserted into the operation panel SD card slot.

6.2.10 SOFTWARE RESET

This software reset is the same as turning the machine off on and with the main power switch, but it is much faster.

1. Hold down  and  together for 10 seconds.
2. When the machine beeps once, release both buttons.
3. After "Now loading. Please wait" shows for a few seconds, the copy window will open. The machine is ready for normal operation.

Note

- You cannot use this procedure to reset the machine after a fatal SC error has occurred.

6.2.11 STAMP DATA DOWNLOAD

This procedure downloads the fixed stamp data ("Confidential", "Secret", etc.) from NVRAM onto the hard disk. You must always execute this SP after replacing or formatting the HDD. If this is not done the operator will not have access to the fixed stamps.

 **Important**

- **After downloading the stamp data, you must cycle the machine off/on.**
1. Enter the SP mode.
 2. Select **SP5853** and then press "EXECUTE". A screen will display "Loading" as the stamp data is downloaded.
 3. When you see "Completed" the down load is finished.
 4. Touch the [Exit].
 5. Cycle the machine off/on.

6.2.12 TEST PATTERN PRINTING

Up to 14 test patterns can be printed with **SP4417**.

1. Enter the SP mode.
2. Open **SP4417**.
3. Select the number of the pattern that you want to print.

No.	Pattern Name
0	Scanned Image
1	Gradation Main Scan A
2	Gradation Sub Scan B
3	Gradation RGBCMYK
4	Grid Pattern A
5	Slant Grid Pattern A
6	Scanned + Grid Pattern A
7	Scanned + Slant Grid A
8	Grid Pattern B
9	Scanned + Grid Pattern B
10	Color Patch 16
11	Gradation Main Scan C
12	Gradation Sub Scan C
13	Slant Grid Pattern C
14	Scanned + Grid Pattern C

6.3 MAIN SP MODES

6.3.1 INSTALLATION

This is a quick reference for installation related SP codes. For details, please refer to the Installation section.

Main Machine Installation

SP	Name	Comment
2012-1	Initial Operation Setting	Enter "9"
2100-4	Special Maintenance – Extract Fill Liquid	Enter "15"
2012-1	Initial Operation Setting	Enter "1"
2012-1	Initial Operation Setting	Enter "0"

Controller Option Installation

SP	For	Name	Comment
5985-1	Network	Device Setting – On Board NIC	Enter "1"
5985-2	USB	Device Setting- On Board USB	Enter "1"
5873-1	Appli Move	SD Card Appli Move – Move Exec	Touch [EXECUTE]
5873-2	Move Undo	SD Card Appli Move – Undo Exec	[EXECUTE]

6.3.2 REPLACEMENT AND ADJUSTMENT

Address Book

SP	Name	Comment
5846-51	Backup All Addr Book	Touch [EXECUTE] to copy to SD card.
5846-52	Restore All Addr Book	Touch [EXECUTE] to copy from SD card.

CIS Replacement

SP	Name	Select/Print
4417	IPU Test Pattern Setting	Select Pattern #8 (Grid Pattern)

Carriage Unit: Move Carriage Unit

SP	Name	Comment
2102-4	Maintenance Unit Exchange – Decapping	Three selections:
	▪ To uncap, but not move	"1"
	▪ To uncap, move to left side	"2"
	▪ To uncap, move to center	"3"

Carriage Unit: Replacement

SP/User Tool	Name	Comment
User Tool	User Tools> Maintenance> Auto Adjust Print Head Position	☛ page 5-321
5885-3	Factory Setting – Head Gap Backup	Touch [EXECUTE]

Controller Board Replacement

SP	Name	Action
5824	NVRAM Data Upload	Touch [EXECUTE] (Data to SD card.)
5825	NVRAM Data Download	Touch [EXECUTE] (Data from SD card).

Cutter Blade, Cutter Unit Replacement

SP	Name	Comment
7960-2	Cutter Drive Count – Clear Drive Count	Touch [EXECUTE] (After blade replacement)
7960-4	Cutter Drive Count – Clear Unit Drive Count	Touch [EXECUTE] (After unit replacement)

Debug Tools

SP	Name	See
5857	Save Debug Log	page 6-5
5888	Save Debug When	
5889	Debug Save Key No.	

DRESS Sensor Replacement

SP	Name
SP4417 #8	IPU Test Pattern Setting - 8 Grid Pattern B
SP4012-007	Scanner Edge Margin - DF: Left Edge
SP4012-008	Scanner Edge Margin - DF: Right Edge
SP2103-003	Printing Erase Pattern - Left Edge
SP2103-004	Printing Erase Pattern - Right Edge
SP2104-001	Paper Edge Detection Delay Adj. - Normal Paper Right Edge
SP2104-002	Paper Edge Detection Delay Adj. - Normal Paper Left Edge
SP2104-031	Paper Edge Detection Delay Adj. - Automatic Conversion

HDD Replacement

SP	Name	Comment
5832	Format HDD	Touch [EXECUTE]
5853	Stamp Data Download (ROM > HDD)	Touch [EXECUTE] (copies from NVRAM to HDD)

Ink Supply Unit Replacement

SP	Name	Comment
2102-4	Maintenance Unit Exchange – Decapping	Enter "3" to move carriage to center
2090-1	NV Clear at Supply Unit Exc – Execute NV Value Clear	Touch [EXECUTE] to clear unit counter
2012-1	Initial Operation Setup	Enter "9" to prevents normal ink level checking/filling sequence
2100-5	Special Maintenance – Extract Air	Enter "31" to exxtracts air from the tubes and tanks

Left Ink Sump Replacement

SP	Name	Comment
7961-5	Waste Ink Analysis – Left Ink Box Amount Counter	Displays ink amount in box (ul)
2505-1	Reset Waste Ink Counter – Waste Ink Left C/R	Touch [EXECUTE] to reset counter for new box

Machine Information

SP	Name	Comment
2959	Engine Control iC ID Indication	This SP displays the name and firmware version number of the engine control module.
5811	Machine Serial Number Set SSP	Enter serial number
5849	Installation Date	Displays date of machine installation.
7801	ROM Part Number	Displays ROM number, firmware version numbers, and other important information about the machine.
7832	Self-Diagnose Result Display	Push [#] to display a list of error codes. Nothing is displayed if no errors have occurred.
7836	Total Memory Size	Displays the contents of the memory on the controller board.
7962	Waste Ink Box	These SP codes display information about the ink collector unit. This information is recorded on the ID chip inside the ink collector unit box.

Maintenance Unit: Replacement

SP	Name	Comment
2102-4	Maintenance Unit Exchange – Decapping	Enter "3" to move carriage to center
2231-3	PM Counter Indication – Maintenance Unit (%)	Displays usage as %
2231-8	PM Counter Indication – PM Counter Maintenance Unit (Distance: mm)	Displays usage as mm
2231-8	PM Counter – Maintenance Unit	PM count (mm)
2102-2	Maintenance Unit Exchange Reset – Exchange Threshold	Threshold setting for PM alert
2102-3	Maintenance Unit Exchange Reset – Remaining Life Display Threshold	Remaining life as %
2102-1	Maintenance Unit Exchange Reset – Reset	Touch [EXECUTE] to reset PM counter for new unit

NVRAM Upload/Download

SP	Name	Comment
5811	Machine Serial Number Set SSP	Serial number must be set
5990-2	SP Print Mode	SP mode data list (SMC report to paper)
5992-2	SP Text Mode	SP mode data list (SMC report to file)
5824	NVRAM Data Upload	Copies to SD card in Slot 1
5825	NVRAM Data Download	Copies from SD card in Slot 1

PM Part Call Alarm

SP	Name	Comment
5516-1	Individual PM Part Alarm Call	Alarm for maintenance unit, left ink sump, right ink sump at @Remote Service Center

Print Head Replacement

The black print heads (K1, K2) are contained in the left cradle, the color print heads (C, Y, M) in the right cradle.

Right Print Heads – Black (K1, K2)

SP	Name	Comment
2102-4	Maintenance Unit Exchange – Decapping	Enter "3" to move carriage to center
2231-6	PM Counter Indication – Carriage Unit (Black)	Usage: mm
2400-1	NV Clear at Carriage Exchange* ¹	Enter "1" to clear for left cradle K1, K2

*¹ Enter "0" if both the black and color cradles were replaced at the same time.

Density Adjustment (Black Print Head Only)

SP	Name	Comment
2902, #11	Internal Test Pattern - 11 Density Pattern 2	---
3132-001	ECB Correction Value - H1	94-97%
3132-002	ECB Correction Value - H2	94-97%

Left Print Heads - Color (C, Y, M)

SP	Name	Comment
2231-7	PM Counter Indication – Carriage Unit (Color)	Displays mm
2400-1	NV Clear at Carriage Exchange* ¹	Enter "2" to clear for right cradle C, Y, M

*¹ Enter "0" if both the black and color cradles were replaced at the same time.

Right Ink Sump Replacement

SP	Name	Comment
2505-2	Reset Waste Ink Counter – Waste Ink Right C/R	Touch [EXECUTE] to reset counter for new box
7961-1	Waste Ink Analysis – Right Ink Box Amount Counter	Amount of ink in box (ml)

Self Diagnostic

SP	Name	Comment
7832-1	Self Diagnose Result Display	Touch [EXECUTE] to display results

SMC Print Report

SP	Name	Comment
5990	SP Print Mode	Touch [EXECUTE] to print report to paper
5992	SP Text Mode	Touch [EXECUTE] to print report to file

SMC Report Print to SD Card

SP	Name	Comment
1001	Enter "Printer SP" mode, open SP1001 Bit Switch	[4]

Software Reset

Key Press	Comments
[*] + [#] hold for 10 sec.	Resets software

Stamp Data Download

Do this SP after replacement of the HDD.

SP	Name	Comment
5883	Stamp Data Download	Touch [EXECUTE] to download fixed stamps from NVRAM to HDD

Test Patterns

SP	Name	Comment
4417	IPU Test Pattern Selection	Patterns 1 to 14
2902	Internal Test Patterns Select – MCU Internal Patterns	Patterns 1 to 11

Touch Screen Calibration

Key Press	Comments
[C] [1] [9] [9] [3] then [C] 5 times	Opens the touch screen calibration screen  page 5-96

TROUBLESHOOTING

REVISION HISTORY		
Page	Date	Added/Updated/New
		None

7. TROUBLESHOOTING

7.1 SERVICE CALL CONDITIONS

There are four levels of service call conditions.

Level	Definition	Reset Procedure
A	Fusing unit SC codes shown on the operation panel. The machine is disabled. The operator cannot reset the machine.	The machine requires immediate servicing by a service technician.
B	These SC codes disable only the features that use the defective item. The user does not see these SC codes in usual conditions. But, they are shown on the operation panel when the defective feature is used.	Cycle the machine off/on with the main power switch..
C	SC codes that are not shown on the operation panel. They are recorded internally.	Recorded only.
D	These SC codes are shown on the operation panel. To reset these SC codes, turn the operation switch or main power switch off and on. These SC codes are shown again if the error occurs again.	Set the operation switch or the main power switch to "off" then to "on".

For details about SC codes and solutions, please refer to the Appendices.

Preliminary Instructions

- If the problem is in an electrical circuit board, disconnect then connect the board connectors again before you replace the PCB.
- If the problem is a motor lock, check the mechanical load before you replace a motor or sensor.
- When a Level A or Level B SC occurs while the machine is in the SP mode, the SC number will not be shown. If this occurs, check the SC number after the machine goes out from the SP mode. This does not include Level B codes.
- Many SC codes contain more than one level (SC303-1, SC303-2, SC303-3, and others). Some SC codes can show a "-1", even if there is only one level.
- The following abbreviations are used in these SC tables: (F) means "Front", (R) means "Rear", "CTL" means "Controller".

7.2 SC100: SCANNING

SC101	D	Scanner Lamp Error
		At power on the scan lamp trigger remained off.
		<ul style="list-style-type: none"> ▪ CIS-to-IPU harness loose, broken, defective ▪ CIS-to-IOB harness loose, broken, defective ▪ IPU defective ▪ IOB defective ▪ CIS defective

SC143	C	Scanner Automatic Adjustment Error
		Automatic adjustment of the CIS failed at power on.
		<ul style="list-style-type: none"> ▪ Standard white strips dirty or not platen white plate installed improperly ▪ CIS LED defective and not lighting ▪ CIS-to-PSU harness loose, broken, defective ▪ CIS-to-IPU harness loose, broken, defective ▪ CIS defective ▪ MCU defective ▪ SIF defective ▪ IPU defective

SC144	D	SIB Communication Error
		SIB serial transmission did not begin after power on.
		<ul style="list-style-type: none"> ▪ SIF-to-IPU harness connector loose, broken, defective ▪ SIF defective ▪ MCU defective ▪ IPU defective

SC161-1	D	IPU Error 1: Volans Configuration Error
		At power on, or when the machine returned from energy save mode, FPGA (flash program) did not configure correctly within 500 ms, or an FPGA communication check failed.
		<ul style="list-style-type: none"> ▪ Check all harness connections to the IPU for a loose, broken, defective connection ▪ IPU defective

SC161-02	D	IPU Error 2: Ri2005 SIB Response Error
		At power on, or when the machine returned from energy save mode, an IPU error occurred because Ri did not respond within 5 ms.
		<ul style="list-style-type: none"> ▪ IPU defective

SC161-03	D	IPU Error 3: Ri2005 S-to-M Response Error
		At power on, or when the machine returned from energy save mode, the Ri2005 chip on the IPU did not respond within 5 ms.
		<ul style="list-style-type: none"> ▪ IPU defective

SC161-05	D	IPU Error: Ri2005 M-to-P Response Error
		At power on, or when the machine returned from energy save mode, the Ri2005 chip on the IPU did not respond within 5 ms.
		<ul style="list-style-type: none"> ▪ IPU defective

SC165	D	Illegal Copy Prevention Function Error
		<p>The illegal copy prevention function failed to initialize at power on, or when the machine returned from the energy save mode, because the ICIB3 board was not detected or was not installed correctly.</p> <p>Note: The ICIB3 (option) is the PCB installed on the back of the machine that controls the function that prohibits illegal copying of currency, bank notes, etc.</p>
		<ul style="list-style-type: none"> ▪ Check installation and connection of the ICIB3 board ▪ ICIB3 defective

7.3 SC200: IMAGE WRITING

SC200	D	Suction Cap HP Sensor Error
		The maintenance unit slide sensor did not detect the suction cap and wiper blade assembly at home position.
		<ul style="list-style-type: none"> ▪ HP sensor connection loose, broken, defective ▪ Paper or other obstacle blocking movement of the mechanism ▪ HP sensor defective

SC201-01	D	Print Head Caps Home Position Sensor Error
		The cap sensor in the maintenance unit failed to detect the left cradle at the up position or down position (home position).
		<ul style="list-style-type: none"> ▪ HP sensor connection loose, broken, defective ▪ Paper or other obstacle blocking movement of the mechanism ▪ HP sensor defective

SC201-02	D	Cleaner Unit Slider Sensor Error
		The slider sensor at the back of the maintenance unit failed to detect the cleaner unit at the forward position or the rear position (home position. The left cradle, suction cap, rubber wiper blade, and wipers comprise the maintenance cleaning unit.
		<ul style="list-style-type: none"> ▪ HP sensor connection loose, broken, defective ▪ Paper or other obstacle blocking operation of the motor ▪ HP sensor defective ▪ Motor defective

SC202	D	Ink Level Detection Feeler Position Error
		<p>One of the following conditions existed:</p> <ul style="list-style-type: none"> ▪ When air was purged one or more of the feelers could not be detected so the operation could not continue. ▪ When the maintenance pump attempted to apply negative pressure on the print head ink tank, the feeler could not be detected at its prescribed position after the pressure was applied. ▪ OCFS could not detect the feeler(s) after the feeler sensor performed the check after filling.
SC202-01	D	Head 1: Ink Level Sensor Feeler Error at Air Release
SC202-02	D	Head 2: Ink Level Sensor Feeler Error at Air Release
SC202-03	D	Head 3: Ink Level Sensor Feeler Error at Air Release
SC202-04	D	Head 4: Ink Level Sensor Feeler Error at Air Release
SC202-05	D	Head 5: Ink Level Sensor Feeler Error at Air Release
		Feeler cannot be detected during air release.
		<ul style="list-style-type: none"> ▪ Feeler cannot be detected because it is out of position (loose, broken, defective, or blocked by an obstruction) ▪ Air release solenoid blocked ▪ Maintenance unit defective ▪ Print head ink tank defective ▪ Air release solenoid defective
SC202-11	D	Head 1: Air Leak at Negative Pressure
SC202-12	D	Head 2: Air Leak at Negative Pressure
SC202-13	D	Head 3: Air Leak at Negative Pressure
SC202-14	D	Head 4: Air Leak at Negative Pressure
SC202-15	D	Head 5: Air Leak at Negative Pressure

SC202-16	D	Head Tanks 4 and 5: Air Leak at Negative Pressure
		Air leak. Pressure applied but immediate leak and air detected.
		<ul style="list-style-type: none"> ▪ Feeler cannot be detected because it is out of position (loose, broken, defective, or blocked by an obstruction) ▪ Air release solenoid blocked ▪ Maintenance unit defective ▪ Print head ink tank defective ▪ Air release solenoid defective
SC202-21	D	Head 1: Nozzle or Filter Clogged (2HT System)
SC202-22	D	Head 2: Nozzle or Filter Clogged (2HT System)
SC202-23	D	Head 3: Nozzle or Filter Clogged (2HT System)
SC202-24	D	Head 4: Nozzle or Filter Clogged (2HT System)
SC202-25	D	Head 5: Nozzle or Filter Clogged (2HT System)
SC202-26	D	Head Tanks 4 and 5: Nozzle or Filter Clogged (2HT System)
		Nozzle or filter clogged (or both clogged). A color nozzle or filter is clogged
		<ul style="list-style-type: none"> ▪ Nozzle check ▪ Nozzle cleaning ▪ Nozzle flushing
SC202-30	D	Insufficient suction
		Nozzle or filter, or both nozzle and filter clogged. Insufficient suction (1HT System) to perform maintenance and solve the problem.
		<ul style="list-style-type: none"> ▪ Nozzle check ▪ Nozzle cleaning ▪ Nozzle flushing ▪ Maintenance unit defective
SC202-41	D	Head 1: Ink Level Feeler Error 1
SC202-42	D	Head 2: Ink Level Feeler Error 1

SC202-43	D	Head 3: Ink Level Feeler Error 1
SC202-44	D	Head 4: Ink Level Feeler Error 1
SC202-45	D	Head 5: Ink Level Feeler Error 1
SC202-46	D	Head Tanks 4 and 5: Ink Level Feeler Error 1
		No air release (ink entry, etc.) Feeler did not release, even when air release valve was pressed manually. Even at negative pressure, the feeler against the wall of the tank did not detect any change.
		<ul style="list-style-type: none"> ▪ Feeler cannot be detected because it is out of position (loose, broken, defective, or blocked by an obstruction) ▪ Air release solenoid blocked ▪ Maintenance unit defective ▪ Print head ink tank defective ▪ Air release solenoid defective
SC202-51	D	Head 1: Ink Level Feeler Error 2
SC202-52	D	Head 2: Ink Level Feeler Error 2
SC202-53	D	Head 3: Ink Level Feeler Error 2
SC202-54	D	Head 4: Ink Level Feeler Error 2
SC202-55	D	Head 5: Ink Level Feeler Error 2
SC202-56	D	Head Tanks 4 and 5
		<p>While ink tank was under negative pressure, ink level sensor feeler was out of position and caused the error. Air is releasing now but not previously.</p> <ul style="list-style-type: none"> ▪ Dirty horizontal encoder strip ▪ Obstruction between feeler and side of the ink tank
SC202-61	D	Head 1: Ink Level Feeler Error 3
SC202-62	D	Head 2: Ink Level Feeler Error 3
SC202-63	D	Head 3: Ink Level Feeler Error 3
SC202-64	D	Head 4: Ink Level Feeler Error 3

SC202-65	D	Head 5: Ink Level Feeler Error 3
		The OCFS could not detect the position of the ink level feeler.
		<ul style="list-style-type: none"> ▪ Feeler cannot be detected because it is out of position (loose, broken, defective, or blocked by an obstruction) ▪ Air release solenoid blocked ▪ Maintenance unit defective ▪ Print head ink tank defective ▪ Air release solenoid defective
SC202-70	D	Ink Level Feeler Error 4: All Feelers
		All ink level sensor feelers were not detected.
		<ul style="list-style-type: none"> ▪ Feeler cannot be detected because it is out of position (loose, broken, defective, or blocked by an obstruction) ▪ Maintenance unit defective ▪ Print head ink tank defective ▪ Air release solenoid defective

SC203	D	Supply Pump Suction Timeout Errors
		<p>The supply pump motor reversed to apply negative pressure, but the sensor failed to detect one or more feelers at the prescribed positions, so pressure could not be detected as normal. Problem may be cause by</p> <ul style="list-style-type: none"> ▪ An air leak ▪ Clogged tubing between the supply pump and print head ▪ Failure to purge air from the tank ▪ A broken or defective feeler
		<ul style="list-style-type: none"> ▪ Feeler broken, damaged, or blocked ▪ Air release solenoid blocked ▪ Air release solenoid defective ▪ Ink supply pump or tube defective
SC203-11	D	Head 1: Air Leak Error



SC203-12	D	Head 2: Air Leak Error
SC203-13	D	Head 3: Air Leak Error
SC203-14	D	Head 4: Air Leak Error
SC203-15	D	Head 5: Air Leak Error
		Air leak: Immediate air leak detected at application of negative pressure
		<ul style="list-style-type: none"> ▪ Feeler broken, damaged, or blocked ▪ Air release solenoid blocked ▪ Air release solenoid defective ▪ Ink supply pump or tube defective
SC203-21	D	Ink Pump 1 Timeout Error
SC203-22	D	Ink Pump 2 Timeout Error
SC203-23	D	Ink Pump 3 Timeout Error
SC203-24	D	Ink Pump 4 Timeout Error
SC203-25	D	Ink Pump 5 Timeout Error
		Ink supply defective, pump faulty and could not form negative pressure, but there was negative pressure at the maintenance unit.
		<ul style="list-style-type: none"> ▪ Feeler broken, damaged, or blocked ▪ Ink supply pump or tube defective
SC203-31	D	Head 1: Purge Error
SC203-32	D	Head 2: Purge Error
SC203-33	D	Head 3: Purge Error
SC203-34	D	Head 4: Purge Error

SC203-35	D	Head 5: Purge Error
		No air release (ink entry, etc.) Feeler does not release, even when air release valve is pressed, and the feeler that is not detecting the negative pressure is depressed and out of position.
		<ul style="list-style-type: none"> ▪ Feeler broken, damaged, or blocked ▪ Air release solenoid blocked ▪ Air release solenoid defective ▪ Ink supply pump or tube defective
SC203-51	D	Ink Supply Error: Head 1
SC203-52	D	Ink Supply Error: Head 2
SC203-53	D	Ink Supply Error: Head 3
SC203-54	D	Ink Supply Error: Head 4
SC203-55	D	Ink Supply Error: Head 5
		<ul style="list-style-type: none"> ▪ Feeler broken, damaged, or blocked ▪ Air release solenoid blocked ▪ Air release solenoid defective ▪ Ink supply pump or tube defective

SC210	D	Carriage Horizontal Initialization Error
		The machine failed to detect the carriage unit at the start position.
		<ul style="list-style-type: none"> ▪ Horizontal encoder installed incorrectly (not inserted into the gap of the horizontal encoder sensor) ▪ Horizontal encoder strip dirty ▪ Horizontal encoder strip loose, broken, defective ▪ Horizontal encoder sensor connector loose, broken, defective ▪ Horizontal encoder sensor defective



SC211-01	D	Carriage Communication Error
		The machine detected no response from the carriage unit.
		<ul style="list-style-type: none"> ▪ Cycle the machine off/on ▪ If the problem recurs, check around the HRB on the carriage unit for a loose, broken, or defective connector ▪ Check around the MCU for a loose broken connector on a harness from the carriage unit.

SC211-02	D	Carriage Hardware Error
		The machine detected a hardware error for the carriage unit.
		<ul style="list-style-type: none"> ▪ Horizontal motor connector loose, broken, defective ▪ Horizontal motor blocked by an obstacle ▪ Horizontal encoder strip dirty ▪ Horizontal encoder strip loose, broken, defective, or installed incorrectly ▪ Horizontal encoder sensor connector loose, broken, defective ▪ Horizontal encoder installed incorrectly ▪ MCU connector loose, broken, defective ▪ Horizontal encoder sensor defective ▪ Horizontal motor defective ▪ MCU defective

SC212	D	Head Lift Motor Error
		<p>The status of the head lift sensor 1 or 2 did not change when the carriage was raised. Within 25 sec.:</p> <ul style="list-style-type: none"> ▪ At initialization, head lift sensor 1 did not go OFF and head lift sensor 2 did not go ON. ▪ When the carriage was raised 1 mm, head lift sensor 1 did not go OFF and head lift sensor 2 did not go OFF. ▪ When the carriage was raised 2 mm, print head sensor 1 did not go ON.
		<ul style="list-style-type: none"> ▪ One or more sensor connector loose, broken, defective ▪ Lift motor connector loose, broken, defective. ▪ One or more sensor defective ▪ Lift motor defective

SC251	D	Deficit Detection: Ink Collector Tank
		The waste ink collection tank of the nozzle check unit is full.
SC251-01	D	Waste ink tank full count has exceeded threshold 1.
		<ul style="list-style-type: none"> ▪ Cycle the machine OFF/ON to cancel the SC error temporarily.
SC251-02	D	Waste ink tank full count has exceeded threshold 2
		<ul style="list-style-type: none"> ▪ The SC error will continue to display until the unit has been replaced and the count has been cleared.

SC280	D	Air detection sensor error
		A problem has occurred at the terminal pin sensor on top of one of the sub tanks, or the maintenance unit is not functioning correctly.
		<ul style="list-style-type: none"> ▪ Terminal pin defective ▪ Maintenance unit defective

SC282	D	Air Detection Frequency Error
		<p>The amount of air allowed in the print head tank exceeded the threshold from the start of checking cycle. If the machine remains idle, small amounts of air will leak slowly into one or more of the sub tanks.</p> <p>There are two thresholds:</p> <ul style="list-style-type: none"> ▪ The first threshold sets the amount of leakage within a 10-day period. ▪ The second threshold sets the amount of leakage allowed greater than a 10-day period.
SC282-11	D	Head 1
SC282-12	D	Head 2
SC282-13	D	Head 3
SC282-14	D	Head 4
SC282-15	D	Multiple Heads
		<ul style="list-style-type: none"> ▪ Cycle the machine off/on.

SC283	D	Ink End Detection Error
		The mechanical ink end sensor has failed, or one of the ink supply pumps has failed.
		<ul style="list-style-type: none"> ▪ Cycle the machine off/on ▪ Ink end sensor defective ▪ Replace ink supply unit

SC285	C	DRESS Sensor Calibration Error
		The reflected beams was measured less than 400 when the head gap was adjusted automatically.
		<ul style="list-style-type: none"> ▪ DRESS sensor harness loose, broken, defective ▪ DRESS sensor defective

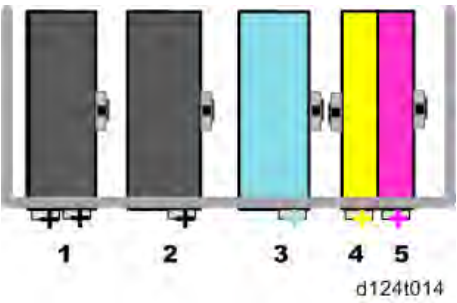
SC290	D	OCFS Ink Pump Reverse Suction Error	
		The OCFS could not detect when the supply pump motor reversed because a feeler was broken or out of position, or an ink supply pump could not siphon ink.	
SC290-01	D	Head 1	
SC290-02	D	Head 2	
SC290-03	D	Head 3	
SC290-04	D	Head 4	
SC290-05	D	Head 5	
		<ul style="list-style-type: none"> ▪ Cycle the machine off/on ▪ Replace print head (with new OCFS) ▪ Replace ink supply unit 	

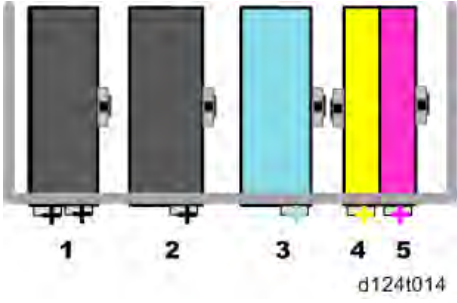
SC293	D	OCFS Ink Timeout During Filling	
		The OCFS feeler is out of position and cannot be read, or one of the ink supply pumps is not pumping ink	
SC293-01	D	Head 1	
SC293-02	D	Head 2	
SC293-03	D	Head 3	
SC293-04	D	Head 4	
SC293-05	D	Head 5	
		<ul style="list-style-type: none"> ▪ Replace the ink supply unit ▪ Replace ink end sensor 	

SC300: Not Used

7.4 SC300: NOT USED

There are no Group 300 service codes for this machine.

7.5 SC400: DRESS SENSOR

SC400	D	DRESS Sensor Calibration Error
		The automatic head gap adjustment (gap between print heads) failed.
		<ul style="list-style-type: none">▪ Sensor connection loose, broken, defective at CN114▪ Sensor defective

7.6 SC500: PAPER FEED, TRANSPORT

SC503	B	Paper Feed Pressure Release Operation Error: Roll 1
		Within 3 sec. after the release and application of pressure in Roll Unit 1, there was no signal from the paper release sensor.
		<ul style="list-style-type: none"> ▪ Sensor harness loose, broken, defective ▪ Sensor defective ▪ MCU defective

SC504	B	Pressure Feed Pressure Release Operation Error: Roll 2
		Within 3 sec. after the release and application of pressure in Roll Unit 2, there was no signal from the paper release sensor.
		<ul style="list-style-type: none"> ▪ Sensor harness loose, broken, defective ▪ Sensor defective ▪ RFDB defective

SC508-01	D	Cutter Sensor Error
		One or both the cutter switches (the return switch on the left and HP switch on the right) remained on during cutting, when the front cover was opened and closed, or when the machine was switched on.
		<ul style="list-style-type: none"> ▪ Cutter left return switch harness loose, broken, defective ▪ Cutter left return switch defective ▪ Cutter right return switch harness loose, broken, defective ▪ Cutter right return switch defective

SC508-02	D	Cutter Motor Error
		The cutter HP sensor on the right did not go off within 300 ms after the cutter motor was switched on. The cutter did not move from its home position.
		<ul style="list-style-type: none"> ▪ Cutter motor harness loose, broken, defective ▪ Something is blocking the horizontal movement of the cutter in its track ▪ Cutter motor defective

SC508-03	D	Cutter Operation Error
		The cutter return switch on the left end of the cutter unit did not switch on within 3 sec. after the cutter motor switched on.
		<ul style="list-style-type: none"> ▪ Something is blocking the cutter in its track ▪ The cutter drive belt is jammed

SC508-04	D	Cutter Home Position Switch Error
		The cutter HP switch on the right end of the cutter unit did not switch on within 3 sec. after the cutter motor reversed to return the cutter to the home position on the right.
		<ul style="list-style-type: none"> ▪ Something is blocking the cutter in its track ▪ The cutter drive belt is jammed

SC520-01	D	Vertical Paper Feed Mechanism Communication Error
		No response from DSP (Digital Signal Processing) that controls intermittent feed from the paper rollers.
		<ul style="list-style-type: none"> ▪ Cycle the machine off/on ▪ Check the harness connections between the roll unit and the MCU, and RFDB if Roll Unit 2 is installed ▪ MCU defective

SC500: Paper Feed, Transport

SC520-02		Vertical Paper Feed Hardware Error
		DSP (Digital Signal Processing) responded with a hardware error.
		<ul style="list-style-type: none"> ▪ Roll paper feed motor harness loose, broken, defective ▪ Encoder sensor harness or encoder wheel loose, broken, defective ▪ Motor defective ▪ MCU defective

SC520-03	D	Vertical Paper Feed Operation Direction Error
		DSP (Digital Signal Processing) responded with a direction movement error.
		<ul style="list-style-type: none"> ▪ Vertical wheel sensor connection loose, broken, defective ▪ Vertical motor connection loose, broken, defective ▪ Check motor to confirm that the polarity of the harness connector is correct ▪ Check the sensor to confirm that the polarity of the harness connection is correct

SC521-01	D	Roll Unit 1 Communication Error
		No response from DSP (Digital Signal Processing) that controls intermittent feed from the paper rollers.
		<ul style="list-style-type: none"> ▪ Roll Unit 1 is not connected ▪ Cycle the machine off/on ▪ Check the harness connections between the roll unit and the MCU ▪ MCU defective

SC521-02	D	Roll Unit 1 Hardware Error
		DSP (Digital Signal Processing) responded with a hardware error.
		<ul style="list-style-type: none"> ▪ Roll paper feed motor harness loose, broken, defective ▪ Encoder sensor harness or encoder wheel loose, broken, defective ▪ Motor defective ▪ MCU defective

SC522-01	D	Roll 2 Communication Error
		No response from DSP (Digital Signal Processing) that controls intermittent feed from the paper rollers.
		<ul style="list-style-type: none"> ▪ Cycle the machine off/on ▪ Check the harness connections between the roll unit, RFDB, MCU ▪ MCU or RFDB defective

SC522-02	D	Roll 2 Hardware Error
		DSP (Digital Signal Processing) responded with a hardware error.
		<ul style="list-style-type: none"> ▪ Roll paper feed motor harness loose, broken, defective ▪ Encoder sensor harness or encoder wheel loose, broken, defective ▪ Motor defective ▪ MCU defective

SC530	D	Intake Fan Error
		The fan was detected rotating at less than 100 rpm three times at 300 ms intervals.
		<ul style="list-style-type: none"> ▪ Fan harness loose, broken, defective ▪ Fan defective ▪ MCU defective

SC540	C	Vertical HP Sensor Error
		Not signal from the vertical HP sensor.
		<ul style="list-style-type: none"> ▪ Edge of the wheel is dirty and requires cleaning ▪ Edge of the vertical wheel not positioned in sensor gap ▪ Sensor connection loose, broken, defective ▪ Sensor defective

SC571-01	D	Head Temperature Sensor Error (Black)
		The head temperature sensor near the black sub tanks registered a temperature that was out of range.
		<ul style="list-style-type: none"> ▪ Connection loose, broken, defective at CN138 ▪ After correcting the problem, cycle the machine off/on

SC571-02	D	Head Temperature Sensor Error (Color)
		The head temperature sensor near the color sub tanks registered a temperature that was out of range.
		<ul style="list-style-type: none"> ▪ Connection loose, broken, defective at CN138 ▪ After correcting the problem, cycle the machine off/on ▪ Sensor defective

SC573-01	D	Temperature/Humidity Sensor – Temperature Error
		The temperature/humidity sensor registered a temperature that was out of range.
		<ul style="list-style-type: none"> ▪ Connection loose, broken, defective at CN217 ▪ After correcting the problem, cycle the machine off/on ▪ Sensor defective

SC573-02	D	Temperature/Humidity Sensor Error (Humidity)
		The temperature/humidity sensor registered a humidity reading that was out of range.
		<ul style="list-style-type: none"> ▪ Connection loose, broken, defective at CN217 ▪ After correcting the problem, cycle the machine off/on ▪ Sensor defective

7.7 SC600: COMMUNICATION

SC632	B	Counter device error 1	CTL
		After 3 attempts to send a data frame to the optional counter device via the serial communication line, no ACK signal was received within 100 ms.	
		<ul style="list-style-type: none"> ▪ Serial line between the optional counter device, the relay board and copier control board is disconnected or damaged. ▪ Make sure that SP5113 is set to enable the optional counter device. 	
		<ul style="list-style-type: none"> ▪ Check if the setting of the SP5113 is correctly set. ▪ Check the connection between the main machine and optional counter device. 	

		Counter device error 2	CTL
		After communication was established, the controller receivee the brake signal from the accounting device.	
SC633	B	<ul style="list-style-type: none"> ▪ Serial line between the optional counter device, the relay board and copier control board is disconnected or damaged. ▪ Make sure that SP5113 is set to enable the optional counter device. 	
		<ul style="list-style-type: none"> ▪ Confirm that the setting of SP5113 is correct. ▪ Check the connection between the main machine and optional counter device. 	

SC634	B	Counter device error 3	CTL
		A backup RAM error was returned by the counter device.	
		<ul style="list-style-type: none"> ▪ Counter device control board defective ▪ Backup battery of counter device defective 	
		<ul style="list-style-type: none"> ▪ Replace the counter device. 	

SC635	B	Counter device error 4	CTL
		A backup battery error was returned by the counter device.	
		<ul style="list-style-type: none"> ▪ Counter device control board defective ▪ Backup battery of counter device defective 	
		<ul style="list-style-type: none"> ▪ Replace the counter device. 	

SC636	D	SD Card Error	CTL
01		Expanded authentication module error	
		There is no expanded authentication module in the machine. The SD card or the file of the expanded authentication module is broken. There is no DESS module in the machine.	
		<ul style="list-style-type: none"> ▪ No expanded authentication module ▪ Defective SD card ▪ Defective file in the authentication module ▪ No DESS module 	
		<ol style="list-style-type: none"> 1. Install the expanded authentication module. 2. Install the SD card. 3. Install the DESS module. 4. In the SSP mode set SP5-401-160 to 0. 5. In the SSP mode, set SP5-401-161 to 0. 6. Cycle the machine off/on. 7. Execute SP5-876-1 (security all clear). 8. If this is a mass-produced machine, replace the NV. 	



02		Version error
		The version of the expanded authentication module is not correct.
		<ul style="list-style-type: none"> ▪ Incorrect module version
		<ul style="list-style-type: none"> ▪ Install the correct file of the expanded authentication module.
11		OSM user code file error
		The correct "usercode" file could not be found in the root folder of the SD card because the file is not present, or the existing file is corrupted or the wrong type file.
		<ul style="list-style-type: none"> ▪ Create the usercode files with the User Setting Tool "IDissuer.exe" . ▪ Store the files in the root folder of the SD card.
		Note: Make sure the eccm.mod file is in the root folder of the SD card.

SC637	D	Tracking information notification error	CTL
01		Tracking application error	
		Tracking information was lost. The machine failed to give notice of the tracking information to the tracking SDK application.	
		<ul style="list-style-type: none"> ▪ Cycle the machine off/on 	
02		Management server error	
		The machine failed to give notice of the tracking information to the management server. Tracking information was lost, and the machine could not count correctly.	
		<ul style="list-style-type: none"> ▪ Cycle the machine off/on 	

SC640	D	Engine-to-Controller Communication Error	CTL
		This is a checksum error.	
		<ul style="list-style-type: none"> ▪ PCI hardware error 	
		<ul style="list-style-type: none"> ▪ Cycle the machine off/on 	

SC641	D	Engine serial communication error	CTL
		An error occurs in serial communication with engine.	
		<ul style="list-style-type: none"> ▪ SC641-1: Timeout error ▪ SC641-2: Retry over ▪ SC641-3: Download error ▪ SC641-4: UART error 	
		<ul style="list-style-type: none"> ▪ Cycle the machine off/on 	

SC650	B	@Remote communication error (Cumin-M)	CTL
01		<p>The authentication for the Cumin-M fails failed at a dial up connection due to one or more of the following:</p> <ul style="list-style-type: none"> ▪ Incorrect SP settings ▪ Disconnected telephone line ▪ Disconnected modem board ▪ Disconnected wireless LAN card 	
		<ul style="list-style-type: none"> ▪ Check and set the correct user name (SP5-816-156) and password (SP5-816-157). 	
04		Communication line error	
		The supplied voltage is not sufficient due to the defective communication line or defective connection.	
		<p>The authentication for the Cumin-M fails failed at a dial up connection due to one or more of the following:</p> <ul style="list-style-type: none"> ▪ Incorrect SP settings ▪ Disconnected telephone line ▪ Disconnected modem board ▪ Disconnected wireless LAN card 	
		<ul style="list-style-type: none"> ▪ Check and set the correct user name (SP5-816-156) and password (SP5-816-157). 	
05		No modem board	
		Modem board is not installed even though the setting at Cumin-M (During the operation)	
		<p>The authentication for the Cumin-M fails failed at a dial up connection due to one or more of the following:</p> <ul style="list-style-type: none"> ▪ Incorrect SP settings ▪ Disconnected telephone line ▪ Disconnected modem board ▪ Disconnected wireless LAN card 	
		<ul style="list-style-type: none"> ▪ Check and set the correct user name (SP5-816-156) and password (SP5-816-157). 	

13	Modem board error 1
	Modem board not installed or the board is defective.
	<ul style="list-style-type: none"> ▪ Install the modem board. ▪ Check correct setting value for modem driver (SP5-816-160, SP5-816-165 to 171, SP5-816-188 and 189). ▪ Replace the modem board.
14	Modem board error 2
	Modem board not installed or the board is defective.
	<ul style="list-style-type: none"> ▪ Uninstall the modem board if it is installed. ▪ Check that the wired/wireless LAN is working properly.

For more details about this SC code error, execute SP5990 to print an SMC report so you can read the error code. The error code is not displayed on the operation panel. Here is a list of error codes:

Error	Problem	Solution
1	Failure to certify dial-up	In the User Tools, check the dial-up user and dial-up password settings
4	Illegal modem setting	Check the setting of SP5816 160 to determine whether the setting for the AT command is correct. If this SP setting is correct, then the problem is a bug in the software.
5	Poor connection due to low power supply on the line.	The problem is on the external power supply line, so there is no corrective action on the machine.
11	Data in the NVRAM became corrupted when the network enable switch and Cumin-M were enabled at the same time.	Use SP5985 1 and set the NIC to "0" (Disable) to disable the network board.
12	The modem board could not enable the NIB.	Replace the modem board.

SC651	C	Incorrect dial up connection	CTL
01	-	Chat program parameter error	
02	-	Chat program execution error	
		An unexpected error occurs when the modem (Cumin-M) tries to call the center with a dial up connection.	
		<ul style="list-style-type: none"> ▪ Caused by a software bug 	
		<ul style="list-style-type: none"> ▪ No action required ▪ This SC does not interfere with operation of the machine. 	

SC652	D	Remote service ID2 mismatching	
		There was an authentication mismatch between ID2 for @Remote, the controller board, and NVRAM.	
		<ul style="list-style-type: none"> ▪ Used controller board installed ▪ Used NVRAM installed ▪ An unexpected error occurs when the modem (Embedded RCG-M) tries to call the center with a dial up connection. 	
		<ul style="list-style-type: none"> ▪ Install the correct controller board or anew controller board. ▪ Install the correct NVRAM or new NVRAM. 	

SC653	D	Incorrect remote service ID2	CTL
		ID2 stored in the NVRAM is incorrect.	
		<ul style="list-style-type: none"> ▪ Used NVRAM installed ▪ An unexpected error occurred when the modem (Embedded RCG-M) tries to call the center with a dial up connection 	
		<ul style="list-style-type: none"> ▪ Clear the ID2 in the NVRAM ▪ Input the correct ID2. 	

SC669	D	EEPROM Communication Error
		Five attempts to communicate between the EEPROM and NVRAM failed.
		<ul style="list-style-type: none"> ▪ Device ID data corrupted ▪ Connection between controller board and MCU loose, broken, defective ▪ NVRAM defective ▪ Controller board defective ▪ MCU defective
SC669-01	D	ID Error at EEPROM OPEN
SC669-02	D	Channel Error at EEPROM OPEN
SC669-03	D	Device Error at EEPROM OPEN
SC669-04	D	Diagnostic Error During Communication at EEPROM OPEN
SC669-05	D	Communication Timeout Error at EEPROM OPEN
SC669-06	D	Operation Stop Error at EEPROM OPEN
SC669-07	D	Buffer Full Error at EEPROM OPEN
SC669-08	D	No Error Code at EEPROM OPEN
SC669-09	D	ID Error at EEPROM CLOSE
SC669-10	D	No Error Code at EEPROM CLOSE
SC669-11	D	ID Error When Writing Data to EEPROM
SC669-12	D	Channel Error When Writing Data to EEPROM
SC669-13	D	Device Error When Writing Data to EEPROM
SC669-14	D	Communication Error When Writing Data to EEPROM
SC669-15	D	Communication Timeout Error When Writing Data to EEPROM
SC669-16	D	Operation Stop Error When Writing Data to EEPROM
SC669-17	D	Buffer Full Error When Writing Data to EEPROM

SC669-18	D	No Error Code When Writing Data to EEPROM
SC669-19	D	ID Error When Reading Data From EEPROM
SC669-20	D	Channel Error When Reading Data From EEPROM
SC669-21	D	Device Error When Reading Data From EEPROM
SC669-22	D	Communication Error When Reading Data From EEPROM
SC669-23	D	Communication Timeout Error When Reading Data From EEPROM
SC669-24	D	Operation Stop Error When Reading Data From EEPROM
SC669-25	D	Buffer Full Error When Reading Data From EEPROM
SC669-26	D	No Error Code When Reading Data From EEPROM
SC669-27	D	ID Error at EEPROM Device Detection
SC669-28	D	Channel Error at EEPROM Device Detection
SC669-29	D	Device Error at EEPROM Device Detection
SC669-30	D	Communication Error at EEPROM Device Detection
SC669-31	D	Communication Timeout Error at EEPROM Device Detection
SC669-32	D	Operation Stop Error at EEPROM Device Detection
SC669-33	D	Buffer Full Error at EEPROM Device Detection
SC669-34	D	No Error Code at EEPROM Device Detection
SC669-51	D	ID Error When Writing Data to EEPROM
SC669-52	D	Channel Error at EEPROM Maintenance Log Data Write
SC669-53	D	Device Error at EEPROM Maintenance Log Data Write
SC669-54	D	Communication Error at EEPROM Maintenance Log Data Write
SC669-55	D	Communication Timeout Error at EEPROM Maintenance Log Data Write
SC669-56	D	Operation Stop Error at EEPROM Maintenance Log Data Write
SC669-57	D	Buffer Full Error at EEPROM Maintenance Log Data Write

SC669-58	D	No Code Error at EEPROM Maintenance Log Data Write
SC669-59	D	ID Error When Reading Data From EEPROM
SC669-60	D	Channel Error at EEPROM Maintenance Log Data Read
SC669-61	D	Device Error at EEPROM Maintenance Log Data Read
SC669-62	D	Communication Error at EEPROM Maintenance Log Data Read
SC669-63	D	Communication Timeout Error at EEPROM Maintenance Log Data Read
SC669-64	D	Operation Stop Error at EEPROM Maintenance Log Data Read
SC669-65	D	Buffer Full Error at EEPROM Maintenance Log Data Read
SC669-66	D	No Error Code at EEPROM Maintenance Log Data Read

SC670	D	Engine startup error	CTL
		The MCU failed to respond within the prescribed time when the machine was turned on.	
		<ul style="list-style-type: none"> ▪ Connections between MCU and controller board are loose, disconnected, or damaged ▪ MCU defective ▪ Controller board defective 	

SC672	D	Controller start up error	CTL
		<ul style="list-style-type: none"> ▪ After the machine was powered on, communication between the controller and the operation panel was not established, or communication with controller was interrupted after a normal startup. ▪ After startup reset of the operation panel, the attention code (FDH) or the attention acknowledge code (FEH) was not sent from the controller within 30 sec.. ▪ After the controller issued a command to check the communication line with the controller at 30-second intervals, the controller failed to respond twice. 	
		<ul style="list-style-type: none"> ▪ Controller stalled ▪ Controller board installed incorrectly ▪ Controller board defective ▪ Operation panel connector loose, broken, or defective ▪ The controller did not completely shut down when the switch was turned off. 	
		<ul style="list-style-type: none"> ▪ Check the setting of SP5-875-001. ▪ If this SP is set to "1 (OFF)", change it to "0 (ON)" 	

SC680-01	D	DSP Start Error
		Correct startup of DSP (Digital Signal Processing) could not be confirmed after three attempts. The CHOPIN module on the MCU handles the digital signal processing (DSP) for the operation of the vertical feed motor (paper feed), horizontal motor (carriage movement), and roll paper motor (roll units).
		<ul style="list-style-type: none"> ▪ Cycle the machine off/on ▪ MCU defective (replace MCU).

SC680-02	D	DSP Initialization Error
		Communication link between CPU and DSP could not be established because DSP did not start up correctly.
		<ul style="list-style-type: none"> ▪ Cycle the machine off/on ▪ MCU defective

SC680-03	D	DSP Communication Error
		Communication between DSP and MCU was lost during machine operation.
		<ul style="list-style-type: none"> ▪ Cycle the machine off/on ▪ MCU defective

SC680-04	D	PWM Control Error
		PWM which controls operation of the motors locked at LOW or HIGH due to damage to the FPGA IO terminal.
		<ul style="list-style-type: none"> ▪ Replace MCU

SC685	C	Ink Collector Tank Communication Error
		There was an error in communication with the ID Chip on the ink collector tank. Five retries were attempted and failed.
		<ul style="list-style-type: none"> ▪ Tank ID data corrupted or chip damaged ▪ Spurious noise ▪ Cycle the machine off/on ▪ Remove the tank and set it again ▪ Switch the machine on ▪ If the problem persists, replace the ink collector tank
SC685-1	C	GJ Unit Device ID Error
SC685-2	C	GJ Unit Channel Error (Path Disconnected)
SC685-3	C	GJ Unit Device Error (No ACK)

SC600: Communication

SC685-4	C	GJ Unit Communication Interruption
SC685-5	C	GJ Unit Communication Timeout Error
SC685-6	C	GJ Unit Communication Stop Error
SC685-7	C	GJ Unit Buffer Full Error
SC685-8	C	GJ Unit Other Parameter Error

SC686-11	C	Ink Cartridge (C): Device ID Error
SC686-12	C	Ink Cartridge (C): Channel Error (Bus Disconnection, etc.)
SC686-13	C	Ink Cartridge (C): Device Error (No ACK Signal)
SC686-14	C	Ink Cartridge (C): Communication Error
SC686-15	C	Ink Cartridge (C): Communication Timeout
SC686-16	C	Ink Cartridge (C): Communication Operation Stop Error
SC686-17	C	Ink Cartridge (C): Buffer Full
SC686-18	C	Ink Cartridge (C): Other Parameter Error
		There was an error in communication with the ID Chip on the Cyan ink cartridge. Five retries were attempted and failed.
		<ul style="list-style-type: none"> ▪ Ink cartridge ID data corrupted or chip damaged ▪ Spurious noise ▪ Cycle the machine off/on ▪ Remove the Cyan ink cartridge and set it again ▪ Switch the machine on ▪ If the problem persists, replace the Cyan ink cartridge

SC686-21	C	Ink Cartridge (M): Device ID Error
SC686-22	C	Ink Cartridge (M): Channel Error (Bus Disconnection, etc.)
SC686-23	C	Ink Cartridge (M): Device Error (No ACK Signal)
SC686-24	C	Ink Cartridge (M): Communication Error
SC686-25	C	Ink Cartridge (M): Communication Timeout
SC686-26	C	Ink Cartridge (M): Communication Operation Stop Error
SC686-27	C	Ink Cartridge (M): Buffer Full
SC686-28	C	Ink Cartridge (M): Other Parameter Error
		There was an error in communication with the ID Chip on the Magenta ink cartridge. Five retries were attempted and failed.
		<ul style="list-style-type: none"> ▪ Ink cartridge ID data corrupted or chip damaged ▪ Spurious noise ▪ Cycle the machine off/on ▪ Remove the Magenta ink cartridge and set it again ▪ Switch the machine on ▪ If the problem persists, replace the Magenta ink cartridge

SC686-31	C	Ink Cartridge (Y): Device ID Error
SC686-32	C	Ink Cartridge (Y): Channel Error (Bus Disconnection, etc.)
SC686-33	C	Ink Cartridge (Y): Device Error (No ACK Signal)
SC686-34	C	Ink Cartridge (Y): Communication Error
SC686-35	C	Ink Cartridge (Y): Communication Timeout
SC686-36	C	Ink Cartridge (Y): Communication Operation Stop Error
SC686-37	C	Ink Cartridge (Y): Buffer Full

SC686-38	C	Ink Cartridge (Y): Other Parameter Error
		There was an error in communication with the ID Chip on the Yellow ink cartridge. Five retries were attempted and failed.
		<ul style="list-style-type: none"> ▪ Ink cartridge ID data corrupted or chip damaged ▪ Spurious noise ▪ Cycle the machine off/on ▪ Remove the Yellow ink cartridge and set it again ▪ Switch the machine on ▪ If the problem persists, replace the Yellow ink cartridge

SC686-41	C	Ink Cartridge (K): Device ID Error
SC686-42	C	Ink Cartridge (K): Channel Error (Bus Disconnection, etc.)
SC686-43	C	Ink Cartridge (K): Device Error (No ACK Signal)
SC686-44	C	Ink Cartridge (K): Communication Error
SC686-45	C	Ink Cartridge (K): Communication Timeout
SC686-46	C	Ink Cartridge (K): Communication Operation Stop Error
SC686-47	C	Ink Cartridge (K): Buffer Full
SC686-48	C	Ink Cartridge (K): Other Parameter Error
		There was an error in communication with the ID Chip on the Black ink cartridge. Five retries were attempted and failed.
		<ul style="list-style-type: none"> ▪ Ink cartridge ID data corrupted or chip damaged ▪ Spurious noise ▪ Cycle the machine off/on ▪ Remove the Black ink cartridge and set it again ▪ Switch the machine on ▪ If the problem persists, replace the Black ink cartridge

SC687	D	PER command error
		The main machine received no PER-command module from the GW controller.
		<ul style="list-style-type: none">▪ Poor communication, cycle the machine power off/on

SC700: Not Used

7.8 SC700: NOT USED

There are no Group 700 service codes for this machine..

7.9 SC800: FIRMWARE

SC816	D	Energy save I/O subsystem error
		The energy save I/O subsystem is defective or this system detected a controller board error.
		<ul style="list-style-type: none"> ▪ Reboot the machine. ▪ Replace the controller board.

SC817	D	Monitor error	CTL
		This is a file detection and electronic file signature check error when the boot loader attempts to read the self-diagnostic module, system kernel, or root system files from the OS Flash ROM, or the items on the SD card in the controller slot are false or corrupted.	
		<ul style="list-style-type: none"> ▪ OS Flash ROM data defective ▪ SD card data defective 	
		<ul style="list-style-type: none"> ▪ Change the controller firmware. ▪ Use another SD card. 	

Error Codes

Code	Meaning
0x0000 0000	BIOS boot error
0x0000 0001	Primary boot start load error
0x0000 0002	Secondary boot load error (Boot3.Elf)
0x0000 0003	Self-diagnostic module error (Diag.Elf)
0x0000 0004	Kernel start error (Netbsd)
0x0000 0005	Root file system file read error (Rootfs)
0xffff ffff	Other error

Example: Data in the self-diagnostic module, system kernel, or root system files are corrupted or do not exist in OS flash ROM or on the SD card

Files in the self-diagnostic module, kernel, or root file system on the SD card have been falsified or altered

- Before discarding the SD card, try to update the data on the card. If the error occurs again, the card may be defective.
- Be sure to use an SD card that contains the correct electronic signature.

SC819	D	Fatal kernel error	
		Due to a control error, a RAM overflow occurred during system processing. One of the following messages was displayed on the operation panel.	
		0x5032	HAIC-P2 error
		0x5245	Link-up fail
		0x5355	L2 Status Time Out
		0x696e	gwinit died
		0x766d	Vm_pageout: VM is full
		554C	USB loader defect
		Other	
		<ul style="list-style-type: none"> ▪ System program defective ▪ Controller board defective ▪ Optional board defective ▪ Replace controller firmware 	

SC821	D	Self-diagnostics error: ASIC	CTL
[0B00]	ASIC register check error		
	A write-verify check occurred in the ASIC.		
	<ul style="list-style-type: none"> ▪ ASIC device 		
	<ul style="list-style-type: none"> ▪ Controller board defective 		
[0B06]	ASIC detection error		
	The I/O ASIC for system control was not detected.		
	<ul style="list-style-type: none"> ▪ Defective ASIC ▪ Defective North Bridge and PCII/F 		
	<ul style="list-style-type: none"> ▪ Controller board defective 		

Note: For more details about this SC code error, execute **SP5990** to print an SMC report so that you can read the error code. The error code is not displayed on the operation panel.

SC822	B	Self-diagnostics error: HDD	CTL
[3003]	HDD timeout		
	Check performed only when HDD is installed:		
	<ul style="list-style-type: none"> ▪ HDD device was busy for over 31 seconds. ▪ A diagnostic command was set for the HDD, but the device remained busy for over 6 seconds. 		
	<ul style="list-style-type: none"> ▪ Defective HDD device ▪ Defective HDD connector ▪ Defective ASIC device 		
<ul style="list-style-type: none"> ▪ Replace or uninstall the HDD device. ▪ Replace the HDD connector. ▪ Replace the controller board. 			

[3004]	Diagnostics command error	
	Diagnostic command issued an error.	
	<ul style="list-style-type: none"> ▪ Defective HDD device 	
	<ul style="list-style-type: none"> ▪ Replace or remove the HDD device. 	
[3013]	HDD timeout (First machine)	
	HDD device was busy for over 31 seconds, or Mandolin was not detected. A diagnostic command is set for the HDD, but the device remains was busy for over 6 seconds.	
	<ul style="list-style-type: none"> ▪ Defective HDD device ▪ Defective HDD connector ▪ Defective ASIC device 	
	<ul style="list-style-type: none"> ▪ Replace or remove the HDD device. ▪ Replace the HDD connector ▪ Replace the controller board 	
[3014]	Diagnostics command error (First machine)	
	Diagnostic command issued an error because Mandolin was not detected, or there was a w/r/c error in the HDD register	
	<ul style="list-style-type: none"> ▪ Defective HDD device 	
	<ul style="list-style-type: none"> ▪ Replace the HDD device. 	

SC823	B	Self-diagnostics error: NIC
[6101]	MAC address check sum error	
	The result of the MAC address check sum did not match the check sum stored in ROM.	
	<ul style="list-style-type: none"> ▪ Defective SEEP ROM ▪ Defective I2C bus (connection) 	
	<ul style="list-style-type: none"> ▪ Replace the controller board 	

[6104]	PHY IC error
	The PHY IC on the controller was not recognized.
	<ul style="list-style-type: none"> ▪ Defective PHY chip ▪ Defective ASIC MII I/F
	<ul style="list-style-type: none"> ▪ Replace the controller board
[6105]	PHY IC loop-back error
	An error occurred during the loop-back test for the PHY IC on the controller.
	<ul style="list-style-type: none"> ▪ Defective PHY chip ▪ Defective MAC of ASIC (SIMAC/COMIC/CELLO) ▪ Defective I/F with the PHY board ▪ Defective soldered connection on the PHY board
	<ul style="list-style-type: none"> ▪ Replace the controller board

SC824	D	Self-diagnostics error: NVRAM (resident)	CTL
[1401]	NVRAM verify error		
	No NVRAM installed or NVRAM is damaged.		
	<ul style="list-style-type: none"> ▪ No NVRAM device ▪ Damaged NVRAM device ▪ NVRAM backup battery exhausted ▪ NVRAM socket damaged 		
	<ul style="list-style-type: none"> ▪ Replace the NVRAM 		

SC833	D	Self-diagnostic error: Engine I/F ASIC	CTL
	[0F30]	ASIC (Mandolin) for engine control could not be detected. After the PCI was configured, the device ID for the ASIC could not be checked.	
		<ul style="list-style-type: none"> ▪ Defective ASIC (Mandolin) for system control ▪ Defective North Bridge and AGPI/F 	
		<ul style="list-style-type: none"> ▪ Replace the motherboard (engine I/F board). 	
	[50B1]	Could not initialize or read the bus connection.	
		<ul style="list-style-type: none"> ▪ Defective connection bus ▪ Defective SSCG 	
		<ul style="list-style-type: none"> ▪ Replace the motherboard (engine I/F board). 	
	[50B2]	SSCG register value was incorrect.	
		<ul style="list-style-type: none"> ▪ Defective connection bus ▪ Defective SSCG 	
		<ul style="list-style-type: none"> ▪ Replace the motherboard (engine I/F board). 	

SC834	D	Self-diagnostic error: optional memory	CTL
	[5101]	An error occurred after write/verify check for optional RAM on the motherboard..	
		<ul style="list-style-type: none"> ▪ Defective memory device 	
		<ul style="list-style-type: none"> ▪ Replace the motherboard (engine I/F board). 	

SC838	D	Self-diagnostic error: Clock generator	CTL
	[2701]	A verify error occurred when setting data was read from the clock generator via the I2C bus	
		<ul style="list-style-type: none"> ▪ Defective clock generator ▪ Defective I2C bus ▪ Defective I2C port on the CPU 	
		<ul style="list-style-type: none"> ▪ Replace the controller board. 	

SC840	D	EEPROM access error	CTL
		A read error occurred during I/O processing. The failure of the 3rd attempt to read caused this error.	
		<ul style="list-style-type: none"> ▪ Defective EEPROM 	
		<ul style="list-style-type: none"> ▪ Replace the EEPROM. 	

SC841	D	EEPROM read error	CTL
		Mirrored data of the EEPROM is different from the original data in EEPROM.	
		<ul style="list-style-type: none"> ▪ Data in the EEPROM was overwritten for some reason. 	
		<ul style="list-style-type: none"> ▪ Cycle the machine off/on 	

SC842	C	Nand-Flash updating verification error	CTL
		A write error for the module written in Nand-Flash occurred while the remote ROM and ROM were being updated.	
		<ul style="list-style-type: none"> ▪ Damaged Nand-Flash 	
		<ul style="list-style-type: none"> ▪ Cycle the machine off/on 	

SC850	B	Network I/F error	CTL
		<ul style="list-style-type: none"> ▪ Network not operating. 	
		<ul style="list-style-type: none"> ▪ Cycle the machine off/on 	

SC851	B	IEEE1394 I/F error	CTL
		There is an incorrect setting in the driver that prevented correct operation of the interface.	
		<ul style="list-style-type: none"> ▪ Check and correct the driver settings ▪ Network (PHY) LINK module defective ▪ PCI interface defective ▪ IEEE1394 I/F board defective ▪ Controller board defective 	

SC853	B	Bluetooth device connection error	CTL
		The Bluetooth interface unit was installed while the machine was turned on.	
		<ul style="list-style-type: none"> ▪ Cycle the machine off/on ▪ Confirm that the Bluetooth interface unit was installed correctly. ▪ Cycle the machine off/on again. 	

SC854	B	Bluetooth device removed	CTL
		The Bluetooth interface unit was removed while the machine was turned on.	
		<ul style="list-style-type: none"> ▪ Cycle the machine off/on ▪ Confirm that the Bluetooth interface unit was installed correctly. ▪ Cycle the machine off/on again. 	

SC855	B	Hardware Problem:wireless LAN board	CTL
		The wireless LAN board can be accessed, but an error was detected.	
		<ul style="list-style-type: none"> ▪ Loose connection ▪ Defective wireless LAN card 	
		<ul style="list-style-type: none"> ▪ Check wireless LAN card connection ▪ Replace wireless LAN card 	

SC857	B	USB I/F Error	CTL
		The USB driver is not stable and caused an error.	
		<ul style="list-style-type: none"> ▪ Poor USB card connection ▪ Replace the controller board 	

SC858	B	Data encryption conversion error	CTL
		These are errors of the HDD Data Encryption Option D377.	
00		Key Acquisition	
		Key could be acquired.	
		<ul style="list-style-type: none"> ▪ Replace the controller board 	
01		HDD Key Setting Error	
		The key was acquired but the HDD could not be set.	
		<ul style="list-style-type: none"> ▪ Turn the machine power off/on several times. ▪ Replace the controller board. 	
02		NVRAM Read Error	
		NVRAM data conversion failed (mismatch with nvram.conf)	
		<ul style="list-style-type: none"> ▪ Replace the NVRAM 	
30		NVRAM Before Replace Error DFU	
		May occur during development.	
		<ul style="list-style-type: none"> ▪ Turn the machine power off/on several times. ▪ Replace the controller board. 	
31		Other Error	
		An unexpected error occurred while data was being converted. This error is the same as SC991. See SC991 below.	

SC859	B	Data encryption conversion errors	CTL
		Data encryption on the HDD failed.	
01		HDD encrypted data restoration error	
		Data could not be restored after encryption.	
		<ul style="list-style-type: none"> ▪ HDD connection loose, broken, defective ▪ Format HDD ▪ HDD defective 	
02		Power interrupt error	
		Power supply was interrupted during data encryption.	
		<ul style="list-style-type: none"> ▪ Cycle the machine off/on 	
08		HDD Check Error	
		<p>Data conversion was attempted with no HDD unit present.</p> <ul style="list-style-type: none"> ▪ Confirm that HDD unit installed correctly ▪ Initialize HDD with SP5832-1 <p>Note: After installation, a new HDD should be formatted with SP5832-1</p>	
09		Power Loss During Data Conversion	
		Data conversion stopped before NVRAM/HDD data was converted.	
		<ul style="list-style-type: none"> ▪ Format HDD with SP5832-1 	
10		Data Read Command Error	
		More than two illegal DMAC communications were returned.	
		<ul style="list-style-type: none"> ▪ HDD defective ▪ Format HDD with SP5832-1 ▪ Replace HDD 	

SC860	B	HDD startup error at power on	CTL
		HDD is connected but a driver error is detected. The driver did not respond with the status of the HDD within 30 sec.	
		<ul style="list-style-type: none"> ▪ HDD is not initialized ▪ Level data is corrupted ▪ Initialize the HDD with SP5-832-001. ▪ HDD is defective 	

SC861	B	HDD Error 2: HDD Startup	CTL
		The hard disks were detected at power on, but the disks were not detected within 30s after recovery from the energy conservation mode.	
		<ul style="list-style-type: none"> ▪ Cable between the hard disks and controller board disconnected or loose ▪ Hard disk power connector loose ▪ One of the hard disks is defective ▪ Controller defective 	

SC862	D	Bad sector overflow	CTL
		There more 100 bad sectors in image storage area of the HDD.	
		<ul style="list-style-type: none"> ▪ Format HDD with SP4911-2 ▪ HDD defective 	

SC863	D	HDD data read failure	CTL
		The data written to the HDD cannot be read normally, due to bad sectors generated during operation.	
		<ul style="list-style-type: none"> ▪ HDD defective ▪ Controller defective 	
		<p>Note: If the bad sectors are generated at the image partition, the bad sector information is written to NVRAM, and the next time the HDD is accessed, these bad sectors will not be accessed for read/write operation.</p>	

SC864	D	HDD data CRC error	CTL
		During HDD operation, the HDD cannot respond to a CRC error query. Data transfer did not execute normally while data was being written to the HDD.	
		<ul style="list-style-type: none"> ▪ Format HDD ▪ HDD defective 	

SC865	D	HDD access error	CTL
		An error was detected during operation of the HDD.	
		<ul style="list-style-type: none"> ▪ HDD defective. 	

SC866	B	SD card authentication error	CTL
		A correct license was not found in the SD card.	
		<ul style="list-style-type: none"> ▪ Wrong type of SD card ▪ SD card data is corrupted. 	
		<ul style="list-style-type: none"> ▪ Used correct SD card ▪ Replace SD card 	

SC867	D	SD card error 2: SD card removed	CTL
		The SD card in the boot slot when the machine was turned on was removed while the machine was on.	
		<ul style="list-style-type: none"> ▪ Insert the SD card ▪ Turn the machine's power off/on 	

SC868	D	SD card access error	CTL
		An error occurred while an SD card was used.	
		<ul style="list-style-type: none"> ▪ SD card not inserted correctly ▪ SD card defective ▪ Controller board defective 	

SC870	B	Address book error	CTL
		Address book data stored on the hard disk was detected as abnormal when it was accessed from either the operation panel or the network.	
		<ul style="list-style-type: none"> ▪ Defective software program ▪ Defective HDD ▪ Incorrect path to the server ▪ Incorrect encryption setting or encryption key ▪ Damaged address book data 	
		<ul style="list-style-type: none"> ▪ Mount the media that stores the address book data ▪ Cycle the machine off/on. ▪ Initialize the address book data with SP5-846-050. ▪ Cycle machine off/on, and then do SP5-832-006. ▪ Replace the HDD. 	

SC872	D	HDD mail RX data error	CTL
		An HDD error was detected immediately after power on. <ul style="list-style-type: none"> ▪ The HDD may be defective or the machine was accidentally powered off while the HDD was being accessed. 	
		<ul style="list-style-type: none"> ▪ Cycle the machine off/on ▪ Reformat the HDD with SP5832-7 (Mail RX Data) ▪ Replace the HDD 	

SC873	D	HDD mail TX error	CTL
		An error was detected on the HDD immediately after the machine was turned on, or power was turned of while the machine used the HDD.	
		<ul style="list-style-type: none"> ▪ Do SP5832-007 to format the HDD. ▪ HDD defective. 	

SC874	D	Delete all error 1 (DOS)	CTL
		A data error was detected for the HDD/NVRAM after the "Delete All" option was used. <p>Note: The source of this error is the Data Overwrite Security Unit running from an SD card.</p>	
		<ul style="list-style-type: none"> ▪ Cycle the machine off/on. ▪ Confirm that DOS has been enabled with SP5878.. ▪ HDD defective. 	

SC875	D	Delete al error 2: Data area	CTL
		An error occurred while the machine deleted data from the HDD <p>Note: The source of this error is the Data Overwrite Security Unit running from an SD card.</p>	
		<ul style="list-style-type: none"> ▪ Cycle the machine off/on 	

SC876	D	Log Data Error	CTL
		An error was detected in the handling of the log data at power on or during machine operation. This can be caused by switching the machine off while it is operating.	
01	D	Log Data Error 1	
		<ul style="list-style-type: none"> ▪ Damaged log data file in the HDD 	
		<ul style="list-style-type: none"> ▪ Initialize the HDD with SP5-832-004. 	
02	D	Log Data Error 2	
		<ul style="list-style-type: none"> ▪ An encryption module not installed 	
		<ul style="list-style-type: none"> ▪ Replace or set again the encryption module. ▪ Disable the log encryption setting with SP9-730-004 ("0" is off.). 	
03	D	Log Data Error 3	
		<ul style="list-style-type: none"> ▪ Invalid log encryption key due to defective NVRAM data 	
		<ul style="list-style-type: none"> ▪ Initialize the HDD with SP5-832-004. ▪ Disable the log encryption setting with SP9-730-004 ("0" is off.) 	
04	D	Log Data Error 4	
		<ul style="list-style-type: none"> ▪ Unusual log encryption function due to defective NVRAM data 	
		<ul style="list-style-type: none"> ▪ Initialize the HDD with SP5-832-004. 	
05	D	Log Data Error 5	
		<ul style="list-style-type: none"> ▪ Installed NVRAM or HDD which is used in another machine. 	
		<ul style="list-style-type: none"> ▪ Reinstall the previous NVRAM or HDD. ▪ Initialize the HDD with SP5-832-004. 	
99	D	Log Data Error 99	
		<ul style="list-style-type: none"> ▪ Other than the above causes 	
		<ul style="list-style-type: none"> ▪ Ask your supervisor. 	

SC877	B	Data Overwrite Security error	CTL
		An error occurred, preventing successful execution of the Data Overwrite Security function, even though it has been enabled with SP5898..	
		<ul style="list-style-type: none"> ▪ Cycle the machine off/on ▪ Replace NVRAM 	

SC878	D	Chip errors	CTL
	00	D	TPM electronic recognition error
	01	D	USB flash error
	02	D	TPM error
	03	D	TCSD error
			<ul style="list-style-type: none"> ▪ Incorrect updating for the system firmware ▪ Incorrect operating of the USB flash ▪ Defective flash ROM on the controller board
			<ul style="list-style-type: none"> ▪ Replace the controller board.

SC880	D	File Format Converter Error (MLB)	CTL
		A request for access to the file format converter board (MLB) was not answered within the specified time.	
		<ul style="list-style-type: none"> ▪ Board defective 	

SC881	D	Authentication area error	CTL
		Authentication application error is detected.	
		Error data in an authentication application reaches the management limit.	
		<ul style="list-style-type: none"> ▪ Turn the main power switch off and on. 	

SC899	D	Software performance error	CTL
		If the processing program shows abnormal performance and the program is abnormally ended, this SC is issued.	
		<ul style="list-style-type: none"> ▪ Controller board defective ▪ Software defective 	
		<ul style="list-style-type: none"> ▪ Replace the controller board. ▪ Turn the main switch off and on. ▪ Update the firmware on the controller. 	

7.10 SC900: SOFTWARE

SC900	D	Electric counter error	CTL
		The total count contains something that is not a number.	
		<ul style="list-style-type: none"> ▪ NVRAM incorrect type ▪ NVRAM defective ▪ NVRAM data scrambled ▪ Unexpected error from external source 	
		<ul style="list-style-type: none"> ▪ Check the connection between the NVRAM and controller. ▪ Replace the NVRAM. ▪ Replace the controller board. 	

SC920	B	Printer application error	CTL
00		No response when PM started up	
01		Timeout error during PM operation	
02		Working memory error	
03		Cannot start filter process	
04		Abnormal exit from filter process	
		An error was detected in the printer application program and operation cannot continue.	
		<ul style="list-style-type: none"> ▪ Defective software ▪ Unexpected hardware resource (e.g., memory shortage) 	
		<ol style="list-style-type: none"> 1. Software err, cycle the machine off/on 2. Insufficient memory, add more memory 	

SC921	B	Printer font error	CTL
		A necessary font is not found when starting up the printer application.	
		<ul style="list-style-type: none"> ▪ A requested font is not found in the SD card. 	
		<ul style="list-style-type: none"> ▪ Cycle the machine off/on 	

SC925	B	NetFile function error	CTL
00		HDD is defective	
01		NetFile management file is broken	
		<p>The NetFile file management on the HDD cannot be used, or a NetFile management file is corrupted and operation cannot continue.</p> <p>The HDDs are defective and they cannot be debugged or partitioned, so the Scan Router functions (delivery of received faxes, document capture, etc.), Web services, and other network functions cannot be used.</p> <p>HDD status codes are displayed below the SC code.</p>	
		<ul style="list-style-type: none"> ▪ Refer to the four procedures below (Recovery from SC925). 	

Here is a list of HDD status codes:

Display	Meaning
(-1)	HDD not connected
(-2)	HDD not ready
(-3)	No label
(-4)	Partition type incorrect
(-5)	Error returned during label read or check
(-6)	Error returned during label read or check
(-7)	"filesystem" repair failed
(-8)	"filesystem" mount failed

Display	Meaning
(-9)	Drive does not answer command
(-10)	Internal kernel error
(-11)	Size of drive is too small
(-12)	Specified partition does not exist
(-13)	Device file does not exist

Recovery from SC 925

Procedure 1

If the machine shows SC codes for HDD errors (SC860 to SC865) with SC 925, do the recovery procedures for SC860 to SC865.

Procedure 2

If the machine does not show one of the five HDD errors (SC860 to SC865), turn the machine power off and on. If this is not the solution for the problem, then initialize the NetFile partition on the HDD with SP5832-011 (HDD Formatting – Ridoc I/F).

NetFiles: Jobs printed from the document server using a PC and DeskTopBinder

- Before you initialize the NetFile partition on the HDD, tell the customer that:
- Received faxes on the delivery server will be erased
- All captured documents will be erased
- DeskTopBinder/Print Job Manager/Desk Top Editor job history will be erased
- Documents on the document server, and scanned documents, will not be erased.
- The first time that the network gets access to the machine, the management information must be configured again (this will use a lot of time).

Before you initialize the Netfile partition with SP5832-011, do these steps:

1. Go into the User Tools mode and do "Delivery Settings" to print all received fax documents that are scheduled for delivery. Then erase them.
2. In the User Tools mode, do Document Management> Batch Delete Transfer Documents.
3. Do SP5832-011, then turn the machine power off and on.

Procedure 3

If "Procedure 2" is not the solution for the problem, do SP5832-001 (HDD Formatting – All), then turn the machine power off and on.

SP5832-001 erases all document and address book data on the hard disks. Ask the customer before you do this SP code.

Procedure 4

If "Procedure 3" is not the solution for the problem, replace the HDD.

SC990	D	Software performance error	CTL
		The software makes an unexpected operation.	
		<ul style="list-style-type: none"> ▪ Defective software ▪ Defective controller ▪ Software error 	
		<ul style="list-style-type: none"> ▪ Cycle the machine off/on. ▪ Reinstall the controller firmware ▪ Reinstall the main firmware 	

SC991	C	Software continuity error	CTL
		The software has attempted to perform an unexpected operation. However, unlike SC 990, the object of the error is continuity of the software.	
		<ul style="list-style-type: none"> ▪ Software program error ▪ Internal parameter incorrect ▪ Insufficient working memory 	
		<ul style="list-style-type: none"> ▪ This SC is not displayed on the LCD (logging only). 	

For more details about SC991:

1. Execute SP7403 or print an SMC Report (SP5990) to read the history of the 10 most recent logged errors.
2. If you press the zero key on the operation panel with the SP selection menu displayed, you will see detailed information about the recently logged SC991, including the software file name, line number, and so on. Of these two methods, 1) is the recommended method, because another SC could write over the information for the previous SC.

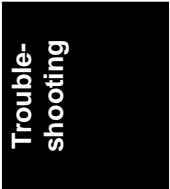

SC992	C	Undefined Error (No SC Code)	CTL
		An error not controlled by the system occurred (the error does not come under any other SC code).	
		<ul style="list-style-type: none"> ▪ Software defective ▪ Turn the machine power off and on. The machine cannot be used until this error is corrected. ▪ Re-install firmware 	

SC994	C	Operation Panel Management Records Exceeded	CTL
		An error occurred because the number of records exceeded the limit for images managed in the service layer of the firmware. This can occur if there are too many application screens open on the operation panel.	
		No action required because this SC does not interfere with operation of the machine.	

SC997	B	Application function selection error	CTL
		The application selected by the operation panel key operated abnormally (No response, abnormal ending).	
		<ul style="list-style-type: none"> ▪ Software (including the software configuration) defective ▪ An option required by the application (RAM, DIMM, board) is not installed. ▪ Nesting of the fax group addresses is too complicated. 	
		<ul style="list-style-type: none"> ▪ Check the devices necessary for the application program. If necessary devices have not been installed, install them. ▪ Check that application programs are correctly configured. ▪ For a fax operation problem, simplify the nesting of the fax group addresses. ▪ Take necessary countermeasures specific to the application program. If the logs can be displayed on the operation panel, see the logs. 	

SC998	D	Application start error	CTL
		No applications start within a specified time after the power is turned on.	
		<ul style="list-style-type: none"> ▪ Loose connection of RAM-DIMM, ROM-DIMM ▪ Defective controller ▪ Software problem 	
		<ul style="list-style-type: none"> ▪ Check the setting of SP5-875-001. If the setting is set to "1 (OFF)", change it to "0 (ON)". ▪ Check if the RAM-DIMM and ROM-DIMM are correctly connected. ▪ Reinstall the controller system firmware. ▪ Replace the controller board. 	

Note 1

If a problem always occurs in a specific condition (for example. printer driver setting, image file), the problem may be caused by a software error. In such a case, the following data and information need to be sent back to your product specialist. Please understand that it may take some time to get a reply on how to solve the problem, because in some cases the design staff in Japan must analyze the data.

- Symptom / Possible Causes / Action taken
- Summary sheet (SP mode "Printer SP", SP1-004 [Print Summary])
- SMC - All (SP5-990-001)
- SMC - Logging (SP5-990-004)
- Printer driver settings used when the problem occurs
- All data displayed on the screen (SC code, error code, and program address where the problem is logged.)
- Image file which causes the problem, if possible

7.11 PRINTING PROBLEMS

7.11.1 BEFORE YOU BEGIN

Before you refer to this section, make sure that you are completely familiar with the procedures described in Print Head Adjustment and Cleaning procedures.  page 5-312

- Clean Print-heads
- Flush Print-heads
- Auto Adjust Print Head Position
- Manual Adjust Head Position
- Print Nozzle Check Pattern
- Adjust Paper Feed
- Adjust Print Position

7.11.2 WHITE LINES, HORIZONTAL BANDING

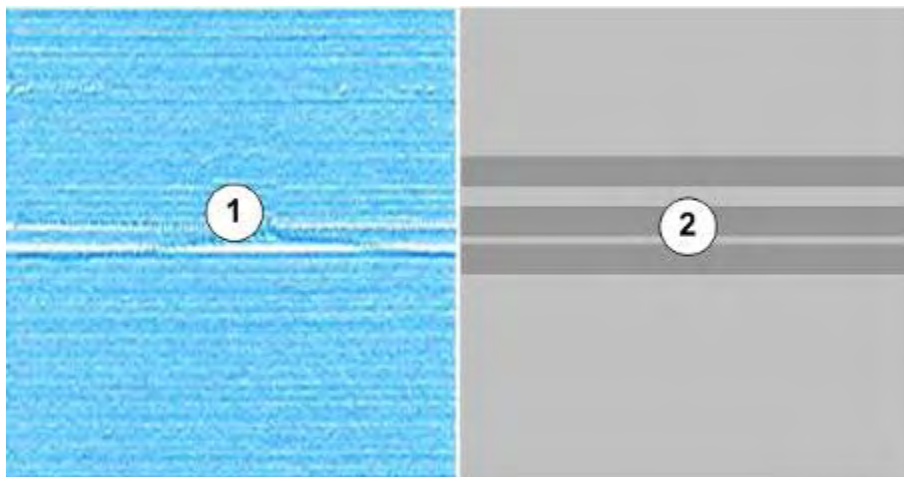

d124t001

White lines ① horizontal banding ②

Print heads clogged

1. Print a Nozzle check
2. Clean the print head(s).
3. Print another Nozzle Check.
4. Leave the machine 5 to 10 minutes
5. Repeat Steps 1 and 2 twice.
6. If cleaning the print heads three times does not solve the problem, flush the print heads.
7. Do the Adjust Paper Feed procedure.

Other Measures

- Clean or replace maintenance unit.
- Inspect vertical encoder wheel for dirt or damage. Clean or replace.
- Replace the print head(s) ➤ page 5-179

7.11.3 HORIZONTAL LINES IN MARGINS

Horizontal lines appear in the margins ① and ②.

Faulty Print Head or Carriage Unit

- Replace the print heads.
- Replace the carriage unit.

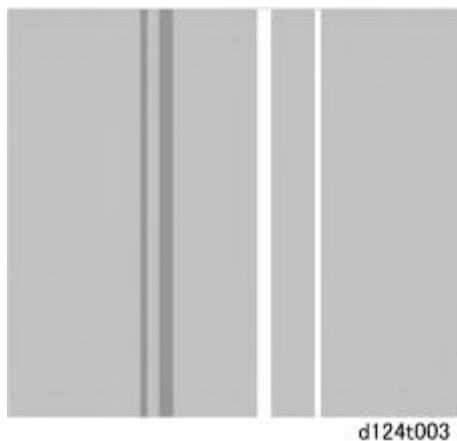
7.11.4 WHITE, COLOR VERTICAL BANDING***Print Head Out of Position, Horizontal Encoder Strip Problem***

- Do the Adjust Print Head procedure.
- Check the horizontal encoder strip and make sure that it has been installed correctly.
- Inspect the horizontal encoder strip for dirt or damage. Clean or replace it.

7.11.5 OVERALL POOR IMAGE QUALITY

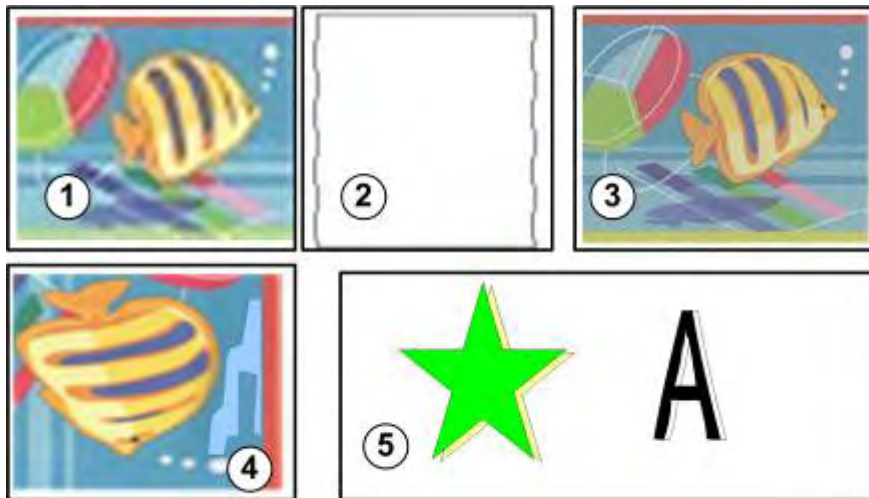

d124t004

- Image blurred ①
- Lines not straight ②
- Overall poor color quality ③
- Uneven density ④
- Double lines in graphics, text ⑤

Gap Adjustment

- Make sure that the gap between the carriage and the platen has been adjusted correctly for the type and thickness of the paper. (See the Operating Instructions.)

Print heads clogged

1. Print a Nozzle check
2. Clean the print head(s).
3. Print another Nozzle Check.
4. Leave the machine 5 to 10 minutes
5. Repeat Steps 1 and 2 twice.
6. If cleaning the print heads three times does not solve the problem, flush the print heads.

Paper Feed Faulty

- Do the Adjust Paper Feed Procedure

Horizontal Encoder Strip

- Make sure the horizontal encoder strip has been installed correctly.
- Inspect the strip for dirt or damage. Clean or replace the strip.

7.11.6 TEXT SHIFTED OUT OF POSITION

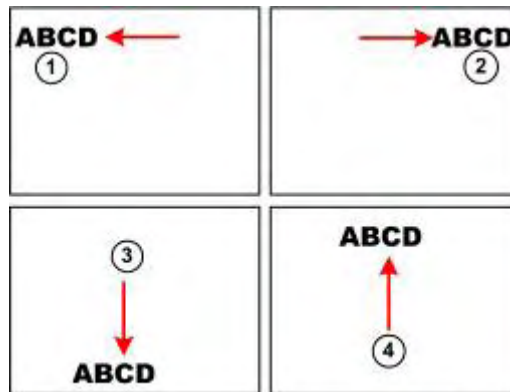

d124t005

Text misaligned, shifted too far

- Left ①
- Right ②
- Down ③
- Up ④

Obstructed, Faulty Paper Feed

- Inspect the horizontal encoder strip for dirt or damage. Clean or replace horizontal encoder strip.
- Inspect the vertical encoder wheel for dirt or damage. Clean or replace vertical encoder wheel.
- Inspect the platen for shreds of paper or other obstacles.
- Inspect the platen plates for dirt or damage. Clean or replace the platen plates.

7.11.7 INK SCATTER

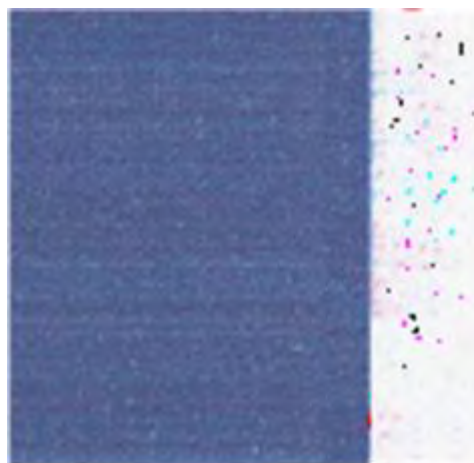

d124t006

Troubleshooting

Gap Adjustment

- Make sure that the gap between the carriage and the platen has been adjusted correctly for the type and thickness of the paper. (See the "Operating Instructions.")

Print heads clogged

1. Print a Nozzle check
2. Clean the print head(s).
3. Print another Nozzle Check.
4. Leave the machine 5 to 10 minutes
5. Repeat Steps 1 and 2 twice.
6. If cleaning the print heads three times does not solve the problem, flush the print heads.

Faulty Maintenance Unit, Carriage Unit

- Clean the maintenance unit
- Replace maintenance unit.
- Replace the carriage unit.

7.11.8 MIXED COLORS



Mixed colors in printout ①, or Nozzle Check Pattern ②

Mixed colors means two ink colors and one color seeps into the track of another color. This can occur only at the YM print head because the print head is shared.

Print heads clogged

1. Print a Nozzle check.
2. Clean the YM (Magenta/Yellow) print head.
3. Print another Nozzle Check.
4. Repeat Steps 1 and 2 twice.
5. If cleaning the print heads three times does not solve the problem, flush the print head.

Faulty Maintenance Unit

- Clean the maintenance unit
- Replace maintenance unit.

7.11.9 IMAGE ABRADED, PAPER TORN, INK RUNNING



Output not clean, paper corner bent

- Print head abrasion ①
- Dog-eared corner of paper ②
- Ink run ③

Gap Adjustment

- Make sure that the gap between the carriage and the platen has been adjusted correctly for the type and thickness of the paper.

Paper Feed Obstruction

- Inspect the platen for paper fragments or dirty plates. Clean the plates.
- Check around the carriage unit for paper fragments.
- Check around the maintenance unit for paper fragments.

Faulty Carriage Unit

- Replace the carriage unit.

7.11.10 COLOR DENSITY TOO LIGHT



Printer Driver Settings

- Make sure the printer driver color settings are set correctly.
- Enhance the image with an image editor.

7.11.11 PART OF IMAGE MISSING, TEXT MISALIGNED



- Image not complete ①
- Part of image missing ②
- Text misaligned ③

Printer Driver Settings

- Make sure that the printer driver settings for paper type match the type of paper loaded.
- Make sure all the print cartridges have sufficient ink.

Faulty Controller

- Replace the controller board.

7.11.12 IMAGE SKEWED ON PAPER

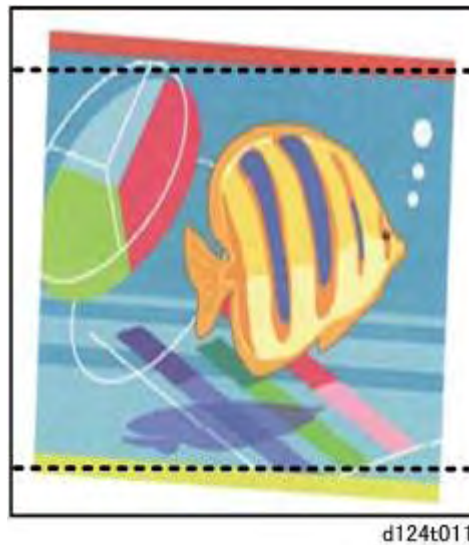

Obstructed Paper Feed

- Inspect the platen, carriage unit, and maintenance unit for paper fragments.

7.11.13 BOLDDED TEXT DOES NOT APPEAR BOLD IN PRINTOUT

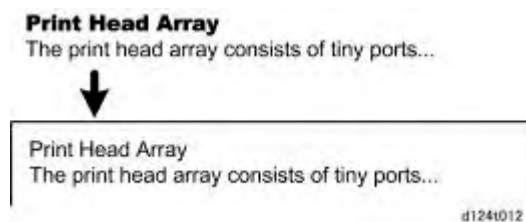

Printer Driver Settings

- Check the Increase bold with font size checkbox.
- Make sure bold was selected in the application.

7.12 SCANNING PROBLEMS

7.12.1 FLOW CHART

Follow this flow chart to determine the cause of an image problem. Use **SP4417** Pattern 8 to print the test pattern and User Tools > Maintenance functions.

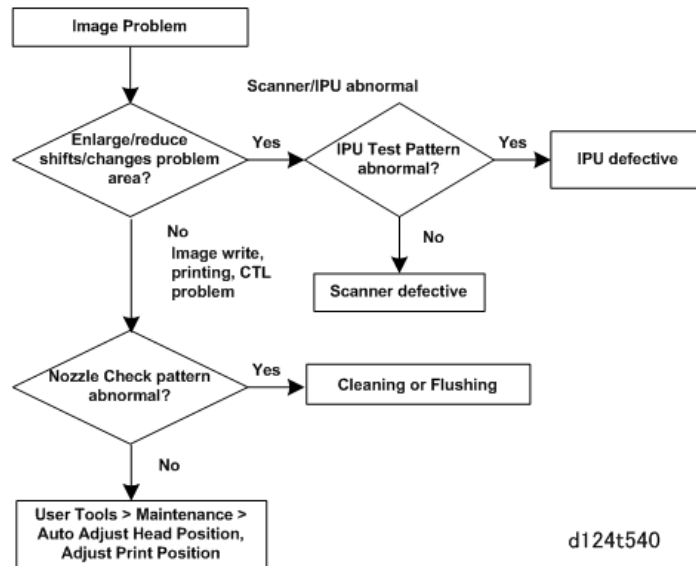

d124t540

7.12.2 SCANNING TROUBLESHOOTING

1. No image

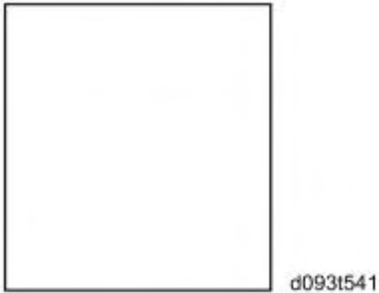

Possible causes:

- Connection problem between CIS and IPU.
- CIS defective

2. No image (solid black copy/print, or no image with only vertical white lines on the output)

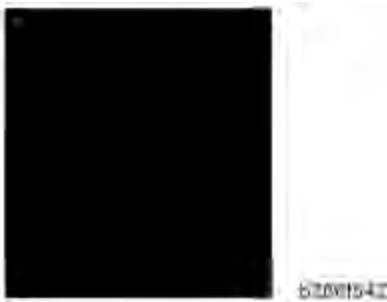

Possible causes:

- Connection problem between CIS and IPU.
- CIS defective

3. Light image

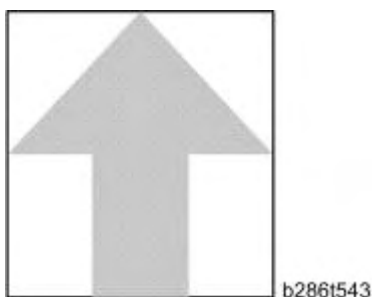

Possible causes:

- Low CIS output
- IPU board defective

4. Vertical black lines

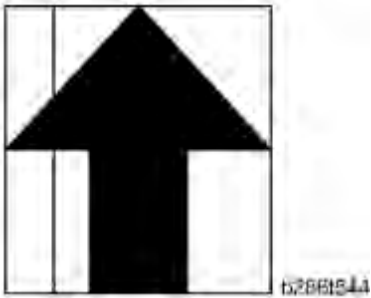

Possible causes:

- Dirty exposure glass
- CIS defective

5. Vertical white lines

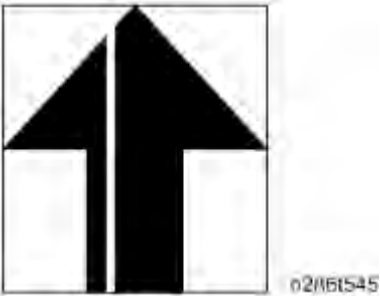

Possible causes:

- Dirty exposure glass
- Dirt or scratches on the white plate above the CIS
- CIS defective

6. Black or white bands with no image-width 1/5 A0 (E) size

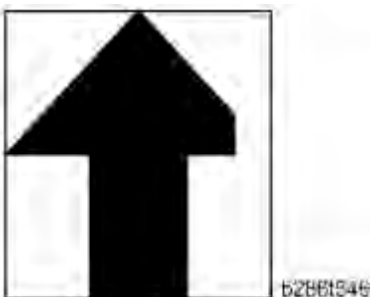

Possible causes:

- Connection problem between CIS and IPU
- CIS output error
- IPU board adjustment error

7. White lines every 1mm pitch in halftone areas



Possible causes:

- CIS defective

Case 8: Dark image density at CIS1, CIS3, and CIS5.



b286t574

Possible cause:

- The machine is near a window and sunlight is hitting the CIS unit
- The light shield have been removed or is tucked inside the machine.



d124r006

★ Important

- This light shield prevents light from entering the scanner unit.
- If this gap is not covered by the shield, strong light could enter the back of the scanner unit and cause image distortion during scanning.
- Make sure that the light shield has not been removed.
- Move the machine away from the window.
- Close the window blinds to block the sunlight.
- If closing the blinds or moving the machine is not possible (or if the light shield has been removed or damaged), cover the top of the machine with one wide sheet of paper (at

Scanning Problems

least 840 mm wide) to block the sunlight.

Case 9: Dark image density at CIS2 and CIS4.

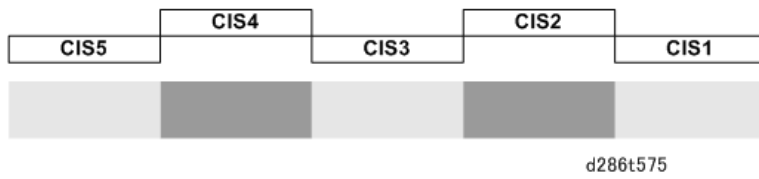

Possible causes:

- The white plate is not flat against the original.
- The original is wrinkled.

7.13 JAM CODE TABLES

7.13.1 OVERVIEW

When a jam occurs:

- The jam indicator lights.
- Dynamic graphic messages on the display panel show the location of the jam and instructions about how to correct the problem.

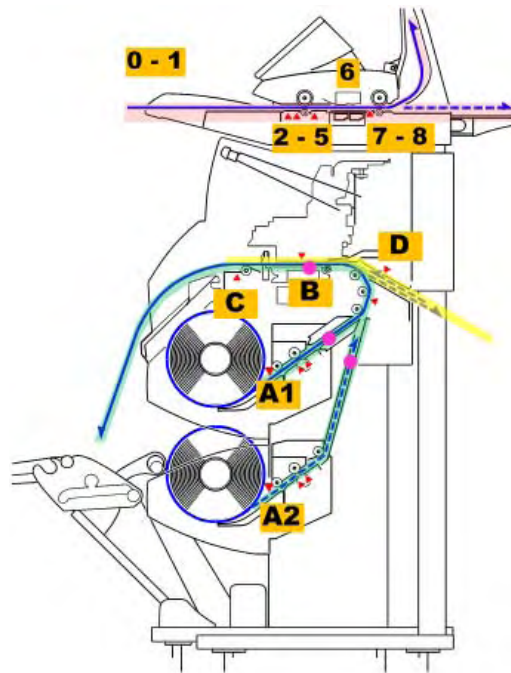

d1248003

Code	Location
0 to 8	Scanner Jams
A1	RF 1: Roll Unit 1 (Standard)
A2	RF 2: Roll Unit 2 (Option)
B	Registration standby position
C	Paper exit (main machine)
D	Bypass paper feed path

Trouble-shooting

- If the operator opens and closes the paper exit cover during copying, this is not recorded in the jam record.
- An original or paper feed jam that occurs just after the main power switch or operation switch comes on is not recorded in the jam record.

★ Important

- **In the tables below "late" and "lag" have the following meanings.**
- **Late.** The original or paper failed to arrive at the sensor location within the prescribed time after original feed started.
- **Lag.** The original or paper failed to leave the sensor location with the prescribed time.

7.13.2 SCANNER ORIGINAL JAMS

Original Jam Names

Code/Area	Jam Name & Description
1	Initial Jam
	At power ON, or when the scanner cover was closed, one of the following sensors was ON. <ul style="list-style-type: none"> ▪ Original set sensor ▪ Original registration sensor ▪ Original exit sensor ▪ Original width sensors
2	Original registration sensor late
	Original registration sensor did not go ON within the prescribed time (after the original should have fed 15 mm).
3	Original registration sensor off jam
	The original set sensor or the original registration sensor went OFF before the exit sensor went ON. This can occur if the original is less than 132.5 mm long. -or- After the exit sensor went ON, the original registration sensor went OFF before the original set sensor went OFF.
4	Original registration sensor lag jam

Code/Area	Jam Name & Description
	After the original set sensor went OFF, the original registration sensor did not go OFF within the prescribed time (after the original should have fed 20 mm).
5	Original exit sensor lag jam
	The original exit sensor did not go off within the prescribed time (after the original should have fed 20 mm).
6	Original stop jam
	The [Original Stop] button on top of the scanner unit was pushed to remove the original so that it could be set again.
7	Original exit late jam
	After the original set sensor went ON, the exit sensor did not go ON within the prescribed time (within the time the original should have fed 20 mm).
8	Next original set jam
	<p>The next original was set on the original feed table too early.</p> <ul style="list-style-type: none"> ▪ The original set sensor detected the trailing edge of the first original. ▪ The paper set sensor detected the leading edge of the next original before the IPU received the scan end signal.

7.13.3 PRINTER PAPER JAMS

Code	Area	Name
1	All	Initial jam
2	B	Main scan HP jam
8	A1	Pre-registration sensor lag jam (Roll Unit 1)
9	A2	Pre-registration sensor lag jam (Roll Unit 2)
13	B	DRESS sensor late jam during image registration
16	C	Exit sensor lag jam
34	B	Bypass paper set jam
41	B	Main scan printing jam
53	A1	Paper out (Roll Unit 1)
54	A2	Paper out (Roll Unit 2)
58	B	Pre-registration sensor lag jam
63	B	DRESS sensor lag jam during image registration
66	C	Exit sensor lag jam
84	B	Bypass sensor late jam

Details

Code	Details
1	<p>One or more of the following sensors detected the presence or absence of paper at a location other than the paper standby or registration standby position when the machine was turned on, when a cover was opened and then closed, or when the machine returned to normal operation from the energy save mode:</p> <ul style="list-style-type: none"> ▪ Roll Unit 1 or 2 exit sensor (paper absent) ▪ Pre-registration sensor (paper absent) ▪ Bypass sensor (paper present) ▪ Exit sensor (paper present) <p>The machine will also signal an initial jam in these cases:</p> <ul style="list-style-type: none"> ▪ If a cover is opened during printing ▪ If an error occurs in edge detection (paper size detection) or skew detection by the DRESS sensor during the first phase of bypass printing..
2	<p>The carriage does not return to the home position on the right side of the machine during edge detection or printing due to an obstruction (torn, wrinkled paper).</p>
8	<p>During paper feed from Roll Unit 1, the pre-registration sensor did not detect any paper:</p> <ul style="list-style-type: none"> ▪ After paper was fed long enough to feed the paper the distance between the pre-registration sensor and the registration roller plus 100 mm ▪ After paper was fed long enough to feed the paper the distance between the paper standby position and the pre-registration sensor plus 100 mm.
9	<p>During paper feed from Roll Unit 2, the pre-registration sensor did not detect any paper:</p> <ul style="list-style-type: none"> ▪ After paper was fed long enough to feed the paper the distance between the pre-registration sensor and the registration roller plus 100 mm ▪ After paper was fed long enough to feed the paper the distance between the paper standby position and the pre-registration sensor plus 100 mm.

Code	Details
13	<p>The DRESS sensor failed to detect the leading edge of the paper at the start of the print job:</p> <ul style="list-style-type: none"> ▪ During roll paper edge detection ▪ Within the prescribed time (enough time for the paper to feed from the paper standby position to the DRESS sensor, plus 100 mm). ▪ Within the prescribed time (enough time for the paper to feed from the paper registration position to the DRESS sensor, plus 100 mm). ▪ The right edge of the paper could not be detected before the start of printing.
16	<p>One of the following occurred:</p> <ul style="list-style-type: none"> ▪ During printing, the exit sensor did not detect the leading edge of the paper within the prescribed time (enough time for the paper to feed to the exit sensor plus 100 mm). ▪ During skew correction, the exit sensor did not detect the leading edge of the paper within the prescribed time (enough time for the paper to feed to the exit sensor plus 100 mm). ▪ Paper was not detected by the roll exit sensor.
34	<p>During paper edge detection during the preparation for bypass printing, the DRESS sensor could not detect the right edge of the paper (returned a "0").</p>
41	<p>The machine detected an overload on the horizontal motor during printing, caused by an obstruction in the paper path (torn or wrinkled paper).</p>
53	<p>Roll end at Roll Unit 1. The roll unit exit sensor did not detect paper for 7 sec.</p>
54	<p>Roll end at Roll Unit 2. The roll unit exit sensor did not detect paper for 7 sec.</p>
58	<ul style="list-style-type: none"> ▪ After the rewind button on either roll unit was pressed, the pre-registration sensor did not detect the absence of paper within the prescribed time (after enough time had elapsed for the paper to reverse feed from the registration standby position to the pre-registration sensor plus 200 mm). ▪ During skew correction forcing a paper rewind (due to excessive skew), the pre-registration sensor did not detect the absence of paper within the prescribed time (after enough time had elapsed for the paper to reverse feed from the registration standby position to the pre-registration sensor plus 200 mm).

Code	Details
63	During paper size detection, immediately after paper cutting, or after skew correction, the DRESS sensor detected no paper within the prescribed time (after enough time had elapsed for the paper to feed as far as the DRESS sensor plus 200 mm).
66	During paper edge detection, the exit sensor detected paper but the paper end sensor signaled paper end. (The paper stopped at the exit sensor.)
84	The bypass sensor signaled no paper present during edge detection in preparation for bypass printing.

7.14 ELECTRICAL COMPONENTS

7.14.1 SCANNER UNIT

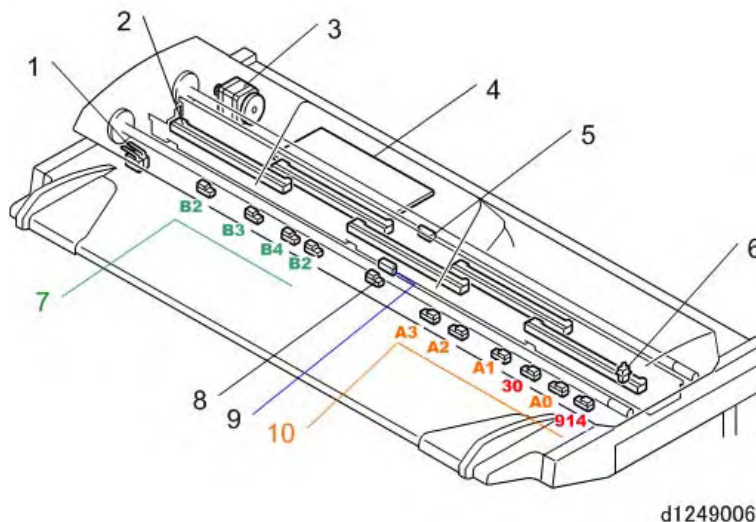

No.	Component	Function
1	Safety switch	A push-switch that detects when the scanner cover is open and disables machine operation. This prevents the CIS from switching on while the cover is open
2	CIS unit	Five CIS elements that transfer scan image signals from CIS LEDs to the SIF
3	Scanner motor	Drives the original feed roller and original exit roller that feed the original through the scanner unit
4	SIB	Scanner Interface Board. This is the board that controls the scanner, and serves as the signal I/F board between the IPU and MCU.
5	Original Exit Sensor	Detects the leading and trailing edges of the original as it leaves the scanner unit. Signals a jam if the edges are not detected within the prescribed time.
6	Original stop switch	Halts original feed after the operator presses this on the operation panel to stop feeding because the original has skewed or wrinkled.

No.	Component	Function
7	Original width sensors (JIS)	Detect the width of the original. Architecture sizes.
8	Original set sensor	Detects the leading edge of the original. This starts the scanner motor. Also functions as an original width sensor (it detects A4 or 8.5" width paper.
9	Original registration sensor	1) Detects the leading edge of the original. Feed pauses briefly at the original feed roller, so that the operator can manually make the original straight. 2) Detects the leading and trailing edges of the original for jam detection.
10	Original width sensors (ISO)	Detect the width of the original. Engineering sizes.

7.14.2 MAIN UNIT SENSORS, MOTORS

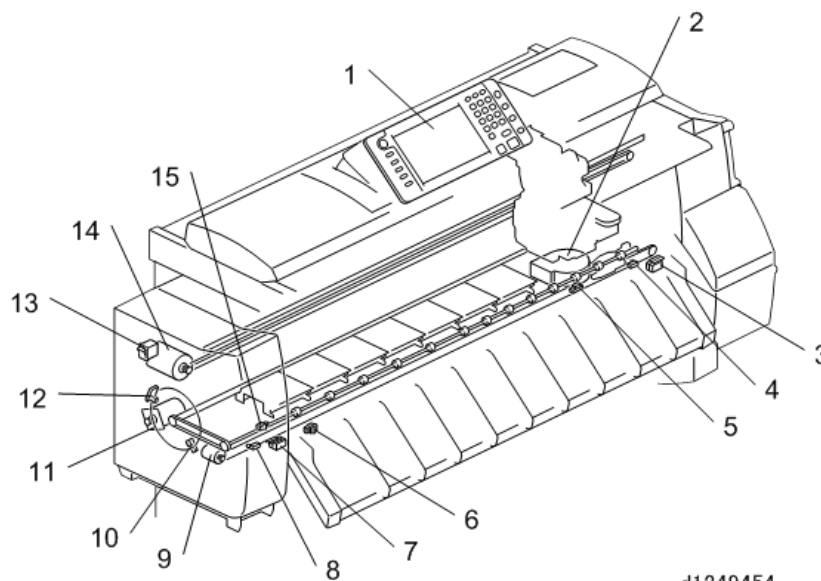

No.	Component	Function
1	Operation panel	Contains the operation keys, touch-panel LCD, and the LEDs. Controlled by the MCU.
2	Paper transport fan	The large fan mounted below the perforated platen plates. This fan creates the suction that holds the paper on the paper path.
3	Front Cover Switch: Right	One of two safety switches that disable the machine when the front cover is opened.
4	Cutter HP Switch	Detects when the cutter has arrived at the home position on the right and switches the cutter motor off.
5	Exit Sensor	Located at the paper exit of the main machine, detects the leading and trailing edges of the paper. Signals an error if the paper fails to arrive or leave the sensor location within the prescribed time.
6	Paper Exit Guide Switch	Detects when the exit guide plate on the front of the machine is opened and closed.
7	Front Cover Switch: Left	One of two safety switches that disable the machine when the front cover is opened.

No.	Component	Function
8	Cutter Return Switch	Detects when the cutter has arrived at the left side of the machine after cutting. Reverses the cutter motor, which moves the cutter back to the home position on the right side of the machine.
9	Cutter Motor	Drives the cutter to the left and right across the paper path when cutting paper. The cutter cuts as it moves from right to left. When the cutter reaches the left side, the cutter return sensor reverses the motor. A guide lever falls into a lower track that lowers the cutter so that it passes under the paper on its return to the home position on the right.
10	Vertical Encoder HP Sensor	Mounted opposite and lower than the vertical encoder sensor on the left side of the machine, this sensor also reads the code on the rim of the vertical encoder wheel, and detects when the wheel reaches the home position and switches off the vertical motor. This sets the encoder wheel at the start position for every job.
11	Vertical Motor	The vertical motor drives the paper feed rollers and exit rollers in the main machine. The operation of this motor is controlled by the vertical encoder sensor and vertical HP sensor which read the encoded rim of the vertical encoder wheel.
12	Vertical Encoder Sensor	The rim of the vertical encoder wheel on the left side of the machine is centered in the gap of this sensor. The sensor reads the code on the rim of the vertical encoder wheel as it rotates, to control the operation of the vertical motor during paper feed.
13	Main Switch	Switches the machine on/off.

Electrical Components

No.	Component	Function
14	Horizontal Motor	Mounted at the left rear corner of the printer, the horizontal motor alternately runs forward and reverse to drive the timing belt that moves the carriage to the left and right during printing. The operation of the motor is controlled by the horizontal encoder strip stretched across the width of the printer and threaded through the horizontal encoder sensor on the right rear corner of the carriage unit. The sensor reads this strip as the carriage moves from side to side and uses these readings to control the operation of the motor.
15	Front Cover Track Switch	A push switch mounted on the left post of the main machine that detects when the pin on the left end of the front cover is mounted correctly in its track.

7.14.3 ROLL UNITS

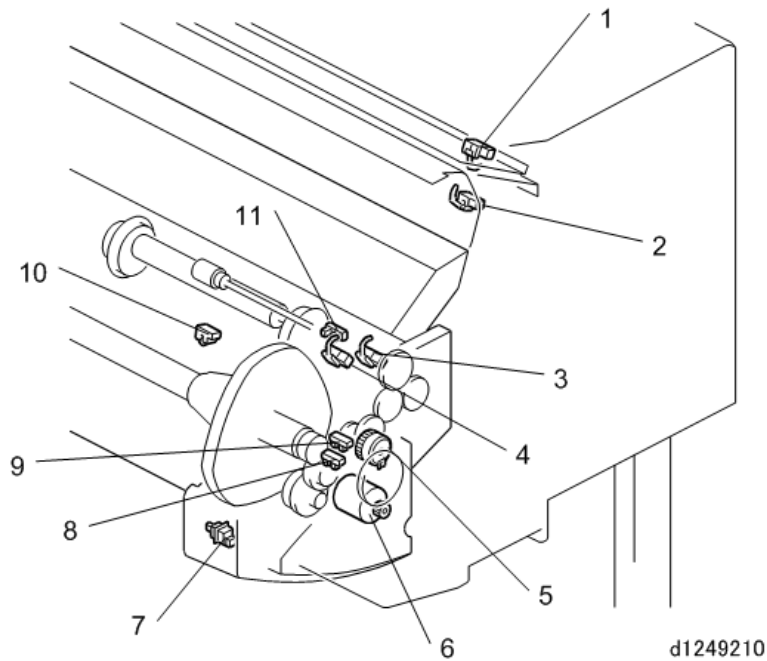

No.	Component	Function
1	Bypass Sensor	Detects the trailing edge of the cut sheet manually inserted into the main machine for bypass feed.
2	Pre-Registration Sensor	Located at the top of the vertical paper feed path in the main unit, detects the leading edge of paper roll paper.
3	Roll Unit Exit Sensor	Detects the leading edge of the roll paper as it leaves the roll unit.
4	Paper Entrance Sensor	Detects the edge of the roll paper when it leaves the roll unit and enters the main paper path.
5	Paper Feed Clutch	Engages and disengages the cam shaft that raises and lowers the roll feed roller idle rollers in the roll unit. This closes and opens the nip of the roll feed roller.
6	Roll Feed Motor	Drives the roll paper feed roller that feeds the roll paper from the roll unit.
7	Roll Rewind Switch	Located on the inside cover of the right end of Roll Unit 1. Depressing the switch rewinds the paper onto the paper roll.

Trouble-shooting

Electrical Components

No.	Component	Function
8	Encoder Sensor 2	Monitors the number of rotations of the drum core. The rotation of the core accelerates as the amount of paper on the roll diminishes. This count is used in a calculation to determine the amount of paper remaining on the roll.
9	Encoder Sensor 1	Monitors the rotations of the roll feed motor. This count is used to calculate the remaining service life of the roll feed motor..
10	Roll End Sensor	Detects when the paper roll runs out of paper.
11	Paper Release Sensor	Controls the raising and lowering of the roll feed roller idle rollers during paper feed .

7.14.4 INK SUPPLY

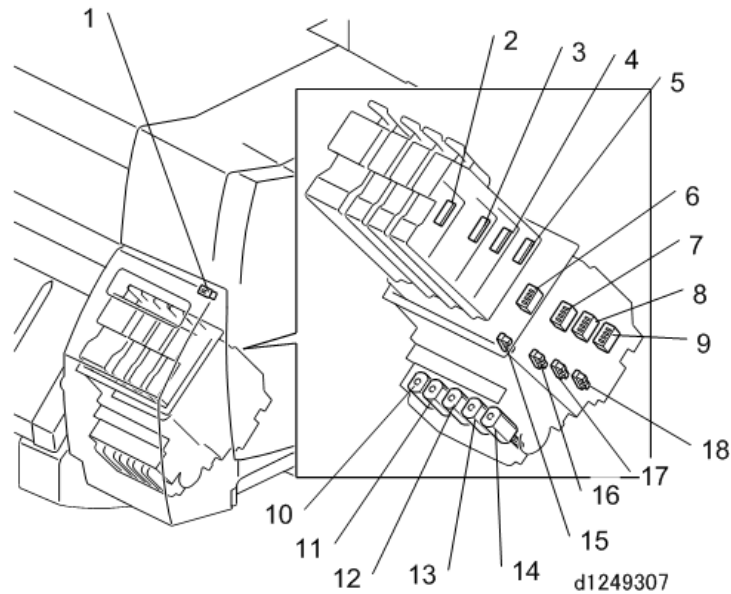

No.	Component	Function
1	Ink cartridge cover switch	Detects when the ink cartridge cover is opened and closed.
2	Ink cartridge ID chip (K)	These ID chips identify each cartridge as the correct type for the machine.
3	Ink cartridge ID chip (C)	
4	Ink cartridge ID chip (M)	
5	Ink cartridge ID chip (Y)	
6	CCB (K)	Cartridge Control Board. Relays the ink cartridge ID chip signals that confirm whether the ink cartridges are installed correctly in the ink cartridge holder.
7	CCB (C)	
8	CCB (M)	
9	CCB (Y)	
10	Ink pump motor (K2)	These motors pump ink from the ink cartridges, through the supply tubes, and into the ink supply tanks of each print head.
11	Ink pump motor (K1)	
12	Ink pump motor (C)	
13	Ink pump motor (M)	

Troubleshooting

Electrical Components

No.	Component	Function
14	Ink pump motor (Y)	
15	Ink end sensor (K)	Located below the supply port of each cartridge. Detects when the ink cartridge is out of ink.
16	Ink end sensor (C)	
17	Ink end sensor (M)	
18	Ink end sensor (Y)	

7.14.5 CARRIAGE UNIT

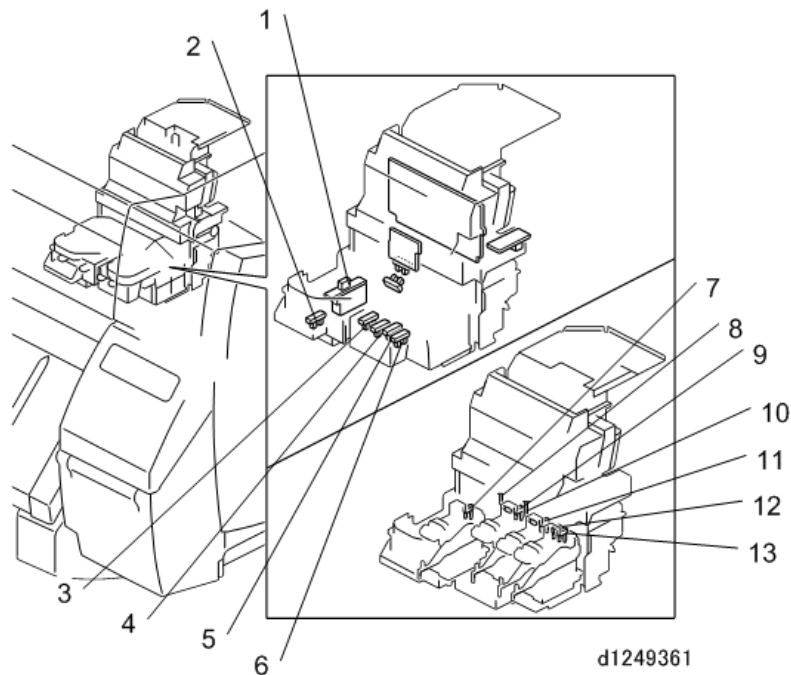

No.	Component	Function
1	DRESS Sensor	Direct Realization Edge Scanning Sensor. The DRESS sensor is mounted on the left lower edge of the carriage unit. It performs both paper registration and image registration.
2	OCFS 1 (K1)	On Carriage Filler Sensor K1. The on-carriage sensor that monitors the position of the feeler arm on the side of the K1 ink sub tank. This movement of this sensor is used to signal low ink in the K1 sub tank.
3	OCFS 2 (K2)	On Carriage Filler Sensor K2 The on-carriage sensor that monitors the position of the feeler arm on the side of the K2 ink sub tank. The movement of this sensor is used to signal low ink in the K2 sub tank.
4	OCFS 3 (C)	On Carriage Filler Sensor C. The on-carriage sensor that monitors the position of the feeler arm on the side of the C ink sub tank. The movement of this sensor is used to signal low ink in the C sub tank.

Troubleshooting

No.	Component	Function
5	OCFS 4 (M)	On Carriage Filler Sensor M. The on-carriage sensor that monitors the position of the feeler arm on the side of the M ink sub tank. The movement of this sensor is used to signal low ink in the M sub tank.
6	OCFS 5 (Y)	On Carriage Filler Sensor Y. The on-carriage sensor that monitors the position of the feeler arm on the side of the Y ink sub tank. The movement of this sensor is used to signal low ink in the Y sub tank.
7	Air Sensor: K1	Detects excess air in the K1 ink sub tank of the K1 print head unit.
8	Head Thermistor (K2)	Monitors the temperature of the black print head unit (K1).
9	Air Sensor: K2	Detects excess air in the K2 ink sub tank of the K2 print head unit.
10	Head Thermistor (C)	Monitors the temperature of the color print head units.
11	Air Sensor: C	Detects excess air in the C ink sub tank of the C print head unit.
12	Air Sensor: Y	Detects excess air in the Y ink sub tank of the YM print head unit.
13	Air Sensor: M	Detects excess air in the M ink sub tank of the YM print head unit.

7.14.6 AROUND THE CARRIAGE UNIT

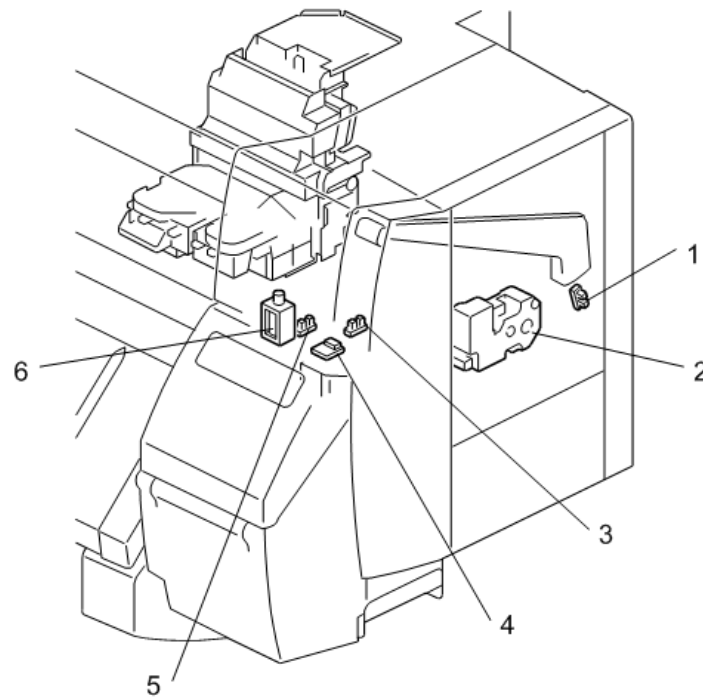

d1249360

No.	Component	Function
1	Registration Release Sensor	Detects the raising and lowering of the paper holding lever which raises and lowers the registration roller when the operator loads a cut sheet manually.
2	Head Lift Motor	Raises and lowers the carriage to adjust the gap between the print heads and the paper for different thickness of paper. The motor is controlled by head lift sensors 1 and 2.
3	Main Ink Level Sensor 2	Checks the position of the K2, C, Y, or M on-carriage filler sensor after one of the OCFS detects a problem in one of the ink sub tanks (low ink, ink end, or excess air). If the reading of main ink level sensor 2 confirms the condition, it will signal the machine to supply more ink or purge air from the tank. This sensor (also known as "FS2") services the OCFS of K2, C, Y, and M.

Trouble-shooting

Electrical Components

No.	Component	Function
4	Temperature/Humidity Sensor	Located on the right side of the machine above the ink supply unit. The temperature/humidity thermistor constantly measures temperature and humidity inside the machine. The printer uses these readings to adjust the operation of the machine.
5	Main Ink Level Sensor 1	Checks the position of the K1 on-carriage filler sensor after the OCFS of the K1 print head detects a problem in the ink sub tank (low ink, ink end, or excess air). If the reading of main ink level sensor 1 confirms the condition, it will signal the machine to supply more ink or purge air from the tank. This sensor (also known as "FS1") services only the OCFS of the K1 ink supply tank.
6	Air Release Solenoid	Located on the right side of the machine. When the air level sensors detect excess air in an ink sub tank, the system activates the plunger of the air release solenoid to purge air from the tank. The partial vacuum created by the suction pulls in the sides of the tank so that the tank can fill with more ink.

7.14.7 MAINTENANCE UNIT

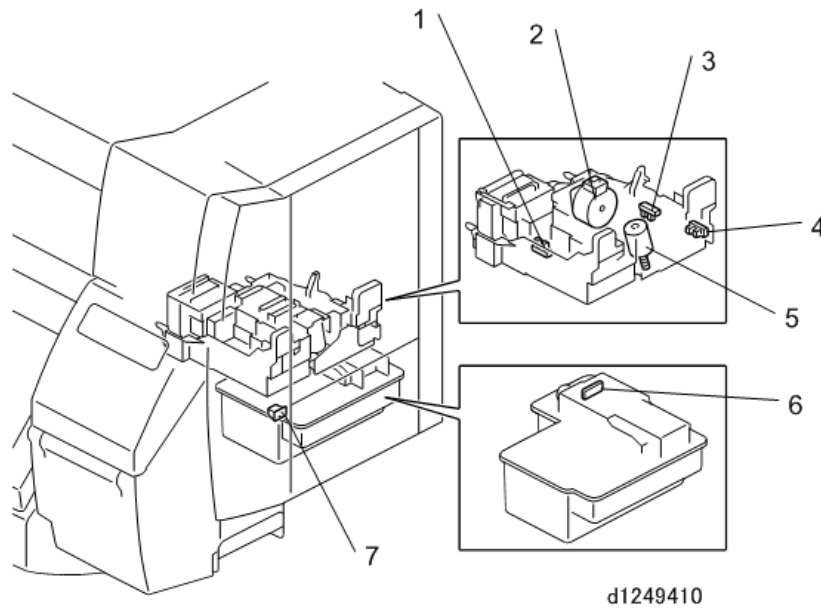

No.	Component	Function
1	Suction Cap Sensor	This sensor switches the maintenance motor on and off when the motor raises and lowers the K1 cradle for capping during the printing cycle or during the print head cleaning cycle.
2	Maintenance Motor	The maintenance motor: 1) Raises and lowers the print head suction cap, 2) Drives the pump that sucks waste ink from the print heads through the suction cap, and 3) Drives the wiper blade and wiper in the cleaning unit.
3	Maintenance Lift Sensor	Controls the operation of the maintenance lift motor that raises and lowers the color cradle (K2, C, YM) during capping.
4	Slide Sensor	This sensor controls the operation of the maintenance motor when it slides the K1 cradle to the front (home position) or to the rear during the print head cleaning cycle.

**Trouble-
shooting**

Electrical Components

No.	Component	Function
5	Maintenance Lift Motor	Raises and lowers the color cradle (K2, C, YM caps) during capping and the print head cleaning cycle. The maintenance lift sensor controls operation of this motor during raising and lowering.
6	BOW Board	This is the ID chip holds the ID code that confirms the tank is the correct one for the machine. The machine software records a count in this chip every time the maintenance unit suction cap operates to suck waste ink from the print heads during cleaning. Once the count is exceeded this signals tank full, and the machine disables the code so that the tank can no longer be used.
7	Ink Collector Cover Switch	Detects when the ink collector tank door is opened and closed. The machine does not operate until the cover is closed.

7.14.8 BOARDS

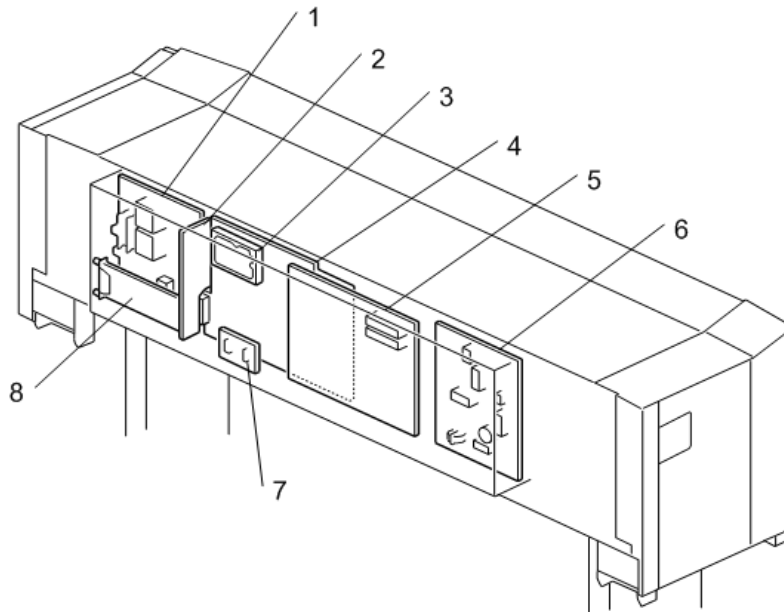

d1249601

No.	Component	Function
1	Controller board	Controls memory and all peripheral devices.
2	MB	Mother Board. Interfaces the operation panel and the controller
3	HDD	160 GB Hard Disk Drive
4	IPU	Image Processing Unit. Takes scan data from the SIF, processes the image data, and sends it to the MCU. The IPU also controls the HDD unit and the PC interfaces.
5	MCU	Main Control Unit. The main board of the machine that controls processing.
6	PSU	Power Supply Unit. Connected to the external power source, provides DC current that runs the machine and all its components.
7	RFDB	Roll Feed Drive Board. Controls the operation of Roll Unit 2. Provided with Roll Unit 2 (option).

Trouble-shooting

Electrical Components

No.	Component	Function
8	MLB	Media Link Board (File Format Converter). An option. Documents saved with the copy/printer function can be received from your client computer via a network, using Desk Top Binder, for example.

7.15 FUSES

7.15.1 SCANNER UNIT

Operation Panel

No.	Rating
FU1	Max. rated voltage/current: 6V/100A Rated 6Vdc , 1.10A
FU4	
FU2	
FU3	

SIB

The SIB (Scanner Interface Board) controls and processes the analog-to-digital (AD) conversion of the image scanned with the CIS.

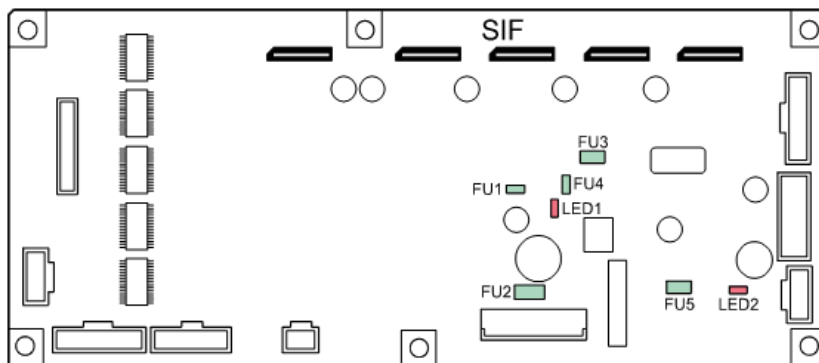

d1249901

No.	Capacity	Voltage	Load Type
FU1, FU4	1.1A 6 (DC) V	3.3V, 1.1V	CIS, 3.3V; 1.1V (PTC)
FU2	2.0A 150 (AC) V	24VINT	Scanner Motor, 24V
FU3	1.1A 16 (DC) V	6.2V	CIS LED, 6.2V (PTC)
FU5	1.1A 8 (DC) V	5.0V	SIB, 5.0V

Trouble-shooting

Fuses

LEDs

No.	Color	State
LED1	Green	+5V input: ON, +3.3V confirm, (OFF for other)
LED2	Green	+5V input ON, (OFF for other)

7.15.2 MAIN BOARDS (REAR BOX)

GW +Controller Board

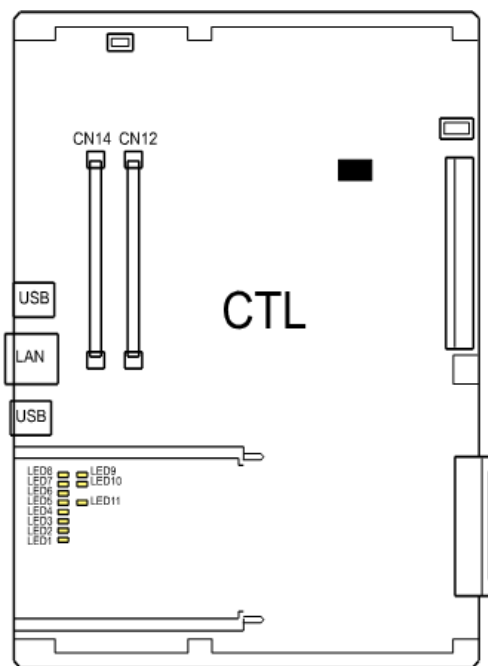

d1249905

The controller board interfaces with the SIPU and accesses all the expansion applications provided on boards and SD cards installed in the slots of the controller board.

LEDs

No.	Color	State
LED1	Red	Normal: ON
LED2	Red	Normal: ON
LED3	Red	Normal: ON
LED4	Red	Normal: ON
LED5	Red	Normal: ON
LED6	Red	Normal: ON
LED7	Red	Normal: OFF
LED8	Red	Normal: FLASH
LED9	Red	Normal: FLASH

Trouble-shooting

Fuses

No.	Color	State
LED10	Green	Normal: ON
LED11	Yellow	Normal: FLASH

DIP Switches: SW 1

★ Important

- Do not change these switch settings.

No.	Factory Setting
1	OFF
2	OFF
3	OFF
4	OFF
5	OFF
6	OFF
7	OFF
8	OFF

DIP Switches: SW 3**★ Important**

- Do not change these switch settings.

No.	Factory Setting
1	OFF
2	OFF
3	OFF
4	OFF
5	ON
6	ON
7	OFF
8	OFF

Mother Board

The MB is mounted sideways at the edge of the controller board. Provides important relay functions 1) for the Rapi Bus I/F between the IPU, GW controller, and file format converter, and 2) for the machine power supply. The standard mother board must be replaced with a larger mother board if the file format converter is installed.

Fuses

No.	Rating
FU1	Max. rated: 8V/100A
FU2	Max. rated: 30V/40A

IPU

The IPU controls image processing. It is only partially visible with the rear cover removed because it is mounted behind the MCU.

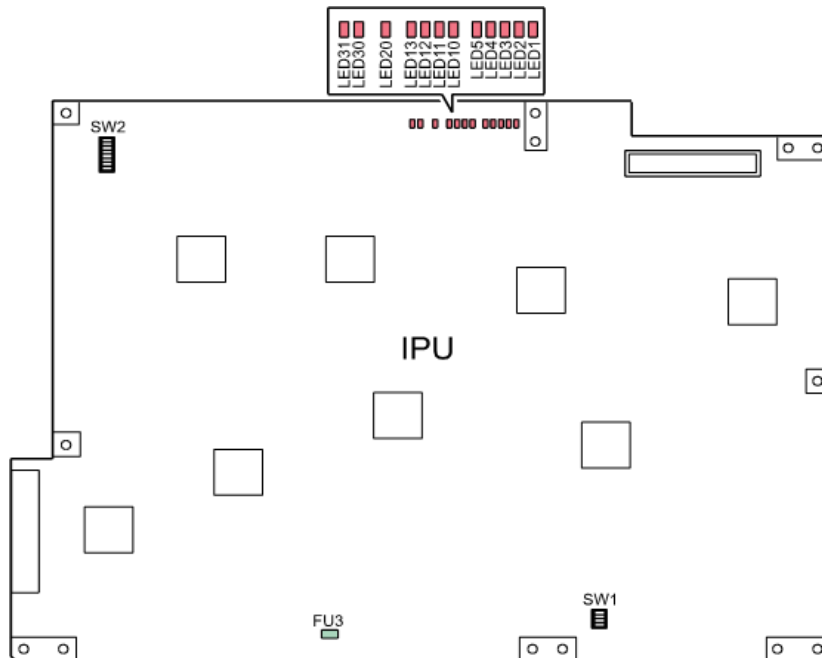

d1249903

No.	Capacity	Voltage	Load Type
FU3	7.1A 76 (DC) V	5V	IPU, 5V

LEDs

No.	Color	State
LED3	Orange	Normal: OFF Abnormal: ON
LED10	Yellow	Standby: FLASH Operation: OFF
LED11	Yellow	Standby: FLASH Operation: OFF

No.	Color	State
LED12	Yellow	Standby: FLASH Operation: OFF
LED13	Yellow	Standby: FLASH Operation: OFF
LED20	Orange	Standby: FLASH Operation: OFF
LED30	Yellow	Normal: FLASH Operation: OFF
LED31	Yellow	Normal: FLASH Operation: OFF

MCU

The MCU (Main Control Unit) performs system control, base engine control, scanner control, and also controls the SIPU. The MCU also controls:

- I/O for the base engine (high voltage power supply, motors, sensors, solenoids, clutches, fusing temperature, customer support systems, etc.)
- Scanning signals (sensors, motors)
- Power supply
- Scanner motor output

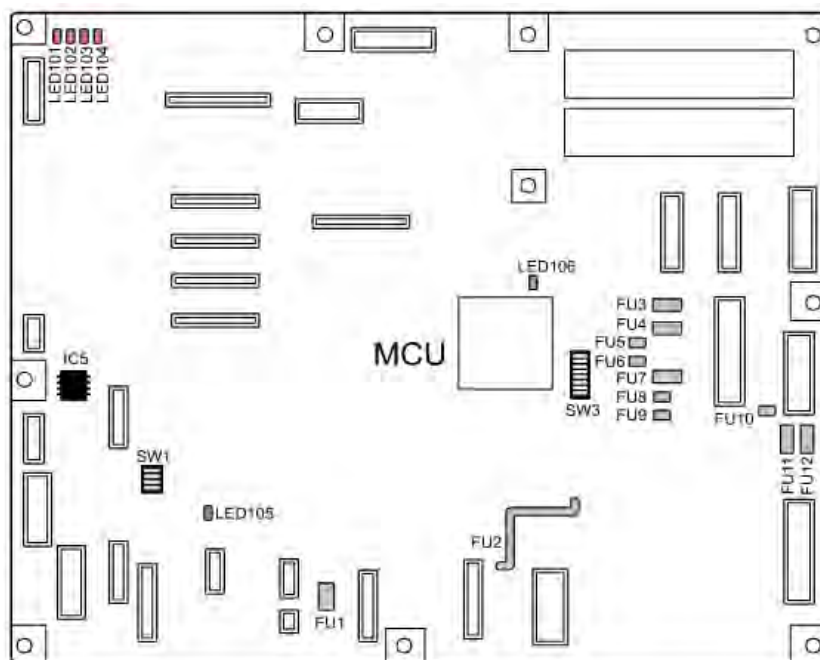

d1249902

No.	Capacity	Voltage	Load Type
FU1	1.1A 30 (DC) V	24V_RESET	Total counter, key counter, 24V
FU2	2.5A 250 (AC) V	24VINT	Roll Unit 2, 24V
FU3	2.5A 250 (AC) V	37V	MCU, 37V
FU4	4A 250 (AC) V	24V	MCU, 24V
FU5	0.5A 72 (DC) V	5VMS1	Sensor power supply 1
FU6	0/5A72 (DC) V	5VMS3	Sensor power supply 3
FU7	2A 250 (AC) V	5VM	MC, 5V

No.	Capacity	Voltage	Load Type
FU8	2.5A 72 (DC) V	5VM_HRB	HRB, 5V
FU9	0.5A 72 (DC) V	5VMS2	Sensor power supply 2
FU10	2.5A 250 (AC) V	24VINT_KYU	Roll Unit 1, 24V
FU11	6.3A 250 (AC) V	24V_PSU	Horizontal motor, 24V
FU12	6.3A 250 (AC) V	24VINT	Vertical motor, 24V
FU13	0.63A 50 (DC) V	37VINT_HRB	HRB, 37V
FU14	2.5A 72 (DC) V	5VM_HRB_IR	HRB, 5V

LEDs

No.	Color	State
LED101	Yellow	Normal: FLASH Abnormal: OFF
LED103	Yellow	Normal: FLASH Abnormal: OFF or ON
LED104	Orange	Normal: OFF
LED105	Yellow	Normal: OFF Abnormal: ON

DIP Switches: SW 3

★ Important

- Do not change these switch settings.

No.	Factory Setting
1	OFF
2	OFF
3	OFF
4	OFF
5	OFF
6	OFF
7	OFF
8	OFF

PSU

The PSU supplies dc current to electrical components and also controls the flow of ac current to the fusing lamp, dehumidifiers (x4), and anti-condensation heaters (x2).

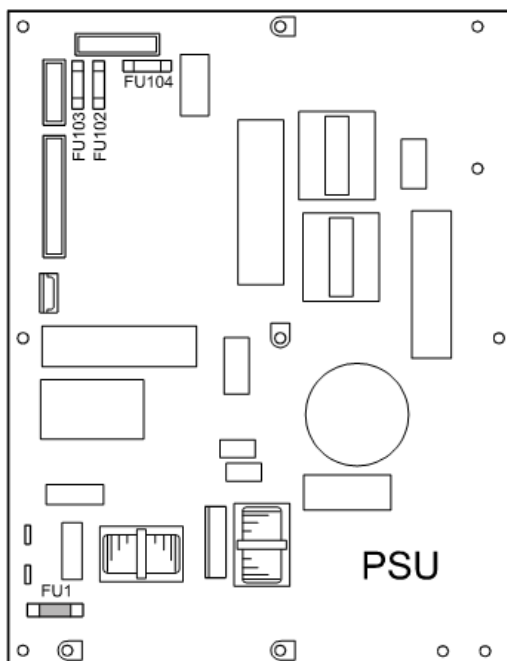

d1249904

No.	Capacity	Load Type
FU1	T10AH/250V	Main Power
FU101	T2.5AL/250V	SIB
FU102	T6.3A/250V	MCU
FU103	T2.5A/250V	SIB
FU104	T6.3A/250V	MCU

7.15.3 CARRIAGE UNIT

HRB

The HRB behind the print heads relays signals to the control board from the horizontal encoder sensor, DRESS sensor, and thermistors.

No.	Rating
FU1	Break capacity: 50V, 16ADC Rated current: 0.63A

ENERGY AND PAPER SAVING

REVISION HISTORY		
Page	Date	Added/Updated/New
		None

8. ENERGY AND PAPER SAVING

8.1 ENERGY SAVE

8.1.1 ENERGY SAVER MODES

Customers should use energy saver modes properly, to save energy and protect the environment.

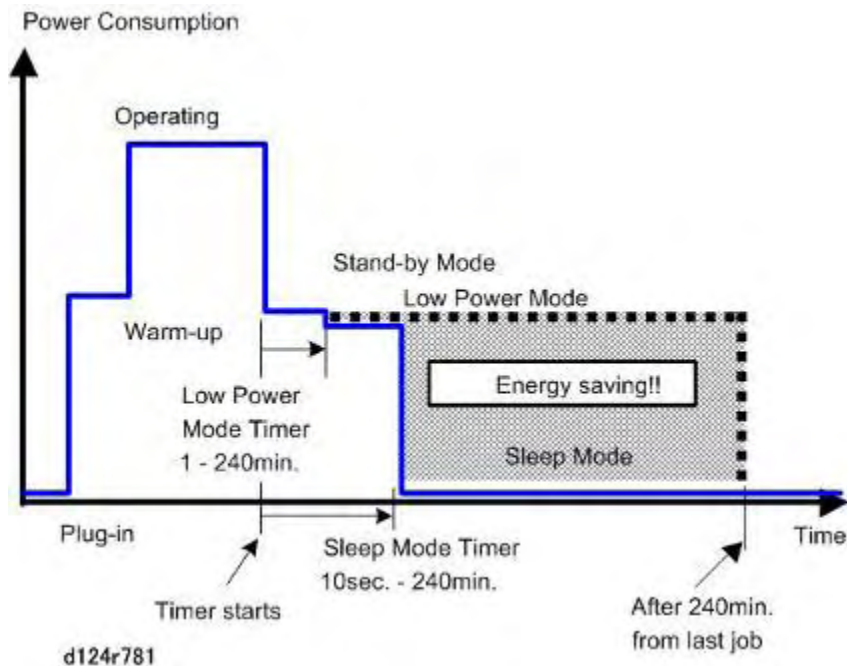

The area shaded grey in this diagram represents the amount of energy that is saved when the timers are at the default settings. If the timers are changed, then the energy saved will be different. For example, if the timers are all set to 240 min., the grey area will disappear, and no energy is saved before 240 min. expires.

8.1.2 TIMER SETTINGS

The user can set these timers with User Tools (System settings > Timer setting)

- Lower power mode timer (1 to 240 min): Default setting: 1 minute
- Sleep mode timer (1 to 240 min): Default setting: 14 min.

8.1.3 RETURN TO STAND-BY MODE

Low Power Mode

Recovery time: 1 sec.

Sleep Mode

Recovery time: 7 sec.

8.1.4 RECOMMENDATION

We recommend that the default settings should be kept.

- If the customer requests that these settings should be changed, please explain that their energy costs could increase, and that they should consider the effects on the environment of extra energy use.
- If it is necessary to change the settings, please try to make sure that the Sleep mode timer is not too long. Try with a shorter setting first, such as 30 min., then go to a longer one (such as 60 min.) if the customer is not satisfied.
- If the timers are all set to the maximum value, the machine will not begin saving energy until 240 minutes has expired after the last job. This means that after the customer has finished using the machine for the day, energy will be consumed that could otherwise be saved.
- If you change the settings, the energy consumed can be measured using SP8941, as explained below.

8.1.5 ENERGY SAVE EFFECTIVENESS

SP 8941 (Machine Status) keeps a record of the amount of time that the machine spends in each mode.

- 8941-001: Operating mode
- 8941-002: Standby mode
- 8941-004: Low power mode
- 8941-005: Off/sleep mode

With this data, and the power consumption values from the specifications, we can estimate the amount of energy that is used by the machine.

This should only be used as a reference value, because the power consumption specifications are measured in a controlled environment with a constant power supply.

To get an exact measurement at the customers site, a watt meter must be used to measure the actual energy consumed.

To use SP8941 to calculate the energy consumed:

- At the start of the measurement period, read the values of SP8941 001 to 005.
- At the end of the measurement period, read the values of SP8941 001 to 005 again.
- Find the amount of time spent in each mode (subtract the earlier measurement from the later measurement).
- Multiply this by the power consumption spec for each mode.
- Convert the result to kWh (kilowatt hours)

Here is an example calculation.

Machine Date	Power Consumption (W) Data: a	SP8941:MachineStatus	Start Time:(min.) Data: b	End Time: (min.) Data: c	Time Differences (Data: c - Data:b) (min.) Data: d	Power Consumption (Data: a x Data: d) (Wmin.) Data: e
① Operating mode	1081.8	001: OperatingTime	21089.0	21386.0	297.0	321294.6
② Ready mode (stand by)	214.0	002: StandbyTime	306163.0	308046.0	1883.0	402962.0
③ Energy mode (Panel off)	214.0	003: Energy Save Time	71386.0	75111.0	3725.0	797150.0
④ Low power mode	153.0	004: Low powerTime	154084.0	156340.0	2256.0	345168.0
⑤ Off/Sleep mode	7.0	005: Off modeTime	508776.0	520377.0	11601.0	81207.0
Total Time of Data: d (min.)					19762.0	
Total Time of Data: d/60min. (Hour)					329.37	
Total Power Consumption of Data: e (Wmin.)						1947781.60
Total Power Consumption of Data: e /60min./1000W (KWH)						32.48

d124r921

D124
SERVICE MANUAL APPENDICES

D124 APPENDICES

TABLE OF CONTENTS

1. APPENDIX: SPECIFICATIONS	1-1
1.1 SPECIFICATIONS	1-1
1.1.1 GENERAL SPECIFICATIONS	1-1
1.1.2 PRINTER SPECIFICATIONS	1-8
1.1.3 1-10	
1.1.4 SCANNING SPECIFICATIONS	1-10
1.1.5 OPTION SPECIFICATIONS	1-12
Roll Feed Units.....	1-12
2. APPENDIX: SERVICE PROGRAM MODE	2-1
2.1 SERVICE PROGRAM MODE	2-1
2.2 SP1000	2-2
2.3 SP2000	2-34
2.4 SP3000	2-93
2.5 SP4000	2-116
2.6 SP5000	2-156
2.7 SP6000	2-228
2.8 SP7000	2-229
2.9 SP8000	2-309
2.10 PRINTER SP TABLES.....	2-364
2.11 SCANNER SP TABLES.....	2-375
2.11.1 SP-1XXX SYSTEM AND OTHERS.....	2-375
2.11.2 SP2-XXX SCANNING IMAGE QUALITY	2-377
2.12 INPUT/OUTPUT CHECK.....	2-378
2.12.1 INPUT CHECK.....	2-378
2.12.2 OUTPUT CHECK.....	2-382
2.13 SP5749 IMPORT/EXPORT	2-383
2.13.1 IMPORT/EXPORT	2-383
2.13.2 DATA THAT CAN BE IMPORTED AND EXPORTED.....	2-383
2.13.3 DATA THAT CANNOT BE IMPORTED OR EXPORTED	2-383
2.13.4 IMPORT/EXPORT CONDITION	2-384
2.13.5 EXPORTING DEVICE INFORMATION.....	2-386
2.13.6 IMPORTING DEVICE INFORMATION	2-388

APPENDIX: SPECIFICATIONS

REVISION HISTORY		
Page	Date	Added/Updated/New
		None

1. APPENDIX: SPECIFICATIONS

1.1 SPECIFICATIONS

1.1.1 GENERAL SPECIFICATIONS

Configuration	Console	
Printing Method	On-demand piezo inkjet system	
Color	Monochrome, Full Color Printing	
Nozzle Numbers	192 nozzles x 2 lines = 384 nozzles Black (K): 768, Color (Y, C, M): 192 each	
Memory	3 GB	
HDD Capacity	250 GB	
Originals		
Type	Sheet	
Thickness	Recommended	0.090 to 0.2 mm (64 to 190 g/m ²)
	Possible	0.035 to 1.0 mm* ¹
Scan Method	Face-down, center set	
Delivery	Top stacker or straight-through* ²	
Size (W x L)	Max.	914.4 x 15,000 mm (36 x 591 in.) * ³
	Min.	210 x 210 mm (8.3 x 8.3 in.)
* ¹ Quality is not guaranteed. A carrier sheet is required for paper less than 0.07 mm thick.		
* ² The original guide should be removed for originals thicker than 135 g/m ² so they can exit the back of the scanner unit.		

- *3
- An original up to 960 mm (37.8") wide can pass through the scanning unit but scanned width is limited to 914.4 mm (36").
 - Width detection of Arch, ANSI sizes possible at same time.

Paper		
Feed Method	Roll paper, cut sheets (bypass feed only)	
Paper Type	Normal, recycled, ink jet standard, tracing paper, matte film, coated paper (CAD), coated paper, special paper	
Paper Thickness	Roll	0.068 to 0.2 mm, 51 to 190 g/m ²
	Sheet	0.068 to 0.4 mm, 51 to 220 g/m ²
Paper Rolls	Core diameter	2 in./3 in. *1
	Circumference	Less than 176 mm (7 in.)
Width*2	mm	297, 364, 420, 440, 490, 515, 594, 610, 620, 625, 660, 680, 707, 728, 800, 841, 880, 914
	in.	11, 12, 15, 17, 18, 22, 24, 30, 34, 36 in.
Paper Size W x L	Max.	914.4 x 15,000 mm (36 x 590 in.) *3
	Min.	279.4 x 210 mm (11 x 8.3 in.)
	Bypass	Max. length: 2,000 mm (79 in.)
Image Borders	Roll	Less than 3 mm (all edges)
	Bypass	Leading edge: Less than 3 mm Trailing edge: Less than 18 mm*4 Left/right edges: Less than 3 mm
Straight Line Deviation	Vertical	Less than ±1/184 mm
	Horizontal	Less than ±2/841 mm
	Angle	Less than 1/200 mm

*1 Roll holders easy to adjust for 2-in. or 3-in. roll cores.

*2 The machine can handle Middle Eastern paper sizes (450, 600, 900 mm) but they cannot be recognized by the firmware.

*3 The maximum length applies to normal and recycled paper only. For other types of paper the maximum length is 3,600 mm (142 in.).

*4 Trailing edge is less than 21 mm for the following: special paper (color/standard mode, color/quality mode), matte film (color/quality mode), tracing paper (color/quality mode).

Resolution*¹	
Scanning	600 dpi
Copying	600 dpi

*1 Resolution is determined by the speed/quality selection in the printer driver. For more details, please refer to the operating instructions.

Warm-up Time	Less than 40 sec. at 23°C (73.4°F).
Recovery	7 sec. (from Sleep Mode)
LCD Recovery	3 sec. (from Low Power Mode)

First Copy	A0 SEF	High Speed	BW: 51 sec. FC: 155 sec.
		Standard	BW: 71 sec. FC: 244 sec.
	A1 LEF	High Speed	BW: 29 sec. FC: 84 sec.
		Standard	BW: 41 sec. FC: 131 sec.
Continuous Copy Speed			
	A0 SEF	High Speed	BW: 1.8 cpm FC: 0.6 cpm
		Standard	BW: 1.1 cpm FC: 0.3 cpm
	A1 LEF	High Speed	BW: 3.4 cpm FC: 1.1 cpm
		Standard	BW: 2.0 cpm FC: 0.6 cpm

Continuous Copy Speed*¹		(After Recovery)	
	A1 LEF	High Speed	BW: 109 sec. FC: 293 sec.
		Standard	BW: 172 sec. FC: 540 sec.
	D Size LEF	High Speed	BW: 116 sec. FC: 318 sec.
		Standard	BW: 183 sec. FC: 576 sec.

*¹ Time (sec.) required to print 5 continuous copies after recovery from the energy save mode.

Magnification	
Fixed	
Engineering (NA)	25.0%, 32.4%, 50.0, 64.7%, 100.0%, 129.4%, 200.0%, 258.8%, 400.0%
Architecture (NA)	25.0%, 33.3%, 50.0%, 66.7%, 100.0%, 133.3%, 200.0%, 266.7%, 400.0%
Other	25.0%, 35.4%, 50.0%, 70.7%, 100.0%, 141.4%, 200.0%, 282.8%, 400.0%
Zoom	25.0% to 400.0% (0.1% Steps)
Magnification Difference	100 to 400%: less than $\pm 0.5\%$ 99.9 to 50%: less than $\pm 0.7\%$ 49.9 to 25%: less than $\pm 0.1\%$
Magnification Deviation	Less than $\pm 0.1\%$
Continuous Copies	1 to 99

Languages	
North America	English, French, Spanish, Portuguese (Brazil)
Europe/Oceania	English, German, French, Italian, Spanish, Dutch, Swedish, Norwegian, Danish, Czech, Hungarian, Finnish, Portuguese, Polish, Russian, Catalan, Turkish, Greek
China	Chinese (simplified characters), English

Paper Feed			
Paper Input	Std.	1 paper roll + bypass feed	
	Max.	2 paper rolls + bypass feed (1 roll option)	
Paper Cutting (Roll)			
		Std. Cut	Synchro Cut
		23°C, 50%	23°C, 50%
Standard	297 mm	±2.0 mm	±3.5 mm
	420 mm	±3.5 mm	±4.0 mm
	594 mm	±3.5 mm	±4.0 mm
	841 mm	±3.5 mm	±4.5 mm
	1219 mm	±3.5 mm	±6.0 mm
Long Size	2 m	±4.5 mm	±12.0 mm
	3 m	±9.0 mm	±18.0 mm
	3.6 m	±11.0 mm	±22.0 mm
	15 m	±150 mm	±150 mm

Ink			
Ink Type	Water-resistant pigment ink		
Supply Method	Ink cartridge, pump tube system		
Ink Cartridges	Colors	K, C, Y, M	
	Capacity	K	60 cc
		C	28 cc
		Y	28 cc
		M	28 cc
Waste Ink Collection			
Left Sump	Capacity	500 cc	
Right Sump	Capacity	147 cc	
Ink Collector	Capacity	1000 cc	

Exit Stacker (Stack Mode)			
Stack Mode	Paper	A0 SEF, A1 LEF, A2 SEF	
	Capacity	10 sheets	A0 SEF/A1 LEF
		10 sheets	A1 SEF/A2 LEF
Basket Mode	1 sheet		

Power Source Required	
North America	110-120V 3.6A 60 Hz
Europe/Asia/China	220-240V 1.5A 50/60 Hz

Power Consumption	Ave.	Less than 120W
	Max.	Less than 180W
Sleep Mode	Less than 2W	
Low Power Mode	Less than 80W	EU, Asia, China
	Less than 70W	NA
Dimensions (w x d x h)	1384 x 1760 x 1214 mm (54.5 x 69 x 48 in.)	
Weight	Less than 120 kg (264 lb.)	

Environment			
Sound Power Level	Standby	40 dB or less	
	Copying	B&W	68 dB or less
		FC	66 dB or less
Sound Pressure Level	Standby	34 dB or less	
	Copying	B&W	62 dB or less
		FC	60 dB or less
Ozone Emission	None		

1.1.2 PRINTER SPECIFICATIONS

Ink	Pigment based YMCK
Interface	
Standard	Ethernet(100BASE-TX/10BASE-T),USB2.0
Options	Wireless LAN (IEEE802.11a/b/g,* ¹), Gigabit Ethernet

*¹ IEEE802.11a/b only in Europe, and wireless LAN not supported in China.

Print Resolution	Determined by driver selection		
	High Speed	600 x 300 dpi (default)	
	Standard	600 x 600 dpi	
	Quality	1200 x 1200 dpi	
Print Speed		BW	Color
A0 SEF	High Speed	1.8 ppm	0.6 ppm
	Standard	1.1 ppm	0.3 ppm
A1 LEF	High Speed	3.2 ppm	1.1 ppm
	Standard	1.9 ppm	0.6 ppm

First Print*¹			
D124 (A0)	A0 SEF	High Speed	BW: 51 sec. FC: 143 sec.
		Standard	BW: 75 sec. FC: 234 sec.
	A1 LEF	High Speed	BW: 32 sec. FC: 77 sec.
		Standard	BW: 44 sec. FC: 121 sec.

*¹ Time elapsed from when the machine receives the print job start command in standby mode until the sheet is cut and stacked (roll stops rotating).

Printer Drivers	PS3, HDI
Supported Languages	RPCS, RP-GL/GL2, RTIFF, PS3 (PDF Direct)
Operating Systems	Windows XP/Vista/7, Windows Server 2003/2008 Mac OS X10.2 and later (option)
Protocols	TCP/IP (IPv4, IPv6) Apple Talk with PS (option)
Built-in Fonts	136 Roman fonts (standard), Euro currency compatible
Interfaces	
Standard	<ul style="list-style-type: none"> ▪ Ethernet (100Base-TX/10Base-T) ▪ USB2.0 ▪ SD card slot ▪ USB Host (built-in)
Option	<ul style="list-style-type: none"> ▪ Gigabit Ethernet (1000Base-T) ▪ IEEE802.11 a/b/g Wireless LAN*¹ ▪ IEEE802.11b Wireless LAN (Europe)
* ¹ Wireless LANs not compatible in China.	

1.1.3

1.1.4 SCANNING SPECIFICATIONS

Scanning Method	Original transport under CIS sensor array	
Illumination	LED array, RGB method for full color and black-and-white scanning	
Scanning Resolution	600 dpi (100/200/300/400/600 dpi)	
RGB Support	Standard	
Gradation		
Monochrome	1-bit (2 steps)	
Grayscale	8-bit (256 steps)	
Full Color	24-bit (RGB 256 steps), 8-bit (RGB 256 steps)	
Scanning Length (at 600 dpi)		
Black-and-White	Max.	914.4 x 15,000 mm (36 x 591 in.)* ¹
	Min.	210 x 210 mm (8.3 x 8.3 in.)
Full Color	Max.	914.4 x 2,774 mm (36 x 109 in.)
	Min.	210 x 210 mm (8.3 x 8.3 in.)
* ¹ 15,000 mm (50 ft.) with File Format Converter (MLB) installed. 2,774 mm (9 ft.) without File Format Converter installed.		
Scanning Speed		
Black-and-White	Resolution	Speed
	600 dpi	80 mm/s
	200 dpi	160 mm/s
Full Color	600 dpi	26.7 mm/s
	200 dpi	40 mm/s

Interfaces	
Standard	<ul style="list-style-type: none"> ▪ Ethernet (100Base-TX/10Base-T) ▪ USB2.0 (SD card slot) ▪ USB Host (built-in)
Option	<ul style="list-style-type: none"> ▪ Gigabit Ethernet (1000Base-T) ▪ IEEE802.11 a/b/g Wireless LAN*¹ ▪ IEEE802.11b Wireless LAN (Europe)

*¹ Wireless LANs not compatible in China.

Mail TX	
Scanning Speed	150, 200, 300, 400, 600 dpi
Protocol	SMTP
Output Format	TIFF (single/multi), JPEG PDF (single/multi, high-compression)
File TX	
Scanning Speed	150, 200, 300, 400, 600 dpi
Protocol	SMTP, FTP
Output Format	TIFF (single/multi), JPEG PDF (single/multi, high-compression)
Network TWAIN Scanning	
Scanning Speed	150 to 1200 dpi (adjustable in 1 dpi steps)
Protocols	TCP/IP (IPv4, IPv6)
Operating Systems	Windows XP/Vista/7, Windows Server 2003/2008

1.1.5 OPTION SPECIFICATIONS

Roll Feed Units

These specifications for Roll Unit 1 (Standard) and Roll Unit 2 (option) are the same.

Power Source	From main machine
Dimensions (w x d x h)	1108 x 432 x 398 mm (43.6 x 17 x 15.7 lb.)
Weight	14.5 kg (32 lb.)

APPENDIX:

SERVICE PROGRAM MODE

APPENDIX 2 SP MODE TABLES REVISION HISTORY		
Page	Date	Added/Updated/New
102	4/9/2013	SP3112-10 Plotter Emergency Stop
156	9/16/2013	SP5045-002 Counter Unit
179	05/09/2013	Added Note to refer to Section 2.13 to SP5749
383 388	05/09/2013	Added SP5749 IMPORT/EXPORT

2. APPENDIX: SERVICE PROGRAM MODE

2.1 SERVICE PROGRAM MODE

Notation	What it means
[range/default step]	Example: [-9 to +9/+3.0/0.1 mm]. <ul style="list-style-type: none">▪ Setting can be adjusted in the range ±9▪ Default: +3.0. Value reset to default after an NVRAM reset▪ Value is changed in 0.1 mm steps with each key push.
DFU	“Design or Factory Use”. Do not change this value. The factory default setting provides optimum performance.
CTL	Means "controller". This is used to denote SP codes related to the GW+ controller.
Not Used	These SP's appear in the SP mode menus but these codes are not used because: <ul style="list-style-type: none">▪ Currently the feature is not available for the main machine, or its use has been discontinued.▪ The SP is intended for use with a peripheral that is currently under development but not available at this time.▪ Executing these SP's has no effect on operation of the main machine or any peripheral device.
Japan Only	This feature or item is for Japan only. Do not change this value.

 **Important**

- Always cycle the machine off/on after changing an SP setting.

2.2 SP1000

1001	Print Position Adj (Top Edge)
	This is vertical registration adjustment for each paper feed station. The adjustment values entered here determine the distance the paper feeds between where the DRESS sensor (functioning as the image registration sensor) detected the leading edge of the paper and where vertical scan stops (1st scan position), and where printing begins. These adjustments are effective for copy jobs as well as print jobs.
1	By-pass Feed
	Adjusts vertical registration for bypass paper feed. [-2 to 2/ 0.0 /0.1 mm]
2	Paper Input 1
	Adjusts vertical registration for roll paper fed from Roll Feeder 1. [-2 to 2/ 0.0 /0.1 mm]
3	Paper Input 2
	Adjusts vertical registration for roll paper fed from Roll Feeder 2. [-2 to 2/ 0.0 /0.1 mm]
4	By-pass Input (Factory Setting) DFU
	[-2 to 2/ 0.0 /0.1 mm]
5	Paper Input 1 (Factory Setting) DFU
	[-2 to 2/ 0.0 /0.1 mm]
6	Paper Input 2 (Factory Setting) DFU
	[-2 to 2/ 0.0 /0.1 mm]

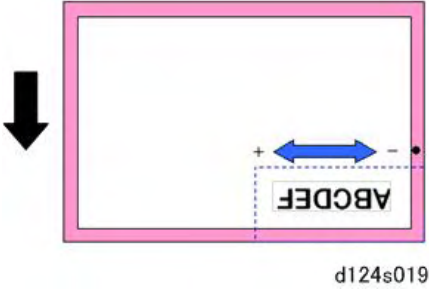
1002	Print Position Adj (Left Edge)
	<p>This SP adjusts the horizontal registration of the image area on paper for each paper feed station. This adjustment determines where the moving carriage starts and ends printing with every horizontal pass across the paper.</p>  <p style="text-align: center;">d124s019</p> <ul style="list-style-type: none"> ▪ A larger setting moves the image to create a wider margin at "+". ▪ A smaller setting moves the image to create narrow margin at "-".
1	By-pass Feed
	<p>Adjusts horizontal registration for bypass paper feed. [-10 to 10/0.0/0.1 mm]</p>
2	Paper Input 1
	<p>Adjusts horizontal registration for roll paper fed from Roll Feeder 1. [-10 to 10/0.0/0.1 mm]</p>
3	Paper Input 2
	<p>Adjusts horizontal registration for roll paper fed from Roll Feeder 2. [-10 to 10/0.0/0.1 mm]</p>
4	By-pass Input (Factory Setting) DFU
	[-10 to 10/0.0/0.1 mm]
5	Paper Input 1 (Factory Setting) DFU
	[-10 to 10/0.0/0.1 mm]
6	Paper Input 2 (Factory Setting) DFU
	[-10 to 10/0.0/0.1 mm]

1017	External Temperature Detection DFU
	<p>The temperature is checked at two points: 1) The temperature/ humidity sensor on the right side of the machine above the maintenance unit, and 2) The K1 thermistor near the K1, K2 print heads.</p> <ul style="list-style-type: none"> ▪ The temperature/humidity sensor measures the "external" temperature. ▪ The K1 thermistor measures the "internal" temperature ▪ The SP codes below affect the readings of the temperature/humidity sensor only (external temperature). <p>Low temperatures can cause paper jams and high temperatures can lead to "misting" of ink around the print head ink ports. If the machine detects that the temperature is out of the operational range, it will display a message, and then the print job print head maintenance operations will stop.</p> <p>If temperature goes out of range during printing:</p> <ul style="list-style-type: none"> ▪ Printing stops and cancels the current job. If print head maintenance is in progress, the cycle completes then cancels the print job. ▪ The print heads are capped to keep them from drying out. ▪ Ink supply stops and the printer goes into standby mode. ▪ Even if the machine cools down to within the operating range a new job cannot be started until the machine has been cycled Off/On. <p>If temperature is out of range at power on</p> <ul style="list-style-type: none"> ▪ The power on maintenance cycle will not execute if the machine is too cold the first time it is powered on at the beginning of the work day. ▪ The print heads remain capped and there is no ink supplied for the power on maintenance cycle. ▪ Once the machine enters the operation range, the power on maintenance cycle will execute and the machine will operate. ▪ In this case, it is not necessary to cycle the machine off/on. <p>The following SP codes can be adjusted to change the temperature ranges measured by the temperature/humidity sensor.</p>
1	High-Stop H
	Shuts down the maintenance cycle and puts the machine in standby mode. [20 to 50/ 48.5 /0.5 °C]
2	High-Detect HM

	<p>If the temperature exceeds HM at power on, the maintenance cycle will not execute, the machine will enter standby mode and wait for the machine to fall below HM, and then normal operation will be restored.</p> <p>[20 to 50/46.5/0.5 °C]</p>
3	High-Resume HL
	<p>When the machine reaches the operation temperature HL after the power is turned off, machine operation will resume after power on.</p> <p>[20 to 50/46.5/0.5 °C]</p>
4	Low-Resume LH
	<p>Once the temperature to LH due to intervention by the operator by cycling the machine off/on, normal operation is restored.</p> <p>[1 to 20/1/0.5 °C]</p>
5	Low-Detect LM
	<p>If the exceeds LM at power on, normal operation will be restored once the temperature rises above LM, but if below LM the machine will enter standby and the maintenance cycle will not execute.</p> <p>[1 to 20/1/0.5 °C]</p>
6	Low-Stop L
	<p>If the exceeds L at power on, normal operation will be restored once the temperature rises above L the machine will enter standby and the maintenance cycle will not execute.</p> <p>[1 to 20/1/0.5 °C]</p>

1018	Internal Temperature Detection DFU
	<p>The temperature is checked at two points: 1) The temperature/ humidity sensor on the right side of the machine above the maintenance unit, and 2) The K1 thermistor near the K1, K2 print heads.</p> <ul style="list-style-type: none"> ▪ The temperature/humidity sensor measures the "external" temperature. ▪ The K1 thermistor measures the "internal" temperature ▪ The SP codes below affect the readings of the K1 thermistor only (internal temperature). <p>Low temperatures can cause paper jams and high temperatures can lead to "misting" of ink around the print head ink ports.</p> <p>If the machine detects that the temperature is out of the operational range, it will display a message, and then the print job print head maintenance operations will stop.</p> <p>If temperature goes out of range during printing:</p> <ul style="list-style-type: none"> ▪ Printing stops and cancels the current job. If print head maintenance is in progress, the cycle completes then cancels the print job. ▪ The print heads are capped to keep them from drying out. ▪ Ink supply stops and the printer goes into standby mode. ▪ Even if the machine cools down to within the operating range a new job cannot be started until the machine has been cycled Off/On. <p>If temperature is out of range at power on</p> <ul style="list-style-type: none"> ▪ The power on maintenance cycle will not execute if the machine is too cold the first time it is powered on at the beginning of the work day. ▪ The print heads remain capped and there is no ink supply for the power on maintenance cycle. ▪ Once the machine enters the operation range, the power on maintenance cycle will execute and the machine will operate. ▪ In this case, it is not necessary to cycle the machine off/on. <p>The following SP codes can be adjusted to change the temperature ranges measured by the K1 thermistor.</p>
1	High-Stop H
	Shuts down the maintenance cycle and puts the machine in standby mode. [20 to 50/ 43.5 /0.5 °C]
2	High-Detect HM

	<p>If the temperature exceeds HM at power on the maintenance cycle will not execute, the machine will enter standby mode and wait for the machine to fall below HM, and then normal operation will be restored.</p> <p>[20 to 50/41.5/0.5 °C]</p>
3	High-Resume HL
	<p>When the machine reaches the operation temperature HL after the power is turned off, machine operation will resume after power on.</p> <p>[20 to 50/41.5/0.5 °C]</p>
4	Low-Resume LH
	<p>Once the temperature to LH due to intervention by the operator by cycling the machine off/on, normal operation is restored.</p> <p>[1 to 20/1/0.5 °C]</p>
5	Low-Detect LM
	<p>If the exceeds LM at power on, normal operation will be restored once the temperature rises above LM, but if below LM the machine will enter standby and the maintenance cycle will not execute.</p> <p>[1 to 20/1/0.5 °C]</p>
6	Low-Stop L
	<p>If the exceeds L at power on, normal operation will be restored once the temperature rises above L the machine will enter standby and the maintenance cycle will not execute.</p> <p>[1 to 20/1/0.5 °C]</p>

1830	Sub Scan Feed Ad (Special) - Thin
	Adjusts the amount of registration "slip" for special thin paper. "Slip" is the amount of paper fed at a prescribed speed, 150 mm/s, for example, so this is a speed adjustment of the vertical motor.
	[-400 to 400/01]
1	Applying Size 1/Rem1/Thin
2	Applying Size 1/Rem2/Thin
3	Applying Size 1/Rem3/Thin
4	Applying Size 1/Rem4/Thin
5	Applying Size 1/Rem5/Thin
6	Applying Size 1/Rem6/Thin
7	Applying Size 1/Rem7/Thin
8	Applying Size 2/Rem1/Thin
9	Applying Size 2/Rem2/Thin
10	Applying Size 2/Rem3/Thin
11	Applying Size 2/Rem4/Thin
12	Applying Size 2/Rem5/Thin
13	Applying Size 2/Rem6/Thin
14	Applying Size 2/Rem7/Thin
15	Applying Size 3/Rem1/Thin
16	Applying Size 3/Rem2/Thin
17	Applying Size 3/Rem3/Thin
18	Applying Size 3/Rem4/Thin
19	Applying Size 3/Rem5/Thin
20	Applying Size 3/Rem6/Thin

21	Applying Size 3/Rem7/Thin
22	Applying Size 4/Rem1/Thin
23	Applying Size 4/Rem2/Thin
24	Applying Size 4/Rem3/Thin
25	Applying Size 4/Rem4/Thin
26	Applying Size 4/Rem5/Thin
27	Applying Size 4/Rem6/Thin
28	Applying Size 4/Rem7/Thin

1831	Sub Scan Feed Ad (Special) - Normal
	Adjusts the amount of registration "slip" for special normal paper. "Slip" is the amount of paper fed at a prescribed speed, 150 mm/s, for example, so this is a speed adjustment of the vertical motor.
	[-400 to 400/01]
1	Applying Size 1/Rem1/Normal
2	Applying Size 1/Rem2/Normal
3	Applying Size 1/Rem3/Normal
4	Applying Size 1/Rem4/Normal
5	Applying Size 1/Rem5/Normal
6	Applying Size 1/Rem6/Normal
7	Applying Size 1/Rem7/Normal
8	Applying Size 2/Rem1/Normal
9	Applying Size 2/Rem2/Normal
10	Applying Size 2/Rem3/Normal
11	Applying Size 2/Rem4/Normal
12	Applying Size 2/Rem5/Normal

13	Applying Size 2/Rem6/Normal
14	Applying Size 2/Rem7/Normal
15	Applying Size 3/Rem1/Normal
16	Applying Size 3/Rem2/Normal
17	Applying Size 3/Rem3/Normal
18	Applying Size 3/Rem4/Normal
19	Applying Size 3/Rem5/Normal
20	Applying Size 3/Rem6/Normal
21	Applying Size 3/Rem7/Normal
22	Applying Size 4/Rem1/Normal
23	Applying Size 4/Rem2/Normal
24	Applying Size 4/Rem3/Normal
25	Applying Size 4/Rem4/Normal
26	Applying Size 4/Rem5/Normal
27	Applying Size 4/Rem6/Normal
28	Applying Size 4/Rem7/Normal

1832	Sub Scan Feed Ad (Special) - Semi Thick
	Adjusts the amount of registration "slip" for semi-thick paper. "Slip" is the amount of paper fed at a prescribed speed, 150 mm/s, for example, so this is a speed adjustment of the vertical motor.
	[-400 to 400/01]
1	Applying Size 1/Rem1/Semi Thick
2	Applying Size 1/Rem2/Semi Thick
3	Applying Size 1/Rem3/Semi Thick
4	Applying Size 1/Rem4/Semi Thick
5	Applying Size 1/Rem5/Semi Thick
6	Applying Size 1/Rem6/Semi Thick
7	Applying Size 1/Rem7/Semi Thick
8	Applying Size 2/Rem1/Semi Thick
9	Applying Size 2/Rem2/Semi Thick
10	Applying Size 2/Rem3/Semi Thick
11	Applying Size 2/Rem4/Semi Thick
12	Applying Size 2/Rem5/Semi Thick
13	Applying Size 2/Rem6/Semi Thick
14	Applying Size 2/Rem7/Semi Thick
15	Applying Size 3/Rem1/Semi Thick
16	Applying Size 3/Rem2/Semi Thick
17	Applying Size 3/Rem3/Semi Thick
18	Applying Size 3/Rem4/Semi Thick
19	Applying Size 3/Rem5/Semi Thick
20	Applying Size 3/Rem6/Semi Thick

21	Applying Size 3/Rem7/Semi Thick
22	Applying Size 4/Rem1/Semi Thick
23	Applying Size 4/Rem2/Semi Thick
24	Applying Size 4/Rem3/Semi Thick
25	Applying Size 4/Rem4/Semi Thick
26	Applying Size 4/Rem5/Semi Thick
27	Applying Size 4/Rem6/Semi Thick
28	Applying Size 4/Rem7/Semi Thick

1833	Sub Scan Feed Ad (Special) – Thick 1
	Adjusts the amount of registration "slip" for special thick (Thick 1) paper. "Slip" is the amount of paper fed at a prescribed speed, 150 mm/s, for example, so this is a speed adjustment of the vertical motor.
	[-400 to 400/01]
1	Applying Size 1/Rem1/Thick 1
2	Applying Size 1/Rem2/Thick 1
3	Applying Size 1/Rem3/Thick 1
4	Applying Size 1/Rem4/Thick 1
5	Applying Size 1/Rem5/Thick 1
6	Applying Size 1/Rem6/Thick 1
7	Applying Size 1/Rem7/Thick 1
8	Applying Size 2/Rem1/Thick 1
9	Applying Size 2/Rem2/Thick 1
10	Applying Size 2/Rem3/Thick 1
11	Applying Size 2/Rem4/Thick 1
12	Applying Size 2/Rem5/Thick 1

13	Applying Size 2/Rem6/Thick 1
14	Applying Size 2/Rem7/Thick 1
15	Applying Size 3/Rem1/Thick 1
16	Applying Size 3/Rem2/Thick 1
17	Applying Size 3/Rem3/Thick 1
18	Applying Size 3/Rem4/Thick 1
19	Applying Size 3/Rem5/Thick 1
20	Applying Size 3/Rem6/Thick 1
21	Applying Size 3/Rem7/Thick 1
22	Applying Size 4/Rem1/Thick 1
23	Applying Size 4/Rem2/Thick 1
24	Applying Size 4/Rem3/Thick 1
25	Applying Size 4/Rem4/Thick 1
26	Applying Size 4/Rem5/Thick 1
27	Applying Size 4/Rem6/Thick 1
28	Applying Size 4/Rem7/Thick 1

1834	Sub Scan Feed Ad (Special) – Thick 2
	Adjusts the amount of registration "slip" for special thick (Thick 2) paper. "Slip" is the amount of paper fed at a prescribed speed, 150 mm/s, for example, so this is a speed adjustment of the vertical motor.
	[-400 to 400/01]
1	Applying Size 1/Rem1/Thick 2
2	Applying Size 1/Rem2/Thick 2
3	Applying Size 1/Rem3/Thick 2
4	Applying Size 1/Rem4/Thick 2
5	Applying Size 1/Rem5/Thick 2
6	Applying Size 1/Rem6/Thick 2
7	Applying Size 1/Rem7/Thick 2
8	Applying Size 2/Rem1/Thick 2
9	Applying Size 2/Rem2/Thick 2
10	Applying Size 2/Rem3/Thick 2
11	Applying Size 2/Rem4/Thick 2
12	Applying Size 2/Rem5/Thick 2
13	Applying Size 2/Rem6/Thick 2
14	Applying Size 2/Rem7/Thick 2
15	Applying Size 3/Rem1/Thick 2
16	Applying Size 3/Rem2/Thick 2
17	Applying Size 3/Rem3/Thick 2
18	Applying Size 3/Rem4/Thick 2
19	Applying Size 3/Rem5/Thick 2
20	Applying Size 3/Rem6/Thick 2

21	Applying Size 3/Rem7/Thick 2
22	Applying Size 4/Rem1/Thick 2
23	Applying Size 4/Rem2/Thick 2
24	Applying Size 4/Rem3/Thick 2
25	Applying Size 4/Rem4/Thick 2
26	Applying Size 4/Rem5/Thick 2
27	Applying Size 4/Rem6/Thick 2
28	Applying Size 4/Rem7/Thick 2

1835	Paper Thickness Correction DFU
	[0 to 1/0/1]
1	Special/Thin
2	Special/Normal
3	Special/Semi Thick
4	Special/Thick 1
5	Special/Thick 2

1850	Paper Feed Start Timing (Size1) DFU
	This SP code is used to adjust the registration roller start timing for roll paper Size 1 based on the amount of paper remaining on the roll.
1	Remaining: less than 10%
	[0 to 1000/400/1 msec]
2	Remaining: 10< to ≦20%
	[0 to 1000/400/1 msec]
3	Remaining: 20< to ≦30%
	[0 to 1000/400/1 msec]

4	Remaining: 30< to \leq 40%
	[0 to 1000/400/1 msec]
5	Remaining: 40< to \leq 60%
	[0 to 1000/400/1 msec]
6	Remaining: 60< to \leq 80%
	[0 to 1000/400/1 msec]
7	Remaining: 80< to \leq 100%
	[0 to 1000/400/1 msec]

1851	Paper Feed Stop Timing (Size1) DFU
	This SP code is used to adjust the registration roller stop timing for roll paper Size 1 based on the amount of paper remaining on the roll.
1	Remaining: less than 10%
	[0 to 1000/200/1 msec]
2	Remaining: 10< to \leq 20%
	[0 to 1000/200/1 msec]
3	Remaining: 20< to \leq 30%
	[0 to 1000/200/1 msec]
4	Remaining: 30< to \leq 40%
	[0 to 1000/200/1 msec]
5	Remaining: 40< to \leq 60%
	[0 to 1000/200/1 msec]
6	Remaining: 60< to \leq 80%
	[0 to 1000/200/1 msec]
7	Remaining: 80< to \leq 100%
	[0 to 1000/200/1 msec]

1852	Paper Feed Start Timing (Size2) DFU
	This SP code is used to adjust the registration roller start timing for roll paper Size 2 based on the amount of paper remaining on the roll.
1	Remaining: less than 10%
	[0 to 1000/ 400 /1 msec]
2	Remaining: 10< to ≤20%
	[0 to 1000/ 400 /1 msec]
3	Remaining: 20< to ≤30%
	[0 to 1000/ 400 /1 msec]
4	Remaining: 30< to ≤40%
	[0 to 1000/ 400 /1 msec]
5	Remaining: 40< to ≤60%
	[0 to 1000/ 400 /1 msec]
6	Remaining: 60< to ≤80%
	[0 to 1000/ 400 /1 msec]
7	Remaining: 80< to ≤100%
	[0 to 1000/ 400 /1 msec]

1853	Paper Feed Stop Timing (Size2) DFU
	This SP code is used to adjust the registration roller stop timing for roll paper Size 2 based on the amount of paper remaining on the roll.
1	Remaining: less than 10%
	[0 to 1000/ 200 /1 msec]
2	Remaining: 10< to \leq 20%
	[0 to 1000/ 200 /1 msec]
3	Remaining: 20< to \leq 30%
	[0 to 1000/ 200 /1 msec]
4	Remaining: 30< to \leq 40%
	[0 to 1000/ 200 /1 msec]
5	Remaining: 40< to \leq 60%
	[0 to 1000/ 200 /1 msec]
6	Remaining: 60< to \leq 80%
	[0 to 1000/ 200 /1 msec]
7	Remaining: 80< to \leq 100%
	[0 to 1000/ 200 /1 msec]

1854	Paper Feed Start Timing (Size3) DFU
	This SP code is used to adjust the registration roller start timing for roll paper Size 3 based on the amount of paper remaining on the roll.
1	Remaining: less than 10%
	[0 to 1000/400/1 msec]
2	Remaining: 10< to ≤20%
	[0 to 1000/400/1 msec]
3	Remaining: 20< to ≤30%
	[0 to 1000/400/1 msec]
4	Remaining: 30< to ≤40%
	[0 to 1000/400/1 msec]
5	Remaining: 40< to ≤60%
	[0 to 1000/400/1 msec]
6	Remaining: 60< to ≤80%
	[0 to 1000/400/1 msec]
7	Remaining: 80< to ≤100%
	[0 to 1000/400/1 msec]

1855	Paper Feed Stop Timing (Size3) DFU
	This SP code is used to adjust the registration roller stop timing for roll paper Size 3 based on the amount of paper remaining on the roll.
1	Remaining: less than 10%
	[0 to 1000/ 200 /1 msec]
2	Remaining: 10< to \leq 20%
	[0 to 1000/ 200 /1 msec]
3	Remaining: 20< to \leq 30%
	[0 to 1000/ 200 /1 msec]
4	Remaining: 30< to \leq 40%
	[0 to 1000/ 200 /1 msec]
5	Remaining: 40< to \leq 60%
	[0 to 1000/ 200 /1 msec]
6	Remaining: 60< to \leq 80%
	[0 to 1000/ 200 /1 msec]
7	Remaining: 80< to \leq 100%
	[0 to 1000/ 200 /1 msec]

1856	Paper Feed Start Timing (Size4) DFU
	This SP code is used to adjust the registration roller start timing for roll paper Size 4 based on the amount of paper remaining on the roll.
1	Remaining: less than 10%
	[0 to 1000/ 400 /1 msec]
2	Remaining: 10< to \leq 20%
	[0 to 1000/ 400 /1 msec]
3	Remaining: 20< to \leq 30%
	[0 to 1000/ 400 /1 msec]
4	Remaining: 30< to \leq 40%
	[0 to 1000/ 400 /1 msec]
5	Remaining: 40< to \leq 60%
	[0 to 1000/ 400 /1 msec]
6	Remaining: 60< to \leq 80%
	[0 to 1000/ 400 /1 msec]
7	Remaining: 80< to \leq 100%
	[0 to 1000/ 400 /1 msec]

1857	Paper Feed Stop Timing (Size4) DFU
	This SP code is used to adjust the registration roller stop timing for roll paper Size 4 based on the amount of paper remaining on the roll.
1	Remaining: less than 10%
	[0 to 1000/ 200 /1 msec]
2	Remaining: 10< to \leq 20%
	[0 to 1000/ 200 /1 msec]

3	Remaining: 20< to $\leq 30\%$
	[0 to 1000/ 200 /1 msec]
4	Remaining: 30< to $\leq 40\%$
	[0 to 1000/ 200 /1 msec]
5	Remaining: 40< to $\leq 60\%$
	[0 to 1000/ 200 /1 msec]
6	Remaining: 60< to $\leq 80\%$
	[0 to 1000/ 200 /1 msec]
7	Remaining: 80< to $\leq 100\%$
	[0 to 1000/ 200 /1 msec]

1921	Cut Length Adjustment - Cutting Position Adjustment
	This SP adjusts the distance between between the DRESS sensor (image registration sensor) and the first cut position. This setting is no longer used after the 2nd cut during continuous printing. Cuts once to test the new setting, then once again to do actual cut.
	[-10 to 10/ 0.0 /0.1 mm] Example <ul style="list-style-type: none"> ▪ To set a length of 297 mm, with the machine cutting at 300 mm, you need to move the cutting position 3 mm upstream with a value of -3 mm. ▪ To set a length of 295 mm, with the machine cutting at 297 mm, you need to move the cutting position downstream with a value of +2 mm

1922	Sub Scan Feed Adjustment DFU
	This SP adjusts the amount of paper feed in the sub scan direction.
1	By-pass Input
	[400 to -400/0/1 pulse]
2	By-pass Input (Factory Setting)
	[400 to -400/0/1 pulse]
3	Paper Input 1
	[400 to -400/0/1 pulse]
4	Paper Input 1 (Factory Setting)
	[400 to -400/0/1 pulse]
5	Paper Input 2
	[400 to -400/0/1 pulse]
6	Paper Input 2 (Factory Setting)
	[400 to -400/0/1 pulse]
7	Feed Offset Forward
	[400 to -400/0/1 pulse]
8	Feed Offset Backward
	[400 to -400/0/1 pulse]
9	Feed Offset Forward Fc
	[400 to -400/0/1 pulse]
10	Feed Offset Backward Fc
	[400 to -400/0/1 pulse]

1923	Cutter Operation Adjustment DFU
	These SP adjust how the cutter operates.
1	Standby Time Period
	<p>The cutter motor rotates clockwise to move the cutter from right to left to perform the cut. When the cutter return sensor on the left detects the cutter, the motor stops and normally pauses for about 50 ms, and then reverses to drive the cutter back to its home position on the right. This SP lengthens the time the cutter motor pauses before it reverses and moves the cutter back to its home position after cutting the paper.</p> <p>[0 to 100/14/1 msec]</p>
2	Leading Edge Cutting Length
	<p>This SP adjusts the length of paper fed for cutting when "Cutting" is selected during installation of the paper roll.</p> <p>[100 to 999/210/1 mm]</p>

1924	Sub Carriage Adjustment - Sub Scan DFU
	<p>This SP adjusts the distance the paper feeds between where the DRESS sensor (image registration sensor) detected the leading edge of the paper and where paper feed stops (1st scan position) and printing begins.</p> <ul style="list-style-type: none"> ▪ Adjustment is done when the margin at the leading edge of the paper does not match the prescribed amount for the margin. ▪ When the margin at the leading edge is too small, make the setting larger. ▪ If the margin is too large, make the setting smaller.
	[-10 to 100/ 0 /1 mm]

1940	Feed Length Correction Table DFU
1	Rotation Angle 0
	[-50 to 50/ 0 /1 pulse]
2	Rotation Angle 1
	[1500 to 1650/ 1600 /1 pulse]
3	Rotation Angle 2
	[3150 to 3250/ 3200 /1 pulse]
4	Rotation Angle 3
	[4750 to 4850/ 4800 /1 pulse]
5	Rotation Angle 4
	[6350 to 6450/ 6400 /1 pulse]
6	Rotation Angle 5
	[7950 to 8050/ 8000 /1 pulse]
7	Rotation Angle 6
	[9550 to 9650/ 9600 /1 pulse]
8	Rotation Angle 7
	[11150 to 11250/ 11200 /1 pulse]
9	Rotation Angle 8
	[12750 to 12850/ 12800 /1 pulse]
10	Rotation Angle 9
	[14350 to 13350/ 14400 /1 pulse]
11	Rotation Angle 10
	[15950 to 16050/ 16000 /1 pulse]

12	Rotation Angle 11
	[17650 to 17550/ 17600 /1 pulse]
21	Feed Length 0 DFU
	[-168 to 168/ 0 /2.1 um]
22	Feed Length 1
	[-168 to 168/ 0 /2.1 um]
23	Feed Length 2
	[-168 to 168/ 0 /2.1 um]
24	Feed Length 3
	[-168 to 168/ 0 /2.1 um]
25	Feed Length 4
	[-168 to 168/ 0 /2.1 um]
26	Feed Length 5
	[-168 to 168/ 0 /2.1 um]
27	Feed Length 6
	[-168 to 168/ 0 /2.1 um]
28	Feed Length 7
	[-168 to 168/ 0 /2.1 um]
29	Feed Length 8
	[-168 to 168/ 0 /2.1 um]
30	Feed Length 9
	[-168 to 168/ 0 /2.1 um]

31	Feed Length 10
	[-168 to 168/ 0 /2.1 um]
32	Feed Length 11
	[-168 to 168/ 0 /2.1 um]

1941	Feed Length Correction Value DFU
1	Base Position and Phase
	[0 to 19200/ 0 /1 pulse]
2	Maximum Amplitude
	[0 to 1689/ 0 /3.3 um]
3	Feed Length Tolerance
	[0 to 1689/ 0.0 /3.3 um]
4	Base Diameter
	[6 to 7/ 6.47 /0.01 mm]
5	Coefficient of Linear Expansion
	[50 to 300/ 117 /1 deg]
6	Base Temperature
	[15 to 30/ 23 /1 deg]
7	Paper Thickness
	[46 to 190/ 92 /1 um]
8	Rolling up Angle
	[0 to 20/11/ 11.5 /0.5 deg]
9	Discharge Direction Correction
	[-100 to 100/ 0 /1 pulse]

1942	Feed Length Correction Select DFU
1	Eccentric Center
	[0 to 1/ 0 /1]
2	Method
	[0 to 1/ 0 /1]
3	Roller Diameter
	[0 to 1/ 0 /1]
4	Temperature
	[0 to 1/ 0 /1]
5	Paper Thickness
	[0 to 1/ 0 /1]
6	Quantization
	[0 to 1/ 0 /1]
7	Discharge Direction
	[0 to 1/ 0 /1]

1943	Paper Feed Standby Postion DFU
1	Absolute Humidity H
	[10 to 100/ 100 /1]
2	Absolute Humidity L
	[0 to 9/ 0 /1]
3	Standby Time
	[0 to 240/ 0 /1]

1. When the leading edge of the paper feeds past the registration roller, paper feed stops and the DRESS sensor reads the position of the right edge of the paper (S1).
2. If S1 (the amount of skew) is greater than ± 10 mm, the roll feed motor rewinds the paper onto the roll and out of the machine, and then the operator must load the paper again.

-or-

If the amount of skew is less than ± 10 mm the paper is fed 100 mm (L) past the S1 detection point and then paper feed stops. The vertical motor rotates forward at 100 mm/s while the roll feed motor rotates in reverse at 35 mm/s. This straightens and stretches the paper in the paper path.

3. The DRESS sensor reads the position of the right edge again (S2) (100 mm upstream of S1).
4. The machine calculates the amount of skew between S1 and S2:

$$|S1 - S2|/L \times 100$$

- If the value is more than ± 5 mm, the roll feed motor rewinds the paper onto the roll and out of the machine, and then the operator must load the paper again.
 - If the value is less than ± 5 mm, the correction is done again.
1. The correction is done twice. If the skew cannot be corrected to ± 3 mm, the roll feed motor rewinds the roll, and then the operator must load the paper again.

1	Skewed Value
	Sets the value for the second reading after correction. [0 to 1/ 0.5 /0.01 %]
2	Skewed Value on Ejecting
	Sets the value of the third reading after correction. [1 to 10/ 3 /0.01 %]
3	Measuring Length
	The length of paper fed between the first and second reading by the DRESS sensor. [50 to 300/ 100 /1 mm]
4	Correcting Length
	The length of paper feed to correct skew. The vertical motor rotates forward while the roll feed motor in the roll feeder rotates in reverse. [300 to 2000/ 800 /100 mm]

1953	Skewed Value Indication DFU
	Use these SPs to display previous readings done with the DRESS sensor during skew correction.
1	Current Skewed Value
	[0 to 10/ 0 /0.01 %]
2	Previous Skewed Value
	[0 to 20/ 0 /0.01 %]
3	Preceding Previous Skewed Value
	[0 to 20/ 0 /0.01 %]

1955	Suction Fan Duty Correction DFU
	<p>These SP codes adjust the operation of the transport fan during paper feed. The efficiency of roll paper feed can be affected by temperature, humidity, paper type, and paper size. The suction of the transport fan below the perforated platen keeps the paper flat during printing. There are three Duty phases applied to change the speed of the motor to create more suction.</p> <ul style="list-style-type: none"> ▪ Duty 1. When the DRESS sensor switches on, the fan motor is in Duty 1 phase while the paper feeds up to 79 mm past the registration standby position. Strongest suction. ▪ Duty 2. After the paper has fed more than 79 mm, the motor enters the Duty 2 phase. Strong suction. ▪ Duty 3. When the leading edge of the paper reaches the cutting position, the fan enters Duty 3 phase. Normal suction. <p>When the cutter reaches the left side of the machine after performing the cut, the cutter return switch switches on, and reverses the cutter motor to return the cutter to its home position on the right side of the machine, and also shifts the paper transport fan down into Duty 2 phase.</p>
1	Suction Fan
	Adjusts fan Duty in the range of $\pm 20\%$ for all Duty phases (1, 2, and 3). The firmware checks the current fan operation setting and then uses a lookup table to fetch the specified setting (the percentage to added to current operation level.)
	[-20 to 20/0/1%]
2	Normal Paper
	Adjusts fan Duty in the range of $\pm 20\%$ for all Duty phases for Normal paper. [-20 to 20/0/1%]
3	Recycled Paper
	Adjusts fan Duty in the range of $\pm 20\%$ for all Duty phases for Recycled paper. [-20 to 20/0/1%]

4	IJ Normal Paper
	Adjusts fan Duty in the range of $\pm 20\%$ for all Duty phases for Ink Jet Normal paper. [-20 to 20/ 0 /1%]
5	Translucent
	Adjusts fan Duty in the range of $\pm 20\%$ for all Duty phases for Translucent paper. [-20 to 20/ 0 /1%]
6	Mat Film
	Adjusts fan Duty in the range of $\pm 20\%$ for all Duty phases for Matte Film. [-20 to 20/ 0 /1%]
7	Coated (CAD) Paper
	Adjusts fan Duty in the range of $\pm 20\%$ for all Duty phases for Coated/CAD Paper. [-20 to 20/ 0 /1%]
8	Coated Paper
	Adjusts fan Duty in the range of $\pm 20\%$ for all Duty phases for Coated Paper. [-20 to 20/ 0 /1%]
10	Special Paper
	Adjusts fan Duty in the range of $\pm 20\%$ for all Duty phases for Coated Paper. [-20 to 20/ 0 /1%]

1956	Suction Fan Duty Correction - Suction Fan Duty DFU
	This SP adjusts the amount of suction created in the Duty 2 phase of the transport fan operation cycle. This setting applied to Duty 2 only for all jobs, regardless of paper type, width, thickness, etc.
	[0 to 100/ 0 /5%]

1980	Exclusive Control DFU
	This SP allows and denies control of the main unit and the scanner by forbidding/allowing access to the SP tables on the machine operation panel.
	[0 to 1/ 0 /1] 0: Enabled 1: Disabled

2.3 SP2000

2010	User Maintenance
	<p>Use this SP to clean or flush (refresh) the print heads. Both SPs start the cleaning cycle to clean the print heads. However, remember that the refreshing cycle ejects a small amount of ink while cleaning does not. Always clean the print heads before flushing. See "Print Head Cleaning and Adjustment" in the Service Manual for more details about how to print the Nozzle Check Pattern and how to clean or flush all (or selected print heads) with the User Tools menu.</p> <ul style="list-style-type: none"> ▪ Every execution of print head cleaning and flushing is recorded in NVRAM by a counter (0 to 999999). ▪ This is done so the service technician can keep track of how many times the operator is cleaning and refreshing the print heads. ▪ Humidity can affect the number of times the print heads require cleaning and refreshing
1	Cleaning
	Touch [EXECUTE] to clean the print heads without ink flushing. Always clean the print heads at least three times before flushing the print heads.
2	Refreshing (Flushing)
	<p>Touch [EXECUTE] to flush the print heads only after you have executed cleaning at least three times.</p> <p>If printing is not satisfactory after three cleanings and one flushing:</p> <ul style="list-style-type: none"> ▪ Repeat the procedure (three cleanings, one flushing). Allow the machine to remain idle for 10 min. between each cleaning. ▪ If printing is still not satisfactory, let the machine remain idle for 8 hours. ▪ After 8 hours clean the print heads and check the Nozzle Check pattern. If printing is still not satisfactory, execute two more cleanings and one flushing. ▪ If the Nozzle Check Pattern is still abnormal, the defective print head must be replaced.
2012	Initial Operation Setting

	<p>This SP code is used to modify the initial ink filling sequence at installation and after one or more print heads have been replaced. Every time the machine is turned on, the machine checks the ink level in each sub tank. If ink is low, then the machine switches on the ink pump motor(s) to fill the tank(s).</p>
	<p>This SP should always be set to "0" unless there are specific instructions that it should be reset temporarily. [0 to 10/0/1]</p>

2013

Initial Filling Progress Mng **DFU**

This SP code records and displays a detailed record of each stage of the initial ink filling for each print head sub tank.

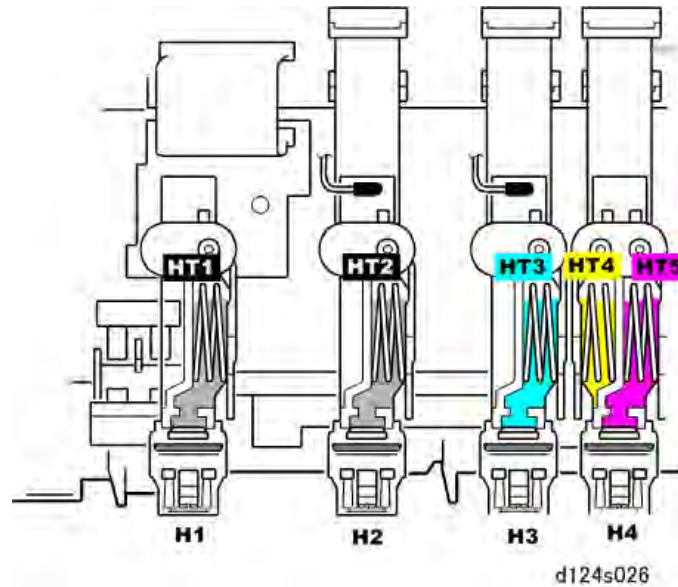

Sequence Table

Action	H1	H2	H3	H4	
	HT1	HT2	HT3	HT4	HT5
1st Fill	1	8	15	22	
2nd Fill	2	9	16	23	
3rd Fill	3	10	17	24	
4th Fill	4	11	18	25	
5th Fill	5	12	19	26	
Refreshing	6	13	20	27	
OCFS Register	7	14	21	28	
Cleaning	29	30	31	32	

Seven steps are performed for each tank. For example, at HT1:

- First, initial ink filling is performed for HT1 (K1) 5 times (1 to 5). This is controlled by switching

the K1 ink supply motor on/off.

- Second, the print head is flushed with a small amount to ink to prime the print head ("Refreshing" 6)
- Third, the OCFS (On Carriage Filling Sensor) registers the full position of the feeler on the side of the sub tank (7).
- This sequence is done in order for the remaining print head units: HT2 (K2) 8 to 14, HT3 (C) 15 to 21, and then HT4/HT5 (C/YM) (22 to 28).
- Finally, each print head is cleaned in the order H1, H2, H3, and H4 (29 to 32).

Once the initial filling starts, if the process is interrupted for any reason (a power failure, accidentally switching the machine off, an SC code, etc.) the filling will stop and then resume from the point of interruption in the sequence after power has been restored to the machine. This initial fill history is stored in NVRAM for each print head.

1	H1
	[0 to 0xFFFF FFFF/0/1]
2	H2
	[0 to 0xFFFF FFFF/0/1]
3	H3
	[0 to 0xFFFF FFFF/0/1]
4	H4
	[0 to 0xFFFF FFFF/0/1]

2014	Fully Auto Cleaning Process Data DFU
	<p>The machine has a "full automatic cleaning" sequence.</p> <ul style="list-style-type: none"> ▪ In order to maintain the same conditions during full automatic cleaning, from the point past the ink supply port of the ink cartridge, to ensure continuous ink filing a flag goes up if the ink end sensor of an ink cartridges signals ink end to prevent air from getting into the line. ▪ Compared to other sequences, the full auto cleaning consumes a lot of ink. The capacity of the ink collector tank can be monitored to keep it from overflowing. ▪ In order to have all heads cleaned, set SP2014-005 to "1" ▪ Set SP2012 to "1" for the initial operation setting after power on.
1	H1
2	H2
3	H3
4	H4
5	Auto Process Progress Status
	(7) 0000 0000 (0)

2030	Extract Filling Liq Prog Mng
	These SP codes monitor the progress of the drainage of the primer fluid from the primer cartridges when the machine is installed.
1	Completed State Flag
2	H1
3	H2
4	H3
5	H4
	Resets to "1" after drainage complete. (7) 0000 0000 (0)

	0	1st sequence finished (initial)
	1	2nd sequence finished
	2	3rd sequence finished
	3	4th sequence finished
	4	5th sequence finished
	5	6th sequence finished
	6	Negative pressure formation incomplete
	7	Completed

2050	Air Detection Check	
	Use this SP to check air sensor detection. There is one air sensor at the top of each print head sub tank (K1, K2, C, Y, M).	
1	Air Detection Sensor: Execute Check	
	<p>Pressing [EXECUTE] acquires the result of air detection by the air sensors and sends them to SP2050-2.</p> <ul style="list-style-type: none"> ▪ Results are displayed at SP2050-2 only if detection succeeds. ▪ Before you execute this SP, open SP2050-2 and record the display so you can compare the values before and after execution of SP2050-1. 	

2	Air Detection Sensor: Check Result			
	<p>0 to 31/0/1]</p> <ul style="list-style-type: none"> ▪ A "1" indicates air (no ink) ▪ A "0" indicates ink (no air) <p>(7) 00000000 (1)</p> <p style="font-size: small;">d124s027</p>			
		Bit	HT (Head Tank)	
		0	M	
		1	Y	
		2	C	
		3	K2	

2090	NV Clear at Supply Unit Exc. - Execute NV Value Clear
	<p>Press [EXECUTE] to clear the service life count for the ink supply unit and reset it to zero. Do this SP after replacement of the ink supply unit with a new unit.</p> <p>[0 to 1/0/1]</p>

2100	Special Maintenance
	These SP codes are for special maintenance tasks.
2	Initial Filling Nozzle Maintenance
	[0 to 15/0/0]
3	Fully Automated Cleaning
	<p>Press [EXECUTE] to clean all the print heads. Full auto cleaning is done:</p> <ul style="list-style-type: none"> ▪ Before the machine is packed for shipping ▪ Before sending the machine to the client ▪ Reset at the design center <p>This operation is essentially the same as print head flushing (refreshing)</p>
4	Extract Filling Liquid
	<p>Press [EXECUTE] to drain the primer fluid from the print heads, print head sub tanks, and ink supply tubing. This is done at installation before the ink cartridges are installed.</p> <ul style="list-style-type: none"> ▪ Special cartridges are provided to hold the drained fluid. ▪ This SP is used only at installation before the print heads are filled with ink. ▪ For more information, refer to "Main Machine Installation" in the Service Manual.
5	Extract Air
	<p>Press [EXECUTE] to expel air from the ink supply tubes after replacement of the ink supply unit.</p> <p>[0 to 31/0/1]</p>

2102	Maintenance Unit Exchange
	These SP codes are used when servicing the maintenance unit.
1	Reset
	Press [EXECUTE] to reset the counter for a new maintenance unit after it has been installed to replace an old maintenance unit. [0 to 1/0/1]
2	Exchange Threshold DFU
	The maintenance threshold is based on a pulse count of the of the clock-wise rotations of the maintenance motor. [0 to 4294967295/20000/1 mm]
3	Remaining Life Display Threshold DFU
	This SP sets the level of usage at which the machine issues an alert that the maintenance unit is near the end of its service life. This number is expressed as a per cent. [0 to 100/99/1%]
4	Decapping
	Press [EXECUTE] to uncap the print heads and move the carriage unit away from the right side of the machine to clear the right side of the machine before removal of the maintenance unit or other servicing procedures. <ul style="list-style-type: none"> ▪ Enter "1" to uncap the print heads (carriage does not move, but it can be moved manually). ▪ Enter "2" to uncap the print heads and move the carriage to the left side of the platen. ▪ Enter "3" to uncap the print heads and move the carriage to the center the platen.

2103	Printing Erase Margin
	These SP codes are used to set the margins for roll paper and bypass paper. Setting 001 to 004 are for roll paper, and 005 to 008 are for bypass paper.
1	Leading Edge (Roll Paper)
	This SP sets the distance from the leading of the paper where the image does not print. [0 to 20/3/0.1 mm] Note: The vertical registration value is an independent setting set with SP4010.
2	Trailing Edge (Roll Paper)
	Sets the size of the margin from the trailing edge where the image will not print. The trailing edge margin is determined by the cut length and value of the margin adjustment. [0 to 20/3/0.1 mm]
3	Left Edge (Roll Paper)
	Sets the size of the margin from the left edge of the paper where the image will not print. For example, if the left margin is set for "2 mm", nothing will print within 2 mm of the left edge. [0 to 20/3/0.1 mm]
4	Right Edge (Roll Paper)
	Sets the size of the margin from the right edge of the paper where the image will not print. For example, if the right margin is set for "2 mm", nothing will print within 2 mm of the left edge. [0 to 20/3/0.1 mm]
5	Leading Edge (By-pass)
	Sets the size of the margin from the leading edge where the image will not print. The left and right margins of the image are determined by the main scan registration. [0 to 20/3/0.1 mm]

6	Trailing Edge (By-pass)
	Sets the size of the margin from the trailing edge where the image will not print. The trailing edge margin is determined by the cut length and value of the margin adjustment. [0 to 20/18/0.1 mm]
7	Left Edge (By-pass)
	Sets the size of the margin from the left edge of the paper where the image will not print. For example, if the left margin is set for "2 mm", nothing will print within 2 mm of the left edge. [0 to 20/3/0.1 mm]
8	Right Edge (By-pass)
	Sets the size of the margin from the right edge of the paper where the image will not print. For example, if the right margin is set for "2 mm", nothing will print within 2 mm of the left edge. [0 to 20/3/0.1 mm]

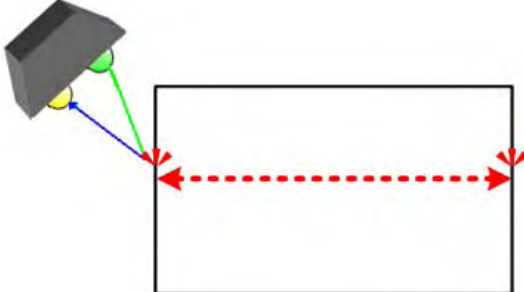
2104	Paper Edge Detection Delay Adj
	<p>The edge detection for image registration can vary depending on paper type due to differences in reflectivity, so printing problems can occur if the same threshold value is used for all types of paper.</p>  <p style="text-align: center;">d124s028</p> <p>For this reason, use this SP code to set the threshold values used by the DRESS sensor to detect the right and left edges of different types of paper.</p>
1	Normal Paper Right Edge
	[-20 to 20/4/0.1 mm]

2	Normal Paper Left Edge
	[-20 to 20/0/0.1 mm]
3	Recycled Paper Right Edge
	[-20 to 20/4/0.1 mm]
4	Recycled Paper Left Edge
	[-20 to 20/0/0.1 mm]
5	IJ Normal Paper Right Edge
	[-20 to 20/4/0.1 mm]
6	IJ Normal Paper Left Edge
	[-20 to 20/0/0.1 mm]
7	Tracing Paper Right Edge
	[-20 to 20/2.5/0.1 mm]
8	Tracing Paper Left Edge
	[-20 to 20/1.0/0.1 mm]
9	Mat Film Right Edge
	[-20 to 20/2.5/0.1 mm]
10	Mat Film Left Edge
	[-20 to 20/1.0/0.1 mm]
11	Coated Paper (CAD) Right Edge
	[-20 to 20/4.0/0.1 mm]
12	Coated Paper (CAD) Left Edge
	[-20 to 20/0.0/0.1 mm]
13	Coated Paper Right Edge
	[-20 to 20/4.0/0.1 mm]
14	Coated Paper Left Edge

	[-20 to 20/ 0.0 /0.1 mm]
17	Special Paper Right Edge
	[-20 to 20/ 4.0 /0.1 mm]
18	Special Paper Left Edge
	[-20 to 20/ 0.0 /0.1 mm]
31	Automatic Conversion
	Touch [EXECUTE] to save any changes made for the settings of this SP code.

2105	Carriage Speed Revision Factor DFU
1	1016 mm/s
	[0 to 100/ 100 /0.1%]
2	847 mm/s
	[0 to 100/ 85 /0.1%]
3	677 mm/s
	[0 to 100/ 68 /0.1%]
4	423 mm/s
	[0 to 100/ 42 /0.1%]
5	200 mm/s
	[0 to 100/ 20 /0.1%]
6	50 mm/s
	[0 to 100/ 5 /0.1%]

2106	Carriage Adjustment DFU	
	These SP codes determine where the carriage stops at the home position on the right over the maintenance unit and where it stops on the left over the left ink sump.	
1	Capping HP Correction Value	
	Corrects the home position of the carriage unit over the maintenance unit are the right side of the machine. [-2 to +2/ 0.1 /0.01 mm]	
2	Waste Ink Box: Left Correction	
	Corrects the position of the carriage unit over the left ink sump on the left side of the machine. [-2 to +2/ 0.1 /0.01 mm]	

2116	Copier Sub Scan Magnification Correct
	Use these SP codes to correct magnification in the sub scan direction, depending on what type of paper is used. Correction is done in the range [+1.0% to -1.0%/0.0/ 0.1%] <ul style="list-style-type: none"> ▪ If a paper type is selected, fine adjustment is done. ▪ If no paper type is selected, there is no fine adjustment.
1	Normal/Recycled Paper
	[-1 to 1/0/0.1%]
2	IJ Normal Paper
	[-1 to 1/0/0.1%]
3	Translucent
	[-1 to 1/0/0.1%]
4	Coated Paper (CAD)
	[-1 to 1/0/0.1%]
5	Coated Paper
	[-1 to 1/0/0.1%]
6	Mat Film
	[-1 to 1/0/0.1%]
7	Special Paper
	[-1 to 1/0/0.1%]
8	Reserved 0
	[-1 to 1/0/0.1%]
9	Reserved 1
	[-1 to 1/0/0.1%]
10	Reserved 2
	[-1 to 1/0/0.1%]

11	Normal/Recycled Paper
	[-1 to 1/0/0.1%]
12	IJ Normal Paper
	[-1 to 1/0/0.1%]
13	Translucent
	[-1 to 1/0/0.1%]
14	Coated Paper (CAD)
	[-1 to 1/0/0.1%]
15	Coated Paper
	[-1 to 1/0/0.1%]
16	Mat Film
	[-1 to 1/0/0.1%]
17	Special Paper
	[-1 to 1/0/0.1%]
18	Reserved 3
	[-1 to 1/0/0.1%]

2190	DRESS Sensor Calibration Result DFU
1	LED PWM Setting Value
	[0 to 4095/ 0 /1 PWM]
2	Magnification Ratio Register Value
	[0 to 255/ 0 /1]
3	Sensor 1 Measured Value
	[0 to 5.1/ 0 /0.005 volt]
4	Sensor 2 Measured Value
	[0 to 5.1/ 0 /0.005 volt]
5	Accum. Calibration Failure Count
	[0 to 65 535/ 0 /1 times]

2192	DRESS Sensor Readout DFU
1	Paper Transport Length A
	[0 to 65 535/ 0 /1 pulse]
2	Paper Transport Length B
	[0 to 65 535/ 0 /1 pulse]
3	Paper Transport Length C
	[0 to 65 535/ 0 /1 pulse]
4	Paper Transport Length D
	[0 to 65 535/ 0 /1 pulse]

2194	DRESS Executed Result
1	Year
	[0 to 99/12/1 year]
2	Month
	[1 to 12/1/1 month]
3	Day
	[1 to 31/1/1 day]
4	Hour
	[0 to 23/0/1 hour]
5	Minute
	[0 to 59/0/1 minute]
6	Head Temperature H1
	[-100 to 100/0/1 deg]
7	Head Temperature H2
	[-100 to 100/0/1 deg]
8	Head Temperature H3
	[-100 to 100/0/1 deg]
9	Head Temperature H4
	[-100 to 100/0/1 deg]
10	Result
	[0 to 255/0/1]
11	Executed Count
	[0 to 65 535/0/1 times]

12	Reading Failure Count
	[0 to 65 535/ 0 /1 times]
13	Calculation Failure Count
	[0 to 65 535/ 0 /1 times]
14	Effect Recognition Failure Count
	[0 to 65 535/ 0 /1 times]
15	Elapsed Failure Notice Count
	[0 to 65 535/ 0 /1 times]

2198	DRESS Mode DFU
	[0 to 65 535/ 0 /1 pulse]

2200	Tank Full Lever Diff Value DFU
1	HT1 Air Purge Filling Execution Trigger
	[0 to 600/ 0 /1 count]
2	HT2 Air Purge Filling Execution Trigger
	[0 to 600/ 0 /1 count]
3	HT3 Air Purge Filling Execution Trigger
	[0 to 600/ 0 /1 count]
4	HT4 Air Purge Filling Execution Trigger
	[0 to 600/ 0 /1 count]
5	HT5 Air Purge Filling Execution Trigger
	[0 to 600/ 0 /1 count]

6	HT1 (Filling Trigger Position)
	[0 to 600/0/1 count]
7	HT2 (Filling Trigger Position)
	[0 to 600/0/1 count]
8	HT3 (Filling Trigger Position)
	[0 to 600/0/1 count]
9	HT4 (Filling Trigger Position)
	[0 to 600/0/1 count]
10	HT5 (Filling Trigger Position)
	[0 to 600/0/1 count]

2210	Air Leakage Alert Monitor Mode
	<p>This SP switches air leakage alert mode on/off. When the machine is in the air leakage alert mode:</p> <ul style="list-style-type: none"> ▪ When a print job ends, the difference between the count for the occurrences of air detections the previous day and the current count is compared to the threshold value. ▪ If the result exceeds the threshold, the machine issues SC282-11 to 15, and then shuts down. ▪ If normal operation cannot be restored by cycling the machine off/on, the machine cannot be used until the problem has been solved. <p>This SP prevents ink spillage if leaks exist during ink supply pumping, air tank purging, ink filling, and print head maintenance.</p> <p>[0 to 1/0/1] 0: Off 1: On</p>

2211	Air Detection Freq. Check Result
	<p>Use this SP to display the current status of the air leak alert monitor turned on with SP2210.</p> <ul style="list-style-type: none"> ▪ If the difference between the number of leakage detections for the previous and present period exceeds threshold, the machine returns "Abnormal". ▪ If the difference does not exceed threshold, the machine returns "Normal".
1	Carriage Unit (Black)
	Touch [EXECUTE] to check the status of the left cradle print head units (K1, K2).
2	Carriage Unit (Color)
	Touch [EXECUTE] to check the status of the right cradle print head units (C, YM).

2212	Operation Start Time DFU
	This SP displays the start timer for the air check diagnostic mode in the format YYear MMonth DDday hhour ss sec..

2213	Air Detection Freq. Checked Date
	This SP displays the starting date for the current air detection count.

2214	Air Detection Freq. Check Result
	<p>Use this SP to display the current status air detections.</p> <ul style="list-style-type: none"> ▪ If the difference between the number of air detections for the previous and present period exceeds threshold, the machine returns "Abnormal". ▪ If the difference does not exceed threshold, the machine returns "Normal".
1	H1
	[0 to 1/0/1]
2	H2
	[0 to 1/0/1]
3	H3
	[0 to 1/0/1]
4	H4
	[0 to 1/0/1]

2215	Air Detection Freq. Check Period
	<p>This SP sets the length of the period for air detections. At the end of the period, the count stops and is then compared with the count for the previous period. Default: 10 days.</p>
	[0 to 255/10/1 day]

2216	Air Purge Filling Count Thresh DFU
	<p>Sets the threshold for the number of purges and fillings.</p> <ul style="list-style-type: none"> ▪ At the end of the period, the difference between the counts between the previous and current period is calculated. ▪ If the result is above the threshold number set with this SP the machine returns "Abnormal". ▪ If the result is equal to or below the number, the machine returns "Normal".
	<p>Enter a number to set the threshold for air purging/filling executions. [0 to 255/17/1]</p>

2217	Prev. Air Leakage Check Counter
	<p>These SP codes display the previous counts of the ink supply purging/filling executions. SP2218-001 to 004 hold the counts for the current period.</p>
1	H1
	[0 to 999 999/0/1]
2	H2
	[0 to 999 999/0/1]
3	H3
	[0 to 999 999/0/1]
4	H4
	[0 to 999 999/0/1]

2218	Accumulated Air Leakage Counter
	These SP codes display the counts for ink supply purging/filling executions caused by air leaks during the current period. SP2217-001 to -004 hold the counts for ink supply purging/filling executions done during the previous period.
1	H1
	[0 to 999 999/ 0 /1]
2	H2
	[0 to 999 999/ 0 /1]
3	H3
	[0 to 999 999/ 0 /1]
4	H4
	[0 to 999 999/ 0 /1]

2231	PM Counter Indication
	These SP codes monitor the service life of parts and display the amount of usage expressed as a percent and mm.
1	Carriage Unit (Black)
	[0 to 500/ 0 /1 %]
2	Carriage Unit (Color)
	[0 to 500/ 0 /1 %]
3	Maintenance Unit
	[0 to 500/ 0 /1 %]
4	Waste Ink Box: Left
	[0 to 200/ 0 /1 %]

5	Waste Ink Box: Right
	[0 to 200/0/1 %]
6	Carriage Unit (Black)
	[0 to 0xFFFF FFFF/0/1 mm]
7	Carriage Unit (Color)
	[0 to 0xFFFF FFFF/0/1 mm]
8	Maintenance Unit
	[0 to 0xFFFF FFFF/0/1 mm]

2245	Air Detection Flag
	<p>This SP keeps track of the progress of ink filling so this information will not be lost in the event that the ink filling is interrupted by the opening of a front cover, loss of power to the machine, and so on.</p> <p>If such a problem occurs, a large amount of air could mix with the ink during filling. Also, air could possibly accumulate in the ink supply system if the machine is remains idle for a long time.</p>
1	H1
	<p>This status of the H1 print head (K1).</p> <p>[0 to 31/0/1]</p> <p>0: Normal</p> <p>1: Air mixing at job end</p> <p>2: Air mixing after idle time</p> <p>4: Air mixing after ink pumps idle</p>
2	H2
	<p>That status of the H2 print head (K2).</p> <p>[0 to 31/0/1]</p> <p>0: Normal</p> <p>1: Air mixing at job end</p> <p>2: Air mixing after idle time</p> <p>4: Air mixing after ink pumps idle</p>

3	H3
	The status of the H3 print head (C). [0 to 31/0/1] 0: Normal 1: Air mixing at job end 2: Air mixing after idle time 4: Air mixing after ink pumps idle
4	H4
	The status of the H4 print head (YM). [0 to 31/0/1] 0: Normal 1: Air mixing at job end 2: Air mixing after idle time 4: Air mixing after ink pumps idle

2246	Ink Supply Operation Time
	This SP code displays the total operation time of the ink pumps during ink supply to the print head sub tanks.
1	H1
	Status of H1 print head (K1). [0xFFFF FFFF/0/1]
2	H2
	Status of H2 print head (K2). [0xFFFF FFFF/0/1]
3	H3
	Status of H3 print head (C). [0xFFFF FFFF/0/1]
4	H4
	Status of H4 print head (YM). [0xFFFF FFFF/0/1]

2247	Ink Supply Seq. Progress Control
	<p>This SP code monitors and displays the progress of each print head unit during the ink filling sequence. If the progress of ink filling is interrupted, the machine will know where to resume filling (and at which unit) after normal operation has been restored. The following actions can interrupt ink filling:</p> <ul style="list-style-type: none"> ▪ Opening any cover that triggers a cover open alert ▪ Power failure on the power supply circuit <p>The ink filling operation resumes automatically upon restoration of normal operation (after close the cover or resumption of normal power supply).</p>
1	H1
	<p>Progress of H1 (K1) print head. [0xFFFF FFFF/0/1]</p>
2	H2
	<p>Progress of H2 (K2) print head. [0xFFFF FFFF/0/1]</p>
3	H3
	<p>Progress of H3 (C) print head. [0xFFFF FFFF/0/1]</p>
4	H4
	<p>Progress of H4 (YM) print head. [0xFFFF FFFF/0/1]</p>

2249	Set Air Detection Flag - Flag Continued Time
	<p>In previous GelJet machines there was a lot of bubble formation in the ink sub tanks, and these bubbles were controlled by an air mixture flag that would trigger a print head maintenance cycle.</p> <ul style="list-style-type: none"> ▪ This flag release (24 hours for older machines) has been shortened to 6 hours after the initial filling and timed by the RTC (Real Time Clock of the machine). ▪ Shortening the flag release time with this SP code improves maintenance operation. However, this SP cannot be adjusted until 6 hours have elapsed after initial filling. <p>[0 to 255/6/1 hour]</p>

2252	Air Purge Fill Feeler Position
------	--------------------------------

If the machine remains idle in a low humidity environment, the ink sub tanks can dry out and the OCFS feelers may not return to their correct positions after air is purged from the tanks. This misalignment could prevent achieving the correct negative pressure in the sub tank.

To prevent this problem:

- A correction value to counteract the effect of humidity has been devised to alter the "full position" of the OCFS feeler to compensate for adverse temperature and humidity.
- Normally, the sub tank feeler points straight forward when the tank is full. However, the machine can automatically shift the full position of the feeler automatically to compensate adverse temperature/humidity.

1	HT1 OFF_ON
	[0 to 65 535/0/1 count]
2	HT2 OFF_ON
	[0 to 65 535/0/1 count]
3	HT3 OFF_ON
	[0 to 65 535/0/1 count]
4	HT4 OFF_ON

	[0 to 65 535/ 0 /1 count]
5	HT5 OFF_ON
	[0 to 65 535/ 0 /1 count]
6	HT1 ON_OFF
	[0 to 65 535/ 0 /1 count]
7	HT2 ON_OFF
	[0 to 65 535/ 0 /1 count]
8	HT3 ON_OFF
	[0 to 65 535/ 0 /1 count]
9	HT4 ON_OFF
	[0 to 65 535/ 0 /1 count]
10	HT5 ON_OFF
	[0 to 65 535/ 0 /1 count]

2255	Ink Pre-near End Threshold DFU	
	<p>Ink consumption is measured with a software count and is expressed as a percentage of ink remaining. The ink near end and ink end alerts are issued in three stages:</p> <ul style="list-style-type: none"> ▪ Pre-near end (35% remains) ▪ Near end (20% remains) ▪ Ink out (0% remains) 	
	Stage	Alert Message
	Pre-near end display	<color> ink low Prepare a new <color> ink cartridge
	Near end display	<color> ink out soon After <color> ink out all printing stops
	Ink out	Ink out

	Use this SP to set the pre-near end threshold setting for the ink near end alerts (Default: 35%).
1	Residual Qty. Ratio K
	Pre-near end alert for K ink cartridge. [0 to 80/ 35 /1%]
2	Residual Qty. Ratio C
	Pre-near end alert for C ink cartridge. [0 to 80/ 35 /1%]
3	Residual Qty. Ratio M
	Pre-near end alert for M ink cartridge. [0 to 80/ 35 /1%]
4	Residual Qty. Ratio Y
	Pre-near end alert for Y ink cartridge. [0 to 80/ 35 /1%]

2256	Ink Near End Threshold DFU	
	Ink consumption is measured with a software count and is expressed as a percentage of ink remaining. The ink near end and ink end alerts are issued in three stages: Pre-near end (35% remains), near end (20% remains), and ink out (0% remains).	
	Stage	Alert Message
	Pre-near end display	<color> ink low Prepare a new <color> ink cartridge
	Near end display	<color> ink out soon After <color> ink out all printing stops
	Ink out	Ink out
	Use this SP to set the near end threshold setting (Default: 20%).	
1	Residual Qty. Ratio K	

	Near-end alert for K ink cartridge. [0 to 80/20/1 %]
2	Residual Qty. Ratio C
	Near-end alert for C ink cartridge. [0 to 80/20/1 %]
3	Residual Qty. Ratio M
	Near-end alert for M ink cartridge. [0 to 80/20/1 %]
4	Residual Qty. Ratio Y
	Near-end alert for Y ink cartridge. [0 to 80/20/1 %]

2257	Ink End Level DFU	
	Ink consumption is measured with a software count and is expressed as a percentage of ink remaining. The ink near end and ink end alerts are issued in three stages: Pre-near end (35% remains), near end (20% remains), and ink out (0% remains).	
	Stage	Alert Message
	Pre-near end display	<color> ink low Prepare a new <color> ink cartridge
	Near end display	<color> ink out soon After <color> ink out all printing stops
	Ink out	Ink out
	Use this SP to adjust the ink out threshold.	
1	K	
	Ink out alert for K ink cartridge. [0 to 8/0/1]	

2	C
	Ink out alert for C ink cartridge. [0 to 8/0/1]
3	M
	Ink out alert for M ink cartridge. [0 to 8/0/1]
4	Y
	Ink out alert for Y ink cartridge. [0 to 8/0/1]

2258	Ink Filled Volume DFU
	Each ink cartridge has an ID memory chip that maps the volume of ink remaining as it diminishes. The primer fluid drain tanks, used to drain primer fluid from the machine before initial ink filling at installation, also have ID memory chips that measure the volume of fluid inside the tank. Use this SP code to acquire the amount of ink or primer fluid inside an ink cartridge or primer fluid cartridge at any time.
1	K
	The amount of ink or fluid in the K cartridge. [0 to 65 535/0/1 x10 ul]
2	C
	The amount of ink or fluid in the C cartridge. [0 to 65 535/0/1 x10 ul]
3	M
	The amount of ink or fluid in the M cartridge. [0 to 65 535/0/1 x10 ul]

4	Y
	The amount of ink or fluid in the Y cartridge. [0 to 65 535/0/1 x10 ul]

2259	Front Cover Open DFU
	This SP flags opening the front cover during the maintenance cycle. [0 to 3/0/1]
1	Recovery Flag H1
2	Recovery Flag H2
3	Recovery Flag H3
4	Recovery Flag H4

2301	OCFS Position Check Start DFU
	Touch [EXECUTE] to check the position of the OCFS feelers.

If the machine remains idle in a low humidity environment the ink sub tanks could dry out and the OCFS feelers may not return to the correct positions even after air is purged from the tanks.

To prevent this problem:

- A correction value to counteract the effect of humidity has been devised to alter the "full position" of the OCFS feeler to compensate for adverse temperature and humidity.
- Normally, the sub tank feeler points straight forward when the tank is full. However, the machine can automatically shift the full position automatically to compensate adverse temperature/humidity.
- This setting is usually done automatically, but you can use this SP to do the setting manually.

2302	OCFS Position Check DFU
1	a
	[0 to 10/ 2.05 /0.01 mm]
2	Delta 1
	[0 to 10/ 1.09 /0.01 mm]
3	R min
	[0 to 0.5/ 0.185 /0.001 ml/mm]
4	Y min
	[0 to 0.5/ 0.185 /0.001 ml/mm]
5	R max
	[0 to 0.5/ 0.265 /0.001 ml/mm]
6	R Ymax
	[0 to 0.5/ 0.265 /0.001 ml/mm]
7	Q max
	[0 to 1/ 0.6 /0.001 ml/mm]
8	E
	[0 to 3/ 1.5 /0.01 ml]
9	Delta 2
	[0 to 0.5/ 0.249 /0.001 ml]
10	S
	[-50 to 50/ 30 /1%]
11	W2
	[0 to 1/ 0.19 /0.01 ml]
12	Feeler Position: Sucking HT1

	[0 to 65 535/ 0 /1 pulse]
13	Feeler Position: Sucking HT2
	[0 to 65 535/ 0 /1 pulse]
14	Feeler Position: Sucking HT3
	[0 to 65 535/ 0 /1 pulse]
15	Feeler Position: Sucking HT4
	[0 to 65 535/ 0 /1 pulse]
16	Feeler Position: Sucking HT5
	[0 to 65 535/ 0 /1 pulse]
17	Fluttering Range after Acceleration
	[0 to 100/ 50.8 /0/1 mm]
18	Fluttering Range after Deceleration
	[0 to 100/ 0 /0.1 mm]

2303	Sucking after Ink End - Sucking Feeler Travel I DFU
	This SP affects the operation of the ink supply pumps after a cartridge runs out of ink. [0 to 10/ 1.5 /0.01 mm]

2306	OCFS Position Check Repeat
	Use these SP codes to check the tank-full position of the OCFS after ink end or removal of a paper jam. 0: Check not needed 1: Check needed
1	H1
2	H2
3	H3
4	H4
	[0 to 1/0/1]

2307	Add Supply Unit Reversal Rotate DFU
1	Supply Pump Suspended Time
	There are frequent ink pump motor timeouts during ink filling. (There are 5 timeouts for each ink tank during initial ink filling.) Every time an ink pump switches on, the firmware checks to confirm that the OCFS is on. If the OCFS does not come on after 2 sec., the motor switches off. [0 to 9999/6/1 hour]
2	Reversal Rotation Period
	The minimum pumping rate for ink supply is 0.25 ml/sec. However, the Duty of each ink cartridge pump motor is temperature dependent. <ul style="list-style-type: none"> ▪ The higher the temperature, the slower the pump motor operates to pump ink (forward and reverse). ▪ Lowering the Duty of the ink pump motor with a rise in temperature controls the amount ink pumped. ▪ The machine uses the readings of the temperature/humidity sensor to set the Duty for operation of the ink cartridge pump motors. ▪ These Duty settings apply to both forward and reverse operation of the pump motors. Use this SP to adjust the setting manually. [0 to 10/0.35/0.01 sec.]

3	Pause Before Normal Rotation
	[0 to 10/ 0.1 /0.01 sec]
4	Pump Stop Time P1
	Displays count for P1 pump (K1). [0 to 0xFFFF FFFF/ 0 /1]
5	Pump Stop Time P2
	Displays count for P2 pump (K2). [0 to 0xFFFF FFFF/ 0 /1]
6	Pump Stop Time P3
	Displays count for P3 pump (C). [0 to 0xFFFF FFFF/ 0 /1]
7	Pump Stop Time P4
	Displays count for P4 pump (Y). [0 to 0xFFFF FFFF/ 0 /1]
8	Pump Stop Time P5
	Displays count for P5 pump (M). [0 to 0xFFFF FFFF/ 0 /1]

2308	Supply Unit Operation Duty DFU
1	C Setting 1
	Sets the pump duty temperature threshold. [0 to 100/ 21 /1 C]
2	C Setting 2
	Sets the pump duty temperature threshold. [0 to 100/ 27 /1 C]
3	C Setting 3
	Sets the pump duty temperature threshold. [0 to 100/ 40 /1 C]

4	C<Pump Duty 1
	Sets the detected temperature at which pump duty changes. [50.1 to 80/ 61 /0.1 %]
5	1 ≧C<Pump Duty 2
	Sets the detected temperature at which pump duty changes. [50.1 to 80/ 60.7 /0.1 %]
6	2 ≧C<Pump Duty 3
	Sets the detected temperature at which pump duty changes. [50.1 to 80/ 59.8 /0.1 %]
7	3 ≧C Pump Duty
	[50.1 to 80/ 59.2 /0.1 %]
8	OCFS Supply + Correction
	Adds a correction value for pump duty during ink filling. [0 to 10/ 1 /0/1 %]
9	Add Twin Pump D%
	Add a correction value for TWIN pump simultaneous drive duty during ink filling. [0 to 10/ 0 /0.1 %] Note: TWIN pump refers to both pumps that pump black ink from the K ink cartridge, one pumps ink to K1 and the other pumps to K2.

2400	NV Clear at Carriage Exchange
	<p>Use this SP code to clear the counts for the print heads stored in the NVRAM. This SP must be done when the print heads are replaced.</p> <ul style="list-style-type: none"> ▪ There two print head PM parts, the left cradle which holds the K1, K2 print heads, and the right cradle which holds the C, YM print heads. ▪ If only one print head requires replacement, the cradle is replaced with both print heads. ▪ Print heads cannot be removed and replaced individually.
	<p>Choose the setting for the replacement. [0 to 2/0/1]</p> <ul style="list-style-type: none"> ▪ 0: Clears counter for all print heads for carriage replacement if both cradles are to be replaced. ▪ 1: Clears counters for K1, K2 if the left black print head cradle is to be replaced. ▪ 2: Clears counters for C, Y, M if the right color cradle is to be replaced.

2505	Reset Waste Ink Counter
	These SP codes reset the counters for the left ink sump and the right ink sump. Neither of these ink collector sumps have an ID chip. The count is maintained by the firmware.
1	Waste Ink: Left C/R
	<p>The firmware count triggers a prompt to tell the operator when the left ink sump tank is near-full, and then finally full and in need of replacement. The count is stored in NVRAM.</p> <ul style="list-style-type: none"> ▪ Near full: 425 cc ▪ Tank full: 500 cc ▪ Estimated Service Life: About 5 years <p>Prompts</p> <ul style="list-style-type: none"> ▪ Tank near full. A prompt appears on the operation panel of the machine, and the machine will continue to operate. ▪ Tank full. A prompt appears on the operation panel of the machine. If a page is being printed, the print will finish, and then the machine will shut down and cannot be used until after the tank has been replaced. <p>The count must be reset with this SP code after the left ink sump has been replaced. There is no sensor to detect when the left ink sump is removed and inserted. Touch [EXECUTE] to reset the counter for the left ink sump.</p> <p>[0 to 1/0/1]</p>

2	Waste Ink: Right C/R
	<p>A software count triggers a prompt to tell the operator when the right ink sump is near-full, and then finally full and in need of replacement.</p> <ul style="list-style-type: none"> ▪ The count is done by counting the usage of the wiper in the maintenance unit. ▪ The two strokes of the wiper remove ink from the cleaning plate and drops the ink down into the sump below. <p>The count is stored in NVRAM.</p> <ul style="list-style-type: none"> ▪ Near full: 125 cc ▪ Tank full: 147 cc ▪ Estimated time between replacements: about 5 years <p>Prompts</p> <ul style="list-style-type: none"> ▪ Tank near full. A prompt appears on the operation panel of the machine, and the machine will continue to operate. ▪ Tank full. A prompt appears on the operation panel of the machine. If a page is being printed, the print will finish, and then the machine will shut down and cannot be used until after the tank has been replaced. <p>The count must be reset with this SP code after the right ink sump has been replaced. There is no sensor to detect when the left ink sump is removed and inserted. Touch [EXECUTE] to reset the counter for the right ink sump.</p> <p>[0 to 1/0/1]</p>

2507	Waste Ink Related Threshold DFU
	<p>These SP codes can be used to change the full and near-full thresholds for the following PM parts:</p> <ul style="list-style-type: none"> ▪ Ink collector tank (right side of the machine) ▪ Right ink sump (behind the ink collector tank) ▪ Left ink sump (left side of the machine)
1	Change Waste Ink Box Full Threshold
	<p>This SP adjusts the threshold for the tank full alert for the ink collector tank on the right side of the machine below the maintenance unit.</p> <ul style="list-style-type: none"> ▪ This tank has its own ID chip which holds the threshold value. ▪ Changing this SP setting does not write a new threshold setting onto the tank ID chip. ▪ Changing this SP does tells the machine to issue the tank full warning with the count reaches the specified percent of the threshold valued stored on the ID chip. <p>[1 to 200/100/1 %]</p>
2	Change Waste Ink Box Near Full Threshold
	<p>This SP adjusts the threshold for the near-tank full alert for the ink collector tank on the right side of the machine below the maintenance unit.</p> <ul style="list-style-type: none"> ▪ This tank has its own ID chip which holds the threshold value. ▪ Changing this SP setting does not write a new threshold setting onto the tank ID chip. ▪ Changing this SP does tells the machine to issue the near-tank full alert when the count reaches the specified percent of the threshold valued stored on the ID chip. <p>[-99 to 99/0/1 %]</p>
3	Waste Ink Box: Right Full Threshold
	<p>This SP adjusts the threshold for the tank full alert for the open right ink sump below the maintenance unit and behind the ink collector tank.</p> <ul style="list-style-type: none"> ▪ The right ink sump has no ID chip. ▪ Changing this SP setting changes the threshold value stored in NVRAM.
	[1 to 180/ 147 /1 ml]

4	Waste Ink Box: Right Near Full Threshold
	<p>This SP adjusts the threshold for the tank near-full alert for the open right ink sump below the maintenance unit and behind the ink collector tank.</p> <ul style="list-style-type: none"> ▪ The right ink sump has no ID chip. ▪ Changing this SP setting changes the threshold value stored in NVRAM. <p>[1 to 100/85/1 %]</p>
5	Waste Ink Box: Left Full Threshold
	<p>This SP adjusts the threshold for the tank full alert for the left ink sump at the far left side of the machine.</p> <ul style="list-style-type: none"> ▪ The left ink sump has no ID chip. ▪ Changing this SP setting changes the threshold value stored in NVRAM. <p>[1 to 800/500/1 ml]</p>
6	Waste Ink Box: Left Near Full Threshold
	<p>This SP adjusts the threshold for the tank near-full alert for the left ink sump at the far left side of the machine.</p> <ul style="list-style-type: none"> ▪ The left ink sump has no ID chip. ▪ Changing this SP setting changes the threshold value stored in NVRAM. <p>[1 to 100/85/1 %]</p>

2510	Flushing Magnification DFU
	<p>The SP adjusts the amount of ink that is purged from the ink heads at the beginning of a print job. Increasing the number of drops purged before printing, prevents image streaking. Consider raising this setting in an environment where the print heads may have a tendency to dry out:</p> <ul style="list-style-type: none"> ▪ If the machine is remaining idle for long periods. ▪ Where the ambient humidity is low. ▪ When the machine is switching infrequently between monochrome and color printing.
	[1 to 20/ 1 /0.1]

2513	Mainten. after Leftover Thresh` DFU
	<p>Even with the print heads capped, if the machine remains idle for a long period, this can cause the ink around the nozzles to dry slightly and become too viscous to produce good quality images. To prevent this, the machine will execute a maintenance cycle appropriate for the length of time that the machine has remained idle. This is done automatically without intervention by the operator after the machine is turned on, or after a print head has not been used for a long period of time.</p> <p>These SP codes allow you to set the threshold settings that trigger SP2520 and SP2521:</p> <ul style="list-style-type: none"> ▪ SP2520 - Maintenance On/Off Switch ▪ SP2521 - Number of maintenance cycle repetitions
	<p>Here is a list of the settings that can be applied for this SP code:</p> <p>10 = 10 hr, 24 = 24 hr (1 day) 72 = 72 hr (3 days) 168 = 168 hr (1 week) 1080 = 1080 hr (45 days) 2160 = 2160 hr (3.5 months) 43,800 = 43,800 hr (5 years)</p>
1	Little Flushing
	<p>Uses only a small amount of ink to flush the print heads. [0 to 255/10/1 hour]</p>
2	Rich Flushing
	<p>Uses more ink to flush the print heads. [0 to 255/24/1 hour]</p>
3	Cleaning after Leftover
	<p>Executes the print head cleaning cycle only (no flushing) and no ink is flushed from the print heads. [0 to 6120/168/1 hour]</p>

4	Ink Supply Sequence
	Determines when the ink supply sequence is executed. [0 to 6120/ 1080 /1 hour]
5	Cleaning after Leftover LV2
	The amount of time each print head has remained idle. [0 to 6120/ 72 /1 hour]
6	Temperature after Leftover Mtn
	[0 to 45/ 10 /0.5 C]
7	Rich Flushing 2
	Uses more ink to flush the print heads. [0 to 255/ 72 /1 hour]

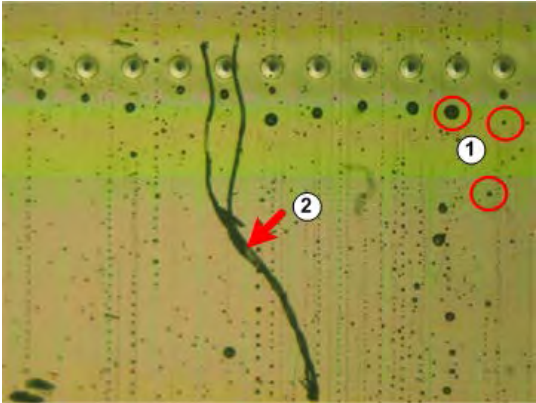
2514	Auto Cleaning Start Threshold DFU
	<p>This SP code sets the threshold setting to trigger automatic cleaning, based on the mist count.</p> <ul style="list-style-type: none"> ▪ The nozzle condition deteriorates while the printer is in use due to ink mist that starts to cling to the nozzles and accumulate inside the suction caps of the maintenance unit. ▪ Paper dust can accumulate and also interfere with the operation of the nozzles.  <p style="text-align: center;">d1245021</p> <p>The illustration above shows droplets of mist ① and paper dust and fibers ② that can collect near the nozzle arrays. This undesirable condition is corrected with periodic automatic cleanings while the printer is in use, greatly extending the length of time the machine can be used without operator intervention.</p> <ul style="list-style-type: none"> ▪ A "mist count" triggers automatic cleaning. This mist count can be extended to increase the timing between automatic cleanings. ▪ The count is adjusted depending on the width of the paper and total print area. For example, the count for very wide paper is much lower than the count for narrower paper because of the difference in the total area covered. ▪ Paper dust count. The width of the paper has been taken into account so the threshold has been extended from 500 to 736 sheets printed, and unneeded coefficients have been eliminated. The paper dust count (the total number of pages printed, cutting count) are used to determine when cleaning is done for paper dust.

1	Mist: Before Capping
	[1 to 4294967295/ 18000000 /1 nI]
2	Mist: Between Pages
	[1 to 4294967295/ 20000000 /1 nI]
3	Paper Dust: Before Capping
	[1 to 65535/ 736 /1]
4	Decapping
	[0 to 86400/ 3600 /1 sec]

2515	OCFS Filling Flag After CL(eaning)
	Shows filling occurred during execution or immediately after the cleaning sequence. [0 to 31/0/1] 0: Not executed, 1: Executed

2516	Mid Cleaning setting DFU
1	Mode Setting
2	Prev Elapsed Count H1
3	Prev Elapsed Count H2
4	Prev Elapsed Count H3
5	Prev Elapsed Count H4
	[0 to 10/ 0 /1]

2517	Mainten. after Leftover Info.
	The machine executes a maintenance cycle at power on, and at the start of a print job after it has remained idle for a significant length of time.

Idle Time	Maintenance Cycle	Time
> 10 hr.< 24 hr.	Small flushing	16 sec.
> 10 hr. < 24 hr.	Full flushing	9 sec. (power on)
> 10 hr. < 24 hr.	Full flushing	16 sec. (print start)
> 24 hr. < 1 week	Idle cleaning	3 min.
> 1 week < 2 weeks	Idle cleaning	3 min.
> 2 weeks < 45 days	Ink sequence	30 min.

	These SP codes set a timer to restrict this operation. If the time does not elapse, then the maintenance cycle or time of cleaning (cleaning or flushing) does not execute. Also, you can set a temperature to be applied to the same time interval. If the temperature does not deviate more than this setting during the same time period, then operation is not done. These SP codes prevent the repetition of maintenance cycles.
1	Printing Standby Time
	This setting writes over the exit time of the most recent paper feed. The machine uses this setting for the start time of maintenance after idle time. [0 to 4294967295/0/1 sec]
2	Last Maintenance Time H1
	This SP codes sets a time interval for the execution of the most recent maintenance cycle for H1 (K1). If this time interval has not elapsed when the machine is powered on, or after it has remained idle, then the maintenance cycle is not done. This prevents useless duplication of the cleaning cycle for H1 (K1). [0 to 4294967295/0/1 sec]

3	Last Maintenance Time H2
	This SP codes sets a time interval for the execution of the most recent maintenance cycle for H2 (K2). If this time interval has not elapsed when the machine is powered, or after it has remained idle, then the maintenance cycle is not done. This prevents useless duplication of the cleaning cycle for H2 (K2)..
	[0 to 4294967295/0/1 sec]
4	Last Maintenance Time H3
	This SP codes sets a time interval for the execution of the most recent maintenance cycle for H3 (C). If this time interval has not elapsed when the machine is powered on, or after it has remained idle, then the maintenance cycle is not done. This prevents useless duplication of the cleaning cycle for H3 (C).
	[0 to 4294967295/0/1 sec]
5	Last Maintenance Time H4
	This SP codes sets a time interval for the execution of the most recent maintenance cycle for H4 (YM). If this time interval has not elapsed when the machine is powered on, or after it has remained idle, then the maintenance cycle is not done. This prevents useless duplication of the cleaning cycle for H4 (YM).
	[0 to 4294967295/0/1 sec]
6	Last Maintenance Type H1
	This SP codes sets a time interval for the execution of the most recent type of maintenance (cleaning, or flushing) for H1 (K1). If this time interval has not elapsed when the machine is powered on, or after it has remained idle (if flushing (or cleaning) was executed during the previous cycle, for example) flushing (or cleaning) will not be done again. This prevents useless duplication of the flushing or cleaning in the maintenance cycle for H1 (K1).
	[0 to 255/0/1]

7	Last Maintenance Type H2
	This SP codes sets a time interval for the execution of the most recent type of maintenance (cleaning, or flushing) for H2 (K2). If this time interval has not elapsed when the machine is powered on, or after it has remained idle (if flushing (or cleaning) was executed during the previous cycle, for example) flushing (or cleaning) will not be done again. This prevents useless duplication of the flushing or cleaning in the maintenance cycle for H2 (K2).
	[0 to 255/0/1]
8	Last Maintenance Type H3
	This SP codes sets a time interval for the execution of the most recent type of maintenance (cleaning, or flushing) for H3 (C). If this time interval has not elapsed when the machine is powered on, or after it has remained idle (if flushing (or cleaning) was executed during the previous cycle, for example) flushing (or cleaning) will not be done again. This prevents useless duplication of the flushing or cleaning in the maintenance cycle for H3 (C). [0 to 255/0/1]
9	Last Maintenance Type H4
	This SP codes sets a time interval for the execution of the most recent type of maintenance (cleaning, or flushing) for H4 (YM). If this time interval has not elapsed when the machine is powered on, or after it has remained idle (if flushing (or cleaning) was executed during the previous cycle, for example) flushing (or cleaning) will not be done again. This prevents useless duplication of the flushing or cleaning in the maintenance cycle for H4 (YM). [0 to 255/0/1]
10	Temperature Leftover Began H1
	If a timer has been set H1 with SP2517-001 above for last maintenance time to prevent useless maintenance cycles, then this setting will set a temperature change to be applied to the same time. If there is no significant temperature change within the time interval, then the maintenance cycle will not execute for H1 (K1). [0 to 45/0/0.5 C]

11	Temperature Leftover Began H2
	If a timer has been set H2 with SP2517-002 above for last maintenance time to prevent useless maintenance cycles, then this setting will set a temperature change to be applied to the same time. If there is no significant temperature change within the time interval, then the maintenance cycle will not execute for H2 (K2). [0 to 45/0/0.5 C]
12	Temperature Leftover Began H3
	If a timer has been set H3 with SP2517-003 above for last maintenance time to prevent useless maintenance cycles, then this setting will set a temperature change to be applied to the same time. If there is no significant temperature change within the time interval, then the maintenance cycle will not execute for H3 (C). [0 to 45/0/0.5]
13	Temperature Leftover Began H4
	If a timer has been set H4 with SP2517-004 above for last maintenance time to prevent useless maintenance cycles, then this setting will set a temperature change to be applied to the same time. If there is no significant temperature change within the time interval, then the maintenance cycle will not execute for H4 (YM). [0 to 45/0/0.5]

2518	All Channel Flushing Time
	This SP code holds and displays the time required to flush all print heads before printing.
	[0 to 0xFFFFFFFF]

2519	Flushing During Printing Set DFU
	Allows setting the time interval between flushings during printing. [-60 to 60/0/0.1 sec.]

2520	Mainten. after Leftover Setting -On/Off Switch
	Use this SP code to switch on/off the number of times that the downtime cycles execute. The settings of SP2521-001 to -003 allow you to set the number of times the cycles (small downtime purge, large downtime purge, and downtime) cleaning execute.
	[0 to 15/0/1]

2521	Mainten. after Leftover Repeat
	These SP codes allow you to set the number of times the cleaning cycles (small downtime purge, large downtime purge, and downtime) execute. To use these settings, SP250 must be set.
1	Little Flushing
	[0 to 10/1/1]
2	Rich Flushing
	[0 to 10/1/1]
3	Cleaning after Leftover
	[0 to 10/1/1]

Example 1

SP	Setting
2520-1	12
2521-1	1
2521-2	2
2521-3	2

H	Setting	Binary							
		-	-	-	-	8	4	2	1
H1	1					0	0	0	1
H2	2					0	0	1	0
H3	4					0	1	0	0
H4	8					1	0	0	0
All	15					1	1	1	1

- The bits are set up for color heads H3, H4 (12) so a small downtime purge is executed 1 time (default), large time purge 2 times, and downtime cleaning 2 times.

Example 2

SP	Setting
2520-1	15
2521-1	2
2521-2	2
2521-3	3

- The bit is set for all heads (15) so small downtime purge and large downtime purge 2 times, and all heads are cleaned 3 times.
- Small/large purging is done in this order: H1>H1>H2>H2>H3>H3>H4>H4
- Cleaning is done in this order: H1>H2>H3>H4 then H1>H2>H3>H4

2522	Maintenance After Leftover Repeat DFU
	Allows changing the number of times the heads are cleaned when the maintenance cycle is triggered by the length of time the machine or print heads have remained idle. [1 to 10/3/1]

2705	Ink on Normal Operation
	This SP code displays the total amount of ink supplied to each print head sub tank. The numbers show the measure amounts in nanoliters.
1	Consumption Counter HT1
	K1 sub tank [0 to 999999999 nl]
2	Consumption Counter HT2
	K2 sub tank [0 to 999999999 nl]

3	Consumption Counter HT3
	C sub tank [0 to 99999999 n]
4	Consumption Counter HT4
	Y sub tank [0 to 99999999/0/1 n]
5	Consumption Counter HT5
	M sub tank [0 to 99999999 n]

2706	Ink On Near End
	This SP displays the amount of ink consumed by each print head sub tank when the near-end ink alert is issued for an ink cartridge.
1	Consumption Counter HT1
2	Consumption Counter HT2
3	Consumption Counter HT3
4	Consumption Counter HT4
5	Consumption Counter HT5
	[0 to 99999999/0/1 n]

2707	OCFS Consumption Counter
	This SP displays the amount of ink consumed by each print head tank for ink filling in response to OCFS ink level detection..
1	HT1
2	HT2
3	HT3
4	HT4
5	HT5
	[0 to 99999999/0/1 nl]

2708	Ink After End
	The ID chips attached to each ink cartridge keep an accurate account of the amount ink sent to each sub tank in the carriage unit. These SP codes display an average of the total amount of ink consumed from each ink cartridge.
1	Consumption Counter K
2	Consumption Counter C
3	Consumption Counter M
4	Consumption Counter Y
	[0 to 2550000000/0/1 nl]

2902	Internal Test Pattern Select - RI20 (MtoP) Internal Patterns	
	Pattern	
	0	No Test Pattern Output
	1	Black Grid Pattern
	2	Cyan Grid Pattern
	3	Magenta Grid Pattern
	4	Yellow Grid Pattern
	5	Frame Pattern
	6	Black 2x2 Pattern
	7	Cyan 2x2 Pattern
	8	Magenta 2x2 Pattern
	9	Yellow 2x2 Pattern
	10	Density Pattern 1
	11	Density Pattern 2
	12	Density Pattern 3

2910	Maintenance Mode Setting DFU	
	1 to 30	Setting 1 to 30

2959	Engine Control IC ID Indication
	<p>This SP displays the name and firmware version number of the engine control module (CHOPIN).</p> <ul style="list-style-type: none"> ▪ The CHOPIN module on the IPU is initialized at power on. ▪ This controls the timing of the electrical system of the machine.
1	IC Name
	<p>Example: CHOP (CHOPIN)</p> <p>[0 to 155/0/1]</p>
2	Version
	<p>Example: 2400Dh</p> <p>[0 to 0xFFFFFFFF/0/1]</p>

2972	Forced Soft Count ON Threshold - t2 DFU`
	<p>This SP sets the threshold value to trigger forced software count. This count is done for the OCFS software count for ink consumption and OCFS ink supply filling</p>
	<p>[0 to 5/0.6/0.05 sec]</p>

2973	OCFS Position Check DFU
	<p>If the temperature/humidity sensor inside the machine measures a significant change in the humidity, this could affect the operation of the machine.</p> <ul style="list-style-type: none"> ▪ A humidification correction value has been devised to alter the "full position" of the OCFS feeler to compensate for adverse temperature and humidity. ▪ Normally, the sub tank feeler points straight forward when the tank is full. However, the machine can automatically shift the full position automatically to compensate for adverse temperature/humidity. ▪ The machine adjusts the position and the sensor "learns" the new full position. <p>These SP codes adjust this procedure.</p>

1	OCFS Position Check Repeat -Humidity Fluctuation
	This SP codes sets the threshold for the number of points for the temperature or humidity to change to activate this feature. [0 to 100/ 30 /0.1 %]
2	Humidity Fluctuation
	[0 to 100/ 5 /0.1 %]
3	HT1 Correction Value
	[-10 to 10/ 0 /0.01 mm]
4	HT2 Correction Value
	[-10 to 10/ 0 /0.01 mm]
5	HT3 Correction Value
	[-10 to 10/ 0 /0.01 mm]
6	HT4 Correction Value
	[-10 to 10/ 0 /0.01 mm]
7	HT5 Correction Value
	[-10 to 10/ 0 /0.01 mm]
8	RE(+)
	[0 to 5/ 0 /0.01 mm]
9	RE(-)
	[0 to 5/ 0.6 /0.01 mm]

2.4 SP3000

3001	Head Gap Adjustment Mj2 – 24KHZ DFU
	[-400 to 400/ 0 /1 dots]
1	Adjusted Value on Fitting B
3	Adjusted Value on Fitting D
6	Adjusted Value on Fitting F
51	By-pass: Normal-Thick B
53	By-pass: Normal-Thick D
56	By-pass: Normal-Thick F
101	Paper Supply 1: Normal-Thick B
103	Paper Supply 1: Normal-Thick D
106	Paper Supply 1: Normal-Thick F
151	Paper Supply 2: Normal-Thick B
153	Paper Supply 2: Normal-Thick D
156	Paper Supply 2: Normal-Thick F

3002	Head Gap Adjust Mj2-24KHz DFU
	[-400 to 400/ 0 /1]
1	Adjusted Value on Fitting B
2	Adjusted Value on Filling C
3	Adjusted Value on Filling D
4	Adjusted Value on Filling E
5	Adjusted Value on Filling A
6	Adjusted Value on Filling F

7	Adjusted Value on Filling G
8	Adjusted Valule on Filling H
51	By-pass: Normal-Thick B
52	By-pass: Normal-Thick C
53	By-pass: Normal-Thick D
54	By-pass: Normal-Thick E
55	By-pass: Normal-Thick A
56	By-pass: Normal-Thick F
57	By-pass: Normal-Thick G
58	By-pass: Normal-Thick H
62	By-pass: Thick C
64	By-pass: Thick E
65	By-pass: Thick A
67	By-pass: Thick G
68	By-pass: Thick H
71	By-pass: Escape B
72	By-pass: Escape C
73	By-pass: Escape D
74	By-pass: Escape E
75	By-pass: Escape A
76	By-pass: Escape F
77	By-pass: Escape G
101	Paper Supply 1: Normal-Thick B
102	Paper Supply 1: Normal-Thick C
103	Paper Supply 1: Normal-Thick D

104	Paper Supply 1: Normal-Thick E
105	Paper Supply 1: Normal-Thick A
106	Paper Supply 1: Normal-Thick F
107	Paper Supply 1: Normal-Thick G
108	Paper Supply 1: Normal-Thick H
112	Paper Supply 1: Thick C
114	Paper Supply 1: Thick E
115	Paper Supply 1: Thick A
117	Paper Supply 1: Thick G
118	Paper Supply 1: Thick H
121	Paper Supply 1: Escape B
122	Paper Supply 1: Escape C
123	Paper Supply 1: Escape D
124	Paper Supply 1: Escape E
125	Paper Supply 1: Escape A
126	Paper Supply 1: Escape F
127	Paper Supply 1: Escape G
151	Paper Supply 2: Normal-Thick B
152	Paper Supply 2: Normal-Thick C
153	Paper Supply 2: Normal-Thick D
154	Paper Supply 2: Normal-Thick E
155	Paper Supply 2: Normal-Thick A
156	Paper Supply 2: Normal-Thick F
157	Paper Supply 2: Normal-Thick G
158	Paper Supply 2: Normal-Thick H

162	Paper Supply 2: Thick C
164	Paper Supply 2: Thick E
165	Paper Supply 2: Thick A
167	Paper Supply 2: Thick G
168	Paper Supply 2: Thick H
171	Paper Supply 2: Escape B
172	Paper Supply 2: Escape C
173	Paper Supply 2: Escape D
174	Paper Supply 2: Escape E
175	Paper Supply 2: Escape A
176	Paper Supply 2: Escape F
177	Paper Supply 2: Escape G

3003	Head Gap Adjust Mj2-20KHz DFU
	[-400 to 400/0/1 dot]
51	By-pass: Normal-Thick A
53	By-pass: Normal-Thick B
56	By-pass: Normal-Thick C
101	Paper Supply 1: Normal-Thick A
103	Paper Supply 1: Normal-Thick B
105	Machine: Normal-Thick K
106	Paper Supply 1: Normal-Thick C
151	Paper Supply 2: Normal-Thick A
153	Paper Supply 2: Normal-Thick B
156	Paper Supply 2: Normal-Thick C

3004	Head Gap Adjust Mj4-10KHz DFU
	[-400 to 400/0/1 dot]
1	Adjusted Value on Fitting A
3	Adjusted Value on Fitting B
6	Adjusted Value on Fitting C
51	By-pass: Normal-Thick A
	[-400 to 400/0/1]]
53	By-pass: Normal-Thick B
56	By-pass: Normal-Thick C
101	Paper Supply 1: Normal-Thick A
103	Paper Supply 1: Normal-Thick B
105	Paper Supply 1: Normal-Thick K
106	Paper Supply 1: Normal-Thick C
151	Paper Supply 2: Normal-Thick A
153	Paper Supply 2: Normal-Thick B
156	Paper Supply 2: Normal-Thick C

3006	Head Gap Adjust Mj5-16KHz DFU
	[-400 to 400/0/1]
1	Adjusted Value on Fitting A
2	Adjusted Value on Fitting C
3	Adjusted Value on Fitting B
4	Adjusted Value on Fitting E
5	Adjusted Value on Fitting A
6	Adjusted Value on Fitting C

7	Adjusted Value on Fitting G
8	Adjusted Value on Fitting H
52	By-pass: Normal-Thick C
54	By-pass: Normal-Thick E
55	By-pass: Normal-Thick A
57	By-pass: Normal-Thick G
62	By-pass: Thick C
64	By-pass: Thick E
65	By-pass: Thick A
67	By-pass: Thick G
68	By-pass: Thick H
71	By-pass: Escape A
73	By-pass: Escape B
76	By-pass: Escape C
102	Paper Supply 1: Normal-Thick C
104	Paper Supply 1: Normal-Thick E
105	Paper Supply 1: Normal-Thick A
107	Paper Supply 1: Normal-Thick G
108	Paper Supply 1: Normal-Thick H
112	Paper Supply 1: Thick C
114	Paper Supply 1: Thick E
115	Paper Supply 1: Thick A
117	Paper Supply 1: Thick G
118	Paper Supply 1: Thick H
121	Paper Supply 1: Escape A

123	Paper Supply 1: Escape D
126	Paper Supply 1: Escape C
152	Paper Supply 2: Normal-Thick C
154	Paper Supply 2: Normal-Thick E
155	Paper Supply 2: Normal-Thick A
157	Paper Supply 2: Normal-Thick G
158	Paper Supply 2: Normal-Thick H
162	Paper Supply 2: Thick C
164	Paper Supply 2: Thick E
165	Paper Supply 2: Thick A
167	Paper Supply 2: Thick G
168	Paper Supply 2: Thick H
171	Paper Supply 2: Escape A
173	Paper Supply 2: Escape B
176	Paper Supply 2: Escape C

3007	Head Gap Adjust InputValue DFU
	[-400 to 400/0/1]]
1	Manually UP A
2	Manually UP B
3	Manually UP C
4	Manually UP D
5	Manually UP E
6	Manually UP F
7	Manually UP G

8	Manually UP H
---	---------------

3109	Test Pattern Output DFU
	<p>The SP codes above (SP3007) reduce the unevenness in the platen gap of the print heads in the main scan direction during bi-directional printing. The wider the horizontal area of printing, the greater the chance of variation in the gap.</p> <p>These are the factors that affect the head/platen gap:</p> <ul style="list-style-type: none"> ▪ The distance between the parallel rod (where the carriage is mounted) and the surface of the platen. ▪ Warp of the parallel rod ▪ Variation in the heights of individual platen plates <p>This adjustment is done at the factory. A test pattern is printed, and then from among the patterns the area where there no streaking is selected.</p> <ul style="list-style-type: none"> ▪ The adjustment is done with reference to H2 (K2) with a full pattern print (right to left) from one edge of the platen to the other. ▪ 10 places at the edges of the platen (at both ends and where the platen plates are joined) the number of the are where streaking is least is selected. ▪ This number is registered in an SP code. <p>Touch [EXECUTE] to execute the following SP codes.</p>
6	Gap Section Correction Pre
7	Gap Section Correction 1016
8	Gap Section Correction 847
9	Gap Section Correction 423
10	Gap Section Correction 1016 K1f
11	Gap Section Correction 1016 K1r
12	Gap Section Correction 1016 H
13	Gap Section Correction 677 K1f
14	Gap Section Correction 677 K1f
15	Gap Section Correction 677 K1r

16	Gap Section Correction 1200
20	Forward-Backward Adjustment Pattern Printing
21	Printing Position Alignment
22	Transport Roller Correction
100	Nozzle Check Pattern Printing (User)
101	Paper Feed Length Adjustment
102	Nozzle Check Pattern Printing (Mj2)
103	Nozzle Check Pattern Printing (Mj4)
104	2 by 2 Pattern (High Speed)
105	2 by 2 Pattern (Standard)

3111	Pattern Notice Paper Selection DFU
1	By-pass Feed
2	Paper Input 1
3	Paper Input 2
	<p>[0 to 255/0/1]</p> <ul style="list-style-type: none"> ▪ No display: 00h ▪ Recycled paper: 01h ▪ IJ Normal: 1Fh ▪ Translucent: 03h ▪ Matte Film: 22h ▪ Coated (CAD): 23h ▪ Coated: 12h ▪ Special: 0Eh

3112	Printing Mode Setting DFU
	(7) 0000 0000 (1) [OH] [0 to 255/0/1]
1	Setting 1
2	Setting 2
3	Setting 3
4	Setting 4
5	Setting 5
6	Setting 6
7	Setting 7
8	Setting 8
9	Setting 9
⇒ 10	Plotter Emergency Stop
	<p>The operator can stop the plotter engine by pressing the [Original Stop Key] on the right side of scanner cover and [Stop key] on the operation panel (in addition to stopping the scanner, which is already possible).</p> <p>1: ON / 0: OFF (default)</p> <p>< Important notes ></p> <p>When the keys are pressed, both the scanner and plotter are immediately stopped. However, the engine cannot be stopped while the machine is performing self-maintenance.</p>
11	Setting 11
12	Setting 12
13	Setting 13
14	Setting 14
15	Setting 15

3113	Pattern Notice Paper Thickness v
1	By-pass Feed
	<p>[0 to 255/0/1]</p> <ul style="list-style-type: none"> ▪ Normal Paper: 0h ▪ Thin Paper: 1h ▪ Medium Thick Paper: 2h ▪ Thick 1: 3h ▪ Thick 2: 4h
2	Paper Input 1
3	Paper Input 2

3114	Avoid Head Friction
1	By-pass Feed
2	Paper Input 1
3	Paper Input 2
	<p>[0 to 2/0/1]</p> <ul style="list-style-type: none"> ▪ 0: Normal height ▪ 1: 1 mm ▪ 2: 2 mm

3115	Pattern Notice Image Mode - Image Mode
	<p>1: Standard 2: Quality 3: High Speed [0 to 255/0/1]</p>

3116	Pattern Notice - Color/Black & White DFU
	[0 to 255/0/1]

3126	Gap Section Correction DFU
	<p>This feature reduces the unevenness in the platen gap of the print heads in the main scan direction during bi-directional printing. The wider the horizontal area of printing, the greater the chance of variation in the gap.</p> <p>[-100 to 100/0/1]</p>
1	1016: Color 2A
2	1016: Color 2B
3	1016: Color 2C
4	1016: Color 2D
5	1016: Color 2E
6	1016: Color 2F
7	1016: Color 2G
8	1016: Color 2H
9	1016: Color 2I
10	1016: Color 2J
11	1016: Color 2K
12	1016: Color 2L
13	847: 2A
14	847: 2B
15	847: 2C
16	847: 2D
17	847: 2E
18	847: 2F
19	847: 2G
20	847: 2H
21	847: 2I

22	847: 2J
23	847: 2K
24	847: 2L
25	423: 2A
26	423: 2B
27	423: 2C
28	423: 2D
29	423: 2E
30	423: 2F
31	423: 2G
32	423:2H
33	423: 2I
34	423: 2J
35	423: 2K
36	423: 2L
37	1016: Black & White 1f A
38	1016: Black & White 1f B
39	1016: Black & White 1f C
40	1016: Black & White 1f D
41	1016: Black & White 1f E
42	1016: Black & White 1f F
43	1016: Black & White 1f G
44	1016: Black & White 1f H
45	1016: Black & White 1f I
46	1016: Black & White 1f J

47	1016: Black & White 1f K
48	1016: Black & White 1f L
49	1016: Black & White 1r A
50	1016: Black & White 1r B
51	1016: Black & White 1r C
52	1016: Black & White 1r D
53	1016: Black & White 1r E
54	1016: Black & White 1r F
55	1016: Black & White 1r G
56	1016: Black & White 1r H
57	1016: Black & White 1r I
58	1016: Black & White 1r J
59	1016: Black & White 1r K
60	1016: Black & White 1r K
61	847: 1A
62	847: 1B
63	847: 1C
64	847: 1D
65	847: 1E
66	847: 1F
67	847: 1G
68	847: 1H
69	847: 1I
70	847: 1J
71	847: 1K

72	847: 1L
73	423: 1A
74	423: 1B
75	423: 1C
76	423: 1D
77	423: 1E
78	423: 1F
79	423: 1G
80	423: 1H
81	423: 1I
82	423: 1J
83	423: 1K
84	423: 1L
85	677: Color 2A
86	677: Color 2B
87	677: Color 2C
88	677: Color 2D
89	677: Color 2E
90	677: Color 2F
91	677: Color 2G
92	677: Color 2H
93	677: Color 2I
94	677: Color 2J
95	677: Color 2K
96	677: Color 2L

97	677: Black & White 1fA
98	677: Black & White 1fB
99	677: Black & White 1fC
100	677: Black & White 1fD
101	677: Black & White 1fE
102	677: Black & White 1fF
103	677: Black & White 1fG
104	677: Black & White 1fH
105	677: Black & White 1fI
106	677: Black & White 1fJ
107	677: Black & White 1fK
108	677: Black & White 1fL
109	677: Black & White 1rA
110	677: Black & White 1rB
111	677: Black & White 1rC
112	677: Black & White 1rD
113	677: Black & White 1rE
114	677: Black & White 1rF
115	677: Black & White 1rG
116	677: Black & White 1rH
117	677: Black & White 1rI
118	677: Black & White 1rJ
119	677: Black & White 1rK
120	677: Black & White 1rL
121	1200: 2A

122	1200: 2B
123	1200: 2C
124	1200: 2D
125	1200: 2E
126	1200: 2F
127	1200: 2G
128	1200: 2H
129	1200: 2I
130	1200: 2J
131	1200: 2K
132	1200: 2L
133	1200: 1A
134	1200: 1B
135	1200: 1C
136	1200: 1D
137	1200: 1E
138	1200: 1F
139	1200: 1G
140	1200: 1H
141	1200: 1I
142	1200: 1J
143	1200: 1K
144	1200: 1L

3130	Head Rank (Pattern) DFU
	<p>Head rank means the wave and voltage rank of the print head.</p> <ul style="list-style-type: none"> ▪ Wave rank: Print eject wave <(A2000-002)> is a, b, c, d (4 types of wave data) ▪ Voltage rank: <Voltage compensation power (A2010-002) is A to H (8 types of correction data) ▪ If no head rank is set, the default values are "d" ("4" in NVRAM) for wave rank and "E" ("4" in NVRAM) for voltage rank: dE <p>Head rank settings</p> <ul style="list-style-type: none"> ▪ Wave rank settings a to d correspond to SP settings 1 to 4. ▪ Voltage rank settings A to H correspond to SP setting 0 to 7. ▪ Head ranks are stored in NVRAM. <p>These head rank settings are done to compensate for temperature of the print heads. The thermistors are used to monitor the temperature of the print heads. This temperature is used to assign the wave and voltage rank which is crucial to setting the force of ejection for the piezo-electric element in the print head.</p> <p>[1 to 4/4/1]</p>
1	H1
2	H2
3	H3
4	H4

3131	Head Rank (Voltage) DFU
	<p>Head rank means the wave and voltage rank of the print head.</p> <ul style="list-style-type: none"> ▪ Wave rank: Print eject wave <(A2000-002)> is a, b, c, d (4 types of wave data) ▪ Voltage rank: <Voltage compensation power (A2010-002) is A to H (8 types of correction data) ▪ If no head rank is set, the default values are "d" ("4" in NVRAM) for wave rank and "E" ("4" in NVRAM) for voltage rank: dE <p>Head rank settings</p> <ul style="list-style-type: none"> ▪ Wave rank settings a to d correspond to SP settings 1 to 4. ▪ Voltage rank settings A to H correspond to SP setting 0 to 7. ▪ Head ranks are stored in NVRAM. <p>These head rank settings are done to compensate for temperature of the print heads. The thermistors are used to monitor the temperature of the print heads. This temperature is used to assign the wave and voltage rank which is crucial to setting the force of ejection for the piezo-electric element in the print head.</p> <p>[0 to 7/4/1]</p>
1	H1
2	H2
3	H3
4	H4

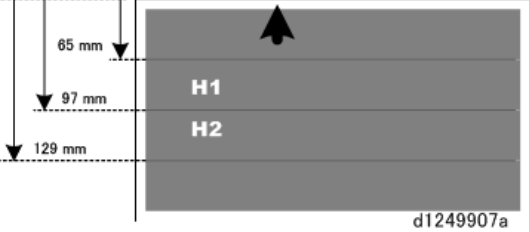
3132	ECB Correction Value
	<p>After replacement of the black print head unit, the density of the black bands (printed by K1, K2) must be checked for equal density.</p>  <p style="text-align: center;">d1249907a</p> <ul style="list-style-type: none"> ▪ If the density is not the same, the lighter band must be adjusted to the appearance of the darker band. ▪ This procedure is described in detail in the Field Service Manual. (See "Reinstallation" at the end of the replacement procedure for the black print head unit.) ▪ This procedure is done after replacement of the black print head unit only.
1	H1
	Do this adjustment if the H1 band is lighter than the H2 band.
	[94 to 97/ 94 /1 %]
2	H2
	Do this adjustment if the H2 band is lighter than the H1 band.
	[94 to 97/ 94 /1 %]
3	H3 DFU
4	H4 DFU

3140	Ink Drying Time Setting
	This SP sets the length of time for the ink to dry before the paper is cut. A drying time can be set for each type of paper.
1	Normal Paper
	[0 to 1800/0/1 sec]
2	Recycled Paper
	[0 to 1800/0/1 sec]
3	IJ Normal Paper
	[0 to 1800/0/1 sec]
5	Translucent
	[0 to 1800/0/1 sec]
6	Mat Film
	[0 to 1800/15/1 sec]
7	Coated (CAD) Paper
	[0 to 1800/0/1 sec]
8	Coated Paper
	[0 to 1800/0/1 sec]
10	Special Paper
	[0 to 1800/0/1 sec]

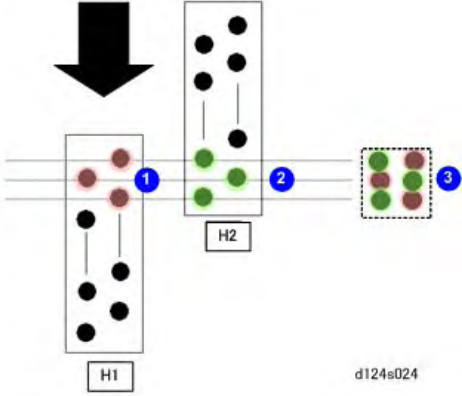
3141	Paper Feed Part Correction
	<p>This SP code switches off the overlap between K1 and K2. The K1 print head (H1) sits forward of the K2 print head (H2) in the direction of paper feed. This allows a greater band of coverage during monochrome printing.</p>  <p>Three nozzles at the rear section of K1 ① and three nozzles at the front section of K2 ② overlap the same area on the paper. However, the arrangement of the nozzle ports is staggered ③ so positions of the nozzle ports complement one another when ink is put down on the paper.</p>
	[0 to 1/1/1]

3142	Outline Correction DFU
	<p>Switches off/on the algorithm to smooth "jaggies" in images and text. Do not change this setting.</p> <p>[0 to 1/1/1] 1:ON 2:OFF</p>

3143	Print Head Joint Correction DFU
------	--

3145	Printing Direction Selection DFU
	<p>The main scan drive control sequence controls:</p> <ul style="list-style-type: none"> ▪ The commands from the CPU drive main scan (horizontal), sub scan (vertical), and roll paper drive (horizontal motor, vertical motor, roll feed motor) ▪ Debug commands from DSP (Digital Signal Processor)
	[0 to 1/0/1]

3146	Sub Scan White Area Skip
	These SP codes switch the skipping of blank areas on/off during printing and scanning.
1	Printer 0:OFF/1:ON
	Blank areas are skipped during printing. [0 to 1/0/1] 0:OFF 1:ON
2	Copy 0:OFF/1:ON
	Blank areas are skipped during copying. [0 to 1/0/1] 0:OFF 1:ON

2.5 SP4000

4008	Scanner Sub Scan - Magnification Adjustment
	<p>Magnification (image enlargement/reduction) in the sub scan (vertical) direction is done by adjusting the speed of the scanner motor when the image is scanned. Adjustment is done relative to the default setting of 100%</p> <ul style="list-style-type: none"> ▪ Reducing the setting, increases the speed of the scanner motor and the image is reduced when it prints. ▪ Increasing the setting, reduces the speed of the scanner motor and the image is enlarged when it is printed.
	[-0.9 to 0.9/ 0.0 /0.1%]

4010	Scanner Sub Scan
	<p>These SP codes adjust sub scan registration to correct skew due to CIS positioning and variation in CIS sensitivity. The adjustment of the on/off timing of the CIS sensors is done with the reading of the scanner registration sensor in the scanner unit.</p>
1	Leading Edge Registration Adjustment
	<p>This SP shifts the leading edge of the scanned image relative to the sub scan direction.</p> <p>[-10 to 10/0.0/ 0.1 mm]</p> <ul style="list-style-type: none"> ▪ A higher setting "+" shifts the image down (against the sub scan direction). ▪ A lower setting "-" shifts the image up (with the sub scan direction).
2	Trailing Edge Registration Adjustment
	<p>This SP shifts the trailing edge of the scanned image relative to the sub scan direction.</p> <p>[-10 to 10/0/0.1 mm]</p> <ul style="list-style-type: none"> ▪ A higher setting "+" shifts the image down (against the sub scan direction). ▪ A lower setting "-" shifts the image up with the sub scan direction).

4011	Scanner Main Scan - Registration Adjustment
	This SP shifts the scanned entire image horizontally left or right (in the main scan direction)
	<p>[-4 to 4/0.0/0.1 mm]</p> <ul style="list-style-type: none"> ▪ A higher setting "+" shifts the image away from the right edge of the paper as it exits for a wider margin. ▪ A lower setting "-" shifts the image to toward the right edge of the paper as it exits for a narrower margin.

4012	Scanner Edge Margin
	These SP's define borders around the image area output by the scanner. Each edge can be set independent of the others.
5	DF: Leading Edge
	[0 to 9/ 0.0 /0.1 mm]
6	DF: Trailing Edge
	[0 to 9/ 0.0 /0.1 mm]
7	DF: Left Edge
	[0 to 9/ 0.0 /0.1 mm]
8	DF: Right Edge
	[0 to 9/ 0.0 /0.1 mm]

4013	Scanner Free Run
	These SP codes set up the scanner for a free run to warm up the machine or for reliability testing.
1	Execute
	<p>Switches free run mode on/off. Executes the free run with the intervals between virtual pages set with SP4013-002 and page length set with SP4013-003.</p> <p>[OFF] [ON]</p>

2	Dummy Page Interval Setting
	Sets the interval between virtual pages for a scanner free run. [0 to 25/ 0.9 /0.1 sec]
3	Dummy Document Length Setting
	Sets the length of the pages for the scanner free rund [0.2 to 30/ 0.6 /0.1 m]

4101	Scanner Main Scan
	The following SP codes (002-010) are used to adjust scanning in the main scan direction in the range -1.0% to +1.0% in 0.1% steps (Default: 0.0%) for different types of paper. If no paper type is selected, then the settings for SP4101-001 and -002 are used (for Normal/Recycled paper).
1	Magnification Adjustment
	[-0.9 to 0.9/ 0 /0.1%]
2	Mag. Adj. Normal, Recycled
	[-1 to 1/ 0 /0.1%]
3	Mag. Adj.: IJ Normal
	[-1 to 1/ 0 /0.1%]
4	Translucent
	[-1 to 1/ 0 /0.1%]
5	Coated (CAD)
	[-1 to 1/ 0 /0.1%]
6	Coated
	[-1 to 1/ 0 /0.1%]
7	Matte Film
	[-1 to 1/ 0 /0.1%]

8	Special
	[-1 to 1/0/0.1%]
9	(Reserved 0)
	[-1 to 1/0/0.1%]
10	(Reserved 1)
	[-1 to 1/0/0.1%]

4417	IPU Test Pattern Setting - Pattern Selection	
	Enter the number for the desired test pattern, switch the display to the "Copy Window" then press the [Start] button. [0 to 14/0/1]	
	No.	Pattern Name
	*0	Scanned Image
	1	Gradation Main Scan A
	2	Gradation Sub Scan A
	3	Gradation RGBCMYK
	4	Grid Pattern A
	5	Slant Grid Pattern A
	6	Scanned + Grid Pattern A
	7	Scanned + Slant Grid A
	8	Grid Pattern B
	9	Scanned + Grid Pattern B
	10	Color Patch 16
	11	Gradation Main Scan C
	12	Gradation Sub Scan C

	13	Slant Grid Pattern C
	14	Scanned + Grid Pattern C

4429	Select Copy Data Security DFU	
1	Copying	
	[0 to 3/3/1]	
2	Scanning	
	[0 to 3/3/1]	

4540	Print Coverage DFU	
1	RY Phase: Option	
	[0 to 255/0/1]	
2	RY Phase: R	
	[-256 to 255/0/1]	
3	RY Phase: G	
4	RY Phase: B	
5	YR Phase: Option	
	[0 to 255/0/1]	
6	YR Phase: R	
	[-256 to 255/0/1]	
7	YR Phase: G	
8	YR Phase: B	
9	YG Phase: Option	
	[0 to 255/0/1]	

10	YG Phase: R
	[-256 to 255/ 0 /1]
11	YG Phase: G
12	YG Phase: B
13	GY Phase: Option
	[0 to 255/ 0 /1]
14	GY Phase: R
	[-256 to 255/ 0 /1]
15	GY Phase: G
16	GY Phase: B
17	GC Phase: Option
	[0 to 255/ 0 /1]
18	GC Phase: R
	[-256 to 255/ 0 /1]
19	GC Phase: G
20	GC Phase: B
21	CG Phase: Option
	[0 to 255/ 0 /1]
22	CG Phase: R
	[-256 to 255/ 0 /1]
23	CG Phase: G
24	CG Phase: B

25	CB Phase: Option
	[0 to 255/ 0 /1]
26	CB Phase: R
	[-256 to 255/ 0 /1]
27	CB Phase: G
28	CB Phase: B
29	BC Phase: Option
	[0 to 255/ 0 /1]
30	BC Phase: R
	[-256 to 255/ 0 /1]
31	BC Phase: G
32	BC Phase: B
33	BM Phase: Option
	[0 to 255/ 0 /1]
34	BM Phase: R
	[-256 to 255/ 0 /1]
35	BM Phase: G
36	BM Phase: B
37	MB Phase: Option
	[0 to 255/ 0 /1]
38	MB Phase: R
	[-256 to 255/ 0 /1]

39	MB Phase: G
40	MB Phase: B
41	MR Phase: Option
	[0 to 255/ 0 /1]
42	MR Phase: R
	[-256 to 255/ 0 /1]
43	MR Phase: G
44	MR Phase: B
45	RM Phase: Option
	[0 to 255/ 0 /1]
46	RM Phase: R
	[-256 to 255/ 0 /1]
47	RM Phase: G
48	RM Phase: B
49	WHITE: Option
	[0 to 255/ 0 /1]
50	WHITE:R
	[-256 to 255/ 0 /1]
51	WHITE:G
52	WHITE:B
53	BLACK: Option
	[0 to 255/ 0 /1]
54	BLACK:R
	[-256 to 255/ 0 /1]

55	BLACK:G
56	BLACK:B

4550	Scan Apli:Txt/Print DFU
	These SP codes enhance the quality of originals scanned in the Text mode (printing) (selected on the operation panel).
5	MTF: 0(Off) 1-15 (Weak-Strong)
	<p>Sets the MTF coefficient scanned in the Text mode (printing). When the original image is converted to electrical signals, the contrast is reduced due to the influence that adjacent white and black pixels have on one another as a result of CIS properties. This may cause very narrow bands or spacing between black and white areas. Use the MTF adjust to correct this problem and emphasize image detail.</p> <p>[0 to 15/8/1] 0 (Weakest), 8 (Medium: Default), 15 (Strongest)</p>
6	Smoothing: 0(x1) 1-7 (Weak-Strong)
	<p>Sets the level of smoothing for originals scanned in the Text mode (printing).</p> <p>[0 to 7/4/1] 0 (Weakest), 4 (Medium: Default), 7 (Strongest)</p>
7	Brightness: 1-255
	<p>Sets the overall brightness images scanned in the Text mode (printing).</p> <p>[1 to 255/128/1] 1 (Weakest), 128 (Medium: Default), 255 (Strongest) Note: Raising the brightness level may increase moiré</p>
8	Contrast: 1-255
	<p>Sets the overall contrast of images scanned in the Text mode (printing).</p> <p>[1 to 255/128/1] 1 (Weakest), 128 (Medium: Default), 255 (Strongest) Note: Raising the contrast level may increase moiré</p>

9	Ind Dot Erase: 0(Off) 1-7 (Weak-Strong)
	<p>Sets the level of independent dot erasure to improve the appearance in the backgrounds of images scanned in the Text mode (printing).</p> <p>[0 to 7/0/1]</p> <p>0: Default (Off) 1 (Weakest) to 7 (Strongest)</p>

4551	Scan Apli:Txt DFU
	These SP codes enhance the quality of originals scanned in the Text mode (copying) (selected on the operation panel).
5	MTF: 0(Off) 1-15 (Weak-Strong)
	<p>Sets the MTF coefficient scanned in the Text mode (copying). When the original image is converted to electrical signals, the contrast is reduced due to the influence that adjacent white and black pixels have on one another as a result of CIS properties. This may cause very narrow bands or spacing between black and white areas. Use the MTF adjust to correct this problem and emphasize image detail.</p> <p>[0 to 15/8/1]</p> <p>0 (Weakest), 8 (Medium: Default), 15 (Strongest)</p>
6	Smoothing: 0(x1) 1-7 (Weak-Strong)
	<p>Sets the level of smoothing for originals scanned in the Text mode (copying).</p> <p>[0 to 7/4/1]</p> <p>0 (Weakest), 4 (Medium: Default), 7 (Strongest)</p>
7	Brightness: 1-255
	<p>Sets the overall brightness images scanned in the Text mode (copying).</p> <p>[1 to 255/128/1]</p> <p>1 (Weakest), 128 (Medium: Default), 255 (Strongest)</p> <p>Note: Raising the brightness level may increase moiré</p>

8	Contrast: 1-255
	<p>Sets the overall contrast of images scanned in the Text mode (copying).</p> <p>[1 to 255/128/1]</p> <p>1 (Weakest), 128 (Medium: Default), 255 (Strongest)</p> <p>Note: Raising the contrast level may increase moiré</p>
9	Ind Dot Erase: 0(Off) 1-7 (Weak-Strong)
	<p>Sets the level of independent dot erasure to improve the appearance in the backgrounds of images scanned in the Text mode (copying).</p> <p>[0 to 7/0/1]</p> <p>0: Default (Off) 1 (Weakest) to 7 (Strongest)</p>

4553	Scan Apli:Txt Dropout DFU
	<p>This SP forces background lines (of section paper, for example) to drop out and not appear in the images. (Forcing blue to drop out may be difficult.)</p> <p>These SP codes enhance the quality of originals scanned in this mode.</p>
5	MTF: 0(Off) 1-15 (Weak-Strong)
	<p>Sets the MTF coefficient scanned in the Background Lines mode. When the original image is converted to electrical signals, the contrast is reduced due to the influence that adjacent white and black pixels have on one another as a result of CIS properties. This may cause very narrow bands or spacing between black and white areas. Use the MTF adjust to correct this problem and emphasize image detail.</p> <p>[0 to 15/8/1]</p> <p>0 (Weakest), 8 (Medium: Default), 15 (Strongest)</p>
6	Smoothing: 0(x1) 1-7 (Weak-Strong)
	<p>Sets the level of smoothing for originals scanned in the Background Lines mode.</p> <p>[0 to 7/4/1]</p> <p>0 (Weakest), 4 (Medium: Default), 7 (Strongest)</p>

7	Brightness: 1-255
	<p>Sets the overall brightness images scanned in the Background Lines mode. [1 to 255/128/1] 1 (Weakest), 128 (Medium: Default), 255 (Strongest) Note: Raising the brightness level may increase moiré</p>
8	Contrast: 1-255
	<p>Sets the overall contrast of images scanned in the Background Lines mode. [1 to 255/128/1] 1 (Weakest), 128 (Medium: Default), 255 (Strongest) Note: Raising the contrast level may increase moiré</p>
9	Ind Dot Erase: 0(Off) 1-7 (Weak-Strong)
	<p>Sets the level of independent dot erasure to improve the appearance in the backgrounds of images scanned in the Background Lines mode. [0 to 7/0/1] 0: Default (Off) 1 (Weakest) to 7 (Strongest)</p>

4554	Scan Apli:Txt·Photo DFU
	These SP codes enhance the quality of originals scanned in the Text/Photo mode (selected on the operation panel).
5	MTF: 0(Off) 1-15 (Weak-Strong)
	<p>Sets the MTF coefficient scanned in the Text/Photo mode. When the original image is converted to electrical signals, the contrast is reduced due to the influence that adjacent white and black pixels have on one another as a result of CIS properties. This may cause very narrow bands or spacing between black and white areas. Use the MTF adjust to correct this problem and emphasize image detail. [0 to 15/8/1] 0 (Weakest), 8 (Medium: Default), 15 (Strongest)</p>

6	Smoothing: 0(x1) 1-7 (Weak-Strong)
	Sets the level of smoothing for originals scanned in the Text/Photo mode. [0 to 7/ 4 /1] 0 (Weakest), 4 (Medium: Default), 7 (Strongest)
7	Brightness: 1-255
	Sets the overall brightness images scanned in the Text/Photo mode. [1 to 255/ 128 /1] 1 (Weakest), 128 (Medium: Default), 255 (Strongest) Note: Raising the brightness level may increase moiré
8	Contrast: 1-255
	Sets the overall contrast of images scanned in the Text/Photo mode. [1 to 255/ 128 /1] 1 (Weakest), 128 (Medium: Default), 255 (Strongest) Note: Raising the contrast level may increase moiré
9	Ind Dot Erase: 0(Off) 1-7 (Weak-Strong)
	Sets the level of independent dot erasure to improve the appearance in the backgrounds of images scanned in the Text/Photo mode. [0 to 7/ 0 /1] 0: Default (Off) 1 (Weakest) to 7 (Strongest)

4555	Scan Apli:Photo DFU
	These SP codes enhance the quality of originals scanned in the Photo mode (selected on the operation panel).
5	MTF: 0(Off) 1-15 (Weak-Strong)
	Sets the MTF coefficient scanned in the Photo mode. When the original image is converted to electrical signals, the contrast is reduced due to the influence that adjacent white and black pixels have on one another as a result of CIS properties. This may cause very narrow bands or spacing between black and white areas. Use the MTF adjust to correct this problem and emphasize image detail. [0 to 15/ 8 /1] 0 (Weakest), 8 (Medium: Default), 15 (Strongest)
6	Smoothing: 0(x1) 1-7 (Weak-Strong)
	Sets the level of smoothing for originals scanned in the Photo mode. [0 to 7/ 4 /1] 0 (Weakest), 4 (Medium: Default), 7 (Strongest)
7	Brightness: 1-255
	Sets the overall brightness images scanned in the Photo mode. [1 to 255/ 128 /1] 1 (Weakest), 128 (Medium: Default), 255 (Strongest) Note: Raising the brightness level may increase moiré
8	Contrast: 1-255
	Sets the overall contrast of images scanned in the Photo mode. [1 to 255/ 128 /1] 1 (Weakest), 128 (Medium: Default), 255 (Strongest) Note: Raising the contrast level may increase moiré
9	Ind Dot Erase: 0(Off) 1-7 (Weak-Strong)
	Sets the level of independent dot erasure to improve the appearance in the backgrounds of images scanned in the Photo mode. [0 to 7/ 0 /1] 0: Default (Off) 1 (Weakest) to 7 (Strongest)

4565	Scan Apli:GrayScale DFU
	These SP codes enhance the quality of originals scanned in the Grayscale mode (selected on the operation panel).
5	MTF: 0(Off) 1-15 (Weak-Strong)
	Sets the MTF coefficient scanned in the Grayscale mode. When the original image is converted to electrical signals, the contrast is reduced due to the influence that adjacent white and black pixels have on one another as a result of CIS properties. This may cause very narrow bands or spacing between black and white areas. Use the MTF adjust to correct this problem and emphasize image detail. [0 to 15/8/1] 0 (Weakest), 8 (Medium: Default), 15 (Strongest)
6	Smoothing: 0(x1) 1-7 (Weak-Strong)
	Sets the level of smoothing for originals scanned in the Grayscale mode. [0 to 7/4/1] 0 (Weakest), 4 (Medium: Default), 7 (Strongest)
7	Brightness: 1-255
	Sets the overall brightness images scanned in the Grayscale mode. [1 to 255/128/1] 1 (Weakest), 128 (Medium: Default), 255 (Strongest) Note: Raising the brightness level may increase moiré
8	Contrast: 1-255
	Sets the overall contrast of images scanned in the Grayscale mode. [1 to 255/128/1] 1 (Weakest), 128 (Medium: Default), 255 (Strongest) Note: Raising the contrast level may increase moiré
9	Ind Dot Erase: 0(Off) 1-7 (Weak-Strong)
	Sets the level of independent dot erasure to improve the appearance in the backgrounds of images scanned in the Grayscale mode. [0 to 7/0/1] 0: Default (Off) 1 (Weakest) to 7 (Strongest)

4570	Scan Apli:Col Txt·Photo DFU
	These SP codes enhance the quality of originals scanned in the Color Text/Photo mode (selected on the operation panel).
5	MTF: 0(Off) 1-15 (Weak-Strong)
	<p>Sets the MTF coefficient scanned in the Color Text/Photo mode. When the original image is converted to electrical signals, the contrast is reduced due to the influence that adjacent white and black pixels have on one another as a result of CIS properties. This may cause very narrow bands or spacing between black and white areas. Use the MTF adjust to correct this problem and emphasize image detail.</p> <p>[0 to 15/8/1] 0 (Weakest), 8 (Medium: Default), 15 (Strongest)</p>
6	Smoothing: 0(x1) 1-7 (Weak-Strong)
	<p>Sets the level of smoothing for originals scanned in the Color Text/Photo mode.</p> <p>[0 to 7/4/1] 0 (Weakest), 4 (Medium: Default), 7 (Strongest)</p>
7	Brightness: 1-255
	<p>Sets the overall brightness images scanned in the Color Text/Photo mode.</p> <p>[1 to 255/128/1] 1 (Weakest), 128 (Medium: Default), 255 (Strongest) Note: Raising the brightness level may increase moiré</p>
8	Contrast: 1-255
	<p>Sets the overall contrast of images scanned in the Color Text/Photo mode.</p> <p>[1 to 255/128/1] 1 (Weakest), 128 (Medium: Default), 255 (Strongest) Note: Raising the contrast level may increase moiré</p>

9	Ind Dot Erase: 0(Off) 1-7 (Weak-Strong)
	<p>Sets the level of independent dot erasure to improve the appearance in the backgrounds of images scanned in the Color Text/Photo mode.</p> <p>[0 to 7/0/1]</p> <p>0: Default (Off) 1 (Weakest) to 7 (Strongest)</p>

4571	Scan Apli:Col Gloss Photo DFU
	These SP codes enhance the quality of originals scanned in the Glossy Photo mode (selected on the operation panel).
5	MTF: 0(Off) 1-15 (Weak-Strong)
	<p>Sets the MTF coefficient scanned in the Glossy Photo mode. When the original image is converted to electrical signals, the contrast is reduced due to the influence that adjacent white and black pixels have on one another as a result of CIS properties. This may cause very narrow bands or spacing between black and white areas. Use the MTF adjust to correct this problem and emphasize image detail.</p> <p>[0 to 15/8/1]</p> <p>0 (Weakest), 8 (Medium: Default), 15 (Strongest)</p>
6	Smoothing: 0(x1) 1-7 (Weak-Strong)
	<p>Sets the level of smoothing for originals scanned in the Glossy Photo mode.</p> <p>[0 to 7/4/1]</p> <p>0 (Weakest), 4 (Medium: Default), 7 (Strongest)</p>
7	Brightness: 1-255
	<p>Sets the overall brightness images scanned in the Glossy Photo mode.</p> <p>[1 to 255/128/1]</p> <p>1 (Weakest), 128 (Medium: Default), 255 (Strongest)</p> <p>Note: Raising the brightness level may increase moiré</p>

8	Contrast: 1-255
	<p>Sets the overall contrast of images scanned in the Glossy Photo mode.</p> <p>[1 to 255/128/1]</p> <p>1 (Weakest), 128 (Medium: Default), 255 (Strongest)</p> <p>Note: Raising the contrast level may increase moiré</p>
9	Ind Dot Erase: 0(Off) 1-7 (Weak-Strong)
	<p>Sets the level of independent dot erasure to improve the appearance in the backgrounds of images scanned in the Glossy Photo mode.</p> <p>[0 to 7/0/1]</p> <p>0: Default (Off) 1 (Weakest) to 7 (Strongest)</p>

4623	Black Level Ad Value: Current DFU
	<p>This SP displays the current black level offset DAC values of analog IC (LM98714) for CIS 1 to CIS 5. The settings stored in NVRAM can be changed, and the specified value is reflected in the black level offset DAC value of IC (LM98714) for CIS 1.</p> <p>Display format: hexadecimal</p> <p>[0 to 1023/0/520/1]</p>
1	CIS1
2	CIS2
3	CIS3
4	CIS4
5	CIS5

4654	Black Level Adj Value:Previous DFU
	<p>This SP displays the previous black level offset DAC values of analog IC (LM98714) for CIS 1 to CIS 5. The machine will use the adjusted value as the default setting when the machine is powered on.</p> <p>Display format: hexadecimal [0 to 1023/0/520/1]</p>
1	CIS1
2	CIS2
3	CIS3
4	CIS4
5	CIS5

4700	FPGA ID Indication – Volans
	<p>This SP displays an hexadecimal string that displays the ID of the FPGA (Volans) on the SIB.</p>

4709	Gray Balance Adj Value: Current
	<p>These SP codes store and display the RGB values set before and after shipping for each grayscale balance adjustment done for each of the five CIS elements.</p> <p>[-1024 to 1023/0/1]</p> <ul style="list-style-type: none"> ▪ Display format: Hexadecimal ▪ The values are stored after the machine is cycled off/on. ▪ The settings are stored in the RI2005-SIB register
1 to 3	CIS1: G, R, B
4 to 6	CIS2: G, R, B
7 to 9	CIS2: G, R, B
10 to 12	CIS4: G, R, B
13 to15	CIS5: G, R, B

4724	Black Level Data DFU
	Displays the minimum value for black level correction for each CIS unit after black level is adjusted after power on. [0 to 1023/ 0 /1]
1	CIS1
2	CIS2
3	CIS3
4	CIS4
5	CIS5

4732	Gain Adjustment: Current DFU
	Displays the gain value of analog ASIC (LM98714) of each CIS unit after white level is adjusted when the machine is powered on. The peak value for standard white plate reading (the shading data peak value) is set to 880 ±20 digits by white level adjustment. The setting can be written with this SP and the set value is reflected in the analog ASIC (LM98174) of the CIS when an original is scanned. [0 to 255/ 84 /1]
1	CIS1
2	CIS2
3	CIS3
4	CIS4
5	CIS5

4733	LED Adjustment: Current DFU
	<p>The following SP codes displays LAMPR OFF setting of each CIS element analog ASIC (LM98714) after RGB white level adjustment when the machine is powered on.</p> <ul style="list-style-type: none"> ▪ The peak value for standard white plate reading (the shading data peak value) is set to 880 ±20 digits by Red white level adjustment. ▪ The setting can be written with this SP and the set value is reflected in the analog ASIC (LM98174) of the CIS when an original is scanned. <p>[23 to 523/304/1]</p>
1	CIS1 R
2	CIS2 R
3	CIS3 R
4	CIS4 R
5	CIS5 R
6	CIS1 G
7	CIS2 G
8	CIS3 G
9	CIS4 G
10	CIS5 G
11	CIS1 B
12	CIS2 B
13	CIS3 B
14	CIS4 B
15	CIS5 B

4735	White Level Data DFU
	Displays the shading peak data after to confirm the data of the last white level adjustment after white level has been adjusted for RGB for each of the five CIS units. [0 to 1023/0/1]
1	CIS1 B
2	CIS1 R
3	CIS1 G
4	CIS2 B
5	CIS2 R
6	CIS2 G
7	CIS3 B
8	CIS3 R
9	CIS3 G
10	CIS4 B
11	CIS4 R
12	CIS4 G
13	CIS5 B
14	CIS5 R
15	CIS5 G

4745	CIS Auto-Adj Error Flag DFU	
	(15) 0000 0000 0000 0000 (0)	
	White Level	
1	White Level CIS 1	
2	White Level CIS 2	
3	White Level CIS 3	
4	White Level CIS 4	
5	White Level CIS 5	
	<p>Displays AGC adjustment or error flags after white level adjustment of each of the five CIS units after the CIS unit self-adjusts when the machine is powered on.</p> <p>0: Normal 1: Abnormal</p>	
	Bit	(7) 0000 0000 (0)
	7	0
	6	0
	5	Green on-time control abnormal.
	4	0
	3	Red on-time control abnormal.
	2	0
	1	Blue on-time control abnormal
	0	0
	Black Level	
6	Black Level: CIS 1	
7	Black Level: CIS 2	
8	Black Level: CIS 3	

9	Black Level: CIS 4	
10	Black Level: CIS 5	
	<p>Displays AGC adjustment or error flags after black level adjustment of each of the five CIS units after the CIS unit self-adjusts when the machine is powered on.</p> <p>0: Normal 1: Abnormal</p>	
	Bit	(7) 0000 0000 (0)
	7	0
	6	0
	5	0
	4	0
	3	0
	2	0
	1	0
	0	Black level adjustment did not reach target values within 10 attempts.

4750	CIS Output Mode Setting DFU
	<p>This SP sets the CIS output mode.</p> <p>[0 to 6 / 0 / 1]</p> <p>0: Normal output 1: Black shading data output 2: White shading data output 3: Black raw data output 4: White raw data output 5: Raw data output 6: Test pattern output</p>

4751	Scanner Test Pattern Setting DFU	
	This SP sets the mode for the CIS test pattern. [0 to 5 /1/1]	
	0	Black coverage 0x000 fixed
	1	Main Scan 1-Pitch Gradation (1 Step/1 Pixel 0x000 0x001 0x002, 0x3FE 0x3FF 0x000 0x001)
	2	Main Scan 4-Pitch gradation (4-Step/1 pixel 0x000 > 0x004 0x0080x3F8 0x3FC 0x000 0x001
	3	Main Scan 0, 1023 Alternate Pattern 1 (0x000 0x03FF 0x000 0x03FF)
	4	Main Scan 0, 1023 Alternate Pattern 2 (0x000 0x03FF 0x000 0x03FF)
	5	White Coverage 0x3FF Fixed

4762	Gain Adjustment: Previous DFU	
	Displays the gain value of analog ASIC (LM98714) of each CIS unit after white level is adjusted when the machine is powered on. The peak value for standard white plate reading (the shading data peak value) is set to 880±20 digits by white level adjustment.	
	1	CIS 1
	2	CIS 2
	3	CIS 3
	4	CIS 4
	5	CIS 5

4763	LED Adjustment: Previous DFU
	<p>Displays LAMPR OFF setting of the CIS1 analog ASIC (LM98714) after RGB white level adjustment when the machine is powered on. The peak value for standard white plate reading (the shading data peak value) is set to 880 ± 20 digits by Red white level adjustment. The adjusted value is used as the default setting for the white level adjustment done for Red when the machine is powered on.</p> <p>[23 to 523 /304/ 1]</p>
1	CIS 1 R
2	CIS 2 R
3	CIS 3 R
4	CIS 4 R
5	CIS 5 R
6	CIS 1 G
7	CIS 2 G
8	CIS 3 G
9	CIS 4 G
10	CIS 5 G
11	CIS 1 B
12	CIS 2 B
13	CIS 3 B
14	CIS 4 B
15	CIS 5 B

4820	Lamp Defective - Lamp Error Flag	
	Displays lamp error flags for the five CIS components. 0: Normal 1: Abnormal	
	Bit	(7) 0000 0000 (0)
	0	CIS 1 lamp
	1	CIS 2 lamp
	2	CIS 3 lamp
	3	CIS 4 lamp
	4	CIS 5 lamp

4901	Shading Correction DFU	
1	AEREF Correction Setting	
	Displays the AEREF value used to supplement shading processing. [-512 to 511/ 0 /1]	
2	Define Target	
	This SP sets the correction coefficient used to achieve the optimum adjustment for shading correction in scanned images. [0 to 1023/ 800 /1]	
3	Digital AE - AEREF Correction Setting	
	This SP displays and sets the AEF value used to obtain the optimum results for shading correction in scanned images. [-63 to 63/ 25 /1]	
4	Digital AE -Low Limit	
	Provides the boundary values to the digital A/E processing address for the scanned image data [0 to 255/ 82 /1]	

5	Digital AE -Start Position
	Defines the start position for digital A/E processing of the scanned image data. [0 to 25.5/ 3 /0.1]
6	Digital AE -Left Start Position
	This SP sets the start position for digital AE processing for scanned image data in the main scan direction (from the center of the original as a reference point), starting at the left side of the original. [0 to 512/ 60 /0.1]
7	Digital AE – Right Start Position
	This SP sets the start position for digital AE processing for scanned image data in the main scan direction (from the center of the original as a reference point), stopping at the right side of the original. [0 to 512/ 60 /1]
8	Threshold Level
	Sets the target level for shading correction. [0 to 1023/ 360 /1]

4903	Filter Setting
	Use this if density is not equal in shaded areas of the copy. The change from high to low density areas in shaded areas must be smooth. Do these SP adjustments if you see “false outlines” in shaded areas of the copy. <ul style="list-style-type: none"> ▪ To increase the effect, use a higher setting. ▪ To decrease the effect, use a lower setting. ▪ The higher settings can make text look better, but can also decrease the quality of the image.
1	Ind Dot Erase: Text
	Sets the independent dot erase mode for scanning Text Mode. [0 to 7/ 4 /1] 0 (Weakest), 4 (Medium: Default), 7 (Strongest)

2	Ind Dot Erase : Generation Copy
	Sets the independent dot erase mode for scanning Generation Mode. [0 to 7/4/1] 0 (Weakest), 4 (Medium: Default), 7 (Strongest)
3	Ind Dot Erase : Drawing
	Sets the independent dot erase mode for scanning independent dot erase in Line Drawing Mode. [0 to 7/0/1] 0 (Weakest), 4 (Medium: Default), 7 (Strongest)

4918	Man Gamma DFU
	Adjusts the offset data of printer gamma for yellow in Photo mode. Touch [CHANGE] to open the manual adjustment screen.

4961	Document Length Adjustment
1	Input Tolerance: 210mm
	Adjusts the synchro-cut position. [-9.9 to +9.9/0.0/0.1 mm] Use the 210 mm position in the sample to check the difference. This setting is used to calculate the motor clock count for adjusting the difference.
2	Input Tolerance: 1000 mm
	Adjusts the synchro-cut position. [-9.9 to +9.9/0.0/0.1 mm] Use the 1000 mm position in the sample to check the difference. This setting is used to calculate the motor clock count for adjusting the difference.
3	Check Document Length
	Displays the original length in meters.

4965	Scan Speed Adjustment
	Use this SP to eliminate distortion of the image at the four points where the five elements of the staggered CIS elements are joined in the CIS unit.
1	Leading Edge
	<p>The original feed roller tries to adjust for slippage of the feed rollers to allow the machine measure the length of the original accurately.</p> <ul style="list-style-type: none"> ▪ The diameter of the upstream exit roller is very slightly larger than the diameter of the downstream original feed roller. ▪ The scanner motor rotates both rollers at the same speed but the exit roller feeds the original slightly faster. This keeps the original taut in the feed path and prevents original skew. ▪ However, the slightly faster speed of the exit roller could cause the original to feed faster than usual, and cause distortion of the image at the joints of the CIS. ▪ Use this SP to lower the speed of the original feed roller to correct this problem if image distortion at the CIS joints occurs. <p>When to Use This SP</p> <ul style="list-style-type: none"> ▪ Adjust this SP if you see image distortion after replacing the original feed roller or exit roller. ▪ You may also need to adjust this SP if you see image distortion after CIS adjustments with SP4972. <p>[-1 to 0/-0.9/0.1%]</p>
2	Position
	<p>Sets the original position where the motor speed adjustment for SP4965-1 starts.</p> <p>[0 to 200/112/1 mm]</p>
3	Trailing Edge
	<p>Specifies the point 14.5 mm past the original set sensor where the speed of the original exit motor should be adjusted.</p> <p>[-1 to 1/0.3/0.1%]</p>

4966	Scan Speed Adjustment
	This SP sets the speed of the scanner motor when it is tested with SP5804.
	[5 to 170/ 80 /0.1 mm/s]

4972	Scan Correction
	These SP's correct the alignment the image scanned by the CIS.
1	CIS Joint Adjustment CIS1-2 Main Scan
	[0 to 656/ 358 /1]
2	CIS Joint Adjustment CIS2 Main Scan
	[0 to 656/ 423 /1]
3	CIS Joint Adjustment CIS2-3 Main Scan
	[0 to 656/ 424 /1]
4	CIS Joint Adjustment CIS3-4 Main Scan
	[0 to 656/ 425 /1]
5	CIS Joint Adjustment CIS4-5 Main Scan
	[0 to 656/ 426 /1]
6	CIS Joint Adjustment CIS1-2 Sub Scan
	[0 to 2815/ 2480 /1]
7	CIS Joint Adjustment CIS2 Sub Scan
	[0 to 255/ 16 /1]
8	CIS Joint Adjustment CIS2-3 Sub Scan
	[0 to 2815/ 2580 /1]
9	CIS Joint Adjustment CIS3-4 Sub Scan
	[0 to 255/ 104 /1]

10	CIS Joint Adjustment CIS4-5 Sub Scan
	[0 to 2815/ 2572 /1]

4973	Scan Correction – CIS Scan Setting Difference in Grade Adj.
	This SP turns on image adjustment feature that corrects slight misalignment of the image at the joints of the CIS elements.
	[0 to 2/ 2 /1] 0: No adjustment 1: Simple adjustment at joints 2: Gradation adjustment at joint

4975	Prevent Document Fall
	This SP sets the scanner unit to hold the trailing edge of the original if it is longer than 450 mm to prevent it from falling on the floor. Use this setting for long originals fed straight out the back of the machine.
	[0 to 1/ 0 /1] 0: The scanner exit roller does not hold the leading edge 1: The scanner exit roller does not release the trailing edge of the original if it is longer than 450 mm. The original remains in the nip of the exit rollers until it is removed manually.

4979	Scan Correction
1	Color Conversion Parameter CIS1 b1
	[-2048 to 2047/ 0 /1]
2	Color Conversion Parameter CIS1 b11
	[-2048 to 2047/ 1024 /1]
3	Color Conversion Parameter CIS1 b12
	[-2048 to 2047/ 0 /1]

4	Color Conversion Parameter CIS1 b13
	[-2048 to 2047/ 0 /1]
5	Color Conversion Parameter CIS1 b2
	[-2048 to 2047/ 0 /1]
6	Color Conversion Parameter CIS1 b21
	[-2048 to 2047/ 1024 /1]
7	Color Conversion Parameter CIS1 b22
	[-2048 to 2047/ 1024 /1]
8	Color Conversion Parameter CIS1 b23
	[-2048 to 2047/ 0 /1]
9	Color Conversion Parameter CIS1 b3
	[-2048 to 2047/ 0 /1]
10	Color Conversion Parameter CIS1 b31
	[-2048 to 2047/ 0 /1]
11	Color Conversion Parameter CIS1 b32
	[-2048 to 2047/ 0 /1]
12	Color Conversion Parameter CIS1 b33
	[-2048 to 2047/ 1024 /1]
13	Color Conversion Parameter CIS2 b1
	[-2048 to 2047/ 0 /1]
14	Color Conversion Parameter CIS2 b11
	[-2048 to 2047/ 1024 /1]
15	Color Conversion Parameter CIS2 b12
	[-2048 to 2047/ 0 /1]

16	Color Conversion Parameter CIS2 b13
	[-2048 to 2047/ 0 /1]
17	Color Conversion Parameter CIS2 b2
	[-2048 to 2047/ 0 /1]
18	Color Conversion Parameter CIS2 b21
	[-2048 to 2047/ 0 /1]
19	Color Conversion Parameter CIS2 b22
	[-2048 to 2047/ 1024 /1]
20	Color Conversion Parameter CIS2 b23
	[-2048 to 2047/ 0 /1]
21	Color Conversion Parameter CIS2 b3
	[-2048 to 2047/ 0 /1]
22	Color Conversion Parameter CIS2 b31
	[-2048 to 2047/ 0 /1]
23	Color Conversion Parameter CIS2 b32
	[-2048 to 2047/ 0 /1]
24	Color Conversion Parameter CIS2 b33
	[-2048 to 2047/ 1024 /1]
25	Color Conversion Parameter CIS3 b1
	[-2048 to 2047/ 0 /1]
26	Color Conversion Parameter CIS3 b11
	[-2048 to 2047/ 1024 /1]
27	Color Conversion Parameter CIS3 b12
	[-2048 to 2047/ 0 /1]

28	Color Conversion Parameter CIS3 b13
	[-2048 to 2047/ 0 /1]
29	Color Conversion Parameter CIS3 b2
	[-2048 to 2047/ 0 /1]
30	Color Conversion Parameter CIS3 b21
	[-2048 to 2047/ 0 /1]
31	Color Conversion Parameter CIS3 b22
	[-2048 to 2047/ 1024 /1]
32	Color Conversion Parameter CIS3 b23
	[-2048 to 2047/ 0 /1]
33	Color Conversion Parameter CIS3 b3
	[-2048 to 2047/ 0 /1]
34	Color Conversion Parameter CIS3 b31
	[-2048 to 2047/ 0 /1]
35	Color Conversion Parameter CIS3 b32
	[-2048 to 2047/ 0 /1]
36	Color Conversion Parameter CIS3 b33
	[-2048 to 2047/ 1024 /1]
37	Color Conversion Parameter CIS4 b1
	[-2048 to 2047/ 0 /1]
38	Color Conversion Parameter CIS4 b11
	[-2048 to 2047/ 1024 /1]
39	Color Conversion Parameter CIS4 b12
	[-2048 to 2047/ 0 /1]

40	Color Conversion Parameter CIS4 b13
	[-2048 to 2047/ 0 /1]
41	Color Conversion Parameter CIS4 b2
	[-2048 to 2047/ 0 /1]
42	Color Conversion Parameter CIS4 b21
	[-2048 to 2047/ 0 /1]
43	Color Conversion Parameter CIS4 b22
	[-2048 to 2047/ 1024 /1]
44	Color Conversion Parameter CIS4 b23
	[-2048 to 2047/ 0 /1]
45	Color Conversion Parameter CIS4 b3
	[-2048 to 2047/ 0 /1]
46	Color Conversion Parameter CIS4 b31
	[-2048 to 2047/ 0 /1]
47	Color Conversion Parameter CIS4 b32
	[-2048 to 2047/ 0 /1]
48	Color Conversion Parameter CIS4 b33
	[-2048 to 2047/ 1024 /1]
49	Color Conversion Parameter CIS5 b1
	[-2048 to 2047/ 0 /1]
50	Color Conversion Parameter CIS5 b11
	[-2048 to 2047/ 1024 /1]
51	Color Conversion Parameter CIS5 b12
	[-2048 to 2047/ 0 /1]
52	Color Conversion Parameter CIS5 b13

	[-2048 to 2047/ 0 /1]
53	Color Conversion Parameter CIS5 b2
	[-2048 to 2047/ 0 /1]
54	Color Conversion Parameter CIS5 b21
	[-2048 to 2047/ 0 /1]
55	Color Conversion Parameter CIS5 b22
	[-2048 to 2047/ 1024 /1]
56	Color Conversion Parameter CIS5 b23
	[-2048 to 2047/ 0 /1]
57	Color Conversion Parameter CIS5 b3
	[-2048 to 2047/ 0 /1]
58	Color Conversion Parameter CIS5 b31
	[-2048 to 2047/ 0 /1]
59	Color Conversion Parameter CIS5 b32
	[-2048 to 2047/ 0 /1]
60	Color Conversion Parameter CIS5 b33
	[-2048 to 2047/ 1024 /1]

4991	IPU Image Pass Selection - RGB Frame Memory DFU
------	--

4992	Document Feed Speed Adjustment - ON/OFF
	This SP switches on adjustment of the scanner motor to improved the scanning of long originals, or special originals fed with a carrier sheet.
	[0 to 1/ 0 /1]

4993	Document Feed Speed Adjustment DFU
	This SP sets the speed adjustments for scanning long originals, or special originals with a carrier sheet, after SP4992 has been turned on. (See detailed description below for SP4994.) [-10 to 10/ 0 /0.1]
1	Speed 1
2	Speed 2
3	Speed 3
4	Speed 4
5	Speed 5
6	Speed 6
7	Speed 7
8	Speed 8
9	Speed 9
10	Speed 10
11	Speed 11
12	Speed 12
13	Speed 13
14	Speed 14
15	Speed 15

4994	Document Feed Speed Adjustment
1	Position 1
	[0 to 15000/0/1]
2	Position 2
3	Position 3
4	Position 4
5	Position 5
6	Position 6
7	Position 7
8	Position 8
9	Position 9
10	Position 10
11	Position 11
12	Position 12
13	Position 13
14	Position 14
15	Position 15

Detailed Description for SP4993, SP4994

When a long original, or a special original (extremely thin or fragile) with a carrier sheet, is fed into the scanner unit, this creates a load on the scanner when the scanned portion of the original behind the scanner unit starts to sag. This can cause the original to slip in the original feed path and interfere with smooth operation of the scanner motor. To correct this, the scanning speed can be switched at a desired location in order to compensate for slippage of the special originals in the original feed path.

The scanning speed can be switched at designated points:

- Up to 15 switching points can be designated for a long original up to the maximum length of 15,000 mm (15 m or approximately 50 ft.).
- The first starting point (the reference point) is upstream of the CIS.
- The points can be entered with SP codes **SP4993**, **SP4994**, **SP4995**
- The speed of the scanner motor can be set in the range of $\pm 10\%$ where it can be adjusted in fine increments ($\pm 0.1\%$)

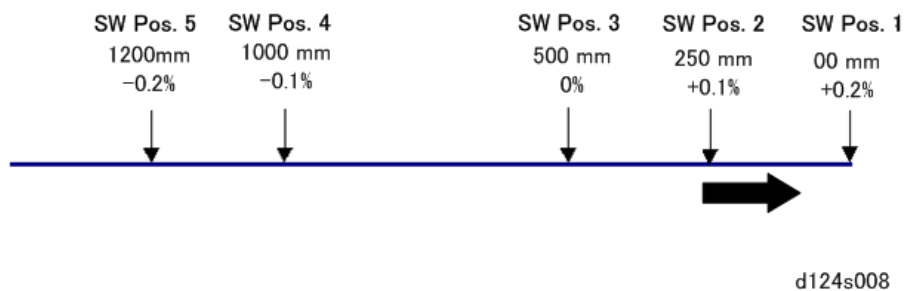

Look at the settings above. Note that as more of the original feeds through the scanner unit, the speed of the scanner motor is decreased slightly.

- If the speed is set at "0" at any point, the speed will be 100% the normal speed of the scanner motor.
- If the image is to be magnified, the speed of the vertical motor is automatically adjusted to account for the changes in scanning speed, so magnification will not be affected.
- The machine can also be set not to release the trailing edge of the original at the end of the scan job. This prevents the original from falling on the floor. The trailing edge is held in the nip of the exit roller until it can be removed manually. This feature can be switched on/off with **SP4975** (Prevent Original Falling).

2.6 SP5000

5024	mm/inch Display Selection
	<p>Selects whether mm or inches are used in the display.</p> <p>Note: After selecting the number, you must turn the main power switch off and on.</p> <p>Europe/Asia model: [0 = mm/1 = inch]</p> <p>American model: [0 = mm/1 = inch]</p>

5045	Accounting Counter	CTL	
	These SP codes setting the method and units for counting.		
1	Counter Method Japan Only		
2	Counter Unit		
	<p>Selects the unit for the counter (m, ft, yards, m², ft², or yd²)</p> <p>[0 to 8/ 5 / 1]</p> <p>0: meters 1: yards 2: feet 3: m² 4: yards² 5: feet² 6: A3 area = 1 unit</p> <p>7: 0.1 meter (key counter only) 8: 0.1 yard (key counter only)</p>		
	0	Meters	
	1	Yards	
	2	Feet	
	3	Meters ²	
	4	Yards ²	
	5	Feet ²	
	6	A3=1	Surface area count
	7	0.1 meters	Only for counting devices by user.
	8	01. yards	



5047	Paper Display
	Switches paper display off/on. [0 to 1/0/1] 0: Disable (no display) 1: Enable (display)

5051	Toner Refill Detection Display Not Used
	This setting disables or enables the toner refill alert on the operation panel.
	[0 to 1/0/1] [0:ON] [1:OFF]

5055	Display IP Address
	Switches the banner display of MFP device display on and off. [0 to 1/0/1] [OFF] [ON]

5062	Part Replacement Alert Display
	This SP determines whether the part replacement alert for the components listed below is displayed on not in a banner on the machine operation panel. [0 to 1/0/1] [0: No display] [1: Display] Note: This display is enabled with SP7624.
1	Maintenance Unit
2	Left Ink Sump
3	Right Ink Sump
9	Print Head Unit: Black
10	Print Head Unit: Color

5066	PM Parts Display
	[*0: No Display] [1: Display]

5067	Part Replacement Operation Type
	[0 to 1/0/1] [0: Service] [1: User]
1	Maintenance Unit
2	Left Ink Sump
3	Right Ink Sump
9	Print Head Unit Black
10	Print Head Unit Color

5071	Set Bypass Paper Size Display
	When this SP is enabled, a pop-up will appear and tell the operator whether the size of the paper in the bypass tray matches the size of the paper selected on the operation panel display. [0 to 1/0/1] 0:Disabled 1:Enabled

5074	Home Screen for User DFU
2	Home Screen Login Setting
	(7) 00000000 (0)
91	Home Key Customize (0:OFF 1:SDK 2:Reserve)
	[0 to 2/0/1]
92	Product ID
	Enter the type of application registered under SP5075-1. This registers the SDK product ID or the legacy ID.
93	Application Screen ID
	Enter the ID to be displayed for SP5075-1, -2 [0 to 255/0/1]

5075	USB Keyboard
	Enables use of an external keyboard equipped with a USB connector. [0 to 1/0/1] 0:Disabled 1:Enabled

5083	LED Light Switch Setting
	[0 to 1/0/1] 0:OFF 1:ON

5112	Non-Std. Paper Sel Not Used
	Determines whether a non-standard paper size can be input for the universal cassette trays (Tray 2, Tray 3) [0 to 1/1/1] 0: No 1: Yes. If "1" is selected, the customer will be able to input a non-standard paper size using the UP mode.

5113	Optional Counter Type
1	Default Optional Counter Type
	Selects the type of counter. [0 to 9/0/1] 0: None 1: Key Card (RK3, 4) 2: Key Card Down 3: Pre-paid Card 4: Coin Rack 5: MF Key Card 8: Key Counter + Vendor 9: Bar Code Printer Note: Items 1, 2, 3, 5, 5 are for Japan Only

	External Optional Counter Type
	<p>Enables the SDK application. This lets you select a number for the external device for user access control.</p> <p>Note: "SDK" refers to software on an SD card.</p> <p>2 [0 to 3/0/1]</p> <ul style="list-style-type: none"> ▪ 0: None ▪ 1: Expansion Device 1 ▪ 2: Expansion Device 2 ▪ 3: Expansion Device 3

5114	Optional Counter I/F
	<p>This SP sets the machine for the MF Key Card Extension.</p> <p>0: OFF, 1: ON</p>

5118	Disable Copying
	<p>Temporarily denies access to the machine. Japan Only</p> <p>[0 to 1/0/1]</p> <p>0: Release for normal operation</p> <p>1: Prohibit access to machine</p>

5120	Mode Clear Opt. Counter Removal
	<p>Do not change. Japan Only</p> <p>[0 to 2/ 0/1]</p> <p>0: Yes. Normal reset</p> <p>1: Standby. Resets before job start/after completion</p> <p>2: No. Normally no reset</p>

5121	Counter Up Timing
	<p>Determines whether the optional key counter counts up at paper feed-in or at paper exit.</p> <p>[0 to 1/1/1]</p> <p>0: Feed count, 1: No feed count</p>

5127	APS OFF Mode
	<p>This SP can be used to switch APS (Auto Paper Select) off when a coin lock or pre-paid key card device is connected to the machine.</p> <p>[0 to 1/0/1]</p> <p>0: On, 1: Off</p>

5128	Code Mode With Key/Card Option Japan Only
------	--

5162	App. Switch Method
	<p>Controls if the application screen is changed with a hardware switch or a software switch.</p> <p>[0: Soft Key Set] [1: Hard Key Set]</p>

5169	CE Login
	<p>If you will change the printer bit switches, you must 'log in' to service mode with this SP before you go into the printer SP mode.</p> <p>[0 to 1/0/1]</p> <p>0: Off. Printer bit switches cannot be adjusted.</p> <p>1: On. Printer bit switches can be adjusted.</p>

5180	Change Count Method Japan Only
------	---------------------------------------

5188	Copy NV Version
	<p>Copies NV version to another NVRAM.</p> <p>Note: NVRAM version management automatically initializes the NV for each machine.</p>

5191	Mode Set
	<p>This setting determines whether the machine is allowed to move into low power mode (energy save).</p> <p>[0 to 1/1/0]</p> <p>1: Allowed 0: Not allowed</p>

5195	Limitless SW Not Used
	<p>Selects the paper feed mode priority (productivity or tray). This is activated only when a customer selects the "Auto paper Select".</p> <ul style="list-style-type: none"> ▪ Productivity priority. Changes the feed station as soon as the machine detects the priority tray even the paper still remains in the current tray. ▪ Tray priority. This changes the feeding tray after the paper in the tray where the machine has been feeding paper has run out of paper. <p>[0 to 1/0/1]</p> <p>0: Productivity priority</p> <p>1: Tray priority</p>

5302	Set Time DFU
	<p>Sets the time clock for the local time. This setting is done at the factory before delivery. The setting is GMT expressed in minutes.</p> <p>[–1440 to 1440/–300/1 min.]</p> <ul style="list-style-type: none"> ▪ JA: +540 (Tokyo) ▪ NA: -300 (NY) ▪ EU: +6- (Paris) ▪ CH: +480 (Peking) ▪ TW: +480 (Taipei) ▪ AS: +480 (Hong Kong)

5305	Auto Off Set
	<p>This SP prevents the user from easily disabling the auto off timer. This is done to conform with international Energy Star standards that specifically state that the user shall not be able to easily switch off the auto off feature.</p> <p>[0 to 1/0/1]</p> <p>0: On (Auto Off cannot be released)</p> <p>1: Off (Auto Off can be released)</p>

5307	Summer Time	
	<p>Lets you set the machine to adjust its date and time automatically with the change to Daylight Savings time in the spring and back to normal time in the fall. This SP lets you set these items:</p> <p>Day and time to go forward automatically in April.</p> <p>Day and time to go back automatically in October.</p> <p>Set the length of time to go forward and back automatically.</p> <p>The settings for 002 and 003 are done with 8-digit numbers:</p>	
	Digits	Meaning
	1st, 2nd	Month. 4: April, 10: October (for months 1 to 9, the first digit of 0 cannot be input, so the eight-digit setting for 002 or 003 becomes a seven-digit setting)
3rd	Day of the week. 0: Sunday, 1: Monday	

	4th	The number of the week for the day selected at the 3rd digit. If "0" is selected for "Sunday", for example, and the selected Sunday is the start of the 2nd week, then input a "2" for this digit.
	5th, 6th	The time when the change occurs (24-hour as hex code). Example: 00:00 (Midnight) = 00, 01:00 (1 a.m.) = 01, and so on.
	7th	The number of hours to change the time. 1 hour: 1
	8th	If the time change is not a whole number (1.5 hours for example), digit 8 should be 3 (30 minutes).
1	Setting	Enables/disables the settings for 002 and 003. [0 to 1/0/1] 0: Disable, 1: Enable
3	Rule Set (Start)	The start of summer time.
4	Rule Set (End)	The end of summer time.

	Access Control DFU	
5401	This SP adjusts the settings below when installing and SDK application. Note: "SDK" is the "Software Development Kit". This data can be converted from SAS (VAS) when installed or uninstalled.	
103	Default Document ACL	
	Used to assign the default access user access privileges to their own documents on the document server.	
104	Authentication Time	
	Standard setting "0" equals 60 sec. [0 to 255/0/1 sec.]	

162	Extend Certification Detail
	Logout without an IC card. [0 to 1/0/1] 0: Not allowed (default) 1: Allowed
200	SDK1 Unique ID
201	SDK1 Certification Method
210	SDK2 Unique ID
211	SDK2 Certification Method
220	SDK3 Unique ID
221	SDK3 Certification Method
230	SDK(Type TF) Unique ID
240	Detail Option

5402	Access Control Not Used
101-170	SDJK1 Limit Settings

5404	User Code Count Clear
	Clears the counts for the user codes assigned by the key operator to restrict the use of the machine. Press [EXECUTE] to clear.

5411	LDAP Certification
4	Simplified Authentication
	Determines whether easy LDAP certification is done. [0 or 1/1/1] 1: On, 0: Off
5	Password Null Not Permit
	Enabled only when SP5411-4 is set to "1" (On). [0 or 1/0/-] 0: Password NULL not permitted. 1: Password NULL permitted.
6	Detail Option
	Pseudonym confirmation
	[0 to 1/0x00/0x01] 0: Off 1:On

5412	Krb Certification
	Kerberos is a computer network authentication protocol which works on the basis of "tickets" to allow nodes communicating over a non-secure network to prove their identity to one another in a secure manner. (7) 00000000 (0)

5413	Lockout Setting
1	Lockout On/Off
	Switches the local address book account lock on/off. [0 or 1/0/-] 0: Off, 1: On
2	Lockout Threshold
	Sets a limit on the frequency of lockouts for account lockouts. [1 to 10/5/1/step]
3	Cancellation On/Off

	<p>Determines whether the system waits the prescribed time for input of a correct user ID and password after an account lockout has occurred.</p> <p>[0 or 1/0-]</p> <p>0: Off (no wait time, lockout not cancelled)</p> <p>1: On (system waits, cancels lockout if correct user ID and password are entered).</p>
4	Cancellation Time
	<p>Determines the length of time that the system waits for correct input of the user ID and password after a lockout has occurred. This setting is used only if SP5413-3 is set to "1" (on).</p> <p>[1 to 999/60/1 min./step]</p>

5414	Access Mitigation
1	Mitigation On/Off
	<p>Switches on/off masking of continuously used IDs and passwords that are identical.</p> <p>[0 or 1/0/1]</p> <p>0: Off, 1: On</p>
2	Mitigation Time
	<p>Sets the length of time for excluding continuous access for identical user IDs and passwords.</p> <p>[0 to 60/15/1 min./step]</p>

5415	Password Attack
1	Permissible Number
	Sets limit on the number of attacks on the system with random passwords to gain illegal access to the system. [0 to 100/ 30 /1 attempt/step]
2	Detect Time
	Sets the time limit to stop a password attack once such an attack has been detected. [1 to 10/ 5 /1 sec./step]

5416	Access Information
1	Access Use Max Num
	Limits the number of users used by the access exclusion and password attack detection functions. [50 to 200/ 200 /1 users/step]
2	Access Password Max Num
	Limits the number of passwords used by the access exclusion and password attack detection functions. [50 to 200/ 200 /1 password/step]
3	Monitor Interval
	Sets the processing time interval for referencing user ID and password information. [1 to 10/ 3 /1 sec./step]

5417	Access Attack
1	Access Permissible Number
	Sets a limit on access attempts when an excessive number of attempts are detected for MFP features. [0 to 500/ 100 /1/step]
2	Attack Detect Time
	Sets the length of time when the frequency of access to MFP features are monitored. [10 to 30/ 10 /1 sec./step]
3	Productivity Fall Wait
	Sets the wait time to slow down the speed of certification when an excessive number of access attempts have been detected. [0 to 9/ 3 /1 sec./step]
4	Attack Max Number
	Sets a limit on the number of requests received for certification in order to slow down the certification speed when an excessive number of access attempts have been detected. [50 to 200/ 200 /1 attempt/step]

5420	User Authentication
	These settings should be done with the System Administrator. Note: These functions are enabled only after the user access feature has been enabled.
1	Copy
	Determines whether certification is required before a user can use the copy applications. [0 or 1/ 0 /1] 0: On, 1: Off
2	Color Security Setting

11	Document Server	
	Determines whether certification is required before a user can use the document server. [0 or 1/ 0 /1] 0: On, 1: Off	
31	Scanner	
	Determines whether certification is required before a user can use the scanner applications. [0 or 1/ 0 /1] 0: On, 1: Off	
41	Printer	
	Determines whether certification is required before a user can use the printer applications. [0 or 1/ 0 /1] 0: On, 1: Off	
51	SDK1	Determines whether certification is required before a user can use the SDK application. [0 or 1/ 0 /1] 0: ON. 1: OFF
61	SDK2	
71	SDK3	
81	Browser	
	Switches browser authentication off and on. [0 to 1/ 0 /1] 0:Authenticate 1:Do not authenticate	

5430	Auth Dialog Message Change
1	Message Change On/Off
2	Message Text Download
3	Message Text ID
	[0 to 1/0/1 0: OFF 1: ON

5431	External Auth User Preset
	Allows or does not allow the copying for each data. [0 or 1/1/1] 0: Not allowed copying, 1: Allowed copying
10	Tag
11	Entry
12	Group
20	Mail
32	Folder
33	ProtectCode
34	SmtpAuth
35	LdapAuth
36	Smb Ftp Fldr Auth
37	AcntAcl
38	Document Acl
40	CertCrypt

5481	Authentication Error Code
	These SP codes determine how the authentication failures are displayed.
1	System Log Disp
	Determines whether an error code appears in the system log after a user authentication failure occurs. [0 or 1/ 0 /1] 0: Off, 1: On
2	Panel Disp
	Determines whether an error code appears on the operation panel after a user authentication failure occurs. [0 or 1/ 1 /1] 0: Off, 1: On

5490	MF Key Card
1	Job Permit Setting
2	Count Mode Setting
	Sets operation of the MF key card. [0 to 1/ 0 /1] 1: Allowed 0: Not allowed 1: Certification executes with a user code (9999 9999). Printing executes and the counter increments for the user code. 0: Certification executes without a user code but printing is cancelled.

5491	Optional Counter Not Used
------	----------------------------------

5501	PM Alarm	CTL
1	PM Alarm Level	
	[0 to 9999/ 0 /1 step] 0: Alarm off 1 to 9999: Alarm goes off when Value (1 to 9999) > PM counter	
2	Original Count Alarm	
	[0 to 1/ 0 /1] 0: No alarm sounds 1: Alarm sounds after the number of originals passing through the ARDF > 10,000	

5504	Jam Alarm Japan Only	
	Sets the alarm to sound for the specified jam level (document misfeeds are not included). RSS use only [0 to 3/ 3 /1 step] 0: Zero (Off) 1: Low (2.5K jams) 2: Medium (3K jams) 3: High (6K jams)	

5505	Error Alarm	
	Sets the error alarm level. Japan only DFU [0 to 255/ 50 /100 copies per step]	

5507	Supply Alarm
1	Power Supply Alarm
3	Toner Supply Alarm
80	Toner Call Timing
97	Interval: 841 mm
98	Interval: 594 mm
99	Interval: 420 mm
100	Interval: 297 mm
101	Interval: 210 mm
106	Interval: 728 mm
107	Interval: 515 mm
109	Interval: 257 mm
128	Interval: Other
132	Interval: A3
133	Interval: A4
141	Interval: B4
160	Interval: DLT
164	Interval: LG
165	Interval: Foolscap
166	Interval: LT
175	Interval: 12x18
225	Interval: 36 inch
227	Interval: 18 inch
226	Interval: 24 inch

228	Interval: 12 inch
229	Interval: 9 inch
234	Interval: 34 inch
235	Interval: 12 inch
236	Interval: 17 inch
237	Interval: 11 inch
238	Interval: 8.5 inch

5508	CC Call Japan Only	
1	Jam Remains	Enables/disables initiating a call. [0 to 1/1] 0: Disabled, 1: Enabled
2	Continuous Jams	
3	Continuous Door Open	
11	Jam Detection: Time Length	
	Sets the length of time to determine the length of an unattended paper jam. [03 to 30/1] This setting is enabled only when SP5508-4 is enabled (set to 1).	
12	Jam Detection Continuous Count	
	Sets the number of continuous paper jams required to initiate a call. [02 to 10/1] This setting is enabled only when SP5508-4 is enabled (set to 1).	
13	Door Open: Time Length	
	Sets the length of time the remains opens to determine when to initiate a call. This setting is enabled only when SP5508-4 is enabled (set to "1"). [03 to 30/1]	

	SC/Alarm Setting
5515	With NRS (New Remote Service) in use, these SP codes can be set to issue an SC call when an SC error occurs. If this SP is switched off, the SC call is not issued when an SC error occurs.
1	SC Call
2	Service Parts Near End Call
3	Service Parts End Call
4	User Call
	[0 to 1/1/1] 0: Off 1: On
6	Communication Test Call
7	Machine Information Notice
8	Alarm Notice
	[0 or 1/1/1] 0: Off 1: On
9	Non-Genuine Toner Alarm
10	Supply Automatic Ordering Call
11	Supply Management Report Call
	[0 to 1/1/1]
12	Jam/Door Open Call
	[0 to 1/1/1]

5516	Individual PM Alarm Call
	<p>This SP determines whether or not PM part alerts are displayed at the @Remote service center. Alerts are issued only for the following PM parts:</p> <ul style="list-style-type: none"> ▪ Maintenance unit ▪ Left ink sump ▪ Right ink sump <p>[0 to 1/0/1] 0:OFF 1:ON</p>
1	Disable/Enable Setting (0: Not Send, 1: Send)
	[0 to 1/0/1]
4	Percent Yield for Triggering PM Alert
	[1 to 255/75/1]

5611	Toner Clear in 2C DFU
1	B-C
2	B-M
3	G-C
4	G-Y
5	R-M
6	R-Y

5618	Color Mode Display Selection
	<p>The color selection key has been moved from a hard key to a soft key.</p> <p>[0 to 1/0/1] 0:EXP 1:DOM</p> <p>0: Presents 5 selections:</p> <ul style="list-style-type: none"> ▪ Auto color select ▪ Full color ▪ B&W ▪ 2-color ▪ Single-color.

5730	Extended Function Setting Not Used
------	---

5731	Counter Effect Not Used
------	--------------------------------

5734	PDF Setting
	<p>This SP limits the types of files that can be used with Scan-to-File, Scan-to-Fax, and Web Download.</p> <p>[0 to 1/0/1] 0:Setting not fixed 1:Setting fixed</p> <ul style="list-style-type: none"> ▪ 0: Allows setting clear write PDF, PDF/A, or encoded PDF on the application screen. ▪ 1: PDF/A can be selected on the application screen, but PDF, Clear Write PDF, or encoded PDF are grayed-out and cannot be selected.

5744	Management DFU
1	ExFile Location Kind
2	Fixed Overwrite Mode
3	Regular Time Import Mode
4	Mail Mode
5	ExFile URL
6	Account Name
7	Password
8	Hour1
9	Minute1
10	Hour2
11	Minute2
12	Retry Times
13	Interval

14	Encrypt Seed
20	Import Test

5747	Browser Setting
201	JPG Quality
202	Extened Memory Limit
203	Browser Setting 1
204	Browser Setting 2
205	Browser Setting 3

⇒ 5749	Import/Export (Refer to Section 2.13 Import/Export for more information)
1	Export
101	Import
251	Export Result Print (SP)
252	Import Result Print (SP)

5801	Memory Clear
	Resets NVRAM data to the default settings. Before executing any of these SP codes, print an SMC Report.
1	All Clear
	Initializes items 2 to 15 below.
2	Engine
	Initializes all registration settings for the engine and copy process settings.
3	SCS
	Initializes default system settings, SCS (System Control Service) settings, operation display coordinates, and ROM update information.

4	IMH Memory Clr
	Clears Image Memory Handler which manages memory and HDD access.
5	MCS
	Initializes the automatic delete time setting for stored documents. (MCS: Memory Control Service)
6	Copier application
	Initializes all copier application settings.
7	Fax application Not Used
	Initializes the fax reset time, job login ID, all TX/RX settings, local storage file numbers, and off-hook timer.
8	Printer application
	Initializes the printer defaults, programs registered, the printer SP bit switches, and the printer CSS counter.
9	Scanner application
	Initializes the defaults for the scanner and all the scanner SP modes.
10	Web Service
	Deletes the Netfile (NFA) management files and thumbnails, and initializes the Job login ID. Netfiles are jobs to be printed from the document server using a PC and the DeskTopBinder software
11	NCS (Network Control Service)
	Initializes the system defaults and interface settings (IP addresses also), the SmartNetMonitor for Admin settings, WebStatusMonitor settings, and the TELNET settings.
12	R-FAX
	Initializes the job login ID, SmartDeviceMonitor for Admin, job history, and local storage file numbers.
14	Clear DCS Setting
	Initializes the DCS (Delivery Control Service) settings.

15	Clear UCS Setting
	Initializes the UCS (User Information Control Service) settings.
16	MIRS Setting
	Initializes the MIRS (Machine Information Report Service) settings.
17	CCS
	Initializes the CCS (Certification and Charge-control Service) settings.
18	SRM Memory Clr
	Initializes the SRM (System Resource Manager) settings.
19	LCS
	Initializes the LCS (Log Count Service) settings.
20	Web Uapl
	Clears Web application utility settings.
21	ECS
	Initializes the ECS settings.
24	Browser
	Initializes browser settings.

5802	Carriage Free Run
11	Release Paper Feed Pressure: Upper
12	Release Paper Feed Pressure: Lower

5803	Input Check
1	Paper Inlet Sensor: Upper
2	Paper Inlet Sensor: Lower
3	Paper Exit Sensor: Upper
4	Paper Exit Sensor: Lower
5	Front Register Sensor
6	By-pass Sensor
7	Output Sensor
10	Paper Feed Pressure Release Sensor: Upper
11	Paper Feed Pressure Release Sensor: Lower
12	Register Pressure Release Sensor: Lower
13	Residual Amount. Sensor Upper
14	Residual Amount. Sensor Lower
15	Residual Qty. Ratio M
16	Residual Qty. Ratio Y
17	Main Scan Encoder Sensor
18	Sub Scan Encoder Sensor
19	Roll End Sensor/Upper
20	Roll End Sensor/Lower
21	Front Cover Pre-Sensor
22	Total Counter
30	Outside Temperature
31	Outside Humidity

41	Head Rising Sensor 1
42	Head Rising Sensor 2
43	Head Temperature Sensor: Color
45	Head Temperature Sensor: Black
48	DRESS Sensor 1
49	DRESS Sensor 2
50	Front Cover Sensor Left
51	Front Cover Sensor Right
52	Cartridge Cover Sensor
53	Roll Paper Cover Sensor
54	Waste Ink Box Cover Sensor
55	Waste Ink Box Setting Sensor
60	Sub Scan HP Sensor
61	Cutter Sensor Right
62	Cutter Sensor Left
70	Maintenance Suction Unit HP Detection Sensor
71	MaintenDehumidify Unit HP Detection Sensor
72	MaintenanceCleaner Slide HP Detection Sensor
91	Ink Cartridge Sensor: Y
92	Ink Cartridge Sensor: M
93	Ink Cartridge Sensor: C
94	Ink Cartridge Sensor: K
150	MainFillerSens Front

151	MainFillerSens Rear
152	OCFS HT1
153	OCFS HT2
154	OCFS HT3
155	OCFS HT4
156	OCFS HT5
157	INKEND SENSOR K
158	INKEND SENSOR C
159	INKEND SENSOR M
160	INKEND SENSOR Y
170	Waste Ink Box
201	Original Width Sensor:A0
202	Original Width Sensor:A1
203	Original Width Sensor:A2
204	Original Width Sensor:A3
205	Original Width Sensor:B1
206	Original Width Sensor:B2
207	Original Width Sensor:B3
208	Original Width Sensor:B4
209	Original Width Sensor:914mm
210	Original Width Sensor:30"
211	Original Set Sensor
212	Original Registration Sensor

213	Original Exit Sensor
214	Original Emergency Stop Sensor
215	Original Feed Unit Open Sensor

5804	Output Check
	Most of these sensors present [OFF] [ON] selections. After pressing the [ON] selection, be sure to press [OFF] to switch the component off.
51	Paper Feed Motor: Upper
52	Paper Feed Motor Speed: Upper
53	Paper Feed Motor: Lower
54	Paper Feed Motor Speed: Lower
55	Paper Feed Clutch: Upper
56	Paper Feed Clutch: Lower
59	Sub Scan Motor
60	Sub Scan Motor Speed
63	Move Cutter Toward Right
64	Move Cutter Toward Left
65	Start Suction Fan
66	Suction Fan Speed
67	Suction Fan Revolution
71	DRESS LED On
110	Air Release Solenoid On/Off
201	Document
211	CIS_LED_R

212	CIS_LED_G
213	CIS_LED_B

5807	Area/Model Selection DFU
	[1 to 7/ 0 /1 Step] 1:Japan 2:NA 3:EU 4:China 5:Taiwan 6:Asia 7:Korea

5811	Machine Serial Number
	Use this SP displays the serial number of the machine and MCU, and displays the ID number of Novita.
1	Set
	Displays the current number. Touch [Soft Key Board] to enter a new number. [0 to 255/ 0 /1]
2	Display
	Displays the current number for Novita. [0 to 255/ 0 /1]

5812	Service Tel. No. Setting
1	Service
	Inputs the telephone number of the CE (displayed when a service call condition occurs.)
2	Facsimile
	Use this to input the fax number of the CE printed on the Counter Report (UP mode).
3	Supply
	Displayed on the initial SP screen.

4	Operation
	Sales representative telephone number.

5816	Remote Service	CTL
	I/F Setting	
1	<p>Selects the remote service setting.</p> <p>[0 to 2/2/1 /step]</p> <p>0: Remote service off</p> <p>1: CSS remote service on</p> <p>2: @Remote service on</p>	
	CE Call	
2	<p>Performs the CE Call at the start or end of the service.</p> <p>[0 or 1/0/1 /step]</p> <p>0: Start of the service</p> <p>1: End of the service</p> <p>NOTE: This SP is activated only when SP 5816-1 is set to "2".</p>	
	Function Flag	
3	<p>Enables or disables the remote service function.</p> <p>[0 to 1/0/1 /step]</p> <p>0: Disabled, 1: Enabled</p> <p>NOTE: This SP setting is changed to "1" after @Remote registor has been completed.</p>	
	SSL Disable	
7	<p>Uses or does not use the RCG certification by SSL when calling the RCG.</p> <p>[0 to 1/0/1 /step]</p> <p>0: Uses the RCG certification</p> <p>1: Does no use the RCG certification</p>	
	RCG Connect Timeout	
8	<p>Specifies the connect timeout interval when calling the RCG.</p> <p>[1 to 90/30/1 second /step]</p>	

	RCG Write Timeout	
9	Specifies the write timeout interval when calling the RCG. [1 to 100/ 60 /1 second /step]	
	RCG Read Timeout	
10	Specifies the read timeout interval when calling the RCG. [1 to 100/ 60 /1 second /step]	
	Port 80 Enable	
11	Enables/disables access via port 80 to the SOAP method. [0 or 1/ 0 /–] 0: Disabled, 1: Enabled	
	RFU (Remote Firmware Update) Timing	
13	Selects the RFU timing. [0 or 1/ 1 /–] <ul style="list-style-type: none"> ▪ 0: RFU is executed whenever update request is received. ▪ 1: RFU is executed only when the machine is in the sleep mode. 	
14	RCG Error Cause	
	Displays the cause of an RCG error. Where Cumin is used, normally displays "0". [0 to 1/ 0 /1] 0:Normal condition 1:Error <ul style="list-style-type: none"> ▪ If "1" is displayed, this means that the authentication from client to server failed when the network re-booted. ▪ To restore normal operation, cycle the machine off/on to return a "0" (normal condition). 	
	RCG – C Registered	
21	This SP displays the Embedded RC Gate installation end flag. 0: Installation not completed 1: Installation completed	

	Connect Type (N/M)	
23	This SP displays and selects the Embedded RC Gate connection method. [0 or 1/0/1 /step 0: Internet connection 1: Dial-up connection	
61	Cert. Expire Timing DFU	
	Proximity of the expiration of the certification.	
62	Use Proxy	
	This SP setting determines if the proxy server is used when the machine communicates with the service center.	
63	Proxy Host	
	This SP sets the address of the proxy server used for communication between Embedded RC Gate-N and the gateway. Use this SP to set up or display the customer proxy server address. The address is necessary to set up Embedded RC Gate-N. Note: The address display is limited to 128 characters. Characters beyond the 128 character are ignored. This address is customer information and is not printed in the SMC report.	
64	Proxy Port Number	
	This SP sets the port number of the proxy server used for communication between Embedded RC Gate-N and the gateway. This setting is necessary to set up Embedded RC Gate-N. Note: This port number is customer information and is not printed in the SMC report.	
65	Proxy User Name	
	This SP sets the HTTP proxy certification user name. Note: The length of the name is limited to 31 characters. Any character beyond the 31st character is ignored. This name is customer information and is not printed in the SMC report.	

66	Proxy Password	
	<p>This SP sets the HTTP proxy certification password.</p> <p>Note: The length of the password is limited to 31 characters. Any character beyond the 31st character is ignored. This name is customer information and is not printed in the SMC report.</p>	
67	CERT: Up State	
	Displays the status of the certification update.	
	0	The certification used by Embedded RC Gate is set correctly.
	1	The certification request (setAuthKey) for update has been received from the GW URL and certification is presently being updated.
	2	The certification update is completed and the GW URL is being notified of the successful update.
	3	The certification update failed, and the GW URL is being notified of the failed update.
	4	The period of the certification has expired and new request for an update is being sent to the GW URL.
	11	A rescue update for certification has been issued and a rescue certification setting is in progress for the rescue GW connection.
	12	The rescue certification setting is completed and the GW URL is being notified of the certification update request.
	13	The notification of the request for certification update has completed successfully, and the system is waiting for the certification update request from the rescue GW URL.
	14	The notification of the certification request has been received from the rescue GW controller, and the certification is being stored.
15	The certification has been stored, and the GW URL is being notified of the successful completion of this event.	
16	The storing of the certification has failed, and the GW URL is being notified of the failure of this event.	

	17	The certification update request has been received from the GW URL, the GW URL was notified of the results of the update after it was completed, but a certification error has been received, and the rescue certification is being recorded.
	18	The rescue certification of No. 17 has been recorded, and the GW URL is being notified of the failure of the certification update.
68	CERT: Error	
	Displays a number code that describes the reason for the request for update of the certification.	
	0	Normal. There is no request for certification update in progress.
	1	Request for certification update in progress. The current certification has expired.
	2	An SSL error notification has been issued. Issued after the certification has expired.
	3	Notification of shift from a common authentication to an individual certification.
	4	Notification of a common certification without ID2.
	5	Notification that no certification was issued.
	6	Notification that GW URL does not exist.
69	CERT: Up ID	
	The ID of the request for certification.	
83	Firmware Up Status	
	Displays the status of the firmware update.	
85	Firm Up Status	
	This SP setting determines if the operator can confirm the previous version of the firmware before the firmware update execution. If the option to confirm the previous version is selected, a notification is sent to the system manager and the firmware update is done with the firmware files from the URL.	

86	Firmware Size	
	Allows the service technician to confirm the size of the firmware data files during the firmware update execution.	
87	CERT: Macro Ver.	
	Displays the macro version of the @Remote certification.	
88	CERT: PAC Ver.	
	Displays the PAC version of the @Remote certification.	
89	CERT: ID2 Code	
	Displays ID2 for the @Remote certification. Spaces are displayed as underscores (_). Asterisks (*) indicate that no @Remote certification exists. "000000_____" indicates "Common certification".	
90	CERT: Subject	
	Displays the common name of the @Remote certification subject. CN = the following 17 bytes. Spaces are displayed as underscores (_). Asterisks (*) indicate that no @Remote certification exists. "000000_____" indicates "Common certification".	
91	CERT: Serial No.	
	Displays serial number for the @Remote certification. Asterisks (*) indicate that no @Remote certification exists.	
92	CERT: Issuer	
	Displays the common name of the issuer of the @Remote certification. CN = the following 30 bytes. Asterisks (*) indicate that no @Remote certification exists.	
93	CERT: Valid Start	
	Displays the start time of the period for which the current @Remote certification is enabled.	

94	CERT: Valid End	
	Displays the end time of the period for which the current @Remote certification is enabled.	
102	CERT: Encrypt Level	
	Displays the strength of encryption used for NRS authentication. The displayed value is not the value acquired from the authentication domain, rather it is the value stored in NVRAM when authentication is written. When NRS starts up, if there is a mismatch between this SP setting and the authentication encryption, then the SP value is updated. [1 to 2/1/1]	
150	Selection Country	
	Not used	
151	Line Type Automatic Judgment	
	Not used	
152	Line Type Judgment Result	
	Not used	
153	Selection Dial/Push	
	Not used	
154	Outside Line/Outgoing Number	
	Not used	
156	Dial Up User Name	
	Not used	
157	Dial Up Password	
	Not used	
161	Local Phone Number	
	Not used	

162	Connection Timing Adjustment: Incoming	
	Not used	
163	Access Point	
	Not used	
164	Line Connecting	
	Not used	
173	Modem Serial Number	
	Not used	
174	Retransmission Limit	
	Not used	
187	FAX TX Priorit	
	Not used	
200	Manual Polling	
	Not used	
201	Regist: Status	
	<p>Displays a number that indicates the status of the @Remote service device.</p> <ul style="list-style-type: none"> ▪ 0: Neither the @Remote device nor Embedded RCG Gate is set. ▪ 1: The Embedded RCG Gate is being set. Only Box registration is completed. In this status, @Remote device cannot communicate with this device. ▪ 2: The Embedded RCG Gate is set. In this status, the @Remote device cannot communicate with this device. ▪ 3: The @Remote device is being set. In this status the Embedded RCG Gate cannot be set. ▪ 4: The @Remote module has not started. 	
202	Letter Number	
	Allows entry of the request number needed for the Embedded RCG Gate.	

203	Confirm Execute	
	Executes the confirmation request to the @Remote Gateway.	
204	Confirm Result	
	Displays a number that indicates the result of the confirmation executed with SP5816-203. 0: Succeeded 1: Confirmation number error 2: Registration in progress 3: Proxy error (proxy enabled) 4: Proxy error (proxy disabled) 5: Proxy error (Illegal user name or password) 6: Communication error 7: Certification update error 8: Other error 9: Confirmation executing	
	Confirm Place	
205	Displays the result of the notification sent to the device from the Gateway in answer to the confirmation request. Displayed only when the result is registered at the Gateway.	
206	Register Execute	
	Executes "Embedded RCG Registration".	
	Register Result	
207	Displays a number that indicates the registration result. 0: Succeeded 2: Registration in progress 3: Proxy error (proxy enabled) 4: Proxy error (proxy disabled) 5: Proxy error (Illegal user name or password) 6: Communication error 7: Certification update error 8: Other error 9: Registration executing	

208	Error Code		
	Displays a number that describes the error code that was issued when either SP5816-204 or SP5816-207 was executed.		
	Cause	Code	Meaning
	Illegal Modem Parameter	-11001	Chat parameter error
		-11002	Chat execution error
-11003		Unexpected error	
Operation Error, Incorrect Setting	-12002	Inquiry, registration attempted without acquiring device status.	
	-12003	Attempted registration without execution of an inquiry and no previous registration.	
	-12004	Attempted setting with illegal entries for certification and ID2.	
-	-12005	@Remote communication is prohibited. The device has an Embedded RC gate-related problem.	
	-12006	A confirmation request was made after the confirmation had been already completed.	
	-12007	The request number used at registration was different from the one used at confirmation.	
	-12008	Update certification failed because mainframe was in use.	
Error Caused by Response from GW URL	-2385	Attempted dial up overseas without the correct international prefix for the telephone number.	
	-2387	Not supported at the Service Center	
	-2389	Database out of service	

		-2390	Program out of service
		-2391	Two registrations for same device
		-2392	Parameter error
		-2393	RCG device not managed
		-2394	Device not managed
		-2395	Box ID for RCG device is illegal
		-2396	Device ID for RCG device is illegal
		-2397	Incorrect ID2 format
		-2398	Incorrect request number format
209	Instl Clear		
	Releases the setting on a machine that has been set for use with Cumin.		
250	CommLog Print	Prints the communication log.	

5821	Remote Service Address	CTL
2	RCG IP Address	
	Sets the IP address of the RCG (Remote Communication Gate) destination for call processing at the remote service center.	
3	RCG Port	
	Sets the RCG port number of the destination for processing calls to the @Remote service center. [0 to 65 535/443/1]	
4	RCG URL Path	
	Sets the URL path of the destination for processing calls to the @Remote service center. 17 Numeric characters allowed (0 to 17)	

5824	NVRAM Data Upload
	Touch [EXECUTE] to upload the UP and SP mode data (except for counters and the serial number) from NVRAM on the control board to an SD card. Note: While using this SP mode, always keep the front cover open. This prevents a software module accessing the NVRAM during the upload.

5825	NVRAM Data Download
	Touch [EXECUTE] to download data from an SD card to the NVRAM in the machine. After downloading is completed, remove the SD card and turn the machine power off and on.

5828	Network Setting	CTL
50	1284 Compatibility (Centro)	
	Enables or disables 1284 Compatibility. [0 or 1/1/1/step] 0: Disabled, 1: Enabled	
52	ECP (Centro)	
	Enables or disables ECP Compatibility. [0 or 1/1/1/step] 0: Disabled, 1: Enabled Note: This SP is activated only when SP5-828-50 is set to "1".	
65	Job Spooling	
	Enables/disables Job Spooling. [0 or 1/0/1/step] 0: Disabled, 1: Enabled	
66	Job Spooling Clear: Start Time	
	Treatment of the job when a spooled job exists at power on. 0: ON (Data is cleared) 1: OFF (Automatically printed)	

69	Job Spooling (Protocol)
	<p>Validates or invalidates the job spooling function for each protocol.</p> <p>0: Validates 1: Invalidates</p> <p>bit0: LPR bit1: FTP bit2: IPP bit3: SMB bit4: BMLinkS bit5: DIPRINT bit6: sftp bit7: (Reserved)</p>
87	@Remote Protocol Cnt
90	TELNET (0: OFF 1: ON)
	<p>Enables or disables the Telnet protocol.</p> <p>[0 or 1/1-] 0: Disable, 1: Enable</p>
91	Web (0: OFF 1: ON)
	<p>Enables or disables the Web operation.</p> <p>[0 or 1/1-] 0: Disable, 1: Enable</p>
145	Active IPv6 Link Local Address
	<p>This is the IPv6 local address link referenced on the Ethernet or wireless LAN (802.11b) in the format: "Link Local Address" + "Prefix Length"</p> <p>The IPv6 address consists of a total 128 bits configured in 8 blocks of 16 bits each.</p>
147	Active IPv6 Stateless Address 1
149	Active IPv6 Stateless Address 2
151	Active IPv6 Stateless Address 3

153	Active IPv6 Stateless Address 4
155	Active IPv6 Stateless Address 5
	<p>SP codes 147 to 155 are the IPv6 status addresses (1 to 5) referenced on the Ethernet or wireless LAN (802.11b) in the format: "Status Address" + "Prefix Length" The IPv6 address consists of a total 128 bits configured in 8 blocks of 16 bits each.</p>
156	IPv6 Manual Address
	<p>This SP is the IPv6 manually set address referenced on the Ethernet or wireless LAN (802.11b) in the format: "Manual Set Address" + "Prefix Length" The IPv6 address consists of a total 128 bits configured in 8 blocks of 16 bits each.</p>
158	IPv6 Gateway Address
	<p>This SP is the IPv6 gateway address referenced on the Ethernet or wireless LAN (802.11b). The IPv6 address consists of a total 128 bits configured in 8 blocks of 16 bits each.</p>
161	IPv6 Stateless Auto Setting
	<p>Enables or disables the automatic setting for IPv6 stateless. [0 or 1/1/1 /step] 0: Disable, 1: Enable</p>
236	Web Item Visible
	<p>Displays or does not display the Web system items. [0 x 0000 to 0 x ffff/0 x ffff] 0: Not displayed, 1: Displayed</p> <ul style="list-style-type: none"> ▪ bit0: Net RICOH ▪ bit1: Consumable Supplier ▪ bit2-15: Reserved (all)

237	Web shopping Link Visible	
	Displays or does not display the link to Net RICOH on the top page and link page of the web system. [0 to 1/1/1] 0: Not display, 1:Display	
238	Web Supplies Link visible	
	Displays or does not display the link to Consumable Supplier on the top page and link page of the web system. [0 to 1/1/1] 0: Not display, 1:Display	
239	Web Link 1 Name	
	This SP confirms or changes the URL1 name on the link page of the web system. The maximum characters for the URL name are 31 characters.	
240	Web Link 1 URL	
	This SP confirms or changes the link to URL1 on the link page of the web system. The maximum characters for the URL are 127 characters.	
241	Web Link 1 visible	
	Displays or does not display the link to URL1 on the top page of the web system. [0 to 1/1/1] 0: Not display, 1:Display	
242	Web Link 2 Name	Same as "-239"
243	Web Link 2 URL	Same as "-240"
244	Web Link 2 visible	Same as "-241"
249	DHCPv6 DUID	

5832	HDD
	Enter the SP number for the partition to initialize, then press #. When the execution ends, cycle the machine power off and on.
1	HDD Formatting (All)
2	HDD Formatting (IMH)
3	HDD Formatting (Thumbnail)
4	HDD Formatting (Job Log)
5	HDD Formatting (Printer Fonts)
6	HDD Formatting (User Info)
7	Mail RX Data
8	Mail TX Data
9	HDD Formatting (Data for Design)
10	HDD Formatting (Log)
11	HDD Formatting (Ridoc I/F) (for Ridoc Desk Top Binder)

5840	IEEE 802.11
6	Channel MAX
	Sets the maximum range of the bandwidth for the wireless LAN. This bandwidth setting varies for different countries. [1 to 14/1]
7	Channel MIN
	Sets the minimum range of the bandwidth for operation of the wireless LAN. This bandwidth setting varies for different countries. [1 to 14/1]
8	Transmission Speed
	Sets transmission speed. Displayed only for machines where the wireless LAN is installed.

	WEP Key Select
11	<p>Determines how the initiator (SBP-2) handles subsequent login requests. [0 to 1/1]</p> <p>0: If the initiator receives another login request while logging in, the request is refused.</p> <p>1: If the initiator receives another login request while logging in, the request is refused and the initiator logs out.</p> <p>Note: Displayed only when the wireless LAN card is installed.</p>
	Fragment Thresh
42	<p>Adjusts the fragment threshold for the IEEE802.11 card. [256 to 2346/2346/1]</p> <p>This SP is displayed only when the IEEE802.11 card is installed.</p>
	11g CTS to Self
43	<p>Determines whether the CTS self function is turned on or off. [0 to 1/1/1] 0: Off, 1: On</p> <p>This SP is displayed only when the IEEE802.11 card is installed.</p>
44	11g Start Time
	<p>Selects the slot time for IEEE802.11. [0 to 1/0/1] 0: 20 mm, 1: 9 mm</p>
	WPA Debug Lv1
45	<p>Selects the debug level for WPA authentication application. [1 to 3/3/1] 1: Info, 2: warning, 3: error</p> <p>This SP is displayed only when the IEEE802.11 card is installed.</p>

5841	Supply Name Setting
	Press the [User Tools] key. These names appear when the user presses the Inquiry button on the User Tools screen.
1	Toner Name Setting: Black
2	Toner Name Setting: Cyan
3	Toner Name Setting: Yellow
4	Toner Name Setting: Magenta

5842	GWS Analysis Setting DFU
	This settings select the output mode for debugging information as each network file is processed.
1	Setting 1
	Default: 00000000 Do not change Netfiles: Jobs to be printed from the document server using a PC and the DeskTopBinder software
2	Setting 2
	Adjusts the debug program modesetting. Bit7: 5682 mmseg-log setting 0: Date/Hour/Minute/Second 1: Minute/Second/Msec. 0 to 6: Not used

5844	USB
	Transfer Rate
1	Sets the speed for USB data transmission. [Full Speed] [Auto Change]
	Vendor ID
2	Sets the vendor ID: Initial Setting: 0x05A Ricoh Company [0x0000 to 0xFFFF/1] DFU
	Product ID
3	Sets the product ID. [0x0000 to 0xFFFF/1] DFU
	Device Release No.
4	Sets the device release number of the BCD (binary coded decimal) display. [0000 to 9999/1] Enter as a decimal number. NCS converts the number to hexadecimal number recognized as the BCD.
5	Fixed USB Port
	Selects the PnP name standardization mode. [0 to 2/0/1/step] 0: Disable 1: Level 1 2: Level 2
6	PnP Model Name
	Specifies PnP name for USB device.
7	PnP Serial Number
	Specifies PnP serial number for USB device.

100	Notify Unsupport
	Displays or does not display USB unsupport message. [0 or 1/1/1] 0: Not displayed,

5845	Delivery Server Setting	CTL
	Provides items for delivery server settings.	
1	FTP Port No.	
	Sets the FTP port number used when image files to the Scan Router Server. [0 to 65535/3670/1 /step]	
2	IP Address (Primary)	
	Use this SP to set the Scan Router Server address. The IP address under the transfer tab can be referenced by the initial system setting. Range: 000.000.000.000 to 255.255.255.255	
6	Delivery Error Display Time	
	Use this setting to determine the length of time the prompt message is displayed when a test error occurs during document transfer with the NetFile application and an external device. [0 to 999/300/1 second /step]	
8	IP Address (Secondary)	
	Specifies the IP address assigned to the computer designated to function as the secondary delivery server of Scan Router. This SP allows only the setting of the IP address without reference to the DNS setting. Range: 000.000.000.000 to 255.255.255.255	

9	Delivery Server Model	
	<p>Allows changing the model of the delivery server registered by the I/O device. [0 to 4/ 0/1 /step]</p> <p>0: Unknown 1: SG1 Provided 2: SG1 Package 3: SG2 Provided 4: SG2 Package</p>	
10	Delivery Svr Capability	
	<p>Changes the capability of the registered that the I/O device registered. [0 to 255/0/1 /step]</p>	
	Bit7 = 1 Comment information exists	
	Bit6 = 1 Direct specification of mail address possible	
	Bit5 = 1 Mail RX confirmation setting possible	
	Bit4 = 1 Address book automatic update function exists	
	Bit3 = 1 Fax RX delivery function exists	
	Bit2 = 1 Sender password function exists	
	Bit1 = 1 Function to link MK-1 user and Sender exists	
	Bit0 = 1 Sender specification required (if set to 1, Bit6 is set to "0")	
11	Delivery Svr Capability (Ext)	
	<p>Changes the capability of the registered that the I/O device registered. [0 to 255/0/1 /step]</p> <p>Bit7 = 1 Address book usage limitation (Limitation for each authorized user) Bit6 = 1 RDH authorization link Bit5 to 0: Not used</p>	
13	Server Scheme (Primary) DFU	
	This is used for the scan router program.	

14	Server Port Number (Primary) DFU
	This is used for the scan router program.
15	Server URL Path (Primary) DFU
	This is used for the scan router program.
16	Server Scheme (Secondary) DFU
	This is used for the scan router program.
17	Server Port Number (Secondary) DFU
	This is used for the scan router program.
18	Server URL Path (Secondary) DFU
	This is used for the scan router program.
22	Rapid Sending Control
	Enables or disables the prevention function for the continuous data sending error. [0 to 1/0/1] 0: Disable, 1: Enable

5846	UCS Settings	CTL
1	Machine ID (For Delivery Server)	
	Displays the unique device ID in use by the delivery server directory. The value is only displayed and cannot be changed. This ID is created from the NIC MAC or IEEE 1394 EUI. The ID is displayed as either 6-byte or 8-byte binary.	
2	Machine ID Clear (For Delivery Server)	
	Clears the unique ID of the device used as the name in the file transfer directory. Execute this SP if the connection of the device to the delivery server is unstable. After clearing the ID, the ID will be established again automatically by cycling the machine off and on.	

	Maximum Entries
3	Changes the maximum number of entries that UCS can handle. If a value smaller than the present value is set, the UCS managed data is cleared, and the data (excluding user code information) is displayed. [2000 to 20000/ 2000 /1 /step]
	Delivery Server Retry Timer
6	Sets the interval for retry attempts when the delivery server fails to acquire the delivery server address book. [0 to 255/ 0 /1 /step]
	Delivery Server Retry Times
7	Sets the number of retry attempts when the delivery server fails to acquire the delivery server address book. [0 to 255/ 0 /1 /step]
	Delivery Server Maximum Entries
8	Sets the maximum number account entries of the delivery server user information managed by UCS. [2000 to 50000/ 2000 /1/step]
	LDAP Search Timeout
10	Sets the length of the timeout for the search of the LDAP server. [1 to 255/ 60 /1 /step]
20	WSD Maximum Entries
21	Fold Auth Change
40	Addr Book Migration (SD -> HDD) Not Used

41	Fill Addr Acl Info.
	<p>This SP must be executed immediately after installation of an HDD unit in a basic machine that previously had no HDD. The first time the machine is powered on with the new HDD installed, the system automatically takes the address book from the NVRAM and writes it onto the new HDD. However, the new address book on the HDD can be accessed only by the system administrator at this stage. Executing this SP by the service technician immediately after power on grants full address book access to all users.</p> <p>Procedure</p> <ol style="list-style-type: none"> 1. Turn the machine off. 2. Install a new HDD. 3. Turn the machine on. 4. The address book and its initial data are created on the HDD automatically. However, at this point the address book can be accessed by only the system administrator or key operator. 6. Enter the SP mode and do SP5846-041. After this SP executes successfully, any user can access the address book.
43	Addr Book Media
	<p>Displays the slot number where an address book data is in. [0 to 30/- /1]</p> <ul style="list-style-type: none"> ▪ 0: Unconfirmed ▪ 1: SD Slot 1 ▪ 2: SD Slot 2 ▪ 4: USB Flash ROM ▪ 20: HDD ▪ 30: Nothing
47	Initialize Local Addr Book
	Clears the local address book information, including the user code.
48	Initialize Delivery Addr Book
	Clears the distribution address book information, except the user code.
49	Initialize LDAP Addr Book
	Clears the LDAP address book information, except the user code.

50	Initialize All Addr Book
	Clears all directory information managed by UCS, including all user codes.
51	Backup All Addr Book
	Uploads all directory information to the SD card.
52	Restore All Addr Book
	Downloads all directory information from the SD card.
53	Clear Backup Info
	<p>Deletes the address book data from the SD card in the service slot. Deletes only the files that were uploaded from this machine. This feature does not work if the card is write-protected. Note: After you do this SP, go out of the SP mode, and then turn the power off. Do not remove the SD card until the Power LED stops flashing.</p>
60	Search Option
	<p>This SP uses bit switches to set up the fuzzy search options for the UCS local address book.</p> <p>Bit: Meaning</p> <p>0: Checks both upper/lower case characters</p> <p>1: Japan Only</p> <p>2: Japan Only</p> <p>3: Japan Only</p> <p>4 to 7: Not Used</p>
62	Complexity Option 1
	<p>Use this SP to set the conditions for password entry to access the local address book. Specifically, this SP limits the password entry to upper case and sets the length of the password.</p> <p>[0 to 32/0/1 /step]</p> <p>Note: This SP does not normally require adjustment.</p> <p>This SP is enabled only after the system administrator has set up a group password policy to control access to the address book.</p>
63	Complexity Option 2 DFU

64	Complexity Option 3 DFU
65	Complexity Option 4 DFU
91	FTP Auth Port Setting
	Specifies the FTP port for getting a distribution server address book that is used in the identification mode. [0 to 65535/ 3671 /1 /step]
	Encryption Stat
94	Shows the status of the encryption function for the address book data.

	Rep Resolution Reduction
5847	5847-002 through 5847-006 changes the default settings of image data sent externally by the Net File page reference function. [0 to 2/1] 5847 21 sets the default for JPEG image quality of image files controlled by NetFile. "Repository" refers to jobs to be printed from the document server with a PC and the DeskTopBinder software.
2	Rate for Copy B&W Text
3	Rate for Copy B&W Other
5	Rate for Printer B&W

	Web Service
5848	5847 2 sets the 4-bit switch assignment for the access control setting. Setting of 0001 has no effect on access and delivery from Scan Router. 5847 100 sets the maximum size of images that can be downloaded. The default is equal to 1 gigabyte.
2	Acc. Ctrl.: Repository (only Lower 4 Bits)
	0000: No access control 0001: Denies access to DeskTop Binder.

3	Acc. Ctrl.: Doc. Svr. Print (Lower 4 Bits)
	Switches access control on/off. 0000: OFF, 0001: ON
4	Acc. Ctrl.: User Directory (Lower 4 Bits)
	Switches access control on/off. 0000: OFF, 0001: ON
7	Access Ctrl: Comm. Log Fax (Lower 4bits)
	Switches access control on/off. 0000: OFF, 0001: ON
9	Acc. Ctrl.: Job Control (Lower 4 Bits)
	Switches access control on/off. 0000: OFF, 0001: ON
11	Acc. Ctrl: Device Management (Lower 4 Bits)
	Switches access control on/off. 0000: OFF, 0001: ON
21	Acc. Ctrl: Delivery (Lower 4 Bits)
	Switches access control on/off. 0000: OFF, 0001: ON
22	Acc. Ctrl: User Administration (Lower 4 Bits)
	Switches access control on/off. 0000: OFF, 0001: ON
99	Repository: Download Image Setting
100	Repository: Download Image Max. Size
	[1 to 1024/1 K]
210	Setting: Log Type: Job 1
	Switches access control on/off. 0000: OFF, 0001: ON

211	Setting: Log Type: Job 2
	Switches access control on/off. 0000: OFF, 0001: ON
212	Setting: LogType Access
	Switches access control on/off. 0000: OFF, 0001: ON
213	Setting: Primary Srv DFU
214	Setting: Secondary Srv
	Specifies the maximum size of the image data that the machine can download. [1 to 1024/ 1024 /1 MB /step]
215	Setting: Start Time
216	Setting: Interval Time
217	Setting: Timing

5849	Installation Date
	Displays or prints the installation date of the machine.
1	Display
	The "Counter Clear Day" has been changed to "Installation Date" or "Inst. Date".
2	Switch to Print
	Determines whether the installation date is printed on the printout for the total counter. [0 to 1/ 0 /1] 0: No Print, 1: Print

3	Total Counter
	Displays the total count from the day set with SP5849-001. [0 to 9999 9999]

5851	Bluetooth Mode
	Sets the operation mode for the Bluetooth unit. Press either key. [0: Public] [1: Private]

5853	Stamp Data Download
	<p>Push [Execute] to download the fixed stamp data from the machine ROM onto the hard disk.</p> <ul style="list-style-type: none"> ▪ After downloading these stamps can be used by the system. If this is not done, the user will not have access to the fixed stamps ("Confidential", "Secret", etc.). ▪ You must always execute this SP after replacing the HDD or after formatting the HDD. Always switch the machine off and on after executing this SP.

5856	Remote ROM Update
	<p>When set to "1" allows reception of firmware data via the local port (IEEE 1284) during a remote ROM update. This setting is reset to zero after the machine is cycled off and on. Allows the technician to upgrade the firmware using a parallel cable.</p> <p>[0 to 1/0/1] 0: Not allowed, 1: Allowed</p>

5857	Save Debug Log	CTL
	On/Off (1:ON 0:OFF)	
1	Switches the debug log feature on and off. The debug log cannot be captured until this feature is switched on. 0: OFF, 1: ON	
	Target (2: HDD 3: SD)	
2	Selects the storage device to save debug logs information when the conditions set with SP5-858 are satisfied. [2 to 3/2/1 /step] 2: HDD, 3: SD Card	
	Save to HDD	
5	Saves the debug log of the input SC number in memory to the HDD. A unique file name is generated to avoid overwriting existing file names on the SD Card. Up to 4MB can be copied to an SD Card. 4 MB segments can be copied one by one to each SD Card.	
	Save to SD Card	
6	Saves the debug log of the input SC number in memory to the SD card.	
9	Copy HDD to SD Card (Latest 4 MB)	
10	Copy HDD to SD Card (Latest 4 MB Any Key)	
11	Erase HDD Debug Data	
12	Erase SD Card Debug Data	
13	Free Space on SD Card	
14	Copy SD to SD (Latest 4 MB)	
15	Copy SD to SD (Latest 4 MB Any Key)	
16	Make HDD Debug	
17	Make SD Debug	

5858	Debug Save When	
	These SPs select the content of the debugging information to be saved to the destination selected by SP5857-002. SP5858-003 stores one SC specified by number.	
1	Engine SC Error (0:OFF 1:ON)	
	Stores SC codes generated by copier engine errors.	
2	Controller SC Error (0:OFF 1:ON)	
	Stores SC codes generated by GW controller errors.	
3	Any SC Error (0:OFF 1:ON)	
	[0 to 65535/0/1]	
4	Jam (0:OFF 1:ON)	
	Stores jam errors.	

5859	Debug Save Key No.	
1	Key 1	These SPs allow you to set up to 10 keys for log files for functions that use common memory on the controller board. [-9999999 to 9999999/1]
2	Key 2	
3	Key 3	
4	Key 4	
5	Key 5	
6	Key 6	
7	Key 7	
8	Key 8	
9	Key 9	
10	Key 10	

5860	SMTP/POP3/IMAP4
	Partial Mail Receive Timeout
20	<p>[1 to 168/72/1]</p> <p>Sets the amount of time to wait before saving a mail that breaks up during reception. The received mail is discarded if the remaining portion of the mail is not received during this prescribed time.</p>
	MDN Response RFC2298Compliance
21	<p>Determines whether RFC2298compliance is switched on for MDN reply mail.</p> <p>[0 to 1/1]</p> <p>0: No, 1: Yes</p>
	SMTP Auth. From Field Replacement
22	<p>Determines whether the FROM item of the mail header is switched to the validated account after the SMTP server is validated.</p> <p>[0 to 1/1]</p> <p>0: No. "From" item not switched.</p> <p>1: Yes. "From" item switched.</p>
	SMTP Auth Direct Sending
25	<p>Occasionally, all SMTP certifications may fail with SP5860 006 set to "2" to enable encryption during SMTP certification for the SMTP server. This can occur if the SMTP server does not meet RFC standards. In such cases you can use this SP to set the SMTP certification method directly. However, this SP can be used only after SP5860 003 has been set to "1" (On).</p> <p>Bit0: LOGIN</p> <p>Bit1: PLAIN</p> <p>Bit2: CRAM_MD5</p> <p>Bit3: DIGEST_MD5</p> <p>Bit4 to Bit 7: Not Used</p>

	S/MIME: MIME Header Settings
26	Selects the MIME header type of an e-mail sent by S/MIME. [0 to 2/0/1] 0: Microsoft Outlook Express standard 1: Internet Draft standard 2: RFC standard
	S/MIME: Authentication Check
28	Determines whether the destination is authenticated for sending S/MIME mail. [0 to 1/0/1] 0: No Checking 1: Checking

5866	E-Mail Report
	This SP controls operation of the email notification function.
1	Report Validity
	Enables or disables the e-mail notification to @Remote. [0 or 1/0/1] 0: Enable, 1: Disable
5	Add Date Field
	Disables and re-enables the addition of a date field to the email notification. [0 to 1/0/1]

5870	Common Key Info Writing Not Used
	Writes to flash ROM the common proof for validating the device for NRS specifications.
1	Writing
3	Initialize
	<p>Initializes the set certification.</p> <p>When the GW controller board is replaced with a new one for repair, you must execute the "Inititalize (-003)" and "Writing (-001)" just after the new board replacement.</p> <p>NOTE: Turn off and on the main power switch after the "Inititalize (-003)" and "Writing (-001)" have been done.</p>
4	Common KeyInfo Writing (2048 bit)
	Writes the authentication data used for @Remote into the flash ROM.

5873	SD Card Appli Move
	Allows you to move applications from one SD card another.
1	Move Exec
	Executes the move from one SD card to another.
2	Undo Exec
	This is an undo function. It cancels the previous execution.

5875	SC Auto Reboot
	<p>This SP determines whether the machine reboots automatically when an SC error occurs.</p> <p>Note: The reboot does not occur for Type A and C SC codes.</p>
1	Reboot Setting
	<p>[0 to 1/0/1]</p> <p>0: On, 1: Off</p> <p>On: default: 0 (Reboots automatically) The machine reboots automatically when the machine issues an SC error and logs the SC error code. If the same SC occurs again, the machine does not reboot.</p> <p>OFF: 1 (Does not reboot automatically. Changing this setting to "0" sets the machine to reboot automatically after an SC occurs.</p>
2	Reboot Type
	<p>This setting determines how the machine reboots after an SC code is issued.</p> <p>[0 to 1/0/1]</p> <p>0: Allows manual reboot, 1: Automatic reboot</p>

5878	Option Setup
	<p>This SP enables the built-in DOS application feature (Data Overwrite Security).</p>
1	Data Overwrite Security
	<p>Enables the Data Overwrite Security unit. Touch [EXECUTE] on the operation panel. Then cycle the machine off/on.</p>
2	HDD Encryption
	<p>Enables the built-in Copy Data Security feature. Touch [EXECUTE] on the operation panel. Then cycle the machine off/on.</p>

5881	Fixed Phase Block Erasing
	Touch [EXECUTE] on the operation panel. Then erase all the fixed phase block.

5884	Factory Setting
1	Restore
2	Backup
3	Head Gap Backup

5885	Set WIM Function DFU	
20	Doc Svr Acc Ctrl	
	Bit	Meaning
	0	Forbid all document server access (1)
	1	Forbid user mode access (1)
	2	Forbid print function (1)
	3	Forbid fax TX (1)
	4	Forbid scan sending (1)
	5	Forbid downloading (1)
	6	Forbid delete (1)
7	Reserved	
50	Doc Svr Format	
51	Doc Svr Trans	
100	Set Signature	

101	Set Encryption
	<p>Determines whether the scanned documents with the WIM are encrypted when they are transmitted by an e-mail.</p> <p>[0 or 1/0/-]</p> <p>0: Not encrypted, 1: Encrypted</p>
200	Detect Memory Leak
201	Doc Server Timeout

5887	SD Get Counter	CTL
	This SP determines whether the ROM can be updated.	
	<p>This SP sends a text file to an SD card inserted in SD card Slot 2 (lower slot). The operation stores. The file is stored in a folder created in the root directory of the SD card called SD_COUNTER. The file is saved as a text file (*.txt) prefixed with the number of the machine.</p> <ol style="list-style-type: none"> 1. Insert the SD card in SD card Slot 2 (lower slot). 2. Select SP5887 then touch [EXECUTE]. 3. Touch [EXECUTE] in the message when you are prompted. 	

5888	Personal Information Protect
	<p>Selects the protection level for logs.</p> <p>[0 to 1/0/1}</p> <p>0: No authentication, No protection for logs</p> <p>1: No authentication, Protected logs (only an administrator can see the logs)</p>

5893	SDK Application Counter DFU
	Displays the counter name of each SDK application.
1	SDK-1
2	SDK-2
3	SDK-3
4	SDK-4
5	SDK-5
6	SDK-6

5907	Plug & Play Maker/Model Name
	<p>Selects the brand name and the production name for Windows Plug & Play. This information is stored in the NVRAM. If the NVRAM is defective, these names should be registered again.</p> <p>After selecting, press the "Original Type" key and "#" key at the same time. When the setting is completed, the beeper sounds five times.</p>

5913	Switchover Permission Time
	<p>If no key is pressed when there is an application with display control rights, these SP settings allow the system to shift to the application standing by after the specified time as elapse. This SP switches the switchover permission timer on/off.</p> <p>[0 to 1/1/1] 0: OFF 1: ON</p>

5967	Copy Server: Set Function
	<p>Enables and disables the document server.</p> <ul style="list-style-type: none"> ▪ This is a security measure that prevents image data from being left in the temporary area of the HDD. ▪ After changing this setting, you must switch the main switch off and on to enable the new setting. <p>[0 to 1/1/1] 0: ON, 1: OFF</p>

5974	Cherry Server
	<p>Selects which version of the Scan Router application program, "Light" or "Full (Professional)", is installed.</p> <p>[0 to 1/0/1 /step] 0: Light version (supplied with this machine) 1: Full version (optional)</p>

5985	Device Setting
	<p>The NIC and USB support features are built into the GW controller. Use this SP to enable and disable these features. In order to use the NIC and USB functions built into the controller board, these SP codes must be set to "1".</p>
1	On Board NIC
	[0: Disable] [1: Enable]
2	On Board USB
	[0: Disable] [1: Enable]

5987	Counter Falsifying Guard - 0:OFF/1:ON DFU
	[0 to 1/0/1]

5990	SP Print Mode
	Prints the SMC report. In the SP mode, press Copy Window to move to the copy screen, select the paper size, then press Start. Select A4/LT (Sideways) or larger to ensure that all the information prints. Press SP Window to return to the SP mode, select the desired print, and press Execute.
1	All (Data List)
2	SP (Mode Data List)
3	User Program Data
4	Logging Data
5	Diagnostic Report
6	Non-Default (Prints only SPs set to values other than defaults.)
7	NIB Summary
8	Capture Log
21	Copier User Program
22	Scanner SP
23	Scanner User Program
24	SDK/J Summary
25	SDK/J Application Info
26	Printer SP

5992	SP Text Mode
	Prints the SMC report to a file on an SD card inserted into the SD card slot on the right side of the machine operation panel.
1	All (Data List)
2	SP (Mode Data List)
3	User Program Data
4	Logging Data
5	Diagnostic Report
6	Non-Default (Prints only SPs set to values other than defaults.)
7	NIB Summary
8	Capture Log
21	Copier User Program
22	Scanner SP
23	Scanner User Program
24	SDK/J Summary
25	SDK/J Application Info
26	Printer SP

2.7 SP6000

There are no SP codes for this group because there are no peripheral units for this machine at the present time.

2.8 SP7000

7001	Operating Period Indication
	The machine maintains a time count for the operation of every motor. [0 to 99999999/0/1 min]
1	Main Scan Motor
2	Scanner Motor
3	Sub Scan Motor
4	Paper Feed Motor: Upper
5	Paper Feed Motor: Lower
7	Suction Fan
8	Head Rising Motor (Lift Motor)
11	Supply Motor P1 (Bk1)
12	Supply Motor P2 (Bk2)
13	Supply Motor P3 (C)
14	Supply Motor P4 (M)
15	Supply Motor P5 (Y)

7002	GL Total Count
	Total counts by page. These SP codes keep a count for the number of pages by color, size, and printing speed. [0 to 99999999/0/1 page]
1	Color (Volume)
2	Black & White (Volume)
3	Color (Converted into A4)
4	Black & White (Converted into A4)

10	Color: width \geq 841 (High Speed/Standard)
	[0 to 0xFFFFFFFF/0/1]
11	Color: width: \geq 841 (Fine)
12	Color: width: \geq 594 (High Speed/Standard)
13	Color: width: \geq 594 (Fine)
14	Color: width: \geq 420 (High Speed/Standard)
15	Color: width: \geq 420 (Fine)
16	Color: width: $<$ 420 (High Speed/Standard)
17	Color: width: $<$ 420 (Fine)
18	Mono: width: \geq 841 (High Speed/Standard)
19	Mono: width: \geq 841 (Fine)
20	Mono: width: \geq 594 (High Speed/Standard)
21	Mono: width: \geq 594 (Fine)
22	Mono: width: \geq 420 (High Speed/Standard)
23	Mono: width: \geq 420 (Fine)
24	Mono: width: $<$ 420 (High Speed/Standard)
25	Mono: width: $<$ 420 (Fine)

7212	User Cleaning
	<p>This SP displays the number of print head cleanings executed manually. Print head cleaning can be done with the User Tools.</p> <ul style="list-style-type: none"> ▪ Every manual execution of print head cleaning is recorded in NVRAM by the counter (0 to 999999). ▪ This is done so the service technician can keep track of how many times the operator is cleaning the print heads. ▪ Humidity can affect the number of times the print heads require cleaning.
11	Count H1
	<p>Manual cleanings done for K1 print head. [0 to 999 999/0/1]</p>
12	Count H2
	<p>Manual cleanings done for K2 print head. [0 to 999 999/0/1]</p>
13	Count H3
	<p>Manual cleanings done for C print head. [0 to 999 999/0/1]</p>
14	Count H4
	<p>Manual cleanings done for YM print head. [0 to 999 999/0/1]</p>

7213	User Refreshing
	<p>This SP displays the number of print head flushings executed manually. Print head flushing (refreshing) can be done with the User Tools.</p> <ul style="list-style-type: none"> ▪ Every manual execution of print head flushing is recorded in NVRAM by the counter (0 to 999999). ▪ This is done so the service technician can keep track of how many times the operator flushed the print heads manually. ▪ Humidity can affect the number of times the print heads require flushing.
11	Count H1
	<p>Manual flushings done for K1 print head. [0 to 999 999/0/1]</p>
12	Count H2
	<p>Manual flushings done for K2 print head. [0 to 999 999/0/1]</p>
13	Count H3
	<p>Manual flushings done for C print head. [0 to 999 999/0/1]</p>
14	Count H4
	<p>Manual flushings done for YM print head. [0 to 999 999/0/1]</p>

7214	Front Cover Open
	If either the front cover or the ink cartridge cover is opened during the maintenance cycle, print head maintenance will stop, and then resume once the cover has been closed. These SP codes keep a count of how many recovery cleanings were done for each print head.
1	Recovery Cleaning Count H1
2	Recovery Cleaning Count H2
3	Recovery Cleaning Count H3
4	Recovery Cleaning Count H4
	[0 to 999 999/0/1]
5	Open Count During Maintenance
	[0 to 3/0/1]

7215	Mid Cleaning
	These SP codes keep a total for the number of times each print head is cleaned during printing.
1	Count H1
2	Count H2
3	Count H3
4	Count H4
	[0 to 999999/0/1]

7217	Cleaning After Leftover
	<p>These SP codes display the length of time that each print head has remained idle ("Leftover"). If a print head remains idle for a long period, this can cause the ink around the nozzles to dry or become too viscous to produce good quality images. To prevent this from occurring, the machine automatically executes a maintenance cycle appropriate to the length of time that the print head has remained idle.</p> <p>These times are used to determine these operations:</p> <ul style="list-style-type: none"> ▪ Print head cleaning and flushing ▪ Air purging (ink supply, purging, filling/maintenance air purging filling together) ▪ Ink supply sequence

Time	Time	Power ON	Job Start	Energy Save
<10 hr	16 s	No	Yes	No
>10 hr<24	9 s (Power ON) 16 s (Job Start)	Yes	Yes	No
>24 hr.<1 week	3 min.	Yes	Yes	No
>1 week<2 weeks	3 min.	Yes	Yes	Yes
>2 weeks<45 days	30 min.	Yes	Yes	Yes

1	Count H1
	Idle time for K1 print head. [0 to 999 999/0/1]
2	Count H2
	Idle time for K2 print head. [0 to 999 999/0/1]

3	Count H3
	Idle time for C print head. [0 to 999 999/ 0 /1]
4	Count H4
	Idle time for YM print head. [0 to 999 999/ 0 /1]
	The following SP codes display the number of cleanings performed for each print head, cleanings done in response to the idle time trigger.
5	Count H1 LV2
	Cleanings done for K1 print head. [0 to 20000/ 0 /1]
6	Count H2 LV2
	Cleanings done for K2 print head. [0 to 20000/ 0 /1]
7	Count H3 LV2
	Cleanings done for C print head. [0 to 20000/ 0 /1]
8	Count H4 LV2
	Cleanings done for YM print head. [0 to 20000/ 0 /1]

7218	Ink Supply Seq. After Leftover
	<p>These SP codes display the number of times that the ink supply sequence was executed for each print head if the print head remained idle for more than two weeks and less than 45 days. The machine monitors two types of downtime.</p> <ul style="list-style-type: none"> ▪ Idle time 1: Starts after the last sheet exits and the print heads are capped. This count is displayed by SP 7218-001 to 004 below. ▪ Idle time 2: Amount of time each head has remained idle. This count is displayed by SP7218-005 to 008 below.
	Idle Time 1
1	Count H1
	Ink supply sequence executions for K1. [0 to 999 999/0/1]
2	Count H2
	Ink supply sequence executions for K2. [0 to 20000/0/1]
3	Count H3
	Ink supply sequence executions for C. [0 to 20000/0/1]
4	Count H4
	Ink supply sequence executions for Ym. [0 to 20000/0/1]
	Idle Time 2
5	Count H1 LV2
	Ink supply sequence executions for K1. [0 to 20000/0/1]
6	Count H2 LV2
	Ink supply sequence executions for K2. [0 to 20000/0/1]

7	Count H3 LV2
	Ink supply sequence executions for C. [0 to 20000/0/1]
8	Count H4 LV2
	Ink supply sequence executions for YM. [0 to 20000/0/1]

7222	Electrified Mist
	<p>This SP is used to set the threshold value that triggers Auto Cleaning. The nozzle condition can deteriorate over time caused by ink that starts to cling to the nozzles and accumulate inside the suction caps of the maintenance unit. Paper dust can accumulate and interfere with the operation of the nozzles. Periodic automatic cleanings execute while the printer is in use, and greatly extend the length of time the machine can be used with operator intervention. This mist threshold can be extended to increase the timing between automatic cleanings.</p> <ul style="list-style-type: none"> ▪ The count is automatically adjusted for the width of the paper and total print area. ▪ For example, the count for very wide paper is much lower than the count for narrower paper because of the difference in the total area covered. <p>[0 to 0xFFFFFFFF/0/1 n]</p>
1	Nozzle 1
2	Nozzle 2
3	Nozzle 3
4	Nozzle 4
5	Nozzle 5
7	Nozzle 6
8	Nozzle 7

7223	Cleaning Total
	<p>These SP display a count for the total number of cleanings done for each print head. The count includes the number of all cleanings triggered by:</p> <ul style="list-style-type: none"> ▪ Idle time cleanings ▪ Manual cleanings ▪ Auto cleanings (mist count).
1	Count H1
	<p>Total cleanings for K1. [0 to 999999/0/1]</p>
2	Count H2
	<p>Total cleanings for K2. [0 to 999999/0/1]</p>
3	Count H3
	<p>Total cleanings for C. [0 to 999999/0/1]</p>
4	Count H4
	<p>Total cleanings for YM. [0 to 999999/0/1]</p>

7224	Refreshing Total
	<p>This SP keeps and displays a running count of every flushing executed for each print head. User maintenance flushing is done with the either User Tools or SP settings triggered by idle time.</p> <ul style="list-style-type: none"> ▪ Every execution of print head flushing (refreshing) is recorded in NVRAM by this counter (0 to 999999). ▪ This is done so the service technician can keep track of how many times the machine has flushed the print heads. ▪ Humidity can affect the number of times the print heads require flushing.

1	Count H1
	Total flushing executions for K1. [0 to 999999/0/1]
2	Count H2
	Total flushing executions for K2. [0 to 999999/0/1]
3	Count H3
	Total flushing executions for C. [0 to 999999/0/1]
4	Count H4
	Total flushing executions for YM. [0 to 999999/0/1]

7227	Automatic Mist Cleaning
	This SP maintains and displays a count for the total number of Auto Cleanings (triggered by mist counts) for each print head.
1	Count H1
	Number of cleanings triggered by mist count threshold for K1. [0 to 999999/0/1]
2	Count H2
	Number of cleanings triggered by mist count threshold for K2. [0 to 999999/0/1]
3	Count H3
	Number of cleanings triggered by mist count threshold for C. [0 to 999999/0/1]

4	Count H4
	Number of cleanings triggered by mist count threshold for YM. [0 to 999999/0/1]

7228	Automatic Paper Dust Cleaning
	This SP maintains and displays a count for the total number of Auto Cleanings triggered by the paper dust counts for each print head. The paper dust count (the total number of pages printed, cutting count) are used to determine when cleaning is done for paper dust.
1	Count H1
	Number of cleanings triggered by paper dust count for K1. [0 to 999999/0/1]
2	Count H2
	Number of cleanings triggered by paper dust count for K2. [0 to 999999/0/1]
3	Count H3
	Number of cleanings triggered by paper dust count for C. [0 to 999999/0/1]
4	Count H4
	Number of cleanings triggered by paper dust count for YM. [0 to 999999/0/1]

7229	Decap Auto Cleaning
	These SP codes maintain and display a total count for the number of times each print head is uncapped for automatic cleaning.
1	Count H1
	Total count for uncapping K1. [0 to 999999/0/1]

2	Count H2
	Total count for uncapping K2. [0 to 999999/0/1]
3	Count H3
	Total count for uncapping C. [0 to 999999/0/1]
4	Count H4
	Total count for uncapping YM. [0 to 999999/0/1]

7302	Paper Dust Count DFU
	<p>This SP is used to set the threshold value of the paper dust count that triggers Auto Cleaning. The nozzle condition can deteriorate over time due to ink that starts to cling to the nozzles and accumulate inside the suction caps of the maintenance unit. Paper dust can also accumulate and interfere with the operation of the nozzles. Periodic automatic cleanings execute while the printer is in use, and greatly extend the length of time the machine can be used without operator intervention.</p> <p>The paper dust counts (the total number of pages printed, cutting count) are used to determine when cleaning is done for paper dust.</p>
1	H1
	The threshold for the paper dust count that triggers cleaning of K1. [0 to 999999/0/1]
2	H2
	The threshold for the paper dust count that triggers cleaning of K2. [0 to 999999/0/1]
3	H3
	The threshold for the paper dust count that triggers cleaning of C. [0 to 999999/0/1]

4	H4
	The threshold for the paper dust count that triggers cleaning of YM. [0 to 999999/0/1]

7401	Total SC Counter	CTL
	Displays the total number of SCs logged.	
1	SC Counter	
	Records and displays the number of occurrences of SC codes. [0 to 65 535/0]	
2	Total SC Counter	
	Records and displays the number of occurrences of SC codes. [0 to 65 535/0]	

7402	Feeler Position Error Count	
	This SP keeps a count of the OCFS feeler position errors for each print head. SC202 is issued every time an error occurs. There is one OCFS feeler arm and sensor for each ink sub tank (K1, K2, C, Y, M).	
1	HT1	
	Error count (SC202) for K1. [0 to 10000/0/1]	
2	HT2	
	Error count (SC202) for K2. [0 to 10000/0/1]	
3	HT3	
	Error count (SC202) for C. [0 to 10000/0/1]	

4	HT4
	Error count (SC202) for Y. [0 to 10000/0/1]
5	HT5
	Error count (SC202) for M. [0 to 10000/0/1]

7403	SC History	CTL
	Display the most recent service calls in their order of occurrence.	
1	Latest	
2	Latest 1	
3	Latest 2	
4	Latest 3	
5	Latest 4	
6	Latest 5	
7	Latest 6	
8	Latest 7	
9	Latest 8	
10	Latest 9	

7404	SC991 History
	This SP determines whether the last 10 occurrences of SC991 are recorded in the log information. SC991 (Software Continuity Error) indicates that the firmware attempted to perform an unexpected operation.

7405	Maintenance Motor Error SC Count	
	These SP codes keep a count of the errors that occur with the operation of the maintenance unit motors.	
1	ST Motor (after Replace)	
	Keeps a count for the occurrences of SC200 that occur after replacement of the lift motor. SC200 occurs if the lift motor fails to move the maintenance cleaning unit from back to front (slide sensor did not detect the slide unit at home position). [0 to 10000/0/1]	
2	ST Motor (Accumulated)	
	Keeps a total count for the occurrences of SC200 that occur during the life of the machine for the lift motor. [0 to 10000/0/1]	
3	DC Motor (after Replace)	
	Keeps a count for the occurrences of SC201 that occur after replacement of the maintenance motor. SC201 occurs if the maintenance motor fails to raise or lower the suction cap during capping or the maintenance cleaning cycle. (cap sensor did not detect the K1 suction cap at the up or home position). [0 to 10000/0/1]	
4	DC Motor (Accumulated)	
	Keeps a total count for the occurrences of SC201 that occur during the life of the machine for the maintenance motor. [0 to 10000/0/1]	

7502	Total Paper Jam Counter	CTL
	Displays the total number of copy jams.	
1	Jam Counter	
2	Total Jam Counter	

7503	Total Original Jam Counter	CTL
	Displays the total number of original jams.	
1	Original Jam Counter	
2	Total Original Counter	

7504	Paper Jam Loc	
	<p>Displays the list of possible locations where a jam could have occurred. These jams are caused by the failure of a sensor to activate. These are jams when the paper does not activate the sensor.</p> <ul style="list-style-type: none"> ▪ Paper late error: Paper failed to arrive at prescribed time. ▪ Paper lag error: Paper failed to leave at prescribed time. 	
1	At Power On	
2	1st Paper Feed SN: Late	
8	2nd Paper Feed SN: Late	
9	3rd Paper Feed SN: Late	
13	3rd Paper Feed SN: Late	
16	2nd Vertical Transport SN: Late	
34	3rd Vertical Transport SN: Late	
41	4th Vertical Transport SN: Late	
53	Relay SN: Late	
54	Registration SN: Late	
58	Fusing Exit SN: Late	
63	Exit Unit Entrance SN: Late	
66	Duplex Transport SN 1: Late	
84	Duplex Transport SN 2: Late	

7505	Original Jam Detection
	Displays the list of possible locations where an original jam could have occurred. These jams are caused by the failure of a sensor to activate.
1	Duplex Transport SN 3: Late
2	Duplex Exit SN: Late
3	1st Paper Feed SN: Lag
4	2nd Paper Feed SN: Lag
5	LCT Paper Feed SN: Lag
6	3rd Vertical Transport SN: Lag
7	4th Vertical Transport SN: Lag
8	Relay SN: Lag

	Jam Count by Paper Size
7506	Displays the total number of jams by paper size. Note: In the following sub levels "T" means "SEF".
97	A0T/A1
98	A1T/A2
99	A2T/A3
100	A3T/A4
101	A4T
106	B1T/B2
107	B2T/B3
108	B3T/B4
109	B4T
225	36x48T/24x36

226	24x36T/18x24
227	18x24T/12x18
228	12x18T/9x12
229	9x12T
234	34x44T/22x34
235	22x34T/17x22
236	17x22T/11x17
237	11x17T/8.5x11
238	8.5x11T
255	Other

7507	Plotter Jam History	
	Displays the copy jam history (the most recent 10 jams)	
1	Last	<p>Sample Display</p> <p>CODE :103</p> <p>SIZE: :00h</p> <p>TOTAL :0000063</p> <p>DATE: Thu Aug 23 00:58:16 2012</p> <p>where:</p> <p>CODE is the SP7504-* number (see above).</p> <p>SIZE is the ASAP paper size code in hex.</p> <p>TOTAL is the total jam error count</p> <p>DATE is the date the jams occurred.</p>
2	Latest 1	
3	Latest 2	
4	Latest 3	
5	Latest 4	
6	Latest 5	
7	Latest 6	
8	Latest 7	
9	Latest 8	
10	Latest 9	

Paper Hex Codes

Size	Code	Size	Code	Size	Code
A4 (S)	05	A3 (L)	84	DLT (L)	A0
A5 (S)	06	A4 (L)	85	LG (L)	A4
B5 (S)	0E	A5 (L)	86	LT (L)	A6
LT (S)	26	B4 (L)	8D	HLT (L)	AC
HLT (S)	2C	B5 (L)	8E	Others	FF

7508	Original Jam History	
	Displays the original jam history of the transfer unit in groups of 10, starting with the most recent 10 jams.	
1	Last	<p>Sample Display:</p> <p>CODE : 002</p> <p>SIZE : aeh</p> <p>TOTAL : 00000063</p> <p>DATE : Thu Sep 20 04:51:14: 2012</p> <p>where:</p> <p>CODE is the SP7-505-* number.</p> <p>SIZE is the paper size code in hex. (See "Paper Size Hex Codes" below.)</p> <p>TOTAL is the total jam error count (SP7003)</p> <p>DATE is the date the previous jam occurred</p>
2	Latest 1	
3	Latest 2	
4	Latest 3	
5	Latest 4	
6	Latest 5	
7	Latest 6	
8	Latest 7	
9	Latest 8	
10	Latest 9	

Paper Size Hex Codes

Paper Size	Code (hex)	Paper Size	Code (hex)
A4 LEF	05	B4 SEF	8D
A5 LEF	06	B5 SEF	8E
B5 LEF	0E	DLT SEF	A0
LT LEF	26	LG SEF	A4
HLT LEF	2C	LT SEF	A6
A3 SEF	84	HLT SEF	AC
A4 SEF	85	Others	FF
A5 SEF	86		

7624	Part Replacement Operation ON/OFF
	0 to 99999999
1	Maintenance Unit
2	Left Ink Sump
3	Right Ink Sump
9	Print Head Unit: Black
10	Print Head Unit: Color

7703	Accumulated Decapping Time
	This SP displays the total number of times the print heads have been uncapped.
	[0 to 65535/0/1 sec]

7704	Move Carriage (Tube)
	This SP displays the total for the carriage move count.

7708	Air Purge Fill Lever Check Temp DFU
	[0 to 100/ 0 /0.1 C]
1	H1
2	H2
3	H3
4	H4

7709	Air Purge Fill Lever Check Temp DFU
	[0 to 100/ 0 /0.1%]
1	H1
2	H2
3	H3
4	H4

7713	Cartridge Empty
	This SP displays a count for the number of times an ink cartridge singles empty and triggers an alert for replacement.
1	Occurrence Count: K
2	Occurrence Count: C
3	Occurrence Count: M
4	Occurrence Count: Y
	[0 to 1000/ 0 /1]

7714	Air Purge Filling after SC202
	<p>This SP displays a count for the number of ink re-fillings after the occurrence of SC202. SC202 is issued when one of the following conditions exist:</p> <ul style="list-style-type: none"> ▪ When air was purged one or more of the feelers could not be detected so the operation could not continue. ▪ When the maintenance pump attempted to apply negative pressure on the print head ink tank, the feeler could not be detected at its prescribed position after the pressure was applied. ▪ OCFS could not detect the feeler(s) after the feeler sensor performed the check after filling.
1	H Sucking Count H1
2	H Sucking Count H2
3	H Sucking Count H3
4	H Sucking Count H4
	[0 to 999999/0/1]

7716	Air Purge Fill after Pressure Lost DFU
1	Negative Pressure Built Count H1
2	Negative Pressure Built Count H2
3	Negative Pressure Built Count H3
4	Negative Pressure Built Count H4
	[0 to 999999/0/1]

7717	Air in SubTank
	<p>This SP displays a count for the number of times excess was detected in an ink sub tank on the carriage unit. The ink sub tanks are checked for the presence of air at these times:</p> <ul style="list-style-type: none"> ▪ At power on ▪ After an ink cartridge is replaced ▪ After the machine has remained idle for a long period
1	Count HT1
	<p>Air detection count for K1. [0 to 999999/0/1]</p>
2	Count HT2
	<p>Air detection count for K2. [0 to 999999/0/1]</p>
3	Count HT3
	<p>Air detection count for C. [0 to 999999/0/1]</p>
4	Count HT4
	<p>Air detection count for M. [0 to 999999/0/1]</p>
5	Count HT5
	<p>Air detection count for Y. [0 to 999999/0/1]</p>

7720	Refilled Cartridge
	<p>This SP displays a count for the number of times an ink cartridge was attempted to be replaced with a re-filled ink cartridge.</p> <ul style="list-style-type: none"> ▪ When the ink end sensor in the ink supply unit signals that an ink cartridge is out of ink, the machine automatically writes the "end history" onto the ID chip of the ink cartridge. ▪ This prevents the ink cartridge from being used as a re-fill. Re-filled cartridges cannot be used with this machine.
1	Detection Count: K
	[0 to 999999/0/1]
2	Detection Count: C
3	Detection Count: M
4	Detection Count: Y

7721	Ink Supply Sequence
	<p>This SP displays a count for the number of times the ink supply sequence has been executed for an in sub tank.</p>
1	Count H1
	<p>Ink supply sequence executions for K1. [0 to 999999/0/1]</p>
2	Count H2
	<p>Ink supply sequence executions for K2. [0 to 999999/0/1]</p>
3	Count H3
	<p>Ink supply sequence executions for C. [0 to 999999/0/1]</p>

4	Count H4
	Ink supply sequence executions for YM. [0 to 999999/0/1]

7722	Under Humidity Change
	This SP displays a count for the times additional air purges were executed during the ink filling sequences as a result of a change in humidity. If the temperature/humidity sensor detects a much lower humidity reading (-15%) compared to the previous reading at the previous power on or previous cleaning cycle, it will execute one additional air purge for the ink sub tanks.
1	Air Purge Filling H1
	Air purge/filling count for K1. [0 to 999999/0/1]
2	Air Purge Filling H2
	Air purge/filling count for K2. [0 to 999999/0/1]
3	Air Purge Filling H3
	Air purge/filling count for C. [0 to 999999/0/1]
4	Air Purge Filling H4
	Air purge/filling count for YM. [0 to 999999/0/1]

7723	Under Humidity Change
	This SP displays a count for the times additional ink supply sequences were executed as a result of a change in humidity. If the temperature/ humidity sensor detects a much lower humidity reading (-15%) compared to the previous reading at the previous power on or previous cleaning cycle, it will execute ink filling sequence for the ink sub tanks.
1	Ink Supply Sequence Count H1
	Count for K1. [0 to 999999/0/1]
2	Count for K2. Ink Supply Sequence Count H2
	[0 to 999999/0/1]
3	Count for C. Ink Supply Sequence Count H3
	[0 to 999999/0/1]
4	Count for YM. Ink Supply Sequence Count H4
	[0 to 999999/0/1]

7724	Supply After Time Out
	<p>This SP displays a count for the number of times a timeout occurred for an ink supply motor during the ink fill sequence.</p> <ul style="list-style-type: none"> ▪ A timeout occurs when the machine fails to detect the feeler at the OCFS or if the ink pump fails to supply ink. ▪ The feeler must change its position within t_sec after the pump starts pumping ink. ▪ If the feeler does not change position, the machine issues one timeout. ▪ The machine will allow up to 6 timeouts before the machine issues SC293 and the ink filling sequence halts.
1	Reverse Success Count HT1
	<p>Count for K1. [0 to 999999/0/1]</p>
2	Reverse Success Count HT2
	<p>Count for K2. [0 to 999999/0/1]</p>
3	Reverse Success Count HT3
	<p>Count for C. [0 to 999999/0/1]</p>
4	Reverse Success Count HT4
	<p>Count for Y. [0 to 999999/0/1]</p>
5	Reverse Success Count HT5
	<p>Count for M. [0 to 999999/0/1]</p>

7725	Air Purge Filling After Leftover
	Idle Time 1
	These SP codes display the number of air purge/ink fill executions after all print heads have remained idle for a time specified (Idle Time 1) after the last printed sheet exits and the print heads are capped.
1	Count H1
	Count for K1. [0 to 999999/0/1]
2	Count H2
	Count for K2. [0 to 999999/0/1]
3	Count H3
	Count for C. [0 to 999999/0/1]
4	Count H4
	Count for YM. [0 to 999999/0/1]
	Idle Time 2 (LV2)
	This SP displays the number of air purge/ink fill executions for each print head (Idle Time 2) after it has remained idle. Note: The measured idle times for K1, K2 and C, Y, M will be different after several days of exclusive monochrome printing when the color print heads have not been used.
5	Count H1 (LV2)
	Count for K1. [0 to 999999/0/1]

6	Count H2 (LV2)
	Count for K2. [0 to 999999/0/1]
7	Count H3 (LV2)
	Count for C. [0 to 999999/0/1]
8	Count H4 (LV2)
	Count for YM. [0 to 999999/0/1]

7726	Little Flushing After Leftover
	These SP codes display the counts for small print head flushing after the prescribed time has elapsed
	Idle Time 1
	This SP displays the count for small print head flushing after the prescribed time has elapsed after the most recent print head capping. This is done once if the print heads have remained idle for more than 10 hours but less than 24 hours.
1	Count H1
	Count for K1. [0 to 999999/0/1]
2	Count H2
	Count for K2. [0 to 999999/0/1]
3	Count H3
	Count for C. [0 to 999999/0/1]

4	Count H4
	Count for YM. [0 to 999999/0/1]
	Idle Time 2
	These SP codes display the counts for large print head flushing after the print head has not been used for a prescribed idle time. This is done once if the print heads have remained idle for more than 10 hours but less than 24 hours. Note: The measured idle times for K1, K2 and C, Y, M will be different after several days of exclusive monochrome printing when the color print heads have not been used.
5	LV2 Count H1
	Count for K1. [0 to 999999/0/1]
6	LV2 Count H2
	Count for K2. [0 to 999999/0/1]
7	LV2 Count H3
	Count for C. 0 to 999999/0/1]
8	LV2 Count YM.
	Count for K1. [0 to 999999/0/1]

7727	Rich Flushing After Leftover
	These SP codes display the counts for large print head flushing after the prescribed time has elapsed
	Idle Time 1
	<p>This SP displays the count for large print head flushing if the prescribed time has elapsed after the most recent print head capping. For example:</p> <ul style="list-style-type: none"> ▪ If the idle time is greater than 24 hours and less than three days, large flushing is done one. ▪ If the idle time is more than 3 days but less than 7 days large flushing is done 3 times.
1	Count H1
	Count for K1. [0 to 999999/0/1]
2	Count H2
	Count for K2. [0 to 999999/0/1]
3	Count H3
	Count for C. [0 to 999999/0/1]

4	Count H4
	Count for YM. [0 to 999999/0/1]
	Idle Time 2
	<p>This SP codes display the count for large print head flushing after the print head has not been used for a prescribed idle time.</p> <p>For example:</p> <ul style="list-style-type: none"> ▪ If the idle time is greater than 24 hours and less than three days, large flushing is done one. ▪ If the idle time is more than 3 days but less than 7 days large flushing is done 3 times. <p>Note: The measured idle times for K1, K2 and C, Y, M will be different after several days of exclusive monochrome printing when the color print heads have not been used.</p>
5	LV2 Count H1
	Count for K1. [0 to 999999/0/1]
6	LV2 Count H2
	Count for K2. [0 to 999999/0/1]
7	LV2 Count H3
	Count for C. 0 to 999999/0/1]
8	LV2 Count YM.
	Count for K1. [0 to 999999/0/1]

7728	Flushing Before Printing
	<p>These SP codes display the counts for flushing of each print head at the left ink sump before print jobs begin.</p> <ul style="list-style-type: none"> ▪ Ink purging may be done before printing, and the timing determines purge position, number of ink drops, head order of purging, and speed. ▪ Many factors affect the frequency and amount of purging: Length of time the machine has remained idle, ambient temperature and humidity, switching from black-and-white to color printing, and so on. ▪ The frequency of purging is controlled by the machine firmware.
1	Count K
	<p>Count for Black ink. [0 to 999999/0/1]</p>
2	Count C
	<p>Count for Cyan ink. [0 to 999999/0/1]</p>
3	Count M
	<p>Count for Magenta ink. [0 to 999999/0/1]</p>
4	Count Y
	<p>Count for Yellow ink. [0 to 999999/0/1]</p>

7729	Before & During Printing
	<p>These SP codes display the counts for amount of ink flushed from each print head at the left ink sump before and during print jobs.</p> <ul style="list-style-type: none"> ▪ Ink purging may be done before or during printing, and the timing determines purge position, number of ink drops, head order of purging, and speed. ▪ Many factors affect the frequency and amount of ink purged: Length of time the machine has remained idle, ambient temperature and humidity, switching from black-and-white to color printing, and so on. ▪ The frequency of purging is controlled by the machine firmware.
1	Flushing Amount K
	<p>Amount of Black ink from K1, K2 print heads. [0 to 999999/0/1x10 nI]</p>
2	Flushing Amount C
	<p>Amount Cyan ink from C print head. [0 to 999999/0/1x10 nI]</p>
3	Flushing Amount M
	<p>Amount of Magenta ink from M print head. [0 to 999999/0/1x10 nI]</p>
4	Flushing Amount Y
	<p>Amount of Yellow ink from Y print head. [0 to 999999/0/1x10 nI]</p>

7730	After Printing
	<p>These SP codes display the amount of ink flushed at each print head after every print job.</p> <ul style="list-style-type: none"> ▪ Color streaking can occur where the humidity is low, where the machine is used infrequently, or if a particular color is seldom used. ▪ After streaking starts the ports will eventually clog. ▪ To prevent this, ink is purged after every job before capping to clear the print heads.
1	Flushing Amount K
	<p>Amount of black ink (from K1, K2). [0 to 999999/0/1x10 nl]</p>
2	Flushing Amount C
	<p>Amount of Cyan ink.. [0 to 999999/0/1x10 nl]</p>
3	Flushing Amount M
	<p>Amount of Magenta ink. [0 to 999999/0/1x10 nl]</p>
4	Flushing Amount Y
	<p>Amount of Yellow ink. [0 to 999999/0/1x10 nl]</p>

7731	User Cleaning
	<p>These SP codes display a count for the execution of user cleanings for each ink color. User maintenance print head cleaning is done with the User Tools.</p> <ul style="list-style-type: none"> ▪ Every execution of print head cleaning is recorded in NVRAM by these counters (0 to 999999). The colors can be selected individually. ▪ This is done so the service technician can keep track of how many times the operator is cleaning the print heads for one or more colors. ▪ Humidity can affect the number of times the print heads require cleaning and refreshing
1	Count/ K Cartridge
	Count for Black ink. [0 to 999999/0/1]
2	Count/ C Cartridge
	Count for Cyan ink. [0 to 999999/0/1]
3	Count/ M Cartridge
	Count for Magenta ink. [0 to 999999/0/1]
4	Count/ Y Cartridge
	Count for Yellow ink. [0 to 999999/0/1]

7732	User Refreshing
	<p>These SP codes display a count for the execution of user flushing for each ink color. User maintenance flushing (refreshing) is done with the User Tools.</p> <ul style="list-style-type: none"> ▪ Every execution of print head flushing is recorded in NVRAM by these counters (0 to 999999). The colors can be selected individually. ▪ This is done so the service technician can keep track of how many times the operator is flushing the print heads for one or more colors. ▪ Humidity can affect the number of times the print heads require flushing.
1	Count/ K Cartridge
	Count for Black ink. [0 to 999999/0/1]
2	Count/ C Cartridge
	Count for Cyan ink. [0 to 999999/0/1]
3	Count/ M Cartridge
	Count for Magenta ink. [0 to 999999/0/1]
4	Count/ Y Cartridge
	Count for Yellow ink. [0 to 999999/0/1]

7733	Cleaning After Leftover
	These SP codes display the counts for the number of cleanings of the print heads for each color (ink cartridge) after the machine has remained idle longer than 7 but less than 30 days.
1	Count/ K Cartridge
	Count for Black ink. [0 to 20000/0/1]
2	Count/ C Cartridge
	Count for Cyan ink. [0 to 20000/0/1]
3	Count/ M Cartridge
	Count for Magenta ink. [0 to 20000/0/1]
4	Count/ Y Cartridge
	Count for Yellow ink. [0 to 20000/0/1]

7734	Ink Supply Seq. After Leftover
	These SP codes display the counts for the number ink supply sequences executed for the print heads of each color (ink cartridge) after the machine has remained idle longer than one month.
1	Count/ K Cartridge
	Count for Black ink. [0 to 20000/0/1]
2	Count/ C Cartridge
	Count for Cyan ink. [0 to 20000/0/1]

3	Count/ M Cartridge
	Count for Magenta ink. [0 to 20000/0/1]
4	Count/ Y Cartridge
	Count for Yellow ink. [0 to 20000/0/1]

7735	Cleaning Total
	These SP codes display the total number of print head cleanings, including those done manually and others triggered automatically (regular cleaning after jobs, auto cleaning after idle time, etc.)
1	Count/ K Cartridge
	Count for Black ink. [0 to 999999/0/1]
2	Count/ C Cartridge
	Count for Cyan ink. [0 to 999999/0/1]
3	Count/ M Cartridge
	Count for Magenta ink. [0 to 999999/0/1]
4	Count/ Y Cartridge
	Count for Yellow ink. [0 to 999999/0/1]

7736	Refreshing Total
	These SP codes display the total number of print head flushings, including those done manually and others triggered automatically (regular cleaning after jobs, auto cleaning after idle time, etc.).
1	Count/ K Cartridge
	Count for Black ink. [0 to 999999/0/1]
2	Count/ C Cartridge
	Count for Cyan ink. [0 to 999999/0/1]
3	Count/ M Cartridge
	Count for Magenta ink. [0 to 999999/0/1]
4	Count/ Y Cartridge
	Count for Yellow ink. [0 to 999999/0/1]

7737	Automatic Mist Cleaning
	These SP codes display the counts for automatic cleanings triggered by the mist count for each print head (ink cartridge). <ul style="list-style-type: none"> ▪ The count is adjusted for the width of the paper and total print area. ▪ For example, the count for very wide paper is much lower than the count for narrower paper because of the difference in the total area covered.
1	Count/ K Cartridge
	Count for Black ink. [0 to 999999/0/1]

2	Count/ C Cartridge
	Count for Cyan ink. [0 to 999999/0/1]
3	Count/ M Cartridge
	Count for Magenta ink. [0 to 999999/0/1]
4	Count/ Y Cartridge
	Count for Yellow ink. [0 to 999999/0/1]

7738	Automatic Paper Dust Cleaning
	These SP codes display the counts for automatic cleanings triggered by the paper dust count for each print head (ink cartridge). Note: The paper dust count (the total number of pages printed, cutting count) are used to determine when cleaning is done for paper dust.
1	Count/ K Cartridge
	Count for Black ink. [0 to 999999/0/1]
2	Count/ C Cartridge
	Count for Cyan ink. [0 to 999999/0/1]
3	Count/ M Cartridge
	Count for Magenta ink. [0 to 999999/0/1]
4	Count/ Y Cartridge
	Count for Yellow ink. [0 to 999999/0/1]

7739	Decap Auto Cleaning
	These SP codes display the counts for number of times the print heads were uncapped for automatic cleanings triggered by the mist/paper dust count for each print head (ink cartridge).
1	Count/ K Cartridge
	Count for Black ink [0 to 999999/0/1]
2	Count/ C Cartridge
	Count for Cyan ink. [0 to 999999/0/1]
3	Count/ M Cartridge
	Count for Magenta ink. [0 to 999999/0/1]
4	Count/ Y Cartridge
	Count for Yellow ink. [0 to 999999/0/1]

7740	Air Purge Filling After SC202
	<p>These SP codes display the counts for the number of times air was purged from the ink sub tanks after the machine issues SC202. SC202 is issued when one of the following conditions exist:</p> <ul style="list-style-type: none"> ▪ When air was purged one or more of the feelers could not be detected so the operation could not continue. ▪ When the maintenance pump attempted to apply negative pressure on the print head ink tank, the feeler could not be detected at its prescribed position after the pressure was applied. ▪ OCFS could not detect the feeler(s) after the feeler sensor performed the check after filling.
1	H Sucking Count/ K Cartridge
	Count for Black ink. [0 to 999999/0/1]

2	H Sucking Count/ C Cartridge
	Count for Cyan ink. [0 to 999999/0/1]
3	H Sucking Count/ M Cartridge
	Count for Magenta ink. [0 to 999999/0/1]
4	H Sucking Count/ Y Cartridge
	Count for Yellow ink. [0 to 999999/0/1]

7741	Front Cover Open CL Count
1	Count/K Cartridge
2	Count/C Cartridge
3	Count/M Cartridge
4	Count/Y Cartridge

7742	Air Purge Fill After Pressure Lost
	<p>These SP codes display counts for the number of air purges/ink re-fillings of each ink sub tank after the loss of negative tank pressure. Typically, these air purges are done to correct these errors:</p> <ul style="list-style-type: none"> ▪ SC202 – Ink Level Detection Feeler Position Error ▪ SC202 – Supply Pump Suction Timeout Error ▪ SC283 – Ink End Detection Error
1	Air Purge Filling/ K Cartridge
	Count for Black ink. [0 to 999999/0/1]
2	Air Purge Filling/ C Cartridge
	Count for Cyan ink. [0 to 999999/0/1]

3	Air Purge Filling/ M Cartridge
	Count for Magenta ink. [0 to 999999/0/1]
4	Air Purge Filling/ Y Cartridge
	Count for Yellow ink. [0 to 999999/0/1]

7743	Air in SubTank
	These SP codes display a count for the number of times the paired air sensor terminals at the top of each ink sub tank detected air in the tanks.
1	Count/ K Cartridge
	Count for Black ink (K1, K2). [0 to 999999/0/1]
2	Count/ C Cartridge
	Count for Cyan ink. [0 to 999999/0/1]
3	Count/ M Cartridge
	Count for Magenta ink. [0 to 999999/0/1]
4	Count/ Y Cartridge
	Count for Yellow ink. [0 to 999999/0/1]

7746	Ink Supply Sequence
	These SP codes display a count for the number of times ink is sent from each ink cartridge.
1	Count/ K Cartridge
	Count for Black ink. [0 to 999999/0/1]

2	Count/ C Cartridge
	Count for Cyan ink. [0 to 999999/0/1]
3	Count/ M Cartridge
	Count for Magenta ink. [0 to 999999/0/1]
4	Count/ Y Cartridge
	Count for Yellow ink. [0 to 999999/0/1]

7747	Under Humidity Change
	These SP codes display the counts for the number of time the purge/re-filling sequence was executed for each color in response to a shift to lower humidity.
1	Air Purge Filling/K Cartridge
	Count for Black ink. [0 to 999999/0/1]
2	Air Purge Filling/C Cartridge
	Count for Cyan ink. [0 to 999999/0/1]
3	Air Purge Filling/M Cartridge
	Count for Magenta ink. [0 to 999999/0/1]
4	Air Purge Filling/Y Cartridge
	Count for Yellow ink. [0 to 999999/0/1]

7748	Under Humidity Change
	These SP codes display the counts for the number of time the ink supply sequence was executed for each color in response to a shift to lower humidity.
1	Ink Supply Sequence Count K Cartridge
	Count for Black ink. [0 to 999999/0/1]
2	Ink Supply Sequence Count C Cartridge
	Count for Cyan ink. [0 to 999999/0/1]
3	Ink Supply Sequence Count M Cartridge
	Count for Magenta ink. [0 to 999999/0/1]
4	Ink Supply Sequence Count Y Cartridge
	Count for Yellow ink. [0 to 999999/0/1]

7749	Air Purge Filling After Leftover
	These SP codes display the counts for the number of time the purge/re-filling sequence was executed for each color in response to idle time.
1	Count/ K Cartridge
	Count for Black ink. [0 to 999999/0/1]
2	Count/ C Cartridge
	Count for Cyan ink. [0 to 999999/0/1]

3	Count/ M Cartridge
	Count for Magenta ink. [0 to 999999/0/1]
4	Count/ Y Cartridge
	Count for Yellow ink. [0 to 999999/0/1]

7750	Little Flushing After Leftover
	These SP codes count the number of small flushing done after the machine has remained idle for more than 10 but less than 24 hours.
1	Count/ K Cartridge
	Count for Black ink. [0 to 999999/0/1]
2	Count/ C Cartridge
	Count for Cyan ink. [0 to 999999/0/1]
3	Count/ M Cartridge
	Count for Magenta ink. [0 to 999999/0/1]
4	Count/ Y Cartridge
	Count for Yellow ink. [0 to 999999/0/1]

7751	Rich Flushing After Leftover
	These SP codes count the number of large flushings done after the machine has remained idle for more than 24 hours. The print heads may be flushed more than once after the idle time exceeds 3 days.
1	Count/ K Cartridge
	Count for Black ink. [0 to 999999/0/1]
2	Count/ C Cartridge
	Count for Cyan ink. [0 to 999999/0/1]
3	Count/ M Cartridge
	Count for Magenta ink. [0 to 999999/0/1]
4	Count/ Y Cartridge
	Count for Yellow ink. [0 to 999999/0/1]

7752	Flushing before Printing
	<p>These SP codes display the counts for flushing at the left ink sump for each ink cartridge before print jobs begin.</p> <ul style="list-style-type: none"> ▪ Ink purging may be done before printing, and the timing determines purge position, number of ink drops, head order of purging, and speed. ▪ Many factors affect the frequency and amount of purging: Length of time the machine has remained idle, ambient temperature and humidity, switching from black-and-white to color printing, and so on. ▪ The frequency of purging is controlled by the machine firmware.
1	Count/ K Cartridge
	Count for Black ink cartridge. [0 to 999999/0/1]

2	Count for Cyn ink cartridge. Count/ C Cartridge
	[0 to 999999/0/1]
3	Count/ M Cartridge
	Count for Magenta ink cartridge. [0 to 999999/0/1]
4	Count/ Y Cartridge
	Count for Yellow ink cartridge. [0 to 999999/0/1]

7753	Before & During Printing
	<p>These SP codes display the counts of amount of ink flushed from each print head at the left ink sump before and during print jobs.</p> <ul style="list-style-type: none"> ▪ Ink purging may be done before or during printing, and the timing determines purge position, number of ink drops, head order of purging, and speed. ▪ Many factors affect the frequency and amount of ink purged: Length of time the machine has remained idle, ambient temperature and humidity, switching from black-and-white to color printing, and so on. ▪ The frequency of purging is controlled by the machine firmware.
1	Flushing Amount K
	Count for Black ink. [0 to 999999/0/1 nI]
2	Flushing Amount C
	Count for Cyan ink. [0 to 999999/0/1 nI]
3	Flushing Amount M
	Count for Magenta ink. [0 to 999999/0/1 nI]

4	Flushing Amount Y
	Count for Yellow ink. [0 to 999999/0/1 nI]

7754	After Printing
	<p>These SP codes display the amount of ink flushed for each color (ink cartridge) after every print job.</p> <ul style="list-style-type: none"> ▪ Color streaking can occur where the humidity is low, where the machine is used infrequently, or if a particular color is seldom used. ▪ After streaking starts the ports will eventually clog. ▪ To prevent this, ink is purged after every job before capping to clear the print heads.
1	Flushing Amount K
	Count for Black ink. [0 to 999999/0/1 nI]
2	Flushing Amount C
	Count for Cyan ink. [0 to 999999/0/1 nI]
3	Flushing Amount M
	Count for Magenta ink. [0 to 999999/0/1 nI]
4	Flushing Amount Y
	Count for Yellow ink. [0 to 999999/0/1 nI]

7755	OCFS Check Execution Count
	These SP codes display the counts for the number of times the position of the OCFS feelers were checked after the machine has remained idle.
1	H1
	Count for K1. [0 to 999999/0/1]
2	H2
	Count for K2. [0 to 999999/0/1]
3	H3
	Check for C. [0 to 999999/0/1]
4	H4
	Check for YM. [0 to 999999/0/1]

7756	OCFS Filling Count per Job
	These SP codes display the counts for re-fillings triggered by the OCFS feelers on the sides of the ink sub tanks. Ink low was detected during normal operation or routine print head maintenance.
1	HT1
	Count for K1 Black ink. [0 to 1000/0/1]
2	HT2
	Count for K2 Black ink. [0 to 1000/0/1]

3	HT3
	Count for C Cyan ink. [0 to 1000/0/1]
4	HT4
	Count for Y Yellow ink. [0 to 1000/0/1]
5	HT5
	Count for M Magenta ink. [0 to 1000/0/1]

7757	Supply T/O: Maintenance Count DFU
	These SP codes display counts for the number of timeouts that occur during ink supply. [0 to 9999/0/1]
1	First-1 HT Suction-1
	Occurrences of 1st timeouts.
2	First-2 HT Suction-1
3	First-1 HT Suction-2
4	First-2 HT Suction-2
5	First-1 HT Filling-1
6	First-2 HT Filling-1
7	First-1 HT Filling
8	First-2 HT Filling
9	Refreshing & Filling-1 HT Filling-2
10	Refreshing & Filling-2 HT Filling-2

11	Refreshing & Filling-1 HT Filling
12	Refreshing & Filling-2 HT Filling
14	Cleaning
15	Air Purge Filling-3 1HT
16	Air Purge Filling-3 2HT
17	Air Purge Filling Over Thresh 1HT Nega Pressure
18	Air Purge Filling Over Thresh 2HT Nega Pressure
19	Air Purge Filling Under Thresh 1HT Nega Pressure
20	Air Purge Filling Under Thresh 2HT Nega Pressure
22	OCFS Reverse T/O-HT1
23	OCFS Reverse T/O-HT2
24	OCFS Reverse T/O-HT3
25	OCFS Reverse T/O-HT4
26	OCFS Reverse T/O-HT5
33	Ink End Sequence T/O-HT1
34	Ink End Sequence T/O-HT2
35	Ink End Sequence T/O-HT3
36	Ink End Sequence T/O-HT4
37	Ink End Sequence T/O-HT5
38	OCFS Filling: Maintenance –HT1
39	OCFS Filling: Maintenance –HT2
40	OCFS Filling: Maintenance –HT3
41	OCFS Filling: Maintenance –HT4
42	OCFS Filling: Maintenance –HT5

7758	OCFS Supply T/O Count DFU
1	OCFS Supply T/O-HT1
	[0 to 9999/0/1]
2	OCFS Supply T/O-HT2
3	OCFS Supply T/O-HT3
4	OCFS Supply T/O-HT4
5	OCFS Supply T/O-HT5

7760	Print Volume from Latest Cleaning
	These SP codes display the how many sheets have been printed since the last auto cleaning triggered by the mist/paper dust count.
1	H1
	Count for K1. [0 to 99999999/0/1 page]
2	H2
	Count for K2. [0 to 99999999/0/1 page]
3	H3
	Count for C. [0 to 99999999/0/1 page]
4	H4
	Count for YM. [0 to 99999999/0/1 page]

7770	No Filling Negative Pressure
	These SP codes display the counts at the print heads for the number of cleaning/re-filling failures due to failure to attain negative pressure in the ink sub tanks as a result of humidity fluctuation or the presence of excess air in the tanks.
1	Pressure/Humidity Fluctuation Count H1
	Count for K1. [0 to 999999/0/1]
2	Pressure/Humidity Fluctuation Count H2
	Count for K2. [0 to 999999/0/1]
3	Pressure/Humidity Fluctuation Count H3
	Count for Cyan. [0 to 999999/0/1]
4	Pressure/Humidity Fluctuation Count H4
	Count for YM. [0 to 999999/0/1]

7771	No Filling Negative Pressure
	These SP codes display the counts at the ink cartridges for the number of cleaning/re-filling failures due to failure to attain negative pressure in the ink sub tanks as a result of humidity fluctuation or the presence of excess air in the tanks.
1	Pressure/Humidity Fluctuation Count/ K Cart
	Count for Black ink. [0 to 999999/0/1]
2	Pressure/Humidity Fluctuation Count/ C Cart
	Count for Cyan ink. [0 to 999999/0/1]
3	Pressure/Humidity Fluctuation Count/ M Cart
	Count for Magenta ink. [0 to 999999/0/1]
4	Pressure/Humidity Fluctuation Count/ Y Cart
	Count for Yellow ink. [0 to 999999/0/1]

7801	ROM Part Number
	This SP displays the ROM number, firmware version numbers, and other important information about the machine.

7803	PM Counter Display
	Displays the PM counter since the last PM.

7804	PM Counter Reset
	Touch [EXECTUE] to reset the PM counter.

7807	SC/Jam Counter Reset
	Touch [EXECUTE] to reset the SC and jam counters. This SP does not reset the jam history counters SP7-507, SP7-508.

7826	MF Error Counter Japan Only
	Displays the number of counts requested of the card/key counter.
1	Error Total
	A request for the count total failed at power on. This error will occur if the device is installed but disconnected.
2	Error Staple
	The request for a staple count failed at power on. This error will occur if the device is installed but disconnected.

7827	MF Error Counter Clear
	Press [Execute] to reset to 0 the values of SP7826. Japan Only

7832	Self-Diagnose Result Display
	Push [#] to display a list of error codes. Nothing is displayed if no errors have occurred.

7835	ACC Counter DFU
------	------------------------

7836	Total Memory Size
	Displays the contents of the memory on the controller board.

7853	Cartridge Replace
	These SP codes clear the machine counter for a new ink cartridge. Execute this SP for appropriate ink cartridge before it is replaced.
1	Count K
	Clears counter for Black ink cartridge. [0 to 1000/0/1]
2	Count C
	Clears counter for Cyan ink cartridge. [0 to 1000/0/1]
3	Count M
	Clears counter for Magenta ink cartridge. [0 to 1000/0/1]
4	Count Y
	Clears counter for Yellow ink cartridge. [0 to 1000/0/1]

7855	Coverage Range DFU
1	Coverage Range 1
2	Coverage Range 2

7901	Assert Info.	
	This SP displays the results of the last occurrence of SC990. SC990 is issued when unexpected branching and decision data is generated by the program, and the module name, line number, and values for the error are displayed for analysis. This data should be reported when SC990 occurs.	
1	File Name	Module name
2	Number of Lines	Lines where error occurred.
3	Location	Component affected by error

7931	Cartridge: Black	
7932	Cartridge: Magenta	
7933	Cartridge: Cyan	
7934	Cartridge: Yellow	
	These SP codes display all the information stored on the ID chips built into each ink cartridge.	
1	Model ID	
		[0 to 255/0/1]
2	Cartridge Version	
3	Brand Name ID	
4	Area ID	
5	Type ID	
6	Color ID	
7	Maintenance ID	
8	Brand New Information	
9	Recycling Counter	

10	Manufactured Date
	[0 to 1/ 0 /1]
11	Serial No.
12	Remaining Ink
	[0 to 100/ 100 /1]
13	EDP Code
14	Empty Log
15	Refill Log
16	Fitted: Total Counter
	[0 to 99999999/ 0 /1]
17	Fitted: Color Counter
18	Empty: Total Counter
19	Empty: Color Counter
20	Fitted Date
	[0 to 1/ 0 /1]
21	Empty Date
22	Ink Consumption Volume
	[0 to 0xFFFFFFFF/ 0 /1]
23	Expiry Date
	[0 to 255/ 0 /1]
24	Initial Fill Count
25	Refreshing Count
26	Cleaning Count

27	Ink Capacity
	[0 to 0xFFFFFFFF/0/1]
28	Air Purge Filling Count
	[0 to 255/0/1]
29	Print Volume per Cartridge
	[0 to 16777215/0/1]
30	Machine Serial Number Log: 1 Previous
	[0 to 255/0/1]
31	Machine Serial Number Log: 2 Previous
32	Machine Serial Number Log: 3 Previous
33	Machine Serial Number Log: 4 Previous
34	Machine Serial Number Log: 5 Previous

7935	Cartridge: Black Log 1
7936	Cartridge: Magenta Log 1
7937	Cartridge: Cyan Log 1
7938	Cartridge: Yellow Log 1
	These SP codes display the log histories from ink cartridge ID chip mapping for each ID chip built into the ink cartridges.
1	Serial No.
	[0 to 1/0/1]
2	Fitted Date & Time
3	Fitted: Total Counter
	[0 to 99999999/0/1]

4	Refill Log
	[0 to 1/0/1]
5	Serial No.
6	Fitted Date & Time
7	Fitted: Total Counter
	[0 to 99999999/0/1]
8	Refill Log
9	Serial No.
10	Fitted Date & Time
11	Fitted: Total Counter
12	Refill Log
	[0 to 1/0/1]
13	Serial No.
14	Fitted Date & Time
15	Fitted: Total Counter
	[0 to 99999999/0/1]
16	Refill Log
	[0 to 1/0/1]
17	Serial No.
18	Fitted Date & Time
19	Fitted: Total Counter
	[0 to 99999999/0/1]
20	Refill Log

7958	Clear Factory Cutter Drive DFU
	This SP is used by touching [EXECUTE] to set the cutter count to zero before the machine leaves the factory.
	[0 to 1/0/1]

7960	Cutter Drive Count
	These SP codes displays counts related to the operation of the cutter unit and provides SPs to also clear these counts.
1	Drive Count
	Displays the cutter blade operation count (number of counts). [0 to 99999999/0/1 times]
2	Clear Drive Count
	Touch [EXECUTE] to clear the cutter blade count after blade replacement.
3	Unit Drive Count
	Displays the count for the operation of the cutter unit. [0 to 99999999/0/1 times]
4	Clear Unit Drive Count
	Touch [EXECUTE] to clear the cutter unit count after the unit has been replaced.

7961	Waste Ink Analysis
	<p>These SP codes are used to analyze the ink collection operations at the following points:</p> <ul style="list-style-type: none"> ▪ Right ink sump ▪ Left ink sump ▪ Carriage unit ▪ Ink collector unit
	Right Ink Sump 001 - 004
	These SP codes display information about the right ink sump.
1	Right Ink Box Amount Counter
	<p>Amount of ink in the right ink sump. The count is done by counting the operation of the wipers of the maintenance cleaning unit.</p> <p>[0 to 999999/0/0.001]</p>
2	Right Ink Box Near Full Date
	<p>Displays the near full date of the right ink sump.</p> <p>[0 to 0xFFFFFFFF/0/1]</p>
3	Right Ink Box Full Date
	<p>Displays the full date of the right ink sump.</p> <p>[0 to 0xFFFFFFFF/0/1]</p>
4	Right Ink Box Fitting Count
	<p>Displays the number of times that the right ink sump has been replaced.</p> <p>[0 to 255/0/1]</p>
	Left Ink Sump

5	Left Ink Box Amount Counter
	Displays the amount of ink in the left ink sump. The count is done by counting the number of times the print heads were purged into the left ink sump.
	[0 to 2000000/0/10.001 ul]
6	Left Ink Box Near Full Date
	Displays the near full date of the right ink sump. [0 to 0xFFFFFFFF/0/1]
7	Left Ink Box Full Date
	Displays the full date of the left ink sump. [0 to 0xFFFFFFFF/0/1]
8	Left Ink Box Fitting Count
	Displays the number of times that the left ink sump has been replaced. [0 to 0xFFFFFFFF/0/1]
	Carriage Unit
9	Carriage Unit (Black) Initial Count
	Displays the count of initial fillings of black ink at installation recorded onto the ID chip of the ink collector unit.
	[0 to 255/0/1]
10	Carriage Unit (Color) Initial Count
	Displays the count of initial fillings of color ink at installation. This information is read from the ID chip in the color ink cartridges.
	[0 to 255/0/1]
11	Total Cleaning Count
	Displays the count for the total number of print head cleanings recorded onto the ID chip of the ink collector unit.. [0 to 65535/0/1]

12	Total Refreshing Count
	Displays the count for the total number of print head flushings recorded onto the ID chip of the ink collector unit.. [0 to 65535/0/1]
13	Total Ink Supply Sequence Count
	Displays the total count for the number of ink filling sequences recorded onto the ID chip of the ink collector unit. [0 to 255/0/1]
14	Air Purge Filling Count: Total
	Displays the total count for the number of air purgings recorded onto the ID chip of the ink collector unit. [0 to 65535/0/1]
15	Air Purge Filling Count: Maintenance Total
	Displays the total count for the number of air purgings followed by in filling recorded onto the ID chip of the ink collector unit. [0 to 65535/0/1]
16	Flushing Count after Printing
	Displays the total count for the number of flushings after printing recorded onto the ID chip of the ink collector unit. [0 to 999999/0/1]
17	Little Flushing Count after Leftover
	Displays the total count for the number of small flushings after idle time recorded onto the ID chip of the ink collector unit. [0 to 65535/0/1]
18	Total Decapping Cleaning Count
	Displays the total for the number of times the print heads have been uncapped recorded onto the ID chip of the ink collector unit. [0 to 65535/0/1]

19	Negative Pressure Recovery Count
	Displays the total for the number of times the negative pressure recovery cycle has been done recorded onto the ID chip of the ink collector unit. [0 to 9999/0/1]
20	User Cleaning Count
	Displays the total for the number times manual cleaning has been executed with the User Tools recorded onto the ID chip of the ink collector unit. [0 to 65535/0/1]
21	User Refreshing Count
	Displays the total for the number times manual flushing has been executed with the User Tools recorded onto the ID chip of the ink collector unit. [0 to 65535/0/1]
22	Cleaning Count after Leftover
	Displays the total for the number times print head cleaning has been executed after idle time recorded onto the ID chip of the ink collector unit. [0 to 65535/0/1]
23	Ink Supply after Leftover Count
	Displays the total for the number of times the ink supply cycle was executed after idle time recorded onto the ID chip of the ink collector unit. [0 to 255/0/1]
24	Air Purge Filling Count: after Leftover
	Displays the total for number of times air purge and filling were executed after idle time recorded onto the ID chip of the ink collector unit. [0 to 65535/0/1]
26	Ink Supply Count
	Displays the total for the number of times ink was supplied after ink cartridge replacement. [0 to 255/0/1]

27	Air Purge Filling Count (Pressure)
	Displays the number of times air was purged from the tanks based on an excess air reading of the air sensors. [0 to 65535/0/1]
28	Air Purge Filling Count (Humidity)
	Displays the total for the number of times air was purged from the tanks based on detection of a change in humidity.. [0 to 65535/0/1]
29	Maintenance Count without Waste Box
	Displays the total for the number of maintenance cycles done with the left ink sump removed from the machine. [0 to 65535/0/1]
30	Flushing Count before Printing
	Displays the total for the number of times ink was flushed before a job began. [0 to 1677215/0/1]
31	Flushing Count during Printing
	Displays the total for the number of times ink was flushed during a job. [0 to 1677215/0/1]
32	Flushing Count after Printing
	Displays the total for the number of times ink was flushed after a job. [0 to 65535/0/1]
33	Feed Count Cleared Count
	Displays the total for the number of times the maintenance cleaning cycle was executed based on paper feed count. [0 to 65535/0/1]

34	Mist Count Cleared Count
	Displays the total for the number of time the maintenance cleaning cycle was executed based on the mist count. [0 to 65535/ 0 /1]
35	Wiping Count after Suction
	Displays the total for the number of times the wipers of the maintenance cleaning unit have cleaned the print heads. [0 to 1677215/ 0 /1]
	Ink Collector Unit
36	Front Ink Box Printed Length
	Displays the total for the length of paper fed through the machine with the previous ink tank collector.. [0 to 72 000 000/ 0 /1 mm]
37	Front Ink Box Amount Counter
	Displays the total for the amount of ink held by the previous ink collector unit. [0 to 3000/ 0 /0.001 ml]
38	Front Right Ink Box Amount Counter
	Displays the total amount for the amount of ink held by the previous right ink sump. [0 to 999/ 0 /0.001 ml]
39	Front Right Ink Box C/R Date
	Displays the date that the right ink sump was replaced. [0 to 0xFFFFFFFF/ 0 /1]
40	Front Left Ink Box Amount Counter
	Displays the total of the amount of ink held by the previous left ink sump. [0 to 2000/ 0 /0.001 ml]

41	Front Left Ink Box C/R Date
	Displays the date that the left ink sump was replaced. [0 to 0xFFFFFFFF/0/1]
42	Ink Box Exchange Count
	Displays the number of times that the ink collector unit has been replaced. [0 to 255/0/1]
43	Cleaning Execution Flag DFU
	This SP code determines whether cleaning resumes after the right cover of the ink collector unit is opened and closed. The default is "0" (cleaning resumes). Important: To prevent ink spillage, never remove the ink collector unit during the maintenance cleaning cycle. [0 to 1/0/1]
44	Front Cover Open Maintenance Count
	Displays the cover front cover open maintenance count.

7962	Waste Ink Box
	These SP codes display information about the ink collector unit. This information is recorded on the ID chip inside the ink collector unit box.
1	Model ID
	[0 to 255/0/1]
2	Waste Ink Box Version
3	Brand Name ID
4	Area ID
5	Type ID
6	Color ID
7	Maintenance ID

8	Brand New Information
9	Recycling Counter
10	Manufactured Date
	[0 to 1/0/1]
11	Serial No.
12	Remaining Capacity
	Displays the remaining capacity of the ink collector unit. [0 to 100/0/1%]
13	EDP Code
14	Full Log
15	Refill Log
16	Fitted: Total Counter
	[0 to 99999999/0/1]
17	Fitted: Color Counter
18	Full: Total Counter
19	Full: Color Counter
20	Fitted Date
	[0 to 1/0/1]
21	Full Date
22	Full Threshold
	Displays the full threshold for the ink collector unit. [0 to 65535/0/0.1 ml]
23	Near Full Threshold
	Displays the near-full threshold for the ink collector unit. [0 to 100/0/1]

24	Waste Volume Count
	Displays the volume of ink currently inside the ink collector unit. [0 to 0xFFFFFFFF/0/1 nl]
25	Accum. Printed Length (High Speed/Standard)
	Displays the length of paper printed at High Speed, Standard. [0 to 0xFFFFFFFF/0/1 mm]
26	Accum. Printed Length (Fine)
	Displays the length of paper printed at Fine. [0 to 0xFFFFFFFF/0/1 mm]
27	User Cleaning Count
	Displays the total for the number of cleanings executed with the User Tools.. [0 to 0xFFFF/0/1]
28	Driven Refreshing Count in Suction
	Displays the total for the number of flushings executed during suction cleaning of the print heads. [0 to 0xFFFF/0/1]
29	Air Purge Filling Count: Weak Pressure
	Displays the total for the number of air purges and re-fillings triggered by detection of weak pressure in the ink sub tanks. [0 to 0xFFFF/0/1]
30	Air Purge Filling Count: Humidity Change
	Displays the total for the number of re-fillings triggered by detection of a change in humidity in the ink sub tanks. [0 to 0xFFFF/0/1]
31	Maintenance Count after Box Cover Open
	Displays the total for the number of maintenance cleanings interrupted by opening and closing the right cover of the ink collector unit. [0 to 255/0/1]

32	Cleaning Count
	Displays the total for the number of cleanings with the ink collector unit. [0 to 0xFFFFFFFF/0/1]
33	Initial Fill Count
	Displays the total for the number of fillings at installation. [0 to 255/0/1]
34	Ink Supply Sequence Count
	Displays the total for the number of inks supply execution sequences. [0 to 255/0/1]

7963	Waste Ink Box Log 1
	These SP codes display the history for usage of the previous 5 ink collector units, to include serial numbers, dates of installation, total counters, etc.
1	Serial No.
	[0 to 1/0/1]
2	Fitted Date & Time
3	Fitted: Total Counter (Box 1)
	[0 to 999999999/0/1]
4	Refill Log
	[0 to 1/0/1]
5	Serial No.
6	Fitted Date & Time
7	Fitted: Total Counter (Box 2)
	[0 to 999999999/0/1]
8	Refill Log
	[0 to 1/0/1]
9	Serial No.

10	Fitted Date & Time
11	Fitted: Total Counter (Box 3)
	[0 to 99999999/0/1]
12	Refill Log
	[0 to 1/0/1]
13	Serial No.
14	Fitted Date & Time
15	Fitted: Total Counter (Box 4)
	[0 to 99999999/0/1]
16	Refill Log
	[0 to 1/0/1]
17	Serial No.
18	Fitted Date & Time
19	Fitted: Total Counter (Box 5)
	[0 to 99999999/0/1]
20	Refill Log
	[0 to 1/0/1]

7964	Waste Ink Status DFU
	These SP codes provide a history of filling, cleanings, etc. broken down for each print head.
1	Initial Fill Count H1
	[0 to 255/0/1]
2	Initial Fill Count H2
3	Initial Fill Count H3
4	Initial Fill Count H4

5	Cleaning Count (Feed) H1
	[0 to 65535/0/1]
6	Cleaning Count (Feed) H2
7	Cleaning Count (Feed) H3
8	Cleaning Count (Feed) H4
9	Cleaning Count (Mist) H1
10	Cleaning Count (Mist) H2
11	Cleaning Count (Mist) H3
12	Cleaning Count (Mist) H4
13	Cleaning Count (User) H1
14	Cleaning Count (User) H2
15	Cleaning Count (User) H3
16	Cleaning Count (User) H4
17	Refreshing Count (User) H1
18	Refreshing Count (User) H2
19	Refreshing Count (User) H3
20	Refreshing Count (User) H4
21	Cleaning Count (Decapping) H1
22	Cleaning Count (Decapping) H2
23	Cleaning Count (Decapping) H3
24	Cleaning Count (Decapping) H4
29	Cleaning Count after Leftover H1
30	Cleaning Count after Leftover H2
31	Cleaning Count after Leftover H3
32	Cleaning Count after Leftover H4

33	Little Flushing after Leftover H1
34	Little Flushing after Leftover H2
35	Little Flushing after Leftover H3
36	Little Flushing after Leftover H4
37	Rich Flushing after Leftover H1
38	Rich Flushing after Leftover H2
39	Rich Flushing after Leftover H3
40	Rich Flushing after Leftover H4
41	Air Purge Filling after Leftover Count H1
42	Air Purge Filling after Leftover Count H2
43	Air Purge Filling after Leftover Count H3
44	Air Purge Filling after Leftover Count H4
45	Ink Supply after Leftover Count H1
	[0 to 255/0/1]
46	Ink Supply after Leftover Count H2
47	Ink Supply after Leftover Count H3
48	Ink Supply after Leftover Count H4
49	Ink Supply after Humidity Change Count H1
	[0 to 65535/0/1]
50	Ink Supply after Humidity Change Count H2
51	Ink Supply after Humidity Change Count H3
52	Ink Supply after Humidity Change Count H4
53	Air Purge Filling after Leftover (Pressure) H1
54	Air Purge Filling after Leftover (Pressure) H2
55	Air Purge Filling after Leftover (Pressure) H3

56	Air Purge Filling after Leftover (Pressure) H4
57	Air Purge Filling after Leftover (Humidity) H1
58	Air Purge Filling after Leftover (Humidity) H2
59	Air Purge Filling after Leftover (Humidity) H3
60	Air Purge Filling after Leftover (Humidity) H4
69	Air Purge Filling after SC202 Count H1
	[0 to 255/0/1]
70	Air Purge Filling after SC202 Count H2
71	Air Purge Filling after SC202 Count H3
72	Air Purge Filling after SC202 Count H4
81	Ink Supply Sequence Count H1
82	Ink Supply Sequence Count H2
83	Ink Supply Sequence Count H3
84	Ink Supply Sequence Count H4
85	Maintenance Count H1/ Loose Ink Box
86	Maintenance Count H2/ Loose Ink Box
87	Maintenance Count H3/ Loose Ink Box
88	Maintenance Count H4/ Loose Ink Box
93	Waste Ink Box Full: Right
	[0 to 2/0/1]
94	Waste Ink Box Full: Left
	[0 to 2/0/1]
95	Loose Waste Ink Box Information
	[0 to 255/0/1]
96	No Filling Negative Pressure CIRf Count H1

	[0 to 65535/0/1]
97	No Filling Negative Pressure CIRf Count H2
98	No Filling Negative Pressure CIRf Count H3
99	No Filling Negative Pressure CIRf Count H4
100	Recovery Cleaning Count H1
101	Recovery Cleaning Count H2
102	Recovery Cleaning Count H3
103	Recovery Cleaning Count H4
104	Cleaning Count (Mid) H1
105	Cleaning Count (Mid) H2
106	Cleaning Count (Mid) H3
107	Cleaning Count (Mid) H4

7966	OCFS Position Log DFU
------	------------------------------

7967	Air Open Position Log DFU
------	----------------------------------

7968	DIFF Position Log DFU
------	------------------------------

7969	Main Filter Check Log 1 DFU
------	------------------------------------

7972	Carriage Unit B Counter - Mono (per A4 Converted)
	This SP shows the total print count for the black (K1,K2) print head holder inside the carriage unit (expressed as an equivalent to A4-size prints). This internal count is different from the total paper count used for machine counter devices. This counter does not update if the paper jams.
	[0 to 99999999/0/1 page]

7973	Carriage Unit C Counter - Color (per A4 Converted)
	This SP shows the total print count for the color (C, YM) print head holder inside the carriage unit (expressed as an equivalent to A4-size prints). This internal count is different from the total paper count used for machine counter devices. This counter does not update if the paper jams.
	[0 to 99999999/0/1 page]

2.9 SP8000

Many of these counters are provided for features that are currently not available, such as sending color faxes, and so on. However, here are some Group 8 codes that when used in combination with others, can provide useful information.

SP Numbers	What They Do
SP8211 to SP8216	The number of pages scanned to the document server.
SP8401 to SP8406	The number of pages printed from the document server
SP8691 to SP8696	The number of pages sent from the document server

Specifically, the following questions can be answered:

- How is the document server actually being used?
- What application is using the document server most frequently?
- What data in the document server is being reused?

Most of the SPs in this group are prefixed with a letter that indicates the mode of operation (the mode of operation is referred to as an 'application'). Before reading the Group 8 Service Table, make sure that you understand what these prefixes mean.

PREFIX	WHAT IT MEANS	
T:	Total: (Grand Total).	Grand total of the items counted for all applications (C, F, P, etc.)..
C:	Copy application.	Totals (pages, jobs, etc.) executed for each application when the job was not stored on the document server.
P:	Print application.	
S:	Scan application.	

PREFIX	WHAT IT MEANS	
L:	Local storage (document server)	Totals (jobs, pages, etc.) for the document server. The L: counters work differently case by case. Sometimes, they count jobs/pages stored on the document server; this can be in document server mode (from the document server window), or from another mode, such as from a printer driver or by pressing the Store File button in the Copy mode window. Sometimes, they include occasions when the user uses a file that is already on the document server. Each counter will be discussed case by case.
O:	Other applications (external network applications, for example)	Refers to network applications such as Web Image Monitor. Utilities developed with the SDK (Software Development Kit) will also be counted with this group in the future.

The Group 8 SP codes are limited to 17 characters, forced by the necessity of displaying them on the small LCDs of printers and faxes that also use these SPs. Read over the list of abbreviations below and refer to it again if you see the name of an SP that you do not understand.

Key for Abbreviations

ABBREVIATION	WHAT IT MEANS
/	"By", e.g. "T:Jobs/Apl" = Total Jobs "by" Application
>	More (2> "2 or more", 4> "4 or more")
AddBook	Address Book
Apl	Application
B/W	Black & White
Bk	Black
C	Cyan
ColCr	Color Create

ABBREVIATION	WHAT IT MEANS
ColMode	Color Mode
Comb	Combine
Comp	Compression
Deliv	Delivery
DesApl	Designated Application. The application (Copy, Fax, Scan, Print) used to store the job on the document server, for example.
Dev Counter	Development Count, no. of pages developed.
Dup, Duplex	Duplex, printing on both sides
Emul	Emulation
FC	Full Color
FIN	Post-print processing, i.e. finishing (punching, stapling, etc.)
Full Bleed	No Margins
GenCopy	Generation Copy Mode
GPC	Get Print Counter. For jobs 10 pages or less, this counter does not count up. For jobs larger than 10 pages, this counter counts up by the number that is in excess of 10 (e.g., for an 11-page job, the counter counts up 11-10 =1)
IFax	Internet Fax
ImgEdt	Image Edit performed on the original with the copier GUI, e.g. border removal, adding stamps, page numbers, etc.
K	Black (YMCK)
LS	Local Storage. Refers to the document server.
LSize	Large (paper) Size
Mag	Magnification
MC	One color (monochrome)

ABBREVIATION	WHAT IT MEANS
NRS	New Remote Service, which allows a service center to monitor machines remotely. "NRS" is used overseas, "CSS" is used in Japan.
Org	Original for scanning
OrgJam	Original Jam
Palm 2	Print Job Manager/Desk Top Editor: A pair of utilities that allows print jobs to be distributed evenly among the printers on the network, and allows files to moved around, combined, and converted to different formats..
PC	Personal Computer
PGS	Pages. A page is the total scanned surface of the original. Duplex pages count as two pages, and A3 simplex count as two pages if the A3/DLT counter SP is switched ON.
PJob	Print Jobs
Ppr	Paper
PrtJam	Printer (plotter) Jam
PrtPGS	Print Pages
R	Red (Toner Remaining). Applies to the wide format model A2 only. This machine is under development and currently not available.
Rez	Resolution
SC	Service Code (Error SC code displayed)
Scn	Scan
Sim, Simplex	Simplex, printing on 1 side.
S-to-Email	Scan-to-E-mail
SMC	SMC report printed with SP5990. All of the Group 8 counters are recorded in the SMC report.
Svr	Server
TonEnd	Toner End

ABBREVIATION	WHAT IT MEANS
TonSave	Toner Save
TXJob	Send, Transmission
WSD	Web Services Devices
YMC	Yellow, Magenta, Cyan
YMCK	Yellow, Magenta, Cyan, Black

Note

- All of the Group 8 SPs are reset with SP5 801 1 Memory All Clear, or the Counter Reset SP7 808.

8001	T:Total Jobs	These SPs count the number of times each application is used to do a job. [0 to 99999999/ 0 / 1] Note: The L: counter is the total number of times the other applications are used to send a job to the document server, plus the number of times a file already on the document server is used.
8002	C:Total Jobs	
8004	P:Total Jobs	
8005	S:Total Jobs	
8006	L:Total Jobs	

- These SPs reveal the number of times an application is used, not the number of pages processed.
- When an application is opened for image input or output, this counts as one job.
- Interrupted jobs (paper jams, etc.) are counted, even though they do not finish.
- Only jobs executed by the customer are counted. Jobs executed by the customer engineer using the SP modes are not counted.
- When using secure printing (when a password is required to start the print job), the job is counted at the time when either "Delete Data" or "Specify Output" is specified.
- When a copy job on the document server is printed, SP8022 also increments, and when a print job stored on the document server is printed, SP8024 also increments.
- When an original is both copied and stored on the document server, the C: and L: counters both increment.
- When a print job is stored on the document server, only the L: counter increments.
- When the user presses the Document Server button to store the job on the document server, only the L: counter increments.

- When the user enters document server mode and prints data stored on the document server, only the L: counter increments.
- When an image received from Palm 2 is received and stored, the L: counter increments.
- When the customer prints a report (user code list, for example), the O: counter increments.

8011	T:Jobs/LS	<p>These SPs count the number of jobs stored to the document server by each application, to reveal how local storage is being used for input.</p> <p>[0 to 9999999/ 0 / 1]</p> <p>The L: counter counts the number of jobs stored from within the document server mode screen at the operation panel.</p>
8012	C:Jobs/LS	
8014	P:Jobs/LS	
8015	S:Jobs/LS	
8016	L:Jobs/LS	
8017	O:Jobs/LS	

- When a scan job is sent to the document server, the S: counter increments. When you enter document server mode and then scan an original, the L: counter increments.
- When a print job is sent to the document server, the P: counter increments.
- When a network application sends data to the document server, the O: counter increments.
- When an image from Palm 2 is stored on the document server, the O: counter increments.

8021	T:Pjob/LS	<p>These SPs reveal how files printed from the document server were stored on the document server originally.</p> <p>[0 to 9999999/ 0 / 1]</p> <p>The L: counter counts the number of jobs stored from within the document server mode screen at the operation panel.</p>
8022	C:Pjob/LS	
8024	P:Pjob/LS	
8025	S:Pjob/LS	
8026	L:Pjob/LS	
8027	O:Pjob/LS	

- When a copy job stored on the document server is printed with another application, the C: counter increments.
- When an application like DeskTopBinder merges a copy job that was stored on the document server with a print job that was stored on the document server, the C: and P: counters both increment.
- When a job already on the document server is printed with another application, the L: counter increments.
- When a scanner job stored on the document server is printed with another application, the S: counter increments. If the original was scanned from within document server mode, then the L: counter increments.
- When images stored on the document server by a network application (including Palm 2), are printed with another application, the O: counter increments.
- When a copy job stored on the document server is printed with a network application (Web Image Monitor, for example), the C: counter increments.

8031	T:Pjob/DesApl
8032	C:Pjob/DesApl
8034	P:Pjob/DesApl
8035	S:Pjob/DesApl
8036	L:Pjob/DesApl
8037	O:Pjob/DesApl
	<p>These SPs reveal what applications were used to output documents from the document server.</p> <p>[0 to 9999999/ 0 / 1]</p> <p>The L: counter counts the number of jobs printed from within the document server mode screen at the operation panel.</p>

- When documents already stored on the document server are printed, the count for the application that started the print job is incremented.
- When the print job is started from a network application (Desk Top Binder, Web Image Monitor, etc.) the L: counter increments.

8041	T:TX Jobs/LS
8042	C:TX Jobs/LS
8044	P:TX Jobs/LS
8045	S:TX Jobs/LS
8046	L:TX Jobs/LS
8047	O:TX Jobs/LS
	<p>These SPs count the applications that stored files on the document server that were later accessed for transmission over the telephone line or over a network (attached to an e-mail).</p> <p>[0 to 99999999/ 0 / 1]</p> <p>Note: Jobs merged for sending are counted separately.</p> <p>The L: counter counts the number of jobs scanned from within the document server mode screen at the operation panel.</p>

- When a stored copy job is sent from the document server, the C: counter increments.
- When images stored on the document server by a network application or Palm2 are sent as an e-mail, the O: counter increments.

8051	T:TX Jobs/DesApl
8052	C:TX Jobs/DesApl
8054	P:TX Jobs/DesApl
8055	S:TX Jobs/DesApl
8056	L:TX Jobs/DesApl
8057	O:TX Jobs/DesApl
	<p>These SPs count the applications used to send files from the document server over the telephone line or over a network (attached to an e-mail). Jobs merged for sending are counted separately.</p> <p>[0 to 9999999/ 0 / 1]</p> <p>The L: counter counts the number of jobs sent from within the document server mode screen at the operation panel.</p>

- If the send is started from Desk Top Binder or Web Image Monitor, for example, then the O: counter increments.

8061	T:FIN Jobs
	<p>[0 to 9999999/ 0 / 1]</p> <p>These SPs total the finishing methods. The finishing method is specified by the application.</p>
8062	C:FIN Jobs
	<p>[0 to 9999999/ 0 / 1]</p> <p>These SPs total finishing methods for copy jobs only. The finishing method is specified by the application.</p>
8064	P:FIN Jobs
	<p>[0 to 9999999/ 0 / 1]</p> <p>These SPs total finishing methods for print jobs only. The finishing method is specified by the application.</p>

8065	S:FIN Jobs	
	[0 to 9999999/ 0 / 1] These SPs total finishing methods for scan jobs only. The finishing method is specified by the application. Note: Finishing features for scan jobs are not available at this time.	
8066	L:FIN Jobs	
	[0 to 9999999/ 0 / 1] These SPs total finishing methods for jobs output from within the document server mode screen at the operation panel. The finishing method is specified from the print window within document server mode.	
8067	O:FIN Jobs	
	[0 to 9999999/ 0 / 1] These SPs total finishing methods for jobs executed by an external application, over the network. The finishing method is specified by the application.	
1	Sort	Number of jobs started in Sort mode. When a stored copy job is set for Sort and then stored on the document server, the L: counter increments. (See SP8066 1)
2	Stack	Number of jobs started out of Sort mode.
3	Staple	Number of jobs started in Staple mode.
4	Booklet	Number of jobs started in Booklet mode. If the machine is in staple mode, the Staple counter also increments.
5	Z-Fold	Number of jobs started In any mode other than the Booklet mode and set for folding (Z-fold).
6	Punch	Number of jobs started in Punch mode. When Punch is set for a print job, the P: counter increments. (See SP8064 6.)
7	Other	Reserved. Not used.
8	Inside-Fold	

9	Three-in-Fold	
10	Three-Out-Fold	
11	Four-Fold	
12	Kannon-Fold	
13	Perfect Bind	
14	Ring Bind	

8071	T:Jobs/PGS
	[0 to 9999999/ 0 / 1] These SPs count the number of jobs broken down by the number of pages in the job, regardless of which application was used.
8072	C:Jobs/PGS
	[0 to 9999999/ 0 / 1] These SPs count and calculate the number of copy jobs by size based on the number of pages in the job.
8074	P:Jobs/PGS
	[0 to 9999999/ 0 / 1] These SPs count and calculate the number of print jobs by size based on the number of pages in the job.
8075	S:Jobs/PGS
	[0 to 9999999/ 0 / 1] These SPs count and calculate the number of scan jobs by size based on the number of pages in the job.
8076	L:Jobs/PGS
	[0 to 9999999/ 0 / 1] These SPs count and calculate the number of jobs printed from within the document server mode window at the operation panel, by the number of pages in the job.

8077	O:Jobs/PGS		
	[0 to 99999999/ 0 / 1] These SPs count and calculate the number of "Other" application jobs (Web Image Monitor, Palm 2, etc.) by size based on the number of pages in the job.		
1	1 Page	8	21 to 50 Pages
2	2 Pages	9	51 to 100 Pages
3	3 Pages	10	101 to 300 Pages
4	4 Pages	11	301 to 500 Pages
5	5 Pages	12	501 to 700 Pages
6	6 to 10 Pages	13	701 to 1000 Pages
7	11 to 20 Pages	14	1001 to Pages

- For example: When a copy job stored on the document server is printed in document server mode, the appropriate L: counter (SP8076 0xx) increments.
- Interrupted jobs (paper jam, etc.) are counted, even though they do not finish.
- If a job is paused and re-started, it counts as one job.
- If the finisher runs out of staples during a print and staple job, then the job is counted at the time the error occurs.
- For copy jobs (SP 8072) and scan jobs (SP 8075), the total is calculated by multiplying the number of sets of copies by the number of pages scanned. (One duplex page counts as 2.)
- The first test print and subsequent test prints to adjust settings are added to the number of pages of the copy job (SP 8072).
- When printing the first page of a job from within the document server screen, the page is counted.

8131	T:S-to-Email Jobs	
	[0 to 9999999/ 0 / 1] These SPs count the total number of jobs scanned and attached to an e-mail, regardless of whether the document server was used or not.	
8135	S:S-to-Email Jobs	
	These SPs count the number of jobs scanned and attached to an e-mail, without storing the original on the document server.	
1	B/W	Count for the number of jobs with black-and-white.
2	Color	Count for the number of jobs with color.
3	ACS	Count for the number of jobs using ACS mode.

- These counters count jobs, not pages.
- If the job is stored on the document server, after the job is stored it is determined to be color or black-and-white then counted.
- If the job is cancelled during scanning, or if the job is cancelled while the document is waiting to be sent, the job is not counted.
- If the job is cancelled during sending, it may or may not be counted, depending on what stage of the process had been reached when the job was cancelled.
- If several jobs are combined for sending to the Scan Router, Scan-to-Email, or Scan-to-PC, or if one job is sent to more than one destination. each send is counted separately. For example, if the same document is sent by Scan-to-Email as well as Scan-to-PC, then it is counted twice (once for Scan-to-Email and once for Scan-to-PC).

8141	T:Deliv Jobs/Svr	
	[0 to 99999999/ 0 / 1] These SPs count the total number of jobs scanned and sent to a Scan Router server.	
8145	S:Deliv Jobs/Svr	
	These SPs count the number of jobs scanned in scanner mode and sent to a Scan Router server.	
1	B/W	Count for the number of jobs with black-and-white.
2	Color	Count for the number of jobs with color.
3	ACS	Count for the number of jobs using ACS mode.

- These counters count jobs, not pages.
- The jobs are counted even though the arrival and reception of the jobs at the Scan Router server cannot be confirmed.
- If even one color image is mixed with black-and-white images, then the job is counted as a "Color" job.
- If the job is cancelled during scanning, or if the job is cancelled while the document is waiting to be delivered, the job is not counted.
- If the job is cancelled during sending, it may or may not be counted, depending on what stage of the process had been reached when the job was cancelled.
- Even if several files are combined for sending, the transmission counts as one job.

8151	T:Deliv Jobs/PC	
	[0 to 9999999/ 0 / 1] These SPs count the total number of jobs scanned and sent to a folder on a PC (Scan-to-PC).	
8155	S:Deliv Jobs/PC	
	These SPs count the total number of jobs scanned and sent with Scan-to-PC.	
1	B/W	Count for the number of jobs with black-and-white.
2	Color	Count for the number of jobs with color.
3	ACS	Count for the number of jobs using ACS mode.

- These counters count jobs, not pages.
- If the job is cancelled during scanning, it is not counted.
- If the job is cancelled while it is waiting to be sent, the job is not counted.
- If the job is cancelled during sending, it may or may not be counted, depending on what stage of the process had been reached when the job was cancelled.
- Even if several files are combined for sending, the transmission counts as one job.

8171	T: Deliv Jobs/WSD	
	Total jobs for WSD (WS-Scanner for Web Services Devices).	
8175	S: Deliv Jobs/WSD	
8181	T: Scan to Media Jobs	
8185	S: Scan to Media Jobs	
	Total number of jobs scanned for WSD.	
	001	B/W
	002	Color
	003	ACS

8191	T:Total Scan PGS
8192	C:Total Scan PGS
8195	S:Total Scan PGS
8196	L:Total Scan PGS
	These SPs count the pages scanned by each application that uses the scanner to scan images. [0 to 9999999/ 0 / 1]

- SP 8191 to 8196 count the number of scanned sides of pages, not the number of physical pages.
- These counters do not count reading user stamp data, or reading color charts to adjust color.
- Previews done with a scanner driver are not counted.
- A count is done only after all images of a job have been scanned.
- Scans made in SP mode are not counted.

Examples:

- If 3 B5 pages and 1 A3 page are scanned with the scanner application but not stored, the S: count is 4.
- If both sides of 3 A4 sheets are copied and stored to the document server using the Store File button in the Copy mode window, the C: count is 6 and the L: count is 6.
- If both sides of 3 A4 sheets are copied but not stored, the C: count is 6.
- If you enter document server mode then scan 6 pages, the L: count is 6.

8211	T:Scan PGS/LS
8212	C:Scan PGS/LS
8215	S:Scan PGS/LS
8216	L:Scan PGS/LS
	These SPs count the number of pages scanned into the document server. [0 to 9999999/ 0 / 1] The L: counter counts the number of pages stored from within the document server mode screen at the operation panel, and with the Store File button from within the Copy mode screen

- Reading user stamp data is not counted.
- If a job is cancelled, the pages output as far as the cancellation are counted.
- If the scanner application scans and stores 3 B5 sheets and 1 A4 sheet, the S: count is 4.
- If pages are copied but not stored on the document server, these counters do not change.
- If both sides of 3 A4 sheets are copied and stored to the document server, the C: count is 6 and the L: count is 6.
- If you enter document server mode then scan 6 pages, the L: count is 6.

8221	ADF Org Feeds
	[0 to 9999999/ 0 / 1] These SPs count the number of pages fed through the ADF for front and back side scanning.
1	Front
	Number of front sides fed for scanning: With an ADF that can scan both sides simultaneously, the Front side count is the same as the number of pages fed for either simplex or duplex scanning. With an ADF that cannot scan both sides simultaneously, the Front side count is the same as the number of pages fed for duplex front side scanning. (The front side is determined by which side the user loads face up.)
2	Back
	Number of rear sides fed for scanning: With an ADF that can scan both sides simultaneously, the Back count is the same as the number of pages fed for duplex scanning. With an ADF that cannot scan both sides simultaneously, the Back count is the same as the number of pages fed for duplex rear-side scanning.

- When 1 sheet is fed for duplex scanning the Front count is 1 and the Back count is 1.
- If a jam occurs during the job, recovery processing is not counted to avoid double counting. Also, the pages are not counted if the jam occurs before the first sheet is output.

	Scan PGS/Mode
8231	[0 to 99999999/ 0 / 1] These SPs count the number of pages scanned by each ADF mode to determine the work load on the ADF.
1	Large Volume
	Selectable. Large copy jobs that cannot be loaded in the ADF at one time.
2	SADF
	Selectable. Feeding pages one by one through the ADF.
3	Mixed Size
	Selectable. Select "Mixed Sizes" on the operation panel.
4	Custom Size
	Selectable. Originals of non-standard size.
5	Platen
	Book mode. Raising the ADF and placing the original directly on the platen.
6	Mixed 1 Side/2 Side
	Mixed scanning jobs with one-side, 2-side originals.

- If the scan mode is changed during the job, for example, if the user switches from ADF to Platen mode, the count is done for the last selected mode.
- If the user selects "Mixed Sizes" for copying in the platen mode, the Mixed Size count is enabled.
- In the SADF mode if the user copies 1 page in platen mode and then copies 2 pages with SADF, the Platen count is 1 and the SADF count is 3.

8241	T:Scan PGS/Org
	[0 to 9999999/ 0 / 1] These SPs count the total number of scanned pages by original type for all jobs, regardless of which application was used.
8242	C:Scan PGS/Org
	[0 to 9999999/ 0 / 1] These SPs count the number of pages scanned by original type for Copy jobs.
8245	S:Scan PGS/Org
	[0 to 9999999/ 0 / 1] These SPs count the number of pages scanned by original type for Scan jobs.
8246	L:Scan PGS/Org
	[0 to 9999999/ 0 / 1] These SPs count the number of pages scanned and stored from within the document server mode screen at the operation panel, and with the Store File button from within the Copy mode screen

	8241	8242	8245	8246
1: Text	Yes	Yes	Yes	Yes
2: Text/Photo	Yes	Yes	Yes	Yes
3: Photo	Yes	Yes	Yes	Yes
4: GenCopy, Pale	Yes	Yes	Yes	Yes
5: Map	Yes	Yes	No	Yes
6: Normal/Detail	Yes	No	No	No
7: Fine/Super Fine	Yes	No	No	No
8: Binary	Yes	No	Yes	No
9: Grayscale	Yes	No	Yes	No

10: Color	Yes	No	Yes	No
11: Other	Yes	Yes	Yes	Yes

- If the scan mode is changed during the job, for example, if the user switches from ADF to Platen mode, the count is done for the last selected mode.

8251	T:Scan PGS/ImgEdt
8252	C:Scan PGS/ImgEdt
8255	S:Scan PGS/ImgEdt
8256	L:Scan PGS/ImgEdt
8257	O:Scan PGS/ImgEdt
	<p>These SPs show how many times Image Edit features have been selected at the operation panel for each application. Some examples of these editing features are:</p> <ul style="list-style-type: none"> ▪ Erase> Border ▪ Erase> Center ▪ Image Repeat ▪ Centering ▪ Positive/Negative <p>[0 to 9999999/ 0 / 1]</p> <p>Note: The count totals the number of times the edit features have been used. A detailed breakdown of exactly which features have been used is not given.</p>

- The L: counter counts the number of pages stored from within the document server mode screen at the operation panel, and with the Store File button from within the Copy mode screen.

8261	T: Scn PGS/ColorCr
8262	C: Scn PGS/ColorCr
8265	S: Scn PGS/ColorCr
8266	L: Scn PGS/ColorCr
1	Color Conversion
2	Color Erase
3	Background
4	Other

8281	T:Scan PGS/TWAIN
8285	S:Scan PGS/TWAIN
	<p>These SPs count the number of pages scanned using a TWAIN driver. These counters reveal how the TWAIN driver is used for delivery functions.</p> <p>[0 to 9999999/ 0 / 1]</p> <p>Note: At the present time, these counters perform identical counts.</p>

8291	T:Scan PGS/Stamp
8295	S:Scan PGS/Stamp

8301	T:Scan PGS/Size
	[0 to 9999999/ 0 / 1] These SPs count by size the total number of pages scanned by all applications. Use these totals to compare original page size (scanning) and output (printing) page size [SP 8-441].
8302	C:Scan PGS/Size
	[0 to 9999999/ 0 / 1] These SPs count by size the total number of pages scanned by the Copy application. Use these totals to compare original page size (scanning) and output (printing) page size [SP 8-442].
8305	S:Scan PGS/Size
	[0 to 9999999/ 0 / 1] These SPs count by size the total number of pages scanned by the Scan application. Use these totals to compare original page size (scanning) and output page size [SP 8-445].
8306	L:Scan PGS/Size
	[0 to 9999999/ 0 / 1] These SPs count by size the total number of pages scanned and stored from within the document server mode screen at the operation panel, and with the Store File button from within the Copy mode screen. Use these totals to compare original page size (scanning) and output page size [SP 8-446].
1	A3
2	A4
4	B4
6	DLT
7	LG
8	LT
100	A2
101	B3

102	A0
103	A1
104	B1
105	B2
106	30x42
107	34x44
108	22x34
109	17x22
110	36x48
111	24x36
112	18x24
113	12x18
114	9x12
254	Other (Standard)
255	Other (Custom)

8311	T:Scan PGS/Rez
	[0 to 9999999/ 0 / 1] These SPs count by resolution setting the total number of pages scanned by applications that can specify resolution settings.
8315	S:Scan PGS/Rez
	[0 to 9999999/ 0 / 1] These SPs count by resolution setting the total number of pages scanned by applications that can specify resolution settings. Note: At the present time, 8311 and 8315 perform identical counts.
1	1200dpi to

2	600dpi to 1199dpi
3	400dpi to 599dpi
4	200dpi to 399dpi
5	to 199dpi

- Copy resolution settings are fixed so they are not counted.

8381	T:Total PrtPGS
8382	C:Total PrtPGS
8384	P:Total PrtPGS
8385	S:Total PrtPGS
8386	L:Total PrtPGS
8387	O:Total PrtPGS
	<p>These SPs count the number of pages printed by the customer. The counter for the application used for storing the pages increments. [0 to 9999999/ 0 / 1]</p> <p>The L: counter counts the number of pages stored from within the document server mode screen at the operation panel. Pages stored with the Store File button from within the Copy mode screen go to the C: counter.</p>
1	Field Number
2	Length (High)
3	Length (Low)
4	Area (High)
5	Area (Low)

- When the A3/DLT double count function is switched on with SP5104, 1 A3/DLT page is counted as 2.
- When several documents are merged for a print job, the number of pages stored are counted for the application that stored them.
- These counters are used primarily to calculate charges on use of the machine, so the following pages are not counted as printed pages:
 - Blank pages in a duplex printing job.
 - Blank pages inserted as document covers, chapter title sheets, and slip sheets.
 - Reports printed to confirm counts.
 - All reports done in the service mode (service summaries, engine maintenance reports, etc.)
 - Test prints for machine image adjustment.
 - Error notification reports.
 - Partially printed pages as the result of a copier jam.

8401	T:PrtPGS/LS
8402	C:PrtPGS/LS
8404	P:PrtPGS/LS
8405	S:PrtPGS/LS
8406	L:PrtPGS/LS
	<p>These SPs count the number of pages printed from the document server. The counter for the application used to print the pages is incremented.</p> <p>The L: counter counts the number of jobs stored from within the document server mode screen at the operation panel.</p> <p>[0 to 9999999/ 0 / 1]</p>

- Print jobs done with Web Image Monitor and Desk Top Binder are added to the L: count.

8421	T:PrtPGS/Dup Comb	
	[0 to 9999999/ 0 / 1] These SPs count by binding and combine, and n-Up settings the number of pages processed for printing. This is the total for all applications.	
8422	C:PrtPGS/Dup Comb	
	[0 to 9999999/ 0 / 1] These SPs count by binding and combine, and n-Up settings the number of pages processed for printing by the copier application.	
8424	P:PrtPGS/Dup Comb	
	[0 to 9999999/ 0 / 1] These SPs count by binding and combine, and n-Up settings the number of pages processed for printing by the printer application.	
8425	S:PrtPGS/Dup Comb	
	[0 to 9999999/ 0 / 1] These SPs count by binding and combine, and n-Up settings the number of pages processed for printing by the scanner application.	
8426	L:PrtPGS/Dup Comb	
	[0 to 9999999/ 0 / 1] These SPs count by binding and combine, and n-Up settings the number of pages processed for printing from within the document server mode window at the operation panel.	
8427	O:PrtPGS/Dup Comb	
	[0 to 9999999/ 0 / 1] These SPs count by binding and combine, and n-Up settings the number of pages processed for printing by Other applications	
1	Simplex> Duplex	
2	Duplex> Duplex	
3	Book> Duplex	
4	Simplex Combine	

5	Duplex Combine	
6	2-in-1	2 pages on 1 side (2-Up)
7	4-in-1	4 pages on 1 side (4-Up)
8	6-in-1	6 pages on 1 side (6-Up)
9	8-in-1	8 pages on 1 side (8-Up)
10	9-in-1	9 pages on 1 side (9-Up)
11	16-in-1	16 pages on 1 side (16-Up)
12	Booklet	
13	Magazine	
14	2-in-1 + Booklet	
15	4-in-1 + Booklet	
16	6-in-1 + Booklet	
17	8-in-1 + Booklet	
18	9-in-1 + Booklet	
19	2-in-1 + Magazine	
20	4-in-1 + Magazine	
21	6-in-1 + Magazine	
22	8-in-1 + Magazine	
23	9-in-1 + Magazine	
24	16-in-1 + Magazine	

- These counts (SP8421 to SP8427) are especially useful for customers who need to improve their compliance with ISO standards for the reduction of paper consumption.
 - Pages that are only partially printed with the n-Up functions are counted as 1 page.
- Here is a summary of how the counters work for Booklet and Magazine modes:

Booklet		Magazine	
Original Pages	Count	Original Pages	Count
1	1	1	1
2	2	2	2
3	2	3	2
4	2	4	2
5	3	5	4
6	4	6	4
7	4	7	4
8	4	8	4

8431	T:PrtPGS/ImgEdt
	[0 to 9999999/ 0 / 1] These SPs count the total number of pages output with the three features below, regardless of which application was used.
8432	C:PrtPGS/ImgEdt
	[0 to 9999999/ 0 / 1] These SPs count the total number of pages output with the three features below with the copy application.
8434	P:PrtPGS/ImgEdt
	[0 to 9999999/ 0 / 1] These SPs count the total number of pages output with the three features below with the print application.
8436	L:PrtPGS/ImgEdt

	[0 to 99999999/ 0 / 1] These SPs count the total number of pages output from within the document server mode window at the operation panel with the three features below.
8437	O:PrtPGS/ImgEdt
	[0 to 99999999/ 0 / 1] These SPs count the total number of pages output with the three features below with Other applications.
1	Cover/Slip Sheet
	Total number of covers or slip sheets inserted. The count for a cover printed on both sides counts 2.
2	Series/Book
	The number of pages printed in series (one side) or printed as a book with booklet right/left pagination.
3	User Stamp
	The number of pages printed where stamps were applied, including page numbering and date stamping.

8441	T:PrtPGS/Ppr Size
	[0 to 9999999/ 0 / 1] These SPs count by print paper size the number of pages printed by all applications.
8442	C:PrtPGS/Ppr Size
	[0 to 9999999/ 0 / 1] These SPs count by print paper size the number of pages printed by the copy application.
8444	P:PrtPGS/Ppr Size
	[0 to 9999999/ 0 / 1] These SPs count by print paper size the number of pages printed by the printer application.
8445	S:PrtPGS/Ppr Size
	[0 to 9999999/ 0 / 1] These SPs count by print paper size the number of pages printed by the scanner application.
8446	L:PrtPGS/Ppr Size
	[0 to 9999999/ 0 / 1] These SPs count by print paper size the number of pages printed from within the document server mode window at the operation panel.
8447	O:PrtPGS/Ppr Size
	[0 to 9999999/ 0 / 1] These SPs count by print paper size the number of pages printed by other applications.
1	A3
2	A4
4	B4
6	DLT

7	LG
8	LT
100	A2
101	B3
102	A0
103	A1
104	B1
105	B2
106	30x42
107	34x44
108	22x34
109	17x22
110	36x48
111	24x36
112	18x24
113	12x18
114	9x12
239	841 mm Custom: A0-
240	841 mm Custom: -A0
241	594 mm Custom
242	420 mm Custom
243	297 mm Custom
244	210 mm Custom
245	228 mm Custom
246	515 mm Custom

247	364 mm Custom
248	257 mm Custom
249	30/34/36 Custom
250	22/24 Custom
251	12/18 Custom
252	11/12 Custom
253	8.5/9 Custom
254	Other (Standard)
255	Other (Custom)

- These counters do not distinguish between LEF and SEF.

8451	PrtPGS/Ppr Tray	
	[0 to 9999999/ 0 / 1] These SPs count the number of sheets fed from each paper feed station.	
1	Bypass	Bypass Tray
2	Tray 1	Copier
3	Tray 2	Copier
4	Tray 3	Paper Tray Unit (Option)
5	Tray 4	Paper Tray Unit (Option)
6	Tray 5	LCT (Option)
7	Tray 6	Currently not used.
8	Tray 7	Currently not used.
9	Tray 8	Currently not used.
10	Tray 9	Currently not used.
11	Tray 10	Currently not used.

12	Tray 11	Currently not used.
13	Tray 12	Currently not used.
14	Tray 13	Currently not used.
15	Tray 14	Currently not used.
16	Tray 15	Currently not used.

8461	T:PrtPGS/Ppr Type
	<p>[0 to 9999999/ 0 / 1]</p> <p>These SPs count by paper type the number pages printed by all applications.</p> <ul style="list-style-type: none"> ▪ These counters are not the same as the PM counter. The PM counter is based on feed timing to accurately measure the service life of the feed rollers. However, these counts are based on output timing. ▪ Blank sheets (covers, chapter covers, slip sheets) are also counted. ▪ During duplex printing, pages printed on both sides count as 1, and a page printed on one side counts as 1.
8462	C:PrtPGS/Ppr Type
	<p>[0 to 9999999/ 0 / 1]</p> <p>These SPs count by paper type the number pages printed by the copy application.</p>
8464	P:PrtPGS/Ppr Type
	<p>[0 to 9999999/ 0 / 1]</p> <p>These SPs count by paper type the number pages printed by the printer application.</p>
8466	L:PrtPGS/Ppr Type
	<p>[0 to 9999999/ 0 / 1]</p> <p>These SPs count by paper type the number pages printed from within the document server mode window at the operation panel.</p>
1	Normal
2	Recycled
3	Special

4	Thick
5	Normal (Back)
6	Thick (Back)
7	OHP
8	Other

8471	PrtPGS/Mag
	[0 to 99999999/ 0 / 1] These SPs count by magnification rate the number of pages printed.
1	- 49%
2	50% to 99%
3	100%
4	101% to 200%
5	201% -

- Counts are done for magnification adjusted for pages, not only on the operation panel but performed remotely with an external network application capable of performing magnification adjustment as well.
- Magnification adjustments done with printer drivers with PC applications such as Excel are also counted.
- Magnification adjustments done for adjustments after they have been stored on the document server are not counted.
- Magnification adjustments performed automatically during Auto Reduce/Enlarge copying are counted.
- The magnification rates of blank cover sheets, slip sheets, etc. are automatically assigned a rate of 100%.

8481	T:PrtPGS/TonSave
8484	P:PrtPGS/TonSave
	<p>These SPs count the number of pages printed with the Toner Save feature switched on.</p> <p>Note: These SPs return the same results as this SP is limited to the Print application.</p> <p>[0 to 9999999/ 0 / 1]</p>

8491	T:PrtPGS/Col Mode
8492	C:PrtPGS/Col Mode
8496	L:PrtPGS/Col Mode
8497	O:PrtPGS/Col Mode
	<p>These SPs count the number of pages printed for each color mode.</p> <p>[0 to 9999999/ 0 / 1]</p>
1	B/W
2	Single Color
3	Two Color
4	Full Color

8501	T:PrtPGS/Col Mode
8504	P:PrtPGS/Col Mode
8507	O:PrtPGS/Col Mode
	<p>These SPs count the number of pages printed for each color mode.</p> <p>[0 to 9999999/ 0 / 1]</p>
1	B/W
2	Mono Color
3	Full Color

4	Single Color	
5	Two Color	

8511	T:PrtPGS/Emul	
	These SPs count by printer emulation mode the total number of pages printed. [0 to 9999999/ 0 / 1]	
8514	P:PrtPGS/Emul	
	These SPs count by printer emulation mode the total number of pages printed. [0 to 9999999/ 0 / 1]	
1	RPCS	
2	RPDL	
3	PS3	
4	R98	
5	R16	
6	GL/GL2	
7	R55	
8	RTIFF	
9	PDF	
10	PCL5e/5c	
11	PCL XL	
12	IPDL-C	
13	BM-Links	Japan Only
14	Other	
15	IPDS	

- SP8511 and SP8514 return the same results as they are both limited to the Print application.
- Print jobs output to the document server are not counted.

8521	T:PrtPGS/FIN
	These SPs count by finishing mode the total number of pages printed by all applications. [0 to 9999999/ 0 / 1]
8522	C:PrtPGS/FIN
	These SPs count by finishing mode the total number of pages printed by the Copy application. [0 to 9999999/ 0 / 1]
8524	P:PrtPGS/FIN
	These SPs count by finishing mode the total number of pages printed by the Print application. [0 to 9999999/ 0 / 1]
8525	S:PrtPGS/FIN
	These SPs count by finishing mode the total number of pages printed by the Scanner application. [0 to 9999999/ 0 / 1]
8526	L:PrtPGS/FIN
	These SPs count by finishing mode the total number of pages printed from within the document server mode window at the operation panel. [0 to 9999999/ 0 / 1]
1	Sort
2	Stack
3	Staple
4	Booklet
5	Z-Fold
6	Punch

7	Other	
8	Inside Fold	Half-Fold (FM2) (Multi Fold Unit)
9	Three-IN-Fold	Letter Fold-in (FM4) (Multi Fold Unit)
10	Three-OUT-Fold	Letter Fold-out (FM3) (Multi Fold Unit)
11	Four Fold	Double Parallel Fold (FM5) (Multi Fold Unit)
12	KANNON-Fold	Gate Fold (FM6) (Multi Fold Unit)
13	Perfect-Bind	Perfect Binder Not Used
14	Ring-Bind	Ring Binder Not Used

- If stapling is selected for finishing and the stack is too large for stapling, the unstapled pages are still counted.
- The counts for staple finishing are based on output to the staple tray, so jam recoveries are counted.

8531	Staples
	This SP counts the amount of staples used by the machine. [0 to 9999999/ 0 / 1]

8551	T: PrtBooks/FIN Not Used	
8552	O: PrtBooks/FIN Not Used	
8554	P: PrtBooks/FIN Not Used	
8556	L: PrtBooks/FIN Not Used	
1	Perfect-Bind	
2	Ring-Bind	

8581	T:Counter
	[0 to 99999999/ 0 / 1]
	These SPs count the total output broken down by color output, regardless of the application used. In addition to being displayed in the SMC Report, these counters are also displayed in the User Tools display on the copy machine.
1	Total
2	Total: Full Colopr
3	B&W/Mono Color
4	Development: CMY
5	Development: K
6	Copy: Color
7	Copy: B/W
8	Print: Color
9	Print: B/W
10	Total: Color
11	Total: B/W
14	Full Color Print
15	Mono Color Print
101	Total: Full Color Length (Low)
102	Total: Full Color Length (High)
103	Total: Full Color Area (Low)
104	Total: Full Color Area (High)
105	B&W/Mono Color Length (Low)
106	B&W/Mono Color Length (High)

107	B&W/Mono Color Area (Low)
108	B&W/Mono Color Area (High)
117	Copy: Color Length (Low)
118	Copy: Color Length (High)
119	Copy: Color Area (Low)
120	Copy: Color Area (High)
121	Color: B/W Length (Low)
122	Color: B/W Length (High)
123	Color: B/W Area (Low)
124	Color: B/W Area (High)
125	Print: Color Length (Low)
126	Print: Color Length (High)
127	Print: Color Area (Low)
128	Print: Color Area (High)
129	Print: B/W Length (Low)
130	Print: B/W Length (High)
131	Print: B/W Area (Low)
132	Print: B/W Area (High)
133	Total Color: Length (Low)
134	Total Color: Length (High)
135	Total Color: Area (Low)
136	Total Color: Area (High)
137	Total B/W Length (Low)
138	Total B/W Length (High)
139	Total B/W Area (Low)

140	Total B/W Area (High)
141	Full Color Print Length (Low)
142	Full Color Print Length (High)
143	Full Color Print Area (Low)
144	Full Color Print Area (High)
145	Mono Color Print Length (Low)
146	Mono Color Print Length (High)
147	Mono Color Print Area (Low)
148	Mono Color Print Area (High)

8582	C: Counter
8584	P: Counter
8586	L: Counter
1	B/W
2	Single Color
3	Two Color
4	Full Color
101	Length (High), B/W
102	Length (Low), B/W
103	Area (High), B/W
104	Area (Low), B/W
111	Length (High), Single
112	Length (Low), Single
113	Area (High), Single
114	Area (Low), Single

121	Length (High), Twin
122	Length (Low), Twin
123	Area (High), Twin
124	Area (Low), Twin
131	Length (High), Full
132	Length (Low), Full
133	Area (High), Full
134	Area (Low), Full

8601	T: Coverage Counter
1	B/W
2	Color
11	B/W Printing Pages
12	Color Printing Pages
21	Coverage Counter 1
22	Coverage Counter 2
23	Coverage Counter 3
31	Coverage Counter 1 (YMC)
32	Coverage Counter 2 (YMC)
33	Coverage Counter 3 (YMC)
41	Cvg Counter 1 Length (High)
42	Cvg Counter 1 Length (Low)
43	Cvg Counter 2 Length (High)
44	Cvg Counter 2 Length (Low)
45	Cvg Counter 3 Length (High)

46	Cvg Counter 3 Length (Low)
51	Cvg Counter 1 (YMC) Length (High)
52	Cvg Counter 1 (YMC) Length (Low)
53	Cvg Counter 2 (YMC) Length (High)
54	Cvg Counter 2 (YMC) Length (Low)
55	Cvg Counter 3 (YMC) Length (High)
56	Cvg Counter 3 (YMC) Length (Low)
61	Cvg Counter 1 Area (High)
62	Cvg Counter 1 Area (Low)
63	Cvg Counter 2 Area (High)
65	Cvg Counter 2 Area (Low)
65	Cvg Counter 3 Area (High)
66	Cvg Counter 3 Area (Low)
71	Cvg Counter 1 (YMC) Area (High)
72	Cvg Counter 1 (YMC) Area (Low)
73	Cvg Counter 2 (YMC) Area (High)
74	Cvg Counter 2 (YMC) Area (Low)
75	Cvg Counter 3 (YMC) Area (High)
76	Cvg Counter 3 (YMC) Area (Low)

8602	D: Coverage Counter
8604	P: Coverage Counter
8606	L: Coverage Counter
	Provide a breakdown about coverage.
1	B/W

2	Single Color
3	Two Color
4	Full Color

8617	SDK Apli Counter DFU
	SDK 1 to 6

8621	Func Use Counter Not Used
	001 to 064: Function 001 to 064

8651	T:S-to-Email PGS
	[0 to 9999999/ 0 / 1] These SPs count by color mode the total number of pages attached to an e-mail for both the Scan and document server applications. Note: This SP is expanded for color MFP and color LP machines. For this machine, the count is done for black only.
1	B/W
2	Color

8655	S:S-to-Email PGS	
	[0 to 9999999/ 0 / 1] These SPs count by color mode the total number of pages attached to an e-mail for the Scan application only. Note: This SP is expanded for color MFP and color LP machines. For this machine, the count is done for black only.	
1	B/W	
2	Color	Color MFP machines only

- For SP8651 and SP8655 the count for B/W and Color pages is done after the document is stored on the HDD. If the job is cancelled before it is stored, the pages are not counted.

- If Scan-to-Email is used to send a 10-page document to 5 addresses, the count is 10 (the pages are sent to the same SMTP server together).
- If Scan-to-PC is used to send a 10-page document to 5 folders, the count is 50 (the document is sent to each destination of the SMB/FTP server).
- Due to restrictions on some devices, if Scan-to-Email is used to send a 10-page document to a large number of destinations, the count may be divided and counted separately. For example, if a 10-page document is sent to 200 addresses, the count is 10 for the first 100 destinations and the count is also 10 for the second 100 destinations, for a total of 20).

8661	T:Deliv PGS/Svr
	[0 to 9999999/ 0 / 1] These SPs count by color mode the total number of pages sent to a Scan Router server by both Scan and LS applications. Note: This SP is expanded for color MFP and color LP machines. For this machine, the count is done for black only.
8665	S:Deliv PGS/Svr
	[0 to 9999999/ 0 / 1] These SPs count by color mode the total number of pages sent to a Scan Router server by the Scan application. Note: This SP is expanded for color MFP and color LP machines. For this machine, the count is done for black only.
1	B/W
2	Color

- The B/W and Color counts are done after the document is stored on the HDD of the Scan Router server.
- If the job is canceled before storage on the Scan Router server finishes, the counts are not done.
- The count is executed even if regardless of confirmation of the arrival at the Scan Router server.

8671	T:Deliv PGS/PC
	[0 to 9999999/ 0 / 1]
	<p>These SPs count by color mode the total number of pages sent to a folder on a PC (Scan-to-PC) with the Scan and LS applications.</p> <p>Note: This SP is expanded for color MFP and color LP machines. For this machine, the count is done for black only.</p>
8675	S:Deliv PGS/PC
	<p>[0 to 9999999/ 0 / 1]</p> <p>These SPs count by color mode the total number of pages sent with Scan-to-PC with the Scan application.</p> <p>Note: This SP is expanded for color MFP and color LP machines. For this machine, the count is done for black only.</p>
1	B/W
2	Color

8691	T:TX PGS/LS
8692	C:TX PGS/LS
8694	P:TX PGS/LS
8695	S:TX PGS/LS
8696	L:TX PGS/LS
	<p>These SPs count the number of pages sent from the document server. The counter for the application that was used to store the pages is incremented.</p> <p>[0 to 9999999/ 0 / 1]</p> <p>The L: counter counts the number of pages stored from within the document server mode screen at the operation panel. Pages stored with the Store File button from within the Copy mode screen go to the C: counter.</p>

- Print jobs done with Web Image Monitor and Desk Top Binder are added to the count.
- If several documents are merged for sending, the number of pages stored is counted for the application that stored them.

8701	TX PGS/Port
	[0 to 99999999/ 0 / 1] These SPs count the number of pages sent by the physical port used to send them. For example, if a 3-page original is sent to 4 destinations via ISDN G4, the count for ISDN (G3, G4) is 12.
1	PSTN-1
2	PSTN-2
3	PSTN-3
4	ISDN (G3,G4)
5	Network

8711	T:Scan PGS/Comp
	[0 to 99999999/ 1] These SPs count the number of compressed pages scanned into the document server, counted by the formats listed below.
1	JPEG/JPEG2000
2	TIFF (Multi/Single)
3	PDF
4	Other
5	PDF/Comp
6	PDF/A

8715	S:Scan PGS/Comp
	[0 to 9999999/ 1] These SPs count the number of compressed pages scanned by the scan application, counted by the formats listed below.
1	JPEG/JPEG2000
2	TIFF (Multi/Single)
3	PDF
4	Other
5	PDF/Comp
6	PDF/A

8721	T: Deliv PGS/WSD
8725	S: Deliv PGS/WSD
8731	T: Scan PGS/Media
8735	S: Scan PGS/Media
	Total number of pages sent via WSD (WS-Scanner for Web Services Devices).
1	B/W
2	Color

8741	RX PGS/Port
	[0 to 99999999/ 0 / 1] These SPs count the number of pages received by the physical port used to receive them.
1	PSTN-1
2	PSTN-2
3	PSTN-3
4	ISDN (G3,G4)
5	Network

8781	Ink_Botol_Info.
	This SP displays the number of toner bottles used. The count is done based on the equivalent of 1,000 pages per bottle.
1	BK
2	Y
3	M
4	C

8791	LS Memory Remain
	This SP displays the percent of space available on the document server for storing documents. [0 to 100/ 0 / 1]

8801	Ink Remain
	This SP displays the percent of ink remaining for each color. This SP allows the user to check the toner supply at any time. [0 to 100/ 0 / 1]
1	BK
2	Y
3	M
4	C

8811	Eco Counter
1	Eco Total
2	Color
3	Full Color
5	Combine
9	Combine (%)
10	Paper Cut (%)
102	Color: Last
103	Full Color: Last
105	Combine: Last
106	Color (%): Last
107	Full Color (%): Last
109	Combine (%): Last
110	Paper Cut (%): Last

8851	Cvr Cnt: 0 - 10%	
8861	Cvr Cnt: 11 - 20%	
8871	Cvr Cnt: 21 – 30%	
8881	Cvr Cnt: 31%	
		[0 to 9999999] These SPs count the percentage of dot coverage for each color.
	1	BK
	2	Y
	3	M
	4	C

8891	Page/Ink Bottle
	Total number of pages per toner bottle.
1	BK
2	Y
3	M
4	C

8901	Page/Toner_Prev1 DFU
1	BK
2	Y
3	M
4	C

8911	Page/Toner_Prev2 DFU
1	BK
2	Y
3	M
4	C

8921	Cvr Cnt/Total
1	Coverage (%): BK
2	Coverage (%): Y
3	Coverage (%): M
4	Coverage (%): C
11	Coverage/P: BK
12	Coverage/P: Y
13	Coverage/P: M
14	Coverage/P: C
21	Ink Cons (ml): BK
22	Ink Cons (ml): Y
23	Ink Cons (ml): M
24	Ink Cons (ml): C

8941	Machine Status
	[0 to 9999999/ 0 / 1] These SPs count the amount of time the machine spends in each operation mode. These SPs are useful for customers who need to investigate machine operation for improvement in their compliance with ISO Standards.
1	Operation Time
	Engine operation time. Does not include time while controller is saving data to HDD (while engine is not operating).
2	Standby Time
	Engine not operating. Includes time while controller saves data to HDD. Does not include time spent in Energy Save, Low Power, or Off modes.
3	Energy Save Time
	Includes time while the machine is performing background printing.
4	Low Power Time
	Includes time in Energy Save mode with Engine on. Includes time while machine is performing background printing.
5	Off Mode Time
	Includes time while machine is performing background printing. Does not include time machine remains powered off with the power switches.
6	SC
	Total down time due to SC errors.
7	PrtJam
	Total down time due to paper jams during printing.
8	OrgJam
	Total down time due to original jams during scanning.
9	Supply PM Wait End
	Total down time due to toner end.

8951	AddBook Register
	These SPs count the number of events when the machine manages data registration.
1	User Code
	User code registrations. [0 to 9999999/ 0 / 1]
2	Mail Address
	Mail address registrations. [0 to 9999999/ 0 / 1]
4	Group
	Group destination registrations. [0 to 9999999/ 0 / 1]
6	F-Code
	F-Code box registrations. [0 to 9999999/ 0 / 1]
7	Copy Program
	Copy application registrations with the Program (job settings) feature. [0 to 255 / 0 / 255]
9	Printer Program
	Printer application registrations with the Program (job settings) feature. [0 to 255 / 0 / 255]
10	Scanner Program
	Scanner application registrations with the Program (job settings) feature. [0 to 255 / 0 / 255]

8999	Admin Counter List	
1	Total	
2	Copy: Full Color	
3	Copy: BW	
4	Copy: Single Color	
5	Copy: Two Color	
6	Printer: Full Color	
7	Printer: BW	
8	Printer: Single Color	
9	Printer: Two Color	
22	Copy: Full Color (%)	
23	Copy: B/W (%)	
24	Copy: Single Color (%)	
25	Copy: Two Color (%)	
26	Printer: Full Color (%)	
27	Printer: B/W (%)	
28	Printer: Single Color (%)	
29	Printer: Two Color (%)	
101	Transmission Total: Color	
102	Transmission Total: BW	
103	Fax Transmission	
104	Scanner Transmission: Color	
105	Scanner Transmission: BW	

2.10 PRINTER SP TABLES

1001	Bit Switch			
1	Bit Switch 1 Settings		0	1
	bit 0	DFU	-	-
	bit 1	DFU	-	-
	bit 2	DFU	-	-
	bit 3	No I/O Timeout	0: Disable	1: Enable
		Enable: The MFP I/O Timeout setting will have no effect. I/O Timeouts will never occur.		
	bit 4	SD Card Save Mode	0: Disable	1: Enable
		Enable: Print jobs will be saved to an SD Card in the GW SD slot.		
	bit 5	DFU	-	-
	bit 6	DFU	-	-
bit 7	[RPCS,PCL]: Printable area frame border	0: Disable	1: Enable	
	Enable: The machine prints all RPCS and PCL jobs with a border on the edges of the printable area.			

1001	Bit Switch			
2	Bit Switch 2 Settings		0	1
	bit 0	DFU	-	-
	bit 1	DFU	-	-
	bit 2	Applying a collation Type	Shift Collate	Normal Collate
		<p>A collation type (shift or normal) will be applied to all jobs that do not already have a "Collate Type" configured.</p> <p>Note: If #5-0 is enabled, this Bit Switch has no effect.</p>		
	bit 3	[PCL5e/c,PS]: PDL Auto Switching	0: Enable	1: Disable
		<p>Disable: The MFPs ability to change the PDL processor mid-job. Some host systems submit jobs that contain both PS and PCL5e/c. If Auto PDL switching is disabled, these jobs will not be printed properly.</p>		
	bit 4	DFU	-	-
bit 5	DFU	-	-	
bit 6	DFU	-	-	
bit 7	DFU	-	-	

1001	Bit Switch			
3	Bit Switch 3 Settings		0	1
	bit 0	DFU	-	-
	bit 1	DFU	-	-
	bit 2	[PCL5e/c]: Legacy HP compatibility	0: Disable	1: Enable
		Enable: Uses the same left margin as older HP models such as HP4000/HP8000. In other words, the left margin defined in the job (usually "<ESC>*r0A") will be changed to "<ESC>*r1A"		
	bit 3	DFU	-	-
	bit 4	DFU	-	-
	bit 5	DFU	-	-
	bit 6	DFU	-	-
bit 7	DFU	-	-	

1001	Bit Switch		
4	Bit Switch 4 Settings DFU	-	-

1001	Bit Switch			
5	Bit Switch 5 Settings		0	1
	bit 0	Show "Collate Type", "Staple Type" and "Punch Type" buttons on the operation panel.	Disable	Enable
		If enabled, users will be able to configure a Collate Type, Staple Type, and Punch Type from the operation panel. The available types will depend on the device and configured options. After enabling the function, the settings will appear under: "User Tools > Printer Features > System"		
	bit 1	DFU	-	-
	bit 2	DFU	-	-
	bit 3	[PS] PS Criteria	Pattern3	Pattern1
		Change the number of PS criterion used by the PS interpreter to determine whether a job is PS data or not. Pattern3: includes most PS commands. Pattern1: A small number of PS tags and headers		
	bit 4	Increase max number of the stored jobs to 1000 jobs.	Disable (100)	Enable (1000)
		Enable: Changes the maximum number of jobs that can be stored on the HDD via Job Type settings to 1000. The default is 100.		
	bit 5	Face-up output	Disable	Enable
		Enable: All print jobs will be output face-up in the destination tray.		

	bit 6	Method for determining the image rotation for the edge to bind on.	Disable	Enable
		<p>Enable: the image rotation will be performed as they were in the specifications of older models for the binding of pages of mixed orientation jobs.</p> <p>The old models are below:</p> <ul style="list-style-type: none"> - PCL: Pre-04A models - PS/PDF/RPCS: Pre-05S models 		
	bit 7	Letterhead mode printing	Disable	Enable (Duplex)
		<p>Routes all pages through the duplex unit.</p> <p>Disable: Simplex pages or the last page of an odd-paged duplex job, are not routed through the duplex unit. This could result in problems with letterhead/pre-printed pages.</p> <p>Only affects pages specified as Letterhead paper.</p>		

1001	Bit Switch		
6	Bit Switch 6 Settings DFU	-	-

1001	Bit Switch			
7	Bit Switch 7 Settings		0	1
	bit 0	Print path	Disable	Enable
		Enable: Simplex pages (in mixed simplex/duplex PS/PCL5 jobs only) and the last page of an odd paged duplex job (PS, PCL5, PCL6), are always routed through the duplex unit. Not having to switch paper paths increases the print speed slightly.		
	bit 1	DFU	-	-
	bit 2	DFU	-	-
	bit 3	DFU	-	-
	bit 4	DFU	-	-
	bit 5	DFU	-	-
	bit 6	DFU	-	-
bit 7	DFU	-	-	

1001	Bit Switch			
8	Bit Switch 8 Settings		0	1
	bit 0	DFU	-	-
	bit 1	DFU	-	-
	bit 2	DFU	-	-
	bit 3	[PCL,PS]: Allow BW jobs to print without requiring User Code	Disable	Enable
		Enable: BW jobs submitted without a user code will be printed even if usercode authentication is enabled. Note: Color jobs will not be printed without a valid user code.		
bit 4	DFU	-	-	
bit 5	DFU	-	-	

	bit 6	DFU	-	-
	bit 7	DFU	-	-

1001	Bit Switch			
9	Bit Switch 9 Settings	DFU	-	-
10	Bit Switch A Settings	DFU	-	-
11	Bit Switch B Settings	DFU	-	-
12	Bit Switch C Settings	DFU	-	-

1003	Clear setting			
1	Initialize Printer System			
	Initializes the settings in the printer feature settings of UP mode.			
3	Delete Program	DFU		

1004	Print Summary			
	Touch [Execute] to print the printer summary sheets.			

1005	Display Version.			
	Printer Application Version			
	Displays the version of the controller firmware.			

1006	Sample/Locked Print			
	<p>This SP disables/enables use of the document server. [0 or 1/ 0 /1]</p> <p>0: Enabled. Document server can be used. 1: Disabled. Document server cannot be used.</p>			

1101	Data Recall Not Used
	<p>The copier firmware has a test pattern with eight stepped gradation scales for each color (KCYM), including background white, for Text and Photo modes. The ACC procedure automatically calibrates the gamma curve when the user selects ACC. Generally, here is what happens:</p> <ul style="list-style-type: none"> ▪ The operator prints the pattern. ▪ Operator places the pattern on the exposure glass. ▪ Copier scans 8 lines (1 for each color in text mode and one for each color in photo mode). ▪ Machine corrects the printer gamma by comparing the ideal settings with the current image density. ▪ Machine combines the corrected gamma curve with the High, Middle, Low ID values currently in memory. ▪ Machine calculates the ID max (amplitude and gamma curve) based on data from the ACC scan. The correct gamma curves can be adjusted with SP4918. <p>Note: This is done only with machines that support ACC.</p>
	The SP codes below display the settings for factory, previous setting, current setting, and ACC setting.
1	Factory
2	Previous
3	Current
4	ACC

1102	Resolution Setting
	This setting matches supported resolution with a dithering mode.

1103	Test Page
1	Color Gray Scale
2	Color Pattern

SP1103-001

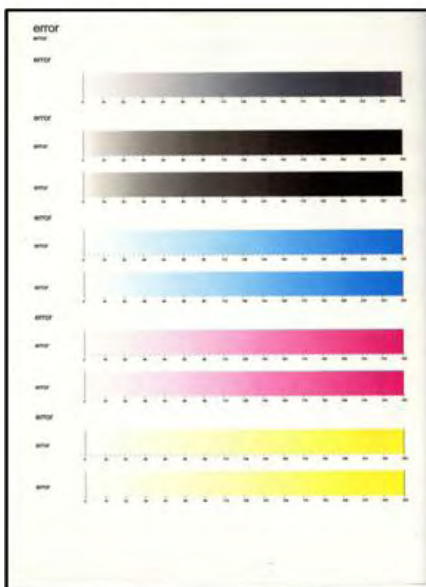

SP1103-002

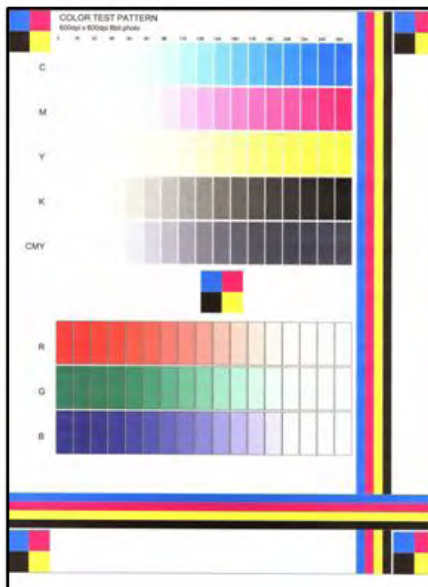

d124r746

1104	Gamma Adjustment
1 to 15	Set Black 1 to 15
21 to 35	Set Cyan 1 to 15
41 to 55	Set Magenta 1 to 15
61 to 75	Set Yellow 1 to 15

1105	Save Tone Control Value
------	-------------------------

1106	Toner Limit
	Full color: Range 0 to 400 2-Color : Range 0 to 200

1108	Ext. Ink Save
1	Mode 1: Text
2	Mode 2: Text
3	Mode 1: Image
4	Mode 2: Image
5	Mode 1: Line
6	Mode 2: Line
7	Mode 1: Paint
8	Mode 2: Paint

1110	Media Print Device Setting
	Sets which tray given priority for paper feed
	The bypass tray is "0". [0 to 4/1/1] 0: Bypass 1:Tray 1 2:Tray 2 3:Tray 3 4:LCT

1111	All Jobs Delete Mode
	This switch determines whether all SCS jobs in progress are included in the SMC report when SP5990 is executed.
	[0 to 1/1/1] 1:Jobs included 0:Jobs not included

1400	RPGL Setting (EXP)
	These SP codes set up the print parameters for RPGL.
1	Set Thin Line Width (EXP)
	[0 to 99/5/1]
2	Correct Line Width (EXP)

	[0 to 3/2/1] 0:Mode 1 1:Mode 2 2:Mode 3 3:Mode 4
4	Character Density (EXP)
	[15 to 30/15/1]
5	Photo Density (EXP)
	[15 to 30/15/1]
6	Default Blank Space (EXP)
	[0 to 1/0/1] 0: Margin 1: No margin
7	Job Reset (EXP)
	[0 to 1/0/1] 0;Enble 1:Disable
8	Search Not Set Tray (EXP)
	[0 to 1/0/1] <ul style="list-style-type: none"> ▪ 0: Include tray not specified in search ▪ 1: Do not included unspecified tray in search
9	Character Total Amount (EXP)
	[99 to 400/99/1]
10	Photo Total Amount (EXP)
	[99 to 400/99/1]
11	Basis of Scale (EXP)
	[0 to 1/1/1] 0: Allow maximum size paper 1: Submenu setting

2.11 SCANNER SP TABLES

2.11.1 SP-1XXX SYSTEM AND OTHERS

1001	Scan Nv Version
	Displays the scanner firmware version stored in NVRAM in a 9-digit format: Func. Name_Model Name_History No.

	Erase Margin (Remote Scan)
1005	Creates an erase margin for all edges of the scanned image. If the machine has scanned the edge of the original, create a margin. [0 to 5/ 0 /1 mm]

	Remote Scan Disable
1009	This SP switches the TWAIN scanner function on/off. This is one of the scanner application functions. [0 or 1 / 0 / 1] 0: ON (enabled- 1: OFF (disabled)

	Non Display Clear Light PDF
1010	This SP switches the Clear Light PDF display off/on. [0 or 1 / 0 / 1] 0: Display ON 1: Display OFF

	Org Count Display
1011	This SP codes switches the original count display on/off. [0 or 1 / 0 / 1] 0: OFF (no display) 1: ON (count displays)

1012	User Info Release
	<p>This SP code sets the machine to release or not release the following items at job end]</p> <ul style="list-style-type: none"> ▪ Destination (E-mail/Folder/CS) ▪ Sender name ▪ Mail Text ▪ Subject line ▪ File name <p>[0 or 1 / 1 / 1] 1: Release 0: Do not release</p>

1013	Scan to Media Device Setting
	<p>This SP code enables/disables the multi-media function.</p> <p>[0 or 1 / 0 / 1] 0: Disable 1: Enable</p>

1015	Add Date/Time to File Name
	<p>Determines whether the date and time are added to the ends of the names of files sent by email.</p> <p>[0 to 1/1/1] 0:Disable adding 1:Enable adding</p>

2.11.2 SP2-XXX SCANNING IMAGE QUALITY

2021	Compression Level (Grayscale)
1	Comp 1: 5-95
	[5 to 95 / 20 / 1]
2	Comp 2: 5-95
	[5 to 95 / 40 / 1]
3	Comp 3: 5-95
	[5 to 95 / 65 / 1]
4	Comp 4: 5-95
	[5 to 95 / 80 / 1]
5	Comp 5: 5-95
	[5 to 95 / 95 / 1]

2026	High Compression of PDF
1	Comp1: 5-95
2	Comp2: 5-95
3	Comp3: 5-95
4	Comp4: 5-95
5	Comp5: 5-95

2.12 INPUT/OUTPUT CHECK

2.12.1 INPUT CHECK

5803	Input Check
1	Paper Inlet Sensor: Upper
2	Paper Inlet Sensor: Lower
3	Paper Exit Sensor: Upper
4	Paper Exit Sensor: Lower
5	Front Register Sensor
6	By-pass Sensor
7	Output Sensor
10	Paper Feed Pressure Release Sensor: Upper
11	Paper Feed Pressure Release Sensor: Lower
12	Register Pressure Release Sensor: Lower
13	Residual Amount. Sensor Upper
14	Residual Amount. Sensor Lower
15	Residual Qty. Ratio M
16	Residual Qty. Ratio Y
17	Main Scan Encoder Sensor
18	Sub Scan Encoder Sensor
19	Roll End Sensor/Upper
20	Roll End Sensor/Lower
21	Front Cover Pre-Sensor

22	Total Counter
30	Outside Temperature
31	Outside Humidity
41	Head Rising Sensor 1
42	Head Rising Sensor 2
43	Head Temperature Sensor: Color
45	Head Temperature Sensor: Black
48	DRESS Sensor 1
49	DRESS Sensor 2
50	Front Cover Sensor Left
51	Front Cover Sensor Right
52	Cartridge Cover Sensor
53	Roll Paper Cover Sensor
54	Waste Ink Box Cover Sensor
55	Waste Ink Box Setting Sensor
60	Sub Scan HP Sensor
61	Cutter Sensor Right
62	Cutter Sensor Left
70	Maintenance Suction Unit HP Detection Sensor
71	MaintenDehumidify Unit HP Detection Sensor
72	MaintenanceCleaner Slide HP Detection Sensor
91	Ink Cartridge Sensor: Y

92	Ink Cartridge Sensor: M
93	Ink Cartridge Sensor: C
94	Ink Cartridge Sensor: K
150	MainFillerSens Front
151	MainFillerSens Rear
152	OCFS HT1
153	OCFS HT2
154	OCFS HT3
155	OCFS HT4
156	OCFS HT5
157	INKEND SENSOR K
158	INKEND SENSOR C
159	INKEND SENSOR M
160	INKEND SENSOR Y
170	Waste Ink Box
201	Original Width Sensor:A0
202	Original Width Sensor:A1
203	Original Width Sensor:A2
204	Original Width Sensor:A3
205	Original Width Sensor:B1
206	Original Width Sensor:B2

207	Original Width Sensor:B3
208	Original Width Sensor:B4
209	Original Width Sensor:914mm
210	Original Width Sensor:30"
211	Original Set Sensor
212	Original Registration Sensor
213	Original Exit Sensor
214	Original Emergency Stop Sensor
215	Original Feed Unit Open Sensor

2.12.2 OUTPUT CHECK

5804	Output Check
	Most of these sensors present [OFF] [ON] selections. After pressing the [ON] selection, be sure to press [OFF] to switch the component off.
51	Paper Feed Motor: Upper
52	Paper Feed Motor Speed: Upper
53	Paper Feed Motor: Lower
54	Paper Feed Motor Speed: Lower
55	Paper Feed Clutch: Upper
56	Paper Feed Clutch: Lower
59	Sub Scan Motor
60	Sub Scan Motor Speed
62	Head Rising Motor
63	Move Cutter Toward Right
64	Move Cutter Toward Left
65	Start Suction Fan
66	Suction Fan Speed
67	Suction Fan Revolution
71	DRESS LED On
110	Air Release Solenoid On/Off
201	Document
211	CIS_LED_R
212	CIS_LED_G
213	CIS_LED_B

⇒ 2.13 SP5749 IMPORT/EXPORT

2.13.1 IMPORT/EXPORT

5749	Import/Export
1	Import
101	Export
251	Export Result Print (SP)
252	Import Result Print (SP)

2.13.2 DATA THAT CAN BE IMPORTED AND EXPORTED:

- Copier / Document Server Features
- Printer Features
- Scanner Features
- Facsimile Features
- Extended Feature Settings
- Program (Document Server)
- Program (Copier)
- Program (Scanner)
- Web Image Monitor Setting
- Web Service Settings
- System Settings

2.13.3 DATA THAT CANNOT BE IMPORTED OR EXPORTED:

- Address book
- Programs (fax function)
- Programs (printer function)
- Scanner function programs that include password settings
- User stamp in the copy default settings
- Settings for configuring from telnet
- @Remote-related data
- Counters
- EFI printer unit settings (At the time of EFI printer unit connection)
- Settings that can be specified using Web Image Monitor or Web Service only (such as Bonjour or SSDP settings)

- Some System Settings*1 *2
 - *1 The setting for the date, those settings that require the device certificate, and those settings that need to be adjusted for each device (for example, image adjustment settings) cannot be imported or exported.
 - *2 Settings only for executing functions and settings only for viewing cannot be imported or exported.

2.13.4 IMPORT/EXPORT CONDITION:

Import/export is possible between devices only if their models, region of use, and the following device configuration match.

- Input Tray
- Output Tray
- Whether or not equipped with the duplex function
- Whether or not equipped with a finisher and the type of finisher
- ADF
- Whether or not equipped with a hard disk
- Whether or not equipped with the Remote Machine function

Location of stored data (log):

- The log is stored in the same location as the exported device setting information file.
- To use this function, it is necessary to create the device setting information file with special software and store it on the web server. For details, contact your sales representative.

Possible solutions for import/export problems:

If an error occurs, check the log's result code first. Values other than 0 indicate that an error occurred.

The result code will appear in the circled area illustrated below.

- Example of a log file

```
*1.0.0*
*ExecType*,*Date*,*SerialNo*,*PnP*,*Model*,*Destination*,*IP*,*Host*,*Storage*,*FileName*
*FileID*,*TotalItem*,*NumOfOkItem*,*ResultCode*,*ResultName*,*Identifier*
*IMPORT*
*2012-07-05T15:29:16+09:00*
*3C35-7M0014*
*Brand Name*
*Product Name*
*0*
*10*
*10.250.155.125*
*RNP00267332582D*
*SD*
*201207051519563C35-710220.csv*
*201207051519563C35-710220*
* 0*
* 2*
*INVALID REQUEST*
*TargetID*,*ModuleID*,*PrefID*,*Item*,*NgCode*,*NgName*
```

If you cannot solve the problem or do not know how to solve it after checking the code, note down the error log entry, and then contact your service representative.

Result Code	Cause	Solutions
2 (INVALID REQUEST)	A file import was attempted between different models or machines with different device configurations.	Import files exported from the same model with the same device configurations.
4 (INVALID OUTPUT DIR)	Failed to write the device information to the destination device.	Check whether the destination device is operating normally.
7 (MODULE ERROR)	An unexpected error occurred during import or export.	Switch the power off and then back on, and then try the operation again. If the error persists, contact your service representative.
8 (DISK FULL)	The available storage space on the external medium is insufficient.	Execute the operation again after making sure there is enough storage space.
9 (DEVICE ERROR)	Failed to write or read the log file.	Check whether the path to the folder for storing the file or the folder in which the file is stored is missing.
10 (LOG ERROR)	The hard disk is faulty.	Contact your service representative.
20 (PART FAILED)	Failed to import some settings.	The reason for the failure is logged in "NgCode". Check the code. ♦ Reason for the Error (Ng-Name) 2. INVALID VALUE The specified value exceeds the allowable range. 3. PERMISSION ERROR The permission to edit the setting is missing. 4. NOT EXIST The setting does not exist in the system. 5. INTERLOCK ERROR The setting cannot be changed because of the system status or interlocking with other specified settings. 6. OTHER ERROR The setting cannot be changed for some other reason.
21 (INVALID FILE)	Failed to import the file because it is in the wrong format in the external medium.	Check whether the file format is correct. The log is in the form of a CSV file
22 (INVALID KEY)	The encryption key is not valid.	Use the correct encryption key.

NOTE:

- When exporting device information from the control panel, the data can be saved only on an SD card.
- The file format for exports is CSV.

2.13.5 EXPORTING DEVICE INFORMATION

When exporting SP device information from the control panel, the data is saved on an SD card.

1. Insert an SD card into the media slot on the side of the control panel.
2. Enter SP mode.
3. Press SP5749-001
4. Select target SP settings to be exported.

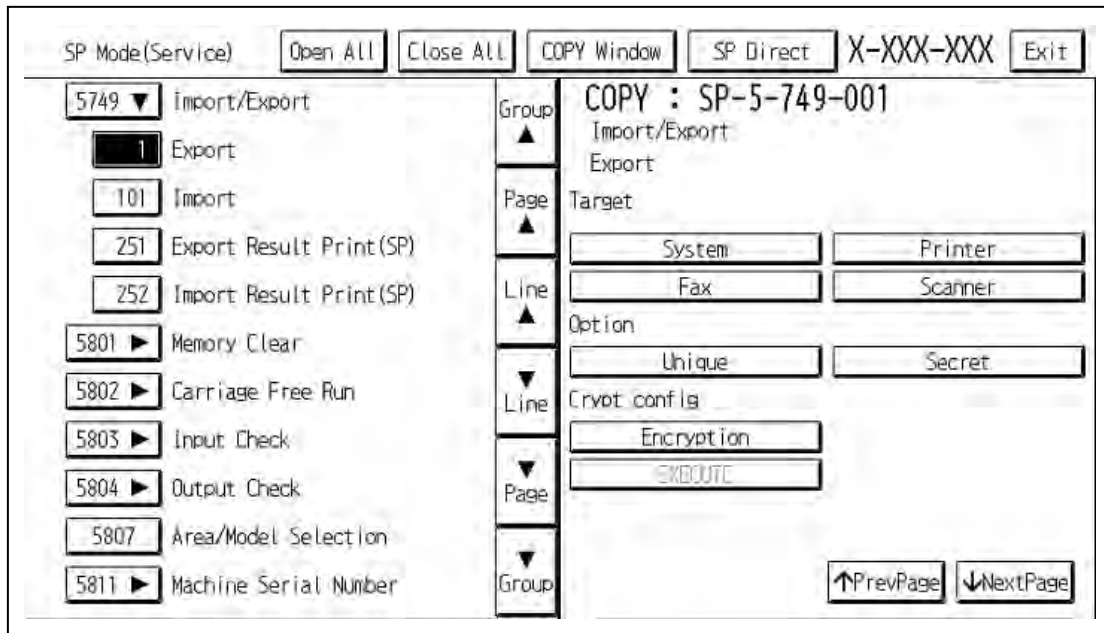

5. Select the option settings.

Item	Specification	Note
Unique	Information unique to the machine is included in the exported file if you have selected the "Unique" setting	<p>Information unique to the machine that can be updated:</p> <ol style="list-style-type: none"> 1. Items that are used to identify the machine among a group of multiple devices. Ex: IP address, host name, information associated with the FAX number, mail address assigned to the machine 2. Items for specifying the options installed on the machine. Ex: Lot number for developer <p>Information unique to the machine that cannot be updated:</p> <ol style="list-style-type: none"> 3. Items for which the problem may occur by importing Ex: Serial number, information related to @Remote 4. Items for managing the history of the machine Ex: Time and date, counter information, installation date 5. Engine settings

Item	Specification	Note
Secret	Confidential information is exported if you select the "Secret" setting.	Confidential information: #1. Data that absolutely cannot be exported. (Asterisks ("*") are used to mask this information inside the exported file.) Ex: Password, encryption key, PIN code #2. Confidential information Ex: User name, user ID, department code, e-mail addresses, phone numbers #3. Personal information Example: Document name. image data #4. Sensitive information Ex: IP address, MAC address, Network parameters

6. Select an encryption setting.

Encryption	Select whether or not encryption will be performed when exporting. If the "Encryption" key is pressed, you can export confidential information (in an encrypted state)	If the encryption function is used, the encryption key must be set through direct input - Type an arbitrary password using the software keyboard - The password can be up to 32 characters in length
-------------------	---	--

7. Press "Execute".

8. Press [OK].

NOTE:

- If data export fails, the details of the error can be viewed in the log.

2.13.6 IMPORTING DEVICE INFORMATION

Import device information saved on an SD card.

1. Insert an SD card into the media slot on the side of the control panel.
2. Enter SP mode.
3. Press SP5749-101

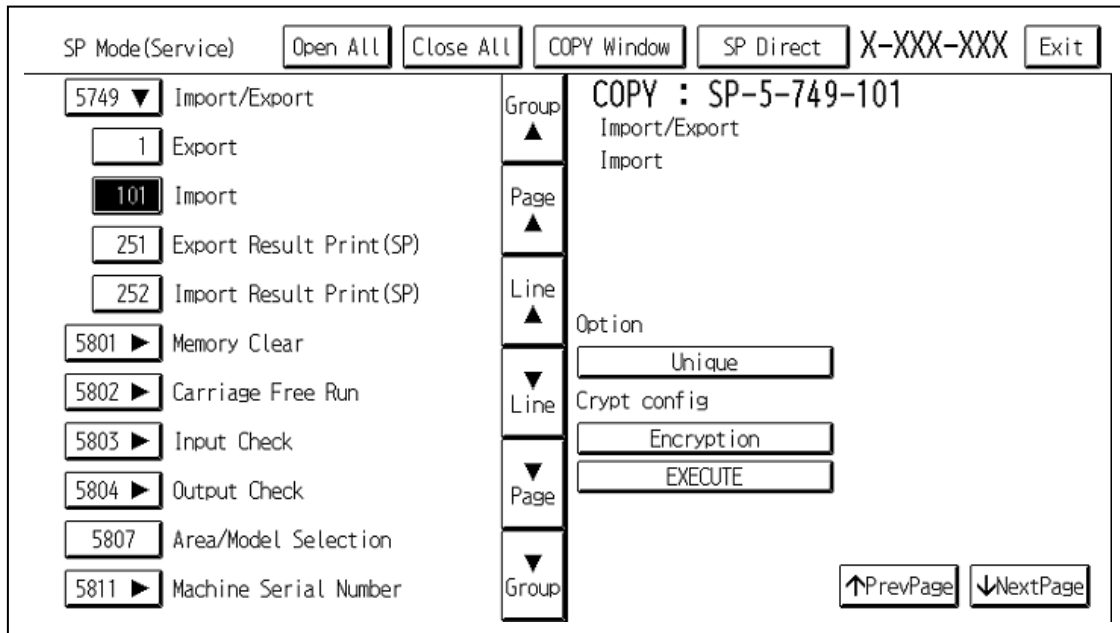

4. Select a unique setting.
5. Press “Encryption key”, if the encryption key was created when the file was exported.

Unique	To import unique information to the machine, press the “Unique” key.	Refer to the above information
Encryption	If the encrypted file is selected as the file to be imported, this setting is required.	

6. Press “Execute”.
7. Press [OK].

Note:

- If data export fails, the details of the error can be viewed in the log.