

HP Color LaserJet 2600n

Service Manual

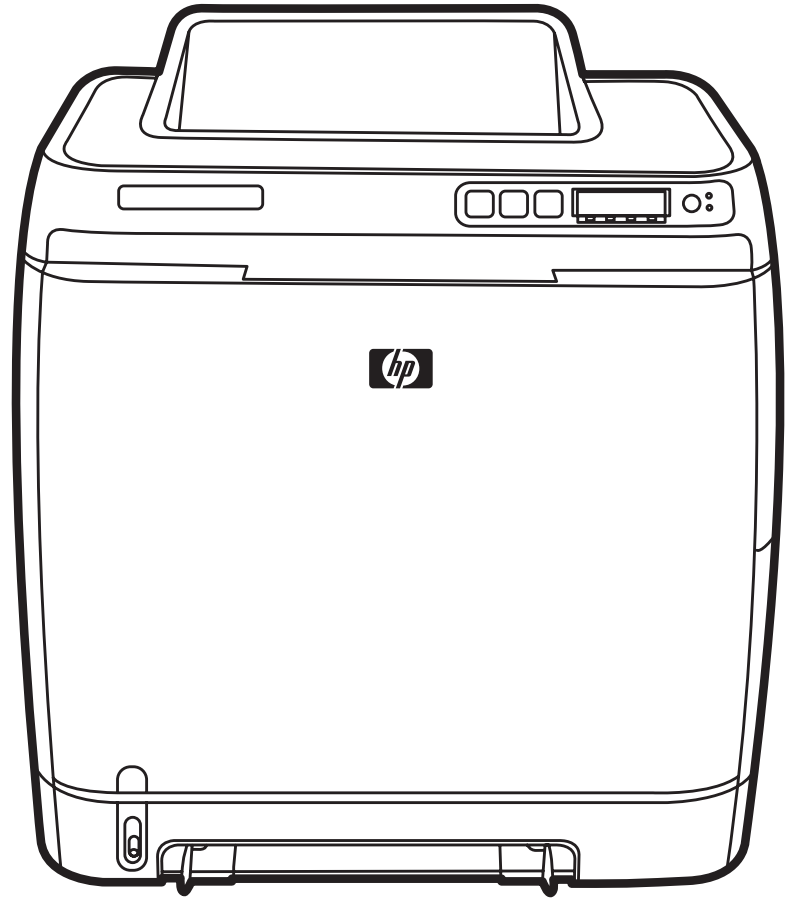

HP Color LaserJet 2600n

Service Manual



Copyright and License

© 2005 Copyright Hewlett-Packard Development Company, L.P.

Reproduction, adaptation, or translation without prior written permission is prohibited, except as allowed under the copyright laws.

The information contained in this document is subject to change without notice.

The only warranties for HP products and services are set forth in the express warranty statements accompanying such products and services. Nothing herein should be construed as constituting an additional warranty. HP shall not be liable for technical or editorial errors or omissions contained herein.

Q6455-90930

Edition 1, 2/2005

FCC Class A Statement

This equipment has been tested and found to comply with the limits for a Class A digital device, pursuant to Part 15 of the FCC Rules. These limits are designed to provide reasonable protection against harmful interference when the equipment is operated in a commercial environment. This equipment generates, uses and can radiate radio frequency energy and, if not installed and used in accordance with the instruction manual, may cause harmful interference to radio communications. Operation of this equipment in a residential area is likely to cause harmful interference, in which case the user will be required to correct the interference at his own expense. The end user of this product should be aware that any changes or modifications made to this equipment without the approval of Hewlett-Packard could result in the product not meeting the Class A limits, in which case the FCC could void the user's authority to operate the equipment.

Trademark Credits

Adobe Photoshop® and PostScript are trademarks of Adobe Systems Incorporated.

CorelDRAW™ is a trademark or registered trademark of Corel Corporation or Corel Corporation Limited.

Microsoft®, Windows®, MS-DOS®, and Windows NT® are U.S. registered trademarks of Microsoft Corporation.

Netscape™ and Netscape Navigator™ are U.S. trademarks of Netscape Communications Corporation.

TrueType™ is a U.S. trademark of Apple Computer, Inc.

ENERGY STAR® and the ENERGY STAR logo® are U.S. registered marks of the United States Environmental Protection Agency.



Table of contents

1 Product information

Quick access to printer information.....	2
Printer configuration.....	3
Printer features.....	4
Walk around.....	6
Front view (shown with optional Tray 3).....	6
Back and side view.....	7
Control panel.....	8
Understanding supplies status.....	8
Understanding printer status.....	8
Understanding control panel layout.....	9
Software.....	11
Supported drivers.....	11
Software and supported operating systems.....	11
Software for Windows.....	11
Software for Macintosh.....	12
Network software.....	12
Uninstalling software.....	12
Windows software.....	12
Macintosh software.....	13
Print-media specifications.....	14
General guidelines.....	14
Paper and print media.....	14
Printing and storage environment.....	14
Envelopes.....	15
Labels.....	17
Transparencies.....	17
Media support tables.....	17
Supported print media for Tray 1, Tray 2, and optional Tray 3.....	17
Unsupported media (media to avoid).....	18

2 Installation

Site preparation	22
Operating environment	22
Minimum system requirements	23
Requirements for PC systems	23
Requirements for Macintosh systems (non-PostScript)	23
Package contents	24
Install input devices	25

Installing optional Tray 3	25
Loading Tray 1	25
Installing supplies	27
Print cartridges	27

3 Managing and maintenance

Managing supplies	32
Life expectancies of supplies	32
Checking and ordering supplies	32
To check status using the control panel	32
To check and order supplies using HP Toolbox	32
Storing supplies	33
Replacing and recycling supplies	33
Replacing the print cartridges	33
HP policy on non-HP supplies	33
HP anti-counterfeit website	33
Cleaning the printer	34
To clean the printer at the printer	34
To clean the fuser using HP Toolbox	35
Cleaning spilled toner	35
Calibrating the printer	36
To calibrate the printer at the printer	36
To calibrate the printer from the HP Toolbox	36

4 Operational theory

Engine control system	38
Basic sequence of operation	38
Power-on sequence	39
Motors and fans	39
Main motor failure detection	40
Fan motor failure detection	40
Image formation system	41
Image formation process	43
Latent image formation	44
Laser/scanner system	45
Developing stage	45
Print cartridge	46
Transfer belt (ETB)	47
Transfer stage	48
Separation stage	49
Fusing stage	49
Pickup and feed system	51
Manual feed slot pickup mechanism	53
Paper feed mechanism	53
Skew correction by the registration shutter	53
Jam detection	54
Solenoid, motor, and fan locations	55
Printed circuit assembly locations	55
250-sheet tray solenoid and printed circuit locations	56
Service-only tools (SERVICE ONLY)	58

General timing chart	58
Printer calibration	59

5 Removal and replacement

Overview.....	62
Service approach.....	63
Pre-service procedures.....	63
Removal and replacement procedures.....	64
Print cartridge replacement.....	64
ETB removal and replacement.....	66
Fuser removal and replacement.....	74
Formatter removal and replacement.....	82
DC controller removal and replacement.....	86
Separation pad removal and replacement.....	88
Paper pickup roller removal and replacement.....	89
Control panel removal and replacement.....	91

6 Troubleshooting

Troubleshooting process.....	98
Troubleshooting checklist.....	98
Clearing jams	99
Paper path.....	99
Common causes of paper jams.....	100
Where to look for jams.....	101
Jams inside the printer.....	102
Input jams.....	103
Tray 1.....	103
Tray 2.....	104
Output jams.....	104
Jams in the top bin.....	104
Pickup delay jam.....	105
Pickup stationary jam.....	105
Delivery delay jam.....	105
Wrapping jam.....	105
Delivery stationary jam.....	105
Start-up residual paper jam.....	105
Door open jam.....	106
Print problems.....	107
Getting information.....	107
Control panel messages.....	107
Alert and warning messages.....	107
Critical error messages.....	108
Supplies messages.....	109
Status messages.....	112
Status log only messages.....	112
Reports menu.....	113
Configuration page.....	114
Supplies Status page.....	116
Status log.....	116
Service menu settings.....	118

Secondary service menu.....	118
Printed image quality problems.....	119
Improving print quality.....	119
Paper Types menu.....	119
Print Modes menu.....	120
Print quality menu.....	121
Understanding print-quality settings.....	121
To temporarily change print-quality settings.....	122
To change print-quality settings for all future jobs.....	122
Identifying and correcting printed image defects.....	122
Print-quality checklist.....	122
Paper handling issues.....	123
Wrong size/type media.....	123
Cannot select a tray or feature to use.....	123
Performance problems.....	123
Functional tests (SERVICE ONLY).....	125
Engine test print.....	125
Service mode functions (SERVICE ONLY).....	126
Cold reset.....	126
NVRAM initializer.....	126
Super NVRAM initializer.....	126
Restoring page counts and serial number.....	127
Cleaning the ETB.....	127
Troubleshooting tools.....	128
Printer pages and reports.....	128
Demo page.....	128
Configuration page.....	129
Event log.....	131
Supplies Status page.....	131
Fuser cleaning page.....	132
Print quality troubleshooting pages.....	132
Control panel messages (error codes).....	132
Alert and warning messages.....	132
Critical error messages.....	133
Supplies messages.....	134
Status messages.....	137
Status log only messages.....	137
Service menu.....	137
Restoring the factory-set defaults.....	138
To restore the factory-set defaults.....	138
General print quality issues.....	138
Solving issues with color documents.....	142
HP Toolbox.....	144
HP Toolbox.....	144
To view HP Toolbox.....	144
Troubleshooting tab.....	144
Print quality troubleshooting pages.....	144
Printer calibration.....	144
Cleaning page.....	144
Configuration page.....	145

Diagnostic resources.....	146
Reports menu.....	146
Network/Web diagnostics tools.....	146
Repetitive image defect ruler.....	147
Firmware and software updates.....	148

7 Parts and diagrams

Overview	150
Assembly locations	154
Covers	160
Internal assemblies	162
Input devices	186
Diagrams	208
Alphabetical parts list.....	209
Numerical parts list.....	230

Appendix A Product specifications

Physical specifications	252
Supplies specifications	253
Print cartridge life	253
Electrical specifications	254
Environmental specifications	255
Acoustical specifications	256

Appendix B Product warranty statements

Hewlett-Packard limited warranty statement	258
Print Cartridge Limited Warranty Statement	259

Appendix C Regulatory statements

Declaration of Conformity	262
Laser safety statement	263
Canadian DOC statement	264
VCCI statement (Japan)	265
Korean EMI statement	266
Finnish laser statement	267

Index.....	269
------------	-----

List of tables

Table 1-1	Printer features.....	4
Table 1-2	HP Color LaserJet 2600n printer software.....	11
Table 1-3	Envelope specifications.....	15
Table 1-4	Envelope size ranges.....	16
Table 1-5	Tray 1 and Tray 2 specifications.....	17
Table 1-6	Optional Tray 3 specifications.....	18
Table 3-1	Print cartridge life	32
Table 4-1	Basic operational sequence	38
Table 4-2	Motor specifications	40
Table 5-1	User-replaceable parts.....	62
Table 6-1	Troubleshooting checklist.....	98
Table 6-2	Status log only messages.....	112
Table 6-3	Configuration page.....	114
Table 6-4	Supplies Status page.....	116
Table 6-5	Status log messages.....	117
Table 6-6	Print modes for paper types.....	120
Table 6-7	Extended print modes.....	120
Table 6-8	Optimize menu.....	121
Table 6-9	Performance issues.....	123
Table 6-10	Configuration page.....	129
Table 6-11	Supplies Status page.....	131
Table 6-12	Status log only messages.....	137
Table 6-13	General print quality issues.....	138
Table 6-14	Color document issues.....	142
Table 6-15	Repetitive image defects.....	147
Table 7-1	Available replaceable parts	150
Table 7-2	Technical support Web sites	152
Table 7-3	Accessories	152
Table 7-4	Assembly locations	155
Table 7-5	External panels and covers (1 of 2)	157
Table 7-6	External panels and covers (2 of 2)	159
Table 7-7	Upper assembly cover	161
Table 7-8	Internal components (1 of 3)	163
Table 7-9	Internal components (2 of 3)	167
Table 7-10	Internal components (3 of 3)	171
Table 7-11	Control panel assembly	175
Table 7-12	Main drive assembly	177
Table 7-13	Fuser assembly	181
Table 7-14	PCB assembly location Tray 2	185
Table 7-15	Tray 2 input tray (cassette)	187

Table 7-16	250-sheet input tray (cassette)	191
Table 7-17	Tray 2 sheet input tray internal components	193
Table 7-18	Paper pick-up feeder assembly for Tray 2	197
Table 7-19	Tray 3 input tray (cassette)	201
Table 7-20	Paper pickup feeder assembly (Tray 3)	205
Table 7-21	Paper pickup feeder assembly (Tray 3)	207
Table 7-22	Alphabetical parts list.....	209
Table 7-23	Numerical parts list.....	230
Table A-1	Printer specifications	252
Table A-2	Supplies specifications	253
Table A-3	Print cartridge specifications	253
Table A-4	Electrical specifications	254
Table A-5	Environmental specifications	255
Table A-6	Acoustical specifications	256

List of figures

Figure 1-1	HP Color LaserJet 2600n printer.....	3
Figure 1-2	Front view (shown with optional Tray 3).....	6
Figure 1-3	Back and side view.....	7
Figure 1-4	Transfer belt (ETB) and print cartridges.....	7
Figure 1-5	Model and serial number information.....	8
Figure 1-6	Control panel layout.....	10
Figure 1-7	Control panel display.....	10
Figure 1-8	Envelope double side-seam construction.....	16
Figure 2-1	Printer dimensions	22
Figure 2-2	Package contents	24
Figure 4-1	Engine control system	39
Figure 4-2	Image formation system	42
Figure 4-3	Image formation process	43
Figure 4-4	Latent image formation	45
Figure 4-5	Laser beam exposure	45
Figure 4-6	Developing stage	46
Figure 4-7	Print cartridge structure	47
Figure 4-8	ETB unit	48
Figure 4-9	Transfer stage	48
Figure 4-10	Separation stage	49
Figure 4-11	Fusing stage	49
Figure 4-12	Paper pickup and feed system	52
Figure 4-13	Skew correction	54
Figure 4-14	Location of solenoids, motors, and fans	55
Figure 4-15	Location of printed circuit assemblies	56
Figure 4-16	Location of 250-sheet tray solenoid and printed circuit assembly	57
Figure 6-1	Paper path.....	99
Figure 6-2	Jam locations and stages.....	101
Figure 6-3	Tray 2 input jam label.....	104
Figure 6-4	Engine test print switch.....	125
Figure 7-1	Assembly location diagram	154
Figure 7-2	External panels and covers (1 of 2)	156
Figure 7-3	External panels and covers (2 of 2)	158
Figure 7-4	Upper cover assembly	160
Figure 7-5	Internal components (1 of 3)	162
Figure 7-6	Internal components (2 of 3)	166
Figure 7-7	Internal components (3 of 3)	170
Figure 7-8	Control panel assembly	174
Figure 7-9	Main drive assembly	176
Figure 7-10	Fuser assembly	180

Figure 7-11	PCB assembly location (Tray 2)	184
Figure 7-12	Tray 2 input tray (cassette)	186
Figure 7-13	250-sheet input tray (cassette)	190
Figure 7-14	Tray 2 input tray internal components	192
Figure 7-15	Paper pick-up feeder assembly for Tray 2	196
Figure 7-16	Tray 3 input tray (cassette)	200
Figure 7-17	Paper pickup feeder assembly (Tray 3)	204
Figure 7-18	PCB assembly location optional Tray 3	206
Figure 7-19	General circuit diagram	208
Figure C-1	VCCI statement	265
Figure C-2	Korean EMI statement	266

1 Product information

This section provides information about the following topics:

- [Quick access to printer information](#)
- [Printer configuration](#)
- [Printer features](#)
- [Walk around](#)
- [Software](#)
- [Print-media specifications](#)

Quick access to printer information

User guide

Contains detailed information for using the printer and troubleshooting problems. This guide is available in two formats on the CD-ROM that came with the printer: in PDF format for printing and HTML format for online viewing. It is also available through the HP Toolbox software.

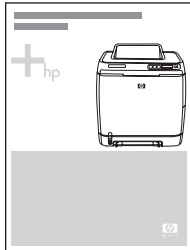

Getting started guide

Provides step-by-step instructions for installing and setting up the printer.

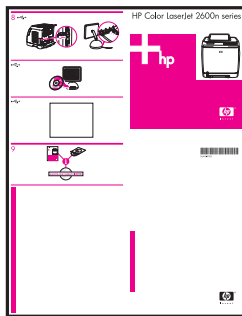

HP Toolbox

Use to check the printer status and settings and to view troubleshooting information and online documentation.



Embedded Web server

Use to view and configure printer settings and networking information.

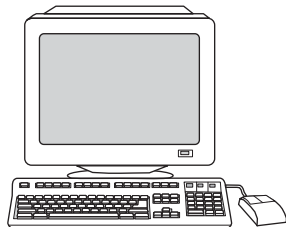

Printer configuration

HP Color LaserJet 2600n

The HP Color LaserJet 2600n printer is available in the configuration described below.

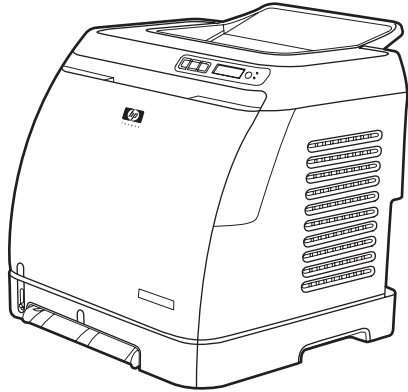

Figure 1-1 HP Color LaserJet 2600n printer

The HP Color LaserJet 2600n printer is a four-color laser printer that prints eight pages per minute (ppm) in both monochrome (black and white) and color.

- **Trays.** The printer comes with a single sheet priority feed slot (Tray 1) and a universal tray (Tray 2) that holds up to 250 sheets of various paper types and sizes or 10 envelopes. It supports an optional 250-sheet paper tray (optional Tray 3).
- **Connectivity.** The printer provides a Hi-Speed Universal Serial Bus (USB) 2.0 port for connectivity and an HP built-in internal print server for connecting to a 10/100Base-T network.
- **Memory.** The printer contains 16 megabytes (MB) of synchronous dynamic random access memory (SDRAM). No additional memory can be added.

Printer features

Table 1-1 Printer features

Feature	HP Color LaserJet 2600n printer
Color printing	<ul style="list-style-type: none">■ Provides laser printing in full color by using the four process colors: cyan, magenta, yellow, and black (CMYK).
Fast print speed	<ul style="list-style-type: none">■ Prints in black on letter-size paper up to 8 ppm and on A4-size paper up to 8 ppm. Prints in color on A4/letter at 8 ppm.
Excellent print quality	<ul style="list-style-type: none">■ ImageREt 2400 provides 2400 dpi equivalent color quality through a multilevel printing process.■ True 600 by 600 dots per inch (dpi) text and graphics.■ Adjustable settings to optimize print quality.■ The HP UltraPrecise print cartridge has a finer toner formulation that provides sharper text and graphics.
Ease of use	<ul style="list-style-type: none">■ Few supplies to order. Supplies are easy to install.■ Convenient access to printer information and settings by using the HP Toolbox software.■ Convenient access to all supplies and to the paper path through the front door.
Flexible paper handling	<ul style="list-style-type: none">■ Trays 1 and 2 for letterhead, envelopes, labels, transparencies, custom-sized media, postcards, HP LaserJet glossy paper, HP LaserJet Tough paper, heavy paper, and HP Laser Photo paper.■ A 125-sheet top output bin.■ Print on Both Sides (manually).
Interface connections	<ul style="list-style-type: none">■ Hi-Speed USB 2.0 port.■ The HP Color LaserJet 2600n printer includes an HP built-in internal print server for connecting to a 10/100Base-T network.
Energy savings	<ul style="list-style-type: none">■ The printer automatically conserves electricity by substantially reducing power consumption when it is not printing.■ As an ENERGY STAR® partner, Hewlett-Packard Company has determined that this product meets ENERGY STAR® guidelines for energy efficiency. ENERGY STAR® is a U.S. registered service mark of the United States Environmental Protection Agency.
Economical printing	<ul style="list-style-type: none">■ N-up printing (printing more than one page on a sheet) and Printing on Both Sides features save paper.

Table 1-1 Printer features (continued)

Feature	HP Color LaserJet 2600n printer
Supplies	<ul style="list-style-type: none">■ A Supplies Status page with print cartridge gauges that show the supply levels that remain. For HP supplies only.■ No-shake cartridge design.■ Authentication for HP print cartridges.■ Internet-enabled, supplies-ordering capability.
Accessibility	<ul style="list-style-type: none">■ Online user guide that is compatible with text screen-readers.■ All doors and covers can be opened by using one hand.
Expandability	<ul style="list-style-type: none">■ Optional Tray 3. This 250-sheet universal tray reduces how often you have to add paper to the printer. Only one additional 250-sheet tray can be installed on the printer.
Memory	<ul style="list-style-type: none">■ 16 MB of DRAM. <p data-bbox="922 856 970 905"></p> <p data-bbox="1002 856 1437 890">NOTE No additional memory can be added.</p>

Walk around

The following illustrations identify the locations and names of key components of this printer.

Front view (shown with optional Tray 3)

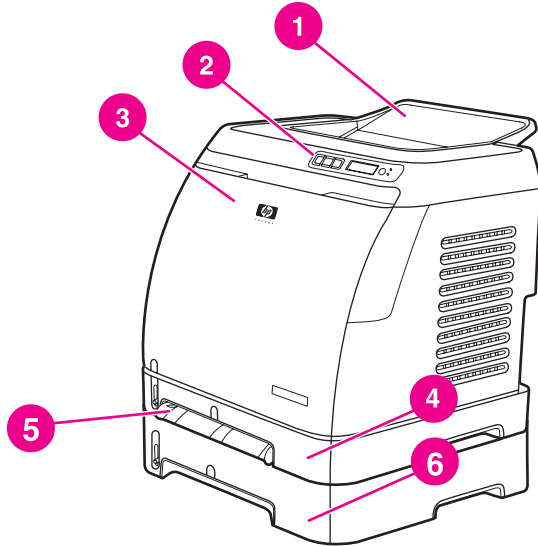

Figure 1-2 Front view (shown with optional Tray 3)

1	Output bin
2	Printer control panel
3	Front door
4	Tray 2 (250 sheets)
5	Tray 1 (single sheet priority feed slot)
6	Tray 3 (optional; 250 sheets)

Back and side view

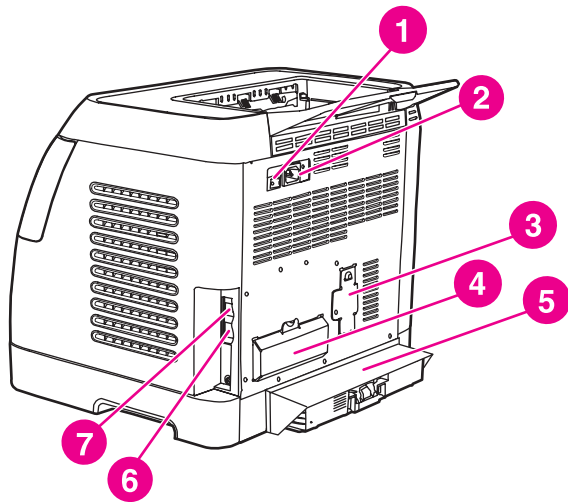

Figure 1-3 Back and side view

1	On/off switch
2	Power connection
3	Engine test button access door
4	Access door
5	Dust cover
6	HP built-in internal print server for connecting to a 10/100Base-T network
7	USB connection

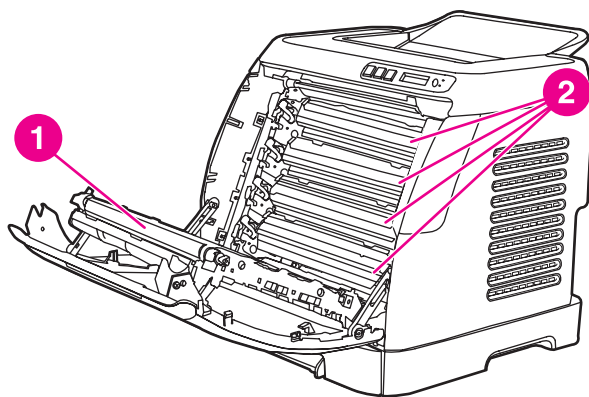

Figure 1-4 Transfer belt (ETB) and print cartridges

1	Transfer belt (ETB)
2	Print cartridges



CAUTION Do not place anything on the transfer belt, which is located on the inside of the front door. Otherwise, the printer may be damaged, adversely affecting print quality.

Model and serial number location

The model number and serial numbers are listed on identification labels located on the rear of the printer. The model number is alphanumeric, such as Q6455A, for the HP Color LaserJet 2600n printer. The serial number contains information about the country/region of origin, the printer version, production code, and the production number of the printer.

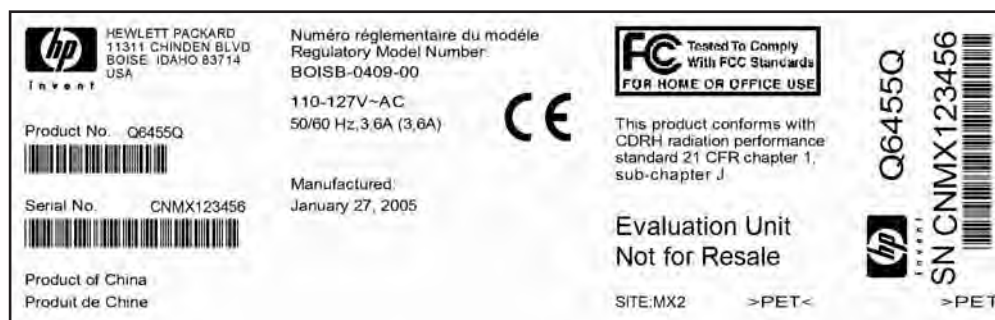

Figure 1-5 Model and serial number information

Control panel

Understanding supplies status

The supplies gauges show the consumption levels of print cartridges (black, yellow, cyan, and magenta).

Black, yellow, cyan, and magenta supplies status gauges



A ? appears instead of the consumption level when the level is not known. This can occur in the following circumstances:

- Missing cartridges
- Incorrectly placed cartridges
- Cartridges with an error
- Some non-HP cartridges

The supplies gauge appears whenever the printer shows the Ready state with no warnings. It will also appear when the printer shows a warning or error message concerning a print cartridge or multiple supplies. If a supply is empty, the gauge will flash.

Understanding printer status

Cancel Job button

- When the Ready light is blinking, pressing  (CANCEL JOB) cancels the current job.
- When a supplies status gauge is blinking and the Attention light is on (indicating that a non-HP supply has been installed), pressing  (SELECT) allows you to continue printing.



CAUTION You might not receive any indication when a non-HP supply is empty. For more information about using non-HP print cartridges, see [HP policy on non-HP supplies](#). If you continue printing after the supply is empty, damage to the printer can occur. See [Hewlett-Packard limited warranty statement](#).

Attention light



Generally, the Attention light blinks when the printer is out of paper, when a jam has occurred, or when other problems that need attention occur.

The Attention light is on and one of the Supplies Status gauges is blinking the first time a non-HP supply is installed.



Ready light

The Ready light is on when the printer is ready to print (experiencing no errors that prevent printing) and blinks when it is receiving data to be printed.

Ready light and Select button

- When the Ready light is on and the Attention light is blinking, pressing  (**SELECT**) continues the print job after you load print media for a manual feed, or clears some errors.
- When the Ready light is blinking, the front door has been opened and then closed. Press  (**SELECT**) to return the printer to the Ready state. If you do not press  (**SELECT**), the printer returns to the Ready state on its own.

Left and Right arrow buttons

Use the  (**LEFT ARROW**) and  (**RIGHT ARROW**) buttons to navigate through the printer control panel menus.

A Demo page can be printed by pressing the  (**LEFT ARROW**) and  (**RIGHT ARROW**) buttons simultaneously.

Understanding control panel layout

This section provides information about printer status and control panel layout.

Control panel layout

The printer contains the following lights and buttons on the control panel:

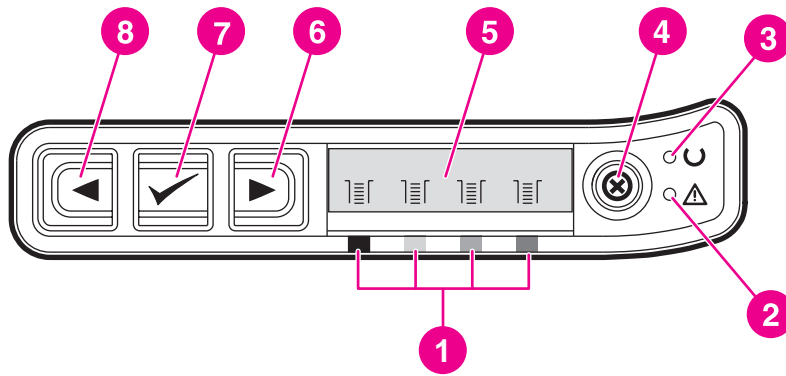



Figure 1-6 Control panel layout

1	Color print cartridge indicators
2	Attention light (amber)
3	Ready light (green)
4	CANCEL JOB  button
5	Message area
6	RIGHT ARROW  button
7	SELECT  button
8	LEFT ARROW  button

Display

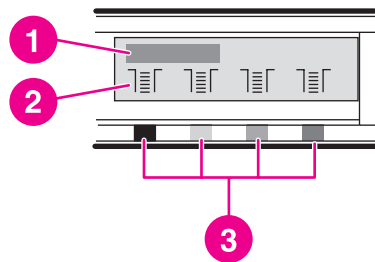

Figure 1-7 Control panel display

The printer display gives you information about the printer, job status, and levels of supplies.

1	Message area
2	Supplies gauges
3	Print cartridge colors are indicated from left to right: black, yellow, cyan, and magenta

Software

This section contains information about the software used with the HP Color LaserJet 2600n printer.

Supported drivers

Software and supported operating systems

For easy printer setup and access to the full range of printer features, HP strongly recommends that you install the software that is provided. Not all software is available in all languages. See the *Getting Started Guide* for installation instructions, and see the Readme file for the latest software information.

The most recent drivers, additional drivers, and other software are available from the Internet and other sources.

The printer supports the following operating systems:

- Microsoft® Windows® 98 Second Edition and Windows Millennium Edition (Me) (Add Printer installation)
- Microsoft® Windows® 2000 and Windows XP
- Microsoft® Windows® Server 2003
- Macintosh OS X v10.2 and later

The following table lists the software that is available for your operating system.

Table 1-2 HP Color LaserJet 2600n printer software

Feature	Windows 98 Second Edition, Me	Windows 2000 and XP	Macintosh OS X v10.2 and later
Windows Installer		✓	
Windows printer driver	✓	✓	
HP Toolbox software	✓	✓	
Macintosh Installer			✓
Macintosh printer drivers			✓

Software for Windows

When you install the software for Windows, you can directly connect the printer to a computer by using a USB cable or you can connect the printer to the network by using HP built-in networking. See the *Getting Started Guide* for installation instructions, and see the Readme file for the latest software information.

The following software is available to all users of the printer, whether you connected the printer directly to a computer by using a USB cable, or to the network through the HP built-in networking internal print server.

Printer drivers

A printer driver is a software component that provides access to printer features and provides the means for the computer to communicate with the printer.

Using Help

The printer driver has **Help** dialog boxes that can be activated from the **Help** button in the printer driver, the **F1** key on the computer keyboard, or the question mark symbol (?) in the upper-right corner of the printer driver. These **Help** dialog boxes give detailed information about the specific printer driver. Help for the printer driver is separate from the Help for your program.

HP Toolbox

You must perform a complete software installation to use the HP Toolbox.

The HP Toolbox provides links to printer status information and help information, such as the user guide; and tools for diagnosing and solving problems. You can also view explanations and animations on the control panel. See [Managing and maintenance](#) for more information.

Software for Macintosh

The printer includes the following software for Macintosh computers.

Macintosh printer driver

When you install the software for Macintosh, you can directly connect the printer to a computer by using a USB cable or you can connect the printer to the network by using HP built-in networking. If you are connected via the network, you can configure your printer using the embedded Web server.

Network software

Supported networks

The HP Color LaserJet 2600n printer supports network printing on Windows and Mac systems.

Supported utilities/applications/tools

- HP Color LaserJet 2600n HP Toolbox

For IP configuration, in HP Toolbox, select **Device Settings**, and then select the **Networking** tab. For more information about the HP Toolbox, see [HP Toolbox](#).

- Embedded Web server (EWS)

If the printer is connected to a network, access the EWS by typing the printer IP address into the address field of a Web browser, and then selecting the **Networking** tab.

Uninstalling software

Uninstall software by using the following directions for your operating system.

Windows software

After a printing system installation, use the uninstall icon in the HP Color LaserJet 2600n printer program group to select and remove any or all of the HP printing system components.

Starting the Uninstaller

- 1 Click **Start**, select **Programs (All Programs)** for Windows XP) and choose **HP**.
- 2 In the **HP Color LaserJet 2600n** program group, click the **HP Color LaserJet 2600n uninstall** icon.
- 3 The uninstaller guides you through removing the printing system components.



NOTE For driver-only (Add Printer/New Driver) installations, delete the printer icon from the Printers folder (Windows 98 Second Edition, Windows Me, Windows 2000, and Windows XP).

Macintosh software

To remove the printer from your Macintosh use the following steps:

- 1 Open Print Center (v10.2) or Print Setup Utility (v10.3).
- 2 Select the printer name.
- 3 Select **Delete**.

Print-media specifications

This section contains information about specifications for the quality of print media, guidelines for print media usage, and guidelines for print media storage.

General guidelines

Some print media might meet all of the guidelines in this manual and still not produce satisfactory results. This problem might be the result of improper handling, unacceptable temperature and humidity levels, or other variables over which Hewlett-Packard has no control.

Before purchasing large quantities of print media, always test a sample and make sure that the print media meets the requirements specified in the *HP LaserJet Printer Family Print Media Guide* available at <http://www.hp.com/support/ljpaperguide>.



CAUTION Using print media that does not meet HP specifications can cause problems for the printer, requiring repair. This repair is not covered by the Hewlett-Packard warranty or service agreements.

CAUTION Use only paper designed for laser printers. Paper for inkjet printers may damage the printer.

This printer accepts a variety of media, such as cut-sheet paper (including up to 100% recycled-fiber-content paper), envelopes, labels, transparencies, HP LaserJet glossy paper, HP LaserJet Tough paper, HP LaserJet Photo paper, and custom-size paper. Properties such as weight, composition, grain, and moisture content are important factors that affect printer performance and output quality. Print media that does not meet the guidelines outlined in this manual can cause the following problems:

- Poor print quality
- Increased jams
- Premature wear on the printer, requiring repair

Paper and print media

For print-media specifications, see [Media support tables](#).

Printing and storage environment

Ideally, the printing and media-storage environment should be at or near room temperature, and not too dry or too humid. Remember that paper is hygroscopic; it absorbs and loses moisture rapidly.

Heat works with humidity to damage paper. Heat causes the moisture in paper to evaporate, while cold causes it to condense on the sheets. Heating systems and air conditioners remove most of the humidity from a room. As paper is opened and used, it loses moisture, causing streaks and smudging. Humid weather or water coolers can cause the humidity to increase in a room. As paper is opened and used it absorbs any excess moisture, causing light print and dropouts. Also, as paper loses and gains moisture it can distort. This issue can cause jams.

As a result, paper storage and handling are as important as the paper-making process itself. Paper storage environmental conditions directly affect the feed operation and print quality.

Care should be taken not to purchase more paper than can be easily used in a short time (about three months). Paper stored for long periods can experience heat and moisture extremes, which can cause damage. Planning is important to prevent damage to a large supply of paper.

Unopened paper in sealed reams can remain stable for several months before use. Opened packages of paper have more potential for environmental damage, especially if they are not wrapped with a moisture-proof barrier.

The media-storage environment should be properly maintained to ensure optimum printer performance. The required condition is 20° to 24°C (68° to 75°F), with a relative humidity of 45% to 55%. The following guidelines should be helpful when evaluating the paper's storage environment:

- Print media should be stored at or near room temperature.
- The air should not be too dry or too humid (to moderate the hygroscopic properties of paper).
- The best way to store an opened ream of paper is to rewrap it tightly in its moisture-proof wrapping. If the printer environment is subject to extremes, unwrap only the amount of paper to be used during the day's operation to prevent unwanted moisture changes.
- Avoid storing paper and print media near heating and air conditioning vents or near windows and doors that are frequently open.

Envelopes

Envelopes can be printed from Tray 1 or Tray 2. Select the type of envelope that you are using from the **Print** dialog box or the printer driver.

In your program, set the margins for the envelope. The following table gives typical address margins for a commercial #10 or DL envelope.

Table 1-3 Envelope specifications

Type of address	Top margin	Left margin
Return address	15 mm (0.6 inch)	15 mm (0.6 inch)
Delivery address	51 mm (2 inches)	89 mm (3.5 inches)

- For the best print quality, position margins no closer than 15 mm (0.6 inch) from the edges of the envelope.
- Avoid printing over the area where the envelope seams meet.

Envelope storage

Proper storage of envelopes helps contribute to print quality. Envelopes should be stored flat. If air is trapped in an envelope and creates an air bubble, then the envelope might wrinkle during printing.

Envelope construction

Envelope construction is critical. Envelope fold lines can vary considerably, not only between manufacturers, but also within a box from the same manufacturer. Successful printing on envelopes

depends upon the quality of the envelopes. When selecting envelopes, consider the following components:

- **Weight:** The weight of the envelope paper should not exceed 90 g/m² (24 lb) or jamming might occur.
- **Construction:** Before printing, envelopes should lie flat with less than 6 mm (0.25 inch) curl, and should not contain air.
- **Condition:** Envelopes should not be wrinkled, nicked, or otherwise damaged.
- **Temperature:** Use envelopes that are compatible with the heat and pressure of the printer. This printer fusing temperature is 210°C (410°F).
- **Size:** Use only envelopes that are within the following size ranges.

Table 1-4 Envelope size ranges

Tray	Minimum	Maximum
Tray 1 or Tray 2	76 x 127 mm (3 x 5 inches)	216 x 356 mm (8.5 x 14 inches)

Envelopes with double side-seams

Double side-seam construction has vertical seams at both ends of the envelope rather than diagonal seams. This style might be more likely to wrinkle. Be sure the seam extends all the way to the corner of the envelope as illustrated below.

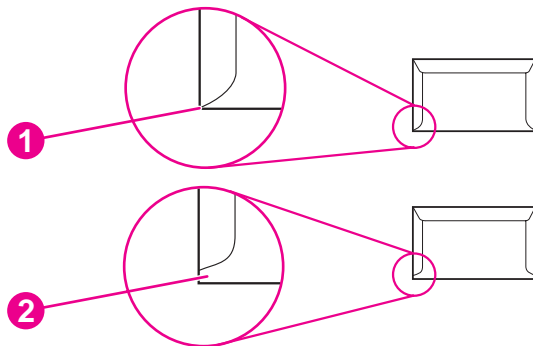

Figure 1-8 Envelope double side-seam construction

1	Acceptable
2	Unacceptable

Envelopes with adhesive strips or flaps

Envelopes with a peel-off adhesive strip or with more than one flap that folds over to seal must use adhesives that are compatible with the heat and pressure in the printer. The extra flaps and strips might cause wrinkling, creasing, or even jams and might damage the fuser.

Labels

Select the type of label that you are using from the **Print** dialog box or the printer driver.



CAUTION To avoid damaging the printer, use only labels that are recommended for laser printers. To prevent serious jams, always use Tray 1 or Tray 2 to print on labels. Never print on the same sheet of labels more than once or print on a partial sheet of labels.

When selecting labels, consider the quality of each component:

- **Adhesives:** The adhesive material should be stable at 210°C (410°F), which is the printer fusing temperature.
- **Arrangement:** Only use labels with no exposed backing between them. Labels can peel off sheets with spaces between the labels, causing serious jams.
- **Curl:** Before printing, labels must lie flat with no more than 13 mm (0.5 inch) of curl in any direction.
- **Condition:** Do not use labels that have wrinkles, bubbles, or other indications of separation.

Transparencies

Use only Tray 1 or Tray 2 to print on transparencies. Select **Transparencies** from the **Print** dialog box or the printer driver.

The printer supports printing on color transparencies. Use only transparencies that are recommended for use in laser printers.

Transparencies that are used in the printer must be able to withstand 210°C (410°F), which is the printer fusing temperature.



CAUTION To avoid damage to the printer, use only transparencies that are recommended for use in laser printers.

Media support tables

This section contains information about the sizes, weights, and capacities of paper and other print media that each tray supports.

Supported print media for Tray 1, Tray 2, and optional Tray 3

This section contains information about the sizes, weights, and capacities of paper and other print media that each tray supports.

Tray 1 and Tray 2 specifications

Table 1-5 Tray 1 and Tray 2 specifications

Tray 1 and Tray 2	Dimensions ¹	Weight	Capacity ²
Paper	Minimum: 76 x 127 mm (3 x 5 inches)	60 to 163 g/m ² (16 to 43 lb)	Single sheet of 75 g/m ² (20 lb) paper for Tray 1

Table 1-5 Tray 1 and Tray 2 specifications (continued)

Tray 1 and Tray 2	Dimensions ¹	Weight	Capacity ²
	Maximum: 216 x 356 mm (8.5 x 14 inches)		Up to 250 sheets for Tray 2
HP LaserJet glossy paper and HP LaserJet photo paper	Same as the preceding listed minimum and maximum sizes.	75 to 163 g/m ² (20 to 43 lb)	Single sheet of HP LaserJet glossy paper or HP LaserJet photo paper for Tray 1 Up to 25 mm (0.99 inch) stack height for Tray 2
HP Premium Cover paper ³		200 g/m ² (75 lb) cover	Single sheet of HP Cover paper for Tray 1 Up to 25 mm (0.99 inch) stack height for Tray 2
Transparencies and opaque film		Thickness: 0.10 to 0.13 mm (3.9 to 5.1 mils)	Single sheet of transparency or opaque film for Tray 1 Up to 50 sheets for Tray 2
Labels		Thickness: up to 0.23 mm (up to 9 mils)	Single sheet of labels for Tray 1 Up to 25 mm (0.99 inch) stack height for Tray 2
Envelopes		Up to 90 g/m ² (16 to 24 lb)	Single envelope for Tray 1 Up to ten envelopes for Tray 2

¹ The printer supports a wide range of standard and custom sizes of print media. Check the printer driver for supported sizes.

² Capacity can vary depending on media weight and thickness, and environmental conditions.

³ Hewlett-Packard does not guarantee results when printing with other types of heavy paper.

Optional Tray 3 specifications

Table 1-6 Optional Tray 3 specifications

Optional Tray 3 (250-sheet tray)	Dimensions ¹	Weight	Capacity ²
Paper	Minimum: 76 x 127 mm (3 x 5 inches) Maximum: 216 x 356 mm (8.5 x 14 inches)	60 to 163 g/m ² (16 to 43 lb)	Up to 250 sheets

¹ The printer supports a wide range of standard and custom sizes of print media. Check the printer driver for supported sizes.

² Capacity can vary depending on media weight and thickness, and environmental conditions.

Unsupported media (media to avoid)

Avoid using the following media:

- Paper that has been stapled. Staples left in reused paper will cause printer damage that will require repairs that may not be covered under the warranty.
- Sheets of labels that have been used more than once or partial sheets of labels

- Labels that are not specifically recommended for laser printers
- Labels that are separating from the backing sheet or are wrinkled or damaged in any way
- Transparencies that are not specifically recommended for laser printers
- Media that has been stored in a high-humidity environment
- Labels with exposed glue or adhesive

2 Installation

This chapter contains information about the following topics.

- [Site preparation](#)
- [Package contents](#)
- [Install input devices](#)

Site preparation

Below are recommendations for the printer location and placement.

Operating environment

The printer must be kept in a proper location to maintain the performance level that has been set at the factory. In particular, be sure that the environment adheres to the specifications listed in this chapter.

The printer must have 2 inches of space above and around it.

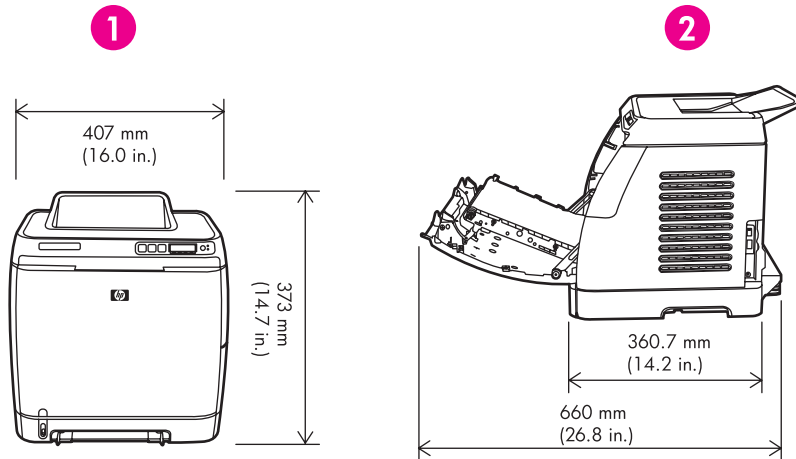

Figure 2-1 Printer dimensions

1	Front view
2	Side view

Make sure the printer has the following:

- A well-ventilated, dust-free area
- As surface that will support up to 18 kg (40 lbs)
- A constant temperature and humidity (Do not install near water sources, humidifiers, air conditioners, refrigerators, or other major appliances.)
- A hard level surface (not more than a 2° angle)

Make sure to keep the printer away from the following:

- Direct sunlight, dust, open flames, or water
- Direct flow of exhaust from air ventilation systems
- Magnets and devices that emit a magnetic field
- Areas subject to vibration

- Walls or other objects. There must be enough space around the printer for proper access and ventilation

Minimum system requirements

The minimum system requirements for the HP Color LaserJet 2600n printer are listed below:

- 150 MB of free hard disk space
- CD-ROM drive
- Available USB or network port



NOTE Networking is only available on Windows 2000, Windows XP, and Macintosh.

Requirements for PC systems

- Windows 98 SE and Me (driver only)
- Windows 2000 and XP (32-bit Home and Professional)
- 233 MHz processor with 64 MB RAM

Requirements for Macintosh systems (non-PostScript)

- G3 processor (G4 processor recommended)
- Mac OS X 10.2 and later

Package contents

Figure 2-2 Package contents lists the package contents for the HP Color LaserJet 2600n.

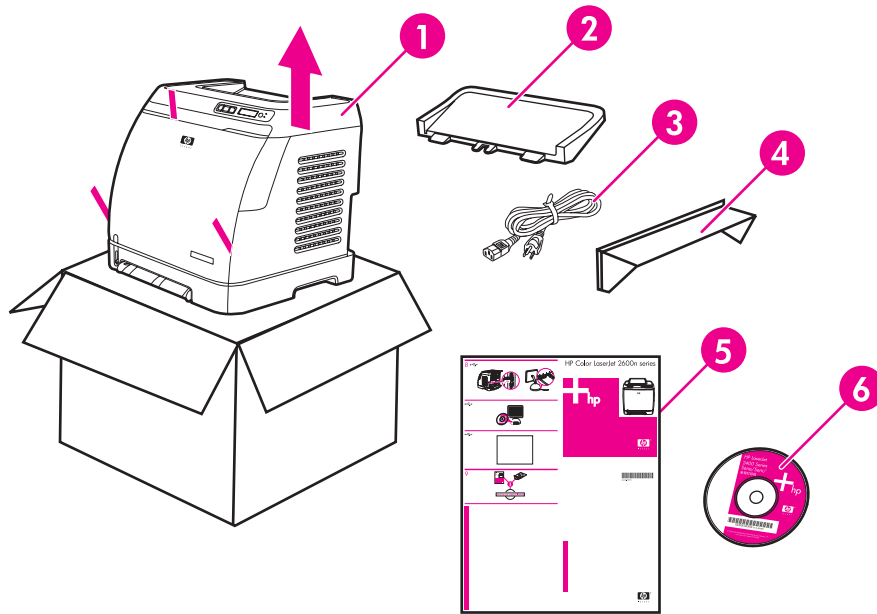

Figure 2-2 Package contents

1	HP Color LaserJet 2600n
2	Output tray
3	Power cable
4	Dust cover
5	<i>Getting Started Guide</i>
6	Software and user documentation CD-ROM

Install input devices

Installing optional Tray 3

- 1 Turn off the power switch on the printer.

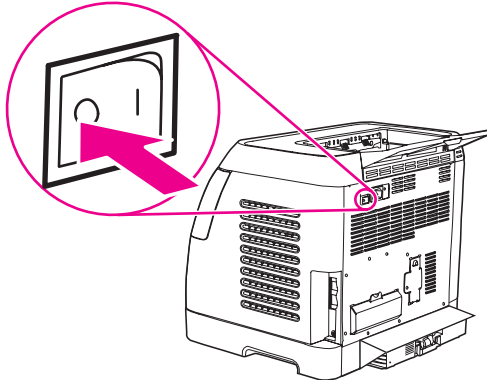

- 2 Unplug the power cable.

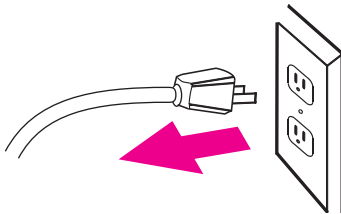

- 3 Place the printer on optional Tray 3, aligning the three (3) pegs on Tray 3 with the holes on the printer.

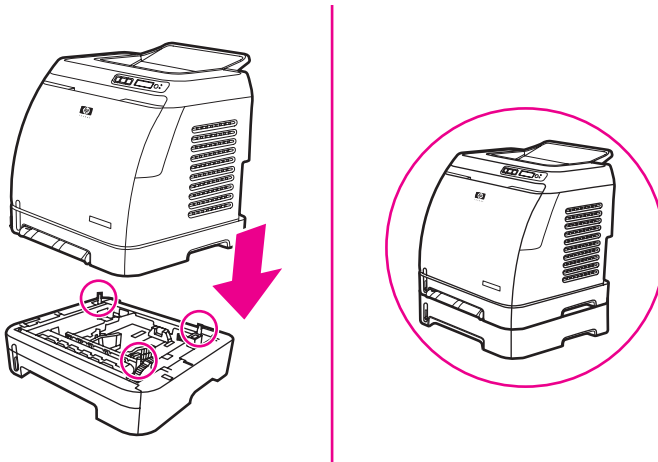

Loading Tray 1

Tray 1 (the single sheet priority feed slot) prints single sheets of print media or a single envelope. Use Tray 1 when feeding one sheet of paper, or one envelope, postcard, label, HP LaserJet glossy paper, HP LaserJet Photo paper, or transparency. You can also use Tray 1 to print the first page on different media than the rest of the document.

For information about loading special print media such as envelopes, labels, and transparencies, see [Print-media specifications](#).

To load Tray 1

- 1 Media guides ensure that the media is correctly fed into the printer and that the print is not skewed. Slide the media-width guides slightly wider than the print media.

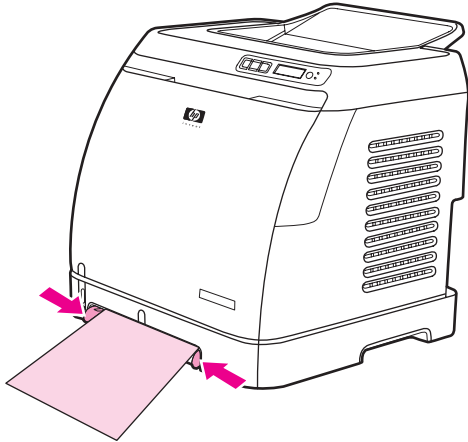

- 2 Feed print media into Tray 1 with the side to be printed down, and the top, short edge in first. Make sure that the media is inserted far enough into the printer for the paper feed mechanism to grab the media. The paper will reach the sensor after 140 mm (5.5 inches) has been inserted. The printer will then pause for .5 second before it pulls the paper into the printer. HP recommends holding the paper on both sides when inserting.



NOTE Light weight paper may buckle if held only on the short (far) edge as it is inserted. As paper is inserted, it trips the registration shutter. For light weight paper, holding it on both sides near the slot increases the ability for the paper to appropriately trip this shutter.

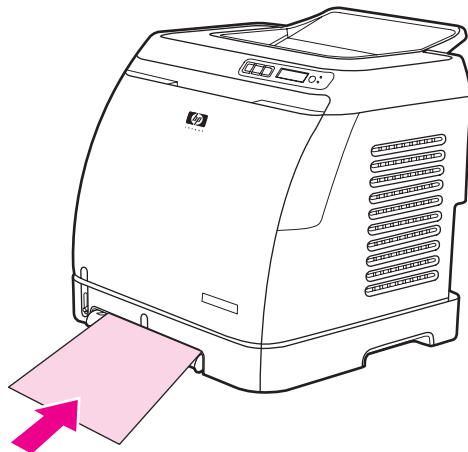

Installing supplies

Print cartridges

When a print cartridge approaches the end of useful life, the control panel displays a message recommending that you order a replacement. The printer can continue to print using the current print cartridge until the control panel displays a message instructing you to replace the cartridge.

The printer uses four colors and has a different print cartridge for each color: black (K), cyan (C), magenta (M), and yellow (Y).

Replace a print cartridge when the printer control panel displays one of the following messages: **Replace yellow cartridge**, **Replace magenta cartridge**, **Replace cyan cartridge**, **Replace black cartridge**. The control panel display also indicates the color that should be replaced (unless a genuine HP cartridge is not currently installed).

To change the print cartridge

- 1 Turn off the printer.
- 2 Open the front door.

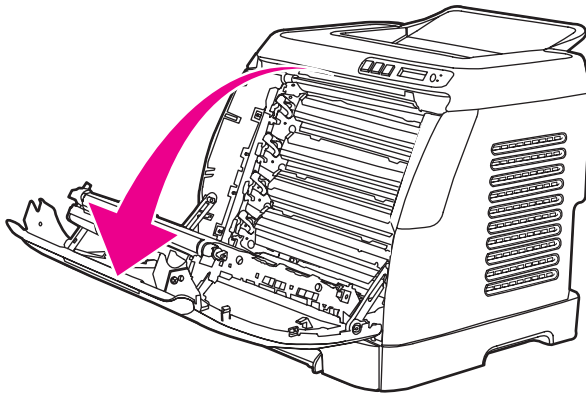

CAUTION Do not place anything on the transfer belt (ETB), which is located on the inside of the front door.

- 3 Remove the used print cartridge from the printer.

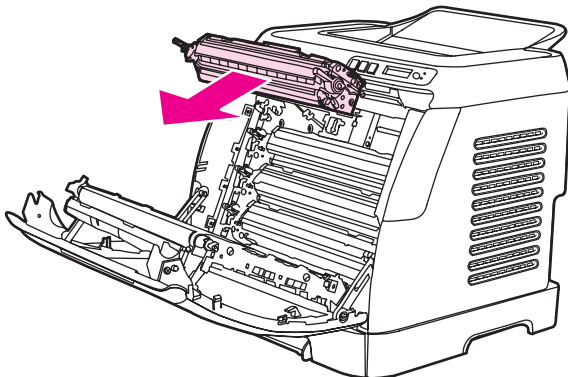

- 4 Remove the new print cartridge from the bag. Place the used print cartridge in the bag for recycling.

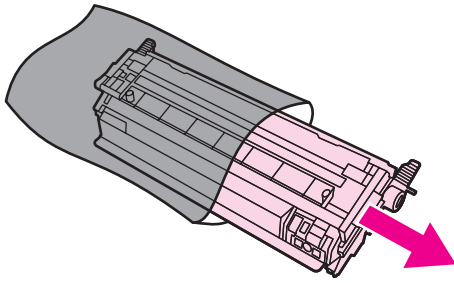

- 5 Grasp both sides of the print cartridge by the blue handles and distribute the toner by gently rocking the print cartridge from front to back.



CAUTION Do not touch the shutter or the surface of the roller.

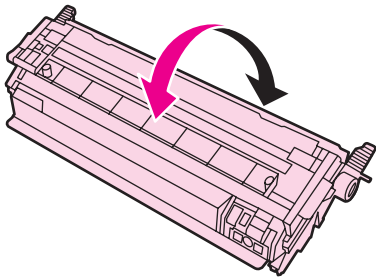

- 6 Remove the orange shipping locks and the orange shipping tape from the new print cartridge. Discard the shipping tape and shipping locks according to local regulations.

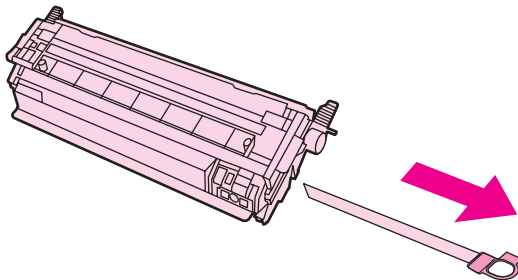

- 7 Align the print cartridge with the tracks inside the printer, and using the handles, insert the print cartridge until it is firmly seated.

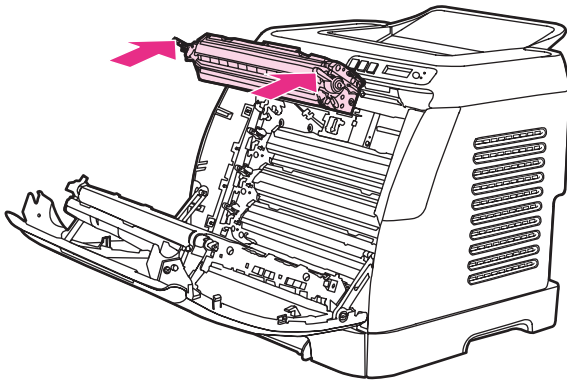

- 8 Firmly close the front door.

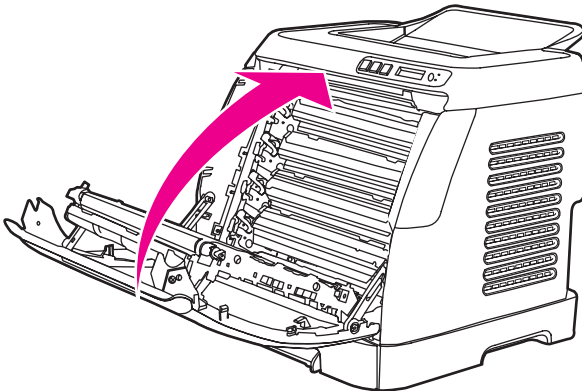

- 9 Turn on the printer. After a short time, the control panel should display **Ready**.



NOTE If a cartridge is in the wrong slot or is the wrong type for the printer, the control panel will display one of the following messages: **Incorrect yellow**, **Incorrect magenta**, **Incorrect cyan**, **Incorrect black**.

- 10 Installation is complete. Place the used print cartridge in the box in which the new cartridge arrived. See the enclosed recycling guide for recycling instructions.
- 11 If you are using a non-HP print cartridge, check the printer control panel for further instructions. For more information about using non-HP print cartridges, see [HP policy on non-HP supplies](#).



NOTE When replacing or changing a black print cartridge, a cleaning page will automatically print. This helps prevent speckles on the front or back of printed documents. A cleaning page can also be generated using the control panel or the HP Toolbox. For information, see [To clean the printer at the printer](#) or [To clean the fuser using HP Toolbox](#).

3 Managing and maintenance

This chapter contains information about the following topics.

- [Managing supplies](#)
- [Cleaning the printer](#)
- [Calibrating the printer](#)

Managing supplies

Life expectancies of supplies

Table 3-1 Print cartridge life

Print-cartridge life (based on approximately 5% coverage)	Black: 2,500 pages
	Yellow, cyan, and magenta: 2,000 pages each

Checking and ordering supplies

You can check the supplies status by using the printer control panel, printing a Supplies Status page, or viewing the HP Toolbox. Hewlett-Packard recommends that you place an order for a replacement print cartridge when you first receive the Order message for a print cartridge. For typical use, the Order message indicates that approximately two weeks of life remains. When you use a new, authentic HP print cartridge, you can obtain the following types of supplies information:

- Amount of cartridge remaining
- Estimated number of pages remaining
- Number of pages printed
- Other supplies information



NOTE If the printer is connected to the network, you can set the HP Toolbox to notify you by e-mail when a print cartridge is low or is near the end of its life. If the printer is directly connected to a computer, you can set HP Toolbox to notify you when supplies are low.

To check status using the control panel

Do one of the following:

- Check the supplies status gauges on the printer control panel. These gauges indicate when a print cartridge is low or empty. The lights also indicate when a non-HP print cartridge is first installed.
- To print the Supplies Status page from the printer, on the printer control panel, select **Reports**, **Supplies Status**, and then (**SELECT**). See [Supplies Status page](#) for more information.

If the supplies levels are low, you can order supplies through your local HP dealer, by telephone, or online.

To check and order supplies using HP Toolbox

You can configure HP Toolbox to notify you when the supplies are low. You can choose to receive alerts by e-mail or as a pop-up message or taskbar icon. To order supplies using the HP Toolbox, in the **Other Links** area, click **Order supplies**. You must have Internet access to connect to the website.

Storing supplies

Follow these guidelines for storing print cartridges:

- Do not remove the print cartridge from its package until you are ready to use it.



CAUTION To prevent damage, do not expose the print cartridge to light for more than a few minutes.

- See [Environmental specifications](#) for operating and storage temperature ranges.
- Store the supply in a horizontal position.
- Store the supply in a dark, dry location away from heat and magnetic sources.

Replacing and recycling supplies

Replacing the print cartridges

To install a new HP print cartridge, follow the instructions that are included on the box that contains the new supply, or see the *Getting Started Guide*.

To recycle supplies, place the used supply in the box in which the new supply arrived. Use the enclosed return label to send the used supply to HP for recycling. For complete information, see the recycling guide that is included with each new HP supply item. Go to <http://www.hp.com/go/recycle> for more information about HP's recycling program.

HP policy on non-HP supplies

Hewlett-Packard Company cannot recommend the use of non-HP supplies, either new or remanufactured. Because they are not HP products, HP cannot influence their design or control their quality. Service or repairs required as a result of using a non-HP supply will **not** be covered under the printer warranty.

When you insert a supply into the printer, the printer will inform you if the supply is not a genuine HP supply. If you insert a genuine HP supply that has reached the low state from another HP printer, the printer identifies the supply as non-HP. Simply return the supply to the original printer to reactivate HP features and functionality.

HP anti-counterfeit website

Visit the HP anti-counterfeit website at <http://www.hp.com/go/anticounterfeit> if the supplies status gauges or HP Toolbox indicates that the print cartridge is not an HP print cartridge and you think that it is genuine.

Cleaning the printer

During the printing process, paper, toner and dust particles can accumulate inside the printer. Over time, this buildup can cause print-quality problems such as toner specks or smearing. This printer has a cleaning mode that can correct and prevent these types of problems.

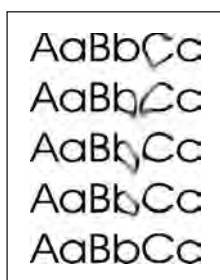
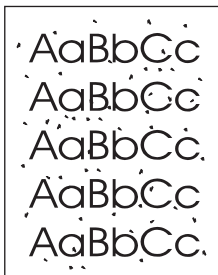







This printer has two processes for generating cleaning pages: one is automatically generated and one is manually generated. When a new black print cartridge is installed, a cleaning page will be automatically generated prior to calibration. To manually generate a cleaning page, see [To clean the fuser using HP Toolbox](#).

To clean the printer at the printer



NOTE If you have access to HP Toolbox, HP recommends cleaning the paper path by using HP Toolbox.

Use the following procedure to clean the printer at the printer.

- 1 Use the  (LEFT ARROW) or  (RIGHT ARROW) button to select **Service**, and then press  (SELECT).
- 2 Use the  (LEFT ARROW) or  (RIGHT ARROW) button to select **Cleaning Mode**, and then press  (SELECT).

A page feeds through the printer slowly. Discard the page when the process is completed.

To clean the fuser using HP Toolbox



NOTE Use the following procedure to clean the fuser using the HP Toolbox. To clean the engine when the computer is running an operating system that does not support HP Toolbox, see the late-breaking Readme on the root of the CD-ROM, or visit <http://www.hp.com/support/cj2600n>.

- 1 Make sure that the printer is turned on and in the Ready state.
- 2 Open the HP Toolbox.
- 3 On the **Troubleshooting** tab, click **Troubleshooting Tools**, and then click **Print**. A page with a pattern prints from the printer.
- 4 At the printer, remove any print media in Tray 2 or optional Tray 3.
- 5 Remove the page that printed and load it face-down into Tray 2 or optional Tray 3.

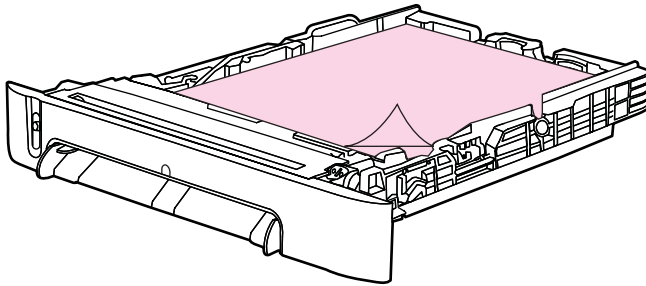

- 6 On the **Troubleshooting Tools** page, click the **Clean** button.

Cleaning spilled toner

Defective print cartridges can develop leaks. Also, after a paper jam has occurred, some toner might remain on the rollers and guides inside the printer. The pages that print immediately after the jam can pick up this toner.



CAUTION When cleaning the printer, do not touch the ETB with a damp cloth or with your fingers.













Calibrating the printer

The printer automatically calibrates at various times. You can adjust the calibration settings by using the HP Toolbox.

Environmental differences or aging print cartridges might cause fluctuations in image density. The printer accounts for this with image stabilization control. The printer automatically calibrates at various times to maintain the highest level of print quality. You can also request a calibration by using the HP Toolbox.

The printer does not interrupt a print job to calibrate. It waits until the job is complete before calibrating or cleaning. While the printer is calibrating, it pauses printing for the time that is required to complete the calibration.

To calibrate the printer at the printer

- 1 To calibrate from the printer, press  (**LEFT ARROW**) or  (**RIGHT ARROW**) until the display reads **SYSTEM SETUP**.
- 2 Press  (**SELECT**).
- 3 Press  (**LEFT ARROW**) or  (**RIGHT ARROW**) until the display reads **PRINT QUALITY**.
- 4 Press  (**SELECT**).
- 5 Press  (**LEFT ARROW**) or  (**RIGHT ARROW**) until the display reads **CALIBRATE COLOR**.
- 6 Press  (**SELECT**).
- 7 Press  (**LEFT ARROW**) or  (**RIGHT ARROW**) until the display reads **CALIBRATE NOW**.
- 8 Press  (**SELECT**).
- 9 Press  (**SELECT**) to confirm **CALIBRATE NOW**.

To calibrate the printer from the HP Toolbox



NOTE This procedure applies to Windows operating systems only. Macintosh users should calibrate the printer manually using the procedure above.

- 1 Open the HP Toolbox in one of these ways:
 - On the desktop, double-click the **HP Toolbox** icon.
 - On the **Start** menu, point to **Programs**, point to **HP**, point to **HP Color LaserJet 2600n**, and click **HP Color LaserJet 2600n Toolbox**.
- 2 Click the **Troubleshooting** tab and then click **Troubleshooting Tools** (on the left side of the screen).
- 3 In the Calibration section, click **CALIBRATE NOW**.

4 Operational theory

This chapter contains information about the following topics.

- [Engine control system](#)
- [Image formation system](#)
- [Pickup and feed system](#)
- [Service-only tools \(SERVICE ONLY\)](#)

Engine control system

Basic sequence of operation

The operational sequence of the printer is controlled by the microcomputer on the DC controller printed circuit board (PCB). The purposes of each period, from power-on until the main motor stops after the completion of printing, are listed below. See [General timing chart](#) for a detailed timing chart.

Table 4-1 Basic operational sequence

	Period	Purpose	Remarks
WAIT (wait period)	From power-on until the end of the main motor initial drive.	To clear the drum surface potential and to clean the ETB.	Detects whether or not the print cartridge is installed.
STBY (standby period)	From the end of WAIT or LSTR until the input of print command from the formatter. Or, from the end of LSTR until power-off.	To keep the printer ready to print.	
INTR (initial rotation period)	From the input of print command from the formatter until the pick-up solenoid is turned on.	To stabilize the photosensitive drum sensitivity for print preparation.	
PRINT (print period)	From the end of INTR until the developing high-voltage is off.	To form the image on the photosensitive drum based on the VIDEO signals input from the formatter, and to transfer the toner image onto paper.	
LSTR (last rotation period)	From the developing high-voltage off until the main motor stops rotating.	To deliver the last page completely. Also used to clean the ETB.	The printer enters INTR after the end of LSTR, when the print command is input from the formatter.

The engine control system coordinates all printer functions. It drives the laser/scanner system, the image formation system, and the pickup and feed system. The engine control system contains the following components:

- DC controller PCB
- Low-voltage power supply unit
- High-voltage power supply PCB

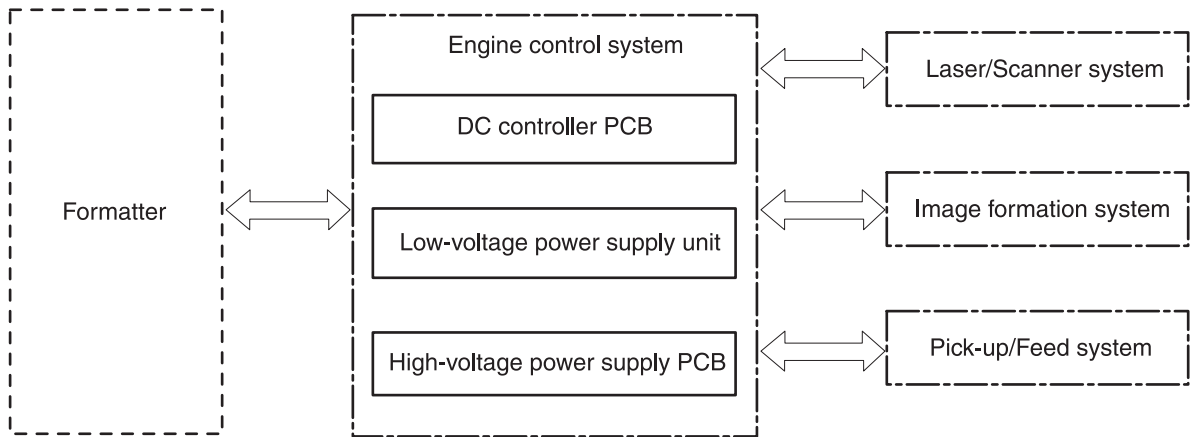

Figure 4-1 Engine control system

Power-on sequence

The power-on sequence is for the purpose of the printer initialization and checking for possible malfunctions.

The following is the sequence from when the printer is turned on until it enters STBY mode.

- 1 Power on
- 2 Central processing unit (CPU) initialization
- 3 ASIC initialization
- 4 Video interface communication start
- 5 Residual paper check by each sensor signaling paper presence
- 6 Initial drive for main motor, pickup motor, and fuser/delivery motor
- 7 Fuser heater initial drive by controlling fuser temperature targeting for 100°C
- 8 Initial drive for scanner motor
- 9 Failure/Abnormality check
 - Detect scanner failure
 - Fuser failure
 - Door open during the above periods
- 10 Communication with memory tag
- 11 Cartridge presence detection

Motors and fans

The DC controller PCB controls four motors.

The specifications of each motor are listed in the following table.

Table 4-2 Motor specifications

Name	Purpose	Type	Direction of rotation	Failure detection	
Motor	Main motor (M1)	Drive ETB belt, photosensitive drum and developing cylinder	DC motor	CW	Yes
	Fuser/delivery motor (M2)	Drive fuser pressure roller, delivery roller and automatic release of fuser pressure	Stepping motor	CW/CCW	No
	Pickup motor (M3)	Drive pickup roller and registration roller	Stepping motor	CW	No
	Fan (FM1)	Cool down around cartridge	DC motor	—	Yes

Main motor failure detection

The CPU determines the main motor failure, stops the printer, and notifies the formatter of error status, when it encounters the following conditions.

- Main motor start-up abnormality

The interval of the MAIN MOTOR SPEED DETECTION signal (/MAINMFG) does not become the specified interval after 1000 ms of the main motor drive start.

- Main motor rotation abnormality

The interval of the /MAINMFG signal stays at an irregular interval for 100 ms and longer after once it has become the specified interval.

Fan motor failure detection

The CPU determines the fan motor failure and notifies the formatter when it encounters the following condition.

The FAN LOCK signal (FANLCK) is “H” for approximately 10 seconds and longer during fan motor rotation.

Image formation system

The image formation system serves as the nerve center of the printer and forms a toner image on paper. It is controlled by the DC controller. The DC controller controls the laser/scanner unit and the high-voltage power supply PCB to form an image on paper according to the VIDEO signals (VDO, / VDO) upon reception of a print command from the formatter. There is a memory tag inside each cartridge. The memory tags read and write data according to the command from the DC controller.

The following figure illustrates the image formation system.

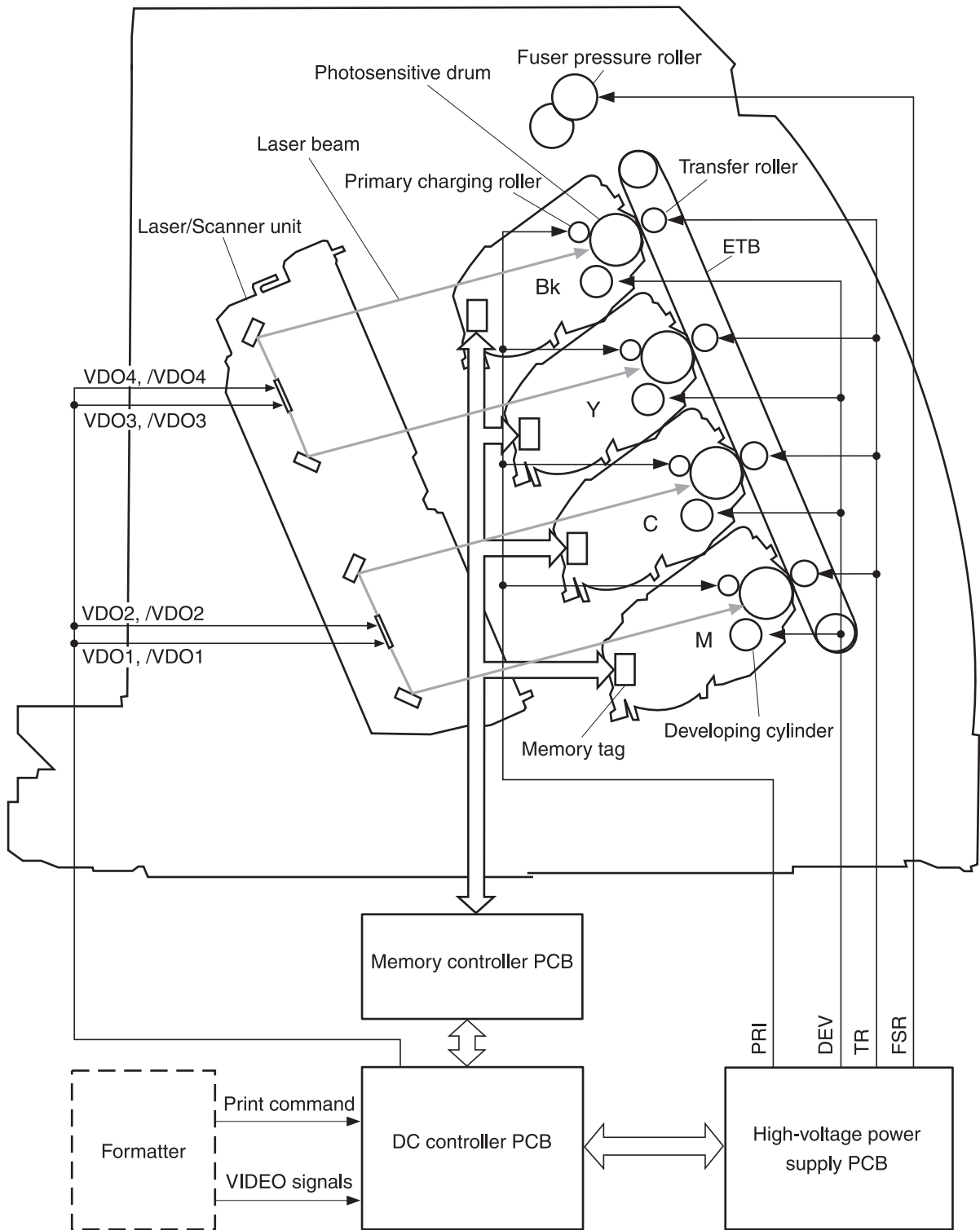

Figure 4-2 Image formation system

Image formation process

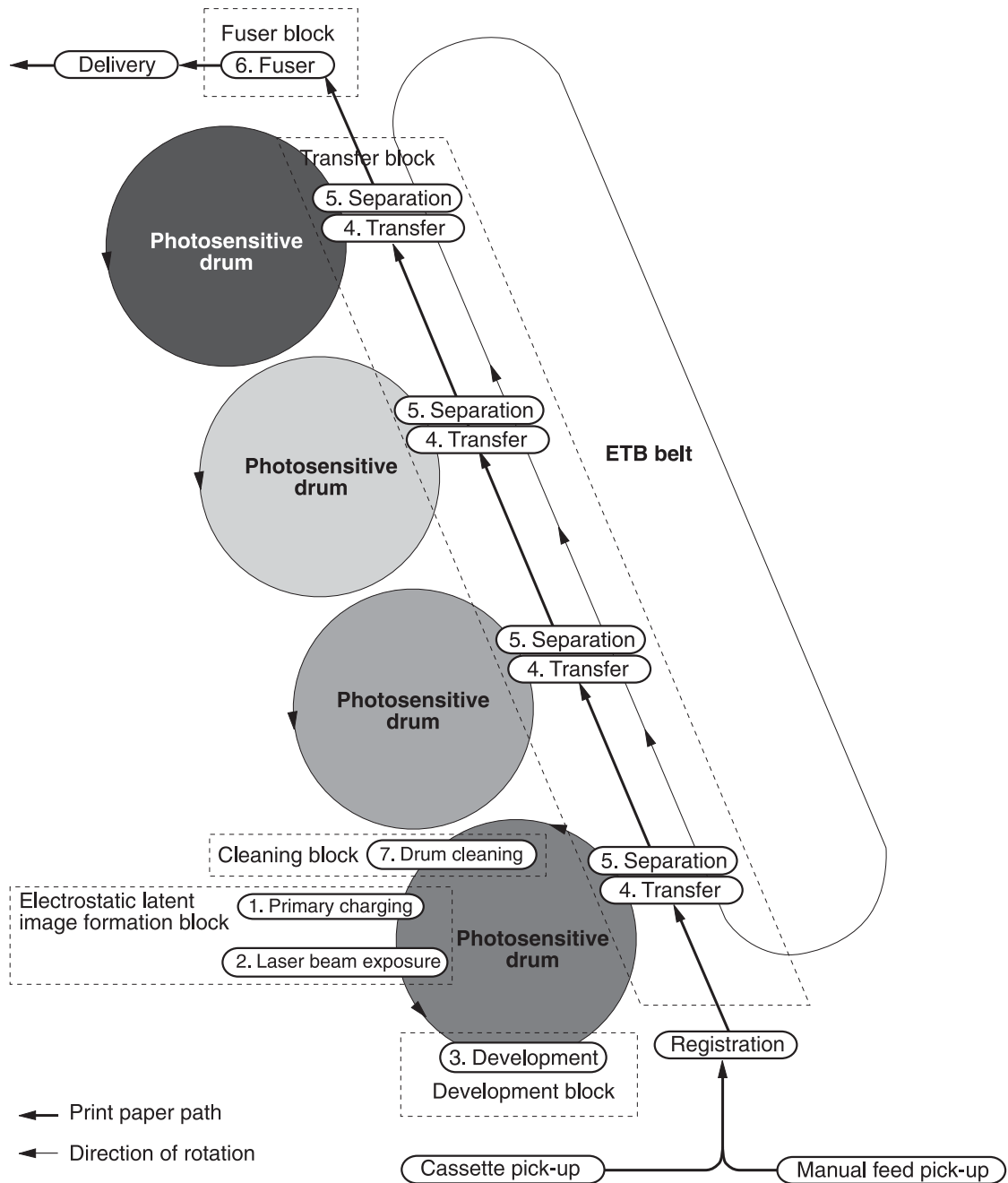

Figure 4-3 Image formation process

The principal process of image formation is described here. The print process can be broadly divided into 5 stages with 7 steps. A toner image is formed on paper as it goes through each process. The following figure illustrates the stages and steps of the print process as follows.

1 Electrostatic latent image formation stage

Forms an electrostatic latent image on the photosensitive drum.

Step 1: Primary charging

Step 2: Laser beam exposure

2 Developing stage

Makes the electrostatic latent image on the photosensitive drum surface visible by applying toner.

Step 3: Development

3 Transfer stage

Transfers a toner image on the photosensitive drum onto paper.

Step 4: Transfer

Step 5: Separation

4 Fuser stage

Fuses the toner image on paper.

Step 6: Fuser

5 ETB cleaning stage

Cleans the residual toner on the photosensitive drum.

Step 7: ETB cleaning

Latent image formation

This stage consists of two steps and forms an electrostatic latent image on the photosensitive drum.

When the last step in this stage is completed, a negative electrical charge remains in the unexposed drum surface area by the laser beam and is removed from the exposed area. The image with negative charge on the drum is called an “electrostatic latent image” as it is invisible to human eyes.

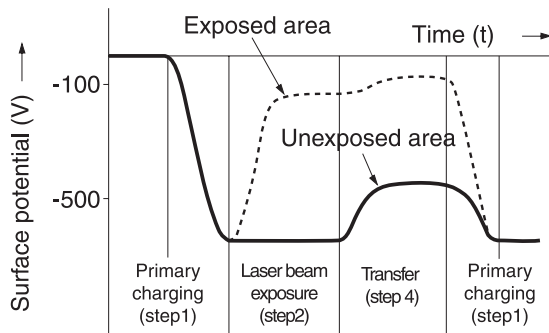

Figure 4-4 Latent image formation

Laser/scanner system

The laser/scanner system forms latent images on the photosensitive drum according to the VIDEO signals sent from the formatter. It consists of the laser driver PCB, the scanner motor, and so forth. The figure below illustrates the laser/scanner unit.

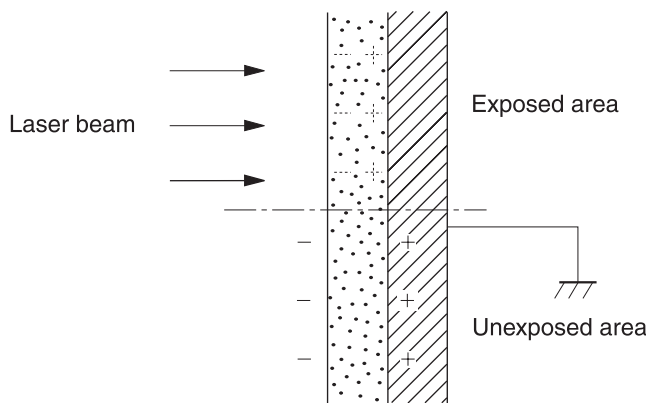

Figure 4-5 Laser beam exposure

Developing stage

The electrostatic latent image on the photosensitive drum surface is visualized by applying the toner in this process. This printer utilizes the projection development method by the non-magnetic, single-component toner.

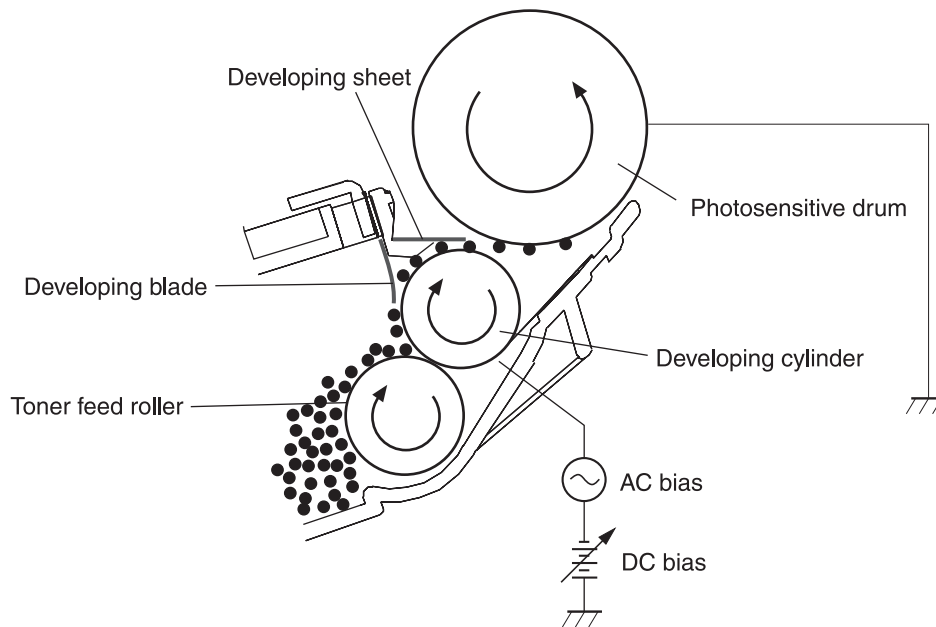

Figure 4-6 Developing stage

The toner has an insulating property and has negative charge potential from friction with the rotating developing cylinder and the developing blade surface.

The area of the photosensitive drum, where the laser beam is exposed, has higher potential than the toner, which is charged negatively on the cylinder. When this area contacts the toner layer (negatively charged), the toner jumps onto the drum surface by the potential difference between the drum surface and the cylinder (higher potential on drum side). This is called the projection development and it visualizes the electrostatic latent image on the drum. The developing cylinder is applied the AC bias in order to make the toner jump easier onto the drum surface and improve the contrast of the output image.

This printer is able to adjust the image density by changing the potential difference between the cylinder and the photosensitive drum surface according to changes of the developing DC bias based on the IMAGE DENSITY INFORMATION signal sent from the formatter.

The developing sheet improves the print quality and also prevents toner scattering.

Print cartridge

The cartridge forms a visible toner image on the photosensitive drum. There are four print cartridges: magenta, cyan, yellow, and black; each having identical structure.

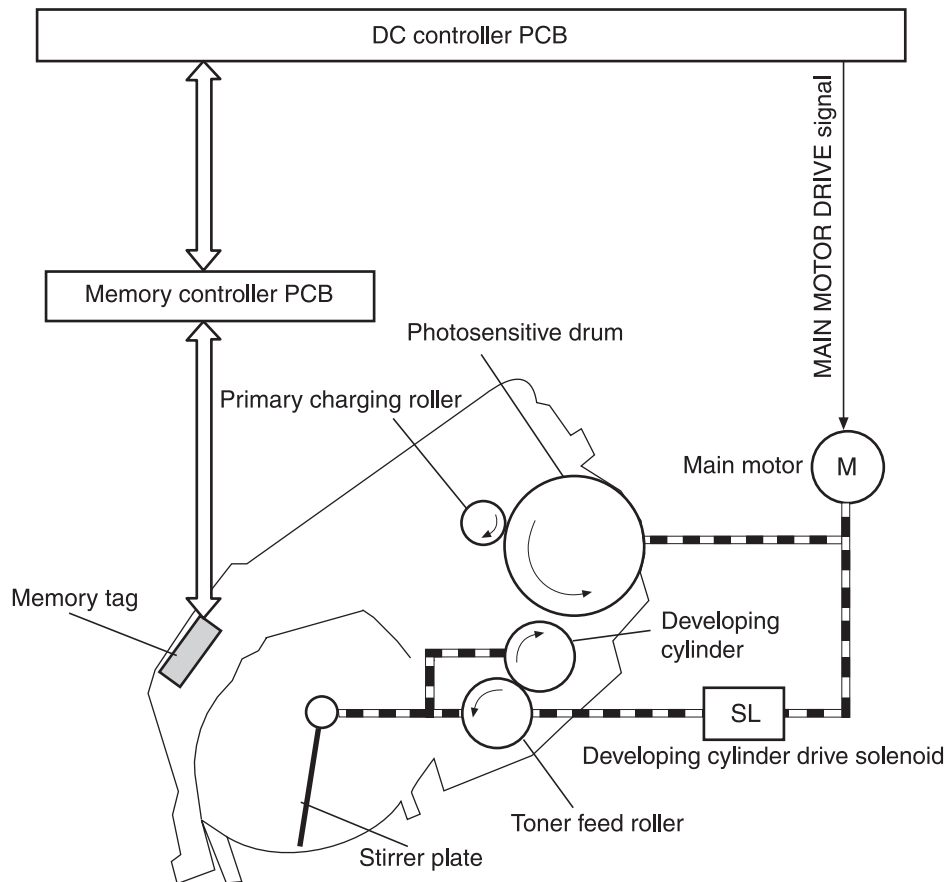

Figure 4-7 Print cartridge structure

Transfer belt (ETB)

The ETB unit feeds paper as well as transfers toner onto the paper.

The ETB unit consists of the ETB, ETB feed roller, ETB driven roller, and color misregistration/density sensor unit.

As the main motor rotates the ETB feed roller, the ETB feed roller rotates the ETB belt. The transfer roller and the ETB driven roller are engaged with the ETB.

During printing, the picked up paper is conveyed in between the ETB and the photosensitive drum, and simultaneously the toner image is transferred onto the paper. The ETB is also used for color misregistration corrective control and the image stabilization control. The pattern image for the color misregistration or image density determination is transferred onto the belt. This pattern image is read in the color misregistration/density sensor unit.

The following is the diagrammatic sketch of the ETB unit.

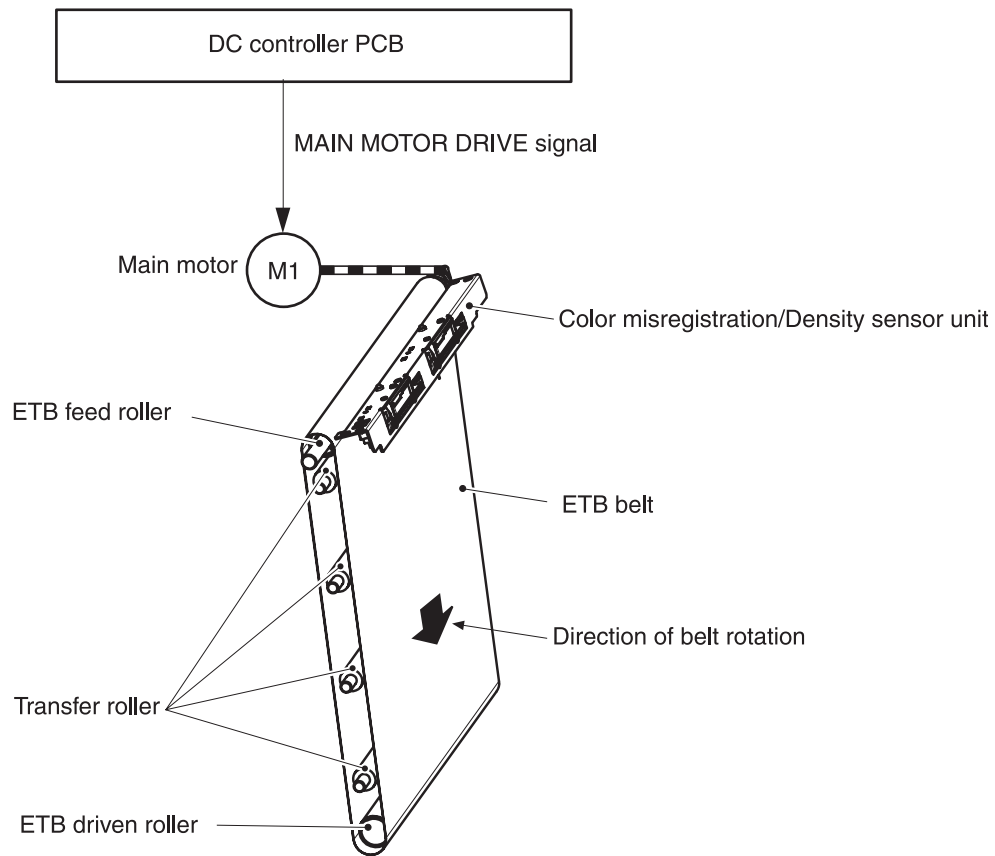

Figure 4-8 ETB unit

Transfer stage

The transfer stage is to transfer the toner image on the photosensitive drum surface onto paper.

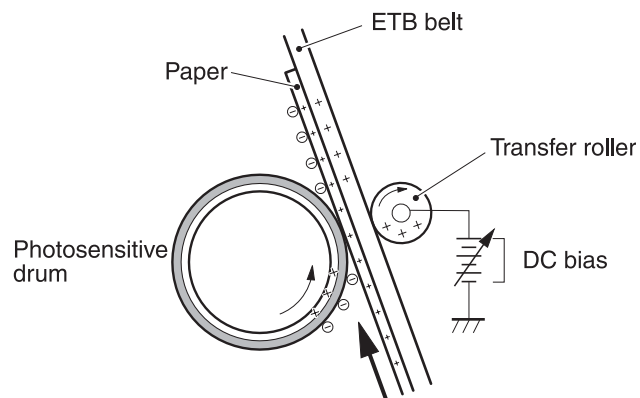

Figure 4-9 Transfer stage

The toner on the photosensitive drum surface is transferred onto the paper according to the positive charge from the back side of the paper. Each color's toner image is transferred in order of M, C, Y, and K, and forms one toner image overlaying one color's image on another.

Separation stage

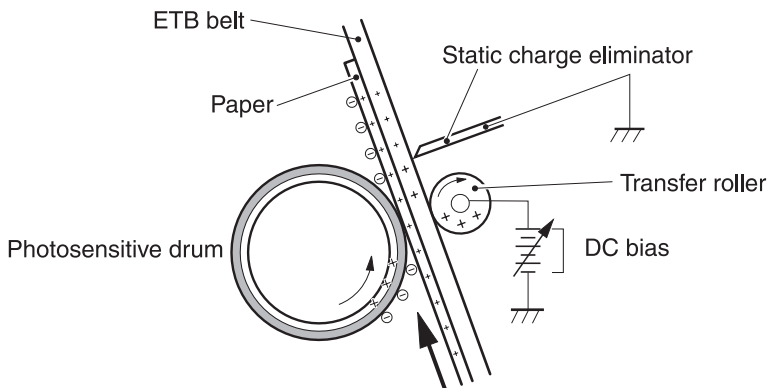

Figure 4-10 Separation stage

The paper is separated from the drum by its elasticity (Curvature Separation). The static charge on the back side of the paper is decreased with the electrostatic eliminator in order to stabilize the feeding operation and prevent the crescent spots of printing image under the low temperature and low humidity environment.

Fusing stage

The toner image is fused onto the paper in this stage. The toner image transferred onto the paper through the transfer stage can be smeared easily by hands since it is only attracted to the paper by the static electricity. The paper and the toner on it are fused by pressure, fused and secondary colored by heat to be a permanent image.

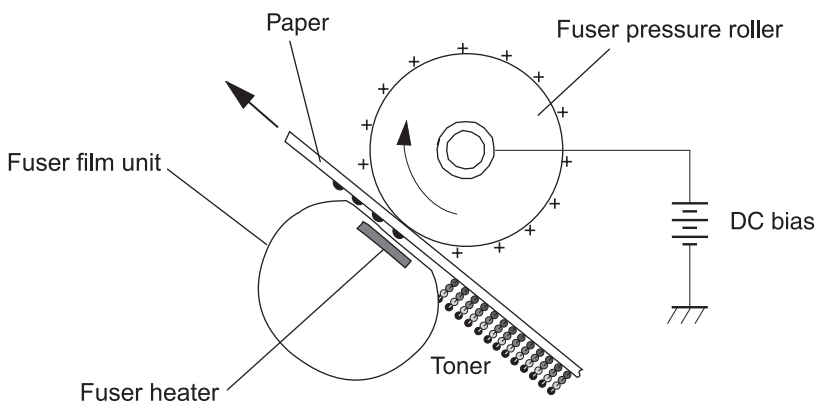

Figure 4-11 Fusing stage

The toner image on the paper is fused onto the paper by using the on-demand fuser method in this step. This printer utilizes the ceramic heater with lower heat capacity, which warms up quickly, does

not require the power supply during STBY mode, and saves energy. As for the printer, the DC positive bias is applied to the fuser pressure roller, so the transferred toner stays harder on the paper and toner scattering to the fuser film (offset) is prevented.

Pickup and feed system

The pickup/feed system, which picks up and feeds paper, consists of the various feed rollers. This printer has two pickup sources: the cassette and the manual feed slot, and one delivery source: the face-down tray. The following components are part of the pickup and feed system:

- Manual feed slot paper sensor (SR3): detects the presence of paper in the manual feed slot
- Cassette paper sensor (SR2): detects the presence of paper in the cassette
- DC controller controls the following to drive each feed roller:
 - Main motor (M1)
 - Fuser/delivery motor (M2)
 - Pickup motor (M3)
 - Solenoid (SL1)
 - Solenoid (SL2)
 - Solenoid (SL3)
- Photo sensors:
 - SR1, SR4, and SR5 on the paper transport path detect the arrival and passage of paper
 - SR9 detects the fuser pressure roller alienation in the fuser
 - SR8 detects the paper width

The figure below illustrates the motors, solenoids, and sensors.



NOTE There is a short pause before the paper is picked up.

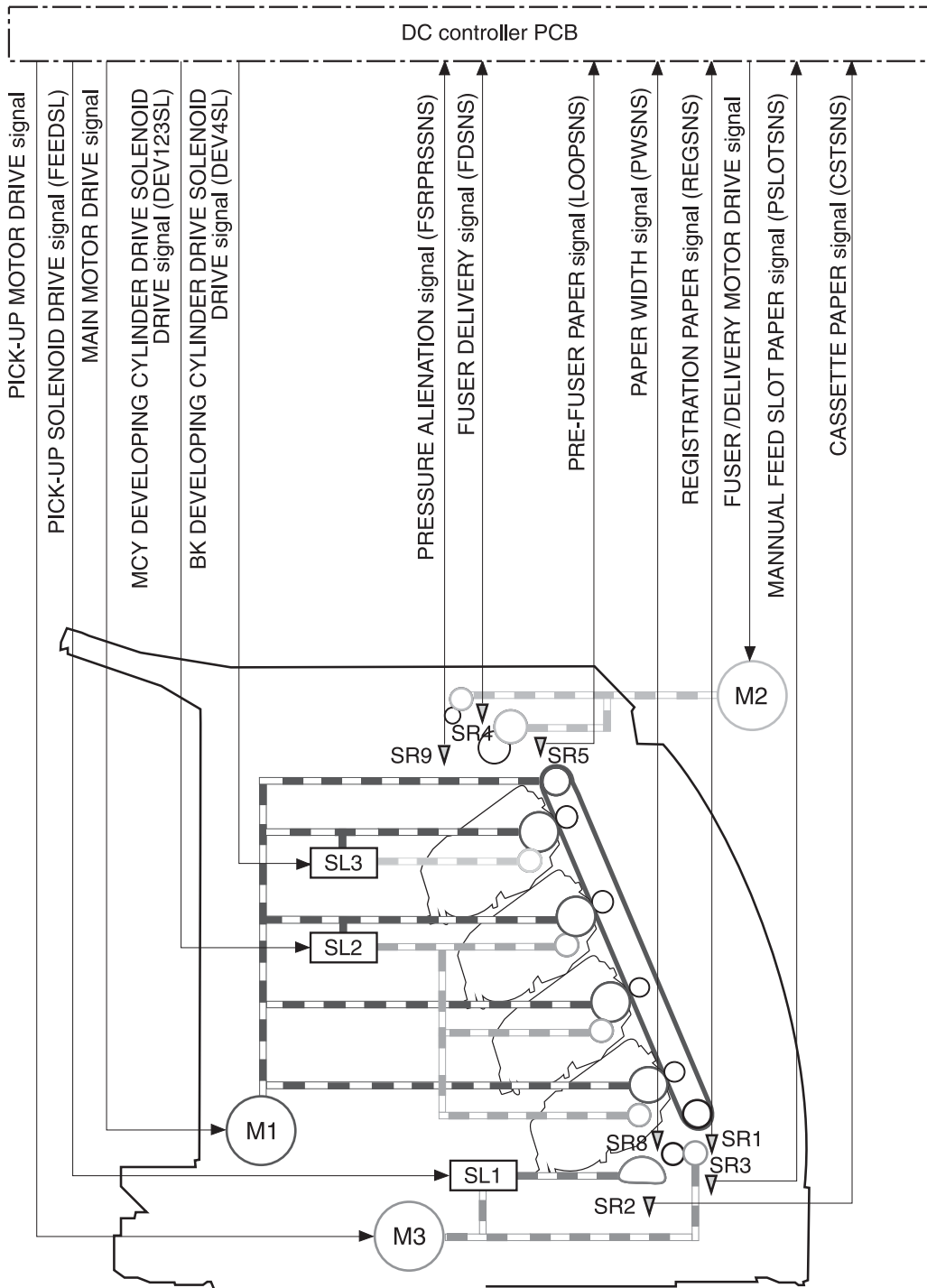

Figure 4-12 Paper pickup and feed system

SR1	Registration paper sensor
SR2	Cassette paper sensor
SR3	Manual feed slot paper sensor

SR4	Fuser delivery paper sensor
SR5	Pre-fuser paper sensor
SR8	Paper width sensor
SR9	Pressure alienation sensor
M1	Main motor
M2	Fuser/Delivery motor
M3	Pickup motor
SL1	Cassette pickup solenoid
SL2	Magenta, cyan, and yellow developing cylinder drive solenoid
SL3	Black developing cylinder drive solenoid

Manual feed slot pickup mechanism

This mechanism picks up one sheet of paper only that is inserted into the manual feed slot and then into the printer. This printer does not have a pickup roller in the manual feed slot. Instead of a pickup roller, the registration roller picks up paper. The presence of paper in the manual feed slot is detected by the manual feed slot paper sensor (SR3). The following is the operational sequence of the manual feed slot pickup.

- 1 If paper is set into the manual feed slot during STBY mode, the manual feed slot paper sensor (SR3) detects it.
- 2 When the paper is detected, the DC controller drives the pickup motor (M3) for 5 seconds. The paper is fed approximately 5 mm (0.2 inch) and is then caught by the registration roller.
- 3 After the above operational sequence, the paper is fed by the drive of the registration roller.

Paper feed mechanism

This mechanism feeds one sheet of picked up paper to the fuser. There is a paper width sensor in the paper transport path to prevent temperature rise at the end of the fuser. It detects paper with widths of shorter than 190 mm (7.5 inches). The following is the operational sequence of paper feed.

- 1 Paper skew is corrected by the registration shutter when the paper is fed into the printer.
- 2 Toner is transferred to the paper from the photosensitive drum and then the paper is fed to the fuser/delivery stage.

Skew correction by the registration shutter

If the paper fed into the printer is skewed, when it hits the registration shutter, it will be adjusted. [Figure 4-13 Skew correction](#) illustrates how skewed paper is corrected by the registration shutter.

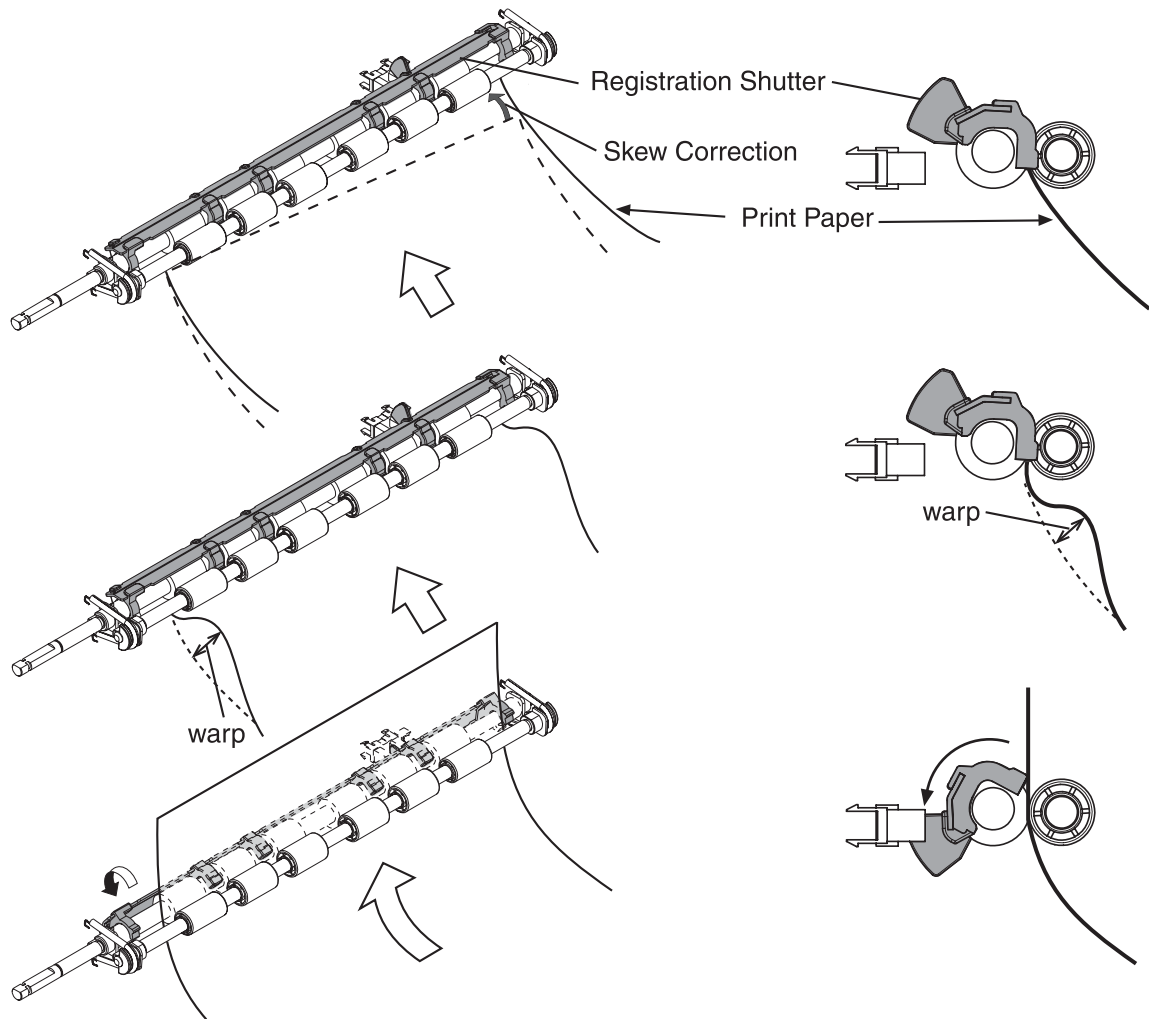

Figure 4-13 Skew correction

Jam detection

This printer is provided with the following paper detection sensors to detect the presence of paper and whether or not the paper feed is operating normally.

- Registration paper sensor (SR1)
- Pre-fuser paper sensor (SR5)
- Fuser delivery paper sensor (SR4)

The CPU determines a paper jam by checking whether or not paper is present at the sensor at the check timing. The check timing is stored in the memory of the CPU. If the CPU determines a jam, it stops the print operation and notifies the formatter of a jam occurrence.

For more information, see [Clearing jams](#).

Solenoid, motor, and fan locations

The following illustration shows the locations of the solenoids, motor, and fan.

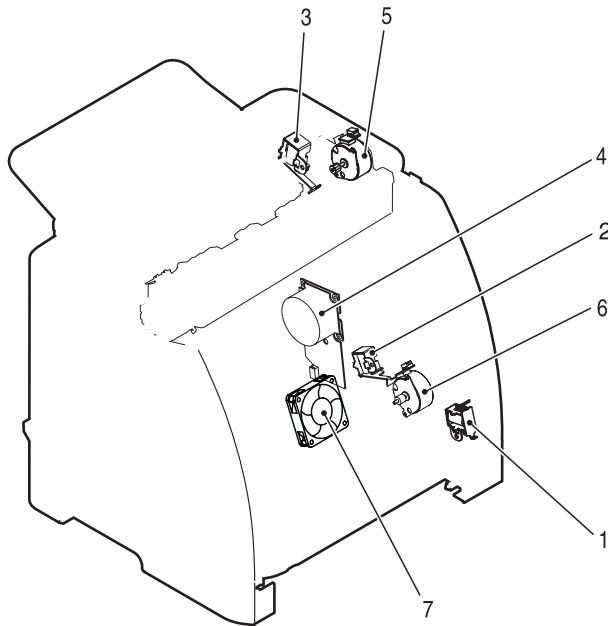

Figure 4-14 Location of solenoids, motors, and fans

1	Pickup solenoid (SL1)
2	Magenta, cyan, and yellow developing cylinder drive solenoid (SL2)
3	Black developing cylinder drive solenoid (SL3)
4	Main motor (M1)
5	Fusing/delivery motor (M2)
6	Pickup motor (M3)
7	Fan (FM1)

Printed circuit assembly locations

The following illustration shows the locations of the printed circuit assemblies. Location of the printed circuit assemblies and list of parts are also identified in [Figure 7-11 PCB assembly location \(Tray 2\)](#).

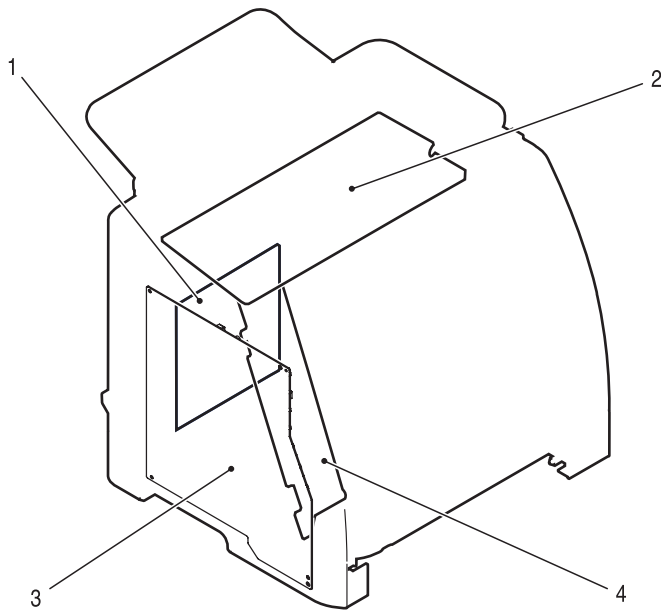

Figure 4-15 Location of printed circuit assemblies

1	DC controller PCB
2	Low-voltage power supply PCB
3	High-voltage power supply PCB
4	Memory controller PCB

250-sheet tray solenoid and printed circuit locations

The following illustration shows the locations of the 250-sheet tray solenoid and printed circuit assembly.

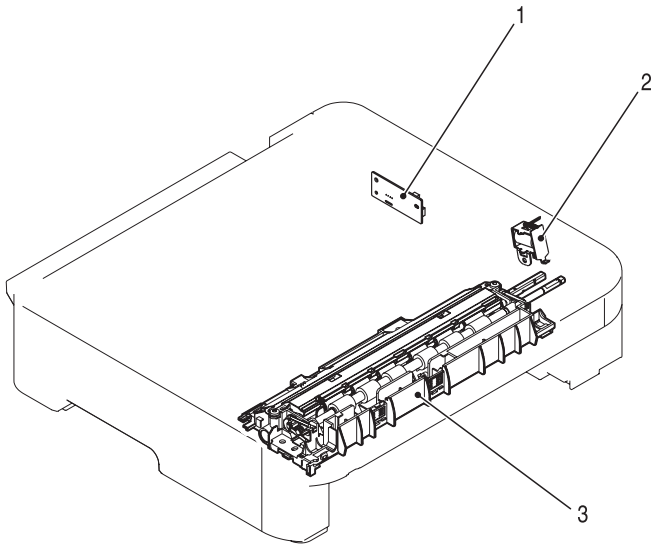
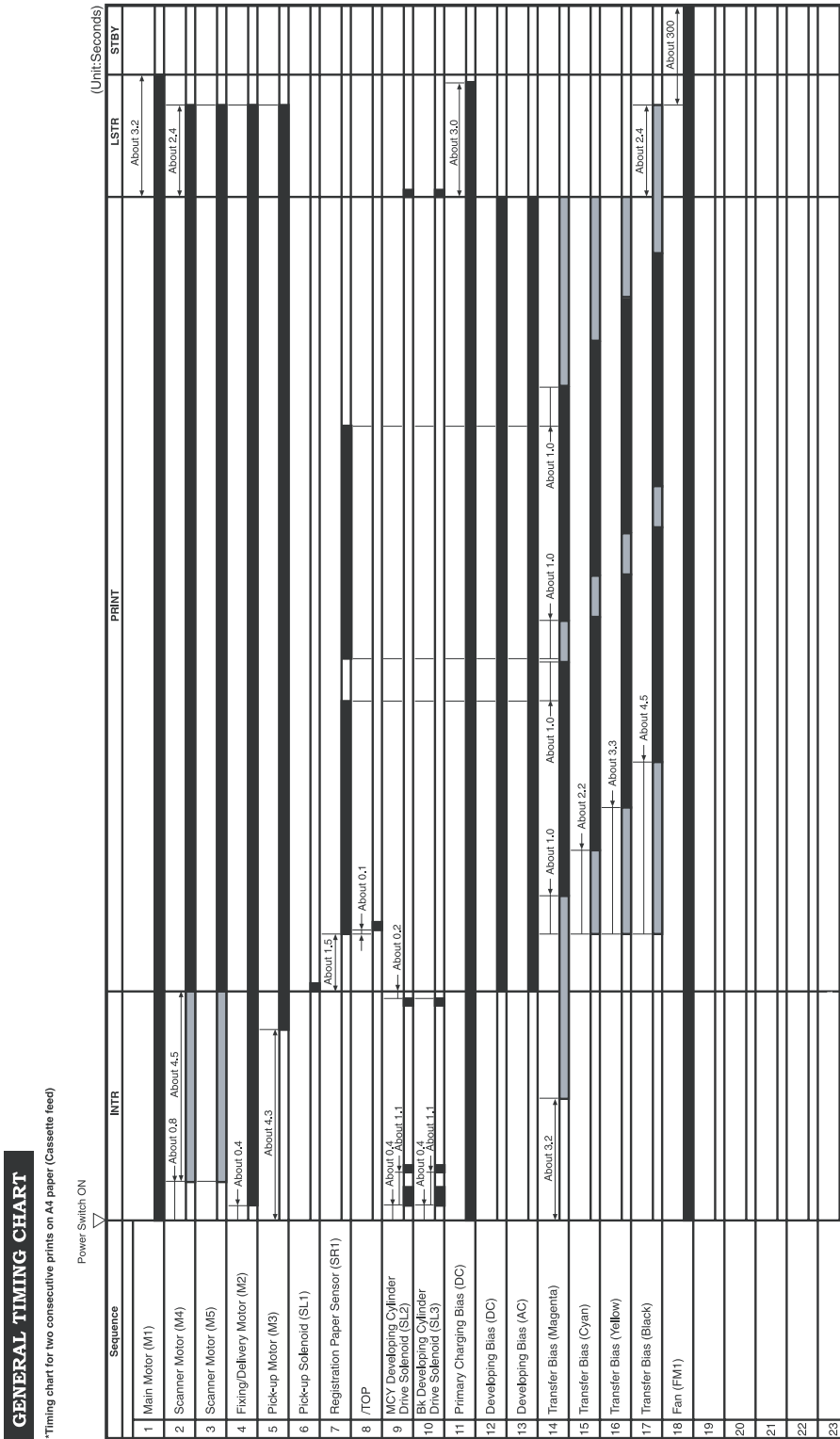

Figure 4-16 Location of 250-sheet tray solenoid and printed circuit assembly

1	Paper feeder PCB
2	Paper feeder pickup solenoid (SL-4)
3	Paper pickup feeder unit

Service-only tools (SERVICE ONLY)

General timing chart



Printer calibration

Calibration settings are configured with Printer Management Language (PML)/Printer Job Language (PJP) commands, except for new cartridge installation. Calibration can also be configured using the embedded Web server and HP Toolbox. Calibration occurs during the following conditions and intervals:

■ Power-on calibration

Calibration during power-on can be configured for the following intervals:

- Always calibrate at power-on
- Never calibrate at power-on
- Calibrate after 1-6 minutes (default is 15 minutes) of idle time after the first job since the printer was turned on or 12, 24, 48, 96, or 168 hours (default is 48 hours) of idle time.

■ Page count calibration

Calibration occurs at the end of the first job that passes 150 color pages since the previous calibration occurred. Page count calibration settings can be configured for the following intervals:

- Do not do page count calibrations
- Calibrate after 150 pages have been printed since the last calibration. This is the default setting.



NOTE Page count calibration cannot be set using the embedded Web server.

■ Elapsed time calibration

Elapsed time calibration will occur when the first job is sent after the elapsed time is exceeded. Use PML/PJP commands to configure the following intervals:

- Do not perform elapsed time calibration
- After 12, 24, 48, 96, or 168 hours (default is 48 hours) or more have elapsed since the last calibration (or power-on), and after 1-6 minutes (default is 15 minutes) of idle time from the first job after 12, 24, 48, 96, or 168 hours (default is 48 hours) have elapsed.

■ On-demand calibration

Calibrate the printer using the printer control panel. For more information about printer calibration, see [Printer calibration](#).

■ New consumable calibration

When a new print cartridge is installed, the printer will calibrate.













NOTE When a new black print cartridge is replaced, a cleaning page will print before the printer calibrates.

If printing stops when the cartridge is out, requiring the user to either install a new cartridge or select to print with toner out override, a calibration will not occur until the depleted cartridge is replaced, printing resumes, and all jobs currently in the queue are finished or cancelled. This could result in an interval of several pages where a new cartridge is using the old cartridge's calibration data.

Calibrating the printer at the control panel

Use the following steps to calibrate the printer using the printer control panel.

- 1 Use the  (LEFT ARROW) or the  (RIGHT ARROW) button to select **SYSTEM SETUP** and then press  (SELECT).
- 2 Use the  (LEFT ARROW) or the  (RIGHT ARROW) button to select **PRINT QUALITY** and then press  (SELECT). **CALIBRATE COLOR** will display on the control panel.
- 3 Press  (SELECT).
- 4 Use the  (LEFT ARROW) or the  (RIGHT ARROW) button to select **CALIBRATE NOW** and then press  (SELECT).
- 5 Press  (SELECT) to start the calibration.

5 Removal and replacement

This chapter contains information about the following topics.

- [Overview](#)
- [Service approach](#)
- [Removal and replacement procedures](#)

Overview

Removal and replacement strategy

Replace parts in the reverse order of their removal. Directions for difficult or critical replacement procedures are included in this section.



WARNING! The sheet-metal edges of the product can be sharp. Use caution when working on the product.



NOTE Note the length, diameter, color, type, and location of each screw. Be sure to return each screw to its original location during reassembly. Incorrectly routed or loose wire harnesses can interfere with other internal components and can become damaged or broken. Frayed or pinched harness wires can be difficult to locate. When replacing wire harnesses, always use the provided wire loops, lance points, or wire harness guides.

Electrostatic discharge

The printer contains parts that are sensitive to electrostatic discharge (ESD). Watch for the ESD reminder shown at the left when removing printer parts. Protect the parts that are sensitive to ESD with protective ESD pouches.

User-replaceable parts

Table 5-1 User-replaceable parts

Product name	Description	Part number
Separation pad and pickup rollers	Replace when the printer is picking up multiple sheets or no sheets. Trying different paper did not resolve the problem.	Q5956-67902
Paper tray	A 250-sheet paper cassette.	Q5956-67901
Dust cover	Protects the output of paper cassette from dust.	Q5956-67903
Output tray extender	An extension for supporting paper in the output bin.	Q5956-67904

Required tools

Before servicing the printer, gather the following tools:

- Phillips #2 magnetized screwdriver (152 mm (6 inch) shaft)
- Small flat-blade screwdriver
- Small needle-nose pliers
- ESD strap
- Penlight (optional)

Service approach

Field Service on this printer is limited to a recommended time of 30 minutes, which includes troubleshooting, teardown, and repair. Repairs that require more time should not be made and the printer should be replaced.

The following are the major internal assemblies that can be replaced on this printer.

- Fuser
- ETB
- DC Controller
- Formatter
- Control Panel display

If troubleshooting or a Control Panel message determines that the failure is not associated with one of these parts, do not attempt to repair the printer, but replace the unit. For more information on messages that would indicate a printer needs to be replaced, refer to the [Critical error messages](#) table and the [Replaceable parts](#) table.

Pre-service procedures

Follow the pre-service procedures before you perform service.

- 1 Turn off the printer.
- 2 Remove all media from the product.
- 3 Place the product on an ESD mat. If an ESD mat or an ESD-protected workstation is not available, discharge body static and ground the product chassis before servicing the product.
- 4 Remove the print cartridges.
- 5 Unplug the power cord and the interface cable.
- 6 Lift the printer off of optional Tray 3 (if it is installed).

Removal and replacement procedures

Print cartridge replacement

- 1 Open the front door.



CAUTION Do not place anything on the transfer belt (ETB), which is located on the inside of the front door.

- 2 Remove the used print cartridge from the printer.



- 3 Remove the new print cartridge from the bag. Place the used print cartridge in the bag for recycling.

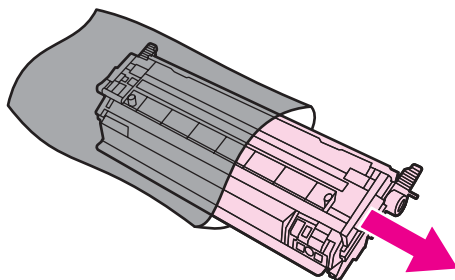

- 4 Grasp both sides of the print cartridge by the blue handles and distribute the toner by gently rocking the print cartridge from back to front.

 **CAUTION** Do not touch the shutter or the surface of the roller.

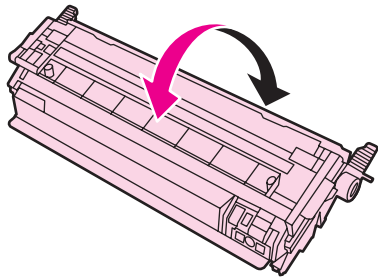

- 5 Remove the orange shipping locks and the orange shipping tape from the new print cartridge. Discard the shipping tape and shipping locks according to local regulations.

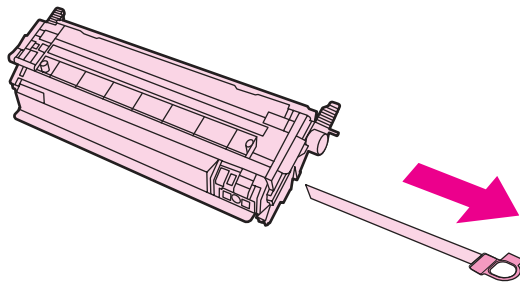

- 6 Align the print cartridge with the tracks inside the printer, and using the handles, insert the print cartridge until it is firmly seated.



- 7 Firmly close the front door.



After a short time, the control panel should display **Ready**.



NOTE If a cartridge is in the wrong slot or is the wrong type for the printer, the control panel will display one of the following messages: **Incorrect yellow**, **Incorrect magenta**, **Incorrect cyan**, or **Incorrect black**.

- 8 Installation is complete. Place the used print cartridge in the box in which the new cartridge arrived. See the enclosed recycling guide for recycling instructions.
- 9 If you are using a non-HP print cartridge, check the printer control panel for further instructions.



NOTE When replacing or changing a black print cartridge, a cleaning page will automatically print. This helps prevent speckles on the front or back of printed documents. For a more thorough cleaning, see [Cleaning the printer](#).

ETB removal and replacement

Use the following procedure to remove the ETB (RM1–1881–000CN).

- 1 Remove or slightly pull out Tray 2 (RM1–1916–000CN).



- 2 Remove three (3) screws, two (2) from the right cover assembly and one (1) from the left cover assembly.

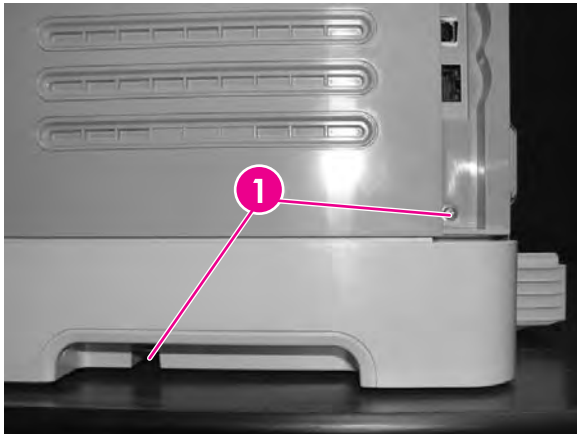

- 1 Two (2) screws on right cover assembly

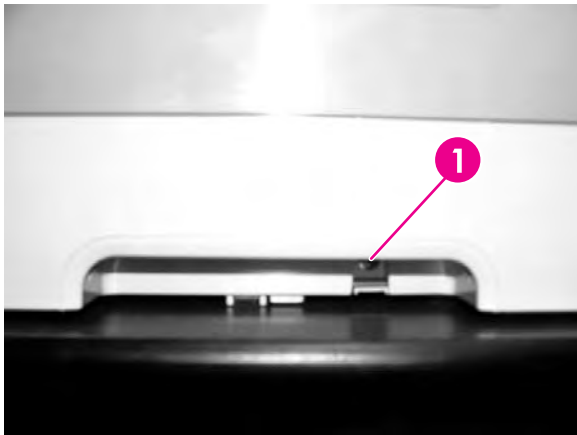

- 1 One (1) screw on left cover assembly

- 3 Open the front door.



- 4 Remove the right cover (RM1-1858-000CN), carefully twisting the front edges of the side covers outward to remove.

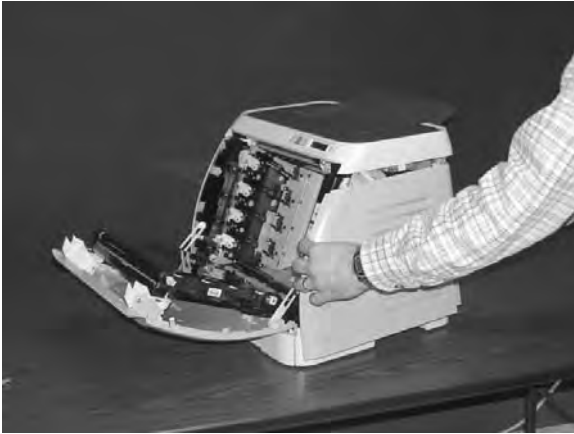

NOTE To make the removal of the right cover assembly easier, release the tab on the inside of the cover.

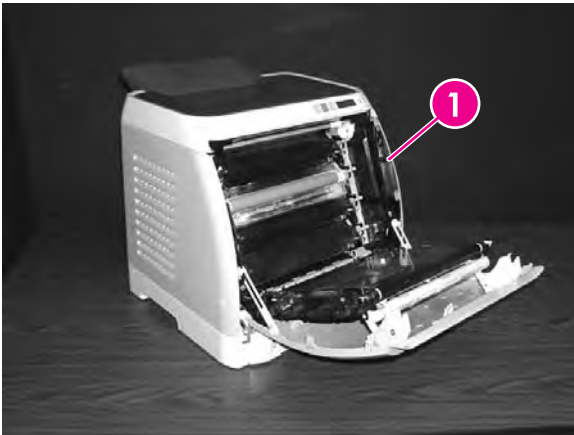

- 1 Release tab

- 5 Remove the left cover.



- 6 Squeeze the white link lever on the left side.

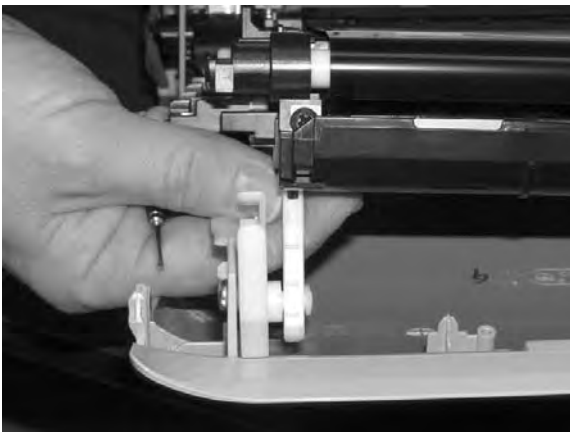

- 7 Remove the screw on the right white plastic catch, and then remove the plastic catch.

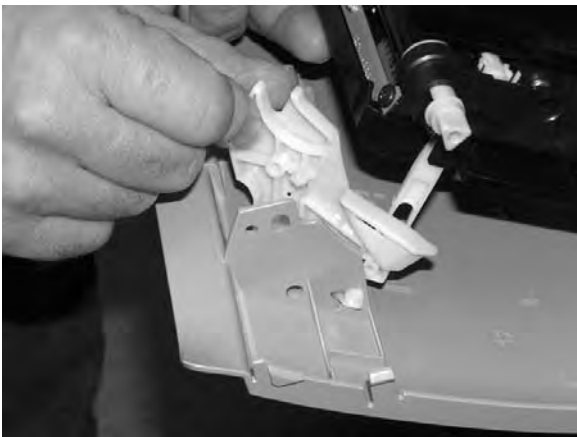
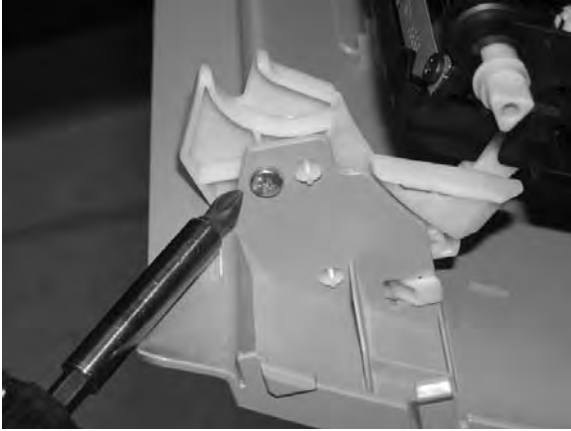

- 8 Close the ETB.

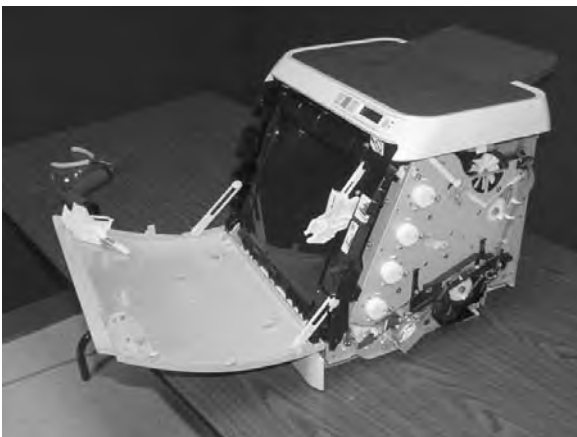

- 9 Remove the small black cable cover (RC1-5147-000CN) on the left side of the printer by carefully snapping it out of place.



- 10 Remove one (1) grounding screw from the ETB harness.

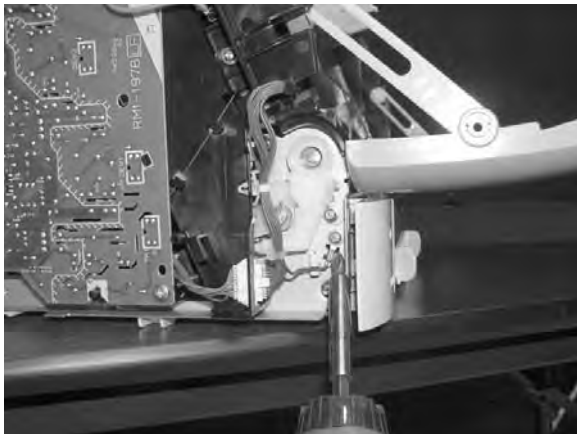

- 11 Pull out the white wire holder by pushing it up.

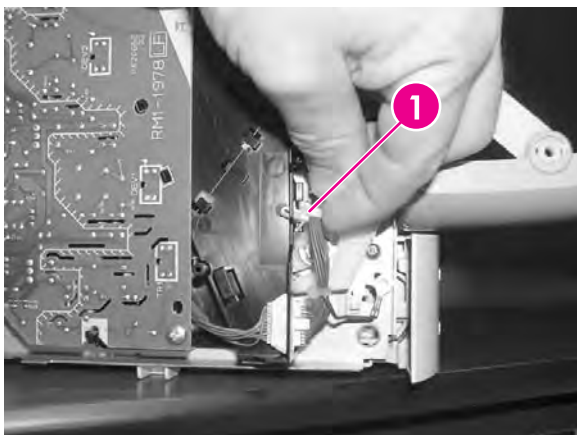

- 1 White wire holder

12 Pull out the ETB connector.

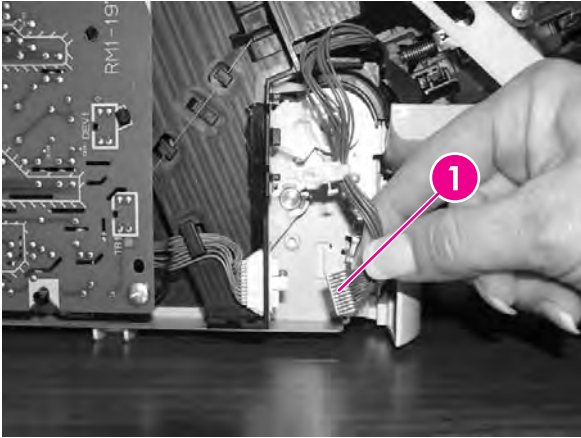

1 | ETB connector

13 Remove one (1) screw from each hinge cam on both sides.



14 Using needle-nose pliers, remove the hinge left cam (RC1-4249-000CN) and the right hinge cam (RC1-5311-000CN).

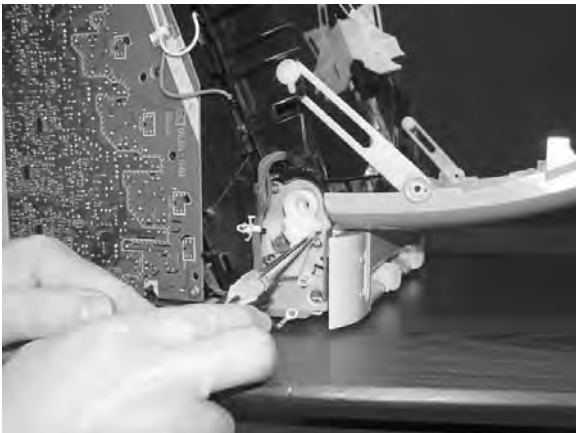

15 Remove the ETB.



Use the following procedure to replace the ETB.

- 1** Align each foot of the ETB with the respective holes, securing the right side first, and then the left side.



1 | Alignment location

- 2** Complete replacement by following steps 1 through 14 above in reverse order.



NOTE When replacing the right cover, align the tabs on the upper edge of the right cover and lower edge of the face-down cover with their respective slots.

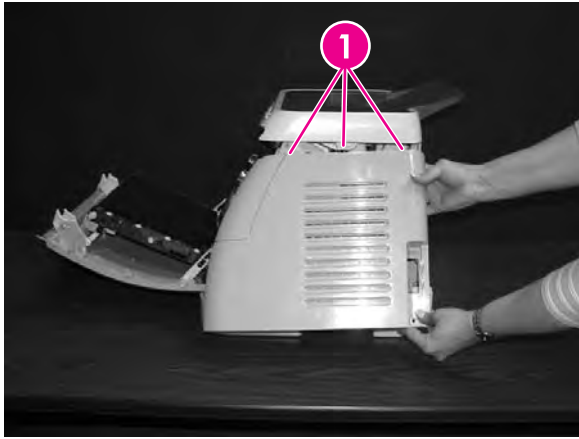

- 1 | Tabs

Fuser removal and replacement

Use the following procedure to remove the fuser.

- 1 Unplug the power cable.



- 2 Remove the paper delivery tray assembly (RM1-1859-000CN).



- 3 Remove two (2) screws from the right cover assembly (RM1-1858-000CN).

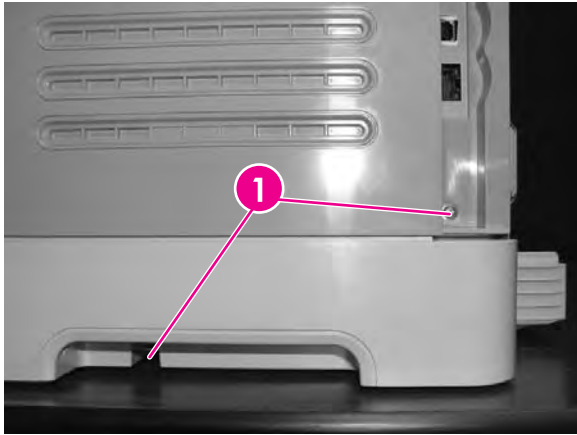

- 1 Two (2) screws

- 4 Remove the right cover assembly, carefully disengaging the catches.

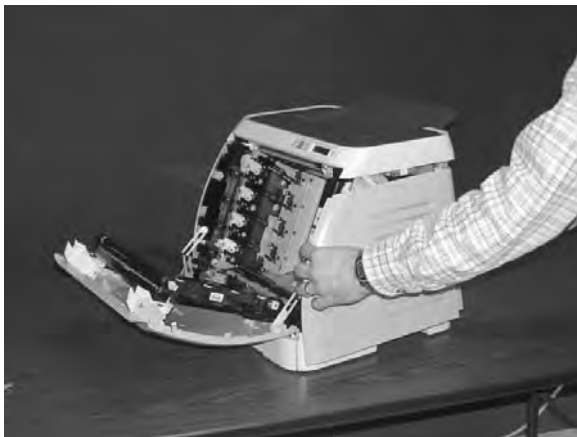

- 5 Unplug the control panel cable.



- 6 Insert a screwdriver to loosen the release tab on each side of the upper face cover.



- 7 Remove the upper face cover (RC1-5174-000CN).



- 8 Remove four (4) screws from the upper cover (RC1-5176-000CN).



- 9 Lift up and remove the face-down cover (RC1-5173-000CN).



- 10 Remove the output tray by releasing the tabs.

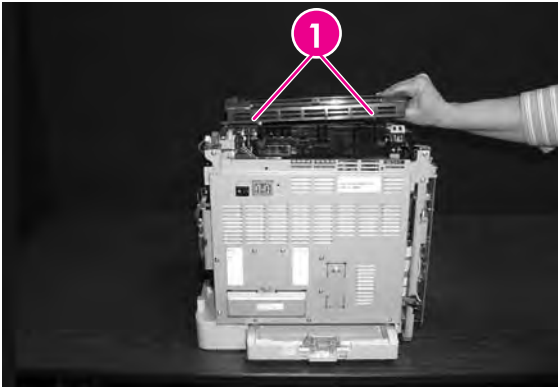

- 1 Release tabs

- 11 Unplug the harness from the fuser motor.

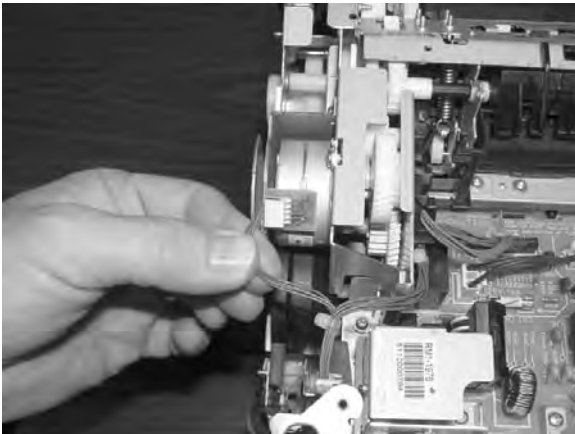

12 Open two (2) clips and remove one (1) clip to remove the fuser connector.

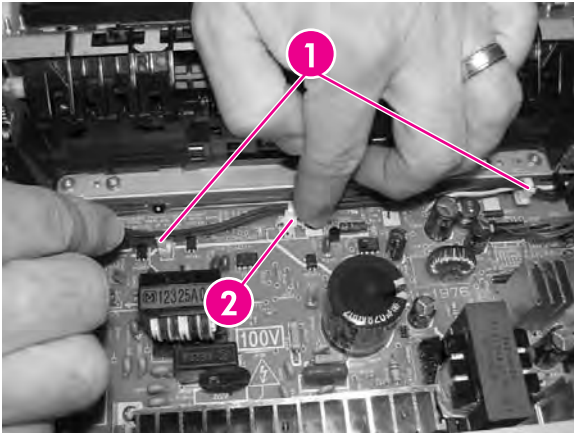

1 | Open clips

2 | Remove clip

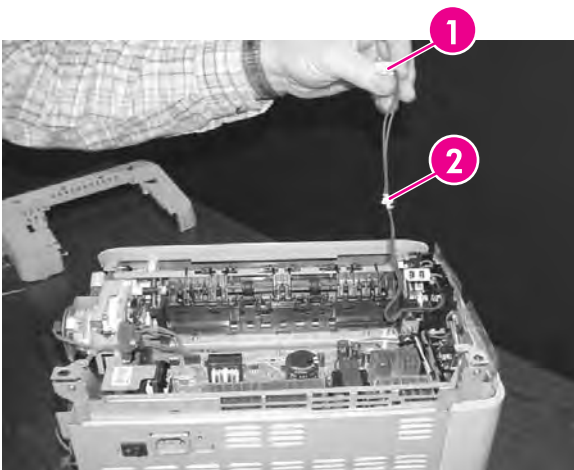

1 | Fuser connector

2 | Remove clip from the board by pulling up

- 13 Unplug two (2) 3-pin optical encoder wires.

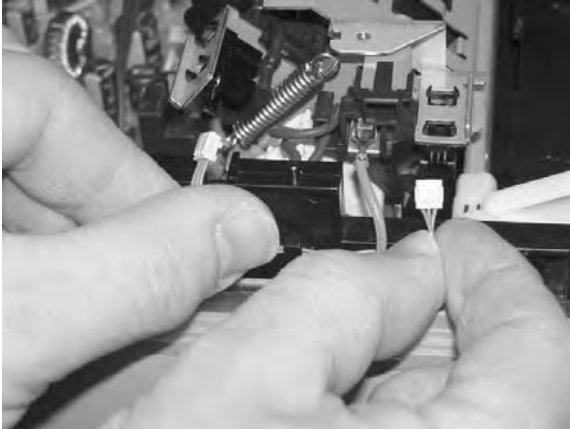

- 14 Unplug the red high-voltage bias wire.



- 15 Remove the thermistor wire.

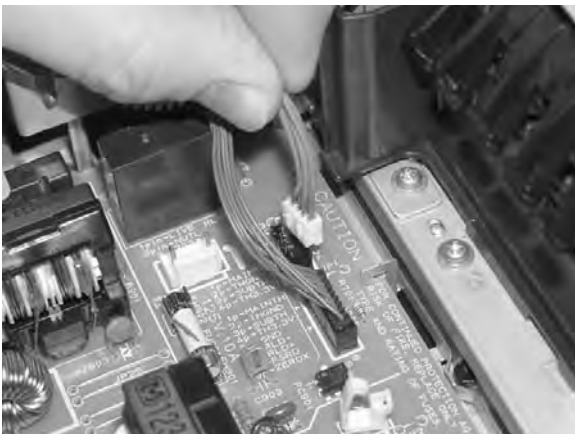

16 Remove the cables from the wiring harness.



17 Remove three (3) screws from the fuser chassis.

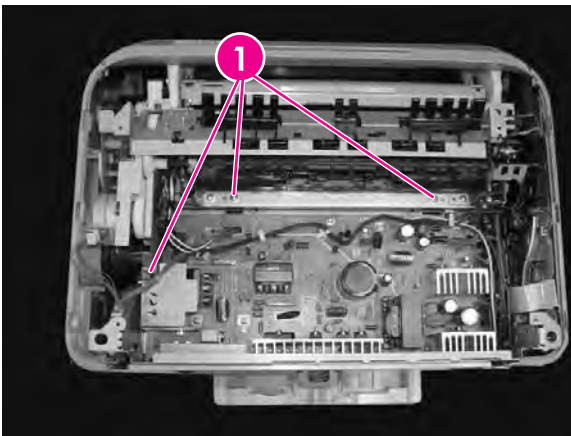

1 | Three (3) screws

18 Gently rocking if necessary, roll the fuser (RM1-1820-00CN for 110V) or (RM1-1821-000CB for 220V) forward to remove.

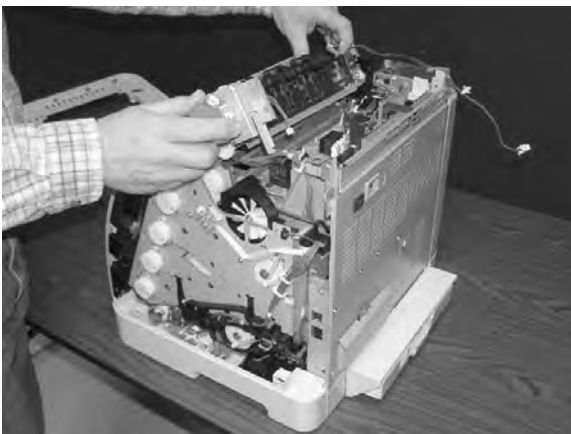

Use the following procedure to replace the fuser.

- 1 Align the fuser tabs with their respective holes.

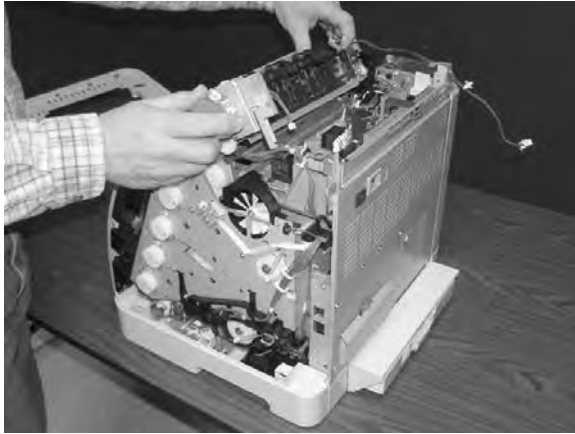

- 2 Complete replacement by following steps 1 through 18 above in reverse order.



NOTE When replacing the right cover, align the tabs on the upper edge of the right cover and lower edge of the face-down cover with their respective slots.

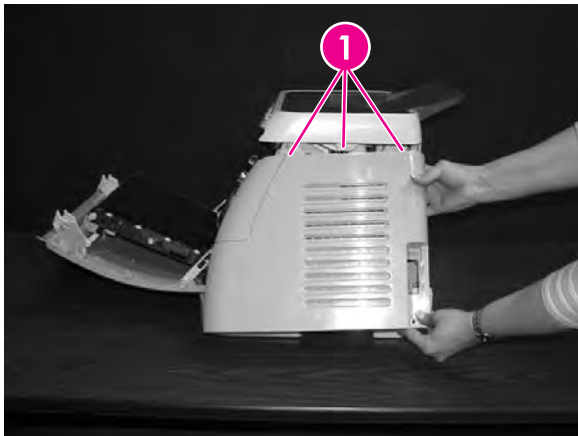

- 1 | Tabs



NOTE Connect the control panel cable before replacing the right cover.

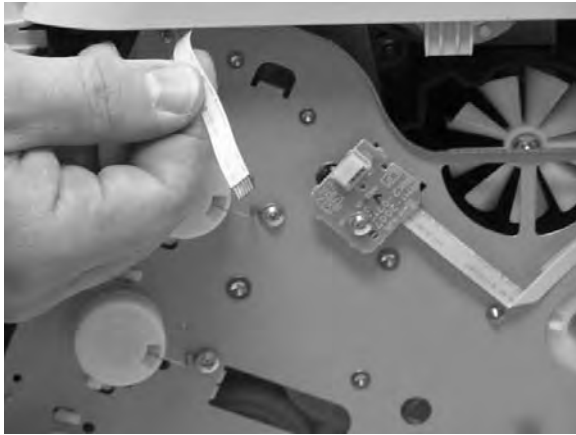

Formatter removal and replacement

Use the following procedure to remove the formatter.

- 1 Remove the cassette dust cover (RC1-5200-000CN).



- 2 Remove nine (9) screws from the rear plate (RC1-5227-000CN).



- 3 Remove the rear plate.



- 4 Unplug three (3) connectors: two (2) data connectors and one (1) power connector.

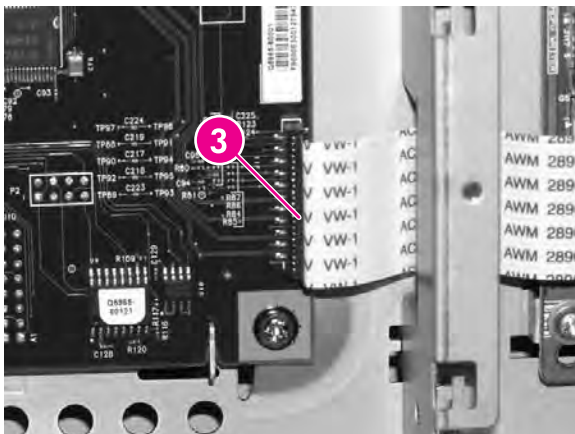
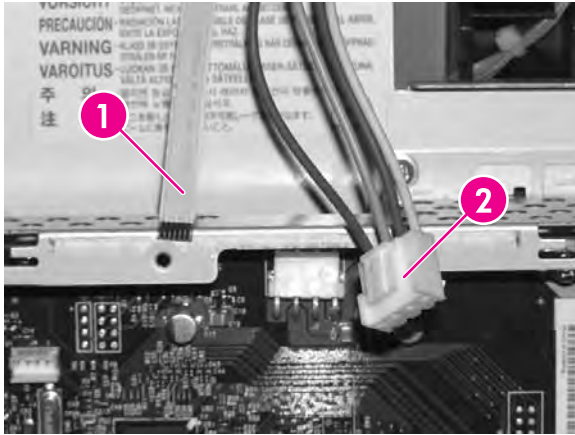

1	Flat cable
2	Power cables
3	VW-1 flat cable

- 5 Remove four (4) screws from the formatter.

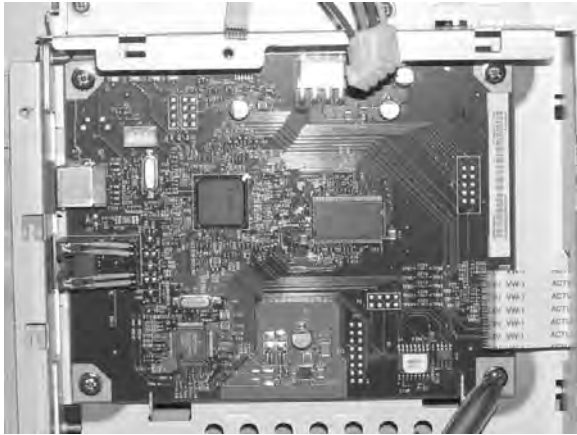

- 6 Lifting it up, remove the formatter.

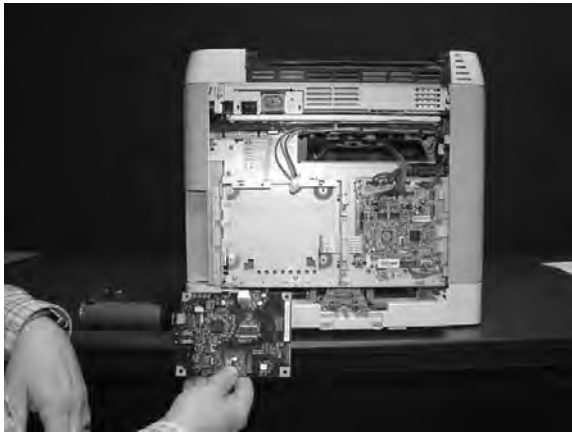

To replace the formatter, follow steps 1 through 6 above in reverse order.



NOTE When replacing the right cover, align the tabs on the upper edge of the right cover and lower edge of the face-down cover with their respective slots.

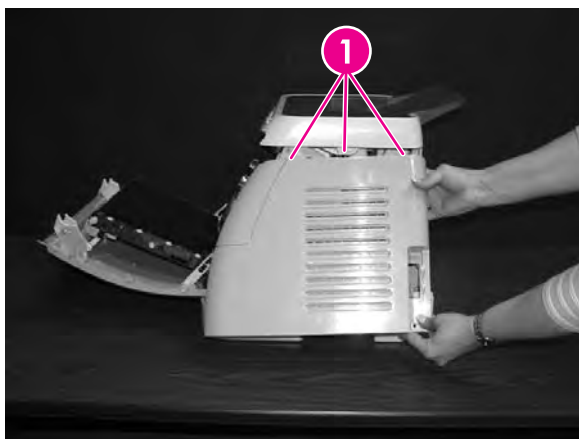

- 1 | Tabs

DC controller removal and replacement

Use the following procedure to remove the DC controller.

- 1 Remove the cassette dust cover (RC1-5200-000CN).



- 2 Remove nine (9) screws from the rear plate (RC1-5227-000CN).



- 3 Remove the rear plate.



- 4 Gently unplug 16 connectors.



- 5 Remove four (4) screws from the DC controller.

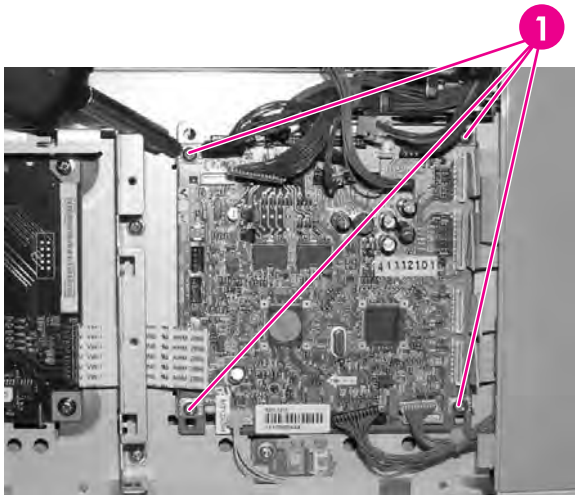

- 1 Four (4) screws

- 6 Remove the DC controller PCB assembly (RM1-1975-000CN).

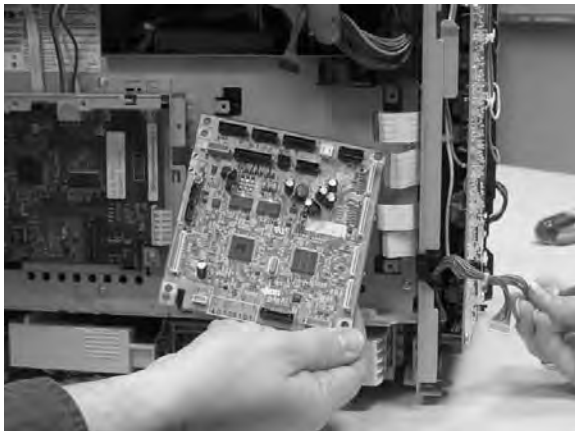

To replace the DC controller, follow steps 1 through 6 above in reverse order.

Separation pad removal and replacement

Use the following procedure to remove the separation pad.

- 1 Remove Tray 2 (shown) or optional Tray 3.

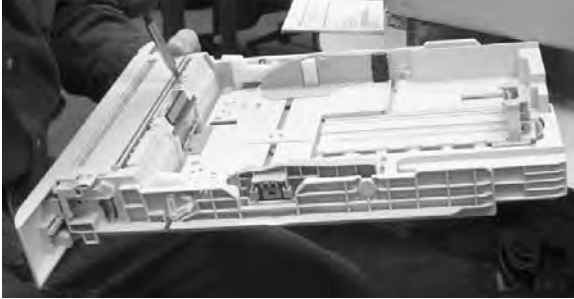

- 2 Remove two (2) screws that attach the separation pad.



- 3 Remove the separation pad assembly (RC1-5356-000CN).

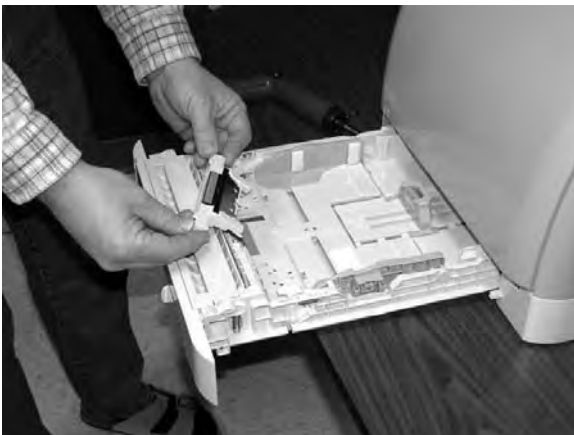

To replace the separation pad, follow steps 1 through 3 above in reverse order.



NOTE Align the tabs with the two (2) slots and then replace the separation pad.

Paper pickup roller removal and replacement

Use the following procedures to remove the paper pickup roller.

- 1 Open the front door.



- 2 Remove the print cartridges.



- 3 Remove two (2) screws.

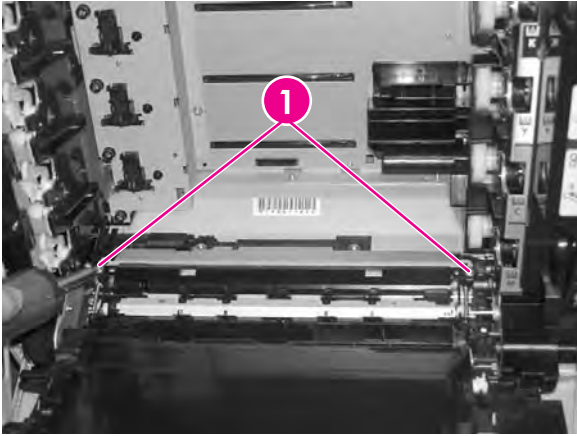

- 1 Two (2) screws

- 4 Remove the pre-transfer guide (RC1-5419-000CN).

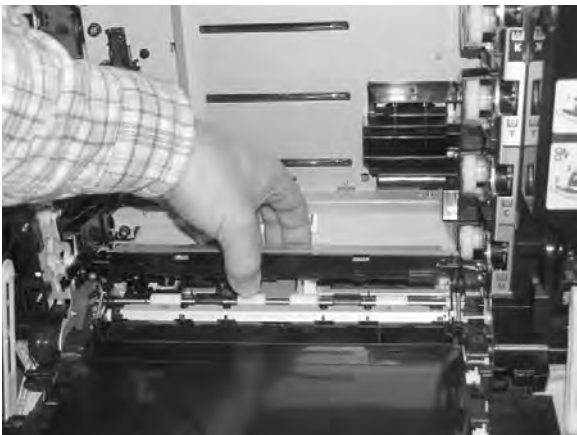

- 5 Use a small screwdriver to pull back on the tabs.

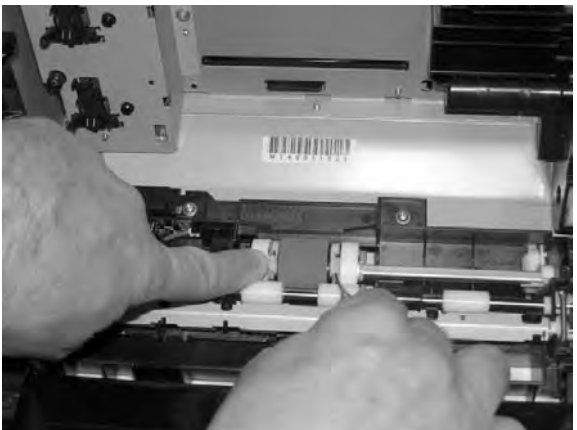

- 6 Rotating it towards the back, remove the paper pickup roller (RC1-5440-000CN).



To replace the paper pickup roller, follow steps 1 through 6 above in reverse order.

Control panel removal and replacement

Use the following procedure to remove the control panel.

- 1 Remove two (2) screws from the right cover assembly.

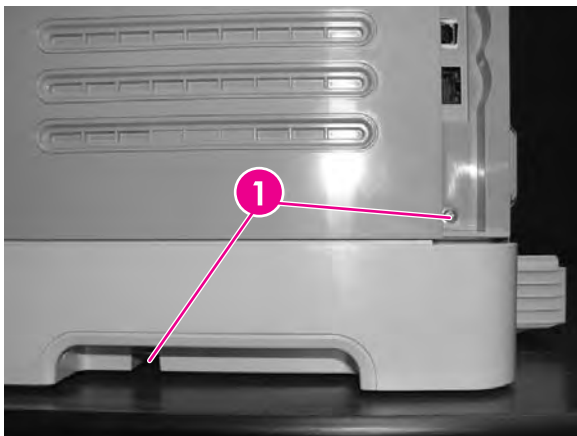

- 1 Two (2) screws

- 2 Remove the paper delivery tray assembly (RM1-1859-000CN).



- 3 Remove the right cover assembly (RM1-1858-000CN), carefully twisting the front edges of the side covers outward to remove.

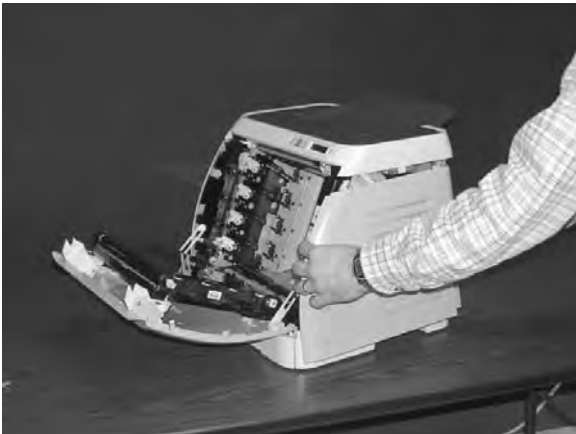

- 4 Unplug the control panel cable.



- 5 Lift up and remove the upper face cover (RC1-5173-000CN).



- 6 Remove four (4) screws from the upper cover (RC1-5176-000CN).

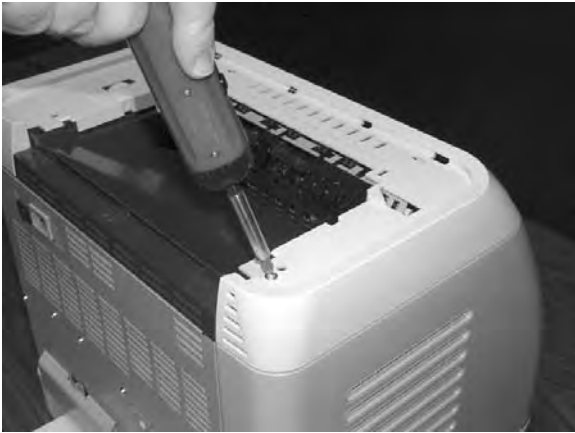

- 7 Remove one (1) screw from the inside upper cover (RC1-5178-000CN) and then remove the black output guide.

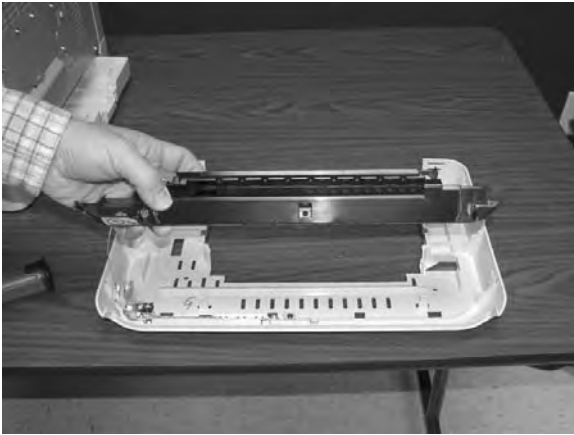
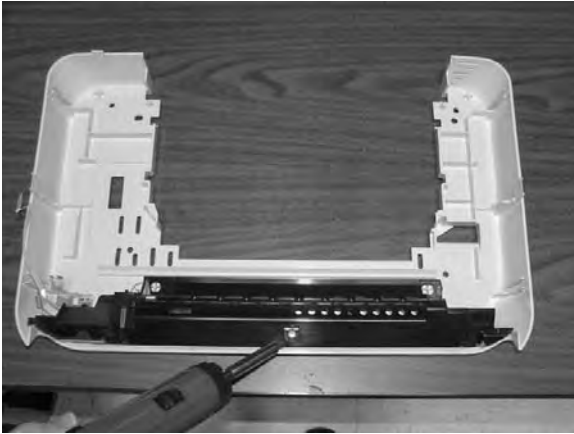

- 8 Remove two (2) screws from the control panel.



- 9 Remove the control panel assembly (RM1-1983-000CN).

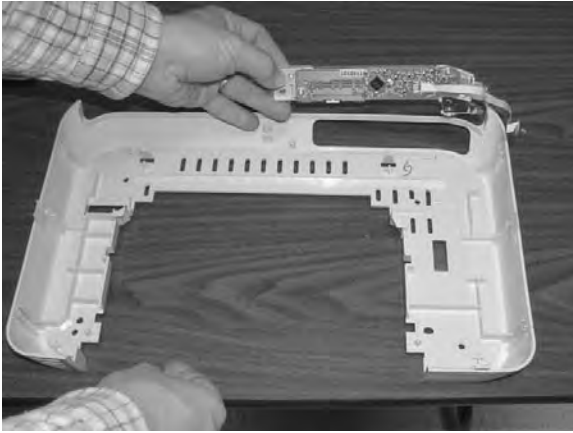

To replace the control panel, follow steps 1 through 9 above in reverse order.



NOTE When replacing the right cover, align the tabs on the upper edge of the right cover and lower edge of the face-down cover with their respective slots.

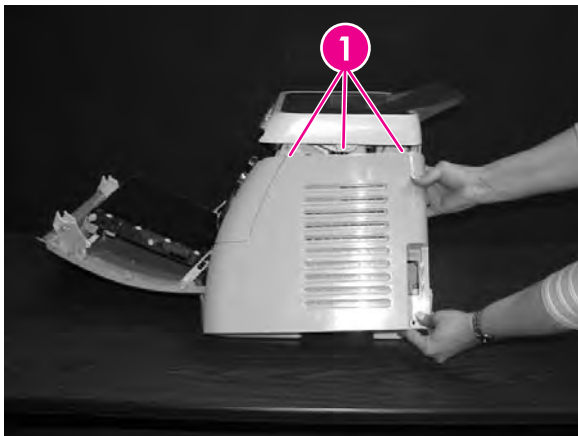

1 | Tabs

6 Troubleshooting

This troubleshooting information is organized to help you resolve printing problems. Choose the general topic or type of problem from the following list.

- [Troubleshooting process](#)
- [Clearing jams](#)
- [Print problems](#)
- [Functional tests \(SERVICE ONLY\)](#)
- [Service mode functions \(SERVICE ONLY\)](#)
- [Troubleshooting tools](#)
- [HP Toolbox](#)
- [Diagnostic resources](#)
- [Repetitive image defect ruler](#)
- [Firmware and software updates](#)

Troubleshooting process

Use the troubleshooting checklist to solve issues with the device.

Troubleshooting checklist

Follow the steps below when trying to solve a problem with the device.

Table 6-1 Troubleshooting checklist

Step number	Verification step	Possible problems	Solutions
1	<p>Is the power on?</p> <p>When the device is connected to a grounded power source, the control panel shows Hewlett-Packard with both the Ready and Attention lights blinking. The control panel will then display Initializing and then Ready, at which time only the green light will be on.</p>	No power due to failed power source, cable, switch, or fuse.	<ol style="list-style-type: none"> 1 Verify that the device is plugged in. 2 Verify that the power cable is functional and that the power switch is on. 3 Check the power source by plugging the device directly into the wall or into a different outlet. 4 Test the outlet or connect another device to the outlet to verify that the outlet is functioning.
2	<p>Does Ready appear in the device control panel?</p> <p>The control panel should function without error messages.</p>	Control panel shows an error.	See Control panel messages for a list of common messages that will help you correct the error.
3	<p>Do information pages print?</p> <p>Print a Configuration page.</p>	<p>Control panel displays an error message.</p> <hr/> <p>Media does not move smoothly through the device paper path.</p> <hr/> <p>Poor print quality.</p>	<p>See Control panel messages for a list of common messages that will help you correct the error.</p> <hr/> <p>Clean the paper path.</p> <hr/> <p>For information, see General print quality issues.</p>
4	<p>Does the device print from the computer?</p> <p>Connect the network cable or USB cable to the device and the computer. Use a word-processing application to send a print job to the device.</p>	<p>Software is not installed correctly or an error occurred during software installation.</p> <hr/> <p>The cable is not connected correctly.</p> <hr/> <p>An incorrect driver is selected.</p> <hr/> <p>Other devices are connected to the USB port.</p> <hr/> <p>There is a port driver problem in Microsoft Windows.</p>	<p>Uninstall and then reinstall the device software. Verify that you are using the correct installation procedure and the correct port setting.</p> <hr/> <p>Reconnect the cable.</p> <hr/> <p>Select the proper driver.</p> <hr/> <p>Disconnect the other devices and try again to print.</p> <hr/> <p>Uninstall and then reinstall the device software. Verify that you are using the correct installation procedure and the correct port setting.</p> <hr/> <p>If the error persists, see the support flyer that came in the device box.</p>

Clearing jams

This section contains information about clearing jams.

Paper path

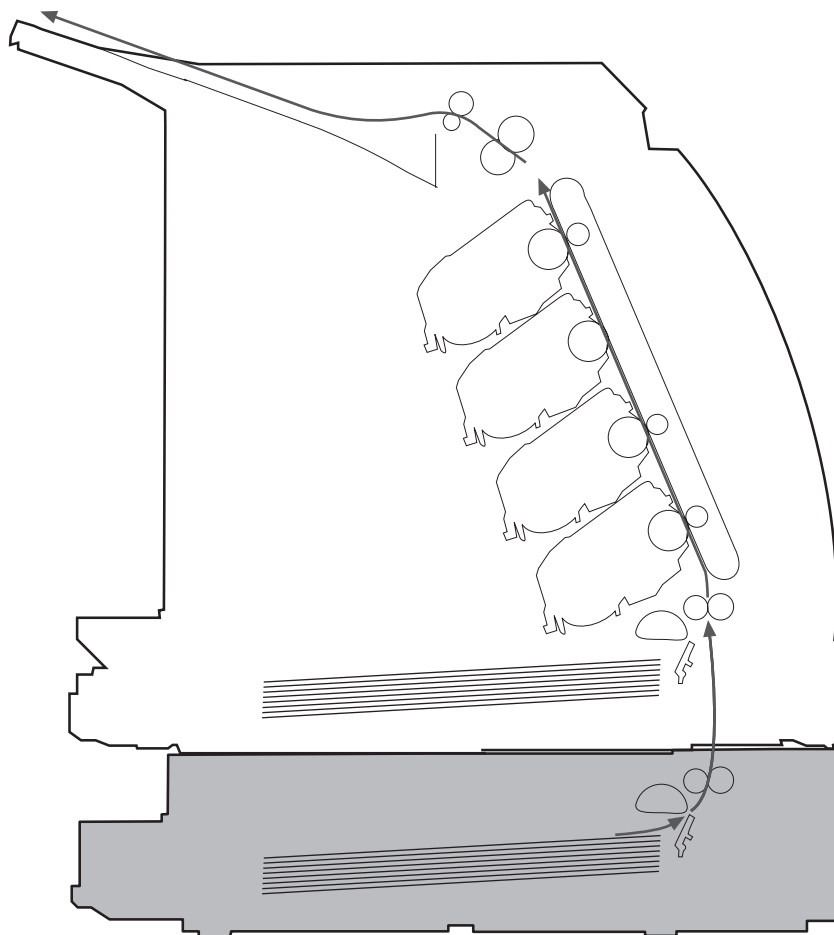



Figure 6-1 Paper path

For paper path sensor locations, see [Figure 4-12 Paper pickup and feed system](#).

Common causes of paper jams

Occasionally, paper or other print media can become jammed during a print job. Some causes include the following events:

Cause	Solution
The input trays are loaded improperly or overfilled.	Remove any excess paper from the input tray. Make sure that the paper does not exceed the maximum stack height mark in the input tray.
Tray 2 or optional Tray 3 is opened during a print job.	Make sure that Tray 2 or optional Tray 3 is closed.
Too many sheets accumulated in the output area or sheets blocked the output area.	Remove any accumulated sheets and clear the output area. For information about clearing jams from the output area, see Output jams .
The print media that is being used does not meet HP specifications.	Use only paper that meets HP specifications. For more information, see the <i>HP LaserJet Printer Family Print Media Guide</i> or go to http://www.hp.com/support/ljpaperguide .
The environment in which the print media was stored is too humid or too dry.	Make sure that the printer environment is within humidity specifications. For more information, see Printing and storage environment .
A supply item is installed incorrectly, causing repeated jams.	Verify that all print cartridges and the ETB are correctly installed.
Print media is skewed.	Input tray guides are not adjusted correctly. Adjust input tray guides so they hold the print media firmly in place without bending it.
	 NOTE Do not fan paper. Fanning can create static electricity, which can cause the paper to stick together.
Print media is binding or sticking together.	Remove paper, flex it, rotate it 180 degrees, or flip it over. Reload paper into the input tray.
Print media is removed before it settles into the output bin.	Reset the printer. Wait until the page completely settles in the output bin before removing it.
Print media is in poor condition.	Replace the paper.
Print media is not picked up by the internal rollers from Tray 2 or Tray 3.	Remove the top sheet of paper. If the paper is heavier than 163 g/m ² (43 lb), it may not be picked from the tray.
Print media has rough or jagged edges.	Replace the paper.
Print media is perforated or embossed.	This paper does not separate easily. Feed single sheets from Tray 1.
The printer supply items have reached the end of life.	Check the printer control panel for messages prompting a replacement of supplies, or print a supplies status page to verify the remaining life of the supplies.
Print media was not stored correctly.	Replace the print media. Print media should be stored in the original packaging in a controlled environment.

Where to look for jams

Jams can occur in these locations:

- Inside the printer
- In input areas
- In the output area
- Paper path

The following illustration identifies the stages when jams can occur.

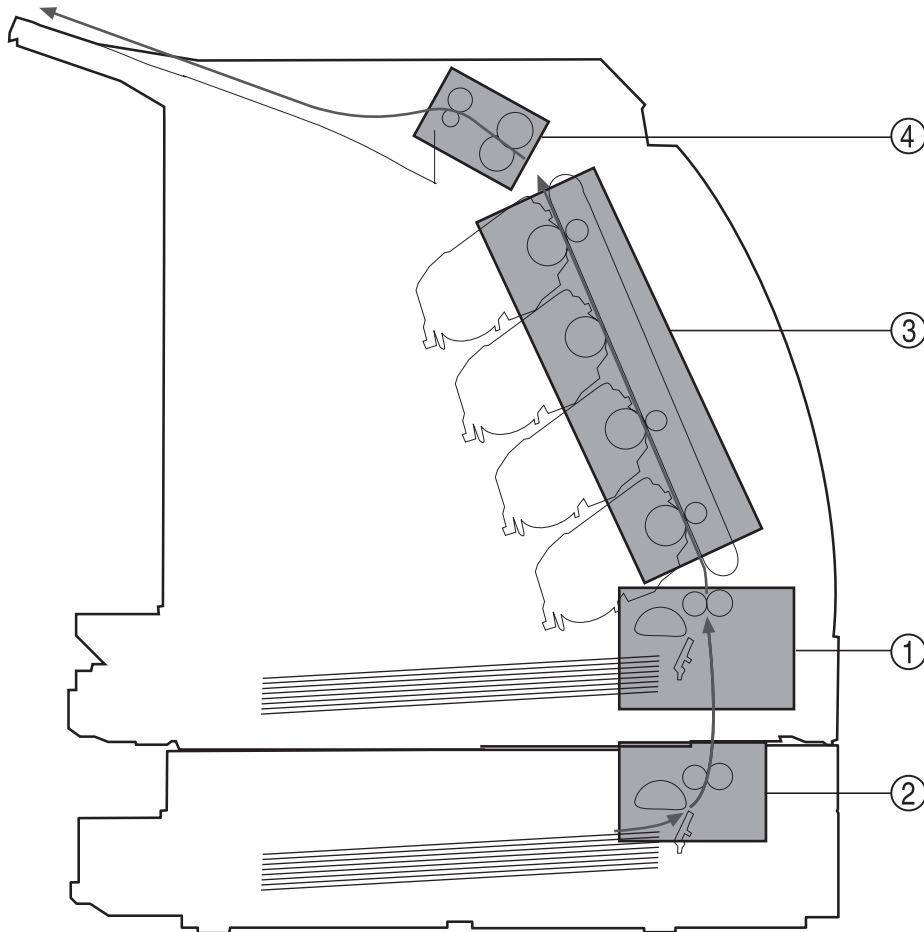

Figure 6-2 Jam locations and stages

1	Pickup stage
2	Feeder stage
3	Transfer/feed stage
4	Fusing/delivery stage

Find and remove the jam by using the instructions on the following pages. If the location of the jam is not obvious, first look inside the printer.

Loose toner might remain in the printer after a jam. This problem should resolve itself after a few sheets have been printed.

Each section below corresponds to an area where a paper jam could occur. Use the following procedures to clear the jam. In all cases, grasp the jammed paper by both corners and pull slowly to remove the paper.

Jams inside the printer

Use the following instructions to clear jams from inside the printer.



CAUTION Jams in this area might result in loose toner on the page. If you get toner on your clothes or hands, wash them in cold water. (Hot water will set the toner into the fabric.)

- 1 Open the front door.

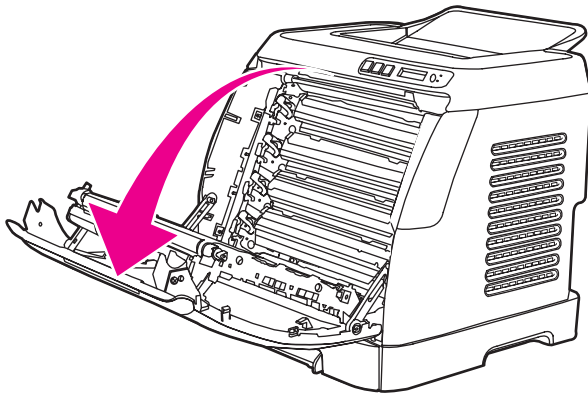

CAUTION Do not place anything on the transfer belt, which is located on the inside of the front door. Otherwise, the printer may be damaged, adversely affecting print quality.

- 2 Carefully grasp the jammed paper by both corners and pull slowly to remove the paper.

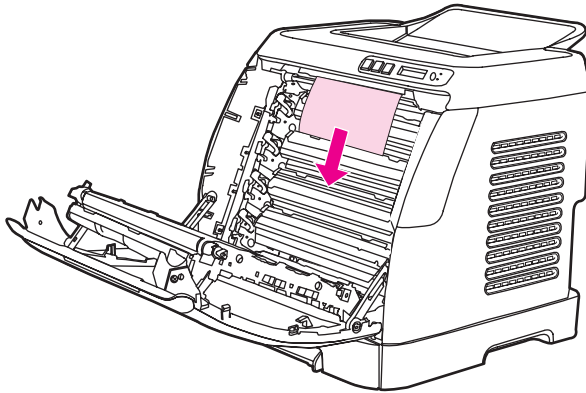
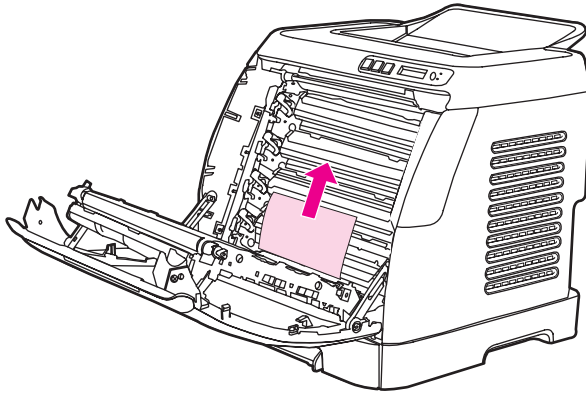

- 3 Close the front door.

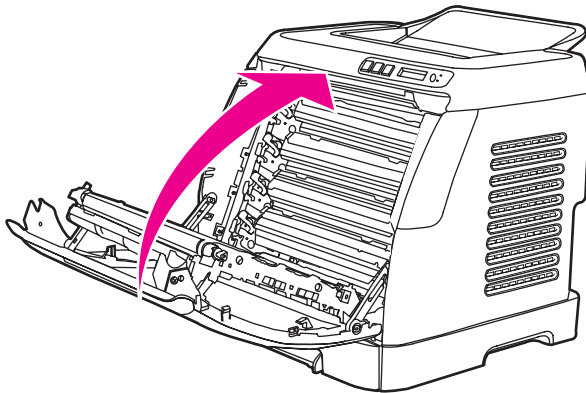

Input jams

Tray 1

If the jammed paper is easily accessible from the outside of the printer, grasp both edges of the paper and firmly pull to remove. Otherwise, follow the directions for Tray 2.

Tray 2

Open the front door of the printer and remove paper as indicated on the jam instruction label, located on the interior right side of the printer. Input jams are indicated on the label with the number 3.

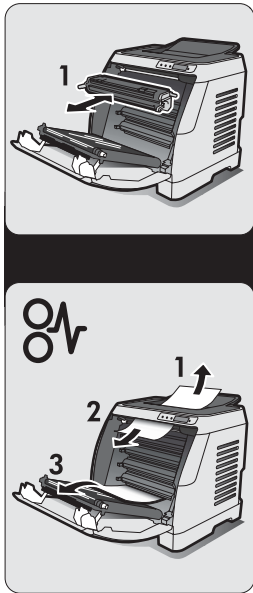

Figure 6-3 Tray 2 input jam label

Output jams

Jams in the top bin



CAUTION Jams in these areas might result in loose toner on the page. If you get toner on your clothes or hands, wash them in cold water. (Hot water will set the toner into the fabric.)

- 1 Carefully grasp the jammed paper by both corners and pull slowly to remove the paper from the top bin.

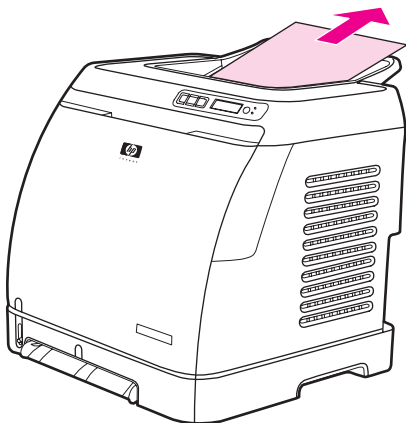

- 2 Open and close the front door.

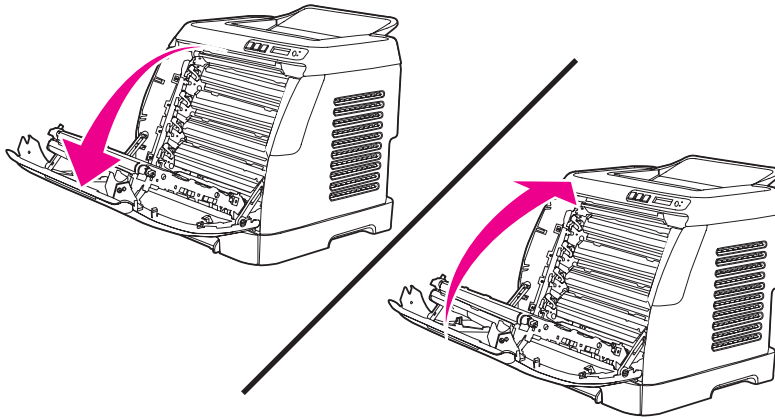

Pickup delay jam

The printer performs the retry control, which executes the pickup operation three times, to retrieve the pickup delay jam caused by the pickup error. When the registration paper sensor (SR1) does not detect the leading edge of the paper within approximately 2.5 seconds (4.5 seconds for optional cassette) after the pickup solenoid (SL1) is turned ON, the CPU tries to pick up the paper three times.

Pickup stationary jam

The CPU determines the pickup stationary jam when the registration paper sensor (SR1) does not detect the trailing edge of the paper within approximately 8.6 seconds after it detects the leading edge.

Delivery delay jam

The CPU determines the delivery delay jam when the fuser delivery paper sensor (SR4) does not detect the leading edge of the paper within approximately 6.6 seconds after the registration paper sensor (SR1) detects the leading edge.

Wrapping jam

The CPU executes the wrapping jam detection after it assesses no delivery delay jam. The CPU determines the wrapping jam, when the fusing delivery paper sensor (SR4) detects the paper absence before the time equivalent to paper passage of its length minus 40 mm (1.6 inches) after the SR4 detected the leading.

Delivery stationary jam

The CPU executes the delivery stationary jam detection after it assesses no wrapping jam. The CPU determines the delivery stationary jam, when the fuser delivery paper sensor (SR4) detects the paper presence after the time equivalent to paper passage of its length plus 50 mm (1.9 inches) from when it detected the trailing edge.

Start-up residual paper jam

The CPU determines the start-up residual paper jam when either the pre-fuser paper sensor (SR5) or the fuser delivery paper width sensor (SR4) detects the paper when the initial rotation is started.

Door open jam

The CPU determines the door open jam, when either the pre-fuser paper sensor (SR5) or the fuser delivery paper width sensor (SR4) detects paper when a door open is detected.

Print problems







Getting information



The following sections contain information about control panel messages, error reports, and available service menus.

Control panel messages

The majority of the control-panel messages are intended to guide the user through typical operation. The control-panel messages indicate the status of the current operation, and include a page count on the second line of the display, if appropriate. When the device is printing data, control-panel messages indicate this status. In addition, alert messages, warning messages, and critical error messages indicate situations that might require some action.

Alert and warning messages

Control panel message	Description	Recommended action
Device error Press ✓	An internal error occurred in the device.	Press  (SELECT) to resume the job.
Door open	The printer door is open.	The door must be closed before printing can continue.
Engine comm. error	The device experienced an internal communication error.	This is a warning message only. Job output might be affected.
Invalid driver	You are using the incorrect printer driver.	Reselect the printer driver appropriate for your device.
Invalid entry	Invalid data or response.	Correct the entry.
Jam in tray 2	A paper jam has occurred in Tray 2.	Clear the jam, and then press the  (SELECT) button on the control panel.
Jam in tray 3	A paper jam has occurred in Tray 3.	Clear the jam, and then press the  (SELECT) button on the control panel.
Jam in print paper path	A paper jam has occurred in the print path.	Open the door and clear the jam. Then press the  (SELECT) button on the control panel.
Jam in Cartridge area	A paper jam has occurred in the print path.	Open the door and clear the jam. Then press the  (SELECT) button on the control panel.
Jam in Output bin	A paper jam has occurred in the output area.	Clear the jam, and then press the  (SELECT) button on the control panel.
Load paper	The HP Color LaserJet 2600n printer is out of paper.	Please load specified paper type into the tray indicated.
Load Tray X [TYPE] [SIZE]	The printer is processing job, but the tray indicated is empty.	Please load specified paper type and size into the tray indicated.

Control panel message	Description	Recommended action
Manual feed Press ✓	The printer is waiting for paper in the tray indicated.	Load the paper as indicated.
Memory is low Press ✓	The device memory has been almost completely filled.	Allow the device to finish the job, or press  (SELECT) to cancel the job. Break the job into smaller jobs that contain fewer pages.
Misprint Press ✓	The printed pages have been incorrectly placed on the paper.	To continue, press the  (SELECT) button on the control panel.
No paper pickup Press ✓	The print engine has failed to pick up a piece of media.	In Tray 1, verify that the media was inserted far enough into the tray. In Tray 2 or optional Tray 3, verify that the paper-length guide is in the correct position for the media size that you are using. Reload the media in the input tray and press  (SELECT) to continue the job.
Unexpected size in tray X	Unexpected paper size error. The media size loaded in the tray does not match the media size configured for the tray.	Verify that the print settings are set to the specified media in the tray.



Critical error messages

Control panel message	Description	Recommended action
50.1 Fuser Error	The device has experienced an internal hardware error.	Turn off the device, wait at least 25 minutes, and then turn on the device.
50.2 Fuser Error	50.1 Fuser Error —low temperature	If a surge protector is being used, remove it. Plug the device directly into the wall socket. Use the power switch to turn on the device. If this does not clear the error, replace the fuser.
50.3 Fuser Error	50.3 Fuser Error —slow fuser	
	50.2 Fuser Error —high temperature	
51.20 Error	The device has experienced an internal hardware error.	Turn off the power by using the power switch, wait at least 30 seconds, and then turn on the power and wait for the device to initialize.
51.21 Error	51.20 Error —black scanner error	If a surge protector is being used, remove it. Plug the device directly into the wall socket. Use the power switch to turn the device on. Laser scanners are not replaceable. Replace the engine.
51.22 Error	51.21 Error —cyan scanner error	
51.23 Error	51.22 Error —magenta scanner error	
	51.23 Error —yellow scanner error	
55.1 Error	DC controller error. The device has experienced an internal hardware error.	Turn off the power by using the power switch, wait at least 30 seconds, and then turn on the power and wait for the device to initialize.



Control panel message	Description	Recommended action
		<p>If a surge protector is being used, remove it. Plug the device directly into the wall socket. Use the power switch to turn the device on.</p> <p>Check the engine (DCC) firmware version. Update if needed. Replace the DCC if a firmware upgrade does not resolve the issue.</p>
<p>57 Fan Error</p> <p>Turn off then on</p>	<p>The device has experienced a problem with its internal fan.</p>	<p>Turn off the power by using the power switch, wait at least 30 seconds, and then turn on the power and wait for the device to initialize.</p> <p>The fan is not replaceable. Replace the engine.</p>

Supplies messages

Control panel message	Description	Recommended action
<p>10.000x Supply error</p>	<p>E-label cannot be read or print cartridge is not properly installed.</p> <p>10.0000 = Black print cartridge</p> <p>10.0001 = Cyan print cartridge</p> <p>10.0002 = Magenta print cartridge</p> <p>10.0003 = Yellow print cartridge</p>	<ol style="list-style-type: none"> 1 Reinstall print cartridge. 2 Turn on the printer. 3 If the problem is not solved, replace the cartridge.
<p>10.100x Supply error</p> <p>alternates with</p> <p>Reinstall</p> <p>The supplies gauge will display the consumption levels of print cartridges.</p>	<p>A print cartridge is missing.</p> <p>10.1000 = Black print cartridge</p> <p>10.1001 = Cyan print cartridge</p> <p>10.1002 = Magenta print cartridge</p> <p>10.1003 = Yellow print cartridge</p>	<p>Install the correct print cartridge.</p>
<p>HP supplies installed</p>	<p>The printer transitioned from having one or more non-HP supplies to having all HP supplies installed.</p>	<p>No action required.</p>
<p>One of the following messages may display:</p> <p>Incorrect black</p> <p>Incorrect cyan</p> <p>Incorrect magenta</p> <p>Incorrect yellow</p>	<p>The <color> print cartridge not installed correctly.</p>	<p>Reinstall the <color> print cartridge.</p>
<p>One of the following messages may display:</p> <p>Install black cartridge</p> <p>Install cyan cartridge</p>	<p>The out threshold has been reached.</p>	<p>The supply must be replaced before printing can continue.</p>

Control panel message	Description	Recommended action
Install magenta cartridge		
Install yellow cartridge		
The supplies gauge will display the consumption levels of print cartridges.		
Install supplies	Multiple supplies are not installed.	Install correct print cartridges.
The supplies gauge will display the consumption levels of print cartridges.		
One of the following messages may display:	A non-HP <color> cartridge is installed.	 <p>NOTE Any printer repair required as a result of using a non-HP or unauthorized supply is not covered under warranty.</p> <hr/> <p>To use this cartridge, override by pressing the  (SELECT) button on the control panel.</p>
Non HP black installed		
Non HP cyan installed		
Non HP magenta installed		
Non HP yellow installed		
alternates with		
To accept		
Press ✓		
Non HP supply in use	A non HP (cloned or refilled) supply has been installed that is not made by HP and was overridden.	If you believe you purchased an HP supply, please call the HP fraud hotline at 1-877-219-3183. Service or repairs required as a result of using non-HP supplies is not covered under HP warranty.
alternates with		
Ready		
The supplies gauge will display the consumption levels of print cartridges.		
One of the following messages may display:	The <color> print cartridge low threshold has been reached.	For more information go to the HP Color LaserJet 2600n toolbox and click Supplies Status . To order supplies online, click Order Supplies .
Order black cartridge,		
Order cyan cartridge,		
Order magenta cartridge, or		
Order yellow cartridge		

Control panel message	Description	Recommended action
<p>alternates with</p> <p>Ready</p> <p>The supplies gauge will display the consumption levels of print cartridges.</p>		
<p>ORDER SUPPLIES</p> <p>alternates with</p> <p>Ready</p> <p>The supplies gauge will display the consumption levels of print cartridges.</p>	Multiple supplies are low.	For more information go to the HP Color LaserJet 2600n toolbox and click Supplies Status . To order supplies online, click Order Supplies .
<p>One of the following messages may display:</p> <p>Replace black cartridge</p> <p>Replace cyan cartridge</p> <p>Replace magenta cartridge</p> <p>Replace yellow cartridge</p>	The out threshold has been reached.	The supply must be replaced before printing can continue.
<p>Replace Supplies</p> <p>The supplies gauge will display the consumption levels of print cartridges.</p>	The out threshold has been reached.	The supply must be replaced before printing can continue.
<p>Replace supplies</p> <p>Override in use</p> <p>alternates with</p> <p>Ready</p> <p>The supplies gauge will display the consumption levels of print cartridges.</p>	Supply override in use. The user has decided to continue printing beyond the out point. A supply is low and using Override may result in unsatisfactory print quality.	Replace the supply that is low.
<p>Replace supply.</p> <p>Override in use</p> <p>alternates with</p> <p>Ready</p> <p>The supplies gauge will display the consumption levels of print cartridges.</p>	Supply override in use. The user has decided to continue printing beyond the out point. A supply is low and using Override may result in unsatisfactory print quality.	Replace the supply that is low.

Control panel message	Description	Recommended action
Unauthorized supply in use alternates with Ready The supplies gauge will display the consumption levels of print cartridges.	A new supply has been installed that is not made by HP and was overridden.	If you believe you purchased an HP supply, please call the HP fraud hotline at 1-877-219-3183. Service or repairs required as a result of using non-HP supplies is not covered under HP warranty.
One of the following messages may display: Unauthorized yellow Unauthorized magenta Unauthorized cyan Unauthorized black	A new supply has been installed that is not made by HP. One of these four messages is displayed until an HP supply is installed or  (SELECT) is pressed.	If you believe you purchased an HP supply, please call the HP fraud hotline at 1-877-219-3183. Service or repairs required as a result of using non-HP supplies is not covered under HP warranty. To continue printing, press  (SELECT).

Status messages

Status messages are used to inform the user of the current state of the system. Status messages do not require user action or acknowledgement, and are for information only.

Control panel message	Description	Recommended action
Calibrating...	The printer is calibrating.	No action is required.
Cleaning...	The printer is in cleaning mode.	No action is required.

Status log only messages

The following messages are not displayed on the control panel. They are printed on the Status log.

Table 6-2 Status log only messages

Error log code	Description
54.06	Color density sensor error
54.10	Color plane registration sensor(s) error
54.11	Yellow density out of range
54.12	Magenta density out of range
54.13	Cyan density out of range
54.14	Black density out of range

Reports menu

The following reports are available from the **Reports** menu.

- **Demo Page**—used to help market the product at retail stores
- **Menu structure**—highlights the control panel menu layout
- **Config report**—details all default device settings including network configuration and information
- **Supplies Status**—provides information on each of the print cartridges, including estimated pages remaining, cartridge serial number, and pages printed

Configuration page

The Configuration page lists the current settings and properties of the printer. You can print a Configuration page from the printer or HP Toolbox. To print the Configuration page from the printer, see [Configuration page](#).

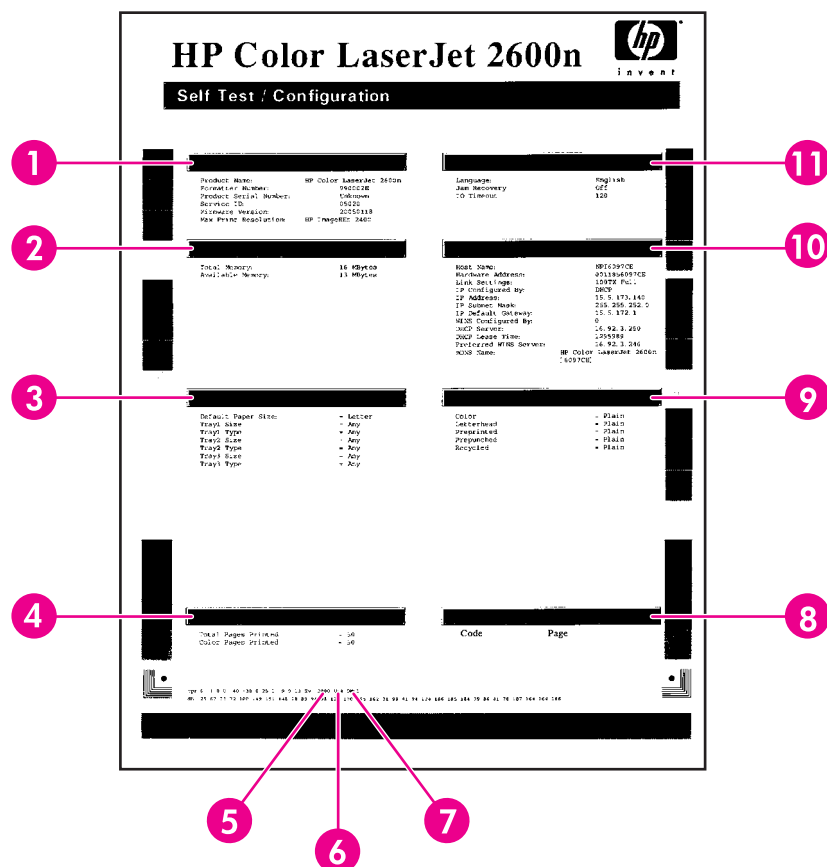

Table 6-3 Configuration page

1	<p>Product information. This section contains the following basic information about the printer:</p> <ul style="list-style-type: none"> ■ Product name ■ Formatter number ■ Serial number ■ Service ID ■ Firmware version ■ Maximum print resolution
2	<p>Memory. This section lists memory-related information, such as the total memory that is installed.</p>
3	<p>Paper settings. This section lists information about the media type for each tray and about the type settings for all the media that the printer supports.</p>
4	<p>Page counts. This section lists the total number of pages printed, the number of color pages printed, and information about paper jams.</p>

5	DC controller version. This section lists the DC controller version.
6	<p>USB settings. This section contains information for the USB setting options.</p> <ul style="list-style-type: none"> ■ U=0 Hi speed ■ U=4 Full speed ■ U=5 Full speed auto switched from hi speed
7	<p>Extended print modes enabled. The following list contains the options for enabling extended print modes.</p> <ul style="list-style-type: none"> ■ DM=0 Default setting ■ DM=1 Extended print mode enabled
8	Status log. This section contains information about printer errors, including an error code and the page count at which the error occurred. For a list of status log messages, see Table 6-5 Status log messages .
9	Paper types. This section contains information about paper types that can be configured by the user. The default setting is Plain.
10	<p>Network settings. This section contains the following network information about the printer.</p> <ul style="list-style-type: none"> ■ Host name ■ Hardware address ■ Link settings ■ IP address information ■ IP subnet mask ■ IP default gateway ■ WINS configuration information ■ DHCP server and lease time information ■ Preferred WINS server information ■ mDNS name
11	<p>Product settings. This section lists the following information that is gathered during software installation:</p> <ul style="list-style-type: none"> ■ Language ■ Company name ■ Jam recovery settings (if set to ON, the last page will reprint if there is a paper jam) ■ I/O timeout information (default is 120 seconds)









NOTE The color bars on the sides of the Configuration page represent 100%, 75%, 50%, and 25% coverage.

Supplies Status page

The Supplies Status page lists the remaining life of HP print cartridges. It also lists the estimated pages remaining, number of pages printed, and other supplies information. You can print a Supplies Status page from the printer or the HP Toolbox.

To print the Supplies Status page from the printer control panel

- 1 Press  (LEFT ARROW) or  (RIGHT ARROW) to select the **Reports** menu.
- 2 Press  (SELECT).
- 3 Press  (LEFT ARROW) or  (RIGHT ARROW) to select **Supplies Status**.
- 4 Press  (SELECT) to print the Supplies Status page.



NOTE Supplies information is also available through the HP Toolbox.

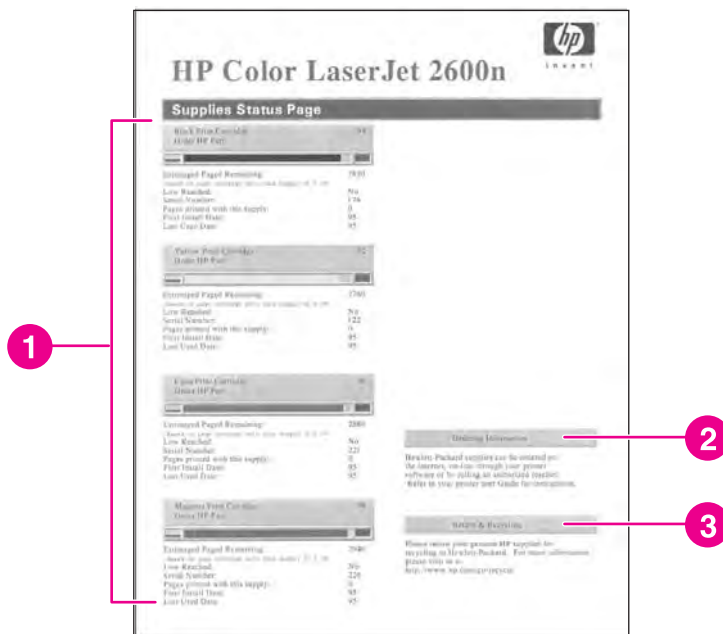

Table 6-4 Supplies Status page

1	Print cartridge area
2	Ordering information
3	Return and recycling information

Status log

The status log for this printer is located on the Configuration page and lists the last five events. For more information, see [Configuration page](#).

Table 6-5 Status log messages

Error log code	Description
10.0000	Black e-label error
10.0001	Cyan e-label error
10.0002	Magenta e-label error
10.0003	Yellow e-label error
10.1000	Black e-label missing
10.1001	Cyan e-label missing
10.1002	Magenta e-label missing
10.1003	Yellow e-label missing
10.3000	Non-HP black
10.3001	Non-HP cyan
10.3002	Non-HP magenta
10.3003	Non-HP yellow
13.0000	Paper jam, Tray 1 area
13.0001	Paper jam, Tray 2 area
13.0002	Paper jam, Tray 3 area
13.0003	Paper jam, registration drum area
13.0004	Paper jam, drum fuser area
13.0005	Paper jam, fuser output area
20.0000	Memory out
21.0000	Video under run
50.1000	Low temperature fuser error
50.2000	Slow fuser error
50.3000	High temperature fuser error
50.4000	Fuser heater wire failure
50.5000	Fuser low temperature subtherm failure
50.6000	Fuser high temperature subtherm failure
52.0000	Scanner error, black laser failure
52.0100	Scanner error, cyan laser failure
52.0200	Scanner error, magenta laser failure
52.0300	Scanner error, yellow laser failure
54.0600	Density sensor error
54.1000	Color plane registration sensor error
54.2800	Sensor density contaminated

Table 6-5 Status log messages (continued)

Error log code	Description
54.2801	Sensor color plane registration contaminated
55.0000	Engine comm fatal error
55.0001	Engine comm critical error
55.1000	DC controller memory error
57.0000	Fan motor error
57.0001	Fan cartridge failure
59.0000	Paper path/ETB rotation failure
59.0001	Paper path/ETB ramp up failure
101.0000	Color plane registration error
102.0000	DMAX calibration error
103.0000	DHALF calibration error

Service menu settings

The service menu is used to calibrate, restore factory default settings, and clean the print paper path.

The following service menu items are available:

- **Restore defaults**—used to reset all customer-accessible menu settings back to the factory default settings (except language) via the control panel or software



NOTE This service menu item does not reset factory-settable settings, including formatter number, page counts, factory paper settings, language, and so on.

- **PowerSave**—used to configure the amount of idle time before the engine enters sleep mode
- **Cleaning mode**—used to remove dust and toner from the print paper path

Secondary service menu

The secondary service menu is intended for use by manufacturing engineers, service engineers, developers, and support personnel. This menu provides options to perform various tests and print out special reports.







The following secondary service menu items are available:

- **Service Reports**—used to print out a continuous configuration report, translation report, and error report
- **USB Speed**—enables or disables the ability for the printer to operate in high speed.

The following **USB Speed** setting options are available:

- Auto
- Hi speed
- Full speed
- **Display test**—verifies that all of the characters on the display function correctly by allowing you to manually scroll through the characters
- **Clean ETB**—used to clean the ETB
- **Calibrations**
 - **All Cals**
 - **CPR Cal**
 - **DMAX/DHALF Cal**
 - **DHALF Only Cal**
 - **Test Page**

To enter the secondary service menu, use the following procedure:

- 1 Confirm that the device is in a **Ready** state.
- 2 Press the  button (**SELECT**) to enter the main menu system.
- 3 Press the  button (**LEFT ARROW**) and the  button (**CANCEL JOB**) simultaneously.
- 4 Press the  button (**SELECT**) to confirm **2ndary Service**.
- 5 Press the  (**LEFT ARROW**) button and  button (**RIGHT ARROW**) to navigate to the secondary service menu.

Printed image quality problems

Improving print quality

Use the print-quality settings in the HP Toolbox to improve print-quality problems. To access the HP Toolbox, see [HP Toolbox](#). The following menus contain paper type, print mode, and print-quality settings. To restore the default settings, open the HP Toolbox and click **Device Settings**. Then click **Settings**, **Service**, and in **Restore Factory Settings**, click **Restore**.

Paper Types menu

The purpose of this menu is to specify the print mode for paper types which are non-specific.

To make changes in the **Paper Types** menu, make the desired selections and click **Apply**.

Table 6-6 Print modes for paper types

Print Modes for paper types	Weight	Default media types
Normal mode	75-89 g/m ²	Plain, color, preprinted, prepunched, recycled
Transparency		Transparencies
Labels		Labels
Light	75-89 g/m ²	Light
Heavy	90-105 g/m ²	Heavy
Cardstock	106-163 g/m ²	Cardstock, bond
Light Glossy	75-105 g/m ²	Light Glossy
Glossy	106-120 g/m ²	Glossy
Heavy Glossy	121-163 g/m ²	Heavy Glossy
HP Tough paper		HP Tough paper
Envelope		Envelopes

Print Modes menu

Under the Print Modes menu in HP Toolbox, each Media Type will have a Fusing menu, a Transfer menu, and a Toner menu. Select a setting for each menu item.

Media types are listed with the plain papers together, glossy papers together, and special media at the end. To make changes in the **Print Modes** menu, make the desired selections and click **Apply**.

Table 6-7 Extended print modes

HP Toolbox extended print mode	Printer adjustment	Change in printer setting
Paper curl	Fusing adjustment	Reduced fuser temperature for less negative paper curl
Heavy coverage	Fusing adjustment	Increased fuser temperature for less positive paper curl with heavy toner coverage
Toner offset	Fusing adjustment	Reduced fuser temperature for less toner offset
Flap sealing	Fusing adjustment	Reduced fuser temperature to keep envelope flaps from sealing
Less fusing	Fusing adjustment	Reduced fuser temperature
More fusing	Fusing adjustment	Increased fuser temperature
Dry paper	Transfer adjustment	Increased transfer bias for high resistivity paper
Humid paper	Transfer adjustment	Decreased transfer bias for high resistivity paper
Rough paper	Transfer adjustment	Increased transfer bias for high resistivity paper

Table 6-7 Extended print modes (continued)

HP Toolbox extended print mode	Printer adjustment	Change in printer setting
Less transfer current	Transfer adjustment	Reduced transfer bias
More transfer current	Transfer adjustment	Increased transfer bias
Less toner	Toner adjustment	Tone curve is scaled back so that solid is not 100% halftone

Print quality menu

Under the Print Quality menu in HP Toolbox, there will be an Optimize section containing a number of On/Off adjustments which will apply to all media types.

Table 6-8 Optimize menu

Adjustment type	Default setting	Extended print mode	Description
Background Toner	Off	EEC95-9	Will reduce the developer DC bias
Extra Cleaning	Off	EEC93-11	Increases rotations of the ETB
Trailing Edge Over-development (full-speed)	Off	EEC95-14	
Trailing Edge Over-development (half-speed)	Off	EEC95-14	
Mottle Prevention	Off	EEC96-12	Will increase the developer DC bias
Less Duplex Transfer Current	Off	EEC68-10 EEC91>16h [*] EEC92>-1 ^{**}	Decreases transfer bias on the 2nd side of duplex jobs. For media that has low resistivity after fusing.
More Duplex Transfer Current	Off	EEC68-10 EEC91>16h [*] EEC92>+1 ^{**}	Increases transfer bias on the 2nd side of duplex jobs. For media that has high resistivity after fusing.

^{*} > means write xxh to bits 11–15

^{**} > means +/-y to bits 9–15

Understanding print-quality settings

Print-quality settings affect how light or dark the print is on the page and the style in which the graphics are printed. You can also use the print-quality settings to optimize the print quality for a specific media type.

You can change the settings in the device properties to accommodate the types of jobs that you are printing. The following settings are available, depending on the printer driver that you are using:

- Draft (600 dpi)
- Normal (Image REt 2400)



NOTE Changing the resolution can change the formatting of your text.

To temporarily change print-quality settings

To change the print-quality settings only for the current software program, open the properties through the **Print Setup** menu in the program that you are using to print.

To change print-quality settings for all future jobs

For Windows 98, Windows 2000, and Windows Me:

- 1 In the Windows system tray, click **Start**, select **Settings**, and then click **Printers**.
- 2 Right-click the device icon.
- 3 Click **Properties** (in Windows 2000, you can also click **Printing Preferences**).
- 4 Change the settings, and click **OK**.

For Windows XP (Classic view):

- 1 In the Windows system tray, click **Start**, and then click **Printers and Faxes**.
- 2 Right-click the device icon.
- 3 Click **Properties**, or click **Printing Preferences**.
- 4 Change the settings, and click **OK**.

Identifying and correcting printed image defects

Use the checklist and print-quality issues charts in this section to solve print-quality problems.

Print-quality checklist

General print-quality problems can be solved by using the following checklist:

- 1 Make sure that the paper or print media that you are using meets specifications. Generally, smoother paper provides better results.
- 2 If you are using a special print media such as labels, transparencies, glossy, or letterhead, ensure that you have printed by type.
- 3 Print a Configuration page and Supplies Status page at the device.
 - Check the Supplies Status page to see if any supplies are low or empty. No information is provided for non-HP print cartridges.
 - If the pages do not print correctly, the problem is with the hardware.
- 4 Print a Demo page from the HP Toolbox. If the page prints, the problem is with the printer driver.
- 5 Try printing from a different program. If the page prints correctly, the problem is with the program from which you were printing.

- 6 Restart the computer and the device and try printing again. If the problem is not resolved, choose one of these options:
 - If the problem is affecting all printed pages, see [General print quality issues](#).
 - If the problem is affecting only pages printed in color, see [Solving issues with color documents](#).

Paper handling issues

The following sections contains information about paper handling issues.

Wrong size/type media

Use the following procedure to troubleshoot and resolve wrong size or type media problems.

- 1 Make sure that the software program is selecting the correct media size or type.
- 2 Make sure that the printer driver for the software program is correctly installed, configured, and capable of requesting the desired media size and type.
- 3 Make sure that the paper guides are touching the edges of the stack of media.
- 4 If the size of media requested is not loaded in the tray selected, the printer draws media from the next default tray that contains the correct size. Load the correct media in the tray and make sure that the tray is adjusted correctly. Load the tray with enough media to complete the print job. (See the *HP Color LaserJet 2600n User Guide* for information about configuring the input trays.)

Cannot select a tray or feature to use

When you cannot select a tray or feature to use, use the following procedure to troubleshoot and resolve problems.

- 1 When the size of media requested is not loaded in the tray selected, the printer draws media from the next default tray that contains the correct size. Load the correct media in the tray and make sure that the tray is adjusted correctly. Load the tray with enough media to complete the print job. (See the *HP Color LaserJet 2600n User Guide* for information about configuring the input trays.)
- 2 Make sure that the driver for the software program is correctly installed, configured, and capable of requesting the desired media size and type, or feature.

Performance problems

Try the tips in this section if pages exit the device, but have nothing printed on them, or when the device does not print any pages.

Table 6-9 Performance issues

Problem	Cause	Solution
Pages print but are totally blank.	The sealing tape might still be in the print cartridges.	Verify that the sealing tape has been completely removed from the print cartridges.
	The document might contain blank pages.	Check the document that you are printing to see if content appears on all of the pages.

Table 6-9 Performance issues (continued)

Problem	Cause	Solution
	The device might be malfunctioning.	To check the device, print a Configuration page.
Pages print very slowly.	Heavier media types can slow the print job.	Print on a different type of media.
	Complex pages will print slower.	Proper fusing may require a slower print speed to ensure the best print quality.
Pages did not print.	The device might not be pulling media correctly.	See Paper handling issues .
	The media is jamming in the device.	Clear the jam.
	The USB cable might be defective or incorrectly connected.	<ul style="list-style-type: none">■ Disconnect the USB cable at both ends and reconnect it.■ Try printing a job that has printed in the past.■ Try using a different USB cable.
	Other devices are running on your computer.	The device might not share a USB port. If you have an external hard drive or network switchbox that is connected to the same port as the device, the other device might be interfering. To connect and use the device, you must disconnect the other device or you must use two USB ports on the computer.

Functional tests (SERVICE ONLY)

Engine test print

The engine test print is used to confirm whether the printer operates correctly or not. It is performed by the engine controller.

If a malfunction occurs in the printer, perform an engine test print while the printer is in STBY mode and then press the test print switch (on the rear side of the printer) once. A one-page test pattern of horizontal lines will print as shown below.

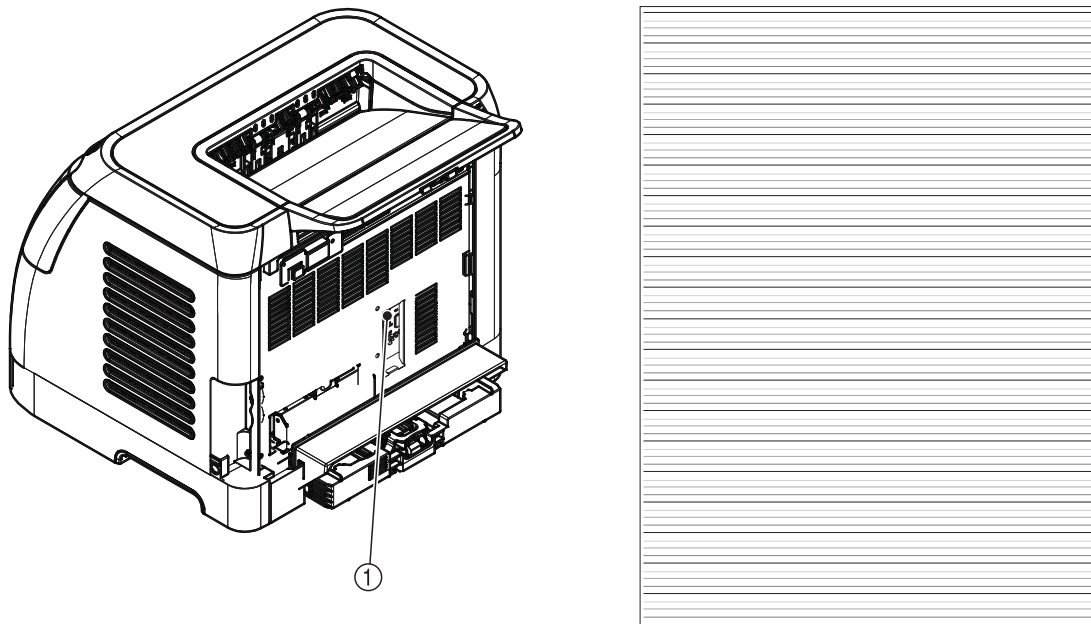

Figure 6-4 Engine test print switch

- 1 Engine test print switch

Service mode functions (SERVICE ONLY)

Cold reset

Cold-reset, which power-cycles the engine with a special button press, is not supported for this printer. Instead, use the feature “Restore defaults” located in the Service menu to reset default settings. For more information, see [Service menu](#).

NVRAM initializer







CAUTION NVRAM initialization will erase all network settings. Before performing NVRAM initialization, print a Configuration page, which contains network setting information.

NVRAM init will perform the following functions:

- Resets all customer-accessible menu settings via control panel and software back to the factory default settings
- Resets the language to the value set at the factory
- Resets the default media size to cold reset media size
- Resets the symbol set to PC-8

Use the following procedure to execute an NVRAM-init.

- 1 Turn off the printer.
- 2 Press and hold the  (SELECT) and  (CANCEL JOB) buttons simultaneously.
- 3 Turn on the printer.
- 4 When you see the message **Permanent storage init** displays, release the  (SELECT) and  (CANCEL JOB) buttons.

When the NVRAM init is complete, the printer will return to the Ready state.

Super NVRAM initializer



CAUTION Super NVRAM initialization will erase all network settings. Before performing Super NVRAM initialization, print a Configuration page, which contains network setting information.



When a super NVRAM init is performed, the printer enters the Generic Product Mode, which changes the language and country/region settings to “undefined.”



NOTE Super NVRAM init will erase all data stored in the protected NVRAM settings.

Use the following procedure to execute a super NVRAM init.

- 1 Turn off the printer.
- 2 Press and hold the  (LEFT ARROW) and  (RIGHT ARROW) buttons simultaneously.

- 3 Turn on the printer.
- 4 When you see the message **Permanent storage init** displays, release the  (**LEFT ARROW**) and  (**RIGHT ARROW**) buttons.

When the super NVRAM init is complete, the printer will return to the Ready state.

Restoring page counts and serial number

A software utility is available on the Service and Support CD-ROM to restore page counts and serial numbers when the formatter is replaced or when any of the following settings are lost:

- Color page count
- Total page count
- Formatter number
- Service ID
- USB serial number

To access the utility on the Service and Support CD-ROM, in the **Library** folder, double-click the **2600config.exe** program. You can run the utility from the CD-ROM or copy it to your computer.



NOTE To use this program, the printer must be directly connected to your computer with a USB cable.

Cleaning the ETB

To clean the ETB, use the following procedure:

- 1 Enter the Secondary service menu. For more information, see [Secondary service menu](#).
- 2 Scroll through the menu and select **CLEAN ETB**.
- 3 Press the  (**SELECT**) button to start the cleaning mode.



Troubleshooting tools

The section describes the tools that can help you solve problems with your device.

Printer pages and reports







This section describes the pages and reports that help you diagnose and solve problems with the device.

Demo page

To print the Demo page, press the  (LEFT ARROW) and  (RIGHT ARROW) buttons on the printer control panel simultaneously. You can also print this page from the HP Toolbox.

Configuration page

The Configuration page lists the current settings and properties of the printer. You can print a Configuration page from the printer or HP Toolbox. To print the Configuration page from the printer, complete the following steps.

- 1 Press the  (LEFT ARROW) or the  (RIGHT ARROW) buttons to select the **Reports** menu.
- 2 Press the  button (**SELECT**).
- 3 Press the  (LEFT ARROW) or the  (RIGHT ARROW) buttons to select **Config report**.
- 4 Press the  button (**SELECT**) to print the Configuration page.

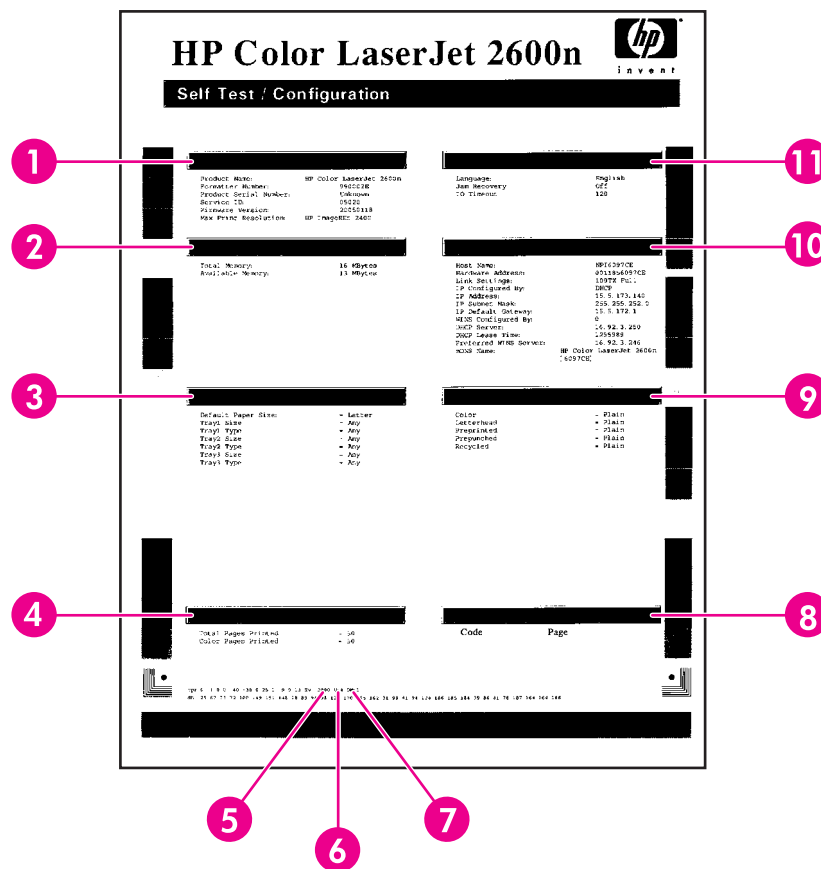

Table 6-10 Configuration page

- 1 **Product information.** This section contains the following basic information about the printer:
 - Product name
 - Formatter number
 - Serial number
 - Service ID
 - Firmware version
 - Maximum print resolution

2	Memory. This section lists memory-related information, such as the total memory that is installed.
3	Paper settings. This section lists information about the media type for each tray and about the type settings for all the media that the printer supports.
4	Page counts. This section lists the total number of pages printed, the number of color pages printed, and information about paper jams.
5	DC controller version. This section lists the DC controller version.
6	<p>USB settings. This section contains information for the USB setting options.</p> <ul style="list-style-type: none"> ■ U=0 Hi speed ■ U=4 Full speed ■ U=5 Full speed auto switched from hi speed
7	<p>Extended print modes enabled. The following list contains the options for enabling extended print modes.</p> <ul style="list-style-type: none"> ■ DM=0 Default setting ■ DM=1 Extended print mode enabled
8	Status log. This section contains information about printer errors, including an error log code and the page count at which the error occurred. For a list of status log messages, see Table 6-5 Status log messages .
9	Paper types. This section contains information about paper types that can be configured by the user. The default settings are Plain.
10	<p>Network settings. This section contains the following network information about the printer.</p> <ul style="list-style-type: none"> ■ Host name ■ Hardware address ■ Link settings ■ IP address information ■ IP subnet mask ■ IP default gateway ■ WINS configuration information ■ DHCP server and lease time information ■ Preferred WINS server information ■ mDNS name
11	<p>Product settings. This section lists the following information that is gathered during software installation:</p> <ul style="list-style-type: none"> ■ Language ■ Company name ■ Jam recovery settings (if set to ON, the last page will reprint if there is a paper jam) ■ I/O timeout information (default is 120 seconds)



NOTE The color bars on the sides of the Configuration page represent 100%, 75%, 50%, and 25% coverage.

Event log

Information for the last five events is available on the Configuration page under the Status log section. For more information, see [Configuration page](#).

For a list of messages that only appear in the event log, see [Status log only messages](#).

Supplies Status page

The Supplies Status page lists the remaining life of the HP print cartridges. It also lists the estimated pages remaining, number of pages printed, and other supplies information. You can print a Supplies Status page from the device or HP Toolbox. To print from the device, complete the following steps.

- 1 Press the (LEFT ARROW) or the (RIGHT ARROW) buttons to select the **Reports**.
- 2 Press (SELECT).
- 3 Use the (LEFT ARROW) or the (RIGHT ARROW) buttons to select **Supplies Status**.
- 4 Press (SELECT) button to print the Supplies Status page.

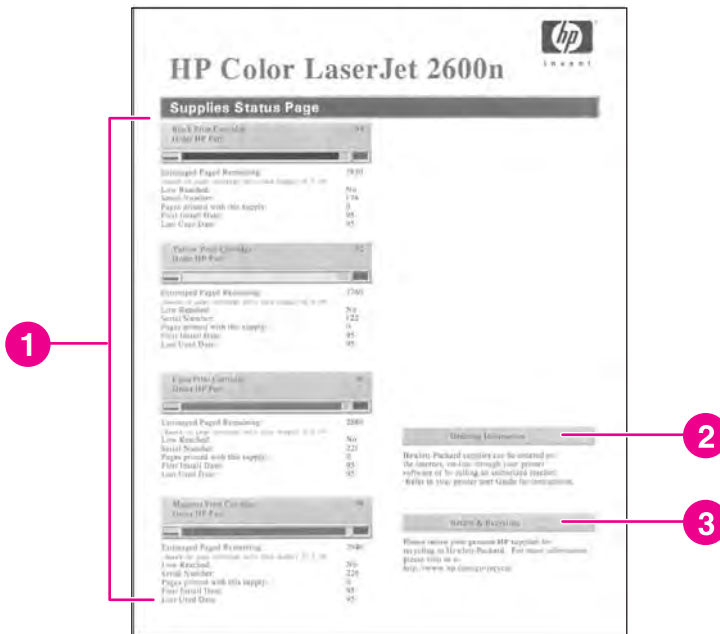

Table 6-11 Supplies Status page

1	Print cartridge area
2	Ordering information
3	Return and recycling information

Fuser cleaning page

For information about fuser cleaning pages, see [Cleaning page](#) and [To clean the fuser using HP Toolbox](#).







Print quality troubleshooting pages

For more information about print quality troubleshooting pages, see [HP Toolbox](#).

Control panel messages (error codes)

The majority of the control-panel messages are intended to guide the user through typical operation. The control-panel messages indicate the status of the current operation, and include a page count on the second line of the display, if appropriate. When the device is printing data, control-panel messages indicate this status. In addition, alert messages, warning messages, and critical error messages indicate situations that might require some action.

Alert and warning messages

Control panel message	Description	Recommended action
Device error Press ✓	An internal error occurred in the device.	Press  (SELECT) to resume the job.
Door open	The printer door is open.	The door must be closed before printing can continue.
Engine comm. error	The device experienced an internal communication error.	This is a warning message only. Job output might be affected.
Invalid driver	You are using the incorrect printer driver.	Reselect the printer driver appropriate for your device.
Invalid entry	Invalid data or response.	Correct the entry.
Jam in tray 2	A paper jam has occurred in Tray 2.	Clear the jam, and then press the  (SELECT) button on the control panel.
Jam in tray 3	A paper jam has occurred in Tray 3.	Clear the jam, and then press the  (SELECT) button on the control panel.
Jam in print paper path	A paper jam has occurred in the print path.	Open the door and clear the jam. Then press the  (SELECT) button on the control panel.
Jam in Cartridge area	A paper jam has occurred in the print path.	Open the door and clear the jam. Then press the  (SELECT) button on the control panel.
Jam in Output bin	A paper jam has occurred in the output area.	Clear the jam, and then press the  (SELECT) button on the control panel.
Load paper	The HP Color LaserJet 2600n printer is out of paper.	Please load specified paper type into the tray indicated.
Load Tray X [TYPE] [SIZE]	The printer is processing job, but the tray indicated is empty.	Please load specified paper type and size into the tray indicated.

Control panel message	Description	Recommended action
Manual feed Press ✓	The printer is waiting for paper in the tray indicated.	Load the paper as indicated.
Memory is low Press ✓	The device memory has been almost completely filled.	Allow the device to finish the job, or press <input checked="" type="checkbox"/> (SELECT) to cancel the job. Break the job into smaller jobs that contain fewer pages.
Misprint Press ✓	The printed pages have been incorrectly placed on the paper.	To continue, press the <input checked="" type="checkbox"/> (SELECT) button on the control panel.
No paper pickup Press ✓	The print engine has failed to pick up a piece of media.	In Tray 1, verify that the media was inserted far enough into the tray. In Tray 2 or optional Tray 3, verify that the paper-length guide is in the correct position for the media size that you are using. Reload the media in the input tray and press <input checked="" type="checkbox"/> (SELECT) to continue the job.
Unexpected size in tray X	Unexpected paper size error. The media size loaded in the tray does not match the media size configured for the tray.	Verify that the print settings are set to the specified media in the tray.



Critical error messages

Control panel message	Description	Recommended action
50.1 Fuser Error 50.2 Fuser Error 50.3 Fuser Error	The device has experienced an internal hardware error. 50.1 Fuser Error —low temperature 50.3 Fuser Error —slow fuser 50.2 Fuser Error —high temperature	Turn off the device, wait at least 25 minutes, and then turn on the device. If a surge protector is being used, remove it. Plug the device directly into the wall socket. Use the power switch to turn on the device. If this does not clear the error, replace the fuser.
51.20 Error 51.21 Error 51.22 Error 51.23 Error	The device has experienced an internal hardware error. 51.20 Error —black scanner error 51.21 Error —cyan scanner error 51.22 Error —magenta scanner error 51.23 Error —yellow scanner error	Turn off the power by using the power switch, wait at least 30 seconds, and then turn on the power and wait for the device to initialize. If a surge protector is being used, remove it. Plug the device directly into the wall socket. Use the power switch to turn the device on. Laser scanners are not replaceable. Replace the engine.
55.1 Error	DC controller error. The device has experienced an internal hardware error.	Turn off the power by using the power switch, wait at least 30 seconds, and then turn on the power and wait for the device to initialize.



Control panel message	Description	Recommended action
		<p>If a surge protector is being used, remove it. Plug the device directly into the wall socket. Use the power switch to turn the device on.</p> <p>Check the engine (DCC) firmware version. Update if needed. Replace the DCC if a firmware upgrade does not resolve the issue.</p>
<p>57 Fan Error</p> <p>Turn off then on</p>	<p>The device has experienced a problem with its internal fan.</p>	<p>Turn off the power by using the power switch, wait at least 30 seconds, and then turn on the power and wait for the device to initialize.</p> <p>The fan is not replaceable. Replace the engine.</p>

Supplies messages

Control panel message	Description	Recommended action
<p>10.000x Supply error</p>	<p>E-label cannot be read or print cartridge is not properly installed.</p> <p>10.0000 = Black print cartridge</p> <p>10.0001 = Cyan print cartridge</p> <p>10.0002 = Magenta print cartridge</p> <p>10.0003 = Yellow print cartridge</p>	<ol style="list-style-type: none"> 1 Reinstall print cartridge. 2 Power cycle device. 3 If the problem is not solved, replace the cartridge.
<p>10.100x Supply error</p> <p>alternates with</p> <p>Reinstall</p> <p>The supplies gauge will display the consumption levels of print cartridges.</p>	<p>A print cartridge is missing.</p> <p>10.1000 = Black print cartridge</p> <p>10.1001 = Cyan print cartridge</p> <p>10.1002 = Magenta print cartridge</p> <p>10.1003 = Yellow print cartridge</p>	<p>Install the correct print cartridge.</p>
<p>HP supplies installed</p>	<p>The printer transitioned from having one or more non-HP supplies to having all HP supplies installed.</p>	<p>No action required.</p>
<p>One of the following messages may display:</p> <p>Incorrect black</p> <p>Incorrect cyan</p> <p>Incorrect magenta</p> <p>Incorrect yellow</p>	<p>The <color> print cartridge not installed correctly.</p>	<p>Reinstall the <color> print cartridge.</p>
<p>One of the following messages may display:</p> <p>Install black cartridge</p> <p>Install cyan cartridge</p>	<p>The out threshold has been reached.</p>	<p>The supply must be replaced before printing can continue.</p>

Control panel message	Description	Recommended action
<p>Install magenta cartridge</p> <p>Install yellow cartridge</p> <p>The supplies gauge will display the consumption levels of print cartridges.</p>		
<p>Install supplies</p> <p>The supplies gauge will display the consumption levels of print cartridges.</p>	Multiple supplies are not installed.	Install correct print cartridges.
<p>One of the following messages may display:</p> <p>Non HP black installed</p> <p>Non HP cyan installed</p> <p>Non HP magenta installed</p> <p>Non HP yellow installed</p> <p>alternates with</p> <p>To accept</p> <p>Press ✓</p>	<p>A non-HP <color> cartridge is installed.</p>	<p> NOTE Any printer repair required as a result of using a non-HP or unauthorized supply is not covered under warranty.</p> <p>To use this cartridge, override by pressing the  (SELECT) button on the control panel.</p>
<p>Non HP supply in use</p> <p>alternates with</p> <p>Ready</p> <p>The supplies gauge will display the consumption levels of print cartridges.</p>	<p>A non-HP (cloned or refilled) supply has been installed that is not made by HP and was overridden.</p>	<p>If you believe you purchased an HP supply, please call the HP fraud hotline at 1-877-219-3183 or go to the HP anti-counterfeit website at http://www.hp.com/go/anticounterfeit. Service or repairs required as a result of using non-HP supplies is not covered under HP warranty.</p>
<p>One of the following messages may display:</p> <p>Order black cartridge,</p> <p>Order cyan cartridge,</p> <p>Order magenta cartridge, or</p> <p>Order yellow cartridge</p>	<p>The <color> print cartridge low threshold has been reached.</p>	<p>For more information go to the HP Color LaserJet 2600n toolbox and click Supplies Status. To order supplies online, click Order Supplies.</p>

Control panel message	Description	Recommended action
<p>alternates with</p> <p>Ready</p> <p>The supplies gauge will display the consumption levels of print cartridges.</p>		
<p>ORDER SUPPLIES</p> <p>alternates with</p> <p>Ready</p> <p>The supplies gauge will display the consumption levels of print cartridges.</p>	<p>Multiple supplies are low.</p>	<p>For more information go to the HP Color LaserJet 2600n toolbox and click Supplies Status. To order supplies online, click Order Supplies.</p>
<p>One of the following messages may display:</p> <p>Replace black cartridge</p> <p>Replace cyan cartridge</p> <p>Replace magenta cartridge</p> <p>Replace yellow cartridge</p>	<p>The out threshold has been reached.</p>	<p>The supply must be replaced before printing can continue.</p>
<p>Replace Supplies</p> <p>The supplies gauge will display the consumption levels of print cartridges.</p>	<p>The out threshold has been reached.</p>	<p>The supply must be replaced before printing can continue.</p>
<p>Replace supplies</p> <p>Override in use</p> <p>alternates with</p> <p>Ready</p> <p>The supplies gauge will display the consumption levels of print cartridges.</p>	<p>Supply override in use. The user has decided to continue printing beyond the out point. A supply is low and using Override may result in unsatisfactory print quality.</p>	<p>Replace the supply that is low.</p>
<p>Replace supply.</p> <p>Override in use</p> <p>alternates with</p> <p>Ready</p> <p>The supplies gauge will display the consumption levels of print cartridges.</p>	<p>Supply override in use. The user has decided to continue printing beyond the out point. A supply is low and using Override may result in unsatisfactory print quality.</p>	<p>Replace the supply that is low.</p>

Control panel message	Description	Recommended action
Unauthorized supply in use alternates with Ready The supplies gauge will display the consumption levels of print cartridges.	A new supply has been installed that is not made by HP and was overridden.	If you believe you purchased an HP supply, please call the HP fraud hotline at 1-877-219-3183. Service or repairs required as a result of using non-HP supplies is not covered under HP warranty.
One of the following messages may display: Unauthorized yellow Unauthorized magenta Unauthorized cyan Unauthorized black	A new supply has been installed that is not made by HP. One of these four messages is displayed until an HP supply is installed or  (SELECT) is pressed.	If you believe you purchased an HP supply, please call the HP fraud hotline at 1-877-219-3183. Service or repairs required as a result of using non-HP supplies is not covered under HP warranty. To continue printing, press  (SELECT).

Status messages

Status messages are used to inform the user of the current state of the system. Status messages do not require user action or acknowledgement, and are for information only.

Control panel message	Description	Recommended action
Calibrating...	The printer is calibrating.	No action is required.
Cleaning...	The printer is in cleaning mode.	No action is required.

Status log only messages

The following messages are not displayed on the control panel. They are printed on the Status log.

Table 6-12 Status log only messages

Error log code	Description
54.06	Color density sensor error
54.10	Color plane registration sensor(s) error
54.11	Yellow density out of range
54.12	Magenta density out of range
54.13	Cyan density out of range
54.14	Black density out of range







Service menu

Use the control-panel Service menu to troubleshoot device problems.

Restoring the factory-set defaults

Restoring the factory-set defaults returns all of the settings to the factory defaults.

To restore the factory-set defaults

- 1 Use the  (LEFT ARROW) or the  (RIGHT ARROW) button to select **Service**, and then press  (SELECT).
- 2 Use the  (LEFT ARROW) or the  (RIGHT ARROW) button to select **Restore defaults**, and then press  (SELECT).

The device automatically restarts.

General print quality issues

The following examples depict letter-size paper that has passed through the device short edge first. These examples illustrate problems that would affect all of the pages that you print, whether you print in color or in black only. The topics that follow list the typical cause and solution for each of these examples.

Table 6-13 General print quality issues

Problem	Cause	Solution
Print is light or faded. 	The media might not meet HP specifications. One or more print cartridges might be low. If you are using non-HP print cartridges, no messages appear on the device control panel or in the HP Toolbox.	Use media that meets HP specifications. Replace any low print cartridges. If none of the print cartridges is low or empty, remove the print cartridges one at a time and inspect the toner roller in each to see if the roller is damaged. If so, replace the print cartridge. Print the Supplies Status page to check the remaining life.
Toner specks appear. 	The media might not meet HP specifications. The paper path might need cleaning.	Use media that meets HP specifications. Clean the paper path. See the HP Toolbox online Help.
Dropouts appear.	A single sheet of print media might be defective. The moisture content of the paper is uneven or the paper has moist spots on its surface.	Try reprinting the job. Try different paper, such as high-quality paper that is intended for color laser printers.

Table 6-13 General print quality issues (continued)

Problem	Cause	Solution
	<p>The paper lot is flawed. The manufacturing processes can cause some areas to reject toner.</p>	<p>Try different paper, such as high-quality paper that is intended for color laser printers.</p>
<p>Vertical streaks or bands appear on the page.</p>	<p>One or more print cartridges might be low or defective. If you are using non-HP print cartridges, no messages appear on the device control panel or in the HP Toolbox.</p>	<p>Replace any low print cartridges.</p>
		
<p>The amount of background toner shading becomes unacceptable.</p>	<p>The media might not meet HP specifications.</p>	<p>Use a different paper with a lighter basis weight.</p>
	<p>Very dry (low humidity) conditions can increase the amount of background shading.</p>	<p>Check the device environment.</p>
	<p>One or more print cartridges might be low. If you are using non-HP print cartridges, no messages appear on the device control panel or in the HP Toolbox.</p>	<p>Replace any low print cartridges.</p>
<p>Toner smears appear on the media.</p>	<p>The media might not meet HP specifications.</p>	<p>Use media that meets HP specifications.</p>
	<p>If toner smears appear on the leading edge of the paper, the media guides are dirty, or debris has accumulated in the print path.</p>	<p>Clean the media guides and the paper path.</p>
<p>The toner smears easily when touched.</p>	<p>The device is not set to print on the type of media on which you want to print.</p>	<p>In the printer driver, select the Paper tab and set Type is to match the type of media on which you are printing. Print speed might be slower if you are using heavy paper.</p>
	<p>The media might not meet HP specifications.</p>	<p>Use media that meets HP specifications.</p>

Table 6-13 General print quality issues (continued)

Problem	Cause	Solution
	<p>The paper path might need cleaning.</p>	<p>Clean the device.</p>
<p>Marks repeatedly appear at even intervals on the printed side of the page.</p> 	<p>The device is not set to print on the type of media on which you want to print.</p>	<p>In the printer driver, select the Paper tab and set Type is to match the type of paper on which you are printing. Print speed might be slower if you are using heavy paper.</p> <p>For more information, see Repetitive image defect ruler.</p>
<p>Marks repeatedly appear at even intervals on the unprinted side of the page.</p> 	<p>Internal parts might have toner on them.</p> <p>The paper path might need cleaning.</p> <p>The fuser might be damaged or dirty.</p>	<p>The problem typically corrects itself after a few more pages.</p> <p>Clean the device.</p> <p>Clean using instructions in HP Toolbox.</p>
<p>The printed page contains misformed characters.</p> 	<p>The media might not meet HP specifications.</p> <p>If characters are incorrectly formed so that they produce a wavy effect, the laser scanner might need service.</p>	<p>Use a different paper, such as high-quality paper that is intended for color laser printers.</p> <p>Verify that the problem also occurs on the Configuration page.</p>

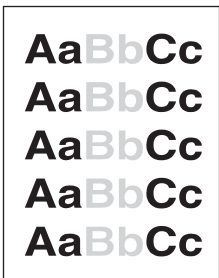
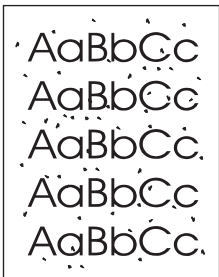
Table 6-13 General print quality issues (continued)

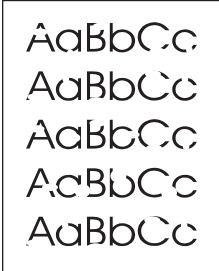
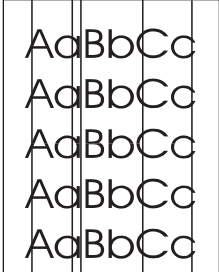
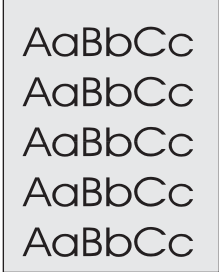
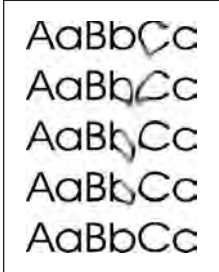

Problem	Cause	Solution
<p>The printed page is curled or wavy.</p> 	<p>The device is not set to print on the type of media on which you want to print.</p> <hr/> <p>The media might not meet HP specifications.</p> <hr/> <p>Both high temperature and humidity can cause paper curl.</p>	<p>In the printer driver, select the Paper tab and set Type is to match the type of paper on which you are printing. Print speed might be slower if you are using heavy paper.</p> <hr/> <p>Use a different paper, such as high-quality paper that is intended for color laser printers.</p> <hr/> <p>Check the device environment.</p>
<p>Text or graphics are skewed on the printed page.</p> 	<p>The media might be loaded incorrectly.</p> <hr/> <p>The media might not meet HP specifications.</p>	<p>Make sure that the paper or other print media is loaded correctly and that the media guides are not too tight or too loose against the stack.</p> <hr/> <p>Use a different paper, such as high-quality paper that is intended for color laser printers.</p>
<p>The printed page contains wrinkles or creases.</p> 	<p>The media might be loaded incorrectly.</p> <hr/> <p>The media might not meet HP specifications.</p>	<p>Verify that the media is loaded correctly and that the media guides are not too tight or too loose against the stack.</p> <hr/> <p>Turn over the stack of paper in the input tray, or try rotating the paper 180° in the input tray.</p> <hr/> <p>Use a different paper, such as high-quality paper that is intended for color laser printers.</p>
<p>Toner appears around the printed characters.</p> 	<p>The media might be loaded incorrectly.</p> <hr/> <p>If large amounts of toner have scattered around the characters, the paper might have high resistivity.</p>	<p>Turn over the stack of paper in the tray.</p> <hr/> <p>Use a different paper, such as high-quality paper that is intended for color laser printers.</p>

Table 6-13 General print quality issues (continued)

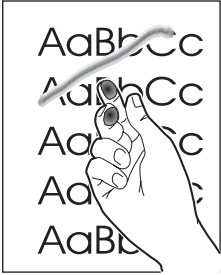
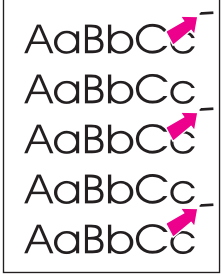
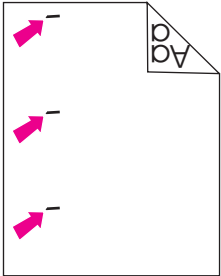
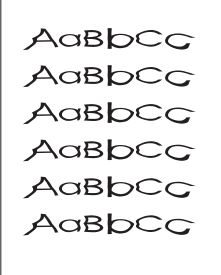
Problem	Cause	Solution
An image that appears at the top of the page (in solid black) repeats farther down the page (in a gray field).	Software settings might affect image printing.	In your software program, change the tone (darkness) of the field in which the repeated image appears. In your software program, rotate the whole page 180° to print the lighter image first.
	The order of images printed might affect printing.	Change the order in which the images are printed. For example, have the lighter image at the top of the page, and the darker image farther down the page.
	A power surge might have affected the device.	If the defect occurs later in a print job, turn the device off for 10 minutes, and then turn on the device to restart the print job.

Solving issues with color documents

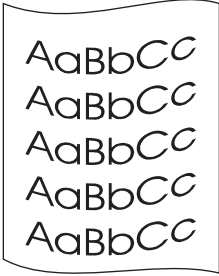
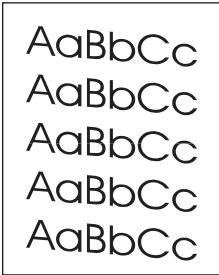
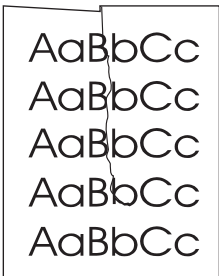
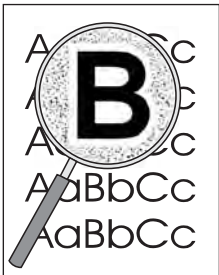
This section describes issues that can occur when you print in color.

Table 6-14 Color document issues





Problem	Cause	Solution
Only black is printing when the document should be printing in color.	Color mode is not selected in your program or printer driver.	Select color mode instead of grayscale mode.
	The correct printer driver might not be selected in the program.	Select the correct printer driver.
	The device might not be correctly configured.	Print a Configuration page.
	Sealing tape might be on the print cartridges.	Verify that the sealing tape has been completely removed from the print cartridges.
	The media might not meet HP specifications.	Use a different paper, such as high-quality paper that is intended for color laser printers.
	The device might be operating in excessively humid conditions.	Verify that the device environment is within humidity specifications.
	One or more print cartridges might be low. If you are using non-HP print cartridges, no messages appear on the device control panel or in the HP Toolbox.	Replace any low print cartridges.
	The control panel is set for override.	Replace low or empty print cartridges.

Table 6-14 Color document issues (continued)

Problem	Cause	Solution
<p>A color is printing inconsistently after you load a new print cartridge.</p>	<p>Another print cartridge might be low. If you are using a non-HP print cartridge, it might be low or empty but you will receive no indication.</p>	<p>Remove the print cartridge for the color that is printing inconsistently and reinstall it.</p>
	<p>The control panel is set for override.</p>	<p>Replace low or empty print cartridges.</p>
<p>The colors on the printed page do not match the colors as they appear on the screen.</p>	<p>The colors on your computer monitor might differ from the device output.</p>	<p>Select Screen Match in the Color tab of the printer driver.</p>
	<p>If extremely light colors or extremely dark colors on screen are not printing, your software program might interpret extremely light colors as white or extremely dark colors as black.</p>	<p>If possible, avoid using extremely light or extremely dark colors.</p>
<p>The finish on the printed color page is inconsistent.</p>	<p>The media might be too rough.</p>	<p>Use a smooth paper or print media, such as a high-quality paper that is made for color laser printers. Generally, smoother media produces better results.</p>
		

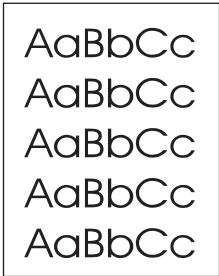
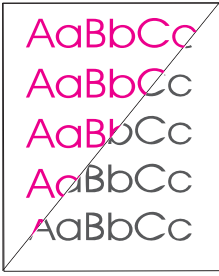
HP Toolbox

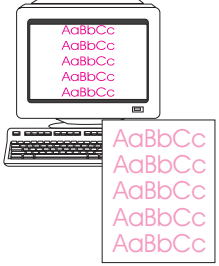
HP Toolbox

HP Toolbox is a Web application that you can use for troubleshooting tasks.

To view HP Toolbox

Open HP Toolbox in one of these ways:

- On the Windows desktop, double-click the HP Toolbox icon.
- On the Windows **Start** menu, click **Programs (All Programs** in Windows XP), click **HP**, click **HP Color LaserJet 2600n**, and then click **HP Color LaserJet 2600n toolbox**.

Troubleshooting tab

HP Toolbox includes a **Troubleshooting** tab that contains links to the following main pages:

- **Clearing Jams**. View information about locating and clearing jams.
- **Print Problems**. View Help topics that can help you solve print problems.
- **Troubleshooting Tools**. Employ such troubleshooting tools as a cleaning page or a color troubleshooting page to maintain the device.
- **Animated Demonstrations**. View animated Help demonstrations for the device.



NOTE Other tabs on HP Toolbox might be helpful in troubleshooting device problems.

Print quality troubleshooting pages

The following features are available from the HP Toolbox.

Printer calibration

Calibrations are performed at regular intervals. For best print quality, a calibration can be performed from the control panel. For information about calibrating the printer at the control panel, see [Printer calibration](#).

Calibrating the printer using HP Toolbox

Use the following steps to calibrate the printer using HP Toolbox.

- 1 Open the HP Toolbox.
- 2 On the **Troubleshooting** tab, click **Calibrate now**.

Cleaning page

The device features a special cleaning mode to clean the paper path.



NOTE If you have access to HP Toolbox, HP recommends cleaning the paper path by using HP Toolbox.

- 1 Make sure that the printer is turned on and in the Ready state.
- 2 Open the HP Toolbox.
- 3 On the **Troubleshooting** tab, click **Troubleshooting Tools**, and then click **Print**. A page with a pattern prints from the printer.
- 4 At the printer, remove any print media in Tray 2 or optional Tray 3.
- 5 Remove the page that printed and load it face-down into Tray 2 or optional Tray 3.

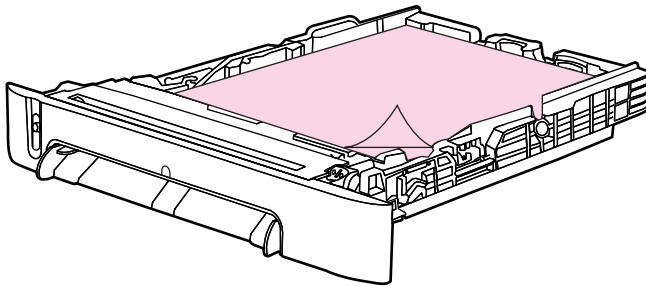

- 6 At the computer, press the **Clean** button.

Configuration page

The Configuration page lists the current settings and properties of the printer. You can print a Configuration page from the printer or HP Toolbox. To print the Configuration page from the printer, see [Configuration page](#).

Diagnostic resources

Reports menu

The Reports menu contains the following diagnostic tools:

- Demo page
- Menu structure report
- Configuration report
- Color supplies status

For a more detailed description about the diagnostic tools available from the Reports menu, see [Reports menu](#) in the [Print problems](#) section.

Network/Web diagnostics tools

For information on available network and Web diagnostic tools, go to <http://www.hp.com/support/clj2600n>.

Repetitive image defect ruler

Use a repetitive image defect ruler to measure occurrences of repetitive image defects to help solve image quality problems. Place the ruler next to the first occurrence of the defect on the page. Find the distance between identical defects and see the [Table 6-15 Repetitive image defects](#) table to identify the component that is causing the defect.

Table 6-15 Repetitive image defects

Measurement	Component
24.7 mm (0.97 inch)	Developer sleeve
26.7 mm (1.05 inches)	Charge roller
32.9 mm (1.3 inches)	RS roller
37.7 mm (1.48 inches)	Transfer roller
54.5 mm (2.15 inches)	ETB rollers
56.6 mm (2.22 inches)	Fuser sleeve
62.8 mm (2.47 inches)	Pressure roller
75.4 mm (2.97 inches)	OPC

Firmware and software updates

Use the following procedure to periodically check for firmware and software updates.

- 1 Go to <http://www.hp.com/support/clj2600n>.
- 2 Select **Download drivers and software** and then select the appropriate operating system for you computer.
- 3 Follow the instructions provided on the download pages.

7 Parts and diagrams



NOTE In this chapter, part numbers are only listed for available replaceable parts. References to non-replaceable parts are provided for identification.

This section contains the following information.

- [Overview](#)
- [Assembly locations](#)
- [Covers](#)
- [Internal assemblies](#)
- [Input devices](#)
- [Diagrams](#)
- [Alphabetical parts list](#)
- [Numerical parts list](#)

Overview

Replaceable parts

The following table lists the replaceable parts available for this printer.

Table 7-1 Available replaceable parts

Description	Part number	Diagram
FORMATTER PCB (replacement)	Q5965–67901	
FLAT FLEX CABLE DCC-FORMATTER	Q6456-60101	
ARM, PAPER RETAINER, LEFT	RC1-5096-000CN	See Figure 7-6 Internal components (2 of 3) .
ARM, PAPER RETAINER, RIGHT	RC1-5097-000CN	See Figure 7-6 Internal components (2 of 3) .
RETAINER, PAPER	RC1-5062-000CN	See Figure 7-6 Internal components (2 of 3) .
CABLE COVER UNIT	RC1-5147-000CN	See Figure 7-6 Internal components (2 of 3) .
COVER, LEFT	RC1-5183-000CN	See Figure 7-3 External panels and covers (2 of 2) .
COVER, CASSETTE, LEFT	RC1-5184-000CN	See Figure 7-3 External panels and covers (2 of 2) .
COVER, CASSETTE, RIGHT	RC1-5188-000CN	See Figure 7-3 External panels and covers (2 of 2) .
COVER, CASSETTE, DUST	RC1-5200-000CN	See Figure 7-3 External panels and covers (2 of 2) , and Figure 7-14 Tray 2 input tray internal components .
PLATE, REAR	RC1-5227-000CN	See Figure 7-3 External panels and covers (2 of 2) .
ROLLER, PICK UP	RC1-5440-000CN	See Figure 7-15 Paper pick-up feeder assembly for Tray 2 and Figure 7-17 Paper pickup feeder assembly (Tray 3) .
COVER, FACE DOWN	RC1-5173-000CN	See Assembly locations .
COVER, UPPER FACE S	RC1-5174-000CN	See Assembly locations .
FUSER ASSY	RM1-1820-000CN 110-127V	See Figure 7-10 Fuser assembly .
FUSER ASSY	RM1-1821-000CN 220-240V	See Figure 7-10 Fuser assembly .
FRONT DOOR ASSY	RM1-1856-000CN	See Figure 7-3 External panels and covers (2 of 2) .
RIGHT COVER ASSY	RM1-1858-000CN	See Figure 7-3 External panels and covers (2 of 2) .
PAPER DELIVERY TRAY ASSY	RM1-1859-000CN	See Figure 7-3 External panels and covers (2 of 2) .

Table 7-1 Available replaceable parts (continued)

Description	Part number	Diagram
COVER, INSIDE, UPPER	RC1-5178-000CN	See Figure 7-4 Upper cover assembly .
ETB UNIT	RM1-1885-000CN	See Figure 7-6 Internal components (2 of 3) .
TRAY 1 & 2 CASSETTE (tray only)	RM1-1916-000CN	See Figure 7-12 Tray 2 input tray (cassette) .
SEPARATION ASSY	RM1-1922-000CN	See Figure 7-12 Tray 2 input tray (cassette) and Figure 7-16 Tray 3 input tray (cassette) .
FEED ASSY	RM1-1923-000CN	See Figure 7-12 Tray 2 input tray (cassette) .
TRAY 3 CASSETTE (tray only)	RM1-1945-000CN	See Figure 7-16 Tray 3 input tray (cassette) .
UPPER COVER	RC1-5176-000CN	See Figure 7-4 Upper cover assembly .
DC CONTROLLER PCB ASSY	RM1-1975-000CN	See Figure 7-7 Internal components (3 of 3) and Figure 7-11 PCB assembly location (Tray 2) .
CONTROL PANEL ASSY	RM1-1983-000CN	See Figure 7-8 Control panel assembly .
Black Toner Cartridge	Q6000A	
Cyan Toner Cartridge	Q6001A	
Yellow Toner Cartridge	Q6002A	
Magenta Toner Cartridge	Q6003A	
Replacement-Toner-Black	Q6000-67901	
Replacement-Toner-Cyan	Q6001-67901	
Replacement-Toner-Yellow	Q6002-67901	
Replacement-Toner-Magenta	Q6003-67901	
Tray 3 paper feeder	Q6459-69001	
Replacement Whole printer units 110v	Q6455-67056	
Replacement Whole printer units 220v	Q6455-67055	
Refurbished Whole printer units 110v	Q6455-69056	
Refurbished Whole printer units 220v	Q6455-69055	
Optional Tray 3	Q6459A	
Replacement Tray 3 (tray and assembly)	Q6459-69001	

Order replacement parts from the following Web site:

<http://www.partsdirect.hp.com>

Related documentation and software

Order documentation and software from the companies listed in the following table; some documentation and software is available at the following Web sites.

Table 7-2 Technical support Web sites

HP Customer Care Online	http://www.hp.com/support
Software drivers, support documentation, and answers to frequently asked questions	
HP Technical Training	http://www.hp.com/education

Supplies

Printer supplies are listed in [Life expectancies of supplies](#). Consumables are available directly from HP at the following numbers.

- US: 1-800-538-8787
- Canada: 1-800-387-3154

Contact your local HP Parts Coordinator for other local phone numbers.

Accessories

Table 7-3 Accessories

Product name	Description	Product number	Part number	Exchange number (replacement number)
Optional 250-sheet tray	Optional Tray 3	Q6459A	Q6459-69001	RM1-1945-000CN

Assembly locations

ASSEMBLY LOCATION DIAGRAM

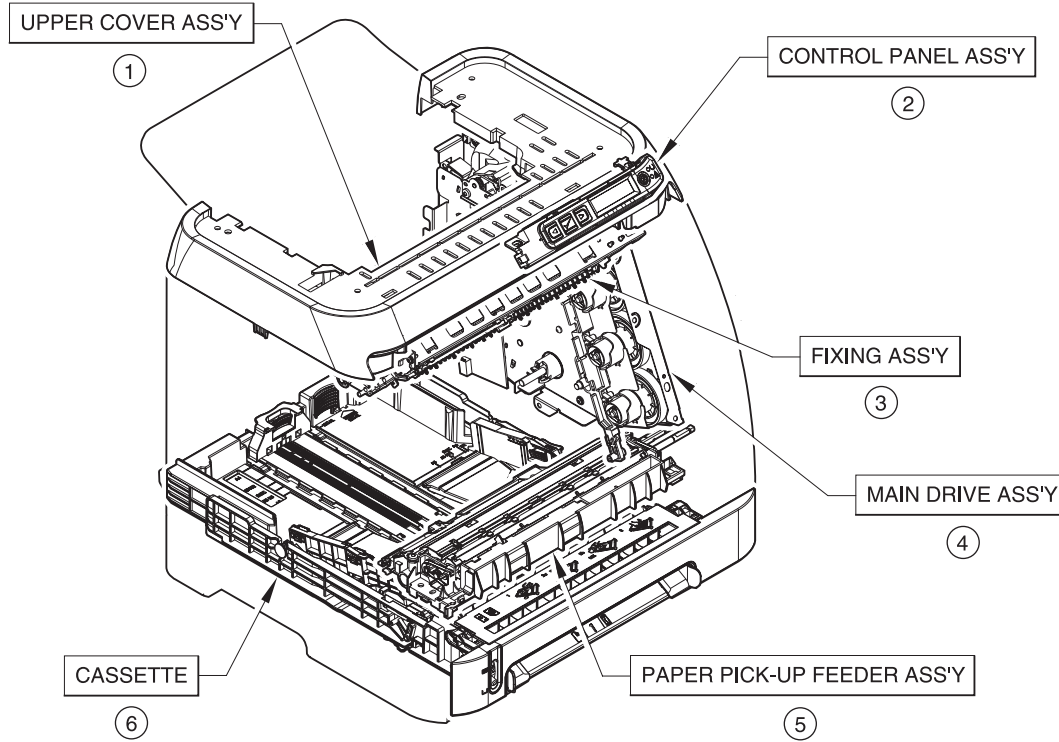

Figure 7-1 Assembly location diagram

Table 7-4 Assembly locations

Ref	Description	Part number	Qty
	* Not set up as a service part		
1	UPPER COVER	*	
2	CONTROL PANEL ASSEMBLY	RM1-1983-000CN	
3	FUSER ASSEMBLY	RM1-1820-000CN (110v) or RM1-1821-000CN (220v)	
4	MAIN DRIVE ASSEMBLY	*	
5	PAPER PICKUP FEEDER ASSEMBLY	*	
6	CASSETTE	RM1-1916-000CN	

EXTERNAL PANELS, COVERS, ETC. (1/2)

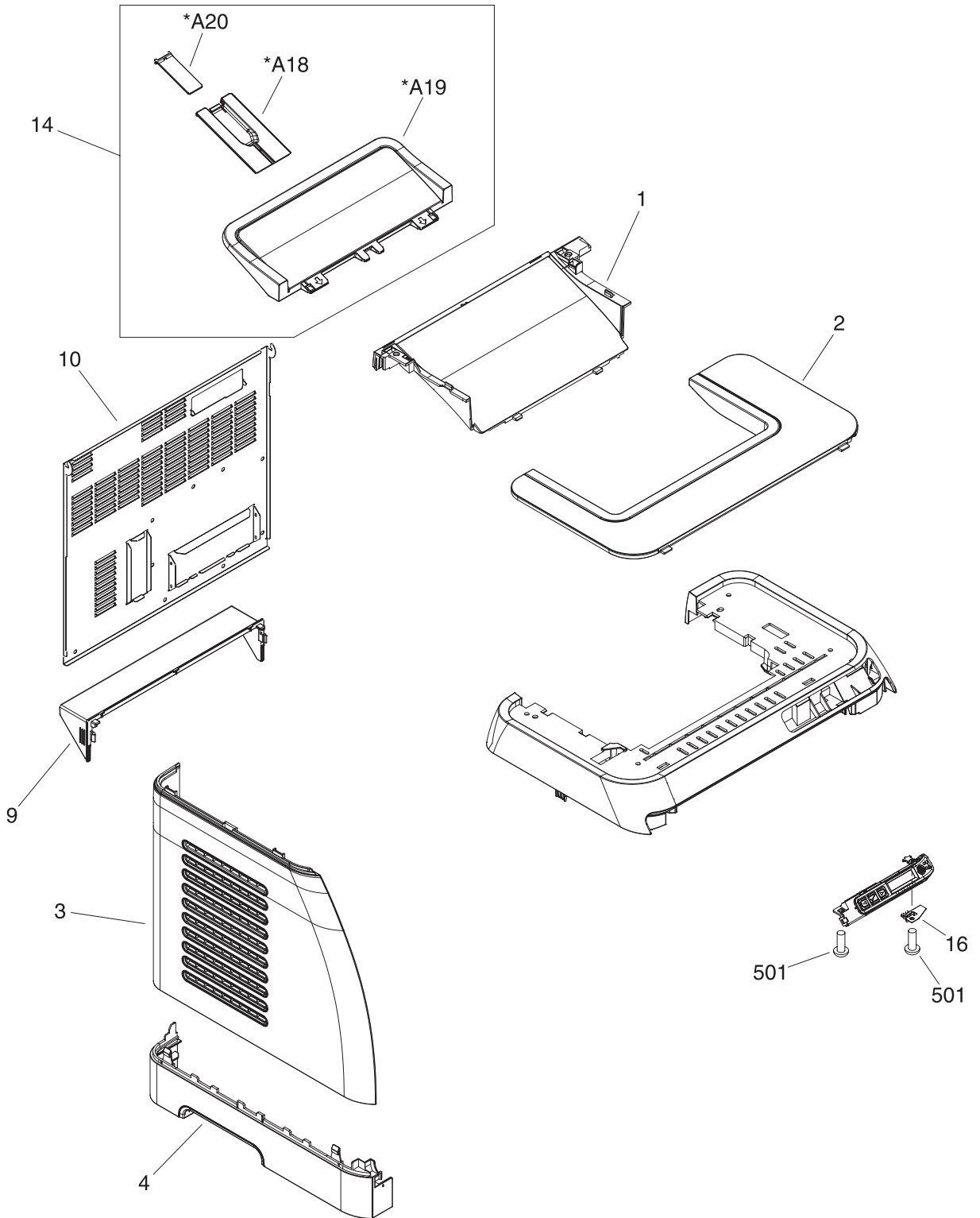

Figure 7-2 External panels and covers (1 of 2)

Table 7-5 External panels and covers (1 of 2)

Ref	Description	Part number	Qty
	* Not set up as a service part		
	EXTERNAL COVERS, PANELS, ETC.	*	RF
	CONNECTOR, SNAP TIGHT	*	1
	CONNECTOR, SNAP TIGHT, BK	*	1
	CLIP, CABLE	*	1
	SADDLE, WIRE	*	1
1	COVER, FACE-DOWN	RC1-5173-000CN	1
2	COVER, UPPER FACE, S	RC1-5174-000CN	1
3	COVER, LEFT	RC1-5183-000CN	1
4	COVER, CASSETTE, LEFT	RC1-5184-000CN	1
9	COVER, CASSETTE DUST	RC1-5200-000CN	1
10	PLATE, REAR	RC1-5227-000CN	1
14	PAPER DELIVERY TRAY ASS'Y	RM1-1859-000CN	1
16	PLATE, GROUNDING	*	1
501	SCREW, TAPPING, TRUSS HEAD, M3X8	*	2
A18	TRAY, EXTENSION	*	1
A19	TRAY, FACE-DOWN	*	1
A20	PLATE, DELIVERY BACK END LIMIT	*	1

EXTERNAL PANELS, COVERS, ETC. (2/2)

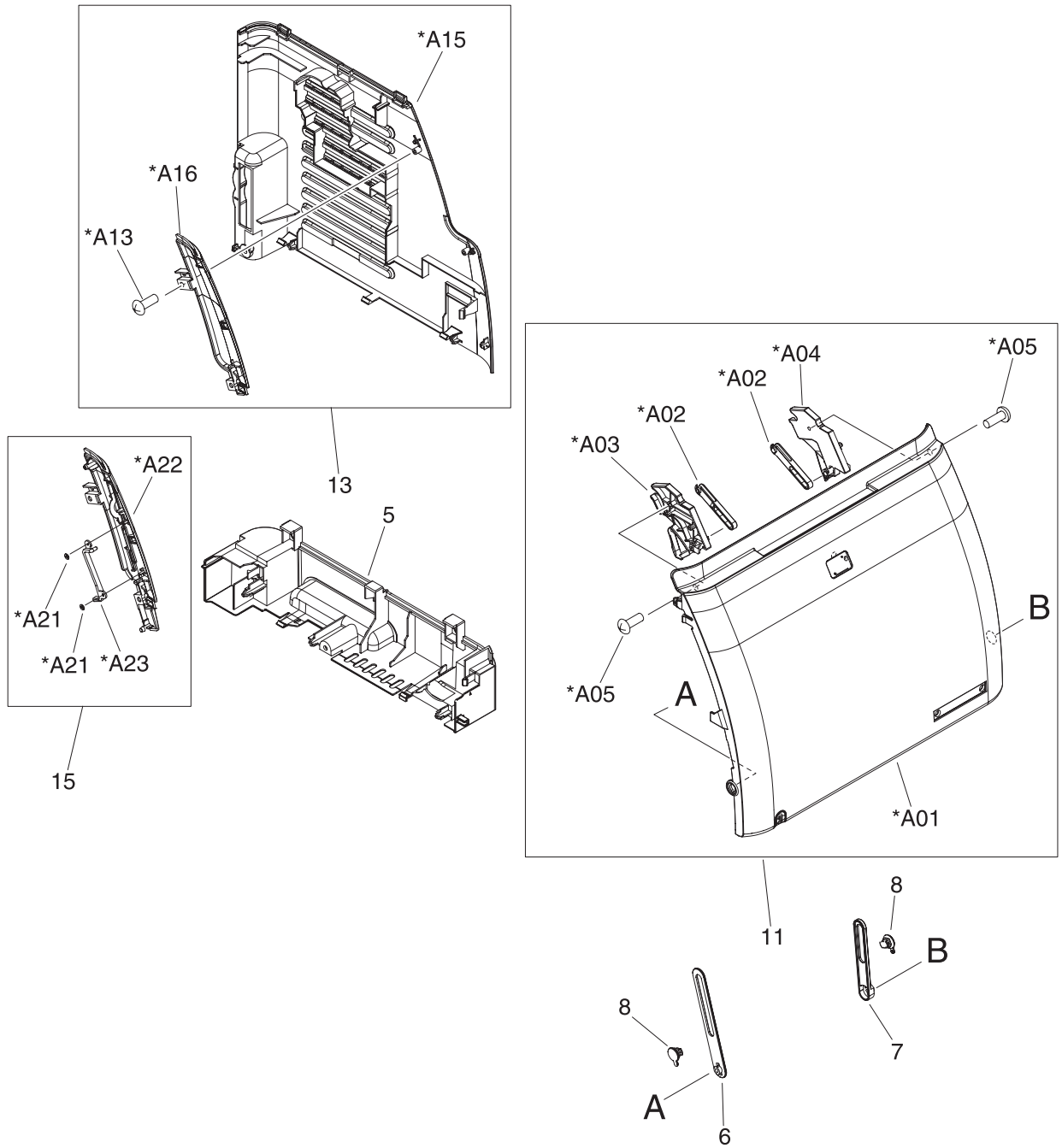

Figure 7-3 External panels and covers (2 of 2)

Table 7-6 External panels and covers (2 of 2)

Ref	Description	Part number	Qty
	* Not set up as a service part		
	EXTERNAL COVERS, PANELS, ETC.	*	RF
	CONNECTOR, SNAP TIGHT	*	1
	CONNECTOR, SNAP TIGHT, BK	*	1
	CLIP, CABLE	*	1
	SADDLE, WIRE	*	1
5	COVER, CASSETTE, RIGHT	RC1-5188-000CN	1
6	ARM, FRONT DOOR, LEFT	*	1
7	ARM, FRONT DOOR, RIGHT	*	1
8	SHAFT, FRONT DOOR ARM	*	2
9	COVER, CASSETTE DUST	RC1-5200-000CN	1
10	PLATE, REAR	RC1-5227-000CN	1
11	FRONT DOOR ASS'Y	RM1-1856-000CN	1
13	RIGHT COVER ASS'Y	RM1-1858-000CN	1
15	COVER, RIGHT FRONT	*	1
A01	DOOR, FRONT	*	1
A02	LEVER, LINK	*	2
A03	LEVER, TOGGLE, LEFT	*	1
A04	LEVER, TOGGLE, RIGHT	*	1
A05	SCREW, TAPPING, TRUSS HEAD, M4X8	*	2
A13	SCREW, TP	*	2
A15	COVER, RIGHT	*	1
A16	COVER, RIGHT FRONT	*	1
A21	BUSHING	*	2
A22	COVER, RIGHT FRONT	*	1
A23	GUIDE, LIGHT	*	1

Covers

UPPER COVER ASS'Y

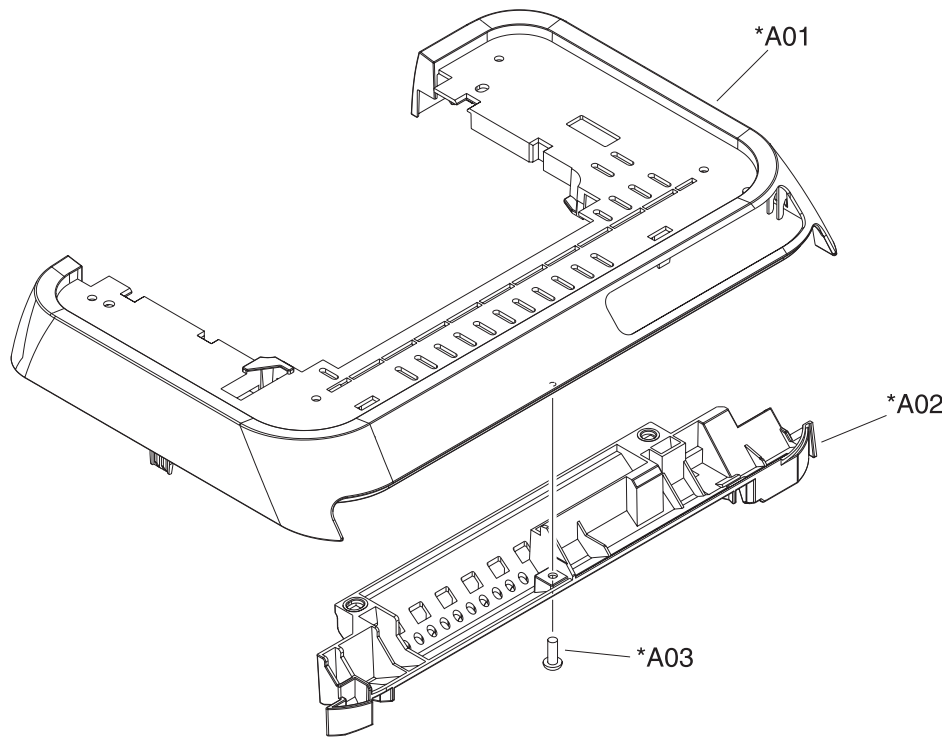

Figure 7-4 Upper cover assembly

Table 7-7 Upper assembly cover

Ref	Description	Part number	Qty
	* Not set up as a service part		
A01	COVER, UPPER	RC1-5176-000CN	1
A02	COVER, INSIDE, UPPER	RC1-5178-000CN	1
A03	SCREW, TAPPING, TRUSS HEAD, M4X8	*	1

Internal assemblies

INTERNAL COMPONENTS 1

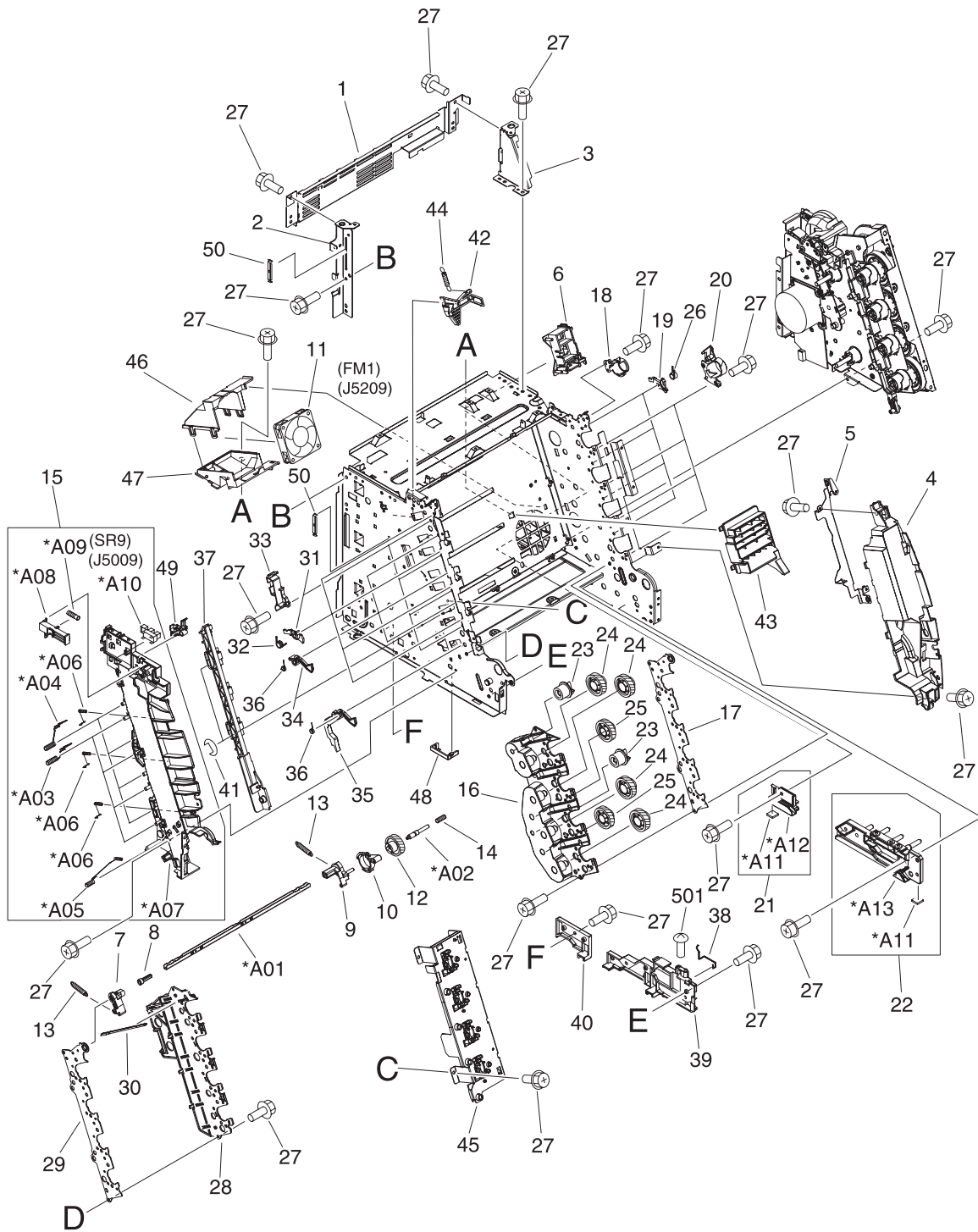

Figure 7-5 Internal components (1 of 3)

Table 7-8 Internal components (1 of 3)

Ref	Description	Part number	Qty
	* Not set up as a service part		
	INTERNAL COMPONENTS 1	*	RF
1	CROSSMEMBER, TOP COVER	*	1
2	BRACKET, LEFT REAR	*	1
3	BRACKET, RIGHT REAR	*	1
4	COVER, INSIDE, RIGHT	*	1
5	BRACKET, CARD READER	*	1
6	HOLDER, FAN RETAINER	*	1
7	LATCH, LEFT	*	1
8	BUSHING	*	1
9	LATCH, RIGHT	*	1
10	LEVER, ETB RELEASE	*	1
11	FAN	*	1
12	GEAR, 54T	*	1
13	SPRING, TENSION	*	2
14	SPRING, COMPRESSION	*	1
15	LEFT INTERNAL COVER ASS'Y	*	1
16	GUIDE, CARTRIDGE, RIGHT	*	1
17	HOLDER, DRUM	*	1
18	BUSHING	*	1
19	PLATE, PRESSURE, RIGHT	*	4
20	BUSHING	*	4
21	GUIDE, CASSETTE, REAR RIGHT	*	1
22	GUIDE, CASSETTE, FRONT RIGHT	*	1
23	GEAR, 20T	*	2
24	GEAR, 36T	*	4
25	GEAR, 36T	*	2
26	SPRING, TORSION	*	4
27	SCREW, RS, M3X8	*	15
27	SCREW, RS, M3X8	*	14
27	SCREW, RS, M3X8	*	1
27	SCREW, RS, M3X8	*	4
28	GUIDE, CARTRIDGE, LEFT	*	1
29	HOLDER, DRUM	*	1

Ref	Description	Part number	Qty
30	LINK, SHUTTER	*	1
31	PLATE, PRESSURE, LEFT	*	4
32	SPRING, TORSION	*	4
33	PLATE, SHAFT	*	4
34	ARM, OPEN/CLOSE	*	3
35	ARM, OPEN/CLOSE	*	1
36	SPRING, TORSION	*	4
37	ROD, LEFT	*	1
38	SPRING, GROUNDING	*	1
39	GUIDE, CASSETTE, FRONT LEFT	*	1
40	GUIDE, CASSETTE, REAR LEFT	*	1
41	RING, E	*	2
42	ARM, LASER SHUTTER	*	1
43	DUCT, FAN	*	1
44	SPRING, TENSION	*	1
45	MEMORY CONTROLLER PCB ASS'Y	*	1
46	DUCT, FAN, UPPER	*	1
47	DUCT, FAN, LOWER	*	1
48	HOLDER, MEMORY CONTROLLER	*	1
49	FLAG, PRESSURE RELEASE SENSOR	*	1
50	CLAMP, FFC	*	2
501	SCREW, TAPPING, TRUSS HEAD, M4X8	*	1
A01	SHAFT, TOGGLE	*	1
A02	SHAFT, ETB DRIVE	*	1
A03	SPRING, GROUNDING	*	4
A04	SPRING, GROUNDING	*	4
A05	SPRING, GROUNDING	*	1
A06	SPRING, GROUNDING	*	3
A07	COVER, INSIDE, LEFT	*	1
A08	ARM, INTERLOCK SWITCH	*	1
A09	SPRING, COMPRESSION	*	1
A10	PHOTO INTERRUPTER (SENSOR)	*	1
A11	FOOT, RUBBER	*	1
A12	GUIDE, CASSETTE, REAR RIGHT	*	1
A13	GUIDE, CASSETTE, FRONT RIGHT	*	1

INTERNAL COMPONENT 2

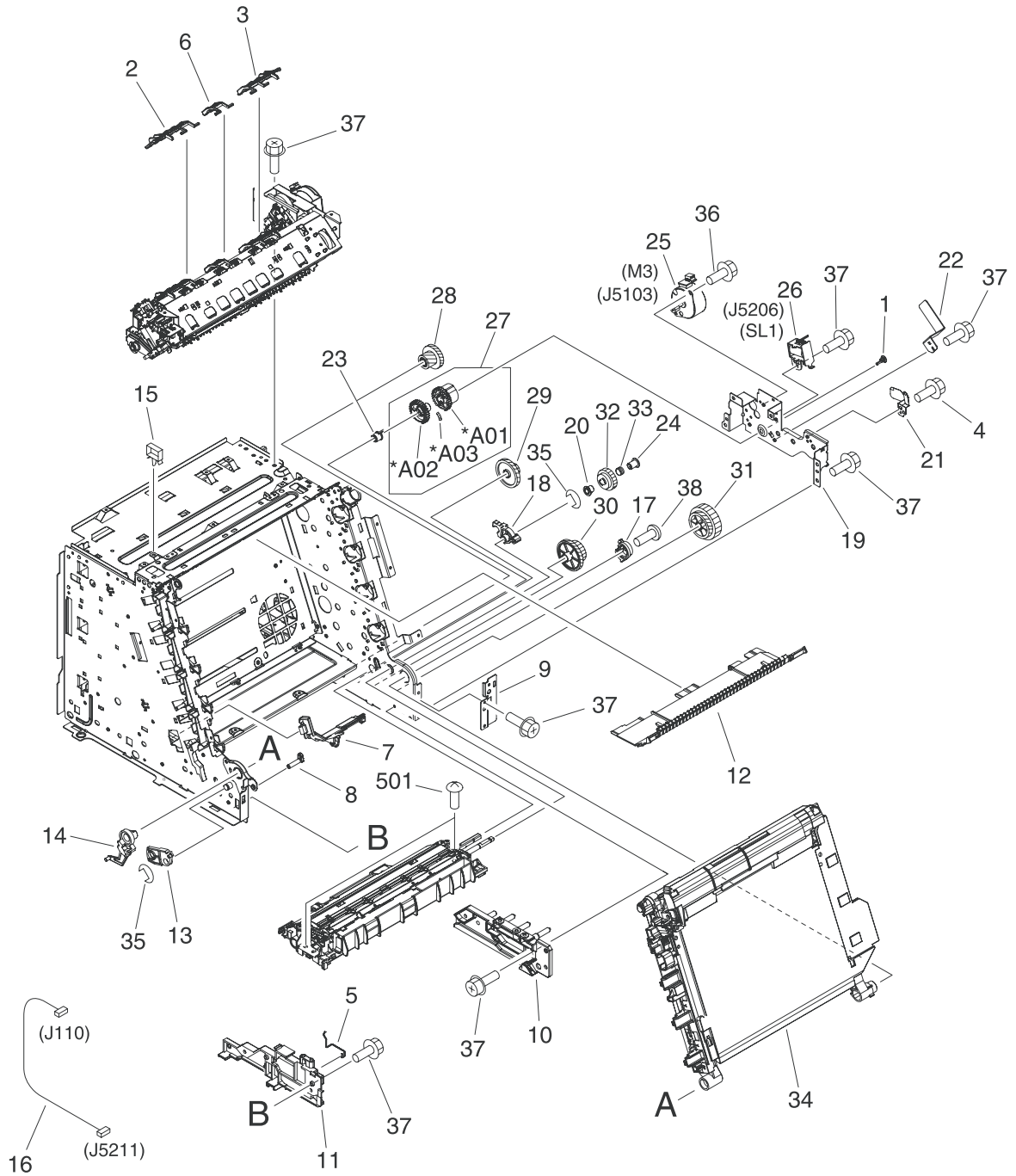

Figure 7-6 Internal components (2 of 3)

Table 7-9 Internal components (2 of 3)

Ref	Description	Part number	Qty
	* Not set up as a service part		
	INTERNAL COMPONENTS 2	*	RF
1	CAP, SHAFT CONDUCTIVE	*	1
2	ARM, PAPER RETAINER, LEFT	RC1-5096-000CN	1
3	ARM, PAPER RETAINER, RIGHT	RC1-5097-000CN	1
4	SCREW, RS, M3X6	*	1
5	SPRING, GROUNDING	RC1-5147-000CN	1
6	RETAINER, PAPER	RC1-5062-000CN	1
7	COVER, PICK-UP FEED CABLE	*	1
8	SHAFT, FRONT DOOR	*	1
9	PLATE, PANEL FIX, RIGHT FRONT	*	1
10	GUIDE, CASSETTE, FRONT RIGHT	*	1
11	GUIDE, CASSETTE, FRONT LEFT	*	1
12	PLATE, HEAT INSULATING	*	1
13	LEVER, CONNECTING, LEFT	*	1
14	CAM, LEFT	*	1
15	SADDLE, WIRE	*	1
16	FEEDER UNIT JOINT CABLE	*	2
17	CAM, HINGE, RIGHT	*	1
18	LEVER, CONNECTING, RIGHT	*	1
19	BASE, MOTOR	*	1
20	CLUTCH, MECHANICAL	*	1
21	SPRING, LEAF	*	1
22	PLATE	*	1
23	BUSHING	*	1
24	STOP, CLUTCH	*	1
25	MOTOR, STEPPING, DC	*	1
26	SOLENOID	*	1
27	PICKUP GEAR ASS'Y	*	1
28	GEAR, 57T/20T	*	1
29	GEAR, 43T/16T	*	1
30	GEAR, 47T/26T	*	1
31	GEAR, 40T/43T	*	1
32	CAM/GEAR, 26T	*	1

Ref	Description	Part number	Qty
33	SPRING, COMPRESSION	*	1
34	ELECT.TRANSPORT BELT ASS'Y	RM1-1885-000CN	1
35	RING, E	*	2
36	SCREW, RS, M3X6	*	2
37	SCREW, RS, M3X8	*	19
38	SCREW, W/WASHER, M4X18	*	2
501	SCREW, TAPPING, TRUSS HEAD, M4X8	*	2
A01	GEAR, 29T	*	1
A02	GEAR, 29T	*	1
A03	SPRING, COMPRESSION	*	1

Table 7-10 Internal components (3 of 3)

Ref	Description	Part number	Qty
	* Not set up as a service part		
	INTERNAL COMPONENTS 3	*	RF
1	GUIDE, CABLE, UPPER	*	1
3	PLATE, SHIELD	*	1
4	PLATE, SHIELD, FRONT	*	1
5	PLATE, CONNECTOR	*	1
6	COVER, CONTROLLER	*	1
7	LID, CONTROLLER	*	1
8	HOLDER, CABLE, LEFT	*	1
9	HOLDER, DC CABLE	*	1
10	HOLDER, CABLE, UPPER	*	1
11	HOLDER, DRAWER	*	1
12	CONNECTOR, DRAWER	*	1
15	SCANNER UNIT	*	1
16	DC CONTROLLER PCB ASS'Y	RM1-1975-000CN	1
17	POWER SUPPLY PCB ASS'Y	*	1
17	POWER SUPPLY PCB ASS'Y	*	2
17	POWER SUPPLY PCB ASS'Y	*	1
18	HIGH-VOLTAGE PCB ASS'Y	*	1
20	POWER CABLE	*	1
21	POWER CONTROLLER CABLE	*	1
22	FIXING SENSOR CABLE	*	1
23	DRIVE CABLE	*	1
23A	CONNECTOR, SNAP TIGHT, BK	*	1
23B	CONNECTOR, SNAP TIGHT, BK	*	1
24	CABLE, CPR	*	1
25	FEEDER UNIT JOINT CABLE	*	1
28	SCREW, W/WASHER, M3X8	*	1
29	SCREW, RS, M3X10	*	4
30	SCREW, RS, M3X8	*	10
32	ROD, BEARING SUPPORT	*	3
33	CABLE, FLAT	*	1
34	CABLE, FLAT	*	1
35	CABLE, FLAT	*	1

Ref	Description	Part number	Qty
37	CLAMP, FFC	*	2
502	SCREW, TAPPING, TRUSS HEAD, M4X8	*	2

CONTROL PANEL ASS'Y

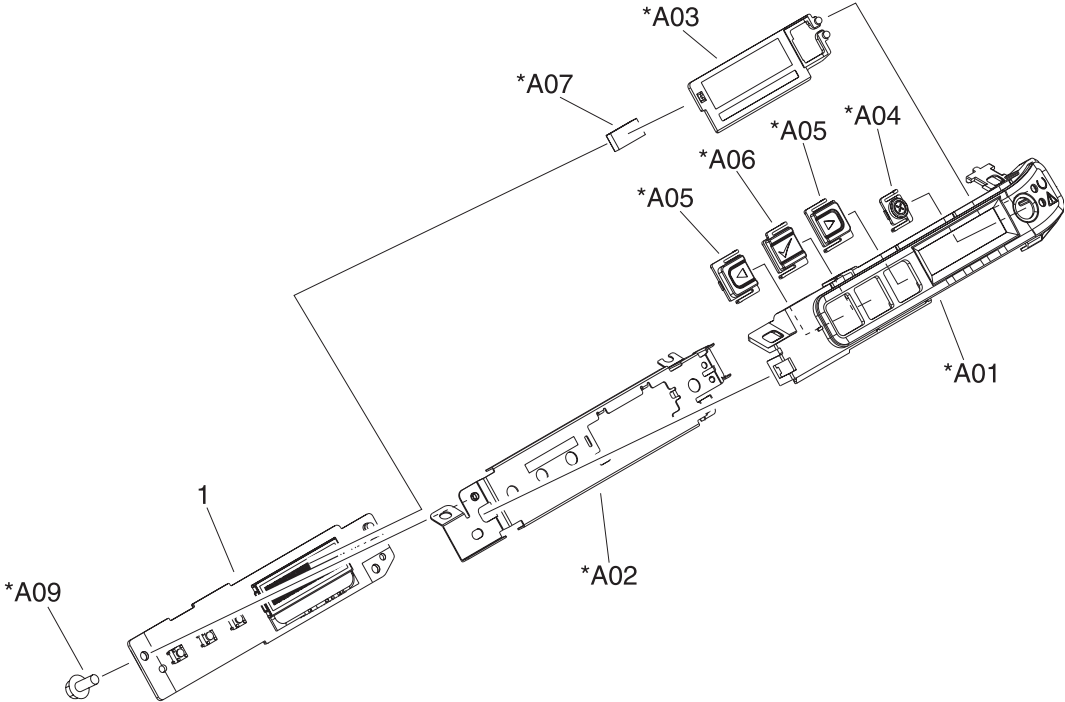

Figure 7-8 Control panel assembly

Table 7-11 Control panel assembly

Ref	Description	Part number	Qty
	* Not set up as a service part		
	CONTROL PANEL ASS'Y	RM1-1983-000CN	1
1	CONTROL PANEL PCB ASS'Y	*	1
1	CONTROL PANEL PCB ASS'Y	*	1
A01	PANEL, CONTROL PANEL	*	1
A02	PLATE, CONTROL PANEL RETAINING	*	1
A03	GUIDE, CONTROL PANEL LIGHT	*	1
A04	BUTTON, CONTROL PANEL, 1	*	1
A05	BUTTON, CONTROL PANEL, 2	*	2
A06	BUTTON, CONTROL PANEL, 3	*	1
A07	SPACER, CONTROL PANEL	*	1
A09	SCREW, RS, M3X8	*	2

MAIN DRIVE ASS'Y

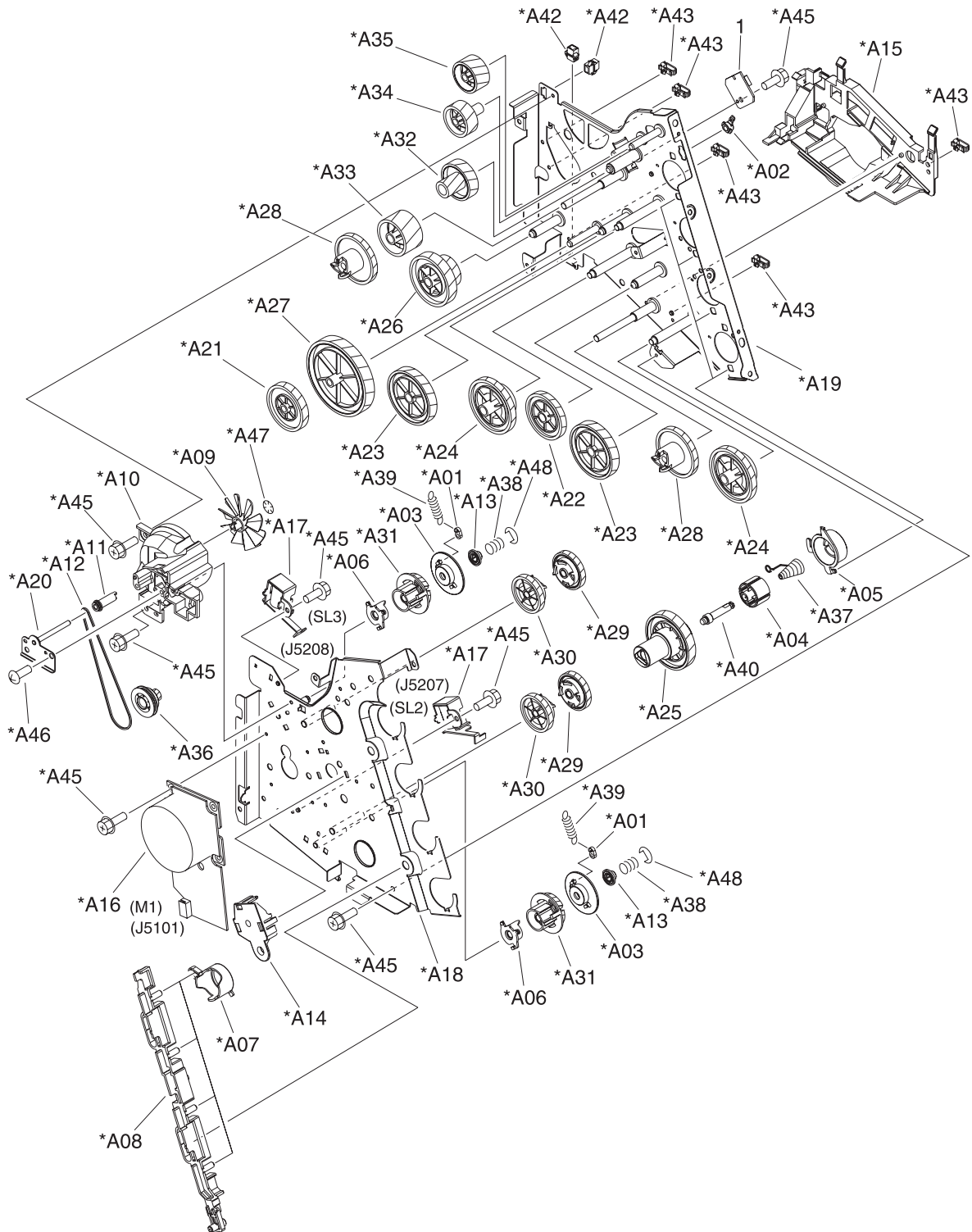

Figure 7-9 Main drive assembly

Table 7-12 Main drive assembly

Ref	Description	Part number	Qty
	* Not set up as a service part		
	MAIN DRIVE ASS'Y	*	1
1	F.F.C. CONNECT PCB UNIT	*	1
A01	COLLAR, SPRING	*	2
A02	BUSHING	*	1
A03	FLANGE, CAM GEAR	*	2
A04	COVER, DRUM	*	4
A05	BUSHING	*	4
A06	BUSHING	*	2
A07	CAM, RELEASE	*	4
A08	ROD, RELEASE, RIGHT	*	1
A09	FAN	*	1
A10	DUCT, FAN	*	1
A11	PULLEY	*	1
A12	BELT, TRANSMISSION	*	1
A13	STOP, CAM GEAR	*	2
A14	BUSHING	*	1
A15	GUIDE, DRIVE CABLE	*	1
A16	MOTOR, DC	*	1
A17	SOLENOID	*	2
A18	PLATE, DRIVE INSIDE	*	1
A19	SIDE PLATE, DRIVE	*	1
A20	PLATE, FAN	*	1
A21	GEAR, 81T	*	1
A22	GEAR, 81T/32T	*	1
A23	GEAR, 96T	*	2
A24	GEAR, 53T/96T	*	2
A25	GEAR, 98T	*	4
A26	GEAR, 89T/53T	*	1
A27	GEAR, 134T	*	1
A28	GEAR, 86T	*	2
A29	GEAR, 64T	*	2
A30	GEAR, 64T	*	2
A31	GEAR, 37T	*	2

Ref	Description	Part number	Qty
A32	GEAR, 27T/64T	*	1
A33	GEAR, 64T	*	1
A34	GEAR, 54T	*	1
A35	GEAR, 54T	*	1
A36	GEAR, 18T	*	1
A37	SPRING, COMPRESSION	*	4
A38	SPRING, COMPRESSION	*	2
A39	SPRING, TENSION	*	2
A40	SHAFT, DRUM GEAR	*	4
A41	CONNECTOR, 2P	*	2
A42	CONNECTOR, SNAP TIGHT, BK	*	2
A43	CLIP, CABLE	*	5
A44	CLIP, EDGE	*	1
A45	SCREW, RS, M3X8	*	18
A46	SCREW, TAPPING, TRUSS HEAD, M4X8	*	2
A47	SE RING	*	1
A48	RING, E	*	2

FUSER ASS'Y

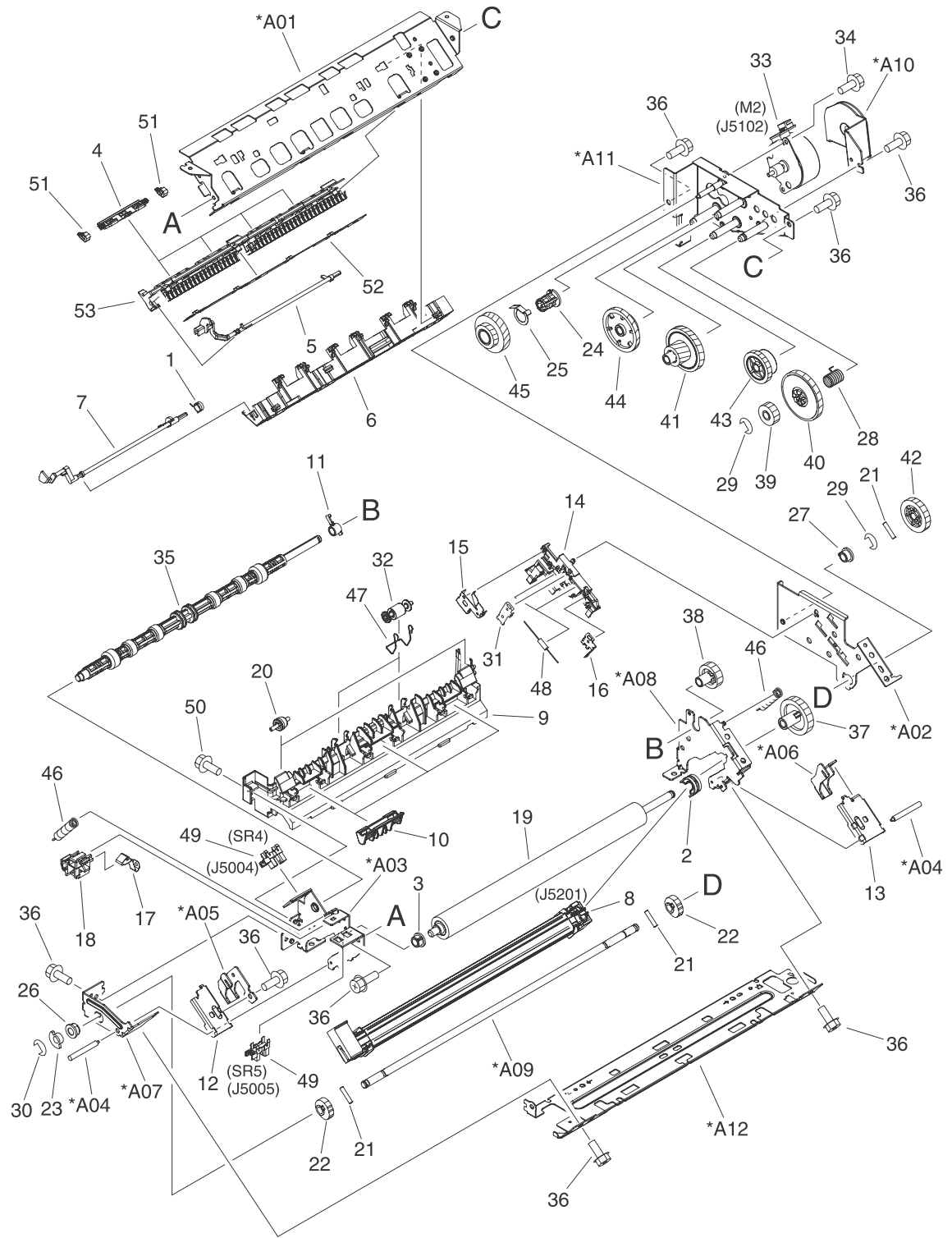

Figure 7-10 Fuser assembly

Table 7-13 Fuser assembly

Ref	Description	Part number	Qty
	* Not set up as a service part		
	FUSER ASS'Y (110v)	RM1-1820-000CN	1
	FUSER ASS'Y (220v)	RM1-1821-000CN	1
1	SPRING, TORSION	*	1
2	BUSHING	*	1
3	BUSHING	*	1
4	RIB, ENTRANCE GUIDE	*	4
5	FLAG, INLET	*	1
6	GUIDE, PAPER DELIVERY UPPER	*	1
7	FLAG, PAPER DELIVERY	*	1
8	FILM GUIDE ASS'Y (110v)	*	1
8	FILM GUIDE ASS'Y (220v)	*	1
9	GUIDE, PAPER DELIVERY LOWER	*	1
10	FLAG, INTERTWINE PREVENTION	*	3
11	BUSHING	*	1
12	PLATE, PRESSURE, LEFT	*	1
13	PLATE, PRESSURE, RIGHT	*	1
14	HOLDER, RESISTOR	*	1
15	SPRING, GROUNDING	*	1
16	SPRING, GROUNDING	*	1
17	SPRING, GROUNDING	*	1
18	GUIDE, CONTACT/SENSOR SUPPORT	*	1
19	ROLLER, PRESSURE	*	1
20	ROLLER, FACE-DOWN BENDING	*	2
21	PIN,DOWEL	*	3
22	CAM, PRESSURE RELEASE	*	2
23	FLAG, PRESSURE RELEASE	*	1
24	HOLDER, PRESSURE RELEASE GEAR	*	1
25	SPRING, LEAF	*	1
26	BUSHING	*	1
27	BUSHING	*	1
28	SPRING, COMPRESSION	*	1
29	RING, E	*	2
30	RING, E	*	1

Ref	Description	Part number	Qty
31	SPRING, GROUNDING	*	1
32	ROLLER, DELIVERY	*	2
33	MOTOR, STEPPING, DC	*	1
34	SCREW, RS, M3X6	*	2
35	SHAFT, FACE-DOWN ROLLER	*	1
36	SCREW, RS, M3X8	*	17
37	GEAR, 30T	*	1
38	GEAR, 19T	*	1
39	GEAR, 16T	*	1
40	GEAR, 49T	*	1
41	GEAR, 19T/71T	*	1
42	GEAR, 27T	*	1
43	GEAR, 26T	*	1
44	GEAR, 20T/44T	*	1
45	GEAR, 22T/38T	*	1
46	SPRING, TENSION	*	2
47	SPRING, TORSION	*	2
48	SOLID RESISTOR, 20MOHM, 1/4W	*	1
49	PHOTO INTERRUPTER (SENSOR)	*	2
50	SCREW, RS, M3X8	*	1
51	CLIP, ENTRANCE GUIDE	*	8
52	PLATE, GROUNDING	*	1
53	GUIDE, FIXING ENTRANCE	*	1
A01	FRAME, FIXING	*	1
A02	SIDE PLATE, FIXING, RIGHT	*	1
A03	SIDE PLATE, FIXING, LEFT	*	1
A04	SHAFT, PRESSURE RELEASE	*	2
A05	PLATE, PRESSURE RELEASE, LEFT	*	1
A06	PLATE, PRESSURE RELEASE, RIGHT	*	1
A07	SIDE PLATE, FIXING, LEFT, 2	*	1
A08	SIDE PLATE, FIXING, RIGHT, 2	*	1
A09	SHAFT, PRESSURE RELEASE CAM	*	1
A10	PLATE, MOTOR ANTI-MAGNETIC	*	1
A11	SIDE PLATE, GEAR	*	1
A12	BASE PLATE, FIXING	*	1

PCB ASS'Y LOCATION DIAGRAM

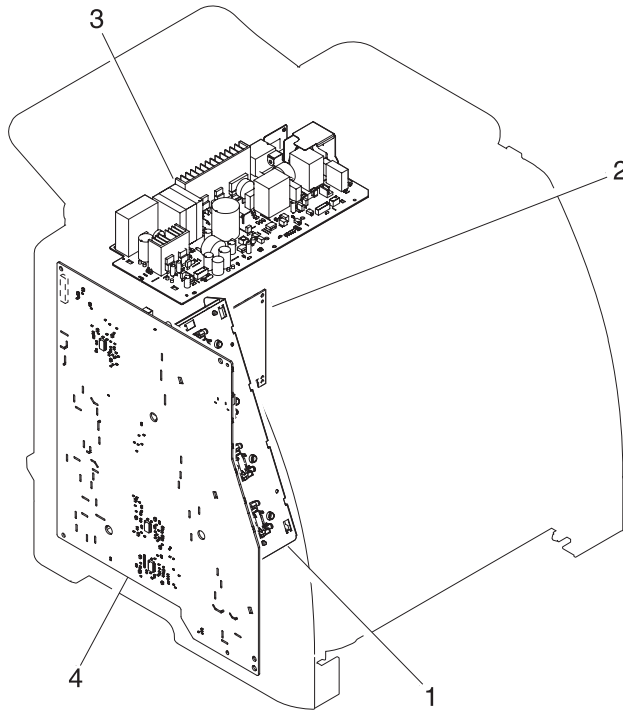

Figure 7-11 PCB assembly location (Tray 2)

Table 7-14 PCB assembly location Tray 2

Ref	Description	Part number	Qty
	* Not set up as a service part		
	PCB ASS'Y LOCATION DIAGRAM	*	RF
1	MEMORY CONTROLLER PCB ASS'Y	*	1
2	DC CONTROLLER PCB ASS'Y	RM1-1975-000CN	1
3	POWER SUPPLY PCB ASS'Y	*	1
3	POWER SUPPLY PCB ASS'Y	*	1
4	HIGH-VOLTAGE PCB ASS'Y	*	1

Input devices

CASSETTE

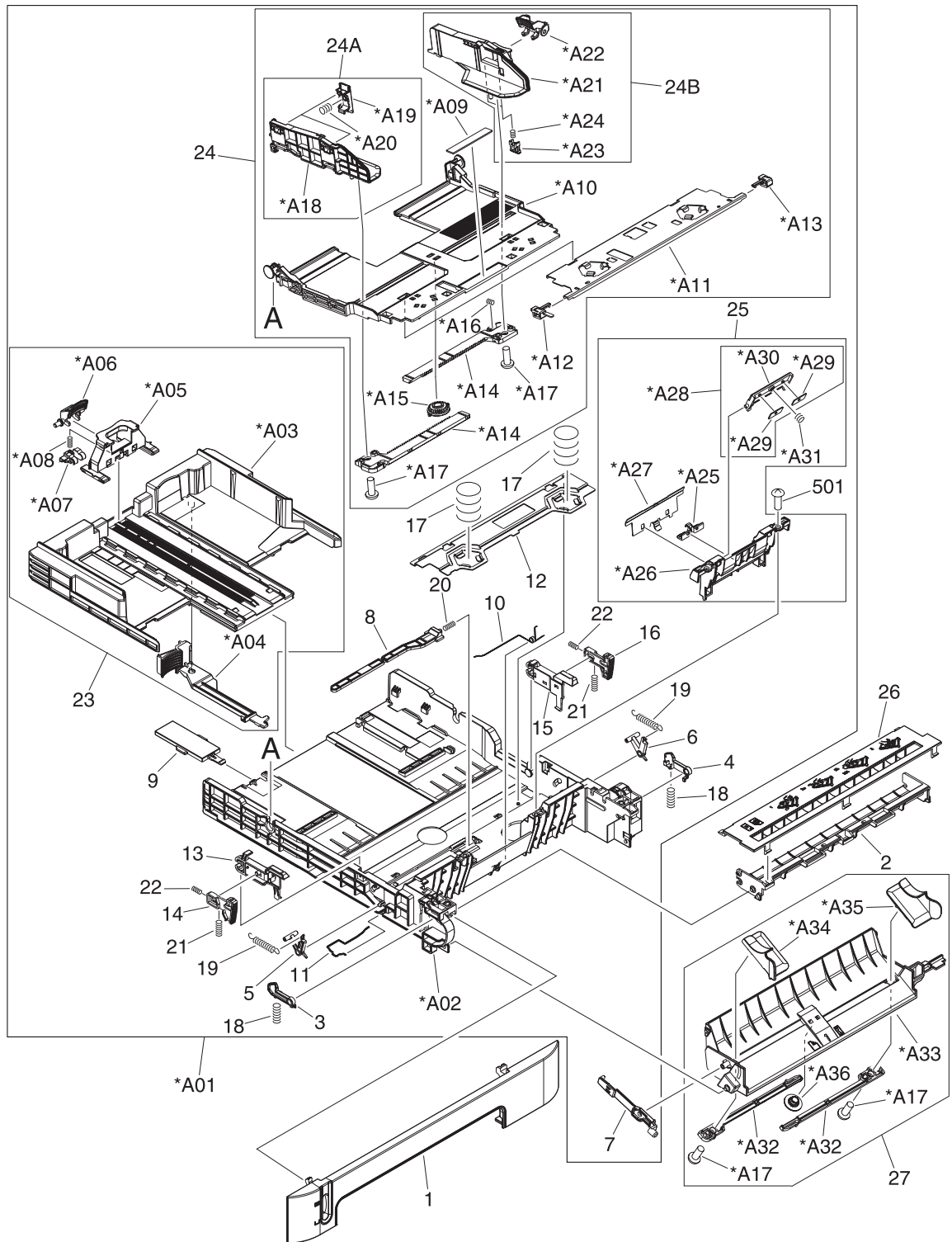

Figure 7-12 Tray 2 input tray (cassette)

Table 7-15 Tray 2 input tray (cassette)

Ref	Description	Part number	Qty
	* Not set up as a service part		
	CASSETTE	RM1-1916-000CN	1
1	PANEL, FRONT	*	1
2	GUIDE, CASSETTE DUPLEX, LOWER	*	1
3	STOPPER, CASSETTE, LEFT	*	1
4	STOPPER, CASSETTE, RIGHT	*	1
5	ARM, CLAW RELEASE, LEFT	*	1
6	ARM, CLAW RELEASE, RIGHT	*	1
7	ARM, REMNANT INDICATION	*	1
8	ARM, PLATE LOCK RELEASE, MD.	*	1
9	SIZE PLATE, PAPER	*	1
10	SPRING, GROUNDING	*	1
11	SPRING, GROUNDING	*	1
12	PLATE, CASSETTE REINFORCEMENT	*	1
13	ARM, MD. PLATE RELEASE, LEFT	*	1
14	CLAW, MD. PLATE RELEASE, LEFT	*	1
15	ARM, MD. PLATE RELEASE, RIGHT	*	1
16	CLAW, MD. PLATE RELEASE, RIGHT	*	1
17	SPRING, COMPRESSION	*	2
18	SPRING, COMPRESSION	*	2
19	SPRING, TENSION	*	2
20	SPRING, COMPRESSION	*	1
21	SPRING, COMPRESSION	*	2
22	SPRING, COMPRESSION	*	2
23	BACK END LIMIT PLATE ASS'Y	*	1
24	MIDDLE PLATE ASS'Y	*	1
24A	LEFT PAPER SIDE END ASS'Y	*	1
24B	RIGHT PAPER SIDE END ASS'Y	*	1
25	SEPARATION ASS'Y	RM1-1922-000CN	1
26	GUIDE, CASSETTE DUPLEX, UPPER	*	1
27	FEED ASS'Y	RM1-1923-000CN	1
501	SCREW, TAPPING, TRUSS HEAD, M4X8	*	2
A01	CASSETTE BODY ASS'Y	*	1
A02	BODY, CASSETTE	*	1

Ref	Description	Part number	Qty
A03	PLATE, BACK END LIMIT, LARGE	*	1
A04	ARM, BACK END LOCK	*	1
A05	PLATE, BACK END LIMIT, SMALL	*	1
A06	LEVER, BACK END LOCK RELEASE	*	1
A07	STOPPER, BACK END LIMIT	*	1
A08	SPRING, COMPRESSION	*	1
A09	SHEET, SEPARATION	*	1
A10	PLATE, MIDDLE	*	1
A11	PLATE, REINFORCEMENT	*	1
A12	CLAW, MIDDLE PLATE, LEFT	*	1
A13	CLAW, MIDDLE PLATE, RIGHT	*	1
A14	RACK	*	2
A15	GEAR, 22T	*	1
A16	SPRING, COMPRESSION	*	1
A17	SCREW, TAPPING, TRUSS HEAD, M3X6	*	2
A17	SCREW, TAPPING, TRUSS HEAD, M3X6	*	2
A19	HOLDER, PAPER RETAINING	*	2
A20	SPRING, COMPRESSION	*	2
A21	PLATE, PAPER SIDE END, RIGHT	*	1
A22	LEVER, SIDE END LOCK RELEASE	*	1
A23	STOPPER, PAPER SIDE END	*	2
A24	SPRING, COMPRESSION	*	2
A25	HOLDER, PAD	*	1
A26	HOLDER, SEPARATION	*	1
A27	PLATE, PAPER GUIDE	*	1
A28	HOLDER, PAD	*	1
A29	WEIGHT, PAD	*	2
A30	HOLDER, PAD	*	1
A31	SPRING, COMPRESSION	*	1
A32	RACK, MANUAL FEED	*	2
A33	GUIDE, MANUAL FEED	*	1
A34	GUIDE, FEED WIDTH, LEFT	*	1
A35	GUIDE, FEED WIDTH, RIGHT	*	1
A36	GEAR, 16T	*	1

ASSEMBLY LOCATION DIAGRAM

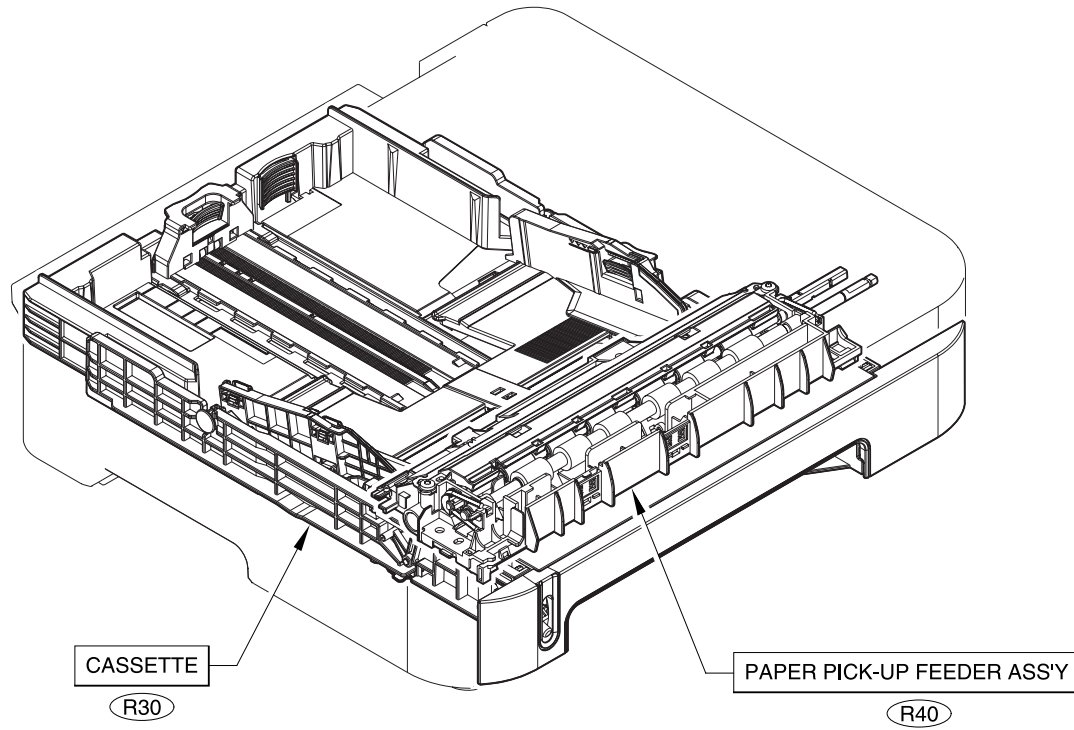

Figure 7-13 250-sheet input tray (cassette)

Table 7-16 250-sheet input tray (cassette)

Ref	Description	Part number	Qty
	* Not set up as a service part		
R30	CASSETTE	RM1-1945-000CN	RF
R40	PAPER PICKUP ROLLER	RC1-5440-000CN	RF

INTERNAL COMPONENTS

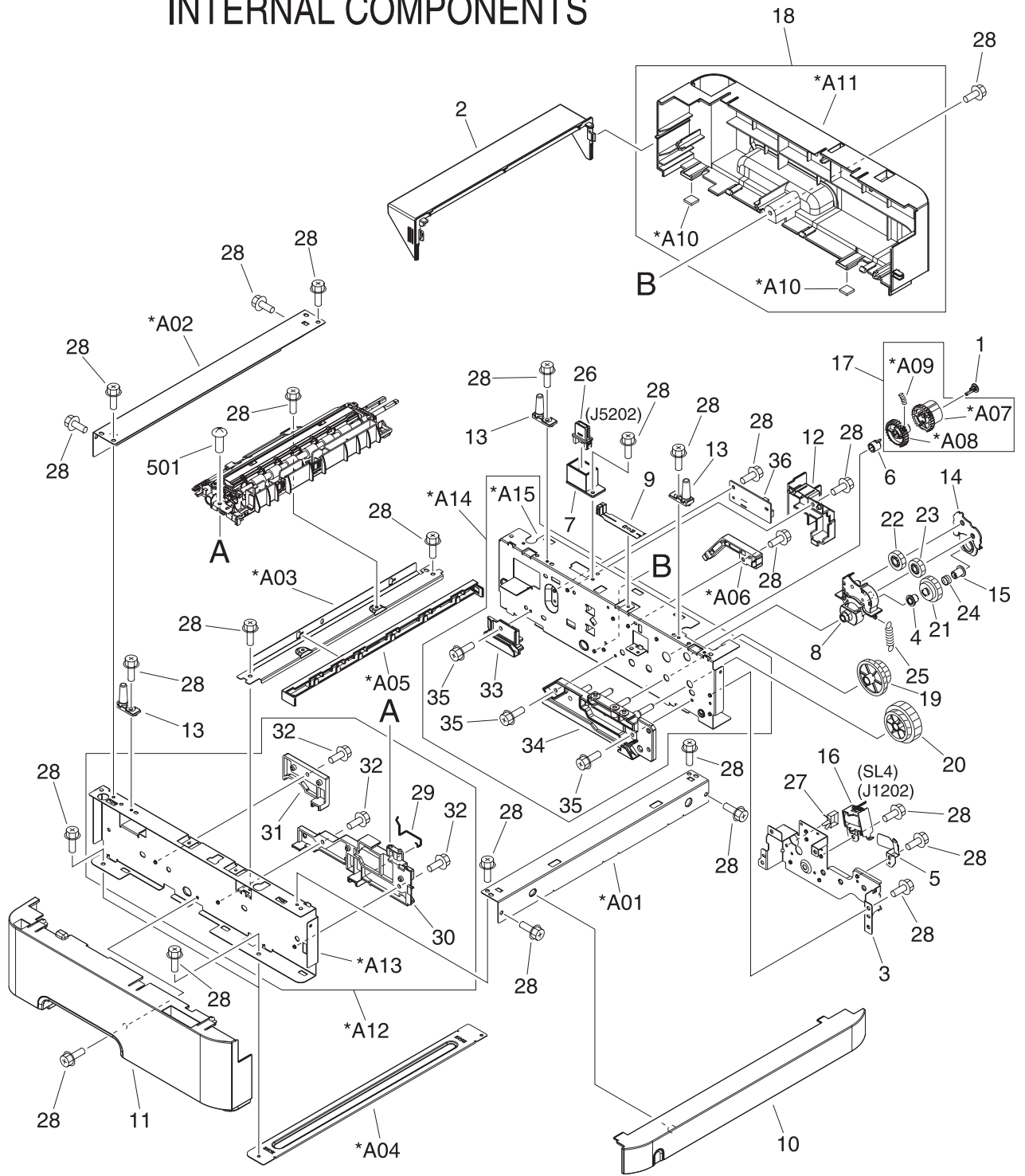

Figure 7-14 Tray 2 input tray internal components

Table 7-17 Tray 2 sheet input tray internal components

Ref	Description	Part number	Qty
	* Not set up as a service part		
	INTERNAL COMPONENTS	*	RF
1	CAP, CONTINUITY	*	1
2	COVER, CASSETTE DUST	RC1-5200-000CN	1
3	BASE, MOTOR	*	1
4	CLUTCH, MECHANICAL	*	1
5	SPRING, LEAF	*	1
6	BUSHING	*	1
7	HOLDER, DRAWER CONNECTOR	*	1
8	HOLDER, SWING GEAR	*	1
9	PLATE, GROUNDING	*	1
10	COVER, OPTION FRONT	*	1
11	COVER, OPTION LEFT	*	1
12	COVER, PCB	*	1
13	SHAFT, POSITIONING	*	3
14	COVER, SWING GEAR	*	1
15	STOP, CLUTCH	*	1
16	SOLENOID	*	1
17	PICKUP GEAR ASS'Y	*	1
18	COVER, OPTION RIGHT	*	1
19	GEAR, 47T/26T	*	1
20	GEAR, 40T/43T	*	1
21	CAM/GEAR, 26T	*	1
22	GEAR, 19T	*	1
23	GEAR, 18T	*	1
24	SPRING, COMPRESSION	*	1
25	SPRING, TENSION	*	1
26	CONNECTOR, DRAWER	*	1
27	SADDLE, WIRE	*	1
28	SCREW, RS, M3X8	*	32
29	SPRING, GROUNDING	*	1
30	GUIDE, CASSETTE, FRONT LEFT	*	1
31	GUIDE, CASSETTE, REAR LEFT	*	1
32	SCREW, RS, M3X8	*	3

Ref	Description	Part number	Qty
33	GUIDE, CASSETTE, REAR RIGHT	*	1
34	GUIDE, CASSETTE, FRONT RIGHT	*	1
35	SCREW, RS, M3X8	*	3
36	PAPER FEEDER PCB ASS'Y	*	1
501	SCREW, TAPPING, TRUSS HEAD, M4X8	*	2
A01	CROSSMEMBER, FRONT	*	1
A02	CROSSMEMBER, REAR	*	1
A03	CROSSMEMBER, MIDDLE	*	1
A04	CROSSMEMBER, LOWER, REAR	*	2
A05	GUIDE, PAPER SENSOR CABLE, 1	*	1
A06	GUIDE, PAPER SENSOR CABLE, 2	*	1
A07	GEAR, 29T	*	1
A08	GEAR, 29T	*	1
A09	SPRING, COMPRESSION	*	1
A10	FOOT, RUBBER	*	2
A11	COVER, OPTION RIGHT	*	1
A12	OPTION FRAME LEFT ASS'Y	*	1
A13	FRAME, OPTION, LEFT	*	1
A14	OPTION FRAME RIGHT ASS'Y	*	1
A15	FRAME, OPTION, RIGHT	*	1

PAPER PICK-UP FEEDER ASS'Y

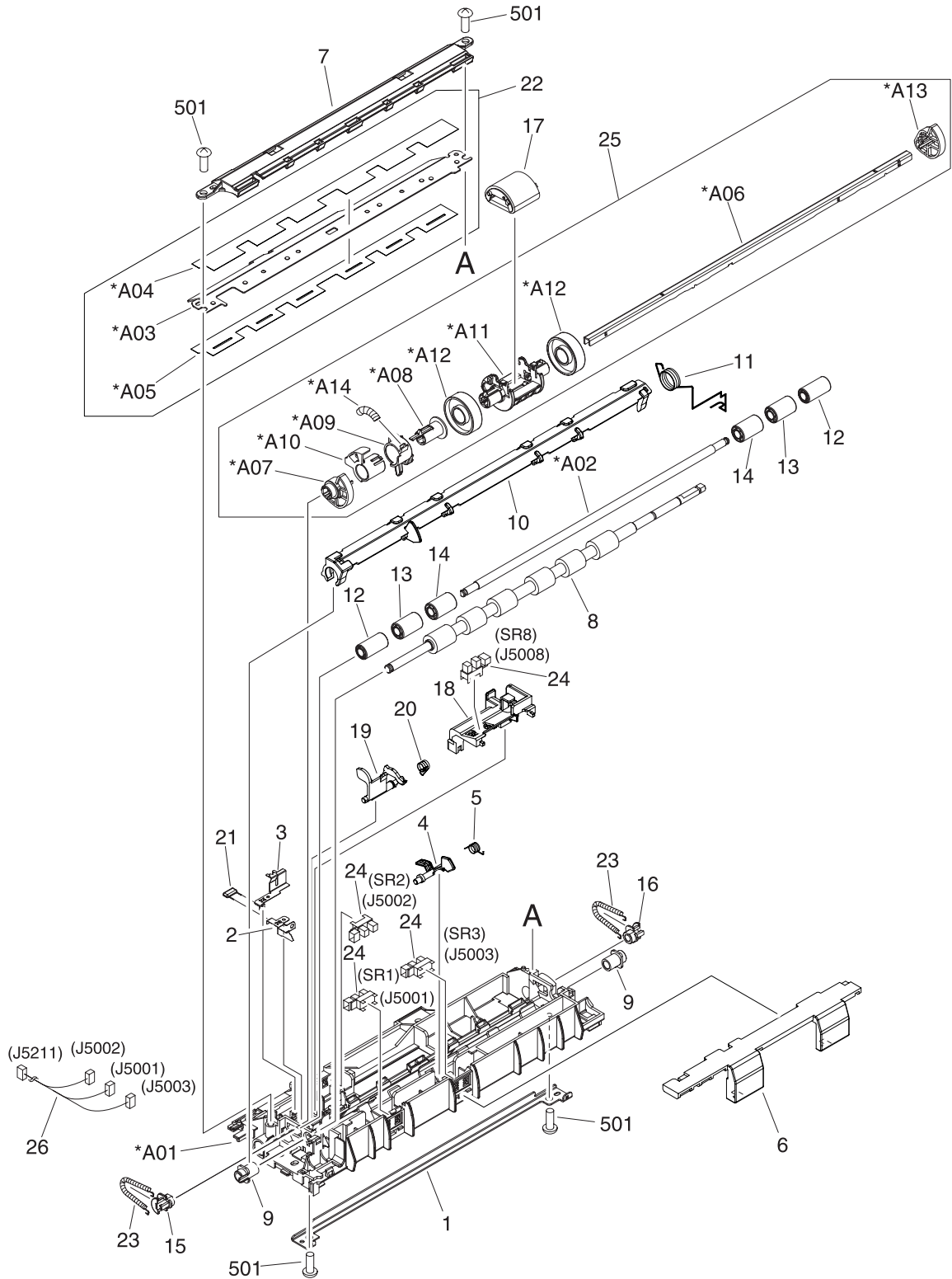

Figure 7-15 Paper pick-up feeder assembly for Tray 2

Table 7-18 Paper pick-up feeder assembly for Tray 2

Ref	Description	Part number	Qty
	* Not set up as a service part		
	PAPER PICKUP FEEDER ASS'Y	*	1
1	GUIDE, REGISTRATION	*	1
2	PLATE, REG. GROUNDING, 1	*	1
3	PLATE, REG. GROUNDING, 2	*	1
4	FLAG, SENSOR	*	1
5	SPRING, TORSION	*	1
6	COVER, SENSOR, TOP	*	1
7	GUIDE, PRE-TRANSFER	*	1
8	ROLLER, REGISTRATION DRIVE	*	1
9	BUSHING	*	2
10	SHUTTER, REGISTRATION	*	1
11	SPRING, TORSION	*	1
12	ROLLER, REGISTRATION, A	*	2
13	ROLLER, REGISTRATION, B	*	2
14	ROLLER, REGISTRATION, C	*	2
15	BUSHING	*	1
16	BUSHING	*	1
17	ROLLER, PAPER PICKUP	RC1-5440-000CN	1
18	HOLDER, PAPER WIDTH SENSOR	*	1
19	FLAG, PAPER WIDTH SENSOR	*	1
20	SPRING, TORSION	*	1
21	RESISTOR, 400 OHM, 0.5W	*	1
22	COVER, PICKUP FEED FRAME	*	1
23	SPRING, TENSION	*	2
24	PHOTO INTERRUPTER (SENSOR)	*	4
25	PAPER PICKUP DRIVE ASS'Y	*	1
26	FEEDER UNIT CABLE	*	1
501	SCREW, TAPPING, TRUSS HEAD, M4X8	*	4
A01	FRAME, PAPER PICKUP FEEDER	*	1
A02	SHAFT, REGISTRATION ROLLER	*	1
A03	COVER, PICKUP FEED FRAME	*	1
A04	SHEET, SCRAPER, 1	*	1
A05	SHEET, SCRAPER, 2	*	1

Ref	Description	Part number	Qty
A06	SHAFT, PAPER PICKUP DRIVE	*	1
A07	BUSHING	*	1
A08	BUSHING	*	1
A09	ARM, CST. PAPER SENSING, 1	*	1
A10	ARM, CST. PAPER SENSING, 2	*	1
A11	HOLDER, PAPER PICKUP ROLLER	*	1
A12	ROLLER, CASSETTE PAPER PICKUP	*	2
A13	BUSHING	*	1
A14	SPRING, COMPRESSION	*	1

CASSETTE

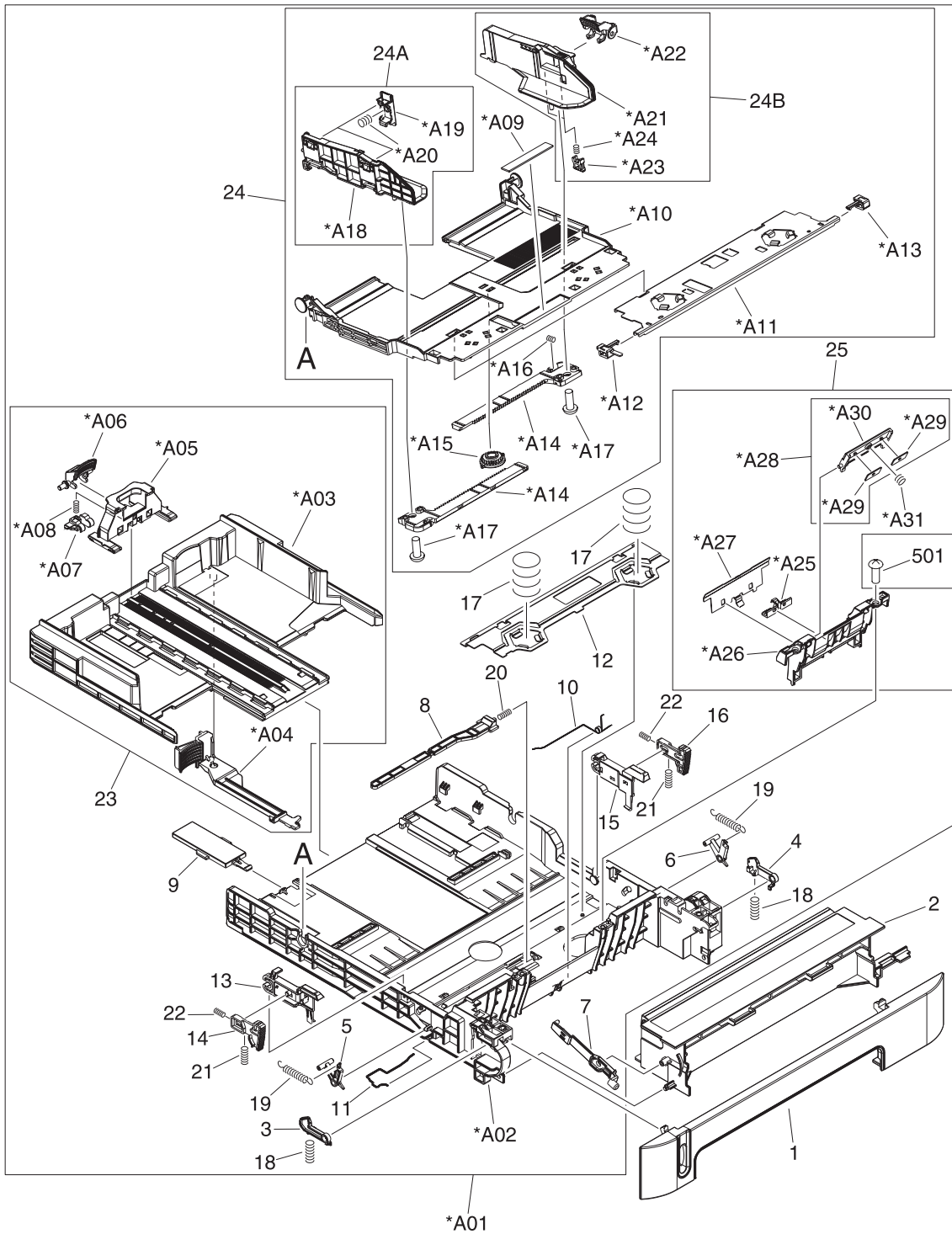

Figure 7-16 Tray 3 input tray (cassette)

Table 7-19 Tray 3 input tray (cassette)

Ref	Description	Part number	Qty
	* Not set up as a service part		
	CASSETTE	RM1-1945-000CN	1
	PAPER PICKUP ROLLER	RC1-5440-000CN	
1	PANEL, FRONT	*	1
2	FRAME, FRONT	*	1
3	STOPPER, CASSETTE, LEFT	*	1
4	STOPPER, CASSETTE, RIGHT	*	1
5	ARM, CLAW RELEASE, LEFT	*	1
6	ARM, CLAW RELEASE, RIGHT	*	1
7	ARM, REMNANT INDICATION	*	1
8	ARM, PLATE LOCK RELEASE, MD	*	1
9	SIZE PLATE, PAPER	*	1
10	SPRING, GROUNDING	*	1
11	SPRING, GROUNDING	*	1
12	PLATE, CASSETTE REINFORCEMENT	*	1
13	ARM, MD. PLATE RELEASE, LEFT	*	1
14	CLAW, MD. PLATE RELEASE, LEFT	*	1
15	ARM, MD. PLATE RELEASE, RIGHT	*	1
16	CLAW, MD. PLATE RELEASE, RIGHT	*	1
17	SPRING, COMPRESSION	*	2
18	SPRING, COMPRESSION	*	2
19	SPRING, TENSION	*	2
20	SPRING, COMPRESSION	*	1
21	SPRING, COMPRESSION	*	2
22	SPRING, COMPRESSION	*	2
23	BACK END LIMIT PLATE ASS'Y	*	1
24	MIDDLE PLATE ASS'Y	*	1
24A	LEFT PAPER SIDE END ASS'Y	*	1
24B	RIGHT PAPER SIDE END ASS'Y	*	1
25	SEPARATION ASS'Y	RM1-1922-000CN	1
501	SCREW, TAPPING, TRUSS HEAD, M4X8	*	2
A01	CASSETTE BODY ASS'Y	*	1
A02	BODY, CASSETTE	*	1
A03	PLATE, BACK END LIMIT, LARGE	*	1

Ref	Description	Part number	Qty
A04	ARM, BACK END LOCK	*	1
A05	PLATE, BACK END LIMIT, SMALL	*	1
A06	LEVER, BACK END LOCK RELEASE	*	1
A07	STOPPER, BACK END LIMIT	*	1
A08	SPRING, COMPRESSION	*	1
A09	SHEET, SEPARATION	*	1
A10	PLATE, MIDDLE	*	1
A11	PLATE, REINFORCEMENT	*	1
A12	CLAW, MIDDLE PLATE, LEFT	*	1
A13	CLAW, MIDDLE PLATE, RIGHT	*	1
A14	RACK	*	2
A15	GEAR, 22T	*	1
A16	SPRING, COMPRESSION	*	1
A17	SCREW, TAPPING, TRUSS HEAD, M3X6	*	2
A18	PLATE, PAPER SIDE END, LEFT	*	1
A19	HOLDER, PAPER RETAINING	*	2
A20	SPRING, COMPRESSION	*	2
A21	PLATE, PAPER SIDE END, RIGHT	*	1
A22	LEVER, SIDE END LOCK RELEASE	*	1
A23	STOPPER, PAPER SIDE END	*	2
A24	SPRING, COMPRESSION	*	2
A25	HOLDER, PAD	*	1
A26	HOLDER, SEPARATION	*	1
A27	PLATE, PAPER GUIDE	*	1
A28	HOLDER, PAD	*	1
A29	WEIGHT, PAD	*	2
A30	HOLDER, PAD	*	1
A31	SPRING, COMPRESSION	*	1

PAPER PICK-UP FEEDER ASS'Y

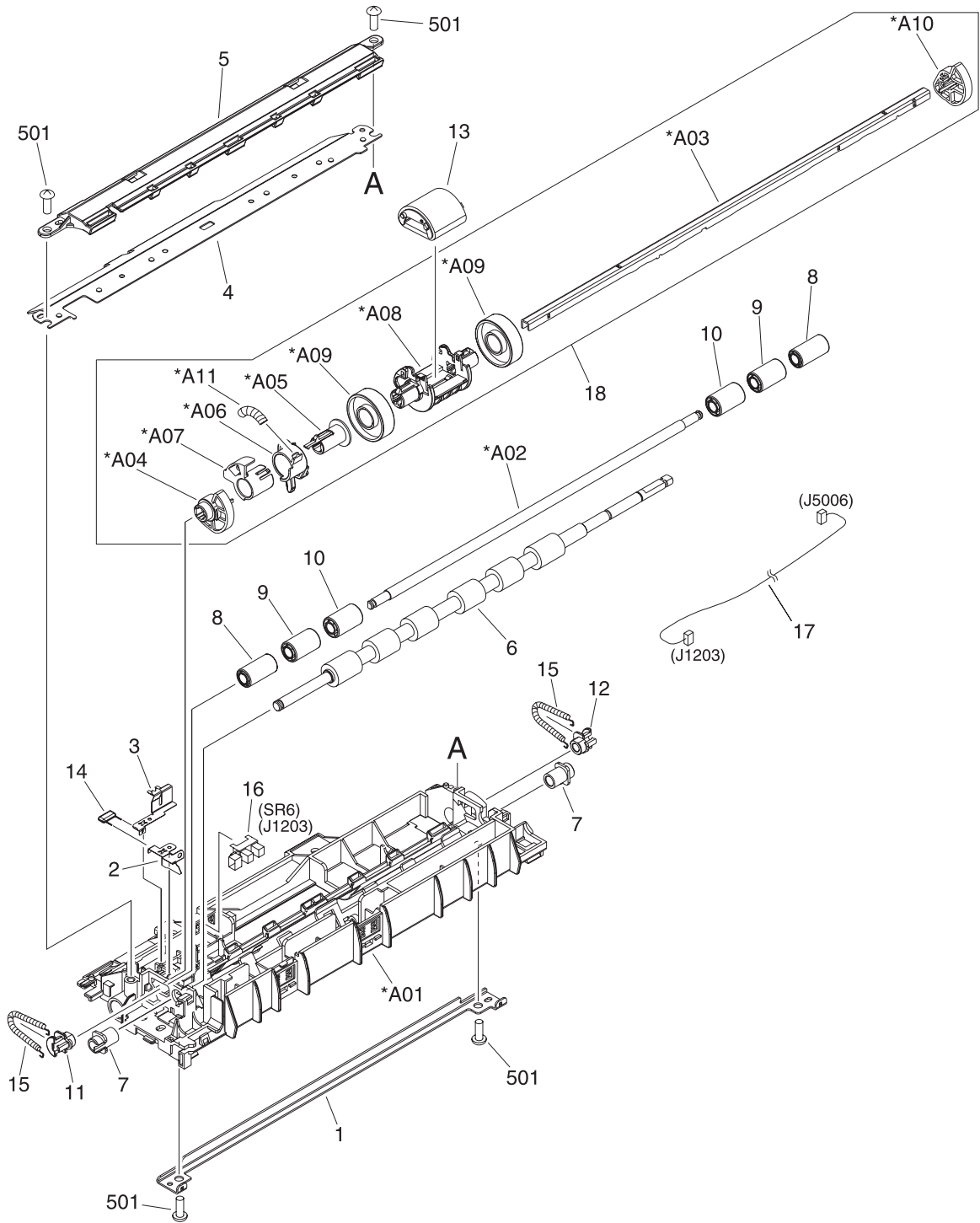

Figure 7-17 Paper pickup feeder assembly (Tray 3)

Table 7-20 Paper pickup feeder assembly (Tray 3)

Ref	Description	Part number	Qty
	* Not set up as a service part		
	PAPER PICKUP ROLLER	RC1-5440-000CN	1
1	GUIDE, REGISTRATION	*	1
2	PLATE, REG. GROUNDING, 1	*	1
3	PLATE, REG. GROUNDING, 2	*	1
4	COVER, PICKUP FEED FRAME	*	1
5	GUIDE, PRE-TRANSFER	*	1
6	ROLLER, REGISTRATION DRIVE	*	1
7	BUSHING	*	2
8	ROLLER, REGISTRATION, A	*	2
9	ROLLER, REGISTRATION, B	*	2
10	ROLLER, REGISTRATION, C	*	2
11	BUSHING	*	1
12	BUSHING	*	1
13	ROLLER, PAPER PICKUP	RC1-5440-000CN	1
14	RESISTOR, 400 OHM, 0.5W	*	1
15	SPRING, TENSION	*	2
16	PHOTO INTERRUPTER (SENSOR)	*	1
17	CABLE, OPTION SENSOR	*	1
18	PAPER PICKUP DRIVE ASS'Y	*	1
501	SCREW, TAPPING, TRUSS HEAD, M4X8	*	4
A01	FRAME, PAPER PICKUP FEEDER	*	1
A02	SHAFT, REGISTRATION ROLLER	*	1
A03	SHAFT, PAPER PICKUP DRIVE	*	1
A04	BUSHING	*	1
A05	BUSHING	*	1
A06	ARM, CST. PAPER SENSING, 1	*	1
A07	ARM, CST. PAPER SENSING, 2	*	1
A08	HOLDER, PAPER PICKUP ROLLER	*	1
A09	ROLLER, CASSETTE PAPER PICKUP	*	2
A10	BUSHING	*	1
A11	SPRING, COMPRESSION	*	1

PCB ASS'Y LOCATION DIAGRAM

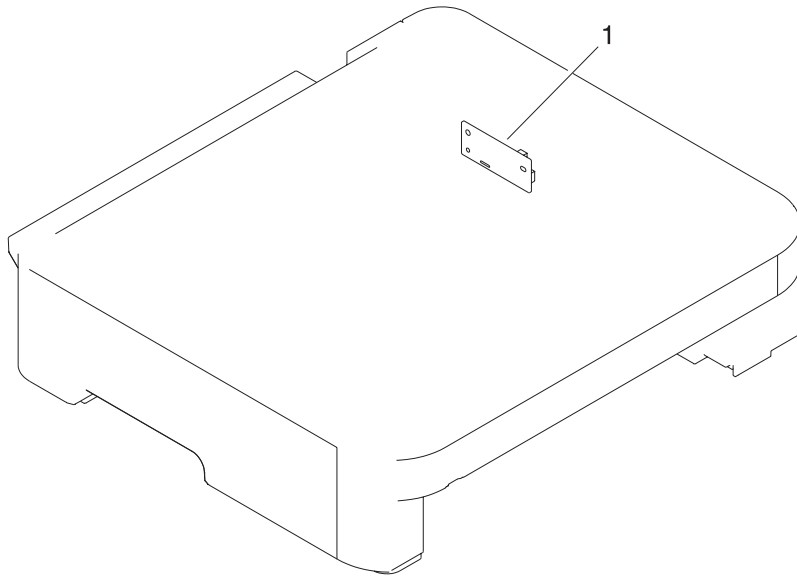

Figure 7-18 PCB assembly location optional Tray 3

Table 7-21 Paper pickup feeder assembly (Tray 3)

Ref	Description	Part number	Qty
	* Not set up as a service part		
	PCB ASS'Y LOCATION DIAGRAM	*	RF
1	PAPER FEEDER PCB ASS'Y	*	1

Diagrams

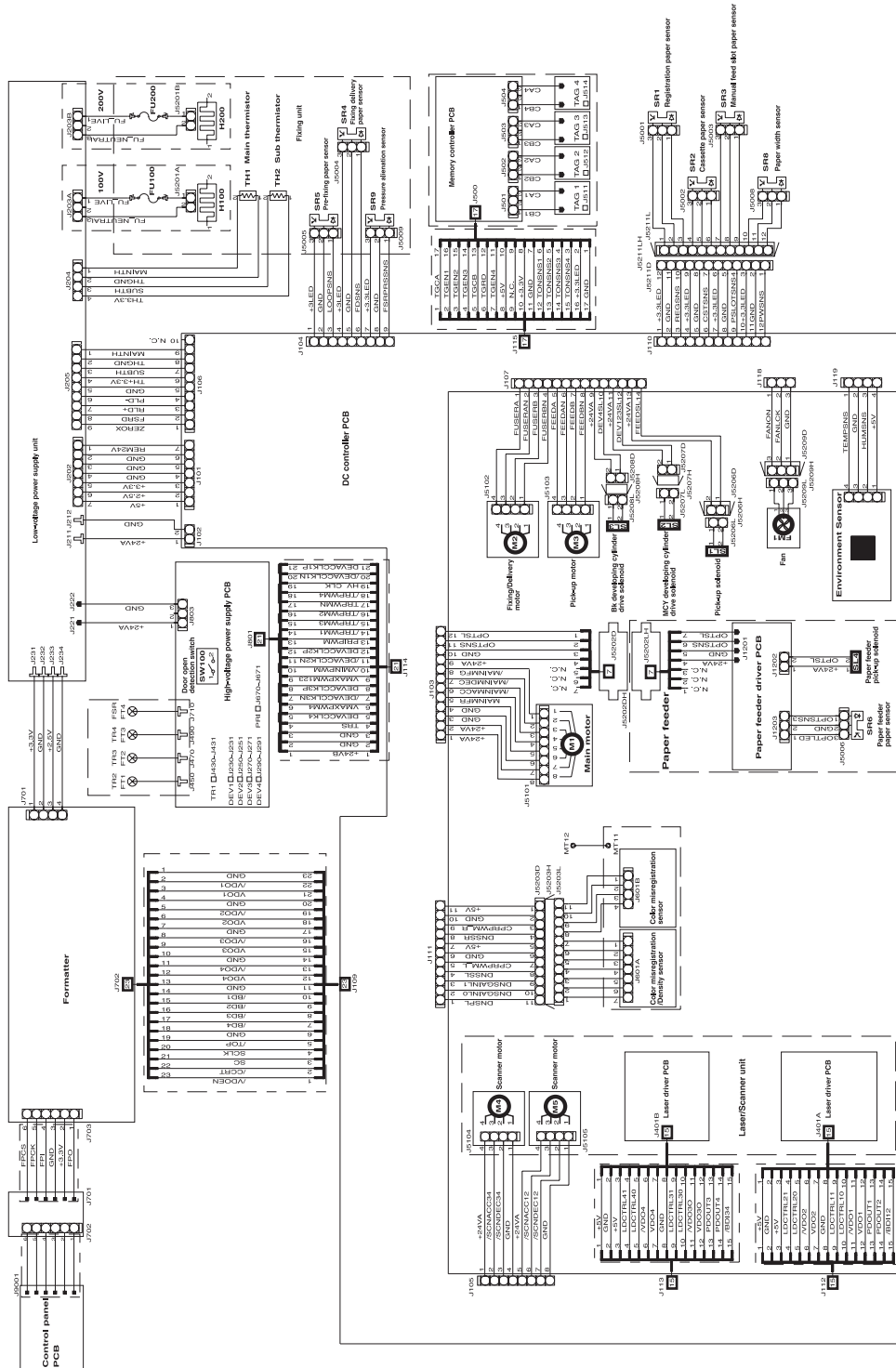

Figure 7-19 General circuit diagram

Alphabetical parts list

Table 7-22 Alphabetical parts list

Description	Part number	Table and page
* Not set up as a service part		Assembly locations
* Not set up as a service part		External panels and covers (1 of 2)
* Not set up as a service part		External panels and covers (2 of 2)
* Not set up as a service part		Upper assembly cover
* Not set up as a service part		Internal components (1 of 3)
* Not set up as a service part		Internal components (2 of 3)
* Not set up as a service part		Internal components (3 of 3)
* Not set up as a service part		Control panel assembly
* Not set up as a service part		Main drive assembly
* Not set up as a service part		Fuser assembly
* Not set up as a service part		PCB assembly location Tray 2
* Not set up as a service part		Tray 2 input tray (cassette)
* Not set up as a service part		250-sheet input tray (cassette)
* Not set up as a service part		Tray 2 sheet input tray internal components
* Not set up as a service part		Paper pick-up feeder assembly for Tray 2
* Not set up as a service part		Tray 3 input tray (cassette)
* Not set up as a service part		Paper pickup feeder assembly (Tray 3)
* Not set up as a service part		Paper pickup feeder assembly (Tray 3)
ARM, BACK END LOCK	*	Tray 2 input tray (cassette)
ARM, BACK END LOCK	*	Tray 3 input tray (cassette)
ARM, CLAW RELEASE, LEFT	*	Tray 2 input tray (cassette)
ARM, CLAW RELEASE, LEFT	*	Tray 3 input tray (cassette)
ARM, CLAW RELEASE, RIGHT	*	Tray 2 input tray (cassette)
ARM, CLAW RELEASE, RIGHT	*	Tray 3 input tray (cassette)
ARM, CST. PAPER SENSING, 1	*	Paper pick-up feeder assembly for Tray 2
ARM, CST. PAPER SENSING, 1	*	Paper pickup feeder assembly (Tray 3)
ARM, CST. PAPER SENSING, 2	*	Paper pick-up feeder assembly for Tray 2

Table 7-22 Alphabetical parts list (continued)

Description	Part number	Table and page
ARM, CST. PAPER SENSING, 2	*	Paper pickup feeder assembly (Tray 3)
ARM, FRONT DOOR, LEFT	*	External panels and covers (2 of 2)
ARM, FRONT DOOR, RIGHT	*	External panels and covers (2 of 2)
ARM, INTERLOCK SWITCH	*	Internal components (1 of 3)
ARM, LASER SHUTTER	*	Internal components (1 of 3)
ARM, MD. PLATE RELEASE, LEFT	*	Tray 2 input tray (cassette)
ARM, MD. PLATE RELEASE, LEFT	*	Tray 3 input tray (cassette)
ARM, MD. PLATE RELEASE, RIGHT	*	Tray 2 input tray (cassette)
ARM, MD. PLATE RELEASE, RIGHT	*	Tray 3 input tray (cassette)
ARM, OPEN/CLOSE	*	Internal components (1 of 3)
ARM, OPEN/CLOSE	*	Internal components (1 of 3)
ARM, PAPER RETAINER, LEFT	RC1-5096-000CN	Internal components (2 of 3)
ARM, PAPER RETAINER, RIGHT	RC1-5097-000CN	Internal components (2 of 3)
ARM, PLATE LOCK RELEASE, MD	*	Tray 3 input tray (cassette)
ARM, PLATE LOCK RELEASE, MD.	*	Tray 2 input tray (cassette)
ARM, REMNANT INDICATION	*	Tray 2 input tray (cassette)
ARM, REMNANT INDICATION	*	Tray 3 input tray (cassette)
BACK END LIMIT PLATE ASS'Y	*	Tray 2 input tray (cassette)
BACK END LIMIT PLATE ASS'Y	*	Tray 3 input tray (cassette)
BASE PLATE, FIXING	*	Fuser assembly
BASE, MOTOR	*	Internal components (2 of 3)
BASE, MOTOR	*	Tray 2 sheet input tray internal components
BELT, TRANSMISSION	*	Main drive assembly
BODY, CASSETTE	*	Tray 2 input tray (cassette)
BODY, CASSETTE	*	Tray 3 input tray (cassette)
BRACKET, CARD READER	*	Internal components (1 of 3)
BRACKET, LEFT REAR	*	Internal components (1 of 3)
BRACKET, RIGHT REAR	*	Internal components (1 of 3)
BUSHING	*	External panels and covers (2 of 2)
BUSHING	*	Internal components (1 of 3)
BUSHING	*	Internal components (1 of 3)

Table 7-22 Alphabetical parts list (continued)

Description	Part number	Table and page
BUSHING	*	Internal components (1 of 3)
BUSHING	*	Internal components (2 of 3)
BUSHING	*	Main drive assembly
BUSHING	*	Main drive assembly
BUSHING	*	Main drive assembly
BUSHING	*	Main drive assembly
BUSHING	*	Fuser assembly
BUSHING	*	Fuser assembly
BUSHING	*	Fuser assembly
BUSHING	*	Fuser assembly
BUSHING	*	Fuser assembly
BUSHING	*	Fuser assembly
BUSHING	*	Tray 2 sheet input tray internal components
BUSHING	*	Paper pick-up feeder assembly for Tray 2
BUSHING	*	Paper pick-up feeder assembly for Tray 2
BUSHING	*	Paper pick-up feeder assembly for Tray 2
BUSHING	*	Paper pick-up feeder assembly for Tray 2
BUSHING	*	Paper pick-up feeder assembly for Tray 2
BUSHING	*	Paper pick-up feeder assembly for Tray 2
BUSHING	*	Paper pick-up feeder assembly for Tray 2
BUSHING	*	Paper pickup feeder assembly (Tray 3)
BUSHING	*	Paper pickup feeder assembly (Tray 3)
BUSHING	*	Paper pickup feeder assembly (Tray 3)
BUSHING	*	Paper pickup feeder assembly (Tray 3)
BUSHING	*	Paper pickup feeder assembly (Tray 3)
BUSHING	*	Paper pickup feeder assembly (Tray 3)
BUSHING	*	Paper pickup feeder assembly (Tray 3)
BUTTON, CONTROL PANEL, 1	*	Control panel assembly
BUTTON, CONTROL PANEL, 2	*	Control panel assembly
BUTTON, CONTROL PANEL, 3	*	Control panel assembly

Table 7-22 Alphabetical parts list (continued)

Description	Part number	Table and page
CABLE, CPR	*	Internal components (3 of 3)
CABLE, FLAT	*	Internal components (3 of 3)
CABLE, FLAT	*	Internal components (3 of 3)
CABLE, FLAT	*	Internal components (3 of 3)
CABLE, OPTION SENSOR	*	Paper pickup feeder assembly (Tray 3)
CAM, HINGE, RIGHT	*	Internal components (2 of 3)
CAM, LEFT	*	Internal components (2 of 3)
CAM, PRESSURE RELEASE	*	Fuser assembly
CAM, RELEASE	*	Main drive assembly
CAM/GEAR, 26T	*	Internal components (2 of 3)
CAM/GEAR, 26T	*	Tray 2 sheet input tray internal components
CAP, CONTINUITY	*	Tray 2 sheet input tray internal components
CAP, SHAFT CONDUCTIVE	*	Internal components (2 of 3)
CASSETTE	RM1-1916-000CN	Assembly locations
CASSETTE	RM1-1916-000CN	Tray 2 input tray (cassette)
CASSETTE	RM1-1945-000CN	250-sheet input tray (cassette)
CASSETTE	RM1-1945-000CN	Tray 3 input tray (cassette)
CASSETTE BODY ASS'Y	*	Tray 2 input tray (cassette)
CASSETTE BODY ASS'Y	*	Tray 3 input tray (cassette)
CLAMP, FFC	*	Internal components (1 of 3)
CLAMP, FFC	*	Internal components (3 of 3)
CLAW, MD. PLATE RELEASE, LEFT	*	Tray 2 input tray (cassette)
CLAW, MD. PLATE RELEASE, LEFT	*	Tray 3 input tray (cassette)
CLAW, MD. PLATE RELEASE, RIGHT	*	Tray 2 input tray (cassette)
CLAW, MD. PLATE RELEASE, RIGHT	*	Tray 3 input tray (cassette)
CLAW, MIDDLE PLATE, LEFT	*	Tray 2 input tray (cassette)
CLAW, MIDDLE PLATE, LEFT	*	Tray 3 input tray (cassette)
CLAW, MIDDLE PLATE, RIGHT	*	Tray 2 input tray (cassette)
CLAW, MIDDLE PLATE, RIGHT	*	Tray 3 input tray (cassette)
CLIP, CABLE	*	External panels and covers (1 of 2)
CLIP, CABLE	*	External panels and covers (2 of 2)

Table 7-22 Alphabetical parts list (continued)

Description	Part number	Table and page
CLIP, CABLE	*	Main drive assembly
CLIP, EDGE	*	Main drive assembly
CLIP, ENTRANCE GUIDE	*	Fuser assembly
CLUTCH, MECHANICAL	*	Internal components (2 of 3)
CLUTCH, MECHANICAL	*	Tray 2 sheet input tray internal components
COLLAR, SPRING	*	Main drive assembly
CONNECTOR, 2P	*	Main drive assembly
CONNECTOR, DRAWER	*	Internal components (3 of 3)
CONNECTOR, DRAWER	*	Tray 2 sheet input tray internal components
CONNECTOR, SNAP TIGHT	*	External panels and covers (1 of 2)
CONNECTOR, SNAP TIGHT	*	External panels and covers (2 of 2)
CONNECTOR, SNAP TIGHT, BK	*	External panels and covers (1 of 2)
CONNECTOR, SNAP TIGHT, BK	*	External panels and covers (2 of 2)
CONNECTOR, SNAP TIGHT, BK	*	Internal components (3 of 3)
CONNECTOR, SNAP TIGHT, BK	*	Internal components (3 of 3)
CONNECTOR, SNAP TIGHT, BK	*	Main drive assembly
CONTROL PANEL ASS'Y	RM1-1983-000CN	Control panel assembly
CONTROL PANEL ASSEMBLY	RM1-1983-000CN	Assembly locations
CONTROL PANEL PCB ASS'Y	*	Control panel assembly
CONTROL PANEL PCB ASS'Y	*	Control panel assembly
COVER, CASSETTE DUST	RC1-5200-000CN	External panels and covers (1 of 2)
COVER, CASSETTE DUST	RC1-5200-000CN	External panels and covers (2 of 2)
COVER, CASSETTE DUST	RC1-5200-000CN	Tray 2 sheet input tray internal components
COVER, CASSETTE, LEFT	RC1-5184-000CN	External panels and covers (1 of 2)
COVER, CASSETTE, RIGHT	RC1-5188-000CN	External panels and covers (2 of 2)
COVER, CONTROLLER	*	Internal components (3 of 3)
COVER, DRUM	*	Main drive assembly

Table 7-22 Alphabetical parts list (continued)

Description	Part number	Table and page
COVER, FACE-DOWN	RC1-5173-000CN	External panels and covers (1 of 2)
COVER, INSIDE, LEFT	*	Internal components (1 of 3)
COVER, INSIDE, RIGHT	*	Internal components (1 of 3)
COVER, INSIDE, UPPER	RC1-5178-000CN	Upper assembly cover
COVER, LEFT	RC1-5183-000CN	External panels and covers (1 of 2)
COVER, OPTION FRONT	*	Tray 2 sheet input tray internal components
COVER, OPTION LEFT	*	Tray 2 sheet input tray internal components
COVER, OPTION RIGHT	*	Tray 2 sheet input tray internal components
COVER, OPTION RIGHT	*	Tray 2 sheet input tray internal components
COVER, PCB	*	Tray 2 sheet input tray internal components
COVER, PICK-UP FEED CABLE	*	Internal components (2 of 3)
COVER, PICKUP FEED FRAME	*	Paper pick-up feeder assembly for Tray 2
COVER, PICKUP FEED FRAME	*	Paper pick-up feeder assembly for Tray 2
COVER, PICKUP FEED FRAME	*	Paper pickup feeder assembly (Tray 3)
COVER, RIGHT	*	External panels and covers (2 of 2)
COVER, RIGHT FRONT	*	External panels and covers (2 of 2)
COVER, RIGHT FRONT	*	External panels and covers (2 of 2)
COVER, RIGHT FRONT	*	External panels and covers (2 of 2)
COVER, SENSOR, TOP	*	Paper pick-up feeder assembly for Tray 2
COVER, SWING GEAR	*	Tray 2 sheet input tray internal components
COVER, UPPER	RC1-5176-000CN	Upper assembly cover
COVER, UPPER FACE, S	RC1-5174-000CN	External panels and covers (1 of 2)
CROSSMEMBER, FRONT	*	Tray 2 sheet input tray internal components
CROSSMEMBER, LOWER, REAR	*	Tray 2 sheet input tray internal components

Table 7-22 Alphabetical parts list (continued)

Description	Part number	Table and page
CROSSMEMBER, MIDDLE	*	Tray 2 sheet input tray internal components
CROSSMEMBER, REAR	*	Tray 2 sheet input tray internal components
CROSSMEMBER, TOP COVER	*	Internal components (1 of 3)
DC CONTROLLER PCB ASS'Y	RM1-1975-000CN	Internal components (3 of 3)
DC CONTROLLER PCB ASS'Y	RM1-1975-000CN	PCB assembly location Tray 2
DOOR, FRONT	*	External panels and covers (2 of 2)
DRIVE CABLE	*	Internal components (3 of 3)
DUCT, FAN	*	Internal components (1 of 3)
DUCT, FAN	*	Main drive assembly
DUCT, FAN, LOWER	*	Internal components (1 of 3)
DUCT, FAN, UPPER	*	Internal components (1 of 3)
ELECT.TRANSPORT BELT ASS'Y	RM1-1885-000CN	Internal components (2 of 3)
EXTERNAL COVERS, PANELS, ETC.	*	External panels and covers (1 of 2)
EXTERNAL COVERS, PANELS, ETC.	*	External panels and covers (2 of 2)
F.F.C. CONNECT PCB UNIT	*	Main drive assembly
FAN	*	Internal components (1 of 3)
FAN	*	Main drive assembly
FEED ASS'Y	RM1-1923-000CN	Tray 2 input tray (cassette)
FEEDER UNIT CABLE	*	Paper pick-up feeder assembly for Tray 2
FEEDER UNIT JOINT CABLE	*	Internal components (2 of 3)
FEEDER UNIT JOINT CABLE	*	Internal components (3 of 3)
FILM GUIDE ASS'Y (110v)	*	Fuser assembly
FILM GUIDE ASS'Y (220v)	*	Fuser assembly
FIXING SENSOR CABLE	*	Internal components (3 of 3)
FLAG, INLET	*	Fuser assembly
FLAG, INTERTWINE PREVENTION	*	Fuser assembly
FLAG, PAPER DELIVERY	*	Fuser assembly
FLAG, PAPER WIDTH SENSOR	*	Paper pick-up feeder assembly for Tray 2
FLAG, PRESSURE RELEASE	*	Fuser assembly
FLAG, PRESSURE RELEASE SENSOR	*	Internal components (1 of 3)

Table 7-22 Alphabetical parts list (continued)

Description	Part number	Table and page
FLAG, SENSOR	*	Paper pick-up feeder assembly for Tray 2
FLANGE, CAM GEAR	*	Main drive assembly
FOOT, RUBBER	*	Internal components (1 of 3)
FOOT, RUBBER	*	Tray 2 sheet input tray internal components
FRAME, FIXING	*	Fuser assembly
FRAME, FRONT	*	Tray 3 input tray (cassette)
FRAME, OPTION, LEFT	*	Tray 2 sheet input tray internal components
FRAME, OPTION, RIGHT	*	Tray 2 sheet input tray internal components
FRAME, PAPER PICKUP FEEDER	*	Paper pick-up feeder assembly for Tray 2
FRAME, PAPER PICKUP FEEDER	*	Paper pickup feeder assembly (Tray 3)
FRONT DOOR ASS'Y	RM1-1856-000CN	External panels and covers (2 of 2)
FUSER ASS'Y (110v)	RM1-1820-000CN	Fuser assembly
FUSER ASS'Y (220v)	RM1-1821-000CN	Fuser assembly
FUSER ASSEMBLY	RM1-1820-000CN (110v) or RM1-1821-000CN (220v)	Assembly locations
GEAR, 134T	*	Main drive assembly
GEAR, 16T	*	Fuser assembly
GEAR, 16T	*	Tray 2 input tray (cassette)
GEAR, 18T	*	Main drive assembly
GEAR, 18T	*	Tray 2 sheet input tray internal components
GEAR, 19T	*	Fuser assembly
GEAR, 19T	*	Tray 2 sheet input tray internal components
GEAR, 19T/71T	*	Fuser assembly
GEAR, 20T	*	Internal components (1 of 3)
GEAR, 20T/44T	*	Fuser assembly
GEAR, 22T	*	Tray 2 input tray (cassette)
GEAR, 22T	*	Tray 3 input tray (cassette)
GEAR, 22T/38T	*	Fuser assembly
GEAR, 26T	*	Fuser assembly

Table 7-22 Alphabetical parts list (continued)

Description	Part number	Table and page
GEAR, 27T	*	Fuser assembly
GEAR, 27T/64T	*	Main drive assembly
GEAR, 29T	*	Internal components (2 of 3)
GEAR, 29T	*	Internal components (2 of 3)
GEAR, 29T	*	Tray 2 sheet input tray internal components
GEAR, 29T	*	Tray 2 sheet input tray internal components
GEAR, 30T	*	Fuser assembly
GEAR, 36T	*	Internal components (1 of 3)
GEAR, 36T	*	Internal components (1 of 3)
GEAR, 37T	*	Main drive assembly
GEAR, 40T/43T	*	Internal components (2 of 3)
GEAR, 40T/43T	*	Tray 2 sheet input tray internal components
GEAR, 43T/16T	*	Internal components (2 of 3)
GEAR, 47T/26T	*	Internal components (2 of 3)
GEAR, 47T/26T	*	Tray 2 sheet input tray internal components
GEAR, 49T	*	Fuser assembly
GEAR, 53T/96T	*	Main drive assembly
GEAR, 54T	*	Internal components (1 of 3)
GEAR, 54T	*	Main drive assembly
GEAR, 54T	*	Main drive assembly
GEAR, 57T/20T	*	Internal components (2 of 3)
GEAR, 64T	*	Main drive assembly
GEAR, 64T	*	Main drive assembly
GEAR, 64T	*	Main drive assembly
GEAR, 81T	*	Main drive assembly
GEAR, 81T/32T	*	Main drive assembly
GEAR, 86T	*	Main drive assembly
GEAR, 89T/53T	*	Main drive assembly
GEAR, 96T	*	Main drive assembly
GEAR, 98T	*	Main drive assembly
GUIDE, CABLE, UPPER	*	Internal components (3 of 3)
GUIDE, CARTRIDGE, LEFT	*	Internal components (1 of 3)

Table 7-22 Alphabetical parts list (continued)

Description	Part number	Table and page
GUIDE, CARTRIDGE, RIGHT	*	Internal components (1 of 3)
GUIDE, CASSETTE DUPLEX, LOWER	*	Tray 2 input tray (cassette)
GUIDE, CASSETTE DUPLEX, UPPER	*	Tray 2 input tray (cassette)
GUIDE, CASSETTE, FRONT LEFT	*	Internal components (1 of 3)
GUIDE, CASSETTE, FRONT LEFT	*	Internal components (2 of 3)
GUIDE, CASSETTE, FRONT LEFT	*	Tray 2 sheet input tray internal components
GUIDE, CASSETTE, FRONT RIGHT	*	Internal components (1 of 3)
GUIDE, CASSETTE, FRONT RIGHT	*	Internal components (1 of 3)
GUIDE, CASSETTE, FRONT RIGHT	*	Internal components (2 of 3)
GUIDE, CASSETTE, FRONT RIGHT	*	Tray 2 sheet input tray internal components
GUIDE, CASSETTE, REAR LEFT	*	Internal components (1 of 3)
GUIDE, CASSETTE, REAR LEFT	*	Tray 2 sheet input tray internal components
GUIDE, CASSETTE, REAR RIGHT	*	Internal components (1 of 3)
GUIDE, CASSETTE, REAR RIGHT	*	Internal components (1 of 3)
GUIDE, CASSETTE, REAR RIGHT	*	Tray 2 sheet input tray internal components
GUIDE, CONTACT/SENSOR SUPPORT	*	Fuser assembly
GUIDE, CONTROL PANEL LIGHT	*	Control panel assembly
GUIDE, DRIVE CABLE	*	Main drive assembly
GUIDE, FEED WIDTH, LEFT	*	Tray 2 input tray (cassette)
GUIDE, FEED WIDTH, RIGHT	*	Tray 2 input tray (cassette)
GUIDE, FIXING ENTRANCE	*	Fuser assembly
GUIDE, LIGHT	*	External panels and covers (2 of 2)
GUIDE, MANUAL FEED	*	Tray 2 input tray (cassette)
GUIDE, PAPER DELIVERY LOWER	*	Fuser assembly
GUIDE, PAPER DELIVERY UPPER	*	Fuser assembly
GUIDE, PAPER SENSOR CABLE, 1	*	Tray 2 sheet input tray internal components
GUIDE, PAPER SENSOR CABLE, 2	*	Tray 2 sheet input tray internal components
GUIDE, PRE-TRANSFER	*	Paper pick-up feeder assembly for Tray 2
GUIDE, PRE-TRANSFER	*	Paper pickup feeder assembly (Tray 3)

Table 7-22 Alphabetical parts list (continued)

Description	Part number	Table and page
GUIDE, REGISTRATION	*	Paper pick-up feeder assembly for Tray 2
GUIDE, REGISTRATION	*	Paper pickup feeder assembly (Tray 3)
HIGH-VOLTAGE PCB ASSY	*	Internal components (3 of 3)
HIGH-VOLTAGE PCB ASSY	*	PCB assembly location Tray 2
HOLDER, CABLE, LEFT	*	Internal components (3 of 3)
HOLDER, CABLE, UPPER	*	Internal components (3 of 3)
HOLDER, DC CABLE	*	Internal components (3 of 3)
HOLDER, DRAWER	*	Internal components (3 of 3)
HOLDER, DRAWER CONNECTOR	*	Tray 2 sheet input tray internal components
HOLDER, DRUM	*	Internal components (1 of 3)
HOLDER, DRUM	*	Internal components (1 of 3)
HOLDER, FAN RETAINER	*	Internal components (1 of 3)
HOLDER, MEMORY CONTROLLER	*	Internal components (1 of 3)
HOLDER, PAD	*	Tray 2 input tray (cassette)
HOLDER, PAD	*	Tray 2 input tray (cassette)
HOLDER, PAD	*	Tray 2 input tray (cassette)
HOLDER, PAD	*	Tray 3 input tray (cassette)
HOLDER, PAD	*	Tray 3 input tray (cassette)
HOLDER, PAD	*	Tray 3 input tray (cassette)
HOLDER, PAPER PICKUP ROLLER	*	Paper pick-up feeder assembly for Tray 2
HOLDER, PAPER PICKUP ROLLER	*	Paper pickup feeder assembly (Tray 3)
HOLDER, PAPER RETAINING	*	Tray 2 input tray (cassette)
HOLDER, PAPER RETAINING	*	Tray 3 input tray (cassette)
HOLDER, PAPER WIDTH SENSOR	*	Paper pick-up feeder assembly for Tray 2
HOLDER, PRESSURE RELEASE GEAR	*	Fuser assembly
HOLDER, RESISTOR	*	Fuser assembly
HOLDER, SEPARATION	*	Tray 2 input tray (cassette)
HOLDER, SEPARATION	*	Tray 3 input tray (cassette)
HOLDER, SWING GEAR	*	Tray 2 sheet input tray internal components
INTERNAL COMPONENTS	*	Tray 2 sheet input tray internal components

Table 7-22 Alphabetical parts list (continued)

Description	Part number	Table and page
INTERNAL COMPONENTS 1	*	Internal components (1 of 3)
INTERNAL COMPONENTS 2	*	Internal components (2 of 3)
INTERNAL COMPONENTS 3	*	Internal components (3 of 3)
LATCH, LEFT	*	Internal components (1 of 3)
LATCH, RIGHT	*	Internal components (1 of 3)
LEFT INTERNAL COVER ASS'Y	*	Internal components (1 of 3)
LEFT PAPER SIDE END ASS'Y	*	Tray 2 input tray (cassette)
LEFT PAPER SIDE END ASS'Y	*	Tray 3 input tray (cassette)
LEVER, BACK END LOCK RELEASE	*	Tray 2 input tray (cassette)
LEVER, BACK END LOCK RELEASE	*	Tray 3 input tray (cassette)
LEVER, CONNECTING, LEFT	*	Internal components (2 of 3)
LEVER, CONNECTING, RIGHT	*	Internal components (2 of 3)
LEVER, ETB RELEASE	*	Internal components (1 of 3)
LEVER, LINK	*	External panels and covers (2 of 2)
LEVER, SIDE END LOCK RELEASE	*	Tray 2 input tray (cassette)
LEVER, SIDE END LOCK RELEASE	*	Tray 3 input tray (cassette)
LEVER, TOGGLE, LEFT	*	External panels and covers (2 of 2)
LEVER, TOGGLE, RIGHT	*	External panels and covers (2 of 2)
LID, CONTROLLER	*	Internal components (3 of 3)
LINK, SHUTTER	*	Internal components (1 of 3)
MAIN DRIVE ASS'Y	*	Main drive assembly
MAIN DRIVE ASSEMBLY	*	Assembly locations
MEMORY CONTROLLER PCB ASS'Y	*	Internal components (1 of 3)
MEMORY CONTROLLER PCB ASS'Y	*	PCB assembly location Tray 2
MIDDLE PLATE ASS'Y	*	Tray 2 input tray (cassette)
MIDDLE PLATE ASS'Y	*	Tray 3 input tray (cassette)
MOTOR, DC	*	Main drive assembly
MOTOR, STEPPING, DC	*	Internal components (2 of 3)
MOTOR, STEPPING, DC	*	Fuser assembly
OPTION FRAME LEFT ASS'Y	*	Tray 2 sheet input tray internal components
OPTION FRAME RIGHT ASS'Y	*	Tray 2 sheet input tray internal components

Table 7-22 Alphabetical parts list (continued)

Description	Part number	Table and page
PANEL, CONTROL PANEL	*	Control panel assembly
PANEL, FRONT	*	Tray 2 input tray (cassette)
PANEL, FRONT	*	Tray 3 input tray (cassette)
PAPER DELIVERY TRAY ASS'Y	RM1-1859-000CN	External panels and covers (1 of 2)
PAPER FEEDER PCB ASS'Y	*	Tray 2 sheet input tray internal components
PAPER FEEDER PCB ASS'Y	*	Paper pickup feeder assembly (Tray 3)
PAPER PICKUP DRIVE ASS'Y	*	Paper pick-up feeder assembly for Tray 2
PAPER PICKUP DRIVE ASS'Y	*	Paper pickup feeder assembly (Tray 3)
PAPER PICKUP FEEDER ASS'Y	*	Paper pick-up feeder assembly for Tray 2
PAPER PICKUP FEEDER ASSEMBLY	*	Assembly locations
PAPER PICKUP ROLLER	RC1-5440-000CN	250-sheet input tray (cassette)
PAPER PICKUP ROLLER	RC1-5440-000CN	Tray 3 input tray (cassette)
PAPER PICKUP ROLLER	RC1-5440-000CN	Paper pickup feeder assembly (Tray 3)
PCB ASS'Y LOCATION DIAGRAM	*	PCB assembly location Tray 2
PCB ASS'Y LOCATION DIAGRAM	*	Paper pickup feeder assembly (Tray 3)
PHOTO INTERRUPTER (SENSOR)	*	Internal components (1 of 3)
PHOTO INTERRUPTER (SENSOR)	*	Fuser assembly
PHOTO INTERRUPTER (SENSOR)	*	Paper pick-up feeder assembly for Tray 2
PHOTO INTERRUPTER (SENSOR)	*	Paper pickup feeder assembly (Tray 3)
PICKUP GEAR ASS'Y	*	Internal components (2 of 3)
PICKUP GEAR ASS'Y	*	Tray 2 sheet input tray internal components
PIN,DOWEL	*	Fuser assembly
PLATE	*	Internal components (2 of 3)
PLATE, BACK END LIMIT, LARGE	*	Tray 2 input tray (cassette)
PLATE, BACK END LIMIT, LARGE	*	Tray 3 input tray (cassette)
PLATE, BACK END LIMIT, SMALL	*	Tray 2 input tray (cassette)
PLATE, BACK END LIMIT, SMALL	*	Tray 3 input tray (cassette)
PLATE, CASSETTE REINFORCEMENT	*	Tray 2 input tray (cassette)

Table 7-22 Alphabetical parts list (continued)

Description	Part number	Table and page
PLATE, CASSETTE REINFORCEMENT	*	Tray 3 input tray (cassette)
PLATE, CONNECTOR	*	Internal components (3 of 3)
PLATE, CONTROL PANEL RETAINING	*	Control panel assembly
PLATE, DELIVERY BACK END LIMIT	*	External panels and covers (1 of 2)
PLATE, DRIVE INSIDE	*	Main drive assembly
PLATE, FAN	*	Main drive assembly
PLATE, GROUNDING	*	External panels and covers (1 of 2)
PLATE, GROUNDING	*	Fuser assembly
PLATE, GROUNDING	*	Tray 2 sheet input tray internal components
PLATE, HEAT INSULATING	*	Internal components (2 of 3)
PLATE, MIDDLE	*	Tray 2 input tray (cassette)
PLATE, MIDDLE	*	Tray 3 input tray (cassette)
PLATE, MOTOR ANTI-MAGNETIC	*	Fuser assembly
PLATE, PANEL FIX, RIGHT FRONT	*	Internal components (2 of 3)
PLATE, PAPER GUIDE	*	Tray 2 input tray (cassette)
PLATE, PAPER GUIDE	*	Tray 3 input tray (cassette)
PLATE, PAPER SIDE END, LEFT	*	Tray 3 input tray (cassette)
PLATE, PAPER SIDE END, RIGHT	*	Tray 2 input tray (cassette)
PLATE, PAPER SIDE END, RIGHT	*	Tray 3 input tray (cassette)
PLATE, PRESSURE RELEASE, LEFT	*	Fuser assembly
PLATE, PRESSURE RELEASE, RIGHT	*	Fuser assembly
PLATE, PRESSURE, LEFT	*	Internal components (1 of 3)
PLATE, PRESSURE, LEFT	*	Fuser assembly
PLATE, PRESSURE, RIGHT	*	Internal components (1 of 3)
PLATE, PRESSURE, RIGHT	*	Fuser assembly
PLATE, REAR	RC1-5227-000CN	External panels and covers (1 of 2)
PLATE, REAR	RC1-5227-000CN	External panels and covers (2 of 2)
PLATE, REG. GROUNDING, 1	*	Paper pick-up feeder assembly for Tray 2
PLATE, REG. GROUNDING, 1	*	Paper pickup feeder assembly (Tray 3)
PLATE, REG. GROUNDING, 2	*	Paper pick-up feeder assembly for Tray 2

Table 7-22 Alphabetical parts list (continued)

Description	Part number	Table and page
PLATE, REG. GROUNDING, 2	*	Paper pickup feeder assembly (Tray 3)
PLATE, REINFORCEMENT	*	Tray 2 input tray (cassette)
PLATE, REINFORCEMENT	*	Tray 3 input tray (cassette)
PLATE, SHAFT	*	Internal components (1 of 3)
PLATE, SHIELD	*	Internal components (3 of 3)
PLATE, SHIELD, FRONT	*	Internal components (3 of 3)
POWER CABLE	*	Internal components (3 of 3)
POWER CONTROLLER CABLE	*	Internal components (3 of 3)
POWER SUPPLY PCB ASS'Y	*	Internal components (3 of 3)
POWER SUPPLY PCB ASS'Y	*	Internal components (3 of 3)
POWER SUPPLY PCB ASS'Y	*	Internal components (3 of 3)
POWER SUPPLY PCB ASS'Y	*	PCB assembly location Tray 2
POWER SUPPLY PCB ASS'Y	*	PCB assembly location Tray 2
PULLEY	*	Main drive assembly
RACK	*	Tray 2 input tray (cassette)
RACK	*	Tray 3 input tray (cassette)
RACK, MANUAL FEED	*	Tray 2 input tray (cassette)
RESISTOR, 400 OHM, 0.5W	*	Paper pick-up feeder assembly for Tray 2
RESISTOR, 400 OHM, 0.5W	*	Paper pickup feeder assembly (Tray 3)
RETAINER, PAPER	RC1-5062-000CN	Internal components (2 of 3)
RIB, ENTRANCE GUIDE	*	Fuser assembly
RIGHT COVER ASS'Y	RM1-1858-000CN	External panels and covers (2 of 2)
RIGHT PAPER SIDE END ASS'Y	*	Tray 2 input tray (cassette)
RIGHT PAPER SIDE END ASS'Y	*	Tray 3 input tray (cassette)
RING, E	*	Internal components (1 of 3)
RING, E	*	Internal components (2 of 3)
RING, E	*	Main drive assembly
RING, E	*	Fuser assembly
RING, E	*	Fuser assembly
ROD, BEARING SUPPORT	*	Internal components (3 of 3)
ROD, LEFT	*	Internal components (1 of 3)
ROD, RELEASE, RIGHT	*	Main drive assembly

Table 7-22 Alphabetical parts list (continued)

Description	Part number	Table and page
ROLLER, CASSETTE PAPER PICKUP	*	Paper pick-up feeder assembly for Tray 2
ROLLER, CASSETTE PAPER PICKUP	*	Paper pickup feeder assembly (Tray 3)
ROLLER, DELIVERY	*	Fuser assembly
ROLLER, FACE-DOWN BENDING	*	Fuser assembly
ROLLER, PAPER PICKUP	RC1-5440-000CN	Paper pick-up feeder assembly for Tray 2
ROLLER, PAPER PICKUP	RC1-5440-000CN	Paper pickup feeder assembly (Tray 3)
ROLLER, PRESSURE	*	Fuser assembly
ROLLER, REGISTRATION DRIVE	*	Paper pick-up feeder assembly for Tray 2
ROLLER, REGISTRATION DRIVE	*	Paper pickup feeder assembly (Tray 3)
ROLLER, REGISTRATION, A	*	Paper pick-up feeder assembly for Tray 2
ROLLER, REGISTRATION, A	*	Paper pickup feeder assembly (Tray 3)
ROLLER, REGISTRATION, B	*	Paper pick-up feeder assembly for Tray 2
ROLLER, REGISTRATION, B	*	Paper pickup feeder assembly (Tray 3)
ROLLER, REGISTRATION, C	*	Paper pick-up feeder assembly for Tray 2
ROLLER, REGISTRATION, C	*	Paper pickup feeder assembly (Tray 3)
SADDLE, WIRE	*	External panels and covers (1 of 2)
SADDLE, WIRE	*	External panels and covers (2 of 2)
SADDLE, WIRE	*	Internal components (2 of 3)
SADDLE, WIRE	*	Tray 2 sheet input tray internal components
SCANNER UNIT	*	Internal components (3 of 3)
SCREW, RS, M3X10	*	Internal components (3 of 3)
SCREW, RS, M3X6	*	Internal components (2 of 3)
SCREW, RS, M3X6	*	Internal components (2 of 3)
SCREW, RS, M3X6	*	Fuser assembly
SCREW, RS, M3X8	*	Internal components (1 of 3)
SCREW, RS, M3X8	*	Internal components (1 of 3)

Table 7-22 Alphabetical parts list (continued)

Description	Part number	Table and page
SCREW, RS, M3X8	*	Internal components (1 of 3)
SCREW, RS, M3X8	*	Internal components (1 of 3)
SCREW, RS, M3X8	*	Internal components (2 of 3)
SCREW, RS, M3X8	*	Internal components (3 of 3)
SCREW, RS, M3X8	*	Control panel assembly
SCREW, RS, M3X8	*	Main drive assembly
SCREW, RS, M3X8	*	Fuser assembly
SCREW, RS, M3X8	*	Fuser assembly
SCREW, RS, M3X8	*	Tray 2 sheet input tray internal components
SCREW, RS, M3X8	*	Tray 2 sheet input tray internal components
SCREW, RS, M3X8	*	Tray 2 sheet input tray internal components
SCREW, TAPPING, TRUSS HEAD, M4X8	*	Internal components (2 of 3)
SCREW, TAPPING, TRUSS HEAD, M4X8	*	Internal components (3 of 3)
SCREW, TAPPING, TRUSS HEAD, M4X8	*	Tray 2 sheet input tray internal components
SCREW, TAPPING, TRUSS HEAD, M3X6	*	Tray 2 input tray (cassette)
SCREW, TAPPING, TRUSS HEAD, M3X6	*	Tray 2 input tray (cassette)
SCREW, TAPPING, TRUSS HEAD, M3X6	*	Tray 3 input tray (cassette)
SCREW, TAPPING, TRUSS HEAD, M3X8	*	External panels and covers (1 of 2)
SCREW, TAPPING, TRUSS HEAD, M4X8	*	External panels and covers (2 of 2)
SCREW, TAPPING, TRUSS HEAD, M4X8	*	Upper assembly cover
SCREW, TAPPING, TRUSS HEAD, M4X8	*	Internal components (1 of 3)
SCREW, TAPPING, TRUSS HEAD, M4X8	*	Main drive assembly
SCREW, TAPPING, TRUSS HEAD, M4X8	*	Tray 2 input tray (cassette)
SCREW, TAPPING, TRUSS HEAD, M4X8	*	Paper pick-up feeder assembly for Tray 2
SCREW, TAPPING, TRUSS HEAD, M4X8	*	Tray 3 input tray (cassette)
SCREW, TAPPING, TRUSS HEAD, M4X8	*	Paper pickup feeder assembly (Tray 3)
SCREW, TP	*	External panels and covers (2 of 2)
SCREW, W/WASHER, M3X8	*	Internal components (3 of 3)
SCREW, W/WASHER, M4X18	*	Internal components (2 of 3)

Table 7-22 Alphabetical parts list (continued)

Description	Part number	Table and page
SE RING	*	Main drive assembly
SEPARATION ASS'Y	RM1-1922-000CN	Tray 2 input tray (cassette)
SEPARATION ASS'Y	RM1-1922-000CN	Tray 3 input tray (cassette)
SHAFT, DRUM GEAR	*	Main drive assembly
SHAFT, ETB DRIVE	*	Internal components (1 of 3)
SHAFT, FACE-DOWN ROLLER	*	Fuser assembly
SHAFT, FRONT DOOR	*	Internal components (2 of 3)
SHAFT, FRONT DOOR ARM	*	External panels and covers (2 of 2)
SHAFT, PAPER PICKUP DRIVE	*	Paper pick-up feeder assembly for Tray 2
SHAFT, PAPER PICKUP DRIVE	*	Paper pickup feeder assembly (Tray 3)
SHAFT, POSITIONING	*	Tray 2 sheet input tray internal components
SHAFT, PRESSURE RELEASE	*	Fuser assembly
SHAFT, PRESSURE RELEASE CAM	*	Fuser assembly
SHAFT, REGISTRATION ROLLER	*	Paper pick-up feeder assembly for Tray 2
SHAFT, REGISTRATION ROLLER	*	Paper pickup feeder assembly (Tray 3)
SHAFT, TOGGLE	*	Internal components (1 of 3)
SHEET, SCRAPER, 1	*	Paper pick-up feeder assembly for Tray 2
SHEET, SCRAPER, 2	*	Paper pick-up feeder assembly for Tray 2
SHEET, SEPARATION	*	Tray 2 input tray (cassette)
SHEET, SEPARATION	*	Tray 3 input tray (cassette)
SHUTTER, REGISTRATION	*	Paper pick-up feeder assembly for Tray 2
SIDE PLATE, DRIVE	*	Main drive assembly
SIDE PLATE, FIXING, LEFT	*	Fuser assembly
SIDE PLATE, FIXING, LEFT, 2	*	Fuser assembly
SIDE PLATE, FIXING, RIGHT	*	Fuser assembly
SIDE PLATE, FIXING, RIGHT, 2	*	Fuser assembly
SIDE PLATE, GEAR	*	Fuser assembly
SIZE PLATE, PAPER	*	Tray 2 input tray (cassette)
SIZE PLATE, PAPER	*	Tray 3 input tray (cassette)

Table 7-22 Alphabetical parts list (continued)

Description	Part number	Table and page
SOLENOID	*	Internal components (2 of 3)
SOLENOID	*	Main drive assembly
SOLENOID	*	Tray 2 sheet input tray internal components
SOLID RESISTOR, 20MOHM, 1/4W	*	Fuser assembly
SPACER, CONTROL PANEL	*	Control panel assembly
SPRING, COMPRESSION	*	Internal components (1 of 3)
SPRING, COMPRESSION	*	Internal components (1 of 3)
SPRING, COMPRESSION	*	Internal components (2 of 3)
SPRING, COMPRESSION	*	Internal components (2 of 3)
SPRING, COMPRESSION	*	Main drive assembly
SPRING, COMPRESSION	*	Main drive assembly
SPRING, COMPRESSION	*	Fuser assembly
SPRING, COMPRESSION	*	Tray 2 input tray (cassette)
SPRING, COMPRESSION	*	Tray 2 input tray (cassette)
SPRING, COMPRESSION	*	Tray 2 input tray (cassette)
SPRING, COMPRESSION	*	Tray 2 input tray (cassette)
SPRING, COMPRESSION	*	Tray 2 input tray (cassette)
SPRING, COMPRESSION	*	Tray 2 input tray (cassette)
SPRING, COMPRESSION	*	Tray 2 input tray (cassette)
SPRING, COMPRESSION	*	Tray 2 input tray (cassette)
SPRING, COMPRESSION	*	Tray 2 input tray (cassette)
SPRING, COMPRESSION	*	Tray 2 input tray (cassette)
SPRING, COMPRESSION	*	Tray 2 input tray (cassette)
SPRING, COMPRESSION	*	Tray 2 sheet input tray internal components
SPRING, COMPRESSION	*	Tray 2 sheet input tray internal components
SPRING, COMPRESSION	*	Paper pick-up feeder assembly for Tray 2
SPRING, COMPRESSION	*	Tray 3 input tray (cassette)
SPRING, COMPRESSION	*	Tray 3 input tray (cassette)
SPRING, COMPRESSION	*	Tray 3 input tray (cassette)
SPRING, COMPRESSION	*	Tray 3 input tray (cassette)
SPRING, COMPRESSION	*	Tray 3 input tray (cassette)
SPRING, COMPRESSION	*	Tray 3 input tray (cassette)
SPRING, COMPRESSION	*	Tray 3 input tray (cassette)

Table 7-22 Alphabetical parts list (continued)

Description	Part number	Table and page
SPRING, COMPRESSION	*	Tray 3 input tray (cassette)
SPRING, COMPRESSION	*	Tray 3 input tray (cassette)
SPRING, COMPRESSION	*	Tray 3 input tray (cassette)
SPRING, COMPRESSION	*	Paper pickup feeder assembly (Tray 3)
SPRING, GROUNDING	*	Internal components (1 of 3)
SPRING, GROUNDING	*	Internal components (1 of 3)
SPRING, GROUNDING	*	Internal components (1 of 3)
SPRING, GROUNDING	*	Internal components (1 of 3)
SPRING, GROUNDING	*	Internal components (1 of 3)
SPRING, GROUNDING	RC1-5147-000CN	Internal components (2 of 3)
SPRING, GROUNDING	*	Fuser assembly
SPRING, GROUNDING	*	Fuser assembly
SPRING, GROUNDING	*	Fuser assembly
SPRING, GROUNDING	*	Fuser assembly
SPRING, GROUNDING	*	Tray 2 input tray (cassette)
SPRING, GROUNDING	*	Tray 2 input tray (cassette)
SPRING, GROUNDING	*	Tray 2 sheet input tray internal components
SPRING, GROUNDING	*	Tray 3 input tray (cassette)
SPRING, GROUNDING	*	Tray 3 input tray (cassette)
SPRING, LEAF	*	Internal components (2 of 3)
SPRING, LEAF	*	Fuser assembly
SPRING, LEAF	*	Tray 2 sheet input tray internal components
SPRING, TENSION	*	Internal components (1 of 3)
SPRING, TENSION	*	Internal components (1 of 3)
SPRING, TENSION	*	Main drive assembly
SPRING, TENSION	*	Fuser assembly
SPRING, TENSION	*	Tray 2 input tray (cassette)
SPRING, TENSION	*	Tray 2 sheet input tray internal components
SPRING, TENSION	*	Paper pick-up feeder assembly for Tray 2
SPRING, TENSION	*	Tray 3 input tray (cassette)
SPRING, TENSION	*	Paper pickup feeder assembly (Tray 3)

Table 7-22 Alphabetical parts list (continued)

Description	Part number	Table and page
SPRING, TORSION	*	Internal components (1 of 3)
SPRING, TORSION	*	Internal components (1 of 3)
SPRING, TORSION	*	Internal components (1 of 3)
SPRING, TORSION	*	Fuser assembly
SPRING, TORSION	*	Fuser assembly
SPRING, TORSION	*	Paper pick-up feeder assembly for Tray 2
SPRING, TORSION	*	Paper pick-up feeder assembly for Tray 2
SPRING, TORSION	*	Paper pick-up feeder assembly for Tray 2
STOP, CAM GEAR	*	Main drive assembly
STOP, CLUTCH	*	Internal components (2 of 3)
STOP, CLUTCH	*	Tray 2 sheet input tray internal components
STOPPER, BACK END LIMIT	*	Tray 2 input tray (cassette)
STOPPER, BACK END LIMIT	*	Tray 3 input tray (cassette)
STOPPER, CASSETTE, LEFT	*	Tray 2 input tray (cassette)
STOPPER, CASSETTE, LEFT	*	Tray 3 input tray (cassette)
STOPPER, CASSETTE, RIGHT	*	Tray 2 input tray (cassette)
STOPPER, CASSETTE, RIGHT	*	Tray 3 input tray (cassette)
STOPPER, PAPER SIDE END	*	Tray 2 input tray (cassette)
STOPPER, PAPER SIDE END	*	Tray 3 input tray (cassette)
TRAY, EXTENSION	*	External panels and covers (1 of 2)
TRAY, FACE-DOWN	*	External panels and covers (1 of 2)
UPPER COVER	*	Assembly locations
WEIGHT, PAD	*	Tray 2 input tray (cassette)
WEIGHT, PAD	*	Tray 3 input tray (cassette)

Numerical parts list

Table 7-23 Numerical parts list

Part number	Description	Table and page
	* Not set up as a service part	Assembly locations
	* Not set up as a service part	External panels and covers (1 of 2)
	* Not set up as a service part	External panels and covers (2 of 2)
	* Not set up as a service part	Upper assembly cover
	* Not set up as a service part	Internal components (1 of 3)
	* Not set up as a service part	Internal components (2 of 3)
	* Not set up as a service part	Internal components (3 of 3)
	* Not set up as a service part	Control panel assembly
	* Not set up as a service part	Main drive assembly
	* Not set up as a service part	Fuser assembly
	RING, E	Fuser assembly
	* Not set up as a service part	PCB assembly location Tray 2
	* Not set up as a service part	Tray 2 input tray (cassette)
	* Not set up as a service part	250-sheet input tray (cassette)
	* Not set up as a service part	Tray 2 sheet input tray internal components
	* Not set up as a service part	Paper pick-up feeder assembly for Tray 2
	* Not set up as a service part	Tray 3 input tray (cassette)
	* Not set up as a service part	Paper pickup feeder assembly (Tray 3)
	* Not set up as a service part	Paper pickup feeder assembly (Tray 3)
*	UPPER COVER	Assembly locations
*	MAIN DRIVE ASSEMBLY	Assembly locations
*	PAPER PICKUP FEEDER ASSEMBLY	Assembly locations
*	EXTERNAL COVERS, PANELS, ETC.	External panels and covers (1 of 2)
*	CONNECTOR, SNAP TIGHT	External panels and covers (1 of 2)
*	CONNECTOR, SNAP TIGHT, BK	External panels and covers (1 of 2)
*	CLIP, CABLE	External panels and covers (1 of 2)

Table 7-23 Numerical parts list (continued)

Part number	Description	Table and page
*	SADDLE, WIRE	External panels and covers (1 of 2)
*	PLATE, GROUNDING	External panels and covers (1 of 2)
*	SCREW, TAPPING,TRUSS HEAD,M3X8	External panels and covers (1 of 2)
*	TRAY, EXTENSION	External panels and covers (1 of 2)
*	TRAY, FACE-DOWN	External panels and covers (1 of 2)
*	PLATE, DELIVERY BACK END LIMIT	External panels and covers (1 of 2)
*	EXTERNAL COVERS, PANELS, ETC.	External panels and covers (2 of 2)
*	CONNECTOR, SNAP TIGHT	External panels and covers (2 of 2)
*	CONNECTOR, SNAP TIGHT, BK	External panels and covers (2 of 2)
*	CLIP, CABLE	External panels and covers (2 of 2)
*	SADDLE, WIRE	External panels and covers (2 of 2)
*	ARM, FRONT DOOR, LEFT	External panels and covers (2 of 2)
*	ARM, FRONT DOOR, RIGHT	External panels and covers (2 of 2)
*	SHAFT, FRONT DOOR ARM	External panels and covers (2 of 2)
*	COVER, RIGHT FRONT	External panels and covers (2 of 2)
*	DOOR, FRONT	External panels and covers (2 of 2)
*	LEVER, LINK	External panels and covers (2 of 2)
*	LEVER, TOGGLE, LEFT	External panels and covers (2 of 2)
*	LEVER, TOGGLE, RIGHT	External panels and covers (2 of 2)
*	SCREW, TAPPING,TRUSS HEAD,M4X8	External panels and covers (2 of 2)
*	SCREW, TP	External panels and covers (2 of 2)
*	COVER, RIGHT	External panels and covers (2 of 2)

Table 7-23 Numerical parts list (continued)

Part number	Description	Table and page
*	COVER, RIGHT FRONT	External panels and covers (2 of 2)
*	BUSHING	External panels and covers (2 of 2)
*	COVER, RIGHT FRONT	External panels and covers (2 of 2)
*	GUIDE, LIGHT	External panels and covers (2 of 2)
*	SCREW, TAPPING, TRUSS HEAD, M4X8	Upper assembly cover
*	INTERNAL COMPONENTS 1	Internal components (1 of 3)
*	CROSSMEMBER, TOP COVER	Internal components (1 of 3)
*	BRACKET, LEFT REAR	Internal components (1 of 3)
*	BRACKET, RIGHT REAR	Internal components (1 of 3)
*	COVER, INSIDE, RIGHT	Internal components (1 of 3)
*	BRACKET, CARD READER	Internal components (1 of 3)
*	HOLDER, FAN RETAINER	Internal components (1 of 3)
*	LATCH, LEFT	Internal components (1 of 3)
*	BUSHING	Internal components (1 of 3)
*	LATCH, RIGHT	Internal components (1 of 3)
*	LEVER, ETB RELEASE	Internal components (1 of 3)
*	FAN	Internal components (1 of 3)
*	GEAR, 54T	Internal components (1 of 3)
*	SPRING, TENSION	Internal components (1 of 3)
*	SPRING, COMPRESSION	Internal components (1 of 3)
*	LEFT INTERNAL COVER ASSY	Internal components (1 of 3)
*	GUIDE, CARTRIDGE, RIGHT	Internal components (1 of 3)
*	HOLDER, DRUM	Internal components (1 of 3)
*	BUSHING	Internal components (1 of 3)
*	PLATE, PRESSURE, RIGHT	Internal components (1 of 3)
*	BUSHING	Internal components (1 of 3)
*	GUIDE, CASSETTE, REAR RIGHT	Internal components (1 of 3)
*	GUIDE, CASSETTE, FRONT RIGHT	Internal components (1 of 3)
*	GEAR, 20T	Internal components (1 of 3)
*	GEAR, 36T	Internal components (1 of 3)
*	GEAR, 36T	Internal components (1 of 3)
*	SPRING, TORSION	Internal components (1 of 3)

Table 7-23 Numerical parts list (continued)

Part number	Description	Table and page
*	SCREW, RS, M3X8	Internal components (1 of 3)
*	SCREW, RS, M3X8	Internal components (1 of 3)
*	SCREW, RS, M3X8	Internal components (1 of 3)
*	SCREW, RS, M3X8	Internal components (1 of 3)
*	GUIDE, CARTRIDGE, LEFT	Internal components (1 of 3)
*	HOLDER, DRUM	Internal components (1 of 3)
*	LINK, SHUTTER	Internal components (1 of 3)
*	PLATE, PRESSURE, LEFT	Internal components (1 of 3)
*	SPRING, TORSION	Internal components (1 of 3)
*	PLATE, SHAFT	Internal components (1 of 3)
*	ARM, OPEN/CLOSE	Internal components (1 of 3)
*	ARM, OPEN/CLOSE	Internal components (1 of 3)
*	SPRING, TORSION	Internal components (1 of 3)
*	ROD, LEFT	Internal components (1 of 3)
*	SPRING, GROUNDING	Internal components (1 of 3)
*	GUIDE, CASSETTE, FRONT LEFT	Internal components (1 of 3)
*	GUIDE, CASSETTE, REAR LEFT	Internal components (1 of 3)
*	RING, E	Internal components (1 of 3)
*	ARM, LASER SHUTTER	Internal components (1 of 3)
*	DUCT, FAN	Internal components (1 of 3)
*	SPRING, TENSION	Internal components (1 of 3)
*	MEMORY CONTROLLER PCB ASS'Y	Internal components (1 of 3)
*	DUCT, FAN, UPPER	Internal components (1 of 3)
*	DUCT, FAN, LOWER	Internal components (1 of 3)
*	HOLDER, MEMORY CONTROLLER	Internal components (1 of 3)
*	FLAG, PRESSURE RELEASE SENSOR	Internal components (1 of 3)
*	CLAMP, FFC	Internal components (1 of 3)
*	SCREW, TAPPING, TRUSS HEAD, M4X8	Internal components (1 of 3)
*	SHAFT, TOGGLE	Internal components (1 of 3)
*	SHAFT, ETB DRIVE	Internal components (1 of 3)
*	SPRING, GROUNDING	Internal components (1 of 3)
*	SPRING, GROUNDING	Internal components (1 of 3)
*	SPRING, GROUNDING	Internal components (1 of 3)
*	SPRING, GROUNDING	Internal components (1 of 3)

Table 7-23 Numerical parts list (continued)

Part number	Description	Table and page
*	COVER, INSIDE, LEFT	Internal components (1 of 3)
*	ARM, INTERLOCK SWITCH	Internal components (1 of 3)
*	SPRING, COMPRESSION	Internal components (1 of 3)
*	PHOTO INTERRUPTER (SENSOR)	Internal components (1 of 3)
*	FOOT, RUBBER	Internal components (1 of 3)
*	GUIDE, CASSETTE, REAR RIGHT	Internal components (1 of 3)
*	GUIDE, CASSETTE, FRONT RIGHT	Internal components (1 of 3)
*	INTERNAL COMPONENTS 2	Internal components (2 of 3)
*	CAP, SHAFT CONDUCTIVE	Internal components (2 of 3)
*	SCREW, RS, M3X6	Internal components (2 of 3)
*	COVER, PICK-UP FEED CABLE	Internal components (2 of 3)
*	SHAFT, FRONT DOOR	Internal components (2 of 3)
*	PLATE, PANEL FIX, RIGHT FRONT	Internal components (2 of 3)
*	GUIDE, CASSETTE, FRONT RIGHT	Internal components (2 of 3)
*	GUIDE, CASSETTE, FRONT LEFT	Internal components (2 of 3)
*	PLATE, HEAT INSULATING	Internal components (2 of 3)
*	LEVER, CONNECTING, LEFT	Internal components (2 of 3)
*	CAM, LEFT	Internal components (2 of 3)
*	SADDLE, WIRE	Internal components (2 of 3)
*	FEEDER UNIT JOINT CABLE	Internal components (2 of 3)
*	CAM, HINGE, RIGHT	Internal components (2 of 3)
*	LEVER, CONNECTING, RIGHT	Internal components (2 of 3)
*	BASE, MOTOR	Internal components (2 of 3)
*	CLUTCH, MECHANICAL	Internal components (2 of 3)
*	SPRING, LEAF	Internal components (2 of 3)
*	PLATE	Internal components (2 of 3)
*	BUSHING	Internal components (2 of 3)
*	STOP, CLUTCH	Internal components (2 of 3)
*	MOTOR, STEPPING, DC	Internal components (2 of 3)
*	SOLENOID	Internal components (2 of 3)
*	PICKUP GEAR ASS'Y	Internal components (2 of 3)
*	GEAR, 57T/20T	Internal components (2 of 3)
*	GEAR, 43T/16T	Internal components (2 of 3)
*	GEAR, 47T/26T	Internal components (2 of 3)

Table 7-23 Numerical parts list (continued)

Part number	Description	Table and page
*	GEAR, 40T/43T	Internal components (2 of 3)
*	CAM/GEAR, 26T	Internal components (2 of 3)
*	SPRING, COMPRESSION	Internal components (2 of 3)
*	RING, E	Internal components (2 of 3)
*	SCREW, RS, M3X6	Internal components (2 of 3)
*	SCREW, RS, M3X8	Internal components (2 of 3)
*	SCREW, W/WASHER, M4X18	Internal components (2 of 3)
*	SCREW, TAPPING, TRUSS HEAD, M4X8	Internal components (2 of 3)
*	GEAR, 29T	Internal components (2 of 3)
*	GEAR, 29T	Internal components (2 of 3)
*	SPRING, COMPRESSION	Internal components (2 of 3)
*	INTERNAL COMPONENTS 3	Internal components (3 of 3)
*	GUIDE, CABLE, UPPER	Internal components (3 of 3)
*	PLATE, SHIELD	Internal components (3 of 3)
*	PLATE, SHIELD, FRONT	Internal components (3 of 3)
*	PLATE, CONNECTOR	Internal components (3 of 3)
*	COVER, CONTROLLER	Internal components (3 of 3)
*	LID, CONTROLLER	Internal components (3 of 3)
*	HOLDER, CABLE, LEFT	Internal components (3 of 3)
*	HOLDER, DC CABLE	Internal components (3 of 3)
*	HOLDER, CABLE, UPPER	Internal components (3 of 3)
*	HOLDER, DRAWER	Internal components (3 of 3)
*	CONNECTOR, DRAWER	Internal components (3 of 3)
*	SCANNER UNIT	Internal components (3 of 3)
*	POWER SUPPLY PCB ASS'Y	Internal components (3 of 3)
*	POWER SUPPLY PCB ASS'Y	Internal components (3 of 3)
*	POWER SUPPLY PCB ASS'Y	Internal components (3 of 3)
*	HIGH-VOLTAGE PCB ASS'Y	Internal components (3 of 3)
*	POWER CABLE	Internal components (3 of 3)
*	POWER CONTROLLER CABLE	Internal components (3 of 3)
*	FIXING SENSOR CABLE	Internal components (3 of 3)
*	DRIVE CABLE	Internal components (3 of 3)
*	CONNECTOR, SNAP TIGHT, BK	Internal components (3 of 3)
*	CONNECTOR, SNAP TIGHT, BK	Internal components (3 of 3)

Table 7-23 Numerical parts list (continued)

Part number	Description	Table and page
*	CABLE, CPR	Internal components (3 of 3)
*	FEEDER UNIT JOINT CABLE	Internal components (3 of 3)
*	SCREW, W/WASHER, M3X8	Internal components (3 of 3)
*	SCREW, RS, M3X10	Internal components (3 of 3)
*	SCREW, RS, M3X8	Internal components (3 of 3)
*	ROD, BEARING SUPPORT	Internal components (3 of 3)
*	CABLE, FLAT	Internal components (3 of 3)
*	CABLE, FLAT	Internal components (3 of 3)
*	CABLE, FLAT	Internal components (3 of 3)
*	CLAMP, FFC	Internal components (3 of 3)
*	SCREW, TAPPING, TRUSS HEAD, M4X8	Internal components (3 of 3)
*	CONTROL PANEL PCB ASS'Y	Control panel assembly
*	CONTROL PANEL PCB ASS'Y	Control panel assembly
*	PANEL, CONTROL PANEL	Control panel assembly
*	PLATE, CONTROL PANEL RETAINING	Control panel assembly
*	GUIDE, CONTROL PANEL LIGHT	Control panel assembly
*	BUTTON, CONTROL PANEL, 1	Control panel assembly
*	BUTTON, CONTROL PANEL, 2	Control panel assembly
*	BUTTON, CONTROL PANEL, 3	Control panel assembly
*	SPACER, CONTROL PANEL	Control panel assembly
*	SCREW, RS, M3X8	Control panel assembly
*	MAIN DRIVE ASS'Y	Main drive assembly
*	F.F.C. CONNECT PCB UNIT	Main drive assembly
*	COLLAR, SPRING	Main drive assembly
*	BUSHING	Main drive assembly
*	FLANGE, CAM GEAR	Main drive assembly
*	COVER, DRUM	Main drive assembly
*	BUSHING	Main drive assembly
*	BUSHING	Main drive assembly
*	CAM, RELEASE	Main drive assembly
*	ROD, RELEASE, RIGHT	Main drive assembly
*	FAN	Main drive assembly
*	DUCT, FAN	Main drive assembly
*	PULLEY	Main drive assembly

Table 7-23 Numerical parts list (continued)

Part number	Description	Table and page
*	BELT, TRANSMISSION	Main drive assembly
*	STOP, CAM GEAR	Main drive assembly
*	BUSHING	Main drive assembly
*	GUIDE, DRIVE CABLE	Main drive assembly
*	MOTOR, DC	Main drive assembly
*	SOLENOID	Main drive assembly
*	PLATE, DRIVE INSIDE	Main drive assembly
*	SIDE PLATE, DRIVE	Main drive assembly
*	PLATE, FAN	Main drive assembly
*	GEAR, 81T	Main drive assembly
*	GEAR, 81T/32T	Main drive assembly
*	GEAR, 96T	Main drive assembly
*	GEAR, 53T/96T	Main drive assembly
*	GEAR, 98T	Main drive assembly
*	GEAR, 89T/53T	Main drive assembly
*	GEAR, 134T	Main drive assembly
*	GEAR, 86T	Main drive assembly
*	GEAR, 64T	Main drive assembly
*	GEAR, 64T	Main drive assembly
*	GEAR, 37T	Main drive assembly
*	GEAR, 27T/64T	Main drive assembly
*	GEAR, 64T	Main drive assembly
*	GEAR, 54T	Main drive assembly
*	GEAR, 54T	Main drive assembly
*	GEAR, 18T	Main drive assembly
*	SPRING, COMPRESSION	Main drive assembly
*	SPRING, COMPRESSION	Main drive assembly
*	SPRING, TENSION	Main drive assembly
*	SHAFT, DRUM GEAR	Main drive assembly
*	CONNECTOR, 2P	Main drive assembly
*	CONNECTOR, SNAP TIGHT, BK	Main drive assembly
*	CLIP, CABLE	Main drive assembly
*	CLIP, EDGE	Main drive assembly
*	SCREW, RS, M3X8	Main drive assembly

Table 7-23 Numerical parts list (continued)

Part number	Description	Table and page
*	SCREW, TAPPING, TRUSS HEAD, M4X8	Main drive assembly
*	SE RING	Main drive assembly
*	RING, E	Main drive assembly
*	SPRING, TORSION	Fuser assembly
*	BUSHING	Fuser assembly
*	BUSHING	Fuser assembly
*	RIB, ENTRANCE GUIDE	Fuser assembly
*	FLAG, INLET	Fuser assembly
*	GUIDE, PAPER DELIVERY UPPER	Fuser assembly
*	FLAG, PAPER DELIVERY	Fuser assembly
*	FILM GUIDE ASS'Y (110v)	Fuser assembly
*	FILM GUIDE ASS'Y (220v)	Fuser assembly
*	GUIDE, PAPER DELIVERY LOWER	Fuser assembly
*	FLAG, INTERTWINE PREVENTION	Fuser assembly
*	BUSHING	Fuser assembly
*	PLATE, PRESSURE, LEFT	Fuser assembly
*	PLATE, PRESSURE, RIGHT	Fuser assembly
*	HOLDER, RESISTOR	Fuser assembly
*	SPRING, GROUNDING	Fuser assembly
*	SPRING, GROUNDING	Fuser assembly
*	SPRING, GROUNDING	Fuser assembly
*	GUIDE, CONTACT/SENSOR SUPPORT	Fuser assembly
*	ROLLER, PRESSURE	Fuser assembly
*	ROLLER, FACE-DOWN BENDING	Fuser assembly
*	PIN, DOWEL	Fuser assembly
*	CAM, PRESSURE RELEASE	Fuser assembly
*	FLAG, PRESSURE RELEASE	Fuser assembly
*	HOLDER, PRESSURE RELEASE GEAR	Fuser assembly
*	SPRING, LEAF	Fuser assembly
*	BUSHING	Fuser assembly
*	BUSHING	Fuser assembly
*	SPRING, COMPRESSION	Fuser assembly
*	RING, E	Fuser assembly
*	SPRING, GROUNDING	Fuser assembly

Table 7-23 Numerical parts list (continued)

Part number	Description	Table and page
*	ROLLER, DELIVERY	Fuser assembly
*	MOTOR, STEPPING, DC	Fuser assembly
*	SCREW, RS, M3X6	Fuser assembly
*	SHAFT, FACE-DOWN ROLLER	Fuser assembly
*	SCREW, RS, M3X8	Fuser assembly
*	GEAR, 30T	Fuser assembly
*	GEAR, 19T	Fuser assembly
*	GEAR, 16T	Fuser assembly
*	GEAR, 49T	Fuser assembly
*	GEAR, 19T/71T	Fuser assembly
*	GEAR, 27T	Fuser assembly
*	GEAR, 26T	Fuser assembly
*	GEAR, 20T/44T	Fuser assembly
*	GEAR, 22T/38T	Fuser assembly
*	SPRING, TENSION	Fuser assembly
*	SPRING, TORSION	Fuser assembly
*	SOLID RESISTOR, 20MOHM, 1/4W	Fuser assembly
*	PHOTO INTERRUPTER (SENSOR)	Fuser assembly
*	SCREW, RS, M3X8	Fuser assembly
*	CLIP, ENTRANCE GUIDE	Fuser assembly
*	PLATE, GROUNDING	Fuser assembly
*	GUIDE, FIXING ENTRANCE	Fuser assembly
*	FRAME, FIXING	Fuser assembly
*	SIDE PLATE, FIXING, RIGHT	Fuser assembly
*	SIDE PLATE, FIXING, LEFT	Fuser assembly
*	SHAFT, PRESSURE RELEASE	Fuser assembly
*	PLATE, PRESSURE RELEASE, LEFT	Fuser assembly
*	PLATE, PRESSURE RELEASE, RIGHT	Fuser assembly
*	SIDE PLATE, FIXING, LEFT, 2	Fuser assembly
*	SIDE PLATE, FIXING, RIGHT, 2	Fuser assembly
*	SHAFT, PRESSURE RELEASE CAM	Fuser assembly
*	PLATE, MOTOR ANTI-MAGNETIC	Fuser assembly
*	SIDE PLATE, GEAR	Fuser assembly
*	BASE PLATE, FIXING	Fuser assembly

Table 7-23 Numerical parts list (continued)

Part number	Description	Table and page
*	PCB ASS'Y LOCATION DIAGRAM	PCB assembly location Tray 2
*	MEMORY CONTROLLER PCB ASS'Y	PCB assembly location Tray 2
*	POWER SUPPLY PCB ASS'Y	PCB assembly location Tray 2
*	POWER SUPPLY PCB ASS'Y	PCB assembly location Tray 2
*	HIGH-VOLTAGE PCB ASS'Y	PCB assembly location Tray 2
*	PANEL, FRONT	Tray 2 input tray (cassette)
*	GUIDE, CASSETTE DUPLEX, LOWER	Tray 2 input tray (cassette)
*	STOPPER, CASSETTE, LEFT	Tray 2 input tray (cassette)
*	STOPPER, CASSETTE, RIGHT	Tray 2 input tray (cassette)
*	ARM, CLAW RELEASE, LEFT	Tray 2 input tray (cassette)
*	ARM, CLAW RELEASE, RIGHT	Tray 2 input tray (cassette)
*	ARM, REMNANT INDICATION	Tray 2 input tray (cassette)
*	ARM, PLATE LOCK RELEASE, MD.	Tray 2 input tray (cassette)
*	SIZE PLATE, PAPER	Tray 2 input tray (cassette)
*	SPRING, GROUNDING	Tray 2 input tray (cassette)
*	SPRING, GROUNDING	Tray 2 input tray (cassette)
*	PLATE, CASSETTE REINFORCEMENT	Tray 2 input tray (cassette)
*	ARM, MD. PLATE RELEASE, LEFT	Tray 2 input tray (cassette)
*	CLAW, MD. PLATE RELEASE, LEFT	Tray 2 input tray (cassette)
*	ARM, MD. PLATE RELEASE, RIGHT	Tray 2 input tray (cassette)
*	CLAW, MD. PLATE RELEASE, RIGHT	Tray 2 input tray (cassette)
*	SPRING, COMPRESSION	Tray 2 input tray (cassette)
*	SPRING, COMPRESSION	Tray 2 input tray (cassette)
*	SPRING, TENSION	Tray 2 input tray (cassette)
*	SPRING, COMPRESSION	Tray 2 input tray (cassette)
*	SPRING, COMPRESSION	Tray 2 input tray (cassette)
*	SPRING, COMPRESSION	Tray 2 input tray (cassette)
*	BACK END LIMIT PLATE ASS'Y	Tray 2 input tray (cassette)
*	MIDDLE PLATE ASS'Y	Tray 2 input tray (cassette)
*	LEFT PAPER SIDE END ASS'Y	Tray 2 input tray (cassette)
*	RIGHT PAPER SIDE END ASS'Y	Tray 2 input tray (cassette)
*	GUIDE, CASSETTE DUPLEX, UPPER	Tray 2 input tray (cassette)
*	SCREW, TAPPING, TRUSS HEAD, M4X8	Tray 2 input tray (cassette)
*	CASSETTE BODY ASS'Y	Tray 2 input tray (cassette)

Table 7-23 Numerical parts list (continued)

Part number	Description	Table and page
*	BODY, CASSETTE	Tray 2 input tray (cassette)
*	PLATE, BACK END LIMIT, LARGE	Tray 2 input tray (cassette)
*	ARM, BACK END LOCK	Tray 2 input tray (cassette)
*	PLATE, BACK END LIMIT, SMALL	Tray 2 input tray (cassette)
*	LEVER, BACK END LOCK RELEASE	Tray 2 input tray (cassette)
*	STOPPER, BACK END LIMIT	Tray 2 input tray (cassette)
*	SPRING, COMPRESSION	Tray 2 input tray (cassette)
*	SHEET, SEPARATION	Tray 2 input tray (cassette)
*	PLATE, MIDDLE	Tray 2 input tray (cassette)
*	PLATE, REINFORCEMENT	Tray 2 input tray (cassette)
*	CLAW, MIDDLE PLATE, LEFT	Tray 2 input tray (cassette)
*	CLAW, MIDDLE PLATE, RIGHT	Tray 2 input tray (cassette)
*	RACK	Tray 2 input tray (cassette)
*	GEAR, 22T	Tray 2 input tray (cassette)
*	SPRING, COMPRESSION	Tray 2 input tray (cassette)
*	SCREW, TAPPING, TRUSS HEAD, M3X6	Tray 2 input tray (cassette)
*	SCREW, TAPPING, TRUSS HEAD, M3X6	Tray 2 input tray (cassette)
*	HOLDER, PAPER RETAINING	Tray 2 input tray (cassette)
*	SPRING, COMPRESSION	Tray 2 input tray (cassette)
*	PLATE, PAPER SIDE END, RIGHT	Tray 2 input tray (cassette)
*	LEVER, SIDE END LOCK RELEASE	Tray 2 input tray (cassette)
*	STOPPER, PAPER SIDE END	Tray 2 input tray (cassette)
*	SPRING, COMPRESSION	Tray 2 input tray (cassette)
*	HOLDER, PAD	Tray 2 input tray (cassette)
*	HOLDER, SEPARATION	Tray 2 input tray (cassette)
*	PLATE, PAPER GUIDE	Tray 2 input tray (cassette)
*	HOLDER, PAD	Tray 2 input tray (cassette)
*	WEIGHT, PAD	Tray 2 input tray (cassette)
*	HOLDER, PAD	Tray 2 input tray (cassette)
*	SPRING, COMPRESSION	Tray 2 input tray (cassette)
*	RACK, MANUAL FEED	Tray 2 input tray (cassette)
*	GUIDE, MANUAL FEED	Tray 2 input tray (cassette)
*	GUIDE, FEED WIDTH, LEFT	Tray 2 input tray (cassette)
*	GUIDE, FEED WIDTH, RIGHT	Tray 2 input tray (cassette)

Table 7-23 Numerical parts list (continued)

Part number	Description	Table and page
*	GEAR, 16T	Tray 2 input tray (cassette)
*	INTERNAL COMPONENTS	Tray 2 sheet input tray internal components
*	CAP, CONTINUITY	Tray 2 sheet input tray internal components
*	BASE, MOTOR	Tray 2 sheet input tray internal components
*	CLUTCH, MECHANICAL	Tray 2 sheet input tray internal components
*	SPRING, LEAF	Tray 2 sheet input tray internal components
*	BUSHING	Tray 2 sheet input tray internal components
*	HOLDER, DRAWER CONNECTOR	Tray 2 sheet input tray internal components
*	HOLDER, SWING GEAR	Tray 2 sheet input tray internal components
*	PLATE, GROUNDING	Tray 2 sheet input tray internal components
*	COVER, OPTION FRONT	Tray 2 sheet input tray internal components
*	COVER, OPTION LEFT	Tray 2 sheet input tray internal components
*	COVER, PCB	Tray 2 sheet input tray internal components
*	SHAFT, POSITIONING	Tray 2 sheet input tray internal components
*	COVER, SWING GEAR	Tray 2 sheet input tray internal components
*	STOP, CLUTCH	Tray 2 sheet input tray internal components
*	SOLENOID	Tray 2 sheet input tray internal components
*	PICKUP GEAR ASS'Y	Tray 2 sheet input tray internal components
*	COVER, OPTION RIGHT	Tray 2 sheet input tray internal components
*	GEAR, 47T/26T	Tray 2 sheet input tray internal components
*	GEAR, 40T/43T	Tray 2 sheet input tray internal components
*	CAM/GEAR, 26T	Tray 2 sheet input tray internal components

Table 7-23 Numerical parts list (continued)

Part number	Description	Table and page
*	GEAR, 19T	Tray 2 sheet input tray internal components
*	GEAR, 18T	Tray 2 sheet input tray internal components
*	SPRING, COMPRESSION	Tray 2 sheet input tray internal components
*	SPRING, TENSION	Tray 2 sheet input tray internal components
*	CONNECTOR, DRAWER	Tray 2 sheet input tray internal components
*	SADDLE, WIRE	Tray 2 sheet input tray internal components
*	SCREW, RS, M3X8	Tray 2 sheet input tray internal components
*	SPRING, GROUNDING	Tray 2 sheet input tray internal components
*	GUIDE, CASSETTE, FRONT LEFT	Tray 2 sheet input tray internal components
*	GUIDE, CASSETTE, REAR LEFT	Tray 2 sheet input tray internal components
*	SCREW, RS, M3X8	Tray 2 sheet input tray internal components
*	GUIDE, CASSETTE, REAR RIGHT	Tray 2 sheet input tray internal components
*	GUIDE, CASSETTE, FRONT RIGHT	Tray 2 sheet input tray internal components
*	SCREW, RS, M3X8	Tray 2 sheet input tray internal components
*	PAPER FEEDER PCB ASS'Y	Tray 2 sheet input tray internal components
*	SCREW, TAPPING, TRUSS HEAD, M4X8	Tray 2 sheet input tray internal components
*	CROSSMEMBER, FRONT	Tray 2 sheet input tray internal components
*	CROSSMEMBER, REAR	Tray 2 sheet input tray internal components
*	CROSSMEMBER, MIDDLE	Tray 2 sheet input tray internal components
*	CROSSMEMBER, LOWER, REAR	Tray 2 sheet input tray internal components
*	GUIDE, PAPER SENSOR CABLE, 1	Tray 2 sheet input tray internal components
*	GUIDE, PAPER SENSOR CABLE, 2	Tray 2 sheet input tray internal components

Table 7-23 Numerical parts list (continued)

Part number	Description	Table and page
*	GEAR, 29T	Tray 2 sheet input tray internal components
*	GEAR, 29T	Tray 2 sheet input tray internal components
*	SPRING, COMPRESSION	Tray 2 sheet input tray internal components
*	FOOT, RUBBER	Tray 2 sheet input tray internal components
*	COVER, OPTION RIGHT	Tray 2 sheet input tray internal components
*	OPTION FRAME LEFT ASS'Y	Tray 2 sheet input tray internal components
*	FRAME, OPTION, LEFT	Tray 2 sheet input tray internal components
*	OPTION FRAME RIGHT ASS'Y	Tray 2 sheet input tray internal components
*	FRAME, OPTION, RIGHT	Tray 2 sheet input tray internal components
*	PAPER PICKUP FEEDER ASS'Y	Paper pick-up feeder assembly for Tray 2
*	GUIDE, REGISTRATION	Paper pick-up feeder assembly for Tray 2
*	PLATE, REG. GROUNDING, 1	Paper pick-up feeder assembly for Tray 2
*	PLATE, REG. GROUNDING, 2	Paper pick-up feeder assembly for Tray 2
*	FLAG, SENSOR	Paper pick-up feeder assembly for Tray 2
*	SPRING, TORSION	Paper pick-up feeder assembly for Tray 2
*	COVER, SENSOR, TOP	Paper pick-up feeder assembly for Tray 2
*	GUIDE, PRE-TRANSFER	Paper pick-up feeder assembly for Tray 2
*	ROLLER, REGISTRATION DRIVE	Paper pick-up feeder assembly for Tray 2
*	BUSHING	Paper pick-up feeder assembly for Tray 2
*	SHUTTER, REGISTRATION	Paper pick-up feeder assembly for Tray 2
*	SPRING, TORSION	Paper pick-up feeder assembly for Tray 2
*	ROLLER, REGISTRATION, A	Paper pick-up feeder assembly for Tray 2

Table 7-23 Numerical parts list (continued)

Part number	Description	Table and page
*	ROLLER, REGISTRATION, B	Paper pick-up feeder assembly for Tray 2
*	ROLLER, REGISTRATION, C	Paper pick-up feeder assembly for Tray 2
*	BUSHING	Paper pick-up feeder assembly for Tray 2
*	BUSHING	Paper pick-up feeder assembly for Tray 2
*	HOLDER, PAPER WIDTH SENSOR	Paper pick-up feeder assembly for Tray 2
*	FLAG, PAPER WIDTH SENSOR	Paper pick-up feeder assembly for Tray 2
*	SPRING, TORSION	Paper pick-up feeder assembly for Tray 2
*	RESISTOR, 400 OHM, 0.5W	Paper pick-up feeder assembly for Tray 2
*	COVER, PICKUP FEED FRAME	Paper pick-up feeder assembly for Tray 2
*	SPRING, TENSION	Paper pick-up feeder assembly for Tray 2
*	PHOTO INTERRUPTER (SENSOR)	Paper pick-up feeder assembly for Tray 2
*	PAPER PICKUP DRIVE ASS'Y	Paper pick-up feeder assembly for Tray 2
*	FEEDER UNIT CABLE	Paper pick-up feeder assembly for Tray 2
*	SCREW, TAPPING, TRUSS HEAD, M4X8	Paper pick-up feeder assembly for Tray 2
*	FRAME, PAPER PICKUP FEEDER	Paper pick-up feeder assembly for Tray 2
*	SHAFT, REGISTRATION ROLLER	Paper pick-up feeder assembly for Tray 2
*	COVER, PICKUP FEED FRAME	Paper pick-up feeder assembly for Tray 2
*	SHEET, SCRAPER, 1	Paper pick-up feeder assembly for Tray 2
*	SHEET, SCRAPER, 2	Paper pick-up feeder assembly for Tray 2
*	SHAFT, PAPER PICKUP DRIVE	Paper pick-up feeder assembly for Tray 2
*	BUSHING	Paper pick-up feeder assembly for Tray 2
*	BUSHING	Paper pick-up feeder assembly for Tray 2

Table 7-23 Numerical parts list (continued)

Part number	Description	Table and page
*	ARM, CST. PAPER SENSING, 1	Paper pick-up feeder assembly for Tray 2
*	ARM, CST. PAPER SENSING, 2	Paper pick-up feeder assembly for Tray 2
*	HOLDER, PAPER PICKUP ROLLER	Paper pick-up feeder assembly for Tray 2
*	ROLLER, CASSETTE PAPER PICKUP	Paper pick-up feeder assembly for Tray 2
*	BUSHING	Paper pick-up feeder assembly for Tray 2
*	SPRING, COMPRESSION	Paper pick-up feeder assembly for Tray 2
*	PANEL, FRONT	Tray 3 input tray (cassette)
*	FRAME, FRONT	Tray 3 input tray (cassette)
*	STOPPER, CASSETTE, LEFT	Tray 3 input tray (cassette)
*	STOPPER, CASSETTE, RIGHT	Tray 3 input tray (cassette)
*	ARM, CLAW RELEASE, LEFT	Tray 3 input tray (cassette)
*	ARM, CLAW RELEASE, RIGHT	Tray 3 input tray (cassette)
*	ARM, REMNANT INDICATION	Tray 3 input tray (cassette)
*	ARM, PLATE LOCK RELEASE, MD	Tray 3 input tray (cassette)
*	SIZE PLATE, PAPER	Tray 3 input tray (cassette)
*	SPRING, GROUNDING	Tray 3 input tray (cassette)
*	SPRING, GROUNDING	Tray 3 input tray (cassette)
*	PLATE, CASSETTE REINFORCEMENT	Tray 3 input tray (cassette)
*	ARM, MD. PLATE RELEASE, LEFT	Tray 3 input tray (cassette)
*	CLAW, MD. PLATE RELEASE, LEFT	Tray 3 input tray (cassette)
*	ARM, MD. PLATE RELEASE, RIGHT	Tray 3 input tray (cassette)
*	CLAW, MD. PLATE RELEASE, RIGHT	Tray 3 input tray (cassette)
*	SPRING, COMPRESSION	Tray 3 input tray (cassette)
*	SPRING, COMPRESSION	Tray 3 input tray (cassette)
*	SPRING, TENSION	Tray 3 input tray (cassette)
*	SPRING, COMPRESSION	Tray 3 input tray (cassette)
*	SPRING, COMPRESSION	Tray 3 input tray (cassette)
*	SPRING, COMPRESSION	Tray 3 input tray (cassette)
*	BACK END LIMIT PLATE ASS'Y	Tray 3 input tray (cassette)
*	MIDDLE PLATE ASS'Y	Tray 3 input tray (cassette)
*	LEFT PAPER SIDE END ASS'Y	Tray 3 input tray (cassette)

Table 7-23 Numerical parts list (continued)

Part number	Description	Table and page
*	RIGHT PAPER SIDE END ASS'Y	Tray 3 input tray (cassette)
*	SCREW, TAPPING,TRUSS HEAD,M4X8	Tray 3 input tray (cassette)
*	CASSETTE BODY ASS'Y	Tray 3 input tray (cassette)
*	BODY, CASSETTE	Tray 3 input tray (cassette)
*	PLATE, BACK END LIMIT, LARGE	Tray 3 input tray (cassette)
*	ARM, BACK END LOCK	Tray 3 input tray (cassette)
*	PLATE, BACK END LIMIT, SMALL	Tray 3 input tray (cassette)
*	LEVER, BACK END LOCK RELEASE	Tray 3 input tray (cassette)
*	STOPPER, BACK END LIMIT	Tray 3 input tray (cassette)
*	SPRING, COMPRESSION	Tray 3 input tray (cassette)
*	SHEET, SEPARATION	Tray 3 input tray (cassette)
*	PLATE, MIDDLE	Tray 3 input tray (cassette)
*	PLATE, REINFORCEMENT	Tray 3 input tray (cassette)
*	CLAW, MIDDLE PLATE, LEFT	Tray 3 input tray (cassette)
*	CLAW, MIDDLE PLATE, RIGHT	Tray 3 input tray (cassette)
*	RACK	Tray 3 input tray (cassette)
*	GEAR, 22T	Tray 3 input tray (cassette)
*	SPRING, COMPRESSION	Tray 3 input tray (cassette)
*	SCREW, TAPPING,TRUSS HEAD,M3X6	Tray 3 input tray (cassette)
*	PLATE, PAPER SIDE END, LEFT	Tray 3 input tray (cassette)
*	HOLDER, PAPER RETAINING	Tray 3 input tray (cassette)
*	SPRING, COMPRESSION	Tray 3 input tray (cassette)
*	PLATE, PAPER SIDE END, RIGHT	Tray 3 input tray (cassette)
*	LEVER, SIDE END LOCK RELEASE	Tray 3 input tray (cassette)
*	STOPPER, PAPER SIDE END	Tray 3 input tray (cassette)
*	SPRING, COMPRESSION	Tray 3 input tray (cassette)
*	HOLDER, PAD	Tray 3 input tray (cassette)
*	HOLDER, SEPARATION	Tray 3 input tray (cassette)
*	PLATE, PAPER GUIDE	Tray 3 input tray (cassette)
*	HOLDER, PAD	Tray 3 input tray (cassette)
*	WEIGHT, PAD	Tray 3 input tray (cassette)
*	HOLDER, PAD	Tray 3 input tray (cassette)
*	SPRING, COMPRESSION	Tray 3 input tray (cassette)

Table 7-23 Numerical parts list (continued)

Part number	Description	Table and page
*	GUIDE, REGISTRATION	Paper pickup feeder assembly (Tray 3)
*	PLATE, REG. GROUNDING, 1	Paper pickup feeder assembly (Tray 3)
*	PLATE, REG. GROUNDING, 2	Paper pickup feeder assembly (Tray 3)
*	COVER, PICKUP FEED FRAME	Paper pickup feeder assembly (Tray 3)
*	GUIDE, PRE-TRANSFER	Paper pickup feeder assembly (Tray 3)
*	ROLLER, REGISTRATION DRIVE	Paper pickup feeder assembly (Tray 3)
*	BUSHING	Paper pickup feeder assembly (Tray 3)
*	ROLLER, REGISTRATION, A	Paper pickup feeder assembly (Tray 3)
*	ROLLER, REGISTRATION, B	Paper pickup feeder assembly (Tray 3)
*	ROLLER, REGISTRATION, C	Paper pickup feeder assembly (Tray 3)
*	BUSHING	Paper pickup feeder assembly (Tray 3)
*	BUSHING	Paper pickup feeder assembly (Tray 3)
*	RESISTOR, 400 OHM, 0.5W	Paper pickup feeder assembly (Tray 3)
*	SPRING, TENSION	Paper pickup feeder assembly (Tray 3)
*	PHOTO INTERRUPTER (SENSOR)	Paper pickup feeder assembly (Tray 3)
*	CABLE, OPTION SENSOR	Paper pickup feeder assembly (Tray 3)
*	PAPER PICKUP DRIVE ASS'Y	Paper pickup feeder assembly (Tray 3)
*	SCREW, TAPPING, TRUSS HEAD, M4X8	Paper pickup feeder assembly (Tray 3)
*	FRAME, PAPER PICKUP FEEDER	Paper pickup feeder assembly (Tray 3)
*	SHAFT, REGISTRATION ROLLER	Paper pickup feeder assembly (Tray 3)
*	SHAFT, PAPER PICKUP DRIVE	Paper pickup feeder assembly (Tray 3)
*	BUSHING	Paper pickup feeder assembly (Tray 3)

Table 7-23 Numerical parts list (continued)

Part number	Description	Table and page
*	BUSHING	Paper pickup feeder assembly (Tray 3)
*	ARM, CST. PAPER SENSING, 1	Paper pickup feeder assembly (Tray 3)
*	ARM, CST. PAPER SENSING, 2	Paper pickup feeder assembly (Tray 3)
*	HOLDER, PAPER PICKUP ROLLER	Paper pickup feeder assembly (Tray 3)
*	ROLLER, CASSETTE PAPER PICKUP	Paper pickup feeder assembly (Tray 3)
*	BUSHING	Paper pickup feeder assembly (Tray 3)
*	SPRING, COMPRESSION	Paper pickup feeder assembly (Tray 3)
*	PCB ASS'Y LOCATION DIAGRAM	Paper pickup feeder assembly (Tray 3)
*	PAPER FEEDER PCB ASS'Y	Paper pickup feeder assembly (Tray 3)
RC1-5062-000CN	RETAINER, PAPER	Internal components (2 of 3)
RC1-5096-000CN	ARM, PAPER RETAINER, LEFT	Internal components (2 of 3)
RC1-5097-000CN	ARM, PAPER RETAINER, RIGHT	Internal components (2 of 3)
RC1-5147-000CN	SPRING, GROUNDING	Internal components (2 of 3)
RC1-5173-000CN	COVER, FACE-DOWN	External panels and covers (1 of 2)
RC1-5174-000CN	COVER, UPPER FACE, S	External panels and covers (1 of 2)
RC1-5176-000CN	COVER, UPPER	Upper assembly cover
RC1-5178-000CN	COVER, INSIDE, UPPER	Upper assembly cover
RC1-5183-000CN	COVER, LEFT	External panels and covers (1 of 2)
RC1-5184-000CN	COVER, CASSETTE, LEFT	External panels and covers (1 of 2)
RC1-5188-000CN	COVER, CASSETTE, RIGHT	External panels and covers (2 of 2)
RC1-5200-000CN	COVER, CASSETTE DUST	External panels and covers (1 of 2)
RC1-5200-000CN	COVER, CASSETTE DUST	External panels and covers (2 of 2)
RC1-5200-000CN	COVER, CASSETTE DUST	Tray 2 sheet input tray internal components
RC1-5227-000CN	PLATE, REAR	External panels and covers (1 of 2)

Table 7-23 Numerical parts list (continued)

Part number	Description	Table and page
RC1-5227-000CN	PLATE, REAR	External panels and covers (2 of 2)
RC1-5440-000CN	PAPER PICKUP ROLLER	250-sheet input tray (cassette)
RC1-5440-000CN	ROLLER, PAPER PICKUP	Paper pick-up feeder assembly for Tray 2
RC1-5440-000CN	PAPER PICKUP ROLLER	Tray 3 input tray (cassette)
RC1-5440-000CN	PAPER PICKUP ROLLER	Paper pickup feeder assembly (Tray 3)
RC1-5440-000CN	ROLLER, PAPER PICKUP	Paper pickup feeder assembly (Tray 3)
RM1-1820-000CN	FUSER ASS'Y (110v)	Fuser assembly
RM1-1820-000CN (110v) or RM1-1821-000CN (220v)	FUSER ASSEMBLY	Assembly locations
RM1-1821-000CN	FUSER ASS'Y (220v)	Fuser assembly
RM1-1856-000CN	FRONT DOOR ASS'Y	External panels and covers (2 of 2)
RM1-1858-000CN	RIGHT COVER ASS'Y	External panels and covers (2 of 2)
RM1-1859-000CN	PAPER DELIVERY TRAY ASS'Y	External panels and covers (1 of 2)
RM1-1885-000CN	ELECT.TRANSPORT BELT ASS'Y	Internal components (2 of 3)
RM1-1916-000CN	CASSETTE	Assembly locations
RM1-1916-000CN	CASSETTE	Tray 2 input tray (cassette)
RM1-1922-000CN	SEPARATION ASS'Y	Tray 2 input tray (cassette)
RM1-1922-000CN	SEPARATION ASS'Y	Tray 3 input tray (cassette)
RM1-1923-000CN	FEED ASS'Y	Tray 2 input tray (cassette)
RM1-1945-000CN	CASSETTE	250-sheet input tray (cassette)
RM1-1945-000CN	CASSETTE	Tray 3 input tray (cassette)
RM1-1975-000CN	DC CONTROLLER PCB ASS'Y	Internal components (3 of 3)
RM1-1975-000CN	DC CONTROLLER PCB ASS'Y	PCB assembly location Tray 2
RM1-1983-000CN	CONTROL PANEL ASSEMBLY	Assembly locations
RM1-1983-000CN	CONTROL PANEL ASS'Y	Control panel assembly

A Product specifications

This chapter contains information about the following topics.

- [Physical specifications](#)
- [Supplies specifications](#)
- [Electrical specifications](#)
- [Environmental specifications](#)
- [Acoustical specifications](#)

Physical specifications

Table A-1 Printer specifications

Product	Height	Depth	Width	Weight
HP Color LaserJet 2600n printer without optional Tray 3 or consumables	370 mm (14.6 inches)	453 mm (17.83 inches)	407 mm (16.02 inches)	15.67 kg (34.54 lbs)
HP Color LaserJet 2600n printer with optional Tray 3 (250-sheet), without consumables	460 mm (18.1 inches)	451 mm (17.76 inches)	485 mm (18.98 inches)	20.16 kg (44.43 lbs)

Supplies specifications

Table A-2 Supplies specifications

Print-cartridge life (based on approximately 5% coverage)	Black: 2,500 pages
	Yellow, cyan, and magenta: 2,000 pages each

Print cartridge life

Table A-3 Print cartridge specifications

Product name	Description	Part number
Black print cartridge	Life of 2,500 pages at approximately 5% coverage.	Q6000A
Cyan print cartridge	Life of 2,000 pages at approximately 5% coverage.	Q6001A
Yellow print cartridge	Life of 2,000 pages at approximately 5% coverage.	Q6002A
Magenta print cartridge	Life of 2,000 pages at approximately 5% coverage.	Q6003A



NOTE Actual yields may vary according to usage.

Electrical specifications

Table A-4 Electrical specifications

Item	110-volt models	220-volt models
Power supply	115-127V (+/-10%)	220-240V (+/-10%)
	50/60 Hz (+/- 2 Hz)	50/60 Hz (+/- 2 Hz)
Power consumption (typical)		
During printing (color)	185 W (average)	185 W (average)
During printing (black and white)	185 W (average)	185 W (average)
During standby	15 W (average)	19 W (average)
Off mode	0 W (average)	0 W (average)
Heat output		
Idle	51 BTU/hr	61 BTU/hr
Rated current	12 A	6 A



CAUTION Power requirements are based on the country/region where the printer is sold. Do not convert operating voltages. This will damage the printer and void the product warranty.

Environmental specifications

Table A-5 Environmental specifications

	Recommended ¹	Operating ¹	Storage ¹
(Printer and print cartridge) Temperature	20° to 27°C (68° to 81°F)	15° to 32.5°C (59° to 90.5°F)	-20° to 40°C (-4° to 104°F)
Relative humidity	20% to 70%	10% to 80%	95% or less

¹ Values are subject to change. See <http://www.hp.com/support/clj2600n> for current information.

Acoustical specifications

Table A-6 Acoustical specifications

Sound Power Level	Declared per ISO 9296¹
Printing (8 ppm)	$L_{wAd} = 6.6$ Bels (A) [66 dB (A)]
SPL-Bystander Position	Declared per ISO 9296¹
Printing (8 ppm)	$L_{pAm} = 52$ dB(A)

¹ Values are subject to change. See <http://www.hp.com/support/clj2600n> for current information.

B Product warranty statements

Hewlett-Packard limited warranty statement

HP PRODUCT

HP Color LaserJet 2600n

DURATION OF LIMITED WARRANTY

1 year, Limited Warranty

HP warrants to you, the end-user customer, that HP hardware and accessories will be free from defects in materials and workmanship after the date of purchase, for the period specified above. If HP receives notice of such defects during the warranty period, HP will, at its option, either repair or replace products which prove to be defective. Replacement products may be either new or equivalent in performance to new.

HP warrants to you that HP software will not fail to execute its programming instructions after the date of purchase, for the period specified above, due to defects in material and workmanship when properly installed and used. If HP receives notice of such defects during the warranty period, HP will replace software which does not execute its programming instructions due to such defects.

HP does not warrant that the operation of HP products will be uninterrupted or error free. If HP is unable, within a reasonable time, to repair or replace any product to a condition as warranted, you will be entitled to a refund of the purchase price upon prompt return of the product.

HP products may contain remanufactured parts equivalent to new in performance or may have been subject to incidental use.

Warranty does not apply to defects resulting from (a) improper or inadequate maintenance or calibration, (b) software, interfacing, parts or supplies not supplied by HP, (c) unauthorized modification or misuse, (d) operation outside of the published environmental specifications for the product, or (e) improper site preparation or maintenance.

TO THE EXTENT ALLOWED BY LOCAL LAW, THE ABOVE WARRANTIES ARE EXCLUSIVE AND NO OTHER WARRANTY OR CONDITION, WHETHER WRITTEN OR ORAL, IS EXPRESSED OR IMPLIED AND HP SPECIFICALLY DISCLAIMS ANY IMPLIED WARRANTIES OR CONDITIONS OF MERCHANTABILITY, SATISFACTORY QUALITY, AND FITNESS FOR A PARTICULAR PURPOSE. Some countries/regions, states or provinces do not allow limitations on the duration of an implied warranty, so the above limitation or exclusion might not apply to you. This warranty gives you specific legal rights and you might also have other rights that vary from country/region to country/region, state to state, or province to province. HP's limited warranty is valid in any country/region or locality where HP has a support presence for this product and where HP has marketed this product. The level of warranty service you receive may vary according to local standards. HP will not alter form, fit or function of the product to make it operate in a country/region for which it was never intended to function for legal or regulatory reasons.

TO THE EXTENT ALLOWED BY LOCAL LAW, THE REMEDIES IN THIS WARRANTY STATEMENT ARE YOUR SOLE AND EXCLUSIVE REMEDIES. EXCEPT AS INDICATED ABOVE, IN NO EVENT WILL HP OR ITS SUPPLIERS BE LIABLE FOR LOSS OF DATA OR FOR DIRECT, SPECIAL, INCIDENTAL, CONSEQUENTIAL (INCLUDING LOST PROFIT OR DATA), OR OTHER DAMAGE, WHETHER BASED IN CONTRACT, TORT, OR OTHERWISE. Some countries/regions, states or provinces do not allow the exclusion or limitation of incidental or consequential damages, so the above limitation or exclusion may not apply to you.

THE WARRANTY TERMS CONTAINED IN THIS STATEMENT, EXCEPT TO THE EXTENT LAWFULLY PERMITTED, DO NOT EXCLUDE, RESTRICT OR MODIFY AND ARE IN ADDITION TO THE MANDATORY STATUTORY RIGHTS APPLICABLE TO THE SALE OF THIS PRODUCT TO YOU.

Print Cartridge Limited Warranty Statement

This HP product is warranted to be free from defects in materials and workmanship.

This warranty does not apply to products that (a) have been refilled, refurbished, remanufactured or tampered with in any way, (b) experience problems resulting from misuse, improper storage, or operation outside of the published environmental specifications for the printer product or (c) exhibit wear from ordinary use.

To obtain warranty service, please return the product to place of purchase (with a written description of the problem and print samples) or contact HP Customer Support. At HP's option, HP will either replace products that prove to be defective or refund your purchase price.

TO THE EXTENT ALLOWED BY LOCAL LAW, THE ABOVE WARRANTY IS EXCLUSIVE AND NO OTHER WARRANTY OR CONDITION, WHETHER WRITTEN OR ORAL, IS EXPRESSED OR IMPLIED AND HP SPECIFICALLY DISCLAIMS ANY IMPLIED WARRANTIES OR CONDITIONS OF MERCHANTABILITY, SATISFACTORY QUALITY, AND FITNESS FOR A PARTICULAR PURPOSE.

TO THE EXTENT ALLOWED BY LOCAL LAW, IN NO EVENT WILL HP OR ITS SUPPLIERS BE LIABLE FOR DIRECT, SPECIAL, INCIDENTAL, CONSEQUENTIAL (INCLUDING LOST PROFIT OR DATA), OR OTHER DAMAGE, WHETHER BASED IN CONTRACT, TORT, OR OTHERWISE.

THE WARRANTY TERMS CONTAINED IN THIS STATEMENT, EXCEPT TO THE EXTENT LAWFULLY PERMITTED, DO NOT EXCLUDE, RESTRICT OR MODIFY AND ARE IN ADDITION TO THE MANDATORY STATUTORY RIGHTS APPLICABLE TO THE SALE OF THIS PRODUCT TO YOU.

C Regulatory statements

This chapter contains information about the following topics.

- [Declaration of Conformity](#)
- [Laser safety statement](#)
- [Canadian DOC statement](#)
- [VCCI statement \(Japan\)](#)
- [Korean EMI statement](#)
- [Finnish laser statement](#)

Declaration of Conformity

Declaration of Conformity

according to ISO/IEC Guide 22 and EN 45014

Manufacturer's Name: Hewlett-Packard Company
Manufacturer's Address: 11311 Chinden Boulevard,
Boise, Idaho 83714-1021, USA

declares, that the product

Product Name: HP Color LaserJet 2600n
Regulatory Model Number³⁾: BOISB-0409-00. Including: Q6459A – Optional 250-sheet input tray
Product Options: ALL

conforms to the following Product Specifications:

Safety: IEC60950:2001-1 / EN60950: 2001-1
IEC 60825-1:1993 +A1: 1997 +A2:2001 / EN 60825-1:1994 +A11:1996 +A2:2001 (Class 1 Laser/LED Product)
GB4943-2001
EMC: CISPR 22:1997 / EN 55022:1998 Class B¹⁾
EN 61000-3-2:2000
EN 61000-3-3:1995/ A1:2001
EN 55024:1998
FCC Title 47 CFR, Part 15 Class B²⁾ / ICES-003, Issue 4/ GB9254-1998, GB17625.1-1998

Supplementary Information:

The product herewith complies with the requirements of the EMC Directive 89/336/EEC and the Low Voltage Directive 73/23/EEC, and carries the CE-Marking accordingly.

- 1) The product was tested in a typical configuration with Hewlett-Packard Personal Computer Systems. Compliance testing of product to standard with exception of Clause 9.5, which is not yet in effect.
- 2) This Device complies with Part 15 of the FCC Rules. Operation is subject to the following two conditions: (1) this device may not cause harmful interference, and (2) this device must accept any interference received, including interference that may cause undesired operation.
- 3) For regulatory purposes, this product is assigned a Regulatory model number. This number should not be confused with the product name or the product number(s).

Boise, Idaho USA

February 24th, 2005

For regulatory topics only:

Australia Contact: Product Regulations Manager, Hewlett-Packard Australia Ltd., 31-41 Joseph Street, Blackburn, Victoria 3130, Australia,
European Contact: Your Local Hewlett-Packard Sales and Service Office or Hewlett-Packard GmbH, Department HQ-TRE / Standards Europe, Herrenberger Strasse 140, Germany D-71034 Böblingen, , (FAX: +49-7031-14-3143),
USA Contact: Product Regulations Manager, Hewlett-Packard Company, PO Box 15, Mail Stop 160, Boise, Idaho 83707-0015, USA, (Phone: 208-396-6000),

Laser safety statement

The Center for Devices and Radiological Health (CDRH) of the U.S. Food and Drug Administration has implemented regulations for laser products manufactured since August 1, 1976. Compliance is mandatory for products marketed in the United States. The printer is certified as a "Class 1" laser product under the U.S. Department of Health and Human Services (DHHS) Radiation Performance Standard according to the Radiation Control for Health and Safety Act of 1968.

Since radiation emitted inside the printer is completely confined within protective housings and external covers, the laser beam cannot escape during any phase of normal user operation.



WARNING! Using controls, making adjustments, or performing procedures other than those specified in this user guide may result in exposure to hazardous radiation.

Canadian DOC statement

Complies with Canadian EMC Class B requirements.

« Conforme à la classe B des normes canadiennes de compatibilité électromagnétiques (CEM). »

VCCI statement (Japan)

この装置は、情報処理装置等電波障害自主規制協議会（VCCI）の基準に基づくクラスB情報技術装置です。この装置は、家庭環境で使用することを目的としていますが、この装置がラジオやテレビジョン受信機に近接して使用されると、受信障害を引き起こすことがあります。
取り扱い説明書に従って正しい取り扱いをして下さい。

Figure C-1 VCCI statement

Korean EMI statement

사용자 안내문 (B 급 기기)

이 기기는 비업무용으로 전자파장해검정을 받은 기기로서, 주거지역에서는 물론 모든 지역에서 사용할 수 있습니다.

Figure C-2 Korean EMI statement

Finnish laser statement

LASERTURVALLISUUS

LUOKAN 1 LASERLAITE

KLASS 1 LASER APPARAT

HP Color LaserJet 2600n -laserkirjoitin on käyttäjän kannalta turvallinen luokan 1 laserlaite. Normaalisissa käytössä kirjoittimen suojakoteloointi estää lasersäteen pääsyn laitteen ulkopuolelle.

Laitteen turvallisuusluokka on määritetty standardin EN60825-1 (1994) mukaisesti.

VAROITUS!

Laitteen käyttäminen muulla kuin käyttöohjeessa mainitulla tavalla saattaa altistaa käyttäjän turvallisuusluokan 1 ylittävälle näkymättömälle lasersäteilylle.

WARNING!

Om apparaten används på annat sätt än i bruksanvisning specificerats, kan användaren utsättas för osynlig laserstrålning, som överskrider gränsen för laserklass 1.

HUOLTO

HP Color LaserJet 2600n -kirjoittimen sisällä ei ole käyttäjän huollettavissa olevia kohteita. Laitteen saa avata ja huoltaa ainoastaan sen huoltamiseen koulutettu henkilö. Tällaiseksi huoltotoimenpiteeksi ei katsota väriainekasetin vaihtamista, paperiradan puhdistusta tai muita käyttäjän käsikirjassa lueteltuja, käyttäjän tehtäväksi tarkoitettuja ylläpitotoimia, jotka voidaan suorittaa ilman erikoistyökaluja.

VARO!

Mikäli kirjoittimen suojakotelo avataan, olet alttiina näkymättömälle lasersäteilylle laitteen ollessa toiminnassa. Älä katso säteeseen.

WARNING!

Om laserprinterns skyddshölje öppnas då apparaten är i funktion, utsättas användaren för osynlig laserstrålning. Betrakta ej strålen.

Tiedot laitteessa käytettävän laserdiodin säteilyominaisuuksista:

Aallonpituus 770-800 nm

Teho 5 mW

Luokan 3B laser

Index

Symbols/Numerics

600 dpi print-quality setting 121

A

accessibility 5
accessories
 ordering 152
 part numbers 253
acoustical specifications 256
adhesive labels
 specifications 17, 18
alert messages 107, 132
Apple LaserWriter 8 driver 12
arrow buttons 9
assembly
 locations 154
 parts list 154
attention light 9

B

background, gray 139
bands, troubleshooting 139
bins, output
 features 4
 jams, clearing 104
black and white printing
 troubleshooting 142
black cartridge
 part number 253
 status gauge 8
blank pages, troubleshooting 123
buttons, control panel 9

C

cables
 USB, troubleshooting 124
calibrating printer
 using HP Toolbox 144
Canadian DOC statement 264
cancel Job button 8

cardstock
 specifications 17, 18
cartridges
 part numbers 253
 recycling 33
 replacing 33, 64
 status gauge 8
 status page, printing 116
 storage specifications 255
characters, troubleshooting 140
checklist, troubleshooting 98
cleaning
 ETB 118, 127
 fuser 132
 mode 118
 printer 34
 using HP Toolbox 35, 144
clearing jams
 common locations 99
 input area 103
 inside printer 102
 output area 104
cold reset 126
color
 calibration 36
 troubleshooting 142
components
 locating 6
configuration page 114, 128, 129
configurations, printer 3
consumables
 part numbers 253
 specifications 253
 status gauge 8
 status page, printing 116
control panel
 layout 9
 lights and buttons, description 9
 messages 107, 132

 removal and replacement 91
control panel display test 118
covers
 locations 160
 parts list 160
covers, document
 paper specifications 17, 18
creases, troubleshooting 141
critical error messages 108, 133
crooked pages 141
curled media 141
cyan cartridge
 part number 253
 status gauge 8

D

DC controller
 removal and replacement 86
declaration of conformity 262
defaults
 restoring 118, 138
defects
 correcting 122
 repetitive image defects 147
demo page 113, 128
diagnostic tools
 network 146
 repetitive image defect ruler 147
diagrams
 assemblies 154
 covers 160
 general circuit 208
 input devices 186
 internal assemblies 162
dimensions, printer 252
display
 control panel 10
documentation
 ordering 152

- dots per inch (dpi)
 - print settings 121
 - specifications 4
- dots, troubleshooting 138
- dpi (dots per inch)
 - print settings 121
 - specifications 4
- drivers
 - operating systems supported 11
 - uninstalling 12
 - Windows, features 12
- E**
- electrical specifications 254
- energy
 - consumption 254
 - savings 4
- engine cleaning 34
- engine control system 38
- engine test print 125
- envelopes
 - construction 15
 - sizes 16
 - specifications 15, 18
- environmental
 - paper specifications 14
 - printer specifications 255
- error messages 107, 132
- ETB
 - removal and replacement 66
- event log 128, 131
- F**
- faded print 138
- Finnish laser statement 267
- firmware updates 148
- formatter
 - removal and replacement 82
- fraud hotline 33
- fuser
 - cleaning page 132
 - removal and replacement 74
- G**
- general circuit diagram 208
- general timing chart 58
- gray background, troubleshooting 139
- grayscale
 - troubleshooting 142
- H**
- heavy paper
 - specifications 17, 18
- HP fraud hotline 33
- HP Toolbox
 - calibrating printer 36
 - calibrating the printer 144
 - cleaning page 144
 - configuration page 145
 - extended print modes 120
 - operating systems supported 11
 - print quality menu 121
 - print quality troubleshooting pages 144
 - print types 119
 - toner level, checking from 32
- humidity specifications
 - paper, storing 14
 - printer environment 255
- I**
- image formation system 41
- image quality
 - print, troubleshooting 122
- input devices
 - locations 186
 - parts list 186
- input trays
 - features 4
 - installing 25
 - media supported 17
- installing
 - input trays 25
 - print cartridges 27
 - supplies 27
- interface ports
 - types included 4
- internal assembly
 - locations 162
 - parts list 162
- J**
- jams
 - causes 100
 - causes of 99
 - delivery delay 105
 - delivery stationary 105
 - door open 106
 - input area 103
- inside printer 102
- output area 104
- pickup delay 105
- pickup stationary 105
- start-up residual 105
- troubleshooting 101
- wrapping 105
- K**
- keys, control panel 9
- Korean EMI statement 266
- L**
- labels
 - specifications 17, 18
- laser safety statements 263
- LaserWriter 8 driver 12
- light print, troubleshooting 138
- lightness
 - faded print, troubleshooting 138
- lights
 - locating 9
- lines, troubleshooting
 - printed pages 139
- location
 - fan 55
 - model and serial number 8
 - printed circuit assemblies 55, 56
 - solenoid 56
 - solenoids 55
- loose toner, troubleshooting 139
- M**
- Macintosh
 - features supported 11
 - software features 12
- magenta cartridge
 - part number 253
 - status gauge 8
- mailing labels
 - specifications 17, 18
- margins, envelopes 15
- media
 - curled, troubleshooting 141
 - envelopes 15
 - jams 99
 - labels 17
 - selecting 14
 - specifications 14

- transparencies 17
- tray 1, types supported 17
- tray 2, types supported 17
- tray 3, types supported 17
- unsupported 18
- wrinkled 141
- wrong size 123
- wrong type 123
- memory 5
- menu structure report 113
- messages
 - alert and warning 107, 132
 - critical error 108, 133
 - error 107, 132
 - event log 131
 - event log only 112, 137
 - status 112, 137
 - status log 116
 - supplies 109, 134
- model number 8
- motors 55

N

- network
 - diagnostic tools 146
- networks supported 12
- NVRAM initializer
 - super 126

O

- operating environment,
 - specifications 255
- operating systems supported 11
- ordering
 - accessories 152
 - parts 151
 - supplies and accessories 253
- output bins
 - features 4
 - jams, clearing 104
- output quality
 - print, troubleshooting 122
- overhead transparencies
 - specifications 17, 18

P

- page counts
 - restoring 127
- pages
 - blank 123
 - not printing 124

- printing slowly 124
 - skewed 141
- pages per minute 4
- paper
 - curled, troubleshooting 141
 - jams 99
 - jams, delivery delay 105
 - jams, delivery stationary 105
 - jams, door open 106
 - jams, input areas 103
 - jams, inside the printer 102
 - jams, output area 104
 - jams, pickup delay 105
 - jams, pickup stationary 105
 - jams, start-up residual 105
 - jams, top bin 104
 - jams, wrapping 105
 - selecting 14
 - tray 1, types supported 17
 - tray 2, types supported 17
 - tray 3, types supported 17
 - unsupported 18
 - wrinkled 141
- paper handling issues 123
- paper input trays
 - features 4
 - media supported 17
- paper output bins
 - features 4
 - jams, clearing 104
- paper pickup roller
 - removal and replacement 89
- parts
 - assembly locations 154
 - cover locations 160
 - input devices 186
 - internal assembly locations 162
 - ordering 151
 - part numbers 253
 - removal and replacement 61
 - replaceable 150
 - user replaceable 62
- paused printing 9
- performance problems 123
- pickup and feed system 51
- pickup rollers, ordering 62
- platforms supported 11
- ports
 - types included 4
- power

- requirements 254
- powersave 118
- print cartridges
 - checking 32
 - HP fraud hotline 33
 - installing 27
 - life expectancy 32
 - ordering 32
 - part numbers 253
 - recycling 33
 - replacing 27, 33
 - status gauge 8
 - status page, printing 116
 - storage specifications 255
- print modes
 - extended 120
 - HP Toolbox 120
- print quality
 - identifying defects 122
 - improving 119
 - issues 138
 - menu 121
 - settings 121
 - specifications 4
 - troubleshooting 122, 132
- print quality defects
 - correcting 122
- print types
 - HP Toolbox 119
- printer
 - calibrating 59
 - dimensions 22
 - performance problems 123
- printer drivers
 - Macintosh 12
 - operating systems supported 11
 - uninstalling 12
 - Windows, features 12
- printing
 - troubleshooting 124
- printing a configuration page
 - using HP Toolbox 145
- procedure
 - pre-service 63

Q

- quality
 - print settings 121
 - print, troubleshooting 122

- specifications 4
- R**
- ready light 9
- ready light and select button 9
- rear output door
 - features 4
- regulatory statements
 - Canadian DOC statement 264
 - declaration of conformity 262
 - Finnish laser statement 267
 - Korean EMI statement 266
 - laser safety 263
 - VCCI statement 265
- removal
 - control panel 91
 - DC controller 86
 - ETB 66
 - formatter 82
 - fuser 74
 - paper pickup roller 89
 - print cartridges 64
 - separation pad 88
- removal and replacement 61
- repetitive defects, troubleshooting 142
- repetitive image defect ruler 147
- replaceable parts 150
- replacing
 - control panel 91
 - DC controller 86
 - ETB 66
 - formatter 82
 - fuser 74
 - paper pickup roller 89
 - print cartridges 33, 64
 - separation pad 88
- reports
 - configuration 113, 114
 - secondary service 118
 - status 113, 116
 - supplies status 116
 - supplies status page 131
- reports menu 146
- reset, cold 126
- resolution
 - print settings 121
 - specifications 4
- restoring
 - defaults 118
 - factory defaults 138
 - page counts 126, 127
 - serial number 126
- restoring serial number 127
- resuming printing 9
- rollers, ordering 62
- S**
- scatter, troubleshooting 141
- secondary service menu
 - clean ETB 118
 - control panel display test 118
 - reports 118
- separation pad
 - ordering 62
 - removal and replacement 88
- sequence of operation 38
- serial number
 - restoring 127
- service
 - part numbers 253
- service approach 63
- service menu 137
- service menu settings
 - cleaning mode 118
 - powersave 118
 - restoring defaults 118
- service mode functions
 - cleaning mode 126, 127
 - cold reset 126
 - NVRAM initializer 126
 - super NVRAM initializer 126
- site preparation 22
- size, printer 252
- skewed pages 141
- smearred toner, troubleshooting 139
- software
 - Macintosh, features 12
 - network 12
 - operating systems supported 11
 - ordering 152
 - supported drivers 11
 - uninstalling 12
 - updates 148
 - Windows systems 11
 - Windows, features 12
- solenoid 56
- solenoids 55
- space requirements 22
- special media
 - envelopes 15
 - labels 17
 - specifications 17, 18
 - transparencies 17
- specifications
 - acoustical 256
 - envelopes 15
 - environmental 255
 - labels 17
 - motors and fans 39
 - print cartridge 253
 - print media 14
 - printer features 4
 - transparencies 17
 - trays, media supported 17
- specks, troubleshooting 138
- speed
 - specifications 4
- spots, troubleshooting 138
- status
 - printer 8
 - Supplies Status page, printing 116
- status log 116
- status page 128
- storing
 - envelopes 15
 - paper 14
 - print cartridges 33
 - printer 255
 - supplies 33
- streaks, troubleshooting 139
- super NVRAM initializer 126
- supplies
 - checking 32
 - life expectancy 32
 - messages 109, 134
 - ordering 32, 152
 - specifications 253
 - status gauge 8
 - status page 116
- supplies status
 - HP Toolbox 116
- supplies status page 131
- support
 - part numbers 253
- system requirements 23
- systems

- engine control 38
 - image formation 41
 - pickup and feed 51
- T**
- technical support
 - part numbers 253
 - web sites 152
 - temperature specifications
 - paper, storing 14
 - printer environment 255
 - text, troubleshooting
 - misformed characters 140
 - timing chart 58
 - toner
 - loose, troubleshooting 139
 - scatter, troubleshooting 141
 - smear, troubleshooting 139
 - specks, troubleshooting 138
 - status gauge 8
 - Toolbox
 - operating systems supported 11
 - top output bin
 - features 4
 - transparencies
 - specifications 17, 18
 - tray 1
 - loading 25
 - trays
 - features 4
 - media supported 17
 - troubleshooting
 - blank pages 123
 - calibrating printer 36
 - checklist 98
 - color 142
 - configuration page 128
 - curled media 141
 - demo page 128
 - event log 128
 - faded print 138
 - jams 99
 - lines, printed pages 139
 - loose toner 139
 - pages not printing 124
 - pages printing slowly 124
 - print quality issues 138
 - process 98
 - repetitive defects 142
 - replacing print cartridges 33
 - reports and tools 128
 - skewed pages 141
 - status page 128
 - text 140
 - toner scatter 141
 - toner smear 139
 - toner specks 138
 - USB cables 124
 - using HP Toolbox 144
 - wrinkles 141
- U**
- uninstalling software 12
 - updates
 - software and firmware 148
 - USB port
 - troubleshooting 124
 - type included 4
 - user replaceable parts 62
- V**
- VCCI statement 265
 - vertical lines, troubleshooting 139
 - voltage requirements 254
- W**
- warning messages 107, 132
 - warranty
 - print cartridge 259
 - product 258
 - wavy paper, troubleshooting 141
 - weight
 - printer 252
 - Windows
 - software features 11
 - uninstalling software 12
 - versions supported 11
 - wrinkles, troubleshooting 141
- Y**
- yellow cartridge
 - part number 253
 - status gauge 8

© 2005 Hewlett-Packard Development Company, L.P.

www.hp.com



Q6455-90930