



# Dell 2350d/dn, 3330dn **Service Manual**

**Information in this document is subject to change without notice.  
2010 Dell Inc. All rights reserved.**

Reproduction in any manner whatsoever without the written permission of Dell Inc. is strictly forbidden.  
Trademarks used in this text: Dell and the DELL logo are trademarks of Dell Inc.

Other trademarks and trade names may be used in this document to refer to the entities claiming the marks and names of their products. Dell Inc. disclaims any proprietary interest in trademarks and trade names other than its own.

---

# Table of contents

<b>Table of contents</b> .....	<b>.iii</b>
<b>Notices and safety information</b> .....	<b>.vi</b>
Laser notice .....	vii
Lithium warning .....	xiii
Safety information .....	xiii
<b>Preface</b> .....	<b>xvi</b>
Conventions .....	xvi
<b>General information</b> .....	<b>1-1</b>
Maintenance approach .....	1-1
Overview of the operator panel .....	1-2
Specifications .....	1-3
Memory .....	1-3
Print quality settings .....	1-3
Connectivity and compatibility .....	1-4
Media trays and supply capacity .....	1-5
Types of print media .....	1-6
Tips on preventing jams .....	1-7
Paper path .....	1-7
Tools .....	1-8
Acronyms .....	1-9
<b>Diagnostics information</b> .....	<b>2-1</b>
Start .....	2-1
Symptom tables .....	2-1
Service errors (9xx.xx's) .....	2-1
User status and attendance messages .....	2-1
Overview of the operator panel and menus .....	2-2
Diagram of the printer menus .....	2-4
Messages and error codes .....	2-5
User attendance messages .....	2-5
Cartridge error messages .....	2-8
Paper jam error codes (200-series) .....	2-9
Service error codes .....	2-13
Symptom tables .....	2-19
POST symptom table .....	2-19
Printer symptom table .....	2-20
Service checks .....	2-21
Controller board service check .....	2-21
Cooling fan service check .....	2-22
Cover interlock switch service check .....	2-22
Dead machine service check .....	2-23
Fuser service check .....	2-24
LVPS/HVPS service check .....	2-24
Main motor service check .....	2-25
Operator panel service check .....	2-26
Paper feed service checks .....	2-26
Paper jam error indication during POST .....	2-26
Media picks but stops halfway through the printer .....	2-26
Media never picks .....	2-27

Media occasionally mispicks or picks multiple sheets at once	2-27
Media skews	2-27
Media “trees,” wrinkles, stacks poorly, or curls	2-28
<b>Parallel or USB port service check</b>	<b>2-28</b>
<b>Print quality service checks</b>	<b>2-29</b>
Blank page	2-29
Black page	2-30
Heavy background	2-30
Partial blank image/white spots (no repeating pattern)	2-31
Variation in image density horizontally across page	2-31
Poor fusing of image	2-31
Light print	2-32
White or black lines or bands	2-32
Toner on back of page	2-32
Solving print quality problems	2-33
<b>Printhead service check</b>	<b>2-36</b>
<b>Transfer roll service check</b>	<b>2-36</b>

## **Diagnostic aids** ..... **3-1**

<b>Accessing service menus</b>	<b>3-1</b>
<b>Configuration menu (CONFIG MENU)</b>	<b>3-2</b>
<b>Entering Configuration Menu</b>	<b>3-2</b>
<b>Available menus</b>	<b>3-2</b>
<b>Maintenance Count Value (Maint Cnt Value)</b>	<b>3-3</b>
<b>Reset Maintenance Count Value (Reset Maint Cnt)</b>	<b>3-3</b>
<b>Reset Photoconductor Maintenance Counter (Reset PC Cnt)</b>	<b>3-3</b>
<b>Print Quality Pages</b>	<b>3-3</b>
<b>Reports</b>	<b>3-4</b>
Menu Settings Page	3-4
Event Log	3-4
<b>Panel Menus</b>	<b>3-4</b>
<b>PPDS Emulation</b>	<b>3-4</b>
<b>Demo Mode</b>	<b>3-4</b>
<b>Factory Defaults</b>	<b>3-4</b>
<b>Action For Prompts</b>	<b>3-5</b>
<b>Energy Conserve</b>	<b>3-5</b>
<b>Font Sharpening</b>	<b>3-5</b>
<b>Exit Configuration Menu (Exit Config Menu)</b>	<b>3-5</b>
<b>Diagnostics menu</b>	<b>3-6</b>
<b>Entering Diagnostics menu</b>	<b>3-6</b>
<b>Registration</b>	<b>3-7</b>
Margins	3-7
Quick Test page	3-8
<b>Print Tests</b>	<b>3-8</b>
Input sources	3-8
Print Quality Pages (Prt Quality Pgs)	3-8
<b>Hardware Tests</b>	<b>3-9</b>
Panel Test	3-9
Button Test	3-9
DRAM Test	3-9
<b>Duplex Tests</b>	<b>3-10</b>
Quick Test	3-10
Top Margin	3-10
Left Margin	3-10
Sensor Test	3-10
Duplex Feed 1	3-11
<b>Input Tray Tests</b>	<b>3-11</b>
Feed Tests	3-11
Sensor Test	3-11

<b>Output bin tests</b> .....	<b>3-12</b>
Feed Tests .....	3-12
Sensor Test .....	3-12
<b>Base Sensor Test (B. Sensor Test)</b> .....	<b>3-12</b>
<b>Printer Setup</b> .....	<b>3-13</b>
Defaults .....	3-13
Printed Page Count (Page Count) .....	3-13
Permanent Page Count (Perm Page Count) .....	3-13
Serial Number .....	3-14
Service Tag (only on some printers) .....	3-14
Engine Setting 1 through 4 .....	3-14
Model Name .....	3-14
Configuration ID .....	3-14
Edge to Edge .....	3-14
Par S Strobe Adj (parallel strobe adjustment) .....	3-14
<b>EP Setup</b> .....	<b>3-15</b>
EP Defaults .....	3-15
Fuser Temperature (Fuser Temp) .....	3-15
Transfer .....	3-15
Print Contrast .....	3-15
Charge Roll .....	3-15
Gap Adjust .....	3-15
Automatic Darkness Adjustment (Auto Dark Adj) .....	3-16
<b>Reports</b> .....	<b>3-16</b>
<b>Event log</b> .....	<b>3-16</b>
Display Log .....	3-16
Print Log .....	3-17
Clear Log .....	3-17
<b>Exit Diagnostics</b> .....	<b>3-17</b>
<b>Printhead assembly electronic adjustment</b> .....	<b>3-18</b>
<b>Printhead assembly mechanical adjustment</b> .....	<b>3-19</b>
<b>Repair information</b> .....	<b>4-1</b>
Handling ESD-sensitive parts .....	4-1
Removal procedures .....	4-2
ACM pick tire roller removal .....	4-3
Bezel removal .....	4-5
Controller board removal .....	4-6
Cover open sensor .....	4-8
Door mount removal .....	4-9
Duplex removal .....	4-11
Duplex/main motor gear drive interface removal .....	4-13
Fan removal .....	4-16
Front access door removal .....	4-17
Fuser removal .....	4-21
Left side cover removal .....	4-24
Lower front cover removal .....	4-26
LVPS/HVPS removal .....	4-28
Main motor gear drive removal .....	4-31
Manual feed clutch removal .....	4-33
Manual feed solenoid removal .....	4-35
Media ACM ASM feeder removal .....	4-37
Media feed clutch with cable removal .....	4-40
Media manual input sensor .....	4-42
Multipurpose feeder (MPF) removal .....	4-45
Multipurpose feeder (MPF) feed clutch removal .....	4-48
Nameplate removal .....	4-50
Operator panel removal .....	4-51
Paper input and duplex sensor assembly removal .....	4-52

Printhead removal .....	4-53
Rear door and rear cover removal .....	4-54
Rear exit guide assembly with sensor and reversing solenoid removal .....	4-56
Right side cover assembly removal .....	4-58
Toner level sensor removal .....	4-60
Top cover assembly removal .....	4-61
Transfer roll removal .....	4-63
Upper front guide assembly removal .....	4-64
Wear strip (tray 1 and 250-sheet tray 2) removal .....	4-65
Wear strip (550-sheet tray 2) removal .....	4-66
<b>Locations and connections .....</b>	<b>5-1</b>
Locations .....	5-1
Front view .....	5-1
Rear view .....	5-1
Dell 3330dn controller board .....	5-2
E460dw controller board .....	5-3
Dell 2350d/dn, 3330dn controller board connector pin values .....	5-4
<b>Preventive maintenance .....</b>	<b>6-1</b>
Safety inspection guide .....	6-1
Lubrication specifications .....	6-1
Maintenance kits .....	6-1
<b>Parts Catalog (Dell 3330dn) .....</b>	<b>7-1</b>
How to use this parts catalog .....	7-1
Assembly 1: Covers .....	7-2
Assembly 2: Electronics .....	7-4
Assembly 3: Frame .....	7-6
Assembly 4: Options .....	7-8
Assembly 5: Power cords .....	7-9
<b>Index .....</b>	<b>I-1</b>
<b>Part number index <math>\square\square\square\square333\square\square\square\square</math> .....</b>	<b>I-3</b>
<b>Parts Catalog (Dell 2350d/dn) .....</b>	<b>8-1</b>
How to use this parts catalog .....	8-1
Assembly 1: Covers .....	8-2
Assembly 2: Electronics and frame .....	8-4
Assembly 3: Exchange units .....	8-6
Assembly 4: Power cords .....	8-7
Assembly 5: Miscellaneous .....	8-8
<b>Part number index <math>\square\square\square\square\square3\square\square\square\square\square\square</math> .....</b>	<b>I-3</b>

---

## Notices and safety information

The following laser notice labels may be affixed to this printer.

---

### Laser notice

The printer is certified in the U.S. to conform to the requirements of DHHS 21 CFR Subchapter J for Class I (1) laser products, and elsewhere is certified as a Class I laser product conforming to the requirements of IEC 60825-1.

Class I laser products are not considered to be hazardous. The printer contains internally a Class IIIb (3b) laser that is nominally a 7 milliwatt gallium arsenide laser operating in the wavelength region of 655-675 nanometers. The laser system and printer are designed so there is never any human access to laser radiation above a Class I level during normal operation, user maintenance, or prescribed service condition.

---

### Laser

Der Drucker erfüllt gemäß amtlicher Bestätigung der USA die Anforderungen der Bestimmung DHHS (Department of Health and Human Services) 21 CFR Teil J für Laserprodukte der Klasse I (1). In anderen Ländern gilt der Drucker als Laserprodukt der Klasse I, der die Anforderungen der IEC (International Electrotechnical Commission) 60825-1 gemäß amtlicher Bestätigung erfüllt.

Laserprodukte der Klasse I gelten als unschädlich. Im Inneren des Druckers befindet sich ein Laser der Klasse IIIb (3b), bei dem es sich um einen Galliumarsenlaser mit 7 Milliwatt handelt, der Wellen der Länge 655-675 Nanometer ausstrahlt. Das Lasersystem und der Drucker sind so konzipiert, daß im Normalbetrieb, bei der Wartung durch den Benutzer oder bei ordnungsgemäßer Wartung durch den Kundendienst Laserbestrahlung, die Klasse I übersteigen würde, Menschen keinesfalls erreicht.

---

### Avis relatif à l'utilisation de laser

Pour les Etats-Unis : cette imprimante est certifiée conforme aux provisions DHHS 21 CFR alinéa J concernant les produits laser de Classe I (1). Pour les autres pays : cette imprimante répond aux normes IEC 60825-1 relatives aux produits laser de Classe I.

Les produits laser de Classe I sont considérés comme des produits non dangereux. Cette imprimante est équipée d'un laser de Classe IIIb (3b) (arséniure de gallium d'une puissance nominale de 7 milliwatts) émettant sur des longueurs d'onde comprises entre 655 et 675 nanomètres. L'imprimante et son système laser sont conçus pour impossible, dans des conditions normales d'utilisation, d'entretien par l'utilisateur ou de révision, l'exposition à des rayonnements laser supérieurs à des rayonnements de Classe I.

---

### Avvertenze sui prodotti laser

Questa stampante è certificata negli Stati Uniti per essere conforme ai requisiti del DHHS 21 CFR Sottocapitolo J per i prodotti laser di classe 1 ed è certificata negli altri Paesi come prodotto laser di classe 1 conforme ai requisiti della norma CEI 60825-1.

I prodotti laser di classe non sono considerati pericolosi. La stampante contiene al suo interno un laser di classe IIIb (3b) all'arseniuro di gallio della potenza di 7mW che opera sulla lunghezza d'onda compresa tra 655 e 675 nanometri. Il sistema laser e la stampante sono stati progettati in modo tale che le persone a contatto con la stampante, durante il normale funzionamento, le operazioni di servizio o quelle di assistenza tecnica, non ricevano radiazioni laser superiori al livello della classe 1.

---

## Avisos sobre el láser

Se certifica que, en los EE.UU., esta impresora cumple los requisitos para los productos láser de Clase I (1) establecidos en el subcapítulo J de la norma CFR 21 del DHHS (Departamento de Sanidad y Servicios) y, en los demás países, reúne todas las condiciones expuestas en la norma IEC 60825-1 para productos láser de Clase I (1).

Los productos láser de Clase I no se consideran peligrosos. La impresora contiene en su interior un láser de Clase IIIb (3b) de arseniuro de galio de funcionamiento nominal a 7 milivatios en una longitud de onda de 655 a 675 nanómetros. El sistema láser y la impresora están diseñados de forma que ninguna persona pueda verse afectada por ningún tipo de radiación láser superior al nivel de la Clase I durante su uso normal, el mantenimiento realizado por el usuario o cualquier otra situación de servicio técnico.

---

## Declaração sobre Laser

A impressora está certificada nos E.U.A. em conformidade com os requisitos da regulamentação DHHS 21 CFR Subcapítulo J para a Classe I (1) de produtos laser. Em outros locais, está certificada como um produto laser da Classe I, em conformidade com os requisitos da norma IEC 60825-1.

Os produtos laser da Classe I não são considerados perigosos. Internamente, a impressora contém um produto laser da Classe IIIb (3b), designado laser de arseneto de potássio, de 7 milliwatts, operando numa faixa de comprimento de onda entre 655 e 675 nanómetros. O sistema e a impressora laser foram concebidos de forma a nunca existir qualquer possibilidade de acesso humano a radiação laser superior a um nível de Classe I durante a operação normal, a manutenção feita pelo utilizador ou condições de assistência prescritas.

---

## Laserinformatie

De printer voldoet aan de eisen die gesteld worden aan een laserproduct van klasse I. Voor de Verenigde Staten zijn deze eisen vastgelegd in DHHS 21 CFR Subchapter J, voor andere landen in IEC 60825-1.

Laserprodukten van klasse I worden niet als ongevaarlijk aangemerkt. De printer is voorzien van een laser van klasse IIIb (3b), dat wil zeggen een gallium arsenide-laser van 7 milliwatt met een golflengte van 655-675 nanometer. Het lasergedeelte en de printer zijn zo ontworpen dat bij normaal gebruik, bij onderhoud of reparatie conform de voorschriften, nooit blootstelling mogelijk is aan laserstraling boven een niveau zoals voorgeschreven is voor klasse 1.

---

## Lasermeddelelse

Printeren er godkendt som et Klasse I-laserprodukt, i overensstemmelse med kravene i IEC 60825-1.

Klasse I-laserprodukter betragtes ikke som farlige. Printeren indeholder internt en Klasse IIIB (3b)-laser, der nominelt er en 7 milliwatt galliumarsenid laser, som arbejder på bølgelængdeområdet 655-675 nanometer. Lasersystemet og printeren er udformet således, at mennesker aldrig udsættes for en laserstråling over Klasse I-niveau ved normal drift, brugervedligeholdelse eller obligatoriske servicebetingelser.



---

## Laserilmoitus

Tämä tulostin on sertifioitu Yhdysvalloissa DHHS 21 CFR Subchapter J -standardin mukaiseksi luokan I (1) - lasertuotteeksi ja muualla IEC 60825-1 -standardin mukaiseksi luokan I lasertuotteeksi.

Luokan I lasertuotteita ei pidetä haitallisina. Tulostimen sisällä on luokan IIIb (3b) laser, joka on nimellisteholtaan 7 mW:n galliumarsenidilaser ja toimii 655 - 675 nanometrin aallonpituuksilla. Laserjärjestelmä ja tulostin ovat rakenteeltaan sellaisia, että käyttäjä ei joudu alttiiksi luokkaa 1 suuremmalle säteilylle normaalin käytön, ylläpidon tai huollon aikana.

---

## Huomautus laserlaitteesta

Tämä kirjoitin on Yhdysvalloissa luokan I (1) laserlaitteiden DHHS 21 CFR Subchapter J -määrityksen mukainen ja muualla luokan I laserlaitteiden IEC 60825-1 -määrityksen mukainen.

Luokan I laserlaitteiden ei katsota olevan vaarallisia käyttäjälle. Kirjoittimessa on sisäinen luokan IIIb (3b) 7 milliwatin galliumarsenidilaser, joka toimii aaltoalueella 655 - 675 nanometriä. Laserjärjestelmä ja kirjoitin on suunniteltu siten, että käyttäjä ei altistu luokan I määräytyksiä voimakkaammalle säteilylle kirjoittimen normaalin toiminnan, käyttäjän tekemien huoltotoimien tai muiden huoltotoimien yhteydessä.

**VARO!** Avattaessa ja suojalukitus ohitettaessa olet alttiina näkymättömälle lasersäteilylle. Älä katso säteeseen.

**WARNING!** Osynlig laserstrålning när denna del är öppnad och spårren är urkopplad. Betrakta ej strålen.

---

## Laser-notis

Denna skrivare är i USA certifierad att motsvara kraven i DHHS 21 CFR, underparagraf J för laserprodukter av Klass I (1). I andra länder uppfyller skrivaren kraven för laserprodukter av Klass I enligt kraven i IEC 60825-1.

Laserprodukter i Klass I anses ej hälsovådliga. Skrivaren har en inbyggd laser av Klass IIIb (3b) som består av en laserenhet av gallium-arsenid på 7 milliwatt som arbetar i våglängdsområdet 655-675 nanometer. Lasersystemet och skrivaren är utformade så att det aldrig finns risk för att någon person utsätts för laserstrålning över Klass I-nivå vid normal användning, underhåll som utförs av användaren eller annan föreskriven serviceåtgärd.

---

## Laser-melding

Skriveren er godkjent i USA etter kravene i DHHS 21 CFR, underkapittel J, for klasse I (1) laserprodukter, og er i andre land godkjent som et Klasse I-laserprodukt i samsvar med kravene i IEC 60825-1.

Klasse I-laserprodukter er ikke å betrakte som farlige. Skriveren inneholder internt en klasse IIIb (3b)-laser, som består av en gallium-arsenlaserenhet som avgir stråling i bølglengdeområdet 655-675 nanometer. Lasersystemet og skriveren er utformet slik at personer aldri utsettes for laserstråling ut over klasse I-nivå under vanlig bruk, vedlikehold som utføres av brukeren, eller foreskrevne serviceoperasjoner.

---

## Avís sobre el Làser

Segons ha estat certificat als Estats Units, aquesta impressora compleix els requisits de DHHS 21 CFR, apartat J, pels productes làser de classe I (1), i segons ha estat certificat en altres llocs, és un producte làser de classe I que compleix els requisits d'IEC 60825-1.

Els productes làser de classe I no es consideren perillosos. Aquesta impressora conté un làser de classe IIIb (3b) d'arseniür de gal.li, nominalment de 7 mil.liwats, i funciona a la regió de longitud d'ona de 655-675 nanòmetres. El sistema làser i la impressora han sigut concebuts de manera que mai hi hagi exposició a la radiació làser per sobre d'un nivell de classe I durant una operació normal, durant les tasques de manteniment d'usuari ni durant els serveis que satisfacin les condicions prescrites.

---

### レーザーに関するお知らせ

このプリンターは、米国ではDHHS 21 CFRサブチャプターJのクラスI (1)の基準を満たしたレーザー製品であることが証明されています。また米国以外ではIEC 825の基準を満たしたクラスIのレーザー製品であることが証明されています。

クラスIのレーザー製品には危険性はないと考えられています。このプリンターはクラスIII b (3 b)のレーザーを内蔵しています。このレーザーは、波長が770 ~ 795ナノメートルの範囲で、通常5ミリワットのガリウム砒化物を放射するレーザーです。このレーザーシステムとプリンターは、通常の操作、ユーザのメンテナンス、規定された修理においては、人体がクラスIのレベル以上のレーザー放射に晒されることのないよう設計されています。

---

### 注意：

本打印机被美国认证合乎 DHHS 21 CFR Subchapter I 对分类 I (1) 激光产品的标准，而在其他地区则被认证合乎 IEC 825 的标准。

分类 I 激光产品一般认为不具危险性，本打印机内部含有分类 IIIb (3b) 的激光，在操作过程中会产生 5 毫瓦含镓及砷的微量激光，其波长范围在 770-795 nm 之间。本激光系统及打印机的设计，在一般操作、使用者维护或规定内的维修情况下，不会使人体接触分类 I 以上等级的辐射。

---

본프린터는 1등급 레이저 제품들에 대한 DHHS 21 CFR Subchapter 3의 규정을 준수하고 있음을 미국에서 인증받았으며, 그외의 나라에서도 IEC 825 규정을 준수하는 1등급 레이저 제품으로서 인증을 받았습니다.

1등급 레이저 제품들은 안전한 것으로 간주됩니다. 본 프린터는 5 밀리와트 갈륨 아르세나이드 레이저로서 770-795 나노미터의 파장대에서 활동하는 Class III (3b) 레이저를 내부에 갖고 있습니다. 본 레이저 시스템과 프린터는 정상 작동 중이나 유지 보수 중 또는 규정된 서비스 상태에서 상기의 Class I 수준의 레이저 방출에 사람이 절대 접근할 수 없도록 설계되어 있습니다.



---

## Lithium warning

	<p><b>CAUTION</b></p> <p>This product contains a lithium battery. THERE IS A RISK OF EXPLOSION IF THE BATTERY IS REPLACED BY AN INCORRECT TYPE. Discard used batteries according to the battery manufacturer's instructions and local regulations.</p>
---	--

---

## Safety information

- The safety of this product is based on testing and approvals of the original design and specific components. The manufacturer is not responsible for safety in the event of use of unauthorized replacement parts.
- The maintenance information for this product has been prepared for use by a professional service person and is not intended to be used by others.
- There may be an increased risk of electric shock and personal injury during disassembly and servicing of this product. Professional service personnel should understand this and take necessary precautions.
-  **CAUTION:** When you see this symbol, there is a danger from hazardous voltage in the area of the product where you are working. Unplug the product before you begin, or use caution if the product must receive power in order to perform the task.

---

## Consignes de sécurité

- La sécurité de ce produit repose sur des tests et des agréments portant sur sa conception d'origine et sur des composants particuliers. Le fabricant n'assume aucune responsabilité concernant la sécurité en cas d'utilisation de pièces de rechange non agréées.
- Les consignes d'entretien et de réparation de ce produit s'adressent uniquement à un personnel de maintenance qualifié.
- Le démontage et l'entretien de ce produit pouvant présenter certains risques électriques, le personnel d'entretien qualifié devra prendre toutes les précautions nécessaires.
-  **ATTENTION :** Ce symbole indique la présence d'une tension dangereuse dans la partie du produit sur laquelle vous travaillez. Débranchez le produit avant de commencer ou faites preuve de vigilance si l'exécution de la tâche exige que le produit reste sous tension.

---

## Norme di sicurezza

- La sicurezza del prodotto si basa sui test e sull'approvazione del progetto originale e dei componenti specifici. Il produttore non è responsabile per la sicurezza in caso di sostituzione non autorizzata delle parti.
- Le informazioni riguardanti la manutenzione di questo prodotto sono indirizzate soltanto al personale di assistenza autorizzato.
- Durante lo smontaggio e la manutenzione di questo prodotto, il rischio di subire scosse elettriche e danni alla persona è più elevato. Il personale di assistenza autorizzato deve, quindi, adottare le precauzioni necessarie.
-  **ATTENZIONE:** Questo simbolo indica la presenza di tensione pericolosa nell'area del prodotto. Scollegare il prodotto prima di iniziare o usare cautela se il prodotto deve essere alimentato per eseguire l'intervento.

---

## Sicherheitshinweise

- Die Sicherheit dieses Produkts basiert auf Tests und Zulassungen des ursprünglichen Modells und bestimmter Bauteile. Bei Verwendung nicht genehmigter Ersatzteile wird vom Hersteller keine Verantwortung oder Haftung für die Sicherheit übernommen.
- Die Wartungsinformationen für dieses Produkt sind ausschließlich für die Verwendung durch einen Wartungsfachmann bestimmt.
- Während des Auseinandernehmens und der Wartung des Geräts besteht ein zusätzliches Risiko eines elektrischen Schlags und körperlicher Verletzung. Das zuständige Fachpersonal sollte entsprechende Vorsichtsmaßnahmen treffen.
-  **ACHTUNG:** Dieses Symbol weist auf eine gefährliche elektrische Spannung hin, die in diesem Bereich des Produkts auftreten kann. Ziehen Sie vor den Arbeiten am Gerät den Netzstecker des Geräts, bzw. arbeiten Sie mit großer Vorsicht, wenn das Produkt für die Ausführung der Arbeiten an den Strom angeschlossen sein muß.

---

## Pautas de Seguridad

- La seguridad de este producto se basa en pruebas y aprobaciones del diseño original y componentes específicos. El fabricante no es responsable de la seguridad en caso de uso de piezas de repuesto no autorizadas.
- La información sobre el mantenimiento de este producto está dirigida exclusivamente al personal cualificado de mantenimiento.
- Existe mayor riesgo de descarga eléctrica y de daños personales durante el desmontaje y la reparación de la máquina. El personal cualificado debe ser consciente de este peligro y tomar las precauciones necesarias.
-  **PRECAUCIÓN:** este símbolo indica que el voltaje de la parte del equipo con la que está trabajando es peligroso. Antes de empezar, desenchufe el equipo o tenga cuidado si, para trabajar con él, debe conectarlo.

---

## Informações de Segurança

- A segurança deste produto baseia-se em testes e aprovações do modelo original e de componentes específicos. O fabricante não é responsável pela segurança, no caso de uso de peças de substituição não autorizadas.
- As informações de segurança relativas a este produto destinam-se a profissionais destes serviços e não devem ser utilizadas por outras pessoas.
- Risco de choques eléctricos e ferimentos graves durante a desmontagem e manutenção deste produto. Os profissionais destes serviços devem estar avisados deste facto e tomar os cuidados necessários.
-  **CUIDADO:** Quando vir este símbolo, existe a possível presença de uma potencial tensão perigosa na zona do produto em que está a trabalhar. Antes de começar, desligue o produto da tomada eléctrica ou seja cuidadoso caso o produto tenha de estar ligado à corrente eléctrica para realizar a tarefa necessária.

---

## Informació de Seguretat

- La seguretat d'aquest producte es basa en l'avaluació i aprovació del disseny original i els components específics.  
El fabricant no es fa responsable de les qüestions de seguretat si s'utilitzen peces de recanvi no autoritzades.
- La informació pel manteniment d'aquest producte està orientada exclusivament a professionals i no està destinada a ningú que no ho sigui.
- El risc de xoc elèctric i de danys personals pot augmentar durant el procés de desmuntatge i de servei d'aquest producte. El personal professional ha d'estar-ne assabentat i prendre les mesures convenients.
-  **PRECAUCIÓ:** aquest símbol indica que el voltatge de la part de l'equip amb la qual esteu treballant és perillós. Abans de començar, desendolleu l'equip o extremeu les precaucions si, per treballar amb l'equip, l'heu de connectar.

---

## 안전 사항

- 본 제품은 원래 설계 및 특정 구성품에 대한 테스트 결과로 안정성이 입증된 것입니다. 따라서 무허가 교체부품을 사용하는 경우에는 제조업체에서 안전에 대한 책임을 지지 않습니다.
- 본 제품에 관한 유지 보수 설명서는 전문 서비스 기술자용으로 작성된 것이므로, 비전문가는 사용할 수 없습니다.
- 본 제품을 해체하거나 정비할 경우, 전기적인 충격을 받거나 상처를 입을 위험이 커집니다. 전문 서비스 기술자는 이 사실을 숙지하고, 필요한 예방 조치를 취하도록 하십시오.
-  **주의:** 이 표시는 해당영역에서 고압전류가 흐른다는 위험 표시입니다. 시작전에 플러그를 뽑으시거나, 주의를 기울여 주시기 바랍니다.

---

## 安全信息

- 本产品的安全性以原来设计和特定产品的测试结果和认证为基础。万一使用未经许可的替换部件，制造商不对安全性负责。
- 本产品的维护信息仅供专业服务人员使用，并不打算让其他人使用。
- 本产品在拆卸、维修时，遭受电击或人员受伤的危险性会增高，专业服务人员对这点必须有所了解，并采取必要的预防措施。
-  **切记:** 当您看到此符号时，说明在您工作的产品区域有危险电压的存在。请在开始操作前拔掉产品的电源线，或者在产品必须使用电源来执行任务时，小心从事。

# Preface

This manual contains maintenance procedures for service personnel. It is divided into the following chapters:

1. **General information** contains a general description of the printer and the maintenance approach used to repair it. Special tools and test equipment, as well as general environmental and safety instructions, are discussed.
2. **Diagnostic information** contains an error indicator table, symptom tables, and service checks used to isolate failing field replaceable units (FRUs).
3. **Diagnostic aids** contains tests and checks used to locate or repeat symptoms of printer problems.
4. **Repair information** provides instructions for making printer adjustments and removing and installing FRUs.
5. **Connector locations** uses illustrations to identify the connector locations and test points on the printer.
6. **Preventive maintenance** contains the lubrication specifications and recommendations to prevent problems.
7. **Parts catalog** contains illustrations and part numbers for individual FRUs.

---

## Conventions

**Note:** A note provides additional information.

**Warning:** A warning identifies something that might damage the product hardware or software.

There are several types of caution statements:

	<b>CAUTION</b> A caution identifies something that might cause a servicer harm.
---	--

	<b>CAUTION</b> This type of caution indicates there is a danger from hazardous voltage in the area of the product where you are working. Unplug the product before you begin, or use caution if the product must receive power in order to perform the task.
---	---

	<b>CAUTION</b> This type of caution indicates a hot surface.
---	---

	<b>CAUTION</b> This type of caution indicates a tipping hazard.
---	--



---

## 1. General information

The Dell 2350d/dn and 3330dn printers are monochrome laser printers designed for single users or small workgroups.

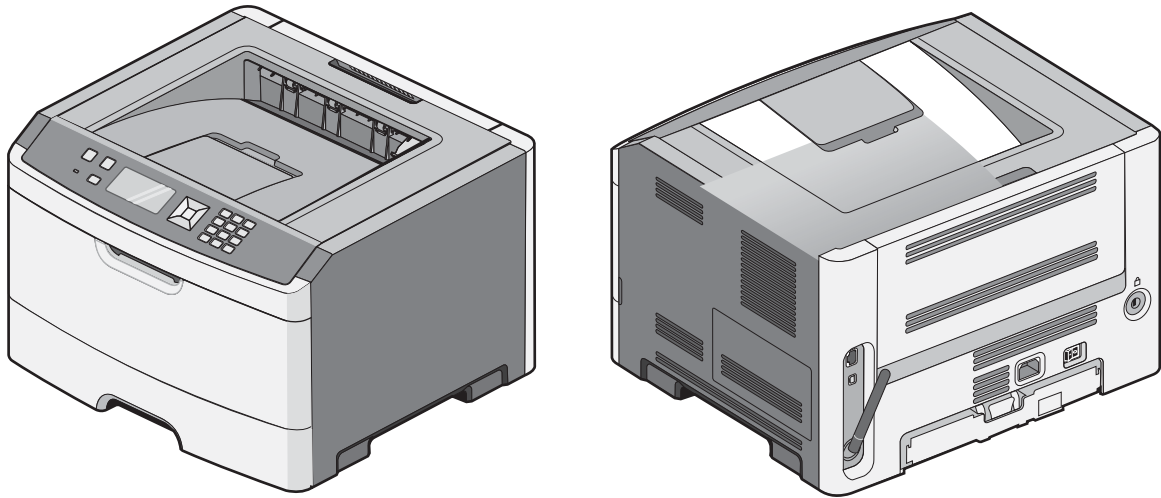

---









## Maintenance approach

The diagnostic information in this manual leads to the correct field replaceable unit (FRU) or part. Use the error code charts, symptom index, and service checks to determine the symptom and repair the failure. See **“Diagnostics information” on page 2-1** for more information. See **“Repair information” on page 4-1** to help identify parts. After completing the repair, perform tests as needed to verify the repair.

---

## Overview of the operator panel

The control panel consists of these items:

- A 4-line, liquid crystal display (APA) that can show both graphics and text
- Eight buttons: Back , Menu , Stop , Select , and Navigation  (up arrow , down arrow , left arrow , and right arrow )
- Keypad
- Indicator light



## Specifications

### Memory

Item	Dell 2350dn	Dell 3330dn
<b>Standard memory</b>	32MB	64MB
<b>Maximum memory</b>	288MB	576MB
<b>Optional memory</b>		
128MB	✓	✓
256MB	✓	✓
512MB	N.A.	✓
<b>Optional flash memory</b>		
64MB	N.A.	✓
256MB	N.A.	✓
<b>Optional font cards (DBCS)</b>	✓	✓
<b>Option slots</b>		
Memory slots	1	1
Flash memory/option card	2 <sup>1</sup>	2 <sup>1</sup>
<sup>1</sup> Both slots are active for either a 256MB Flash memory card, a font card, or a DLE. Multiple Flash, font, or DLE cards are not supported.		

### Print quality settings

Item	Dell 2350dn	Dell 3330dn
<b>Print resolution</b>		
1200 Image quality <sup>1</sup>	✓	✓
2400 Image quality <sup>2</sup>	✓	✓
600 X 600 dpi	✓	✓
1200 X 1200 dpi <sup>3</sup>	✓	✓
<sup>1</sup> 1200 Image quality is defined as 600 dpi with 2 bit IET (Image Technology) default mode for all models.		
<sup>2</sup> 2400 Image quality is defined as 600 dpi with 4 bit IET.		
<sup>3</sup> True 1200 dpi at 1/2 the rated speed		

## Connectivity and compatibility

Item	Dell 2350dn	Dell 3330dn
<b>Data stream emulations</b>		
Host based printing	✓	✓
PCL 5e and PCL 6	✓	✓
PostScript 3	✓	✓
PPDS migration tool	N.A.	✓
PDF v1.6	N.A.	✓
XPS <sup>1</sup>	N.A.	✓
HTML (including DBCS)	N.A.	✓
Direct image	N.A.	✓
Compatibility	Windows/Macintosh/Linux	Windows/Macintosh/Linux
<b>Standard local connections</b>		
Parallel	✓	✓
USB*	✓	✓
<b>Standard network connections</b>		
Ethernet (10/100 Base Tx)	✓	✓
Wireless ethernet 802.11b/g/n	N.A.	N.A.
<b>Optional local connections</b>		
Optional network connections: external print server support	✓	✓
<p>*All models are USB 2.0 Certified devices supporting Hi-Speed data transfer.</p> <p><sup>1</sup> Includes the HD photo image format</p> <p><sup>2</sup> Includes support for the following graphics formats: TIFF, TIF, JPG, GIF, PNG, BMP, PCX, AND DCX</p>		

## Media trays and supply capacity

Item	Dell 2350dn	Dell 3330dn
<b>Available input trays</b>		
Integrated 250-sheet tray	✓	✓
50-sheet MP feeder	✓	✓
1-sheet manual feed slot	x	x
<b>Optional input sources</b>		
250-sheet drawer	✓	✓
550-sheet drawer	✓	✓
<b>Maximum input sheet capacity</b>	850 (excluding envelopes)	850 (excluding envelopes)
<b>Manual/integrated print duplex</b>	Integrated	Integrated
<b>Envelope conditioning</b>	x	x
<b>Available output trays</b>		
Standard 150-sheet sensing bin	✓	✓
<b>Toner and photoconductor</b>		
Toner cartridge	2,000 pages (ship with capacity) <sup>1</sup> 2,000 pages (standard capacity) <sup>1</sup>	7,000 pages (ship with capacity) <sup>1</sup> 7,000 pages (standard capacity) <sup>1</sup>
High toner cartridge	6,000 pages <sup>1</sup>	14,000 pages <sup>1</sup>
Photoconductor kit	Up to 30,000 <sup>2</sup>	Up to 30,000 <sup>2</sup>
<sup>1</sup> Declared value in accordance with ISO/IEC 19752.		
<sup>2</sup> Up to 30,000 pages, based on an average of 3 pages per job and approximately 5% coverage per page. Yields may vary based on customer usage.		

## Types of print media

**Note:** Ensure trays are properly loaded. Never mix media types within a tray.

Source	Sizes	Types	Weight	Input capacity* (sheets)
Input tray 1 (250-sheet tray)	A4, A5, A6, JIS <sup>1</sup> -B5, letter, legal, executive, oficio (Mexico) <sup>2</sup> , folio <sup>2</sup> , statement	Plain paper, recycled, labels, bond, letterhead, preprinted, colored paper, light paper, heavy paper, rough/cotton, custom type [x]	60-90 g/m <sup>2</sup> (16-24 lb)	<ul style="list-style-type: none"> <li>• 250 paper</li> <li>• 50 labels**</li> </ul>
2nd Drawer option (250/550-sheet drawer)	A4, A5, JIS <sup>1</sup> -B5, letter, legal, executive, oficio (Mexico) <sup>2</sup> , folio <sup>2</sup> , statement	Plain paper, recycled, labels, bond, letterhead, preprinted, colored paper, light paper, heavy paper, rough/cotton, custom type [x]	60-90 g/m <sup>2</sup> (16-24 lb)	<ul style="list-style-type: none"> <li>• 250 paper</li> <li>• 550 paper</li> <li>• 50 labels**</li> </ul>
Multipurpose feeder	A4, A5, A6, JIS <sup>1</sup> -B5, letter, legal, executive, oficio (Mexico) <sup>2</sup> , folio <sup>2</sup> , statement	Plain paper, transparency, recycled, labels, bond, letterhead, preprinted, colored paper, light paper, heavy paper, rough/cotton, custom type [x]	60-163 g/m <sup>2</sup> (16-43 lb)	<ul style="list-style-type: none"> <li>• 50 paper</li> <li>• 15 labels**</li> <li>• 10 transparencies</li> </ul>
		Card stock***	<ul style="list-style-type: none"> <li>• 120-163 g/m<sup>2</sup> (16-43 lb) Index Bristol</li> <li>• 75-163 g/m<sup>2</sup> (46-100 lb) Tag</li> </ul>	20
	7 ¾, 9, 10, DL, C5, B5, other	Envelopes Rough envelopes	75 g/m <sup>2</sup> (20 lb)	7
Duplex	A4, letter, legal, oficio (Mexico) <sup>2</sup> , folio <sup>2</sup>	Plain paper, recycled, bond, letterhead, preprinted, colored paper, light paper, heavy paper, custom type [x]	60-90 g/m <sup>2</sup> (16-24 lb)	
<p>* Capacity for 20 lb print media, unless otherwise noted.  ** Use for occasional printing only.  *** Grain short is recommended. Use rear exit for best results.  <sup>1</sup>Japanese Industry Standard  <sup>2</sup> If a source supports size sensing and is activated, then neither the “oficio” value nor the “folio” value appears in that source’s list of supported media sizes. These values only appear in a source’s list of supported media sizes either when the source is non-size sensing or when the source’s size sensing hardware is deactivated and then the device is power cycled.</p>				

## Tips on preventing jams

### *Paper path*

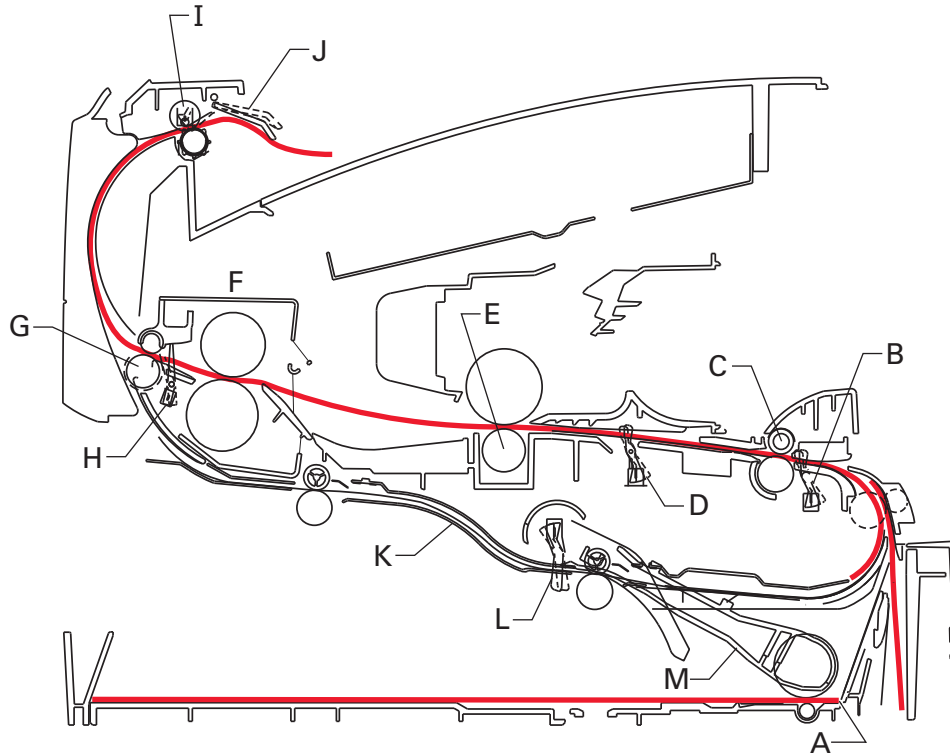

A	Paper path	A – B	125.3 mm
B	Manual feed sensor	B – C	9.0 mm
C	Upper end feed rolls	C – D	59.8 mm
D	Input sensor	D – E	44.9 mm
E	Transfer roll	E – F	112.7 mm
F	Fuser	F – G	21.4 mm
G	Fuser exit rolls	G – H	114.8 mm
H	Fuser exit sensor	H – I	7.5 mm
I	Exit rolls	I – J	17.0 mm
J	Exit sensor/narrow media sensor	I – K	211.7 mm
K	Duplex unit	K – L	93.4 mm
L	Duplex sensor	L – M	8.4 mm
M	Auto compensator		

Most paper jams can be avoided by correctly loading paper and specialty media in the printer.

The following hints can help prevent paper jams:

- Use only the recommended print media.
- Do not overload the print media sources. Make sure the stack height does not exceed the maximum height indicated by the stack line on the labels in the sources.
- Do not load wrinkled, creased, damp, or curled print media.
- Flex, fan, and straighten print media before loading it. If jams do occur with the print media, then try feeding one sheet at a time through the manual feeder.

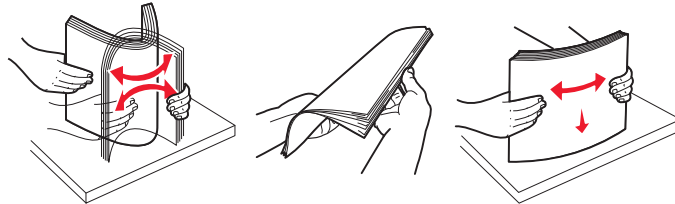

- Do not mix print media sizes, weights, or types in the same print media source.
- Push all trays in firmly after loading them.

**Note:** Make sure the media stack is below the maximum media fill indicators on the 250-sheet tray before pushing the tray into the printer.

- Make sure paper guides are positioned before loading the paper or specialty media.
- Do not remove trays while a job is printing.
- Before loading transparencies, fan the stack to prevent sheets from sticking together.
- Do not use envelopes that:
  - Have excessive curl
  - Are stuck together
  - Are damaged in any way
  - Contain windows, holes, perforations, cutouts, or embossments
  - Have metal clasps, string ties, or metal folding bars
  - Have postage stamps attached
  - Have any exposed adhesive when the flap is in the sealed position
- Use only recommended media. Refer to the *Card Stock & Label Guide* available on the Dell Web site at [www.dell.com](http://www.dell.com) for more information about which media provides optimum results for the current printing environment.

---

## Tools

The removal and adjustment procedures require the following tools and equipment:

- Spring hook
- Needle nose pliers
- Volt-ohmmeter
- #1 and #2 Phillips screwdriver
- Slotted screwdriver



---

## Acronyms

ACM	Autocompensator Mechanism (or paper feed)
ADC	Analog-to-digital Converter
ASIC	Application Specific Integrated Circuit
CBM	Complete Bill Of Material
DEV	Development Roll (of print cartridge/photoconductor system)
DIMM	Dual In-Line Memory Module
ENA	External Network Adapter
FRU	Field Replaceable Unit
HBP	Host Based Printing
HVPS	High Voltage Power Supply
LCD	Liquid Crystal Diode
LED	Light Emitting Diode
LSU	Laser Scanning Unit
LVPS	Low Voltage Power Supply
NVRAM	Nonvolatile Random Access Memory
PC	Photoconductor
PCL	Printer Control Language
POR	Power-On Reset
POST	Power-On Self Test
PPDS	Personal Printer Data Stream
PRC	People's Republic of China
TAR	Toner Add Roll
SDR	Synchronous Dynamic RAM
SWE	Shipped With Equipment
USB	Universal Serial Bus
V ac	Volts alternating current
V dc	Volts direct current



---

## 2. Diagnostics information

---

### Start



**CAUTION:** Unplug power from the printer before connecting or disconnecting any cable, assembly, or electronic card. This is a precaution for personal safety and to prevent damage to the printer.

Use the service error code, user status message, user error message, symptom table, service checks, and diagnostic aids in this chapter to determine the corrective action necessary to repair a malfunctioning printer. They will lead you to solutions or service checks, including use of various tests.

### Symptom tables

If your machine completes the **“Power–On Self Test (POST) sequence”** on page 2-1 without an error and you have a symptom, then go to **“Messages and error codes”** on page 2-5. Locate your symptom, and take the appropriate action.

### Service errors (9xx.xx’s)

If a service error code appears while you are working on the machine, then go to **“Messages and error codes”** on page 2-5, and take the indicated action for that error.

Service error codes are indicated by a three-digit error code followed by a period and additional numbers in the format XXX.YY. In most cases, five digits are shown.

### User status and attendance messages

- User status messages provide the user with information on the current status of the printer. `Ready` displays on the first line of the display unless invoked, and then `Power Saver` displays. If a user status message is displayed, then go to **“Messages and error codes”** on page 2-5.
- User attendance messages are indicated by a two- or three-digit error code that provides the user with information that explains a problem with a print cartridge, paper jam, option, port, and so on. If a user error message displays, then go to **“User attendance messages”** on page 2-5 and **“Paper jam error codes (200-series)”** on page 2-9.

---

## Power–On Self Test (POST) sequence

The following is an example of the events that occur during the POR sequence when the printer is turned on.

1. `Diamonds` are displayed on the operator panel.
2. While code is being loaded into DRAM, dots scroll across the operator panel.
3. A screen is displayed with the memory and processor speed. A typical example of this message is:

\*64MB

4. `Performing Self Test` is displayed.
5. `Busy` is displayed.
6. `Close Door` will be displayed if the cover is open.
7. Any cartridge errors, such as `Defective Cartridge`, are displayed.
8. Applicable maintenance messages are displayed.
9. Applicable toner low messages are displayed.
10. The printer displays `Ready`.





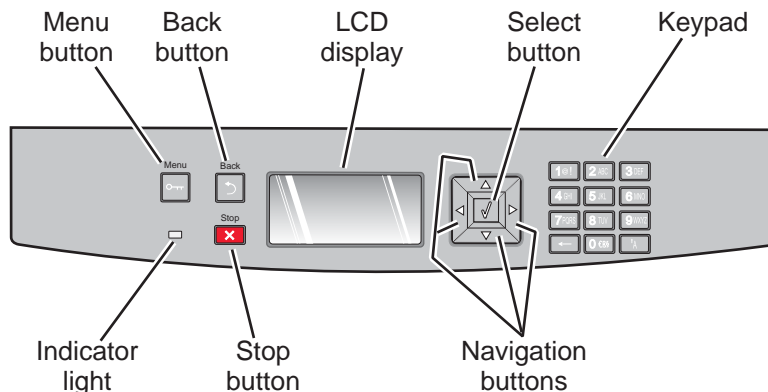















## Overview of the operator panel and menus

The operator panel on your printer is a 4-line, back-lit, grayscale display that can show both graphics and text. The **Back**, **Menu**, and **Stop** buttons are located to the left of the display, the navigation buttons are located below the display, and the numeric keypad is located to the right of the display.





The use of the buttons and the layout of the display panel are described in the following table.

### Operator panel

Button	Function
Back 	Press and release  to return to the previous screen.
Menus 	Press and release  to open the menus. The menus are available only when the printer is in the <b>Ready</b> state.  Pressing  also returns the operator panel to the top level menu screen if pressed while in a menu.
Stop 	<ul style="list-style-type: none"> <li>• Press  once to return to the previous display screen while in the menus.</li> <li>• Press  twice to exit the menus and return to the <b>Ready</b> state.</li> <li>• Press  to stop printer activity.</li> <li>• Press  to cancel a print job. <b>stopping</b> will display momentarily. <b>stopped</b> will then display to offer a list of settings that may be selected.</li> </ul>
Navigation 	<div style="border-bottom: 1px solid black; padding-bottom: 5px;"> <p> Up arrow and Down arrow buttons  </p> <p>Press  or  to scroll through menus, menu items, or printer options.</p> </div> <div style="border-bottom: 1px solid black; padding-bottom: 5px;"> <p>  Left arrow and Right arrow buttons</p> <p>Press  or  to increase or decrease a value or to scroll through text that rolls to another screen.</p> </div> <div> <p> Select button</p> <p>Press and release  to open a menu, to display the available values or settings, or to save the displayed value as the new user default setting.</p> <p><b>Note:</b> When a new setting is saved as the default setting, it remains in effect until new settings are saved or until factory defaults are restored. Settings chosen from a software program can also change or override the user default settings selected from the operator panel.</p> </div>

## Operator panel (Continued)

Button	Function
<p data-bbox="313 289 396 317">Keypad</p> 	<p data-bbox="618 289 1252 317">Use the keypad to enter numbers or symbols on the display.</p>
<p data-bbox="313 480 461 508">Indicator light</p> 	<p data-bbox="618 480 1062 508">The indicator light indicates printer status.</p> <ul data-bbox="634 516 1458 653" style="list-style-type: none"><li data-bbox="634 516 1127 543">• If the light is off, then the printer power is off.</li><li data-bbox="634 546 1458 596">• If the light is blinking green, then the printer is warming up, processing data, or printing.</li><li data-bbox="634 598 1235 625">• If the light is solid green, then the printer is on, but idle.</li><li data-bbox="634 627 1382 653">• If the light is blinking red, then operator panel intervention is needed.</li></ul>
<p data-bbox="313 667 461 695">Display panel</p>	<p data-bbox="618 667 1414 718">The display shows messages describing the current state of the printer and indicating possible printer problems that must be resolved.</p> <p data-bbox="618 726 1463 798">The top line of the display is the header line. It will display the current status and the Supplies (Warnings) status. This is where printer status, supplies messages, and show-me screens are viewed.</p>

## Diagram of the printer menus

The diagram shows the menu index on the operator panel and the menus and items available under each menu. Not all menus or selections will be available in all situations. These are accessed through the driver.

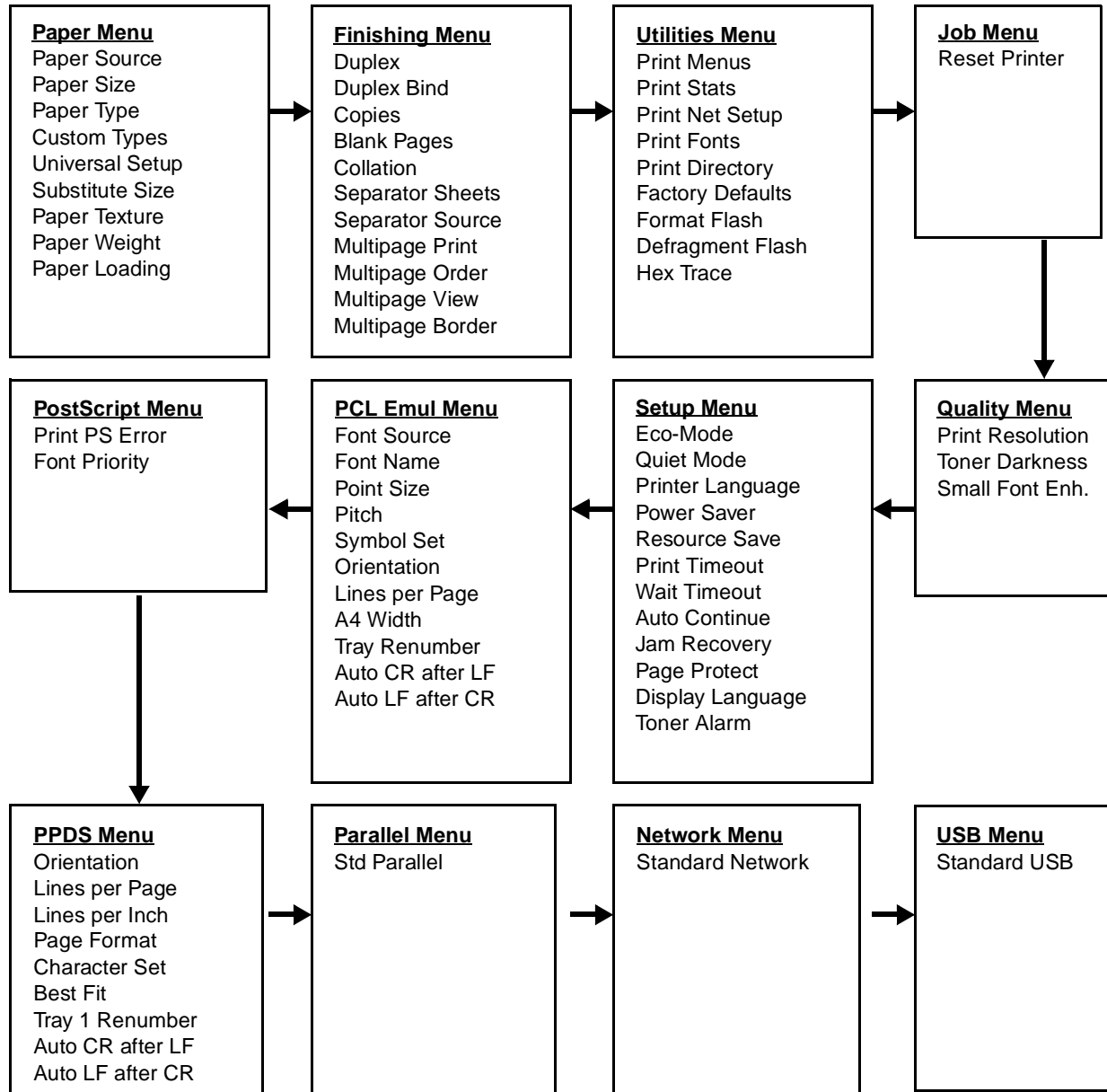

## Messages and error codes

### User attendance messages



The printer control panel displays messages describing the current state of the printer and indicates possible printer problems that must be resolved. This topic provides a list of all printer messages, explains what they mean, and tells how to clear the messages.

The following table lists the messages in alphanumerical order. A message can also be located using the index.

#### User attendance messages



Message	Action
Activating Demo Mode	Wait for the message to clear.
Activating Menu Changes	Wait for the message to clear.
Activating/Deactivating PPDS	Wait for the message to clear.
Busy	Wait for the message to clear, or cancel the print job.
Cancelling Job	Wait for the message to clear.
Change Cartridge Invalid Refill	The printer has detected an unsupported refilled cartridge. Remove the indicated print cartridge, and install a new one.
Close door	Close the specified door to clear the message.
Deactivating Demo Mode	Wait for the message to clear.
Defragmenting Flash DO NOT POWER OFF	<b>Warning:</b> Do not turn the printer off while this message is displayed. Wait for the message to clear.
Disabling Menus	Wait for the message to clear. <b>Note:</b> The printer settings cannot be changed from the control panel while the menus are disabled.
Enabling Menus	Wait for the message to clear.
Flushing Buffer	Wait for the message to clear.
Formatting Flash DO NOT POWER OFF	<b>Warning:</b> Do not turn the printer off while this message is displayed. Wait for the message to clear.
Invalid Engine Code	Download valid engine code to the printer.
Invalid Standard Network Code	The code in an internal print server is not valid. The printer cannot receive and process jobs until valid code is programmed into the internal print server. Download valid code to the internal print server. <b>Note:</b> The network code can be downloaded while this message is displayed.
Load manual feeder with <Custom Type>	<ul style="list-style-type: none"><li>• Load the specified media in the manual feed tray or multipurpose feeder.</li><li>• To ignore the manual feed request and print on media already installed in one of the input sources, press <input checked="" type="checkbox"/>.</li><li>• If the printer finds a tray that has media with the correct media type and size, then it feeds media from that tray. If the printer cannot find a tray with the correct media type and size, then it prints on whatever media is installed in the default input source.</li><li>• Cancel the current job.</li></ul>
Load manual feeder with <Custom String>	
Load manual feeder with <size>	
Load manual feeder with <size> <type>	

## User attendance messages (Continued)

Message	Action
Load <src> with <Custom Type Name>	<ul style="list-style-type: none"> <li>• Load the input source with the correct type and size media.</li> <li>• Cancel the current job.</li> </ul>
Load <src> with <Custom String>	
Load <src> <size>	
Load <src> <type> <size>	
Maintenance	Replace the maintenance items and, if necessary, reset the printer maintenance counter.
Menus Disabled	<p>The printer menus are disabled. The printer settings cannot be changed from the control panel.</p> <p><b>Note:</b> A job can still be canceled.</p> <p>Contact a system support person.</p>
Network	A network interface is the active communication link.
Network Card Busy	An internal print server (also called an internal network adapter or INA) is being reset. Wait for the message to clear.
Not Ready	The printer is not ready to receive or process data. Someone pressed  to take the printer offline. Press  to make the printer ready to receive jobs.
Parallel	A parallel interface is the active communication link.
Performing Self Test	The printer is running the series of start-up tests it performs after it is turned on. Wait for the message to clear.
Power Saver	<ul style="list-style-type: none"> <li>• Send a job to print.</li> <li>• Press  to warm the printer to normal operating temperature and display the Ready message.</li> </ul>
Printing Directory List	The printer is processing or printing a directory of all files stored in flash memory. Wait for the message to clear.
Printing Font List	The printer is processing or printing a list of all available fonts for the specified printer language. Wait for the message to clear.
Printing Menu Settings	The printer is processing or printing the menu settings page. Wait for the message to clear.
Printing Device Statistics	The printer is printing statistical information about the printer. Wait for the message to clear.
Printing Quality Test Pages	The printer is formatting and printing the Print Quality Test, which consists of 4 pages. Page 1 contains a mixture of graphics and text, pages 2 and 3 contain only graphics, and page 4 is a blank page. If Duplex is turned on, then the pages are duplexed; otherwise they are simplex. Wait for the message to clear.
Prog Engine Code DO NOT POWER OFF	<p>The printer is programming new engine code. Wait for the message to clear and the printer to reset.</p> <p><b>Warning:</b> Do not turn the printer off while this message is displayed.</p>
Program Flash DO NOT POWER OFF	<p>The printer is storing resources, such as fonts or macros, in flash memory. Wait for the message to clear.</p> <p><b>Warning:</b> Do not turn the printer off while this message is displayed.</p>



## User attendance messages (Continued)

Message	Action
Prog System Code DO NOT POWER OFF	The printer is programming new system code. Wait for the message to clear and the printer to reset. <b>Warning:</b> Do not turn the printer off while this message is displayed.
Ready	Send a job to print.
Remove Paper Standard Bin	The standard output bin is full.
Resetting Maint Cnt Valu	The printer is resetting the counter that tracks wear on the fuser.
Resetting PC Cnt Value	The printer is resetting the counter that tracks wear on the photoconductor.
Resetting the Printer	Wait for the message to clear.
Res Reduced	The printer is reducing the resolution of a page in the current job from 600 dots per inch (dpi) to 300 dpi to prevent a 38 Memory Full error. Res Reduced remains on the display while the job prints.
Restoring Factory Defaults	Wait for the message to clear. <b>Note:</b> When factory default settings are restored: <ul style="list-style-type: none"> <li>• All downloaded resources (fonts, macros, symbol sets) in the printer memory are deleted.</li> <li>• All menu settings return to the factory default <i>except</i>: <ul style="list-style-type: none"> <li>– The Display Language setting in the Setup Menu</li> <li>– All settings in the Parallel Menu, Network Menu, and USB Menu</li> </ul> </li> </ul>
Std Bin Full	The standard bin is full.
Toner Low	<ul style="list-style-type: none"> <li>• Replace the toner cartridge.</li> <li>• Press  to clear the message and continue printing.</li> </ul>
Tray <x> Missing	Insert the tray into the printer.
USB	The printer is processing data through the specified USB port.
Waiting	The printer has received a page of data to print, but is waiting for an End of Job command, a Form Feed command, or additional data. <ul style="list-style-type: none"> <li>• Press  to print the contents of the buffer.</li> <li>• Cancel the current job.</li> </ul>

## Cartridge error messages

Error	Description	Action
<b>30.XX Cartridge errors</b>		
30.01	No bucket transition out of the top bucket. If the cartridge has not been refilled, then it usually is a mechanical problem with the cartridge. During development, it could also have the wrong chip installed.	Replace the cartridge.
30.02	No bucket transition out of the middle buckets. If the cartridge has not been refilled, then it usually is a mechanical problem with the cartridge. During development, it could also have the wrong chip installed.	
30.03	No bucket transition out of the lowest bucket. If the cartridge has not been refilled, then it usually is a mechanical problem with the cartridge. During development, it could also have the wrong chip installed.	
30.04	Excessive bucket jump. If the cartridge has not been refilled, then it usually is a mechanical problem with the cartridge.	
30.05	Cartridge has run past it's life such that the cartridge has to been totally void of printable toner. During development, it could also have the wrong chip installed.	
<b>31.XX Defective cartridge errors</b>		
31.01	Cartridge missing. Smartchip installed backwards or missing. Cable loose on controller board. Bad, dirty or broken contacts. Bad chip. Wrong cartridge installed.	Replace the cartridge.
31.02	Authentication Failure. Failed to authenticate the device, possible cartridge is from another family, or the chip is defective.	
31.03	ECC Failure. Clone or defective device.	
31.04	Read Failure. Intermittent contact with the device, cable on system card not seated well, gross electrical noise, defective device.	Check the contact pins (on the right side, under the cartridge) for damage. Replace if possible.
31.05	Write Failure. Intermittent contact with the device, cable on system card not seated well, gross electrical noise, defective device.	
31.06	SRL. Clone device.	Replace the cartridge.
31.07	Penalty. Too many POR/CC events have occurred.	
31.08	Unsupported SC Firmware. Clone or defective device.	
<b>32.XX Unsupported cartridge errors</b>		

Error	Description	Action
32.01	MC CC Mismatch. Incorrect cartridge installed in printer or printer settings are incorrect (based on cartridge capacity).	Replace the cartridge.
32.02	Down-level device installed on cartridge.	
32.03	Down-level device installed on cartridge.	
32.04	Unknown toner type indicated by the device.	
32.05	OEM Mismatch. Incorrect cartridge installed in printer, or printer settings are incorrect (based on cartridge OEM identification).	
32.06	Printer already married to a SWE cartridge. Must purchase after-market cartridge.	Replace the cartridge with a new one from the correct geography.
32.07	SWE cartridge already married to a printer.	

### **Paper jam error codes (200-series)**

**Note:** The Event log (See **“Event log” on page 3-16**) will list any of these errors that have occurred.

Repeating jams or jam messages can be caused by any of the following:

- Faulty/contaminated pick solenoids or worn cams of the solenoids.
- Faulty/contaminated flags or springs.
- Debris in the paper path.
- Media not of the specified length.

Error	Description	Action
200.00	Paper jam around input sensor.	Remove the PC kit and paper or debris at the input sensor.
200.01	Classic input jam. The media is too long over the input sensor. Possible causes include multi-sheet feed, tray size sensing problem, and media slippage.	First, remove the PC kit and paper or debris at the input sensor. Then, inspect the flag on the input sensor. It should rotate freely. Replace the sensor if necessary. Finally, check the paper size settings in the printer and the driver.
200.02	The main input sensor never became uncovered from the sheet ahead.	
200.03	The video never started on the page at the input sensor within two inches after hitting the input sensor	Check the printhead. See <b>“Printhead service check” on page 2-38</b> .
200.04	The media at the input sensor before interrupt occurred—not enough time elapsed since the printhead started to expect the printhead mirror motor lock. Possible causes include bouncy sensor or exceptionally fast pick—perhaps due to media pre-staged in the source tray.	Carefully remove the tray and notice if the leading edge of the media is pointed upward and out of the tray. If so, then inspect the tray wear strips and replace if necessary.  Inspect the input sensor flag and replace it if it does not rotate freely or is too loose.
200.06	Imaged page not expected page (bouncy passthru sensor)	Remove the toner cartridge/PC kit. At the front, remove the upper front guide, and inspect the flag on the manual input sensor. If the flag is loose, then replace it. See <b>“Media manual input sensor removal” on page 4-42</b> .
200.08	Media reached the input sensor before the EP was ready	Inspect the tray for prestaging. Verify the proper media and inspect the tray wear strips. Replace the wear strips if necessary.

Error	Description	Action
200.09	Transfer servo never started	Inspect the LVPS/HVPS. See <b>“Controller board service check” on page 2-23.</b>
200.12	Media detected at manual feeder sensor when not expected. Possible causes include user insert of media when motor is running or pre-staged media in the tray.	Carefully remove the tray and notice if the leading edge of the media is pointed upward and out of the tray. If so, then inspect the tray wear strips and replace if necessary.  Inspect the input sensor flag and replace it if it does not rotate freely or is too loose.
200.13	The input sensor is covered when the media is not expected (media in machine during warm-up)	Remove the toner cartridge/PC kit and inspect the input sensor flag. Replace the flag if necessary.
200.14	Trailing edge cleared manual feed, but did not successfully debounce the sensor. Potential causes are a small gap or a bouncy manual feed sensor.	Remove the toner cartridge/PC kit. At the front, remove the upper front guide, and inspect the flag on the manual input sensor. If the flag is loose, then replace it. See <b>“Media manual input sensor removal” on page 4-42.</b>
200.15	UNRECOVERABLE NO GAP JAM. Engine detected no gap at the manual feeder sensor, attempted to open the gap by stopping the feed rolls, but no trailing edge was ever seen at the input sensor.	Remove the toner cartridge/PC kit. At the front, remove the upper front guide, and inspect the flag on the manual input sensor. If the flag is loose, then replace it. See <b>“Media manual input sensor removal” on page 4-42.</b>  Verify that the media is approved. Inspect the wear strips in the input tray, and replace if necessary.
200.16	Transport motor error detected	Inspect the main motor. See <b>“Main motor service check” on page 2-27.</b>
200.17	Took too long to ramp up transport motor	
200.18	Manual feeder sensor never became uncovered from the sheet ahead.	Remove the toner cartridge/PC kit. At the front, remove the upper front guide, and inspect the flag on the manual input sensor. If the flag is loose, then replace it. See <b>“Media manual input sensor removal” on page 4-42.</b>
200.19	The media never reached the input sensor, but was detected at manual feeder sensor.	Remove the toner cartridge/PC kit, and inspect for debris in the paper path. Check the bottom of the PC kit for any obstructions. Remove the upper front guide, and inspect the pinch rollers.
200.20	The media is too long over the manual feeder sensor. Possible causes include multi-sheet feed, media size (length) problem, pre-staged media in the tray.	Verify that the media is approved. Inspect the wear strips in the tray, and replace if they are worn.
200.22	FAILED SMALL GAP OR NO GAP JAM RECOVERY. Engine detected small gap or no gap at the manual feeder sensor, opened the gap by stopping the feed rolls, but never saw the leading edge of the second page at the input sensor.	
200.23	Laser Servo never started due to potential conflict with the transfer servo. Possible causes: slow or missing transport motor positional feedback, or the media is transferred too quickly to the input sensor.	Verify that the media is approved. Inspect the wear strips in the tray, and replace if they are worn.  Check the main motor. See <b>“Main motor service check” on page 2-27.</b>

Error	Description	Action
200.24	The measured gap at the input sensor is too small to meet the video delivery requirements. (There is not enough time since prior image finished to start new image)	Verify that the media is approved. Inspect the wear strips in the tray, and replace if they are worn.
200.26	The trailing edge never cleared the input sensor when feeding out the media that was detected during warm-up.	
200.27	<p>Printhead Driver: Mirror motor fell out of lock condition after the media at the input sensor—more time elapsed since the printhead than the expected stable lock time, but less than the printhead jitter-stable specification.</p> <p>Mirror motor fell out of lock condition after media at the input sensor—more time elapsed since the printhead than expected stable lock time, but less than the printhead jitter-stable specification.</p>	Check the printhead. See <b>“Printhead service check” on page 2-38.</b>
200.28	First writing line of a page at the developer nip, but laser servo cleanup is not complete. Likely pre staged media or a fast paper feed.	Verify that the media is approved. Inspect the wear strips in the tray, and replace if they are worn.
200.29	Printhead drive control out of range due to an external event beyond what the control is designed to handle. Probable causes: ESD or noise on hsync signal.	Check the cable routing for the printhead. See <b>“Printhead service check” on page 2-38.</b>
200.30	Narrow media sensor covered during warm-up.	Check that the narrow media flag rotates freely and securely. If it is dislodged or broken, then repalce the rear exit guide. See <b>“Rear exit guide assembly with sensor and reversing solenoid removal” on page 4-56.</b>
200.32	Media more than 14 inches too long over the manual feeder sensor. Possible causes include multi-sheet feed or pre-staged media in the tray.	Verify that the media is approved. Inspect the wear strips in the tray, and replace if they are worn.
200.33	Page from tray 1 did not reach the input sensor after multiple attempts. Page did make it out of the tray at least as far as the manual feeder sensor. Possible cause is that the page stalled at the alignment gate.	Verify that the pick tires are clean, not worn, or filled with paper dust. Replace the pick tires if necessary. See <b>“ACM pick tire roller removal” on page 4-3.</b>
200.34	Timed out waiting for page from tray 1 to reach the input sensor after multiple pick attempts, but the page was later detected at the input sensor while waiting for any page(s) ahead to clear the paper path. Possible cause is that the page is delayed at the alignment gate.	The alignment roller may be binding. Call the next level of support.
200.35	Failed to create hsync during auto alignment	Check the printhead. See <b>“Printhead service check” on page 2-38.</b>
200.36	Lost hsyncs during auto alignment	
200.37	Timeout on data collection during auto alignment	
200.38	Interpage servo gap is smaller than expected for printhead offset target evaluation	
200.42	Rogue sheet is at the manual feed sensor while flushing the paper path prior to declaring MPF source empty.	Retry alignment.
200.43	The media is at the input sensor before interruption occurs. Possible causes include bouncy sensor or an exceptionally small gap, perhaps due to the media being pre-staged in the source tray.	Remove the media, realign the stock, and re-insert. Do not let the top sheets to go beyond the wear strips.

Error	Description	Action
201.00	Paper jam between input and exit sensor	Remove the toner cartridge/PC kit and check for obstructions between the input sensor and the fuser. If the media continues to stop at the entrance or in the fuser, then replace the fuser. See <b>“Fuser removal” on page 4-21</b> .
201.01	Transport motor identification failed to identify either motor after two tries.	Check the main motor. See <b>“Main motor service check” on page 2-27</b> .
201.02	Exit sensor never made by leading edge of page. Also known as internal jam.	Remove the PC kit and paper or debris at the input sensor.
201.03	Video never started on the page at the input sensor within two inches after hitting the input sensor	Check the printhead. See <b>“Printhead service check” on page 2-38</b> .
201.05	Restart attempted after an internal jam without the cover open/close event. It is likely that the jam was never cleared.	Check the paper path and remove any media in the path.
201.25	Exit sensor never made by leading edge of media when feeding out the media that was detected during warm-up.	Remove the toner cartridge/PC kit and check for obstructions between the input sensor and the fuser. If the media continues to stop at the entrance or in the fuser, then replace the fuser. See <b>“Fuser removal” on page 4-21</b> .
201.26	Page at fuser nip before fuser started ramping toward desired temperature. Indicates code may be receiving more interrupts than intended	
201.27	Page at fuser nip before fuser reached acceptable operating temperature. Page arrived at fuser earlier than expected, so it was probably staged prematurely.	
202.00	Paper jam around exit sensor.	Open the rear cover and look for obstructions in the path way. If there are none, then inspect for damage at the fuser, rear door, exit guide, and top cover. Often, the leading edge of the media will indicate the vicinity of damage. If damage is found, then replace the damaged part. <b>Note:</b> Print a page with the rear door open to isolate the fuser from the other parts.
202.01	Exit sensor never broke on the trailing edge of the sheet at the exit sensor.	Open the rear door, and inspect the flag on the exit sensor. The flag is located behind the fuser exit rollers, about mid printer. If the flag does not rotate freely or has no spring action, then replace the fuser. See <b>“Fuser removal” on page 4-21</b> .
202.02	Exit sensor never broke from sheet ahead of page heading toward the exit sensor.	
202.06	Exit sensor bounced	
202.13	Exit sensor covered, media not expected (media not in machine during warm-up)	
202.25	Exit sensor never broke from the sheet ahead of the page heading toward the exit sensor when feeding out the media detected during warm-up.	
202.26	Trailing edge never cleared exit sensor when feeding out media that was detected during warm-up.	Open the rear door, and inspect the flag on the exit sensor. The flag is located behind the fuser exit rollers, about mid printer. If the flag does not rotate freely or has no spring action, then replace the fuser. See <b>“Fuser removal” on page 4-21</b> .

Error	Description	Action		
202.32	Long media or shingled multi feed stopped before sending to duplex.	Check the paper setting and correct if needed. While feeding along the media, and immediately after it enters the output bin, open the rear door and obscure the trailing edge and the sensor flag. If there is slippage in the exit guide, then replace the exit guide. See <b>“Rear exit guide assembly with sensor and reversing solenoid removal” on page 4-56.</b>		
231.00	Duplex jam while reversing into the device	<p>Open the rear cover and look for obstructions between the rear cover ribs, the fuser exit rollers, and below. The media entering the duplex passes outside the exit roller while the media exiting the fuser passes above and inside the exit rollers. Remove the tray, open the duplex door, and remove the obstructions. If there are no obstructions and the problem persists, then disconnect all of the cables, tilt the printer onto its back (be sure to protect the antenna on a wireless unit), and inspect the flag of the duplex sensor. If the flag does not rotate freely, then replace the paper input and duplex sensor. See <b>“Paper input and duplex sensor assembly removal” on page 4-52.</b></p> <p>Check the belt and drive of the duplex unit. Replace it if necessary.</p>		
231.01	Duplex sensor never made by leading edge reversing into the duplex.			
231.02	Bouncy duplex sensor never made.			
232.00	Duplex jam while staging in the device			
232.01	Duplex sensor never broke by the sheet ahead after reversing into the duplex.			
232.02	Page in duplex ahead of current reversing page never staged.			
233.00	Duplex jam while picking from the device			
233.01	Page in duplex never picked.			
233.02	Feed error picking from the duplex.			
233.03	Paper never reached the input sensor, but was detected at the manual feed sensor.			
234.01	Duplex sensor covered during warm-up.	<p>Check the media. Duplex supports A4, letter, legal, oficio, and folio media sizes.</p>		
235.01	Invalid duplex media			
241.00	Paper jam near tray 1.		<p>Remove the tray and inspect the media path for obstructions. Check the pick rollers. Replace the pick rollers if they are worn or clogged with dust. See <b>“ACM pick tire roller removal” on page 4-3.</b> Also check the wear strips, and replace if necessary.</p> <p>Remove the tray and inspect the media path for obstructions. Check the pick rollers. Replace the pick rollers if they are worn or clogged with dust. See <b>“ACM pick tire roller removal” on page 4-3.</b> Also check the wear strips and the manual feeder, and replace if necessary.</p>	
241.10	Second pick attempt failed from Tray 1			
241.12	Second pick from manual feeder, tray 1, or feeder failed when the media was in the source while other sheets were committed to the paper path.			
241.16	Failed to feed from tray 1. Pages in the paper path have been flushed to the output bin.			
241.17	MISIDENTIFIED SMALL GAP JAM. Engine detected small gap at the manual feeder sensor, attempted to open the gap by stopping the feed rolls, trailing edge was seen at the input sensor, manual feeder sensor is no longer covered.			
241.19	Second pick attempted failed from Tray 1, no pages printed since calling a 241.10 or a prior 241.19.			
242.00	Paper jam near tray 2.			<p>Remove Tray 2 and inspect for obstruction in the paper path. Check the pick tires for wear or paper dust. Replace if necessary. Check the wear strips and replace if necessary.</p> <p>Check the connection with Tray 2. (Lift the printer and re-set it on Tray 2.) If the error persists, then replace Tray 2.</p>
242.01	Took too long to ramp up dc feed motor			
242.08	Received lots of dc feed interrupts before losing them			

Error	Description	Action
242.10	Second pick attempt failed from Tray 2	Remove Tray 2 and inspect for obstruction in the paper path. Check the pick tires for wear or paper dust. Replace if necessary. Check the wear strips and replace if necessary.
242.12	Second pick from manual feeder, tray 1, or feeder failed when media was in the source, other sheets were committed to the paper path.	Check the wear strips and replace them if worn.
242.16	Failed to feed from tray 2. Pages in the paper path have been flushed to the output bin.	Remove Tray 2 and inspect for obstruction in the paper path. Check the pick tires for wear or paper dust. Replace if necessary. Check the wear strips and replace if necessary.
251.00	Paper jam near the manual feeder.	Inspect the pick roller on the MPF or the rollers on the manual feed. If the MPF pick roller is damaged or worn, then replace the MPF. For a printer with a manual feed only (no MPF), clean the roller.
251.10	Second pick attempt failed from manual feeder.	
251.11	Failed to feed from manual feeder. Pages in the paper path have been flushed to the output bin.	
251.12	Second pick from manual feeder, tray 1, or feeder failed when media was in the source while the other sheets were committed to the paper path.	
251.19	Media never reached the input sensor from the manual feeder.	
251.20	The media in the MPF has been pushed in too far.	Remove the media, realign the stock, and re-insert. Do not let the top sheets to go beyond the wear strips.
251.21	The media in the MPF has been pushed in too far.	



## Service error codes

Service error codes are generally non-recoverable except in an intermittent condition when the printer can be put into POR to temporarily recover from the error condition.

Error	Description	Action
<b>Engine software service errors</b>		
902.xx	Engine software error	Replace the controller board. See <b>“Controller board service check” on page 2-23</b>
<b>DC pick motor errors</b>		
914.00	DC pick motor error	
914.01	Lost encoder feedback	
<b>Transfer service errors</b>		
917.xx	Transfer service error	Replace the transfer roll. See <b>“Transfer roll service check” on page 2-38.</b>
<b>Fuser service errors</b>		
920.00	Under temperature during steady state control.	Replace the fuser. See <b>“Fuser service check” on page 2-26.</b>
920.01	Fuser took too long to heat up after transitioning to new enhanced mode.	
920.02	Fuser fell too far below desired temperature while printing.	
920.03	Fuser too cool while checking for slope change.	
920.04	Fuser too cool when heating to desired temperature after slope change.	
920.05	Fuser under temperature while printing	
920.06	Fuser under temperature while printing	
920.07	Fuser under temperature while printing	
920.08	Fuser temperature did not increase after IR recovery.	
920.20	Belt fuser under temperature during steady state control. This can occur in printing or standby modes.	
921.00	Under temperature during standby control.	
921.01	Fuser temperature did not reach standby temperature after two attempts	
922.00	Fuser failed to ramp to target temperature	
922.01	Fuser did not reach standby temperature in time (standby control)	
922.02	Hot roll took too long to reach the beginning lamp detection temperature.	
922.03	Hot roll reached final lamp detection temperature, but took longer than largest time in lookup table.	
922.04	Hot roll timed out in trying to reach the final lamp detection temperature.	

Error	Description	Action
922.05	Did not roll over to a steady state control in time after the hot roll lamp detection.	Replace the fuser. See <b>“Fuser service check” on page 2-26.</b>
922.06	Hot roll did not reach the operating temperature in time (new enhanced control).	
922.07	Media reached fuser nip, and fuser is under temperature	
922.08	Fuser warm-up failure (motor start condition)	
922.09	Fuser warm-up failure (compression set)	
922.20	Belt fuser failed to reach the preheat temperature for the motor to start during warm-up.	
922.21	Belt fuser was under temperature when the media reached the fuser nip.	
923.00	Fuser is over temperature.	
923.01	Fuser is over temperature. This applies to the fuser and belt fusers.	
924.00	Open thermistor check.	
924.01	Open thermistor check failure. This applies to the fuser and belt fusers.	
924.02	Open thermistor check failure. The ADC failed to converge. Possible noisy thermistor signal. This applies to the fuser and belt fusers.	
925.xx	Wrong fuser installed. The fuser type stored in the cartridge ID does not match the actual fuser installed in the printer.	
<b>Fan service errors</b>		
927.00	Service fan error	Replace the fan. See <b>“Cooling fan service check” on page 2-24.</b>
927.03	Main fan took too long to ramp up	
927.04	Main fan is under speed or stalled during speed adjustment state	
927.05	Main fan overspeed during speed adjustment state.	
927.06	Main fan capture data is invalid, and speed control is at maximum in fan control idle state	
927.07	Main fan capture data is invalid, and speed control is at maximum in fan control adjustment state.	
<b>Toner service errors</b>		
929.00	Toner sensor error	Remove the toner cartridge, and shake it Try a different toner cartridge, if possible. If the error persists, then replace the toner level sensor. See <b>“Toner level sensor removal” on page 4-60.</b>
929.01	No home window	
929.02	No sensor transition (closed)	
929.03	No sensor transition (open)	
<b>Printhead service errors</b>		
930.00	Wrong printhead installed	Replace the printhead. See <b>“Printhead service check” on page 2-38.</b>
931.00	No first hsync	

Error	Description	Action
931.01	No first hsync	Replace the printhead. See <b>“Printhead service check” on page 2-38.</b>
932.00	Lost hsyncs	
932.01	Lost hsyncs	
933.01	Printhead boost signal failure	
934.00	Mirror motor lost lock.	
934.01	Mirror motor lost lock.	
935.00	No initial mirror motor lock	
935.01	Timed out waiting for mirror motor lock	
935.10	Printhead sweep error, swept through Hz range without finding the resonant frequency	
935.12	Printhead sweep error, coarse sweep state	
935.15	Printhead open-loop error, check prelim amp state	
935.16	Printhead open-loop error, enable amp Kp state	
935.17	Printhead closed-loop error, amp Kp failed to converge	
935.18	Printhead closed-loop error, enable amp Ki state	
935.19	Printhead closed-loop error, amp Ki failed to converge	
935.20	Printhead closed-loop error, enable offset controller state	
935.21	Printhead closed-loop error, load scan regs state	
935.22	Printhead closed-loop error, fwd and rev capture times differ by too much	
935.23	Printhead closed-loop error, check sweep accuracy state	
935.25	Printhead closed-loop error, off-resonant PI effort state	
935.26	Timed out on POR sweep	
935.27	Exceeded maximum open loop drive level when configuring for sweep re-try.	
935.28	Exceeded maximum open loop drive level when setting operating Hz.	
<b>Transport motor service errors</b>		
936.01	No lock detected at normal motor start	Replace the main motor gear drive. See <b>“Main motor service check” on page 2-27</b>
936.02	No lock detected at motor start for motor ID	
936.03	No halls detected at motor start	
936.04	Failed to stop within timeout	
936.05	Stall detected during speed control	

Error	Description	Action
937.00	Main transport motor lost lock	Replace the main motor gear drive. See <b>“Main motor service check” on page 2-27</b>
937.01	Main transport motor lost lock, detected by engine control	
937.02	Overspeed detected during position control	
937.03	Overspeed detected during speed control	
<b>Power supply service errors</b>		
940.00	LVPS service error	Replace the LVPS/HVPS. See <b>“LVPS/HVPS service check” on page 2-26</b> .
940.01	Line frequency outside allowed range of 45Hz-64Hz	
940.02	Line frequency below 43Hz	
940.03	No zero cross detected on belt fuser model	
<b>Controller board and operator panel service errors</b>		
948.xx	Failed engine board	Replace the controller board. See <b>“Controller board service check” on page 2-23</b> .
949.xx		
950.xx	Mismatch between EEPROM and mirror memory <b>Note:</b> A new controller board or operator panel has been installed, and has not been properly prepared for this use. Install a new note. Do not install both the controller board and the operator panel at the same time without a POR in between.	Install a new controller board or operator panel. See <b>“Controller board service check” on page 2-23</b> or <b>“Operator panel service check” on page 2-28</b> .
951.xx	Error with secure NVRAM on the controller board	Replace the controller board. See <b>“Controller board service check” on page 2-23</b> .
952.xx	A recoverable MVRAM Cyclic Redundancy Check error occurred.	Performing POR will clear this error.
953.xx	NVRAM chip failure with mirror	Replace the operator panel. See <b>“Operator panel service check” on page 2-28</b> .
954.xx	NVRAM chip failure with system part.	Replace the controller board. See <b>“Controller board service check” on page 2-23</b> .
955.xx	The code ROM or NAND flash failed the Cyclic Redundancy Check or the NAND experienced an uncorrectible multi-bit failure.	
956.00	RIP card failure: processor failure	
956.01	Processor overtemp	
957.xx	RIP card failure: ASIC failure	
958.xx	Printer has performed more than 100 “shift and reflash” operations as a result of ECC bit corrections	
<b>Firmware or controller board errors</b>		
959.01	Controller verification failure of pensive boot code	Call the next level of support to update the firmware, or replace the controller board. See <b>“Controller board service check” on page 2-23</b> .
959.02	Failure to authenticate Signature Verification Code	

Error	Description	Action
959.03	Signature Verification Code failed to authenticate a code partition.	Update firmware and call the next level of support, or replace the controller board. See <b>“Controller board service check” on page 2-23.</b>
959.04	Jump to unverified address	
959.05	Unknown boot failure	Update firmware and call the next level of support, or replace the controller board. See <b>“Controller board service check” on page 2-23</b>
959.20	Pensive hardware failure	Replace the controller board. See <b>“Controller board service check” on page 2-23.</b>
959.21	Pensive did not respond to command request.	
959.22	Challenge secret failure	
959.23	Pensive self test failed during initialization.	Replace the controller board. See <b>“Controller board service check” on page 2-23.</b>
959.24	EEPROM retention error	
959.25	Insufficient device space during HW prog	
959.26	Incremental counter reset exceeds maximum value	
959.27	Increment count failed due to max value limit	
959.28	Invalid SP memory configuration	
<b>Memory and emulation errors</b>		
960.xx	RAM memory error: RAM soldered on the controller board is bad	Replace the controller board. See <b>“Controller board service check” on page 2-23.</b>
961.xx	RAM memory error: memory card in slot is bad.	Replace the memory card.
964.xx	Download Emulation Cyclic Redundancy Check Error: checksum failure detected in the emulation header or emulation file.	Disable the Download Emulation. Program the download emulation into the firmware card again. If this does not resolve the problem, then replace the firmware card and download the emulation again.
<b>Network errors</b>		
975.xx	Unrecognizable network	Call the next level of support.
976.xx	Unrecoverable software error in network port	
978.xx	Bad checksum while programming network port	
979.xx	Flash parts failed while programing network port	
<b>Other errors</b>		
980.xx	Engine experiencing unreliable communication with the specified device	Call the next level of support.
981.xx	Engine protocol violation detected by the specified device	
982.xx	Communications error detected by the specified device	
983.xx	Invalid command received by the specified device	

Error	Description	Action
984.xx	Invalid command parameter received by the specified device	Call the next level of support.
990.xx	An equipment check condition has occurred in the specified device, but the device is unable to identify the exact component failure.	
991.xx	The specified device has detected an equipment check in its system card.	

---

## Symptom tables

### *POST symptom table*

Symptom	Action
The main motor, cooling fan, and fuser do not come on.	See <b>“Cover interlock switch service check” on page 2-24.</b>
POST completes, but the LCD does not come on.	See <b>“Operator panel service check” on page 2-28.</b>
Main motor does not come on.	See <b>“Main motor service check” on page 2-27.</b>
Fan does not come on.	See <b>“Cooling fan service check” on page 2-24.</b>
Fuser does not cycle.	See <b>“Fuser service check” on page 2-26.</b>
Fuser does not turn on and off.	See <b>“Fuser service check” on page 2-26.</b>
The paper feed picks and tries to feed media.	See <b>“Paper feed service checks” on page 2-28.</b>

**Note:** Investigate any displayed codes before proceeding with these symptoms. For example, a missing toner cartridge will prevent POST from completing.

## Printer symptom table

Symptom	Action
Fan noisy or fan not working.	See <b>“Cooling fan service check” on page 2-24.</b>
Fuser parts melted.	See <b>“LVPS/HVPS service check” on page 2-26.</b>
Toner not fused to the media.	See <b>“Fuser service check” on page 2-26</b> or <b>“Solving print quality problems” on page 2-35.</b>
Paper jams.	See <b>“Paper feed service checks” on page 2-28.</b>
Main motor noisy or not moving.	See <b>“Main motor service check” on page 2-27.</b>
Media skew.	See <b>“Paper feed service checks” on page 2-28.</b>
Printer not communicating with host.	See <b>“Parallel or USB port service check” on page 2-30.</b>
Front access door will not close.	See <b>“Cover interlock switch service check” on page 2-24.</b>
Operator panel button not responding.	See <b>“Operator panel service check” on page 2-28.</b>
Operator panel lights are off or very dim.	See <b>“Operator panel service check” on page 2-28.</b>
Blank page.	See <b>“Blank page” on page 2-31.</b>
Black page.	See <b>“Black page” on page 2-32.</b>
Heavy background.	See <b>“Heavy background” on page 2-32.</b>
Light print.	See <b>“Light print” on page 2-34.</b>
White or black lines or bands.	See <b>“White or black lines or bands” on page 2-34.</b>
Toner on back of page.	See <b>“Toner on back of page” on page 2-34.</b>
Media never picks.	See <b>“Media never picks” on page 2-29.</b>
Media feeds continuously.	See <b>“Media occasionally mispicks or picks multiple sheets at once” on page 2-29.</b>
Media wrinkled or bent.	See <b>“Media “trees,” wrinkles, stacks poorly, or curls” on page 2-30.</b>
Dead machine (no power).	See <b>“Dead machine service check” on page 2-25.</b>
Print quality problems <ul style="list-style-type: none"> <li>• Light print</li> <li>• Blurred characters</li> <li>• Toner on both sides of media</li> <li>• Toner not fused</li> <li>• Streaks</li> <li>• Blank pages</li> </ul>	See <b>“Solving print quality problems” on page 2-35.</b>



## Service checks



Service checks which involve measuring voltages on the LVPS/HVPS (low voltage power supply/ high voltage power supply board) should be performed with the printer positioned on its back side.

**Note:** When making voltage readings, always use frame ground unless another ground is specified. See the wiring diagram in the back of the book for more information.

### Controller board service check

#### Controller board service check

FRU	Action
<p>Controller board assembly</p> <p><b>Warning:</b> Do not replace the operator panel and controller board at the same time. Each card contains the printer settings. When either of these cards is new, it obtains some of the settings from the other card. Settings are lost when both are new and replaced at the same time.</p>	<p><b>POST (Power-On Self Test)</b></p> <p><b>Note:</b> The printer should complete POST in approximately 30 seconds.</p> <p>If the printer fails to display lights or activate the drive motor, fuser, or fan, then check the following order:</p> <ol style="list-style-type: none"> <li>1. Power to the LVPS/HVPS</li> <li>2. Power from the LVPS/HVPS to the controller board</li> <li>3. Cables are plugged in correctly, especially for the operator panel. The printer will not power-up without a functioning operator panel.</li> <li>4. The controller board assembly. The LED adjacent to J12 will be illuminated if the card is powered and good.</li> <li>5. The operator panel. See <b>“Operator panel service check” on page 2-28.</b></li> </ol>
	<p>Verify +24 V dc input from the LVPS/HVPS.</p> <ol style="list-style-type: none"> <li>1. Turn the printer off.</li> <li>2. Disconnect the LVPS/HVPS cable from the controller board at J502.</li> <li>3. Turn the printer on.</li> <li>4. Verify +24 V dc on positions 6, 17, and 19 of the cable connector (LVPS/HVPS).</li> <li>5. If voltage is correct, then check the continuity in the other conductors of the cable. If the cable is good, then turn the printer off, and check the connectors to the controller board.</li> <li>6. Verify that pins 10, 12, 14, 16, and 18 on both the cable and the card connector are grounded.</li> <li>7. If grounds are not correct on the cable, but the cable passes continuity otherwise, then check the LVPS/HVPS.</li> <li>8. If the grounds are not correct on the controller board, then replace the controller board. (Check with one probe on the connector pin and the other on the card's ground plane found at each screw head.)</li> </ol>
	<p>Controller board voltage outputs</p> <p>Turn the printer off, and plug the LVPS/HVPS cable into J502 of the controller board. See the wiring diagram at the end of the manual which identifies the output voltages and grounds for a good controller board.</p> <p>Turn the printer off before plugging or unplugging any connectors.</p>

### Controller board service check (Continued)

FRU	Action						
LVPS/HVPS	<p><b>Verify main power to controller board</b></p> <p>With the printer off, unplug the LPS/HVPS cable at J502 on the controller board. Verify grounds on pins 10, 12, 14, 16 and 18 for both the cable and the controller board. If any of these grounds are incorrect, then check the cable for continuity. If the cable fails continuity, then call the next level of support.</p> <p>Turn the printer on with the cable still unplugged, and verify the following on the cable (controller board will not be powered):</p> <table border="1" data-bbox="740 510 1117 661"> <thead> <tr> <th>Pins</th> <th>Voltage</th> </tr> </thead> <tbody> <tr> <td>6, 17, 19</td> <td>+24 V dc</td> </tr> <tr> <td>1, 3-5, 11, 13, 15</td> <td>+5 V dc</td> </tr> </tbody> </table> <p>If any of the voltages are incorrect, then replace the LVPS/HVPS. See <b>“Dead machine service check” on page 2-25.</b></p>	Pins	Voltage	6, 17, 19	+24 V dc	1, 3-5, 11, 13, 15	+5 V dc
Pins	Voltage						
6, 17, 19	+24 V dc						
1, 3-5, 11, 13, 15	+5 V dc						

### Cooling fan service check

FRU	Action
Cooling fan	<p>Make sure the fan cable plug is properly seated at J9 (controller board).</p> <p>Turn the printer on. Within a few seconds, the controller board assembly should apply +24 V dc to pin 2.</p> <ul style="list-style-type: none"> <li>• If voltage is not present, then check or replace the controller board. See <b>“Controller board removal” on page 4-6.</b></li> <li>• If voltage is present then check pin 1 for 24 V dc as well. If it is close to 24 V dc while the fan is still idle, then replace the fan. See <b>“Fan removal” on page 4-16.</b></li> </ul>

### Cover interlock switch service check

**Note:** Make sure a print cartridge assembly is installed and the cover closes all the way, engaging the cover open switch lever.

FRU	Action
Cover interlock switch	<p>Disconnect the cover interlock cable from the controller board at J7.</p> <p>With the printer turned off:</p> <ol style="list-style-type: none"> <li>1. Verify continuity between cable pin 1 and pin 2 with the door closed and discontinuity with the door open.</li> <li>2. Verify continuity between cable pin 1 and pin 3 with the door open and discontinuity with the door closed.</li> <li>3. Verify discontinuity between cable pins 2 and 3 whether the door is open or closed. <ul style="list-style-type: none"> <li>• If any fail, then replace the cover interlock switch.</li> <li>• If both pass continuity, then turn the printer on, and measure +5 V dc on pin 2 at J7 on the controller board.</li> <li>• Verify pin 3 at J7 is ground.</li> <li>• If voltage or ground is not present, then see <b>“Controller board service check” on page 2-23</b> for more information.</li> </ul> </li> </ol>

## Dead machine service check



**CAUTION:** Check the AC line voltage. The voltage should be within the following limits:

- 100 V ac (volts alternating current) – 127 V ac for the 110 V printer
- 200 V ac – 240 V ac for the 220 V printer

FRU	Action								
 LVPS/HVPS	<p>Unplug the printer. Remove the LVPS/HVPS, and check the fuses for continuity.</p> <ul style="list-style-type: none"> <li>• If open, then replace the LVPS/HVPS.</li> <li>• If not open, then check the switch continuity across its conductors with the switch on. Turn the switch off. Plug the AC line into the LVPS/HVPS and switch unit on.</li> </ul> <p><b>Note:</b> Voltages may be exposed at several places on the board. Do these verifications, and then unplug the card:</p> <table border="1" data-bbox="787 653 1164 894"> <thead> <tr> <th>Pins</th> <th>Voltage</th> </tr> </thead> <tbody> <tr> <td>CN201-6, 17, 19</td> <td>+24 V dc</td> </tr> <tr> <td>CN201-10, 12, 14, 16, 18</td> <td>Ground</td> </tr> <tr> <td>CN201-1,3, 5, 11,13, 15</td> <td>+5 V dc</td> </tr> </tbody> </table> <ul style="list-style-type: none"> <li>• If voltages are not correct, then replace the LVPS/HVPS.</li> <li>• If voltages are correct, then check the controller board. See <b>“Controller board service check” on page 2-23.</b></li> </ul>	Pins	Voltage	CN201-6, 17, 19	+24 V dc	CN201-10, 12, 14, 16, 18	Ground	CN201-1,3, 5, 11,13, 15	+5 V dc
Pins	Voltage								
CN201-6, 17, 19	+24 V dc								
CN201-10, 12, 14, 16, 18	Ground								
CN201-1,3, 5, 11,13, 15	+5 V dc								

## Fuser service check

When toner is partially fused to the media, it is usually caused by low fuser temperature.



The line voltage to the printer must be within the following limits:

- 100 V ac-127 V ac for the 110 V model printer
- 200 V ac-240 V ac for the 220 V model printer



This printer uses a belt fuser and therefore does not have a lamp.

Fuser service check

FRU	Action
 <p>Fuser power cable LVPS/HVPS Fuser</p>	<p>Unplug the printer, and disconnect the fuser cable plug from the LVPS/HVPS board connector at CN102.</p> <p>Check for continuity across the fuser by checking across the connector pins.</p> <ul style="list-style-type: none"> <li>• If there is continuity, then check the LVPS/HVPS. See <b>“LVPS/HVPS service check” on page 2-26.</b></li> <li>• If there is no continuity, then disconnect the fuser power cable at both ends, and check each conductor for continuity. Replace cable if necessary.</li> <li>• If the cable tests good, then replace the fuser.</li> </ul> <p>Reconnect the cables, turn the printer on, and at &amp;12, check for approximately +5 V dc on pin 1 and ground on pin 2. If line voltage is incorrect on pin 1, then see <b>“Controller board service check” on page 2-23</b> for more information.</p>
 <p>Fuser</p>	<p>Disconnect the thermistor cable from J12 on the controller board.</p> <p>Measure the resistance across the ends of the thermistor cable.</p> <p>Replace the fuser assembly if the resistance is lower than 1K ohm or shorted.</p> <p><b>Note:</b> Resistance measures approximately 400K ohms when cool and 1K ohms hot.</p>

## LVPS/HVPS service check

FRU	Action
 <p>LVPS/HVPS</p>	<p><b>LVPS portion of board</b></p> <p>Fuses that open typically indicate a faulty LVPS/HVPS.</p> <p>Disconnect the power cable, and open the LVPS/HVPS enough to test the switch. The switch will show continuity across the conductors with a meter when the switch is on. If the switch is good, then see <b>“Dead machine service check” on page 2-25</b> for more diagnostics.</p> <p><b>HVPS portion of board</b></p> <p>Problems with the HVPS are exhibited in the print quality. See <b>“Print quality service checks” on page 2-31</b> for more information.</p>

## Main motor service check

FRU	Action						
 <p>Main motor gear drive Main motor cable LVPS/HVPS Controller board</p> <p><b>Warning:</b> <i>Do not</i> replace the operator panel and controller board at the same time. Each card contains the printer settings. When either of these cards is new, it obtains the settings from the other card. Settings are lost when both are new and replaced at the same time.</p>	<p>Turn off the printer, and unplug the main motor cable at J17. Turn on the printer, and check for the following voltages at J17:</p> <table border="1" data-bbox="769 394 1182 520"> <thead> <tr> <th>J17 pins</th> <th>Voltages</th> </tr> </thead> <tbody> <tr> <td>Pins 1-4, 6</td> <td>Approx. 5 V dc</td> </tr> <tr> <td>Pins 7-9</td> <td>18 V dc–24 V dc</td> </tr> </tbody> </table> <p>Verify ground at pin 5 for both the card and cable.</p> <ul style="list-style-type: none"> <li>• If these voltages are correct, then check the main motor cable for continuity. <ul style="list-style-type: none"> <li>- Remove the left side cover to access the connector on the motor.</li> <li>- If continuity exists on each wire, then replace the main motor gear drive which includes the motor.</li> <li>- If continuity does not exist on one or more of the wires, then call the next level of support.</li> </ul> </li> <li>• If these voltages are not correct, then see <b>“Dell 2350d/dn, 3330dn controller board connector pin values” on page 5-4</b>, or replace the controller board. See <b>“Controller board removal” on page 4-6</b>.</li> </ul>	J17 pins	Voltages	Pins 1-4, 6	Approx. 5 V dc	Pins 7-9	18 V dc–24 V dc
J17 pins	Voltages						
Pins 1-4, 6	Approx. 5 V dc						
Pins 7-9	18 V dc–24 V dc						

## Operator panel service check

Inspect the operator panel cable for damage. Make sure the cable is plugged in securely. Run POST, and check each light for proper operation. See **“Power-On Self Test (POST) sequence” on page 2-1.**

### LCD Operator panel service check

FRU	Action
Operator panel (LCD) Controller board  <b>Warning:</b> Do not replace the operator panel and controller board at the same time. Each card contains the printer settings. When either of these cards is new, it obtains the settings from the other card. Settings are lost when both are new and replaced at the same time.	<p><b>Lights</b></p> <p>If the LCD does not come on, then open the controller board cage and locate the operator panel connector at J3. Make sure the cable is properly connected to the controller board and the controller board has input voltage to it.</p> <p>With the printer on, verify the following without disconnecting the cable:</p> <ul style="list-style-type: none"> <li>• Pins 1, 3, 5, and 6: 3.3 v</li> <li>• Pin 2: 5 v</li> <li>• Pins 4 and 7: GND</li> </ul> <p>If these are approximately correct and the operator panel is not functioning, then replace the operator panel.</p> <p>If any are incorrect, then see <b>“Controller board service check” on page 2-23.</b></p>
	<p><b>Buttons</b></p> <p>If the buttons do not respond, then replace the operator panel. There is no test or repair for the faulty switches on the operator panel.</p>

## Paper feed service checks

### Paper jam error indication during POST

FRU	Action
Fuser (exit sensor)	If the exit sensor flag, which is visible at the back of the fuser, is in any position other than vertical, then the printer will display a paper jam. Make sure the flag is operating freely. Replace the fuser if the sensor is damaged.
Input/duplex sensor Manual feed sensor	Make sure the input paper feed sensors are working properly. A stuck or incorrectly installed sensor causes a paper jam indication.

### Media picks but stops halfway through the printer

FRU	Action
Input/duplex sensors (under print cartridge assembly) Input sensor (manual)	<p>Make sure the input sensors are working properly.</p> <p>Check for a broken or stuck flag on the input sensors. Clear anything that keeps the flags from rotating freely.</p> <p>Make sure the cables are seated on the controller board at J27 (input/duplex sensor) and J23 (manual input).</p> <p>Check for +5 V dc on pin 2 and 5 at J27 (input/duplex sensors) and pin 2 at J23 (Input sensor). Voltages on pins 1 and 4 at J27 pin 1 at J23 should change as the flags intersect with the sensor.</p> <ul style="list-style-type: none"> <li>• If correct, then replace the input paper feed sensor.</li> <li>• If these voltages are not correct, then replace the controller board.</li> <li>• Check the pick tires. Clean or replace as necessary.</li> </ul>

## Media never picks

FRU	Action
Paper feed (pick tires) tray 1 Paper feed (pick tires) tray 2 Media drive ASM Media feed clutch ASM Manual feed clutch ASM P/U and manual feed solenoid ACM drive shaft	Open the left cover, and verify that the solenoids and clutches are functioning when an attempt is made to feed the media.  Make sure the rubber tires on the ACM are installed and clean.  Replace the tires, ACM drive, clutch assemblies, solenoids, or drive shaft as necessary.

## Media occasionally mispicks or picks multiple sheets at once

FRU	Action
Tray 1 Tray 2 (option)	Check tray for media catch points.  If the sheet being fed stops momentarily, then the ACM applies additional vertical force, causing additional sheets to feed.  Do not mix media types in one tray.
Paper pick tires (Tray 1 or tray 2)	Check the tires in the ACM assembly for signs of wear or damage.  Replace the tires as necessary.
ACM clutch Manual feed clutch Media feed clutch ASM (tray 1 only) Manual feed clutch solenoid	Open left cover, and observe the solenoid and clutch actions at the ACM and manual feed shafts as a print job is attempted.  Replace the faulty part.
Controller board P/U and manual feed solenoid ASM.	Disconnect the solenoid cable at J26 on the controller board and measure the resistance across cable pins 1 and 2. <ul style="list-style-type: none"> <li>• The resistance should be approximately 70 ohms.</li> <li>• If it is not, then replace the solenoid.</li> <li>• If the resistance is approximately 70 ohms, then check the controller board. Pin 1 at J26 should be +24 V dc. See <b>“Controller board service check” on page 2-23</b> for more information.</li> </ul> Replace controller board as necessary.

## Media skews

FRU	Action
Paper feed (pick tires) tray 1 Paper feed (pick tires) tray 2 Tray 1 Tray 2 (option)	Check tires for debris. If tires are new, then try reversing each on its hub.  Check side guides on Tray 1 and Tray 2. Guides set for a full stack of media may be too wide when the stack is short.

## Media “trees,” wrinkles, stacks poorly, or curls

FRU	Action
Fuser	<p>This problem is most likely due to a worn backup roll. It causes the printer to run hotter than required for the media being printed. Excessive heat can cause media treeing problems, poor stacking, or curl.</p> <p>Print the menu sheet found under Utilities.</p> <p>Look at the media settings. Some, such as card stock or rough texture, may require a higher fuser temperature, which leads to more of these problems (except stacking) in plain paper.</p> <ul style="list-style-type: none"><li>• Change settings using the printer driver.</li><li>• Use the local printer setup utility (included on the CD) to change the NVRAM settings.</li></ul> <p>Try a different ream of paper. Moist media has a higher tendency to crease (treeing) and curl.</p>

### ***Parallel or USB port service check***

1. Perform a print test to make sure the printer prints correctly. Verify that the indicator light is on, then print the menu settings by selecting Print Menu under Utilities.
2. Be sure the printer parallel cable is designed for bidirectional printing.
3. Be sure the user's application is set up correctly.
4. If the internal print test page prints correctly, then the user's application/printer driver is set up correctly, and the correct bidirectional parallel cable is installed, but the printer still fails to print on command from the host computer, replace the controller board.
5. Check the USB cable for continuity.









## Print quality service checks

**Note:** Ensure the cover closes tightly. A gap in the opening may allow light to expose the photoconductor, resulting in a 'dirty' print. Extreme environmental conditions, temperatures, and humidity will affect the print quality.

### Using print quality test pages

To help isolate print quality problems, like streaking, print test pages using the print quality test pages. To print the print quality test pages:

1. Enter Configuration Menu.
  - a. Turn off the printer.
  - b. Turn on the printer while pressing and holding  and .
  - c. Release the buttons when Performing Self Test displays.
  - d. The message CONFIG MENU displays.
  - e. Press  to Prt Quality Pgs.
  - f. Press  to print the pages.
 

Four pages print to help evaluate print quality. The first page has various fonts and a graphic, the second page is gray with graphics, the third page is black, and the last page is blank.
2. Use the test pages to isolate problems such as light or toner streaks. See **“POST symptom table” on page 2-21** for solutions to these problems.
3. Press  to Exit Config Menu, and press .

To exit configuration, turn the printer off.

**Note:** Refer to the print defects guide at the end of the manual for repeating defects.

### Blank page

FRU	Action
Toner cartridge (not a FRU)	Remove the toner cartridge, and gently shake it to evenly distribute the toner. Check for cartridge damage.
 Printhead LVPS/HVPS Controller board	Blank pages can be caused by a defective printhead assembly, LVPS/HVPS, or controller board. <ul style="list-style-type: none"> <li>• Printhead errors typically result in printer service errors unless there is blockage of the beam or dust on the lens. Check the lens and opening for blockage.</li> <li>• Blank pages typically are caused by the PC roll not being properly charged. Try a different PC kit.</li> <li>• With the cartridge out, check the spring loaded contacts on the right side for free motion. None should be ground except for #4 contact from the front.</li> </ul> Unplug the printer, and check the cable continuity between the LVPS/HVPS connector marked OPC (at CN202) and the corresponding wire form (spring) found about 14 mm above and to the right of the transfer roll gear. <ul style="list-style-type: none"> <li>• If there is not continuity, then call the next level of service.</li> </ul> Try a different toner cartridge and PC kit. <ul style="list-style-type: none"> <li>• If those fail, then replace the LVPS/HVPS, controller board, or the printhead in that order.</li> </ul>

## Black page

**Note:** Incorrect laser exposure or incorrect charging of the photoconductor causes an all black page. Always verify the same results from a different print cartridge assembly and developer before proceeding.

FRU	Action
Toner electrodes (not a FRU)	<p>Check the three rearward electrodes below the toner cartridge assembly for contamination, damage, or a short to ground. Correct as necessary.</p> <p>Check continuity between the cable (DEV, TAR, and doctor blade) connection PCN3 and on the contact tips below the toner cartridge assembly.</p> <ul style="list-style-type: none"> <li>• If continuity fails, then call the next level of service.</li> </ul>
 <p>LVPS/HVPS board Controller board Miscellaneous cables</p>	<p>With the printer off, disconnect the LVPS/HVPS cable from J502 on the controller board.</p> <p>Turn the printer on, and verify +24 V dc on pins 17 and 19 of the cable.</p> <p>Verify +5 V dc on pins 1, 3, 5, 13, and 15.</p> <p>Verify ground on pins 10, 12, 14, 16, and 18.</p> <ul style="list-style-type: none"> <li>• If any of the values are incorrect, then replace LVPS/HVPS board.</li> <li>• If the grounds are incorrect, then check ground paths.</li> <li>• Check continuity in the cable. If the cable is bad, then call the next level of support.</li> <li>• If the values are correct and the toner electrodes are good, then replace the controller board.</li> <li>• See the <b>“LVPS/HVPS service check” on page 2-26</b> and the <b>“Controller board service check” on page 2-23</b>, if necessary.</li> </ul>

## Heavy background

Poor development or poorly charged toner particles cause excessive background. This is more noticeable as the toner cartridge nears end-of-life.

FRU	Action
Toner cartridge (not a FRU) Photoconductor kit (not a FRU)	<p>Check the toner darkness setting in the driver. Try a lower setting.</p> <p>Make sure the toner cartridge and photoconductor kit are correctly installed and the high voltage contacts are clean.</p> <p>If the toner cartridge and photoconductor kit are installed correctly, then try a new photoconductor kit first and then toner cartridge.</p>
 <p>LVPS/HVPS Controller board</p>	<p>Check the contacts for correct installation and contamination where contact is made between the print cartridge assembly and spring contacts which connect to the LVPS/HVPS board at CN203. Clean as necessary.</p> <p>If this does not correct the problem, then replace the following FRUs one at a time in the order shown:</p> <ul style="list-style-type: none"> <li>• LVPS/HVPS board (See <b>“Black page” on page 2-32</b> for pin values.)</li> <li>• Controller board</li> </ul>

### Partial blank image/white spots (no repeating pattern)

FRU	Action
Toner cartridge (not a FRU)	<p>Remove the toner cartridge assembly, and gently shake the assembly to evenly distribute the toner.</p> <p>Check to make sure that the laser light path is not blocked.</p> <p>If toner cartridge is low, then try a new one.</p>
Paper (not a FRU)	<p>Make sure recommended media is being used.</p> <p>Check the media settings in the printer driver. A heavier media may require higher heat to properly fuse.</p>

### Variation in image density horizontally across page

FRU	Action
Photoconductor kit (not a FRU)	<p>The charge roll may have an unbalanced force against the PC (photoconductor) drum.</p> <p>Try a new photoconductor kit.</p>
Transfer roll	<p><b>Note:</b> Do not touch the transfer roll except at its ends. Place a sheet of paper over the roll to prevent damage from finger oils or hand lotion.</p> <p>Check the springs in the left and right transfer roll bearings. The bearing assemblies should support the transfer roll, applying evenly distributed forces to the PC drum.</p> <p>Replace the transfer roll assembly if the springs or bearings show signs of damage or fatigue.</p> <p>Inspect the transfer roll for signs of wear, damage, or contamination.</p> <p>Replace as necessary.</p>

### Poor fusing of image

FRU	Action
Fuser	<p>The fuser may not be operating at the proper temperature to fuse the toner to the paper. See <b>“LVPS/HVPS service check” on page 2-26</b> for more information. Try changing the setting to heavier paper or even card stock.</p>
Media (not a FRU)	<p>Make sure recommended media is being used.</p> <p>Check the media settings in the printer driver.</p>

## Light print

FRU	Action
Toner cartridge (not a FRU)	<p>Make sure the toner cartridge and photoconductor kit are installed correctly and that the toner cartridge is not low on toner.</p> <p>If the problem continues, then install a new toner cartridge.</p> <p>Recheck condition before replacing photoconductor kit, if necessary.</p>
 Transfer roll LVPS/HVPS card	<p>Check the transfer roll for signs of toner buildup and contamination.</p> <p>Inspect the HVPS contact (transfer roll) for contamination.</p> <p>Verify the high voltage cable is plugged into the LVPS/HVPS.</p> <p>If all components appear free of contamination, then replace the following FRUs one at a time in the order shown:</p> <ul style="list-style-type: none"> <li>• Transfer roll</li> <li>• LVPS/HVPS card</li> </ul>

## White or black lines or bands

FRU	Action
Print cartridge assembly (not a FRU) Developer drive coupling assembly Main motor gear drive	<p>Banding appears as light or dark horizontal lines on a uniformly gray page or on a page with a large area of graphics. Banding is primarily due to a variation in the speed of the media as it feeds through the printer, especially in the developer and transfer process. It may also be a result of overly dry or moist environments.</p> <p>With the printer off, check to make sure that the laser beam is not blocked.</p> <p>Inspect the toner cartridge and paper feed components, especially the drive coupler and drive gears for debris, binds, or damage.</p>

## Toner on back of page

FRU	Action
Photoconductor kit (not a FRU)	<p>Print a menu page found under Utilities, and check settings for media type.</p> <p>Inspect the overall paper path for signs of spilled toner.</p> <p>Gently clean the contaminated areas with a soft cloth.</p>
Fuser	<p>Inspect the fuser for signs of contamination.</p> <p>Replace the fuser as necessary.</p>
Transfer roll	<p>A transfer roll contaminated with toner can cause toner to transfer to the back of pages.</p> <p>Inspect the transfer roll for contamination and its cable for continuity.</p>
HVPS or controller board	<p>Loss of the proper high voltages can cause excessive toner to contaminate the transfer roller. None of these voltages can be measured, but the contacts and continuities can be checked. To check the lower voltage, see J502 on the wiring diagram. Replace the LVPS/HVPS or controller board as necessary.</p>

## Solving print quality problems

**Note:** Refer to the print defects guide at the end of the manual for repeating defects.

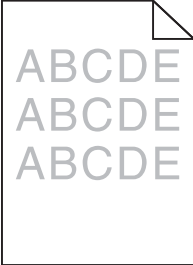
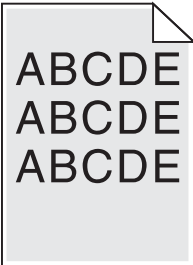
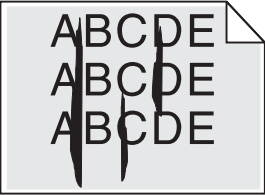

### Print quality problems

Problem	Cause / action
<p>Light or blurred characters.</p> 	<p><b>Light print</b> See <b>“Light print” on page 2-34</b>.</p> <p>The toner cartridge may be getting low on toner:</p> <ul style="list-style-type: none"> <li>• Remove the toner cartridge and print cartridge assembly.</li> <li>• Shake it from side to side to redistribute the toner.</li> <li>• Reinstall it, and recheck for condition.</li> <li>• Make sure to use the recommended print media (see media types and sizes in the <i>User's Guide</i>).</li> <li>• Use MarkVision™ Professional to define the custom type setting for media type, media texture, or media weight.</li> <li>• The toner cartridge or photoconductor kit may be defective. Replace the photoconductor kit first, and recheck.</li> </ul> <p><b>Blurred characters</b> Blurred images, including characters, are usually caused by a defective printhead.</p> <p><b>Vertical white lines</b> See <b>“Vertical streaks”</b> below.</p> <p>Vertical white lines may be caused by the laser beam, which may be partially blocked. With the printer off, clear the path or clean the lens. The toner cartridge or fuser may be defective. Try a different toner cartridge. Inspect the fuser at its entry for debris.</p>
<p>Toner smudges appear on the front or back of the page.</p> 	<ul style="list-style-type: none"> <li>• Make sure the media is straight and unwrinkled.</li> <li>• Replace the photoconductor kit, and recheck before replacing the toner cartridge. See <b>“Toner on back of page” on page 2-34</b> for more information.</li> </ul>
<p>Vertical or horizontal streaks appear on the page.</p> 	<p><b>Vertical streaks</b> Something could be caught between the photoconductor kit and the fuser. Check the paper path around the fuser entry. Try a different toner cartridge.</p> <p>Vertical white lines may be caused by the laser beam, which may be partially blocked. With the printer off, clear the path or clean the lens. The toner cartridge or fuser may be defective. Try a different toner cartridge. Inspect the fuser at its entry for debris.</p> <p><b>Horizontal streaks</b> The toner cartridge or the fuser may be the cause due to excessive page count or defect. Replace as needed.</p> <p>If the lines are parallel and match the two intended ghost images, then the Form Type may be incorrectly set. Check those settings.</p> <p>The PC cleaner sump may be full. Replace the photoconductor kit.</p>

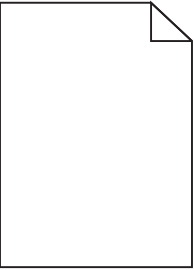
**Print quality problems (Continued)**

Problem	Cause / action
<p>Toner smears or rubs off the page.</p> 	<ul style="list-style-type: none"> <li>• Toner is not being fused to the paper. Replace the fuser.</li> <li>• Change the media texture setting in the driver. If special media is being used, such as card stock or labels, then be sure to select the correct media type.</li> <li>• Try a different kind of paper. Paper designed for copiers gives the best quality fusing.</li> </ul>
<p>The print is getting light, but the printer has not indicated it is low on toner.</p>	<ul style="list-style-type: none"> <li>• Toner is becoming low in the cartridge.</li> <li>• The Toner Low message does not display if the 1,500-page toner cartridge is installed.</li> <li>• Remove the toner cartridge, and gently shake it from side to side to redistribute the toner.</li> <li>• Replace the toner cartridge.</li> </ul>
<p>The Toner Low message displays.</p>	<ul style="list-style-type: none"> <li>• Remove the toner cartridge, and gently shake it from side to side to redistribute the toner.</li> <li>• Replace the toner cartridge.</li> </ul>
<p>Solid black areas on transparencies</p>	<ul style="list-style-type: none"> <li>• There is a mismatch in the transparency and what the software is expecting.</li> <li>• Choose a different fill pattern in the software program.</li> <li>• Remove the toner cartridge, and gently shake it from side to side to redistribute the toner.</li> <li>• Try a different type of transparency.</li> <li>• Replace the toner cartridge.</li> </ul>
<p>Faint images or repetitive spots appear on the page.</p>	<ul style="list-style-type: none"> <li>• Select a different media type or form type setting from the printer driver.</li> <li>• Try a different type of paper. Media designed for copiers gives the best quality.</li> <li>• Replace the toner cartridge.</li> </ul>
<p>Pages are blank.</p> 	<ul style="list-style-type: none"> <li>• The print cartridge may be out of toner or defective. Replace the cartridge.</li> <li>• There may be a software error. Re-initialize the printer by turning it off and back on.</li> <li>• With the printer off, check the printhead beam path. If clear, then check for a printhead error on POR. See <b>“Printhead service check” on page 2-38.</b></li> <li>• Also, see <b>“Blank page” on page 2-31.</b></li> </ul>

## Print quality problems (Continued)

Problem	Cause / action
The printer is on and indicates ready, but nothing prints.	<ul style="list-style-type: none"> <li>• Make sure the parallel or USB cable is not damaged and is firmly plugged into the connector on the back of the printer.</li> <li>• Make sure the toner cartridge assembly is installed properly.</li> <li>• Print the menu page found under Utilities.               <ul style="list-style-type: none"> <li>- If a menu settings page cannot be printed, then contact the next level of support.</li> <li>- If a menu settings page can be printed, then the problem is one of the following:                   <ul style="list-style-type: none"> <li>• Computer</li> <li>• Software program</li> <li>• Cable</li> <li>• (USB only) A failed controller board. Replace card.</li> </ul> </li> </ul> </li> </ul> <p><b>Note:</b> Test by unplugging USB and plugging it with the printer on. If the computer indicates "unknown device," replace the controller board.</p>
Toner Low light is on and printing stops.	If a 3.5K or more page toner cartridge is being used and the Toner Low alarm is set to on, then the printer stops printing until the toner cartridge is replaced.
The Error light alone is on.	Make sure the front printer cover is closed.
The Toner Low light is blinking, and the Error light is on.	<ul style="list-style-type: none"> <li>• Make sure the toner cartridge is installed correctly.</li> <li>• Install a new toner cartridge.</li> </ul>
The media skews or buckles.	<ul style="list-style-type: none"> <li>• Tray is overfilled or media is too loose.</li> <li>• Don't overfill Tray 1 or the optional Tray 2 (see media capacities in the media types and sizes table in the <i>User's Guide</i>).</li> <li>• Make sure the paper guides are flush against the edges of the media.</li> </ul>
The media sticks together, resulting in the printer feeding multiple sheets.	<ul style="list-style-type: none"> <li>• The friction between sheets is too high.</li> <li>• Remove the media from Tray 1 or Tray 2, and fan it.</li> <li>• Don't overfill Tray 1 or the optional Tray 2 (see media capacities in the media types and sizes chart in the <i>User's Reference</i>).</li> </ul>
The media fails to feed from Tray 1.	<ul style="list-style-type: none"> <li>• Frictional force between tires and media is less than resisting force.</li> <li>• Remove the media from Tray 1, and fan it.</li> <li>• Make sure Tray 1 is selected from the printer driver. Do not overfill the tray.</li> <li>• Check the condition of the rubber on the paper feed rolls. Replace if worn or contaminated.</li> <li>• Verify that the ACM clutch is functioning correctly.</li> </ul>
The media fails to feed from the optional Tray 2.	<ul style="list-style-type: none"> <li>• Incorrect tray selection or inadequate picking force by tires.</li> <li>• Make sure the correct tray and media type are selected from the driver.</li> <li>• Make sure the tray is pushed all the way in.</li> <li>• Remove the media from the optional Tray 2, fan it, and reload.</li> <li>• Check the rubber on the paper feed tires for dirt or any other debris. Replace as necessary.</li> <li>• Check the paper path in the tray for burrs or debris that may hinder media movement.</li> <li>• Make sure the media does not exceed the stack height indicator.</li> </ul>
Load Paper displays even though there is media loaded in the optional Tray 2.	<ul style="list-style-type: none"> <li>• The input sensor does not sense media after picking.</li> <li>• Make sure the tray is pushed all the way in.</li> <li>• Press .</li> <li>• Check the feed tires. (See two preceding actions.)</li> </ul>
The printer does not print after a paper jam has been cleared.	<ul style="list-style-type: none"> <li>• The printer is waiting on the next command.</li> <li>• Clear all jams.</li> <li>• Press and release , or open and close the printer cover to restart the printer.</li> <li>• Make sure the print cartridge assembly is installed properly.</li> </ul>

### Print quality problems (Continued)

Problem	Cause / action
Unexpected characters print, or characters are missing.	<ul style="list-style-type: none"> <li>• Ensure correct printer driver is being used.</li> <li>• Select hex trace mode to determine what the problem is.</li> <li>• Restore factory defaults.</li> <li>• Make sure the parallel cable or USB cable is firmly plugged in at the back of the printer.</li> </ul>
Jobs are not printing, and an error message is displayed.	<ul style="list-style-type: none"> <li>• The printer is waiting for an appropriate command.</li> <li>• Make sure the print cartridge assembly is installed properly.</li> <li>• Make sure the printer front cover is closed.</li> </ul>
While in PostScript 3 emulation, the printer is flushing data (an error message is displayed).	<ul style="list-style-type: none"> <li>• Ensure the correct PostScript driver is being used.</li> <li>• The printer doesn't have enough memory to print the job. Install more memory.</li> </ul>

### Printhead service check

FRU	Action
 <p>Printhead</p> <p><b>Note:</b> New printhead must be aligned. See <b>“Printhead assembly electronic adjustment” on page 3-18.</b></p>	<p>Turn the printer off.</p> <p>Disconnect the printhead cables from J8 and J100 on the controller board.</p> <p>Turn the printer on with the front door closed.</p> <p>On the controller board, verify +5 V dc on pin 10 at J8 and +5 V dc on pins 1, 2, and 3 at J100.</p> <p>Verify grounds on pins 2, 4, and 7 at J8 and on pin 4 at J100.</p> <ul style="list-style-type: none"> <li>• If voltages or grounds are incorrect, then check the controller board. See <b>“Controller board service check” on page 2-23</b> for more information.</li> <li>• If voltages are correct, then replace the printhead (comes with cables).</li> </ul>

### Transfer roll service check

FRU	Action
 <p>Transfer roll</p>	<p><b>Note:</b> Do not touch the transfer roll except at its ends. Place a sheet of paper over the roll to prevent damage from finger oils or hand lotion.</p> <p>Check the springs in the left and right transfer roll bearings. Do not try to move the left spring. The bearing assemblies should support the transfer roll, applying evenly distributed forces to the PC drum.</p> <p>Replace the transfer roll assembly if the springs or bearings show signs of damage, or fatigue.</p> <p>Inspect the transfer roll for signs of wear, damage, or contamination.</p> <p>Replace as necessary.</p>



## Tray 2 service check

FRU	Action
Tray 2	<p>Turn the printer off.</p> <p>Separate the printer from Tray 2.</p> <p>Turn the printer on and check the voltages on connector J28 on the controller board. See the wiring diagram at the end of the service manual, or <b>“Dell 2350d/dn, 3330dn controller board connector pin values” on page 5-4</b> for the J28 connector.</p> <p>Pins 1, 4: 3.3 V</p> <p>Pin 2: 24 V</p> <p>Pin 6: Ground</p> <p>If the voltages are incorrent, then replace the controller board. If the voltages are correct, then try using Tray 2 again. If the printer error persists, then replace Tray 2.</p>







## 3. Diagnostic aids

This chapter explains the tests and procedures to identify printer failures and verify repairs have corrected the problem.

### Accessing service menus

There are different test menus that can be accessed during POR to identify problems with the printer.



Configuration Menu	<ol style="list-style-type: none"><li>1. Turn off the printer.</li><li>2. Press and hold  and .</li><li>3. Turn on the printer.</li><li>4. Release the buttons when the clock displays.</li></ol>	<p>The Configuration Menu group contains a set of menus, settings, and operations which are infrequently required by a user. Generally, the options made available in this menu group are used to configure a printer for operation.</p> <p>See <b>“Configuration menu (CONFIG MENU)” on page 3-2</b> for more information.</p>
Diagnostics Mode	<ol style="list-style-type: none"><li>1. Turn off the printer.</li><li>2. Press and hold  and .</li><li>3. Turn on the printer.</li><li>4. Release the buttons when the clock displays.</li></ol>	<p>The Diagnostics Mode group contains the settings and operations used while manufacturing and servicing the printer.</p> <p>See <b>“Diagnostics menu” on page 3-6</b> for more information.</p>

To run the printer diagnostic tests described in this chapter, the printer must be in Diagnostic Mode.

---

## Configuration menu (CONFIG MENU)

### Entering Configuration Menu

1. Turn off the printer.
2. Press and hold  and .
3. Turn on the printer.
4. Release the buttons when the clock displays.

### Available menus

The menus display on the operator panel in the order shown:

Maintenance Count Value	See <b>“Maintenance Count Value (Maint Cnt Value)”</b> on page 3-3.
Reset Maintenance Count	See <b>“Reset Maintenance Count Value (Reset Maint Cnt)”</b> on page 3-3.
Reset Photoconductor Maintenance Count	See <b>“Reset Photoconductor Maintenance Counter (Reset PC Cnt)”</b> on page 3-3.
Print Quality Pages	See <b>“Print Quality Pages”</b> on page 3-3.
Reports	See <b>“Reports”</b> on page 3-4.
Panel Menus	See <b>“Panel Menus”</b> on page 3-4.
PPDS Emulation	See <b>“PPDS Emulation”</b> on page 3-4.
Demo Mode	See <b>“Demo Mode”</b> on page 3-4.
Factory Defaults	See <b>“Factory Defaults”</b> on page 3-4.
Action for Prompts	See <b>“Action For Prompts”</b> on page 3-5.
Energy Conserve	See <b>“Energy Conserve”</b> on page 3-5.
Font Sharpening	See <b>“Font Sharpening”</b> on page 3-5.
Exit Config Menu	See <b>“Exit Configuration Menu (Exit Config Menu)”</b> on page 3-5.

**Note:** Menus may vary depending on the features and options of the printer.

## **Maintenance Count Value (Maint Cnt Value)**

The Maintenance Count Value displays the current value of the Maintenance Kit counter which provides a rough gauge of the printer's usage. A simplex print job increases the counter by one, and a duplex print job increases the counter by two. Press  to enter this setting. The following displays:

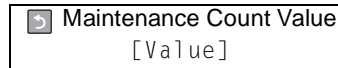

Press  to return to the **Configuration Menu**.

**Note:** When the Maintenance Count Value is equal to the Maintenance Kit's rated life, the operator panel displays the "80 Scheduled Maintenance" message. Perform the required maintenance, and then reset the Maintenance Kit counter to "0."



## **Reset Maintenance Count Value (Reset Maint Cnt)**

This setting resets the maintenance count value to "0."

1. Press  to enter the **Reset Maintenance Count Value** setting. The following displays:



2. Select **Reset**.
3. **Resetting Maintenance Counter** displays.

Once initiated, the reset operation cannot be canceled. Press  or  to return to the **Configuration Menu**.

## **Reset Photoconductor Maintenance Counter (Reset PC Cnt)**

This setting resets the photoconductor kit page counter and clears any warnings or photoconductor exhausted messages. This operation should be performed only after a new photoconductor unit has been installed.



## **Print Quality Pages**

This setting is a limited version of the **Print Quality Pages** setting that appears in the **Diagnostics** menu. This setting reports the values of a broad range of printer settings and tests the printer's ability to generate acceptable printed output. Press  to print the report. **Printing Quality Test Pages** will display. Once started, the printing cannot be canceled and no buttons are active until the printing completes.

## Reports

The Reports menu contains two selections: Menu Settings Page and Event Log.

### Menu Settings Page

To print the Menu Settings page, press . Press  to return to the Configuration menu.

### Event Log

The event log provides a history of printer errors. The event log can only be printed in the Configuration menu. Additional options are available in the Diagnostics menu. See **“Reports” on page 3-16**.

To print the event log:

1. Select **Print Event Log** from the Event Log menu.
2. Press  to return to the Configuration menu.

**Note:** An event log printed from the CONFIG MENU will not contain debug information or secondary codes for 900 service errors. However, the event log printed from DIAGNOSTICS mode does include this information.

## Panel Menus

The settings are **On** and **Off**. The default is **On**.

### PPDS Emulation

This menu item activates or deactivates the PPDS emulation data stream. The selections are **Deactivate** (default) and **Activate**. When PPDS emulation is activated, the following settings are also changed:

- SmartSwitch settings for each port are turned off.
- The printer language is changed to PPDS Emulation.

Users can still switch languages on the operator panel and through the PJI data stream.

### Demo Mode

This setting contains a built-in demonstration mode. The settings allow you to turn the Demo Mode **Off** (default) or **On**. While Demo Mode is set, the printer will start in Demo Mode until you change the setting.

**Note:** While Demo Mode is set to **On**, only demonstration files can print. Files received across the network or from the host computer are ignored.

### Factory Defaults

This setting enables a user to restore all the printer settings to the original factory settings. The selections are **Do not restore** (default) and **Restore now**. Network does not appear unless you have a network printer. The following settings are not changed:

- Display language
- Settings in the NETWORK/PORTS MENU group.

## Action For Prompts

This setting determines which input source receives paper-related or envelope-related change prompts when they occur. Press  to enter **Action For Prompts** from the **Configuration Menu**. The following displays:

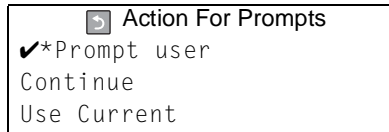

Press  to select a prompt. Submitting Selection displays. The screen automatically returns to the **Configuration Menu**.

Press  to exit the **Env Prompts** setting at anytime.

## Energy Conserve

This menu controls what values appear on the Power Saver menu. If **Off** is selected in the Energy Conserve menu, then the Power Saver can be turned off. If **On** (default) is set in Energy Conserve, then the Power Saver feature cannot be turned off.

## Font Sharpening

This menu allows a user to set a text point-size value below which the high-frequency screens will be used when printing font data. For example, if this setting's value is "24," then all fonts sized 24 points or less will use the high-frequency screens. To increase this setting's value by 1, press . To decrease this setting's value by 1, press .



## Exit Configuration Menu (Exit Config Menu)

Press  to exit the Configuration menu. The printer performs a POR and restarts in normal mode.

---

## Diagnostics menu

### *Entering Diagnostics menu*

1. Turn off the printer.
2. Press and hold  and .
3. Turn on the printer.
4. Release the buttons when the clock displays.

### **Available tests**

The tests display on the operator panel in the order shown:

Registration	See <b>“Registration” on page 3-7.</b>
Print tests	See <b>“Print Tests” on page 3-8.</b>
Hardware tests	See <b>“Hardware Tests” on page 3-9.</b>
Duplex tests	See <b>“Duplex Tests” on page 3-10.</b>
Input Tray Tests	See <b>“Input Tray Tests” on page 3-11.</b>
Output Bin Tests	See <b>“Output bin tests” on page 3-12.</b>
Base Sensor Test	See <b>“Base Sensor Test (B. Sensor Test)” on page 3-12.</b>
Printer setup	See <b>“Printer Setup” on page 3-13.</b>
EP Setup	See <b>“EP Setup” on page 3-15.</b>
Reports	See <b>“Reports” on page 3-16.</b>
Event Log	See <b>“Reports” on page 3-16.</b>
Exit Diagnostics	See <b>“Exit Diagnostics” on page 3-17.</b>



**Note:** Menus may vary depending on the features and options of the printer.





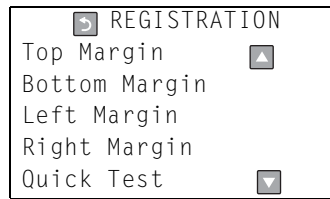

## Registration

The Registration menu settings adjust the black plane's margins. To set print registration, select **REGISTRATION** from the Diagnostics menu. The following will display:



Press  or  to move to the desired setting, and then press .

### Margins

To change the value of any margin setting, press  or  to increase or decrease the margin setting value, and then press  to save. The panel displays *Submitting changes...* and returns to the initial **REGISTRATION** menu screen. To exit the margin setting menu without changing the setting's value, press .

#### Top Margin

This setting moves the black plane's top margin up or down. Increasing the margin value moves text down the page and increases the amount of space between the page's top edge and the top margin. Decreasing the margin value moves text up the page and narrows the amount of space between the page's top edge and the top margin. The default margin is 1/6 inch.

**Note:** Modifying the top margin moves the entire image either up or down on the physical page. In order to preserve the bottom margin, changing the top margin does not compress or expand the image.

#### Bottom Margin

This setting moves the black plane's bottom margin up or down. Increasing the margin value moves text down the page and narrows the amount of space between the bottom edge of the page and the bottom margin. Decreasing the margin value moves text up the page and widens the amount of space between the bottom edge of the page and the bottom margin. The default margin is 1/6 inch.

**Note:** Modifying the bottom margin affects the rate of the stepper motor and may cause the page image to be compressed or expanded.

#### Left Margin

This setting moves the position of the black plane to the right or left. Increasing the margin value moves the plane to the right. Decreasing the margin value moves the plane to the left. The default margin is 1/4 inch.

**Note:** The left margin adjustment is used to center the image from left to right. The image will remain the same width.

#### Right Margin

This setting is used to adjust the printhead, but only after determining that it is out of adjustment by observing the Quick Test Page.

**Note:** The right margin setting is not a margin adjustment and should not be used unless a new printhead is installed. To adjust a new printhead, see "**Printhead assembly electronic adjustment**" on page 3-18 or "**Printhead assembly mechanical adjustment**" on page 3-19.

## Quick Test page

Print a Quick Test page to verify that the **REGISTRATION** margin values are set appropriately. The **Quick Test** page consists of the following:

- Alignment diamonds
- Horizontal lines used for skew adjustment
- General device information (current page count, installed memory, etc.)
- The printer's serial number, code levels, and print registration settings

While the Quick Test page prints, *Printing...* will display. No buttons are active while the Quick Test page prints. When the Quick Test page is finished printing, the display returns to the initial **REGISTRATION** menu screen.

**Note:** Print the Quick Test page on Letter- or A4-sized media.





## Print Tests

This setting tests the printer's ability to generate printed output from each of its installed input sources and to test the printer's current print quality.

### Input sources

**PRINT TESTS** contains the following installed input sources:

- Tray1
- Tray 2
- Multi-Purpose Feeder
- Print Quality Pages

Press  or  to scroll through the **PRINT TESTS** menu, and then press  to select the desired input source. *Single* or *Continuous* is displayed on the screen. A Single test feeds one sheet of media from the selected input and prints a test page on it. No buttons are active during the Single test. The Continuous test feeds media from the selected input and prints test pages until  is pressed. The printer always generates a simplex version of the Print Test page in its default resolution. While the Single or Continuous tests print, *Printing...* will display. After the Single test prints or the Continuous test is canceled, the display returns to the **PRINT TESTS** menu screen.

**Note:** The type of media installed in the selected input source will affect the contents of the page.

### Print Quality Pages (Prt Quality Pgs)

This setting reports the values of a broad range of printer settings and tests the printer's ability to generate acceptable printed output. Press  to print the report. *Printing Quality Test Pages* will display. Once started, the printing cannot be canceled, and no buttons are active until the printing completes.

## Hardware Tests

This setting contains the following tests:





- Panel Test
- Button Test
- DRAM Test
- CACHE Test

Press  or  to scroll through the **Hardware Tests** menu, and then press  to select the desired test.

### Panel Test

Once the **Panel Test** setting is selected, the printer automatically performs the operator panel test. This test toggles each pixel in the operator panel through every contrast level, beginning with the darkest and ending with the lightest. Once the pixels are toggled, the backlight of the operator panel comes on and then goes off. Non-functioning pixels will appear as blank spaces during the test's darker stages. Press  anytime to cancel the LCD Test. Once the test is canceled, the display returns to the initial **Hardware Tests** screen.

### Button Test

The **Button Test** verifies the operation of each button on the operator panel. Press  to select the **Button Test** from the **HARDWARE TESTS** menu. All of the buttons and the backlight illuminate, and `PANEL TEST Press Count: 0` displays. Press , , or  to increase the value of the Press count field by one. If the final Press count does not match the total number of buttons that are pressed, then one or more buttons are malfunctioning. Press  to return to the **HARDWARE TESTS** menu screen.

### DRAM Test

The purpose of this test is to check the validity of DRAM, both standard and optional. The test writes patterns of data to SDRAM to verify that each bit in memory can be set and read correctly.

To run the SDRAM Memory Test:

1. Select **DRAM Test** from the menu. The power indicator *blinks*, indicating the test is in progress.

DRAM Test	xxxMb
P:#####	F:#####

xxxMB represents the amount of installed DRAM memory in MB.

P:##### represents the number of times the memory test has passed and finished successfully. Initially, 000000 displays with the maximum pass count being 999,999.

F:##### represents the number of times the memory test has failed and finished with errors. Initially, 000000 displays with the maximum fail count being 999,999.

2. Once the maximum pass count or fail count is reached, the test stops, the power indicator is turned on solid, and the final results display. If the test fails, then the message `DRAM Error` displays for approximately three seconds, and the failure count increases by 1.
3. To stop the test before it completes, turn off the printer. The test does not terminate.

## Duplex Tests

The following tests are used to determine if the duplex is working correctly:

- Quick Test
- Top Margin
- Left Margin
- Sensor Test
- Duplex Feed 1

### Quick Test

The Quick Test contains the following information on a duplexed page:

- Print registration settings
- Alignment diamonds at the top and bottom
- Horizontal lines to check for skew
- General printer information, including current page count, installed memory, serial number, and code level.

To print the duplexed Quick Test page:

1. Select **Quick Test** from the **DUPLEX TESTS** menu.
2. Select **Single** or **Continuous** by pressing  or .
3. Press  to print the page.

### Top Margin

1. Select **Top Margin** from the **DUPLEX TESTS** menu.
2. To change the margin value, press  to increase the value or  to decrease the value.
3. Press  to save the desired margin value.

### Left Margin

1. Select **Left Margin** from the **DUPLEX TESTS** menu.
2. To change the margin value, press  to decrease the value or  to increase the value.
3. Press  to save the desired margin value.

### Sensor Test

This test is used to determine if the input sensor is operating correctly.

- If the sensor is operating correctly, then **OP (Open)** will appear on the display:

```
Sensor Test
Input=OP
```

- Press  to return to the **DUPLEX TESTS** menu.

## Duplex Feed 1

1. Select **Duplex Feed 1** from the **DUPLEX TESTS** menu. The following will appear on the display:

Duplex Feed 1  
Feeding...

2. A blank page will feed through the printer. The following will appear on the display:

Duplex Feed 1  
Clear Paper...

3. Remove the blank page from the printer, and press  to return to the **DUPLEX TESTS** menu.

## Input Tray Tests

The **INPUT TRAY TESTS** setting is used to test the printer's installed input trays and their sensors.





### Feed Tests

The Feed Test observes the paper path of media as it passes through the printer. This setting contains the following tests:

- Tray 1
- Tray 2
- MP Feeder, if installed

To observe the paper path, open the upper rear door during the feed test.

**Note:** The upper front door cannot be opened during the feed test.

The feed test can be performed by using media from any of the installed input sources. All pages used during this test drop into the default output bin. For each installed input source, press  to select **Single**, or press  and  to select **Continuous**. The **Single** test feeds one sheet of media to the default output bin. The **Continuous** test feeds media to the default output bin until  is pressed. The operator panel displays [Select Input Tray] Feeding... while either of these tests perform.





### Sensor Test

The Sensor Test verifies that the Tray 1, Tray 2, and MP Feeder (if installed) sensors are working correctly. Press  to select this test from the **INPUT TRAY TESTS** menu. [Select Input Tray...] Tray Present will display on the operator panel.

## Output bin tests

The **Output bin tests** setting is used to test the printer's output bins and its sensors.

### Feed Tests





This test verifies that the media from the printer's default input source feeds to the specific output bin. Press  to select *Single*, or press  and  to select *Continuous*. The *Single* test feeds one sheet of media to the default output bin. No buttons are active during this test. The *Continuous* test feeds media to the default output bin until  is pressed. The indicator light blinks green, and the operator panel displays [Select Output Bin] Feeding... while either of these tests perform.

### Sensor Test

This test verifies that the selected output bin's sensors are working correctly. The following sensors are available in each output bin:

Output bin	Full sensor	Near full sensor	Passthru 1 sensor	Passthru 2 sensor	Level sensor*
Standard bin	✓	x	x	x	x
-bin Mailbox	x	x	✓	✓	✓



\*This sensor will register the following levels: "empty," "normal," "near full," and "full.

Press  to select this test from the **Output bin tests** menu, and then press  again to select the desired output bin. *Closed* will display on the operator panel if the sensor is closed. *Open* will display on the operator panel if the sensor is open. If the wrong message is displayed, then the sensor is malfunctioning. To exit the **Sensor Test**, press  or .

## Base Sensor Test (B. Sensor Test)

The **Base Sensor Test** verifies the correct functioning of the following sensors:

- Toner level open
- Input open
- Exit open
- Narrow media open
- Front door open

This test toggles each of these sensors. If a sensor does not toggle, then the sensor is malfunctioning. To exit the **Base Sensor Test**, press  or .

## Printer Setup

**Printer Setup** displays the following selections:

- Defaults (U.S.\*, Non-U.S.)
- Printed Page Count
- Perm Page Count
- Serial Number
- Engine Setting (1 through 4)
- Model Name
- Configuration ID
- Edge to Edge
- Par S Strobe Adj (displayed only if the printer has a standard parallel port)

### Defaults

The value of this setting determines whether the printer uses the U.S. or Non-U.S. factory default value for the settings listed below:

Device Setting	U.S. value	Non-U.S. value
Paper sizes	Letter	A4
Envelope size	10	DL Envelope
PCL Symbol Set	PC-8	PC-850
PPDS Code Page	437	850
Universal Units of Measure	Inches	Millimeters

If the value of a setting is changed, then *Submitting Changes...* displays. Press  to exit the **Defaults** setting and return to the **Printer Setup** menu.

### Printed Page Count (Page Count)

The value of this setting gauges the amount of usage on the printer. The Page Count setting's value will equal the values of the Picked Sides meter. After all print tests have been completed, the value will reset to "0."

**Note:** The value of this setting cannot be changed manually.

Press  to exit the **Page Count** setting and return to the **Printer Setup** menu.

### Permanent Page Count (Perm Page Count)

The value of this setting indicates the total number of pages that have been printed. After all print tests have been completed, the value will reset to "0."

**Note:** The Permanent Page Count's value cannot be reset.

Press  to exit the **Permanent Page Count** and return to the **Printer Setup** menu.

## Serial Number

The serial number can only be viewed and cannot be changed.

To view the serial number:

1. Select **Serial number** from **PRINTER SETUP**.
2. Press **Return** to return to **PRINTER SETUP**.

## Service Tag (only on some printers)

The service tag number can only be viewed and cannot be changed.

1. Select **Service Tag** from the **PRINTER SETUP** menu.
2. Press **Back** to return to **PRINTER SETUP**.

## Engine Setting 1 through 4

**Warning:** Do not change these settings unless requested to do so by your next level of support.

## Model Name

The serial number can only be viewed and cannot be changed.

## Configuration ID

The configuration ID is used to communicate characteristics of certain areas of the printer that cannot be determined by hardware sensors. The configuration ID was originally set when the printer was manufactured and is located on the printer label.

## Edge to Edge

When Edge to Edge is set to **On**, text and graphics are printed with all margins set to the physical edges of the page. This feature does not work in PPDS emulation.

## Par S Strobe Adj (parallel strobe adjustment)

This setting adjusts the factory setting for the amount of time the strobe is sampled to determine that valid data is available on the parallel port. Incrementing this value by one means the strobe is sampled 50 nanoseconds longer. The range of values are between -4 and +6, in increments of one. A value of zero indicates no change is made from the factory setting.



## **EP Setup**

**EP Setup** displays the following selections:

- EP Defaults
- Fuser Temperature (Fuser Temp)
- Fuser Page Count
- Warm up Time
- Transfer
- Print Contrast
- Charge Roll
- Gap Adjust
- Automatic Darkness Adjustment (Auto Dark Adj)

### **EP Defaults**

Restores all EP settings to factory default values. Selections are **Restore** and **Do Not Restore**.

### **Fuser Temperature (Fuser Temp)**

Changing this setting can reduce media curl or melting of some letterhead images. Selections are **Normal** (default), **Lower**, and **Lowest**.

### **Transfer**

The transfer can be adjusted to **Low**, **Medium**, or **High**. The default setting is Medium.

### **Print Contrast**

The print contrast can be adjusted to **Low**, **Medium**, or **High**. The default setting is Medium.

### **Charge Roll**

The charge roll can be adjusted to **Low**, **Medium**, or **High**. The default setting is Medium.

### **Gap Adjust**

Adjusts the minimum gap between sheets during printing. This setting reduces speed (pages per minute), but can be used to reduce curl of printed media and improve stacking in the output bin.

The range is 0 (default) to 255. Adjusting by one results in 9 mm of increased gap.

## Automatic Darkness Adjustment (Auto Dark Adj)

This setting attempts to optimize the amount of toner used when printing with a specific operating point. Each time this setting executes, the printer performs the following:

- Calibrates its toner density sensor
- Measures the reflectivity of its bare drum
- Prints patches on the drum and measures the drum's reflectivity through the patches
- Cleans the transfer roll
- Calculates reflectivity ratios and operating points in order to attain each operating point's darkness target
- Modifies the EP mechanism as necessary to adjust toner darkness

No messages are displayed on the operator panel to give any indication that this test is running. When deactivated, the printer disables.

## Reports

This setting prints the Diagnostic menu settings page. Press  to print the menu settings page.

## Event log

### Display Log



Selecting **EVENT LOG** provides a history of printer errors. The most recent error displays in position 1, and the oldest error displays in position 10 (if 10 errors have occurred). If an error occurs after the log is full, then the oldest error is discarded. Identical errors in consecutive positions in the log are entered. All 2xx and 9xx error messages are stored in the event log as well as the photoconductor kit and maintenance counter resets and NVRAM resets initiated by the **Factory Defaults** setting in the UTILITIES menu.

To view the display log:

1. Select **Display Log** from the **EVENT LOG** menu.

The error log is displayed one error per display screen. For example:

```
Event 1/6
936 Svc Error
```

This error is the first of six errors (it is also the latest error). This error was a 936 service error. To see the second service error, press . Pressing  will display the sixth error as shown:

```
Event 6/6
202.01 Paper Jam
```

2. Press **Back** once to exit the Display log, or press twice to exit the **EVENT LOG**.

## Print Log

Additional diagnostic information is available when you print the error log. Some of the additional information includes:

- Detailed printer information, including model and serial number
- Time and date stamps
- Page counts for each error

The printed error log can be faxed to Dell or your next level of support for verification or diagnosis. This report can also be printed from the Configuration Menu. Because you can clear error logs, the contents of this log may not match the contents when you view the error log.

To print the error log:

1. Press  to enter **Print Log** from the **EVENT LOG** menu.
2. Press **Back** to exit the **EVENT LOG** menu.

## Clear Log

1. Select **Clear Log** from the Error Log menu.

Clear Log =Yes
-------------------

2. Select **No** to exit without clearing the log. Press **Yes** to confirm. The log is immediately erased, and the display indicates **No Events Logged**.
3. Press **Return** to exit the Clear Log menu after clearing the log.

## Exit Diagnostics

Selecting **EXIT DIAGNOSTICS** exits the Diagnostics menu, and **Resetting the Printer** displays. The printer performs a POR, and the printer returns to normal mode.

# Printhead assembly electronic adjustment

**Note:** Before aligning the printhead electronically, first align the printhead mechanically, if needed. See **“Printhead assembly mechanical adjustment” on page 3-19.**

1. Enter the Diagnostics menu. See **“Entering Diagnostics menu” on page 3-6.**
2. Press  to enter the Registration menu.
3. Press  to print the Quick test page.

**Quick Test page  
(sample only; use actual sheet)**

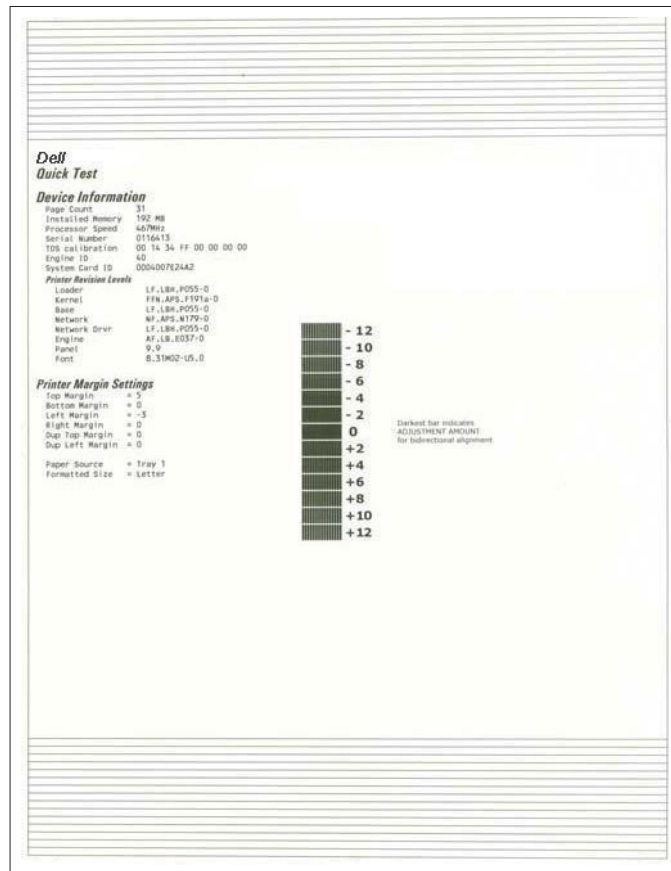

4. In the Registration menu, select the right margin setting.
5. To determine the margin setting, choose the value that is closest to the darkest bar on the center graph of the margin page. Add that value to the current right margin setting printed on the left hand side of the margin page. (The right margin setting will also appear on the operator panel display.) For example, if the right margin setting on the page is -2, and the number that is closest to the darkest line on the graph is 3 (-2+3), then the right margin setting will be equal to +1.
6. Press  or  to the desired setting, and press .
7. Print the Quick Test page again and check that the darkest line in the center graph is equal to zero. If it is, then check to see if the left, top, and bottom margins are detected. If it is not, then repeat step 5.

**Note:** The alignment of the left margin positions the black plane to the right or left. The alignment of the right margin does not alter the margins and should only be used to adjust the printhead.

---

## Printhead assembly mechanical adjustment

A printhead needs to be correctly positioned after it has been removed. Use a pencil to mark the screw locations of the old printhead on the metal frame. Align the new printhead relative to the location of the old printhead.

**Note:** Skew is caused by a sheet being fed through the printer while misaligned. The entire image is rotated relative to the sheet edges. However, a mechanically misaligned printhead causes the horizontal lines to appear skewed, while the vertical lines remain parallel to the vertical edges. There are no adjustments for skew. Check the pick roll (paper pick assembly) for wear, the paper path for obstructions, the fuser for proper setting, and the tray paper guides for fit to the media.

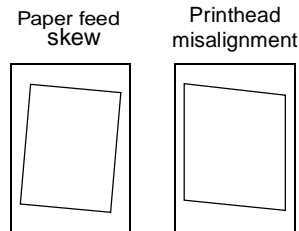

### To adjust the printhead:

1. Enter the Diagnostics Menu. See **“Entering Diagnostics menu” on page 3-6.**
2. Select PRINT TESTS.
3. Select Tray 1.
4. Select Single.
5. Fold the printed test page on the left side so that a few millimeters of grid lines wrap around the outside of the fold. See photo below.
6. Fold a second vertical fold near the center so that the left side top edge aligns with the right side top edge.

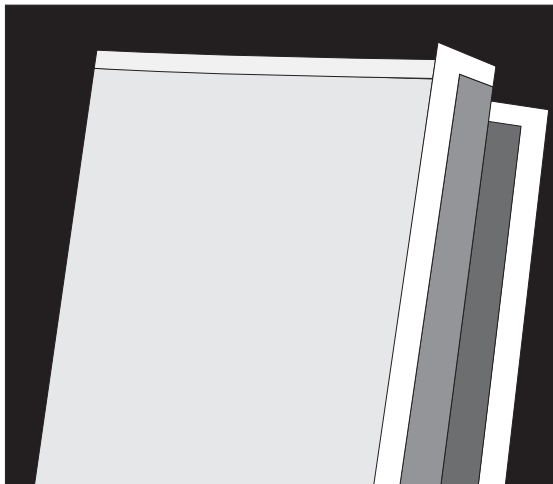

7. If the grid lines of the right flap align below the corresponding lines on the left flap, then adjust the printhead clockwise relative to the printer, and recheck. (See the left side of the figure below.) If the grid lines of the left flap align below the corresponding lines of the right side, then adjust the printhead counterclockwise. (See the right side of the figure below.)

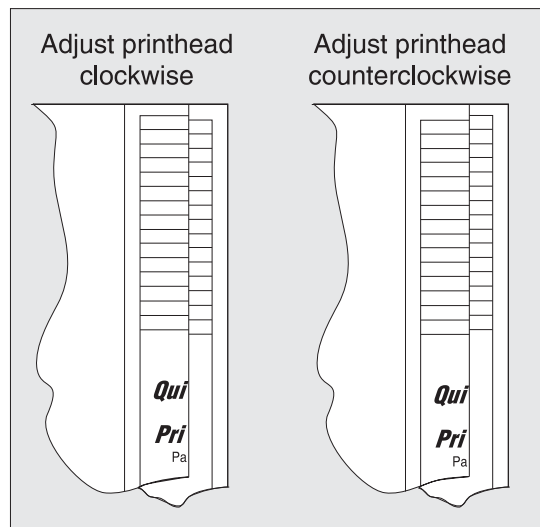

8. After obtaining a properly adjusted image on the paper, tighten all three screws.

**Note:** The printhead **must** be aligned electronically. See **“Printhead assembly electronic adjustment”** on **page 3-18**.

---

## 4. Repair information

**Warning:** Read the following before handling electronic parts.

---

### Handling ESD-sensitive parts

Many electronic products use parts that are known to be sensitive to electrostatic discharge (ESD). To prevent damage to ESD-sensitive parts, follow the instructions below in addition to all the usual precautions, such as turning off power before removing logic cards:

- Keep the ESD-sensitive part in its original shipping container (a special “ESD bag”) until the part is ready to be installed into the printer.
- Make the least-possible body movements to prevent an increase of static electricity from clothing fibers, carpets, and furniture.
- Put the ESD wrist strap on your wrist. Connect the wrist band to the system ground point. This discharges any static electricity in your body to the printer.
- Hold the ESD-sensitive part by its edge connector shroud (cover); do not touch its pins. If a pluggable module is being removed, then use the correct tool.
- Do not place the ESD-sensitive part on the MFP cover or on a metal table; if the ESD-sensitive part needs to be put down for any reason, then first put it into its special bag.
- Machine covers and metal tables are electrical grounds. They increase the risk of damage, because they make a discharge path from your body through the ESD-sensitive part. (Large metal objects can be discharge paths without being grounded.)
- Prevent ESD-sensitive parts from being accidentally touched by other personnel. Install machine covers when the machine is not being worked on, and do not put unprotected ESD-sensitive parts on a table.
- If possible, keep all ESD-sensitive parts in a grounded metal cabinet (case).
- Be extra careful in working with ESD-sensitive parts when cold-weather heating is used, because low humidity increases static electricity.

---

## Removal procedures

### Note:

- Remove the toner cartridge and media tray before removing other printer parts. The toner cartridge should be protected from light while out of the printer.
- We recommend disconnecting all external cables from the printer to prevent damage during service.
- Unless otherwise stated, reinstall the parts in reverse order of removal.
- When reinstalling a part held with several screws, start all screws before final tightening.
- Remove the paper tray and print cartridge before proceeding with a removal.





## ***ACM pick tire roller removal***

1. Place the printer on its side.

**Note:** Be careful to not mar the finish of the printer.

2. Open the duplex jam door just far enough to pull out the ACM pick tires.

**Warning:** Open the duplex door only far enough to remove the ACM pick tires. If the door is opened too far, then it can become disengaged and interfere with the paper tray. The tray may go in but will not come out, and will render the printer as non-serviceable.

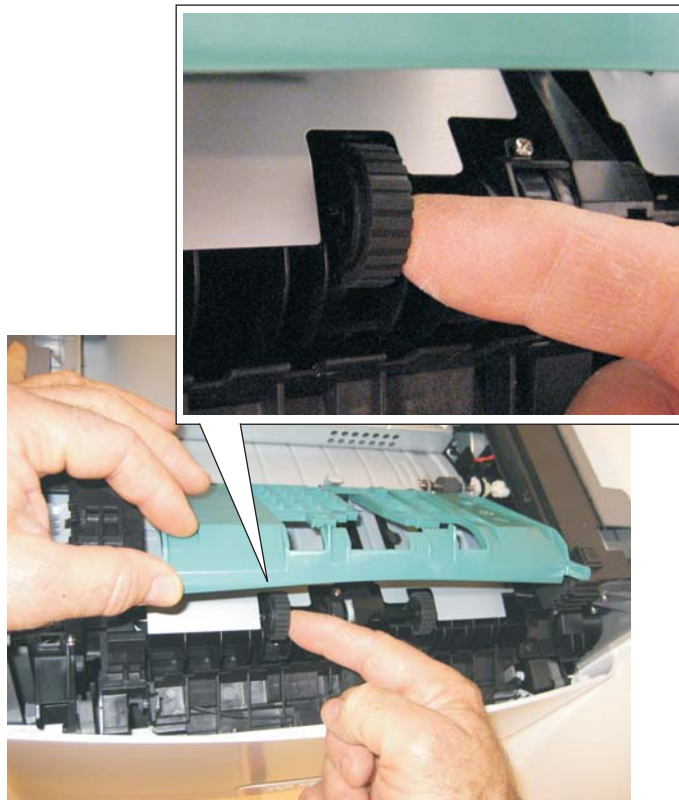

3. After the ACM pick tires have been pulled out, close the duplex door.

**4.** Remove the ACM pick tire roller (A).

**Note:**

- If the left hub is gray, then disconnect the old right and left tire/hub assemblies from the ACM, and replace with the new right and left tire/hub assemblies.
- If the left hub is black, then remove the old right and left tires from the ACM hubs, and replace with the new tires. Do not attempt to remove the hubs.

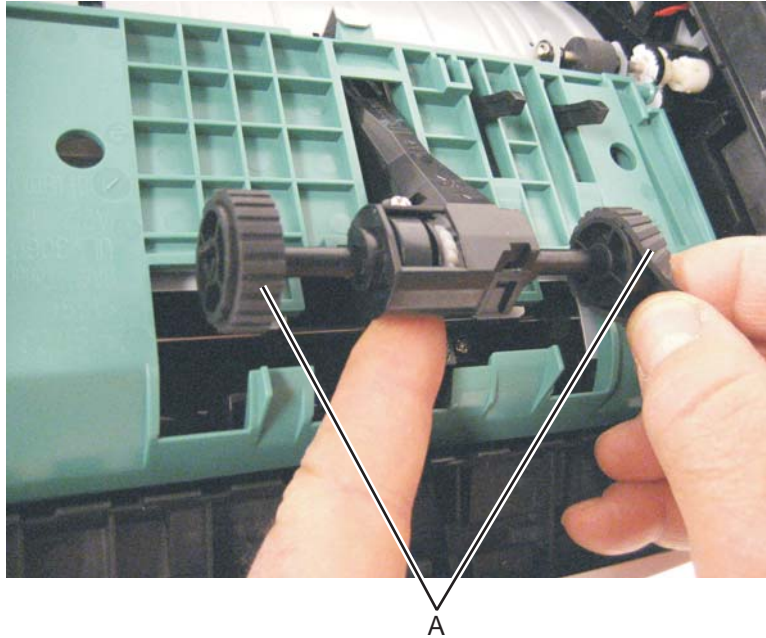

## Bezel removal

1. Open the front access door.
2. Flex the top of the bezel, and disconnect the latch (A) from the upper front cover.



A

3. Disconnect the bezel from the upper front cover.



4. Remove the bezel.

## Controller board removal



### CAUTION

This product contains a lithium battery. THERE IS A RISK OF EXPLOSION IF THE BATTERY IS REPLACED BY AN INCORRECT TYPE. Discard used batteries according to the battery manufacturer's instructions and local regulations.

### Warning:

- Always touch a ground before touching the board.
  - Handle the board carefully by the edges.
  - Never replace the operator panel and controller board without a successful POR in between.
  - Never replace the operator panel and the controller board at the same time. Each card contains the printer settings. When either of these cards is new, it obtains its settings from the other card. Critical factory settings are lost when both cards are new and are replaced at the same time.
1. Remove the right side cover. See **“Right side cover assembly removal” on page 3-58.**
  2. Remove the three screws (A) from the USB port.

**Note:** The E460dw printer has a wireless antenna and does not have a parallel port.

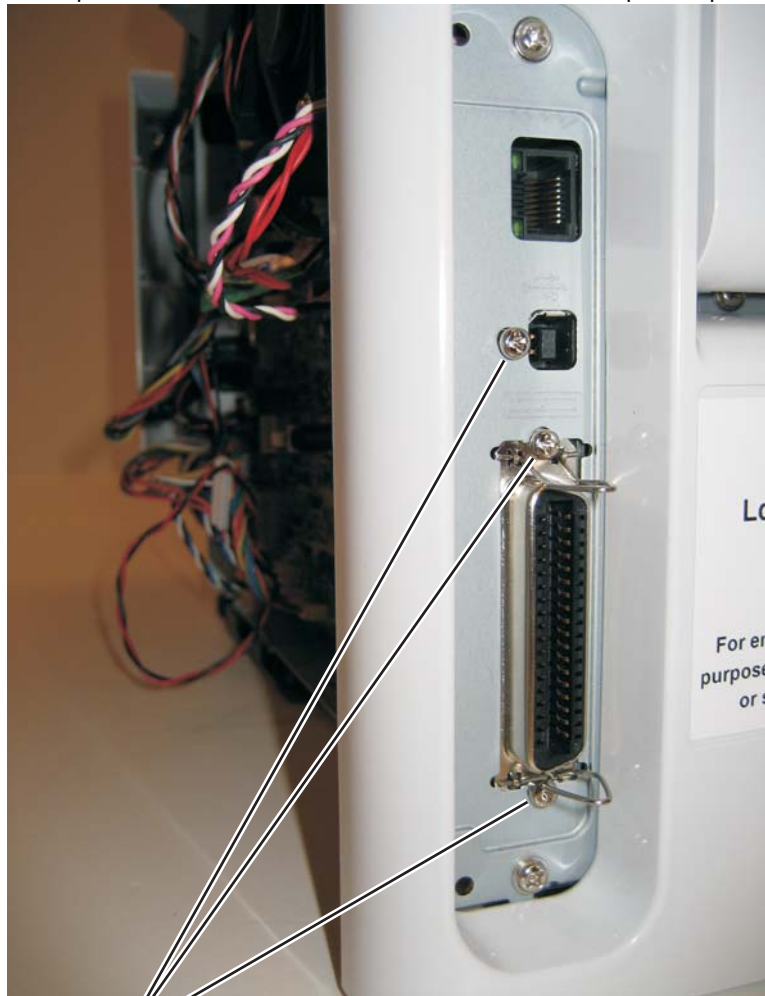

A

3. Disconnect all of the cables from the controller board.

**Note:** A drip guard (B) has been added below the controller board. The drip guard may need to be removed to access to the controller board.

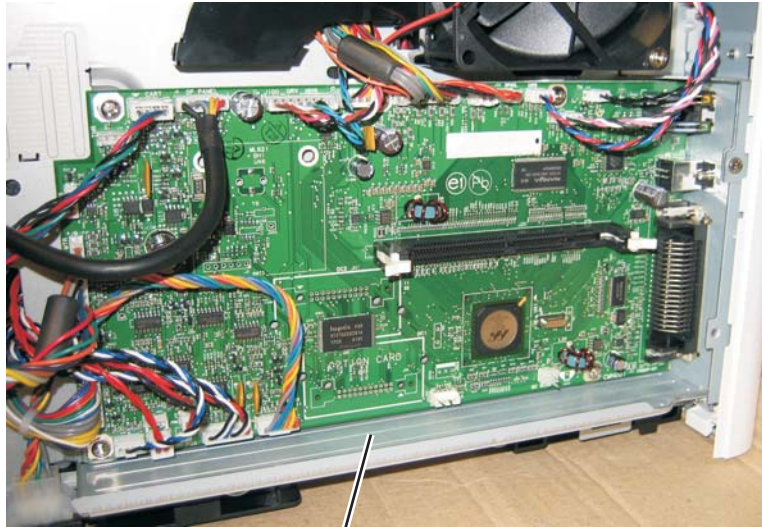

B

4. Remove the five screws (C) from the controller board.

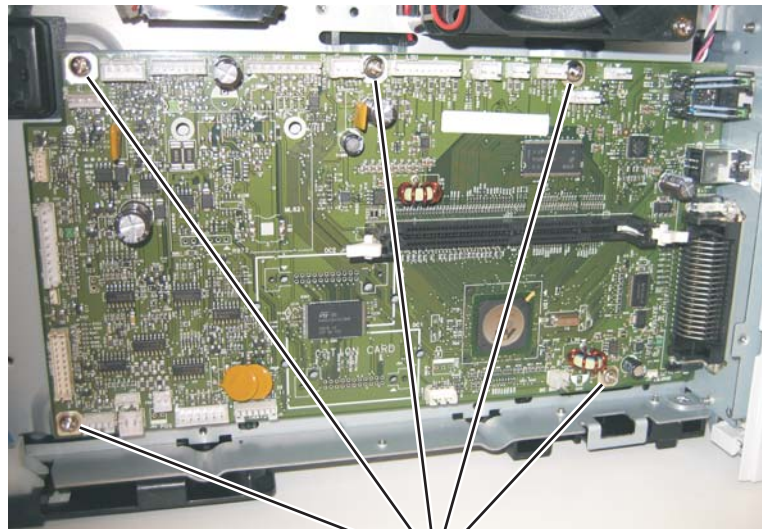

C

5. Lift the controller board, and remove.

**Note:** When installing the controller board, place the USB port and parallel port screws first, and then place the other controller board screws.

## Cover open sensor

1. Remove the right side cover. See **“Right side cover assembly removal” on page 3-58.**
2. Disconnect the cable (A) from the controller board.
3. Use a #1 Phillips screwdriver to remove the screw (B) holding the sensor.

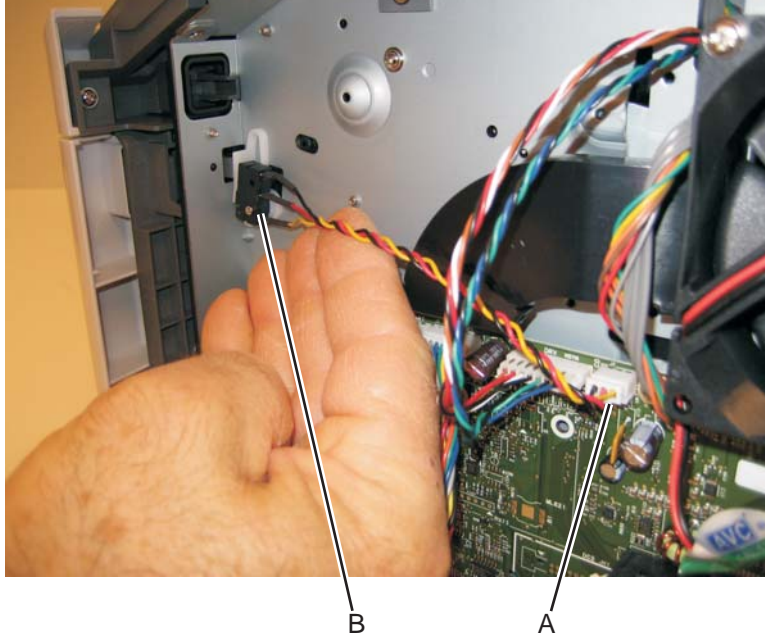

4. Remove the cover open sensor.

## Door mount removal

1. Open the front cover.
2. Remove the lower front cover. See **“Lower front cover removal”** on page 3-26.
3. Remove the left side cover. See **“Left side cover removal”** on page 3-24
4. Remove the right side cover. See **“Right side cover assembly removal”** on page 3-58.
5. Disconnect the operator panel cable (A).

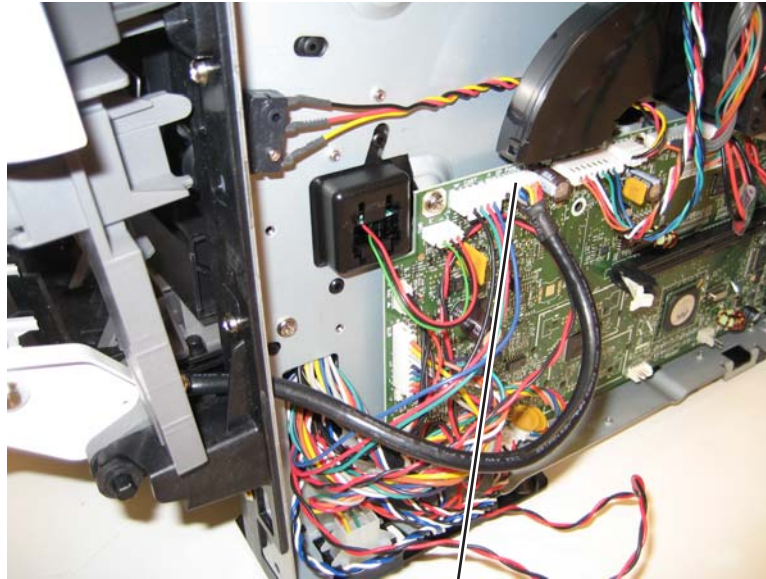

A

6. Remove the cable through the opening.
7. Remove the three screws (B) from the right side of the printer.

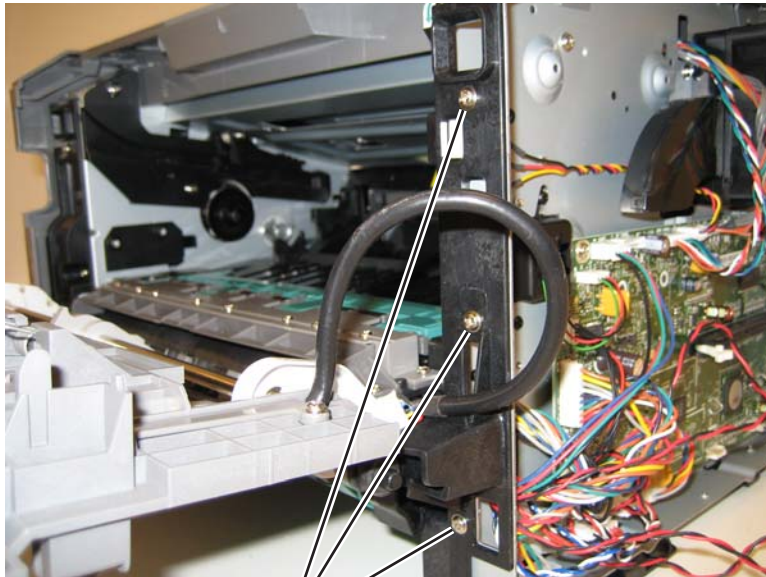

B

8. Disconnect the fuser link (C).

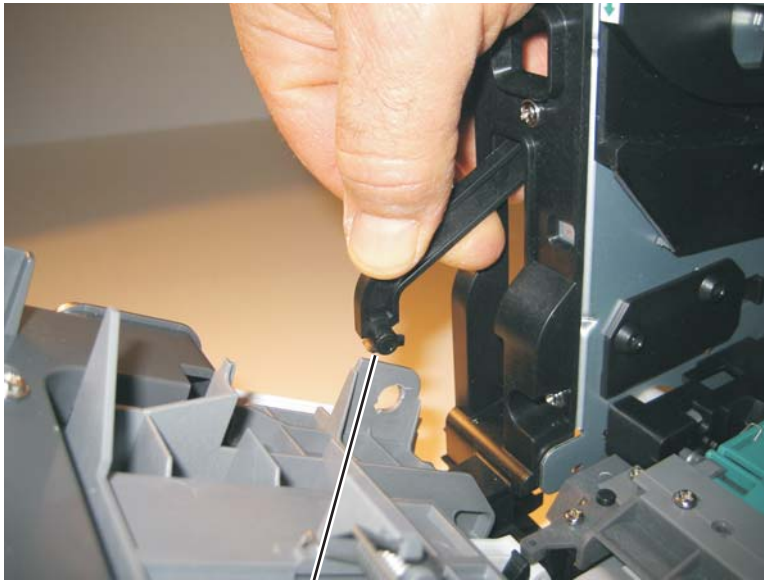

C

9. Remove the three screws (D) from the left side of the printer.



D

10. Remove the door mounts.



## Duplex removal

1. Remove the right side cover. See **“Right side cover assembly removal”** on page 3-58.
2. Remove the LVPS/HVPS. See **“LVPS/HVPS removal”** on page 3-28.
3. Remove the three screws (A) from the shield.

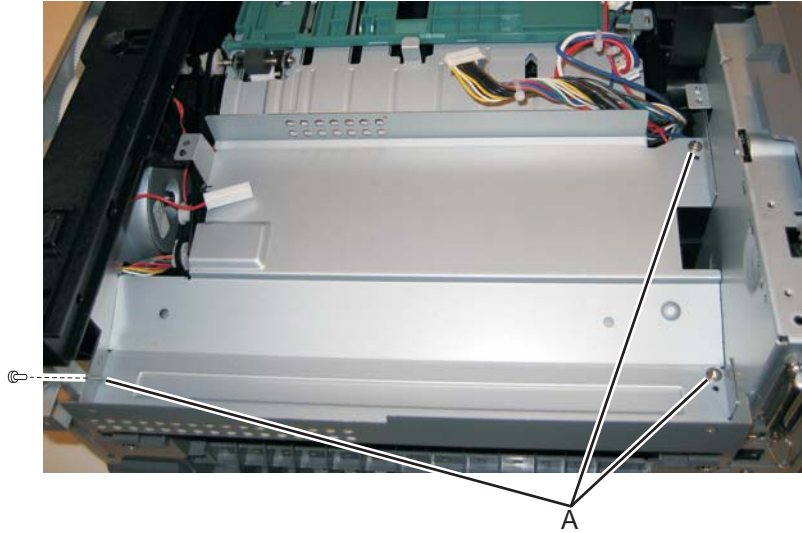

4. Remove the four screws (B) from the duplex.

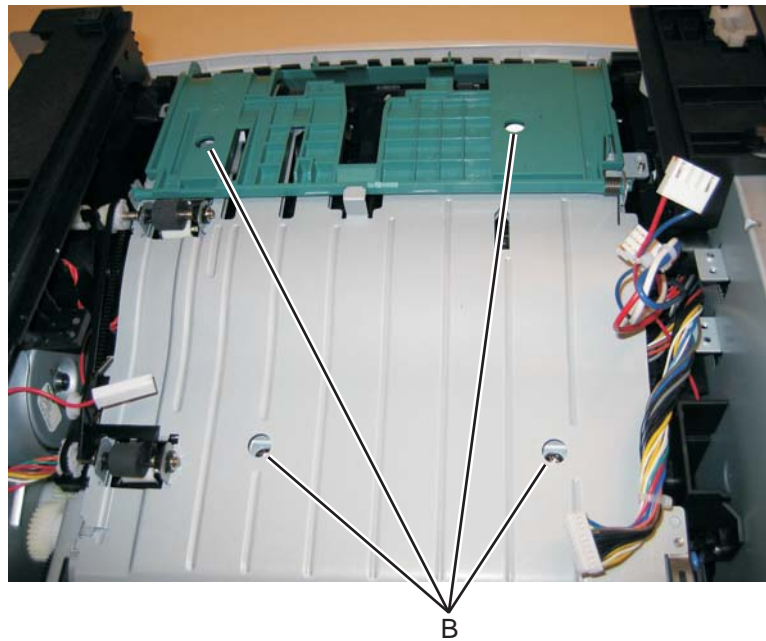

5. Lift the duplex slightly, push to the left, and tilt to clear the right side of the printer.



6. Remove the duplex.

## Duplex/main motor gear drive interface removal

1. Remove the LVPS/HVPS. See **“LVPS/HVPS removal”** on page 3-28.
2. Remove the duplex. See **“Duplex removal”** on page 3-11.
3. Remove the main motor gear drive. See **“Main motor gear drive removal”** on page 3-31.
4. Remove the e-clip (A) from the gear.

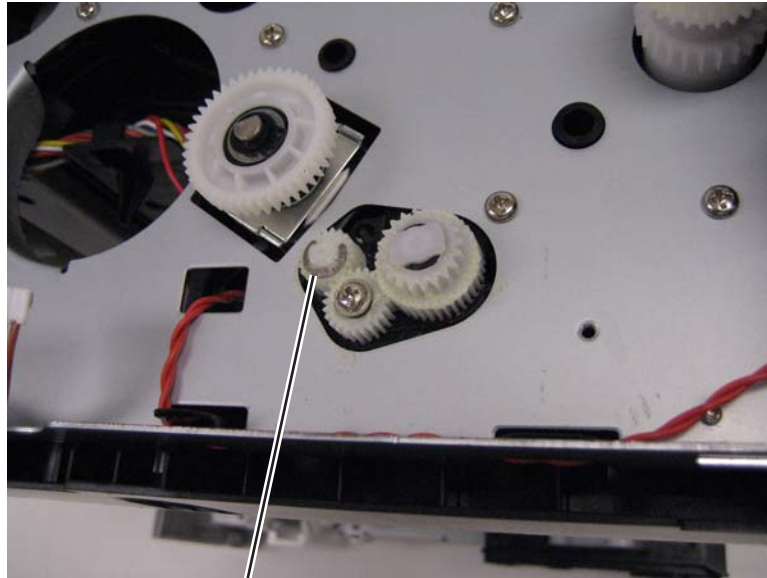

A

5. Remove the gear (B) and gear shaft (C).

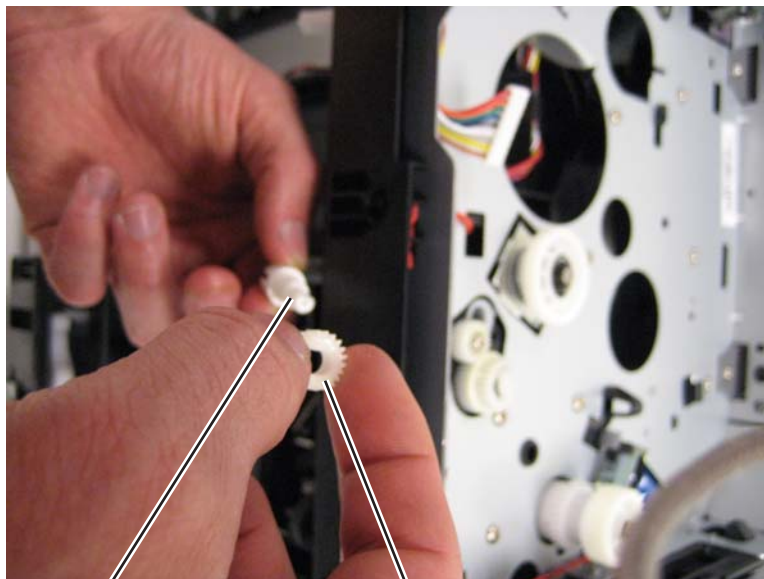

C

B

6. Remove the screw (D) from the gear (E).

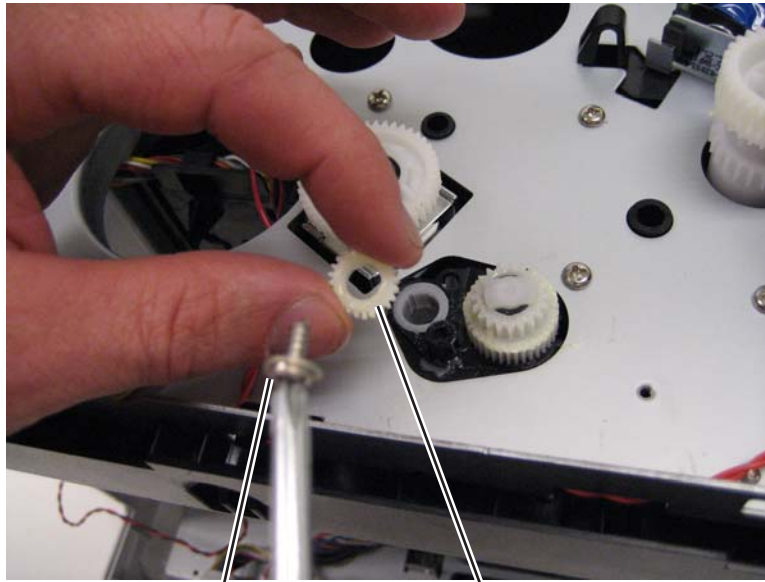

D

E

7. Remove the plastic bushing (F).

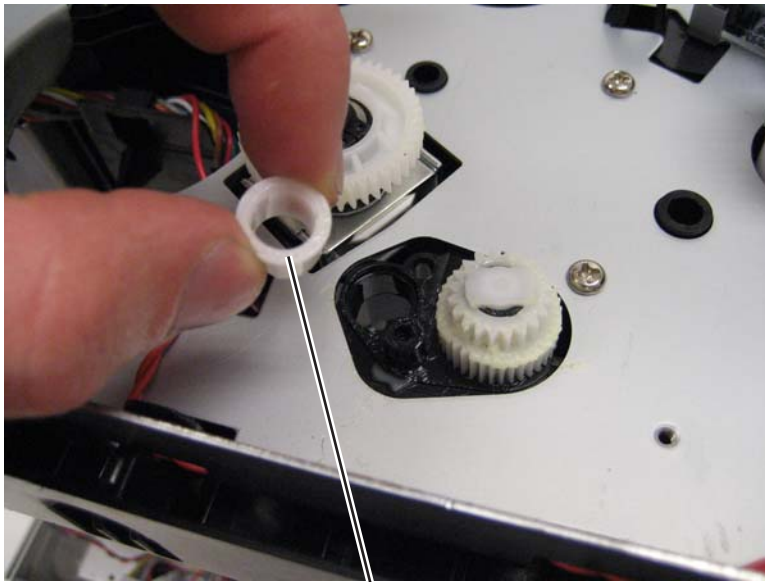

F

8. Use a screwdriver to pop the retainer clip (G) loose from the gear.

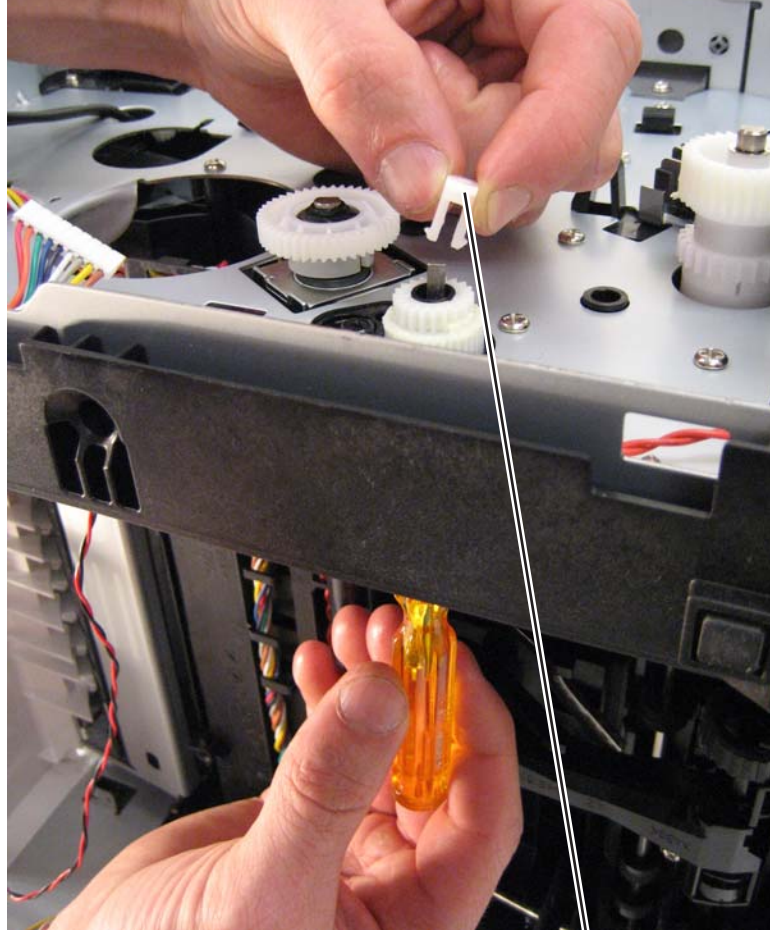

G

9. Remove the gear (H).

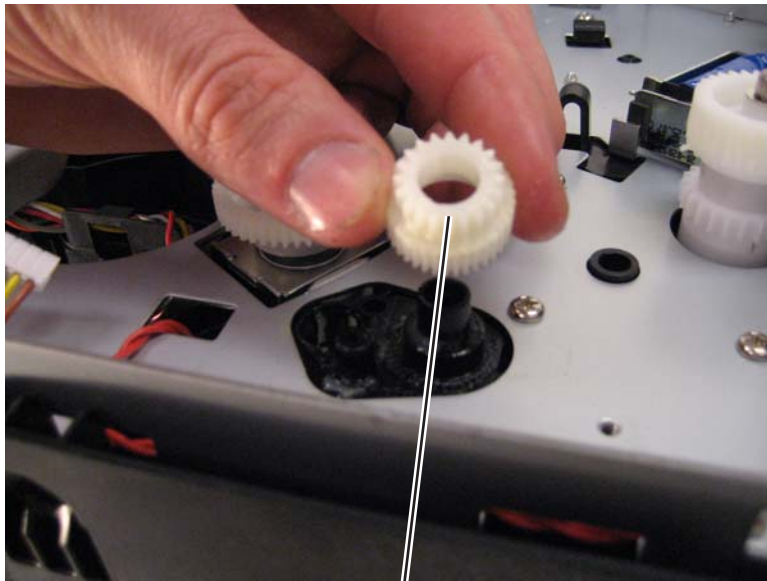

H

## Fan removal

1. Remove the right side cover. See **“Right side cover assembly removal” on page 3-58.**
2. Disconnect the cable (A) from the controller board, and remove the two screws (B) holding the fan to the right side frame.

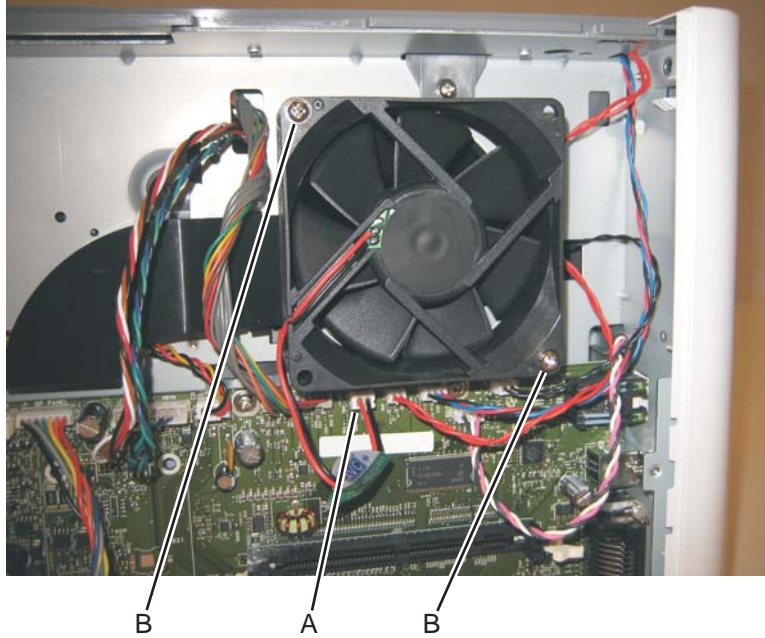

3. Remove the fan.

## ***Front access door removal***

1. Remove the operator panel. See **“Operator panel removal”** on page 3-51.
2. Remove the left side cover. See **“Left side cover removal”** on page 3-24.
3. Remove the upper front guide assembly. See **“Upper front guide assembly removal”** on page 3-64, steps 1-3.
4. Close the front access door.
5. While closing the MPF cover, pull up on the MPF by the steel shaft until the MPF lifts from its hinges.



6. Disconnect the MPF from the lower front cover.

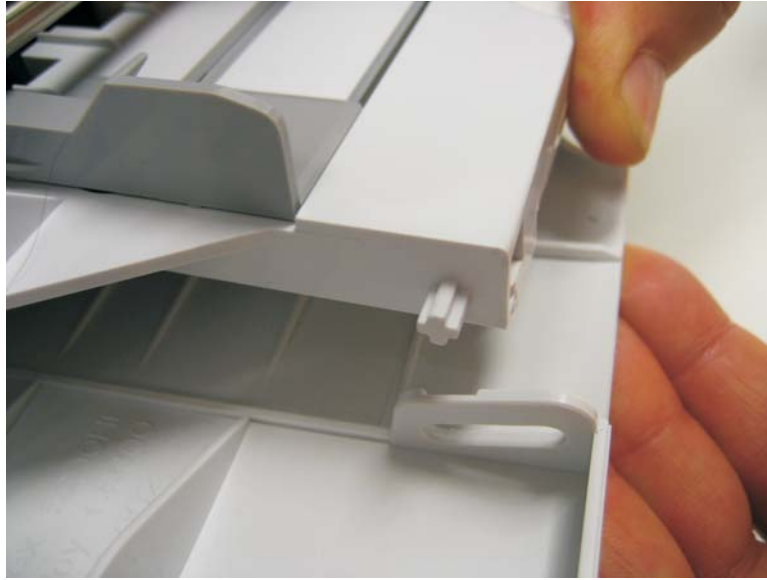

7. Disconnect the fuser link (A) from the front access door.

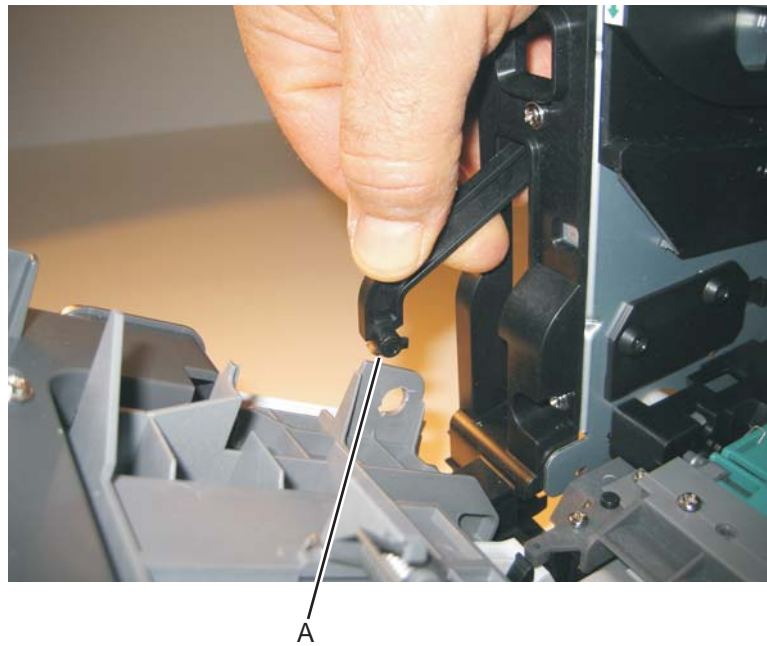



8. Disconnect the front access door cable (B), and pull it through the opening to clear the side frame.

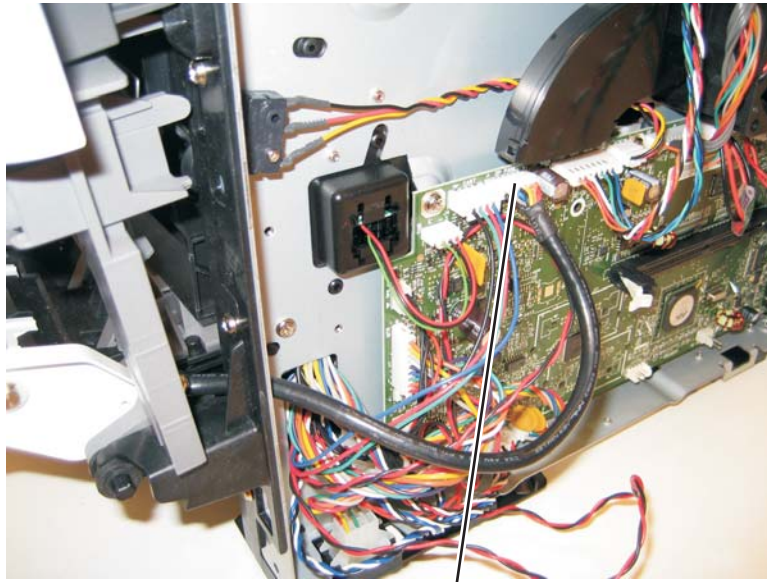

B

9. Disconnect the front access door from its hinges, and remove.

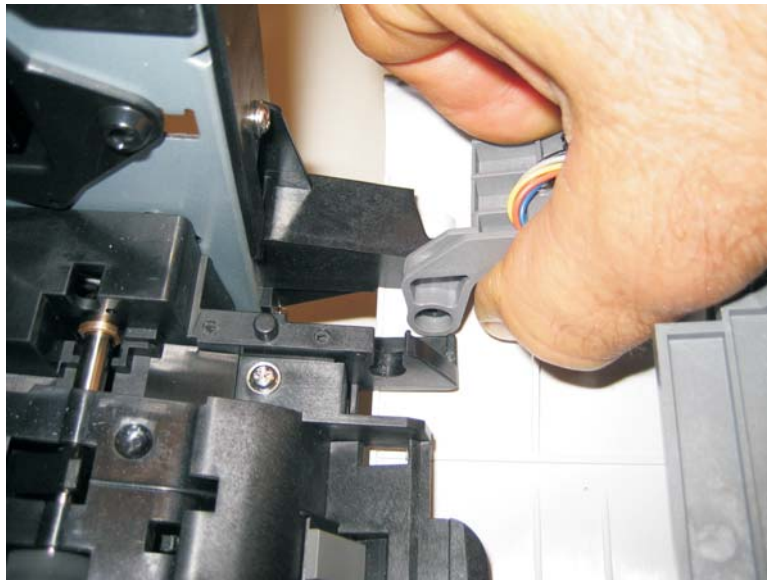

**Installation note:**

- a. Install a new front access door at its hinges.
- b. Push the cable (C) through the side frame and into the controller board area.
- c. Connect the fuser link.
- d. Remove the two screws (D).
- e. Slide the latch to the left to free it, and then rest it on the door. Keep the spring in place.
- f. Remove the two screws (E), and lift off the cable cover.
- g. Connect the operator panel to the cable, and pull the cable through the front access door until the operator panel can be held lightly with the four screws (F).

**Note:** Do not over pull the cable.

- h.** Reinstall the cable cover and latch, assuring that the tab (G) is in place.
- i.** Pull all the excess cable through the frame opening at the hinge and into the controller board area.
- j.** Connect the cable to the controller board and loop it so that the closing and opening of the front access door does not cause bending.
- k.** Finish tightening the screws (F), and reinstall the remaining parts.

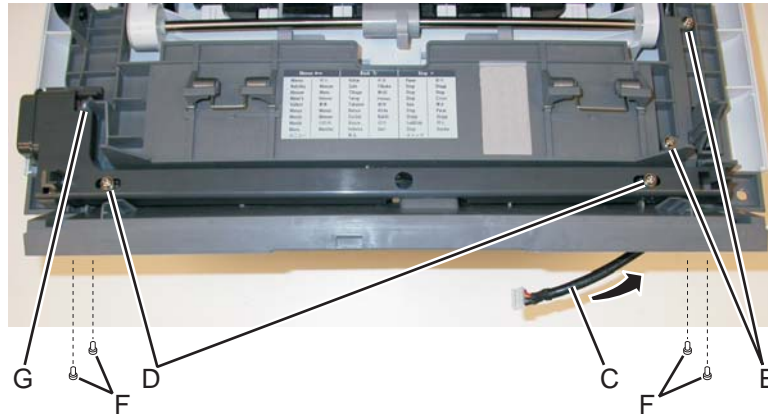

## Fuser removal



1. Remove the rear exit guide. See **“Rear exit guide assembly with sensor and reversing solenoid removal” on page 3-56.**
2. Remove the two screws (A).

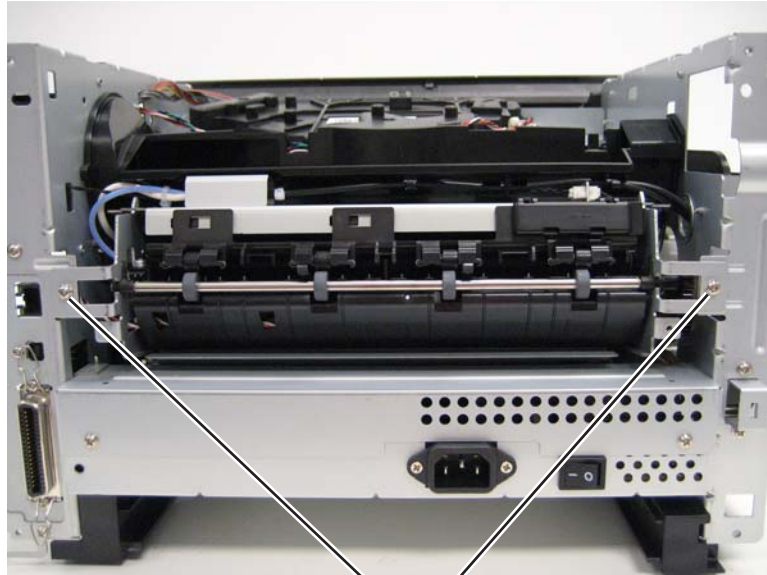

A

3. Partially pull the fuser forward for better access.

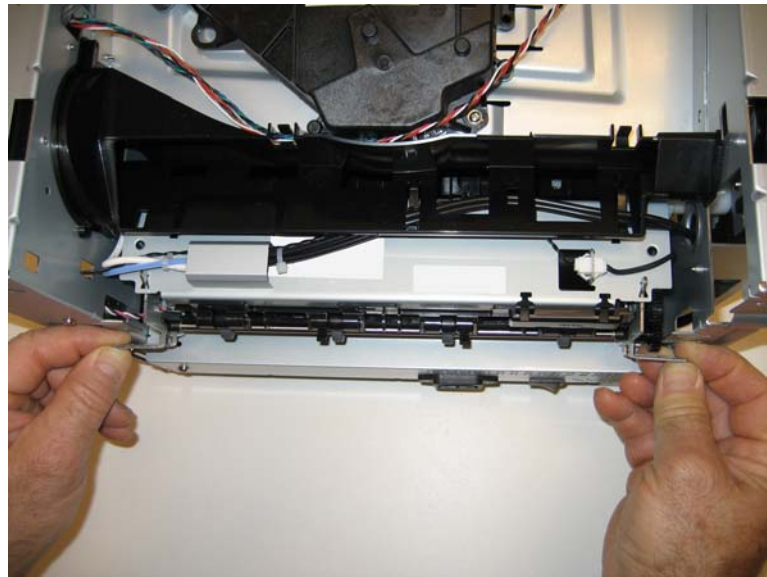

4. Push in on the cable connector cover (B), and remove.

5. Disconnect the AC cable (C).

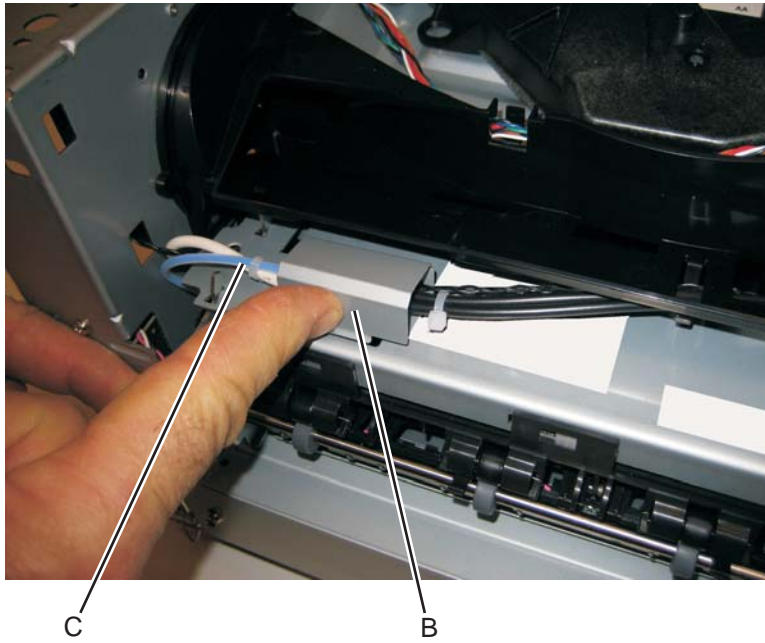

6. Disconnect the thermistor cable (D).

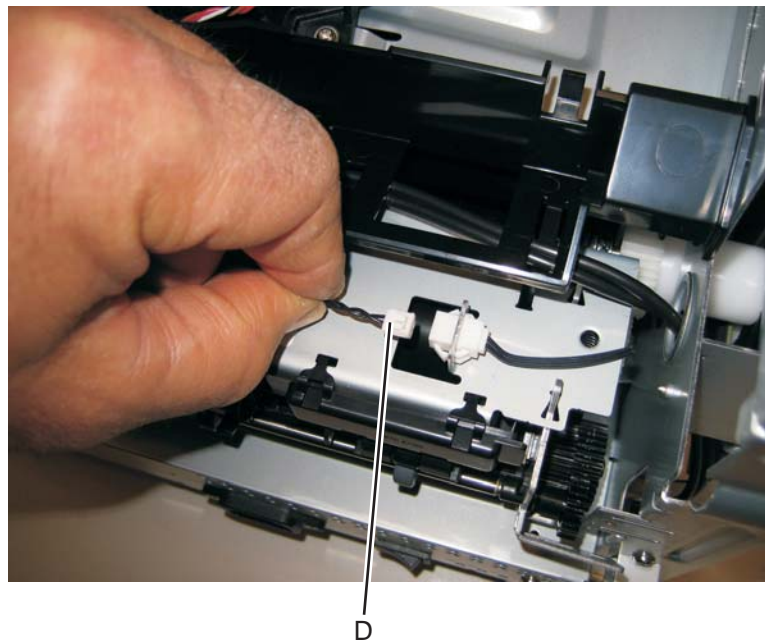

7. Disconnect the exit sensor cable (E) from the controller board.

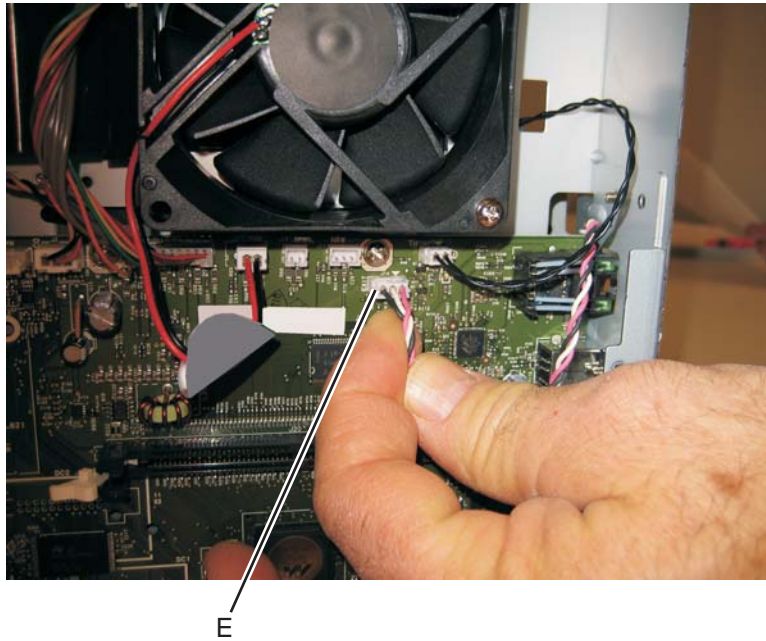

8. Remove the fuser.

**Note:**

- Be careful to not damage the gears during the fuser installation.
- Be sure to reinstall the AC cable during the fuser installation.

## Left side cover removal

**Note:**

- Leave the front door closed when removing the left side cover.
  - Make sure that the fuser cables are out of the way when removing the left side cover.
1. Remove the paper tray.
  2. Remove the screw (A) from the rear left side of the printer.

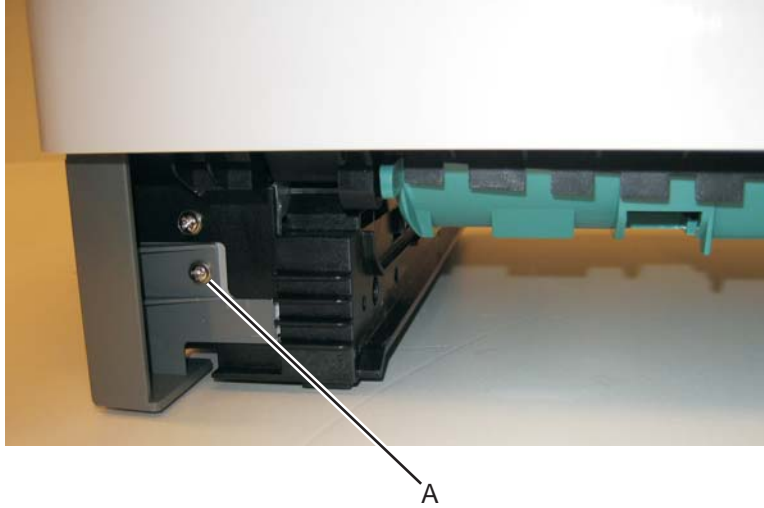

3. Remove the screw (B), and press the two latches (C) on the bottom of the left side cover.

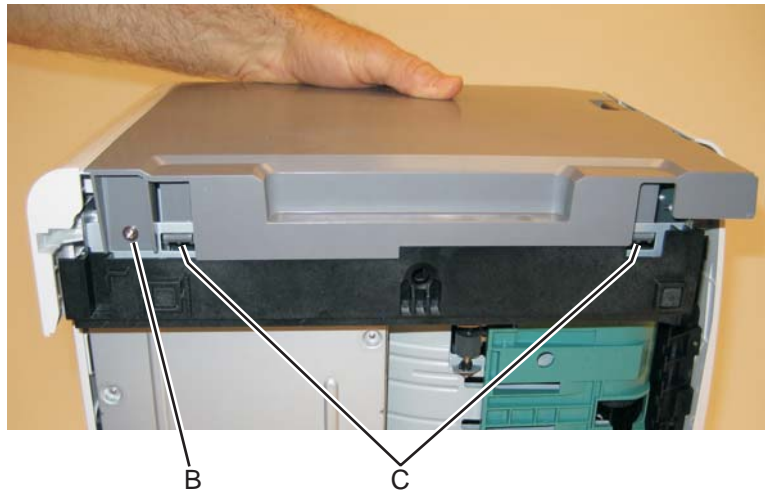

4. Swing the cover open, and lift to remove the left side cover.



## ***Lower front cover removal***

1. Open the lower front cover.
2. Disconnect the MPF pins (A) from the right and left sides of the lower front cover.

**Note:** The picture below shows the E260d, E260dn printer. The lower front cover removal is the same for all models.

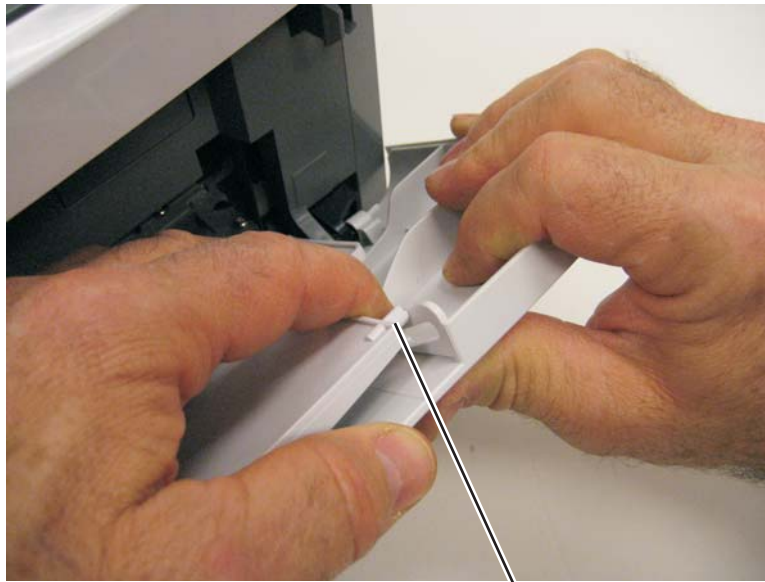

3. Flex the lower front cover, and disconnect it first from its right hinge and then from its left hinge.



**Note:** An alternative to step 3 is to remove the front access door, and remove the three screws from the right door mount. See **“Front access door removal”** on page 3-17 and **“Door mount removal”** on page 3-9.



**Installation note:** Use a flathead screw driver to press in on the door mount (B) while pulling on the front access door to connect the cover to the hinge (C).

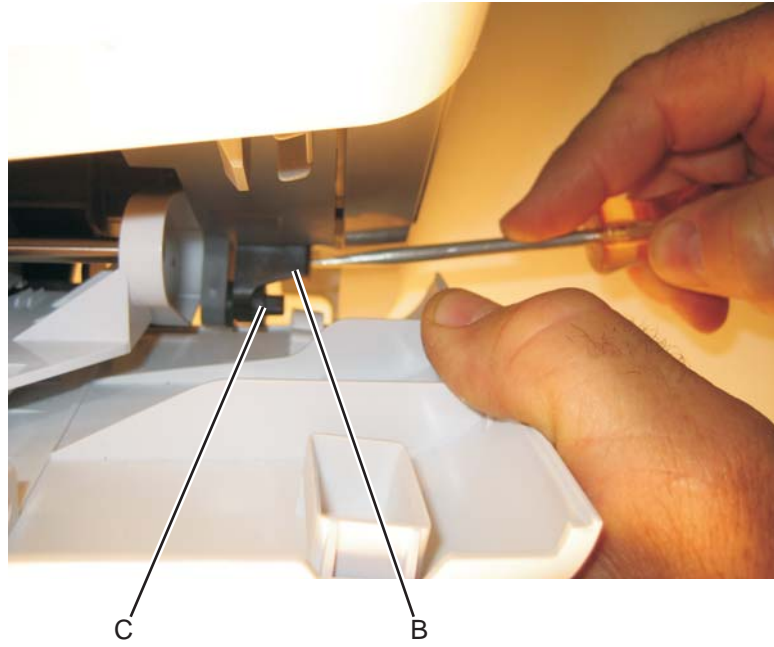

## LVPS/HVPS removal



1. Remove the rear door cover. See **“Rear door and rear cover removal”** on page 3-54.
2. Remove the left side cover. See **“Left side cover removal”** on page 3-24.
3. Place the printer on its top with the rear facing you.

**Note:** Be careful to not mar the finish of the printer.

4. Remove the two screws (A) from the right rear foot assembly.

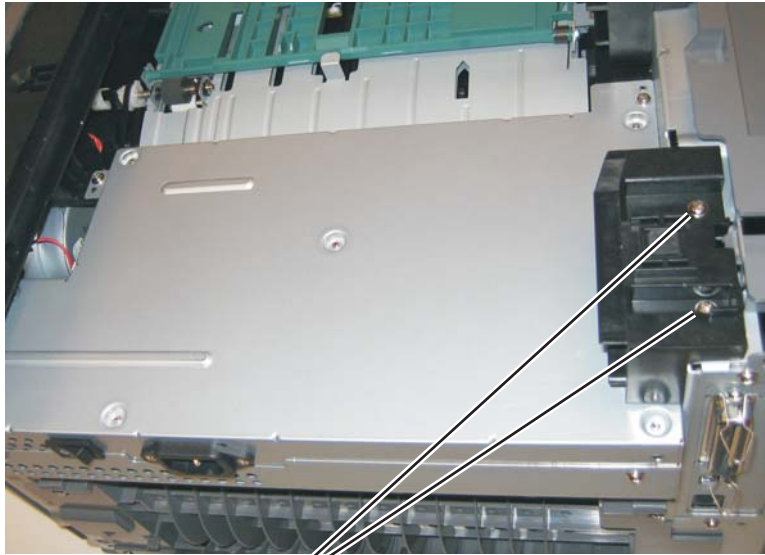

A

5. Disconnect the fuser power cable (B).



B

6. Remove the four screws (C) from the LVPS/HVPS shield.

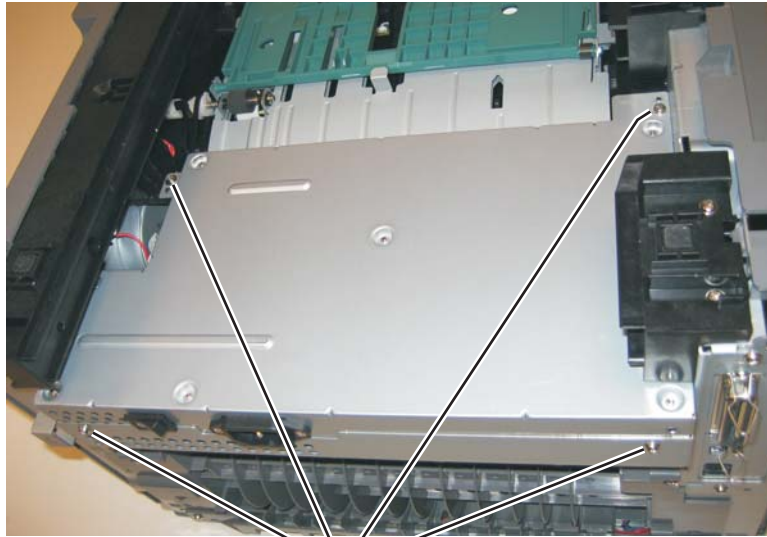

C

7. Lift the LVPS/HVPS, and disconnect the three cables (D).

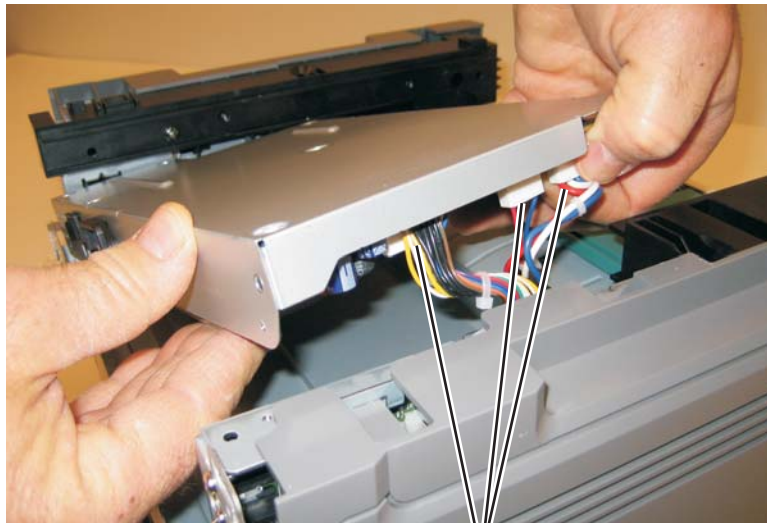

D

**Note:** Squeeze the clip to remove the cables from their connectors (E).

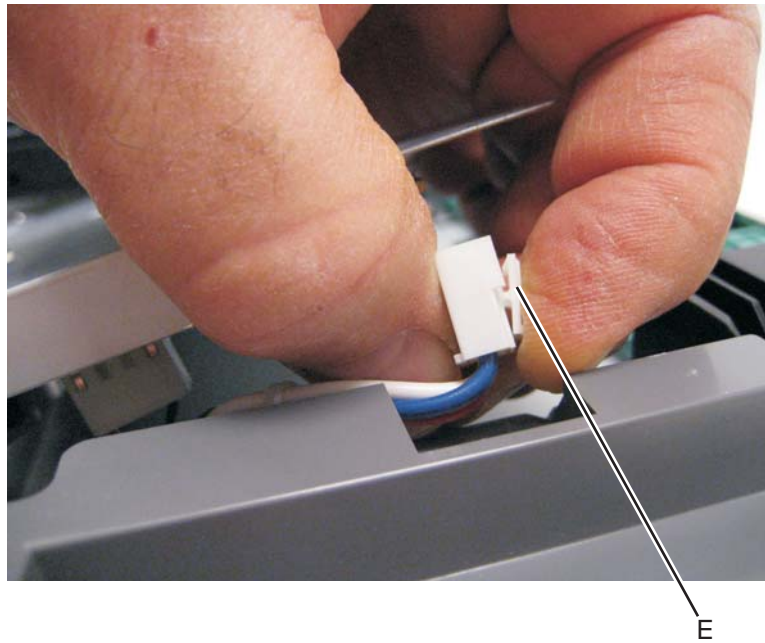

**8.** Disconnect the transfer roll cable (F).

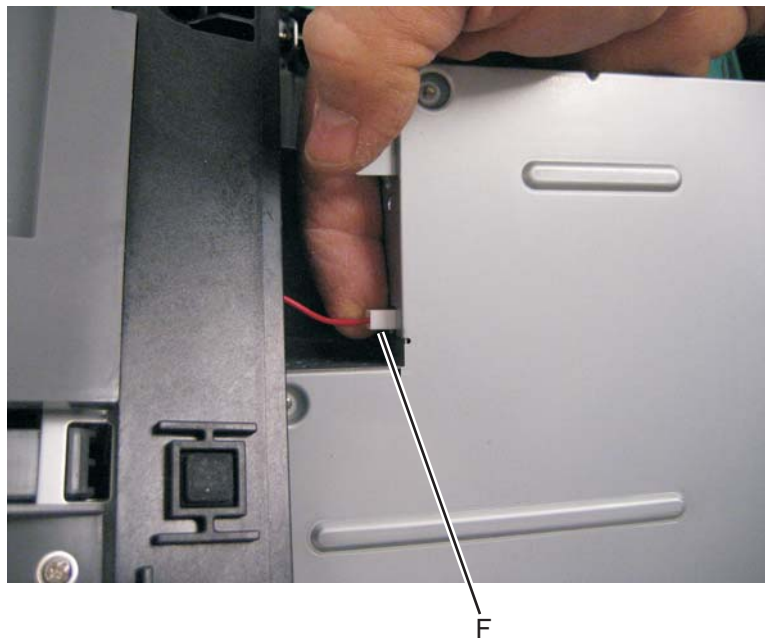

**9.** Lift and remove the LVPS/HVPS.

## Main motor gear drive removal

1. Remove the left side cover. See **“Left side cover removal”** on page 3-24.
2. Disconnect the fuser link (A) from the front access door.

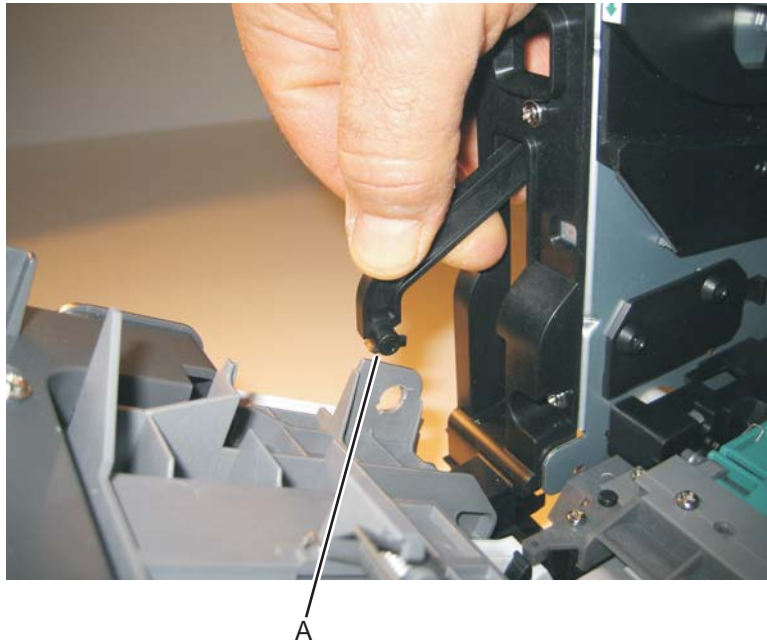

3. Place the printer on its right side.
- Note:** Be careful to not mar the finish of the printer.
4. Remove the four screws (B) from the main motor gear drive.

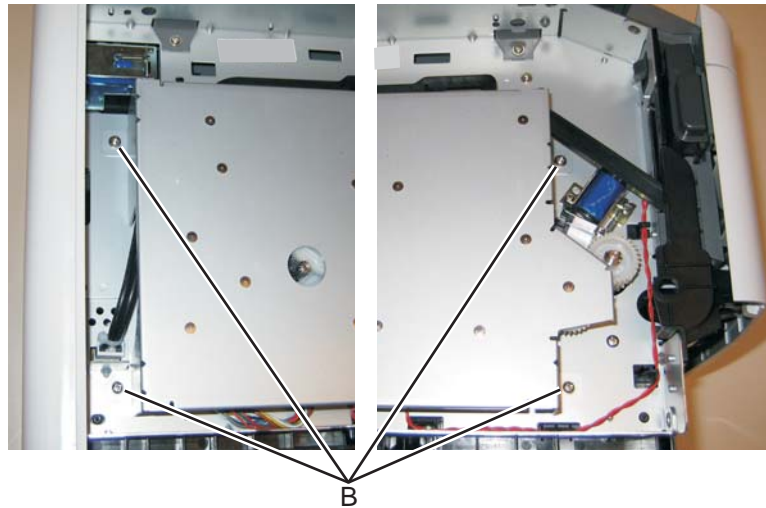

5. Lift the gear drive, and disconnect the main motor gear drive cable (C).

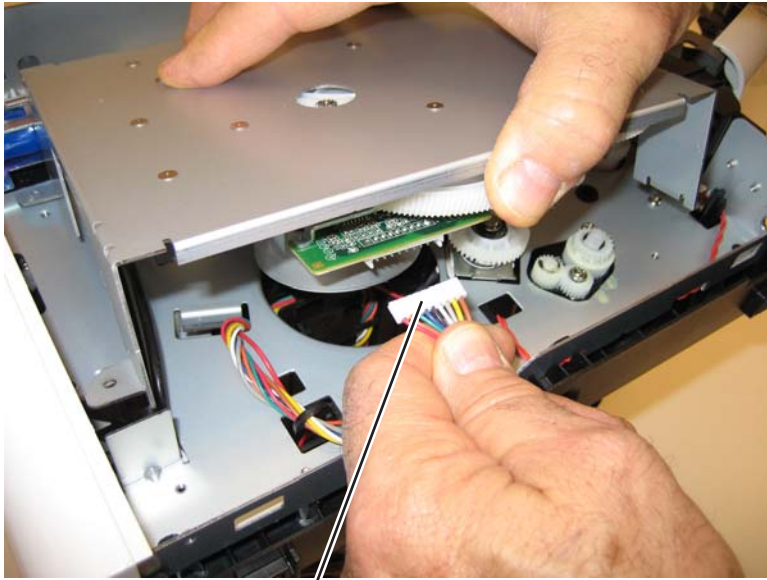

C

6. Remove the main motor gear drive.

## Manual feed clutch removal

1. Remove the left side cover. See **“Left side cover removal”** on page 3-24.
2. Open the front access door, and disconnect the fuser link (A).

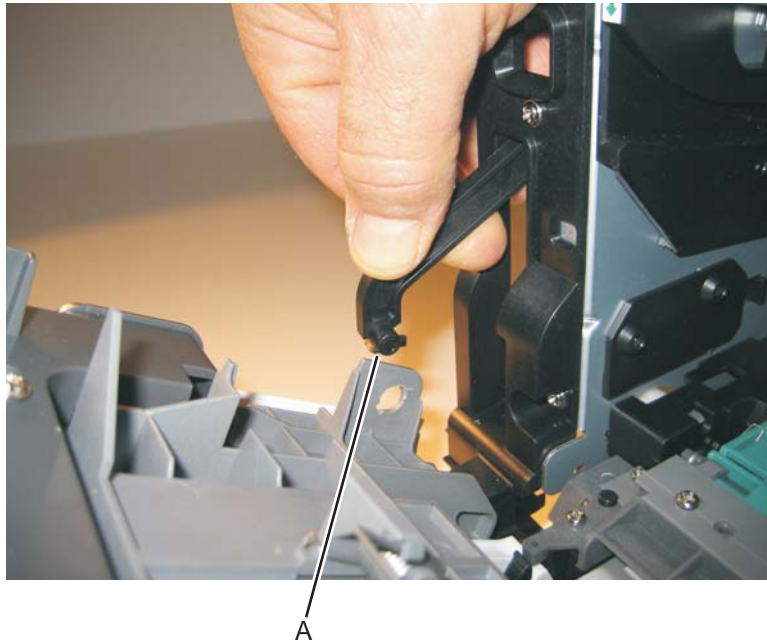

3. Place the printer on its right side.
- Note:** Be careful to not mar the finish of the printer.
4. Remove the four screws (B) from the main motor gear drive.

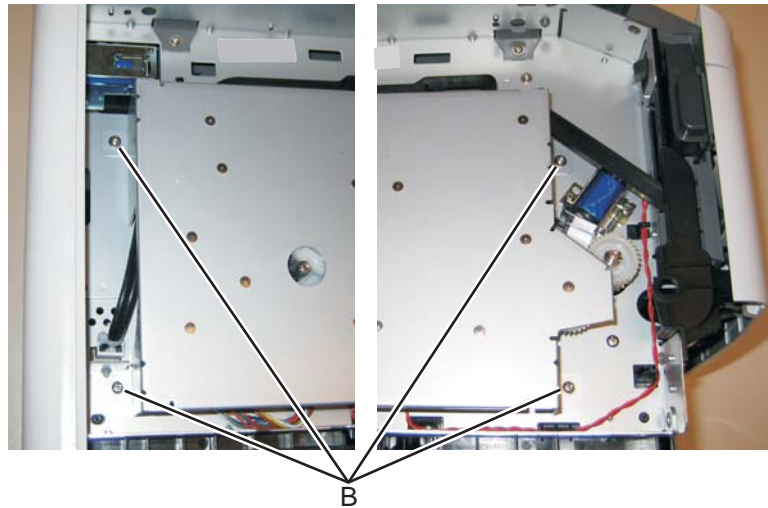

5. Rotate the main motor gear drive enough to access the manual feed solenoid.

**6.** Use a screwdriver to remove the e-clip (C) from the manual feed clutch.

**Note:** The picture below shows the E260d, E260dn printer. The manual feed clutch removal is the same for all models.

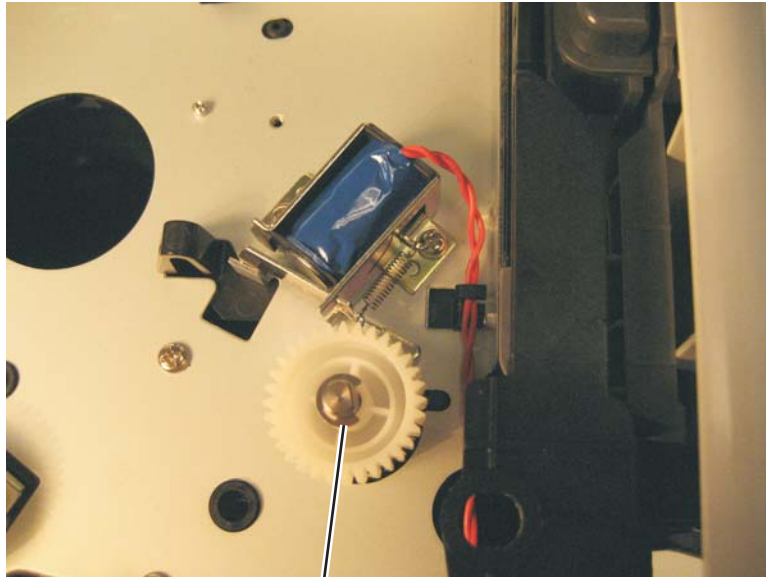

C

**7.** Remove the manual feed clutch (D).

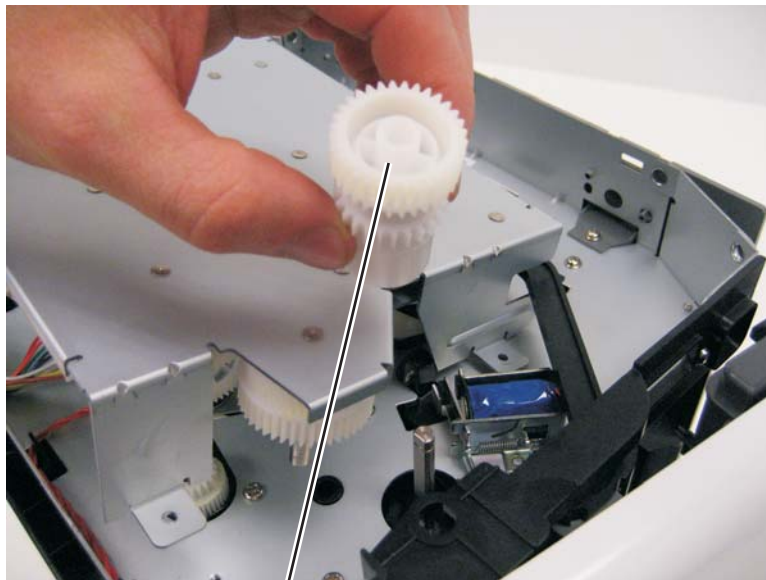

D



## Manual feed solenoid removal

1. Remove the right side cover. See **“Left side cover removal” on page 3-24.**
2. Remove the duplex. See **“Duplex removal” on page 3-11.**
3. Open the front access door, and place the printer on its right side.

**Note:** Be careful to not mar the finish of the printer.

4. Remove the two screws (A).

**Note:** The picture below shows the E260d, E260dn printer. The manual feed solenoid removal is the same for all models.

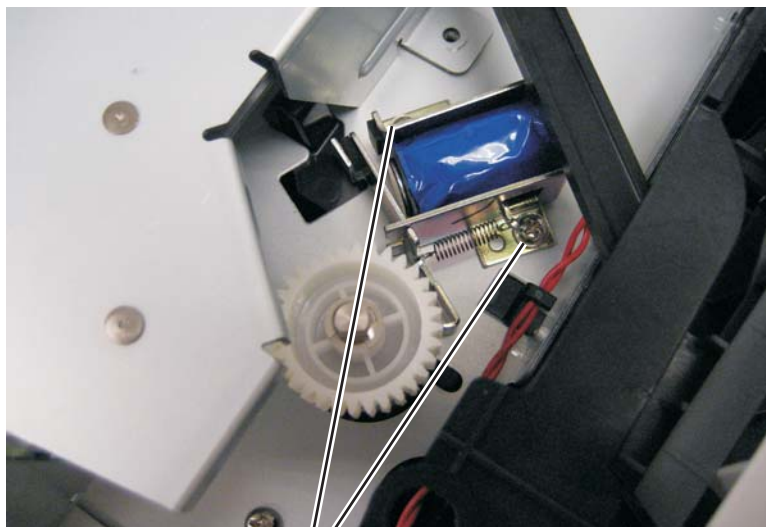

A

5. Remove the three screws (B) from the left door mount.



B

6. Lift the left door mount (C) away from the side frame, and unrout the cable (D) with a spring hook.
7. Reinstall the left door mount, and place the printer on it's top.

**Note:** Be careful to not mar the finish of the printer.

8. Disconnect the cable (D) from J25 on the controller board, and remove the manual feed solenoid.

**Installation note:**

Install the two screws holding the new solenoid in place, and route the cable (D) behind the MPF clutch (E).

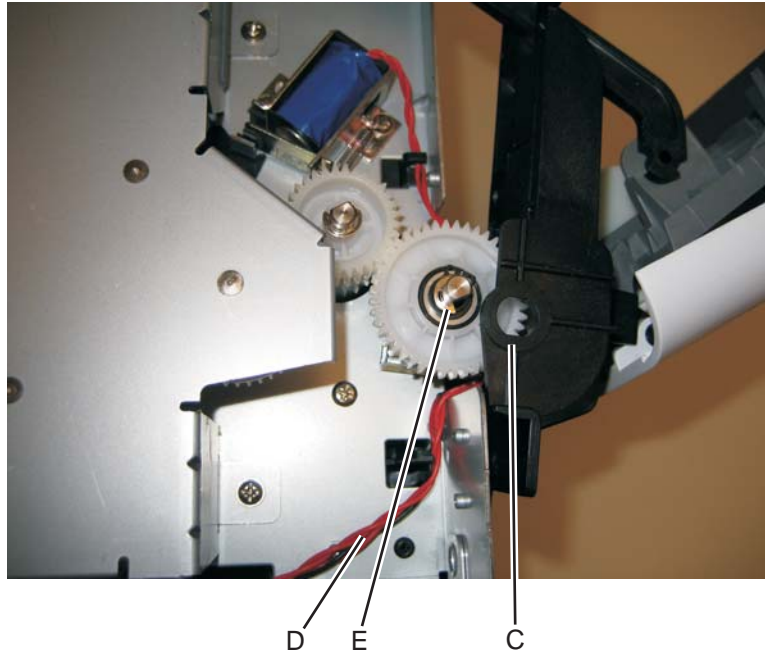

## Media ACM ASM feeder removal

1. Remove the left side cover. See **“Left side cover removal”** on page 3-24.
2. Remove the LVPS/HVPS. See **“LVPS/HVPS removal”** on page 3-28.
3. Remove the duplex. See **“Duplex removal”** on page 3-11.
4. Remove the main motor gear drive. See **“Main motor gear drive removal”** on page 3-31.
5. Remove the media feed clutch. See **“Media feed clutch with cable removal.”** on page 3-40.
6. Use a screwdriver to pop the shaft retainer tab (A) loose from the ACM feed shaft.

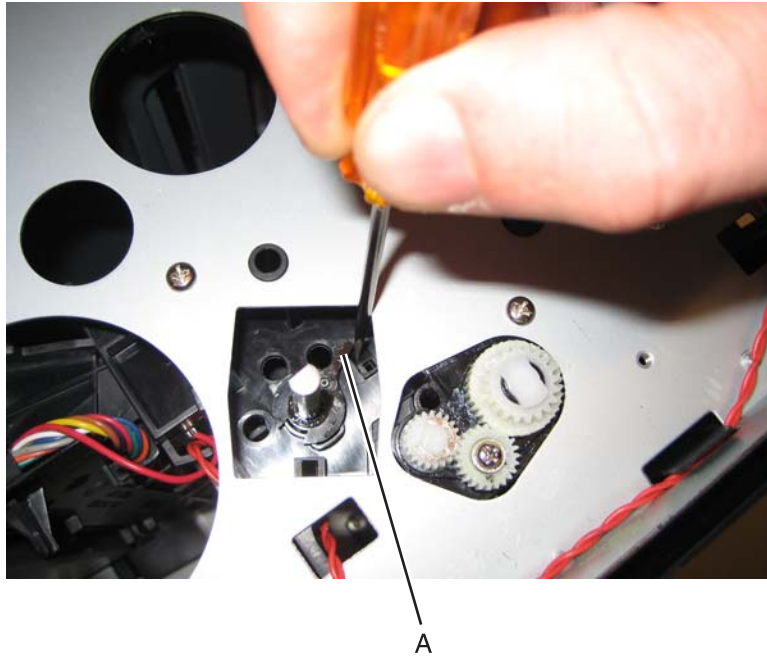

7. Use a small pair of pliers to remove the shaft retainer tab.

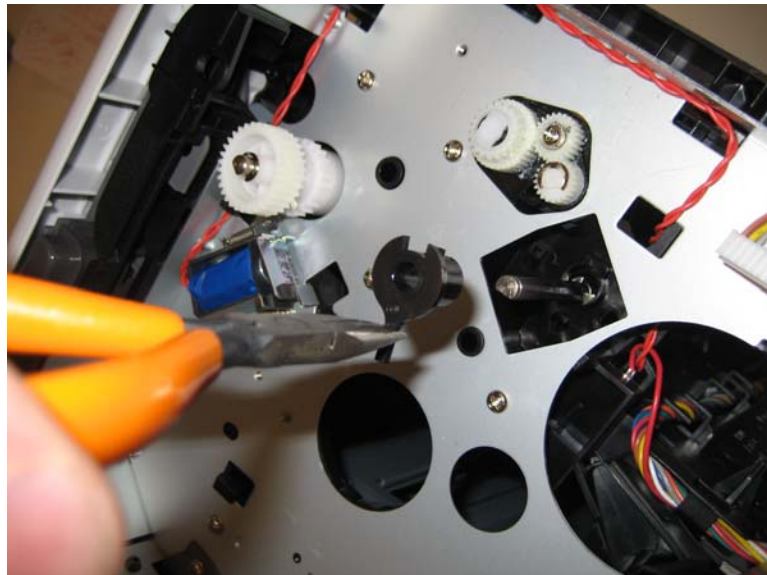

8. Use a screwdriver to pop the inner shaft lock (B) loose.

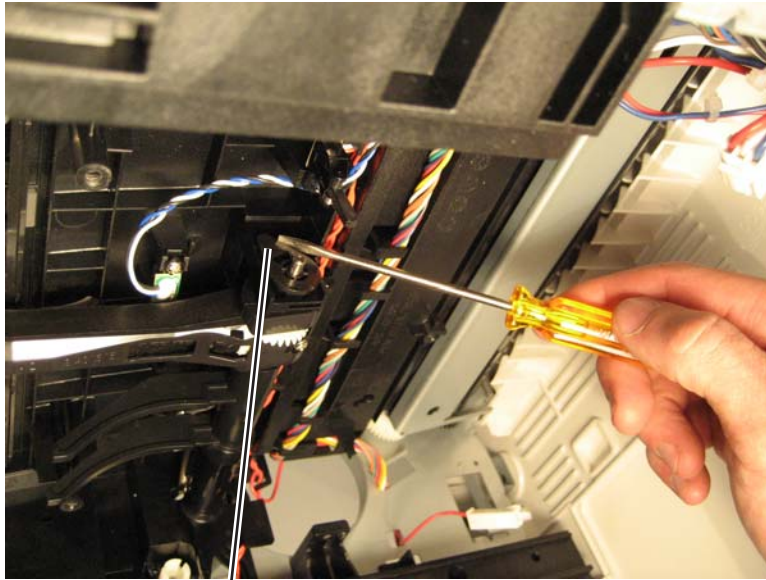

B

9. Remove the inner shaft lock (C).

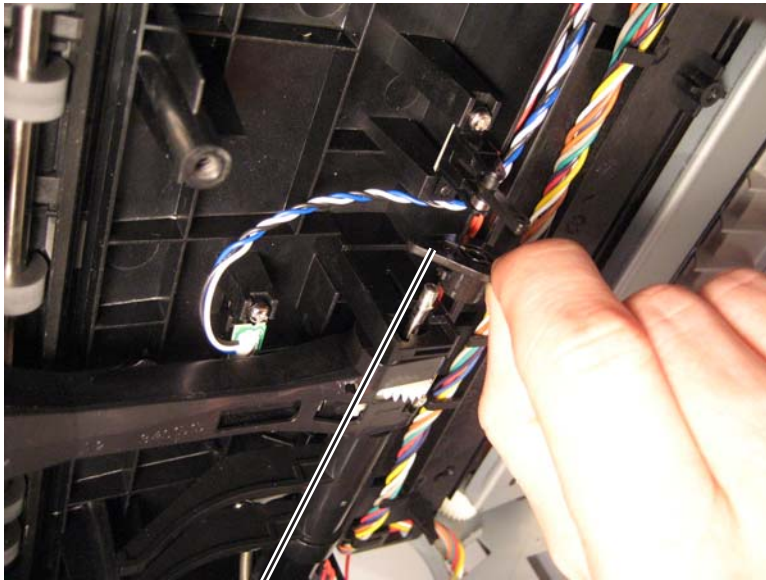

C

- 10.** Pull out the auto compensator shaft, and remove the spring (D).

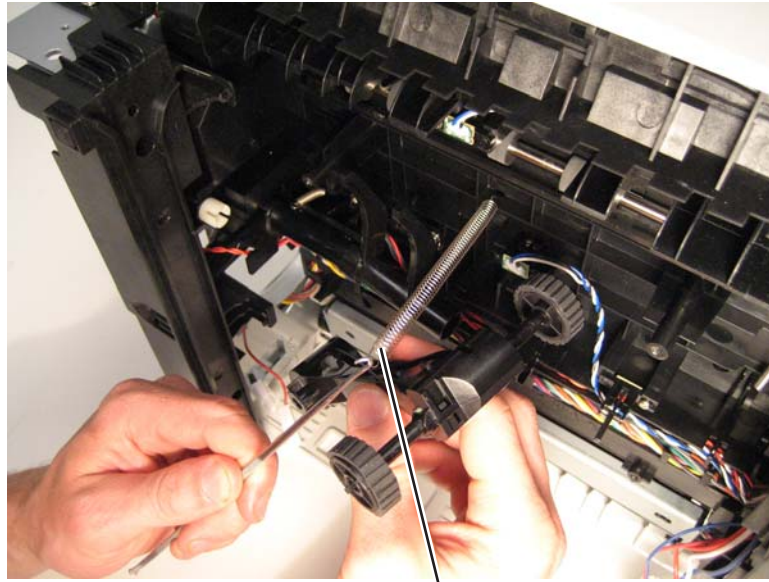

D

- 11.** Remove the auto compensator shaft.  
**12.** Disconnect the spring (E) from the cylinder.

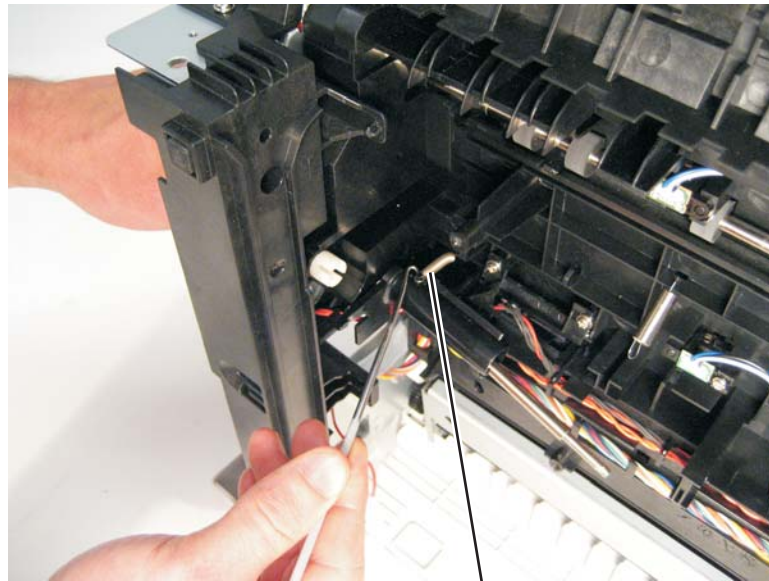

E

- 13.** Remove the media ACM ASM feeder.

### ***Media feed clutch with cable removal.***

1. Remove the main motor gear drive. See **“Main motor gear drive removal”** on page 3-31.
2. Remove the duplex. See **“Duplex removal”** on page 3-11.
3. Disconnect the media feed clutch cable (A) from the controller board.



A

4. Unroute the cable from the bottom of the printer.

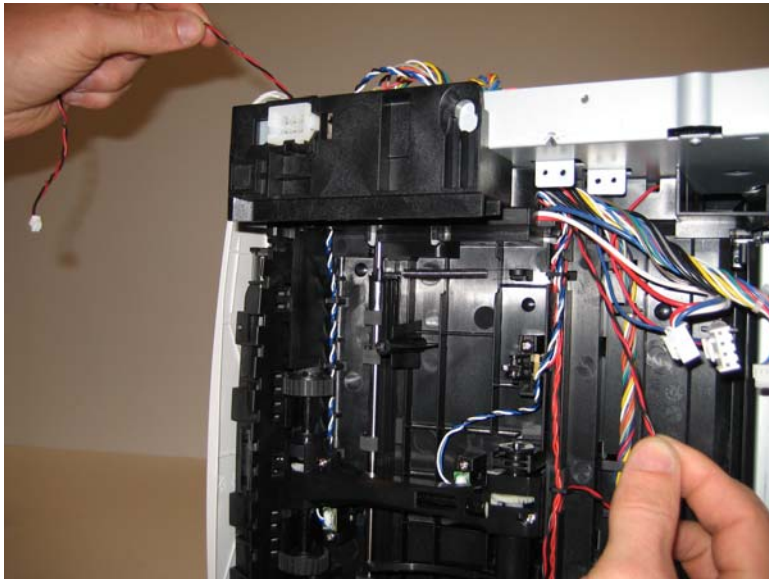

5. Remove the e-clip (B).

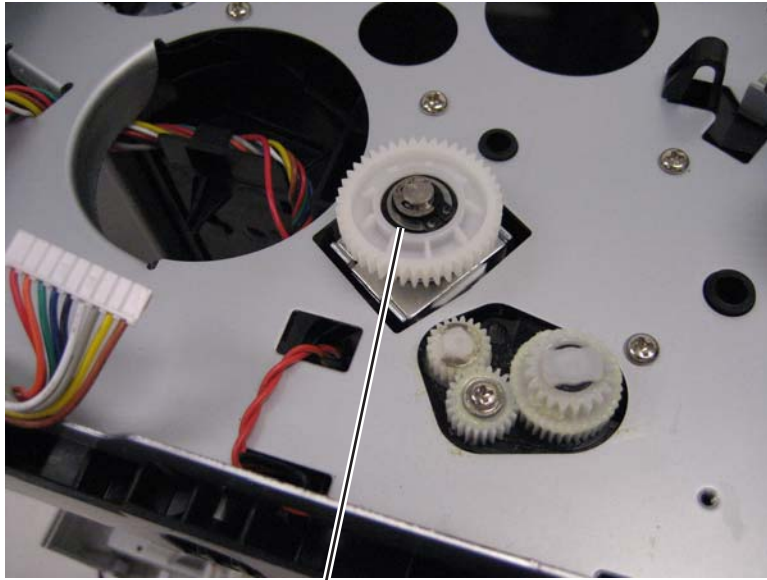

B

6. Remove the media feed clutch with cable (C).

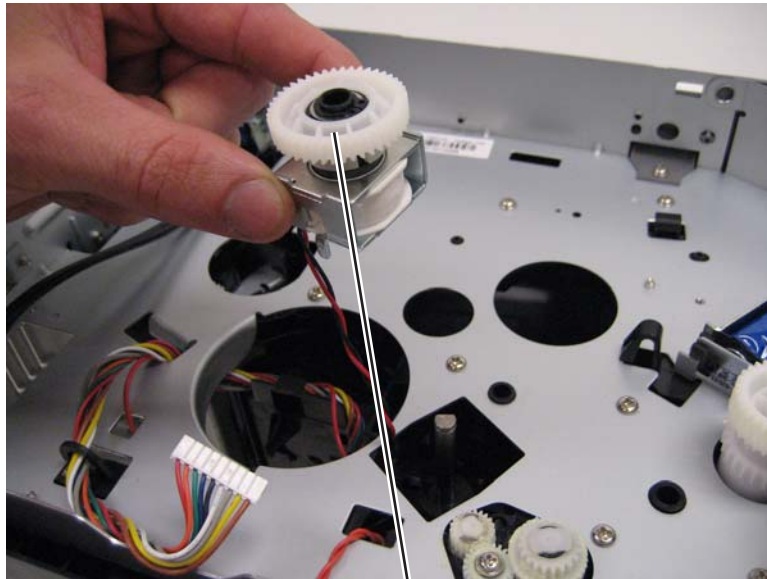

C

## Media manual input sensor removal

1. Remove the right side cover. See **“Right side cover assembly removal”** on page 3-58.
2. Place the machine on its top.

**Note:** Be careful to not mar the finish of the printer.

3. Disconnect the sensor cable (A) from J23 (MPFS) on the controller board.

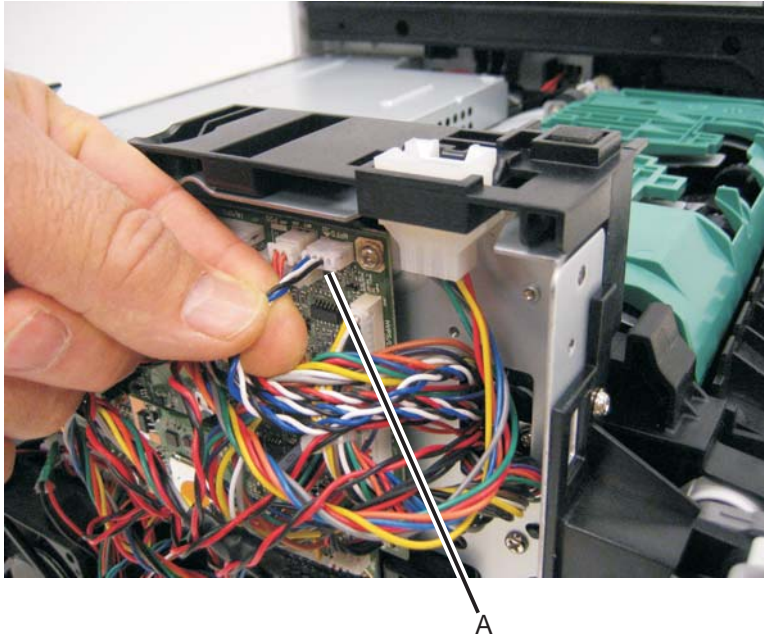

4. Remove the screw (B) holding the sensor.

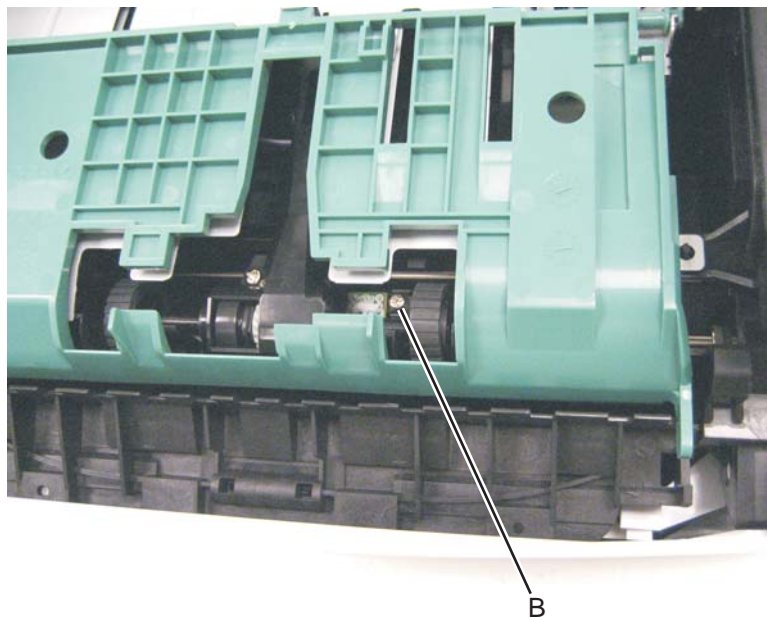

5. Free the cable from its retainers, and pull it through the opening toward the sensor mount.



**Re-installation note:**

- Prop open the duplex door, and insert the hook end of the spring hook through the frame opening (C) from the controller board side. Extend the hook until the sensor connector can be hooked.
- Hook the spring hook (D) to the connector (E), and pull it through the opening.

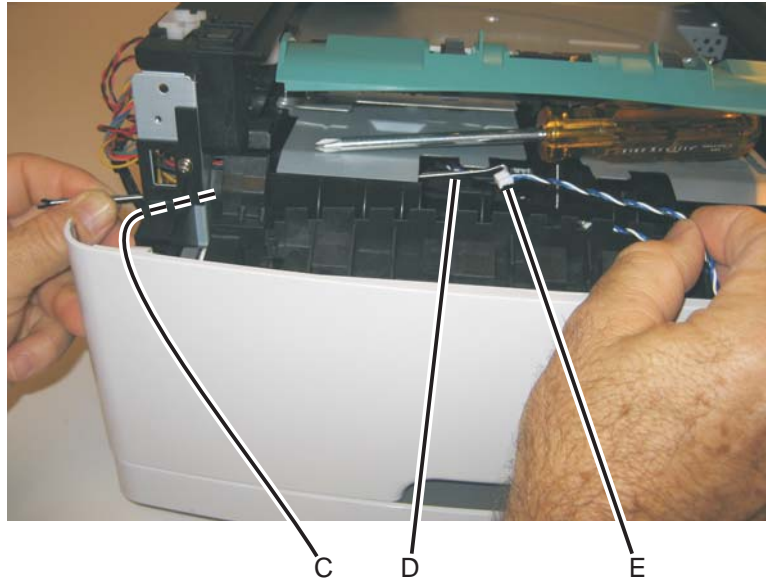

- Place the sensor into position, and reconnect the cable on the controller board.
- Using the spring hook, be sure to reroute the cable through the three retainers (F) between the sensor and side frame.



**Note:** If the cable is not properly installed in its retainers, then the loose cable will obstruct the paper path.

**Warning:** Check to make sure the duplex paper jam door is in its proper position. If it is not, then the paper tray will become lodged and the printer will need to be replaced.

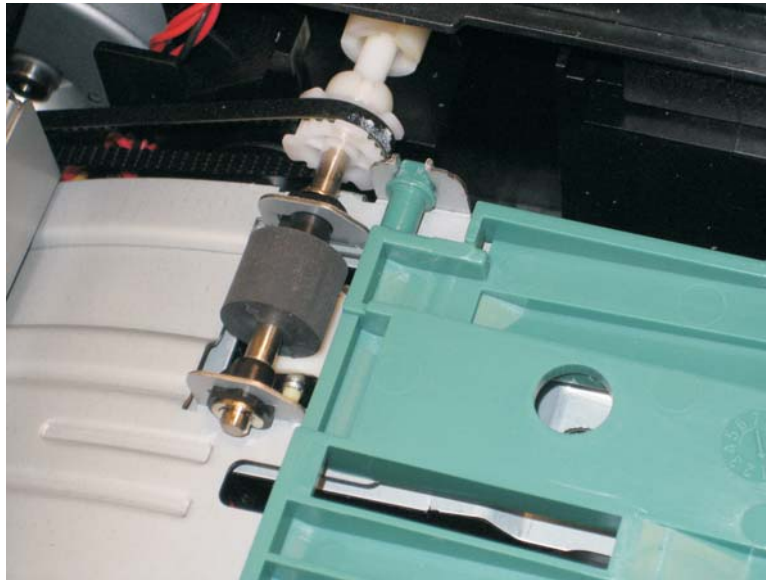

## ***Multipurpose feeder (MPF) removal***

1. Open the front access door.
2. Remove the four screws (A) from the upper front guide.

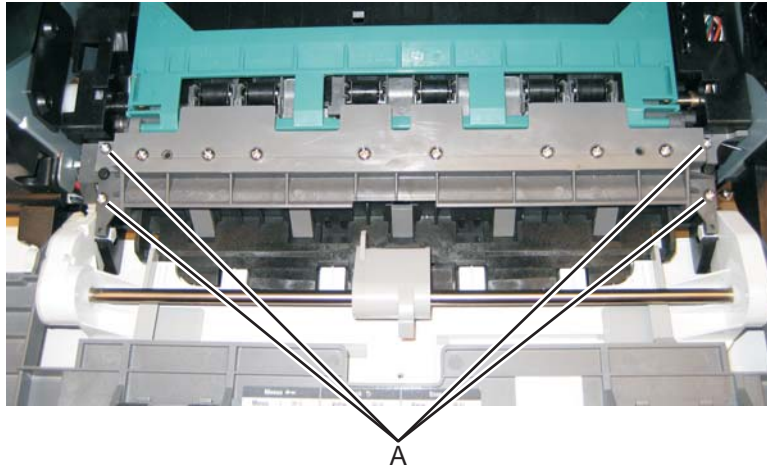

3. Remove the upper front guide.
4. Remove the two screws (B).

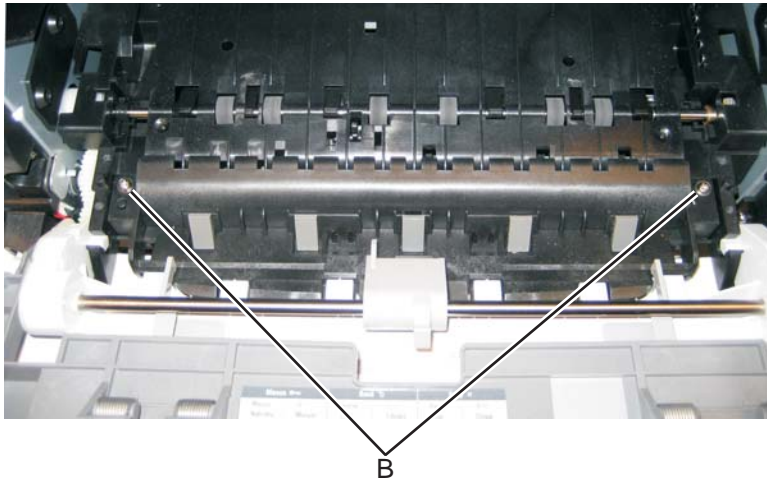

5. Close the front access door, and pull up on the MPF by the steel shaft until the MPF lifts from its hinges.



6. Disconnect the MPF from the lower front cover.

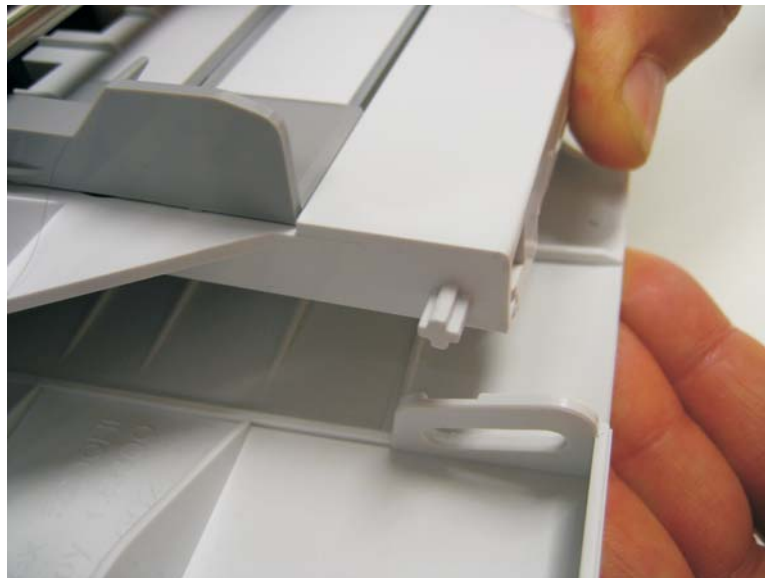

7. Open the front access door, and remove the lower paper guide.



## ***Multipurpose feeder (MPF) feed clutch removal***

1. Remove the left side cover. See **“Left side cover removal”** on page 3-24.
2. Remove the duplex. See **“Duplex removal”** on page 3-11.
3. Disconnect the cable (A) from the controller board.

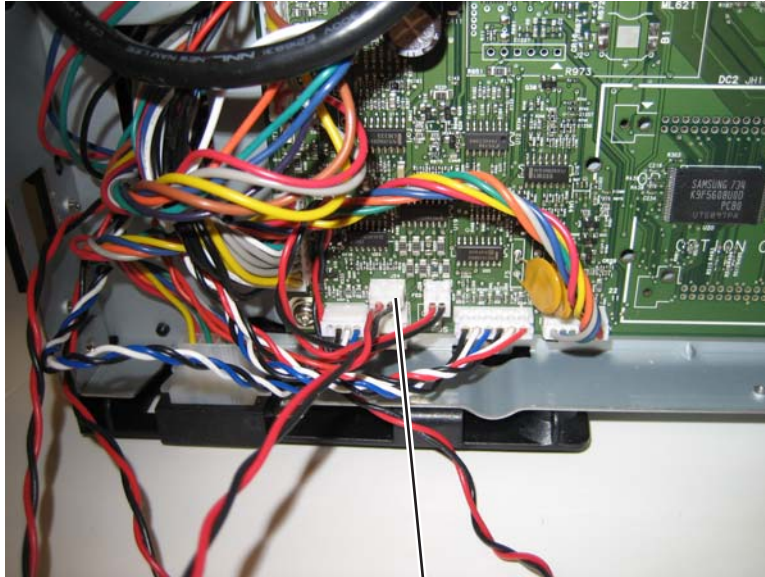

A

4. Place the printer on its right side.

**Note:** Be careful to not damage any cables or mar the finish of the printer.

5. Remove the three screws (B) from the left side of the printer.



B

6. Disconnect the left hinge (C) from the feed clutch, and remove the e-clip (D).

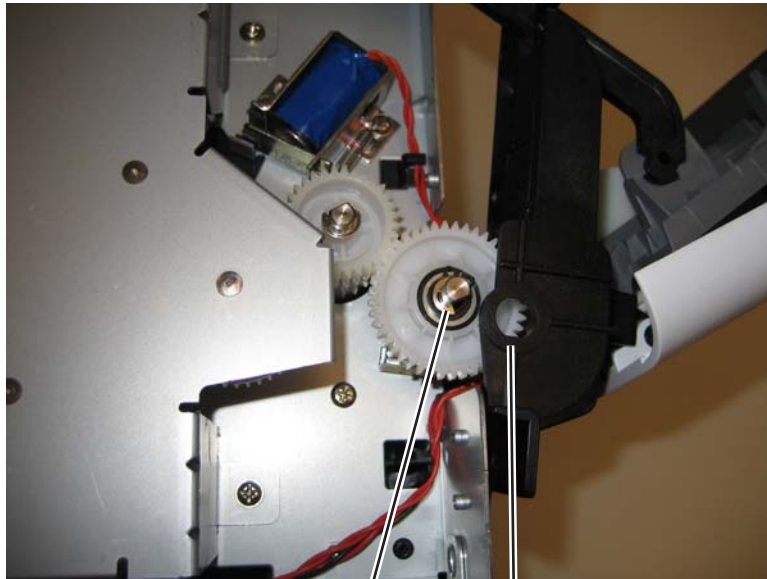

D

C

7. Lift and remove the multipurpose feeder (MPF) feed clutch.

## ***Nameplate removal***

1. Open the front access door.
2. Remove the three screws (A).

**Note:** The picture below shows the E260d, E260dn printer. The nameplate removal is the same for all models.

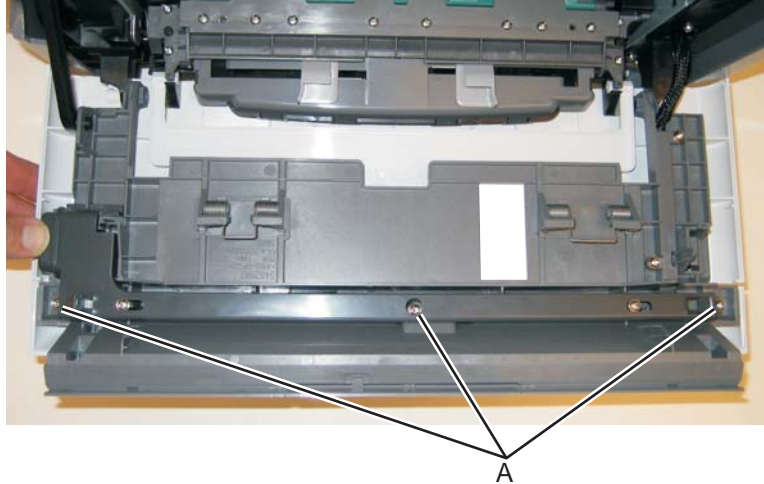

3. Remove the nameplate.



## Operator panel removal

1. Remove the nameplate. See **"Nameplate removal"** on page 3-50.
2. Remove the bezel. See **"Bezel removal"** on page 3-5.
3. Remove the four screws (A) from the display plate.



4. Lift the operator panel cover, and disconnect the operator panel cable (B).

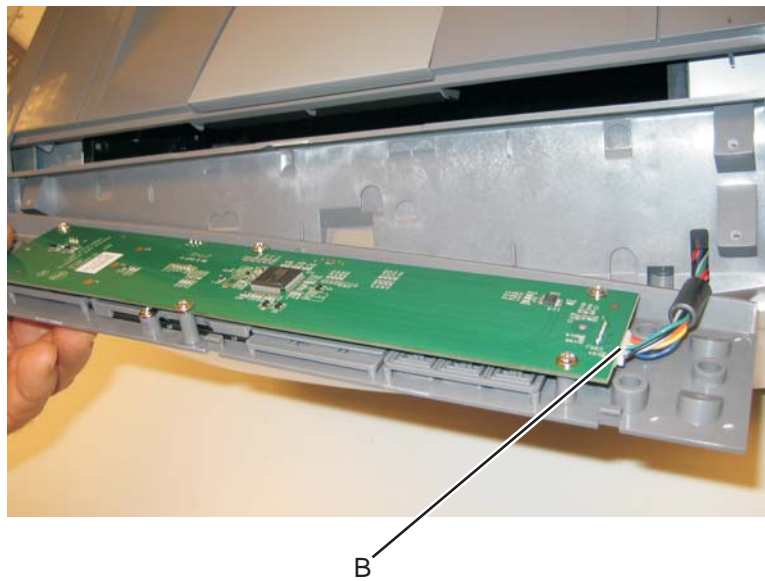

5. Remove the operator panel.

## ***Paper input and duplex sensor assembly removal***

1. Remove the right side cover. See **“Right side cover assembly removal”** on page 3-58.
2. Remove the duplex. See **“Duplex removal”** on page 3-11.
3. Remove the two screws (A) from the sensors.

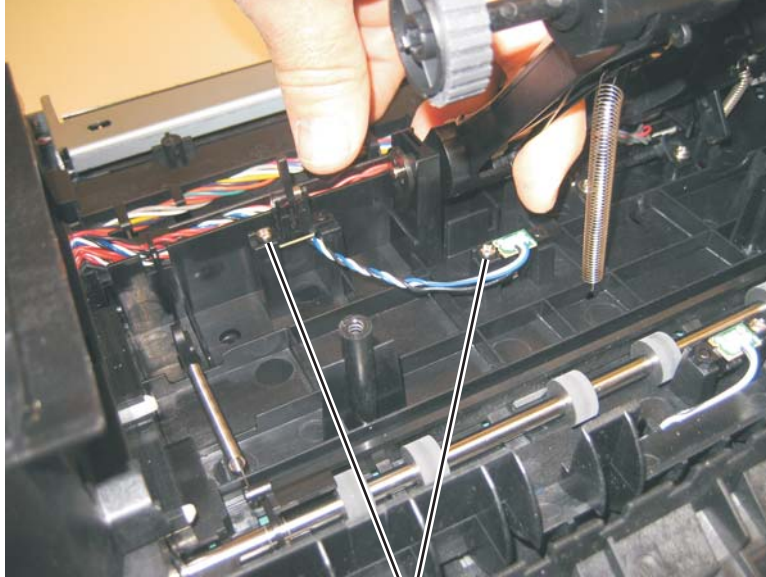

A

4. Disconnect the sensor cable (B) from the controller board.

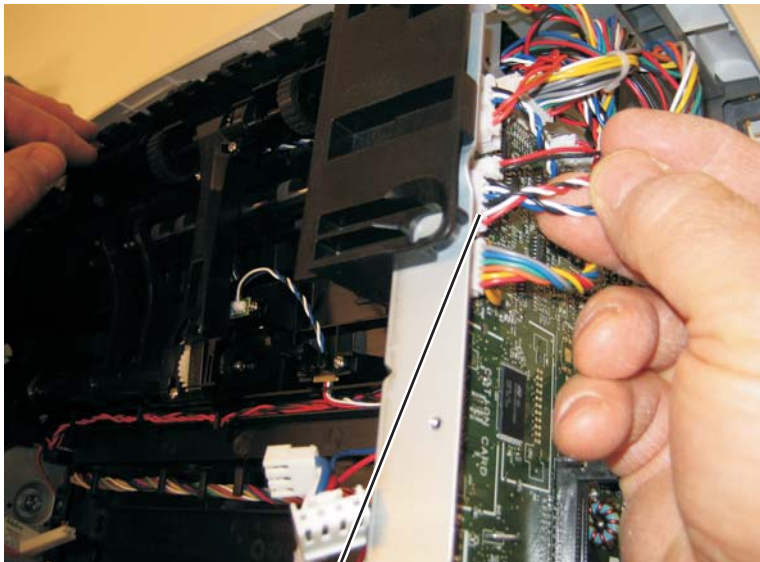

B

5. Remove the paper input and duplex sensor assembly.

## Printhead removal

1. Remove the top cover. See **“Top cover assembly removal”** on page 3-61.
2. Remove the right side cover. See **“Right side cover assembly removal”** on page 4-58
3. Disconnect the two cables (A), and unroute them back through the frame toward the printhead.

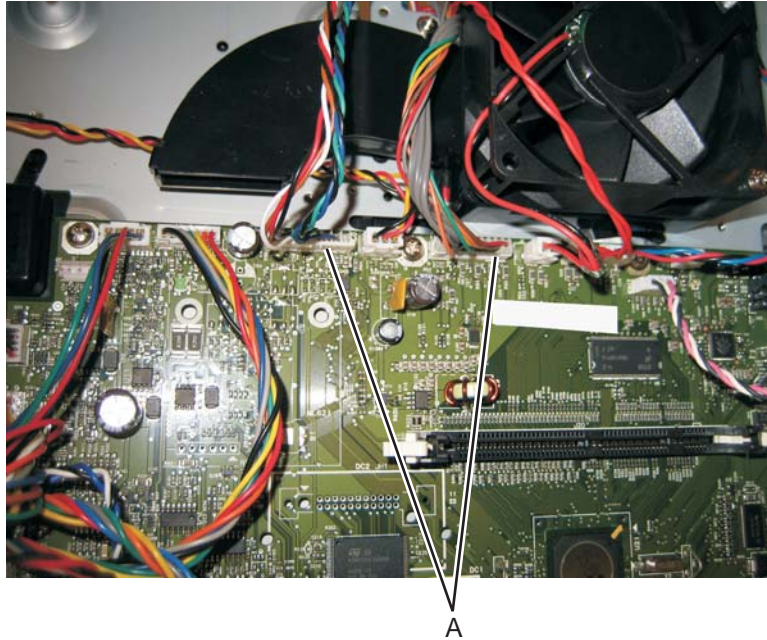

4. Remove the three screws (B).

**Note:** Use a pencil to mark the screw locations of the printhead on the metal frame. Align the new printhead relative to the location of the old printhead. See **“Printhead assembly mechanical adjustment”** on page 3-19.

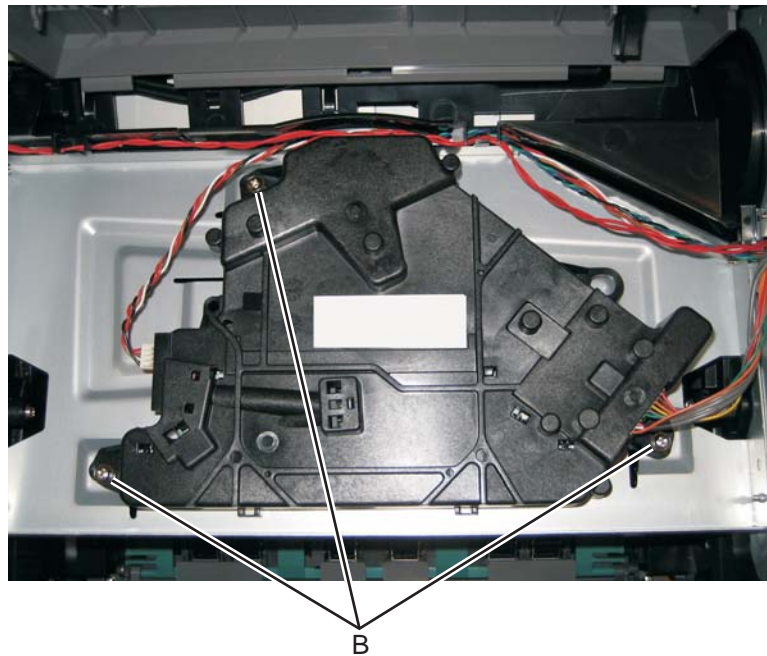

5. Remove the printhead.

## ***Rear door and rear cover removal***

1. Open the rear door.
2. Pull the rear door up at an angle, disconnect the door from the notch (A), and remove.



3. Remove the two screws (B) from the top of the rear cover.

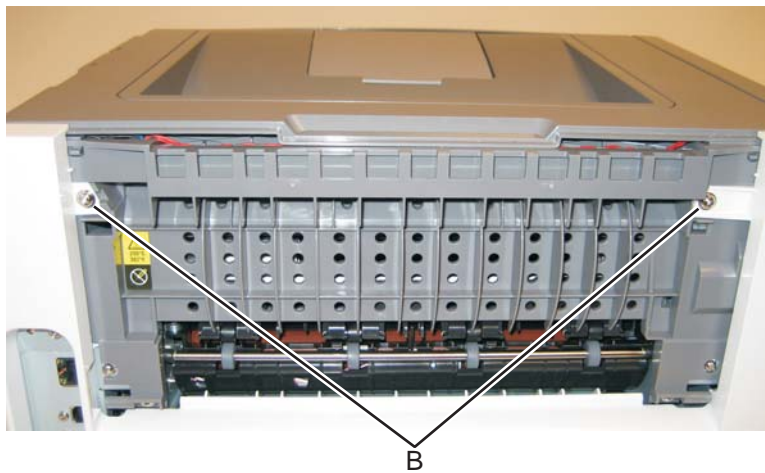

4. Tilt the rear cover, and remove.



## Rear exit guide assembly with sensor and reversing solenoid removal

1. Remove the top cover. See **“Top cover assembly removal”** on page 3-61.
2. Remove the rear door and rear cover. See **“Rear door and rear cover removal”** on page 3-54.
3. Disconnect the narrow media sensor cable and the reversing solenoid cable (A).

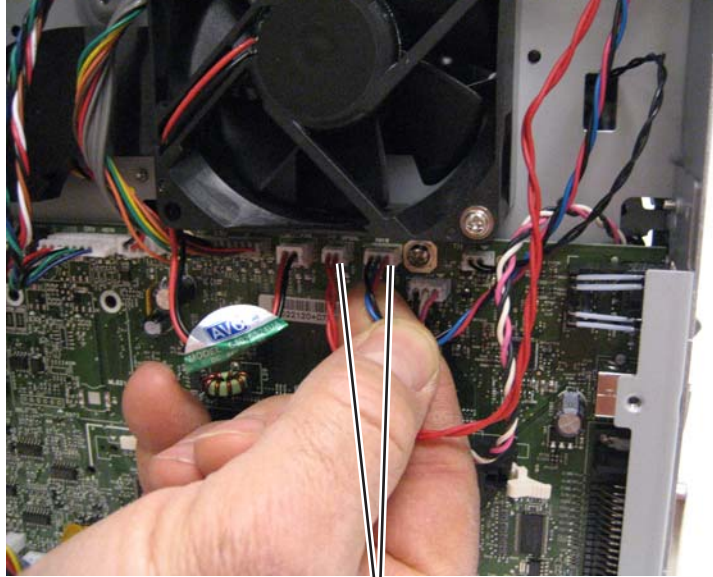

A

4. Remove the six screws (B) from the rear exit guide assembly.

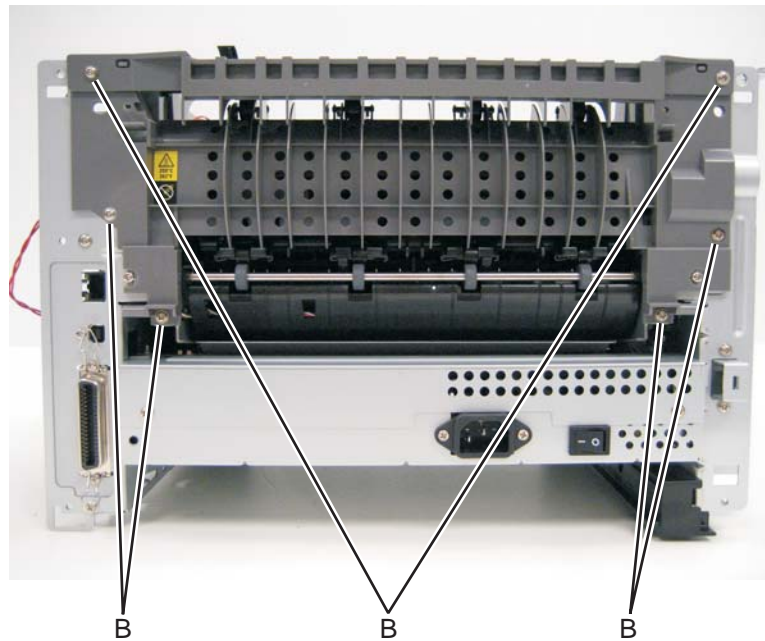

5. Remove the solenoid cable (C) through the opening.

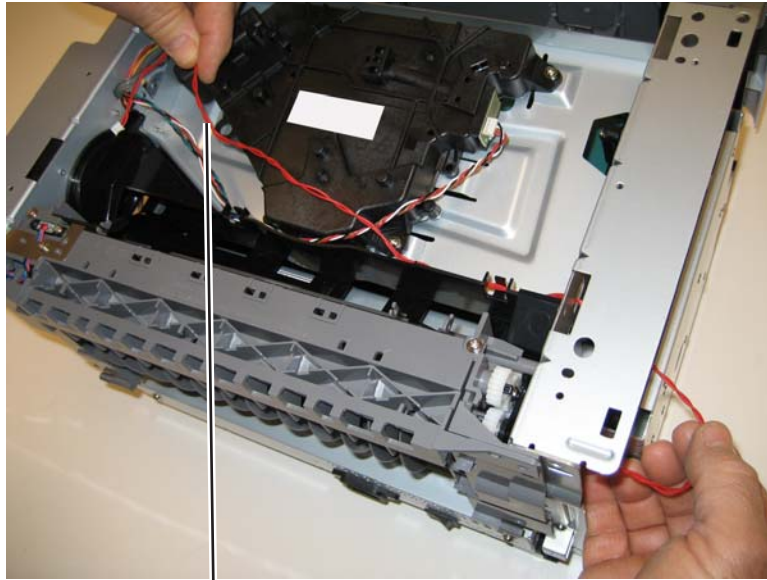

C

6. Remove the narrow media sensor cable (D) through the opening.

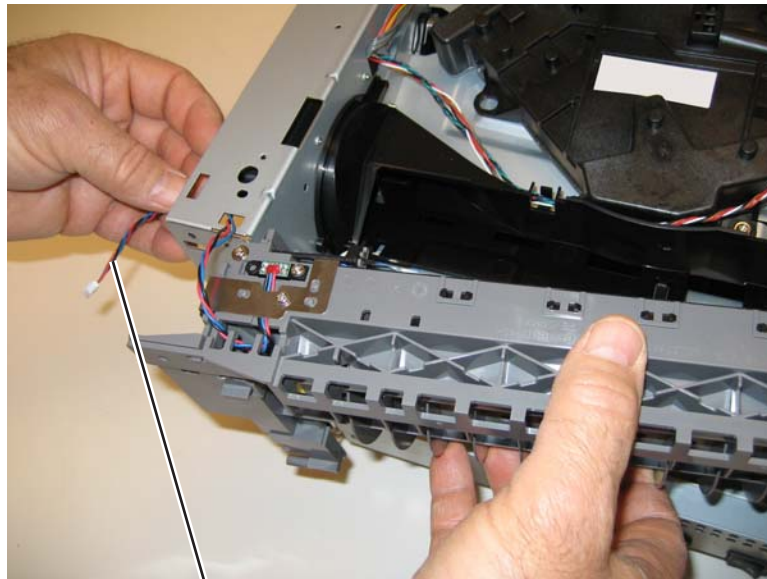

D

7. Remove the rear exit guide assembly.

**Note:** Be careful to not damage the gears during the rear exit guide assembly removal and reinstallation.

## ***Right side cover assembly removal***

**Note:** Leave the front cover closed when removing the right side cover assembly.

1. Remove the one screw (A) from behind the paper tray.



A

2. Remove the screw (B) from the bottom right side of the printer.

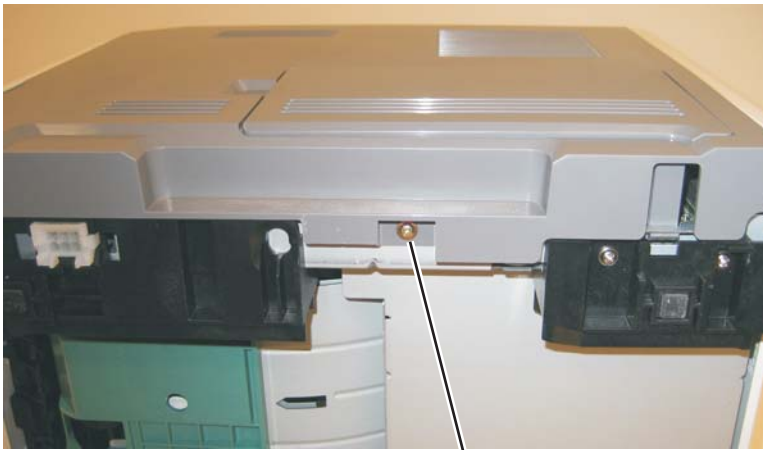

B



3. Press the latches (C).

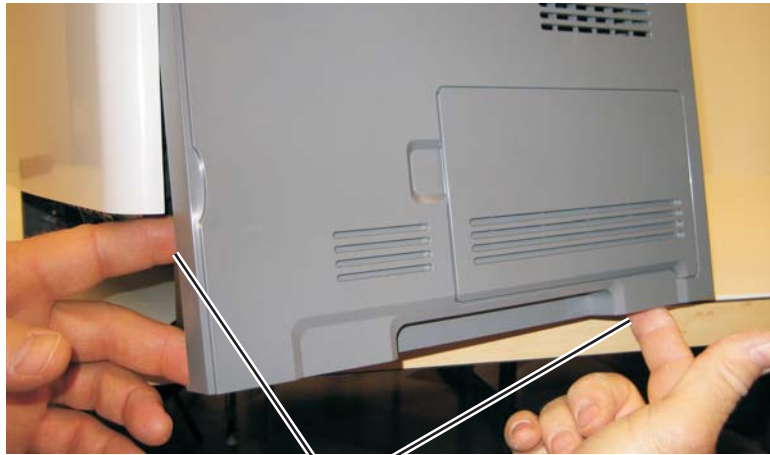

C

4. Rotate the right side cover assembly, and remove.

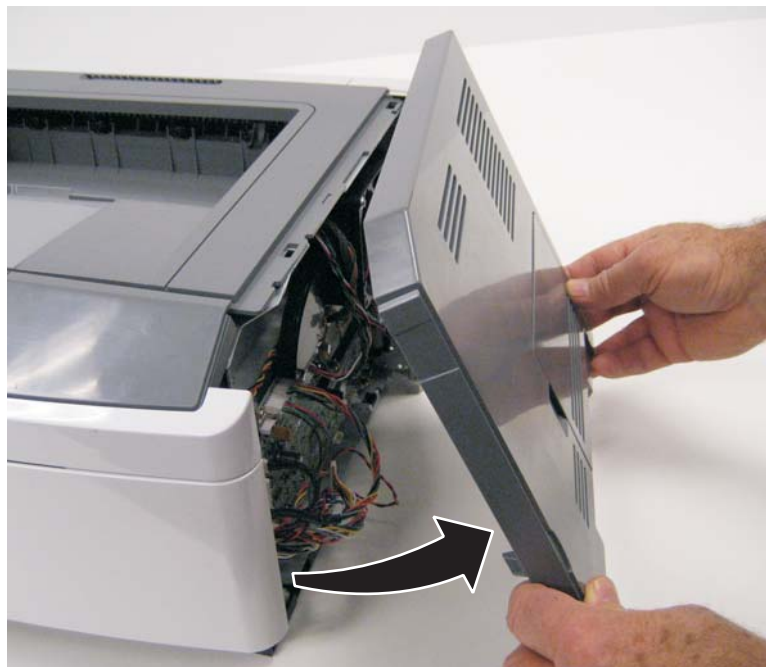

## ***Toner level sensor removal***

1. Open the front access door.
2. Remove the right side cover. See **“Right side cover assembly removal” on page 3-58.**
3. Disconnect the toner level sensor cable (A) from the controller board.
4. Squeeze the lower tabs (B) of the toner level sensor, and push it from its holder.

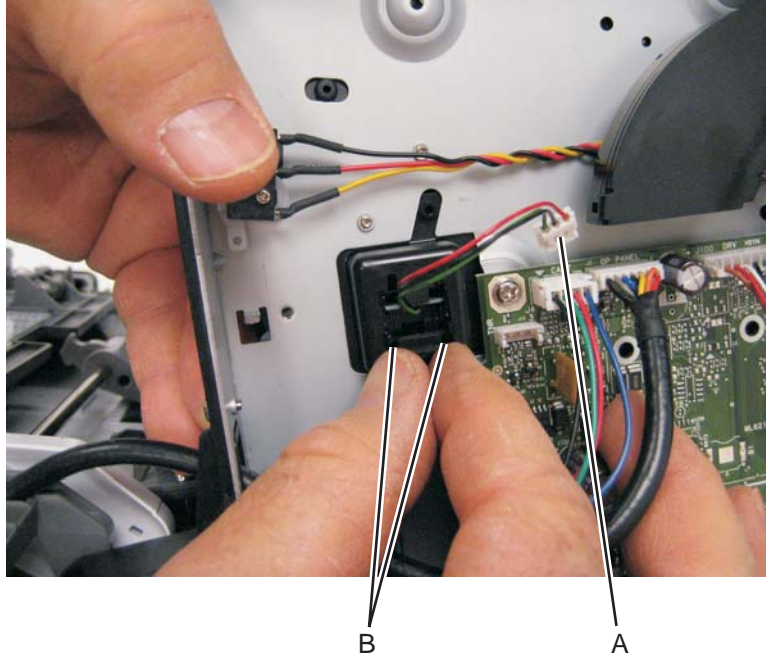

5. Remove the toner level sensor through the inside of the printer.

**Note:** The toner level sensor must be installed properly, or the printer will not function.

## Top cover assembly removal

1. Open the front access door.
2. Remove the left side cover. See **“Left side cover removal” on page 3-24.**
3. Remove the right side cover. See **“Right side cover assembly removal” on page 3-58.**
4. Remove the rear door and rear cover. See **“Rear door and rear cover removal” on page 3-54.**
5. Remove the two screws (A) from the left side of the printer.

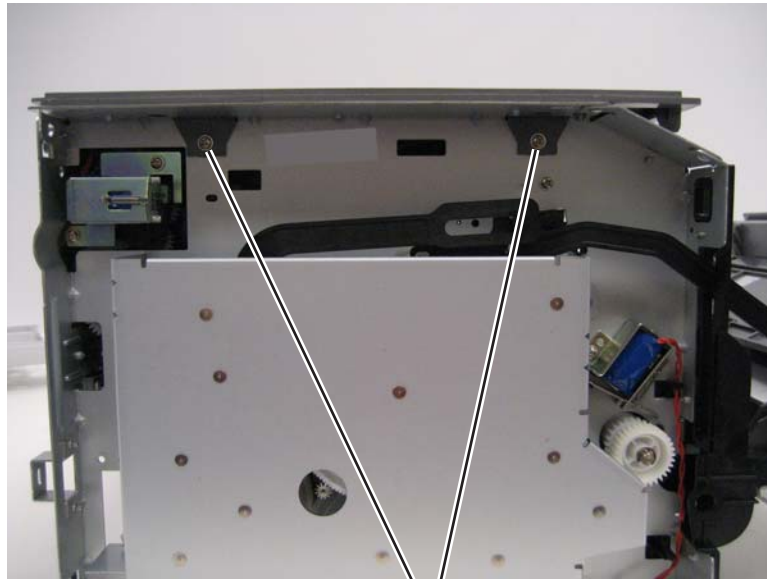

A

6. Remove the two screws (B) from the right side of the printer.

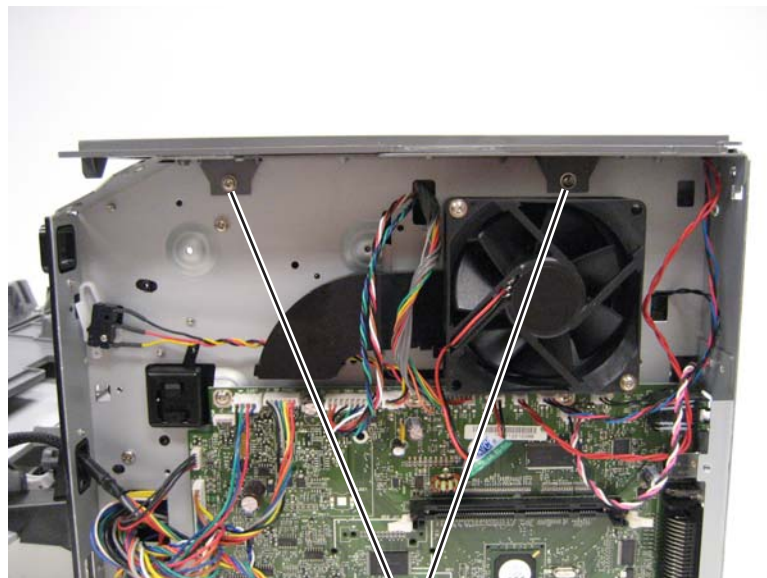

B

7. Lift the top cover, and remove.

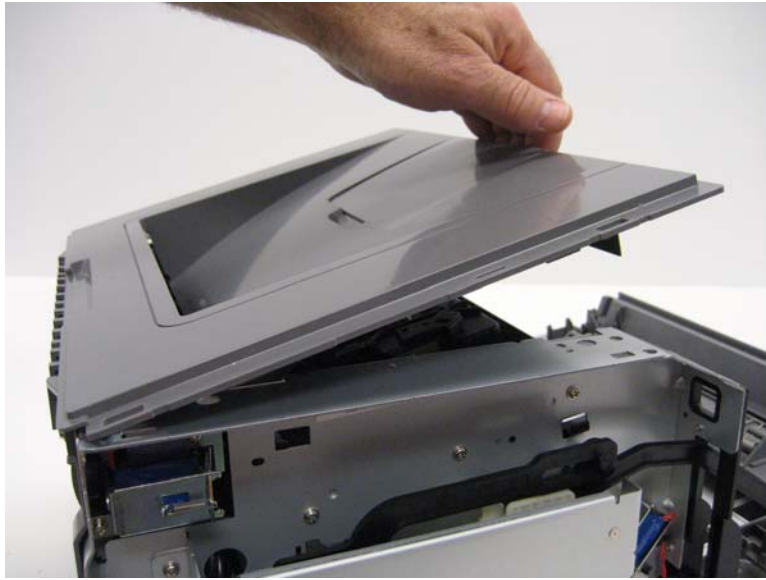

**Note:**

- Be sure to lift the top cover assembly from the front to remove.
- During reinstallation, be sure the exit guide and the paper bin align correctly. A mismatch can cause paper jams.

## Transfer roll removal

**Note:** A flashlight may be useful to remove the transfer roll.

1. Open the front access door.
2. At the right side of the transfer roll, squeeze the holder arms (A) with the left hand while lifting. Stop when the holder is unlatched.

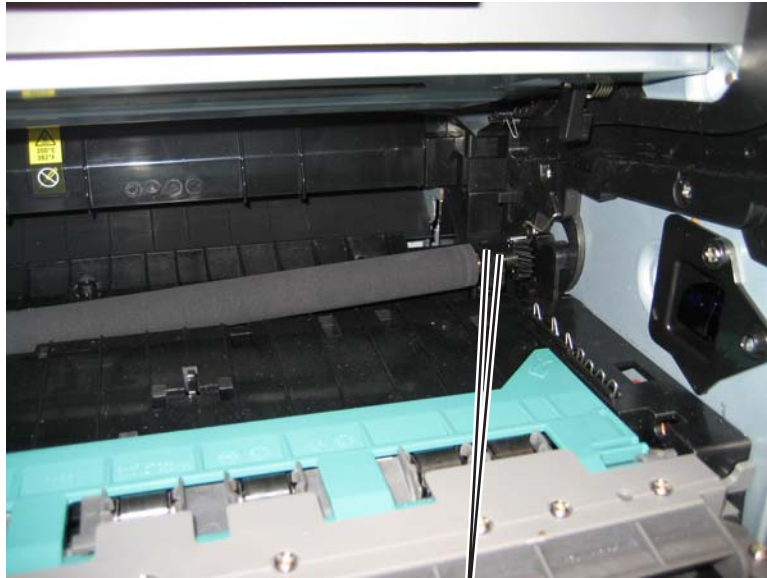

A

3. At the left side of the transfer roll, squeeze the holder arms with the right hand while lifting with the left hand. Stop when the left holder is unlatched.
4. With a hand at each end, lift the transfer roll out.

**Note:** Do not try removing the spring on the left; it is not removeable but can be dislodged. The spring included with the FRU is to be used only if the old right-side spring is damaged or lost. Both springs must be positioned on posts that cannot be seen. If the old springs are moved, then feel the base of the springs to assure that they are on the posts. The top of the springs must be captured in the bearings of the transfer roll.

## ***Upper front guide assembly removal***

1. Open the front access door.
2. Remove the four screws (A) from the upper front guide.

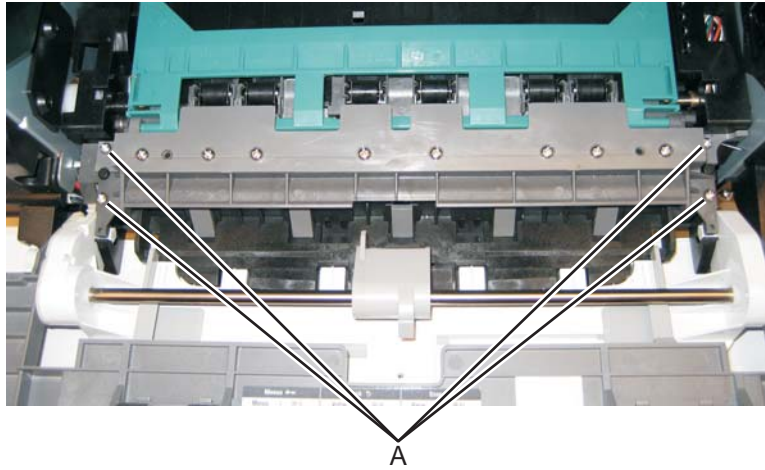

3. Remove the upper front guide.

### ***Wear strip (tray 1 and 250-sheet tray 2) removal***

1. Hold the tray with the bottom up.
2. Use a spring hook to disconnect the strip from the top of the tray.



3. Remove the strip from inside the tray.



## ***Wear strip (550-sheet tray 2) removal***

1. Use a spring hook to disconnect the strip from the top of the tray.

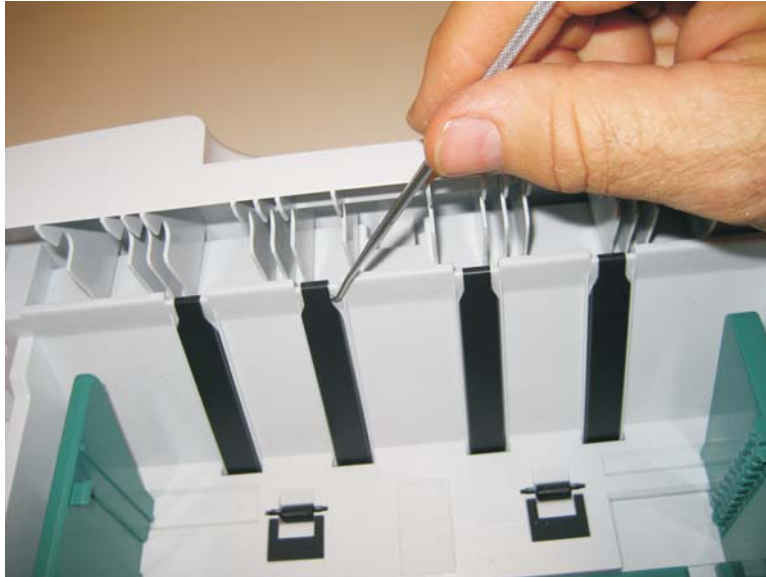

2. Lift the strip, and remove.

**Note:** When replacing the strip (for all trays):

- Carefully insert the strip from the top of the tray, and push it down through the opening until it snaps into place.

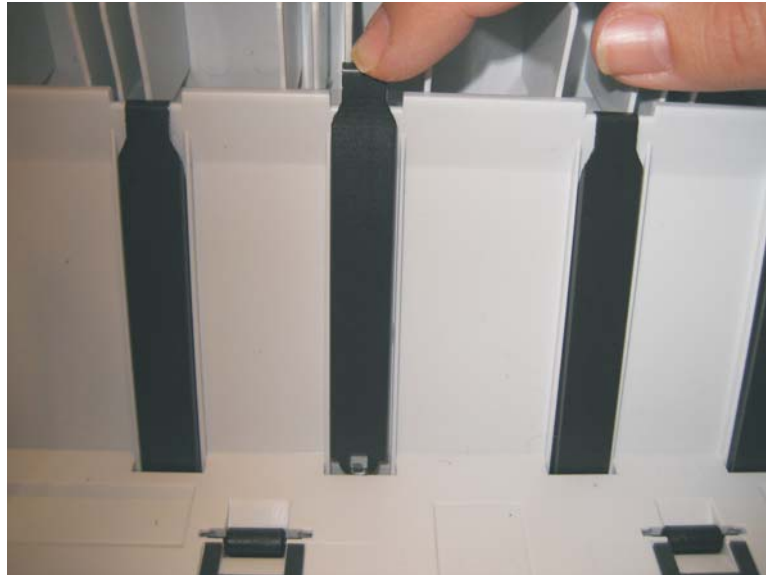

- Turn the tray over to view the bottom of the strip. Using the spring hook, check to make sure that the end of the strip is fastened tightly.
- Be sure that the drafted edge of the strip is installed toward the bottom of the tray.



## 5. Locations and connections

### Locations

#### Front view

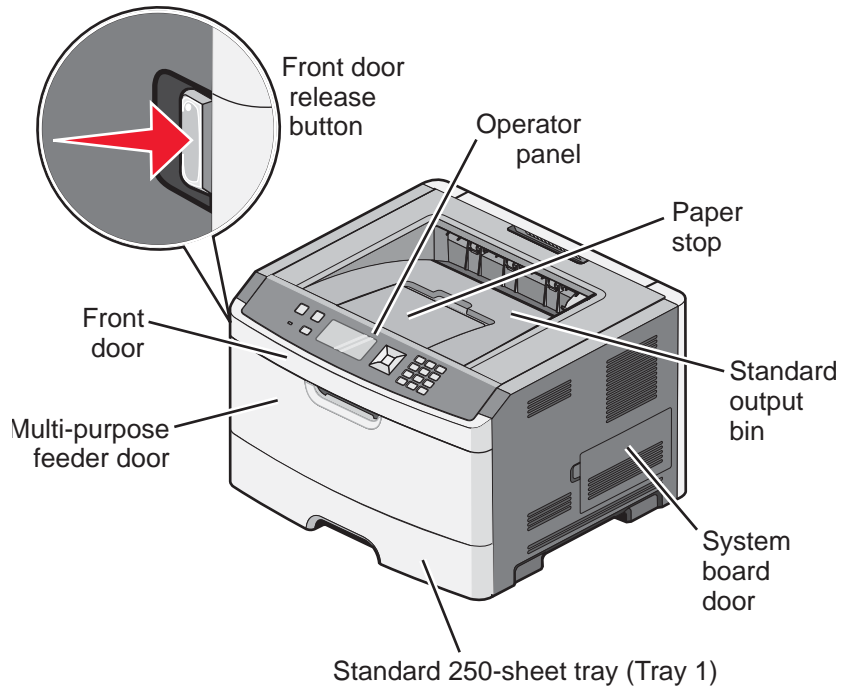

#### Rear view

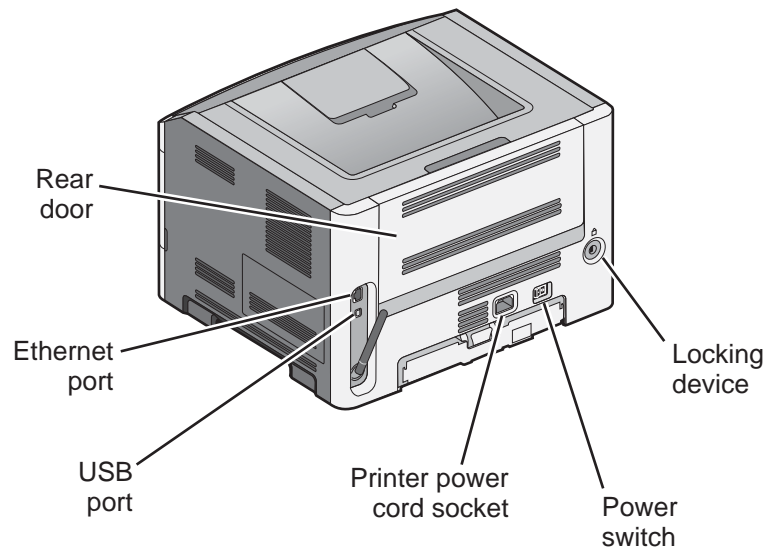

# Dell 3330dn controller board

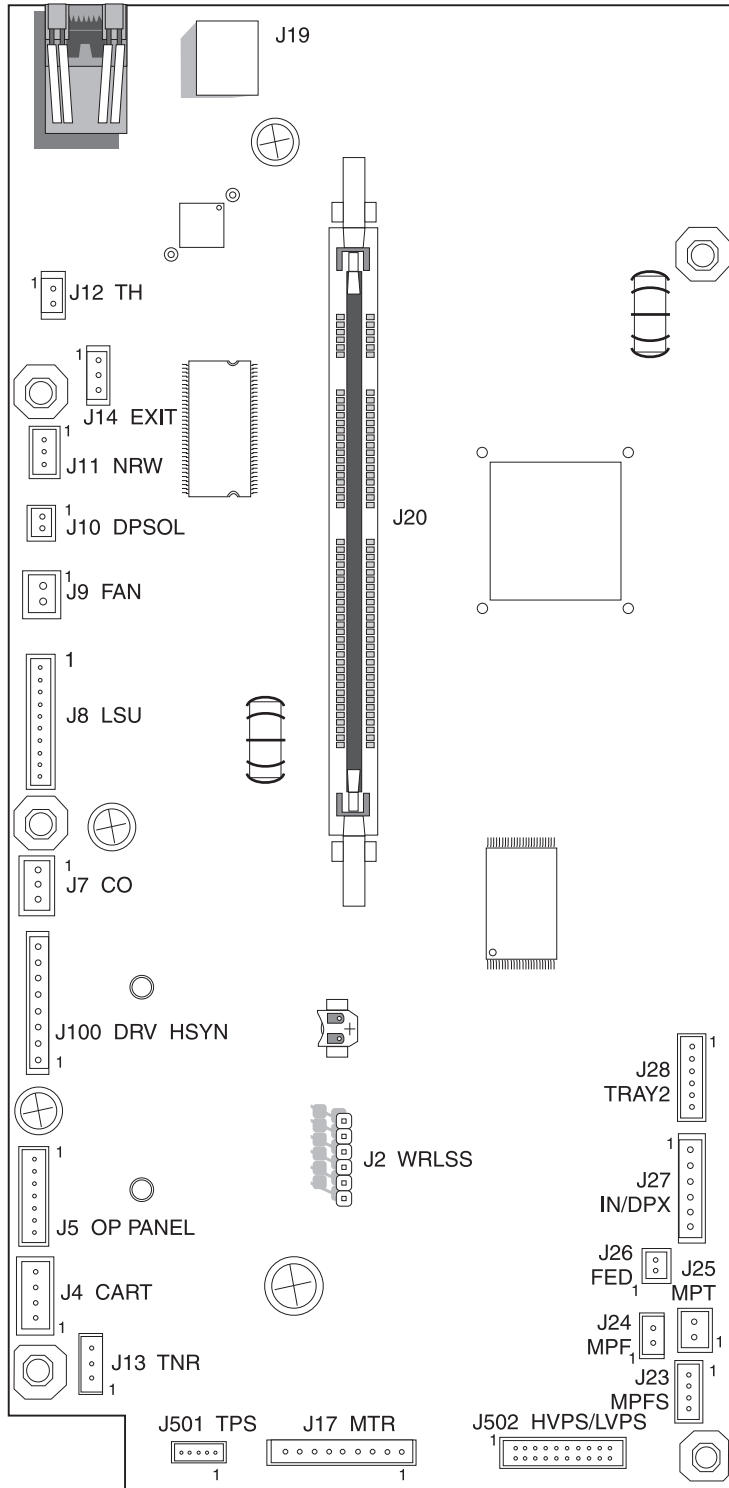

# E460dw controller board

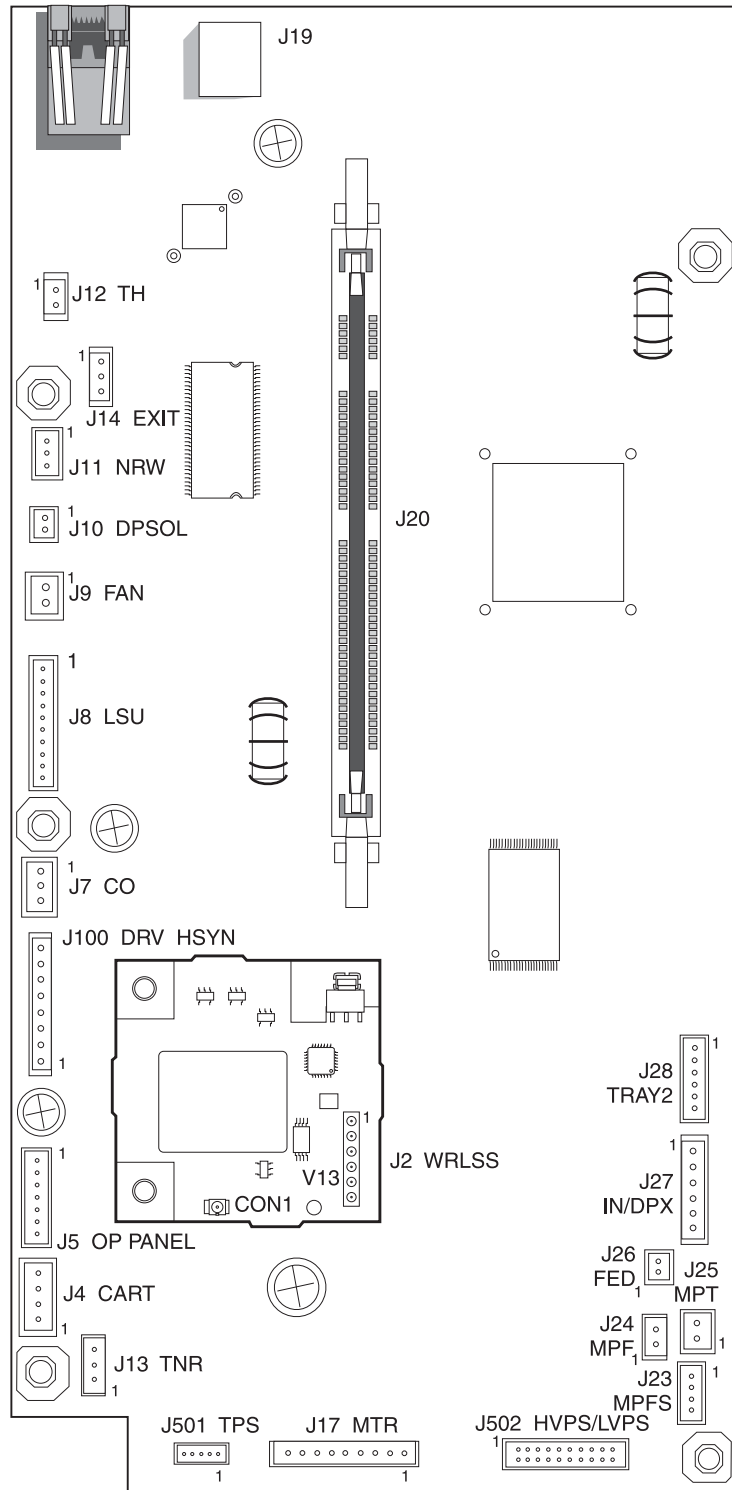

## Dell 2350d/dn, 3330dn controller board connector pin values

**Note:** See the wiring diagram at back of book.

These values were measured with all connections made (plugged) or with only one connector at a time unplugged to expose the pins. Always disconnect and connect with the printer power off. Otherwise, the values below may not match.

Connector	Pin #	Value cable plugged	Value cable unplugged (if different)	Comments
J2	1, 2, 3, 4	0 V dc		Wireless card (E460 dw only). Not applicable to Dell 2350d/dn, 3330dn.
	5	5 V dc		
	6	3.3 V dc		
J4	1	Ground		Cartridge (The front access door must be closed.)
	2	1.7 V dc		
	3, 4	3.3 V dc		
J5	1, 3, 5, 6	3.3 V dc		Operator panel
	2	5.0 V dc		
	4, 7	Ground		
J100	1	> 0 V dc	5 V dc	Printhead
	2, 3	5 V dc		
	4, 5, 6, 7	Ground		
J7	1	5 V dc (door closed)		Open door sensor
		0 V dc (door open)		
	2	5 V dc		
	3	Ground		
J8	1, 10	5 V dc		LSU
	9	2.9 V dc		
J9	1	24 V dc	0 V dc	Cooling fan
	2	24 V dc		
J10	1	24 V dc	24 V dc	Duplex solenoid
	2	24 V dc	0 V dc	
J11	1		5 V dc	Narrow media sensor
	2	5 V dc	5 V dc	
	3	Ground		
J12	1	5 V dc		Thermistor
	2	Ground		
J13	1	0.6 V dc		Toner level sensor
	2	Ground		
	3	0 V dc		
J14	1	> 0 V dc	5 V dc	Fuser exit sensor
	2	5 V dc		
	3	Ground		

Connector	Pin #	Value cable plugged	Value cable unplugged (if different)	Comments
J17	1, 4	0.1 V dc	5 V dc	Main gear drive motor
	2, 3, 6	5 V dc		
	5	Ground		
	7, 8, 9	24 V dc		
J19				USB port
J21				Parallel port
J23	1	1.1 V dc	5 V dc	Manual feed sensor
	2	5 V dc		
	3	Ground		
J24	1	24 V dc		MPF clutch
	2	24 V dc	0 V dc	
J25	1	24 V dc		Manual feed solenoid
	2	24 V dc	0 V dc	
J26	1	24 V dc		Media feed clutch
	2	24 V dc	0 V dc	
J27	1, 4	1.1 V dc	5 V dc	Input and duplex sensor
	2, 5	5 V dc		
	3, 6	Ground		
J28	1, 4	3.3 V dc		Tray 2
	2	24 V dc		
	6	Ground		
J501	1	5 V dc		Toner patch (density) sensor
	3	1 V dc	0 V dc	
	4	Ground		
	5	5 V dc	0V dc	
J502	1, 3, 5, 7, 11, 13, 15		5V dc	LVPS/HVPS
	4		5 V dc	
	6		24 V dc	
	17, 19		24 V dc	
	Other		0 V dc	



---

## 6. Preventive maintenance

This chapter describes procedures for printer preventive maintenance. Follow these recommendations to help prevent problems and maintain optimum performance.

---

### Safety inspection guide

The purpose of this inspection guide is to aid you in identifying unsafe conditions.

If any unsafe conditions exist, then find out how serious the hazard could be and if you can continue before you correct the hazard.

Check the following items:

- Damaged, missing, or altered parts, especially in the area of the On/Off switch and the power supply
- Damaged, missing, or altered covers, especially in the area of the top cover and the power supply cover
- Possible safety exposure from any non-Dell attachments.

---

### Lubrication specifications

FRUs are typically lubricated as needed from the factory. If not, then lubricate only when parts are replaced or as needed, not on a scheduled basis. Use of lubricants other than those specified can cause premature failure. Some unauthorized lubricants may chemically attack parts. Use P/N 99A0394 (Nyogel 744) to lubricate appropriate areas. Lubricate gears that were lubricated in the original part.

---

### Maintenance kits

Maintenance kits include:

- Fuser (P/N 40X5344, 40X5345, or 40X5346)
- Tray 1 ACM feed tires (P/N 40X5451)
- Transfer roll (P/N 40X5364)

#### Maintenance kits

Description	Part number
Low voltage (110 V) maintenance kit	40X5400
High voltage (220 V) maintenance kit	40X5401
100 V maintenance kit	40X5402





## 7. Parts Catalog (Dell 3330dn)

---

### How to use this parts catalog

The following legend is used in the parts catalog:

Asm-Index	Part number	Units/mach	Units/FRU	Description
-----------	-------------	------------	-----------	-------------

- **Asm-index:** identifies the assembly and the item in the diagram. For example, 3-1 indicates assembly 3 and the item number 1.
- **Part number:** identifies the unique number that identifies this FRU.
- **Units/mach:** refers to the number of units actually used in the machine or product.
- **Units/FRU:** refers to the number of units packaged together and identified by the part number.
- **NS:** (Not shown) in the Asm-Index column indicates that the part is procurable but is not pictured in the illustration.
- **PP:** (Parts Packet) in the parts description column indicates the part is contained in a parts packet.
- Model information used in the parts catalog.

## Assembly 1: Covers

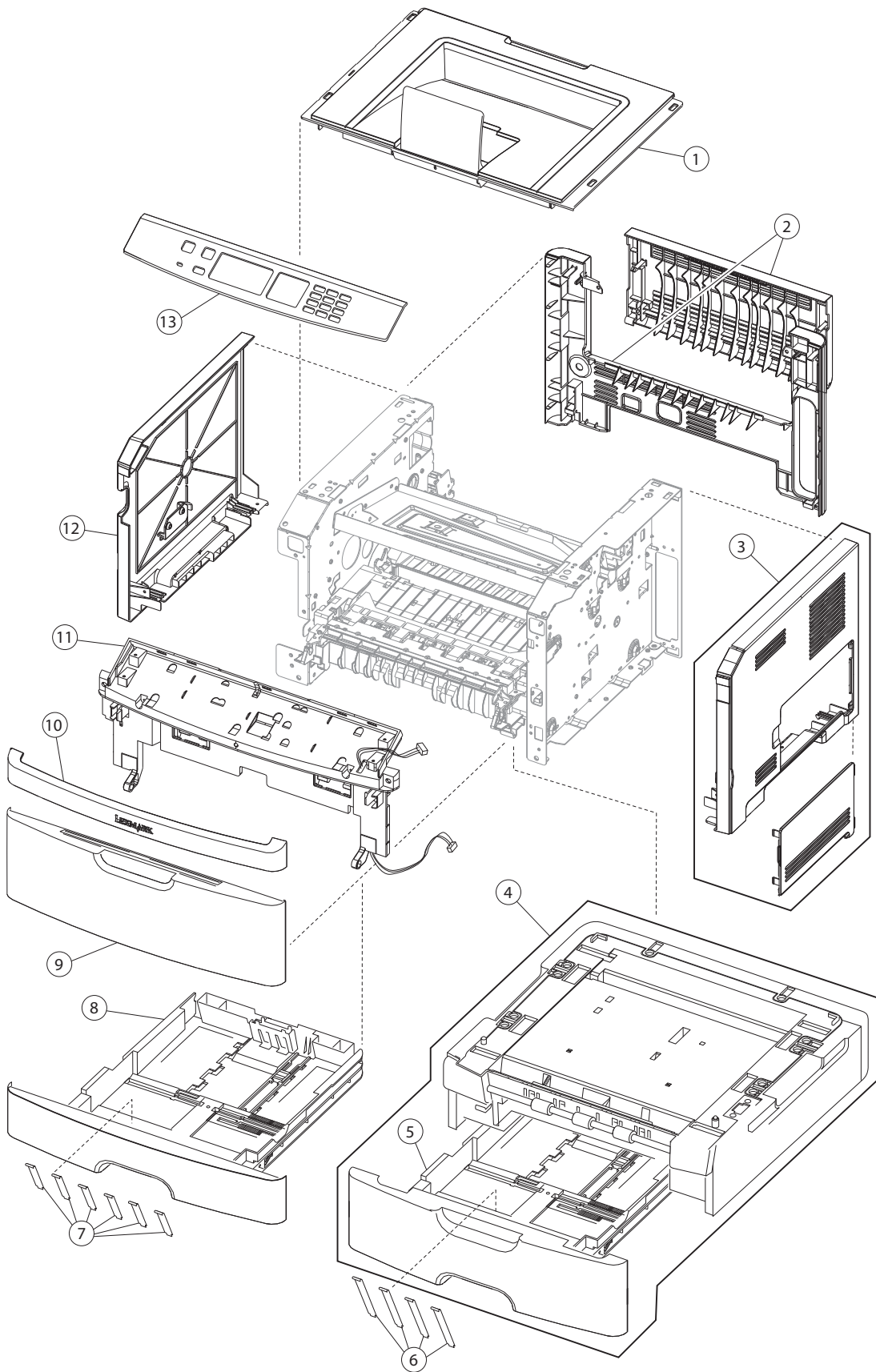

## Assembly 1: Covers

Asm-Index	Part number	Units/mach	Units/FRU	Description
1-1	40X5373	1	1	Top cover assembly
2	40X5377	1	1	Rear upper and lower cover assembly
3	40X5375	1	1	Right side cover
4	40X5398	1	1	Optional 250-sheet tray
4	40X5399	1	1	Optional 550-sheet tray
5	40X5394	1	1	250-sheet (Tray 2) assembly
5	40X5395	1	1	550-sheet (Tray 2) assembly
6	40X2855	1	4	Tray 2 wear strips (550-sheet tray only)
7	40X5382	1	6	Wear strips (250-sheet trays, optional and primary)
8	40X5381	1	1	Primary tray
9	40X5379	1	1	Front door cover
10	40X5359	1	1	Nameplate cover
11	40X5378	1	1	Front access door assembly
12	40X5374	1	1	Left side cover
13	40X5357	1	1	LCD bezel cover, Dell 3330dn

## Assembly 2: Electronics

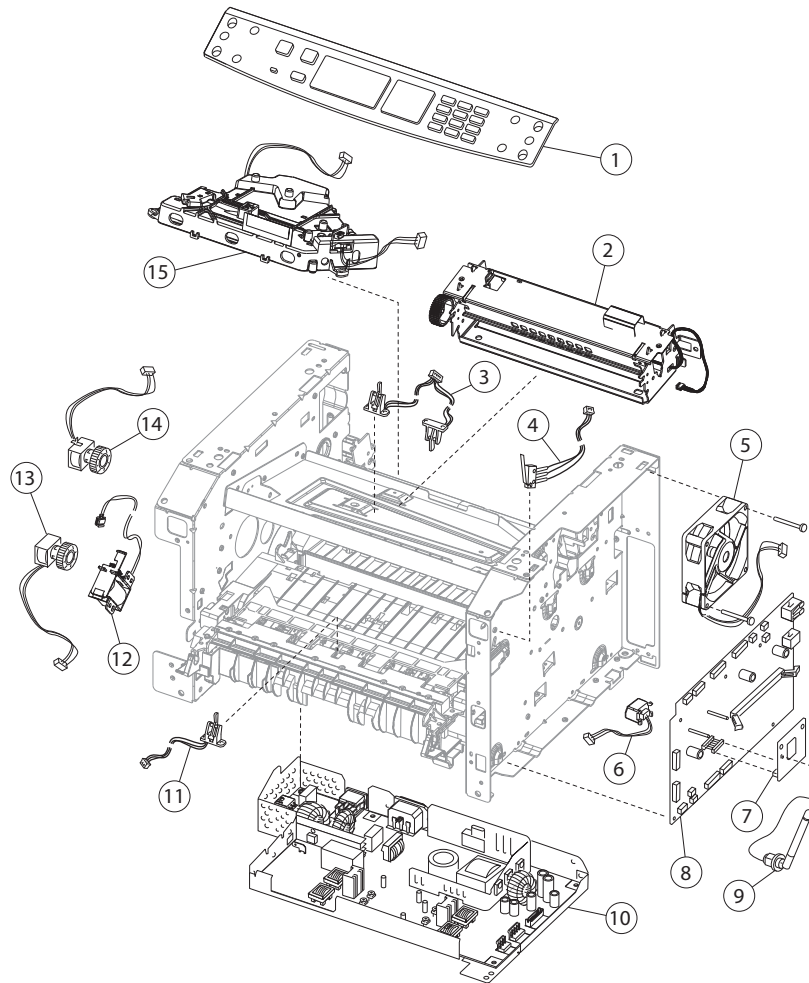

## Assembly 2: Electronics

Asm-Index	Part number	Units/mach	Units/FRU	Description
2-1	40X5356	1		LCD operator panel assembly, Dell 3330dn/E460dw
2	40X5344	1		Fuser assembly, 115 V
2	40X5345	1		Fuser assembly, 230 V
2	40X5346	1		Fuser assembly, 100 V
3	40X5365	1	1	Duplex and media sensor assembly
4	40X5360	1	1	Access door open sensor assembly
5	40X5392	1	1	Cooling fan (screws included)
6	40X5385	1	1	Toner low sensor
7	40X5036	1	1	Wireless card, E460dw (Not applicable to Dell 3330dn)
8	40X5350	1	1	Controller board, Dell 3330dn
8	40X5351	1	1	Controller board, E460dw
9	40X5320	1	1	Antenna (11 inch cable)
10	40X5361	1		LVPS/HVPS card assembly, 110 V/100 V
10	40X5362	1		LVPS/HVPS card assembly, 220 V
11	40X5366	1	1	Manual input sensor assembly
12	40X5369	1	1	Manual feed solenoid
13	40X5371	1	1	MPF feed clutch
14	40X5370	1	1	Media feed (ACM) clutch
15	40X5387	1		LSU, Dell 3330dn/E460dw (printhead)

## Assembly 3: Frame

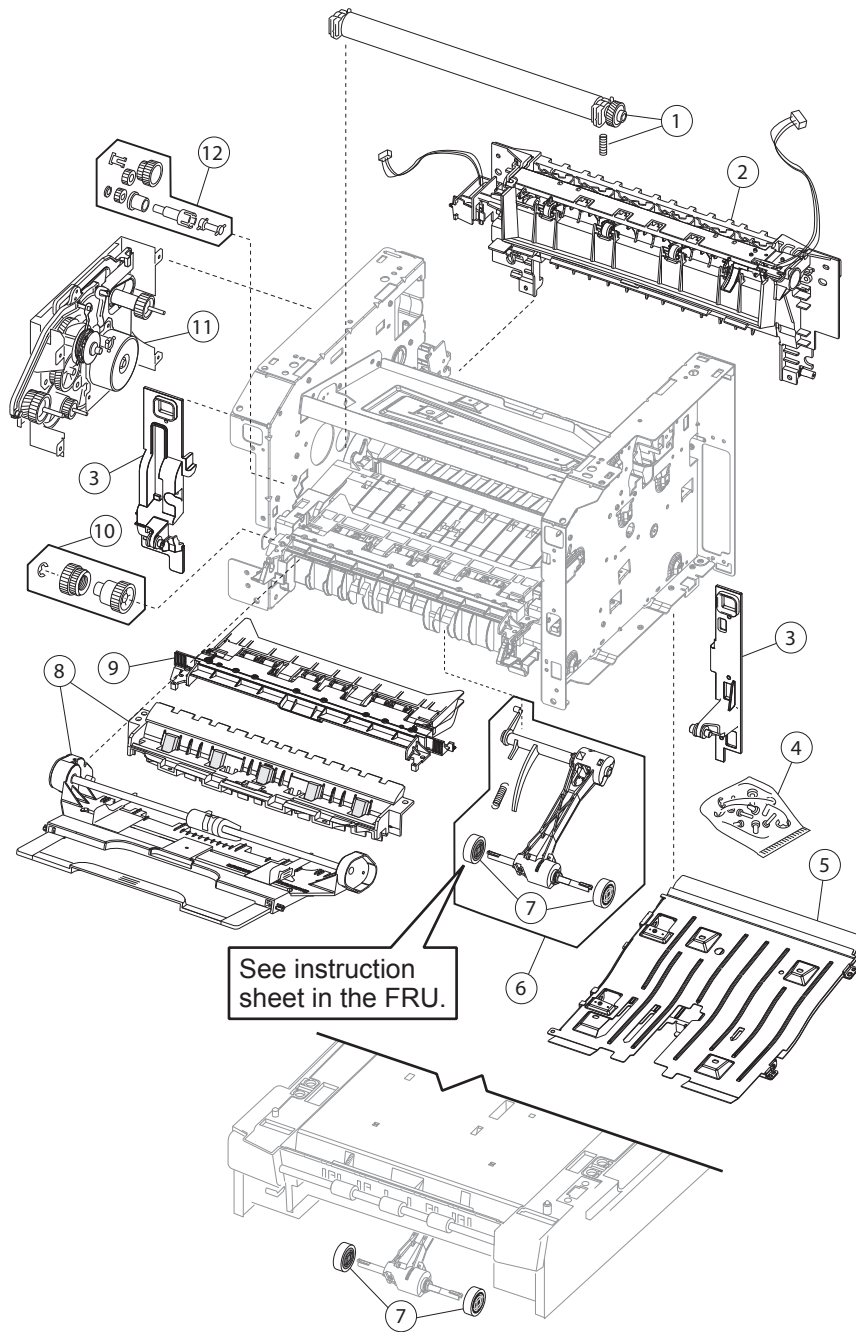

### Assembly 3: Frame

Asm-Index	Part number	Units/mach	Units/FRU	Description
3-1	40X5364	1		Transfer roll, bearings, gear, spring (CBM)
2	40X5372	1		Media exit guide assembly (redrive)
3	40X5397	1	1	Front mounts
4	40X5396	N/A		Screws, miscellaneous
			4	TP2NCX3X6PF-Ni
			4	TP2C-4.0+8PF-Ni
			4	M3.0*0.5+6PF-Ni
			2	M3.0*0.5+4PF-Ni
			2	M3.5*0.6+6P-Ni
5	40X5380	1	1	Complete duplex assembly
6	40X5453	1	1	Media (ACM) drive assembly
7	40X5451	2	2	Paper feed, ACM tires
7	40X5440	1	2	Tray 2 paper feed tires
8	40X5358	1	1	MPF tray assembly
9	40X5383	1	1	Upper front frame assembly
10	40X5368	1	1	Manual feed clutch CBM
11	40X5367	1	1	Main drive gearbox (in motor)
12	40X5363	1	1	Duplex gear drive CBM
NS	40X5400	1	1	110 V maintenance kit
NS	40X5401	1	1	220 V maintenance kit
NS	40X5402	1	1	100 V maintenance kit
				<b>Note:</b> Kit contains the following: Fuser (40X5344, 40X5345, or 40X2802) Tray 1 ACM feed tires (40X5451) Transfer roll CBM (40X5364)
NS	7470094	1		Field relocation package assembly

## Assembly 4: Options

Asm-Index	Part number	Units/mach	Units/FRU	Description
NS	40X5972	1	1	Japanese font card assembly
NS	40X5970	1	1	Simplified Chinese font card assembly
NS	40X5971	1	1	Traditional Chinese font card assembly
NS	40X5969	1	1	Korean font card assembly
NS	40X5952	1	1	Print cryption card assembly
NS	40X5951	1	1	Korean KS/KSSM/KSP
NS	40X5940	1	1	Bar code and forms
NS	40X5937	1	1	128MB DIMM
NS	40X5938	1	1	256MB DIMM
NS	40X5939	1	1	512MB DIMM
NS	40X5704	1	1	256MB flash
NS	40X1367	1	1	Parallel cable, packaged (3 m) (Dell 3330dn only)
NS	40X1368	1	1	USB cable, packaged (2 m)



## Assembly 5: Power cords

Asm-Index	Part number	Units/mach	Units/FRU	Description
NS	40X0297	1		Power cord, 1.8M (straight)—USA, Canada
NS	40X0278	1		Power cord, 6 foot (straight)—Europe and others
NS	40X0288	1		Power cord, 8 foot (straight)—Argentina
NS	40X0286	1		Power cord, 8 foot (straight)—United Kingdom
NS	40X0275	1		Power cord, 6 foot (straight)—Israel
NS	40X0274	1		Power cord, 6 foot (straight)—Switzerland
NS	40X0276	1		Power cord, 6 foot (straight)—South Africa
NS	40X0287	1		Power cord, 6 foot (straight)—Italy
NS	40X0279	1		Power cord, 6 foot (straight)—Denmark
NS	40X0277	1		Power cord, 6 foot (straight)—Brazil
NS	40X0282	1		Power cord, 1.8M (straight)—PRC
NS	40X0270	1		Power cord, 2.5M (straight)—Japan
NS	40X0280	1		Power cord, 1.8M (straight)—Korea
NS	40X0281	1		Power cord, 1.8M (straight)—Taiwan
NS	40X0296	1		Power cord, 1.8M (straight)—Australia



# Index

## A

abbreviations **1-9**  
acronyms **1-9**

## B

buttons  
    accessing service menus **3-1**

## C

Charge Roll, diagnostics mode **3-15**  
compatibility **1-4**  
configuration ID **3-14**  
configuration menu  
    accessing **3-1, 3-2**  
    available menus **3-2**  
    Demo Mode **3-4**  
    Energy Conserve **3-5**  
    Factory Defaults **3-4**  
    Panel Menus **3-4**  
    PPDS Emulation **3-4**  
control panel **1-2**  
controller card  
    service check **2-21**

## D

defaults  
    factory defaults **3-4**  
diagnostics mode **3-6**  
    accessing **3-1**  
    available tests **3-6**  
diagnostics mode—  
    EP Setup  
        Charge Roll **3-15**  
        EP Defaults **3-15**  
        Fuser Temp **3-15**  
        Gap Adjust **3-15**  
        Print Contrast **3-15**  
        Transfer **3-15**  
    Event Log  
        Clear Log **3-17**  
        Display Log **3-16**  
        Print Log **3-17**  
    Hardware Tests  
        DRAM Test **3-9**  
    Printer Setup  
        Configuration ID **3-14**  
        Edge to Edge **3-14**  
        Engine Settings **3-14**  
        Model Name **3-14**  
        Par S Strobe Adj **3-14**  
    Registration **3-7**  
DRAM Test **3-9**

## E

Edge to Edge **3-14**  
EP Defaults **3-15**  
error log  
    clear log (diagnostics mode) **3-17**  
    display log (diagnostics mode) **3-16**  
    Print Log **3-17**  
error messages  
    service error codes **2-13**  
    user attendance messages **2-5**  
ESD-sensitive parts **4-1**

## F

fan  
    parts catalog **7-5**  
    service check **2-22**  
frame, parts catalog **7-6**  
fuser  
    parts catalog **7-5**  
    service check **2-24**  
Fuser Temp **3-15**

## G

Gap Adjust **3-15**

## H

handling ESD-sensitive parts **4-1**  
History  
    *see error log 3-17*

## L

lithium battery **v-xv, 4-6**  
locations  
    front views **5-1**  
    rear views **5-1**  
lubrication specifications **6-1**  
LVPS/HVPS  
    parts catalog **7-5**  
    service check **2-24**

## M

maintenance approach **1-1**  
maintenance kits **6-1**  
menus  
    accessing service menus **3-1**  
messages  
    service error codes **2-13**  
    user attendance messages **2-5**  
Model Name **3-14**  
models  
    comparison **1-1**  
    diagrams **5-1**  
    operator panels **1-2**  
    trays available **1-5**

## N

navigation buttons **2-2**

## O

operator panel

LCD— **2-2**

LED—

service check **2-26**

LED

overview **1-2**

## P

panel, control **1-2**

paper jams

tips on preventing **1-7**

parallel port service check **2-28**

parts catalog

covers **7-2**

electronics **7-4**

frame **7-6**

options **7-8**

power-on self test (POST) **2-1**

symptoms **2-19**

Print Contrast **3-15**

print media

preventing jams **1-7**

trays by model **1-5**

types and sizes **1-6**

print quality pages

using **2-29**

print quality problems

print media **1-7**

service check **2-29**

solving **2-33**

printer symptom table **2-20**

printhead

service check **2-36**

## R

registration **3-7**

removals

covers

front access cover **4-6**

procedures **4-2**

## S

safety information **v**

safety inspection guide **6-1**

service checks **2-21**

controller card **2-21**

cooling fan **2-22**

cover interlock switch **2-22**

dead machine **2-23**

fuser **2-24**

LVPS/HVPS **2-24**

main motor **2-25**

operator panel **2-26**

paper feed **2-26**

paper jam during POST **2-26**

paper never picks **2-27**

paper picks but stops **2-26**

paper picks sheets **2-27**

paper trees, curls **2-28**

parallel port **2-28**

print quality **2-29**

black page **2-30**

blank page **2-29**

heavy background **2-30**

image density **2-31**

light print **2-32**

partial blank image **2-31**

poor fusing of image **2-31**

toner on back of page **2-32**

white or black lines **2-32**

printhead **2-36**

transfer roll **2-36**

service error codes **2-13**

special tools **1-8**

specifications

connectivity **1-4**

input trays **1-5**

memory **1-3**

operating systems **1-4**

photoconductor capacity **1-5**

print media **1-6**

toner capacity **1-5**

start **2-1**

strobe adjustment **3-14**

symptom tables **2-19**

POST **2-19**

printer **2-20**

## T

tools **1-8**

Top Margin **3-7**

Transfer **3-15**

transfer roll

parts catalog **7-7**

service check **2-36**

## U

user attendance messages **2-5**

## Part number index (Dell 3330dn)

P/N	Description	Page
40X0270	Power cord, 1.77M (straight)—Japan	7-9
40X0274	Power cord, 6 foot—Switzerland	7-9
40X0275	Power cord, 6 foot (straight)—Israel	7-9
40X0276	Power cord, 6 foot—South Africa	7-9
40X0277	Power cord, 6 foot (straight)—Brazil	7-9
40X0278	Power cord, 6 foot (straight)—Europe and others	7-9
40X0279	Power cord, 6 foot (straight)—Denmark	7-9
40X0280	Power cord, 1.77M (straight)—Korea	7-9
40X0281	Power cord, 1.77M (straight)—Taiwan	7-9
40X0282	Power cord, 1.77M (straight)—PRC	7-9
40X0286	Power cord, 6 foot—United Kingdom	7-9
40X0287	Power cord, 6 foot (straight)—Italy	7-9
40X0288	Power cord, 6 foot—Argentina	7-9
40X0296	Power cord, 1.8M (straight)—Australia	7-9
40X0297	Power cord, 1.77M (straight)—USA, Canada	7-9
40X1367	Parallel cable, packaged (3 m)	7-8
40X1368	USB cable, packaged (2 m)	7-8
40X2855	Tray 2 wear strips (550-sheet tray only)	7-3
40X5036	Wireless card, E460dw	7-5
40X5320	Antenna (11 inch cable)	7-5
40X5344	Fuser assembly, 115 V	7-5
40X5345	Fuser assembly, 230 V	7-5
40X5346	Fuser assembly, 100 V	7-5
40X5350	Controller board, Dell 3330dn	7-5
40X5351	Controller board, E460dw	7-5
40X5356	LCD operator panel assembly, Dell 3330dn/E460dw	7-5
40X5357	LCD bezel cover, Dell 3330dn	7-3
40X5358	MPF tray assembly	7-7
40X5359	Nameplate cover	7-3
40X5360	Access door open sensor assembly	7-5
40X5361	LVPS/HVPS card assembly, 110 V/100 V	7-5
40X5362	LVPS/HVPS card assembly, 220 V	7-5
40X5363	Duplex gear drive CBM	7-7
40X5364	Transfer roll, bearings, gear, spring (CBM)	7-7
40X5365	Duplex and media sensor assembly	7-5
40X5366	Manual input sensor assembly	7-5
40X5367	Main drive gearbox (in motor)	7-7
40X5368	Manual feed clutch CBM	7-7
40X5369	Manual feed solenoid	7-5
40X5370	Media feed (ACM) clutch	7-5
40X5371	MPF feed clutch	7-5
40X5372	Media exit guide assembly (redrive)	7-7
40X5373	Top cover assembly	7-3
40X5374	Left side cover	7-3
40X5375	Right side cover	7-3
40X5377	Rear upper and lower cover assembly	7-3
40X5378	Front access door assembly	7-3
40X5379	Front door cover	7-3
40X5380	Complete duplex assembly	7-7
40X5381	Primary tray	7-3
40X5382	Wear strips (250-sheet trays, optional and primary)	7-3
40X5383	Upper front frame assembly	7-7

40X5385	Toner low sensor	7-5
40X5387	LSU, E460dn/E460dw (printhead)	7-5
40X5391	LLCD bezel cover, E460dw	7-3
40X5392	Cooling fan (screws included)	7-5
40X5394	Tray 2 assembly	7-3
40X5395	550-sheet (Tray 2) assembly	7-3
40X5396	Screws, miscellaneous	7-7
40X5397	Front mounts	7-7
40X5398	Optional 250-sheet tray	7-3
40X5399	Optional 550-sheet tray	7-3
40X5400	110 V maintenance kit	7-7
40X5400	Low voltage (110 V) maintenance kit	6-1
40X5401	220 V maintenance kit	7-7
40X5401	High voltage (220 V) maintenance kit	6-1
40X5402	100 V maintenance kit	6-1, 7-7
40X5440	Tray 2 paper feed tires	7-7
40X5451	Paper feed, ACM tires	7-7
40X5453	Media (ACM) drive assembly	7-7
40X5704	256MB flash	7-8
40X5937	128MB DIMM	7-8
40X5938	256MB DIMM	7-8
40X5939	512MB DIMM	7-8
40X5940	Bar code and forms	7-8
40X5951	Korean KS/KSSM/KSP	7-8
40X5952	Print crypton card assembly	7-8
40X5969	Korean font card assembly	7-8
40X5970	Simplified Chinese font card assembly	7-8
40X5971	Traditional Chinese font card assembly	7-8
40X5972	Japanese font card assembly	7-8
7470094	Field relocation package assembly	7-7

## 8. Parts Catalog (Dell 2350d/dn)

---

### How to use this parts catalog

The following legend is used in the parts catalog:

Asm-Index	Part number	Units/mach	Units/FRU	Description
-----------	-------------	------------	-----------	-------------

- **Asm-index:** Identifies the assembly and the item in the diagram. For example, 2-1 indicates assembly 2 and item number 1.
- **Part number:** Identifies the unique number that identifies this FRU.
- **Units/mach:** Refers to the number of units actually used in the machine or product.
- **Units/FRU:** Refers to the number of units packaged together and identified by the part number.
- **NS:** (Not shown) in the Asm-Index column indicates that the part is procurable but is not pictured in the illustration.
- **PP:** (Parts Packet) in the parts description column indicates the part is contained in a parts packet.

## Assembly 1: Covers

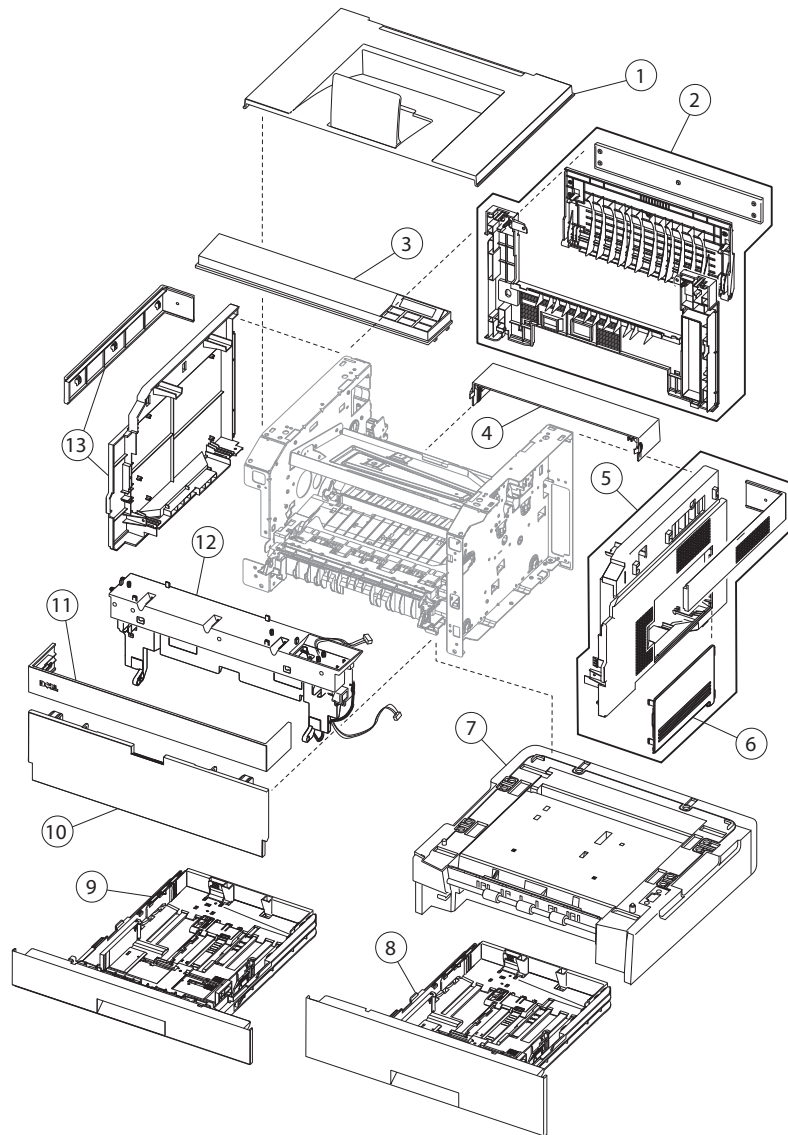



## Assembly 1: Covers

Asm-Index	Part number	Units/mach	Units/FRU	Description
1-1	R716D	1	1	Top cover assembly
2	P657D	1	1	Rear door/cover assembly
3	T362D	1	1	Operator panel (text)
3	F453J	1	1	Operator panel (DBCS)
3	Y857J	1	1	Operator panel (non-US, icons only)
4	P651D	1	1	Legal media dust cover
5	P639D	1	1	Right side cover with ring
6	R719D	1	1	Memory door
7	R511D	1	1	550-sheet Tray 2 (without tray)
8	DP304	1	1	550-sheet Tray 2 (without drawer)
9	P646D	1	1	Main tray
10	N823D	1	1	Front MPF door
11	V8Y9J	1	1	Nameplate 2350d
11	HMX11	1	1	Nameplate 2350dn
12	H226J	1	1	Front access cover assembly
13	M729D	1	1	Left side cover with ring

## Assembly 2: Electronics and frame

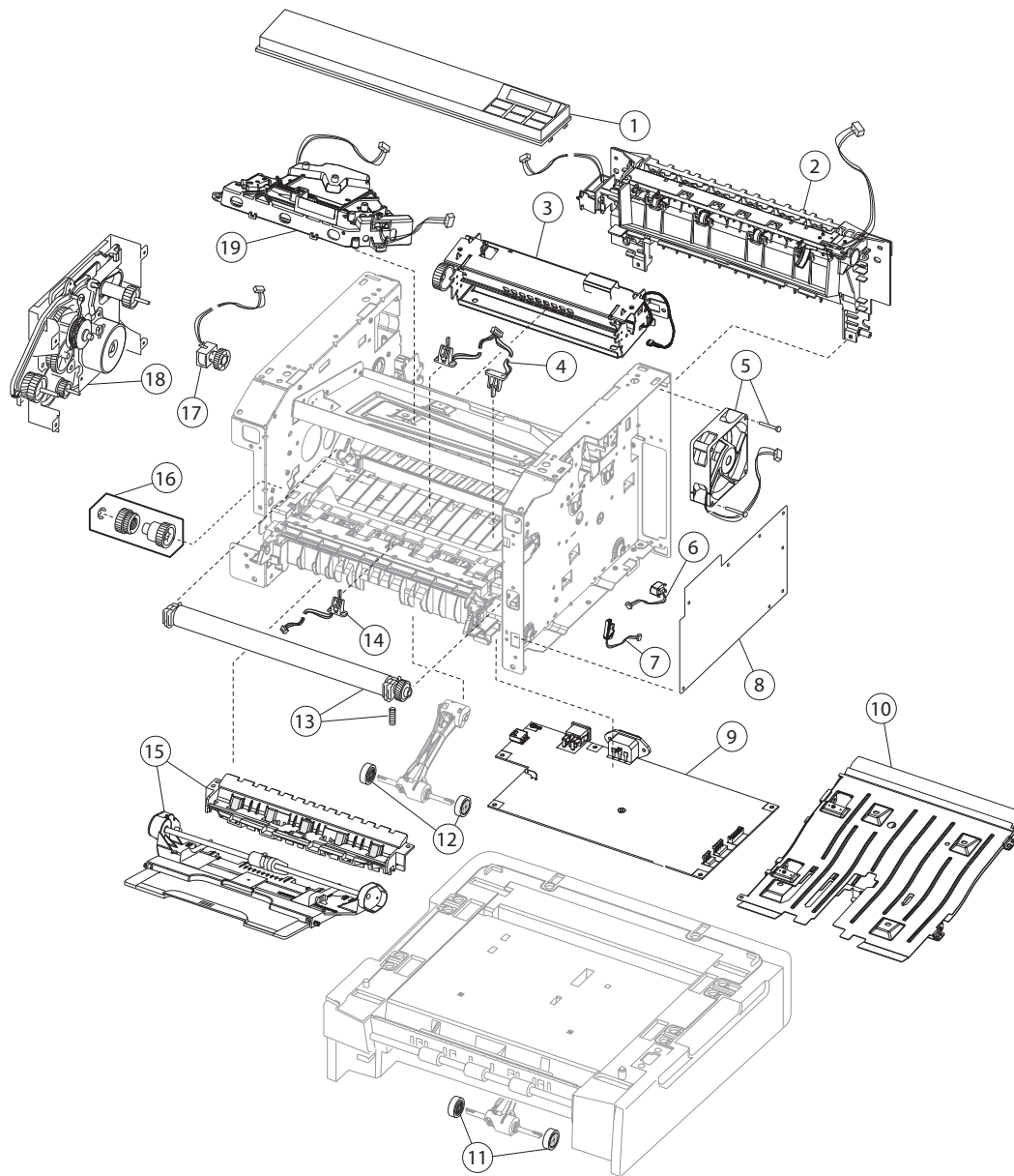

## Assembly 2: Electronics and frame

Asm-Index	Part number	Units/mach	Units/FRU	Description
2-1	T362D	1	1	Operator panel (text)
1	F453J	1	1	Operator panel (DBCS)
1	Y857J	1	1	Operator panel (non-US, icons only)
2	P329M	1	1	Exit guide with sensor redrive
3	N821D	1	1	110 V fuser assembly
3	R714D	1	1	220 V fuser assembly
3	C997J	1	1	100 V fuser assembly
4	M663M	1	1	Duplex/media input sensor assembly
5	H317J	1	1	Cooling fan
6	P649D	1	1	Toner level sensor
7	T375D	1	1	Access cover open sensor
8	N69G0	1	1	Controller board, 2350d
8	NH3TJ	1	1	Controller board, 2350dn
9	M733D	1	1	LVPS/HVPS 110/100 V card assembly
9	N826D	1	1	LVPS/HVPS 220 V card assembly
10	500VF	1	1	Duplex complete assembly
11	N845D	1	1	Tray 2 ACM pick tires
12	T376D	1	1	Main tray ACM pick tires
13	N828D	1	1	Transfer roll CBM
14	M664M	1	1	Manual input sensor assembly
15	R730D	1	1	MPF/paper guide
16	N382M	1	1	Manual feed clutch
17	N383M	1	1	Media feed ACM clutch
18	M6T57	1	1	Gear box assembly main drive with motor
19	H623T	1	1	Printhead assembly
NS	H963K	1	1	128MB DIMM memory card
NS	J793K	1	1	256MB DIMM memory card

### Assembly 3: Exchange units

Asm-Index	Part number	Units/mach	Units/FRU	Description
NS	N40VH	1	1	Exchange unit 100 V base
NS	30G71	1	1	Exchange unit 100 V network
NS	C6N5K	1	1	Exchange unit 220 V base
NS	JW7NM	1	1	Exchange unit 220 V network
NS	VJ088	1	1	Exchange unit Sanbao base
NS	77RY3	1	1	Exchange unit Sanbao network
NS	05H56	1	1	Exchange unit TAA/GSA 110 V network
NS	CHD62	1	1	Exchange unit TAA/GSA 220 V network
NS	TJ8CR	1	1	Exchange unit 110 V base
NS	1NP25	1	1	Exchange unit 110 V network
NS	H7NN3	1	1	Printer, Service, 220 V, China, 2350d
NS	N9YW3	1	1	Printer, Service, 220 V, China, 2350dn

## Assembly 4: Power cords

Asm-Index	Part number	Units/mach	Units/FRU	Description
NS	0C861	1	1	United Kingdom
NS	J7512	1	1	PRC straight 1.8 m
NS	0D600	1	1	USA/Canada
NS	0C047	1	1	Australia
NS	0D254	1	1	Euro
NS	0D096	1	1	Japan (3 prong)
NS	UD330	1	1	Japan (2 prong)
NS	Y6355	1	1	Singapore/Malaysia
NS	FF518	1	1	Switzerland 6 ft.
NS	FF523	1	1	Danish 6 ft. straight
NS	UJ372	1	1	Israel 6 ft. straight
NS	GF366	1	1	South Africa 6 ft. straight
NS	PF882	1	1	Italy 6 ft. straight

## Assembly 5: Miscellaneous

Asm-Index	Part number	Units/mach	Units/FRU	Description
NS	W61F8	1	1	110 V Maintenance kit
NS	M0XCF	1	1	220 V Maintenance kit

## Part number index (Dell 2350d/dn)

P/N	Description	Page
05H56	Exchange unit TAA/GSA 110 V network -----	8-6
0C047	Australia -----	8-7
0C861	United Kingdom -----	8-7
0D096	Japan (3 prong) -----	8-7
0D254	Euro -----	8-7
0D600	USA/Canada -----	8-7
1NP25	Exchange unit 110 V network -----	8-6
30G71	Exchange unit 100 V network -----	8-6
500VF	Duplex complete assembly -----	8-5
77RY3	Exchange unit Sanbao network -----	8-6
<b>C</b>		
C6N5K	Exchange unit 220 V base -----	8-6
C997J	100 V fuser assembly -----	8-5
CHD62	Exchange unit TAA/GSA 220 V network -----	8-6
<b>D</b>		
DP304	550-sheet Tray 2 (without drawer) -----	8-3
<b>F</b>		
F453J	Operator panel (DBCS) -----	8-3, 8-5
FF518	Switzerland 6 ft. -----	8-7
FF523	Danish 6 ft. straight -----	8-7
<b>G</b>		
GF366	South Africa 6 ft. straight -----	8-7
<b>H</b>		
H226J	Front access cover assembly -----	8-3
H317J	Cooling fan -----	8-5
H623T	Printhead assembly -----	8-5
H7NN3	Printer, Service, 220 V, China, 2350d -----	8-6
H963K	128MB DIMM memory card -----	8-5
HMX11	Nameplate 2350dn -----	8-3
<b>J</b>		
J7512	PRC straight 1.8 m -----	8-7
J793K	256MB DIMM memory card -----	8-5
JW7NM	Exchange unit 220 V network -----	8-6
<b>M</b>		
M0XCF	220 V Maintenance kit -----	8-8
M663M	Duplex/media input sensor assembly -----	8-5
M664M	Manual input sensor assembly -----	8-5
M6T57	Gear box assembly main drive with motor -----	8-5
M729D	Left side cover with ring -----	8-3
M733D	LVPS/HVPS 110/100 V card assembly -----	8-5
<b>N</b>		
N382M	Manual feed clutch -----	8-5
N383M	Media feed ACM clutch -----	8-5
N40VH	Exchange unit 100 V base -----	8-6
N69G0	Controller board, 2350d -----	8-5
N821D	110 V fuser assembly -----	8-5
N823D	Front MPF door -----	8-3
N826D	LVPS/HVPS 220 V card assembly -----	8-5

N828D	Transfer roll CBM -----	<b>8-5</b>
N845D	Tray 2 ACM pick tires -----	<b>8-5</b>
N9YW3	Printer, Service, 220 V, China, 2350dn -----	<b>8-6</b>
NH3TJ	Controller board, 2350dn -----	<b>8-5</b>
<b>P</b>		
P329M	Exit guide with sensor redrive -----	<b>8-5</b>
P639D	Right side cover with ring -----	<b>8-3</b>
P646D	Main tray -----	<b>8-3</b>
P649D	Toner level sensor -----	<b>8-5</b>
P651D	Legal media dust cover -----	<b>8-3</b>
P657D	Rear door/cover assembly -----	<b>8-3</b>
PF882	Italy 6 ft. straight -----	<b>8-7</b>
<b>R</b>		
R511D	550-sheet Tray 2 (without tray) -----	<b>8-3</b>
R714D	220 V fuser assembly -----	<b>8-5</b>
R716D	Top cover assembly -----	<b>8-3</b>
R719D	Memory door -----	<b>8-3</b>
R730D	MPF/paper guide -----	<b>8-5</b>
<b>T</b>		
T362D	Operator panel (text) -----	<b>8-3, 8-5</b>
T375D	Access cover open sensor -----	<b>8-5</b>
T376D	Main tray ACM pick tires -----	<b>8-5</b>
TJ8CR	Exchange unit 110 V base -----	<b>8-6</b>
<b>U</b>		
UD330	Japan (2 prong) -----	<b>8-7</b>
UJ372	Israel 6 ft. straight -----	<b>8-7</b>
<b>V</b>		
V8Y9J	Nameplate 2350d -----	<b>8-3</b>
VJ088	Exchange unit Sanbao base -----	<b>8-6</b>
<b>W</b>		
W61F8	110 V Maintenance kit -----	<b>8-8</b>
<b>Y</b>		
Y6355	Singapore/Malaysia -----	<b>8-7</b>
Y857J	Operator panel (non-US, icons only) -----	<b>8-3, 8-5</b>



# Dell 3330dn Wiring Diagram

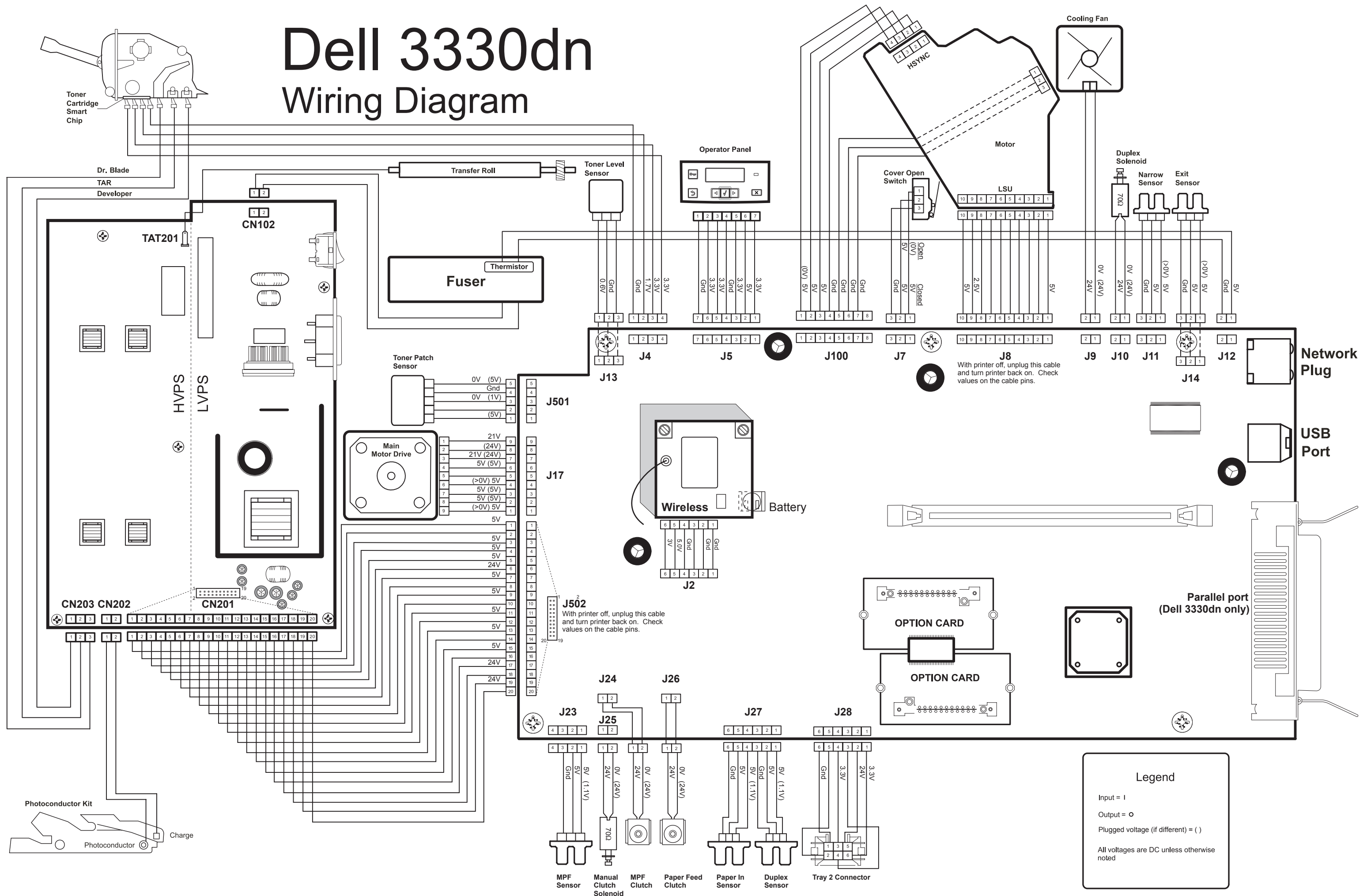

# Dell 2350d/2350dn : Recommended Spare-parts List

15 Nov 2010

MFG P/N	MFG Part Description	Dell P/N	Dell RSL Online Description	CRU or FRU
<b>Base Unit</b>				
DRU1054	110V 2350d US/CA/LA	TJ8CR	Printer, Service, 110V, 2350d	CRU
DRU1055	110V 2350dn US/CA/LA	1NP25	Printer, Service, 110V, 2350dn	CRU
DRU1058	TAA/GSA 110V 2350dn	05H56	Printer, Service, 110V, TAA, 2350dn	CRU
DRU1059	TAA/GSA 220V 2350dn	CHD62	Printer, Service, 220V, TAA, 2350dn	CRU
DRU1056	220V 2350d EMEA/ANZ/SG/MY/AP	C6N5K	Printer, Service, 220V, EMEA/ANZ/SG/MY, 2350d	CRU
DRU1057	220V 2350dn EMEA/NZ/SG/MY/AP	JW7NM	Printer, Service, 220V, EMEA/ANZ/SG/MY, 2350dn	CRU
DRU1052	100V 2350d JAP	N40VH	Printer, Service, 100V, Japan, 2350d	CRU
DRU1053	100V 2350dn JAP	30G71	Printer, Service, 100V, Japan, 2350dn	CRU
DRU1081	220V 2350d China	H7NN3	Printer, Service, 220V, China, 2350d	CRU
DRU1082	220V 2350dn China	N9YW3	Printer, Service, 220V, China, 2350dn	CRU
DRU1060	SANBAO 2350d	VJ088	Printer, Service, 220V, China, San Bao, 2350d	CRU
DRU1061	SANBAO 2350dn	77RY3	Printer, Service, 220V, China, San Bao, 2350dn	CRU
<b>Accessory</b>				
PK492	Dell E360 2K UAR Cartridge	PK492	Toner Cartridge, 2K, Use/Return, 2330d/dn, 2350d/dn	CRU
PK941	Dell E360 6K UAR Cartridge	PK941	Toner Cartridge, 6K, Use/Return, 2330d/dn, 2350d/dn	CRU
DM254	Dell E360 2K BAU Cartridge	DM254	Toner Cartridge, 2K, Regular, 2330d/dn, 2350d/dn	CRU
PK937	Dell E360 6K BAU Cartridge	PK937	Toner Cartridge, 6K, Regular, 2330d/dn, 2350d/dn	CRU
PK496	Imaging Drum Kit	PK496	Drum Cartridge, 30K, 2330d/dn, 2350d/dn	CRU
DRU0204	Dell SVC Tray 250 SHEET	P646D	Paper Tray, Primary, 250 sheets, 2330d/dn, 2350d/dn	CRU
DRU0206	550 TRAY (W/O DWR)	DP304	Paper Tray, Without Drawer, 550 sheets, 2330d/dn, 2350d/dn	CRU
DRU0205	550 SHEET W/O TRAY	R511D	Drawer, Without Tray, 550 sheets, 2330d/dn, 2350d/dn	CRU
DRU0209	MPF	R730D	Paper Tray, Multipurpose Feeder, 2330d/dn, 2350d/dn	FRU
TG532328LEX323J1S	KIT,DIMM,128MB,DDR1,2330	H963K	Memory, 128MB, SDRAM-DIMM, 2330d/dn, 2350d/dn, 3330dn, 5230n/dn	CRU
TG532648LEX323J1S	KIT,DIMM,256MB,DDR1,2330DN	J793K	Memory, 256MB, SDRAM-DIMM, 2330d/dn, 2350d/dn, 3330dn, 5230n/dn	CRU
<b>Controller Cards</b>				
DRU1049	CONTROLLER 2350d	N69G0	Controller Board, Base, 2350d	FRU
DRU1041	CONTROLLER 2350dn	NH3TJ	Controller Board, Network, 2350dn	FRU
<b>Cables and Cords</b>				
CA10 0402 02 139 10	CBL,USB,10FT,PTR	YY498	Cable, USB, 10FT, Printer	CRU
CD25 C06L 36-C38-DF	CBL,USB,10FT,PTR	GH686	Cabel, Parallel, IEEE-1284, Black, Printer	CRU
<b>Heatsinks, Fans and Accessories</b>				
DRC0325	COOLING (2 WIRE) FAN	H317J	Fan, Cooling, 2 wire, 24V, 2330d/dn, 2350d/dn	FRU
<b>Power Source (or Power Supply)</b>				
DRU0202	LVPS/HVPS 110V CARD ASM	M733D	Power Supply, LVPS/HVPS , 100V-110V, 2330d/dn, 2350d/dn	FRU
DRU0203	LVPS/HVPS 220V CARD ASM	N826D	Power Supply, LVPS/HVPS, 220V, 2330d/dn, 2350d/dn	FRU
<b>Miscellaneous Hardware</b>				
DRU0217	100V FUSER ASM	C997J	Fuser, 100V, 2330d/dn, 2350d/dn	FRU
DRU0196	110V FUSER ASM	N821D	Fuser, 110V, 2330d/dn, 2350d/dn	FRU
DRU0197	220V FUSER ASM	R714D	Fuser, 220V, 2330d/dn, 2350d/dn	FRU
DRU0081	LSU (H) PRTHD ASM	H623T	Printhead, Laser Scanning Unit, 3330d/dn, 2350d/dn	FRU
DRC0324	ROLL CBM TRANSFER	N828D	Transfer Roller, 2330d/dn, 2350d/dn	FRU

DRU0207	ACM TIRE PAPER FEED	T376D	Pickup Roller, 2 tires, 2330d/dn, 2350d/dn	CRU
DRU0219	TRAY2 ACM TIRE	N845D	Pickup Roller, 550-sheet tray, 2330d/dn, 2350d/dn	CRU
DRU0201	OP PANEL ASM	T362D	Control Panel Card, Single Byte Character String, 2330d/dn, 2350d/dn	FRU
DRU0208	OP PANEL ASM DBCS	F453J	Control Panel Card, Double Byte Character String, 2330d/dn, 2350d/dn	FRU
DRU0233	OP PANEL (ICONS ONLY)	Y857J	Control Panel Card, Icon, 2330d/dn, 2350d/dn	FRU
DRC0326	TONER LEVEL RO SENSOR	P649D	Toner Level Sensor, 2330d/dn, 2350d/dn	FRU
DRC0327	ACCESS COVER OPEN SENSOR ASM	T375D	Cover Open Sensor, 2330d/dn, 2350d/dn	FRU
DRC0330	DPLX/PAPER INPUT ASM	M663M	Paper input and duplex sensor, 2330d/dn, 2350d/dn	FRU
DRC0331	MANUAL INPUT ASM	M664M	Media manual input sensor, 2330d/dn, 2350d/dn	FRU
DRC0328	MANUAL FEED	N382M	Manual feed clutch, 2330d/dn, 2350d/dn	FRU
DRC0329	MEDIA FEED (ACM)	N383M	Media feed clutch, 2330d/dn, 2350d/dn	FRU
DRC0332	EXIT GUIDE W/SENSOR	P329M	Rear exit guide assembly with sensor, 2330d/dn, 2350d/dn	FRU
40X5380	DUPLEX COMPLETE ASM	500VF	Duplex Unit	FRU
40X5367	GEAR BX ASMAIN DRIVE W/MOTOR	M6T57	Main Motor Gear Drive	FRU
<b>Mechanical/Chassis</b>				
DRU1083	NAMEPLATE 2350D	V8Y9J	Nameplate Cover, Base, 2350d	FRU
DRU1084	NAMEPLATE 2350DN	HMX11	Nameplate Cover, Network, 2350dn	FRU
DRU0212	TOP COVER ASM	R716D	Top cover assembly, 2330d/dn, 2350d/dn	FRU
DRU0213	LEFT COVER ASM	M729D	Left side cover, 2330d/dn, 2350d/dn	FRU
DRU0214	RIGHT COVER	P639D	Right side cover, 2330d/dn, 2350d/dn	CRU
DRU0215	REAR UPPR AND LWR COVER CBM	P657D	Rear upper and lower cover, 2330d/dn, 2350d/dn	FRU
DRU0218	MPF COVER	N823D	Multipurpose feeder cover, 2330d/dn, 2350d/dn	FRU
DRU0220	LEGAL EXTENDER COVER	P651D	Legal paper extender cover, 2330d/dn, 2350d/dn	CRU
DRU0234	MEMORY ACCESS DOOR	R719D	Memory access door, 2330d/dn, 2350d/dn	FRU
DRU0235	FRONT ACCESS ASM	H226J	Front access door assembly, 2330d/dn, 2350d/dn	FRU
DRU0077	110V MAINTENANCE KIT	W61F8	Maintenance Kit, 110V, 120K, 3330dn/2350dn <ul style="list-style-type: none"> <li>• Fuser 110V, 2330d/dn,2350d/dn, 3330dn (Dell P/N N821D)</li> <li>• Pickup Roller, 2 tires, 2350d/dn, 3330dn (Dell P/N T376D)</li> <li>• Transfer Roller, 2330d/dn, 2350d/dn, 3330dn (Dell P/N N828D)</li> </ul>	FRU
DRU0076	220V MAINTENANCE KIT	MOXCF	Maintenance Kit, 220V, 120K, 3330dn/2350dn <ul style="list-style-type: none"> <li>• Fuser 220V, 2350d/dn, 3330dn (LXK P/N DRU0197, Dell P/N R714D)</li> <li>• Pickup Roller, 2 tires, 2350d/dn, 3330dn (LXK P/N DRU0207, Dell P/N T376D)</li> <li>• Transfer Roller, 2350d/dn, 3330dn (LXK P/N DRC0324, Dell P/N N828D)</li> </ul>	FRU

**Notes**

CRU : Customer Replaceable Units - refers to parts that can easily be replaced by the customer without sending an onsite technician.

FRU : Field Replaceable Unit - a part that can be replaced or added by onsite technician.

# Dell 3330dn : Recommended Spare-parts List

23 Apr 2010

MFG P/N	MFG Part Description	Dell P/N	Dell Part Description	CRU or FRU
<b>FUSER AND ACCESSORIES</b>				
DRU0217	100V FUSER ASM	C997J	ASSEMBLY, FUSER, 100V, PRINTER/PRINTER ACCESSORIES, 2330	FRU
DRU0196	110V FUSER ASM	N821D	ASSEMBLY, FUSER, 110V, PRINTER/PRINTER ACCESSORIES, 2330	FRU
DRU0197	220V FUSER ASM	R714D	ASSEMBLY, FUSER, 220V, PRINTER/PRINTER ACCESSORIES, 2330	FRU
<b>TONER / INK</b>				
00P976R	7K Use and Return Cartridge	P976R	CARTRIDGE, TONER, 7K, USE/RETURN, 3330	CRU
00C233R	14K Use and Return Cartridge	C233R	CARTRIDGE, TONER, 14K, USE/RETURN, 3330	CRU
00W895P	7K Regular Cartridge	W895P	CARTRIDGE, TONER, 7K, REGLR, 3330	CRU
00W896P	14k Regular Cartridge	W896P	CARTRIDGE, TONER, 14K, REGLR, 3330	CRU
<b>FEEDER, TRAY AND TRAY HOUSING</b>				
DRU0204	PRIMARY MEDIA TRAY ASM	P646D	TRAY, PAPER, ASSEMBLY, PRIMARY, 2330 (with Instruction sheet)	CRU
DRU0205	OPTIONAL (W/O TRAY) DRAWER ASM	R511D	DRAWER, PAPER, 550SHT, 2330 (w/o Tray)	CRU
DRU0206	OPTIONAL (W/O DWR) TRAY ASM	DP304	TRAY,PAPER,550SHT,2330	CRU
<b>DRUM</b>				
24B3422	Imaging Drum Kit	PK496	CARTRIDGE, DRUM, 30K, PHOTO CONDUCTOR, 2330	CRU
<b>BASE UNIT</b>				
DRU0298	EXCH 100V H PRNTR ASM	4GC89	ASSEMBLY, Base, SERVICE KIT, Japan, 3330DN	CRU
DRU0086	EXCH 110V H PRNTR ASM TEXT	F876T	ASSEMBLY, Base, SERVICE KIT, LOW VOLTAGE, 3330DN	CRU
DRU0088	EXCH 220V H PRNTR ASM	J522T	ASSEMBLY, Base, SERVICE KIT, HIGH VOLTAGE, ICON, 3330DN	CRU
DRU0090	EXCH TAA/GSA 115V H	H621T	ASSEMBLY, Base, SERVICE KIT, LOW VOLTAGE, TRADE AGREEMENT ACT, 3330DN	CRU
DRU0119	EXCH TAA/GSA 230V H	G744T	ASSEMBLY, Base, SERVICE KIT, HIGH VOLTAGE, TRADE AGREEMENT ACT, 3330DN	CRU
DRU0296	EXCH SANBAO BASE PRNTR ASM	DP1YK	ASSEMBLY, Base, SERVICE KIT, HIGH VOLTAGE, 3B, 3330DN	CRU
<b>CABLES AND POWER CORDS</b>				
CA100 40202 139 10	CABLE, USB, 10FT, PRINTER/PRINTER ACCESSORIES	YY498	CABLE, USB, 10FT, PRINTER/PRINTER ACCESSORIES	CRU
CD25C 06L36 -C38-DF	PTR,CBL,IEEE-1284,LT,PRL,BLK	GH686	PRINTER/PRINTER ACCESSORIES, CABLE, IEEE-1284, LT, PARALLEL, BLACK	CRU
<b>ELECTRICAL / ELECTRONICS BOARDS AND CARDS</b>				
DRU0021	CARD ASM Controller 3330DN	K663T	Controller network card assembly	FRU
30G0828	Japanese font card	DRMXP	Japanese font card	CRU
30G0825	Korean font card	W7HK3	Korean font card	CRU
30G0826	Simplified Chinese font card	2X4W9	Simplified Chinese font card	CRU
30G0827	Traditional Chinese font card	6W2JH	Traditional Chinese font card	CRU
14F0245	256M FLASH memory	HWM4W	256M FLASH memory	CRU
14T0220	Ethernet gigabite card	P75H8	Ethernet gigabite card	CRU
<b>PRINT MEDIA</b>				
DRU0081	LSU (H) PRTHD ASM	H623T	PRINthead, LASER SCANNING UNIT, PRINTER/PRINTER ACCESSORIES, 3330DN	FRU
<b>MEMORY</b>				
TG532328 LEX323J1S	128MB DIMM, DDR1	H963K	KIT, PTR, MEM, 128MB, SDRAM-DIMM	CRU
TG532648 LEX323J1S	256MB DIMM, DDR1	J793K	KIT, PTR, MEM, 256MB, SDRAM-DIMM	CRU
SG532288 LEX323J2S	512MB DDR1 DIMM	1C7JG	KIT, PTR, MEM, 512MB, SDRAM-DIMM	CRU
<b>PLASTICS</b>				
DRU0212	TOP COVER ASM	R716D	COVER, TOP, ASSEMBLY, PRINTER/PRINTER ACCESSORIES, 2330	FRU
DRU0218	MPF COVER	N823D	COVER, MULTIPURPOSE FEEDER, PRINTER/PRINTER ACCESSORIES, 2330	FRU
DRU0085	FRT ACCESS ASM (H)	G745T	ASSY,DOOR,FRONT,LATCH,PTR,3330	FRU
DRU0215	REAR UPPR AND LWR COVER CBM	P657D	COVER, REAR, PRINTER/PRINTER ACCESSORIES, 2330	FRU
DRU0214	RIGHT COVER	P639D	COVER, RIGHT, PRINTER/PRINTER ACCESSORIES, 2330	FRU
DRU0213	LEFT COVER ASM	M729D	COVER, LEFT, PRINTER/PRINTER ACCESSORIES, 2330	FRU

DRU0082	OP PANEL ASM H	K664T	ASSEMBLY, Card, CONTROL PANEL, 3330	FRU
DRU0050	OP PANEL ASM H (ICONS ONLY)	5W5H3	ASSEMBLY, Card, CONTROL PANEL, ICON, 3330	FRU
DRU0083	NAME PLATE RING NW H	G746T	COVER, FRONT-TRIM-RING, NTWK, 3330	FRU
DRU0234	Memory Access door	R719D	COVER, MEM-ACCESS-DOOR, PRINTER/PRINTER ACCESSORIES, 2330	FRU
POWER SOURCES				
DRU0202	LVPS/HVPS 110V CARD ASM	M733D	PWA, POWER DISTRIBUTION BOARD, 100V-110V, PRINTER/PRINTER ACCESSORIES, 2330	FRU
DRU0203	LVPS/HVPS 220V CARD ASM	N826D	PWA, POWER DISTRIBUTION BOARD, 220V, PRINTER/PRINTER ACCESSORIES, 2330	FRU
MISCELLANOUS HARDWARE				
DRC0325	COOLING (2 WIRE) FAN	H317J	FAN, COOLING, 2WIRE, 24V, PRINTER/PRINTER ACCESSORIES, 2330	FRU
DRC0324	ROLL CBM TRANSFER	N828D	ROLLER, TRANSFER, PRINTER/PRINTER ACCESSORIES, 2330	FRU
DRU0207	ACM TIRE PAPER FEED	T376D	ROLLER, PK-ARM, 2TIRES, PRINTER/PRINTER ACCESSORIES, 2330 (with Instruction sheet)	CRU
DRC0326	TONER LEVEL RO SENSOR	P649D	SENSOR, CARTRIDGE, TONER, CBL-NO, 2330	FRU
DRC0327	ACCESS COVER OPEN SENSOR ASM	T375D	SNSR,CVR-ACCESS,ASSY,PTR,2330	FRU
DRU0219	TRAY2 ACM TIRE	N845D	ROLLER, PK-ARM, 550-TRAY, PRINTER/PRINTER ACCESSORIES, 2330 (with Instruction sheet)	CRU
DRU0209	MFP TRAY ASSM.	R730D	TRAY, PAPER, ASSEMBLY, MULTIPURPOSE FEEDER, 2330	FRU
DRU0220	LEGAL EXTENDER COVER	P651D	COVER, EXTENDER, LGL-PAPER, PRINTER/PRINTER ACCESSORIES, 2330 (with Instruction sheet)	CRU
DRC0328	Clutch Manual Feed	N382M	CLCH,FDR,MNL,PTR,LS,2330	FRU
DRC0329	Clutch Media Feed (ACM)	N383M	CLCH,FDR,MEDIA,PTR,LS,2330	FRU
DRC0330	Sensor DPLX/Paper Input Asm	M663M	ASSY,SNSR,PAPER,INPUT,PTR,2330	FRU
DRC0331	Sensor Manual Input Asm	M664M	ASSY,SNSR,MNL,INPUT,PTR,2330	FRU
DRC0332	Redrive Exit Guide w/sensor	P329M	GDE,EXIT,REDR,SNSR,PTR,2330	FRU
DRU0299	100V Maintenance Kit	VP8Y8	KIT, PRINTER/PRINTER ACCESSORIES, MAINTENANCE, 100V, 120K	FRU
DRU0077	110V Maintenance Kit	W61F8	KIT, PRINTER/PRINTER ACCESSORIES, MAINTENANCE, 110V, 120K	FRU
DRU0076	220V Maintenance Kit	MOXCF	KIT, ACCESSORY, MAINTAINENCE, 220V, 3330	FRU

**Notes**

CRU : Customer Replaceable Units - refers to parts that can easily be replaced by the customer without sending an onsite technician.  
FRU : Field Replaceable Unit - a part that can be replaced or added by onsite technician.