



User guide

Matrix printer 2810 2820



Table of contents

Introduction.....	1
Printer features.....	1
Symbols used.....	1
About this manual.....	2
Printer at a glance.....	3
Printer in tractor mode.....	4
Paperway.....	5
Installation.....	6
Unpacking the printer.....	6
Placing your printer.....	7
Connecting the printer.....	8
Switching on the printer.....	9
Inserting the ribbon cassette.....	10
Printer drivers.....	15
Installing a printer driver in Windows.....	15
Other operating systems.....	16
Changing printer settings.....	17
Form settings (Windows 2000/2003/XP/Vista/Windows 7/2008).....	17
Loading optional firmware.....	18
The control panel.....	19
The LC display.....	20
Online mode.....	21
Offline mode.....	21
Setup mode.....	22
Messages in the LC display.....	23
Key functions when turning on the printer.....	24
USB host interface.....	24
Firmware Download.....	24
Configuration File Upload.....	24
Configuration File Download.....	25

Paper handling.....	26
Loading paper.....	26
Paper transport.....	29
Moving the paper to the tear position.....	30
Removing paper.....	31
Settings.....	32
Setting the print head gap.....	32
Setting the tear position.....	33
Setting the first printing line (TOF).....	34
Selecting character density and font.....	35
The Menu.....	36
Programming via the control panel.....	36
Enabling access to menu mode.....	36
Calling up the menu.....	37
Menu configurations.....	37
Menu handling.....	38
Save settings.....	38
Selecting the LC display language.....	39
Terminating Setup mode.....	40
Menu structure.....	41
Menu parameters.....	42
Printing out menu configurations (Print).....	42
Loading menu configurations (Menu).....	42
Reset to default values (Reset).....	43
Quietmode (Quietm.).....	43
Selecting font (Font).....	44
Setting character density (CPI).....	45
Setting line spacing (LPI).....	45
Skipping perforation (Skip).....	46
Selecting start signal for escape sequence (ESCChar).....	46
Selecting emulation (Emulate).....	47
Bidirectional printing (Bidir).....	47
Settings for interfaces (I/O).....	48
Serial interface (Serial).....	48
Data transmission rate (Baud).....	48
Data format (Format).....	49
Further Settings (Special).....	50
Error handling (ErrMode).....	50
Block end character (Blockend).....	50

Signal feedback (Remote).....	51
Transparence (Handthr).....	51
Protocol (Protocol).....	52
Signal Processing (DTR).....	52
Selecting interface (Interf.).....	53
Interface buffer (Buffer).....	53
Ethernet interface (ETH-INT).....	54
Setting Gateway address (Gateway).....	54
Setting IP address (IPv4 Addr).....	55
Setting Subnet mask (Subnet).....	55
IP address administration (IP Get M).....	56
Banner page (Banner).....	56
Ethernet speed (EthSpeed).....	57
Selecting character set (CG-Tab).....	57
IBM character set (CharSet).....	58
National character set (Country).....	58
Slashed zero (Sl.Zero).....	58
Automatic carriage return (Auto-CR).....	59
Automatic line feed (Auto-LF).....	59
Menu lock (MenLock).....	60
Language (Language).....	60
Paper parameters (Paper).....	61
Form length (Forml).....	61
First printing position (FormAdj).....	62
Printhead gap manually (Head).....	63
View and tear position (AutoTear).....	64
Line length (Width).....	65
Barcode (Barcode).....	65
Normal characters and barcode (Barmode).....	66
Vertical position after oversized barcode (BarTop).....	67
Vertical position after oversized character (LCPTop).....	67
Form feed mode (Ffmode).....	68
Setting and activating options (PapOpt).....	69
Activation of tractors (AutoTra).....	69
Setting the left margin (LeftMrg).....	70
Setting the right margin (RightMrg).....	70
Local copy (screen print) from a Coax or Coax/IPDS (FFaftLC).....	71
Enable/Disable paper handling features (Paphand).....	71
Menu settings (example).....	72

Advanced menu.....	73
Test functions.....	73
Printer self-test (Rolling ASCII).....	74
Exiting Rolling ASCII test mode.....	75
Interface test (Hex-Dump).....	76
Printout in Hex-Dump.....	76
Terminating Hex-Dump.....	77
Paper sensor display.....	77
Advanced settings.....	78
Automatic paper motion sensor (PMS).....	80
Form length (Forml).....	81
Automatic gap adjustment (AGA).....	81
Paper handling (Paphand).....	82
Increasing the printhead gap (Head up).....	82
Paper width (Pagewid).....	83
Left-hand area (Leftzon).....	83
Right-hand area (Rightzo).....	84
Physical left margin (Physlm).....	84
Bidirectional parallel interface (CX-bid).....	85
Line wrap (Wrap).....	85
Beep at paper end (Sound).....	86
Activate PjL language (Jobcntl).....	86
Settings for paper with dark back (Pap.back).....	87
Graphic print speed (GrSpeed).....	87
Setting for printing copy paper (HvyForm).....	88
Automatic paper width detection (APW).....	88
Automatic detection of the top paper margin (AED).....	89
Serial number (SerialN).....	90
Asset number (AssetN).....	90
Ignore characters (Ignore).....	91
Ignore character (IgnorChr).....	91
Troubleshooting.....	92
General print problems.....	93
Problems with the print quality.....	95
Error messages via the display.....	96
Additional display messages.....	99

Care and maintenance.....	100
Replacing the fuse.....	100
Cleaning the housing.....	101
Cleaning the interior.....	101
Cleaning the platen.....	102
Ribbon.....	102
Cleaning the upper friction.....	103
Carriage shafts.....	103
Specifications.....	104
Printer specifications.....	104
Interface specifications.....	107
Paper specifications.....	108
Character sets.....	109
MTPL standard character set.....	110
MTPL, international substitution characters.....	111
OCR-A character set.....	112
OCR-B character set.....	113
Available character sets and fonts.....	114
Emulations.....	117
General.....	117
Escape sequences.....	117
What are escape sequences?.....	118
MTPL sequences.....	118
Control codes.....	118
The \$\$ procedure.....	118
Example.....	118
How are escape sequences used?.....	119
MTPL.....	119
Example in BASIC.....	119
Example in Pascal.....	119
Printout.....	119
List of available control codes.....	120
Genicom ANSI Emulation.....	130
PJM commands.....	132

Barcode.....	133
List of available barcodes.....	133
US Postnet barcode.....	134
Royal Mail Customer barcode.....	134
KIX barcode.....	135
USPS Intelligent Mail barcode.....	135
Large character printing.....	136
List of additional control codes.....	137
Interfaces.....	138
USB 2.0 (Full-Speed, 12MBit/s).....	138
Ethernet interface.....	139
Hardware.....	139
Supported operating systems.....	139
Supported protocols.....	139
Designation of IP address.....	139
Configuration.....	139
Parallel interface (optional).....	140
Connector assignment.....	140
Serial interface V.24/RS232C (optional).....	141
Connector assignment.....	141
Interface cable (serial interface).....	142
Input signals.....	142
Output signals.....	142
Protocols.....	143
Memory mode XON/XOFF.....	143
Memory mode Robust XON/XOFF.....	143
Extended menu functions with the ENQ/STX and ETX/ACK protocols selected.....	143
ENQ/STX protocol.....	144
ETX/ACK protocol.....	144
Management.....	145
Setup.....	145
Physical printer port in Ethernet with TCP/IP.....	145

- Options and accessories..... 146
 - Options..... 146
 - Tractor 2, front..... 146
 - Autocut facility..... 146
 - Printer pedestal..... 146
 - Basket..... 146
 - Interface modules..... 146
 - Optional firmware..... 146
 - Accessories..... 147
 - Ribbon cassettes..... 147
 - Programming manuals..... 147

Introduction

Printer features

Your printer has outstanding product features, such as a high print speed, an excellent print quality, a high workload and low running costs. Furthermore it withstands dusty, dirty and hostile environments.

For all these reasons it is a professional solution for many industrial sectors.

Symbols used

Important information is highlighted in this manual by two symbols.



CAUTION highlights information which must be observed in order to prevent injuries to the user and damage to the printer.



NOTE highlights general or additional information about a specific topic.

About this manual

The user guide contains a detailed description of the printer, its characteristic features and additional information.

- ▶ Chapter 1 *Printer at a glance* lists all the parts of the printer.
- ▶ Chapter 2 *Installation* contains start-up instructions and points to note.
- ▶ Chapter 3 *Inserting the ribbon cassette* provides step-by-step instructions for changing the ribbon cassette.
- ▶ Chapter 4 *Printer drivers* provides step-by-step instructions for installing the printer driver.
- ▶ Chapter 5 *The control panel* explains how to control printer operations.
- ▶ Chapter 6 *Paper handling* tells you how to load, transport and move the paper to the tear-off position.
- ▶ Chapter 7 *Settings* tells you how to adjust the basic settings such as font, character density, print head distance, print line height and tearoff position.
- ▶ Chapter 8 *The Menu* contains all the information necessary for controlling the printer via the control panel.
- ▶ Chapter 9 *Advanced menu* describes the possible test settings and other technical adjustments of the printer.
- ▶ Chapter 10 *Troubleshooting* provides instructions for rectifying faults which do not require the intervention of qualified personnel.
- ▶ Chapter 11 *Care and maintenance* provides information on the upkeep of the printer.
- ▶ Appendix A *Specifications* informs you about the technical specifications of your printer and the paper which should be used.
- ▶ Appendix B *Character sets* lists the available MTPL character sets.
- ▶ Appendix C *Emulations* deals with programming via the interface. The available programming sequences are listed.
- ▶ Appendix D *Interfaces* explains the interfaces.
- ▶ Appendix E *Options and accessories* contains information about options and accessories you can purchase for your printer.

Printer at a glance

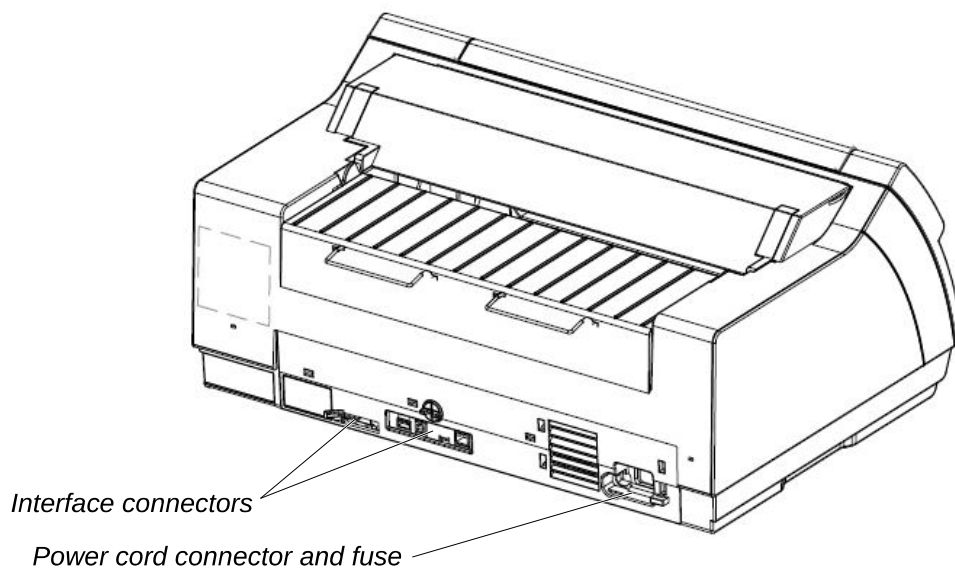
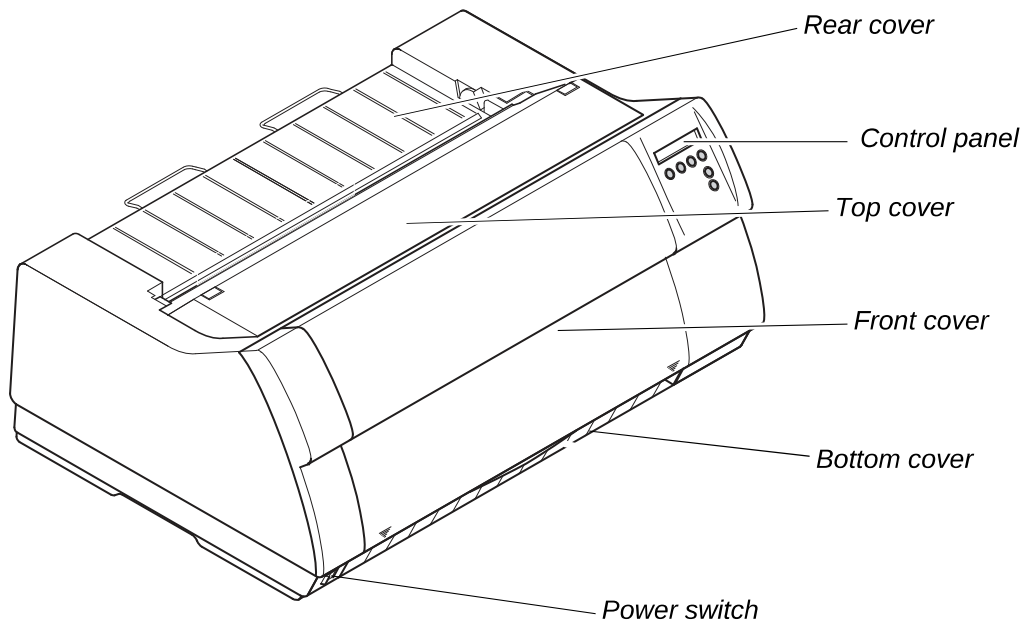

Printer in tractor mode

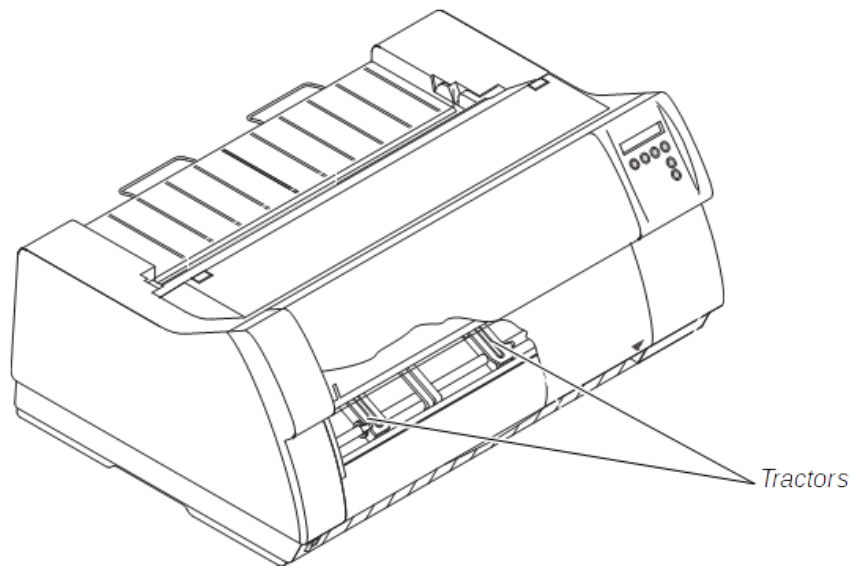

Paperway

Standard printer: Tractor 1

Options: Tractor 2

i For additional paper options, please contact your dealer.

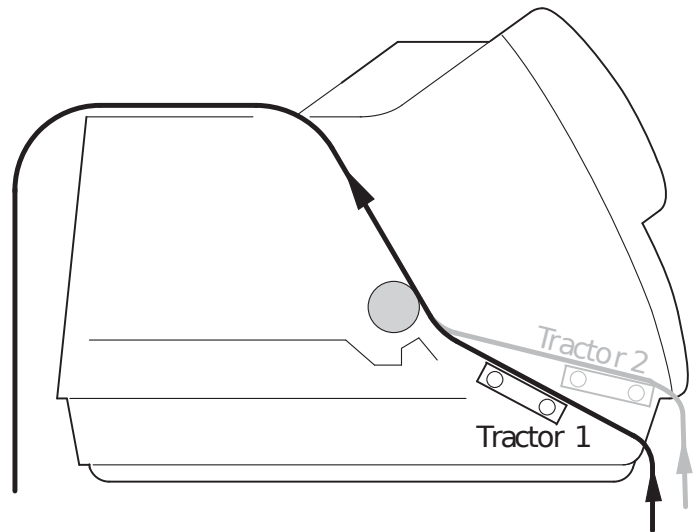

Installation

Unpacking the printer

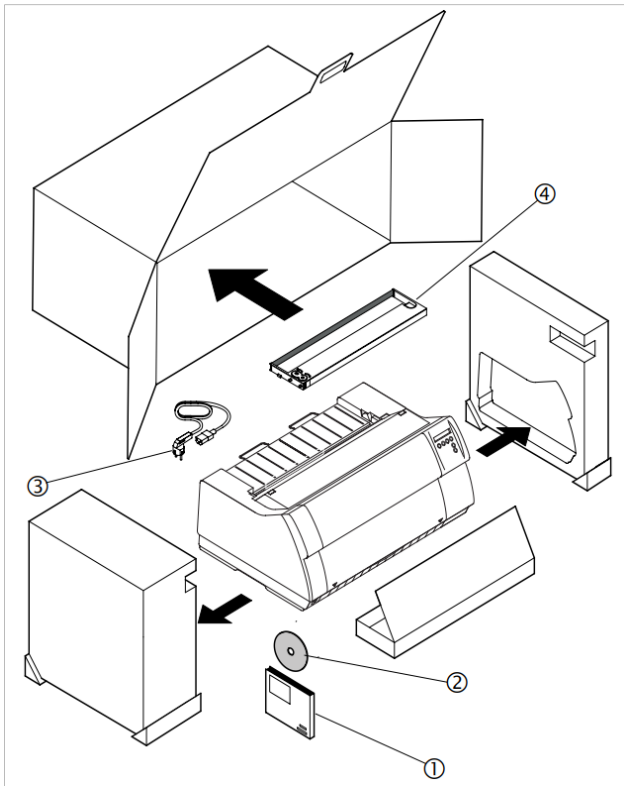

Place your printer on a solid surface (*see Placing your printer*).

Make sure that the “Up” symbols point in the correct direction.

Open the packaging, take out the accessory cassette and unpack it. Pull the printer out of the cardboard box towards you and remove the remaining packaging material.

Check the printer for any visible transport damage and completeness. Apart from this CD-ROM (①) the Quick start guide (②), the power cable (③) and the ribbon (④) must be included.

If you find any transport damage or if any accessories are missing, please contact your dealer.

Placing your printer

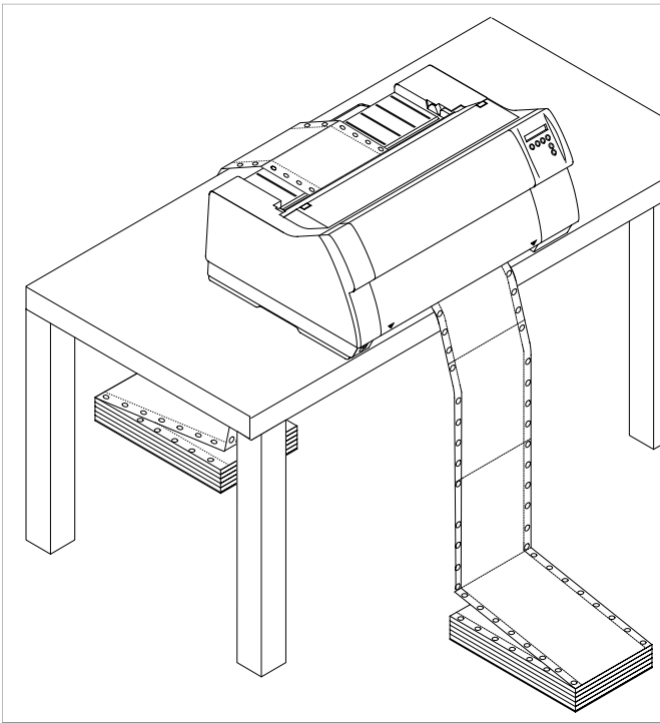

Place the printer on a solid, flat, surface, ensuring that the printer is positioned in such a way that it can not topple, and that there is easy access to the control panel and paper input devices. Also ensure that there is sufficient space for the printed output.

If you expect that frequent forward and reverse feeds will occur, you should place the printer as shown in the figure, if possible.

STOP The power supply cable may be damaged if the paper edges constantly chafe the insulating sheath. The user must always ensure that there is sufficient distance between the power supply cable and the paper.

When selecting the printer location, observe the following additional instructions:



Never place the printer in the vicinity of inflammable gas or explosive substances.

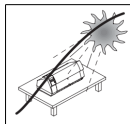

Do not expose the printer to direct sunlight. If you cannot avoid placing the printer near a window, protect it from the sunlight with a curtain.

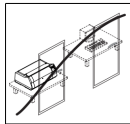

When connecting the computer with the printer, make sure not to exceed the permitted cable length (*see Interface specifications*).

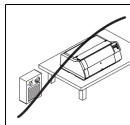

Ensure sufficient distance between the printer and any heating radiators.

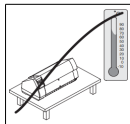

Avoid exposing the printer to extreme temperature or air humidity fluctuations. Above all take care to avoid the influence of dust.

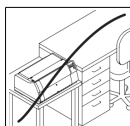

It is recommended to install the printer in a place which is acoustically isolated from the workplace because of the noise it may produce.

Connecting the printer

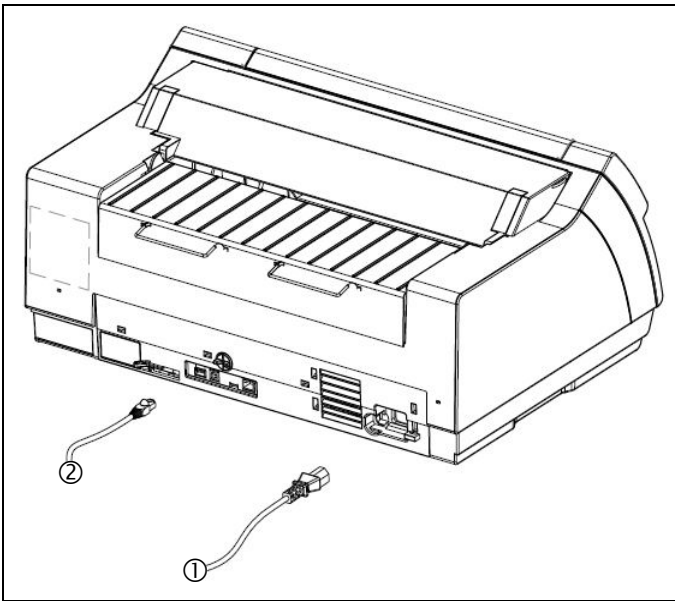

Connect the power cable (1) to the power inlet of the printer. Connect the power cable plug to a mains socket.

Make sure that the printer and the computer are switched off and connect the data cable (2) between the printer and the computer.

i The printer by default is provided with a USB and an Ethernet interface. For further information about the interfaces, refer to the section ***Interfaces***.

Switching on the printer

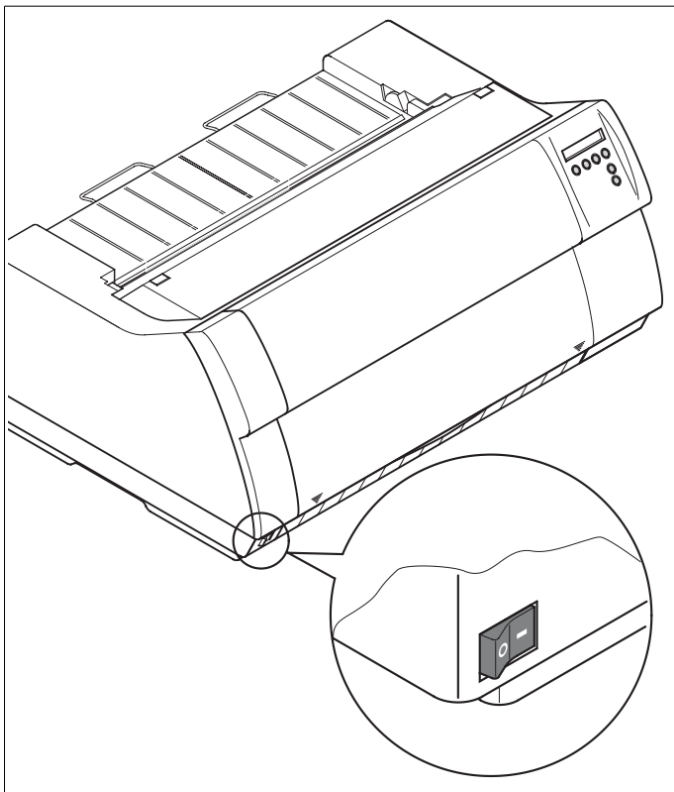

The power switch for switching on the printer is located at the bottom left at the front of the printer when viewed from the front.

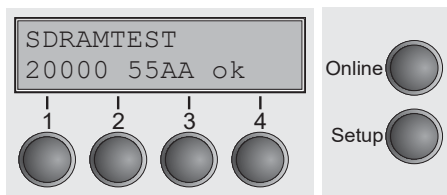

After switching on, the printer passes through a memory test during the initialization phase. In the display appears temporary the message "SDRAMTEST XXXXX XX ok".

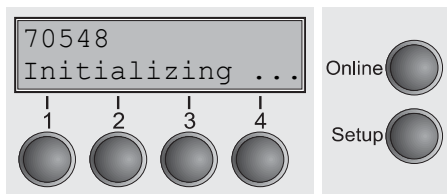

If the memory test is successful finished, the firmware number appears in the display.

After finishing the initialization the printer switches to online mode (see *Online mode*).

Inserting the ribbon cassette

STOP During the process of initialization after powering on, the printer checks if a ribbon cassette is installed. It also checks during the execution of a print job the operativeness of the ribbon cassette. These functions mandatory require the use of the manufacturers original ribbon cassettes (see **Accessories**). If other ribbon cassettes were used, the message Check Ribbon appears in the display, it is impossible to print.

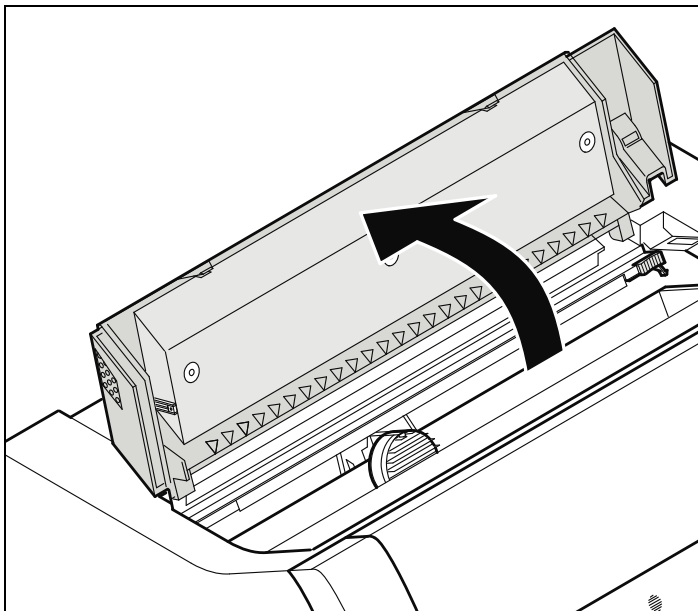

i Before opening the cover, make sure that the printer is switched on so that it can execute automatic preparations for ribbon changing (widening the print head gap).

Open the printer top cover.

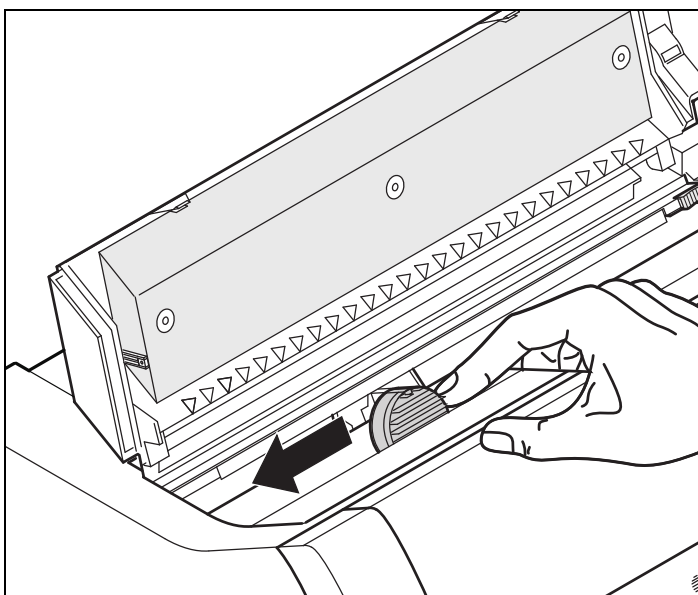

Cautiously slide the print head carriage to the left stop (viewed from the printer front).

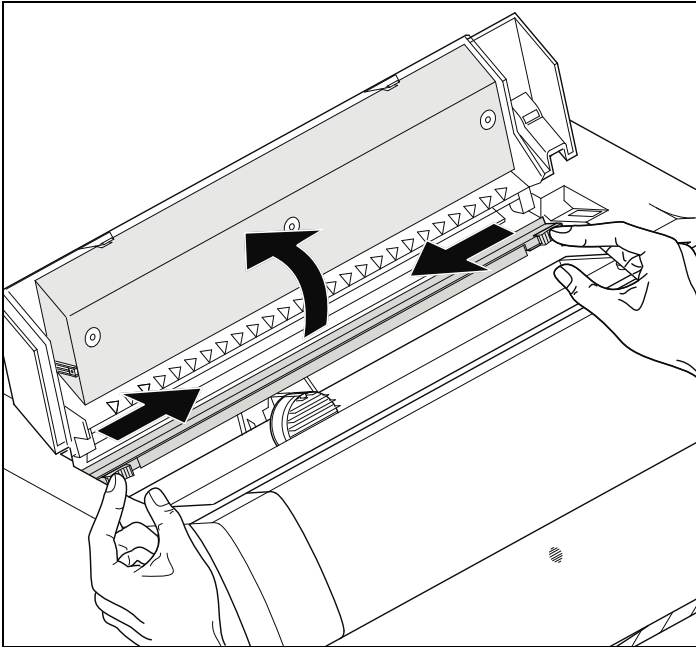

Move the coloured friction tabs to the left and right (direction of the arrows) as shown in the figure and raise the friction mechanism.

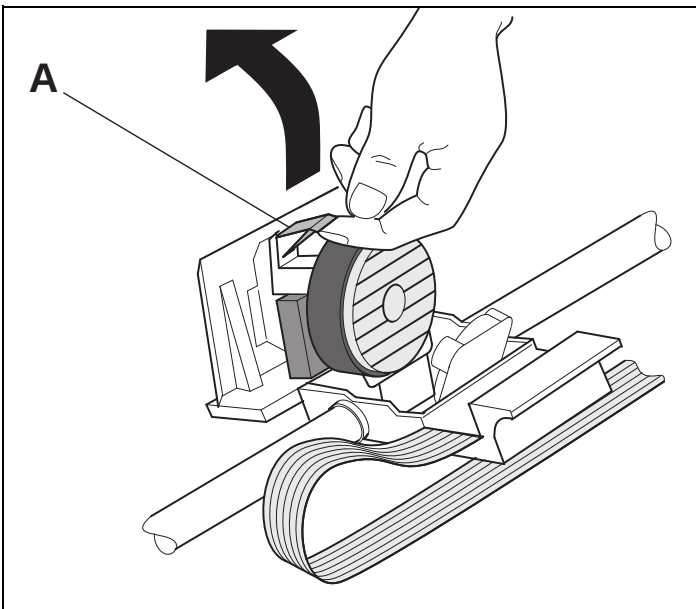

Raise the coloured insertion tongue A.

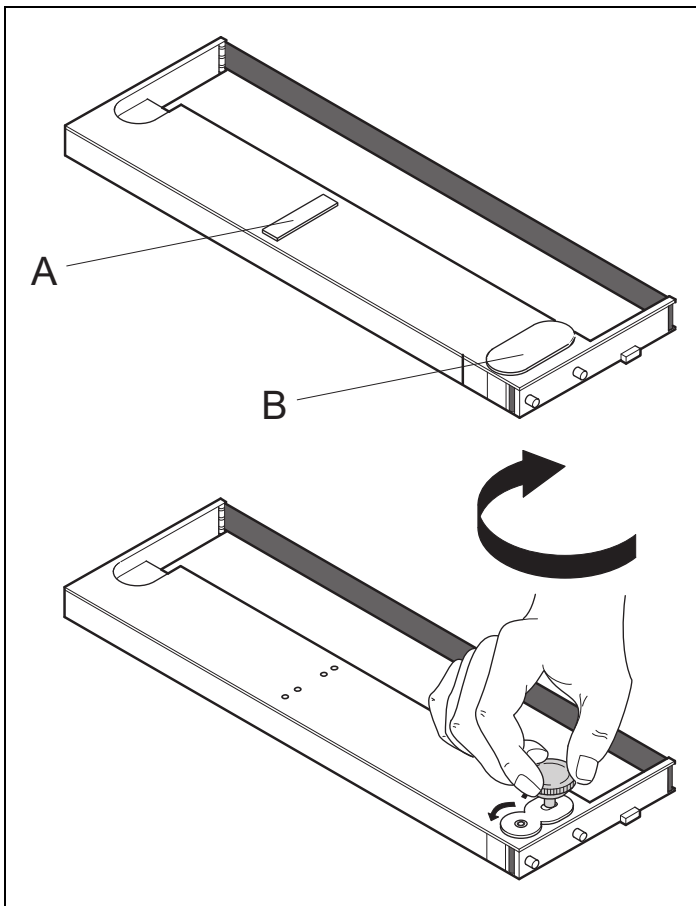

Pull out and remove the coloured strip **A**.

Insert the coloured ribbon tension knob into the right-hand front location of the new ribbon cassette. Turn the knob in the direction of the arrow in order to take up slack of the ribbon.

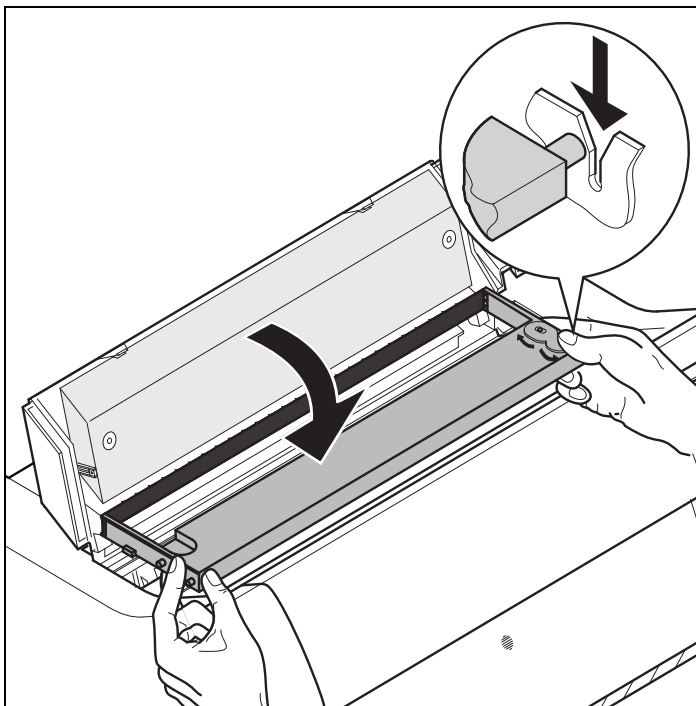

Slightly tilt the ribbon cassette forwards and thread in the ribbon between the coloured insertion tongue and the ribbon support (transparent plastic plate).

Align and insert the cassette into the guides on the left and right, then press down until it clicks into place.

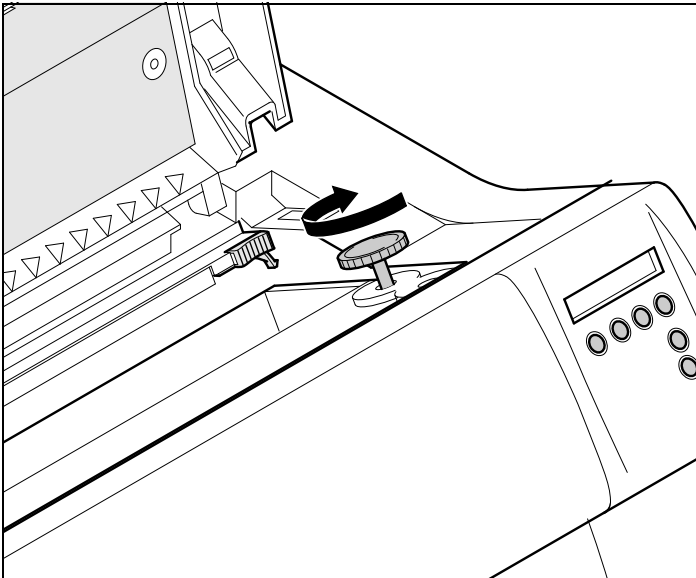

Insert the coloured tension knob into one of the two locations.

Turn the tension knob in the direction of the arrow to take up slack in the ribbon until it is seated correctly at the bottom in the ribbon support.



Remove the knob.

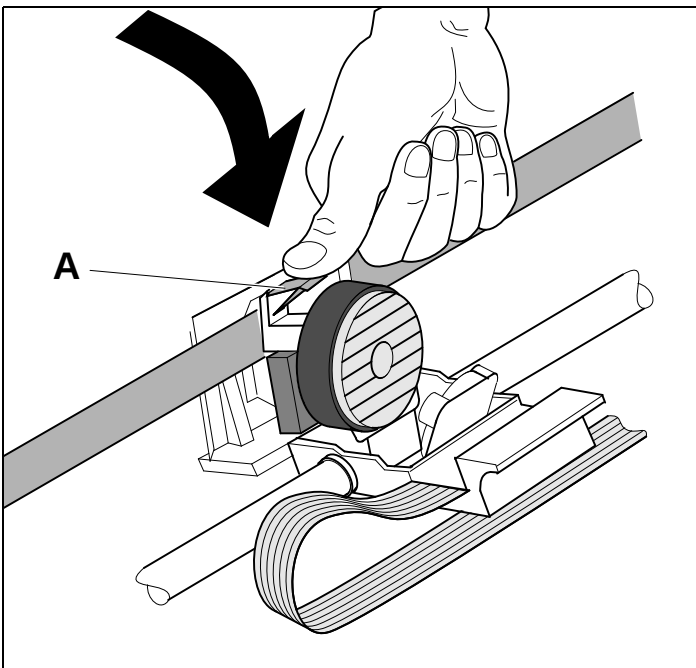

Press down the coloured insertion tongue **A**.

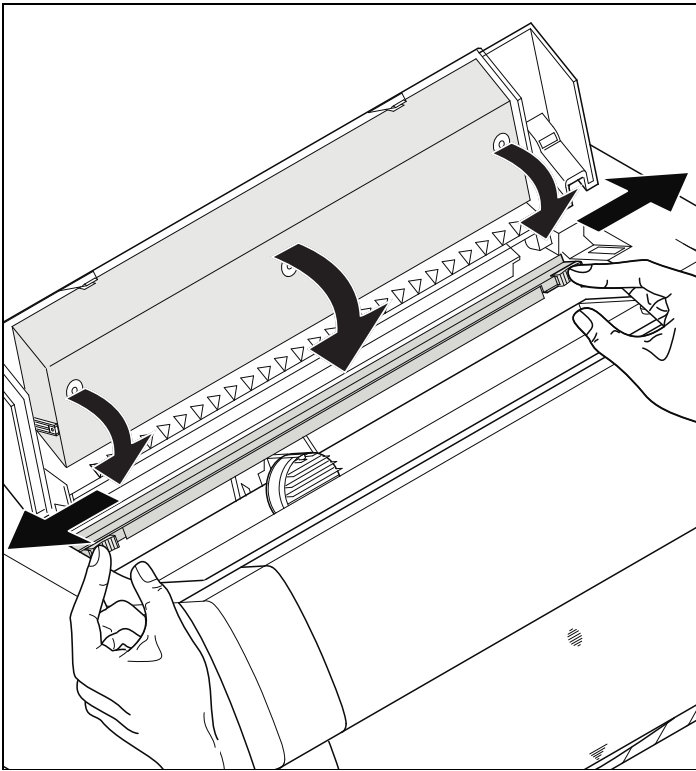

Press the friction mechanism down until it clicks into place.

Close the top cover.

Printer drivers

You need to install a printer driver so that the printer can process the data from your application programs.

An original driver offers the best conditions for optimal printing results. All available printer drivers can be found on the CD-ROM enclosed with the printer, as well as on our [internet](#) site, from which you can also download updated versions as necessary.

We are offering the following drivers:

- ▶ Windows V3 driver for Vista/7/8/8.1/10 and Server 2008-2016 (32/64bit)
V3 is the previous driver architecture from Windows supporting internal printer fonts.
- ▶ Windows V4 driver for 8/8.1/10 and Server 2012-2016 (32/64bit)
V4 is the new, prospective driver architecture from Windows which will not support printer internal fonts - only Windows fonts will be supported!

Installing a printer driver in Windows

To install the printer drivers easily please use the DriverSetup.exe wizard which will be part of the drivers:



For instructions on installing the printer as a network printer, please consult the documentation supplied with your network operating system and/or printer server, or contact the network administrator. To install a network printer, you will need Administrator rights.

Other operating systems

The printer can also be used with other operating systems such as Linux or Unix. In this case, set the printer to one of the Epson emulations (LQ-2550/LQ-2170) or IBM emulations (Proprinter XL 24e/Proprinter XL 24e + AGM) for which default drivers are available in most operating systems.

Changing printer settings

You can make permanent changes to the printer settings using the control panel of the printer (see *The Menu*). Various printer settings can also be entered in the operating system of your PC, however.

- 1 Click on the **Start** button in the Windows taskbar.
- 2 Click on **Printers and Faxes** to open the printer folder.
- 3 Move the mouse pointer to the appropriate printer symbol, press the right mouse key and click on **Properties**.

Details of the settings available in this window can be found in the Windows documentation or help pages.



Settings entered in the printer driver via Windows have priority over settings entered via the printer menu. It is therefore possible that the former may overwrite the latter.

Form settings (Windows 2000/2003/XP/Vista/Windows 7/2008)

If you want to set up a form not included in the Windows default settings, proceed as follows.



You will need Administrator rights to define new forms.

- 1 Click on the **Start** button in the Windows taskbar.
- 2 Click on **Printers and Faxes** to open the printer folder.
- 3 In the menu bar, click on **File** and **Server Properties**.
- 4 In the window **Printer Server Properties**, click on **Form** if necessary.
- 5 Either select an existing form from the **Forms** list or activate the option **New Form**.
- 6 Enter a form name and the desired values.
- 7 Click on **Save** to save the new form.

You can now assign this form to the paper feeds of your printer (see *Changing printer settings*).



The form cannot be assigned if its dimensions exceed the permissible paper sizes of the specified paper feed.

Loading optional firmware



If you download new firmware as described below, all menu settings except the settings for the transmission speed of the Ethernet interface and the IP address administration will be overwritten. For this reason you should print a menu dump in or to be able to reestablish the previous settings if necessary (see *Printing out menu configurations (Print)*).



The most current version of the firmware can be downloaded from our *internet* page.

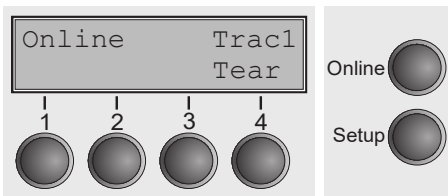

Loading the Firmware will be possible via the following ports in ONLINE Mode:

- ▶ via USB (PrintFile)
For doing so you will need an additional application called "Print File" which can be downloaded as freeware from www.lerup.com/printfile.
- ▶ via Ethernet (WebPanel)
Via Webpanel the according download pages will be available for doing this in a comfortable way.
- ▶ via Parallel CTX (copy/b) – only if the combi interface is installed
For doing this please open command prompt under Windows and enter "Copy/b x\path\DOWNLOAD.MOT PRN".

The control panel

The control panel keys are used for controlling your work with the printer. The control panel is located on the front right side of your printer and consists of a two-line liquid crystal display and six keys.

The functions of the keys depend on the printer's current mode (status). There are four basic modes.

- ▶ The *Online* mode is the printer's normal operating mode. Data from your computer can be received and printed.
- ▶ In the *Offline* mode the link between printer and computer is interrupted, i.e. no data can be received and printed.
- ▶ In the *Setup* mode you can either select the printer menu or carry out the so-called quick-switch function. The quick-switch option was included so that you can change the most important parameters (for example adjustments, character density, font, paper path, adjustments i.e. head gap) directly without having to enter them via the menu. The settings for the parameters character density and font are lost when the printer is switched off. They can be selected permanently in the menu mode of the printer.
- ▶ In the *Menu* mode further printer settings (line spacing, size of the interface buffer etc.) can be altered and saved permanently.

The LC display

The LC display tells you all the important printer settings and informs you which functions are currently assigned to which keys.

The upper line informs you that the printer is either in online or offline mode (in the example below the printer is in the Online mode), and the selected paperpath (below: **Trac1** = Tractor 1 = tractor mode, key 4 is currently activating the manual tear).

Example:

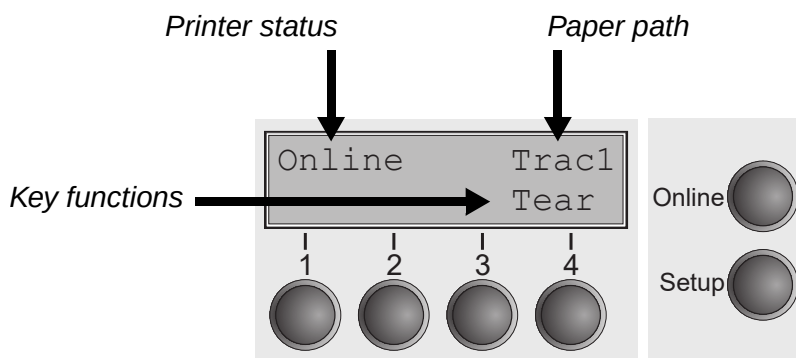

Online mode

After switching on, the printer is automatically set to online mode. Only in this mode can it receive data from the computer.

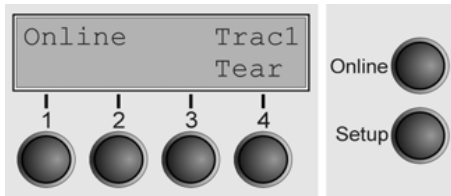

- ▶ **Tear key (4):** Activates the tear function when fanfold paper is loaded, see *Moving the paper to the tear position*. If **Load** is displayed above this key, no paper is loaded in the printer or the printer is in park position. In this case the display switches between **Online** and **Load paper fromTrac1**. Press the key to feed paper to the printing position.
- ▶ **Setup key:** Sets the printer to setup mode.
- ▶ **Online key:** Sets the printer to offline mode.

Offline mode

Only in this mode is it possible to perform step, line, or form feeds from the control panel, see *Paper transport*; however, data cannot be received.

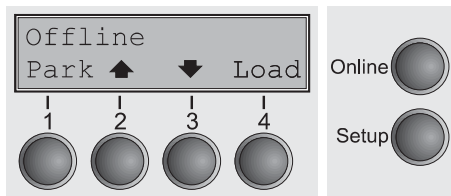

- ▶ **Park key (1):** Clears the paper path with paper loaded and activates paper path quick selection.
- ▶ **Key (2):** Short keypress: Microstep forward. Long keypress: Continuous paper feed.
- ▶ **Key (3):** Short keypress: Microstep reverse. Long keypress: Continuous paper reverse feed up to the park position.
- ▶ **Load key (4):** Displays that no paper is loaded in the printer or the printer is in park position. In this case the display switches between **Online** and **Load paper fromTrac1**.
- ▶ If paper is loaded: Loads paper from the selected paper source; the display changes to **LF/FF**. Short keypress: Line Feed (**LF**). Long keypress: Form Feed (**FF**).
- ▶ **Setup key:** Sets the printer to setup mode.
- ▶ **Online key:** Sets the printer to online mode.

Setup mode

In this mode, the following settings are available:

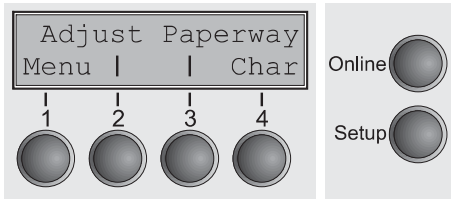

- ▶ **Setup** key: Sets the printer to setup mode, in which the following settings can be selected:
- ▶ **Menu** key (1): Other menu settings. Access may be disabled by the manufacturer (see note below).
- ▶ **Adjust** key (2): Sets the Tear position, first printing line and print head gap.
- ▶ **Paperway** key (3): Sets the Paper path.
- ▶ **Char** key (4): Sets the font and the number of characters per inch.

i **Access to the other menu settings (Menu) may be disabled by the manufacturer.**

Proceed as follows to release this lock temporarily:

Hold depressed the **Setup** key or the **Menu** key (1) for five seconds.

Or:

- 1 Switch off the printer for approx. 5 seconds.
- 2 Switch the printer on again keeping the **Setup** key pressed.

i **For information on how to enable access permanently and about the available settings, refer to the section *Menu lock (MenLock)* and *Menu parameters*.**

Messages in the LC display

If the printer detects an internal fault or user error or if it expects you to do something, a message will appear in the LC display. It also displays the status during an operation (e.g. **Initializing**). Below you will find a list of messages with brief descriptions of each message. The messages are described in greater detail in the chapter *Error messages via the display*.

Message	Meaning
Eject error	The printer cannot eject the paper/advance it to park position.
Hardware Alarm	Internal hardware error. Try power cycling the printer. If the message appears again, contact your dealer or service technician.
Initializing	This message appears during the printer's initializing phase after switching on the printer.
Load error	The printer cannot draw in the loaded paper.
Load paper from	The printer has detected paper end during operation/printer was switched on with no paper loaded.
Loading default	Factory defined parameters will be reloaded in all available menus after switching on the printer.
Out of paper	The printer has detected paper end during operation / printer was switched on with no paper loaded.
Paperwidth error	Print characters override the detected right paper margin.
Parity error	A parity error during data transmission is indicated.
Park position	Paper is not being fed into print position.
Press any key	The user is requested to press any key.
PW sensor defect	The automatic paper width detection cannot detect the left paper margin.
Selftest	After power-on, the printer executes a short hardware self-test.
Tear Paper off	The user is requested to tear off paper which has been advanced to the tear edge.
AED Error	AED sensor cannot locate paper transport holes (only if a cut device is installed).

Key functions when turning on the printer

If you keep one of the following keys pressed during power-on until the printer has completed initialisation, the corresponding function is activated:

- ▶ If you keep the **Online** key depressed while turning on the printer, you enter the printer's advanced menu mode. The advanced menu mode is described in the section *Advanced menu* of this manual.
- ▶ If you keep the **Setup** key depressed while turning on the printer, you regain access to the printer menu if you had locked it before with the help of the MenLock function. The **MenLock** function is described in the section *Menu lock (MenLock)*.
- ▶ If the four **function** and **select** keys (keys 1 to 4) are depressed simultaneously while turning on the power, all printer settings are reset to the default values, except the **Forml** (Form length) setting in advanced menu mode.



This causes all the user's previous settings to be lost.

USB host interface

The printer is equipped with a USB host interface. A standard USB memory device can be plugged into this interface and can then be used for firmware download and config file up- and download. The USB device must be formatted with FAT16 or FAT32 file system, other formats like NTFS are not supported. It is strongly recommended to use an empty and newly formatted device; otherwise the data transfer may not work. The firmware or config files for download must always be located in the root directory! The format of the config files is the same that is used when you up-/download the printer configuration via the webpanel or via the config tool.

Firmware Download

This function will be activated by pressing key 1 during power on. The display now shows **USBH firm. down.** and **Insert USB stick**. After a USB stick was connected, the printer will search the root directory for a file with the extension *.mot. If more than one file with this extension is found, the first one will be used. If no file was found, the display will show **no file found**. After the download was completed, the printer will reboot.

Configuration File Upload

This function will be activated by pressing key 2 during power on. The display will now show **upload cfg file.** and **Insert USB stick**. After a USB stick was connected, the printer will write the config file (extension *.cfg) to the USB stick. The file name is the same as the firmware ID number. During the write time, the display will show **please wait**. If the same file already exists, the display will show **cfg file exists** and **please delete it**. Then the user should delete the file and try it again. After the upload was completed, the printer will reboot.

Configuration File Download

The function will be activated by pressing key 3 during power on. The display will now show “USBH cfg down.” and “Insert USB stick”. After a USB stick was connected, the printer will search the root directory for a file with the extension *.cfg. If more than one file with this extension is found, the first one will be used. If no file was found, the display will show “no file found”. You then have the chance to remove the USB stick and try again, maybe with a different device. After the download was completed, the printer will reboot.

Paper handling

This section describes how to load fanfold paper, transport paper and move the paper to the tear position.

Loading paper

Your printer can process fanfold paper. For information on allowable paper formats, refer to the section *Paper specifications*.



Only use dust-free or low-dust paper. Many paper qualities are suitable for this printer. For more information, please refer to the section *Paper specifications*.

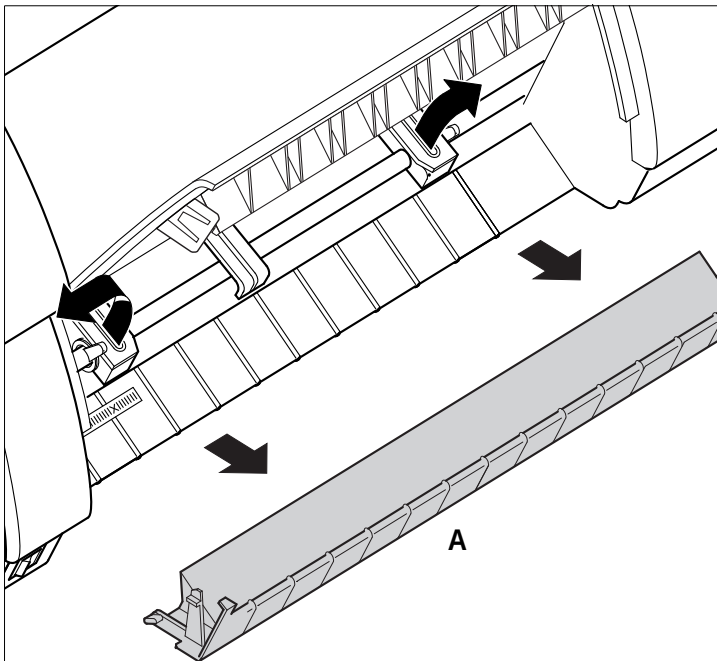

Open the front cover.

Remove the bottom cover A.

Open the right and left tractor flaps.

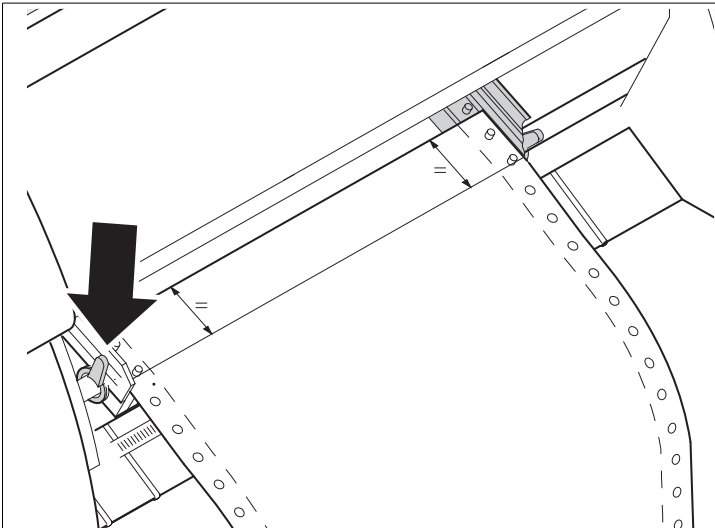

Release the coloured latch lever of the lefthand tractor and align the tractor so that the first printing position on the paper matches the X mark on the printer housing.

Lock the coloured lever again.

Place fanfold paper into the left-hand tractor.

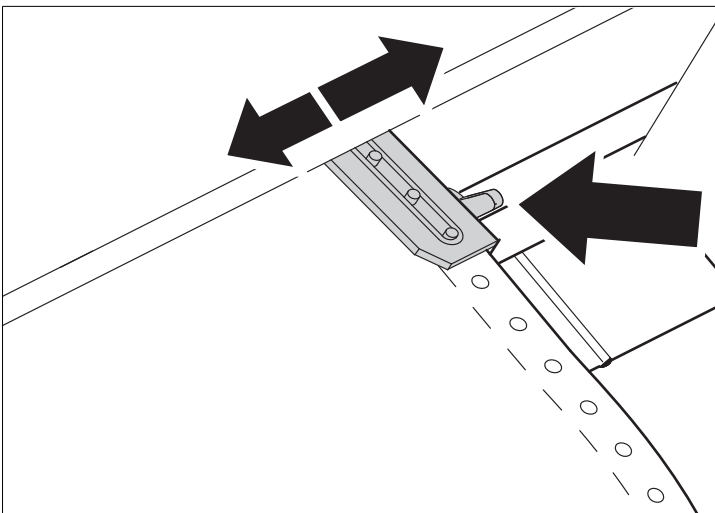

Open the coloured latch lever of the right-hand tractor and align it to the paper width.

Insert the fanfold paper into the right-hand tractor.

Make sure that it is inserted by the same length as on the left-hand tractor in order to avoid any paper jam.

Close the tractor flap and lock the tractor by turning the tractor lever to the rear.



Do not tension the paper excessively to avoid tearing the perforation holes; do not allow excessive slack since in this case the paper will bulge and there may be problems in the feeding process.

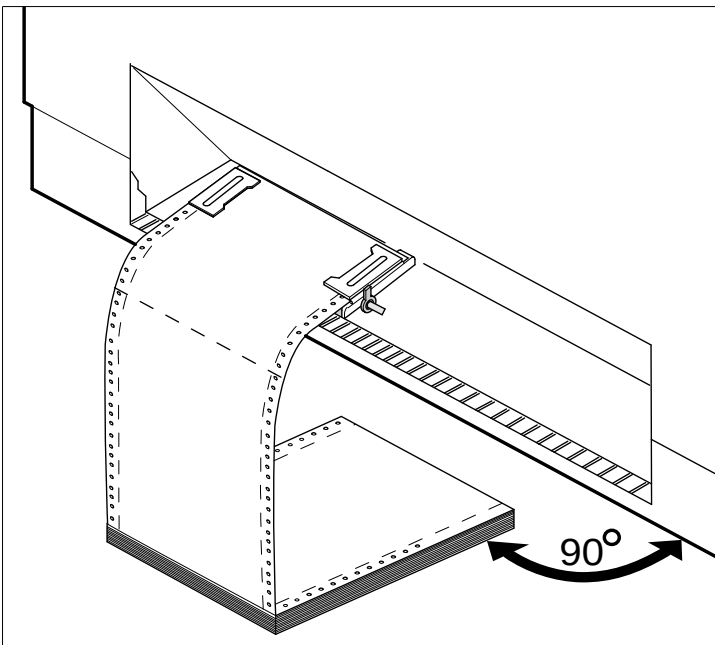

Make sure to align the paper stack in parallel with the printer and that the paper flow is unobstructed.

Lower the front cover.

Switch the printer on. The active paper source (**Tractor1**) appears in the display. The display alternates between...

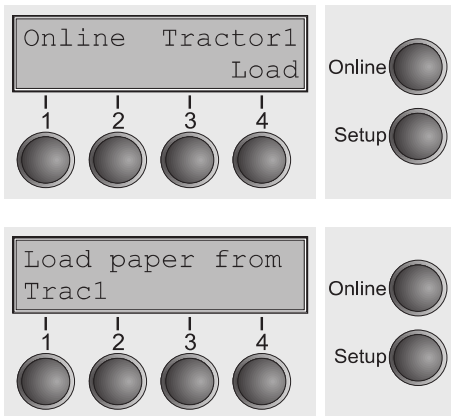

and ...

The paper is automatically loaded when the printer is in online mode and receives data from the computer.



Press the Load (4) key only to load paper before starting the printout. However it is recommended to let the receiving data load the paper.

Paper transport

Loaded paper can be transported in the printer in several ways.

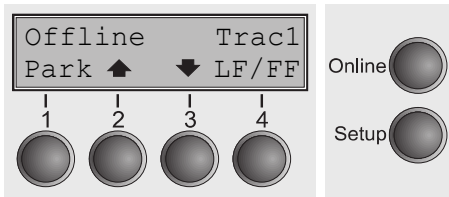

Make sure that the printer is in offline mode; press the **Online** key, if necessary.

- ▶ **Key Park (1)** – If fanfold paper is loaded in the printer, it is fed to the park position or the tear position.
- ▶ **Key (2)** – Short keypress: Paper is transported upwards step by step. Long keypress: Continuous transport upwards.
- ▶ **Key (3)** – Short keypress: Paper is transported downwards step by step. Long keypress: Continuous transport downwards.
- ▶ **LF/FF key (4)** – Short keypress: Line Feed (**LF**) is executed. Long keypress: Form Feed (**FF**) is executed.



The maximum value of the paper return feed is 22 inches.

Moving the paper to the tear position

You can use the **Tear** key to move the paper to the tear position. The tear edge is located at the front side of the paper output opening.

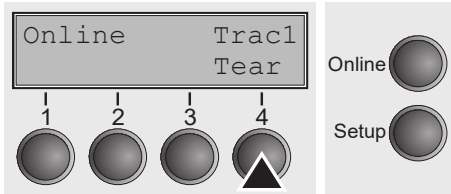

Make sure that the printer is in online mode. If necessary, press the **Online** key.

Press the **Tear** (4) key. The printer moves the perforation edge of the fanfold paper to the tear edge. The tear edge is located at the front side of the paper output opening (see below).

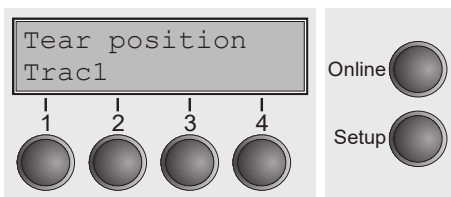

The display alternates between ...

and ...

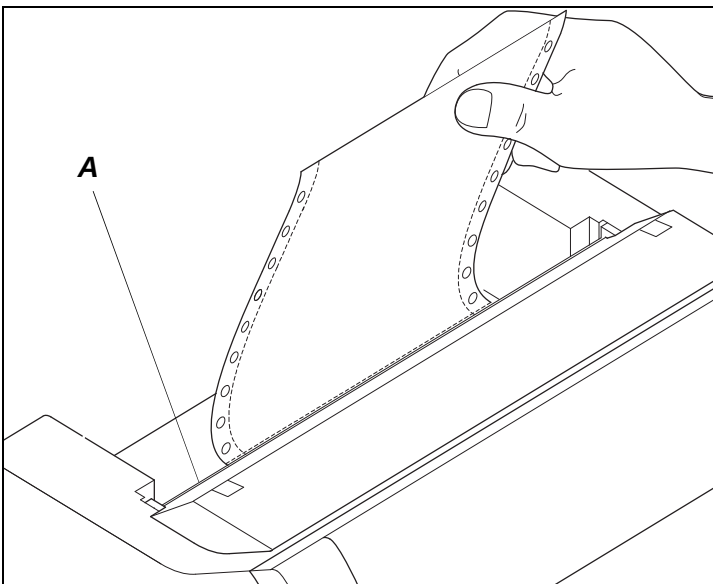
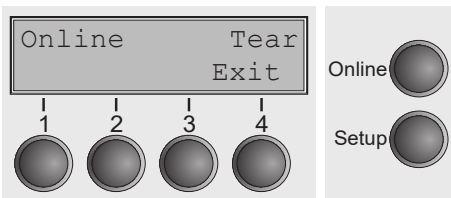

Tear off paper at the tear edge **A**.



Make sure you tear the paper off straight, otherwise a paper jam may occur.

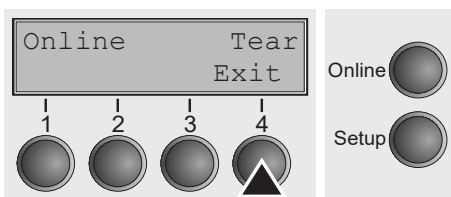

After having torn off the paper, press the **Exit** (4) key. The printer returns the paper to the first printing position.

If a print job is active, the printer returns the paper automatically to the next printing position.

Removing paper



Never use force to remove the paper from the printer. Otherwise the mechanical components may be damaged.

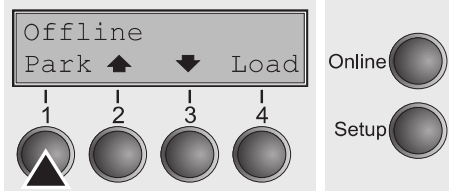

Make sure that the printer is in offline mode; press the **Online** key, if necessary.

Press the **Park** (1) key. If fanfold paper is loaded in the printer, it is fed to the tear position. The text **Tear paper off** appears in the display.

Now remove the paper from the tractor. Then press any key.

Settings

This section describes how to set the tear position, the first printing line, the print head gap as well as the font and the character density.

Setting the print head gap

The printer features automatic print head gap adjustment to the thickness of the paper used. In setup mode, you can enter a correction value to modify the head gap determined automatically. This correction is useful for modifying the appearance of the type face.

i The AGA (automatic gap adjustment) function must be set to On. For more detailed information, refer to the section **Automatic gap adjustment (AGA)**.

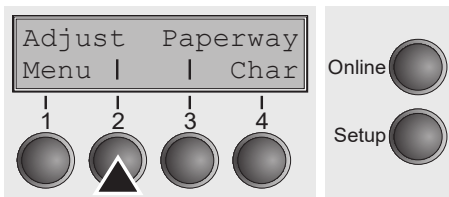

Press the **Setup** key. The printer changes to setup mode.

Press the **Adjust (2)** key.

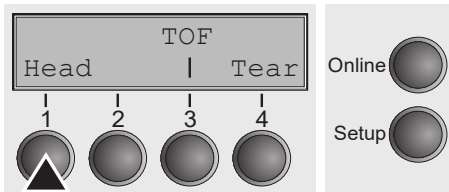

Press the **Head (1)** key.

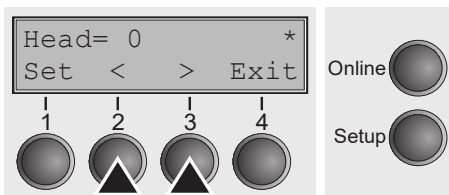

Use the **< (2)** or **> (3)** key to set the range within which the automatic gap adjustment is to be corrected. You can select values in the range from -10 to +10.

Confirm the input by pressing the **Set (1)** key.

Press the **Setup** key. The printer returns to the initial status.

i **Negative values decrease the print head gap, positive values increase it. Changing the automatically determined value may have a strong effect on the printing quality. The setting made will be retained after switching off the printer.**

i **If the printout shows signs of smudging, we recommend that you increase the print head gap up to +10 (if AGA is on, see **Automatic gap adjustment (AGA)**) and use a less smooth type of paper.**

Setting the tear position

If the tear position of the paper is not aligned with the tear edge of the printer, you can adjust it. Inserted paper needs to be torn off if necessary and retracted to park position.

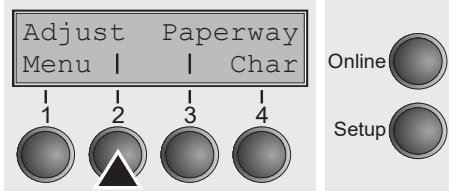

Press the **Setup** key. The printer changes to setup mode.

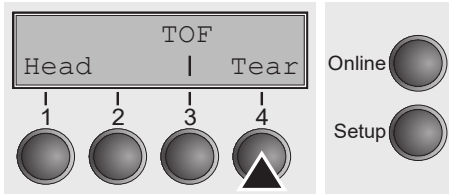

Press the **Adjust (2)** key.

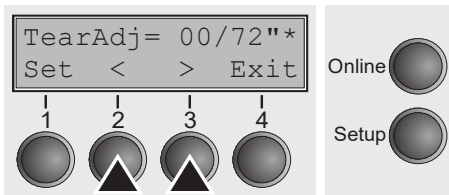

Press the **Tear (4)** key.



Press the **< (2)** or **> (3)** key to move the perforation to the desired position. Confirm the input by pressing the **Set (1)** key. Confirm the input again by pressing the **Setup** key. The printer is reset to the initial status.

-  **The correction made – a maximum of approx. 1" (2.5 cm) in each direction – will be retained after switching the printer off. It can be set separately for each paper path.**
-  **Make sure that the set form length corresponds to the actual length of the forms you are using.**

Setting the first printing line (TOF)

You can use the TOF function for setting the position of the first printing line for each paper source and each menu individually.

i Before using the TOF function, you should first set the tear position; see *Setting the tear position*.

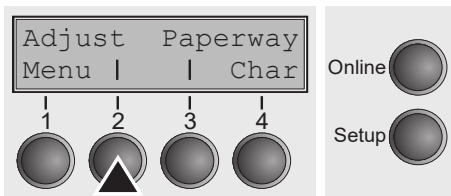

Press the **Setup** key. The printer changes to setup mode.

Press the **Adjust (2)** key.

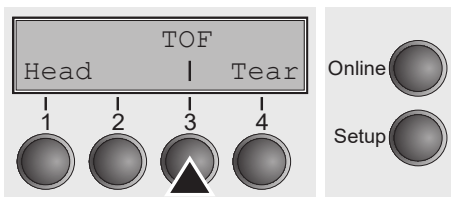

Press the **TOF (3)** key.

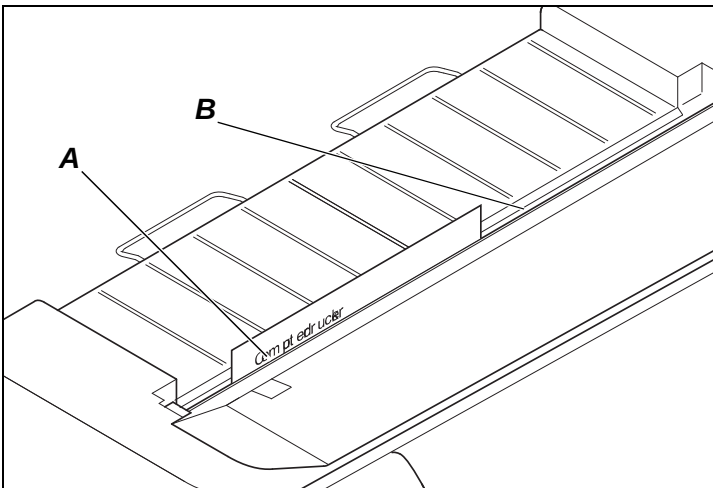

The paper is fed to the position where the bottom edge of the first printing line **A** is aligned with the tear edge **B** of the printer. The factory setting for the first printing position (TOF) is 12/72" (4,23 mm/1/6 inch). This is equivalent to the second line from the top.

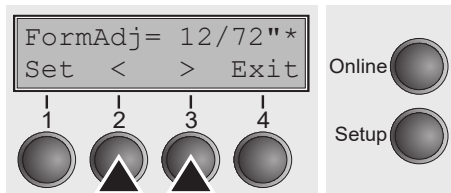

Press the **< (2)** or **> (3)** key to move the first printing line to the desired position. You can set values from 0 to 220/72" for fanfold paper.

Confirm the input by pressing the **Set (1)** key. Press the **Setup** key. The printer returns to the initial status.

i The selection made will be retained after switching off the printer.

Selecting character density and font

You can use the **CPI (Character Per Inch)** key in setup mode to select the number of characters per inch to be printed. You can use the **Font** key to select resident fonts.

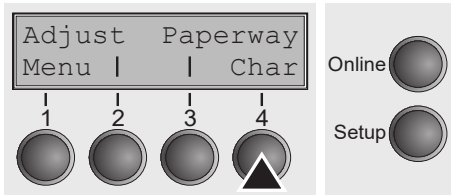

Press the **Setup** key, then the **Char** (4) key.

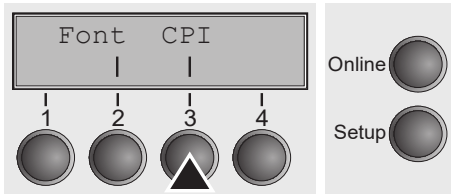

Press the **CPI** (4) or **Font** (1) key (in our example, press **CPI**).

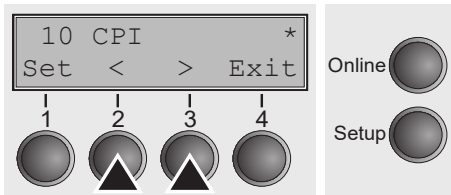

Use the **<** (2) or **>** (3) key to set the desired character density. Confirm the selection by pressing the **Set** (1) key.

You can cancel the selection and leave the setting unchanged by pressing the **Exit** (4) key.

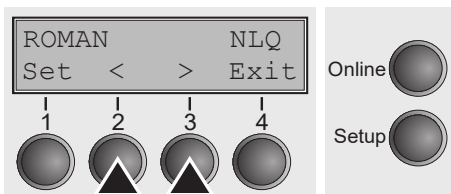

If you pressed the **Font** (1) key, use the **<** (2) or **>** (3) key to select the desired font. Confirm the selection by pressing the **Set** (1) key.

You can cancel the selection and leave the setting unchanged by pressing the **Exit** (4) key.

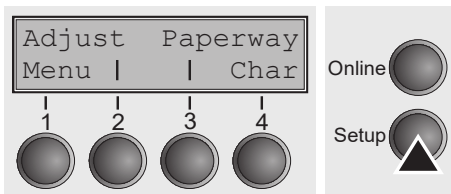

Press the **Setup** key. The printer returns to the initial status.

It is also possible to press the **Online** key. The printer then changes directly to online mode.



The selection made will not be retained after switching off the printer. For more details on how to set the character density and fonts permanently, please refer to the chapter **Setting character density (CPI)** and **Selecting font (Font)**.

The Menu

Programming via the control panel

Apart from being able to control your printer via the applications software you use, you can also program the printer directly. There are two programming options you can use:

- ▶ Programming via the control panel.
- ▶ Programming via the interface using Escape sequences or control codes.

 **Settings made by escape sequences have priority over settings made in menu mode; therefore they will override these. Informations on Escape sequences can be found in Appendix E, *Emulations*.**

Programming via the interface gives you far greater freedom for designing your printed pages, however, it is also a more sophisticated method and requires some experience with programming languages and printer control systems.

All programming via the interface is lost after you turn off the printer, whereas the programming carried out using the control panel, is saved and stored even after you turn off the printer.

Enabling access to menu mode

The menu can be locked by default to protect it from accidental or unauthorised access.

Proceed as follows to release this lock temporarily: Hold the **Setup** key or the **Menu** key (1) depressed for five seconds.

Or:

- 1 Switch off the printer for approx. 5 seconds.
- 2 Switch the printer on again keeping the **Setup** key pressed.

 **For information on how to enable access permanently and about the available settings, refer to the section *Menu lock (MenLock)*.**

Calling up the menu

You can access the menu in the following way:

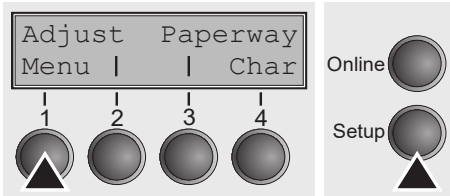

Press the **Setup** key. The printer switches to Setup mode. (can be selected both in the Online and Offline mode). To access the printer menu, press the key directly underneath the word **Menu** (1).

Menu configurations

Every printer is shipped with factory default settings. Basic settings such as emulation, character size, form length etc., which many applications make use of, are set. At the end of this chapter you will find a menu printout which shows you the printer's default settings.

Your printer allows you to set and use five independent menu configurations.

If one of your applications for example requires an IBM printer while another program works better with an EPSON printer, you can set an IBM emulation configuration with the desired settings, and set the second configuration as an EPSON emulation.

The active menu is always the one you used last. When you switch on the printer for the very first time, menu no. 1 is loaded. Menu no. 1 only remains active until you load another menu. The last active menu is stored even after the printer is switched off and is reloaded automatically when the printer is switched on again.

For example, to change from menu no. 1 to menu no. 3:

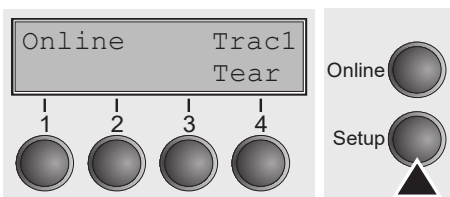

Press **Setup** key.

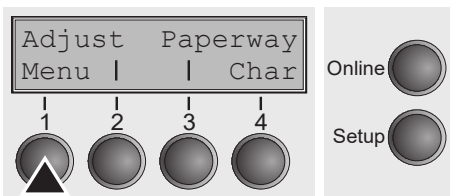

Press **Menu** (1) key.

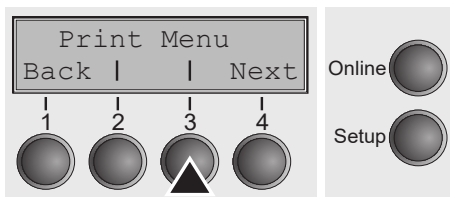

Press **Menu** (3) key.

Now the following message appears in the LC display:

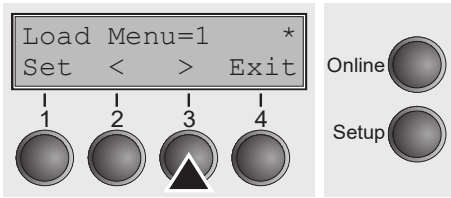

Now press the < (2) or > (3) key repeatedly until **Load Menu=3** appears.

Then select menu no. 3 as the current setting using the **Set** key (1). The currently active setting is marked with an asterisk (*).

i If changing menus it is possible that the printer initializes due to different emulation settings.

Menu handling

You can navigate in the current menu using the four function and selection keys arranged below the LC display field. Each function and parameter displayed in the LCD is executed or selected by the corresponding key below, respectively. Usually two parameter groups are combined at one level. In the following example, these are the **LPI** and **Skip** parameter groups.

If you do not wish to change one of the two parameters you can either press the **Next** key (to access the two following parameter groups in the menu), or you can press the **Back** key (to access the two previous parameter groups in the menu).

If you want to change a setting, (e.g. the line density), then press the **LPI** key (LPI = lines per inch) to access the actual parameter level.

The currently valid setting is marked by a * (in the example below the current setting is 6 lpi). With the < and > keys you can view the other parameters available for this setting.

Example:

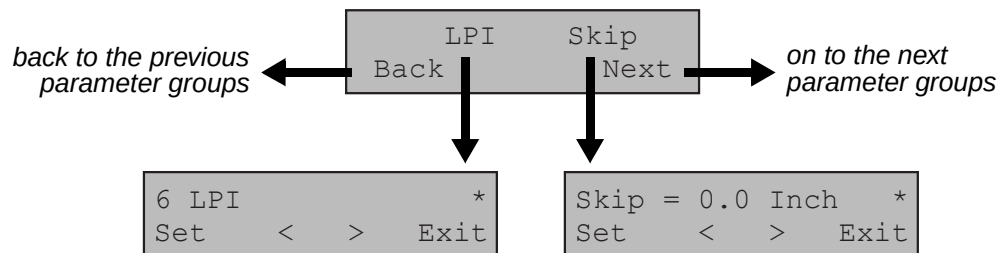

Save settings

Once the desired parameter is displayed on the LC display, you can save it by pressing the **Set** key. The parameter is then set and the printer automatically displays the parameter groups again. With the **Exit** key you can leave the sublevel without saving your changes.

Selecting the LC display language

This section describes how to make settings in the menu, using the selection of the national language as an example.

In this user guide all LC display messages are shown in English language. Your printer offers also the possibility to show the display messages in German, French, Italian or Spanish language. This example shows how to change from the English language to the German language. The same procedure applies to the other languages (French, Italian and Spanish).

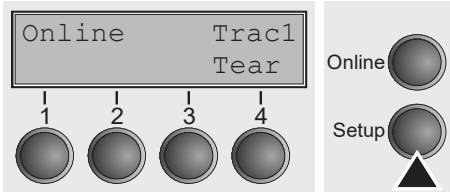

Select the **Setup** mode by pressing the **Setup** key.

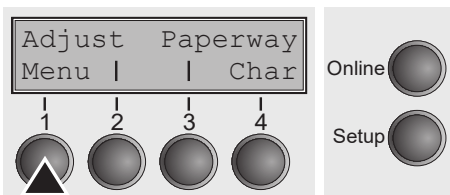

Press the **Menu** key (1).

i **Setup mode and Menu mode may be disabled. Hold down the Setup key while switching on the printer to enable menu mode. If you want to enable access to this mode permanently, you need to change the appropriate setting in the menu; see *Menu lock (MenLock)*.**

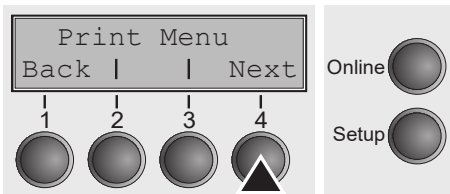

Press the **Next** key (4) several times until the display indicates **Language**.

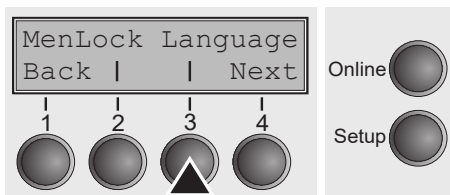

Press the **Language** key (3).

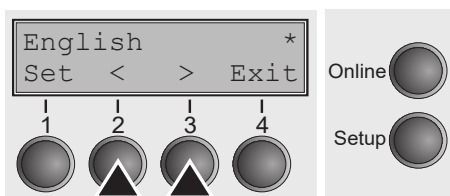

The display now changes to Parameter mode and indicates **English** in the top line.

The lower line displays **Set** and **Exit**. The two arrows < (2) and > (3) represent the symbols for parameter selection (“<” indicates descending and “>” ascending). Press the < (2) or > (3) key until the desired language is displayed, in our example **German**.

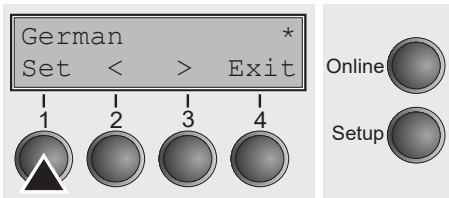

Save your selection by pressing the **Set** key (1). An acoustic signal verifies this action.

You can exit Parameter mode without saving a setting by pressing the **Exit** key (4), the old setting is retained.

After saving your setting (**Set**), the display in our example indicates the following text:

 **This setting is retained even after switching off your printer.**

Terminating Setup mode

Press either the **Setup** key to change into Offline mode or the **Online** key to change to Online mode.

Menu structure

The menu structure of your printer may be slightly different from the example shown here, depending on the printer software.

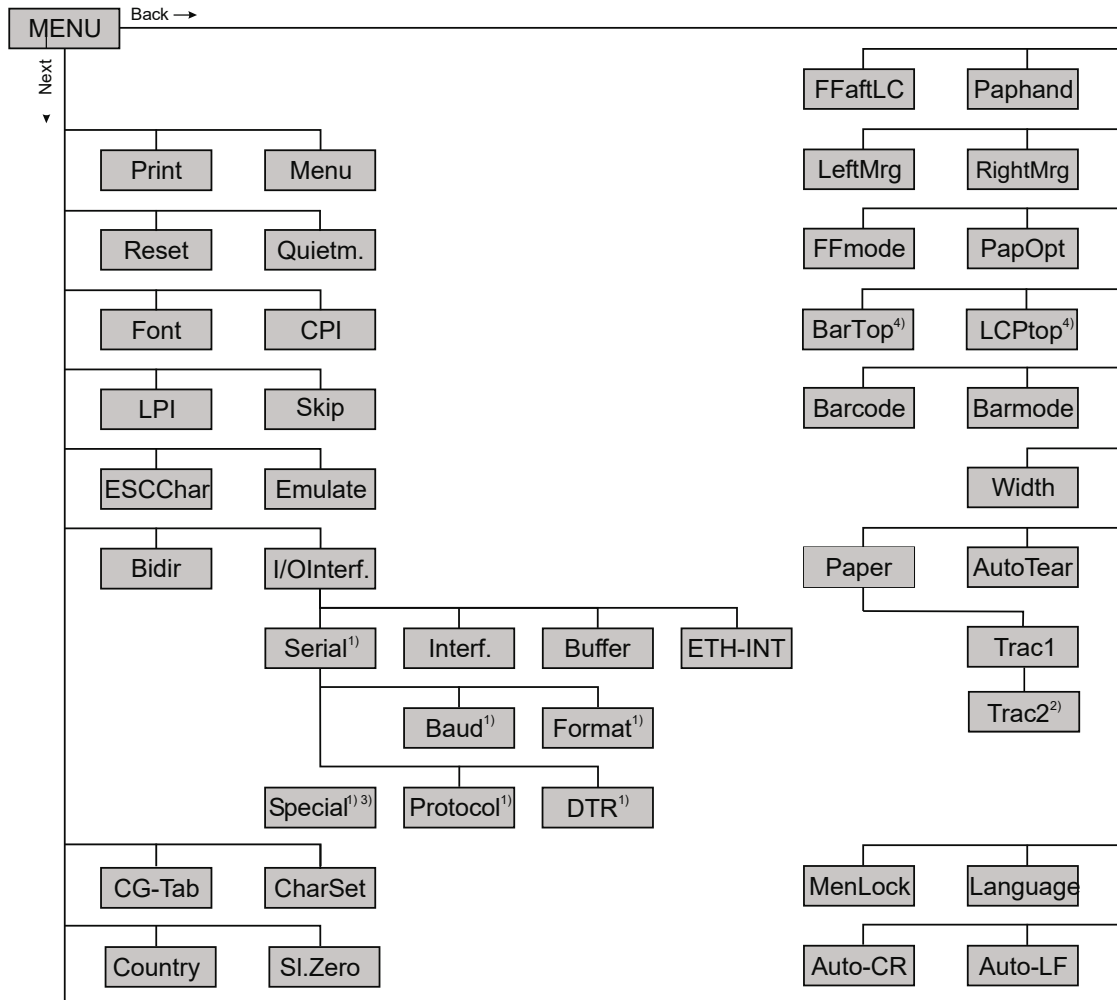

1) only with optional serial interface

2) only with optional tractor

3) only if ENQ/STX, ETX/ACK or ACK/NAK protocol is selected

4) only effective in Genicom ANSI emulation

Menu parameters

The following section introduces and explains all the possible menu settings.

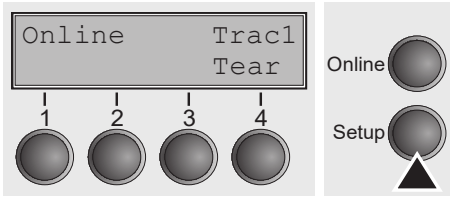

Press **Setup** key.

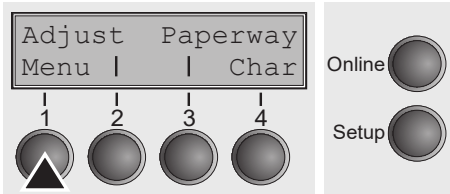

Press **Menu (1)** key.

i **Setup mode and Menu mode may be disabled. Hold down the Setup key while switching on the printer to enable menu mode. If you want to enable access to this mode permanently, you need to change the appropriate setting in the menu; see *Menu lock (MenLock)*.**

Printing out menu configurations (Print)

Prints the menu configurations using the active paper feed; see *Menu settings (example)*.

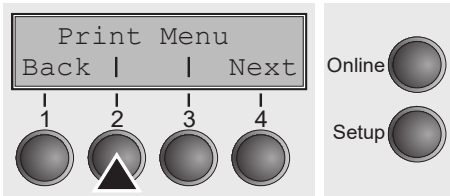

Press **Print (2)** key, to start the printout.

Loading menu configurations (Menu)

A menu is loaded, you can choose between five menus; see *Menu handling*.

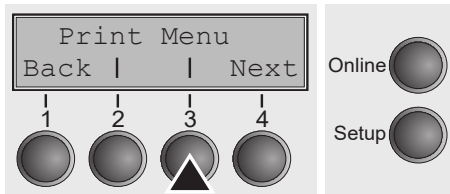

Press **Menu (3)** key.

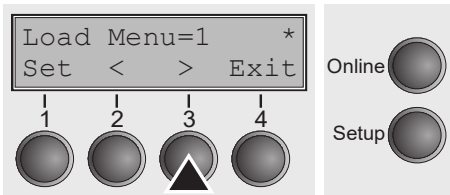

Use the < (2) or > (3) key to select the desired setting.

Setting Options: **Load Menu=1/2/3/4/5**
Default Setting: **Load Menu=1**

Confirm the setting by pressing the **Set** key (1). Press the **Next** key (4) to access the next group of parameters.

Reset to default values (Reset)

The current menu returns to the default values (factory settings).

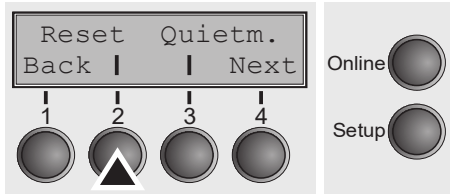

Press **Reset** (2) key.

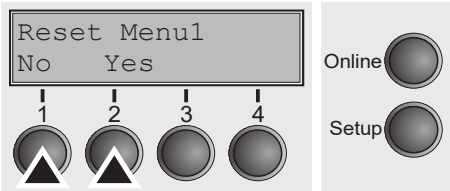

Press the **No** (1) or **Yes** (2) key to select the desired setting.

i All manually altered settings in the current menu are lost when it is reset to the default settings. We therefore recommend that you print out the menu first.

Confirm the setting by pressing the **Set** key (1).

Quietmode (Quietm.)

Switches between normal and quiet mode printing. For all printing modes, the print-out is made with the bidirectional method in quiet mode printing. In the first step the first row of pins is activated, during the second step the second row is used.

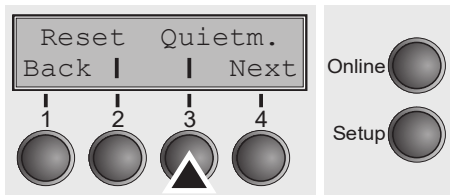

Press **Quietm.** (3) key.

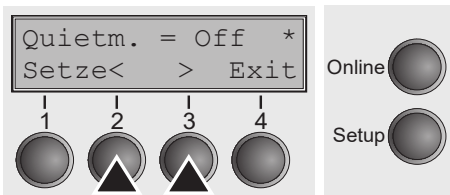

Use the < (2) or > (3) key to select the desired setting.

Setting Options: **Quietm. = On/Off**
 Default Setting: **Off**

i Please note that the activation of Quietmode decreases the throughput.

Confirm the setting by pressing the **Set** key (1). Press the **Next** key (4) to access the next group of parameters.

Selecting font (Font)

This parameter selects the character style and its quality permanently.

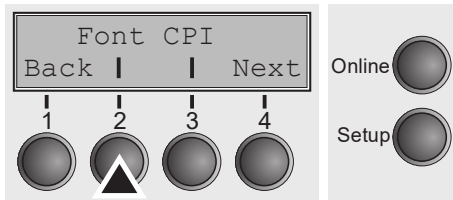

Press **Font** (2) key.

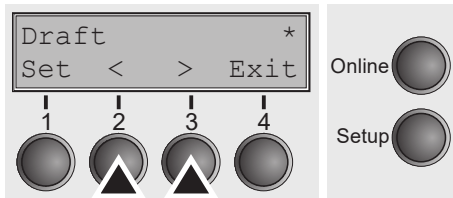

Use the < (2) or > (3) key to select the desired setting.

Setting Options: see table below

Default Setting: **Draft**

Character styles marked with an **I**(for example **Courier I LQ**) are IBM compatible fonts.

Fonts with the identifier PS in their name are proportional fonts which use only the space actually required for the character width.

Example:

Roman NLQ: **W i l l i i**

Roman PS NLQ: **Willi**

The abbreviation NLQ stands for Near Letter print quality, which means that the printer works faster but with a slightly lower resolution. LQ stands for Letter Quality, which means that the resolution is higher at the expense of a slightly slower speed.

Available fonts		
HIGH SPEED	COURIER LQ	COUR I PS NLQ
DRAFT*	COURIER NLQ	COUR I PS LQ
DRAFT COPY	PRESTIGE NLQ	ORATOR NLQ
ROMAN NLQ	PRESTIGE LQ	ORATOR LQ
ROMAN LQ	SCRIPT NLQ	GOTHIC NLQ
ROMAN PS NLQ	SCRIPT LQ	GOTHIC LQ
ROMAN PS LQ	OCRB NLQ	SOUVENIR NLQ
SANS SERIF NLQ	COURIER LQ	SOUVENIR LQ
SANS SERIF LQ	OCRA NLQ	COUR I PS NLQ
S SERIF PS NLQ	OCRA LQ	COUR I PS LQ
S SERIF PS LQ	COURIER I NLQ	ORATOR NLQ
	COURIER I LQ	ORATOR LQ

* scalable fonts (LQ2170 emulation)

Confirm the setting by pressing the **Set** key (1).

Setting character density (CPI)

Sets the characters per inch (character pitch). The higher the parameter the smaller the character spacing.

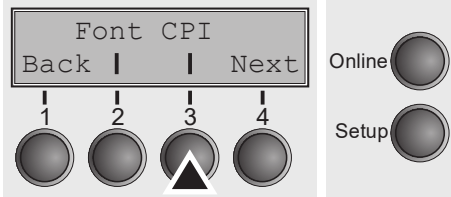

Press **CPI (3)** key.

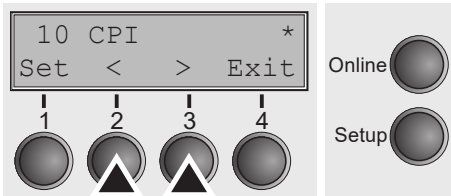

Use the < (2) or > (3) key to select the desired setting.

Setting Options: **5 CPI, 6 CPI, 7.5 CPI, 8.6 CPI, 10 CPI, 12 CPI, 13.3 CPI, 15 CPI, 17.1 CPI, 20 CPI**

Default Setting: **10 CPI**

Confirm the setting by pressing the **Set** key (1). Press the **Next** key (4) to access the next group of parameters.

Setting line spacing (LPI)

Sets the lines per inch (line density). The higher the parameter the smaller the line spacing (random LPI can be selected via the ESC sequences).

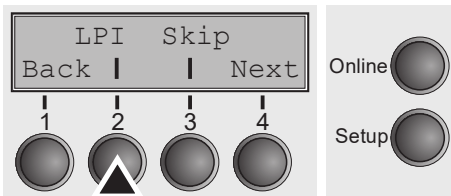

Press **LPI (2)** key.

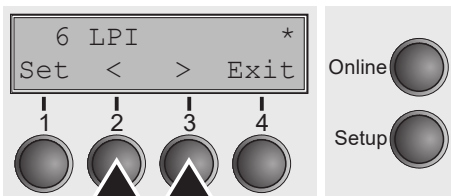

Use the < (2) or > (3) key to select the desired setting.

Setting Options: **2 LPI, 3 LPI, 4 LPI, 6 LPI, 8 LPI, 12 LPI**

Default Setting: **6 LPI**

Confirm the setting by pressing the **Set** key (1).

Skipping perforation (Skip)

Skips the perforation; 7 different values (in inches) can be defined.

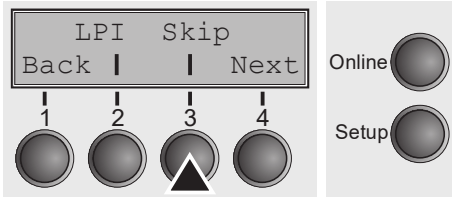

Press **Skip** (3) key.

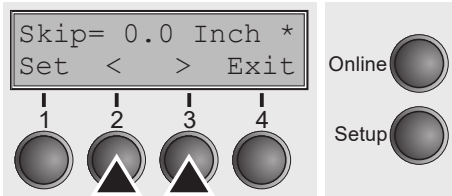

Use the < (2) or > (3) key to select the desired setting.

Setting Options: **0.0 to 3.5 Inch in steps of 0.5 inch**

Default Setting: **0.0 Inch**

Confirm the setting by pressing the **Set** key (1). Press the **Next** key (4) to access the next group of parameters.

Selecting start signal for escape sequence (ESCChar)

Selects the start signal for control sequences. Setting ESC: Only character Escape can be used. Setting ESC+\$\$: Character Escape or alternatively two \$ characters

(\$\$) can be used. For more information see the section *The \$\$ procedure*.

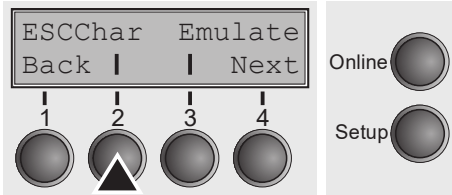

Press **ESCChar** (2) key.

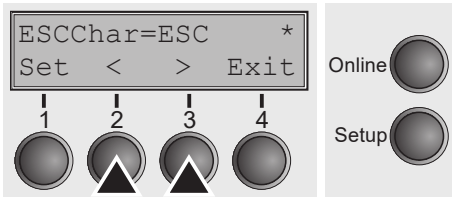

Use the < (2) or > (3) key to select the desired setting.

Setting Options: **ESC/ESC+\$\$**

Default Setting: **ESC**

Confirm the setting by pressing the **Set** key (1).

Selecting emulation (Emulate)

Selects the emulation. When a printer understands the control set written for another printer type, it is said to emulate the other printer.

i **MTPL is also active in IBM or Epson emulation mode.**

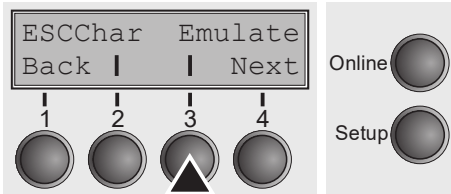

Press **Emulate** (3) key.

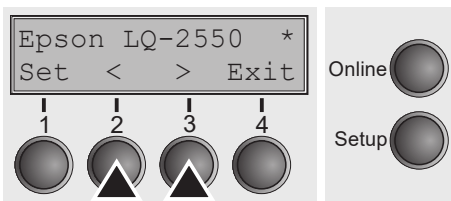

Use the < (2) or > (3) key to select the desired setting.

Setting Options: **Epson LQ-2550, Epson LQ-2170, IBM Propr. XL24, IBM ProXL24+AGM, MTPL, Genicom ANSI**

Default Setting: **Epson LQ-2550**

i **You are using a sophisticated product. However you may find additional or different emulations in this section depending on the loaded firmware.**

If the printer is switched to online mode after changing the emulation, it performs a reset.

Confirm the setting by pressing the **Set** key (1). Press the **Next** key (4) to access the next group of parameters.

Bidirectional printing (Bidir)

Setting **On**: Printer prints in both directions (bidirectional). Setting **Off**: Printer prints only in one direction (from left to right).

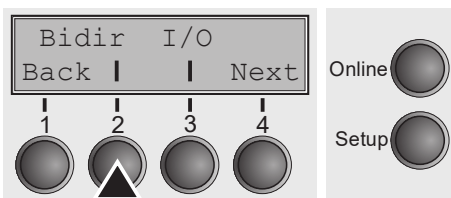

Press **Bidir** (2) key.

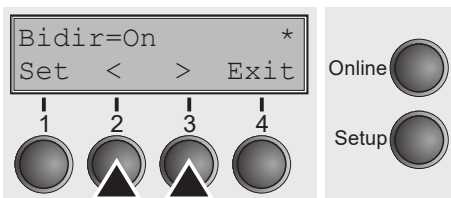

Use the < (2) or > (3) key to select the desired setting.

Setting Options: **On/Off**

Default Setting: **On**

Confirm the setting by pressing the **Set** key (1).

i **The setting On will not be overwritten by ESC sequences.**

Settings for interfaces (I/O)

In this parameter group, you can choose various settings for the printer interfaces. See also *Interfaces*.

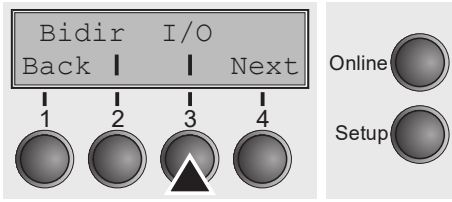

Press **I/O** (3) key.

Serial interface (Serial)

This parameter group only is valid, if an optional serial interface module is installed.



To ensure the proper functioning of serial data transfers, the serial settings of the printer and computer (host) must coincide.



Depending on your printer model the serial interface is already installed or it is available as an option.

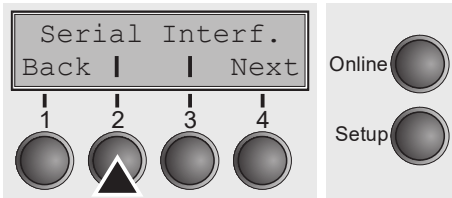

Press **Serial** (2) key.

Data transmission rate (Baud)

Selects the data transmission rate (baud rate) (baud = bit per second).

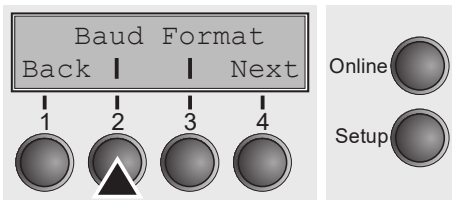

Press **Baud** (2) key.

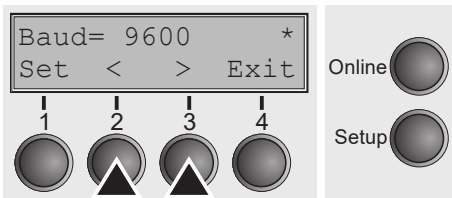

Use the < (2) or > (3) key to select the desired setting.
 Setting Options: **600, 1200, 2400, 4800, 9600, 19200**
 Default Setting: **9600**



Printer and computer must have the same baud rate.

Confirm the setting by pressing the **Set** key (1).

Data format (Format)

This parameter serves to define the number of data bits, the parity check for received data bytes and the number of stop bits per data byte.

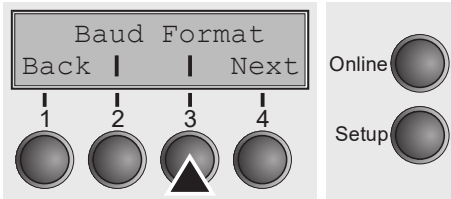

Press **Format** (3) key.

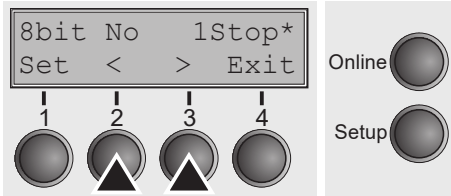

Use the < (2) or > (3) key to select the desired setting.

Setting Options: see table below

Default Setting: **8 Bit No 1 Stop**

1 number of data bits	2 parity test	3 number of stop bits
7 Bit	No	2 Stop
7 Bit	Even	1 Stop
7 Bit	Odd	1 Stop
7 Bit	Even	2 Stop
7 Bit	Odd	2 Stop
7 Bit	Mark	1 Stop
7 Bit	Spc	1 Stop
7 Bit	Mark	2 Stop
7 Bit	Spc	2 Stop
8 Bit	No	1 Stop
8 Bit	No	2 Stop
8 Bit	Even	1 Stop
8 Bit	Odd	1 Stop
8 Bit	Mark	1 Stop
8 Bit	Spc	1 Stop

1 Sets the number of data bits: You can select 7 or 8.

2 The parity test for received data bytes can be selected. **NO** causes transmission in both directions without parity bit. If **EVEN** or **ODD** is selected, the bytes are checked if they have even or odd parity. The selection of **MARK** or **SPACE** causes a data byte transmission with parity bit, but without checking the received data. Transmission data with parity bit is always marked with **1 (MARK)** or **0 (SPACE)**.

3 Selects one or two stop bits per data byte.

Confirm the setting by pressing the **Set** key (1). Press the **Next** key (4) to access the next group of parameters.

Further Settings (Special)

This parameter subgroup only appears if the serial port is used and the ENQ/STX, ETX/ACK or ACK/NAK protocol is activated.

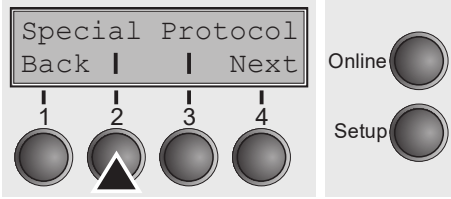

Press **Special (2)** key.

Error handling (ErrMode)

On replaces the incorrect character with ?, **Off** deletes the entire block.

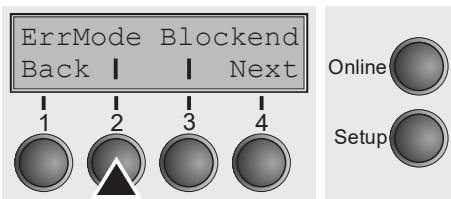

Press **ErrMode (2)** key.

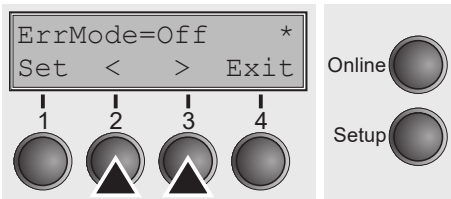

Use the < (2) or > (3) key to select the desired setting.

Setting Options: **On/Off**

Default Setting: **Off**

Confirm the setting by pressing the **Set** key (1).

Block end character (Blockend)

End-of-block character definition; **On**: LF, FF, CR, VT, ETX, DEL; **Off**: ETX, DEL.

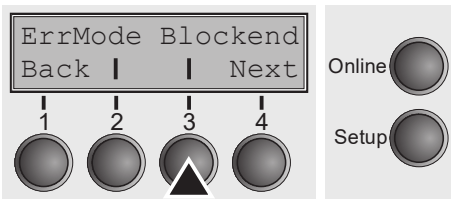

Press **Blockend (3)** key.

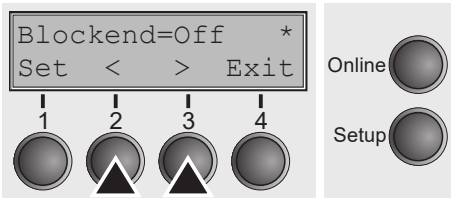

Use the < (2) or > (3) key to select the desired setting.

Setting Options: **On/Off**

Default Setting: **Off**

Confirm the setting by pressing the **Set** key (1). Press the **Next** key (4) to access the next group of parameters.

Signal feedback (Remote)

Signal feedback; **On** = RDY/BUSY available, **Off** = No RDY/BUSY control.

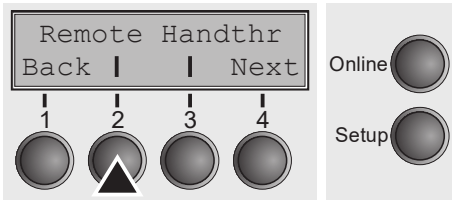

Press **Remote** (2) key.

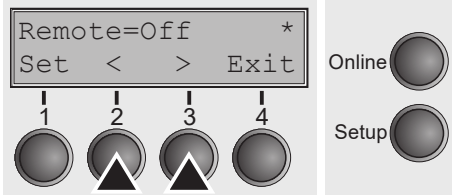

Use the < (2) or > (3) key to select the desired setting.

Setting Options: **On/Off**

Default Setting: **Off**

Confirm the setting by pressing the **Set** key (1).

Transparence (Handthr)

Affects the transparence of control sequences and block acknowledgement, depending on the selected protocol.

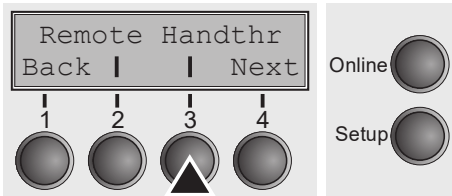

Press **Handthr** (3) key.

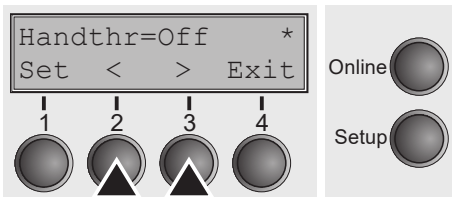

Use the < (2) or > (3) key to select the desired setting.

Setting Options: **On/Off**

Default Setting: **Off**

Confirm the setting by pressing the **Set** key (1). Press the **Next** key (4) to leave the parameter subgroup **Special**.

Protocol (Protocol)

This parameter serves to select the type of protocol, i.e. a certain set of rules and procedures for ensuring error-free data exchanges between computer and printer.

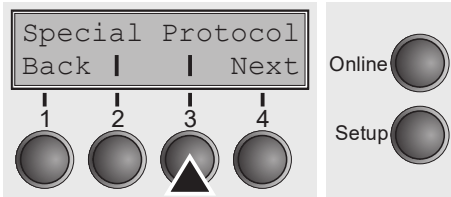

Press **Protocol** (3) key.

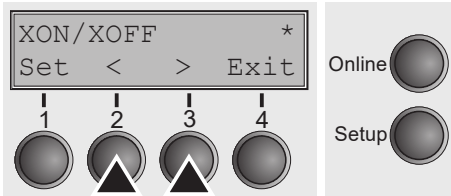

Use the < (2) or > (3) key to select the desired setting.

Setting Options: **XON/XOFF, Robust XON/XOFF, ENQ/STX, ETX/ACK, ACK/NAK**

Default Setting: **XON/XOFF**

Confirm the setting by pressing the **Set** key (1). Press the **Next** key (4) to access the next group of parameters.

Signal Processing (DTR)

Defines the conductor to which the DTR signal is connected (DTR = Data Terminal Ready).

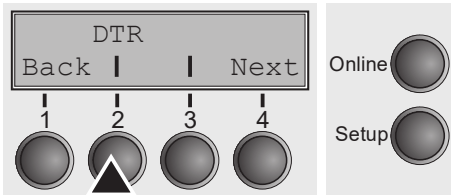

Press **DTR** (2) key.

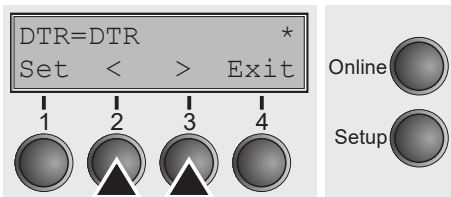

Use the < (2) or > (3) key to select the desired setting.

Setting Options: **DTR/READY**

Default Setting: **DTR**

DTR=DTR: DTR signal is assigned to DTR line.

DTR=READY: READY signal is assigned to DTR line.

DTR = Pin 20 on 25-pin female RS232 connector.

DTR = Pin 4 on 9-pin female RS232 connector.

Confirm the setting by pressing the **Set** key (1). Press the **Next** key (4) to access the next group of parameters.

Selecting interface (Interf.)

Selects the interface. Printer is configured either for parallel, Ethernet or optional serial connection or in automatic change for the parallel or the optional serial interface (**Shared**).

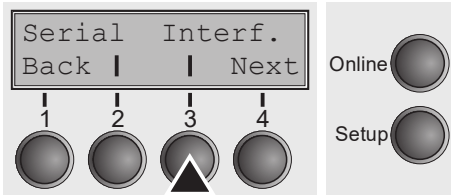

Press **Interf.** (3) key.

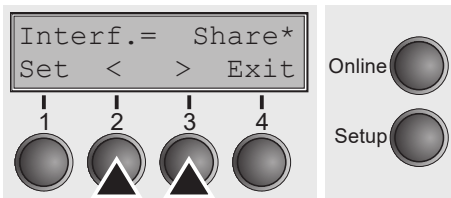

Use the < (2) or > (3) key to select the desired setting.

Setting Options: **Share, Parallel, Serial**

Default Setting: **Share**

Interf.=Share: Printer switches automatically between parallel, ethernet and optional serial interface.

Interf.=Parallel: Printer using parallel interface only.

Interf.=Serial: Printer using serial interface only.

Confirm the setting by pressing the **Set** key (1). Press the **Next** key (4) to access the next group of parameters.

Interface buffer (Buffer)

Selects the size of the interface buffer.

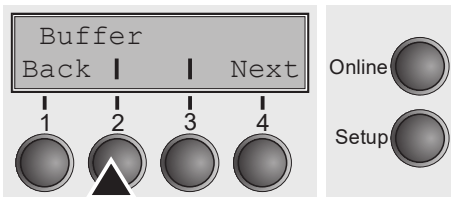

Press **Buffer** (2) key.

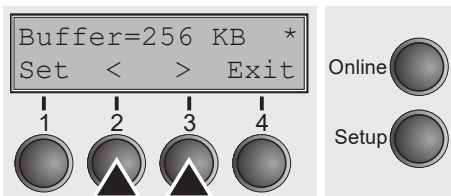

Use the < (2) or > (3) key to select the desired setting.

Setting Options: **0–256 KB**

Default Setting: **256 KB**

If buffer = 0 KB and the serial interface is selected, or if the setting “Share” is active, the actual buffer size will be 512 bytes.

Confirm the setting by pressing the **Set** key (1). Press the **Next** key (4) to leave the parameter group **Interf.**. Press the **Next** key (4) again to access the next group of parameters.

Ethernet interface (ETH-INT)

In this parameter group you can choose settings for the internal Ethernet interface.

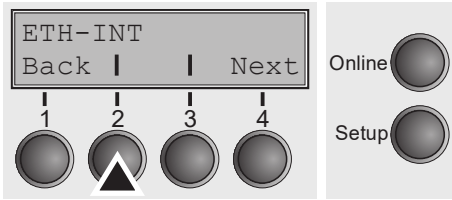

Press **ETH-INT** (2) key.



If an optional Ethernet print server (modular or pocket) is installed, **ETH-EXT** can be set via key 3.

Setting Gateway address (Gateway)

Input of the Gateway address of the printer.

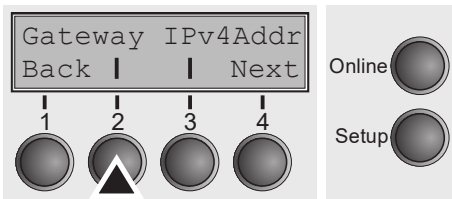

Press **Gateway** (3) key.

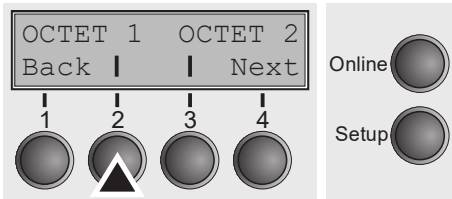

This menu level offers the possibility to set the IP address, which is divided into four digit groups (octet 1 to 4). You can activate octet 3 and 4 by pressing the **Next** (2) key.

Press **OCTET 1** (1) key.

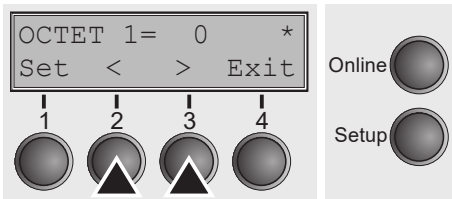

Use the < (2) or > (3) key to select the desired digit.

Setting Options: **0 to 255**

Default Setting: **0**

Confirm the setting by pressing the **Set** key (1).

Set the remaining three digit groups in the same way.

Press the **Next** key (4) to access the next group of parameters.

Setting IP address (IPv4 Addr)

Input of the IP address of the printer.

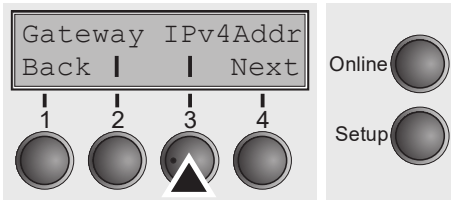

Press **IPv4 Addr** (3) key.

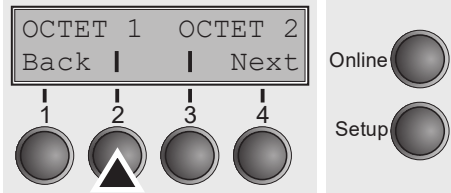

This menu level offers the possibility to set the IP address, which is divided into four digit groups (octet 1 to 4). You can activate octet 3 and 4 by pressing the **Next** (2) key.

Press **OCTET 1** (1) key.

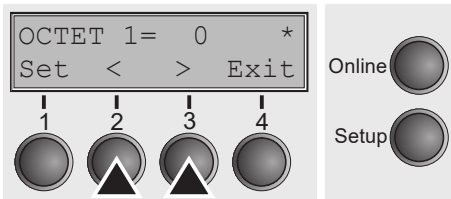

Use the < (2) or > (3) key to select the desired digit.

Setting Options: **0 to 255**

Default Setting: **0**

Confirm the setting by pressing the **Set** key (1).

Set the remaining three digit groups in the same way.

Setting Subnet mask (Subnet)

Input of the Subnet mask address of the printer.

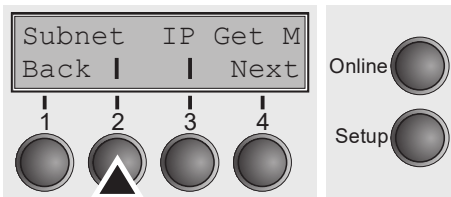

Press **Subnet** (2) key.

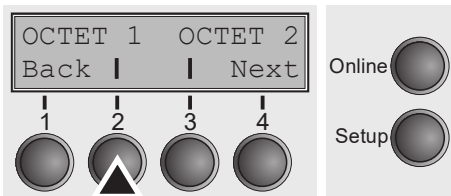

This menu level offers the possibility to set the IP address, which is divided into four digit groups (octet 1 to 4). You can activate octet 3 and 4 by pressing the **Next** (2) key.

Press **OCTET 1** (1) key.

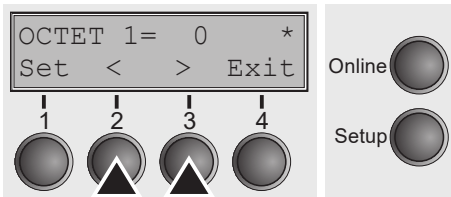

Use the < (2) or > (3) key to select the desired digit.

Setting Options: **0 to 255**

Default Setting: **0**

Confirm the setting by pressing the **Set** key (1).

Set the remaining three digit groups in the same way.

IP address administration (IP Get M)

Selects the way of administrating the IP address.

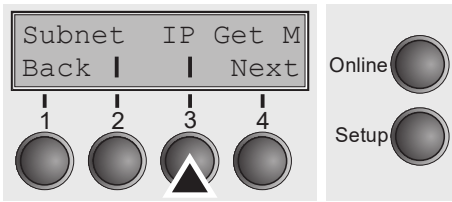

Press **IP Get M** (3) key.

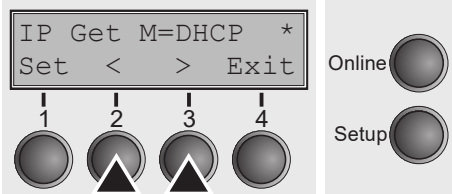

Use the < (2) or > (3) key to select the desired setting.

Setting Options: **Static, DHCP, BOOTP**

Default Setting: **Static**

Confirm the setting by pressing the **Set** key (1).

The setting **Static** is the precondition that the values entered in the parameter **IP Addr** become valid, see **Setting IP address (IPv4 Addr)**. For further informations, refer to the **Web Panel Manual** on the Online-CD-ROM.

Press the **Next** key (4) to access the next group of parameters.

Banner page (Banner)

Specifies whether a banner page is to be printed out, when using the LPD/LPR protocol.

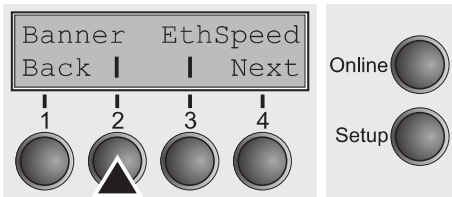

Press **Banner** (2) key.

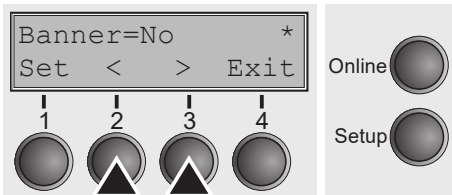

Use the < (2) or > (3) key to select the desired setting.

Setting Options: **Yes/No**

Default Setting: **No**

Yes: When using the LPD/LPR protocol a banner page will be printed out in front of every print job, containing the file name and the print queue name. The width of the banner page is 8".

Confirm the setting by pressing the **Set** key (1).

Ethernet speed (EthSpeed)

Specifies the transmission speed of the Ethernet interface.

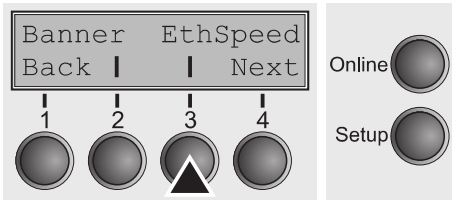

Press **EthSpeed** (3) key.

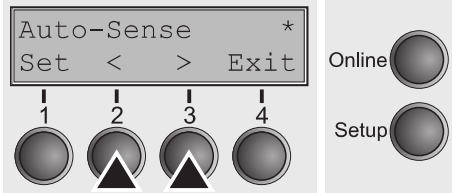

Setting Options: **Auto-Sense, 10Mbit Half, 10Mbit Full, 100Mbit Half, 100Mbit Full**

Default Setting: **Auto-Sense**

Auto-Sense: The transmission speed is detected automatically.

10Mbit Half: Sets the transmission speed to 10 MBit half duplex per second.

10Mbit Full: Sets the transmission speed to 10 MBit full duplex per second.

100Mbit Half: Sets the transmission speed to 100 MBit half duplex per second.

100Mbit Full: Sets the transmission speed to 100 MBit full duplex per second.



It is recommended that the ethernet interface transmission speed setting of the printer and the connected transmission device coincide. The printout of the current menu settings contains the ethernet link status (item EthConnected).

Confirm the setting by pressing the **Set** key (1).

Press the **Next** key (4) to leave the parameter group **Interf.**. Press the **Next** key (4) again to access the next group of parameters.

Selecting character set (CG-Tab)

Only available for Epson LQ 2550/LQ2170 emulation. Either the Epson character set Italics or the IBM graphics character set or a DLL (download) character set, as defined before, can be activated in the code range from hex. A0 to hex. FE.

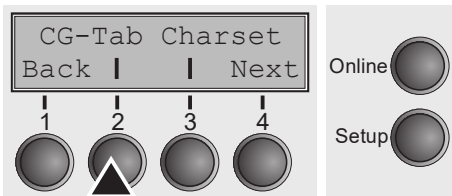

Press **CG-Tab** (2) key.

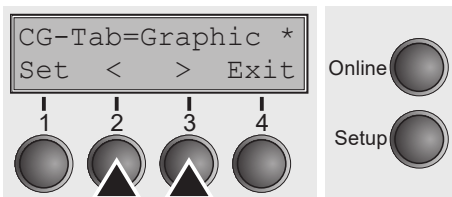

Use the **<** (2) or **>** (3) key to select the desired setting.

Setting Options: **Graphic, DLL, Italic**

Default Setting: **Graphic**

Confirm the setting by pressing the **Set** key (1).

IBM character set (CharSet)

Selects the IBM standard characters or the extended IBM characters.

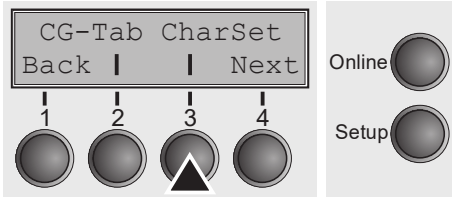

Press **CharSet** (3) key.

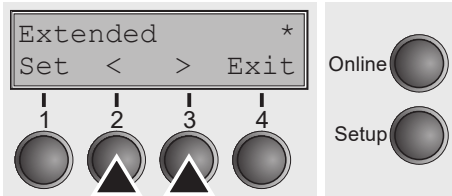

Use the < (2) or > (3) key to select the desired setting.

Setting Options: **Standard/Extended**

Default Setting: **Extended**

Confirm the setting by pressing the **Set** key (1). Press the **Next** key (4) to access the next group of parameters.

National character set (Country)

Selects the national character set. These character sets can be used according to the selected emulation. The character sets are not necessarily available for all fonts; see also *Available character sets and fonts*.

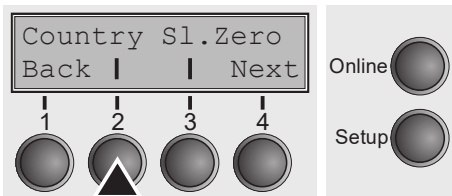

Press **Country** (2) key.

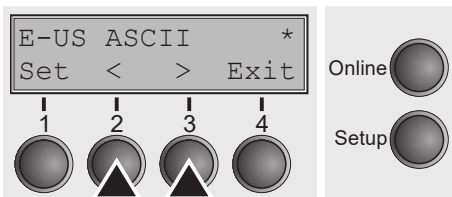

Use the < (2) or > (3) key to select the desired setting.

Setting Options: See *Available character sets and fonts*.

Default Setting: **E-US ASCII**

Confirm the setting by pressing the **Set** key (1).

Slashed zero (Sl.Zero)

Selects if normal zero (0) or the slashed zero (Ø) is printed.



Press **Sl.Zero** (3) key.

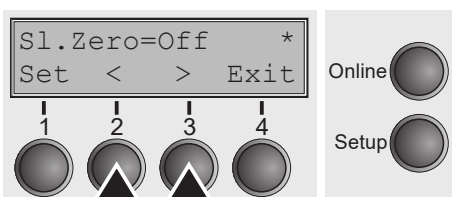

Use the < (2) or > (3) key to select the desired setting.

Setting Options: **Off/On**

Default Setting: **Off**

Confirm the setting by pressing the **Set** key (1). Press the **Next** key (4) to access the next group of parameters.

Automatic carriage return (Auto-CR)

Switches the automatic carriage return on or off after receiving the signal LF (line feed).

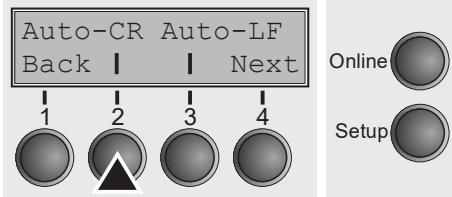

Press **Auto-CR** (2) key.

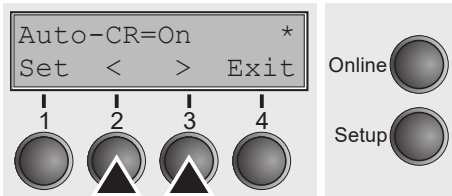

Use the < (2) or > (3) key to select the desired setting.

Setting Options: **Off/On**

Default Setting: **On**

Confirm the setting by pressing the **Set** key (1).

Automatic line feed (Auto-LF)

Switches the automatic line feed (LF) on or off after receiving the signal CR (carriage return).

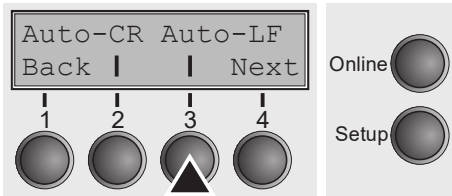

Press **Auto-LF** (3) key.

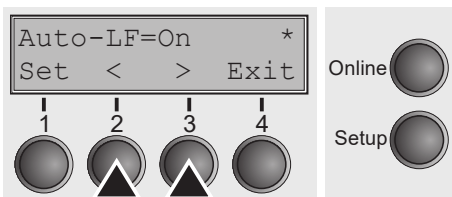

Use the < (2) or > (3) key to select the desired setting.

Setting Options: **Off/On**

Default Setting: **Off**

Confirm the setting by pressing the **Set** key (1). Press the **Next** key (4) to access the next group of parameters.

Menu lock (MenLock)

With **MenLock = Off**, all functions and settings are accessible without restriction in Online, Offline and Setup mode.

If **MenLock = Menu** is activated, all functions and settings are still accessible in Online and Offline mode, however, in Setup mode you can only access the parameter groups **Adjust** (setting the print head gap [**Head**], top of form [**TOF**] and tear position [**Tear**]), **Paperway** (setting the paper path), **Font** (setting the font) and the character spacing (**CPI**), while access to Menu mode (**Menu** key) is disabled.

If you select **MenLock = All**, you can access the Online/Offline, Load/Park, Paper and Paper Feed (LineFeed/Form Feed, ↑/↓) functions in Online and Offline mode while Setup mode is disabled.

In this case, the Setup menu can only be called up by holding the key **Setup** while switching on the printer.

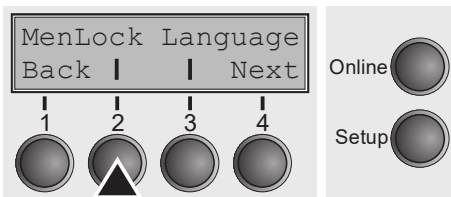

Press **MenLock** (2) key.

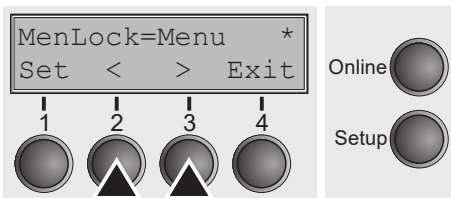

Use the < (2) or > (3) key to select the desired setting.

Setting Options: **Off, Menu, All**

Default Setting: **Menu**

Confirm the setting by pressing the **Set** key (1).

Language (Language)

The menu can be shown in six languages on the LC display.

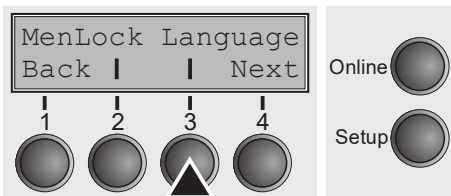

Press **Language** (3) key.

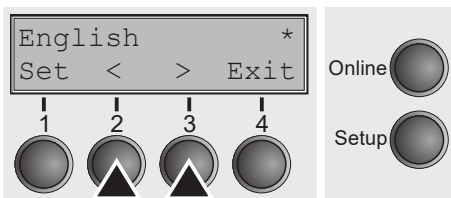

Use the < (2) or > (3) key to select the desired setting.

Setting Options: **English, German, French, Italian, Spanish, Turkish**

Default Setting: **English**

Confirm the setting by pressing the **Set** key (1). Press the **Next** key (4) to access the next group of parameters.

Paper parameters (Paper)

Selects the paper parameters **Formlen** (form length), **FormAdj** (first printing position) and **Head** (printhead gap, only if **AGA=Off**) separately for each paper source in the current menu.

Non-installed and with the parameter **PapOpt** activated options cannot be selected.

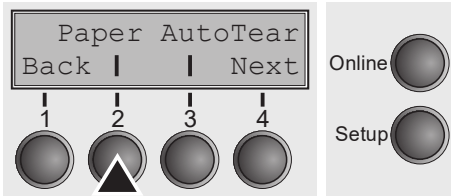

Press **Paper (2)** key.

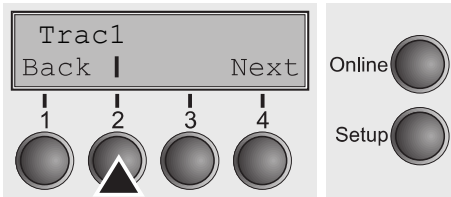

You can now choose between the following paper options:

- ▶ Tractor 1
- ▶ Tractor 2 (front, option)

Select the desired paperway, in our example **Trac1 (2)**. Press **Next (4)** key, to proceed to the installed optional paperways.

Form length (Forml)

You can define the form length in one of two ways: via the number of lines or via standard formats (e.g. DIN A4).

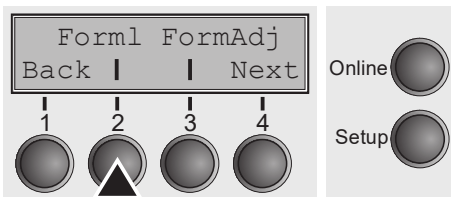

Press **Forml (2)** key.

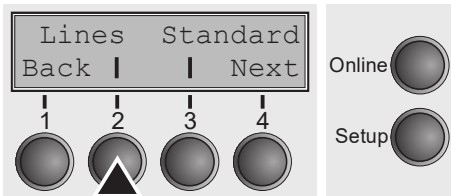

If you wish to define the form length via a line format, press **Line (2)** key.

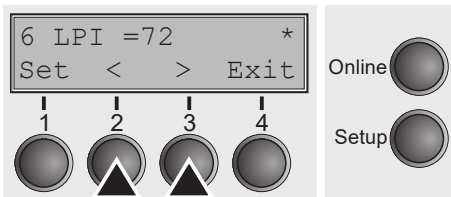

Use the **< (2)** or **> (3)** key to select the desired setting.

Setting Options: **6 bis 144**

Default Setting: **72**

Sets the form length via line formats. Please note that the adjustment in **Lines** depends on the selected LPI. For example 8 LPI at a selected line number of 96 lines results in a formlength of 12 inches ($96 \text{ lines} / [8 \text{ lines/inch}] = 12 \text{ inches}$). The selectable range is between 3 and 21 inches, i.e. for 2 LPI from 6 to 42 lines and for 12 LPI from 24 to 262 lines.

If the form length is set it will not be changed by changing the LPI later on.

Confirm the setting by pressing the **Set** key (1).

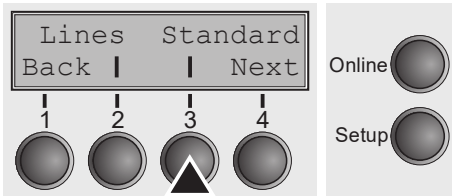

If you wish to define the form length via standard formats, press **Standard** (3) key.

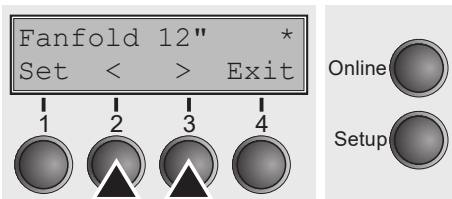

Use the < (2) or > (3) key to select the desired setting.

Setting Options: **Fanfold 12"**, **DIN A3**, **DIN A4**, **DIN A5**, **DIN B5**, **DIN B6**, **Exective 10.5"**, **Letter 11"**, **Legal 14"**, **No Format**

Default Setting: **Fanfold 12"**

Selects the form length by standard formats. Using **Standard**, different paper formats can be selected directly, e.g. DIN A4, Legal, Letter.

The LC display indicates **No Format** if a value is selected by the **Line** function or ESC sequences, which does not correspond to a standard format.

Confirm the setting by pressing the **Set** key (1).

First printing position (FormAdj)

Sets the first print position of a form in n/72 inch, separately adjustable for each paper path. The settings made here reduce the height of the printable area.

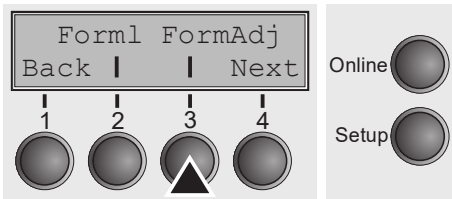

Press **FormAdj** (3) key.

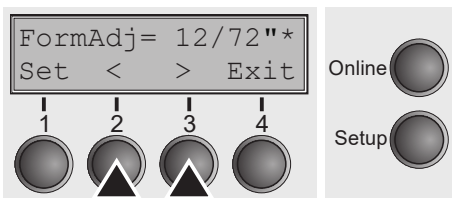

Use the < (2) or > (3) key to select the desired setting.

Setting Options: **0/72"** to **220/72"**

Default Setting: **12/72"**

Confirm the setting by pressing the **Set** key (1). Press the **Next** key (4) to access the next group of parameters.



An alternative notation for FormAdj is TOF (Top Of Form).

Printhead gap manually (Head)

This parameter is ignored if the automatic gap adjustment (AGA) is activated; see *Automatic gap adjustment (AGA)*.

Adjusts the printhead gap manually; separately adjustable for each paper path.

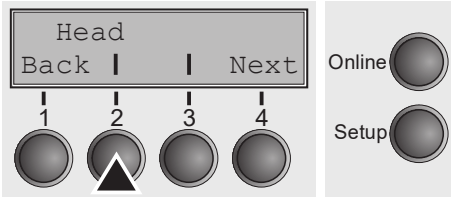

Press **Head (2)** key.

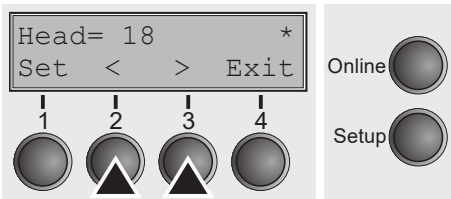

Use the < (2) or > (3) key to select the desired setting.

Setting Options: **0 to 100**

Default Setting: **18**

Select the **Head = 18** parameter for normal paper. Use a greater distance for thicker paper.

Recommended values for the print head gap:

thin					thick
18	26	34	42	50	58

i If you change this value, this may affect the print quality. If the printout shows signs of smudging, we recommend that you increase the print head gap.

Confirm the setting by pressing the **Set** key (1). Press the **Next** key (4) to access the next group of parameters.

View and tear position (AutoTear)

The auto tear function or the auto view function can be selected as desired.

When auto view is switched on, the last printed text is visible. As soon as data is received the paper moves to the “normal” print position. After printing the printer waits for the given interval to bring the paper once more to the auto view position.

The paper is in the tear off position when auto tear is switched on, the perforation of the paper is positioned at the tear off edge of the printer. If data is received, the paper returns to the normal print position. After printing, the printer waits for the given interval to bring the paper once more to the tear off position. If the tear off edge does is not aligned with the perforation of the paper then this can be corrected.

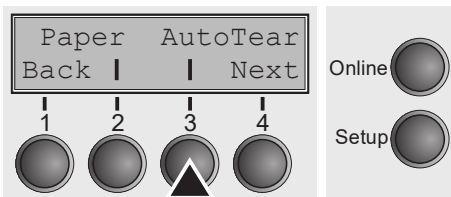

Press **AutoTear** (3) key.

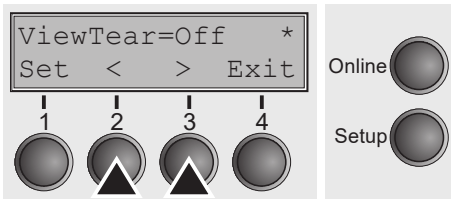

Use the < (2) or > (3) key to select the desired setting.

Setting Options: **ViewTear=Off, View=1s/3s/6s, Tear=1s/3s/6s, Tear at TOF**

Default Setting: **ViewTear=Off**

If the parameter **View Tear = Off** is set, the paper can still be brought into a View or Tear position via a specific sequence (see *List of available control codes*) or the **Tear** key.

If the parameter **Tear at TOF** is set, the paper perforation is automatically positioned at the tear off edge as long as the current print position TOF is activated. Feeding takes place after approx. 1.5 seconds (hold time). If any data is received during this period of time the paper is not positioned at the tear off edge. With this function it must be noted that the printer may only be switched off when the print position is at TOF.

Confirm the setting by pressing the **Set** key (1). Press the **Next** key (4) to access the next group of parameters.

Line length (Width)

Selects the line length in inches. With the setting of **8 Inch**, the printer operates like a printer with a width of only 8 inches.

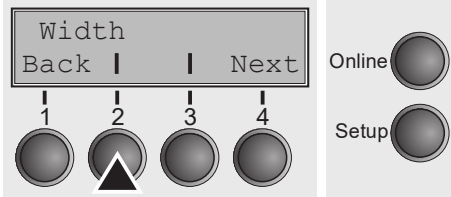

Press **Width** (2) key.

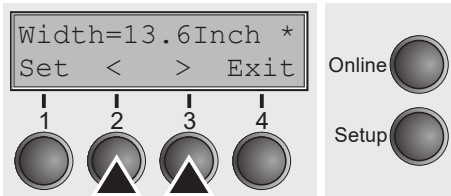

Use the < (2) or > (3) key to select the desired setting.

Setting Options: **8 Inch, 13.2 Inch, 13.6 Inch**

Default Setting: **13.6 Inch**

Confirm the setting by pressing the **Set** key (1). Press the **Next** key (4) to access the next group of parameters.

Barcode (Barcode)

With this function selected it is possible to print different barcodes and LCP (Large Character Printing).

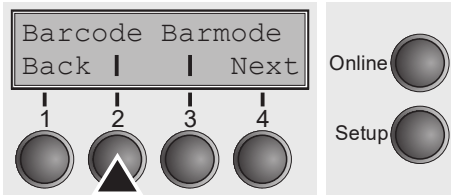

Press **Barcode** (2) key.

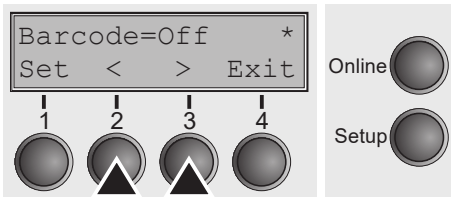

Use the < (2) or > (3) key to select the desired setting.

Setting Options: **On/Off**

Default Setting: **Off**

The definition and activation is performed by special sequences through the interface. Since this selection is possible for all emulations it must be noted that conflicts in sequence conformity with the selected emulation may occur. For this reason the barcode function can also be switched on and off by MTPL sequences. (The possible barcodes, LCP characters and the operation of these functions are described in the *Barcode Programmer's Application Manual*).

Confirm the setting by pressing the **Set** key (1).

Normal characters and barcode (Barmode)

Allows printing of normal characters on the left and right of the barcode.

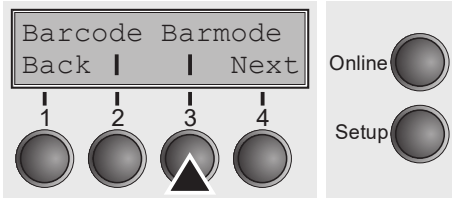

Press **Barmode** (3) key.

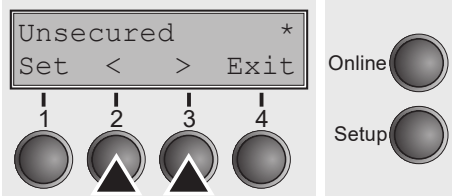

Use the < (2) or > (3) key to select the desired setting.

Setting Options: **Secured/Unsecured**

Default Setting: **Unsecured**

In **secured** mode, the space which the barcode characters require is “protected”. In each line, other barcode or normal characters can also be printed. These additional characters are printed in the line currently being printed and in the subsequent lines, without affecting the barcode which is already being printed. Consequently, normal characters can be printed in every line to the right or left of the barcode.

In **unsecured** mode, the required paper transport for printing barcodes and LCP is carried out automatically, it is not possible to print more than one line of normal characters in the barcode line. All characters in the mixed line are printed such that their bottom edges are in a straight line. This function may be switched on and off by sequences.



This function can be activated/deactivated by sequences.

Confirm the setting by pressing the **Set** key (1). Press the **Next** key (4) to access the next group of parameters.

Vertical position after oversized barcode (BarTop)

This parameter controls the vertical position of characters with standard height which follow oversized characters.

i This function is only effective in Genicom ANSI emulation.

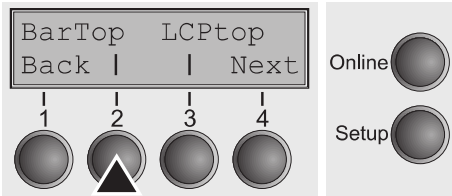

Press **BarTop** (2) key.

Use the < (2) or > (3) key to select the desired setting.

Setting Options: **Off/On**

Default Setting: **Off**

If this option is disabled (**Off**), then the printer advances paper 1/8 inch when exiting oversized characters. This characteristic is retained for compatibility with older products.

If the option is enabled (**On**), then the current vertical position following the printing of an oversized character will be the top of the oversized character cell. If the next object on the page is located below this point, then the printer uses vertical logic seeking to economize on paper movement.

Confirm the setting by pressing the **Set** key (1).

Vertical position after oversized character (LCPTop)

This parameter controls the vertical position of characters with standard height which follow oversized characters.

i This function is only effective in Genicom ANSI emulation.



Press **LCPTop** (3) key.

Use the < (2) or > (3) key to select the desired setting.

Setting Options: **Off/On**

Default Setting: **Off**

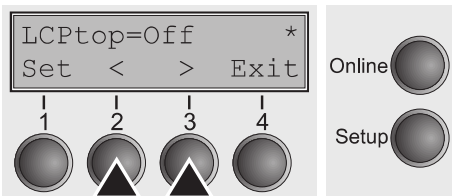

If this option is disabled (**Off**), then the printer advances paper 1/8 inch when exiting oversized characters. This characteristic is retained for compatibility with older products.

If the option is enabled (**On**), then the current vertical position following the printing of an oversized character will be the top of the oversized character cell. If the next object on the page is located below this point, then the printer uses vertical logic seeking to economize on paper movement.

Confirm the setting by pressing the **Set** key (1). Press the **Next** key (4) to access the next group of parameters.

Form feed mode (Ffmode)

Specifies whether a form feed is to be performed when the paper reaches the top print line.

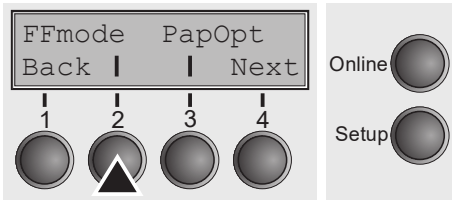

Press **FFmode** (2) key.

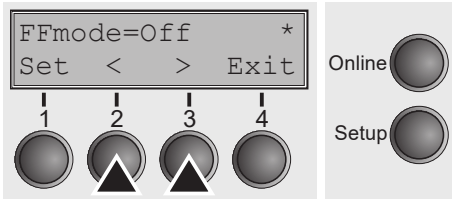

Use the < (2) or > (3) key to select the desired setting.

Setting Options: **On/Off**
Default Setting: **Off**

FFmode = On: If the paper is positioned in the first printing line (TOF), form feeds will be ignored.

FFmode = Off: Form feed will be performed in all cases.

Confirm the setting by pressing the **Set** key (1).

Setting and activating options (PapOpt)

For setting the optional automatic sheet feeders (ASFs) and optional tractors; see *Paperway*. Also regulates the activation of ASFs and/or optional tractors.

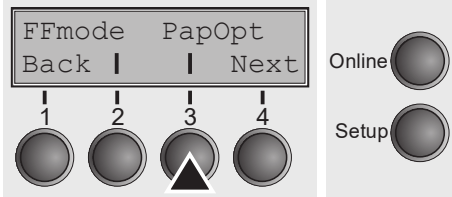

Press **PapOpt** (3) key.

Activation of tractors (AutoTra)

This parameter only appears if at the optional tractor is installed. It regulates the activation of tractors when there is no more paper left in one of them.

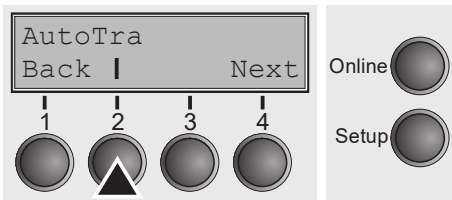

Press **AutoTra** (2) key.

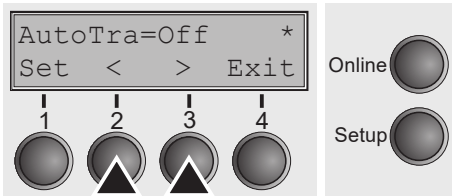

Use the < (2) or > (3) key to select the desired setting.

Setting Options: **Off/T1=T2**

Default Setting: **Off**

If an optional tractor is not installed, **Off** is displayed (factory default). If an optional tractor is installed and the **Off** parameter is activated, only the selected tractor is supported (either via the menu or an ESC sequence). If the selected tractor is out of paper, printing stops.

If an optional tractor is installed and you select **T1=T2**, the printer will load paper from the other tractor if the selected one is empty.

Confirm the setting by pressing the **Set** key (1). Press the **Next** key (4) to access the next group of parameters.

Setting the left margin (LeftMrg)

The left print margin can be set to a fixed value.

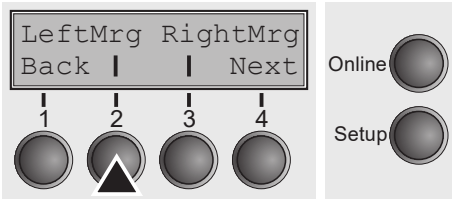

Press **LeftMrg** (2) key.

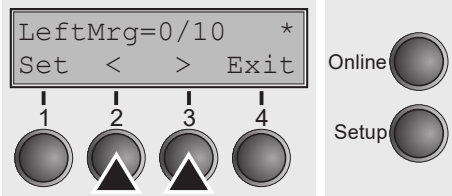

Use the < (2) or > (3) key to select the desired setting.

Setting Options: **2-134/10**

Default Setting: **134/10**

The value may not fall below the **RightMrg** value.

Confirm the setting by pressing the **Set** key (1).

Setting the right margin (RightMrg)

The right print margin can be set to a fixed value.

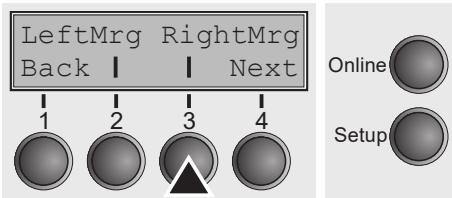

Press **RightMrg** (3) key.

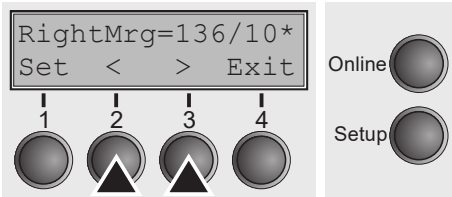

Use the < (2) or > (3) key to select the desired setting.

Setting Options: **2-136/10**

Default Setting: **136/10**

The value may not fall below the **LeftMrg** value.

Confirm the setting by pressing the **Set** key (1). Press the **Next** key (4) to access the next group of parameters.

Local copy (screen print) from a Coax or Coax/IPDS (FFaftLC)

To provide maximum compatibility to Coax/Twinax interfaces the function "FormFeed after Local Copy" has been implemented. This feature is ON per default. It is recommended to disable this feature (OFF) if problems in connection with Coax/Twinax/IPDS interfaces occur.

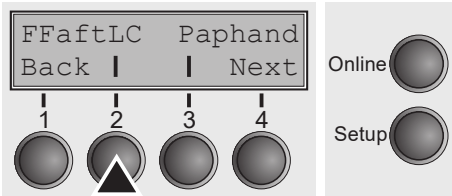

Press **FFaftLC** (2) key.

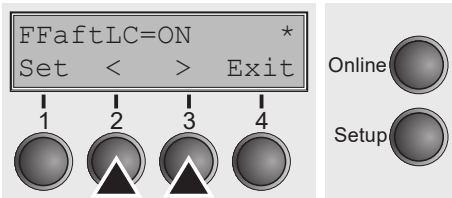

Use the < (2) or > (3) key to select the desired setting.

Setting Options: **Off/On**
Default Setting: **On**

Confirm the setting by pressing the **Set** key (1).

Enable/Disable paper handling features (Paphand)

In the "Advanced menu" are several possibilities to improve the paper handling of the printer even with critical paper and forms. This menu parameter enables or disables the set features in the current active menu.

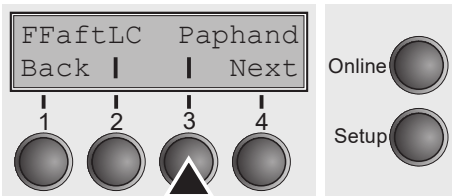

Press **Paphand** (3) key.

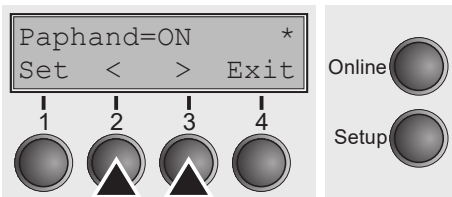

Use the < (2) or > (3) key to select the desired setting.

Setting Options: **Off/On**
Default Setting: **On**

Confirm the setting by pressing the **Set** key (1).

Menu settings (example)

Current settings Wally Dascom 2010						
Id.No.	Menu 1	Menu 2	Menu 3	Menu 4	Menu 5	Current
Serial No.						
Asset No.						
ID:70540v14	PRG					
ID:70546v2	BOOT1					
ID:70547v5	BOOT					
ID:70544	F2 FPGA					
ID:70545	F2 FPGA					
ID:40215H	Gen					
ID:40149E	Gen					
Font	Draft	Draft	Draft	Draft	Draft	Draft
CPI	10 CPI	10 CPI	10 CPI	10 CPI	10 CPI	10 CPI
LPI	6 LPI	6 LPI	6 LPI	6 LPI	6 LPI	6 LPI
Skip	0.01inch	0.01inch	0.01inch	0.01inch	0.01inch	0.01inch
ESDChar	ESC	ESC	ESC	ESC	ESC	ESC
Emulate	Epson LQ-2550	IBM Propr. K124	Epson LQ-2550	Epson LQ-2550	Epson LQ-2550	Epson LQ-2550
Midr	On	On	On	On	On	On
CS-Tab	Graphic	Graphic	Graphic	Graphic	Graphic	Graphic
CharSet	Extended	Extended	Extended	Extended	Extended	Extended
Country	E-US ASCII	Table 437	E-US ASCII	E-US ASCII	E-US ASCII	E-US ASCII
Sl.Zero	Off	Off	Off	Off	Off	Off
Auto-CR	On	On	On	On	On	On
Auto-LF	Off	Off	Off	Off	Off	Off
AutoTear	ViewTear-Off	ViewTear-Off	ViewTear-Off	ViewTear-Off	ViewTear-Off	ViewTear-Off
Width	13.61inch	13.61inch	13.61inch	13.61inch	13.61inch	13.61inch
LeftMrg	0/10"	0/10"	0/10"	0/10"	0/10"	0/10"
RightMrg	136/10"	136/10"	136/10"	136/10"	136/10"	136/10"
Papband	On	On	On	On	On	On
Barcode	Off	Off	Off	Off	Off	Off
Barcode	Unsecured	Unsecured	Unsecured	Unsecured	Unsecured	Unsecured
Fractor1	*	*	*	*	*	*
FormLen	Fanfold 12"	Fanfold 12"	Fanfold 12"	Fanfold 12"	Fanfold 12"	Fanfold 12"
Lead	18	18	18	18	18	18
FormAdj	12/72"	12/72"	12/72"	12/72"	12/72"	12/72"
Interf.	Shared					
Buffer	256 KB					
CS-bid	On					
Menu	1					
FormAdj Tract	0/72"					
AutoPRA	Off					
Inletm.	Off					
VGA	On					
VGA offset	0					
Pap.back	normal					
MMS	Low					
MPW	On					
AED	On					
Sound	On					
Fmode	Off					
Wrap	On					
Rightao	Off					
Leftao	Off					
Head up	Off					
Pagewid	136/10"					
Physle	0/10"					
Key Form	Off					
BarTop	Off					
LCPTop	Off					
Ignore	Off					
FFaTtLC	On					
TrSpeed	high					
Robcatl	Off					
Serial						
Baud	9600					
Format	8Bit No 1Stop					
Protocol	XON/XOFF					
YER	DTR					
ETH-INT	OCTET 1	OCTET 2	OCTET 3	OCTET 4		
IPv4Addr	172	20	10	12		
Gateway	172	20	0	253		
Subnet	255	255	0	0		
IP Get Method	DHCP					
LinkSpeed	Auto-Sense					
LinkConnected	100Mbit Full					
Banner	Off					
MAC Adr	DC-9D-A5-F7-70					
IPv6Addr1	fe80::be9d:a5ff:feff:ff70					
IPv6Addr2	::					
IPv6Addr3	::					
IPv6Addr4	::					
IPv6Addr5	::					
IPv6Addr6	::					

Advanced menu

The advanced menu consists of test functions and advanced settings.

Test functions

Various tests to check proper operation of the printer are available at any time. With these tests it is possible to check the print quality, proper operation of the printhead and the mechanics, as well as efficient data transmission from the computer to the printer.

The extended menu contains three test functions (**ASCII 80**, **ASCII 136**, **H-Dump**).

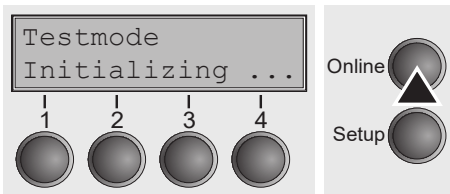
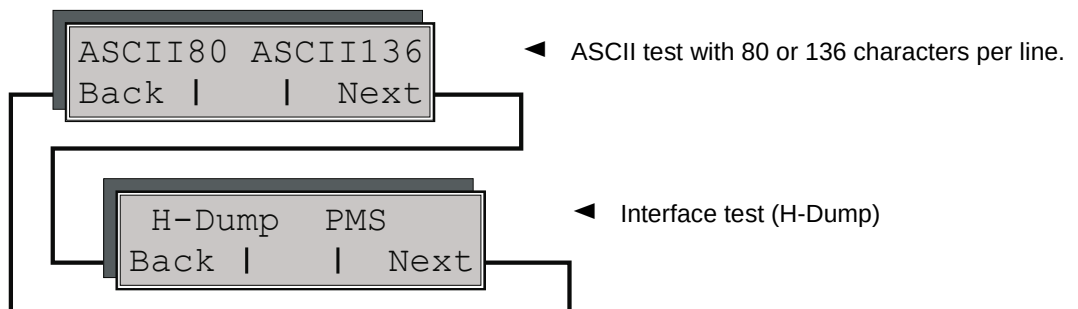

Enter advanced menu mode by pressing the key **Online** while switching on the printer.

The display shows **Test mode** for approx. 1 second and then automatically changes to display **ASCII 80 ASCII 136**.

Printer self-test (Rolling ASCII)

To check operational readiness, your printer contains a self-test routine which allows testing of the printer configuration, the print quality and correct operation of your printer.

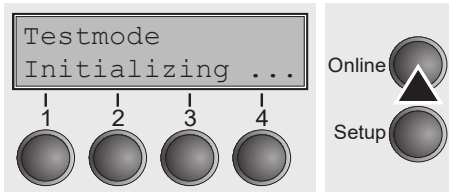

Before performing a self-test, your printer must be switched off. Ensure that paper is inserted. Keep the key **Online** pressed while switching on the printer, until **Testmode** appears on the display.

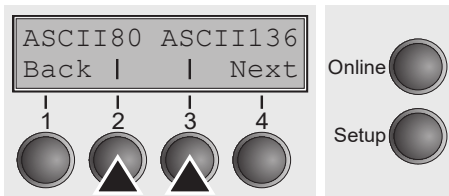

Press the soft key for the ASCII 80 format (corresponds to Legal Portrait) or for ASCII 136 (Double or Legal Landscape). The display will indicate **Test mode Off**.

Press the **Online** key, to start the test.

It is also possible to change to Setup mode when you are in Rolling test mode if you want to change the configuration for the test printout.

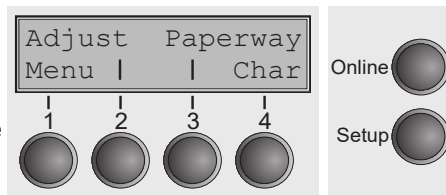

To do this, press the key **Setup**.

The printer then changes to Setup mode and the first of the main levels is then displayed.

Program your printer in the usual way for the test printout to change the parameters. See section *Programming via the control panel*.

Some changes in menu mode may cause the printer to reinitialize; in this case the Rolling ASCII test is aborted.



By pressing the key Setup you exit Setup mode and the printer once again returns to Rolling ASCII test mode.

Testmode Off is displayed. Press the key **Online**, the test printout starts.

The self-test can be interrupted by pressing the key **Online** which will stop printing and put the printer into Offline status.

Before you begin printing, you can adjust the paper for the printout with soft keys ↑ and ↓.

```
3456789:;<=>?@ABCDEFGHIJKLMNOPQRSTUVWXYZ[\ ]^
456789:;<=>?@ABCDEFGHIJKLMNOPQRSTUVWXYZ[\ ]
56789:;<=>?@ABCDEFGHIJKLMNOPQRSTUVWXYZ[\
6789:;<=>?@ABCDEFGHIJKLMNOPQRSTUVWXYZ[
789:;<=>?@ABCDEFGHIJKLMNOPQRSTUVWXYZ
89:;<=>?@ABCDEFGHIJKLMNOPQRSTUVWXYZ
9:;<=>?@ABCDEFGHIJKLMNOPQRSTUVWXYZ
:;<=>?@ABCDEFGHIJKLMNOPQRSTUVWXYZ
;<=>?@ABCDEFGHIJKLMNOPQRSTUVWXYZ
```

Example of an ASCII test
printout



If you selected a proportional font (PS font) , the printed length of the lines varies.



This test can also be used to determine and set the optimal printhead gap (see the section [Setting the print head gap](#)).

Exiting Rolling ASCII test mode

The self-Rolling ASCII test mode test mode can only be terminated by switching off your printer. For this operation the printer must be Offline.

If you want to stop the test printout before switching off the printer, press the key Online.

Interface test (Hex-Dump)

With the interface test (Hex-Dump/H-Dump) you can test data transmission from the computer to the printer. During this test, the data from the computer is printed out in two columns. The text in the left column is printed in hexadecimal format and in the right column in ASCII format.

Printout in Hex-Dump

Put the printer into advanced menu mode by pressing the key **Online** while switching on the printer.



Press the key Online until Test mode is shown on the display.

The display shows **Test mode** for approx. 1 second and then automatically changes to display **ASCII 80 ASCII 136**.



Press the key **Next** (4), the display shows the next menu level.

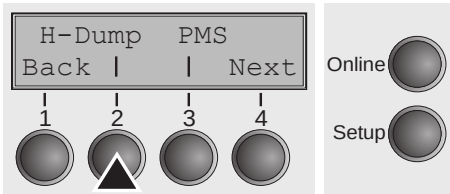

If you press the key **H-Dump** (2) you select the H-Dump mode and **Offline H-Dump** is shown on the display.

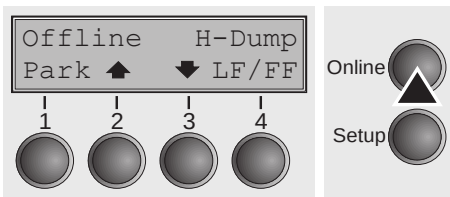

Put the printer into **Online H-Dump** mode by pressing the key **Online**. The printer is now ready to receive data from the computer and to print it out in hexadecimal format. The printed data can now be analyzed and evaluated.

```

1B 5B 30 3B 30 20 44 1B 5B 31 3B 31 20 44 1B 5B
32 3B 32 20 44 1B 5B 33 3B 33 20 44 1B 5B 34 3B
34 20 44 1B 5B 35 3B 35 20 44 1B 5B 36 3B 36 20
44 1B 5B 3F 35 32 68 1B 5B 35 3B 3B 30 7B 1B 32
1B 5B 38 34 31 38 74 1B 5B 37 32 38 20 68 0A 1B
5B 31 32 30 20 68 1B 5B 37 31 32 60 1B 5B 31 30
6D 1B 5B 34 79 1B 5B 34 77 54 68 69 73 20 69 73
20 61 20 73 61 6D 70 6C 65 20 74 65 78 74 20 73
68 6F 77 69 6E 67 20 74 68 65 20 66 75 6E 63 74
69 6F 6E 61 6C 69 74 79 20 6F 66 20 74 68 65 20
68 65 78 2D 64 75 6D 70 20 0D 1B 5B 31 32 30 20
68 0A 1B 5B 31 32 30 20 68 1B 5B 37 31 32 60 66
65 61 74 75 72 65 2E 20 69 74 20 69 73 20 69 6E
74 65 6E 64 65 64 20 74 6F 20 61 6E 61 6C 79 73
65 20 74 68 65 20 69 6E 63 6F 6D 69 6E 67 20 64
61 74 61 20 73 74 72 65 61 6D 2E 20 20 0C 1B 5B
35 34 7B 1B 5B 36 7E
1B 5B 36 7E 1B 5B
?6~.t..6.(r.[11h
.[0;0.D.[1;1.D.[
2;2.D.[3;3.D.[4;
4.D.[5;5.D.[6;6.
D.[?52h.[5;;0{.2
.[8418t.[728.h..
[120.h.[712'.[10
m.[4y.[4wThis.is
.a.sample.text.s
howing.the.funct
ionality.of.the.
hex-dump...[120.
h..[120.h.[712'f
eature..it.is.in
tended.to.analys
e.the.incoming.d
ata.stream....[
54{.[6~

```

Example of a Hex-Dump printout



After the transmission you must switch the printer to Offline. Any remaining data left in the interface buffer is then printed.

Terminating Hex-Dump

Hex-Dump mode can only be terminated by switching off the printer.



If you want to stop the Hex-Dump printout before switching off the printer, press the key Online and then the key LF/FF (4) once.

Paper sensor display

If the keys 1 and 2 are pressed at power on and then (after releasing the keys) key 3 is pressed within 2 seconds (the time is marked by an asterisk in the upper right corner of the LCD display), the printer will show the paper sensor value in millivolts on the LCD display. PE shows the value of the paper end sensor.

Advanced settings

In the advanced menu, there are other settings available besides the test functions.

- ▶ With the function **PMS** you have the possibility of activating the automatic paper motion sensor (**PMS**) in case of a paper jam.
- ▶ With the function **Forml** you can adjust the form length.
- ▶ The function **AGA** switches the automatic printhead gap function on or off.
- ▶ You can also select adjustments which facilitate handling paper which may cause problems in printing due to its structure (**Paphand**).
- ▶ The **CX-bid** menu option controls the bidirectionality of the parallel interface.
- ▶ With the function **Wrap**, you can set line wrap and with the function **Sound** beep at paper end.
- ▶ The function **JobCtrl** activates the PJP functionality.
- ▶ The function **Pap.back** allows printing on paper with a dark back.
- ▶ With the function **GrSpeed**, you can select an improved graphic speed.
- ▶ You can use the **HvyForm** function to set the print head to print the same line twice at double strike force in order to ensure that copy paper produces optimum results even if it has a faint copying effect.
- ▶ The **APW** function can be used to activate the automatic paper width detection feature to prevent the printer from printing beyond the paper edge.
- ▶ The **AED** menu option only appears, if a cut device is installed. It corrects possible inaccuracies of the paper positioning at the tear edge if the paper path is changed after a cutting action.
- ▶ With the **SerialN** function, you have the possibility to change the serial number of the printer.
- ▶ With the **AssetN** function, you have the possibility to change the asset number of the printer.
- ▶ The **Ignore** function allows to ignore any character (to be defined in **IgnoreChr**).
- ▶ The **IgnoreChr** function set the character to be ignored as a decimal number.

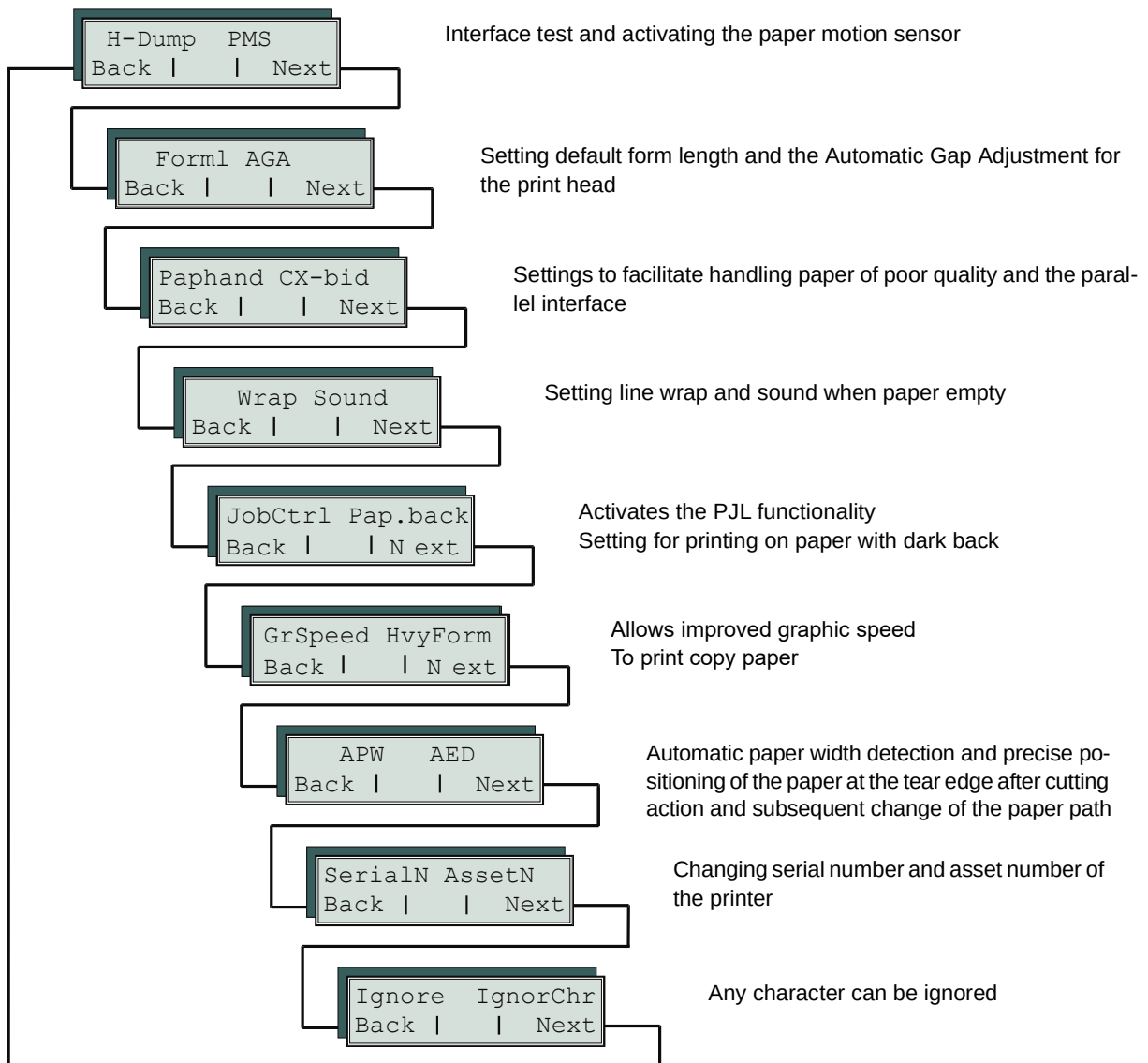

Enter advanced menu mode by pressing the key **Online** while switching on the printer.

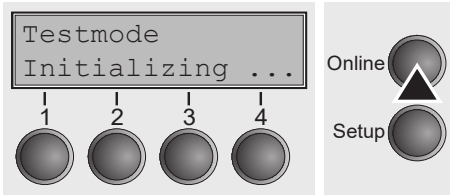

The display shows **Test mode** for approx. 1 second and then automatically changes to display **ASCII 80 ASCII 136**.

Automatic paper motion sensor (PMS)

You can use this function to activate or deactivate the paper motion detection feature. When it is active, printing and paper movements stop in case of a paper jam and an error message is output in the display. Set the printer to test mode by pressing the **Online** key while you switch on the printer.

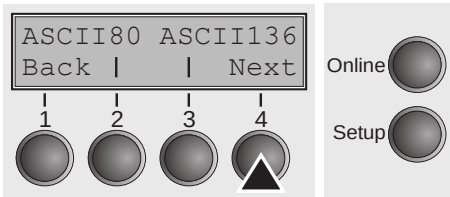

Press the **Next** key (4).

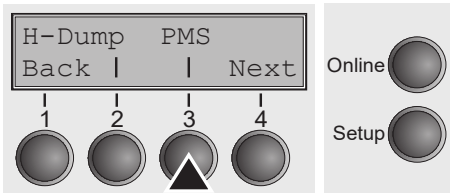

Select the **PMS** menu (3).

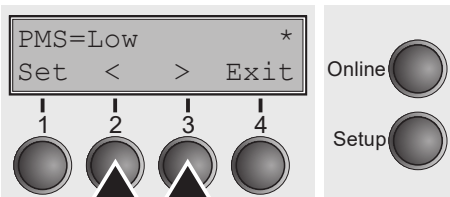

Setting options: **Off/Low/Mid/High**

Default setting: **Low**

PMS=Low/Mid/High: The form movements of the active paper path are monitored. In case of a paper jam, printing and paper movements stop and an error message (**paper jam**) is displayed.

Low: Sensitivity 800/360"

Mid: Sensitivity 600/360"

High: Sensitivity 300/360"

PMS=Off: A paper jam will not produce an error message.



The Paper Motion Sensor (PMS) detects any paper jam or unintended paper end condition and provides efficient protection against any paper transport problems together with the paper end sensor. This prevents the printer from printing on jammed paper or printing without paper. Disabling the PMS can affect the operational reliability of your printer and should therefore be avoided.

Confirm the setting by pressing the **Set** (1) key. Change to the next parameter group with the **Next** key (4).

Form length (Forml)

The **Formlen** function allows you to set the basic form length to meet your requirements. 11 inches are usual in the USA, as opposed to 12 inches in Europe.

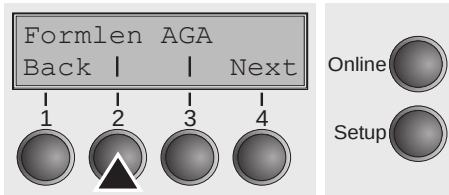

Select the **Forml** menu (2).

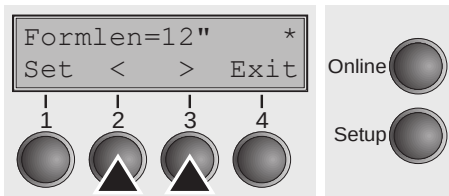

Setting options: **12** or **11** Inch

Default setting: **12 inches** for 220–240 V printers, **11 inches** for 120 V printers

The value defined here is set in all five menus and for all paper paths. The setting made here is not changed by loading the default (factory) settings by pressing all four function keys; see section *Key functions when turning on the printer*.

Confirm the setting by pressing the **Set** (1) key.

Automatic gap adjustment (AGA)

This function allows you to switch the Automatic Gap Adjustment (AGA) off or on.

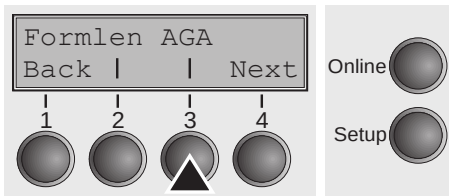

Select the **AGA** menu (3).

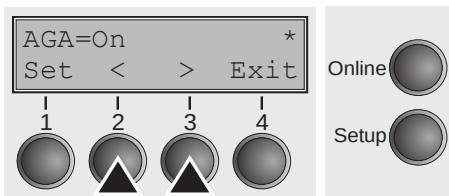

Setting options: **Off/On**

Default setting: **On**

AGA=On: printer checks paper thickness and changes gap adjustment if necessary (default). Measurements take place
 – after power-on
 – whenever changing the paper path, when loading paper

AGA = Off: selects manual gap adjustment; the value can be set for each paper source and each of the five menus available.

Confirm the setting by pressing the **Set** (1) key. The printer automatically leaves test mode and assumes online mode.

Paper handling (Paphand)

The **Paphand** group of menus improves the possibilities for the troublefree printing of paper with properties likely to cause problems (perforations etc.) or paper of poor finish.

Put the printer into Test mode by pressing the key **Online** while switching on the printer. The display shows **ASCII80 ASCII136**. Change to the parameter group **Formlen AGA** by pressing the key **Next** three times.

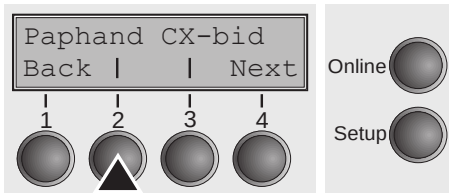

Select the **Paphand** menu (1).

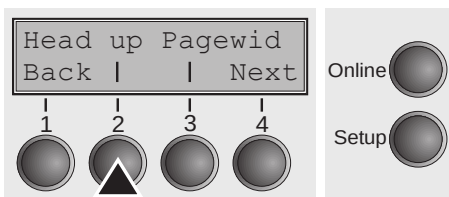

Select the **Head up** menu (2).

Increasing the printhead gap (Head up)

With this function you can increase the printhead gap before and after the perforation of the form.

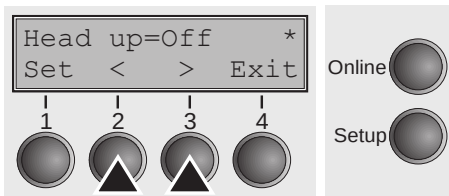

Setting options: **On/Off**

Default setting: **Off**

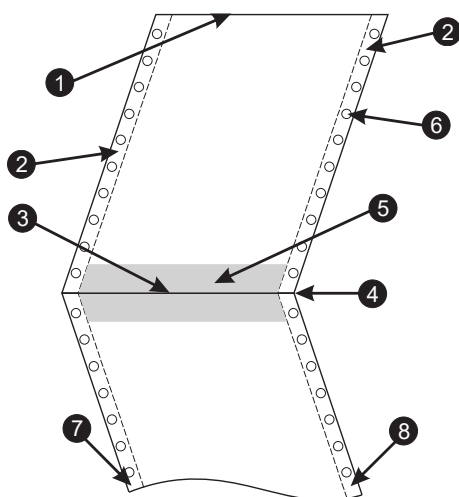

If the parameter is set to **On**, the printhead gap increases during form feed and line feed four lines before and after the perforation on the form (= protected zone). The printhead gap is always increased during form feeding past the perforation even when feeding takes place outside the protected zone.

i **Printing is possible in the protected area.**

Confirm the setting by pressing the **Set** (1) key.

- | | |
|-------------------------------|-------------------|
| 1 Top edge of form | 5 Protected zone |
| 2 Paper transport strip | 6 Transport holes |
| 3 Bottom edge of form | 7 Left Zone |
| 4 Form separation perforation | 8 Right Zone |

Paper width (Pagewid)

This parameter determines the actual paper width.

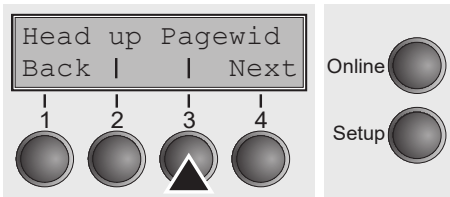

Select the **Pagewid** menu (3)

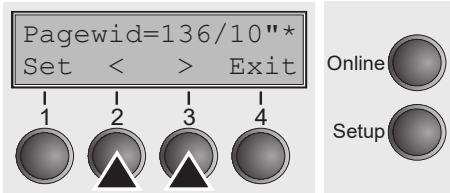

Setting options: From **20** to **136** in 1/10 inch steps

Default setting: **136/10** inch (136 characters at 10 characters/inch)

If **Head up = On**, the printhead moves to the calculated centre of the paper during the time the paper is moving in the protected zone. If **Rightzo = On** (see below), the printhead moves out of the perforation zone on the right as long as the paper is being transported.



Set the printing width rather than the actual paper width.

Confirm your settings with the **Set** key (1) and press the **Next** key (4) to access the next group of parameters.

Left-hand area (Leftzon)

If the parameter is On, the printhead moves out of the perforation zone (area) on the left as long as the paper is being transported. The Pagewid setting has no influence (see above).

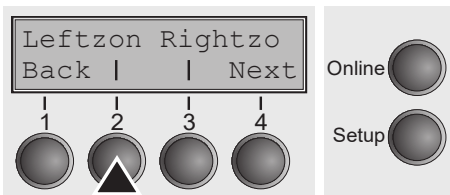

Select the **Leftzon** menu (2) (stands for left zone).

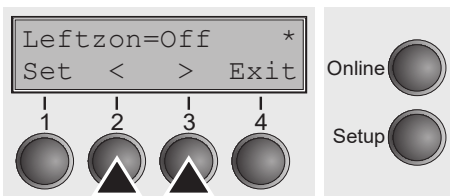

Setting options: **On/Off**

Default setting: **Off**

Confirm your settings with the **Set** key (1).

Right-hand area (Rightzo)

If the parameter is On, the print head travels from the right-hand perforation area towards the centre of the paper while the paper is moving. The Pagewid option must be correctly set in this case, see *Paper width (Pagewid)*.

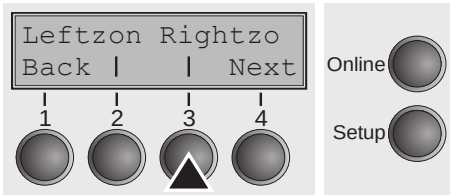

Select the **Rightzo** menu (3).

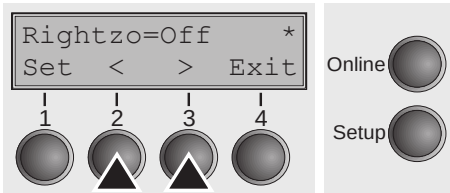

Setting options: **On/Off**
Default setting: **Off**

i If this parameter is **On**, the print head carriage travels to the centre of the form while the paper is loaded.

Confirm your setting with the **Set** key (1) and press the **Next** key (4) to access the next group of parameters.

Physical left margin (Physlm)

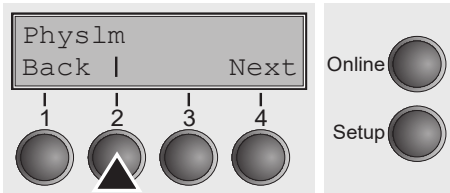

Select the **Physlm** menu (2).

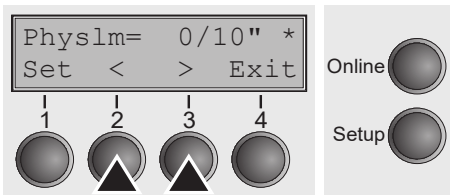

Setting options: **0 to 30** in 1/10 inch steps
Default setting: **0/10** Inch

Permanent (physical) setting of the left margin. This parameter cannot be changed by emulation-dependent margin settings. Margin setting values entered by ESC sequences are added to the **Physlm**.

i Note that this value is subtracted from the maximum printing width of 13.6 inches.

Confirm the setting by pressing the **Set** (1) key.

i All parameters described in the Paphand group may also be defined via an ESC sequence (see *Emulations* or *Programmer's Application Manual*).

Press the **Next** key (4) to access the next group of parameters.

Bidirectional parallel interface (CX-bid)

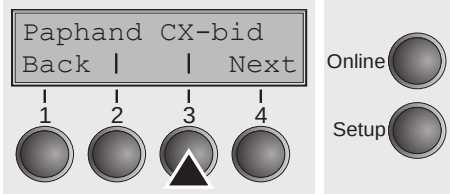

Select the **CX-bid** menu (3).

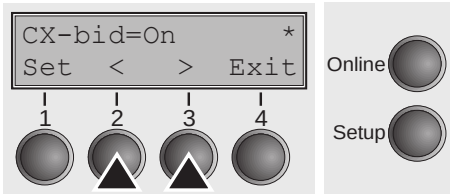

Setting options: **On/Off**
 Default setting: **On**

CX-bid = ON sets the parallel interface of the printer to bidirectional mode (IEEE 1284, Nibble mode), e.g. for Windows Plug & Play.

CX-bid = OFF sets the interface to compatibility mode in order to ensure reliable operation with special external boxes.

Confirm the setting by pressing the **Set** (1) key. Change to the next parameter group with the **Next** key (4).

Line wrap (Wrap)

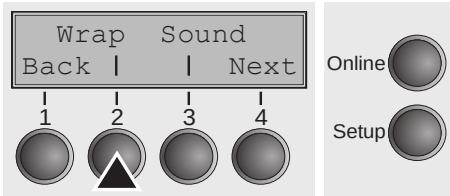

Select the **Wrap** menu (2).

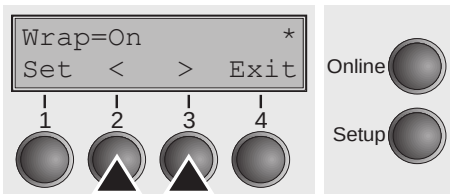

Setting options: **On/Off**
 Default setting: **On**

Wrap = On: If more characters than can be printed are transmitted per line, the characters which cannot be printed on this line are printed at the beginning of next line.

Wrap = Off: If more characters than can be printed are transmitted per line, the characters which cannot be printed on this line are cut off.

Confirm the setting by pressing the **Set** (1) key.

Beep at paper end (Sound)

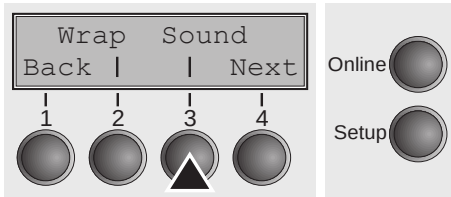

Select the **Sound** menu (3).

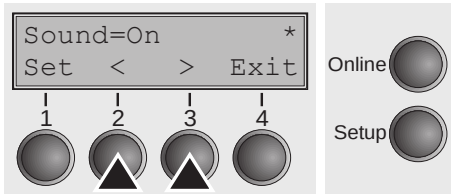

Setting options: **On/Off**
 Default setting: **On**

When **Sound = On**, a beep is generated every second to notify that paper is empty.

Confirm the setting by pressing the **Set** (1) key. Change to the next parameter group with the **Next** key (4).

Activate PJL language (Jobcntl)

This parameter activates the printer language PJL (Printer Job Language).

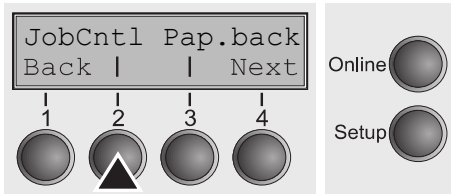

Select the **Jobcntl** (2) menu.

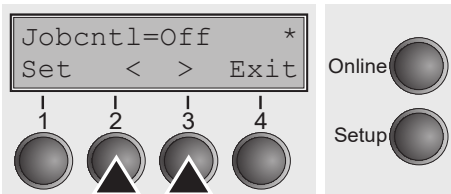

Setting options: **Off/On**
 Default setting: **Off**

On activates the PJL printer language (see *PJL commands*).

Confirm the setting by pressing the **Set** (1) key.

Settings for paper with dark back (Pap.back)

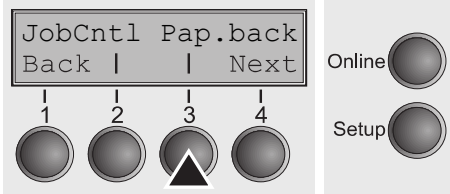

Select the **Pap.back** (3) menu.

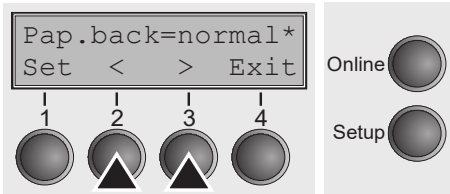

Setting options: **normal/dark**
 Default setting: **normal**

Pap.back = normal is the standard for normal paper.

Pap.back = dark can be set to process paper with a grey back.

i Paper with a completely black back side cannot be used if the ink is carbon-based. However, the printer can handle anilinebased black paper (undefined colors).

Confirm the setting by pressing the **Set** (1) key. Change to the next parameter group with the **Next** key (4).

Graphic print speed (GrSpeed)

This parameter allows improved graphic speed independently to the driver. It affects only the print speed of graphic printouts at 180 x 180 dpi.

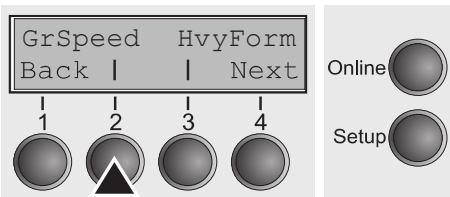

Select the **GrSpeed** (2) menu.

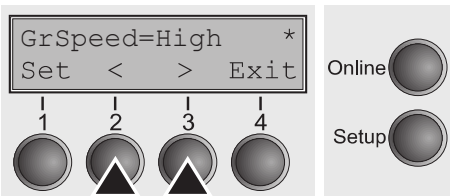

Setting options: **Normal/High**
 Default setting: **High**

Normal means 180 dpi normal print speed (full space) and **High** means 180 dpi double speed (half space).

Confirm the setting by pressing the **Set** (1) key.

Setting for printing copy paper (HvyForm)

If you set **HvyForm = ON**, the printer prints the same line twice at double strike. This setting ensures that copy paper produces optimum results.

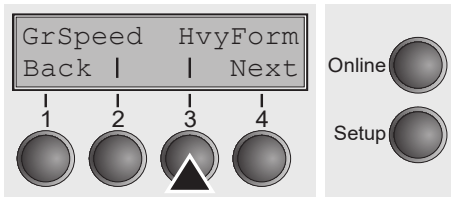

Select the HvyForm menu (3).

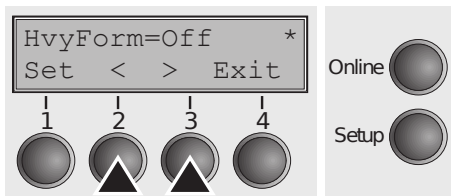

Setting options: **On/Off**

Default setting: **Off**

i With the Copy Draft, NLQ and LQ print qualities, the line is printed twice, however, at single strike.

Confirm the setting by pressing the **Set** (1) key. Change to the next parameter group with the **Next** key (4).

Automatic paper width detection (APW)

The automatic paper width detection feature **APW** prevents the printer from printing beyond the paper edge. This is useful to prevent the printer from printing on the platen, for example, because of an incorrect driver setting.

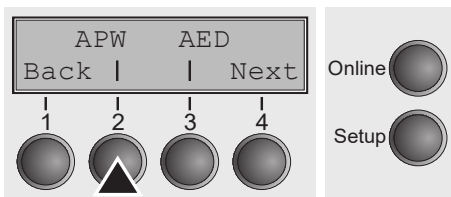

Select the **APW** (2) menu.

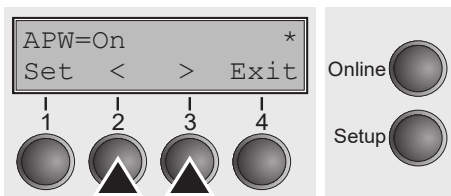

Setting options: **On/Off**

Default setting: **On**

If **APW=On**, the printer is in the standard mode and truncates all data located beyond the right-hand and left-hand paper edge. These print data are lost.

When you select **APW=Off**, the printer does not prevent undesirable printing on the platen.

The printer determines the paper width by means of an optical sensor in the print head module. The print head carriage moves once across the maximum possible printable area of the paper and stores the width measured in this process. The measuring process varies, depending on the paper source selected.

The measurement is made

- ▶ after power-on and before the first print job;
- ▶ after paper end and before the subsequent print job; after
- ▶ changing the paper source (e.g. from Tractor 1 to Tractor 2).

When you submit a print job which exceeds the paper width, the following message appears in the display:

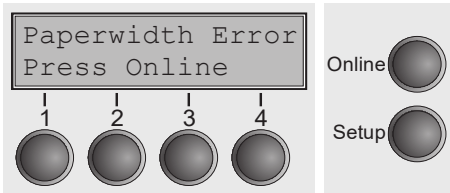

The print job is stopped at the measured paper-end position after printing the first line.

You can now either cancel the print job or load suitable paper. In the latter case, the printer will resume the print job upon pressing the **Online** key.

i If you press the **Online** key without having changed the paper, another line is printed until reaching the measured paper-end position.

The sensor interprets dark areas with a width of 13 mm or more as the right-hand paper edge.

i If the sensor does not detect any black area, the maximum possible printing width is used as the printable area.

STOP If there is a sensor malfunction (e.g. because of dirt, a defect or misinterpretation of the paper width) it is necessary to deactivate the APW function (**APW=Off**), since otherwise the printout will be too narrow or there will be no printout at all. In this case contact your service technician.

Confirm the setting by pressing the **Set** (1) key.

Automatic detection of the top paper margin (AED)

This menu option only appears, if a cut device is installed. It corrects possible inaccuracies of the paper positioning at the cut edge if the paper path is changed after a cutting action.

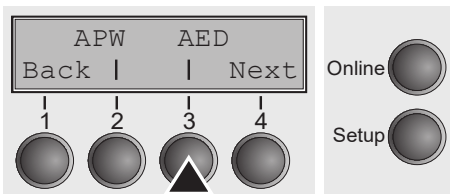

Select the **AED** (3) menu.

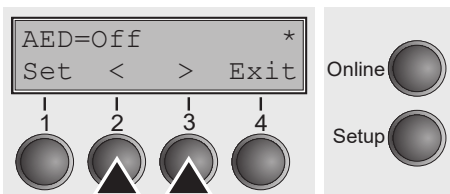

Setting options: **On/Off**

Default setting: **Off**

Confirm the setting by pressing the **Set** (1) key. Change to the next parameter group with the **Next** key (4).

Serial number (SerialN)

With the SerialN function you have the possibility to change the 12 digit serial number of the printer. The number can be written with any ASCII character between hex 20 and hex 7E.

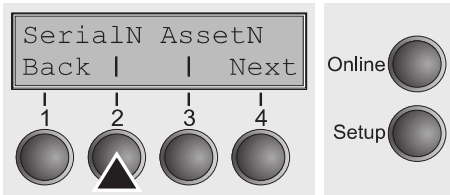

Select the **SerialN** (2) menu.

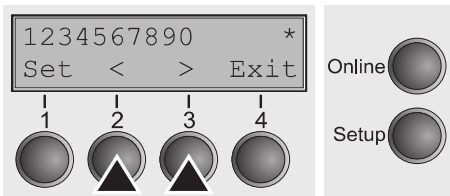

Setting options: **12 digits of all ASCII characters (hex 20 to 7E)**

Default setting: **factory set**

To change a digit select one character with the > or < key and press the **Set** (1) key. Press < or > key to decrement or increment the selected character. When the desired character appears press **Set** (1) key and the new character is stored.

After you have changed all desired digits leave the menu by pressing **Exit** (4) key.



This setting is not reset by loading the default factory settings.

Asset number (AssetN)

With the AssetN function you have the possibility to change the 10 digit asset number of the printer. The number can be written with any ASCII character between hex 20 and hex 7E.

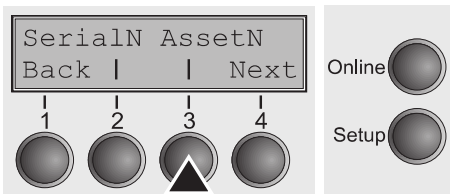

Select the **AssetN** (3) menu.

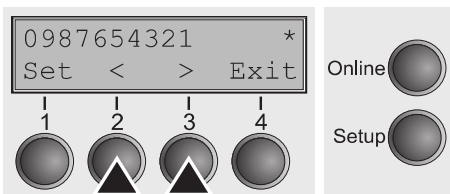

Setting options: **10 digits of all ASCII characters (hex 20 to 7E)**

Default setting: **factory set**

To change a digit select one character with the > or < key and press the **Set** (1) key. Press < or > key to decrement or increment the selected character. When the desired character appears press **Set** (1) key and the new character is stored.

After you have changed all desired digits leave the menu by pressing **Exit** (4) key.



This setting is not reset by loading the default factory settings.

Ignore characters (Ignore)

With this function set to **On** the printer ignores the character defined in IgnorChr.

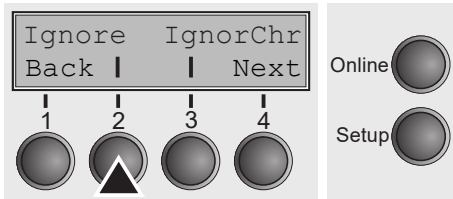

Select the **Ignore** (2) menu.

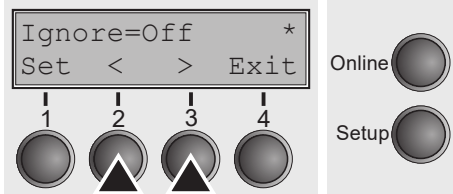

Setting options: **On/Off**

Default setting: **Off**

Confirm the setting by pressing the **Set** (1) key.

Ignore character (IgnorChr)

Set the character to be ignored as a decimal number.

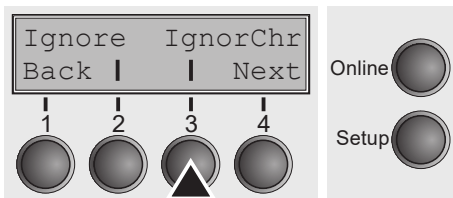

Select the **IgnorChr** (3) menu.

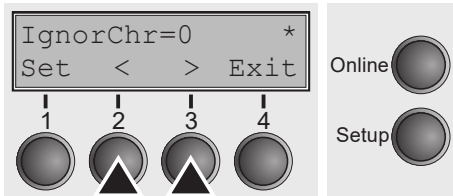

Setting options: **0-255**

Default setting: **0**

Confirm the setting by pressing the **Set** (1) key. Change to the next parameter group with the **Next** key (4).

Troubleshooting

Many of the faults and problems which may occur while using the printer are minor problems which you can solve yourself. The following chapter should help you to distinguish between a simple operating error and a major malfunction.

This chapter provides information on the rectification of faults without the assistance of specially trained personnel. Follow the advice and tips in this chapter if your printer is not working correctly.

Important notes on the care and maintenance of your printer can be found at the end of this chapter.



Repairs should only be performed by authorised service personnel.

General print problems

Problem	Corrective action
<p><i>The display remains dark</i> The printer is switched on, but nothing happens (nothing is displayed, no noise).</p>	<p>Switch off the printer and proceed as follows:</p> <ol style="list-style-type: none"> 1 Check that the power plug is correctly connected to the socket on the printer. 2 Check that the power plug is seated properly in the wall socket. 3 Switch on the printer again. If the printer is now connected correctly, the printer initializes and text is shown on the display. <p>If these steps do not eliminate the fault:</p> <ul style="list-style-type: none"> ▶ Replace the power cord and repeat step 3. ▶ Check whether the fuse is faulty and if so exchange it; see Replacing the fuse. ▶ Check that power flows at the socket e.g. using a desk lamp, if necessary use a different socket and repeat step 3. ▶ Contact your dealer if the printer cannot be powered up. <p> Do not attempt to open the printer. You might suffer an electric shock.</p>
<p><i>The display is lit, but the printer does not print</i></p>	<ol style="list-style-type: none"> 1 Check that the printer is Online. If the displays shows Offline, then press the key Online. Try to print again. 2 Check the connection from the printer to the computer (interface cable): <ul style="list-style-type: none"> ▶ Check that the interface cable is properly connected to the computer and to the printer. ▶ Check that it is the correct interface cable for your printer. Information on the interface is located in the section Connecting the printer, and in chapter Interfaces. ▶ Check that the printer is properly adapted to the computer (configured). Refer to section The control panel. Check the parameter set in the Setup menu under Settings for interfaces (I/O), and if necessary correct it. 3 Check whether the printer is working properly. To do this, print out a copy of the menu; siehe Printing out menu configurations (Print). 4 Check that the top cover is closed. 5 Check that paper is inserted and loaded. Refer to the section Loading paper.

Problem	Corrective action						
<p>Problems with the paper feed The paper is not fed in</p>	<ol style="list-style-type: none"> 1 Check that the display shows the correct paperway, if necessary select the correct paperway with the key Park. If you wish to use optional paper types, make sure they are correctly installed. 2 Make sure that the paper guide is correctly adjusted at the side. <p> When having torn off the fanfold paper the fanfold paper moves to the park position. If necessary, drive the remaining paper manually to the park position with the ↓ key.</p>						
<p>Paper jam</p>	<ol style="list-style-type: none"> 1 Open the top cover. If a paper jam should occur, then remove the jammed paper by tearing it off at the tear off edge (the tear off edge is located at the outfeed for the fanfold paper). 2 Press the key to transport the paper backwards. 3 You may support the paper return feed by cautiously pulling the paper in the correct direction. <p>Before you replace the fanfold paper, refer to the instructions in the section <i>Loading paper</i>.</p> <p>You should pay special attention to the following points:</p> <ul style="list-style-type: none"> ▶ Insert the paper straight. ▶ After inserting the paper, close the tractors. ▶ Adjust the tractors, the paper should be positioned in the tractors straight but without tension. ▶ Adjust the printhead gap to the paper thickness (if AGA=Off). ▶ Set the parameter Head-up to On, see section <i>Increasing the printhead gap (Head up)</i>. ▶ Clean upper friction, see section <i>Cleaning the upper friction</i>. 						
<p>Does not or intermittently not print with the internal Ethernet interface (ETH-INT)</p>	<ol style="list-style-type: none"> 1 Check if a proper interface cable is used: Cat.5e, 100 MHz 2 Check if the connected switch or hub is set like the printers interface e.g. <table border="0" data-bbox="651 1576 1262 1682"> <tr> <td style="padding-right: 40px;">Switch</td> <td>Printer</td> </tr> <tr> <td style="padding-right: 40px;">100 MHz, Full duplex</td> <td>100/Full</td> </tr> <tr> <td style="padding-right: 40px;">or Autosense</td> <td>Autosensing</td> </tr> </table> 3 Refer to the printers menu. In the printout of the menu settings the actual connection link status is reported. 4 The LED next to the RJ45 connector are indicating the link status of the ETH-INT. green off: no link green flash: link orange off: half duplex orange on: full duplex 	Switch	Printer	100 MHz, Full duplex	100/Full	or Autosense	Autosensing
Switch	Printer						
100 MHz, Full duplex	100/Full						
or Autosense	Autosensing						

Problems with the print quality

Problem	Corrective action
Print is too pale	<ol style="list-style-type: none"> 1 The ribbon is used up or the ribbon cassette is not correctly fitted. Refer to the section <i>Inserting the ribbon cassette</i>. 2 The printhead to platen gap is not correctly set, refer to the section <i>Setting the print head gap</i>. 3 For printers with the AGA = ON: Enter a correction value <0. See the section Setting the print head gap, (page 43).
Smudged print	<ol style="list-style-type: none"> 1 The ribbon is damaged (e.g. frayed). Change the ribbon as described in the section <i>Inserting the ribbon cassette</i>. 2 The printhead gap is too small, increase the gap. See the section <i>Setting the print head gap</i>. 3 For printers with the AGA = ON: Enter a correction value >0 (correction value 0 to +10). See the section Setting the print head gap, (page 43).
Prints undefined characters	<ol style="list-style-type: none"> 1 Check that the interface plug is correctly connected to the computer and to the printer. 2 Check that the proper emulation and the correct character set (country, CG table or character set) is selected in the Setup menu. 3 Check the length of the interface cable, see section <i>Interface specifications</i>. 4 Set CX-bid in the advanced menu to Off, see section <i>Bidirectional parallel interface (CX-bid)</i>. 5 Check that the printer is properly adapted to the computer (configured). Refer to section <i>The control panel</i>. Check the parameter set in the Setup menu under <i>Settings for interfaces (I/O)</i>, and if necessary correct it.
The first line is not completely printed out at the top	Check the function FormAdj. Refer to the section <i>First printing position (FormAdj)</i> .
Dots within characters are missing	<ol style="list-style-type: none"> 1 Check whether the ribbon is damaged, if necessary replace it; see the section <i>Inserting the ribbon cassette</i>. 2 Set the correct printhead gap. 3 Check whether the platen is damaged. 4 Check whether the printhead is damaged. <p> Only use genuine ribbon cassettes. In case of points 3 or 4, please contact your dealer.</p>

Error messages via the display

Message	Possible cause	Corrective action
Eject Error	The printer cannot eject the paper or cannot place the paper in the park position.	<p>Check the following:</p> <ul style="list-style-type: none"> ▶ Whether the paper path is blocked by a foreign object. ▶ Whether the paper is damaged. ▶ Whether the upper friction is down and clicked into place. ▶ Whether the printhead gap is too small; see section <i>Setting the print head gap</i>.
Load Error	The printer cannot feed in the loaded paper.	<p>Check the following:</p> <ul style="list-style-type: none"> ▶ Whether the paper path is blocked by a foreign object. ▶ Whether the paper is damaged. ▶ Whether the tractors are closed and locked. ▶ Whether the paper is too tight or loose. ▶ Whether the paper is within the specified range. <p>Details see section <i>Loading paper</i>.</p>
<p>Load paper from ...</p> <p>alternating with</p> <p>Printing</p>	The paper has run out during operation.	<ol style="list-style-type: none"> 1 Printer is switched on but no paper is loaded in the displayed (active) paper compartment. 2 The paper is not fed past the light barrier. <ul style="list-style-type: none"> ▶ Insert paper in the active sheet feeder. ▶ Place the paper more to the left. <p>If the display shows Online or Offline instead of Print, the printer has loaded no paper and there is no print job. It is no error message in this case, actions are not required.</p>
Paper Jam	Paper jam.	<ul style="list-style-type: none"> ▶ Eliminate the paper jam detected by the paper motion sensor. For the procedure, see <i>Paper jam</i>.
Cover open	Top cover is open.	<ul style="list-style-type: none"> ▶ Close the top cover.

Message	Possible cause	Corrective action
Hardware Alarm	Internal hardware error.	<ul style="list-style-type: none"> ▶ Try switching off and on. ▶ Check if changes to options have been previously carried out. ▶ Note down the display message. Contact your dealer.
Parity Error	Transmission error from computer to printer via the optional serial interface.	<ul style="list-style-type: none"> ▶ Compare the interface configuration of your printer with the settings of your computer (protocol), see <i>Interfaces</i>. ▶ Check the cable, if necessary replace it. ▶ The cable exceeds the maximum allowed length, see <i>Interface specifications</i>.
Frame Error	Transmission error (serial interface).	<ul style="list-style-type: none"> ▶ Compare the format setting of your printer with the setting of your computer. ▶ Check the permissible cable length, see <i>Interface specifications</i>. ▶ See parity error.
Overrun Error	Received data which has not yet been printed is overwritten with new data.	<ul style="list-style-type: none"> ▶ If an optional serial interface is installed: Check that the correct busy protocol (e.g. XON XOFF) is set in the menu Serial interface, protocol, see <i>Protocol (Protocol)</i>. ▶ Check the interface cable, see section <i>Connecting the printer</i>, and <i>Interfaces</i>.
Paperwidth Error Press Online	A print job exceeds the paper width with the automatic paper width detection active.	<ul style="list-style-type: none"> ▶ Cancel the print job or load suitable paper, see also <i>Automatic paper width detection (APW)</i>. ▶ Try shifting the paper slightly to the right. ▶ Try shifting the paper slightly to the left. ▶ Check if the setted paper width in your driver and application. <p>If this message appears although the loaded paper is wide enough, please contact your technical service.</p>
Head Hot	The printer prints at lower speed.	<ul style="list-style-type: none"> ▶ No action required. <p>When this message comes up even in a "cold" printer, please contact your</p>

Message	Possible cause	Corrective action
AED Error	<p>Only if an automatic cutting device is installed.</p> <p>No standard paper, transport holes are not like standard.</p> <p>Paper moved too far to the right.</p> <p>Paper width sensor defect.</p>	<p>technical service.</p> <ul style="list-style-type: none"> ▶ Remove all paper from the printer, align paper correctly on the left side. ▶ Use different paper. ▶ Disable the AED sensor, see <i>Automatic detection of the top paper margin (AED)</i>. <p>If you cannot remove the error, please contact your technical service.</p>
PW Sensor defect	<p>Paper moved too far to the right.</p> <p>Preprinted black area on the left side of the paper.</p> <p>Paper width sensor defect.</p>	<ul style="list-style-type: none"> ▶ Remove all paper from the printer, align paper correctly on the left side. ▶ Use different paper. ▶ Disable the APW sensor, see <i>Automatic paper width detection (APW)</i>. <p>If you cannot remove the error, please contact your technical service.</p>
Check Ribbon	<p>The ribbon misses, is damaged and blocked or a non-genuine ribbon is installed.</p>	<ul style="list-style-type: none"> ▶ Only use genuine ribbon cassettes of the manufacturer. <p>i During the process of initialization after powering on, the printer checks if a ribbon cassette is installed. It also checks during the execution of a print job the operativeness of the ribbon cassette. These functions mandatory require the use of the manufacturers original ribbon cassettes <i>Accessories</i>.</p> <ul style="list-style-type: none"> ▶ Replace the ribbon. ▶ Check that the print head carriage moves easily.

Additional display messages

These are not error messages, they give operating instructions and information from the printer to the user.

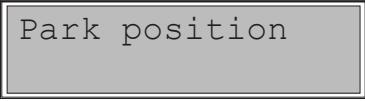
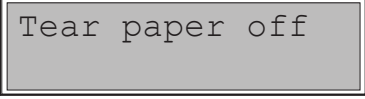
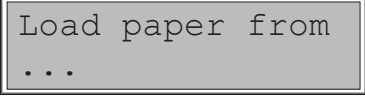
Message	Possible cause	Corrective action
	—	► To proceed press any key.
	The factory-set parameters are loaded and are written into all menus.	► No action required.
	You are informed when the fanfold paper is in the park position.	► No action required.
	Note for the operator to tear off the paper automatically positioned at the tear off edge.	► Tear paper off.
	Paper is not available in the selected paper path (... indicates the active paper path). Data is in the interface receiver buffer.	► Load paper, see section <i>Loading paper</i> .



If messages appear which are not described here, please contact your customer service representative with exact details of the message.

Care and maintenance

The printer is designed to operate with minimal maintenance. It is advisable to clean the inside of the printer from time to time with a vacuum cleaner.



Before cleaning, turn off the printer, wait 5 to 10 seconds and disconnect the power cable.



Do not oil or grease the printer, especially the sliderails and shafts.

Replacing the fuse

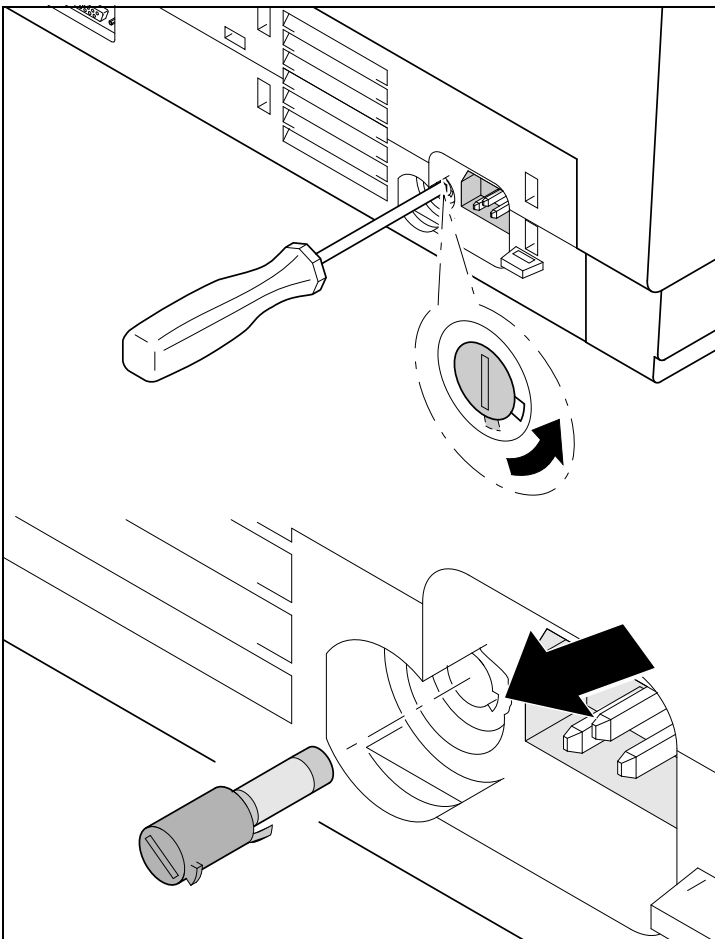

The printer is provided with a line fuse accessible from the exterior. Press the fuse cover slightly inwards with a screwdriver and turn it until the cover tab comes out through the recess in housing. Then remove the fuse.

Install the fuse in reverse order of steps.



Only use the same type of fuse for replacement.

The fuse ratings are specified on the printer type plate which is mounted above the power connector on the rear:
T6.3AH250V

Cleaning the housing

Clean the printer housing with mild detergent (use a dishwashing agent, if necessary, or a plastic cleaning agent) and a soft lint-free cloth.



Do not use abrasive cleaners. Never use solvents.

Cleaning the interior

Remove paper and dust with a soft brush.

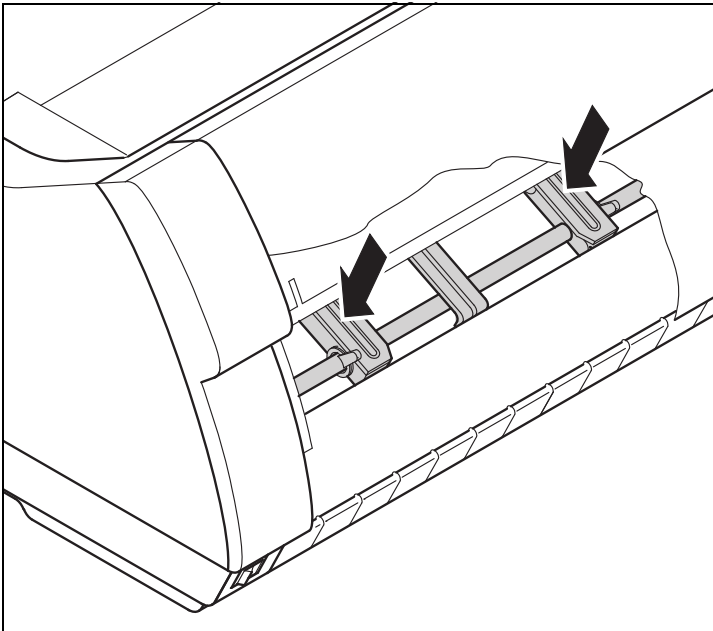

Check that any paper has been removed from the tractors.



For optimal function of the print head the interior of the printer has to be as dust free as possible. Clean the interior with a vacuum cleaner if necessary.

Cleaning the platen

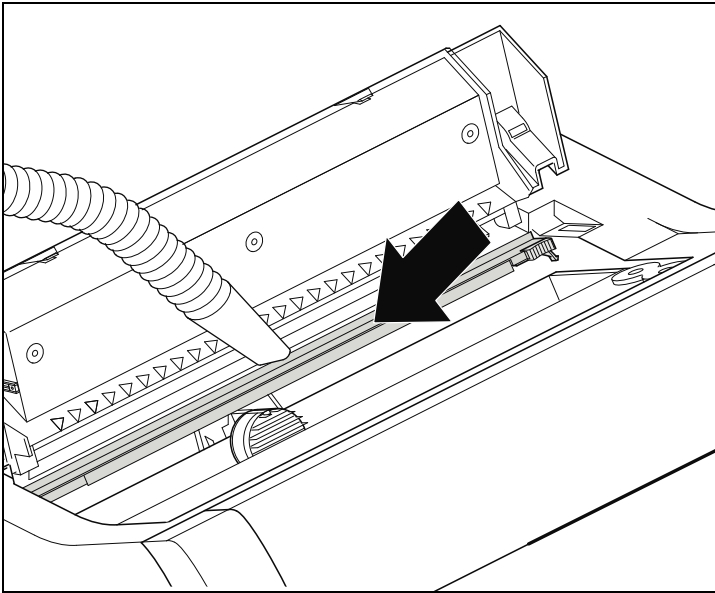

Switch off the printer and open the upper cover after 4 to 5 seconds.

Remove dust and possible ribbon and ink remains carefully from the platen.



Avoid touching parts and components in the printer interior.

Ribbon

Check whether the ribbon is worn or damaged. The ribbon must be replaced if it is frayed, see *Inserting the ribbon cassette*, and *Error messages via the display*.



The service life of the ribbon is 20 million characters.

Cleaning the upper friction

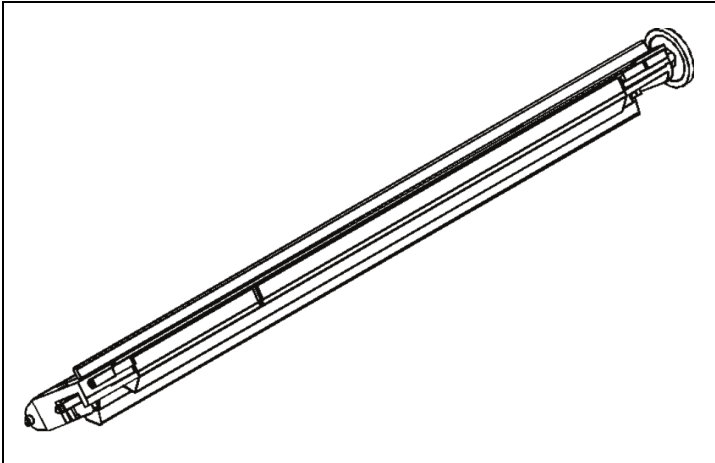

Clean the rollers of the upper friction as necessary with a mild cleaning agent and a soft, lintfree cloth.

Carriage shafts



Carriage shafts must not be oiled or greased; otherwise damage will occur on the printer.

Specifications

Printer specifications

	2810	2820
Printer system	Serial impact matrix printer Printhead with 24 needles, Ø 0.25 mm bidirectional printing	
Print speed and character matrices		
HSQ (High Speed Quality)	800 cps 12 x 10, 10.0 CPI 90 x 100 960 cps 12 x 08, 12.0 CPI 90 x 96 1000 cps 08 x 08, 15.0 CPI *) 90 x 120 1000 cps 12 x 08, 15.0 CPI 90 x 120 1143 cps 12 x 06+1, 17.1 CPI 90 x 120 1333 cps 12 x 05+1, 20.0 CPI 90 x 120	1000cps 12 x 10, 10.0 CPI 90 x 100 1200 cps 12 x 08, 12.0 CPI 90 x 96 1250 cps 08 x 08, 15.0 CPI *) 90 x 120 1250 cps 12 x 08, 15.0 CPI 90 x 120 1428 cps 12 x 06+1, 17.1 CPI 90 x 120 1667 cps 12 x 05+1, 20.0 CPI 90 x 120
Draft (Data Print Quality)	667 cps 12 x 12, 10.0 CPI 90 x 120 800 cps 12 x 10, 12.0 CPI 90 x 120 1000 cps 08 x 08, 15.0 CPI *) 90 x 120 1000 cps 12 x 08, 15.0 CPI 90 x 120 571 cps 12 x 12+2, 17.1 CPI 90 x 240 667 cps 12 x 10+2, 20.0 CPI 90 x 240	833 cps 12 x 12, 10.0 CPI 90 x 120 1000 cps 12 x 10, 12.0 CPI 90 x 120 1250 cps 08 x 08, 15.0 CPI *) 90 x 120 1250 cps 12 x 08, 15.0 CPI 90 x 120 714 cps 12 x 12+2, 17.1 CPI 90 x 240 833 cps 12 x 10+2, 20.0 CPI 90 x 240
Copy Draft (Copy Print Quality)	333 cps 24 x 12, 10.0 CPI 180 x 120 400 cps 24 x 10, 12.0 CPI 180 x 120 500 cps 16 x 08, 15.0 CPI *) 180 x 120 500 cps 24 x 08, 15.0 CPI 180 x 120 285 cps 24 x 12+2, 17.1 CPI 180 x 240 333 cps 24 x 12+2, 20.0 CPI 180 x 240	417 cps 24 x 12, 10.0 CPI 180 x 120 500 cps 24 x 10, 12.0 CPI 180 x 120 625 cps 16 x 08, 15.0 CPI *) 180 x 120 625 cps 24 x 08, 15.0 CPI 180 x 120 356 cps 24 x 12+2, 17.1 CPI 180 x 240 417 cps 24 x 12+2, 20.0 CPI 180 x 240
NLQ (Near Letter Quality)	222 cps 24 x 18, 10.0 CPI 180 x 180 267 cps 24 x 15, 12.0 CPI 180 x 180 333 cps 16 x 12, 15.0 CPI *) 180 x 180 167 cps 24 x 18+6, 15.0 CPI 180 x 360 190 cps 24 x 18+3, 17.1 CPI 180 x 360 222 cps 24 x 15+3, 20.0 CPI 180 x 360	278 cps 24 x 18, 10.0 CPI 180 x 180 333 cps 24 x 15, 12.0 CPI 180 x 180 417 cps 16 x 12, 15.0 CPI *) 180 x 180 208 cps 24 x 18+6, 15.0 CPI 180 x 360 238 cps 24 x 18+3, 17.1 CPI 180 x 360 278 cps 24 x 15+3, 20.0 CPI 180 x 360
	* Only with ESC/P (sub-/superscript, 15 CPI) and MTPL Micro-script	

	2810	2820
LQ (Letter Quality)	111 cps 24 x 36, 10.0 CPI 180 x 360 133 cps 24 x 30, 12.0 CPI 180 x 360 167 cps 16 x 24, 15.0 CPI *) 180 x 360 167 cps 24 x 18+6, 15.0 CPI 180 x 360 190 cps 24 x 18+3, 17.1 CPI 180 x 360 222 cps 24 x 15+3, 20.0 CPI 180 x 360	139 cps 24 x 36, 10.0 CPI 180 x 360 167 cps 24 x 30, 12.0 CPI 180 x 360 208 cps 16 x 24, 15.0 CPI *) 180 x 360 208 cps 24 x 18+6, 15.0 CPI 180 x 360 238 cps 24 x 18+3, 17.1 CPI 180 x 360 278 cps 24 x 15+3, 20.0 CPI 180 x 360
	* Only with ESC/P (sub-/superscript, 15 CPI) and MTPL Micro-script	
Tab speed	65 ips (inch per second)	80 ips (inch per second)
Print width	136 characters at 10 cpi 163 characters at 12 cpi 204 characters at 15 cpi 232 characters at 17.1 cpi 272 characters at 20 cpi	
Character pitch	5 / 6 / 7,5 / 8,6 / 10 / 12 / 15 / 17.1 / 20 cpi	
Character size		
Height	3.32 mm (incl. descenders)	
Width	2.19 mm, max. 2,43 mm	
Fonts		
Standard	High Speed Draft, DPQ, Copy Draft; Courier, Roman, Sans Serif, OCR A + B, Gothic,	
Barcodes (Standard)	Prestige, Orator, Souvenir, (all resident in NLQ and LQ); DLL is standard 23 + Large Character Printing (LCP), see <i>Barcode</i>	
Emulations	MTPL, Genicom ANSI, Epson LQ2550/LQ2170, IBM XL 24, PJI; others on request	
Resolution	60 to 360 dpi horizontal 90 to 360 dpi vertical	
Print attributes in all character pitches	Double width, italics, right justification, shadowed, auto centered, double height, bold, proportionally spaced, underlined, overlined, superscript, subscript, heavy form mode	
Self-test	ASCII test, hexdump, fault display, ribbon test	
Print buffer	128 KB max.	
Panel	LCD display, backlight, 2 x 16 digits Online, Setup, 4 softkeys	
Noise		
Sound pressure level (mean A-weighted level at the four bystander positions)	LPA = 54 dB(A) in HS mode at LQ SanSerif, 24 x 26, 111cps	LPA = 55 dB(A) in HS mode at LQ SanSerif, 24 x 26, 139cps
Sound power level (ISO 7779 declared values according ISO 9296:1988-04)	LWAd = ≤ 7.2 B(A) at LQ SanSerif, 24 x 36, 111cps	LWAd = ≤ 7.2 B(A), at LQ SanSerif, 24 x 36, 139cps (ISO 7779[1988])

	2810	2820
Continuous operation		
Workload	50 000 pages/month	50 000 pages/month
Throughput (ECMA 132)	640 pages/hour, 10.66 pages/min	690 pages/hour, 11.5 pages/min
MTBF	20 000 h; 25% DC	20 000 h; 25% DC
Mains voltage	120 V \pm 10% or 220–240 V -10%, +15% 50/60 Hz, depending on the power pack setting	
Power consumption	when printing: 75 W sleeping mode (power save): < 2.0 W	when printing: 90 W power save mode: < 2.1 W
Approvals	CE, GS, UL, FCC, GOST, Energy Star	
Dimensions		
Width	624 mm	
Height	280 mm	
Depth	432 mm	
Paper feed		
Feed speed	10"/sec	
Feed first line	(6 lpi) 35 ms	
View position	10"/sec	
Reverse motion	Up to max. form length (22 inch)	
Printhead gap		
Standard	Automatic gap adjustment	
Paper transport		
Standard	Tractor 1 with parking position	Tractor 1 with parking position
Optional	Tractor 2 (front)	Tractor 2 (front)
Service life		
Print head	750 Mio., DPQ, 12 x 12 Matrix	750 Mio., DPQ, 12 x 12 Matrix
Print head	20 Mio. characters	20 Mio. characters
Environmental conditions		
Operation		
Temperature	+10° to +35°C	
Rel. Humidity	15 to 75%	
Climate	IEC/EN 60721-3-3, class 3K2	
Storage		
Temperature	-5° to +45°C	
Rel. humidity	5 to 95%	
Climate	IEC/EN 60721-3-1, class 1K3	
Transport		
Temperature	-20° to +60°C	
Rel. humidity	5 to 95%	
Climate	IEC/EN 60721-3-2, class 2K2	

Interface specifications

<p>Parallel interface</p> <p>Type of data transmission</p> <p>Transmission rate</p> <p>Signal status</p> <p>Connection cable</p> <p>Voltage supply of external devices on pin 18</p> <p>Interface connections</p>	<p>bidirectional</p> <p>8-bit parallel interface (Centronics compatible) IEEE-1284; Nibble mode</p> <p>Max. 30 KHz</p> <p>Low: 0.0 V to +0.4 V High: +2.4 V to +5.0 V</p> <p>Material: AWG 28 at least Length: up to 2.0 m</p> <p>Twisted-pair cable with double-shield, acc. IEEE Std 1284 – 1294</p> <p>U = +5 V ±10% I = 0.5 A_{max}</p> <p>Printer side: Amphenol 57-40360, 36-pin (or compatible) Cable side: Amphenol 57-30360, 25-pin (or compatible)</p>
<p>USB interface</p> <p>Conformity</p> <p>Speed</p> <p>Connector</p>	<p>USB 2.0 I/O full speed</p> <p>Conforms to the Universal Serial Bus 2.0 Specifications</p> <p>Full Speed mode at 12 Mbps</p> <p>“B” type USB connector</p>
<p>USB A Host</p>	<p>With this additional connectivity it is possible to improve the serviceability for example to load the firmware or to upload or download Configuration easily by an USB stick. Refer to section USB host interface for further information.</p>
<p>Ethernet interface</p> <p>Transmission rate</p> <p>Supported protocols</p> <p>Network print protocols</p> <p>IP address designation</p> <p>Connection cable</p> <p>Network print management protocols</p> <p>Capacity of data buffer</p>	<p>Onboard 10/100BaseT Ethernet-RJ45 with 2 LEDs</p> <p>100 Mbps / Full Duplex</p> <p>TCP/IP</p> <p>LPR/LPD, RAW Port</p> <p>DHCP, BootP and manually over the control panel</p> <p>RJ45; Cat 5e, 6</p> <p>HTTP, HTML, SNMP</p> <p>8 MB</p>

Character sets

This chapter shows the MTPL character sets and contains a list of all available character sets which can be selected via control panel or by escape sequences.

Note that MTPL sequences are available in all emulation modes.

The following example shows you how to find the hexadecimal value for a character from the symbol set tables.

hex	0	1	2	3	4
dec					
0	NUL 0		SP 32	0 48	@ 64
1			! 33	1 49	A 65
2			" 34	2 50	B 66
3			# 35	3 51	C 67

ASCII „B“ = hex.42 = dez 66



Information about supported character sets can be found on our [internet](#) site in the Support section.

MTPL standard character set

hex dec	0	1	2	3	4	5	6	7	8	9	A	B	C	D	E	F		
0	NUL 0		SP 32	0 48	é 64	Þ 80	ˆ 96	p 112			á 144	◌̇ 160	Ł 176	⊥ 192	α 208	≡ 224	240	
1		DC1 17	! 33	1 49	A 65	Q 81	a 97	q 113			í 145	◌̈ 161	⊥ 177	⊥ 193	β 209	± 225	241	
2	STX 2		" 34	2 50	B 66	R 82	b 98	r 114			ó 146	◌̈́ 162	⊥ 178	⊥ 194	Γ 210	≥ 226	242	
3	ETX 3	DC3 19	# 35	3 51	C 67	S 83	c 99	s 115			ú 147	 163	⊥ 179	⊥ 195	π 211	≤ 227	243	
4			\$ 36	4 52	D 68	T 84	d 100	t 116	IND 132		ñ 148	⊥ 164	— 180	⊥ 196	Σ 212	∫ 228	244	
5	ENQ 5	NAK 21	& 37	5 53	E 69	U 85	e 101	u 117	NEL 133		Ñ 149	⊥ 165	⊥ 181	⊥ 197	σ 213	∫ 229	245	
6	ACK 6		' 38	6 54	F 70	V 86	f 102	v 118			ª 146	⊥ 166	⊥ 182	⊥ 198	μ 214	÷ 230	246	
7	BEL 7		' 39	7 55	G 71	W 87	g 103	w 119			º 151	⊥ 167	⊥ 183	⊥ 199	τ 215	≈ 231	247	
8	BS 8		(40	8 56	H 72	X 88	h 104	x 120	HTS 136		¿ 152	⊥ 168	⊥ 184	⊥ 200	Φ 216	° 232	248	
9	HT 9) 41	9 57	I 73	Y 89	i 105	y 121			⌞ 153	⊥ 169	⊥ 185	⊥ 201	Θ 217	· 233	249	
A	LF 10		* 42	: 58	J 74	Z 90	j 106	z 122	VTS 138		⌞ 154	⊥ 170	⊥ 186	⊥ 202	Ω 218	· 234	250	
B	VT 11	ESC 27	+ 43	; 59	K 75	[91	k 107	{ 123	PLD 139	CSI 155	½ 171	⊥ 187	⊥ 203	█ 219	δ 235	√ 251		
C	FF 12		, 44	< 60	L 76	\ 92	l 108	 124	PLU 140		¼ 172	⊥ 188	⊥ 204	█ 220	∞ 236	η 252		
D	CR 13		- 45	= 61	M 77] 93	m 109	} 125	RI 141		ı 157	⊥ 173	⊥ 189	= 205	█ 221	φ 237	² 253	
E	SO 14		. 46	> 62	N 78	^ 94	n 110	~ 126	SS2 142		« 158	⊥ 174	⊥ 190	⊥ 206	█ 222	€ 238	· 254	
F	SI 15		/ 47	? 63	O 79	_ 95	o 111	DEL 127	SS3 143		» 159	⊥ 175	⊥ 191	⊥ 207	█ 223	∩ 239	DEL 255	

MTPL, international substitution characters

	dec	35	36	64	91	92	93	94	96	123	124	125	126
	hex	23	24	40	5B	5C	5D	5E	60	7B	7C	7D	7E
US ASCII		#	\$	@	[\]	^	`	{		}	~
UK ASCII		£	\$	@	[\]	^	`	{		}	—
Swedish		#	Å	É	Ë	Ö	Ä	Ü	é	ä	ö	å	ü
German		#	\$	§	Ë	Ö	Ü	^	`	ä	ö	ü	ß
Portuguese		#	\$	§	Ã	Ç	Õ	^	`	ã	ç	õ	°
French		£	\$	à	°	ç	§	^	`	é	ù	è	¨
Italian		£	\$	§	°	ç	é	^	`	à	ò	è	ì
Spanish		£	\$	§	í	Ñ	¿	^	`	°	ñ	ç	~
Norwegian		#	\$	@	Æ	Ø	Å	^	`	æ	ø	å	—

OCR-A character set

hex	0	1	2	3	4	5	6	7
dec								
0	NUL 0		SP 32	0 48	a 64	P 80	H 96	p 112
1		DC1 17	! 33	1 49	A 65	Q 81	a 97	q 113
2	STX 2		" 34	2 50	B 66	R 82	b 98	r 114
3	ETX 3	DC3 19	# 35	3 51	C 67	S 83	c 99	s 115
4			\$ 36	4 52	D 68	T 84	d 100	t 116
5	ENQ 5	NAK 21	% 37	5 53	E 69	U 85	e 101	u 117
6	ACK 6		& 38	6 54	F 70	V 86	f 102	v 118
7	BEL 7		' 39	7 55	G 71	W 87	g 103	w 119
8	BS 8		(40	8 56	H 72	X 88	h 104	x 120
9	HT 9) 41	9 57	I 73	Y 89	i 105	y 121
A	LF 10		* 42	: 58	J 74	Z 90	j 106	z 122
B	VT 11	ESC 27	+ 43	; 59	K 75	[91	k 107	{ 123
C	FF 12		, 44	< 60	L 76	\ 92	l 108	 124
D	CR 13		- 45	= 61	M 77] 93	m 109	} 125
E	SO 14		. 46	> 62	N 78	^ 94	n 110	~ 126
F	SI 15		/ 47	? 63	O 79	_ 95	o 111	

OCR-B character set

hex	0	1	2	3	4	5	6	7
dec								
0	NUL 0		SP 32	0 48	a 64	P 80	H 96	p 112
1		DC1 17	! 33	1 49	A 65	Q 81	a 97	q 113
2	STX 2		" 34	2 50	B 66	R 82	b 98	r 114
3	ETX 3	DC3 19	# 35	3 51	C 67	S 83	c 99	s 115
4			\$ 36	4 52	D 68	T 84	d 100	t 116
5	ENQ 5	NAK 21	% 37	5 53	E 69	U 85	e 101	u 117
6	ACK 6		& 38	6 54	F 70	V 86	f 102	v 118
7	BEL 7		' 39	7 55	G 71	W 87	g 103	w 119
8	BS 8		(40	8 56	H 72	X 88	h 104	x 120
9	HT 9) 41	9 57	I 73	Y 89	i 105	y 121
A	LF 10		* 42	: 58	J 74	Z 90	j 106	z 122
B	VT 11	ESC 27	+ 43	; 59	K 75	[91	k 107	{ 123
C	FF 12		, 44	< 60	L 76	\ 92	l 108	 124
D	CR 13		- 45	= 61	M 77] 93	m 109	} 125
E	SO 14		. 46	> 62	N 78	^ 94	n 110	~ 126
F	SI 15		/ 47	? 63	0 79	Y 95	o 111	

Available character sets and fonts

The following list includes all the character sets you can select from the control panel or via ESC sequences and specifies the fonts in which they are available.

	ID for ESC R/ESC (High Speed	Draft	Draft Copy	Roman	Sans Serif	Courier (incl. Courier IBM)	OCR-B	OCR-A	Prestige	Script	Orator	Gothic	Souvenir
ISO USA	42	X	X	X	X	X	X	X	X	X	X	X	X	X
ISO UK	41	X	X	X	X	X	X	X	X	X	X	X	X	X
ISO France	52	X	X	X	X	X	X	X	X	X	X	X	X	X
ISO Germany	4B	X	X	X	X	X	X	X	X	X	X	X	X	X
ISO Italy	59	X	X	X	X	X	X	X	X	X	X	X	X	X
ISO Sweden	48	X	X	X	X	X	X	X	X	X	X	X	X	X
ISO Norway	60	X	X	X	X	X	X	X	X	X	X	X	X	X
ISO Spain	5A	X	X	X	X	X	X	X	X	X	X	X	X	X
ISO Portugal	4C	X	X	X	X	X	X	X	X	X	X	X	X	X
Epson USA	00	X	X	X	X	X	X	X	X	X	X	X	X	X
Epson France	01	X	X	X	X	X	X	X	X	X	X	X	X	X
Epson Germany	02	X	X	X	X	X	X	X	X	X	X	X	X	X
Epson UK	03	X	X	X	X	X	X	X	X	X	X	X	X	X
Epson Denmark	04	X	X	X	X	X	X	X	X	X	X	X	X	X
Epson Sweden	05	X	X	X	X	X	X	X	X	X	X	X	X	X
Epson Italy	06	X	X	X	X	X	X	X	X	X	X	X	X	X
Epson Spain	07	X	X	X	X	X	X	X	X	X	X	X	X	X
Epson Japan	08	X	X	X	X	X	X	X	X	X	X	X	X	X
Epson Norway	09	X	X	X	X	X	X	X	X	X	X	X	X	X
Epson Denmark II	0A	X	X	X	X	X	X	X	X	X	X	X	X	X
Epson Spain II	0B	X	X	X	X	X	X	X	X	X	X	X	X	X
Epson Latin America	0C	X	X	X	X	X	X	X	X	X	X	X	X	X
Epson Korea	0D	X	X	X	X	X	X	X	X	X	X	X	X	X
Epson Legal	40	X	X	X	X	X	X	X	X	X	X	X	X	X
CRO-ASCII	3C	X	X	X	-	X	X	-	-	-	-	-	-	-
Arabic Farsi	96	-	-	-	*1	*1	*1	*1	-	-	-	-	-	-

	ID for ESC R/ESC (High Speed	Draft	Draft Copy	Roman	Sans Serif	Courier (incl. Courier IBM)	OCR-B	OCR-A	Prestige	Script	Orator	Gothic	Souvenir
Arabic Urdu	97	-	-	-	*1	*1	*1	*1	-	-	-	-	-	-
Greek DEC	46	X	X	X	-	X	-	-	-	-	-	-	-	-
Greek ELOT 928	6C	X	X	X	-	X	-	-	-	-	-	-	-	-
CP437 Latin US	80	X	X	X	X	X	X	X	X	X	X	X	X	X
CP737 Greek	93	X	X	X	-	X	-	-	-	-	-	-	-	-
CP850 Latin 1	82	X	X	X	X	X	X	X	X	X	X	X	X	X
CP851 Greek	88	X	X	X	-	X	-	-	-	-	-	-	-	-
CP852 Latin 2	87	X	X	X	-	X	X	-	-	-	-	-	-	-
Tarama (Turkish)	A8	X	X	X	-	X	X	-	-	-	-	-	-	-
CP857 Turkish	8D	X	X	X	-	X	X	-	-	-	-	-	-	-
CP858 (IBM with €)	9E	X	X	X	X	X	X	X	X	X	X	X	X	X
CP860 Portugal	84	X	X	X	X	X	X	X	X	X	X	X	X	X
CP861 Icelandic	94	X	X	X	X	X	X	X	X	-	-	-	-	-
CP863 French Canada	85	X	X	X	X	X	X	X	X	X	X	X	X	X
CP864 Arabic	8C	-	-	-	*1	*1	*1	*1	-	-	-	-	-	-
CP864 Arab. Extended	95	-	-	-	*1	*1	*1	*1	-	-	-	-	-	-
CP865 Nordic	86	X	X	X	X	X	X	X	X	X	X	X	X	X
CP866 Cyrillic	8E	X	X	X	-	X	X	-	-	-	-	-	-	-
CP866 Bulgaria	9D	X	X	X	-	X	X	-	-	-	-	-	-	-
Siemens Turkish	9B	X	X	X	-	X	X	-	-	-	-	-	-	-
DEC Turkish	9C	X	X	X	-	X	X	-	-	-	-	-	-	-
CP1250 Win Latin 2	70	X	X	X	-	X	X	-	-	-	-	-	-	-
CP1251 Win Cyrillic	71	X	X	X	-	X	X	-	-	-	-	-	-	-
CP1252 Win Latin 1	72	X	X	X	X	X	X	X	X	-	-	-	-	-
CP1253 Win Greek	73	X	X	X	-	X	-	-	-	-	-	-	-	-
CP1254 Win Turkish	74	X	X	X	-	X	X	-	-	-	-	-	-	-
CP1256 Arabic	76	-	-	-	*1	*1	*1	*1	-	-	-	-	-	-
8859-1 Latin 1	25	X	X	X	X	X	X	X	X	X	X	X	X	X
8859-1 Latin 1 (SAP)	2B	X	X	X	X	X	X	X	X	X	X	-	-	-
8859-2 Latin 2	26	X	X	X	-	X	X	-	-	-	-	-	-	-

	ID for ESC R/ESC (High Speed	Draft	Draft Copy	Roman	Sans Serif	Courier (incl. Courier IBM)	OCR-B	OCR-A	Prestige	Script	Orator	Gothic	Souvenir
8859-5 Cyrillic	2A	X	X	X	-	X	X	-	-	-	-	-	-	-
8859-6 Arabic	24	-	-	-	*1	*1	*1	*1	-	-	-	-	-	-
8859-7 Greek	2D	X	X	X	-	X	-	-	-	-	-	-	-	-
8859-9 Turkish	2E	X	X	X	-	X	X	-	-	-	-	-	-	-
8859-15 Latin 9 (Euro)	2F	X	X	X	X	X	X	X	X	X	X	-	-	-
BRASCII	6D	X	X	X	X	X	X	X	X	-	-	-	-	-
Abicomp	6E	X	X	X	X	X	X	X	X	-	-	-	-	-
Roman 8	4D	X	X	X	X	X	X	X	X	-	-	-	-	-
Coax/Twinax(Hebrew)	4F	X	X	X	X	X	*2	-	-	*3	*4	-	-	-
New-437 (Hebrew)	81	X	X	X	X	X	*2	-	-	*3	*4	-	-	-
New-DIG 850 (Hebr.)	83	X	X	X	X	X	*2	-	-	*3	*4	-	-	-
Old-Code 860 (Hebr.)	98	X	X	X	X	X	*2	-	-	*3	*4	-	-	-
Flarro 863 (Hebrew)	99	X	X	X	X	X	*2	-	-	*3	*4	-	-	-
Table 865 (Hebrew)	9A	X	X	X	X	X	*2	-	-	*3	*4	-	-	-
CP775 Baltic	A6	X	X	X	-	X	X	-	-	-	-	-	-	-
CP1257 Baltic	77	X	X	X	-	X	X	-	-	-	-	-	-	-
Mazovia (Poland)	92	X	X	X	-	X	X	-	-	-	-	-	-	-
Kamenicky (Czech)	91	X	X	X	-	X	X	-	-	-	-	-	-	-
CP866 Ukraine	8F	X	X	X	-	X	X	-	-	-	-	-	-	-
CP866 Kazakhstan	90	X	X	X	-	X	X	-	-	-	-	-	-	-

*1: only in 10 and 12 cpi, *2 : as with Sans Serif, *3 : as with Roman, *4 : only in 10 cpi

Emulations

General

When a printer understands the control set written for another printer type, it is said to emulate the other printer. Your printer emulates, i.e. “understands” the Epson LQ-2550 in its standard version.

Escape sequences

Escape sequences or control codes tell the printer that the following transmitted code is a printer command and not a printable character

They allow the selection of printer functions or the changing of printer parameters from the computer. By transmitting an escape sequence, you are able to change the previously set configuration of the printer (e.g. character set).

This chapter contains an introduction into the sequences and control codes which are used by your printer.



The settings made by escape sequences have priority over the settings made in menu mode; therefore they override these.

What are escape sequences?

An escape sequence consists of an ESCape control character (ESC = decimal 27 or hexadecimal 1B) followed by one or more characters, which represent commands to the printer. Please note that this escape character has nothing to do with the ESC key on your computer keyboard.

For example, the control character ESC followed by the character “4” tells your printer to print the subsequent text in italics.

MTPL sequences

Apart from the Escape sequences and control codes your printer is equipped with MTPL sequences. These sequences provide a large number of additional ways to control your printer. Many functions can only be carried out using the MTPL sequences as you will see when you look at the list of available command codes.

Control codes

Control codes give simple instructions to the printer to do a specific function. Unlike escape sequences, control codes do not begin with the ESC control code. Instead, they consist of special single-character non-printing commands (e.g. LF, FF, DC2).

The \$\$ procedure

Most of the printer functions can be selected with control sequences (ESC sequences). For this purpose, the signal character ESC, followed by the specific sequence must be transmitted from the computer to the printer.

The printer replaces \$\$ characters in the data stream with ESC (hex. 1B) if the parameter Escape=ESC+\$\$ is selected in the printer menu.

Example

In the MTPL + IBM Proprinter emulation, bold print can be switched on by the sequence <ESC>E and can be switched off with the sequence <ESC>F.

Input	Highlight the word \$\$E Printer \$\$F with bold print
Output	Highlight the word Printer with bold print



This procedure is significant when you are working with older text programs that do not have any or an inadequate printer driver. It is also possible to insert ESC sequences in normal ASCII texts (e.g. program listings) with this procedure. The function of the ESC character remains unaffected.

How are escape sequences used?

Escape sequences are transmitted to the printer by your computer software via the printer driver. Experienced users and programmers can also control the printer directly via control sequences, however before you start working with escape sequences and control codes, we recommend that you study the computer software manual.

To enter control codes the Ctrl key and an ASCII character must be pressed simultaneously. For instance, by pressing Ctrl and J a line feed is accomplished (it is required to output the character string on the printer). More information concerning this topic is contained in

your computer software manual and the corresponding Programmer's Application Manuals (see section Programming manuals).



The selected emulation must correspond to the printer driver of your application program. Settings caused by ESC sequences remain valid, until they are switched off by another control code. All settings are reset to the original menu, when the printer is switched off.

MTPL

As the emulations do not cover the entire scope of your printer, a new printer language, which is adapted to this printer model, has been created. Using MTPL you are able to optimize operation and handling.

MTPL can be used in connection with other emulations or can be used alone.

Example in BASIC

```
open "LPT1:" as #1
width #1,255
Text1$ = "10 characters/inch"
Text2$ = "15 characters/inch"
ESC$ = chr$(27)
print
#1,ESC$;"[4w";Text1$;ESC$;"[6w";Text2$;ESC$;"[4w";Text1$
end
```

Example in Pascal

```
program cpi_example;
uses printer;
const ESC = #27;
Text1 = "10 characters/inch";
Text2 = "15 characters/inch";
begin
writeln(1st,Esc,"[4w",Text1,ESC,"[6w",Text2,Esc,"[4w",Text1);
end.
```

Printout

After the program has been completed the following text will be printed out:
10 characters/inch 15 characters/inch 10 characters/inch

List of available control codes

The following table shows sequences marked by a 3 if they are available in the various emulations. The MTPL sequences can be used within all emulation modes. The corresponding sequences are marked by a *.



If you want to know more about control codes, we recommend our *Programmer's Application Manual* on this CD-ROM.

MTPL	IBM XL24	IBM AGM	Epson LQ-2550	Epson LQ-2170	Code	Function
✓	✓		✓	✓	<BEL>	Signal tone
✓	✓	✓	✓	✓	<BS>	Control character BS (Backspace)
			✓	✓	<CAN>	Deleting a data line
✓	✓	✓	✓	✓	<CR>	Control character CR (Carriage return)
✓					<CSI>	Start character for MTPL sequences, corr. ESC [
			✓	✓	<DC1>	Selecting the printer
			✓	✓	<DC2>	Condensed printing OFF (set by <SI> or <ESC><SI>)
			✓	✓	<DC3>	Deselecting the printer
			✓	✓	<DC4>	Double-wide printing OFF (set by <SO> or <ESC><SO>)
✓	✓	*	✓	✓		Delete line. Epson: Delete last character
✓	✓	✓	✓	✓	<ESC>	Start character for programming sequence
	✓	✓	✓	✓	<ESC>!<n>	Print mode selection
		✓	✓	✓	<ESC>#	Bit 8 = unchanged
			✓	✓	<ESC>\$<n1><n2>	Perform absolute horizontal step
			✓	✓	<ESC>%<0><0>	Select ROM character generator
			✓	✓	<ESC>%<1><0>	Select download generator
✓	*	*	*	*	<ESC>%1<n1><n2>	Graphics print with 180 dpi/HQ
✓	*	*	*	*	<ESC>%2<n1><n2>	Graphics print with 360 dpi/HQ
✓	*	*	*	*	<ESC>%3<n1> <n2>	Graphics print with 60 dpi
✓	*	*	*	*	<ESC>%4<n1> <n2>	Graphics print with 120 dpi
✓	*	*	*	*	<ESC>%5<n1> <n2>	Graphics print with 80 dpi
✓	*	*	*	*	<ESC>%7<n1> <n2>	Graphics print with 240 dpi
✓	*	*	*	*	<ESC>%8<n1> <n2>	Graphics print with 72 dpi
✓	*	*	*	*	<ESC>%9<n1><n2>	Graphics print with 90 dpi
			✓	✓	<ESC>&<s><x><y>..	Define download character
✓	*	*	*	*	<ESC>(&	Character set ISO 8859-2
✓	*	*	*	*	<ESC>(*	Character set ISO 8859-5
✓	*	*	*	*	<ESC>(+	Character set ISO 8859-1 SAP
✓	*	*	*	*	<ESC>{.	Character set ISO 8859-9

MTPL	IBM XL24	IBM AGM	Epson LQ-2550	Epson LQ-2170	Code	Function
✓	*	*	*	*	<ESC>/	Character set ISO 8859-15
✓	*	*	*	*	<ESC><	Character set Cro ASCII
				✓	<ESC>(c	Defining the page format
				✓	<ESC>(v	Relative vertical printing position
				✓	<ESC>(t	Assigning a character table
✓	*	*	*	*	<ESC>(m	Character set BRASCII
✓	*	*	*	*	<ESC>(n	Character set Abicomp
✓	*	*	*	*	<ESC>(p	Windows character set 1250 (Latin2)
✓	*	*	*	*	<ESC>(q	Windows character set 1251 (Cyrillic)
✓	*	*	*	*	<ESC>(r	Windows character set 1252 (Latin1)
✓	*	*	*	*	<ESC>(t	Windows character set 1254 (Turkish)
✓	*	*	*	*	<ESC>(`	Character set Norwegian
				✓	<ESC>(^<n1><n2><d1><dn>	Print data as characters
✓	*	*	*	*	<ESC>(A	Character set UK-ASCII
✓	*	*	*	*	<ESC>(B	Character set US-ASCII
				✓	<ESC>(C	Defining the page length
✓	*	*	*	*	<ESC>(M)I>F	Assign character set G0
				✓	<ESC>(G	Selecting graphics mode
✓	*	*	*	*	<ESC>(H	Character set Swedish-Finnish
✓	*	*	*	*	<ESC>(K	Character set German
✓	*	*	*	*	<ESC>(L	Character set Portuguese
✓	*	*	*	*	<ESC>(R	Character set French
				✓	<ESC>(U	Setting positioning units in n/3600 inch
				✓	<ESC>(V	Absolute vertical printing position
✓	*	*	*	*	<ESC>(Y	Character set Italian
✓	*	*	*	*	<ESC>(Z	Character set Spanish
✓	*	*	*	*	<ESC>_)M)I>F	Assign character set G1
		✓	✓	✓	<ESC>*<0><n1> <n2>	Set graphics print to 60 dpi
		✓	✓	✓	<ESC>*<1><n1> <n2>	Set graphics print to 120 dpi
		✓	✓	✓	<ESC>*<2><n1> <n2>	Set graphics print to 120 dpi
		✓	✓	✓	<ESC>*<3><n1> <n2>	Set graphics print to 240 dpi
		✓	✓	✓	<ESC>*<32><n1> <n2>	Set graphics print to 60 dpi
		✓	✓	✓	<ESC>*<33><n1> <n2>	Set graphics print to 120 dpi
		✓	✓	✓	<ESC>*<38><n1> <n2>	Set graphics print to 90 dpi
		✓	✓	✓	<ESC>*<39><n1> <n2>	Set graphics print to 180 dpi
		✓	✓	✓	<ESC>*<4><n1> <n2>	Set graphics print to 80 dpi
		✓	✓	✓	<ESC>*<40><n1> <n2>	Set graphics print to 360 dpi

MTPL	IBM XL24	IBM AGM	Epson LQ-2550	Epson LQ-2170	Code	Function
✓	*	*	*	*	<ESC>*MI>F	Assign character set G2
	✓	✓	✓		<ESC>-<n>	Underlining ON/OFF
			✓		<ESC>/<m>	Select vertical tab channels
				✓	<ESC>.	Printing raster graphics
	✓	✓			<ESC>:	Condensed printing 12 cpi ON
			✓	✓	<ESC>:<0><n><m>	Copy ROM character set
			✓	✓	<ESC><	Unidirectional printing for 1 line
			✓	✓	<ESC>=	Set bit 8 = 0
	✓	✓			<ESC>=<C1><C2>...	Load font/character set
			✓	✓	<ESC>>	Set bit 8 = 1
			✓	✓	<ESC>?<s><n>	Reload a graphics mode
			✓	✓	<ESC>@	Initialize printer
✓	*	*	*	*	<ESC>[MTPL start character for programming sequence
✓	✓	✓	✓	✓	<ESC>[\$A<n1><n2>	Fast graphic print with 90 dpi
✓	✓	✓	✓	✓	<ESC>[\$B<n1><n2>	Fast graphic print with 180 dpi
✓	*	*	*	*	<ESC>[+0<u>	Compmode = On
✓	*	*	*	*	<ESC>[+1<u>	Compmpde = Off
✓	*	*	*	*	<ESC>[:y	Right justification and centering OFF
✓	*	*	*	*	<ESC>[\$A<n1><n2>	Fast graphic print 90 dpi vertical
✓	*	*	*	*	<ESC>[\$B<n1><n2>	Fast graphic print 180 dpi vertical
✓	*	*	*	*	<ESC>[=z	Bold ON
✓	*	*	*	*	<ESC>[>z	Bold OFF
✓	*	*	*	*	<ESC>[?1~	MTPL command set
✓	*	*	*	*	<ESC>[?10~	Barcode interpretation OFF
✓	*	*	*	*	<ESC>[?11~	Start barcode interpretation
✓	*	*	*	*	<ESC>[?4~	MTPL + IBM Proprinter-24 command set
✓	*	*	*	*	<ESC>[?50h	Selecting character sets with 256 characters
✓	*	*	*	*	<ESC>[?50l	Selecting character sets with 94 characters
✓	*		*	*	<ESC>[?51h	Proportional fonts automatic NLQ and LQ
✓	*		*	*	<ESC>[?51l	Proportional fonts in draft mode possible (default)
✓	*	*	*	*	<ESC>[?52h	Font selection (ESC[10...19m]) possible only for NLQ and LQ
✓	*	*	*	*	<ESC>[?52l	Font selection (ESC[10...19m]) Draft possible (default)
✓	*	*	*	*	<ESC>[?53h	Extended character set
✓	*	*	*	*	<ESC>[?53l	Standard character set
✓	*	*	*	*	<ESC>[?6~	MTPL + EPSON LQ command set
✓	*	*	*	*	<ESC>[?7h	Line overrun = CR + LF
✓	*	*	*	*	<ESC>[?7l	Line overrun = Truncating data outside of the printing area

MTPL	IBM XL24	IBM AGM	Epson LQ-2550	Epson LQ-2170	Code	Function
✓	*	*	*	*	<ESC>[?<n>~	Change emulation
	✓	✓			<ESC>[@<n1> <n2>...	Set double height
	✓	✓			<ESC>[\<n1> <n2>...	Change vertical base units
✓	*	*	*	*	<ESC>[0;;n{	Select single sheet operation
✓	*	*	*	*	<ESC>[0;0r	Clear top and bottom margin
✓	*	*	*	*	<ESC>[0;0s	Clear left and right margin
✓	*	*	*	*	<ESC>[0g	Clear horizontal tab at the current printhead position
✓	*	*	*	*	<ESC>[0m	Clear all selected fonts
✓	*	*	*	*	<ESC>[0m	Reset colour (reserved)
✓	*	*	*	*	<ESC>[0 SP I	Measuring unit decipoint
✓	*	*	*	*	<ESC>[0 SP K	Set horizontal pitch to 10 cpi
✓	*	*	*	*	<ESC>[0 SP L	Set vertical spacing to 6 lpi
✓	*	*	*	*	<ESC>[0 SP X	High print quality
✓	*	*	*	*	<ESC>[0w	Set 5 cpi
✓	*	*	*	*	<ESC>[0y	Selecting Draft or HS printing quality
✓	*	*	*	*	<ESC>[0z	Superscript ON
✓	*	*	*	*	<ESC>[10m	Font 0 Default: Draft or HS Roman
✓	*	*	*	*	<ESC>[10y	Right and centre adjustment OFF
✓	*	*	*	*	<ESC>[10z	Microscript ON
✓	*	*	*	*	<ESC>[11e	Set PUM (absolute measuring unit) to OFF
✓	*	*	*	*	<ESC>[11h	Set PUM (absolute measuring unit) to ON
✓	*	*	*	*	<ESC>[11m	Font 1 Default: HS Courier
✓	*	*	*	*	<ESC>[11w	Set 20 cpi
✓	*	*	*	*	<ESC>[11y	Select print quality Draft or HS
✓	*	*	*	*	<ESC>[12m	Font 2 Default: HQ Courier
✓	*	*	*	*	<ESC>[12 SP K	Set horizontal pitch to 12 cpi
✓	*	*	*	*	<ESC>[12w	Set horizontal pitch to 10 cpi
✓	*	*	*	*	<ESC>[12y	Select print quality LQ or HQ
✓	*	*	*	*	<ESC>[12z	Double height ON (top portion)
✓	*	*	*	*	<ESC>[13m	Font üDefault: HS S Serif
✓	*	*	*	*	<ESC>[13y	HQ with high resolution
✓	*	*	*	*	<ESC>[13z	Double height ON (lower portion)
✓	*	*	*	*	<ESC>[14m	Font 4 Default: HQ S Serif
✓	*	*	*	*	<ESC>[15m	Font 5 Default: HQ Roman
✓	*	*	*	*	<ESC>[15 SP K	Set horizontal pitch to 15 cpi
✓	*	*	*	*	<ESC>[16m	Font 6 Default: HQ in actual font
✓	*	*	*	*	<ESC>[17m	Font 7 Default: HQ in actual font

MTPL	IBM XL24	IBM AGM	Epson LQ-2550	Epson LQ-2170	Code	Function
✓	*	*	*	*	<ESC>[18m	Font 8 Default: HQ OCRB
✓	*	*	*	*	<ESC>[19m	Font 9 Default: HQ OCRA
✓	*	*	*	*	<ESC>[1 g	Clear vertical tab at current position
					<ESC> [1 SP k	Printout in Royal Mail customer barcode
✓	*	*	*	*	<ESC>[1 SP L	Set vertical spacing to 4 lpi
✓	*	*	*	*	<ESC>[1 SP p	Initiate US Postnet Barcode
✓	*	*	*	*	<ESC>[1 SP X	Print quality medium or HQ
✓	*	*	*	*	<ESC>[1w	Set 6 cpi
✓	*	*	*	*	<ESC>[1y	Print quality HS
✓	*	*	*	*	<ESC>[1z	Subscript ON
✓	*	*	*	*	<ESC>[21{	ASF-1: Select feeder front
✓	*	*	*	*	<ESC>[22{	ASF-2: Select feeder rear
✓	*	*	*	*	<ESC>[21m	Double underlining
✓	*	*	*	*	<ESC>[23m	Italics OFF
✓	*	*	*	*	<ESC>[24m	Underline OFF
✓	*	*	*	*	<ESC>[26m	Proportional font ON
✓	*	*	*	*	<ESC>[2g	Clear all horizontal tabs in the current line
✓	*	*	*	*	<ESC>[2J	Print page
✓	*	*	*	*	<ESC>[2 SP I	Measuring unit decipoint
✓	*	*	*	*	<ESC> [2 SP k	Printout in Kix barcode
✓	*	*	*	*	<ESC>[2 SP L	Set vertical spacing to ũlpi
✓	*	*	*	*	<ESC>[2 SP X	Print quality low/HS
✓	*	*	*	*	<ESC>[2w	Set 7.5 cpi
✓	*	*	*	*	<ESC>[2y	Proportional font ON
✓	*	*	*	*	<ESC>[2z	Double height OFF
✓	*	*	*	*	<ESC>[2z	Superscript, subscript and microscript OFF
✓	*	*	*	*	<ESC>[30m	Black
✓	*	*	*	*	<ESC>[<n>m	Color; n = 31–36
✓	*	*	*	*	<ESC>[3g	Clear all horizontal tabs
✓	*	*	*	*	<ESC>[3m	Italics ON
✓	*	*	*	*	<ESC>[üSP L	Set vertical spacing to 12 lpi
✓	*	*	*	*	<ESC>[3w	Set 8.6 cpi
✓	*	*	*	*	<ESC>[3z	Line density 6 lpi (= line spacing 1/6 inch)
✓	*	*	*	*	<ESC>[4g	Clear all vertical tabs
✓	*	*	*	*	<ESC>[4m	Underline ON
✓	*	*	*	*	<ESC>[4 SP L	Set vertical spacing to 8 lpi
✓	*	*	*	*	<ESC>[4w	Set 10 cpi

MTPL	IBM XL24	IBM AGM	Epson LQ-2550	Epson LQ-2170	Code	Function
✓	*	*	*	*	<ESC>[4y	Selecting NLQ or HS printing quality at 10 cpi
✓	*	*	*	*	<ESC>[4z	Line density 8 lpi (= line spacing 1/8 inch)
✓	*	*	*	*	<ESC>[5{	Select fanfold paper mode tractor 1
✓	*	*	*	*	<ESC>[6{	Select fanfold paper mode tractor 2
✓	*	*	*	*	<ESC>[50m	Proportional font OFF
✓	*	*	*	*	<ESC>[50{	Page at print position
✓	*	*	*	*	<ESC>[51{	Page at tear off position (perforation)
✓	*	*	*	*	<ESC>[52{	Page at view position
✓	*	*	*	*	<ESC>[53m	Overlining ON
✓	*	*	*	*	<ESC>[54{	Cut at current line (option)
✓	*	*	*	*	<ESC>[55m	Overlining OFF
✓	*	*	*	*	<ESC>[5n	Request status report
✓	*	*	*	*	<ESC>[5w	Set 12 cpi
✓	*	*	*	*	<ESC>[5y	NLQ or HS with 12 cpi
✓	*	*	*	*	<ESC>[5z	Graphics normal
✓	*	*	*	*	<ESC>[6~	Initialize the printer
✓	*	*	*	*	<ESC>[6 SP K	Set horizontal pitch to 6 cpi
✓	*	*	*	*	<ESC>[6w	Set 15 cpi
✓	*	*	*	*	<ESC>[6z	Graphics inverted
✓	*	*	*	*	<ESC>[7w	Set 17.1 cpi
✓	*	*	*	*	<ESC>[7y	Proportional font OFF
✓	*	*	*	*	<ESC>[7z	Bit 8 = unchanged
✓	*	*	*	*	<ESC>[8w	Reset double stroke
✓	*	*	*	*	<ESC>[8y	Right justification ON
✓	*	*	*	*	<ESC>[8z	Set bit 8 = 0
✓	*	*	*	*	<ESC>[9 SP L	Set vertical spacing to 2 lpi
✓	*	*	*	*	<ESC>[9w	Set double stroke
✓	*	*	*	*	<ESC>[9y	Centering ON
✓	*	*	*	*	<ESC>[9z	Set bit 8 = 1
	✓				<ESC>[g<n1> <n2><0>	Set graphics print to 60 dpi
	✓				<ESC>[g<n1> <n2><1>	Set graphics print to 120 dpi
	✓				<ESC>[g<n1> <n2><11>	Set graphics print to 180 dpi
	✓				<ESC>[g<n1> <n2><12>	Set graphics print to 360 dpi
	✓				<ESC>[g<n1> <n2><2>	Set graphics print to 120 dpi
	✓				<ESC>[g<n1> <n2><3>	Set graphics print to 240 dpi
	✓				<ESC>[g<n1> <n2><8>	Set graphics print to 60 dpi
	✓				<ESC>[g<n1> <n2><9>	Set graphics print to 120 dpi

MTPL	IBM XL24	IBM AGM	Epson LQ-2550	Epson LQ-2170	Code	Function
			✓	✓	<ESC>[j	Position paper back 1/180"
✓	*	*	*	*	<ESC>[<n1> <n2>f	Set absolute horizontal and vertical position
✓	*	*	*	*	<ESC>[<n>+w	Interface holding time n = 1 - 30 s
✓	*	*	*	*	<ESC>[<n>+x	Head position horizontal in n/720", also paper load pos.
✓	*	*	*	*	<ESC>[<n>+y	Printhead gap n = (0 - 100)
✓	*	*	*	*	<ESC>[<n>+z	Auto. or man. printhead gap adjustment
✓	*	*	*	*	<ESC>[<n>SP q	Load menu
✓	*	*	*	*	<ESC>[<n1>...<n5>+v	Paper handling options
✓	*	*	*	*	<ESC>[<n1>...<n16>SP r	Print transparent characters
✓	*	*	*	*	<ESC>[<n1> <n2>f	Set absolute horizontal and vertical position
✓	*	*	*	*	<ESC>[<n1> <n2>SP 0	Change character size
✓	*	*	*	*	<ESC>[<n1> <n2>SP D	Select font
✓	*	*	*	*	<ESC>[<n1> <n2>SP G	Set character/line spacing
✓	*	*	*	*	<ESC>[<n1> <n2>r	Set top and bottom margin
✓	*	*	*	*	<ESC>[<n1> <n2>s	Set left and right margin
✓	*	*	*	*	<ESC>[<n> a	Set relative horizontal position
✓	*	*	*	*	<ESC>[<n> d	Set absolute vertical position
✓	*	*	*	*	<ESC>[<n> e	Set relative vertical position
✓	*	*	*	*	<ESC>[<n> j	Relative horizontal position back (to the left)
✓	*	*	*	*	<ESC>[<n> k	Relative vertical position back (to the top)
✓	*	*	*	*	<ESC>[<n> p	Set HMI
✓	*	*	*	*	<ESC>[<n> q	Set horizontal step
✓	*	*	*	*	<ESC>[<n> SP \	Set additional spaces
✓	*	*	*	*	<ESC>[<n> SP C	Select character size
✓	*	*	*	*	<ESC>[<n> SP f	Set reduced spacing
✓	*	*	*	*	<ESC>[<n> SP g	Set character spacing
✓	*	*	*	*	<ESC>[<n> SP h	Line spacing
✓	*	*	*	*	<ESC>[<n> SP s	Transmits the "n" character as an ASCII character (n= 0–255)
✓	*	*	*	*	<ESC>[<n> SP U	Beginning of line (default value)
✓	*	*	*	*	<ESC>[<n> SP V	End of line (default value)
✓	*	*	*	*	<ESC>[<n> t	Set form length in lines
✓	*	*	*	*	<ESC>[<n> u	Set horizontal tab
✓	*	*	*	*	<ESC>[<n> v	Set vertical tab
			✓	✓	<ESC>[<n1><n2>	Perform relative horizontal step
	✓				<ESC>\<n1>;<n2>	Transparent mode for the characters following
	✓				<ESC>^	Transparent mode for the character following
	✓				<ESC>_<n>	Overline ON/OFF

MTPL	IBM XL24	IBM AGM	Epson LQ-2550	Epson LQ-2170	Code	Function
	✓	✓	✓	✓	<ESC>0	Set line feed to 1/8 inch
	✓				<ESC>1	Set line feed to 7/72 inch
	✓	✓	✓	✓	<ESC>2	Set line feed to 1/6 inch
	✓				<ESC>2	Set line feed to n/72 inch
		✓	✓	✓	<ESC>3<n>	Set line feed to n/180 inch
	✓				<ESC>3>n>	Set line feed to n/216 inch
			✓	✓	<ESC>4	Italics ON
	✓	✓			<ESC>4	Set beginning of form
			✓	✓	<ESC>5	Italics OFF
	✓	✓			<ESC>5<n>	Autom. line feed ON/OFF
			✓	✓	<ESC>6	Print ASCII codes dec. 129 to dec. 159
	✓	✓			<ESC>6	PC character set 2 (expanded)
			✓	✓	<ESC>7	Suppress ASCII codes 129 to 159
	✓	✓			<ESC>7	PC character set 1 (standard)
			✓		<ESC>a<n>	Select orientation
		✓	✓	✓	<ESC>A<n>	Line spacing n/60 inch
	✓				<ESC>A<n>	Prepare line spacing n/72 inch
			✓		<ESC>b<m><0>	Clear all tabs
			✓		<ESC>b<m><n><0>	Set vertical tabs in channels
	✓	✓	✓	✓	<ESC>B<0>	Clear all vertical tabs
			✓	✓	<ESC>B<n1>...<n16><0>	Set vertical tabs
	✓	✓			<ESC>B<n1>...<n64><0>	Set vertical tabs
✓					<ESC>c	Reset to initialisation status
				✓	<ESC>c	Setting the horizontal motion index (HMI)
	✓	✓	✓	✓	<ESC>C<0><n>	Set form length in inches
	✓	✓	✓	✓	<ESC>C<n>	Set form length in lines
	✓	✓		✓	<ESC>d<n1> <n2>	Perform relative horizontal step
	✓	✓	✓	✓	<ESC>D<0>	Clear all horizontal tabs
	✓	✓	✓	✓	<ESC>D<n1>...<n32><0>	Set horizontal tabs
	✓	✓			<ESC><DC2>	Condensed printing OFF
	✓	✓			<ESC><DC4>	Double-wide printing OFF (set with <SO> or <ESC><SO>)
	✓	✓	✓	✓	<ESC>E	Bold ON
			✓	✓	<ESC>0	Deselect single sheet operation
			✓	✓	<ESC>1	Bin 1 rear (ASF-R), option
			✓	✓	<ESC>2	Bin 2 front (ASF-F), option
			✓	✓	<ESC>4	Select single sheet operation

MTPL	IBM XL24	IBM AGM	Epson LQ-2550	Epson LQ-2170	Code	Function
			✓	✓	<ESC>R	Print page
	✓	✓	✓	✓	<ESC>F	Bold OFF
			✓	✓	<ESC>g	Set character pitch to 15 cpi
	✓	✓	✓	✓	<ESC>G	Set double stroke
	✓	✓	✓	✓	<ESC>H	Reset double stroke
✓					<ESC>H	Set horizontal tab at current printhead position
	✓	✓			<ESC>I<n>	n = 0, 8: Draft; n = 4, 12, 20: Draft DLL/n = 0, 8: HS; n = 4, 12, 20: HS DLL
			✓	✓	<ESC>j<n>	Single line feed back n/180 inch
	✓	✓			<ESC>j	Set printer to Off Line
		✓	✓	✓	<ESC>J<n>	Single line feed n/180 inch
	✓				<ESC>J<n>	Single line feed n/216 inch
			✓	✓	<ESC>k<n>	Select font
	✓	✓	✓	✓	<ESC>K<n1> <n2>	Set graphics print to 60 dpi
			✓	✓	<ESC>l<n>	Set left margin
	✓	✓			<ESC>l<n>	Select print mode
	✓	✓	✓	✓	<ESC>L<n1> <n2>	Set graphics print to 120 dpi
			✓	✓	<ESC>M	Set character pitch to 12 cpi (Elite)
✓	*	*	*	*	<ESC>n	Character generator LS2
	✓		✓	✓	<ESC>N<n>	Set perforation skip
✓	*	*	*	*	<ESC>o	Character generator LSü
	✓	✓	✓	✓	<ESC>O	Reset perforation skip
			✓	✓	<ESC>p<n>	Proportional font ON/OFF
			✓	✓	<ESC>P	Set character pitch to 10 cpi (Pica)
	✓	✓			<ESC>P<n>	Proportional font ON/OFF
	✓	✓			<ESC>Q<35>	Deselect printer
			✓	✓	<ESC>Q<n>	Set right margin
			✓	✓	<ESC>r<n>	Select colour (reserved)
	✓	✓			<ESC>R	Reset all tabs
			✓	✓	<ESC>R<n>	Select national character set
	✓	✓	✓	✓	<ESC>S<n>	Superscript or subscript ON
	✓	✓	✓	✓	<ESC><SI>	Condensed printing 17.1 cpi ON
	✓	✓	✓	✓	<ESC><SO>	Double-wide printing ON
			✓	✓	<ESC><SP><n>	Set character spacing
			✓	✓	<ESC>t<n>	Select character set
	✓	✓	✓	✓	<ESC>T	Superscript or subscript OFF
	✓	✓	✓	✓	<ESC>U<n>	Unidirectional print ON/OFF
			✓	✓	<ESC>Un	Unidirectional print ON/OFF

MTPL	IBM XL24	IBM AGM	Epson LQ-2550	Epson LQ-2170	Code	Function
	✓	✓	✓	✓	<ESC>W<n>	Continuous double width ON/OFF
			✓	✓	<ESC>w<n>	Double height print ON/OFF
			✓	✓	<ESC>x<n>	Set print quality (PQ)
			✓	✓	<ESC>x<0>	sets Draft or HS
			✓	✓	<ESC>x<1>	sets LQ or HQ
				✓	<ESC>X	Font selection according to pitch and points
	✓	✓			<ESC>X<n><m>	Set left and right margin
	✓	✓	✓	✓	<ESC>Y<n1> <n2>	Set graphics print to 120 dpi
	✓	✓	✓	✓	<ESC>Z<n1> <n2>	Set graphics print to 240 dpi
✓	*	*	*	*	<ESC>+F	Assign character set Gü
✓	*	*	*	*	<ESC>	Character generator LS3R
✓	*	*	*	*	<ESC>}	Character generator LS2R
✓	*	*	*	*	<ESC>~	Character generator LS1R
✓	✓	✓	✓	✓	<FF>	Form feed
✓	✓	✓	✓	✓	<HT>	Horizontal tab jump
✓					<HTS>	Set tab stop at actual horizontal position
✓					<IND>	Line feed without CR
✓	✓	✓	✓	✓	<LF>	Line feed
✓					<NEL>	Line feed with CR
✓					<PLD>	Half step line feed
✓					<PLU>	Half step line feed back
✓					<RI>	Line feed without CR back
	✓	✓	✓	✓	<SI>	Condensed printing of 17.1 cpi ON
✓					<SI>	Switching the character generator (SS 3)
	✓	✓	✓	✓	<SO>	Double-wide printing ON
✓					<SO>	Switching the character generator (SS 2)
✓	✓	✓	✓	✓	<VT>	Vertical tab jump
✓					<VTS>	Set tab stop at current vertical position



Additional information is provided in the *Programmer's Application Manual* on this CD-ROM.

Genicom ANSI Emulation

Code	Function
ACK	Acknowledge
BEL	Bell
BS	Back Space
CR	Carriage Return
CSI	Control String Introducer, ESC [
DC1	Select printer (Data Control 1)
DC3	Deselect printer (Data Control 3)
DEL	Delete
ENQ	Enquiry
ESC	Escape
ESC \ or ST	String Terminator
ESC c	Reset to Initial State (RIS)
ESC D or IND	Index
ESC E or NEL	Next line
ESC H or HTS	Horizontal Tab Setting
ESC J or VTS	Vertical Tab Setting
ESC K or PLD	Partial Line Down
ESC L or PLU	Partial Line Up
ESC M or RI	Reverse Index
ESC P data or DCS	Enter Dot Graphics Mode (Device Control String)
ESC [p1; pn }	Sets bar code parameters (GENBC)
ESC [p1;....pn m	Select Graphics Rendition (SGR), Character Pitch, Print Modes and Color Ribbon color.
ESC [p1; p2 SP B	Graphic Size Modification (GSM)
ESC [p1; p2 s	Left/Right Margin Set (GENSLR)
ESC [p1; pn u	Sets horizontal tab stops at specified positions Multiple Horizontal Tab Set (GENHTS)
ESC [p1; pn g	Tab Clear (TBC)
ESC [p1; pn v	Sets vertical tab stops at specified positions (Multiple Vertical Tab Set - GENVTS)
ESC [p1; p2; p3 r	Form Definition (GENFD)
ESC [p1; p2 <SP> G	Sets the line/character spacing
ESC [p1;...pn h	Set Mode (SM)
ESC [p1; pn l	Reset mode (RM)
ESC [p1 '	Horizontal Position Absolute (HPA)

Code	Function
ESC [p1 a	Horizontal Position Relative (HPR)
ESC [p1 d	Vertical Position Absolute (VPA)
ESC [p1 j	Horizontal Position Backward (HPB)
ESC [p1 k	Vertical Position Backward (VPB)
ESC [p1 q	Select Graphics Mode/Density (GENGRM)
ESC [p1 t	Special Print Mode (Oversize/Expanded/Bar code Mode – GENSPM)
ESC [p1; p2 f	Horizontal and Vertical Position Absolute (HVP)
ESC [p1 e	Vertical Position Relative (VPR)
ESC [p1; pn p	Assign Source for Forms (GENASF)
ESC [p1 x	Selects National character set (National Characters – GENSNCR)
ESC [p1; p2 SP{	Cut paper at current position
ETX	End of transmission
FF	Form Feed
HT	Horizontal tab
LF	Line Feed
NUL	Ignored
OSC	Operating System Command, ESC]
SI	Shift In
SO	Shift Out
SP	Space
VT	Vertical tab



Additional information is provided in the *Genicom Programmer's Application Manual* on this CD-ROM.

PJL commands

The following PJL commands can be used either with the internal Ethernet interface or with a TallyCom III interface (or compatible).

This functionality may be activated via the parameter **Jobcntl** in the Advanced Menu.

Sequence	Brief description
"ESC"%-12345X@PJL	Universal Exit Language (UEL) commands
@PJL ECHO	ECHO command
@PJL EOJ @PJL EOJ NAME=	EOJ (End of Job) commands
@PJL INFO STATUS	INFO (Information Request) command
@PJL INFO CONFIG	INFO of the printer configuration
@PJL INFO VARIABLES	INFO of variables which can be set by SET
@PJL INFO MEMORY	INFO about the memory of the printer
@PJL USTATUS DEVICE = ON @PJL USTATUS DEVICE = OFF @PJL USTATUS DEVICE = VERBOSE @PJL USTATUS JOB = ON @PJL USTATUS JOB = OFF @PJL USTATUS PAGE = ON @PJL USTATUS PAGE = OFF @PJL USTATUSOFF	USTATUS (unsolicited status) commands
@PJL JOB NAME = @PJL JOB FILE = @PJL JOB START = @PJL JOB END = @PJL JOB COPY =	JOB (Start of Job) commands
@PJL ENTER LANGUAGE	Exit PJL and start normal parser
@PJL INFO USTATUS	List each type of unsolicited status
@PJL USTATUS TIMED	Enables timed unsolicited status

Barcode

Even the standard version of your printer has the possibility of using up to 23 different barcode types.



Barcode mode can be accessed within every emulation. The user can decide whether barcode is activated permanently or activated depending on the situation by means of an escape sequence.

List of available barcodes

Type	Barcode	Type	Barcode
A*	2/5 Matrix (default)	N	UPC A (with HRI)
B*	2/5 Industrial	O	UPC A (without HRI)
C*	2/5 Interleaved	P	UPC E (with HRI)
D*	Code 11	Q	UPC E (without HRI)
E*	BCD Matrix	R*	Delta Distance (IBM)
F*	Code 39	S	Code 128
G*	Codabar	T	EAN 128
H*	EAN 8 (with HRI)	1)	US-Postnet
I*	EAN 8 (without HRI)	1)	KIX Barcode
K*	EAN 13 (with HRI)	1)	Royal Mail Customer Barcode
L*	EAN 13 (without HRI)	1)	USPS Intelligent Mail Barcode
M*	MSI /modified PLESSEY		

* These barcodes may be printed out horizontal and vertical, the unmarked only horizontal.

1) See description on the following pages.

The barcode types K, L, N, O may be expanded by using Add-On Barcodes: Add-On 2 and Add-On 5.

The information to be printed is transmitted in a "bracket" (DC4).

A control sequence (Header) defines the parameters of the used barcode once (e.g. type, ratio, etc.). If no header is defined, the information in the "bracket" will be printed in Code 2/5 Matrix.



Please note that within the Barcode environment the barcode commands have priority in case of conflicts with the emulation.



Additional information is provided in the *Barcode Programmer's Application Manual* on this CD-ROM.

US Postnet barcode

Postnet is a special US-American type of barcode. It is printed in character size. Numeric values from 0 to 9 are printable.

After activating this barcode type, numeric characters from 0 (hex. 30) to 9 (hex. 39) are interpreted as barcode figures. All other characters terminate the Barcode mode. Exception: the TAB function (hex. 09) is allowed within Barcode mode. The Postnet sequence is accessible in every emulation. The printer can print barcode in HS (180 dpi) and HQ (360 dpi).



The character (e.g. CR = carriage return, hex. 0D), which terminates the barcode is not printed or carried out. US Postnet barcode does not require a barcode bracket.

Example:

ASCII	ESC [1 SP p 12345 CR
HEX	1B 5B 31 20 70 31 32 33 34 35 0D

The numbers 1 to 5 are printed as Postnet stripes.

Royal Mail Customer barcode

The Royal Mail Customer barcode is a special Mail type barcode. It is printed in character size. Numeric values from 0 to 9 and alphanumeric values from A to Z are printable.

After activating this barcode type, numeric characters from 0 (hex. 30) to 9 (hex. 39) and alphanumeric values from A (hex. 41) to Z (hex. 5A) are interpreted as barcode figures. Lower cases from a (hex. 61) to z (hex. 7a) are automatically converted to capital characters. Control characters from hex. 0 (dec. 0) to hex. 1F (dec. 31) terminates this barcode mode. All other characters are ignored. Exception: the TAB function (hex. 09) is allowed within Barcode mode.

The Royal Mail Customer sequence is accessible in MTPL emulation. The printer prints barcode in LQ.



The character (e.g. CR = carriage return, hex. 0D), which terminates the barcode is not printed or carried out. Royal Mail Customer barcode does not require a barcode bracket.

Example:

ASCII	ESC [1 SP k SO36XY1A CR
HEX	1b 5b 31 20 6b 53 4f 33 36 58 59 31 41 0D

The characters "SO36XY1A" are printed as Royal Mail Customer stripes.

KIX barcode

The KIX barcode prints numeric values from 0 to 9 and alphanumeric values from A to Z as barcode characters.

After activating this barcode type, numeric characters from 0 (hex. 30) to 9 (hex. 39) and alphanumeric values from A (hex. 41) to Z (hex. 5A) are interpreted as barcode figures. Lower cases from a (hex. 61) to z (hex. 7a) are automatically converted to capital characters. Control characters from hex. 0 (dec. 0) to hex. 1F (dec. 31) terminates this barcode mode. All other characters are ignored.

Exception: the TAB function (hex. 09) is allowed within Barcode mode.

The KIX sequence is accessible in MTPL emulation. The printer prints barcode in LQ.



The character (e.g. CR = carriage return, hex. 0D), which terminates the barcode is not printed or carried out.

KIX barcode does not require a barcode bracket.

Example:

ASCII	ESC [2 k SO36XY1A CR
HEX	1b 5b 32 6b 53 4f 33 36 58 59 31 41 0D

The characters "SO36XY1A" are printed as KIX stripes.

USPS Intelligent Mail barcode

The USPS Intelligent Mail barcode is a 4-state barcode which works in MTPL, IBM, Epson and ANSI emulation. 4-state barcode data must be converted into only 0, 1, 2 or 3. Each number represents one of the four possible bars. Tabs (Hex 09) and spaces can separate either the bars or the barcodes horizontal, but every other character unseer Hex 20 will terminate barcode mode.

You can enter the barcode mode with the sequence ESC [? 11 ~, the sequence ESC [10 ~ exits the barcode mode.

Example:

ASCII	ESC [9 SP k <data>
HEX	1b 5b 39 02 6b <data>

Large character printing

Certain professional applications may require unusually large character sizes. Therefore your printer has the possibility of scaling standard size characters up to factor 99 by means of control sequences (LCP1).

The Header sequence defines the parameters (e.g. height) once.

This definition remains until the printer is switched off.

The printable LCP (**L**arge **C**harager **P**rinting) information is transmitted in an LCP "bracket" (SI).

The following character sets (with national characters) are available:



	ID	23	24	40	5B	5C	5D	5E	60	7B	7C	7D	7E
US ASCII	01	#	\$	@	[\]	?	`	{		}	~
GERMAN	02	#	\$	§	Ä	Ö	Ü	?	`	ä	ö	ü	ß

The character sets are selected via the following LCP sequence:

ESC "P" "L" "S" n ESC "\". The value of n may range between 01 and 02 (as ASCII characters) – see ID column in the above table.

To select e.g. the german character set, you must use the following data set:

ASCII	ESC	P	L	S	0	1	ESC	\
hex.	1B	50	4C	53	30	31	1B	5C
dec.	27	80	76	83	48	49	27	92

-  **The printout of LCP characters can be selected in all of the emulations. Prerequisite: Printer must be in Barcode mode.**
-  **Note that this printer supports some scalable fonts in the LQ-2170 emulation if a compatible driver is used.**

List of additional control codes

You can use both the ESC sequences and the control codes.

Sequences	Control codes	Function
<ESC>[?10~	—	Barcode Off
<ESC>[?11~	—	Barcode On
<ESC> PSC 0 <ESC> \	—	Unsecured mode
<ESC> PSC 1 <ESC> \	—	Secured mode
<ESC> PLS <n> <ESC> \	—	LCP character set
<ESC>[<n><SP>s	—	Sends a character as ASCII character; n > 0–255 decimal
<ESC>[20<SP>s	<DC4>	Barcode bracket
<ESC>[16<SP>s	<DLE>	Start code LCP Header
<ESC>[25<SP>s		Termination code Header
<ESC>[15<SP>s	<SI>	LCP bracket
<ESC>[26<SP>s	<SUB>	Start code Barcode-Header
<ESC>[1 SP p	—	US-Postnet Barcode
<ESC>[1 SP k	—	Royal Mail Customer Barcode
<ESC>[2 SP k	—	Kix-Barcode
<ESC>[9 SP k	—	USPS Intelligent Mail Barcode

Header	Function
<DLE> [!] nn EM	LCP header [] = optional nn = factor
<SUB> [F] a [nn][;xyz][;p] EM	Barcode header [] = optional a = Barcode type p = 0: Barcode horizontal p = 9: Barcode vertical



Additional Information is provided In the *Barcode Programmer's Application Manual* on this CD-ROM.

Interfaces

Your printer offers by default the possibility of operating either via USB or Ethernet. Optional, an parallel or serial interface can be used.

This chapter informs you about the USB and Ethernet interface and the optional serial and parallel interface and describes the communication between your computer and the printer.

The USB, the internal ethernet and the optional parallel and serial interface are linked to form a so-called **shared interface**. Your printer can be configured to use only one interface or all alternately. When only one interface is used, it is monitored by the printer. If the printer is configured to use all interfaces simultaneously it monitors all interfaces for incoming data. As soon as the printer recognizes a signal it switches to the respective interface and sends the BUSY signal to the other interfaces. After finishing the data transmission, the printer remains switched to this interface for a certain period of time (30 seconds). When this time has elapsed, the controller reenables both interfaces and the sequence described restarts. If incoming data is on the other interface and the current print position is not "Top of Form", a form feed is carried out.



If shared = parallel or shared = serial is set, all other interfaces are disabled.

In the chapter *Options*, the interfaces which can be purchased with your printer are listed.

USB 2.0 (Full-Speed, 12MBit/s)

The USB interface conforms to the Universal Serial Bus 2.0 Specifications. It supports the Full Speed mode at 12 Mbps. It uses the "B" type USB connector. Max. cable length: 5.0m (according to USB 2.0 specification)

Ethernet interface

The Ethernet interface affords the printer to connect to local area networks. Its attributes are:

Hardware

- ▶ LAN/Ethernet: RJ45, Ethernet 100BaseTX with 100 Mbps (IEEE802.3u), 10Base-T with 10 Mbps (IEEE802.3)
- ▶ RAM: 8 MB
- ▶ Flash: 4 MB
- ▶ Speed: 100 Mbps / Full Duplex

Supported operating systems

- ▶ Windows NT, 200, XP, Vista, 7, 8, 8.1, 10 and 2003-2016 Server
- ▶ Linux
- ▶ Unix
- ▶ Sun Solaris

Supported protocols

- ▶ SNMP
- ▶ SMTP
- ▶ TCP/IP
- ▶ lpr/lpd
- ▶ Port 9100

Designation of IP address

- ▶ DHCP
- ▶ BOOTP
- ▶ Static (manually via the printer's control panel)

Configuration

- ▶ HTTP
- ▶ TCP/IP
- ▶ Status SNMP
- ▶ TCP/IP
- ▶ SMTP
- ▶ PING

Parallel interface (optional)

The bidirectional parallel interface offers the so called “nibble” mode of the IEEE1284 interface norm. This enables installation in accordance with Windows “Plug & Play”.

The standard parallel interface is able to transfer data at a speed of max. 30,000 bytes per second. When the receiving buffer is full, the data input is blocked until the data buffer is empty. This guarantees data transmission in blocks of 1 KB.

Connector assignment

	Printer-PC	Signal
1	←	STROBE (active low)
2	←	DATA 1
3	←	DATA 2
4	←	DATA 3
5	←	DATA 4
6	←	DATA 5
7	←	DATA 6
8	←	DATA 7
9	←	DATA 8
10	→	$\overline{\text{ACK}}$ (active low)
11	↔	BUSY
12	↔	PAPER EMPTY (PE)
13	↔	SELECT
14	↔	$\overline{\text{AUTO FEED}}$ (active low)
15		not used
16	–	SIGNAL GROUND
17	–	CHASSIS GROUND
18	–	5 V ($I_{\text{max}} = 500 \text{ mA}$)
19–30	–	SIGNAL GROUND
31	←	$\overline{\text{INIT}}$ (active low)
32	↔	$\overline{\text{ERROR}}$ (active low)
33	–	SIGNAL GROUND
34–35		not used
36	←	SELECT IN

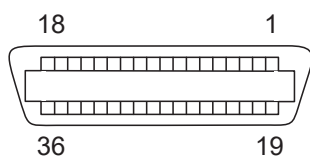

Transmission length: max. 2,0 m

Serial interface V.24/RS232C (optional)

Your printer's serial interface supports the RS232C specification. The signals are received and transmitted by a 9 pin connector.

Basically 3 lines are already enough for exchanging information between computer and printer (one receive line, one send line, one line for common grounding).

Type	RS232C interface
Synchronization	Asynchronous
Transmission rate	600 Baud to 19.200 Baud
Signal status	OFF (log. 1) -3 V to -15 V ON (log. 0) +3 V to +15 V
Connection cable	up to 15 m length
Interface connections	ITT Cannon connector, series DB-9 S
Transmission protocol	XON/XOFF, ENQ/STX, READY/ BUSY, Robust XON/XOFF, ETX/ ACK
Capacity of data buffer	1024 KB max.

Connector assignment

Connector no.	Direction Printer-PC	Signal
3	→	TxD
4	→	DTR
2	←	RxD
6	←	DSR
7	→	RTS
8	←	CTS
5	-	Signal Ground SG
Shield	-	Frame Ground FG



Interface cable (serial interface)

The cables used must be shielded. The cable shield must be connected to the connector shield on both ends.

PC/AT (9-pin)		Printer (9-pin)	
RxD	2	3	TxD
TxD	3	2	RxD
CTS	8	4	DTR/RDY
SG	5	5	SG
DSR	6		
DTR	4		

PC/AT (25-pin)		Printer (9-pin)	
FG	1		FG
TxD	2	2	RxD
RxD	3	3	TxD
CTS	8	4	DTR/RDY
SG	5	5	SG
DSR	6		
DTR	4		



It depends on the menu setting whether DTR or RDY is active at pin 4.

Input signals

Signal	Function
CTS	Clear to Send
DSR	Data Set Ready
RxD	Receive Data

Output signals

Signal	Function
DTR	Data Terminal Ready
RTS	Request to Send
READY	Ready to receive data
TxD	Transmit Data

Protocols

Memory mode XON/XOFF

The received characters are stored in a FIFO buffer (first in/first out). The characters are processed in this buffer.

The buffer capacity can be adjusted from 0 to 128 Kb.

If the buffer is full, the interface signals NOT READY (signal acknowledgement: Level 1, -12 V) and XOFF (hex. 13, dec. 19). This results in stopping the data transmission. When the FIFO buffer is empty again, the interface signals READY (level 0, +12 V) and XON (hex. 11, dec. 17). Data transmission can be continued.

In addition, the READY signal is influenced by the status of the printer (On/Off Line). If the printer assumes an undefined state, the interface also signals NOT READY and XOFF.

Memory mode Robust XON/XOFF

Robust XON/XOFF is similar to XON/XOFF. However, the state of the printer (XON or XOFF) is also periodically transmitted via the TxD line in the case of Robust XON/XOFF.

Extended menu functions with the ENQ/STX and ETX/ACK protocols selected

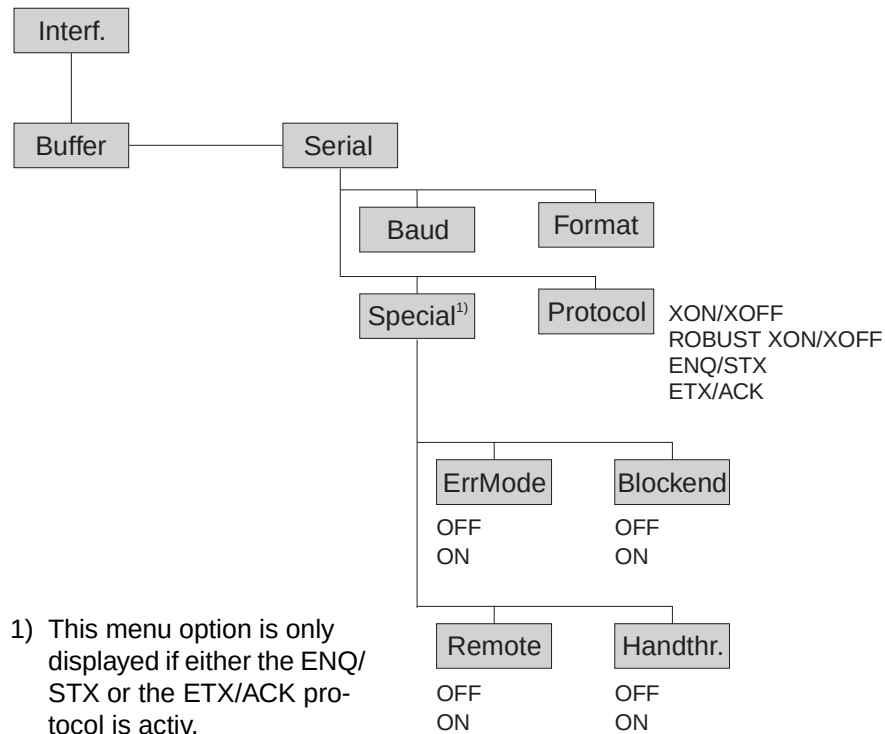

ENQ/STX protocol

In addition to this XON/XOFF message, the possibility exists of requesting a status byte from the printer using the ENQ code (hex. 05, dec. 5). The STX code (hex 02, dec. 2) is used to clear any error messages (parity error, buffer overflow).

Status byte	Bit 0 – 1	BUSY
	Bit 1 – 1	Off Line
	Bit 2 – 0	Paper end
	Bit 3 – 1	Always 1
	Bit 4 – 1	Cover open
	Bit 5 – 1	Buffer overflow
	Bit 6 – 1	Parity or frame error
	Bit 7 – 0	Always 0

- STX (hex02) Clears any previous parity or framing error as well as any buffer overflow error.
- ENQ (hex05) The current printer status is sent to the host.
- XON/XOFF This protocol is automatically used for data flow control and printer status handling.
- HandThr.= ON The STX and ENQ characters are not filtered out of the data stream and control the interface in addition.
- HandThr.= OFF The STX and ENQ are filtered out of the data stream and handled immediately by the interface.

ETX/ACK protocol

- ETX (hex03) Block end character
- ACK (hex06) Acknowledgement informing the host that further data may be transmitted.
- XON/XOFF This protocol is used in addition to data flow control and printer status handling.
- HandThr.=ON An ETX is not acknowledged by ACK before all previously arrived data have been printed.
- HandThr.=OFF When the printer receives an ETX, it returns an ACK to the host. Any previously sent data or blocks may still be present in the printer buffer.

Management

- ▶ Web Panel
- ▶ HP Web Jet Admin
- ▶ E-Mail notification with SMTP
- ▶ TallyCom Print Guide
- ▶ Pre-string, Post-String

Setup

- ▶ Setup via the printer’s control panel
- ▶ Web Panel (HTTP/HTML)
- ▶ TallyCom Admin

Physical printer port in Ethernet with TCP/IP

When using your printer in a local network with Ethernet connections and the TCP/IP protocol, you have to assign several address informations.

i **Address information for the Ethernet port can only be made available by your network administrator, who has the necessary rights to install printers on the network and/or make any changes.**

- ▶ The assumed address space corresponds to the TCP/IP adress, class C, 192.168.1.xxx.
- ▶ The subnet mask to be used is 255.255.255.0
- ▶ The address of the router, or gateway, is 0.0.0.0, if not available.

Example of a printer connected to a computer in an Ethernet

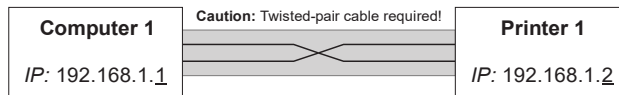

Example of several devices in an Ethernet

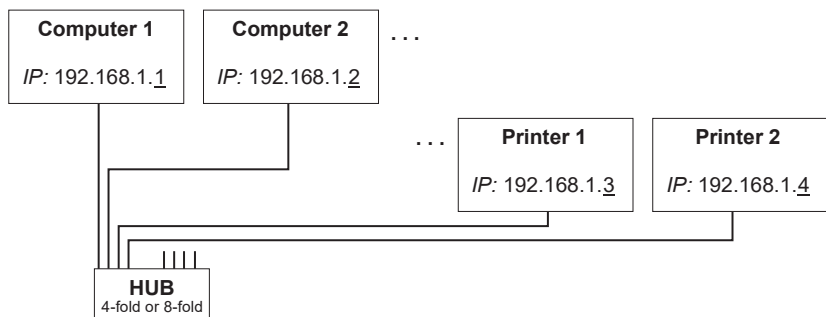

i You will find more information on our [internet](#) page.

Options and accessories

Options

The following options can be ordered for your printer.

Tractor 2, front

The push tractor is suitable for fanfold paper. You can use paper formats with a width in the range from 76 to 406 mm; you can set any intermediate format.

Part no.: 061052

Autocut facility

An additional module for automatic cutting.

Part no.: 062661

Printer pedestal

A cabinet to be used as a printer stand and for storing fanfold paper stacks.

Part no.: 062690

Basket

Part no.: 062833

Interface modules

The following interface modules are available.

Name	Part no.
Combi parallel and serial interface module, RS-232C, Sub D 9 pin-f connector	070566
Ethernet interface module 10/100 Mb/s, compatible to TallyCom Pocket-I/F	043886
Ethernet interface module 10/100 IPDS	043888
Ethernet interface module 10/100 SCS	043887

Optional firmware

On request.

Accessories

Ribbon cassettes

Ribbon cassettes are available in the following versions.

Name	Part no.
Ribbon cassette, black	062471
Ribbon cassette, long-life, black	533199

Programming manuals

The following programming manuals are available. You can download the manuals from our [internet](#) page.

Name	Part no.
Programmer's application manual MTPL (in English)	379298
Programmer's application manual Barcode (in English)	379300
Programmer's application manual Epson (in English)	379302
Programmer's application manual Genicom ANSI (in English)	GEK-1064

“All rights reserved. Translations, reprinting or copying by any means of this manual complete or in part or in any different form requires our explicit approval. We reserve the right to make changes to this manual without notice. All care has been taken to ensure accuracy of information contained in this manual. However, we cannot accept responsibility for any errors or damages resulting from errors or inaccuracies of information herein.”

DASCOM REPRESENTATIVES

GERMANY

DASCOM Europe GmbH
Heuweg 3
D-89079 Ulm
Deutschland
Tel.: +49 (0) 731 2075 0
Fax: +49 (0) 731 2075 100
www.dascom.com

AMERICAS

Dascom Americas LLC
34 Lakeview Court
Verona, VA 24482
USA
Phone: +1 (877) 434 1377
Fax: +1 (540) 242 7221
www.dascom.com

UNITED KINGDOM

DASCOM GB Ltd
Hart House, Priestley Road
Basingstoke, Hampshire
RG24 9PU, England
Phone: +44 (0) 1256 355130
Fax: +44 (0) 1256 481400
www.dascom.com

SINGAPORE (Asia Pacific)

DASCOM AP Pte Ltd
2 Jurong East Street 21
#05-42, IMM Building
Singapore 609601
Phone: +65 6760 8833
Fax: +65 6760 1066
www.dascom.com

FRANCE

DASCOM Europe GmbH
117 Avenue Victor Hugo
92100 Boulogne-Billancourt
France
Phone: +33 (1)73 02 51 98
www.dascom.com