

# **PRISMAsync V4.1**

**for**

## **imagePRESS C800 Series**

# **Technical Service Manual**



# **Canon**

**April 27, 2015**



# Contents

## Chapter 1

<b>Preface</b> .....	<b>7</b>
Preface.....	8

## Chapter 2

<b>Introduction</b> .....	<b>11</b>
Features.....	12

## Chapter 3

<b>Installation</b> .....	<b>13</b>
Passwords.....	14
Installation sequence.....	15
Verify site conditions.....	15
Assemble the Operator panel.....	17
Unpack the PRISMAsync.....	18
Install the PRISMAsync supports/pedestals.....	19
Install the DIP-SW PCB and the Open I/F PCB.....	20
Connect the PRISMAsync.....	21
Finish the installation.....	25
Installation wizard.....	27

## Chapter 4

<b>Using the PRISMAsync</b> .....	<b>31</b>
The operator panel.....	32
System settings.....	34
Maintenance and Service.....	37
System service mode (PRISMAsync service mode).....	39
Engine service mode (during printing).....	42
Service mode and host machine state.....	45
Colour adjustments.....	47
Media management.....	51

## Chapter 5

<b>Start, shutdown and restart the system</b> .....	<b>53</b>
Turn on the system.....	54
Turn off the system.....	55
Restart the system.....	56
Restart the host machine in service mode.....	57
Restart the host machine after error has occurred.....	59

## Chapter 6

<b>The Settings Editor</b> .....	<b>61</b>
The Settings editor.....	62

## Chapter 7

<b>Service procedures</b> .....	<b>65</b>
Service procedures.....	66

Hardware components overview.....	67
Access internal components.....	68
Replace the GPU board.....	69
Replace the DDI board.....	71
Replace the AUX control board.....	72
Replace the DDR3 modules.....	74
Replace the Hard Disk Drives.....	75
Install/Replace the Ethernet board.....	76
Replace the Base controller.....	77
Connect Harness 22W01.....	79

## Chapter 8

<b>Firmware upgrades via PRISMAsync.....</b>	<b>83</b>
Firmware upgrade settings.....	84
Firmware upgrade of Engine and Accessories via PRISMAsync (by FST) .....	88
Firmware upgrade of Engine and Accessories from USB stick .....	91
Firmware upgrade in Safe download mode .....	95
Firmware upgrade additional information.....	100

## Chapter 9

<b>System software.....</b>	<b>103</b>
System software.....	104
Create a backup of the settings and licenses.....	105
Preparation of the USB stick.....	106
Reuse an USB stick after installation.....	108
Re-installation of the system software.....	109
Installing patches.....	111
Installing a license.....	114
Installing the printer driver.....	115
Configure the machine for the USA.....	116

## Chapter 10

<b>Troubleshooting.....</b>	<b>119</b>
Troubleshooting.....	120
Check external connections.....	121
Check internal components.....	122
Comprehensive system inspection.....	123
Diagnose LEDs.....	125
Error messages and conditions.....	128
11504 Error Screen behaviour.....	132
11504 MRE and Hansiplast procedure.....	135
PRISMAsync beep codes.....	136
Escalation procedure.....	138

## Chapter 11

<b>Appendix.....</b>	<b>141</b>
Appendix A: Specifications.....	142
Hardware features.....	142
Connectivity.....	143
Appendix B: Parts overview.....	144
Overview of the service parts.....	144
DIP switch board.....	145
Appendix C: Tips & Tricks.....	147
How to check if DDR memory is defect or missing.....	147
How to print transparencies with best quality.....	148
How to improve black density on the print.....	149
Strange colors after editing CMYK curves.....	150



Appendix D: System log files.....	151
How to create a datadump file.....	151
How to create a trace file.....	153
How to create a trace file including the printer logging.....	155
Appendix E: Engine reports.....	158
Engine reports.....	158
Appendix F: The Trapping editor.....	163
The Trapping editor.....	163
Appendix G: EAC document.....	166
EAC model number overview.....	166



# **Chapter 1**

## **Preface**

# Preface

## Application

This manual has been issued for qualified persons to learn technical theory, installation, maintenance, and repair of products.

This Service Manual is written for world-wide markets.

As such it may contain information relating to accessories or licensed functionality not supported by Canon U.S.A., Inc. as of the date of the manual publication.

## Corrections

This manual may contain technical inaccuracies or typographical errors due to improvements or changes in products. When changes occur in applicable products or in the contents of this manual, Océ will release technical information as the need arises. In the event of major changes in the contents of this manual over a long or short period, Océ will issue a new edition of this manual.

The following paragraph does not apply to any countries where such provisions are inconsistent with local law.

## Trademarks

The product names and company names used in this manual are the registered trademarks of the individual companies.

## Copyright

This manual is copyrighted with all rights reserved. Under the copyright laws, this manual may not be copied, reproduced or translated into another language, in whole or in part, without the written consent of Océ.

## Safety and emissions compliance

The imagePRESS Server has been certified to meet or surpass the following government standards:

Safety approvals: EMI/EMC approvals:

- UL 60950-1 (TUV/CU mark)
- FCC Class B
- CSA 22.2 #60950-1
- VCCI Class B
- EN 60950-1 (TUV/GS mark)
- EN55022 Class B CB scheme IEC 60950-1
- EN55024 AS/NZS CISPR22: 2004 Class B



### **CAUTION**

**All parts inside the PRISMAsync have a fire safety class V2 or higher. It is therefore forbidden to store objects or paper (USB-key, reports etc.) inside the PRISMAsync controller**

---

## Points to notice when handling the Lithium Battery

---



**CAUTION**

**RISK OF EXPLOSION IF BATTERY IS REPLACED BY AN INCORRECT TYPE.  
DISPOSE OF USED BATTERIES ACCORDING TO THE INSTRUCTIONS.**

---



**CAUTION**

**WENN MIT DEM FALSCHEN TYP AUSGEWECHSELT, BESTEHT EXPLOSIONSGEFAHR.  
GEBRAUCHTE BATTERIEN GEMASS DER ANLEITUNG BESEITIGEN.**

---



# **Chapter 2**

## **Introduction**

This Service manual describes the service aspects of the PRISMAsync V4.1 controller for the PRISMAsync for imagePRESS C800 Series.

The PRISMAsync for imagePRESS C800 Series colour controller sets the tone for all colour print production on the imagePRESS C800 Series printers. High processing power, professional colour management, ease of use and superb media handling, all ensure consistent output at every stage.

The PRISMAsync for imagePRESS C800 Series colour controller uses the latest Adobe RIP and colour management technologies.

## Features

The PRISMAsync for imagePRESS C800 Series features:

- Harmonized workflow for cutsheet production systems. Both black & white and colour.
- Clear task split between prepress and print operation.
- Job submission from a user's desktop via the printer driver or Océ PRISMAprepare software.
- Media driven operation by using a detailed media catalogue.
- High speed colour calibration allowing you to calibrate for all media and halftone screening in one go.
- Basic or professional colour management depending on access rights of users.
- Simple colour presets for inexperienced operators and users.
- Automated workflows allowing users to define their own templates.
- Last minute colour correction buttons to apply last-minute correction to brightness and contrast when copying and printing.
- Both 1200x1200 dpi and 600x600 dpi support.
- Intuitive time schedule.
- Support of 17 languages.
- Extensive colour libraries. Pantone and Pantone Goe libraries are available in the controller as a default along with HKS libraries.
- Support for IPDS.
- Native Adobe PDF interpreter APPE support.
- Device links.
- Named Colour Profiles.
- JDF/JMF connector.
- eRDS support.
- DocBox.
- VDP-support.
- In-RIP Trapping for APPE.
- Automatic restore of settings and jobs after installation.



# **Chapter 3**

## **Installation**

# Passwords

When servicing the PRISMAsync for imagePRESS C800 Series or making adjustments you often will need a password for a specific task.

See the list below for an overview of the default passwords.

- Enter Service Mode: 675756
- System Administrator: 71617000
- Key Operator: 13524
- Engine maintenance: 12345
- Remote manager: 12345678

## Resetting the passwords

It could occur that the password for the system administrator, Key Operator or Engine maintenance is lost.

The service technician is able to reset these passwords to the default value.

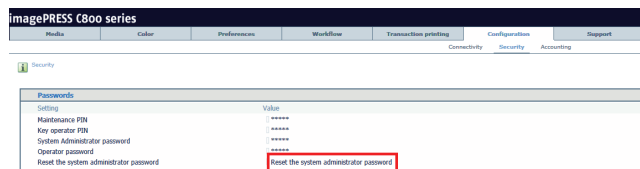

### NOTE

In the settings editor the Remote Manager password is called Operator password.

Do the following steps to reset the passwords:

## Procedure

1. Open the Settings Editor on a remote PC connected to the network of the customer.  
See [The Settings editor on page 62](#)
2. Browse to [Configuration] -> [Security] and click on [Reset the system administrator password].
3. Enter the Service password
4. Confirm your choice.  
The System Administrator password is reset to the factory default.
5. You can use the system administrator password to change the other passwords.

## Installation sequence

This chapter describes the installation sequence for the PRISMAsync for imagePRESS C800 Series controller.

Because the PRISMAsync is connected to the customer's network please coordinate your installation with the network administrator at the customer site.



### NOTE

Make sure the PRISMAsync is connected to the host machine before entering Engine Service mode.

### Procedure

1. [Verify site conditions on page 15](#)
2. [Assemble the Operator panel on page 17](#)
3. [Unpack the PRISMAsync on page 18](#)
4. [Install the PRISMAsync supports/pedestals on page 19](#)
5. [Install the DIP-SW PCB and the Open I/F PCB on page 20](#)
6. [Connect the PRISMAsync on page 21](#)
7. [Finish the installation on page 25.](#)

## Verify site conditions

### Introduction

Before installing the PRISMAsync controller check the site conditions.

### Host Machine

- Is the host machine configured for use with the PRISMAsync controller? For the proper settings, see the documentation that comes with the host machine.
- Is space available for the PRISMAsync controller behind the host machine? The PRISMAsync controller is placed behind the host machine. Be sure that there is enough room for servicing either the host machine or the PRISMAsync controller. You may need to move the host machine away from the wall so that interface connectors are accessible.
- Check if the interface cables between host machine and PRISMAsync controller are present.
  - One data cable must be delivered together with the host machine.
  - One Ethernet cross cable is delivered with the PRISMAsync controller.

### Power & Network

- Is a dedicated, grounded electrical outlet for the PRISMAsync controller available near the host machine?
  - Locate the grounded electrical outlet that will supply power to the PRISMAsync controller. Do not run the PRISMAsync controller and the host machine on the same circuit.
  - Do not plug the PRISMAsync controller into a switchable wall outlet. This can result in the PRISMAsync controller being turned off accidentally.
  - Do not plug the PRISMAsync controller into a circuit with heating or refrigeration equipment (including water coolers).
  - Do not pull on the cable when unplugging the PRISMAsync controller. Pull the plug instead.
- Make sure that there is a wired network connection available at installation time.



### NOTE

A wireless network cannot be used with the PRISMAsync controller.

## Verify site conditions

---

- Contact the Network Administrator for the following settings:
  - The hostname of the system
  - The host IP address
  - The email address of the system administrator (for password recovery)
  - The hostname or IP address of the email server

## Environment

- A networked computer (PC or Mac OS) must be available close to the host machine.

## Assemble the Operator panel

Before connecting the PRISMAsync to the engine it is necessary to assemble the Operator panel.

For the assembly instructions refer to the  
**[iPR\\_C800\\_Series\\_Installation\\_Procedure\\_for\\_PRISMAsync.pdf](#)**.

# Unpack the PRISMAsync

## Introduction

The PRISMAsync controller is assembled and shipped from the factory with pre-installed software.

## Unpack procedure

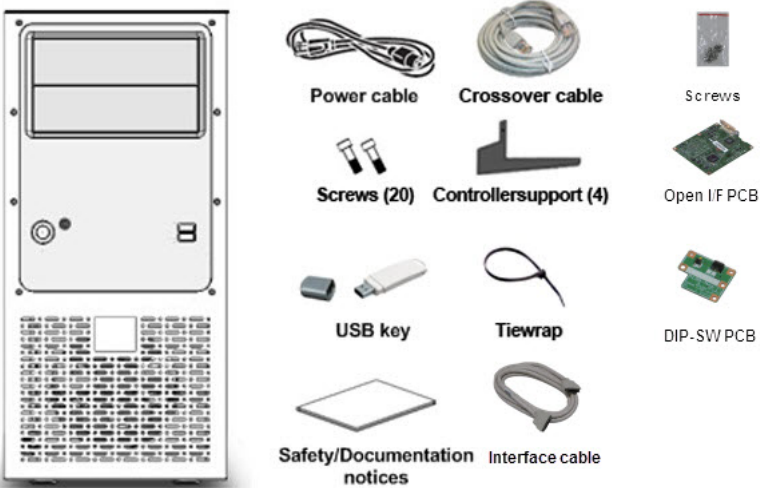
Step	Action
1	Open the box and carefully lift the PRISMAsync out of the box. Store the original box and packing material in case the PRISMAsync controller needs to be transported at a later date.
2	Check the contents of the box 
3	Provide the customer with the Safety Notice and User Documentation leaflet and Printer Driver Notice leaflet. The PRISMAsync for imagePRESS C800 Series user documentation can also be downloaded from <a href="http://downloads.oce.com/">http://downloads.oce.com/</a> .



**NOTE**

Also see [iPR\\_C800\\_Series\\_Installation\\_Procedure\\_for\\_PRISMAsync.pdf](#)

## Install the PRISMAsync supports/pedestals



### NOTE

To reduce the amount of dust that enters the PRISMAsync controller the supports installed on the controller have to be replaced with the supplied pedestals.

### Replace the installed supports

1. Remove the 4 supports installed on the PRISMAsync controller. The removed supports and screws will not be used.



2. Install the supports delivered with the PRISMAsync controller (4x M3x16 Hex bolt).



## Install the DIP-SW PCB and the Open I/F PCB

When a PRISMAsync is connected to the host machine you first have to install the DIP-SW PCB and the Open I/F PCB.

For instructions please refer to the [iPR\\_C800\\_Series\\_Installation\\_Procedure\\_for\\_PRISMAsync.pdf](#).



## Connect the PRISMAsync

You are now ready to make the following connections:

- Operator console
- Host machine interface connections
- Operator Attention Light
- Network cable connection
- Power cable connection



### NOTE

Please follow standard Electro Static Discharge (ESD) precautions when handling electronic components.

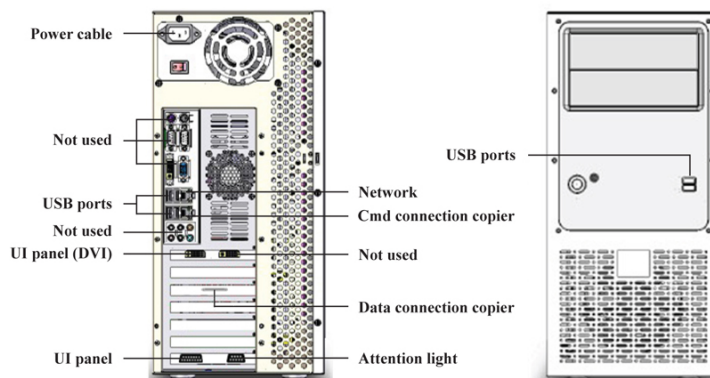

## Connect the operator panel

Step	Action
1	The cables needed for the connections are part of the operator attachment kit
2	Open the backside of the Operator Panel.
3	Connect the DVI cable to the backside of the Operator panel. Connect the other side to the left DVI port on the backside of the PRISMAsync controller.
4	Connect the 15-pins D-sub connector to the connector on the backside of the PRISMAsync controller. Connect the other side to the backside of the Operator Panel.
5	Connect a USB cable to the backside of the Operator Panel. Connect the other side to the backside of the PRISMAsync controller.
6	Close the backside of the Operator Panel.

## Connect to the host machine

Step	Action
1	Connect one side of the Ethernet crossover-cable to the <b>lower</b> RJ45 connector on the backside of the PRISMAsync (Command/Status). Connect the other side to the RJ45 connector on the backside of the host machine.
2	Connect the host machine interface cable to the Data connection port of the PRISMAsync.

## Connect the PRISMAsync

---

Step	Action
3	Connect the other end to the connector of the Open I/F PCB on the host machine corresponding ports on the PRISMAsync.

## Connect the Operator Attention Light

Step	Action
1	Install the Operator Attention Light to the backside of the host machine
2	Connect the cable with the 9-pins D-sub connector to the connector on the backside of the PRISMAsync.
3	Connect the other side of the cable to the connector attached to the Attention Light

## Connect to the network

Step	Action
1	Connect one side of a straight-through Ethernet cable to the <b>upper</b> RJ45 connector on the backside of the PRISMAsync.
2	Connect the other side of the Ethernet cable to the Ethernet wall-outlet



## Connect the power



Step	Action
1	Connect recessed end of the power cable to the power connector on the back of the PRISMAsync.
2	Connect the other end of the power cable to a wall outlet.

## Bundle the cables with a tie wrap

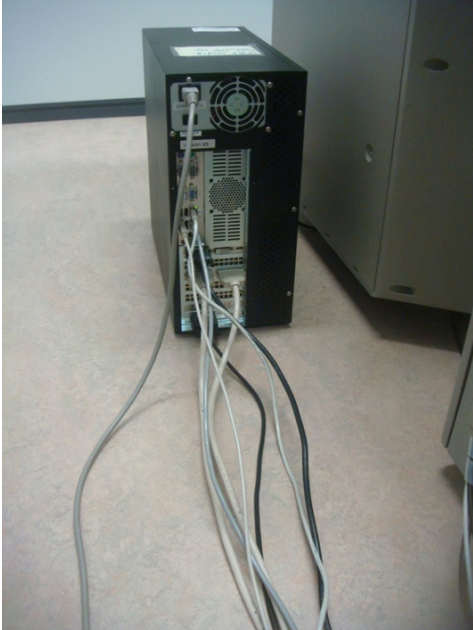
The PRISMAsync will be delivered with a reusable tie-wrap.

This tie wrap is used to regulate and fix all the PRISMAsync's data cables. The power cord is not fixed with the tie wrap.

Step	Action	Remark
1	<p>Bundle all <b>data</b> cables and guide them in the same direction.</p> <p> <b>NOTE</b> Do not bundle the power cable with the data cables.</p>	
2	<p>Guide the bundle in a loop going upwards and then downwards.</p> <p> <b>NOTE</b> Make sure there is not too much tension on the connectors.</p>	

Step	Action	Remark
3	<p>Guide the tie wrap through the two eyes at the rear-side of the controller as shown and lead the bundle in a curve along the rear side of the controller downwards.</p> <p> <b>NOTE</b> Fasten the tie wrap without drawing the cables too tight. The tie wrap can be released and reused.</p>	 A photograph showing the rear panel of a server controller. A bundle of white cables is secured with a black tie wrap. The tie wrap is looped through two circular holes on the top of the controller. The controller has a fan and various ports. A label on the front of the controller reads "Version V3".

## Finish the installation

To finish the installation of the PRISMAsync for imagePRESS C800 Series do the following:

Step	Action
1	Make sure to finish the <b>iPR_C800_Series_Installation_Procedure_for_PRISMA-sync.pdf</b> procedure.
2	Power on the host machine.
3	Power on the PRISMAsync controller by positioning the On/Off switch at the back-side of the controller to the On position. If the PRISMAsync controller does not start automatically, press the On/Off button at the front side of the PRISMAsync controller. The startup may take a while, please wait until the user interface displays the splash screen .
4	Perform the PRISMAsync installation wizard. Refer to <a href="#">Installation wizard on page 27</a> .
5	If the licences on PRISMAsync controller are not pre-installed, please install them now. Refer to <a href="#">Installing a license on page 114</a> .
6	Perform any required system software upgrades. Before updating the PRISMAsync controller, please make sure to create a backup of the settings. This backup also contains the licenses installed on your PRISMAsync controller . Updates for the system software may be available on a FTP server. Patches may need to be installed after installation. (See <a href="#">Installing patches on page 111</a> )
7	Change the Sleep mode timer (default = 1 minute) Consult the customer for the new sleep mode setting.
8	After the software is installed and all settings are made, always make a backup of these settings. See: "Service Mode" in <a href="#">Maintenance and Service on page 37</a>
9	Set the billing counters that have to be displayed on the Operator Panel. Go to Service Mode. Select: COPIER -> OPTION -> USER 11. Make the following settings: <ul style="list-style-type: none"> <li>• CNT_SW 0</li> <li>• Counter1 112 Total (Black/Large)</li> <li>• Counter2 113 Total (Black/Small)</li> <li>• Counter3 122 Total (Full Color + Single Color/Large)</li> <li>• Counter4 123 Total (Full Color + Single Color/Small)</li> <li>• Counter5 102 Total 2</li> <li>• Counter6 0</li> <li>• Counter7 0</li> <li>• Counter8 0</li> </ul> <p> <b>NOTE</b> Additional toner bottle counters can be displayed. Ask the customer for preferences.</p> <ul style="list-style-type: none"> <li>• Selection of counters via Engine Service mode</li> <li>• Counters can be retrieved via eRDS/UGW</li> <li>• Not supported by SNMP</li> </ul>

Step	Action
10	<p>Assist the customer with the installation of the printer driver on 1 workstation. The printer driver can be found by using the Settings Editor.</p> <ul style="list-style-type: none"><li>• On your PC open an Internet browser (e.g. Microsoft Explorer)</li><li>• In the Address bar enter <code>http://&lt;hostname&gt;</code> or IP-address</li><li>• A window with the Settings Editor will open. Go to the <b>[Support]</b> tab</li><li>• Select <b>[Software]</b> at the bottom of the page you will find the drivers which can be downloaded to your computer.</li><li>• Install the driver needed (Windows, Mac OS)</li><li>• Make some test prints with the driver.</li></ul>
11	<p>Instruct the customer to make sure all media (CDs and/or USB sticks) shipped with the PRISMAsync is stored in a safe location.</p> <p> <b>CAUTION</b> Do not store any media or paper (USB keys or reports) inside the PRISMAsync because of fire hazard.</p>

# Installation wizard

## Introduction

This procedure describes the installation wizard for the new and re-installation of the PRISMAsync software.

## When to do

- New installation of a machine with a PRISMAsync controller
- Re-installation of the PRISMAsync software



### NOTE

To restart the installation wizard after completion select from the splash screen [Local key operator settings] -> [System settings] and set Show install wizard after the next startup to [Yes].

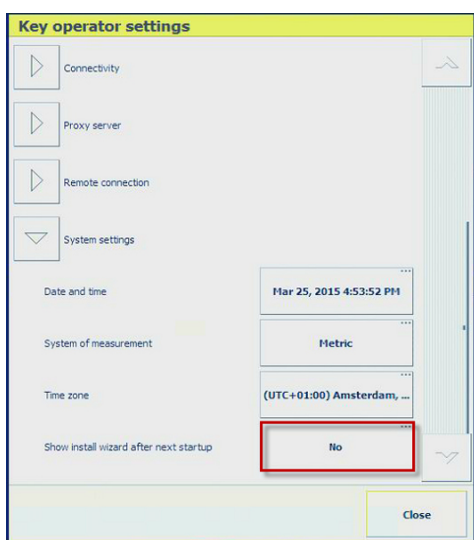



## Before you begin



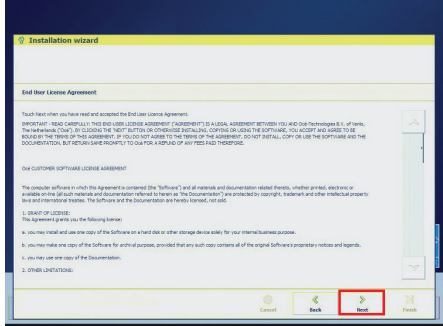
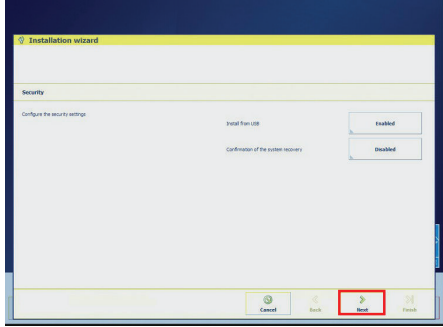

Make sure to have the following information available:

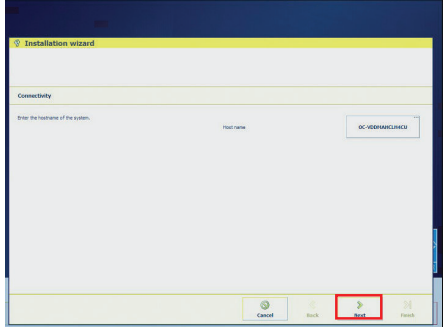
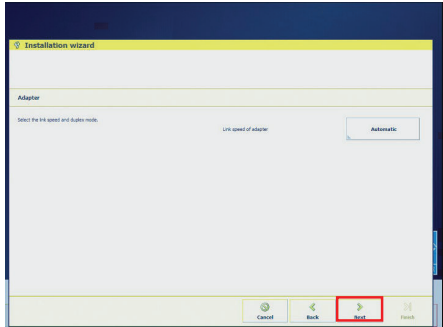
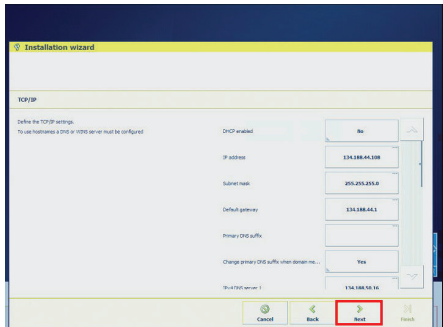

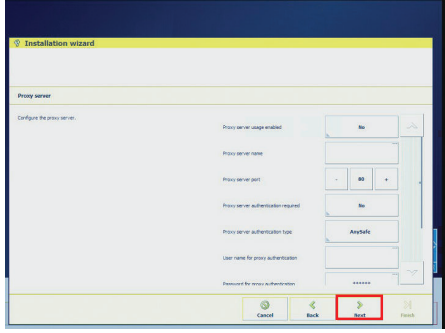

- Hostname of the system
- Host IP address
- Email address of the system administrator (necessary for password recovery)
- Hostname or IP address of the email server

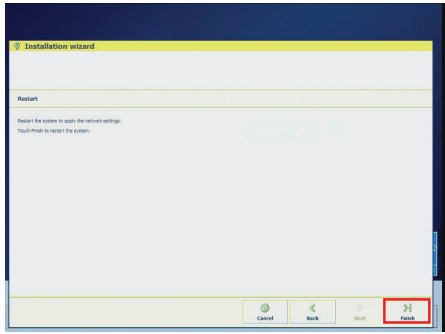
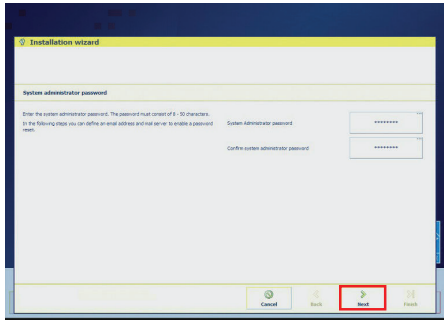
Step	Action	Additional information
1	<b>Languages</b> Select the system language and then select [Next].	

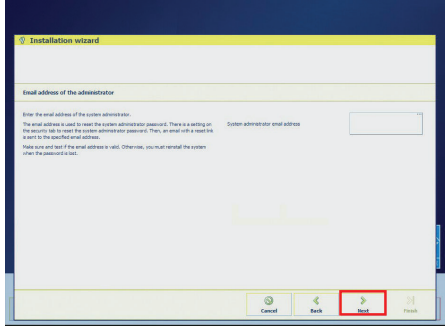
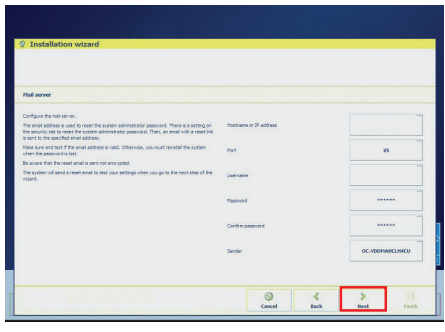
Step	Action	Additional information
2	<p><b>End User License Agreement</b> Read the End Users License Agreement and select [Next].</p>	
3	<p><b>Installation wizard</b> Leave the security settings unchanged and select [Next].</p>	
4	<p><b>Connectivity</b> Enter the hostname of the system and select [Next].</p> <p> <b>NOTE</b> If a system restore is done the hostname will be corrected automatically.</p>	
5	<p><b>Adaptor</b> Select the link speed and duplex mode then select [Next].</p>	
6	<p><b>TCP/IP</b> Make sure DHCP enabled is set to <b>No</b> and enter the host IP address then select [Next] Ask the system administrator to provide the IP address or check the configuration report (if available).</p>	

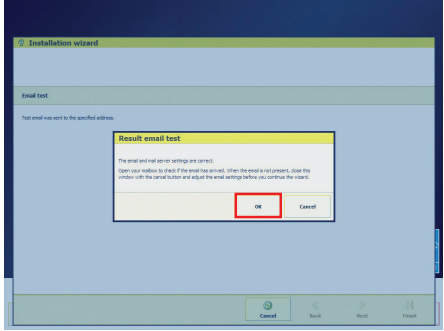

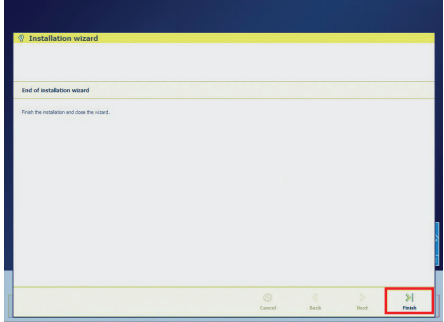
Step	Action	Additional information
7	<p><b>Proxy Server</b> Leave the Proxy server settings unchanged and select [Next].</p>	
8	<p><b>Restart</b> Select [Finish] to apply the network settings.</p> <p> <b>NOTE</b> The system re-boots.</p>	
9	<p><b>System administrator password</b> Leave the System administrator password unchanged and select [Next].</p>	
10	<p><b>Email address of the administrator</b> Enter the email address of the system administrator and select [Next].</p> <p> <b>NOTE</b> This email address will be used to reset the system administrator's password.</p>	
11	<p><b>Mail server</b> Enter the Hostname or IP address of the email server then select [Next].</p>	

Step	Action	Additional information
12	<p><b>Email test</b></p> <p>If the email and mail server settings are correct select [OK] if not follow the instructions on the screen.</p> <p> <b>NOTE</b> Check if the system administrator has received a mail from the PRISMAsync controller.</p> <p>Dear system administrator, This test email checks your email address. This email address will be necessary to reset the system administrator password on the OC-HPIAUEBFVT8? when the password is lost. Best regards, PRISMAsync.</p>	
13	<p><b>End of installation wizard</b></p> <p>Select [Finish] to finish the installation and close the wizard.</p> <p> <b>NOTE</b> The wizard closes and the splash screen is displayed.</p>	
14	<p><b>Splash screen</b></p> <p>Press the [Sleep] button to update the firmware of the host machine and connected finishingers.</p>	<p> <b>NOTE</b> Make sure all connected finishing devices are switched on.</p>

# **Chapter 4**

## **Using the PRISMAsync**

# The operator panel

## Introduction

This topic describes the main components of the operator panel.



### NOTE

You can clean the screen of the operator panel with a 50% mix of water and isopropyl alcohol. Use a lint-free cloth. Always put the cleaner onto the cloth and not directly on the screen.

## Components of the operator panel



1. **Sleep button (Moon button)**  
Depending on whether the host machine is currently active or in the sleep mode
  - Put the machine in to sleep mode, or
  - Wake up the machine from the sleep mode
  - shut down the host machine and the controller
  - Startup the controller after a shutdown
2. **Stop button**  
Stop the host machine
  - After a set, or
  - As soon as possible
3. **Paper tray button**  
Get direct access to the tray section on the operator panel to do the following:
  - Check the content of all paper trays.
  - Load a new media type into a paper tray.
  - Change the media type which is available in one of the paper trays.
  - Create a trace log on a USB stick. If an 11504 error is displayed, insert a USB stick and press this key to create a trace log on the stick.
4. **USB port**  
Used for:
  - Connect spectrophotometer for calibration
  - USB-stick for software installation
  - USB-stick for backup/Restore

- USB-stick to scan to and/or print from
  - USB-stick to store log-files
  - USB-stick for installation of patches and licenses
5. **Schedule button**

Access the 'Schedule' view to manage the jobs in the schedule.
  6. **Jobs button**

Access all functions to print, copy and scan documents.

    - Manage or change the settings of jobs in the lists of Waiting jobs, Scheduled jobs and Printed jobs.
    - Carry out copy jobs and scan jobs.
  7. **Paper tray button**

Get direct access to the tray section on the operator panel to do the following:

    - Check the content of all paper trays.
    - Load a new media type into a paper tray.
    - Change the media type which is available in one of the paper trays.
  8. **System button**

Access the System section to do the following, for example:

    - Check the status of the toner, staples and other supplies.
    - Read the counters
    - Start maintenance
    - Set up the preferred work flows
    - Change a number of default system settings
    - Adjust the brightness and contrast of the LCD panel
    - Shut down the host machine
    - View the content of the Media catalogue or add temporary media to the Media catalogue
  9. **Dashboard**

The dashboard displays information about the system status such as:

    - Information about the current printing process
    - Information about operator intervention that is required soon
    - Information about errors
    - Information about the status of the toner reservoir and staple cartridges
  10. **Status LED**

This LED describes the status of the system and also applies for the operator attention light.

    - **Green:**

The machine is busy printing. No operator attention required
    - **Orange:**

The machine will stop soon, e.g. because an output location is almost full or more paper is required
    - **Red:**

The machine has stopped, e.g. because a required media type is not available or an error has occurred. Operator attention is required.

# System settings

In the [Setup] tab of the [System] section some important settings can be made regarding system setup.

## System setup

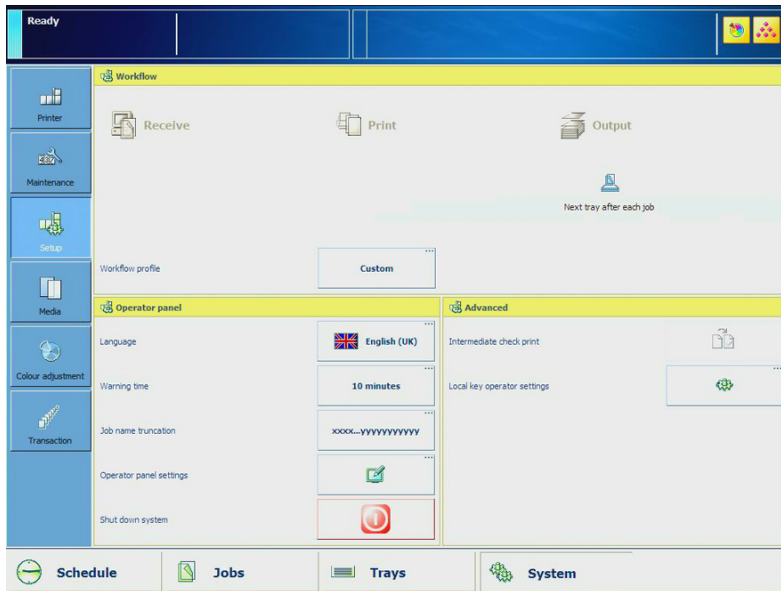

## settings

- **[Workflow profile]**  
Select a workflow profile or manually define the settings that match your needs.
- **[Language]**  
[Change language] of the operator panel.
- **[Warning time]**  
Define the moment when the [System] warns you about an action that is required soon, for example 10 minutes in advance. The warning is displayed in the dashboard and indicated through the operator attention light.
- **[Job name truncation]**  
Define the way the [System] shortens the job name when the job name is too long to display fully.
- **[Operator panel settings]**  
Adjust the brightness and contrast of the screen of the operator panel.
- **[Shut down system]**  
[Shut down] the host machine and the controller in a controlled way.

The advanced section displays the following button.

- **[ Intermediate Check Print]**  
Press the button to force a test print from the current job. This print is used for evaluation of Print quality.
- **[Local key operator settings]**  
Get direct access to a number of important key operator settings in the Settings Editor on the PRISMAsync for imagePRESS C800 Series controller.

## Local access to settings of the Settings Editor

The Settings Editor application on the PRISMAsync controller is a web based application that allows key operators and system administrators to adapt the system completely to the situation in an organisation and production environment. The Settings Editor allows key operators and system administrators to manage settings with regard to network configuration, system preferences, job preferences and media.

For convenience reasons, a subset of frequently used settings is accessible through the operator panel.



### NOTE

You need the Key operator, Service or the System Administrator password to make changes in this section.

#### 1. About

- [Serial number] (read only)
- [Version of printer software] (read only)
- [Upgrade software (from USB)]  
With this option you can install a patch on the PRISMAsync controller.
- Upgrade software (from server)  
With this option you can install a patch that is stored on a remote server. If there is a patch available it will be downloaded and installed

#### 2. Software licenses

- [Upload] license  
When you have a new license to activate a new feature on the printer, you can upload the license file through this section. After uploading the license file, the feature becomes active

#### 3. [Logging]

- [Save the datadump file]  
When an error occurs, you can create a datadump file. The datadump file is a .zip file that contains detailed technical information about the [System].
- [Save the trace file]  
The [System] can also store trace log files in .zip files. These contain an even more detailed and technical description of occurrences in the [System].
- [Print the configuration report]  
The configuration report contains information about the configuration of your printing [System], for example information about the [System] configuration, controller configuration or network settings.

#### 4. [Connectivity]

The [Connectivity] section contains the main settings to integrate the printer into a network. After you adapted the network settings, you can test the connection from here. A more detailed description of the settings can be found in the Settings Editor Document.

- [MAC address] (read-only)
- [Host name]
- [Link speed and connection type]
- [Primary DNS suffix]
- [DNS suffix follows domain]
- [Test the TCP/IP connection]
- [DHCP enabled]
- [TCP/IP address]
- [Subnet mask]
- [Default gateway]
- DNS 1
- DNS 2
- WINS 1
- WINS 2

- [IPv6 enabled]
  - [IPv6 DHCP enabled]
  - [IPv6 TCP/IP address]
  - [IPv6 link local address]
  - [IPv6 prefix length]
  - [IPv6 gateway]
  - IPv6 DNS 1
  - IPv6 DNS 2
5. **[System settings]**
- [Date and time]
  - [System of measurement]
  - [Time zone]



# Maintenance and Service

## Introduction

This topic describes the different maintenance and service screens for the PRISMAsync.

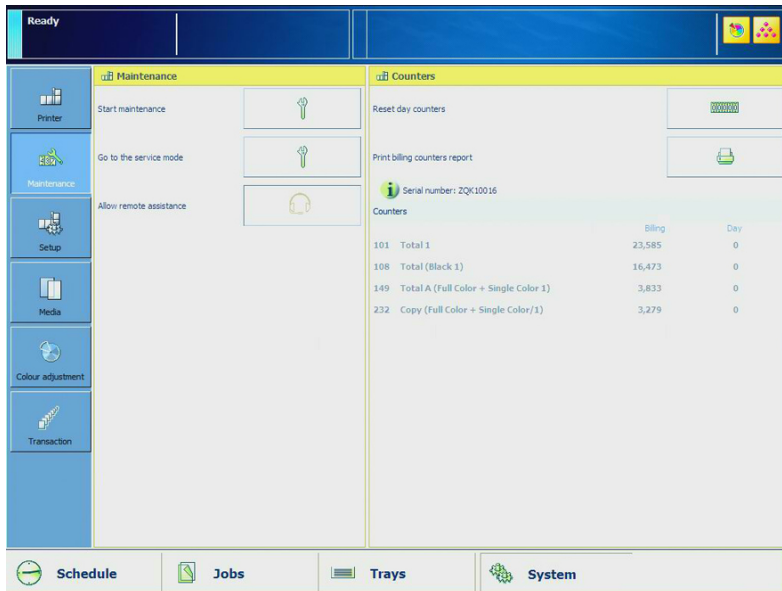

The maintenance screen displays the following information.

- Maintenance:
  - [Start maintenance] to enter [Maintenance mode on page 37](#).
  - [Go to service mode] to enter [System service and engine service mode on page 38](#).
  - [Allow remote assistance] to allow to the system by a service help desk.
- Counters:
  - [Reset day counters]
  - [Print billing counter report]
  - Counters

Each counter has two values. The first value displays the total number of prints that have been made since the machine was installed. The second value displays the same counters but this value can be reset to "0" (e.g. reset the day counters at the beginning of a working day). In Service Mode it is possible to select which counters to display and additional toner bottle counters can be added.

## Maintenance mode

When you push the [Start maintenance] button you will enter a mode in which you can perform some adjustments to the system. All the adjustments are guided by a wizard to make your job easier. A password is required to enter the maintenance mode (default: 12345).

1. **Stacker: Replace flip rings**  
A wizard to help you replace the four flip rings of the High Capacity Stacker-G1
2. **Auto colour mismatch correction**  
You can automatically correct colour mismatching that occurs in the output. The Auto colour mismatch correction aligns the position of the four different colours.
3. **Clean the clean roller (main unit)**  
If dirt or stripes appear on printed output, clean the roller inside of the main unit. The procedure takes approximately one minute to finish

4. **Clean the corona wires**

If stripes appear on printed output or random parts of the printed image are missing, clean the corona assembly wires inside the main unit.. The procedure takes approximately 35 seconds to finish.

5. **Clean the rollers of the ADF**

If your originals have black stripes or appear dirty after transporting them through the feeder, clean the rollers of the feeder. The procedure takes approximately 20 seconds to finish.

6. **Clean the scanner sensors**

Procedure for cleaning the sensors of the scanner/reader.

7. **Refresh the fixing belt**

When paper with a longer width is used after copying or printing 100 or more sheets of paper with a shorter width (for example, when you use A3 paper after A4R paper), gloss lines may appear on both edges in the feeding direction. In addition, patches of uneven gloss may appear in the high density areas of the printed heavy paper or coated paper. In this case, the lines and patches of uneven gloss may be reduced by refreshing the fixing roller and cleaning its surface.

### System service and engine service mode

To enter service mode via the maintenance screen:

1. Select the **[Go to the service mode]** button.
2. Enter the PIN
3. The following screen is displayed:

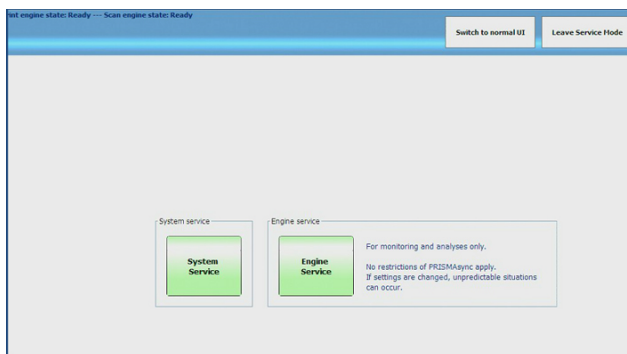

- Select **[System Service]** to access the PRISMAsync service mode. For a detailed description see: [System service mode \(PRISMAsync service mode\) on page 39](#)
- Select **[Engine Service]** to access the print engine service mode during printing. This mode is used for monitoring and analyses during printing. For a detailed description see: [Engine service mode \(during printing\) on page 42](#)



#### NOTE

The Engine Service mode (during printing) is only accessible via the [Maintenance] tab in normal user mode.

# System service mode (PRISMAsync service mode)

## Introduction

The system service mode is the Service Diagnostic System (SDS) as available on the PRISMAsync controller.

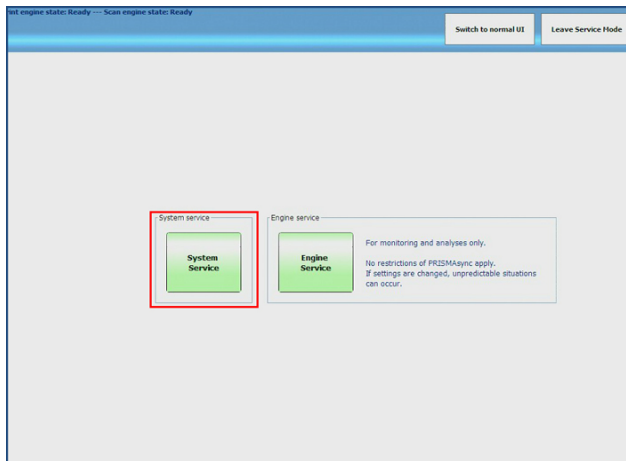

The SDS is used by the FST to configure, diagnose, backup and restore settings, for the print engine, accessories and PRISMAsync controller.

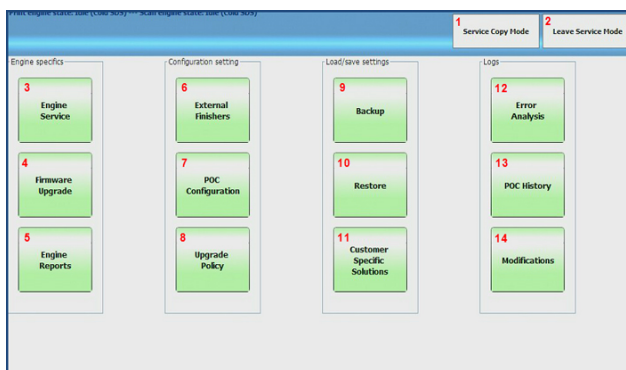

## System service mode (PRISMAsync service mode)

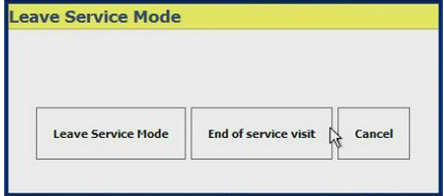

No.	Function	Additional
1	<b>[Service Copy Mode]</b> This button is used to temporarily switch to Normal mode. In this mode printing and scanning is possible. You can re-enter SDS without the need of the PIN.	NOTE Printing must be stopped before re-entering Service mode

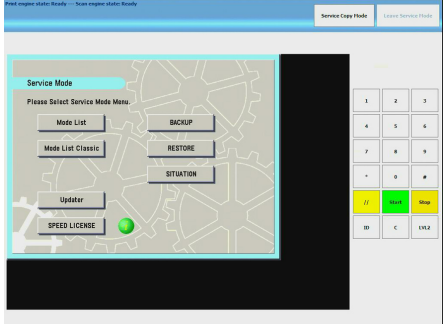
No.	Function	Additional
2	<p><b>[ Leave Service Mode]</b></p> <ul style="list-style-type: none"> <li>• [Leave Service Mode]: leaves the service mode and switch to the Normal User Mode. This is used to temporarily leave Service Mode.</li> <li>• [ End of service visit]: leaves the service mode and the error analysis tab is cleared and an entry in the data dump file is created before returning to the Normal User Mode.</li> </ul>	
3	<p><b>[Engine Service]</b></p> <p>The [Engine Service] button is used enter the host machine service mode. All service functionality is available.</p> <p> <b>NOTE</b> The [Updater] button is not supported in this screen and therefore the result is unpredictable. The function of the other buttons is described in the service manual of the host machine.</p>	
4	<p><b>[Firmware Upgrade]</b></p> <p>With this button you can start the upgrade procedure of the firmware of the host machine. A USB-stick containing the firmware should be available. The upgrade is done from this USB-stick and not via the SST-tool. See the Service Manual of the host machine for detailed instructions.</p>	
5	<p><b>[Engine Reports]</b></p> <p>In the service mode a sorted list of all durables and periodically replaceable parts of the engine and accessories can be generated and displayed on the operator panel. The list is sorted by lifetime. Doing so is the easiest way for the Field Service Technician to get an overview of the status of all parts. For a more detailed description see the appendix.</p>	
6	<p><b>[External Finishers]</b></p> <p>If there are External finishers connected to the host machine you have to set parameters to make the connection work properly. For a description of the parameters see the Service Manual of the host machine.</p>	
7	<p><b>[POC Configuration]</b></p> <p>In the POC (Printer Operator Care) configuration screen you can determine which key operator tasks the customer is allowed to do with respect to the High Capacity Stacker F1/G1. If it is enabled a wizard appears and guides the customer through these tasks.</p>	
8	<p><b>[Upgrade Policy]</b></p> <p>The Manual upgrade policy is by default disabled and the installed software is controlled by the PRISMAsync controller. If the manual upgrade policy is enabled it is possible to update the software of the host machine and finishers by using an USB stick.</p>	

No.	Function	Additional
9	<p><b>[Backup]</b> Create a backup of the PRISMAsync settings. Insert a USB-stick into the USB-port on the operator panel. The system will point to this stick. After accepting the pathname the settings are written to this USB stick. The filename will contain the time of the backup. Always create a backup, before servicing the PRISMAsync controller.</p>	
10	<p><b>[Restore]</b> Restore the settings that were written on the USB-stick during a backup procedure. Insert the USB-stick into the USB-port on the operator panel. The system will ask for a filename. After selecting the correct file, the settings are restored on the PRISMAsync controller. When restoring is ready the PRISMAsync will reboot automatically.</p>	
11	<p><b>[Customer Specific Solutions]</b> For some customers it is possible that specific solutions for their system are made. In this screen you can disable or enable these solutions.</p>	
12	<p><b>[Error Analysis]</b> An overview of the most recent errors is presented on the screen.</p>	
13	<p><b>[POC history]</b> The most recent Key Operator Maintenance actions are presented on the screen</p>	
14	<p><b>[Modifications]</b> An overview of the modifications on the system is presented on the screen. You can view/register modifications for the host machine, the scanner and the PRISMAsync controller.</p>	

# Engine service mode (during printing)

## Introduction

In the PRISMAsync service mode it is not possible to enter Engine Service mode during printing.

To make it possible to enter the Engine Service mode for monitoring and analysis during printing a dialogue is introduced.



### NOTE

The Engine Service mode (during printing) is only accessible via the [Maintenance] tab in normal user mode.

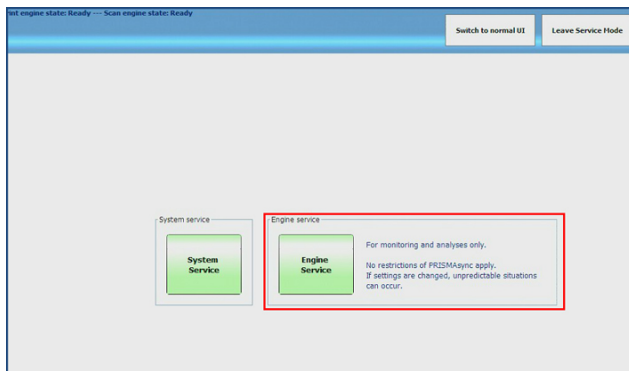

## Engine Service mode



### NOTE

The illustrations below should be used as a reference and might differ from the actual content displayed on the user interface.

**The engine service mode is for monitoring and analysis only. This mode can be used during printing.**

1. Select **[Engine Service]** to enter the engine service mode during a print run.

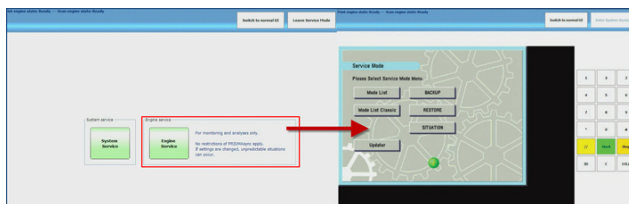

### NOTE

This service mode is only for diagnostic and monitor purposes.

Do not change any settings in the Engine Service mode, changing settings could lead to unpredictable machine behaviour.

2. From the engine service mode select **[Switch to normal UI]** to switch to normal user interface.

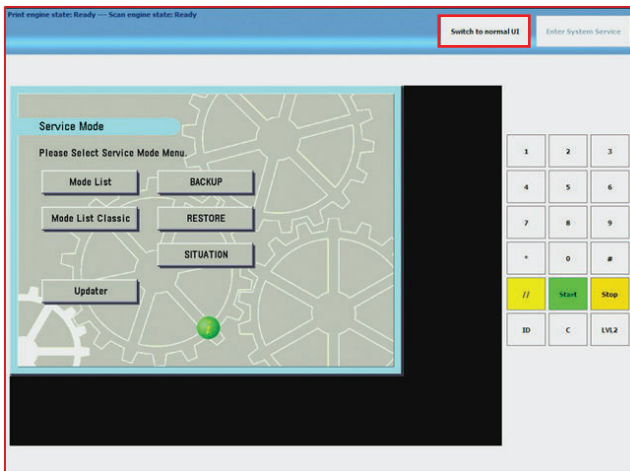

- From the normal user interface select **[Go to the service mode]** to switch back to engine service (during printing).

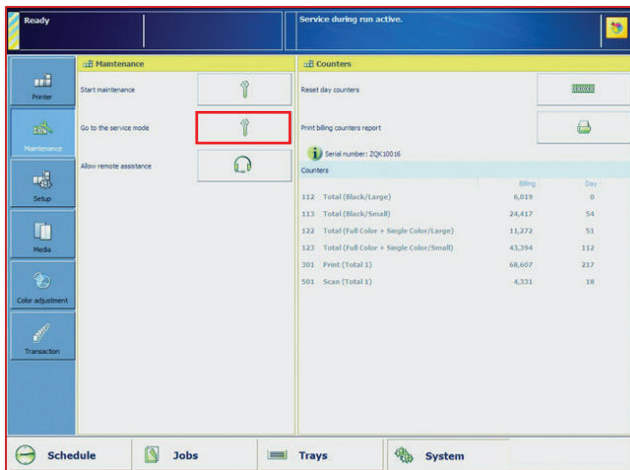

- The coloured bar on the Dashboard in the normal user interface indicates the engine service mode during printing is still active

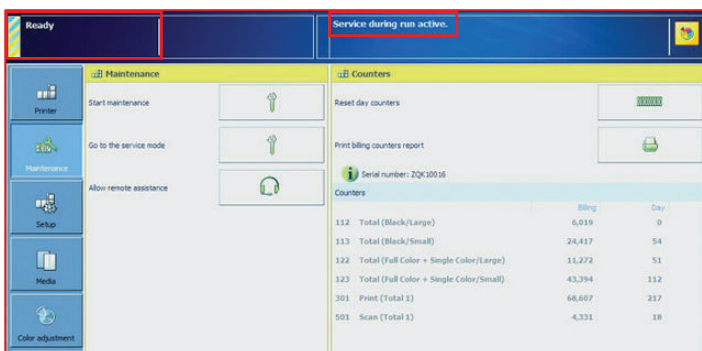

- To leave the engine service mode and return to the normal user mode, select **[Leave Service Mode]**.

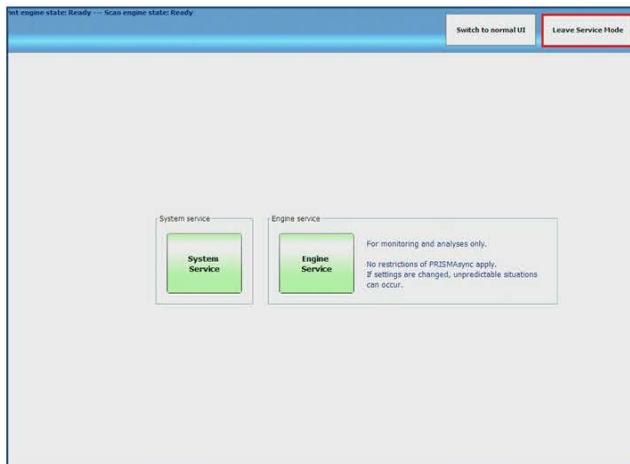





# Service mode and host machine state

## Introduction

This topic describes the different possibilities to enter the Service mode and the corresponding state of the host machine.

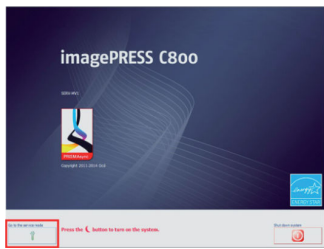
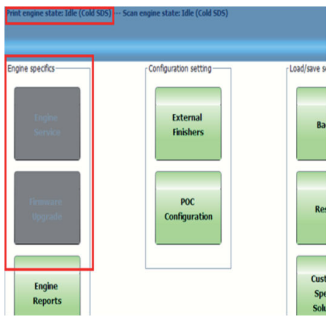
## Service mode and the corresponding host machine state

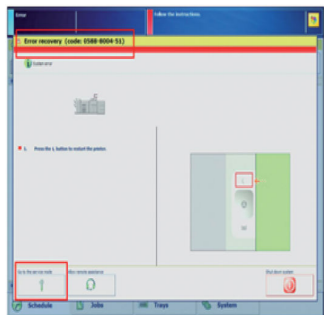
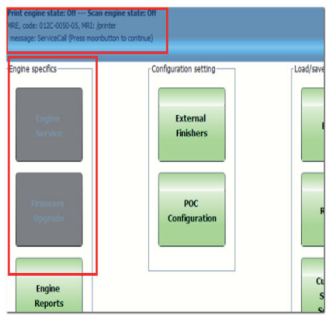
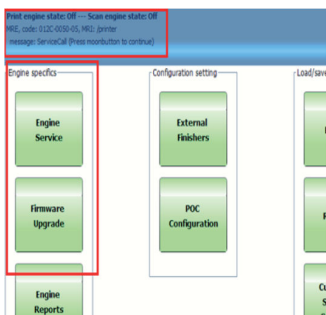
Via the Splash screen	Description	User Interface
 <p>Select [Service mode] on splash screen .</p>	<p>Engine state: Off                      Status bar: Engine Idle (Cold SDS)                      Level = low                      Purpose:</p> <ul style="list-style-type: none"> <li>Analyse and execute settings / adjustments via system SDS</li> </ul>	
	<p>Engine state: On                      Status bar: Engine Idle (Cold SDS)                      Level = low                      Purpose:</p> <ul style="list-style-type: none"> <li>Analyse and execute settings / adjustments via system SDS</li> <li>To analyse the engine when in an error situation</li> </ul>	
After an error occurred	Description	User Interface
 <p>Select [Go to service mode] on error screen</p>	<p>Engine state: Off                      Status bar: Off                      Level = low                      Purpose:</p> <ul style="list-style-type: none"> <li>To analyse the PRISMAsync in an error situation</li> </ul>	
	<p>Engine state: On with error                      Status bar: Off                      Level=low                      Purpose:</p> <ul style="list-style-type: none"> <li>To analyse the engine and PRISMAsync in an error situation</li> </ul>	

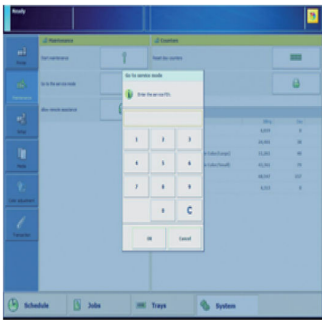
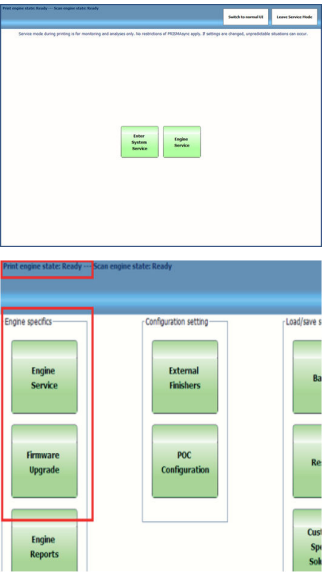
Via the Maintenance tab.	Description	User Interface
 <p>Select [Maintenance] and then [Go to service mode] . Select [Enter System Service] or [Engine Service]</p>	<p>Engine state: On Status bar: Ready Level: Standby Purpose:</p> <ul style="list-style-type: none"> <li>For all situations described above and maintenance checks</li> </ul>	 <p>The user interface shows a status bar at the top with 'Print engine state: Ready' and 'Scan engine state: Ready'. Below this is a grid of buttons organized into three columns: 'Engine specific', 'Configuration setting', and 'Load/save'. The 'Engine specific' column contains 'Engine Service', 'Firmware Upgrade', and 'Engine Reports'. The 'Configuration setting' column contains 'External Fibers' and 'POC Configuration'. The 'Load/save' column contains 'Ba', 'Re', and 'Cust Spk Sok'. A red box highlights the 'Engine Service' and 'Firmware Upgrade' buttons.</p>

## Colour adjustments

In the [System] tab there is a dedicated section called [Colour adjustments] in which colour aspects can be adjusted. In this section you can perform the **Colour calibrations** and **edit the CMYK curves**.

### Calibrations

Due to external environmental circumstances, like temperature and humidity, consumables and print quality change over time. These changes effect the colour quality of the printed documents. Although the printer performs automatic adjustments on a regular basis, you are advised to calibrate the printer configuration regularly. The calibration procedure consists of 3 steps. Always perform these steps in the given order.

- **Shading correction**

The Shading correction procedure corrects slight density unevenness from front to back across an image drum. After measuring a test print the power of the laser beam is automatically adjusted across a laser scan line. The Shading correction assures consistent colour planes over the whole print.

- **Auto gradation adjustment**

The Auto gradation adjustment procedure is a precise calibration of the gradation, density and colour settings of the printer. A test print is used to scan and to correct the irregularities automatically. In this part you can choose between:

1. Full adjustment

This option does the auto gradation adjustment by printing sheets and measuring them, either automatically or via the glass platen.

2. Quick adjustment

The measurement is done without printing any paper but is considered to be less accurate than the Full adjustment. We advise not to use this adjustment.

This calibration can be done for all paper types (normal, heavy, extra heavy) in one step or for each paper type individually. This can be selected in the Settings Editor.

- **Media family calibration**

The Media family is a group of media that uses the same output profile. The controller provides by default the media families coated and uncoated. An expert can create a new media family for a specific group of media. A media family refers to 1 colour profile per halftone: 'Normal', 'Fine' and 'Error diffusion'. The controller has to be calibrated for each media family and halftone.

The shading correction and media family calibration are executed by using an I1 photo spectrometer. The PRISMAsync for imagePRESS C800 Series supports both UV- and non-UV meters.

The customer can set some parameters regarding the engine calibration. These settings are:

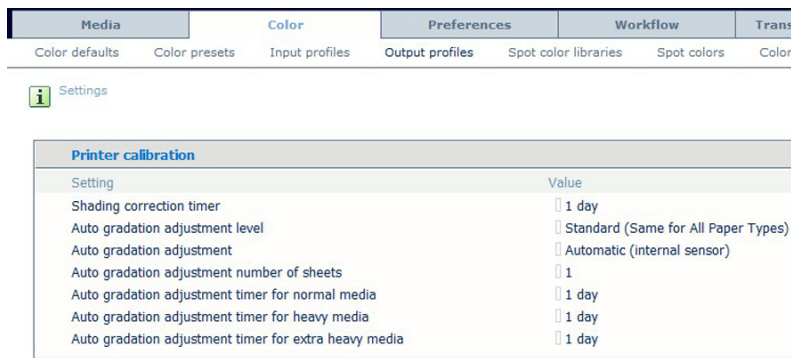

[2] Set calibration settings

- **Shading correction timer**  
When the shading correction timer is enabled, the system indicates that a shading correction adjustment is required. The indication displays at the beginning of the last day of the time interval. To disable the shading correction timer set the time interval to zero days. (Default: 1 Day)
- **Auto gradation adjustment level**  
Set the preferred Auto gradation adjustment level. You can set it to apply the auto gradation to all paper types or to a specific paper type group. (Default: Standard(Same for all paper types))
- **Auto gradation adjustment**  
You can set which method you want to use for Auto gradation adjustment. Possibilities are Automatic (using the internal sensor) or Scanner (using the glass plate). (Default: Automatic)
- **Auto gradation adjustment number of sheets**  
Number of copies of each gradation adjustment chart. Only the last copy of each gradation adjustment chart should be measured. (Value: 1 to 5, Default:1)
- **Auto gradation adjustment timer for normal media**  
When the auto gradation adjustment timer is enabled, the system automatically requests an auto gradation adjustment at the beginning of the last day of the time interval. Set the time interval to zero days to disable the auto gradation adjustment timer. (Default: 1 Day)
- **Auto gradation adjustment timer for heavy media**  
When the auto gradation adjustment timer is enabled, the system automatically requests an auto gradation adjustment at the beginning of the last day of the time interval. Set the time interval to zero days to disable the auto gradation adjustment timer. (Default: 1 Day)
- **Auto gradation adjustment timer for extra heavy media**  
When the auto gradation adjustment timer is enabled, the system automatically requests an auto gradation adjustment at the beginning of the last day of the time interval. Set the time interval to zero days to disable the auto gradation adjustment timer. (Default: 1 Day)



[3] Calibration warning

In the Colour adjustment tab is displayed which calibration has to be executed as a result of reaching the interval.

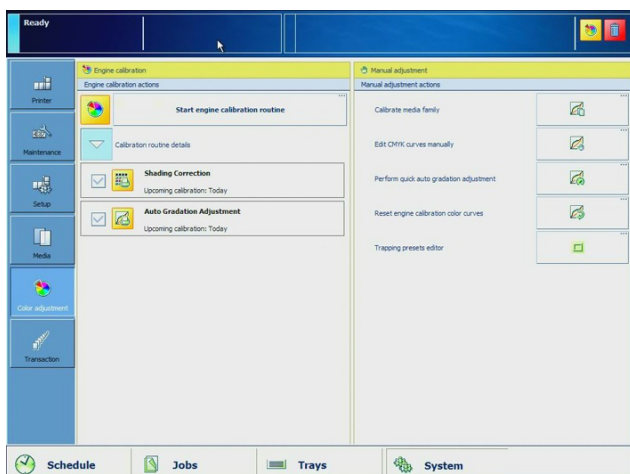

[4] Calibration Screen

In the left part of the screen the calibration parts that are due are checked. By pressing the “Start engine calibration routine” button these checked parts are executed. It is possible to (un)check parts manually, thus overriding the current setting.

In the right part of the screen you can start the Media family calibration. In most cases this calibration does not have to be done very often.

### Edit CMYK curves

With this option you can adjust the CMYK curves per media family and halftone. The settings are applied for all new jobs. It is also possible to edit the CMYK curve for a specific job. This can be done in the properties field of the job. Other jobs will remain unaffected.

You can make adjustments separately for C, M, Y and K.



#### NOTE

When editing the CMYK curves on a system level (not in the properties of the job) you have to do the adjustment for all halftones of the media family. Very often images and fonts are printed with a different halftone. If you only change the curve for one halftone differences in colour will occur between fonts and images.

This is not applicable for changing the curve on a job level.

### Quick Auto gradation

The Auto gradation adjustment procedure is a precise calibration of the gradation, density and colour settings of the printer.

The measurement is done without printing any paper but is considered to be less accurate than the Full adjustment. We advise not to use this adjustment.

### Reset engine calibration curves

It is possible to reset the actual calibration (shading) curves. In the dialogue you have to select the curve to delete. After deletion you have to perform the calibration again to get the best image quality.

### Trapping presets editor

In-RIP trapping is implemented in the PRISMAsync. It is only applicable for the PDF print path (APPE) in document printing mode (Not transaction). It is set on job level.

Trapping is a digital compensation for colour-to-colour mis-registration in the print engine. It typically tries to reduce the white gaps resulting from this mis-registration.

Trapping can generate artificial edges between adjacent objects, so trapping should be used with care.

Trapping in the PRISMAsync:

### Procedure

1. Trapping control & editor on Operator panel
2. Trapping control in Automated Workflow
3. Trapping control in PRISMAprepare & PRISMAaccess
4. Using Adobe in-RIP trapping technology, editable trapping settings are in line with settings of Adobe Creative Suite
5. Set of trap parameters can be saved as trap pre-set on Operator panel; default trap pre-set delivered from factory for easy application
6. Trap settings are shown on printed job ticket, colour configuration report & selectable for information bar
7. Factory default: trapping disabled

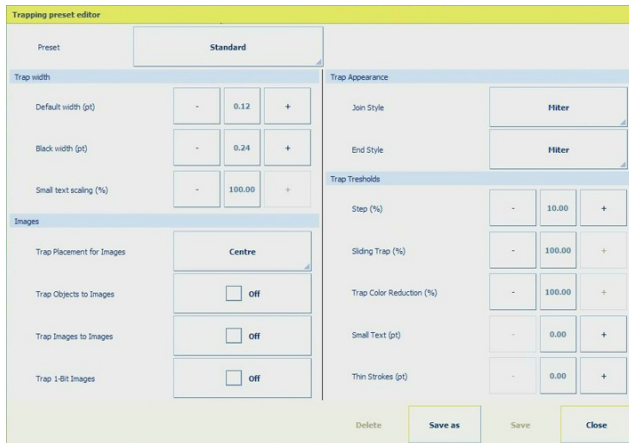

[5] Trapping Preset Editor



### NOTE

See the appendix for a description of the trapping presets.

# Media management

The PRISMAsync for imagePRESS C800 Series uses a [Media] catalogue in which all the possible media that are used, are defined. Definition of these new paper types is done in the **Settings Editor**. On the Operator Panel you can gain access to the catalogue via the [**System**] -> [**Media**] tab.

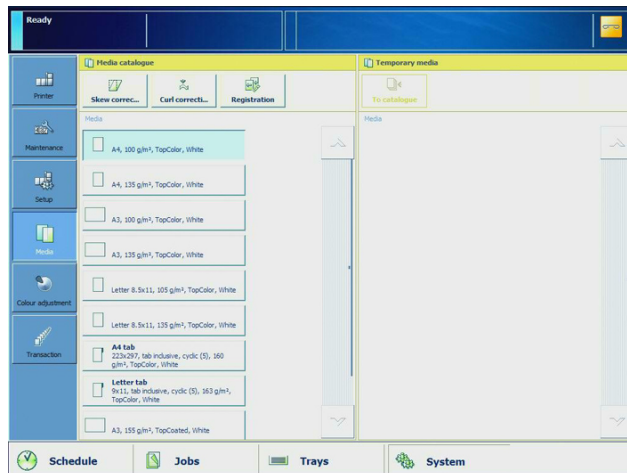

[6] Media management

## Procedure

### 1. Skew and right-angle correction

Select a specific media that you want to adjust. Select the Skew Correction adjustment. A wizard will start, guiding you through the adjustment.

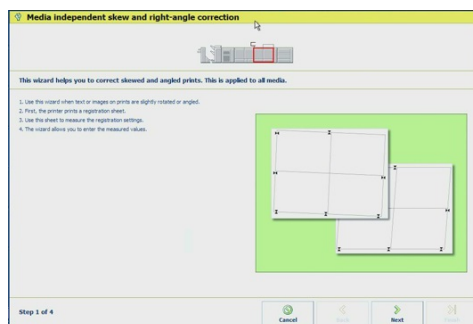

[7] Skew correction

### 2. [Curl correction]

Select a specific media that you want to adjust. Select the Curl correction adjustment. A screen will pop up in which you can enter the values.

Descriptive images tell you if these values need to be positive or negative.

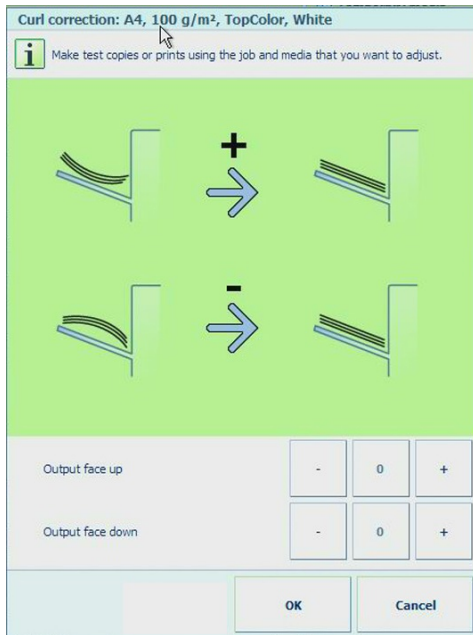

[8] Curl correction

### 3. [Registration]

Select a specific media that you want to adjust. Select the Registration correction adjustment.

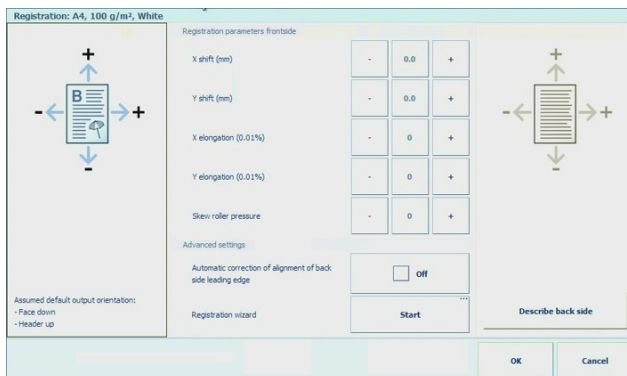

[9] Registration correction

## Result

1. Repeat the procedures for each paper type you want to adjust.
2. The calculated values can be checked in the Settings Editor.



# **Chapter 5**

## **Start, shutdown and restart the system**

## Turn on the system

You are advised to turn on the system in the following order.

1. The host machine
2. The PRISMAsync controller

### Turn on the host machine

1. Put the main power switch of the host machine in the 'I' position.
2. If required, wait until the controller is ready.
3. Press the Sleep button (Moon) at the right-hand side of the operator panel.

### Turn on the PRISMAsync

Use one of the following options to turn on the controller.

1. Press the Sleep button at the right-hand side of the operator panel if the system was shut down from the operator panel.
2. Press the on/off button of the controller



#### NOTE

The controller needs some time to start up. In the beginning the screen will be black. Please be patient until the flash screen appears.

# Turn off the system

## Turn off the system



### NOTE

Leave the power switch of the main unit in the 'I' position.

When the PRISMAsync is off, switch the power button of the main unit to the '0' position. If you switch off the power of the host machine while the PRISMAsync is On, the PRISMAsync will generate an 11506 error.

## To turn off the host machine

### Procedure

1. Select [System] -> [Setup] -> [Shut down system].  
The operator panel displays the message 'Are you sure you want to shut down?'.
2. Select [Yes].  
A message indicates when the shut down will begin. The shut down can take a maximum of 60 minutes.



### NOTE

Using the [Shut down now] option can damage the host machine. Use the [Shut down now] option only to turn host machine off and on within 10 minutes.

## Restart the system

You can restart the system via the Settings Editor or via the operator panel. In both cases only the PRISMAsync will be restarted.

### To restart the system via the Settings Editor

1. Open the Settings Editor (on a PC).
2. Go to [Support] -> [Troubleshooting]
3. Select [Restart the system].

### To restart the system via the operator panel

1. Touch [System] -> [Setup] -> [Shut down system].  
The operator panel displays the message 'Are you sure you want to shut down?'.  
2. Touch [Restart].



#### NOTE

In some cases the system needs to reboot the engine (max. 2x) to reach the correct start-up situation.

## Restart the host machine in service mode

After the host machine is switched off using the power switch an errorcode (11506 Connection lost) will occur. The PRISMAsync has to be restarted to resolve this error.

To reduce the time necessary to restart the PRISMAsync in such a case, two situations are described below to restart the host machine only.

### Restart host machine in Service Mode

1. In Service Mode, switch off the host machine. The following screen will be displayed:

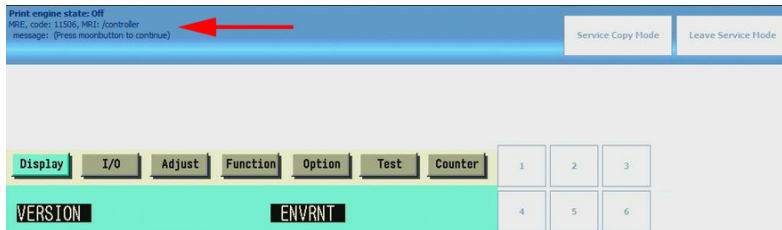

In the bar the error code 11506 is shown and the message "Press moon button to continue" is displayed.

2. Press the [Sleep] button.
  - After this the error will be reset. If you do not press this button and you will switch to normal user mode the error screen will be displayed.
3. The Service screen will not function now because the host machine is off. You might get the following screen.

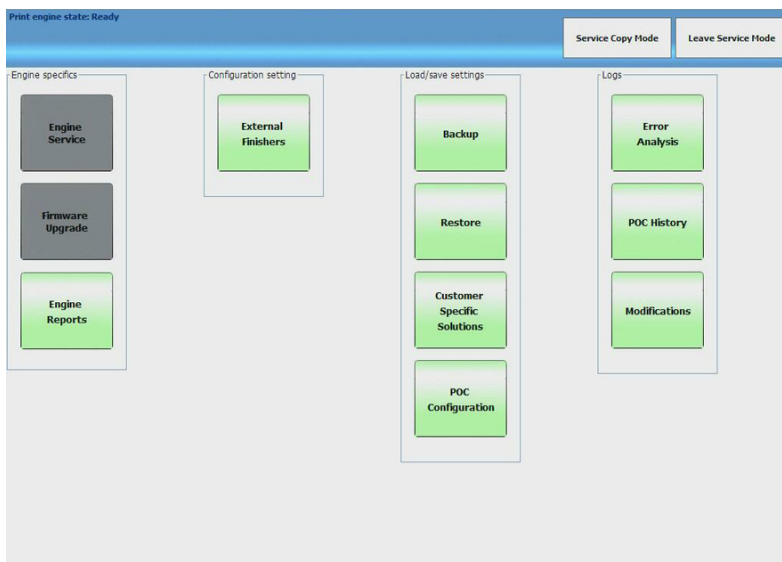

4. Switch on the host machine. After a few seconds the buttons will turn green again.

### Restart host machine in Normal Mode

1. In Normal mode switch off the host machine with the power switch. The following screen will appear.

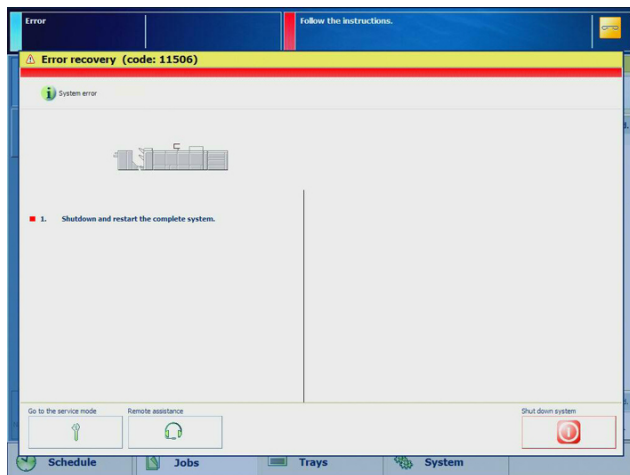

2. Press [Go to the service mode]
3. The next screen will appear.

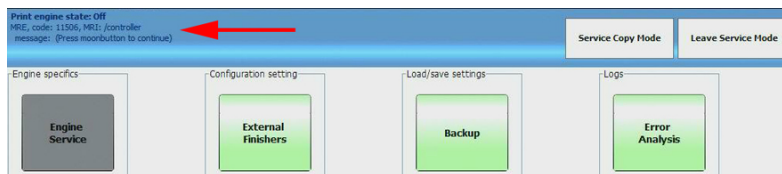

4. Press the [Sleep] button to reset the error.
5. From this point on you have the same situation as previously described (Restart host machine in Service Mode).



### NOTE

In some cases the system needs to reboot the engine (max. 2x) to reach the correct start-up situation.

## Restart the host machine after error has occurred

It is possible to restart the host machine without restarting the PRISMAsync controller. This is useful if an error occurred in the host machine resulting in an E-code.

The customer has to follow the steps indicated at the left side on the operator panel.

### Procedure

1. Switch all finishers and paper modules off
2. Check if power cords are plugged in
3. Wait at least 3 seconds
4. Switch all finishers and paper modules on
5. Press the [Sleep] button to restart the host machine.



#### NOTE

The host machine will restart without restarting the PRISMAsync.



#### NOTE

In some cases the system needs to re-boot the host machine (max. 2x) to reach the correct start-up situation.





# **Chapter 6**

## **The Settings Editor**

## The Settings editor

The Settings Editor is a web-based application and therefore accessible via an Internet browser.

The Settings Editor enables you to manage settings or to display information in the following areas.

- [Media]
- [Colour]
- [Preferences]
- [Workflow]
- [Transaction Printing] (only with IPDS-license)
- [Configuration]
- [Support]

### Accessing the Settings Editor

Before using the Settings Editor make sure that you have the following information:

- The IP-address or hostname of the controller
- The Service- or Key Operator password. (675756 or 13524)

There are 2 ways to get access to the Settings Editor:

- Via a remote PC connected to the client network
- Via a laptop directly connected to the PRISMAsync for imagePRESS C800 Series controller

#### Access via client network

To get access to the Settings Editor do the following:

- Be sure the PC and the PRISMAsync for imagePRESS C800 Series are connected to the client network
- On the PC open an Internet browser (eg. Microsoft Explorer)
- In the address bar, enter the IP-address or the Hostname of the PRISMAsync for imagePRESS C800 Series. As a result the Settings Editor will open. It is now possible to make changes in the above listed areas.

#### Access via direct connection to PRISMAsync for imagePRESS C800 Series

Sometimes you can not access the Settings Editor via the client network. In this case it is better to connect a PC/laptop directly to the PRISMAsync for imagePRESS C800 Series controller.

Follow these steps

### Procedure

1. Disconnect the cross-over Ethernet cable from the copier and connect it to the Ethernet port on your laptop.
2. Set the IP-address of your laptop to 134.188.254.21
3. Set the Subnet mask of your laptop to 255.255.255.0
4. On the laptop open an Internet browser (eg. Microsoft Explorer)
5. In the address bar, enter **http://134.188.254.11**
6. The Settings Editor will open in your Internet browser.

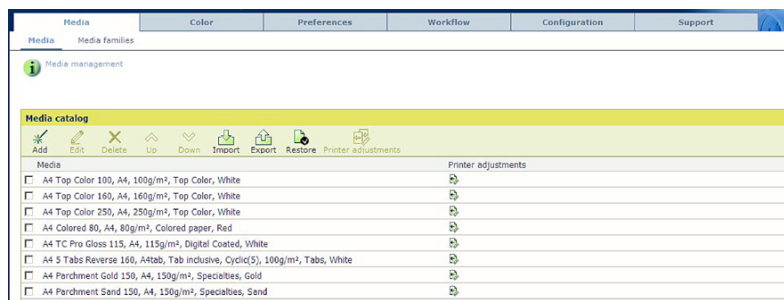

[10] Fig. Settings Editor

**NOTE**

See the Settings Editor user manual for important printer adjustments for media.



# **Chapter 7**

## **Service procedures**

## Service procedures

In general the PRISMAsync controller does not require regular service or maintenance. Use the procedures in this chapter to inspect and/or replace major hardware components.

# Hardware components overview

## Introduction

The following chapters describe the servicing of the following components:

- Boards, cables
- DIMMs (memory modules)
- Fan
- Power supply
- Hard disk drive

## Hardware component overview

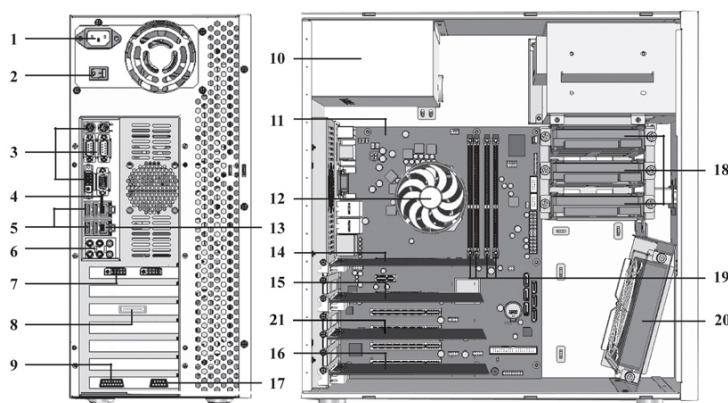

1	Power connector	12	CPU cooler
2	On/Off switch	13	CMD connection copier
3	Not used	14	Graphics board (GPU)
4	Network connection	15	DDI Interface board
5	USB ports	16	AUX control board
6	Not Used	17	Attention light connection
7	UI panel (DVI)	18	Hard Disk Drives (250GB)
8	Data connections copier	19	DIMMs
9	UI panel	20	System fan
10	Power supply	21	Network card (IPDS)
11	Motherboard		



**NOTE**  
See the

## Access internal components

This section describes how to open the PRISMAsync controller and gain access to the internal components.

### Procedure

**1. Shutdown the System.**

If the system is in sleep mode then touch the **On/Off** button to shutdown the system. If the system is not in sleep-mode then touch the [System] tab followed by the [Setup] tab. In this screen touch the **On/Off** button. In the next screen touch [Shut down].

The system will shut down.



**NOTE**

Do not switch off the power button of the copier. It will switch off automatically. You can also touch the **[Sleep]** button when the system is not in sleep mode.

**2. Remove all cables from the back of the PRISMAsync controller.**

If you have wrapped the cables then release the tie-wrap.

**3. Remove the left side cover of the PRISMAsync controller.**

To remove the side cover, remove the 3 screws at the right side on the back of the PRISMAsync controller. Then shift the cover to the back to let it come off.

**4. Open the cable ties attached to the middle bracket.**

These ties are re-usable and are meant for keeping the cable bundles in place and to avoid them from making contact with the fan.

**5. Loosen the 2 spring screws to remove the middle bracket..**

Rotate the bracket a little in counter clockwise direction to get it out of the PRISMAsync. Be careful with the fixings that hold the PCB boards on their position.

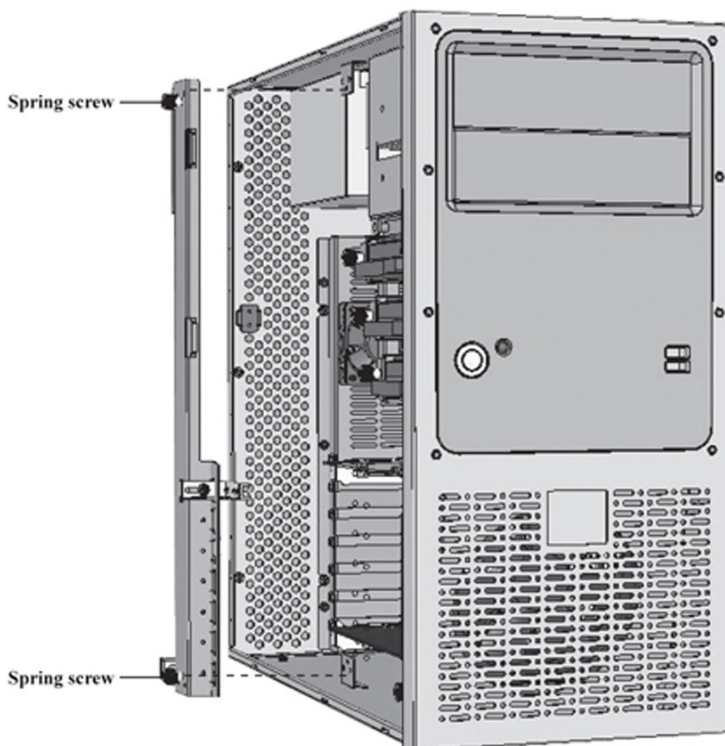

[11] Remove the bracket from the PRISMAsync



## Replace the GPU board



### NOTE

When servicing components of the PRISMAsync always wear a grounded strap around your wrist, to avoid electrostatic discharge that will harm your equipment.



### NOTE

It might be possible that you have to re-install the software of the PRISMAsync after exchanging the GPU.

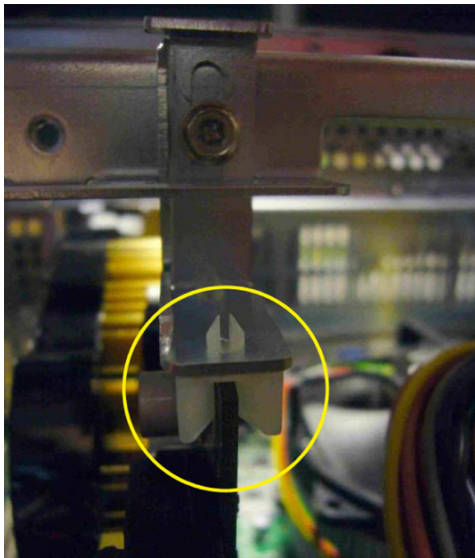
Step	Action
1	<b>Remove side cover and middle bracket.</b> <ul style="list-style-type: none"> <li>Follow the instructions as described in <a href="#">Access internal components on page 68</a></li> </ul>
2	<b>Unplug the power connector of the board.</b>
3	<b>Remove the screw of the metal PCI bracket.</b> <ul style="list-style-type: none"> <li>Use a small Philips screwdriver to remove the screw used to mount the bracket to the backside of the PRISMAsync.</li> </ul>
4	<b>Firmly press the PCI-E lock-mechanism to unlock the board.</b> <ul style="list-style-type: none"> <li>The lock-mechanism is located at the bottom right side of the PCI-E connector on the motherboard. Pressing it down will lift the board out of the connector.</li> </ul>
5	<b>Remove the board from the PRISMAsync.</b>
6	<b>Install the new board in the PCI-E connector.</b> <ul style="list-style-type: none"> <li>Firmly press the board in the PCI-E 1 connector (the upper). Check that the lock mechanism is closed.</li> </ul>
7	<b>Fasten the graphic board.</b> <ul style="list-style-type: none"> <li>Fix the board with a single screw on the PCI bracket side with a Philips screwdriver.</li> </ul>
8	<b>Connect the power connector to the board.</b>
9	<b>Re-install middle bracket and the side cover.</b> <ul style="list-style-type: none"> <li>Make sure the fixing on the middle bracket is in position. It should fit exactly on the GPU-board.</li> </ul>  <p>[12] Fixing of the PCI board</p>

Step	Action
10	<b>Re-install software if necessary.</b> <ul style="list-style-type: none"><li>• Check if the old GPU board is the same as the new one. If not, it could be necessary to reinstall system software needs to be re-installed because of a new driver that is needed for this GPU.</li></ul>

## Replace the DDI board

The DDI board handles the interfacing between the copier and the PRISMAsync for imagePRESS C800 Series.

Only replace the board if you have checked the cables connected to the board.



### NOTE

When servicing components of the PRISMAsync for imagePRESS C800 Series always wear a grounded strap around your wrist, to avoid electrostatic discharge that will harm your equipment.

Step	Action
1	<b>Remove side cover and middle bracket.</b> Follow the instructions as described in <a href="#">Access internal components on page 68</a> .
2	<b>Unplug the power connector and internal connectors of the board.</b>
3	<b>Remove the screw of the metal PCI bracket.</b> Use a small Philips screwdriver to remove the screw used to mount the bracket to the backside of the PRISMAsync for imagePRESS C800 Series.
4	<b>Remove the PCI card from it's slot</b> Hold the PCI card by the two top corners. Pull it straight out of the socket.
5	<b>Take the board out of the PRISMAsync for imagePRESS C800 Series.</b>
6	<b>Unpack the new board.</b>
7	<b>Place the board in the PCI-E connector.</b> Firmly press the board in the PCI-E connector. Use the PCI-E 3 port.
8	<b>Fix the DDI board.</b> Fix the board with a single screw on the PCI bracket side with a Philips screwdriver.
9	<b>Plug the internal connectors to the board.</b>
10	<b>Re-install middle bracket and side cover.</b> Take care that the fixing on the middle bracket is in position. It should fit exactly on the DDI-board.

## Replace the AUX control board

The AUX control board supplies power to the operator panel and controls the Operator Attention Light.



### NOTE

When servicing components of the PRISMAsync for imagePRESS C800 Series always wear a grounded strap around your wrist, to avoid electrostatic discharge that will harm your equipment.

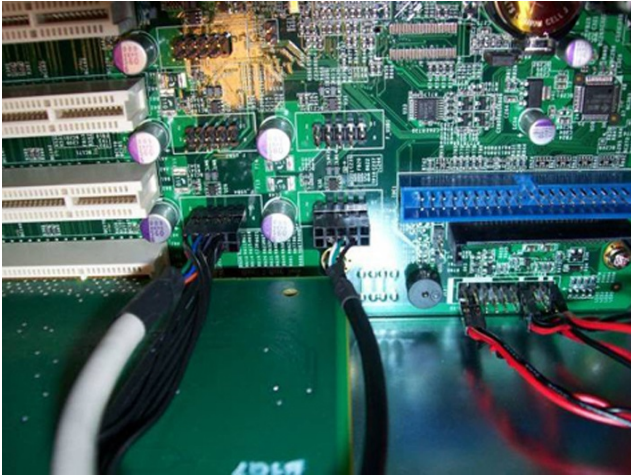
Step	Action
1	<b>Remove side cover and middle bracket.</b> <ul style="list-style-type: none"> <li>Follow the instructions as described in <a href="#">Access internal components on page 68</a>.</li> </ul>
2	<b>Disconnect the power connector and internal connectors of the board.</b>
3	<b>Remove the screw of the metal PCI bracket.</b> <ul style="list-style-type: none"> <li>Use a small Philips screwdriver to remove the screw used to mount the bracket to the backside of the PRISMAsync for imagePRESS C800 Series</li> </ul>
4	<b>Remove the PCI card from it's slot</b> <ul style="list-style-type: none"> <li>Hold the PCI card by the two top corners. Pull it straight out of the socket.</li> </ul>
5	<b>Remove the board from the PRISMAsync for imagePRESS C800 Series.</b>
6	<b>Unpack the new board.</b>
7	<b>Connect the USB-wire connector</b> <ul style="list-style-type: none"> <li>The USB wire connector (white side) must be connected to the Auxiliary Board. Because of the space between Board and controller box, it's advised to do this before inserting the board into the PCI connector.</li> </ul>  <p>[13] AUX board USB connector</p> <ul style="list-style-type: none"> <li>Connect the other side of the connector to the nearest available USB pin header of the motherboard.</li> </ul>  <p>[14] AUX to Motherboard USB connector</p>

Step	Action
8	<b>Install the board into the PCI slot.</b> <ul style="list-style-type: none"><li>Firmly press the board in the PCI connector. Use the PCI 4 port. It is the lowest PCI connector on the Motherboard.</li></ul>
9	<b>Fasten the AUX control board.</b> <ul style="list-style-type: none"><li>Fix the board with a single screw on the PCI bracket side with a Philips screwdriver</li></ul>
10	<b>Connect the internal connectors to the board.</b> <ul style="list-style-type: none"><li>See <a href="#">Access internal components on page 68</a></li></ul>
11	<b>Re-install middle bracket and side cover.</b> <ul style="list-style-type: none"><li>Make sure the fixing on the middle bracket is in position. It should fit exactly on the AUX control board.</li></ul>

## Replace the DDR3 modules

The MB950 board supports four DDR3 memory socket for a maximum total memory of 16GB of the DDR3 DIMM memory type.

The PRISMAsync for imagePRESS C800 Series is equipped with 4x4GB DIMM (total memory size 16GB).



### NOTE

When servicing components of the PRISMAsync for imagePRESS C800 Series always wear a grounded strap around your wrist, to avoid electrostatic discharge that will harm your equipment.

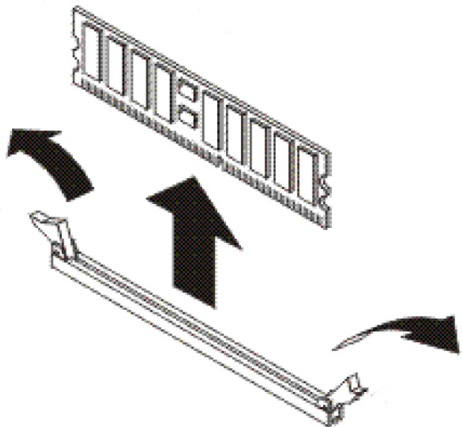
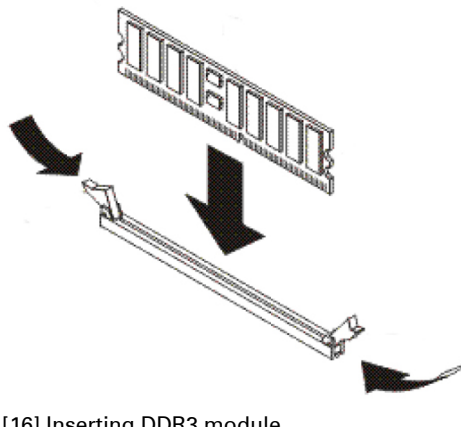
Step	Action
1	<b>Remove side cover and middle bracket.</b> <ul style="list-style-type: none"> <li>Follow the instructions as described in <a href="#">Access internal components on page 68</a>.</li> </ul>
2	<b>Open the clips by pressing them outward.</b> <ul style="list-style-type: none"> <li>Firmly press on the clips on the left and the right side of the connector. The DDR3 module will be lifted out of the connector.</li> </ul>
3	<b>Align the DDR3 module with memory slot.</b>
4	<b>Install the DDR3 module in memory slot</b> <ul style="list-style-type: none"> <li>Gently push the DDR3 module in an upright position until the clips of the slot close, to hold the DDR3 module in place when the DDR3 module touches the bottom of the slot.</li> </ul> <div style="display: flex; justify-content: space-around; align-items: flex-end;"> <div style="text-align: center;">  <p>[15] Removing DDR3 module</p> </div> <div style="text-align: center;">  <p>[16] Inserting DDR3 module</p> </div> </div>
5	<b>Re-install middle bracket and side cover.</b>

## Replace the Hard Disk Drives

The PRISMAsync for imagePRESS C800 Series is equipped with 3 x 250GB 3.5" SATA II HDD @ 7200rpm Hard Disk Drives. One of the drives is used for the System software. The other 2 drives are for data. Please check the table below for connections and purpose.



### NOTE

When servicing components of the PRISMAsync for imagePRESS C800 Series always wear a grounded strap around your wrist, to avoid electrostatic discharge that will harm your equipment.

HDD # (position)	Connector	Purpose
0 (top)	SATA J18	System disk
1 (middle)	SATA J24	Data
2 (bottom)	SATA J16	Data



### NOTE

- After replacement of the HDDs you will have to re-install the system software.
- Always exchange all 3 drives at once.
- The 2 data drives are Raid0 configured. This means that if 1 disk has crashed, all the data will be lost.

Step	Action
1	<b>Remove side cover.</b> <ul style="list-style-type: none"> <li>• Follow the instructions as described in <a href="#">Access internal components on page 68</a>.</li> </ul>
2	<b>Disconnect the connectors.</b> <ul style="list-style-type: none"> <li>• Unplug the power and the SATA connectors on the HDD.</li> </ul>
3	<b>Remove the 2 screws on the front side.</b>
4	<b>Slide the HDD outward.</b>
5	<b>Insert the new HDD until it clicks into position.</b>
6	<b>Fasten the HDD with the 2 screws</b>
7	<b>Connect the connectors.</b> <ul style="list-style-type: none"> <li>• Plug the power and the SATA connector on the HDD.</li> </ul>
8	<b>Repeat steps 2 thru 7 for the other 2 HDDs</b>
9	<b>Re-install middle bracket and side cover.</b>
10	<b>Re-install the system software.</b> <ul style="list-style-type: none"> <li>• See <a href="#">Re-installation of the system software on page 109</a>.</li> </ul>



## Install/Replace the Ethernet board

The extra Ethernet board (Intel PRO/1000 GT Desktop Adapter) is needed when IPDS functionality is enabled (Extra license). The board is needed for the Codishell tool to analyse IPDS-problems. It can also be used to connect the laptop to the PRISMAsync for imagePRESS C800 Series.

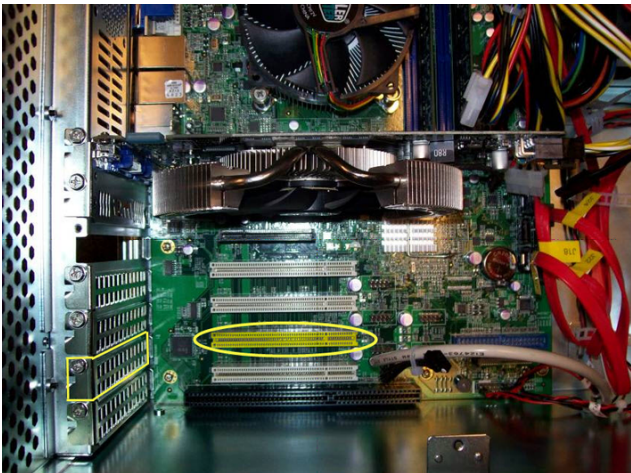

**NOTE**

When servicing components of the PRISMAsync for imagePRESS C800 Series always wear a grounded strap around your wrist, to avoid electrostatic discharge that will harm your equipment.

Step	Action
1	<p><b>Remove side cover and middle bracket.</b></p> <ul style="list-style-type: none"> <li>Follow the instructions as described in <a href="#">Access internal components on page 68.</a></li> </ul>
2	<p><b>Unpack the new board.</b></p>
3	<p><b>Remove the fifth metal bracket (starting from the CPU).</b></p> <ul style="list-style-type: none"> <li>Use a Philips screwdriver to remove the bracket..</li> </ul>
4	<p><b>Place the board in the PCI connector.</b></p> <ul style="list-style-type: none"> <li>Firmly press the board in the PCI connector.</li> </ul>  <p> <b>NOTE</b> Make sure to use the indicated slot.</p>
5	<p><b>Fasten the Ethernet board.</b></p> <ul style="list-style-type: none"> <li>Fasten the board with a single screw on the PCI bracket side with a Philips screwdriver.</li> </ul>
6	<p><b>Re-install middle bracket and side cover.</b></p> <ul style="list-style-type: none"> <li>Make sure the fixing on the middle bracket is in position. It should fit exactly on the Ethernet board.</li> </ul>
7	<p><b>Re-install system software</b></p> <ul style="list-style-type: none"> <li>If the Ethernet board is installed for the first time (no replacement) there will be no driver installed for it. Therefore you have to re-install the PRISMAsync software.</li> </ul>



## Replace the Base controller

If it is clear that an error can only be solved by replacing the motherboard a new base controller can be ordered as a service part. This controller has all the hardware in it without the extra boards that are added to make it a PRISMAsync controller (DDI board, AUX Control Board, Ethernet Board, 22W1 Harness).



### NOTE

When servicing components of the PRISMAsync for imagePRESS C800 Series always wear a grounded strap around your wrist, to avoid electrostatic discharge that will harm your equipment.

Perform the following actions to exchange the controller:

Step	Action
1	<b>Remove side cover and middle bracket.</b> <ul style="list-style-type: none"> <li>Follow the instructions as described in <a href="#">Access internal components on page 68</a>.</li> </ul>
2	<b>Remove extra boards</b> <ul style="list-style-type: none"> <li>Remove the following boards: <ul style="list-style-type: none"> <li>DDI board (See: <a href="#">Replace the DDI board on page 71</a> )</li> <li>AUX Control board (See: <a href="#">Replace the AUX control board on page 72</a> ) Check if you need a newer version of the AUX control board. (See conditions above) If so, you do not have to remove the board.</li> <li>Additional Ethernet board (IPDS) (See: <a href="#">Install/Replace the Ethernet board on page 76</a> )</li> <li>(Optional) HDDs. (See: <a href="#">Replace the Hard Disk Drives on page 75</a> ) If HDDs are still working you can exchange the hard disks. In this case all settings and jobs will be saved and no new system software installation is needed.</li> </ul> </li> </ul>
3	<b>Remove harness 22W01</b>
4	<b>Remove the connections at the backside of the PRISMAsync</b>
5	<b>Unpack the base controller</b>
6	<b>Remove side cover and middle bracket.</b> <ul style="list-style-type: none"> <li>Follow the instructions as described in <a href="#">Access internal components on page 68</a> .</li> </ul>
7	<b>Insert previously removed boards</b> <ul style="list-style-type: none"> <li>Insert the following boards: <ul style="list-style-type: none"> <li>DDI board (See: <a href="#">Replace the DDI board on page 71</a> )</li> <li>AUX Control board (See: <a href="#">Replace the AUX control board on page 72</a> ) Re-use the old board if possible, otherwise insert the new board. Be aware that you have to connect the 22W01 harness too.</li> <li>Additional Ethernet board (IPDS) (See: <a href="#">Install/Replace the Ethernet board on page 76</a> )</li> <li>(Optional) HDDs. (See: <a href="#">Replace the Hard Disk Drives on page 75</a> ) See conditions above if it is possible to re-use the HDDs.</li> </ul> </li> </ul>
8	<b>Connect Harness 22W01</b> <ul style="list-style-type: none"> <li>See <a href="#">Connect Harness 22W01 on page 79</a></li> </ul>
9	<b>Re-install middle bracket and side cover.</b> <ul style="list-style-type: none"> <li>Take care that the fixing on the middle bracket is in position. It should fit exactly on the boards.</li> </ul>

Step	Action
10	<b>Install the supports/pedestals</b> <ul style="list-style-type: none"> <li>• See: <a href="#">Install the PRISMAsync supports/pedestals on page 19</a></li> </ul>
11	<b>Connect the cables at the backside of the controller</b> <ul style="list-style-type: none"> <li>• See: <a href="#">Connect the PRISMAsync on page 21</a></li> </ul>
12	<b>Install old HDDs</b> <ul style="list-style-type: none"> <li>• If you have removed the HDDs from the defect controller you can mount them in the new controller. First remove the HDDs that are in the new controller. Be aware that you mount the disks on the same position as they were mounted in the defect controller. See also "Hard Disk Drives".</li> </ul>
13	<b>Install system software</b> <ul style="list-style-type: none"> <li>• In case that the hard disks were not exchanged, you have to install the latest PRISMAsync software.</li> </ul>
14	<b>Restore a backup</b> <ul style="list-style-type: none"> <li>• If you have a backup of the system before it crashed you can restore it now. All settings will be restored except the licenses because they belong to the "old" controller.</li> </ul>
15	<b>Re-host and install licenses</b> <ul style="list-style-type: none"> <li>• Since the MAC-address of the PRISMAsync controller has changed it is necessary to re-host the licenses. Please contact your local service organization for the new licenses.</li> </ul>

## Connect Harness 22W01



### NOTE

When servicing components of the PRISMAsync always wear a grounded strap around your wrist, to avoid electrostatic discharge that will harm your equipment.

### Illustration



[17] Harness 22W01

Step	Action
1	<b>Be sure the AUX control board is mounted correctly in the PRISMAsync</b> 

[18] Connected AUX control board

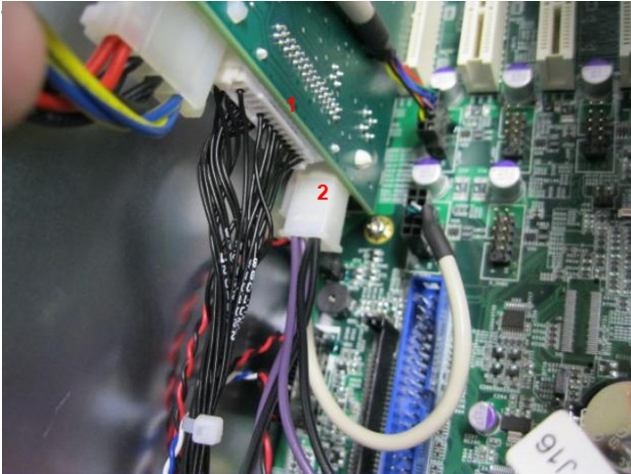
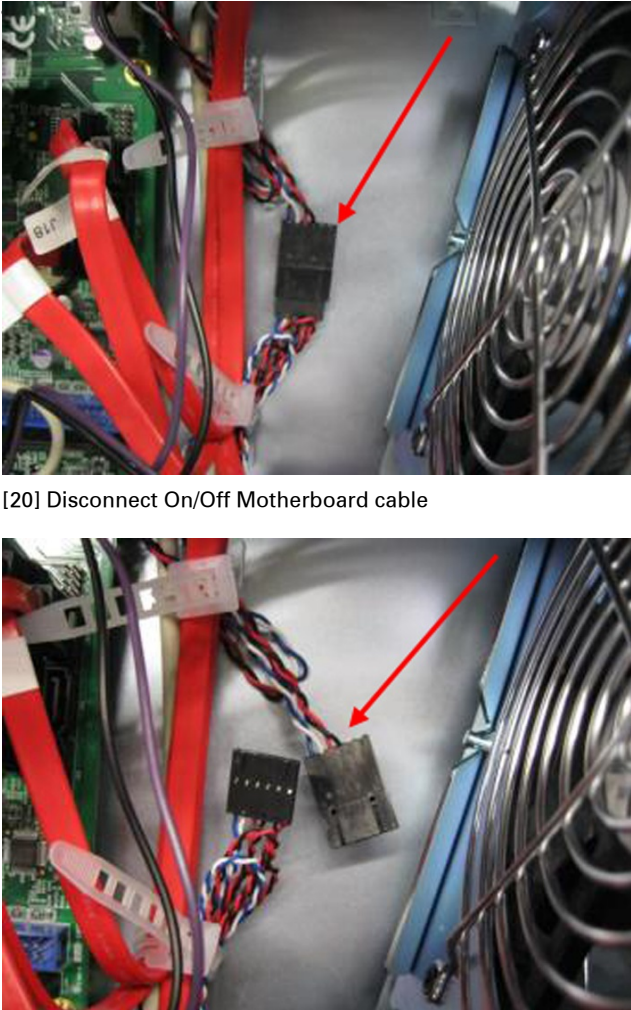
Step	Action
2	<p data-bbox="384 264 954 295"><b>Connect the harness to the AUX control board</b></p>  <p data-bbox="384 786 751 815">[19] Connect harness to AUX board</p> <ol data-bbox="384 833 1161 898" style="list-style-type: none"><li>1. Connect harness 22W1 to the AUX board.</li><li>2. Connect standby power supply connector to the AUX board.</li></ol>
3	<p data-bbox="384 920 900 949"><b>Disconnect the On/Off motherboard cable</b></p>  <p data-bbox="384 1440 820 1469">[20] Disconnect On/Off Motherboard cable</p>

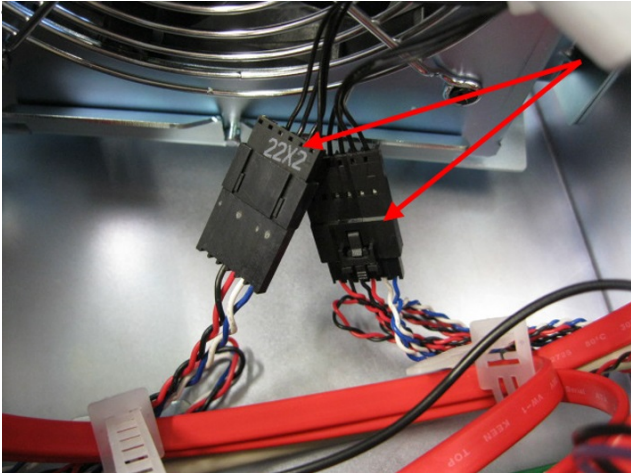
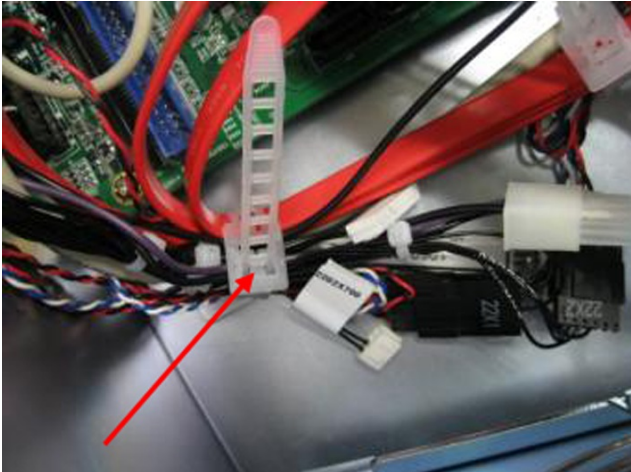
Step	Action
4	<p data-bbox="400 266 1007 295"><b>Connect the harness 22W01 to On/Off connectors</b></p>  <p data-bbox="400 786 836 815">[21] Connect harness to On/Off connectors</p>
5	<p data-bbox="400 851 635 880"><b>Fasten the harness</b></p> <ul data-bbox="400 884 1426 947" style="list-style-type: none"><li data-bbox="400 884 1426 947">• Fasten the harness 22W01 with the bundle holder. Make sure no cables or connectors can touch the fan.</li></ul>  <p data-bbox="400 1438 603 1467">[22] Fasten harness</p>



# **Chapter 8**

## **Firmware upgrades via PRISMAsync**

# Firmware upgrade settings

## Introduction

With the introduction of PRISMAsync v1.2 for the imagePRESS C800 series, the PRISMAsync controller software also contains the firmware for the host machine and its accessories.

By default the firmware supplied with the PRISMAsync software is used for the host machine and accessories. This guarantees a correct operation of the system.

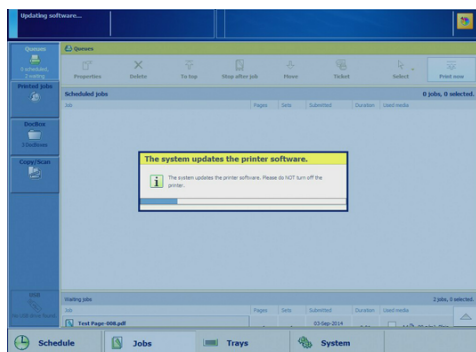

### NOTE

The update at startup is always done incremental.

## Automatic firmware check/update by PRISMAsync at startup (default)

The PRISMAsync software contains the compatible firmware for the host machine and accessories.

By default the PRISMAsync controller checks the firmware installed on the host machine and accessories after pressing the **[Sleep]** button on the operator panel at startup. If the installed firmware differs from the firmware available on the PRISMAsync controller, the firmware will be upgraded or downgraded with the firmware available on the PRISMAsync controller.



### Automatic firmware update by PRISMAsync at startup

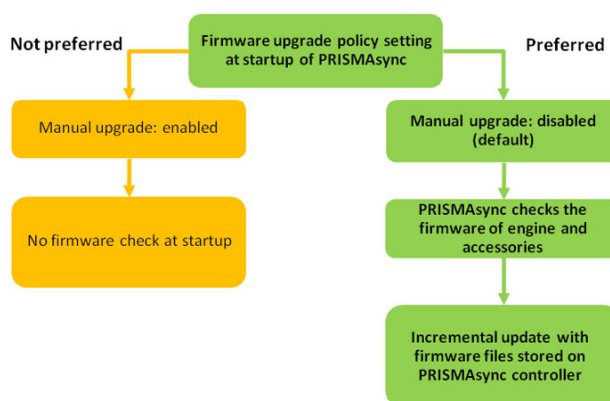

## Firmware upgrade policy

The firmware upgrade policy is controlled by the [Upgrade Policy] setting available in Service mode.

- **Manual upgrade disabled (default)**

By default "Manual upgrade" is disabled. At startup the PRISMAsync controller verifies the installed firmware on engine and accessories. If the installed firmware differs from the firmware stored on the PRISMAsync, the firmware of the engine and accessories will either be upgraded or downgraded with the version on the PRISMAsync. This setting ensures the compatibility between engine firmware, accessories firmware and PRISMAsync software.

- **Manual upgrade enabled**

After "Manual upgrade" is enabled, the PRISMAsync will no longer check the firmware versions on engine and accessories at startup. A firmware update of the engine and accessories can be done by using a USB stick (created with SST tool) which contains the firmware files.

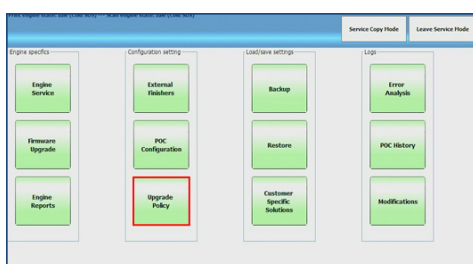

#### NOTE

Enabling "Manual upgrade" could lead to incompatibilities between engine, accessories and PRISMAsync.

## Manual firmware update by Field Service Technician (FST)

Besides the automatic firmware upgrade done by the PRISMAsync controller, it is also possible for a FST to update the firmware of the host machine and accessories. This update can be done

with the firmware files which are available on the PRISMAsync controller (preferred) or with firmware files stored on a USB-stick.

During a manual firmware update it is possible for a FST to look at the detailed feedback of the upgrade. This may be necessary for troubleshooting purposes. It is also possible to change the Upgrade auto setting and force an overwrite of all firmware even if the same version is already installed.

- Firmware update with the files stored on the PRISMAsync controller  
Service mode: [Upgrade Policy] -> manual upgrade disabled (default) -> [Firmware Upgrade]
- Firmware update with files stored on a USB-stick  
Service mode: [Upgrade Policy] -> manual upgrade enabled -> [Firmware Upgrade]



**NOTE**

After "Manual upgrade enabled" is enabled the PRISMAsync controller will no longer check or update the firmware of the engine and accessories at startup.

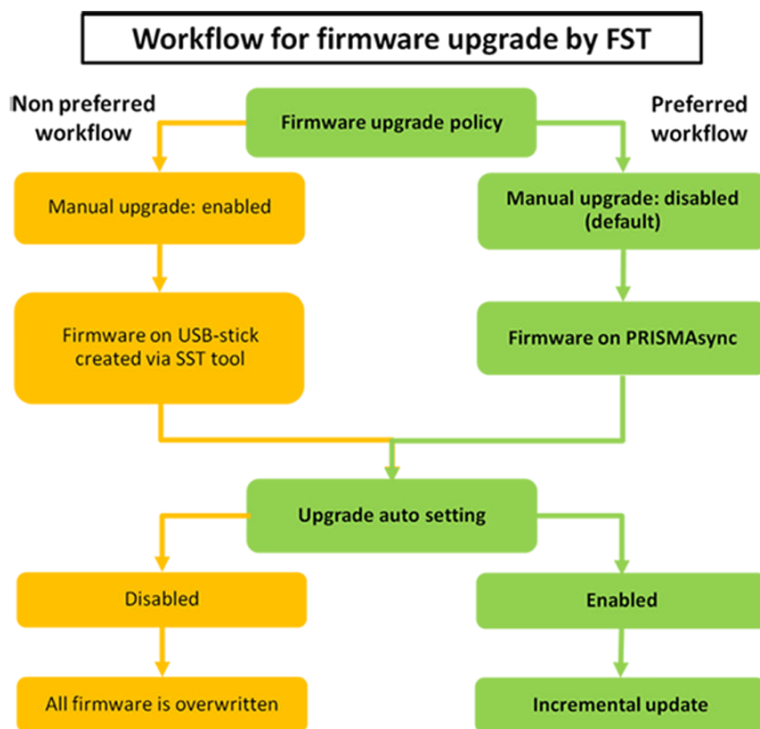

**Upgrade auto settings**

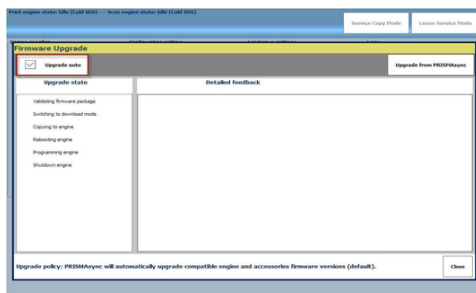

Auto upgrade determines how an upgrade or downgrade is executed. There are two settings:

- **Upgrade auto enabled (default)**

Only firmware files which differ from the installed firmware on engine and accessories are transferred to and installed onto engine and accessories (incremental firmware update)

- **Upgrade auto disabled**

All firmware files are transferred to engine and accessories even if the same version is already installed (overwrite all).

The table below gives an overview of the different settings and their actions

engine or accessories	Installed version	Version on PRISMAsync or USB stick	upgrade auto enabled (default)	Upgrade auto disabled
Module 1	2	3	2 -> 3	2 -> 3
Module 2	5	5	no action	3 -> 3 (overwrite)
Module 3	8	7	8 -> 7	8 -> 7

### Safe download mode

The safe download mode is used in exceptional situations to force the installation of the engine firmware.

See [Firmware upgrade in Safe download mode on page 95](#)

# Firmware upgrade of Engine and Accessories via PRISMAsync (by FST)

## Introduction

This topic describes the preferred procedure for an Field Service Technician (FST) to update engine and accessories firmware.



To make sure firmware installed on engine and accessories is compatible with the PRISMAsync software, the firmware files are distributed together with the PRISMAsync software and stored on the PRISMAsync controller. By default the PRISMAsync checks the installed firmware on engine and accessories at start-up.



It is also possible for a FST to do this manually. During a manual firmware update it is possible for a FST to look at the detailed feedback of the upgrade. This may be necessary for troubleshooting purposes. It is also possible to change the Upgrade auto setting and force an overwrite of all firmware even if the same version is already installed. The procedure below describes the manual firmware upgrade with software available on the PRISMAsync controller.

## Before you begin

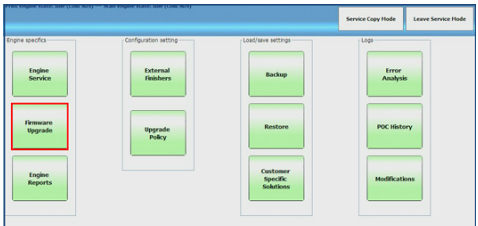
- Manual upgrade must be disabled (default)  
See [Firmware upgrade policy](#) on page 85.

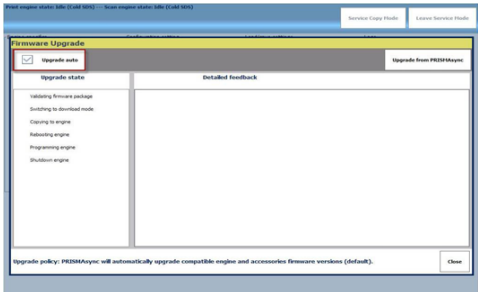
## Firmware upgrade of Engine and Accessories via PRISMAsync by the FST

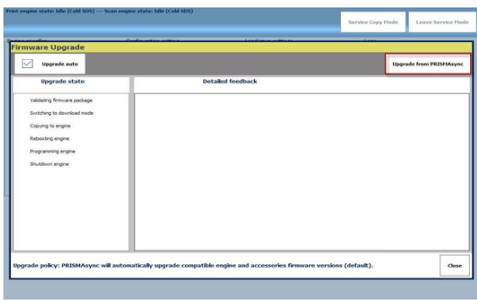
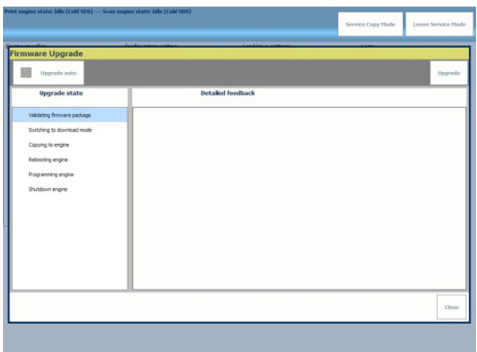
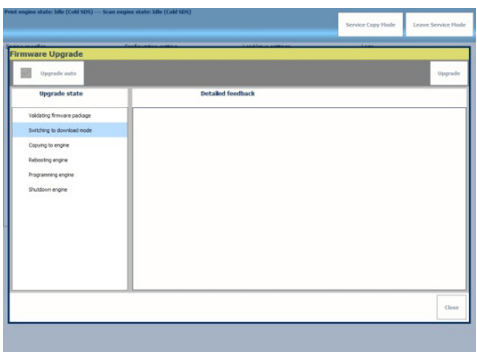
step	Action	additional Info
1	Go to PRISMAsync service mode, and log in.	
2	Select [Firmware upgrade]   <b>NOTE</b> Make sure the Firmware upgrade policy "Manual upgrade" is disabled (default).	
3	Both "Upgrade auto" enabled and "Upgrade auto" disabled are supported. See <a href="#">Upgrade auto settings</a> on page 86   <b>NOTE</b> By default "Upgrade auto" is enabled	

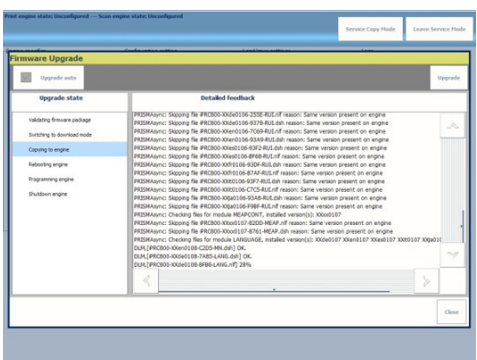
step	Action	additional Info
4	<p>Select [Upgrade from PRISMAsync] Steps 5.1-5.6 will be executed automatically by PRISMAsync.</p>	
5.1	<p>Validating firmware: PRISMAsync will validate the firmware folder of the USB key.</p>	
5.2	<p>Switching to download mode: System will automatically switch to normal download mode</p>	
5.3	<p>Copying to engine: Firmware is transferred.</p> <p> <b>NOTE</b> If "Upgrade auto" is enabled: Only firmware files with a lower or higher version will be transferred to the engine and/or accessories. If "Upgrade auto" is disabled: All firmware files are transferred from the USB to engine and/or accessories</p>	

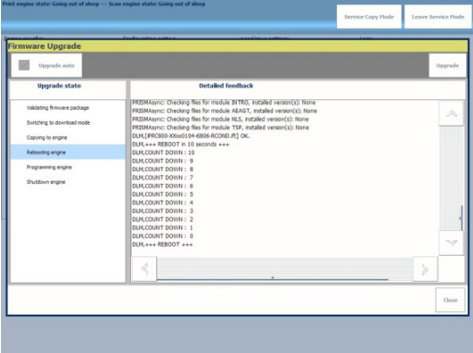
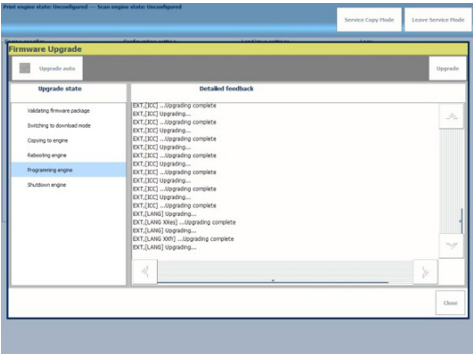
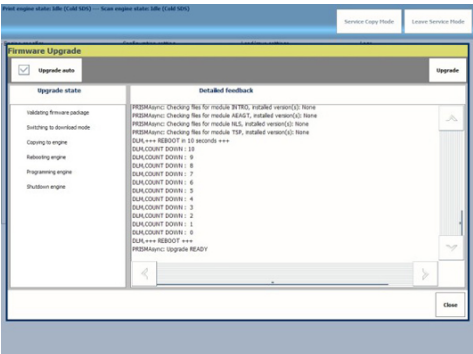
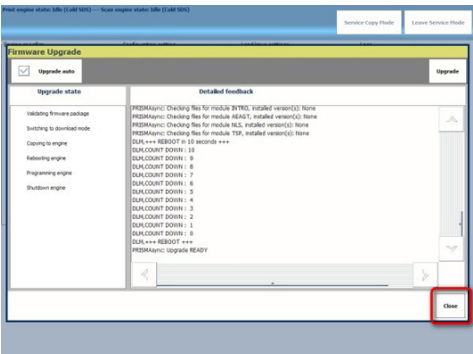
step	Action	additional Info
5.4	Rebooting engine: After files are copied engine will be re-booted.	
5.5	Programming engine	
5.6	Ready	
6	Press [Close] to leave firmware upgrade and return to service mode screen.	

## Example

## Additional information

For additional information see [Firmware upgrade additional information on page 100](#)

# Firmware upgrade of Engine and Accessories from USB stick

## Introduction

This topic describes the firmware upgrade of the host machine and accessories by a FST with a USB stick which contains the firmware files.

By default the PRISMAsync automatically updates the host machine and accessories with compatible firmware stored on the PRISMAsync controller.

After changing the upgrade policy to "manual upgrade enabled", it is possible to update the host machine and accessories firmware from a USB stick.

During a manual firmware update it is possible for a FST to look at the detailed feedback of the upgrade. This may be necessary for troubleshooting purposes. It is also possible to change the Upgrade auto setting and force an overwrite of all firmware even if the same version is already installed.



### NOTE

Changing the upgrade policy to "manual upgrade enabled" may result in incompatibilities between the host machine, accessories firmware and the PRISMAsync software.



### NOTE

After changing the upgrade policy to "manual upgrade enabled" it is no longer possible to upgrade the PRISMAsync software.

## Before you begin

- USB Key created via SST tool as described in service manual of the host machine.
- Create the USB key with the required firmware packages for the applicable PRISMAsync version.







### NOTE

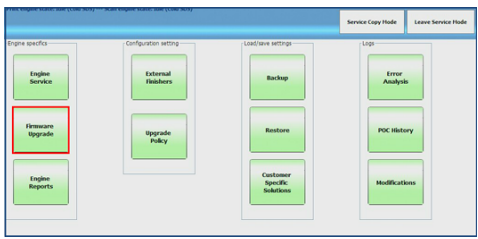

The folder name on the USB key must be equal to the target-name reported by the host machine (e.g. for imagePRESS C800 series folder name is: iPRC800)

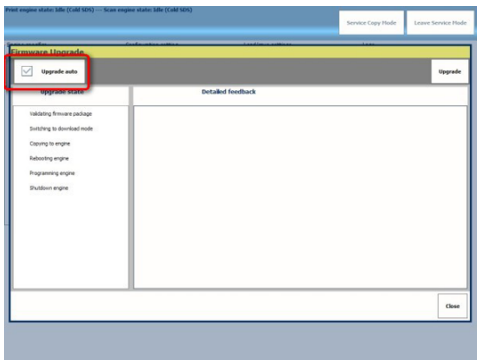
## Firmware upgrade of engine and accessories from USB

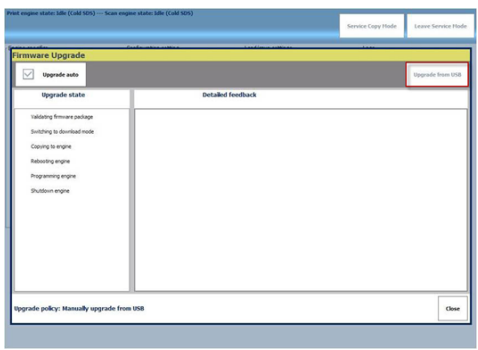
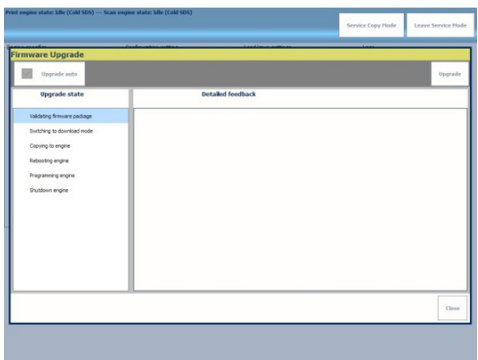
step	Action	additional Info
1	Create a USB key containing the required firmware packages via SST.	
2	Insert USB key in the slot of the PRISMAsync operator panel.	
3	Go to PRISMAsync service mode, and log in.	

step	Action	additional Info
4	Select [Firmware upgrade]   <b>NOTE</b> Make sure the Upgrade Policy is set to "Manual upgrade enabled". This is required to upgrade the firmware from a USB stick	
5	Both "Upgrade auto" enabled and "Upgrade auto" disabled are supported. See <a href="#">Upgrade auto settings on page 86</a>   <b>NOTE</b> By default "Upgrade auto" is enabled	
6	Select [Upgrade from USB]   <b>NOTE</b> Steps 6.1-6.6 will be executed automatically by PRISMAsync.	
6.1	Validating firmware: PRISMAsync will validate the firmware folder of the USB stick.	

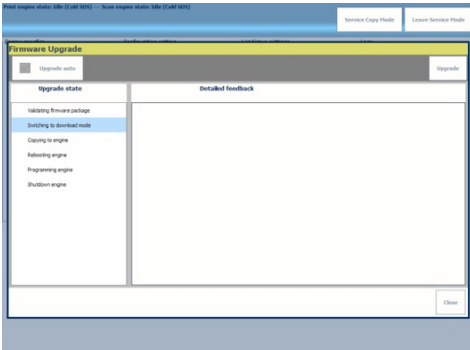

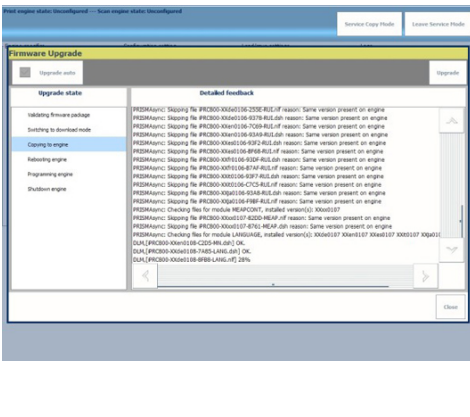
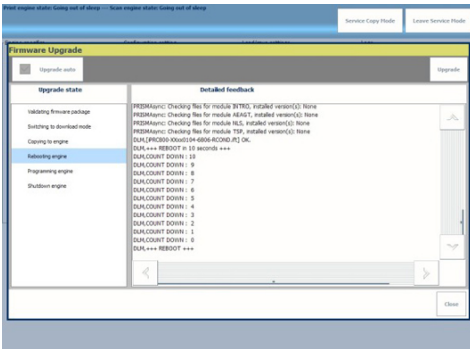
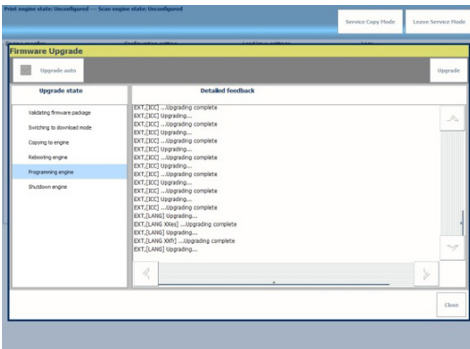
step	Action	additional Info
6.2	Switching to download mode: System will automatically switch to normal download mode	
6.3	Copying to engine: Firmware is transferred   <b>NOTE</b> If "Upgrade auto" is enabled: Only firmware files with a lower or higher version will be transferred to the engine and/or accessories. If "Upgrade auto" is disabled: All firmware files are transferred from the USB to engine and/or accessories	
6.4	Rebooting engine: After all files are copied, the engine will be re-booted.	
6.5	Programming engine	

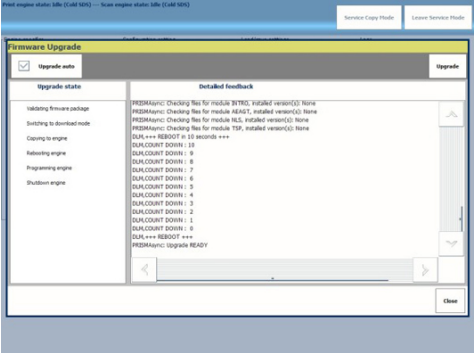
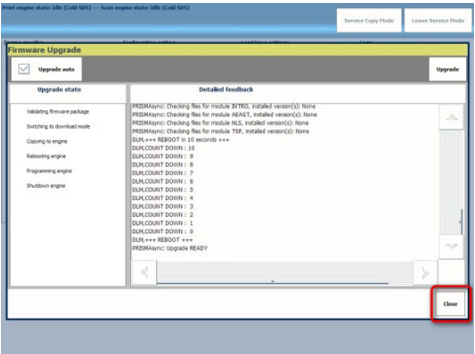
step	Action	additional Info
6.6	Ready	
7	Press [Close] to leave firmware upgrade and return to service mode screen.	

### Example

### Additional information

For additional information see [Firmware upgrade additional information on page 100](#)

# Firmware upgrade in Safe download mode

## Introduction

This topic describes the firmware upgrade of the host machine in the safe download mode. The safe download mode can be used in case it is not possible to update the engine firmware via the normal firmware upgrade procedure.

## Firmware upgrade in safe download mode

- The firmware upgrade can be done via PRISMAsync or via an USB stick
- This procedure is applicable for both "update auto" (incremental) and "update auto disabled" (overwrite all) mode.
- All applicable firmware files are transferred to the engine and accessories but **only engine firmware is installed** the first time after the engine is re-booted. A second re-boot is necessary to install the firmware on the accessories.

## Before you begin



The prerequisites below are only applicable when a USB stick is used to update the firmware.





- USB Key created via SST tool.
- Create the USB key with the required firmware packages for the applicable PRISMAsync version.
- The folder name on the USB key must be equal to the target-name reported by the engine. Example for imagePRESS C800 series folder name is: iPRC800.

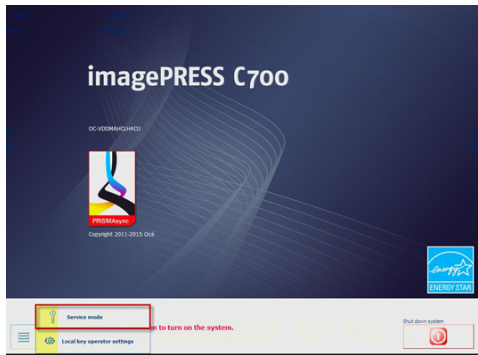



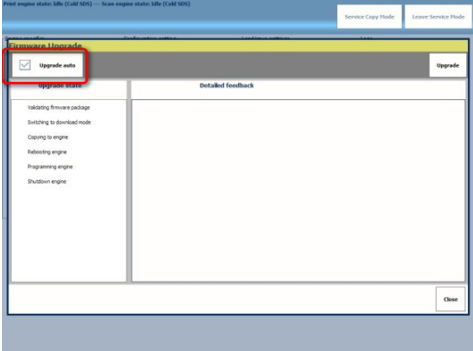

### NOTE

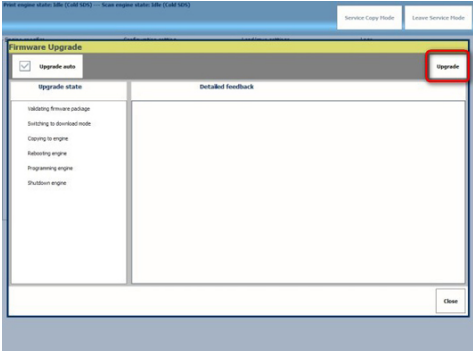
the SST tool will take care that folder name is correct for the applicable product. When they do not match the upgrade is aborted.

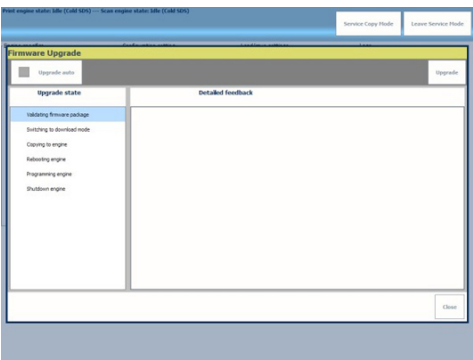
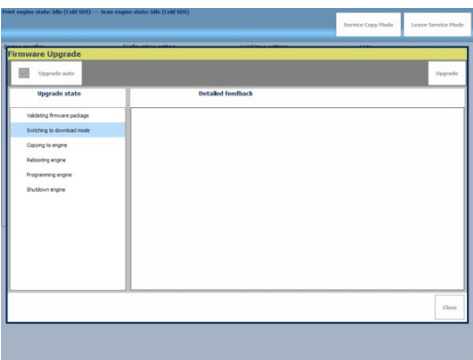
Step	Action	additional Info
1	 <b>NOTE</b> Make sure the engine is switched off.	
2	Switch on the PRISMAsync controller. <ul style="list-style-type: none"> <li>• Select [Service mode] from the splash screen.</li> </ul>	
3	Insert the USB stick in USB slot of PRISMAsync operator panel (if applicable).	 <b>NOTE</b> Manual upgrade must be enabled to upgrade from a USB stick.

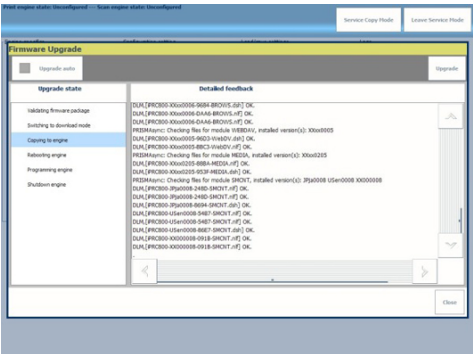
Step	Action	additional Info
4	<ul style="list-style-type: none"> <li>Set dip switch SW1 to "on"</li> <li>Switch on engine</li> </ul>	
5	<p>Blue bar: print engine state; Un-configured</p> <ul style="list-style-type: none"> <li>Select [Firmware Upgrade]</li> </ul> <p> <b>NOTE</b> Make sure the Upgrade Policy is set to "Manual upgrade enabled" to upgrade from a USB stick. Leave "Manual upgrade disabled" to upgrade via the PRISMAsync controller.</p>	
6	<p>Select or deselect [Upgrade auto] See <a href="#">Upgrade auto settings</a> on page 86.</p>	
7.0	<p>Select [Upgrade from PRISMAsync] or Select [Upgrade from USB]</p> <p> <b>NOTE</b> Following steps will be executed automatically by PRISMA-sync.</p>	

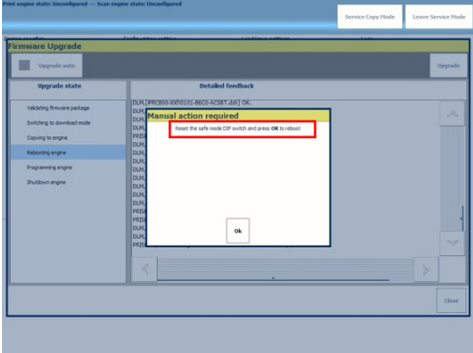
Step	Action	additional Info
7.1	Validating firmware: PRISMAsync will validate the firmware.	
7.2	Switching to download mode: System will automatically switch to download mode	
7.3	Copying to engine.   <b>NOTE</b> Depending on the "Upgrade auto" setting a n incremental update or a full overwrite of the firmware files is done.	

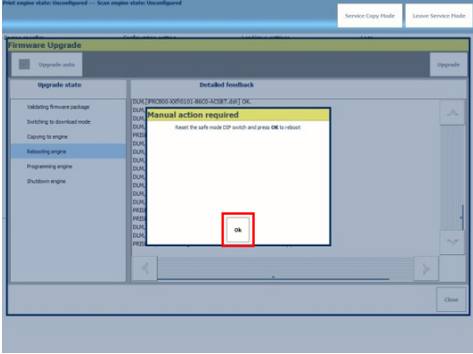
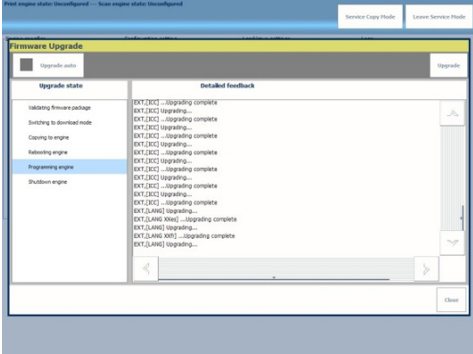
Step	Action	additional Info
8.1	When all files are copied a pop-up screen will appear to: <ul style="list-style-type: none"> <li>Set Dip Switch one (1) to off (0).</li> </ul>	 
8.2	Rebooting engine: Press [Ok] to re-boot the engine.	
9	Programming engine	

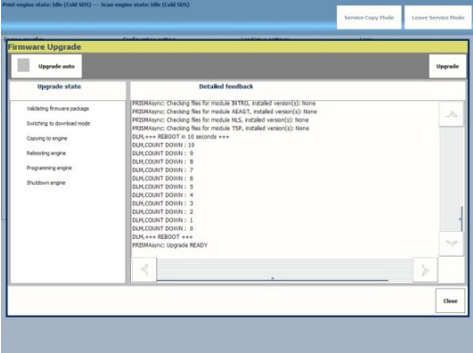
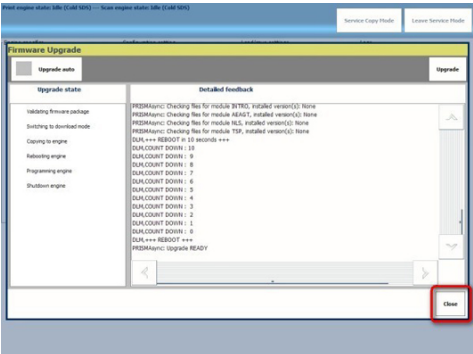
Step	Action	additional Info
10	Ready	
11	Press [Close] to leave firmware upgrade and return to service mode.	

**Example**

**Additional information**

For additional information see [Firmware upgrade additional information](#) on page 100

# Firmware upgrade additional information

## Additional information related to a firmware upgrade

### Feedback:

The feedback shown combines the feedback of both the engine and PRISMAsync during the firmware upgrade. The PRISMAsync (lines starting with PRISMAsync) will include information on which files actually transferred to the engine and which files are skipped because of version is present already or a module being non-present.

### Version checking.

In order the system to operate correctly the engine and accessories and PRISMAsync must have compatible firmware installed. Therefore version checking is executed by PRISMAsync controller.

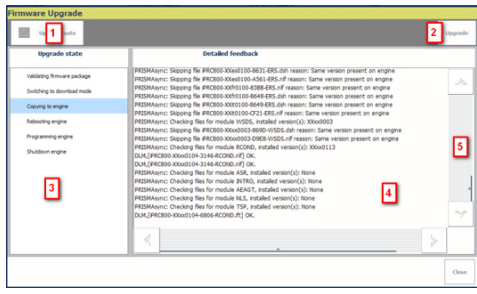
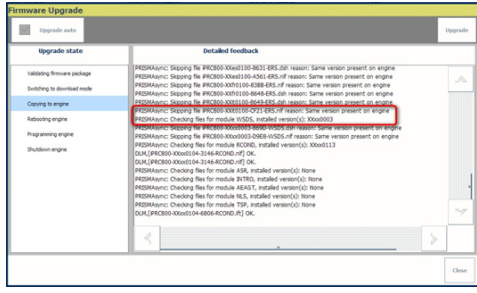

- Each PRISMAsync version will contain a list with compatible engine and accessories firmware.
- PRISMAsync will check if the installed engine and accessories firmware level matches with the actual installed PRISMAsync version.
- Version checking is executed when starting a connection with the engine in normal user mode. In (safe) download mode version checking is not executed.
- If non matching firmware is found PRISMAsync will report this in the data-log. The data log information can be viewed in service mode -> error analysis.

Information on screen

Information on screen	Explanation
	<ol style="list-style-type: none"> <li>1. Button to select             <ol style="list-style-type: none"> <li>a. Auto upgrade</li> <li>b. Non auto upgrade</li> </ol> </li> <li>2. Button to start upgrade process.</li> <li>3. Running process step</li> <li>4. Detailed information by engine and or PRISMAsync.</li> <li>5. Via scroll bar text can be scrolled back.</li> </ol>
 <p>PRISMAsync.....</p>	<p>PRISMAsync at beginning of a row:              Message generated by PRISMAsync.              Messages with e.g. DLM, EXT ...in front are messages generated by engine.</p>

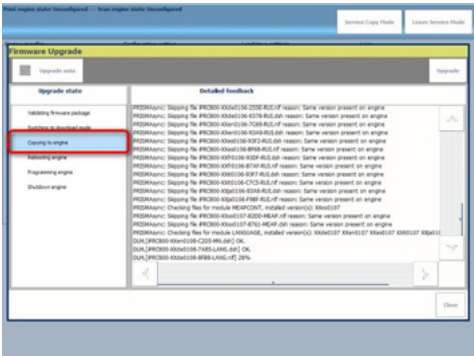
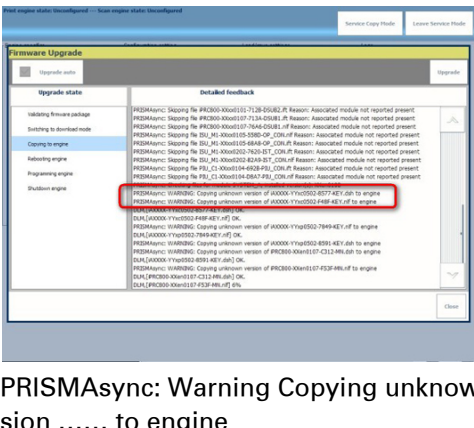
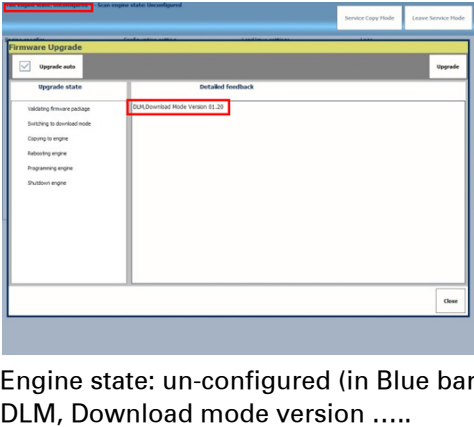
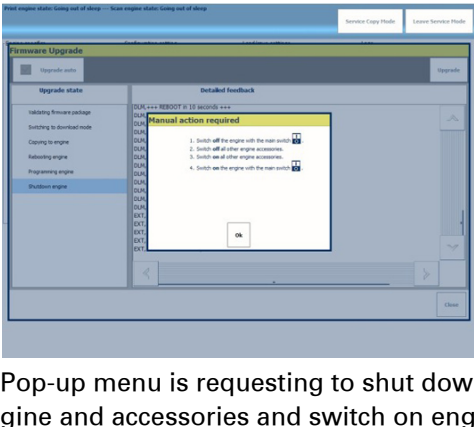

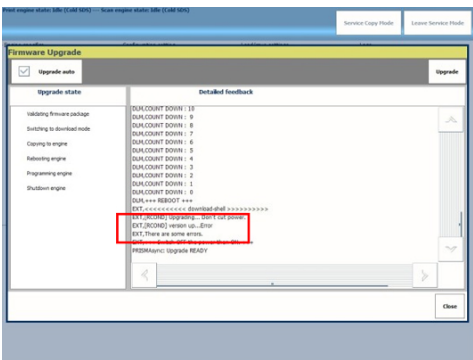
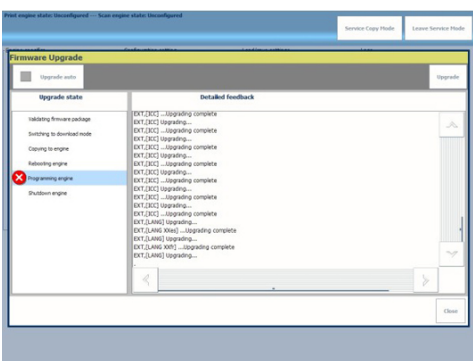
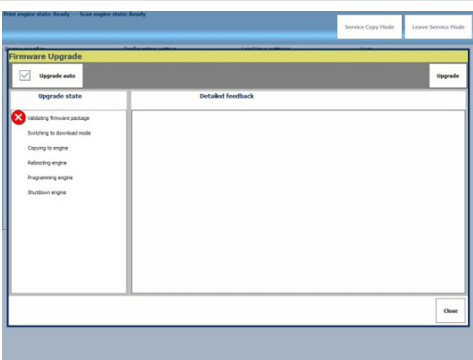
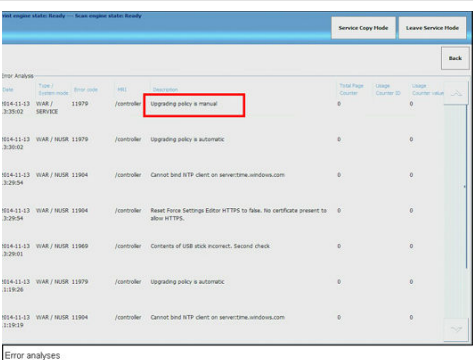
Information on screen	Explanation
	<p>The Blue bar is indicating the current process step. When upgrade is ready; no blue bar</p>
	<p>This message is reported when for PRISMA-sync an unknown version is present on the USB key and copied to the engine.</p>
	<p>Engine is set to safe download mode.</p>
	<p>This pop-up screen is indicating that a fault is occurred. Most likely the firmware of one of the accessories is not installed correctly. Check for reason and take corrective actions. Action required: Power off and on the engine.</p> <p><b>NOTE</b> For imagePRESS C800 series the accessories are switched on and off by the engine automatically.</p>

Information on screen	Explanation
 <p>EXT... Version-up error</p>	<p>Engine reports an error when upgrading. Check for reason and take corrective actions. The scroll bar can be used to review the information to find the applicable module.</p>
	<p>This screen is indicating that a module is not programmed. Not necessarily an error. Possible case: module is not present. The scroll bar can be used to review the information to find the applicable module. Check for reason and take corrective actions.</p>
	<p>Fault detected with USB key. File name or content is invalid.</p>
	<p>For analysis the current upgrade policy can be checked via PRISMAsync service mode -&gt; Error analyses. The current policy is showed. After each PRISMAsync the policy is checked again.</p> <p> <b>NOTE</b> Only applicable for PRISMAsync for imagePRESS C800 series.</p>

# **Chapter 9**

## **System software**

# System software

## Introduction

At installation the Field Service Technician should always check if the required software (version, release, level and patch) is installed on the PRISMAsync. The software is distributed as an .iso image via FTP.

You will be informed about new software by means on an Service Information Bulletin. This bulletin contains also a link to the FTP site.

## Software version management

Number	Name	Incremented
V	Version	New functionality, new architecture or major redesign
R	Release	Improvement of product features, addition of new modules
L	Level	Group of consolidated bug fixes
P	Patch	Customer specific bug fix

The PRISMAsync controller is pre-installed with a system software version.

To check the software version:

1. Open the **Settings Editor** and browse to [Support] -> [About]. In the field [Version of the printer main software] the version is given.
2. In the [System] section of the setup tab on the Operator panel, touch [Local key operator settings]. In the section [About] you will find the version number.

In some cases it is necessary to re-install the system software:

- A newer version of the software is available.  
If a new version of the software is available you can obtain this via your Service channel.
- The currently installed software seems to be corrupt.  
If the current software reacts in an undefined way and it is obvious that there is no hardware defect, re-installing the software might be a solution.
- After replacement of the HDDs.  
If the HDDs drives have been replaced it is necessary to re-install the software.

# Create a backup of the settings and licenses

## Introduction

This topic describes how to create a backup of the settings and licenses on the PRISMAsync controller.

## Before you begin



### NOTE

Do not use the same USB stick for creation of the backup and the installation of the system software.

- A USB stick

## Procedure

1. Insert the USB stick into the USB port on left side of the operator panel.
2. In the [System] section of the [Maintenance] tab on the Operator panel, touch [Go to service mode].
3. Select the [Backup] button. The system will detect the USB stick and will ask to confirm the location and filename. After confirmation, the settings are copied to the USB stick.  
The system will detect the USB stick and will ask to confirm the location and filename. After confirmation, the settings are copied onto the USB stick.
4. Remove the USB stick from the operator panel after the settings are copied.

## Preparation of the USB stick

For installation of the PRISMAsync software you need a pre-programmed USB stick. This chapter describes how to prepare the stick.

### Before you begin

- a 16 GB USB stick (available via the normal service channel)
- an image of the PRISMAsync software (available via ftp-site or your service channel)
- the USB creation tool called CreateUSB (available via ftp-site or your service channel or inside the PRISMAsync .iso file).
- a laptop or pc with Windows Vista or Windows 7

### Procedure

**1. Check if .NET 4.5 is installed on the laptop.**

If .NET 4.5 not installed please download and install the .NET 4.5 framework.

**2. Insert USB key and start CreateUSB Tool.**

1. Fill out the fields in the tool. Once the .iso file is selected the tool will check if a newer version is available (in the .iso file). If there is a new version available it will install this version and overwrites the old one.

The following dialogue will appear:

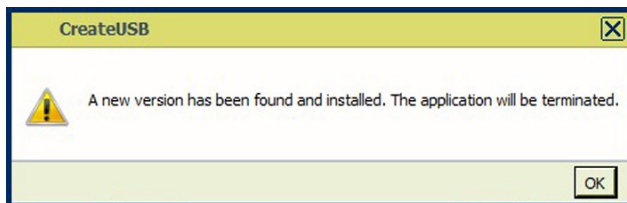

**3. Restart the Create USB Tool.**

Restart the tool and make the settings as described below.



1. Installation media: Browse to the location where the media .iso image is located.
2. Product: Select the applicable product
3. Installation of GPL media: Browse to location where the GPL media .iso image is located. This image file contains the firmware for engine and accessories.
4. USB drive to use: Select the USB drive to write the software.

5. Legacy file system: Some antivirus software intervenes with the CreateUSB tool. To make sure the USB stick is created correctly enable the legacy file system.
6. Select Start.

Check that you have the .NET 4.5 framework installed, and press OK if it is installed. Otherwise Exit the CreateUSB tool and install the .NET 4.5 version. If you don't do this the tool will not work.



#### NOTE

If the message below appears make sure to download and install the .NET 4.5 framework. The CreateUSB tool will not work without the .NET 4.5 framework.

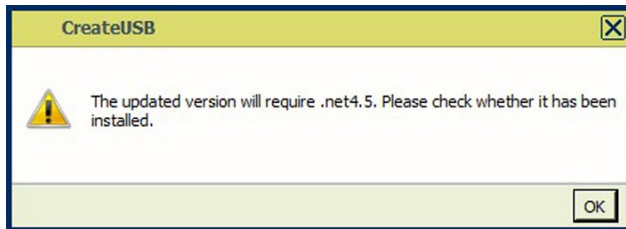

#### 4. Press [OK] to start the programming process.

Additional illustration needed.

1. After pressing [OK] the following window will pop-up.  
Select [Yes] to store existing jobs and settings, and to restore them automatically after the installation.



#### NOTE

Do not select "Yes" when the PRISMAsync software version is V1.1

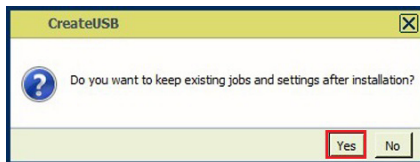

After making the selection, the process will start and the .iso image is programmed to the stick.

Please wait until the CreateUSB tool indicates that the USB-stick is ejected and the process is ready.

#### 5. Remove the USB-stick from the PC.

The USB-stick is now ready for use. The name of the stick is OCEINSTALL

### After you finish

*Reuse an USB stick after installation on page 108*

# Reuse an USB stick after installation

## Prepare a USB stick for reuse

It is possible to re-use the USB stick after an installation. When a USB stick is used for an installation the name of the USB stick is changed from "OCEINSTALL" to "USEDKEY".

Please take the following steps to re-use the stick for a new installation of the system software.

## Procedure

1. Put the USB stick into a USB port of your computer.
2. Open the Explorer window.
3. Check if the name of the USB stick is "USEDKEY" .
4. To prepare the USB-stick for re-use, open the contents of the stick in your explorer and double-click the "ReUseKey.bat" file.

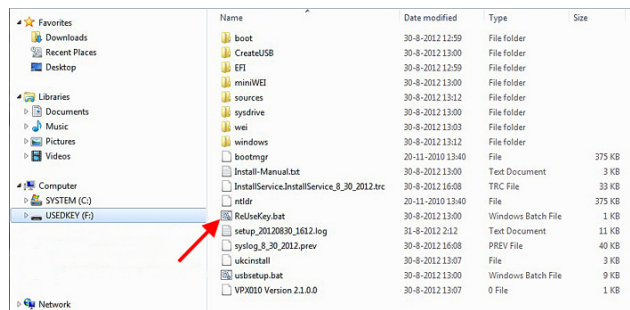

5. Check (in your explorer screen) if the name of the USB stick has changed to "OCEINSTALL". If the name did not change it might be needed that you remove the stick and insert it again.
6. Your USB stick is now ready for a new installation.



## NOTE

Be aware that the settings you selected at creation of the USB stick (e.g. "keep existing jobs and settings after installation") will be used after the stick is prepared for re-use.



# Re-installation of the system software

This topic describes the re-installation of the system software on the PRISMAsync controller



## NOTE

The installation process takes approximately 30 minutes.

## Before you begin

- A bootable USB stick containing the system software.  
Preparation of this USB stick is described in [Preparation of the USB stick on page 106](#).



## NOTE

If the USB stick was created with the setting to "Keep existing jobs and settings after installation" (default setting), it is not necessary to create a backup and restore. For safety reasons we advise to create a backup. When the controller or the hard disks have to be exchanged you will lose all settings.

Before upgrading always print the configuration report to have the Network-settings at your disposal.

## Procedure

### 1. Print a configuration report



## NOTE

If the system software seems to be corrupt or the HD drives have been replaced it is not possible to execute steps 1 and 2.

### 2. Create a backup of the settings and licenses

See [Create a backup of the settings and licenses on page 105](#)

### 3. Insert the USB stick with the system software into the USB-port of the operator panel

Make sure the PRISMAsync controller is switched on before inserting the USB stick. This is necessary for the operating system to detect the USB stick.

### 4. Restart the PRISMAsync

On the Operator Panel touch the **[Shutdown system]** button in the Setup tab of the System section. In the next window select **[Restart]**.

The PRISMAsync will restart and boots from the stick. This can take a few minutes because the system has to check the contents of the USB stick. After some time the PRISMAsync will reboot and the installation process will start.

Status messages are displayed on the Operator panel. The PRISMAsync will reboot a few times during the installation process. After installation of the software the installation wizard is displayed.



## NOTE

The software installation will take approx. 30 minutes. Do not switch off the controller during the installation process.

### 5. Remove the USB stick from the operator panel.

### 6. Perform the [Installation wizard on page 27](#)

### 7. Restore the system settings and licenses



**NOTE**

The "Restore the system settings and licenses" procedure is applicable when:

- The setting "Keep existing jobs and settings after installation" was **NOT** selected during creation of the USB stick.
- The HDDs or controller has been replaced.

If you installed the software because the controller was exchanged, you have to re-host the license. The original license that was stored in the back-up is not valid anymore.

To restore the settings and licenses do the following:

1. Insert the USB stick you used to backup the settings, into the left side of the Operator panel.
  2. In the System section of the Maintenance tab on the Operator panel, touch [Go to service mode].  
See also **Service mode** in [Maintenance and Service on page 37](#).
  3. In the first screen touch the 'Restore' button. The system will detect the USB stick and will ask to confirm the location and filename. After confirmation, the settings are copied to the PRISMAsync.
  4. When all the settings are copied, the PRISMAsync will automatically reboot. When ready, please remove the USB stick. If you were not able to make a backup of the settings before installation, please use the last backup file you have created.
- 8. Install patches.** (if applicable)  
It is possible that there are patches belonging to the new installed system software. Install these patches now. See next chapter.
- 9. Create a new backup of settings**  
See [Create a backup of the settings and licenses on page 105](#)

## Installing patches

In case a patch for the system software of the PRISMAsync is released, the patch will resolve 1 or more problems but does not require a complete re-installation of the system software.

The patch is released in an .EXE- or .MSU format (for Microsoft patch).



### NOTE

Do not change the filename of the patch, because it will become unusable.

There are 4 methods to install a patch:

- The patch is stored on a PC/laptop. The upgrade is done via the Settings Editor.
- The patch is stored on a USB stick. This stick is entered into the PRISMAsync and the upgrade is done via the Operator Panel.
- The patch is located on a remote server. The patch is downloaded from the server and installed on the controller via the Settings Editor. (License Remote Service needed)
- The patch is located on a remote server. The patch is downloaded from the server and installed on the controller via the Operator Panel. (License Remote Service needed)

### Install a patch from a PC via the Settings Editor

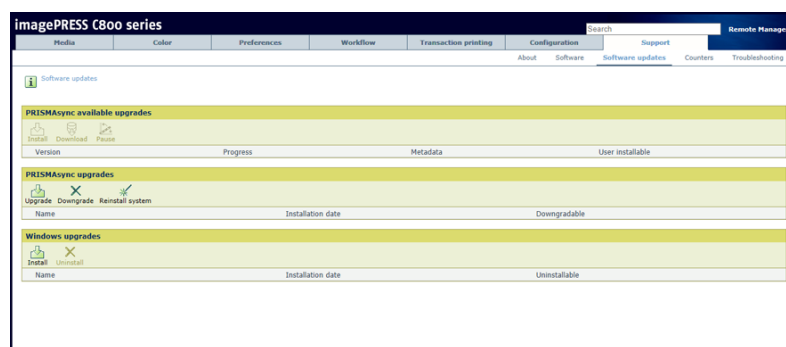

To install a patch from a PC via the Settings Editor take the following steps:

1. **Be sure the patch is installed on your PC/laptop**
2. **Browse to the software upgrade section**  
In your web browser open the Settings Editor and browse to "Support -> Software". Select the "Upload upgrade package 1" option. Depending on the new software version, sometimes 3 packages must be uploaded. It is recommended to finish and remove your jobs before you perform the upgrade.
3. **Select the location of the patch**  
In the next window browse to the location of the patch, and select "Upload".
4. **Select "OK"**
5. **If needed repeat this for the other packages**
6. **Start the upgrade.**  
The packages are uploaded to the PRISMAsync but they are not installed yet. Select "Start upgrade" in the Settings Editor. In the next window select "Start".
7. **Select "OK"**  
A window will pop-up saying, you have to restart the controller after upgrade. Press "OK" until the installation starts.
8. **Restart the PRISMAsync and the host machine**

## Install a patch with a USB stick via the Operator Panel

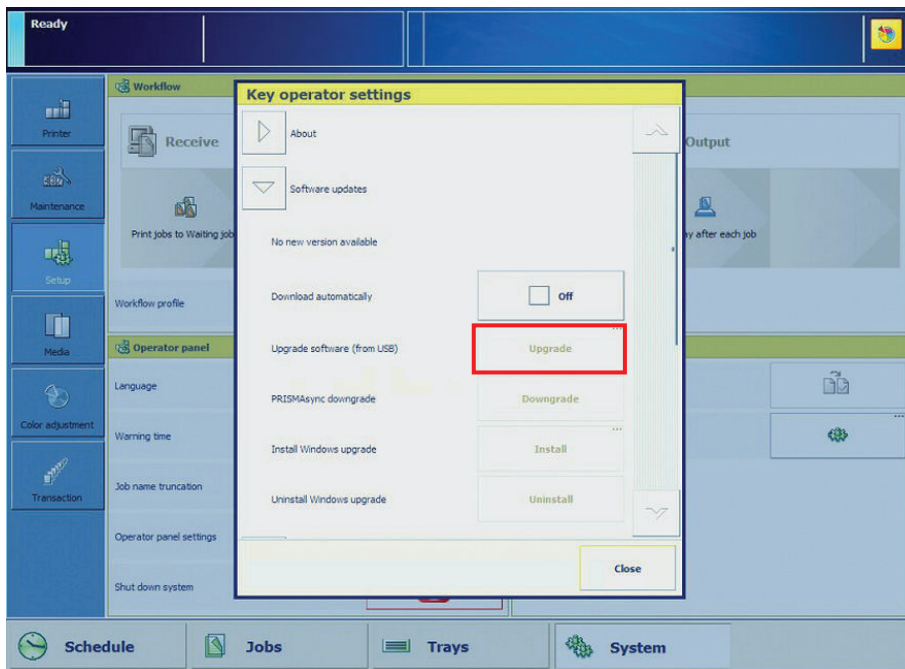

To install a patch with a USB stick via the Operator Panel take the following steps:

1. **Copy the patch to a USB stick**
2. **Start the install patches procedure**  
On the Operator Panel in the System section of the Setup tab choose 'Local key operator settings'. In the next window choose 'About -> Upgrade software (from USB)'. The system will ask you for the location of the USB-stick and the filename.
3. **Select the patch-file.**  
In the next window browse to the location where the EXE-file with the patch resides. Select the file and select "Upgrade" on the Operator Panel.
4. **Wait until the installation finishes.**  
When the installation has finished the message 'Installation successful' is shown.
5. **Restart the PRISMAsync and the host machine.**

## Install (uninstall) a Windows patch via the Operator Panel

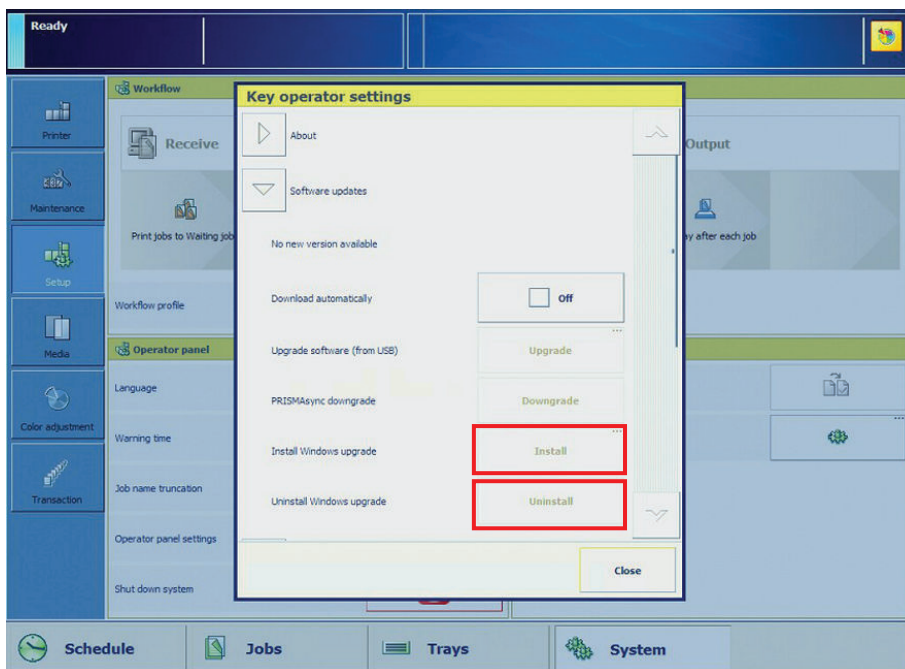

To install or uninstall a Windows a patch via the Operator Panel take the following steps:

1. **Copy the patch to a USB stick**
2. **Start the install patches procedure**
  1. On the Operator Panel in the System section of the Setup tab choose 'Local key operator settings'.
  2. Install Windows upgrade (or uninstall Windows upgrade)
3. **Select the patch-file.**

In the next window browse to the location where the .MSU-file with the patch resides. Select the file and select "Install" on the Operator Panel.
4. **Wait until the installation finishes.**

When the installation has finished the message 'Installation successful' is shown.
5. **Restart the PRISMAsync and the host machine.**

## Installing a license

For some functionality the PRISMAsync requires a separate license. The licenses are generated by the configuration centre, and delivered as a license file. This license file has to be uploaded to the PRISMAsync controller.

To install a license there are 2 possibilities:

### Procedure

#### 1. Via the Operator panel

- Copy the license file to a USB stick
- Insert the USB stick into a USB port on the PRISMAsync controller. You can use any port, but for convenience it is best to use the port on the operator panel.
- In the **[System]** section of the **[Setup]** tab choose **[Local key operator settings]**.
- In the next window choose **[Software licenses]** -> **[upload license]**. The system will ask you for the location of the USB stick and the filename.
- Select the correct file and touch **[Start]**.
- After the file is uploaded restart the PRISMAsync.
- Create a backup of the settings.

#### 2. Via the Settings Editor

- Locate the license file on your PC.
- Open the Settings Editor  
(See [The Settings editor on page 62](#))
- Browse to **[Support]** -> **[Software]**.
- Click **[Upload license file]** (Key Operator or System Administrator password required)
- Browse to the License file on your PC.
- Start the upload of the license file.
- When the file is uploaded, restart the PRISMAsync controller and the copier.
- Create a backup of the settings.

# Installing the printer driver

## Introduction

With a new release of the PRISMAsync software there is often also a new release of the printer driver.

## Download and install the printer driver

The latest version can be obtained in two ways:

1. **Via the Océ downloads website.**

Goto <http://downloads.oce.com/> select [product] -> [Drivers] -> [Operating System] -> [Language] and then download the driver from the search result list.

Follow the standard instruction for installing printer drivers on your Operating System.

2. **Via the Settings Editor.**

Open the Settings Editor and go to the tab **[Support] > [Software]** and download the printer driver from the printer driver section.

A key Operator or System Administrator password is required. After the download is completed, follow the standard instruction for installing printer drivers on your Operating System.

# Configure the machine for the USA

After installing the controller software, the system is ready for use in all countries except for the US and Japan. For use in the US following the additional steps below:

## Procedure

### 1. In the Settings editor

- [Preferences] -> [System settings] -> [Regional settings] -> Region -> USA
- [Preferences] -> [System settings] -> [System of measurement] -> [Imperial]
- [Preferences] -> [Print job defaults] -> [Separator sheet] -> Letter 28 lb
- [Preferences] -> [Print job defaults] -> Front Cover -> Letter 28 lb
- [Preferences] -> [Print job defaults] -> Back Cover -> Letter 28 lb
- [Preferences] -> [Print job defaults] -> [Banner] -> Letter 28 lb
- [Preferences] -> [Print job defaults] -> [Calibration media] -> Tabloid 28 lb
- [Preferences] -> [Print job defaults] -> [Calibration media] -> [Heavy] -> Tabloid 134 lb
- [Preferences] -> [Print job defaults] -> [Calibration media] -> [Extra heavy] -> Tabloid 150 lb
- [Preferences] -> PostScript -> Media -> Letter 28 lb
- [Preferences] -> PDF>Media -> Letter 28 lb
- Colour -> Colour defaults -> Device CMYK input profile -> US Web Coated SWOP
- Colour -> Colour defaults -> Default media Family -> uncoated US
- Colour -> Colour presets -> Photographic content -> Device CMYK input profile -> US Web Coated SWOP
- Media -> select\* -> edit -> Media family -> depending region\*\*
  - \* : All Uncoated Media
  - \*\* :
  - Use "Uncoated " media family for uncoated media in the EU
  - Use "Uncoated US" media family for uncoated media in the US
  - Use "Uncoated JP" media family for uncoated media in Japan
- For transaction printing US set media and Colour Management (IPDS #36 media / PCL #16 media)



### NOTE

For optimization purposes:

- Use "Uncoated" media family in the US (or Japan) when the media is Mondi paper (or similar, like Océ TopColor)
- Use "Uncoated US" media family in the EU (or Japan) when the media is Hammermill Color Copy Digital paper (or similar)
- Use "Uncoated JP" media family in the US (or EU) when the media is GF-C081 paper (or similar)

### 2. On the Operator panel

- Change the language on the Operator panel to English-US

### 3. On the application PC

- Change in the Control panel the regional setting to English-US

### 4. In the UPD Printer driver

- Printing [Preferences] -> paper letter-28

### 5. Enter the media weights

When using "Imperial" as measurement system, then all media weights have to be entered according to the following table.



	Bond Ledger	Offset Text	Cover	Tag	Index	Points	*Caliper (inches)	millimeters	Metric (grams/sq meter)
Equivalent Weight	18	40	22	37	33	3.2	.0032	0.081	60.2 gsm
	18	45	24	41	37	3.6	.0036	0.092	67.72 gsm
	20	50	28	46	42	3.8	.0038	0.097	75.2 gsm
	24	60	33	56	50	4.8	.0048	0.12	90.3 gsm
	28	70	39	64	58	5.8	.0058	0.147	105.35 gsm
	29	73	40	62	60	6	.0060	0.152	109.11 gsm
	31	81	45	73	66	6.1	.0061	0.155	116.63 gsm
	35	90	48	80	74	6.2	.0062	0.157	131.68 gsm
	36	90	50	82	75	6.8	.0068	0.173	135.45 gsm
	39	100	54	90	81	7.2	.0072	0.183	146.73 gsm
	40	100	56	93	83	7.3	.0073	0.185	150.5 gsm
	43	110	60	100	90	7.4	.0074	0.188	161.78 gsm
	44	110	61	102	92	7.6	.0076	0.193	165.55 gsm
	47	120	65	108	97	8	.0078	0.198	176.83 gsm
	53	135	74	122	110	9	.0085	0.216	199.41 gsm
	54	137	75	125	113	9	.009	0.229	203.17 gsm
	58	146	80	134	120	9.5	.0092	0.234	218.22 gsm
	65	165	90	150	135	10	.0095	0.241	244.56 gsm
	67	170	93	156	140	10.5	.010	0.25	252.08 gsm
72	183	100	166	150	11	.011	0.289	270.9 gsm	
76	192	105	175	158	13	.013	0.33	285.95 gsm	
82	208	114	189	170	14	.014	0.356	308.52 gsm	
87	220	120	200	180	15	.015	0.38	312 gsm	
				552					999 gsm

Media weights up to 161.78 grams/square meter must be entered in Bond and media with a higher media weight must be entered as index.



# **Chapter 10**

## **Troubleshooting**

## Troubleshooting

The PRISMAsync controller is part of a printing system.

Problems with respect to the PRISMAsync controller are divided in three areas:

- Inside the PRISMAsync controller.
- The interface between the PRISMAsync controller and the host machine.
- Between the PRISMAsync controller and the networked computers.

This chapter does not try to describe the possible problems that exist in the computers or the network.

The following paragraphs describe checks required to locate and resolve problems.



### NOTE

If an error code is displayed on the operator panel, please check [Error messages and conditions on page 128](#).

Check that the network of the customer operational. If this is not the case direct the problem to the appropriate service department or the network administrator.

Check that a problem is not related to a specific job. If other jobs are printed correctly focus on the problematic job.

## Check external connections

Before opening the PRISMAsync controller first check the external connections.

Check the following:

### Procedure

1. Power cable is connected to the PRISMAsync controller and is switched on
2. Network cable is connected and status LED is blinking.
3. Crossover Ethernet cable (lower network port) is connected to the host machine.
4. Crossover Ethernet cable (lower network port) and normal Ethernet cable (upper network port) are connected.
5. Both data cables are connected correctly between the PRISMAsync controller and host machine.
6. USB cable from the PRISMAsync controller to operator panel is connected.
7. DVI cable from the PRISMAsync controller (Left DVI port) to operator panel is connected.
8. 15-pin D-sub cable from the PRISMAsync to the operator panel is connected.
9. 9-pin D-sub cable from the PRISMAsync to Operator attention light is connected
10. The cables at the backside of the Operator panel are connected. Remove the cover on the backside of the operator panel to check.

## Check internal components

For checking the internal components, the PRISMAsync controller has to be opened.

See [Access internal components on page 68](#).



### NOTE

Please follow standard Electro Static Discharge (ESD) precautions when handling electronic components.

Check the following:

### Procedure

1. No foreign objects are inside the PRISMAsync controller.
2. Check for loose boards and reseal each board including DDR3 modules.
3. Check for loose connectors and reseal each connector.
4. Make sure that hard disk drives are connected to the correct SATA port.  
See [Replace the Hard Disk Drives on page 75](#).

## Comprehensive system inspection

If the previous checks did not solve the problem, perform a component inspection.

A comprehensive inspection allows you to verify that each hardware component is properly installed and configured. It also prevents the unnecessary replacement of expensive components.

Component	Actions
External connectors	<ul style="list-style-type: none"> <li>• See <a href="#">Check external connections on page 121</a></li> <li>• Cables, cable connectors, and mating connectors are undamaged.</li> </ul>
Internal components	<p>All replaceable parts are:</p> <ul style="list-style-type: none"> <li>• Present</li> <li>• Properly aligned</li> <li>• Installed securely</li> <li>• Installed on the appropriate site</li> <li>• The correct part for the system</li> <li>• Appear undamaged</li> </ul> <p>Chassis and contents have not been tampered with. Chassis does not contain any foreign objects.</p>
Motherboard	<ul style="list-style-type: none"> <li>• Motherboard, including components and traces, appear undamaged, and no foreign objects are evident</li> <li>• CPU is present, well-seated, and appears undamaged.</li> <li>• CPU cooling assembly is well-aligned and firmly attached.</li> <li>• Each fan (including fan cable) is well-positioned (not upside down), installed in the correct connector (CPU_FAN1), and appears undamaged.</li> <li>• Boards required on the motherboard are present, well-seated, and in the correct slots.</li> <li>• Battery is installed.</li> </ul>
DDR3 modules	<ul style="list-style-type: none"> <li>• Each DIMM is well-seated.</li> <li>• Each DIMM is of the same brand and type.</li> <li>• Each DIMM is seated in the correct port. Pairs DIMM1/DIMM3 and DIMM2/DIMM4</li> </ul>
PCI boards	<p>Each board required is:</p> <ul style="list-style-type: none"> <li>• Present</li> <li>• Installed in the correct slot</li> <li>• Well-seated</li> <li>• Appears undamaged</li> </ul> <p>Required cables (if applicable) are</p> <ul style="list-style-type: none"> <li>• Present</li> <li>• Firmly connected in the correct connectors</li> <li>• Appear undamaged</li> </ul>

Component	Actions
Power supply	<p>The power supply required is:</p> <ul style="list-style-type: none"> <li>• Present</li> <li>• Correctly installed</li> <li>• Appears undamaged</li> </ul> <p>Cable connectors are:</p> <ul style="list-style-type: none"> <li>• Firmly connected</li> <li>• Appear undamaged</li> <li>• Installed in the correct devices</li> </ul>
HDDs	<p>The HDDs required are:</p> <ul style="list-style-type: none"> <li>• Present</li> <li>• Correctly installed</li> <li>• Appear undamaged</li> </ul> <p>HDD data cables are:</p> <ul style="list-style-type: none"> <li>• Present and firmly connected in correct motherboard connectors: <ul style="list-style-type: none"> <li>• HDD 0 (upper drive in bracket) to J18</li> <li>• HDD 1 (middle drive in bracket) to J24</li> <li>• HDD 2 (lower drive in bracket) to J16</li> </ul> </li> <li>• Appear undamaged</li> </ul>
System fan	<p>The system fan is:</p> <ul style="list-style-type: none"> <li>• Present</li> <li>• Correctly installed</li> <li>• Appears undamaged</li> </ul> <p>System fan cables are:</p> <ul style="list-style-type: none"> <li>• Present</li> <li>• Firmly connected in correct motherboard connector (SYS_FAN1)</li> <li>• Appears undamaged</li> </ul>



## Diagnose LEDs

There are LEDs present on the outside and the inside of the PRISMAsync controller. The LEDs can be used to diagnose a problem.

### Network Status LEDs

Next to each Ethernet connector there are 2 LEDs indicating the network speed.

When data is transferred, the appropriate LED will blink to indicate network activity.

- **No LED activity on upper Ethernet connector.**

There is no connection to the customer network.

- Check if cables are connected correctly in the PRISMAsync controller and wall outlet.
- Check if cable is not defect.
- Check if normal and crossover Ethernet cables are not exchanged.
- Check if the network is functioning.

- **No LED activity on lower Ethernet connector.**

There is no connection between the copier and the PRISMAsync controller.

- Check if cables are connected correctly in the PRISMAsync controller and wall outlet
- Check if cable is not defect
- Check if normal and crossover Ethernet cables are not exchanged.

### LED in power button

In the power on/off button on the front side of the PRISMAsync controller a LED is integrated.

If the PRISMAsync controller is switched on this LED is shining blue.

If the LED remains off check the following:

- Does the PRISMAsync controller switch on? If so there is probably an open connection in the LED wiring.
- If the PRISMAsync controller cannot be switched on or off then there is either a problem with the wiring of the button or with the power supply.

### LEDs on AUX control board

On the AUX control board you can find some LEDs. These LEDs indicate the presence of power on the board. All LEDs should be shining green. If one of the LEDs is off, the board will not function.

Please first check the connectors and the cables before replacing the board.

The function of the LEDs are:

- 3.3 Volt
- 5 Volt
- 12 Volt
- 24 Volt



#### NOTE

The board is mounted upside down in the PRISMAsync controller so it might be difficult to check the boards.

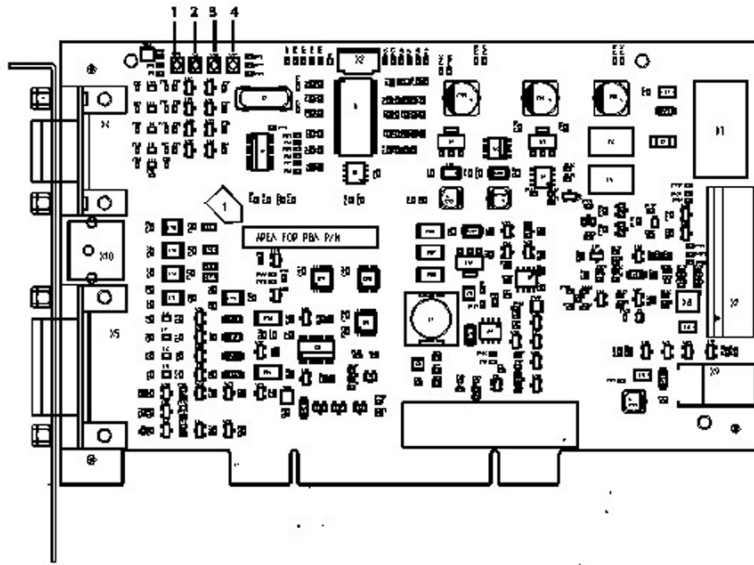

**LEDs on DDI board**

On the DDI control board you can find some LEDs. These LEDs indicate the working of the board. The LEDs are situated at the bottom side of the print.

Please first check the LEDs, connectors and the cables before replacing the board.

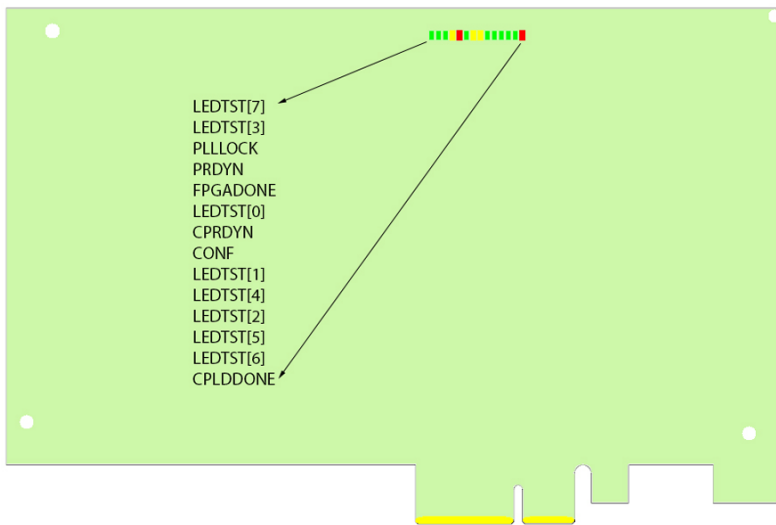

LED	Colour	Function
LEDFPGA-DONE	Red	Is ON as long as the FPGA is not booted successfully
LEDCPRDYN1)	Yellow	Is OFF when CPRDYN is active. Indicating that the controller PC is ready.
LEDPRDYN1)	Yellow	Is OFF when PRDYN is active. Indicating that the Engine / Test PC is ready.
LEDCONF1)	Yellow	Is ON, Indicating cable length of 3 m - 5.5 m

LED	Colour	Function
LEDPLL-LOCK1)	Green	Is ON when clock synchronization between Controller PC and Engine / Test PC was successful.
LEDTST[0]	Green	Always ON (PCI Express link status is tied high)
LEDTST[1]	Green	Is ON when Serial link between Controller PC and Engine / Test PC is initialized correctly.
LEDTST[2]	Green	ON when DDR is initialized
LEDTST[3]	Green	OFF when SOFT RST Button Pushed
LEDTST[4]	Green	OFF when HARD RST Button pushed
LEDTST[5]	Green	Always ON
LEDTST[6]	Green	Always ON
LEDTST[7]	Green	Flashing when PCI Express clock is detected.
LEDCPLD-DONE	Green	Is ON when CPLD is powered and programmed

## Error messages and conditions

The table below gives an overview of possible error situations of the PRISMAsync controller.

Effect	Check	Action
Blank screen	Check USB Cable	Disconnect/connect USB cable on backside of PRISMAsync controller.
PRISMAsync controller cannot be switched on PRISMAsync controller cannot be switched off.	<ul style="list-style-type: none"> <li>• Check Power supply</li> <li>• Check power button</li> <li>• Check connection with Operator panel</li> </ul>	<ul style="list-style-type: none"> <li>• Replace power supply or Power button</li> <li>• Replace AUX control board</li> <li>• Replace the motherboard</li> </ul>
Excessive noise	Check fans	Replace fan
Garbled prints or blank pages	Check data cables	Replace data cable
Strange colours on operator panel or blank screen or stripes on screen or skewed image on screen or rolling screen	Check DVI cable	Connect or replace DVI cable
“no signal” on operator panel	<ul style="list-style-type: none"> <li>• Check DVI cable</li> <li>• Check GPU board</li> </ul>	Replace cable or GPU board
Spectrometer not recognized	Check the spectrometer	Try another USB port. Probably USB port on operator panel defect.
Impossible to install via USB port on operator panel	Check USB stick	Try another USB port. Probably USB port on operator panel defect.
Led on operator panel always off.	<ul style="list-style-type: none"> <li>• Check cable</li> <li>• Check AUX control board</li> </ul>	Replace cable or AUX control board
Operator panel dark and Attention light off.	<ul style="list-style-type: none"> <li>• Check 12V on AUX control board</li> <li>• Check power cable to AUX control board</li> <li>• Check fuse on AUX control board.</li> </ul>	Connect power cable. Replace AUX control board
“Press sleep button” during start up or Pressing Sleep-button has no effect.	Check 3V3 connection on AUX control board	Connect power cable. Replace AUX control board
One of Attention lights always on		Replace AUX control board
One or more of the attention lights always off.	Check fuse on AUX control board	Replace AUX control board
Message “No OS found”	Check cables to HDD	Replace HDDs
FPGA Led on DDI stays red	Check cable to DDI board	Replace cable Replace DDI board

Effect	Check	Action
PLL lock led is off.	Check cable to DDI board	Replace cable
1 of 4 diagnose Led's on AUX control board is off.	Check power supply to AUX control board	<ul style="list-style-type: none"> <li>If no power on connector check the cable or power supply</li> <li>Replace AUX control board</li> </ul>

In some cases the PRISMAsync controller will give an error code which is displayed on the operator panel screen. These MREs (Machine Recoverable Errors) can only be recovered by rebooting the system. This is done by touching the Operator panel screen. If the problems persist please check the table below for a description of the error and the checks to make.

### Types of error codes

The error code has 5 or 7 digits. The explanation of the error code is as follows.

Code: XXYZZ (5 digits)

- XX gives the CAS code of the 'defective' unit.
- Y gives the type of error (See the table below)
- ZZ is a sequence number of an error.

Code: XXYMZZZ (7 digits)

- XX gives the CAS code of the 'defective' unit.
- Y gives the type of error (See the table below)
- M gives the module number 1,2 or 3 (eg PIM1, PIM2, PIM3)
- ZZZ is a sequence number of an error.

Code	Type	Description	Recovery
0	Fatal Error (FE)	The control of the unit is not reliable and the operation of the unit is not safe or not possible. The unit is immediately shut-down . This error type is used for low level hardware / software errors. Some examples are ROM / RAM failures, power-up failures, watchdogs etc.	Switch the print engine OFF, wait ± 20 seconds and switch the print engine ON.
1	Permanent Error (PE)	This error type is used when it is not possible to restart the unit. The problem in that unit can cause a defect or can cause a damage to the customer or environment.	A service action is necessary to correct the problem. You can reset the error in SDS.
3	Machine Operator Recoverable Permanent Error (MORPE)	This error type is used when it is not possible to restart the unit. The problem in that unit can cause a defect or can cause a damage to the customer or environment.	A trained key operator is necessary to correct the problem. You can reset the error in KOM.

Code	Type	Description	Recovery
5	Machine Recoverable Error (MRE)	This error type is used for the problems where you can restart the machine. (Causes no more machine damage or damage to the customer / environment). When some errors occur a second time, the error becomes a Permanent Error.	Switch the print engine OFF, wait ± 20 seconds and switch the print engine ON.
7	Operator Recoverable Error (ORE)	This errors type is used when panels are open or when paper is jammed. Follow the instruction (pictures) on the operator panel to solve the problem.	Follow the job recovery instructions on the display of the operator panel.
9	Warning (WAR)	A warning for the service engineer, detection of a small machine failure. The warning is logged in SDS. (The user will not see the warning)	These errors are saved for service only.

The table shows the error type, the full name, the description and how to recover the error.

Error code	Problem	Action
11015	Incorrect installation Inconsistent configuration	Create new USB stick with system software. Re-install the software
11501	Message “No OS found”	Replace HDDs and re-install system software.
11502	Message “HDD2 failure”	Replace HDDs
11504	Software failure	Reboot the system. Check the error history (Service Mode) the description. Contact your Service representative. Also see <a href="#">11504 Error Screen behaviour on page 132</a> .
11506	Lost logical command connection with engine	Check your Ethernet cross-over cable. Reboot the system.
11520	No Logical Command Connection with Print Engine	Check your Ethernet cross-over cable. Reboot the system.
11526	Lost Physical Command Connection with Print Engine	Check your Ethernet cross-over cable. Reboot the system.
11529	No Physical Connection with On/Off Controller	Check connection between operator panel and PRISMA-sync controller. Check if the correct AUX control board is installed (verify the if the part number is valid for the used system).

Error code	Problem	Action
11530	Lost Physical Connection with On/Off Controller	Check connection between operator panel and PRISMA-sync controller.
11531	SRA error	Reboot the PRISMAsync controller. Problem with IPDS.
11535	Software failure	Software failure in copier firmware. Reboot the system. Re-install the host machine firmware.
11558	No VGA connection with UI Panel	Check connection between operator panel and PRISMA-sync controller. Check GPU PCB.
11559	No-Lost Physical Connection With UI Panel	Check connection between operator panel and PRISMA-sync controller.
11560	No-Lost Logical Connection with UI Panel	Check connection between operator panel and PRISMA-sync controller.
11561	System error at the printer module. Invalid configuration.	Check the firmware version of the host machine. Upgrade to the latest level.
11563	No Logical Connection with On/Off Controller	Reboot the system. Check connection between Operator panel and PRISMAsync controller
11564	Lost Logical Connection with On/Off Controller	Reboot the system. Check connection between Operator panel and PRISMAsync controller
11570	Upgrading the touch screen failed	Reboot the system. Check connection between Operator panel and PRISMAsync
11571	Printer Interface board hardware failure	Check the DDI board in the PRISMAsync controller and the interface board in the copier.
11572	Scanner Interface board hardware failure	Check the interface board of the scanner.
11573	Printer Interface board software failure	Re-install the software of the PRISMAsync controller
11574	Scanner Interface board software failure	
11575	Engine boot failure	Check LEDs and hardware of engine. This is not a PRISMAsync controller failure
11578	Motherboard defect	Replace the PRISMAsync controller
11587	Software failure	Re-install the host machine firmware.
2259990	Machine recoverable error in copier	Check the description that comes with this code. It describes where in the copier, the error occurred.
2259992	Machine recoverable error in scanner	Check the description that comes with this code. It describes where in the scanner, the error occurred.
2279991	Operator recoverable error in copier	A normal error in the copier, like a paper jam. It also comes with a description to determine where the error occurred.

Error code	Problem	Action
2279993	Operator recoverable error in scanner	A normal error in the scanner, like a paper jam. It also comes with a description to determine where the error occurred.

## 11504 Error Screen behaviour

### Introduction

Release R1.2 introduces a new screen for the 11504 software error.

The screen displays an additional CRC code which is unique within a software release and only shown in case of a 11504 error.

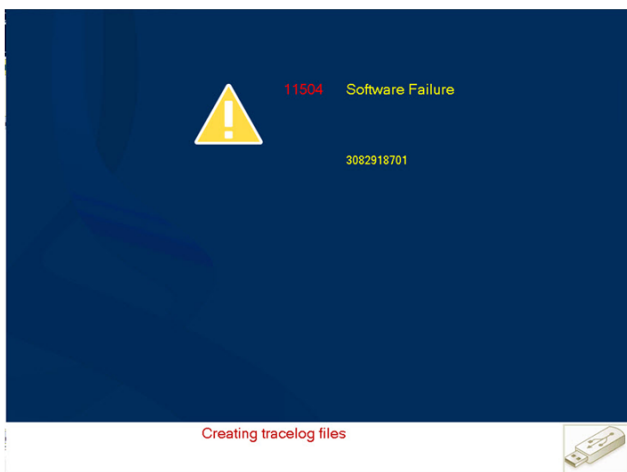

### CRC code

The CRC code is related to the cause of the 11504 software error and the software version present on the machine:

- If an 11504 error occurs and the CRC code is the same as a previous 11504 error, the cause of the problem is the same.
- If an 11504 error occurs and the CRC code is different from a previous error, the cause of the problem is also different.



#### NOTE

This only applies when the software version has not been changed.

### Trace log

After a 11504 error occurs, a trace log is automatically created.

1. You can insert a USB key to export the trace log or touch the screen to exit.



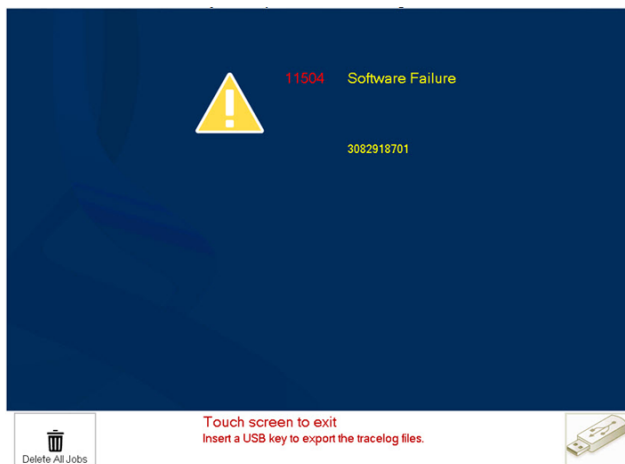

2. After you inserted the USB key, press the USB key icon to store the logging on the USB key.

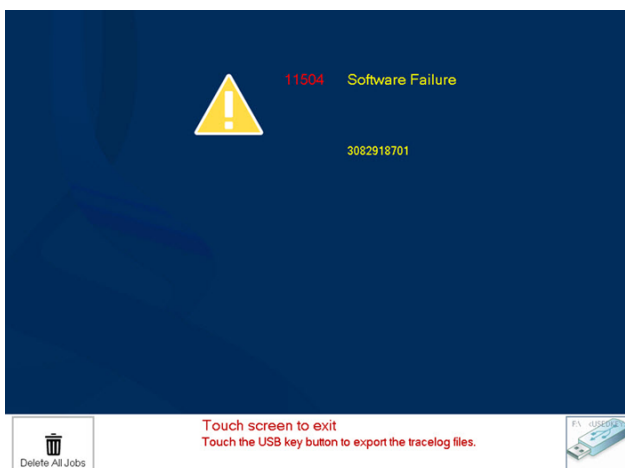

3. After the trace log files are copied to the USB key, the USB icon disappears and you can remove the USB key.

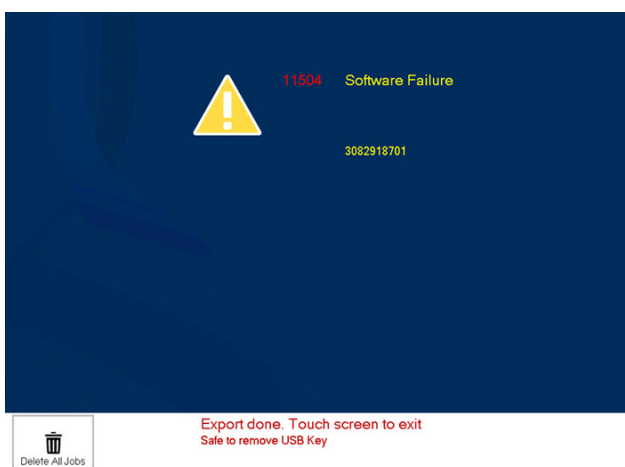



**NOTE**

If the error is caused by a job on the system that cannot be printed, press the **[Delete All Jobs]** button on the screen to remove the print jobs.

The **[Delete all Jobs]** button is only visible the second time a 11504 error occurs.

After all print jobs are deleted, the system will reboot and start up normally.

## 11504 MRE and Hansiplast procedure

### Introduction

The 11504 error indicates a software error in the PRISMAsync controller from which it can not restore. On the display a yellow triangle is displayed asking you to press the panel to restart.

In most of the cases, rebooting the system will solve the problem, however it might occur that the 11504 error is persistent. In such case follow the procedure below.

- For analysis by R&D you can insert a USB stick in the PRISMAsync controller and press the tray button on the right side of the operator panel when the error is active (Yellow triangle on the screen)
- During rebooting the stop button and the tray button on the right side of the operator panel will start flashing simultaneously. When this happens press both buttons for a few seconds. All the jobs in the queue will be removed and if a job in the scheduled queue causes the 11504 error it is removed and the system will reboot correct.
- After a **Third** consecutive occurrence of the 11504 error the Hansiplast procedure will start

Also see [11504 Error Screen behaviour on page 132](#).



#### NOTE

In case a 11504 or 11561 error occurs at installation or during a software upgrade, check the version of host machine firmware and PRISMAsync software. Make sure there is no mismatch between these versions.

### Hansiplast procedure

Hansiplast is the name of a procedure which starts automatically after three consecutive 11504 occurrences, for instance if the PRISMAsync controller is not able to start up completely (e.g. the software has become corrupt).

An image of the software is stored on the PRISMAsync controller and during the Hansiplast procedure this image is restored. This restore is equivalent to a new installation of the software and all jobs will be lost.

The complete Hansiplast procedure will take approximately 45 minutes.



#### NOTE

- Do not switch off the PRISMAsync controller during the Hansiplast procedure. If the PRISMAsync controller is switched off the software has to be installed manually.
- After completion the settings will be restored e.g. a manual restore of a backup.

# PRISMAsync beep codes

## Introduction

In case the PRISMAsync will not start up or unknown errors (e.g 11504) occur, it is possible that the PRISMAsync performs an internal hardware check. The result of this hardware check is given by a specific number of beeps during booting of the system.



### NOTE

If you are not able to determine the error please reboot the system and check if a beep-code is given during the startup.

## Boot Block Beep Codes

Beeps	Description
1	Insert diskette in floppy drive A:
2	'AMIBOOT.ROM' file not found in root directory of diskette in A:
3	Base Memory Error
4	Flash Programming successful
5	Floppy read error
6	Keyboard controller BAT command failed
7	No Flash EPROM detected
8	Floppy controller failure
9	Boot Block BIOS checksum error
10	Flash Erase error
11	Flash Programme error
12	'AMIBOOT.ROM' file size error
13	BIOS ROM image mismatch

## Post BIOS Beep Codes

Beeps	Description
1	Memory refresh timer error
2	Parity error in base memory (first 64K block)
3	Base memory read/write test error
4	Motherboard timer not operational
5	Processor error
6	8042 Gate A20 test error (cannot switch to protected mode)
7	General exception error (processor exception interrupt error)
8	Display memory error (system video adapter)
9	AMIBIOS ROM checksum error
10	CMOS shutdown register read/write error

---

Beeps	Description
11	Cache memory test failed.

### Troubleshooting Post BIOS Beep Codes

Beeps	Description
1,2 or 3	Reseat the memory, or replace with known good module
4-7, 9-11	<p>Fatal error indicating a serious problem with the system. Consult your service representative. Before declaring the motherboard beyond all hope, eliminate the possibility of interference by a malfunctioning add-in card. Remove all expansion cards except the video adapter.</p> <ul style="list-style-type: none"><li>• If beep codes are generated when all other expansion cards are absent, consult your service representative.</li><li>• If beep codes are not generated when all other expansion cards are absent, one of the add-in cards is causing the malfunction. Insert the cards back into the system one at a time until the problem happens again. This will reveal the malfunctioning card.</li></ul>
8	If the system video adapter is an add-in card, replace or reseat the video adapter. If the video adapter is an integrated part of the system board, the board may be faulty.

# Escalation procedure

## Introduction

This topic describes the required information when an issue is escalated (via a Trust call).

## Required information

	Print quality	Media	Drivers	PRISMAsync
Config report	*	*	*	*
Data dump	*	*	*	*
Print file	*		*	If applicable
Customer print sample	*	*		
Trace file	*			*
Color reference file	*	*		
P-print	*	*	*	*

## Attachments

1. **Configuration report:**
  - The configuration report can be created from the settings editor.  
Select: Support -> Troubleshooting -> Save the configuration report
2. **Data dump:**
  - The data dump can be created from the settings editor.  
Select: Support -> Troubleshooting -> Create a new data dump file.
3. **Print file:**
  - In case of print (quality) problems caused by wrong interpreted files, ask the customer for a file sample and attach it to the report.
4. **Customer Print sample:**
  - Print sample of customer problem (on request)
5. **Trace file:**
  - The trace file can be created from the settings editor  
SE: support -> trouble shooting -> logging -> create a new trace file
  - When an issue is expected to be related to the engine, include the engine logging.  
SE: support -> trouble shooting -> logging -> include printer logging
6. **Color reference file**
  - Add the color reference file to the report.
  - SE: Media -> Media family -> Print -> Color reference file
7. **P-Print report**
  - Add the P-Print report
  - LUI -> Service mode -> Engine Reports -> generate engine report.

## Faults/Problems:

1. **Print Quality:**
  - The defect is visible on the print of a customer file.  
Not to be mixed up with Image quality which is visible on bitmap printouts.
2. **Media:**
  - What is the customer complaint?
  - How does the print quality look (send pictures or prints of problem)?

- What paper is used (brand name, supplier, grammage, bulkiness e.g.)?
3. **Driver:**
- Ask the operator how to reproduce the problem
  - Create a driver report (about tab in printer driver)
  - Create a print file of the problem, by changing the port of the driver temporary to "print to File". Retrieve this file from the PC and include in the report.
4. **PRISMAsync**
- Ask the local IT for a correct description of the operating system of the Host, type and version of the used driver, and network communication protocol which is needed to describe the workflow.





# **Chapter 11**

## **Appendix**

## Appendix A: Specifications

### Hardware features

- Intel Core i7 860 @ 2.8GHz – 8MB cache CPU
- 4 x 4GB DDR3 @ 1333MHz SDRAM non-ECC (Dual channel mode)
- 1 x 250GB 3.5" SATA II HDD @ 7200rpm (System disk)
- 2 x 250GB 3.5" SATA II HDD @ 7200rpm (2 x Data disk Raid0)
- ATX power supply, 600W, 80+ Bronze
- Dimensions (HxWxD): 42 cm (16.5 in.) x 20 cm (7,9 in.) x 43 cm (16.9 in.)
- Weight: 16 Kg.
- Power consumption: 100-240V, 10-5A, 50-60Hz



#### NOTE

All Hard Disk Drives and memory modules integrated in one system must all have:

- the same brand, model for the Hard Disk Drives
- the same brand, model, organization and layout for the memory modules

---

## Connectivity

- 10/100/1000 Base T
- TCP/IP
  - lpr/lpd
  - 9100 socket
  - SMB
- IP-version: IPv4
- IP-version: IPv6
- static/auto IP (BOOTP, DHCP)
- SNMP v1-v3 support
  - Host resources MIB
  - System group MIB
  - Printer MIB
  - Job MIB
  - Job Monitor MIB
- Embedded WebServer
  - WEB Settings Editor
  - Operator Maintenance Application (not for imagePRESS C800 Series)

# Appendix B: Parts overview

## Overview of the service parts

### Illustration

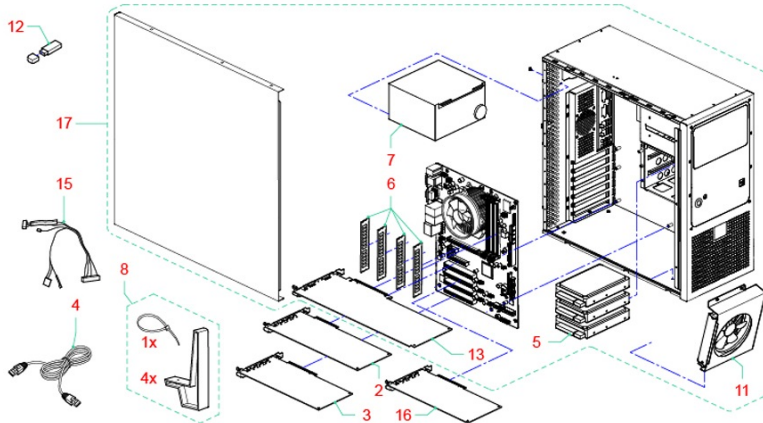

### Component - function table

No	Part
2	PBA DDI IF BOARD
3	PBAP AUX_CONTROL
4	DATA CABLE RJ45-RJ45CRSVR SFTP 2.8M
5	HDD 3,5" SATA II 250GB 7200RPM (3X)
6	MEMORY MODULE 4GB DDR3 (4X)
7	POWER SUPPLY 600W
8	PEDESTAL (4X) + TIEWRAP
11	SYSTEM FAN 120MM
12	USB KEY
13	PCI-E X16 GRAPHIC BOARD
15	HARNESS 22W01
16	ETHERNET BOARD ROHS (IPDS)
17	INDUSTRIAL CONTROLLER iBase



#### NOTE

For the part numbers see the parts catalogue.

# DIP switch board

## Introduction

To connect the PRISMAsync controller to the imagePRESS C800 engine it is necessary to install the DIP switch board

Via the DIP switch settings, the communication between engine and PRISMAsync controller is enabled.

## Illustration

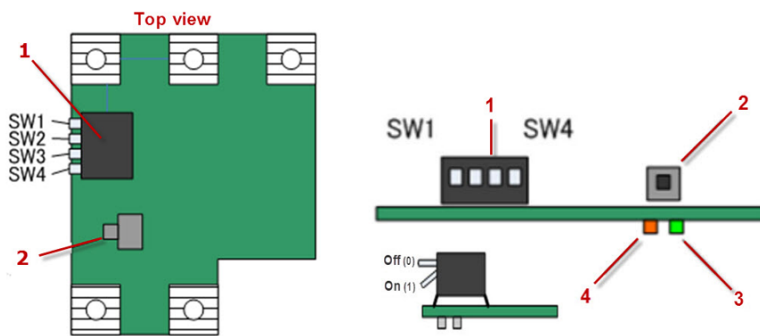

## Component - function table

No	Part
1	DIP switch
2	Power switch
3	Power LED
4	Tally LED

## DIP switch

The DIP switch has four bi-state (OFF/ON) switches. The table below gives an overview of different states.

DIP switch State	Model	Boot Mode	IP Address
<p>OFF</p> <p>ON</p> <p>SW1 SW2 SW3 SW4</p>	PRISMAsync	Normal boot mode	134.188.254.21

DIP switch State	Model	Boot Mode	IP Address
<p>OFF</p> <p>ON</p> <p>SW1 SW2 SW3 SW4</p>	PRISMAsync	Safe download mode (2+8 key boot)	134.188.254.21
<p>OFF</p> <p>ON</p> <p>SW1 SW2 SW3 SW4</p>	Canon/Fiery	-	-

### Power switch

The Power switch (push button) located on the DIP switch board is not used.

The behaviour of the switch is equal to the "Energy safer key" on the Canon user interface.

### LEDs

The DIP switch board has two LEDs.

The Power LED is used to identify whether the engine is energized or not.



#### NOTE

If the Power LED is On and the Tally LED is OFF this could indicate a problem during the start-up sequence. The problem occurs before the main controller software is fully operational.

LED	Colour	Function	Information
Tally LED	Amber	Processing / data indicator	Controlled by main controller software
Power LED	Green	Main power indicator	Controlled by hardware

## Appendix C: Tips & Tricks

### How to check if DDR memory is defect or missing

#### Description

- The controller responds in an uncontrolled way and is very slow in performance.
- A particular 11504 error occurs very frequently.
- Fails to install new software

#### Possible causes

Defect or missing memory DIMM.



#### NOTE

Check the parts catalogue for compatibility.

#### Analysis

#### Procedure

1. Check the configuration report. There you can find the amount of memory available in your system. This should be 4 or 16GB depending on the controller version used. Be sure that you create a new Configuration Report in the Settings Editor. The configuration Report that is visible on the screen might be older of age.
2. On the Operator Panel go to Service Mode. In the first screen select "Error Analysis". If you see multiple 11504 errors with the description described below, it is possible that a memory module is defect.  
Description 11504: Can't allocate run length block number xx (size 11366400)
3. If, during re-installation the screen below is shown, it is possible that a defect memory module causes this.

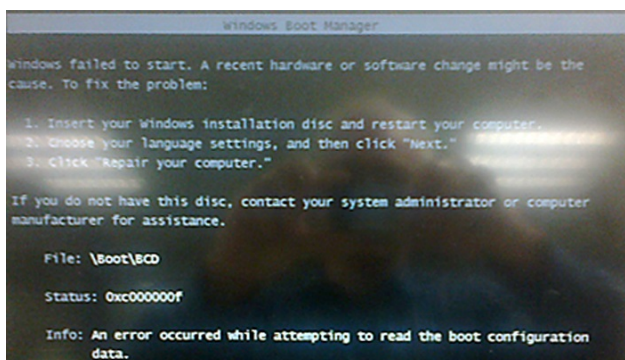

[24] Fig. Unable to boot

4. Reboot the PRISMAsync. If during the boot sequence Beep codes are heard, count the number of beeps. Compare the number with the number given in the chapter [PRISMAsync beep codes on page 136](#). If the number of beeps is 1, 2 or 3 check the memory modules.

## How to print transparencies with best quality

### Description

Transparencies might cause image quality problems like darker areas etc. The copier and the PRISMAsync will make a difference between Text/Vector and Images. Different screens can be specified for these objects.

### Solution

Some tips for improving Image Quality in these situations are:

1. Use the APPE engine for printing. This means
  - Use Hotfolder, Automated Workflow or PRISMAprepare.
  - Do not use the driver, since this creates Postscript.
2. Make sure a good calibrations was performed for both screenings (Normal and Fine) for all media families
3. Make the screening for text and images the same for 600 dpi printing (No screen jump will occur)
4. Make a new preset if you do not want to do this for all jobs



## How to improve black density on the print

### Description

On some media the density of black is too low.

### Solution

There is a setting available to improve the Black density. It can be adjusted in the "Printer adjustment" section of the specified media.

### Procedure

1. In your browser open the Settings Editor and go to "Media"
2. Select the media and then select "Printer adjustment".
3. In the "Advanced" section select "Gloss and Fine black adjustment"
4. Adjust the value to your need. You can change it between -2 and +2. These values are related to the Gloss-setting. However the Fine-Black setting will also change when you change the Gloss-Setting. The following relation exists:

Gloss	Fine Black
-2	2
-1	1
0	0
+1	0
+2	0

5. Please take care that this setting can only be used for Plain paper. (So not for coated, vellum etc.)

## Strange colors after editing CMYK curves

### Description

After editing the CMYK curves one might get strange effects with the colors. Colors that were the same before editing, now are different.

### Solution

First thing you must know is that there is a big difference between editing the CMYK curves on a job-level and editing on system-level.

### Procedure

1. Job-Level

On the Operator Panel, select the job and open the properties (double-click). Select "Adjust Image". In the next window you can change the CMYK-curves. If you then print the job the result will be good, because the curve has been adjusted for this particular job and media.

2. System-Level

Changing the CMYK-curves on system level means that the curves will be changed for all the jobs to come. In the "Color Adjustment" section of the "System" tab you will find the "Edit CMYK curves manually". After selecting this, you are able to adjust the curves per media family. Very important however is that you do the changes for all halftones/screens. If you forget this, it is very well possible that you get differences in colors between text and images. This is caused by the fact that text is often printed with another halftone than images.

To overcome these differences you have to either edit the curve for all halftones or force the system to print text and images with the same halftone.

# Appendix D: System log files

## How to create a datadump file

### Question

How to create a datadump file?

### Answer

A datadump file contains system information about counters, versions and errors and is useful for analysis of the system behaviour.

To create a datadump file:

1. Open the Setting Editor by entering the name of your system in the address bar of your internet browser (e.g. Internet Explorer). In the example the system name is: ipc6010s-sns.



2. Do the following steps:
  1. Select [Support]
  2. Select [Troubleshooting]
  3. Select [Create a new datadump file]

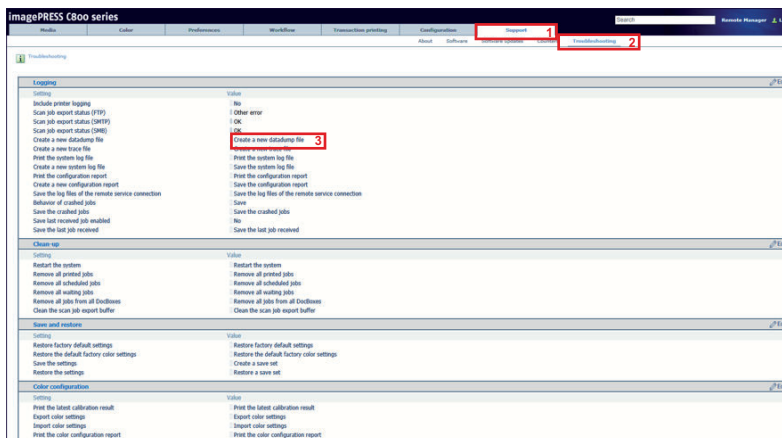

3. To download the file you have to be logged in as [Key operator] or [System administrator]. Select the correct Username and enter the Password. Then click on **[Login]**.



4. Select [Create a new datadump file] to create a new datadump file. The name of the new file appears in the window. It is possible that a name was already present, but to be sure that you will get the most recent version it is recommended to execute this step.

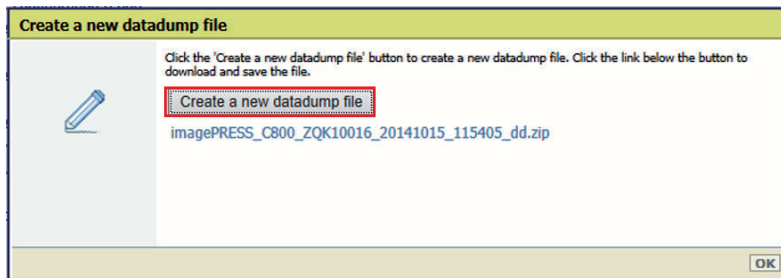

5. Select the trace file which you want to download.

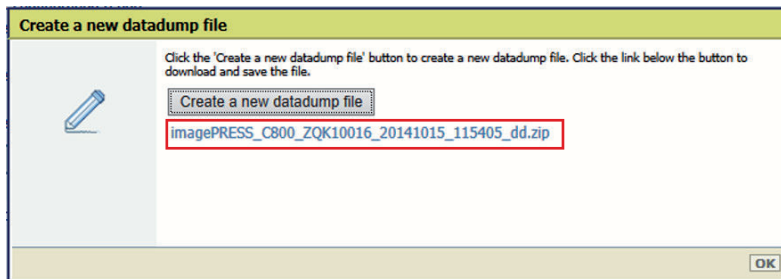

6. Select [Save] and enter a filename and confirm your choice.
7. Select [OK] to close the window.

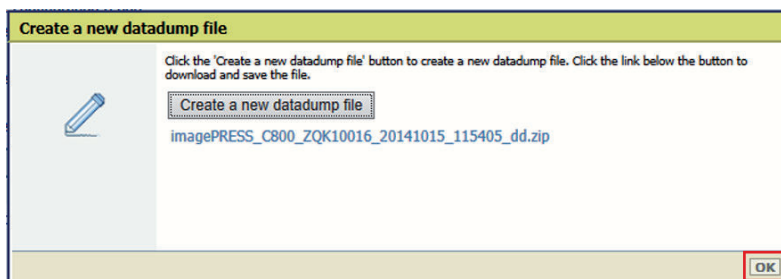

## How to create a trace file

### Question

How to create a trace file

### Answer

A trace file provides detailed system information about the data- and event flow of the PRISMAsync for imagePRESS C800 Series software. This information is necessary for the analysis of the system behaviour and to determine the cause of errors.

To create a trace file including the printer logging:

1. Open the Setting Editor by entering the name of your system in the address bar of your internet browser (e.g. Internet Explorer).  
(In the example the system name is: **ipc6010s-sns**)



2. Do the following steps:
  1. Select [Support]
  2. Select [Troubleshooting]
  3. Select [Create a new trace file].

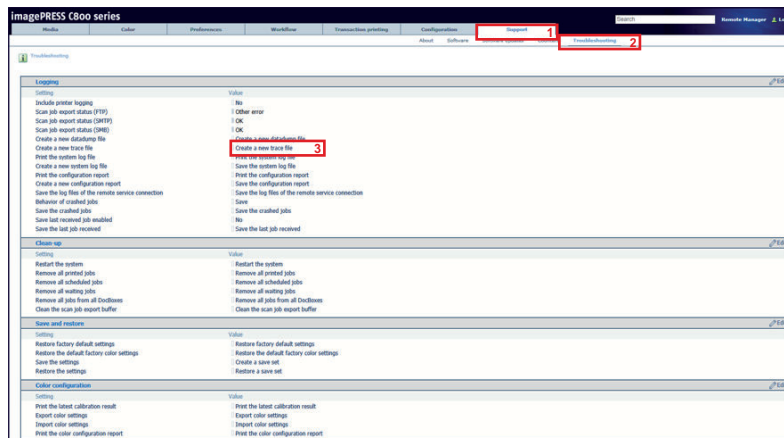

3. To download the file you have to be logged in as [Key operator] or [System administrator].  
Select the correct Username and enter the Password. Then click on [Login].



4. Select [Create a new trace file] to create a new trace file.  
A new file is created and added at the top of the list. Trace files are also generated due to the occurrence of an error and normal logs. If an error occurs and a trace file is generated, the error code will be present in the name of the trace file.

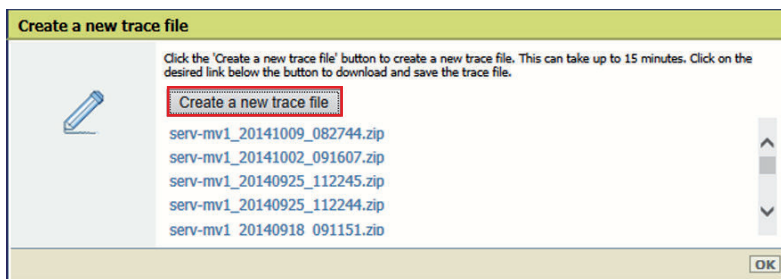

5. Select the trace file which you want to download.

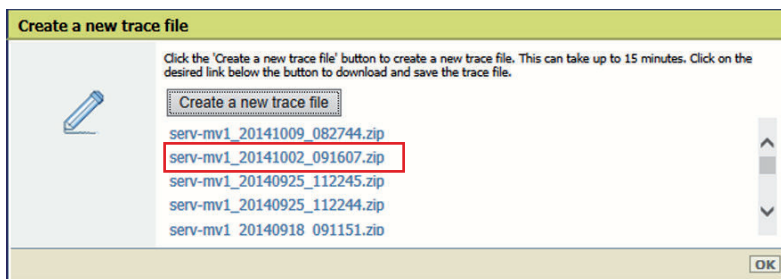

6. Select [Save] and enter a file name and confirm your choice.  
Repeat this procedure if you want to download more than one file.
7. Select [OK] to close the window.

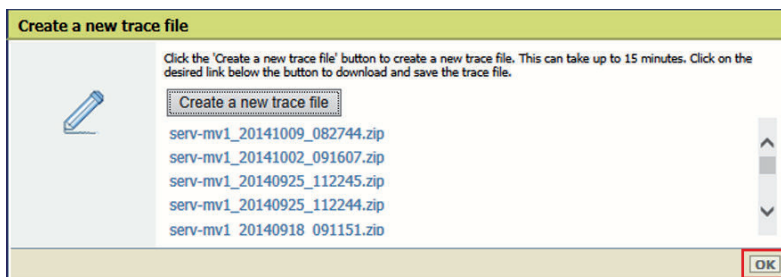

## How to create a trace file including the printer logging

### Question

How to create a trace file including the printer logging?

### Answer

A trace log gives very detailed system information about the data- and event flow of the PRISMAsync for imagePRESS C800 Series software. This information is necessary for the analysis of the system behaviour and to determine the cause of the occurrence of errors. It is possible to include the printer logging in the trace file.



### NOTE

Including the printer logging makes the trace file much larger.

To create a trace file including the printer logging:

1. Open the Setting Editor by entering the name of your system in the address bar of your internet browser (e.g. Internet Explorer).  
(In the example the system name is: **ipc6010s-sns**)



2. Select the following steps:
  1. Select [Support]
  2. Select [Troubleshooting]
  3. Select [**include printer logging**].

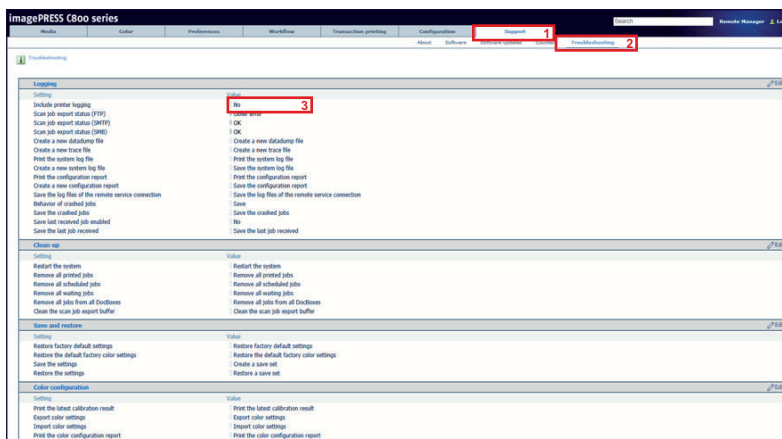

3. To change this settings you have to be logged in as [Key operator] or [System administrator]. Select the correct Username and enter the Password. Then click on [**Login**].



4. Select [Yes] to include the printer logging in the trace file.

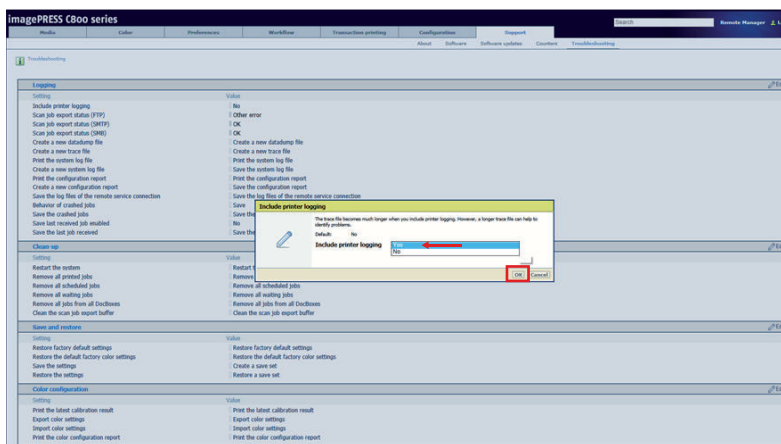

5. Select [Create a new trace file].

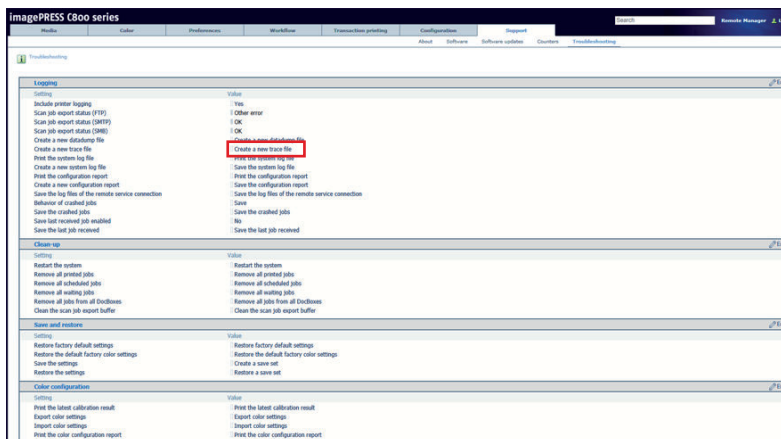

6. Select [Create a new trace file] to create a new trace file.

A new file is created and added at the top of the list. Trace files are also generated due to the occurrence of an error and normal logs. If an error occurs and a trace file is generated, the error code will be present in the name of the trace file.



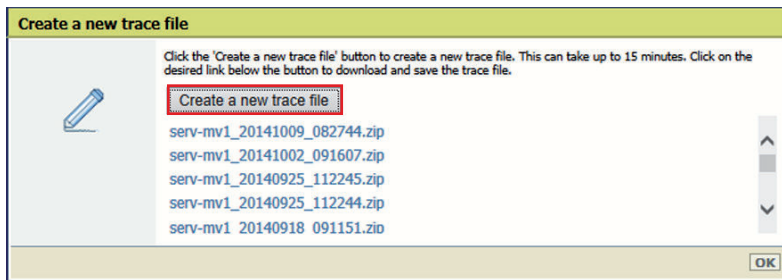

7. Select the trace file which you want to download.

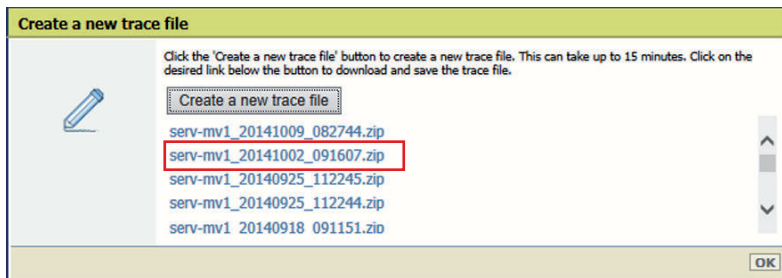

8. Select [Save] and enter a file name and confirm your choice.

Repeat this procedure if you want to download more than one file.

9. Select [OK] to close the window.

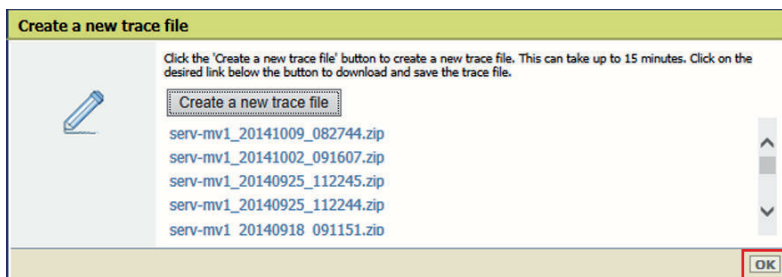

# Appendix E: Engine reports

## Engine reports

- In the service mode a sorted list of all durables and periodically replaceable parts of the engine and accessories can be generated and displayed on the LUI. The list is sorted by lifetime. Doing so is the easiest way for the Field Service Technician to get an overview of the status of all parts.

Consumption Rate (%)	Part Code (with counter path)	Current Counter Value	Part Lifetime
188	COUNTER > CLEANING > PO-C-RL	282171	150000
188	COUNTER > CLEANING > 2TR-C-RL	282171	150000
128	COUNTER > DRBL-1 > ITB-WEB	128131	100000
128	COUNTER > CLEANING > FX1-4FRL	128131	100000
128	COUNTER > CLEANING > FX1-4FCL	128131	100000
127	COUNTER > DRBL-1 > 2TR-BURL	765520	600000
127	COUNTER > DRBL-1 > ITB-CLN1	765520	600000
127	COUNTER > DRBL-1 > FX4B-ST	765520	600000
112	COUNTER > PRDC-1 > PRM-W-Y	282171	250000
112	COUNTER > PRDC-1 > GR-PAD-Y	282171	250000
112	COUNTER > PRDC-1 > PRM-G-Y	282171	250000

- A digital version of the P-PRINT, CP-PRINT, D-PRINT, ENV-PRINT and the HIST-PRINT can be generated and displayed on the LUI. The prints can be stored on a USB stick when needed e.g. for escalation purposes.

```

28/10 2012 MON 09:55
SERVICE NAME: 11PR_C701079
*****
***  CPU SERVICE REPORT  ***
*****

SERIAL NO          HASH          ONT00202
MANUFACTURING ENGINE
FIXING STATION

SYSTEM NAME        DISPLAY          Canon iPRCT010799_V2
DISPLAY
VERSION
SC-COM             66.01
PANEL              00.03
ECO                00.00
SYSTEM            40.04
SER                09.00
DECK               42.02
MP-COM            20.04
RTI                80.46
*****
FRM               20.04
LANG-ES            21.05
LANG-FR            21.05
LANG-DE            21.05
LANG-IT            21.05
LANG-SP            20.04
LANG-CS            ---
LANG-DA            ---
LANG-EL            ---
LANG-ES            21.05
LANG-ET            ---
LANG-PT            ---
LANG-RO            ---
LANG-RU            ---
LANG-SL            ---
LANG-SO            ---
LANG-PL            ---
LANG-PT            ---
LANG-PT            ---
    
```

### Logging of the firmware upgrade

During the firmware upgrade a logging is created. This logging can be viewed and checked for analysis and for escalations it can be downloaded.

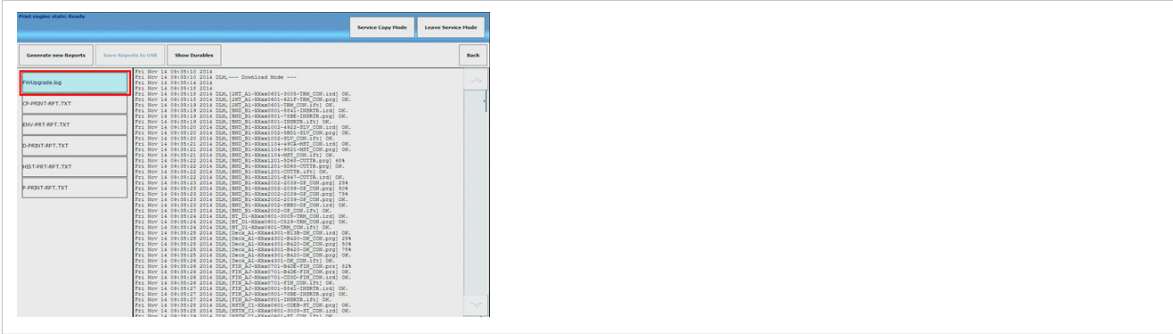

How to view & store engine reports

Step	Action	Remarks																																																												
1	Go to service mode.																																																													
2	Press button –engine reports																																																													
3	Click on -generate new reports- button	<table border="1"> <thead> <tr> <th>Report Name</th> <th>Consumption Rate (%)</th> <th>Part Code (with counter part)</th> <th>Current Counter Value</th> <th>Part Lifetime</th> </tr> </thead> <tbody> <tr> <td>E-PRNT.RPT.TXT</td> <td>613</td> <td>COUNTER + DBL-1 + DEV-P-C</td> <td>1034787</td> <td>250000</td> </tr> <tr> <td>S-V-PRNT.RPT.TXT</td> <td>613</td> <td>COUNTER + DBL-1 + DEV-P-K</td> <td>1034787</td> <td>250000</td> </tr> <tr> <td>D-PRNT.RPT.TXT</td> <td>172</td> <td>COUNTER + DBL-1 + PCH-S-R</td> <td>1034787</td> <td>600000</td> </tr> <tr> <td>HST-PRNT.RPT.TXT</td> <td>117</td> <td>COUNTER + DBL-2 + DL-G-FO</td> <td>117949</td> <td>100000</td> </tr> <tr> <td>P-PRNT.RPT.TXT</td> <td>103</td> <td>COUNTER + PRDC-1 + PR-ED-TS</td> <td>1034787</td> <td>1000000</td> </tr> <tr> <td></td> <td>103</td> <td>COUNTER + PRDC-1 + CO-FB-3</td> <td>1034787</td> <td>1000000</td> </tr> <tr> <td></td> <td>103</td> <td>COUNTER + DBL-1 + JOB-RLT</td> <td>1034787</td> <td>1000000</td> </tr> <tr> <td></td> <td>103</td> <td>COUNTER + DBL-1 + DCLR-RL</td> <td>1034787</td> <td>1000000</td> </tr> <tr> <td></td> <td>93</td> <td>COUNTER + PRDC-1 + FB-TH1</td> <td>931199</td> <td>1000000</td> </tr> <tr> <td></td> <td>93</td> <td>COUNTER + PRDC-1 + FB-TH2</td> <td>931199</td> <td>1000000</td> </tr> <tr> <td></td> <td>93</td> <td>COUNTER + PRDC-1 + FB-TH4</td> <td>931199</td> <td>1000000</td> </tr> </tbody> </table>	Report Name	Consumption Rate (%)	Part Code (with counter part)	Current Counter Value	Part Lifetime	E-PRNT.RPT.TXT	613	COUNTER + DBL-1 + DEV-P-C	1034787	250000	S-V-PRNT.RPT.TXT	613	COUNTER + DBL-1 + DEV-P-K	1034787	250000	D-PRNT.RPT.TXT	172	COUNTER + DBL-1 + PCH-S-R	1034787	600000	HST-PRNT.RPT.TXT	117	COUNTER + DBL-2 + DL-G-FO	117949	100000	P-PRNT.RPT.TXT	103	COUNTER + PRDC-1 + PR-ED-TS	1034787	1000000		103	COUNTER + PRDC-1 + CO-FB-3	1034787	1000000		103	COUNTER + DBL-1 + JOB-RLT	1034787	1000000		103	COUNTER + DBL-1 + DCLR-RL	1034787	1000000		93	COUNTER + PRDC-1 + FB-TH1	931199	1000000		93	COUNTER + PRDC-1 + FB-TH2	931199	1000000		93	COUNTER + PRDC-1 + FB-TH4	931199	1000000
Report Name	Consumption Rate (%)	Part Code (with counter part)	Current Counter Value	Part Lifetime																																																										
E-PRNT.RPT.TXT	613	COUNTER + DBL-1 + DEV-P-C	1034787	250000																																																										
S-V-PRNT.RPT.TXT	613	COUNTER + DBL-1 + DEV-P-K	1034787	250000																																																										
D-PRNT.RPT.TXT	172	COUNTER + DBL-1 + PCH-S-R	1034787	600000																																																										
HST-PRNT.RPT.TXT	117	COUNTER + DBL-2 + DL-G-FO	117949	100000																																																										
P-PRNT.RPT.TXT	103	COUNTER + PRDC-1 + PR-ED-TS	1034787	1000000																																																										
	103	COUNTER + PRDC-1 + CO-FB-3	1034787	1000000																																																										
	103	COUNTER + DBL-1 + JOB-RLT	1034787	1000000																																																										
	103	COUNTER + DBL-1 + DCLR-RL	1034787	1000000																																																										
	93	COUNTER + PRDC-1 + FB-TH1	931199	1000000																																																										
	93	COUNTER + PRDC-1 + FB-TH2	931199	1000000																																																										
	93	COUNTER + PRDC-1 + FB-TH4	931199	1000000																																																										
4	New reports will be generated																																																													

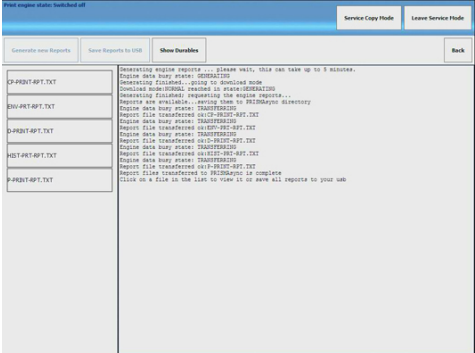
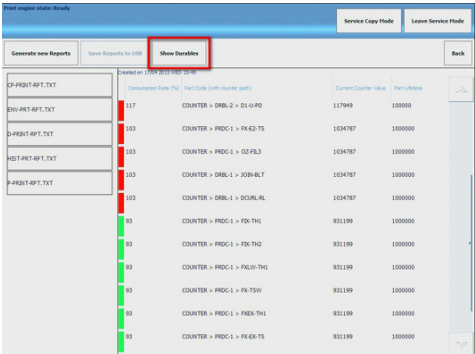
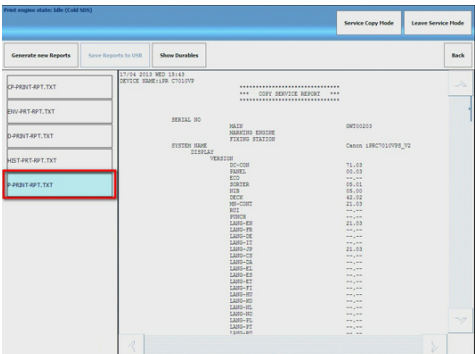
Step	Action	Remarks																																																
5	By toggling -Show Durable- and -XX print- buttons the durables and the engine reports will be shown	 <p>The screenshot shows the 'Print engine status' window with the 'Show Durables' button highlighted. The main area displays a list of reports with their respective status and details.</p>																																																
6		 <p>The screenshot shows the 'Print engine status' window with the 'Show Durables' button highlighted. The main area displays a detailed table of counter values for various components.</p> <table border="1"> <thead> <tr> <th>Counter Name (No.)</th> <th>Part Code (with counter part)</th> <th>Current Counter Value</th> <th>Part Lifetime</th> </tr> </thead> <tbody> <tr> <td>117</td> <td>COUNTER + DBL-2 &gt; DL-6-PD</td> <td>117999</td> <td>1000000</td> </tr> <tr> <td>103</td> <td>COUNTER + PDC-1 &gt; FK-2-TS</td> <td>1034787</td> <td>1000000</td> </tr> <tr> <td>103</td> <td>COUNTER + PDC-1 &gt; GD-F-3</td> <td>1034787</td> <td>1000000</td> </tr> <tr> <td>103</td> <td>COUNTER + DBL-1 &gt; XDB-6LT</td> <td>1034787</td> <td>1000000</td> </tr> <tr> <td>103</td> <td>COUNTER + DBL-2 &gt; DDBL-RL</td> <td>1034787</td> <td>1000000</td> </tr> <tr> <td>93</td> <td>COUNTER + PDC-1 &gt; FK-7H1</td> <td>931199</td> <td>1000000</td> </tr> <tr> <td>93</td> <td>COUNTER + PDC-1 &gt; FK-7H2</td> <td>931199</td> <td>1000000</td> </tr> <tr> <td>93</td> <td>COUNTER + PDC-1 &gt; FK-7H3</td> <td>931199</td> <td>1000000</td> </tr> <tr> <td>93</td> <td>COUNTER + PDC-1 &gt; FK-7S1</td> <td>931199</td> <td>1000000</td> </tr> <tr> <td>93</td> <td>COUNTER + PDC-1 &gt; FK-7S2</td> <td>931199</td> <td>1000000</td> </tr> <tr> <td>93</td> <td>COUNTER + PDC-1 &gt; FK-6X-TS</td> <td>931199</td> <td>1000000</td> </tr> </tbody> </table>	Counter Name (No.)	Part Code (with counter part)	Current Counter Value	Part Lifetime	117	COUNTER + DBL-2 > DL-6-PD	117999	1000000	103	COUNTER + PDC-1 > FK-2-TS	1034787	1000000	103	COUNTER + PDC-1 > GD-F-3	1034787	1000000	103	COUNTER + DBL-1 > XDB-6LT	1034787	1000000	103	COUNTER + DBL-2 > DDBL-RL	1034787	1000000	93	COUNTER + PDC-1 > FK-7H1	931199	1000000	93	COUNTER + PDC-1 > FK-7H2	931199	1000000	93	COUNTER + PDC-1 > FK-7H3	931199	1000000	93	COUNTER + PDC-1 > FK-7S1	931199	1000000	93	COUNTER + PDC-1 > FK-7S2	931199	1000000	93	COUNTER + PDC-1 > FK-6X-TS	931199	1000000
Counter Name (No.)	Part Code (with counter part)	Current Counter Value	Part Lifetime																																															
117	COUNTER + DBL-2 > DL-6-PD	117999	1000000																																															
103	COUNTER + PDC-1 > FK-2-TS	1034787	1000000																																															
103	COUNTER + PDC-1 > GD-F-3	1034787	1000000																																															
103	COUNTER + DBL-1 > XDB-6LT	1034787	1000000																																															
103	COUNTER + DBL-2 > DDBL-RL	1034787	1000000																																															
93	COUNTER + PDC-1 > FK-7H1	931199	1000000																																															
93	COUNTER + PDC-1 > FK-7H2	931199	1000000																																															
93	COUNTER + PDC-1 > FK-7H3	931199	1000000																																															
93	COUNTER + PDC-1 > FK-7S1	931199	1000000																																															
93	COUNTER + PDC-1 > FK-7S2	931199	1000000																																															
93	COUNTER + PDC-1 > FK-6X-TS	931199	1000000																																															
7		 <p>The screenshot shows the 'Print engine status' window with the 'Show Durables' button highlighted. The main area displays a detailed report of engine parameters, including system name, version, and various engine metrics.</p>																																																

How to save reports

Step	Action	Remarks
1	Insert a USB key.	If no key is inserted, the button – Save Reports to USB- will be greyed-out.
2	Click on one of the buttons to show the desired report	

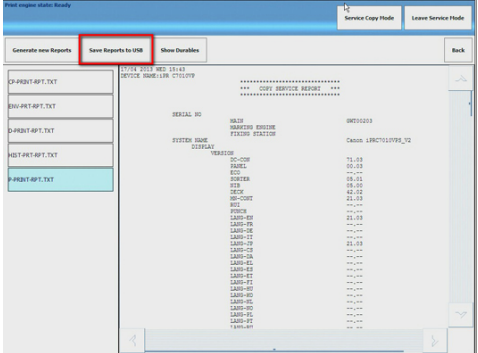
Step	Action	Remarks
3	Click on – Save Reports to USB- and all reports will be saved to the USB key	

**Durable list**

The durable list on the PRISMAasync Local User Interface is derived from the DRBL’s and PRDC as present on the P-print. The parts with the highest lifetime percentage are on top.

In service operations some parts are not actively monitored and thus counters are not reset.

Part counters with a threshold of -0- (zero) will be ignored by PRISMAasync and not displayed on the LUI.

**Advice**

To have an accurate list of parts in the durable list it is advised to set the threshold value of –non actively monitored parts- in engine service mode to -0-.

**Example:**

In picture 1 the lifetime of ITB-WEB and DEV-P-X are displayed. Go to service mode > Copier> Counter> AVE-DRB1 and set the threshold to -0-. In picture 2 the ITB-WEB and DEV-P-X parts are no longer displayed. Result; a more accurate list.

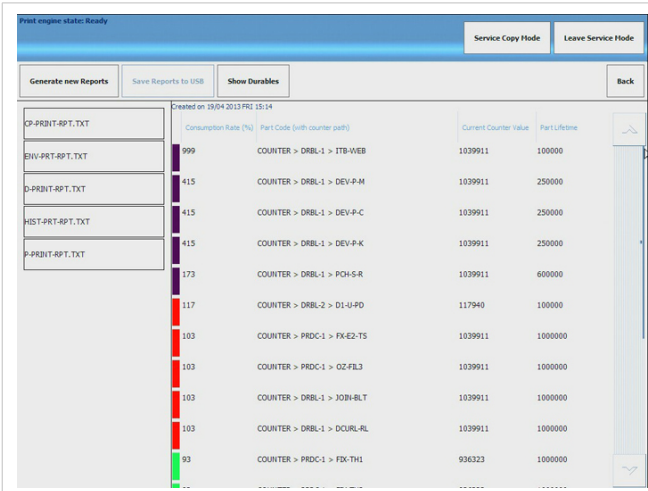

Consumption Rate (%)	Part Code (with counter part)	Current Counter Value	Part Lifetime
999	COUNTER > DRBL-1 > ITB-WEB	1039911	100000
415	COUNTER > DRBL-1 > DEV-P-M	1039911	250000
415	COUNTER > DRBL-1 > DEV-P-C	1039911	250000
415	COUNTER > DRBL-1 > DEV-P-K	1039911	250000
173	COUNTER > DRBL-1 > PCH-S-R	1039911	600000
117	COUNTER > DRBL-2 > D1-J-PD	117940	100000
103	COUNTER > PRDC-1 > FX-E2-TS	1039911	1000000
103	COUNTER > PRDC-1 > OZ-FB3	1039911	1000000
103	COUNTER > DRBL-1 > JOBN-BLT	1039911	1000000
103	COUNTER > DRBL-1 > DCURL-RL	1039911	1000000
93	COUNTER > PRDC-1 > FXD-TH1	936323	1000000

[25] Picture 1

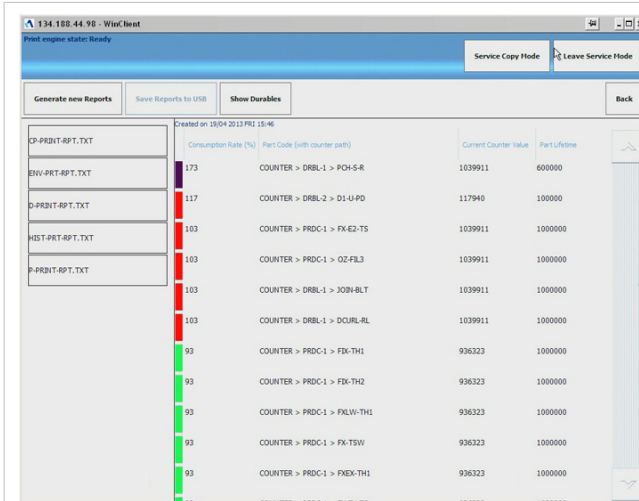

[26] Picture 2

# Appendix F: The Trapping editor

## The Trapping editor

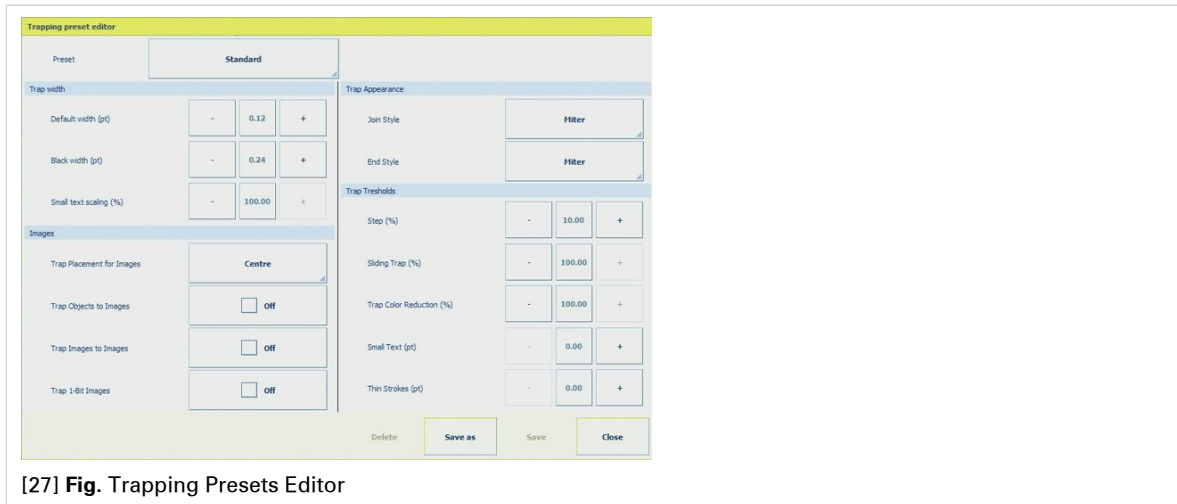

[27] Fig. Trapping Presets Editor

### Trap width

Trap width is the amount of overlap for each trap. Differences in paper characteristics, screen rulings, and printer conditions require different trap widths.

- **Default width:**  
Specifies the trap width in points for trapping all colors except those involving solid black. The default value is 0p0.25.
- **Black width:**  
Indicates the distance that toners spread into solid black, or the holdback amount—the distance between black edges and underlying toners for trapping rich blacks. The default value is 0p0.5. This value is often set to be 1.5 to 2 times the value of the default trap width.

### Trap Appearance

- **Join Style:**  
A join is where two trap edges meet at a common endpoint. You can control the shape of the outside join of two trap segments and the intersection of three traps. Join Style Controls the shape of the outside join of two trap segments. Choose from Miter, Round, and Bevel. (Left to right)

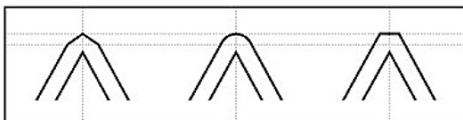

[28] Fig. Trap Join Styles

- **End Style:**  
Controls the intersection of three-way traps. Miter (the default) shapes the end of the trap to keep it away from the intersecting object. Overlap affects the shape of the trap generated by the lightest neutral density object that intersects with two or more darker objects. The end of the lightest trap is wrapped around the point where the three objects intersect. In the example the left image shows the miter effect. The right image shows the overlap.



## Trap thresholds

- **Step**

Specifies the color change threshold at which the trapping engine creates a trap. Some jobs need only the most extreme color changes trapped, while others require traps for more subtle color changes. The Step value indicates the degree to which components (such as CMYK values) of abutting colors must vary before trapping occurs. To change how much the component toners in abutting colors can vary before causing those colors to trap, increase or decrease the value for Step. The default is 10%. For best results, use a value from 8% to 20%. Lower percentages increase sensitivity to color differences and result in more traps.
- **Sliding Trap**

Determines when the trapping engine starts to straddle the centerline of the color boundary. The value refers to the proportion of the lighter color's neutral density value to a darker, abutting color's neutral density value. For example, setting the Sliding Trap value to 70% moves the point at which the trap begins to straddle the centerline to where the lighter color exceeds 70% of the darker color in neutral density (lighter color's neutral density divided by darker color's neutral density > 0.70). Colors of identical neutral density will always have their traps exactly straddle the centerline, unless the Sliding Trap is set to 100%.
- **Trap Color Reduction**

Indicates the degree to which components from abutting colors are used to reduce the trap color. This setting is useful for preventing certain abutting colors (such as pastels) from making an unsightly trap that is darker than either color. Specifying a Trap Color Reduction lower than 100% begins to lighten the color of the trap; a Trap Color Reduction value of 0% makes a trap with a neutral density equal to the neutral density of the darker color.

## Images

- **Trap Placement for Images** Provides options for determining where the trap falls when you trap vector objects to bitmap images. All options except "Normal" create a visually consistent edge.
  - o Center creates a trap that straddles the edge between objects and images.
  - o Choke causes objects to overlap the abutting image.
  - o Normal applies the same trapping rules as used elsewhere in the document. Trapping an object to a photograph with the "Normal" setting can result in noticeably uneven edges as the trap moves from one side of the edge to another.
  - o Spread causes the bitmap image to overlap the abutting object.
- **Trap Objects To Images**

Ensures that vector objects (such as frames used as keylines) trap to images, using the Trap Placement settings. If vector objects don't overlap images in a trapping page range, consider turning this option off to speed trapping of that page range.
- **Trap Images To Images**

Turns on trapping along the boundary of overlapping or abutting bitmap images.
- **Trap 1-Bit Images**

Ensures that 1-bit images trap to abutting objects. This option doesn't use the Image Trap Placement settings, because 1-bit images use only one color. In most cases, leave this option



selected. In some cases, such as with 1-bit images where pixels are widely spaced, selecting this option may darken the image and slow the trapping.

# Appendix G: EAC document

## EAC model number overview

### Introduction

This topic provides an overview of the Océ model numbers used for the imagePRESS C800 Series configuration.

### location overview

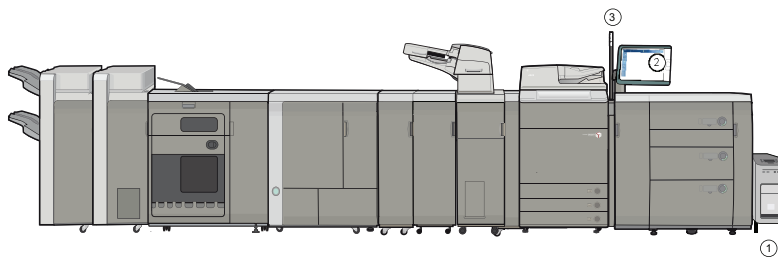

Item nr	Commercial Name	Mercury Code	Parts list chapter	Remark
1	PRISMAsync iPR C800 Series-A1	9661B001AA	Figure U10	
	Add. Network Adapter	6123B001AA		Optional part if IPDS is ordered
2	Operating Panel A3	8117B007AA	Figure W10	
	Operating Panel Attachment Kit-B1	5613B001AA		
3	Operator Attention Light	5614B001AA	Figure V10	



#### NOTE

Specific parts can be found in a separate parts list. The parts are located in the chapters indicated in the table above.



# Canon

**Canon Inc.**

[www.canon.com](http://www.canon.com)

**Canon U.S.A., Inc.**

[www.usa.canon.com](http://www.usa.canon.com)

**Canon Canada Inc.**

[www.canon.ca](http://www.canon.ca)

**Canon Europa Inc.**

[www.canon-europe.com](http://www.canon-europe.com)

**Canon Latin America Inc.**

[www.cla.canon.com](http://www.cla.canon.com)

**Canon Australia PTY. Ltd**

[www.canon.com.au](http://www.canon.com.au)

**Canon China Co., Ltd**

[www.canon.com.cn](http://www.canon.com.cn)

**Canon Singapore PTE. Ltd**

[www.canon.com.sg](http://www.canon.com.sg)

**Canon Hongkong Co., Ltd**

[www.canon.com.hk](http://www.canon.com.hk)