

# Technical Service Manual

## **PRISMAsync v3.2** **for** **imagePRESS** **C7010VPS Series** **C7011VPS Series**



# Canon

January 5, 2015



# Contents

## Chapter 1

<b>Preface</b> .....	<b>7</b>
Preface.....	8

## Chapter 2

<b>Introduction</b> .....	<b>11</b>
Features.....	12

## Chapter 3

<b>Installation</b> .....	<b>13</b>
Passwords.....	14
Installation sequence.....	15
Verify site conditions.....	15
Assemble the Operator panel.....	16
Unpack the PRISMAsync.....	17
Install the PRISMAsync supports/pedestals.....	18
Connect the PRISMAsync.....	19
Finish the installation.....	23

## Chapter 4

<b>Using the PRISMAsync</b> .....	<b>25</b>
The operator panel.....	26
System settings.....	28
Maintenance and Service.....	31
System service mode (PRISMAsync service mode).....	35
Engine service mode (during printing).....	38
Colour adjustments.....	41
Media management.....	45
Operator maintenance.....	47

## Chapter 5

<b>Start, shutdown and restart the system</b> .....	<b>49</b>
Turn on the system.....	50
Turn off the system.....	51
Restart the system.....	52
Restart the copier only.....	53
Restart copier after error in copier.....	55

## Chapter 6

<b>The Settings Editor</b> .....	<b>57</b>
The Settings editor.....	58

## Chapter 7

<b>Service procedures</b> .....	<b>61</b>
Controller compatibility.....	62
Hardware components overview.....	66
Access internal components.....	67

Replace the GPU board.....	68
Replace the DDI board.....	70
Replace the AUX control board.....	71
Replace the DDR3 modules.....	73
Replace the Hard Disk Drives.....	74
Install/Replace the Ethernet board.....	75
Replace the Base controller.....	76
Connect Harness 22W01.....	78

## Chapter 8

<b>Firmware upgrades via PRISMAsync.....</b>	<b>81</b>
Firmware upgrade of Engine and Accessories .....	82
Firmware upgrade of Engine and Accessories (safe download mode) .....	86
Firmware upgrade additional information.....	92

## Chapter 9

<b>System software.....</b>	<b>95</b>
System software.....	96
Preparation of the USB-stick.....	97
Reuse an USB-stick after installation.....	99
Re-installation of the system software.....	100
Installing patches.....	102
Installing a license.....	105
Installing the printer driver.....	106
Configure the machine for the USA.....	107

## Chapter 10

<b>Troubleshooting.....</b>	<b>109</b>
Troubleshooting.....	110
Check external connections.....	111
Checking internal components.....	112
Comprehensive system inspection.....	113
Diagnose LEDs.....	115
Error messages and conditions.....	118
11504 Error Screen behaviour.....	122
Handling of 11504 MRE.....	125
Beep codes PRISMAsync.....	126

## Chapter 11

<b>Appendix.....</b>	<b>129</b>
Appendix A: Specifications.....	130
Hardware features.....	130
Connectivity.....	131
Appendix B: Parts overview.....	132
Overview of the service parts.....	132
Appendix C: Tips & Tricks.....	133
How to check if DDR memory is defect or missing.....	133
How to print transparencies with best quality.....	134
How to improve black density on the print.....	135
Strange colors after editing CMYK curves.....	136
Omapp does not work.....	137
Important media printer adjustments.....	138
Appendix D: System log files.....	146
How to create a datadump file.....	146
How to create a trace file.....	148
How to create a trace file including the printer logging.....	150
Appendix E: Engine reports.....	153

Engine reports..... 153

Appendix F: The Trapping editor..... 158

    The Trapping editor..... 158

Appendix G: EAC document..... 161

    EAC model number overview..... 161

Appendix H: System overview..... 162

    System overview..... 162



# **Chapter 1**

## **Preface**

# Preface

## Application

This manual has been issued for qualified persons to learn technical theory, installation, maintenance, and repair of products.

This Service Manual is written for world-wide markets.

As such it may contain information relating to accessories or licensed functionality not supported by Canon U.S.A., Inc. as of the date of the manual publication.

## Corrections

This manual may contain technical inaccuracies or typographical errors due to improvements or changes in products. When changes occur in applicable products or in the contents of this manual, Océ will release technical information as the need arises. In the event of major changes in the contents of this manual over a long or short period, Océ will issue a new edition of this manual.

The following paragraph does not apply to any countries where such provisions are inconsistent with local law.

## Trademarks

The product names and company names used in this manual are the registered trademarks of the individual companies.

## Copyright

This manual is copyrighted with all rights reserved. Under the copyright laws, this manual may not be copied, reproduced or translated into another language, in whole or in part, without the written consent of Océ.

## Safety and emissions compliance

The imagePRESS Server has been certified to meet or surpass the following government standards:

Safety approvals: EMI/EMC approvals:

- UL 60950-1 (TUV/CU mark)
- FCC Class B
- CSA 22.2 #60950-1
- VCCI Class B
- EN 60950-1 (TUV/GS mark)
- EN55022 Class B CB scheme IEC 60950-1
- EN55024 AS/NZS CISPR22: 2004 Class B



### **CAUTION**

**All parts inside the PRISMAsync have a fire safety class V2 or higher. It is therefore forbidden to store objects or paper (USB-key, reports etc.) inside the PRISMAsync controller**

---



## Points to notice when handling the Lithium Battery

---



**CAUTION**

**RISK OF EXPLOSION IF BATTERY IS REPLACED BY AN INCORRECT TYPE.  
DISPOSE OF USED BATTERIES ACCORDING TO THE INSTRUCTIONS.**

---



**CAUTION**

**WENN MIT DEM FALSCHEN TYP AUSGEWECHSELT, BESTEHT EXPLOSIONSGEFAHR.  
GEBRAUCHTE BATTERIEN GEMASS DER ANLEITUNG BESEITIGEN.**

---



# **Chapter 2**

## **Introduction**

### Introduction

This Service manual describes the service aspects of the PRISMAsync V3.2 controller for imagePRESS C7010VPS/C7011VPS.

The PRISMAsync colour controller sets the tone for all colour print production on the imagePRESS C7010VPS/C7011VPS printers. High processing power, professional colour management, ease of use and superb media handling, all ensure consistent output at every stage.

The PRISMAsync colour controller uses the latest Adobe RIP and colour management technologies.

## Features

The PRISMAsync features:

- Harmonized workflow for cutsheet production systems. Both black & white and colour.
- Clear task split between prepress and print operation.
- Job submission from a user's desktop via the printer driver or Océ PRISMAprepare software.
- Media driven operation by using a detailed media catalogue.
- High speed colour calibration allowing you to calibrate for all media and halftone screening in one go.
- Basic or professional colour management depending on access rights of users.
- Simple colour presets for inexperienced operators and users.
- Automated workflows allowing users to define their own templates.
- Last minute colour correction buttons to apply last-minute correction to brightness and contrast when copying and printing.
- Both 1200x1200 dpi and 600x600 dpi support.
- Intuitive time schedule.
- Support of 17 languages.
- Extensive colour libraries. Pantone and Pantone Goe libraries are available in the controller as a default along with HKS libraries.
- Support for IPDS.
- Native Adobe PDF interpreter APPE support.
- Device links.
- Named Colour Profiles.
- JDF/JMF connector.
- eRDS support.
- DocBox.
- VDP-support.
- In-RIP Trapping for APPE.
- Automatic restore of settings and jobs after installation.

# **Chapter 3**

## **Installation**

# Passwords

When servicing the PRISMAsync or making adjustments you often will need a password for a specific task. See the list below for an overview of the default passwords, used in the PRISMAsync.

- Enter Service Mode: 675756
- System Administrator: 71617000
- Key Operator: 13524
- Engine maintenance: 12345
- Remote manager: 12345678
- OMAApp (on remote PC): 1836671

## Resetting the passwords

It could occur that the password for the System Administrator, Key Operator or Engine maintenance is lost. In that case a service technician has to reset the password.

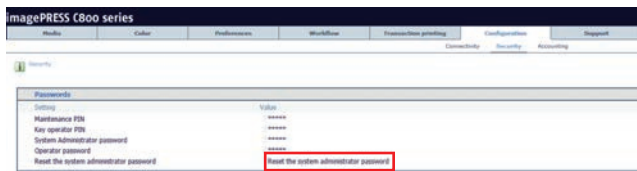

### NOTE

The Remote Manager password is called Operator password in the Settings Editor.

Do the following steps to reset the passwords:

## Procedure

1. Open the Settings Editor on a remote PC connected to the network of the customer. (See [The Settings editor on page 58](#))
2. Browse to [Configuration]→[Security] and select **Reset the system administrator password**.
3. Enter the Service password (675756)
4. Confirm your choice.  
Now the System Administrator password is reset to the factory default. (71617000)
5. This password can be used to set the new passwords.

# Installation sequence

This chapter describes the installation sequence for the PRISMAsync controller.

Because the PRISMAsync is connected to the customer's network please coordinate your installation with the network administrator at the customer site.



## NOTE

Make sure the PRISMAsync is connected to the copier before entering Engine Service mode.

## Procedure

1. [Verify site conditions on page 15](#)
2. [Assemble the Operator panel on page 16](#)
3. [Unpack the PRISMAsync on page 17](#)
4. [Install the PRISMAsync supports/pedestals on page 18](#)
5. [Connect the PRISMAsync on page 19](#)
6. Bundle the cables with a tie wrap.
7. [Finish the installation on page 23](#)

# Verify site conditions

## Introduction

Before installing the PRISMAsync, check the site conditions.

### Copier

- Is the copier configured for use with the PRISMAsync? For the proper settings, see the documentation that comes with the copier.
- Is space available for the PRISMAsync behind the copier? The PRISMAsync is placed behind the copier. Be sure that there is enough room for servicing either the copier or the PRISMAsync. You may need to move the copier away from the wall so that interface connectors are accessible.
- Check if the interface cables between copier and PRISMAsync are present. 1 data cable must be delivered together with the copier. 1 Ethernet cross cable is delivered with the PRISMAsync.

### Power & Network

- Is a dedicated, grounded electrical outlet for the PRISMAsync available near the copier?
  - Locate the grounded electrical outlet that will supply power to the PRISMAsync. Do not run the PRISMAsync and the copier on the same circuit.
  - Do not plug the PRISMAsync into a switchable wall outlet. This can result in the PRISMAsync being turned off accidentally.
  - Do not plug the PRISMAsync into a circuit with heating or refrigeration equipment (including water coolers).
  - Do not pull on the cable when unplugging the PRISMAsync. Pull the plug instead.
- Make sure that there is a working network connection available at installation time. A wireless network will not work on the PRISMAsync
- Contact the Network Administrator for the following settings:
  - The Hostname of the system
  - Static IP-address or DHCP
  - Subnet mask, Gateway, DNS-server

### Environment

- A networked computer (PC or Mac OS) must be available close to the copier.

## Assemble the Operator panel

Before connecting the PRISMAsync to the engine it is necessary to assemble the Operator panel.

For the assembly instructions refer to the imagePRESS C7010VPS/C7011VPS engine service manual (chapter 2 installation).



## Unpack the PRISMAsync

### Introduction

The PRISMAsync is assembled and shipped from the factory with pre-installed software.

### Unpack procedure

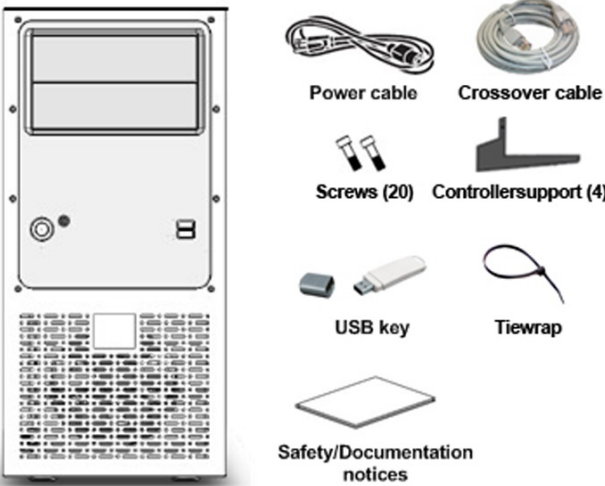
Step	Action
1	Open the box and carefully lift the PRISMAsync out of the box. Store the original box and packing material in case the PRISMAsync needs to be transported at a later date.
2	Check the contents of the box 
3	Provide the customer with the Safety Notice and User Documentation and Printer Driver Notice. The user documentation can also be downloaded from <a href="http://downloads.oce.com/">http://downloads.oce.com/</a> .



#### NOTE

Also see the engine service manual.

## Install the PRISMAsync supports/pedestals



### NOTE

To reduce the amount of dust that enters the PRISMAsync controller the supports installed on the controller have to be replaced with the supplied pedestals.

### Replacement of the installed supports

1. Remove the 4 supports installed on the PRISMAsync controller. The removed supports and screws will not be used.



2. Install the supports delivered with the PRISMAsync controller (4x M3x16 Hex bolt).



## Connect the PRISMAsync

You are now ready to make the following connections:

- Operator console
- Copier interface connections
- Operator Attention Light
- Network cable connection
- Power cable connection



### NOTE

Please follow standard Electro Static Discharge (ESD) precautions when handling electronic components.

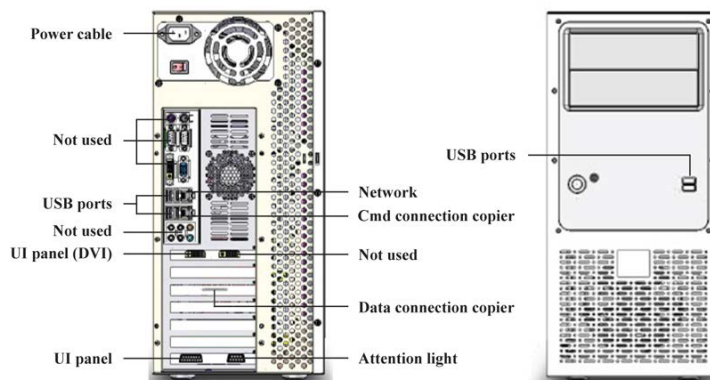



### Connect the operator panel

Step	Action
1	The cables needed for the connections are part of the operator attachment kit
2	Open the backside of the monitor.
3	Connect the DVI cable to the backside of the Operator panel. Connect the other side to the left DVI port on the backside of the PRISMAsync.
4	Connect the 15-pins D-sub connector to the connector on the backside of the PRISMAsync. Connect the other side to the backside of the operator panel.
5	Connect a USB cable to the backside of the operator panel. Connect the other side to the backside of the PRISMAsync
6	Close the backside of the operator panel.

### Connect to the copier

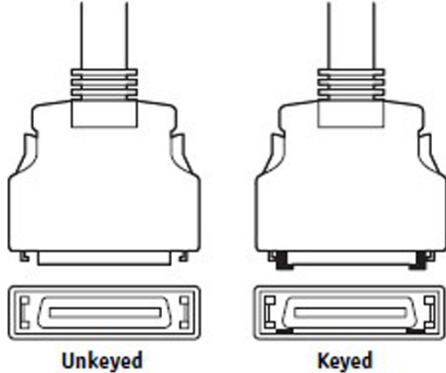
Step	Action
1	Connect one side of the Ethernet crossover-cable to the <b>lower</b> RJ45 connector on the backside of the PRISMAsync (Command/Status). Connect the other side to the RJ45 connector on the backside of the copier. ▶

Step	Action
2	<p>Locate the two copier interface cables, and identify the keyed and unkeyed connector ends on each cable. Each cable has one keyed connector and one un-keyed connector.</p>  <p>Fig.: Copier interface cable connections</p>
3	Connect the cables to the interface ports on the copier.
4	<p>Connect the other ends to their corresponding ports on the PRISMAsync. Each cable connector is designed to fit only one way when properly oriented.</p> <p> <b>NOTE</b> If a cable connector does not fit into an interface port, change the orientation of the cable. Do not force a connection that is mis-keyed. Doing so may permanently damage the port or the cable.</p>

### Connect the Operator Attention Light

Step	Action
1	Install the Operator Attention Light to the backside of the copier
2	Connect the cable with the 9-pins D-sub connector to the connector on the backside of the PRISMAsync.
3	Connect the other side of the cable to the connector attached to the Attention Light

### Connect to the network

Step	Action
1	Connect one side of a straight-through Ethernet cable to the <b>upper</b> RJ45 connector on the backside of the PRISMAsync.
2	Connect the other side of the Ethernet cable to the Ethernet wall-outlet

### Connect the power



Step	Action
1	Connect recessed end of the power cable to the power connector on the back of the PRISMAsync.



Step	Action
2	Connect the other end of the power cable to a wall outlet.

**Bundle the cables with a tie wrap**

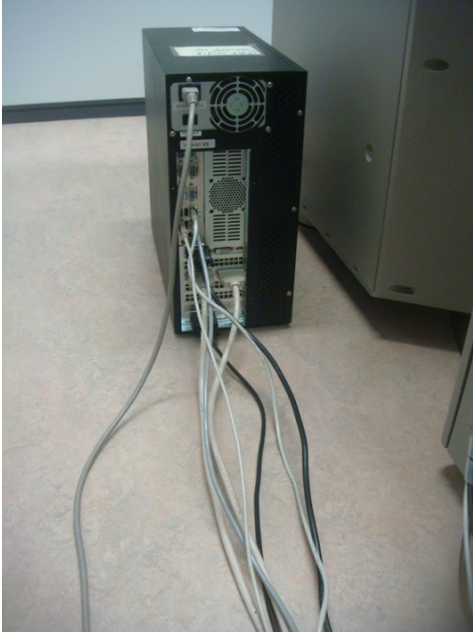
The PRISMAsync will be delivered with a reusable tie-wrap.

This tie wrap is used to regulate and fix all data cables to the PRISMAsync. The power cord is not fixed with the tie wrap.



Step	Action	Remark
1	Bundle all <b>data</b> cables and guide them in the same direction.   <b>NOTE</b> Do not bundle the power cable with the data cables.	
2	Guide the bundle in a loop going upwards and then downwards.   <b>NOTE</b> Make sure there is not too much tension on the connectors.	

Step	Action	Remark
3	<p>Guide the tie wrap through the two eyes at the rear-side of the controller as shown and lead the bundle in a curve along the rear side of the controller downwards.</p> <p> <b>NOTE</b> Fasten the tie wrap without drawing the cables too tight. The tie wrap can be released and reused.</p>	 A photograph showing the rear panel of a PRISMAsync controller. The device is black with a silver front panel. A white tie wrap is used to bundle several cables (white, blue, and black) that are plugged into the rear ports. The tie wrap is looped around the top of the device and secured to the bottom. The device is labeled 'Version V3' and 'PRISMAsync'.

## Finish the installation

To finish the installation of the PRISMAsync make sure to do the following:

Step	Action
1	Make sure to finish the installation procedure as described in the engine service manual.
2	Power on the copier.
3	Power on the PRISMAsync. To power on the PRISMAsync, switch the On/Off switch on the backside to the On-position. If the PRISMAsync does not start automatically, press the On/Off button on the front side of the PRISMAsync. The PRISMAsync will start up. This may take a while. Please wait until the panel displays a splash screen with the printer type.
4	Press the <b>[Sleep]</b> button to wake up the system.
5	Set the UI language. <ul style="list-style-type: none"> <li>On the panel, touch [System] -&gt; [Setup]</li> <li>Select the desired language</li> </ul>
6	Change the settings (e.g. TCP/IP, Hostname) of the system. Contact the customer for the appropriate settings. <ul style="list-style-type: none"> <li>You need the key operator PIN (13524) to make changes in the settings.</li> <li>On the panel, touch [System] -&gt; [Setup] -&gt; [Local key operator settings]</li> <li>Touch the button of the group that contains the setting you want to change. (e.g. Connectivity for network settings)</li> <li>Touch the required setting and enter the desired value.</li> <li>Touch [OK]</li> </ul>
7	If the PRISMAsync came with no licenses, please install them now. Refer to <a href="#">Installing a license on page 105</a> .
8	Perform any required system software upgrades. Before updating the PRISMAsync, please take care that you always make a backup of the settings. This backup also contains the licenses installed on your PRISMAsync . Updates for the system software may be available on a FTP server. Patches may need to be installed after installation. (See <a href="#">Installing patches on page 102</a> )
9	Change the Sleep mode timer (default = 40 minutes) Consult the customer for the new sleep mode setting.
10	When the PRISMAsync is installed and all the appropriate settings are made, always make a backup of these settings. See: "Service Mode" in <a href="#">Maintenance and Service Mode on page 31</a>

Step	Action
11	<p>Set the billing counters that have to be displayed on the Operator Panel.</p> <ol style="list-style-type: none"> <li>Go to Service Mode</li> <li>Select COPIER&gt;OPTION&gt;USER 11.</li> <li>Make the following settings:                             <ul style="list-style-type: none"> <li>- CNT_SW 0</li> <li>- Counter1 112 Total (Black/Large)</li> <li>- Counter2 113 Total (Black/Small)</li> <li>- Counter3 122 Total (Full Color + Single Color/Large)</li> <li>- Counter4 123 Total (Full Color + Single Color/Small)</li> <li>- Counter5 102 Total 2</li> <li>- Counter6 0</li> <li>- Counter7 0</li> <li>- Counter8 0</li> </ul> </li> </ol> <p> <b>NOTE</b>                      Additional toner bottle counters can be displayed . Ask the customer for preferences</p> <ul style="list-style-type: none"> <li>• Selection of counters via Engine Service mode</li> <li>• Counters can be retrieved via eRDS/UGW</li> <li>• Not supported by SNMP</li> </ul>
12	<p>Assist the customer with the installation of the printer-driver on 1 workstation. The printer driver can be found by using the Settings Editor.</p> <ul style="list-style-type: none"> <li>• On your PC open an Internet browser (e.g. Microsoft Explorer)</li> <li>• In the Address bar enter <code>http://&lt;hostname&gt;</code> or IP-address</li> <li>• A window with the Settings Editor will open. Go to the <b>[Support]</b> tab</li> <li>• Touch <b>[Software]</b>. At the bottom of the page you will find the drivers which can be downloaded to your computer</li> <li>• Install the driver needed (Windows, Mac OS)</li> <li>• Make some test prints with the driver.</li> </ul>
13	<p>Ask the customer to make sure that all media (CDs and/or USB sticks) shipped with the PRISMAsync are stored in a safe location.</p>
	<p> <b>CAUTION</b>  <b>Do not store any media or paper (USB keys or reports) inside the PRISMAsync because of fire-hazard.</b></p>



# **Chapter 4**

## **Using the PRISMAsync**

# The operator panel

## Introduction

This topic describes the main components of the operator panel.



### NOTE

You can clean the screen of the operator panel with a 50% mix of water and isopropyl alcohol. Use a lint-free cloth. Always put the cleaner onto the cloth and not directly on the screen.

## Components of the operator panel



1. **[Sleep] button (also known as Moon button)**  
Depending on whether the copier is currently active or in the sleep mode
  - Put the machine in to sleep mode, or
  - Wake up the machine from the sleep mode
  - shut down the printer and the controller
  - Startup the controller after a shutdown
2. **[Stop] button**  
Stop the printer
  - After a set, or
  - As soon as possible
3. **[Paper tray] button**  
Get direct access to the tray section on the operator panel to do the following:
  - Check the content of all paper trays.
  - Load a new media type into a paper tray.
  - Change the media type which is available in one of the paper trays.
  - Create a trace log on a USB stick. If an 11504 error is displayed, insert a USB stick and press this key to create a trace log on the stick.
4. **USB port**  
Used for:
  - Connect spectrophotometer for calibration
  - USB-stick for software installation
  - USB-stick for backup/Restore

- USB-stick to scan to and/or print from.
  - USB-stick to store log-files
  - USB-stick for installation of patches and licenses
5. **[Schedule] button**  
Access the 'Schedule' view to manage the jobs in the schedule.
  6. **[Jobs] button**  
Access all functions to print, copy and scan documents.
    - Manage or change the settings of jobs in the lists of Waiting jobs, Scheduled jobs and Printed jobs.
    - Carry out copy jobs and scan jobs.
  7. **[Paper tray] button**  
Get direct access to the tray section on the operator panel to do the following:
    - Check the content of all paper trays.
    - Load a new media type into a paper tray.
    - Change the media type which is available in one of the paper trays.
  8. **[System] button**  
Access the System section to do the following, for example:
    - Check the status of the toner, staples and other supplies.
    - Read the counters
    - Start maintenance.
    - Set up the preferred work flows.
    - Change a number of default system settings.
    - Adjust the brightness and contrast of the LCD panel.
    - Shut down the printer.
    - View the content of the Media catalogue or add temporary media to the Media catalogue.
  9. **Dashboard**  
The dashboard displays information about the system status such as:
    - Information about the current printing process.
    - Information about operator intervention that is required soon.
    - Information about errors.
    - Information about the status of the toner reservoir and staple cartridges.
  10. **Status LED**  
This LED describes the status of the system and also applies for the operator attention light.
    - **Green:**  
The machine is busy printing. No operator attention required
    - **Orange:**  
The machine will stop soon, e.g. because an output location is almost full or more paper is required.
    - **Red:**  
The machine has stopped, e.g. because a required media type is not available or an error has occurred. Operator attention is required.

# System settings

In the [Setup] tab of the [System] section some important settings can be made regarding system setup.

## System setup

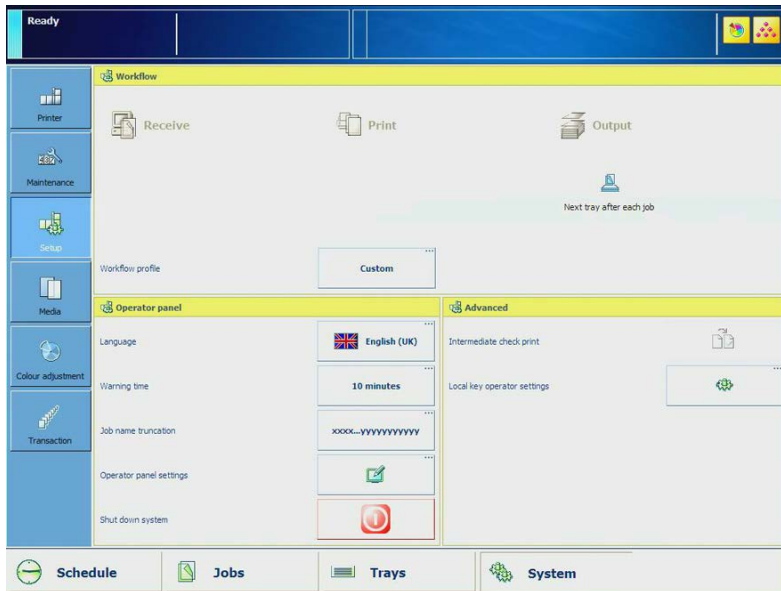

## settings

- **[Workflow profile]**  
Select a workflow profile or manually define the settings that match your needs.
- **[Language]**  
[Change language] of the operator panel.
- **[Warning time]**  
Define the moment when the [System] warns you about an action that is required soon, for example 10 minutes in advance. The warning is displayed in the dashboard and indicated through the operator attention light.
- **[Job name truncation]**  
Define the way the [System] shortens the job name when the job name is too long to display fully.
- **[Operator panel settings]**  
Adjust the brightness and contrast of the screen of the operator panel.
- **[Shut down system]**  
[Shut down] the printer and the controller in a controlled way.

The advanced section displays the following button.

- **[ Intermediate Check Print]**  
Press the button to force a test print from the current job. This print is used for evaluation of Print quality.
- **[Local key operator settings]**  
Get direct access to a number of important key operator settings in the Settings Editor on the PRISMAsync controller.

## Local access to settings of the Settings Editor

The Settings Editor application on the PRISMAsync controller is a web based application that allows key operators and system administrators to adapt the system completely to the situation in an organisation and production environment. The Settings Editor allows key operators and system administrators to manage settings with regard to network configuration, system preferences, job preferences and media.

For convenience reasons, a subset of frequently used settings is accessible through the operator panel.



### NOTE

You need the key operator PIN (13524), Service Password (675756) or the [System] Administrator PIN (71617000) to make changes in this section.

#### 1. About

- [Serial number] (read only)
- [Version of printer software] (read only)
- [Upgrade software (from USB)]  
With this option you can install a patch on the PRISMAsync controller.
- Upgrade software (from server)  
With this option you can install a patch that is stored on a remote server. If there is a patch available it will be downloaded and installed

#### 2. Software licenses

- [Upload] license  
When you have a new license to activate a new feature on the printer, you can upload the license file through this section. After uploading the license file, the feature becomes active

#### 3. [Logging]

- [Save the datadump file]  
When an error occurs, you can create a datadump file. The datadump file is a .zip file that contains detailed technical information about the [System].
- [Save the trace file]  
The [System] can also store trace log files in .zip files. These contain an even more detailed and technical description of occurrences in the [System].
- [Print the configuration report]  
The configuration report contains information about the configuration of your printing [System], for example information about the [System] configuration, controller configuration or network settings.

#### 4. [Connectivity]

The [Connectivity] section contains the main settings to integrate the printer into a network. After you adapted the network settings, you can test the connection from here. A more detailed description of the settings can be found in the Settings Editor Document.

- [MAC address] (read-only)
- [Host name]
- [Link speed and connection type]
- [Primary DNS suffix]
- [DNS suffix follows domain]
- [Test the TCP/IP connection]
- [DHCP enabled]
- [TCP/IP address]
- [Subnet mask]
- [Default gateway]
- DNS 1
- DNS 2
- WINS 1
- WINS 2

- [IPv6 enabled]
  - [IPv6 DHCP enabled]
  - [IPv6 TCP/IP address]
  - [IPv6 link local address]
  - [IPv6 prefix length]
  - [IPv6 gateway]
  - IPv6 DNS 1
  - IPv6 DNS 2
5. **[System settings]**
- [Date and time]
  - [System of measurement]
  - [Time zone]

# Maintenance and Service

## Introduction

This topic describes the different maintenance and service screens for the PRISMAsync.

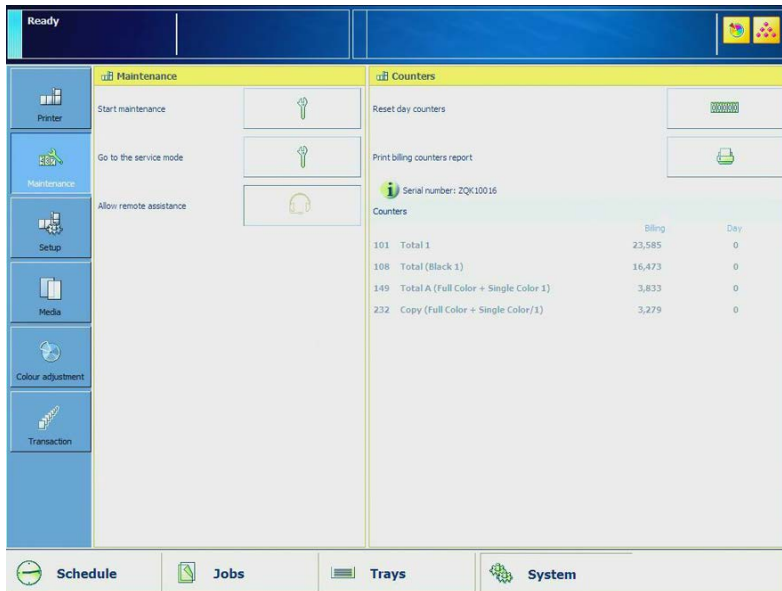

The maintenance screen displays the following information.

- Maintenance:
  - [Start maintenance] to enter [Maintenance mode on page 31](#).
  - [Go to service mode] to enter [System service and engine service mode on page 32](#).
  - [Allow remote assistance] to allow to the system by a service help desk.
- Counters:
  - [Reset day counters]
  - [Print billing counter report]
  - Counters

Each counter has two values. The first value displays the total number of prints that have been made since the machine was installed. The second value displays the same counters but this value can be reset to "0" (e.g. reset the day counters at the beginning of a working day). In Service Mode it is possible to select which counters to display and additional toner bottle counters can be added.

## Maintenance mode

When you push the [Start maintenance] button you will enter a mode in which you can perform some adjustments to the system. All the adjustments are guided by a wizard to make your job easier. A password is required to enter the maintenance mode (default: 12345).

### 1. Stacker: Replace flip rings

A wizard to help you replace the four flip rings of the High Capacity Stacker-G1

### 2. Auto colour mismatch correction

You can automatically correct colour mismatching that occurs in the output. The Auto colour mismatch correction aligns the position of the four different colours.

### 3. [Clean the clean roller (main unit)]

If dirt or stripes appear on printed output, clean the roller inside of the main unit. The procedure takes approximately one minute to finish

4. **[Clean the corona wires]**

If stripes appear on printed output or random parts of the printed image are missing, clean the corona assembly wires inside the main unit.. The procedure takes approximately 35 seconds to finish.

5. **[Clean the rollers of the ADF]**

If your originals have black stripes or appear dirty after transporting them through the feeder, clean the rollers of the feeder. The procedure takes approximately 20 seconds to finish.

6. **Clean the scanner sensors**

Procedure for cleaning the sensors of the scanner/reader.

7. **Refresh the fixing belt**

When paper with a longer width is used after copying or printing 100 or more sheets of paper with a shorter width (for example, when you use A3 paper after A4R paper), gloss lines may appear on both edges in the feeding direction. In addition, patches of uneven gloss may appear in the high density areas of the printed heavy paper or coated paper. In this case, the lines and patches of uneven gloss may be reduced by refreshing the fixing roller and cleaning its surface.

### System service and engine service mode

To enter service mode via the maintenance screen:

1. Select the **[Go to the service mode]** button.
2. Enter the PIN (675756).
3. The following screen is displayed:

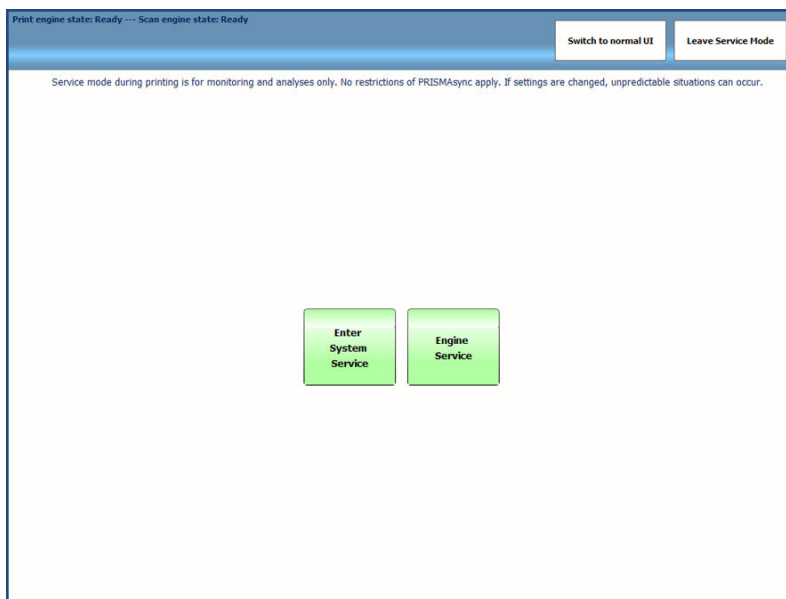





- Select **[Enter System Service]** to access the PRISMAsync service mode. For a detailed description see: [System service mode \(PRISMAsync service mode\) on page 35](#)
- Select **[Engine Service]** to access the print engine service mode during printing. This mode is used for monitoring and analyses during printing. For a detailed description see: [Engine service mode \(during printing\) on page 38](#)



### Service mode and the engine state

Below you will find an overview of how to enter service mode and the corresponding engine state.

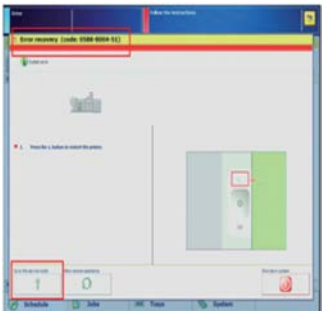

How to access	Description	User Interface
<p><b>Via the Splash screen.</b></p>  <p>Select [Go to service mode] on splash screen .</p>	<p>Engine state: Off                      Status bar: Engine Idle (Cold SDS)                      Level = low                      Purpose:</p> <ul style="list-style-type: none"> <li>Analyse and execute settings / adjustments via system SDS</li> </ul>	
	<p>Engine state: On                      Status bar: Engine Idle (Cold SDS)                      Level = low                      Purpose:</p> <ul style="list-style-type: none"> <li>Analyse and execute settings / adjustments via system SDS</li> <li>To analyse the engine when in an error situation</li> </ul>	

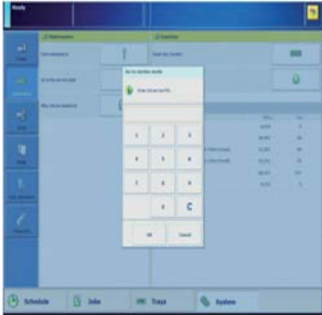
How to access	Description	User Interface
<p><b>After an error occurred.</b></p>  <p>Select [Go to service mode] on error screen</p>	<p>Engine state: Off                      Status bar: Off                      Level = low                      Purpose:</p> <ul style="list-style-type: none"> <li>To analyse the PRISMAsync in an error situation</li> </ul>	
	<p>Engine state: On with error                      Status bar: Off                      Level=low                      Purpose:</p> <ul style="list-style-type: none"> <li>To analyse the engine and PRISMAsync in an error situation</li> </ul>	

How to Access	Description	User Interface
<p><b>Via the Maintenance tab.</b></p>  <p>Select [Maintenance] and then [Go to service mode]. Select [Enter System Service] or [Engine Service]</p>	<p>Engine state: On Status bar: Ready Level: Standby Purpose:</p> <ul style="list-style-type: none"> <li>For all situations described above and maintenance checks</li> </ul>	 <p>The screenshot shows the PRISMAsync user interface. At the top, there are buttons for 'Add a device' and 'Close this view'. Below that, there are two green buttons: 'Data' and 'Home'. The main area is divided into three columns: 'Engine specific', 'Configuration setting', and 'Load/Save'. Under 'Engine specific', there are three buttons: 'Engine Service' (highlighted with a red box), 'Firmware Upgrade', and 'Engine Reports'. Under 'Configuration setting', there are two buttons: 'External Fibbers' and 'POC Configuration'. Under 'Load/Save', there are three buttons: 'Ba', 'Re', and 'Cost Spe Sol'.</p>



**NOTE**

The Engine Service mode (during printing) is only accessible via the [Maintenance] tab in normal user mode.

# System service mode (PRISMAsync service mode)

## Introduction

The system service mode is the Service Diagnostic System (SDS) as available on the PRISMAsync controller.

The SDS is used by the FST to configure, diagnose, backup and restore settings, for the print engine, accessories and PRISMAsync controller.

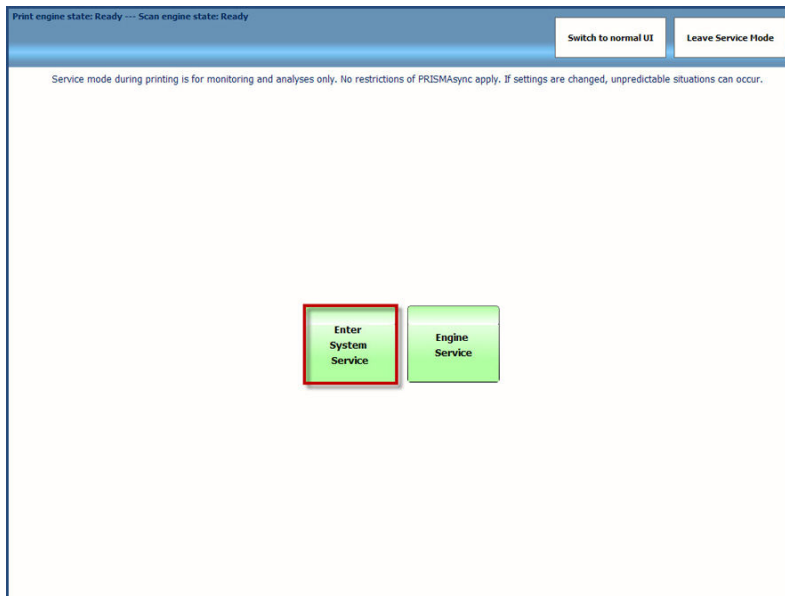

## System service mode (PRISMAsync service mode)

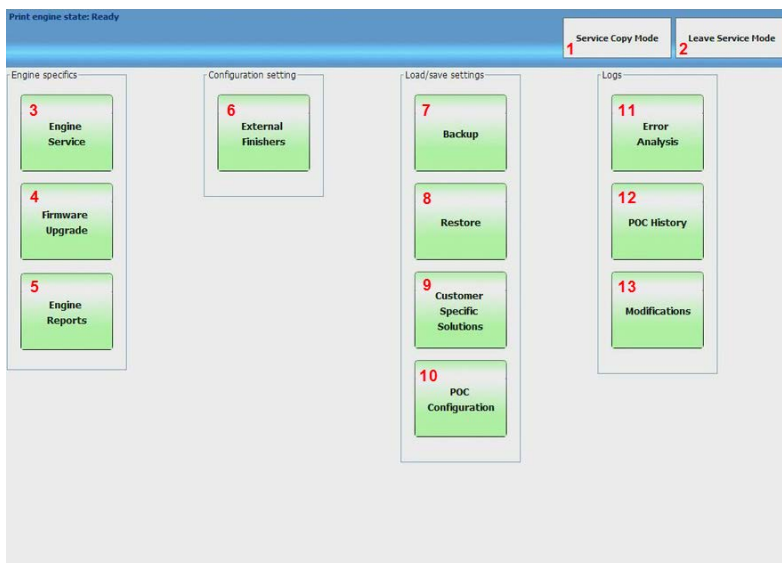

[2] Service Diagnostic System

### 1. Service Copy Mode

This button is used to temporarily switch to Normal mode. In this mode printing and scanning is possible. You can re-enter SDS without the need of the PIN.



**NOTE**

Printing must be stopped before re-entering Service mode

**2. Leave Service Mode**



[3] Leave Service Mode

- Leave Service Mode: leaves the service mode and switch to the Normal User Mode. This is used to temporarily leave Service Mode.
- End of service visit: leaves the service mode and the error analysis tab is cleared and an entry in the data dump file is created before returning to the Normal User Mode.

**3. Engine Service**

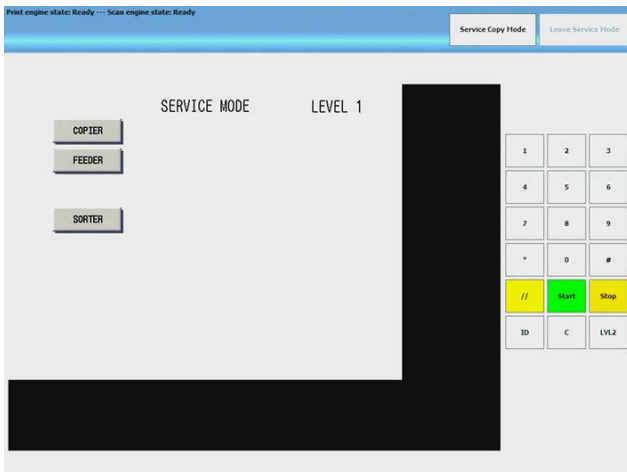

The [Engine service] button is used enter the print engine service mode. All service functionality is available.



**NOTE**

The <Updater> button is not supported in this screen and therefor the result is unpredictable. The function of the other buttons is described in the service manual of the engine.

**4. Firmware Upgrade**

With this button you can start the upgrade procedure of the firmware of the copier. A USB-stick containing the firmware should be available.

The upgrade is done from this USB-stick and not via the SST-tool. See the Service Manual of the copier for detailed instructions.

**5. Engine Reports**

In the service mode a sorted list of all durables and periodically replaceable parts of the engine and accessories can be generated and displayed on the LUI. The list is sorted by

lifetime. Doing so is the easiest way for the Field Service Technician to get an overview of the status of all parts. For a more detailed description see the appendix

6. **External Finishers**

If there are External finishers connected to the copier then you have to set parameters to make the connection work properly.

For a description of these parameters see the Service Manual of the copier.

7. **Backup**

Make a backup of the PRISMAsync settings. Insert a USB-stick into the USB-port on the operator panel. The system will point to this stick. After accepting the pathname the settings are written to this USB stick. The filename will contain the time of the backup. Always perform the backup, before servicing the PRISMAsync.

8. **Restore**

Restore the settings that were written on the USB-stick during a backup procedure. Insert the USB-stick into the USB-port on the operator panel. The system will ask for a filename. After selecting the correct file, the settings are restored to the PRISMAsync. When restoring is ready the PRISMAsync will reboot automatically.

9. **Customer Specific Solutions**

For some customers it is possible that specific solutions for their system are made.

In this screen you can disable or enable these solutions.

10. **POC Configuration**

In the POC configuration screen you can determine which Key Operator (Printer Operator Care) actions the customer is allowed to do with respect to the High Capacity Stacker F1.

If it is enabled then a wizard will show up guiding the customer through the actions.

11. **Error Analysis**

An overview of the most recent errors is presented on the screen.

12. **POC history**

The most recent Key Operator Maintenance actions are presented on the screen

13. **Modifications**

An overview of the modifications on the system is presented on the screen. You can view/register modifications for the copier, the scanner and the PRISMAsync controller.

# Engine service mode (during printing)

## Introduction

In the PRISMAsync service mode it is not possible to enter Engine Service mode during printing.

To make it possible to enter the Engine Service mode for monitoring and analysis during printing a dialogue is introduced.



### NOTE

The Engine Service mode (during printing) is only accessible via the [Maintenance] tab in normal user mode.

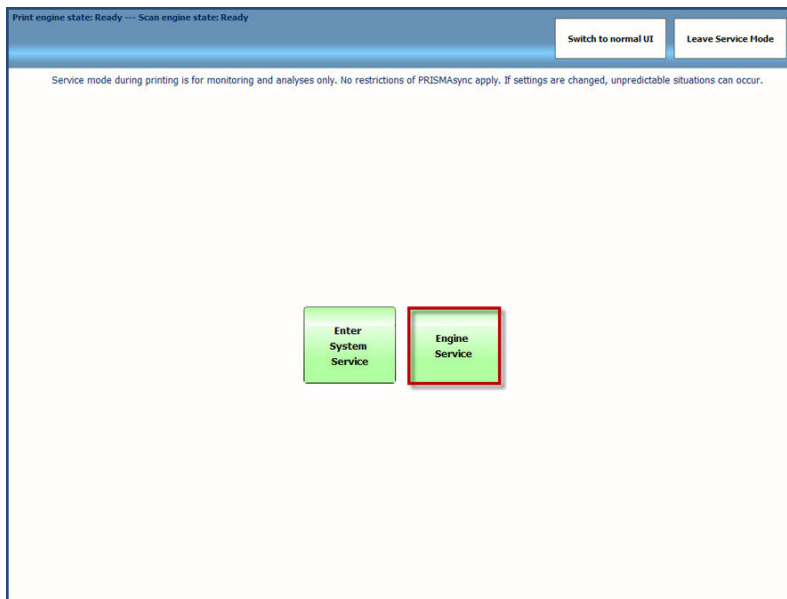

## Engine Service mode



### NOTE

The illustrations below should be used as a reference and might differ from the actual content displayed on the user interface.

**The engine service mode is for monitoring and analysis only. This mode can be used during printing.**

1. Select **[Engine Service]** to enter the engine service mode during a print run.





**NOTE**

This service mode is only for diagnostic and monitor purposes. Do not change any settings in the Engine Service mode, changing settings could lead to unpredictable machine behaviour.

- From the engine service mode select **[Switch to normal UI]** to switch to normal user interface.

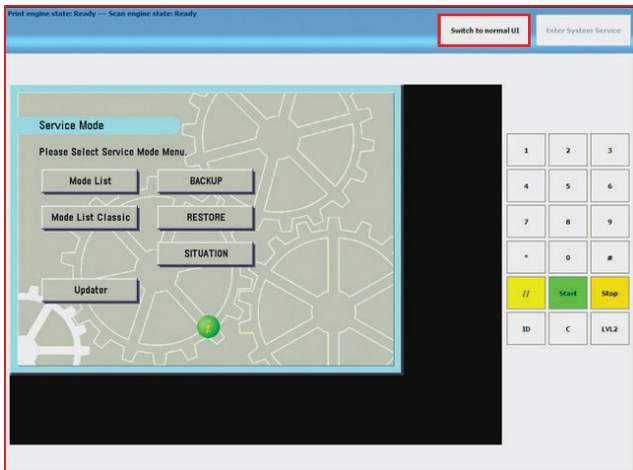

- From the normal user interface select **[Go to the service mode]** to switch back to engine service (during printing).

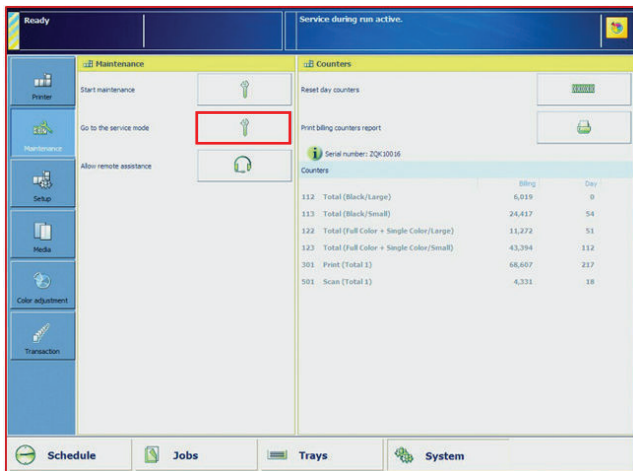

- The coloured bar on the Dashboard in the normal user interface indicates the engine service mode during printing is still active

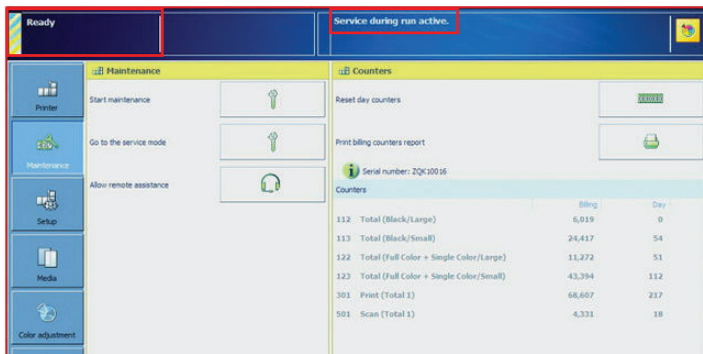

5. To leave the engine service mode and return to the normal user mode, select **[Leave Service Mode]**.

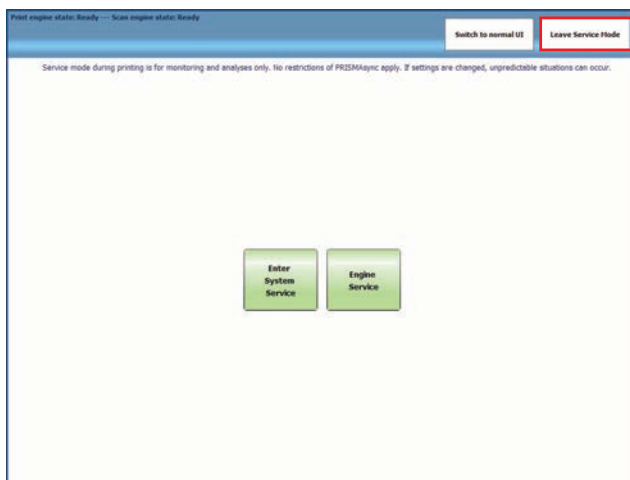



## Colour adjustments

In the [System] tab there is a dedicated section called [Colour adjustments] in which colour aspects can be adjusted. In this section you can perform the **Colour calibrations** and **edit the CMYK curves**.

### Calibrations

Due to external environmental circumstances, like temperature and humidity, consumables and print quality change over time. These changes effect the colour quality of the printed documents. Although the printer performs automatic adjustments on a regular basis, you are advised to calibrate the printer configuration regularly. The calibration procedure consists of 3 steps. Always perform these steps in the given order.

- **Shading correction**

The Shading correction procedure corrects slight density unevenness from front to back across an image drum. After measuring a test print the power of the laser beam is automatically adjusted across a laser scan line. The Shading correction assures consistent colour planes over the whole print.

- **Auto gradation adjustment**

The Auto gradation adjustment procedure is a precise calibration of the gradation, density and colour settings of the printer. A test print is used to scan and to correct the irregularities automatically. In this part you can choose between:

1. Full adjustment

This option does the auto gradation adjustment by printing sheets and measuring them, either automatically or via the glass platen.

2. Quick adjustment

The measurement is done without printing any paper but is considered to be less accurate than the Full adjustment. We advise not to use this adjustment.

This calibration can be done for all paper types (normal, heavy, extra heavy) in one step or for each paper type individually. This can be selected in the Settings Editor.

- **Media family calibration**

The Media family is a group of media that uses the same output profile. The controller provides by default the media families coated and uncoated. An expert can create a new media family for a specific group of media. A media family refers to 1 colour profile per halftone: 'Normal', 'Fine' and 'Error diffusion'. The controller has to be calibrated for each media family and halftone.

The shading correction and media family calibration are executed by using an I1 photo spectrometer. The PRISMAsync supports both UV- and non-UV meters.

The customer can set some parameters regarding the engine calibration. These settings are:

Media	Color	Preferences	Workflow	Trans
Color defaults	Color presets	Input profiles	Output profiles	Spot color libraries
			Spot colors	Color

Printer calibration	
Setting	Value
Shading correction timer	1 day
Auto gradation adjustment level	Standard (Same for All Paper Types)
Auto gradation adjustment	Automatic (internal sensor)
Auto gradation adjustment number of sheets	1
Auto gradation adjustment timer for normal media	1 day
Auto gradation adjustment timer for heavy media	1 day
Auto gradation adjustment timer for extra heavy media	1 day

[4] Set calibration settings

- **Shading correction timer**  
When the shading correction timer is enabled, the system indicates that a shading correction adjustment is required. The indication displays at the beginning of the last day of the time interval. To disable the shading correction timer set the time interval to zero days. (Default: 1 Day)
- **Auto gradation adjustment level**  
Set the preferred Auto gradation adjustment level. You can set it to apply the auto gradation to all paper types or to a specific paper type group. (Default: Standard(Same for all paper types))
- **Auto gradation adjustment**  
You can set which method you want to use for Auto gradation adjustment. Possibilities are Automatic (using the internal sensor) or Scanner (using the glass plate). (Default: Automatic)
- **Auto gradation adjustment number of sheets**  
Number of copies of each gradation adjustment chart. Only the last copy of each gradation adjustment chart should be measured. (Value: 1 to 5, Default:1)
- **Auto gradation adjustment timer for normal media**  
When the auto gradation adjustment timer is enabled, the system automatically requests an auto gradation adjustment at the beginning of the last day of the time interval. Set the time interval to zero days to disable the auto gradation adjustment timer. (Default: 1 Day)
- **Auto gradation adjustment timer for heavy media**  
When the auto gradation adjustment timer is enabled, the system automatically requests an auto gradation adjustment at the beginning of the last day of the time interval. Set the time interval to zero days to disable the auto gradation adjustment timer. (Default: 1 Day)
- **Auto gradation adjustment timer for extra heavy media**  
When the auto gradation adjustment timer is enabled, the system automatically requests an auto gradation adjustment at the beginning of the last day of the time interval. Set the time interval to zero days to disable the auto gradation adjustment timer. (Default: 1 Day)



[5] Calibration warning

In the Colour adjustment tab is displayed which calibration has to be executed as a result of reaching the interval.

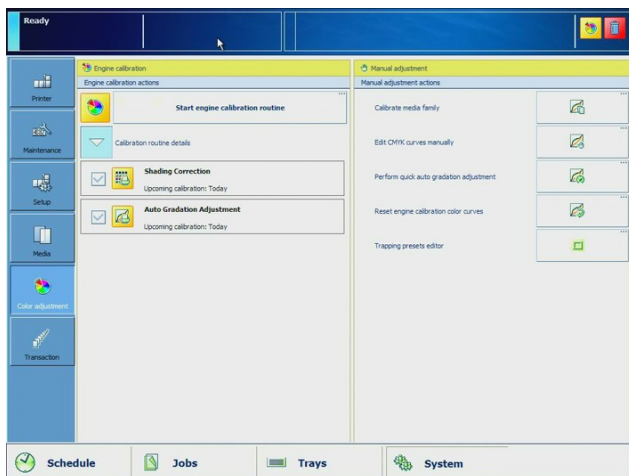

[6] Calibration Screen

In the left part of the screen the calibration parts that are due are checked. By pressing the “Start engine calibration routine” button these checked parts are executed. It is possible to (un)check parts manually, thus overriding the current setting.

In the right part of the screen you can start the Media family calibration. In most cases this calibration does not have to be done very often.

### Edit CMYK curves

With this option you can adjust the CMYK curves per media family and halftone. The settings are applied for all new jobs. It is also possible to edit the CMYK curve for a specific job. This can be done in the properties field of the job. Other jobs will remain unaffected.

You can make adjustments separately for C, M, Y and K.



#### NOTE

When editing the CMYK curves on a system level (not in the properties of the job) you have to do the adjustment for all halftones of the media family. Very often images and fonts are printed with a different halftone. If you only change the curve for one halftone differences in colour will occur between fonts and images.

This is not applicable for changing the curve on a job level.

### Quick Auto gradation

The Auto gradation adjustment procedure is a precise calibration of the gradation, density and colour settings of the printer.

The measurement is done without printing any paper but is considered to be less accurate than the Full adjustment. We advise not to use this adjustment.

### Reset engine calibration curves

It is possible to reset the actual calibration (shading) curves. In the dialogue you have to select the curve to delete. After deletion you have to perform the calibration again to get the best image quality.

### Trapping presets editor

In-RIP trapping is implemented in the PRISMAsync. It is only applicable for the PDF print path (APPE) in document printing mode (Not transaction). It is set on job level.

Trapping is a digital compensation for colour-to-colour mis-registration in the print engine. It typically tries to reduce the white gaps resulting from this mis-registration.

Trapping can generate artificial edges between adjacent objects, so trapping should be used with care.

Trapping in the PRISMAsync:

### Procedure

1. Trapping control & editor on Operator panel
2. Trapping control in Automated Workflow
3. Trapping control in PRISMAprepare & PRISMAaccess
4. Using Adobe in-RIP trapping technology, editable trapping settings are in line with settings of Adobe Creative Suite
5. Set of trap parameters can be saved as trap pre-set on Operator panel; default trap pre-set delivered from factory for easy application

- 6. Trap settings are shown on printed job ticket, colour configuration report & selectable for information bar
- 7. Factory default: trapping disabled

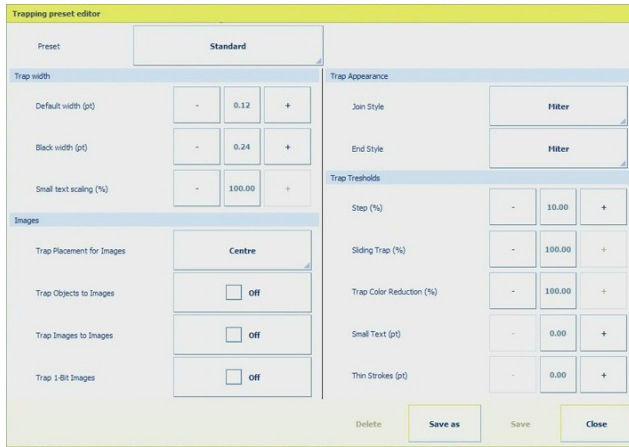

[7] Trapping Preset Editor



**NOTE**

See the appendix for a description of the trapping presets.

# Media management

The PRISMAsync uses a [Media] catalogue in which all the possible media that are used, are defined. Definition of these new paper types is done in the **Settings Editor**. On the Operator Panel you can gain access to the catalogue via the **[System] -> [Media]** tab.

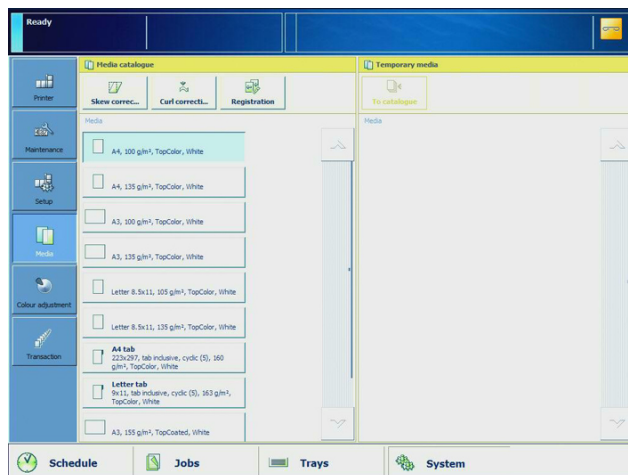

[8] Media management

## Procedure

### 1. Skew and right-angle correction

Select a specific media that you want to adjust. Select the Skew Correction adjustment. A wizard will start, guiding you through the adjustment.

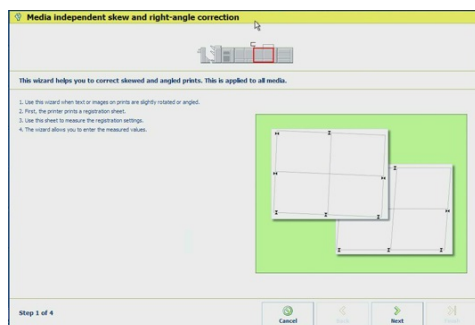

[9] Skew correction

### 2. [Curl correction]

Select a specific media that you want to adjust. Select the Curl correction adjustment. A screen will pop up in which you can enter the values.

Descriptive images tell you if these values need to be positive or negative.

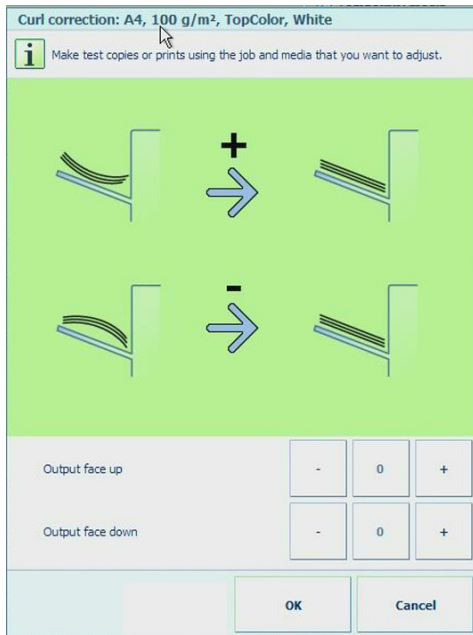

[10] Curl correction

### 3. [Registration]

Select a specific media that you want to adjust. Select the Registration correction adjustment.

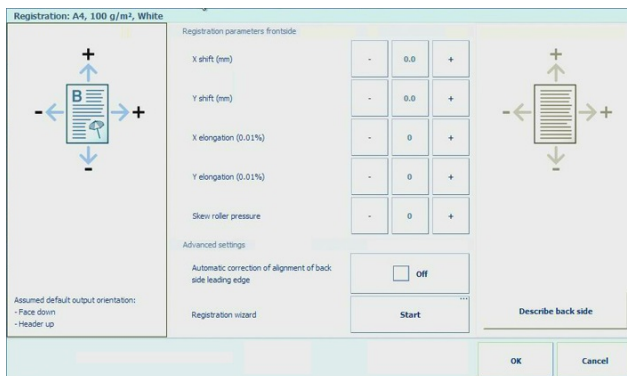

[11] Registration correction

## Result

1. Repeat the procedures for each paper type you want to adjust.
2. The calculated values can be checked in the Settings Editor.

## Operator maintenance

Trained operators are allowed to perform more complicated maintenance actions themselves without the need of a service technician. For this an application exists, that is called **Operator Maintenance Application (Abbr. omapp)**. The operator can use a web browser to gain access to the PRISMAsync omapp. From this web browser he can start different maintenance actions like replacing and cleaning of parts. The application is password protected to avoid improper use. Since the application is started from a remote PC you must be sure that the system is not in use, so it is safe to start the maintenance. For that reason the system has to be put in an Advanced Operator Mode which can be done by the **'Engine Maintenance'** button in the **Maintenance Mode** section. Follow the steps below to use the **Operator Maintenance Application**:

### Procedure

1. Select 'Engine Maintenance' out of the options. The following window is displayed:

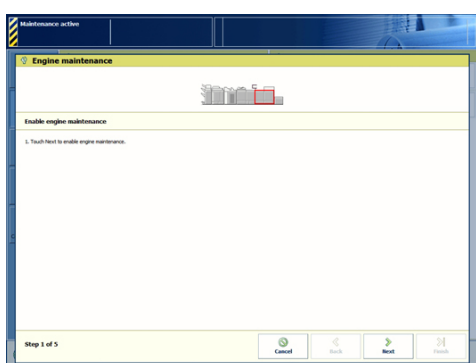

Fig. Operator maintenance screen 1

2. Click [Next]. After a few seconds the following screen is displayed

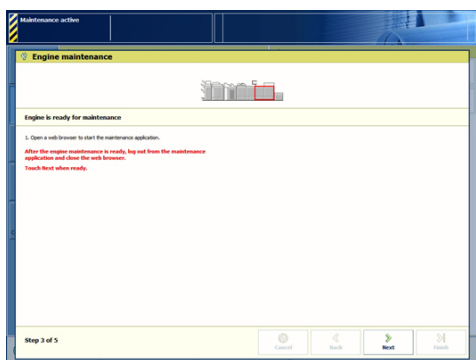

Fig. Operator maintenance screen 2

3. It is now safe to start the omapp from a remote PC. Open a web browser and in the address bar enter the ip-address or DNS-name of the printer followed by the word "omapp" (**http://systemname/omapp**). Take care that this is case-sensitive.
4. On the PC the application will start. Enter the password for the application (default: 1836671).
5. When ready, log out from the application and close the web browser.
6. On the Operator Panel click [Next].
7. On the Operator Panel click [Finish] to exit the wizard for engine maintenance.





# **Chapter 5**

## **Start, shutdown and restart the system**

## Turn on the system

You are advised to switch on the system in the following order.

1. The optional equipment (Paper and finishing modules)
2. The copier
3. The controller



### NOTE

If you switch on the controller first, the omapp feature will not work!

### Procedure

1. Turn on the optional equipment.
2. Put the main power switch on top of the main unit in the 'I' position.
3. If required, wait until the controller is ready.
4. Press the Sleep button (Moon) at the right-hand side of the operator panel.  
If the controller was switched off completely press the on/off button on the controller.



### NOTE

The controller needs some time to start up. In the beginning the screen will be black. Please be patient until the splash screen is displayed.



### NOTE

In some cases the system needs to reboot the engine (max. 2x) to reach the correct start-up situation.

# Turn off the system

## Turn off the system



### NOTE

Leave the power switch of the main unit in the 'I' position. When you shut down, the power switch will automatically switch to the 'O' position.

If you switch off the power of the copier, the PRISMAsync will generate the error 11506.

## Procedure

1. Touch [System] -> [Setup] -> [Shut down system].  
The operator panel displays the message 'Are you sure you want to shut down?'.
2. Touch [Yes].  
A message indicates when the shut down will begin. The shut down can take a maximum of 60 minutes.



### NOTE

Using the [Shut down now] option can damage the printer. Use the [Shut down now] option only to turn the printer off and on within 10 minutes.

3. Turn off the optional equipment.

## Restart the system

You can restart the system via the Settings Editor or via the operator panel. In both cases only the PRISMAsync will be restarted.

### To restart the system via the Settings Editor

1. Open the Settings Editor (on a PC).
2. Go to [Support] -> [Troubleshooting]
3. Select [Restart the system].

### To restart the system via the operator panel

1. Touch [System] -> [Setup] -> [Shut down system].  
The operator panel displays the message 'Are you sure you want to shut down?'.  
2. Touch [Restart].



#### NOTE

In some cases the system needs to reboot the engine (max. 2x) to reach the correct start-up situation.

## Restart the copier only

After the copier is switched off using the power switch an errorcode (11506 Connection lost) will occur. The PRISMAsync has to be restarted to resolve this error.

To reduce the time necessary to restart the PRISMAsync in such a case, two situations are described below to restart the copier only.

### Restart copier in Service Mode

1. In Service Mode, switch off the copier. The following screen will be displayed:



[12] Error 11506 in Service Screen

In the bar the error code 11506 is shown and the message "Press moonbutton to continue" is displayed.

2. Press the [Sleep] button.
  - After this the error will be reset. If you do not press this button and you will switch to normal user mode the error screen will be displayed.
3. The Service screen will not function now because the copier is off. You might get the following screen.

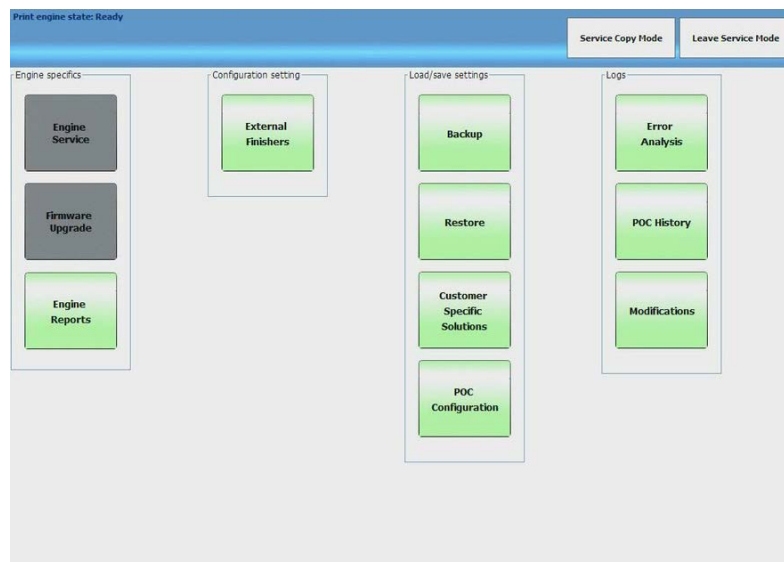

[13] Service Screen when copier is off

4. Switch on the copier. After a few seconds the buttons will turn green again.

### Restart copier in Normal Mode

1. In Normal mode switch off the copier with the power switch. The following screen will appear.

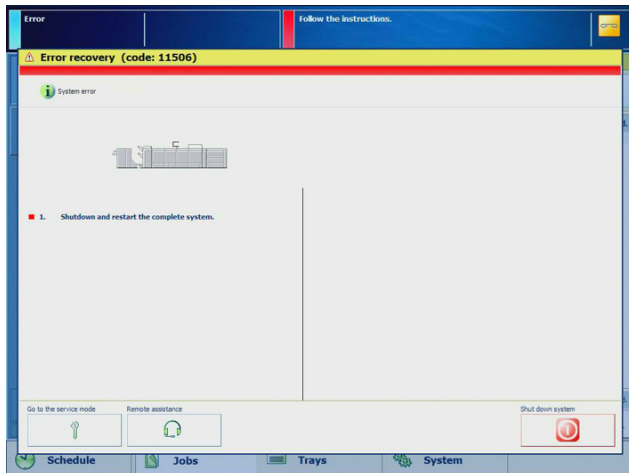

[14] Error 11506 in Normal mode

2. Press [Go to the service mode]
3. The next screen will appear.



[15] 11506 in Service screen and engine off

4. Press the [Sleep] button to reset the error.
5. From this point on you have the same situation as previously described (Restart copier in Service Mode).



**NOTE**

In some cases the system needs to reboot the engine (max. 2x) to reach the correct start-up situation.

## Restart copier after error in copier

It is possible to restart the copier without restarting the PRISMAsync. This is useful if an error occurred in the copier resulting in an E-code.

The customer has to follow the steps indicated at the left side of the screen.

### Procedure

1. Switch all finishers and paper modules off.
2. Check if power cords are plugged in.
3. Wait at least 3 seconds
4. Switch all finishers and paper modules on
5. Press the [Sleep] button to restart the printer.



#### NOTE

The copier will restart without restarting the PRISMAsync.



#### NOTE

In some cases the system needs to reboot the engine (max. 2x) to reach the correct start-up situation.





# **Chapter 6**

## **The Settings Editor**

## The Settings editor

The Settings Editor is a web-based application and therefore accessible via an Internet browser.

The Settings Editor enables you to manage settings or to display information in the following areas.

- [Media]
- [Colour]
- [Preferences]
- [Workflow]
- [Transaction Printing (only with IPDS-license)]
- [Configuration]
- [Support]

### Accessing the Settings Editor

Before using the Settings Editor make sure that you have the following information:

- The IP-address or hostname of the controller
- The Service- or Key Operator password. (675756 resp. 13524)

There are 2 ways to get access to the Settings Editor:

- Via a remote PC connected to the client network
- Via a laptop directly connected to the PRISMAsync controller

#### Access via client network

To get access to the Settings Editor do the following:

- Be sure the PC and the PRISMAsync are connected to the client network
- On the PC open an Internet browser (eg. Microsoft Explorer)
- In the address bar, enter the IP-address or the Hostname of the PRISMAsync. As a result the Settings Editor will open. It is now possible to make changes in the above listed areas.

#### Access via direct connection to PRISMAsync

Sometimes you can not access the Settings Editor via the client network. In this case it is better to connect a PC/laptop directly to the PRISMAsync controller.

Follow these steps

### Procedure

1. Disconnect the cross-over Ethernet cable from the copier and connect it to the Ethernet port on your laptop.
2. Set the IP-address of your laptop to 134.188.254.21
3. Set the Subnet mask of your laptop to 255.255.255.0
4. On the laptop open an Internet browser (eg. Microsoft Explorer)
5. In the address bar, enter **http://134.188.254.11**
6. The Settings Editor will open in your Internet browser.

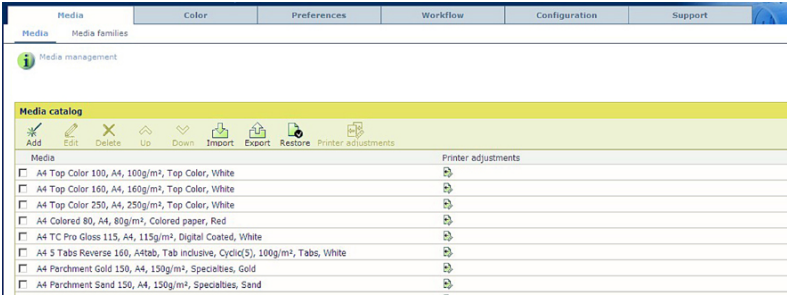

[16] Fig. Settings Editor



**NOTE**

See the Settings Editor user manual for important printer adjustments for media.



# **Chapter 7**

## **Service procedures**

# Controller compatibility

## Introduction

In general the PRISMAsync controller does not require regular service or maintenance. Use the procedures in this chapter to inspect and/or replace major hardware components.

## Hardware versions

There are multiple version of PRISMAsync controllers in the field numbered from V1 to V4 (Or A4).

- **Version 1 hardware**  
The initial version of the PRISMAsync controller.
- **Version 2 hardware**  
This version has a new motherboard compared to Version 1.
- **Version 3 hardware**  
Differences with the previous versions:
  - o New ErP compliant motherboard
  - o New PBA AUX control board. Old boards not supported anymore.
  - o NVIDIA GTS450 GPU Graphic Board not longer supported
  - o No DVD player
  - o There are 2 different sub-versions of this controller in the field. These have different GPU boards installed:
    - Version 3 with N550GTX-TI GPU (1070006840)
    - Version 3 with GTX650 GPU (1070026100)The N550GTX GPU will not be delivered anymore.
- **Version 4 hardware**  
This version is also known as A4. Differences with the previous versions:
  - o More RAM-memory. This version has four memory modules of 4Gb on board.
  - o A new BIOS of the motherboard

## Identification of controller version

You can identify the version of the controller on the outside by the following characteristics:

- **Version 1 and Version 2 hardware**
  - o DVD player
  - o No sticker at the bottom with the partnumber/codenummer
  - o Red Océ Tag mounted on the front



Fig. Océ Red Tag

### **Version 3 hardware**

- No DVD player anymore

- On the sticker at the bottom of the controller the Océ partnumber/codenummer is printed (1070006840 or 1070026100)
- Red Océ Tag mounted on the front

#### Version 4 hardware

- No DVD player present
- On the sticker at the bottom of the controller the Océ partnumber/codenummer is printed (1070033079)
- PRISMAsync logo mounted on the front



Fig. PRISMAsync logo

- Standard delivered with pedestal (is service part and can be mounted on older versions too.)

### Compatibility issues

When exchanging parts the technician has to be aware of the controller hardware version that is concerned. In the following list the compatibility issues are mentioned.

- Controller hardware version 3 is **only** compatible with Version 2.x and 3.x system software.
- Controller hardware version 2 is compatible with Release 2 system software. This means that you can upgrade the version 2 PRISMAsync hardware with Version 2 software.
- Automatic loading of DDI firmware depending on XPe or W7 platform.
- Old PBA AUX board from version 2 controller (1060111070) is not compatible with version 3 or higher controller hardware. If you have to exchange the Base controller from a version 2 controller hardware with a higher version you also need a new PBA AUX control board.
- A new PBA AUX control board (1070005457) can be used in a version 2 controller hardware.
- Controller hardware version 4 is only compatible with Version 3 system software
- If you install Version 3 software on a version 3 controller hardware you will not have the same performance as on a V4 controller hardware.
- 4GB memory modules are not supported for V1, V2 or V3 controllers hardware.
- 2 GB memory is not supported for V4 controller hardware.
- The Graphical board MSI- 550GTX (1060131773) is not supported on a V4 controller hardware .

In the table below you can find an overview of the compatibility.

Item	Description	V1		V2		V3	V4
		V1.x WinXP	V2.x Win7	V1.x WinXP	V2.x Win7	V2.x Win7	V3.x Win7

Item	Description	V1		V2		V3	V4
1060118890	CABLE, USB 2.0 CT2-4P HDR-10P 0.3M.	v	v	v	v	v	v
1060069477	DATACABLE,RJ45-RJ45 CRSVR SFTP 2.8M	v	v	v	v	v	v
1060130444	HARNESS,22W01	n/a	n/a	n/a	n/a	v	v
1060099125	PBA,DDI IF BOARD	v	v	v	v	v	v
1060111070	PBAP,AUX_CONTROL	v	v	v	v	-	-
1070005457	PBAP,AUX_CONTROL	v	v	v	v	v	v
1060131771	VHE-CTRL-MB950 V2 INDUSTRIAL CONTROLLER (GPU 1060115734 or 1060131773 included)	v	v	v	v	n/a	n/a
1070006840	VHE-CTRL-MB950 V3 INDUSTRIAL CONTROLLER (GPU 1060131773 included)	n/a	n/a	n/a	n/a	v	v (1)
1070026100	VHE-CTRL-MB950 V3 INDUSTRIAL CONTROLLER (GPU 1070026086 included)	n/a	n/a	n/a	n/a	<b>V2.2</b>	v (1)
1070033079	VHE-CTRL-MB950 V4 INDUSTRIAL CONTROLLER	n/a	n/a	n/a	n/a	n/a	v
1060120116	MEMORY MODULE 2GB DDR3	v	v	v	v	v	n/a
1070037688	4GB DDR3 DIMM, SPARE PART	n/a	n/a	n/a	n/a	n/a	v
1070026086	GPU, SPARE PART	-	<b>V2.2</b>	-	<b>V2.2</b>	<b>V2.2</b>	v
1060131773	MSI N550GTX-TI PCI-E X16 GRAPHIC BOARD	v	v	v	v	v	-
1060115734	NVIDIA GTS450 PCI-E X16 GRAPHIC BOARD	v	v	v	v	-	-
1060127337	USER INTERFACE PANEL TYPE 4	v	v	v	v	v	v



Item	Description	V1		V2		V3	V4
1070003522	USER INTERFACE PANEL TYPE 4	v	v	v	v	v	v
1060118980	SIGNAL LAMP ASSY	v	v	v	v	v	v

<b>V2.2</b>	--> SW Version V2.x or higher is mandatory for hardware configuration support
v (1)	--> see release notes for performance limitation of specific features
-	Not Supported

# Hardware components overview

## Introduction

The following chapters describe the servicing of the following components:

- Boards, cables
- DIMMs (memory modules)
- Fan
- Power supply
- Hard disk drive

## Hardware component overview

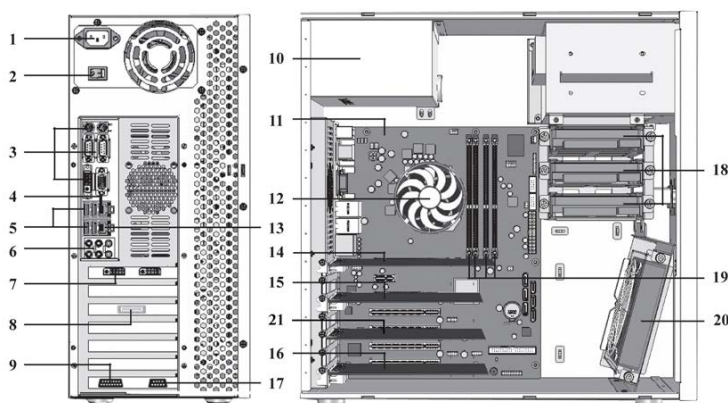

1	Power connector	12	CPU cooler
2	On/Off switch	13	CMD connection copier
3	Not used	14	Graphics board (GPU)
4	Network connection	15	DDI Interface board
5	USB ports	16	AUX control board
6	Not Used	17	Attention light connection
7	UI panel (DVI)	18	Hard Disk Drives (250GB)
8	Data connections copier	19	DIMMs
9	UI panel	20	System fan
10	Power supply	21	Network card (IPDS)
11	Motherboard		



**NOTE**  
See the

## Access internal components

This section describes how to open the PRISMAsync controller and gain access to the internal components.

### Procedure

#### 1. Shutdown the System.

If the system is in sleep mode then touch the **On/Off** button to shutdown the system. If the system is not in sleep-mode then touch the [System] tab followed by the [Setup] tab. In this screen touch the **On/Off** button. In the next screen touch [Shut down].

The system will shut down.



#### NOTE

Do not switch off the power button of the copier. It will switch off automatically. You can also touch the **[Sleep]** button when the system is not in sleep mode.

#### 2. Remove all cables from the back of the PRISMAsync controller.

If you have wrapped the cables then release the tie-wrap.

#### 3. Remove the left side cover of the PRISMAsync controller.

To remove the side cover, remove the 3 screws at the right side on the back of the PRISMAsync controller. Then shift the cover to the back to let it come off.

#### 4. Open the cable ties attached to the middle bracket.

These ties are re-usable and are meant for keeping the cable bundles in place and to avoid them from making contact with the fan.

#### 5. Loosen the 2 spring screws to remove the middle bracket..

Rotate the bracket a little in counter clockwise direction to get it out of the PRISMAsync. Be careful with the fixings that hold the PCB boards on their position.

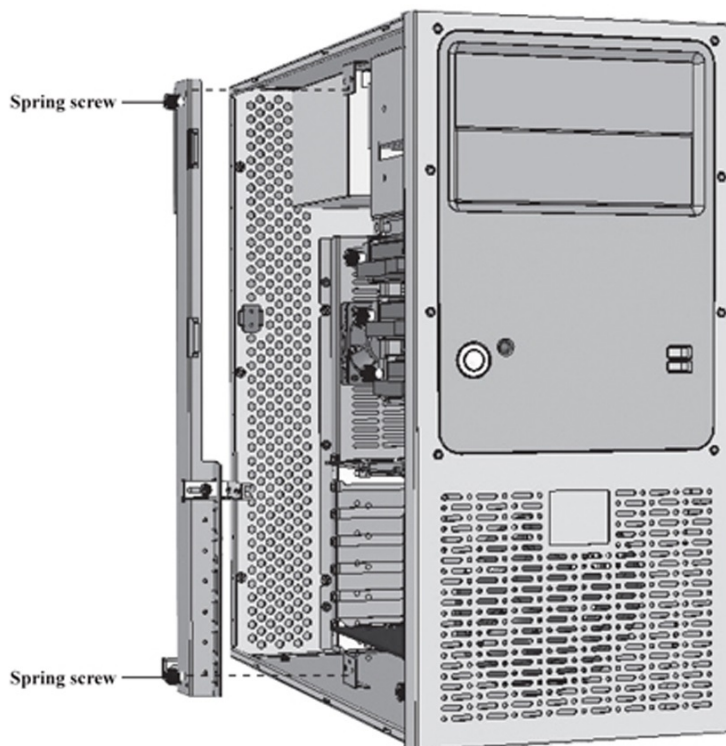

[17] Remove the bracket from the PRISMAsync

# Replace the GPU board



**NOTE**

When servicing components of the PRISMAsync always wear a grounded strap around your wrist, to avoid electrostatic discharge that will harm your equipment.



**NOTE**

It might be possible that you have to re-install the software of the PRISMAsync after exchanging the GPU.

Step	Action
1	<b>Remove side cover and middle bracket.</b> <ul style="list-style-type: none"> <li>Follow the instructions as described in <a href="#">Access internal components on page 67</a></li> </ul>
2	<b>Unplug the power connector of the board.</b>
3	<b>Remove the screw of the metal PCI bracket.</b> <ul style="list-style-type: none"> <li>Use a small Philips screwdriver to remove the screw used to mount the bracket to the backside of the PRISMAsync.</li> </ul>
4	<b>Firmly press the PCI-E lock-mechanism to unlock the board.</b> <ul style="list-style-type: none"> <li>The lock-mechanism is located at the bottom right side of the PCI-E connector on the motherboard. Pressing it down will lift the board out of the connector.</li> </ul>
5	<b>Remove the board from the PRISMAsync.</b>
6	<b>Install the new board in the PCI-E connector.</b> <ul style="list-style-type: none"> <li>Firmly press the board in the PCI-E 1 connector (the upper). Check that the lock mechanism is closed.</li> </ul>
7	<b>Fasten the graphic board.</b> <ul style="list-style-type: none"> <li>Fix the board with a single screw on the PCI bracket side with a Philips screwdriver.</li> </ul>
8	<b>Connect the power connector to the board.</b>
9	<b>Re-install middle bracket and the side cover.</b> <ul style="list-style-type: none"> <li>Make sure the fixing on the middle bracket is in position. It should fit exactly on the GPU-board.</li> </ul> <div data-bbox="387 1355 863 1910" data-label="Image"> </div> <p>[18] Fixing of the PCI board</p>

---

Step	Action
10	<b>Re-install software if necessary.</b> <ul style="list-style-type: none"><li>• Check if the old GPU board is the same as the new one. If not, it could be necessary to reinstall system software needs to be re-installed because of a new driver that is needed for this GPU.</li></ul>

## Replace the DDI board

The DDI board handles the interfacing between the copier and the PRISMAsync.

Only replace the board if you have checked the cables connected to the board.



### NOTE

When servicing components of the PRISMAsync always wear a grounded strap around your wrist, to avoid electrostatic discharge that will harm your equipment.

Step	Action
1	<b>Remove side cover and middle bracket.</b> Follow the instructions as described in <a href="#">Access internal components on page 67</a> .
2	<b>Unplug the power connector and internal connectors of the board.</b>
3	<b>Remove the screw of the metal PCI bracket.</b> Use a small Philips screwdriver to remove the screw used to mount the bracket to the backside of the PRISMAsync.
4	<b>Remove the PCI card from it's slot</b> Hold the PCI card by the two top corners. Pull it straight out of the socket.
5	<b>Take the board out of the PRISMAsync.</b>
6	<b>Unpack the new board.</b>
7	<b>Place the board in the PCI-E connector.</b> Firmly press the board in the PCI-E connector. Use the PCI-E 3 port.
8	<b>Fix the DDI board.</b> Fix the board with a single screw on the PCI bracket side with a Philips screwdriver.
9	<b>Plug the internal connectors to the board.</b>
10	<b>Re-install middle bracket and side cover.</b> Take care that the fixing on the middle bracket is in position. It should fit exactly on the DDI-board.

## Replace the AUX control board

The AUX control board supplies power to the operator panel and controls the Operator Attention Light.



### NOTE

When servicing components of the PRISMAsync always wear a grounded strap around your wrist, to avoid electrostatic discharge that will harm your equipment.

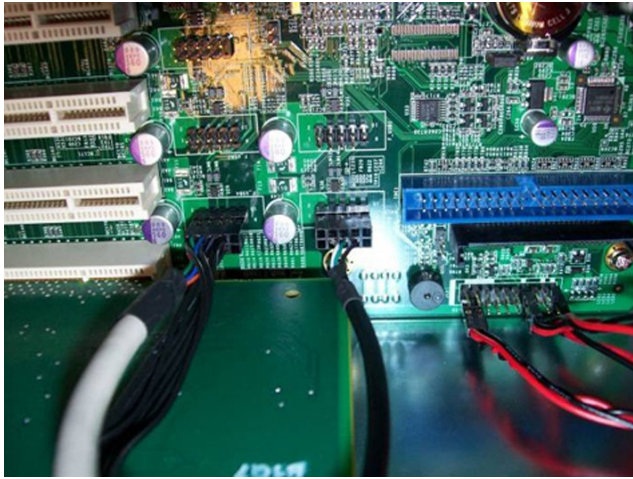
Step	Action
1	<b>Remove side cover and middle bracket.</b> <ul style="list-style-type: none"> <li>Follow the instructions as described in <a href="#">Access internal components on page 67</a>.</li> </ul>
2	<b>Disconnect the power connector and internal connectors of the board.</b>
3	<b>Remove the screw of the metal PCI bracket.</b> <ul style="list-style-type: none"> <li>Use a small Philips screwdriver to remove the screw used to mount the bracket to the backside of the PRISMAsync</li> </ul>
4	<b>Remove the PCI card from it's slot</b> <ul style="list-style-type: none"> <li>Hold the PCI card by the two top corners. Pull it straight out of the socket.</li> </ul>
5	<b>Remove the board from the PRISMAsync.</b>
6	<b>Unpack the new board.</b>
7	<b>Connect the USB-wire connector</b> <ul style="list-style-type: none"> <li>The USB wire connector (white side) must be connected to the Auxiliary Board. Because of the space between Board and controller box, it's advised to do this before inserting the board into the PCI connector.</li> </ul>  <p>[19] AUX board USB connector</p> <ul style="list-style-type: none"> <li>Connect the other side of the connector to the nearest available USB pin header of the motherboard.</li> </ul>  <p>[20] AUX to Motherboard USB connector</p>
8	<b>Install the board into the PCI slot.</b> <ul style="list-style-type: none"> <li>Firmly press the board in the PCI connector. Use the PCI 4 port. It is the lowest PCI connector on the Motherboard.</li> </ul>

Step	Action
9	<b>Fasten the AUX control board.</b> <ul style="list-style-type: none"><li>Fix the board with a single screw on the PCI bracket side with a Philips screwdriver</li></ul>
10	<b>Connect the internal connectors to the board.</b> <ul style="list-style-type: none"><li>See <a href="#">Access internal components on page 67</a></li></ul>
11	<b>Re-install middle bracket and side cover.</b> <ul style="list-style-type: none"><li>Make sure the fixing on the middle bracket is in position. It should fit exactly on the AUX control board.</li></ul>



## Replace the DDR3 modules

The MB950 board supports four DDR3 memory socket for a maximum total memory of 16GB of the DDR3 DIMM memory type.

The PRISMAsync is equipped with 4x4GB DIMM (total memory size 16GB).



### NOTE

When servicing components of the PRISMAsync always wear a grounded strap around your wrist, to avoid electrostatic discharge that will harm your equipment.

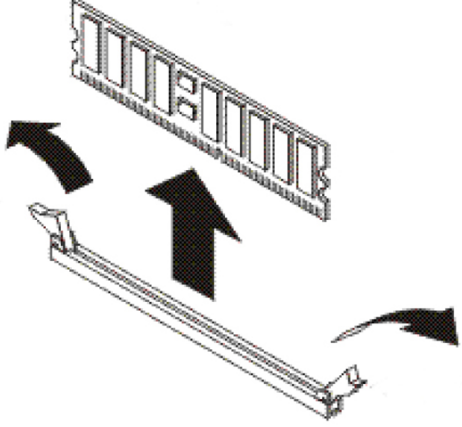
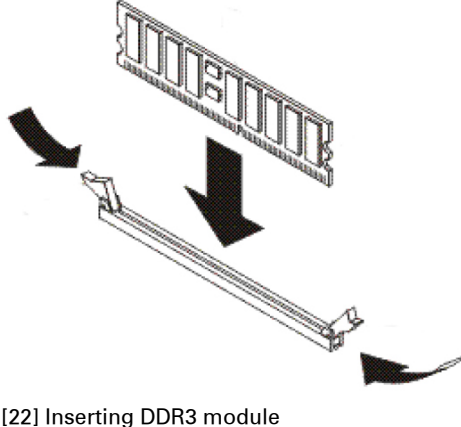
Step	Action
1	<b>Remove side cover and middle bracket.</b> <ul style="list-style-type: none"> <li>Follow the instructions as described in <a href="#">Access internal components on page 67</a>.</li> </ul>
2	<b>Open the clips by pressing them outward.</b> <ul style="list-style-type: none"> <li>Firmly press on the clips on the left and the right side of the connector. The DDR3 module will be lifted out of the connector.</li> </ul>
3	<b>Align the DDR3 module with memory slot.</b>
4	<b>Install the DDR3 module in memory slot</b> <ul style="list-style-type: none"> <li>Gently push the DDR3 module in an upright position until the clips of the slot close, to hold the DDR3 module in place when the DDR3 module touches the bottom of the slot.</li> </ul> <div style="display: flex; justify-content: space-around;"> <div style="text-align: center;">  <p>[21] Removing DDR3 module</p> </div> <div style="text-align: center;">  <p>[22] Inserting DDR3 module</p> </div> </div>
5	<b>Re-install middle bracket and side cover.</b>

## Replace the Hard Disk Drives

The PRISMAsync is equipped with 3 x 250GB 3.5" SATA II HDD @ 7200rpm Hard Disk Drives. One of the drives is used for the System software. The other 2 drives are for data. Please check the table below for connections and purpose.



### NOTE

When servicing components of the PRISMAsync always wear a grounded strap around your wrist, to avoid electrostatic discharge that will harm your equipment.

HDD # (position)	Connector	Purpose
0 (top)	SATA J18	System disk
1 (middle)	SATA J24	Data
2 (bottom)	SATA J16	Data



### NOTE

- After replacement of the HDDs you will have to re-install the system software.
- Always exchange all 3 drives at once.
- The 2 data drives are Raid0 configured. This means that if 1 disk has crashed, all the data will be lost.

Step	Action
1	<b>Remove side cover.</b> <ul style="list-style-type: none"> <li>• Follow the instructions as described in <a href="#">Access internal components on page 67</a>.</li> </ul>
2	<b>Disconnect the connectors.</b> <ul style="list-style-type: none"> <li>• Unplug the power and the SATA connectors on the HDD.</li> </ul>
3	<b>Remove the 2 screws on the front side.</b>
4	<b>Slide the HDD outward.</b>
5	<b>Insert the new HDD until it clicks into position.</b>
6	<b>Fasten the HDD with the 2 screws</b>
7	<b>Connect the connectors.</b> <ul style="list-style-type: none"> <li>• Plug the power and the SATA connector on the HDD.</li> </ul>
8	<b>Repeat steps 2 thru 7 for the other 2 HDDs</b>
9	<b>Re-install middle bracket and side cover.</b>
10	<b>Re-install the system software.</b> <ul style="list-style-type: none"> <li>• See <a href="#">Re-installation of the system software on page 100</a>.</li> </ul>



## Install/Replace the Ethernet board

The extra Ethernet board (Intel PRO/1000 GT Desktop Adapter) is needed when IPDS functionality is enabled (Extra license). The board is needed for the Codishell tool to analyse IPDS-problems. It can also be used to connect the laptop to the PRISMAsync.



### NOTE

When servicing components of the PRISMAsync always wear a grounded strap around your wrist, to avoid electrostatic discharge that will harm your equipment.

Step	Action
1	<b>Remove side cover and middle bracket.</b> <ul style="list-style-type: none"> <li>Follow the instructions as described in <a href="#">Access internal components on page 67</a>.</li> </ul>
2	<b>Unpack the new board.</b>
3	<b>Remove the fifth metal bracket (starting from the CPU).</b> <ul style="list-style-type: none"> <li>Use a Philips screwdriver to remove the bracket..</li> </ul>
4	<b>Place the board in the PCI connector.</b> <ul style="list-style-type: none"> <li>Firmly press the board in the PCI connector.</li> </ul>  <p>The image shows the internal components of a server chassis. A yellow oval highlights the fifth PCI slot from the CPU side, which is the correct location for the Ethernet board. The board is partially inserted into this slot.</p>
	 <b>NOTE</b> Make sure to use the indicated slot.
5	<b>Fasten the Ethernet board.</b> <ul style="list-style-type: none"> <li>Fasten the board with a single screw on the PCI bracket side with a Philips screwdriver.</li> </ul>
6	<b>Re-install middle bracket and side cover.</b> <ul style="list-style-type: none"> <li>Make sure the fixing on the middle bracket is in position. It should fit exactly on the Ethernet board.</li> </ul>
7	<b>Re-install system software</b> <ul style="list-style-type: none"> <li>If the Ethernet board is installed for the first time (no replacement) there will be no driver installed for it. Therefore you have to re-install the PRISMAsync software.</li> </ul>

## Replace the Base controller

If it is clear that an error can only be solved by replacing the motherboard a new base controller can be ordered as a service part. This controller has all the hardware in it without the extra boards that are added to make it a PRISMAsync controller (DDI board, AUX Control Board, Ethernet Board, 22W1 Harness).



### NOTE

When servicing components of the PRISMAsync always wear a grounded strap around your wrist, to avoid electrostatic discharge that will harm your equipment.

Perform the following actions to exchange the controller:

Step	Action
1	<b>Remove side cover and middle bracket.</b> <ul style="list-style-type: none"> <li>Follow the instructions as described in <a href="#">Access internal components on page 67</a>.</li> </ul>
2	<b>Remove extra boards</b> <ul style="list-style-type: none"> <li>Remove the following boards:                             <ul style="list-style-type: none"> <li>DDI board (See: <a href="#">Replace the DDI board on page 70</a> )</li> <li>AUX Control board (See: <a href="#">Replace the AUX control board on page 71</a> ) Check if you need a newer version of the AUX control board. (See conditions above) If so, you do not have to remove the board.</li> <li>Additional Ethernet board (IPDS) (See: <a href="#">Install/Replace the Ethernet board on page 75</a>)</li> <li>(Optional) HDDs. (See: <a href="#">Replace the Hard Disk Drives on page 74</a> ) If HDDs are still working you can exchange the hard disks. In this case all settings and jobs will be saved and no new system software installation is needed.</li> </ul> </li> </ul>
3	<b>Remove harness 22W01</b>
4	<b>Remove the connections at the backside of the PRISMAsync</b>
5	<b>Unpack the base controller</b>
6	<b>Remove side cover and middle bracket.</b> <ul style="list-style-type: none"> <li>Follow the instructions as described in <a href="#">Access internal components on page 67</a> .</li> </ul>
7	<b>Insert previously removed boards</b> <ul style="list-style-type: none"> <li>Insert the following boards:                             <ul style="list-style-type: none"> <li>DDI board (See: <a href="#">Replace the DDI board on page 70</a> )</li> <li>AUX Control board (See: <a href="#">Replace the AUX control board on page 71</a> ) Re-use the old board if possible, otherwise insert the new board. Be aware that you have to connect the 22W01 harness too.</li> <li>Additional Ethernet board (IPDS) (See: <a href="#">Install/Replace the Ethernet board on page 75</a> )</li> <li>(Optional) HDDs. (See: <a href="#">Replace the Hard Disk Drives on page 74</a> ) See conditions above if it is possible to re-use the HDDs.</li> </ul> </li> </ul>
8	<b>Connect Harness 22W01</b> <ul style="list-style-type: none"> <li>See <a href="#">Connect Harness 22W01 on page 78</a></li> </ul>
9	<b>Re-install middle bracket and side cover.</b> <ul style="list-style-type: none"> <li>Take care that the fixing on the middle bracket is in position. It should fit exactly on the boards.</li> </ul>

Step	Action
10	<b>Install the supports/pedestals</b> <ul style="list-style-type: none"><li>• See: <a href="#">Install the PRISMAsync supports/pedestals on page 18</a></li></ul>
11	<b>Connect the cables at the backside of the controller</b> <ul style="list-style-type: none"><li>• See: <a href="#">Connect the PRISMAsync on page 19</a></li></ul>
12	<b>Install old HDDs</b> <ul style="list-style-type: none"><li>• If you have removed the HDDs from the defect controller you can mount them in the new controller. First remove the HDDs that are in the new controller. Be aware that you mount the disks on the same position as they were mounted in the defect controller. See also "Hard Disk Drives".</li></ul>
13	<b>Install system software</b> <ul style="list-style-type: none"><li>• In case that the hard disks were not exchanged, you have to install the latest PRISMAsync software.</li></ul>
14	<b>Restore a backup</b> <ul style="list-style-type: none"><li>• If you have a backup of the system before it crashed you can restore it now. All settings will be restored except the licenses because they belong to the "old" controller.</li></ul>
15	<b>Re-host and install licenses</b> <ul style="list-style-type: none"><li>• Since the MAC-address of the PRISMAsync controller has changed it is necessary to re-host the licenses. Please contact your local service organization for the new licenses.</li></ul>

# Connect Harness 22W01



**NOTE**

When servicing components of the PRISMAsync always wear a grounded strap around your wrist, to avoid electrostatic discharge that will harm your equipment.

**Illustration**



[23] Harness 22W01

Step	Action
1	<p data-bbox="384 999 1259 1032"><b>Be sure the AUX control board is mounted correctly in the PRISMAsync</b></p>  <p data-bbox="389 1352 740 1379">[24] Connected AUX control board</p>

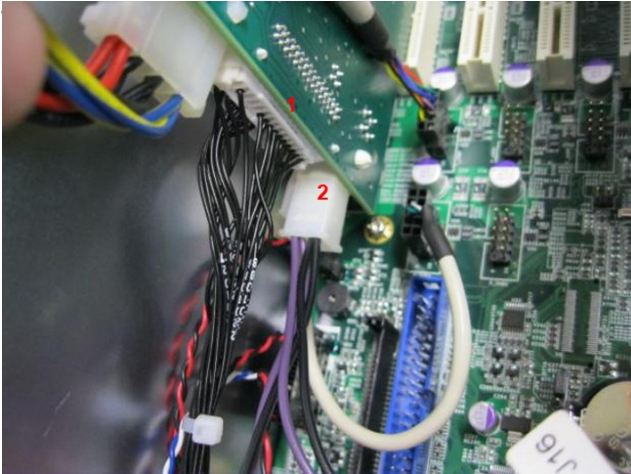
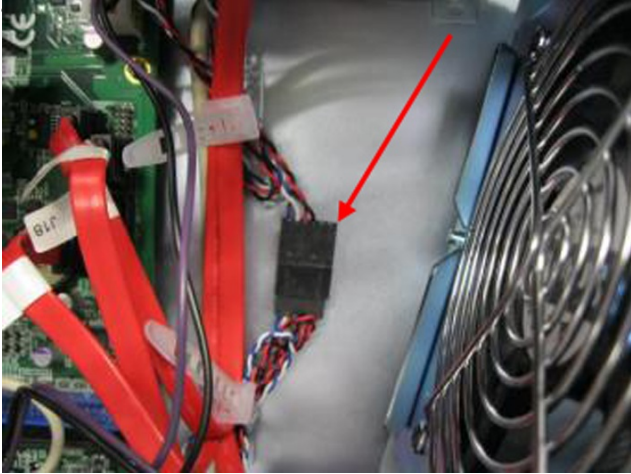
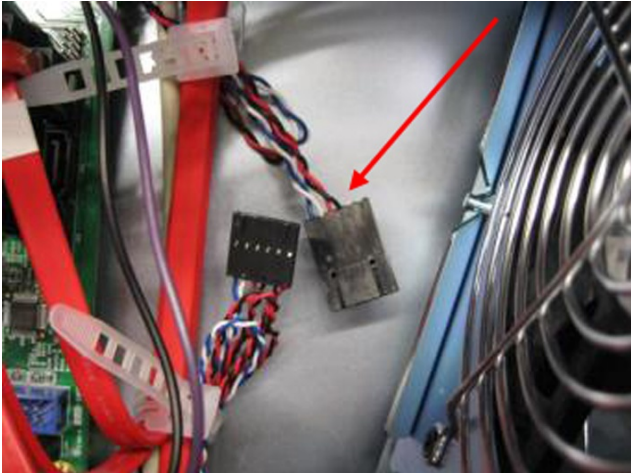
Step	Action
2	<p data-bbox="400 264 970 293"><b>Connect the harness to the AUX control board</b></p>  <p data-bbox="400 786 767 815">[25] Connect harness to AUX board</p> <ol data-bbox="400 831 1177 898" style="list-style-type: none"><li>1. Connect harness 22W1 to the AUX board.</li><li>2. Connect standby power supply connector to the AUX board.</li></ol>
3	<p data-bbox="400 918 916 947"><b>Disconnect the On/Off motherboard cable</b></p>  <p data-bbox="400 1440 836 1469">[26] Disconnect On/Off Motherboard cable</p> 

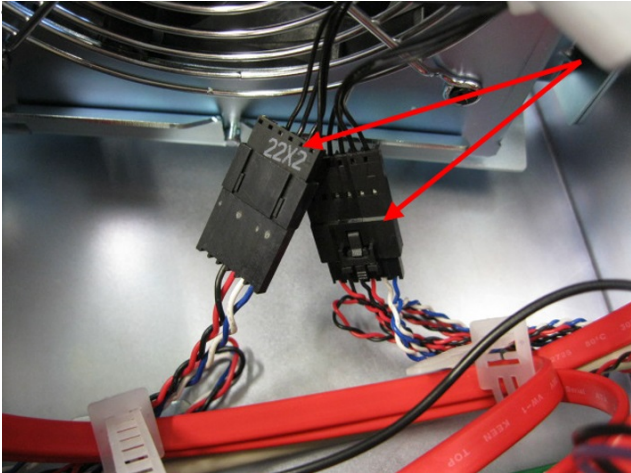
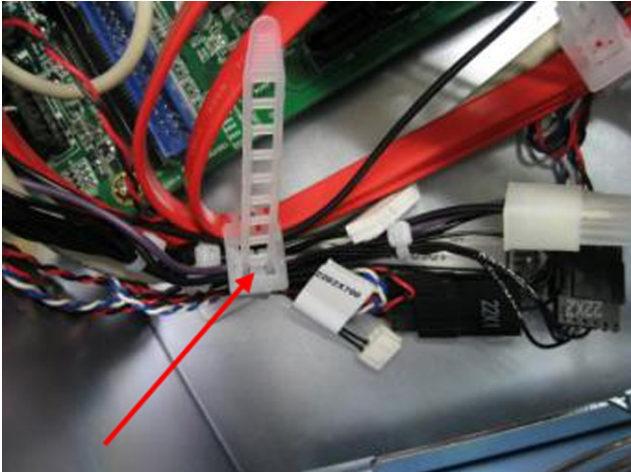
Step	Action
4	<p data-bbox="384 264 991 295"><b>Connect the harness 22W01 to On/Off connectors</b></p>  <p data-bbox="384 786 820 815">[27] Connect harness to On/Off connectors</p>
5	<p data-bbox="384 853 619 882"><b>Fasten the harness</b></p> <ul data-bbox="384 887 1410 949" style="list-style-type: none"><li>• Fasten the harness 22W01 with the bundle holder. Make sure no cables or connectors can touch the fan.</li></ul>  <p data-bbox="384 1438 587 1467">[28] Fasten harness</p>



# **Chapter 8**

## **Firmware upgrades via PRISMAsync**

# Firmware upgrade of Engine and Accessories

## Introduction

This topic describes the firmware upgrade of engine and accessories by a FST.

The firmware files should be stored on a USB stick created with the Service Support Tool (SST)



### NOTE

Firmware upgrade via direct connection between laptop (SST) and engine is not supported for the imagePRESS C7010VPS series.

## Before you begin

- Make sure to have the following tools at your disposal:
  - 1 USB key for Printer firmware (FAT32 formatted)
  - SST (Service Support Tool) version 4.72EK or higher
- Create a Canon Firmware USB installation key by using the SST-Tool.
- Print the PRISMAsync configuration report, colour configuration report and the printer P\_PRINT (Service Mode).

## Firmware upgrade of engine and accessories from USB





### NOTE

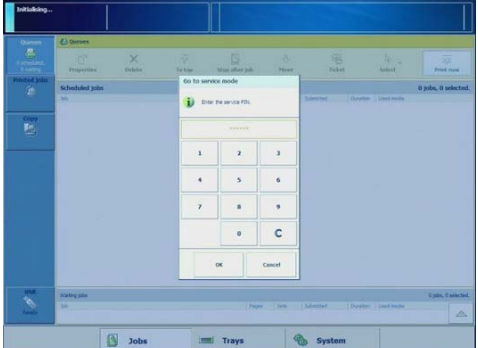

Please follow the steps in the exact order as described below. Any changes in the order might give unpredictable results

### Enter Service Mode

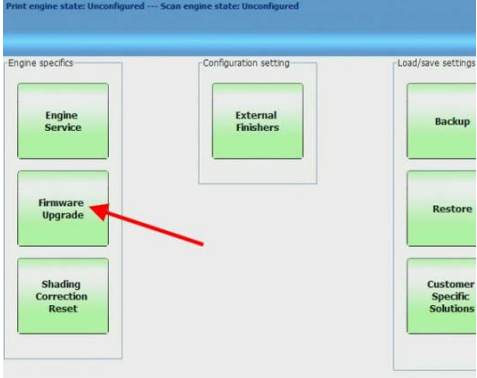
step	Action	additional Info
1	<p> <b>NOTE</b> Make sure the engine and all accessories are switched on.</p> <p><b>Go to service mode</b> When the splash-screen is shown, press the [go to service mode] button.</p>	
2	<p><b>Logon to service mode</b> In the next screen, enter the Service Password.</p>	

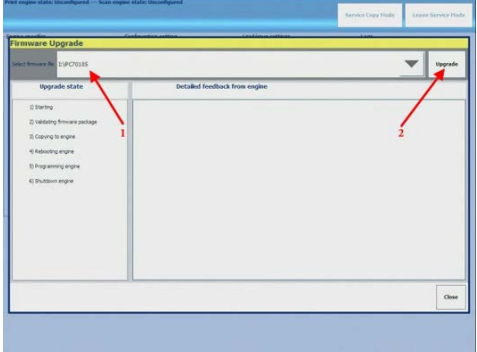
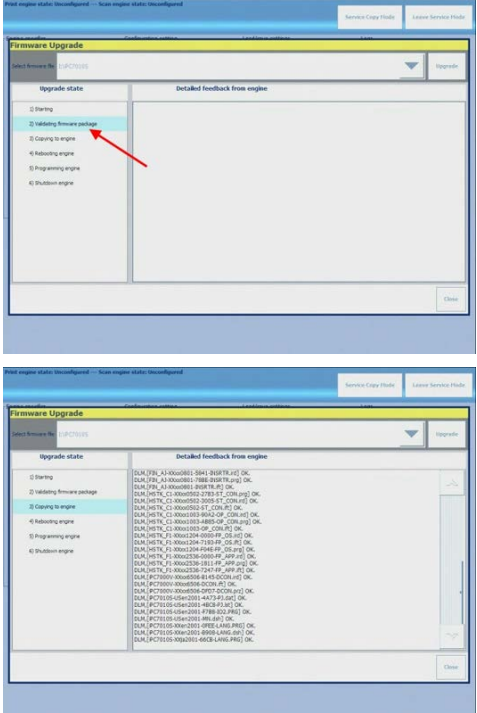
### Start upgrade procedure

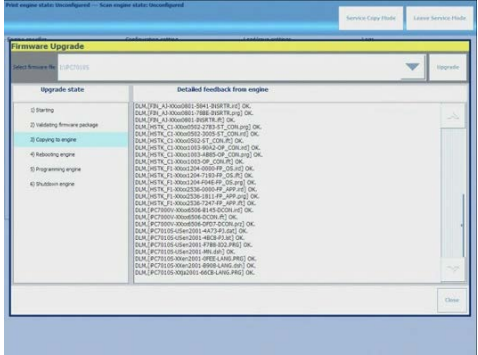
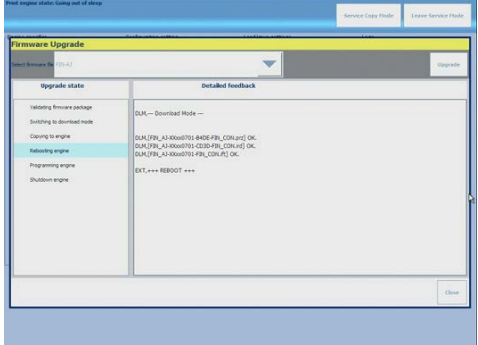
step	Action	additional Info
1	<p><b>Firmware upgrade</b> Select [Firmware Upgrade].</p>	 <p>The screenshot shows the 'Engine specific' configuration page. The 'Firmware Upgrade' button is highlighted with a red arrow. Other buttons include 'Engine Service', 'Shading Correction Reset', 'External Finishers', 'Backup', 'Restore', and 'Customer Specific Solutions'.</p>
2	<p><b>Insert USB key with printer and options firmware in the PRISMAsync</b></p>	
3	<p><b>Firmware upgrade</b></p> <ol style="list-style-type: none"> <li>1. Select the correct firmware to install (iPC7010S)</li> <li>2. Press 'Upgrade' to start the upgrade process.</li> </ol> <p> <b>IMPORTANT</b> Do not switch off the PRISMA-sync and the printer during the installation process.</p>	 <p>The screenshot shows the 'Firmware Upgrade' dialog box. The 'Upgrade' button is highlighted with a red arrow. The progress steps are: 1. Starting, 2. Validating firmware package, 3. Copying to engine, 4. Reloading engine, 5. Programming engine, 6. Shutdown engine. A red arrow points to the 'Upgrade' button.</p>
4	<p><b>Firmware upgrade; validation</b> As a first step a validation of the firmware will take place.</p>	 <p>The top screenshot shows the 'Firmware Upgrade' dialog box with the progress steps: 1. Starting, 2. Validating firmware package, 3. Copying to engine, 4. Reloading engine, 5. Programming engine, 6. Shutdown engine. A red arrow points to the 'Validating firmware package' step.</p> <p>The bottom screenshot shows the 'Firmware Upgrade' dialog box with the progress steps: 1. Starting, 2. Validating firmware package, 3. Copying to engine, 4. Reloading engine, 5. Programming engine, 6. Shutdown engine. A red arrow points to the 'Validating firmware package' step. The 'Detailed feedback from engine' section is visible, showing a list of validation results for various components.</p>

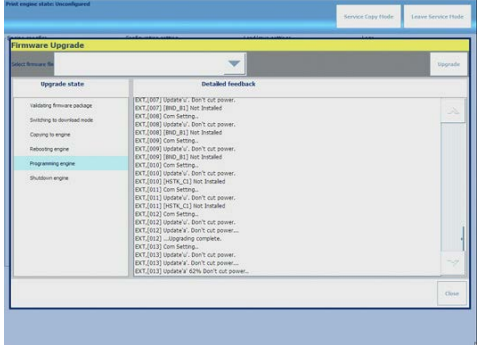
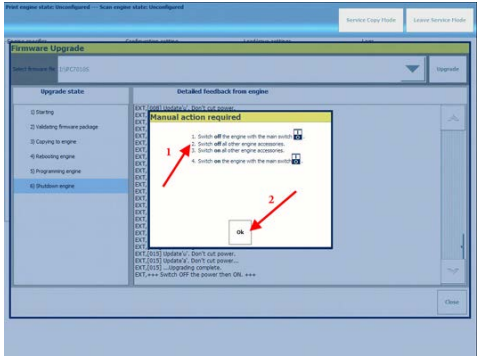
step	Action	additional Info
5	<p><b>Firmware upgrade; copy to HDD</b> After the validation the software is copied to the printer.</p>	
6	<p><b>Firmware upgrade; Reboot</b> After all files are copied the engine will reboot.</p>	
7	<p><b>Firmware upgrade; Programming</b> The firmware files will be installed.</p> <p> <b>NOTE</b> If your system does NOT have a READER attached you might get an error message in the feedback screen. You can ignore the message. The installation will continue without any problems.</p>	
10	<p><b>Switch off and on the printer</b> When the process is completed a screen is displayed prompting you to switch the printer off and on again. Take the following steps:</p> <ol style="list-style-type: none"> <li>Restart the printer                     <ul style="list-style-type: none"> <li>Switch off the printer with the power switch</li> <li>Switch off all accessories (finishing, paper-decks etc.)</li> <li>Switch on all accessories</li> <li>Switch on the printer with the power switch</li> </ul> </li> <li>Select [OK]</li> </ol>	
11	<p><b>Leave firmware upgrade mode</b> Press [Close] to leave the firmware Upgrade mode.</p>	

step	Action	additional Info
12	<b>Remove USB key with Printer firmware</b>	The duration of the printer upgrade procedure depends on the configuration that is installed. Example: Main Engine, POD Deck, Finisher AJ2 and 3 knife trimmer will take approx. 45 minutes. If a HCS-F1/G1 is connected the additional time will be approx. 30 minutes.

**Check the versions**

step	Action	additional Info
1	<b>Print configuration pages:</b> <ul style="list-style-type: none"> <li>• PRISMAsync configuration report</li> <li>• PRISMAsync color configuration report</li> <li>• Printer: P-Print</li> </ul>	Compare the configuration report and the P-Print with the version list as stated in the service bulletin and release notes.   <b>NOTE</b> Explicitly check the SORTER version. If the version does not correspond, make a USB key with the SORTER package only and do an installation again. There is no need to go to Safe Download Mode now.

**Example**

**Additional information**

For additional information see [Firmware upgrade additional information on page 92](#)

# Firmware upgrade of Engine and Accessories (safe download mode)

## Introduction

This topic describes the firmware upgrade of engine and accessories by a FST in safe download mode.

The firmware files should be stored on a USB stick created with the Service Support Tool (SST)

## Before you begin

- Make sure to have the following tools at your disposal:
  - 1 USB key for Printer firmware (FAT32 formatted)
  - SST (Service Support Tool) version 4.72EK or higher
- Create a Canon Firmware USB installation key by using the SST-Tool.
- Print the PRISMAsync configuration report, colour configuration report and the printer P\_PRINT (Service Mode).

## Firmware upgrade of engine and accessories from USB



### NOTE



This firmware update is done in Safe Download Mode to guaranty the data transfer between PRISMAsync controller and the print engine. Please follow the steps in the exact order as described below. Any changes in the order might give unpredictable results

### Set up the system to enable upgrade

step	Action	additional Info
1	<b>Shutdown system</b> Shut down the system with the [Sleep] button. Select [Shutdown] and then [Shutdown]. The complete system will shut down, including the printer. (If it was on)	 <b>IMPORTANT</b> Do not use 'Forced shutdown' because the printer will stay off for a long time. The 'Forced shutdown' procedure might harm your system.

### Switch engine to Safe Download Mode

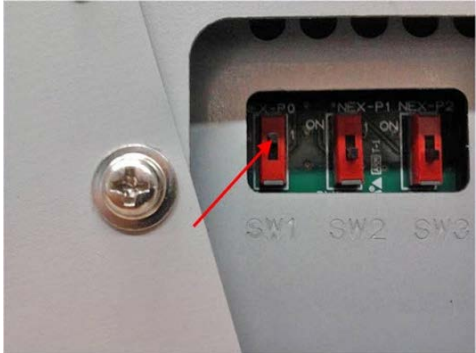
step	Action	additional Info
1	<b>Locate DIP switch panel</b> On the backside of the printer, open the DIP switch panel.	

step	Action	additional Info
2	<p><b>Set DIP switches</b> Set the printer in Safe Download Mode by setting switch SW1 to 'ON' (Upper position)</p>	
3	<p><b>Switch on PRISMAsync</b> Switch on the PRISMAsync with the [Sleep] button.</p> <p> <b>NOTE</b> Do NOT switch on the printer.</p>	

**Enter Service Mode**

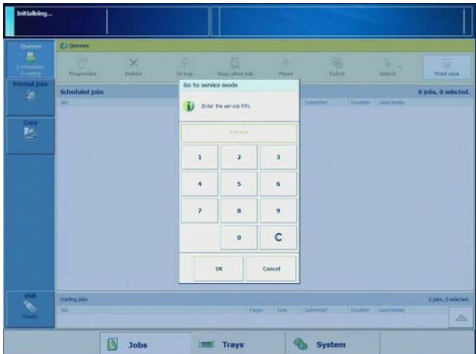
step	Action	additional Info
1	<p><b>Go to service mode</b> When the splash-screen is shown, press the [go to service mode] button.</p>	
2	<p><b>Logon to service mode</b> In the next screen, enter the Service Password.</p>	

step	Action	additional Info
3	<p><b>Service screen</b></p> <p>Wait until the 'Service Screen' is displayed.</p> <p>The 3 blocks on the left are greyed-out, meaning there is no connection with the printer.</p>	

**Start upgrade procedure**

step	Action	additional Info
1	<p><b>Switch on the printer</b></p> <p>Switch on the engine with the power-switch. When the connection between the printer and the PRISMAsync is established, the 3 blocks will become green.</p> <p> <b>NOTE</b> Be sure to switch on the printer within 2 minutes after switching on the PRISMAsync.</p>	
2	<p><b>Firmware upgrade</b></p> <p>Select [Firmware Upgrade].</p>	
3	<p><b>Insert USB key with printer and options firmware in the PRISMAsync</b></p>	
4	<p><b>Firmware upgrade</b></p> <ol style="list-style-type: none"> <li>Select the correct firmware to install (iPC7010S)</li> <li>Press 'Upgrade' to start the upgrade process.</li> </ol> <p> <b>IMPORTANT</b> Do not switch off the PRISMAsync and the printer during the installation process.</p>	

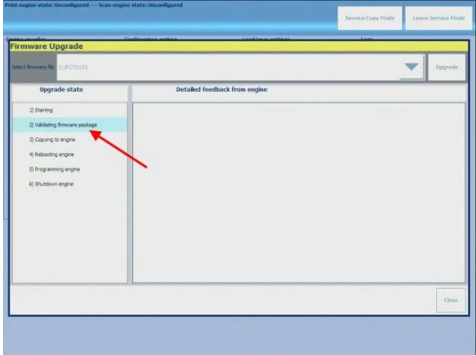
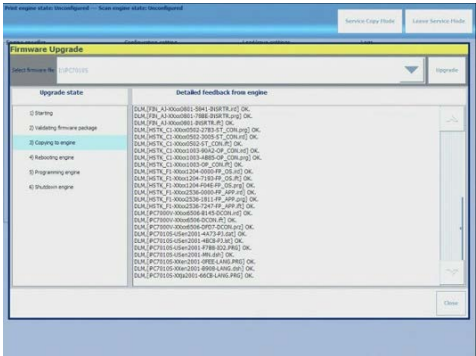
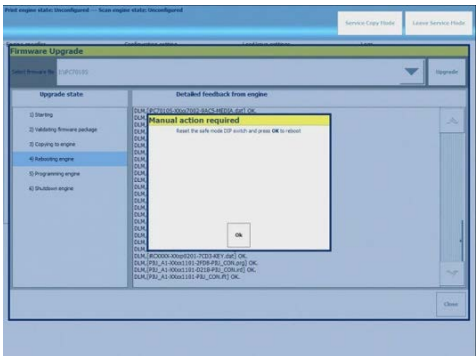
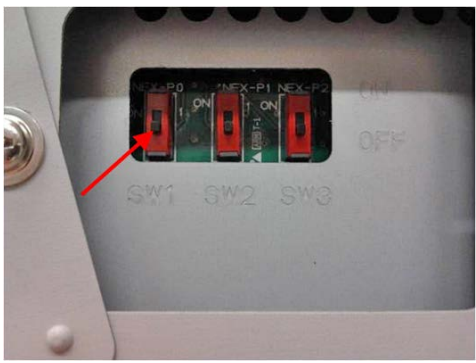

step	Action	additional Info
5	<p><b>Firmware upgrade; validation</b></p> <p>As a first step a validation of the firmware will take place.</p>	
6	<p><b>Firmware upgrade; copy to HDD</b></p> <p>After the validation the software is copied to the printer.</p>	
7	<p><b>Normal download mode</b></p> <p>As soon as all the software is copied, a screen is displayed telling you to reset the DIP switch.</p>	
8	<p><b>Switch to Normal download mode</b></p> <p>On the backside of the printer, Set the DIP switch SW1 to 'OFF' (Lower position).</p>	

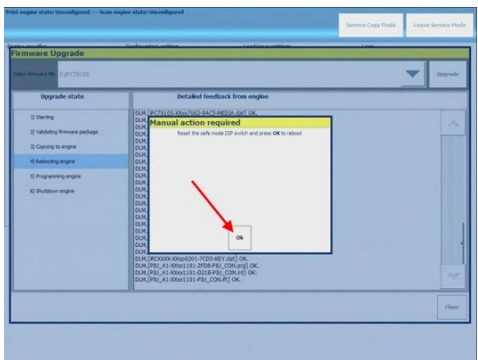
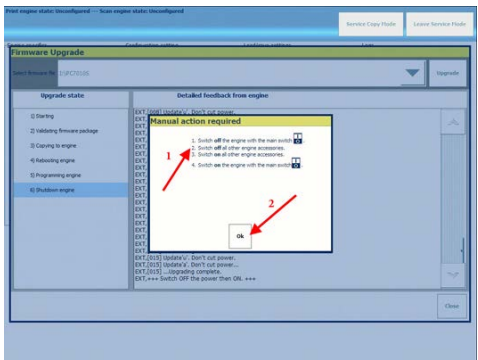
step	Action	additional Info
9	<p> <b>NOTE</b> If your system does NOT have a READER attached you might get an error message in the feedback screen. You can ignore the message. The installation will continue without any problems.</p> <p><b>Reboot to start installation</b> Press 'OK' to reboot the printer and to continue with the upgrade. After pressing 'OK' the printer will reboot and start installing firmware packages.</p>	
10	<p><b>Switch off and on the printer</b> When the process is completed a screen is displayed prompting you to switch the printer off and on again. Take the following steps:</p> <ol style="list-style-type: none"> <li>Restart the printer                     <ul style="list-style-type: none"> <li>Switch off the printer with the power switch</li> <li>Switch off all accessories (finishing, paper-decks etc.)</li> <li>Switch on all accessories</li> <li>Switch on the printer with the power switch</li> </ul> </li> <li>Select [OK]</li> </ol>	
11	<p><b>Leave firmware upgrade mode</b> Press [Close] to leave the firmware Upgrade mode.</p>	
12	<p><b>Remove USB key with Printer firmware</b></p>	<p>The duration of the printer upgrade procedure depends on the configuration that is installed. Example: Main Engine, POD Deck, Finisher AJ2 and 3 knife trimmer will take approx. 45 minutes. If a HCS-F1/G1 is connected the additional time will be approx. 30 minutes.</p>

**Check the versions**

step	Action	additional Info
1	<b>Print configuration pages:</b> <ul style="list-style-type: none"><li>• PRISMAsync configuration report</li><li>• PRISMAsync color configuration report</li><li>• Printer: P-Print</li></ul>	Compare the configuration report and the P-Print with the version list as stated in the service bulletin and release notes.   <b>NOTE</b> Explicitly check the SORTER version. If the version does not correspond, make a USB key with the SORTER package only and do an installation again. There is no need to go to Safe Download Mode now.

### Example

### Additional information

For additional information see [Firmware upgrade additional information on page 92](#)

# Firmware upgrade additional information

## Additional information related to a firmware upgrade

### Feedback:

The feedback shown combines the feedback of both the engine and PRISMAsync during the firmware upgrade. The PRISMAsync (lines starting with PRISMAsync) will include information on which files actually transferred to the engine and which files are skipped because of version is present already or a module being non-present.

### Version checking.



In order the system to operate correctly the engine and accessories and PRISMAsync must have compatible firmware installed. Therefore version checking is executed by PRISMAsync controller.

- Each PRISMAsync version will contain a list with compatible engine and accessories firmware.
- PRISMAsync will check if the installed engine and accessories firmware level matches with the actual installed PRISMAsync version.
- Version checking is executed when starting a connection with the engine in normal user mode. In (safe) download mode version checking is not executed.
- If non matching firmware is found PRISMAsync will report this in the data-log. The data log information can be viewed in service mode -> error analysis.

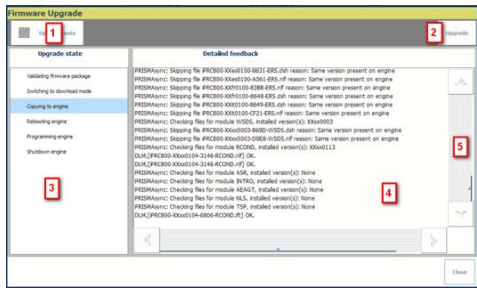
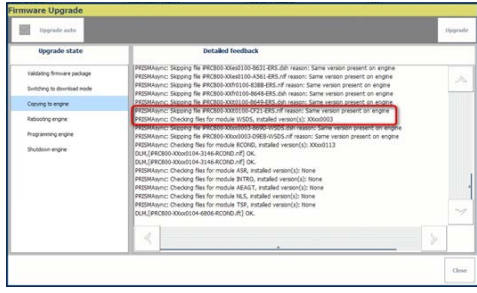
Information on screen

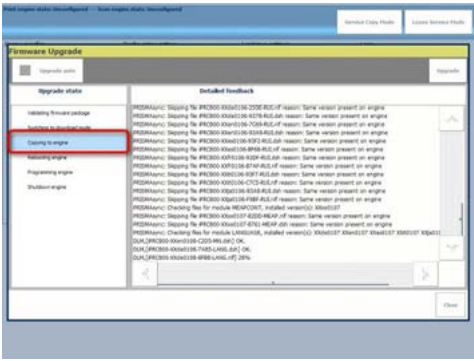
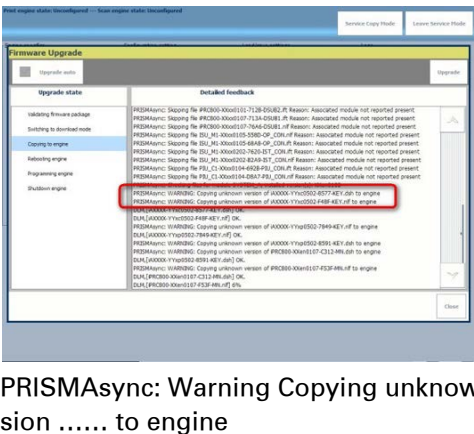
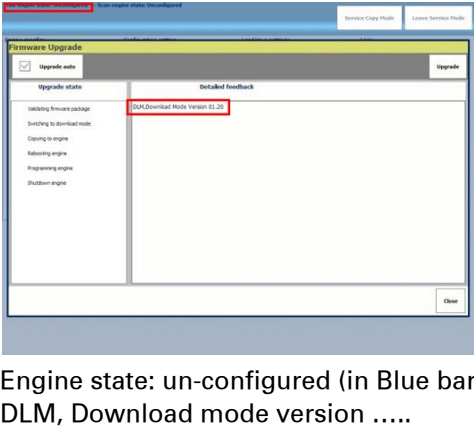
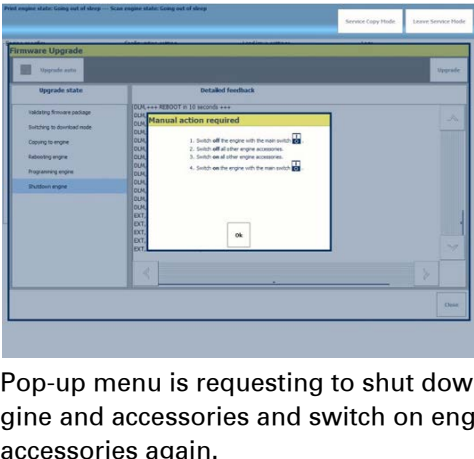
Information on screen	Explanation
	<ol style="list-style-type: none"> <li>1. Button to select             <ol style="list-style-type: none"> <li>a. Auto upgrade</li> <li>b. Non auto upgrade</li> </ol> </li> <li>2. Button to start upgrade process.</li> <li>3. Running process step</li> <li>4. Detailed information by engine and or PRISMAsync.</li> <li>5. Via scroll bar text can be scrolled back.</li> </ol>
 <p>PRISMAsync.....</p>	<p>PRISMAsync at beginning of a row:              Message generated by PRISMAsync.              Messages with e.g. DLM, EXT ...in front are messages generated by engine.</p>

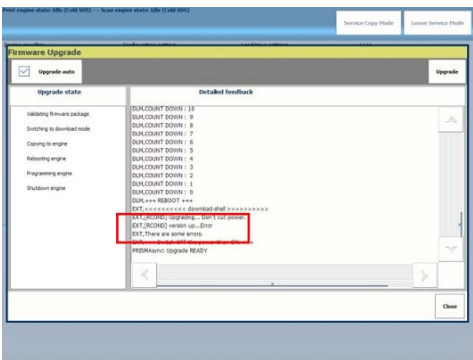
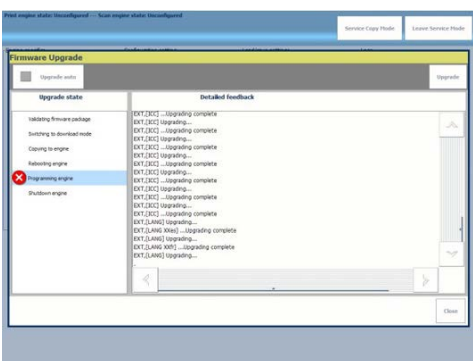
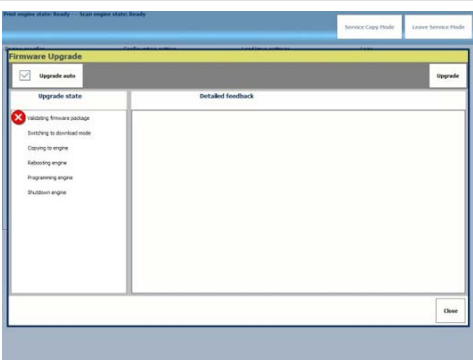
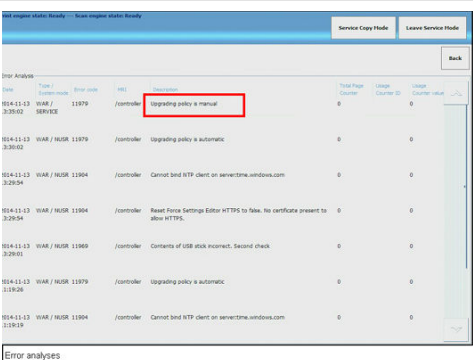
Information on screen	Explanation
	<p>The Blue bar is indicating the current process step. When upgrade is ready; no blue bar</p>
	<p>This message is reported when for PRISMA-sync an unknown version is present on the USB key and copied to the engine.</p>
	<p>Engine is set to safe download mode.</p>
	<p>This pop-up screen is indicating that a fault is occurred. Most likely the firmware of one of the accessories is not installed correctly. Check for reason and take corrective actions. Action required: Power off and on the engine.</p> <p><b>NOTE</b> For imagePRESS C800 series the accessories are switched on and off by the engine automatically.</p>

Information on screen	Explanation
 <p>EXT... Version-up error</p>	<p>Engine reports an error when upgrading. Check for reason and take corrective actions. The scroll bar can be used to review the information to find the applicable module.</p>
	<p>This screen is indicating that a module is not programmed. Not necessarily an error. Possible case: module is not present. The scroll bar can be used to review the information to find the applicable module. Check for reason and take corrective actions.</p>
	<p>Fault detected with USB key. File name or content is invalid.</p>
	<p>For analysis the current upgrade policy can be checked via PRISMAsync service mode -&gt; Error analyses. The current policy is showed. After each PRISMAsync the policy is checked again.</p> <p> <b>NOTE</b> Only applicable for PRISMAsync for imagePRESS C800 series.</p>

# **Chapter 9**

## **System software**

# System software

## Introduction

At installation the Field Service Technician should always check if the required software (version, release, level and patch) is installed on the PRISMAsync. The software is distributed as an .iso image via FTP.

You will be informed about new software by means on an Service Information Bulletin. This bulletin contains also a link to the FTP site.

## Software version management

Number	Name	Incremented
V	Version	New functionality, new architecture or major redesign
R	Release	Improvement of product features, addition of new modules
L	Level	Group of consolidated bug fixes
P	Patch	Customer specific bug fix

The PRISMAsync is pre-installed with a system software version.

To check the software version:

1. Open the **Settings Editor** and browse to [Support] -> [About]. In the field [Version of the printer main software] the version is given.
2. In the [System] section of the setup tab on the Operator panel, touch [Local key operator settings]. In the section [About] you will find the version number.

In some cases it is necessary to re-install the system software:

- A newer version of the software is available.  
If a new version of the software is available you can obtain this via your Service channel.
- The currently installed software seems to be corrupt.  
If the current software reacts in an undefined way and it is obvious that there is no hardware defect, re-installing the software might be a solution.
- After replacement of the HDDs.  
If the HDDs drives have been replaced it is necessary to re-install the software.



## Preparation of the USB-stick

For installation of the PRISMAsync software you need a pre-programmed USB-stick. This chapter describes how to prepare the stick.

### Before you begin

- a 16 GB USB-stick (available via the normal service channel)
- an image of the PRISMAsync software (available via ftp-site or your service channel)
- the USB creation tool called CreateUSB (available via ftp-site or your service channel or inside the PRISMAsync iso-file).
- a laptop or pc with Windows Vista or Windows 7

### Procedure

#### 1. Check if .NET 4.5 is installed on the laptop.

If .NET 4.5 not installed please download and install the .NET 4.5 framework.

#### 2. Insert USB key and start CreateUSB Tool.

1. Fill out the fields in the tool. Once the iso-file is selected the tool will check if a newer version is available (in the image-file). If there is a new version available it will install this version and overwrites the old one.

The following dialogue will appear:

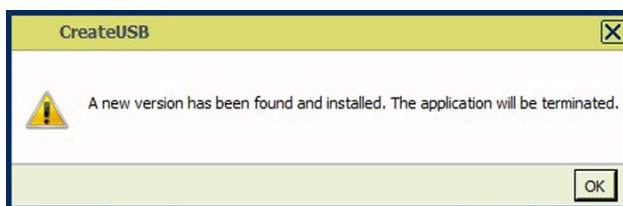

#### 3. Restart the Create USB Tool.

Restart the tool and make the settings as described below.

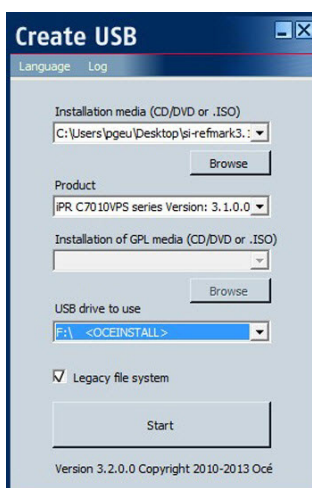

1. Installation media: Browse to the location where the media .iso-image is located.
2. Product: Select the applicable product
3. USB drive to use: Select the USB drive for writing the software to.
4. Legacy file system: Some antivirus software intervenes with the CreateUSB tool. To make sure the USB-stick is created correctly enable the legacy file system.

**5. Select Start.**

Check that you have the .NET 4.5 framework installed, and press OK if it is installed. Otherwise Exit the CreateUSB tool and install the .NET 4.5 version. If you don't do this the tool will not work.



**NOTE**

If the message below appears make sure to download and install the .NET 4.5 framework. The CreateUSB tool will not work without the .NET 4.5 framework.

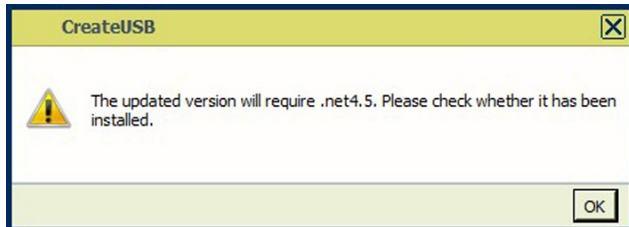

**4. Press OK to start the programming process.**

Additional illustration needed.

**1. After pressing OK the following window will pop-up.**

Select "Yes" to store existing jobs and settings, and to restore them automatically after the installation.



**NOTE**

The "keep existing jobs and settings after installation" setting is supported in version 3.2 and higher.

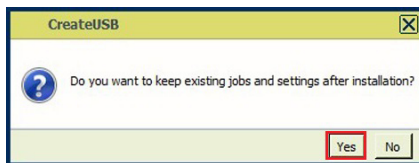

After making the selection, the process will start and the iso-image is programmed to the stick.

Please wait until the CreateUSB tool indicates that the USB-stick is ejected and the process is ready

**5. Remove the USB-stick from the PC.**

The USB-stick is now ready for use. The name of the stick is OCEINSTALL

**After you finish**

*Reuse a USB-stick after installation on page 99*

# Reuse an USB-stick after installation

## Prepare a USB-stick for reuse

It is possible to re-use the USB-stick after an installation. You can check if a USB-stick is ready or not. A USB stick that is ready for installation is called "OCEINSTALL". When it is used, the name is "USEDKEY". Please take the following steps to re-use the stick for installation of the system software.

## Procedure

1. Put the USB-stick into a USB port of your computer.
2. Open the Explorer window.
3. Check if the name of the USB-stick is "USEDKEY" .
4. To prepare the USB-stick for reuse open the contents of the stick in your explorer. Double-click the "ReUseKey.bat" file.

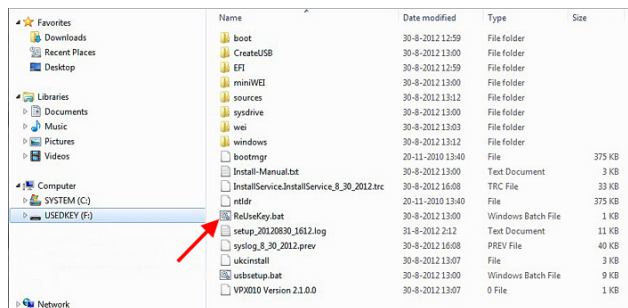

5. Check (in your explorer screen) if the name of the USB-stick has changed to "OCEINSTALL". If the name did not change it might be needed that you remove the stick and insert it again.
6. Your USB-stick is now ready for a new installation.



## NOTE

Be aware that the settings you selected at creation of the USB-stick (e.g. "keep existing jobs and settings after installation") will be used after the stick is prepared for reuse.

# Re-installation of the system software

This topic describes the re-installation of the system software on the PRISMAsync controller



## NOTE

The installation process takes approximately 30 minutes.

## Before you begin

- A bootable USB-stick containing the system software.  
Preparation of this USB-stick is described in [Preparation of the USB-stick on page 97](#).



## NOTE

If the USB-stick was created with the setting to "Keep existing jobs and settings after installation" (default setting), it is not necessary to create a backup and restore.

For safety reasons we advise to create a backup. When the controller or the hard disks have to be exchanged you will lose all settings.

Before upgrading always print the configuration page so you have the Network-settings to your disposal.

## Procedure



## NOTE

If the system software seems to be corrupt or the HD drives have been replaced it is not possible to execute steps 1 and 2.

- 1. Print a configuration page**
- 2. Create a backup of the settings and licenses**  
To create a backup do the following:
  - 1.** Insert a USB stick into the left side of the Operator panel.  
It is not allowed to use the USB-stick with the system software on it. It will become unusable.
  - 2.** In the [System] section of the [Maintenance] tab on the Operator panel, touch [Go to service mode].
  - 3.** In the first screen touch the [Backup] button. The system will detect the USB-stick and will ask to confirm the location and filename. After confirmation, the settings are copied to the USB stick.
  - 4.** Remove the USB-stick after the settings are copied.
- 3. Insert the USB-stick that contains the system software into a USB-port**  
Be sure to insert the USB-stick while the PRISMAsync is switched on. The Operating System has to recognize the USB-stick.
- 4. Restart the PRISMAsync**

On the Operator Panel touch the [**Shutdown system**] button in the Setup tab of the System section. In the next window select [**Restart**].

The PRISMAsync will boot from the stick. This can take a few minutes because the system is checking the contents of the USB-stick. A text will be displayed telling you that it is checking the USB-stick. After some time the PRISMAsync will reboot again and the installation process will start.

Status messages are displayed on the Operator panel. The PRISMAsync will reboot a few times during installation.



## NOTE

Do not switch off the controller during the installation process.

At the end of the process the PRISMAsync will switch off automatically. The total process will take approx. 30 minutes.

After the PRISMAsync is switched off, remove the USB-stick.

### 5. Switch on the PRISMAsync

Press the **[Sleep]** button to switch on the PRISMAsync. In case the "keep existing jobs and settings after installation" was enabled during creation of the USB-stick an additional reboot after restoring the jobs and settings will be executed.



#### NOTE

The "Restore the system settings and licenses" procedure is applicable when:

- The setting "Keep existing jobs and settings after installation" was **NOT** selected during creation of the USB stick.
- The HDDs or controller has been replaced

### 6. Restore the system settings and licenses

To restore the settings and licenses do the following:

1. Insert the USB stick you used to backup the settings, into the left side of the Operator panel.
2. In the System section of the Maintenance tab on the Operator panel, touch [Go to service mode].  
See also **Service mode** in [Maintenance and Service on page 31](#).
3. In the first screen touch the 'Restore' button. The system will detect the USB stick and will ask to confirm the location and filename. After confirmation, the settings are copied to the PRISMAsync.
4. When all the settings are copied, the PRISMAsync will automatically reboot. When ready, please remove the USB-stick. If you were not able to make a backup of the settings before installation, please use the last backup file you have created.

### 7. If necessary install patches. (if applicable)

It is possible that there are patches belonging to the new installed system software. Install these patches now. See next chapter.

### 8. Make a new backup of settings



#### NOTE

If you installed the software because the controller was exchanged you have to re-host the license because the original license that was stored in the back-up is not valid.

## Installing patches

Sometimes a patch for the system software of the PRISMAsync will be released. This patch will resolve 1 or more problems, but does not require a complete re-installation of the software.

The patch is released in an .EXE- or .MSU format (for Microsoft patch). Do not change the filename of the patch, because it will become unusable.

There are 4 methods to install a patch:

- The patch resides on a PC/laptop. The upgrade is done via the Settings Editor.
- The patch resides on a USB stick. This stick is entered into the PRISMAsync and the upgrade is done via the Operator Panel.
- The patch resides on a remote server. The patch is downloaded from the server and installed on the controller via the Settings Editor. (License Remote Service needed)
- The patch resides on a remote server. The patch is downloaded from the server and installed on the controller via the Operator Panel. (License Remote Service needed)

### Install a patch from a PC via the Settings Editor

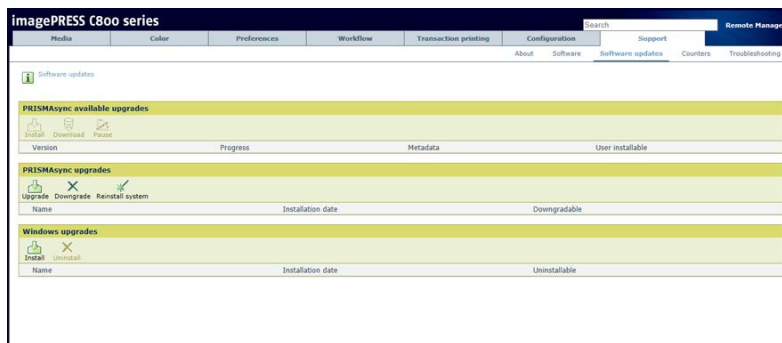

To install a patch from a PC via the Settings Editor take the following steps:

1. **Be sure the patch is installed on your PC/laptop**
2. **Browse to the software upgrade section**  
In your web browser open the Settings Editor and browse to "Support -> Software". Select the "Upload upgrade package 1" option. Depending on the new software version, sometimes 3 packages must be uploaded. It is recommended to finish and remove your jobs before you perform the upgrade.
3. **Select the location of the patch**  
In the next window browse to the location of the patch, and select "Upload".
4. **Select "OK"**
5. **If needed repeat this for the other packages**
6. **Start the upgrade.**  
The packages are uploaded to the PRISMAsync but they are not installed yet. Select "Start upgrade" in the Settings Editor. In the next window select "Start".
7. **Select "OK"**  
A window will pop-up saying, you have to restart the controller after upgrade. Press "OK" until the installation starts.
8. **Restart the PRISMAsync and the copier**

## Install a patch with a USB stick via the Operator Panel

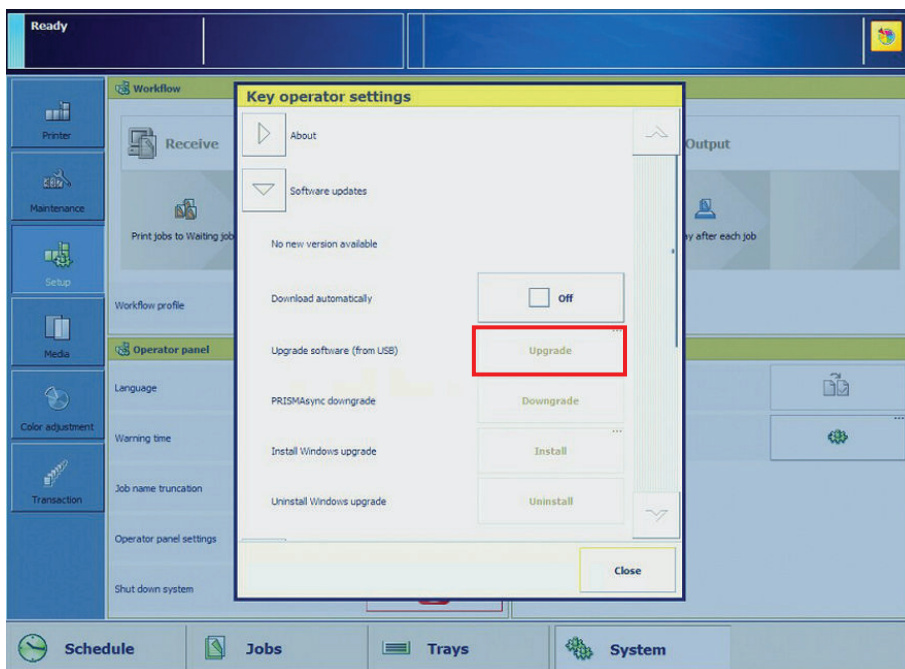

To install a patch with a USB stick via the Operator Panel take the following steps:

1. **Copy the patch to a USB stick**
2. **Start the install patches procedure**  
On the Operator Panel in the System section of the Setup tab choose 'Local key operator settings'. In the next window choose 'About -> Upgrade software (from USB)'. The system will ask you for the location of the USB-stick and the filename.
3. **Select the patch-file.**  
In the next window browse to the location where the EXE-file with the patch resides. Select the file and select "Upgrade" on the Operator Panel.
4. **Wait until the installation finishes.**  
When the installation has finished the message 'Installation successful' is shown.
5. **Restart the PRISMAsync and the copier.**

## Install (uninstall) a Windows patch via the Operator Panel

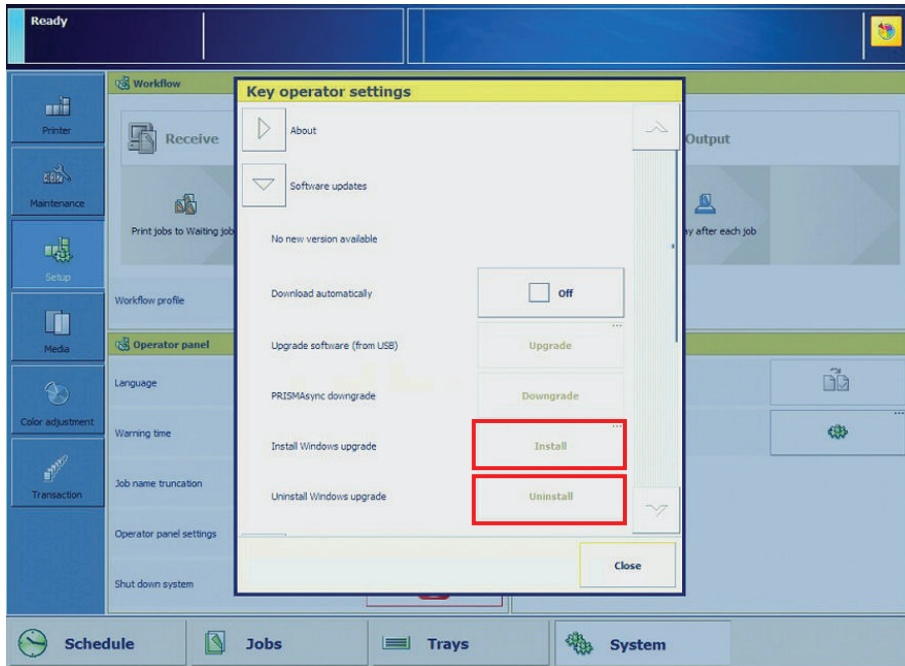

To install or uninstall a Windows a patch via the Operator Panel take the following steps:

1. **Copy the patch to a USB stick**
2. **Start the install patches procedure**
  1. On the Operator Panel in the System section of the Setup tab choose 'Local key operator settings'.
  2. Install Windows upgrade (or uninstall Windows upgrade)
3. **Select the patch-file.**

In the next window browse to the location where the .MSU-file with the patch resides. Select the file and select "Install" on the Operator Panel.
4. **Wait until the installation finishes.**

When the installation has finished the message 'Installation successful' is shown.
5. **Restart the PRISMAsync and the copier.**



## Installing a license

For a lot of the functionality to work, the PRISMAsync will need licenses. These licenses are generated by the configuration centre, and delivered in a license-file. This license file has to be uploaded to the PRISMAsync.

To install the licenses there are 2 possibilities:

### Procedure

#### 1. On the Operator panel

- Copy the license file to a [USB]-stick
- Insert the [USB]-stick into a [USB] port on the PRISMAsync. You can use any port, but for convenience it is best to use the port on the operator panel.
- In the **[System]** section of the **[Setup]** tab choose **[Local key operator settings]**.
- In the next window choose '**Software licenses -> upload license**'. The [System] will ask you for the location of the [USB]-stick and the filename.
- Choose the correct file and touch **[Start]**.
- When the file is uploaded, restart the PRISMAsync.
- Make a backup of the settings

#### 2. In the Settings Editor

- Locate the license file on your PC
- On your PC open the Settings Editor (See [The Settings editor on page 58](#) ).
- Browse to **[Support] -> [Software]**.
- Click '**Upload license file**' (You will need the Key Operator or [System] Administrator password).
- Browse to the License file on your PC.
- Start the upload of the license file.
- When the file is uploaded, restart the PRISMAsync and the copier.
- Make a backup of the settings

## Installing the printer driver

After a release of new PRISMAsync software, most of the time a new printer driver is released. This driver can be obtained in 2 ways:

### Procedure

**1. Via the support section on the Océ website.**

Download the driver from the website and install it according to the standard installation instruction of printer drivers of your Operating System

**2. Download it via the Settings Editor.**

It is possible to obtain the printer driver via the **Settings Editor**. Open a web browser and browse to your system. Go to the tab **[Support] > [Software]**. Here you will find an item to download the printer driver. You will need the Key operator PIN or System Administrator password for this. After entering the PIN, a window will pop up, asking you to select the appropriate driver. Click on the needed item. The driver will be downloaded to your system. Now you can install it according to the standard installation instruction of printer drivers of your Operating System.

# Configure the machine for the USA

After installing the controller software the system is ready for use in all countries except for the US and Japan. For use in the US the following additional steps need to be performed:

## Procedure

### 1. In the Settings editor

- [Preferences]->[System settings]->[Regional settings]->Region->USA
- [Preferences]->[System settings]->[System of measurement]->[Imperial]
- [Preferences]> [Print job defaults]> [Separator sheet] > Letter 28 lb
- [Preferences]> [Print job defaults]> Front Cover > Letter 28 lb
- [Preferences]> [Print job defaults]> Back Cover > Letter 28 lb
- [Preferences]> [Print job defaults]> [Banner] > Letter 28 lb
- [Preferences]> [Print job defaults]> [Calibration media] > Tabloid 28 lb
- [Preferences]> [Print job defaults]> [Calibration media] [Heavy]> Tabloid 134 lb
- [Preferences]> [Print job defaults]> [Calibration media] [Extra heavy]> Tabloid 150 lb
- [Preferences]> PostScript> Media > Letter 28 lb
- [Preferences]>PDF>Media>Letter 28 lb
- Colour> Colour defaults> Device CMYK input profile> US Web Coated SWOP
- Colour> Colour defaults> Default media Family> uncoated US
- Colour> Colour presets> Photographic content> Device CMYK input profile> US Web Coated SWOP
- Media> select\* > edit> Media family> depending region\*\*
  - \* : All Uncoated Media
  - \*\* :
  - Use "Uncoated " media family for uncoated media in the EU
  - Use "Uncoated US" media family for uncoated media in the US
  - Use "Uncoated JP" media family for uncoated media in Japan
- For transaction printing US set media and Colour Management (IPDS #36 media / PCL #16 media)



### NOTE

For optimization purposes:

- Use "Uncoated" media family in the US (or Japan) when the media is Mondi paper (or similar, like Océ TopColor)
- Use "Uncoated US" media family in the EU (or Japan) when the media is Hammermill Color Copy Digital paper (or similar)
- Use "Uncoated JP" media family in the US (or EU) when the media is GF-C081 paper (or similar)

### 2. On the Operator panel

- Change the language on the Operator panel to English-US

### 3. On the application PC

- Change in the Control panel the regional setting to English-US

### 4. In the UPD Printer driver

- Printing [Preferences]->paper letter-28

### 5. Entering [media:] weights

When using "Imperial" as measurement system, then all media weights have to be entered according to the following table.

	Bond Ledger	Offset Text	Cover	Tag	Index	Points	*Caliper (inches)	millimeters	Metric (grams/sq meter)
Equivalent Weight	18	40	22	37	33	3.2	.0032	0.081	60.2 gsm
	18	45	24	41	37	3.6	.0036	0.092	67.72 gsm
	20	50	28	46	42	3.8	.0038	0.097	75.2 gsm
	24	60	33	56	50	4.8	.0048	0.12	90.3 gsm
	28	70	39	64	58	5.8	.0058	0.147	105.35 gsm
	29	73	40	62	60	6	.0060	0.152	109.11 gsm
	31	81	45	73	66	6.1	.0061	0.155	116.63 gsm
	35	90	48	80	74	6.2	.0062	0.157	131.68 gsm
	36	90	50	82	75	6.8	.0068	0.173	135.45 gsm
	39	100	54	90	81	7.2	.0072	0.183	146.73 gsm
	40	100	56	93	83	7.3	.0073	0.185	150.5 gsm
	43	110	60	100	90	7.4	.0074	0.188	161.78 gsm
	44	110	61	102	92	7.6	.0076	0.193	165.55 gsm
	47	120	65	108	97	8	.0078	0.198	176.83 gsm
	53	135	74	122	110	9	.0085	0.216	199.41 gsm
	54	137	75	125	113	9	.009	0.229	203.17 gsm
	58	146	80	134	120	9.5	.0092	0.234	218.22 gsm
	65	165	90	150	135	10	.0095	0.241	244.56 gsm
	67	170	93	156	140	10.5	.010	0.25	252.08 gsm
	72	183	100	166	150	11	.011	0.289	270.9 gsm
76	192	105	175	158	13	.013	0.33	285.95 gsm	
82	208	114	189	170	14	.014	0.356	308.52 gsm	
87	220	120	200	180	15	.015	0.38	312 gsm	
				552					999 gsm

[29] Fig: Table media weights

Media weights up to 161.78 grams/square meter must be entered in Bond and media with a higher media weight must be entered as index.

# **Chapter 10**

## **Troubleshooting**

## Troubleshooting

The PRISMAsync is part of a copier/printer system. Problems with respect to the PRISMAsync are always in one of these 3 areas:

- Inside the PRISMAsync,
- In the interface between the PRISMAsync and the copier,
- In the interface between the PRISMAsync and the networked computers.

This chapter does not try to describe the possible problems that exist in the networked computers or the network itself.

The following paragraphs describe the checks you can perform to locate and resolve problems. Always check the external and internal before replacing any components.



### NOTE

If an error code is displayed on the operator panel, please check the list with error codes in [Error messages and conditions on page 118](#).

Check that the network of the customer is functioning. If this is not the case direct these problems to the appropriate service department or the network administrator.

Check that the problems are not caused by trying to print a specific job. If other jobs are printed correctly, then focus on the problematic job.

## Check external connections

Before opening the PRISMAsync first check the external connections.

Check the following:

### Procedure

1. Power cable is connected to the PRISMAsync and the wall outlet.
2. Power is present on the wall outlet.
3. Network cable is connected and status LED is blinking.
4. Crossover Ethernet cable (lower network port) is connected to the copier.
5. Crossover Ethernet cable and normal Ethernet cable (upper network port) are not exchanged.
6. Both data cables are connected correctly to PRISMAsync and copier.
7. USB cable to operator panel is connected.
8. DVI cable to operator panel is properly connected (Left DVI port).
9. 15-pin D-sub cable to operator panel is connected.
10. 9-pin D-sub cable to Operator attention light is connected
11. Cables in the backside of the Operator panel are connected (Remove the cover on the backside of the operator panel).

## Checking internal components

When checking the internal components the PRISMAsync has to be opened. See [Access internal components on page 67](#).



### NOTE

Please follow standard Electro Static Discharge (ESD) precautions when handling electronic components.

Check the following:

### Procedure

1. No strange objects are inside the PRISMAsync.
2. Look for obvious loose boards. Reseat each board including DDR3 modules.
3. Look for obvious loose connectors. Reseat each connector firmly.
4. Be sure that HDDs are connected to the right SATA port. See [Replace the Hard Disk Drives on page 74](#)



## Comprehensive system inspection

If none of the previous checks did help you might have to do a component by component inspection. A comprehensive inspection allows you to verify that each hardware component is properly installed and configured, and helps you avoid replacing expensive components unnecessarily.

Component	Actions
External connectors	<ul style="list-style-type: none"> <li>• See '<a href="#">Check external connections on page 111</a>'</li> <li>• Cables, cable connectors, and mating connectors appear undamaged.</li> </ul>
Internal components	<ul style="list-style-type: none"> <li>• All replaceable parts are: <ul style="list-style-type: none"> <li>– Present</li> <li>– Properly aligned</li> <li>– Installed securely</li> <li>– Installed on the appropriate site</li> <li>– The correct part for the system</li> <li>– Appear undamaged</li> </ul> </li> <li>• Chassis and contents have not been tampered with.</li> <li>• Chassis does not contain any foreign objects.</li> </ul>
Motherboard	<ul style="list-style-type: none"> <li>• Motherboard, including components and traces, appear undamaged, and no foreign objects are evident</li> <li>• CPU is present, well-seated, and appears undamaged.</li> <li>• CPU cooling assembly is well-aligned and firmly attached.</li> <li>• Each fan (including fan cable) is well-positioned (not upside down), installed in the correct connector (CPU_FAN1), and appears undamaged.</li> <li>• Boards required on the motherboard are present, well-seated, and in the correct slots.</li> <li>• Battery is installed.</li> </ul>
DDR3 modules	<ul style="list-style-type: none"> <li>• Each DIMM is well-seated.</li> <li>• Each DIMM is of the same brand and type.</li> <li>• Each DIMM is seated in the correct port. Pairs DIMM1/DIMM3 and DIMM2/DIMM4</li> </ul>
PCI boards	<ul style="list-style-type: none"> <li>• Each board required is: <ul style="list-style-type: none"> <li>- Present</li> <li>- Installed in the correct slot</li> <li>- Well-seated</li> <li>- Appears undamaged</li> </ul> </li> <li>• Required cables (if applicable) are <ul style="list-style-type: none"> <li>- Present</li> <li>- Firmly connected in the correct connectors</li> <li>- Appear undamaged</li> </ul> </li> </ul>

Component	Actions
Power supply	<ul style="list-style-type: none"> <li>• The power supply required is:                             <ul style="list-style-type: none"> <li>- Present</li> <li>- Correctly installed</li> <li>- Appears undamaged</li> </ul> </li> <li>• Cable connectors are:                             <ul style="list-style-type: none"> <li>- Firmly connected</li> <li>- Appear undamaged</li> <li>- Installed in the correct devices</li> </ul> </li> </ul>
HDD's	<ul style="list-style-type: none"> <li>• The HDDs required are:                             <ul style="list-style-type: none"> <li>- Present</li> <li>- Correctly installed</li> <li>- Appear undamaged</li> </ul> </li> <li>• HDD data cables are:                             <ul style="list-style-type: none"> <li>- Present</li> <li>- Firmly connected in correct motherboard connectors:                                     <ul style="list-style-type: none"> <li>- HDD 0 (upper drive in bracket) to J18</li> <li>- HDD 1 (middle drive in bracket) to J24</li> <li>- HDD 2 (lower drive in bracket) to J16</li> </ul> </li> <li>- Appear undamaged</li> </ul> </li> </ul>
System fan	<ul style="list-style-type: none"> <li>• The system fan is:                             <ul style="list-style-type: none"> <li>- Present</li> <li>- Correctly installed</li> <li>- Appears undamaged</li> </ul> </li> <li>• System fan cables are:                             <ul style="list-style-type: none"> <li>- Present</li> <li>- Firmly connected in correct motherboard connector (SYS_FAN1)</li> <li>- Appears undamaged</li> </ul> </li> </ul>

## Diagnose LEDs

There are some LEDs present on the outside and the inside of the PRISMAsync.

These LEDs might lead you to the cause of a problem. Always check these LEDs first to get some first impression.

### Network Status LEDs

Next to each Ethernet connector there are 2 LEDs indicating the network speed.

When data is transferred, the appropriate LED will blink to indicate network activity.

- **No LED activity on upper Ethernet connector.**

There is no connection to the customer network. First checks to perform:

- Check if cables are connected correctly in PRISMAsync and wall outlet.
- Check if cable is not defect.
- Check if normal and crossover Ethernet cables are not exchanged.
- Check if the network is functioning.

- **No LED activity on lower Ethernet connector.**

There is no connection between the copier and the PRISMAsync. First checks to perform:

- Check if cables are connected correctly in PRISMAsync and wall outlet
- Check if cable is not defect
- Check if normal and crossover Ethernet cables are not exchanged.

### LED in power button

In the power on/off button on the front side of the PRISMAsync a LED is integrated.

If the PRISMAsync is switched on this LED is shining blue.

If the LED stays off check the following:

- Does the PRISMAsync switch on? If so there is probably an open connection in the LED wiring.
- If the PRISMAsync cannot be switched on or off then there is either a problem with the wiring of the button or with the power supply.

### LEDs on AUX control board

On the AUX control board you can find some LEDs. These LEDs indicate the presence of power on the board. All LEDs should be shining green. If one of the LEDs is off, the board will not function.

Please first check the connectors and the cables before replacing the board.

The function of the LEDs are

1. 3.3 Volt
2. 5 Volt
3. 12 Volt
4. 24 Volt

**Note:**

- The board is mounted upside down in the PRISMAsync, so it might be difficult to check the boards.

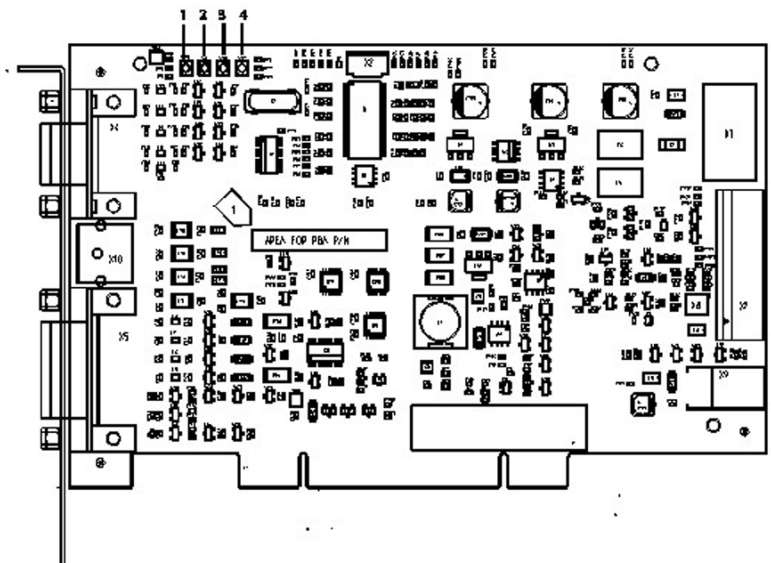

[30] Fig. AUX control board

**LEDs on DDI board**

On the DDI control board you can find some LEDs. These LEDs indicate the working of the board. The LEDs are situated at the bottom side of the print.

Please first check the LEDs, connectors and the cables before replacing the board.

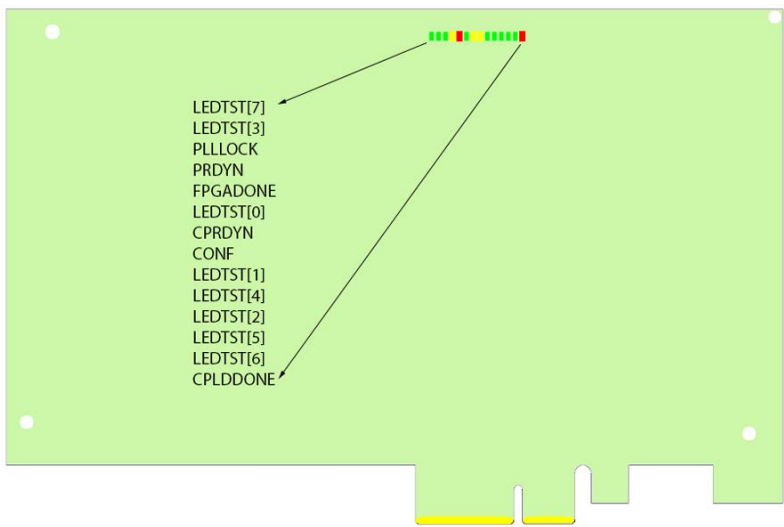

[31] Fig. LEDs on DDI board

LED	Colour	Function
LEDFPGADONE	Red	Is ON as long as the FPGA is not booted successfully
LEDCPRDYN1)	Yellow	Is OFF when CPRDYN is active. Indicating that the controller PC is ready.
LEDPRDYN1)	Yellow	Is OFF when PRDYN is active. Indicating that the Engine / Test PC is ready.

LED	Colour	Function
LEDCONF1)	Yellow	Is ON, Indicating cable length of 3 m - 5.5 m
LEDPLLLOCK1)	Green	Is ON when clock synchronization between Controller PC and Engine / Test PC was successful.
LEDTST[0]	Green	Always ON (PCI Express link status is tied high)
LEDTST[1]	Green	Is ON when Serial link between Controller PC and Engine / Test PC is initialized correctly.
LEDTST[2]	Green	ON when DDR is initialized
LEDTST[3]	Green	OFF when SOFT RST Button Pushed
LEDTST[4]	Green	OFF when HARD RST Button pushed
LEDTST[5]	Green	Always ON
LEDTST[6]	Green	Always ON
LEDTST[7]	Green	Flashing when PCI Express clock is detected.
LEDCPLDDONE	Green	Is ON when CPLD is powered and programmed

## Error messages and conditions

The table below gives an overview of possible error situations of the PRISMAsync.

Effect	Check	Action
Blank screen	- Check USB Cable	Disconnect/connect USB cable on backside of PRISMAsync.
PRISMAsync cannot be switched on PRISMAsync cannot be switched off.	- Check Power supply - Check power button - Check connection with Operator panel	Replace power supply or Power button. Replace PBA-AUX. If that does not solve the problem replace the motherboard.
Excessive noise	- Check fans	Replace fan
Garbled prints or blank pages	- Check data cables	Replace data cable
Strange colours on operator panel or blank screen or stripes on screen or skewed image on screen or rolling screen	- Check DVI cable	Connect or replace DVI cable
"no signal" on operator panel	- Check DVI cable - Check GPU board	Replace cable or GPU board
Spectrometer not recognized	- Check meter	Try another USB port. Probably USB port on oper. panel defect.
Impossible to install via USB port on operator panel	- Check USB key	Try another USB port. Probably USB port on oper. panel defect.
Led on operator panel always off.	- Check cable - Check AUX control board	Replace cable or AUX cntrl board
Operator panel dark and Attention light off.	- Check 12V on AUX board - Check power cable to AUX board - Check fuse on AUX board.	Connect power cable. Replace AUX board
"Press sleep button" during start up or Pressing Sleep-button has no effect.	- Check 3V3 connection on AUX board	Connect power cable. Replace AUX board
One of Attention lights always on		Replace AUX board
One or more of the attention lights always off.	- Check fuse on AUX board	Replace AUX board
Message "No OS found"	- Check cables to HDD	Replace HDDs
FPGA Led on DDI stays red	- Check cable to DDI board	Replace cable Replace DDI board
PLL lock led is off.	- Check cable to DDI board	Replace cable

Effect	Check	Action
1 of 4 diagnose Led's on AUX board is off.	- Check power supply to AUX	If no power on connector check the cable or power supply. Replace AUX board

In some cases the PRISMAsync controller will give an error code which is displayed on the operator panel screen. These MRE's (Machine Recoverable Errors) can only be recovered by rebooting the system. This is done by touching the Operator panel screen. If the problems persist please check the table below for a description of the error and the checks to make.

### Types of error codes

The error code has 5 or 7 digits. The explanation of the error code is as follows.

Code: XXYZZ (5 digits)

- XX gives the CAS code of the 'defective' unit.
- Y gives the type of error (See the table below)
- ZZ is a sequence number of an error.

Code: XXYMZZZ (7 digits)

- XX gives the CAS code of the 'defective' unit.
- Y gives the type of error (See the table below)
- M gives the module number 1,2 or 3 (eg PIM1, PIM2, PIM3)
- ZZZ is a sequence number of an error.

Code and type	Name	Description	Recovery
0 = FE	Fatal Error	The control of the unit is not reliable and the operation of the unit is not safe or not possible. The unit is immediately shut-down . This error type is used for low level hardware / software errors. Some examples are ROM / RAM failures, power-up failures, watchdogs etc.	Switch the print engine OFF, wait ± 20 seconds and switch the print engine ON.
1 = PE	Permanent Error	This error type is used when it is not possible to restart the unit. The problem in that unit can cause a defect or can cause a damage to the customer or environment.	A service action is necessary to correct the problem. You can reset the error in SDS.
3 = MORPE	Machine Operator Recoverable Permanent Error	This error type is used when it is not possible to restart the unit. The problem in that unit can cause a defect or can cause a damage to the customer or environment.	A trained key operator is necessary to correct the problem. You can reset the error in KOM.

Code and type	Name	Description	Recovery
5 = MRE	Machine Recoverable Error	This error type is used for the problems where you can restart the machine. (Causes no more machine damage or damage to the customer / environment). When some errors occur a second time, the error becomes a Permanent Error.	Switch the print engine OFF, wait ± 20 seconds and switch the print engine ON.
7 = ORE	Operator Recoverable Error	This errors type is used when panels are open or when paper is jammed. Follow the instruction (pictures) on the operator panel to solve the problem.	Follow the job recovery instructions on the display of the operator panel.
9 = WAR	Warning	A warning for the service engineer, detection of a small machine failure. The warning is logged in SDS. (The user will not see the warning)	These errors are saved for service only.

The table shows the error type, the full name, the description and how to recover the error.

Error code	Problem	Action
11115	Incorrect installation Inconsistent configuration	Create new [USB] key with system software. Re-install the software
11501	Message “No OS found”	Replace HDDs and re-install system software
11502	Message “HDD2 failure”	Replace HDDs
11504	Software failure	Reboot the system. Check in error history (Service Mode) the description. Contact your Service representative. Also see <a href="#">11504 Error behavior (R2.1) on page 122</a> .
11506	Lost logical command connection with engine	Check your Ethernet cross-over cable. Reboot the system.
11520	No Logical Command Connection with Print Engine	Check your Ethernet cross-over cable. Reboot the system.
11526	Lost Physical Command Connection with Print Engine	Check your Ethernet cross-over cable. Reboot the system.
11529	No Physical Connection with On/Off Controller	Check connection between operator panel and PRISMA-sync.



Error code	Problem	Action
11530	Lost Physical Connection with On/Off Controller	Check connection between operator panel and PRISMAAsync
11531	SRA error	Reboot the PRISMAAsync. Problem with IPDS.
11535	Software failure	Software failure in copier firmware. Reboot the system. Re-install the firmware. If problem persists contact your service representative.
11558	No VGA connection with UI Panel	Check connection between operator panel and PRISMAAsync. Check GPU PCB.
11559	No-Lost Physical Connection With UI Panel	Check connection between operator panel and PRISMAAsync.
11560	No-Lost Logical Connection with UI Panel	Check connection between operator panel and PRISMAAsync.
11561	System error at the printer module. Invalid configuration.	Check the version of the printer firmware. Upgrade to the latest level.
11563	No Logical Connection with On/Off Controller	Reboot the system. Check connection between Operator panel and PRISMAAsync
11564	Lost Logical Connection with On/Off Controller	Reboot the system. Check connection between Operator panel and PRISMAAsync
11570	Upgrading the touch screen failed	Reboot the system. Check connection between Operator panel and PRISMAAsync
11571	Printer Interface board hardware failure	Check the DDI board in the PRISMAAsync and the interface board in the copier.
11572	Scanner Interface board hardware failure	Check the interface board of the scanner.
11573	Printer Interface board software failure	Re-install the software of the PRISMAAsync
11574	Scanner Interface board software failure	
11575	Engine boot failure	Check LEDs and hardware of engine. This is not a PRISMAAsync failure
2259990	Machine recoverable error in copier	Check the description that comes with this code. It describes where in the copier, the error occurred.
2259992	Machine recoverable error in scanner	Check the description that comes with this code. It describes where in the scanner, the error occurred.
2279991	Operator recoverable error in copier	A normal error in the copier, like a paper jam. It also comes with a description to determine where the error occurred.

Error code	Problem	Action
2279993	Operator recoverable error in scanner	A normal error in the scanner, like a paper jam. It also comes with a description to determine where the error occurred.

## 11504 Error Screen behaviour

### Introduction

Release R1.2 introduces a new screen for the 11504 software error.

The screen displays an additional CRC code which is unique within a software release and only shown in case of a 11504 error.

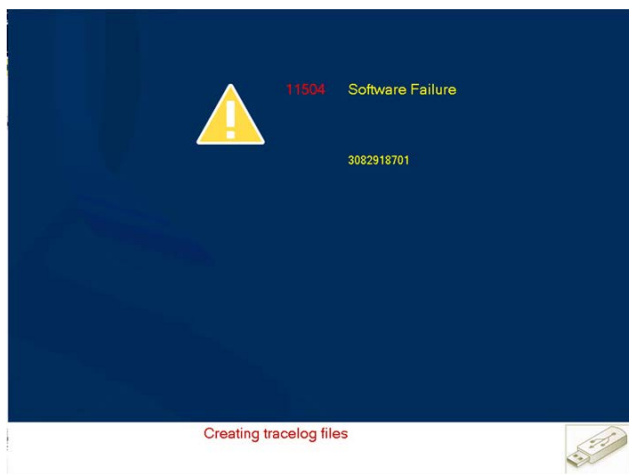

### CRC code

The CRC code is related to the cause of the 11504 software error and the software version present on the machine:

- If an 11504 error occurs and the CRC code is the same as an previous 11504 error, the cause of the problem is the same.
- If an 11504 error occurs and the CRC code is different from a previous error, the cause of the problem is also different.



#### NOTE

This only applies when the software version has not been changed.

### Trace log

After a 11504 error occurs, a trace log is automatically created.

1. You can insert a USB key to export the trace log or touch the screen to exit.

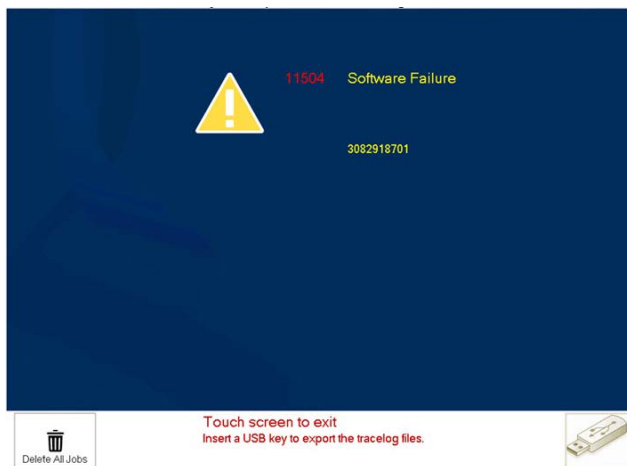

2. After you inserted the USB key, press the USB key icon to store the logging on the USB key.

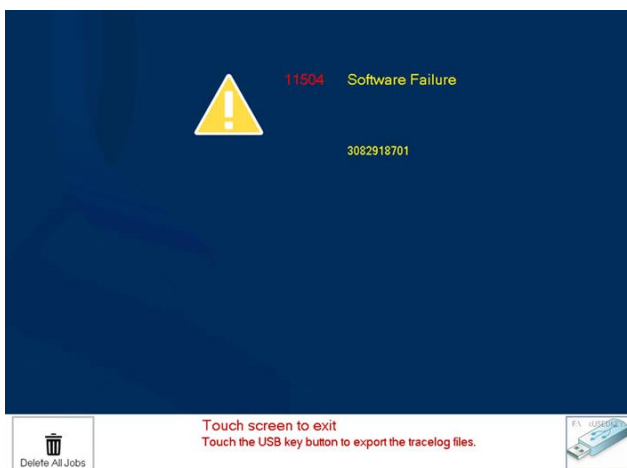

3. After the trace log files are copied to the USB key, the USB icon disappears and you can remove the USB key.

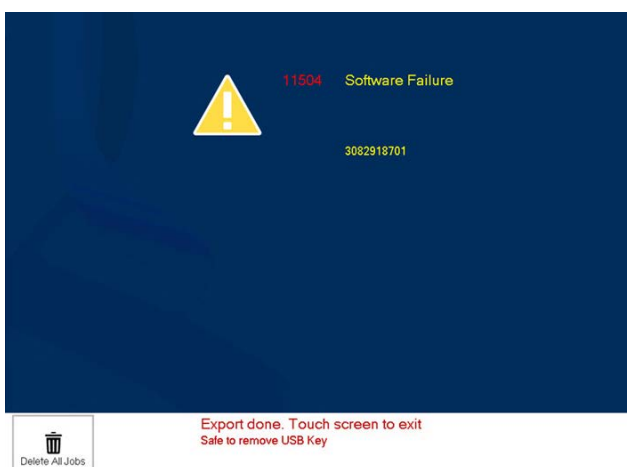



**NOTE**

If the error is caused by a job on the system that cannot be printed, press the **[Delete All Jobs]** button on the screen to remove the print jobs.

The **[Delete all Jobs]** button is only visible the second time a 11504 error occurs.

After all print jobs are deleted, the system will reboot and start up normally.

## Handling of 11504 MRE

### Introduction

The 11504 error indicates a software error in the PRISMAsync from which it can not restore. On the display a yellow triangle is displayed asking you to press the panel to restart the PRISMAsync.

In most of the cases, rebooting the system will solve the problem, however it might happen that the 11504 is persistent and occurs again after reboot. In this case the following actions can be taken:

- For analysis by R&D you can insert a [USB]-key in the PRISMAsync and press the tray button on the right side of the panel when the error is active (Yellow triangle on the screen)/
- During rebooting the stop-button and the tray-button on the right side of the operator panel will start flashing simultaneously. When this happens press both buttons for a few seconds. All the jobs in the queue will be removed, so if a job in the scheduled queue causes the 11504 it is removed and the system will reboot correct.
- After a **Third** consecutive occurrence of the error caused by the fact that the PRISMAsync does not startup correctly, the Hansiplast procedure will start

Also see [11504 Error Screen behaviour on page 122](#).



#### NOTE

If the 11504 or 11561 error occurs at the first start after an installation or a software upgrade check the version of printer firmware and PRISMAsync software. Probably there is a mismatch between the versions.

### Hansiplast procedure

Hansiplast is the name of a procedure that is started after 3 consecutive 11504 crashes of the PRISMAsync because it is not possible to start up completely (e.g. the software has become corrupt).

An image of the software is stored on the PRISMAsync and during the Hansiplast procedure this image is restored. This restore is equivalent to a new installation of the software, hence all jobs will be lost.

The display will show that Windows is installing. The total procedure will take approximately 45 minutes to complete.



#### NOTE

- Do not switch off the PRISMAsync during the Hansiplast procedure. If the PRISMAsync is switched the software has to be installed manually.
- After completion the settings will be restored just like when you do a manual restore after a backup.

# Beep codes PRISMAsync

## Introduction

In case the PRISMAsync will not start up or unknown errors (11504) keep coming up, it is possible that the PRISMAsync itself does some internal hardware checks. The result of this hardware check is given by a specific number of beeps during booting of the system.



### NOTE

If you are not able to determine the error please reboot the system and check if beep-codes are given during startup.

## Boot Block Beep Codes

Beeps	Description
1	Insert diskette in floppy drive A:
2	'AMIBOOT.ROM' file not found in root directory of diskette in A:
3	Base Memory Error
4	Flash Programming successful
5	Floppy read error
6	Keyboard controller BAT command failed
7	No Flash EPROM detected
8	Floppy controller failure
9	Boot Block BIOS checksum error
10	Flash Erase error
11	Flash Program error
12	'AMIBOOT.ROM' file size error
13	BIOS ROM image mismatch

## Post BIOS Beep Codes

Beeps	Description
1	Memory refresh timer error
2	Parity error in base memory (first 64K block)
3	Base memory read/write test error
4	Motherboard timer not operational
5	Processor error
6	8042 Gate A20 test error (cannot switch to protected mode)
7	General exception error (processor exception interrupt error)
8	Display memory error (system video adapter)
9	AMIBIOS ROM checksum error
10	CMOS shutdown register read/write error

Beeps	Description
11	Cache memory test failed.

### Troubleshooting Post BIOS Beep Codes

Beeps	Description
1,2 or 3	Reseat the memory, or replace with known good module
4-7, 9-11	<p>Fatal error indicating a serious problem with the system. Consult your service representative. Before declaring the motherboard beyond all hope, eliminate the possibility of interference by a malfunctioning add-in card. Remove all expansion cards except the video adapter.</p> <ul style="list-style-type: none"><li>• If beep codes are generated when all other expansion cards are absent, consult your service representative.</li><li>• If beep codes are not generated when all other expansion cards are absent, one of the add-in cards is causing the malfunction. Insert the cards back into the system one at a time until the problem happens again. This will reveal the malfunctioning card.</li></ul>
8	If the system video adapter is an add-in card, replace or reseat the video adapter. If the video adapter is an integrated part of the system board, the board may be faulty.





# **Chapter 11**

## **Appendix**

## Appendix A: Specifications

### Hardware features

- Intel Core i7 860 @ 2.8GHz – 8MB cache CPU
- 4 x 4GB DDR3 @ 1333MHz SDRAM non-ECC (Dual channel mode)
- 1 x 250GB 3.5" SATA II HDD @ 7200rpm (System disk)
- 2 x 250GB 3.5" SATA II HDD @ 7200rpm (2 x Data disk Raid0)
- ATX power supply, 600W, 80+ Bronze
- Dimensions (HxWxD): 42 cm (16.5 in.) x 20 cm (7,9 in.) x 43 cm (16.9 in.)
- Weight: 16 Kg.
- Power consumption: 100-240V, 10-5A, 50-60Hz



#### NOTE

All Hard Disk Drives and memory modules integrated in one system must all have:

- the same brand, model for the Hard Disk Drives
- the same brand, model, organization and layout for the memory modules

---

## Connectivity

- 10/100/1000 Base T
- TCP/IP
  - lpr/lpd
  - 9100 socket
  - SMB
- IP-version: IPv4  
IP-version: IPv6
- static/auto IP (BOOTP, DHCP)
- SNMP v1-v3 support
  - Host resources MIB
  - System group MIB
  - Printer MIB
  - Job MIB
  - Job Monitor MIB
- Embedded WebServer
  - WEB Settings Editor
  - Operator Maintenance Application

# Appendix B: Parts overview

## Overview of the service parts

### Illustration

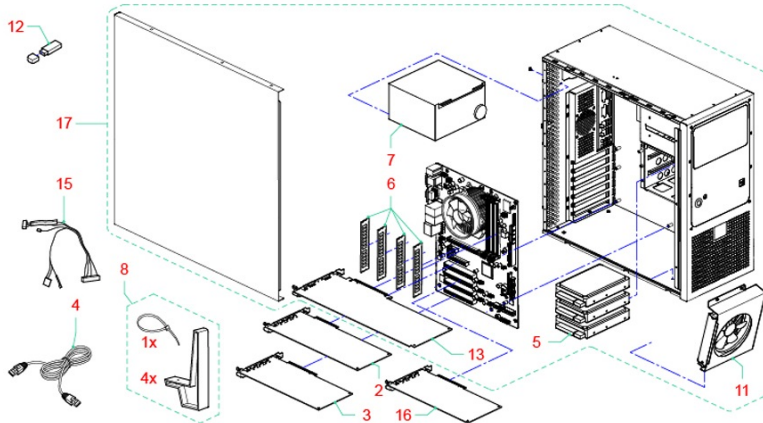

### Component - function table

No	Part
2	PBA DDI IF BOARD
3	PBAP AUX_CONTROL
4	DATA CABLE RJ45-RJ45CRSVR SFTP 2.8M
5	HDD 3,5" SATA II 250GB 7200RPM (3X)
6	MEMORY MODULE 4GB DDR3 (4X)
7	POWER SUPPLY 600W
8	PEDESTAL (4X) + TIEWRAP
11	SYSTEM FAN 120MM
12	USB KEY
13	PCI-E X16 GRAPHIC BOARD
15	HARNESS 22W01
16	ETHERNET BOARD ROHS (IPDS)
17	INDUSTRIAL CONTROLLER iBase



#### NOTE

For the part numbers see the parts catalogue.

## Appendix C: Tips & Tricks

### How to check if DDR memory is defect or missing

#### Description

- The controller responds in an uncontrolled way and is very slow in performance.
- A particular 11504 error occurs very frequently.
- Fails to install new software

#### Possible causes

Defect or missing memory DIMM.



#### NOTE

Check the parts catalogue for compatibility.

#### Analysis

#### Procedure

1. Check the configuration report. There you can find the amount of memory available in your system. This should be 4 or 16GB depending on the controller version used. Be sure that you create a new Configuration Report in the Settings Editor. The configuration Report that is visible on the screen might be older of age.
2. On the Operator Panel go to Service Mode. In the first screen select "Error Analysis". If you see multiple 11504 errors with the description described below, it is possible that a memory module is defect.  
Description 11504: Can't allocate run length block number xx (size 11366400)
3. If, during re-installation the screen below is shown, it is possible that a defect memory module causes this.

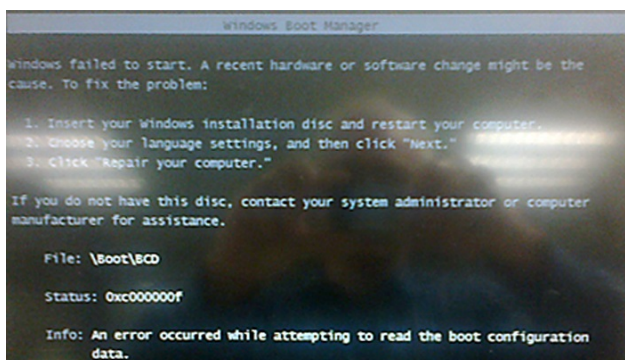

[32] Fig. Unable to boot

4. Reboot the PRISMAsync. If during the boot sequence Beep codes are heard, count the number of beeps. Compare the number with the number given in the chapter [Beep codes PRISMAsync on page 126](#). If the number of beeps is 1, 2 or 3 check the memory modules.

## How to print transparencies with best quality

### Description

Transparencies might cause image quality problems like darker areas etc. The copier and the PRISMAsync will make a difference between Text/Vector and Images. Different screens can be specified for these objects.

### Solution

Some tips for improving Image Quality in these situations are:

1. Use the APPE engine for printing. This means
  - Use Hotfolder, Automated Workflow or PRISMAprepare.
  - Do not use the driver, since this creates Postscript.
2. Make sure a good calibrations was performed for both screenings (Normal and Fine) for all media families
3. Make the screening for text and images the same for 600 dpi printing (No screen jump will occur)
4. Make a new preset if you do not want to do this for all jobs

## How to improve black density on the print

### Description

On some media the density of black is too low.

### Solution

There is a setting available to improve the Black density. It can be adjusted in the "Printer adjustment" section of the specified media.

### Procedure

1. In your browser open the Settings Editor and go to "Media"
2. Select the media and then select "Printer adjustment".
3. In the "Advanced" section select "Gloss and Fine black adjustment"
4. Adjust the value to your need. You can change it between -2 and +2. These values are related to the Gloss-setting. However the Fine-Black setting will also change when you change the Gloss-Setting. The following relation exists:

Gloss	Fine Black
-2	2
-1	1
0	0
+1	0
+2	0

5. Please take care that this setting can only be used for Plain paper. (So not for coated, vellum etc.)

## Strange colors after editing CMYK curves

### Description

After editing the CMYK curves one might get strange effects with the colors. Colors that were the same before editing, now are different.

### Solution

First thing you must know is that there is a big difference between editing the CMYK curves on a job-level and editing on system-level.

### Procedure

1. Job-Level

On the Operator Panel, select the job and open the properties (double-click). Select "Adjust Image". In the next window you can change the CMYK-curves. If you then print the job the result will be good, because the curve has been adjusted for this particular job and media.

2. System-Level

Changing the CMYK-curves on system level means that the curves will be changed for all the jobs to come. In the "Color Adjustment" section of the "System" tab you will find the "Edit CMYK curves manually". After selecting this, you are able to adjust the curves per media family. Very important however is that you do the changes for all halftones/screens. If you forget this, it is very well possible that you get differences in colors between text and images. This is caused by the fact that text is often printed with another halftone than images.

To overcome these differences you have to either edit the curve for all halftones or force the system to print text and images with the same halftone.



## Omapp does not work

### Description

When starting the Operator maintenance Application the user gets a network error and is unable to access the application.

### Procedure

1. The problem is caused by the fact that the PRISMAsync was turned on before the engine is turned on. To solve the problem, shut down the whole system and switch off the optionals. Then turn on the optionals, turn on the copier and finally turn on the PRISMAsync.

## Important media printer adjustments

### Introduction

In the table below some important media printer adjustments that are available in the Settings Editor are described.



**NOTE**

The complete media adjustments are described in the Settings editor user manual.

### General

Item	Setting	Objective	When/How
Saddle stitch position adjustment (mm)	Range: -2.00 to +2.00 mm, step 0,25 mm., default 0.0 mm	Move the stitch position towards the intended centre of the booklet. If necessary, perform the 'Saddle stitch fold position adjustment' to move the fold towards the intended centre too.	Change the value when the saddle stitch position is slightly offset from the paper center. - Increase: the saddle stitch position is shifted to the right of the printing side. - Decrease: the saddle stitch position is shifted to the left of the printing side.
Saddle stitch fold position adjustment (mm)	Range: -2.00 to +2.00 mm, step 0,25 mm., default 0.0 mm	When the saddle stitch function of the Saddle Finisher is used, the value is changed if the fold placement is not exactly on the centre of the paper.	- Increase the setting value to shift the fold placement to the right of the printing surface. - Decrease the setting value to shift the fold placement to the left of the printing surface
Punch hole position adjustment (mm)	Range: -2.0 to +2.0 mm, step 0.25 mm., default 0.0 mm	Use this function when the punch hole position is offset due to the paper type used.	- Increased values: the punch hole position is shifted to the bottom. - Decreased values: the punch hole position is shifted to the top.
Saddle fold position adjustment (mm)	Range: -2.00 to +2.00 mm, step 0.25 mm, default 0.0 mm	When the saddle fold function of the Saddle Finisher is used, the value is changed if the fold placement is not exactly on the centre of the paper.	- Increase the setting value to shift the fold placement to the left. - Decrease the setting value to shift the fold placement to the right.

## Advanced

Item	Setting	Objective	When/How
Face up curl correction	Range: -15 to +15, step 1, default 0	Adjust the paper curl level cause at the output of the system..	Increased values: higher curl correction level Decreased values: lower curl correction level
Face down curl correction	Range: -15 to +15, step 1, default 0	Adjust the paper curl level cause at the output of the system..	Increased values: higher curl correction level Decreased values: lower curl correction level
Gloss and fine black adjustment	Range: -2 to +2, step 1, default 0	Adjust the paper gloss. By changing the values, switch fixing temperatures and the paper feed methods either going through only the primary fixing unit or both primary and secondary fixing units. The fine black adjustment changes with this setting also.	Increased values: glossier Decreased values: less glossy Fine black adjustment is not valid for transparency, 1-sided coated paper, 2-sided coated paper and vellum paper.
Paper separation fan level	Range: 1 to 7, step 1, default 4	Adjust the amount of air to improve the media separation in the input trays.	Decrease when high-density areas are not printed evenly, or when the curl is exceptionally high due to a lack of moisture, media characteristics and variable humidity of the environment. Increase the value when paper jams occur frequently, or in case of high temperature and humidity.
Paper separation from the ITB (Intermediate Transfer Belt)	Range: -5 to 5, step 1, default 0	Improve the separation of media from the ITB	
Image clear level adjustment <sup>1</sup>	Range: -10 to +10, step 1, default 0	If residual toner is attached on the paper, ITB cleaning may be insufficient. If this occurs, increase/decrease the value on a step-by step basis until the symptom is improved.	Increased values: Higher ITB cleaning bias Decreased values: Lower ITB cleaning bias

Registration: Front

Item	Setting	Objective	When/How
X shift (0.1mm)	Value: -50.0 mm to +50.0 mm, step 0.1 mm, default 0.0 mm	To make adjustment to enable printing with correct alignment of paper and image	Incorrect image position with respect to the leading edge of paper in the feed direction.
Y shift (0.1mm)	Value: -50.0 mm to +50.0 mm, step 0.1 mm, default 0.0 mm	To make adjustment to enable printing with correct alignment of paper and image	Incorrect image position with respect to the side edge of paper perpendicular to the feed direction.
X elongation (0.01%)	Value: -1.00 to +1.00%, step 0.01%, default 0.00%	To make adjustment (enlargement/reduction) of image size in feed direction	Incorrect image size/magnification in the feed direction.
Y elongation (0.01%)	Value: -1.00 to +1.00%, step 0.01%, default 0.00%	To make adjustment (enlargement/reduction) of image size perpendicular to feed direction	Incorrect image size/magnification perpendicular to the feed direction.
Skew roller pressure	Value: -2 to +2, step 1 default 0	If the printed image is skewed on a specific media only, such as thin paper the settings enables you to adjust the transferring position of this media. The skew correction rollers are located in the feeding unit of the printer. The rollers adjust the registered position of the fed media. When the value is too low, the image on the media may still be skewed. When the value is set too high or too low, a paper jam can occur.	Skew image position with respect to side edge of paper.
Tail end white patch correction threshold	Level: -10 to +10	Improve the image quality on curled media or curl-prone media types in 2-sided printing when at the tail end of the media, white areas or fading appears. Fading in high-density area: choose negative values. White areas: choose positive values	Fading in highdensity area: choose negative values. White patch: choose positive values.

Item	Setting	Objective	When/How
Tail end white patch correction amount (mm)	Level: -20 to +20	<p>Improve the image quality on curled media or curl-prone media types in 2-sided printing when at the tail end of the media, white areas or fading appears. Depending on the media type and curl, the size of the area on the tail end of the media where white areas appear may differ. Use this setting to adjust the starting position to correct the area. The default position of the 'Tail end white patch correction' starts at 20 mm/0,8" from the tail edge of the media. To make the area bigger, decrease the value. To make the area smaller, increase the value.</p>	<p>Lower value: Increase the area Higher value: Decrease the area.</p>

Item	Setting	Objective	When/How
Secondary transfer voltage	Range: -10 to +10 Increased values: Higher secondary transfer bias Decreased values: Lower secondary transfer bias	When image blurring occurs, adjust the voltage that transfers toner to the paper. This setting can affect the 'Image clear level adjustment' and 'Tail end white patch correction' settings. If necessary, readjust these settings too. Decrease the value when: 1) thin paper is used, 2) tiny white spots appear in low-density areas (when density in high-density areas is normal), 3) white spots appear in high-density areas and 4) the used paper has a rough surface (such as embossed paper) and white spots appear on the concave side. Increase the value when: 1) thick paper is used, 2) the density level in high-density areas and low-density areas is low, 3) uneven glossy areas occur in high-density images and 4) outlines in high-density images blur. Change this setting in small steps and check the output after each adjustment.	

**Registration: Back**

Item	Setting	Objective	When/How
X shift (0.1mm)	Value: -50.0 mm to +50.0 mm, step 0.1 mm, default 0.0 mm	To make adjustment to enable printing with correct alignment of paper and image	Incorrect image position with respect to the leading edge of paper in the feed direction.
Y shift (0.1mm)	Value: -50.0 mm to +50.0 mm, step 0.1 mm, default 0.0 mm	To make adjustment to enable printing with correct alignment of paper and image	Incorrect image position with respect to the side edge of paper perpendicular to the feed direction.
X elongation (0.01%)	Value: -1.00 to +1.00%, step 0.01%, default 0.00%	To make adjustment (enlargement/reduction) of image size in feed direction	Incorrect image size/magnification in the feed direction.

Item	Setting	Objective	When/How
Y elongation (0.01%)	Value: -1.00 to +1.00%, step 0.01%, default 0.00%	To make adjustment (enlargement/reduction) of image size perpendicular to feed direction	Incorrect image size/magnification perpendicular to the feed direction.
Automatic correction of alignment of back side leading edge	On/Off, default On	To make automatic adjustment for change in length of media for backside image.	Incorrect image size/magnification for backside image in the feed direction.
Skew roller pressure	Value: -2 to +2, step 1 default 0	If the printed image is skewed on a specific media only, such as thin paper the settings enables you to adjust the transferring position of this media. The skew correction rollers are located in the feeding unit of the printer. The rollers adjust the registered position of the fed media. When the value is too low, the image on the media may still be skewed. When the value is set too high or too low, a paper jam can occur.	Skew image position with respect to side edge of paper.
Tail end white patch correction threshold	Level: -10 to +10	Improve the image quality on curled media or curl-prone media types in 2-sided printing when at the tail end of the media, white areas or fading appears. Fading in high-density area: choose negative values. White areas: choose positive values	Fading in highdensity area: choose negative values. White patch: choose positive values.



Item	Setting	Objective	When/How
Tail end white patch correction amount (mm)	Level: -20 to +20	<p>Improve the image quality on curled media or curl-prone media types in 2-sided printing when at the tail end of the media, white areas or fading appears. Depending on the media type and curl, the size of the area on the tail end of the media where white areas appear may differ. Use this setting to adjust the starting position to correct the area. The default position of the 'Tail end white patch correction' starts at 20 mm/0,8" from the tail edge of the media. To make the area bigger, decrease the value. To make the area smaller, increase the value.</p>	<p>Lower value: Increase the area Higher value: Decrease the area.</p>



Item	Setting	Objective	When/How
Secondary transfer voltage	Range: -10 to +10 Increased values: Higher secondary transfer bias Decreased values: Lower secondary transfer bias	When image blurring occurs, adjust the voltage that transfers toner to the paper. This setting can affect the 'Image clear level adjustment' and 'Tail end white patch correction' settings. If necessary, readjust these settings too. Decrease the value when: 1) thin paper is used, 2) tiny white spots appear in low-density areas (when density in high-density areas is normal), 3) white spots appear in high-density areas and 4) the used paper has a rough surface (such as embossed paper) and white spots appear on the concave side. Increase the value when: 1) thick paper is used, 2) the density level in high-density areas and low-density areas is low, 3) uneven glossy areas occur in high-density images and 4) outlines in high-density images blur. Change this setting in small steps and check the output after each adjustment.	

# Appendix D: System log files

## How to create a datadump file

### Question

How to create a datadump file?

### Answer

A datadump file contains system information about counters, versions and errors and is useful for analysis of the system behaviour.

To create a datadump file:

1. Open the Setting Editor by entering the name of your system in the address bar of your internet browser (e.g. Internet Explorer). In the example the system name is: ipc6010s-sns.



2. Do the following steps:
  1. Select [Support]
  2. Select [Troubleshooting]
  3. Select [Create a new datadump file]

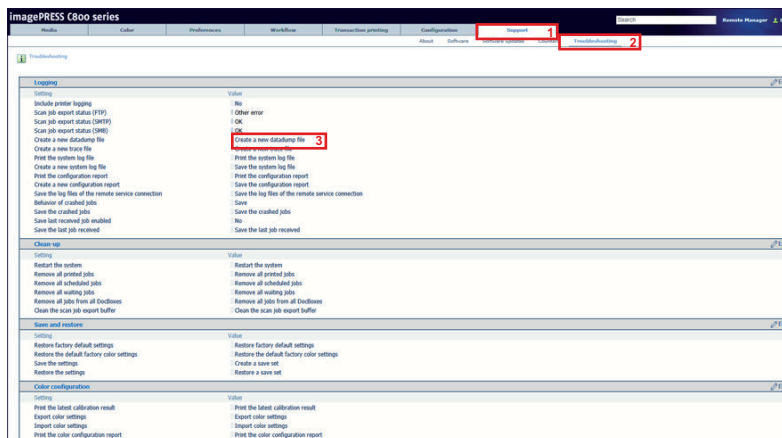

3. To download the file you have to be logged in as [Key operator] or [System administrator]. Select the correct Username and enter the Password. Then click on **[Login]**.



4. Select [Create a new datadump file] to create a new datadump file. The name of the new file appears in the window. It is possible that a name was already present, but to be sure that you will get the most recent version it is recommended to execute this step.

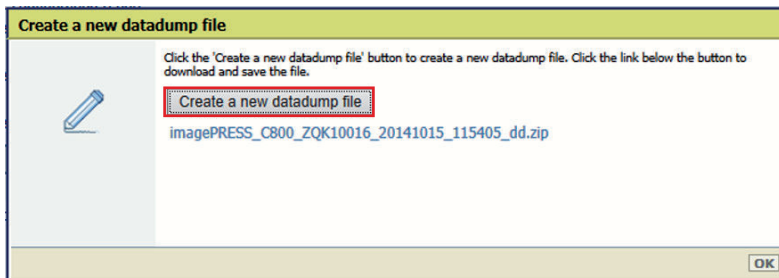

5. Select the trace file which you want to download.

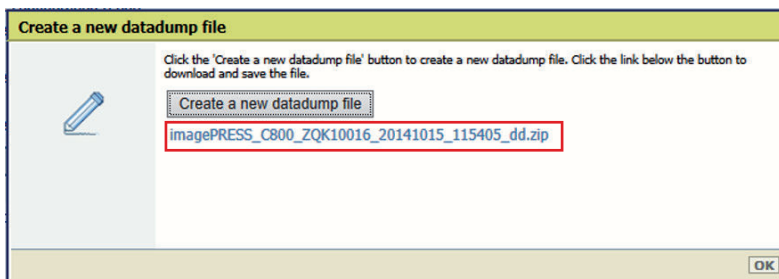

6. Select [Save] and enter a filename and confirm your choice.
7. Select [OK] to close the window.

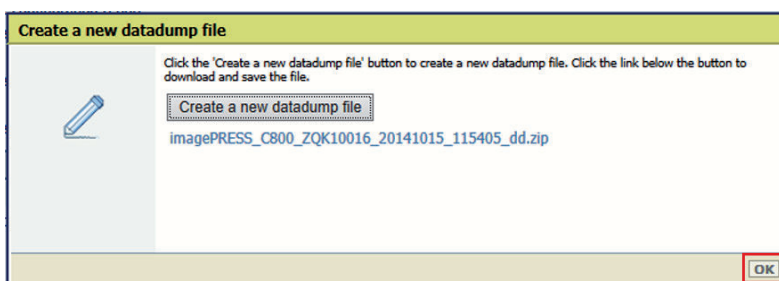

## How to create a trace file

### Question

How to create a trace file

### Answer

A trace file provides detailed system information about the data- and event flow of the PRISMAsync software. This information is necessary for the analysis of the system behaviour and to determine the cause of errors.

To create a trace file including the printer logging:

1. Open the Setting Editor by entering the name of your system in the address bar of your internet browser (e.g. Internet Explorer).  
(In the example the system name is: **ipc6010s-sns**)



2. Do the following steps:
  1. Select [Support]
  2. Select [Troubleshooting]
  3. Select [Create a new trace file].

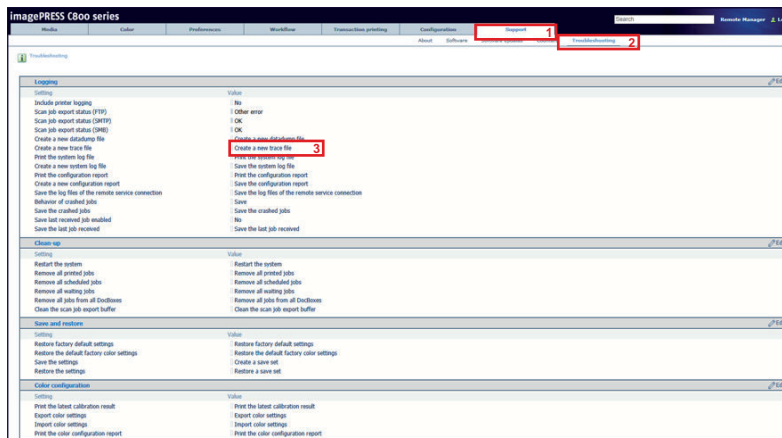

3. To download the file you have to be logged in as [Key operator] or [System administrator]. Select the correct Username and enter the Password. Then click on **[Login]**.



4. Select [Create a new trace file] to create a new trace file.  
A new file is created and added at the top of the list. Trace files are also generated due to the occurrence of an error and normal logs. If an error occurs and a trace file is generated, the error code will be present in the name of the trace file.

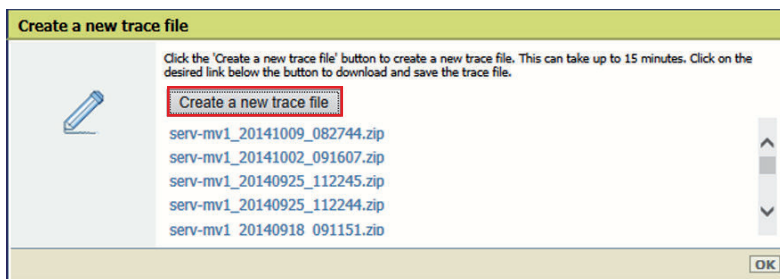

5. Select the trace file which you want to download.

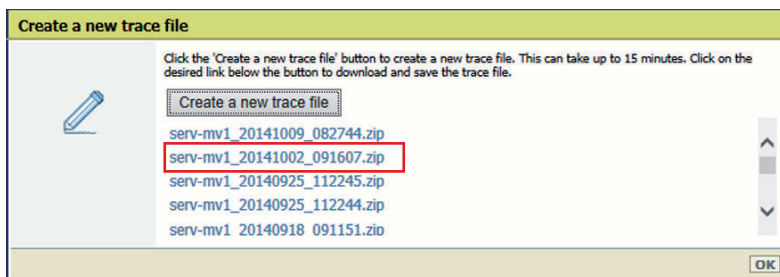

6. Select [Save] and enter a file name and confirm your choice.  
Repeat this procedure if you want to download more than one file.
7. Select [OK] to close the window.

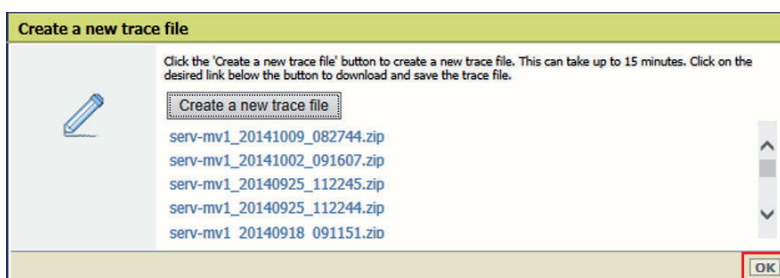

## How to create a trace file including the printer logging

### Question

How to create a trace file including the printer logging?

### Answer

A trace log gives very detailed system information about the data- and event flow of the PRISMAsync software. This information is necessary for the analysis of the system behaviour and to determine the cause of the occurrence of errors. It is possible to include the printer logging in the trace file.



#### NOTE

Including the printer logging makes the trace file much larger.

To create a trace file including the printer logging:

1. Open the Setting Editor by entering the name of your system in the address bar of your internet browser (e.g. Internet Explorer).  
(In the example the system name is: **ipc6010s-sns**)



2. Select the following steps:
  1. Select [Support]
  2. Select [Troubleshooting]
  3. Select [**include printer logging**].

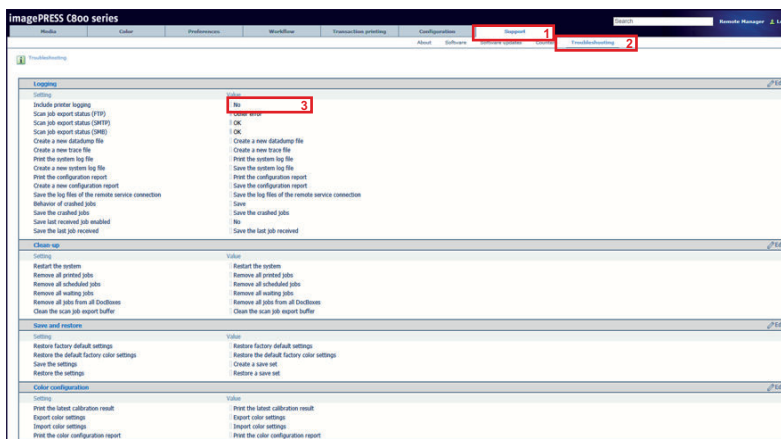

3. To change this settings you have to be logged in as [Key operator] or [System administrator]. Select the correct Username and enter the Password. Then click on [**Login**].



4. Select [Yes] to include the printer logging in the trace file.

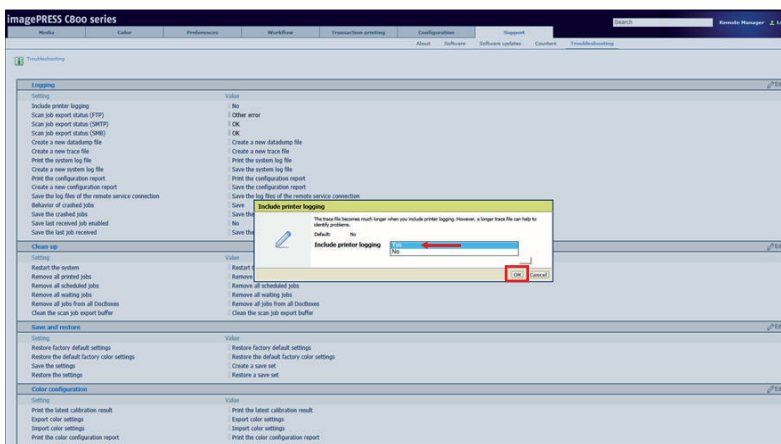

5. Select [Create a new trace file].

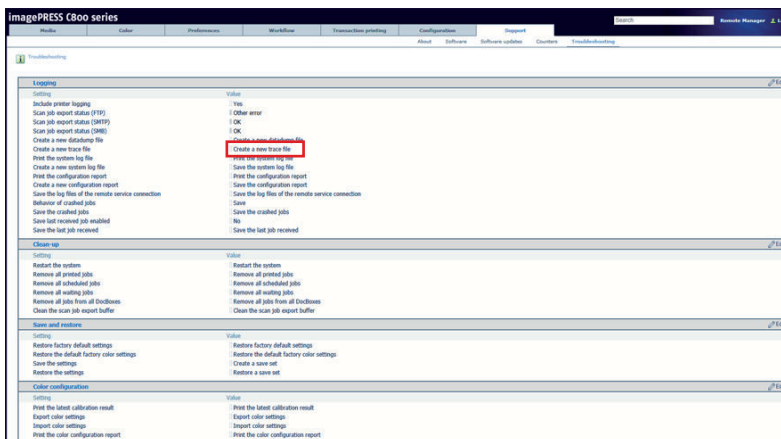

6. Select [Create a new trace file] to create a new trace file.

A new file is created and added at the top of the list. Trace files are also generated due to the occurrence of an error and normal logs. If an error occurs and a trace file is generated, the error code will be present in the name of the trace file.

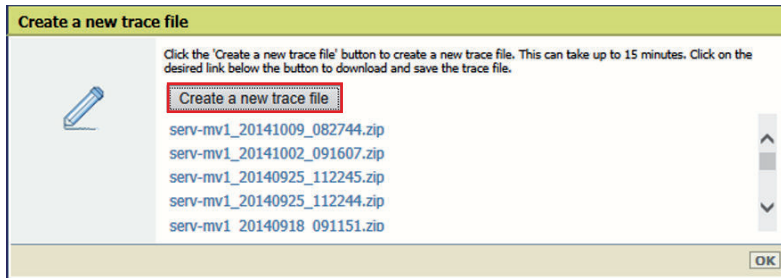

7. Select the trace file which you want to download.

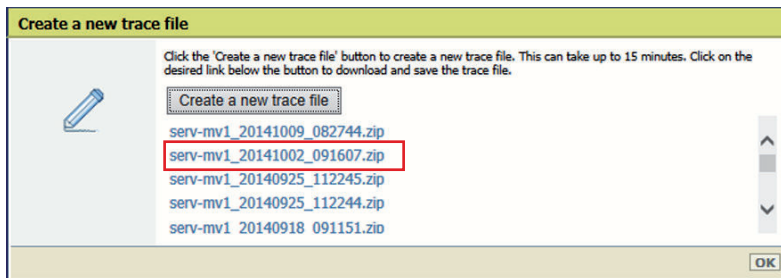

- 8. Select [Save] and enter a file name and confirm your choice.  
Repeat this procedure if you want to download more than one file.
- 9. Select [OK] to close the window.

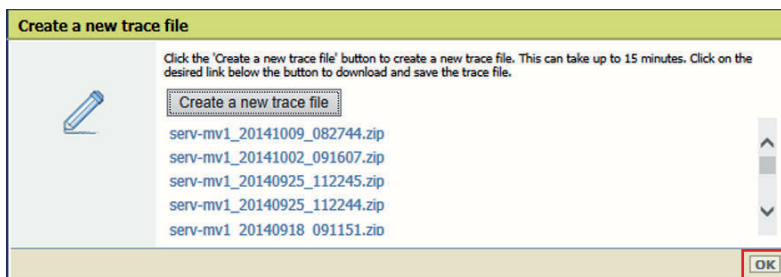



## Appendix E: Engine reports

### Engine reports

- In the service mode a sorted list of all durables and periodically replaceable parts of the engine and accessories can be generated and displayed on the LUI. The list is sorted by lifetime. Doing so is the easiest way for the Field Service Technician to get an overview of the status of all parts.

Print engine state: Idle (Cold S05) — Scan engine state: Idle (Cold S05)

Service Copy Mode Leave Service Mode

Generate new Reports Save Reports to USB Show Durables Back

Created on 20/10 2012 MON 09:57

Consumption Rate (%)	Part Code (with counter path)	Current Counter Value	Part Lifetime
188	COUNTER > CLEANING > PO-C-RL	282171	150000
188	COUNTER > CLEANING > 2TR-C-RL	282171	150000
128	COUNTER > DRBL-1 > ITB-WEB	128131	100000
128	COUNTER > CLEANING > FX1-4FRL	128131	100000
128	COUNTER > CLEANING > FX1-4FCL	128131	100000
127	COUNTER > DRBL-1 > 2TR-BWRL	765520	600000
127	COUNTER > DRBL-1 > ITB-CLN1	765520	600000
127	COUNTER > DRBL-1 > FX4B-ST	765520	600000
112	COUNTER > PRDC-1 > PRM-W-Y	282171	250000
112	COUNTER > PRDC-1 > GRPAD-Y	282171	250000
112	COUNTER > PRDC-1 > PRM-G-Y	282171	250000

- A digital version of the P-PRINT, CP-PRINT, D-PRINT, ENV-PRINT and the HIST-PRINT can be generated and displayed on the LUI. The prints can be stored on a USB stick when needed e.g. for escalation purposes.

Print engine state: Idle (Cold S05) — Scan engine state: Idle (Cold S05)

Service Copy Mode Leave Service Mode

Generate new Reports Save Reports to USB Show Durables Back

20/10 2012 MON 09:55  
SERVICE NAME: 119R\_C701079

```

*****
***  CPU SERVICE REPORT  ***
*****

SERIAL NO      HASH      0MT00202
MANUFACTURE ENGINE
FIXING STATION

SYSTEM ISSUE  DISPLAY      Canon iPRCT010799_V2
VERSION
SC-COP      66.01
PANEL      00.03
ECU         ---
SOFTWER     40.04
ITE        09.00
DECK       42.02
IMP-COMP   20.04
RUI        80.46
---
ENGINE
LANG-ES    20.04
LANG-FR    21.05
LANG-DE    21.05
LANG-IT    21.05
LANG-ES    20.04
LANG-CS    ---
LANG-DA    ---
LANG-EL    ---
LANG-ES    21.05
LANG-ET    ---
LANG-PT    ---
LANG-RO    ---
LANG-RS    ---
LANG-SI    ---
LANG-SL    ---
LANG-PT    ---
LANG-ES    ---

```

#### Logging of the firmware upgrade

During the firmware upgrade a logging is created. This logging can be viewed and checked for analysis and for escalations it can be downloaded.

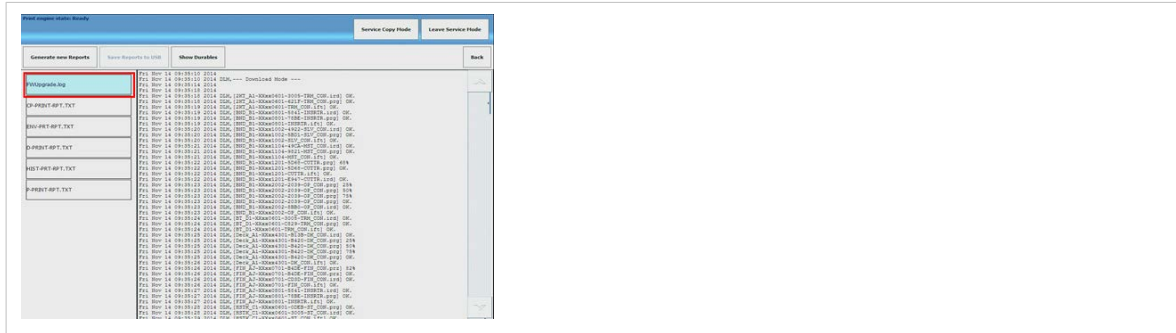

How to view & store engine reports

Step	Action	Remarks																																																												
1	Go to service mode.																																																													
2	Press button –engine reports	<p>The screenshot shows the 'Print engine state: Ready' screen with three main sections: 'Engine specifics', 'Configuration setting', and 'Load/save settings'. The 'Engine Reports' button in the 'Engine specifics' section is highlighted with a red box.</p>																																																												
3	Click on -generate new reports- button	<p>The screenshot shows the 'Print engine state: Ready' screen with a list of reports. The 'Generate new Reports' button is highlighted with a red box. The list of reports includes columns for report type, consumption rate, part code, current counter value, and part lifetime.</p> <table border="1"> <thead> <tr> <th>Report Type</th> <th>Consumption Rate (%)</th> <th>Part Code (with counter part)</th> <th>Current Counter Value</th> <th>Part Lifetime</th> </tr> </thead> <tbody> <tr> <td>CP-PRNT-APT.TXT</td> <td>113</td> <td>COUNTER + DRB-1 + DEV-P-C</td> <td>1034787</td> <td>250000</td> </tr> <tr> <td>SVU-PRNT-APT.TXT</td> <td>113</td> <td>COUNTER + DRB-1 + DEV-P-K</td> <td>1034787</td> <td>250000</td> </tr> <tr> <td>D-PRNT-APT.TXT</td> <td>172</td> <td>COUNTER + DRB-1 + FOS-S-R</td> <td>1034787</td> <td>600000</td> </tr> <tr> <td>HST-PRNT-APT.TXT</td> <td>117</td> <td>COUNTER + DRB-2 + S1-Q-P0</td> <td>117949</td> <td>100000</td> </tr> <tr> <td>P-PRNT-APT.TXT</td> <td>103</td> <td>COUNTER + PRDC-1 + PK-EZ-TS</td> <td>1034787</td> <td>1000000</td> </tr> <tr> <td></td> <td>103</td> <td>COUNTER + PRDC-1 + O2-FE-3</td> <td>1034787</td> <td>1000000</td> </tr> <tr> <td></td> <td>103</td> <td>COUNTER + DRB-1 + JOB-BLT</td> <td>1034787</td> <td>1000000</td> </tr> <tr> <td></td> <td>103</td> <td>COUNTER + DRB-1 + DOUR-AL</td> <td>1034787</td> <td>1000000</td> </tr> <tr> <td></td> <td>93</td> <td>COUNTER + PRDC-1 + FD-TH-6</td> <td>931199</td> <td>1000000</td> </tr> <tr> <td></td> <td>93</td> <td>COUNTER + PRDC-1 + FD-TH-2</td> <td>931199</td> <td>1000000</td> </tr> <tr> <td></td> <td>93</td> <td>COUNTER + PRDC-1 + FOLV-TH-6</td> <td>931199</td> <td>1000000</td> </tr> </tbody> </table>	Report Type	Consumption Rate (%)	Part Code (with counter part)	Current Counter Value	Part Lifetime	CP-PRNT-APT.TXT	113	COUNTER + DRB-1 + DEV-P-C	1034787	250000	SVU-PRNT-APT.TXT	113	COUNTER + DRB-1 + DEV-P-K	1034787	250000	D-PRNT-APT.TXT	172	COUNTER + DRB-1 + FOS-S-R	1034787	600000	HST-PRNT-APT.TXT	117	COUNTER + DRB-2 + S1-Q-P0	117949	100000	P-PRNT-APT.TXT	103	COUNTER + PRDC-1 + PK-EZ-TS	1034787	1000000		103	COUNTER + PRDC-1 + O2-FE-3	1034787	1000000		103	COUNTER + DRB-1 + JOB-BLT	1034787	1000000		103	COUNTER + DRB-1 + DOUR-AL	1034787	1000000		93	COUNTER + PRDC-1 + FD-TH-6	931199	1000000		93	COUNTER + PRDC-1 + FD-TH-2	931199	1000000		93	COUNTER + PRDC-1 + FOLV-TH-6	931199	1000000
Report Type	Consumption Rate (%)	Part Code (with counter part)	Current Counter Value	Part Lifetime																																																										
CP-PRNT-APT.TXT	113	COUNTER + DRB-1 + DEV-P-C	1034787	250000																																																										
SVU-PRNT-APT.TXT	113	COUNTER + DRB-1 + DEV-P-K	1034787	250000																																																										
D-PRNT-APT.TXT	172	COUNTER + DRB-1 + FOS-S-R	1034787	600000																																																										
HST-PRNT-APT.TXT	117	COUNTER + DRB-2 + S1-Q-P0	117949	100000																																																										
P-PRNT-APT.TXT	103	COUNTER + PRDC-1 + PK-EZ-TS	1034787	1000000																																																										
	103	COUNTER + PRDC-1 + O2-FE-3	1034787	1000000																																																										
	103	COUNTER + DRB-1 + JOB-BLT	1034787	1000000																																																										
	103	COUNTER + DRB-1 + DOUR-AL	1034787	1000000																																																										
	93	COUNTER + PRDC-1 + FD-TH-6	931199	1000000																																																										
	93	COUNTER + PRDC-1 + FD-TH-2	931199	1000000																																																										
	93	COUNTER + PRDC-1 + FOLV-TH-6	931199	1000000																																																										
4	New reports will be generated	<p>The screenshot shows the 'Print engine state: Ready' screen with a message: 'Generating engine reports... please wait, this can take up to 5 minutes. Please do not power down the device.' Below the message is a progress bar.</p>																																																												

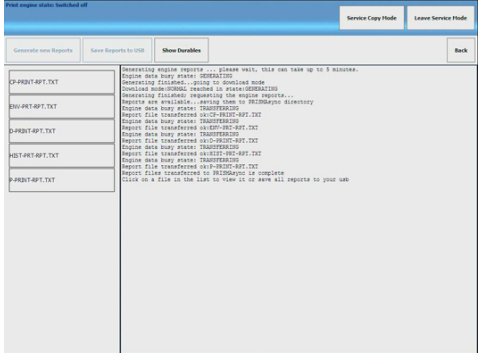
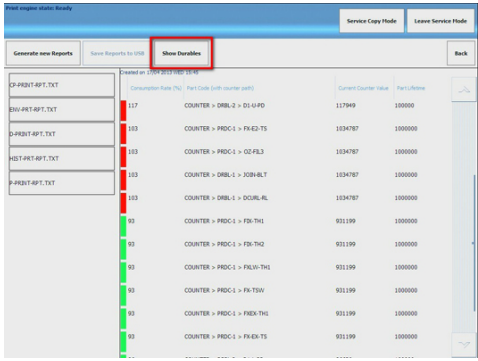
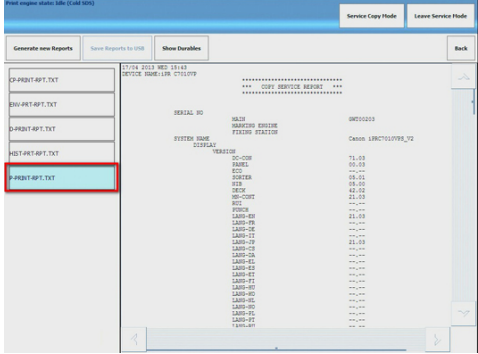
Step	Action	Remarks																																																
5	By toggling -Show Durable- and -XX print- buttons the durables or the engine reports will be shown																																																	
6		 <table border="1"> <thead> <tr> <th>Consumption Rate (%)</th> <th>Part Code (with counter part)</th> <th>Current Counter Value</th> <th>PartLifeTime</th> </tr> </thead> <tbody> <tr> <td>117</td> <td>COUNTER &gt; DBL2 &gt; DL4-PD</td> <td>117949</td> <td>1000000</td> </tr> <tr> <td>113</td> <td>COUNTER &gt; PDC1 &gt; FR-E2-TS</td> <td>1034787</td> <td>1000000</td> </tr> <tr> <td>113</td> <td>COUNTER &gt; PDC1 &gt; Q2-F4-3</td> <td>1034787</td> <td>1000000</td> </tr> <tr> <td>113</td> <td>COUNTER &gt; DBL1 &gt; J00N-BLT</td> <td>1034787</td> <td>1000000</td> </tr> <tr> <td>113</td> <td>COUNTER &gt; DBL1 &gt; Q0UR-RL</td> <td>1034787</td> <td>1000000</td> </tr> <tr> <td>93</td> <td>COUNTER &gt; PDC1 &gt; FR-TH1</td> <td>931199</td> <td>1000000</td> </tr> <tr> <td>93</td> <td>COUNTER &gt; PDC1 &gt; FR-TH2</td> <td>931199</td> <td>1000000</td> </tr> <tr> <td>93</td> <td>COUNTER &gt; PDC1 &gt; FR-V-TH1</td> <td>931199</td> <td>1000000</td> </tr> <tr> <td>93</td> <td>COUNTER &gt; PDC1 &gt; FR-TSV</td> <td>931199</td> <td>1000000</td> </tr> <tr> <td>93</td> <td>COUNTER &gt; PDC1 &gt; FR-V-TH2</td> <td>931199</td> <td>1000000</td> </tr> <tr> <td>93</td> <td>COUNTER &gt; PDC1 &gt; FR-E-TS</td> <td>931199</td> <td>1000000</td> </tr> </tbody> </table>	Consumption Rate (%)	Part Code (with counter part)	Current Counter Value	PartLifeTime	117	COUNTER > DBL2 > DL4-PD	117949	1000000	113	COUNTER > PDC1 > FR-E2-TS	1034787	1000000	113	COUNTER > PDC1 > Q2-F4-3	1034787	1000000	113	COUNTER > DBL1 > J00N-BLT	1034787	1000000	113	COUNTER > DBL1 > Q0UR-RL	1034787	1000000	93	COUNTER > PDC1 > FR-TH1	931199	1000000	93	COUNTER > PDC1 > FR-TH2	931199	1000000	93	COUNTER > PDC1 > FR-V-TH1	931199	1000000	93	COUNTER > PDC1 > FR-TSV	931199	1000000	93	COUNTER > PDC1 > FR-V-TH2	931199	1000000	93	COUNTER > PDC1 > FR-E-TS	931199	1000000
Consumption Rate (%)	Part Code (with counter part)	Current Counter Value	PartLifeTime																																															
117	COUNTER > DBL2 > DL4-PD	117949	1000000																																															
113	COUNTER > PDC1 > FR-E2-TS	1034787	1000000																																															
113	COUNTER > PDC1 > Q2-F4-3	1034787	1000000																																															
113	COUNTER > DBL1 > J00N-BLT	1034787	1000000																																															
113	COUNTER > DBL1 > Q0UR-RL	1034787	1000000																																															
93	COUNTER > PDC1 > FR-TH1	931199	1000000																																															
93	COUNTER > PDC1 > FR-TH2	931199	1000000																																															
93	COUNTER > PDC1 > FR-V-TH1	931199	1000000																																															
93	COUNTER > PDC1 > FR-TSV	931199	1000000																																															
93	COUNTER > PDC1 > FR-V-TH2	931199	1000000																																															
93	COUNTER > PDC1 > FR-E-TS	931199	1000000																																															
7																																																		

How to save reports

Step	Action	Remarks
1	Insert a USB key.	If no key is inserted, the button – Save Reports to USB- will be greyed-out.
2	Click on one of the buttons to show the desired report	

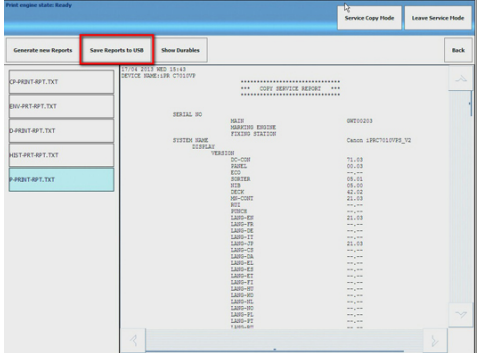
Step	Action	Remarks
3	Click on – Save Reports to USB- and all reports will be saved to the USB key	

**Durable list**

The durable list on the PRISMAsync Local User Interface is derived from the DRBL's and PRDC as present on the P-print. The parts with the highest lifetime percentage are on top.

In service operations some parts are not actively monitored and thus counters are not reset.

Part counters with a threshold of -0- (zero) will be ignored by PRISMAsync and not displayed on the LUI.

**Advice**

To have an accurate list of parts in the durable list it is advised to set the threshold value of –non actively monitored parts- in engine service mode to -0-.

**Example:**

In picture 1 the lifetime of ITB-WEB and DEV-P-X are displayed. Go to service mode > Copier> Counter> AVE-DRB1 and set the threshold to -0-. In picture 2 the ITB-WEB and DEV-P-X parts are no longer displayed. Result; a more accurate list.

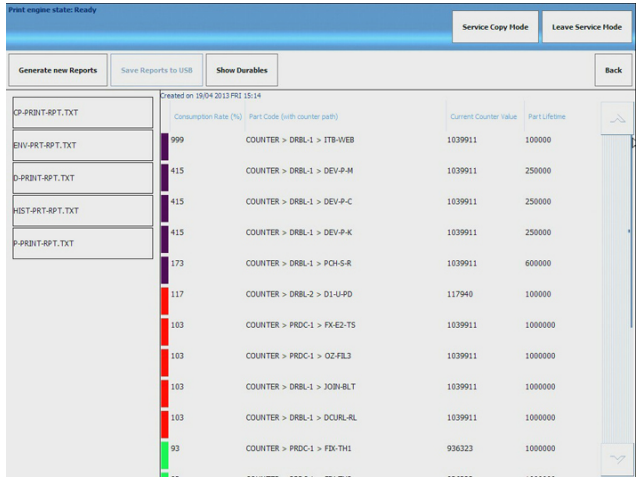

Consumption Rate (%)	Part Code (with counter part)	Current Counter value	Part Lifetime
999	COUNTER > DRBL-1 > ITB-WEB	1039911	100000
415	COUNTER > DRBL-1 > DEV-P-M	1039911	250000
415	COUNTER > DRBL-1 > DEV-P-C	1039911	250000
415	COUNTER > DRBL-1 > DEV-P-K	1039911	250000
173	COUNTER > DRBL-1 > PCH-S-R	1039911	600000
117	COUNTER > DRBL-2 > D1-U-PD	117940	100000
103	COUNTER > PRDC-1 > FX-E2-T5	1039911	1000000
103	COUNTER > PRDC-1 > OZ-FB3	1039911	1000000
103	COUNTER > DRBL-1 > JOBN-BLT	1039911	1000000
103	COUNTER > DRBL-1 > DCURL-RL	1039911	1000000
93	COUNTER > PRDC-1 > FXK-TH1	936323	1000000

[33] Picture 1

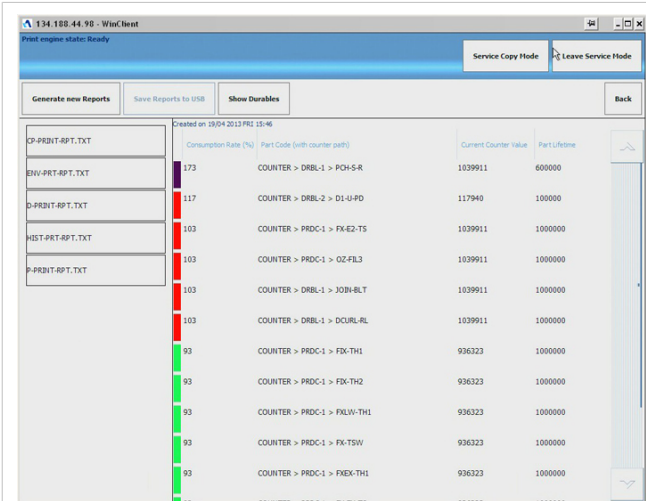

[34] Picture 2

## Appendix F: The Trapping editor

### The Trapping editor

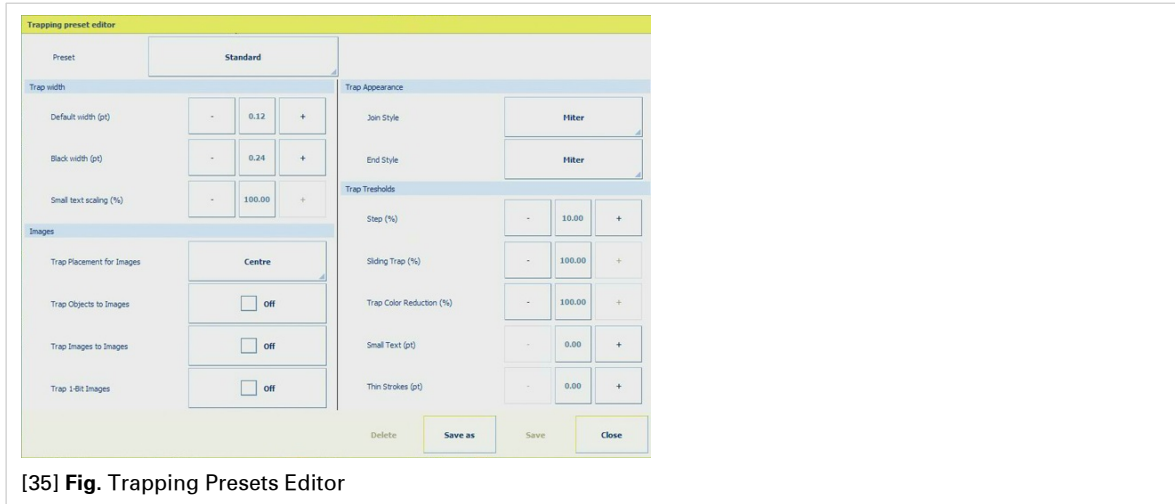

[35] Fig. Trapping Presets Editor

#### Trap width

Trap width is the amount of overlap for each trap. Differences in paper characteristics, screen rulings, and printer conditions require different trap widths.

- **Default width:**  
Specifies the trap width in points for trapping all colors except those involving solid black. The default value is 0p0.25.
- **Black width:**  
Indicates the distance that toners spread into solid black, or the holdback amount—the distance between black edges and underlying toners for trapping rich blacks. The default value is 0p0.5. This value is often set to be 1.5 to 2 times the value of the default trap width.

#### Trap Appearance

- **Join Style:**  
A join is where two trap edges meet at a common endpoint. You can control the shape of the outside join of two trap segments and the intersection of three traps. Join Style Controls the shape of the outside join of two trap segments. Choose from Miter, Round, and Bevel. (Left to right)

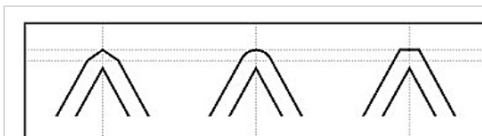

[36] Fig. Trap Join Styles

- **End Style:**  
Controls the intersection of three-way traps. Miter (the default) shapes the end of the trap to keep it away from the intersecting object. Overlap affects the shape of the trap generated by the lightest neutral density object that intersects with two or more darker objects. The end of the lightest trap is wrapped around the point where the three objects intersect. In the example the left image shows the miter effect. The right image shows the overlap.



## Trap thresholds

- **Step**  
Specifies the color change threshold at which the trapping engine creates a trap. Some jobs need only the most extreme color changes trapped, while others require traps for more subtle color changes. The Step value indicates the degree to which components (such as CMYK values) of abutting colors must vary before trapping occurs.  
To change how much the component toners in abutting colors can vary before causing those colors to trap, increase or decrease the value for Step. The default is 10%. For best results, use a value from 8% to 20%. Lower percentages increase sensitivity to color differences and result in more traps.
- **Sliding Trap**  
Determines when the trapping engine starts to straddle the centerline of the color boundary. The value refers to the proportion of the lighter color's neutral density value to a darker, abutting color's neutral density value. For example, setting the Sliding Trap value to 70% moves the point at which the trap begins to straddle the centerline to where the lighter color exceeds 70% of the darker color in neutral density (lighter color's neutral density divided by darker color's neutral density > 0.70). Colors of identical neutral density will always have their traps exactly straddle the centerline, unless the Sliding Trap is set to 100%.
- **Trap Color Reduction**  
Indicates the degree to which components from abutting colors are used to reduce the trap color. This setting is useful for preventing certain abutting colors (such as pastels) from making an unsightly trap that is darker than either color. Specifying a Trap Color Reduction lower than 100% begins to lighten the color of the trap; a Trap Color Reduction value of 0% makes a trap with a neutral density equal to the neutral density of the darker color.

## Images

- **Trap Placement for Images** Provides options for determining where the trap falls when you trap vector objects to bitmap images. All options except "Normal" create a visually consistent edge.
  - o Center creates a trap that straddles the edge between objects and images.
  - o Choke causes objects to overlap the abutting image.
  - o Normal applies the same trapping rules as used elsewhere in the document. Trapping an object to a photograph with the "Normal" setting can result in noticeably uneven edges as the trap moves from one side of the edge to another.
  - o Spread causes the bitmap image to overlap the abutting object.
- **Trap Objects To Images**  
Ensures that vector objects (such as frames used as keylines) trap to images, using the Trap Placement settings. If vector objects don't overlap images in a trapping page range, consider turning this option off to speed trapping of that page range.
- **Trap Images To Images**  
Turns on trapping along the boundary of overlapping or abutting bitmap images.
- **Trap 1-Bit Images**  
Ensures that 1-bit images trap to abutting objects. This option doesn't use the Image Trap Placement settings, because 1-bit images use only one color. In most cases, leave this option

selected. In some cases, such as with 1-bit images where pixels are widely spaced, selecting this option may darken the image and slow the trapping.



# Appendix G: EAC document

## EAC model number overview

### Introduction

This topic provides an overview of the Océ model numbers used for the imagePRESS C7010VPS Series configuration.

### location overview

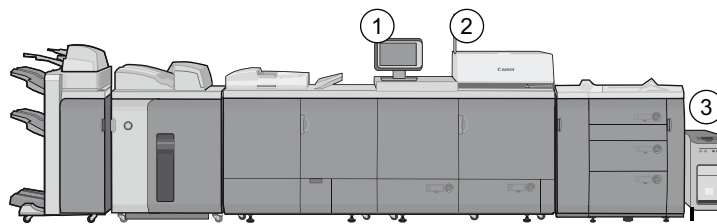

Item nr	Commercial Name	Mercury Code	Parts list chapter	Remark
1	Operating Panel A3	8117B007AA	Figure 130	
	Operating Panel Attachment Kit-A1	5612B001AA		
2	Operator Attention Light	5614B001AA	Figure V10	
3	PRISMAsync iPR C7010VPS series-A3	8321B001AA	Figure U10	
	• Add. Network Adapter	6123B001AA		Optional part if IPDS is ordered



### NOTE

Specific parts can be found in the parts catalogue of the engine. The parts are located in the chapters indicated above.

# Appendix H: System overview

## System overview

### Illustration

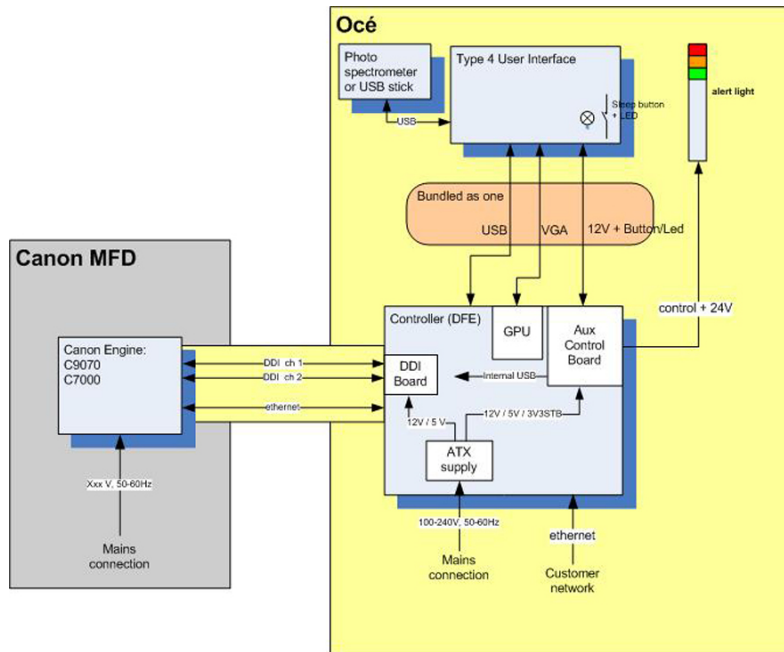

Fig. System overview



# Canon

**Canon Inc.**

[www.canon.com](http://www.canon.com)

**Canon U.S.A., Inc.**

[www.usa.canon.com](http://www.usa.canon.com)

**Canon Canada Inc.**

[www.canon.ca](http://www.canon.ca)

**Canon Europa Inc.**

[www.canon-europe.com](http://www.canon-europe.com)

**Canon Latin America Inc.**

[www.cla.canon.com](http://www.cla.canon.com)

**Canon Australia PTY. Ltd**

[www.canon.com.au](http://www.canon.com.au)

**Canon China Co., Ltd**

[www.canon.com.cn](http://www.canon.com.cn)

**Canon Singapore PTE. Ltd**

[www.canon.com.sg](http://www.canon.com.sg)

**Canon Hongkong Co., Ltd**

[www.canon.com.hk](http://www.canon.com.hk)