



Maintenance Guide

imagePRESS C7000VP

CONTENTS

Manuals for the Machine.....	1
Contents.....	2
Preface	4
1 Routine Maintenance	5
2 Reducing the Frequency of Paper Jams	7
3 Screens Indicating the Locations of Paper Jams	8
4 Symbol Indication	11
5 Labels for Clearing Paper Jams.....	13
6 Clearing Paper Jams	22
7 Clearing Staple Jams	94
8 List of Error Messages.....	101
9 If Memory Becomes Full during Scanning....	112
10 Service Call Message	114
11 Main Power and Control Panel Power	118
12 When the Power Does Not Turn ON.....	127

Store this guide next to the machine for future reference.

Manuals for the Machine

The manuals for this machine are divided as follows. Please refer to them for detailed information.

* Indicates the manuals supplied with optional equipment. Depending on the system configuration and product purchased, some manuals may not be needed.



Guides with this symbol are printed manuals.



Guides with this symbol are included on the accompanying CD-ROM. (See footnote on this page.)

Safety Instructions	<ul style="list-style-type: none">• Important safety instructions and machine specifications• Please read this manual before operating the machine.	
Easy Operation Guide	<ul style="list-style-type: none">• Quick Reference for Basic Operations	
Maintenance Guide (This Document)	<ul style="list-style-type: none">• Routine Maintenance and Troubleshooting Instructions	
Manual CD-ROM <ul style="list-style-type: none">• Additional Functions• Paper Type Management Settings• Troubleshooting• Routine Maintenance• Basic Operations• Optional Equipment• Job Hold Function• Copying and Mail Box Functions• Sending Function• Remote UI Function• Network Function• Safety Instructions• How to Use These Manuals	<ul style="list-style-type: none">• Manuals for Using and Setting Up the Machine	
Network Quick Start Guide*	<ul style="list-style-type: none">• Setting Up the Network Connection and Installing the CD-ROM Software	
Color Network ScanGear User's Guide*	<ul style="list-style-type: none">• Color Network ScanGear Installation and Instructions	
PS/PCL/UFR II Printer Guide*	<ul style="list-style-type: none">• PS/PCL/UFR II Printer Instructions	
PCL Driver Guide*	<ul style="list-style-type: none">• PCL Printer Driver Installation and Instructions	
PS Driver Guide*	<ul style="list-style-type: none">• PS Printer Driver Installation and Instructions	
UFR II Driver Guide*	<ul style="list-style-type: none">• UFR II Printer Driver Installation and Instructions	
Mac PS Driver Guide*	<ul style="list-style-type: none">• Mac OS X PS Printer Driver Installation and Instructions	
Mac UFR II Driver Guide*	<ul style="list-style-type: none">• Mac OS X UFR II Printer Driver Installation and Instructions	
MEAP SMS Administrator Guide	<ul style="list-style-type: none">• Installing MEAP Applications and Using the Login Service	



Contents

Preface	4
Symbols Used in This Manual	4
1 Routine Maintenance	5
Automatic Feeder Cleaning	5
Wire Cleaning	5
Roller Cleaning	6
2 Reducing the Frequency of Paper Jams	7
3 Screens Indicating the Locations of Paper Jams	8
4 Symbol Indication	11
5 Labels for Clearing Paper Jams	13
(A) Buffer Pass (If the Optional POD Deck is attached)	13
(A) If the Optional Stack Bypass-A1 or Paper Deck-AC1 is attached	14
(B) Main Station	15
(C) Sub Station	16
(D) POD Deck-A1 (Single Installation)/Secondary POD Deck-A1	18
(D) Secondary POD Deck-A1 (Left Side at the Tandem Installation)	19
(F) Finisher-AB1/Saddle Finisher-AB2 and Document Insertion Unit-C1	20
6 Clearing Paper Jams	22
Main Station (Inside the Main Unit)	22
Lower Feeding Unit/Paper Decks of the Main Unit	23
Feeding Unit	30
Sub Station (Inside the Main Unit)	35
Primary Fixing Assembly	35
Secondary Fixing Assembly	41
Delivery/Reverse Unit	46
Feeder (DADF-R1) (Optional)	51
SADF Tray	54
Between the Main Unit and the POD Deck-A1/Secondary POD Deck-A1, or Between the Main Unit and the Paper Deck-AC1 (Main Unit Side)	55
POD Deck-A1/Secondary POD Deck-A1 (Front Right Cover/Horizontal Pass) (Optional)	59
Paper Decks of POD Deck-A1/Secondary POD Deck-A1 (Optional)	64
Between the Main Unit and POD Deck-A1/Secondary POD Deck-A1 (POD Deck Side)	65
Stack Bypass-A1 (Optional)	70
Paper Deck-AC1 (Optional)	74
Inside the Top Cover of the Finisher-AB1/Saddle Finisher-AB2 (Optional)	76
Inside the Front Cover of the Finisher-AB1/Saddle Finisher-AB2 (Optional) ..	82
Document Insertion Unit-C1 (Optional)	85
Saddle Stitcher Unit (Optional)	88
7 Clearing Staple Jams	94
Finisher-AB1/Saddle Finisher-AB2 (Optional)	94
Saddle Stitcher Unit (Optional)	97
8 List of Error Messages	101
Self-Diagnostic Display	101





List of Error Codes without Messages	106
9 If Memory Becomes Full during Scanning.	112
10 Service Call Message	114
Contacting Your Local Authorized Canon Dealer.	114
Setting the Limited Functions Mode from the Service Call Message Screen	115
11 Main Power and Control Panel Power.	118
How to Turn ON the Main Power	118
Control Panel Power Switch.	123
Shutting Down the Machine.	123
12 When the Power Does Not Turn ON	127

Preface

Thank you for purchasing the Canon imagePRESS C7000VP. Please read this manual thoroughly before operating the machine to familiarize yourself with its capabilities, and to make the most of its many functions. After reading this manual, store it in a safe place for future reference.

Symbols Used in This Manual

The following symbols are used in this manual to explain procedures, restrictions, handling precautions, and instructions that should be observed for safety.

-  **WARNING** Indicates a warning concerning operations that may lead to death or injury to persons if not performed correctly. To use the machine safely, always pay attention to these warnings.
-  **CAUTION** Indicates a caution concerning operations that may lead to injury to persons, or damage to property if not performed correctly. To use the machine safely, always pay attention to these cautions.
-  **IMPORTANT** Indicates operational requirements and restrictions. Be sure to read these items carefully to operate the machine correctly, and avoid damage to the machine.
-  **NOTE** Indicates a clarification of an operation, or contains additional explanations for a procedure. Reading these notes is highly recommended.

1 Routine Maintenance

Automatic Feeder Cleaning

1

If your originals have black streaks or appear dirty after scanning them through the feeder, clean the rollers of the feeder.



IMPORTANT

For more information on paper weights, See Chapter 9, "Appendix," in the *Reference Guide*.



NOTE

- It takes approximately 15 seconds to clean the feeder.
- [Feeder Cleaning] appears only if the optional Feeder (DADF-R1) is attached.

1 Press  (Additional Functions) → [Adjustment/Cleaning] → [Feeder Cleaning].

2 Place 10 sheets of blank paper into the feeder → press [Start].

Make sure that you fan the sheets of paper well.

Use LTR paper (60 to 80 g/m²).

When cleaning is complete, try scanning again.



NOTE

To cancel feeder cleaning while it is in progress, press [Cancel].

Wire Cleaning

If streaks appear on printed output, or random parts of the printed image are missing, clean the corona assembly wires inside the main unit.



NOTE

- It takes approximately 35 seconds to clean the wires.
- Wire cleaning cannot be performed during printing.

1 Press  (Additional Functions) → [Adjustment/Cleaning] → [Wire Cleaning].

2 Press [Start].

When cleaning is complete, try printing again.

Roller Cleaning

If dirt or streaks appear on the printed output, clean the roller inside the main unit.

 NOTE

It takes approximately one minute to clean the roller.

1 Press  (Additional Functions) → [Adjustment/Cleaning] → [Roller Cleaning].

2 Press [Start].

When cleaning is complete, try printing again.



2 Reducing the Frequency of Paper Jams

If paper jams occur frequently, even though there is no apparent problem with the machine, either one of the following two reasons may be the cause. Follow the instructions described below to reduce the frequency of paper jams.

■ **There are torn pieces of paper left inside the machine.**

Pulling jammed paper out of the machine by force may leave parts of the paper torn inside, leading to frequent paper jams. If paper tears while you are trying to remove jammed paper from the machine, make sure that you remove all of the torn pieces.

■ **The paper size loaded in a paper source is not registered.**

Make sure that the paper size that is loaded is registered in Register Paper in Common Settings (from the Additional Functions screen). If the paper size loaded does not match the paper size that is registered, paper jams may occur more frequently.

3 Screens Indicating the Locations of Paper Jams

If a paper jam occurs, the following screens appear on the touch panel display.

The screen indicating the location of the paper jam and instructions on how to clear the paper jam appear on the touch panel display. This screen repeatedly appears on the touch panel display until the jam is entirely cleared. The screen shots below may vary, depending on the optional equipment that is attached to the machine.

If you press [Recover Later], you can continue operations, such as setting modes and scanning originals, even if the jammed paper is not removed immediately.

■ Example of a Screen Indicating the Location of the Paper Jam in the Main Unit

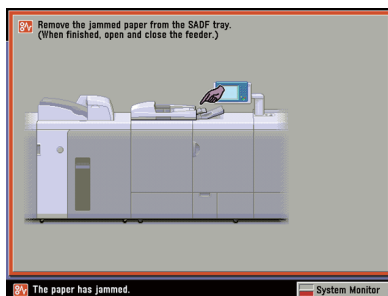

■ Example of a Screen Indicating How to Clear the Paper Jam

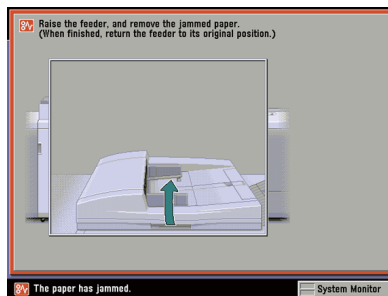

■ Example of a Screen Indicating How to Clear the Paper Jam

You can confirm the symbol where paper jam occurred by [Unit], and you can also confirm the label number that you should clear the paper jam by [Operation Order]. The label number corresponds to the label attached to the internal section of this machine. Follow the steps indicated on [Priority] and remove the jammed paper.

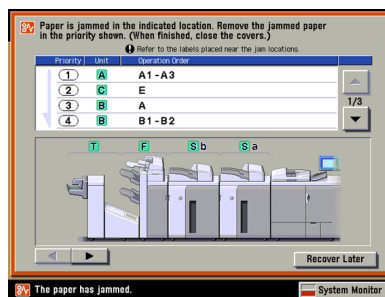
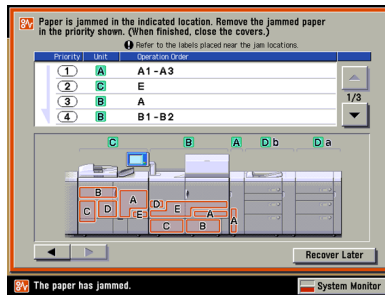

⚠ WARNING

There are some areas inside the machine which are subject to high-voltages. When removing jammed paper or when inspecting the inside of the machine, do not allow necklaces, bracelets, or other metal objects to touch the inside of the machine, as this may result in burns or electrical shock.

⚠ CAUTION

- When removing jammed originals or paper, take care not to cut your hands on the edges of the originals or paper.
- When removing jammed originals or paper, take care not to cut your hands on the inside of the machine. If you cannot remove the paper, contact your local authorized Canon dealer.
- When removing paper which has become jammed inside the machine, take care not to allow the toner on the jammed paper to come into contact with your hands or clothing, as this will dirty your hands or clothing. If they become dirty, wash them immediately with cold water. Washing them with warm water will set the toner, and make it impossible to remove the toner stains.
- When removing paper which has become jammed inside the machine, remove the jammed paper gently to prevent the toner on the paper from scattering and getting into your eyes or mouth. If the toner gets into your eyes or mouth, wash them immediately with cold water and immediately consult a physician.
- The fixing assembly and its surroundings inside the machine may become hot during use. When removing jammed paper or when inspecting the inside of the machine, do not touch the fixing assembly and its surroundings, as doing so may result in burns or electrical shock.
- After clearing all paper jams, remove your hands from the machine immediately. Even if the machine is not in operation, your hands, hair, or clothing may get caught in the feed rollers, which could result in personal injury or damage if the machine suddenly starts printing.



IMPORTANT

- If a paper jam occurs in the optional feeder, you cannot continue operating the machine. Follow the directions on the touch panel display to clear the paper jam. (See "Feeder (DADF-R1) (Optional)," on p. 51.)
- If a MEAP application screen is displayed, a message appears in the Job/Print monitor area. Press [System Monitor] → follow the procedures that appear on the touch panel display to help you remove the jammed paper.



NOTE

If paper is jammed in several locations, remove the jammed paper in the order indicated on the touch panel display.

4 Symbol Indication

To indicate each unit simply, symbols assigned to the main unit and optional equipment. The symbols described below correspond to the screen indication when clearing paper jams and the label attached to the internal section of this machine.

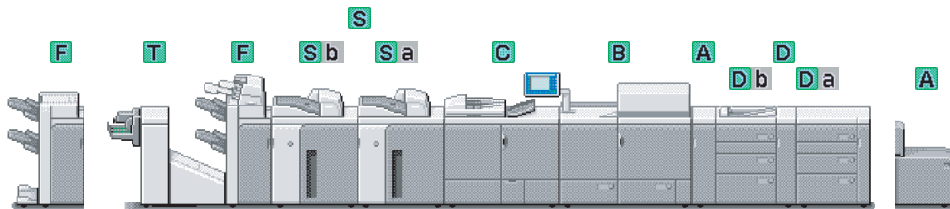

A Buffer Pass

Between the Main Unit and the POD Deck-A1/Secondary POD Deck-A1, or Between the Main Unit and the Paper Deck-AC1 (Main Unit Side): p. 55

Between the Main Unit and POD Deck-A1/Secondary POD Deck-A1 (POD Deck Side): p. 65

Stack Bypass-A1

Stack Bypass-A1 (Optional): p. 70

Paper Deck-AC1

Paper Deck-AC1 (Optional): p. 74

B Main Station

Main Station (Inside the Main Unit): p. 22

Lower Feeding Unit/Paper Decks of the Main Unit: p. 23

Feeding Unit: p. 30

C Sub Station

Sub Station (Inside the Main Unit): p. 35

Primary Fixing Assembly: p. 35

Secondary Fixing Assembly: p. 41

Delivery/Reverse Unit: p. 46

Feeder (DADF-R1) (Optional): p. 51

SADF Tray: p. 54

D POD Deck-A1/Secondary POD Deck-A1

POD Deck-A1/Secondary POD Deck-A1 (Front Right Cover/Horizontal Pass) (Optional): p. 59

Paper Decks of POD Deck-A1/Secondary POD Deck-A1 (Optional): p. 64

Between the Main Unit and the POD Deck-A1/Secondary POD Deck-A1, or Between the Main Unit and the Paper Deck-AC1 (Main Unit Side): p. 55

Between the Main Unit and POD Deck-A1/Secondary POD Deck-A1 (POD Deck Side): p. 65



NOTE

If the only POD Deck-A1 is attached, the label is displayed as "(D)." If the POD Deck-A1 and Secondary POD Deck-A1 are attached, the label for the POD Deck-A1 is displayed as "(Db)" and the label for the Secondary POD Deck-A1 is displayed as "(Da)."

F Finisher-AB1/Saddle Finisher-AB2

Inside the Top Cover of the Finisher-AB1/Saddle Finisher-AB2 (Optional): p. 76

Inside the Front Cover of the Finisher-AB1/Saddle Finisher-AB2 (Optional): p. 82

Saddle Stitcher Unit (Optional): p. 88

S High Capacity Stacker-C1

See the instruction manual of the High Capacity Stacker-C1.

T Booklet Trimmer-C1

See the instruction manual of the Booklet Trimmer-C1.

5 Labels for Clearing Paper Jams

Labels for clearing paper jams are attached inside the machine. The label corresponds to the screen appears when a paper jam occurs. Follow the table below to clear the paper jam.



IMPORTANT

The Stack Bypass-A1, POD Deck-A1/Secondary POD-Deck-A1, Paper Deck-AC1, and Finisher-AB1/Saddle Finisher-AB2 are optional.

(A) Buffer Pass (If the Optional POD Deck is attached)

If the paper jam occurs inside the buffer pass, a label similar to the one shown below appears on the screen that displays the procedure to solve the problem. Follow [Operation Order] to clear the paper jam.

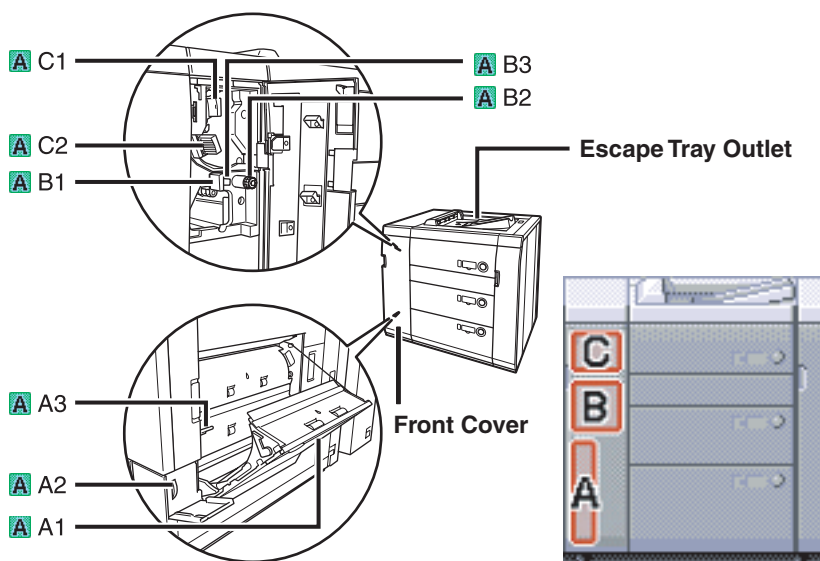

Order	Location (Label)
1	Front Cover
2	(A) A1
3	(A) A2
4	(A) A3
5	(A) B1
6	(A) B2
7	(A) B3
8	Escape Tray Outlet
9	(A) C1

Order	Location (Label)
10	(A) C2

(A) If the Optional Stack Bypass-A1 or Paper Deck-AC1 is attached

If the paper jam occurs inside the Stack Bypass-A1 or Paper Deck-AC1, follow [Operation Order] to clear the paper jam.

■ Stack Bypass-A1

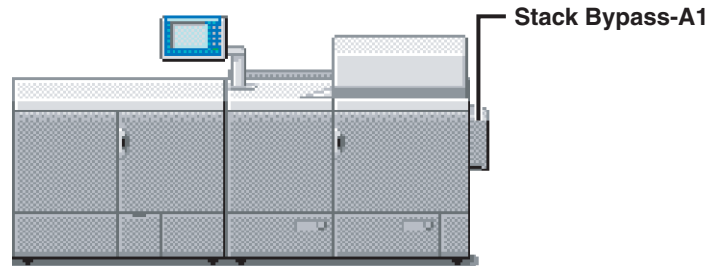

Order	Location (Label)
1	On the Stack Bypass
2	In the Stack Bypass (Open Button)
3	Stack Bypass (Open Button)

■ Paper Deck-AC1

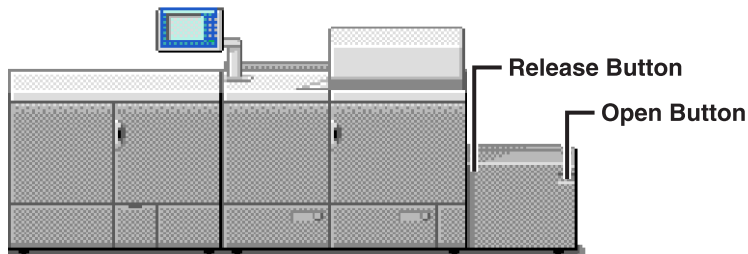

Order	Location (Label)
1	Release Button
2	Open Button

(B) Main Station

If the paper jam occurs inside the main station, a label similar to the one shown below appears on the screen that displays the procedure to solve the problem. Follow [Operation Order] to clear the paper jam.

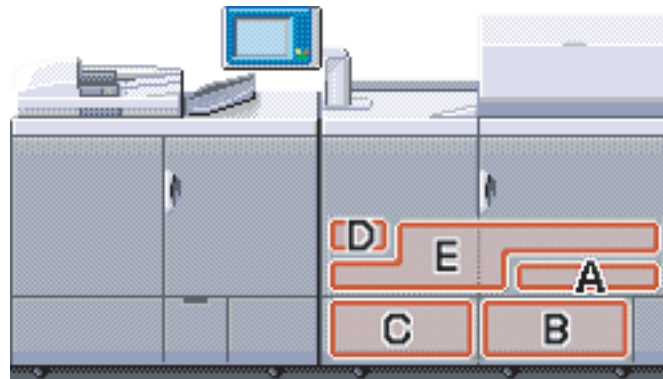
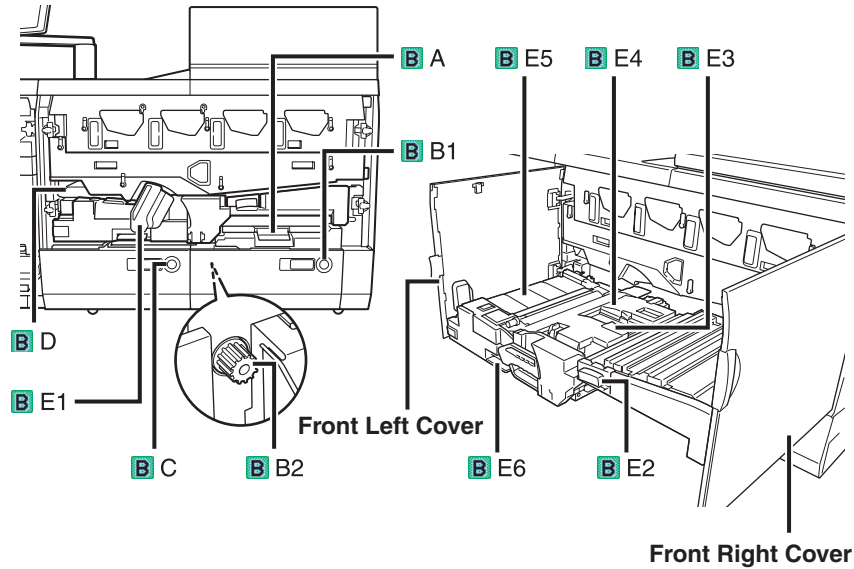

Order	Location (Label)
1	Front Right Cover
2	Front Left Cover
3	(B) A
4	(B) B1
5	(B) B2
6	(B) C
7	(B) D
8	(B) E1
9	(B) E2
10	(B) E3

Order	Location (Label)
11	(B) E4
12	(B) E5
13	(B) E6

(C) Sub Station

If the paper jam occurs inside the sub station, a label similar to the one shown below appears on the screen that displays the procedure to solve the problem. Follow [Operation Order] to clear the paper jam.

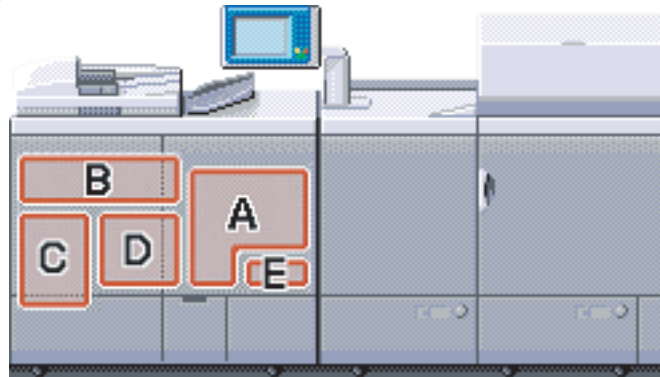
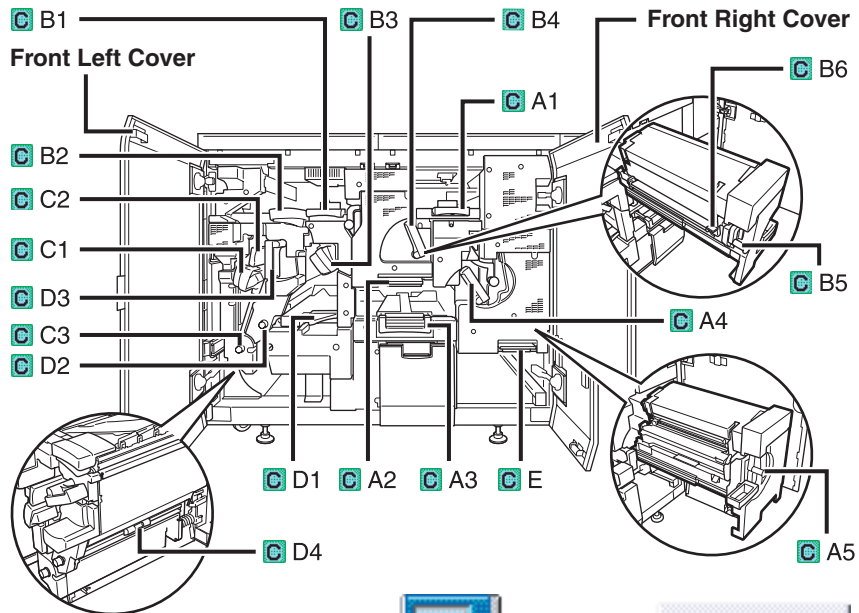

Order	Location (Label)
1	Front Right Cover
2	Front Left Cover
3	(C) A1
4	(C) A2
5	(C) A3

Order	Location (Label)
6	(C) A4
7	(C) A5
8	(C) B1
9	(C) B2
10	(C) B3
11	(C) B4
12	(C) B5
13	(C) B6
14	(C) C1
15	(C) C2
16	(C) C3
17	(C) D2
18	(C) D1
19	(C) D3
20	(C) D4
21	(C) E

(D) POD Deck-A1 (Single Installation)/Secondary POD Deck-A1

If the paper jam occurs inside the POD Deck-A1 (single installation) or the Secondary POD Deck-A1, a label similar to the one shown below appears on the screen that displays the procedure to solve the problem. Follow [Operation Order] to clear the paper jam.

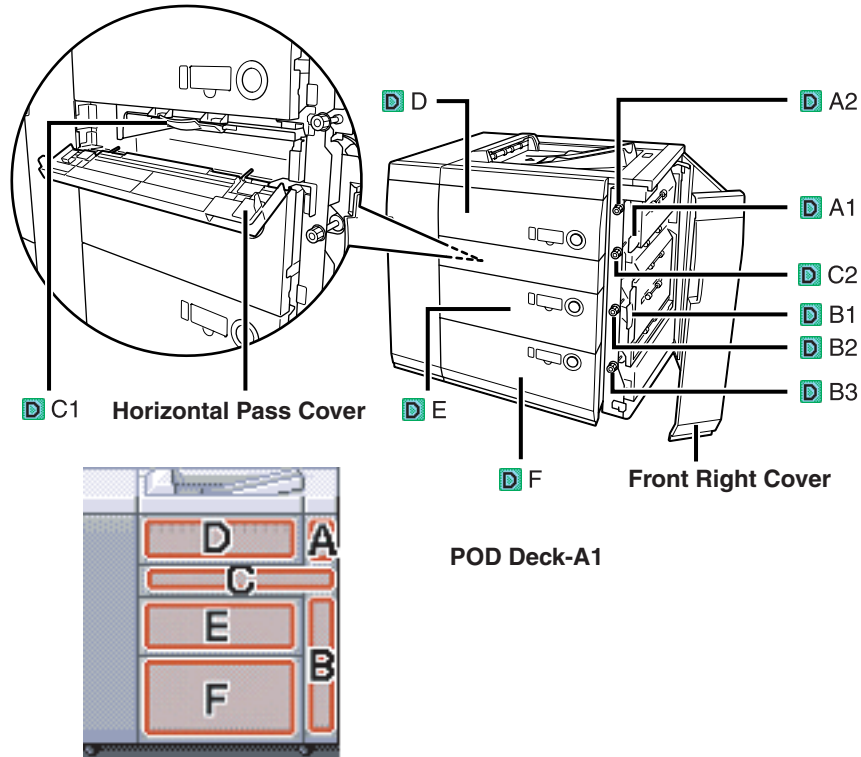

5

NOTE

If the only POD Deck-A1 is attached, the label is displayed as "(D)." If the POD Deck-A1 and Secondary POD Deck-A1 are attached, the label for the POD Deck-A1 is displayed as "(Db)" and the label for the Secondary POD Deck-A1 is displayed as "(Da)."

Order	Location (Label)
1	Front Right Cover
2	(D) A1
3	(D) A2
4	(D) B1
5	(D) B2
6	(D) B3
7	Horizontal Pass Cover
8	(D) C1
9	(D) C2
10	(D) D
11	(D) E

Order	Location (Label)
12	(D) F

(D) Secondary POD Deck-A1 (Left Side at the Tandem Installation)

If the paper jam occurs inside the connection part of the Secondary POD Deck-A1 and the POD Deck-A1, a label similar to the one shown below appears on the screen that displays the procedure to solve the problem. Follow [Operation Order] to clear the paper jam.

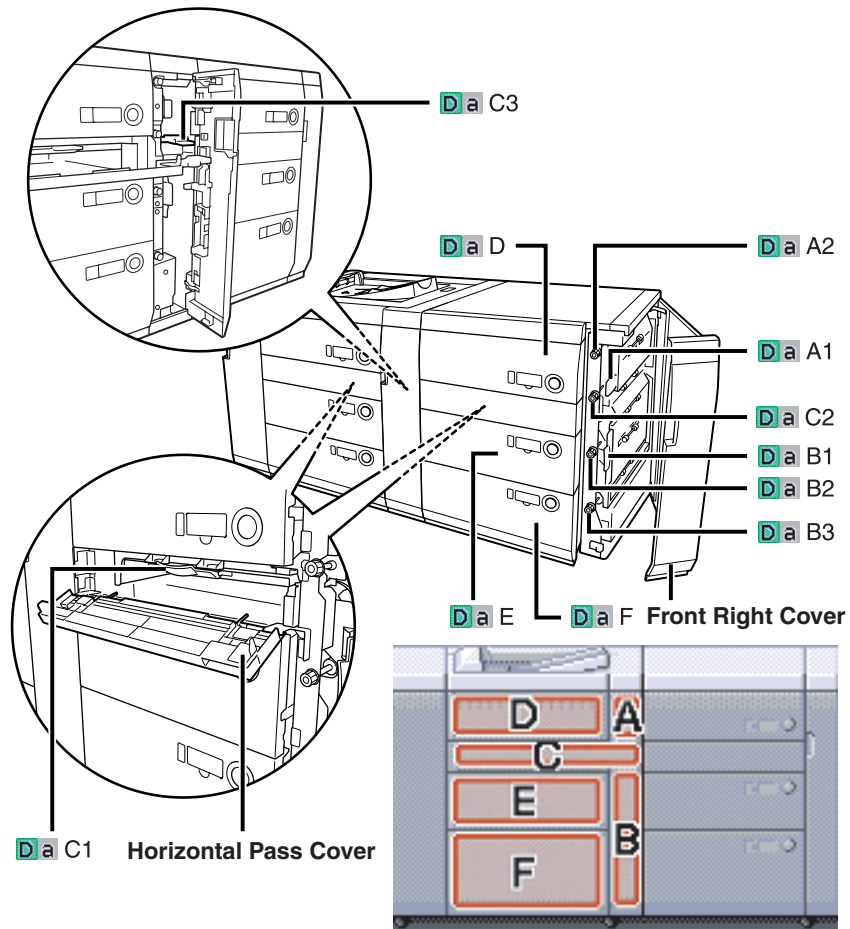

NOTE

The label for the Secondary POD Deck-A1 is displayed as "(Da)."

Order	Location (Label)
1	Front Right Cover
2	(Da) A1
3	(Da) A2
4	(Da) B1
5	(Da) B2
6	(Da) B3

Order	Location (Label)
7	Horizontal Pass Cover
8	(Da) C1
9	(Da) C2
10	(Da) C3
11	(Da) D
12	(Da) E
13	(Da) F

(F) Finisher-AB1/Saddle Finisher-AB2 and Document Insertion Unit-C1

5

If the paper jam occurs inside the Finisher-AB1/Saddle Finisher-AB2 and Document Insertion Unit-C1, a label similar to the one shown below appears on the screen that displays the procedure to solve the problem. Follow [Operation Order] to clear the paper jam.

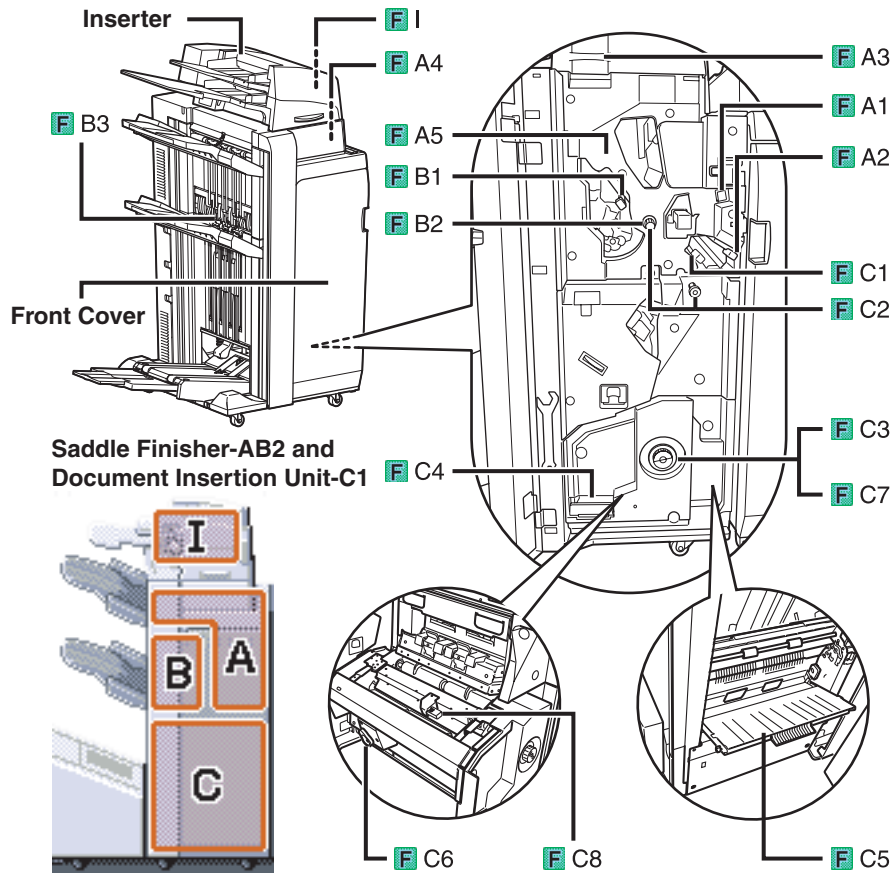

Order	Location (Label)
1	Front Cover
2	(F) A1
3	(F) A2
4	Document Insertion Unit
5	(F) A3
6	(F) A4
7	(F) A5
8	(F) B1
9	(F) B2
10	(F) B3
11	(F) C1
12	(F) C2
13	(F) C3
14	(F) C4
15	(F) C5
16	(F) C6
17	(F) C8
18	(F) C7

6 Clearing Paper Jams

If a paper jam occurs, the screen indicating the location of the paper jam and instructions on how to clear the paper jam appears on the touch panel display. Inspect all paper jam locations indicated on the touch panel display, and remove any jammed paper.

If jammed paper tears while it is being removed, be sure to remove any remaining pieces from inside the machine.



IMPORTANT

- If the machine's power is turned OFF when there is a paper jam, detection of paper jams is not possible after the power is turned back ON. Clear paper jams without turning the power OFF.
- The Stack Bypass-A1, POD Deck-A1/Secondary POD-Deck-A1, Paper Deck-AC1, and Finisher-AB1/Saddle Finisher-AB2 are optional.



NOTE

- Some areas that are shown to have paper jams may not actually have paper jams. However, always check all locations indicated on the touch panel display in the order that is given.
- You do not have to re-enter the number of copies or prints, even if you are printing multiple sets. The machine automatically recalculates the number of copies or prints to make based on the number of sheets that have jammed.

Main Station (Inside the Main Unit)

If a paper jam occurs inside the main station, a screen indicating the location of the paper jam and instructions on how to clear the paper jam appears on the touch panel display.

Follow the procedure described below to remove the jammed paper.



CAUTION

- **When removing jammed originals or paper, take care not to cut your hands on the edges of the originals or paper.**
- **When removing jammed originals or paper, take care not to cut your hands on the inside of the machine. If you cannot remove the paper, contact your local authorized Canon dealer.**
- **When removing paper which has become jammed inside the machine, take care not to allow the toner on the jammed paper to come into contact with your hands or clothing, as this will dirty your hands or clothing. If they become dirty, wash them immediately with cold water. Washing them with warm water will set the toner, and make it impossible to remove the toner stains.**
- **When removing paper which has become jammed inside the machine, remove the jammed paper gently to prevent the toner on the paper from scattering and getting into your eyes or mouth. If the toner gets into your eyes or mouth, wash them immediately with cold water and immediately consult a physician.**

Lower Feeding Unit/Paper Decks of the Main Unit



IMPORTANT

Make sure to perform all procedures without omitting.

1 Open the front cover of the main station.

Open the right side of the front cover first.

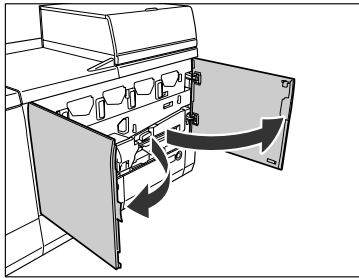

2 Open the guide (B-A) until it clicks into place.

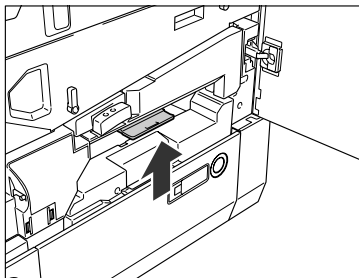

CAUTION

When opening the guide, be careful not to get your fingers caught, as this may result in personal injury.

3 Remove any jammed paper.

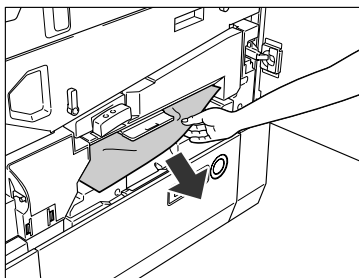

4 Perform the following operations.

● If the POD Deck-A1/Secondary POD Deck-A1 is attached:

- Open the front cover of the buffer pass unit.

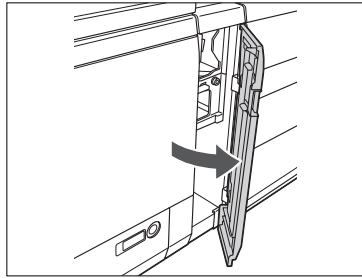

● If the Paper Deck-AC1 is attached:

- Press the release button, and move the paper deck away from the main unit.

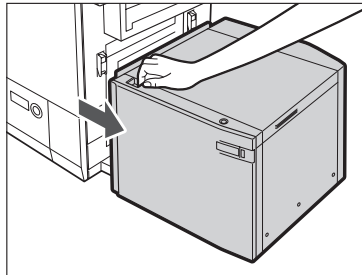

5 Press the button to open the cover (A-A1).

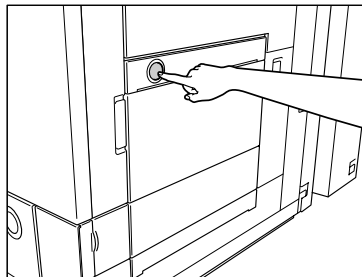

6 Remove any jammed paper.

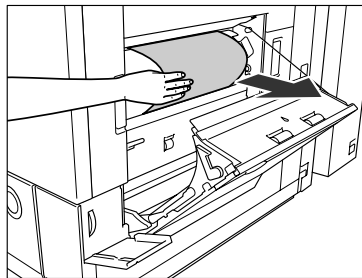

- 7** Turn the dial (A-A2) in the direction of the arrow, and remove any jammed paper.

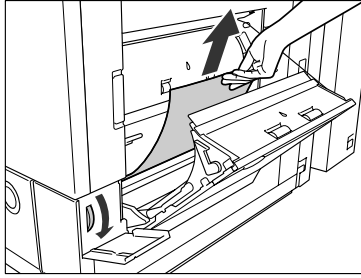

- 8** Push the lever to open the guide (A-A3).

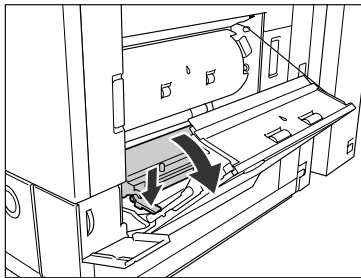

- 9** Remove any jammed paper.

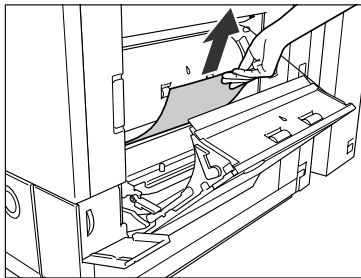

- 10** Close the guide (A-A3).

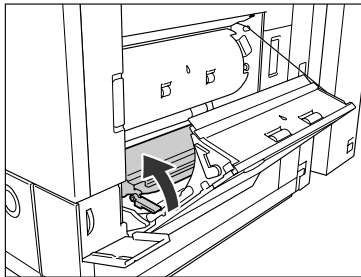

CAUTION

When closing the guide, be careful not to get your fingers caught, as this may result in personal injury.

11 Close the cover (A-A1) until it clicks into place.

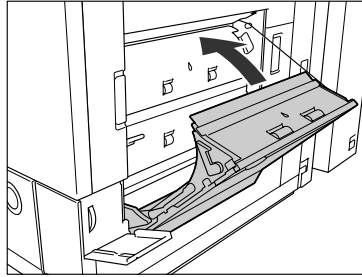

! CAUTION

When closing the guide, be careful not to get your fingers caught, as this may result in personal injury.

12 Perform the following operations.

● If the POD Deck-A1/Secondary POD Deck-A1 is attached:

- Close the front cover of the buffer pass unit.

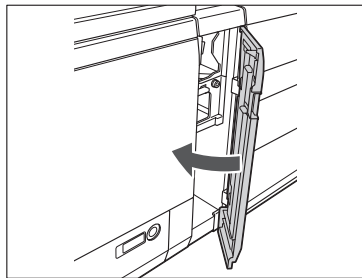

! CAUTION

When closing the cover, be careful not to get your fingers caught, as this may result in personal injury.

● If the Paper Deck-AC1 is attached:

- Place your hand where the hand symbol (👉) is located on the paper deck and reconnect it to the main unit.

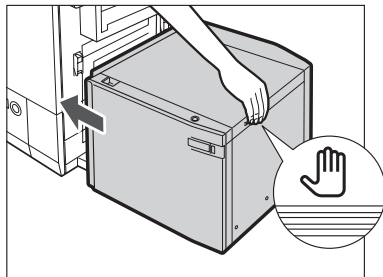

! CAUTION

When reconnecting the paper deck to the main unit, be careful not to get your fingers caught, as this may result in personal injury.



IMPORTANT

When reconnecting the paper deck to the main unit, confirm that the cover (A-A1) of the main unit side is closed properly.

13 Push the button on the right paper deck.

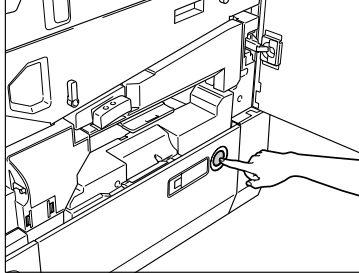

14 Grip the handle, and pull out the paper deck until it stops.

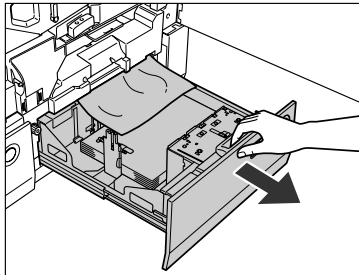

IMPORTANT

Do not pull out the paper deck by force.

15 Remove any jammed paper.

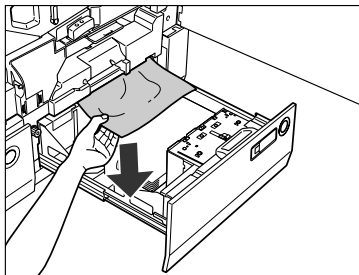

16 Turn the dial (B-B2) in the direction of the arrow (clockwise).

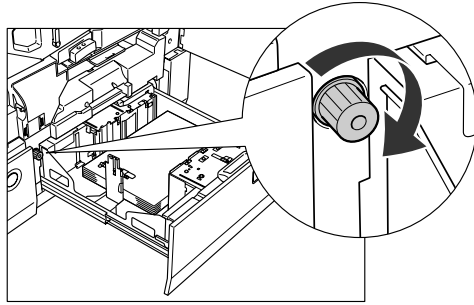

17 Remove any jammed paper.

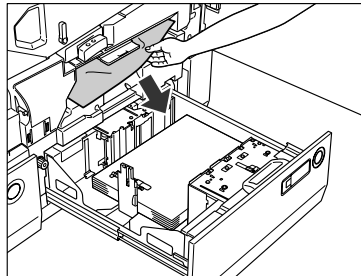

18 Close the right paper deck.

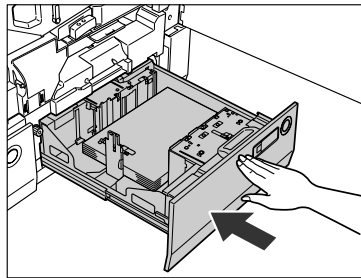

19 Lift up the guide (B-A) and close it.

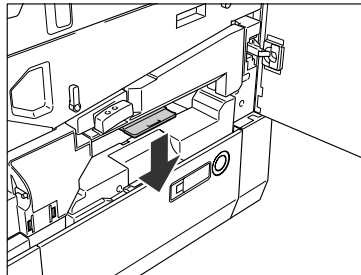

⚠ CAUTION

When closing the guide, be careful not to get your fingers caught, as this may result in personal injury.

20 Push the button on the left paper deck.

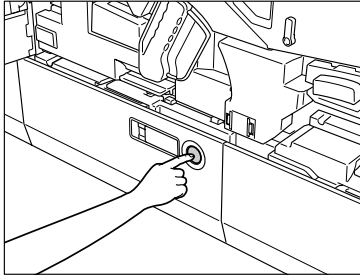

21 Grip the handle, and pull out the paper deck until it stops.

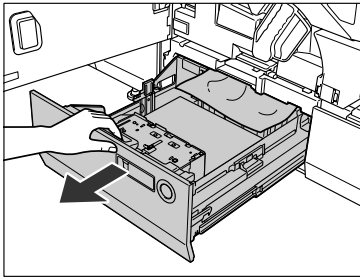

 **IMPORTANT**
Do not pull out the paper deck by force.

22 Remove any jammed paper.

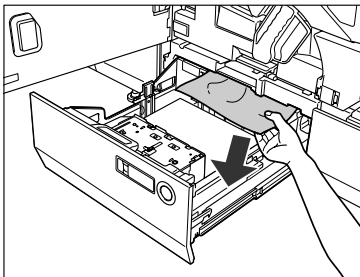

23 Close the left paper deck.

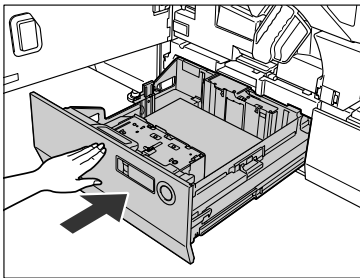

⚠ CAUTION

When closing the paper deck, be careful not to get your fingers caught, as this may result in personal injury.

24 Close the front cover of the main station.

Close the left side of the front cover first.

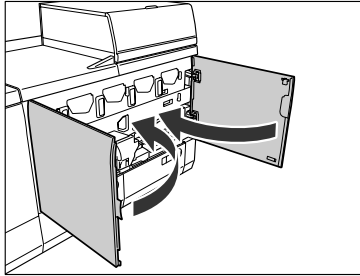

⚠ CAUTION

When closing the front cover, be careful not to get your fingers caught, as this may result in personal injury.

25 Follow the instructions on the touch panel display.

✎ NOTE

The screen indicating the location of the paper jam is displayed on the touch panel display until the paper jam is entirely cleared. For more information, see "3 Screens Indicating the Locations of Paper Jams," on p. 8.

Feeding Unit

1 Open the front cover of the main station.

Open the right side of the front cover first.

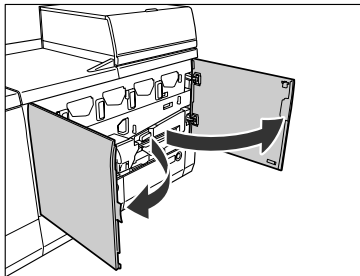

2 Remove any jammed paper from the B-D.

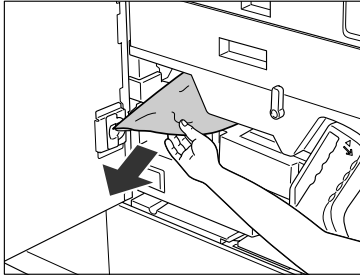

3 Tilt the lever (B-E1) to the right.

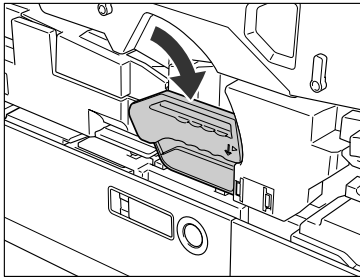

4 Grip the lever (B-E1), and pull out the feeding unit.

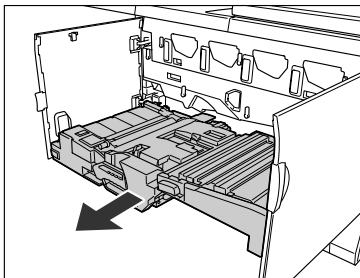

5 Open the guide (B-E2).

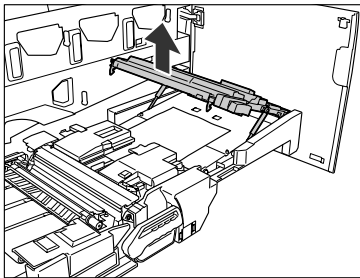

- 6** Open the guide (B-E3), and push the lever to open the guide (B-E4).

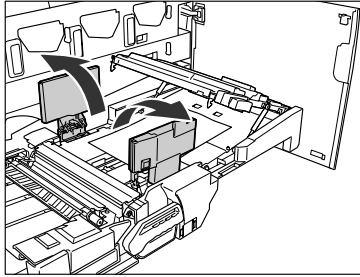

- 7** Remove any jammed paper.

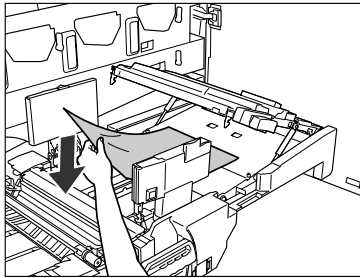

- 8** Close the guides (B-E4, B-E3, and B-E2).

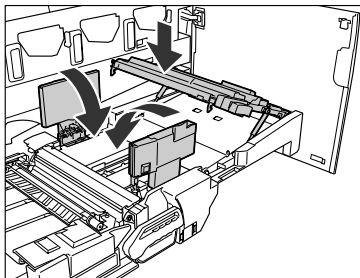

⚠ CAUTION

When closing the guide, be careful not to get your fingers caught, as this may result in personal injury.

- 9** Remove any jammed paper from the B-E5.

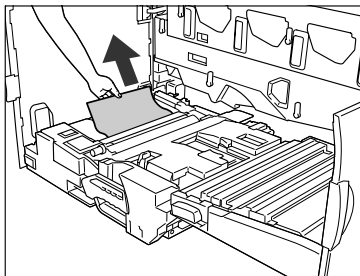

10 Open the guide (B-E6).

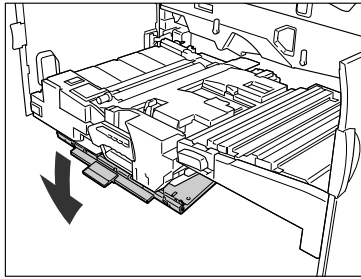

11 Remove any jammed paper.

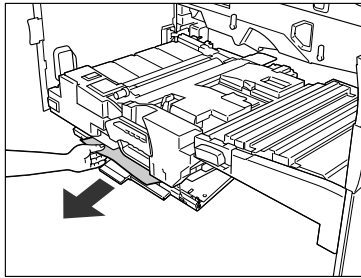

12 Close the guide (B-E6).

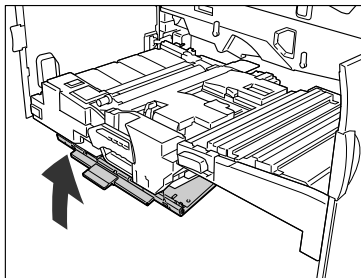

⚠ CAUTION

When closing the guide, be careful not to get your fingers caught, as this may result in personal injury.

13 Close the feeding unit.

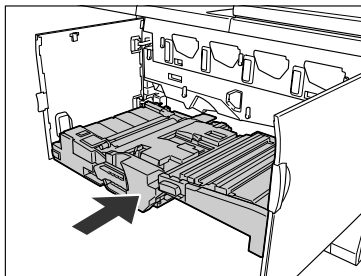

⚠ CAUTION

- Make sure that the feeding unit is returned to its original position properly.
- When returning the feeding unit to its original position, be careful not to get your fingers caught, as this may result in personal injury.

14 Return the lever (B-E1) to its original position.

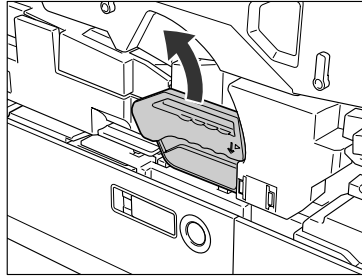

15 Close the front cover of the main station.

Close the left side of the front cover first.

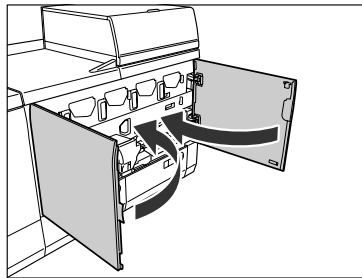

⚠ CAUTION

When closing the front cover, be careful not to get your fingers caught, as this may result in personal injury.

16 Follow the instructions on the touch panel display.

✎ NOTE

The screen indicating the location of the paper jam is displayed on the touch panel display until the paper jam is entirely cleared. For more information, see "3 Screens Indicating the Locations of Paper Jams," on p. 8.

Sub Station (Inside the Main Unit)

If a paper jam occurs inside the sub station, a screen indicating the location of the paper jam and instructions on how to clear the paper jam appears on the touch panel display.

Follow the procedure described below to remove the jammed paper.

CAUTION

- When removing jammed originals or paper, take care not to cut your hands on the edges of the originals or paper.
- When removing jammed originals or paper, take care not to cut your hands on the inside of the machine. If you cannot remove the paper, contact your local authorized Canon dealer.
- When removing paper which has become jammed inside the machine, take care not to allow the toner on the jammed paper to come into contact with your hands or clothing, as this will dirty your hands or clothing. If they become dirty, wash them immediately with cold water. Washing them with warm water will set the toner, and make it impossible to remove the toner stains.
- When removing paper which has become jammed inside the machine, remove the jammed paper gently to prevent the toner on the paper from scattering and getting into your eyes or mouth. If the toner gets into your eyes or mouth, wash them immediately with cold water and immediately consult a physician.
- The fixing assembly and its surroundings inside the machine may become hot during use. When removing jammed paper or when inspecting the inside of the machine, do not touch the fixing assembly and its surroundings, as doing so may result in burns.

6

Primary Fixing Assembly

1 Open the front cover of the sub station.

Open the right side of the front cover first.

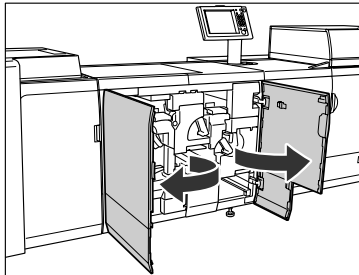

2 Open the guide (C-A1).

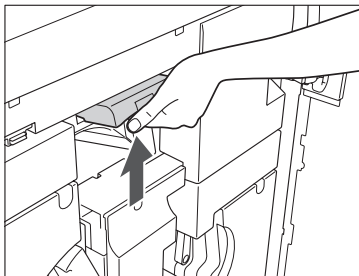

⚠ CAUTION

When opening the guide, be careful not to get your fingers caught, as this may result in personal injury.

3 Remove any jammed paper.

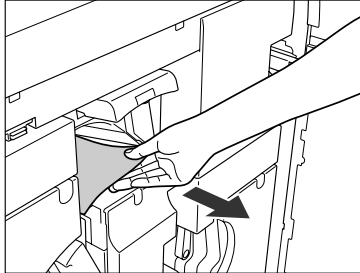

4 Close the guide (C-A1).

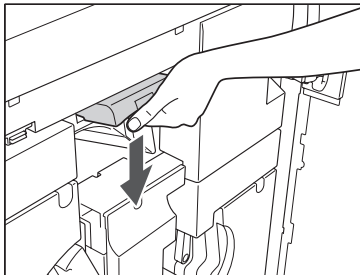

⚠ CAUTION

When closing the guide, be careful not to get your fingers caught, as this may result in personal injury.

5 Open the guide (C-A2).

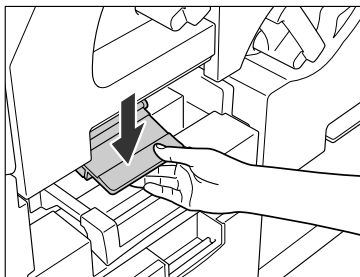

⚠ CAUTION

When opening the guide, be careful not to get your fingers caught, as this may result in personal injury.

6 Remove the any remaining paper.

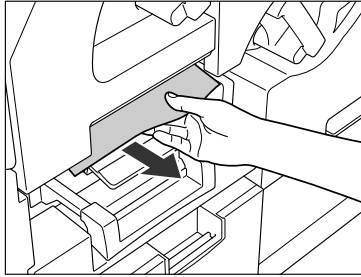

7 Return the guide (C-A2) until it clicks into place.

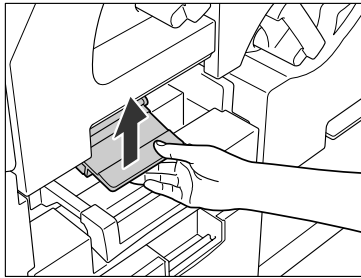

⚠ CAUTION

When closing the guide, be careful not to get your fingers caught, as this may result in personal injury.

8 Lift up the guide (C-A3) and push it up into the machine.

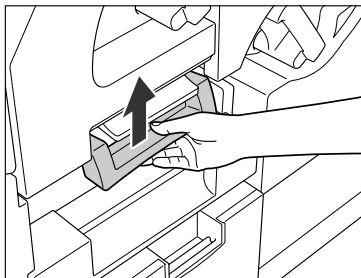

⚠ CAUTION

When opening the guide, be careful not to get your fingers caught, as this may result in personal injury.

9 Remove any jammed paper.

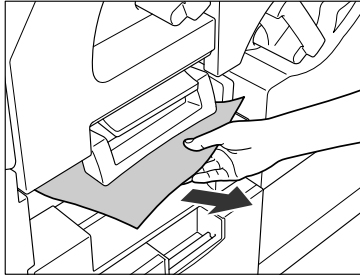

10 Lift up the guide (C-A3) slightly to close it.

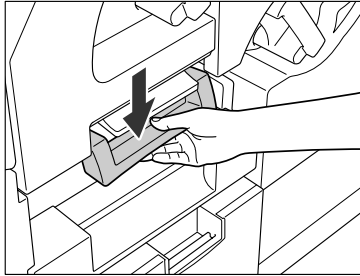

⚠ CAUTION

When closing the guide, be careful not to get your fingers caught, as this may result in personal injury.

11 Tilt the lever (C-A4) to the left.

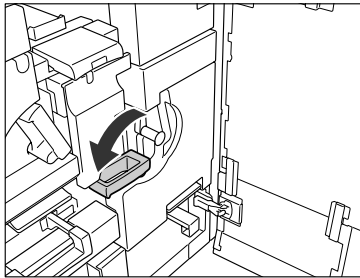

12 Pull out the primary fixing unit until it stops.

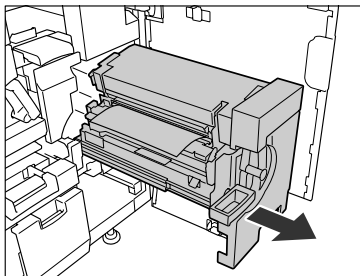

⚠ CAUTION

The parts located around the fixing unit are subject to high-temperatures. When removing jammed paper, take care not to touch anything in this area, except for the cover.

13 Remove any jammed paper.

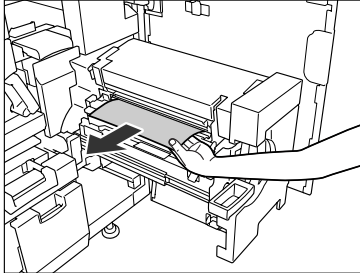

14 Open the cover (C-A5).

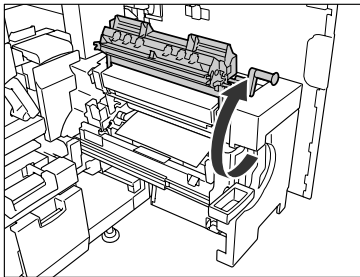

6

15 Remove any jammed paper.

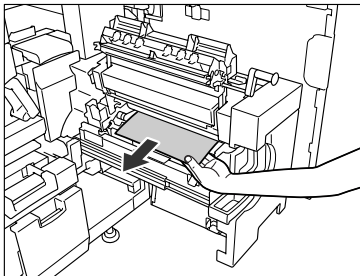

⚠ CAUTION

The parts located around the fixing unit are subject to high-temperatures. When removing jammed paper, take care not to touch anything in this area, except for the cover.

16 Close the cover (C-A5) until it clicks into place.

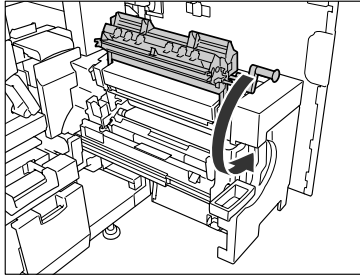

⚠ CAUTION

When closing the cover, be careful not to get your fingers caught, as this may result in personal injury.

17 Close the primary fixing unit until it clicks into place.

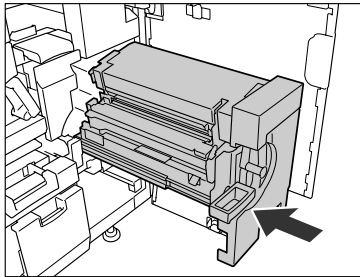

18 Return the lever (C-A4) to its original position.

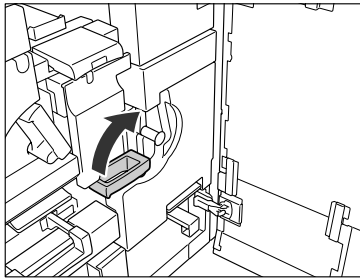

19 Close the front cover of the sub station.

Close the left side of the front cover first.

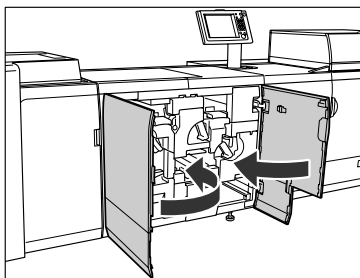

20 Follow the instructions on the touch panel display.



NOTE

The screen indicating the location of the paper jam is displayed on the touch panel display until the paper jam is entirely cleared. For more information, see "3 Screens Indicating the Locations of Paper Jams," on p. 8.

Secondary Fixing Assembly

1 Open the front cover of the sub station.

Open the right side of the front cover first.

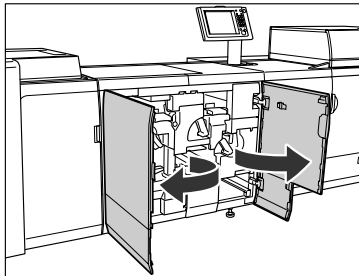

6

2 Open the guide (C-B1).

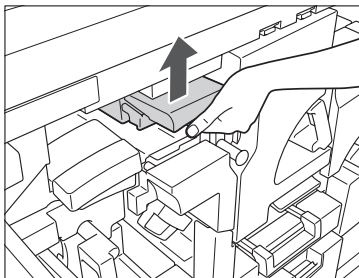

⚠ CAUTION

When opening the guide, be careful not to get your fingers caught, as this may result in personal injury.

3 Grip the lever to open the guide (C-B2).

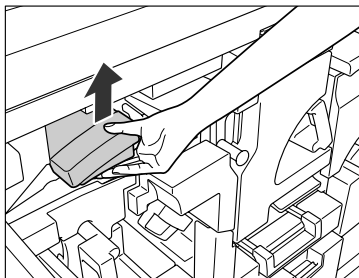

⚠ CAUTION

When opening the guide, be careful not to get your fingers caught, as this may result in personal injury.

4 Remove any jammed paper.

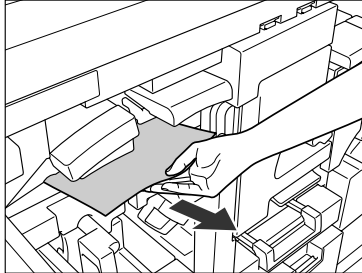

5 Lift up the guide (C-B2) and close it.

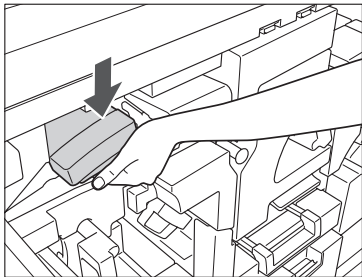

⚠ CAUTION

When closing the guide, be careful not to get your fingers caught, as this may result in personal injury.

6 Close the guide (C-B1).

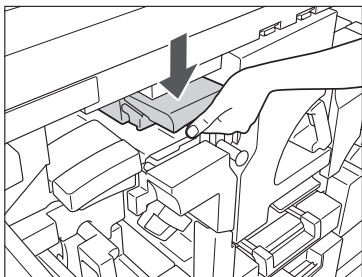

⚠ CAUTION

When closing the guide, be careful not to get your fingers caught, as this may result in personal injury.

7 Open the guide (C-B3).

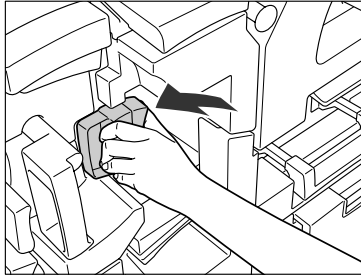

⚠ CAUTION

When opening the guide, be careful not to get your fingers caught, as this may result in personal injury.

8 Remove any jammed paper.

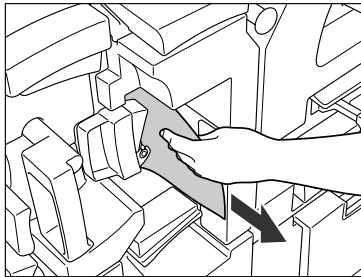

9 Close the guide (C-B3).

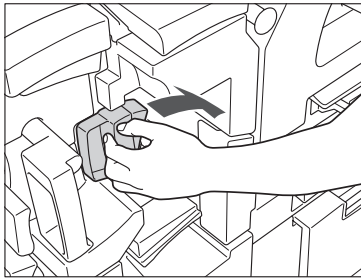

10 Tilt the lever (C-B4) to the left.

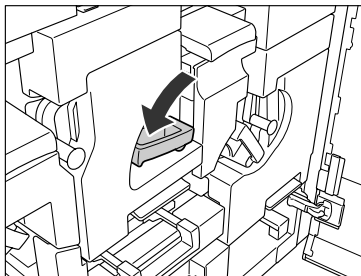

11 Pull out the secondary fixing unit until it stops.

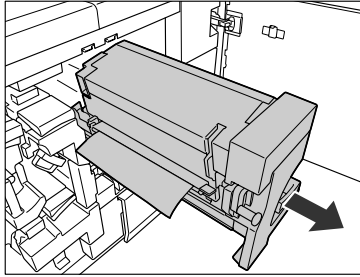

⚠ CAUTION

The parts located around the fixing unit are subject to high-temperatures. When removing jammed paper, take care not to touch anything in this area, except for the cover.

12 Open the cover (C-B5).

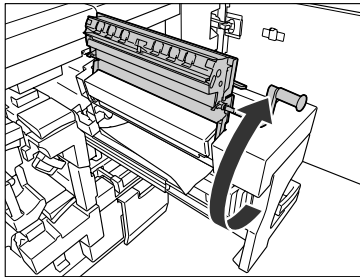

13 Remove any jammed paper.

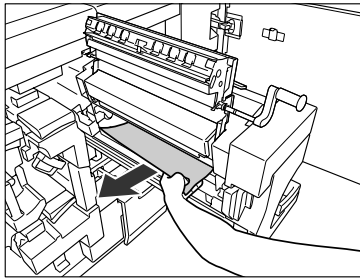

14 Close the cover (C-B5) slowly.

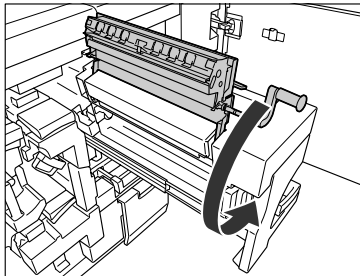

⚠ CAUTION

When closing the cover, be careful not to get your fingers caught, as this may result in personal injury.

15 Lift up the guide (C-B6), and remove any jammed paper.

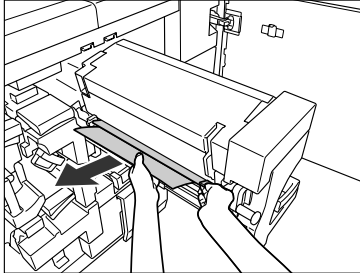

16 Close the secondary fixing unit until it clicks into place.

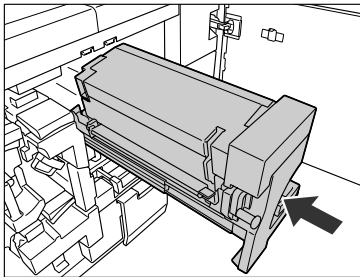

17 Return the lever (C-B4) to its original position.

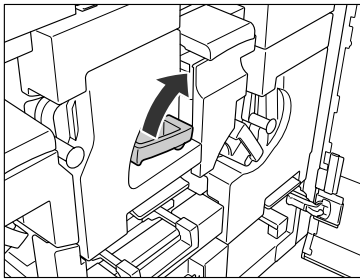

18 Close the front cover of the sub station.

Close the left side of the front cover first.

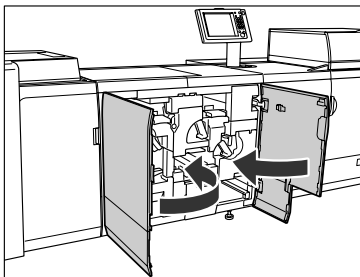

19 Follow the instructions on the touch panel display.

 NOTE

The screen indicating the location of the paper jam is displayed on the touch panel display until the paper jam is entirely cleared. For more information, see "3 Screens Indicating the Locations of Paper Jams," on p. 8.

Delivery/Reverse Unit

1 Open the front cover of the sub station.

Open the right side of the front cover first.

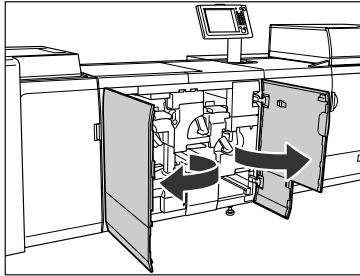

2 Grip the guide (C-C1), and open it.

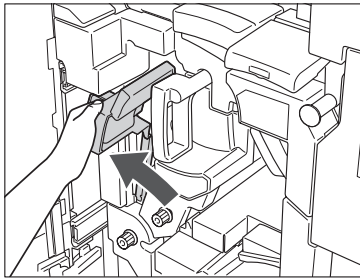

The guide (C-C2) opens at the same time.

 **CAUTION**

When opening the guide, be careful not to get your fingers caught, as this may result in personal injury.

3 Remove any jammed paper.



- 4** Turn the dial (C-C3) in the direction of the arrow (counterclockwise).

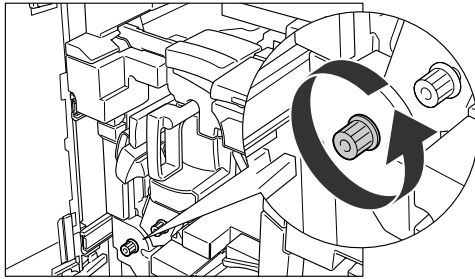

- 5** Remove any jammed paper.

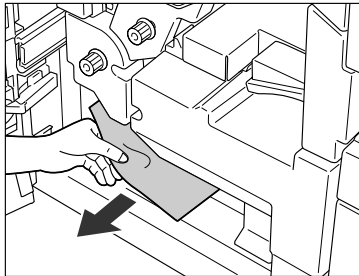

- 6** Close the guide (C-C1).

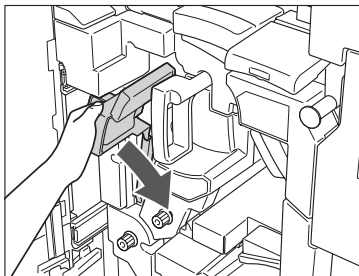

Close the guide (C-C2) at the same time.

- 7** Open the guide (C-D1).

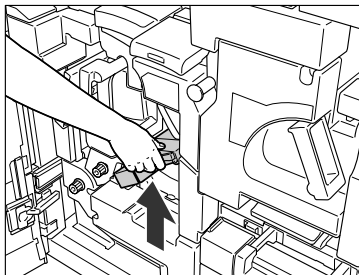

⚠ CAUTION

When opening the guide, be careful not to get your fingers caught, as this may result in personal injury.

8 Remove any jammed paper.

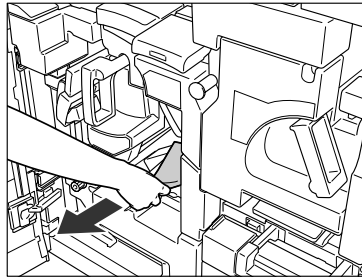

9 Turn the dial (C-D2) in the direction of the arrow (counterclockwise).

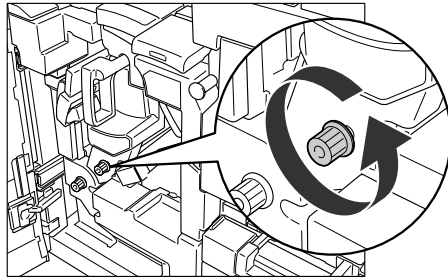

10 Remove any jammed paper.

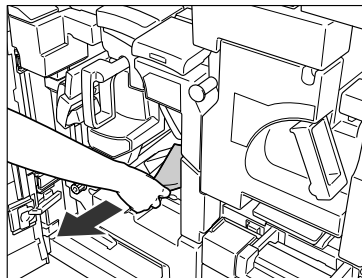

11 Lift up the guide (C-D1), and close it.

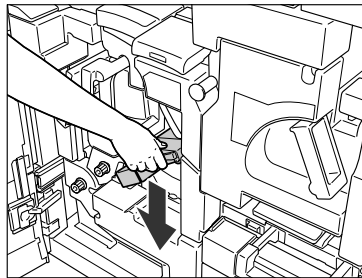

12 Tilt the lever (C-D3) to the right.

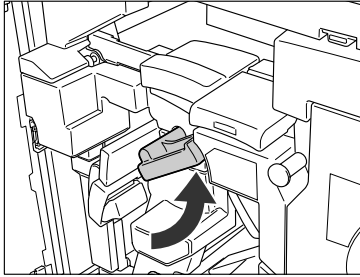

13 Pull out the delivery/reverse unit until it stops.

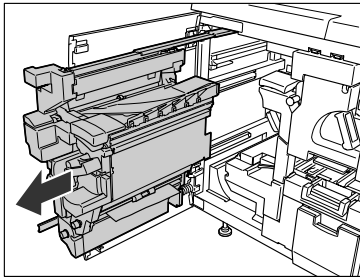

14 Lift up the guide (C-D4), and remove any jammed paper.

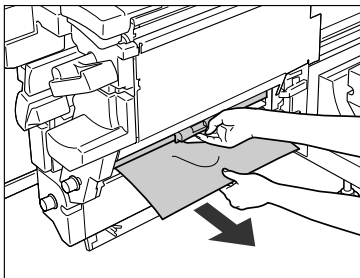

15 Close the delivery/reverse unit until it clicks into place.

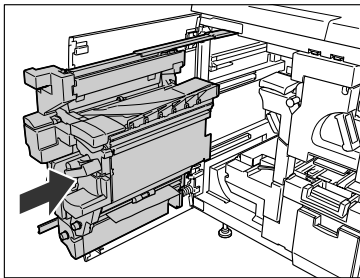

16 Return the lever (C-D3) to its original position.

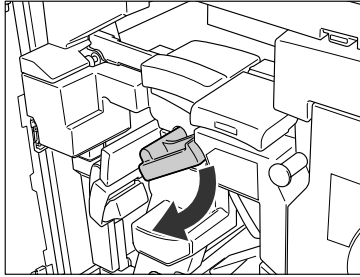

17 Open the guide (C-E).

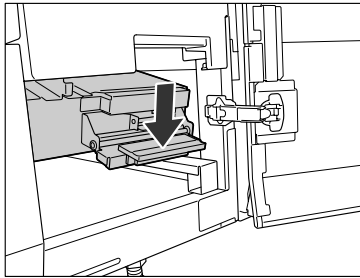

18 Remove any jammed paper.

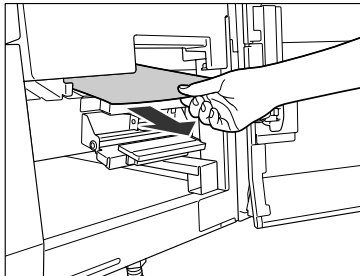

19 Close the guide (C-E) until it clicks into place.

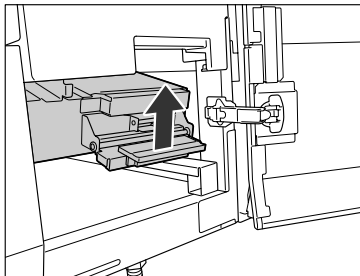

CAUTION

When closing the guide, be careful not to get your fingers caught, as this may result in personal injury.

20 Close the front cover of the sub station.

Close the left side of the front cover first.

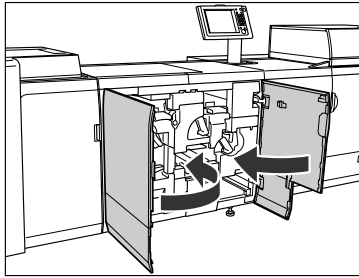

21 Follow the instructions on the touch panel display.

NOTE

The screen indicating the location of the paper jam is displayed on the touch panel display until the paper jam is entirely cleared. For more information, see "3 Screens Indicating the Locations of Paper Jams," on p. 8.

Feeder (DADF-R1) (Optional)

6

If a paper jam occurs in the Feeder (DADF-R1), the screen indicating the instructions on how to clear the paper jam appears on the touch panel display. Check the location of the paper jam, and follow the procedure described below, and the procedure that appears on the touch panel display, to remove the jammed paper.

CAUTION

- When removing jammed originals or paper, take care not to cut your hands on the edges of the originals.
- When removing jammed originals or paper, take care not to cut your hands on the inside of the machine. If you cannot remove the paper, contact your local authorized Canon dealer.

1 Open the feeder cover, and remove any originals remaining in the feeder.

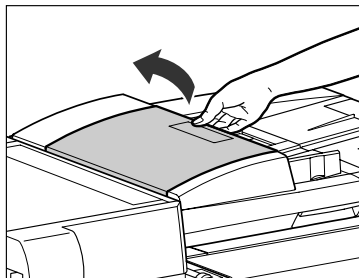

- 2** Open the feeder cover completely, and remove any jammed originals.

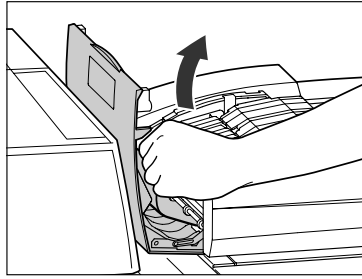

- 3** Open the inner cover of the feeder, holding by its tab.

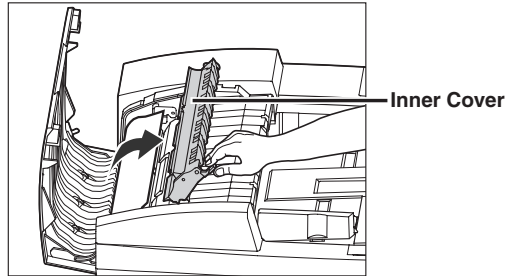

- 4** Remove any jammed originals.

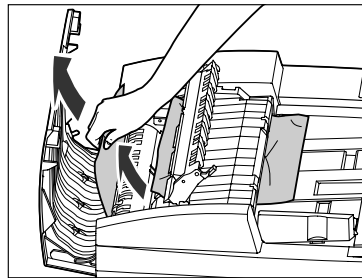

- 5** Close the inner cover of the feeder.

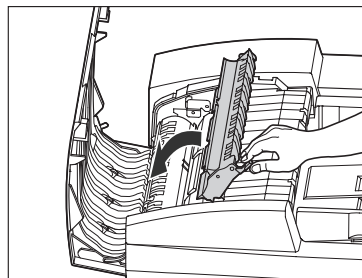

⚠ CAUTION

When closing the cover, be careful not to get your fingers caught, as this may result in personal injury.

- 6** Lift the feeder, and remove any jammed originals from the lower left cover.

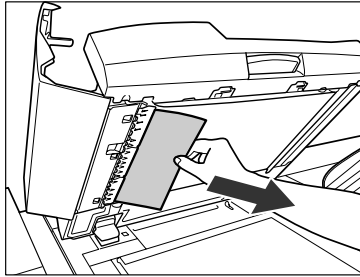

- 7** Open the lower right cover, and remove any jammed originals.

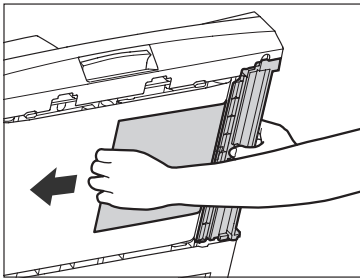

- 8** Remove any jammed originals from the platen glass.

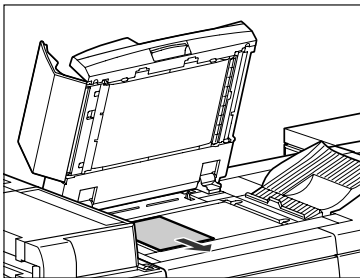

- 9** Close the feeder.

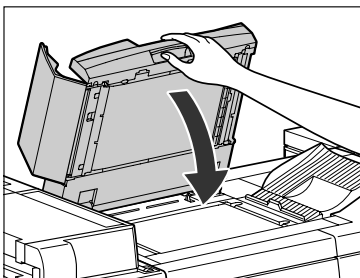

⚠ CAUTION

Close the feeder gently to avoid catching your hand, as this may result in personal injury.

10 Close the feeder cover.

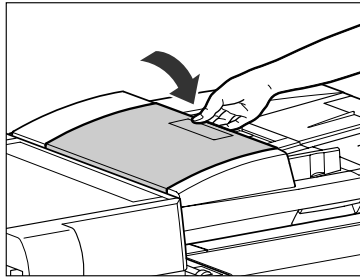

CAUTION

When closing the feeder, be careful not to get your fingers caught, as this may result in personal injury.

11 Follow the instructions on the touch panel display.

NOTE

The screen indicating the location of the paper jam repeatedly appears on the touch panel display until the paper jam is entirely cleared. For more information, see "3 Screens Indicating the Locations of Paper Jams," on p. 8.

SADF Tray

If a paper jam occurs inside the SADF tray, the screen indicating the instructions on how to clear the paper jam appears on the touch panel display. Check the location of the paper jam, and follow the procedure described below, and the procedure that appears on the touch panel display, to remove the jammed paper.

CAUTION

- When removing jammed originals or paper, take care not to cut your hands on the edges of the originals.
- When removing jammed originals or paper, take care not to cut your hands on the inside of the machine. If you cannot remove the paper, contact your local authorized Canon dealer.

1 Remove any jammed originals from the SADF tray.

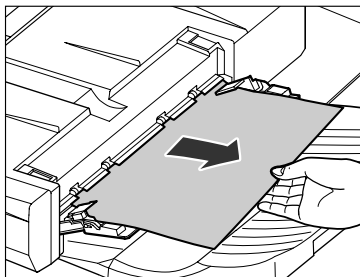

2 Lift the feeder, and then close it.

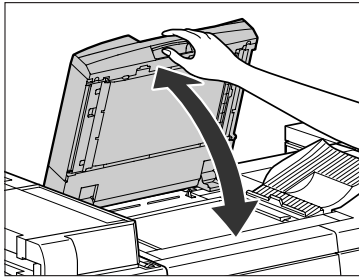

CAUTION

Close the feeder gently to avoid catching your hand, as this may result in personal injury.

3 Follow the instructions on the touch panel display.

NOTE

The screen indicating the location of the paper jam repeatedly appears on the touch panel display until the paper jam is entirely cleared. For more information, see "3 Screens Indicating the Locations of Paper Jams," on p. 8.

Between the Main Unit and the POD Deck-A1/Secondary POD Deck-A1, or Between the Main Unit and the Paper Deck-AC1 (Main Unit Side)

If a paper jam occurs between the main unit and the POD Deck or between the main unit and the Paper Deck-AC1, a screen indicating the location of the paper jam and instructions on how to clear the paper jam appears on the touch panel display.

Follow the procedure described below to remove the jammed paper.

CAUTION

- When removing jammed originals or paper, take care not to cut your hands on the edges of the originals.
- When removing jammed originals or paper, take care not to cut your hands on the inside of the machine. If you cannot remove the paper, contact your local authorized Canon dealer.

NOTE

If you attach the POD Deck-A1/Secondary POD Deck-A1 or the Paper Deck-AC1, you can remove the jammed paper following the same procedure. However, this manual explains the procedure using the POD Deck-A1/Secondary POD Deck-A1.

1 Perform the following operations.

● If the POD Deck-A1/Secondary POD Deck-A1 is attached:

- Open the front cover of the buffer pass unit.

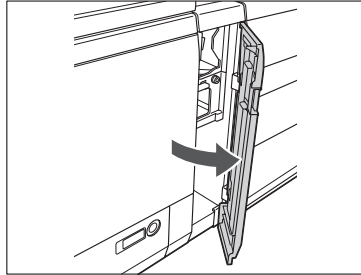

● If the Paper Deck-AC1 is attached:

- Press the release button, and move the paper deck away from the main unit.

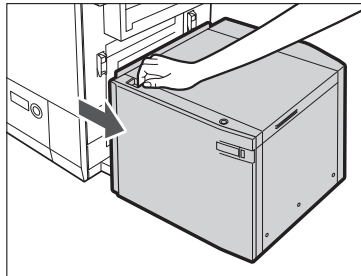

2 Press the button to open the cover (A-A1).

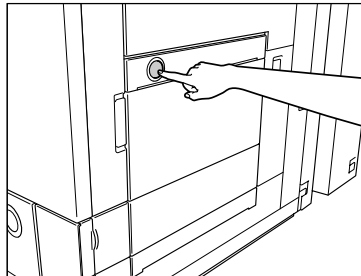

3 Remove any jammed paper.

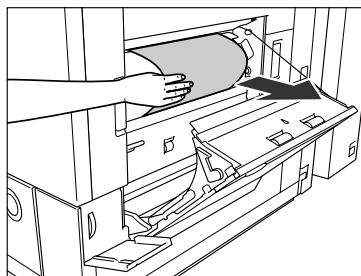

- 4** Turn the dial (A-A2) in the direction of the arrow, and remove any jammed paper.

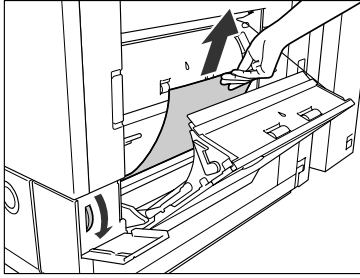

- 5** Push the lever to open the guide (A-A3).

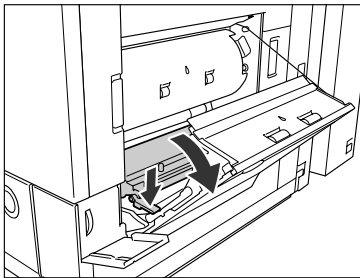

- 6** Remove any jammed paper.

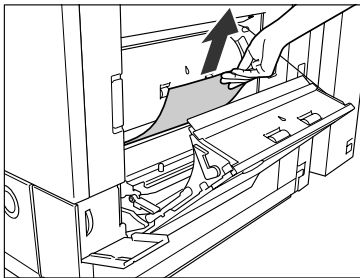

- 7** Close the guide (A-A3).

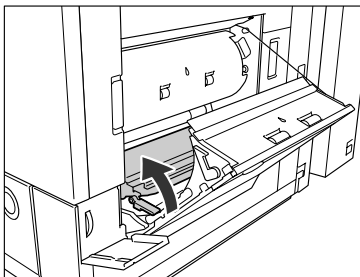

⚠ CAUTION

When closing the guide, be careful not to get your fingers caught, as this may result in personal injury.

8 Close the cover (A-A1) until it clicks into place.

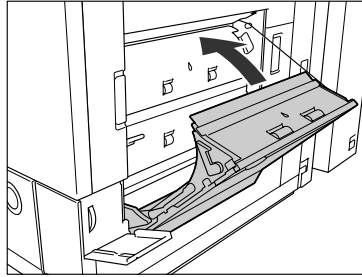

CAUTION

When closing the guide, be careful not to get your fingers caught, as this may result in personal injury.

9 Perform the following operations.

● If the POD Deck-A1/Secondary POD Deck-A1 is attached:

- Close the front cover of the buffer pass unit.

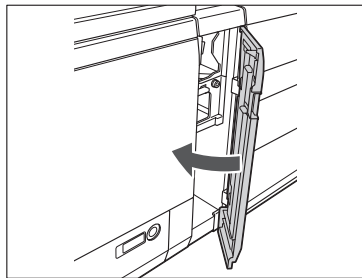

CAUTION

When closing the cover, be careful not to get your fingers caught, as this may result in personal injury.

● If the Paper Deck-AC1 is attached:

- Place your hand where the hand symbol (🖐️) is located on the paper deck and reconnect it to the main unit.

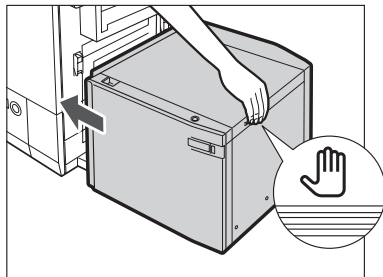

CAUTION

When reconnecting the paper deck to the main unit, be careful not to get your fingers caught, as this may result in personal injury.



IMPORTANT

When reconnecting the paper deck to the main unit, confirm that the cover (A-A1) of the main unit side is closed properly.

10 Follow the instructions on the touch panel display.



NOTE

The screen indicating the location of the paper jam is displayed on the touch panel display until the paper jam is entirely cleared. For more information, see "3 Screens Indicating the Locations of Paper Jams," on p. 8.

POD Deck-A1/Secondary POD Deck-A1 (Front Right Cover/Horizontal Pass) (Optional)

If a paper jam occurs inside the POD Deck, a screen indicating the location of the paper jam and instructions on how to clear the paper jam appears on the touch panel display.

Follow the procedure described below to remove the jammed paper.

CAUTION

- When removing jammed originals or paper, take care not to cut your hands on the edges of the originals.
- When removing jammed originals or paper, take care not to cut your hands on the inside of the machine. If you cannot remove the paper, contact your local authorized Canon dealer.



NOTE

If you attach only the POD Deck-A1 or the POD Deck-A1/Secondary POD Deck-A1, you can remove the jammed paper following the same procedure. However, this manual explains the procedure using only the POD Deck-A1.

1 Open the front right cover of the POD Deck.

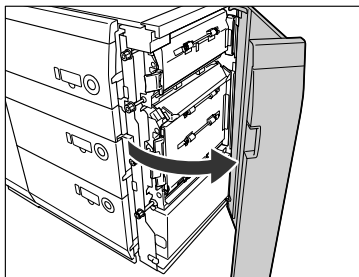

2 Open the guides (D-A1 and D-B1).

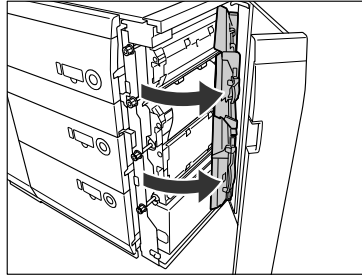

3 Remove any jammed paper.

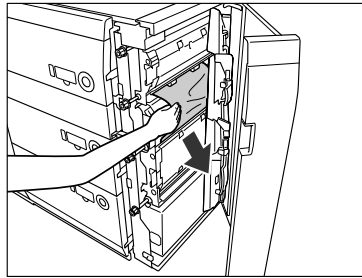

4 Turn the dials (D-A2, D-B2, and D-B3) in the direction of the arrow (clockwise), in the locations where paper jam has occurred.

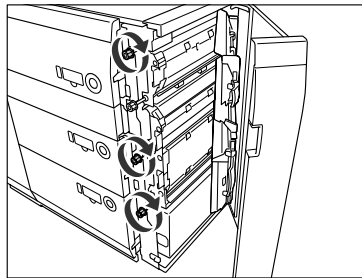

5 Remove any jammed paper.

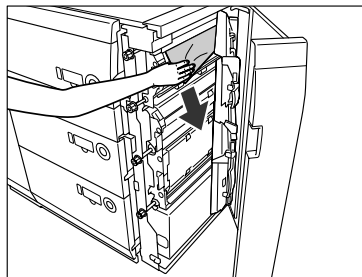

6 Close the guides (D-A1 and D-B1).

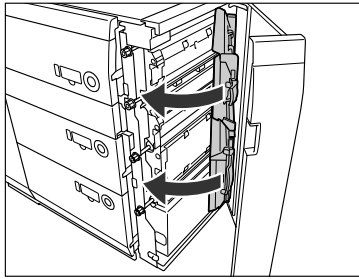

⚠ CAUTION

When closing the guide, be careful not to get your fingers caught, as this may result in personal injury.

7 Open the horizontal pass cover.

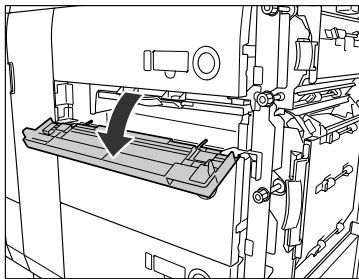

8 Open the guide (D-C1).

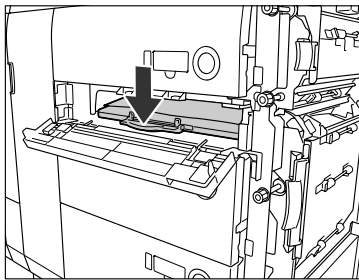

9 Remove any jammed paper.

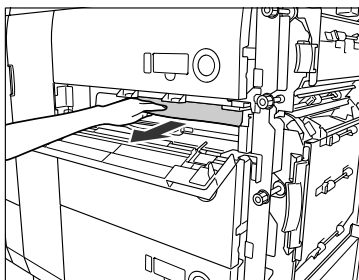

- 10** Turn the dial (D-C2) in the direction of the arrow (clockwise), and remove any jammed paper.

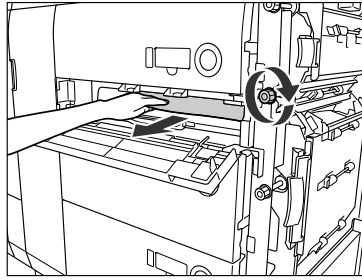

- 11** Close the guide (D-C1).

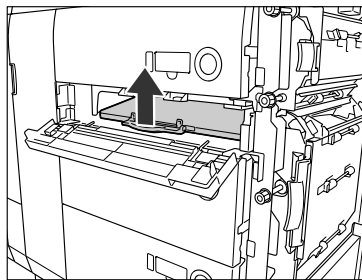

CAUTION

When closing the guide, be careful not to get your fingers caught, as this may result in personal injury.

- 12** Open the guide (D-C3) (only when the POD Deck-A1/Secondary POD Deck-A1 is attached).

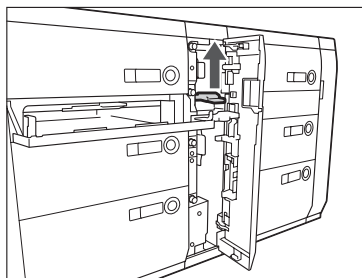

- 13** Remove any jammed paper (only when the POD Deck-A1/Secondary POD Deck-A1 is attached).

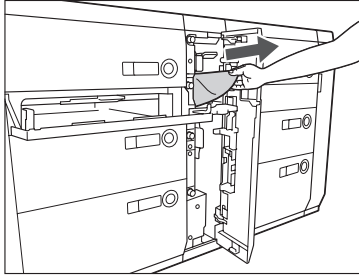

- 14** Close the guide (D-C3) (only when the POD Deck/Secondary POD Deck-A1 is attached).

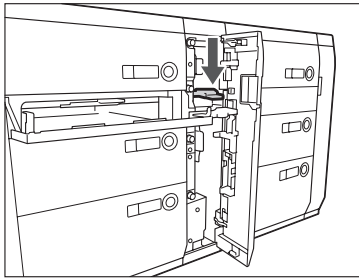

- 15** Close the horizontal pass cover.

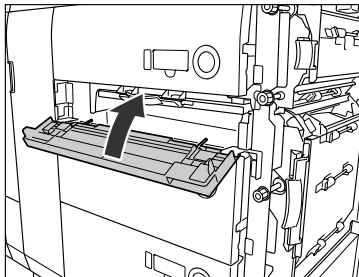

- 16** Close the front right cover of the POD Deck.

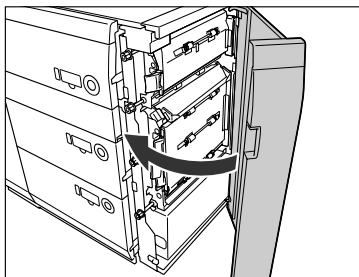

⚠ CAUTION

When closing the cover, be careful not to get your fingers caught, as this may result in personal injury.

Paper Decks of POD Deck-A1/Secondary POD Deck-A1 (Optional)

If a paper jam occurs in a paper deck of the POD Deck, a screen indicating the location of the paper jam and instructions on how to clear the paper jam appears on the touch panel display.

Follow the procedure described below to remove the jammed paper.

CAUTION

- When removing jammed originals or paper, take care not to cut your hands on the edges of the originals.
- When removing jammed originals or paper, take care not to cut your hands on the inside of the machine. If you cannot remove the paper, contact your local authorized Canon dealer.

- 1** Push the open button of the paper deck indicated on the touch panel display.

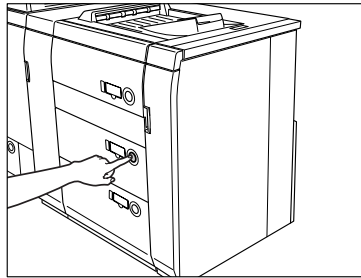

IMPORTANT

If the machine is in the Sleep mode (the touch panel is not displayed, and only the main power indicator is lit), you may not be able to open the paper deck. In this case, press the control panel power switch to reactivate the machine, then press the open button on the POD Deck-A1.

- 2** Grip the handle, and pull out the paper deck until it stops.

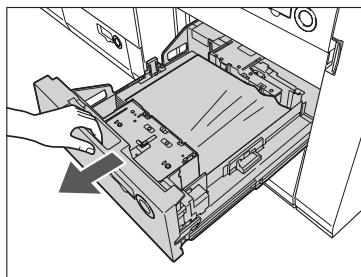

IMPORTANT

Do not pull out the paper deck by force.

3 Remove any jammed paper.

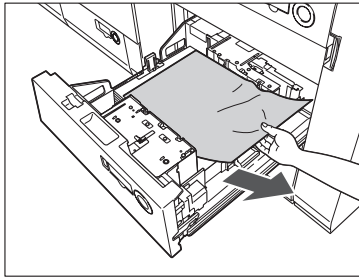

4 Gently push the paper deck back into the machine until it clicks into place in the closed position.

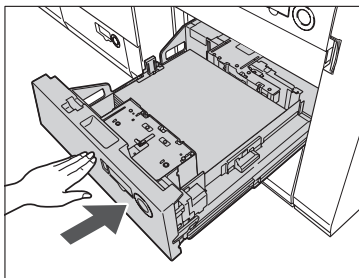

CAUTION

When returning the paper deck to its original position, be careful not to get your fingers caught, as this may result in personal injury.

5 Follow the instructions on the touch panel display.

NOTE

The screen indicating the location of the paper jam is displayed on the touch panel display until the paper jam is entirely cleared. For more information, see "3 Screens Indicating the Locations of Paper Jams," on p. 8.

Between the Main Unit and POD Deck-A1/Secondary POD Deck-A1 (POD Deck Side)

If a paper jam occurs between the main unit and POD Deck, a screen indicating the location of the paper jam and instructions on how to clear the paper jam appears on the touch panel display.

Follow the procedure described below to remove the jammed paper.

CAUTION

- When removing jammed originals or paper, take care not to cut your hands on the edges of the originals.
- When removing jammed originals or paper, take care not to cut your hands on the inside of the machine. If you cannot remove the paper, contact your local authorized Canon dealer.

-
- 1** Open the front cover of the buffer pass unit.

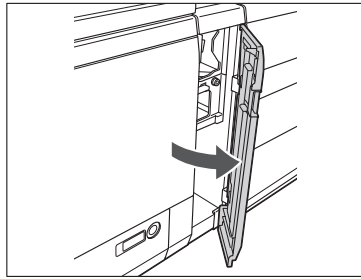

- 2** Open the guide (A-B1).

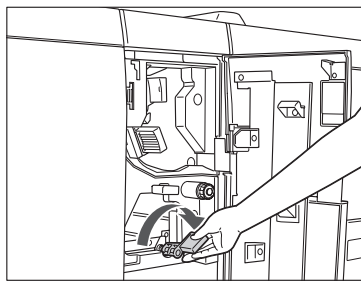

- 3** Remove any jammed paper.

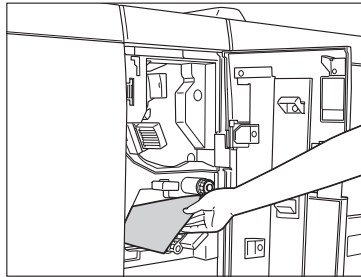

- 4** Turn the dial (A-B2) in the direction of the arrow, and remove any jammed paper.

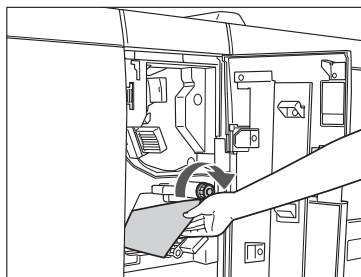

- 5** Turn the dial (A-B2) in the direction of the arrow, and open the guide (A-B3).

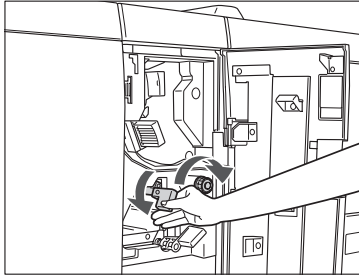

- 6** Remove any jammed paper.

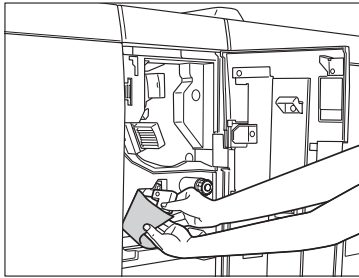

- 7** Close the guide (A-B3) until it clicks into place.

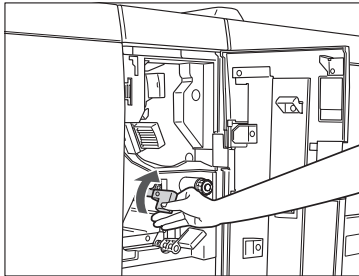

⚠ CAUTION

When closing the guide, be careful not to get your fingers caught, as this may result in personal injury.

- 8** Close the guide (A-B1).

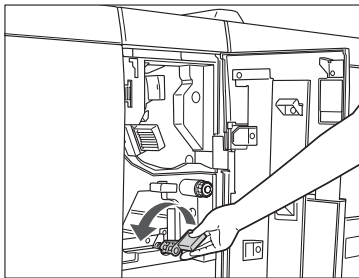

⚠ CAUTION

When closing the guide, be careful not to get your fingers caught, as this may result in personal injury.

9 Remove any jammed paper from the escape tray output exit.

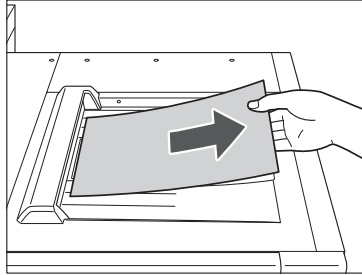

10 Open the guide (A-C1).

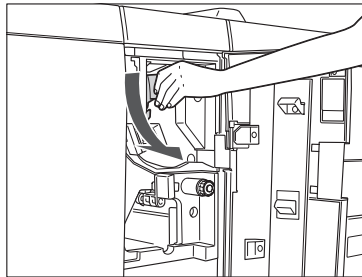

11 Open the guide (A-C2).

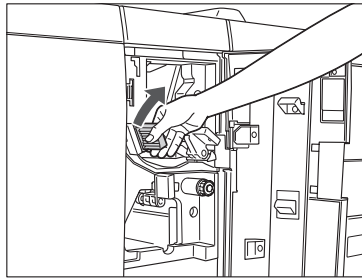

12 Remove any jammed paper.

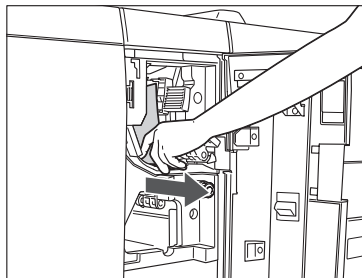

13 Close the guide (A-C2).



⚠ CAUTION

When closing the guide, be careful not to get your fingers caught, as this may result in personal injury.

14 Close the guide (A-C1).

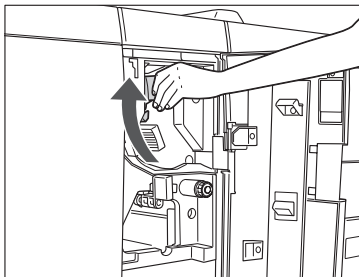

⚠ CAUTION

When closing the guide, be careful not to get your fingers caught, as this may result in personal injury.

15 Close the front cover of the buffer pass unit.

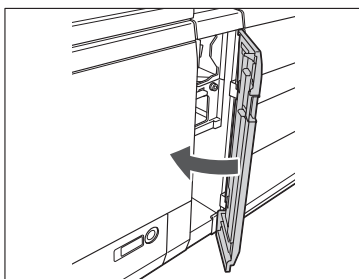

⚠ CAUTION

When closing the cover, be careful not to get your fingers caught, as this may result in personal injury.

16 Follow the instructions on the touch panel display.

 NOTE

The screen indicating the location of the paper jam is displayed on the touch panel display until the paper jam is entirely cleared. For more information, see "3 Screens Indicating the Locations of Paper Jams," on p. 8.

Stack Bypass-A1 (Optional)

If a paper jam occurs inside the stack bypass, a screen indicating the location of the paper jam and instructions on how to clear the paper jam appears on the touch panel display.

Follow the procedure described below to remove the jammed paper.

1 Remove all of the paper that is not jammed from the stack bypass.

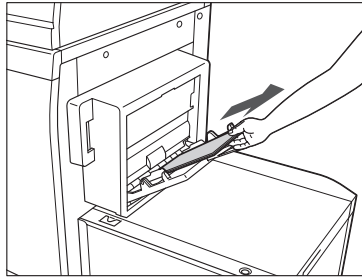

2 Open the stack bypass.

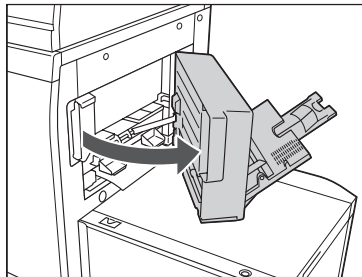

3 Remove any jammed paper.

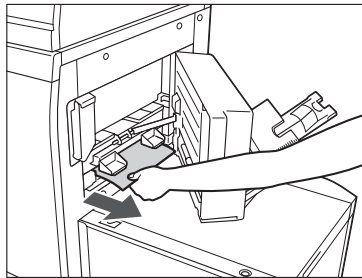

4 Close the stack bypass.

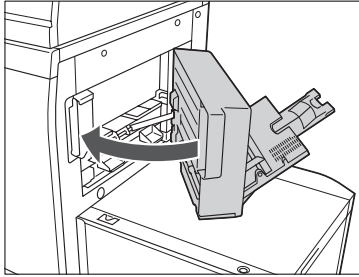

⚠ CAUTION

When closing the stack bypass, be careful not to get your fingers caught, as this may result in personal injury.

5 Press the release button, and move the paper deck away from the main unit.

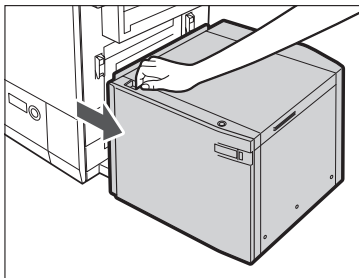

If the optional Paper Deck-AC1 is not attached, proceed to step 6.

6 Press the button to open the cover (A-A1).

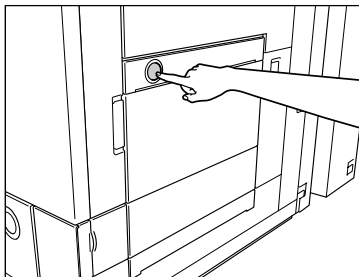

7 Remove any jammed paper.

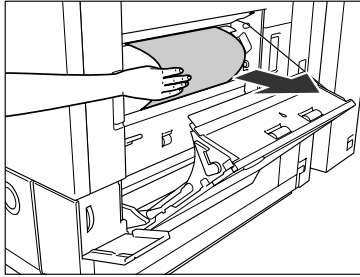

8 Turn the dial (A-A2) in the direction of the arrow, and remove any jammed paper.

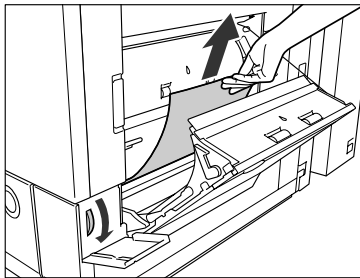

9 Push the lever to open the guide (A-A3).

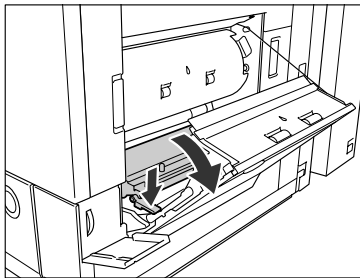

10 Remove any jammed paper.

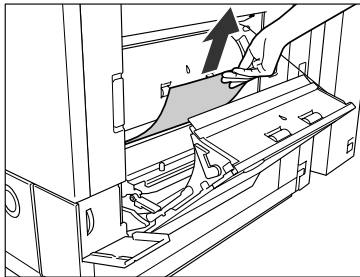

11 Close the guide (A-A3).

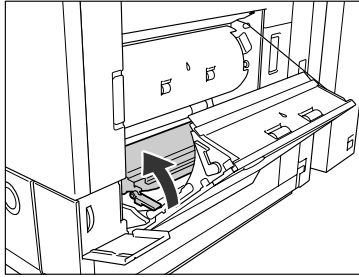

⚠ CAUTION

When closing the guide, be careful not to get your fingers caught, as this may result in personal injury.

12 Close the cover (A-A1) until it clicks into place.

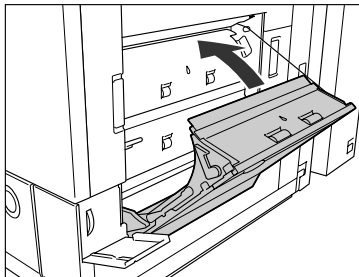

⚠ CAUTION

When closing the guide, be careful not to get your fingers caught, as this may result in personal injury.

13 Place your hand where the hand symbol (👉) is located on the paper deck and reconnect it to the main unit.

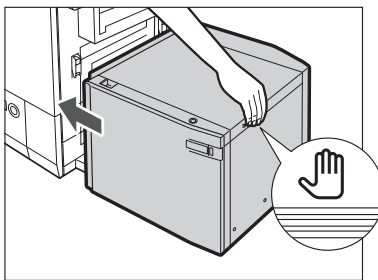

⚠ CAUTION

When reconnecting the paper deck to the main unit, be careful not to get your fingers caught, as this may result in personal injury.

👉 IMPORTANT

When reconnecting the paper deck to the main unit, confirm that the cover (A-A1) of the main unit side is closed properly.

If the optional Paper Deck-AC1 is not attached, proceed to step 14.

14 Close the stack bypass.

15 Follow the instructions on the touch panel display.

 NOTE

The screen indicating the location of the paper jam is displayed on the touch panel display until the paper jam is entirely cleared. For more information, see "3 Screens Indicating the Locations of Paper Jams," on p. 8.

Paper Deck-AC1 (Optional)

If a paper jam occurs in the optional paper deck, a screen indicating the location of the paper jam and instructions on how to clear the paper jam appears on the touch panel display.

Follow the procedure described below to remove the jammed paper.

CAUTION

- When removing jammed originals or paper, take care not to cut your hands on the edges of the originals.
- When removing jammed originals or paper, take care not to cut your hands on the inside of the machine. If you cannot remove the paper, contact your local authorized Canon dealer.

1 Press the release button, and move the paper deck away from the main unit.

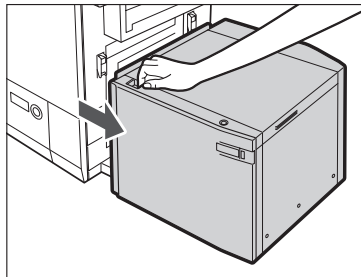

2 Remove any jammed paper from the feeding area.

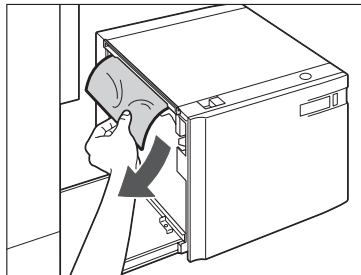

Paper can also be jammed in the feeding slot on the side of the main unit. Remove any jammed paper from the feeding slot in accordance with steps 2 to 8 of "Between the Main Unit and the POD Deck-A1/Secondary POD Deck-A1, or Between the Main Unit and the Paper Deck-AC1 (Main Unit Side)," on p. 55.

3 Press the open button to open the paper deck.

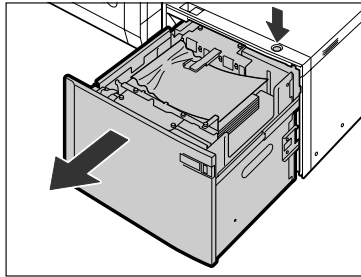

The inside lifter descends automatically.



IMPORTANT

If the machine is in the Sleep mode (the touch panel is not displayed, and only the main power indicator is lit), you may not be able to open the paper deck. In this case, press the control panel power switch to reactivate the machine, then press the open button on the paper deck.

4 Remove any jammed paper.

Look carefully, as jammed paper may be difficult to see.

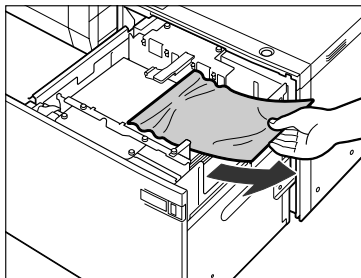

5 Close the paper deck.

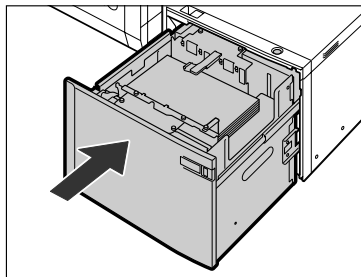

CAUTION

When closing the paper deck, be careful not to get your fingers caught, as this may result in personal injury.

- 6** Place your hand where the hand symbol (👉) is located on the paper deck and reconnect it to the main unit.

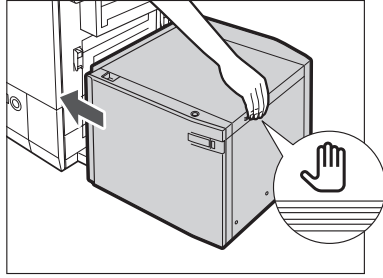

⚠ CAUTION

When reconnecting the paper deck to the main unit, be careful not to get your fingers caught, as this may result in personal injury.

👉 IMPORTANT

When reconnecting the paper deck to the main unit, confirm that the cover (A-A1) of the main unit side is closed properly.

- 7** Follow the instructions on the touch panel display.

📝 NOTE

The screen indicating the location of the paper jam repeatedly appears on the touch panel display until the paper jam is entirely cleared. For more information, see "3 Screens Indicating the Locations of Paper Jams," on p. 8.

Inside the Top Cover of the Finisher-AB1/Saddle Finisher-AB2 (Optional)

If a paper jam occurs when using the optional Finisher-AB1 or Saddle Finisher-AB2, a screen indicating the location of the paper jam and instructions on how to clear the paper jam appears on the touch panel display.

Follow the procedure described below to remove the jammed paper.

⚠ WARNING

There are some areas inside the machine which are subject to high-voltages. When removing jammed paper or when inspecting the inside of the machine, do not allow necklaces, bracelets, or other metal objects to touch the inside of the machine, as this may result in burns or electrical shock.

⚠ CAUTION

- When removing jammed originals or paper, take care not to cut your hands on the edges of the paper.
- When removing jammed originals or paper, take care not to cut your hands on the inside of the machine. If you cannot remove the paper, contact your local authorized Canon dealer.
- When removing paper which has become jammed inside the machine, take care not to allow the toner on the jammed paper to come into contact with your hands or clothing, as this will dirty your hands or clothing. If they become dirty, wash them immediately with cold water. Washing them with warm water will set the toner, and make it impossible to remove the toner stains.

- When removing paper which has become jammed inside the machine, remove the jammed paper gently to prevent the toner on the paper from scattering and getting into your eyes or mouth. If the toner gets into your eyes or mouth, wash them immediately with cold water and immediately consult a physician.

1 Open the front cover of the finisher.

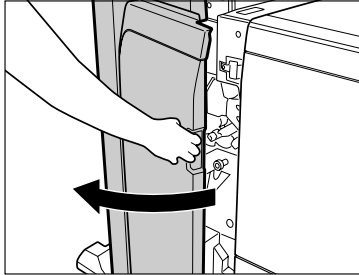

2 Press the button on the optional Punch Unit-V1 (F-A1), as far as it can go, to return the punch unit to its original position.

This procedure is only required if the optional Punch Unit-V1 is attached, and the button on the optional Punch Unit-V1 (F-A1) is protruding.

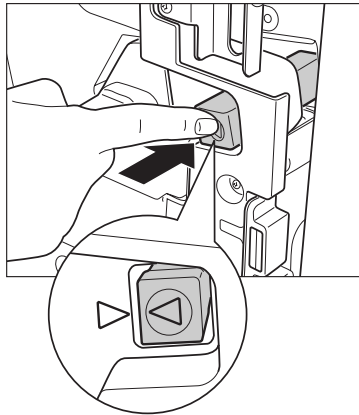

3 Open the entrance guide (F-A2).

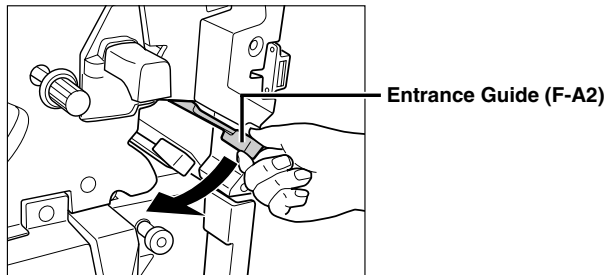

4 Remove any jammed paper.

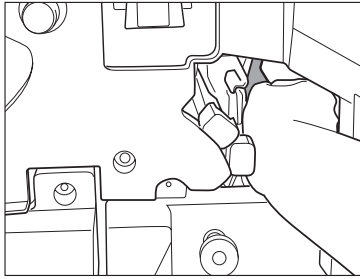

5 Close the entrance guide (F-A2).

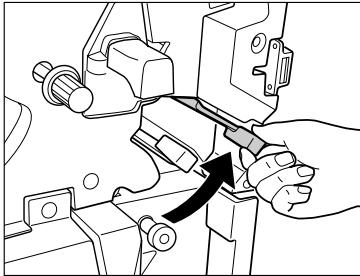

6 Lift the optional document insertion unit.

This procedure is only required if the optional Document Insertion Unit-C1 is attached.

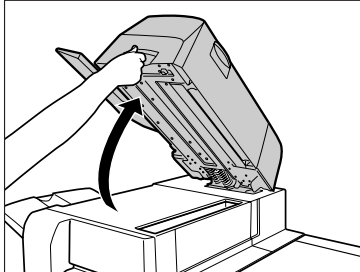

7 Open the top cover (F-A3) of the finisher, and check the inside of the finisher for any jammed paper.

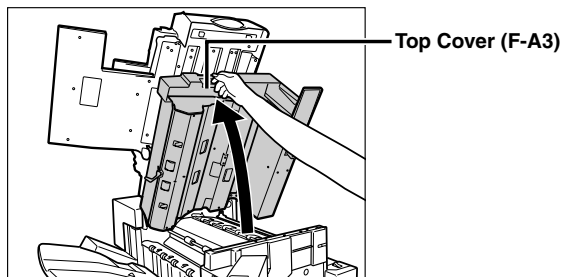

⚠ CAUTION

Open the top cover slowly, as opening it too fast may result in personal injury.



IMPORTANT

Do not turn OFF the main power switch of the finisher when you open the top cover to remove the jammed paper. If you do so accidentally, follow the procedures to turn OFF the main power switches of the attached optional equipments and the machine, and then back ON. (See "11 Main Power and Control Panel Power," on p. 118.)

8 Remove any jammed paper protruding from the right side of the finisher.

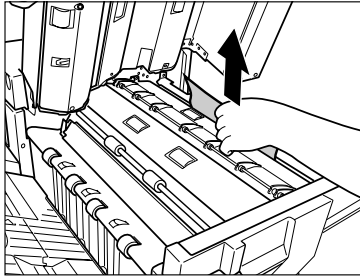

9 Remove any jammed paper protruding from the left side of the finisher.

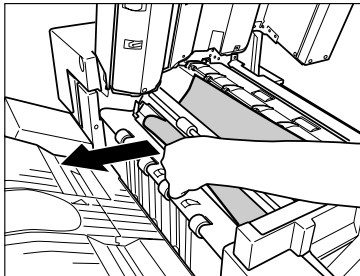

10 Tilt the delivery guide (F-A4).

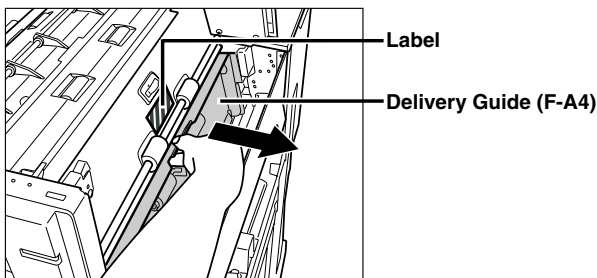

NOTE

Make sure to position the handle of the delivery guide properly (in the middle, and aligned with the designated label). If the delivery guide is not aligned properly with the label, it may not open.

11 Remove any jammed paper.

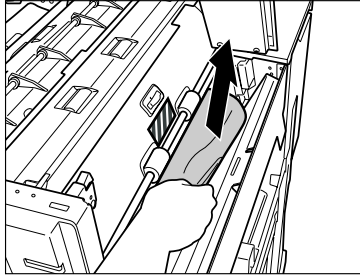

12 Return the delivery guide (F-A4) to its original position, making sure that it clicks into place.

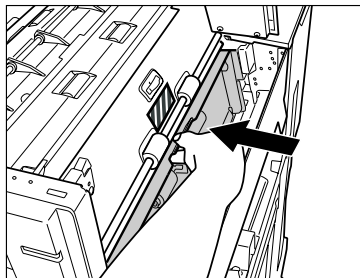

13 Close the top cover (F-A3) of the finisher.

After closing the top cover of the finisher, press down on the top cover, in the locations indicated by the labels to make sure the cover is securely closed.



CAUTION

When closing the top cover of the finisher, be careful not to get your fingers caught, as this may result in personal injury.

IMPORTANT

Do not turn OFF the main power switch of the finisher when you close the top cover. If you do so accidentally, follow the procedures to turn OFF the main power switches of the attached optional equipments and the machine, and then back ON. (See "11 Main Power and Control Panel Power," on p. 118.)

14 Close the document insertion unit.

This procedure is only required if the optional Document Insertion Unit-C1 is attached.

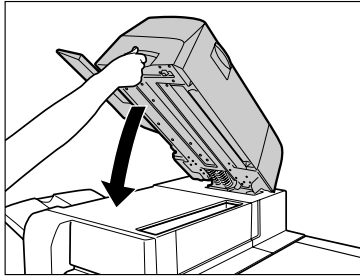

CAUTION

When closing the document insertion unit, be careful not to get your fingers caught, as this may result in personal injury.

15 Remove any jammed paper protruding from the opened part (F-A5) inside the finisher.

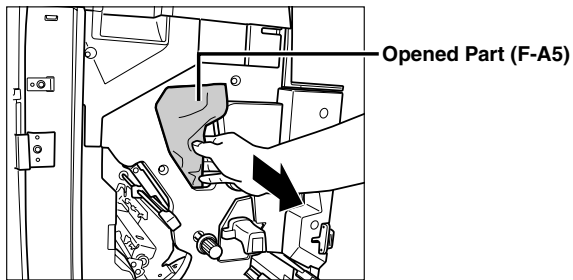

16 Close the front cover of the finisher.

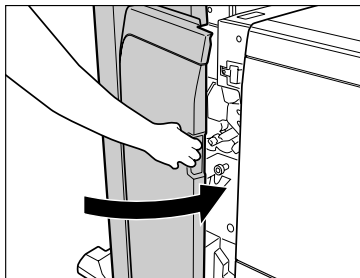

CAUTION

When closing the front cover of the finisher, be careful not to get your fingers caught, as this may result in personal injury.

17 Continue to follow the instructions on the touch panel display.

NOTE

The screen indicating the location of the paper jam is displayed on the touch panel display until the paper jam is entirely cleared. For more information, see "3 Screens Indicating the Locations of Paper Jams," on p. 8.

Inside the Front Cover of the Finisher-AB1/Saddle Finisher-AB2 (Optional)

If a paper jam occurs inside the front cover of the optional Finisher-AB1 or Saddle Finisher-AB2, a screen indicating the location of the paper jam and instructions on how to clear the paper jam appears on the touch panel display.

Follow the procedure described below to remove the jammed paper.

WARNING

There are some areas inside the machine which are subject to high-voltages. When removing jammed paper or when inspecting the inside of the machine, do not allow necklaces, bracelets, or other metal objects to touch the inside of the machine, as this may result in burns or electrical shock.

CAUTION

- When removing jammed originals or paper, take care not to cut your hands on the edges of the paper.
- When removing jammed originals or paper, take care not to cut your hands on the inside of the machine. If you cannot remove the paper, contact your local authorized Canon dealer.
- When removing paper which has become jammed inside the machine, take care not to allow the toner on the jammed paper to come into contact with your hands or clothing, as this will dirty your hands or clothing. If they become dirty, wash them immediately with cold water. Washing them with warm water will set the toner, and make it impossible to remove the toner stains.
- When removing paper which has become jammed inside the machine, remove the jammed paper gently to prevent the toner on the paper from scattering and getting into your eyes or mouth. If the toner gets into your eyes or mouth, wash them immediately with cold water and immediately consult a physician.

IMPORTANT

Take care when handling the optional equipment that is attached to the machine. When an optional unit's cover is opened to replace a staple cartridge, discard punch waste, or clear paper or staple jams, prints may still be output if other optional units are operating normally, and are not involved in the paper or staple jam removal procedure.

1 Open the front cover of the finisher.

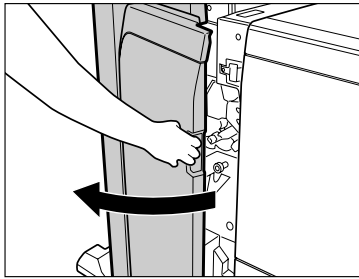

2 Open the guide (F-B1).

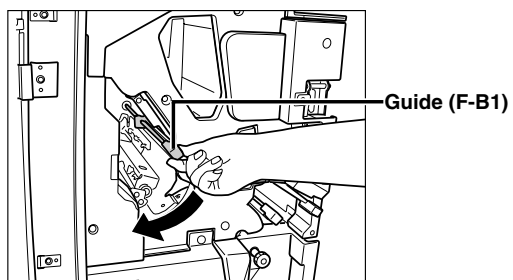

3 Remove any jammed paper.



4 Close the guide (F-B1).

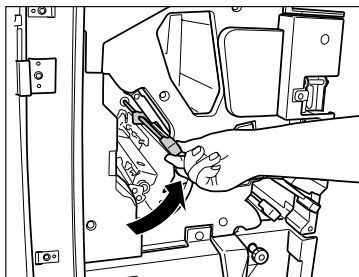

- 5** Turn the dial (F-B2) in the direction of the arrow (counterclockwise), to feed the jammed paper to the output slot (F-B3).

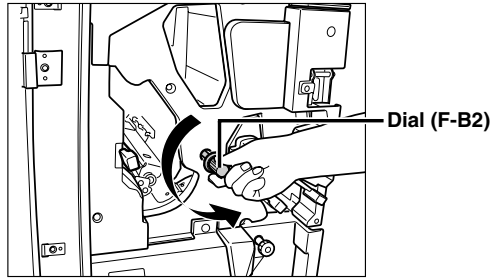

- 6** Open the output slot (F-B3), and remove any jammed paper.

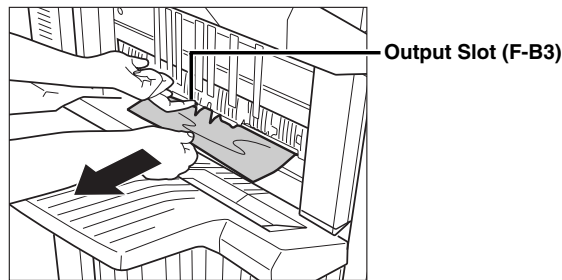

- 7** Close the front cover of the finisher.

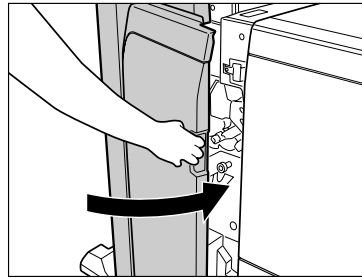

CAUTION

When closing the front cover of the finisher, be careful not to get your fingers caught, as this may result in personal injury.

- 8** Continue to follow the instructions on the touch panel display.

NOTE

The screen indicating the location of the paper jam is displayed on the touch panel display until the paper jam is entirely cleared. For more information, see "3 Screens Indicating the Locations of Paper Jams," on p. 8.

Document Insertion Unit-C1 (Optional)

If a paper jam occurs inside the optional Document Insertion Unit-C1, a screen indicating the location of the paper jam and instructions on how to clear the paper jam appears on the touch panel display.

Follow the procedure described below to remove the jammed paper.

CAUTION

- When removing jammed originals or paper, take care not to cut your hands on the edges of the paper.
- When removing jammed originals or paper, take care not to cut your hands on the inside of the machine. If you cannot remove the paper, contact your local authorized Canon dealer.
- When removing paper which has become jammed inside the machine, take care not to allow the toner on the jammed paper to come into contact with your hands or clothing, as this will dirty your hands or clothing. If they become dirty, wash them immediately with cold water. Washing them with warm water will set the toner, and make it impossible to remove the toner stains.
- When removing paper which has become jammed inside the machine, remove the jammed paper gently to prevent the toner on the paper from scattering and getting into your eyes or mouth. If the toner gets into your eyes or mouth, wash them immediately with cold water and immediately consult a physician.

IMPORTANT

- This section assumes that the optional Document Insertion Unit-C1 is attached to the optional Finisher-AB1 or Saddle Finisher-AB2.
- Take care when handling the optional equipment that is attached to the machine. When an optional unit's cover is opened to replace a staple cartridge, discard punch waste, or clear paper or staple jams, prints may still be output if other optional units are operating normally, and are not involved in the paper or staple jam removal procedure.

NOTE

This procedure is necessary only if the optional Document Insertion Unit-C1 is attached.

1 Remove all of the paper that is not jammed from the document insertion unit.

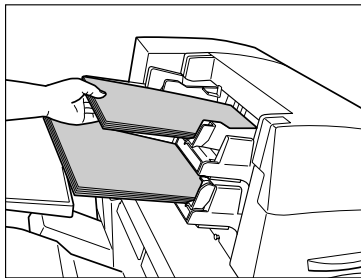

2 Open the upper cover of the document insertion unit.

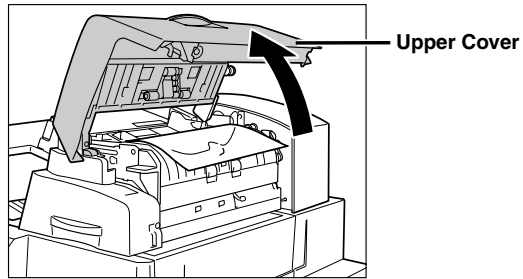

3 Remove any jammed paper.

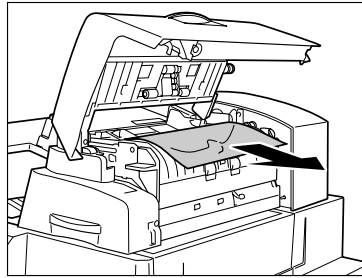

4 Open the inner cover (F-I) of the document insertion unit.

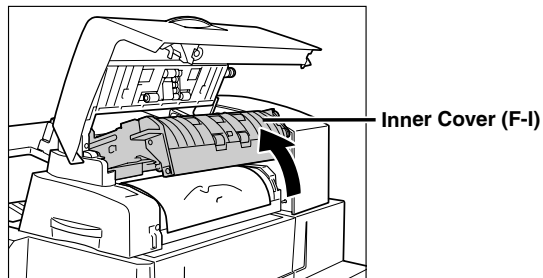

5 Remove any jammed paper inside the inner cover (F-I).

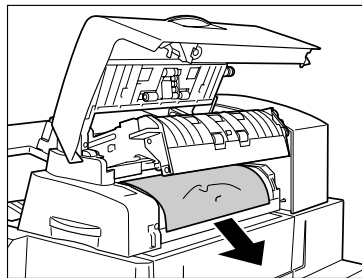

6 Close the inner cover (F-I) and upper cover of the document insertion unit.

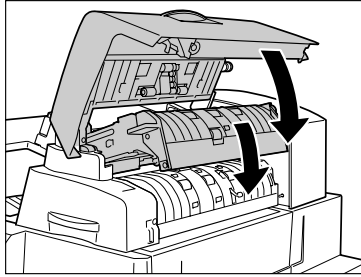

⚠ CAUTION

When closing the inner cover and upper cover of the document insertion unit, be careful not to get your fingers caught, as this may result in personal injury.

7 Lift the document insertion unit.

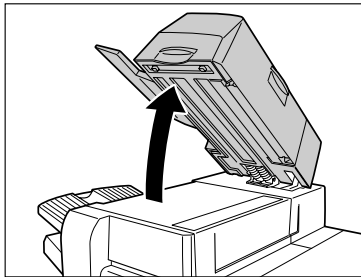

✎ NOTE

If you cannot lift the document insertion unit, the paper may be jammed inside the optional finisher. Pulling jammed paper out of the finisher by force may leave parts of the paper torn inside. For instructions on removing jammed paper inside the finisher, see "Inside the Top Cover of the Finisher-AB1/Saddle Finisher-AB2 (Optional)," on p. 76.

8 Remove any jammed paper inside the document insertion unit.

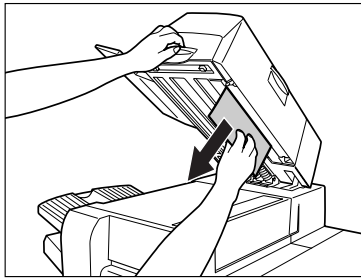

9 Close the document insertion unit.

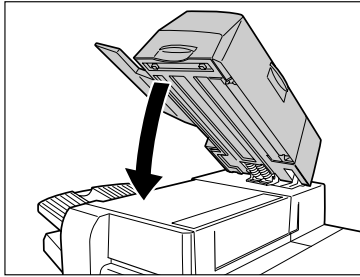

CAUTION

When closing the document insertion unit, be careful not to get your fingers caught, as this may result in personal injury.

10 Reload the paper into the document insertion unit.

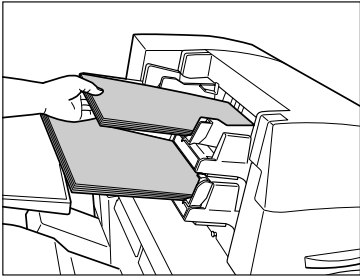

11 Continue to follow the instructions on the touch panel display.

NOTE

The screen indicating the location of the paper jam is displayed on the touch panel display until the paper jam is entirely cleared. For more information, see "3 Screens Indicating the Locations of Paper Jams," on p. 8.

Saddle Sticher Unit (Optional)

If a paper jam occurs inside the saddle sticher unit of the optional Saddle Finisher-AB2, a screen indicating the location of the paper jam and instructions on how to clear the paper jam appears on the touch panel display.

Follow the procedure described below to remove the jammed paper.

WARNING

There are some areas inside the machine which are subject to high-voltages. When removing jammed paper or when inspecting the inside of the machine, do not allow necklaces, bracelets, or other metal objects to touch the inside of the machine, as this may result in burns or electrical shock.

CAUTION

- When removing jammed originals or paper, take care not to cut your hands on the edges of the paper.

- When removing jammed originals or paper, take care not to cut your hands on the inside of the machine. If you cannot remove the paper, contact your local authorized Canon dealer.
- When removing paper which has become jammed inside the machine, take care not to allow the toner on the jammed paper to come into contact with your hands or clothing, as this will dirty your hands or clothing. If they become dirty, wash them immediately with cold water. Washing them with warm water will set the toner, and make it impossible to remove the toner stains.
- When removing paper which has become jammed inside the machine, remove the jammed paper gently to prevent the toner on the paper from scattering and getting into your eyes or mouth. If the toner gets into your eyes or mouth, wash them immediately with cold water and immediately consult a physician.



IMPORTANT

Take care when handling the optional equipment that is attached to the machine. When an optional unit's cover is opened to replace a staple cartridge, discard punch waste, or clear paper or staple jams, prints may still be output if other optional units are operating normally, and are not involved in the paper or staple jam removal procedure.

1 Open the front cover of the finisher.

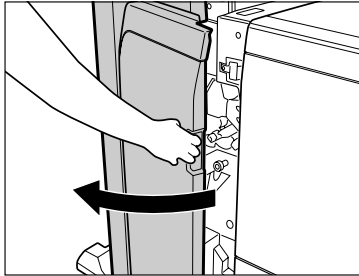

2 Open the guide (F-C1).

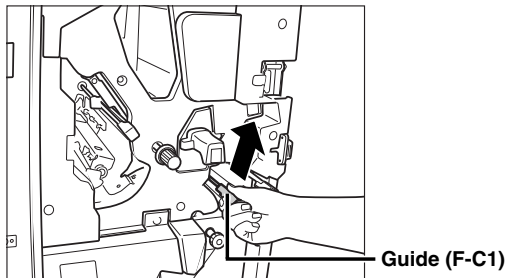

3 Turn the lower dial (F-C2) in the direction of the arrow (counterclockwise), to feed the jammed paper to the guide (F-C1).

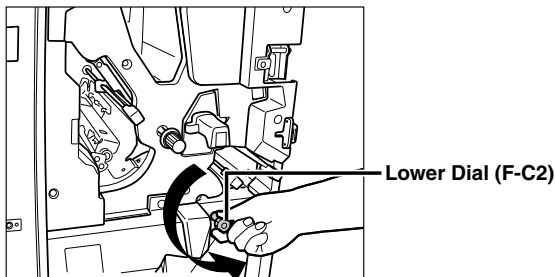

- 4** Turn the upper knob (F-C2) in the direction of the arrow (counterclockwise), to feed the jammed paper to the guide (F-C1).

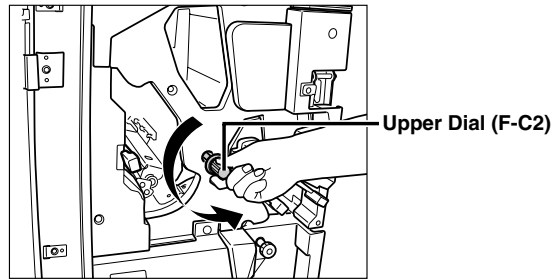

- 5** Remove any jammed paper.

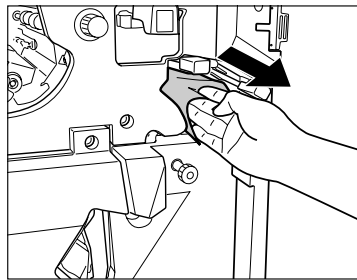

- 6** Close the guide (F-C1).



- 7** If the lamp is ON, while pushing in the dial (F-C3), turn it in the direction of the arrow (clockwise) until the lamp turns off.

Turning the dial, feeds the jammed paper to the delivery guide of the booklet tray.

If the optional Booklet Trimmer-C1 is attached, turning the dial feeds the jammed paper to the feeding belt of the booklet trimmer.

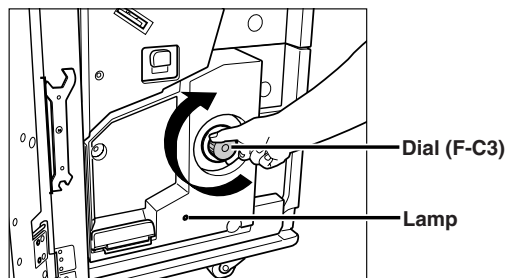

If the lamp is OFF, proceed to step 9.

8 Remove any jammed paper protruding from the booklet tray.

If the optional Booklet Trimmer-C1 is attached, remove any jammed paper protruding from the feeding belt.

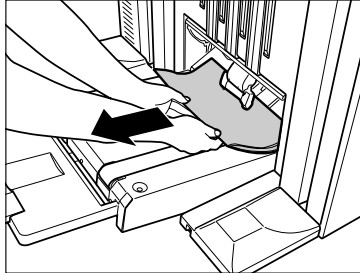

9 Pull out the saddle stitcher unit (F-C4).

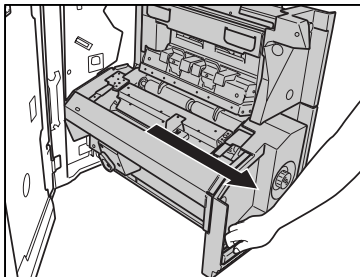

10 Open the right cover of the saddle stitcher unit (F-C5), and remove any jammed paper.

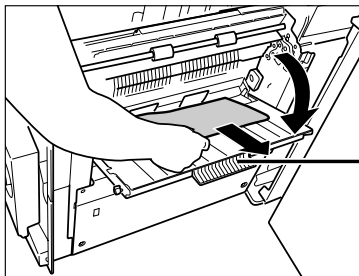

Right Cover of
the Saddle Stitcher
Unit (F-C5)

11 Close the right cover of the saddle stitcher unit (F-C5).

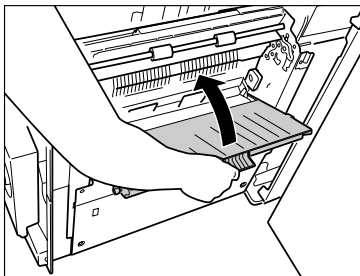

CAUTION

When closing the right cover of the saddle stitcher unit, be careful not to get your fingers caught, as this may result in personal injury.

12 Turn the dial on the pressing unit (F-C6) in the direction of the arrow (counterclockwise), and push it as far left as it will go.

If the pressing unit is in its proper position, this procedure is unnecessary.

The pressing unit is for ensuring a clean fold in the center of the paper to create a booklet. If the pressing unit is not in its proper position, the paper to be saddle stitched cannot be fed to the booklet tray.

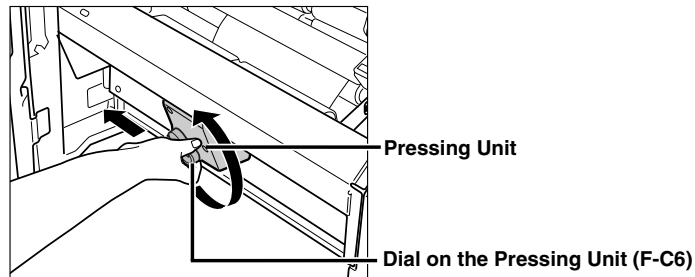

13 Open the delivery guide (F-C8).

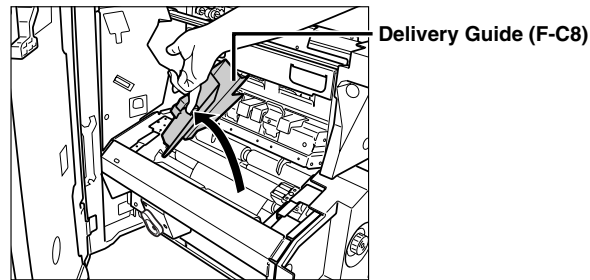

14 While pushing in the dial (F-C7), turn it in the direction of the arrow (clockwise) until the lamp turns off. Remove any jammed paper.

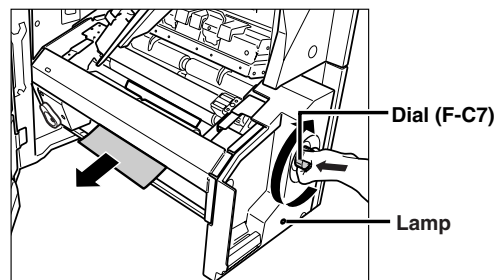

15 Close the delivery guide (F-C8).

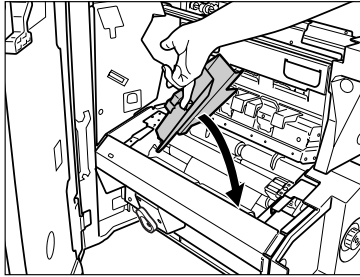

16 Gently push the saddle stitcher unit (F-C4) back into the machine.

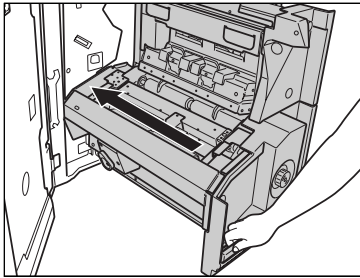

⚠ CAUTION

When returning the saddle stitcher unit to its original position, be careful not to get your fingers caught, as this may result in personal injury.

17 Close the front cover of the finisher.

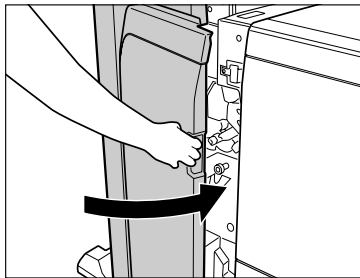

⚠ CAUTION

When closing the front cover of the finisher, be careful not to get your fingers caught, as this may result in personal injury.

18 Continue to follow the instructions on the touch panel display.

✎ NOTE

The screen indicating the location of the paper jam is displayed on the touch panel display until the paper jam is entirely cleared. For more information, see "3 Screens Indicating the Locations of Paper Jams," on p. 8.

7 Clearing Staple Jams

If a staple jam occurs, follow the procedure described below to remove the jammed staples.

Finisher-AB1/Saddle Finisher-AB2 (Optional)

If a staple jam occurs in the stapler unit of the optional Finisher-AB1 or Saddle Finisher-AB2, a screen similar to the one shown below appears on the touch panel display. Check the location of the staple jam, and follow the procedure described below, and the procedure that appears on the touch panel display, to remove any jammed staples.

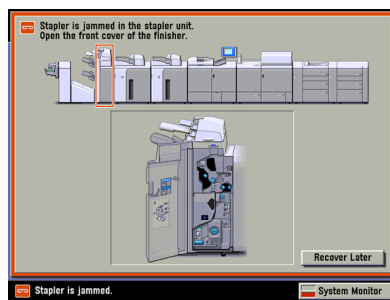

IMPORTANT

Take care when handling the optional equipment that is attached to the machine. When an optional unit's cover is opened to replace a staple cartridge, discard punch waste, or clear paper or staple jams, prints may still be output if other optional units are operating normally, and are not involved in the paper or staple jam removal procedure.

1 Open the front cover of the finisher.

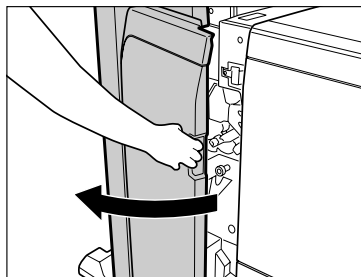

- 2** Remove the paper waiting to be stapled from the delivery tray.



- 3** Pull out the staple case.

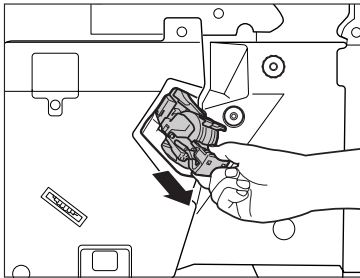

NOTE

When the stapler unit is at the back and it is difficult to pull out the staple case, turn the dial on the bottom left hand side to the left to push the case to front.

- 4** Push up the bracket on the staple case.

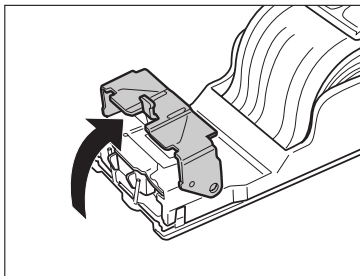

- 5** Remove all of the jammed and protruding staples from the staple cartridge.

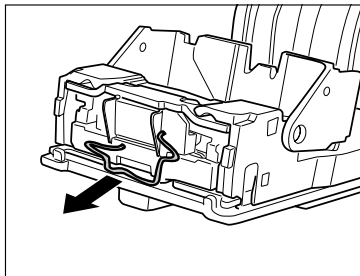

- 6** Return the bracket on the staple case to its original position.

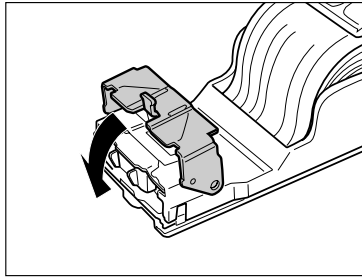

- 7** Gently push the staple case back into the stapler unit until it is securely in place.

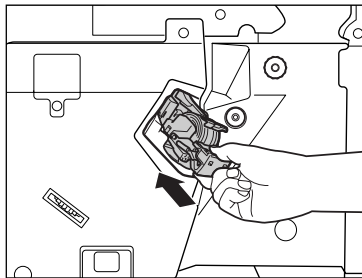

- 8** Close the front cover of the finisher.

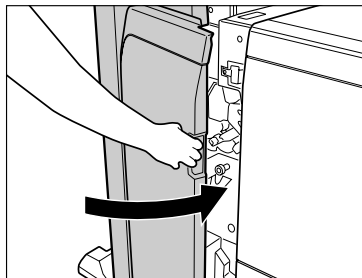

⚠ CAUTION

When closing the front cover of the finisher, be careful not to get your fingers caught, as this may result in personal injury.

Saddle Stitcher Unit (Optional)

If a staple jam occurs inside the saddle stitcher unit of the optional Saddle Finisher-AB2, a screen similar to the one shown below appears on the touch panel display. Check the location of the staple jam, and follow the procedure described below, and the procedure that appears on the touch panel display, to remove any jammed staples.

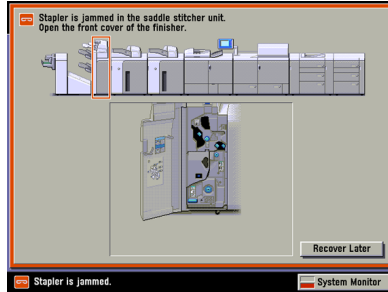

IMPORTANT

- Take care when handling the optional equipment that is attached to the machine. When an optional unit's cover is opened to replace a staple cartridge, discard punch waste, or clear paper or staple jams, prints may still be output if other optional units are operating normally, and are not involved in the paper or staple jam removal procedure.
- This procedure is only required when the optional Saddle Finisher-AB2 is attached to the machine.
- Before clearing the staple jam, remove all output sheets from the booklet tray.

NOTE

If a paper jam occurs at the same time as a staple jam, remove the jammed paper before removing the jammed staples.

1 Open the front cover of the finisher.

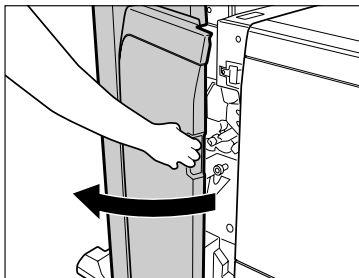

- 2** Pull out the saddle stitcher unit (F-C4).

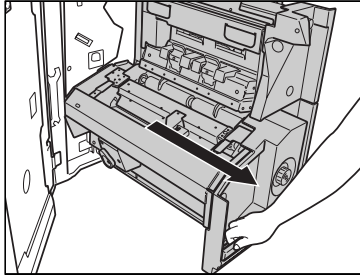

- 3** Pull out the saddle case from the saddle stitcher unit.

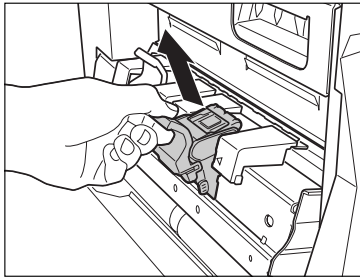

- 4** Hold the staple case by its left and right sides, and lower the bracket on the staple case.

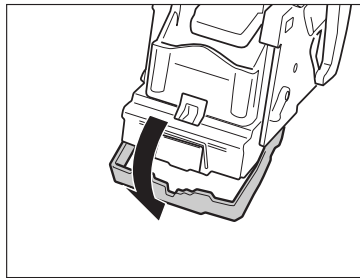

- 5** Remove the jammed staples from the staple cartridge.

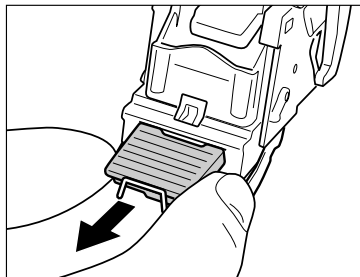

- 6** Return the bracket on the staple case to its original position.

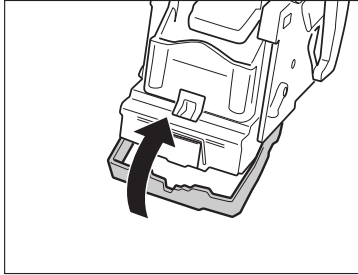

- 7** Gently push the staple case back into the saddle stitcher unit until it is securely in place.

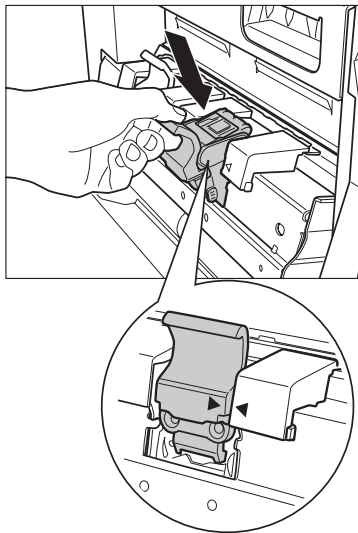

7

- 8** Gently push the saddle stitcher unit (F-C4) back into the machine.

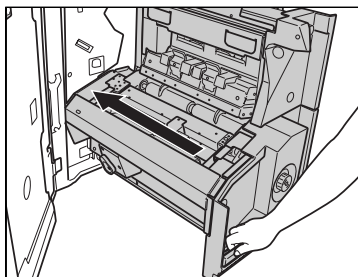

⚠ CAUTION

When returning the saddle stitcher unit (C4) to its original position, be careful not to get your fingers caught, as this may result in personal injury.

9 Close the front cover of the finisher.

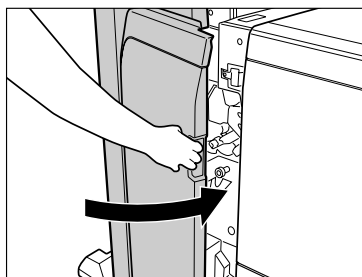

⚠ CAUTION

When closing the front cover of the finisher, be careful not to get your fingers caught, as this may result in personal injury.

8 List of Error Messages

This section explains the various messages that appear on the touch panel display, along with possible causes and remedies.

For explanations of messages that are not listed here, see the *Sending Guide* and *Network Guide*.

Self-Diagnostic Display

If the machine displays a self-diagnostic error message, follow the instructions on the touch panel display.

Self-diagnostic error messages appear on the touch panel display at the following times:

- When scanning or printing cannot be performed because of an operational error.
- When you need to make a decision or take some action during scanning, copying, or printing.
- When you need to make a decision or take some action while browsing the network.

The following is a list of self-diagnostic error messages, along with their possible causes and remedies.

Load paper.

Cause 1 The machine has run out of paper. No more prints can be made.

Remedy Load paper. (See Chapter 7, "Routine Maintenance," in the *Reference Guide*.)

Cause 2 The paper deck is not correctly inserted.

Remedy Insert the paper deck as far as it will go. (See Chapter 7, "Routine Maintenance," in the *Reference Guide*.)

Load LTR size paper.

Cause The optimum paper size selected by the Automatic Paper Selection mode is not available in the machine.

Remedy 1 Load the indicated paper size into the machine. If you press  (Start) while this message is displayed, prints are made with the currently selected paper size.

Remedy 2 If the message continues to be displayed even if the indicated paper size is loaded, set Drawer Eligibility For APS/ADS in Common Settings (from the Additional Functions screen) for that paper source to 'On'. (See Chapter 4, "Customizing Settings," in the *Reference Guide*.)

Return page 1 to the top, and then press the Start key.

Cause Scanning was stopped due to a problem with the optional feeder.

Remedy Arrange the originals in page order with the first page on top. Place the originals back into the feeder's original supply tray, and press  (Start).

 Return page 1 to the top and press the Start key. (Data for the scanned image has exceeded the file size limitations of the machine. Settings will be automatically adjusted and originals re-scanned).

Cause Scanning was stopped because the data size of the scanned original exceeded the maximum data size that the machine can handle.

Remedy Try scanning the original again from the first page. If scanning is still not possible, reduce the Sharpness mode setting, and select [Text] for the original type.

 Scanning has stopped because the size of the data for the scanned original exceeds the limit. Scanning may be possible if [Sharpness] is reduced and/or the type of original is set to [Text].

Cause Scanning was stopped because the data size of the scanned original exceeded the maximum data size that the machine can handle.

Remedy Reduce the Sharpness mode settings, and select [Text] for the original type.

 Remove the paper from the output tray.

Cause Prints from the previous job remain in the output tray.

Remedy Remove the prints remaining in the output tray. Printing automatically resumes.

 Remove the paper from the booklet tray.

Cause Prints from the previous job remain in the Booklet tray of the optional Saddle Finisher-AB2.

Remedy Remove the prints remaining in the Booklet tray. Printing automatically resumes.

 The toner cartridge can be replaced. (Black)

Cause Toner of the displayed color is running low.

Remedy Prepare the displayed color's toner cartridge for replacement. (See Chapter 7, "Routine Maintenance," in the *Reference Guide*.)

 Replace toner cartridge. (Black)

Cause Printing will not possible soon because the toner of the displayed color is running low.

Remedy Replace the displayed color's toner cartridge. (See Chapter 7, "Routine Maintenance," in the *Reference Guide*.)

Insert toner cartridge. (Black)

Cause The toner cartridge of the displayed color is not inserted properly.

Remedy Make sure that the toner cartridge is inserted properly. (See Chapter 7, "Routine Maintenance," in the *Reference Guide*.)

 Place the original on the platen glass.

Cause The specified mode requires that the original be placed on the platen glass, but there is no original on the platen glass.

Remedy Place the original on the platen glass.

 Remove the original from the platen glass.

Cause An original remains on the platen glass.

Remedy Remove the original from the platen glass, and place the new original.

 Remove the original from the feeder.

Cause The machine cannot scan your original using the feeder. An original is placed both in the feeder and on the platen glass.

Remedy Remove the original from the feeder.

The platen glass is dirty.

Cause The feeder scanning area is dirty.

Remedy Clean the feeder scanning area. (See Chapter 7, "Routine Maintenance," in the *Reference Guide*.)

Adjusting gradation. Please wait a moment.

Cause The machine is performing an automatic gradation adjustment.

Remedy Wait for the machine to finish the automatic gradation adjustment. When the adjustment is complete, printing automatically resumes.

Primary cleaning web is low. Call service representative.

Cause Replacing a cleaning web is required.

Remedy Contact your local authorized Canon dealer.

Secondary cleaning web is low. (Call service rep.)

Cause Replacing a cleaning web is required.

Remedy Contact your local authorized Canon dealer.

ITB web is low. (Call service representative.)

Cause Replacing ITB web is required.

Remedy Contact your local authorized Canon dealer.

The waste toner is near full. Replacemnt not yet needed.

Cause The waste toner will be full soon.

Remedy Prepare the waste toner for replacement.

Replace the waste toner container.

Cause Printing will not possible soon because the waste toner container is full.

Remedy Replace the waste toner container. (See Chapter 7, "Routine Maintenance," in the *Reference Guide*.)

 Remove paper from the output tray of stacker a (right)/b (left).

Cause Output from a previous job remains in the output tray of the High Capacity Stacker-C1.

Remedy Remove the paper in the output tray of the High Capacity Stacker-C1. For more information, see the instruction manual for the High Capacity Stacker-C1.

 Remove paper from the stack area of stacker a (right)/b (left).

Cause Output from a previous job remains in the output tray of the High Capacity Stacker-C1.

Remedy Remove the paper in the output tray of the High Capacity Stacker-C1. For more information, see the instruction manual for the High Capacity Stacker-C1.

 Set the tray in the stack area of stacker a (right)/b (left).

Cause The stacker tray of the High Capacity Stacker-C1 is not inserted.

Remedy Insert the stacker tray into the High Capacity Stacker-C1. For more information, see the instruction manual for the High Capacity Stacker-C1.

 Close the stack guide of stacker a (right)/b (left).

Cause The stack guide of the High Capacity Stacker-C1 is open.

Remedy Close the stack guide of the High Capacity Stacker-C1. For more information, see the instruction manual for the High Capacity Stacker-C1.

 The stacker cover is open.

Cause The cover of the High Capacity Stacker-C1 is open.

Remedy Close the cover of the High Capacity Stacker-C1. For more information, see the instruction manual for the High Capacity Stacker-C1.

 Empty the trimmer booklet waste tray.

Cause The trimmer booklet waste tray of the Booklet Trimmer-C1 is full.

Remedy Remove the trimmer booklet waste in the trimmer booklet waste tray of the Booklet Trimmer-C1. For more information, see the instruction manual for the Booklet Trimmer-C1.

 Remove the paper from the trimmer stacker.

Cause Output from a previous job remains in the output tray of the Booklet Trimmer-C1.

Remedy Remove the paper in the output tray of the Booklet Trimmer-C1. For more information, see the instruction manual for the Booklet Trimmer-C1.

 A finisher device cover is open.

Cause A finisher device cover is open.

Remedy 1 Check that the cover of the Booklet Trimmer-C1 is closed. For more information, see the instruction manual for the Booklet Trimmer-C1.

Remedy 2 Check that covers of the Finisher-AB1 or Saddle Finisher-AB2 are closed.

 Insert the trimmer booklet waste tray.

Cause The trimmer booklet waste tray of the Booklet Trimmer-C1 is not inserted.

Remedy Insert the trimmer booklet waste tray of the Booklet Trimmer-C1. For more information, see the instruction manual for the Booklet Trimmer-C1.

 Load staples.

Cause There are no staples in the staple cartridge of the Finisher-AB1 or Saddle Finisher-AB2 stapler unit.

Remedy Replace the staple cartridge of the Finisher-AB1 or Saddle Finisher-AB2 stapler unit. (See Chapter 7, "Routine Maintenance," in the *Reference Guide*.)

 Check the staple waste tray.

Cause The staple waste tray of the Finisher-AB1 or Saddle Finisher-AB2 stapler unit is full or almost full.

Remedy Remove the staple waste in the staple waste tray of the Finisher-AB1 or Saddle Finisher-AB2 stapler unit. (See Chapter 7, "Routine Maintenance," in the *Reference Guide*.)

 Check the punch waste tray.

Cause The punch waste tray of the Finisher-AB1 or Saddle Finisher-AB2 is full.

Remedy Remove the punch waste in the punch waste tray of the Finisher-AB1 or Saddle Finisher-AB2. (See Chapter 7, "Routine Maintenance," in the *Reference Guide*.)

 Load staples for the saddle stitcher unit.

Cause There are no staples in the staple cartridge of the Saddle Finisher-AB2 saddle stitcher unit.

Remedy Replace the staple cartridge of the Saddle Finisher-AB2 saddle stitcher unit. (See Chapter 7, "Routine Maintenance," in the *Reference Guide*.)

Output extra paper is on the upper tray of the paper unit.

Cause Prints remain in the escape tray.

Remedy Remove the prints remaining in the escape tray.

Remove paper from the upper tray of the paper unit.

Cause The escape tray has reached its stacking limit.

Remedy Remove the prints in the escape tray.

The front cover of paper unit a (right)/b (left) is open.

Cause The horizontal pass cover of the POD deck is open.

Remedy Close the horizontal pass cover of the POD deck.

The left cover of paper unit b (left) is open.

Cause The front cover of the buffer pass unit is open.

Remedy Close the front cover of the buffer pass unit.

The right cover of paper unit a (right)/b (left) is open.

Cause The front right cover of the POD deck is open.

Remedy Close the front right cover of the POD deck.

List of Error Codes without Messages

If a job or operation does not complete successfully, check the error code, and perform the necessary operations according to the error code displayed. You can check the error code on the Details screen under [Log] from the System Monitor screen. (See Chapter 5, "Checking Job and Device Status," in the *Reference Guide*.)

If a send or receive job does not complete successfully, the error code is printed in the Results column on the Activity Report and Send Report. However, if a send job is canceled, "STOP" is printed in the Results column on the Send report. (See Chapter 11, "Printing Communication Reports," in the *Sending Guide*.)

Perform the necessary procedures according to the error code.

001

Cause 1 A paper jam occurred in the feeding slot of the stack bypass.

Remedy Place your originals, specify the scanning mode, and try scanning again.

Cause 2 Differently sized originals were scanned, and the Different Size Originals mode was not set.

Remedy Place your originals, specify the Different Size Originals mode, and try scanning again.

Cause 3 Differently sized originals were scanned in the 2-Sided mode, and the Different Size Originals mode was not set.

Remedy Place your originals, specify the 2-Sided and Different Size Originals modes, and try scanning again.

009

Cause 1 There is no paper.

Remedy Load paper. (See Chapter 7, "Routine Maintenance," in the *Reference Guide*.)

Cause 2 The paper deck is not inserted correctly into the machine.

Remedy Insert the paper deck properly. (See Chapter 7, "Routine Maintenance," in the *Reference Guide*.)

037

Cause Documents could not be received because there was insufficient memory available.

Remedy Erase unwanted documents and documents with errors from memory to increase the amount of available memory. (See Chapter 3, "Introduction to the Mail Box Functions," in the *Copying and Mail Box Guide*, and Chapter 6, "Receiving Documents," in the *Sending Guide*.)

099

Cause Copying/printing was interrupted.

Remedy Try copying/printing again.

701

Cause 1 The specified Department ID does not exist, or the password has changed.

Remedy Enter the correct Department ID or password using \odot - \odot (numeric keys) on the control panel, and try again.

Cause 2 The Department ID or password was changed while the machine was processing a job, or <Allow Printer Jobs with Unknown IDs> is set to 'Off'.

Remedy Contact your System Manager.

703

Cause The hard disk is full, and no more images can be scanned.

Remedy 1 Wait a few moments, and try scanning again after the other send jobs are complete.

Remedy 2 Erase documents stored in inboxes. If the machine still does not operate normally, turn the main power OFF, and then back ON again. (See "11 Main Power and Control Panel Power," on p. 118.)

#711

Cause The inbox memory is full.

Remedy Erase unnecessary documents stored in the inbox. (See Chapter 3, "Introduction to the Mail Box Functions," in the *Copying and Mail Box Guide*, and Chapter 6, "Receiving Documents," in the *Sending Guide*.)

712

Cause The maximum number of documents are already stored in the inbox.

Remedy Erase unnecessary documents stored in the inbox. (See Chapter 3, "Introduction to the Mail Box Functions," in the *Copying and Mail Box Guide*, and Chapter 6, "Receiving Documents," in the *Sending Guide*.)

749

Cause You could not execute the job because a service call message is being displayed.

Remedy Turn the main power OFF, wait 10 or more seconds, and turn the main power back ON. If the machine still does not work normally, turn the main power OFF, disconnect the machine, and contact your local authorized Canon dealer. (See "11 Main Power and Control Panel Power," on p. 118.)

759

Cause An error occurred while sending the URL of a User Inbox.

Remedy Contact your System Manager.

816

Cause You cannot print because the set page limit total has been reached.

Remedy Contact your System Manager.

849

Cause Device information could not be delivered because the client machine is processing a job.

Remedy Try delivering device information again after the client machine finishes processing the job.

850

Cause Device information could not be delivered because a screen relating to the delivered device information is being displayed.

Remedy Try delivering the device information again after the screen is cleared from the client machine.

851

Cause 1 There is insufficient memory remaining in the system.

Remedy Check the system's available memory, and delete any unnecessary documents stored in inboxes.

Cause 2 The machine's memory is full.

Remedy Erase unnecessary documents and documents with errors from memory to increase the amount of available memory. (See Chapter 3, "Introduction to the Mail Box Functions," in the *Copying and Mail Box Guide*, and Chapter 6, "Receiving Documents," in the *Sending Guide*.)

Cause 3 The document cannot be stored because there are more than 2,000 documents in the specified inbox.

Remedy If there are a large number of documents, delete the unnecessary ones from the specified inbox.

852

Cause An error occurred because the main power switch was turned to the "⏻" side while a job was being processed.

Remedy Check to see if the main power switch is turned to the "I" side. Try processing the job again, if necessary. (See "11 Main Power and Control Panel Power," on p. 118.)

853

Cause 1 When trying to print a large number of pages, the job is not performed due to insufficient memory resources.

Remedy Reduce the number of pages to print, or perform the print job again when no other jobs are reserved.

Cause 2 The job could not be processed, because it was canceled from the printer driver while the print data was being sent to the machine.

Remedy Try printing again.

Cause 3 The spool memory is full when Use Spooler in Network Settings in System Settings (from the Additional Functions screen) is set to 'On', therefore, data received from the host could not be spooled.

Remedy Set Use Spooler in Network Settings in System Settings (from the Additional Functions screen) to 'Off', and try sending the print data again. (See Chapter 2, "Setting Common to the Network Protocols," in the *Network Guide*.)

Cause 4 The maximum number of receivable data exceeds the receive limit. (See Chapter 6, "Receiving Documents," in the *Sending Guide*.)

Remedy Try printing the documents again after all current jobs are complete. If you still cannot print, check the sent data.

Cause 5 The number of secured documents exceeded the maximum limit that can be reserved at a time.

Remedy Print or erase the secured documents that are stored in the machine, and try printing again.

Cause 6 The job could not be processed, because there are more than 400 page ranges in the processing job.

Remedy Try printing again after all current jobs are complete.

854

Cause Device information could not be delivered because the client machine has Restrictions for Receiving Device Info. in Device Information Delivery Settings in System Settings (from the Additional Functions screen) set to 'On'.

Remedy Try delivering device information again after setting Restrictions for Receiving Device Info. in Device Information Delivery Settings in System Settings (from the Additional Functions screen) to 'Off'.

855

Cause Device information could not be delivered because a language that the client machine does not support was included in the device information.

Remedy Contact your local authorized Canon dealer.

#856

Cause The job was canceled because there was not enough free space on the hard disk to store the temporary data.

Remedy Contact your System Manager.

857

Cause Data reception timed out, or the job was canceled at the host.

Remedy Check that the network is functioning properly, and then try printing again.

858

Cause There is a problem with the print data sent from an external application.

Remedy Check the settings of the data sent to the machine, make sure they are compatible with the machine, and try sending the data again.

859

Cause 1 A compression error occurred with the image data.

Remedy Check the print settings, and try printing again.

Cause 2 An original was not scanned properly, or the orientation of the original was incorrect.

Remedy Check the scan settings, and try scanning again.

860

Cause 1 A paper jam occurred during printing.

Remedy Try printing again.

Cause 2 You tried to print on transparency sheets that are not made for this machine.

Remedy Load transparencies made for this machine and then try printing again.

861

Cause An error occurred while processing PDL data or image data.

Remedy Confirm the print settings you made when printing from a computer.

862

Cause 1 Unsupported print data or unsupported settings were received.

Remedy Change the print data or print settings, and try printing again.

Cause 2 The saddle finisher trays have exceeded their stacking limits.

Remedy Change the print data or print settings, and try printing again.

Cause 3 A combination of settings which is not supported was set.

Remedy Change the print data or print settings, and try printing again.

Cause 4 Image data or data which is not guaranteed to be compatible was printed.

Remedy Change the print data or print settings, and try printing again.

863

Cause An error occurred while processing PDL data or image data.

Remedy Check the settings, and try printing again.

864

Cause 1 The external controller or controller board is not attached, or is not functioning properly.

Remedy Contact your System Manager.

Cause 2 The external controller or controller board cannot be recognized correctly.

Remedy Contact your System Manager.

865

Cause The functions related to job execution are restricted.

Remedy Contact your System Manager.

#887

Cause Device information could not be delivered because the paper database information that the client machine does not support was included in the device information.

Remedy Contact your local authorized Canon dealer.

9 If Memory Becomes Full during Scanning

If memory becomes full during the scanning of originals, the following screens appear on the touch panel display.

 NOTE

The machine's memory can store approximately 6,200 pages of scanned images. Approximately 6,000 pages of that total is shared by the various functions, including the Copy, Print, and Mail Box functions. In addition, each function is guaranteed to be able to store the following number of pages:

Copy: 100 pages

Print: 100 pages (excluding Secured Print jobs)

For example, the Copy function can store up to 3,800 pages of scanned images.

$100 + 6,000 = 6,100$ pages (approximate figures)

However, the number of pages that the machine's memory can store may differ depending on the amount of memory required for documents stored in inboxes and jobs that are in the print queue.

1 Follow this procedure:

- If the message asking whether to print the original pages scanned into memory appears:

- Select [Yes], [No], or [Another Function].

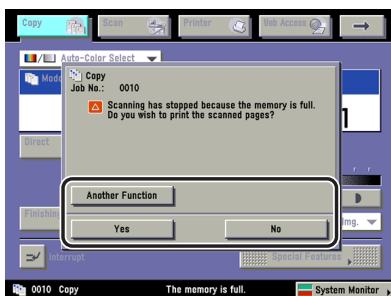

Details of each item are shown below.

[Yes]: The pages scanned into memory are printed. When printing is complete, scan the remaining originals.

[No]: The pages scanned into memory are not printed.

[Another Function]: Select to use another function that is not being used.



● If the screen shown below appears:

- Select [Cancel] or [Another Function].

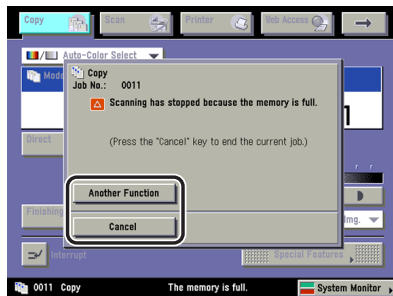

Details of each item are shown below.

[Another Function]: Select to use another function that is not being used.

[Cancel]: The current job is canceled, and the display returns to the Basic Features screen. Scan the job again when the current job is complete.



10 Service Call Message

If a malfunction occurs and the machine cannot operate normally, a screen like the one shown below is displayed. Follow the instructions that appear on the touch panel display.

Contacting Your Local Authorized Canon Dealer

If a message like the one shown below appears, follow the procedure described below.

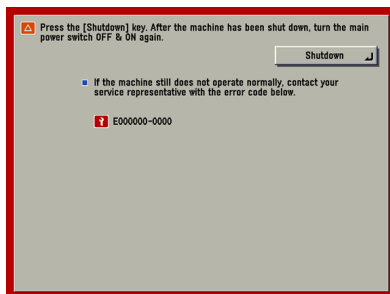

WARNING

Do not connect or disconnect the power cord with wet hands, as this may result in electrical shock.

CAUTION

Always grasp the power plug when disconnecting the power cord. Pulling on the power cord may expose or snap the core wire, or otherwise damage the power cord. If the power cord is damaged, this could cause current to leak, resulting in a fire or electrical shock.

IMPORTANT

If you turn the main power switch to the "⏻" side when there is a job waiting to print, that job is erased.

1 Press [Shutdown], perform the necessary operations, and turn the main power switch to the "⏻" side.

IMPORTANT

For instructions on shutting down the machine, see "Shutting Down the Machine," on p. 123.

- 2** Wait at least 10 seconds before turning the main power switch to the "I" side.

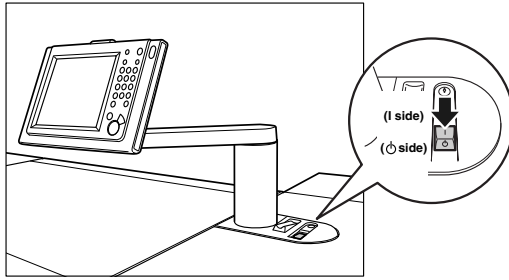

IMPORTANT

For instructions on turning the main power switch to the "I" side, see "How to Turn ON the Main Power," on p. 118.

- 3** If the machine still does not operate normally, follow the procedure below, then contact your local authorized Canon dealer.

- Press [Shutdown] and turn the main power switch to the "⏻" side.
- Remove the power plug from the power outlet.



IMPORTANT

For instructions on shutting down the machine, see "Shutting Down the Machine," on p. 123.



NOTE

When you contact your local authorized Canon dealer, have the following information available:

- Product name
- Details of the malfunction
- The error code displayed on the touch panel display

Setting the Limited Functions Mode from the Service Call Message Screen

If the Service Call Message screen appears, even after you restart the machine, there are some cases in which you can continue operation the machine. If the screen in step 1 below appears, turn the Limited Functions Mode 'On' as a temporary solution, until the problems is resolved.



IMPORTANT

If you turn the main power switch to the "⏻" side when there is a job waiting to print, that job is erased.



NOTE

If you set Limited Functions Mode to 'On' from the Service Call Message screen, Limited Functions Mode in Common Settings (from the Additional Functions screen) is also set to 'On'. (See Chapter 4, "Customizing Settings," in the *Reference Guide*.)

1 Press [Limited Fcnctns Mode].

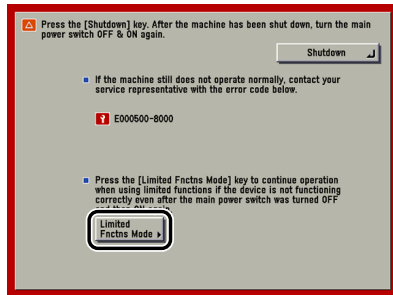

2 Press [Yes].

If you do not want to turn the Limited Functions Mode 'On', press [No].

A message prompting you press [Shutdown], and turn the main power switch to the "⏻" side and the "I" side appears.

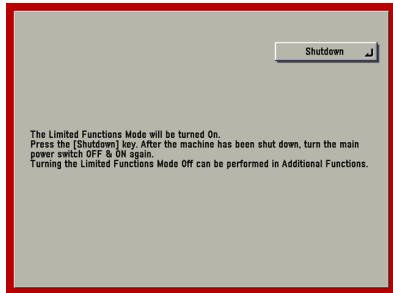

10

3 Press [Shutdown], perform the necessary operations, and turn the main power switch to the "⏻" side.



IMPORTANT

For instructions on shutting down the machine, see "Shutting Down the Machine," on p. 123.

4 Wait at least 10 seconds before turning the main power switch to the "I" side.

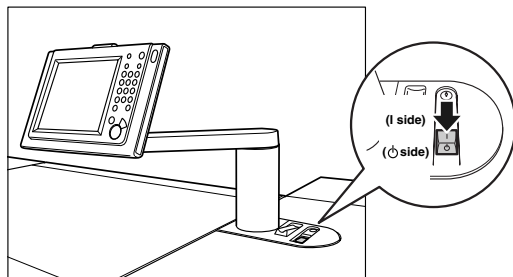

The machine starts up in the Limited Functions mode.

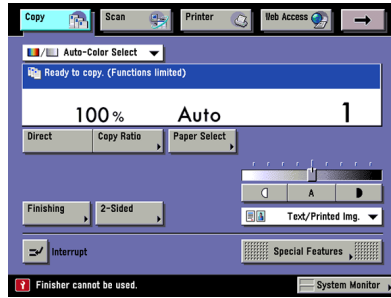

IMPORTANT

For instructions on turning the main power switch to the "I" side, see "How to Turn ON the Main Power," on p. 118.

11 Main Power and Control Panel Power

The machine is provided with two power switches, a main power switch and a control panel power switch, as well as a breaker that detects excess current or leakage current.

How to Turn ON the Main Power

This section explains how to turn ON the main power.

- 1** Make sure that the power plug is firmly inserted into the power outlet.

! WARNING

Do not connect or disconnect the power cord with wet hands, as this may result in electrical shock.

- 2** If the optional security key is inserted into the machine, make sure that it is in the ON position (turn it to the right).

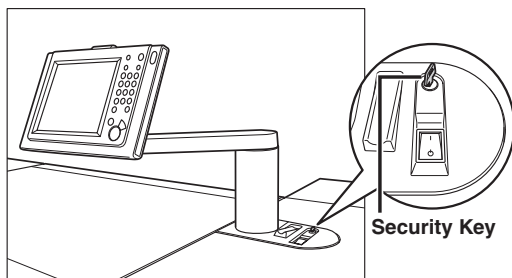

- 3** Turn ON the optional equipment (i.e., POD Deck-A1, Finisher-AB1, Saddle Finisher-AB2, High Capacity Stacker-C1) attached to the machine. Press the main power switch to the "I" side. The main power switch is located to the right of the control panel's stand.

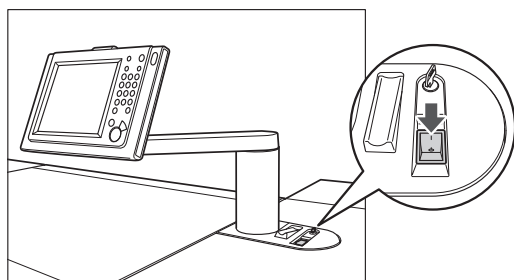

The main power indicator on the control panel lights when the main power switch is turned to the "I" side.

 **IMPORTANT**

- If the main power indicator on the control panel does not light even though the main power switch is turned to the "I" side, be sure to check the breaker to see if it is OFF. (See "12 When the Power Does Not Turn ON," on p. 127.)
- If you want to restart the machine, it is necessary to first turn OFF the optional equipment and then the machine. Wait at least 10 seconds, and then turn the optional equipment and the machine back ON.

 **NOTE**

If any optional equipment is not turned ON or properly connected to the machine when you turn ON the main power, a screen similar to the one shown below appears on the touch panel display. Check the power switches and connections to the machine of the optional equipment indicated on the touch panel display, and then press [Recognize Unit]. If you want the machine to start up without recognizing the optional equipment, press [Continue Startup]. If you want to change the configuration of your optional equipment, contact your local authorized Canon dealer.

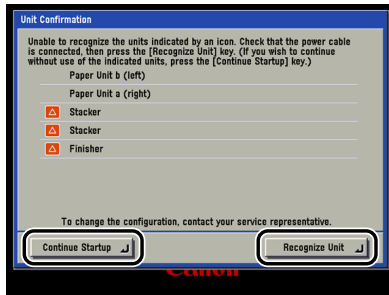

4 The following screens are displayed while the system software is loading.

- If login authentication by a login service (SDL (Simple Device Login) or SSO (Single Sign-On)) is not set, and an application other than MEAP is selected as the initial function in Common Settings (from the Additional Functions screen):
 - The Start Up screen is displayed until the machine is ready to scan.



If a message is displayed on the touch panel display, proceed to step 5.

- The screen below is displayed when the machine is ready to scan.

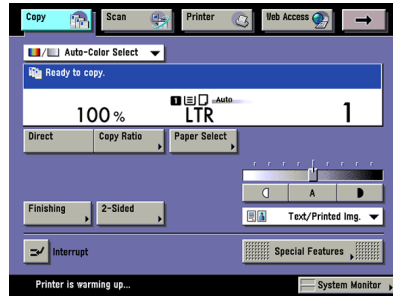

The machine is ready to scan in approximately one minute after the screen above appears.

NOTE

- Once the message <Reservation copies can be made.> appears on the touch panel display, you can specify settings, and copying or printing begins automatically as soon as the machine finishes warming up. (See Chapter 2, "Introduction to the Copy Functions," in the *Copying and Mail Box Guide*.)
- In the case above, the standard settings are selected.
- The standard copy settings are:
 - Copy Ratio: Direct (100%)
 - Paper Selection: Auto Paper Selection
 - Copy Exposure: Manual Exposure Adjustment
 - Copy Quantity: 1
 - Color Mode: Auto-Color Select
 - Copy Function: 1▶1-Sided copy
- The standard settings for each function of the machine (Copy, Mail Box, and Send) are already set at the factory, but you can change them to suit your needs. (See Chapter 9, "Customizing Settings," in the *Copying and Mail Box Guide*, and Chapter 8, "Customizing Communications Settings," in the *Sending Guide*.)
- You can select which functions to display on the Basic Features screen when turning ON the main power, according to the Additional Functions settings. (See Chapter 4, "Customizing Settings," in the *Reference Guide*.)
- If you press [→] on the Basic Features screen right after the machine is activated, the screen will be blank. Wait for a moment, and then press [→] again.
- If a Macintosh computer, which has been shut down, is connected to the machine via a USB cable and you turn ON the machine, the Macintosh computer may also turn ON. In this case, disconnect the Macintosh computer from the machine. (You may also be able to solve this problem by using a USB hub between the machine and the Macintosh computer.)

- If login authentication by a login service (SDL or SSO) is not set, and MEAP is selected as the initial function in Common Settings (from the Additional Functions screen):

- The Start Up screen is displayed until the machine is ready to scan.



- After the Start Up screen disappears, the MEAP Start Up screen is displayed.



You can press [→] to switch to the Basic Features screen to use the Copy, Mail Box, etc. functions even if the MEAP Start Up screen is still displayed.

- The MEAP Application screen is displayed.

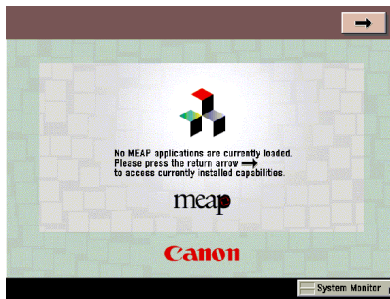

Press [→] to switch to the Basic Features screen.

● If login authentication by a login service (SDL or SSO) is set:

- The Start Up screen is displayed until the machine is ready to scan.



- After the Start Up screen disappears, the MEAP Start Up screen is displayed regardless of the Initial Function settings.

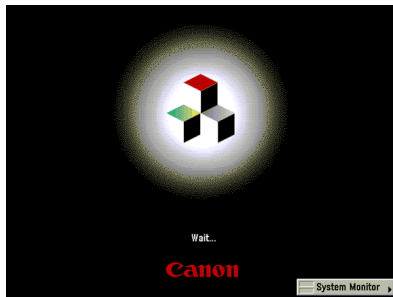

IMPORTANT

- If you turn OFF the main power, wait at least 10 seconds before turning the main power back ON. For instructions on restarting (turning the main power switch to the "⏻" side and then to the "I" side) the machine, see "11 Main Power and Control Panel Power," on p. 118.
- Do not turn the main power OFF, if the optional Color Universal Send Kit is activated. Sending or receiving I-fax documents cannot be done when the main power is turned OFF.
- If SSO or SDL is set as the login service, the machine will take longer to become ready to scan.

5 If you are using a login service, log in using the procedure for the login service you are using.

NOTE

- If you are using the optional Card Reader-C1 for Department ID Management, see Chapter 3, "Optional Equipment," in the *Reference Guide*.
- If you are using Department ID Management, see Chapter 2, "Basic Operations," in the *Reference Guide*.
- For instructions on logging in using a login service, see Chapter 2, "Basic Operations," in the *Reference Guide*.

Control Panel Power Switch

Press the control panel power switch to cancel the Sleep mode and resume normal machine operations.

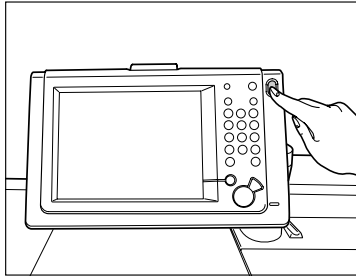

NOTE

- The machine can receive and print documents from a personal computer when it is in the Sleep mode. I-fax documents can also be received while the machine is in the Sleep mode.
- It takes a maximum of 11 minutes and 30 seconds for the machine to recover after the Sleep mode is deactivated.
- If Energy Consumption in Sleep Mode is set to 'Low', it may take more than 10 seconds for the touch panel display to be displayed after pressing the control panel power switch.
- Press and hold down the control panel power switch for more than three seconds to initiate the Shutdown mode. (See Chapter 1, "Before You Start Using This Machine," in the *Reference Guide*.)

Shutting Down the Machine

If there are any jobs currently being processed, or a MEAP application is running when the Shutdown mode is activated, the machine asks you to confirm and cancel any existing jobs, and then access to the hard disk is restricted. This procedure protects the hard disk from access errors the next time the machine is turned ON. When the machine shuts down, it also performs an internal cooling down process, which enables the machine to be shut down safely. Follow the instructions below to safely shutdown the machine.

IMPORTANT

- If you turn the main power of the machine OFF without following the procedure below, copies that are output the next time the machine is turned ON may not be printed correctly. In this case, printing will return to normal after a certain number of copies are output.
- Do not initiate the Shutdown mode while fonts are being downloaded.

1 Press and hold the control panel power switch for more than three seconds.

If the machine is in the Sleep mode, press the control panel power switch one time to cancel the Sleep mode, and then press and hold the control panel power switch again for more than three seconds.

The job confirmation screen is displayed.

 NOTE

- You can also force the machine into the Shutdown mode by pressing  (Additional Functions) → [Common Settings] → [Shutdown Mode].
- You cannot force the machine into the Shutdown mode in the following cases:
 - When the machine is receiving and updating device information
 - When the machine is importing or exporting data using the Remote UI function
- In a rare instance, the machine may not go into the Shutdown mode even if you press and hold the control panel power switch for more than three seconds. In this case, follow the instructions on the touch panel display to turn OFF the main power.

2 Confirm the jobs currently being processed or waiting to be processed → press [Start].

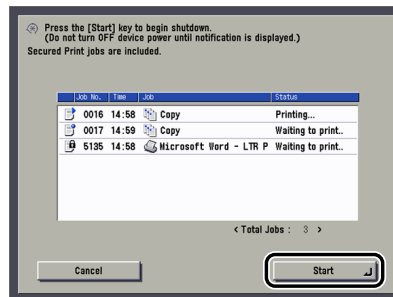

Jobs continue to be processed until [Start] is pressed.

To cancel the Shutdown mode, press [Cancel].

If there are no current jobs, proceed to step 4.

 NOTE

- Jobs that are displayed on the job confirmation screen are:
 - Current copy and print jobs (including secured print jobs)
 - Copy and print jobs (including secured print jobs) that are waiting to be processed
- On the job confirmation screen, the current job is displayed on the first line, and the other jobs are processed in the order in which they were reserved (up to seven jobs).

3 Confirm the message displayed → press [Yes].

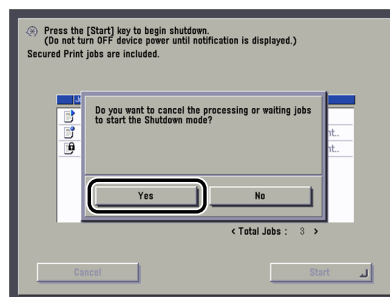

If There Are Jobs Currently Being Processed or Waiting to Be Processed

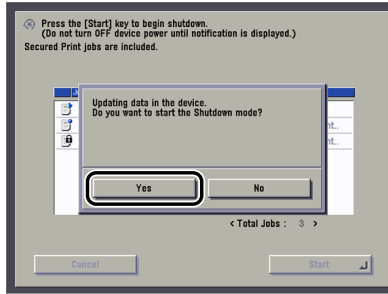

If Device Information Is Being Delivered

To return to the job confirmations screen press [No].

All of the jobs on the confirmation screen that are currently being processed or waiting to be processed are canceled. The machine and any network communication processes also start to shut down.

The Performing Shutdown screen appears.

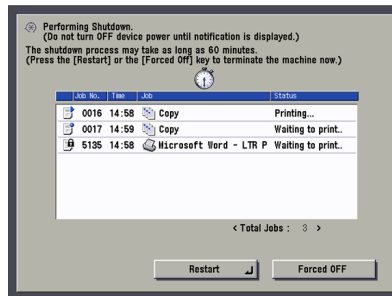

If you need to immediately operate the machine after starting the shutdown process, press [Restart] → [Yes].

If you press [Restart] while device information is being updated, a message asking for your confirmation to continue appears on the screen. Press [Yes].

CAUTION

- You can also force the shutdown of the machine (omitting the normal job cancellation process) by pressing [Forced Off]. However, since pressing [Forced Off] stops the shutdown operation before it is complete, which may result in damaging parts of the machine, or destroying data which is being processed, it is not recommended. Note that Canon will not be liable for any damages resulting from the loss of data on the hard disk drive. For more information, contact your local authorized Canon dealer.
- Never turn OFF the power switch of the optional equipment until the screen of the step 4 appears.

NOTE

- It may take up to one hour for the machine to completely shut down because of the internal cooling down process and the status of the network.
- It may take more than one hour for the machine to completely shut down, depending on the application you are using.
- It may take several minutes for [Forced Off] to be displayed.
- A confirmation message appears when you press [Forced Off] in any of the following cases. Follow the instructions in the message.
 - When the machine is shutting down
 - When device information is being delivered or updated

- 4** When the following screen appears, turn OFF the optional equipment (i.e., POD Deck-A1, Finisher-AB1, Saddle Finisher-AB2, High Capacity Stacker-C1) to the "○" side.

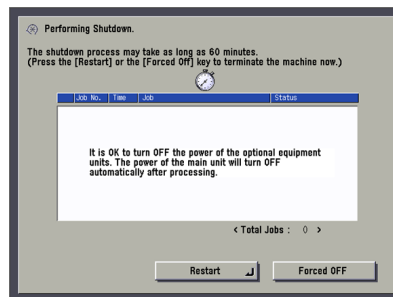

When the shutdown process completes, the main power switch of the machine switches to the "○" side automatically.

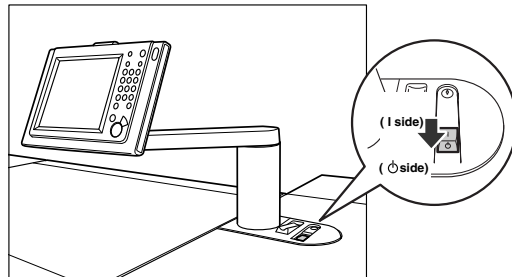

IMPORTANT

The machine may continue to operate during or after the shutdown process. Do not unplug the power cord until the device sounds stop.

12 When the Power Does Not Turn ON

If you cannot operate the machine, even though the main power switch and the control panel power switch are both turned to the "I" side, always check that the breaker is not in the OFF position.

If the breaker is in the OFF position, contact your local authorized Canon dealer without turning the breaker back ON.

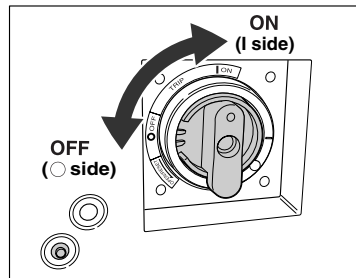

WARNING

If the breaker is in the OFF position, do not switch the current leakage breaker back ON. Doing so may lead to a fire, electrical shock, smoke, or the tripping of other breakers in the facility.



CANON INC.

30-2, Shimomaruko 3-chome, Ohta-ku, Tokyo 146-8501, Japan

CANON U.S.A., INC.

One Canon Plaza, Lake Success, NY 11042, U.S.A.

CANON CANADA INC.

6390 Dixie Road Mississauga, Ontario L5T 1P7, Canada

CANON EUROPA N.V.

Bovenkerkerweg 59-61 1185 XB Amstelveen, The Netherlands

CANON FRANCE S.A.S.

17, quai du Président Paul Doumer 92414 Courbevoie Cedex, France

CANON (U.K.) LTD.

Woodhatch, Reigate, Surrey, RH2 8BF, United Kingdom

CANON DEUTSCHLAND GmbH

Europark Fichtenhain A10, 47807 Krefeld, Germany

CANON ITALIA S.p.A.

Via Milano, 8 20097 San Donato Milanese (MI) Italy

CANON LATIN AMERICA, INC.

703 Waterford Way Suite 400 Miami, Florida 33126 U.S.A.

CANON AUSTRALIA PTY. LTD

1 Thomas Holt Drive, North Ryde, Sydney, N.S.W. 2113, Australia

CANON CHINA CO., LTD

15F Jinbao Building No.89 Jinbao Street, Dongcheng District, Beijing 100005, China

CANON SINGAPORE PTE. LTD.

1 HarbourFront Avenue #04-01 Keppel Bay Tower, Singapore 098632

CANON HONGKONG CO., LTD

19/F., The Metropolis Tower, 10 Metropolis Drive, Hunghom, Kowloon, Hong Kong

