

imageFORMULA ScanFront 400

SERVICE MANUAL



Canon

December 6, 2016
Rev. 2

COPYRIGHT © CANON ELECTRONICS INC. 2016

Use of this manual should be strictly supervised to avoid disclosure of confidential information.

This Service Manual describes necessary basic information for field service and maintenance for maintaining the product quality and functions of this machine.

Contents

Chapter 1: General description

Product specifications, name of parts, operation method

Chapter 2: Functions and operation

Description of operation of machine system and electrical system by function

Chapter 3: Disassembly and reassembly

Disassembly method, reassembly method

Chapter 4: Installation and maintenance

Installation method, maintenance method

Chapter 5: Troubleshooting

Error display and troubleshooting

Appendix: General diagram etc.

Information in this manual is subject to change. Notification of such changes will be given in Service Information Bulletins.

Thoroughly read the information contained in this Service Manual and the Service Information Bulletins to gain a correct and deeper understanding of the machine. This is one way of fostering response for ensuring prolonged quality and function, and for investigating the cause of trouble during troubleshooting.

“ScanFront 400” is abbreviated to SF-400 in this manual.

Quality Assurance Center
Canon Electronics Inc.

CONTENTS

CHAPTER 1 GENERAL DESCRIPTION

I.	PRODUCT OUTLINE	1-1
	1. Features	1-1
	2. Main Specifications	1-2
	3. Precautions	1-5
II.	NAME OF PARTS.....	1-6
	1. Front/Side View.....	1-6
	2. Rear View	1-6
III.	USER OPERATION.....	1-7
	1. Preparation	1-7
	2. Flow of Scanner Operations	1-9

CHAPTER 2 FUNCTIONS & OPERATION

I.	OUTLINE	2-1
	1. System Configuration	2-1
	2. Basic Software Configuration	2-2
	3. Main Body Structure	2-3
	4. Motor Drive	2-4
	5. Electrical Circuits	2-5
	6. Timing Chart.....	2-6
	7. Basic Knowledge of Network	2-7
II.	READING SYSTEM.....	2-8
	1. Reading Unit	2-8
	2. Shading.....	2-9
III.	FEED SYSTEM	2-10
	1. Feeding Mechanism.....	2-10
	2. Feed Error Detection.....	2-14
IV.	CONTROL SYSTEM	2-16
	1. Motherboard.....	2-16
	2. Control PCB	2-18
	3. Image Processing Control	2-19
V.	POWER SUPPLY	2-21
	1. Outline.....	2-21
	2. Lithium Battery	2-22
VI.	ELECTRICAL PARTS LAYOUT	2-23

	1. Lower Base Unit.....	2-23
	2. Upper Base Unit.....	2-24
	3. Front Unit	2-25
VII.	PARTS LAYOUT ON EACH PCB	2-26
	1. Motherboard.....	2-26
	2. Control PCB	2-27
	3. Sub PCB	2-28
	4. Interface Circuit Board	2-39
	5. Panel Relay PCB	2-30
	6. Power Supply Switch Circuit Board ..	2-31

CHAPTER 3 DISASSEMBLY & REASSEMBLY

I.	EXTERNAL PARTS	3-1
	1. Pickup Tray	3-1
	2. Eject Tray	3-1
	3. Lower Cover.....	3-2
II.	FRONT UNIT	3-3
	1. Front Panel Assembly	3-3
	2. LCD Assembly	3-4
	3. Sub PCB	3-5
	4. Stop Cam Drive Unit	3-7
	5. Upper Drive Unit	3-7
	6. Front Unit	3-8
	7. Upper Feed Guide Plate	3-9
	8. Follower Roller (Regist Side)	3-10
	9. Follower Roller (Eject Side)	3-10
III.	BASE UNIT	3-11
	1. Motherboard.....	3-11
	2. Interface PCB.....	3-12
	3. Lithium Battery	3-13
	4. Memory	3-13
	5. Control PCB	3-14
	6. Damper Unit.....	3-15
	7. Feed Motor.....	3-16
	8. Main Motor	3-17
	9. Dust Cover	3-18
	10. Clutch.....	3-19

11. Drive Roller.....	3-20
IV. READING UNIT.....	3-22
1. Upper Reading Unit.....	3-22
2. Upper Reading Guide.....	3-23
3. Lower Reading Unit.....	3-23
4. Lower Reading Guide.....	3-24

CHAPTER 4 INSTALLATION & MAINTENANCE

I. INSTALLATION.....	4-1
1. Unpacking.....	4-1
2. Removal of protective components.....	4-1
3. Connecting and Setup.....	4-3
II. REPLACEMENT PARTS.....	4-5
1. Periodic Replacement Parts.....	4-5
2. Consumable Parts.....	4-5
3. Main Parts List.....	4-6
III. MAINTENANCE.....	4-7
1. User Maintenance.....	4-7
2. Service Maintenance.....	4-9

CHAPTER 5 TROUBLESHOOTING

I. OUTLINE.....	5-1
1. Outline and Categories.....	5-1
II. USER INFORMATION PROTECTION.....	5-2
1. Outline.....	5-2
2. Backup/Restore.....	5-2
3. Initialization.....	5-4
III. ERROR DISPLAY.....	5-5
1. Machine's Screen.....	5-5
IV. SERVICE MODE.....	5-9
A. Introduction.....	5-9
1. Outline.....	5-9
2. Starting Up Service Mode.....	5-10
3. Exiting Service Mode.....	5-12
B. Scanner Information.....	5-13
1. Version.....	5-13

2. Error history.....	5-14
3. Serial number.....	5-14
4. Counter.....	5-15
5. Write Log.....	5-17
C. Scanner Adjustment.....	5-18
1. Selection Screen.....	5-18
2. Regist Adjustment (Auto).....	5-18
3. Contraction Adjustment (Auto).....	5-20
4. Light Adjustment.....	5-22
5. Regist Adjustment (Manual).....	5-24
6. Contraction Adjustment (Manual).....	5-27
7. Touch Panel Adjustment.....	5-31
D. Motor/Sensor Information.....	5-32
1. Basic screen.....	5-32
E. Analog Value Information.....	5-34
1. Operating Procedure.....	5-34
F. Scan Test.....	5-36
1. Outline.....	5-36
2. Operating Procedure.....	5-36
G. Version Up.....	5-37
1. Outline.....	5-37
2. Operating Procedure.....	5-37
H. Log File Recovery.....	5-40
V. NETWORK FUNCTION CHECK.....	5-42
1. Outline.....	5-42
2. Preparation.....	5-42
3. Network Setting for the Machine.....	5-43
4. Setting for Computer.....	5-44
5. Creating a User.....	5-45
6. Creating a Shared Folder.....	5-47
7. Sending Image Data.....	5-50
8. Initialization.....	5-50
VI. OTHER OPERATIONS.....	5-51
1. Initialization (factory shipping state).....	5-51
2. Battery Replacement.....	5-52
VII. DEFECTIVE PHENOMINON LIST.....	5-54
1. Operation Failures.....	5-54
2. Image Failures.....	5-54
3. Poor Communication.....	5-55
VIII. OPERATION TROUBLESHOOTING.....	5-56
1. Power Does Not Come ON.....	5-56

2. Scanning Does Not Start	5-57
3. Scanner Does Not Feed Properly.....	5-58
IX. OPERATION TROUBLESHOOTING	5-60
1. All Black/All White/All Streaked.....	5-61
2. Too Dark/Too Light.....	5-61
3. Streaks in Image	5-62
4. Image Slanted.....	5-62
5. Wrong Image Size	5-63
6. Text Cannot be Seen	5-64
X. COMMUNICATION TROUBLESHOOTING	
.....	5-65
1. The machine cannot connect to the network	5-65
2. The network cannot connect to the machine	5-66
XI. AFTER REPLACING PARTS	5-67

APPENDIX

I. GENERAL DIAGRAM.....	A-1
II. LIST OF SPECIAL TOOLS	A-2

CHAPTER 1

GENERAL DESCRIPTION

I. PRODUCT OUTLINE	1-1	III. USER OPERATION	1-7
II. NAME OF PARTS	1-6		

I. PRODUCT OUTLINE

1. Features

- 1) The core model of network document scanner in our imageFORMULA line-up
The successor/high-end model of SF-330
- 2) Substantial improvement of pickup/feed performance
Adopts DR-M160II's mechanism
- 3) Scanning speed (A4, 200 dpi)
Black and White, Grayscale: 45 ppm/90 ipm
Color: 45 ppm/90 ipm
- 4) New features
 - a) Achieves entire web browser-based operations within the main scanner body
 - b) Skew mitigation function (uses a feed roller to prevent chain of skewed conditions)
 - c) Recovery process function (DFR - Double Feed Release) + Separation Retry function when a double feed occurs
 - d) A 10.1-inch wide LCD and capacitance touch panel
- 5) Serviceability
 - a) Installation by users
 - b) Roller replacement by users (replacement roller kit)
 - c) Does not require periodic maintenance by service personnel
 - d) Dedicated-type service tools
 - e) User log collection function

"Windows" is a trademark of Microsoft Corporation in the U.S. and other countries.
Other company names and product names mentioned in this document are registered trademarks or trademarks of the respective companies.

2. Main Specifications

No.	Item	Specifications
Appearance/Installation		
1	Type	Desktop type sheet-fed network scanner
2	Dimensions	1) With the pickup tray and eject tray closed: 305 (W) x 282 (D) x 230 (H) mm 2) With the pickup tray and eject tray open: 305 (W) x 629 (D) x 366 (H) mm
3	Weight	4.5 kg (Main body only)
4	Power supply	AC adaptor 1) Input: AC100V - 240V, 50/60Hz 2) Output: DC24V, 2.0A
5	Power consumption	1) Operating: 36 W or less 2) Low power mode: 2.0 W or less 3) Power switch OFF: 0.2 W or less
6	External interface	1) USB 2.0 (Hi-speed) x 3 2) LAN (10, 100 Base-TX, 1000 Base-T)
7	Expected product life (In-house information)	One of the following two items, whichever comes first. 1) 5 years 2) 2,500,000 sheets (A4) *Replace parts if necessary.
8	Installation	By user
9	Consumable parts (Commercial goods)	1) Exchange roller kit Feed roller and retard roller Replacement by users, recommended replacement cycle: each 200,000 sheets 2) Carrier sheet 3) Lithium button battery (use market products)
Controller/Network		
10	OS	Linux
11	CPU	Intel Celeron J1900 2.0GHz x 4Core
12	Memory	1) DDR3 SO-DIMM for program area/image area: 2GBytes 2) MicroSD Card for OS/set-up variables/address book: 8GBytes
13	Operation/Display	1) 10.1-inch TFT WSVGA (1024x600 pixels) 260,000-color liquid-crystal display 2) Capacitance touch panel

Table 1-101a

No.	Item	Specifications		
14	Sending function	1) Scan To Mail 2) Scan To Folder 3) Scan To FTP 4) Scan To USB Memory 5) Scan To FAX 6) Scan To Printer		
15	Bundle software	1) SF Administration Tool for SF-400		
Document reading/Out putting				
16	Sensor type, Density	1 line/4 parallel-CMOS contact image sensor, 600 dpi		
17	Effective elements, width	5184 pixels/line, 219 mm		
18	Light source	3-color (RGB) LED, Single-side illumination		
19	Operation mode	600 dpi/300 dpi		
20	Background color	White		
21	Image data memory	SDRAM 32 MB *Used for the working memory together.		
22	Output mode	1) Binary: Black & White, Error diffusion, Text enhance 2) Grayscale: 8 bit (JPEG) 3) Color: 24 bit (JPEG)		
23	Output resolution	100 x 100 dpi, 150 x 150 dpi, 200 x 200 dpi, 300 x 300 dpi, 400 x 400 dpi, 600 x 600 dpi		
24	Scanning speed-1 (A4, Image processing OFF)	File style: PDF (Standard compression, without OCR)		
		Mode	Resolution	One-sided/two-sided
		B & W Grayscale	200 dpi	45 ppm/90 ipm
			300 dpi	45 ppm/90 ipm
			400 dpi	18 ppm/36 ipm
			600 dpi	8 ppm/16 ipm
		Color	200 dpi	45 ppm/90 ipm
			300 dpi	35 ppm/70 ipm
400 dpi	8 ppm/16 ipm			
600 dpi	3.5 ppm/7 ipm			

Table 1-101b

No.	Item	Specifications
Document feeding		
25	Document feed path	Straight pass
26	Document size	1) Width: 50 to 216 mm 2) Length: 54 to 356 mm
27	Document weight (Thickness)	1) Separation: 27 to 209 g/m ² (0.04 to 0.25 mm) 2) Non-separation: 27 to 255 g/m ² (0.04 to 0.30 mm)
28	Special document	Works with plastic cards, business cards, postcards, folios, passports, and long documents (3048mm), etc. *There are some restrictions on the use of carrier sheets when scanning passports.
29	Document storage	1) Pickup: A4 or smaller documents: 60 sheets (80 g/m ²) Larger than A4 documents: 40 sheets (80 g/m ²) In each case, a document should be within 10 mm thickness (including curled sheets) 2) Eject: Same as for Pickup
30	Double feed detection	1) Length detection by registration sensor 2) Double feed detection by ultrasonic sensor

Table 1-101c

◆ External dimensions (Unit: mm)

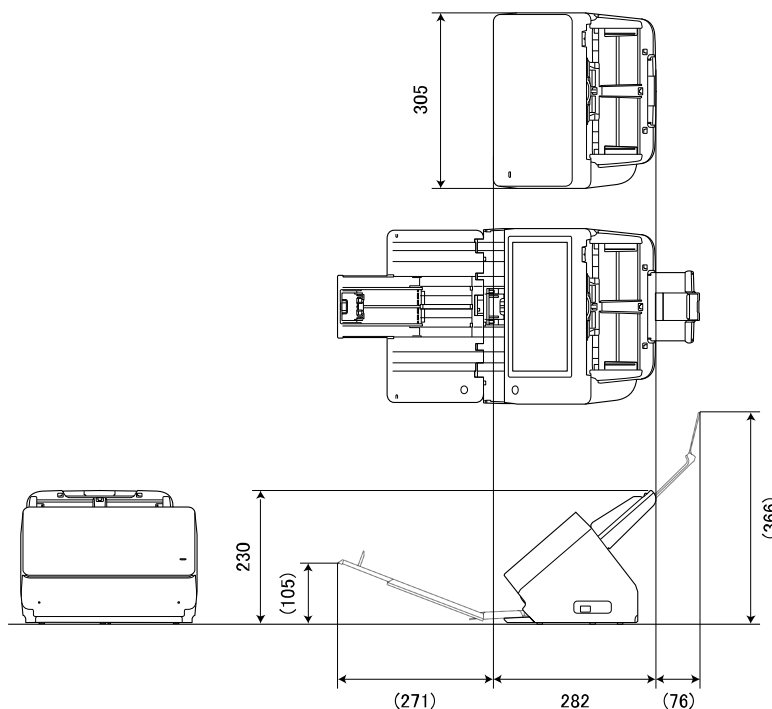

Figure 1-101

3. Precautions

This section describes items that require particular care, for example, regarding human safety.

These precautions must be observed. The user should be explained the items that relate to user safety and instructed to take appropriate actions.

1) Power OFF in emergency

If such abnormal conditions as extraordinary noise, smoke, heat and odor occur, immediately unplug the power.

Be careful not to get clothing (ties, long hair, etc.) caught in this machine as it may cause injury. Should this occur, immediately unplug the power cord.

Do not insert fingers in the feed section while rollers are moving.

2) Power OFF on disassembling

When disassembling and assembling are performed, unplug the power cord.

3) Prohibition of modify

This machine must not arbitrarily be modified or remade. If it is modified or remade, use of this machine may be forcibly suspended.

To change the specifications or disassemble and reassemble this machine, follow the instructions described in this manual and the service information.

4) Electromagnetic wave interference

This machine complies with some standards regarding electromagnetic wave interference, such as VCCI and FCC. However, the user may have to take countermeasures if the machine causes electromagnetic wave interference.

5) "User Manual"

Read each "User Manual" thoroughly prior to use of this machine.

6) Disposal

Follow local regulations when disposing the product and parts. This product is subject to the WEEE Directive in Europe. A lithium battery is installed on the motherboard inside the machine.

Before disposing, make sure that user has initialized (deleted) the user data saved in the machine's memory.

II. NAME OF PARTS

1. Front/Side View

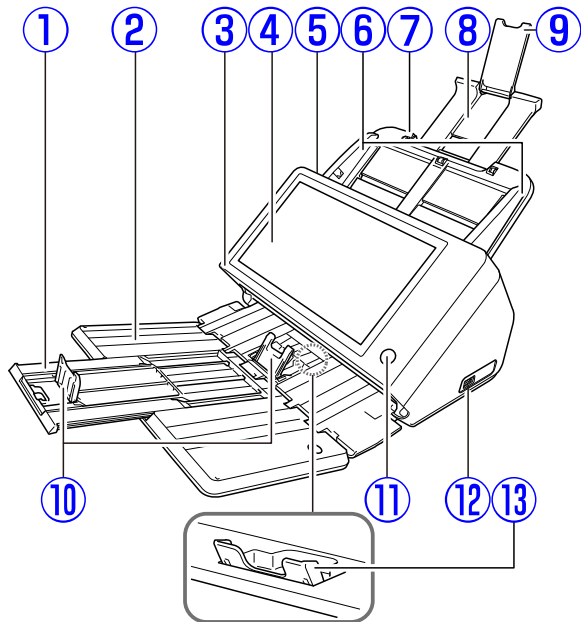

Figure 1-201

- ① Document eject tray extension
- ② Document eject tray
- ③ Panel unit
- ④ Touch panel
- ⑤ Lock lever
- ⑥ Document guides
- ⑦ Document feed tray
- ⑧ Feed support
- ⑨ Feed extension support
- ⑩ Document eject stopper
- ⑪ Power button
- ⑫ USB port (Side face)
- ⑬ Eject tray support

Note:The “panel unit” is referred to as the “front unit” in Chapter 2 and later chapters of this document.

2. Rear View

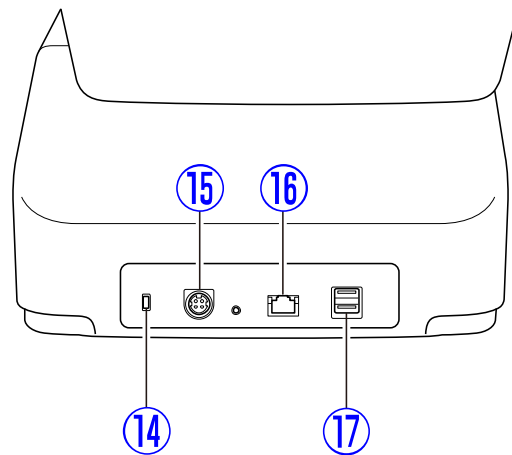

Figure 1-202

- ⑭ Kensington slot
- ⑮ Power connector (24 VDC)
- ⑯ LAN port (RJ-45)
- ⑰ USB ports (Two ports on rear face)

III. USER OPERATION

For details, refer to the “User Manual” of this machine.

For installation and maintenance, refer to “CHAPTER 4 INSTALLATION & MAINTENANCE”.

1. Preparation

◆ Tray

Make preparations of the trays to suit the document and, as necessary, of the eject tray extension.

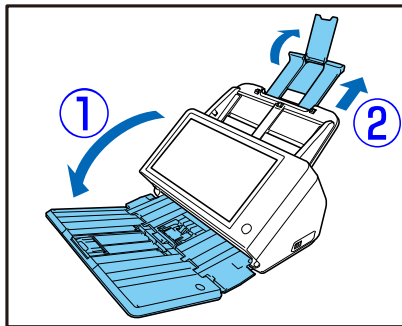

Figure 1-301

◆ USB ports

A USB memory can be connected. Refer to the “restrictions” below.

Also, a USB keyboard or mouse can be connected here.

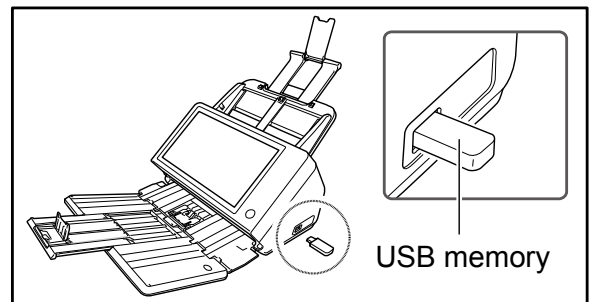

Figure 1-302

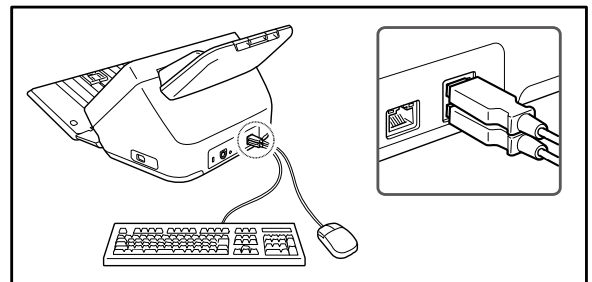

Figure 1-303

Note: Restrictions on USB memories

- 1) Connect a USB memory after the power is turned ON (after activation completed).
- 2) The format must be FAT16 or FAT32.
- 3) Special USB memories with a security function, a data encryption function or a password function cannot be used. CD-ROM-type USB memories cannot be used either.

◆ Document

Flip through documents.

Adjust the document guides to fit the document width.

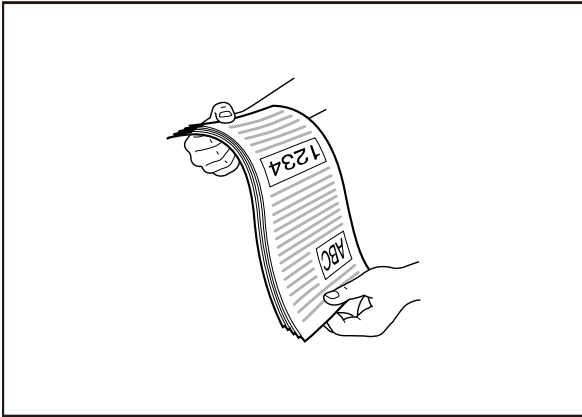

Figure 1-304

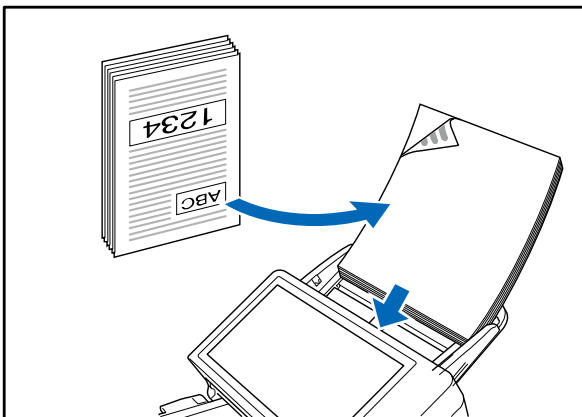

Figure 1-305

◆ Turning on the machine

Press the power button to turn on the machine. The power button is lit and the [Home] screen or the [login] screen is displayed.

Each setting can be configured from this screen.

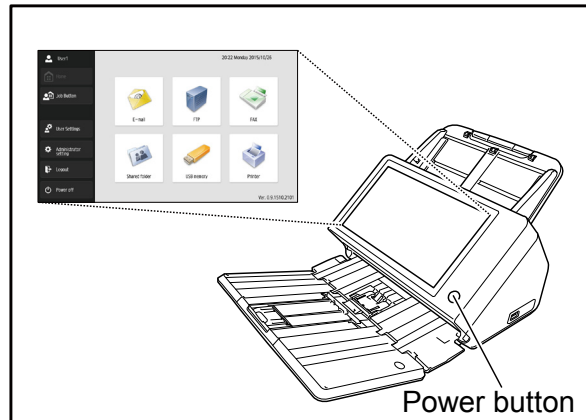

Figure 1-306

◆ Turning off the machine

Press [Power off] displayed at the lower left of the screen to turn off the machine.

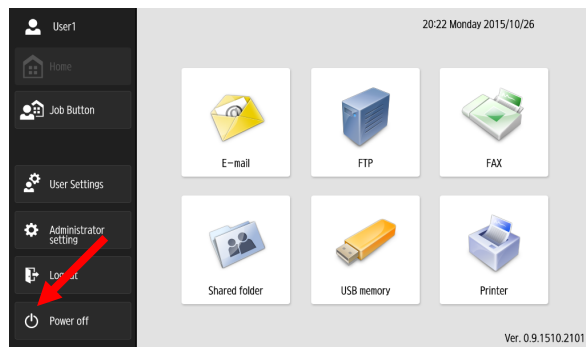

Figure 1-307

2. Flow of Scanner Operations

The procedure and screen transitions for the process from turning the machine ON to sending an image file are as follows.

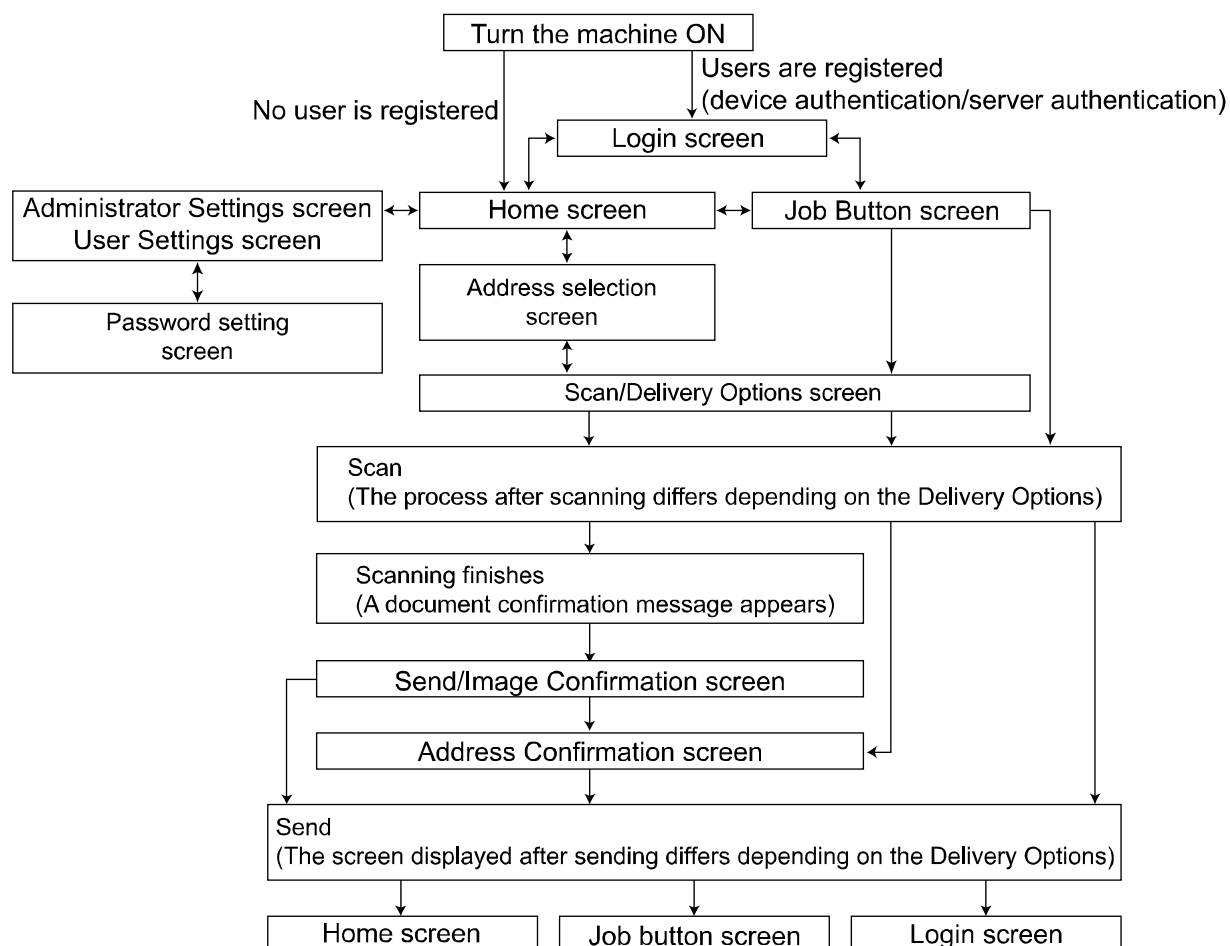

Figure 1-308

CHAPTER 2

FUNCTIONS & OPERATION

I. OUTLINE.....	2-1	V. POWER SUPPLY.....	2-21
II. READING SYSTEM.....	2-8	VI. ELECTRICAL PARTS LAYOUT.....	2-23
III. FEED SYSTEM.....	2-10	VII. PARTS LAYOUT ON EACH PCB.....	2-26
IV. CONTROL SYSTEM.....	2-16		

I. OUTLINE

1. System Configuration

This machine is a network scanner. This machine makes it possible to transfer scanned image data to a shared folder on file server computers, client computers, or an FTP server on the network, to send them to the printer to print, or to distribute them via e-mail or internet FAX service. Also it is possible to save image data on a USB memory connected to this machine.

This machine has both the normal mode that uses Canon's built-in web application and the web app mode that uses the web application on an external web server. You can use these 2 modes by switching them. The external web applications are developed by ISVs using the SDKs provided.

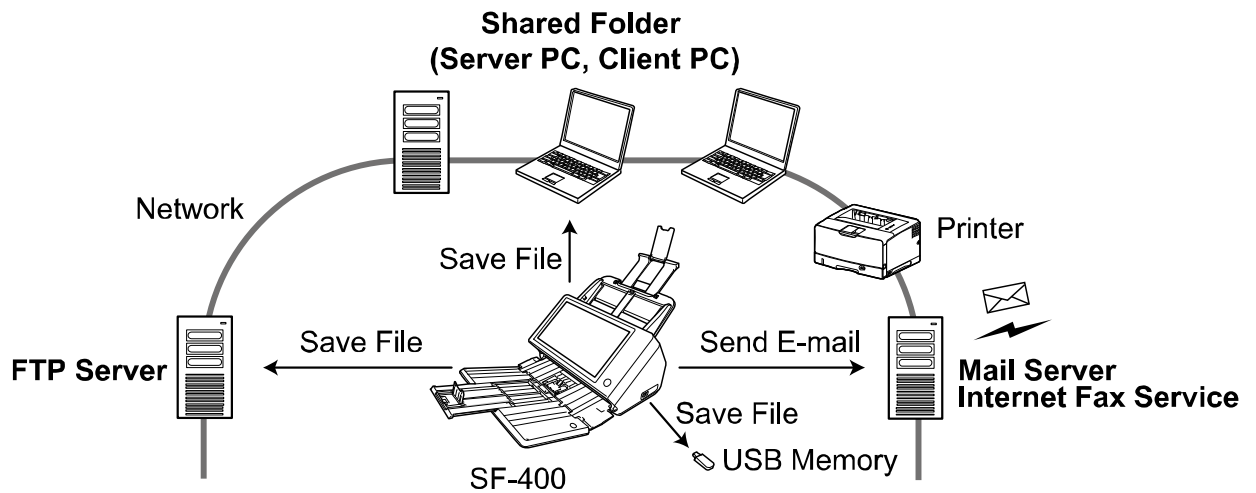

Figure 2-101

◆ Major Network Environment for the Machine

	Item	Description
1	Protocol	TCP/IP
2	IP address	Auto (DHCP) or Fixed
3	Interface	10Base-T/100Base-TX/1000Base-T

Table 2-101

2. Basic Software Configuration

The basic software configuration within SF-400 is shown below.

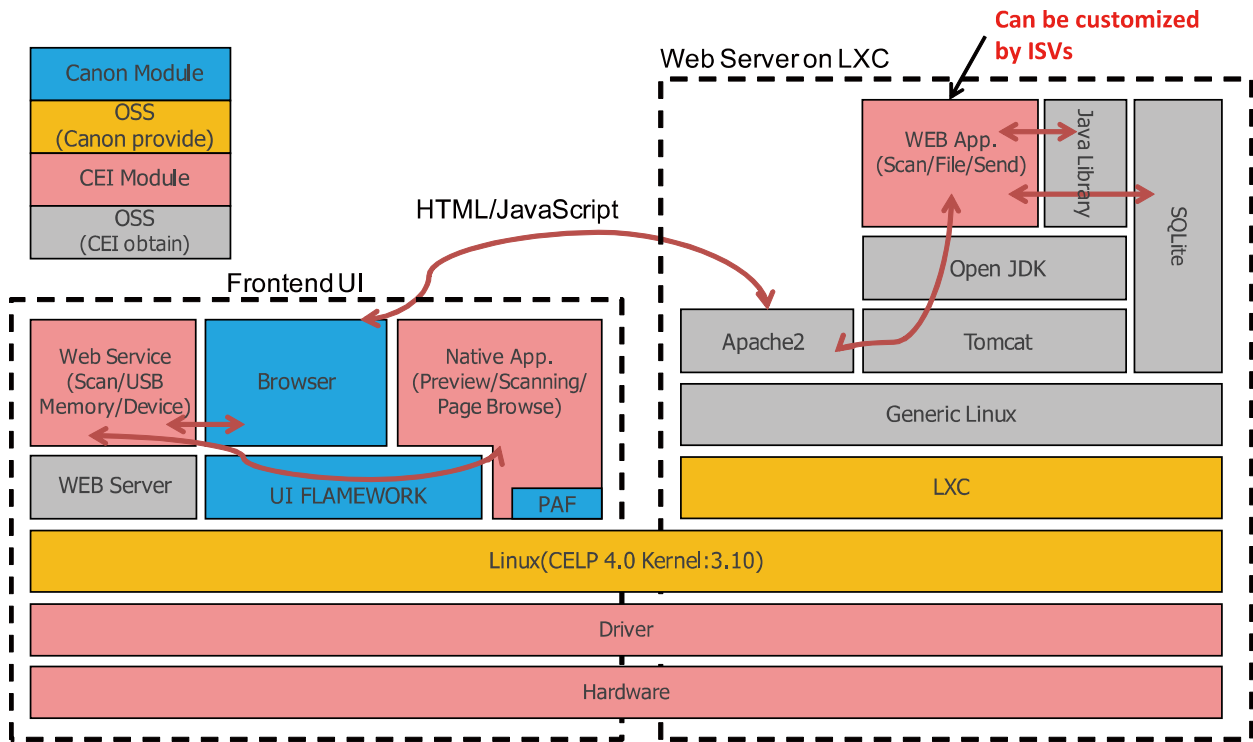

Figure 2-102

3. Main Body Structure

The main body structure of this machine is shown below.

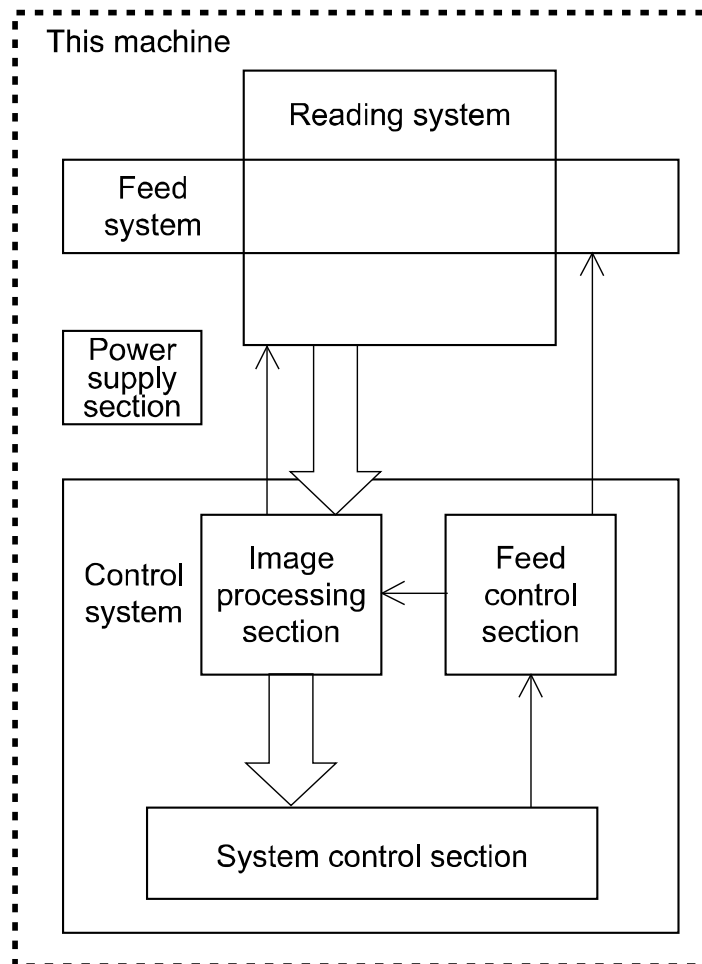

Figure 2-103

- 1) **Reading system**
This system reads image data from image sensors.
 - 2) **Feed system**
This system performs from document pickup to document ejection.
 - 3) **Control system**
This system is comprised of an image processing section, a feed control section, and a system control section. The image processing section controls the reading system, and processes the read image data.
 - 4) **Power supply section**
This section supplies DC power, converted from AC power with the packaged AC adapter, to the machine motherboard.
- The feed control section controls the feed system.
The system control section controls the machine's internal system and communicates with the network.

4. Motor Drive

This machine has a feed motor for pickup and separation of documents and has a main motor for feeding documents. The stopper and press roller of the sheet pickup part are moved up and down by the main motor.

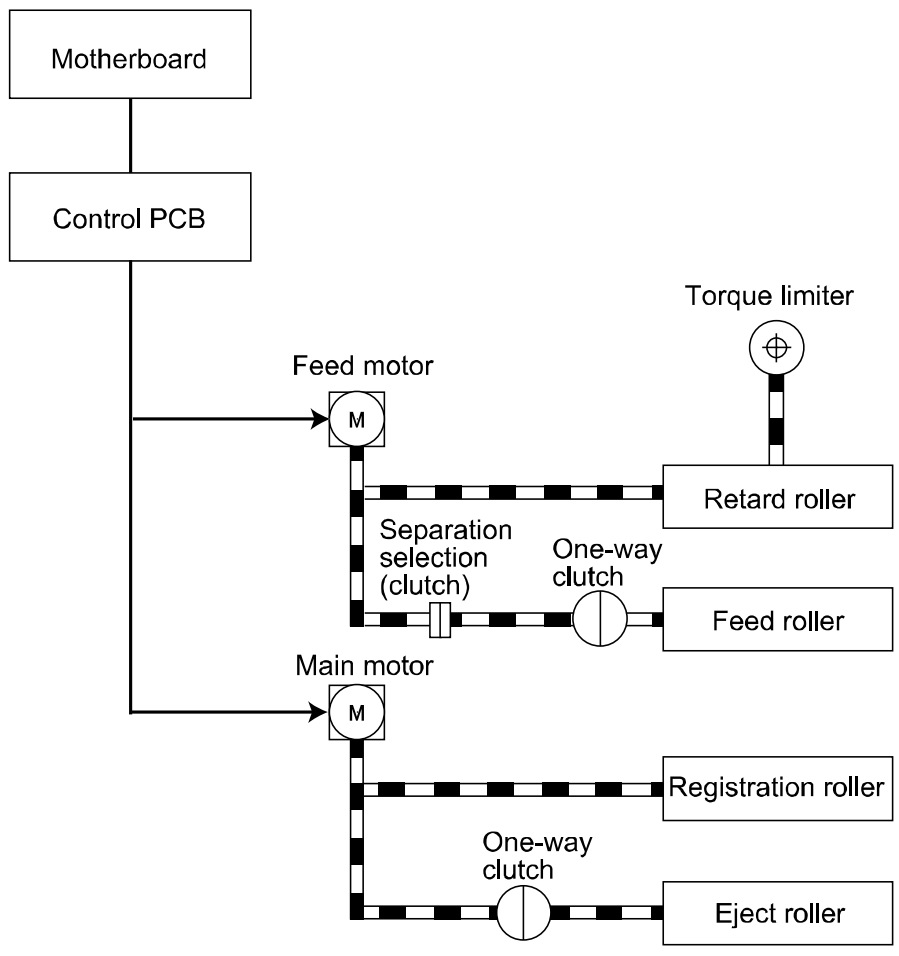

Figure 2-104

5. Electrical Circuits

An overview of the electrical circuits block diagram of this machine is shown below.

The overall system is controlled by the motherboard and the scanning system is by the control PCB.

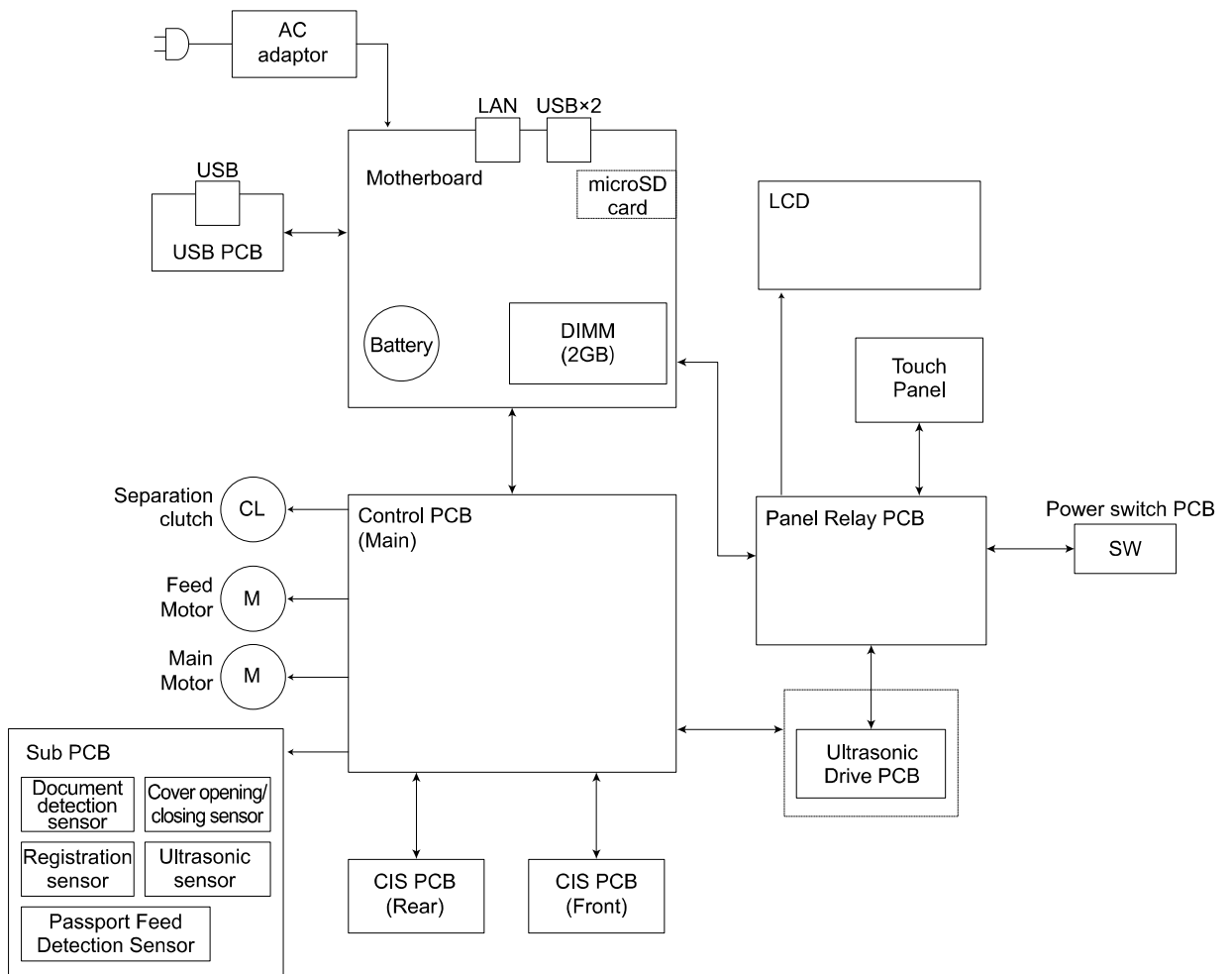
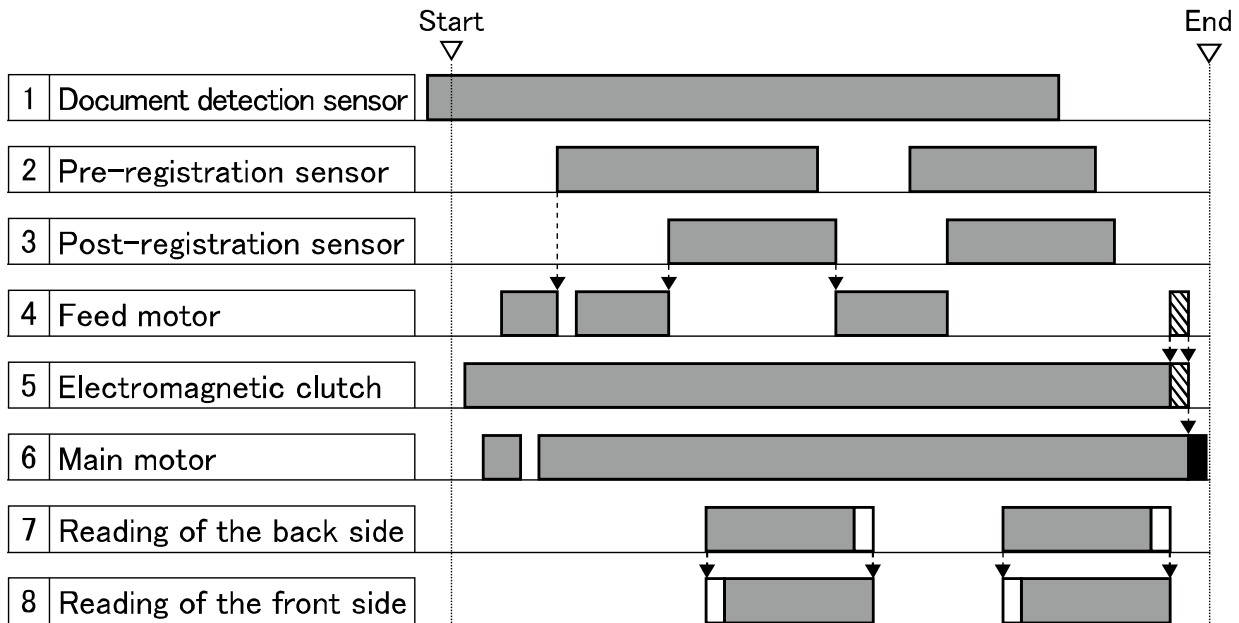

Figure 2-105

6. Timing Chart

The timing chart when you pickup 2 sheets of document separately without separation retry is shown below.

Once the machine starts scanning, it activates the feed motor and the main motor, and feeds the document after initial operation.





Note:  indicates the motor should be turned a certain amount in order to address the non-feed of the last sheet
 indicates reverse operation to eject the stopper
 indicates the offset part

Figure 2-106

7. Basic Knowledge of Network

This machine transmits scanned image data over a network as well as saving it on a USB memory connected to the machine. Since the network itself belongs to a user, you don't know its configuration. Before checking operations of the machine, obtain necessary information from the user or the network administrator. The personal in-

formation such as a password must be input by the user or the network administrator.

However, since service technicians should have knowledge of networks to do their work, they should learn it or use training courses provided by each sales company.

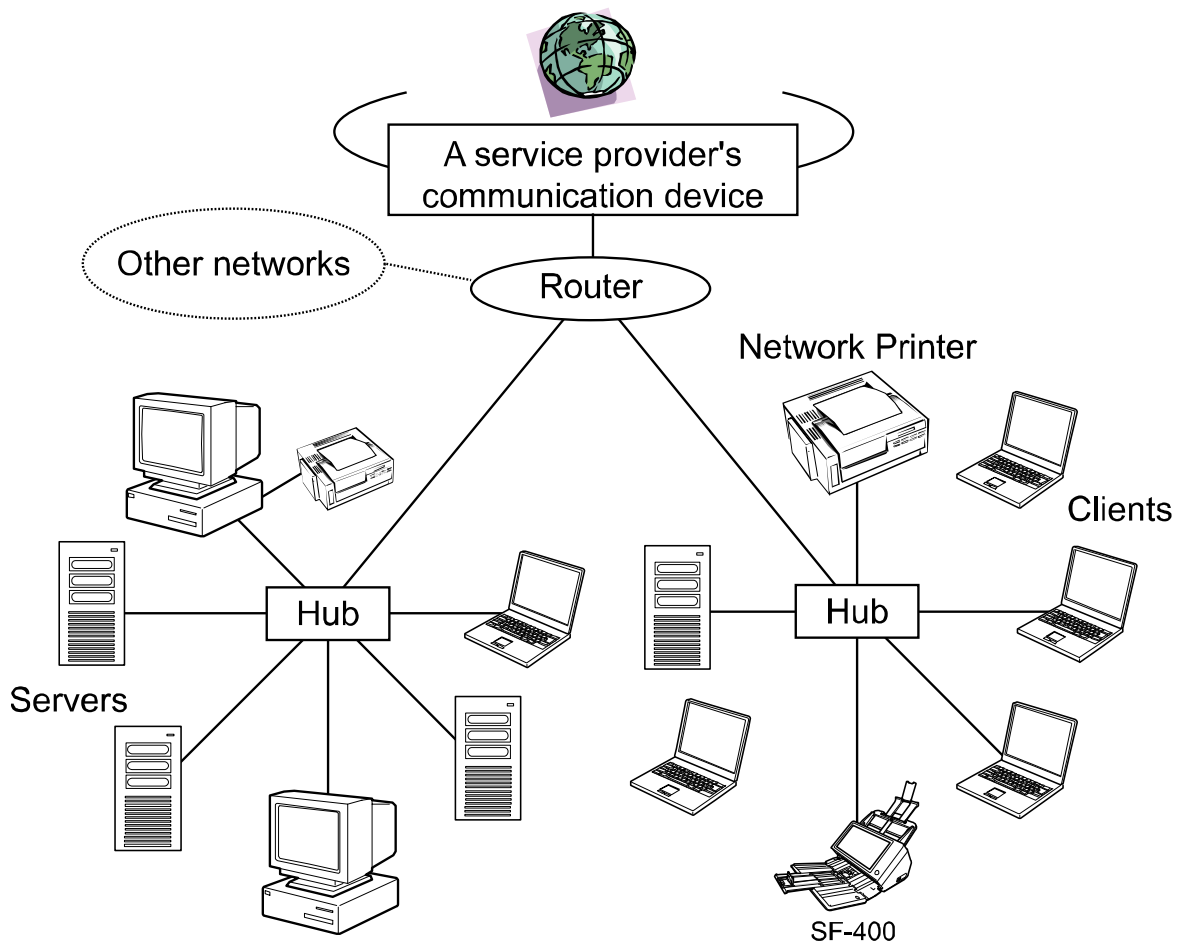

Figure 2-107

II. READING SYSTEM

1. Reading Unit

The configuration of the reading system is shown below.

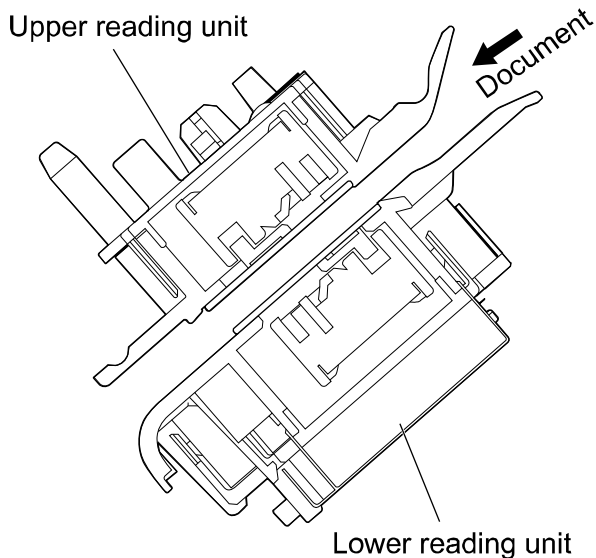

Figure 2-201

The upper reading unit reads the back side of the documents and the lower reading unit reads the front side of the documents. This configuration enables the machine to read both front and back sides of a document using a single scan.

The read image data are sent to the image processing section of the control PCB.

To prevent slowdown of the reading speed, the image data is divided by four and output in parallel.

The sectional view of the lower reading unit is shown below. The upper and lower reading units have the same configuration but the different holder shapes.

The scanning unit consists of CIS unit, holder, and cover.

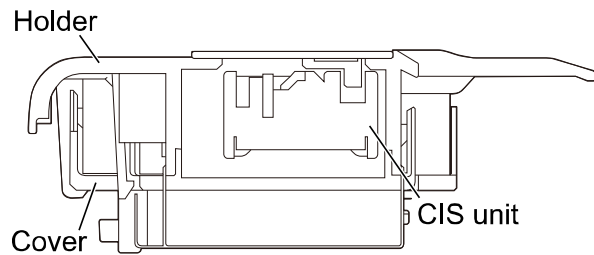

Figure 2-202

The CIS unit consists of CIS PCB, lens array, LED (R/G/B), light guide, and case.

The reading glass and white reference sheet are mounted on the holder.

Light receiving elements are mounted on the CIS PCB with a density of 600 dpi in a line. The effective reading width is 219 mm, and the number of effective picture elements is 5184.

A set of three basic color LEDs, red, green, and blue (RGB), is mounted only on the one side.

In the binary or grayscale modes, image data are read with composite light generated by lighting the RGB LEDs simultaneously. In the color mode, the LED is successively lit, and reads image data with each color. As documents are being fed at regular speed while image data are read, the reading positions of RGB are shifted slightly.

In the color dropout mode, only the LED of a designated color lights. In the color emphasis mode, the LED of a color other than a designated color lights.

2. Shading

This section explains the reading mechanism of the white reference sheet for determination of the shading correction

value.

The sectional view of the reading unit is shown below.

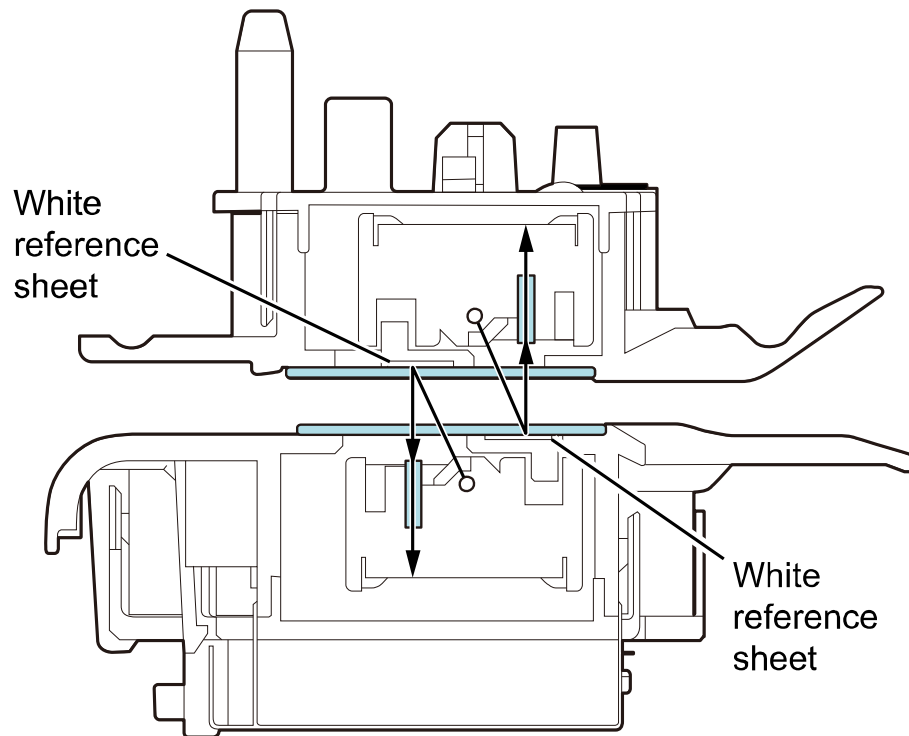

Figure 2-203

Unlike other scanners having the black background color, this machine can read the white reference data at the document reading position because its background color is white. Therefore, there is neither need to feed the shading sheet nor to move the internal shading sheet or the reading units.

For example, when the lower reading unit reads the white reference data, the LED emitted from the lower unit is reflected from the white reference sheet on the upper unit to be input to the sensor on the CIS PCB.

Since the white reference sheet is placed under the reading glass, document feeding does not cause dirt on it.

When this machine is turned on or starts scanning, it reads the white reference data to determine the shading correction value.

However, the slightly different optical paths to the light receiving element are used for the actual document and the white reference sheet. Therefore this machine needs fine adjustment of the shading correction value using the service mode. This fine adjustment is necessary after replacing the reading unit or after replacing the control PCB recording the shading correction value.

III. FEED SYSTEM

1. Feeding Mechanism

The sectional view of the feed system is shown below.

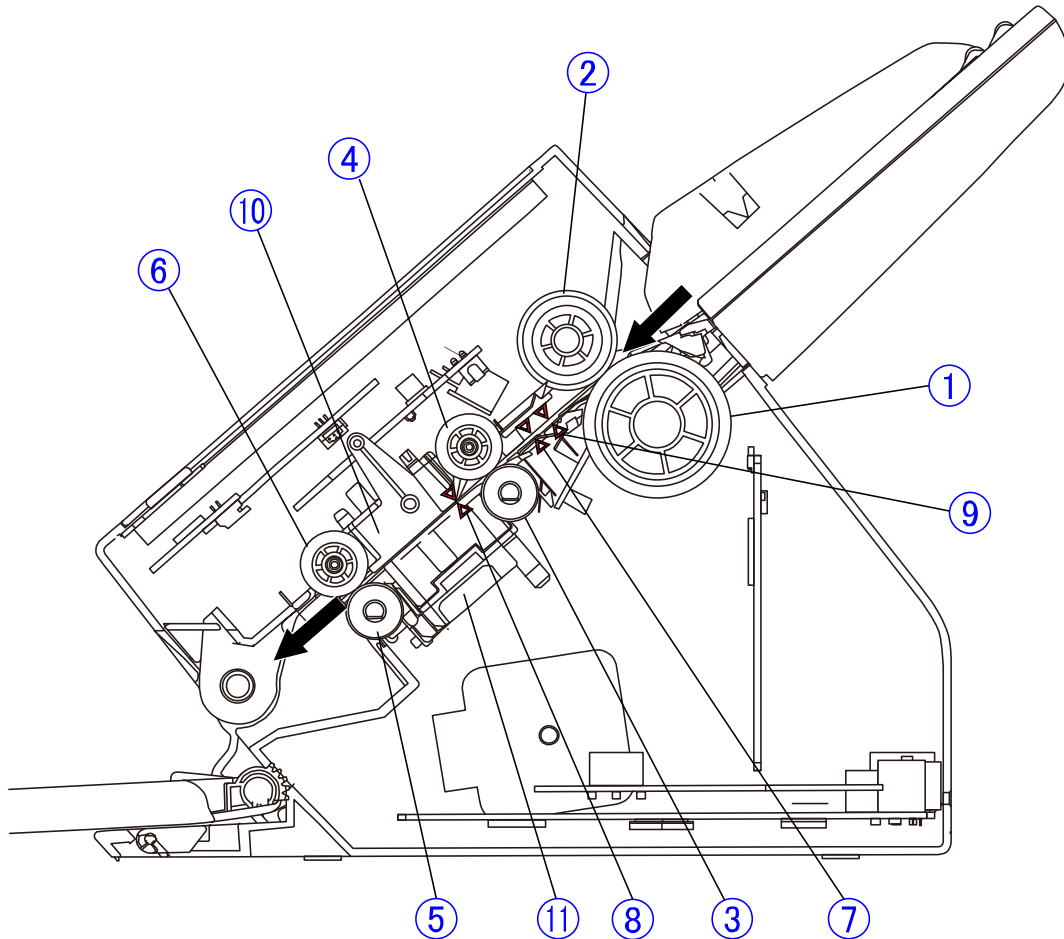

Figure 2-301

- | | |
|----------------------------------|--|
| ① Feed roller | ⑥ Eject roller (follower) |
| ② Retard roller | ⑦ Pre-registration sensor detection point |
| ③ Registration roller (drive) | ⑧ Post-registration sensor detection point |
| ④ Registration roller (follower) | ⑨ Ultrasonic sensor detection point |
| ⑤ Eject roller (drive) | ⑩ Upper reading unit |
| | ⑪ Lower reading unit |

1) Feed path

The feed path of this machine is a straight path tilting at an angle of approximately 40 degrees.

For details on the arrangement of the rollers, sensors, and other components, refer to the cross sectional diagram of the feed system in Figure 2-301.

Documents placed in the inlet are ejected to the eject tray. When feeding cards, orient the card sideways.

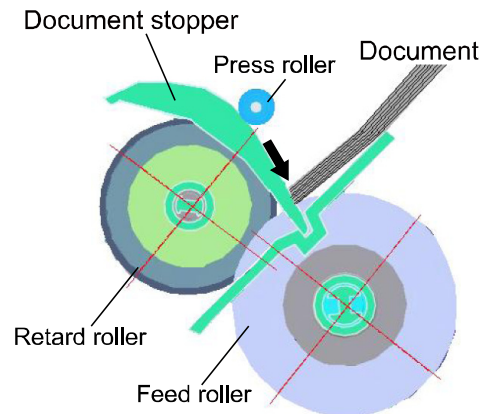

Figure 2-302

2) Drive

The feed motor drives the feed roller and the retard roller, and the main motor drives the registration roller and the eject roller. The scanning condition determines each drive speed.

Furthermore, the document stopper and pressure roller are moved up and down by rotating the main motor backwards.

3) Feed

The following shows a cross-sectional diagram of the pickup area before starting the feed. The document stopper is in the lowered position.

When a document is placed in the inlet, the edge of the document lines up at the document stopper. When a scan is started, the pressure roller moves down and then the document stopper moves up and the document begins to feed. Documents feed from the lower side of the placed document.

4) Separation

Separation of the documents is performed by the retard roller.

Since the torque limiter is built in the retard roller, when the outside pressure on the roller exceeds the specified value into the feed direction, the roller begins to rotate in the same direction.

As shown in Figure 2-303-a, when overlapped documents enter into the clearance between the feed roller and the retard roller, the document in contact with the feed roller is fed in the feed direction, and the retard roller rotates in the opposite direction so that the document in contact with the retard roller is not pushed in.

As shown in Figure 2-303-b, once a single document remains, the feed roller and the document add torque on the retard roller. When this torque exceeds the retard roller torque, the retard roller rotates in the direction to feed the document due to the torque limiter.

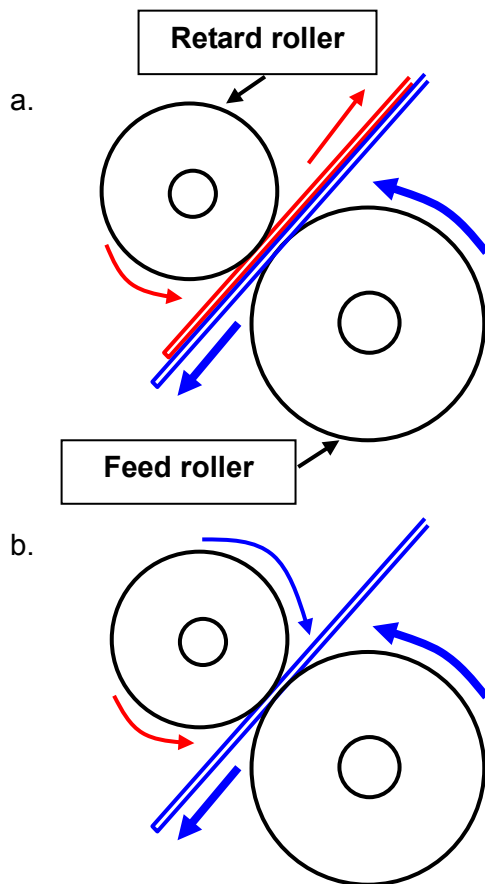

Figure 2-303

Note that if Folio mode or non-separating mode is selected, the separation clutch (electromagnetic clutch) is operated to allow the feed roller to rotate freely and the feed motor is driven in reverse with the document fed by the rotation of the retard roller.

To provide space between the trailing edge of a document and the leading edge of the next document, the drive speed of the feed roller is slightly lower than of the registration roller and eject roller. If it is left as it is, the document is braked when it touches the feed roller and the registration roller, therefore, a one-way clutch is built into the gear used in the feed roller drive system to follow the drive speed of the registration roller.

5) Pickup and separation retry

This machine is equipped with normal mode, thin paper mode, and thick paper mode. You can select the mode from the [Document type] of the detailed settings screen shown below.

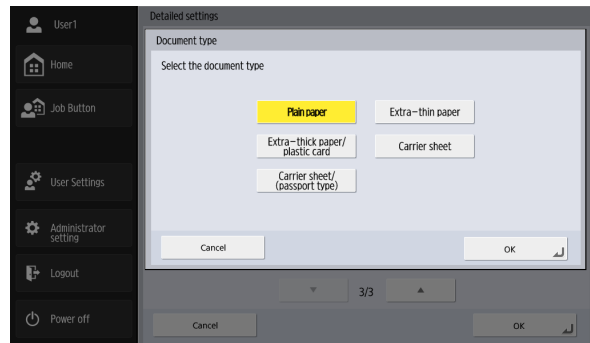

Figure 2-304

Normal mode is active when [Plain paper] or [Carrier sheet] is selected for [Document type], thin paper mode is active when [Extra-thin paper] is selected, and thick paper mode is active when [Extra-thick paper/plastic card] or [Carrier sheet (passport type)] is selected.

Normal mode continuously sends documents by repeating the rotation and stop of the feed roller to provide a carrying interval between paper sheets.

Thin paper mode operates in normal mode at a lower speed.

Thick paper mode continuously sends documents by continuing the rotation of the feed roller to obtain a difference in conveying speed between the feed roller and resist roller to provide a carrying interval between paper sheets.

This machine is equipped with pickup retry and separation retry functions. When a misfeed or double feed (faulty separation) occurs, scanning is able to continue if the

fault can be cleared by repeating these operations.

If the document is not detected by the pre-registration sensor within a designated period of time, the pickup retry stops the feed motor and moves the separation clutch to allow the feed roller to rotate freely, then re-activates the separation clutch and feed motor.

Separation retry stops the feed motor momentarily once the document is detected by the pre-registration sensor, and detects whether or not the document has double fed using an ultrasonic sensor. If a double feed is detected, the machine moves the separation clutch to make rotation of the feed roller free and rotates the retard roller to return the document to the inlet before trying again.

The following shows the state when a double fed document begins to be returned.

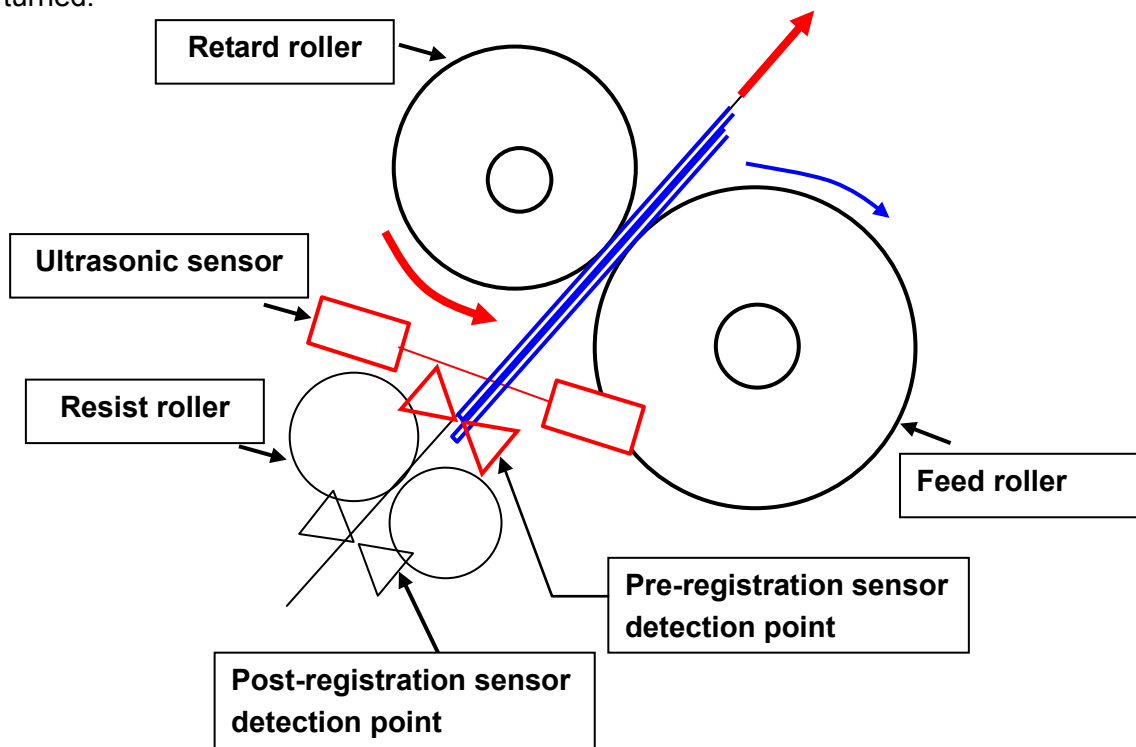

Figure 2-305

2. Feed Error Detection

1) Paper Jam Detection

Paper jams are detected by the registration sensors (pre and post). The types of the document jams are described as follows.

a) Pickup Delay Jam (Pickup Error)

The leading edge of the document was not detected by the pre-registration sensor within the specified time after the machine starts scanning.

b) Early Reach Jam

The leading edge of the following document was detected after the trailing edge of the document was detected by the pre-registration sensor before the document has been fed for a specified length.

c) Residual Jam

The trailing edge of the document was not detected even though the document has been fed for the maximum specified length after the leading edge of the document was detected by the pre- and post-registration sensors.

d) Fast Feed Jam

The trailing edge of the document was detected after the leading edge of the document was detected by the pre-registration sensor before the document has been fed for the minimum specified length.

e) Non-removal Jam

The machine starts scanning while the document is detected by the pre- and post-registration sensors and still remains inside this machine.

2) Double Feed Detection

There are 2 types of double feed detection methods : the document length detection by the registration sensor and the docu-

ment overlapping detection by the ultrasonic sensor.

◆ Registration sensor

The registration sensor uses the first document length of the scanned batch as a reference to detect the document length. The 35 mm or more difference from the standard is interpreted as a double feed. Note that the left and right registration sensors function only as paper jam detection sensor at the first time of shipment from a factory. Although these sensors are planned to work as registration sensors in the future, a firmware update and adjustment by service tool are required.

◆ Ultrasonic sensor

The ultrasonic drive sensor transmits the ultrasonic and the ultrasonic receive sensor receives the ultrasonic signal to gain a specific signal level. When overlapping documents are fed, the signal level is different from when properly feeding a single document. This machine interprets this difference as a double feed.

Note that since this difference in the signal occurs depending on the presence of a layer of air, a double feed will not be detected if the document is tightly adhered by static electricity or adhesive. Furthermore, double feed is judged if a double feed is detected continuously for a specific amount of time. As a result, if the overlap between sheets is less than 50 mm when a document is being fed, it might not be judged as a double feed because the detection time is short. In the case of separation retry, since the detection is performed with the document stopped momentarily, double feed can be judged even if the overlap is short.

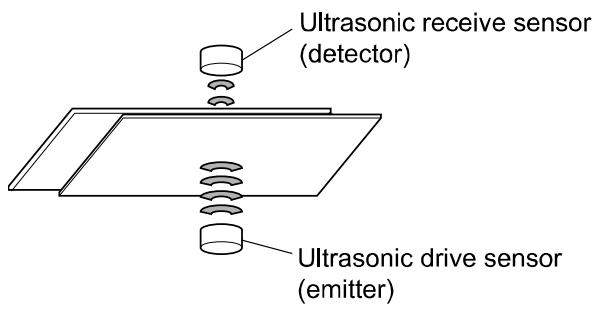

Figure 2-306

IV. CONTROL SYSTEM

1. Motherboard

The overall system of the machine including scanning and networking systems is controlled by the motherboard. The OS

and application software are installed on the micro SD Card (8GBytes).

The block diagram and the main function list of ICs are shown below.

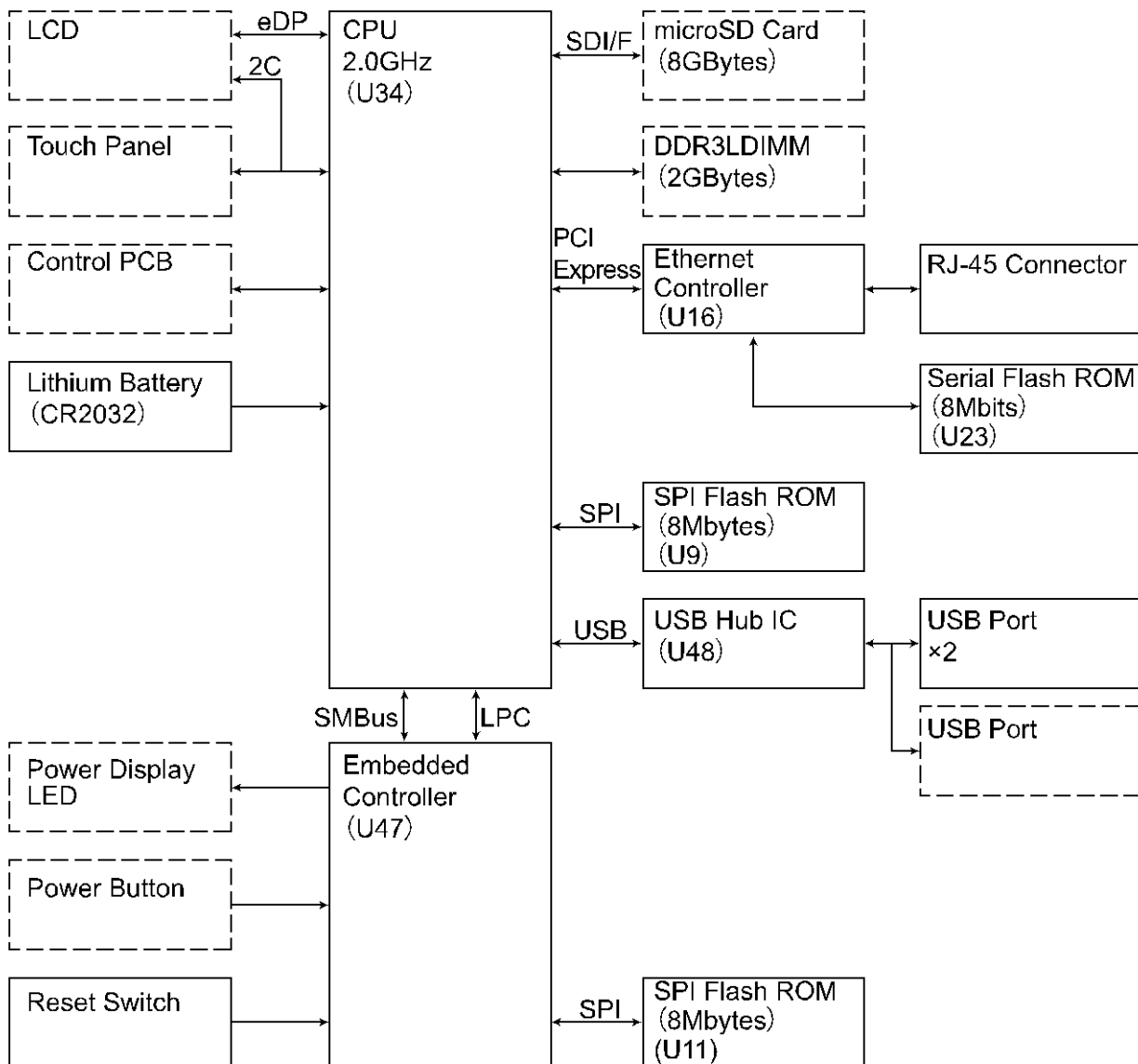

Figure 2-401

◆ Function list of major ICs

IC No.	Name	Function
U34	CPU (SoC: System on Chip)	Controls the overall system (x86 CPU)
U9	SPI Flash ROM	Stores BIOS (firm)
U47	Ethernet Controller	Controls Ethernet (LAN)
U23	Serial Flash ROM	Saves Mac address and Ethernet Controller firm
U16	Embedded Controller	Manages power supply
U11	SPI Flash ROM	Saves Ethernet Controller firm
U48	USB Hub IC	USB hub

Table 2-401

2. Control PCB

This PCB controls scanning system, which is equivalent to the control PCB on

the DR scanner. The block diagram and the main function list of ICs are shown below.

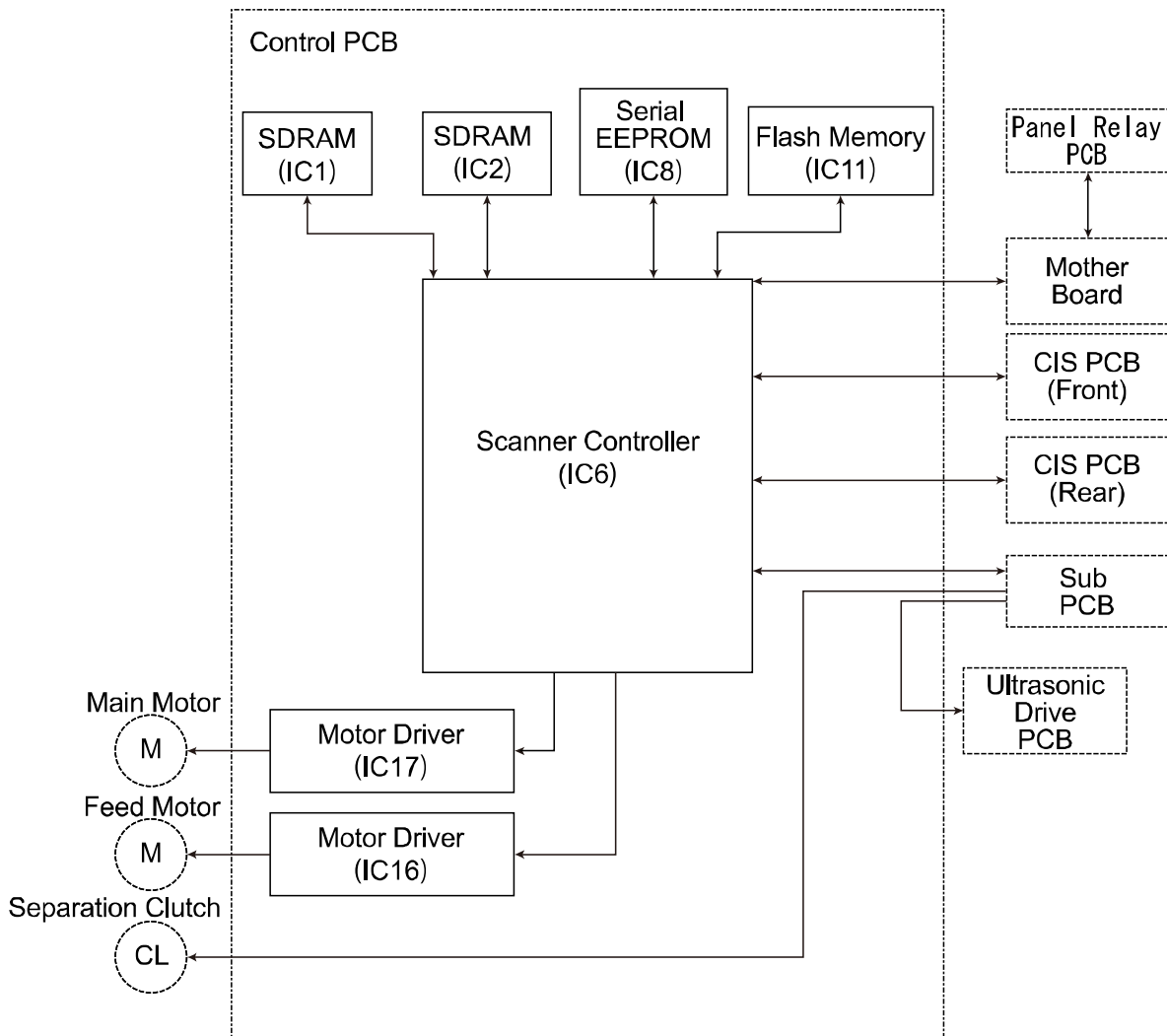

Figure 2-402

◆ Function list of major ICs

IC No.	Name	Function
IC6	Scanner Controller	Controls scanning system
IC8	EEPROM	Stores each setting
IC11	Flash ROM	Stores firmware
IC1, 2	DDR SDRAM	Stores image data temporarily, and serves as a work memory for the Scanner Controller
IC17	Motor Driver	Drives the main motor
IC16	Motor Driver	Drives the feed motor

Table 2-402

3. Image Processing Control

The block diagram of the image processing in the main body is shown below.

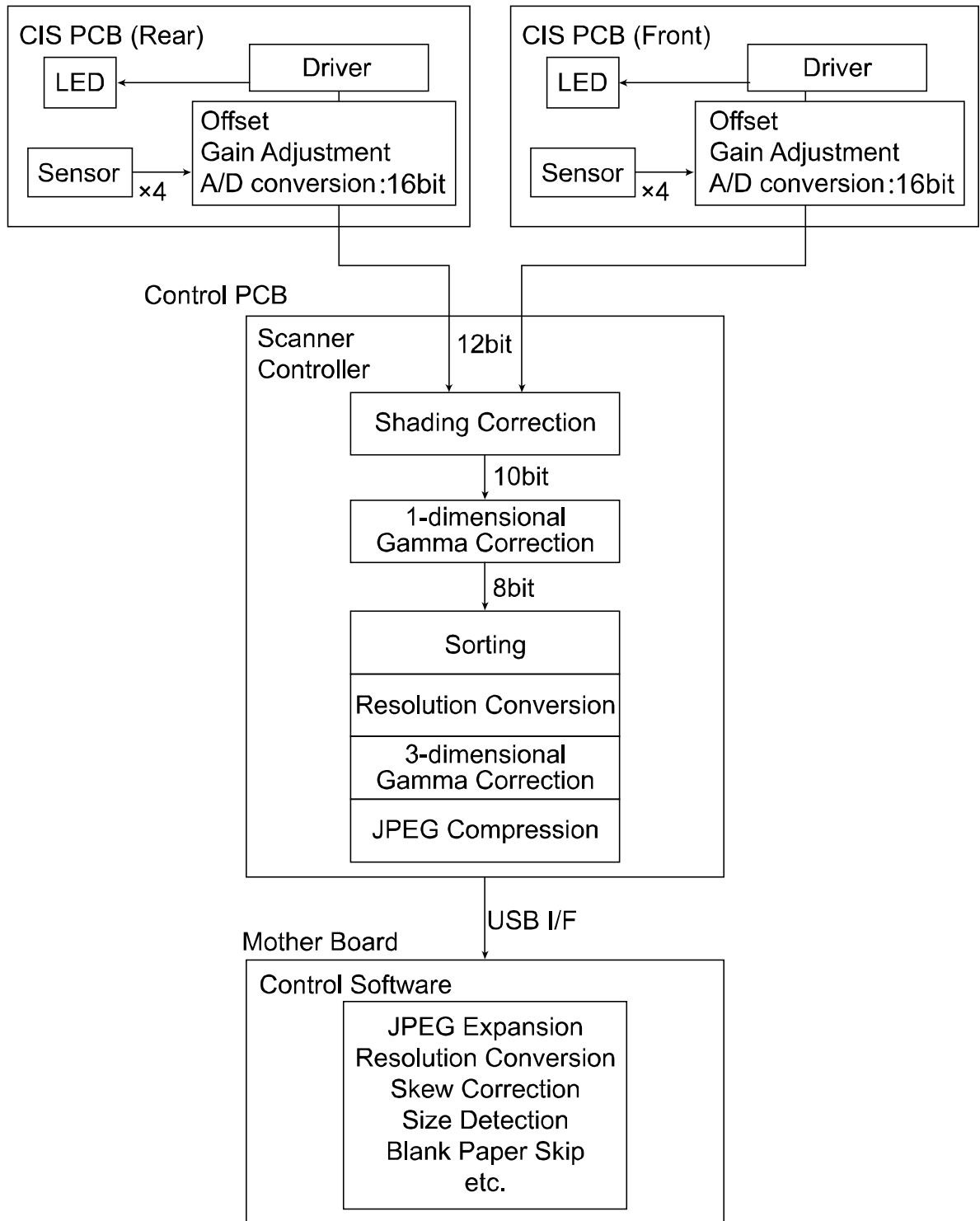

Figure 2-403

Analog signals proportionate to the density of each picture element are output as 4 parallel lines from the image sensor on the CIS PCB to the analog processor. The analog processor carries out offset adjustment, gain adjustment, and A/D conversion. Analog signals are converted into 16 bit digital signals in the analog processor.

This image data is sent to the scanner controller on the control PCB where shading correction and one-dimensional gamma correction are performed, and the data is simultaneously converted into 8-bit data. After this, data reordering, resolution conversion, three-dimensional gamma correction, and JPEG compression are performed, and the data is output to the motherboard via the USB interface.

Inside the motherboard, the various image processing is executed according to the user settings using the driver for this machine.

V. POWER SUPPLY

1. Outline

This machine runs on the AC adapter, whose rated input voltage is 100-240 VAC 50/60Hz and output is 24 VDC. Use the AC adapter bundled with this machine.

Plugging the AC adapter to the machine activates the monitoring system on the power switch. When the power switch is ON, the CPU is powered on and supplies the power to each PCB.

The motherboard and control PCB generate various DC low voltages. The relay PCB has an inverter circuit to generate AC high voltage and supply it to the LCD backlight. The motherboard has a lithium battery for the real-time clock.

In case of excess voltage or current applied to the AC adapter output, the safety system cuts the power. In this case, unplug

the AC plug. After about 10 minutes, the machine recovers automatically. After removing the cause, plug it back.

For power saving, the machine switches to sleep mode after the period of time which the main unit set elapses. When switching to sleep mode, the machine confirms if it is connected to the network cable. If not connected, the machine wakes up from sleep mode after 4 hours. When waking up from sleep mode, the machine confirms again the network connection, and if still not connected, it turns off the power (complying with Lot6). If the machine detects network connection, it enters into sleep mode again after the period of time which the main unit set elapses.

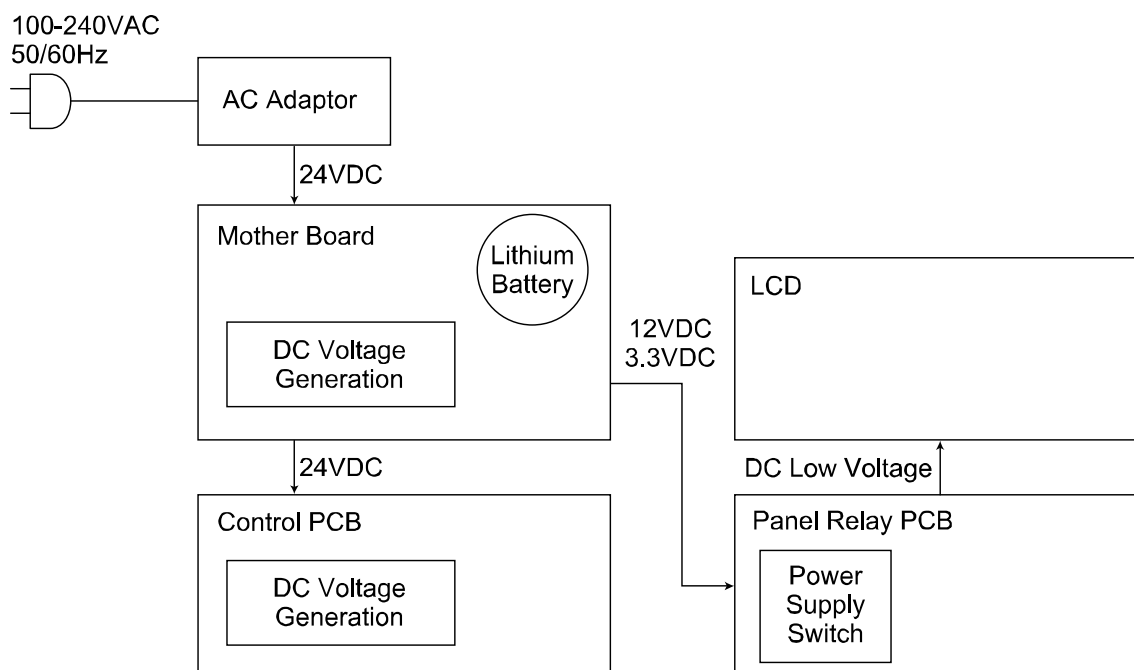

Figure 2-501

2. Lithium Battery

The motherboard of the machine mounts a lithium battery for the real-time clock. The battery specification is as follows:

Manufacturer: Sony Corporation (or equivalent competitor products)

Model: CR2032

Supply voltage: 3V

Capacity: 220mAh

However, when 24V is supplied from the AC adapter, this function is maintained by the power supplied from the AC adapter, not from the lithium battery.

When the battery has run out, the clock setting is disabled. The reconfiguration is necessary after replacing the battery. The clock needs to be reconfigured from the main unit. The reconfigurations are also necessary when the battery is removed temporarily.

For replacing the battery, refer to the "CHAPTER 3 DISASSEMBLY & REASSEMBLY". The battery is not assigned as a service part. Purchase the same or equivalent battery as described above.

◆ Notes on lithium battery

Improper installation may cause an explosion. Make sure that the direction of the battery is correct when installing. Use the same or equivalent battery as described above. Do not attempt to recharge or disassemble it. Do not throw it in the fire. Store it out of the reach of children.

Follow battery manufacturer's instructions or local regulations when disposing a used battery or a PCB mounting a battery.

◆ For California, USA Only

Included battery contains Perchlorate Material - special handling may apply.

See

<http://www.dtsc.ca.gov/hazardouswaste/perchlorate/>
for detail.

VI. ELECTRICAL PARTS LAYOUT

1. Lower Base Unit

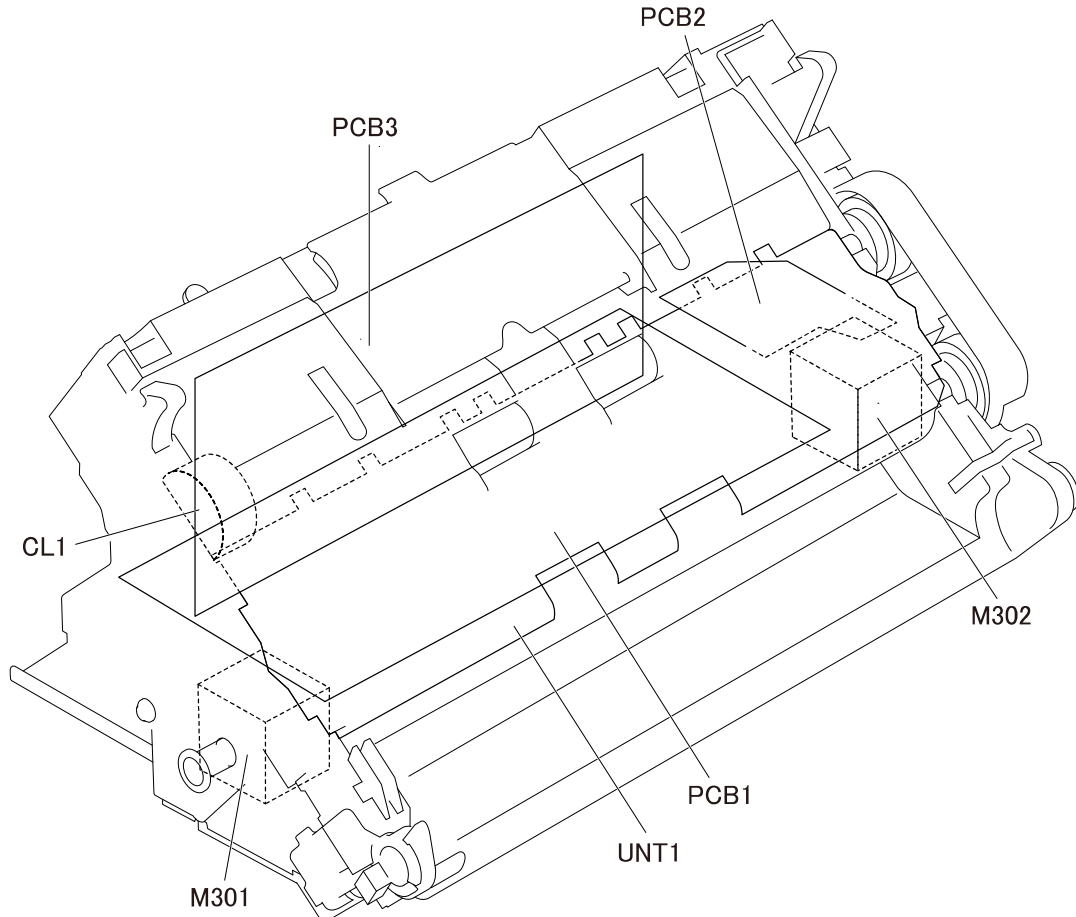

Figure 2-601

Category	Name	Symbol
Clutch	Separation clutch	CL1
Motor	Feed motor	M301
	Main motor	M302
PCB	Motherboard	PCB1
	Interface board	PCB2
	Control PCB	PCB3
Unit	Lower reading unit	UNT1

Note:For the parts on the PCBs, refer to “VII. PARTS LAYOUT ON EACH PCB”.

Table 2-601

2. Upper Base Unit

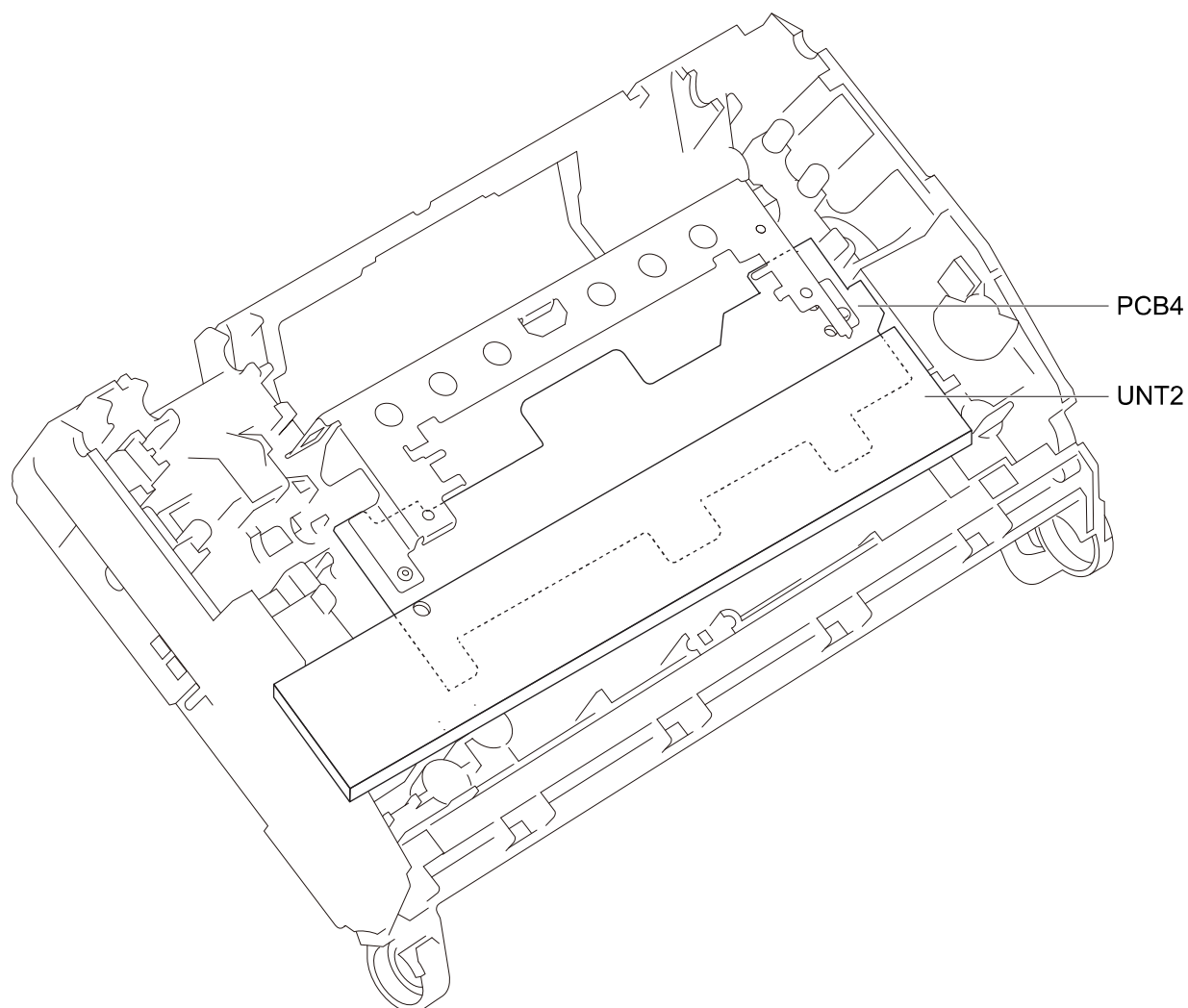

Figure 2-602

Category	Name	Symbol
PCB	Sub PCB	PCB4
Unit	Upper reading unit	UNT2

Note:For the parts on the PCBs, refer to “VII. PARTS LAYOUT ON EACH PCB”.

Table 2-602

3. Front Unit

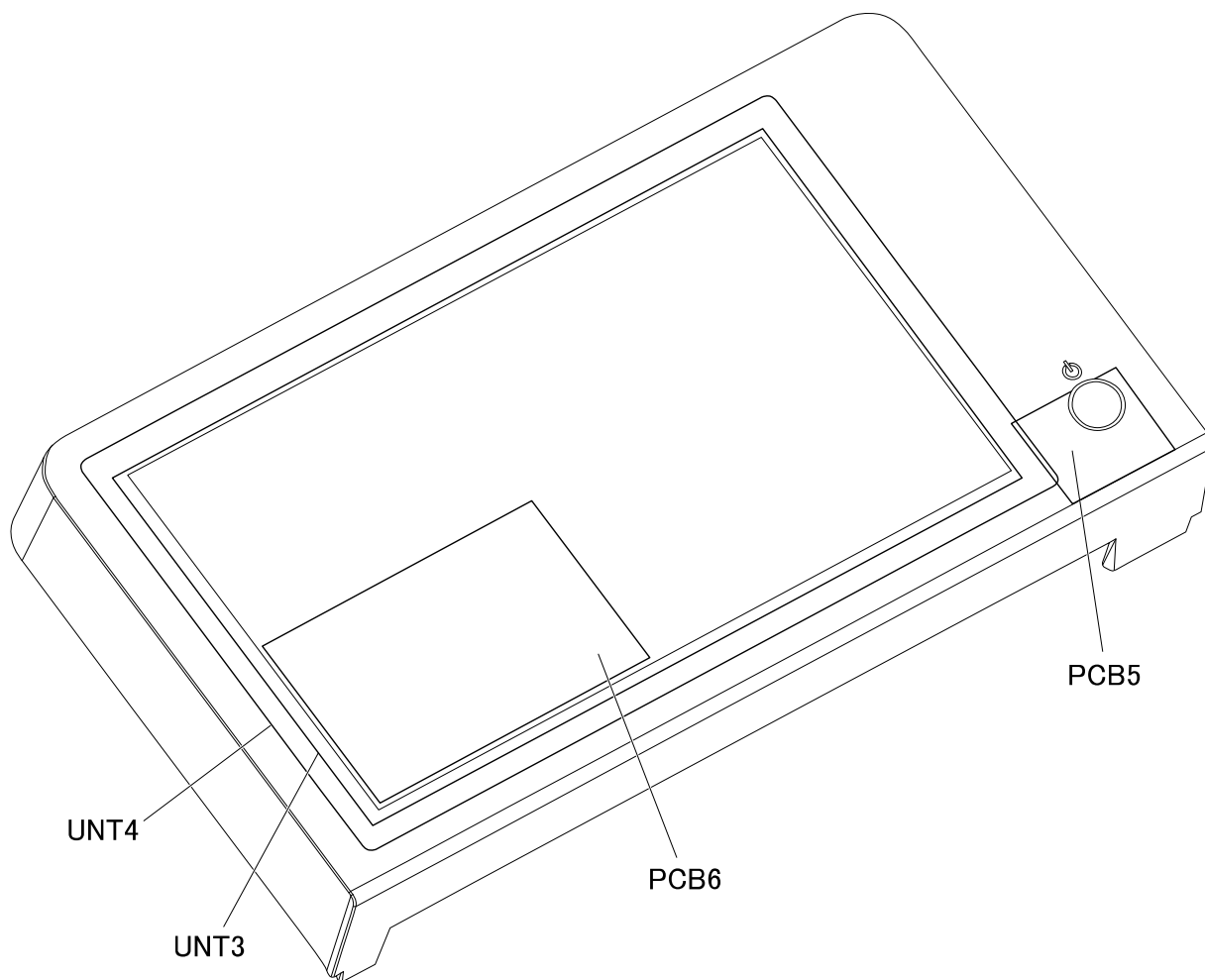

Figure 2-603

Category	Name	Symbol
PCB	Power switch PCB	PCB5
	Panel Relay PCB	PCB6
Unit	LCD	UNT3
	Touch panel	UNT4

Note:For the parts on the PCBs, refer to “VII. PARTS LAYOUT ON EACH PCB”.

Table 2-603

VII. PARTS LAYOUT ON EACH PCB

1. Motherboard

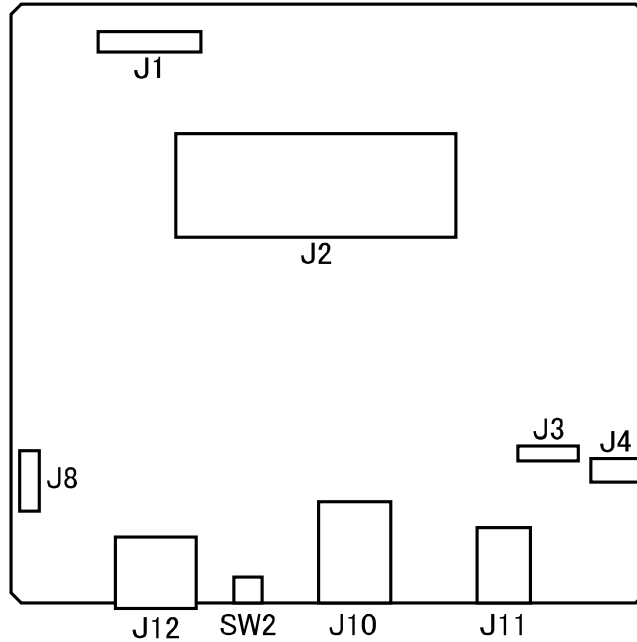

Figure 2-701

Connector		Description
J1	30P	LCD, connector for touch panel
J2	204P	Connector for SO-DIMM
J3	20P	USB connector for scanner controller
J4	4P	Power supply connector for scanner controller
J8	20P	Connector for external substrate
J10	12P	Connector for Ethernet (RJ-45)
J11	8P	Connector for USB (double)
J12	4P	DC power connector

Table 2-701

Symbol	Description
SW2	Reset switch

Table 2-702

Note1: SO-DIMM

Memory SO-DIMM is inserted into the connector J2 and this is included with the service part motherboard.

2. Control PCB

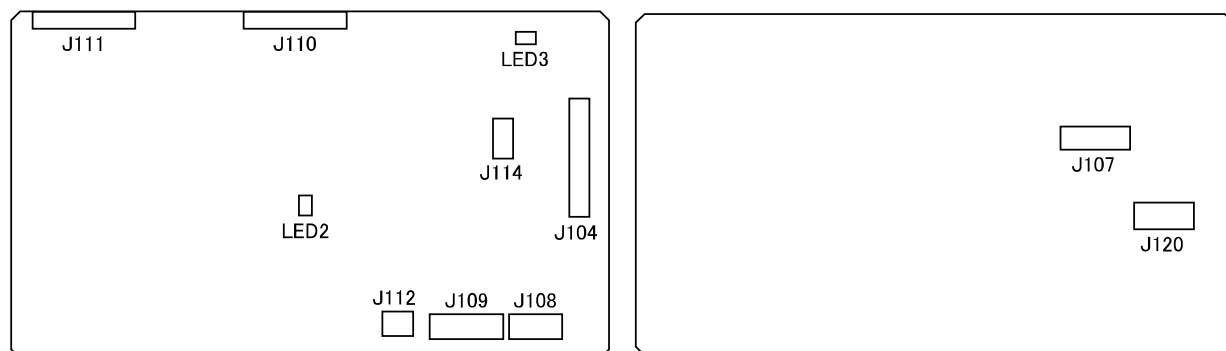

Figure 2-702

Connector		Description
J104	16P	Connector for sub PCB
J107	20P	USB connector for scanner controller (to be connected to mother board J3)
J108	4P	Connector for main motor
J109	6P	Connector for feed motor
J110	20P	Connector for backside CIS
J111	20P	Connector for front side CIS
J112	2P	Connector for clutch
J114	4P	Connector for ultrasonic drive PCB
J120	4P	Power supply connector for scanner controller (to be connected to mother board J4)

Table 2-703

Symbol	Description
LED3	Power supply LED (Lighting: Power ON)
LED2	Operation LED (Blinking: Operating normally)

Table 2-704

3. Sub PCB

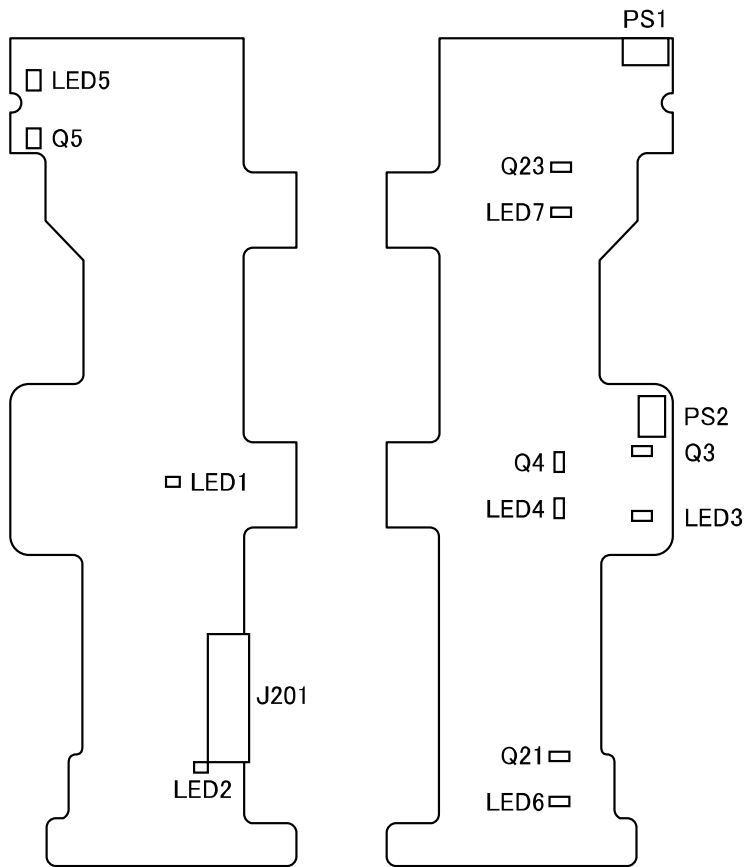

Figure 2-703

Connector		Description
J201	16P	Connector for Sub PCB (connected to J104 of the control PCB)

Table 2-705

Symbol	Description
LED2	Power supply LED (Lighting: Power on)
LED1	Boot complete LED (Blinking: Normal boot complete)
LED4/Q4	Post-registration (center) sensor
LED3/Q3	Pre-registration sensor
LED6/Q21	Post-registration (left) sensor
LED7/Q23	Post-registration (right) sensor
LED5/Q5	Document stand document detection sensor
PS1	Upper cover opening and closing detection sensor
PS2	Passport feed detection sensor

Table 2-706

4. Interface Circuit Board

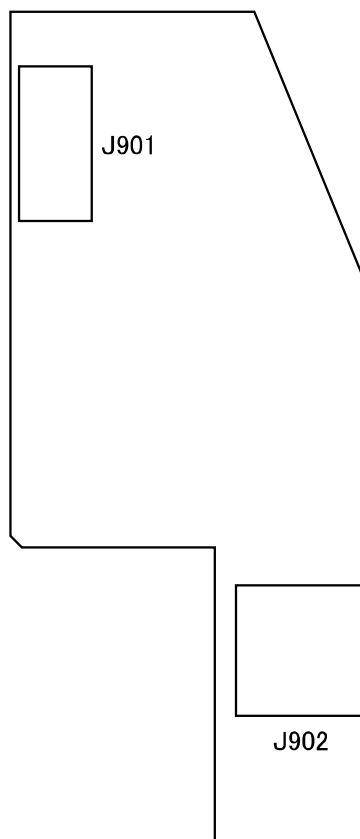

Figure 2-704

Connector		Description
J901	20P	Connector for external circuit board (To be connected to mother board J8)
J902	4P	USB connector

Table 2-707

5. Panel Relay PCB

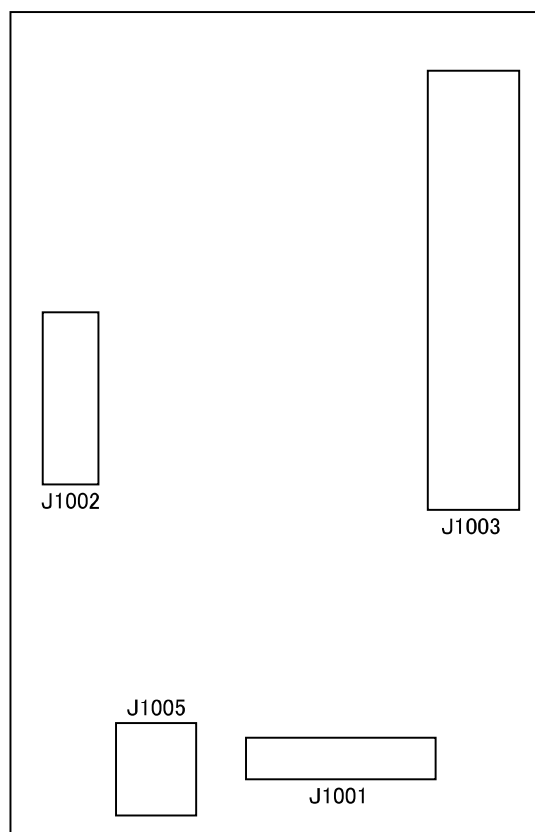

Figure 2-705

Connector		Description
J1001	30P	Connector for LCD and touch panel (to be connected to mother board J1)
J1002	30P	Connector for connecting LCD
J1003	80P	Connector for connecting touch panel
J1005	3P	Connector for power switch PCB

Table 2-708

6. Power Supply Switch Circuit Board

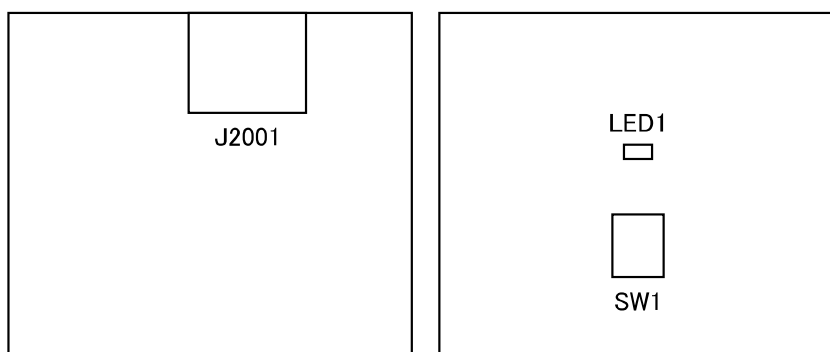

Figure 2-706

Connector		Description
J2001	3P	Connector for power switch PCB (To be connected to LCT/TP circuit board)

Table 2-709

Symbol	Description
SW1	Power supply SW
LED1	Power supply LED (Lighting: Power ON, Blinking: in suspended condition)

Table 2-710

CHAPTER 3

DISASSEMBLY & REASSEMBLY

Note: The machine shown in the photographs of the figures in this chapter may be different from some mass-produced machines.

I. EXTERNAL PARTS.....	3-1	III. BASE UNIT	3-11
II. FRONT UNIT.....	3-3	IV. READING UNIT.....	3-22

I. EXTERNAL PARTS

1. Pickup Tray

- 1) Pull up the document feed tray ① to remove it.



Figure 3-101

Note: This component may be removed before disassembling other components even if not specifically directed.

2. Eject Tray

- 1) Open the front unit and remove 2 screws ①.

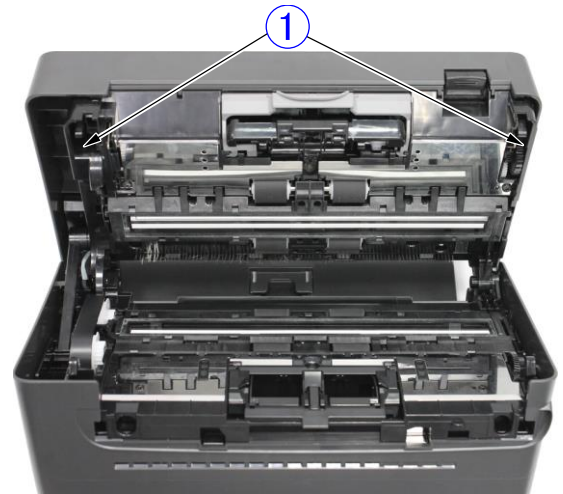

Figure 3-102a

- 2) Open the document eject tray ①, then unhook the fitting part ② (4 places) located on the backside of the front panel assembly.

Remove the screw ③ (M3x8, BH, self-tapping) and while lifting up the front panel assembly to the arrow direction, move the fitting part ⑤ on the right side toward you and remove it. Then, unhook the fitting part ⑥ on the left side, and remove the document eject tray.

Note: When the document eject tray is removed, the document eject tray hinge unit may be removed.

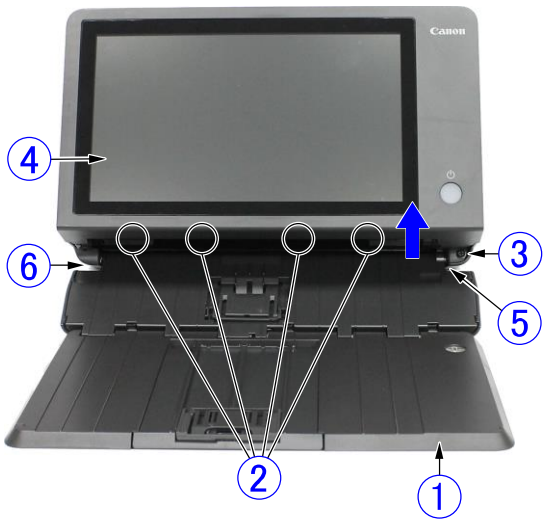

figure 3-102

Note: This component may be removed before disassembling other components even if not specifically directed.

◆ **Notes on assembling**

When mounting the document eject tray, be careful not to damage the base unit by the end of the center torsion spring.

3. Lower Cover

- 1) Use a tool with thin and flat edge to unhook the fitting part ① (4 places; 2 each on the left and right sides), and remove the lower cover ② while opening the gap between the lower cover and base unit.

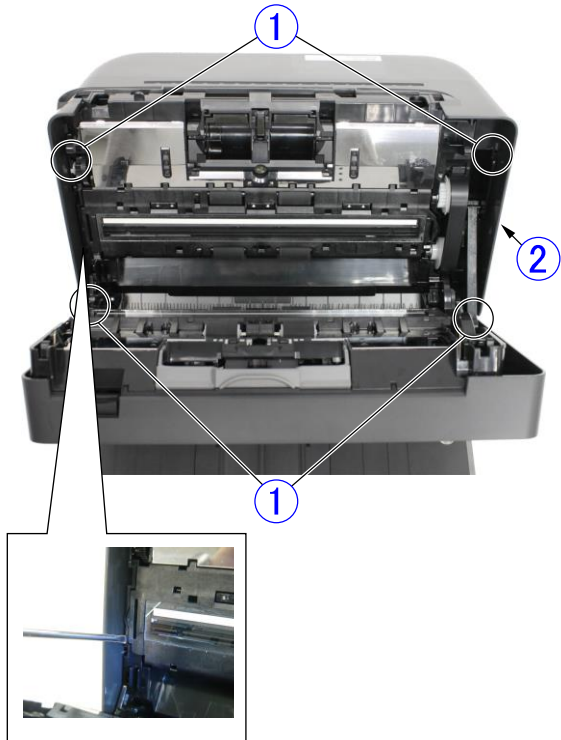

Figure 3-103

II. FRONT UNIT

1. Front Panel Assembly

- 1) Open the front unit and remove 2 screws ①.

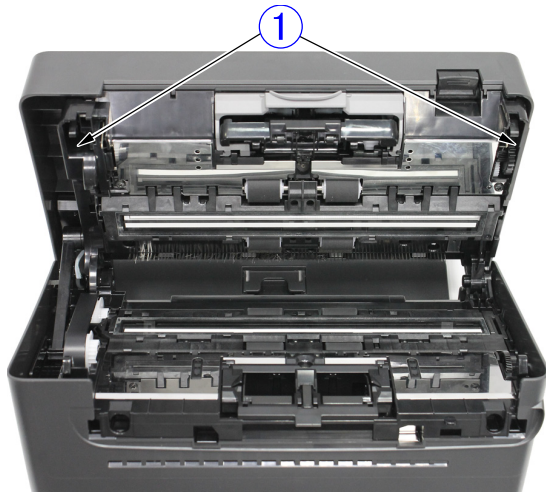

Figure 3-201

- 2) Put the main unit on its side as shown in the below figure, and unhook the fitting part ① (4 places).

Note: Unhook the fitting parts by bending the hooks in the upward direction.

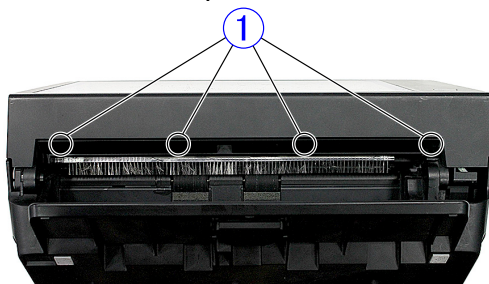

Figure 3-202

- 3) Open the front unit, unhook the fitting part ① (2 places). Remove the face type connector connected to the backside of the front panel assembly, and then remove the front panel assembly.

Note: If the front panel assembly is not held with a hand, it hits the table when it is removed. Do not pull it excessively because the cable ① is connected to the backside of it. When removing the face type connector ②, pull the tape in vertical direction. When you remove the front panel assembly, the lock lever shaft and the coil spring on the inside may become detached.

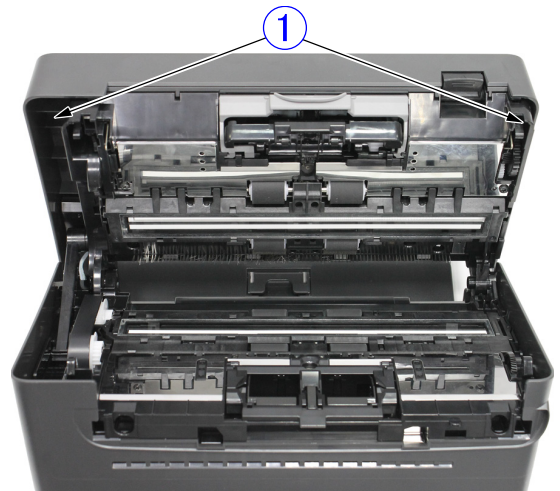

Figure 3-203

◆ **Notes on assembling**

The face type connector may be damaged if you attach it obliquely. To attach it correctly, press down the center of the connector in vertical direction.

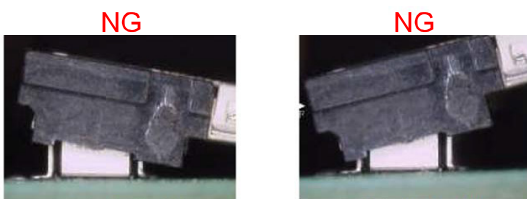
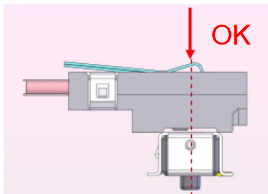

Figure 3-204

2. LCD Assembly

Note: Do not disassemble this component needlessly because dust may enter inside the touch panel when it is disassembled.

When disassembling, be careful that the dust does not enter inside. Also be careful not to touch the LCD surface and inside of the touch panel.

- 1) Remove the front panel assembly. [\(Page 3-3\)](#)
- 2) Remove the 2 screws ① (M3x10, BH, self-tapping) and remove the document eject slot cover ②.

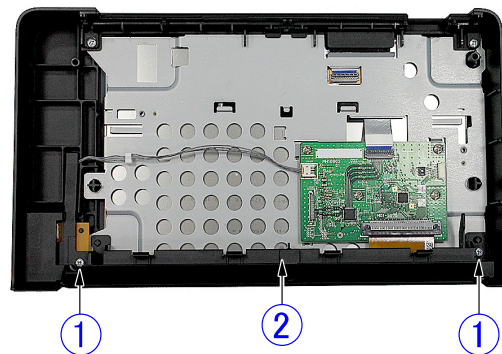

Figure 3-205

- 3) Remove the 3 screws ① (M3x10, BH, self-tapping) and remove the document feed slot cover ②.

Next, detach the connector ③, and remove the power switch PCB ④.

Unlock the connector ⑤ to remove the cable. Then remove the LCD assembly ⑥ from the upper cover (with touch panel).

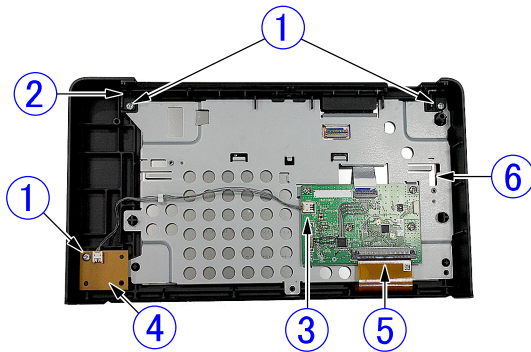

Figure 3-206

◆ **Notes on assembling**

If the surface of the display panel is stained with fingerprints, etc., clean it before assembling.

This also applies to the inner surface of the touch panel.

3. Sub PCB

- 1) Remove the front panel assembly.

[\(Page 3-3\)](#)

- 2) Remove the lock lever shaft ① and a coil spring ②.

Note: The document detection lever attached to the lock lever shaft is hooked on the document stopper and should be unhooked.

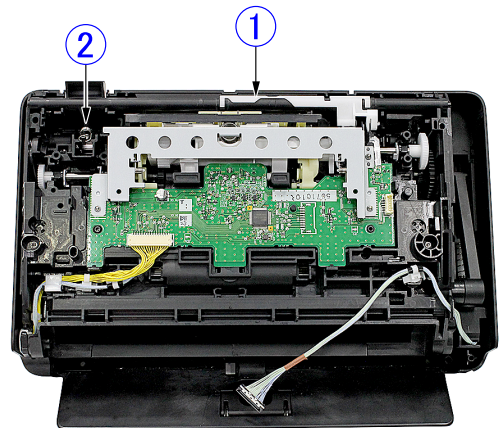

Figure 3-207

3) Remove the 2 screws ① (M3, BH, round head) and remove the sub PCB ②.

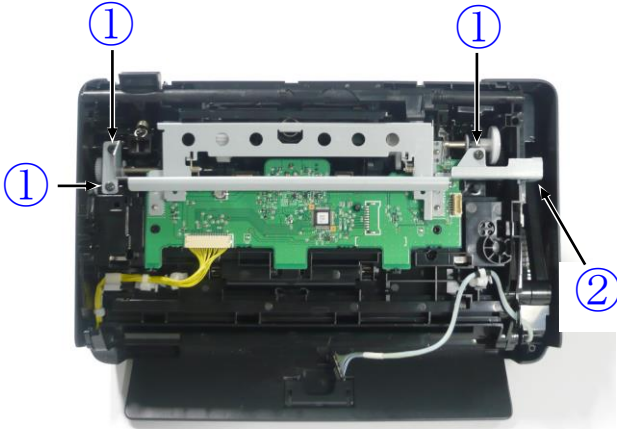

Figure 3-207b

4) Disconnect the connector ①. Next, while unhooking the fitting part ② (4 places), tilt the sub PCB unit ③ toward you. It is easy to unhook the upper metal fitting parts first. Then, while unhooking the fitting part ④ (2 places), remove the sub PCB unit.

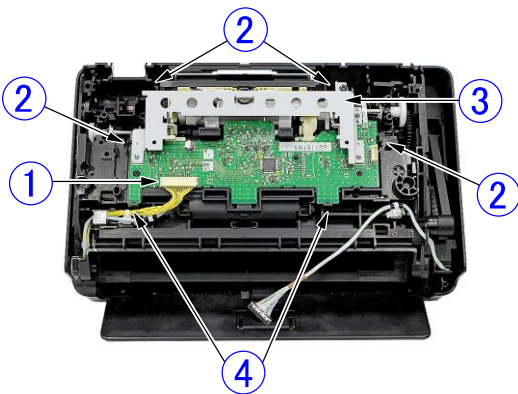

Figure 3-208

4) Remove the 2 screws ① (M3, BH, round head) and remove the sub PCB ②.

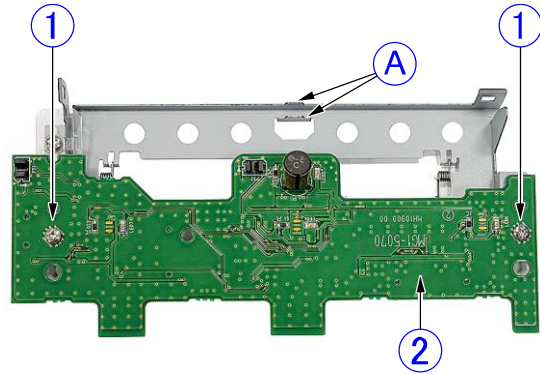

Figure 3-209

◆ Notes on assembling

You should attach the screws after inserting the 2 protrusions on the mounting plate into the holes for setting the position on the sub PCB.

When mounting the PCB unit on the base, mount it so that 2 protrusions A of the sub PCB unit fit into the coil spring of the separation float unit. Also, all of the fitting parts (7 places) should be fully seated. There should not be any raised parts.

When you attach the Reinforcement plate, you should attach the screws with a turn of ①→②→③.

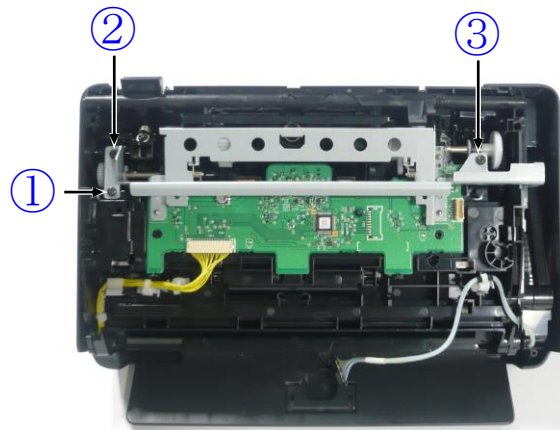

Figure 3-209b

4. Stop Cam Drive Unit

- 1) Remove the sub PCB unit.
Refer to "3. Sub PCB".
(Page 3-5)
- 2) Remove the 2 screws ① (M3x8, BH, self-tapping). Next, detach the retaining ring ② and slide the bearing ③ in the direction of the arrow. Then, remove the cam on the left side of the stop cam drive unit ④ while removing it from the bottom of the pickup arm unit ⑤.

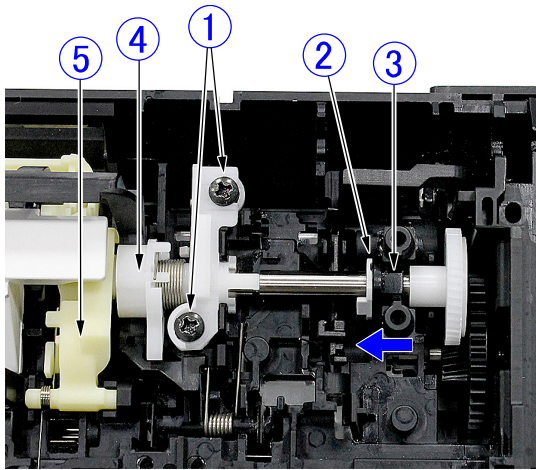

Figure 3-210

◆ Notes on assembling

The cam should be mounted between the pickup arm unit and the document stopper unit.

Mount the bearing so that the flat face is facing toward you.

When fixing the stop cam drive unit with the screws, first tighten the upper screw and then tighten the lower one.

5. Upper Drive Unit

- 1) Remove the stop cam drive unit.
(Page 3-7)
- 2) Unhook the fitting part ① (4 places), then remove the document stopper unit ②. Next, slide the separation float unit ③ to the right while pulling it upward to remove it. Then, unhook the fitting part ④ (2 places) and remove the pickup arm unit ⑤. It is easy to unhook the left fitting part first.

Note:The torsion spring that fits into the document stopper unit may become detached.

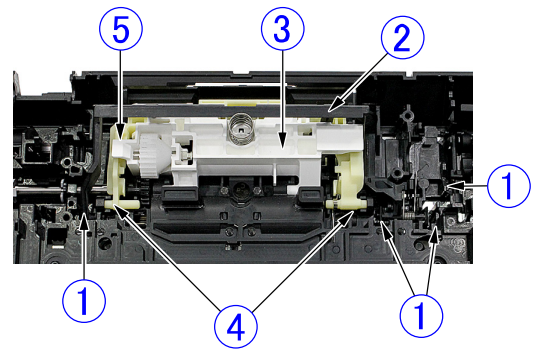

Figure 3-211

- 3) Detach the 2 retaining rings ①, slide the bearing ② in the direction of the arrow, and then detach the upper drive unit ③.

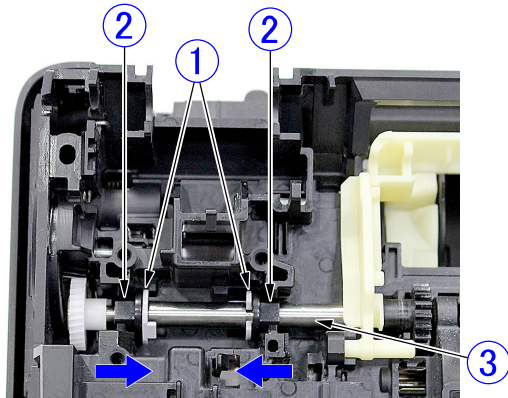

Figure 3-212

◆ **Notes on assembling**

Mount the bearing so that the flat face is facing toward you.

When mounting the document stopper unit, fit the torsion spring into the shape of the upper frame as shown in the below figure.

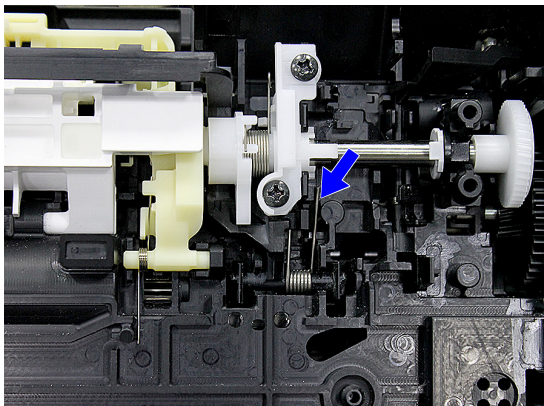

Figure 3-213

6. Front Unit

- 1) Remove the upper reading unit.
[\(Page 3-22\)](#)
- 2) Remove the damper unit.
[\(Page 3-15\)](#)
- 3) Remove the front panel assembly.
[\(Page 3-3\)](#)
- 4) Detach a connector ①. Next, release a cable holder ③ and 3 cable holder ② (reusable type). Then, free the cable ④ from the front unit ⑤.

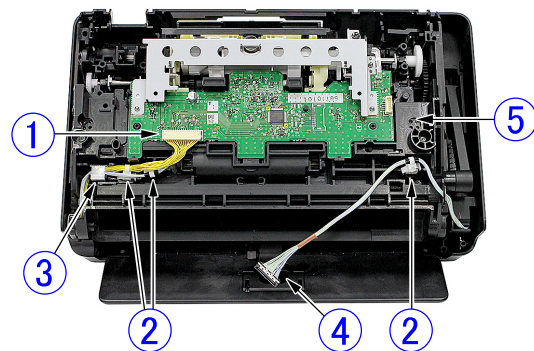

Figure 3-214

- 5) Open the front unit ①, and remove it from the base unit by sliding it to the direction of the arrow.

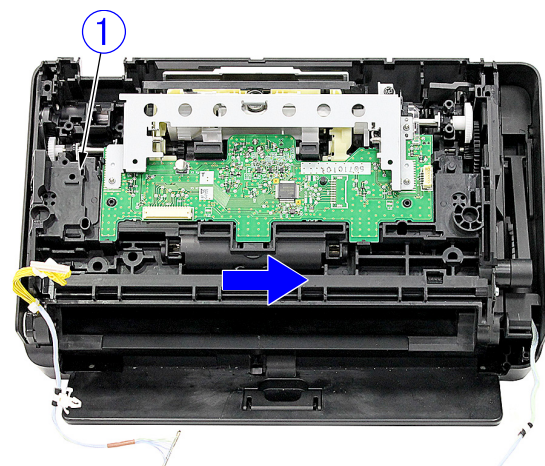

Figure 3-215

7. Upper Feed Guide Plate

- 1) Remove the upper reading unit.
([Page 3-22](#))
- 2) Remove the 2 screws ① (M3x8, BH, self-tapping). Unhook the center fitting part ② by using the tool with the thin and flat edge, pull the lower side of the upper feed guide plate ③ toward you, release the plate from the fitting part ④ (4 places), and then remove the plate.

Note: To unhook the central fitting part ②, bend the part upward by using the tool with thin and flat edge.

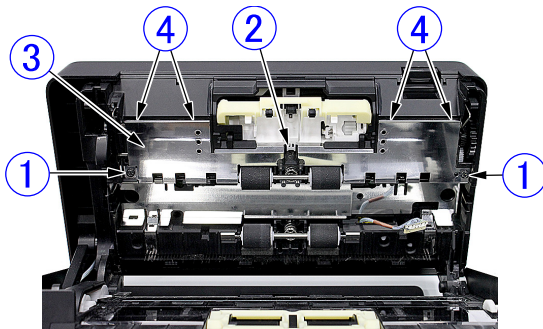

Figure 3-216

◆ Notes on assembling

You should attach the screws after inserting the upper frame protrusion ⑤ positioned to the left of the right side screw ① into the hole for setting the position on the upper feed guide plate.

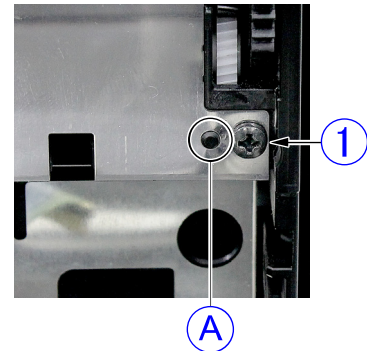

Figure 3-217

Do not damage the light guide by the edge of the upper feed metal plate.

All of the fitting parts (5 places) should be fully seated. There should not be any raised parts.

If the upper feed guide plate is largely deformed and cannot be return to the original shape, a malfunction may occur in the feeding process. In that case, correct the deformation of the upper feed guide plate, or replace it with a new one.

8. Follower Roller (Regist Side)

Note: There is a difference between the follower roller on registration side and on eject side that is parts for the shaft. The shaft on the registration side is in D cut shape at both ends, and the one on the eject side is in circular shape at both ends.

- 1) Remove the upper feed guide plate.
[\(Page 3-9\)](#)
- 2) Remove the sub PCB unit.
Refer to “3. Sub PCB”.
[\(Page 3-5\)](#)
- 3) Unhooking the fitting part ① (2 places) at the same time detaches the follower roller on the backside (2 rollers ②, shaft ③, and shaft holder ④) and the coil spring ⑤.

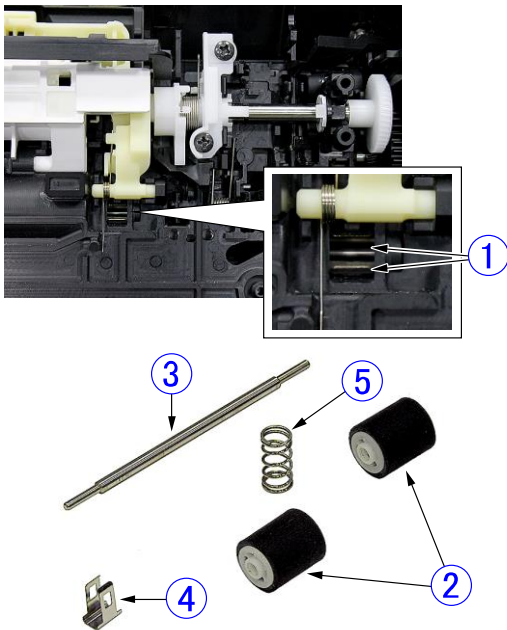

Figure 3-218

◆ Notes on assembling

The end of the coil spring should touch the central flat side of the axle.

9. Follower Roller (Eject Side)

- 1) Remove the upper reading unit.
[\(Page 3-22\)](#)
- 2) Remove the front panel assembly.
[\(Page 3-3\)](#)
- 3) Unhooking the fitting part ① (2 places) at the same time detaches the follower roller on the backside and the coil spring. (② to ⑤ in the Figure 3-218).

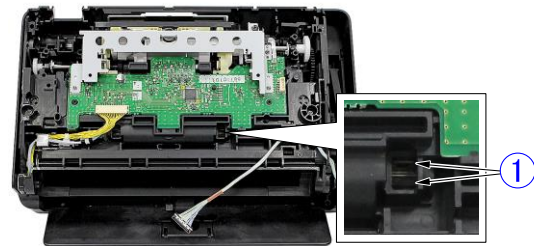

Figure 3-219

◆ Notes on assembling

The end of the coil spring should touch the central flat side of the axle.

III. BASE UNIT

1. Motherboard

- 1) Remove the lower cover.
([Page 3-2](#))
- 2) Use a tool with thin and flat edge to unhook a fitting part ①, and then remove the earth plate ②. Next, unlock the connector ③ to remove the cable, and remove the cable ④.

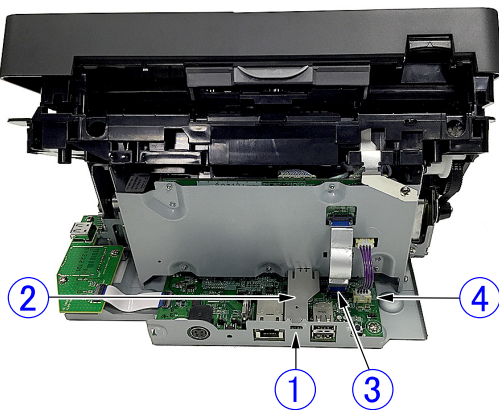

Figure 3-301

- 3) Put the main unit on its side, remove the 5 screws ① (M3, BH, round head), and open the mounting plate ② (with PCB) by rotating it toward you.

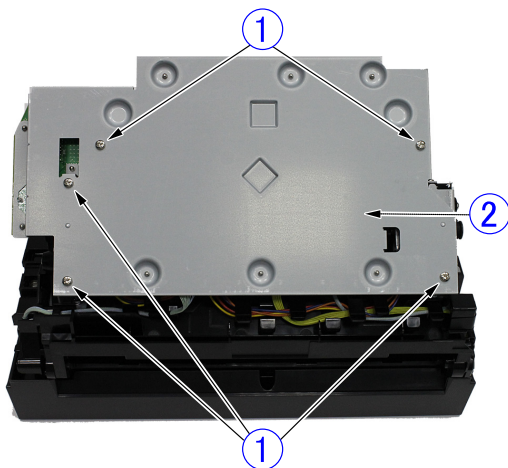

Figure 3-302

Note: Do not pull the cable excessively because it is connected to the rear side of the mounting plate.

- 4) Disconnect a face type connector ①, and detach the mounting plate ② (with PCB).

Note: For handling of face type connector, refer to "Front Panel Assembly".

([Page 3-3](#))

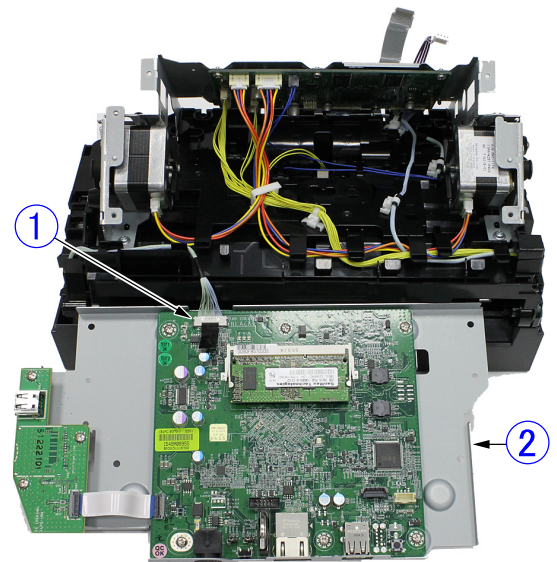

Figure 3-303

- 5) Unlock the connector ① to remove the cable, remove 6 screws ② (M3, BH, round head), and remove the motherboard ③.

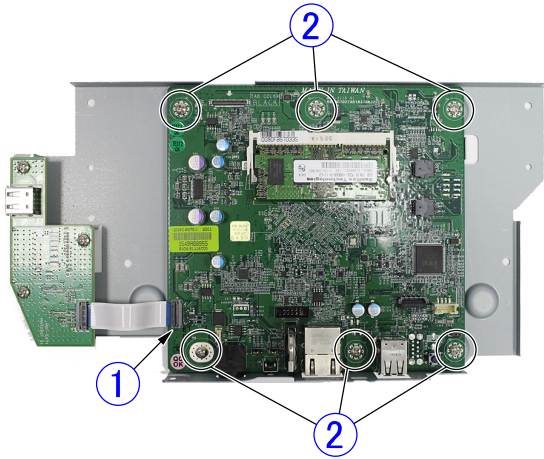

Figure 3-304

◆ Notes on assembling

The face type connector may be damaged if you attach it obliquely.

To attach it correctly, press down the center of the connector in vertical direction.

2. Interface PCB

- 1) Remove the mounting plate (with PCB). Refer to "1. Motherboard".
[\(Page 3-11\)](#)
- 2) Remove 3 screws ① (M3, BH, round head), unlock the connector ② to remove the cable, and remove the interface PCB ③.

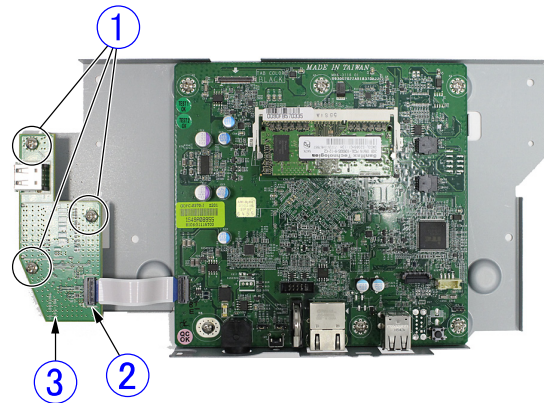

Figure 3-305

3. Lithium Battery

Note: The lithium battery is not assigned as a service part. Use a commercially available one.

Type: CR2032, Voltage: 3V

For details, refer to “Chapter 2. V. POWER SUPPLY 2. Lithium Battery.”

- 1) Remove the mounting plate (with PCB).
Refer to "1. Motherboard".

[\(Page 3-11\)](#)

- 2) While unhooking the fitting part ①, lift up the lithium battery ② to remove it from the housing.

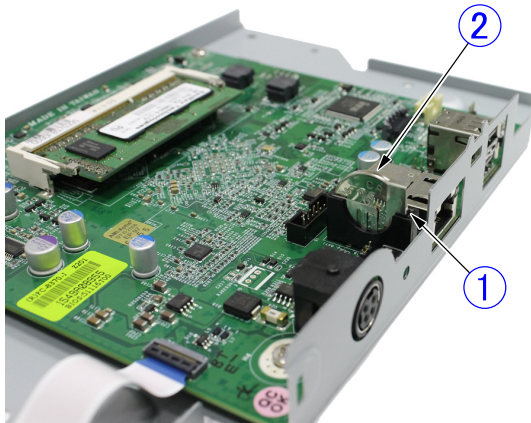

Figure 3-306

◆ Notes on assembling

Make sure that the positive electrode (+) of the lithium battery faces the AC adapter connector when installing it. The polarity is marked on the battery. Do not short out the battery.

4. Memory

- 1) Remove the mounting plate (with PCB).
Refer to "1. Motherboard".
[\(Page 3-11\)](#)
- 2) Push the left and right lever ① outward to lift up the memory ② and detach it from the connector.

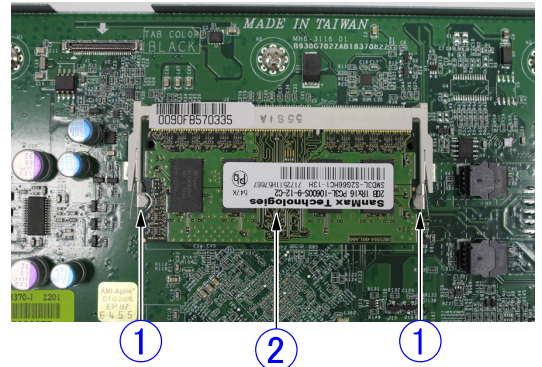

Figure 3-307

5. Control PCB

1) Remove the mounting plate (with PCB).
Refer to "1. Motherboard".

[\(Page 3-11\)](#)

2) Remove a screw ① (M3, BH, round head).
Next, unhook the fitting part ② of the
earth plate, and slide the earth plate ③
in the direction of the arrow to remove it.
Then, remove the 2 screws ④ (M3, BH,
round head) to remove the mounting plate
⑤ (with control PCB).

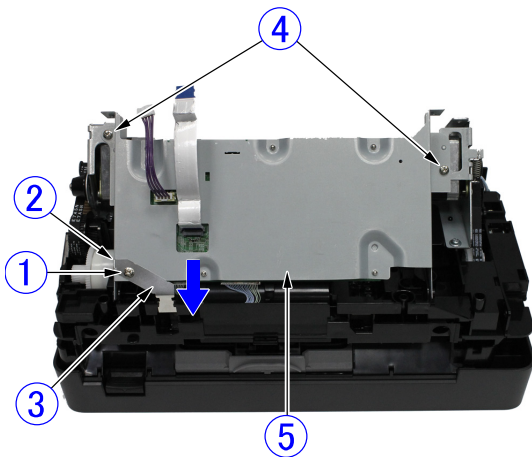

Figure 3-308

3) Disconnect the 3 cables ② that are con-
nected to the mounting plate ① (with
control PCB). Next, disconnect a cable ③
while rotating the mounting plate ① (with
control PCB) away from you to open it.

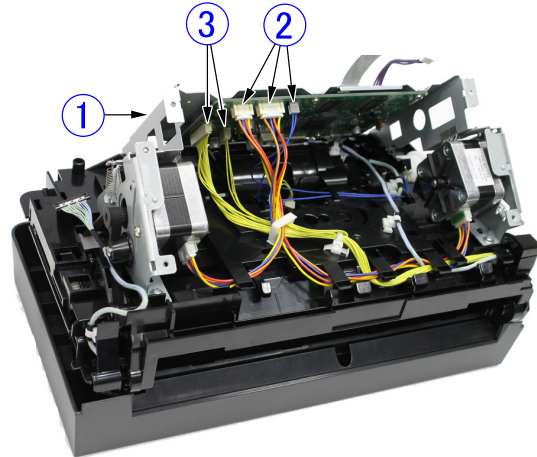

Figure 3-309

4) Remove the mounting plate ① (with con-
trol PCB) from the fitting part ② (2 places),
disconnect the 2 connectors ③ for read-
ing unit.

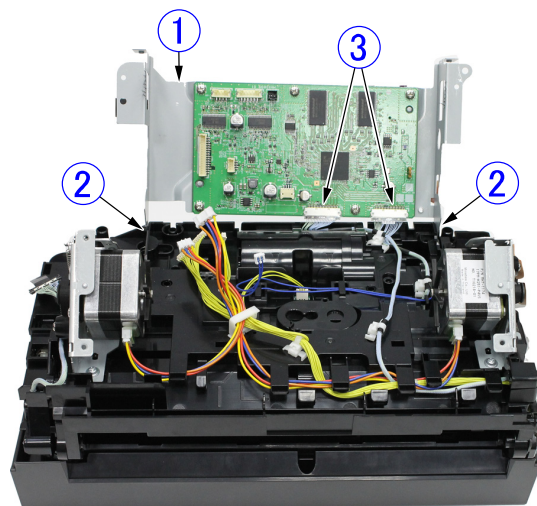

Figure 3-310

- 5) Remove the 5 screws ① (M3, BH, round head), and then remove the control PCB. At this time, it is recommended to remove the 2 cables connected to the rear side.

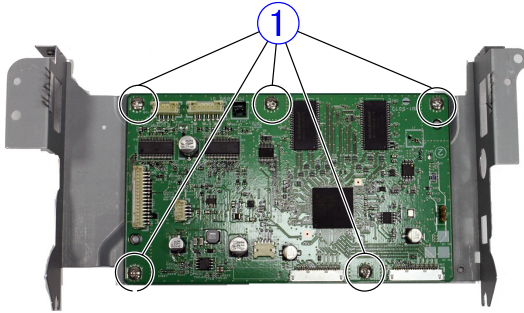

Figure 3-311

◆ **Notes on assembling**

After fixing the mounting plate (with control PCB) with screws, bring the discharging brush of the mounting plate to contact with the metal part of the motor.

6. Damper Unit

- 1) Remove the lower cover. [\(Page 3-2\)](#)
- 2) Release a cable holder ① and remove the 2 screws ② (M3, TP, self-tapping). Next, slide the damper unit ③ toward you to remove it from the base unit.

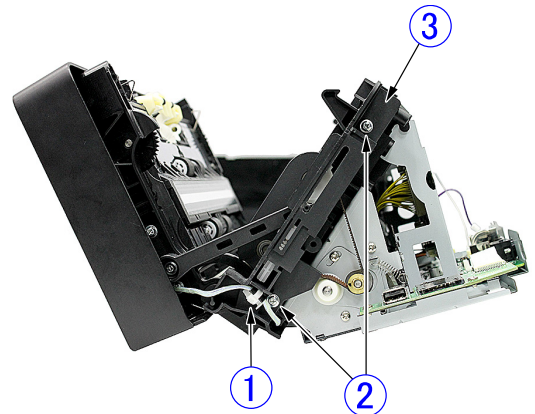

Figure 3-312

- 3) Open the front unit, and rotate the damper unit ② in the direction of the arrow while slightly lifting the damper rod ① to remove the damper unit from the fitting part ③.

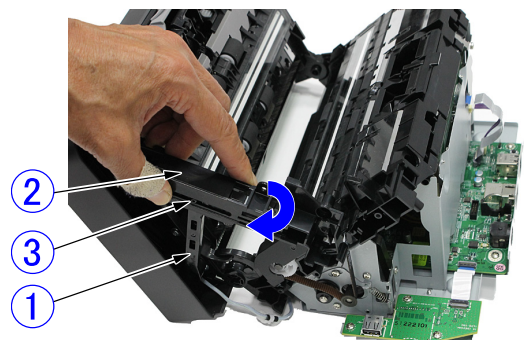

Figure 3-313

7. Feed Motor

Note: The connector size for the feed motor is different from the one for the main motor. The larger connector is the one for the feed motor.

- 1) Remove the mounting plate (with PCB). Refer to "1. Motherboard".
(Page 3-11)
- 2) Disconnect the connector of the feed motor ① mounted on the control PCB to free the cable of the feed motor from the cable guide.

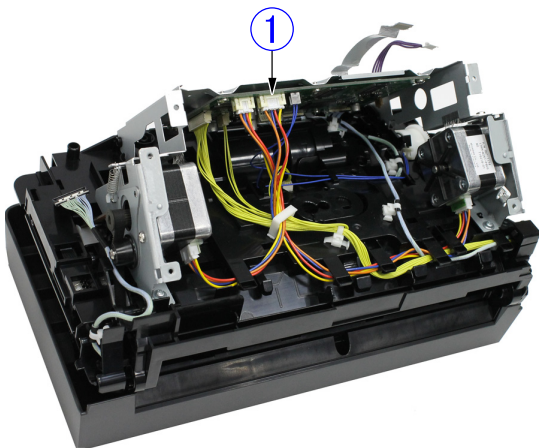

Figure 3-314

- 3) Remove the 2 screws ① (M3, BH, round head) to remove the feed motor.

Note: At this time, it is recommended to remove the tapered roller ② to avoid losing it when working.

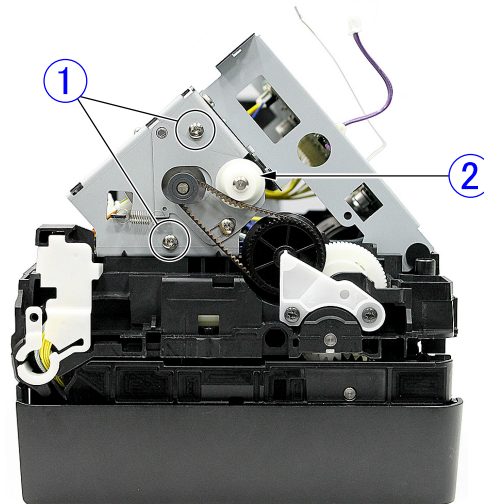

Figure 3-315

◆ Notes on assembling

To adjust the belt tension correctly, loosen a little the screw ① after mounting the motherboard.

After that, start the service mode, rotate the feed motor for 3 seconds or longer with the setting of color 600dpi, and then tighten the screw ①.

For details of service mode, refer to "CHAPTER 5 IV. SERVICE MODE".

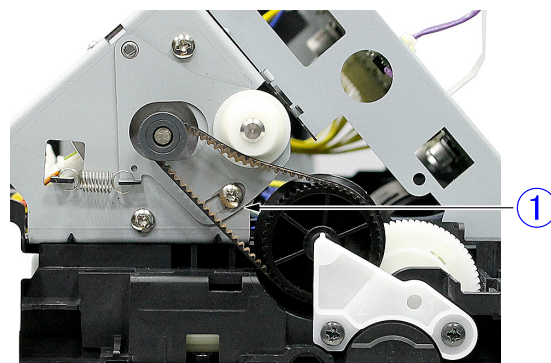

Figure 3-316

8. Main Motor

Note: The connector size for the feed motor is different from the one for the main motor. The smaller connector is the one for the main motor.

- 1) Remove the mounting plate (with PCB). Refer to "1. Motherboard".
(Page 3-11)
- 2) Disconnect the connector of the main motor ① mounted on the control PCB to free the cable of the main motor from the cable guide.

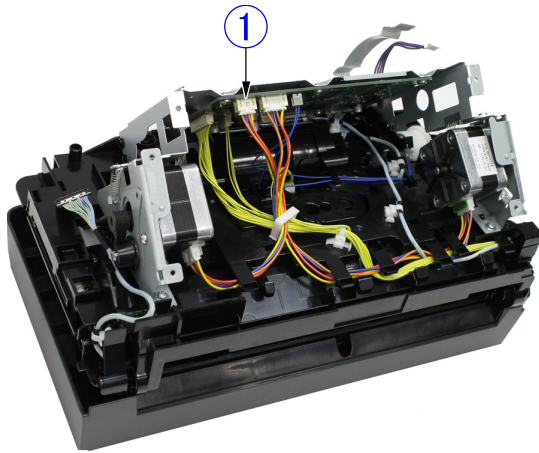

Figure 3-317

- 3) Remove the 2 screws ① (M3, BH, round head) to remove the main motor.

Note: At this time, it is recommended to remove the tapered roller ② to avoid losing it when working.

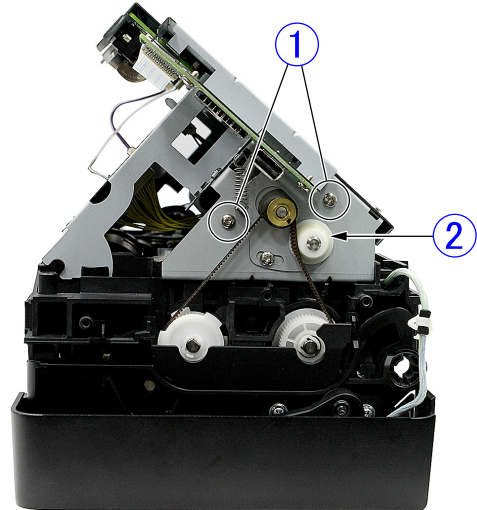

Figure 3-318

◆ Notes on assembling

To adjust the belt tension correctly, loosen a little the screw ① after mounting the motherboard.

After that, start the service mode, rotate the main motor for 3 seconds or longer with the setting of color 600dpi, and then tighten the screw ①.

For details of service mode, refer to "CHAPTER 5 IV. SERVICE MODE".

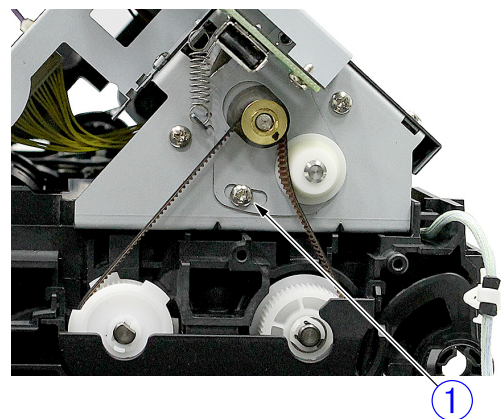

Figure 3-319

9. Dust Cover

- 1) Remove the mounting plate (with control PCB).

Refer to "5. Control PCB".

[\(Page 3-14\)](#)

- 2) Remove the feed motor.

[\(Page 3-16\)](#)

- 3) Remove the main motor.

[\(Page 3-17\)](#)

- 4) Remove the connector ①, release the 4 cable holders ② (reusable type), and disconnect each cable from the dust cover ③. Next, use a tool with thin and flat edge to unhook the fitting part ④ (6 places), and then remove the dust cover.

Note: Once you remove the dust cover, you will be able to access and remove the ultrasonic drive PCB.

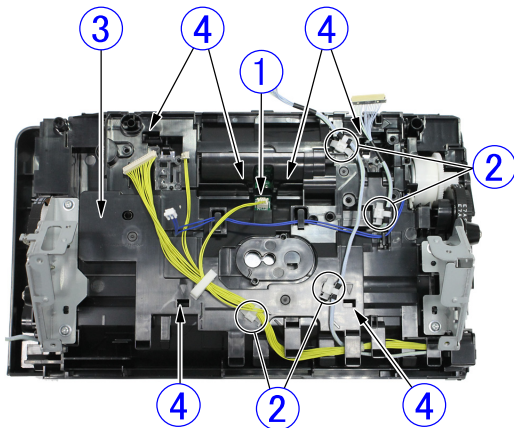

Figure 3-320

◆ Notes on assembling

Attach the ultrasonic drive PCB first. All of the fitting parts (6 places) should be fully seated. There should not be any raised parts.

The cable holder should be inserted in the original position and the cable should be positioned to align with the cable guide.

When mounting the dust cover, put the clutch rotation stopper ① against the frame, and then mount the dust cover.

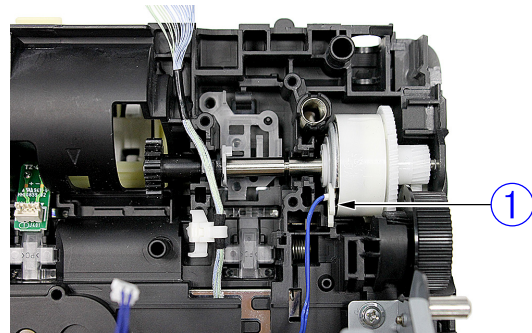

Figure 3-321

10. Clutch

- 1) Remove the dust cover.
([Page 3-18](#))
- 2) Remove the 2 screws ① (M3x8, BH, self-tapping) to remove the stopper ②. Next, remove the belt and pulley.

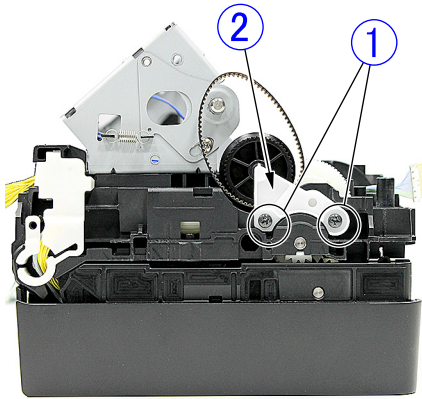

Figure 3-322

- 3) Remove a retaining ring ① and slide the bearing ② in the direction of the arrow to remove the feed drive/clutch assembly ③.

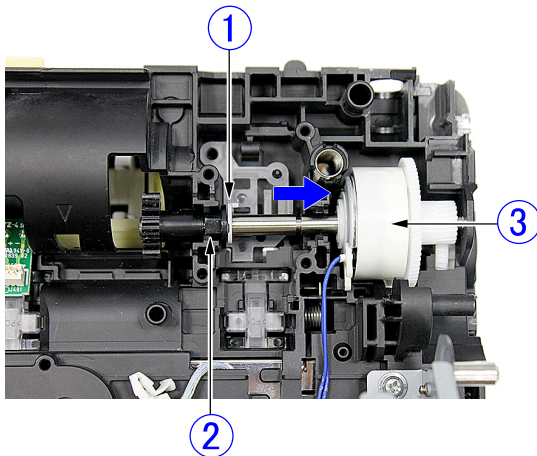

Figure 3-323

◆ Notes on assembling

Mount the feed drive/clutch assembly after removing the spring ①, and then attach the spring ① again. When fixing the stopper with the screw, fix the location of the stopper on which "1" is written. Then fix the location on which "2" is written.

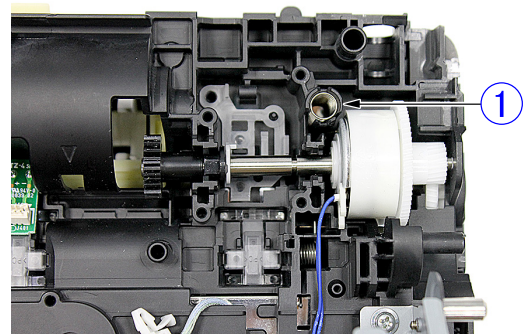

Figure 3-324

11. Drive Roller

Note: Some of the removable parts for the regist side and eject side rollers are different, but the disassembling procedure is the same. The procedure for the regist side roller is described below.

- 1) Remove the damper unit.
[\(Page 3-15\)](#)
- 2) Remove the lower reading unit.
[\(Page 3-23\)](#)
- 3) Slide the pulley cover ① in the direction of the arrow to remove it from the fitting part ② (2 places). It is easy to unhook the lower fitting part first. Then, remove the belt from the pulley.

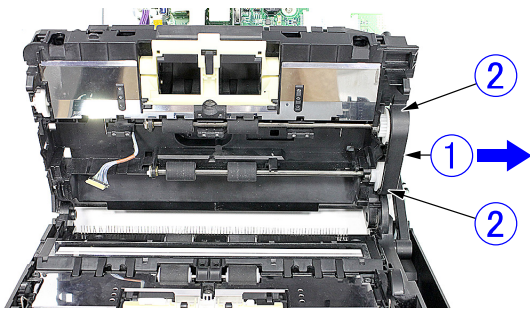

Figure 3-325

- 4) Remove the 2 retaining rings ① to remove the pulley, gear, and washer ②. For the eject side roller, remove the pulley and washer. Next, slide the bearing ③ to remove the drive roller ④.

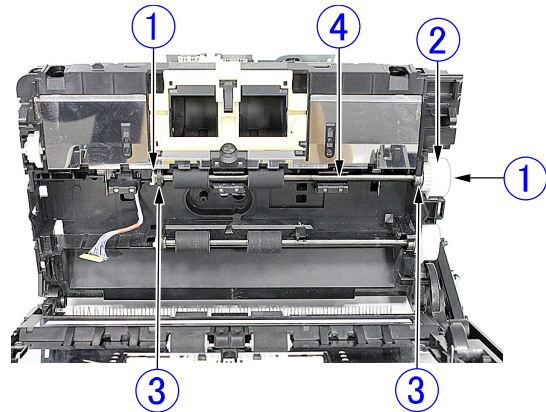

Figure 3-326

◆ Notes on assembling

The edge shape of the regist side drive roller shaft is different from the eject side drive roller shaft. The regist side drive roller shaft has the D-shaped edge. Mount the correct drive roller on each side.

When mounting the drive roller, follow the below procedure to keep the quality of earth conduction.

The procedure for the regist side roller is described below.

- 1) Remove the spring ①.

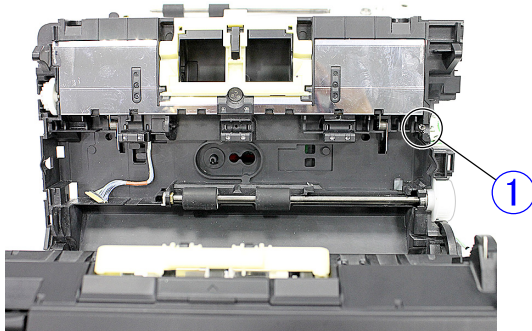

Figure 3-327

- 2) Mount the drive roller referring to the disassembling procedure.
- 3) Remove the mounting plate (with control PCB).

Refer to "5. Control PCB".

[\(Page 3-14\)](#)

- 4) Remove the 2 screw ① (M3x8, TP, self-tapping) to remove the main motor mounting plate ②.

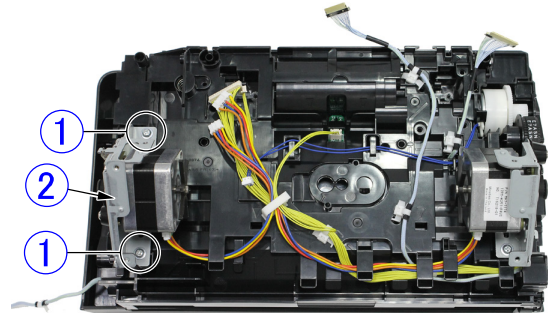

Figure 3-328

- 5) Insert the spring that is removed in step 1 into the hole ① to fix the main motor mounting plate with screw.

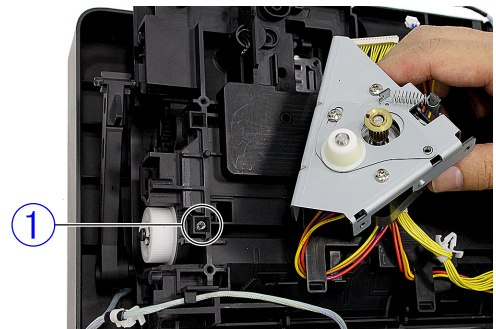

Figure 3-329

Note:After fixing the main motor mounting plate, adjust the belt tension referring to "8. Main Motor".

[\(Page 3-17\)](#)

IV. READING UNIT

1. Upper Reading Unit

Note:The shapes of the reading guides for the upper reading unit and the lower reading unit are different.

- 1) Insert a tool with thin and flat edge into the left and right holes ①, and lift up the upper reading unit ② a little bit using the tool while unhooking the inside fitting parts. Next, remove the upper reading unit by pulling it straight up.

Note:Do not pull the cable excessively because it TMis connected to the rear side of the upper reading unit.

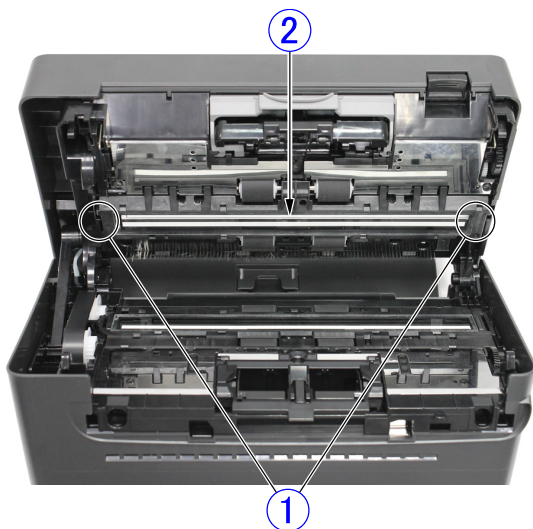

Figure 3-401

- 2) Remove the cable ① from the cable holder ②, disconnect the connector ③, and remove the upper reading unit ④.

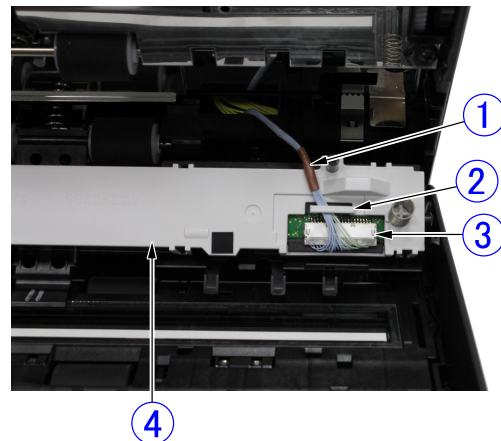

Figure 3-402

◆ Notes on assembling

After connecting the cable, and then attach the upper reading unit while pushing the cable inside of the upper frame.

Check if the upper reading unit move smoothly when the unit is attached. If it does not move smoothly, attach it again.

2. Upper Reading Guide

Note:This component has the reading glass and white reference sheet mounted on it. This component should not be disassembled unless necessary because once the component has been removed, there is a risk of dust getting inside the reading unit.

When disassembling, be careful with dusts and do not touch the inner surface of the glass or the surface of the lens array.

- 1) Remove the upper reading unit.

[\(Page 3-22\)](#)

- 2) Remove the 2 coil springs ①. Next, using a tool with thin and flat edge, unhook the fitting part ② (8 places) and remove the lid ③. Next, remove the CIS unit from the upper reading guide ④.

Note:Unhook the fitting parts without damaging the hooks. When removing the lid, do not drop the CIS unit and shading plate because they are detached. If the shading plate is detached, mount the shading plate aligning it with the protrusions of the reading guide.

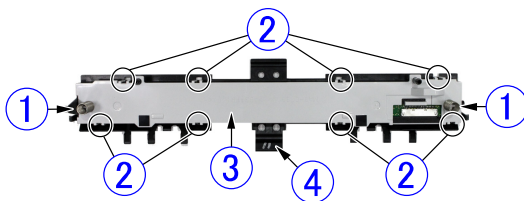

Figure 3-403

◆ Notes on assembling

The hooks of the fitting parts should not be raised or have gaps.

3. Lower Reading Unit

Note:The shapes of the reading guides for the upper reading unit and the lower reading unit are different.

- 1) Insert a tool with thin and flat edge into the left and right holes ① (4 places), and lift up the lower reading unit ② a little bit using the tool while unhooking the inside fitting parts. Next, remove the lower reading unit by pulling it straight up.

Note:Do not pull the cable excessively because it TMis connected to the rear side of the lower reading unit.

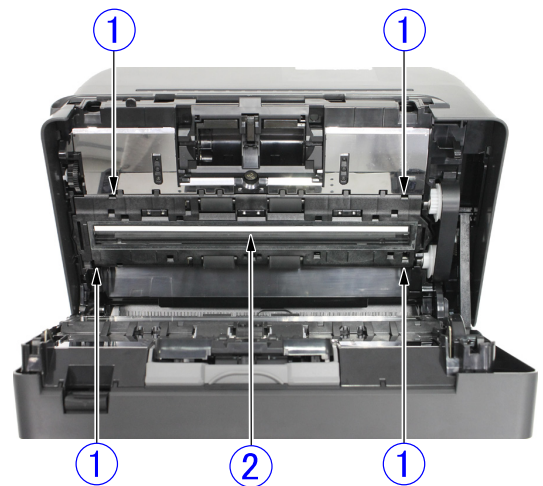

Figure 3-404

- 2) Remove the cable ① from the cable holder ②, disconnect the connector ③, and remove the lower reading unit ④.

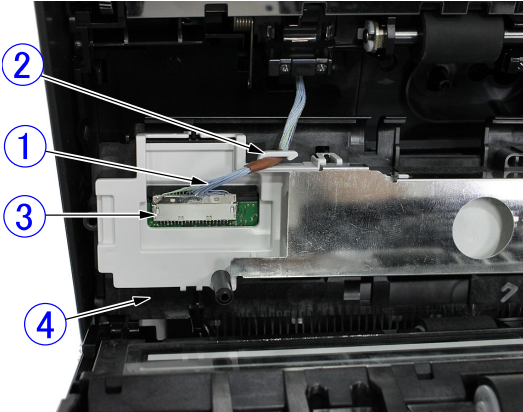

Figure 3-405

◆ **Notes on assembling**

After connecting the cable, and then attach the lower reading unit while pushing the cable inside of the frame.

4. Lower Reading Guide

Note: This component has the reading glass and white reference sheet mounted on it. This component should not be disassembled unless necessary because once the component has been removed, there is a risk of dust getting inside the reading unit.

When disassembling, be careful with dusts and do not touch the inner surface of the glass or the surface of the lens array.

- 1) Remove the lower reading unit.
[\(Page 3-23\)](#)
- 2) Using a tool with thin and flat edge, unhook the fitting part ① (8 places), and remove the lid ②. Next, remove the CIS unit from the lower reading guide ③.

Note: Unhook the fitting parts without damaging the hooks. When removing the lid, do not drop the CIS unit and shading plate because they are detached. If the shading plate is detached, mount the shading plate aligning it with the protrusions of the reading guide.

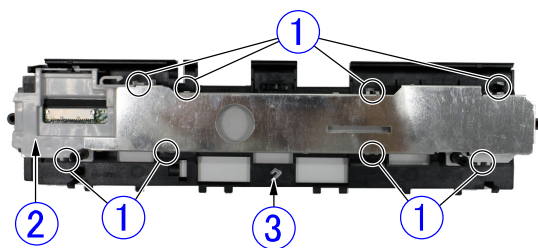

Figure 3-406

◆ **Notes on assembling**

The hooks of the fitting parts should not be raised or have gaps.

CHAPTER 4

INSTALLATION & MAINTENANCE

I. INSTALLATION	4-1	III. MAINTENANCE	4-7
II. REPLACEMENT PARTS.....	4-5		

I. INSTALLATION

This machine is installed by user. The user should be advised to install the scanner by reading the "Setup Guide" thoroughly.

2 printed manuals are included with this machine; the "Setup Guide" and the "Operation Guide." In addition, the CD-ROM contains the "Instructions" electronic manual data with these manuals.

This section presents an outline of the procedures and important matters.

1. Unpacking

Open the package, and take out the machine and its accessories. The accessories are contained in the accessory box placed under the machine.

Check if any of the machine and accessories are not missing or damaged.

- 1) Main body
- 2) Pickup tray
- 3) AC adapter
- 4) Power cord
- 5) Setup/operation guide
- 6) CD-ROM (user manual, application disk)
- 7) Warranty etc. (depending on the region)

Note: Make sure to use the AC adapter and power cord supplied with the machine.

2. Removal of protective components

Remove all components protecting the main body of ScanFront.

- 1) Remove the orange tape on the outer package (2 places) and the protective sheet.

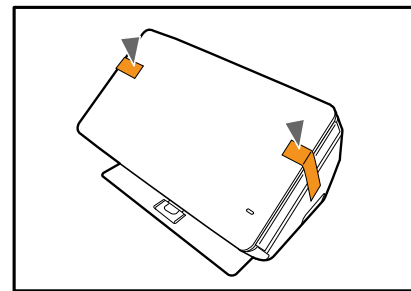

Figure 4-101

- 2) Attach the pickup tray and open the eject tray gently.

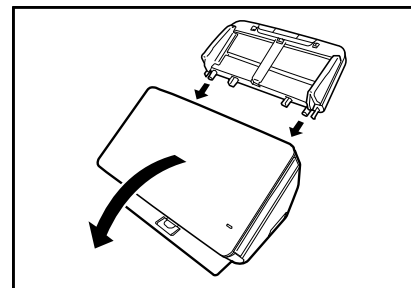

Figure 4-102

- 3) Remove the sheet.

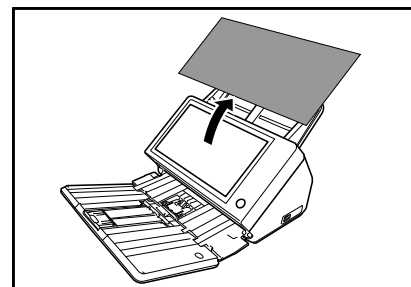

Figure 4-103

- 4) Pull out the lock lever and open the front unit until it won't open any further.

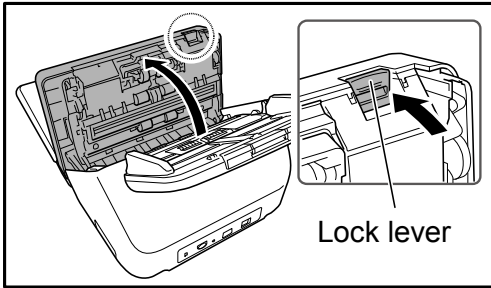

Figure 4-104

- 7) Close the front unit slowly then press both sides of the unit and check that it clicks and locks.

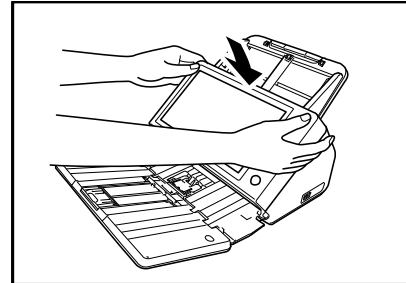

Figure 4-107

- 5) Remove the sheet.

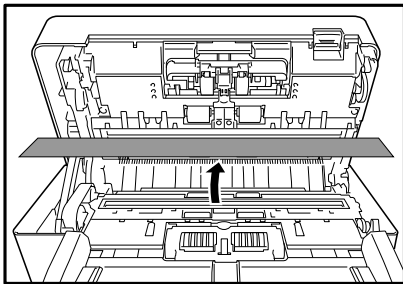

Figure 4-105

- 8) Close the eject tray gently.

- 6) Remove the stopper and sheet from the feed roller.

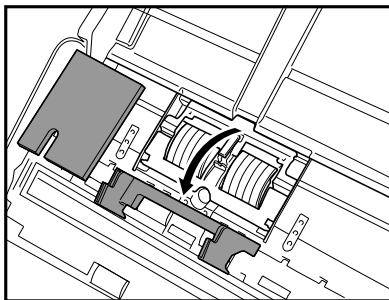

Figure 4-106

3. Connecting and Setup

Connect the AC adapter and network cable (LAN cable).

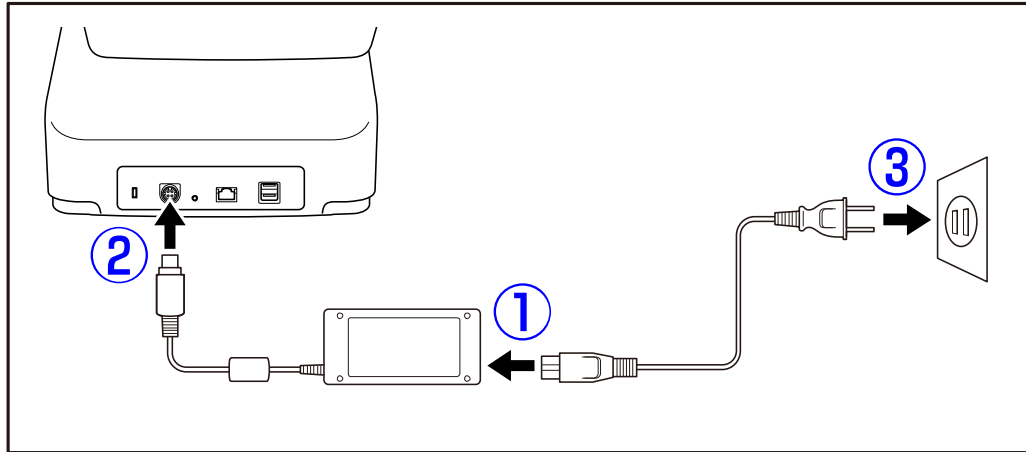

Figure 4-108

To set up this machine, you must configure the network setting items under [Administrator setting] on the machine. The list of setting items in the user manual is shown below. Configure each setting referring to the user manual for detailed setting procedure.

Setting Item	Description	Administrator setting	User settings
User management	Performs registration of new users and edits existing users. In user settings, you can only edit settings, and editing of some settings is restricted	Yes	Yes/No
Address book settings	Performs registration and editing of the [shared address book.]. In user settings, registration and editing of [shared address book] and [my address book] is performed. Users whose functions are restricted by the administrator cannot perform registration and editing.	Yes	Yes
Job button settings	Performs registration and editing of the [shared job buttons.] In user setting, registration and editing of [shared job buttons] and [my job buttons] is performed. Users whose functions are restricted by the administrator cannot perform registration and editing.	Yes	Yes
Device settings	Setting of the ScanFront main body is performed.	Yes	No
Setting the device's network settings	Check the [device name] and [IP address] set in the ScanFront main body.	Yes	No

Table 4-101a

Setting Item	Description	Administrator setting	User settings
Setting language/time zone	Set the languages to be displayed on the ScanFront panel and regions in which this machine is used.	Yes	No
Setting date/time	Sets the date/time for the ScanFront main body.	Yes	No
ScanFront maintenance	Performs setting of display-off, reset of the roller counter, and setting of passwords.	Yes	No
Initialization of ScanFront	This is used when you want to delete all current settings, such as when the operating environment of ScanFront is changed.	Yes	No
Communication settings	Performs registration of the mail server and authentication server.	Yes	No
Mail server, FAX	Registers the SMTP server for sending Emails and Fax.	Yes	No
Authentication server	Registers the domain server that can search users using Active Directory or OpenLDAP.	Yes	No
Address book server	Registers the LDAP server that can search the Email address book.	Yes	No
FTP server	Performs settings related to the saving of image files to the FTP server.	Yes	No
System settings	Perform settings for managing ScanFront.	Yes	No
Backup of all settings/restore of all settings	Backs up and restores ScanFront settings.	Yes	No
Version information	Displays ScanFront module version information and performs version upgrades.	Yes	No
System management	Performs system management for ScanFront.	Yes	No
Selection of login type	Selects user login screen.	Yes	No
Network test	Tests communication between ScanFront and other devices on the network.	Yes	No
Administrator settings	Registers the administrator password and email address.	Yes	No

Table 4-101b

II. REPLACEMENT PARTS

1. Periodic Replacement Parts

This machine does not have any periodically replaced parts.

2. Consumable Parts

1) Replaced by users

No.	Parts name	Parts number	Expected life	Remarks
1	Feed Roller	MG1- 5152	200,000 sheets	Replace when their surfaces are worn and cause paper feed defect even after cleaning.
2	Retard Roller	MG1-5123	200,000 sheets	

Note:The items above are assigned as service parts and an exchange roller kit is assigned as commercially available products for a set.

Table 4-201

2) Replaced by service technicians

No.	Parts name	Parts number	Expected life	Remarks
1	Lithium button battery	Not assigned (Note1)	Total OFF time: 3 years	An error message is displayed on the BIOS screen. (Note2)

Note1: Refer to “Chapter 2, V. POWER SUPPLY, 2. Lithium Battery.”

Note2: Refer to “Chapter 5, VI. OTHER OPERATIONS, 2. Battery replacement.”

Table 4-202

3. Main Parts List

The list below shows the major service parts, except for user replaceable parts. Refer to the "Parts Catalog" for the details.

No.	Parts name	Parts number	Remarks
1	MOTHERBOARD unit	MG1-5140-000	
2	Control PCB	MG1-5072-000	
3	Reading unit (Upper)	MG1-8331-000	
4	Reading unit (Lower)	MG1-8330-000	
5	Sub PCB	MG1-5070-000	
6	Ultrasonic drive PCB	MG1-4599-000	
7	Registration roller	MA3-0670-000	
8	Eject roller	MA3-0671-000	
9	Follower roller	MA2-9469-000	
10	Feed motor	MH7-1174-000	For document feed
11	Main motor	MH7-1199-000	For document separation
12	LCD unit	MF1-4901-000	
13	Panel relay board	MG1-5075-000	
14	Power supply adapter	MG1-5039-020	

Table 4-203

III. MAINTENANCE

1. User Maintenance

Refer to the user manual for details.

1) List

[▲: Cleaning, ●: Replace]

No.	Location/Parts	Intervals		Details
		As necessary	200,000 sheets	
1	Main body	▲		Use a cloth slightly dampened with water and well wrung out to remove any dirt, and then use a clean, dry cloth to wipe the main body.
2	Touch panel	▲		Use a soft, dry cloth to wipe lightly without applying pressure to the panel surface.
3	Scanning glass	▲		
4	Feed roller	▲	●	Use a cloth slightly dampened with water and well wrung out to remove any dirt, and then use a clean, dry cloth to wipe the main body.
5	Retard Roller	▲	●	
6	Other rollers	▲		
7	Feed path	▲		Use such as commercially available air blowers to remove any dust and paper particles that have accumulated on the feed.

Table 4-301

2) Locations to be cleaned

- Main body

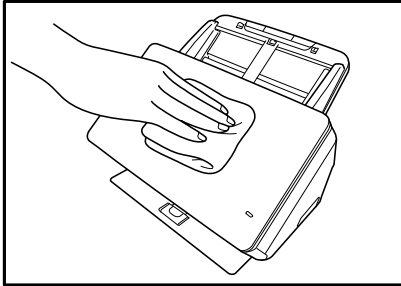

Figure 4-301

- Feed roller/Retard roller

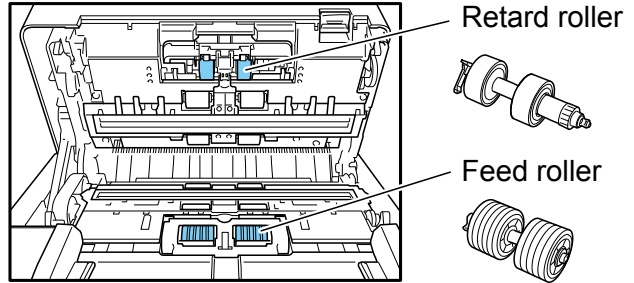

Figure 4-304

- Touch panel

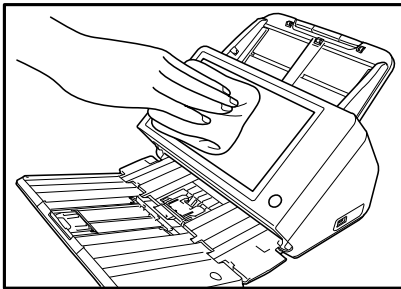

Figure 4-302

- Other rollers

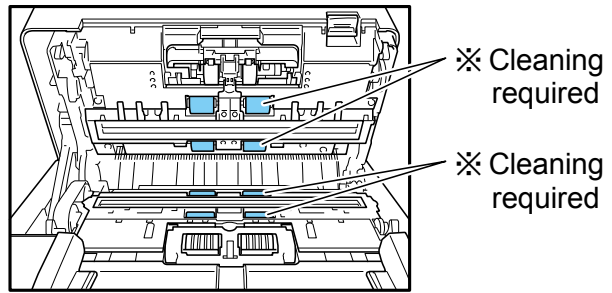

Figure 4-305

- Scanning glass

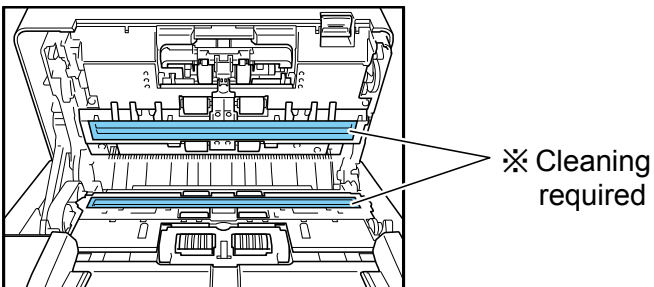

Figure 4-303

3) Roller counter

Confirm the number of papers fed on the [Roller counter reset] screen by pressing the [Administrator setting]-[Device setting]-[ScanFront maintenance]-[Roller counter reset] buttons.

Users are advised to ensure they reset the counter when the roller is replaced.

- Press [Roller counter reset] to display the [Roller counter reset] screen.



Figure 4-306

- [Roller counter reset] screen is displayed, so press [Reset] to reset the counter.

2. Service Maintenance

For this machine, there is no periodical maintenance item by the service technicians.

However, when visiting a user, check whether the scanning glasses and the rollers are dirty. If they are very dirty, instruct the user to follow the “user maintenance” procedures. Recommend the user to replace consumable parts if necessary.

CHAPTER 5

TROUBLESHOOTING

I. OUTLINE.....	5-1	VII. DEFECTIVE PHENOMINON LIST.....	5-54
II. USER INFORMATION PROTECTION.....	5-2	VIII. OPERATION TROUBLESHOOTING	5-56
III. ERROR DISPLAY	5-5	IX. IMAGE TROUBLESHOOTING.....	5-60
IV. SERVICE MODE.....	5-9	X. COMMUNICATION TROUBLESHOOTING	
V. NETWORK FUNCTION CHECK.....	5-42	5-65
VI. OTHER OPERATIONS	5-51	XI. AFTER REPLACING PARTS.....	5-67

I. OUTLINE

1. Outline and Categories

This machine is network scanner that has both scanner function and network function unlike DR scanners. Therefore, it is important to determine which function, scanner or network, causes the trouble. When a trouble occurs, you can determine which, this machine or user's LAN system, is the cause of the defect by following the procedure shown in the below figure.

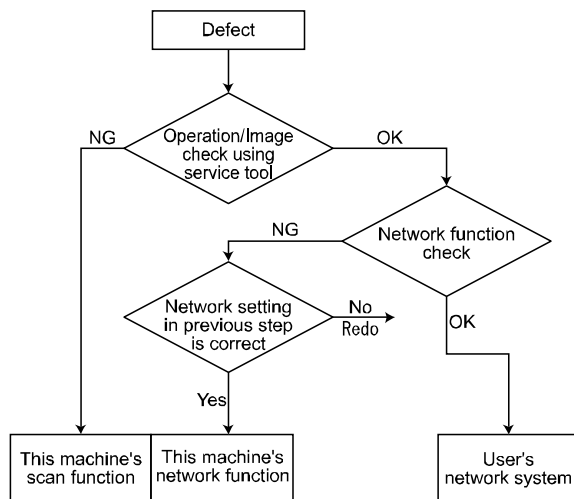

Figure 5-101

The troubleshooting for scanner issues is basically the same as those for conventional DR scanners.

The troubleshooting for network issues is roughly categorized into machine's network function issues, user's network setting issues, and user's network system issues. Therefore, to determine whether the machine's network function itself works properly, the method to connect this machine to the computer for servicing directly with LAN cable is described in "V. NETWORK FUNCTION CHECK".

The specific actions for defective phenomenon are described in "VII. DEFECTIVE PHENOMINON LIST", "VIII. OPERATION TROUBLESHOOTING", "IX. IMAGE TROUBLESHOOTING", and "X. COMMUNICATION TROUBLESHOOTING".

How to use the service mode is described in "IV. SERVICE MODE".

When handling the machine, including when troubleshooting, make sure to protect user information such as user password, network information, and mail address. Make absolutely sure neither to delete nor to leak user information. The details will be discussed in the next section.

II. USER INFORMATION PROTECTION

1. Outline

Recently, the demands on “personal information protection” increase. This machine stores user information such as user password and address. These are considered to be subjects of personal information protection. The deletion or leak of such user information will be a big problem. Service technicians must as well be careful with this during their work including troubleshooting.

Never obtain user information without the user’s permission. When performing maintenance in user’s presence, ask the user to input user information. Also, if you need to bring the machine back, ask the user administrator to backup and initialize user data.

If you need to bring back the machine which is not operable, tell the user that the user information may be deleted. When the machine becomes able to display user information after you have brought it back, inform the user of that and ask the user what to do with user information.

The procedures for [Backup/Restore] and [Initialization] of user information are described below. For details, refer to the user manual.

2. Backup/Restore

Perform backup and restoration from the machine’s screen or the Web application that is displayed on the PC connected to the machine via a network. Here is described how to perform them on the machine’s screen.

- 1) On the [Home] screen, press [Administrator setting].

Note: If you have logged in as the user, press [Logout] before performing this procedure.

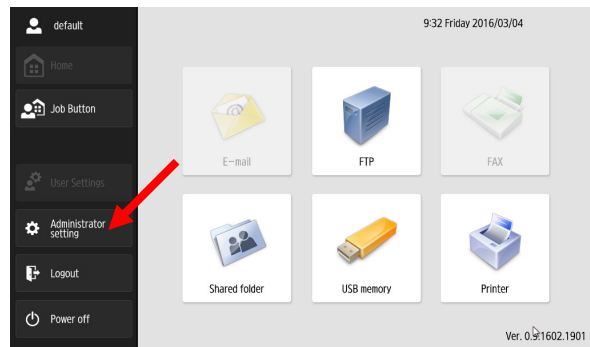

Figure 5-201

- 2) After inputting password, press [OK].

Note: No password is set by default.

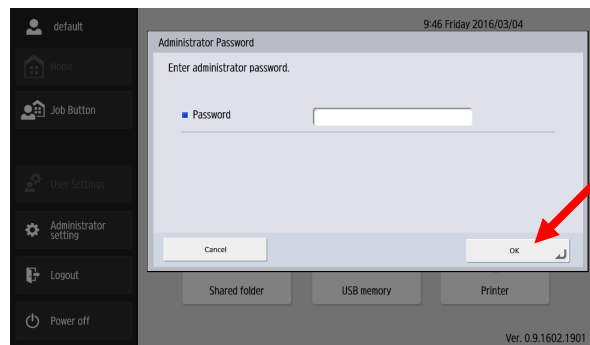

Figure 5-202

3) Press [System Settings].

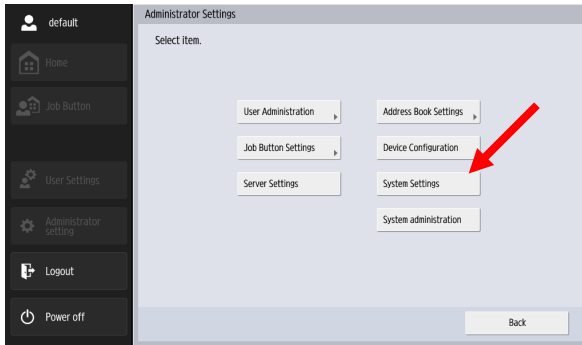

Figure 5-203

4) Press [Backup All Settings] or [Restore All Settings].

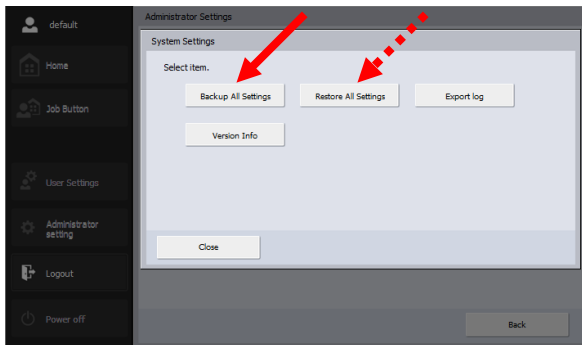

Figure 5-204

5) If you select to backup settings, input the host name, user name, password, domain/work group and folder path, then press [OK].

Likewise, if you select to restore settings, input the host name, user name, password, domain/work group and file name, then press [OK].

Note:You cannot execute this unless each item of data has been inputted.

◆ Back up

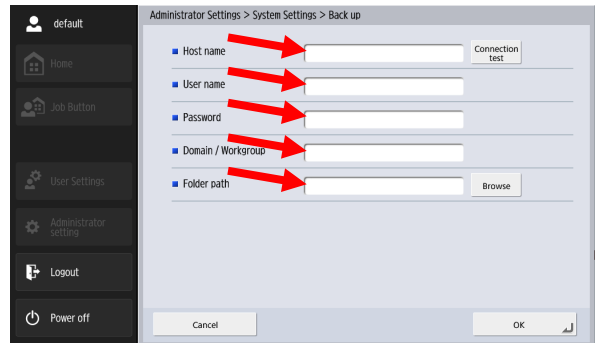

Figure 5-205

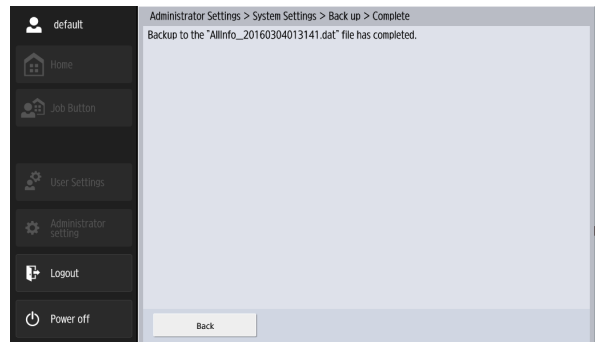

Figure 5-206

Note:The following data is not backed up.

- IP address
- Device name
- Touch panel adjustment values

◆ Restore

Input the host name, user name, password, domain/workgroup, and file name.

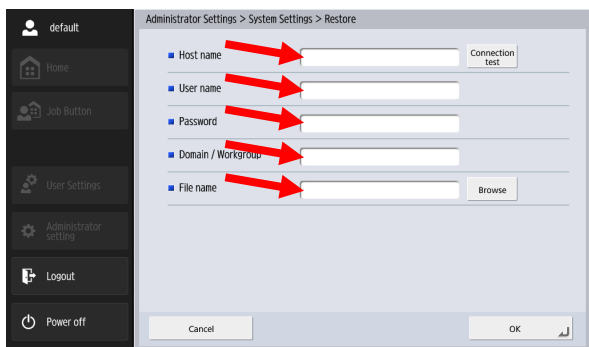

Figure 5-207

When the setup is completed, the below screen is displayed.

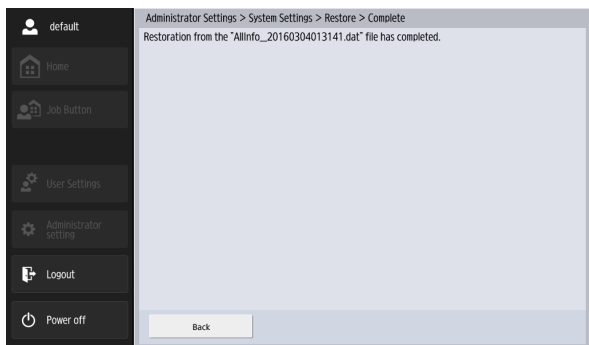

Figure 5-208

3. Initialization

Perform initialization from the machine's screen.

1) On the [Home] screen, press [Administrator Settings].

Note: If you have logged in as the user, press [Logout] before performing this procedure.

2) After inputting password, press [OK].

Note: No password is set by default.

3) Press [Device Configuration].

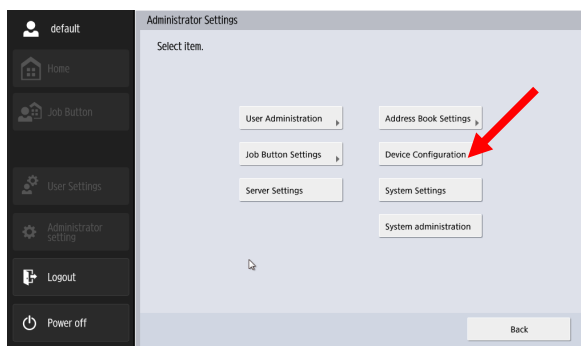

Figure 5-209

4) Check the message on the [Note] screen, then press [Yes] to execute initialization.

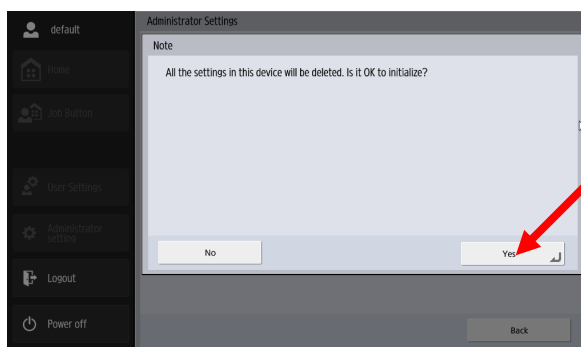

Figure 5-210

Note: Initialization erases all user data including IP address and address book data.

The software version is not changed.

III. ERROR DISPLAY

Error messages will be displayed on the machine or the Web application. Basically, these errors are caused by improper use or document jams. Users take action

according to error message contents.

The lists described on the user manual are the following. However, not all errors are shown.

1. Machine's Screen

Failed to connect FTP server.	Cause	The settings of the registered FTP server are incorrect.
	Solution	Check the settings of the FTP server.
	Cause	The computer that is being used as the FTP server is not running.
	Solution	Check the computer that is being used as the FTP server.
Please set SMTP server address.	Cause	The mail server settings have not been registered, or have been deleted.
	Solution	Contact the administrator of the ScanFront, and check the settings of "Mail Server".
This is restricted item.	Cause	The administrator has set send restrictions for the selected e-mail address.
	Solution	Contact the administrator of the ScanFront.
Same Username exists. Please change Username, and try again.	Cause	A user that has the same name as the user name to be registered is already registered.
	Solution	Check the user name prior to registration.
Paper JAM occurred. Remove the paper.	Cause	The rollers are dirty or worn out.
	Solution	(1) Verify that the rollers are installed properly, and clean them if necessary. (2) Proper scanning may not be possible if the document pages stick together due to static electricity. Fan the document before placing it. (3) If paper jams or double feed errors occur, set [Document type] to [Extra-thin paper] in the Detailed Settings screen. In addition, limit the number of documents placed on the scanner to about 10 sheets.
Blank field exists.	Cause	An operation such as address book/job button importing, restoring, or version updating was executed without specifying the setting file to be loaded on the ScanFront.
	Solution	Specify the setting file and then execute the operation.

(Continued)

A double paper-feed has occurred. Please check the document and the scanned image on the display and scan the document again.	Cause	The pages of the document are sticking together because of, for example, static electricity, too many documents were loaded, the rollers are dirty, etc.
	Solution	(1) Verify that the rollers are installed properly, and clean them if necessary. (2) Proper scanning may not be possible if the document pages stick together due to static electricity. Fan the document before placing it. (3) If paper jams or double feed errors occur, set [Document type] to [Extra-thin paper] in the Detailed Settings screen. In addition, limit the number of documents placed on the scanner to about 10 sheets.
You cannot paste the copied address to the different address type.	Cause	The copy source and the paste address are of a different type.
	Solution	Make sure the copied address and paste address are of the same type.
Restricted address is included.	Cause	The job button settings include an address that has been restricted by the administrator.
	Solution	Contact the administrator of the ScanFront.
Settings cannot be changed or stored. A user may be logged in to the device. Check the status of the device.	Cause	Modifying settings and registration are not possible because a user is logged in.
	Solution	Try again after the user logs off.
Maximum address has been registered. You can't register any more.	Cause	The limit for the number of addresses has been exceeded.
	Solution	Delete addresses that are no longer used and then try again.
Maximum Job Buttons has been registered. You can't register any more.	Cause	The limit for the number of job button registrations has been exceeded.
	Solution	Delete job button registrations that are no longer used and then try again.
Maximum users has been registered. You can't register any more.	Cause	The limit for the number of user registrations has been exceeded.
	Solution	Delete user registrations that are no longer used and then try again.
Log in failed. Authentication server is not found.	Cause	The user specified when logging in does not exist in the authentication server.
	Solution	Make sure you correctly enter your user name and password. Contact the administrator of the ScanFront if this problem persists.

(Continued)

The authentication server cannot be used. Please check the connection and setting of the server.	Cause	The authentication server settings are incorrect.
	Solution	Check the authentication server settings.
	Cause	The computer acting as the authentication server is not turned on.
	Solution	Turn on the computer acting as the authentication server.
A character that cannot be used for a path is included.	Cause	An invalid character exists in the specified path.
	Solution	Do not use the following characters when specifying paths. /:?*"<>
Confirm Password doesn't match. (New password and confirmation password do not match.)	Cause	The new password and confirmation password do not match.
	Solution	Enter the same password for the new password and the confirmation password.
Password is not registered. OK to proceed?	Cause	A password has not been set for the user to be registered.
	Solution	Check the password prior to registration.
Password is incorrect.	Cause	The password that was entered is incorrect.
	Solution	Enter the uppercase and lowercase letters for the password correctly.
There is no file name specified. Enter a file name or enable the 'Auto file name' setting.	Cause	A file name was not entered and "Auto file name" is set to [None].
	Solution	Enter a file name or set "Auto file name" to other than [None].
Failed to send the files.	Cause	The destination is incorrect, or connection to the destination cannot be established.
	Solution	Check whether the host name, FTP server, email address, or folder path registered as the destination is correct, and check whether connection to the destination is possible.
You can't use following character for File name.	Cause	Invalid characters have been used to set the custom file name.
	Solution	Make sure the custom file name does not contain any of the following characters: /:?* "<>
Can not create folder.	Cause	The USB memory device is not connected properly.
	Solution	Check the connection of the USB memory device.
A character that cannot be used for a host name is included.	Cause	An invalid character exists in the specified host name.
	Solution	Do not use the following characters when specifying host names. /:?* "<>

(Continued)

You can't choose JPEG when Binary Mode is selected.	Cause	The scanner cannot be used with the selected mode and file format combination.
	Solution	Check which mode and file format combinations can be used.
You can't choose Bleed-through reduction when Text enhance is selected.	Cause	The scanner cannot be used with the selected mode and setting combination.
	Solution	Check which mode and setting combinations can be used.
The character string includes invalid character.	Cause	Invalid characters have been used to set the index file.
	Solution	Make sure none of the following characters are used in strings contained in the index file: & " ' < >
Cannot write log file. Sending files will be aborted.	Cause	Write permission has not been granted for the shared folder specified as the save destination of the log file.
	Solution	Check the settings and access permissions of the shared folder.
Please select user.	Cause	User data is trying to be exported from the scanner without a user being selected at the user settings screen.
	Solution	Select a user name to export.

Table 5-301

IV. SERVICE MODE

A. Introduction

1. Outline

The service mode of this machine is executed by starting up the service mode software installed in this machine. All of the

displayed messages are in English.

The list of the service modes is shown below.

Level-1	Level-2	Description
Information	Version	Display of the main body version
	Error history	Display of error history
	Serial number	Input and display of the serial number
	Counter	Display of counter (Display and change of the number of sheets fed and the number of paper jam occurrences)
Adjustment	Scale(Auto)	Execution of contraction ratio adjustment (Auto)
	Regist(Auto)	Execution of regist adjustment (Auto)
	Light(Auto)	Execution of optical adjustment (Auto)
	Detail&Manual	Execution of contraction ratio adjustment (Manual) and regist adjustment (Manual)
	TouchPanel(Auto)	Touch panel sensitivity adjustment
Motor/Sensor		Confirmation of the operation of sensors, motors, etc.
Analog		Display of analogue values of sensors
NetworkTest		Display of the main body's IP address
		Execution of Ping to connected IP addresses
Scan Test	Scanning condition	Selection of a scan mode, a scan resolution, etc.
	Image display	Display of scanned images
Version up		Change of the software

Table 5-401

Note: The service mode includes the Network Test function for checking connection when the communication is poor. However, the same function called [Network Test] exists in this machine's administrator settings, so ask user to check connection by using this function. Therefore, the Network Test of the service mode is introduced just briefly here.

2. Starting Up Service Mode

There are two ways to start service mode.

◆ Starting service mode when starting the main body

- 1) Turn on the power of the main body and move to the BIOS screen. The letters of "ScanFront" appear at the center of the black screen, and the progress bar showing the startup progress is displayed.
- 2) Then, the words "ScanFront" and the cursor are displayed in the center of the screen.
Touch the left side of the screen twice, the right side once, and then the left side once in succession.

Note: Touch the screen within 5 seconds after the words "ScanFront" and the cursor are displayed in the center of the screen. The touch operation is not effective after 5 seconds pass.

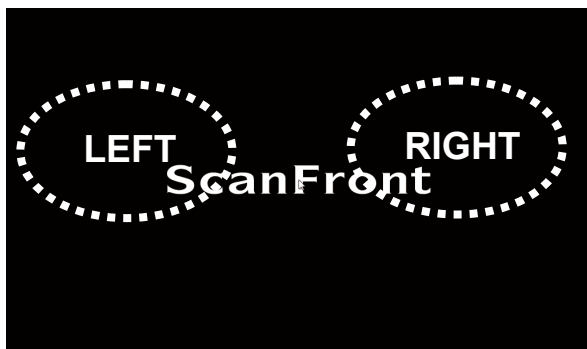

Figure 5-401

- 3) On the [Service password] screen, press the password input box.

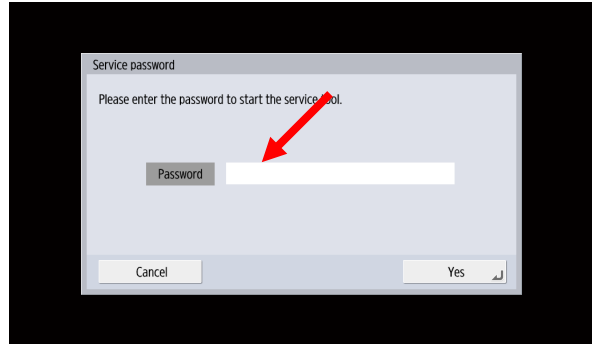

Figure 5-402

- 4) On the [Password] screen displaying the keyboard, input the 6 letters "market", then press [OK].

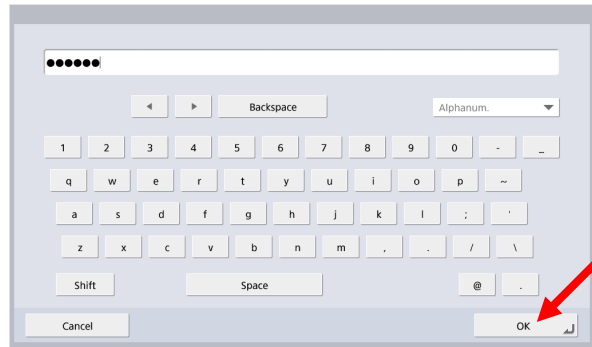

Figure 5-403

- 5) On the [Service password] screen, press [Yes].

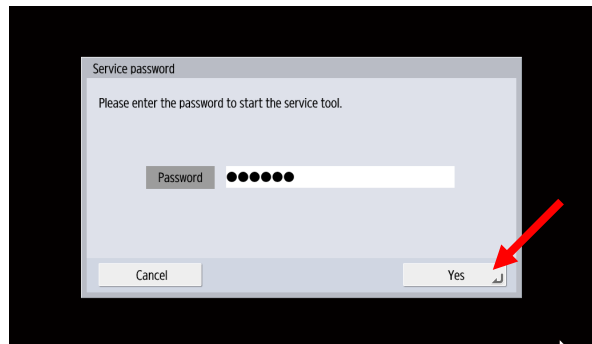

Figure 5-404

- 6) Confirm that the [Service Tool] screen is displayed.

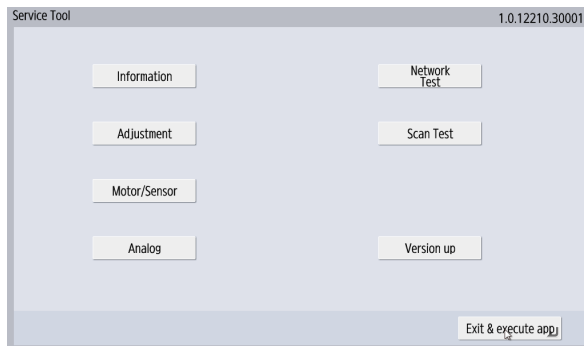

Figure 5-405

- ◆ Starting service mode after starting the main body

An explanation of how to start the service mode after starting the main body will be given. A USB-connectable keyboard is necessary.

- 1) Turn ON the power and bring up the "Home" screen.
- 2) Touch the screen of the main body once.
- 3) Press Ctrl+Alt+S using the keyboard.
- 4) The service password screen is displayed.

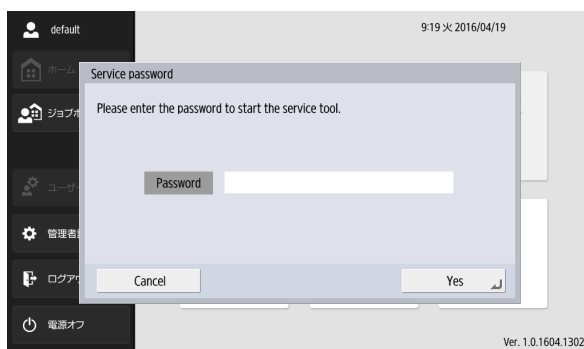

Figure 5-406

Note:The step 2) is needed to focus the screen. Touch the location indicated by the red circle in the below figure.

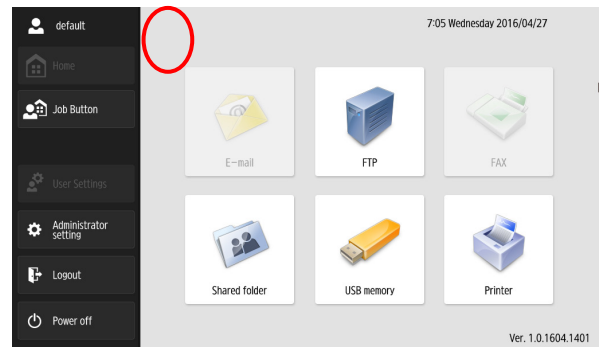

Figure 5-407

Note:If the screen is not responded to the touch operation because of the defect of the panel, connect the mouse to the main body and click the indicated location to focus the screen. This will display the service password screen.

3. Exiting Service Mode

With the following procedure, the service mode can return to the "Home" screen for users.

- 1) Press [Exit & execute app] of the [Service Tool] screen.

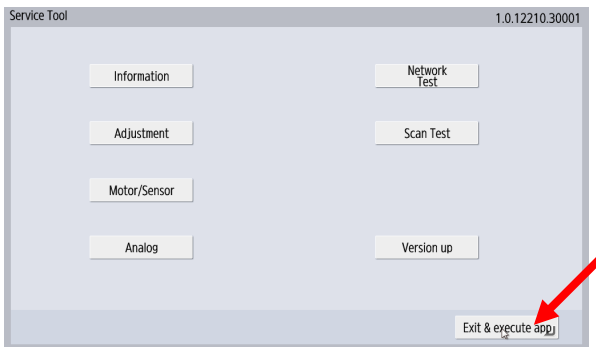

Figure 5-408

- 2) Return to the [Home] screen.

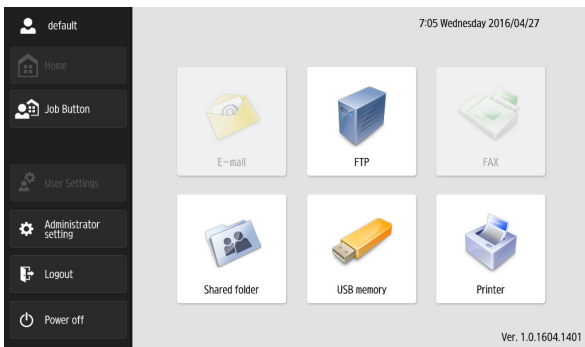

Figure 5-409

B. Scanner Information

By pressing the Information button on the [Service Tool] screen, the screen displaying the version, error history, serial number and counter appears.

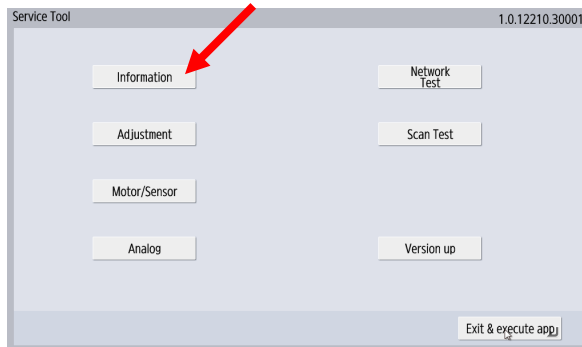

Figure 5-410

This mode displays the versions and error history of the firmware of the scanner's main body and the devices within the main body, and serial number of the main body, and displays and changes the number of sheets to be fed and the number of paper jam occurrences.

1. Version

The version of each software is displayed.

- "MAIN CONTROLLER"

The version of the firmware of the scanner's main body

- "SUB PCB"

The version of the sub PCB

- "OS"

The version of LinuxOS

- "Web Application"

The version of Web application

- "Web Service"

The version of Web service

- "Kernel"

The version of the kernel

- "BIOS"

The version of BIOS

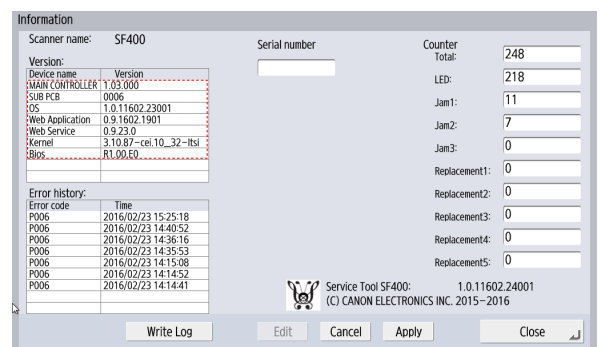

Figure 5-411

2. Error history

The 9 most recent error codes and time of occurrences are displayed.

The content of error codes is shown below, however, note that not all codes are displayed, and the codes recognized first are displayed, which means the displayed content may differ from what is observed visually. For example, when a cable in the reading unit list is not connected, it causes an error at the initial processing instead of E054, therefore, E036 and E041 will be displayed.

Display	Description
E031	ASIC image sensor Line count error
E036	ASIC image processing error
E041	Light amount adjustment scanning error
E050	Batch code decode error
E054	Front side image sensor connection error
E055	Back side image sensor connection error
E086	EEPROM writing error
J018	Skew detection
P001	Pre-registration sensor trailed entry JAM
P002	Pre-registration sensor passage JAM
P004	Eject JAM
P006	Post-registration sensor entry JAM
P007	Post-registration sensor passage JAM
P050	Force stop instruction from the controller

Table 5-402

3. Serial number

For this mode, you need to input the serial number shown on the rating label of the main body, which is required when the control PCB is replaced because the serial number data is saved in the control PCB. Follow the procedure below to enter the serial number.

- 1) Press the Edit button.

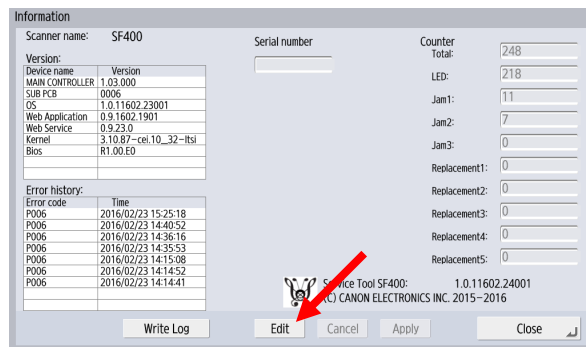

Figure 5-412

- 2) Press the Serial number input box.

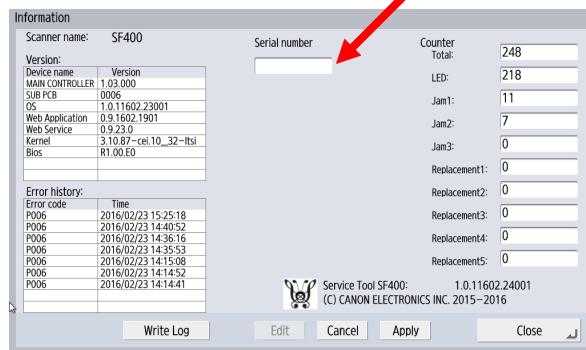

Figure 5-413

3) Input the Serial number and press OK.

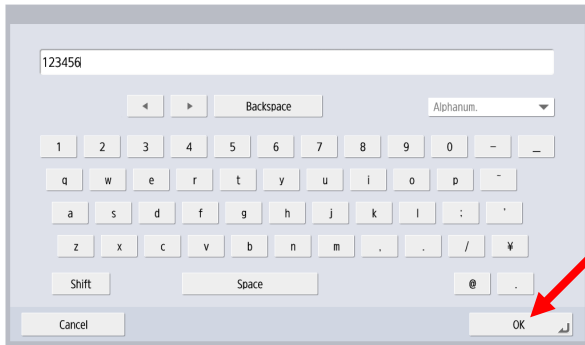

Figure 5-414

4) Returns to the Information screen. Press Apply to enable the setting.

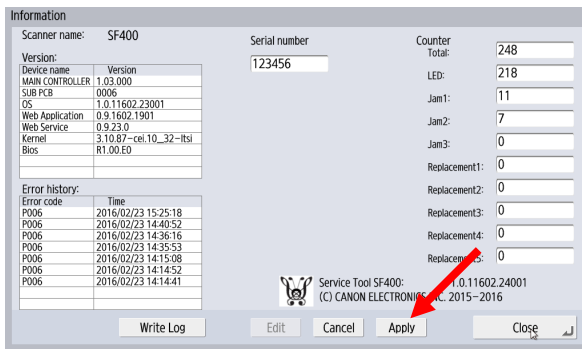

Figure 5-415

4. Counter

This mode displays and changes the number of sheets fed and the number of paper jam occurrences.

◆ Display

Display	Description
Total	Total number of fed sheets
LED	Total lighting time of LED used for reading unit (upper/lower). The value is in "seconds".
Jam1	The number of paper jams at the pickup part. Error code is P001.
Jam2	The number of paper jams at the regist part. Error code is P002/006/007.
Jam3	The number of paper jams at the eject part. Error code is P004.
Replacement 1	The number of fed sheets at the time of replacement of the part that can be replaced by user (standard replacement cycle is 200,000 sheets). Displays the total number of fed sheets at the time of reset in the user mode.
Replacement 2	For Replacement 2 to 5, the service person enters the total number of fed sheets manually at the time of replacement. This value can be considered as estimated timing for next replacement. Each sales area or service person can decide which part should be replaced if necessary.
Replacement 3	
Replacement 4	
Replacement 5	

Table 5-403

◆ Change

Because these values change if the scanner PCB is replaced, the values before the replacement need to be inputted after replacement. If the values before the replacement are unknown, estimated values will work.

1) Press the Edit button.

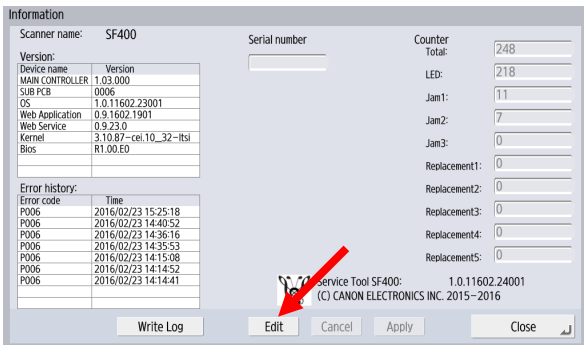

Figure 5-416

2) Press the input box for the Counter value to be changed. As an example, reset the Jam1's Counter. Press the Jam1 input box.

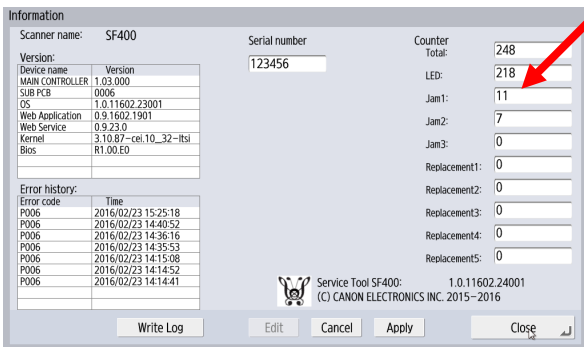

Figure 5-417

3) Reset the Counter value and press OK.

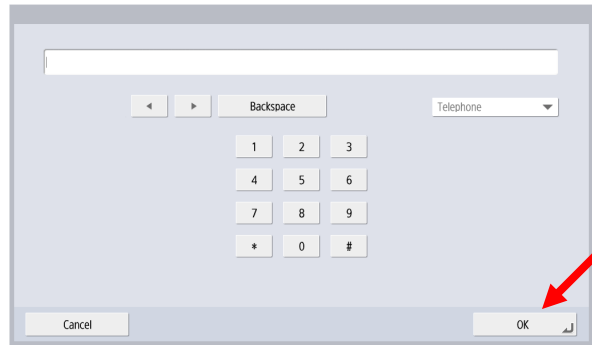

Figure 5-418

4) Returns to the Information screen. Press the Apply button.

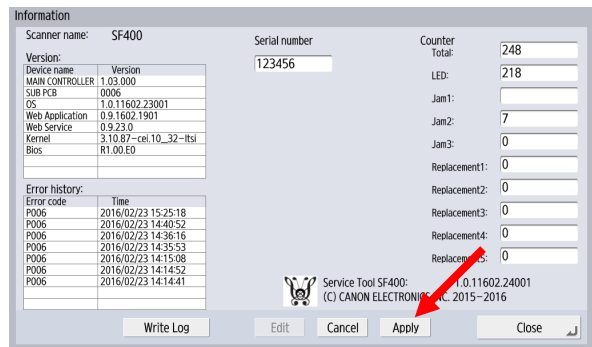

Figure 5-419

5. Write Log

This mode collects the main body's Version, Error history, Serial number, Counter information when a defect occurs, and is used to collect confirmation data of version (if the latest or not), the history of errors related to defect, and usage status of the scanner. You can use this mode to examine the design and solve the problems.

Each item can be saved to the USB memory in text format.

The file name is ServiceToolInfo.txt.

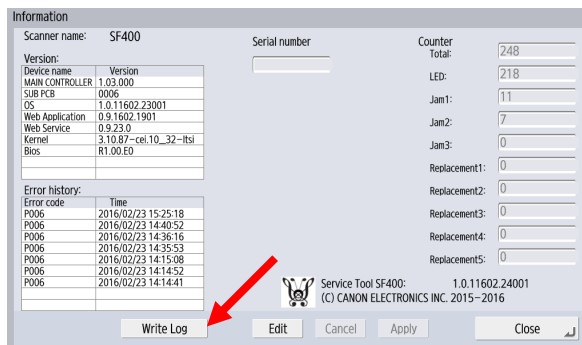

Figure 5-420

A part of the contents of the saved file is shown below.

Service Tool Version for SF400:
1.0.11604.80001

Scanner OS Version Info:
MAIN CONTROLLER : 1.06.000
SUB PCB : 0001
OS : 1.0.11604.13001
Web Application : 1.0.1604.1302
Web Service : 1.0.9.0
Kernel : 3.10.87-cei.10_32-ltsi
Bios : 60310T00

Error Code Info:
P002 : 2016/04/14 00:18:32
P002 : 2016/04/14 00:17:44
P002 : 2016/04/14 00:17:25
P002 : 2016/04/14 00:16:48
P002 : 2016/04/14 00:16:27
P002 : 2016/04/14 00:13:56
P002 : 2016/04/14 00:12:57

Serial Number:

Counter Name: Count
TotalCounter : 166
LedCounter : 211
P01JamCount : 0
P02JamCount : 16
P03JamCount : 0
Replace01Count : 0
Replace02Count : 0
Replace03Count : 0
Replace04Count : 0
Replace05Count : 0

Figure 5-421

C. Scanner Adjustment

1. Selection Screen

The scanner adjustment modes are contained under [Adjustment]. The basic selection screen is shown below.

- 1) On the [Service Tool] screen, press [Adjustment].

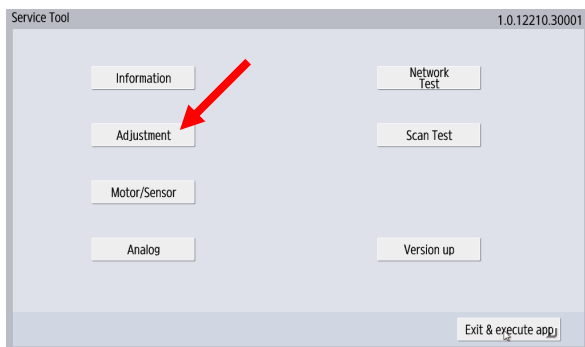

Figure 5-422

- 2) Confirm that the [Adjustment] screen is displayed. Select a menu to execute on this screen.



Figure 5-423

The [Adjustment] screen displays the selection buttons for the contraction rate adjustments, regist adjustments, light adjustment, and touch panel adjustments.

2. Regist Adjustment (Auto)

This mode performs adjustments on a reading-start position and reading-end position for feeding.

If the leading- and trailing-edge positions of a scanned image are improper, perform this adjustment.

Also perform this adjustment after replacing or reassembling the reading unit, or after replacing the scanner PCB recording the adjustment data.

◆ Registration sheet

In order to execute this mode, ordinary copy paper is required. The size should be regular A4 or LTR. This is not set as a service tool since it is readily available.

Do not use the paper which is apparently slanting or tends to cause jams or skews. Shading sheet: TKM-0326/0332 can be used.

Note: Do not use adjustment sheet with black edges used in other DR scanners. They prevent correct adjustments.

◆ Operation Procedure

- 1) Clean the feed path, the rollers, and the scanning glasses.
- 2) Press Regist (Auto) button.



Figure 5-424

- 3) When the message that instructs to place one regist adjustment sheet is displayed, set one adjustment sheet, align with the document guide, and press Yes button.

Regist adjustment sheet

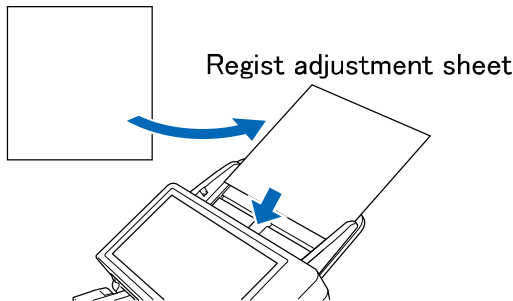

Figure 5-425

- 4) Adjustments start automatically, the regist adjustment sheet is fed, and the adjustment is completed.
- 5) In order to confirm that the regist adjustment was made, confirm the scanning position with the test sheet. If fine tuning is necessary, refer to "5. Regist Adjustment (Manual)".
- 6) If a paper jam occurs due to the setting of documents, the screen of the below figure is displayed. Remove the test sheet and set one test sheet again to perform adjustment again.

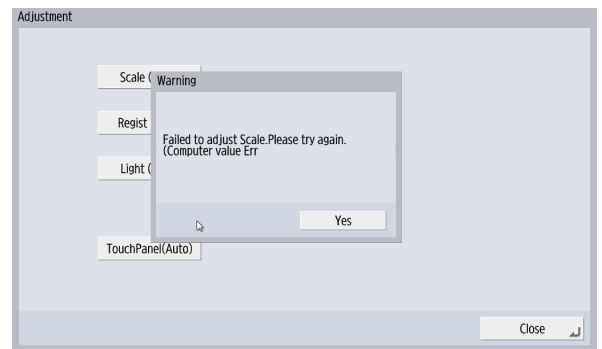

Figure 5-427

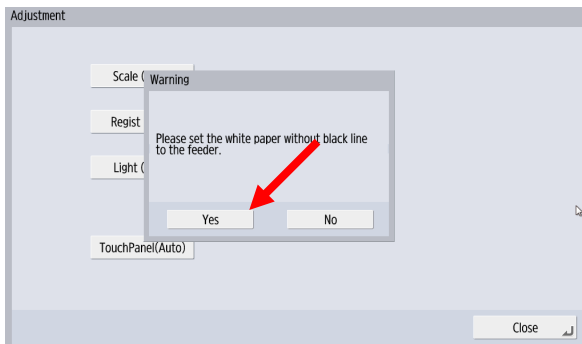

Figure 5-426

3. Contraction Adjustment (Auto)

This mode automatically adjusts the contraction rate of an image in order to correct the length of its feeding direction.

The adjustment is made using the image on the surface. The same values are applied for the image on the backside. If the front edge locations differ, regist adjustment shall be made first.

This mode is used to automatically adjust the contraction rate when retard roller and feed roller as consumable products are replaced with new ones, or when the scanner PCB in which adjustment data is recorded is replaced.

◆ Adjustment Sheet

Service tools: Prepare two contraction adjustment sheets TKM-0348.

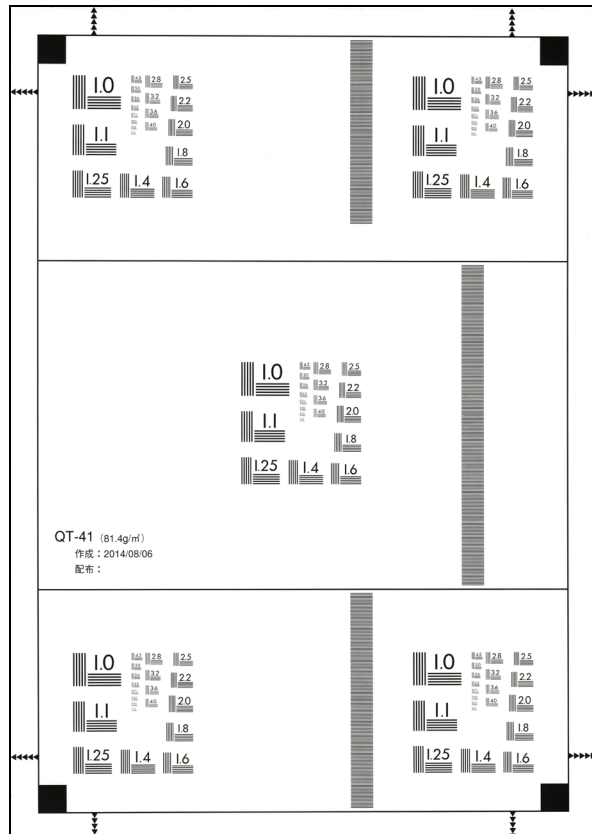

Figure 5-428

◆ Operating Procedure

- 1) Clean the feeding path.
- 2) Press Scale (Auto) button.



Figure 5-429

- 3) When a message instructing you to place two contraction adjustment sheets is displayed, set two adjustment sheets with picture side facing up, align the document guides, and press the Yes button.

Contraction adjustment sheet

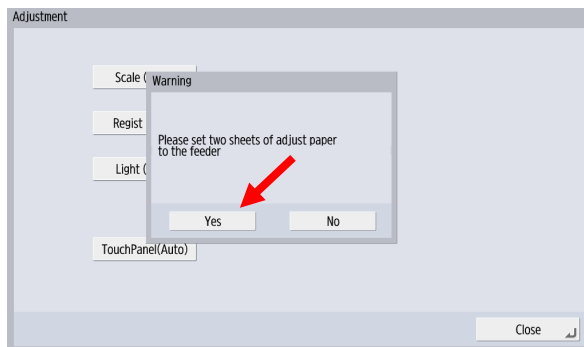
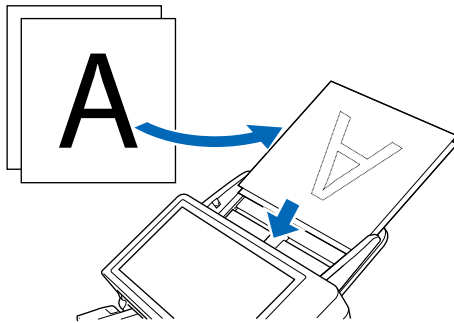

Figure 5-430

- 4) Adjustment starts automatically, and the two contraction adjustment sheets are fed. The Yes button is lit yellow during adjustment, and when completed, yellow light turns off and the dialog box closes.
- 5) In order to confirm that the contraction rate adjustment was made, confirm the scanning position with the contraction adjustment sheet of the service tool.

- 6) Press the Close button of the “Adjustment” screen.



Figure 5-431

- 7) In the [Service Tool] screen, Press the Scan Test button to scan the contraction adjustment sheet and check the image.

For details of Scan Test function, refer to “F. Scan Test”.

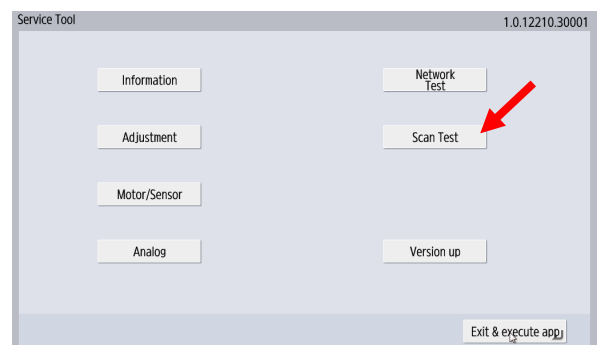

Figure 5-432

If fine tuning is necessary, refer to “6. Contraction Adjustment (Manual)”.

- 8) If a paper jam occurred during the adjustment due to the setting of documents, the screen of the below figure is displayed. Remove the test sheet and set two test sheets again to perform adjustment again.

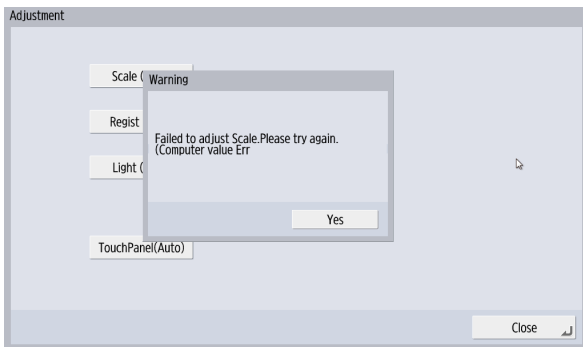

Figure 5-433

4. Light Adjustment

This mode performs fine adjustments on the shading correction values since the reading point differs between the shading sheet inside of the reading unit and the actual document.

If the scanned image quality is degraded, perform this adjustment.

Also perform this adjustment after replacing the reading unit or after replacing the control PCB recording the adjustment data.

◆ Adjustment sheet

The special shading sheet is required to execute this mode. Use TKM-0326 or TKM-0332.

Do not use a sheet with any dirt or creases.

◆ Operation Procedure

- 1) Clean the feeding path, roller, and reading glass.
- 2) Press Light (Auto) button.

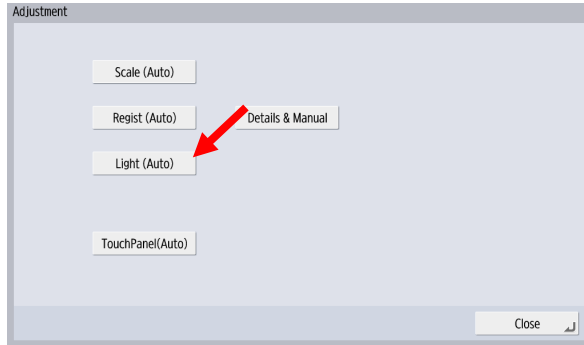

Figure 5-434

- 3) When a message instructing you to place one shading sheet is displayed, set one sheet, align with the document guides, and press Yes button.

Shading sheet

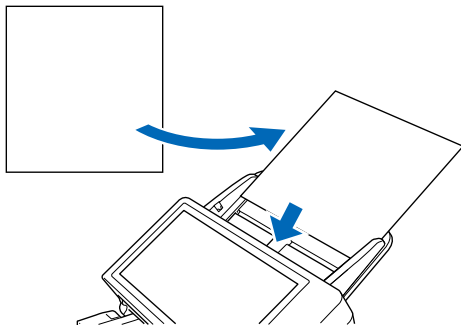

Figure 5-435

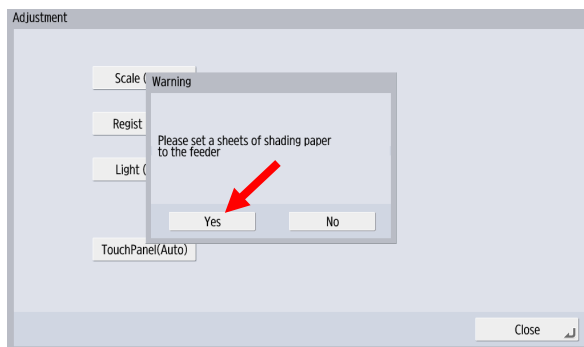

Figure 5-436

- 4) Adjustment starts automatically, one test sheet is fed, and the adjustment is completed.
- 5) In order to confirm that the light adjustment was made, confirm the scanned image with the test sheet of the service tool.
- 6) Press the Close button of the "Adjustment" screen.



Figure 5-437

- 7) In the [Service Tool] screen, Press the Scan Test button to scan the test sheet of the service tool and check the image. For details of Scan Test function, refer to "F. Scan Test".

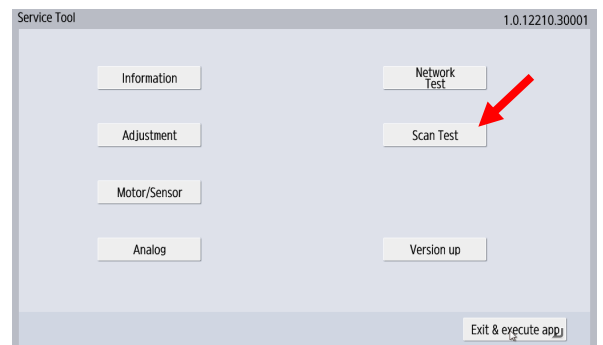

Figure 5-438

5. Regist Adjustment (Manual)

Registration adjustment is normally made in the automatic mode.

Manual adjustment is a mode to make fine-tuning adjustment to the results of the automatic adjustment. However, it is not for reducing the registration position gap.

Move the screen to the adjustment screen by pressing "Details & Manual".



Figure 5-439

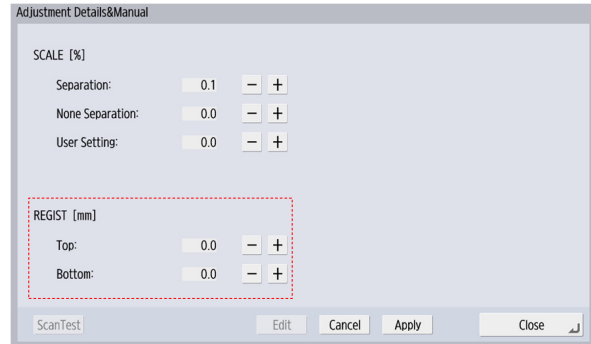

Figure 5-440

◆ Adjustment Sheet

Use the same adjustment sheet as the one used for the registration adjustment (Auto).

Note: Do not use adjustment sheets with black edges used in other DR scanners. They prevent correct adjustments.

◆ Type

Two types of registration adjustment are provided.

- Top (Top edge registration. Registration value of the reading start position. Setting range is $\pm 5.0\text{mm}$. The [+] direction delays the start timing of image scanning.)
- Bottom (Bottom edge registration. Registration value of the reading finish position. Setting range is $\pm 5.0\text{mm}$. The [+] direction delays the end timing of image scanning.)

◆ Adjustment Sheet

Service tools: contraction adjustment sheets TKM-0348 or hand-made sheets as shown below shall be used.

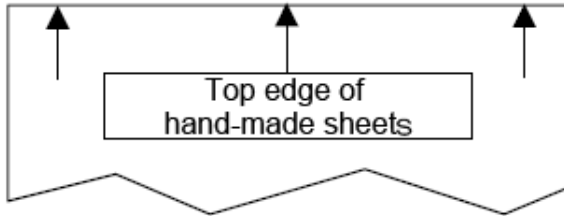

Figure 5-441

◆ Operating procedure

- 1) Set one contraction adjustment sheet TKM-0348 or hand-made sheet, and align the document guide. The sheet should be set so that the picture side is facing upward.
- 2) Press Scan Test button.

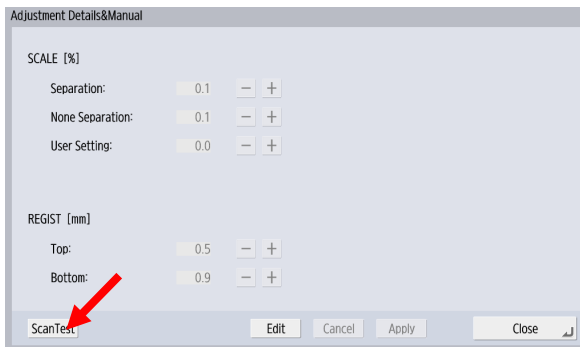

Figure 5-442

- 3) Set scanning conditions and select the "Scan" button.

Note:The mode is gray, resolution 300dpi, paper size same as the sheet size. Non-separation/separation mode can be set to either mode.

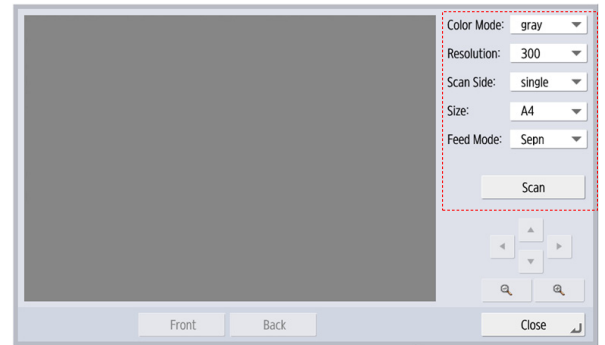

Figure 5-443

- 4) Press the "Scan" button.

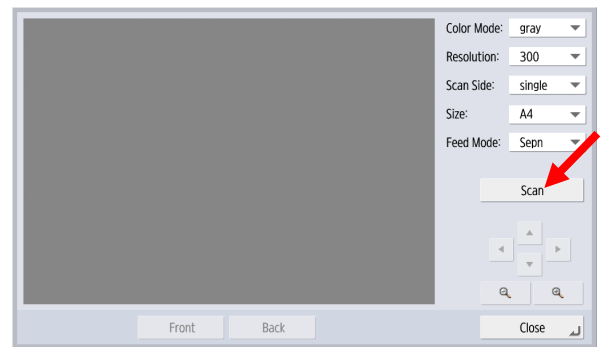

Figure 5-444

- 5) Expand the image to confirm the top edge position.

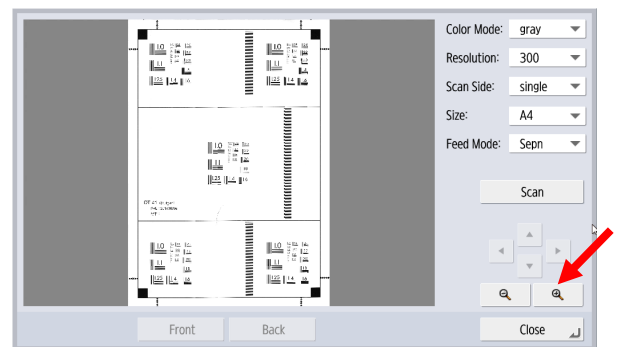

Figure 5-445

- 6) Close the ScanTest screen by the "Close" button.

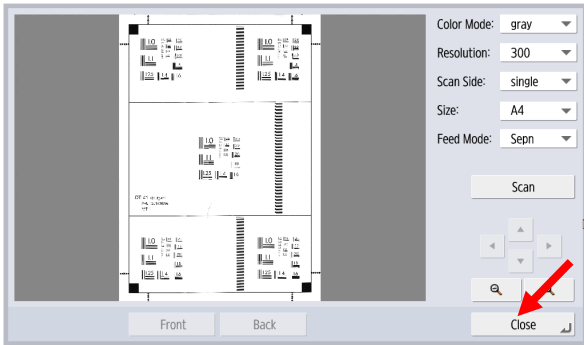

Figure 5-446

- 7) Press the Edit button to configure REGIST adjustment value.

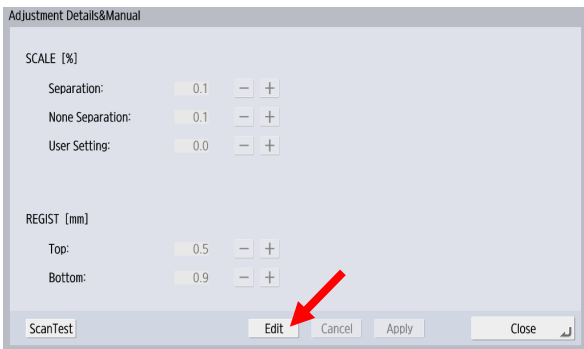

Figure 5-447

- 8) The registration adjustment values are changed using + and - buttons. Further changes are added to the values that have already been adjusted automatically.

For example, when the Top and Bottom values have been set to 0.4 respectively, and if it is desirable to increase 1 mm to the top edge of the document, i.e., to advance the start of reading by the amount of 1 mm, the value is changed to -0.6, or to 1.4, if it is desirable to decrease 1 mm to the top edge of the document, i.e., to delay the start of reading by 1 mm. Likewise, the value of the Bottom is changed to -0.6 if it is desirable to advance the finish of reading by the amount of 1 mm, or to 1.4 to delay 1 mm. As an example here, a case in which the start of reading is to be advanced by the amount of 1 mm is explained.

- 9) In the current registration value settings, set the contraction rate adjustment sheet, perform ScanTest and confirm the amount of deviation of the top edge registration, and press the Close button.

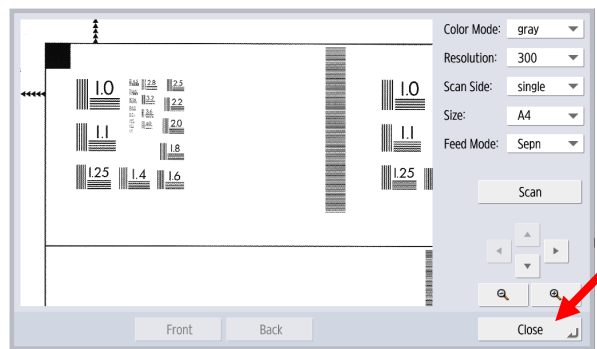

Figure 5-448

- 10) To advance the start of reading by 1mm, change the Top value from 0.4→-0.6, and press the Apply button.

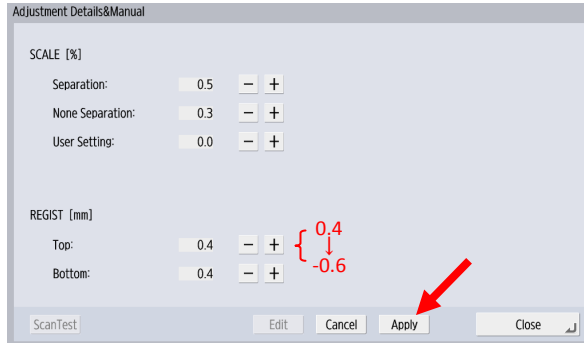

Figure 5-449

- 11) Set the contraction adjustment sheet, run scan on ScanTest and confirm the top edge registration position after the changes in the settings.

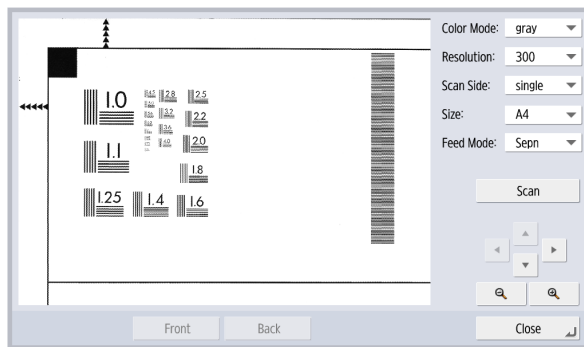

Figure 5-450

- 12) Confirm the displayed image. Try again if it has not been corrected properly.

6. Contraction Adjustment (Manual)

This mode adjusts the contraction ratio of an image to correct the length of its feeding direction. Adjustment is made using the image on the surface. The same values are applied for the image on the reverse. If the top edge positions differ, regist adjustment shall be made first.

By pressing the "Details & Manual" button, the screen moves to the adjustment screen.



Figure 5-451

◆ Adjustment Sheet

Prepare an A4 or LTR sheet with a picture which can be used to make the top and bottom positions clear. Service tools: Contraction adjustment sheets of TKM-0348 or hand-made sheets shown below should be used.

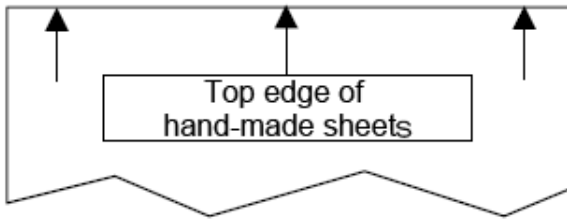

Figure 5-452

◆ Type

Three types of contraction ratio adjustments are provided.

- Separation (Factory setting value of contraction rate adjustment in the separation mode)
- None Separation (Factory setting value of contraction rate adjustment in the non-separation mode)
- User Setting (Contraction ratio set by users)

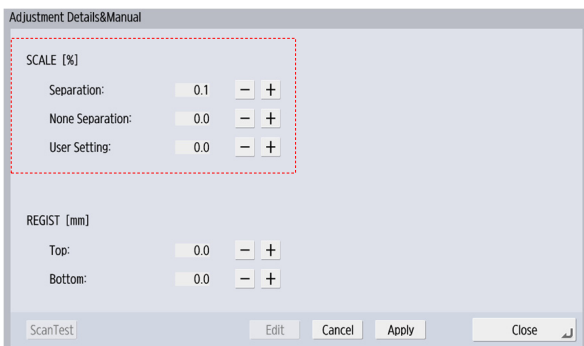

Figure 5-453

There are slight differences in contraction ratios due to the difference in the

feeding method between separation and non-separation modes. Therefore, default contraction ratio is set for each mode at the time of shipment from factory.

User contraction ratio is also provided so that the ratio can be re-adjusted by users after shipment.

The ratio can be set on the operation screens for users, the "Administrator setting/device setting/ScanFront maintenance/detailed device setting". The values on this screen and the "Contraction ratio set by users" in this mode are linked.

◆ Operation Procedure

Note: If contraction rate adjustment is made after the replacement of the control PCB or if contraction rate adjustment is made manually, the image from step 3 onwards, to be described later, also impacts the contraction rate in User Setting. So, set the adjustment values of all three types, Separation, None Separation, User Setting to [0.0], and select the [Apply] button.

- 1) Set one contraction rate adjustment sheet and align with the document guide. The surface on which a picture is drawn should be set on the front side.
- 2) Press Scan Test button.

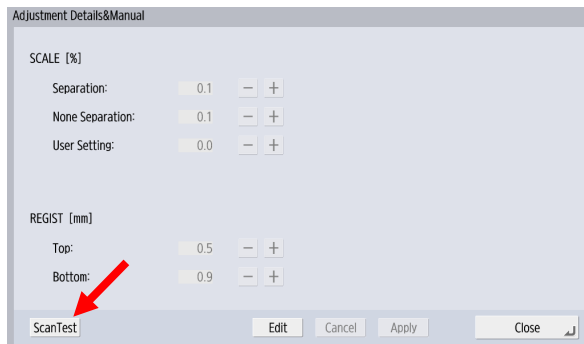

Figure 5-454

- 3) Set the scanning conditions. To check the contraction ratio of separation mode, select Sepn in Feed Mode. To check the contraction ratio of non-separation mode, select Non Sepn in Feed Mode.

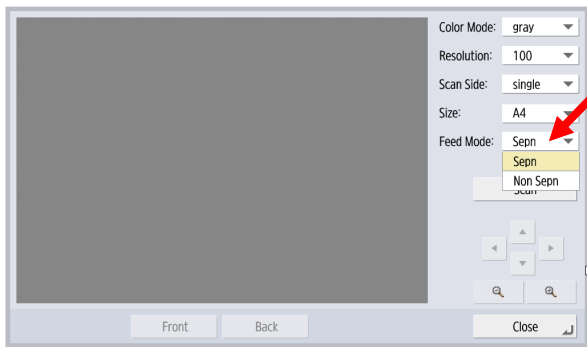

Figure 5-455

- 5) Expand the image to confirm the top edge position is correct.

Note: If the top edge position is not correct, or the image is skewed, scan the image again.

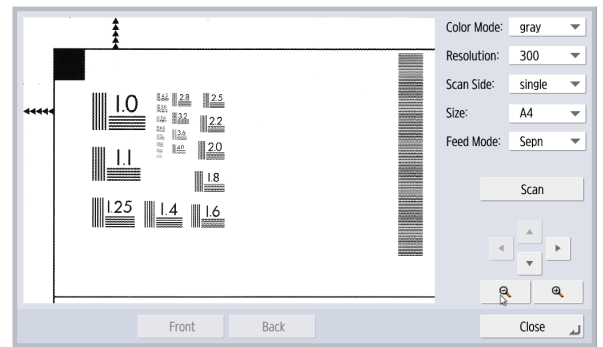

Figure 5-457

- 4) Press the Scan button.

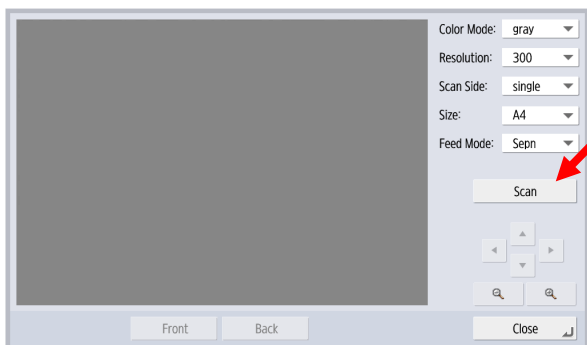

Figure 5-456

6) Then, check the bottom edge position to determine the adjustment value. For example, if the size of the contraction rate adjustment sheet is A4 and needs to be 2.0 mm longer, $2.0 \div 297 \rightarrow 0.7\%$, so, add [0.7] to the setting value. If the original value is [0.0], the setting value is [0.7]. After setting the values, select the [Apply] button. In the figure below, values are set to "the factory value of the contraction rate adjustment in the separation mode".

Note: If the correction was not properly made, retry the operation once again.

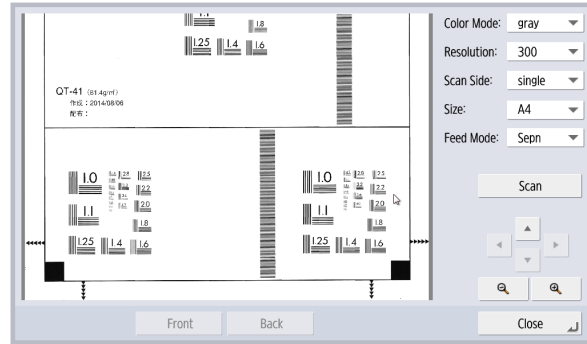

Figure 5-459

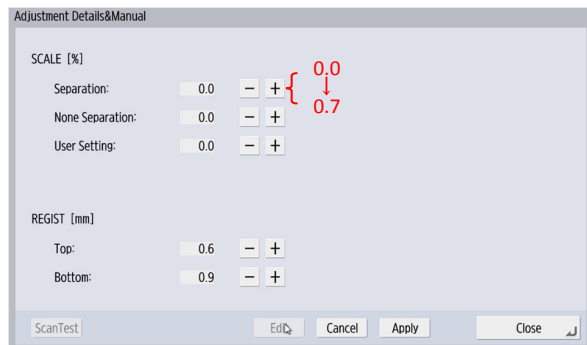
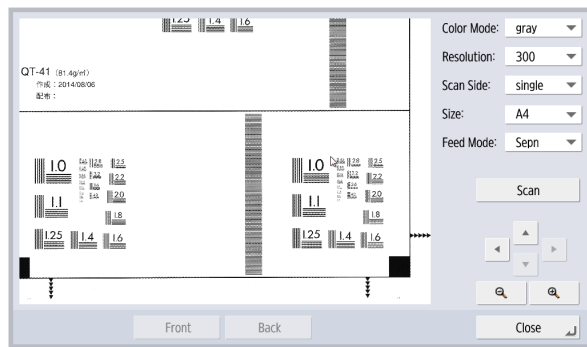

Figure 5-458

Note: Adjustment may not be fully successful using only factory adjustment values. In this case, also use user adjustment values.
Or, replace the roller.

7) Set the adjustment sheet again and scan. Then check the image displayed.

The schematic procedure to adjust the contraction rate including automatic and manual registration adjustments is shown in the following flow chart.

For details, refer to each item.

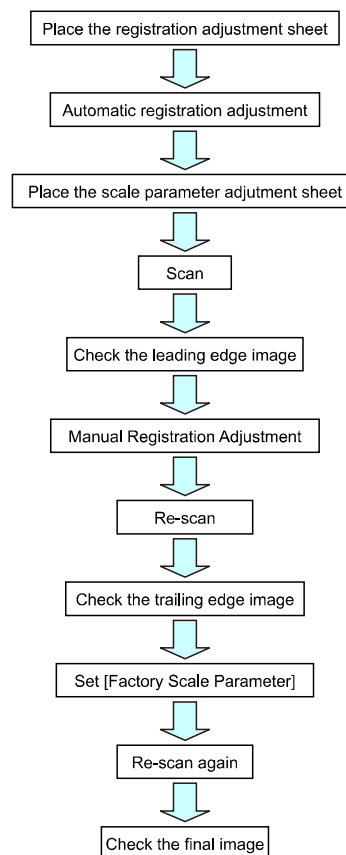

Figure 5-460

7. Touch Panel Adjustment

This mode is for making the touch panel responsive with the same pressure at any points on the touch panel.

Adjustment (calibration) is carried out automatically eliminating variation in the sensitivity.

If the initialization of user information or re-installation of software is performed, the sensitivity adjustment data of touch panel returns to initial values. When these operations are performed, or after the service replacement of touch panels, the adjustment is carried out.

◆ Operating Procedure

- 1) Press Touch Panel (Auto) button.



Figure 5-461

- 2) Press YES button when the confirmation screen appears.

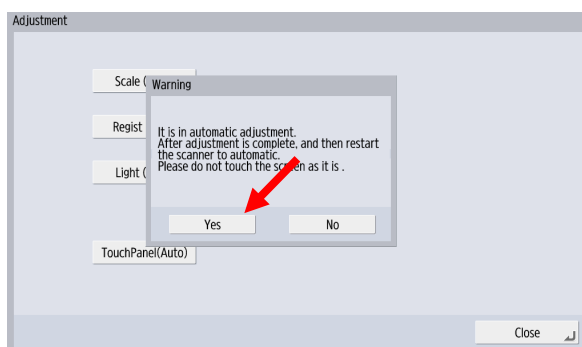

Figure 5-462

Note: During the adjustment, the YES button in the confirmation screen lights up in yellow and remain lit.

Note: Do not touch the touch panel during the adjustment.

- 3) When the adjustment is complete, the confirmation screen disappears and the main body restarts.

D. Motor/Sensor Information

This mode is used for checking the operations of hardware and sensor inside of the machine, as well as identifying the failure location when a failure occurs in paper feed, transportation, and double feed detection.

1. Basic screen

- 1) On the [Service Tool] screen, press the Motor/Sensor button.

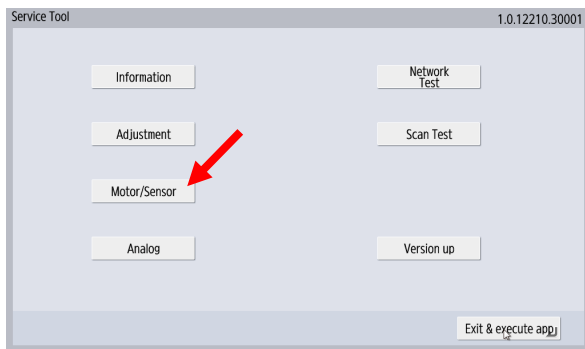

Figure 5-463

- 2) Confirm the [Motor/Sensor] screen is displayed.
Select a menu to execute on this screen.

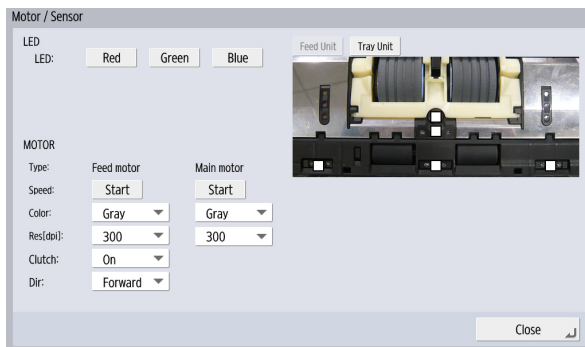

Figure 5-464

- a. LED on CIS unit

The LED lights up by pressing the corresponding LED button. Press the button after fully opening the upper unit. The LED goes off by pressing the button once again.



When lights are off

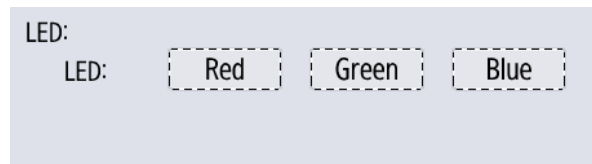

When lights are on

Figure 5-465

b. Sensors

Operation confirmation of sensors is performed. When the sensor detects its target, the corresponding mark lights.

The display screen is divided into "Feed Unit" and "Tray Unit". The content is displayed by selecting each tab.

1) Feed Unit

Open the front unit and expose suitable paper to the sensor, then close the front unit. When the sensor detects its target, the corresponding sensor displays ○. The ultrasonic sensor displays ◎ when more than two sheets of papers are exposed to it.

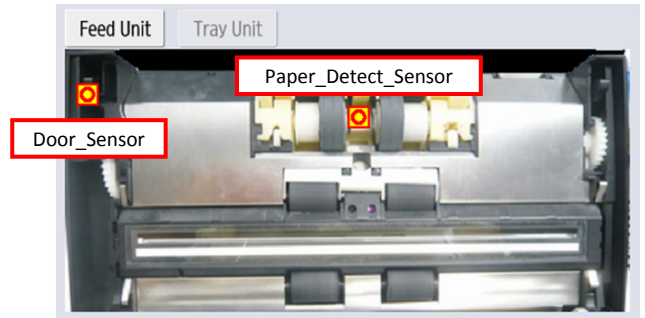

Figure 5-467

c. Motor

Confirm the clutch operation of the Feed motor by turning the paper feed roller by hand.

If you switch ON the "Clutch", the clutch starts functioning and the paper feed roller cannot be reversed. If it is OFF, the feed roller rotates in both directions.

Further, it is possible to specify the direction of motor rotation. Forward will lead to normal direction and Reverse will lead to reverse direction.

- [Main motor]: Feed motor
- [Feed motor]: Pickup motor

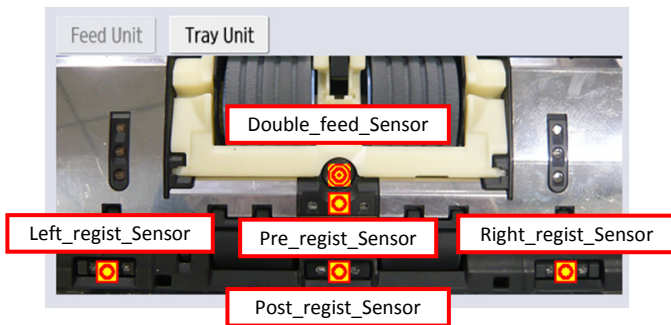

Figure 5-466

2) Tray Unit

Open the front unit and expose suitable paper to the sensor, then close the front unit. When the sensor detects its target, the corresponding sensor displays ○.

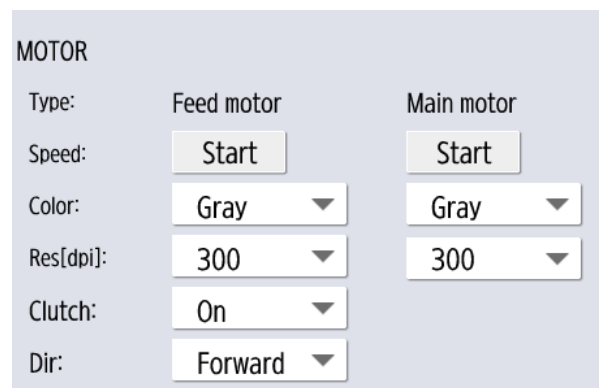

Figure 5-468

E. Analog Value Information

This mode is used to check operations of each sensor using the information of the previous section D. Motor/Sensor information when a failure occurs in paper feeding, transportation, and double feed detection, further collect the output information of each sensor and identify the cause.

By pressing the [Analog] button, the screen moves to the confirmation screen.

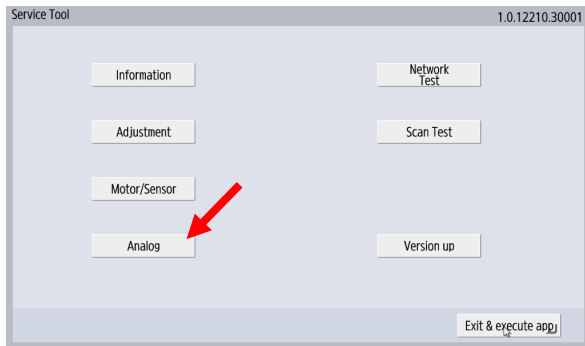

Figure 5-469

1. Operating Procedure

Explanation is given on the analog data of each sensor displayed.

- Pre Regist Sensor: Analog value of the front regist sensor
- Post Regist Sensor: Analog value of the rear regist sensor
- Right Regist Sensor: Analog value of the right regist sensor
- Left Regist Sensor: Analog value of the left regist sensor

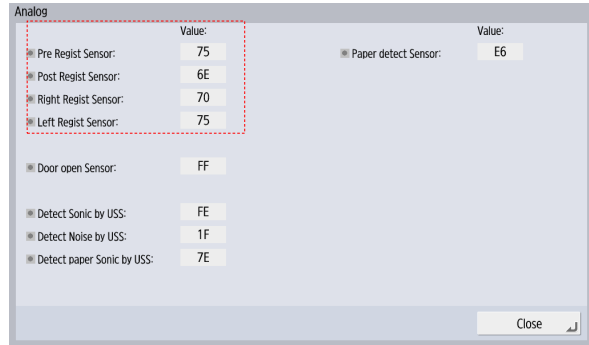

Figure 5-470

- Door open Sensor: Analog value of the door opening and closing detection sensor

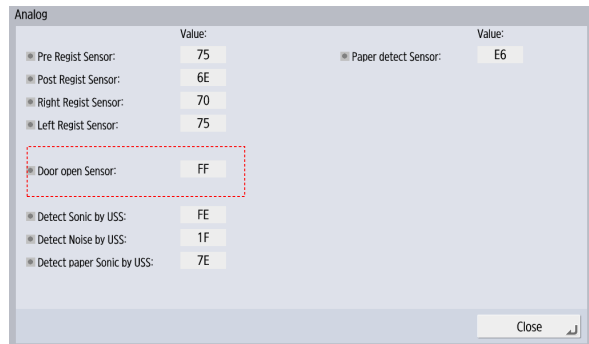

Figure 5-471

- Detective Sonic by USS: Ultrasonic analog value of the double feed detection sensor
- Detective Noise by USS: Analog value of the ultrasonic noise component of the double feed detection sensor
- Detective paper Sonic by USS: Analog value of the double feed detection sensor when detecting a document

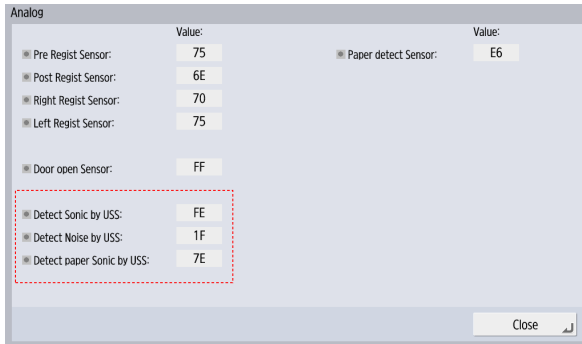

Figure 5-472

- Paper detect Sensor: Analog value of the document detecting sensor.

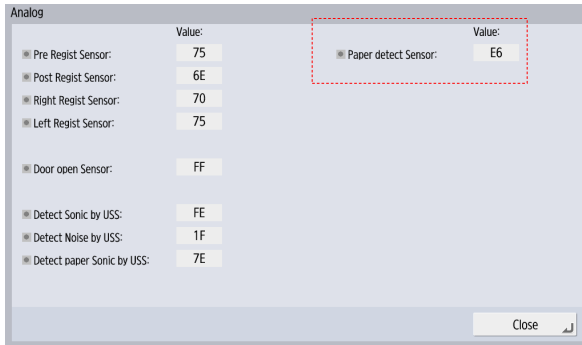

Figure 5-473

F. Scan Test

1. Outline

This mode is used to check scanned images.

This mode can be started from the service mode, instead from the normal screen for users, allowing scanning operations and scanned images to be checked without bothering users.

This mode is also used to check images after contraction ratio adjustments and regist adjustments. Since this mode does not use a network, it is possible to isolate the cause of failure, e.g., whether the problem is with the main body's scanning function itself, user setting, or with the networking function.

2. Operating Procedure

- 1) Press [Scan Test] in the [Service Tool] screen.

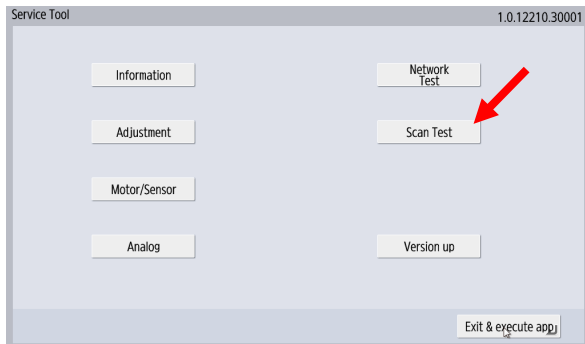

Figure 5-474

- 2) "Scan Test" screen is displayed. Select a menu to execute on this screen.

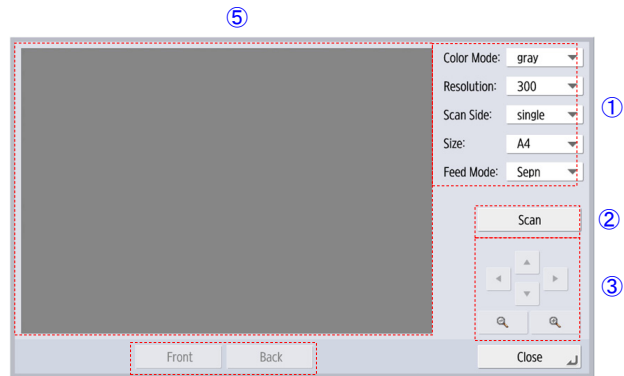

Figure 5-475

No	Description
①	Scanning conditions Specification of modes, resolution, one sided/two sided, paper size and separation/non-separation mode
②	Scan button Executes scanning
③	Expansion/contraction button Expand or contract the image shown in ⑤ above.
④	Button to select front of back of a scanned image When two-sided scanning was performed, the front or back side of the scanned image is shown on the above-mentioned ⑤.
⑤	Scanned image The scanned image is displayed.

Table 5-403

G. Version Up

1. Outline

This mode is used to change the software of the machine to the latest version. The user can also carry out this by using the Administration Tool.

It writes the new software file into the USB memory and overwrites the internal software by connecting it with the machine.

It is also possible to return to the old version by running this mode.

◆ Writing into the USB memory

The file used in updating must be written in the root directory of the USB (Uppermost hierarchy). It will be invalid if written in a sub directory. File name will be as follows.

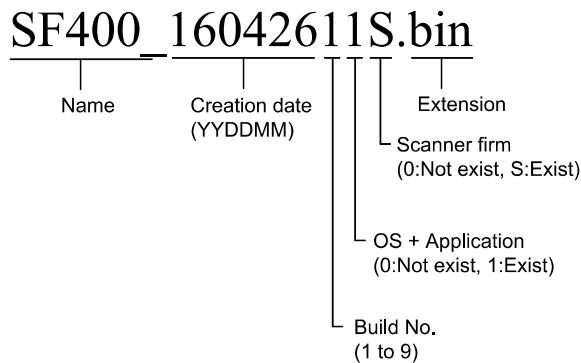

Figure 5-476

Note: The maximum size of the file is 400MB.

Note: Just one file that is to be used must be placed in the root directory of the USB memory. It will not function properly if there are other files. For other files that are required, create a folder in the root directory and save them in that folder.

Note: Updating is performed automatically. Its flow includes the "Backup/Restore" function of the user information.

2. Operating Procedure

- 1) Prepare the USB memory with the necessary files have been written.

Note: The USB memory to be used must be FAT16 or FAT32, with no special functions such as security functions. For restrictions on the USB memory, refer to the user manual or "Chapter III. User operations 1. Preparations". For the method to write the files, refer to the previous section.

- 2) Start the service tool.
- 3) Confirm the current Version number in the Version by clicking the Information button on the [Service Tool] screen.
- 4) Insert the prepared USB memory in the USB port of the machine.

- 5) Press [Version up] in the [Service Tool] screen.

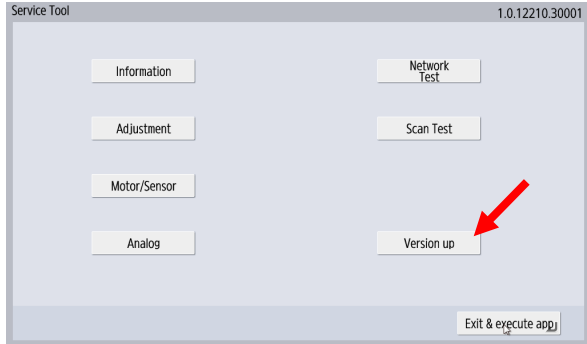

Figure 5-477

Note: The updating operation starts as soon as the [Version Up] button is pressed without any display of the confirmation message.

- 6) The operation starts automatically. During version up, the light of the Version up button is illuminated in yellow. The time required differs according to the user data volume. It takes approximately 40 minutes if the data volume is maximum.

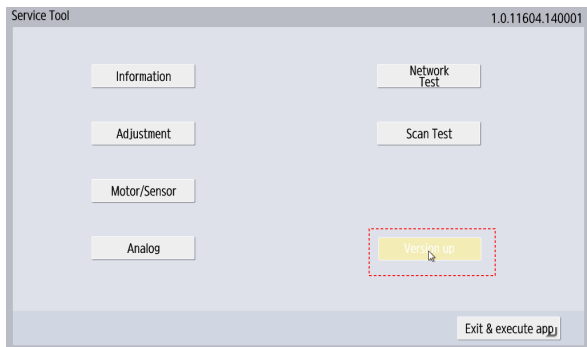

Figure 5-478

- 7) The completion dialog is displayed at the completion of the operation. Press the Yes button to reboot.

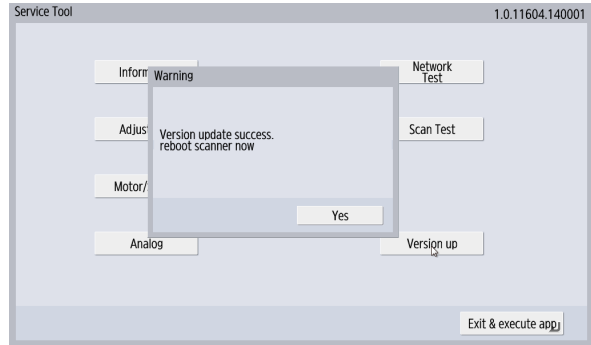
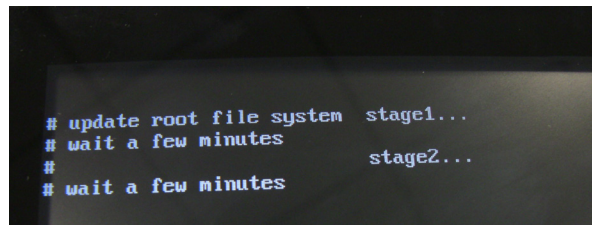
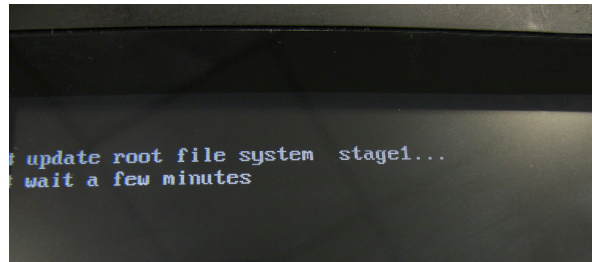
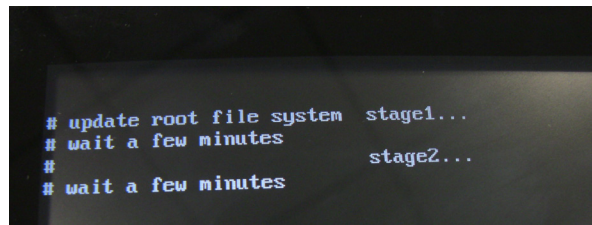

Figure 5-479

- 8) Rebooting is started and the update continuation screen is displayed.



Go to Stage 2



Go to Reboot

Figure 5-480

- 9) Rebooting is performed once again and finishes with the display of home screen.
- 10) Confirm the post update Version number in the [Service Tool] Information screen.

H. Log File Recovery

The machine has the function to collect the usage status of the user as information in the log files, and to recover them.

Since it is helpful for solving problems during the design study, the users may be requested to perform the recovery operation.

Furthermore, to recover the log files, it is necessary to access using a Web browser on the external terminal. For the access method, refer to the "Chapter 5 Administrator settings, 9. [Device operation settings] screen, Access using a Web browser on the external terminal" in the user manual.

◆ Types of information

- 1) User operation
- 2) Error
- 3) Settings
- 4) Debug
- 5) Latest information at the time of recovery

◆ Recovery procedure

- 1) Use the external browser to access to this machine.
- 2) Press Administrator setting to display the Administrator Settings screen, and press System Settings button.

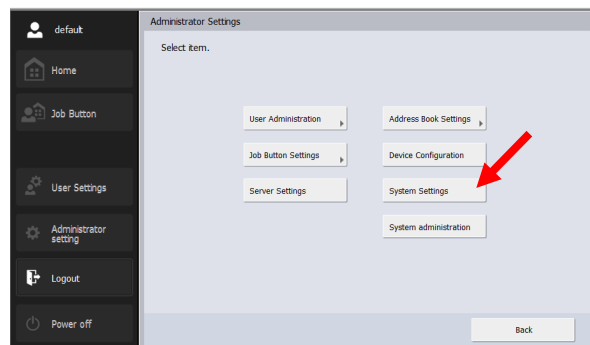

Figure 5-481

- 3) Press the Export log button in the System Settings screen.

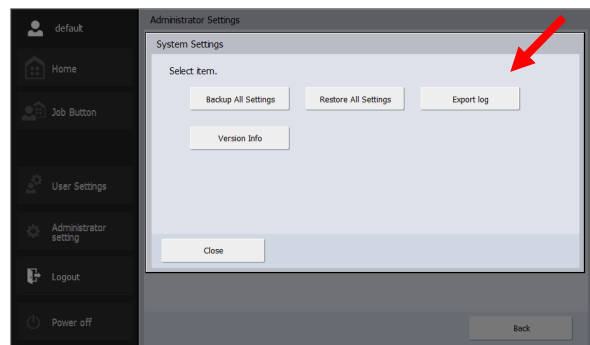

Figure 5-482

- 4) The Export log screen is displayed.
Select the Applicable date, and press
OK.

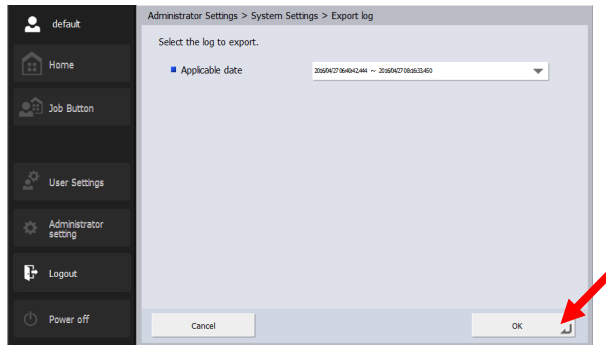

Figure 5-483

- 5) The save dialog is displayed. Click
Save to save the log file.
The file is saved in the following loca-
tion.
Windows7/Windows8.1/Windows10
C:\Users\user name\Downloads
The user name is the name for the user
who is logging in the external PC
connected to this machine.

V. NETWORK FUNCTION CHECK

1. Outline

If a user executes network test included in this machine's function and finds that there is no problem with user network settings and LAN system, and concludes that the problem is due to LAN function of this machine, disconnect this machine from the user's network, connect this machine to the servicing PC through LAN cable, and check if the user can send image data to the shared folder on that PC.

◆ Outline steps

- 1) Preparation
- 2) Network setting for the machine
- 3) Network setting for computer
- 4) Creating a user
- 5) Creating a shared folder
- 6) Sending image data
- 7) Initialization

Note:The user data is highly confidential. You have to ask the user to backup the user data and execute an initialization before this operation. And before you will return the machine to the user, you have to execute the initialization. For details, refer to "USER INFORMATION PROTECTION" in this chapter or the user manual.

Note:Since the operations and screens differ depending on the operation system, take appropriate steps to the operating system to perform this procedure. In here, Windows 7 is used.

2. Preparation

- 1) Necessaries
 - Computer:
 - Microsoft Windows Network available
 - TCP/IP protocol available
 - LAN cable:
 - Signal straight connection or cross connection may be used for this machine.
- 2) Confirmation
 - Confirm the user that the user data has been backup and initialized.
- 3) Connection
 - Connect the machine and the computer with LAN cable.

3. Network Setting for the Machine

◆ Purpose

Set the network settings for the machine. Set the same network address part in the IP address on the machine and the computer.

- 1) Turn on the machine to display the [Home] screen. And press [Administrator Settings].
- 2) The [Administrator Password] screen is displayed. Press [OK] without inputting a password.

Note: When the user has initialized, you don't need to input any password.

- 3) When the [Administrator Settings] screen appears, press the device configuration button.

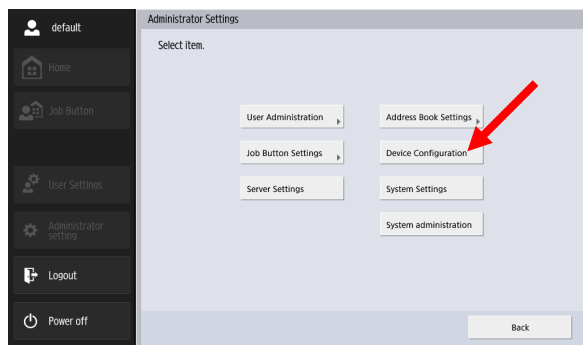

Figure 5-501

- 4) On the [Device Configuration] screen, press the network setting button.

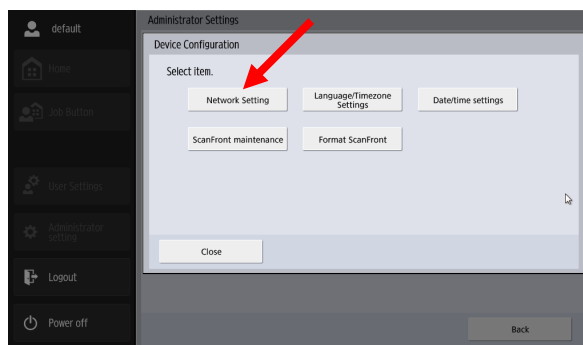

Figure 5-502

Note: Connect the computer with the machine using a LAN cable. If the following procedure is performed without connection, the setting values are valid, but the display returns to the initial values, causing misunderstanding.

- 5) On the next screen, disable the DHCP server, and then input a suitable address. For the IP address for the machine and the computer, the network address should be the same but the host address should be different.

After that, press [OK].

- IP address: 1.1.1.2
- Subnet mask: 255.255.255.0
- Default gateway: 1.1.1.1
- DNS (primary): 1.1.1.1
- NTP (primary): 1.1.1.1

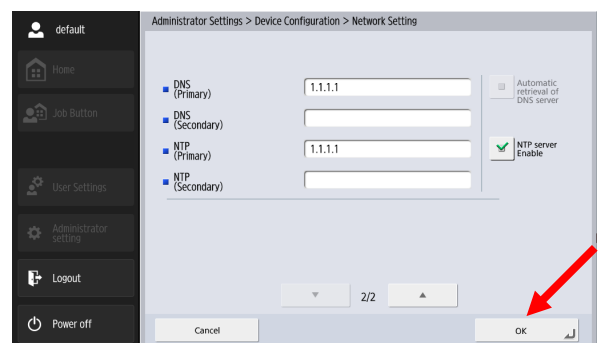
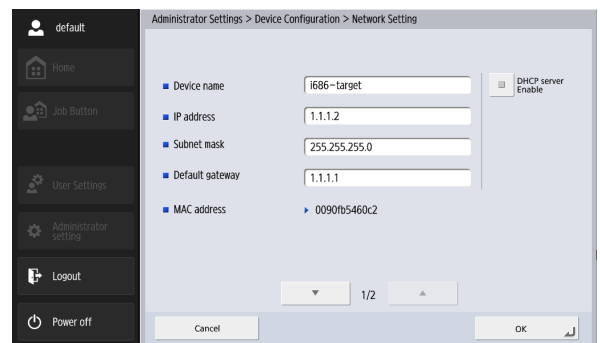

Figure 5-503

4. Setting for Computer

The operation method and screens are different according to the computer being used. Understand the purpose and perform operations to be consistent with the computer being used. In this example, Windows 7 is used as an operating system.

◆ Purpose

Set the network setting for the computer to be consistent with the machine.

- 1) Click [View network status and tasks] in Control Panel.

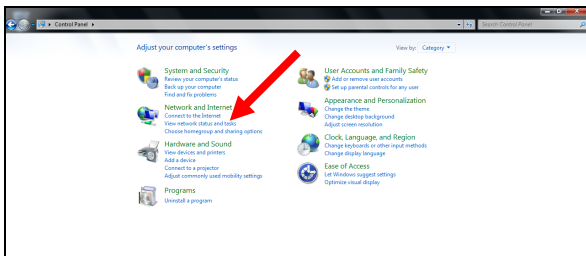

Figure 5-504

- 2) On the next screen, click [Change adapter settings].

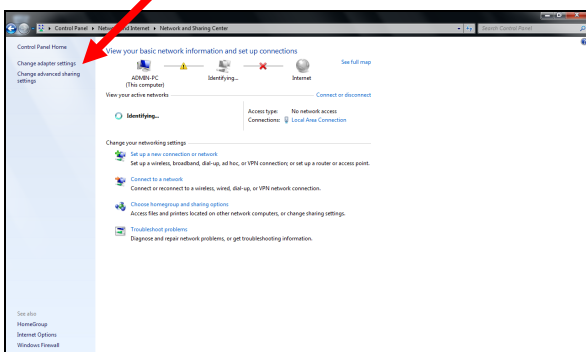

Figure 5-505

- 3) On the next screen, right-click [Local Area Connection], then click [Properties].

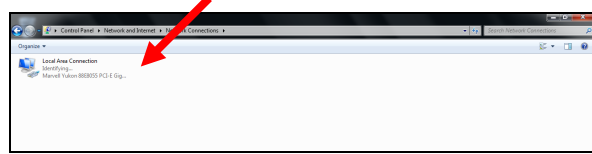

Figure 5-506

- 4) On the next screen, select [Internet Protocol Version 4 (TCP/IPv4)], then click [Properties].

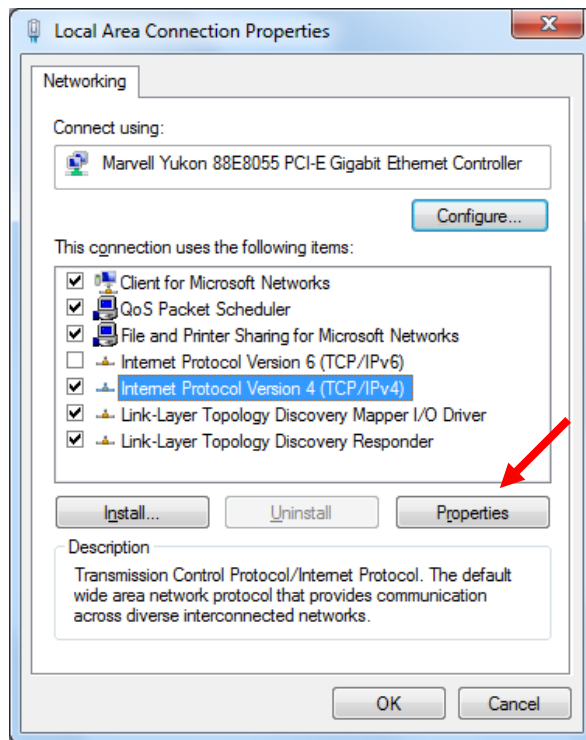

Figure 5-507

- 5) On the next screen, input each address. They should be consistent with the addresses input at the previous section for the machine. After that, click [OK]. The input data in this example is as follows.
- IP address: 1.1.1.1
 - Subnet mask: 255.255.255.0
 - Default gateway: 1.1.1.1
 - Preferred DNS server: 1.1.1.1

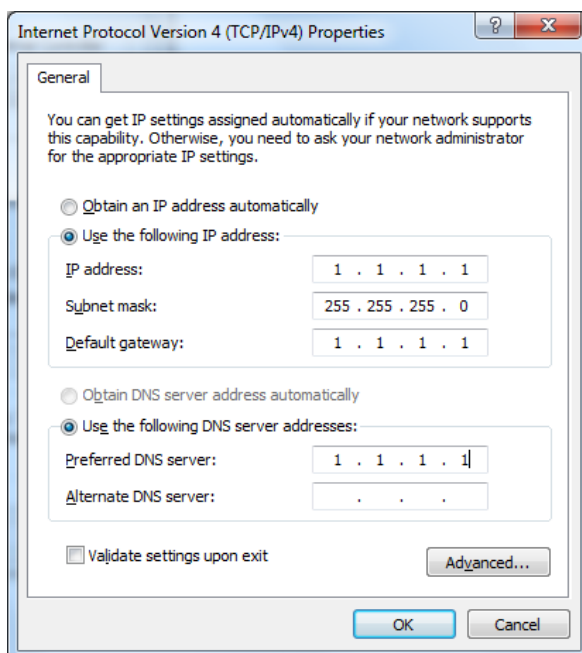

Figure 5-508

5. Creating a User

◆ Purpose

Create a user account with administrative rights to access a shared holder. You can use any existing user account if you know its password; otherwise you need to create a new user.

- 1) Click [Add or remove user accounts] in Control Panel.

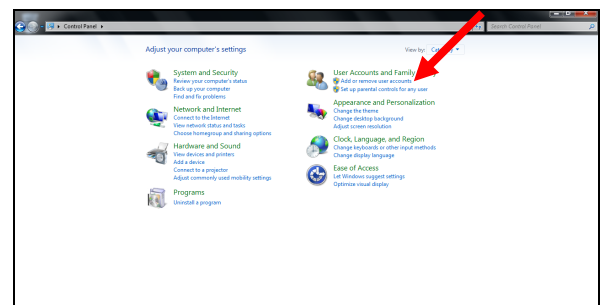

Figure 5-509

- 2) On the next screen, click the [Create a new account] tab.

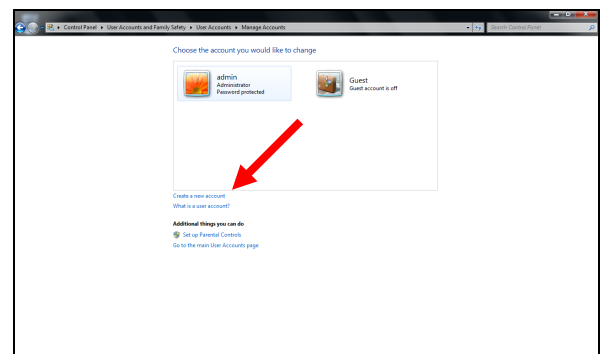

Figure 5-510

- 3) On the next screen, input the name in [New Account Name]. Select Administrator as the type of account. The new account name in this example is sf.

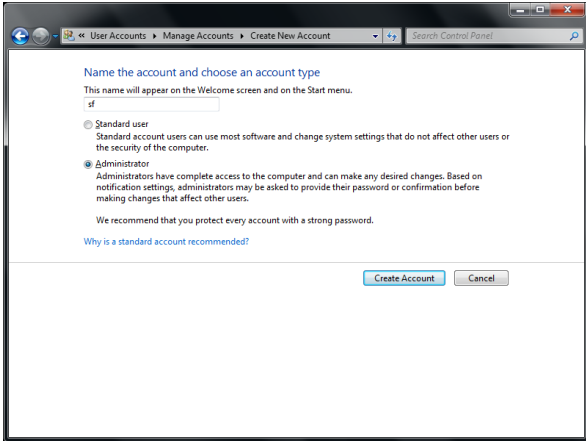

Figure 5-511

- 4) By pressing the create account button, the following screen appears and the account is created.

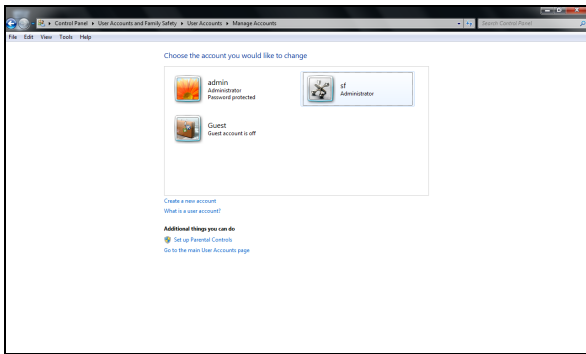

Figure 5-512

- 5) Click the added user "sf" with Administrator Authority, and click [Create password] in the next screen. The screen then moves to the following diagram.

Set a password. The password here shall be "sf". After input, click the [Create password] button.

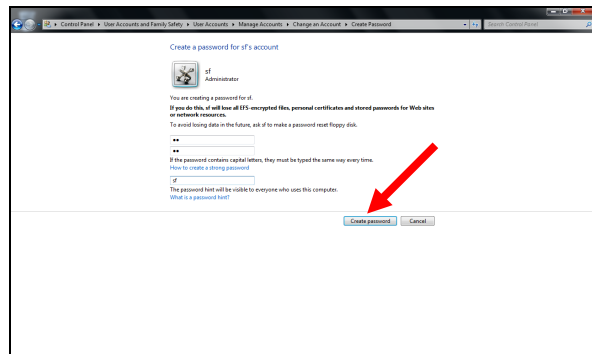

Figure 5-513

- 6) The password-protected user "sf" with Administrator Authority was registered.

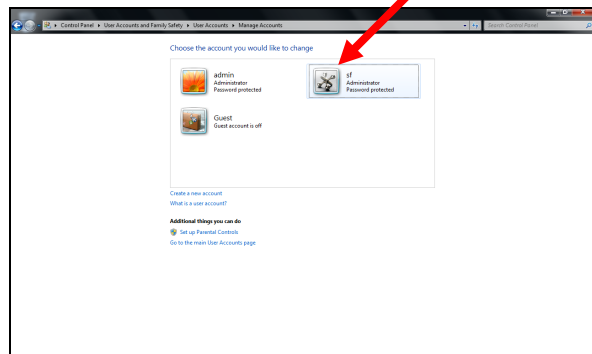

Figure 5-514

6. Creating a Shared Folder

◆ Purpose

To send image data, create a shared folder. And then add the permission to access the folder to the user account created at the previous section.

- 1) Create a new folder in any directory.
In here, a folder named [test] is created on Desktop.
- 2) Open [Properties] of the folder, then click the [Sharing] tab.

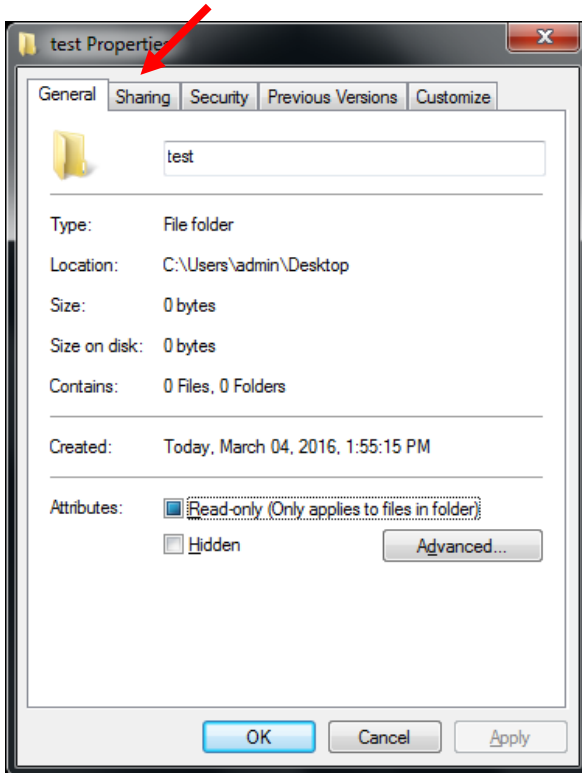

Figure 5-515

- 3) Click the [Advanced Sharing] button.

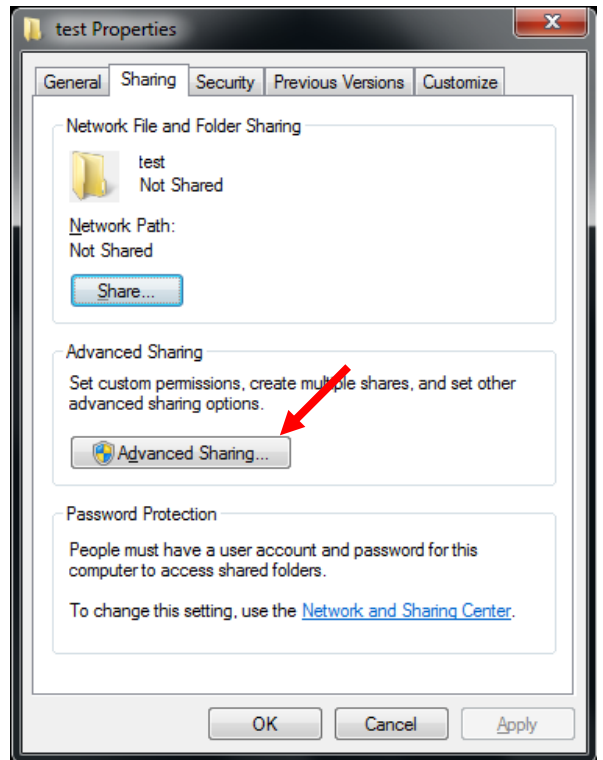

Figure 5-516

- 4) A detailed shared screen is displayed. Next, check [Share this folder] and click the [Permissions] button.

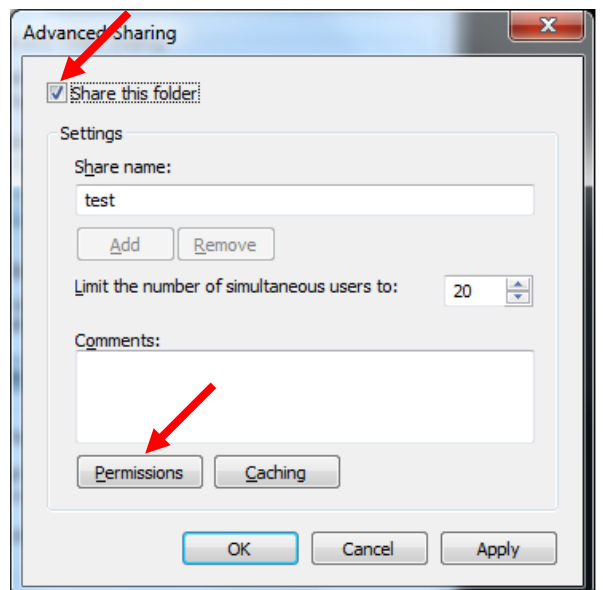

Figure 5-517

5) Click [Add] button on the following screen.

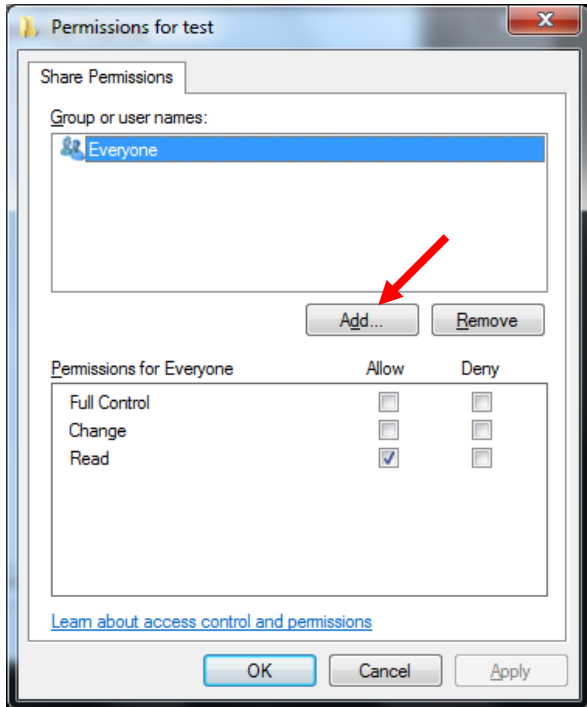

Figure 5-518

6) Press the object type button on the following screen.

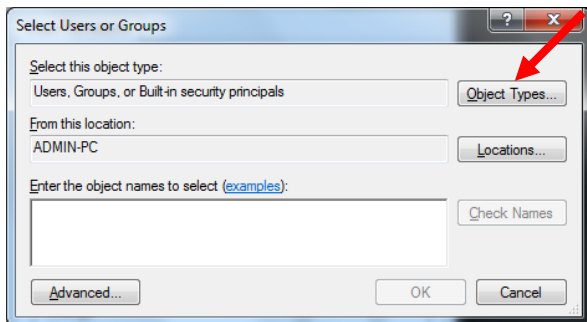

Figure 5-519

7) Uncheck the checkboxes of built-in security principal and group, and press the OK button.

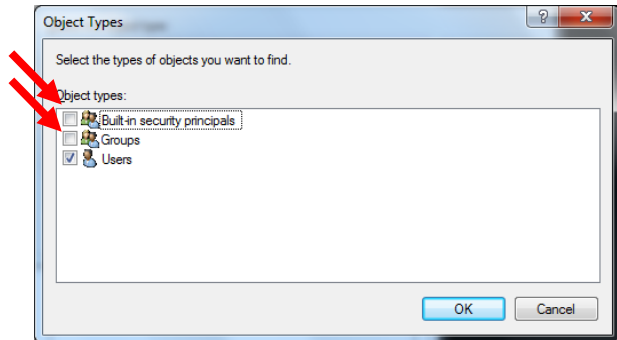

Figure 5-520

8) When the screen changes to the following screen, input "sf" in the input field of the selected object name, press the name confirmation button, then press the OK button.

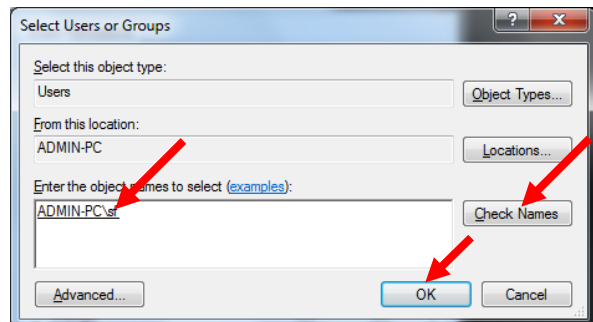

Figure 5-521

- 9) The screen changes to the following screen and sf is added to user names. Select sf and check the change checkbox for access permit and full control.

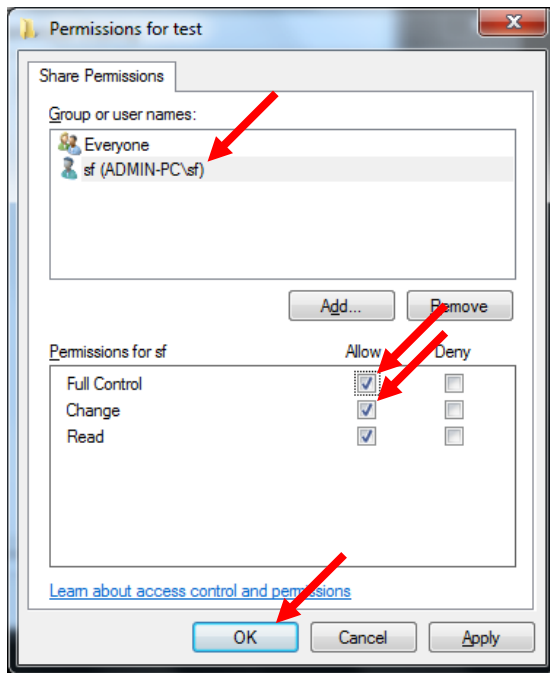

Figure 5-522

- 11) When the screen changes to the following screen, press the Close button.

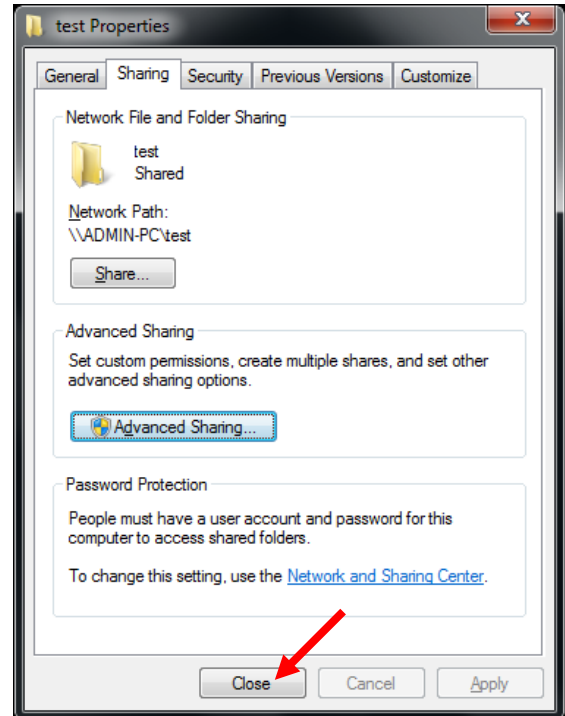

Figure 5-524

- 10) When the screen changes to the following screen, press the OK button.

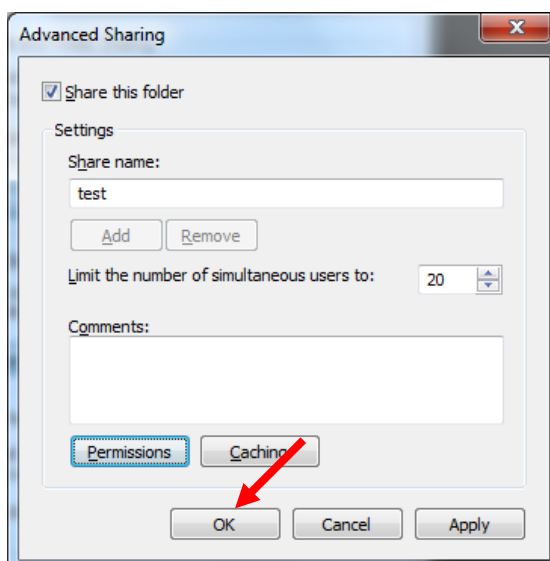

Figure 5-523

7. Sending Image Data

Refer to the user manual for details.

Note: On the setting screen, you need to input user name and password of the shared folder, then click [Browse].

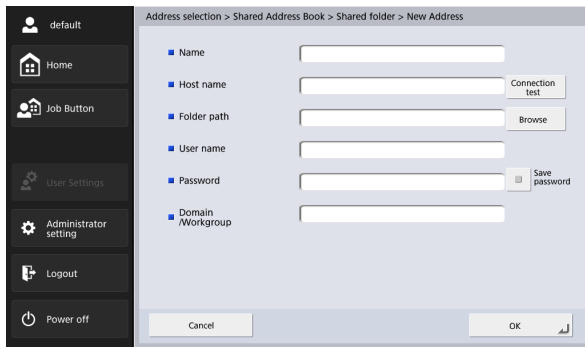

Figure 5-525

8. Initialization

Initialize the machine before returning it to the user.

And restore the TCP/IP setting of the computer.

VI. OTHER OPERATIONS

1. Initialization (factory shipping state)

This operation is used to initialize the software and return the machine to factory default settings for recovery when the machine becomes inoperable due to OS failure.

Do not use this operation needlessly because all of user data are deleted and the software version is returned to the factory shipping state.

◆ Necessary Items

External keyboard

◆ Operation Procedure

- 1) Press the power supply button of the main body.
- 2) When the product name screen appears, press the [Shift + 2] key repeatedly.
- 3) The Boot Loader select screen is displayed.

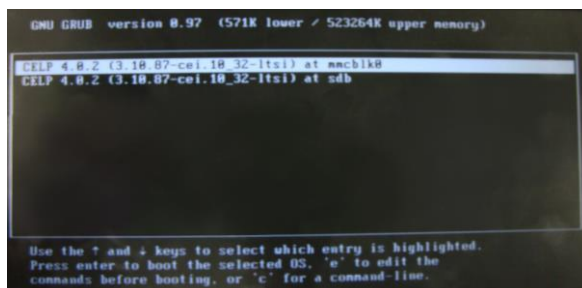

Figure 5-601

- 4) Select [CELP 4.0.2 (3.10.87-cei.10_32-1tsi) at mmcblk0] in the highlight selection mode using arrows on the keyboard.

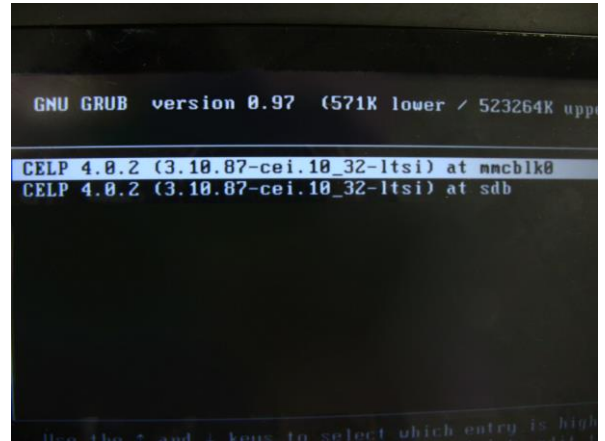

Figure 5-602

- 5) Press [e] on the keyboard.
- 6) The screen changes. Select [kernel/vmlinuz-3.10.87-cei.10_32-1tsi rw root=/dev/mmcblk0p3 rootdel] in the highlight selection mode.

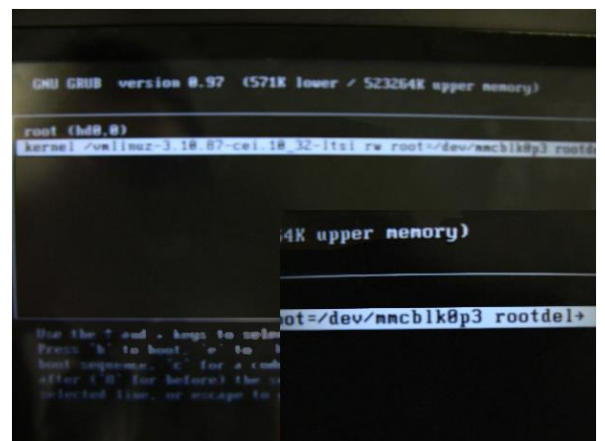

Figure 5-603

- 7) Press [e] on the keyboard.
- 8) The screen changes. Move the screen to the left using the arrow key and change mmcbk0p3 in the rw root=/dev/mmcbk0p3 to mmcbk0p2.

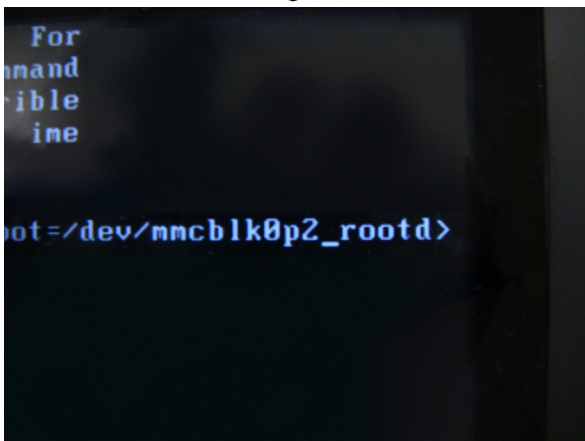
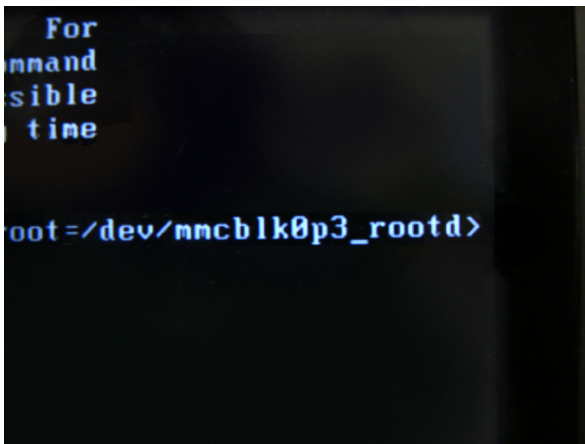

Figure 5-604

- 9) Press [Enter] on the keyboard.

- 10) Return to the previous screen. Confirm that the screen has changed to [kernel /vmlinuz-3.10.87-cei.10_32-1tsi rw root=/dev/mmcbk0p2 rootdel].

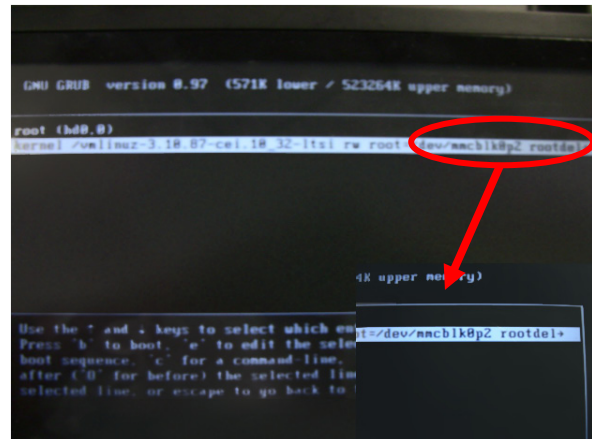

Figure 5-605

- 11) Press [b] on the keyboard.

- 12) After the black screen and product name screen are displayed, the process to return the machine to the factory default setting starts.

```
-----
-FACTORY RESET-----
-----
^[
# restore root file system stage1...
# wait a few minutes
```

```
-----
-FACTORY RESET-----
-----
^[
# restore root file system stage1...
# wait a few minutes
#                               stage2...
# wait a few minutes
```

Go to Stage 2

```
-----
-FACTORY RESET-----
-----
^[
# restore root file system stage1...
# wait a few minutes
#                               stage2...
# wait a few minutes

# restore kernel
# wait a few minutes
-
```

Go to restart

Figure 5-606

- 13) Restart is performed. After the black screen and product name screen are displayed, the [Service Tool] screen is displayed and the operation is complete.

2. Battery Replacement

If 3 years pass without AC adapter connected, the lithium battery attached to the motherboard comes to the end of its life and becomes dead.

If you turn on this machine in this state, the below screen is displayed. Push the power button of the machine for about 4 seconds to turn off the power, and then replace the battery.

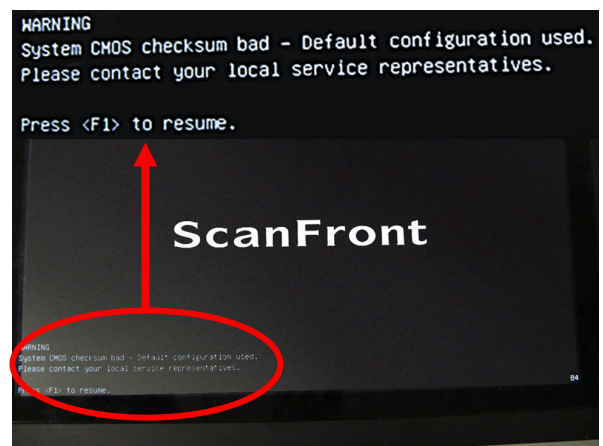

Figure 5-607

For the replacement procedure, refer to "CHAPTER 3 DISASSEMBLY & REASSEMBLY, III. BASE UNIT, 3. Lithium Battery". You also need to configure the time settings again after replacement. For the time setting procedure, refer to the user manual.

If you want to sustain the starting state, connect the external keyboard to the main body, and press F1 key.

VII. DEFECTIVE PHENOMINON LIST

Some of the parts used in this machine require adjustments and settings after being replaced or disassembled/reassembled. The list is the following.

1. Operation Failures

Note: Major causes of each failure are marked "X".

No.	Cause Failure	System/ Software	Hard- ware	Connec- tion	Dirt/ dust	Docu- ment	Settings
1	Power does not come ON.		X	X			
2	No scanner is found.	X		X			
3	Scanner does not start.	X	X	X			X
4	Scanning does not feed properly.		X		X	X	
5	Scanning speed is slow.	X					X

Table 5-701

2. Image Failures

Note: Major causes of each failure are marked "X".

No.	Cause Failure	System/ Software	Hard- ware	Connec- tion	Dirt/ dust	Docu- ment	Settings
1	All black/all white/all streaked.	X	X	X	X		X
2	Too dark/too light.				X		X
3	Streaks in image.		X		X		
4	Image slanted.		X			X	X
5	Wrong image size.					X	X
6	Text cannot be seen.					X	X
7	Moire in image.					X	X

Table 5-702

3. Poor Communication

Note: Major causes of each failure are marked "X".

No.	Cause Failure	System/ Software	Hard- ware	Connec- tion	Dirt/ dust	Docu- ment	Settings
1	The machine cannot connect to the network	X		X			X
2	The network cannot connect to the machine	X		X			X

Table 5-703

VIII. OPERATION TROUBLESHOOTING

When an operation problem occurs, check the error message displayed on this machine's panel. Also perform an operation check on the sensors and motors using the [Service Tool].

1. Power Does Not Come ON

The power indicator is not lit.

Note: Make sure to use the AC adapter and power cord supplied with the machine.

Cause/Faulty Locations	Step	Check Item	Result	Action
Connection of power cord	1	Is the power cord connected?	NO	Connect the connectors correctly.
AC power supply voltage	2	Is the power outlet supplying power at the rated voltage?	NO	Explain to the user that this is not a problem with the machine.
Connection of AC adapter	3	Is the AC adapter connected?	NO	Connect the connectors correctly.
Power button	4	Is the power button on?	NO	Turn the power button on.
Power cord	5	Does replacing the power cord fix the problem?	YES	Done.
AC adapter	6	Does replacing the AC adapter fix the problem?	YES	Done.
Control PCB	7	Is the LED2 on the control PCB blinking?	YES	Proceed to Step 8.
			NO	Replace the control PCB.
Motherboard Control PCB Relay PCB Power switch board	8	Is the cable connected?	NO	Connect the connectors correctly.
			YES	Replace the PCB.

Table 5-801

2. Scanning Does Not Start

Note:The “cover open” and “no document” error messages may be displayed and scanning may not start due to sensor problems.

Cause/Faulty Locations	Step	Check Item	Result	Action
System	1	Was the problem solved by turning the power of the scanner OFF/ON or re-starting this machine?	YES	Done.
Connection of the connector (control PCB)	2	Are the motor and sensor connectors connected correctly?	NO	Connect the connectors correctly.
Drive transmission system	3	Is the transmission system of the motors normal? Are parts such as gears and belts normal?	NO	Attach the parts correctly. Replace the parts.
Motors	4	Is the operation normal when you perform an operation check with the service mode?	NO	Check the cable connections. Replace the motors.
Sensors	5	Is the operation normal when you perform an operation check with the service mode?	NO	Check the attachment of sensors and sensor levers. Check the connections of sensor cables.
Sub PCB	6	Was the problem solved by replacing the sub PCB?	YES	Done.
Control PCB	7	Was the problem solved by replacing the control PCB?	YES	Done.
Motherboard	8	Was the problem solved by replacing the motherboard?	YES	Done.

Table 5-802

3. Scanner Does Not Feed Properly

Note:A “paper jam” or “double-feed” error message may be displayed due to a sensor problem.

Cause/Faulty Locations	Step	Check Item	Result	Action
Document	1	Specified document? (thickness, size, fold or curl)	NO	Use documents compliant with the specified.
Placing documents	2	Are documents stuck together?	YES	Fan the documents well.
	3	Is the position of the document guide correct?	NO	Correct the position.
	4	Do you use the extension support?	NO	Use the extension support depending on the document.
Feed selection lever	5	Is the feed selection lever switched to the appropriate position?	NO	Switch to the appropriate position.
Rollers	6	Are the rollers and the roller covers attached correctly?	NO	Attach the rollers correctly.
	7	Are they dirty or deformed?	NO	Clean or replace the rollers.
Parts in feed path	8	Parts touching documents installed properly? (no float, slant or gaps)	NO	Attach the parts correctly.
	9	Is the surface touching documents smooth? (No scratches or burrs)	NO	Replace inferior parts.
Drive transmission system	10	Does an abnormal noise occur while feeding? Are any of the gears damaged or the belts loose?	YES	Attach the parts correctly. Replace inferior parts.
Motors	11	Is the operation normal when you perform an operation check with the service mode?	NO	Check the cable connections. Replace the motors.
Sensors	12	Is the operation normal when you perform an operation check with the service mode?	NO	Check the attachment of sensors, sensor levers, and light guide. Check the connections of sensor cables.
Sub PCB Ultrasonic drive PCB	13	Was the problem solved by replacing the PCB?	YES	Done.
Control PCB	14	Was the problem solved by replacing the control PCB?	YES	Done.

Table 5-803

Note:For passports and A4 carrier sheets

- For details about conditions for scanning a passport and how to set the passport, refer to the user manual.

- If part of the scan image is missing, or if the scanner's correction function does not operate correctly, change the [Page Size] setting to a larger size (such as A4) in the setting screen of the scanner driver, and then scan the image again.
- If misfeeds or paper jams occur frequently, clean the feed roller and change the carrier sheet to a new one.
- If the scan image is blurred, clean the carrier sheet or change the sheet to a new one.

IX. IMAGE TROUBLESHOOTING

◆ Image Sample



Document 	Normal (B&W) 	All black 	All white 	All streaked 
Too dark 	Too light 	Streaks 1 	Streaks 2 	Streaks 3 
Slanting 	Skew correction 	Wrong size 	Auto size 	Has shadows 
Original document (B) 	Missing leading edge 	Margin at leading edge 	Stretched 	Compressed 

Table 5-901

Note:The level of reproducing the image depends on types of documents and setup conditions. Changing setup conditions sometimes works.

1. All Black/All White/All Streaked

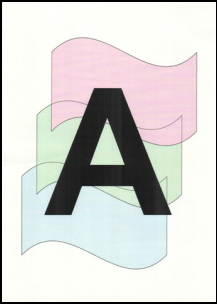
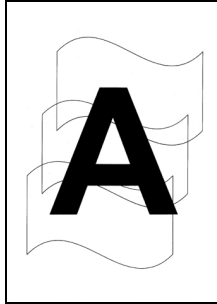
The image is all black, all white, or all streaked.

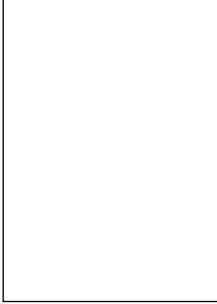
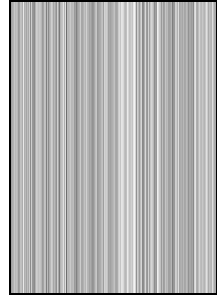
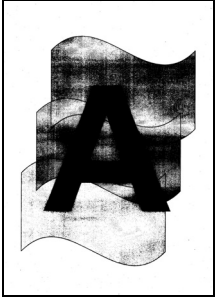
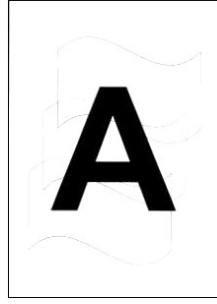
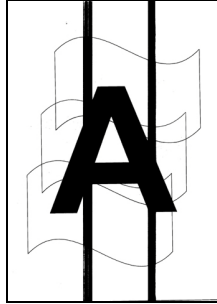
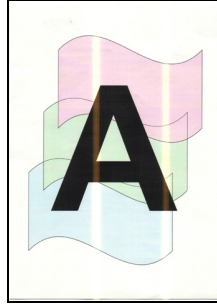
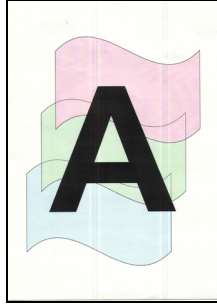
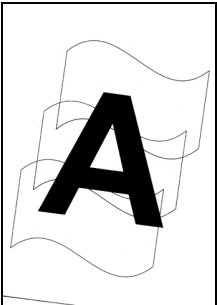
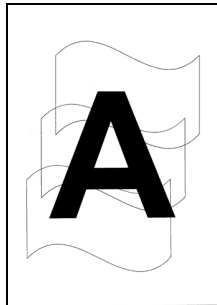
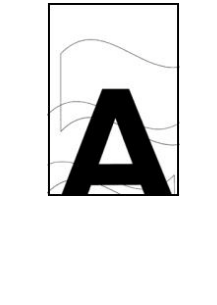
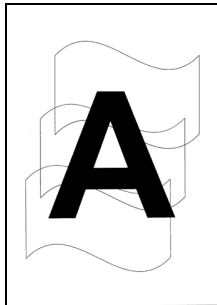
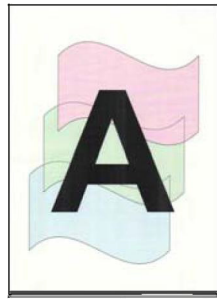
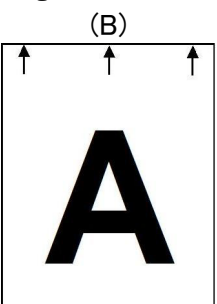
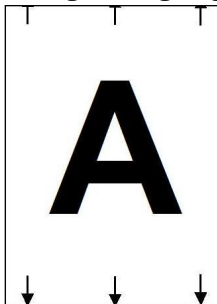
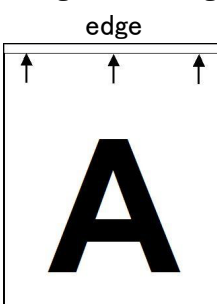
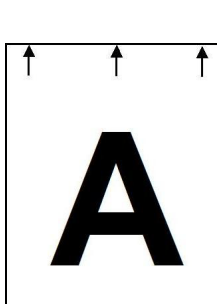
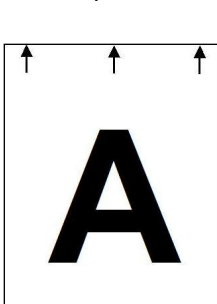
Cause/Faulty Locations	Step	Check Item	Result	Action
Placing documents	1	Is the document placed with the front/back around the right way?	NO	Place properly.
Setup of "Brightness"	2	"Brightness" setup properly?	NO	Change the setup. Change "Contrast" if necessary.
System	3	Was the problem solved by turning the power of the scanner OFF/ON?	YES	Done.
Reading Unit	4	Reading-related cables connected properly?	NO	Connect properly.
	5	Was the problem solved by changing the reading-related cables?	YES	Done.
	6	Was the problem solved by replacing the reading unit?	YES	Done.
Control PCB	7	Was the problem solved by replacing the control PCB?	YES	Done.

Table 5-902

2. Too Dark/Too Light

The image cannot be seen properly because the brightness is inappropriate.

Cause/Faulty Locations	Step	Check Item	Result	Action
Setup of "Brightness"	1	"Brightness" setup properly? Normally middle value is fine, but this may need to be changed, depending on the document.	NO	Change the setup.
Setup of "Contrast"	2	"Contrast" setup properly?	NO	Change the setup.
Light Adjustment	3	Have you executed Light Adjustment?	NO	Execute the adjustment.

Table 5-903

3. Streaks in Image

Streaks in the feeding direction may appear in the image due to dirt on the reading glass. Dirt on the feeding rollers may also be transferred to the document.

When white streaks appear in the image, this is due to shading correction being performed when the reading glass is dirty.

Cause/Faulty Locations	Step	Check Item	Result	Action
Reading glass	1	Is the reading glass clean?	NO	Clean it. Replace the reading guide (reading glass) if it is damaged.
Roller	2	Is the surface clean?	NO	Clean or replace it.
Feed Unit	3	Is the feed path clean?	NO	Clean it.
CIS unit	4	Is the inside of the CIS unit clean?	NO	Clean or replace the reading unit.
Light Adjustment	5	Have you executed Light Adjustment?	NO	Execute the adjustment.

Table 5-904

4. Image Slanted

If the document is fed at an angle, the image will become slanted.

Cause/Faulty Locations	Step	Check Item	Result	Action
Placing documents	1	Is the document placed properly?	NO	Place properly.
	2	Are the document guides adjusted to fit the document width?	NO	Correct the position.
Setup of "Skew correction"	3	Was "Skew correction" set?	NO	Set it. You can correct the slant of an image using image processing.
Feeding documents	4	Are documents fed straight?	NO	Perform the checks in "IV. RESOLVING MALFUNCTIONS, 4.The Document Does Not Feed Properly".

Table 5-905

5. Wrong Image Size

There are margins around the image, or some of the image is missing.

Note: Set the paper size to “auto detection” when scanning batch of different size documents.

Cause/Faulty Locations	Step	Check Item	Result	Action
Setup of “Paper size”	1	Is the setup of “Paper size” correct?	NO	Change the setup.
Placing documents	2	Was the document placed in the correct position?	NO	Place the document in the correct position.
Setup of “Auto detection” for the paper size	3	Was “Auto detection” set?	NO	Set it.
Registration adjustment	4	Have you executed automatic registration adjustment or manual registration adjustment?	NO	Execute the adjustment.
Scale parameter adjustment	5	Have you executed scale parameter adjustment?	NO	Execute the adjustment.

Table 5-906

Note: For passports and A4 carrier sheets

- For details about conditions for scanning a passport and how to set the passport, refer to the user manual.
- If part of the scan image is missing, or if the scanner's correction function does not operate correctly, change the [Page Size] setting to a larger size (such as A4) in the setting screen of the scanner driver, and then scan the image again.
- If misfeeds or paper jams occur frequently, clean the feed roller, and clean the carrier sheet or change it to a new one.
- If the scan image is blurred, clean the carrier sheet or change the sheet to a new one.

6. Text Cannot be Seen

When the background includes colors or patterns, text may be hidden by the background when scanning in black and white. There are special modes such as "Text enhance" etc. for solving this problem.

Note: The problem may not be fixed, depending on the type of document.

Cause/Faulty Locations	Step	Check Item	Result	Action
Setup of "Mode"	1	Was the problem solved by setting to "Color" or "Grayscale"?	YES	Done.
	2	Was the problem solved by setting to a special mode such as "Text enhance" etc.?	YES	Done.
Setup of "Brightness"	3	Was the problem solved by changing the setup of "Brightness"?	YES	Done.
Setup of "File Type"	4	Is "Compression rate" high?	YES	Set "Compression rate" lower.

Table 5-907

X. COMMUNICATION TROUBLESHOOTING

1. The machine cannot connect to the network

An error occurs when the network test is executed from the machine.

Cause/Faulty Locations	Step	Check Item	Result	Action
LAN cable wiring	1	Is LAN cable connected correctly?	NO	Connect the cable correctly.
	2	Is the IP address you set already used for other device?	NO	Ask the network system administrator to change the IP address setting.
Contention of Device name	3	Is the device name you set already used for other device?	NO	Ask the network system administrator to change the IP address setting. (If you are using two or more of this machine, ask the administrator not to apply the same device name to them.)

Table 5-1001

2. The network cannot connect to the machine

An error occurs when the Ping command is sent to this machine from the other device on the network.

The Ping command is successfully sent, but you cannot connect to the Web application of this machine.

Cause/Faulty Locations	Step	Check Item	Result	Action
LAN cable wiring	1	Is LAN cable connected correctly?	NO	Connect the cable correctly.
Contention of IP address	2	Is the IP address you set already used for other device?	NO	Ask the network system administrator to change the IP address setting.
Contention of Device name	3	Is the device name you set already used for other device?	NO	Ask the network system administrator to change the IP address setting. (If you are using two or more of this machine, ask the administrator not to apply the same device name to them.)
[Allow remote operation] of this machine is set to OFF	4	Is [Allow remote operation] set to ON?	NO	Set [Allow remote operation] to ON.

Table 5-1002

Note: Other than above, there may be the cases where a user's environment causes a poor communication. For necessary actions for a case other than above, refer to the sections such as "Chapter 9 Troubleshooting," "1. Troubleshooting" of the user manual.

XI. AFTER REPLACING PARTS

Some of the parts used in this machine require adjustments and settings after being replaced or disassembled/reassembled. The list is the following.

Parts	Scale Adjust.	Regist Adjust.	Light Adjust.	Software Update	Data Restore	Time setting	Counter setting
Motherboard				Execute *1	Execute *2	Execute	
Control PCB	Execute	Execute	Execute	Execute *1			Execute
Reading unit	Execute	Execute	Execute				
Regist related		Execute					
Lithium battery						Execute	
Consumable parts replaced by users	Execute	Execute					Execute *3

Table 5-1101

***1: Software update**

Confirm the version after replacement, then execute if necessary.

***2: Data restoration**

Ask the user to restore or reconfigure data.

***3: Counter resetting**

When the user replaces an exchange roller kit, the user resets the counter.

When the service technician replaces it, ask the user to reset the counter.

APPENDIX

I. GENERAL DIAGRAM	A-1		II. LIST OF SPECIAL TOOLS.....	A-2
--------------------------	-----	--	--------------------------------	-----

I. GENERAL DIAGRAM

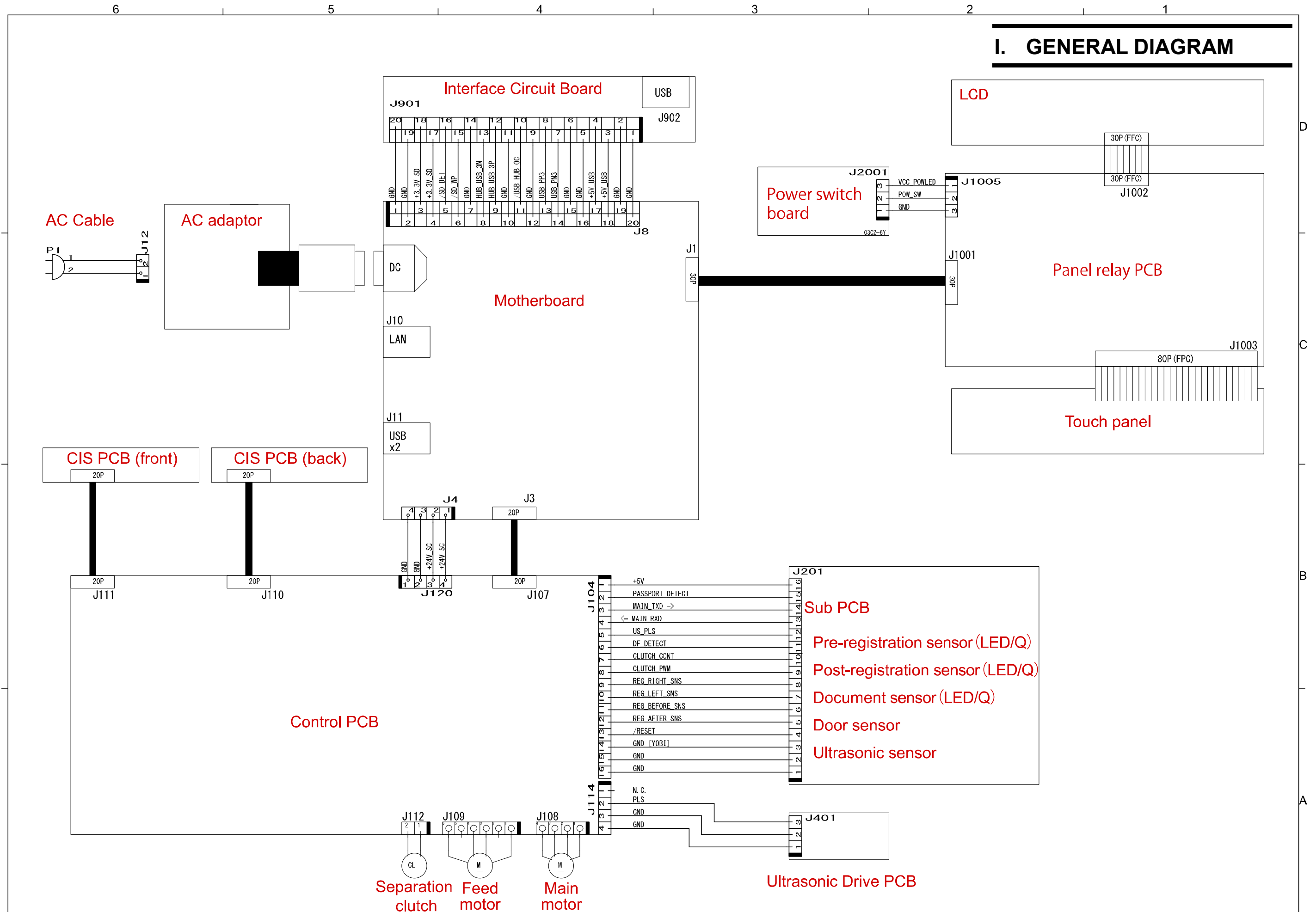

II. LIST OF SPECIAL TOOLS

The adjustment sheets are the same as for DR-M1060 and other tools are the same as for SF-330.

The computer needs to conform to the SF-400 specifications. The keyboard should be corresponding to USB.

No.	Tool name	Tool number	Rank	Usage/Remarks
1	Test sheet	TKM-0271	A	For general image check
2	Shading sheet	TKM-0326 TKM-0332	B	For the light adjustment
3	Regist adjustment sheet	Self-made TKM-0326 TKM-0332	B	For the regist adjustment
4	Reduction ratio adjustment sheet	TKM-0348	B	For the manual adjustment
5	Computer	Commercial	B	For checking each setting Windows, network compatible
6	LAN cable	Commercial	B	For checking each setting
7	USB memory	Commercial	B	For software update With no security function
8	Keyboard	Commercial	B	For BIOS settings USB interface compatible

Figure A-201

Note: Rank symbol

- A: Each service technician must have one.
- B: A group of five technicians must have one.
- C: A workshop must have one.

Prepared by

**Quality Assurance Center
Canon Electronics Inc.**

**3-5-10, Shibakoen, Minato-ku,
Tokyo 105-0011, Japan**

FIRST EDITION: JUNE 2016

Canon