

Color imageCLASS LBP612Cdw

SERVICE MANUAL



Canon

March 7, 2017
Rev. 2

Introduction

Important Notices

Application

This manual has been issued by Canon Inc. for qualified persons to learn technical theory, installation, maintenance, and repair of products.

This manual covers all localities where the products are sold. For this reason, there may be information in this manual that does not apply to your locality.

Corrections

This manual may contain technical inaccuracies or typographical errors due to improvements or changes in products. When changes occur in applicable products or in the contents of this manual, Canon will release technical information as the need arises. In the event of major changes in the contents of this manual over a long or short period, Canon will issue a new edition of this manual.

The following paragraph does not apply to any countries where such provisions are inconsistent with local law.

Trademarks

The product names and company names used in this manual are the registered trademarks of the individual companies.

Copyright

The copyright of this document belongs to Canon Inc. This document may not be copied, reproduced or translated into another language, in whole or in part, without the prior consent of Canon Inc.







Copyright CANON INC. 2017















Caution

Use of this manual should be strictly supervised to avoid disclosure of confidential information.



Explanation of Symbols

The following symbols are used throughout this Service Manual.

Symbols	Explanation	Symbols	Explanation
	Check.		Remove the claw.
	Check visually.		Insert the claw.
	Check a sound.		Push the part.

Symbols	Explanation	Symbols	Explanation
	Disconnect the connector.		Connect the power cable.
	Connect the connector.		Disconnect the power cable.
	Remove the cable/wire from the cable guide or wire saddle.		Turn on the power.
	Install the cable/wire to the cable guide or wire saddle.		Turn off the power.
	Remove the screw.		Loosen the screw.
	Install the screw.		Tighten the screw.
	Cleaning is needed.		Measurement is needed.

The following rules apply throughout this Service Manual:

- Each chapter contains sections explaining the purpose of specific functions and the relationship between electrical and mechanical systems with reference to the timing of operation.
In the diagrams,  represents the path of mechanical drive; where a signal name accompanies the symbol, the arrow  indicates the direction of the electric signal.
The expression "turn on the power" means flipping on the power switch, closing the front door, and closing the delivery unit door, which results in supplying the machine with power.
- In the digital circuits, '1' is used to indicate that the voltage level of a given signal is "High", while '0' is used to indicate "Low". (The voltage value, however, differs from circuit to circuit.) In addition, the asterisk (*) as in "DRMD*" indicates that the DRMD signal goes on when '0'.
In practically all cases, the internal mechanisms of a microprocessor cannot be checked in the field. Therefore, the operations of the microprocessors used in the machines are not discussed: they are explained in terms of from sensors to the input of the DC controller PCB and from the output of the DC controller PCB to the loads.

The descriptions in this Service Manual are subject to change without notice for product improvement or other purposes, and major changes will be communicated in the form of Service Information bulletins.

All service persons are expected to have a good understanding of the contents of this Service Manual and all relevant Service Information bulletins and be able to identify and isolate faults in the machine.

Contents

- Safety Precautions..... 1**
 - Laser Safety..... 2
 - How to Handle the Laser Scanner Unit..... 2
 - Toner Safety..... 2
 - About Toner..... 2
 - Handling Adhered Toner..... 2
 - Notes When Handling a Lithium Battery..... 3
 - Notes on Assembly/Disassembly..... 3

- 1. Product Overview..... 4**
 - Product Lineup..... 5
 - Host Machine..... 5
 - Option..... 5
 - Features..... 5
 - Specifications..... 6
 - Specifications of Host Machine..... 6
 - Paper type..... 7
 - Paper size..... 7
 - Parts Name..... 9
 - External view..... 9
 - Cross Section View..... 11
 - Control Panel..... 11

- 2. Technical Explanation (Device)..... 13**
 - Basic Configuration..... 14
 - Functional Configuration..... 14
 - Laser Exposure System..... 15
 - Functional Configuration..... 15
 - Failure Detection..... 15
 - Controller System..... 17
 - Configuration/Function..... 17
 - Main Controller PCB..... 18
 - Motor Control..... 18
 - Door Open Detection..... 18
 - Fan Control..... 19
 - Low-voltage Power Supply Control..... 19
 - Protection Function..... 20
 - Power-saving Mode..... 20
 - Image Formation System..... 21
 - Major Components..... 21
 - Image Formation Process..... 21
 - High Voltage Power Supply Control..... 21
 - Image Stabilization Control..... 22
 - Cartridge..... 24

Pickup Feed System.....	27
Overview.....	27
Parts Configuration.....	28
Drive Configuration.....	29
Layout of Sensors.....	30
Cassette Detection.....	30
Cassette Pickup Control.....	30
Multi-purpose Tray Pickup Control.....	31
Skew Correction.....	31
Paper Width Detection.....	32
Arch Control.....	32
Delivery Tray Full Detection.....	33
Jam Detection.....	34
Fixing System.....	36
Functional Configuration.....	36
Fixing Temperature Control.....	36
Protection Function.....	37
Fixing Assembly Failure Detection.....	37
3. Technical Explanation (System).....	39
Overview of System Management.....	40
Version Upgrade.....	41
Function Overview.....	41
Version Upgrade Using UST.....	42
Version Upgrade via Internet.....	42
Version Upgrade Using USB.....	43
Setting Information Export/Import Function (DCM).....	45
Overview.....	45
Import/Export Procedure from [Settings/Registration] of Remote UI.....	47
Procedure for Exporting/Importing Service Mode Setting Information.....	50
List of Items Which Can Be Imported.....	51
Monitoring Function (e-Maintenance/imageWARE Remote).....	58
Overview of System.....	58
Servicing Notes.....	59
Setting Procedure.....	59
Maintenance.....	60
4. Periodical Service.....	61
Periodically Replaced Parts.....	62
Consumable Parts.....	63
Periodical Services.....	64
5. Parts Replacement and Cleaning.....	65
List of Parts.....	66
Major Units.....	66
Layout Drawing of Electrical Components.....	67
External Cover System.....	70
Removing the Toner Cartridge.....	70
Removing the Left Cover.....	71

Removing the Right Cover.....	72
Removing the Rear Cover Unit.....	75
Removing the Cartridge Cover	76
Removing the Cartridge Tray.....	77
Removing the Upper Cover Unit	78
Controller System.....	80
Removing the Controller Cover	80
Removing the Wireless LAN PCB (Wi-Fi model only).....	80
Removing the Wireless LAN Support Plate (Wi-Fi model only).....	81
Removing the Main Controller PCB.....	81
Removing the Main Controller Support Plate.....	82
Removing the Engine Controller PCB.....	83
Removing the Low Voltage Power Supply Unit.....	84
Removing the Main Motor.....	85
Removing the 5-line Control Panel Unit.....	85
Removing the NCU Support Plate.....	86
Removing the USB PCB.....	86
Removing the Fan.....	87
Removing the Power Switch Unit.....	89
Image Formation System.....	90
Removing the Secondary Transfer Roller.....	90
Removing the Secondary Transfer Feed Unit.....	91
Removing the ITB Unit.....	92
Removing the Color Displacement Density Sensor Unit.....	93
Fixing System.....	95
Removing the Fixing Assembly.....	95
Removing the Fixing Motor.....	96
Pickup Feed Delivery System.....	97
Removing the Delivery Sensor Unit.....	97
Removing the Cassette Pickup Roller/Feed Roller Unit	97
Removing the Cassette Separation Roller Unit	99
Removing the Duplex Reverse Drive Unit.....	100
Removing the Pickup Guide.....	101
Removing the Multi-purpose Tray Pickup Unit.....	104

6. Adjustment..... 107

Adjustment at Parts Replacement.....	108
After Replacing the ITB Unit.....	108
After Replacing the Color Displacement Density Sensor Unit.....	108
Engine Controller PCB.....	108
Main Controller PCB.....	108

7. Troubleshooting..... 110

Test Print.....	111
Engine Test Print.....	111
Controller test print.....	112
Cartridge Log Report.....	122
Troubleshooting Items.....	124
Recurring faulty image.....	124
Confirming nip width.....	124

Debug Log.....	126
Function Overview.....	126
Conditions for collecting logs.....	126
Collection procedure.....	126
8. Error/Jam/Alarm.....	128
Overview.....	129
Error/Jam/Alarm Log indication.....	129
JAM/ERR LOG REPORT.....	130
Location Code.....	130
Pickup Position Code.....	131
Error Code.....	132
Error Code Details.....	132
Jam Code.....	138
Jam Code Details.....	138
Alarm Code.....	140
Alarm Code Details.....	140
9. Service Mode.....	141
Overview.....	142
Entering Service Mode.....	142
Remote UI Service Mode.....	142
COPIER (Service mode for copier).....	144
DISPLAY (State display mode).....	144
ADJUST (Adjustment mode).....	145
FUNCTION (Operation / inspection mode).....	151
OPTION (Specification setting mode).....	162
COUNTER (Counter mode).....	169
TESTMODE (Service mode for test print, operation check, etc.).....	173
PRINT (Print test mode).....	173
APPENDICES.....	177
Service Tools.....	178
Special Tools.....	178
Solvents and Oil List.....	178
General Circuit Diagram.....	179
Backup Data List.....	181
Soft counter specifications.....	183

Safety Precautions

Laser Safety.....	2
How to Handle the Laser Scanner Unit	2
Toner Safety.....	2
Notes When Handling a Lithium Battery.....	3
Notes on Assembly/Disassembly.....	3

Laser Safety

Since radiation emitted inside this machine is completely confined with protective housings and external covers, the laser beam cannot escape from the machine during any phase of normal use by users.

Therefore, this machine is classified as a Class 1 laser product under the international standard IEC60825-1 that is regarded as safe during normal use.

How to Handle the Laser Scanner Unit

This machine is classified as a Class 1 laser product.

However, the laser scanner unit contains source of Class 3B laser beam and exposure to the beam may cause eye injuries.

Therefore, be sure not to disassemble the laser scanner unit. No adjustment can be made to the laser scanner unit in the machine in the field.

The label shown in the following figure is affixed on the laser scanner unit.

Dieses Gerät ist der Klasse 1 der Laserprodukte zugeordnet.

Allerdings enthält die Laserscannereinheit eine Laserstrahlquelle der Klasse 3B, die Augenschäden verursachen kann, wenn man in diesen Strahl blickt.

Deshalb darf die Laserscannereinheit nicht zerlegt werden. An der Laserscannereinheit kann keine Justage vor Ort vorgenommen werden.

Der in folgendem Bild dargestellte Aufkleber ist auf der Laserscannereinheit angebracht.

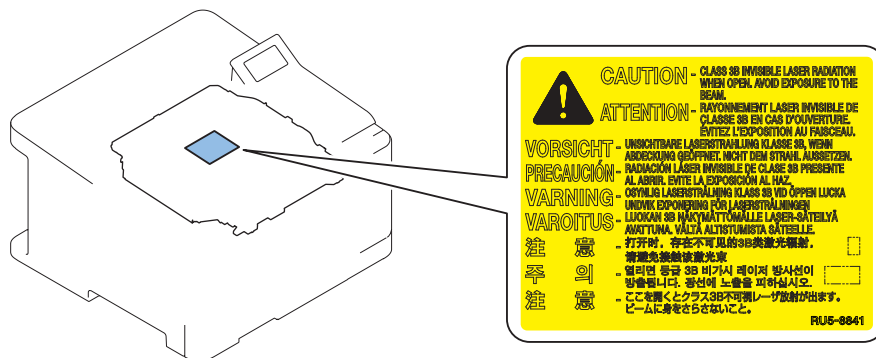

Toner Safety

About Toner

Toner is a nontoxic matter composed of plastic, iron and a trace of pigments.

⚠ CAUTION:

Never throw toner in flames to avoid explosion.

Handling Adhered Toner

- Use dry tissue paper to wipe off toner adhered to skin or clothes and wash in water.
- Never use warm water for cleaning up toner to prevent toner particles from being gelated to soak into fibers permanently.
- Toner particles are reactive with vinyl polymers. Avoid contacting these materials.

Notes When Handling a Lithium Battery

Dispose of used batteries according to the instructions.

⚠ CAUTION:

Risk of explosion if battery is replaced by an incorrect type.

The following warnings are given to comply with Safety Principles (EN60950-1).

⚠ CAUTION:

Wenn mit dem falschen Typ ausgewechselt, besteht Explosionsgefahr.
Gebrauchte Batterien gemäß der Anleitung beseitigen.

警告

如果更換不正確之電池型式會有爆炸的風險
請依製造商說明書處理用過之電池

Notes on Assembly/Disassembly

Follow the items below to assemble/disassemble the device.

1. Disconnect the power plug to avoid any potential dangers during assembling/disassembling works.
2. If not specially instructed, reverse the order of disassembly to reinstall.
3. Ensure to use the right screw type (length, diameter, etc.) at the right position when assembling.
4. To keep electric conduction, binding screws with washers are used to attach the grounding wire and the varistor. Ensure to use the right screw type when assembling.
5. Unless it is specially needed, do not operate the device with some parts removed.
6. Never remove the paint-locked screws when disassembling.



Product Overview

Product Lineup.....	5
Specifications.....	6
Parts Name.....	9

Product Lineup

Host Machine



	LBP613Cdw	LBP612Cdw	LBP611Cn
Print	Yes	Yes	Yes
Remote UI	Yes	Yes	Yes
2-sided printing	Yes	Yes	-
Control Panel	5 lined LCD + Numeric keys	5 lined LCD + Numeric keys	5 lined LCD + Numeric keys
NFC	-	-	-
Backup of counter	-	-	-
MEAP	-	-	-
Network	Yes	Yes	Yes
Wireless LAN	Yes	Yes	-

PDL

	LBP613Cdw	LBP612Cdw	LBP611Cn
PS	Yes	-	-
PCL	Yes	-	-

Option

Name	Description
None	-

Features

Low - Middle Class A4/LTR Color Laser SFP

- Support for mobile print
Printing from smartphones, tablets and PCs via an application such as Apple AirPrint, proprietary application, Google Cloud Print and Mopria Print becomes available.
- Support for wireless LAN
Wireless LAN supported (LBP613Cdw/LBP612Cdw only)
Communication via mobile device and wireless LAN becomes available by connecting a wireless LAN router to the network to which this machine is connected.

Specifications

Specifications of Host Machine

Item	Specification / Function
Device Installation	Desktop
Photoreceptor	OPC drum (φ24)
Light exposure method	Laser beam exposure
Charging method	Roller charging
Developing method	Contact development
Transfer method	Primary transfer: Sequential 4 colors transfer to Intermediate Transfer Belt Secondary transfer: 4-color batch transfer onto the transfer material by the Transfer Roller
Separation method	Curvature separation
Cassette paper feed	Simple separation retard
Drum cleaning method	Cleaning blade
Transfer cleaning method	Cleaning brush and roller
Fixing method	On-demand fixing
Paper delivery method	Face-down
Toner level sensor	Mounted
Toner type	Non-magnetic one-component toner
Toner supply method	All-in-one cartridge (drum + toner)
Toner save mode	N/A
Warm-up Time *1	13 seconds or less
Recovery Time *2	Approx. 6.1 seconds
Print resolution	600 x 600 dpi
First print time	Color: Approx. 12.0 seconds(A4), Approx. 11.9 seconds(LTR) B&W: Approx. 10.9 seconds(A4), Approx. 10.7 seconds(LTR)
Print Speed *3	At 1-sided printing: • Color/B&W: Approx. 18 sheets/min.(A4), Approx. 19 sheets/min.(LTR) At 2-sided printing: • Color/B&W: Approx. 11.0 sheets/min.(A4), Approx. 11.3 sheets/min.(LTR)
Available paper type for cassette	Thin paper, Recycled paper, Color paper, Plain paper, Heavy paper, Coated paper, Label, Envelope (Refer to "Paper type" on page 7)
Available paper type for Multi-purpose Tray	Thin paper, Recycled paper, Color paper, Plain paper, Heavy paper, Coated paper, Label, Envelope (Refer to "Paper type" on page 7)
Available paper size in cassette	A4, B5, A5, LGL, LTR, STMT, EXEC, OFFICIO, B-OFFICIO, M-OFFICIO, GLTR, GLGL, FLS, AFLS, indLGL, K16, Postcard, Envelopes (COM10, Monarch, Nagagata 3, Yougatanaga 3, C5, DL), Custom Paper Size (Refer to "Paper size" on page 7)
Multi-purpose tray paper size	A4, B5, A5, LGL, LTR, STMT, EXEC, OFFICIO, B-OFFICIO, M-OFFICIO, GLTR, GLGL, FLS, AFLS, indLGL, K16, Envelopes (COM10, Monarch, Nagagata 3, Yougatanaga 3, C5, DL), Custom Paper Size (Refer to "Paper size" on page 7)
Cassette capacity	Cassette: 150 sheets (60 to 90 g/m ²)
Multi-purpose Tray capacity	1 sheet (60 to 90 g/m ²)
Delivery tray stacking capacity *4	100 sheets (75 g/m ²)
Automatic 2-sided *5	Available (A4, B5, LGL, LTR, EXEC, FLS)
Memory capacity	1 GB
Sleep mode	Available
Allowable environmental temperature	10 to 30 deg C
Allowable humidity	20 to 80% in relative humidity (no condensation)
Power rating	Rated input voltage: 120 V system: 120 to 127 V (60Hz) 200 V system: 220 to 240 V (50/60Hz)
Maximum power consumption	1000 W or lower

Item	Specification / Function
Average power at operation	120 V : Approx. 340 W 230 V : Approx. 330 W
Average power at standby	120 V : Approx. 10.2 W 230 V : Approx. 10.8 W
Average power at sleep mode	Approx. 1.0 W
Power consumption at Main Power Switch OFF	0.3 W or lower
Dimensions (W x D x H)	430 × 418 × 274 mm
Weight (Excluding toner cartridges)	Approx. 15.5 kg

*1 : Warm-up time is an interval between when the machine is turned ON and when the main screen appears on the display. Warm-up time may vary depending on the use conditions and environment of the machine.

*2 : Time for recovery from sleep to standby.

*3 : The print speed may become lower depending on the settings such as output resolution, paper size, type, orientation, and number of sheets printed. In the case of 2-sided printing, 1 page on the front side and 1 page on the back side are output as 1 sheet.

*4 : The actual stack capacity varies depending on the site environment and the type of paper used.

*5 : Except MF611Cn

Paper type

(Yes: Pickup possible -: Pickup not possible)

Type of paper		Paper settings in this machine	Standard Cassette/	Multi-purpose Tray	Auto 2-sided printing *2
Thin paper	60 to 70 g/m2	Thin 1	Yes	Yes	Yes
	60 g/m2	Thin 2 *1	Yes	Yes	Yes
	52 to 59 g/m2	Thin 3	Yes	-	-
Recycled	60 to 75 g/m2	Recycled 1	Yes	Yes	Yes
	71 to 82 g/m2	Recycled 2	Yes	Yes	Yes
Color	71 to 82 g/m2	Color	Yes	Yes	Yes
Plain	71 to 82 g/m2	Plain 1	Yes	Yes	Yes
	83 to 90 g/m2	Plain 2	Yes	Yes	Yes
Heavy paper	91 to 119 g/m2	Heavy 1	Yes	Yes	Yes
	120 to 128 g/m2	Heavy 2	Yes	Yes	Yes
	129 to 163 g/m2	Heavy 3	Yes	Yes	Yes
Coated	100 to 120 g/m2	Coated 1	Yes	Yes	Yes
	121 to 150 g/m2	Coated 2	Yes	Yes	Yes
	151 to 200 g/m2	Coated 3	Yes	Yes	Yes
Label paper		Label paper	Yes	Yes	-
Envelope (Nagagata 3, Yougatanaga 3, C5)		Envelope 1	Yes	Yes	-
Envelope (COM10, Monarch, DL)		Envelope 2	Yes	Yes	-

*1: When the paper of 60 g/m2 is curled while <Thin 1> is set, select <Thin 2>.

*2: Except MF611Cn

Paper size

(Yes: Pickup possible -: Pickup not possible)

Paper size		Standard Cassette/	Multi-purpose Tray	Auto 2-sided printing *5
A4	210.0 mm x 297.0 mm	Yes	Yes	Yes

Paper size		Standard Cassette/	Multi-purpose Tray	Auto 2-sided printing *5
B5	182.0 mm x 257.0 mm	Yes	Yes	Yes
A5	148.0 mm x 210.0 mm	Yes	Yes	-
LGL	215.9 mm x 355.6 mm	Yes	Yes	Yes
LTR	215.9 mm x 279.4 mm	Yes	Yes	Yes
STMT	139.7 mm x 215.9 mm	Yes	Yes	-
EXEC	184.2 mm x 266.7 mm	Yes	Yes	Yes
OFFICIO*4	215.9 mm x 317.5 mm	Yes	Yes	Yes
B-OFFICIO*4	216 mm x 355 mm	Yes	Yes	Yes
M-OFFICIO*4	216 mm x 341 mm	Yes	Yes	Yes
G-LTR*4	203.2 mm x 266.7 mm	Yes	Yes	Yes
G-LGL*4	203.2 mm x 330.2 mm	Yes	Yes	Yes
FLSC	215.9 mm x 330.2 mm	Yes	Yes	Yes
AFLS*4	206 mm x 338 mm	Yes	Yes	Yes
Indian LGL*4	215.0 mm x 345.0 mm	Yes	Yes	-
Envelope No.10 (COM10)	104.7 mm x 241.3 mm	Yes	Yes	-
Envelope Monarch	98.4 mm x 190.5 mm	Yes	Yes	-
Envelope C5	162.0 mm x 229.0 mm	Yes	Yes	-
Envelope DL	110.0 mm x 220.0 mm	Yes	Yes	-
Custom paper	-	Yes *1	Yes *2	Yes *3

*1: 76.2 × 127 mm to 215.9 × 355.6 mm

*2: 676.2 × 127 mm to 215.9 × 355.6 mm

*3: 182 × 257 mm to 215.9 × 355.6 mm

*4: Only when the user-defined size is configured on the driver

*5: Except MF611Cn

Parts Name

External view

Front side of the machine

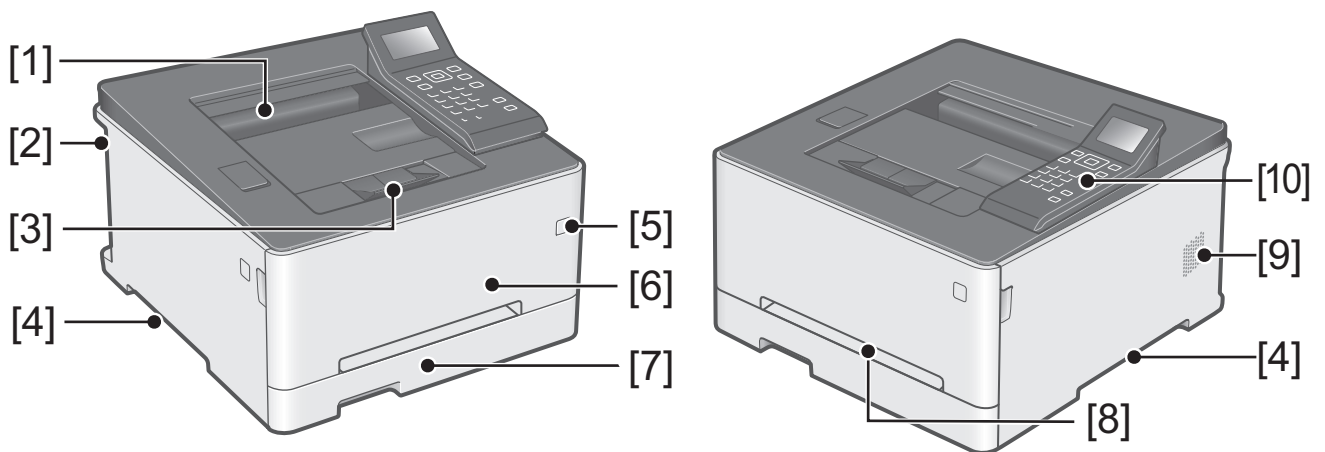

No.	Name	No.	Name
1	Delivery Tray	6	Front Cover
2	USB port (for USB device)	7	Pickup Cassette
3	Delivery Stopper	8	Multi-purpose Tray Pickup Slot
4	Handle for carrying	9	Ventilation hole
5	Power Switch	10	Control Panel

■ Rear side of the machine

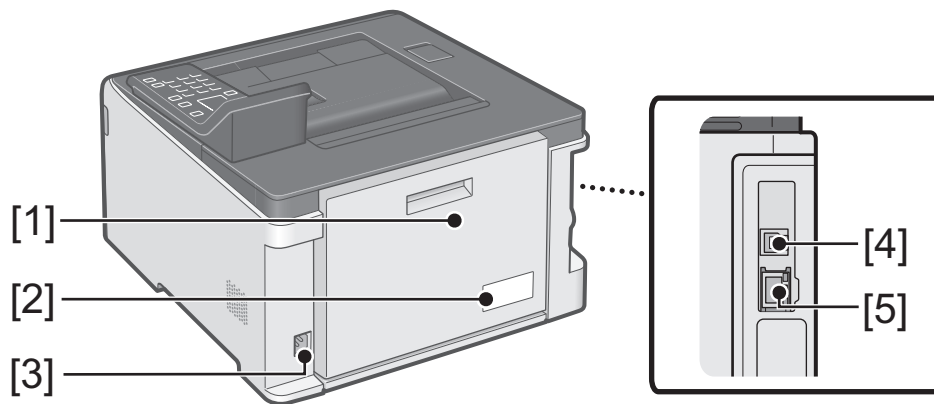

No.	Name
1	Rear Cover
2	Rating name plate label
3	Power Socket
4	USB port (for PC)
5	LAN Port

■ Inside of the host machine

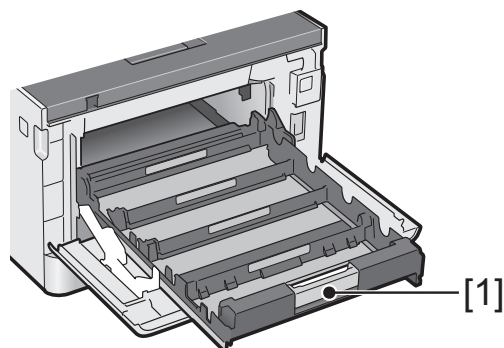

No.	Name
1	Toner Cartridge Tray

Cross Section View

■ Host machine

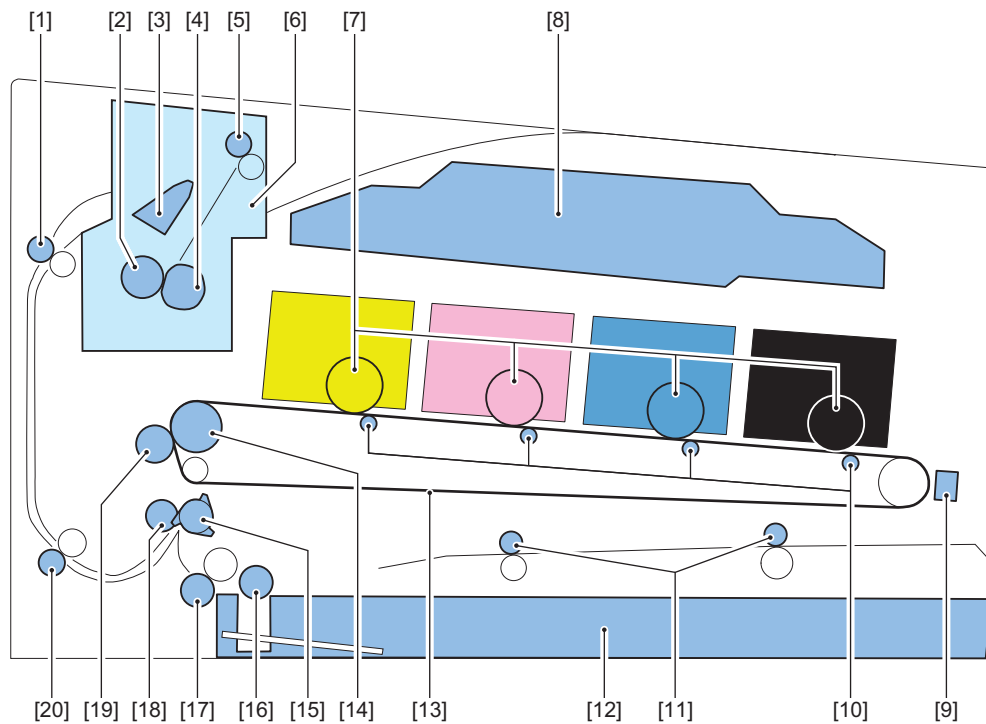

No.	Name	No.	Name
[1]	Duplex Feed Roller	[11]	Priority Slot Feed Roller
[2]	Pressure Roller	[12]	Cassette
[3]	Duplex Flapper	[13]	ITB
[4]	Fixing Film	[14]	ITB Drive Roller
[5]	Delivery Roller	[15]	Registration Shutter
[6]	Fixing Assembly	[16]	Pickup Roller
[7]	Photosensitive Drum	[17]	Separation Roller
[8]	Laser Scanner Unit	[18]	Registration Roller
[9]	Color Displacement Density Sensor	[19]	Secondary Transfer Roller
[10]	Primary Transfer Roller	[20]	Duplex Re-pickup Roller

Control Panel

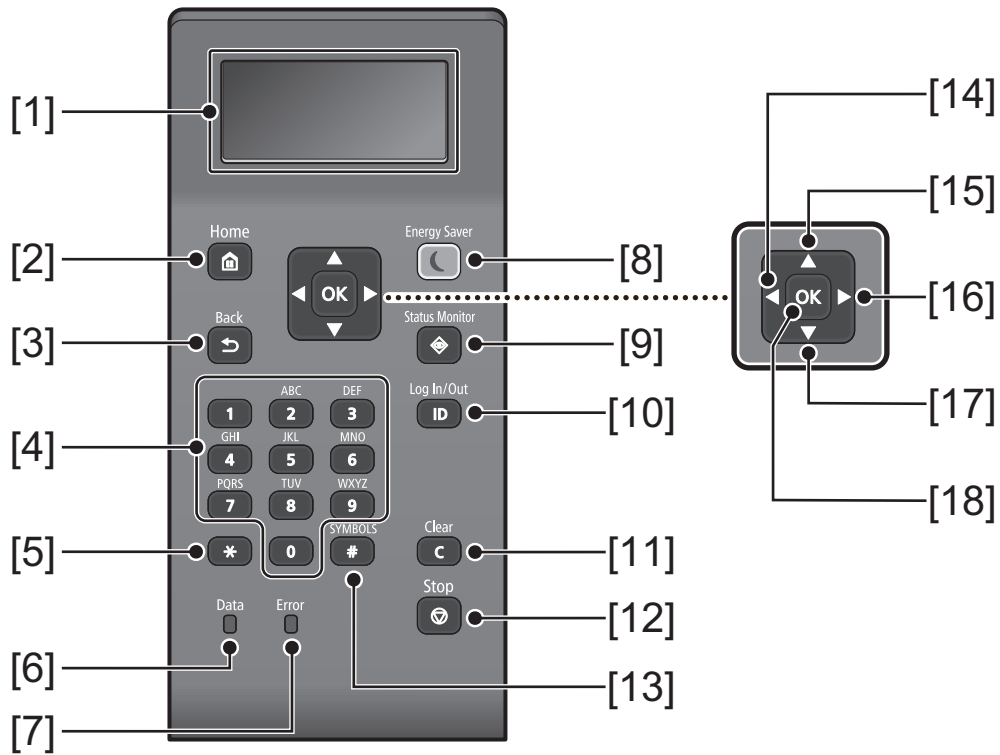

No.	Name	No.	Name
1	Display	10	[Authentication] key
2	[Home] key	11	[Clear] key
3	[Back] key	12	[Stop] key
4	Numeric Keys ([0] to [9])	13	[Symbol] key
5	[Kana/Alphabetic/Numeric] key	14	[Utility] key / [<] key
6	[Data] Lamp	15	[Job] key / [^] key
7	[Error] Lamp	16	[Setup] key / [>] key
8	[Energy Saver] key	17	[Reset] key/[V] key
9	[Status Monitor] key	18	[OK] key



Technical Explanation (Device)

Basic Configuration.....	14
Laser Exposure System.....	15
Controller System.....	17
Image Formation System.....	21
Pickup Feed System.....	27
Fixing System.....	36

Basic Configuration

Functional Configuration

Description

This machine is roughly composed of the following five blocks.

- Laser Exposure System
- Controller System
- Image Formation System
- Pickup Feed System
- Fixing System

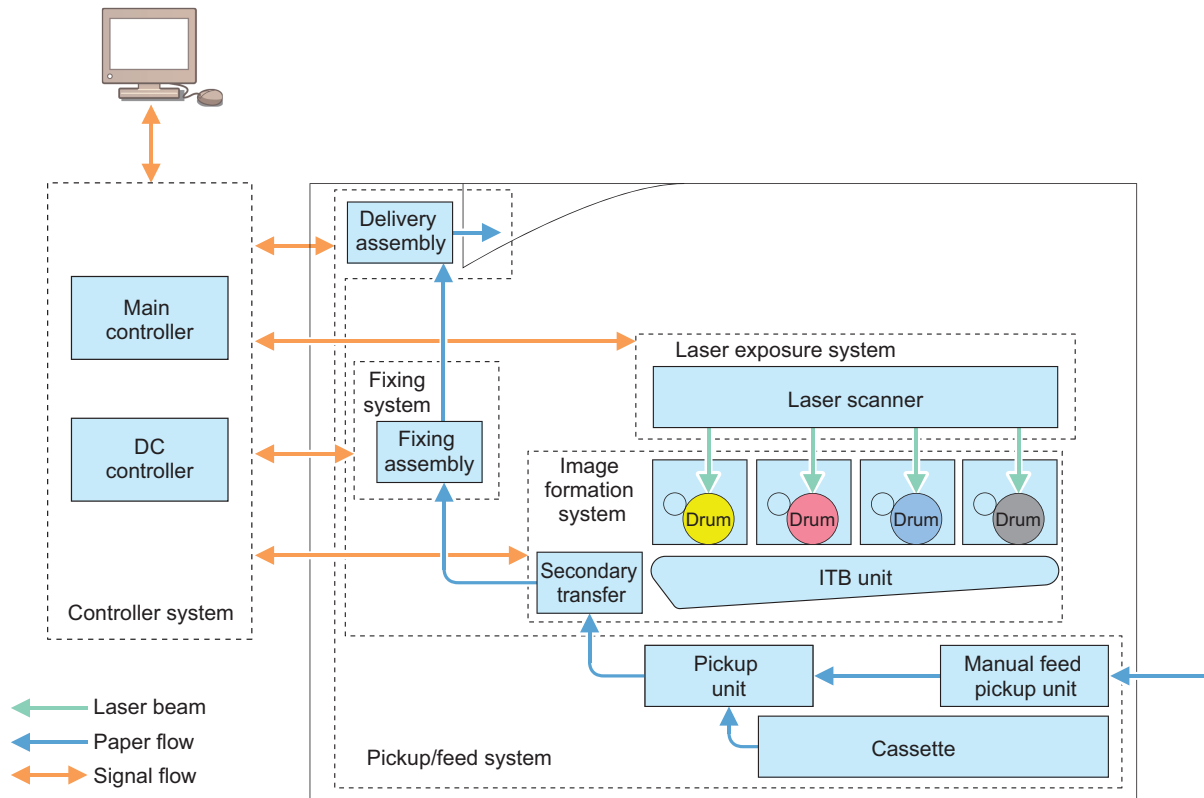

Laser Exposure System

Functional Configuration

Overview

The Laser Exposure system irradiates the Photosensitive Drum with a laser to form a latent image on it according to the video signal sent from the Main Controller.

Description

The Laser Scanner Unit consists of the Laser Unit and the Scanner Motor Unit, and is controlled by the signal input from the DC Controller.

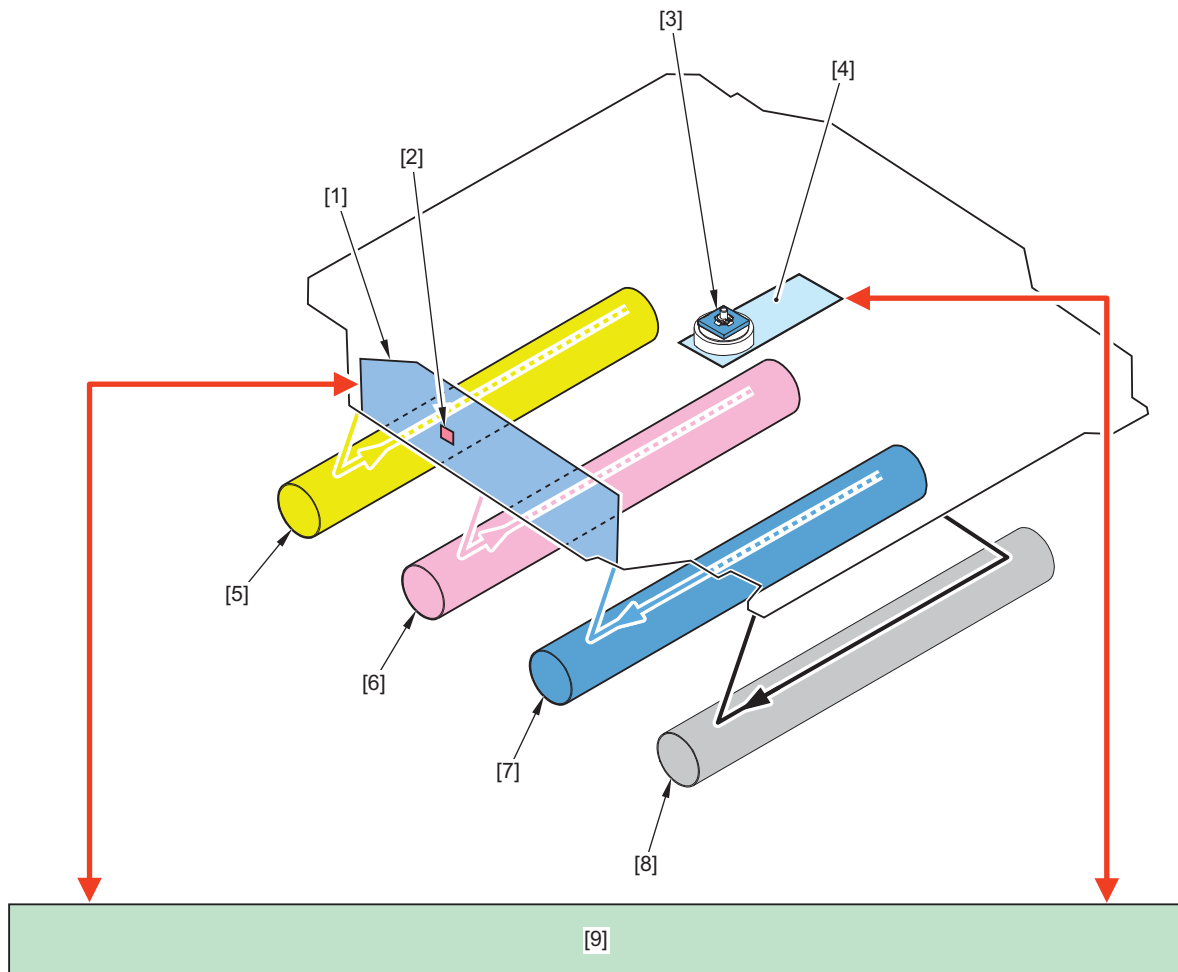

No.	Name	No.	Name
[1]	Laser Unit	[6]	Photosensitive Drum (M)
[2]	BD Sensor	[7]	Photosensitive Drum (C)
[3]	Scanner Mirror	[8]	Photosensitive Drum (Bk)
[4]	Scanner Motor Unit	[9]	DC Controller
[5]	Photosensitive Drum (Y)	-	-

Failure Detection

Overview

The DC Controller detects the following failures in the Laser Scanner Unit.

- Scanner area failure
- Scanner Motor startup failure

Description

Scanner area failure detection

If an error in any of the Scanner Motor, Laser Driver, or BD detection in the scanner area is detected, an error code is notified.

Scanner Motor startup failure detection

If the scanner does not start although a specified period of time has elapsed after the Scanner Motor is driven, an error code is notified.

Error Code

E100: Scanner area failure

- E100-0000: Yellow scanner area failure
- E100-0001: Magenta scanner area failure
- E100-0002: Cyan scanner area failure
- E100-0003: Black scanner area failure

E110: Scanner Motor startup failure

- E110-0000: Primary Pseudo BD correction failure

Controller System

Configuration/Function

Description

This product is mainly controlled by the main and DC controllers.

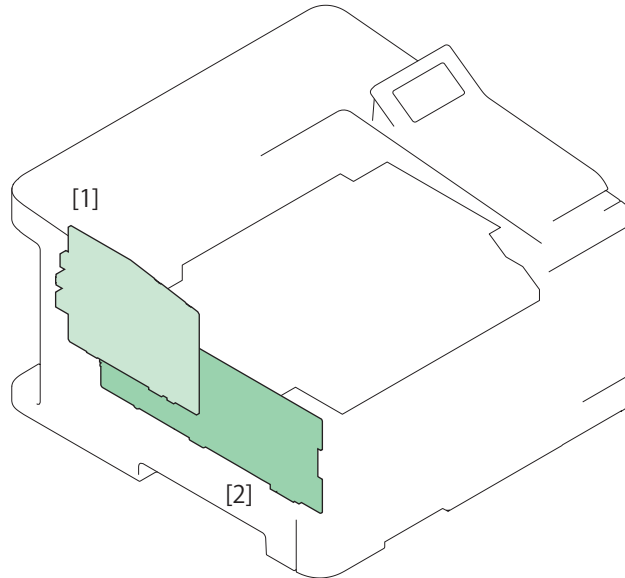

No.	Parts name	Role
[1]	Main Controller PCB	Provides controls on the system, image processing, network and maintain various setting values.
[2]	Engine Controller PCB *1	Provides controls on printer, laser, high-voltage PCBs, I/O, etc. and maintain setting values.

*1: The engine controller PCB consists of it by a high voltage power supply circuit and a DC controller circuit.

Main Controller PCB

Description

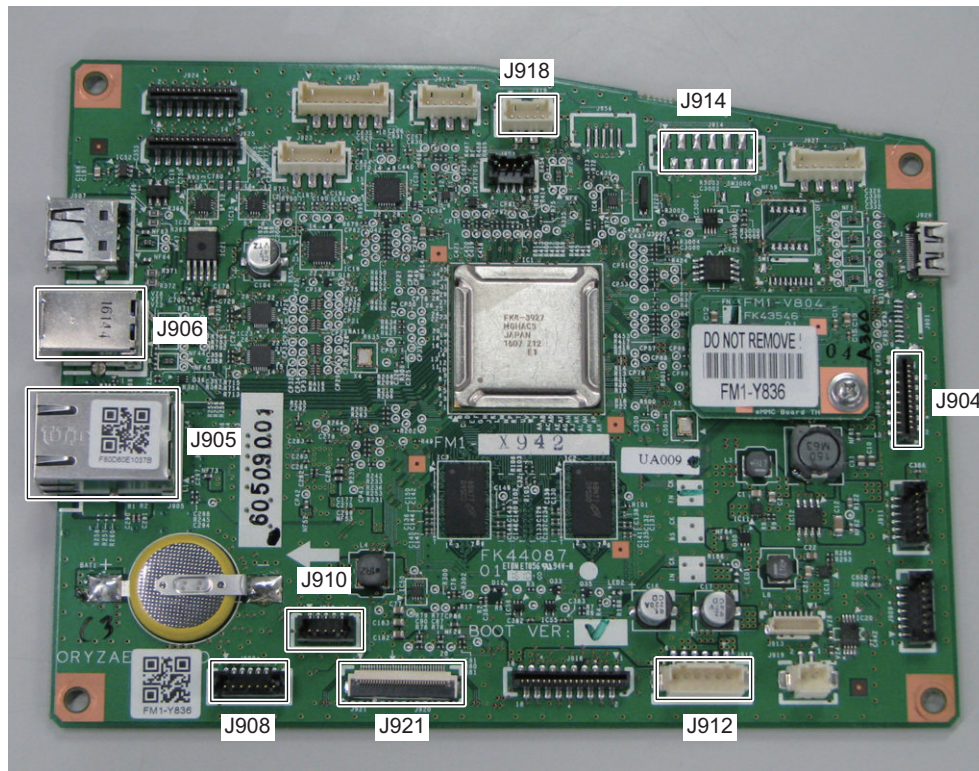

Jack	Function	Jack	Function
J904	Wireless LAN PCB I/F	J912	Engine Controller PCB I/F
J905	LAN I/F	J914	5-line Control Panel PCB I/F
J906	USB TypeB	J918	USB 2.0 Relay PCB I/F
J908	CC-VI (OP)	J921	Engine Controller PCB I/F
J910	New card reader (OP)		

Motor Control

Overview

This machine uses motors for paper feed and image formation.

Description

Name	Symbol	Drive parts	Failure Detection
Main Motor	M701	Photosensitive Drum, Developing Assembly, ITB, Developing Roller, and engagement/disengagement of the Developing Roller	Yes
Fixing Motor	M702	Pressure Roller, engagement/disengagement of the Pressure Roller, and Delivery Roller	None
Pickup Motor	M703	Pickup Roller, Feed Roller, Registration Roller, Duplex Feed Roller*, and Duplex Re-pickup Roller*	None
Scanner Motor	M704	Scanner Mirror	None

*: Duplex models only

Door Open Detection

Overview

This machine uses the Door Open Sensor to detect whether the door is opened or closed.

Description

Sensor name	Symbol	Role
Front Cover Sensor	SW4	To detect whether the Front Cover is opened or closed.
Rear Cover Sensor	SW3	To detect whether the Rear Cover is opened or closed.

When door open is detected by this sensor, the DC Controller stops drive of the motors and the solenoids.

Fan Control

Overview

This machine uses a fan for preventing temperature rising inside the machine and for cooling the delivered paper.

Description

Name	Sym- bol	Cooling area	Type	Speed
Main Fan	FM1	Around the cartridge and low voltage power supply	Suction	Full speed

Low-voltage Power Supply Control

Overview

This circuit converts the AC voltage to DC power supply and provides it to each load.

Description

The following shows a block diagram of the low voltage power supply .

- Low voltage power supply: Generates the DC power supply needed inside the printer. In addition, provides AC power supply to the low voltage power supply and controls the fixing heater temperature of the Fixing Assembly.

The low voltage power supply starts to operate when the AC power supply is connected to the inlet. The AC power supply is converted to +24 V, which is the DC power supply required by the printer, and +3.3 V.

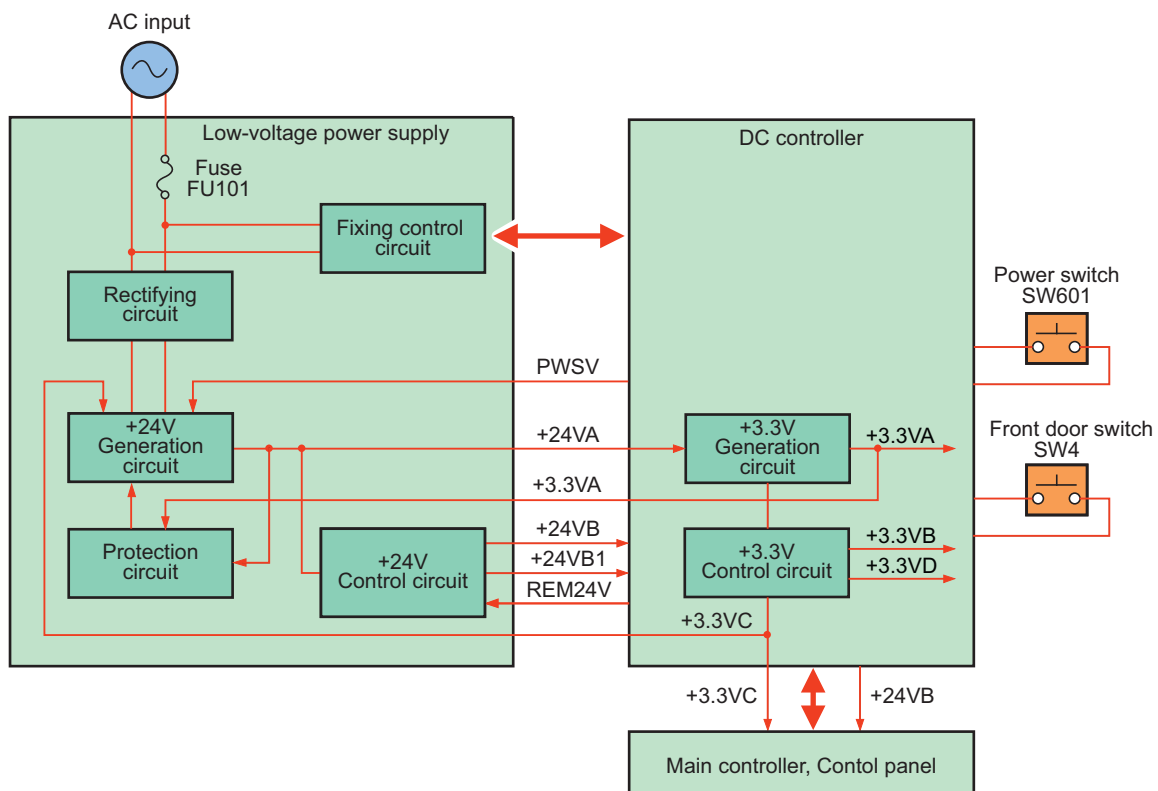

Protection Function

Overview

This machine has a protection function against overcurrent and overvoltage.

Description

If overcurrent or abnormal voltage occurs due to a trouble, the DC voltage is automatically cut off to prevent damage to the Power Supply PCBs.

When no DC voltage is output from the Low Voltage Power Supply Assembly, it is possible that the protection function has been activated. Therefore, turn OFF the Power Switch, disconnect the AC Power Supply Cord from the inlet, and then fix the trouble before turning ON the Power Switch again.

NOTE:

Leave the machine as it is for approx. 15 minutes after disconnecting the cord from the inlet. There are cases where electric charge remains in the electrolytic capacitor on the primary side of the Power Supply PCB, and time for releasing the electric charge is needed.

Power-saving Mode

Overview

Power-saving mode is a function that reduces the printer power consumption.

Description

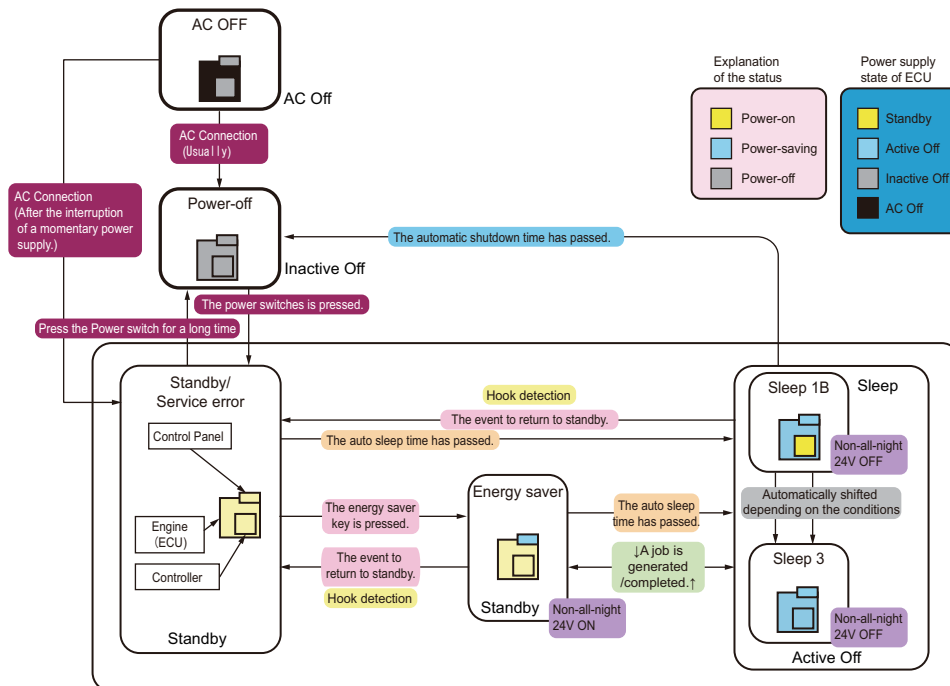

Engine (ECU) Power state	CNT All-night 3.3 V	CNT Non-all-night 24 V	ECU CPU power supply	Remarks
Standby	ON	ON	ON	Standby/Energy saving
Active Off	ON	OFF	ON	Sleep 1B/Sleep 3
Inactive Off	OFF	OFF	ON	AC applied

The low voltage power supply stops supplying power from the +24V generation circuit when it receives a power-saving transition mode signal (REM24V) from the DC Controller.

Image Formation System

Major Components

Description

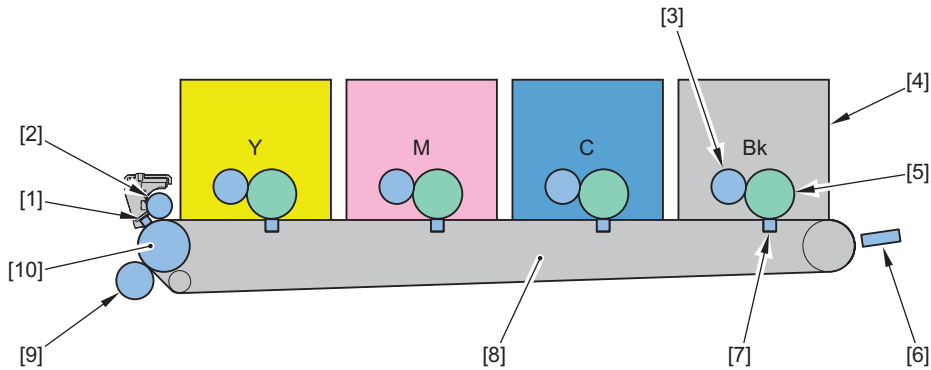

No.	Name	No.	Name
[1]	ITB Cleaning Brush	[6]	Color Displacement/Density Sensor
[2]	ITB Cleaning Roller	[7]	Primary Transfer Pad
[3]	Developing Cylinder	[8]	ITB Unit
[4]	Toner Cartridge	[9]	Secondary Transfer Roller
[5]	Photosensitive Drum	[10]	ITB Drive Roller

Image Formation Process

Description

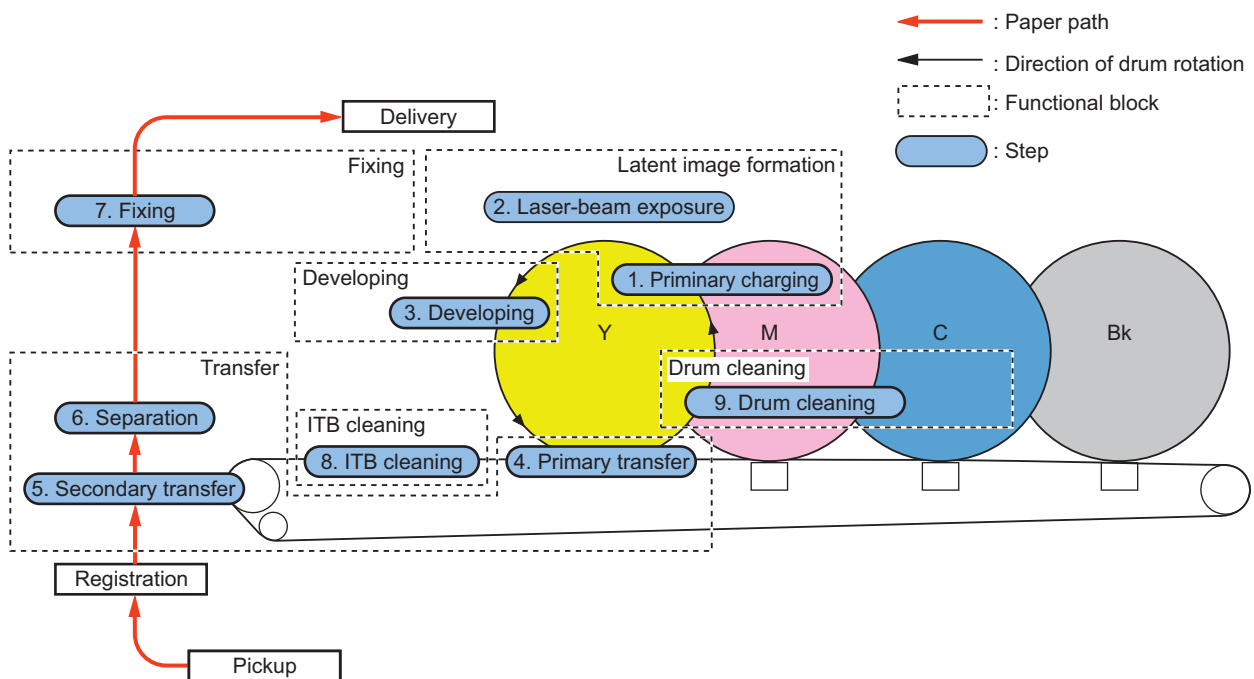

High Voltage Power Supply Control

Description

The High Voltage Power Supply applies high voltage biases to the following:

- Static Eliminator

- Primary Charging Roller (inside the cartridge)
- Developing Cylinder (inside the cartridge)
- Primary Transfer Pad
- Secondary Transfer Roller
- ITB Cleaning Assembly

The high voltage biases are generated by the DC Controller controlling the High Voltage Power Supply.

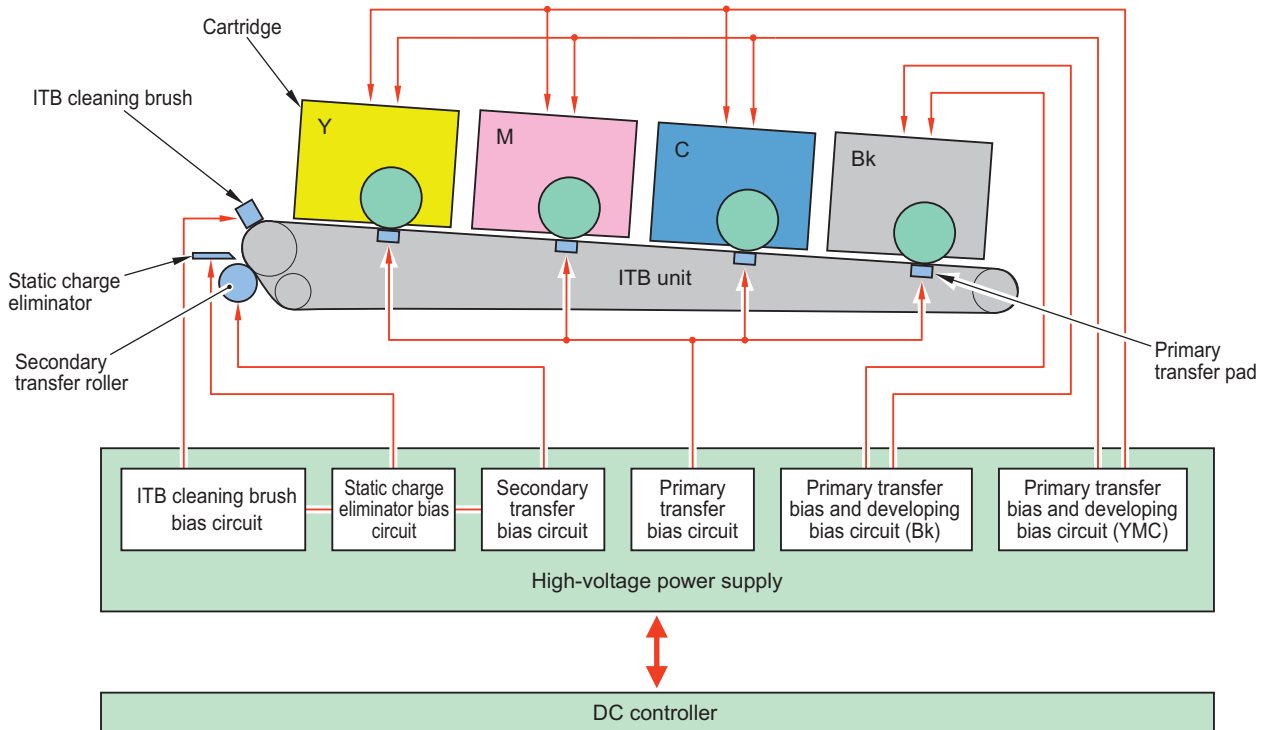
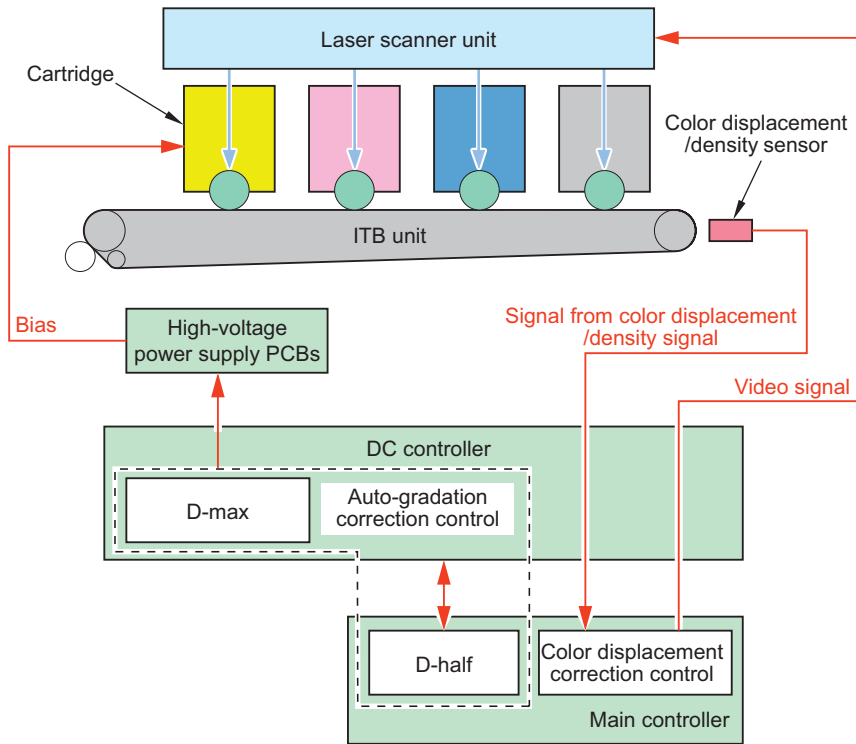

Image Stabilization Control

Overview

Image stabilization control is performed in order to prevent image failure due to change of the environment, deterioration of the Photosensitive Drum, deterioration of the toner, etc. and to ensure stable printing.

- Image Density Correction Control (D-max control)
- Image Gradation Correction Control (D-half control)
- Color Displacement Correction Control
- Auto Gradation Adjustment Control



Execution Condition/Timing

Correction controls are performed under the following conditions:

Execution timing	D-max	D-half	Color displacement correction
At power-on	Yes	Yes	Yes
When the Toner Cartridge is replaced	Yes	Yes	Yes
When the environment (temperature) changes	Yes	Yes	Yes
After printing the specified number of pages	Yes	Yes	Yes
After the specific period of time has passed	Yes	Yes	Yes
When recovering from sleep mode (8 hours or more)	Yes	Yes	-
When [Quick Adjust] is executed	Yes	Yes	-
When [Correct Print Color Mismatch] is executed	-	-	Yes

Description

Image Density Correction Control (D-max control)

It is performed to stabilize the image density of the printer.
The DC Controller corrects the primary charging bias and developing bias values.

Image Gradation Correction Control (D-half control)

It is performed to stabilize the image gradation of the printer.
The Main Controller performs gradation adjustment based on the measurement results of the halftone density performed by the DC Controller.

Color Displacement Correction Control

Color displacement that occurs due to the individual differences of the Laser Scanner Unit and Toner Cartridge is corrected. The Main Controller performs the following color displacement corrections by controlling the video signal based on the color displacement information measured by the DC Controller.

- Write-start position in the horizontal scanning direction
- Horizontal scanning magnification ratio
- Write-start position in the vertical scanning direction

Auto Gradation Adjustment Control

It is performed to stabilize the gradation density characteristics of the image.

Item	Description	Test pattern	
		Number of output sheets	Type
Quick Adjust	Gradation adjustment is performed by D-half Control without outputting a test pattern.	-	-

Additional Functions Mode/Menu

- Menu > Adjustment/Maintenance > Adjust Image Quality > Auto Adjust Gradation > Quick Adjust
- Menu > Adjustment/Maintenance > Adjust Image Quality > Correct Print Color Mismatch

Cartridge

Description

The cartridge of this machine has the function to form a visible image on the Photosensitive Drum with toner. There are 4 types: yellow, magenta, cyan, and black, and all of them have the same structure.

The cartridge of this machine consists of the Photosensitive Drum, Developing Unit, Primary Charging Roller, Memory, etc.

The DC Controller rotates the Main Motor, and drives the Photosensitive Drum, Developing Unit, and Primary Charging Roller.

The DC Controller detects the toner level by monitoring the toner level detection signal.

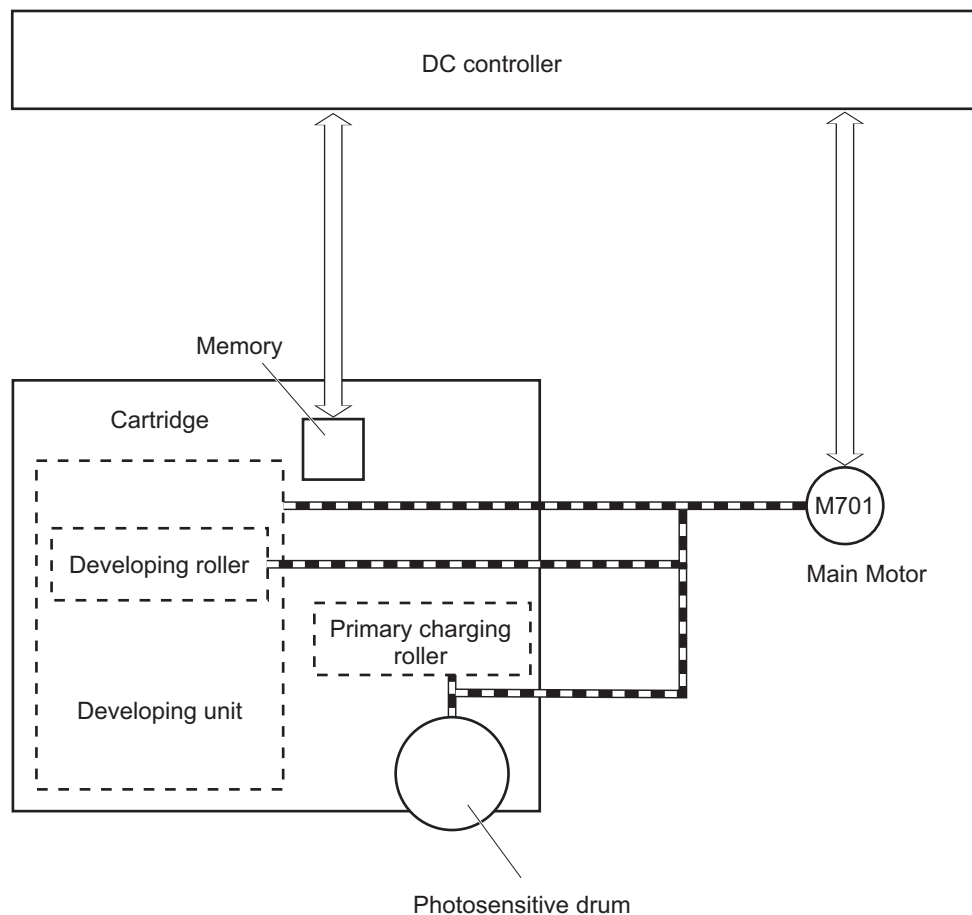

Memory

Description

This machine detects/records the cartridge usage status, etc. by reading/writing data stored in the memory by the DC Controller. If the memory cannot be detected, "Cartridge Communication Error. A counterfeit or non-Canon cartridge may be in use." is displayed.

■ Cartridge Detection

Execution Condition/Timing

- At power-on
- When the Front Cover is closed

Description

The DC Controller detects whether a cartridge is installed according to the change in primary charging current. The DC Controller notifies the Main Controller of the absence of a cartridge if it judges there is no cartridge.

Display on the Control Panel:
Insert the toner cartridge.

■ Cartridge Life Detection

Description

The DC Controller notifies the Main Controller when cartridge consumption reaches the specified value.

Upon reception of the notification the Main Controller displays a warning or a message that the cartridge has reached the end of its life.

	Warning display*2	End of life display*4, *5
Toner level*1	Differs depending on the setting*3	0%
Detected to (location)	Memory	Memory
Message (machine operation)	<ul style="list-style-type: none"> • Prepare the cyan cartridge. • Prepare the magenta cartridge. • Prepare the yellow cartridge. • Prepare the black cartridge. 	<ul style="list-style-type: none"> • Cyan cartridge has reached end of life. • Magenta cartridge has reached end of life. • Yellow cartridge has reached end of life. • Black cartridge has reached end of life.

*1: Select the following to check the remaining toner level.

- Status Monitor > Device Information > Cartridge Information

*2: Whether to display or hide warnings can be specified in the menu.

*3: The threshold value to display a warning can be specified in the menu.

*4: The operation when the cartridge has reached the end of life can be specified in service mode.

*5: The reference value of cartridge life (Photosensitive Drum, Developing Unit, and Waste Toner) can be specified in service mode.

Service Mode

- Setting of the behavior when the cartridge reaches the end of its estimated life
COPIER > OPTION > FNC-SW > CRG-PROC
- Setting of the reference values for replacement of the Photosensitive Drum, Developing Assembly, and Waste Toner (Bk)
COPIER > OPTION > FNC-SW > CRGLF-K
- Setting of the reference values for replacement of the Photosensitive Drum, Developing Assembly, and Waste Toner (Y/M/C)
COPIER > OPTION > FNC-SW > CRGLF-CL
- ON/OFF of display of the screen for setting the threshold value for preparation of the cartridge
COPIER > OPTION > DSPLY-SW > CRGLW-LV

Additional Functions Mode/Menu

- Setting of whether to display or hide warnings
Menu > Preferences > Display Settings > Display Timing for Cartridge Prep. Notif.
- Setting of the threshold value to display a warning
Menu > Preferences > Display Settings > Display Timing for Cartridge Prep. Notif. > Custom

■ Developing Cylinder Engagement/Disengagement Control

Overview

The DC Controller engages/disengages the Developing Cylinder in the Toner Cartridge with/from the Photosensitive Drum.

Execution Condition/Timing

The Developing Cylinder is engaged or disengaged depending on the state of this machine.

State of this machine	Y/M/C	Bk
Power Supply Off/Standby	Disengagement	
B&W Print	Disengagement	Engagement
Full Color Print	Engagement	

Description

In accordance with the specified print mode (full color or B&W), only the Developing Cylinder(s) necessary for the mode is engaged with the Photosensitive Drum.

The Developing Cylinders are engaged only when needed, and this prevents deterioration of the Photosensitive Drum and ensures the maximum life.

For engagement/disengagement of the Developing Cylinders, the DC Controller drives the Developing Disengagement Solenoid (SL711) while the Main Motor (M701) is driving to change the orientation of the Engagement/Disengagement Cam.

The DC Controller detects the current state using the Developing HP Switch (SW1), and determines the state (engaged or disengaged) of the Developing Cylinders on the basis of the amount of rotation of the Main Motor after the Developing Disengagement Solenoid starts to be driven.

Error Code

- E015-0000: Error in Developing Disengagement Motor

Pickup Feed System

Overview

Overview

The pickup, feed, and delivery systems are controlled by the DC Controller.

The DC Controller controls the blocks in the pickup, feed, and delivery systems to pickup, feed, and deliver paper inside the machine.

Description

The pickup, feed, and delivery systems consist of the following three blocks.

- Pickup/Feed: From each pickup slot to the inlet of the Fixing Assembly
- Fixing/Delivery: From the Fixing Assembly to the delivery outlet
- Duplex*: From the Duplex Reverse Assembly to the Duplex Re-pickup Assembly

*: Duplex models only

- ▶ Simplex paper path
- ⋯▶ Duplex paper path

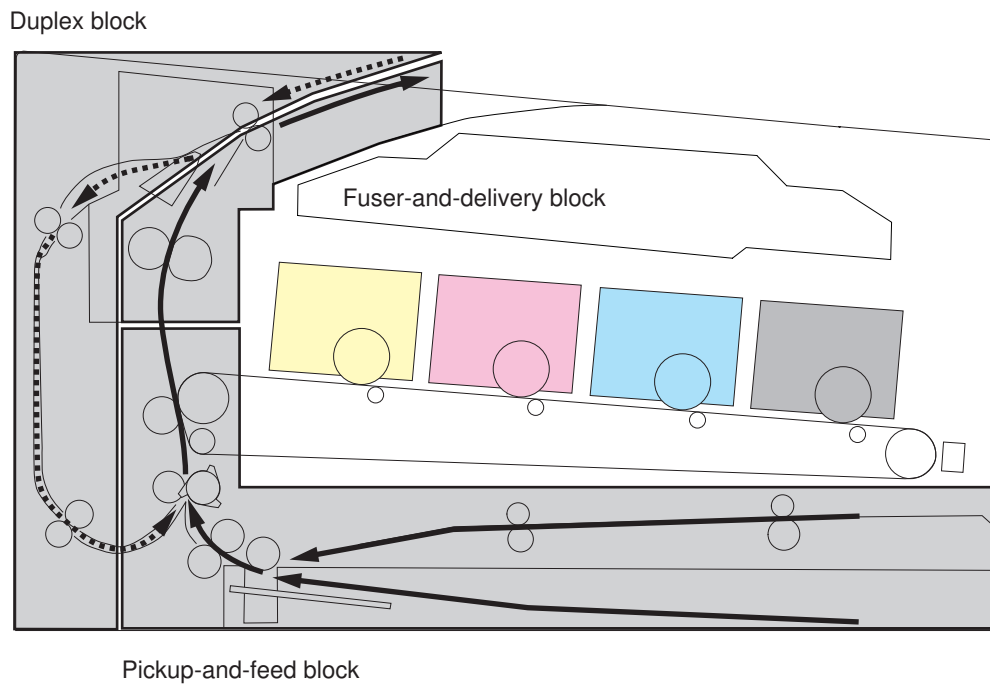

Parts Configuration

Description

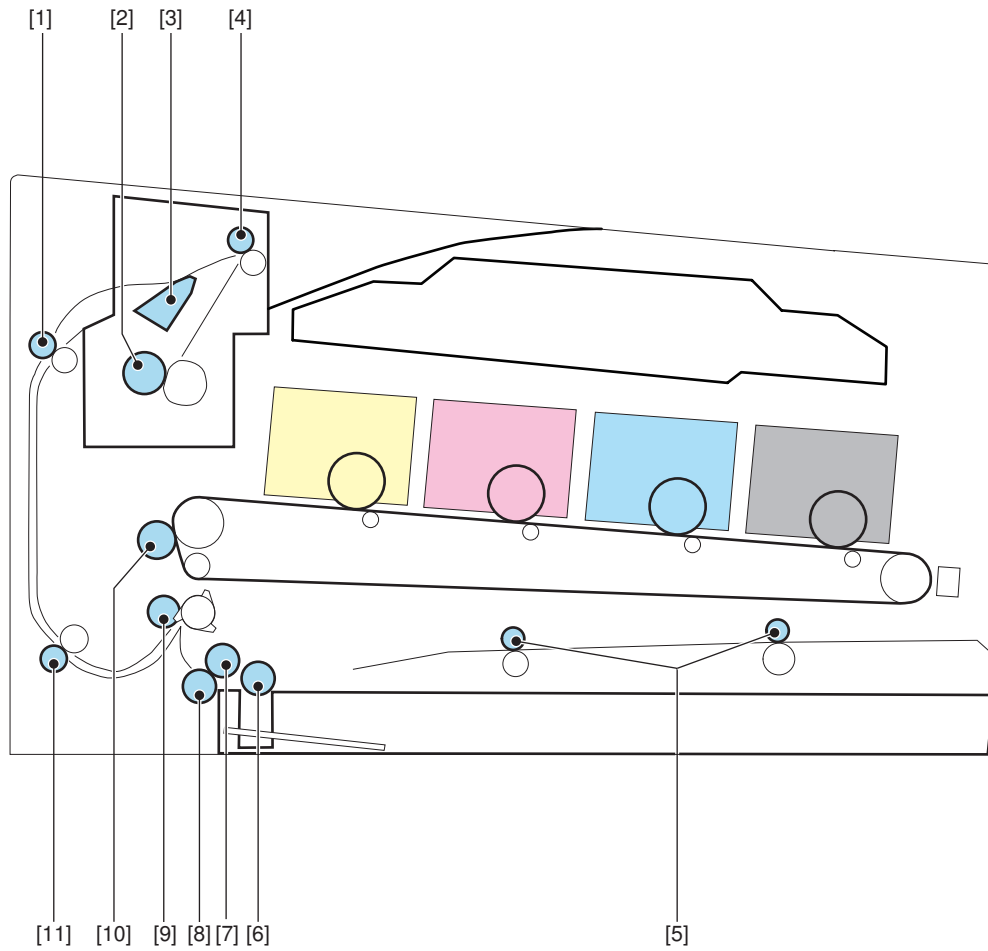

No.	Name	No.	Name
[1]	Duplex Feed Roller	[7]	Feed Roller
[2]	Pressure Roller	[8]	Separation Roller
[3]	Duplex Flapper	[9]	Registration Roller
[4]	Delivery Roller	[10]	Secondary Transfer Roller
[5]	Multi-purpose Tray Feed Roller	[11]	Duplex Re-pickup Roller
[6]	Pickup Roller		

Drive Configuration

Description

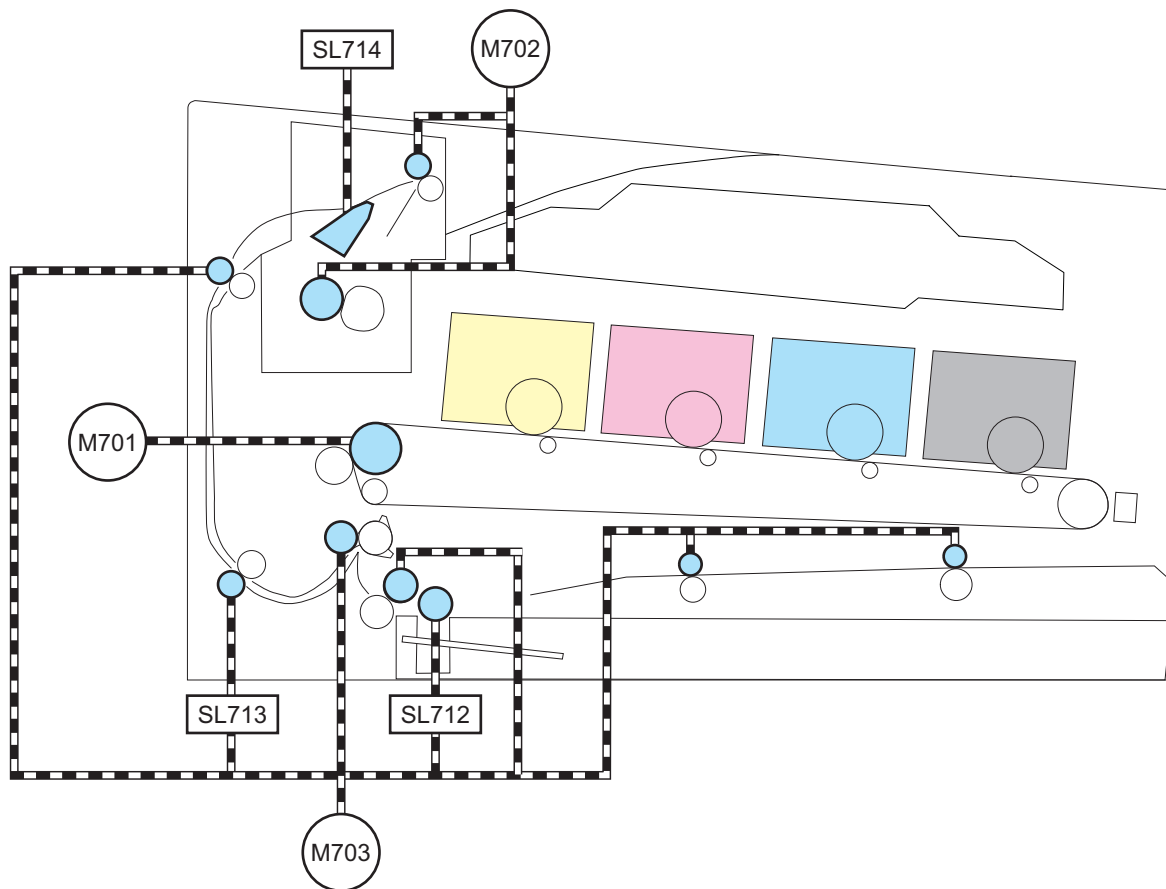

Symbol	Name	Symbol	Name
M701	Main Motor	SL712	Pickup Solenoid
M702	Fixing Motor	SL713	Duplex Re-pickup Solenoid*
M703	Pickup Motor	SL714	Duplex Reverse Solenoid*

*: Duplex models only

Layout of Sensors

Description

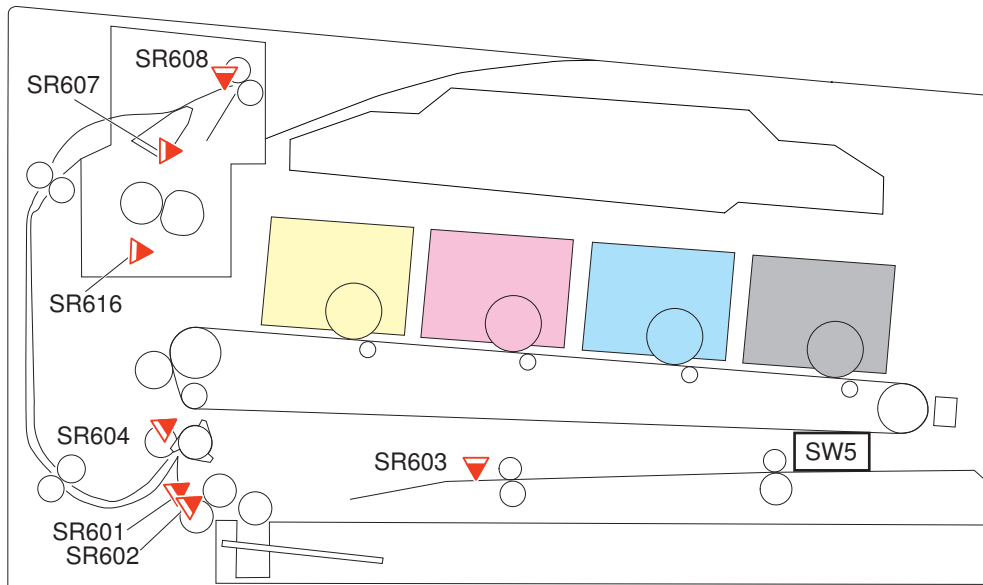

Sym- bol	Name	Sym- bol	Name
SW5	Multi-purpose Pickup Switch	SR604	Registration Sensor
SR601	Paper Width Sensor (Right)	SR607	Fixing Delivery Sensor
SR602	Paper Width Sensor (Left)	SR608	Delivery Sensor
SR603	Multi-purpose Tray Pickup Sensor	SR616	Loop Sensor

Cassette Detection

Description

Presence of the cassette is detected using the Multi-purpose Pickup Sensor (SR603).

The cassette detection flag of the cassette is detected by the Multi-purpose Pickup Sensor in the host machine.

Cassette Pickup Control

Description

The DC Controller rotates the Pickup Roller by rotating the Pickup Motor (M703).

The Pickup Arm is lifted and lowered to feed the paper by rotating the Pickup Cam with the Pickup Solenoid (SL712).

Double Feed Prevention Mechanism

This machine employs the Separation Roller method for double feed prevention.

The Separation Roller method of this machine is a method that prevents paper double feeds by using the Separation Roller without drive.

The Separation Roller is driven and rotated by the Pickup Roller.

- At normal time

The Separation Roller is driven by the Pickup Roller drive via paper. This causes the Separation Roller to rotate in the feed direction.

- During Double Feed

Since the friction force between sheets of paper becomes weaker when there are multiple sheets of paper, the Pickup Roller drive force transmitted to the Separation Roller becomes extremely weak. Since force suppressing rotation is applied to the Separation Roller of this machine, this mechanism does not allow rotation by the weak drive force transmitted from the Pickup Roller during double feed. The Separation Rollers therefore do not rotate and do not pickup double feed paper.

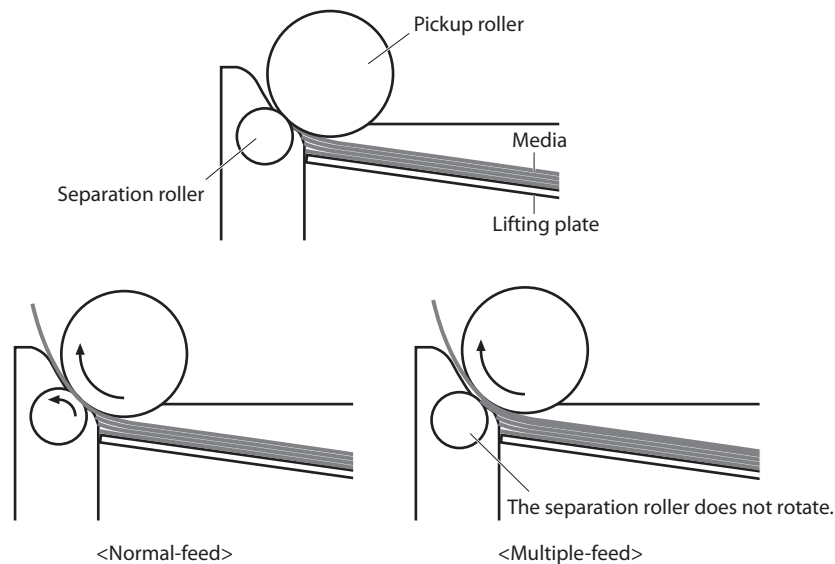

Multi-purpose Tray Pickup Control

Description

The Multi-purpose Tray pickup feeds paper from the Multi-purpose Tray one sheet at a time into the machine. The following describes the operation of the Multi-purpose Tray pickup.

1. When paper is inserted into the Multi-purpose Tray, the Multi-purpose Pickup Switch (SW5) detects the paper.
2. When the Multi-purpose Pickup Switch (SW5) detects paper, the DC Controller rotates the Pickup Motor (M703).
3. When the Pickup Motor (M703) rotates, the Multi-purpose Tray Pickup Roller rotates and feeds paper.
4. When the Multi-purpose Pickup Sensor (SR603) detects paper, the Pickup Motor (M703) stops after feeding the paper for a specified period of time.

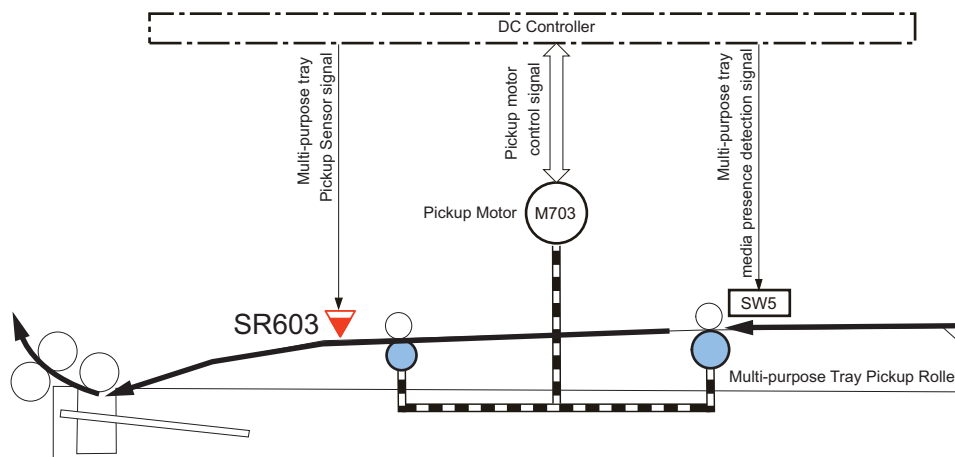

Skew Correction

Description

This machine can correct paper skew without lowering throughput. Skew is corrected as follows.

1. The paper leading edge pushes against the Registration Shutter to align the leading edge of the paper.
2. The trailing edge of the paper is fed and slack is generated at the leading edge of the paper.
3. When the trailing edge is fed even further, the paper leading edge for which slack was generated pushes up the Registration Shutter and then the paper is fed to the Registration Roller while the paper leading edge is aligned.

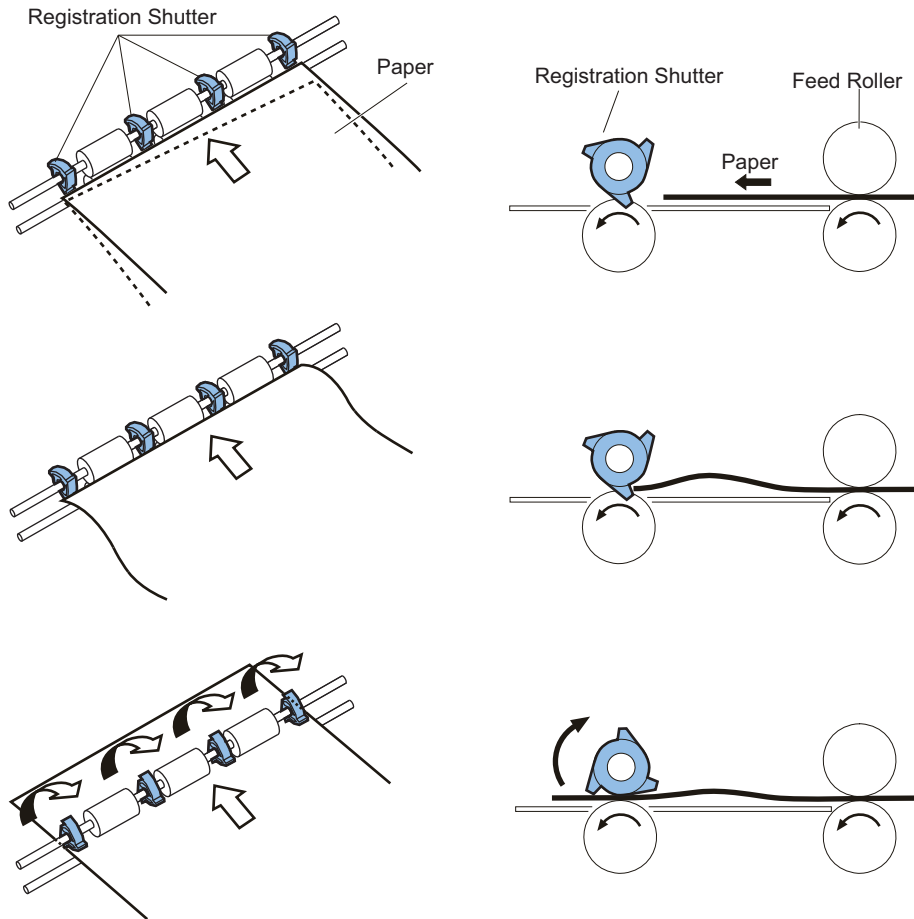

Paper Width Detection

Description

Detection of paper width is performed to prevent temperature increase at the edge of the Fixing Heater.

The width of paper being fed is detected by the Paper Width Sensor (Right) (SR601) and Paper Width Sensor (Left) (SR602). When either of the Paper Width Sensor Flags on the right and left is turned ON, it is detected that the paper width is 210 mm or wider.

If the paper width detected by the Paper Width Sensor Front did not match the paper size set in the paper size of the Select Feeder menu, "Check paper size." is displayed on the Control Panel.

Paper Width Sensor (SR601/SRS602)	Detection result	Paper size
ON	Paper width: 210 mm or wider	A4, LTR, LGL, Indian LGL
OFF	Paper width: shorter than 210 mm	EXEC, B5, A6, A5

Arch Control

Description

Arch control keeps the appropriate slack on paper to prevent image failure and feed failure.

- If the rotation speed of the Fixing Motor is slower than the rotation speed of the Main Motor, the slack on the paper becomes larger.
- If the rotation speed of the Fixing Motor is faster than the rotation speed of the Main Motor, the slack on the paper becomes smaller.

The DC Controller detects the slack on paper by the Loop Sensor (SR616), and controls the rotation speed of the Fixing Motor.

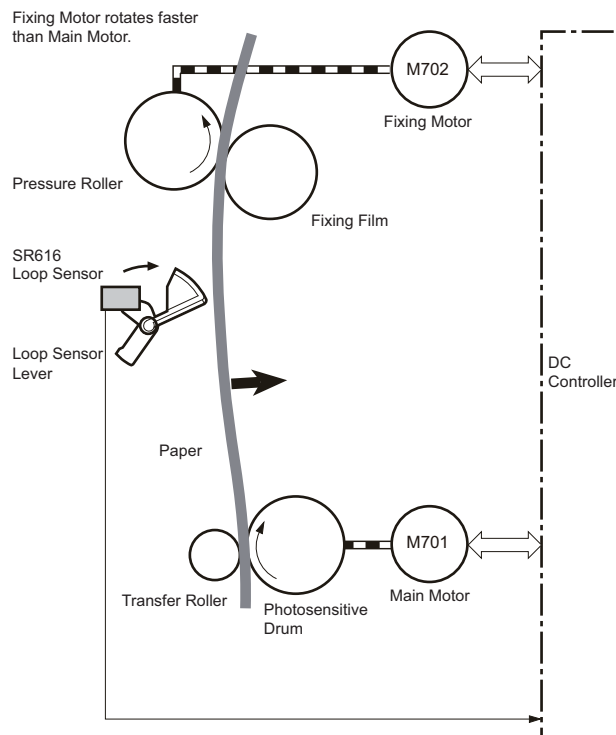
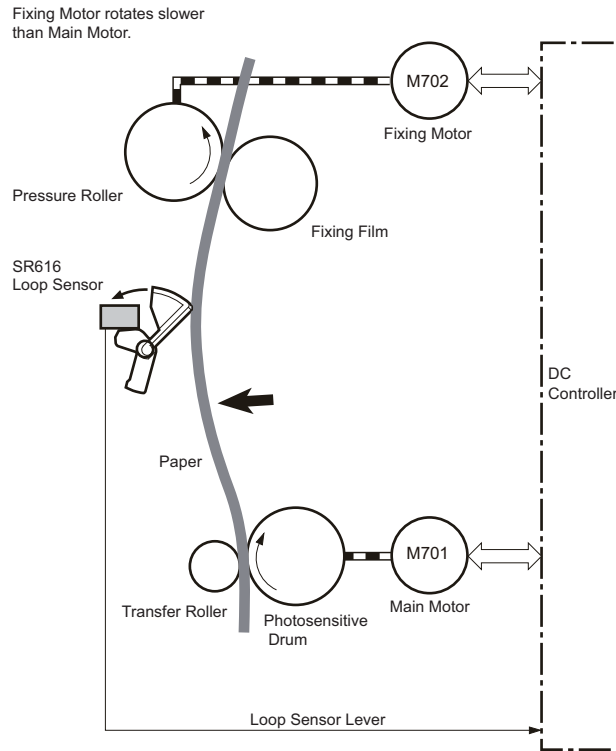

Delivery Tray Full Detection

Description

The DC Controller detects paper full in the Delivery Tray using the Delivery Sensor (SR608). The DC Controller judges that the Delivery Tray is full and notifies the Main Controller when the Delivery Sensor detects paper for a specified period of time during printing.

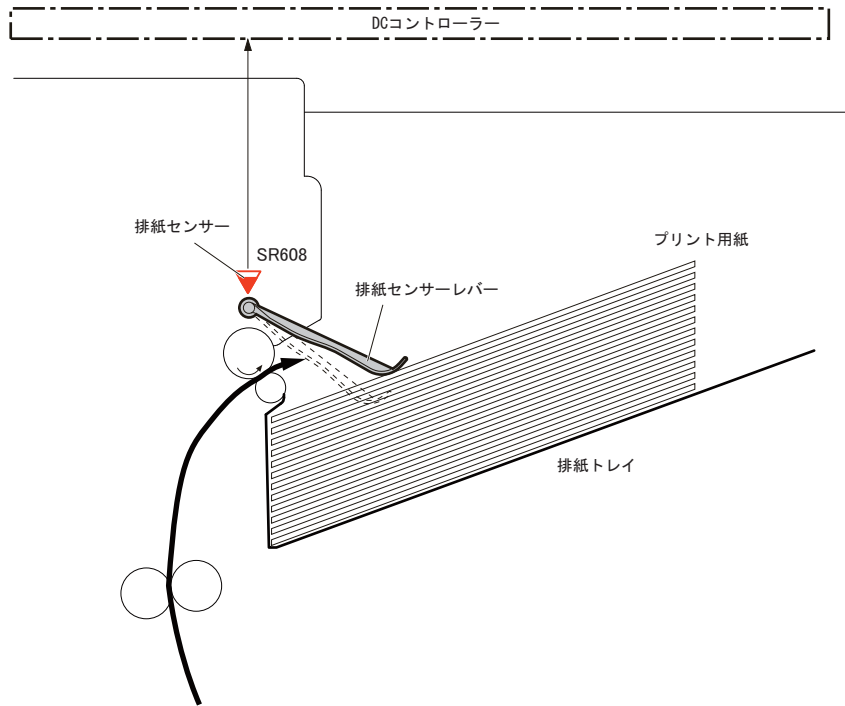

Jam Detection

Description

The sensors are provided at the locations shown below to detect the presence of print paper and whether the print paper is being fed correctly.

- ▶ Simplex paper path
- ⋯▶ Duplex paper path

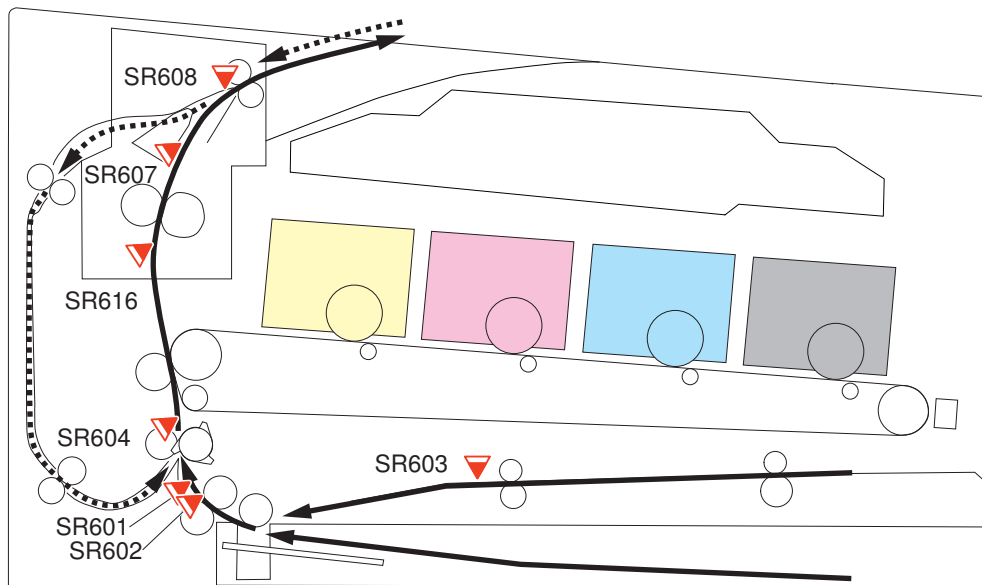

Occurrence of a jam is judged by whether paper is in the sensor area at the timings stored in the DC Controller. When the DC Controller judges that a jam has occurred, the printing operation is stopped and the jam is notified to the Main Controller at the same time.

The following shows the jams that are detected.

Jam name	Details
Pickup delay jam 1	When the Registration Sensor (SR604) fails to detect the leading edge of paper after the start of image formation and before the start of re-pickup

Jam name	Details
Pickup delay jam 2	When the Multi-purpose Pickup Sensor (SR603) fails to detect the leading edge of paper within a specified period of time after the start of pickup from the Multi-purpose Tray
Pickup Stationary Jam	When the Registration Sensor (SR604) fails to detect the trailing edge of paper within a specified period of time after the start of re-pickup
Fixing delivery delay jam	When the Fixing Delivery Sensor (SR607) fails to detect the leading edge of paper within a specified period of time after the start of re-pickup
Fixing delivery stationary jam	When the Fixing Delivery Sensor (SR607) fails to detect the trailing edge of paper within a specified period of time after the Registration Sensor (SR604) detects the trailing edge of paper
Internal stationary jam	When one of the following sensors detects presence of paper at power-on, door close, or before/after print operation <ul style="list-style-type: none"> • Multi-purpose Pickup Sensor (SR603) • Registration Sensor (SR604) • Fixing Delivery Sensor (SR607) • Delivery Sensor (SR608)
Door Open Jam	When one of the sensors detects presence of paper when door open is detected during printing
Wrapping jam	When the Fixing Delivery Sensor (SR607) turns OFF after the Fixing Delivery Sensor (SR607) detects the trailing edge of paper and before detection of a fixing delivery stationary jam is started
Duplex Re-pickup Assembly Jam	At 2-sided print, the paper was reversed, but the Registration Sensor (SR604) failed to detect the leading edge of paper within a specified period of time.
Delivery Delay Jam	When the Delivery Sensor (SR608) fails to detect the leading edge of paper within a specified period of time after the Fixing Delivery Sensor (SR607) detects the trailing edge of paper
Delivery Stationary Jam	When the Delivery Sensor (SR608) fails to detect the trailing edge of paper within a specified period of time after the Delivery Sensor (SR608) detects the leading edge of paper

Fixing System

Functional Configuration

Overview

The fixing system forms a permanent image by melting the toner on the paper using pressure and heat.

Description

The fixing control circuit controls the temperature of the Fixing Assembly.

The Fixing Assembly of this machine uses the on-demand fixing method.

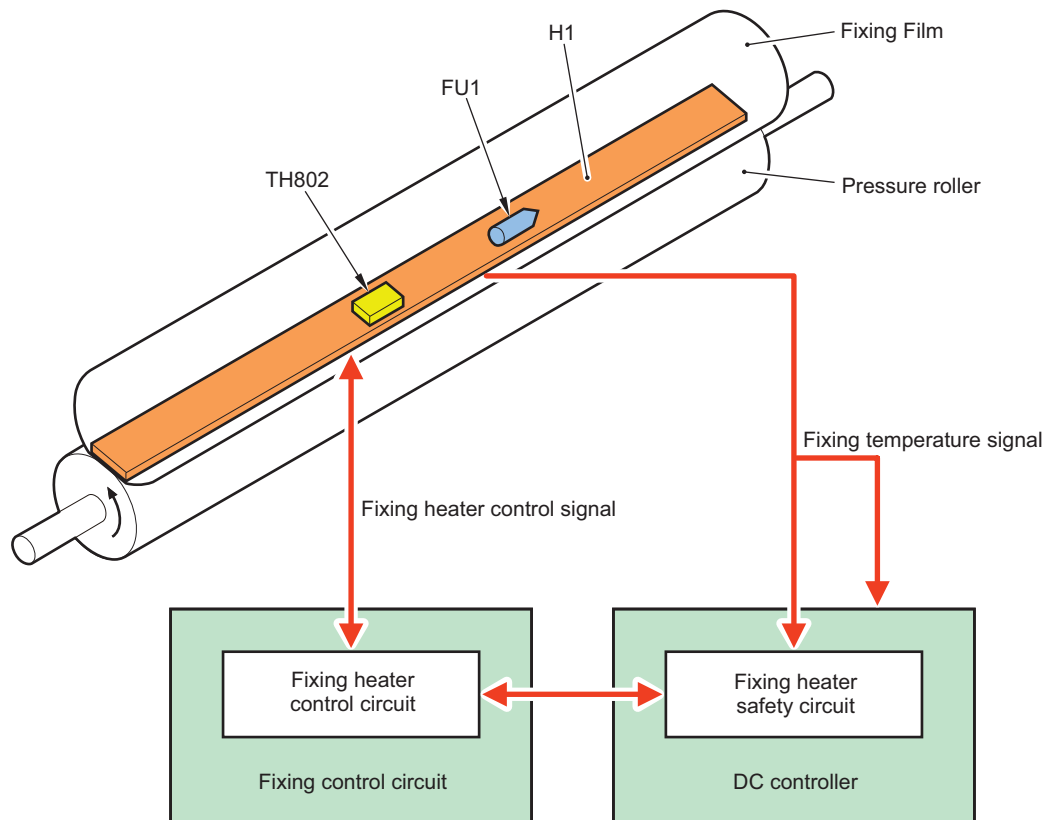

Symbol	Parts name
H1	Fixing Heater
TH802	Main Thermistor
FU1	Temperature Fuse

Temperature control of the Fixing Assembly which consists of these parts is performed by the Fixing Heater control circuit and Fixing Heater safety circuit according to the command of the DC Controller.

Fixing Temperature Control

Overview

This control circuit controls the temperature such that the Fixing Heater reaches the target temperature.

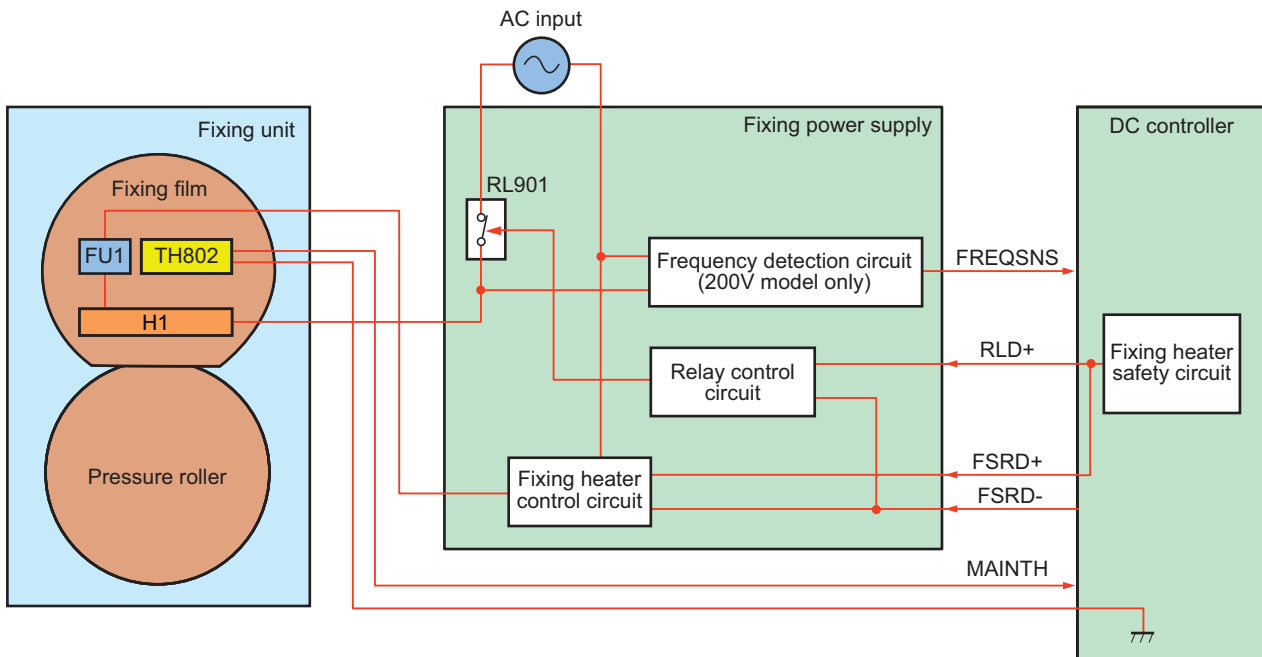

Description

The DC Controller monitors the fixing temperature detection signal and outputs a fixing control signal according to the detected temperature. The fixing control circuit controls the Fixing Heater on the basis of this signal, and controls the temperature of the Fixing Heater to the target value.

Protection Function

Overview

This machine has a function to detect abnormal temperature rising in the Fixing Assembly and cut off the power supply to the Fixing Heater.

Description

This machine has the following three protection functions to prevent abnormal temperature rising in the Fixing Heater.

- DC Controller
- Fixing Heater safety circuit
- Temperature Fuse

The following describes the details.

DC Controller

The DC Controller monitors the thermistor temperature of the Fixing Heater (Center). When it exceeds the specified temperature, it is judged that the temperature of the Fixing Assembly is abnormally high, and the fixing control signal (FSRD) output is stopped, the relay is turned OFF, and the power supply to the heater is turned OFF.

Fixing Heater safety circuit

The Fixing Heater safety circuit monitors the thermistor temperature of the Fixing Heater (Center). When it exceeds the specified temperature, it is judged that the temperature of the Fixing Assembly is abnormally high, and the relay is turned OFF and the power supply to the heater is turned OFF.

Temperature Fuse

If the temperature of the Fixing Heater rises abnormally and the temperature of the Fixing Fuse exceeds the specified temperature, the Temperature Fuse opens and the power supply to the heater turns OFF.

Fixing Assembly Failure Detection

Overview

When the machine is under the following conditions, the DC Controller shuts down the power supply to the Fixing Assembly and notifies an error.

- Startup failure

- Abnormal high temperature failure
- Abnormal low temperature failure
- Fixing power supply drive circuit failure

Description

Fixing Assembly startup failure

An error code is notified if the Fixing Assembly does not reach a certain temperature within a specified period of time.

Abnormal high temperature failure

An error code is notified if an abnormally high temperature is detected in the Fixing Assembly.

Abnormal low temperature failure

An error code is notified if an abnormally low temperature is detected in the Fixing Assembly.

Fixing power supply drive circuit failure

An error code is notified if a zero cross signal is not detected for the specified period of time or more.

Error Code

E000: Startup failure

- E000-0000: Fixing Assembly startup failure

E001: Abnormal high temperature failure

- E001-0000: Abnormal high temperature of Fixing Assembly

E003: Abnormal low temperature failure

- E003-0000: Abnormal low temperature of Fixing Assembly

E004: Error in fixing power supply drive circuit

- E004-0000: Error in fixing power supply drive circuit



Technical Explanation (System)

Overview of System Management.....	40
Version Upgrade.....	41
Setting Information Export/Import Function (DCM).....	45
Monitoring Function (e-Maintenance/ imageWARE Remote).....	58

Overview of System Management

This chapter describes information for service technicians on the system of this machine. Although this chapter contains some information described in the User's Guide, for details on the functions for users, refer to the e-Manual.

Version Upgrade

Function Overview

The following firmware upgrade methods are available with this device.

Version upgrade using User Support Tool (UST).

Upgrade the firmware of the device using UST

Open the file for UST version upgrade on a PC connected with the device and upgrade the firmware.

Since the host machine and the PC are connected using a USB cable, version upgrades can be performed in an environment where a network is not available.

Version upgrade via Internet

Access the dedicated server, and download and upgrade the firmware.

Provided that Internet connection is available, the system automatically configures the connection destination setting and executes processing such as download and version upgrade.

Version upgrade using a USB flash drive

Upgrade the firmware of this machine using a USB flash drive.

Connect a USB flash drive where the firmware is stored to the device, and update the firmware in service mode.

Version upgrades can be performed in an environment where a PC or network is not available.

Version upgrade by replacing the PCB

Version upgrade by replacing the existing PCB with a PCB where the latest firmware is installed

Version upgrade using Local CDS

Use iW EMC/iW MC and DFU plug-in to download firmware from Local CDS and upgrade the host machine.

NOTE:

When using Local CDS to upgrade it, refer to the manual/material of iW EMC/iW MC DFU plug-in.

CAUTION:

A message appears when an attempt is made to upgrade a host machine to which specified firmware has been applied.

This is a precaution not to use wrong firmware to upgrade a host machine to which specified firmware has been applied.

See the following regarding the combination of whether the message will be displayed:

Type of firmware applied to the host machine	Firmware to upgrade	
	General firmware	Specified firmware
General firmware	No message	No message
Specified firmware	Message displayed	Message displayed

Version Upgrade Using UST

UST is included in the firmware for the machine that can be downloaded from the website of CINC. Firmware is downloaded as a zip file and a folder containing UST is extracted by decompressing the file.

When executing UST on the PC connected to the machine with a USB Cable, the firmware can be upgraded by downloading it from the PC to the machine. For the detailed procedure, refer to "User Support Tool Operation Guide" stored in the decompressed folder. "User Support Tool Operation Guide" is also available on the website of CINC.

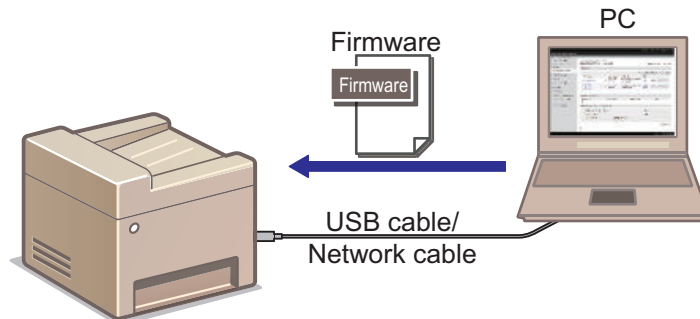

Version Upgrade via Internet

Connect to the Internet using the network function of the device, and download and upgrade the latest firmware from the server. If the device is in an environment where Internet connection is available, firmware versions can be upgraded only by operation from the menu without using PC.

Prerequisite

In order to perform version upgrade of the device via Internet, the following conditions must be met.

There should be no other jobs being executed.

Firmware cannot be upgraded while there is a job being executed. If there is a job being executed, wait for completion of the job and then perform the work.

The device should be able to be connected to the external network.

If connection is not available because, for example, there is a proxy server, follow the e-Manual to configure the proxy server settings and enable connection to the external network.

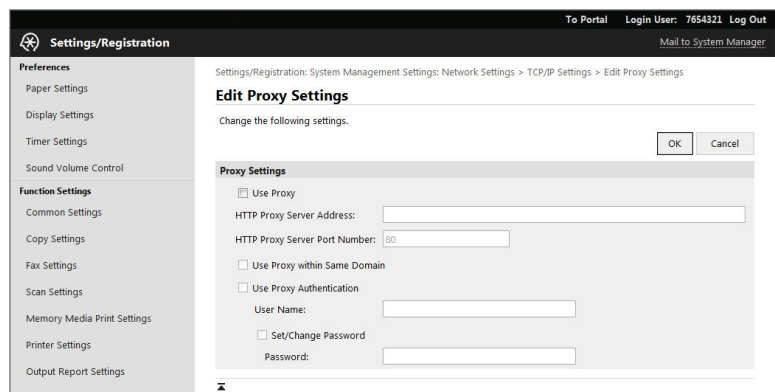

The serial number of the host machine should be shown on the Main Controller PCB.

Whether or not the serial number of the host machine is shown on the Main Controller PCB can be checked from the Control Panel or SPEC REPORT.

Procedure to check from SPEC REPORT

- Execute the following service mode to print SPEC REPORT.
 - COPIER > FUNCTION > MISC-P> SPEC

2. Check if the serial number (3 alphabetical characters + 5-digit number) is shown in [BODY No.] of the printed SPEC REPORT.

***** *** SPEC REPORT *** *****	
Device Info	ZZ999 Series
ROM Version	
MAIN	00.75
BOOT	00.25
LANG	01.36
ECONT	00.10
PANEL	05.01
Device Code	A0000000
Locale	9
Version TVno	0
BODY No.	ZZZ99999
Factory Flag	12345678

■ Procedure for Upgrading the Firmware via Internet

1. Select the following menu to upgrade the firmware via Internet:

- [Management Settings] > [Remote UI Settings/Update Firmware] > [Update Firmware] > [Via Internet] > [Yes]
- When the upgrading of firmware is completed, the machine automatically restarts.

2. Select the following menu, and check that the firmware has been correctly upgraded:

- [Management Settings] > [Remote UI Settings/Update Firmware] > [Update Firmware] > [Version Information]

CAUTION:

This function does not support the operations from remote UI. ([Update Firmware] does not exist in the [System Management Settings] menu of the remote UI.)

■ Messages

The message displayed on the device operation panel is as follows.

No	Error message	The timing of occurrence	Remedy
1	Job in progress... Wait a moment, then try again.	If there is a job being executed:	1. Wait until the job is completed. 2. Cancel the job.
2	Cannot check the firmware version. (Server communication error.)	Network error	1. Check whether the device can be connected to the external network. 2. Check whether the proxy setting has been made (in case of access via a proxy server).
3	Cannot download the firmware. (Error during download.)		1. Check whether the device can be connected to the external network. 2. Check whether the proxy setting has been made (in case of access via a proxy server). 3. Check that the serial number of the host machine is shown on the Main Controller PCB.
4	***DOWNLOAD MODE*** NETWORK AVAILABLE IP ADDRESS IP address of the machine PRESS STOP KEY TO EXIT	If update (writing) of the firmware has ended in failure:	1. Update the firmware again using UST.
5	***DOWNLOAD MODE*** FAILED TO UPDATE		
6	***DOWNLOAD MODE*** UPDATE IS COMPLETE	If the update of the firmware is successful	-

● Version Upgrade Using USB

Connect a USB flash drive where the firmware is stored to this machine, and update the firmware in service mode.

■ Prerequisite

In order to perform version upgrade of the machine using a USB flash drive, the following conditions must be met.

There should be no other jobs being executed.

Firmware cannot be upgraded while there is a job being executed. If there is a job being executed, wait for completion of the job and then perform the work.

■ Procedure for Upgrading the Firmware Using a USB Flash Drive

1. **Connect a USB flash drive where the firmware is stored to this machine.**
2. **Execute one of the following service modes.**
 - COPIER > FUNCTION > SYSTEM > DOWNLOAD
 - COPIER > FUNCTION > SYSTEM > DOWNLOAD_FORCE

NOTE:

If you want to apply only firmware that is newer than the firmware currently applied in the machine, execute DOWNLOAD. If you want to apply all the firmware contained in the USB flash drive regardless of whether it is newer or older, execute DOWNLOAD_FORCE.

3. **The signature data of the downloaded file is verified, and download instruction information is written to the designated area of the flash memory only if the verification result is correct.**
4. **The machine is automatically restarted.**
5. **When the upgrading of firmware is completed, the machine automatically restarts.**

Setting Information Export/Import Function (DCM)

Overview

Various data is stored in the storage inside the device.

Depending on the works to be done such as replacing parts, this data needs to be backed up and restored.

There are some ways to back up and restore data, and the appropriate one should be used depending on the purpose and storage destination.

This section describes the procedure for backing up and restoring service mode setting values.

For the procedure for backing up and restoring other information, refer to the e-Manual.

Function Overview

This machine has a setting information export/import function (hereinafter referred to as DCM (Device Configuration Management) function) which exports/imports the machine's setting value information as a file. The file exported/imported using the DCM function is called a DCM file, and the target setting information is as follows:

- Setting information of the menu ([Settings/Registration] menu)
- Service mode setting information
- Address Book

The DCM file is exported to a USB flash drive or PC local disk from the Control Panel or remote UI.

The exported DCM file can be returned to the original device or imported to a different device.

When the file is returned to the original device, this can be used as a function to back up the settings, and when the file is imported to a different device, this can be used as a function to copy setting information.

Data can also be imported to or exported from an iR-ADV machine by using iW EMC/MC DCM Plug-in.

In the case of the setting value backup function before implementation of the DCM function, an exported file could be imported only to the same device, but the DCM function enables import of an exported file to a different device.

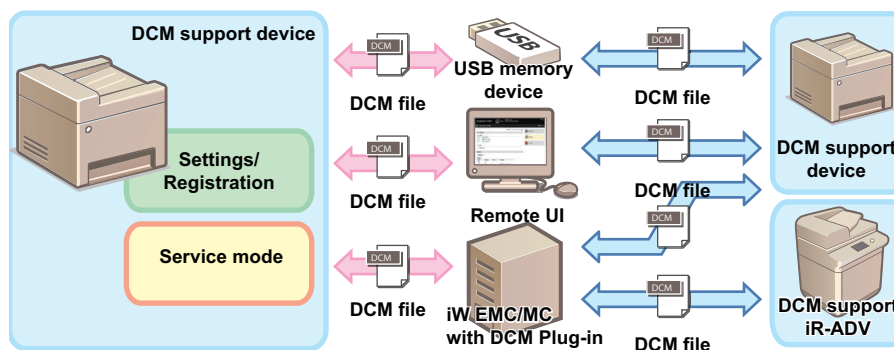

Conceptual diagram

NOTE:

In order to export or import setting information using DCM, it is necessary that the device supports DCM.

Backup/Restoration for Service Technicians

Backup and Restoration from the Menu ([Settings/Registration] Menu)

Setting information can be backed up and restored from the Control Panel of the device or from the menu ([Settings/Registration] menu) of remote UI.

Although the menu ([Settings/Registration] menu) is for users, the service mode settings information can be backed up and restored from the Import/Export function by changing the service mode setting.

The service mode settings information can be backed up and restored only by accessing from the remote UI [Settings/Registration] menu.

Backup/Restoration Using Service Mode

Some of the functions in service mode can be used to backup and restore data.

Setting value information and service counter (DC-CON) values can be backed up and restored.

■ Combination of Information Exported/Imported by DCM, Means, and Storage Locations

A DCM file is exported and imported using the Control Panel, remote UI, or the iW EMC server, depending on the situation of the site.

The information exported/imported differs depending on the means.

Combinations of them are shown in the following table.

Menu used	Operation	Information exported			Save destination
		Setting values of menu options	Address book ^{**1}	Service mode setting values	
[Settings/Registration] menu	Control panel	Yes (fixed) ^{*2}	Yes (fixed) ^{*2}	No	USB flash drive
	Remote UI	Yes	Yes	With conditions ^{*3}	USB flash drive
Service mode	Control panel	No	No	Yes	USB flash drive / Storage in the host machine
	Remote UI	No	No	Yes	PC local disk

■ Compatibility of Data

The following table shows compatibility of data in the case where the device from which the data is exported and the device to which the data is imported differ in model and/or serial number.

For items that are imported in Cases A, B, and C, refer to “List of Items Which Can Be Imported” on page 51.

Model	Serial number	Import process
Same	Same	Items corresponding to Case A are imported. ^{*4}
Same	Different ^{*5}	Items corresponding to Case B are imported. ^{*4}
Different	Different ^{*5}	Items corresponding to Case C are imported. ^{*6}
Different	Same	The file is judged to be invalid, and the process ends with an error.

■ Replacement Mode

When this function is used for migrating the setting data upon replacement of a device, some of the data cannot be migrated depending on the model to which the data is migrated.

When this function is used in normal mode, data that is applicable to either Case B (of different serial number) or Case C (of different mode) cannot be imported.

When replacement mode of the device to which the data is imported is enabled, data can be forcibly migrated even to a device of a different serial number or even between different models.

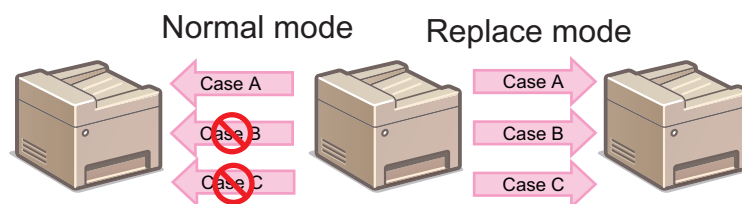

^{*1}. Models without address books are excluded. In the case of a fax option model without SEND function, address books are exported only if a fax option is connected with the device.

^{*2}. When the [Settings/Registration] menu is used from the Control Panel, both the setting menu information and the address book are imported/exported. It is not possible to export/import only either of them. Information which is not included in the data to be imported is not imported.

^{*3}. Service mode is added to the data to be exported only when service mode COPIER > OPTION > USER > SMD-EXPT is set. For information on items that are imported, refer to “List of Items Which Can Be Imported” on page 51.

^{*4}. If the firmware version at the time of import differs from that at the time of export, predetermined corrective processing may be performed.

^{*5}. If a serial number is missing, the serial numbers are judged to be mismatched.

^{*6}. Predetermined corrective processing may be performed.

The following shows the procedure to turn ON replacement mode of the device to which the data is imported:

1. Set the following service mode setting value to "1":

- COPIER > OPTION > USER > RPL-IMP

NOTE:

Refer to "List of Items Which Can Be Imported" on page 51 for the target data of replacement mode.

CAUTION:

Since replacement mode is not lifted automatically, the setting value of the foregoing service mode needs to be changed back to "0" to return to normal mode.

Import/Export Procedure from [Settings/Registration] of Remote UI

This section describes the procedure for backing up and restoring service mode setting information by using the [Import/Export] function in the [Settings/Registration] menu of Remote UI.

CAUTION:

- The service mode setting information can be backed up and restored only from the [Settings/Registration] menu on Remote UI, and the operation cannot be performed from the [Settings/Registration] menu on the Control Panel.
- In the case of backing up and restoring only the setting information of the [Settings/Registration] menu or the address book, refer to the procedure described in the e-Manual.

■ Limitations

The following limitations exist when backing up and restoring the service mode settings information from the [Settings/Registrations] menu of remote UI.

A job must not be accepted during an import/export processing.

Except for the calibration requested by the engine, a job is not allowed to be accepted during a processing. In addition, import/export must not be performed during execution of a job.

Firmware must not be updated during an import/export processing.

Fax cannot be received while firmware is updated during a processing. In addition, import/export must not be performed also during firmware update.

Power must not be turned off during an import/export processing.

If power discontinuity occurs during an import processing, a rollback processing is not performed, therefore the settings imported up to that point are reflected while the rest of the settings remain as-is.

When power discontinuity occurs during an export processing, export is not executed.

■ Procedure for Export from Remote UI ([System Management Settings] Menu)

Service mode setting information can be exported from the [System Management Settings] menu by setting the following service mode setting value to "1".

1. Enter service mode, and set the following item to "1".

- COPIER > OPTION > USER > SMD-EXPT

NOTE:

The [SMD-EXPT] setting can be configured either from the Control Panel or from the remote UI.

2. Exit service mode, start remote UI, log in as a system administrator, and then select the following item:

- [Settings/Registration] > [Import/Export] > [Export]

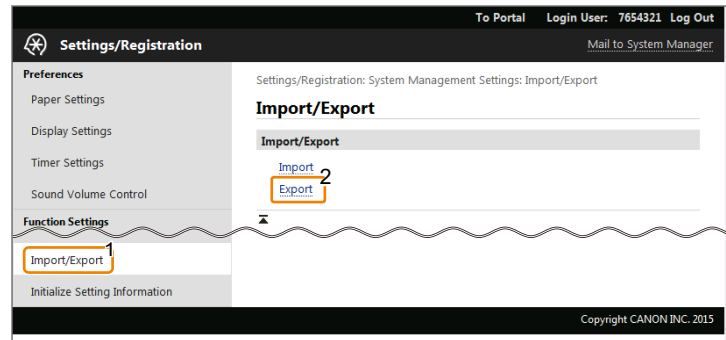

3. After confirming that [Service Mode] is displayed/selected in [Select Item to Export], enter the password and click [Start Exporting].

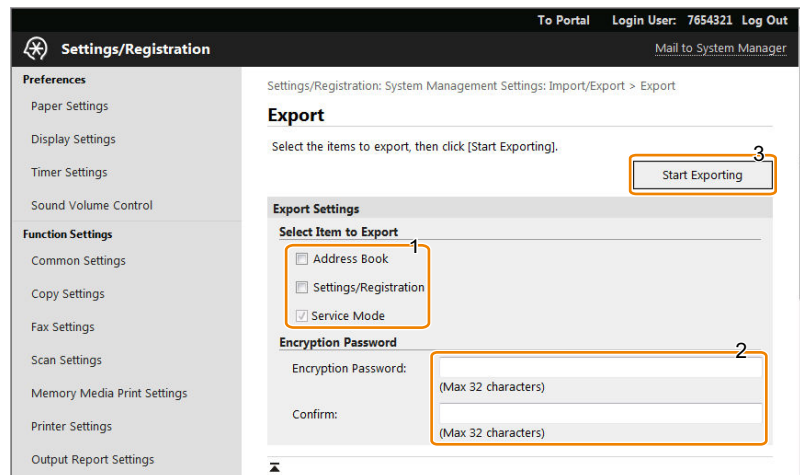

Address Book

Select the check box to export the address book data.

Settings/Registration

Select this check box to import the menu option data.

Encryption password

Enter 32 or less numeric characters set when the file was exported.

4. The file download dialog box will appear. Save the file to any location.
5. Enter service mode, and set the following item to "0".
- COPIER > OPTION > USER > SMD-EXPT

CAUTION:

Since the screen of export function can also be accessed by the user, be sure to disable the [SMD-EXPT] setting (setting value: 0).

■ Procedure for Import from Remote UI ([System Management Settings] Menu)

Import the service mode setting information file that was exported in the previous procedure.

1. Enter service mode, and set the following item to "1".
- COPIER > OPTION > USER > SMD-EXPT

NOTE:

The [SMD-EXPT] setting can be configured either from the Control Panel or from the remote UI.

2. Exit service mode, start remote UI, log in as a system administrator, and then select the following item:

- [Settings/Registration] > [Import/Export] > [Import]

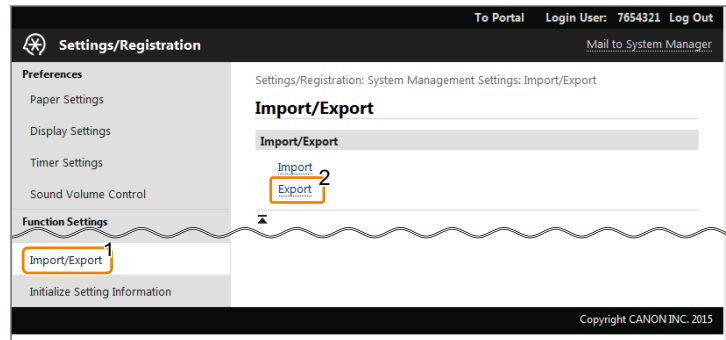

3. Configure the import settings, and click [Start Importing].

Entering the password and clicking [Start Importing] imports the menu option data.

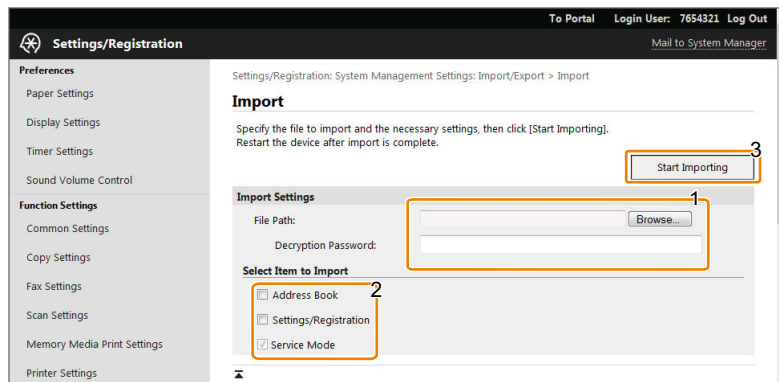

[Browse...] button

Click to select the file to import.

Decryption password

Enter 32 or less numeric characters set when the file was exported.

Address Book

Select the check box to import the address book data.

Settings/Registration

Select this check box to import the menu option data.

4. Click [OK] when a dialog box confirming whether you want to execute the import process is displayed.

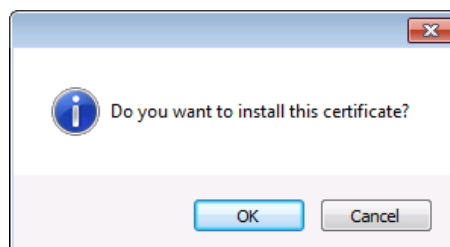

5. When a message indicating completion of the processing appears, click [OK].



6. Restart this machine, enter service mode, and confirm that the setting information is reflected. This completes the procedure for importing a setting information file.
7. Enter service mode, and set the following item to "0".
 - COPIER > OPRION > USER > SMD-EXPT

CAUTION:

Since the screen of export function can also be accessed by the user, be sure to disable the [SMD-EXPT] setting (setting value: 0).

Procedure for Exporting/Importing Service Mode Setting Information

Service mode setting information can be backed up and restored by using service mode functions. The backup file can be saved to a USB flash drive or a storage in the machine.

Backup/restoration to a USB flash drive

COPIER > FUNCTION > SYSTEM > EXPORT
COPIER > FUNCTION > SYSTEM > IMPORT

Backup/restoration to a storage in the machine

COPIER > FUNCTION > SYSTEM > SAVE-SM
COPIER > FUNCTION > SYSTEM > RSTR-SM

	Backup/restoration to a USB flash drive	Backup/restoration to a storage in the machine
Storage destination	USB flash drive	Storage in the machine
Number of files saved	Depends on the capacity of the USB flash drive	One
Duplication of the setting values for other machines	Possible	Not possible

■ Procedure for Exporting to a USB Flash Drive

Use the service mode function to save the service mode setting information to a USB flash drive.

This operation can be performed both from the Control Panel and remote UI.

The following USB flash drives can be used for export/import.

- USB flash drive in FAT 16 format (storage capacity: 2 GB)
- USB flash drive in FAT 32 format (storage capacity: 32 GB)

Note that the descriptions in parenthesis in the procedure are the descriptions in the case of remote UI.

1. Connect the USB flash drive to the USB Memory Port.
2. Enter service mode, and execute the following service mode.
 - COPIER > FUNCTION > SYSTEM > EXPORT

CAUTION:

Even if the service mode is executed without connecting a USB flash drive, an error is not displayed. It looks as if the process has been completed successfully, but the file has not been exported to anywhere. For the reason shown above, be sure to check before execution that a USB flash drive is connected.

3. The message displayed during the process will disappear. When the display has returned to the original state, remove the USB flash drive.
4. Check that a setting information file (service.dcm) exists in the directory directly under the root of the USB flash drive.

This completes the export of a setting information file.

■ Procedure for Import from USB Flash Drive

1. Save the setting information file (service.dcm) to be imported to directly under the root of the USB flash drive.
2. Connect the USB flash drive to the USB Memory Port.

3. Enter service mode, and execute the following service mode.

- COPIER > FUNCTION > SYSTEM > IMPORT

4. The message displayed during the process will disappear. When the display has returned to the original state, remove the USB flash drive.**5. Restart this machine, enter service mode, and confirm that the setting information is reflected.**

This completes the the import of a setting information file.

■ Backup Procedure to the Storage in the Machine

Use the service mode function to back up the service mode setting information to the storage in the machine.

This operation can be performed both from the Control Panel and remote UI.

The setting information that can be saved in the machine's storage is only one.

1. Enter service mode, and execute the following service mode.

- COPIER > FUNCTION > SYSTEM > SAVE-SM

2. Backup process is complete after checking that the message displayed during the process disappears and the display returns to the original state.

■ Procedure for Restoration from Internal Storage

Restore the service mode setting information that has been backed up to the storage in the machine in the previous procedure.

1. Enter service mode, and execute the following service mode.

- COPIER > FUNCTION > SYSTEM > RSTR-SM

2. Restoration process is complete after checking that the message displayed during the process disappears and the display returns to the original state.

● List of Items Which Can Be Imported

The following shows the items to be imported for this model.

Note that the setting values are not imported in cases such as below:

- Items which are originally not included in a DCM file (e.g.: "Settings/Registration Basic Information" of a DCM file exported using service mode)
- Not included in the import coverage (Cases A to C)
- There are no options and functions related to setting values

The import coverage shown in the table below is as shown below. Those that are not described here cannot be imported.

Import coverage	Description
Case A: The same machine	Import to the same machine (for backup and restoration, etc.)
Case B: The same model	Import to a different machine of the same model (the same series)
Case C: Different model	Import to a different machine of a different model (a different series)

■ Service Mode Settings

Initial screen	Main item	Intermediate item	Sub item	Case A	Case B	Case C
COPIER	ADJUST	FEED-ADJ	ADJ-MFY	Yes	-	-
COPIER	ADJUST	FEED-ADJ	ADJ-MFX	Yes	-	-
COPIER	ADJUST	FEED-ADJ	ADJ-MFYR	Yes	-	-
COPIER	ADJUST	FEED-ADJ	ADJ-MFXR	Yes	-	-
COPIER	ADJUST	FEED-ADJ	ADJ-C1Y	Yes	-	-
COPIER	ADJUST	FEED-ADJ	ADJ-C1X	Yes	-	-
COPIER	ADJUST	FEED-ADJ	ADJ-C1YR	Yes	-	-
COPIER	ADJUST	FEED-ADJ	ADJ-C1XR	Yes	-	-
COPIER	ADJUST	FEED-ADJ	ADJ-C2Y	Yes	-	-
COPIER	ADJUST	FEED-ADJ	ADJ-C2X	Yes	-	-
COPIER	ADJUST	FEED-ADJ	ADJ-C2YR	Yes	-	-

3. Technical Explanation (System)

Initial screen	Main item	Intermediate item	Sub item	Case A	Case B	Case C
COPIER	ADJUST	FEED-ADJ	ADJ-C2XR	Yes	-	-
COPIER	ADJUST	VIFADJ	DEV-HV-Y	Yes	-	-
COPIER	ADJUST	VIFADJ	DEV-HV-M	Yes	-	-
COPIER	ADJUST	VIFADJ	DEV-HV-C	Yes	-	-
COPIER	ADJUST	VIFADJ	DEV-HV-K	Yes	-	-
COPIER	ADJUST	VIFADJ	TR2SF-HV	Yes	-	-
COPIER	ADJUST	VIFADJ	TR2BK-HV	Yes	-	-
COPIER	ADJUST	VIFADJ	ICL-HV	Yes	-	-
COPIER	ADJUST	VIFADJ	FU-TMP	Yes	-	-
COPIER	ADJUST	SCNR	SUB-S-Y0	Yes	-	-
COPIER	ADJUST	SCNR	SUB-S-M0	Yes	-	-
COPIER	ADJUST	SCNR	SUB-S-C0	Yes	-	-
COPIER	ADJUST	SCNR	SUB-S-K0	Yes	-	-
COPIER	ADJUST	SCNR	SUB-S-Y1	Yes	-	-
COPIER	ADJUST	SCNR	SUB-S-M1	Yes	-	-
COPIER	ADJUST	SCNR	SUB-S-C1	Yes	-	-
COPIER	ADJUST	SCNR	SUB-S-K1	Yes	-	-
COPIER	ADJUST	SCNR	SUB-S-Y2	Yes	-	-
COPIER	ADJUST	SCNR	SUB-S-M2	Yes	-	-
COPIER	ADJUST	SCNR	SUB-S-C2	Yes	-	-
COPIER	ADJUST	SCNR	SUB-S-K2	Yes	-	-
COPIER	ADJUST	SCNR	MAI-S-Y0	Yes	-	-
COPIER	ADJUST	SCNR	MAI-S-M0	Yes	-	-
COPIER	ADJUST	SCNR	MAI-S-C0	Yes	-	-
COPIER	ADJUST	SCNR	MAI-S-K0	Yes	-	-
COPIER	ADJUST	SCNR	MAI-S-Y1	Yes	-	-
COPIER	ADJUST	SCNR	MAI-S-M1	Yes	-	-
COPIER	ADJUST	SCNR	MAI-S-C1	Yes	-	-
COPIER	ADJUST	SCNR	MAI-S-K1	Yes	-	-
COPIER	ADJUST	SCNR	MAI-S-Y2	Yes	-	-
COPIER	ADJUST	SCNR	MAI-S-M2	Yes	-	-
COPIER	ADJUST	SCNR	MAI-S-C2	Yes	-	-
COPIER	ADJUST	SCNR	MAI-S-K2	Yes	-	-
COPIER	FUNCTION	VIFFNC	SMEAR-PV	Yes	-	-
COPIER	FUNCTION	VIFFNC	FEED-IMP	Yes	-	-
COPIER	FUNCTION	VIFFNC	ICL-IMP	Yes	-	-
COPIER	FUNCTION	SPLMAN	SPL14159	Yes	Yes	Yes
COPIER	FUNCTION	SPLMAN	SPL37510	Yes	-	-
COPIER	FUNCTION	SPLMAN	SPL65677	Yes	-	-
COPIER	FUNCTION	SPLMAN	SPL68676	Yes	-	-
COPIER	FUNCTION	SPLMAN	SPL68677	Yes	-	-
COPIER	FUNCTION	SPLMAN	SPL25607	Yes	-	-
COPIER	FUNCTION	SPLMAN	SPL93822	Yes	Yes	Yes
COPIER	FUNCTION	SPLMAN	SPL78788	Yes	Yes	Yes
COPIER	FUNCTION	SPLMAN	SPL15176	Yes	-	-
COPIER	FUNCTION	SPLMAN	SPL71100 *1	Yes	-	-
COPIER	FUNCTION	SPLMAN	SPL00171	Yes	Yes	Yes
COPIER	FUNCTION	SPLMAN	SPL80100	Yes	Yes	Yes
COPIER	FUNCTION	SPLMAN	SPL84194	Yes	Yes	Yes
COPIER	FUNCTION	INSTALL	ERDS	Yes	Yes	Yes
COPIER	FUNCTION	INSTALL	RGW-PORT	Yes	Yes	Yes

*1. FAX model only

Initial screen	Main item	Intermediate item	Sub item	Case A	Case B	Case C
COPIER	OPTION	BODY	MIBCOUNT	Yes	Yes	Yes
COPIER	OPTION	BODY	NS-CMD5	Yes	-	-
COPIER	OPTION	BODY	NS-PLN	Yes	-	-
COPIER	OPTION	BODY	NS-LGN	Yes	-	-
COPIER	OPTION	BODY	SLPMODE	Yes	Yes	Yes
COPIER	OPTION	BODY	SDTM-DSP	Yes	Yes	Yes
COPIER	OPTION	FNC-SW	IMGCNTPR	Yes	Yes	Yes
COPIER	OPTION	FNC-SW	LCDSFLG	Yes	Yes	Yes
COPIER	OPTION	FNC-SW	CRG-PROC	Yes	Yes	-
COPIER	OPTION	FNC-SW	CRGLF-K	Yes	Yes	-
COPIER	OPTION	FNC-SW	CRGLF-CL	Yes	Yes	-
COPIER	OPTION	DSPLY-SW	CRGLW-LV	Yes	Yes	Yes
COPIER	OPTION	IMG-MCON	TMIC-BK	Yes	-	-
COPIER	OPTION	IMG-MCON	TMIC-CMY	Yes	-	-
COPIER	OPTION	USER	CTCHKDSP	Yes	-	-
COPIER	OPTION	USER	SMD-EXPT	Yes	-	-
COPIER	OPTION	USER	ACC-SLP	Yes	Yes	Yes
Fax	SSSW	SW01 *1	-	Yes	-	-
Fax	SSSW	SW02 *1	-	Yes	-	-
Fax	SSSW	SW03 *1	-	Yes	-	-
Fax	SSSW	SW04 *1	-	Yes	-	-
Fax	SSSW	SW05 *1	-	Yes	-	-
Fax	SSSW	SW06 *1	-	Yes	-	-
Fax	SSSW	SW07 *1	-	Yes	-	-
Fax	SSSW	SW08 *1	-	Yes	-	-
Fax	SSSW	SW09 *1	-	Yes	-	-
Fax	SSSW	SW10 *1	-	Yes	-	-
Fax	SSSW	SW11 *1	-	Yes	-	-
Fax	SSSW	SW12 *1	-	Yes	-	-
Fax	SSSW	SW13 *1	-	Yes	-	-
Fax	SSSW	SW14 *1	-	Yes	-	-
Fax	SSSW	SW15 *1	-	Yes	-	-
Fax	SSSW	SW16 *1	-	Yes	-	-
Fax	SSSW	SW17 *1	-	Yes	-	-
Fax	SSSW	SW18 *1	-	Yes	-	-
Fax	SSSW	SW19 *1	-	Yes	-	-
Fax	SSSW	SW20 *1	-	Yes	-	-
Fax	SSSW	SW21 *1	-	Yes	-	-
Fax	SSSW	SW22 *1	-	Yes	-	-
Fax	SSSW	SW23 *1	-	Yes	-	-
Fax	SSSW	SW24 *1	-	Yes	-	-
Fax	SSSW	SW25 *1	-	Yes	-	-
Fax	SSSW	SW26 *1	-	Yes	-	-
Fax	SSSW	SW27 *1	-	Yes	-	-
Fax	SSSW	SW28 *1	-	Yes	-	-
Fax	SSSW	SW29 *1	-	Yes	-	-
Fax	SSSW	SW30 *1	-	Yes	-	-
Fax	SSSW	SW31 *1	-	Yes	-	-
Fax	SSSW	SW32 *1	-	Yes	-	-

*1. FAX model only

Initial screen	Main item	Intermediate item	Sub item	Case A	Case B	Case C
Fax	MENU	005 *1	-	Yes	-	-
Fax	MENU	006 *1	-	Yes	-	-
Fax	MENU	007 *1	-	Yes	-	-
Fax	MENU	008 *1	-	Yes	-	-
Fax	MENU	009 *1	-	Yes	-	-
Fax	MENU	010 *1	-	Yes	-	-
Fax	NUM	002 *1	-	Yes	-	-
Fax	NUM	003 *1	-	Yes	-	-
Fax	NUM	004 *1	-	Yes	-	-
Fax	NUM	005 *1	-	Yes	-	-
Fax	NUM	006 *1	-	Yes	-	-
Fax	NUM	008 *1	-	Yes	-	-
Fax	NUM	010 *1	-	Yes	-	-
Fax	NUM	011 *1	-	Yes	-	-
Fax	NUM	012 *1	-	Yes	-	-
Fax	NUM	013 *1	-	Yes	-	-
Fax	NUM	015 *1	-	Yes	-	-
Fax	NUM	016 *1	-	Yes	-	-
Fax	NUM	017 *1	-	Yes	-	-
Fax	NUM	018 *1	-	Yes	-	-
Fax	NUM	019 *1	-	Yes	-	-
Fax	NUM	020 *1	-	Yes	-	-
Fax	NUM	021 *1	-	Yes	-	-
Fax	NUM	022 *1	-	Yes	-	-
Fax	NUM	023 *1	-	Yes	-	-
Fax	NUM	024 *1	-	Yes	-	-
Fax	NUM	025 *1	-	Yes	-	-
Fax	NUM	026 *1	-	Yes	-	-
Fax	NUM	027 *1	-	Yes	-	-
Fax	NUM	029 *1	-	Yes	-	-
Fax	NUM	049 *1	-	Yes	-	-
Fax	NUM	051 *1	-	Yes	-	-
Fax	NUM	053 *1	-	Yes	-	-
Fax	NUM	054 *1	-	Yes	-	-
Fax	NCU	TONE	001 *1	Yes	-	-
Fax	NCU	TONE	002 *1	Yes	-	-
Fax	NCU	PULSE	FORM *1	Yes	-	-
Fax	NCU	PULSE	001 *1	Yes	-	-
Fax	NCU	PULSE	002 *1	Yes	-	-
Fax	NCU	PULSE	003 *1	Yes	-	-
Fax	NCU	PULSE	004 *1	Yes	-	-
Fax	NCU	DIALTONE	BIT *1	Yes	-	-
Fax	NCU	DIALTONE	001 *1	Yes	-	-
Fax	NCU	DIALTONE	002 *1	Yes	-	-
Fax	NCU	DIALTONE	003 *1	Yes	-	-
Fax	NCU	DIALTONE	004 *1	Yes	-	-
Fax	NCU	DIALTONE	005 *1	Yes	-	-

*1. FAX model only

Initial screen	Main item	Intermediate item	Sub item	Case A	Case B	Case C
Fax	NCU	DIALTONE	006 *1	Yes	-	-
Fax	NCU	DIALTONE	007 *1	Yes	-	-
Fax	NCU	DIALTONE	008 *1	Yes	-	-
Fax	NCU	2ND DLTN	BIT *1	Yes	-	-
Fax	NCU	2ND DLTN	001 *1	Yes	-	-
Fax	NCU	2ND DLTN	002 *1	Yes	-	-
Fax	NCU	2ND DLTN	003 *1	Yes	-	-
Fax	NCU	2ND DLTN	004 *1	Yes	-	-
Fax	NCU	2ND DLTN	005 *1	Yes	-	-
Fax	NCU	2ND DLTN	006 *1	Yes	-	-
Fax	NCU	2ND DLTN	007 *1	Yes	-	-
Fax	NCU	2ND DLTN	008 *1	Yes	-	-
Fax	NCU	BUSTONE0	BIT *1	Yes	-	-
Fax	NCU	BUSTONE0	001 *1	Yes	-	-
Fax	NCU	BUSTONE0	002 *1	Yes	-	-
Fax	NCU	BUSTONE0	003 *1	Yes	-	-
Fax	NCU	BUSTONE0	004 *1	Yes	-	-
Fax	NCU	BUSTONE0	005 *1	Yes	-	-
Fax	NCU	BUSTONE0	006 *1	Yes	-	-
Fax	NCU	BUSTONE0	007 *1	Yes	-	-
Fax	NCU	BUSTONE0	008 *1	Yes	-	-
Fax	NCU	BUSTONE1	BIT *1	Yes	-	-
Fax	NCU	BUSTONE1	001 *1	Yes	-	-
Fax	NCU	BUSTONE1	002 *1	Yes	-	-
Fax	NCU	BUSTONE1	003 *1	Yes	-	-
Fax	NCU	BUSTONE1	004 *1	Yes	-	-
Fax	NCU	BUSTONE1	005 *1	Yes	-	-
Fax	NCU	BUSTONE1	006 *1	Yes	-	-
Fax	NCU	BUSTONE1	007 *1	Yes	-	-
Fax	NCU	BUSTONE1	008 *1	Yes	-	-
Fax	NCU	REORDRTN	BIT *1	Yes	-	-
Fax	NCU	REORDRTN	001 *1	Yes	-	-
Fax	NCU	REORDRTN	002 *1	Yes	-	-
Fax	NCU	REORDRTN	003 *1	Yes	-	-
Fax	NCU	REORDRTN	004 *1	Yes	-	-
Fax	NCU	REORDRTN	005 *1	Yes	-	-
Fax	NCU	REORDRTN	006 *1	Yes	-	-
Fax	NCU	REORDRTN	007 *1	Yes	-	-
Fax	NCU	REORDRTN	008 *1	Yes	-	-
Fax	NCU	AUTO RX	001 *1	Yes	-	-
Fax	NCU	AUTO RX	002 *1	Yes	-	-
Fax	NCU	AUTO RX	003 *1	Yes	-	-
Fax	NCU	AUTO RX	004 *1	Yes	-	-
Fax	NCU	AUTO RX	005 *1	Yes	-	-
Fax	NCU	AUTO RX	006 *1	Yes	-	-
Fax	NCU	AUTO RX	007 *1	Yes	-	-
Fax	NCU	AUTO RX	008 *1	Yes	-	-

*1. FAX model only

Initial screen	Main item	Intermediate item	Sub item	Case A	Case B	Case C
Fax	NCU	AUTO RX	009 *1	Yes	-	-
Fax	NCU	CNGDTCT	001 *1	Yes	-	-
Fax	NCU	CNGDTCT	002 *1	Yes	-	-
Fax	NCU	CNGDTCT	006 *1	Yes	-	-
Fax	NCU	CNGDTCT	007 *1	Yes	-	-
Fax	NCU	CNGDTCT	008 *1	Yes	-	-
Fax	NCU	CNGDTCT	009 *1	Yes	-	-
Fax	NCU	CNGDTCT	011 *1	Yes	-	-
Fax	NCU	CNGDTCT	012 *1	Yes	-	-
Fax	NCU	SPECIALB	SW01 *1	Yes	-	-
Fax	NCU	SPECIALB	SW02 *1	Yes	-	-
Fax	NCU	SPECIALB	SW03 *1	Yes	-	-
Fax	NCU	SPECIALB	SW04 *1	Yes	-	-
Fax	NCU	SPECIALB	SW05 *1	Yes	-	-
Fax	NCU	SPECIALB	SW06 *1	Yes	-	-
Fax	NCU	SPECIALB	SW07 *1	Yes	-	-
Fax	NCU	SPECIALB	SW08 *1	Yes	-	-
Fax	NCU	SPECIALB	SW09 *1	Yes	-	-
Fax	NCU	SPECIALB	SW10 *1	Yes	-	-
Fax	NCU	SPECIALB	SW11 *1	Yes	-	-
Fax	NCU	SPECIALB	SW12 *1	Yes	-	-
Fax	NCU	SPECIALB	SW13 *1	Yes	-	-
Fax	NCU	SPECIALB	SW14 *1	Yes	-	-
Fax	NCU	SPECIALB	SW15 *1	Yes	-	-
Fax	NCU	SPECIALB	SW16 *1	Yes	-	-
Fax	NCU	SPECIALB	SW17 *1	Yes	-	-
Fax	NCU	SPECIALB	SW18 *1	Yes	-	-
Fax	NCU	SPECIALB	SW19 *1	Yes	-	-
Fax	NCU	SPECIALB	SW20 *1	Yes	-	-
Fax	NCU	SPECIALB	SW21 *1	Yes	-	-
Fax	NCU	SPECIALB	SW22 *1	Yes	-	-
Fax	NCU	SPECIALB	SW23 *1	Yes	-	-
Fax	NCU	SPECIALB	SW24 *1	Yes	-	-
Fax	NCU	SPECIALB	SW25 *1	Yes	-	-
Fax	NCU	SPECIALB	SW26 *1	Yes	-	-
Fax	NCU	SPECIALB	SW27 *1	Yes	-	-
Fax	NCU	SPECIALB	SW28 *1	Yes	-	-
Fax	NCU	SPECIALB	SW29 *1	Yes	-	-
Fax	NCU	SPECIALB	SW30 *1	Yes	-	-
Fax	NCU	SPECIALN	004 *1	Yes	-	-
Fax	NCU	SPECIALN	005 *1	Yes	-	-
Fax	NCU	SPECIALN	006 *1	Yes	-	-
Fax	NCU	SPECIALN	007 *1	Yes	-	-
Fax	NCU	SPECIALN	008 *1	Yes	-	-
Fax	NCU	SPECIALN	009 *1	Yes	-	-
Fax	NCU	SPECIALN	011 *1	Yes	-	-
Fax	NCU	SPECIALN	012 *1	Yes	-	-

*1. FAX model only

Initial screen	Main item	Intermediate item	Sub item	Case A	Case B	Case C
Fax	NCU	SPECIALN	013 *1	Yes	-	-
Fax	NCU	SPECIALN	014 *1	Yes	-	-
Fax	NCU	SPECIALN	015 *1	Yes	-	-
Fax	NCU	SPECIALN	016 *1	Yes	-	-
Fax	NCU	SPECIALN	017 *1	Yes	-	-
Fax	NCU	SPECIALN	019 *1	Yes	-	-
Fax	NCU	SPECIALN	020 *1	Yes	-	-
Fax	NCU	SPECIALN	024 *1	Yes	-	-
Fax	NCU	SPECIALN	025 *1	Yes	-	-
Fax	NCU	SPECIALN	026 *1	Yes	-	-
Fax	NCU	SPECIALN	027 *1	Yes	-	-
Fax	NCU	SPECIALN	030 *1	Yes	-	-
Fax	NCU	SPECIALN	040 *1	Yes	-	-
Fax	NCU	SPECIALN	041 *1	Yes	-	-
Fax	NCU	SPECIALN	042 *1	Yes	-	-
Fax	NCU	SPECIALN	044 *1	Yes	-	-
Fax	NCU	SPECIALN	045 *1	Yes	-	-
Fax	NCU	SPECIALN	046 *1	Yes	-	-
Fax	NCU	SPECIALN	047 *1	Yes	-	-
Fax	NCU	SPECIALN	048 *1	Yes	-	-
Fax	NCU	SPECIALN	065 *1	Yes	-	-
Fax	NCU	SPECIALN	066 *1	Yes	-	-
Fax	NCU	RKEY	001 *1	Yes	-	-
Fax	NCU	RKEY	002 *1	Yes	-	-
Fax	NCU	PBXDIALT	BIT *1	Yes	-	-
Fax	NCU	PBXDIALT	001 *1	Yes	-	-
Fax	NCU	PBXDIALT	002 *1	Yes	-	-
Fax	NCU	PBXDIALT	003 *1	Yes	-	-
Fax	NCU	PBXDIALT	004 *1	Yes	-	-
Fax	NCU	PBXDIALT	005 *1	Yes	-	-
Fax	NCU	PBXDIALT	006 *1	Yes	-	-
Fax	NCU	PBXDIALT	007 *1	Yes	-	-
Fax	NCU	PBXDIALT	008 *1	Yes	-	-
Fax	NCU	PBXBUSYT	BIT *1	Yes	-	-
Fax	NCU	PBXBUSYT	001 *1	Yes	-	-
Fax	NCU	PBXBUSYT	002 *1	Yes	-	-
Fax	NCU	PBXBUSYT	003 *1	Yes	-	-
Fax	NCU	PBXBUSYT	004 *1	Yes	-	-
Fax	NCU	PBXBUSYT	005 *1	Yes	-	-
Fax	NCU	PBXBUSYT	006 *1	Yes	-	-
Fax	NCU	PBXBUSYT	007 *1	Yes	-	-
Fax	NCU	PBXBUSYT	008 *1	Yes	-	-

*1. FAX model only

Monitoring Function (e-Maintenance/imageWARE Remote)

Overview of System

Function Overview

E-RDS (Embedded RDS) is a monitoring program that runs on the host machine. When the monitoring option is enabled by making the setting on this machine, information such as the status change of the machine, counter information, and failure information are collected. The collected device information is sent to a remote maintenance server called UGW (Universal Gateway Server) via Internet.

The information to be monitored is:

- Billing counter
- Parts counter
- ROM version
- Service call error log
- Jam log
- Alarm log
- Change of status (such as status of consumables)

Since the information shown above is customer information, HTTPS/ SOAP protocol is used for communication between the UGW server and the host machine to improve security.

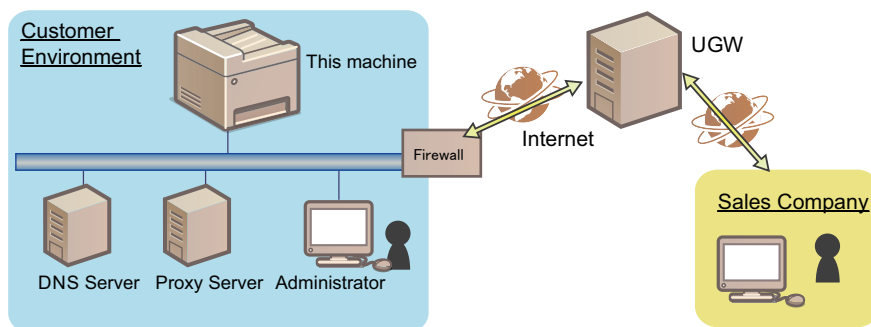

Features

E-RDS is embedded in the network module of the device, and the front-end module of the e-Maintenance/ imageWARE Remote system is realized without requiring hardware besides the device.

Main Functions

Functional category	Sub category	Description
Communication Test	Test	By executing the following service mode, E-RDS communicates with UGW, retrieves schedule information, and establish communication. COPIER > FUNCTION > INSTALL > COM-TEST
Transmission of counters	Billing/all resources/parts/mode-by-mode counters	E-RDS Periodically send billing/all resources/parts/mode-by-mode counters to the server.
Transmission of event logs	Service call/alarm/jam log	Each time a service call, alarm, or jam log occurs, the error log is sent to the server. Having alarm log or not is different by a model.
Data transmission	ROM version / Device configuration	E-RDS periodically sends the firmware information of the device to UGW. E-RDS sends the device configuration information only when there is any change in the configuration.
	E-RDS Debug log	Debug logs of E-RDS are stored in E-RDS, and they are sent to UGW only when they exceed a specific size.
	Sublog transmission	When E-RDS catches the sublog transmission of a message designation than UGW, send data such as device Sublogs and DCON logs to the server.
Operation instruction	Operation check	E-RDS contacts UGW to check if there is processing to be executed next, and receives the following instructions if any. <ul style="list-style-type: none"> • Linkage with CDS • Sublog transmission

Servicing Notes

- After clearing the Main Controller PCB, initialization of the E-RDS setting (ERDS-DAT) and a communication test (COM-TEST) need to be performed. If this work is omitted, an error may occur when counters are sent to UGW. After replacing the Main Controller PCB, all the settings need to be reconfigured.
- Do not change the values of the following service modes unless otherwise instructed. If they are changed, a communication error will occur with UGW.
 - Port number of UGW
[COPIER] > [FUNCTION] > [INSTALL] > [RGW-PORT]
Default: 443
- If the e-Maintenance/imageWARE Remote contract of the device becomes invalid, be sure to turn OFF the E-RDS setting (E-RDS: 0).

Setting Procedure

■ Preparation

Since this function communicates with the UGW server, it is necessary to connect to the external network. Check the following items, and make the settings if not yet set.

- IP address settings
- DNS server settings
- Proxy server settings^{*1}
- Installation of CA certificate (arbitrary ^{*2})

CAUTION:

- Obtain the information on the network environment from the system administrator of the user.
- When having changed the network settings, turn OFF and then ON the main power of the machine.

■ Procedure for Setting E-RDS

1. In the following service mode, select the following service mode to initialize the E-RDS setting values:

- COPIER > FUNCTION > CLEAR > ERDS-DAT

NOTE:

This operation initializes the E-RDS settings to factory setting values.

For the setting values to be initialized, see the section of ["Setting values and data to be initialized"](#) on page 60 .

2. Enable the E-RDS function in the following service mode, and perform a communication test.

1. Select the following item:
 - COPIER > FUNCTION > INSTALL > ERDS
2. Enter [1] from the keyboard, and press [Apply].

CAUTION:

The following settings i.e. RGW-PORT in Service mode must not be change unless there are specific instructions to do so. Changing these values will cause error in communication with UGW.

When the E-RDS function is enabled, the function to communicate with UGW is enabled.

^{*1}. If authentication is necessary, make the settings of the authentication information as well.

^{*2}. When using a certificate other than those pre-installed in the device

3. Select [COM-TEST] and then touch [Yes].

If the communication is successful, "OK" is displayed. If "NG" is displayed, check the network settings and USW server address (URL).

CAUTION:

The communication results with UGW can be distinguished by referring to the COM-LOG. By performing the communication test with UGW, E-RDS acquires schedule information and starts monitoring and meter reads operation.

Maintenance

■ Initializing E-RDS settings

It is possible to clear the FLASH data of E-RDS and change the E-RDS setting back to the default value.

● Initialization procedure

Follow the procedure shown below to initialize E-RDS.

1. Enter service mode as a system administrator user.
2. Select the following service mode, and press [OK] to execute.
 - COPIER > Function > CLEAR > ERDS-DAT

● Setting values and data to be initialized

The following E-RDS settings, internal data, and Alarm filtering information are initialized.

- COPIER > FUNCTION > INSTALL > ERDS
- COPIER > FUNCTION > INSTALL > RGW-PORT
- COPIER > FUNCTION > INSTALL > COM-LOG

CAUTION:

If a certificate other than the CA certificate at the time of shipment has been installed, initializing the E-RDS setting will not change the settings back to those at the time of shipment. To change the certificate back to the CA certificate at the time of shipment, delete the certificate (install the CA certificate at the time of shipment) after initializing the E-RDS settings.

■ Report Output of Communication Error Log (COM-LOG)

A report of communication error log information on five affairs can be output.

● Report output procedure

1. Select the following service mode, and press [Yes].
 - COPIER > FUNCTION > MISC-P > ERDS-LOG

```

12/09 2015 10:14AM
*****
*** E-RDS-COM-LOG***
*****

No.01  DATE    12/09 2015      TIME 03:21 AM   CODE 05000003
Information  SUSPEND: Communication test is not performed.

No.02  DATE    12/09 2015      TIME 03:21 AM   CODE 00000000
Information  SUSPEND: mode changed.

No.03  DATE    12/09 2015      TIME 03:18 AM   CODE 05000003
Information  SUSPEND: Communication test is not performed.

No.04  DATE    12/09 2015      TIME 03:18 AM   CODE 00000000
Information  SUSPEND: mode changed.

No.05  DATE    12/09 2015      TIME 01:56 AM   CODE 05000003
Information  SUSPEND: Communication test is not performed.

```

Output sample



Periodical Service

Periodically Replaced Parts.....	62
Consumable Parts.....	63
Periodical Services.....	64

Periodically Replaced Parts

This machine does not have any periodically replaced parts.

Consumable Parts

This machine does not have any consumable parts.

Periodical Services

This machine does not require any periodical service.



5

Parts Replacement and Cleaning

List of Parts.....	66
External Cover System.....	70
Controller System.....	80
Image Formation System.....	90
Fixing System.....	95
Pickup Feed Delivery System.....	97

List of Parts

Major Units

Host Machine

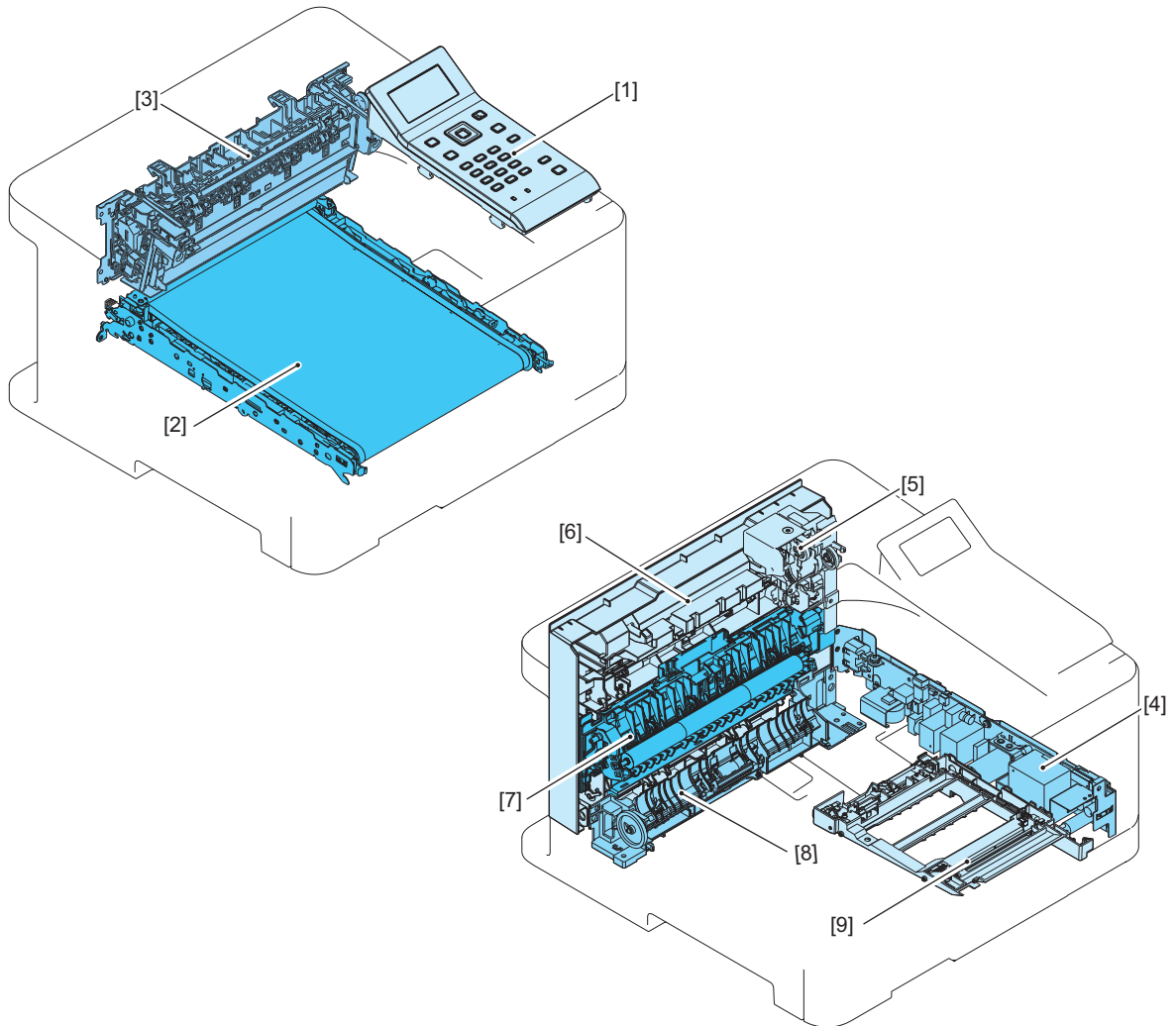

No.	Name
[1]	5-line Control Panel Unit
[2]	ITB Unit
[3]	Fixing Assembly
[4]	Low Voltage Power Supply Unit
[5]	Duplex Reverse Drive Unit
[6]	Rear Cover Unit
[7]	Secondary Transfer Feed Unit
[8]	Pickup Guide
[9]	Multi-purpose Tray Pickup Unit

Layout Drawing of Electrical Components

■ Motor/Fan

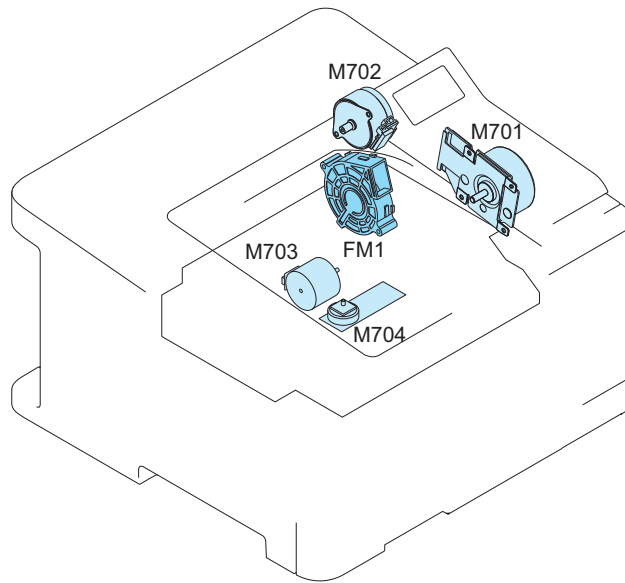

Electric code	Name
FM1	Main Fan
M701	Main Motor
M702	Fixing Motor
M703	Pickup Motor
M704	Scanner Motor

■ Heater

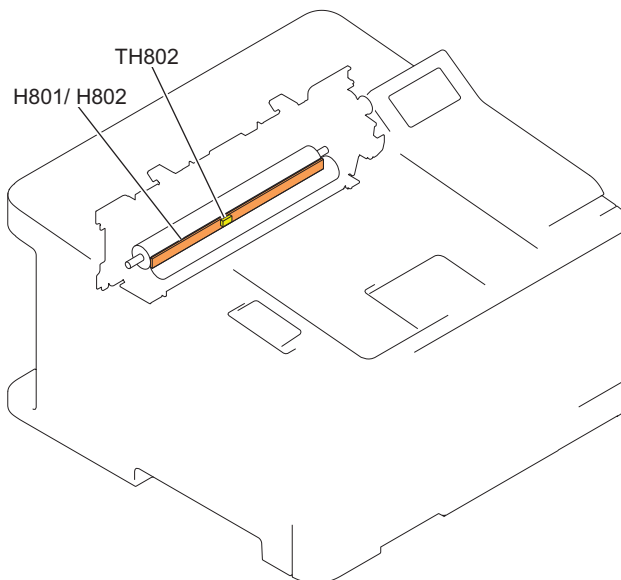

Electric code	Name
H801	Heater (120V)
H802	Heater (200V)
TH802	Thermistor

■ Switch/Solenoid

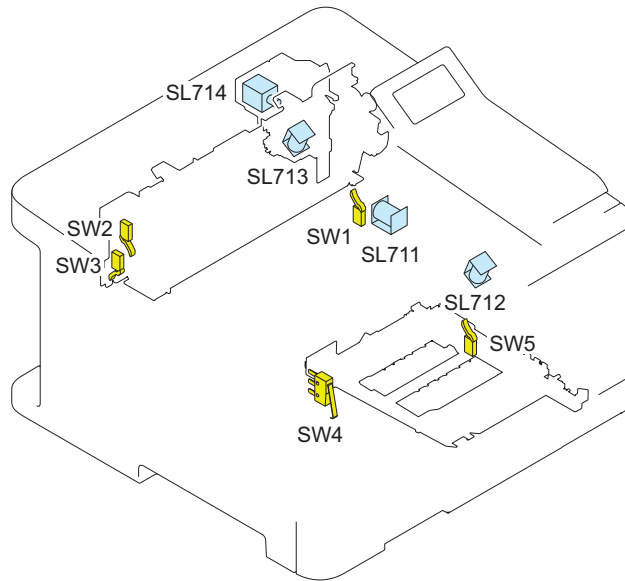

Electric code	Name
SL711	Developing Separation Solenoid
SL712	Pickup Solenoid
SL713	Duplex Re-pickup Solenoid
SL714	Duplex Reverse Solenoid
SW1	Developing HP Switch
SW2	Fixing Pressure Release Switch
SW3	Rear Door Switch (Left)
SW4	Front Door Switch
SW5	MP Pickup Switch

■ Sensor

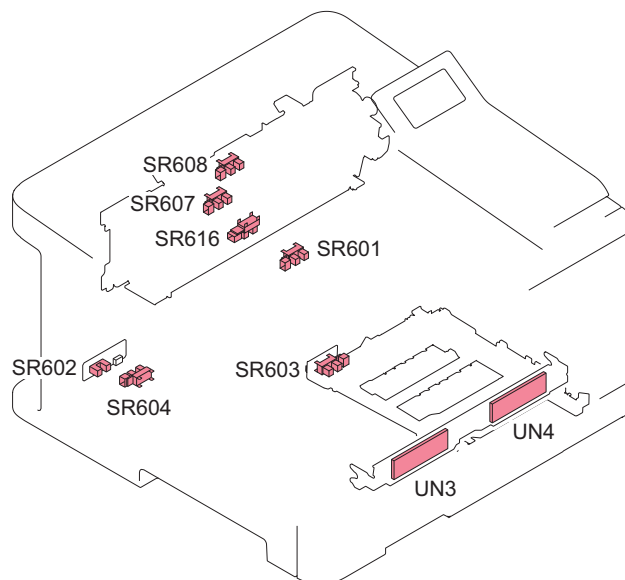

Electric code	Name
SR601	Paper Width Sensor (Right)
SR602	Paper Width Sensor (Left)
SR603	MP Pickup Sensor
SR604	Registration Sensor
SR607	Fixing Delivery Sensor

Electric code	Name
SR608	Delivery Sensor
SR616	Arch Sensor
UN3	Density Sensor
UN4	Color Displacement Sensor

■ PCB

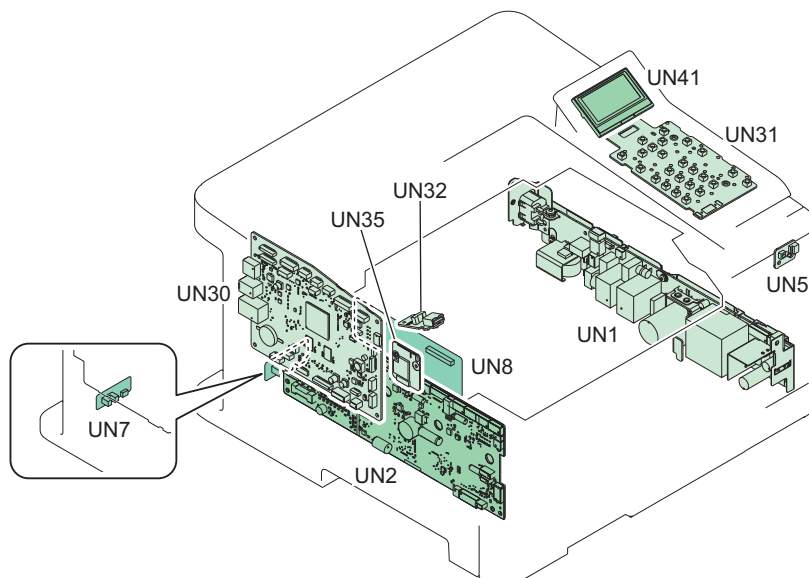

Electric code	Name
UN1	Low Voltage Power Supply Unit
UN2	Engine Controller PCB
UN5	Power Switch PCB
UN7	Environment Sensor
UN8	Laser Driver/ BD PCB
UN30	Main Controller PCB
UN31	Control Panel PCB
UN32	USB PCB
UN35	Wireless LAN PCB
UN41	LCD

External Cover System

● Removing the Toner Cartridge

■ Procedure

CAUTION:

- Be careful not to damage the Photosensitive Drum.

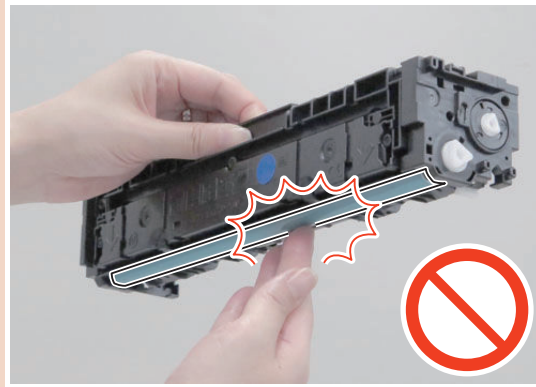

- Be sure to cover the drums with paper to block light.

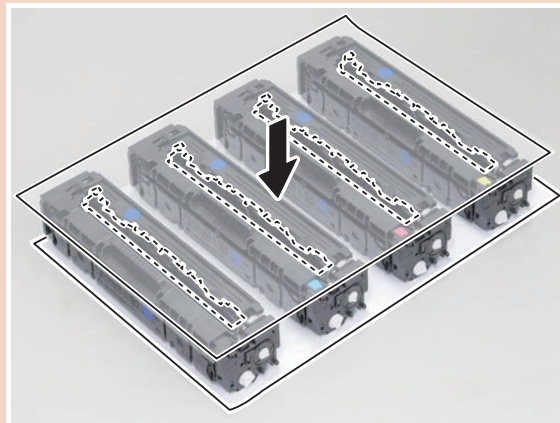

1. Pull out the Cartridge Tray, and remove the Toner Cartridges (Y, M, C, and Bk).

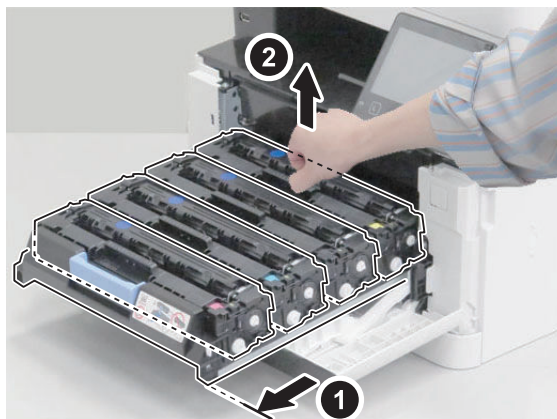

● Removing the Left Cover

■ Preparation

1. “Removing the Toner Cartridge” on page 70

■ Procedure

1. Shift the host machine by approximately 70 mm from the working table to release the claws on the bottom of the Left Cover.

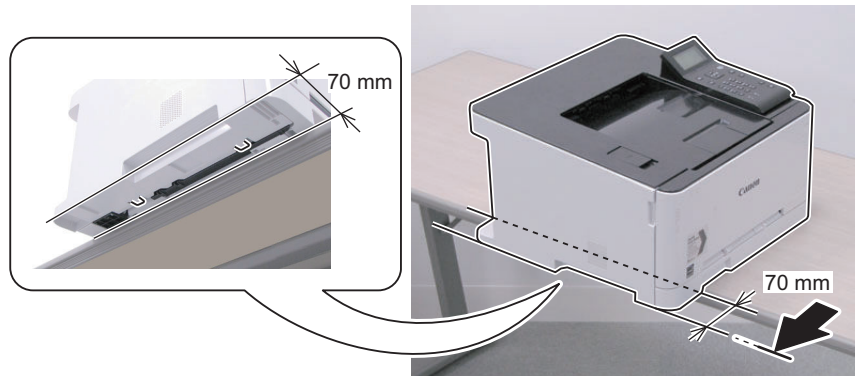

2. Pull out the cassette by approximately 80 mm.

⚠ CAUTION:

Do not completely pull out the cassette, as doing so will disturb the balance of the product and may cause it to fall down.

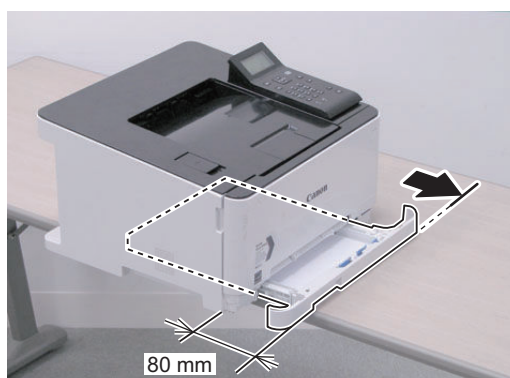

3. Open the Cartridge Cover and the Rear Cover Unit, and remove the screws.

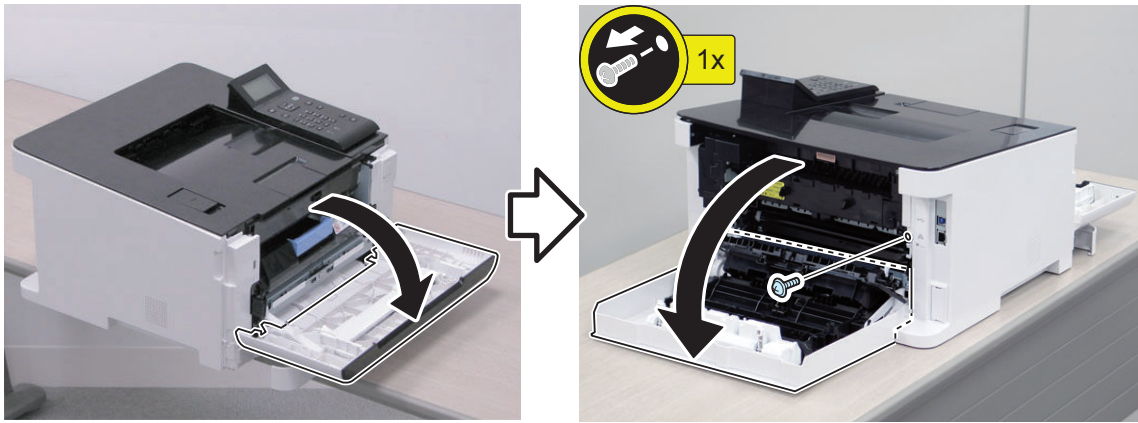

4. Free the bosses and claws, and remove the Left Cover.

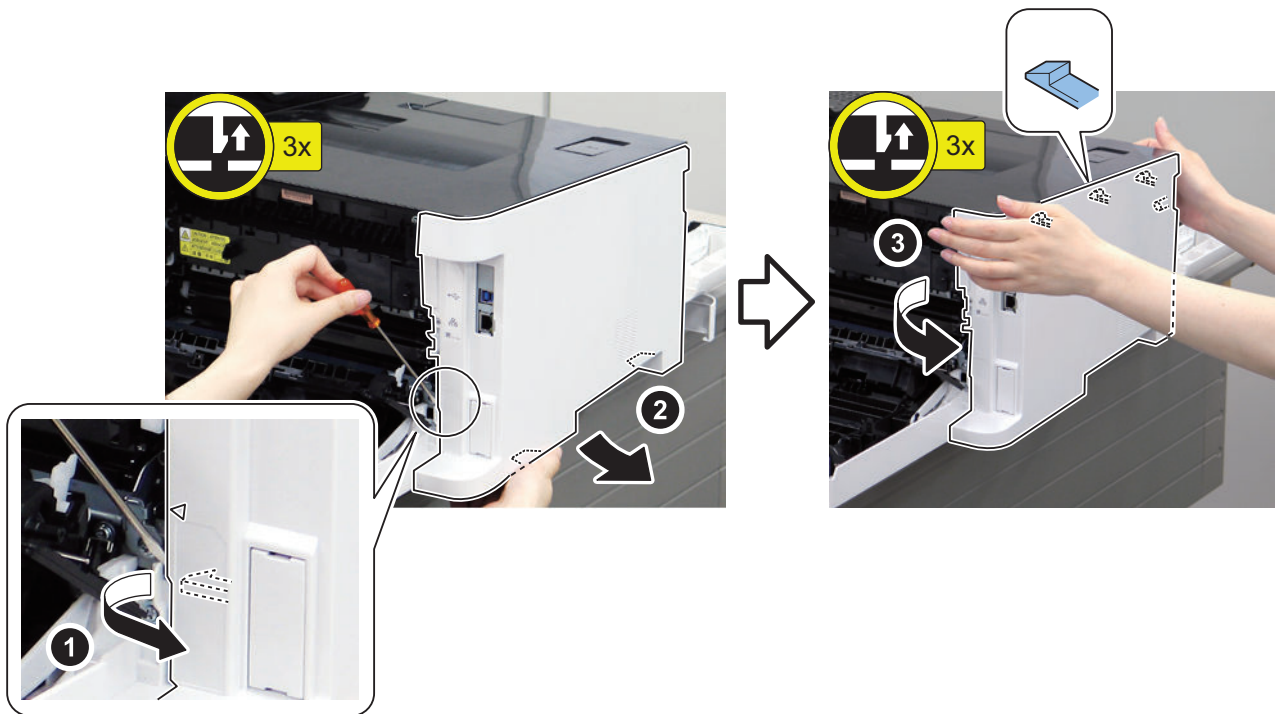

5. Shift the host machine back to the center of the working table to prevent it from falling down.

● Removing the Right Cover

■ Preparation

1. "Removing the Toner Cartridge" on page 70

■ Procedure

1. Shift the host machine by approximately 50 mm from the working table to release the claws on the bottom of the Right Cover.

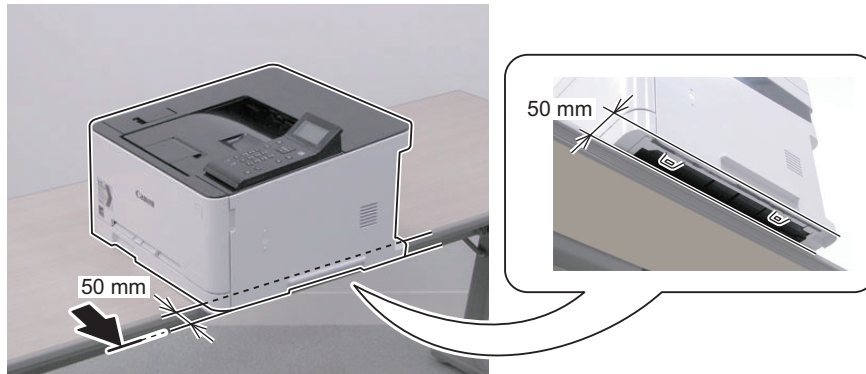

2. Pull out the cassette by approximately 80 mm.

⚠ CAUTION:

Do not completely pull out the cassette, as doing so will disturb the balance of the product and may cause it to fall down.

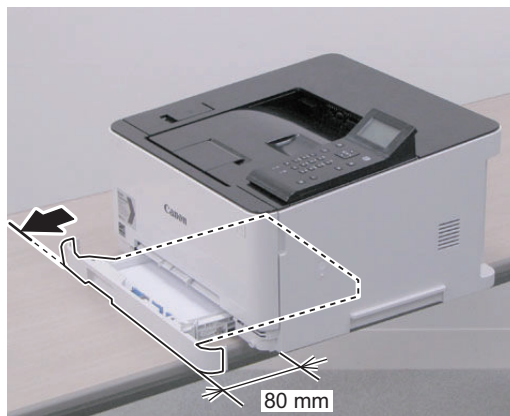

3. Open the Cartridge Cover and the Rear Cover Unit, and remove the screws. Close the Secondary Transfer Unit.

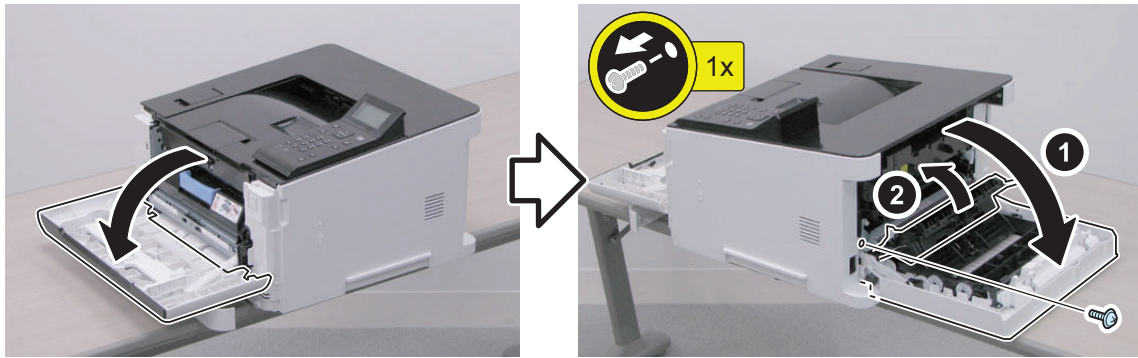

4. Release the claws while opening the Right Cover in the direction of the arrow.

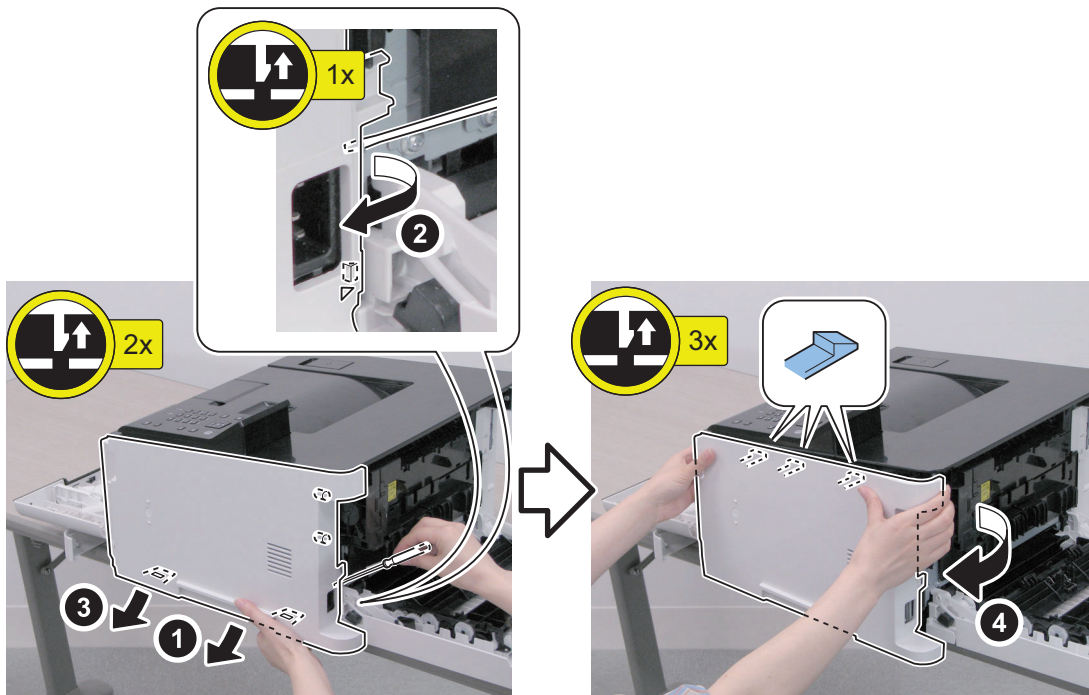

5. Free the bosses and claw, and remove the Right Cover.

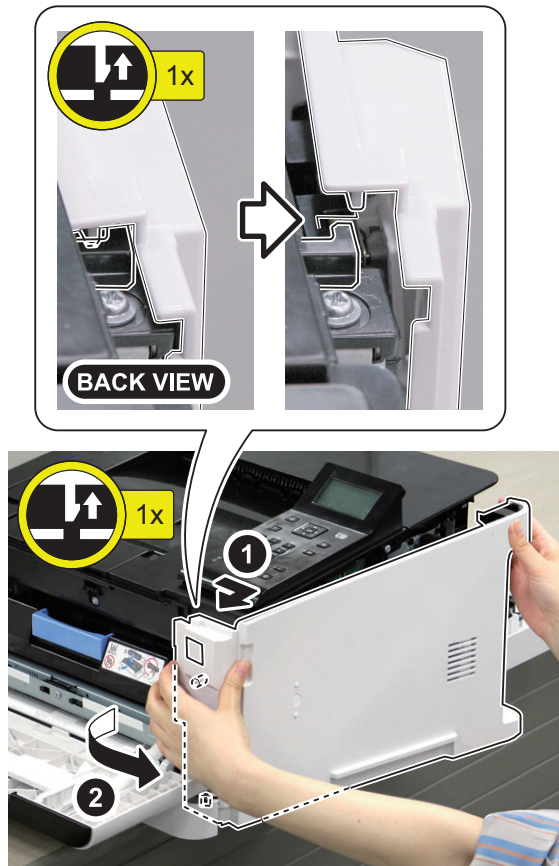

6. Shift the host machine back to the center of the working table to prevent it from falling down.

● Removing the Rear Cover Unit

■ Procedure

1. Open the Rear Cover Unit, and close the Secondary Transfer Unit.

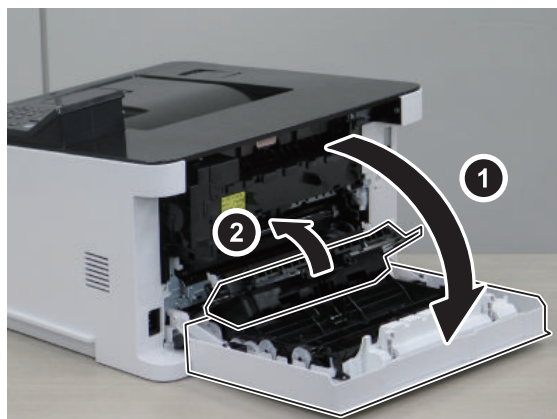

2. Remove the 2 holders.

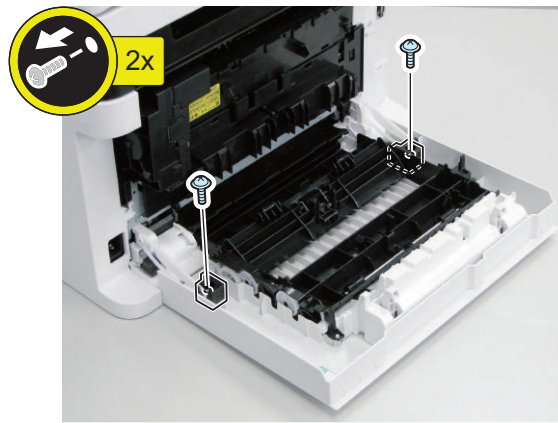

3. Remove the shaft.

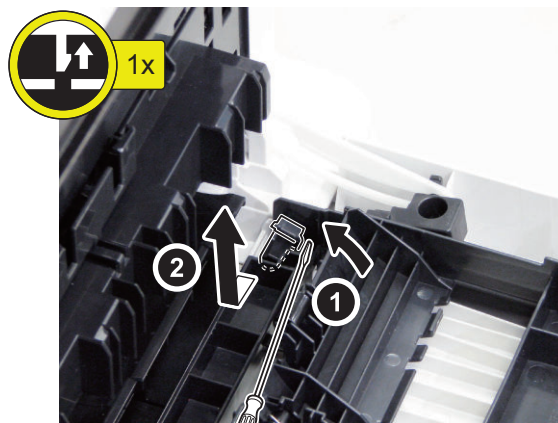

4. Remove the Rear Cover Unit.

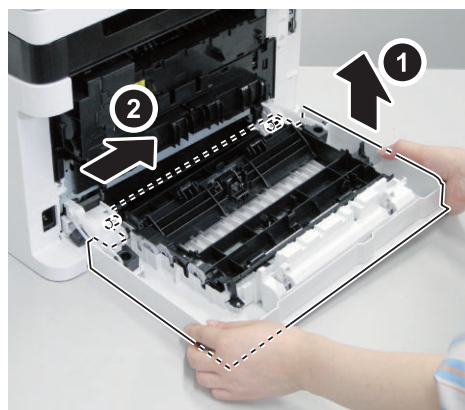

● Removing the Cartridge Cover

■ Preparation

1. "Removing the Toner Cartridge" on page 70

■ Procedure

1. Open the Cartridge Cover, release the Cartridge Cover Retainers (right and left), and remove the Cartridge Cover.

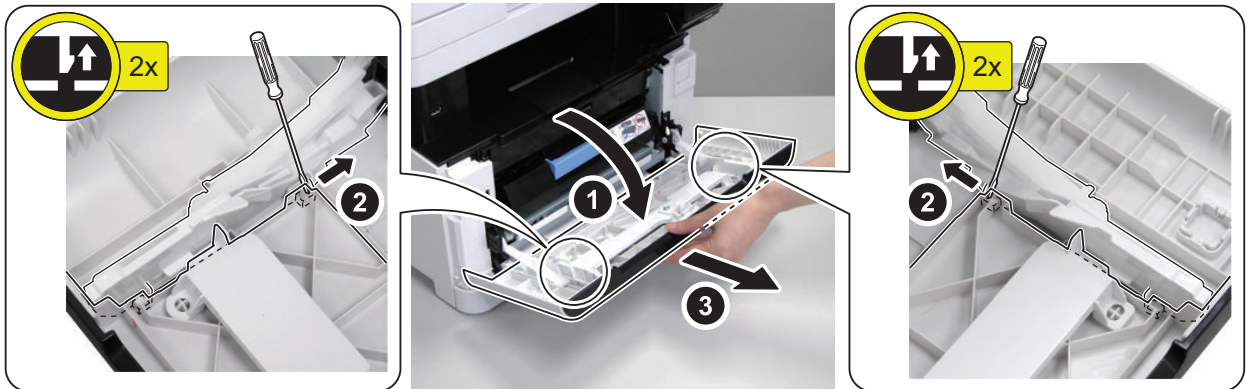

● Removing the Cartridge Tray

■ Preparation

1. "Removing the Toner Cartridge" on page 70
2. "Removing the Cartridge Cover" on page 76

■ Procedure

1. After pulling out the Cartridge Tray, lift up the Cartridge Door Links on the right and left.

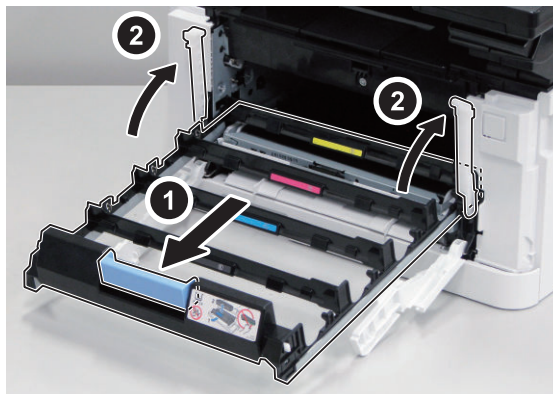

2. Remove the pin from the groove of the left side rail while lifting up the left side of the Cartridge Tray, and turn the Cartridge Tray counterclockwise to remove the tray.

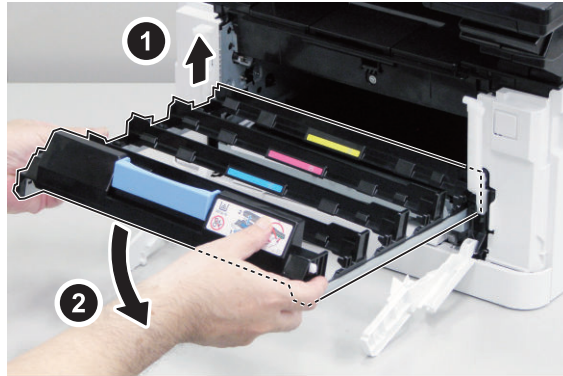
**NOTE:**

When installing the Cartridge Tray, raise the right and left links, insert the pin in the rail groove on the right side of the tray, and then do the same on the left side. Next, lower the right and left Cartridge Door Links, and insert the Cartridge Tray in all the way.

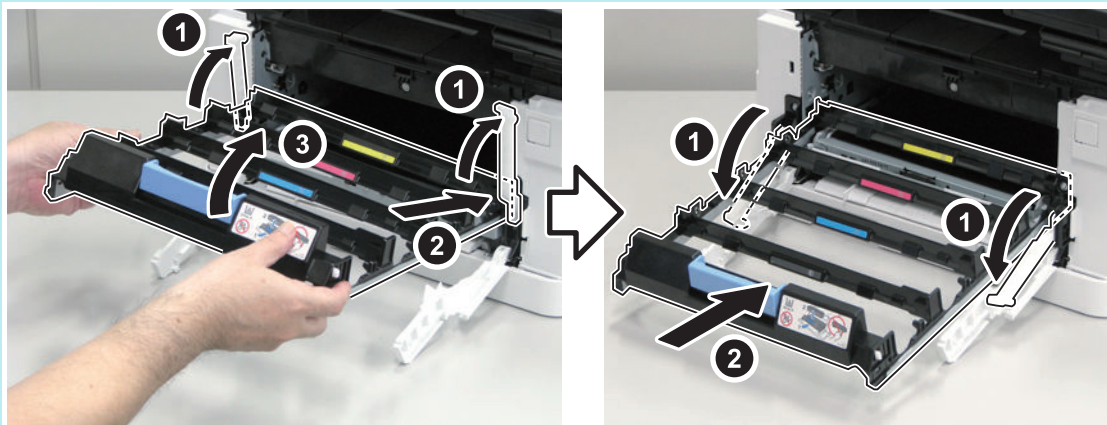

● Removing the Upper Cover Unit

■ Preparation

1. "Removing the Toner Cartridge" on page 70
2. "Removing the Left Cover" on page 71
3. "Removing the Right Cover" on page 72
4. "Removing the 5-line Control Panel Unit" on page 85

■ Procedure

1. Remove the Upper Front Cover Unit.

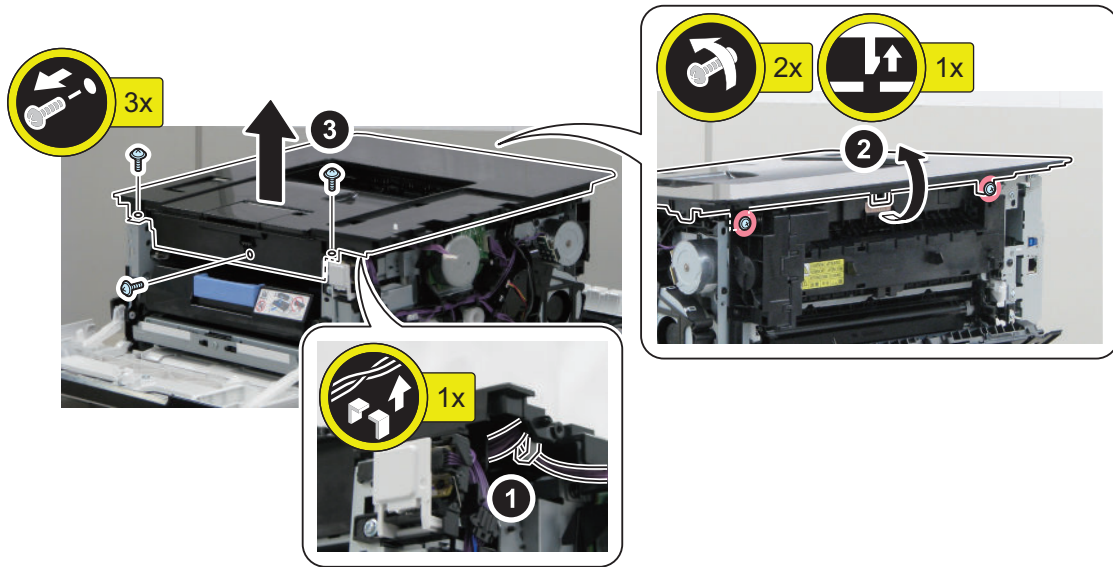

Controller System

● Removing the Controller Cover

■ Preparation

1. “Removing the Toner Cartridge” on page 70
2. “Removing the Left Cover” on page 71

■ Procedure

1. Remove the Controller Cover.

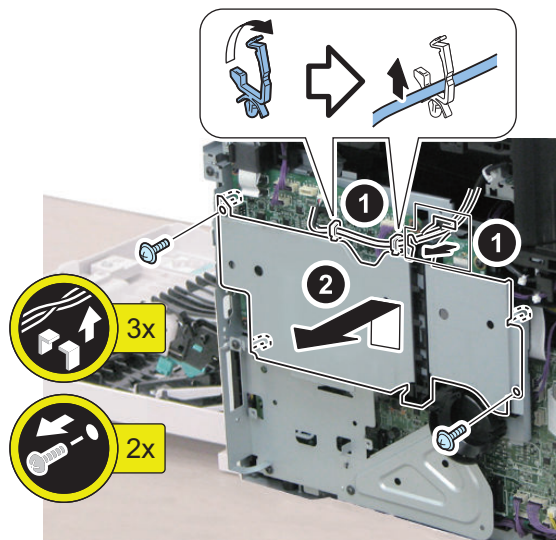

● Removing the Wireless LAN PCB (Wi-Fi model only)

■ Preparation

1. “Removing the Toner Cartridge” on page 70
2. “Removing the Left Cover” on page 71
3. “Removing the Controller Cover ” on page 80

■ Procedure

1. Remove the Wireless LAN PCB.

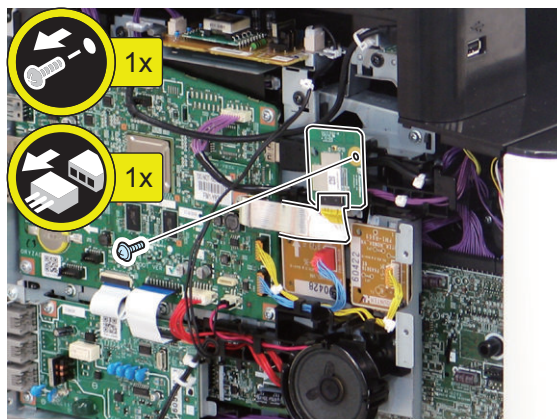

● Removing the Wireless LAN Support Plate (Wi-Fi model only)

■ Preparation

1. “Removing the Toner Cartridge” on page 70
2. “Removing the Left Cover” on page 71
3. “Removing the Controller Cover ” on page 80
4. “Removing the Wireless LAN PCB (Wi-Fi model only)” on page 80

■ Procedure

1. Remove the Wireless LAN Support Plate.

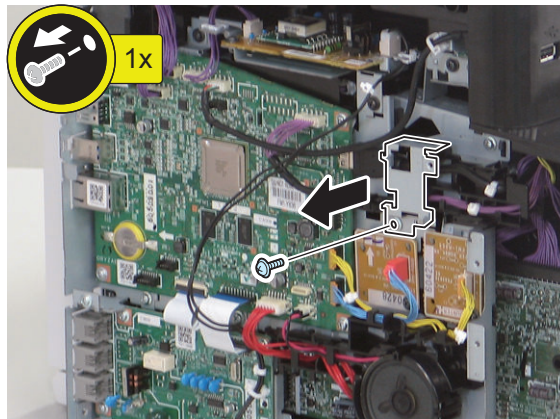

● Removing the Main Controller PCB

■ Preparation

1. “Removing the Toner Cartridge” on page 70
2. “Removing the Left Cover” on page 71
3. “Removing the Controller Cover ” on page 80

■ Procedure

1. Disconnect all connectors from the Main Controller PCB and then remove the PCB.

<LBP613Cdw>

<LBP612Cdw>

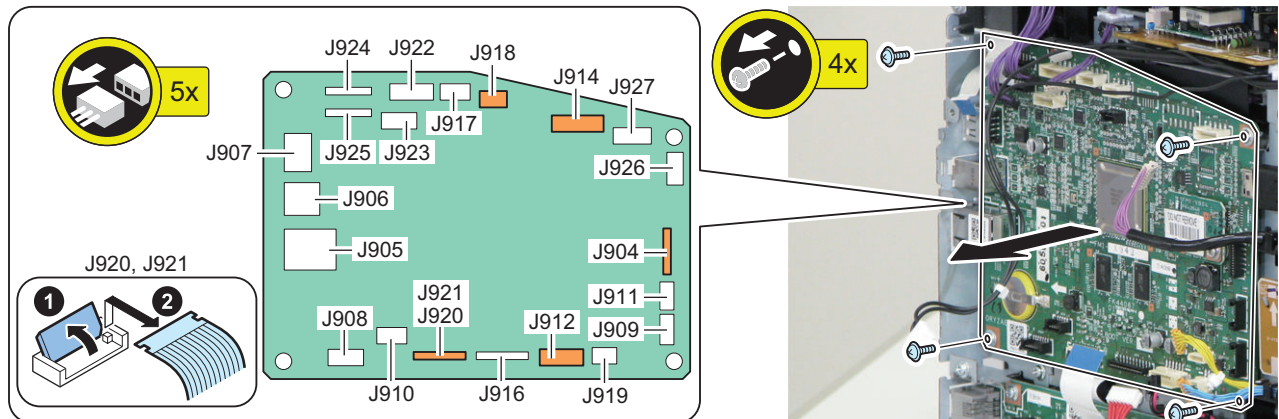

<LBP611Cn>

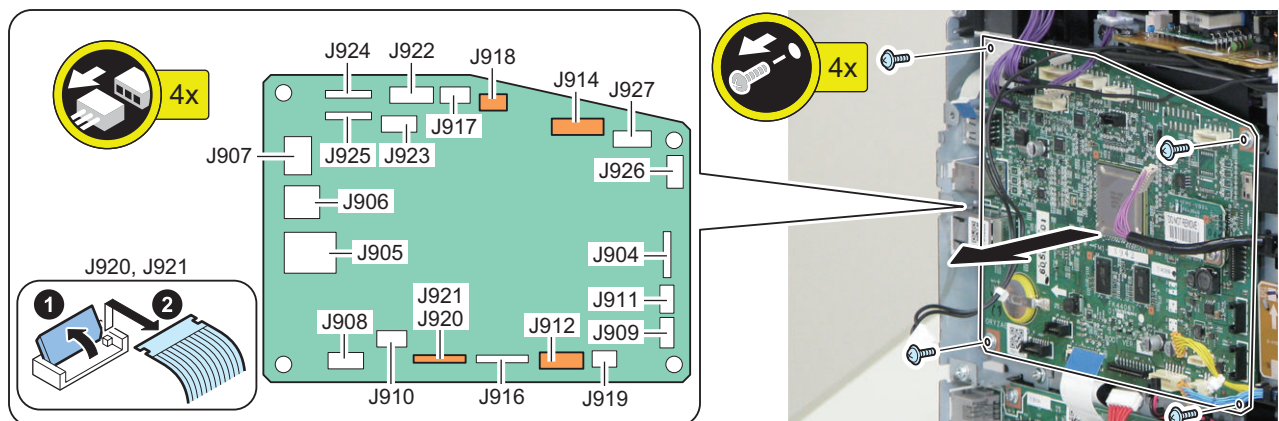

2. Actions after replacement: “After Replacing the Main Controller PCB” on page 109

● Removing the Main Controller Support Plate

■ Preparation

1. “Removing the Toner Cartridge” on page 70
2. “Removing the Left Cover” on page 71
3. “Removing the Controller Cover ” on page 80
4. “Removing the Main Controller PCB” on page 81
5. “Removing the Wireless LAN Support Plate (Wi-Fi model only)” on page 81

■ Procedure

1. Remove the Main Controller Support Plate.

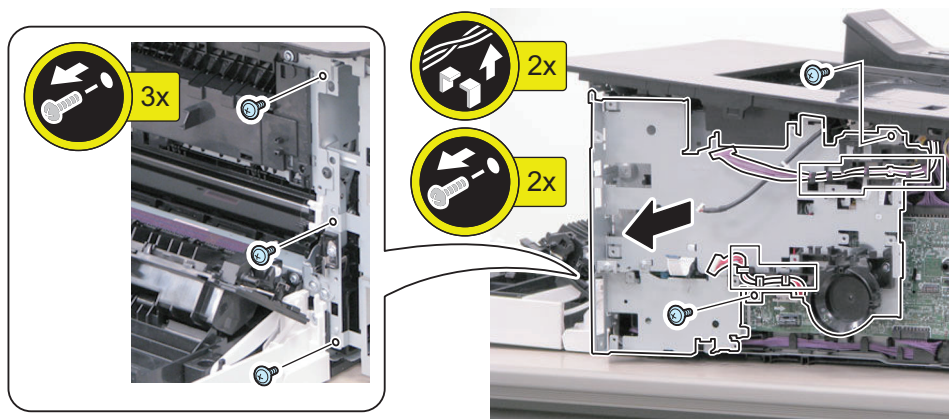

● Removing the Engine Controller PCB

■ Preparation

1. “Removing the Toner Cartridge” on page 70
2. “Removing the Left Cover” on page 71
3. “Removing the Controller Cover ” on page 80
4. “Removing the Main Controller PCB” on page 81
5. “Removing the Wireless LAN Support Plate (Wi-Fi model only)” on page 81
6. “Removing the Main Controller Support Plate” on page 82

■ Procedure

1. Remove the Engine Controller PCB.

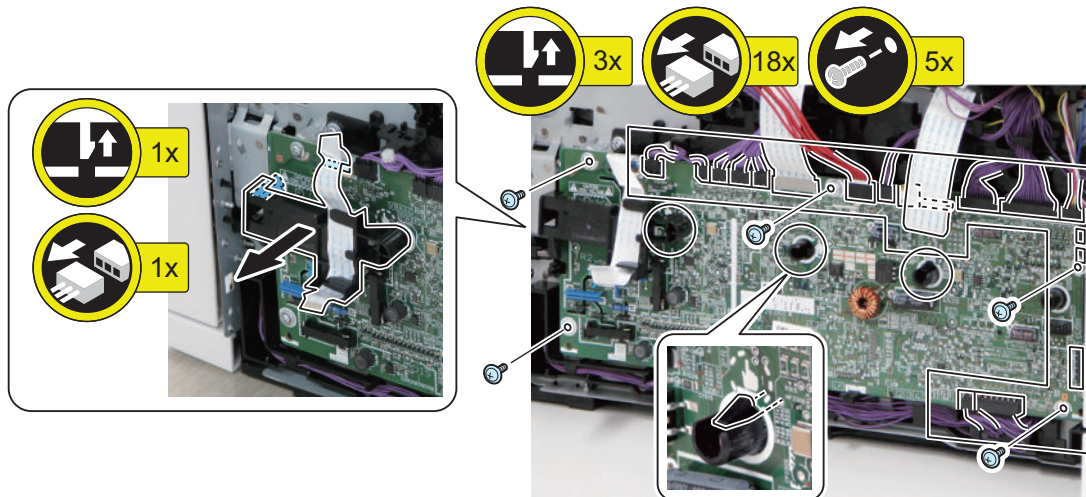

NOTE:

Be sure that the Contact Spring is in the correct position.

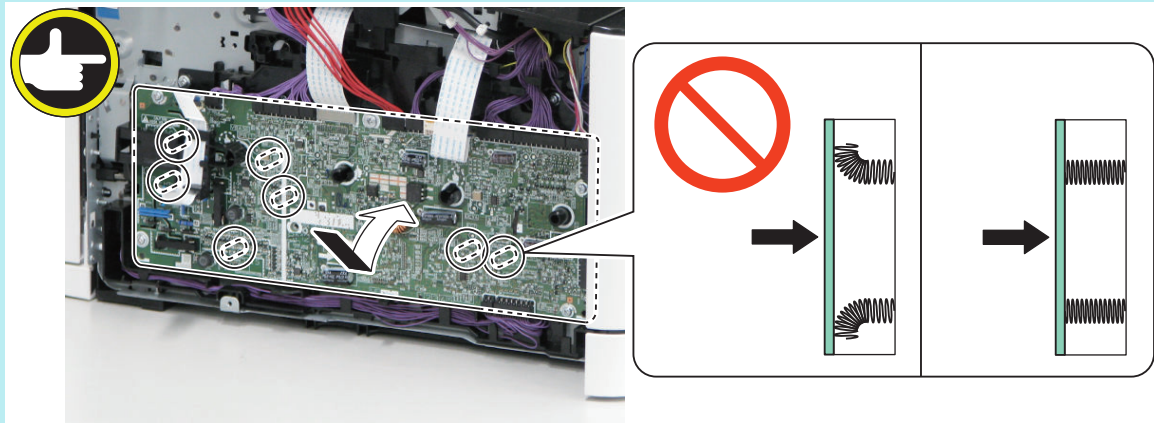

2. Actions after replacement: [“After Replacing the Engine Controller PCB” on page 108](#)

● Removing the Low Voltage Power Supply Unit

■ Preparation

1. [“Removing the Toner Cartridge” on page 70](#)
2. [“Removing the Right Cover” on page 72](#)

■ Procedure

1. Remove the Low Voltage Power Supply Unit.

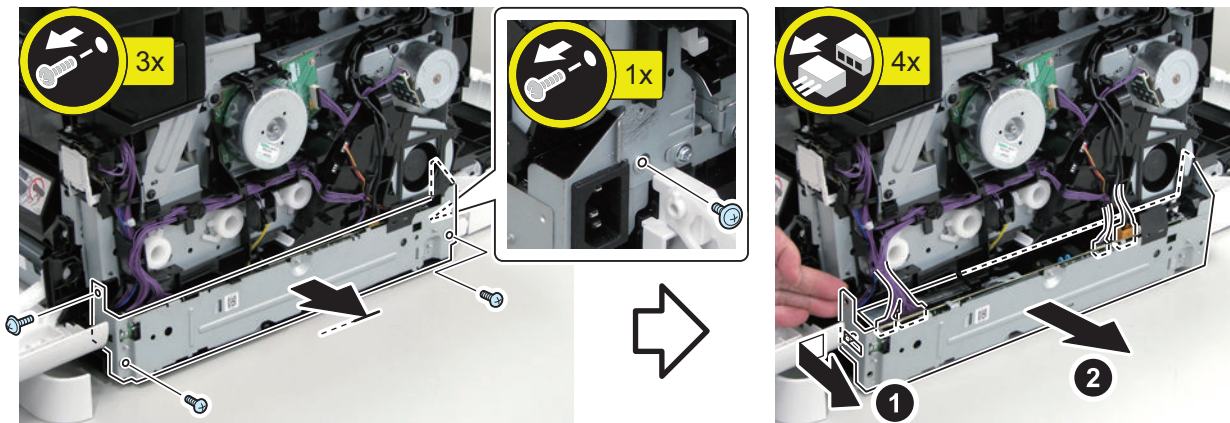

● Removing the Main Motor

■ Preparation

1. "Removing the Toner Cartridge" on page 70
2. "Removing the Right Cover" on page 72

■ Procedure

1. Remove the Main Motor.

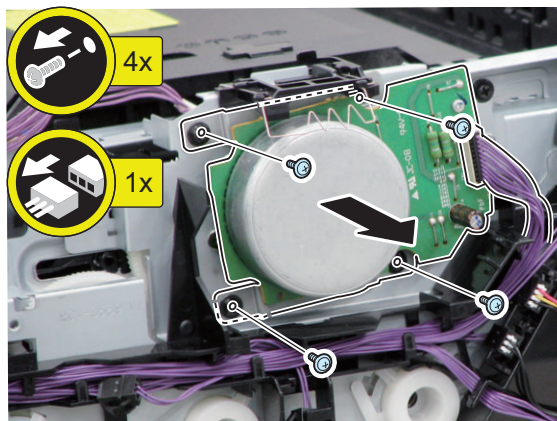

● Removing the 5-line Control Panel Unit

■ Preparation

1. "Removing the Toner Cartridge" on page 70
2. "Removing the Right Cover" on page 72

■ Procedure

1. Remove the 5-line Control Panel Unit.

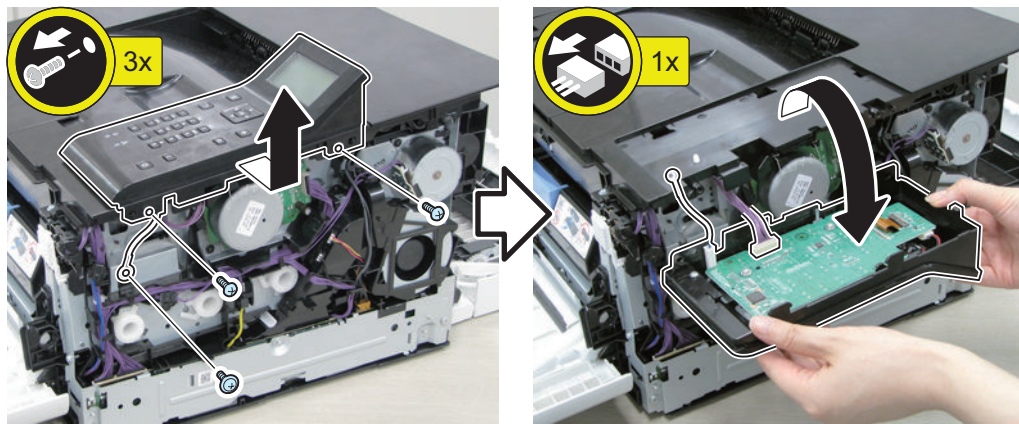

● Removing the NCU Support Plate

■ Preparation

1. “Removing the Toner Cartridge” on page 70
2. “Removing the Left Cover” on page 71

■ Procedure

1. Remove the NCU Support Plate.

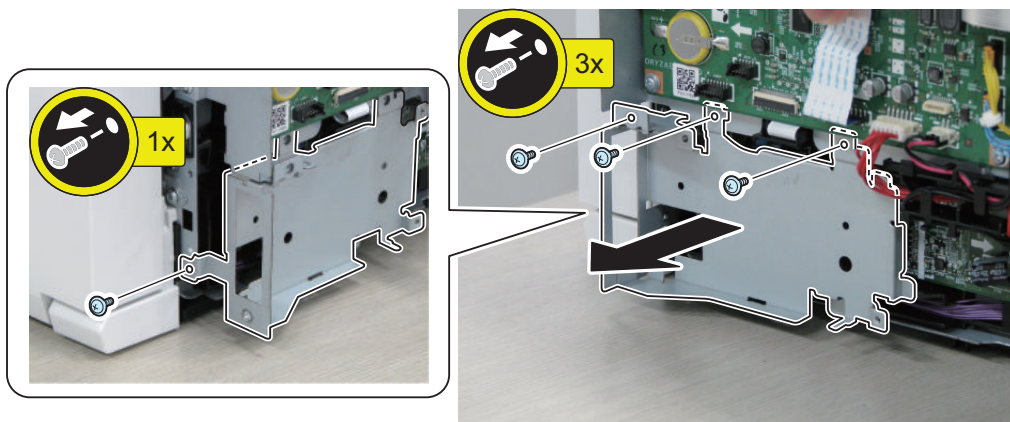

● Removing the USB PCB

■ Preparation

1. “Removing the Toner Cartridge” on page 70
2. “Removing the Left Cover” on page 71
3. “Removing the Right Cover” on page 72
4. “Removing the 5-line Control Panel Unit” on page 85
5. “Removing the Upper Cover Unit ” on page 78

■ Procedure

1. Remove the USB Cover.

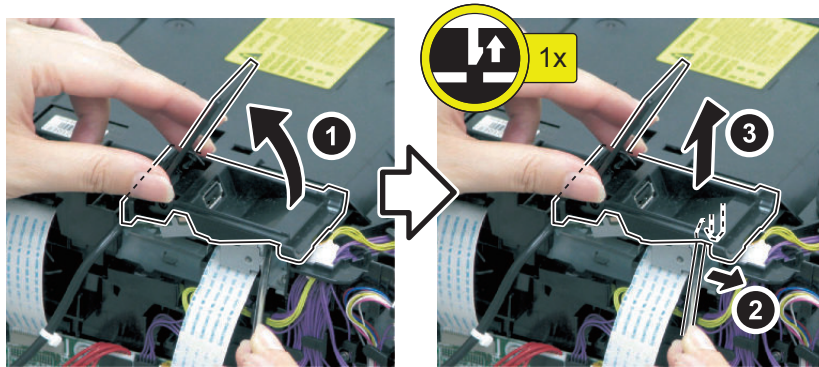

2. Remove the USB PCB Unit.

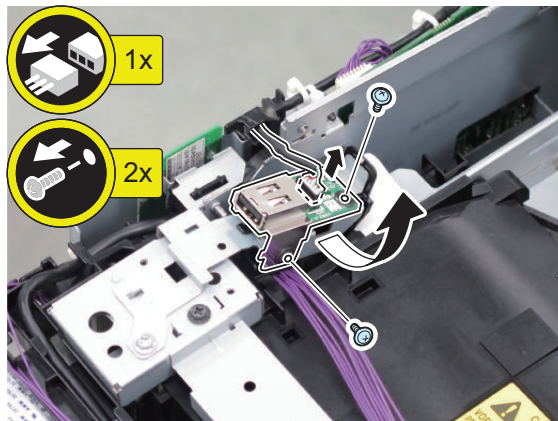

3. Remove the USB Connector Cover.

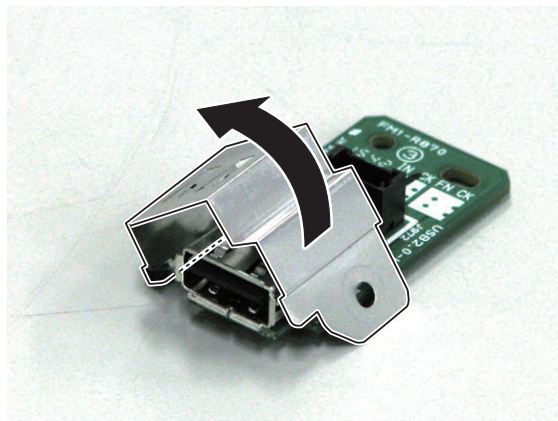

● Removing the Fan

■ Preparation

1. "Removing the Toner Cartridge" on page 70
2. "Removing the Right Cover" on page 72

■ Procedure

1. Remove the Duct.

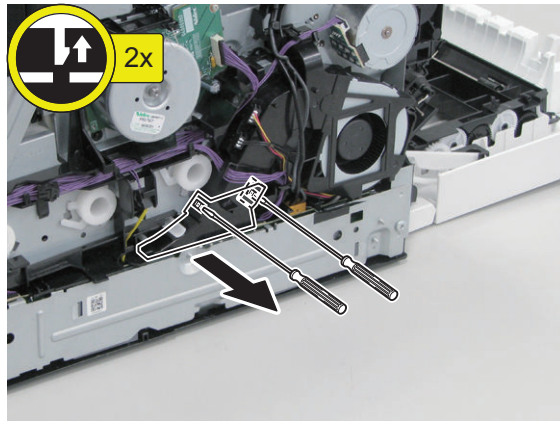

2. Free the harness, and remove the Fan Unit.

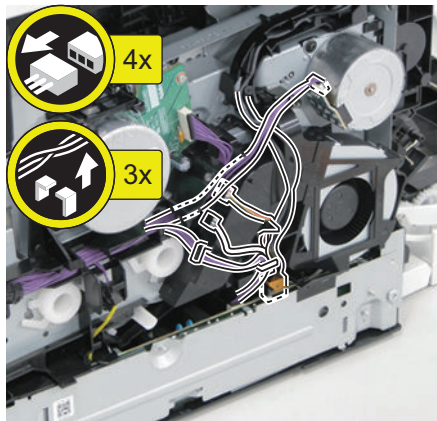

3. Remove the Fan Unit.

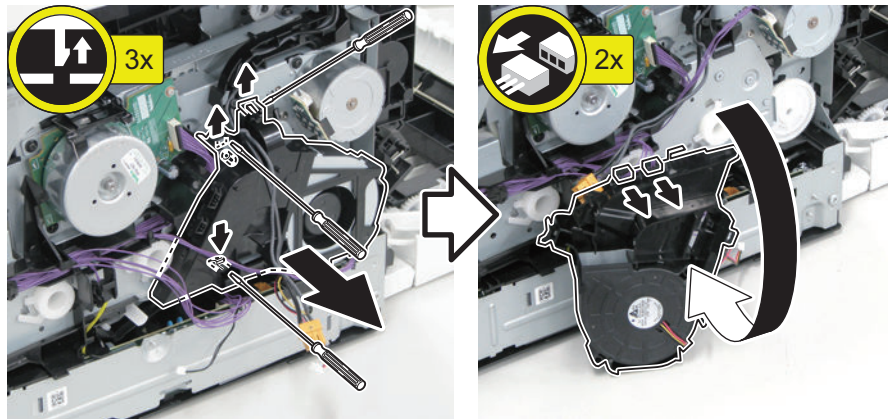

4. Remove the fan from the unit.

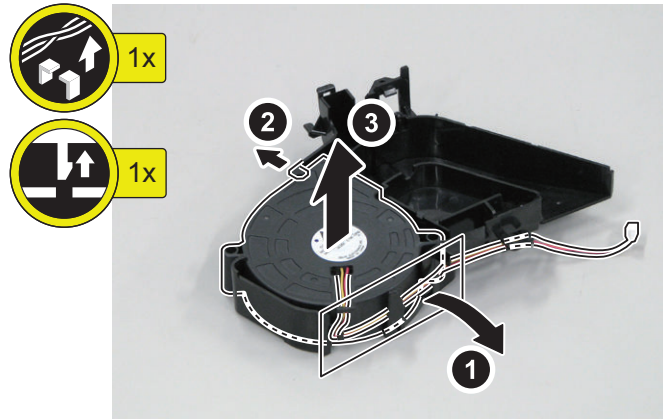

● Removing the Power Switch Unit

■ Preparation

1. “Removing the Toner Cartridge” on page 70
2. “Removing the Right Cover” on page 72

■ Procedure

1. Remove the Power Switch Unit.

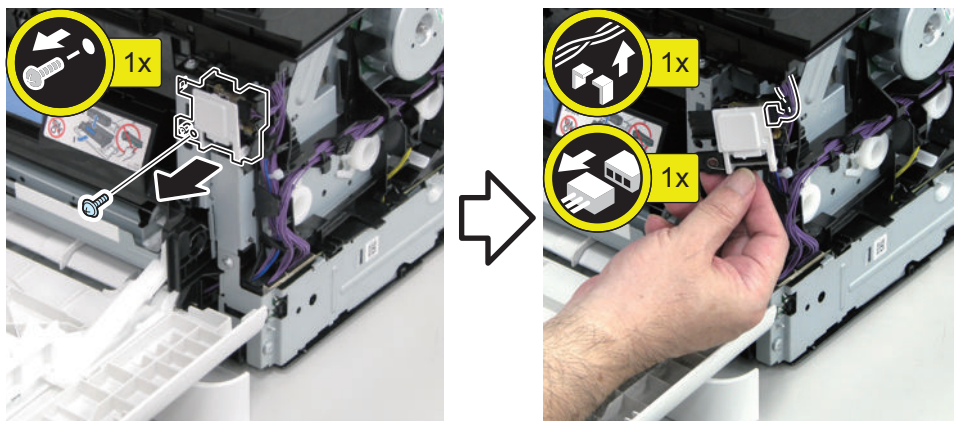

Image Formation System

● Removing the Secondary Transfer Roller

■ Preparation

1. "Removing the Toner Cartridge" on page 70

■ Procedure

CAUTION:

Do not touch the surface of the Secondary Transfer Roller.

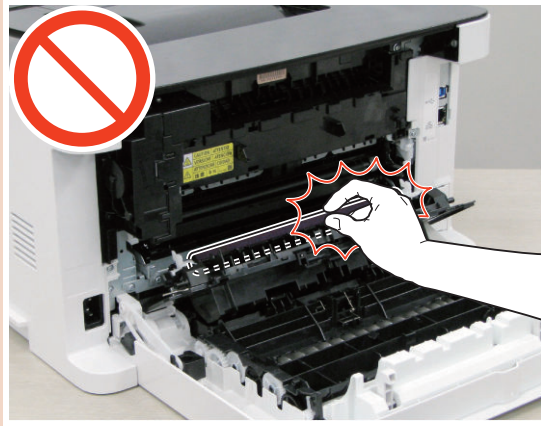

1. Open the Rear Cover Unit and the Secondary Transfer Feed Unit.

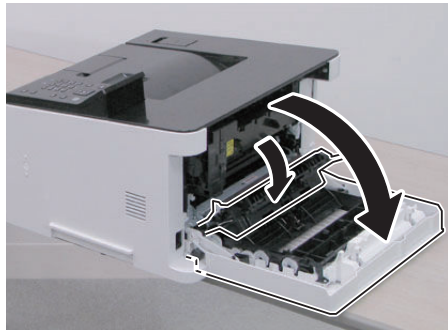

2. Remove the Secondary Transfer Roller.

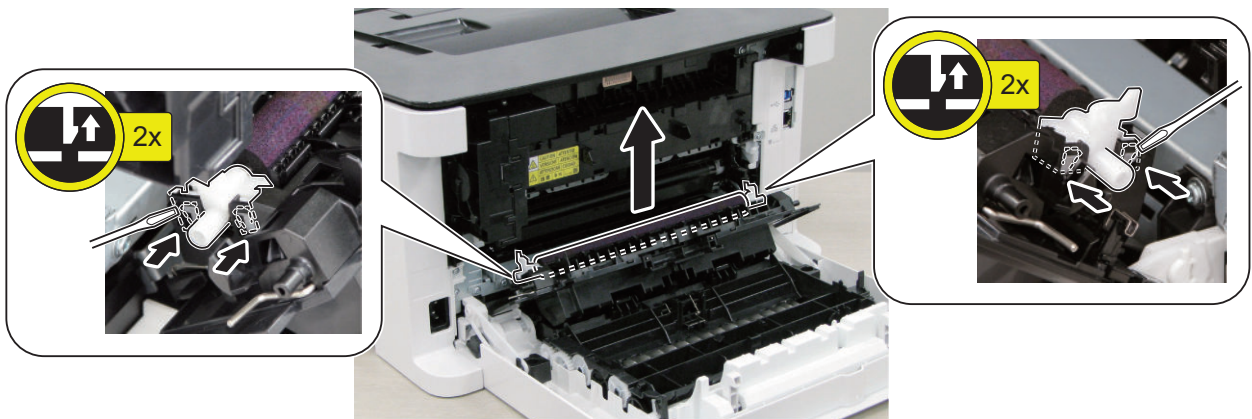

● Removing the Secondary Transfer Feed Unit

■ Preparation

1. "Removing the Toner Cartridge" on page 70
2. "Removing the Rear Cover Unit" on page 75

■ Procedure

1. Remove the Right Holder.

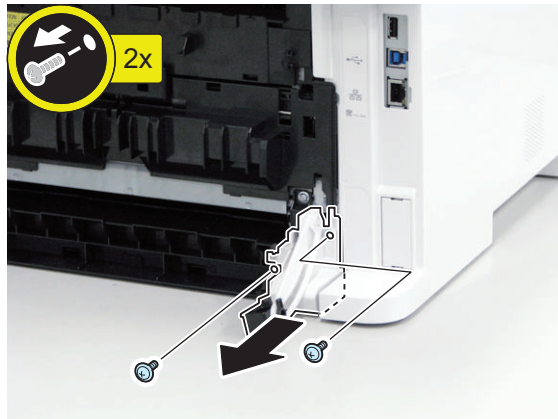

2. Remove the Shaft Retainer Holder.

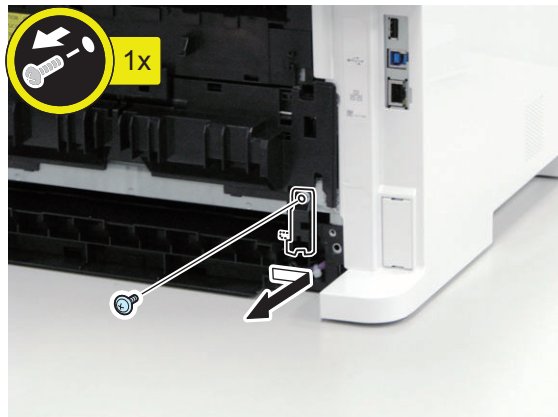

3. Remove the Secondary Transfer Feed Unit.

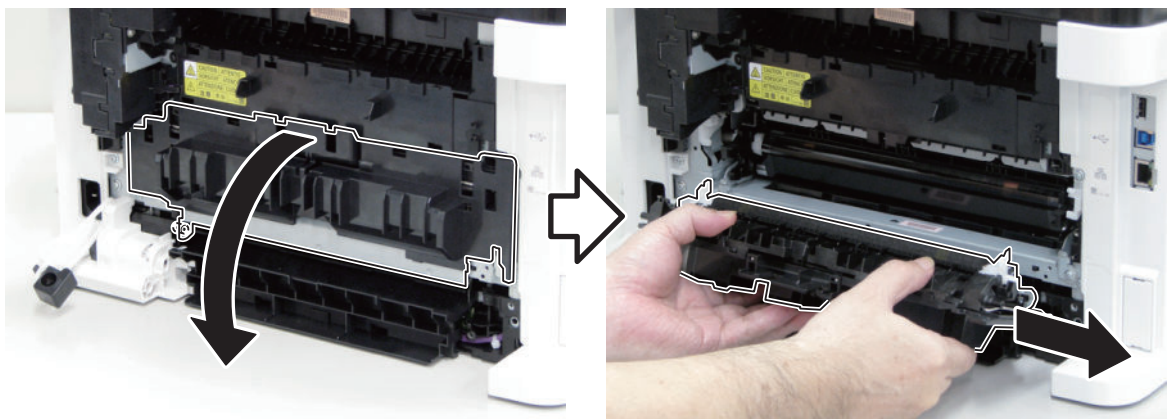

● Removing the ITB Unit

■ Preparation

1. “Removing the Toner Cartridge” on page 70
2. “Removing the Right Cover” on page 72
3. “Removing the Rear Cover Unit” on page 75
4. “Removing the Secondary Transfer Feed Unit” on page 91

■ Procedure

CAUTION:

- Place the ITB Unit on a sheet of paper.
- Be sure not to damage or touch the ITB Unit.

1. Remove the Duct Cover.

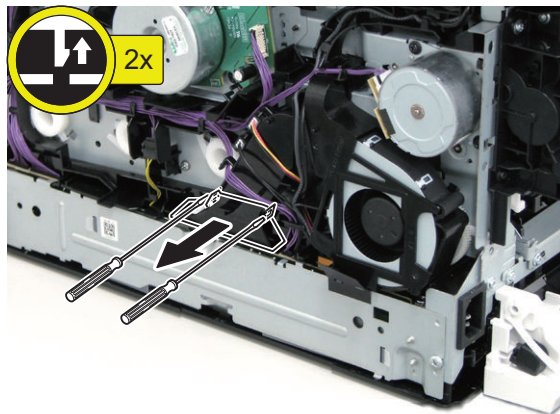

2. With the Cartridge Cover closed, rotate the lever approximately 45 degrees in the direction of the arrow while pulling it toward the front, and then pull it further toward the front.

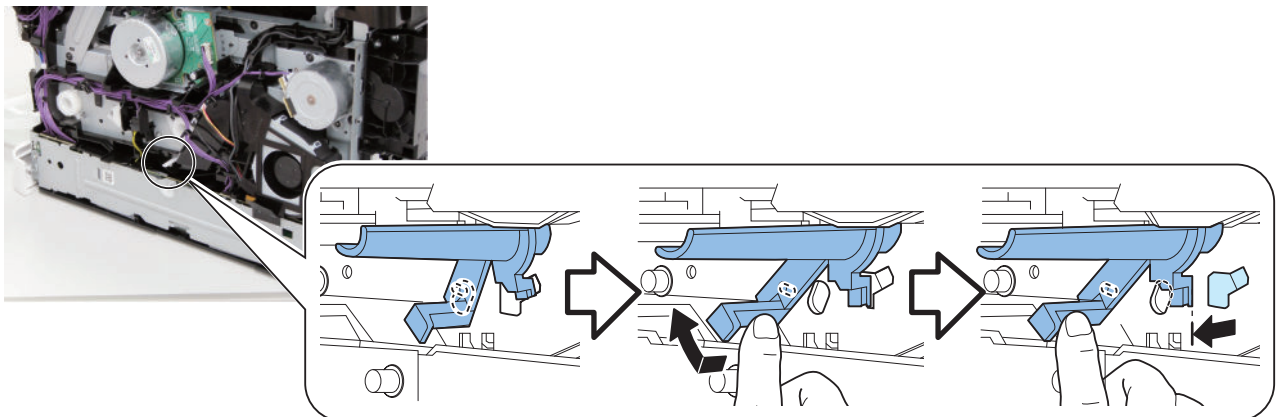

- Slide the gear to the left to disengage the shaft from the ITB Unit.

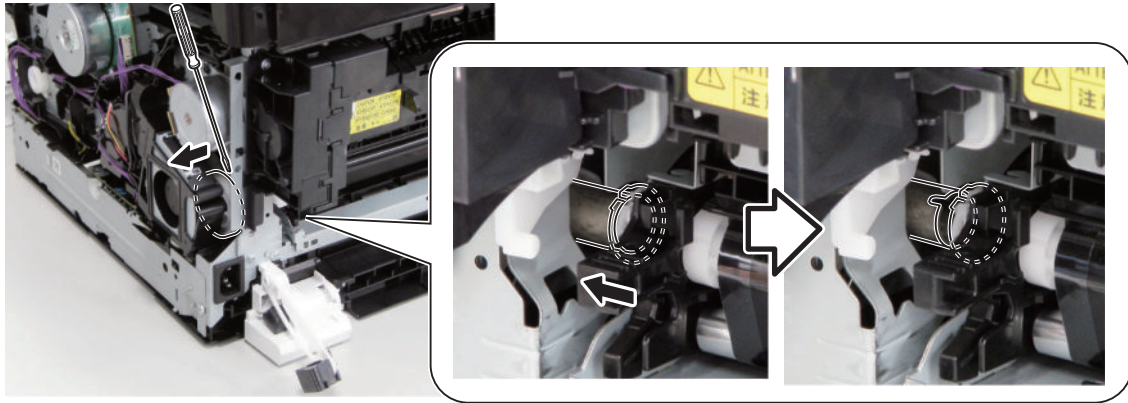

- With the Cartridge Cover opened, remove the screws, and pull out the ITB Unit while lifting the stoppers and holding the handles on the left and right sides.

CAUTION:

When installing the ITB Unit, be sure to install it with the Toner Cartridge Cover opened and the shaft on the left side disengaged from the ITB Unit. After properly installing the ITB Unit, be sure to return the shaft on the left side and the levers back to their original positions.

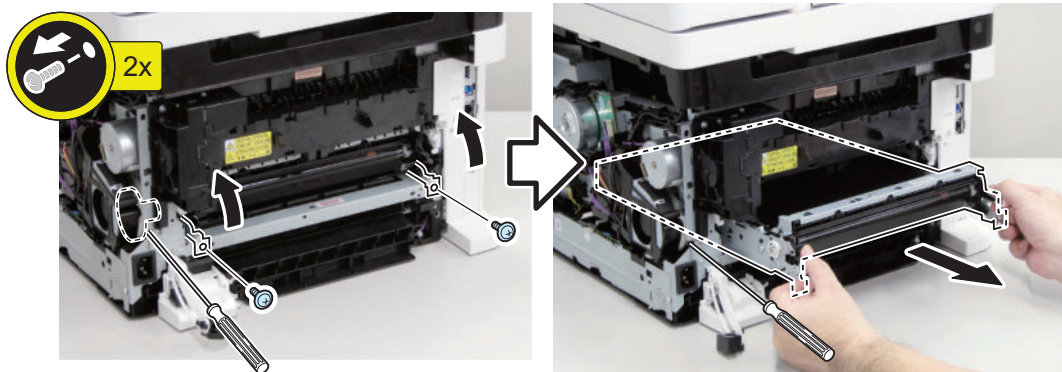

- Actions after replacement: [“After Replacing the ITB Unit” on page 108](#)

● Removing the Color Displacement Density Sensor Unit

■ Preparation

- [“Removing the Toner Cartridge” on page 70](#)
- [“Removing the Left Cover” on page 71](#)
- [“Removing the Right Cover” on page 72](#)
- [“Removing the Rear Cover Unit” on page 75](#)
- [“Removing the Secondary Transfer Feed Unit” on page 91](#)
- [“Removing the ITB Unit” on page 92](#)
- [“Removing the Cartridge Cover” on page 76](#)

■ Procedure

1. Remove the Color Displacement Density Sensor Unit.

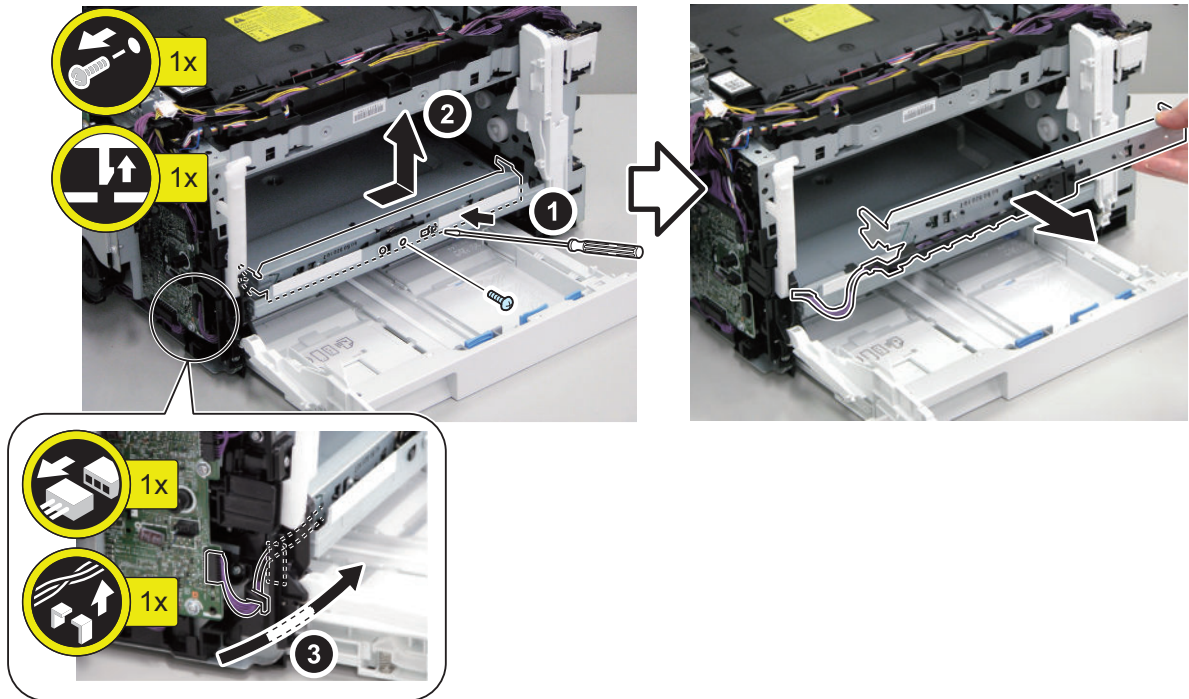

2. Actions after replacement: [“After Replacing the Color Displacement Density Sensor Unit”](#) on page 108

Fixing System

● Removing the Fixing Assembly

■ Preparation

1. “Removing the Toner Cartridge” on page 70
2. “Removing the Left Cover” on page 71
3. “Removing the Right Cover” on page 72
4. “Removing the 5-line Control Panel Unit” on page 85
5. “Removing the Upper Cover Unit ” on page 78
6. “Removing the Duplex Reverse Drive Unit” on page 100
7. “Removing the Low Voltage Power Supply Unit” on page 84

■ Procedure

CAUTION:

Since the Fixing Assembly is hot immediately after the power is turned OFF, give it time to cool down before removing it.

1. Free the harness from the guide.

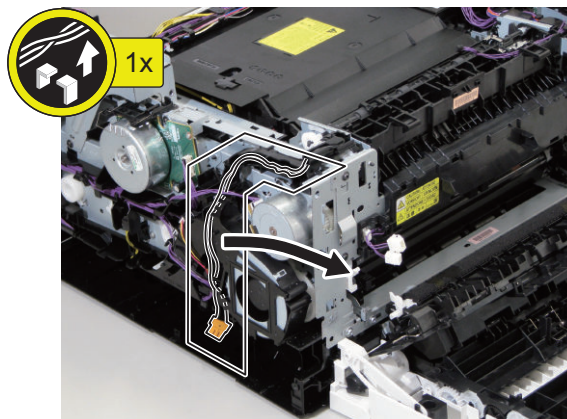

2. Free the harness.

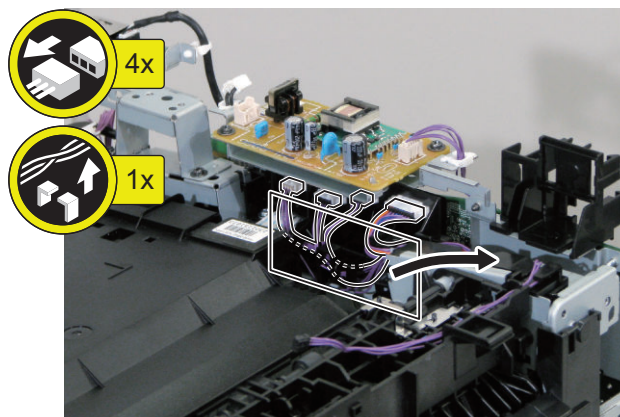

3. Remove the Fixing Assembly.

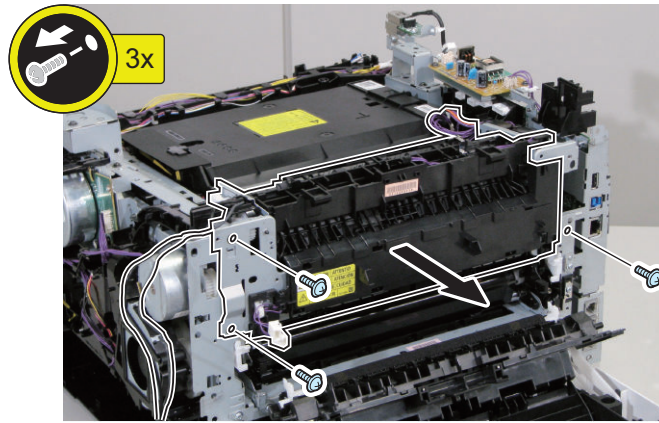

● Removing the Fixing Motor

■ Preparation

1. "Removing the Toner Cartridge" on page 70
2. "Removing the Right Cover" on page 72

■ Procedure

1. Remove the Fixing Motor.

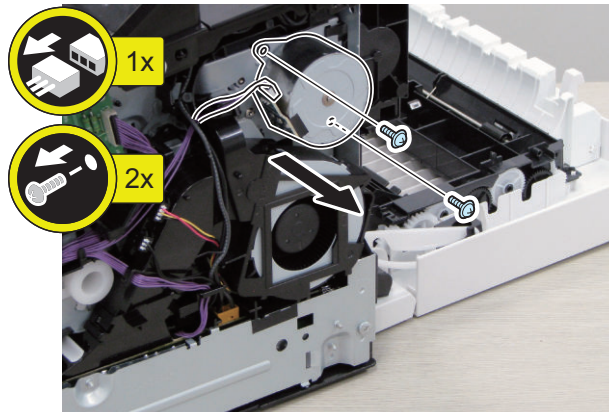

Pickup Feed Delivery System

● Removing the Delivery Sensor Unit

■ Preparation

1. “Removing the Toner Cartridge” on page 70
2. “Removing the Left Cover” on page 71
3. “Removing the Right Cover” on page 72
4. “Removing the 5-line Control Panel Unit” on page 85
5. “Removing the Upper Cover Unit ” on page 78

■ Procedure

1. Remove the Delivery Sensor Unit.

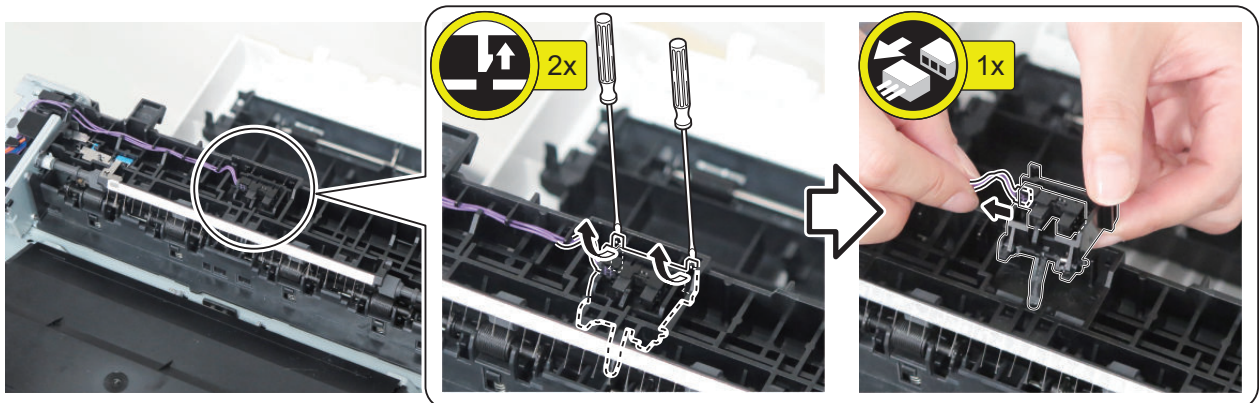

CAUTION:

When installing it, be sure to insert the flag inside the [A] part to install it.

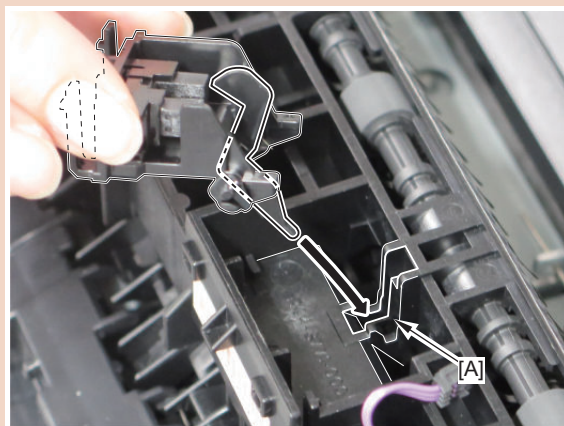

● Removing the Cassette Pickup Roller/Feed Roller Unit

■ Preparation

1. “Removing the Toner Cartridge” on page 70

■ Procedure

CAUTION:

Be sure not to touch the surface of the Cassette Pickup Roller and the surface of the Feed Roller.

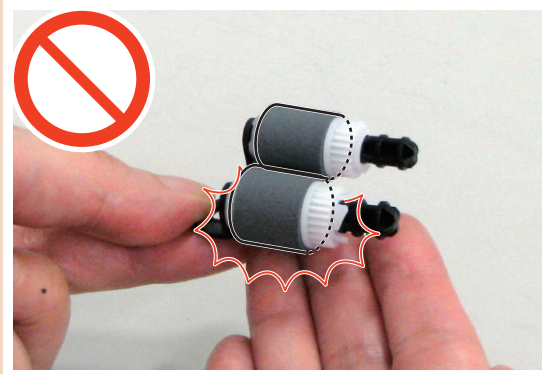

1. Pull out the cassette, and stand the host machine with its rear side down.

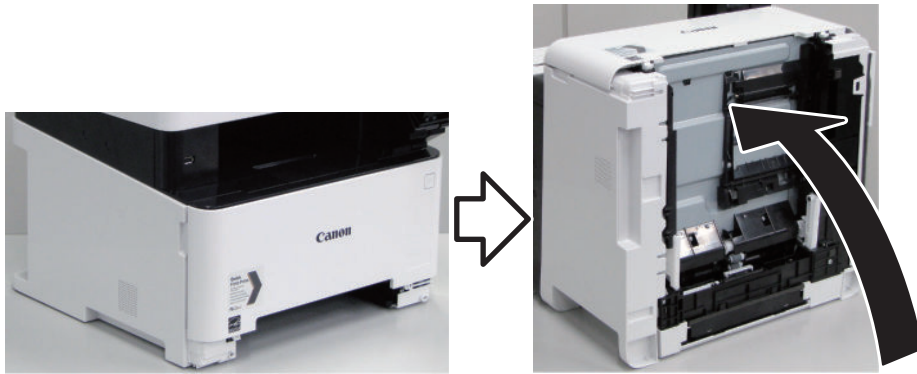

2. Remove the Cassette Pickup Roller.

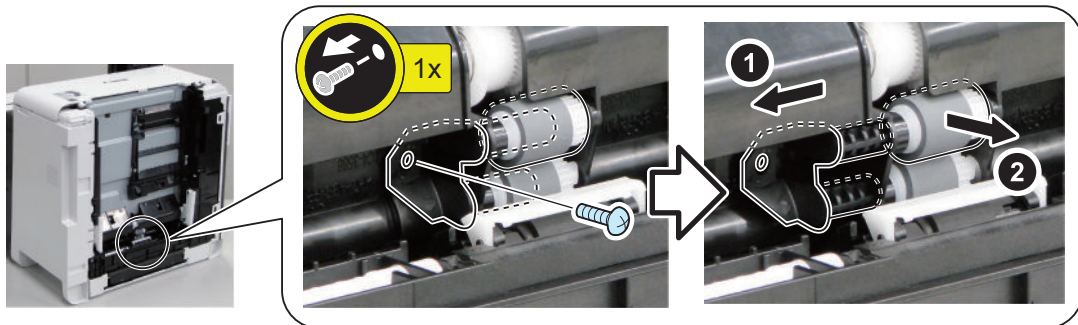

3. Remove the Cassette Feed Roller.

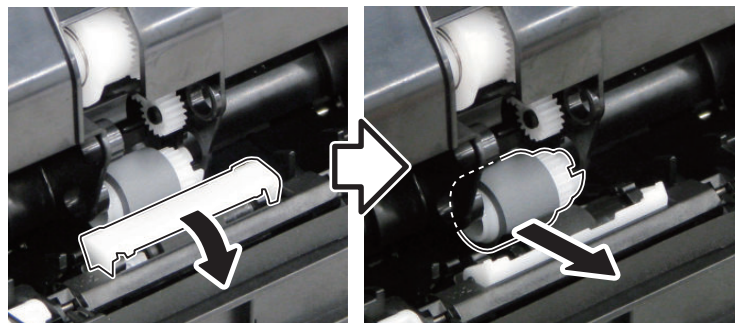

● Removing the Cassette Separation Roller Unit

■ Preparation

1. "Removing the Toner Cartridge" on page 70

■ Procedure

CAUTION:

Be sure not to touch the surface of the Separation Roller.



1. Pull out the cassette, and stand the host machine with its rear side down.

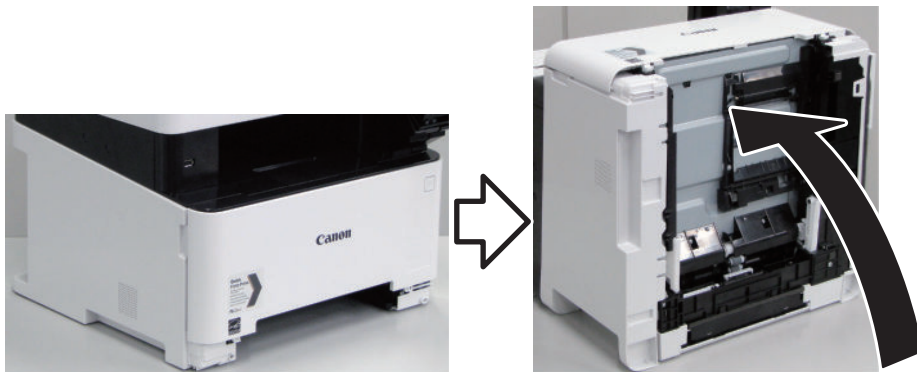

2. Open the cover, and remove the Separation Roller.

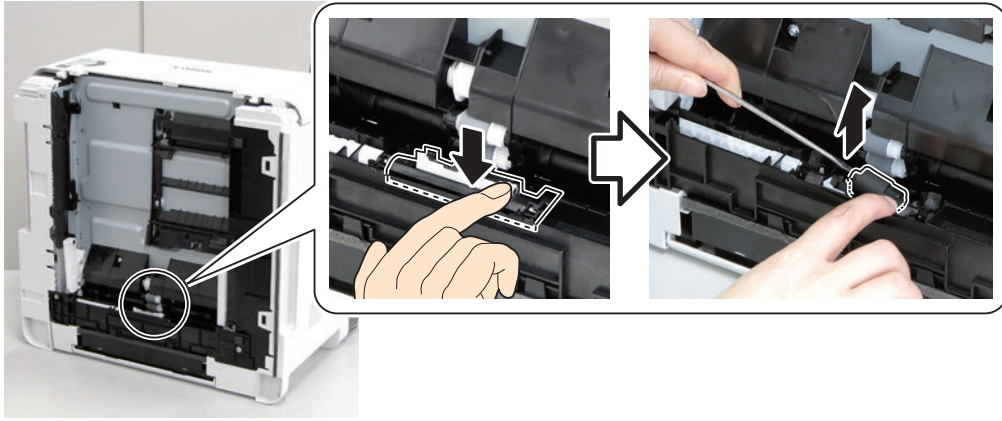

CAUTION:

When installing it, be sure that the D-cut is fitted properly.

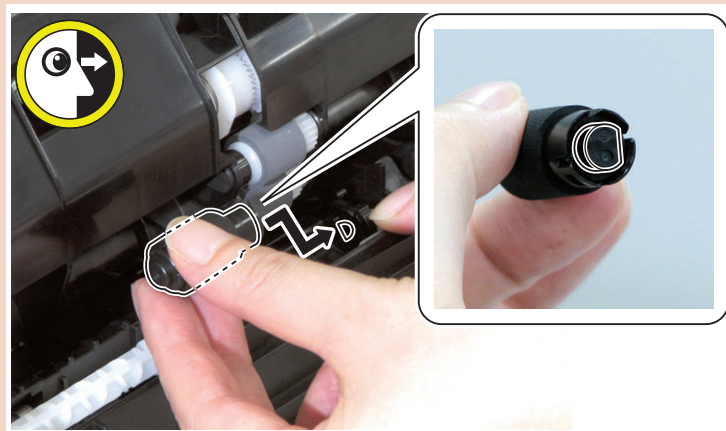

● Removing the Duplex Reverse Drive Unit

■ Preparation

1. "Removing the Toner Cartridge" on page 70
2. "Removing the Right Cover" on page 72

■ Procedure

1. Remove the cover.

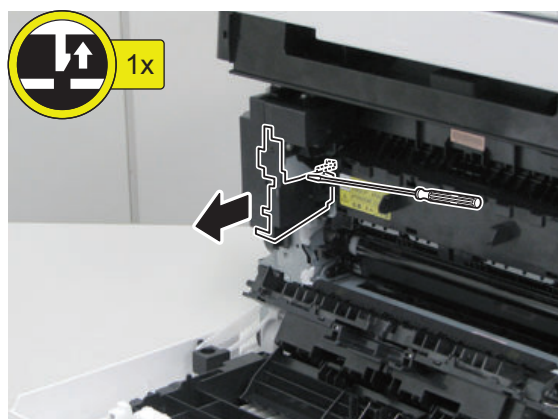

2. Free the harness from the guides, and disconnect the connectors.

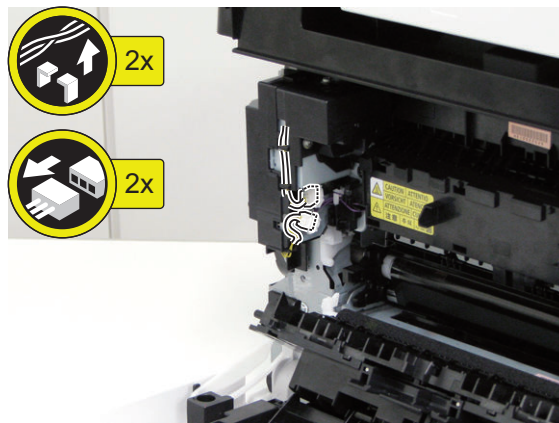

3. Remove the Duplex Reverse Drive Unit.

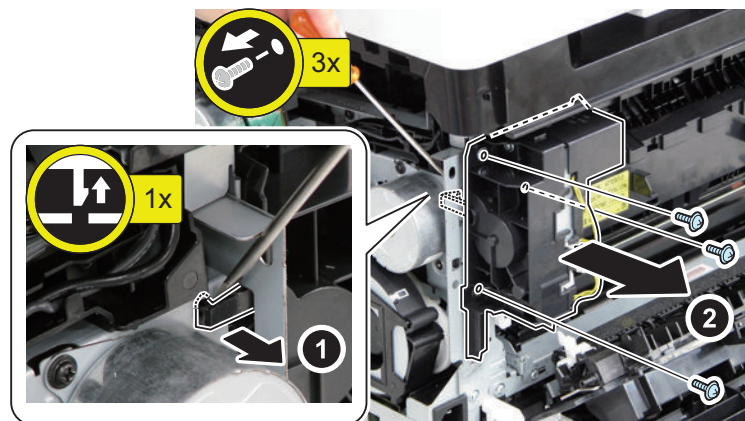

● Removing the Pickup Guide

■ Preparation

1. "Removing the Toner Cartridge" on page 70
2. "Removing the Left Cover" on page 71
3. "Removing the Rear Cover Unit" on page 75
4. "Removing the Controller Cover" on page 80
5. "Removing the NCU Support Plate" on page 86

■ Procedure

1. Remove the Duplex Gear Assembly.



2. Remove the Right Holder.

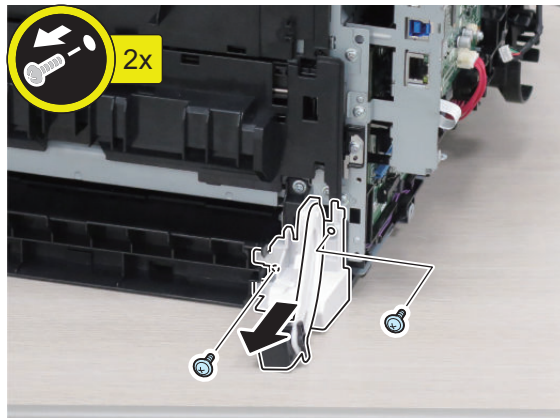

3. Remove the guide.

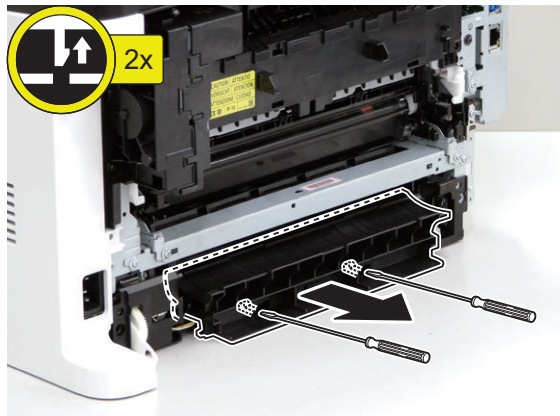

4. Disconnect the connector, and free the harness from the harness guide.

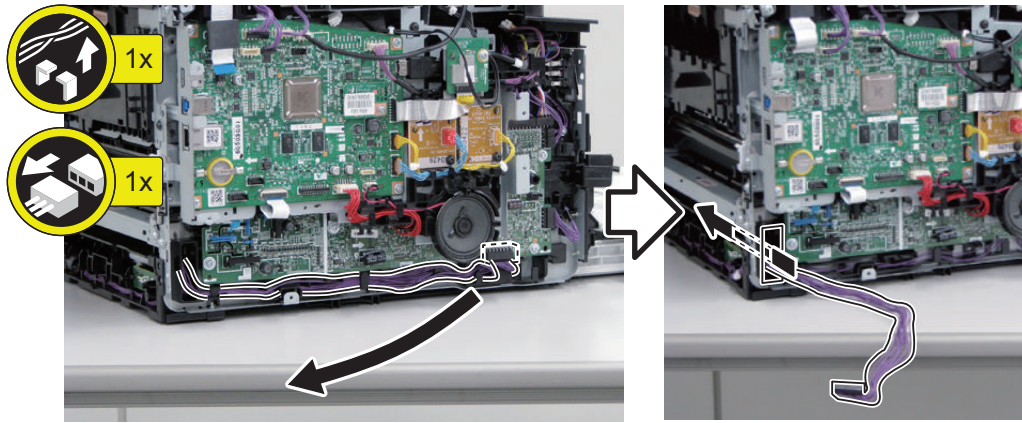

5. Shift the host machine by approximately 100 mm from the working table.

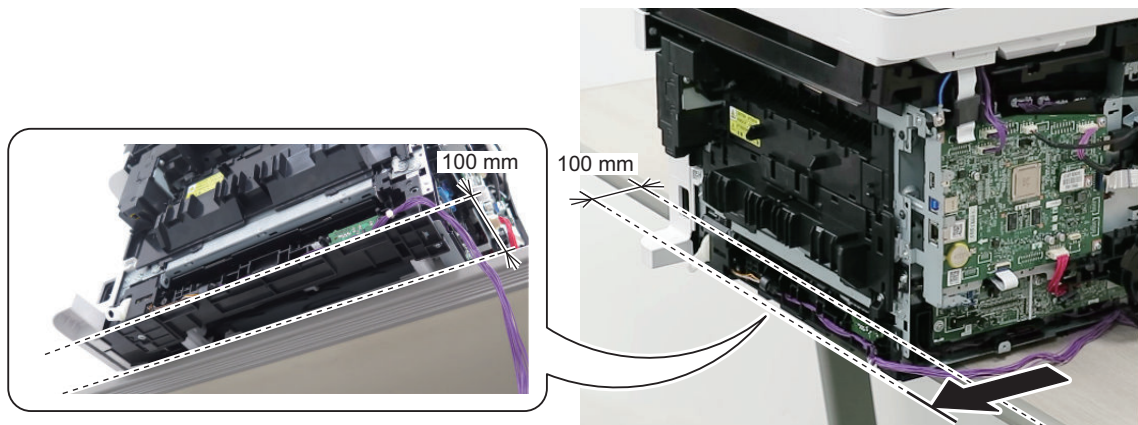

6. Remove the connector and core.

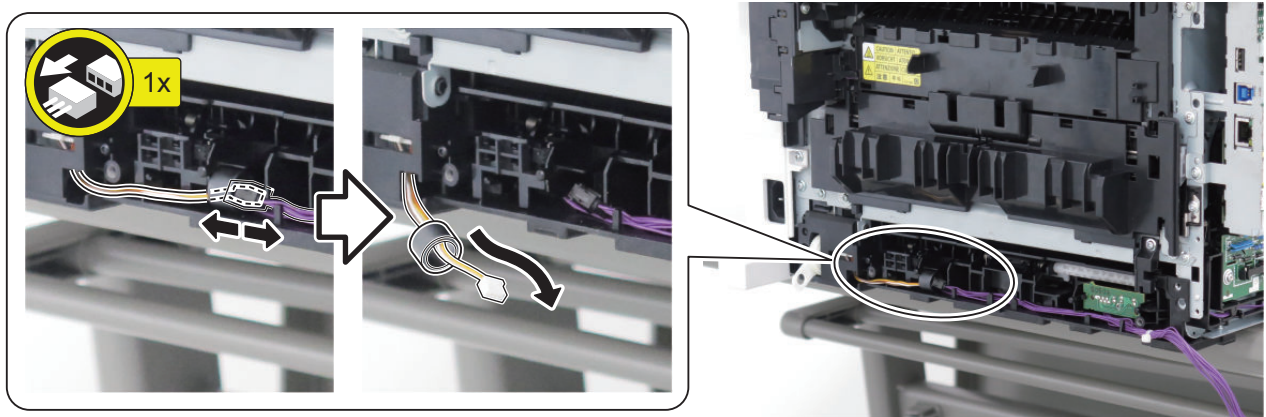

7. Open the Secondary Transfer Feed Unit and remove the Pickup Guide.

CAUTION:

- Remove the Pickup Guide with the Cassette pulled out.
- When the Secondary Transfer Feed Unit is opened, the Secondary Transfer Feed Unit and Pickup Guide may fall so make sure to remove the Pickup Guide while holding them with hands.

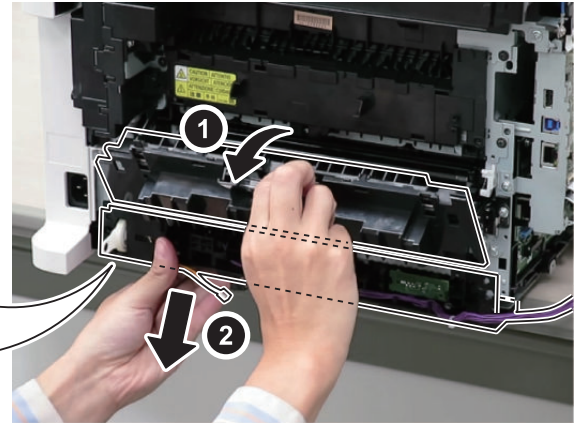
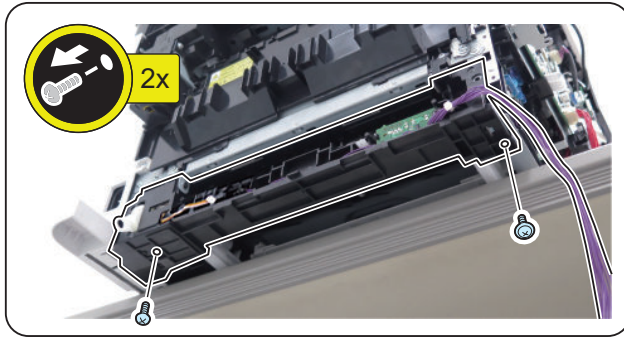

● Removing the Multi-purpose Tray Pickup Unit

■ Preparation

1. "Removing the Toner Cartridge" on page 70
2. "Removing the Right Cover" on page 72

■ Procedure

1. Close the Cartridge Cover.
2. Remove the cassette, and remove the Multi-purpose Tray Assembly.



3. Open the Cartridge Cover.

4. Free the harness from the guide, and then disconnect the connector.

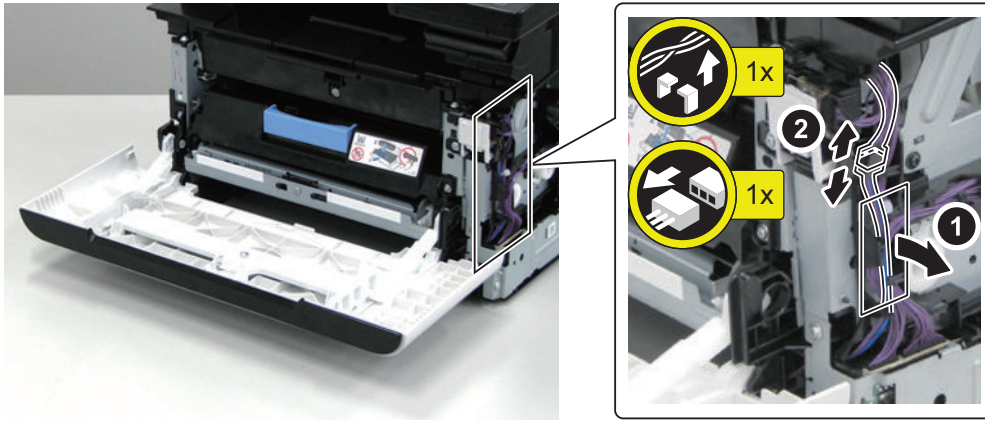

5. Close the Cartridge Cover and Rear Cover Unit, and stand the host machine with its rear side down.

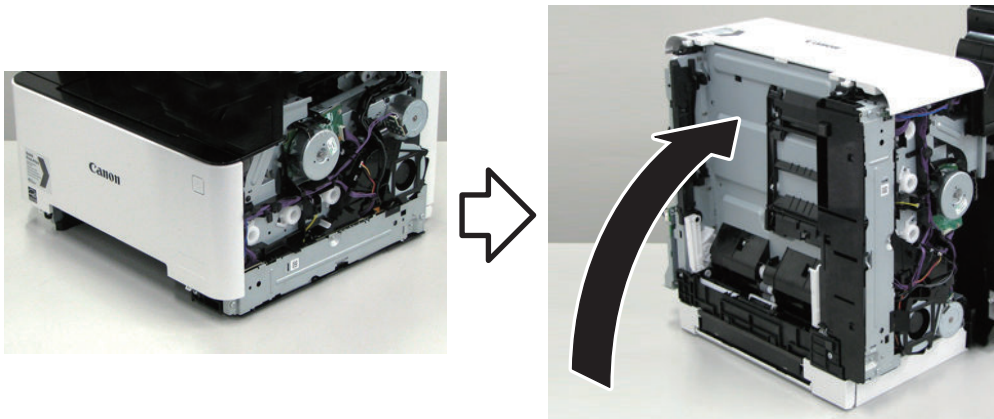

6. Open the Cartridge Cover, and remove the screws of the plate of the Low Voltage Power Supply Unit.

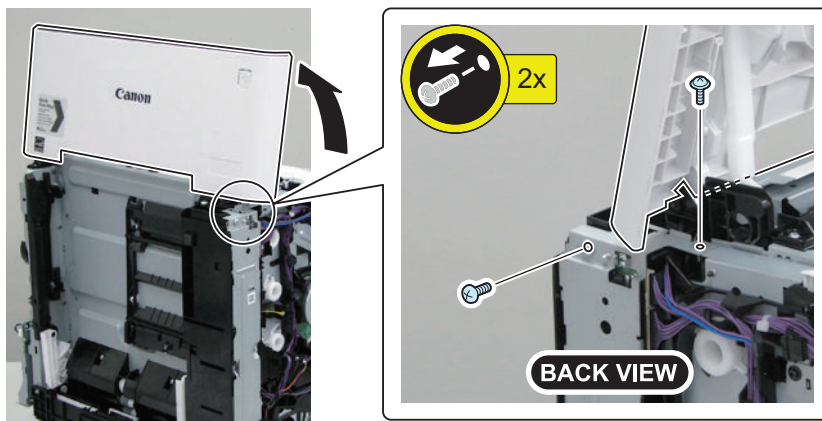

7. Free the harness from the guide.

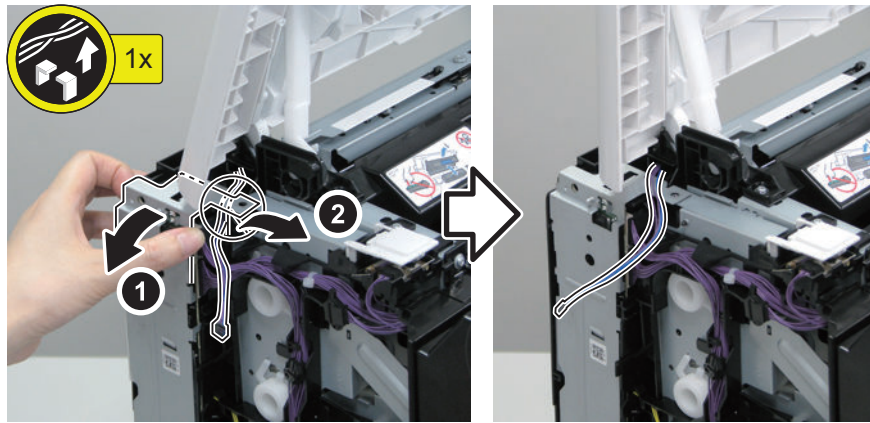

8. Remove the Multi-purpose Tray Pickup Unit.

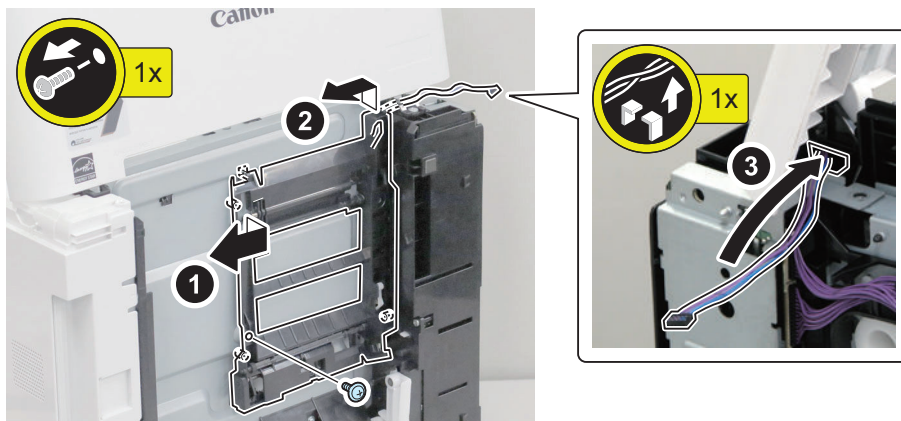

CAUTION:

When installing it, be careful not to drop the gear and spring.

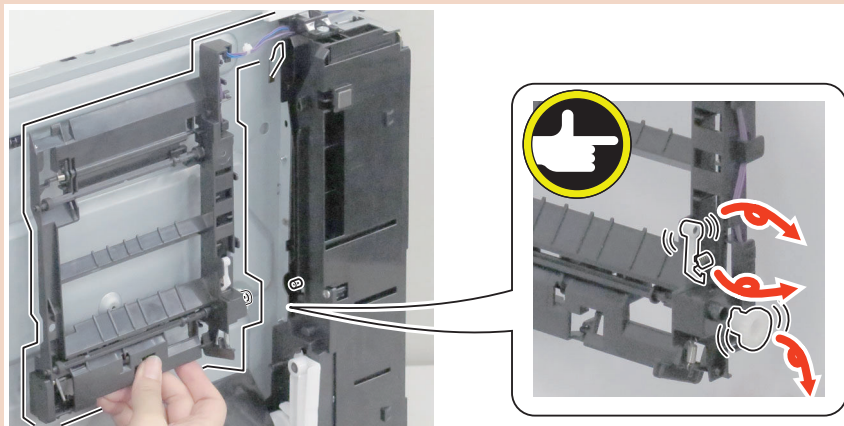



Adjustment

Adjustment at Parts Replacement.... 108

Adjustment at Parts Replacement

After Replacing the ITB Unit

1. Perform the following

- Adjustment / Maintenance >> Adjust Image Quality > Quick Adjust

After Replacing the Color Displacement Density Sensor Unit

1. Perform the following

- Adjustment / Maintenance >> Adjust Image Quality > Quick Adjust

Engine Controller PCB

■ Before Replacing the Engine Controller PCB

The setting values stored in the Engine Controller PCB NVRAM can be backed up to the Main Controller PCB NVRAM. The setting values can be backed up by performing the following method.

- SERVICE MODE > COPIER > FUNCTION > VIFFNC > STOR-DCN

Turn OFF and then ON the power.

CAUTION:

Perform backup immediately before replacing the Engine Controller PCB.

■ After Replacing the Engine Controller PCB

The setting values of the NVRAM on the Engine Controller PCB are stored in the NVRAM on the Main Controller PCB as a backup.

The setting values can be restored by performing the following method.

- SERVICE MODE > COPIER > FUNCTION > VIFFNC > RSTR-DCN

Turn OFF and then ON the power.

Main Controller PCB

■ Before Replacing the Main Controller PCB

The following setting values are recorded in the Main Controller PCB. When the Main Controller PCB is replaced, these setting values are all returned to the default unless they are restored.

- User mode setting values
- Service mode setting values

These setting values can be restored by performing backup by either of the following methods.

Refer to the Backup List for the details of items that are backed up. [“Backup Data List” on page 181](#)

- SERVICE MODE > COPIER > FUNCTION > SYSTEM > EXPORT
- Menu > Management Settings > Data Management > Import/Export > Export
- RUI > Settings/Registration > Management Settings > Data Management > Import/Export > Export

CAUTION:

Perform backup immediately before replacing the Main Controller PCB.

■ After Replacing the Main Controller PCB

1. **Restore the data in the same way as that of backup. Refer to the Backup List for the setting values that are restored.**

Refer to the Backup List for the details of items that are backed up. [“Backup Data List” on page 181](#)

- SERVICE MODE > COPIER > FUNCTION > SYSTEM > IMPORT
- Menu > Management Settings > Import/Export > Export
- RUI > Settings/Registration > Management Settings > Import/Export > Export.

Update firmware as necessary.

CAUTION:

Be sure to restore the data after replacing the Main Controller PCB.



Troubleshooting

Test Print.....	111
Troubleshooting Items.....	124
Debug Log.....	126

Test Print

Engine Test Print

This machine has an engine test print function to check whether the printer engine is operating normally.

NOTE:

In the case of engine test print, a test print can be performed by using only the Engine Controller.

There are two types of engine test print: 1-sided print and 2-sided print*.

*: Duplex models only

1. Load A4/LTR paper in the Pickup Tray or Multi-purpose Tray Pickup Tray.
2. While the machine is in the standby mode, open and close the Front Cover [1] for the predetermined number of times in a row.

CAUTION:

Be sure to perform the next cycle of open/close within 1.5 seconds after the last cycle of open/close.

- In case of 1-sided print
4 times
- In case of 2-sided print
5 times or more

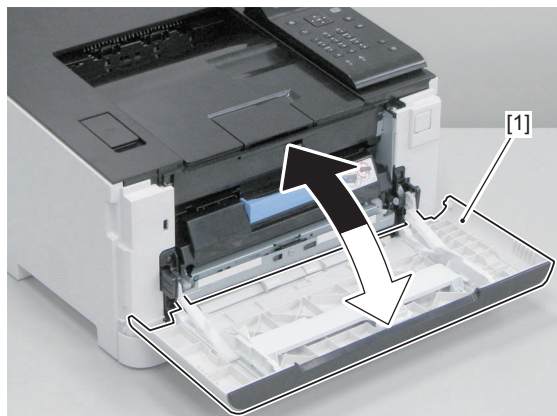

3. An engine test print is executed, and the test pattern as shown below is printed on one side or both sides of a sheet of paper.

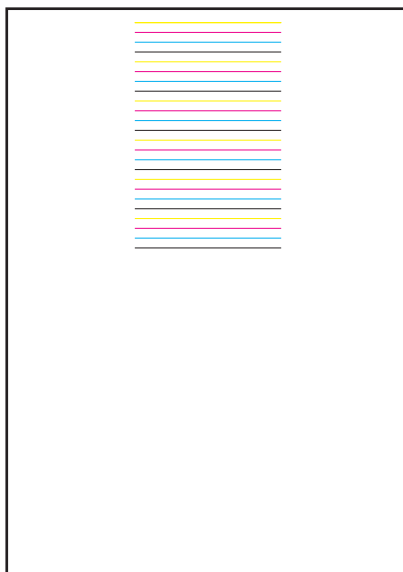

Controller test print

The following test print types are available with this machine, and you can check for failure of an image with a circle 'Yes' described in the image check items in the table below. When no failure is found in the test print in normal output mode, it can be caused in PDL input or Reader.

The image of the test print is generated by the Main Controller PCB.

PG TYPE	TYPE Pattern	Image check items													
		Gra-dation	Fog-ging	Trans-fer Fault	Black line (Color line)	White line	Un-even Den-sity	Un-even Den-sity at the Front / Rea	Right Angle	Straight Lines	Color displacement	Color	Ghost	Density	White spots
0-1	For R&D use														
2	Color chart										Yes				
3	For R&D use														
4	Rainbow chart (vertical scanning direction, A4)										Yes				
5	Rainbow chart (horizontal scanning direction, A4)										Yes				
6	Color grid (A4)								Yes	Yes	Yes				
7	Rainbow chart (vertical scanning direction, LTR/LGL)										Yes				
8	Rainbow chart (horizontal scanning direction, LTR/LGL)										Yes				
9	Color grid (LTR/LGL)								Yes	Yes	Yes				
10	16 gradations	Yes	Yes			Yes		Yes							
11	17 gradations of Y/M/C/Bk/R/G/B	Yes													
12	Halftone			Yes	Yes	Yes	Yes	Yes							

PG TYPE	TYPE Pattern	Image check items													
		Gra-dation	Fog-ging	Trans-fer Fault	Black line (Color line)	White line	Un-even Den-sity	Un-even Den-sity at the Front / Rea	Right Angle	Straig-ht Lines	Color dis-placement	Color	Ghost	Den-sity	White spots
13	For checking ghost due to transfer failure												Yes		
14	For checking the density patch							Yes						Yes	
15	For checking transfer				Yes	Yes		Yes							
20	For R&D use														
21	For checking de-veloping perform-ance (white spots)	Yes													Yes
22	For checking res-olution				Yes	Yes	Yes								
23	For checking banding image				Yes	Yes	Yes								
24	4 colors (land-scape)			Yes	Yes	Yes		Yes							
25	4 colors (portrait)			Yes	Yes	Yes	Yes								
26	For calibrating color difference between the front and back sides with DADF (1-path model)														

Follow the procedure shown below to output the test print.

1. Select the following service mode.

TESTMODE > PRINT > PG-TYPE

2. Enter the type number of the test print using the numeric keypad, and press the [Apply] key.

NOTE:

If necessary, change the settings for test print in the following service mode.

If the settings are not changed, a test print will be executed with the initial values of service mode settings.

- Setting of the number of output sheets:
TESTMODE > PRINT > COUNT
- Setting of 1-sided/2-sided printing:
TESTMODE > PRINT > PHASE
- Setting of the image formation method:
TESTMODE > PRINT > MODE
- Setting of the image correction table:
TESTMODE > PRINT > THRU
- Setting of ON/OFF of the laser scanning interpolation process:
TESTMODE > PRINT > NRKE
- Setting of ON/OFF of the test print interpolation process:
TESTMODE > PRINT > BLND
- Setting of the paper source used when outputting a test print:
TESTMODE > PRINT > FEED

3. Execute the following service mode to output a test print.

TESTMODE > PRINT > START

■ How to use the test print

● Color chart (TYPE=2)



Check item	Checking method	Assumed cause
Color	Check the color.	Cartridge error Soiling on the Color Displacement/Density Sensor ITB Unit error

● Rainbow chart (vertical scanning direction) (TYPE=4, TYPE=7)

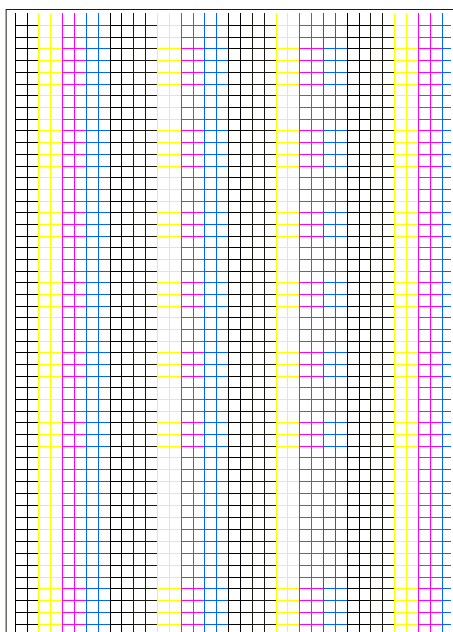

Check item	Checking method	Assumed cause
Color displacement	Output the PG after performing color displacement correction, and check the displacement for each color in the feed direction.	Soiling on the Color Displacement/Density Sensor Cartridge error ITB Unit error Main Drive Unit error

• **Rainbow chart (horizontal scanning direction) (TYPE=5, TYPE=8)**

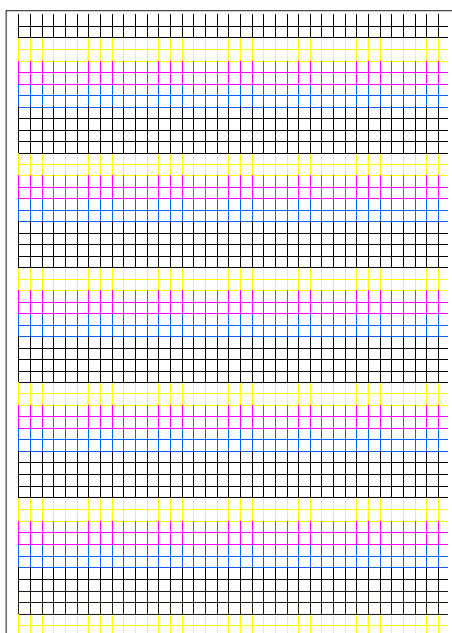

Check item	Checking method	Assumed cause
Color displacement	Output the PG after performing color displacement correction, and check the displacement for each color in the shaft direction.	Soiling on the Color Displacement/Density Sensor Cartridge error ITB Unit error Laser Scanner Unit error Main Controller PCB error

• **Color grid (TYPE=6, TYPE=9)**

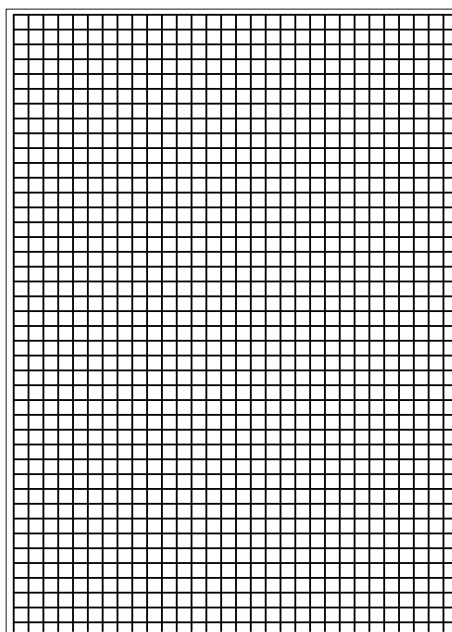

Check item	Checking method	Assumed cause
Color displacement	Check that there is no displacement between the lines of the respective colors.	Laser Scanner Unit error ITB Unit error Soiling on the Registration Sensor Secondary Transfer Roller error Main Drive Unit (drum rotation) error
Right angle accuracy and linearity	Check that there is nothing wrong with the right angle accuracy and linearity between the lines of the respective colors.	Laser Scanner Unit error Registration Roller error Secondary Transfer Roller error

- 16 gradations (TYPE=10)

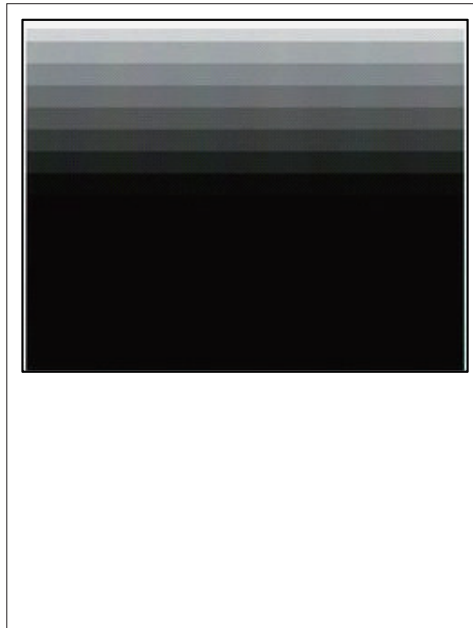

Check item	Checking method	Assumed cause
Gradation	Check that the 16 density gradations are recognizable.	Photosensitive Drum error Laser Scanner Unit error
Fogging	Check whether fogging appears only in the blank area.	Photosensitive Drum error Laser Scanner Unit error
White line	Check the entire image for any white line.	Photosensitive Drum error Laser Scanner Unit error
Uneven density between the front and rear	Check for any uneven density between the rear and front sides.	Photosensitive Drum error Laser Scanner Unit error Soiling on the laser light path

- 17 gradations of Y/M/C/Bk/R/G/B (TYPE=11)

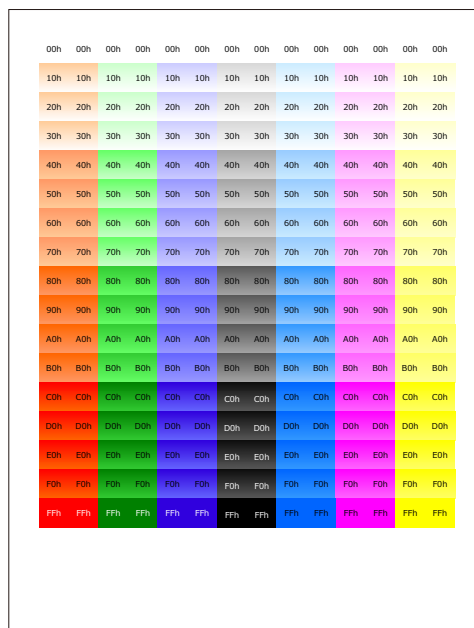

Check item	Checking method	Assumed cause
Gradation	Check that the 16 density gradations are recognizable.	Photosensitive Drum error Laser Scanner Unit error

- Halftone (TYPE=12)

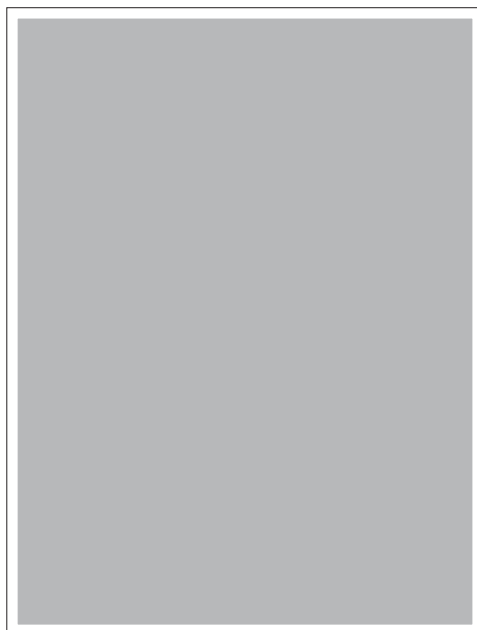
**NOTE:**

Various settings can be configured in the following service mode.

- Output of each developing color:
 - TESTMODE > PRINT > SW-Y
 - TESTMODE > PRINT > SW-M
 - TESTMODE > PRINT > SW-C
 - TESTMODE > PRINT > SW-K
- Print density setting:
 - TESTMODE > PRINT > DENS-Y
 - TESTMODE > PRINT > DENS-M
 - TESTMODE > PRINT > DENS-C
 - TESTMODE > PRINT > DENS-K

Check item	Checking method	Assumed cause
Transfer failure	Check the entire image for any transfer failure.	ITB error (scratches or soiling) Primary Transfer Pad error (scratches or soiling) Secondary Transfer Roller error (scratches or soiling)
Black line (colored line)	Check the entire image for any black line.	Scratches on the Photosensitive Drum
White line	Check the entire image for any white line.	ITB Unit error Secondary Transfer Roller error Soiling on the laser light path
Uneven density at regular intervals	Check the entire image for any uneven density at regular intervals.	Photosensitive Drum error
Uneven density	Check the entire image for any uneven density.	Soiling on the Dustproof Glas Deterioration of the ITB

- For checking ghost due to transfer failure (TYPE=13)

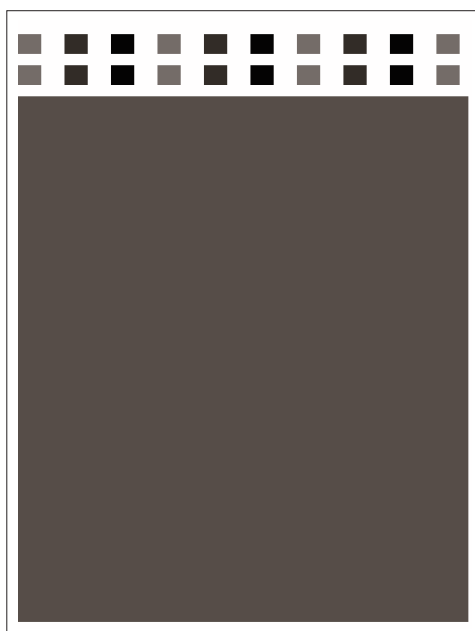

Check item	Checking method	Assumed cause
Ghost	Check the degree of ghosting (area where the density is too high or low) in halftone areas.	Cartridge error ITB Unit error

- For checking the density patch (TYPE=14)

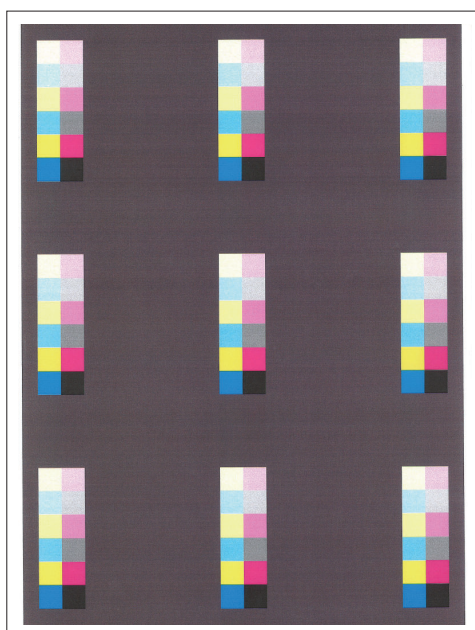

Check item	Checking method	Assumed cause
Density	Check the density of each patch after calibration.	Cartridge error ITB Unit error Secondary Transfer Roller error Soiling on the Color Displacement/Density Sensor
Uneven density	Check the difference in density among patches.	Cartridge error ITB Unit error

- For checking transfer (TYPE=15)

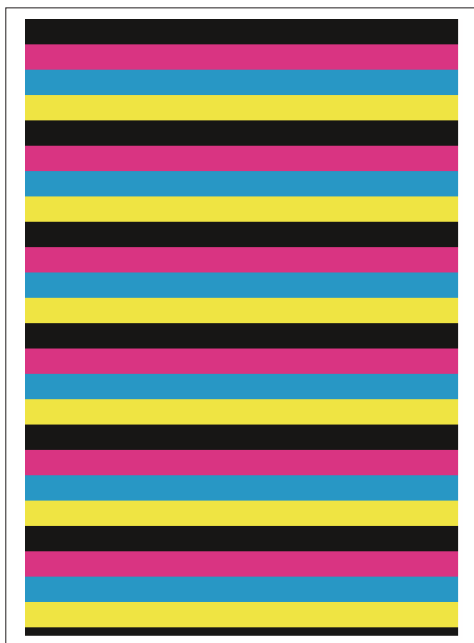

Check item	Checking method	Assumed cause
Uneven density	Check that there is no uneven density in the solid area of each color.	Laser Scanner Unit error Cartridge error Primary Transfer Pad error
Black line (colored line)	Check that there is no black line (colored line) in the solid area of each color.	Scratches on the Photosensitive Drum Soiling on the Primary Charging Roller
White line	Check that there is no white line in the solid area of each color.	ITB Unit error Secondary Transfer Roller error Soiling on the laser light path

- For checking developing performance (white spots) (TYPE=21)



Check item	Checking method	Assumed cause
Gradation	Check the gradation performance.	Cartridge error Soiling on the Color Displacement/Density Sensor ITB Unit error

Check item	Checking method	Assumed cause
White spots	White spots near the solid patches in halftone patches just before and after the solid patches	Cartridge error

• For checking resolution (TYPE=22)

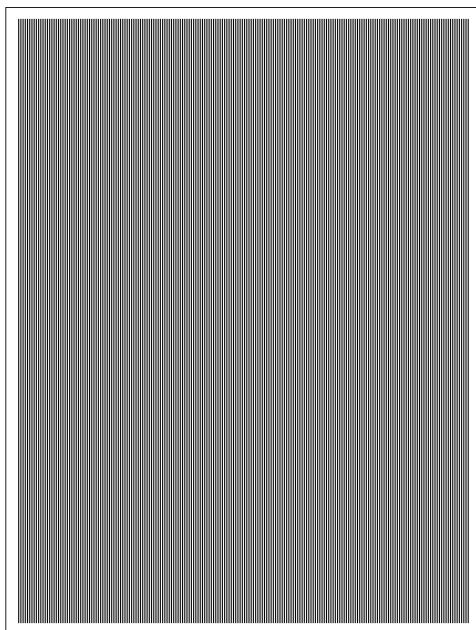

Check item	Checking method	Assumed cause
Line	Check the position and interval.	Laser Scanner Unit error Main Controller PCB error

• For checking banding image (TYPE=23)

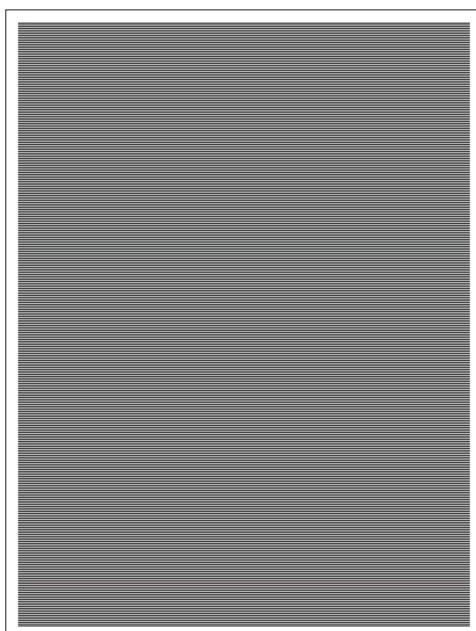

Check item	Checking method	Assumed cause
Line	Check the position and interval.	Cartridge error Main Drive Unit error ITB Unit error Fixing Assembly error Error in the feed path Paper slip at paper pickup

- 4 colors (landscape) (TYPE=24)

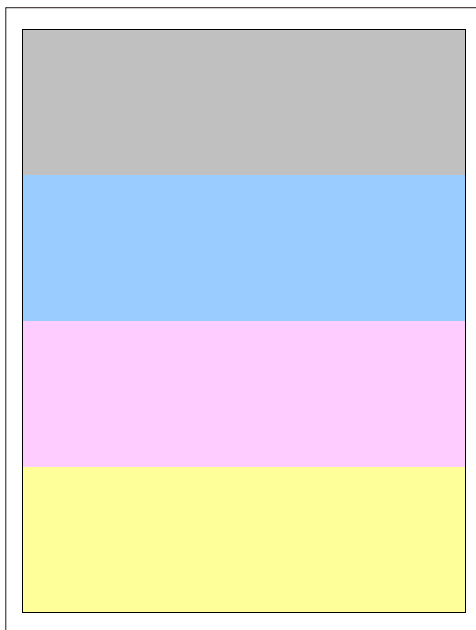

Check item	Checking method	Assumed cause
Line	Check the position of the line, and check whether the line occurs in all colors.	<p>If it occurs only in a single color:</p> <ul style="list-style-type: none"> Cartridge error Laser Scanner Unit error ITB Unit error <p>If it occurs in all colors:</p> <ul style="list-style-type: none"> ITB Unit error Secondary Transfer Roller error Fixing Assembly error

- 4 colors (portrait) (TYPE=25)

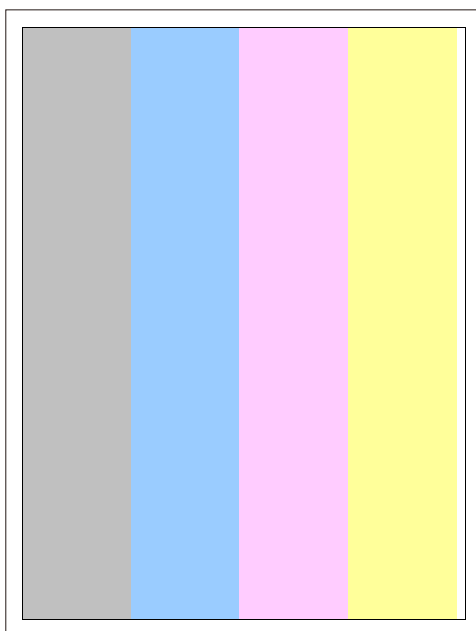

Check item	Checking method	Assumed cause
Line	Check the position of the line, and check whether the line occurs in all colors.	If it occurs only in a single color: Cartridge error Laser Scanner Unit error ITB Unit error If it occurs in all colors: ITB Unit error Secondary Transfer Roller error Fixing Assembly error

Cartridge Log Report

Logs such as history of cartridge replacement are output as a report.

There are two types of cartridge log reports; one for users and one for service technicians.

CAUTION:

Do not provide users with the cartridge log report for service technicians because it contains detailed information that is not disclosed to end users.

```

08/25/2016 9:16PM LBP653C/654C                                0001
*****
*** CARTRIDGE LOG REPORT ***
*****
BODY No.                ABCD123456
Cyan
(1)
Serial No.  Type  Cpcty.  (4/6)          (S1/S5)  (5/7)  (S2/S6)  (S3/S7)  (S4/S8)
First/Last Used  Pg. Count  Left  Toner  Drum  Parts
0100728959  C1   Large  08/25/2016 09:13 PM  00001763  0%    78%    80%    78%
08/25/2016 09:16 PM  00001764  0%    78%    80%    78%

Magenta
(1)
Serial No.  Type  Cpcty.  (4/6)          (S1/S5)  (5/7)  (S2/S6)  (S3/S7)  (S4/S8)
First/Last Used  Pg. Count  Left  Toner  Drum  Parts
0100729012  C1   Starter 08/25/2016 09:13 PM  00001220  26%   25%    63%    25%
08/25/2016 09:16 PM  00001221  26%   25%    63%    25%

Yellow
(1)
Serial No.  Type  Cpcty.  (4/6)          (S1/S5)  (5/7)  (S2/S6)  (S3/S7)  (S4/S8)
First/Last Used  Pg. Count  Left  Toner  Drum  Parts
0100729187  C1   Large  08/25/2016 09:13 PM  00001609  0%    80%    83%    82%
08/25/2016 09:16 PM  00001610  0%    80%    83%    82%

Black
(1)
Serial No.  Type  Cpcty.  (4/6)          (S1/S5)  (5/7)  (S2/S6)  (S3/S7)  (S4/S8)
First/Last Used  Pg. Count  Left  Toner  Drum  Parts
0100729123  C1   Large  08/25/2016 09:13 PM  00000806  82%   83%    88%    83%
08/25/2016 09:16 PM  00000807  82%   83%    88%    83%

C4: 00000 0000000000
C5: 00000 0000000000
C6: 00000 0000000000
C7: 00000 0000000000
C8: 00000 0000000000

```

No.	Description
[1]	Replacement logs
[2]	Cartridge type: The number of times a non-genuine cartridge has been detected
[3]	Non-genuine cartridge page count

NOTE:

In addition to output as a report, cartridge logs can also be displayed on the remote UI service mode screen (for service technicians) or remote UI screen (for users).

- To display cartridge logs (for service technicians):
SERVICE REPORT > CRG-LOG
- To display cartridge logs (for users):
Status Monitor/Cancel > Cartridge Log

Output method

Execute the following service mode to output a cartridge log report for service technicians.

- To output a report on cartridge replacement history:
COPIER > FUNCTION > MISC-P > CRG-LOG

NOTE:

- To output a cartridge log report (for users)
Menu > Output Reports > Print List > Cartridge Log Report

Replacement logs

The record of replacement and usage of cartridges will be printed.

CAUTION:

Just after the cartridge has been replaced with a genuine cartridge or when a non-genuine cartridge is used, accurate information cannot be obtained and a random or approximate value may be printed. The remaining lives of some of the parts are not supported depending on the model.

Item	Description	Remarks
(1) Serial No.	Serial number of the cartridge	
(2) Type	Cartridge type	<ul style="list-style-type: none"> C1: Genuine C2 to C8: Non-genuine C0: Unknown
(3) Cpcty.	Cartridge capacity	Displayed in accordance with the toner fill-up amount
(4/6) First/Last Used	The date and time it was installed/last used	
(S1/S5) Pg. Count *	Cartridge page count (when it was installed/last used)	00000000 to 99999999
(5/7) Left	The amount remaining in the cartridge (when it was installed/last used)	0 to 100 % (New cartridge: 100%)
(S2/S6) Toner *	The remaining life of the toner (when it was installed/last used)	-128 to 100 % (New: 100%, Indefinite: -%)
(S3/S7) Drum *	The remaining life of the drum (when it was installed/last used)	-128 to 100 % (New: 100%, Indefinite: -%)
(S4/S8) Parts *	The remaining life of the Developing Assembly (when it was installed/last used)	-128 to 100 % (New: 100%, Indefinite: -%)

*: S1 to S8 are printed only on reports for service technicians.

Number of detections of non-genuine cartridge / Page count of non-genuine cartridge

When a non-genuine cartridge is installed, it is classified as a cartridge type C2 to C8 according to the reason for judging it non-genuine, and the number of detections of each type and the number of pages printed with the cartridge installed are recorded.

Reason for judging it non-genuine	Cartridge type		Description
	Report for users*	Report for service	
OEM	C3	C5	The number of detections of an OEM cartridge, and the number of pages printed
Communication error	C2	C4	The number of detections of a cartridge without memory and the number of pages printed
Refill	C3	C6	The number of detections of a cartridge prepared by refilling toner into a genuine cartridge, and the number of pages printed
Copied memory	C3	C7	The number of detections of a cartridge prepared by refilling toner into a genuine cartridge and copying the contents of a normal memory, and the number of pages printed
Authentication failed	C2	C8	The number of detections of a cartridge that cannot be authenticated, and the number of pages printed

*: Only C2 and C3 are displayed. The total count of the values of the reasons for judging the cartridge non-genuine is displayed.

Troubleshooting Items

Recurring faulty image

Overview

Foreign matters or lines on rollers along the paper feed path may cause faulty images in the vertical scanning direction.

Field Remedy

See the roller pitches listed in the tables below to clean and/or replace the corresponding parts.

CAUTION:

Since the Primary Charging Roller, Photosensitive Drum, and Developing Roller are located inside the cartridge and cannot be cleaned, replace the cartridge.

Roller pitch	Parts
Approx. 44 mm	Registration Roller
Approx. 50 mm	Secondary Transfer Roller
Approx. 19 mm	Primary Charging Roller
Approx. 63 mm	Photosensitive Drum
Approx. 31 mm	Developing Roller
Approx. 57 mm	Fixing Firm
Approx. 57 mm	Pressure Roller

Confirming nip width

Overview

Although the nip width of the Fixing Assembly cannot be adjusted with this machine, it can be checked.

By checking the nip width when fixing failure occurs, it is possible to judge whether there is a problem with the Fixing Assembly.

Field Remedy

Check the nip width of the Fixing Assembly by the following procedure.

1. Print a solid black image on an A4/LTR size paper using the cartridge of this machine and bring it to the customer site.
2. Load the solid black printed paper with its printing side facing down in a cassette of the machine.
3. Use an external device to print a solid white image.
4. Open the Front Cover after approx. 25 seconds, leave it for 10 seconds or more, and then take out the printed paper.

5. Measure the widths of the glossy part of the toner on the printed paper, and check that they are within the range as follows.

- Center (a): 6.0 to 8.1 mm
- Edge (b) and (c): 6.3 to 8.5 mm each
- Difference between left and right ($|b - c|$): 1.0 mm or less

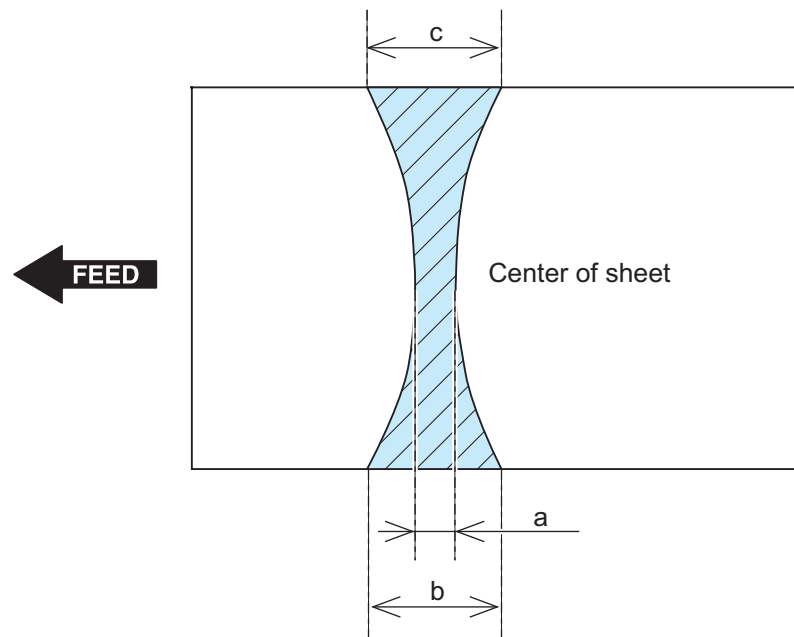

Debug Log

Function Overview

The debug log is a log that analyzes the program behavior of the machine to enable developers to identify problems. This machine is embedded with a function that compiles the log of the behavior of each software module as debug log and outputs it as integrated log for analyzing problems.

Be sure to collect the debug log when the Support Dept. of sales company so instructs.

Note that there is no need for service technicians to check the content of collected debug log.

Cases in which collection of debug log is effective

Collection of debug log is effective in the following cases:

- Neither the Support Dept. of sales company nor CINC can reproduce the trouble that occurred at the customer site
- When the error frequency is low
- When the failure is suspected to be due to firmware rather than a mechanical/electrical failure.

CAUTION:

If the procedure for reproducing the failure is clear and the Support Dept. of sales company and CINC can reproduce it, collection of debug log is not necessary.

Conditions for collecting logs

Conditions for not being able to collect logs

In the following cases, the procedure for obtaining logs is not required because logs cannot be obtained.

- Service mode screen cannot be accessed
- The machine cannot recognize a USB flash drive
- No USB port is installed in the machine (when the model has only a copy function)

What is necessary to collect logs

A USB flash drive that satisfies the following conditions is required to obtain the debug logs of the machine:

- Formatted in FAT 16/FAT32
- There is a free space of approx. 100MB.
- Can be recognized by the machine

Collection procedure

The following shows the procedure for collecting the debug log from the Control Panel.

1. **Connect a USB flash drive to the machine. In the case of a model having a USB connector on a side of the Control Panel, be sure to connect the USB flash drive to the Control Panel. In the case of a model having a USB connector only on the rear side, connect the USB flash drive to the USB connector on the rear side.**

CAUTION:

In the case of a model having a USB connector on the Control Panel, if the USB flash drive is connected to the USB connector on the rear side, debug logs are not transferred to the USB flash drive.

2. **Execute the following service mode from the Control Panel or Remote UI.**

- COPIER > FUNCTION > SYSTEM > LOGWRITE

"Executing..." is displayed while log collection is executed. When it is completed, the screen shows the service mode screen again.

3. **Execute the following service mode from the Control Panel or Remote UI.**

- COPIER > FUNCTION > SYSTEM > LOG2USB

"Executing..." is displayed while log collection is executed. When it is completed, the screen shows the service mode screen again.

4. Remove the USB flash drive by the correct procedure.

Connect the USB flash drive to the PC, and check that the log file shown below has been saved.

- Output by LOGWRITE: SUBLOG.TXT
- Output by LOG2USB: SUBLOG_YYYYMMDD.HHMMSS_XXX.GZ (the file may be divided into multiple files)



Error/Jam/Alarm

Overview.....	129
Error Code.....	132
Jam Code.....	138
Alarm Code.....	140

Overview

This section describes the error codes that are displayed when failure has occurred.

Code type	Description	Reference
Error Code	This code is displayed when a failure caused by the host machine has occurred.	List of Error Codes
Jam code	This code is displayed when a jam has occurred.	List of Jam Codes
Alarm Code	This code is displayed when the machine's function has been partially lost.	List of Alarm Codes

Error/Jam/Alarm Log indication

Error log

Service Mode > COPIER > DISPLAY > ERR

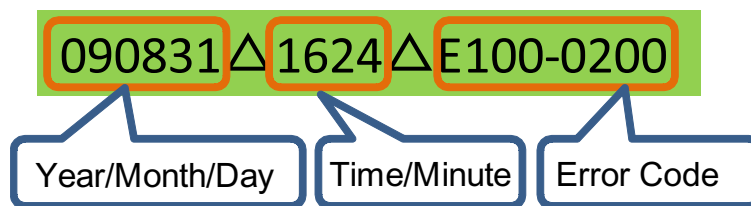

Indication example

```

ERR
090831 1624 E100-0200
-----
-----
-----
-----
-----

```

Jam log

Service Mode > COPIER > DISPLAY > JAM

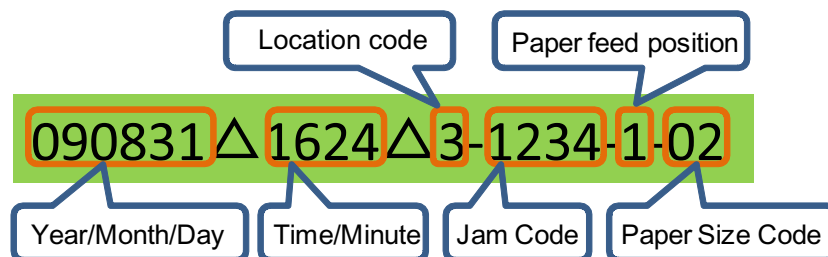

Indication example

```

JAM
090831 1624 3-1234-1-02
-----
-----
-----
-----
-----

```

Alarm log

Service Mode > COPIER > DISPLAY > ALARM-2, ALARM-3

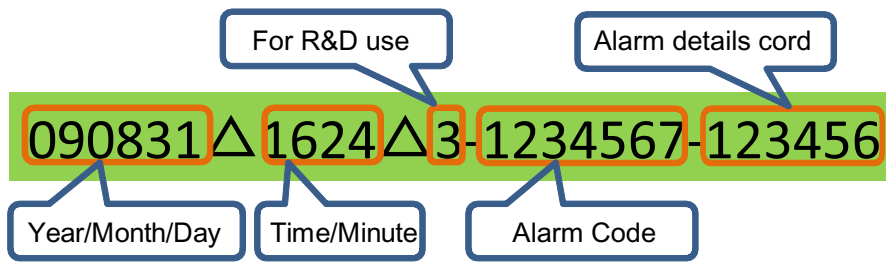

Indication example

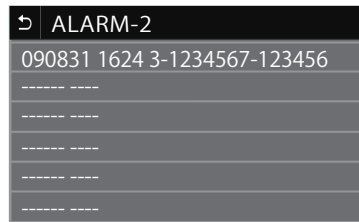

JAM/ERR LOG REPORT

Output procedure of the JAM/ERR LOG REPORT

Service Mode > COPIER > FUNCTION > MISC-P > ERR-LOG

The explanation of mention contents

```

*****
***  JAM/ERR LOG REPORT  ***
*****
JAM
001  [1] 21/10 10:52 AM 10:53 AM [2] [3] [4] [5] [6] [7]
002  30/10 11:58 PM 11:58 PM 3 0 0B00 000022 1 00002
003  01/11 08:15 AM 08:15 AM 4 0 0049 000022 0 00000
ERROR
001  [8] [9] [10] [11]
002  20/10 10:11 AM 3 733 0000 000010
    25/10 07:35 AM 3 004 0002 000018
    
```

No.	Item
1	Day/Month Time/Minute
2	Outbreak division
3	Not used
4	Jam code
5	Total counter
6	Paper feed position
7	Paper size
8	Location code
9	Error code
10	Error details code
11	Total counter

Location Code

The jam codes of this machine contain information on the location.

The location information is displayed in a single digit and has the meaning shown below:

Device	Location code
Host machine	3

Pickup Position Code

When a jam occurs, the pickup location is indicated with the following pickup position code.

Pickup position	Pickup position code
Pickup from Multi-purpose Tray	0
Cassette 1	1
Option cassette	2
At duplex printing	7

Error Code

Error Code Details

E000-0000---	Error in temperature rising of Fixing Assembly
Detection Description	Temperature of the Fixing Assembly did not reach a certain temperature within the specified period of time.
Remedy	<ol style="list-style-type: none"> 1. Check the connector connection between the Fixing Assembly and the Engine Controller PCB. 2. Replace the Fixing Assembly. 3. Replace the Engine Controller PCB.
E001-0000---	Abnormal high temperature of Fixing Assembly
Detection Description	It was detected that the temperature of the Fixing Assembly was abnormally high.
Remedy	<ol style="list-style-type: none"> 1. Check the connector connection between the Fixing Assembly and the Engine Controller PCB. 2. Replace the Fixing Assembly. 3. Replace the Engine Controller PCB.
E001-0001---	Abnormal high temperature of Fixing Assembly
Detection Description	It was detected that the temperature of the Fixing Assembly (Sub Thermistor) was abnormally high.
Remedy	<ol style="list-style-type: none"> 1. Check the connector connection between the Fixing Assembly and the Engine Controller PCB. 2. Replace the Fixing Assembly. 3. Replace the Engine Controller PCB.
E003-0000---	Abnormal low temperature of Fixing Assembly
Detection Description	It was detected that the temperature of the Fixing Assembly was abnormally low.
Remedy	<ol style="list-style-type: none"> 1. Check the connector connection between the Fixing Assembly and the Engine Controller PCB. 2. Replace the Fixing Assembly. 3. Replace the Engine Controller PCB.
E003-0001---	It was detected that the temperature of the Fixing Assembly (Sub Thermistor) was abnormally low.
Detection Description	It was detected that the temperature of the Fixing Assembly (Sub Thermistor) was abnormally low.
Remedy	<ol style="list-style-type: none"> 1. Check the connector connection between the Fixing Assembly and the Engine Controller PCB. 2. Replace the Fixing Assembly. 3. Replace the Engine Controller PCB.
E004-0000---	Error in fixing power supply drive circuit
Detection Description	The zero cross signal was not detected for the specified period of time or more.
Remedy	<ol style="list-style-type: none"> 1. Check the connector connection between the Fixing Assembly and the Engine Controller PCB. 2. Replace the Fixing Assembly. 3. Replace the Engine Controller PCB.
E012-0000---	Black Drum Motor error
Detection Description	An error in the initial operation of the Drum Motor was detected.
Remedy	<ol style="list-style-type: none"> 1. Reconnect the connector of the Main Motor. 2. Replace the Engine Controller PCB.
E012-0001---	Black Drum Motor error
Detection Description	Rotation error of the Drum Motor was detected.
Remedy	<ol style="list-style-type: none"> 1. Reconnect the connector of the Main Motor. 2. Replace the Engine Controller PCB.
E014-0000---	Error in startup of the Main Motor
Detection Description	Revolution of the Main Motor did not reach the specified value.
Remedy	<ol style="list-style-type: none"> 1. Check the connector connection between the Main Motor and the Engine Controller PCB. 2. Replace the Main Motor. 3. Replace the Engine Controller PCB.

E014-0001---	Error in startup of the Main Motor
Detection Description	Revolution of the Main Motor was out of the specified range.
Remedy	<ol style="list-style-type: none"> 1. Check the connector connection between the Main Motor and the Engine Controller PCB. 2. Replace the Main Motor. 3. Replace the Engine Controller PCB.
E015-0000---	Error in Developing Disengagement Motor
Detection Description	The engine detected an error in the Developing Disengagement Motor.
Remedy	<ol style="list-style-type: none"> 1. Check the harnesses/connectors connecting the Developing Disengagement Switch, the Developing Disengagement Solenoid and the Engine Controller PCB. 2. Check that the Developing Disengagement Switch is properly installed. 3. Replace the Developing Disengagement Switch. 4. Replace the Developing Disengagement Solenoid. 5. Replace the Engine Controller PCB.
E015-0001---	Cassette 1 lift-up error
Detection Description	After lift-up of the Lifting Plate of the cassette of the host machine started, ON status of the Lifter Sensor of the cassette of the host machine was not detected within the specified period of time.
Remedy	<ol style="list-style-type: none"> 1. While the cassette of the host machine is removed, turn ON the power and insert the cassette, then check the operation sound of the motor. When there is operation sound of the motor, check if the Lifting Plate has been lifted up. When the Lifting Plate has been lifted up: <ol style="list-style-type: none"> 1-1. Check that the Lifter Sensor of the cassette of the host machine is properly installed. 1-2. Check the harness/connector between the Engine Controller PCB and the Lifter Sensor. 1-3. Replace the Lifter Sensor. 1-4. Replace the Engine Controller PCB. When the Lifting Plate has not been lifted up: <ol style="list-style-type: none"> 2-1. Check the condition of the gear at the host machine side (missing teeth, swing). 2-2. Check the harness/connector between the Engine Controller PCB and the Lifter Solenoid of the cassette of the host machine. 2-3. Replace the Lifter Solenoid. 2-4. Replace the Pickup Motor of the cassette of the host machine. 2-5. Replace the Driver PCB. 2-6. Replace the Engine Controller PCB. When there is no operation sound of the motor, check the followings: <ol style="list-style-type: none"> 3-1. Check the harness/connector between the Engine Controller PCB and the Pickup Motor of the cassette of the host machine. 3-2. Check the condition of the gear at the host machine side (missing teeth, swing). 3-3. Check the Pickup Motor. 3-4. Replace the Driver PCB. 3-5. Replace the Engine Controller PCB.

E015-0002---	Cassette 2 lift-up error
Detection Description	After lift-up of the Lifting Plate of the 1-Cassette Unit started, ON status of the Lifter Sensor of the 1-Cassette Unit was not detected within the specified period of time.
Remedy	<p>1. While the cassette of the 1-Cassette Unit is removed, turn ON the power and insert the cassette, then check the operation sound of the motor. When there is operation sound of the motor, check if the Lifting Plate has been lifted up. When the Lifting Plate has been lifted up:</p> <p>1-1. Check that the Lifter Sensor of the Cassette Unit is properly installed. 1-2. Check the harness/connector between the Engine Controller PCB and the Lifter Sensor. 1-3. Replace the Lifter Sensor. 1-4. Replace the Cassette Feeder Driver PCB. 1-5. Replace the Engine Controller PCB.</p> <p>When the Lifting Plate has not been lifted up:</p> <p>2-1. Check the condition of the gear of the Cassette Unit (missing teeth, swing). 2-2. Check the harness/connector between the Engine Controller PCB and the Lifter Solenoid of the Cassette Unit. 2-3. Replace the Lifter Solenoid. 2-4. Replace the Pickup Motor of the Cassette Unit. 2-5. Replace the Cassette Feeder Driver PCB. 2-6. Replace the Engine Controller PCB.</p> <p>When there is no operation sound of the motor, check the followings:</p> <p>3-1. Check the harness/connector between the Engine Controller PCB and the Pickup Motor of the Cassette Unit. 3-2. Check the condition of the gear at the Cassette Unit side (missing teeth, swing). 3-3. Replace the Pickup Motor. 3-4. Replace the Cassette Feeder Driver PCB. 3-5. Replace the Engine Controller PCB.</p>
E020-0000---	Density Sensor error
Detection Description	An error in the Density Sensor was detected.
Remedy	<p>1. Check the remaining toner level. 2. Replace the Toner Cartridge. 3. Check the harness/connector between the Color Displacement/Density Sensor and the Engine Controller PCB. 4. Replace the Color Displacement/Density Sensor. 5. Replace the ITB. 6. Replace the Engine Controller PCB.</p>
E021-1000---	Yellow Developing Motor rotation error
Detection Description	It was judged that the Developing Motor did not rotate.
Remedy	<p>1. Check the harness/connector between the Developing Motor and the Engine Controller PCB. 2. Replace the Developing Motor. 3. Replace the Driver PCB. 4. Replace the Engine Controller PCB.</p>
E021-1001---	Magenta Developing Motor rotation error
Detection Description	It was judged that the Developing Motor did not rotate.
Remedy	<p>1. Check the harness/connector between the Developing Motor and the Engine Controller PCB. 2. Replace the Developing Motor. 3. Replace the Driver PCB. 4. Replace the Engine Controller PCB.</p>
E021-1002---	Cyan Developing Motor rotation error
Detection Description	It was judged that the Developing Motor did not rotate.
Remedy	<p>1. Check the harness/connector between the Developing Motor and the Engine Controller PCB. 2. Replace the Developing Motor. 3. Replace the Driver PCB. 4. Replace the Engine Controller PCB.</p>

E021-1003---	Black Developing Motor rotation error
Detection Description	It was judged that the Developing Motor did not rotate.
Remedy	<ol style="list-style-type: none"> 1. Check the harness/connector between the Developing Motor and the Engine Controller PCB. 2. Replace the Developing Motor. 3. Replace the Driver PCB. 4. Replace the Engine Controller PCB.
E021-2000---	Error in startup of the Yellow Developing Motor
Detection Description	Revolution of the Developing Motor did not reach the specified value.
Remedy	<ol style="list-style-type: none"> 1. Check the harness/connector between the Developing Motor and the Engine Controller PCB. 2. Replace the Developing Motor. 3. Replace the Driver PCB. 4. Replace the Engine Controller PCB.
E021-2001---	Error in startup of the Magenta Developing Motor
Detection Description	Revolution of the Developing Motor did not reach the specified value.
Remedy	<ol style="list-style-type: none"> 1. Check the harness/connector between the Developing Motor and the Engine Controller PCB. 2. Replace the Developing Motor. 3. Replace the Driver PCB. 4. Replace the Engine Controller PCB.
E021-2002---	Error in startup of the Cyan Developing Motor
Detection Description	Revolution of the Developing Motor did not reach the specified value.
Remedy	<ol style="list-style-type: none"> 1. Check the harness/connector between the Developing Motor and the Engine Controller PCB. 2. Replace the Developing Motor. 3. Replace the Driver PCB. 4. Replace the Engine Controller PCB.
E021-2003---	Error in startup of the Black Developing Motor
Detection Description	Revolution of the Developing Motor did not reach the specified value.
Remedy	<ol style="list-style-type: none"> 1. Check the harness/connector between the Developing Motor and the Engine Controller PCB. 2. Replace the Developing Motor. 3. Replace the Driver PCB. 4. Replace the Engine Controller PCB.
E052-0000---	Duplex Feed Unit absent error
Detection Description	Connection of the Duplex Feed Unit was not correct.
Remedy	<ol style="list-style-type: none"> 1. Reinstall the Duplex Feed Unit.
E066-0000---	Environment Sensor error
Detection Description	An error in the Environment Sensor was detected.
Remedy	<ol style="list-style-type: none"> 1. Check the harness/connection of the Environment Sensor and the Engine Controller PCB. 2. Replace the Environment Sensor. 3. Replace the Engine Controller PCB.
E078-0000---	Primary transfer disengagement mechanism error
Detection Description	Primary transfer disengagement mechanism did not work properly.
Remedy	<ol style="list-style-type: none"> 1. Check the harnesses/connectors connecting the Primary Transfer Disengagement Switch, the Primary Transfer Disengagement Solenoid and the Engine Controller PCB. 2. Replace the Primary Transfer Disengagement Switch. 3. Replace the Primary Transfer Disengagement Solenoid. 4. Replace the Engine Controller PCB.
E100-0000---	Yellow scanner area failure
Detection Description	Error in the Scanner Motor, Laser Unit, or BD detection in the yellow scanner area
Remedy	<ol style="list-style-type: none"> 1. Check the harness/FFC/connector between the Laser Unit and the Engine Controller PCB. 2. Replace the FFC. 3. Replace the Laser Unit. 4. Replace the Engine Controller PCB.

E100-0001---	Magenta scanner area failure
Detection Description	Error in the Scanner Motor, Laser Unit, or BD detection in the magenta scanner area
Remedy	<ol style="list-style-type: none"> 1. Check the harness/FFC/connector between the Laser Unit and the Engine Controller PCB. 2. Replace the FFC. 3. Replace the Laser Unit. 4. Replace the Engine Controller PCB.
E100-0002---	Cyan scanner area failure
Detection Description	Error in the Scanner Motor, Laser Unit, or BD detection in the cyan scanner area
Remedy	<ol style="list-style-type: none"> 1. Check the harness/FFC/connector between the Laser Unit and the Engine Controller PCB. 2. Replace the FFC. 3. Replace the Laser Unit. 4. Replace the Engine Controller PCB.
E100-0003---	Black scanner area failure
Detection Description	Error in the Scanner Motor, Laser Unit, or BD detection in the black scanner area
Remedy	<ol style="list-style-type: none"> 1. Check the harness/FFC/connector between the Laser Unit and the Engine Controller PCB. 2. Replace the FFC. 3. Replace the Laser Unit. 4. Replace the Engine Controller PCB.
E110-0000---	Primary pseudo BD correction error
Detection Description	The scanner failed to be Ready within 3 seconds after start of pseudo BD control.
Remedy	<ol style="list-style-type: none"> 1. Check that the engine test print is properly printed. 2. Check the FFC between the Main Controller PCB and the Engine Controller PCB. 3. Replace the Main Controller PCB.
E194-0000---	CPR Sensor error
Detection Description	An error in the CPR Sensor was detected.
Remedy	<ol style="list-style-type: none"> 1. Replace the Toner Cartridge. 2. Check the harness/connector between the Color Displacement/Density Sensor and the Engine Controller PCB. 3. Replace the Color Displacement/Density Sensor Unit. 4. Replace the Engine Controller PCB. 5. Replace the ITB Unit.
E196-0000---	Engine Controller error
Detection Description	Update of the Engine Controller was failed. (RFU mode right after the startup)
Remedy	<ol style="list-style-type: none"> 1. Replace the Engine Controller PCB.
E198-0000---	Engine Controller memory failure
Detection Description	Error in the nonvolatile memory on the Engine Controller PCB
Remedy	<ol style="list-style-type: none"> 1. Turn OFF and then ON the power and check if the symptom occurs again. 2. Replace the Engine Controller PCB.
E246-0000---	System error
Detection Description	System error
Remedy	Contact the sales company.
E247-0000---	System error
Detection Description	System error
Remedy	Contact the sales company.
E350-0000---	System error
Detection Description	System error
Remedy	Contact the sales company.

E354-0000---	System error
Detection Description	System error
Remedy	Contact the sales company.
E355-0000---	System error
Detection Description	System error
Remedy	Contact the sales company.
E355-0004---	System error
Detection Description	System error
Remedy	Contact the sales company.
E355-0005---	System error
Detection Description	System error
Remedy	Contact the sales company.
E733-0000---	Printer communication error
Detection Description	Communication error between the Engine Controller PCB and the Main Controller PCB occurred.
Remedy	<ol style="list-style-type: none"> 1. Check the connector connection between the Engine Controller PCB and the Main Controller PCB. 2. Install the set of the controller firmware. 3. Replace the Main Controller PCB. 4. Replace the Engine Controller PCB.
E743-0000---	DDI communication error
Detection Description	Software sequence error
Remedy	1. Turn OFF and then ON the main power.
E805-0005---	Sub Fan error
Detection Description	The Sub Fan was locked for a specified consecutive period of time.
Remedy	<ol style="list-style-type: none"> 1. Check the connection of the Sub Fan. 2. Replace the Sub Fan.
E806-0000---	Main Fan error
Detection Description	The Main Fan was locked for a specified consecutive period of time.
Remedy	<ol style="list-style-type: none"> 1. Check the connection of the Main Fan. 2. Replace the Main Fan.
E808-0000---	Low-voltage power supply failure detection
Detection Description	Printer detected low-voltage power supply failure.
Remedy	1. Replace the Engine Controller PCB
E840-0000---	Pressure release mechanism error
Detection Description	An error in pressure release mechanism of the Fixing Assembly was detected.
Remedy	<ol style="list-style-type: none"> 1. Replace the Fixing Assembly. 2. Replace the Fixing Motor.

Jam Code

Jam Code Details

■ Host machine

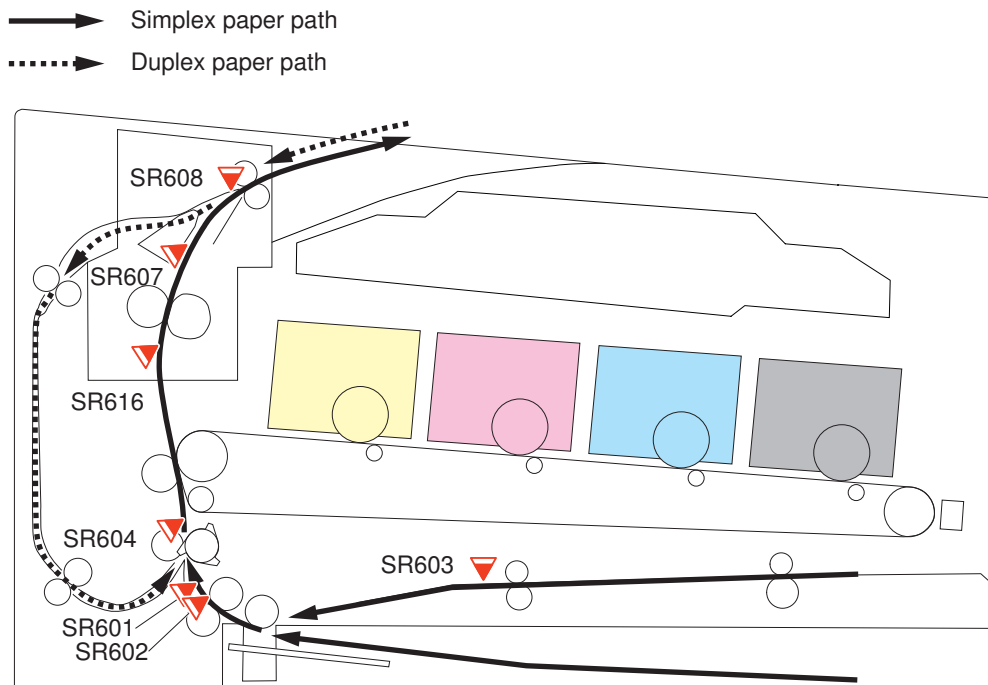

Jam Code	Type	Sensor Name	Sensor ID	Area
0104	Pickup Delay Jam 1	Registration sensor/Multi-purpose Pickup Sensor	SR604/SR603	Cassette1/Multi-purpose Tray
0105	Pickup Delay Jam 2	Registration sensor	SR604	Cassette1
014C	Fixing Delivery Delay Jam1	Registration sensor/Fixing Delivery Sensor/Delivery Sensor	SR604/SR607/SR608	Cartridge to Fixing Roller Area
0248	Pickup Stationary Jam 1	Registration sensor/Fixing Delivery Sensor/Delivery Sensor	SR604/SR607/SR608	Registration Area to Cartridge
0250	Fixing Delivery Stationary Jam 1	Registration sensor/Fixing Delivery Sensor/Delivery Sensor	SR604/SR607/SR608	Fixing Roller to Delivery Area
025C	Wrap Jam1	Registration sensor/Fixing Delivery Sensor/Delivery Sensor	SR604/SR607/SR608	Fixing Roller to Delivery Area
02A4	Duplex Re-pickup Assembly Jam1	Registration sensor	SR604	Duplex Re-pickup Assembly
1014	Power ON Jam 1	Multi-purpose Pickup Sensor	SR603	Multi-purpose Tray
1054	Power ON Jam 1	Registration sensor/Fixing Delivery Sensor/Delivery Sensor	SR604/SR607/SR608	Registration Area to Delivery Area
1055	Power ON Jam 2	Registration sensor/Fixing Delivery Sensor/Delivery Sensor	SR604/SR607/SR608	Registration Area to Cartridge Cartridge to Fixing Roller Area
1095	Power ON Jam 2	Registration sensor/Fixing Delivery Sensor/Delivery Sensor	SR604/SR607/SR608	Duplex Re-pickup Assembly
10D5	Power ON Jam 2	Registration sensor/Fixing Delivery Sensor/Delivery Sensor	SR604/SR607/SR608	Registration Area to Delivery Area Duplex Re-pickup Assembly

Jam Code	Type	Sensor Name	Sensor ID	Area
1056	Power ON Jam 3	Registration sensor/Fixing Delivery Sensor/Delivery Sensor	SR604/SR607/SR608	Registration Area to Cartridge Cartridge to Fixing Roller Area
1017	Power ON Jam 4	Multi-purpose Pickup Sensor	SR603	Multi-purpose Tray
1057	Power ON Jam 4	Registration sensor/Fixing Delivery Sensor/Delivery Sensor	SR604/SR607/SR608	Registration Area to Delivery Area
1118	Door Open Jam1	Registration sensor/Multi-purpose Pickup Sensor	SR604/SR603	Cassette1/Multi-purpose Tray
1158	Door Open Jam1	Registration sensor/Fixing Delivery Sensor/Delivery Sensor	SR604/SR607/SR608	Registration Area to Delivery Area
1198	Door Open Jam1	Registration sensor/Fixing Delivery Sensor/Delivery Sensor	SR604/SR607/SR608	Duplex Re-pickup Assembly
11D8	Door Open Jam1	Registration sensor/Fixing Delivery Sensor/Delivery Sensor	SR604/SR607/SR608	Registration Area to Delivery Area Duplex Re-pickup Assembly

Alarm Code

Alarm Code Details

10-0401	Toner Bottle empty alarm (Y)
A. Operation / B. Cause / C. Remedy	When the Toner Bottle empty was detected
10-0402	Toner Bottle empty alarm (M)
A. Operation / B. Cause / C. Remedy	When the Toner Bottle empty was detected
10-0403	Toner Bottle empty alarm (C)
A. Operation / B. Cause / C. Remedy	When the Toner Bottle empty was detected
10-0404	Toner Bottle empty alarm (BK)
A. Operation / B. Cause / C. Remedy	When the Toner Bottle empty was detected



Service Mode

Overview.....	142
COPIER (Service mode for copier)...	144
TESTMODE (Service mode for test print, operation check, etc.).....	173

Overview

Entering Service Mode

For information on how to enter service mode, contact the Support Dept. of the sales company.

Remote UI Service Mode

Function Overview

It is possible to display, configure, and execute various service mode modes as well as restart the host machine by using remote UI.

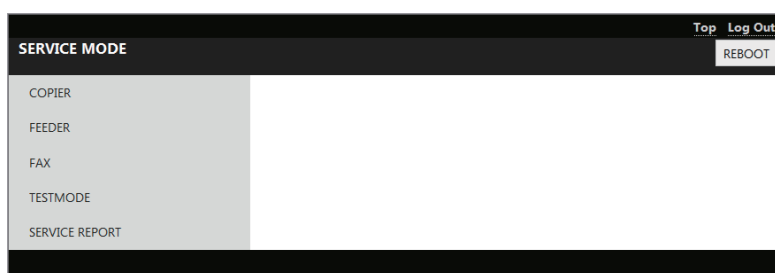

Operating conditions

In order to operate service mode using Remote UI, the following conditions must be met.

- Service mode is not used on the Control Panel.
If service mode is accessed from the Control Panel of the host machine, "Log-in user exists already." is displayed when service mode is accessed from Remote UI.

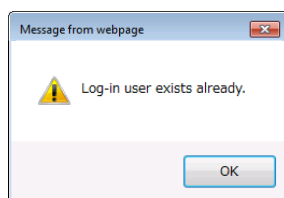

- When Remote UI service mode (this function) is not being logged in by other users
When service mode is being accessed from Remote UI, "Remote service mode" is displayed on the UI of the host machine.

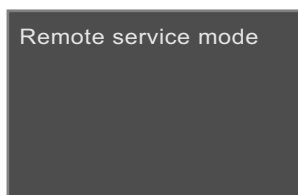

- When Remote UI is enabled in the setting on the Control Panel
[Settings/Registration] > [System Settings] > [Remote UI Settings] > [Use Remote UI] > [ON]
- When the following setting (Remote UI service mode function) is enabled (setting value: 1) in service mode
COPIER > OPTION > BODY > RMT-SW
0:OFF(default), 1:ON



How to Use

1. **Activate the Web browser, and access the following URL:**
`http://<Host machine's IP address or host name>/servicemode.html`

2. Enter the password, and click [LOGIN].

Password required for authentication differs depending on the following service mode setting: COPIER > OPTION > BODY > PSWD-SW

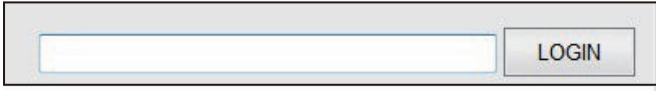
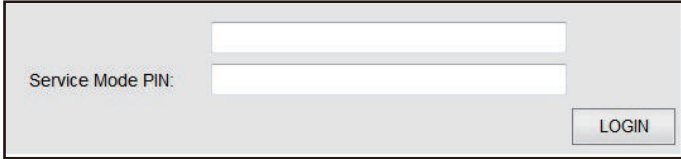
Combinations of service mode settings and required passwords

PSWD-SW setting value	Password required for authentication	Authentication screen
0	<ul style="list-style-type: none"> Password of remote UI service mode 	
1	<ul style="list-style-type: none"> Password of remote UI service mode Service mode password 	
2	<ul style="list-style-type: none"> Password of RUI service mode User's system administrator ID Password of system administrator Service mode password 	

NOTE:

- If you do not know the password of remote UI service mode, contact the Support Dept. of the sales company.
- Password of service mode can be changed in COPIER > OPTION > BODY > SM-PSWD.

3. If you do not know the password of remote UI service mode, contact the Support Dept. of the sales company. When finishing the operation, click [REBOOT] or [Log Out].**NOTE:**

If the user logged in and then closed the browser without logging out, connection status remains as "LOGIN". If the user attempts to log in to service mode under "LOGIN" status, exclusive control is executed so that the user cannot access service mode. In that case, wait for a fixed time (3 minutes) from the last access to let the user be automatically logged out, or turn OFF/ON the power of the machine to be forcibly logged out.

COPIER (Service mode for copier)

DISPLAY (State display mode)

VERSION

COPIER (Service mode for copier) > DISPLAY (State display mode) > VERSION

MAIN	Display of Bootable version
Detail	To display the firmware version of Main Controller PCB.
Use Case	When upgrading the firmware
Adj/Set/Operate Method	N/A (Display only)
Display/Adj/Set Range	00.00 to 99.99
BOOT	Display of BootROM version
Detail	To display the version of Boot ROM (BOOT program).
Use Case	When upgrading the firmware
Adj/Set/Operate Method	N/A (Display only)
Display/Adj/Set Range	00.00 to 99.99
LANG	Display of language pack version
Detail	To display the version of language pack.
Use Case	When upgrading the firmware
Adj/Set/Operate Method	N/A (Display only)
Display/Adj/Set Range	00.00 to 99.99
DEMODATA	Display of demo print data version
Detail	To display the version of demo print data. For the models not having demo print function, "FF.FF" is displayed.
Use Case	When upgrading the firmware
Adj/Set/Operate Method	N/A (Display only)
Display/Adj/Set Range	00.00 to 99.99
ECONT	Display of Engine Controller version
Detail	To display the version of Engine Controller PCB.
Use Case	When upgrading the firmware
Adj/Set/Operate Method	N/A (Display only)
Display/Adj/Set Range	00.00 to 99.99
PANEL	Display of firmware version of panel
Detail	To display the firmware version of Control Panel CPU PCB.
Use Case	When upgrading the firmware
Adj/Set/Operate Method	N/A (Display only)
Display/Adj/Set Range	00.00 to 99.99
Related Service Mode	COPIER> FUNCTION> SYSTEM> PANEL-UP

ADJUST (Adjustment mode)

■ FEED-ADJ

COPIER (Service mode for copier) > ADJUST (Adjustment mode) > FEED-ADJ

ADJ-MFY	Adjustment of write start position in feed direction at Multi-purpose Tray pickup (1-sided print/2nd side of 2-sided print)
Detail	To adjust the image write start position in the feed direction at the time of pickup from the Multi-purpose Tray. As the value is changed by 1, the leading edge margin is changed by 0.001 mm. +: Leading edge margin becomes larger. (An image moves to the trailing edge side.) -: Leading edge margin becomes smaller. (An image moves to the leading edge side.) When replacing the Engine Controller PCB/clearing RAM data, enter the value of service label. The setting is applied to the 1st side at 1-sided print and the 2nd side at 2-sided print.
Use Case	When replacing the Engine Controller PCB/clearing RAM data
Adj/Set/Operate Method	Enter the setting value (switch negative/positive by +/- key) and press Apply key.
Display/Adj/Set Range	-5080 to 5080
Unit	0.001 mm
Default Value	0
ADJ-MFX	Adjustment of write start position in horizontal scanning direction at Multi-purpose Tray pickup (1-sided print/2nd side of 2-sided print)
Detail	To adjust the write start position in the horizontal scanning direction for the image on the 1st side at the time of pickup from the Multi-purpose Tray. As the value is changed by 1, the left margin is changed by 0.001 mm. +: Left margin becomes larger. (An image moves to the right.) -: Left margin becomes smaller. (An image moves to the left.) When replacing the Engine Controller PCB/clearing RAM data, enter the value of service label. The setting is applied to the 1st side at 1-sided print and the 2nd side at 2-sided print.
Use Case	When replacing the Engine Controller PCB/clearing RAM data
Adj/Set/Operate Method	Enter the setting value (switch negative/positive by +/- key) and press Apply key.
Display/Adj/Set Range	-5080 to 5080
Unit	0.001 mm
Default Value	0
ADJ-MFYR	Adjustment of write start position in feed direction at Multi-purpose Tray pickup (1st side of 2-sided print)
Detail	To adjust the write start position in the feed direction for the image on the 2nd side at the time of pickup from the Multi-purpose Tray. As the value is changed by 1, the leading edge margin is changed by 0.001 mm. +: Leading edge margin becomes larger. (An image moves to the trailing edge side.) -: Leading edge margin becomes smaller. (An image moves to the leading edge side.) When replacing the Engine Controller PCB/clearing RAM data, enter the value of service label. The setting is applied to the 1st side at 2-sided print.
Use Case	When replacing the Engine Controller PCB/clearing RAM data
Adj/Set/Operate Method	Enter the setting value (switch negative/positive by +/- key) and press Apply key.
Display/Adj/Set Range	-5080 to 5080
Unit	0.001 mm
Default Value	0

COPIER (Service mode for copier) > ADJUST (Adjustment mode) > FEED-ADJ

ADJ-MFXR	Adjustment of write start position in horizontal scanning direction at Multi-purpose Tray pickup (1st side of 2-sided print)
Detail	To adjust the write start position in the horizontal scanning direction for the image on the 2nd side at the time of pickup from the Multi-purpose Tray. As the value is changed by 1, the left margin is changed by 0.001 mm. +: Left margin becomes larger. (An image moves to the right.) -: Left margin becomes smaller. (An image moves to the left.) When replacing the Engine Controller PCB/clearing RAM data, enter the value of service label. The setting is applied to the 1st side at 2-sided print.
Use Case	When replacing the Engine Controller PCB/clearing RAM data.
Adj/Set/Operate Method	Enter the setting value (switch negative/positive by +/- key) and press Apply key.
Display/Adj/Set Range	-5080 to 5080
Unit	0.001 mm
Default Value	0
ADJ-C1Y	Adjustment of write start position in feed direction at Cassette 1 pickup (1-sided print/2nd side of 2-sided print)
Detail	To adjust the image write start position in the feed direction at the time of pickup from the Cassette 1. As the value is changed by 1, the leading edge margin is changed by 0.001 mm. +: Leading edge margin becomes larger. (An image moves to the trailing edge side.) -: Leading edge margin becomes smaller. (An image moves to the leading edge side.) When replacing the Engine Controller PCB/clearing RAM data, enter the value of service label. The setting is applied to the 1st side at 1-sided print and the 2nd side at 2-sided print.
Use Case	When replacing the Engine Controller PCB/clearing RAM data
Adj/Set/Operate Method	Enter the setting value (switch negative/positive by +/- key) and press Apply key.
Display/Adj/Set Range	-5080 to 5080
Unit	0.001 mm
Default Value	0
ADJ-C1X	Adjustment of write start position in horizontal scanning direction at Cassette 1 pickup (1-sided print/2nd side of 2-sided print)
Detail	To adjust the write start position in the horizontal scanning direction for the image on the 1st side at the time of pickup from the Cassette 1. As the value is changed by 1, the left margin is changed by 0.001 mm. +: Left margin becomes larger. (An image moves to the right.) -: Left margin becomes smaller. (An image moves to the left.) When replacing the Engine Controller PCB/clearing RAM data, enter the value of service label. The setting is applied to the 1st side at 1-sided print and the 2nd side at 2-sided print.
Use Case	When replacing the Engine Controller PCB/clearing RAM data
Adj/Set/Operate Method	Enter the setting value (switch negative/positive by +/- key) and press Apply key.
Display/Adj/Set Range	-5080 to 5080
Unit	0.001 mm
Default Value	0

COPIER (Service mode for copier) > ADJUST (Adjustment mode) > FEED-ADJ

ADJ-C1YR	Adjustment of write start position in feed direction at Cassette 1 pickup (1st side of 2-sided print)
Detail	To adjust the write start position in the feed direction for the image on the 2nd side at the time of pickup from the Cassette 1. As the value is changed by 1, the leading edge margin is changed by 0.001 mm. +: Leading edge margin becomes larger. (An image moves to the trailing edge side.) -: Leading edge margin becomes smaller. (An image moves to the leading edge side.) When replacing the Engine Controller PCB/clearing RAM data, enter the value of service label. The setting is applied to the 1st side at 2-sided print.
Use Case	When replacing the Engine Controller PCB/clearing RAM data
Adj/Set/Operate Method	Enter the setting value (switch negative/positive by +/- key) and press Apply key.
Display/Adj/Set Range	-5080 to 5080
Unit	0.001 mm
Default Value	0
ADJ-C1XR	Adjustment of write start position in horizontal scanning direction at Cassette 1 pickup (1st side of 2-sided print)
Detail	To adjust the write start position in the horizontal scanning direction for the image on the 2nd side at the time of pickup from the Cassette 1. As the value is changed by 1, the left margin is changed by 0.001 mm. +: Left margin becomes larger. (An image moves to the right.) -: Left margin becomes smaller. (An image moves to the left.) When replacing the Engine Controller PCB/clearing RAM data, enter the value of service label. The setting is applied to the 1st side at 2-sided print.
Use Case	When replacing the Engine Controller PCB/clearing RAM data
Adj/Set/Operate Method	Enter the setting value (switch negative/positive by +/- key) and press Apply key.
Display/Adj/Set Range	-5080 to 5080
Unit	0.001 mm
Default Value	0
ADJ-C2Y	Adjustment of write start position in feed direction at Cassette 2 pickup (1-sided print/2nd side of 2-sided print)
Detail	To adjust the image write start position in the feed direction at the time of pickup from the Cassette 2. As the value is changed by 1, the leading edge margin is changed by 0.001 mm. +: Leading edge margin becomes larger. (An image moves to the trailing edge side.) -: Leading edge margin becomes smaller. (An image moves to the leading edge side.) When replacing the Engine Controller PCB/clearing RAM data, enter the value of service label. The setting is applied to the 1st side at 1-sided print and the 2nd side at 2-sided print.
Use Case	When replacing the Engine Controller PCB/clearing RAM data
Adj/Set/Operate Method	Enter the setting value (switch negative/positive by +/- key) and press Apply key.
Display/Adj/Set Range	-5080 to 5080
Unit	0.001 mm
Default Value	0

COPIER (Service mode for copier) > ADJUST (Adjustment mode) > FEED-ADJ

ADJ-C2X	Adjustment of write start position in horizontal scanning direction at Cassette 2 pickup (1-sided print/2nd side of 2-sided print)
Detail	To adjust the write start position in the horizontal scanning direction for the image on the 1st side at the time of pickup from the Cassette 2. As the value is changed by 1, the left margin is changed by 0.001 mm. +: Left margin becomes larger. (An image moves to the right.) -: Left margin becomes smaller. (An image moves to the left.) When replacing the Engine Controller PCB/clearing RAM data, enter the value of service label. The setting is applied to the 1st side at 1-sided print and the 2nd side at 2-sided print.
Use Case	When replacing the Engine Controller PCB/clearing RAM data
Adj/Set/Operate Method	Enter the setting value (switch negative/positive by +/- key) and press Apply key.
Display/Adj/Set Range	-5080 to 5080
Unit	0.001 mm
Default Value	0
ADJ-C2YR	Adjustment of write start position in feed direction at Cassette 2 pickup (1st side of 2-sided print)
Detail	To adjust the write start position in the feed direction for the image on the 2nd side at the time of pickup from the Cassette 2. As the value is changed by 1, the leading edge margin is changed by 0.001 mm. +: Leading edge margin becomes larger. (An image moves to the trailing edge side.) -: Leading edge margin becomes smaller. (An image moves to the leading edge side.) When replacing the Engine Controller PCB/clearing RAM data, enter the value of service label. The setting is applied to the 1st side at 2-sided print.
Use Case	When replacing the Engine Controller PCB/clearing RAM data
Adj/Set/Operate Method	Enter the setting value (switch negative/positive by +/- key) and press Apply key.
Display/Adj/Set Range	-5080 to 5080
Unit	0.001 mm
Default Value	0
ADJ-C2XR	Adjustment of write start position in horizontal scanning direction at Cassette 2 pickup (1st side of 2-sided print)
Detail	To adjust the write start position in the horizontal scanning direction for the image on the 2nd side at the time of pickup from the Cassette 2. As the value is changed by 1, the left margin is changed by 0.001 mm. +: Left margin becomes larger. (An image moves to the right.) -: Left margin becomes smaller. (An image moves to the left.) When replacing the Engine Controller PCB/clearing RAM data, enter the value of service label. The setting is applied to the 1st side at 2-sided print.
Use Case	When replacing the Engine Controller PCB/clearing RAM data
Adj/Set/Operate Method	Enter the setting value (switch negative/positive by +/- key) and press Apply key.
Display/Adj/Set Range	-5080 to 5080
Unit	0.001 mm
Default Value	0

■ VIFADJ

COPIER (Service mode for copier) > ADJUST (Adjustment mode) > VIFADJ

DEV-HV-Y	Adjustment of developing bias setting value (Y)
Detail	To adjust the setting value of Y-color developing bias.
Use Case	When an image failure occurs
Adj/Set/Operate Method	Enter the setting value (switch negative/positive by +/- key), and then press Apply key.
Display/Adj/Set Range	-5 to 5
Default Value	0
Related Service Mode	COPIER> ADJUST> VIFADJ> DEV-HV-M/C/K
DEV-HV-M	Adjustment of developing bias setting value (M)
Detail	To adjust the setting value of M-color developing bias.
Use Case	When an image failure occurs
Adj/Set/Operate Method	Enter the setting value (switch negative/positive by +/- key), and then press Apply key.
Display/Adj/Set Range	-5 to 5
Default Value	0
Related Service Mode	COPIER> ADJUST> VIFADJ> DEV-HV-Y/C/K
DEV-HV-C	Adjustment of developing bias setting value (C)
Detail	To adjust the setting value of C-color developing bias.
Use Case	When an image failure occurs
Adj/Set/Operate Method	Enter the setting value (switch negative/positive by +/- key), and then press Apply key.
Display/Adj/Set Range	-5 to 5
Default Value	0
Related Service Mode	COPIER> ADJUST> VIFADJ> DEV-HV-Y/M/K
DEV-HV-K	Adjustment of developing bias setting value (Bk)
Detail	To adjust the setting value of Bk-color developing bias.
Use Case	When an image failure occurs
Adj/Set/Operate Method	Enter the setting value (switch negative/positive by +/- key), and then press Apply key.
Display/Adj/Set Range	-5 to 5
Default Value	0
Related Service Mode	COPIER> ADJUST> VIFADJ> DEV-HV-Y/M/C
TR2SF-HV	Adj sec transfer bias set VL (1st side)
Detail	To adjust the setting value of secondary transfer bias applied to the 1st side.
Use Case	When an image failure occurs
Adj/Set/Operate Method	Enter the setting value (switch negative/positive by +/- key), and then press Apply key.
Display/Adj/Set Range	-5 to 5
Default Value	0
Related Service Mode	COPIER> ADJUST> VIFADJ> TR2BK-HV
TR2BK-HV	Adj sec transfer bias set VL (2nd side)
Detail	To adjust the setting value of secondary transfer bias applied to the 2nd side.
Use Case	When an image failure occurs
Adj/Set/Operate Method	Enter the setting value (switch negative/positive by +/- key), and then press Apply key.
Display/Adj/Set Range	-5 to 5
Default Value	0
Related Service Mode	COPIER> ADJUST> VIFADJ> TR2SF-HV

COPIER (Service mode for copier) > ADJUST (Adjustment mode) > VIFADJ

ICL-HV		Adj of ITB cleaning bias setting value
Detail		To adjust the setting value of the bias to be applied at the time of ITB cleaning.
Use Case		When an image failure occurs
Adj/Set/Operate Method		Enter the setting value (switch negative/positive by +/- key), and then press Apply key.
Display/Adj/Set Range		-5 to 5
Default Value		0
FU-TMP		Adj of Fixing Film surface temp set VL
Detail		To adjust the setting value of the surface temperature of the Fixing Film.
Use Case		When an image failure occurs
Adj/Set/Operate Method		Enter the setting value (switch negative/positive by +/- key), and then press Apply key.
Display/Adj/Set Range		-2 to 2
Default Value		0

■ SCNR

COPIER (Service mode for copier) > ADJUST (Adjustment mode) > SCNR

SUB-S-Y0	Not use
SUB-S-M0	Not use
SUB-S-C0	Not use
SUB-S-K0	Not use
SUB-S-Y1	Not use
SUB-S-M1	Not use
SUB-S-C1	Not use
SUB-S-K1	Not use
SUB-S-Y2	Not use
SUB-S-M2	Not use
SUB-S-C2	Not use
SUB-S-K2	Not use
MAI-S-Y0	Not use
MAI-S-M0	Not use
MAI-S-C0	Not use
MAI-S-K0	Not use
MAI-S-Y1	Not use
MAI-S-M1	Not use
MAI-S-C1	Not use
MAI-S-K1	Not use
MAI-S-Y2	Not use
MAI-S-M2	Not use
MAI-S-C2	Not use
MAI-S-K2	Not use

FUNCTION (Operation / inspection mode)

■ INSTALL

COPIER (Service mode for copier) > FUNCTION (Operation / inspection mode) > INSTALL

ERDS		ON/OFF of Embedded-RDS
Detail	To set whether to use the Embedded-RDS function.	
Use Case	When using Embedded-RDS	
Adj/Set/Operate Method	1) Enter the setting value, and then press Apply key. 2) Turn OFF/ON the main power switch.	
Caution	Be sure to use ERDS, RGW-PORT, COM-TEST, COM-RSLT, and COM-LOG as a set.	
Display/Adj/Set Range	0 to 1 0: OFF 1: ON	
Default Value	It differs according to the location.	
Related Service Mode	COPIER> FUNCTION> INSTALL> RGW-PORT, COM-TEST, COM-RSLT, COM-LOG	
Supplement/Memo	Embedded-RDS: Function to send device information such as the device counter, failure, and consumables to UGW via SOAP protocol UGW (Universal Gate Way): Remote monitoring service system	
RGW-PORT		Setting of UGW port number when using Embedded-RDS
Detail	To set the port number of UGW to be used for Embedded-RDS.	
Use Case	When using Embedded-RDS	
Adj/Set/Operate Method	1) Enter the setting value, and then press Apply key. 2) Turn OFF/ON the main power switch.	
Caution	Be sure to use ERDS, RGW-PORT, COM-TEST, COM-RSLT, and COM-LOG as a set.	
Display/Adj/Set Range	1 to 65535	
Default Value	443	
Related Service Mode	COPIER> FUNCTION> INSTALL> ERDS, COM-TEST, COM-RSLT, COM-LOG	
Supplement/Memo	Embedded-RDS: Function to send device information such as the device counter, failure, and consumables to the sales company's server via SOAP protocol	
COM-TEST		Execution of Embedded-RDS communication test
Detail	To execute Embedded-RDS communication test. If the connection fails, the information is added to the communication error log.	
Use Case	When using E-RDS	
Adj/Set/Operate Method	Select the item, and then press Yes key.	
Caution	Be sure to use ERDS, RGW-PORT, COM-TEST, COM-RSLT, and COM-LOG as a set.	
Related Service Mode	COPIER> FUNCTION> INSTALL> ERDS, RGW-PORT, COM-RSLT, COM-LOG	
Supplement/Memo	Embedded-RDS: Function to send device information such as the device counter, failure, and consumables to UGW via SOAP protocol UGW (Universal Gate Way): Remote monitoring service system	

COPIER (Service mode for copier) > FUNCTION (Operation / inspection mode) > INSTALL

COM-RSLT	Display of Embedded-RDS comctn test result
Detail	To display the Embedded-RDS communication test result.
Use Case	When using E-RDS
Adj/Set/Operate Method	N/A (Display only)
Caution	Be sure to use ERDS, RGW-PORT, COM-TEST, COM-RSLT, and COM-LOG as a set.
Display/Adj/Set Range	When not in execution: Unknown When connection is completed: OK When connection is failed: NG
Default Value	Unknown
Related Service Mode	COPIER> FUNCTION> INSTALL> ERDS, RGW-PORT, COM-TEST, COM-LOG
Supplement/Memo	Embedded-RDS: Function to send device information such as the device counter, failure, and consumables to UGW via SOAP protocol UGW (Universal Gate Way): Remote monitoring service system

COM-LOG	Display of Embedded-RDS comctn error log
Detail	To display the Embedded-RDS communication error log. The dates, times, and error codes of the latest 5 errors that occurred are displayed. As for the error detail information, the report can be output by executing ERDS-LOG.
Use Case	When using Embedded-RDS
Adj/Set/Operate Method	N/A (Display only)
Caution	Be sure to use ERDS, RGW-PORT, COM-TEST, COM-RSLT, and COM-LOG as a set.
Display/Adj/Set Range	Date: 6 digits Time: 4 digits Error code: 8 digits
Related Service Mode	COPIER> FUNCTION> INSTALL> ERDS, RGW-PORT, COM-TEST, COM-RSLT COPIER> FUNCTION> MISC-P> ERDS-LOG
Supplement/Memo	Embedded-RDS: Function to send device information such as the device counter, failure, and consumables to UGW via SOAP protocol UGW (Universal Gate Way): Remote monitoring service system

■ CLEAR

COPIER (Service mode for copier) > FUNCTION (Operation / inspection mode) > CLEAR

SRVC-DAT	Clearing of service mode setting values
Detail	To clear the service mode setting values. The user mode setting values are not cleared. The factory adjustment values of the Reader/DADF are not initialized.
Adj/Set/Operate Method	1) Select the item, and then press Yes key. 2) Turn OFF/ON the main power switch.
COUNTER	Clearing of service counter
Detail	To clear the counter by maintenance/part. The numerator printed on a system dump list becomes 0.
Adj/Set/Operate Method	1) Select the item, and then press Yes key. 2) Turn OFF/ON the main power switch.
HIST	Clearing of logs
Detail	To clear the communication management/print/jam/alarm/error log.
Use Case	When clearing logs
Adj/Set/Operate Method	1) Select the item, and then press Yes key. 2) Turn OFF/ON the main power switch.

COPIER (Service mode for copier) > FUNCTION (Operation / inspection mode) > CLEAR

ALL		Clearing of setting information
	Detail	To clear/initialize the following setting information according to the location set in LOCALE and SIZE-LC. - User mode setting values - Service mode setting values (excluding the service counter) - ID and password of the system administrator - Communication management/print/jam/alarm/error log - E719 error (counter meter-installed models only) The following items are not cleared/initialized. - Service counter - Factory adjustment values of the Reader/DADF
	Use Case	At installation
	Adj/Set/Operate Method	1) Select the item, and then press Yes key. 2) Turn OFF/ON the main power switch.
	Default Value	0
	Related Service Mode	COPIER> OPTION> BODY> LOCALE, SIZE-LC COPIER> FUNCTION> CLEAR> E719-CLR
ERDS-DAT		Initialize of Embedded-RDS setting value
	Detail	To initialize the Embedded-RDS setting values. ON/OFF of Embedded-RDS, UGW port number and communication error log set in ERDS, RGW-PORT, and COM-LOG are cleared.
	Use Case	When upgrading the Bootable in the Embedded-RDS environment
	Adj/Set/Operate Method	Select the item, and then press Yes key.
	Caution	Use of the SRAM in Embedded-RDS differs depending on the Bootable version. Therefore, unless initialization is executed at the time of version upgrade, data inconsistency occurs.
	Related Service Mode	COPIER> FUNCTION> INSTALL> ERDS, RGW-PORT, COM-LOG
	Supplement/Memo	Embedded-RDS: Function to send device information such as the device counter, failure, and consumables to UGW via SOAP protocol UGW (Universal Gate Way): Remote monitoring service system
PLPW-CLR		Clear security policy setting password
	Detail	To clear the password of the security administrator set in the security policy settings.
	Use Case	When clearing the password of the security administrator
	Adj/Set/Operate Method	Select the item, and then press Yes key.

■ MISC-P

COPIER (Service mode for copier) > FUNCTION (Operation / inspection mode) > MISC-P

SRVC-DAT		Output system data list/system dump list
	Detail	To output the system data list and the system dump list in the form of a report. System data list: The service software switches and parameters used in FAX function System dump list: The number of sends/receives, the number of pages sent/received, the number of sheets printed/read, the number of errors, etc.
	Adj/Set/Operate Method	Select the item, and then press Yes key.
	Supplement/Memo	FAX model only
SYS-DAT		Output of system data list
	Detail	To output the system data list in the form of a report. The service software switches and parameters used in FAX function are output.
	Adj/Set/Operate Method	Select the item, and then press Yes key.
	Supplement/Memo	FAX model only

COPIER (Service mode for copier) > FUNCTION (Operation / inspection mode) > MISC-P

SYS-DMP		Output of system dump list
Detail		To output the system dump list in the form of a report. The number of sends/receives, the number of pages sent/received, the number of sheets printed/read, the number of errors, etc. are output.
Adj/Set/Operate Method		Select the item, and then press Yes key.
Supplement/Memo		FAX model only
CNTR		Output of counter report
Detail		To output the counter values in the form of a report. The usage of functions (reading, recording, communication and copy) is output.
Adj/Set/Operate Method		Select the item, and then press Yes key.
ERR-LOG		Output of error log report
Detail		To output the error log in the form of a report.
Adj/Set/Operate Method		Select the item, and then press Yes key.
SPEC		Output of spec report
Detail		To output the specifications in the form of a report. The current device specifications such as the location, model information, and ROM version are output.
Adj/Set/Operate Method		Select the item, and then press Yes key.
ERDS-LOG		Output of Embedded-RDS log report
Detail		To output the log relating to Embedded-RDS in the form of a report. The date, time, and code (8 digits) of each error that occurred are output.
Use Case		When using Embedded-RDS
Adj/Set/Operate Method		Select the item, and then press Yes key.
Related Service Mode		COPIER> FUNCTION> INSTALL> COM-LOG
Supplement/Memo		Embedded-RDS: Function to send device information such as the device counter, failure, and consumables to UGW via SOAP protocol UGW (Universal Gate Way): Remote monitoring service system
CRG-LOG		Output cartridge replacement log report
Detail		To output the cartridge replacement log in the form of a report.
Use Case		When checking the cartridge replacement log
Adj/Set/Operate Method		Select the item, and then press Yes key.

■ SYSTEM

COPIER (Service mode for copier) > FUNCTION (Operation / inspection mode) > SYSTEM

DOWNLOAD		Upgrading of machine firmware: difference
Detail		To upgrade the machine firmware using a USB flash drive. Compare the versions of firmware in the machine and the USB flash drive, and update the differences.
Use Case		At upgrade
Adj/Set/Operate Method		1) Connect the USB flash drive. 2) Select the item, and then press Yes key. The machine restarts in download mode.
Caution		Do not turn OFF/ON the power before "Executing..." disappears.
Related Service Mode		COPIER> FUNCTION> SYSTEM> DL-FORCE

COPIER (Service mode for copier) > FUNCTION (Operation / inspection mode) > SYSTEM

PANEL-UP	Upgrading of Control Panel CPU PCB firm
Detail	To upgrade the firmware of the Control Panel CPU PCB using a USB flash drive. Upgrading is performed when PANEL exists in the root directory of the USB flash drive.
Use Case	At upgrade
Adj/Set/Operate Method	1. Connect the USB flash drive. 2. Select the item, and then press Yes. 3. Turn OFF/ON the main power.
Caution	Do not turn OFF/ON the power before "Executing..." disappears.
Related Service Mode	COPIER> DISPLAY> VERSION> PANEL
LOGWRITE	Writing sublog to USB flash drive
Detail	To write sublog that includes the following information to the USB flash drive. - Job list (job names, user names, and destinations) - Communications log (destinations and user names) - Job log (user names and job names)
Use Case	When analyzing the cause of a problem
Adj/Set/Operate Method	1. Connect the USB flash drive. 2. Select the item, and then press Yes. 3. Turn OFF/ON the main power.
Caution	Do not turn OFF/ON the power before "Executing..." disappears.
Related Service Mode	COPIER> FUNCTION> SYSTEM> LOG2USB
IMPORT	Read s-mode set VL from USB flash drive
Detail	To read the service mode setting information (excluding those related to Reader/DADF, but including those related to Finisher) from the USB flash drive.
Use Case	When replacing the Main Controller PCB
Adj/Set/Operate Method	1. Connect the USB flash drive. 2. Select the item, and then press Yes. 3. Turn OFF/ON the main power.
Caution	Do not turn OFF/ON the power before "Executing..." disappears.
Related Service Mode	COPIER> FUNCTION> SYSTEM> EXPORT
EXPORT	Writing of service mode setting value to USB memory
Detail	To write the service mode setting information (excluding those related to Reader/DADF, but including those related to Finisher) to the USB flash drive.
Use Case	When replacing the Main Controller PCB
Adj/Set/Operate Method	1) Connect the USB flash drive. 2) Select the item, and then press Yes key. "Executing..." disappears when writing is completed.
Related Service Mode	COPIER> FUNCTION> SYSTEM> IMPORT
SAVE-SM	Backup of service mode setting info
Detail	To back up the service mode setting information (excluding those related to Reader/DADF, but including those related to Finisher) as a file to the USB flash drive using DCM function. The setting information which has been backed up can be restored with RSTR-SM.
Use Case	When saving the setting information before changing the service mode settings
Adj/Set/Operate Method	Select the item, and then press Yes key.
Related Service Mode	COPIER> FUNCTION> SYSTEM> RSTR-SM
Supplement/Memo	DCM (Device Configuration Management): A function to export/import the machine's setting information as a file.

COPIER (Service mode for copier) > FUNCTION (Operation / inspection mode) > SYSTEM

RSTR-SM		Restore of service mode setting info
Detail		To restore the service mode setting information (excluding those related to Reader/DADF, but including those related to Finisher) which has been backed up with SAVE-SM from the USB flash drive using DCM function.
Use Case		When changing the service mode settings back to those before the change
Adj/Set/Operate Method		Select the item, and then press Yes key.
Caution		It is necessary to back up the setting information using SAVE-SM in order to restore the information with RSTR-SM.
Related Service Mode		COPIER> FUNCTION> SYSTEM> SAVE-SM
Supplement/Memo		DCM (Device Configuration Management): A function to export/import the machine's setting information as a file.
LOG2USB		Writing of debug log to USB flash drive
Detail		To write the debug log stored in the eMMC PCB to the USB flash drive.
Use Case		When analyzing the cause of a problem
Adj/Set/Operate Method		1) Connect the USB flash drive. 2) Select the item, and then press Yes key.
Related Service Mode		COPIER> FUNCTION> SYSTEM> LOGWRITE
LOG-DEL		Deletion of debug log
Detail		To delete the debug log stored in the eMMC PCB.
Use Case		When the debug log is no longer needed
Adj/Set/Operate Method		Select the item, and then press Yes key.
DL-FORCE		Install machine firmware: overwriting
Detail		To forcibly overwrite the machine firmware with the firmware stored in the USB flash drive.
Use Case		At upgrade/downgrade
Adj/Set/Operate Method		1) Connect the USB flash drive. 2) Select the item, and then press Yes key.
Caution		Do not turn OFF/ON the power before "Executing..." disappears.
Related Service Mode		COPIER> FUNCTION> SYSTEM> DOWNLOAD

■ SPLMAN

COPIER (Service mode for copier) > FUNCTION (Operation / inspection mode) > SPLMAN

SPL14159		ON/OFF of USB device ID fixing
Detail		To set whether to fix the USB device ID to "000000000000". A PC attempts to install the driver every time it is connected to a machine. However, by fixing the USB device ID, it recognizes that the same machine is connected so that it does not attempt to install the driver again.
Use Case		When saving the trouble of selecting a device used for printing from the candidate devices because the driver is installed every time a USB is connected
Adj/Set/Operate Method		1) Enter the setting value, and then press Apply key. 2) Turn OFF/ON the main power switch.
Display/Adj/Set Range		0 to 1 0: OFF, 1: ON
Default Value		0

COPIER (Service mode for copier) > FUNCTION (Operation / inspection mode) > SPLMAN

SPL37510	ON/OFF of ITB cleaning at paper size mismatch
Detail	Normally, when paper other than that of the specified size is fed, ITB cleaning is executed to remove toner. When 1 is set, ITB cleaning is not executed even if paper size is mismatched. Productivity improves, but toner soiling may occur.
Use Case	When paper size is mismatched
Adj/Set/Operate Method	Enter the setting value, and then press Apply key.
Caution	Be sure to get approval from the user by telling that toner soiling may occur to improve productivity.
Display/Adj/Set Range	0 to 1 0: OFF 1: ON
Default Value	0
SPL65677	Increase of paper leading edge margin
Detail	To increase the margin on the leading edge of paper. As the value is incremented by 1, the margin is increased by 0.1 mm. Actually, a value where the setting value of SPL68676 is subtracted from the setting value of this item is applied. The margin settings which are job-specific or based on the printable area are applied regardless of the setting of this item.
Adj/Set/Operate Method	1) Enter the setting value, and then press Apply key. 2) Turn OFF/ON the main power switch.
Display/Adj/Set Range	0 to 20
Unit	0.1 mm
Default Value	0
Related Service Mode	COPIER> FUNCTION> SPLMAN> SPL68676
SPL68676	Decrease of paper leading edge margin
Detail	To decrease the margin on the leading edge of paper. As the value is incremented by 1, the margin is decreased by 0.1 mm. Actually, a value where the setting value of this item is subtracted from the setting value of SPL65677 is applied. The margin settings which are job-specific or based on the printable area are applied regardless of the setting of this item.
Adj/Set/Operate Method	1) Enter the setting value, and then press Apply key. 2) Turn OFF/ON the main power switch.
Display/Adj/Set Range	0 to 20
Unit	0.1 mm
Default Value	0
Related Service Mode	COPIER> FUNCTION> SPLMAN> SPL65677
SPL68677	Increase of paper right and left margins
Detail	To increase the margins on the right and left edges of paper. As the value is incremented by 1, the margin is increased by 0.1 mm. Actually, a value where the setting value of SPL25607 is subtracted from the setting value of this item is applied. The margin settings which are job-specific or based on the printable area are applied regardless of the setting of this item.
Adj/Set/Operate Method	1) Enter the setting value, and then press Apply key. 2) Turn OFF/ON the main power switch.
Display/Adj/Set Range	0 to 20
Unit	0.1 mm
Default Value	0
Related Service Mode	COPIER> FUNCTION> SPLMAN> SPL25607

COPIER (Service mode for copier) > FUNCTION (Operation / inspection mode) > SPLMAN

SPL25607	Decrease of paper right and left margins
Detail	To decrease the margins on the right and left edges of paper. As the value is incremented by 1, the margin is decreased by 0.1 mm. Actually, a value where the setting value of this item is subtracted from the setting value of SPL68677 is applied. The margin settings which are job-specific or based on the printable area are applied regardless of the setting of this item.
Adj/Set/Operate Method	1) Enter the setting value, and then press Apply key. 2) Turn OFF/ON the main power switch.
Display/Adj/Set Range	0 to 20
Unit	0.1 mm
Default Value	0
Related Service Mode	COPIER> FUNCTION> SPLMAN> SPL68677
SPL93822	Setting of department ID count all clear
Detail	To set whether to disable clearing of all department ID counts.
Use Case	When prohibiting clearing of all department ID counts
Adj/Set/Operate Method	1) Enter the setting value, and then press Apply key. 2) Turn OFF/ON the main power switch.
Caution	Be sure to perform this mode after consulting with the system administrator at user's site.
Display/Adj/Set Range	0 to 1 0: Disabled 1: Enabled
Default Value	0
Related Service Mode	COPIER> FUNCTION> SPLMAN> SPL78788
SPL78788	Setting of department ID count clear
Detail	To set whether to disable clearing of department ID count.
Use Case	When prohibiting clearing of department ID count
Adj/Set/Operate Method	1) Enter the setting value, and then press Apply key. 2) Turn OFF/ON the main power switch.
Caution	Be sure to perform this mode after consulting with the system administrator at user's site.
Display/Adj/Set Range	0 to 1 0: Disabled 1: Enabled
Default Value	0
Related Service Mode	COPIER> FUNCTION> SPLMAN> SPL93822
SPL41250	Initialize color displacement correction
Detail	To initialize the color displacement correction result. If shortage of toner occurs while [Continue Printing (Quality Not Guaranteed)] is selected by the user, color displacement correction cannot be executed. If color displacement correction cannot be executed while 1 is set, printing is continued based on the setting at the time of factory shipment. When 1 is set in the case that color displacement correction fails after replacement of the cartridge, the correction may succeed.
Use Case	- When prioritizing productivity over image quality - When color displacement correction fails even though there is sufficient toner remains
Adj/Set/Operate Method	1) Select the item, and then press Yes key. 2) Turn OFF/ON the main power switch. 3) Execute print color displacement correction.
Caution	- Do not turn OFF/ON the power before "Executing..." disappears. - Be sure to perform print color displacement correction after turning OFF/ON the power.
Additional Functions Mode	Adjustment/Maintenance> Adjust Image Quality> Correct Print Color Mismatch

COPIER (Service mode for copier) > FUNCTION (Operation / inspection mode) > SPLMAN

SPL15176	Not use
SPL71100	Setting of the duty of Off-hook PCB
Detail	This is the mode to make handsets of particular manufacturers to ring when fax reception mode is set to "Fax / Tel (Auto Switch)".
Use Case	When making the handsets of particular manufacturers to ring at the time of switching Fax/Tel
Adj/Set/Operate Method	1) Enter the setting value, and then press Apply key. 2) Turn OFF/ON the main power switch.
Display/Adj/Set Range	1 to 99
Default Value	50
Supplement/Memo	FAX model only
SPL00171	Set auto sleep shift time maximum value
Detail	To set the maximum auto sleep shift time displayed in [Auto Sleep Time] in [Settings/Registration]. When 0 is set, the time that can be set is 60 minutes maximum.
Use Case	When changing the setting time to shift to auto sleep mode
Adj/Set/Operate Method	1) Enter the setting value, and then press Apply key. 2) Turn OFF/ON the main power switch.
Display/Adj/Set Range	0 to 1 0: 60 minutes 1: Time specified for each model
Default Value	0 (Europe)/1 (Others)
Additional Functions Mode	Timer Settings> Auto Sleep Time
SPL80100	ON/OFF image left edge mask: book mode
Detail	To set whether to mask the left edge of the image at copyboard reading. When 0 is set, mask with the width based on the specification is applied for each job. When 1 is set, mask is canceled.
Use Case	Upon user's request (to print the left edge of the image)
Adj/Set/Operate Method	1) Enter the setting value, and then press Apply key. 2) Turn OFF/ON the main power switch.
Display/Adj/Set Range	0 to 1 0: ON, 1: OFF
Default Value	0
SPL27354	For R&D
SPL84194	ON/OFF of Embedded-RDS
Detail	To set ON/OFF of Embedded-RDS function.
Use Case	When using Embedded-RDS
Adj/Set/Operate Method	1) Enter the setting value, and then press Apply key. 2) Turn OFF/ON the main power switch.
Display/Adj/Set Range	0 to 1 0: ON, 1: OFF
Default Value	It differs according to the location.
Supplement/Memo	Embedded-RDS: Function to send device information such as the device counter, failure, and consumables to UGW via SOAP protocol UGW (Universal Gate Way): Remote monitoring service system

COPIER (Service mode for copier) > FUNCTION (Operation / inspection mode) > SPLMAN

SPL32620	ON/OFF of PC-less update function
Detail	To set whether to disable the PC-less update function.
Adj/Set/Operate Method	1) Enter the setting value, and then press Apply key. 2) Turn OFF / ON the main power switch.
Caution	When LCDSFLG is 1, the setting of this item is disabled (the PC-less update function is turned OFF).
Display/Adj/Set Range	0 to 1 0: OFF, 1: ON
Default Value	1
Related Service Mode	COPIER> OPTION> FNC-SW> LCDSFLG
Supplement/Memo	PC-less update: A function to directly download the firmware from the GDLS server and update it.
SPL60061	Dspl/hide cloud print connct dest URL chng scrn
Detail	To set whether to display or hide the connection destination URL settings for Google Cloud Print on remote UI.
Use Case	When Google has changed the connection destination URL for cloud print
Adj/Set/Operate Method	1) Enter the setting value, and then press Apply key. 2) Turn OFF / ON the main power switch.
Display/Adj/Set Range	0 to 1 0: Display 1: Hide
SPL71700	Writing sublog to USB flash drive
Detail	To write the sublog stored in the eMMC PCB to the USB flash drive.
Use Case	When analyzing the cause of a problem
Adj/Set/Operate Method	Select the item, and then press Yes key.
SPL01734	ON/OFF of remote UI service mode
Detail	To set whether to allow using service mode on remote UI.
Use Case	When using service mode on remote UI
Adj/Set/Operate Method	1) Enter the setting value, and then press Apply key. 2) Turn OFF/ON the main power switch.
Caution	The setting value is linked with that of RMT-SW.
Display/Adj/Set Range	0 to 1 0: OFF, 1: ON
Default Value	1
Related Service Mode	COPIER> OPTION> BODY> RMT-SW

■ VIFFNC

COPIER (Service mode for copier) > FUNCTION (Operation / inspection mode) > VIFFNC

SMEAR-PV	ON/OFF of image smear prevention mode
Detail	To set whether to execute the image smear prevention mode. Depending on the paper type or environment (especially in a high humidity environment), thin line or fine halftone may become lighter
Use Case	When thin line or fine halftone becomes lighter
Adj/Set/Operate Method	Enter the setting value, and then press Apply key.
Display/Adj/Set Range	0 to 1 0: OFF, 1: ON
Default Value	0

COPIER (Service mode for copier) > FUNCTION (Operation / inspection mode) > VIFFNC

FEED-IMP	ON/OFF of pickup jam reduction mode
Detail	To set whether to execute the pickup jam reduction mode. When using paper with which double feed is more likely to occur, pickup operation cannot be performed at the appropriate timing because of double feed. As a result of that, pickup delay jam may occur. In such cases, the pickup interval is extended by setting 1. As a result of that, jam occurrence can be reduced, but productivity is decreased.
Use Case	When pickup jam occurs with paper with which double feed is more likely to occur
Adj/Set/Operate Method	Enter the setting value, and then press Apply key.
Caution	Be sure to get approval from the user by telling that the productivity decreases to prevent jam occurrence.
Display/Adj/Set Range	0 to 1 0: OFF, 1: ON
Default Value	0
ICL-IMP	ON/OFF ITB clean failure alleviate mode
Detail	To set whether to execute ITB cleaning failure alleviation mode. An image that was on 2 sheets before may appear lightly depending on paper type and image ratio (in case of high image ratio). In such a case, set 1 to execute process to alleviate ITB cleaning failure.
Use Case	When an image failure (ghosting of an image on the 2 sheets before) occurs
Adj/Set/Operate Method	Enter the setting value, and then press Apply key.
Display/Adj/Set Range	0 to 1 0: OFF, 1: ON
Default Value	0
FD-R-CHG	Not use
STOR-DCN	Backup of Engine Controller PCB NVRAM
Detail	To back up the setting information in NVRAM of the Engine Controller PCB to NVRAM of the Main Controller PCB.
Use Case	Before replacing the Engine Controller PCB
Adj/Set/Operate Method	Select the item, and then press Yes key.
Caution	During operation, the setting information changes by manual or automatic adjustment. When backup data which has been left for a long period of time is restored, it is overwritten with the old setting information and the new information is deleted.
Related Service Mode	COPIER> FUNCTION> SYSTEM> RSTR-DCN
RSTR-DCN	Restoration of Engine Controller PCB NVRAM
Detail	To restore the setting information which has been backed up to NVRAM of the Main Controller PCB to the NVRAM of the Engine Controller PCB.
Use Case	After replacing the Engine Controller PCB
Adj/Set/Operate Method	1) Select the item, and then press Yes key. 2) Turn OFF/ON the main power switch.
Caution	During operation, the setting information changes by manual or automatic adjustment. When backup data which has been left for a long period of time is restored, it is overwritten with the old setting information and the new information is deleted.
Related Service Mode	COPIER> FUNCTION> SYSTEM> STOR-DCN

OPTION (Specification setting mode)

■ BODY

COPIER (Service mode for copier) > OPTION (Specification setting mode) > BODY

LOCALE	Setting of location
Detail	To set the location. Set the location in this item and the paper size configuration in SIZE-LC, and then clear the setting information in ALL.
Use Case	- When replacing the Main Controller PCB - When changing the location information
Adj/Set/Operate Method	1) Enter the setting value in this item, and then press Apply key. 2) Set the paper size configuration in SIZE-LC. 3) Execute ALL. 4) Turn OFF/ON the main power switch.
Caution	The setting information such as user mode and service mode is initialized by executing ALL. The settings of this item and SIZE-LC are not initialized.
Display/Adj/Set Range	1 to 10 1: Japan 2: North America 3: Korea 4: China 5: Taiwan 6: Europe 7: Asia 8: Oceania 9: Brazil 10: Latin
Related Service Mode	COPIER> FUNCTION> CLEAR> ALL COPIER> OPTION> BODY> SIZE-LC
SIZE-LC	Setting of paper size configuration
Detail	To set the paper size configuration. When replacing the Main Controller PCB, set the location in LOCALE and the paper size configuration in this item, and then clear the setting information in ALL.
Use Case	- When replacing the Main Controller PCB - Upon user's request
Adj/Set/Operate Method	1) Set the location in LOCALE. 2) Enter the setting value in this item, and then press Apply key. 3) Execute ALL. 4) Turn OFF/ON the main power switch.
Caution	The setting information such as user mode and service mode is initialized by executing ALL. The settings of this item and LOCALE are not initialized.
Display/Adj/Set Range	1 to 4 1: AB configuration 2: Inch configuration 3: A configuration 4: AB/Inch configuration
Related Service Mode	COPIER> FUNCTION> CLEAR> ALL COPIER> OPTION> BODY> LOCALE
MIBCOUNT	Not use

COPIER (Service mode for copier) > OPTION (Specification setting mode) > BODY

NS-CMD5	Limit CRAM-MD5 auth method: SMTP auth
Detail	To restrict use of CRAM-MD5 authentication method at the time of SMTP authentication.
Use Case	Upon user's request
Adj/Set/Operate Method	1) Enter the setting value, and then press Apply key. 2) Turn OFF/ON the main power switch.
Display/Adj/Set Range	0 to 1 0: SMTP server-dependent 1: Not used
Default Value	0
Supplement/Memo	SMTP authentication: Protocol in which user authentication function is added to SMTP, which is the protocol to be used for e-mail transmission. At the time of e-mail transmission, this protocol executes authentication of the user account and the password between the SMTP server and the user to approve e-mail transmission only when it's authenticated.
NS-PLN	Limit plaintext auth: SMTP auth, noencyr
Detail	To restrict use of PLAIN/LOGIN authentication, which is plaintext, at the time of SMTP authentication under the environment where the communication packet is not encrypted.
Use Case	Upon user's request
Adj/Set/Operate Method	1) Enter the setting value, and then press Apply key. 2) Turn OFF/ON the main power switch.
Display/Adj/Set Range	0 to 1 0: SMTP server-dependent 1: Not used
Default Value	0
Supplement/Memo	SMTP authentication: Protocol in which user authentication function is added to SMTP, which is the protocol to be used for e-mail transmission. At the time of e-mail transmission, this protocol executes authentication of the user account and the password between the SMTP server and the user to approve e-mail transmission only when it's authenticated.
NS-LGN	Limit LOGIN authentication: SMTP auth
Detail	To restrict use of LOGIN authentication at the time of SMTP authentication.
Use Case	Upon user's request
Adj/Set/Operate Method	1) Enter the setting value, and then press Apply key. 2) Turn OFF/ON the main power switch.
Display/Adj/Set Range	0 to 1 0: SMTP server-dependent 1: Not used
Default Value	0
Supplement/Memo	SMTP authentication: Protocol in which user authentication function is added to SMTP, which is the protocol to be used for e-mail transmission. At the time of e-mail transmission, this protocol executes authentication of the user account and the password between the SMTP server and the user to approve e-mail transmission only when it's authenticated.
SLPMODE	Setting of shift to sleep mode
Detail	To restrict shift to sleep mode 1/sleep mode 3. When 1 is set, the machine does not shift to sleep mode.
Use Case	When sleep failure occurs
Adj/Set/Operate Method	1) Enter the setting value, and then press Apply key. 2) Turn OFF/ON the main power switch.
Display/Adj/Set Range	0 to 1 0 : Shift is available. 1 : Shift is not available.
Default Value	0

COPIER (Service mode for copier) > OPTION (Specification setting mode) > BODY

SDTM-DSP		ON/OFF of auto shutdown shift time dsp
Detail	To set whether to display [Auto Shutdown Time] in [Menu]. The setting is enabled only for the model with automatic shutdown function.	
Use Case	When switching to display or hide the items related to auto shutdown	
Adj/Set/Operate Method	Enter the setting value, and then press Apply key.	
Caution	For the model without automatic shutdown function, the setting is disabled even if it is configured.	
Display/Adj/Set Range	0 to 1 0: OFF 1: ON	
Default Value	It differs according to the location.	
Additional Functions Mode	Preferences> Timer/Energy Settings> Auto Shutdown Time	
RMT-SW		ON/OFF of remote UI service mode
Detail	To set whether to allow using service mode on remote UI.	
Use Case	When using service mode on remote UI	
Adj/Set/Operate Method	1) Enter the setting value, and then press Apply key. 2) Turn OFF/ON the main power switch.	
Display/Adj/Set Range	0 to 1 0: OFF, 1: ON	
Default Value	1	
PSWD-SW		Set password type to enter service mode
Detail	To set the type of password that is required to enter when getting into service mode. 2 types are available: one for "service technician" and the other for "system administrator + service technician". When selecting the type for "system administrator + service technician", enter the password for service technician after the password entry by the user's system administrator.	
Use Case	Upon request from the user who concerns security	
Adj/Set/Operate Method	1) Enter the setting value, and then press Apply key. 2) Turn OFF/ON the main power switch.	
Display/Adj/Set Range	0 to 2 0: No password 1: Service technician 2: System administrator + service technician	
Default Value	0	
SM-PSWD		Password setting for service technician
Detail	To set password for service technician that is used when getting into service mode.	
Use Case	When password is required to get into service mode	
Adj/Set/Operate Method	1) Enter the setting value, and then press Apply key. 2) Turn OFF/ON the main power switch.	
Caution	Be sure to select 1 or 2 with PSWD-SW in advance.	
Display/Adj/Set Range	11111111 to 99999999	
Default Value	11111111	
Related Service Mode	COPIER> OPTION> BODY> PSWD-SW	

■ FNC-SW

COPIER (Service mode for copier) > OPTION (Specification setting mode) > FNC-SW

IMGCNTPR	Setting of image quality mode
Detail	To set the image quality mode. When 0 is set, "image quality priority mode" is applied. When 1 is set, "counter priority mode" is applied. When 2 is set, "image quality priority (photo) mode" is applied.
Use Case	Upon user's request
Adj/Set/Operate Method	Enter the setting value, and then press Apply key.
Display/Adj/Set Range	0 to 2 0: Image quality priority mode 1: Counter priority mode 2: Image quality priority (photo) mode
Default Value	1
LCDSFLG	Enabling of local CDS server
Detail	To set whether to use the local CDS server.
Use Case	When using the local CDS server
Adj/Set/Operate Method	Enter the setting value, and then press Apply key.
Display/Adj/Set Range	0 to 1 0: Disabled 1: Enabled
Default Value	0
Related Service Mode	COPIER> FUNCTION> SPLMAN> SPL32620
Supplement/Memo	When local CDS is used, iW EMC/MC device firmware update plug-in is required.
CRG-PROC	Set oprtn at cartridge estd life reach
Detail	To set the operation of the machine when the parts counter of the cartridge reaches the estimated life value.
Adj/Set/Operate Method	Enter the setting value, and then press Apply key.
Display/Adj/Set Range	0 to 2 0: Not stopped 1: Stopped once 2: Completely stopped
Default Value	0
CRGLF-K	Set replacement ref VL (Bk): drum, etc.
Detail	To set the reference values for judging replacement of the component other than toner (Photosensitive Drum, Developing Assembly, and waste toner) included in the life of Bk-color cartridge. These values are used as the basis for calculation of component other than toner when deriving the estimated life value of the cartridge.
Use Case	When toner consumption is low (when the life of the Photosensitive Drum or the Developing Assembly decreases faster than that of toner)
Adj/Set/Operate Method	Enter the setting value, and then press Apply key.
Display/Adj/Set Range	100 to 200
Unit	1%
Default Value	100

COPIER (Service mode for copier) > OPTION (Specification setting mode) > FNC-SW

CRGLF-CL	Set replacement ref VL(Y/M/C):drum, etc.
Detail	To set the reference values for judging replacement of the component other than toner (Photosensitive Drum, Developing Assembly, and waste toner) included in the life of Y/M/C-color cartridge. These values are used as the basis for calculation of component other than toner when deriving the estimated life value of the cartridge.
Use Case	When toner consumption is low (when the life of the Photosensitive Drum or the Developing Assembly decreases faster than that of toner)
Adj/Set/Operate Method	Enter the setting value, and then press Apply key.
Display/Adj/Set Range	100 to 200
Unit	1%
Default Value	100

■ DSPLY-SW

COPIER (Service mode for copier) > OPTION (Specification setting mode) > DSPLY-SW

CRGLW-LV	ON/OFF ctrdg prep thrshld set scrn dspl
Detail	To set whether to display the screen to set the threshold value for the toner level to prompt preparation of a cartridge. When 1 is set, [Custom] is displayed in [Display Timing for Cartridge Prep. Notif.] so that the user can set the toner level (1 to 99%). When 0 is set, the item is not displayed, so the user cannot set the toner level.
Adj/Set/Operate Method	Enter the setting value, and then press Apply key.
Display/Adj/Set Range	0 to 1 0: OFF, 1: ON
Default Value	1
Additional Functions Mode	Preferences > Display Settings > Display Timing for Cartridge Prep. Notif.

■ IMG-MCON

COPIER (Service mode for copier) > OPTION (Specification setting mode) > IMG-MCON

TMIC-BK	TMIC Bk PASCAL gamma LUT end edge crrct
Detail	To set whether to perform the trailing edge correction of Bk-color PASCAL gamma LUT used by TMIC. When 1 is set, the trailing edge correction is not performed so that density of the high density area becomes high. Consequently, texts and thin lines become clear; however, gradation of photos may become unnatural. When 0 is set, density of the high density area becomes low by the trailing edge correction. Consequently, gradation of photos is improved, but thin lines may be partly missing or texts may be faded.
Use Case	- When gradation of photos become unnatural - When thin lines are partly missing or characters are faded
Adj/Set/Operate Method	Enter the setting value, and then press Apply key.
Display/Adj/Set Range	0 to 1 0: OFF, 1: ON
Default Value	1
Supplement/Memo	TMIC: Error diffusion correction of photo/high image quality.

COPIER (Service mode for copier) > OPTION (Specification setting mode) > IMG-MCON

TMIC-CMY	TMIC Y/M/C PASCAL gamma LUT end correct
Detail	To set whether to perform the trailing edge correction of Y/M/C-color PASCAL gamma LUT used by TMIC. When 1 is set, the trailing edge correction is not performed so that density of the high density area becomes high. Consequently, texts and thin lines become clear; however, gradation of photos may become unnatural. When 0 is set, density of the high density area becomes low by the trailing edge correction. Consequently, gradation of photos is improved, but thin lines may be partly missing or texts may be faded.
Use Case	- When gradation of photos become unnatural - When thin lines are partly missing or characters are faded
Adj/Set/Operate Method	Enter the setting value, and then press Apply key.
Display/Adj/Set Range	0 to 1 0: OFF, 1: ON
Default Value	1
Supplement/Memo	TMIC: Error diffusion correction of photo/high image quality.

■ USER

COPIER (Service mode for copier) > OPTION (Specification setting mode) > USER

CTCHKDSP	ON/OFF of charge counter list output
Detail	To set whether to print the charge counter in the system management data list.
Use Case	Upon user's request
Adj/Set/Operate Method	1) Enter the setting value, and then press Apply key. 2) Turn OFF/ON the main power switch.
Display/Adj/Set Range	0 to 1 0: ON, 1: OFF
Default Value	1
Additional Functions Mode	Output Report > Print List > System Manager Data List

PS-MODE	Setting of compatible mode at PS usage
Detail	To set the image processing at PS print. Set 8 when line width differs depending on the drawing position although the same line width is set. Setting of a value other than the setting values means that multiple settings are combined. (Example: 12=4+8)
Use Case	Upon user's request
Adj/Set/Operate Method	1) Enter the setting value, and then press Apply key. 2) Turn OFF/ON the main power switch.
Display/Adj/Set Range	0 to 63 4: Compatible with EFI at PS 2-sided delivery 8: strokeadjustment is enabled Any value other than those mentioned above: Not used
Default Value	0

COPIER (Service mode for copier) > OPTION (Specification setting mode) > USER

SMD-EXPT		Set of service mode set VL export target
Detail	To set whether to export "service mode data" from remote UI. When 1 is set, "service mode data" is displayed as the target data of export on remote UI. When installing more than 1 machine at the same time, the same service mode data can be registered.	
Use Case	When installing more than 1 machine at the same time	
Adj/Set/Operate Method	1) Enter the setting value, and then press Apply key. 2) Turn OFF/ON the main power switch.	
Display/Adj/Set Range	0 to 1 0: Not targeted 1: Targeted	
Default Value	0	
Supplement/Memo	If selecting "service mode data" as the target data of export on remote UI after setting SMD-EXPT to 1, service mode data can be exported.	
ACC-SLP		Set shift to sleep3: Card Reader connect
Detail	To set whether to shift to sleep mode 3 when the Card Reader is connected.	
Adj/Set/Operate Method	Enter the setting value, and then press Apply key.	
Display/Adj/Set Range	0 to 1 0: Not shifted 1: Shifted	
Default Value	1	
RPL-IMP		ON/OFF of replacement mode
Detail	To set whether to import the setting information of a machine which has been exported to a different one of the same model using DCM function. When 0 is set, the setting information which has been exported can be imported only to the same machine. When 1 is set, the machine-specific setting information such as IPv4 address setting can be imported to a different machine.	
Use Case	When migrating the setting of a machine to a different machine of the same series that has been replaced	
Display/Adj/Set Range	0 to 1 0: OFF, 1: ON	
Default Value	0	
Supplement/Memo	DCM (Device Configuration Management): A function to export/import the machine's setting information as a file.	

■ ACC

COPIER (Service mode for copier) > OPTION (Specification setting mode) > ACC

WLAN		Setting of wireless LAN function
Detail	To set whether to enable the wireless LAN function.	
Use Case	Upon user's request	
Adj/Set/Operate Method	1) Enter the setting value, and then press Apply key. 2) Turn OFF/ON the main power switch.	
Display/Adj/Set Range	0 to 1 0: Disabled 1: Enabled	
Default Value	It differs according to the model.	

■ SERIAL

COPIER (Service mode for copier) > OPTION (Specification setting mode) > SERIAL

SN-MAIN	Registration of serial number
Detail	To write the serial number of this machine in the Main Controller PCB. When this item is executed, the 1-byte alphanumeric characters entered in [Location] in [Settings/Registration] are written in the Main Controller PCB. When replacing the Main Controller PCB, be sure to write the serial number in the new PCB to prepare for trouble since the serial number of the device is not succeeded.
Use Case	When replacing the Main Controller PCB
Adj/Set/Operate Method	1) Write down the current data in [Location]. 2) Turn OFF the main power switch. 3) Replace the Main Controller PCB. 4) Turn ON the main power switch. 5) Enter the serial number of the machine in [Location]. 6) Execute this item. 7) Turn OFF/ON the main power switch. After the serial number of this machine is written in the Main Controller PCB, data in [Location] is deleted. 8) Output the spec report by SPEC, and check that the entered serial number is registered. 9) Enter the data backed up in step 1 in [Location].
Caution	Since the above "Location" is only temporarily used to store data, back up the data before input and enter it again after writing is completed.
Related Service Mode	COPIER> FUNCTION> MISC-P> SPEC
Additional Functions Mode	System Settings> Device Information> Location

COUNTER (Counter mode)

■ TOTAL

COPIER (Service mode for copier) > COUNTER (Counter mode) > TOTAL

SERVICE1	Service-purposed total counter 1
Detail	To count up when the printout is delivered outside the machine. Large size: 1, Small size: 1 A blank sheet is not counted.
Adj/Set/Operate Method	N/A (Display only)
Display/Adj/Set Range	0 to 99999999
Unit	1 sheet
Default Value	0
SERVICE2	Service-purposed total counter 2
Detail	To count up when the printout is delivered outside the machine. Large size: 2, Small size: 1 A blank sheet is not counted.
Adj/Set/Operate Method	N/A (Display only)
Display/Adj/Set Range	0 to 99999999
Unit	1 sheet
Default Value	0

COPIER (Service mode for copier) > COUNTER (Counter mode) > TOTAL

TTL		Total counter
Detail	To display the total of counters of COPY, PDL-PRT, FAX-PRT, RPT-PRT, and MD-PRT.	
Adj/Set/Operate Method	N/A (Display only)	
Display/Adj/Set Range	0 to 99999999	
Unit	1 sheet	
Default Value	0	
Related Service Mode	COPIER> COUNTER> TOTAL> COPY, PDL-PRT, FAX-PRT, RPT-PRT, MD-PRT	
PDL-PRT		PDL print counter
Detail	To count up when the printout is delivered outside the machine/2-sided printout is stacked according to the charge counter at PDL print. Large size: 1, Small size: 1 A blank sheet is not counted.	
Adj/Set/Operate Method	N/A (Display only)	
Display/Adj/Set Range	0 to 99999999	
Unit	1 sheet	
Default Value	0	
FAX-PRT		FAX reception print counter
Detail	To count up when the FAX reception print is delivered outside the machine/2-sided printout is stacked. Large size: 1, Small size: 1 The counter is not advanced by blank paper or delivery in service mode.	
Adj/Set/Operate Method	N/A (Display only)	
Display/Adj/Set Range	0 to 99999999	
Unit	1 sheet	
Default Value	0	
Related Service Mode	COPIER> COUNTER> TOTAL> TTL	
Supplement/Memo	FAX model only	
RPT-PRT		Report print counter
Detail	To count up when the report print is delivered outside the machine/2-sided printout is stacked. Large size: 1, Small size: 1 The counter is not advanced by blank paper or delivery in service mode.	
Adj/Set/Operate Method	N/A (Display only)	
Display/Adj/Set Range	0 to 99999999	
Unit	1 sheet	
Default Value	0	
Related Service Mode	COPIER> COUNTER> TOTAL> TTL	
MD-PRT		Media print counter
Detail	To count up when the media print is delivered outside the machine. Large size: 1, Small size: 1 The counter is not advanced by blank paper or delivery in service mode.	
Adj/Set/Operate Method	N/A (Display only)	
Display/Adj/Set Range	0 to 99999999	
Unit	1 sheet	
Default Value	0	
Related Service Mode	COPIER> COUNTER> TOTAL> TTL	

■ PICK-UP

COPIER (Service mode for copier) > COUNTER (Counter mode) > PICK-UP

C1		Cassette 1 pickup total counter
Detail	To count up the number of sheets picked up from the Cassette 1. Large size: 1, Small size: 1 The counter is advanced by printout in service mode.	
Adj/Set/Operate Method	N/A (Display only)	
Display/Adj/Set Range	0 to 99999999	
Unit	1 sheet	
Default Value	0	
MF		Multi-purpose Tray pickup total counter
Detail	To count up the number of sheets picked up from the Multi-purpose Tray Pickup Unit. Large size: 1, Small size: 1 The counter is advanced by printout in service mode.	
Adj/Set/Operate Method	N/A (Display only)	
Display/Adj/Set Range	0 to 99999999	
Unit	1 sheet	
Default Value	0	
2-SIDE		2-sided pickup total counter
Detail	To count up the number of sheets picked up in duplex mode. Large size: 1, Small size: 1 The counter is advanced by printout in service mode.	
Adj/Set/Operate Method	N/A (Display only)	
Display/Adj/Set Range	0 to 99999999	
Unit	1 sheet	
Default Value	0	

■ JAM

COPIER (Service mode for copier) > COUNTER (Counter mode) > JAM

TOTAL		Total jam counter
Detail	To count up the number of total jam occurrences.	
Use Case	When checking the jam counter	
Adj/Set/Operate Method	N/A (Display only)	
Display/Adj/Set Range	0 to 99999999	
Unit	1 time	
Default Value	0	
2-SIDE		Duplex Unit jam counter
Detail	To count up the number of jam occurrences in the Duplex Unit.	
Use Case	When checking the jam counter	
Adj/Set/Operate Method	N/A (Display only)	
Display/Adj/Set Range	0 to 99999999	
Unit	1 time	
Default Value	0	

COPIER (Service mode for copier) > COUNTER (Counter mode) > JAM

MF		Multi-purpose Tray jam counter
Detail	To count up the number of jam occurrences in the Multi-purpose Tray. The counter is advanced even in the case of paper size mismatch or misprint.	
Use Case	When checking the jam counter	
Adj/Set/Operate Method	N/A (Display only)	
Display/Adj/Set Range	0 to 99999999	
Unit	1 time	
Default Value	0	
C1		Cassette 1 jam counter
Detail	To count up the number of jam occurrences in the Cassette 1. The counter is advanced even in the case of paper size mismatch or misprint.	
Use Case	When checking the jam counter	
Adj/Set/Operate Method	N/A (Display only)	
Display/Adj/Set Range	0 to 99999999	
Unit	1 time	
Default Value	0	

TESTMODE (Service mode for test print, operation check, etc.)

PRINT (Print test mode)

TESTMODE (Service mode for test print, operation check, etc.) > PRINT (Print test mode)

PG-TYPE		Setting of PG number
	Detail	To set the PG number of the test print.
	Use Case	At trouble analysis
	Adj/Set/Operate Method	Enter the setting value, and then press Apply key.
	Display/Adj/Set Range	0 to 26 0 to 1: For R&D use 2: Color chart 3: For R&D use 4: Rainbow chart (vertical scanning direction, A4) 5: Rainbow chart (horizontal scanning direction, A4) 6: Color grid (A4) 7: Rainbow chart (vertical scanning direction, LTR/LGL) 8: Rainbow chart (horizontal scanning direction, LTR/LGL) 9: Color grid (LTR/LGL) 10: 16 gradations 11: 17 gradations of Y/M/C/Bk/R/G/B 12: Halftone 13: For checking ghost due to transfer failure 14: For checking the density patch 15: For checking transfer 20: For R&D use 21: For checking developing performance (white spots) 22: For checking resolution 23: For checking banding image 24: 4 colors (landscape) 25: 4 colors (portrait) 26: For calibrating color difference between the front and back sides with DADF (1-path model)
	Default Value	0
COUNT		Setting of PG output quantity
	Detail	To set the number of sheets for PG output.
	Use Case	At trouble analysis
	Adj/Set/Operate Method	Enter the setting value, and then press Apply key.
	Display/Adj/Set Range	1 to 99
	Unit	1 sheet
	Default Value	1
PHASE		Set 1-sided/2-sided print for PG output
	Detail	To set 1-sided/2-sided print for PG output. Even if 1 is set for a machine supporting 1-sided print, the setting is disabled.
	Use Case	At trouble analysis
	Adj/Set/Operate Method	Enter the setting value, and then press Apply key.
	Display/Adj/Set Range	0 to 1 0: 1-sided 1: 2-sided
	Default Value	0

TESTMODE (Service mode for test print, operation check, etc.) > PRINT (Print test mode)

MODE		Setting of test print image formation method
Detail		To set the image formation method for the test print. If PG-TYPE is 0 or 1, this setting is disabled because a specific image formation method is applied.
Use Case		At trouble analysis
Adj/Set/Operate Method		Enter the setting value, and then press Apply key.
Display/Adj/Set Range		0 to 3 0: T-MIC 1: High screen ruling (SCA) 2: Low screen ruling (SCB) 3: TBIC
Default Value		0
Related Service Mode		TESTMODE> PRINT> PG-TYPE
THRU		Setting of image correction table at test print
Detail		To set the image correction table that is used at the time of test print output. When 0 is set, normal gamma LUT is used so that the density characteristics by the density correction process can be checked. When 1 is set, linear gamma LUT is used so that the density characteristics of this machine can be checked. When 2 is set, the high density area of Bk-color is printed darker.
Use Case		At trouble analysis
Adj/Set/Operate Method		Enter the setting value, and then press Apply key.
Display/Adj/Set Range		0 to 2 0: Normal gamma LUT 1: Through (linear) gamma LUT 2: With trailing edge correction of Bk-color
Default Value		0
Supplement/Memo		Gamma LUT: Density gradation characteristic table
NRKE		ON/OFF of laser scanning transfer process of test print
Detail		To set whether to perform line transfer process for skew correction of laser scanning at test print.
Use Case		At trouble analysis
Adj/Set/Operate Method		Enter the setting value, and then press Apply key.
Display/Adj/Set Range		0 to 1 0: OFF 1: ON
Default Value		0
Supplement/Memo		Transfer process: A process to correct skew of laser scanning toward vertical scanning direction
BLND		ON/OFF of interpolation process at test print
Detail		To set whether to perform interpolation process at test print. When 1 is set, interpolation process is performed (no phase shift).
Use Case		At trouble analysis
Adj/Set/Operate Method		Enter the setting value, and then press Apply key.
Display/Adj/Set Range		0 to 1 0: OFF 1: ON
Default Value		0
Supplement/Memo		Interpolation process: A process to predict, for pixels holding no color information, color based on the surrounding pixels, and then set up the color information.

TESTMODE (Service mode for test print, operation check, etc.) > PRINT (Print test mode)

DENS-Y	Adj of Y-color density at test print
Detail	To adjust Y-color density when performing test print . As the value is larger, the image gets darker.
Use Case	At test print
Adj/Set/Operate Method	Enter the setting value, and then press Apply key.
Display/Adj/Set Range	0 to 255
Default Value	128
Related Service Mode	TESTMODE> PRINT> PG-TYPE
DENS-M	Adj of M-color density at test print
Detail	To adjust M-color density when performing test print . As the value is larger, the image gets darker.
Use Case	At test print
Adj/Set/Operate Method	Enter the setting value, and then press Apply key.
Display/Adj/Set Range	0 to 255
Default Value	128
Related Service Mode	TESTMODE> PRINT> PG-TYPE
DENS-C	Adj of C-color density at test print
Detail	To adjust C-color density when performing test print . As the value is larger, the image gets darker.
Use Case	At test print
Adj/Set/Operate Method	Enter the setting value, and then press Apply key.
Display/Adj/Set Range	0 to 255
Default Value	128
Related Service Mode	TESTMODE> PRINT> PG-TYPE
DENS-K	Adj of Bk-color density at test print
Detail	To adjust Bk-color density when performing test print . As the value is larger, the image gets darker.
Use Case	At test print
Adj/Set/Operate Method	Enter the setting value, and then press Apply key.
Display/Adj/Set Range	0 to 255
Default Value	128
Related Service Mode	TESTMODE> PRINT> PG-TYPE
SW-Y	ON/OFF of Y-color output at test print
Detail	To set whether to output Y-color at the time of test print .
Use Case	At test print
Adj/Set/Operate Method	Enter the setting value, and then press Apply key.
Display/Adj/Set Range	0 to 1 0: OFF, 1: ON
Default Value	1
Related Service Mode	TESTMODE> PRINT> PG-TYPE
SW-M	ON/OFF of M-color output at test print
Detail	To set whether to output M-color at the time of test print .
Use Case	At test print
Adj/Set/Operate Method	Enter the setting value, and then press Apply key.
Display/Adj/Set Range	0 to 1 0: OFF, 1: ON
Default Value	1

TESTMODE (Service mode for test print, operation check, etc.) > PRINT (Print test mode)

SW-C	ON/OFF of C-color output at test print
Detail	To set whether to output C-color at the time of test print .
Use Case	At test print
Adj/Set/Operate Method	Enter the setting value, and then press Apply key.
Display/Adj/Set Range	0 to 1 0: OFF, 1: ON
Default Value	1
SW-K	ON/OFF of Bk-color output at test print
Detail	To set whether to output Bk-color at the time of test print .
Use Case	At test print
Adj/Set/Operate Method	Enter the setting value, and then press Apply key.
Display/Adj/Set Range	0 to 1 0: OFF, 1: ON
Default Value	1
MONOMODE	ON/OFF of black mode at test print
Detail	To set whether to enable black mode at the time of test print.
Use Case	At test print
Adj/Set/Operate Method	Enter the setting value, and then press Apply key.
Display/Adj/Set Range	0 to 1 0: OFF, 1: ON
Default Value	0
FEED	Setting of paper source at test print
Detail	To set the paper source at the time of test print output. If this mode is set when there is no Cassette 2 (option Pickup Cassette), the output is made from Cassette 1 (standard Pickup Cassette).
Use Case	At trouble analysis
Adj/Set/Operate Method	Enter the setting value, and then press Apply key.
Caution	In case of using the Multi-purpose Tray, be sure to place paper on the tray before executing this item.
Display/Adj/Set Range	0 to 4 0: Multi-purpose Tray 1: Cassette 1 2: Cassette 2 3: Cassette 3 4: Cassette 4
Default Value	1
START	Output of test print
Detail	To output a test print with the PG pattern set in PG-TYPE, MODE, etc.
Use Case	At trouble analysis
Adj/Set/Operate Method	Select the item, and then press Yes key.
Related Service Mode	TESTMODE> PRINT

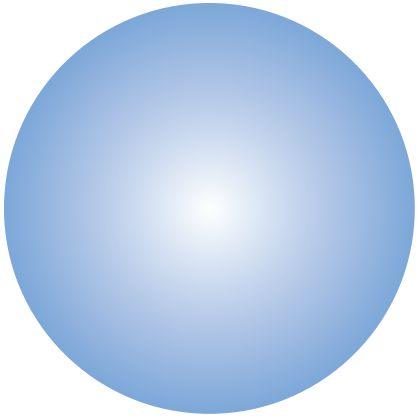

APPENDICES

Service Tools.....	178
General Circuit Diagram.....	179
Backup Data List.....	181
Soft counter specifications.....	183

Service Tools

Special Tools

In addition to the standard tools set, the following special tools are required when servicing the machine:

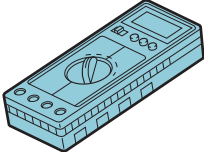
Name of Tool	Parts.No	Use
Digital Multimeter	FY9-2002	Used as a probe extension when making electrical checks. 

Solvents and Oil List

No.	Type	Purpose	Remark
1	Ethyl alcohol	<ul style="list-style-type: none"> Cleaning: metal part, oil stains, toner stains 	<ul style="list-style-type: none"> Purchase locally Keep away from flame

General Circuit Diagram

General Circuit Diagram(1/2)

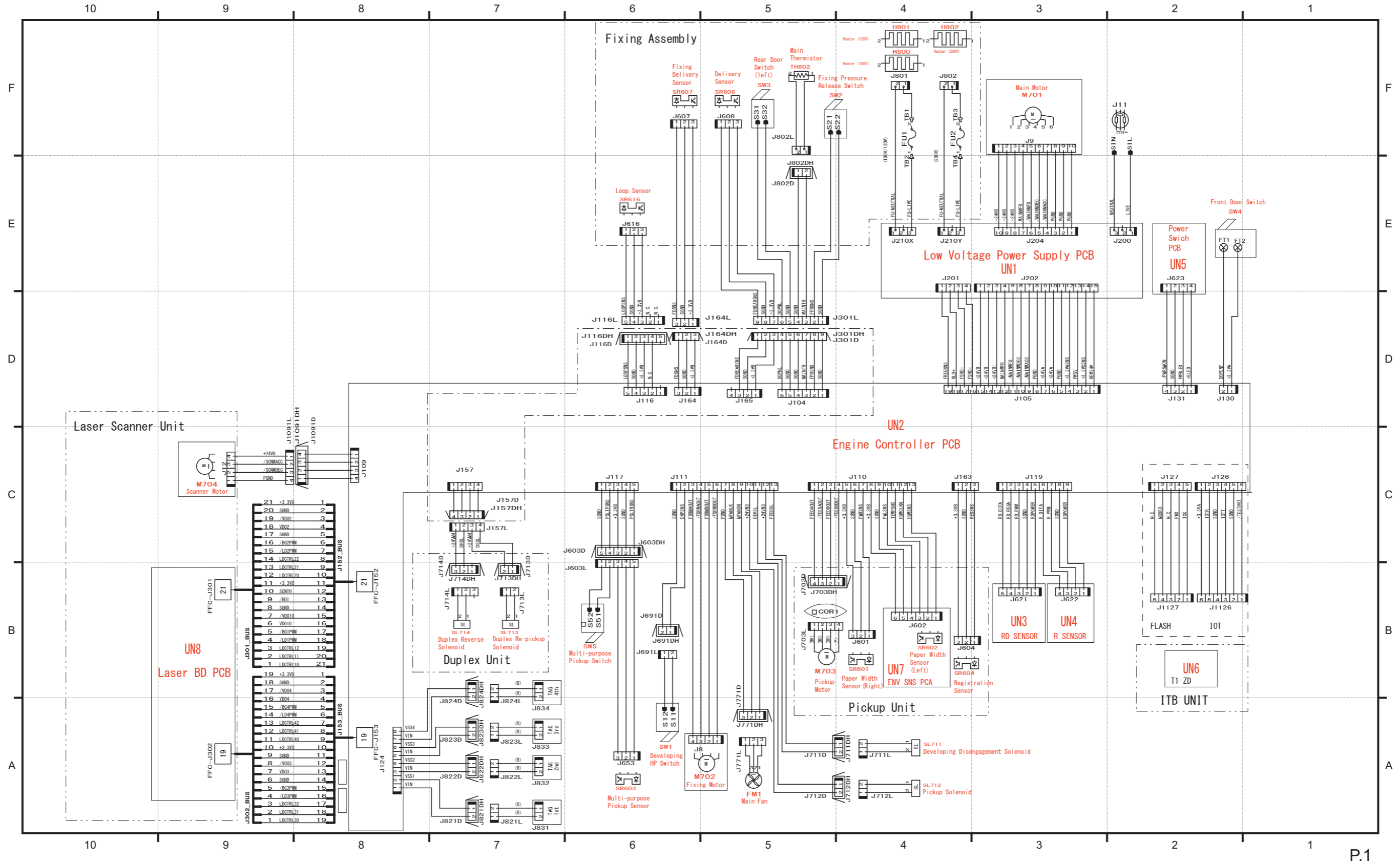

General Circuit Diagram(2/2)

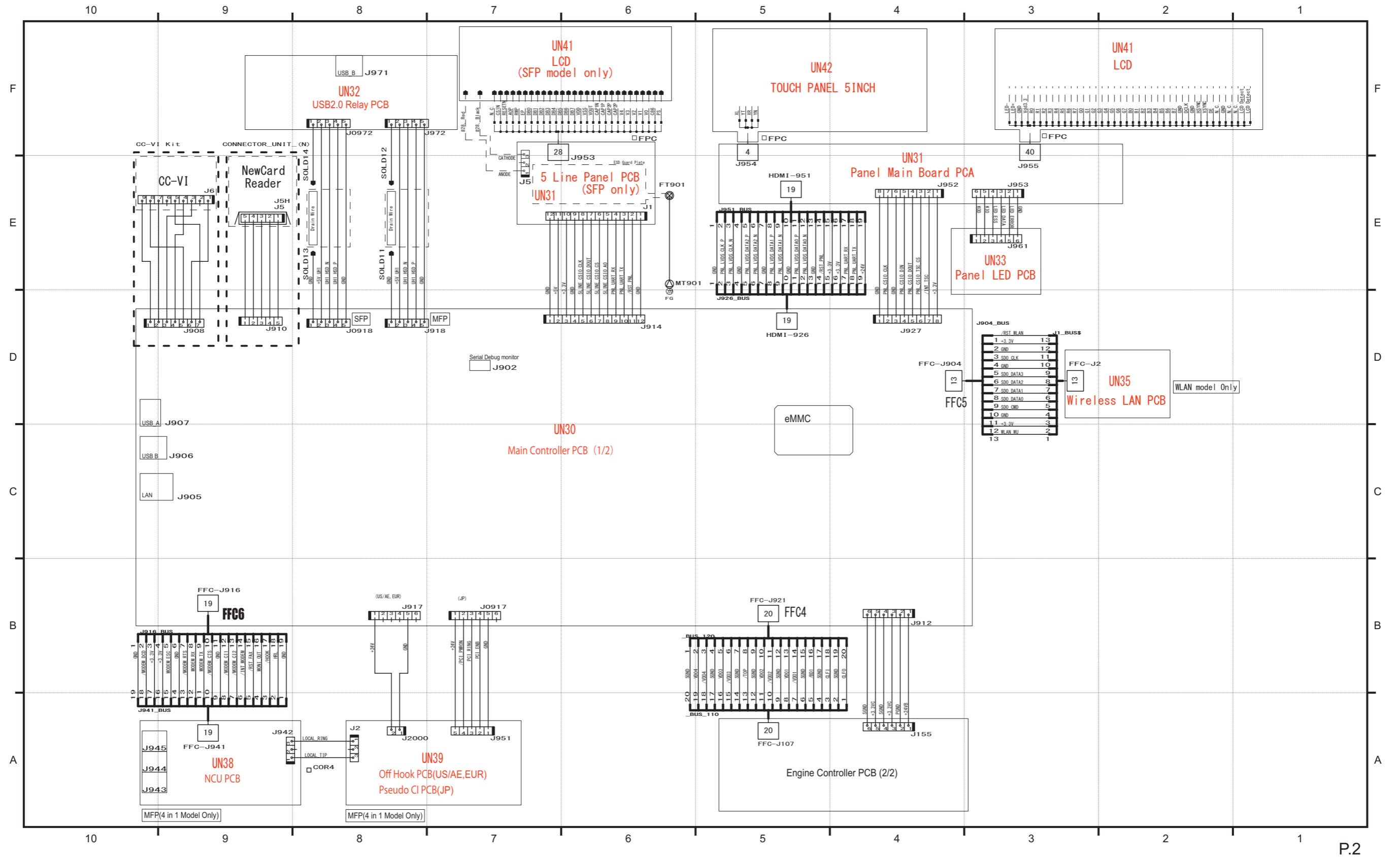

Backup Data List

Data	Location	Replace		Delete															Backup by User			Backup by Service			
				Menu > System Management Settings								Service Mode > COPIER > FUNCTION >													
		Engine Controller PCB	Main Controller PCB	Initialize All Data / Settings	Initializing Key and Certificate	Initializing Address Book	Menu Clear					CLEAR					SPLMAN	Yes/No	Method	Location to be stored	Yes/No	Method	Location to be stored		
							Preferences	Function Settings	Set Destination	Management Settings	Network Settings	Clear All	SRVCDAT*1	COUNTER	HIST *2	ALL								PLPW-CLR	DC-CON
Address Book	Main Controller PCB	-	Clear	Clear	-	Clear	-	-	-	-	-	-	-	-	Clear	-	-	-	Yes	Remote UI *5 LUI *6	PC, USB memory	No	-	-	
Settings Menu																									
Preferences	Main Controller PCB	-	Clear	Clear	-	-	Clear*8	-	-	-	Clear*9	Clear	-	-	-	Clear	-	-	-	Yes	Remote UI *5 LUI *6	PC, USB memory	No	-	-
Function Settings	Main Controller PCB	-	Clear	Clear	-	-	-	Clear	-	-	-	Clear	-	-	-	Clear	-	-	-	Yes	Remote UI *5 LUI *6	PC, USB memory	No	-	-
Set Destination	Main Controller PCB	-	Clear	Clear	-	-	-	-	Clear	-	-	Clear	-	-	-	Clear	-	-	-	Yes	Remote UI *5 LUI *6	PC, USB memory	No	-	-
Management Settings	Main Controller PCB	-	Clear	Clear	-	-	-	-	-	Clear	-	Clear	-	-	-	Clear	-	-	-	Yes	Remote UI *5 LUI *6	PC, USB memory	No	-	-
Status Monitor/Cancel																									
Job Log	Main Controller PCB	-	Clear	Clear	-	-	-	-	-	-	-	-	-	-	Clear	Clear	-	-	-	No	-	-	No	-	-
Counter																									
Page counter (Main Controller)	Main Controller PCB	-	Clear	-	-	-	-	-	-	-	-	-	-	-	-	-	-	-	-	No	-	-	No	-	-
Part counter (Main Controller)	Main Controller PCB	-	Clear	Clear	-	-	-	-	-	-	-	-	Clear	-	-	-	-	-	-	No	-	-	No	-	-
Part counter (DC Controller)	Engine Controller PCB	Clear	-	-	-	-	-	-	-	-	-	-	-	-	-	-	-	-	-	No	-	-	No	-	-
Other																									
Serial number	Main Controller PCB	-	Clear	-	-	-	-	-	-	-	-	-	-	-	-	-	-	-	-	No	-	-	No	-	-
Key and Certificate Settings	Main Controller PCB	-	Clear	Clear	Clear	-	-	-	-	-	-	-	-	-	Clear	-	-	-	-	No	-	-	No	-	-
Service mode																									
Service mode setting values (Main Controller)	Main Controller PCB	-	Clear	-	-	-	-	-	-	-	-	Clear	-	-	Clear	-	-	-	-	Yes	Remote UI *5 LUI *6	PC, USB memory	Yes	Service mode *4	USB memory

Data	Location	Replace		Delete																Backup by User			Backup by Service			
				Menu > System Management Settings								Service Mode > COPIER > FUNCTION >														
		Engine Control-ler PCB	Main Control-ler PCB	Initialize All Data / Settings	Initializ-ing Key and Cer-tificate	Initializ-ing Ad-dress Book	Menu Clear					CLEAR					SPLMAN	Yes/No	Method	Location to be stor-ed	Yes/No	Method	Location to be stor-ed			
							Preferen-ces	Function Settings	Set Desti-nation	Manage-ment Set-tings	Network Settings	Clear All	SRVC-DAT*1	COUN-TER	HIST *2	ALL								PLPW-CLR	DC-CON	SPL43810
Service mode setting values (DC Controller)	Engine Controller PCB	Clear	-	-	-	-	-	-	-	-	-	-	-	-	-	-	-	Clear	-	Yes	Remote UI *5 LUI *6	PC, USB memory	Yes	Service mode *4 *7	USB memory / Main Controller	
Password																										
System Administrator password	Main Controller PCB	-	Clear*3	Clear*3	-	-	-	-	Clear*3	-	Clear*3	-	-	-	Clear*3	-	-	-	Clear*10	No	-	-	No	-	-	
Security Policy Administrator password	Main Controller PCB	-	Clear	Clear	-	-	-	-	Clear	-	Clear	-	-	-	Clear	Clear	-	-	-	No	-	-	No	-	-	
Service Mode password*11	Main Controller PCB	-	Clear	Clear	-	-	-	-	-	-	-	-	-	-	-	-	-	-	-	No	-	-	No	-	-	

*1. Service data (Except "COPIER > COUNTER" and "COPIER > FEED-ADJ") are cleared. The factory adjustment values of the Reader and ADF are not initialized.

*2. Service data is cleared. User data is not cleared. The factory adjustment values of the Reader and ADF are not initialized.

*3. In except counter meter-installed model: The user data and service data and each history and the settings of the system administrator are cleared. (The system manager ID and password are changed back to the default values ID: 0/PWD: 0)
The factory adjustment values of the Reader and ADF are not initialized.

*4. COPIER > FUNCTION > SYSTEM > IMPORT / COPIER > FUNCTION > SYSTEM > EXPORT

*5. Settings/Registration >Management Settings >Data Management > Import/Export

*6. Settings Menu > Management Settings > Data Management > Import/Export

*7. COPIER > FUNCTION > VIFFNC > STOR-DCN

*8. Except "Preferences > Network Settings"

*9. Clear only an item of the "Preferences > Network Settings".

*10. Because the settings of the "System Manager ID and PIN" are cleared, set "System Manager ID and PIN" again.

*11. COPIER > OPTION > BODY > SM-PSWD(Setup password by SM-PSWD)

Soft counter specifications

The numbers entered for software counters are classified as follows:

No.	Counter Details
100 to 199	Total
300 to 399	Print

100 to 199

No.	Counter Name
101	Total 1
108	Total (Black1)
113	Total (Black / Small)
114	Total 1 (2-Sided)
123	Total (full color +mono color /small)
149	Total A (full color +mono color 1)
191	Toner replacement /Yellow
192	Toner replacement /Magenta
193	Toner replacement /Cyan
194	Toner replacement /Black

300 to 399

No.	Counter Name
322	Print (full color +mono color /small)