

# imageRUNNER LBP3480

## Service Manual



Troubleshooting

### Application

This manual has been issued by Canon Inc. for qualified persons to learn technical theory, installation, maintenance, and repair of products. This manual covers all localities where the products are sold. For this reason, there may be information in this manual that does not apply to your locality.

### Corrections

This manual may contain technical inaccuracies or typographical errors due to improvements or changes in products. When changes occur in applicable products or in the contents of this manual, Canon will release technical information as the need arises. In the event of major changes in the contents of this manual over a long or short period, Canon will issue a new edition

of this manual.

The following paragraph does not apply to any countries where such provisions are inconsistent with local law.

### Trademarks

The product names and company names used in this manual are the registered trademarks of the individual companies.

### Copyright

This manual is copyrighted with all rights reserved. Under the copyright laws, this manual may not be copied, reproduced or translated into another language, in whole or in part, without the written consent of Canon Inc.







(C) CANON INC. 2012

### Caution

Use of this manual should be strictly supervised to avoid disclosure of confidential information.

## Explanation of Symbols

The following symbols are used throughout this Service Manual.

Symbols	Explanation		Symbols	Explanation
	Used to show permission.			Remove the screw.
	Used to show prohibition.			Tighten the screw.
	Check.			Remove the claw.
	Check visually.			Insert the claw.
	Check the noise.			Use the bundled part.
	Disconnect the connector.			Push the part.
	Connect the connector.			Plug the power cable.
	Remove the cable/wire from the cable guide or wire saddle.			Turn on the power.
	Set the cable/wire to the cable guide or wire saddle.			

T-0-1

The following rules apply throughout this Service Manual:

1. Each chapter contains sections explaining the purpose of specific functions and the relationship between electrical and mechanical systems with reference to the timing of operation.

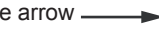
In the diagrams,  represents the path of mechanical drive; where a signal name accompanies the symbol, the arrow  indicates the direction of the electric signal.

The expression "turn on the power" means flipping on the power switch, closing the front door, and closing the delivery unit door, which results in supplying the machine with power.

2. In the digital circuits, '1' is used to indicate that the voltage level of a given signal is "High", while '0' is used to indicate "Low". (The voltage value, however, differs from circuit to circuit.) In addition, the asterisk (\*) as in "DRMD\*" indicates that the DRMD signal goes on when '0'.

In practically all cases, the internal mechanisms of a microprocessor cannot be checked in the field. Therefore, the operations of the microprocessors used in the machines are not discussed: they are explained in terms of from sensors to the input of the DC controller PCB and from the output of the DC controller PCB to the loads.

The descriptions in this Service Manual are subject to change without notice for product improvement or other purposes, and major changes will be communicated in the form of Service Information bulletins.

All service persons are expected to have a good understanding of the contents of this Service Manual and all relevant Service Information bulletins and be able to identify and isolate faults in the machine.

# Contents

## Safety Precautions

Safety Information	0-6
Laser Safety	0-6
CCDRH Regulation	0-6
Toner Safety	0-6
About Toner	0-6
How to Handle Adhered Toner	0-6
Ozone Safety	0-6
How to Handle the Laser Scanner Unit	0-7
Points to Note when Replacing/Discarding a Lithium Battery	0-7
Points to Note when Performing Disassembly/Assembly	0-7

## Product Description

Product Lineups	1-2
Main unit	1-2
Options	1-2
Features	1-2
Specification	1-3
Product Specifications	1-3
Printing Speed	1-3
List of Parts	1-4
External View	1-4
Cross Sectional View	1-4
Operation	1-5
Control panel	1-5

## Technology

Basic Operation	2-2
Function Structure	2-2
Sequence of Operation	2-2
Outline	2-2

Laser Exposure System	2-3
Outline	2-3
Optical Unit Failure Detection	2-3
Image Formation System	2-4
Outline	2-4
Image Formation Process	2-4
Outline	2-4
Latent image formation block	2-5
Developing block	2-5
Transfer block	2-6
Fixing block	2-6
Drum cleaning block	2-6
High-voltage Power Supply	2-7
Outline	2-7
Fixing System	2-8
Outline	2-8
Fixing control circuit	2-9
Small Size Paper Printing Speed Control (Throughput Reduction Control)	2-9
Fixing temperature control	2-10
Protective function	2-10
Failure detection	2-11
Pickup Feeding System	2-12
Outline	2-12
Jam Detection	2-13
Outline	2-13
Pickup Delay Jam	2-13
Pickup Stationary Jam	2-13
Delivery Delay Jam	2-13
Fixing Paper Wrap Jam	2-13
Delivery Stationary Jam	2-13
Reverse Delay Jam	2-13
Reverse Stationary Jam	2-14
Internal Residual Jam	2-14
Door Open Jam	2-14
Controller System	2-15
Outline	2-15
DC Controller	2-15

Outline-----	2-15	Enhanced System Application Management-----	2-45
Motor control-----	2-16	Outline-----	2-45
Fan control-----	2-17	About Login Service-----	2-45
Failure Detection-----	2-17	Default Authentication overview-----	2-45
Low-voltage Power Supply-----	2-17	Other Log in service-----	2-45
Outline-----	2-17	Procedure Changing Login Services-----	2-45
Protective function-----	2-18	Procedure Installing Login Services-----	2-46
Safety-----	2-18	Procedure Uninstalling Login Services-----	2-47
Low-voltage power supply unit failure detection-----	2-18	System Application Management-----	2-47
Energy Saving Function-----	2-18	Procedure to manage System Application-----	2-47
MEAP-----	2-19	System Information-----	2-48
Introduction-----	2-19	Outline-----	2-48
References by purpose-----	2-19	Checking the System Information-----	2-48
About MEAP-----	2-19	Display of System Information Details-----	2-48
Overview-----	2-19	Printing the System Information of a MEAP Application-----	2-49
About SMS-----	2-20	Content of MEAP system information-----	2-49
Overview-----	2-20	MEAP Application Information-----	2-50
About the MEAP Application Management Screen-----	2-20	Outline-----	2-50
About the MEAP Application Installation Screen-----	2-20	Procedure to Check MEAP Application Information-----	2-50
About System Management-----	2-21	Check License-----	2-51
Preparation for Using SMS-----	2-21	Outline-----	2-51
Preparation of PC for Accessing SMS-----	2-21	Procedure to Check the License File-----	2-51
Device Settings-----	2-22	Changing SMS Login Password-----	2-51
How to Check the Serial Number-----	2-27	Outline-----	2-51
Login to SMS-----	2-28	Procedure to Change the SMS Login Password-----	2-51
Procedure to Log in-----	2-28	MEAP Application Setting Information Management and Log Management-----	2-52
Installing an MEAP Application-----	2-31	Outline-----	2-52
Outline-----	2-31	Advantages Obtained When Using the Services-----	2-52
Procedure to install applications-----	2-31	MEAP Application Setting Information Management-----	2-53
Resource Information-----	2-33	MEAP Application Log Management-----	2-53
About MEAP Application Management Page-----	2-33	Maintenance-----	2-54
MEAP Specifications-----	2-34	When Replacing the PCB-----	2-54
What is MEAP Specifications (MEAP Spec Version)?-----	2-34	Actions to be taken when E616 is displayed-----	2-55
MEAP Application Management-----	2-36	MEAP Safe Mode-----	2-56
Outline-----	2-36	Using USB Devices-----	2-57
Starting, Stopping, or Uninstalling the MEAP Application-----	2-36	Reference material-----	2-58
Managing the License File-----	2-38	Glossary-----	2-58
Other License File Management Functions-----	2-42		

Embedded RDS .....	2-61
Product Overview .....	2-61
Overview .....	2-61
Features and benefits .....	2-61
Service cautions .....	2-62
E-RDS Setup .....	2-62
Confirmation and preparation in advance .....	2-62
E-RDS setting items (service mode) .....	2-63
Steps to E-RDS settings .....	2-63
Initializing E-RDS settings .....	2-65
FAQ .....	2-66
Troubleshooting .....	2-67
Error code and strings .....	2-69

## Disassembly/Assembly

Preface .....	3-2
List Of Parts .....	3-2
External View .....	3-2
List of Main Unit .....	3-3
Motor .....	3-4
Solenoid .....	3-5
Heater / Thermo Switch / Thermistor / Switch .....	3-5
Sensor .....	3-6
PCB .....	3-6
Connector Layout Drawing .....	3-7
Connector List .....	3-7
Main Controller PCB .....	3-7
Engin Controller PCB .....	3-7
Internal .....	3-7
External Cover, Internal Cover .....	3-9
Removing the Left Cover .....	3-9
Removing the Right Cover .....	3-9
Removing the Rear Cover Unit / Duplex Feed Unit .....	3-10
Removing the Upper Cover Unit .....	3-11
Removing the Cartridge Cover Unit .....	3-11
Controller System .....	3-12

Removing the Main Controller Board .....	3-12
Remove the Duplex Reverse Sensor Unit .....	3-13
Remove the All-Night Power Supply PCB .....	3-13
Remove the Power Supply PCB .....	3-14
Removing the Engine Controller Board .....	3-14
Removing the Control Panel Unit .....	3-17
Removing the Main Motor .....	3-17
Removing the Main Fan .....	3-18
Removing the Main Drive Unit .....	3-18
Removing the Duplex Drive Unit .....	3-20
Removing the Cassette Pickup Solenoid .....	3-20
Removing the Multi-purpose Solenoid .....	3-21
Removing the Duplex Reversal Solenoid .....	3-21
Laser Exposure System .....	3-22
Removing the Laser Scanner Unit .....	3-22
Image Forming System .....	3-23
Removing the Transfer Roller .....	3-23
Removing the Registration Unit .....	3-23
Fixing System .....	3-25
Removing the Fixing Unit .....	3-25
Paper Pickup/Transport/Output System .....	3-27
Removing the Cassette Pickup Roller .....	3-27
Removing the Cassette Separation Pad .....	3-28
Removing the Multi-purpose Pickup Roller .....	3-28
Removing the Multi-purpose Separation Pad .....	3-29

## Maintenance and Inspection

Periodically Replaced Parts .....	4-2
Periodically Replaced Parts .....	4-2
Consumable Parts .....	4-2
Durables Replaced by the Service Person .....	4-2
Periodical Service .....	4-2
Periodical Service .....	4-2
Cleaning .....	4-2
Cleaning at Service Visit .....	4-2

# Troubleshooting

Troubleshooting	5-2
Test Pages	5-2
Engine-test page	5-2
Controller-Test page	5-2
Device Log List	5-3
Adjustment of Fixing System	5-3
Nip-width specifications	5-3
Error Codes	5-4
Error Code Details	5-4
Jam Codes	5-7
Service Mode	5-8
ADJUST GR.	5-8
OPTION GR.	5-8
FUNCTION GR.	5-8
LOG GR.	5-9
PANEL GR.	5-9
F/W UPDATE GR.	5-9
NETWORK GR.	5-9
SP.ADMIN.MODE	5-11
Version Upgrade	5-12
Overview	5-12
Overview of Version Upgrade	5-12
Checking the Version	5-12
Version Upgrade Using UST	5-13
Preparation	5-13
Downloading the Firmware	5-14
Updater	5-17
Overview	5-17
Outline	5-17
System Configuration	5-18
List of Functions	5-18
Distribution Flow	5-19
Limitations and Cautions	5-20
Preparation	5-21
System Management Operations	5-27
a. UGW-linked Download and Update (Full-remote Update)	5-30

b. UGW-linked Download (Remote Distribution Update)	5-30
Deleting the Scheduled Firmware Delivery	5-31
Updating the Downloaded Firmware (Application of Firmware)	5-31
Deleting the Downloaded Firmware	5-32
Maintenance	5-33
FAQ	5-34
Error Messages	5-37
Error Codes	5-43
Debug log	5-48
Sublog	5-48
Function Overview	5-48
How the log is written	5-48
Collecting Sublog	5-49
Flow of collecting Sublog	5-49
Installing the Sublog Board	5-49
Generating the log	5-49
Collecting log	5-50
Backup/Restoration by Expansion ROM for servicing and Sublog Board	5-53
Function Overview	5-53
What to Prepare	5-53
Prerequisites	5-53
Target Data for Backup	5-53
Backup and Restoration (Export and Import)	5-54
Flow of Export and Import	5-54
Installing the Expansion ROM for servicing and Sublog Board	5-54
Backup Procedure (Export)	5-55
Restoration Procedure (Import)	5-55
Others	5-56
Deletion (Erase)	5-56
List of Error Messages	5-57

# Appendix

Service Tools	II
Special Tools	II
Solvents and Oil List	II
General Timing Chart	III

General Timing Chart-----	III
General Circuit Diagram-----	IV
General Circuit Diagram -----	IV
Backup Data-----	V



# Safety Precautions

- Laser Safety
- CCDRH Regulation
- Toner Safety
- Ozone Safety
- How to Handle the Laser Scanner Unit
- Points to Note when Replacing/Discarding a Lithium Battery
- Points to Note when Performing Disassembly/Assembly

## Safety Information

### Laser Safety

Laser beam radiation sometimes causes a danger to human body. To prevent such a danger, the optical laser system used in this machine is hermetically closed by the protection housing and external cover so that a laser beam does not leak to outside. Therefore, a laser beam does not leak out of this machine as long as a user operates the machine in an ordinary manner.

### CCDRH Regulation

CDRH (Center for Devices and Radiological Health), which belongs to Food and Drug Administration in USA, put a regulation concerning laser products on August 2, 1976. This regulation is applied to laser products manufactured on and after August 1, 1976, and sales activities are prohibited in USA without receiving permission under the regulation. The following figure shows the label indicating that permission has been received under the CDRH regulation, and it is obliged to attach it on all products sold in USA.

**CANON INC.**

30-2,SHIMOMARUKO,3-CHOME,OHTA-KU,TOKYO,  
146,JAPAN

**MANUFACTURED :**

THIS PRODUCT CONFORMS WITH DHHS RADIATION  
PERFORMANCE STANDARD 21CFR CHAPTER I  
SUBCHAPTER J.

F-0-2

**CAUTION:**

A part of the description may be different depending on the type of product model.

### Toner Safety

#### About Toner

Toner is a nontoxic substance which consists of plastic, iron, and a small amount of pigment.

**CAUTION:**

Be sure not to throw toner into the fire. Doing so may cause an explosion.

#### How to Handle Adhered Toner

When toner adhered to skin or clothes, completely remove it with dried tissue and wash with water.

If hot water is used, toner cannot be removed because it becomes gel and penetrates into clothes permanently.

Do not make toner come into contact with vinyl because it easily reacts with a vinyl materia

### Ozone Safety

An infinitesimal amount of ozone gas (O<sub>3</sub>) is generated during corona discharge from the charging roller

used in this printer. The ozone gas is emitted only during the printer operation.

The printer meets ozone emission reference value set by Underwriters Laboratory (UL) at the time of shipping from the manufacture.

## How to Handle the Laser Scanner Unit

An invisible laser beam is irradiated in the laser scanner unit.  
 If the laser beam enters an eye, it may cause damage to the eye. So, be sure not to disassemble the laser scanner unit. No adjustment can be made to the laser scanner unit in this machine in the field.  
 The label shown in the following figure is attached to the bottom of the laser scanner unit.



F-0-3

## Points to Note when Replacing/Discarding a Lithium Battery

The main controller PCB in this machine contains a lithium battery as backup power supply for various data just in the case when a blackout occurs or the power plug is removed.

**CAUTION:**

- The battery installed in this machine is fixed and cannot be replaced.
- Do not replace the battery only.
- Replacing the battery with another type of battery can result in explosion.
- When disposing the old PCB with battery, remove the battery and follow the local regulation.

## Points to Note when Performing Disassembly/Assembly

- Be sure to follow the instruction shown below when performing disassembly/assembly.
1. Be sure to unplug the power plug for safety when performing disassembly/assembly.
  2. If not otherwise specified, perform assembly in the procedure opposite to that of disassembly.
  3. Perform assembly using correct types of screws, etc. (length/diameter) at correct positions.
  4. A washer screw is used as a screw to fix a grounding wire and varistor, etc., to secure electrical conduction. Be sure to use this screw when performing assembly.
  5. In principle, do not operate the machine in the condition where parts are removed.
  6. Do not remove a paint-locked screw when performing disassembly.



# Product Description

- Product Lineups
- Features
- List of Parts
- Operation

## Product Lineups

### Main unit

Function	imageRUNNER LBP3480	
Appearance		
Copy	X	F-1-1
Print	O	
FAX	X	
Remote UI	O	
Automatic 2-sided Print (60 to 120g / m2 paper)	O	
MEAP	O	
Network	O	
WLAN	X	

T-1-1

## Features

### 1. Small and high-speed printer

The printer is compact size that realizes print speed of approximately 35 pages per minute on letter-size media and approximately 33 pages per minute on A4-size media by imageRUNNER LBP3480, and approximately 35 pages per minute on letter-size and A4-size media.

### 2. Automatic duplex print

Automatic two-sided printing is available with standard equipped duplex unit.

### 3. High-volume continuous printing

In addition to the standard equipped universal cassette (holds up to 250 sheets of 80g/m2 paper) and Multi-purpose tray (holds up to 50 sheets of 80g/m2 paper), the printer supports optional paper feeder (holds up to 500 sheets of 80g/m2 paper) for a total capacity of 800 sheets. Thus high-volume continuous printing is available.

### Options

Name	Description	Remarks
Paper FeederUnit PF-44	Approx. 500 Sheets (Plain paper 80g/ m2)	-
Barcode Printing Kit-F1		
SD CARD-B1		

T-1-2

## Specification

### Product Specifications

Item	Specification/function
Installation Format	Desktop type page printer
Photosensitive Element	OPC drum
Exposure Principle	Laser beam method
Development Principle	Jumping development
Transfer Principle	Roller transfer
Separation Principle	Self stripping
Cassette Feed Principle	Separate design
Multi Purpose Tray Principle	Pad separation
Drum Cleaning Principle	Rubber blade cleaning
Fixing Method	On-demand
Paper Output Principle	Face-down/Face-up
Toner Supply Principle	Toner cartridgesNumber
Warm-up Time	From power ON: max. 28 seconds
Recovery Time	Approx. 10.0 seconds or less
Print Area	Top 5.0 mm, Bottom 5.0 mm, Left/Right 5.0 mm (Envelope: Top/Bottom/Left/Right 10.0 mm, Right 10.0 mm)
Printing Resolution	600 dpi
First Print Output Time	Approx. 7.0 seconds or less
Printing Speed	A4: 33 , LTR: 35 pages/minute
Cassette Paper Size	Standard sizes: A4, B5, A5, A6, Legal, Letter, Executive Custom size range (user-specified): (Width 105.0 to 215.9 mm, Length 148.0 to 355.6 mm)
Multi Purpose Paper Size	Standard sizes: A4, B5, A5, A6, Legal, Letter, Executive, Postcard, Reply-paid Postcard, Four-side Postcard, Japanese Western-style Envelope Size No. 3, Envelope Size No. 3 Custom size range (user-specified): (Width 76.2 to 215.9 mm, Length 127.0 to 355.6 mm)
Cassette Paper Type	Plain paper (60 to 90 g/m <sup>2</sup> ), Heavy paper (91 to 120 g/m <sup>2</sup> ),
Multi Purpose Paper Type	Plain paper (60 to 90 g/m <sup>2</sup> ), Heavy paper (91 to 163 g/m <sup>2</sup> ), OHP film, label paper, postcard, envelope
Cassette Paper Capacity	Approx. 250 sheets (Plain paper 80 g/m <sup>2</sup> )
Multi Purpose Paper Capacity	Approx. 50 sheets (Plain paper 80 g/m <sup>2</sup> )
Output Tray Paper Capacity	Face-down output: approx. 150 sheets (80 g/m <sup>2</sup> ), face-up output: 1 sheet
Duplex Printing Principle	Auto Duplex
Interfaces	USB: Hi-Speed USB/USB2.0 Network: 10 Base-T/100BASE-T common (RJ-45) Full duplex/half duplex
Memory Capacity	Standard: 16 MB, Option: None
Hard Disk Capacity	Standard: None, Option: None

Item	Specification/function
Ambient Temperature Range for Use	10 to 30 degrees Celsius
Ambient Humidity Range for Use	20 to 80% RH
Operation Noise Level	53.5 dB or less (During printing: rated sound emission level according to ISO9296)
Power Requirements	120 to 127V( +/- 10%), 50/60( +/- 2Hz) 220 to 240V( +/- 10%), 50/60( +/- 2Hz)
Max. Power Consumption	1060 W or less (120 V) 1140 W or less (230 V)
Power Consumption	Average power consumption during operation: approx. approx. 550 W (120 V), approx. 560 W (230 V) Average power consumption during standby: approx. 13.2 W (120 V), approx. 13.9 W (230 V)
Dimensions	400 (W) x 376 (D) x 289 (H) mm
Weight	Printer main unit: approx. 11.6 kg (excl. toner cartridges)
Device Option	Paper Feeder

T-1-3

### Printing Speed

	Face-down output					
	Cassette feed		Manual tray feed		OP cassette feed	
	Single-sided	Duplex print	Single-sided	Duplex print	Single-sided	Duplex print
A4	33	16.8	33	16.8	33	16.8
LTR	35	17	35	17	35	17
LGL	28.7	13.5	28.7	13.5	28.7	13.5
B5/EXE	13.7>12>8>6		17>12>8>6		10.7>8>6	
A5	15.2>12>8>6		17>12>8>6		11.7>8>6	
A6	17.3>12>8>6		17>12>8>6		13.2>12>8>6	
16K	17>14		17>14			
Strip (90 – 297 mm)			3			
Envelope (Japanese Western-style)			17>12>8>6			
Postcard			12>8>6>4			

T-1-4

# List of Parts

## External View

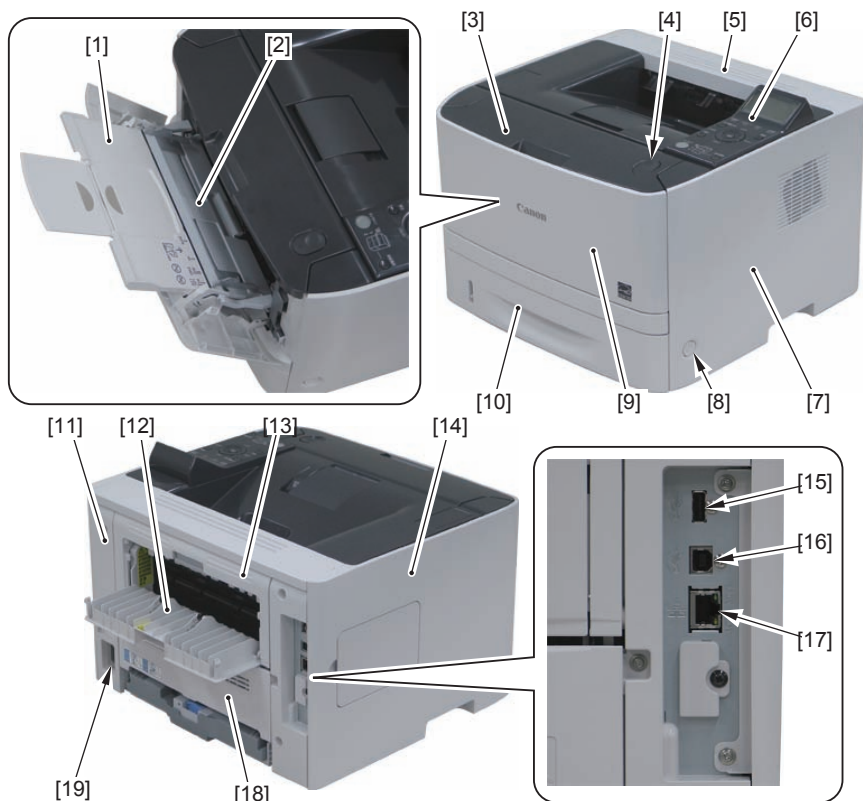

No.	Name	No.	Name
[1]	Auxiliary Tray	[11]	Rear Cover
[2]	Multi-purpose Tray	[12]	Face-up Output Tray
[3]	Front Cover	[13]	Pressure Release Cover
[4]	Open Button	[14]	Left Cover
[5]	Upper Cover	[15]	USB Host
[6]	Control Panel	[16]	USB Device
[7]	Right Cover	[17]	LAN Port
[8]	Power Switch	[18]	Duplex Unit Cover
[9]	Face-down Output Tray Cover	[19]	Power Socket
[10]	Paper Cassette		

T-1-5

## Cross Sectional View

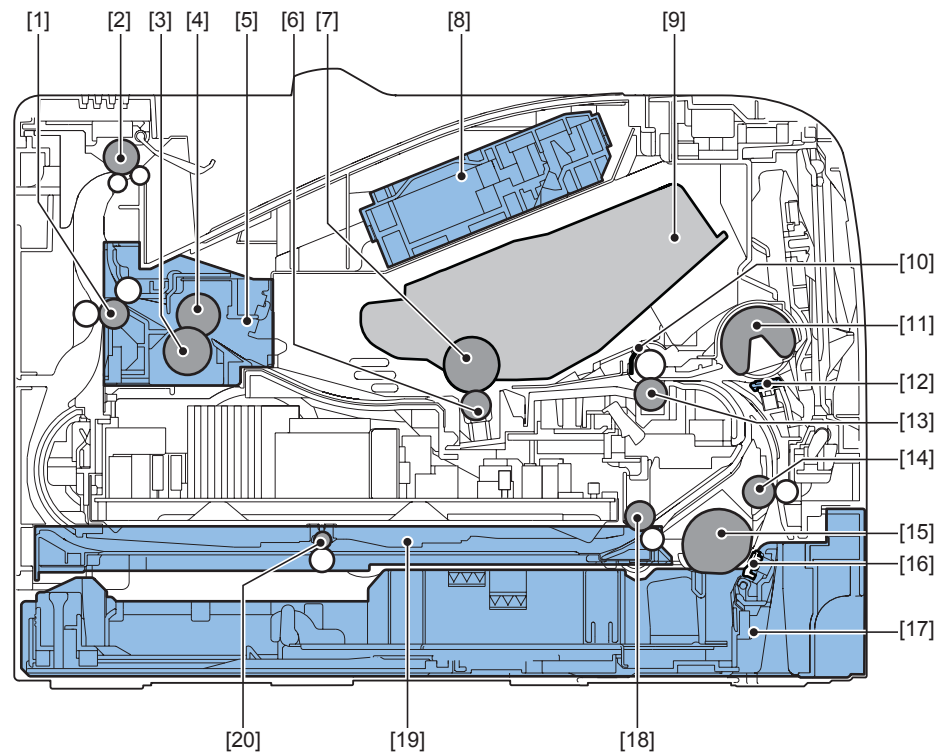

F-1-2

No.	Name	No.	Name
[1]	Fixing Delivery Roller	[11]	Multi-purpose Tray Pickup Roller
[2]	Face-down Delivery Roller	[12]	Multi-purpose Tray Separation Pad
[3]	Pressure Roller	[13]	Registration Roller
[4]	Fixing Film Unit	[14]	Feed Roller
[5]	Fixing Unit	[15]	Cassette Pickup Roller
[6]	Transfer Roller	[16]	Cassette Separation Pad
[7]	Photosensitive Drum	[17]	Cassette
[8]	Laser Scanner Unit	[18]	Duplex Re-pickup Roller
[9]	Cartridge	[19]	Duplex Feed Unit
[10]	Registration Shutter	[20]	Duplex Feed Roller

T-1-6

## Operation

### Control panel

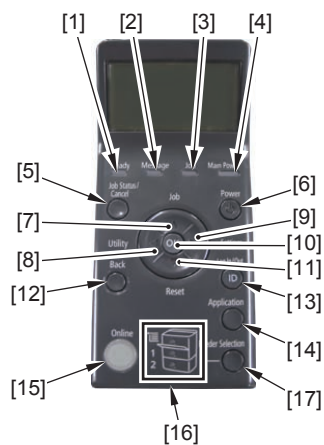

No.	Name	Discription	
[1]	Ready Indicator	On	The printer is ready to print.
		Blinking	The printer is preparing to print.
[2]	Message Indicator	Blinking	A problem has occurred and printing cannot be performed. (If the printer's Sleep Mode when it is offline, the Message indicator comes on even when no problem is occurring)
		On	The printer is receiving data. Data remains in the printer memory.
[3]	Job Indicator	On	The printer is receiving data. Data remains in the printer memory.
		Blinking	The printer is processing data.
[4]	Main Power Indicator	On	The power of the printer is ON.

T-1-7

No.	Name	Function		
		When the printer is online	When the printer is offline	When the menu is displayed
[5]	Status/Cancel Key	If pressed when the Job indicator is on or blinking (When data is being processed or received), display the job list. Select a job from the list to cancel the job.		Does not function.
[6]	Power Key	If [Sleep Mode] is set to a setting other than [Off], the printer enters Sleep Mode.		
[7]	Job Key	Displays the [Job] menu. You can print various log list.	Does not function.	Select the next upper item in the same hierarchy. When the setting value is numeric, increase the value.
[8]	Utility Key	Display the [Utility Menu] menu. Prints information about the printer settings including the current settings.	Does not function.	Goes back up the previous hierarchy.
[9]	Settings Key	Displays the [Setup] menu.		Goes down the hierarchy
[10]	OK Key	Does not function.		Goes down the hierarchy
[11]	Reset Key	Display the [Reset] menu. Performs the printer reset operation, the print data output, and the shutdown operation.		Select the next lower item in the same hierarchy. When the setting value is numeric, reduces the value.
[12]	Back Key	Does not function.		Goes back up the previous hierarchy.
[13]	Log In/Out Key	The log in screen for using MEAP functions is displayed. Enter the Dept. ID/PIN and log in to the printer.		
[14]	Application Key	It will transition to the Menu Screen. Whenever the key is pressed, the Printing Screen switches to → MEAP Application 1 → MEAP Application 2. Meap Application 8 → USB Direct Print → Printing Screen → Menu Screen		
[15]	Online Key	Switches between online and offline. The printer is online when the indicator under the key is on and is offline when the indicator is off.		
[16]	Paper Source Indicator	On	A paper source is selected.	
		Blinking	Printing cannot be performed because no paper is loaded. The paper drawer is not installed.	
[17]	Feeder Selection Key	Displays the [Select Feeder] menu. Specify which paper source is used to print between the paper drawer and multi-purpose tray and the paper size.		Does not function.

T-1-8



# 2

## Technology

- Basic Operation
- Sequence of Operation
- Laser Exposure System
- Image Formation System
- Fixing System
- Pickup Feeding System
- Controller System
- MEAP
- Embedded RDS

## Basic Operation

### Function Structure

The function structure of the printer contains the following five systems:

- Engine control system
- Laser scanner system
- Image-formation system
- Media feed system
- Option

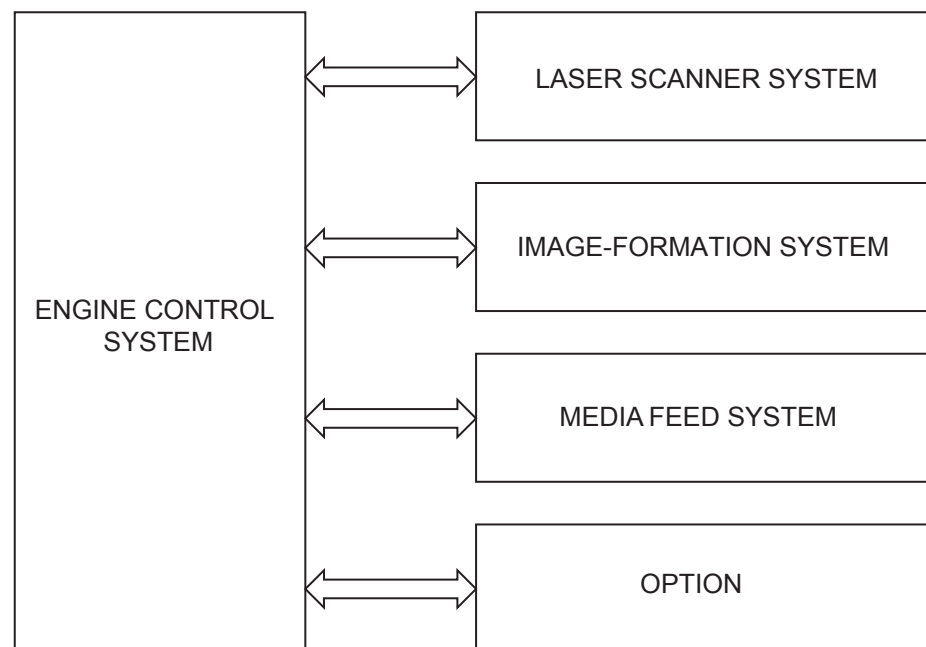

F-2-1

## Sequence of Operation

### Outline

The operation sequence is controlled by the DC Controller in the engine control system.

Operations for each period of a print operation from the machine is turned on until the motor stops rotating are described below.

Period	Duration	Operation
WAIT	From the time power switch is turned on or the dooe is closed until the printer gets ready for a print operation.	Brings the printer to printable condition. The rpinter performs the following during this period:-Detects cartridge presence.
STBY (Standby)	From the end of WAIT or LSTR period until either the print command is received the main controller or the power switch is turned off.	Maintains the printer in printable condition.
INTR (Initial rotation)	From the time print command is received from the main controller unit the temperature of the fixing unit reaches its targeted temperature.	Starts up each high-voltage biases, laser scanner and fixing unit in preparing for print operation.
PRINT	From the end of INTR period unit the last media completes the fixing operation.	Forme the image on the photosensitive drum based on the VIDEO signals from the main controlloer. Transfers and fuses the toner image to the print media.
LSTR (Last rotation)	From the end of PRINT period unit the motor stops rotating.	Moves the last printed sheet out of the printer. Stops laser scanner operation and high-voltage biases output. The printer enters INTR period as the LSTR period is completed if the main controller sends another print command.

T-2-1

## Laser Exposure System

### Outline

The laser exposure system forms a latent image on the photosensitive drum according to the VIDEO signals sent from the Main Controller.

The main components of the laser scanner are the laser unit and the scanner motor unit, which are controlled by the signals sent from the DC controller.

Diagram of the Laser Scanner Unit is shown below.

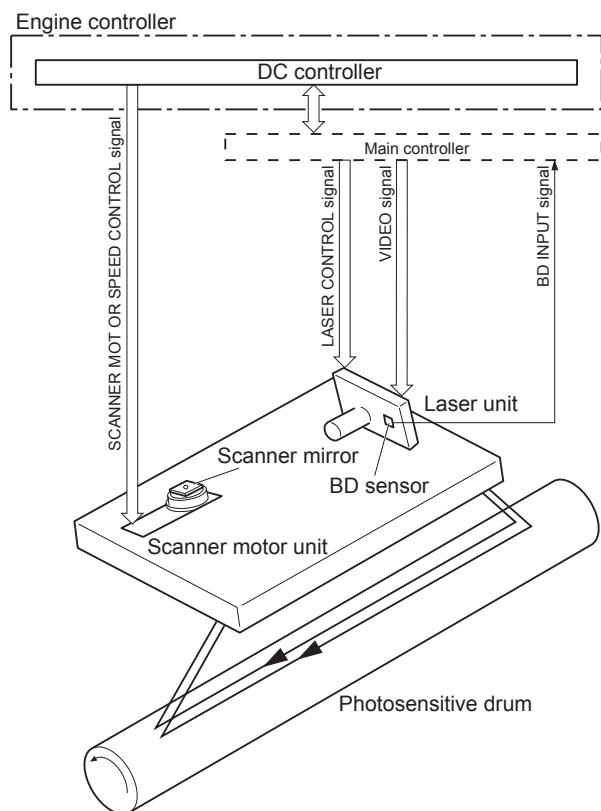

F-2-2

### Optical Unit Failure Detection

The optical unit failure detection manages the laser scanner failure detection functions.

The DC controller determines an optical unit failure and notifies E100 to the Main controller if the laser scanner encounters the following conditions:

- If the scanner motor does not reach a specified rotation within a specified period of start-up.
- If the rotation of the scanner motor is out of specified range for a specified period during drive.
- If an out of specified BD interval is detected during a print operation.

## Image Formation System

### Outline

The image formation system forms a toner image on print media.

The following are the main components of the image formation system:

- Cartridge
- Transfer roller
- Fixing unit
- Laser scanner

The DC controller controls the laser scanner and high-voltage power supply to form the toner image on the photosensitive drum. The image is transferred to the print media and fixed.

Diagram of the image formation system is shown below.

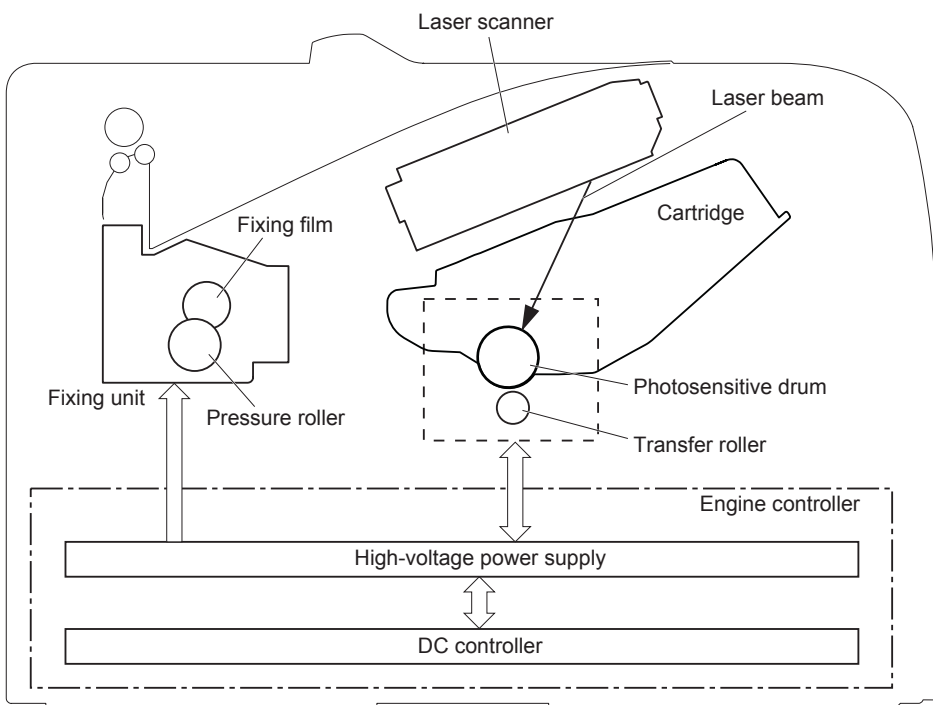

F-2-3

## Image Formation Process

### Outline

The image formation process consists of the following seven steps divided among five functional blocks:

Latent image formation block

Step 1: Primary charging

Step 2: Laser-beam exposure

Developing block

Step 3: Developing

Transfer block

Step 4: Transfer

Step 5: Separation

Fixing block

Step 6: Fixing

Drum cleaning block

Step 7: Drum cleaning

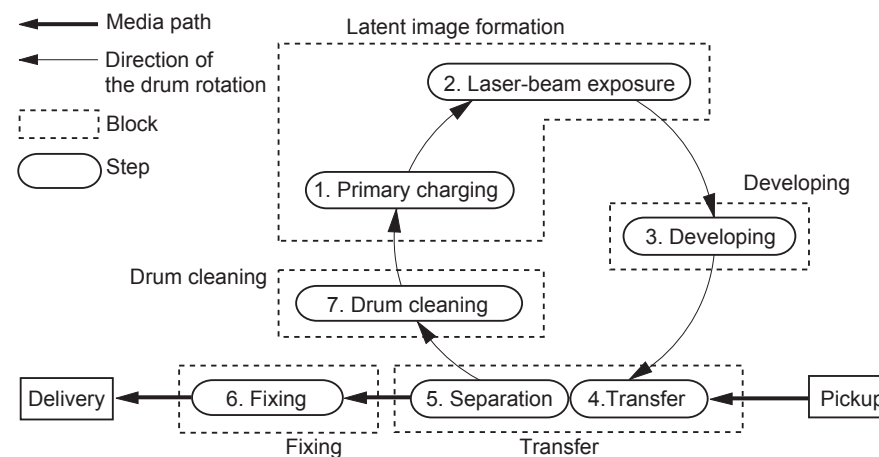

F-2-4

## Latent image formation block

During the two steps that comprise this block, an invisible latent image is formed on the photosensitized drum.

### Step 1: Primary charging

To prepare for latent image formation, the surface of the photosensitive drum is charged with a uniform negative potential. The primary charging bias is applied to the primary charging roller and the roller charges the drum directly.

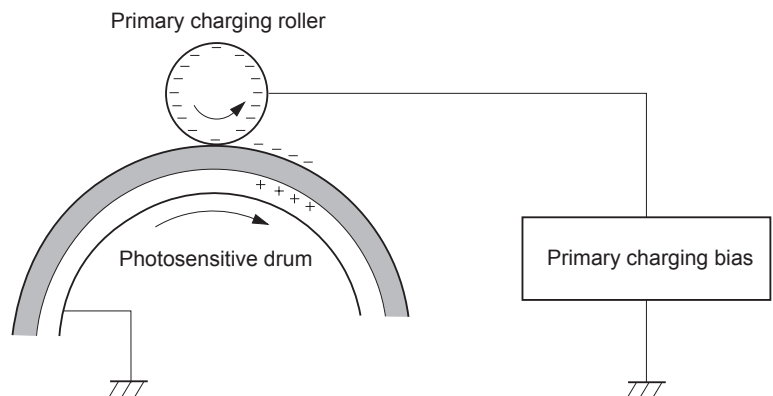

F-2-5

### Step 2: Laser-beam exposure

The laser beam scans the photosensitive drum to neutralize the negative charge on portions of the drum surface. An electrostatic latent image forms where the negative charge was neutralized.

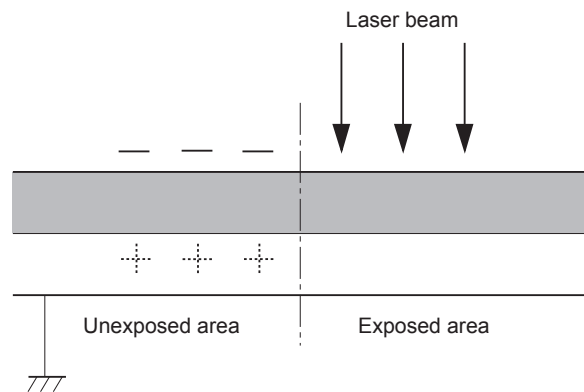

F-2-6

## Developing block

Toner adheres to the electrostatic latent image on the photosensitive drum, which becomes visible.

### Step 3: Developing

Toner acquires a negative charge from the friction that occurs when the developing roller rotates against the developing blade. The negatively charged toner is attracted to the latent image on the photosensitive drum surface because the drum surface has a higher potential. The developing bias is applied to the developing roller.

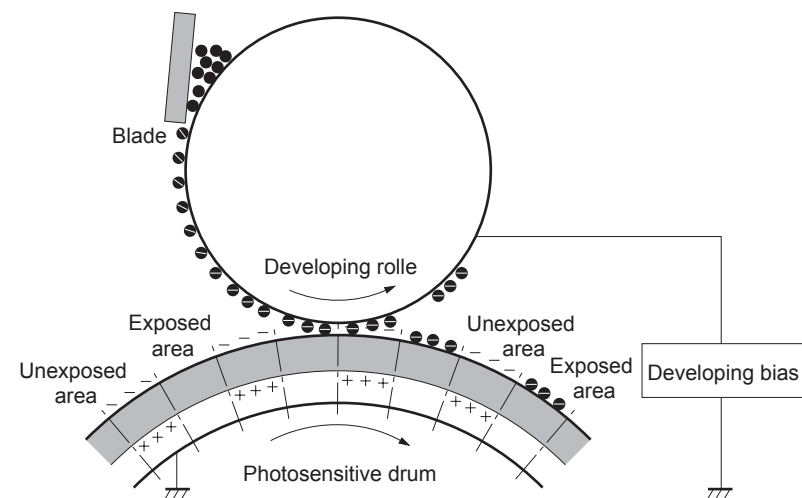

F-2-7

## Transfer block

During the two steps that comprise this block, a toner image on the photosensitive drum is transferred to the print media.

### Step 4: Transfer

The transfer bias is applied to the transfer roller to charge the print media positive. The positively charged media attracts the negatively charged toner from the photosensitive drum surface.

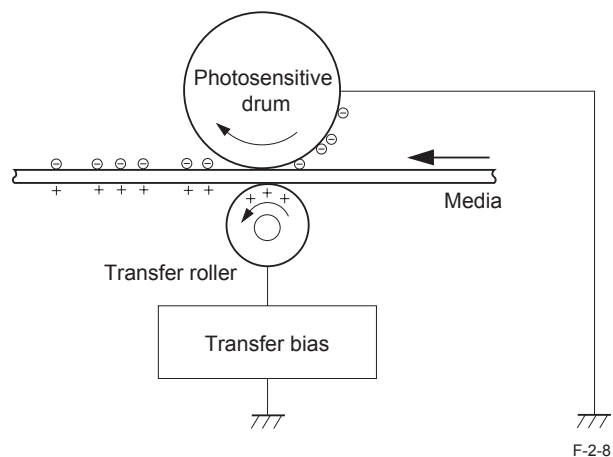

### Step 5: Separation

The elasticity of the print media and the curvature of the photosensitive drum cause the media to separate from the drum surface. The static charge eliminator reduces back side static discharge of the media for stable media feed and image quality.

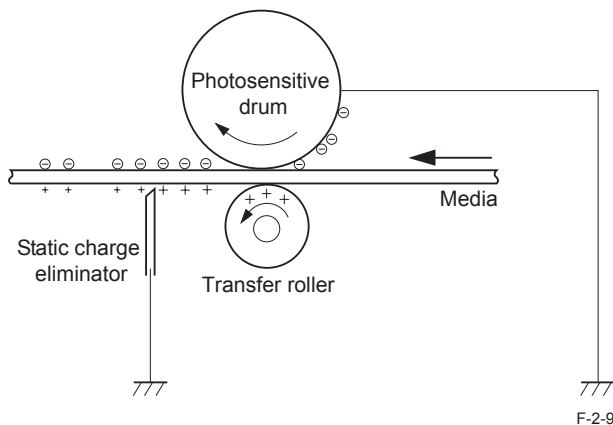

## Fixing block

The toner image is fixed onto the print media.

### Step 6: Fixing

The printer uses an on-demand fixing method. The toner image is permanently affixed to the print media by heat and pressure. The fixing bias is applied to the fixing film to improve image quality.

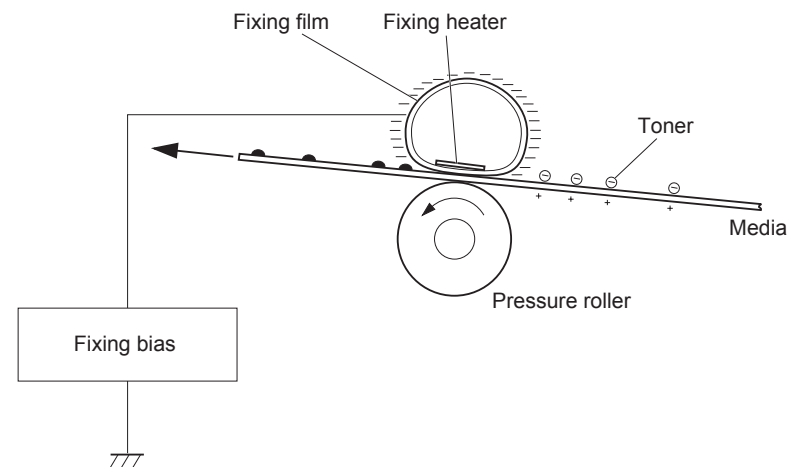

## Drum cleaning block

The residual toner is cleared from the photosensitive drum surface.

### Step 7: Drum cleaning

The cleaning blade scrapes the residual toner off the surface of the photosensitive drum. The residual toner is deposited in the toner collection box.

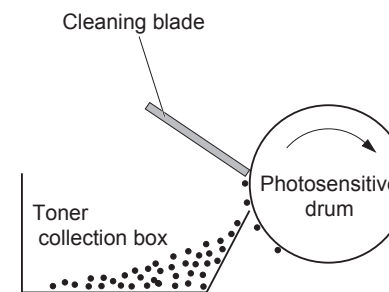

## High-voltage Power Supply

### Outline

The high-voltage power supply applies biases to the following components:

- Primary charging roller
- Developing roller
- Transfer roller
- Fixing film

The DC controller controls the high-voltage power supply to generate biases. See "IV. IMAGE-FORMATION SYSTEM"(Refer to page 2-4)for detailed information.

The Figure below shows the configuration of the High-voltage Power Supply.

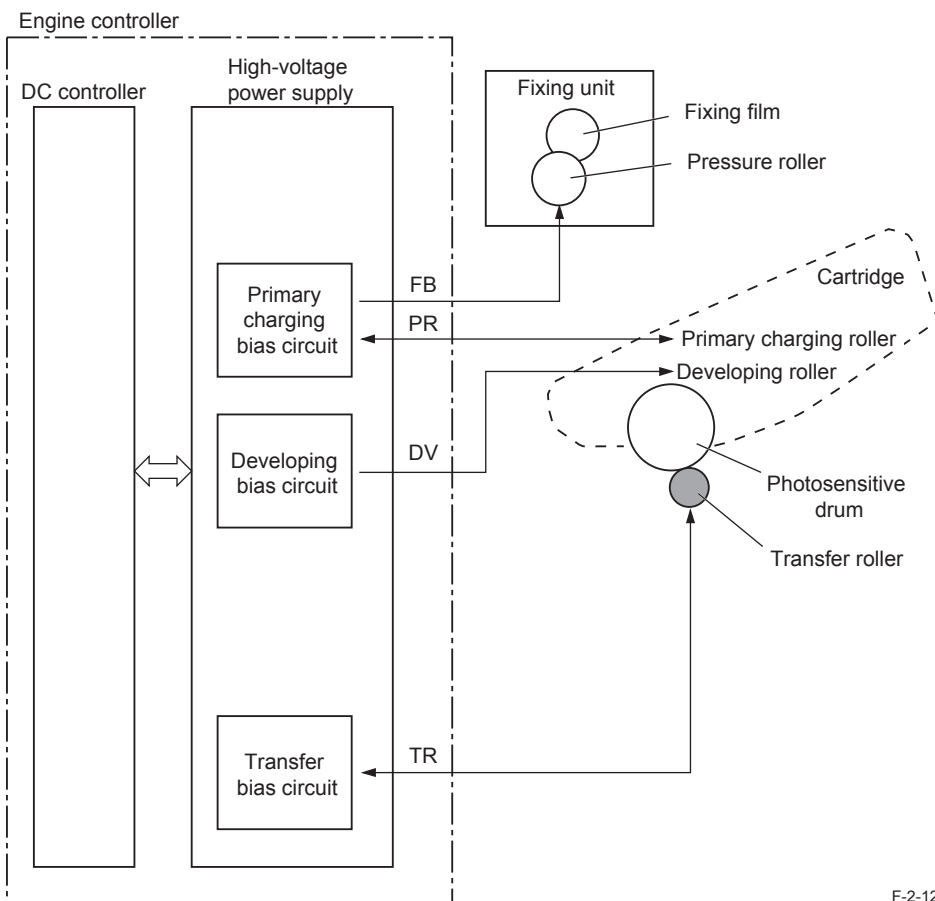

F-2-12

## Fixing System

### Outline

The fixing/delivery unit fixes the toner onto a print paper and delivers it to the delivery tray. The operation of the fixing/delivery unit is explained in the following.

- 1) The print paper fed from the pick-up/feed unit is fused the toner by the fixing film and the pressure roller.
- 2) The print paper delivered from the fixing unit is delivered to the face-down delivery tray or the face-up delivery slot. When the engine controller detects that the heater temperature reaches 50 deg C after the last rotation is completed, it drives the main motor for 50 msec. and dislocates the nip part. This prevents the toner adhering to the pressure roller.

The fixing unit of this printer utilizes the on-demand fixing method. It is structured as shown below.

- Heater:

This fixing unit incorporates one heater.

Fixing heater (H1): To heat the fixing film (ceramic heater)

- Thermistor:

This fixing unit incorporates one thermistor.

Thermistor (TH1): Sit almost at the center of the fixing film. (contact type)

To control the temperature of the fixing film

- Thermal switch:

Thermoswitch (TP1): Sit almost at the center of the fixing film (contact type)

If the temperature of the heater rises abnormally high, the contact gets broken and cuts off the AC voltage supply to the fixing heater to interrupt the power supply to the heater.

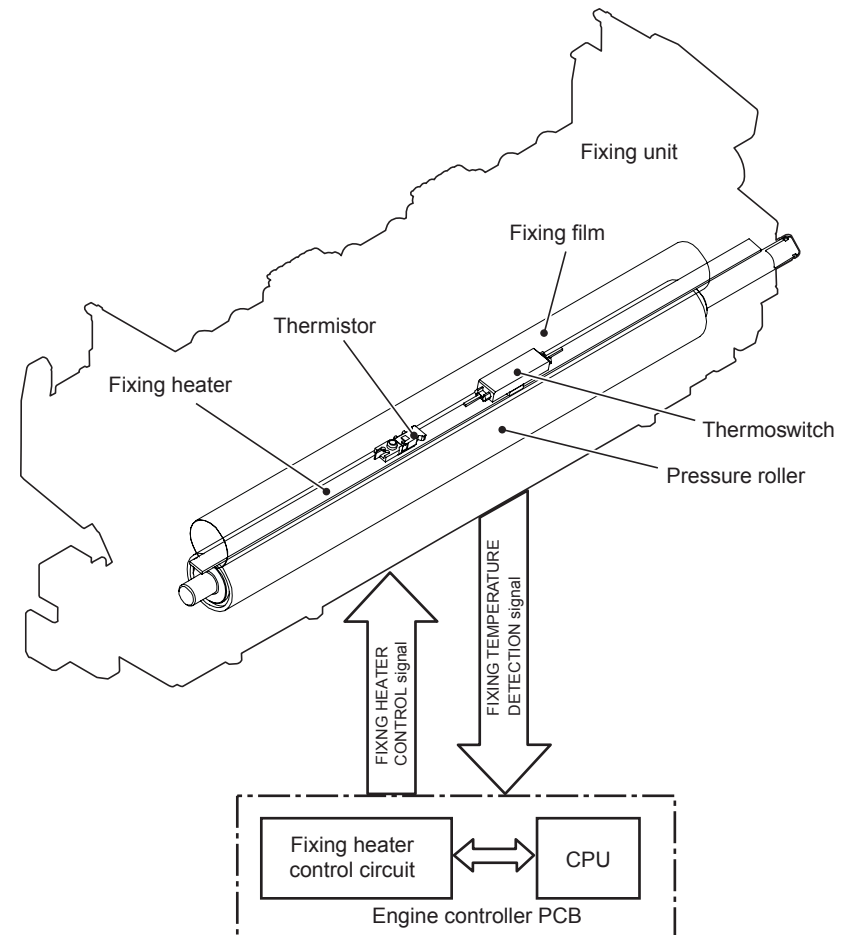

F-2-13

The temperature control of the fixing unit incorporated as above is operated by the fixing temperature control circuit according to the command from the CPU (IC201) on the DC controller.

The followings describe the each circuit and function of the temperature control of the fixing unit.



## Fixing control circuit

The fixing control circuit controls the temperature in the fixing unit. The printer uses an on-demand fixing method.

The Figure below shows the configuration of the fixing control circuit.

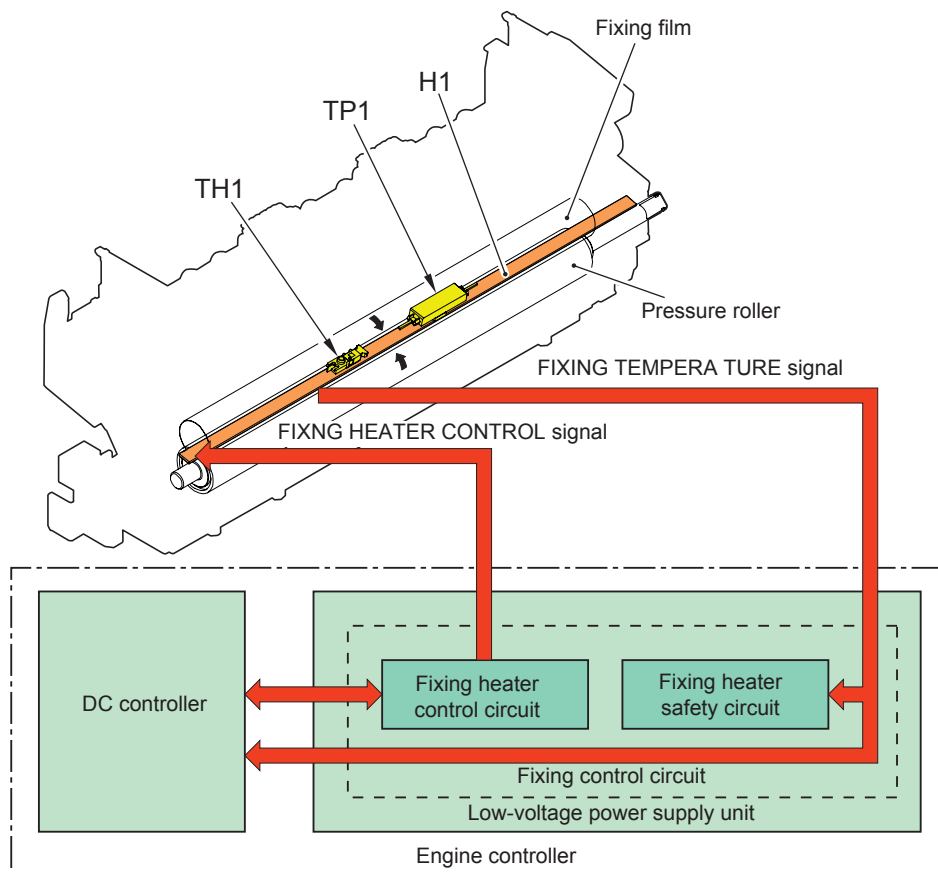

F-2-14

- Fixing heater (H1): Heats the fixing film
- Thermistor (TH1): Detects fixing temperature (Contact type)
- Thermoswitch (TP1): Prevents an abnormal temperature rise of the fixing heater (Contact type)

These temperature controls in the fixing unit are performed by the fixing heater control circuit and the fixing heater safety circuit according to the commands from the DC controller.

## Small Size Paper Printing Speed Control (Throughput Reduction Control)

During continuous printing, the throughput is changed to reduce heat buildup on parts not in contact with paper, to improve fixing characteristics and reduce curling.

The throughput reduction is implemented according to the following conditions.

Fixing Mode	Throughput			
	1 – 23 imprints	23 – 39 imprints	40 – 47 imprints	48 imprints or more
Envelope	17 ppm	12 ppm	8 ppm	6 ppm
Envelope 2	1 – 27 imprints	28 – 62 imprints	63 – 174 imprints	175 imprints or more
Envelope 3	1 – 31 imprints	32 – 47 imprints	48 – 79 imprints	80 imprints or more
Postcard	1 – 31 imprints	32 – 47 imprints	48 imprints or more	
16K	1 – 89 imprints	90 imprints or more		
16K Rough	1 – 34 imprints	35 imprints or more		
Long Narrow	1 imprint or more			
	3 ppm			

T-2-2

## Fixing temperature control

The fixing temperature control maintains the temperature of the fixing heater at its targeted temperature.

Block diagram of this control is shown below.

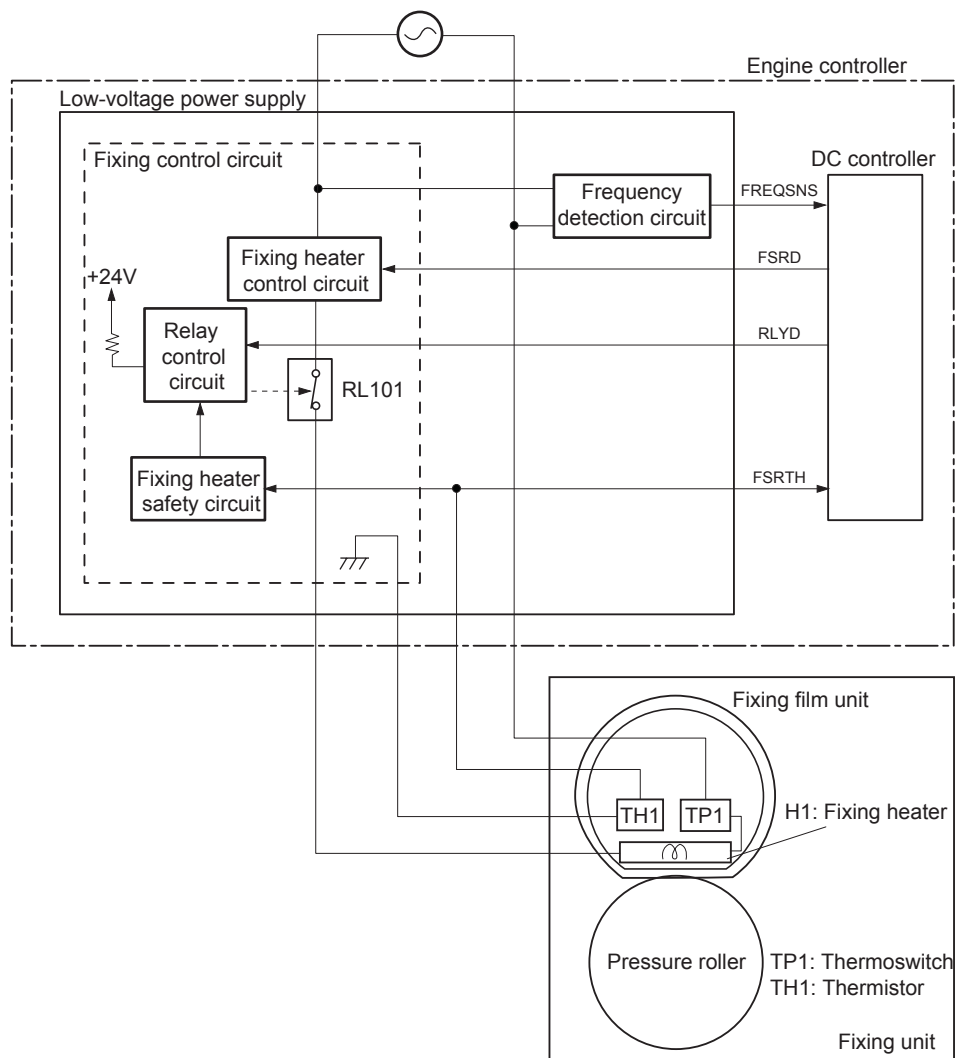

F-2-15

The DC controller monitors the FIXING TEMPERATURE (FSRTH) signal and sends the FIXING HEATER CONTROL (FSRD) signal according to the detected temperature. The fixing

heater control circuit controls the fixing heater depending on the signal so that the heater remains at the targeted temperature.

## Protective function

The protective function detects an abnormal temperature rise in the fixing unit and interrupts power supply to the fixing heater.

The following three protective components prevent an abnormal temperature rise of the fixing heater:

- DC controller
- Fixing heater safety circuit
- Thermoswitch

### 1) Thermoswitch

The contact of the thermoswitch is broken to interrupt power supply to the fixing heater under the following condition:

- Temperature fuse: 228°C (442.4°F) or higher

### 2) DC controller

The DC controller monitors the detected temperature of the thermistor. The DC controller makes the FIXING HEATER CONTROL signal inactive and releases the relay to interrupt power supply to the fixing heater under the following condition:

- Thermistor: 240°C (464°F) or higher

### 3) Fixing heater safety circuit

The fixing heater safety circuit monitors the detected temperature of the thermistor. The fixing heater safety circuit releases the relay control circuit to interrupt power supply to the fixing heater under the following condition:

- Thermistor: 270°C (518°F) or higher

## ■ Failure detection

The DC controller determines a fixing unit failure, makes the FIXING HEATER CONTROL signal inactive, releases the relay to interrupt power supply to the fixing heater and notifies the Main Controller of a failure state when it encounters the following conditions:

### 1) Start-up failure (E000)

- If the detected temperature of the thermistor is kept a specified degrees or higher for a specified period of heater start-up during the wait period.
- If the detected temperature of the thermistor is kept a specified degrees or lower for a specified period under the heater temperature control during the initial rotation period.
- If the detected temperature of the thermistor is kept a specified degrees or lower for a specified period under the heater temperature control during the print period.
- If the detected temperature of the thermistor does not reach its targeted temperature within a specified period under the heater temperature control during the initial rotation period.

### 2) Abnormal high temperature (E001)

- If the detected temperature of the main thermistor is kept a specified degrees or higher for a specified period.

### 3) Abnormal low temperature (E003)

- If the detected temperature of the thermistor is kept a specified degrees or lower for a specified period under the heater temperature control.

### 4) Drive circuit failure (E004)

- If a specified frequency of the FREQUENCY signal is not detected within a specified period after the printer is turned on.
- If an out of specified frequency of the FREQUENCY signal is detected after the printer is turned on and the signal is once detected.

## Pickup Feeding System

### Outline

The pickup feeding system picks up, feeds and delivers the print media. It consists of several types of rollers.

The duplex feed unit in the duplex model reverses and refeeds the print media to print on both sides of media.

The media path is shown below.

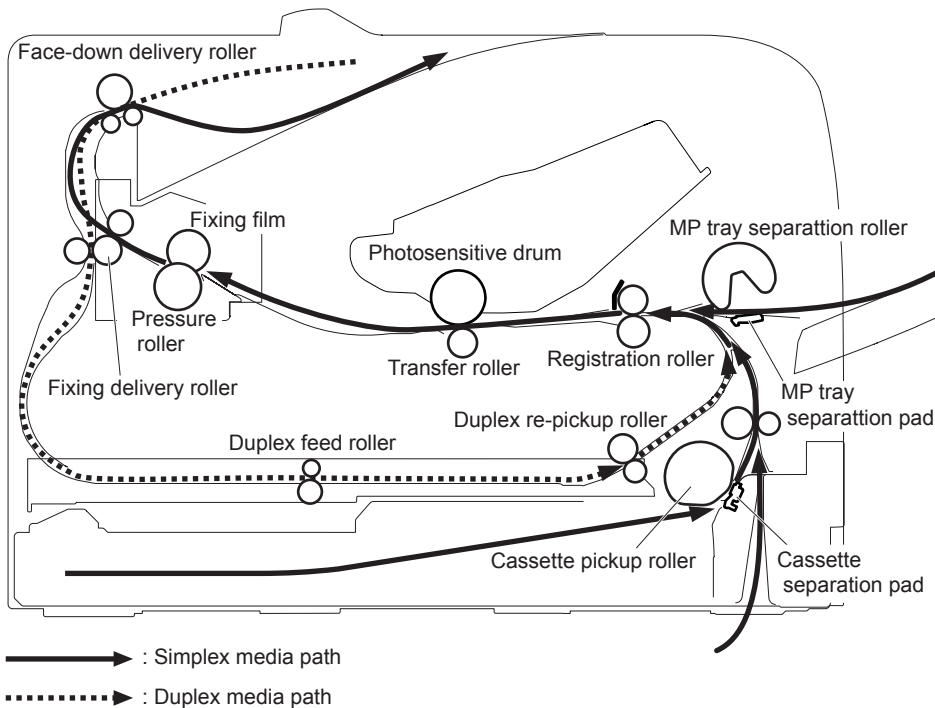

F-2-16

Diagram and table of the electrical components are shown below.

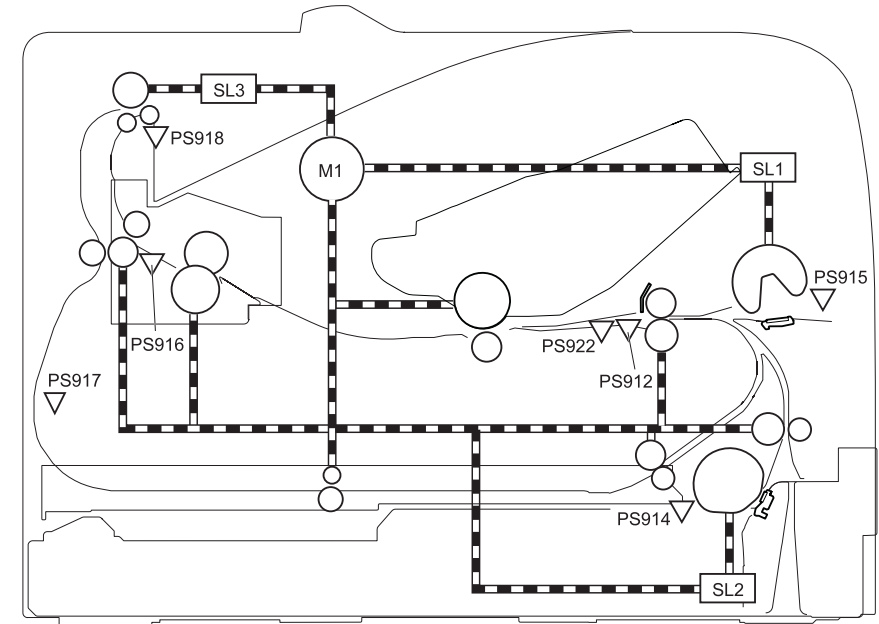

F-2-17

Electrical component		Signal
Main Motor	M1	Main Motor Control Signal
Cassette Pickup Solenoid	SL1	Cassette Pickup Solenoid Control Signal
Multi-purpose Tray Pickup Solenoid	SL2	Multi-purpose Tray Pickup Solenoid Control Signal
Duplex Reverse Solenoid	SL3	Duplex Reverse Solenoid Control Signal
TOP Sensor	PS912	TOP Signal
Cassette Media Presence Sensor	PS914	Cassette Media Presence Signal
Multi-purpose Tray Presence Sensor	PS915	Multi-purpose Tray Media Presence Signal
Fixing Delivery Sensor	PS916	Fixing Delivery Signal
Duplex Reverse Sensor	PS917	Duplex Reverse Signal
FD Tray Media Full Sensor	PS918	FD Tray Media Full Signal
Media Width Sensor	PS922	Media Width Signal

T-2-3

## Jam Detection

### Outline

The printer uses the following sensors to check whether media is being fed correctly or has jammed:

- TOP sensor (PS912)
- Fixing delivery sensor (PS916)
- Duplex reverse sensor (PS917)
- Media width sensor (PS922)

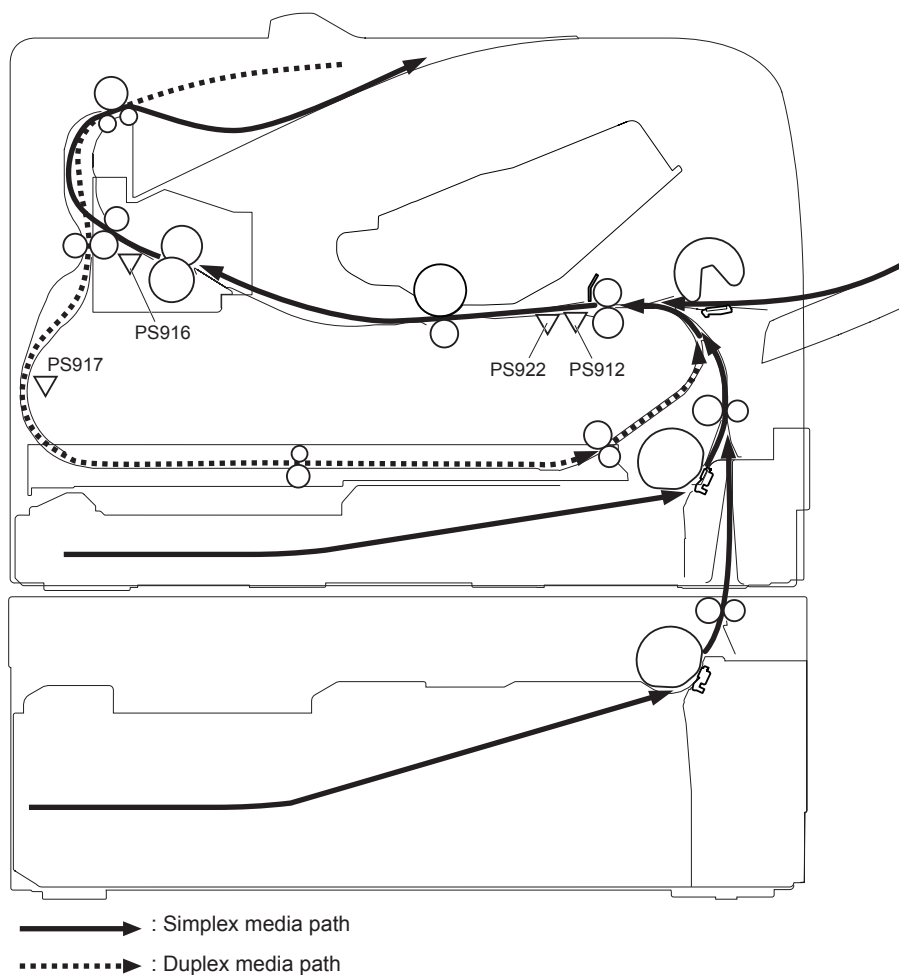

F-2-18

### Pickup Delay Jam

When the TOP Sensor (PS912) cannot detect the leading edge of paper within the specified time after starting pickup from a cassette, pickup retry is executed twice. After that, the sensor still cannot detect the leading edge of paper within the specified time, it is judged as a pickup jam.

### Pickup Stationary Jam

When the TOP Sensor (PS912) cannot detect the trailing edge of paper after the specified time has passed since it detected the leading edge of paper, it is judged as a pickup stationary jam.

### Delivery Delay Jam

When the Fixing Delivery Sensor (PS916) cannot detect the leading edge of paper after the specified time has passed since the TOP Sensor (PS912) detected the leading edge of paper, it is judged as a delivery delay jam.

### Fixing Paper Wrap Jam

After judging that it is not a delivery delay jam, execute the detection of fixing paper wrap jam. It is judged as a fixing paper wrap jam when all of the following conditions are met: after the specified time had passed since the Fixing Delivery Sensor (PS916) detected the leading edge of paper, after the specified time had passed since the TOP Sensor (PS912) detected the leading edge of paper, and the Fixing Delivery Sensor (PS916) detects no paper.

### Delivery Stationary Jam

After judging that it is not a fixing paper wrap, execute the detection of delivery stationary jam. When the Fixing Delivery Sensor (PS916) does not detect no paper within the specified time since the TOP Sensor (PS912) detected the trailing edge of paper, it is judged as a delivery stationary jam.

### Reverse Delay Jam

After judging that it is not a delivery stationary jam, execute the detection of reverse stationary jam.

When the Duplex Reverse Sensor (PS917) does not detect paper after the specified time has passed since the Fixing Delivery Sensor (PS916) detected the trailing edge of paper, it is judged as a reverse delay jam.

## ■ Reverse Stationary Jam

When the Duplex Reverse Sensor (PS917) cannot detect the trailing edge of paper after the specified time has passed since the sensor detected the leading edge of paper, it is judged as a reverse stationary jam.

## ■ Internal Residual Jam

When a paper is detected by the TOP Sensor (PS912), Fixing Delivery Sensor (PS916), Paper Width Sensor (PS922), or Duplex Reverse Sensor (PS917) at the time of starting initial rotation, it is judged as an internal residual jam.

## ■ Door Open Jam

When a door-open is detected while feeding papers, it is judged as a door open jam.

## Controller System

### Outline

The controller system controls all the other systems according to commands from the Main Controller.

The controller system contains the following components:

- DC controller
- Low-voltage power supply
- High-voltage power supply

Block diagram of the controller system is shown below.

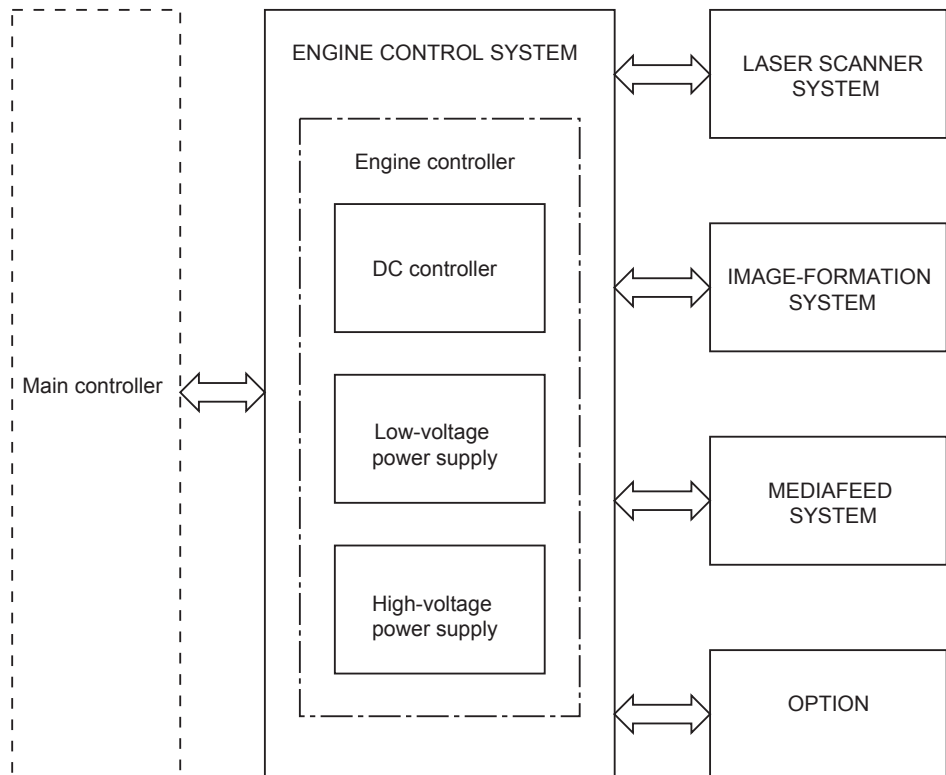

F-2-19

## DC Controller

### Outline

The DC controller controls the operational sequence of the printer.

Block diagram of the DC Controller and table of the electrical components are shown below.

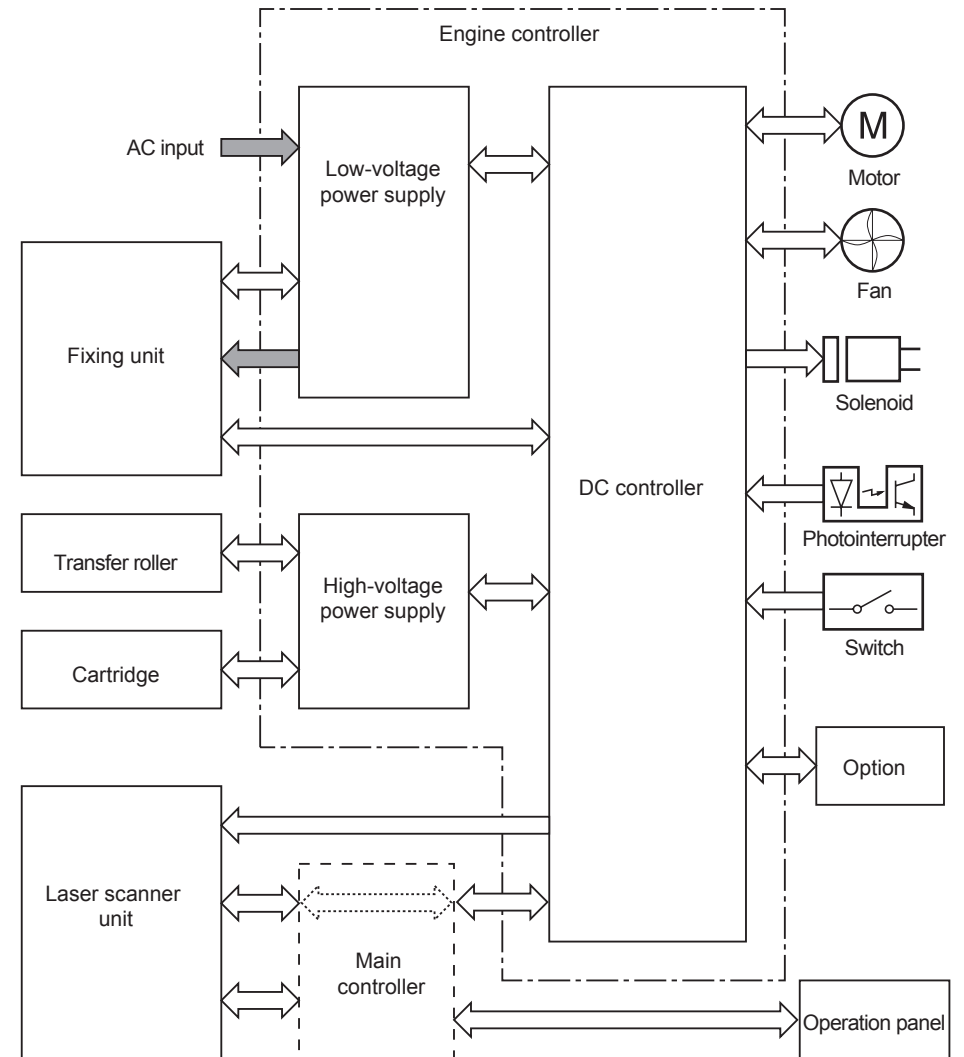

F-2-20

Symbol for component		Component
Fan	FM1	Main Fan
Motor	M1	Main Motor
Solenoid	SL1	Multi-purpose Tray Pickup Solenoid
	SL2	Cassette Pickup Solenoid
	SL3	Duplex Reverse Solenoid (NOTE)
Switch	SW1001	Power Switch
	SW301	Door Switch
Photointerrupter	PS912	TOP Sensor
	PS914	Cassette Media Presence Sensor
	PS915	Multi-purpose Tray Media Presence Sensor
	PS916	Fixing Delivery Sensor
	PS917	Duplex Reverse Sensor (NOTE)
	PS918	FD Tray Media Full Sensor (NOTE)
	PS922	Media Width Sensor

T-2-4

## Motor control

The printer has one motor for media feed and image formation.

Arrangement of motor and the specifications are shown below.

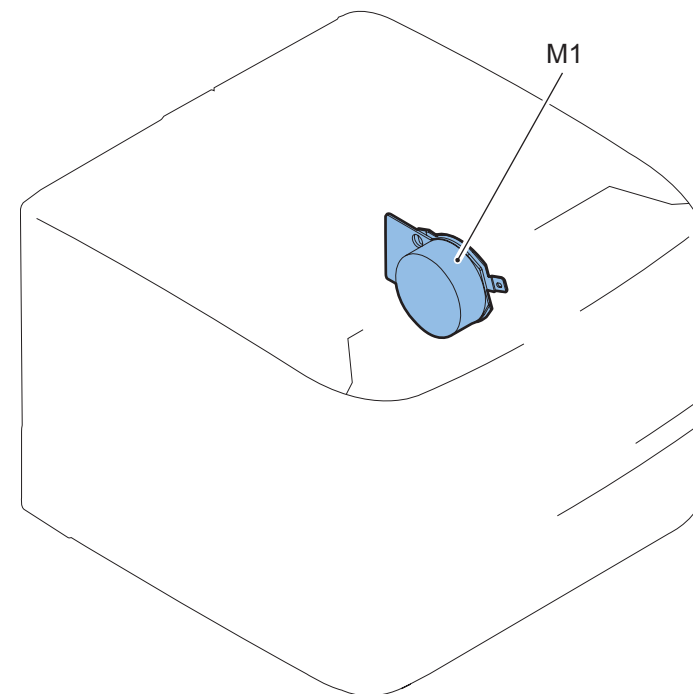

F-2-21

Description	Driving part	Failure detection
M1 Main Motor	Roller in the printer and rollers in the paper feeder	Yes

T-2-5



### Fan control

The printer has one fan for preventing a temperature rising inside the printer. Arrangement of fan motor and the specifications are shown below.

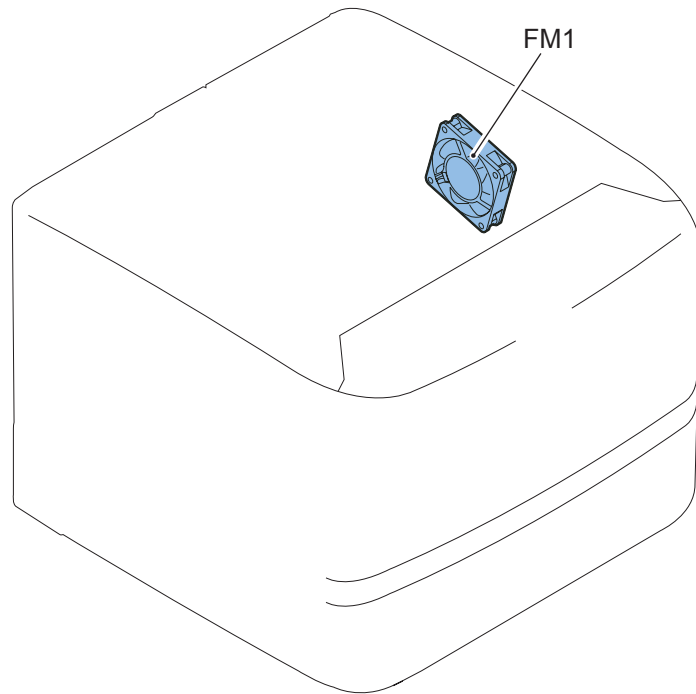

Description	Cooling area	Type	Speed
Main Fan	inside the printer	intake	Full

T-2-6

### Failure Detection

Failure Point	Error Code	Cause of Failure
Main Motor	E014	In the case that the speed of motor does not reach the specified speed after the specified time has passed since the startup of the Main Motor.
Main Fan	E805	In the case that the fan has been locked continuously for the specified period of time since the startup of the Main Fan Motor.

T-2-7

## Low-voltage Power Supply

### Outline

The low-voltage power supply converts AC power from the power receptacle into DC power to cover the DC loads.

Block diagram of the Low Voltage Power Supply is shown below.

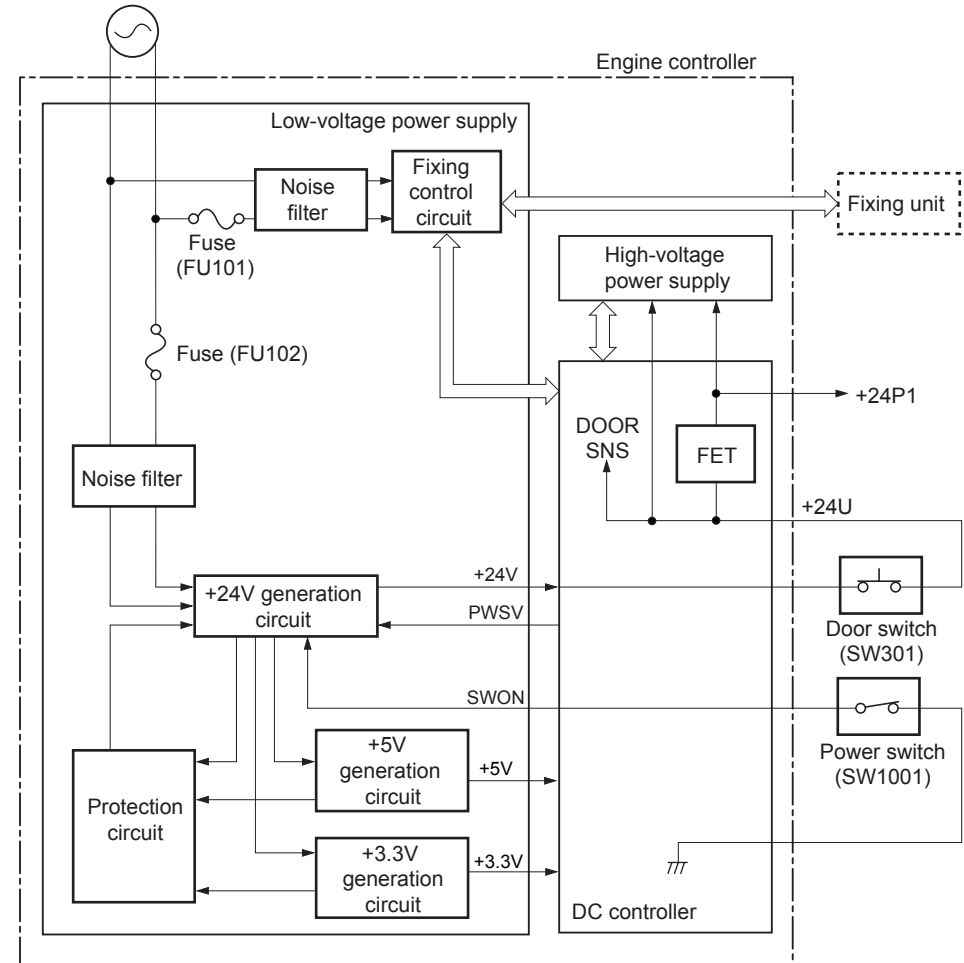

F-2-23

## Protective function

The low-voltage power supply has a protective function against overcurrent and overvoltage to prevent failures in the power supply circuit. If there flows an overcurrent or an overvoltage, the system automatically cuts off the output voltage.

If the DC power is not being supplied from the low-voltage power supply, the protective function may

be running. In such case, turn off the power switch and unplug the power cord. Do not plug in the power cord or turn the power switch on again until the root cause is found.

In addition, two fuses in the low-voltage power supply protect against overcurrent.

If overcurrent flows into the AC line, the fuse blows and cuts off the power distribution.

## Safety

For user and service technician's safety, the printer has a function to interrupt 24V power supply to the fixing unit and the high-voltage power supply unit.

The door switch is turned off and 24V stops under the following condition:

- If the cartridge door is opened (SW301 is turned off)

The printer has the power switch on the DC line so the AC power flows even the power switch is turned off. Be sure to unplug the power cord before disassembling the printer.

## Low-voltage power supply unit failure detection

The DC controller determines a low-voltage power supply unit failure, stops +24V1 output and notifies E808 to the Main controller when it encounters the following condition:

- +24V is higher than a specified voltage

## Energy Saving Function

This machine is equipped with energy saving function.

The following shows energy saving status and condition of transition.

Condition	Description	Condition of Transition
Panel off	Turn OFF the panel.	Press [Power key].
Deep sleep	Turn OFF the panel, engine and controller. (Only the power lamp lights up.)	Transition time to sleep mode has elapsed. (Default setting: 5 minutes) * When USB is connected, the machine does not enter deep sleep.

T-2-8

### Conditions for Not Entering Deep Sleep

Conditions for Not Entering Deep Sleep
<ul style="list-style-type: none"> <li>- When a job is in progress (including internal jobs in progress such as calibration and cleaning except stop state)</li> <li>- During waiting state (initialization)</li> <li>- While a door is open</li> <li>- During the occurrence of a service call (failure)</li> <li>- During a jam</li> <li>- During a firmware update</li> <li>- When connection of an option (Option Cassette) is poor</li> <li>- When the Toner Cartridge is not installed</li> <li>- When information cannot be read from the Toner Cartridge memory (including a failure of memory tag and a disconnection state of memory tag)</li> <li>- When the life warning of the Toner Cartridge is displayed</li> </ul>

T-2-9

# MEAP

## Introduction

### References by purpose

This chapter describes information for maintenance related to MEAP.

The following table lists references (item names and pages) by purpose.

Purpose	Reference
To install a MEAP application.	Installing an MEAP Application
To start or stop a MEAP application.	Procedure to start and stop a MEAP application
To uninstall a MEAP application.	Procedure to uninstall the MEAP application
To change the method to log in to SMS.	Procedure to manage System Application
To change the password for logging in to SMS.	Changing SMS Login Password
To change the method to log in to the device.	Procedure Changing Login Services
To install a login service for the device.	Procedure Installing Login Services
To check the device's resource information.	Resource Information
To check the device's platform information.	System Information
To check the device's system application information.	MEAP Application Information
To check the contents of the license file.	Check License
To delete the MEAP application's setting information.	MEAP Application Setting Information Management
To download the MEAP application's log information.	MEAP Application Log Management
To check information for using SMS	Preparation for Using SMS
To check the version of MEAP Specifications supported by the device.	MEAP Specifications

T-2-10

## About MEAP

### Overview

MEAP (Multifunctional Embedded Application Platform) is an application platform (execution platform) that allows the user to execute an application written in the Java language on a Java virtual machine installed on the device.

In this chapter, a device with MEAP is called a device supporting MEAP, and an application which runs on MEAP is called a MEAP application.

MEAP applications are installed on a MEAP device to provide various functions to the device.

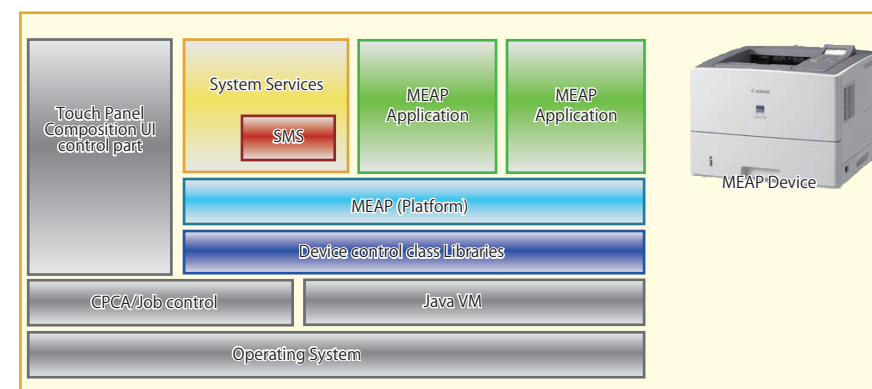

F-2-24

## About SMS

### Overview

MEAP has SMS (Service Management Service) as a service for managing login services and MEAP applications.

SMS is a servlet-type service which is used via a PC's browser.



F-2-25

Example of the SMS screen

Application Name	Installed on	Status	License
SampleApp_A	4.4.0 11/03 2011	Installed	Installed
SampleApp_B	4.4.0 11/03 2011	Installed	Installed
SampleApp_C	4.4.0 11/03 2011	Installed	Installed

Resource Name	Amount Used	Remaining	Percent Used
Storage	12505 KB	20263 KB	38%
Memory	1050 KB	19430 KB	5%
Threads	5	123	4%
Sockets	0	128	0%
File Descriptors	4	124	3%

F-2-26

## About the MEAP Application Management Screen

This screen is used to perform basic management of MEAP applications. Its main functions are listed below.

- Start and stop a MEAP application.
- Uninstall a MEAP application.
- Disable or delete a license file.
- Check the MEAP application information.
- Check the resource information.

Example of the MEAP application management screen

Application Name	Installed on	Status	License
SampleApp_A	4.4.0 11/03 2011	Installed	Installed
SampleApp_B	4.4.0 11/03 2011	Installed	Installed
SampleApp_C	4.4.0 11/03 2011	Installed	Installed

Resource Name	Amount Used	Remaining	Percent Used
Storage	12505 KB	20263 KB	38%
Memory	1050 KB	19430 KB	5%
Threads	5	123	4%
Sockets	0	128	0%
File Descriptors	4	124	3%

F-2-27

For details of this function, see "MEAP Application Management" in this chapter.

## About the MEAP Application Installation Screen

It is used to install a MEAP application and license. Its main functions are listed below.

- Install a MEAP application and license file.

Example of the MEAP application installation screen

For details of this function, see "Install MEAP Application" in this chapter.

F-2-28

## About System Management

It is used to perform MEAP management other than management of MEAP applications and installation of MEAP applications. Its main functions are listed below.

- Enhanced System Application Management
- System Application Management
- System Information
- MEAP Application Information
- Check License
- Change Password (Change SMS login password)
- MEAP Application Setting Information Management
- MEAP Application Log Management

Example of the system management screen

The screenshot displays the 'Service Management Service' interface. The left sidebar contains a tree view with 'System Management' selected, which includes options like 'Panel Display Order Settings', 'Enhanced System Application Management', 'System Application Management', 'System Information', 'MEAP Application Information', 'Check License', 'Change Password', 'MEAP Application Setting Information Management', and 'MEAP Application Log Management'. The main content area shows 'MEAP Application Management' with a table of installed applications:

Application Name	Installed on	Status	Start	Uninstall	License
SampleApp_A	4.4.0 11/03 2011	Installed	Start	Uninstall	Installed
SampleApp_B	4.4.0 11/03 2011	Installed	Start	Uninstall	Installed
SampleApp_C	4.4.0 11/03 2011	Installed	Start	Uninstall	Installed

Below the table is a 'Resource Information' section with a table showing system resource usage:

Resource Name	Amount Used	Remaining	Percent Used
Storage	12505 KB	20263 KB	38%
Memory	1050 KB	19430 KB	5%
Threads	5	123	4%
Sockets	0	128	0%
File Descriptors	4	124	3%

The interface also shows the 'meap' logo and version information: 'Version 3.1.0.16 Copyright CANON INC. 2011 All Rights Reserved'.

F-2-29

## Preparation for Using SMS

To use SMS, you need to set up network settings for the PC, browser, and devices that are used to access SMS.

### Preparation of PC for Accessing SMS

#### Checking of operation environment

The PC and browser used to access SMS require the following system environment.

Operating System	Supported browser
Windows XP Professional	Microsoft Internet Explorer 6 SP1 or later
Windows Vista SP2	Windows Internet Explorer 8
Windows 7	Windows Internet Explorer 8
Mac OS X 10.3	Safari 1.3.2
Mac OS X 10.4	Safari 2.0.4
Mac OS X 10.5	Safari 3.1.2
Mac OS X 10.6	Safari 4.0.3

T-2-11

#### PC and browser settings

The PC and browser used to access SMS must meet the following conditions.

- Session cookie is enabled.
- Java Script is enabled.

## Device Settings

### Network configuration ( Activate Network Settings )

To support a MEAP-enabled iR device via network (SMS, etc.), set up the network setting on the touch panel of the iR device (this setting is [ ON ] by default).

1) Press [ Setup ] button, select [ Network ] > [ Control Menu ] > [ HTTP ] and select [ On ].

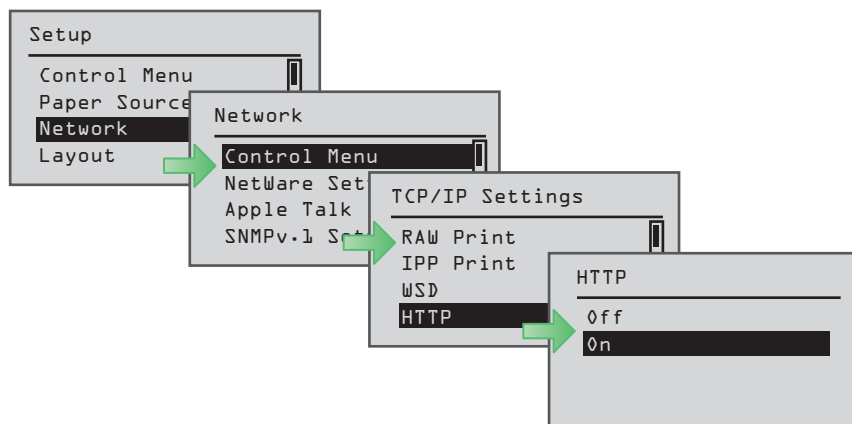

F-2-30

2) Select [ On ], and then press [ OK ] on the Control Panel.

3) Restart the machine.

#### CAUTION:

- The setting [ Use HTTP ] is not actually enabled/disabled until you have restarted the device.
- You cannot make a connection through a proxy server. If a proxy server is in use, enter the IP address of the MEAP device in the Exceptions field for the browser. Open Internet Options dialog of Internet Explorer and select Connections tab, LAN Settings button, Use a proxy server option, and Advanced button of Proxy server group. Proxy Settings dialog will open. The Exceptions field is in the dialog. As network settings vary among environments, consult the network administrator.
- If Cookie and JavaScript are not enabled in the Web browser, you will not be able to use SMS.

### Key Pair and Server Certificate when Using Encrypted SSL Communication

To use SMS via SSL connection, it is required to specify a key pair and server certificate as the key to be used.

Since a key (default key) that can be used for encrypted SSL communication is installed as standard on the device, advance setting of the key pair and server certificate is not required. In order to use an encryption key other than the default key, follow the procedure "Generating a key pair" shown below to make settings for the key pair and server certificate necessary for encrypted SSL communication.

#### Note:

- The states of the SSL encryption key and the server certificate can be changed back to the states at the time of shipment by executing CA-KEY clear in service mode level 2 ([COPIER] > [Function] > [CLEAR] > [CA-KEY]). Please note that the encryption keys created by the user and the server certificates added by the user are deleted when CA-KEY clear is executed.
- For detailed procedures of the Default Key setting, refer to [e-Manual > Security].
- As for SMS, by setting a Default Key, encrypted SSL communication is always executed regardless of the following setting: [Settings/Registration] > [Management Settings] (Settings/Registration) > [MEAP Settings] > [SSL Settings]: ON/OFF.

#### Generating a key pair

1) From a PC on the same network as the device, use a web browser to access the remote UI's portal page. Then, select [ Settings/Registration ] from the menu on the right side of the screen.

URL to access: <http://<device's IP address>:8000/>

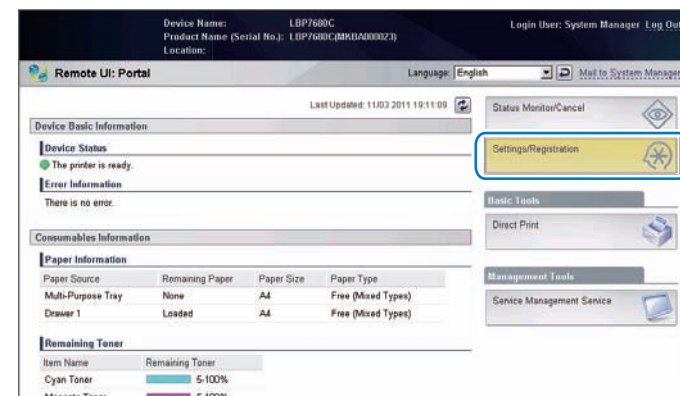

F-2-31

2) Click [ Management Settings ] > [ Security ] > [ Key and Certificate Settings ].

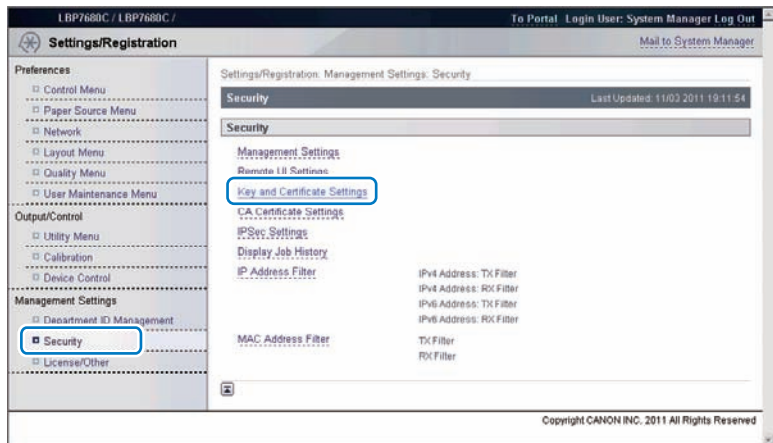

F-2-32

3) Click [ Generate Key... ] button.

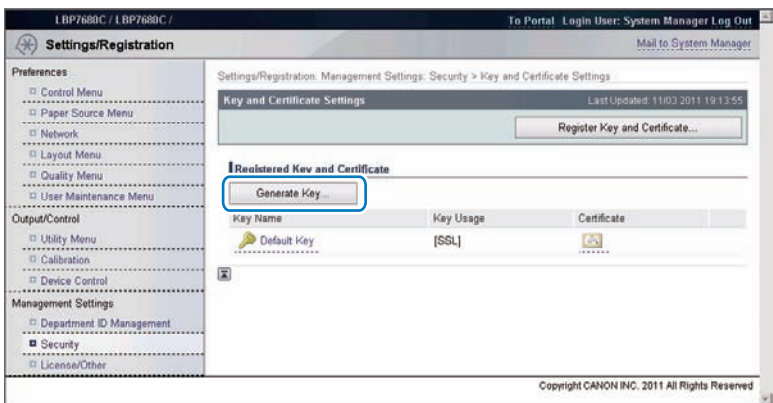

F-2-33

4) Enter the necessary information, and then click the [ OK ] button.

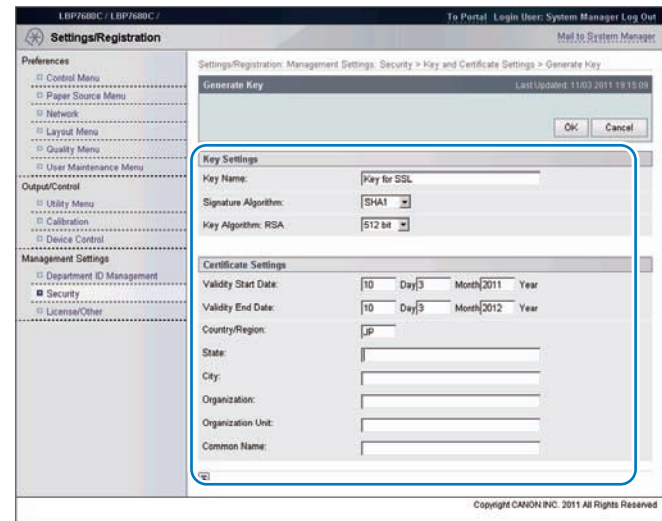

F-2-34

Input example

Item name	Type	Content	Entry
<b>Key Settings</b>			
Key Name	Compulsory	An arbitrary character string	Default Key
Signature Algorithm	Compulsory	Selected from:SHA1/SHA256/SHA384/SHA512	RSA
Key Algorithm	Compulsory	Selected from:512/1024/2048/4096	512
<b>Certificate Settings</b>			
Validity Start Date	Compulsory	Date	15/5/2011
Validity End Date	Compulsory	Date	15/5/2036
Country/Region	Compulsory	Country or region name	US
State	Arbitrary	State name	-
City	Arbitrary	City name	-
Organization	Arbitrary	Organization name	-
Organization Unit	Arbitrary	Organization unit	-
Common Name	Arbitrary	Common Name*	-

T-2-12

**Note:**

When the IP address of the device has been entered in the [Common Name] entry field, if you install a server certificate to the browser ( see "Installing a server certificate (reference information)" ), the message "Certificate Error" that usually appears when access is made from Internet Explorer 7 or later will not be displayed.

5) Check to see that the generated key appears in [ Registered Key and Certificate ].

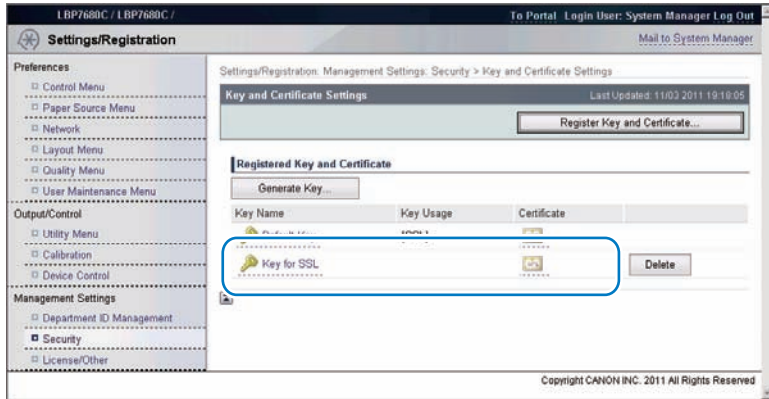

F-2-35

3) Select the generated key, and then click the [ Default Key Settings ] button.

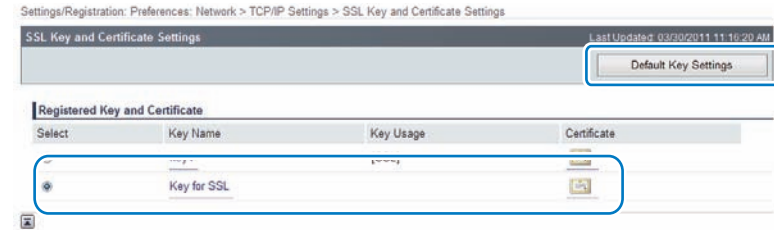

F-2-38

4) Check that [ SSL ] is displayed in the [ Key Usage ] entry field.

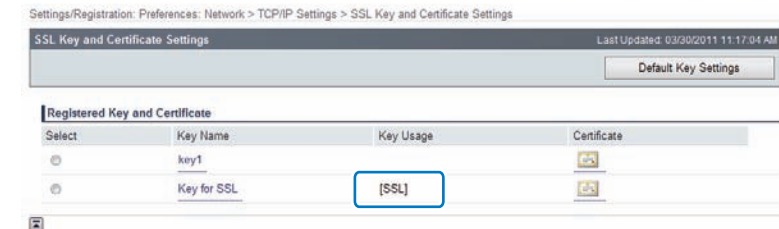

F-2-39

5) Log out from the remote UI, and then restart the device.

### Installing a server certificate (reference information)

On Internet Explorer 7 (IE) or later, if [ Default Key ] installed as standard on the device is used, "Certificate Error" appears during access due to "Internet Explorer Enhanced Security Configuration".

### Error display example



F-2-40

To disable display of "Certificate Error", use the following procedure (for IE8) to set the key generated in "Key Pair and Server Certificate when Using Encrypted SSL Communication" (i.e. the key with the IP address of the device specified as the shared name) as an SSL key.

1) Access SMS from the browser, and then click "Certificate Error" in the URL entry field.

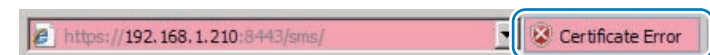

F-2-41

### Default Key Settings

1) Click [ Preferences ] > [ Network ] > [ TCP/IP Settings ].

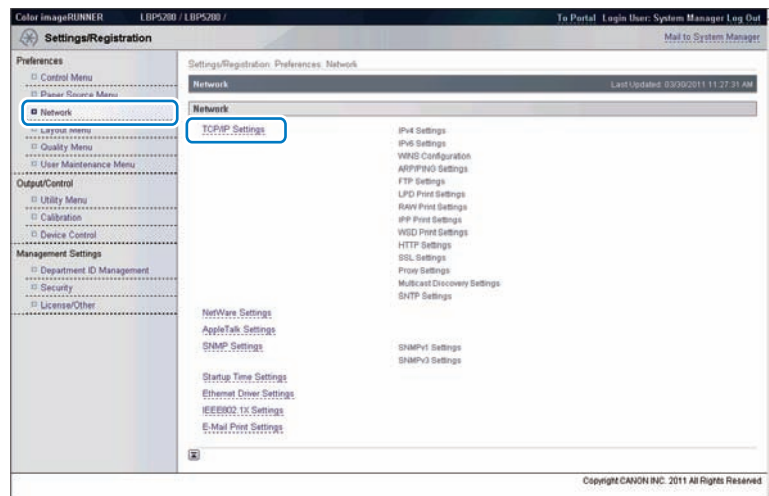

F-2-36

2) Click [ Key and Certificate... ] button.

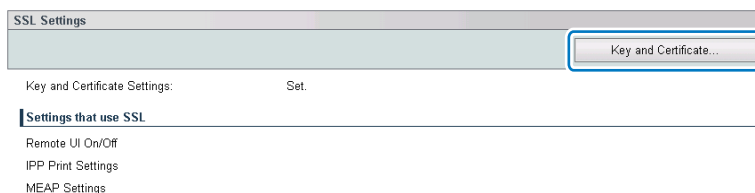

F-2-37



2) Click [ View certificates ].

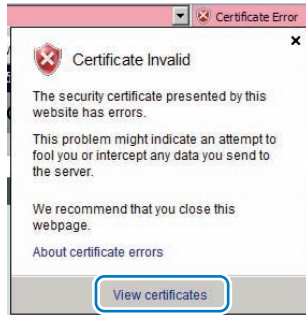

F-2-42

3) Click the [ Install Certificate... ] button on the [ General ] tab.



F-2-43

4) [ Certificate Import Wizard ] will appear. Click the [ Next ] button.



F-2-44

5) In [ Certificate Store ], select the [ Place all certificates in the following store ] option, and then click the [ Browse ] button.

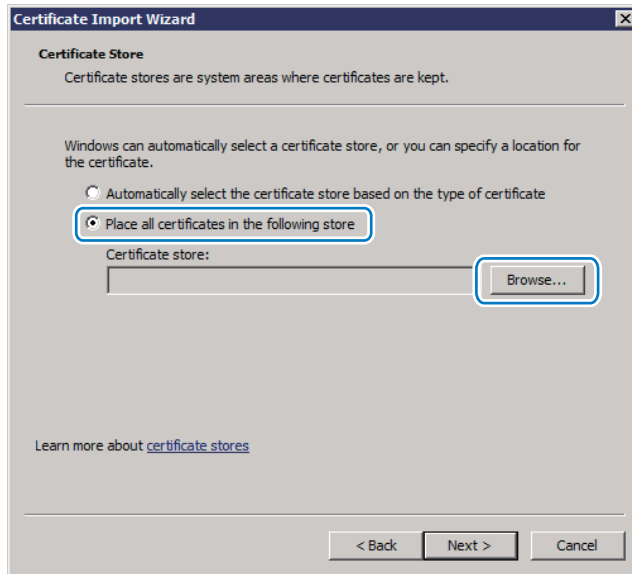

F-2-45

6) In [ Select Certificate Store ], select [ Trusted Root Certification Authorities ], and then click the [ OK ] button.

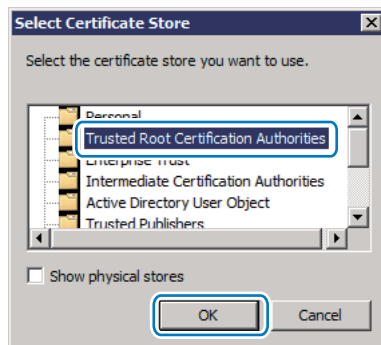

F-2-46

7) You will return to the [ Certificate Store ] dialog. Check that "Trusted Root Certification Authorities" appears in [ Certificate ], and then click the [ Next ] button.

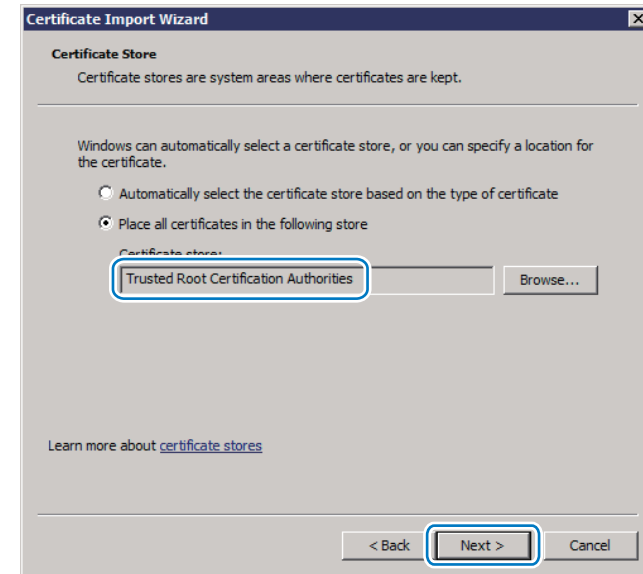

F-2-47

8) [ Completing the Certificate Import Wizard ] will appear. Click the [ Finish ] button.

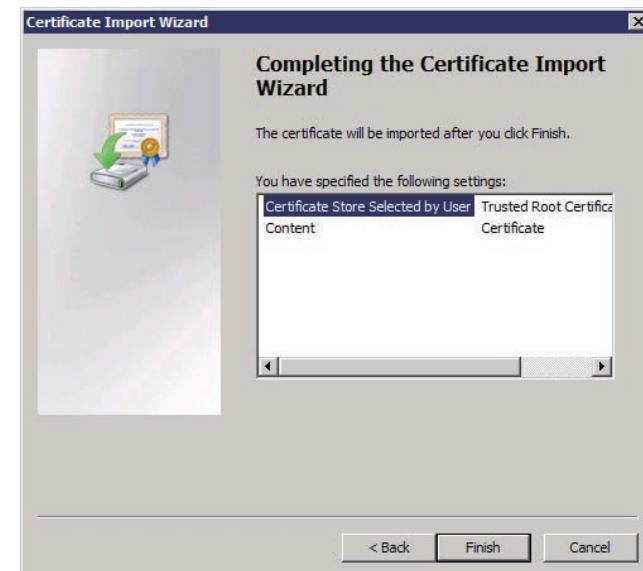

F-2-48

9) A message will appear to indicate that import has been completed successfully. Click the [ OK ] button.



F-2-49

## ● Network Port Settings

The default port of the HTTP server used for MEAP and MEAP applications to provide the servlet function is 8000, and the HTTPS server's default port is 8443. In the case that these ports have already been used by the customer who is to introduce this application, the MEAP application cannot use the HTTP (or HTTPS) server(s).

By changing the following ports to use, however, the MEAP application can be used as well as the existing system.

The procedure for setting the HTTP/HTTPS server port is shown below.

1) Start service mode. From the [ Setup ] menu, select [ SERVICE MODE ] > [ FUNCTION GR. ] > [ MEAP ].

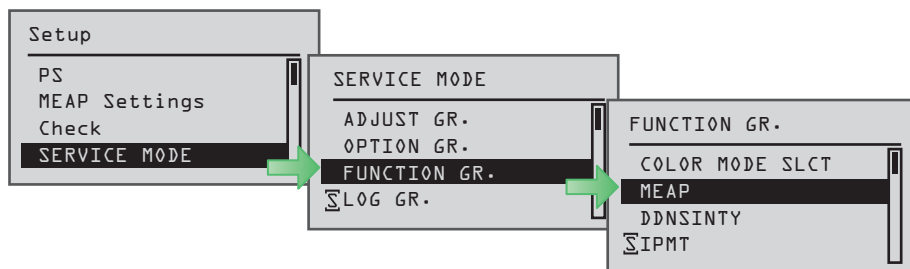

F-2-50

2) To set up the HTTP server port, select [ MEAP-PN ]. To set up the HTTPS server port, select [ MEAP-SSL ]. When the port number setting screen appears, specify a port number. Use the Up and Down keys to specify the setting.

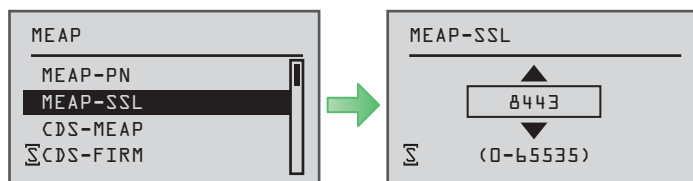

F-2-51

Note:

A port number can be any integer from 0 to 65535. To avoid port numbers that are frequently used, do not use any integer from 0 to 1023.

Server	Setting value	Default value / Value after RAM clear
HTTP Server	1024 to 65535	8000
HTTPS Server	1024 to 65535	8443

T-2-13

Note:

If PS Print Server Unit is connected, do not specify port 8080.

If port 8080 is specified, the RUI of the device where the MEAP authentication application is running cannot be displayed. (Port 8080 is reserved to allow the PS Print Server Unit to redirect to the iR device.)

3) Restart the device if the port number is set.

## ■ How to Check the Serial Number

When performing MEAP device support, the serial number of the device is necessary in some cases.

Examples of where the serial number is necessary

- When initializing SMS login password (obtaining a switch license)
- When obtaining a MEAP application license from LMS
- When obtaining a transfer license of MEAP application
- When obtaining a special license for reinstalling MEAP application

If a problem occurs in the MEAP device and you want to contact the support department of the sales company, you need to provide the serial number. Perform the following procedure to get the serial number.

### ● Checking from the PC browser

The serial number of the device is displayed on the SMS login screen, SMS screen, and remote UI portal screen.

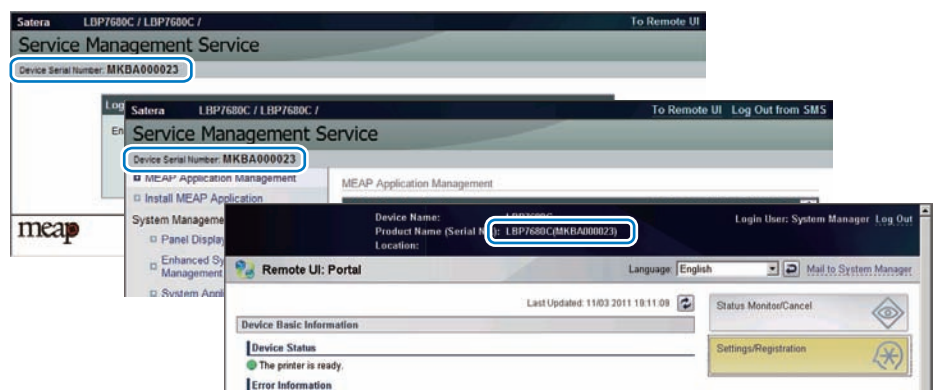

F-2-52

### ● Checking from the device's Control Panel

From [ Utility Menu ], select [ Serial Number ].

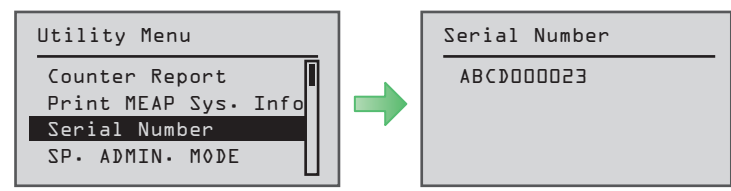

F-2-53

**Note:**  
While MFPs of iR and iR-ADV series have 8-digit serial numbers, this machine (SFP) has a 10-digit serial number.

## ● Login to SMS

### ■ Procedure to Log in

Use the following procedure to log in to SMS.

1) From a browser of a PC on the same network as the device, enter the following URL to access SMS.

URL: `https://<MEAP Device IP address>:8443/sms/`  
 Ex.) `https://172.16.188.240:8443/sms/`

**Note:**  
To encrypt the password information input when logging in, SSL of the login screen was made effective. However, even if you access SMS using a URL that has not been encrypted with SSL (non-SSL), you will be redirected to a SSL encrypted URL (SSL enabled).

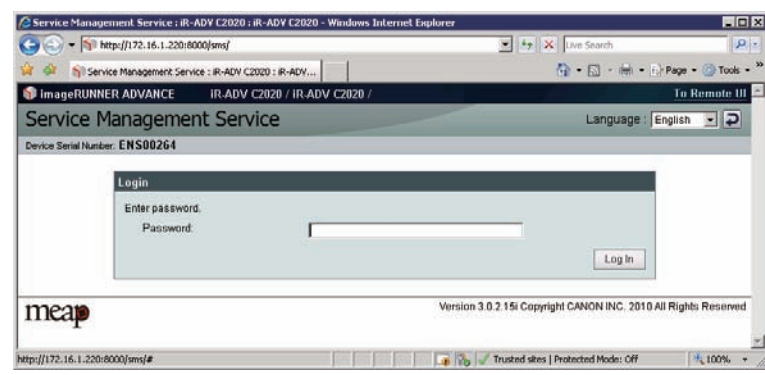

F-2-54

2) Enter the SMS login password in the password entry field, and then click the [ Log In ] button.

**Note:**

- The default password is "MeapSmsLogin." (The password is case-sensitive.)
- When you want to change the display original language, change in the box in the right of the screen. This setting is not affect by the setting of the language of the device.

**Note:**

SMS Access can be gained also from Remote UI.

Access Remote UI and click on SMS shortcut shown on the lower right of the screen to gain access to SMS.

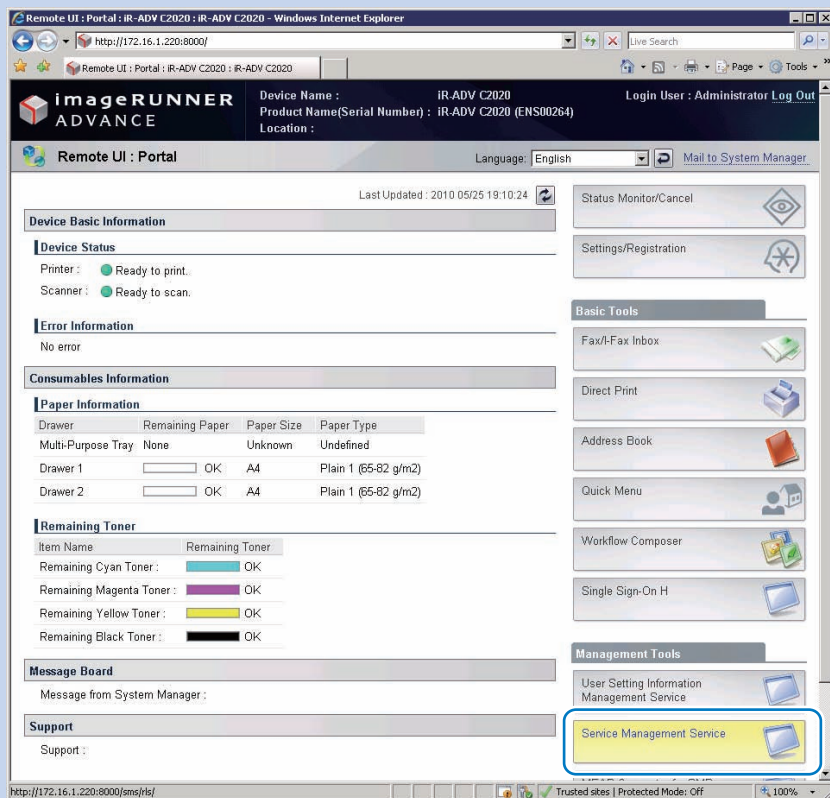

F-2-55

### ● When SMS Cannot Be Accessed

If you forgot the password (SMS login password initialization)

After changing the default SMS login password, if you forgot the new password and cannot log in to SMS, you can use a switch license for password initialization to change the password back to the default value "MeapSmsLogin".

Note that there is no special password for service.

1) Obtain a switch license file for password initialization.

Contact the person in charge of support at the sales company, give the device's serial number, and have a switch license file for password initialization issued.

2) Load the switch license file.

With nothing entered, click the [ Log in ] button to display the area for specifying a switch license file for password initialization.

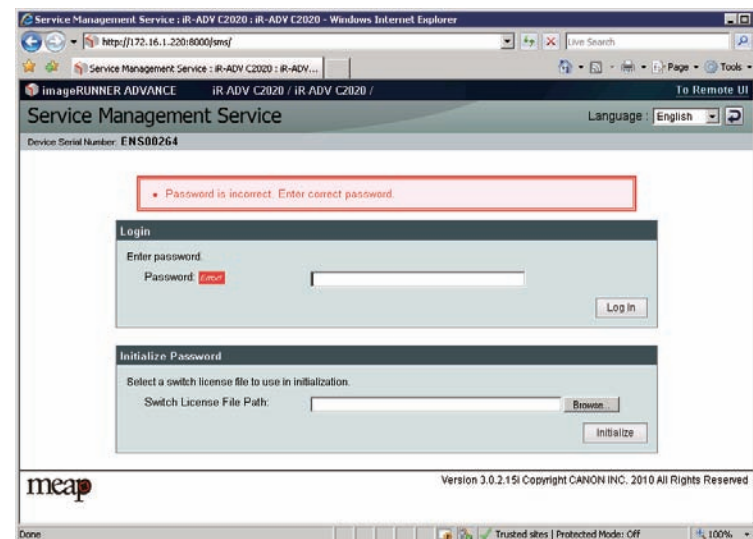

F-2-56

3) Specify the switch license file.

Click the [ Browse ] button and specify the switch license file.

4) Initialize the login password.

Click the [ Initialize ] button to display an initialization confirmation page, and click the [ OK ] button.

**Note:**

- The default password is "MeapSmsLogin." (The password is case-sensitive.)
- If you click the [Cancel] button on the initialization confirmation page, password initialization is not performed and the login page appears.

### ● If login is not possible due to exclusive control

Because SMS uses exclusive control, if there is another user already logged in to the SMS of the same device, then you cannot log in.

Exclusive control message example

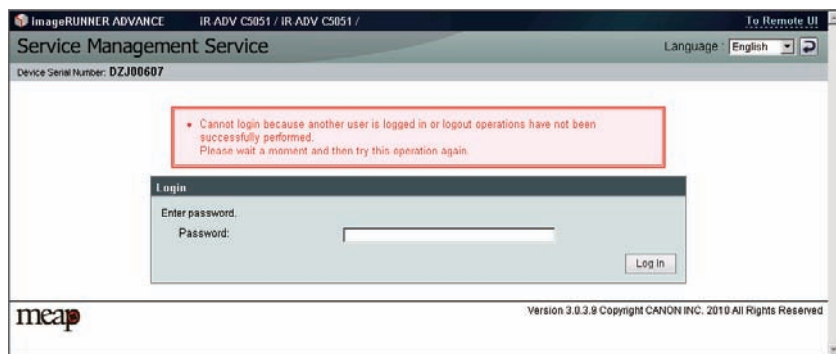

F-2-57

If you cannot log in due to exclusive control, you need to ask the other user to log out before you can try again.

**Note:**

If you close the browser without logging out, the session remains active. In this case, you cannot log in again.  
If this problem occurs, you can wait for 5 minutes so that the session is disconnected.  
Or, you can restart the device to force the session to disconnect.

### ● If [ Key and Certificate Settings ] is not set

If [ Key and Certificate Settings ] is not set correctly, you cannot access the URL for SMS (<https://<device's IP address>:8443/sms/>). In this case, you can use the following procedure to solve the problem.

1. Go to <http://<device's IP address>:8000/sms/>, and check to see that "HTTP 500 Internal Server Error" appears.
2. If the message is displayed, see the procedure described in "Key Pair and Server Certificate when Using Encrypted SSL Communication" in this manual to deal with the problem.

**Note:**

As for SMS, by setting the key to be used, encrypted SSL communication is always executed regardless of the following setting: (Settings/Registration) > [Management Settings] > [License/Other] > [MEAP Settings] > [Use SSL] > ON/OFF.

### ● How to deal with a message "Certificate Error" appearing during access

If "Certificate Error" appears when you access SMS from a browser, refer to the procedure described in "Installing a server certificate (reference information)" in this manual to deal with the problem.

## Installing an MEAP Application

### Outline

From the MEAP application installation screen, you can install the MEAP application as well as the license file.

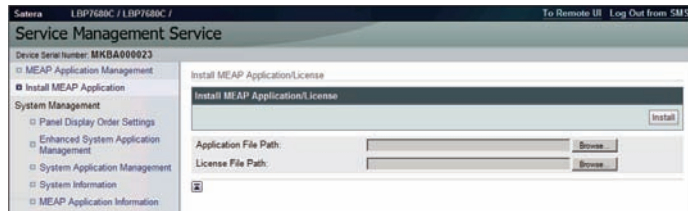

F-2-58

Before installing the MEAP application, be sure to check the following items.

### Device compatibility with the MEAP application

To find out whether the device is compatible with the MEAP application, check the devices supported by the MEAP application. Depending on the application, the device's firmware may require version upgrade.

### Resources availability (remaining amount)

The necessary resources (free storage space and free memory available) must be secured for an MEAP application to run; otherwise, you cannot install the MEAP application.

To check the resource information, see "Device's resources," on p. 2-34. in this manual.

## Procedure to install applications

- 1) Long on to SMS.
- 2) Click [ Install MEAP Application ] on the menu.

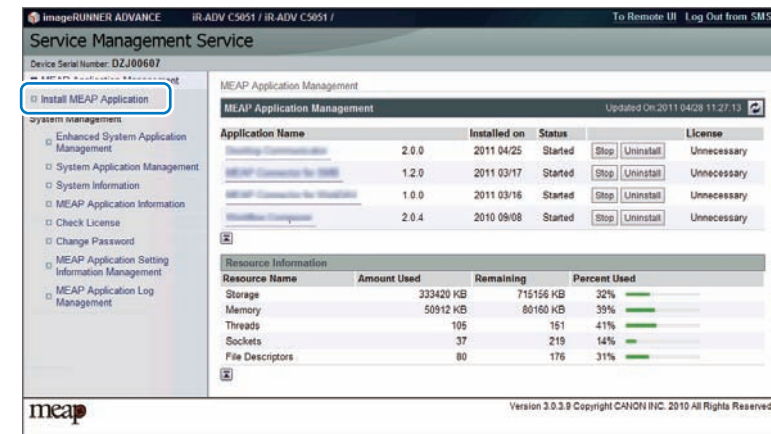

F-2-59

- 3) Check [ Install MEAP Application/License ] page appears.
- 4) Click [ Browse.. ] button, and select the application file and the license file of the application; then, click [ Install ] button.

Note:  
 Application File: identified by the extension "jar".  
 License File: identified by the extension "lic".

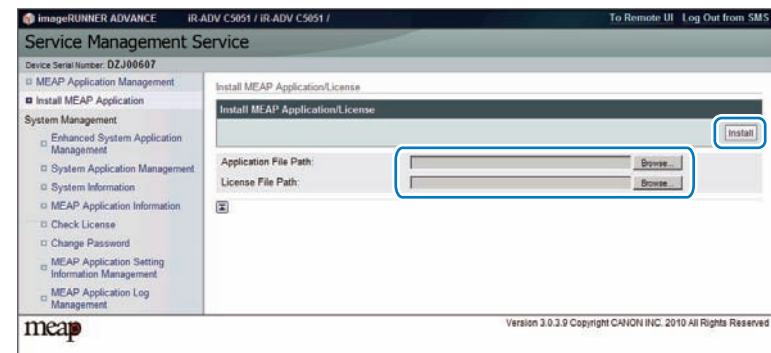

F-2-60

CAUTION:

- You cannot install only the license.
- You will not be able to install the application without using the appropriate license. Be sure to select its license file.
- If you are adding a license to an existing application, see "Procedure adding a license file".
- If you are updating an existing application, stop the application; then, install the new application or its license file. You will not be able to update an application while it is running.

5) Check the contents of the Confirm page; then, click [ Yes ] button.

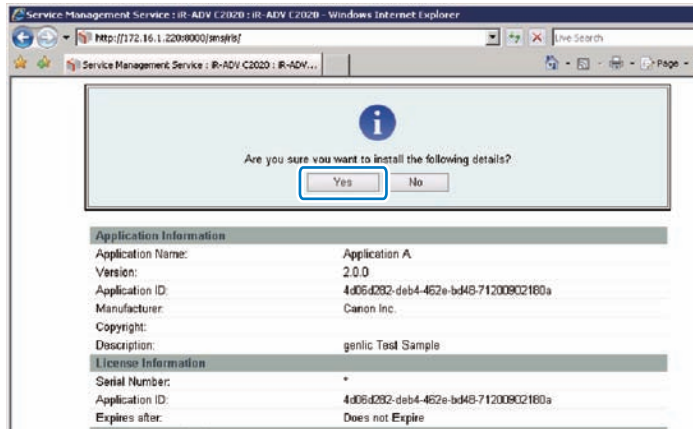

F-2-61

6) Some applications show a screen to indicate the terms of agreement. Read the terms, and click [ OK ].

7) Check the message "Installing...Please wait." appears, beginning the installation.

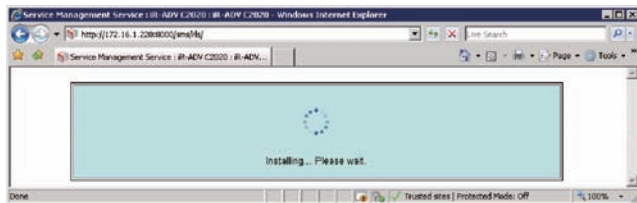

F-2-62

8) Upon installation completed, click [ To MEAP Application Management ] button shown on the screen to view MEAP Application Management page.

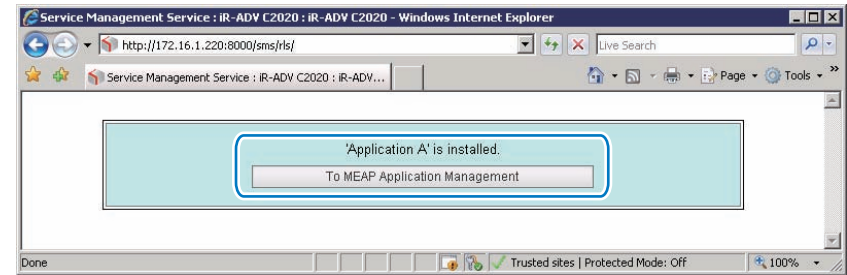

F-2-63

Note:

To use the application that you have just installed, you must make sure that the application status is Started.

Note:

The license file is provided in text file format, enabling to view in a text editor. The application ID and device serial number shown in the file allow users to confirm which device to install with the license file.

Note that any changes added to the license file may disable installation. Cares should be taken when confirming the contents of the license file.

Sample file

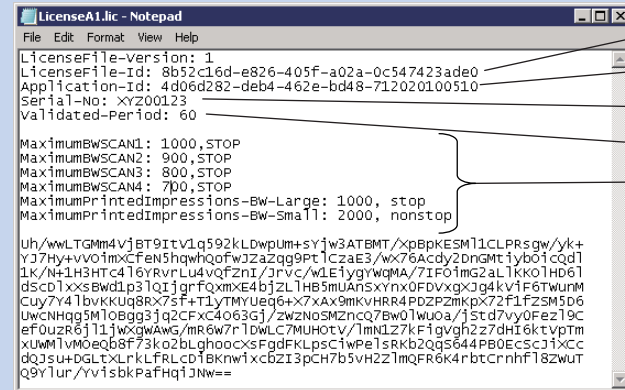

- License File ID
- Application ID
- Serial Number
- Validated Period
- Counter informations

F-2-64



**Note:**

There are two ways to install an MEAP application. You can install using SMS, or install using the [Register/Update Software] screen of the remote UI.

Screen example

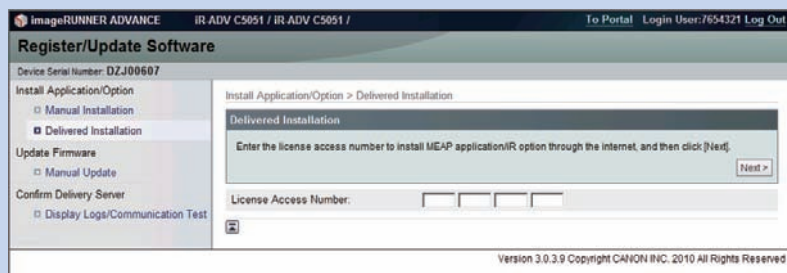

F-2-65

[Register/Update Software] provides two types of installations. One is [Manual Installation] where you specify a jar file and a license file and then install. The other is [Delivered Installation] where you enter a license access number. For details of the procedures, please refer to the e-Manual.

## Resource Information

### About MEAP Application Management Page

Application Management page shows [ resource information ] for information of the whole device resources including Amount Used, Remaining, and Percent Used.

This function enables users to judge the remaining resources before installing the additional application. Such resource information is shown based on the manifest header stated at the top of each application, which declares the resources required in the application. Therefore, the information does not necessarily show the resources actually in use.

The following resource information is shown:

- Storage
- Memory
- Thread
- Socket
- File Descriptor

You will not be able to install an application if the size of the remaining disk space falls short of the size declared by the application. Moreover, the specifications have been designed so that an application will not be able to start up if there is a shortage of memory for any of the foregoing items (i.e., memory, thread, socket, file descriptor).

Follow the steps below to check the remaining memory:

- 1) Log in to SMS.
- 2) Click [ MEAP Application Management ].
- 3) Check [ Resource Information ] for information of the whole device resources.

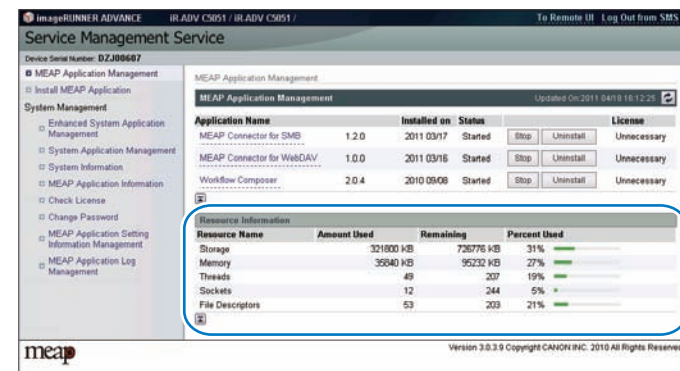

F-2-66

## ● Device's resources

When 1 MEAP application operates, the resource volume allocated to each device is as follows (loaded resource list). Since the following value is an estimate, when installing the MEAP applications, it needs to check the available resource of SMS.

Since the indication of SMS resource volume fluctuates by the login service (authentication function) and configuration (future model), which the user selected, it may show a bigger value than the following values.

List of Available Resources

Product Name	Storage	Memory	Thread	Socket	File Description
imageRUNNER LBP5280	32MB	20MB	128	128	128
imageRUNNER LBP3480	32MB	20MB	128	128	128

T-2-14

### Note:

- As for memory, check the available resource when starting up the application. For other resources other than memory, check them when installing.
- Some applications call for a specific set of conditions for installation. For details, see the User's Guide that comes with the individual applications.
- Maximum installable application is up to 20 even if the remaining resource is adequate. (However, the Send function consumes 1, it must be 19 in practice.) Authentication application is not included in this number.
- The MEAP application, which can be started simultaneously, is up to 19. (Authentication application is not included in this number.)

### CAUTION:

To install an application, the user needs to use the following URL when accessing the license control system to obtain a license file. In doing so, he/she needs to register the license access number of the application and the serial number of the device.

<http://www.canon.com/lms/license/>

## ● MEAP Specifications

### ■ What is MEAP Specifications (MEAP Spec Version)?

MEAP Specifications is one of the information required to judge whether MEAP applications can be operated or not. With MEAP Specifications, you can prevent an application that uses a specific function of device from being installed onto the device that does not have the function.

### ● About Name

MEAP Specification is shown as 'MEAP Specifications' in the screen to check the version on the side of device that supports MEAP (counter confirmation button) and MEAP platform (SMS). On the other hand, in the manifest file of MEAP application, it is shown as 'MeapSpecVersion' (described in the same way in the SDK document) (Note) 'MEAP Specifications' hereafter in this document.

### ● Mechanism

MEAP platform judges whether MEAP applications can be operated on it using on the 2 information below:

- Device Specification ID
- MEAP Specifications

Device Specification ID shows information such as the original functions of MFP (including print, scan, and copy), and one that differs by model such as maximum copy number, thus each model has a different ID. (It is easy to determine the IDs for this reason.) MEAP application declares 1 or more Device Specification ID required for its execution. Declaration of multiple Device Specification IDs means that the application is operable in all the models declared. Upon installation of MEAP application in (using) SMS or MEAP Enterprise Service Manager, matching of Device Specification ID is executed on the side of MEAP platform machine. The machine which doesn't support the ID declared by the application rejects installation of such an application.

Meanwhile, MEAP Specifications shows other information than defined by Device Specification ID above, including network and security. Thus each model does not always have the same version.

MEAP application declares 1 or more MEAP Specifications required for its execution. Declaration of multiple Device Specification IDs means that the application is operable in all the environments declared. Upon installation of MEAP application in SMS or MEAP Enterprise Service Manager, matching of MEAP Specifications is executed on the side of MEAP platform machine. The machine which doesn't support the version declared by the application rejects installation of such an application.

## MEAP Specifications for each model

Product Name	Initial MEAP SpecVer
imageRUNNER LBP5280	15, 19, 25, 26, 27, 29, 34, 39, 45, 47, 50, 51, 52, 54, 55, 57, 58, 60, 61, 62, 63
imageRUNNER LBP3480	15, 19, 25, 26, 27, 29, 34, 39, 45, 47, 50, 51, 52, 54, 55, 57, 58, 60, 61, 62, 63

T-2-15

## MEAP Specifications List

Ver	Description
1	MEAP basic function
2	MEAP Spec Version 1 function and SSL/TSL + Proxy
5	MEAP Spec Version 1 function and CPCA V2 + ERS (Error Recovery Service) + New SSL/TSL
6	Reserved
7	MEAP Spec Version 5 function and Compact PDF + OCR PDF (Text Searchable) + USB Host (Buffering of Interrupt Transfer)
9	Reserved
10	MEAP Spec Version 5 function and USB-Host (Exception + Clear Feature + Set Feature+ Hot Plug) + WINS address acquisition using MIB Agent + Timer Service + SSL client authentication
11	MEAP Spec Version 5 function and AMS
13	MEAP Spec Version 5 function and J2ME1.1 Support + Encrypted PDF + Trace and smooth PDF + CTK2.0
14	Device signature PDF
15	IMI + ERS (API addition for IMI) , IPv6, Extended encryption function (AES/RC4)
17	Acquiring images of JBIG format
18	Parsing XML documents (XML parser)
19	Enhancement of IMI function (IMI Version1.2 series)
21	Reserved
25	API to access the HID/Mass Storage class devices.
26	MEAP driver preference function
27	Symbols that can be used with MibAgent added. (symbols for IPv6 address acquisition)
29	IMI API added (IMI version 1.2.1 enabled)
30	Extended address book function. (e-mail/group/i-FAX/file)
31	Integrated ERS function
32	Extended Imaging function (function to generate PDF/OOXML (PowerPoint) with visible signature)
33	Extended function for imageRUNNER / iR ADVANCE series (API for address book/ CTK/ TopMenu)
34	Extended IMI Box function (v1.3.0)
35	Extended SIS function (function to check the network cable status, function to check PS print server unit status)
36	Reserved
37	CLS (Contextual Login Service) Supporting API Added
38	imageRUNNER / iR ADVANCE Series administrative privileges supported
39	MEAP Specifications added according to Jcrypto API Specification Change
40	ImagingAPI (Creation API of Visible Signature PDF) added

Ver	Description
41	Reserved
42	Reserved
44	imageRUNNER / iR ADVANCE Series Remote Address Book Supported, RemoteFAX Supported.
45	Addition of API that allows acquisition of the HID installation status
46	Multilingualization of the USB keyboard of the System Driver
47	Addition of API which executes a print order from the MEAP application of the IMI encryption PDF document
48	ID expressing the scan function for iR-ADV C2030/C2025/C2020 series
49	Reserved
50	SecurityOptionalPackage
51	IMI function expansion of iR-ADV C5051 series (Ver.50.xx or later) or later
52	(iR-ADV C5051 series (Ver.50.xx or later)) Addition of registered API to enable SSL communication setting (On/Off) for each URL
53	Disclosure of registration/deletion function to/from Quick Menu
54	Function to notify an event to the application at recovery from the sleep mode.
55	System account release function
56	MEAP User Preference Service
57	MEAP Application Configuration Service
58	MEAP Application Log Service
59	Reserved
60	SFP basic functions
61	LAVS
62	LSIS
63	LDT
64	IMI customization
65	Extension of MEAP User Preference Service (application sharing preference).
66	Reserved
68	Addition of Office Open XML's Word creation API
69	Extension of the encrypted PDF function (AES 128 bit/256 bit)

T-2-16

## MEAP Application Management

### Outline

You can use the MEAP application management screen to perform basic management tasks of the MEAP application (start, stop, uninstall), or check the device's resource information.

### Starting, Stopping, or Uninstalling the MEAP Application

#### Procedure to start and stop a MEAP application

- 1) Log in to the SMS. (Refer to 'Login to SMS' in this manual.)
- 2) Click [ Application List ]. (If the Application List is already being displayed, this operation is not necessary.)
- 3) Click [ Start ] or [ Stop ] button shown for the MEAP application to be started or stopped.

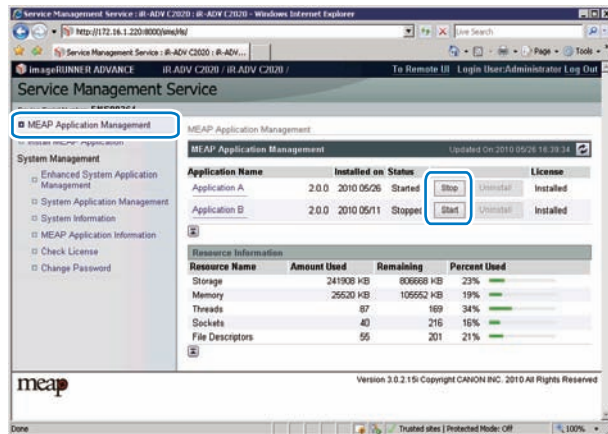

F-2-67

- 4) Check to see that the status of the MEAP application in question is either [ Started ] or [ Stopped ].

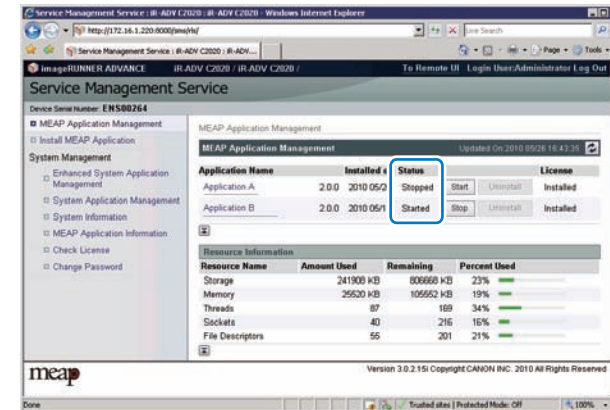

F-2-68

#### If the MEAP application cannot be started

If the conditions to start the MEAP application are not satisfied, the MEAP application cannot be started.

If the MEAP application cannot be started, check the following items.

##### Is a valid license installed?

If the license has expired, you cannot start the application. If the license has already expired, obtain a new license and then update the license. ( See "Managing the License File" in this manual.)

##### Are the necessary resources available?

If the resources such as memory capacity or number of threads are not sufficient, the application also cannot be started.

Delete any unnecessary data to secure sufficient resources.

If the application still cannot be started after checking the foregoing conditions, contact the support department of the sales company.

## Procedure to uninstall the MEAP application

Before uninstalling the MEAP application, check that the following conditions are met.

- The MEAP application has stopped.
- The license has been disabled or deleted. (The status is "Not Installed".)

Application Name	Installed on	Status	Start	Uninstall	License
Application A	2.0.0 2010 05/26	Stopped	Start	Uninstall	Not Installed
Application B	2.0.0 2010 05/11	Started	Stop	Uninstall	Installed

F-2-69

For information on the procedure to stop the MEAP application, see the previous section "Procedure to start and stop a MEAP application".

For information on the procedure to delete the license file, see the following section "Managing the License File".

### Note:

When a user tries to uninstall an application before deleting the license, the following message is shown.

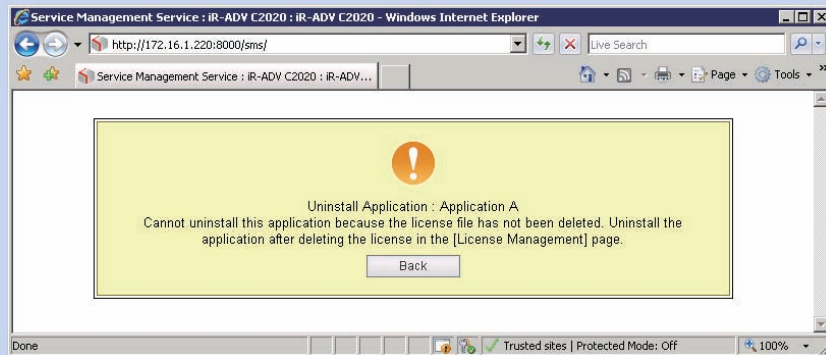

F-2-70

If the license file of the selected application cannot be deleted, the [Uninstall] button is grayed out and therefore the application cannot be uninstalled.

### CAUTION:

If the application you are uninstalling is associated with another application, a message will appear to indicate that the package exported by the application will no longer be available. Uninstalling such an application may also disable its associated applications.

1) Log in to SMS to click [ MEAP Application Management ] on the menu.

2) Check that the status of the application you want to uninstall is [ Stop ] and the license has been disabled. (The status is "Not Installed".)

Application Name	Installed on	Status	Start	Uninstall	License
Application A	2.0.0 2010 05/26	Stopped	Start	Uninstall	Not Installed
Application B	2.0.0 2010 05/11	Started	Stop	Uninstall	Installed

F-2-71

3) Click [ Uninstall ] button for the application to be uninstalled.

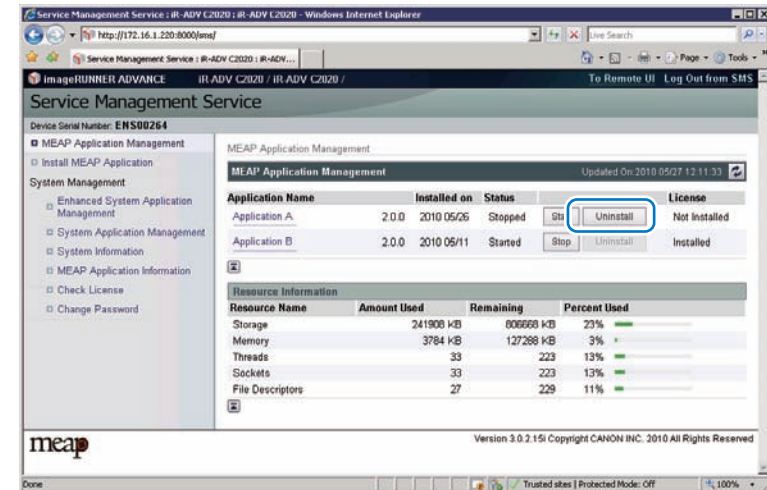

F-2-72

4) Check the application name to be uninstalled shown on the screen to click [ Yes ] button. Upon [ Yes ] button clicked, uninstallation process is started.

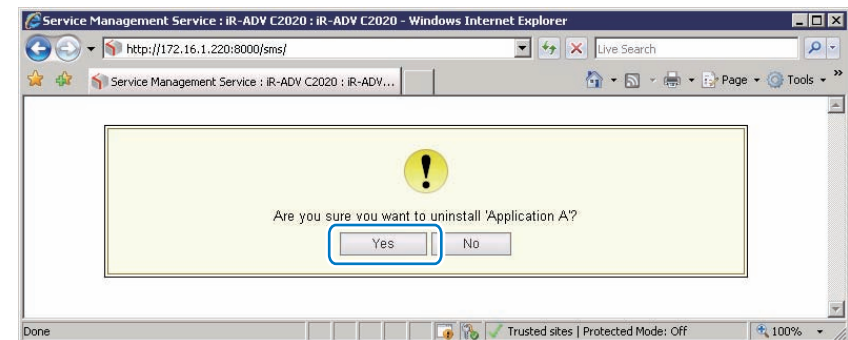

F-2-73

## Managing the License File

### Outline

The license file management functions allow you to perform the following operations related to the license file necessary for the MEAP application to run.

- Update the license which has already expired.
- Disable or delete the license file in order to uninstall the MEAP application.

These license management functions can be performed from the [ MEAP Application Management ] screen.

The main license management functions are as follows:

### Adding a license

When the license has expired, you can add a license file.

### Disabling a License File

Before uninstalling the MEAP application, the license needs to be deleted. In that case, you must first disable the license file because a license file which has not been disabled cannot be downloaded or deleted.

### Downloading / Removing an Invalidated License File

Before uninstalling the MEAP application, you need to delete its license file which has already been disabled.

By downloading the license file to your PC before it is deleted, you can use it when installing the application again to the same device.

#### WARNING:

After deleting the license file which has been disabled, you can no longer download the license file.

### Procedure adding a license file

- 1) Log on to SMS.
- 2) On MEAP Application Management, click the name of the application to which you want to add a license file.

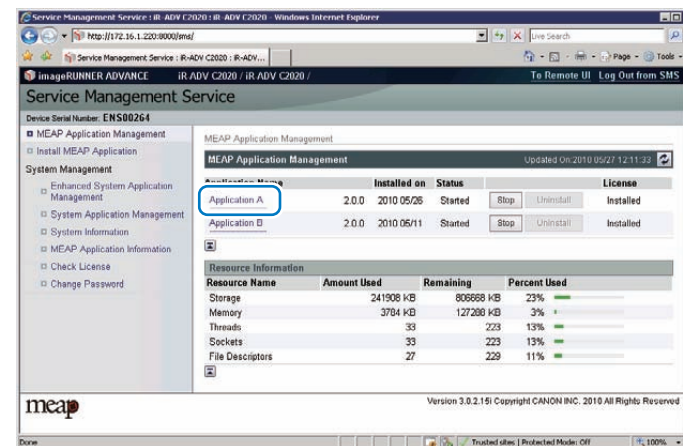

F-2-74

- 3) In [ Application / License Information ] page shown on the screen, click [ License Management ] button.

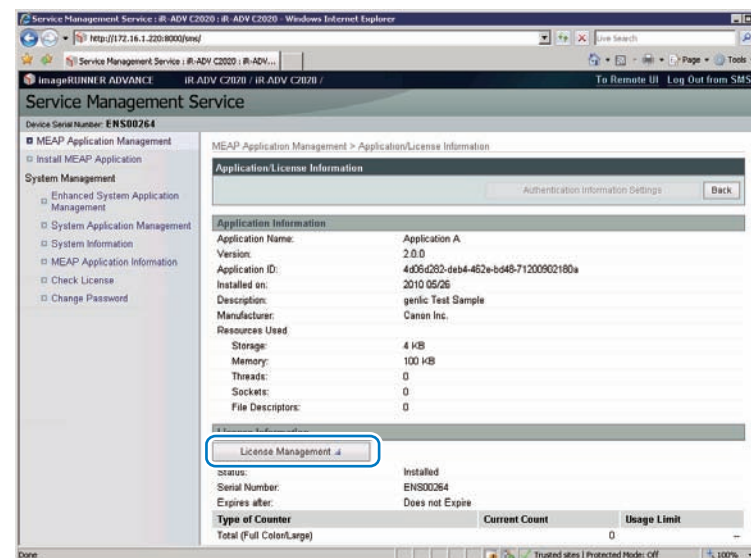

F-2-75

4) Click [ Browse ] button, and select the license file you want to install.

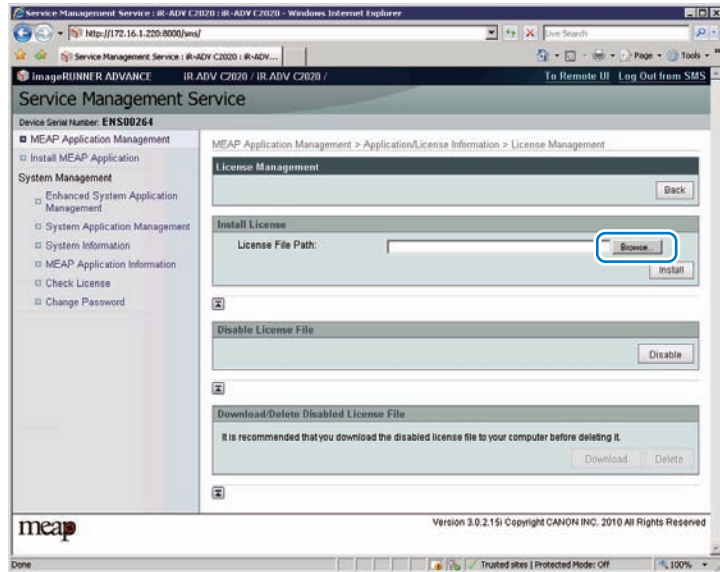

F-2-76

5) Click [ Install ] button.

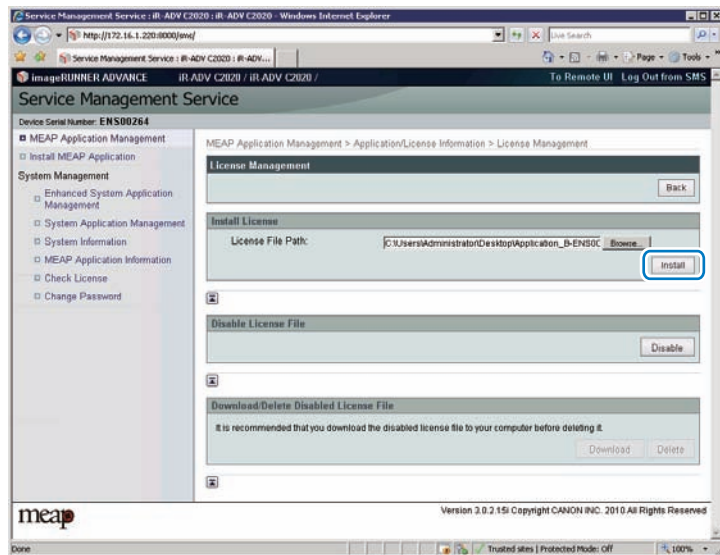

F-2-77

6) Check the content of the confirmation page, and click [ OK ] button.

● Procedure disabling a license file (suspending a license)

CAUTION:

- Since the license file cannot be disabled when the application is still running, the application needs to be stopped before disabling the license file.
- Once suspended, the status of the license will be 'Not Installed', and its application will no longer be available for use.
- You can later restore a suspended license file as long as you are doing so on the same iR, the device with the same device serial number.
- If the machine needs to be replaced due to a device failure, use the transfer license during the replacement. (See "License for forwarding")

1) Stop the application you want to uninstall on MEAP Application Management page.

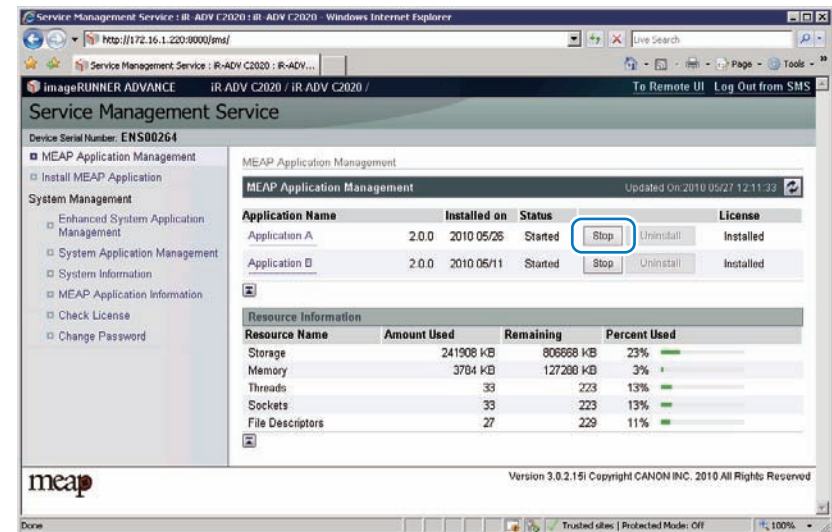

F-2-78

2) Click the name of the application that you want to disable.

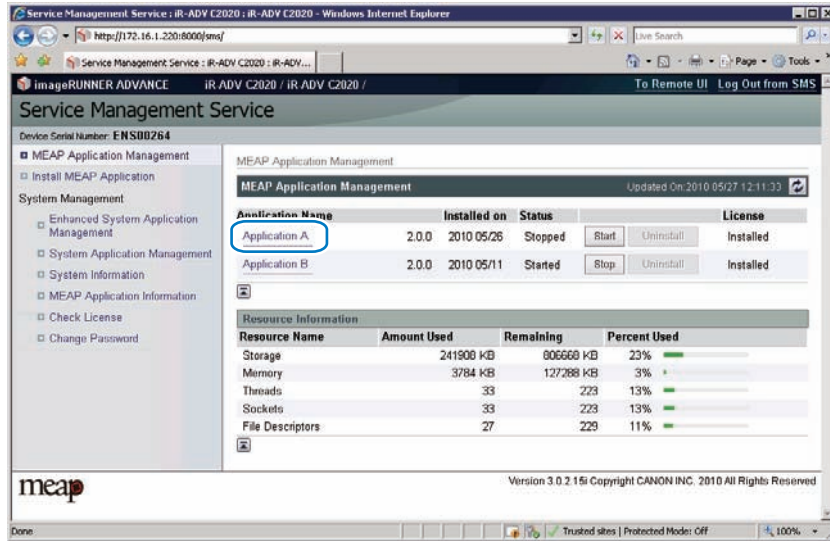

F-2-79

3) On Application/ License Information page, click [ License Management ] button.

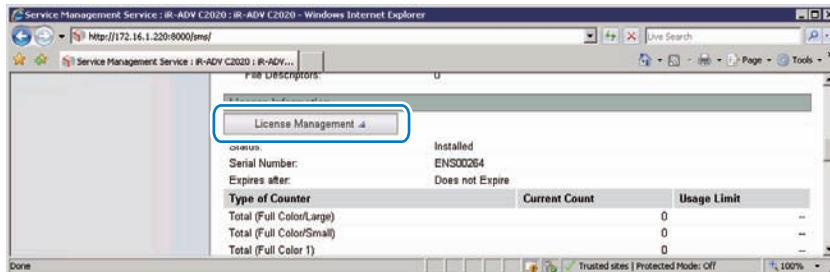

F-2-80

4) License Management page appears. Click [ Disable ] button.

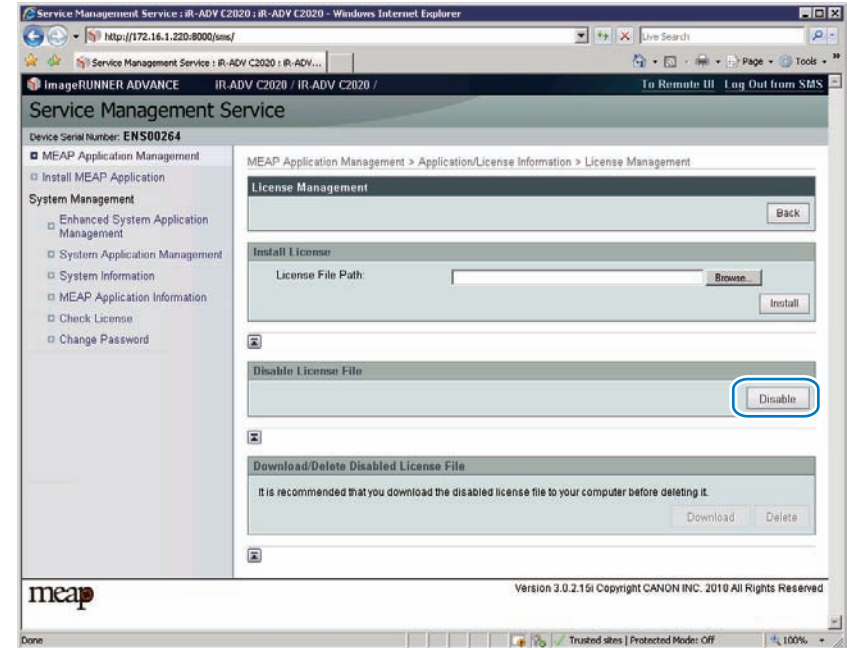

F-2-81

5) Click [ Yes ].

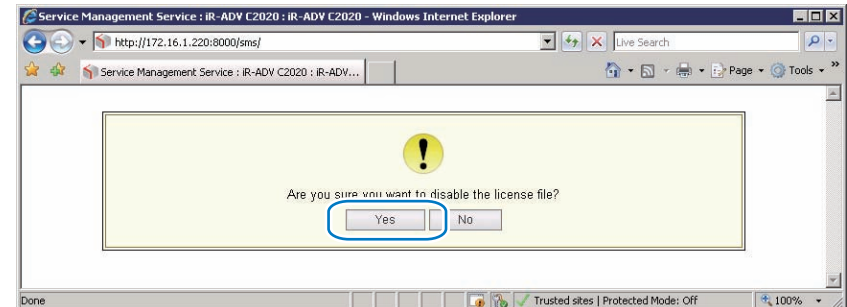

F-2-82



## Procedure downloading / removing an invalidated license file

### Note:

The downloaded license file can be used for reinstallation only in the same iR device (with the same device serial number).

- 1) Login to SMS.
- 2) Application List page appears. On MEAP Application Management page, click the name of the application you want.

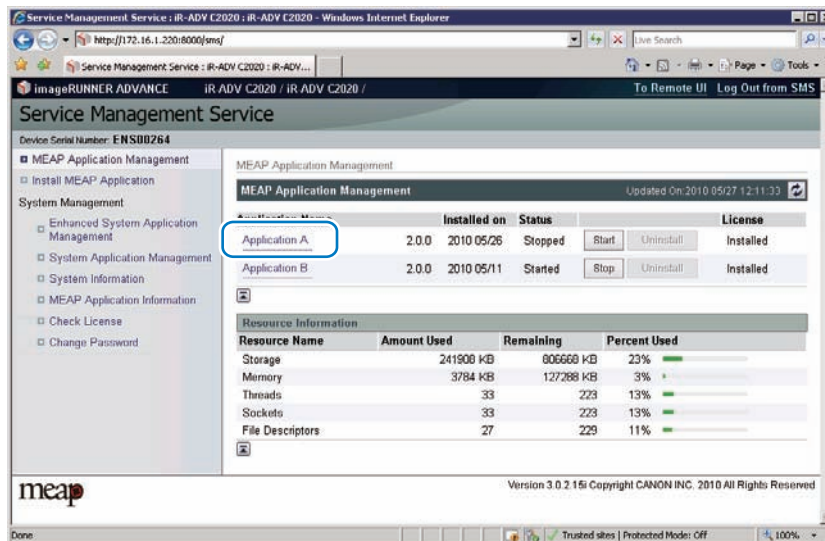

F-2-83

- 3) Check Application/ License Information page appears.
- 4) On Application / License Information page, click [ License Management ] button.

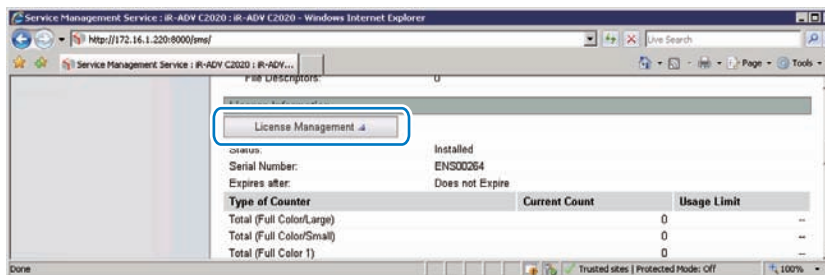

F-2-84

- 5) License Management page appears. To download, click [ Download ] button.

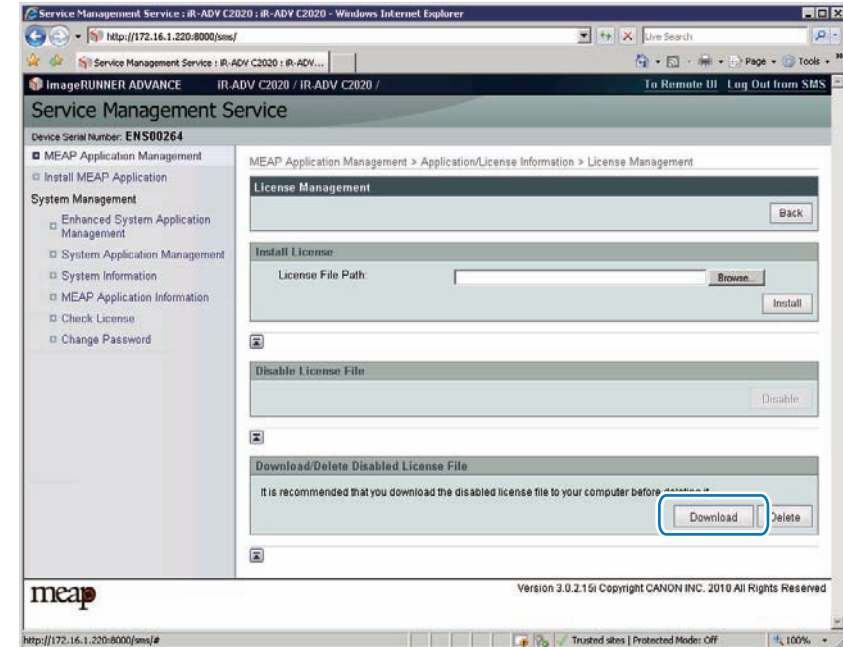

F-2-85

- 6) When you have selected [ Download ] button, specify where you want to store the file by following the instructions on the screen.

7) To delete, click [ Delete ] button.

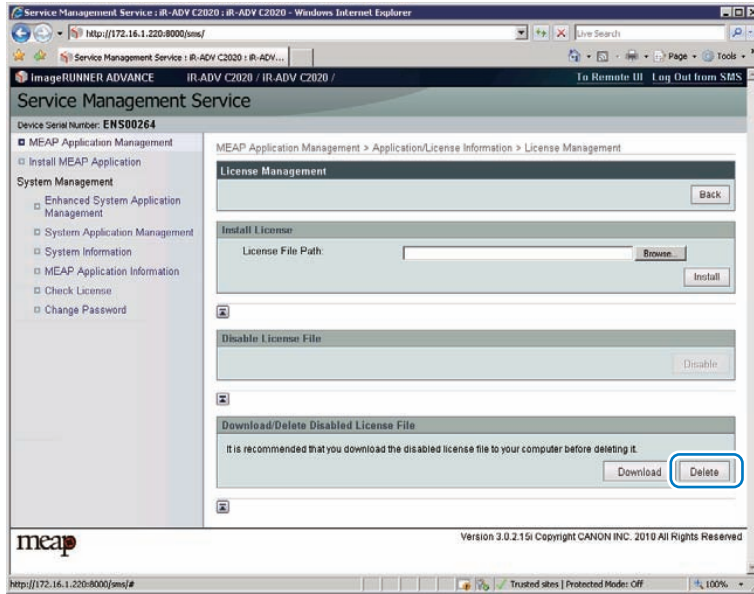

F-2-86

8) When the dialog to confirm deletion is shown, click [ Yes ] button.

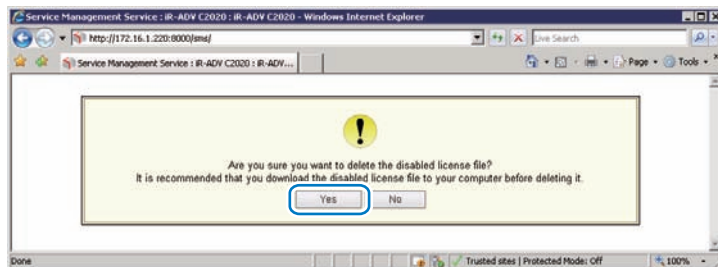

F-2-87

#### WARNING:

Without the license file, an application cannot be reinstalled even to the MEAP de-vice that the application had been installed last time. Download and save the license file before deleting the application.

## Other License File Management Functions

### Reusable license

When reinstalling, Disable License file should be downloaded (see "Disabling a License File ." and see "Downloading / Removing an Invalidated License File." in this manual) or a license for reinstallation should be obtained from LMS, before reinstallation.

This specification aims to prevent misuse of applications.

To increase convenience of users, only application with unlimited validity date and application counter (e.g. Portal Service, SDL, SSO) has been made to be able to install as many times as needed by the same license file. This kind of license is called 'Reusable license'.

After replacing the Main PCB, the MEAP applications need to be reinstalled.

In that case, the installation requires use of reusable licenses.

As for other MEAP applications without reusable licenses, use special license files for reinstallation, in the same as way as handling a storage drive failure.

For information on how to obtain a special license for reinstallation, refer to "Special license for reinstallation" in this chapter.

## License for forwarding

If the machine needs to be replaced due to a device failure, you can transfer the license information used in the MEAP application to the new machine and continue its usage. Service engineers are responsible for license transfer as this task requires the SMS hidden page (not open to users).

The procedure is shown below.

- 1) Log in to SMS, stop the application to be forwarded (see Chapter 0, "Starting and Stopping a MEAP Application." in this manual).

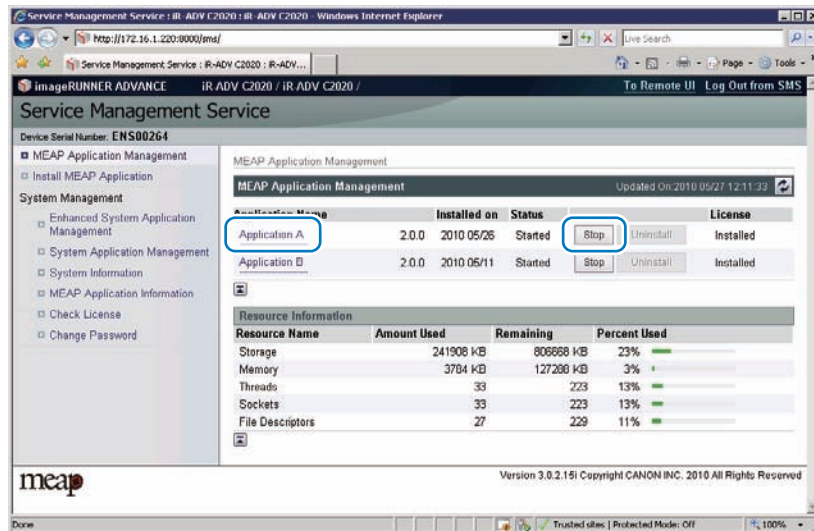

F-2-88

- 2) Move to the download page of license forwarded for the device as sender ([https:// IP address of device: 8443/sms/ForwardLicense](https://IP address of device: 8443/sms/ForwardLicense)).



F-2-89

- 3) Specify the application to be forwarded.

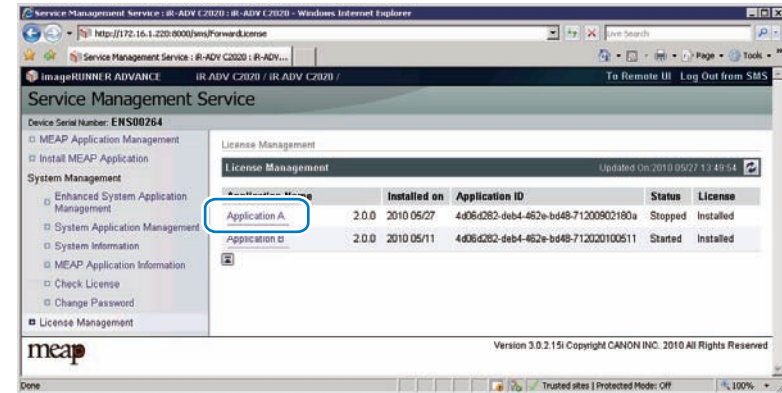

F-2-90

- 4) Click [ Disable ] button on the [ Disable License File ].

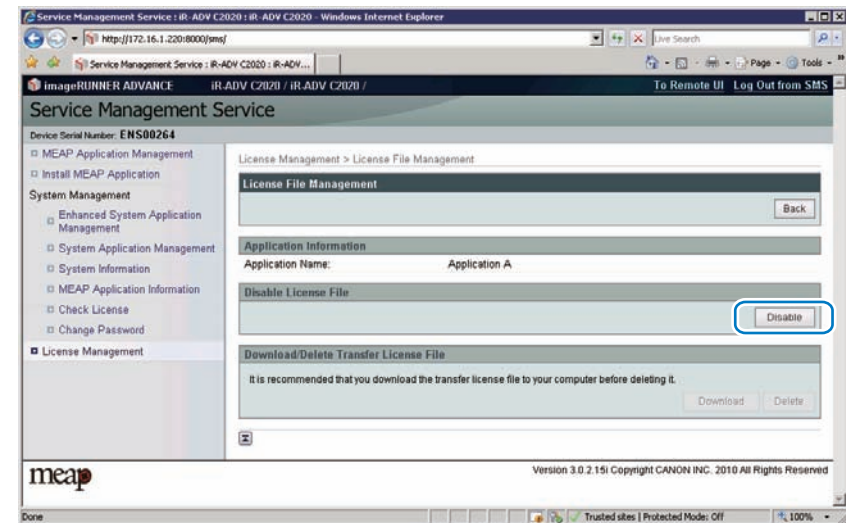

F-2-91

5) The window to confirm whether to create a transfer licence will be displayed. Click [ Yes ].

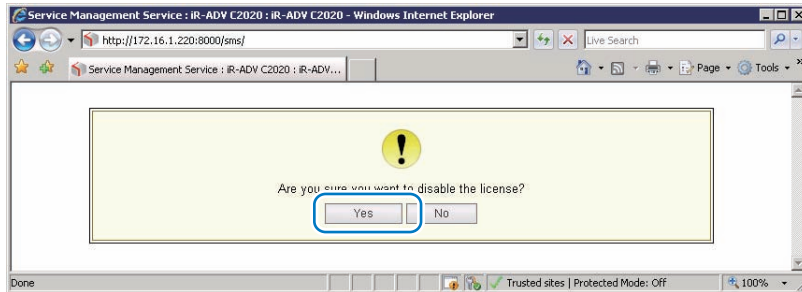

F-2-92

6) When [Download] button on the [ Download / Delete Transfer License File ] becomes effective, click [Download] button.

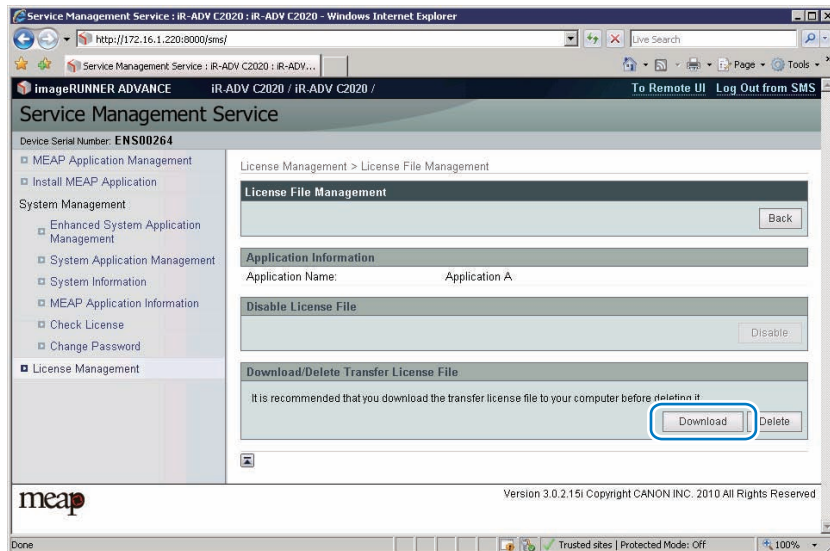

F-2-93

7) The dialogue [ File Download ] is displayed. Click [ Save ].

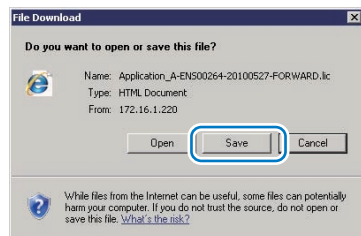

F-2-94

8) Specify the download destination, click [ Save ].

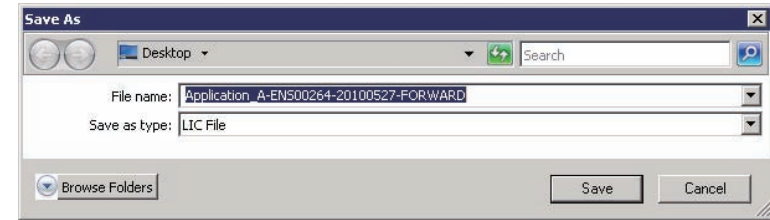

F-2-95

9) After downloading the license file for forwarding, click [ Delete ] to display the confirmation screen and click [ Yes ] to delete the file (in consideration of breakage of license for forwarding, deleting disabled license can be executed after all steps have been completed).

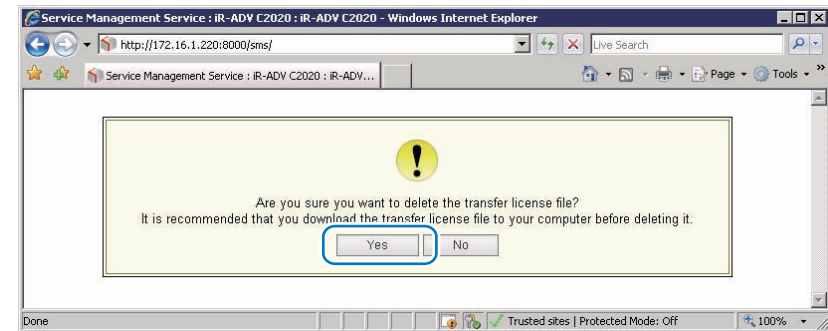

F-2-96

10) Log out of SMS.

11) Since this downloaded transfer license is the file only to prove the license invalidation, it cannot be used for installation to the other device as it is. Send the transfer license to the service support contact of your nearest sales company to request issuance of the new license for installation in the new device.

**Note:**

When requesting issuance of license for forwarding, inform the sales company of the name of product name and serial No. of the device as sender, and of the name of product name and serial No. of the forwarding destination.

12) Install application using the license for forwarding issued by the sales company.

## Enhanced System Application Management

### Outline

[ Enhanced System Application Management ] mainly manages the login services for logging in to devices.

- Installing and uninstalling Enhanced System Application Management (login services, etc.)
- Switching login services (switching the method to log in to devices)
- Checking installation status of other System Applications

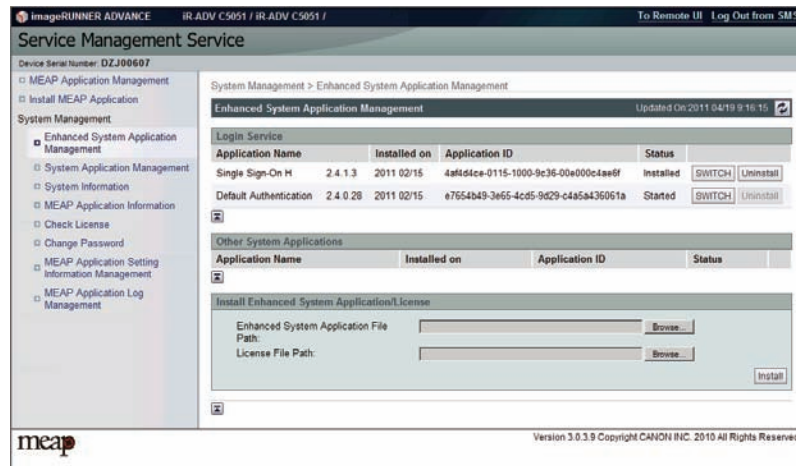

F-2-97

### About Login Service

The login service is started up to authenticate the user when MEAP-enabled iR device is booted up. Login service changes and install/ uninstall are carried out from the 'System Management' page.

The pre-installed login application is Default Authentication, and the default setting is [ Start ].

### Default Authentication overview

Default Authentication is a pre-installed login application that runs by default. It provides authentication functions to allow minimum operation of the Controller System, even when no other login application is running.

### Other Log in service

There are login services besides the foregoing Default Authentication, such as card authentication. For details, refer to the manuals for those login services.

### Procedure Changing Login Services

If 2 or more login services are installed, you can use the following procedure to switch among them.

- 1) Access SMS. From the [ System Management ] menu, select [ Enhanced System Application Management ].

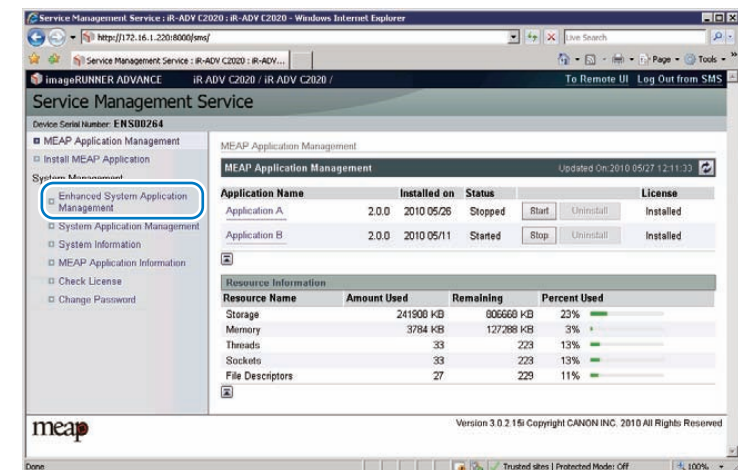

F-2-98

2) Click the [ SWITCH ] button of the login service you want to switch to.

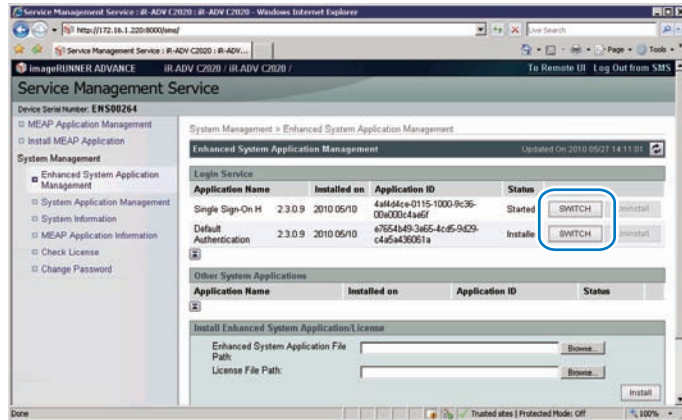

F-2-99

3) Check that the status of the selected login service application has changed to [ Start after Restart ]. Then, log out of SMS and restart the device.

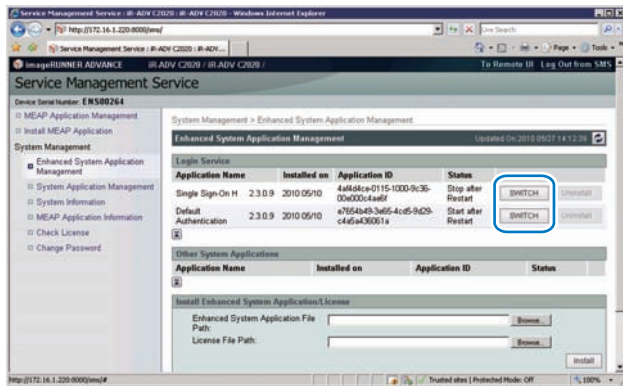

F-2-100

## Procedure Installing Login Services

Use the following procedure to install the login services.

- 1) Access SMS, and then click [ System Management ] > [ Enhanced System Application Management ].
- 2) Click the [ Browse ] button, and specify the Enhanced System Application file/License file.

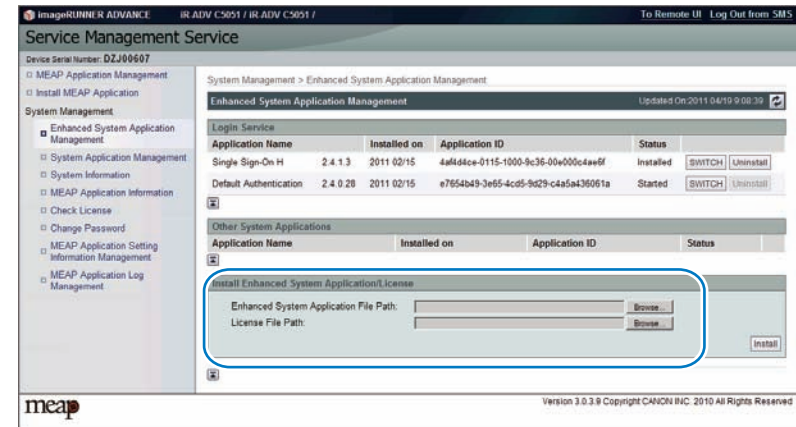

F-2-101

3) Click [ Install ] button.

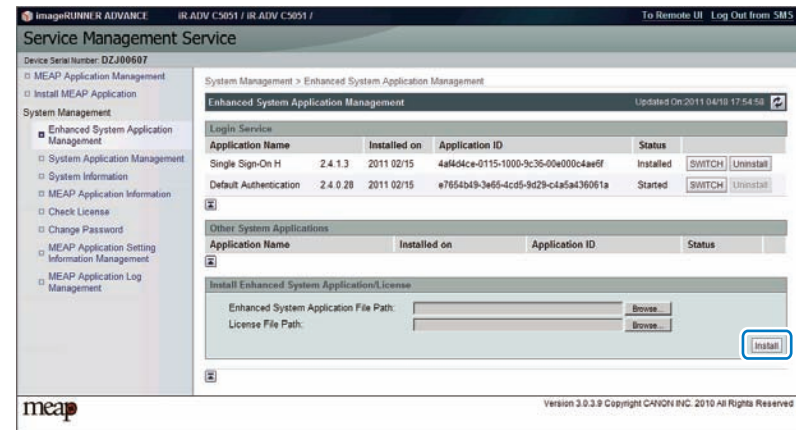

F-2-102

## ■ Procedure Uninstalling Login Services

Use the following procedure to uninstall the login services.

Also, note that the services need to be stopped ("Installed" status) in order to uninstall the login services.

- 1) Access SMS, and then select [ System Management ] > [ Enhanced System Application Management ].

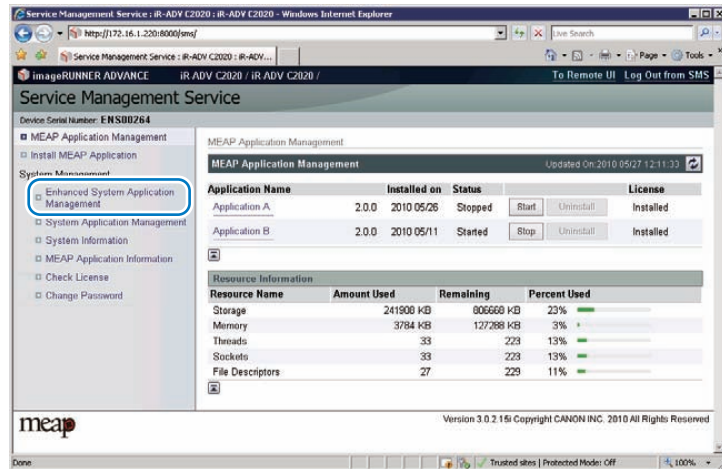

F-2-103

- 2) Click the [ Uninstall ] button of the login service you want to uninstall.

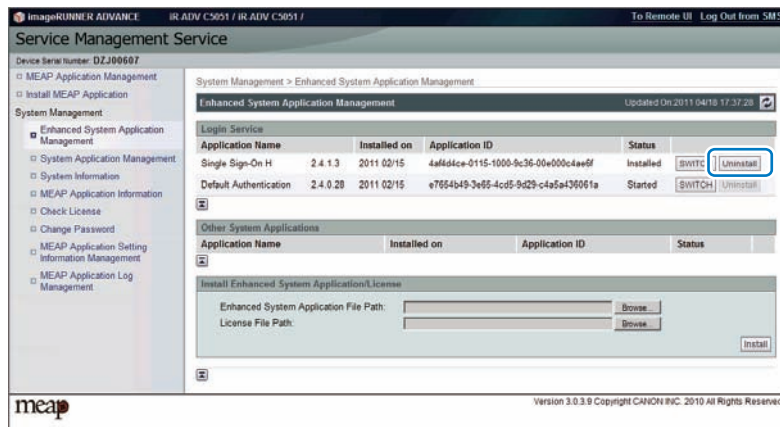

F-2-104

## ● System Application Management

This function manages the login services for logging in to SMS.

### ■ Procedure to manage System Application

Use the following procedure to manage the System Application.

- 1) Access SMS, and then click [ System Management ] > [ System Application Management ].
- 2) Click [ Start ] or [ Stop ] button in the status column of the system application that wants to start or stops.

System Management > System Application Management

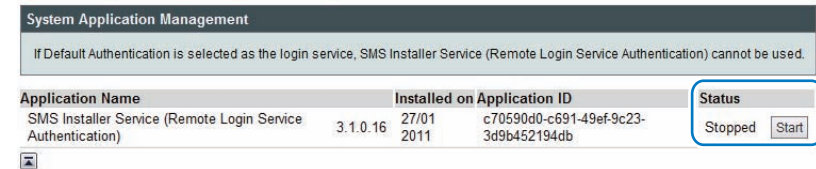

F-2-105

- 3) Log out of SMS. ( When you log in next time, a set content becomes effective. )

## System Information

### Outline

You can check the device's platform information and the MEAP application's system information.

### Checking the System Information

System information that can be checked from the screen:

- Platform information
  - MEAP Specifications version (MEAP Spec Ver)
  - MEAP Contents version
  - Java Virtual Machine version
- System application information
  - The name of the installed system application
  - The installation date of the installed system application
  - Application ID of the installed system application
  - The status of the installed system application

The checking procedure is shown below.

- 1) Log in to SMS.
- 2) On System Management menu, click [ System Information ] button.

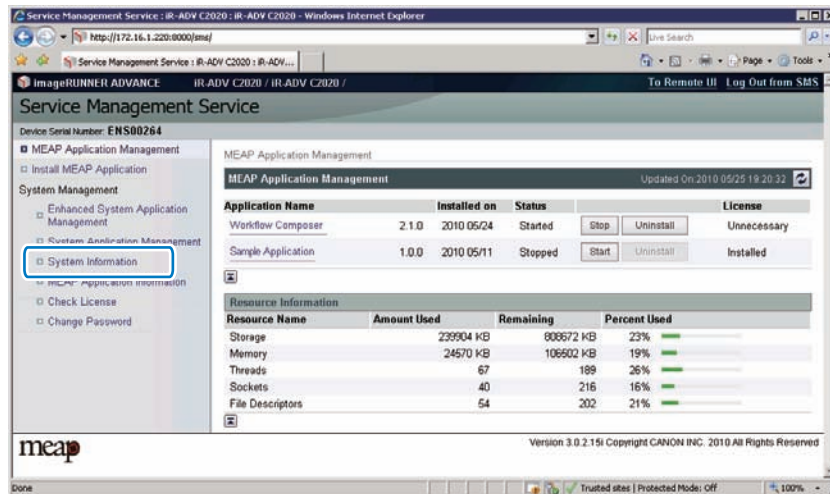

F-2-106

### Display of System Information Details

The system information details can be displayed to check more than one pieces of information all at the same time: platform information, system application information, information on the installed MEAP applications, etc.

- 1) Log in to SMS.
- 2) On System Management menu, click [ System Information ].
- 3) Click [ Display Details ] button.

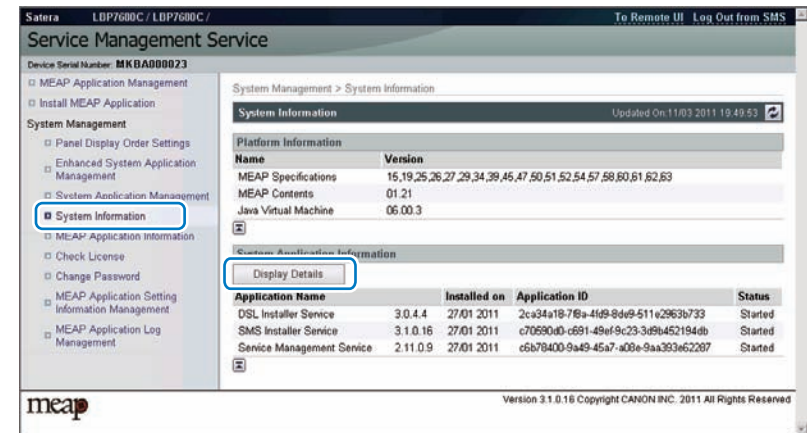

F-2-107

- 4) The system information of each application (including System Application) is shown in a separate window. Copy and paste all the information in a file to attach to AR reports as text information. This function is useful to check status information of each application.



F-2-108



## Printing the System Information of a MEAP Application

MEAP system information can be printed out with iR device for confirmation.

### Note:

The system information of the MEAP application that you checked in the previous section is exactly the same as the system information of the MEAP application that is output.

Follow the steps below when confirming information:

- 1) From [ Utility Menu ], select [ Print MEAP Sys. Info ].
- 2) When the execution confirmation screen appears, select [ Yes ] and then press the [ OK ] button on the Control Panel.

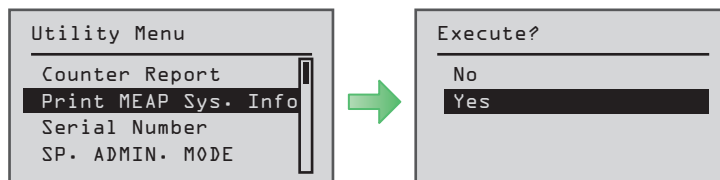

F-2-109

## Content of MEAP system information

Application System Information

```
Application Name: C-Cabinet Gateway for MEAP
Application ID/System Application Name: 03a46668-63e4-4636-9cbb-492b6cef05d5
Application Version: 1.0.0
Status: Resolved
Installed on: Tue Oct 21 14:00:11 GMT+09:00 2003
Vendor : Canon Inc.
License Status : Installed
Maximum Memory Usage : 1024
Registered Service :
```

Item	Content
Status	It indicates the status of the application in question; specifically, Installed: the application has been installed. Active: the application is being in use. Resolved: the application is at rest.
Installed On	It indicates the date on which the application was installed.
Vendor	It is the name of the vendor that developed the application, and is the name (bundle-vendor) declared in a statement within the application program.
License Status	It indicates the status of the license; specifically, None: no license is needed. Not Installed: no license has been installed. Installed: the appropriate license has been installed. Invalid: the license has been invalidated. Overlimt: the license has been used beyond its permitted limit.
License Expires After	It indicates the date after which the license expires. If the status of the license is 'none', this item will not be printed.
License Upper Limit	It indicates the limit imposed on individual counter readings. If the status of the license is 'none', this item will not be printed.
Counter Value	It is the current counter reading of a specific counter. If the status of the license is 'none', this item will not be printed.
Maximum Memory Usage	It indicates the maximum amount of memory that the application uses. It is the amount (maximum memory usage) declared in a statement within the application program, and is expressed in kilobytes.
Registered Service	It is a list of services that have been registered by the application with the MEAP framework. Some services may not have printable data.

T-2-17

Item	Content
Application Name	It is the name (bundle-name) declared in a statement within the application program. It may not necessarily be identical to the name of the program.
Application ID/System Application Name	Application ID (application-id) items which are declared on the declaration statement in the application program are printed.
Application Version	It is the version of the application (bundle-version) declared in a statement within the application program.

## MEAP Application Information

### Outline

You can use this function to check the MEAP application installed on the device.

The following information can be checked on the MEAP application information screen.

- Application Name
- Application ID
- Installed on
- Status
- License Status
- Counter Information

### Procedure to Check MEAP Application Information

- 1) Log in to SMS.
- 2) On System Management menu, click [ MEAP Application Information] button.

3) The MEAP application information screen appears.

The screenshot displays the 'Service Management Service' interface. The left sidebar shows a navigation menu with 'MEAP Application Information' selected. The main content area shows the 'MEAP Application Information' screen for 'SampleApp\_A'. It includes fields for Application Name, Application ID, Installed on date, Status, License Status, and Expires after. Below this is a table of counter information.

Type of Counter	Current Count	Usage Limit
Total (Full Color/Large)	0	--
Total (Full Color/Small)	0	--
Total (Full Color 1)	0	--
Total (Single Color/Large)	0	--
Total (Single Color/Small)	0	--
Total (Single Color)	0	--
Total (Black and White/Large)	0	1000

F-2-111

The screenshot displays the 'Service Management Service' interface. The left sidebar shows a navigation menu with 'MEAP Application Information' selected. The main content area shows the 'MEAP Application Management' screen. It includes a table of installed applications and a 'Resource Information' section with a table of resource usage.

Application Name	Version	Installed on	Status	Start	Uninstall	License
SampleApp_A	4.4.0	11/03 2011	Installed	Start	Uninstall	Installed
SampleApp_B	4.4.0	11/03 2011	Installed	Start	Uninstall	Installed
SampleApp_C	4.4.0	11/03 2011	Installed	Start	Uninstall	Installed

Resource Name	Amount Used	Remaining	Percent Used
Storage	12505 KB	20263 KB	36%
Memory	1050 KB	19430 KB	5%
Threads	5	123	4%
Sockets	0	128	0%
File Descriptors	4	124	3%

F-2-110

## Check License

### Outline

You can use this function to check the contents of the license file.

### Procedure to Check the License File

- 1) Log in to SMS.
- 2) On System Management menu, click [ Check License ] button.

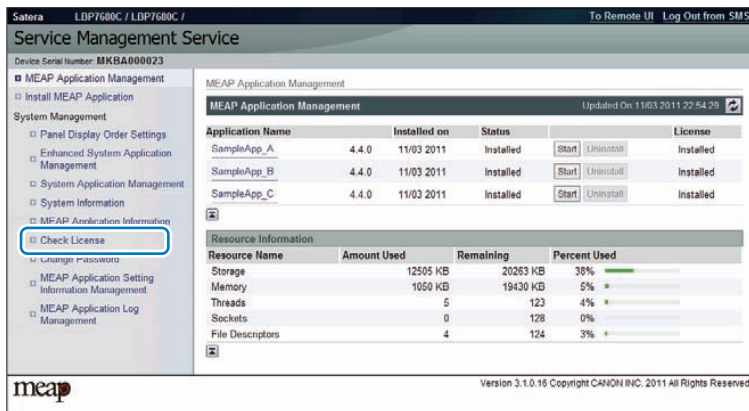

F-2-112

- 3) Click the [ Browse.. ] button, specify a license file, and click the [ Check ] button.

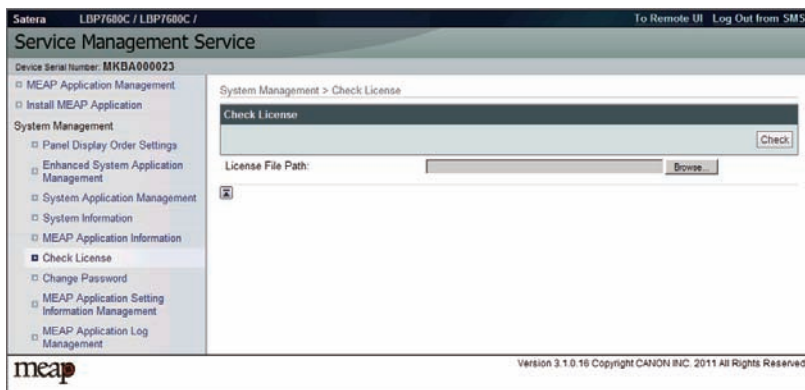

F-2-113

## Changing SMS Login Password

### Outline

You can change the password for logging in to SMS.

If you forgot the login password and you want to change the password back to the default value (MeapSmsLogin), see "When SMS Cannot Be Accessed" in this manual.

### Procedure to Change the SMS Login Password

- 1) Log in to SMS.
- 2) On System Management menu, click [ Change Password ] button.

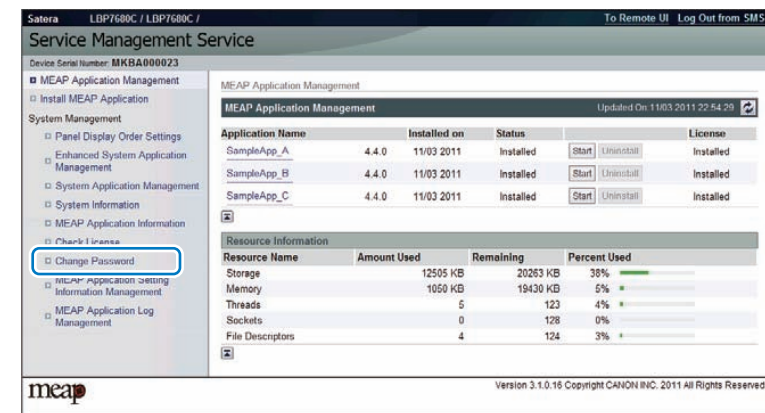

F-2-114

- 3) Enter both the current password and a new password, and then click the [ Change ] button.

System Management > Change Password

The screenshot shows the 'Change Password' dialog box. It contains three input fields: 'Old Password:', 'New Password:', and 'Confirm:'. There are 'Change' and 'Reset' buttons at the top right.

F-2-115

#### Note:

The [Reset] button on the [Change Password] screen is used to clear the value entered in the text field. It is not a button for changing the SMS login password back to the default value.

## MEAP Application Setting Information Management and Log Management

### Outline

The MEAP Application Setting Information Management page and the MEAP Application Log Management page provide menu related to "MEAP Application Configuration Service" for managing MEAP application setting information and "MEAP Application Log Service" for managing log information respectively.

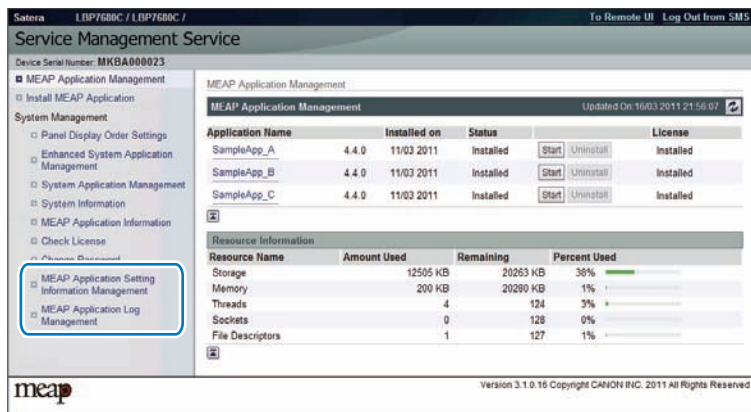

F-2-116

### MEAP Application Configuration Service

This service manages the MEAP application setting information. It has functions such as saving setting information to the MEAP area. Ver 57 of MEAP Specifications supports this service.

### MEAP Application Log Service

This service is used to collect MEAP application logs (debug logs and authentication logs). Ver.58 of MEAP Specifications supports this service.

## Advantages Obtained When Using the Services

By using MEAP Application Configuration Service and MEAP Application Log Service, as long as the MEAP application supports these services, you can perform data management tasks all together.

### In case of devices and MEAP application that do not support the service

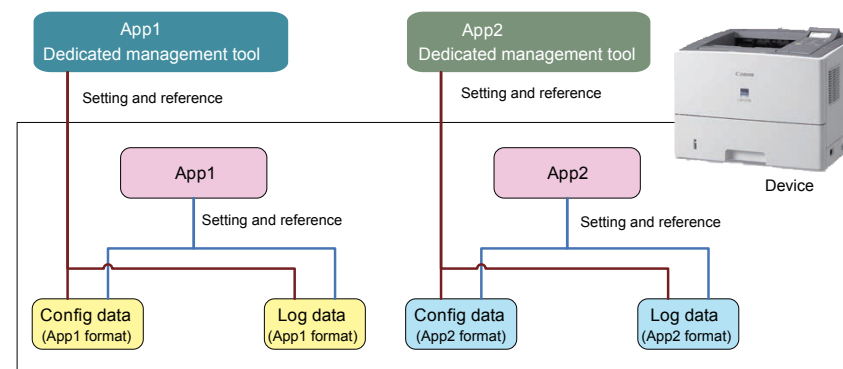

F-2-117

As for devices and MEAP application that do not support the service, the setting information and log data are managed separately by application.

### In case of devices and MEAP application that support the service

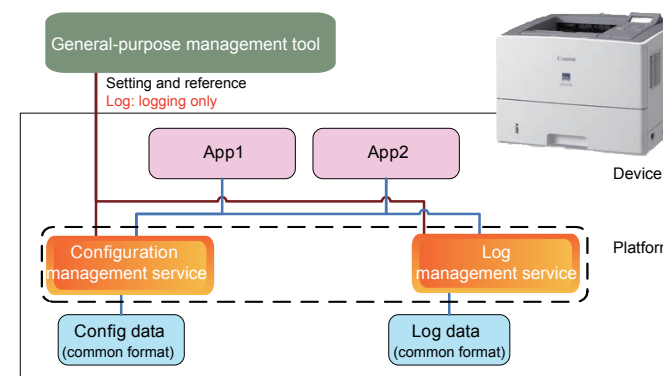

F-2-118

As for devices and MEAP application that support the service, information can be managed all together.

## MEAP Application Setting Information Management

The setting data (stored on the device) of the MEAP application which supports the Configuration Service can be deleted. The procedure is shown below.

- 1) Log in to SMS.
- 2) On System Management menu, click [ MEAP Application Setting Information Management ] button.



F-2-119

- 3) Select an application you want to delete, and then click the [ Delete ] button.

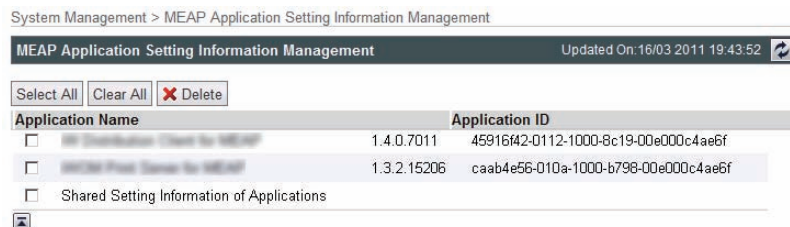

F-2-120

### Note:

If the installed MEAP application contains setting data which is not dedicated to the application but can be shared, the application name [Shared Setting Information of Applications] will be displayed.

## MEAP Application Log Management

The log data (stored on the device) of the MEAP application which supports the Log Service can be downloaded or deleted. The procedure is shown below.

- 1) Log in to SMS.
- 2) On System Management menu, click [ MEAP Application Log Management ] button.

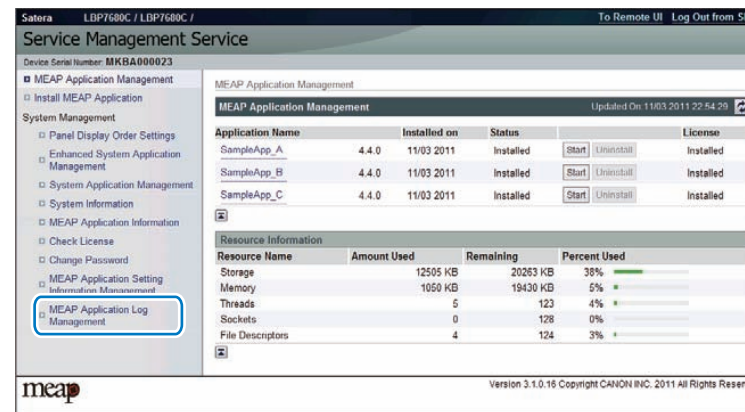

F-2-121

- 3) Click [ Download Application Logs ] or [ Delete Application Logs ].

System Management &gt; MEAP Application Log Management

### MEAP Application Log Management

[Download Application Logs](#)
[Delete Application Logs](#)

F-2-122

- 4) To download the log

The file save dialog for the log file will appear. Specify a destination and save the file.

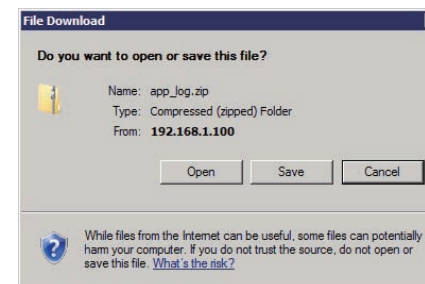

F-2-123

## 5) To delete the log

The confirmation screen will appear to prompt you to delete the log. Click the [ Yes ] button to delete the log.

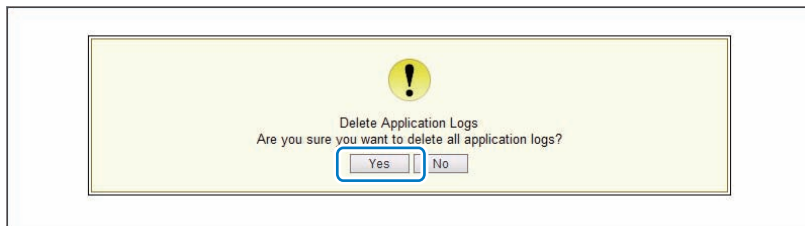

F-2-124

## Maintenance

### When Replacing the PCB

#### Outline

If the machine fails to operate normally due to a storage drive (Flash PCB) failure or a system (other than MEAP application) trouble, the storage drive needs to be replaced.

However, since the storage drive in this machine is directly mounted on to the PCB, replacement of the part alone is not possible; it is necessary to replace the PCB.

Since the storage drive of the machine cannot be backed up or restored, the MEAP application and the license file need to be reinstalled when replacing the PCB.

When the storage drive and the system are operating normally but the PCB is replaced due to other reasons, the MEAP application and license file need to be reinstalled.

The MEAP counter information cannot be lost because it is backed up like other conventional counters.

**Note:**

When the device has E code 616 displayed, this indicates that the trouble was caused by damage to the Flash PCB. If this error occurs, the PCB needs to be replaced.

#### Special license for reinstallation

When replacing the PCB, a special license file is required to reinstall the application with the expiration date of the current counter value migrated as it is. This special license file is handled as a service tool and cannot be obtained by end users.

In order to obtain a special license file, the service technician needs to contact the person in charge of support at the sales company.

The service technician needs to give the device serial number and the names of the MEAP applications that had been installed.

Since the support department of the sales company manages all the issued application license files by device serial number, it is basically possible for them to successively issue license files once the device serial number is confirmed.

**Note:**

The application that is installed with a reusable license can be reinstalled by using the same license.

## ● Procedure for reinstalling MEAP applications after replacing the PCB

The following shows the procedure when replacing the PCB.

### 1) Preparation before replacement

The following work needs to be done before replacing the PCB.

- Some MEAP applications have a function to back up or export the data to be used. If such a MEAP application is installed, back up or export the data in advance.
- In order to reinstall the applications, copy the licenses (special licenses, reusable licenses, etc.) of all the MEAP applications to the laptop PC.

### 2) Replacing the drive

Prepare the necessary service parts, and replace the drive.

### 3) Reinstalling the MEAP application

When the device has started normally, obtain the jar files of the MEAP applications from the user, and install them using the license files for reinstallation.

Installation method is the same as normal installation.

### 4) Importing user information

As necessary, make login service selections and import user information.

#### Note:

When you replace the PCB without uninstalling MEAP applications, make sure to reinstall the previously installed applications. Unless reinstalling them, MEAP counter will not be released and the message "The number of applications that can be installed has exceeded the limit. Try to install this application after uninstalling other applications." is displayed so that the installation of new applications may not be accepted. If you want to install new applications in this case, once reinstall the applications in-stalled before formatting and uninstall unnecessary applications.

#### WARNING:

- Do not install a Main PCB of another device and conduct operation check in order to check whether an error has occurred in the Main PCB. If the PCB is replaced and the system is started, the data on the installed PCB will be initialized.
- If an application was installed using a license other than reusable licenses and then installed using a special license for reinstallation, the moved MEAP counter information is migrated to the application.
- If the serial number is changed due to device replacement, a transfer license needs to be obtained and installed by a service technician as is the case with iR devices.

## ■ Actions to be taken when E616 is displayed.

### ● Overview

When E602 is displayed and then the device is restarted as a remedy, E616 may be displayed in some cases.

This is a symptom that occurs when the power is cut off without shutdown (such as disconnecting the plug of the device). The error code is displayed when the file system of the MEAP storage area is in an abnormal status.

When the device is started, it checks the file system. If the device detects an error, it displays the error code E602, disables the MEAP function, and then starts.

When the device is restarted according to the remedy for E602, the file system is recovered automatically in the system. If the recovery procedure succeeds, the device starts normally with the MEAP function enabled.

However, if the file system could not be recovered by auto recovery, E616 is displayed.

Since the system is automatically formatted when E616 is displayed, the installed MEAP applications will disappear and the device's MEAP function itself will also be disabled.

For this reason, it is necessary to enable the MEAP function and then reinstall the MEAP applications.

### ● Work procedure

Perform the following procedure when E616 is displayed.

- 1) Start the device in service mode.
- 2) Select [ Setup ] > [ SERVICE MODE ] > [ FUNCTION GR. ] > [ MEAP FUNCTION ] > On to enable the MEAP function.
- 3) Restart the device to start the MEAP function.
- 4) Access SMS, and then use a reusable license or special license for reinstallation to install the MEAP application.

#### Note:

As for MEAP applications that were installed using reusable licenses, the reusable licenses can be used to reinstall the applications. For other MEAP applications without reusable licenses, use special license files to reinstall them, in the same as way as handling a storage drive failure.

For information on how to obtain a special license for reinstallation, see "Special license for reinstallation" in this chapter. Then contact the support department of the sales company to have the license issued before starting the work.

- 5) Start the MEAP application.

## MEAP Safe Mode

### Outline

Use safe mode if you need to start up the system without worrying about extra applications. It will start up only those system software files (including SMS) that normally start up as default files while preventing MEAP applications and the like from starting up.

When you have made changes and restart the device, the control panel will indicate 'MPSF' in its lower right corner. The MEAP applications that may have been active before you shut down the equipment will not start up on their own. Make use of safe mode when restoring the system software as when MEAP applications or services cause a fault as the result of a conflict or wrong sequence of registration/use. You can access to SMS in this condition so that you can take necessary measures, for example, you can stop application that may cause the trouble.

If default authentication has been selected, the mode of authentication remains valid; otherwise, the message "The login service must be set again with SMS" appears. Change the login service as necessary.

### Starting in Safe Mode

To start the device in the MEAP SAFE mode, turn ON the power with the [ Application ] key and the [ ID ] key pressed.

### How to cancel MEAP SAFE mode

If you want to cancel MEAP SAFE mode, just restart the device as usual. It will start in normal mode.

#### Note:

If accessed to SMS in MEAP SAFE mode, the device started mode is shown on the title bar of the browser.

When normally started:

Service Management Service : <Device Name>: <Product Name>

When starting in MEAP SAFE mode:

Service Management Service : <Device Name>:<Product Name>: Safe Mode

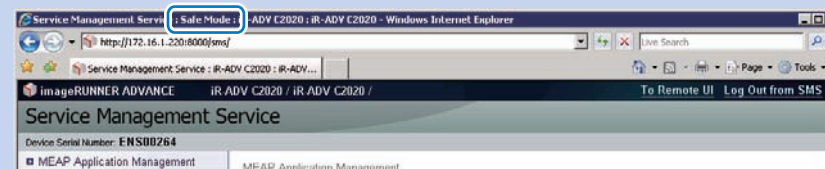

F-2-125

#### WARNING :

If the device has been started in the MEAP SAFE mode, all MEAP applications stop and the status becomes "Installed".

This status remains unchanged even if the MEAP SAFE mode is cancelled and the device is started again in normal mode. It is therefore necessary to access SMS after normal startup, and start the MEAP application.

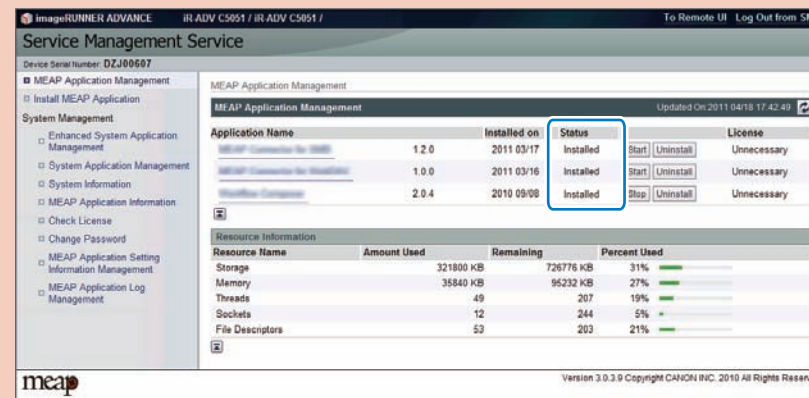

F-2-126



## Using USB Devices

### USB Driver

#### Two types of USB drivers

While the USB driver that can be used in iR series is only the USB driver designed exclusively for MEAP application (hereinafter referred to as “MEAP driver”), not only MEAP driver but also USB system driver (hereinafter referred to as “system driver”) can be used in iR-ADV series.

System driver and MEAP driver cannot be used together. When either of them is used, the other driver cannot be used.

In this model, the USB system driver supports only Mass Storage; HID is not supported. In other words, storage devices such as USB Flash memory can be used via system driver, but interface devices such as USB keyboard cannot be used via system driver.

### USB driver setting

System driver is active by default in iR-ADV series.

The driver can be changed in setup menu.

Usually, It is not necessary to change the setting because it is specified in the MEAP application side.

Only in the case of a special MEAP application, it is necessary to change the USB driver setting.

For details, refer to specifications of MEAP application side.

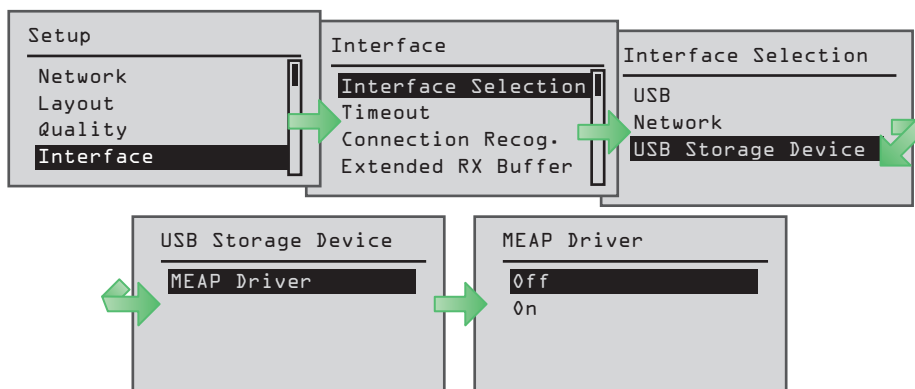

F-2-127

USB Storage Device Settings: [ MEAP Driver ]	Application that supports mass storage device	MEAP application that supports system driver
ON * MEAP driver (compatibility mode)	Can use USB mass storage device. Can work only on the applications that support the MEAP application driver.	Cannot use USB mass storage device.
OFF (*default) * Native driver	Cannot use USB mass storage device. (Device cannot be detected.)	Can use USB mass storage device.

T-2-18

Note:  
When any settings changes are made, the device must be restarted.

## ● Setting the USB driver for each USB device (MEAP driver preference registration)

If it is set to use the system driver, the conventional applications that support the MEAP application driver cannot use the USB input device.

Therefore, for the USB drivers used by USB devices/MEAP applications, there is setting function (MEAP driver preference registration) to give priority to the MEAP driver.

If you register the ID of the USB device by using this function, the USB device can use the MEAP driver despite the Additional Function settings.

Using this function requires the conditions below:

- Supported MEAP Spec Ver: 26
- Describe the idVendeor(VID) and idProduct(PID) of USB device in the manifest or activate/deactivate the VID and PID by calling API from MEAP applications.

The driver setting that is used in a manifest file is reflected in the following timing.

When registering from a manifest file.

- The registration will be enabled when an application is activated and device is restarted.
- The registration will be disabled when an application is stopped and device is restarted.

Availability for MEAP application of the USB device A (either HID keyboard or Mass Storage) plugged to iR device

Registration status of USB device A	USB Setting [ Use MEAP driver for USB input device ]	Native application	MEAP application		
			System driver supported application	System driver not supported/ conventional application	Application with VID/PID declared in Manifest for x
Not registered	OFF	YES	YES	NO	
	ON	NO	NO	YES	
Registered	OFF	NO	NO	YES	YES
	ON	NO	NO	YES	YES

YES: USB device available      NO: USB device not available

T-2-19

## ● Reference material

### ■ Glossary

Terms & Acronyms	Definitions and Explanations
Application	A program unit to provide users with solutions.
Application ID	An identifier assigned to each application. A unique ID is assigned to each MEAP application.
Applet (Applet Type Application)	A MEAP application type created in Java. This type of applications show buttons on the touch panel display.
Code Sign	Information to check if an application is genuine. An application marketed in the normal procedure has a code sign assigned by LMS. MEAP platform rejects applications without Canon code signs for being installed or executed on the device.
CPCA (Common Peripheral Controlling Architecture)	Common Peripheral Controlling Architecture. CPCA defines an object model of peripheral devices. A client can control a device by creating or modifying objects in the device.
CPCA Java CL (Class Library)	CPCA Java Class Library. A Java class library, which is used to control a device.
Default Authentication -Department ID Management	Default Authentication is a pre-installed login application that runs by default. It provides authentication functions to allow minimum operation of the Controller System, even when no other login application is running.
Device Specification ID	ID allocated to each device type. This represents CPCA API specification and the version number to use MFP generic functions or obtain information including maximum allowable copies.
Esplet (Esplet Type Application)	A MEAP application type created in Java. This type of applications do not show user interfaces either on Local UI or Web. Esplet is a coined word created by Canon, consisting of [ Espresso ] or Italian coffee and [ let ] derived from Applet/Service.
File Description	An identifier for the OS to identify the destination file requested by a program. A program descriptor includes an identifier and information such as a file name and size, which helps OS to judge the file to be edited.
HID class	HID stands for Human Interface Device, representing man-machine interfaces of PC components and peripheral devices. HID class means USB class classified as HID.
iR Native application	The functionalities that existing imageRUNNER has such as Copy, Universal Send and Mailbox.
ISV (Independent Software Vendor)	Independent Software Vender. Software manufacturer who develops and/or sells applications and tools but does not entire computer systems. Refers application developer in this document.
J2ME (Java2 Platform Micro Edition)	Java 2 Platform Micro Edition. One of Java Platforms licensed by Sun Microsystems, Inc. It is applied for MEAP. Other devices such as cellular phones and PDA.

Terms & Acronyms	Definitions and Explanations
J2RE (Java 2 Runtime Environment)	A set of basic programs to run applications developed in the programming language of Java2. This set includes Java virtual machine providing runtime environment for Java applications among others. Java applets do not require J2RE since these are executed on Web browsers using Java runtime environment provided on browsers. However, standalone Java applications require Java runtime environment such as J2RE for execution. Runtime environments can be downloaded for free of charge from the Web site of Sun Microsystems, the Java developer.
Java	A programming language developed by Sun Microsystems, in the U. S. A. Low dependent on models and OSes and runs on various platforms. Taking advantage of this feature, many applications that runs on web servers uses Java. The MEAP platform uses J2ME - a type of Java.
JavaScript	A script language developed by Netscape Communications, in the U.S. A., runs on web browsers such as Netscape Navigator and Internet Explorer. Allows web designers to create interactive pages with HTML files such as animated buttons and display of timetables.
Java VM (Java Virtual Machine)	JAVA Virtual Machine. The Java byte code interpreter. The Virtual Machine acts as an interpreter for processing the byte code using the native instruction set.
License Access Number	A number issued for accessing license file. The Licensing server requires entries of application ID, expiration date/times information, and the number of access numbers, to issue license access numbers
License File	A software manufacture of a MEAP application provides the users with the license files. Specifies the terms of agreement that a user concludes with the manufacturer. Required for installing a MEAP application.
LMS (License Management System)	The license is required for installing a MEAP application in a MEAP-enabled iR device. LMS is the server issuing [ License Files ] as well as license access numbers.
Login Service	Manages user information of MEAP device. Authenticates users with user names and passwords. Three login services are available for MEAP device - Default Authentication, which provides department ID control, SDL (Simple Device Login) and SSO (Single Sign-On).
Mass Storage class	Mass Storage means a storage device with large capacity, generally secondary storage devices. Mass Storage class means USB class classified in the secondary storage device group.
MEAP (Multifunction Embedded Application Platform)	Multifunctional Embedded Application Platform. Provides an environment for executing application programs on a peripheral device. Uses the Java platform (J2ME - Java 2 platform Micro Edition) to run Java application for MEAP.
MEAP Contents	Required to install an MEAP application to a MEAP device.

Terms & Acronyms	Definitions and Explanations
MEAP Specifications (MEAP Spec Version)	MEAP Spec Version, the term used for the SDK. The version number that shows the APIs of the MEAP platform other than CPCA, such as network and security. The version number is not assigned for each device model. MEAP Application Runs on MEAP platform. Consists of application files (*.jar) and the license file (*.lic).
MEAP-enabled iR device	imageRUNNER devices with built-in MEAP platform.
MFP (Multi Function Peripheral)	Multi Function Peripheral. Peripheral device that supports more than one function, such as digital copier, printer, scanner, and fax.
OSGi (Open Service Gateway Initiative)	Open Service Gateway Initiative. See " <a href="http://www.osgi.org/">http://www.osgi.org/</a> ".
Portal Service	The web portal to gain access to a MEAP-enabled device. This service has been integrated in Remote UI top page in iR ADVANCE series.
Protocol	A set of rules applied to data transmission procedures over network. Major communication protocols include: <ul style="list-style-type: none"> <li>• FTP: File Transfer Protocol. This is a communication protocol or protocol-implemented commands to provide file transfer between a host and clients over TCP/IP network.</li> <li>• DHCP: An upward compatible protocol of BOOTP. This communication protocol allocates a dynamic IP address to each client machine upon communication startup on TCP/IP network and collects the allocated IP address when communication is completed. The server allocates one of multiple IP addresses and notifies the setup information to a client.</li> <li>• BOOTP: A communication protocol to automatically load setup information including IP address and a domain name from the server to a client on TCP/IP network.</li> <li>• RARP: A communication protocol to request IP address information via the network adaptor address (MAC address) of a client.</li> <li>• IPP: A communication protocol to execute remote printing between the print server and clients via Internet.</li> <li>• TCP/IP: A standard communication protocol required to access to Internet and other large-scale network.</li> </ul>
Proxy Server	Provides functions to store data fetched from remote servers. When a user request to display a web page that has been displayed and stored in the proxy, the proxy server reads the stored data but does not access the remote server where the original page is present, for efficient access services. When a proxy server receives a URL from a PC, it searches the file in the cache and sends it to the PC if the requested file is found. If the requested file is not stored in the cache, it accesses the remote server of the URL to acquire the file and, at the same time, stores the acquired file in the cache so that the proxy server can quickly send the file at the next request.
Redistribution module	A built-in module of an application created with SDK. Applications without this module cannot work on MEAP platform.

Terms & Acronyms	Definitions and Explanations
SDK (Software Development Kit)	The kit containing information and tools required for software development.
Service	A functional unit or an application program working on MEAP platform. [ Applications ] are generally termed [ Services ] in Java world.
Servlet (Servlet Type Application)	A MEAP application type created in Java. This type of applications is designed to show user interface on the Web browser.
SMS (Service Management Service)	The web-base service to provide user interfaces for application life cycle management.
Socket	A virtual interface of an application for network communication. A user only needs to specify a socket as a unit of an address and a port from an application. This establishes the network connection for data transmission, eliminating complication related to detailed communication procedures.
SSO-H (Single Sign-On H)	Login service providing features of both local device authentication and domain authentication. The former is the method that iR device independently authorizes users; whereas the latter is that iR device links to the domain controller on the network in the Active Directory environment to authorize users.
Thread	A unit for program execution. A multi-task system allowing multiple programs to run concurrently assigns a memory space and other resources independently to each program, providing users with a feel as if only a program is running. At least one thread is generated upon a program generated.
URL (Uniform Resource Locator)	The method to denote Web page locations on Internet and the like. For instance, a URL on the Web is denoted as [ http://www.w3.org/default.html ]. [ http ] at the beginning means that an address following this is in a web page on the Internet.
USB	Abbreviation of Universal Serial Bus. This is the interface standard to link between information devices.
USB system driver	The general-purpose driver that control the behavior of the device, there are HID class driver, Mass Storage class driver and so on.

T-2-20

## Embedded RDS

### Product Overview

#### Overview

Embedded RDS (hereafter, referred to as E-RDS, which stands for EMBEDDED-RDS) is a network module embedded with a customer's device and enables e-Maintenance/ imageWARE Remote (Remote Diagnosis System), which can collect and transmit status changes, counter values, error logs, and consumable information such as the toner low/ out of the device to a remote maintenance server called UGW (Universal Gateway Server) via Internet.

The following device information/ status can be monitored.

- Service mode counter (Billing counts)
- Global click counter
- Parts counter
- Mode counter
- Firmware info
- Service call error log
- Jam log
- Alarm log
- Status changes (Toner low/ out, etc.)

Since high confidentiality is required for the information shown above, it performs communication between a device and the UGW using HTTPS/ SOAP protocol.

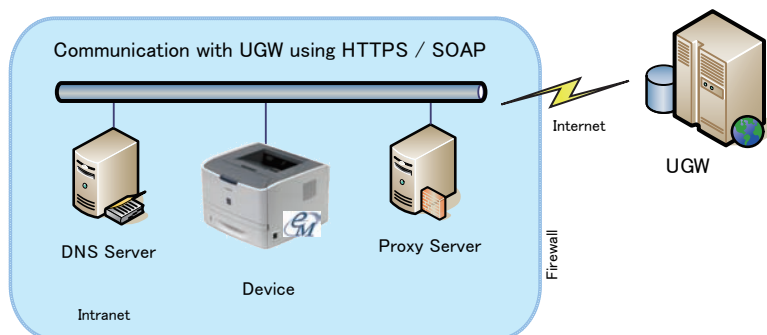

The e-Maintenance/ imageWARE Remote system using E-RDS

F-2-128

#### Features and benefits

E-RDS embedded with a network module in advance can realize a front-end processing of e-Maintenance/ imageWARE Remote system without attaching any extra hardware equipment.

## Service cautions

1) After performing the following service actions, it is necessary to perform initializing E-RDS settings (CLEAR), E-RDS settings (E-RDS SWITCH : ON) and communication test (COM-TEST).

Failure to do so will result that the counter transmitting value to the UGW may become unusual.

- RAM clear of MNCON

Also, after replacing the main controller board, all settings must be reprogrammed.

2) The following settings in service mode must not be change unless there are specific instructions to do so. Changing these values will cause error in communication with UGW.

- Set port number of UGW

[SERVICE MODE] > [NETWORK GR.] > [E-RDS] > [RGW-PORT]

Default : 443

- URL setting of UGW

[SERVICE MODE] > [NETWORK GR.] > [E-RDS] > [RGW-ADDRESS]

Default : https://a01.ugwdevice.net/ugw/agentif010

3) Conducting a communication test from service mode allows the service technician to see the communication log and judge the status of communication with the host. If the communication result is "NG", it appears in the latest communication log. As for models supporting communication tests in the user mode, the user can conduct a communication test and seen the communication test result. If the communication result is "NG", an error code (a hexadecimal number, 8 digits) appears in the communication log of LUI.

- During a communication test in user mode, do not take any actions such as pressing a key. Actions are not accepted until the communication test is completed (actions are ignored).
- When a communication test is being conducted from service mode or user mode, do not conduct a communication test from the other. These operations are not guaranteed.

4) If the e-Maintenance/imageWARE Remote contract of the device is invalid, be sure to turn OFF the E-RDS setting (E-RDS SWITCH).

## E-RDS Setup

### Confirmation and preparation in advance

To monitor a device with e-Maintenance/ imageWARE Remote, the following settings are required.

#### (1) Advance confirmation

Confirm with the UGW administrator that the device to be monitored with e-Maintenance/ imageWARE Remote is registered in the UGW.

#### (2) Advance preparations

Interview the user's system administrator in advance to find out the following information about the network.

##### Information item 1

IP address settings

- Automatic setting : DHCP, RARP, BOOTP (ON/ OFF selection)
- Manual setting : IP address, subnet mask and gateway address to be set

##### Information item 2

Is there a DNS server in use?

If there is a DNS server in use, find out the following.

- Primary DNS server address
- Secondary DNS server address

##### Information item 3

Is there a proxy server?

If there is a proxy server in use, find out the following.

- Proxy server address
- Port No. for proxy server

##### Information item 4

Is proxy server authentication required?

If proxy server authentication is required, find out the following.

- User name and password required for proxy authentication

### (3) Network settings

Based on the results of the information obtained in (2) Advance preparations, make the device network related settings.

See Users' Guide for detailed procedures.

#### CAUTION:

Ensure to reboot the device when any change is added to the network setting.

## E-RDS setting items (service mode)

Item	Description
E-RDS SWITCH (NETWORK GR. > E-RDS)	Set use/ no use of Embedded-RDS function Off: Function not used / On: Function used e-Maintenance/ imageWARE Remote system to send device information, counter data, error statuses to the UGW. Default : Off (Function not used)
RGW-ADDRESS (NETWORK GR. > E-RDS)	URL setting of UGW Max 128 characters Default : https://a01.ugwdevice.net/ugw/agentif01
RGW-PORT (NETWORK GR. > E-RDS)	Set port number of UGW Validation : 1 to 65535 Default : 443
COM-TEST (NETWORK GR. > E-RDS)	Execution of a communication test with UGW / Display of the result Perform Communication test with UGW and set "Done." or "Could not execute." as the result.
COM-LOG (NETWORK GR. > E-RDS)	Display of detailed information about a communication error with UGW Error information of a connection failure with UGW is displayed. Error occurrence date and time, error code, and detailed error information are displayed. Max 5 latest loggings retained Max 128 characters for Error information.
CLEAR (NETWORK GR. > E-RDS)	Initialization of E-RDS SRAM data SRAM data of E-RDS is initialized and returned to the factory setting value at shipment.
CLEAR (NETWORK GR. > CA-KEY)	Initialization of CA certificate When the power is turned OFF/ ON after execution, the CA certificate in the factory setting is automatically installed.

T-2-21

## Steps to E-RDS settings

1. Start [Service Mode].
2. Select [NETWORK GR.] and press [OK] or [▶] button to go to the network setting menu.

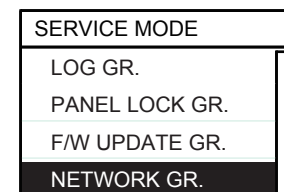

F-2-129

3. Select [E-RDS] and press [OK] or [▶] button to go to E-RDS setting menu.

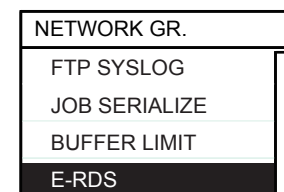

F-2-130

4. Select [CLEAR] and press [OK] or [▶] button to display Confirm Initialization screen. Select [Yes] and press [OK] button.

#### NOTE:

This operation initializes the E-RDS settings to factory setting values. For the setting values to be initialized, see the section of "Initializing E-RDS settings".

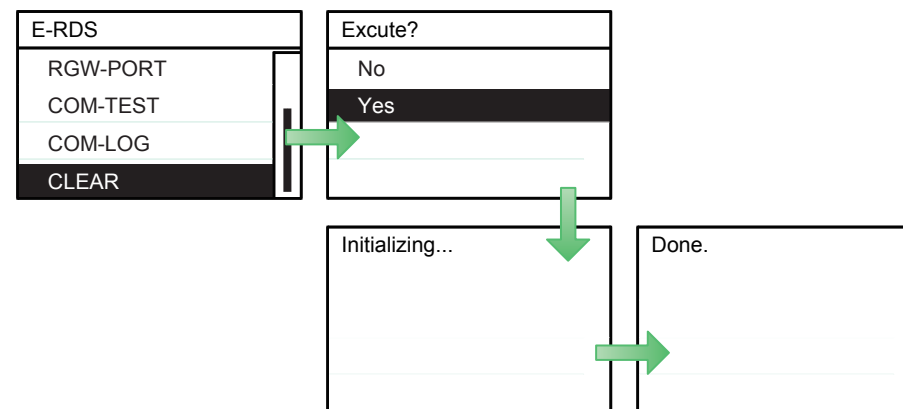

F-2-131

5. Perform installation or deletion of the CA certificate if necessary, and reboot the device.
- Installation of the CA certificate: Perform installation from SST.
  - Deletion of the CA certificate: When the following operation is performed, the CA certificate in the factory setting is automatically installed.

**CAUTION:**

After following procedure, the registered key and CA certificate are deleted, and only the CA certificate installed at the time of shipment is registered.  
It is therefore necessary to check with the user in advance.

- 1) Select [NETWORK GR.] > [CA-KEY] > [CLEAR] and press [OK] or [▶] button to display Confirm Clear screen. Select [Yes] and press [OK] button.

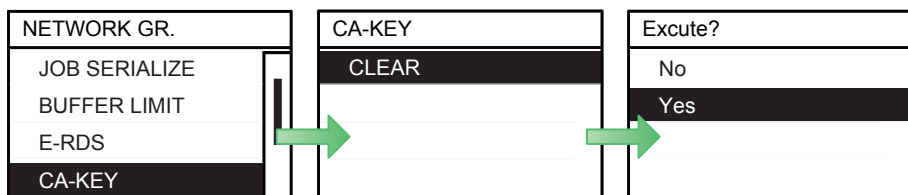

F-2-132

- 2) Reboot the device.

**CAUTION:**

If a key and a CA certificate have been registered in order to use a function other than E-RDS, it is necessary to register again from SST.

6. Activate [SERVICE MODE].

7. Select [NETWORK GR.] > [E-RDS] > [E-RDS SWITCH] and press [OK] or [▶] button.

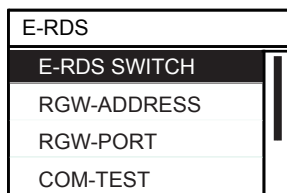

F-2-133

8. Select [On] and press [OK] button.

**NOTE:**

This operation enables the communication function with UGW.

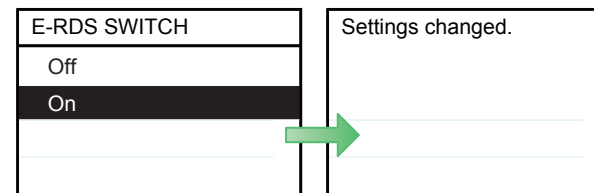

F-2-134

9. Press [Back] or [◀] button to go back to E-RDS Setup menu.

**CAUTION:**

The following settings i.e. RGW-PORT and RGW-ADDRESS in Service mode must not be change unless there are specific instructions to do so.

Changing these values will cause error in communication with UGW.

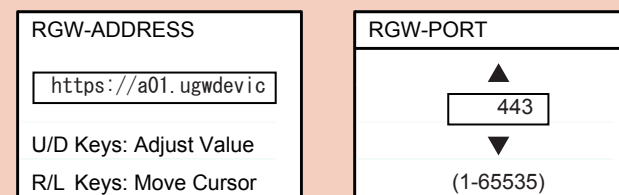

10. Select [COM-TEST] and press [OK] or [▶] button to display Confirm Communication Test screen. Select [Yes] and press [OK] button.

**NOTE:**

This initiates the communication test between the device and the UGW.

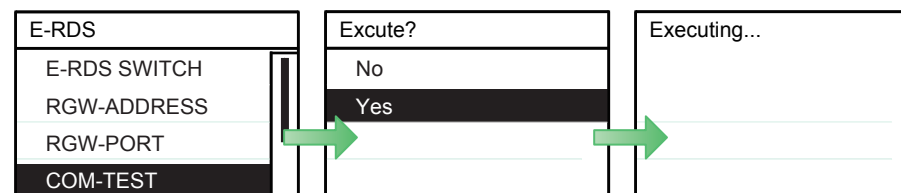

F-2-135



If the communication is successful, "Done." is displayed. If "Could not execute." (failed) appears, refer to the "Troubleshooting" and repeat until "Done." is displayed.

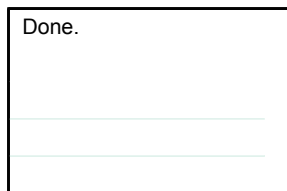

F-2-136

**NOTE:**

The communication results with UGW can be distinguished by referring to the communication log. By performing the communication test with UGW, E-RDS acquires schedule information and starts monitoring and meter reads operation.

## ■ Initializing E-RDS settings

It is possible to return E-RDS Settings to factory-shipments value.

### ● Setting values and data to be initialized

The following E-RDS settings, internal data, and Alarm filtering information are initialized.

- E-RDS > E-RDS SWITCH
- E-RDS > RGW-ADDRESS
- E-RDS > RGW-PORT
- E-RDS > COM-LOG

**CAUTION:**

In case of replacing the CA certificate file, even if initialization of E-RDS is executed, the status is not returned to the factory default.

When installing the certificate file other than the factory default CA certificate file, it is required to delete the certificate file after E-RDS initialization and install the factory default CA certificate file.

For detailed procedures, see "Steps to E-RDS settings - step 5."

### ● Initialization procedure

1. Start [Service Mode].
2. Select [NETWORK GR.] and press [OK] or [▶] button to go to the network setting menu.

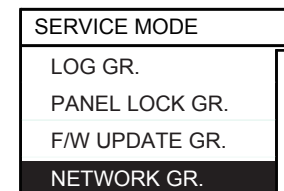

F-2-137

3. Select [E-RDS] and press [OK] or [▶] button to go to E-RDS setting menu.

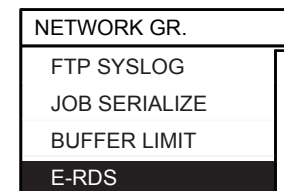

F-2-138

4. Select [CLEAR] and press [OK] or [▶] button to display Confirm Initialization screen. Select [Yes] and press [OK] button.

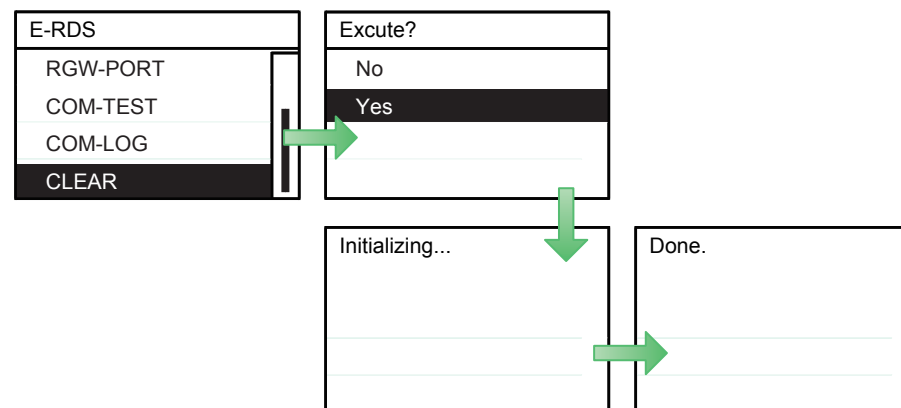

F-2-139

## FAQ

### No.1

#### Q: In what case does a communication test with UGW fail?

A: The following cases can be considered in the becoming "Could not execute." case.

1. Name resolution was failed due to an incorrect host name or DNS server has been halted.
2. Network cable is blocked off.
3. Proxy server settings is not correct.

### No.2

#### Q: I want to know the interval of data transmitting from E-RDS to the UGW, and what data size is sent to the UGW?

A: The schedule of data transmitting, the start time are determined by settings in the UGW side. The timing is once per 16 hours by default, and counter data volume could be maximum 250 bytes.

### No.3

#### Q: Does error-retry carry out at the time of a communication error with the UGW?

A: Retry of SOAP communication is performed as follows.

- In the case of an error in SOAP communication (i.e. a trouble at UGW side) at transmission of the alarm code list and the service mode counter (postAlert) due to change of device status, the data failed in transmission equivalent to 3 retries is to be stored in the RAMDISC. In the case of another transmission error (the 4th error), the oldest data of the stored data is deleted and the newly-generated retry data is stored in the RAMDISC.
- In the case of SOAP transmission errors as described below, the unsent (and remaining) data is sent again depending on the storage status of CPCA data:
  - At transmission of a jam log and service mode counter (postJamLog) when the jam log was obtained from the device.
  - At transmission of a service call log and service mode counter (postServiceCallLog) when the service log was obtained from the device.
  - At transmission of an alarm log and service mode counter (postAlarmLog) when the alarm log was obtained from the device.

#### NOTE:

- The retry data will be sent at interval of 5\*n minutes. (n: retries, 5, 10, 15 minutes...up to 30 minutes)
- HDD is not installed in this device; even after the power is turned OFF/ON, postAlert, postJamLog, postServiceCallLog, postAlarmLog will not be resent.

### No.4

#### Q: How many log-data can be stored?

A: Up to 5 log data can be saved. The data size of error information is maximum 128 characters.

### No.5

#### Q: Although Microsoft ISA as a proxy server is introduced, the authentication check is failed. Can E-RDS adopt with Microsoft ISA?

A: E-RDS must comply with "Basic" while "Integrated" authentication is used for Microsoft ISA (as default); therefore, authentication with E-RDS is available if you change the setting to "Basic" authentication on the server.

### No.6

#### Q: Can I turn the device power off during the e-Maintenance/ imageWARE Remote system operation?

A: While operating the e-Maintenance/ imageWARE Remote system, the power of the device must be ON. If power OFF is needed, do not leave the device power OFF for long time. It will become "Device is busy, try later" errors if the power supply of network equipment such as HUB is made prolonged OFF.

### No.7

#### Q: Although a Service call error may not be notified to UGW, the reason is what?

A: If a service technician in charge turns off the power supply of a device immediately after error occurred once, It may be unable to notify to UGW because data processing does not take a time from the controller of the device to NIC though, the data will be saved on the RAM.

If the power supply is blocked off while starting up, the data will be inevitably deleted.

### No.8

#### Q: How does E-RDS operate while the device is placed in the sleep mode?

A: While being in Real Deep Sleep, and if data to be sent is in E-RDS, the system wakes up asleep, then starts to send the data to the UGW. The system also waits for completion of data transmission and let the device to shift to asleep status again.

However, transition time to the Real Deep Sleep depends on the device, and the transition to sleep won't be done if the next data transmission will be done within 1 minute.

### No.9

#### Q: Is E-RDS compatible with Department counter?

A: No, E-RDS does not support Department counter.

## Troubleshooting

### No.1

**Symptom:** A communication test (COM-TEST) has failed.

**Cause:** Initial settings or network conditions is incomplete.

**Remedy 1:** Check and take actions mentioned below.

#### 1) Check network connections

Is the status indicator LED for the HUB port to which the main unit is connected ON?

YES: Proceed to Step 2).

NO: Check that the network cable is properly connected.

#### 2) Confirmation from another PC connected to same network.

Request the user to ping the main unit from a PC connected to same network.

Does the main unit respond?

YES: Proceed to Step 3).

NO: Confirm the details of the main unit's IP address and subnet mask settings.

#### 3) Confirm DNS connection

(a) Take a note of both primary and secondary DNS server addresses.

See Users' Guide for detailed procedures.

(b) Use ping command to confirm the primary DNS server IP address against the note taken in Step (a).

See Users' Guide for detailed procedures.

Is the IP address properly configured?

YES: Proceed to Remedy 2.

NO: Confirm the secondary DNS server IP address against the note taken in Step (a).

Is the IP address properly configured?

YES: Proceed to Remedy 2.

NO: There is a possibility that the DNS server address is wrong. Reconfirm the address with the user's system administrator.

**Remedy 2:** Troubleshooting using communication log (COM-LOG)

1) Start [Service Mode].

2) Select [NETWORK GR.] > [E-RDS] > [COM-LOG] and press [OK] or [▶] button to display List Communication Log screen.

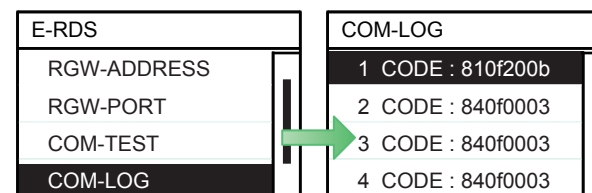

F-2-140

#### NOTE:

- Only the initial part of error information is displayed in the communication log list screen.
- "None." is shown when nothing is logged.

3) Select the log of your interest and press [OK] or [▶] button to show the date and time of the error occurrence.

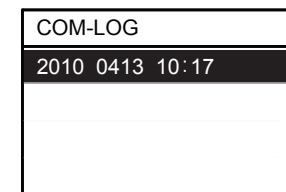

F-2-141

4) Press [OK] or [▶] button to show the detailed error information.

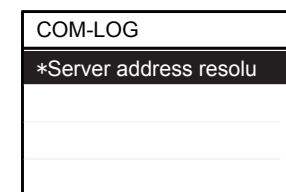

F-2-142

## NOTE:

- The detailed error information will be displayed in multiple screens as shown below. Use [◀] or [▶] button to move around the screens.

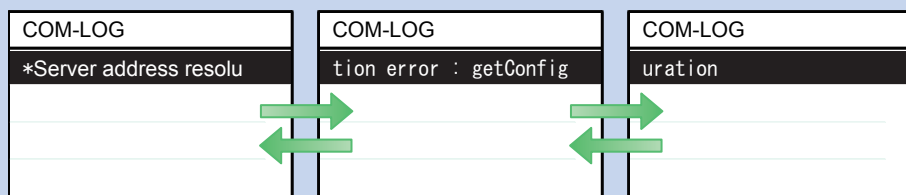

- The data size of error details information is Max 128 characters.
- Press [Back] button to return to Date and Time of Error Occurrence screen.

- When a message is displayed, take an appropriate action referring to "Error code and strings".

## No.2

Symptom: A communication test has failed even if network setting is set properly.

Causes: The network environment is inappropriate, or RGW-ADDRESS or RGW-PORT settings for E-RDS have been changed.

Remedy: The following points should be checked.

- Check network conditions such as proxy server settings and so on.
- Check the E-RDS setting values.
  - Check the communication log from COM-LOG.
  - Check whether RGW-ADDRESS or RGW-PORT settings has changed. If RGW-ADDRESS or RGW-PORT settings has changed, restore initial values. For initial values, see "E-RDS setting items (service mode)".

## No.3

Symptom: Registration information of the E-RDS machine was deleted from the device information on Web Portal, and then registered again. After that, if a communication test is left unperformed, the device setting in the UGW becomes invalid.

Causes: When the registration information of the E-RDS machine is deleted, information related to E-RDS is also deleted.

Therefore, when 7 days have passed without performing a communication test after registering the E-RDS machine again, the device setting becomes invalid.

Remedy: Perform a communication test before the device setting becomes invalid.

## No.4

Symptom: There was a log, indicating "Device is not ready, try later" in error details of COM-LOG list.

Cause: A certain problem occurred in networking.

Remedy: Check and take actions mentioned below.

- Check networking conditions and connections.
- Turn on the power supply of a device and perform a communication test about 60 seconds later.

## No.5

Symptom: "Unknown error" is displayed though a communication test has done successfully.

Cause: It could be a problem at the UGW side or the network load is temporarily faulty.

Remedy: Try again after a period of time. If the same error persists, check the UGW status with a network and UGW administrator.

## Error code and strings

The following error information is output in the communication error log details display screen. (Here, "a server" means UGW.)

- The error information are displayed in the following form.  
[\*] [Error strings] [Method name] [Error details provided by UGW]

### NOTE:

"\*\*" is added to the top of the error text in the case of an error in communication test (method name: getConfiguration or communicationTest) only.

No.	Code	Error strings	Cause	Remedy
1	0000 0000	SUSPEND: mode changed.	Unmatched Operation Mode	Initialize the E-RDS setting (E-RDS > CLEAR).
2	0500 0003	SUSPEND: Communication test is not performed.	Rebooting the device while the communication test had not been performed although E-RDS is enabled.	Perform a communication test (COM-TEST).
3	0xxx 0003	Server schedule is not exist	Blank schedule data have been received from UGW.	Perform and complete a communication test (COM-TEST).
4	0xxx 0003	Communication test is not performed	Communication test has not completed.	Perform and complete a communication test (COM-TEST).
5	84xx 0003	E-RDS switch is setted OFF	A communication test has been attempted with the E-RDS switch being OFF.	Set E-RDS switch (E-RDS) to ON, and then perform a communication test (COM-TEST).
6	8600 0002 8600 0003 8600 0101 8600 0201 8600 0305 8600 0306 8600 0401 8600 0403 8600 0414 8600 0415	Event Registration is Failed	Processing (event processing) within the device has failed.	Turn the device OFF/ ON. If the error persists, replace the device system software. (Upgrade)
7	8700 0306	SRAM version unmatch!	Improper value is written in at the head of the Main Controller PCB 2 SRAM domain of E-RDS.	Turn the device OFF/ ON.
8	8xxx 0004	Operation is not supported	Method which E-RDS is not supporting attempted.	Contact help desk

No.	Code	Error strings	Cause	Remedy
9	8xxx 0101	Server response error (NULL)	Communication with UGW has been successful, but an error of some sort has prevented UGW from responding. When (Null) is displayed at the end of the message, this indicates that there has been an error in the HTTPS communication method.	Perform and complete a communication test (COM-TEST).
10	8xxx 0201 8xxx 0202 8xxx 0203 8xxx 0204 8xxx 0206	Server schedule is invalid	During the communication test, there has been some kind of error in the schedule values passed from UGW.	When the error occurs, report the details to the support section. And then, after the UGW side has responded, try the communication test again.
11	8xxx 0207 8xxx 0208	Internal Schedule is broken	The schedule data in the inside of E-RDS is not right.	Perform a communication test (COM-TEST).
12	8xxx 0221	Server specified list is too big	Alert filtering error: The number of elements of the list specified by the server is over restriction value.	Alert filtering is not supported by UGW.
13	8xxx 0222	Server specified list is wrong	Alert filtering error: Unjust value is included in the element of the list specified by the server.	Alert filtering is not supported by UGW.
14	8xxx 0304	Device is busy, try later	The semaphore consumption error at the time of a communication test.	Try again a communication test after a period of time.
15	8xxx 2000	Unknown error	Some other kind of communication error has occurred.	Perform and complete a communication test (COM-TEST).
16	8xxx 2001	URL Scheme error(not https)	The header of the URL of the registered UGW is not in https format.	Check that the value of URL of UGW (RGW-ADDRESS) is https://a01.ugwdevice.net/ugw/agentif010.
17	8xxx 2002	URL server specified is illegal	A URL different to that specified by the UGW has been set.	Check that the value of URL of UGW (RGW-ADDRESS) is https://a01.ugwdevice.net/ugw/agentif010.
18	8xxx 2003	Network is not ready, try later	Communication attempted without confirming network connection, just after booting up a device in which the network preparations are not ready.	Check the network connection, as per the initial procedures described in the troubleshooting. Perform a communication test (COM-TEST) about 60 seconds later, after turn on the device.

No.	Code	Error strings	Cause	Remedy
19	8xxx 2004	Server response error ([Hexadecimal]) [Error detailed in the UGW] *1	Communication with UGW has been successful, but an error of some sort has prevented UGW from responding.	Try again after a period of time. Check detailed error code (Hexadecimal) and [Error details in UGW] from UGW displayed after the message.
20	8xxx 200A	Server connection error	<ul style="list-style-type: none"> <li>TCP/IP communication fault</li> <li>The IP address of device is not set.</li> </ul>	Check the network connection, as per the initial procedures described in the troubleshooting.
21	8xxx 200B	Server address resolution error	Server address name resolution has failed.	Check that the value of URL of UGW (RGW-ADDRESS) is https://a01.ugwdevice.net/ugw/agentif010.
22	8xxx 2014	Proxy connection error	Could not connect to proxy server due to improper address.	Check proxy server address and re-enter as needed.
23	8xxx 2015	Proxy address resolution error	Could not connect to proxy server due to name resolution error of proxy address.	Check that the proxy server name is correct. If the proxy server name is correct, check the DNS connection, as per the initial procedures described in the troubleshooting.
24	8xxx 201E	Proxy authentication error	Proxy authentication is failed.	Check the user name and password required in order to login to the proxy, and re-enter as needed.
25	8xxx 2028	Server certificate error	<ul style="list-style-type: none"> <li>No route certificate installed in device.</li> <li>Certificate other than that initially registered in the user's operating environment is being used, but has not been registered with the device.</li> </ul>	Install the latest device system software. (Upgrade)
26	8xxx 2029	Server certificate verify error	The server certificate verification error occurred.	Check that the value of URL of UGW (RGW-ADDRESS) is https://a01.ugwdevice.net/ugw/agentif010.
27	8xxx 2046	Server certificate expired	<ul style="list-style-type: none"> <li>The route certificate registered with the device has expired.</li> <li>Certificate other than that initially registered in the user's operating environment is being used, but has not been registered with the device.</li> <li>The device time and date is outside of the certificated period</li> </ul>	Check that the device time and date are correctly set. If the device time and date are correct, upgrade to the latest system software.

No.	Code	Error strings	Cause	Remedy
28	8xxx 2047	Server response time out	Due to network congestion, etc., the response from UGW does not come within the specified time. (HTTPS level time out)	If this error occurs when the communication test is being run, try again after a period of time.
29	8xxx 2048	Service not found	There is a mistake in the UGW URL, and UGW cannot be accessed. (Path is wrong)	Check that the value of URL of UGW (RGW-ADDRESS) is https://a01.ugwdevice.net/ugw/agentif010.
30	8xxx 2052	URL error	The data which is not URL is inputted into URL field.	Check that the value of URL of UGW (RGW-ADDRESS) is https://a01.ugwdevice.net/ugw/agentif010.
31	8xxx 2058	Unknown error	SOAP Client fails to obtain SOAP Response. Possibility of a problem in the server or of a temporary problem in the network load.	Perform and complete a communication test (COM-TEST).
32	8xxx 2063	SOAP Fault	SOAP communication error has occurred.	Check that the value of port number of UGW (RGW-PORT) is 443.
33	xxxx xxxx	Device internal error	An internal error, such as memory unavailable, etc., has occurred during a device internal error phase.	Turn the device OFF/ ON. Or replace the device system software. (Upgrade)
34	xxxx xxxx	SUSPEND: Initialize Failure!	Internal error occurred at the initiating E-RDS.	Turn the device OFF/ ON.

T-2-22

\*1 [Hexadecimal]: indicates an error code returned from UGW.  
[Error details in UGW]: indicates error details returned from UGW.

# 3

## Disassembly/ Assembly

- List Of Parts
- External Cover, Internal Cover
- Controller System
- Laser Exposure System
- Image Forming System
- Fixing System
- Paper Pickup/Transport/Output System

## Preface

### ● Outline

This chapter describes disassembly and reassembly procedures of the printer.

Note the following precautions when working on the printer.

1. **CAUTION:** Before disassembling or reassembling the printer, be sure to disconnect its power cord from the electrical outlet
2. During disassembly, reassembly or transportation of the printer, remove the cartridge if required.  
When the cartridge is out of the printer, put it in a protective bag even in a short period of time to prevent the adverse effect of light.
3. Reassembling procedures are followed by the reverse of disassembly unless otherwise specified.
4. Note the length, diameters, and locations of screws as you remove them. When reassembling the printer, be sure to use them in their original locations.
5. Do not run the printer with any parts removed as a general rule.
6. Ground yourself by touching the metal part of the printer before handling the PCB to reduce the possibility of damage caused by static electricity.
7. When you replace the part that the rating plate or the product code label is attached, be sure to remove the rating plate or the product code label and put it to the new part.

## List Of Parts

### ● External View

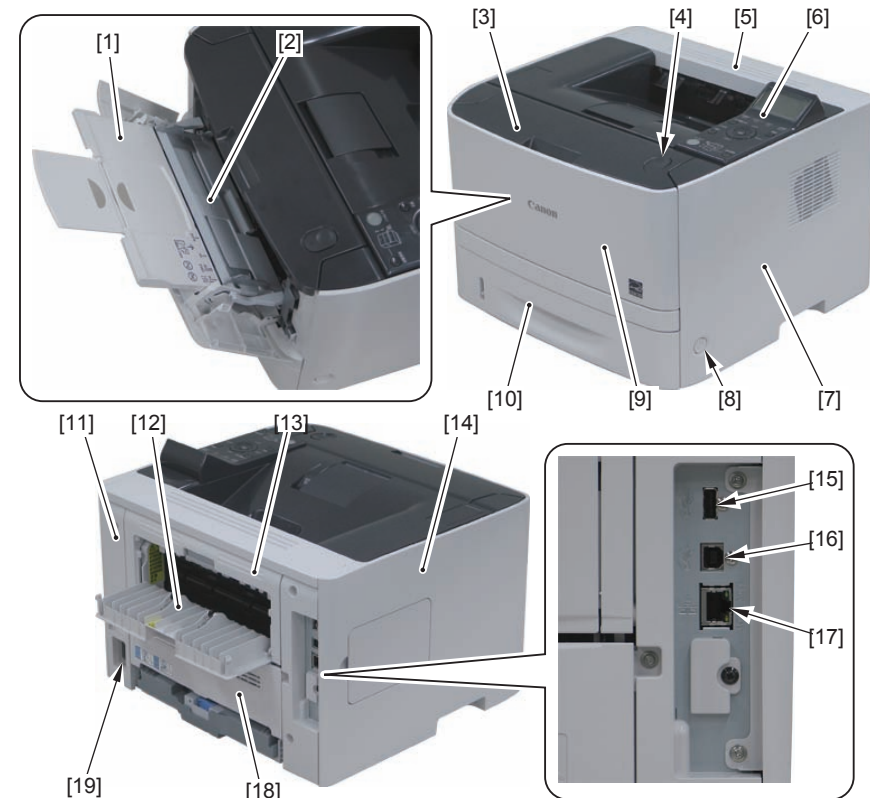

No.	Name	No.	Name
[1]	Auxiliary Tray	[11]	Rear Cover
[2]	Multi-purpose Tray	[12]	Face-up Output Tray
[3]	Front Cover	[13]	Pressure Release Cover
[4]	Open Button	[14]	Left Cover
[5]	Upper Cover	[15]	USB Host
[6]	Control Panel	[16]	USB Device
[7]	Right Cover	[17]	LAN Connector
[8]	Power Switch	[18]	Duplex Unit Cover
[9]	Face-down Output Tray Cover	[19]	Power Socket
[10]	Paper Cassette		

T-3-1



## List of Main Unit

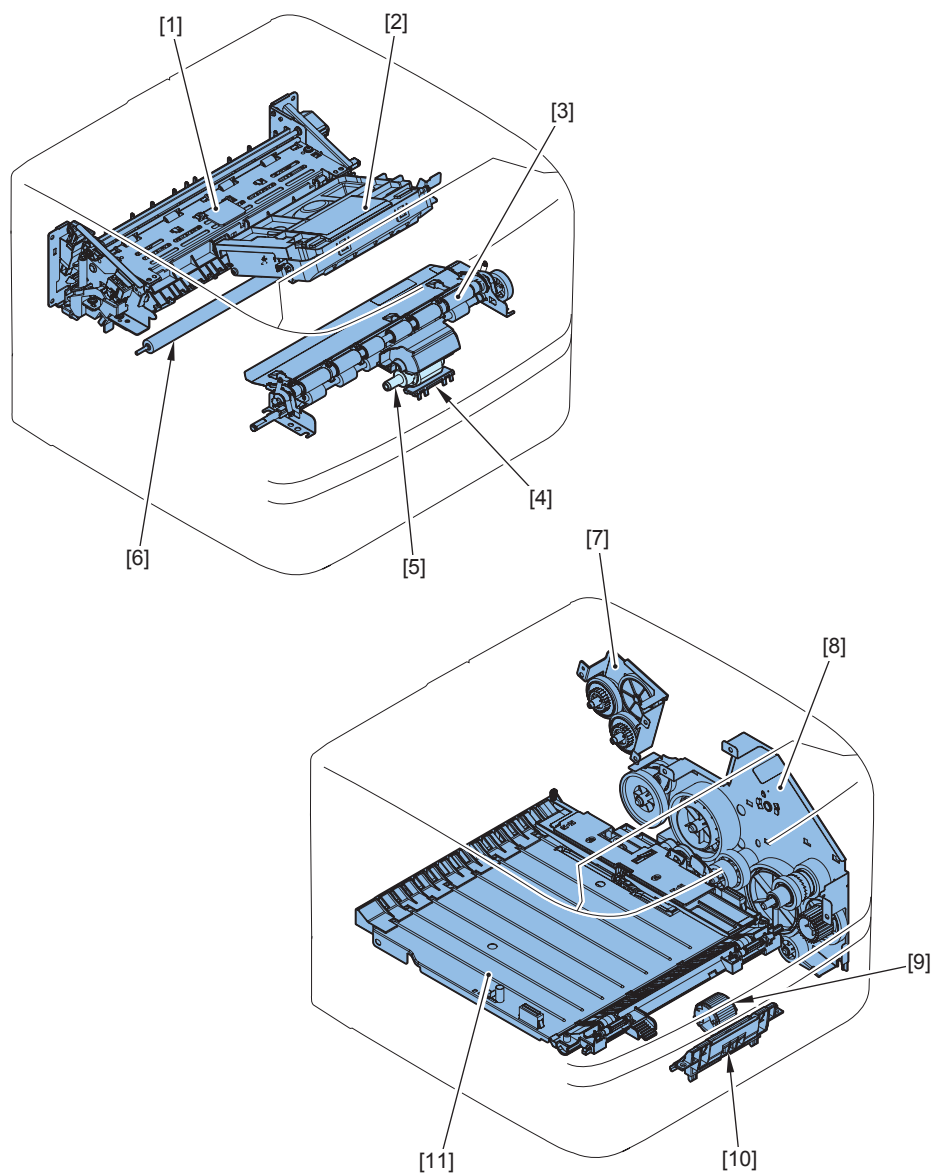

F-3-1

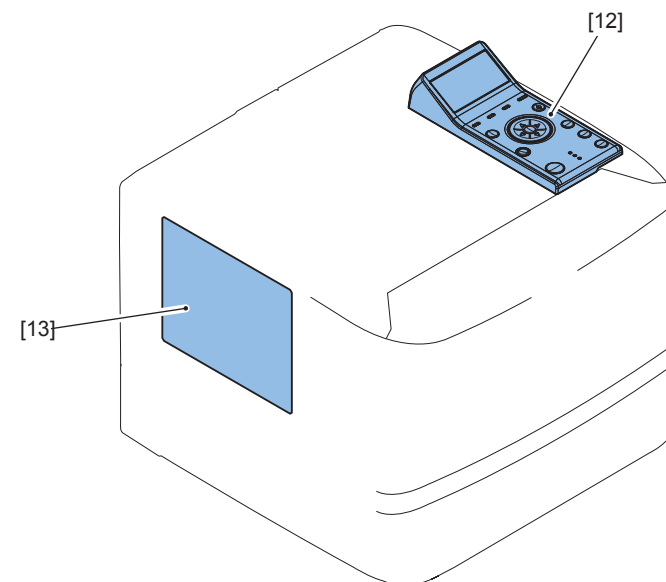

No.	Name	Reference
[1]	Fixing Unit	(Refer to page 3-25)
[2]	Laser Scanner Unit	(Refer to page 3-22)
[3]	Registration Unit	(Refer to page 3-23)
[4]	Multi-purpose Separation Pad	(Refer to page 3-29)
[5]	Multi-purpose Pickup Roller	(Refer to page 3-28)
[6]	Transfer Roller	(Refer to page 3-23)
[7]	Duplex Drive Unit	(Refer to page 3-20)
[8]	Main Drive Unit	(Refer to page 3-18)
[9]	Cassette Pickup Roller	(Refer to page 3-27)
[10]	Cassette Separation Pad	(Refer to page 3-28)
[11]	Duplex Feed Unit	(Refer to page 3-10)
[12]	Control Panel	(Refer to page 3-17)
[13]	Main Controller Board	(Refer to page 3-12)

T-3-2

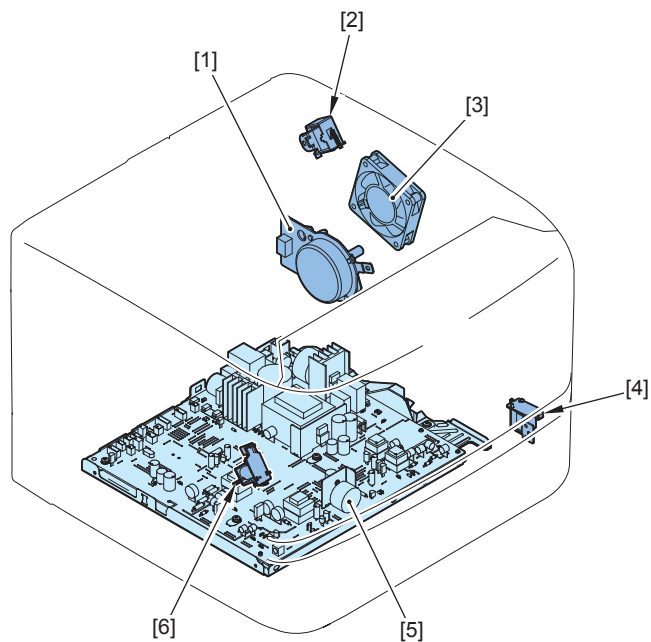

F-3-2

No.	Name	Reference
[1]	Main Motor	(Refer to page 3-17)
[2]	Duplex Reversal Solenoid	(Refer to page 3-21)
[3]	Main Fan	(Refer to page 3-18)
[4]	Cassette Pickup Solenoid	(Refer to page 3-20)
[5]	Engine Controller Board	(Refer to page 3-14)
[6]	Multi-purpose Solenoid	(Refer to page 3-21)

T-3-3

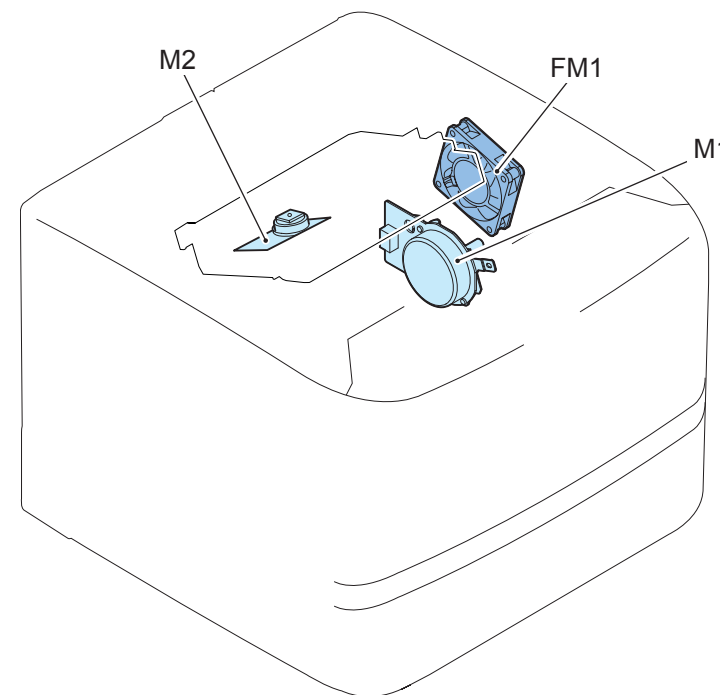

F-3-3

No.	Name	Main Units	Reference
M1	Main Motor	-	(Refer to page 3-17)
M2	Scanner Motor	Laser Scanner Unit	(Refer to page 3-22)
FM1	Main Fan	-	(Refer to page 3-18)

T-3-4

## Solenoid

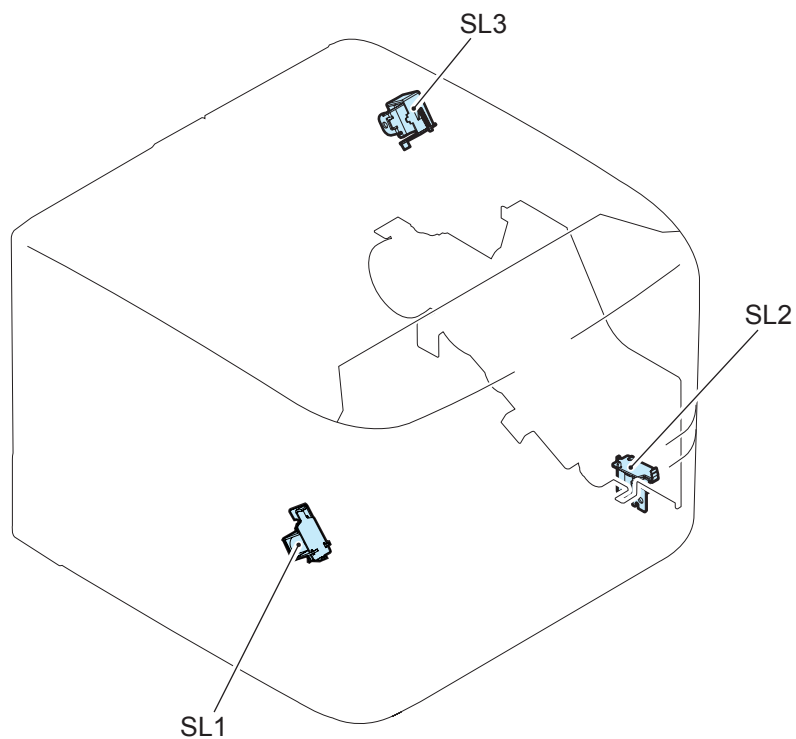

F-3-4

No.	Name	Main Units	Reference
SL1	Multi-purpose Solenoid	-	(Refer to page 3-21)
SL2	Cassette Pickup Solenoid	Main Drive Unit	(Refer to page 3-20)
SL3	Duplex Reversal Solenoid	-	(Refer to page 3-21)

T-3-5

## Heater / Thermo Switch / Thermistor / Switch

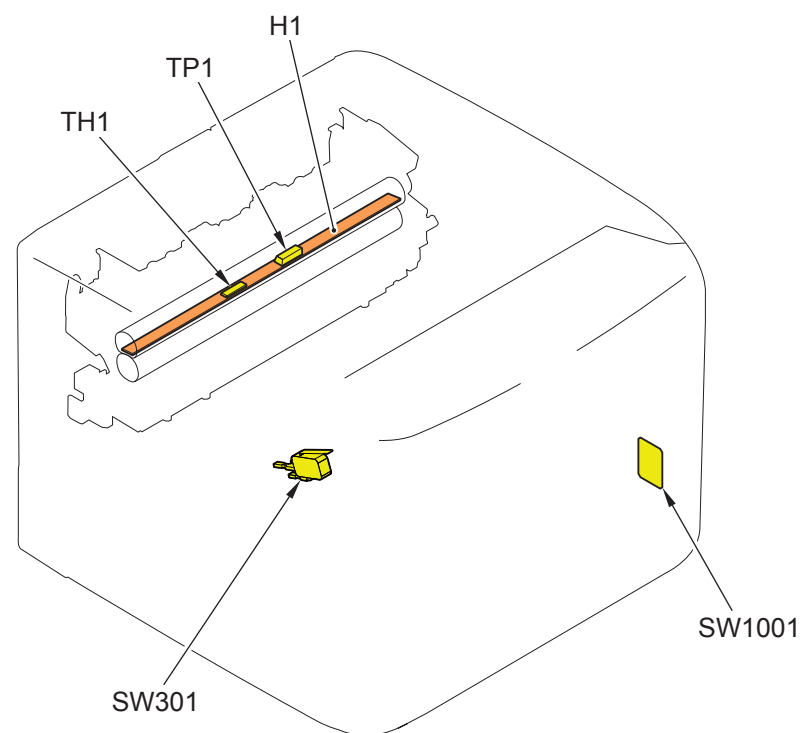

F-3-5

No.	Name	Main Units	Reference
H1	Fixing Heater	Fixing Unit	-
TP1	Fixing Thermo Switch	Fixing Unit	-
TH1	Fixing Thermistor	Fixing Unit	-
SW1001	Power Switch	-	-
SW301	Door Switch	-	-

T-3-6

Sensor

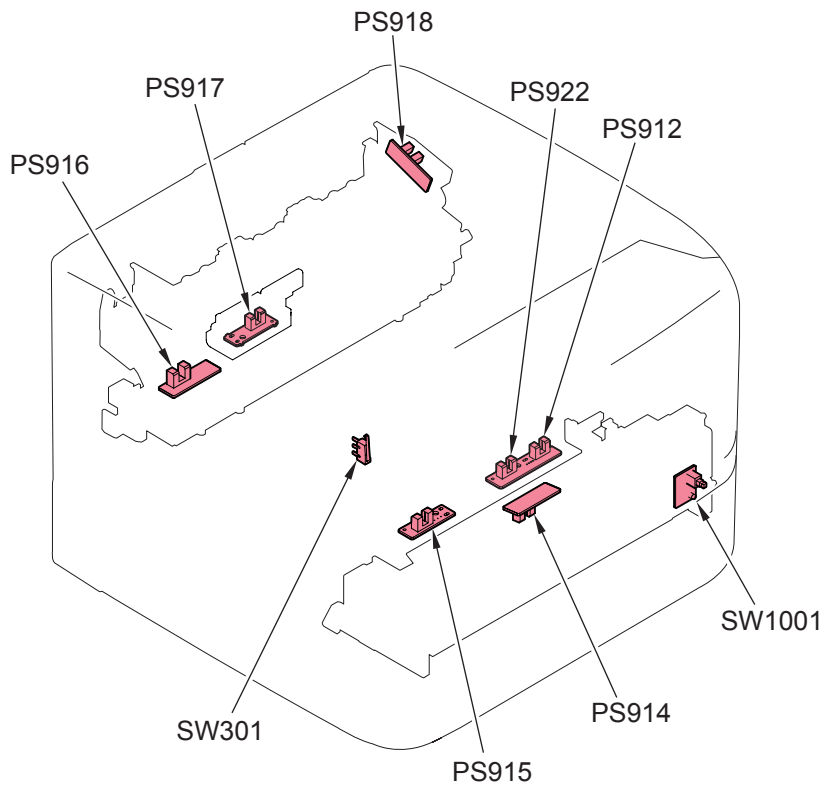

F-3-6

No.	Name	Main Units	Reference
PS912	Top Sensor	-	-
PS914	Cassette Paper Sensor	-	-
PS915	Manual Tray Detection Sensor	-	-
PS916	Fixing Paper Output Sensor	-	-
PS917	Duplex Reverse Sensor	-	-
PS918	Output Tray Full Sensor	-	-
PS922	Paper Width Sensor	-	-
SW1001	Power Switch	-	-
SW301	Door Switch	-	-

T-3-7

PCB

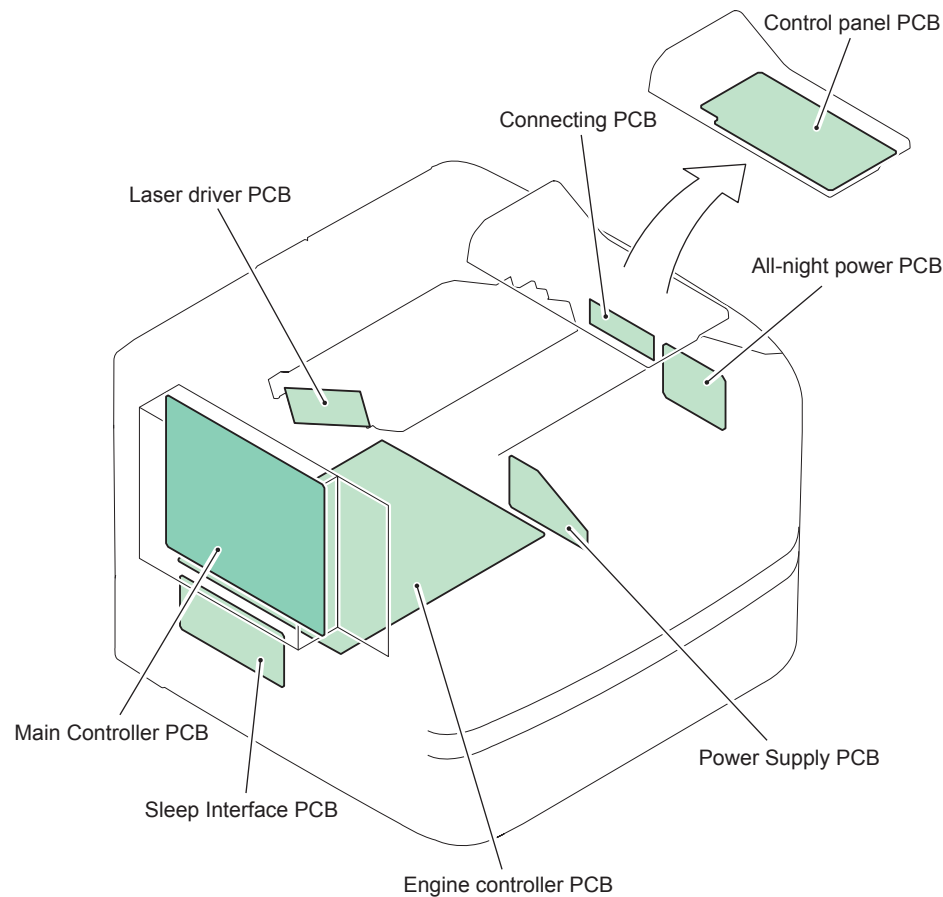

F-3-7

Name	Main Units	Reference
Laser Driver PCB	Laser Scanner Unit	(Refer to page 3-22)
Connecting PCB	-	-
Control Panel PCB	-	-
All-night power PCB	-	-
Engine Controller PCB	-	(Refer to page 3-14)
Main Controller PCB	-	(Refer to page 3-12)
Sleep Interface PCB	-	-

T-3-8

# Connector Layout Drawing

## Internal

### Connector List

#### Main Controller PCB

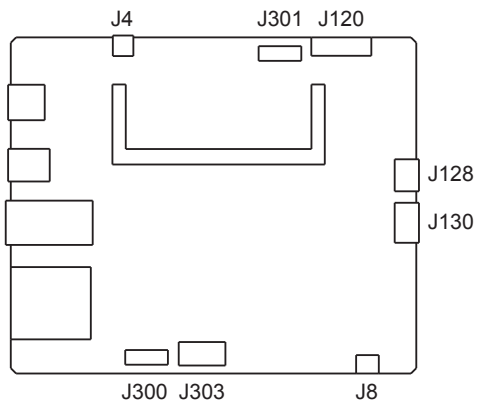

#### Engine Controller PCB

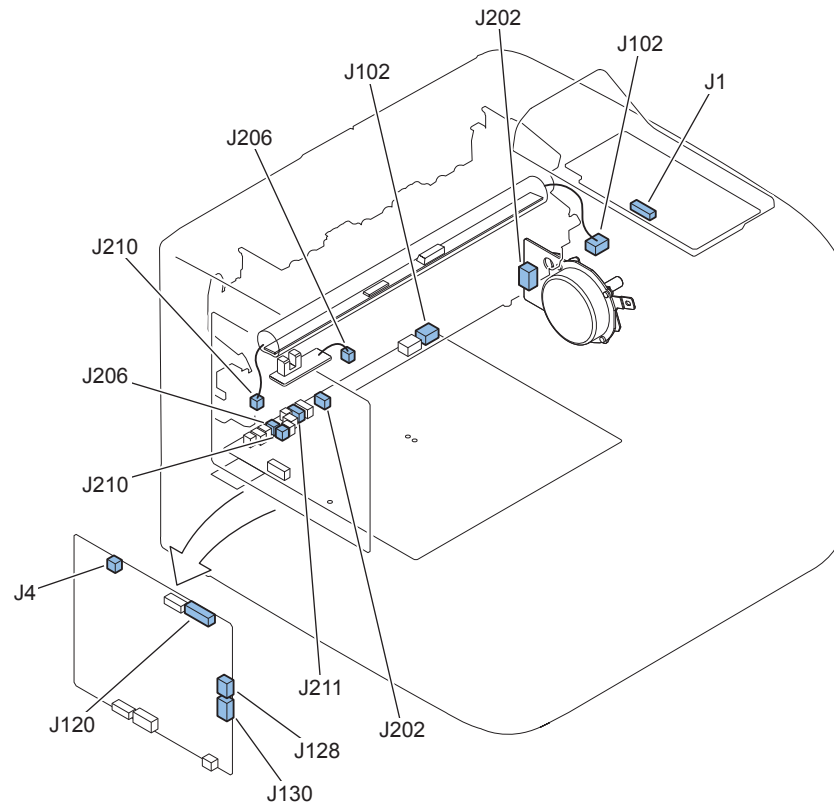
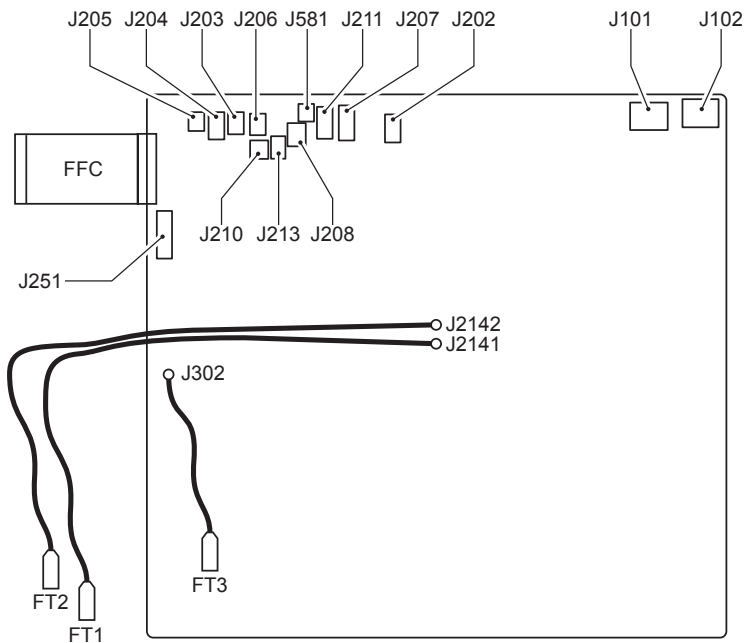

F-3-8

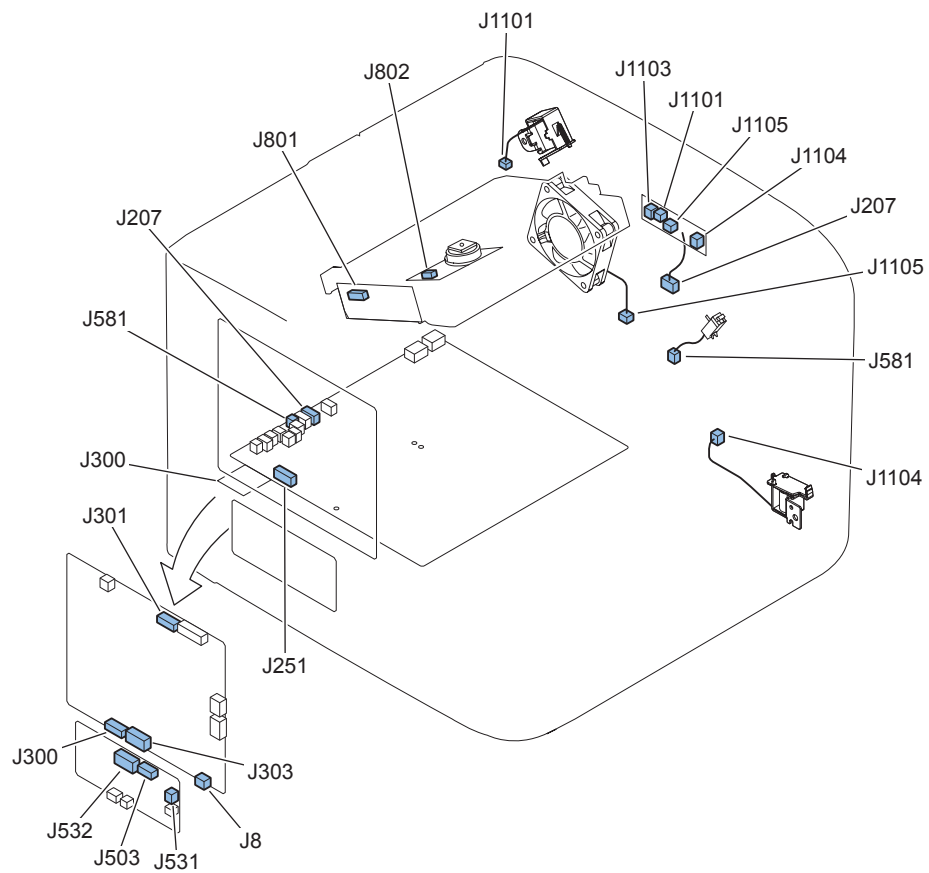

F-3-9

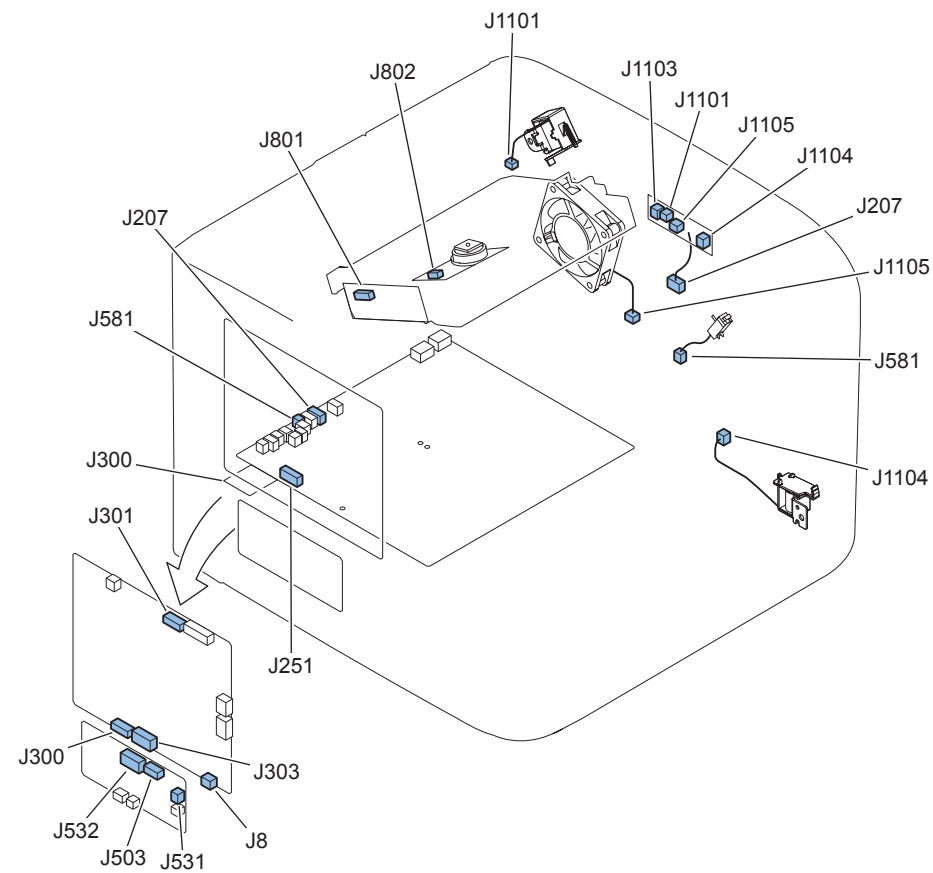

F-3-10

## External Cover, Internal Cover

### Removing the Left Cover

- 1) Remove Cassette [1].
- 2) Press Release Button [2] and open Cartridge Door Unit [3].

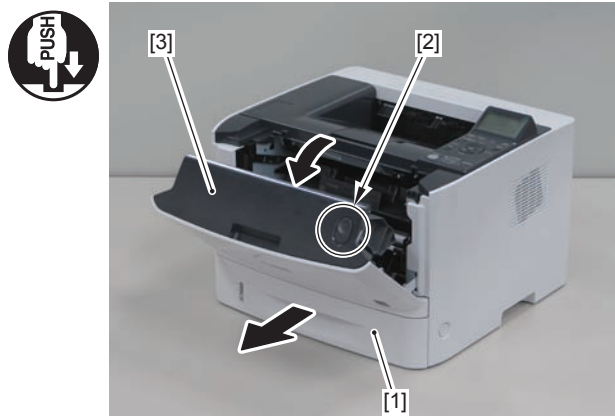

F-3-11

- 3) Remove 2 screw [2] and 3 disengage tab [3] in direction.
- 4) Remove Left Cover [1] in direction.

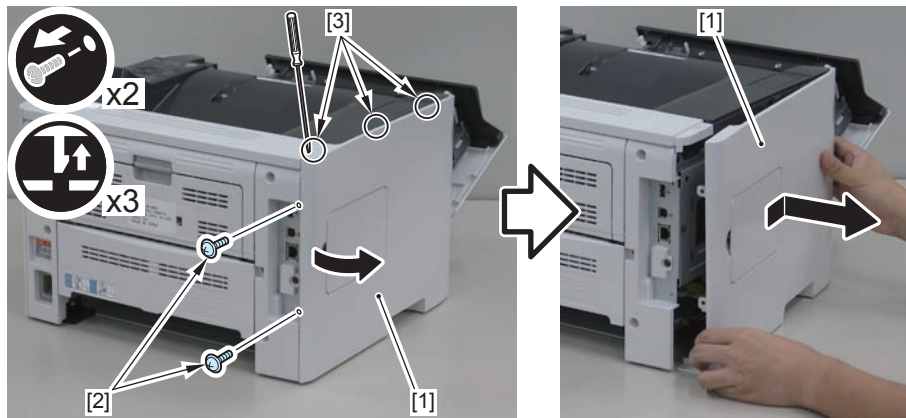

F-3-12

### Removing the Right Cover

- 1) Remove Cassette [1].
- 2) Press Release Button [2] and open Cartridge Door Unit [3].

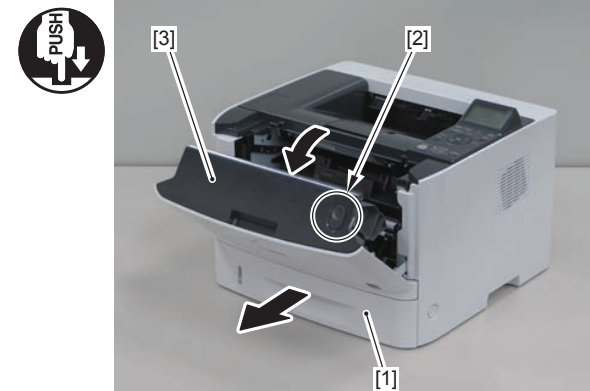

- 3) Release the 5 claws [1] and remove the Right Cover [2] while opening it in the direction of the arrow.

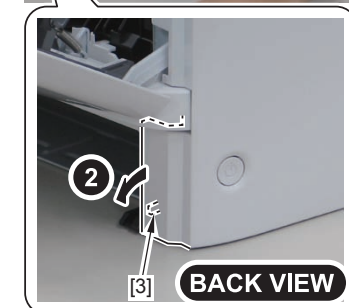
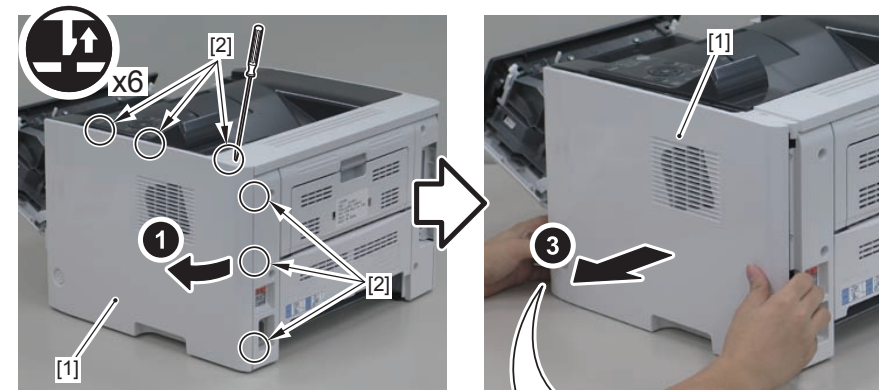

## Removing the Rear Cover Unit / Duplex Feed Unit

### Preparations

- 1) Remove Right Cover. (Refer to page 3-9)
- 2) Remove Left Cover. (Refer to page 3-9)

### Procedure

- 1) Lift Lever [1] and move Duplex Feed Unit [2] downwards.

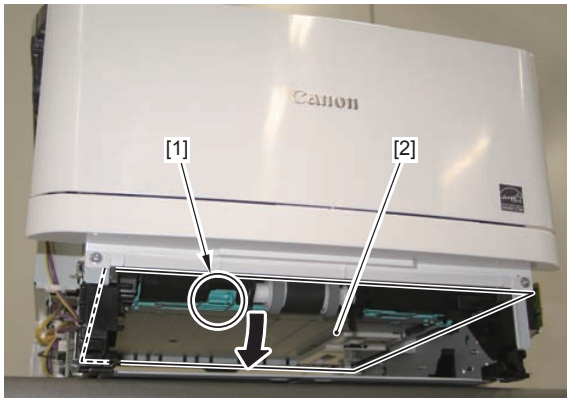

### CAUTION:

During reassembly, 2 raise Lever of Duplex Feed Unit and attach Duplex Feed Unit to Main Unit by using 2 magnet on each side.

- 2) Open Rear Cover [1].
  - 3) Remove Rear Cover Unit [2] together with Duplex Feed Unit.
- 5 Screw [3]

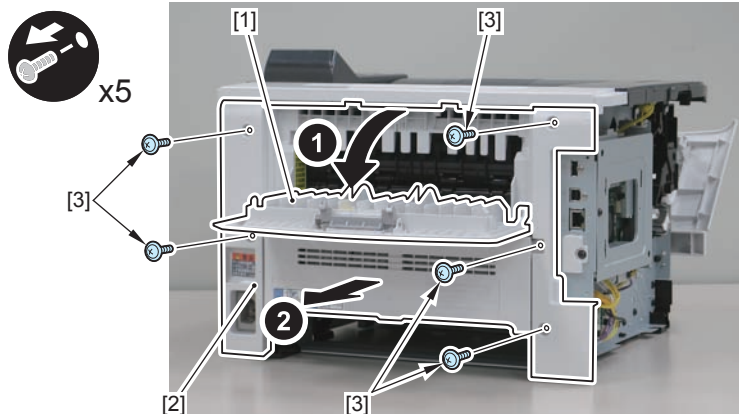

- 4) Remove Rear Cover Unit [1] together with Duplex Feed Unit [2].
- 2 Boss [3]

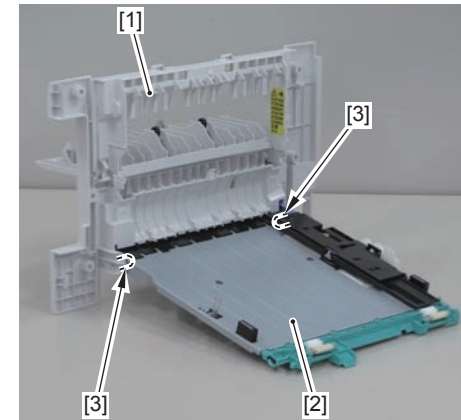

### Procedure at installation:

- 1) Fit the 2 Upper Claw [2] of the Rear Cover Unit [1] With the Upper Cover.
- 2) Open the Rear Upper Cover [3] and While Pushing the Duplex Reverse Sensor Flag [4] Downward, Install the Rear Cover Unit.

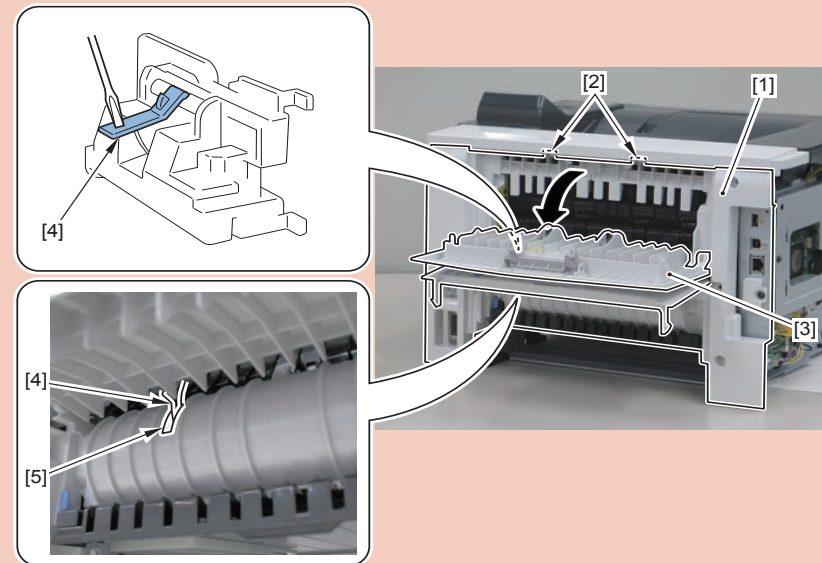



## Removing the Upper Cover Unit

### Preparations

- 1) Remove Right Cover. (Refer to page 3-9)
- 2) Remove Left Cover. (Refer to page 3-9)
- 3) Remove Rear Cover Unit. (Refer to page 3-10)

### Procedure

- 1) Remove 5 connector [2] and remove Upper Cover Unit [1].

- 5 Wire Saddles [3]
- 2 Edge Saddles [4]
- 3 Screws [5]
- 1 Screw (bind) [6]

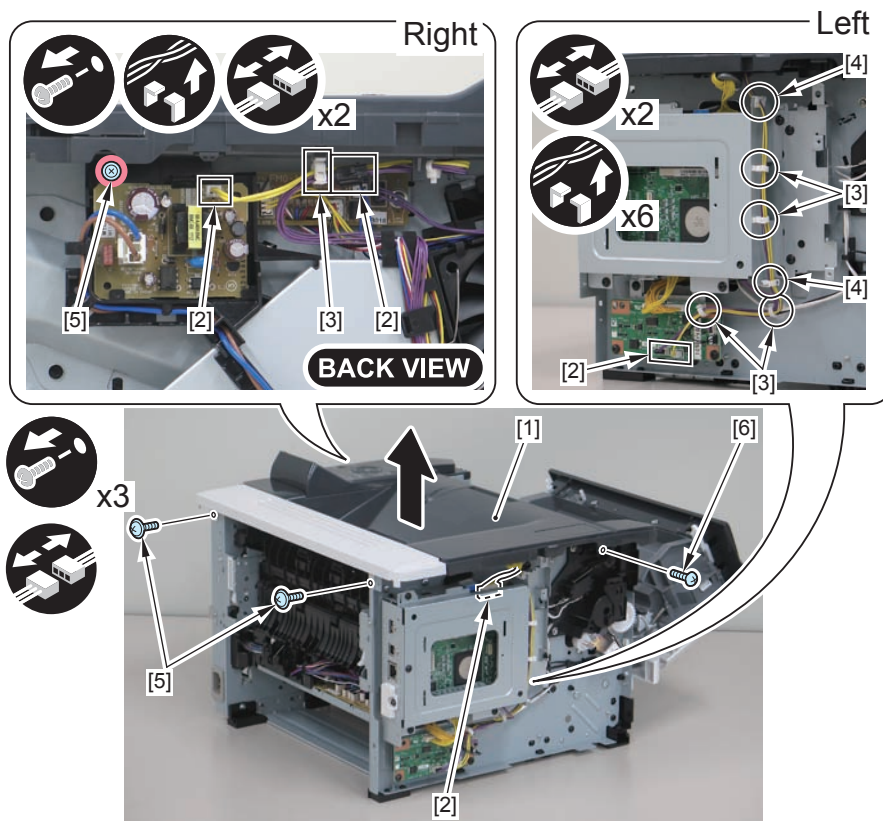

F-3-13

## Removing the Cartridge Cover Unit

### Preparations

- 1) Remove Right Cover. (Refer to page 3-9)
- 2) Remove Left Cover. (Refer to page 3-9)

### Procedure

- 1) Close Front Cover [1] and remove Link arm [2].
- 2 Tab [3]

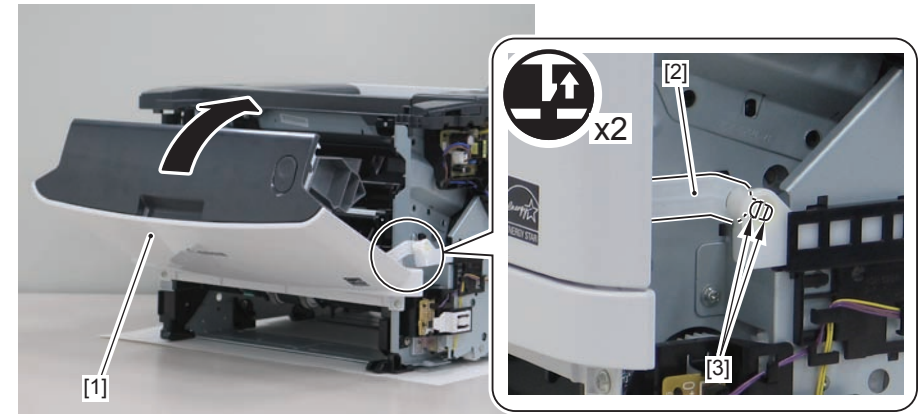

- 2) Remove Cartridge Cover Unit [1].

- 2 Screw [2]

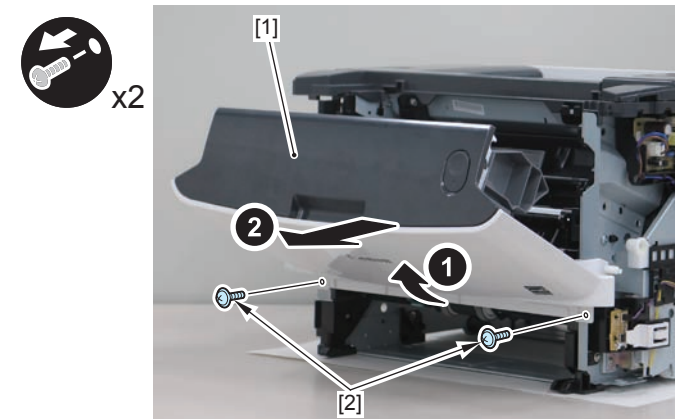

F-3-14

## Controller System

### Removing the Main Controller Board

Actions before Replacement:

- Back up the setting value (refer to the following backup method).
- \* When backup is not possible, the setting data cannot be migrated.

#### Backup Method

Backup Method	Items which can be backed up	Refer
USB	Setting Value (USER MODE, SERVICE MODE, etc)	
Expansion ROM for servicing/Sublog Board	Setting Value (USER MODE, SERVICE MODE, etc) Management Data (Page Counter, Serial No.)	

T-3-9

#### Backup procedure using USB memory

- 1) Connect the USB memory to the host machine.
- 2) SERVICE MODE > FUNCTION GR. > ECONF > EXPORT > ALL > Yes

#### Backup procedure using Expansion ROM for servicing/Sublog Board

Refer to Chapter 5 [Backup/Restoration by Expansion ROM for servicing and Sublog Board].

### Removing the Main Controller Board

#### Preparations

- 1) Remove Left Cover.(Refer to page 3-9)

#### Procedure

- 1) Remove Controller Cover [1].

- 2 Flat cable [2]
- 2 Connector [3]
- 4 Screw [4]

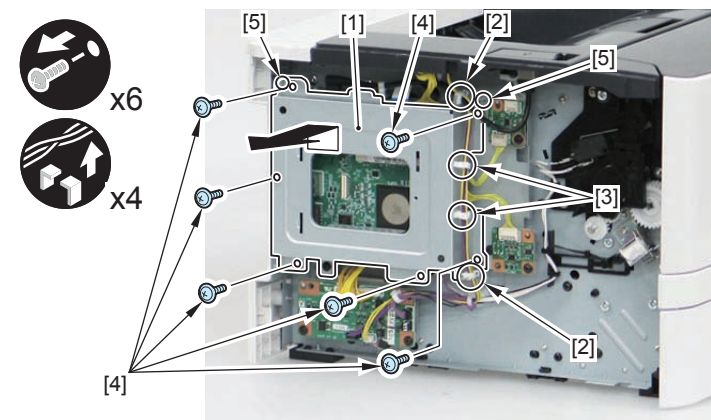

- 2) Remove Main Controller Board [1].

- 2 Flat Cables [2]
- 5 Connectors [3]
- 4 Screws [4]
- 2 Screws [5]

F-3-15

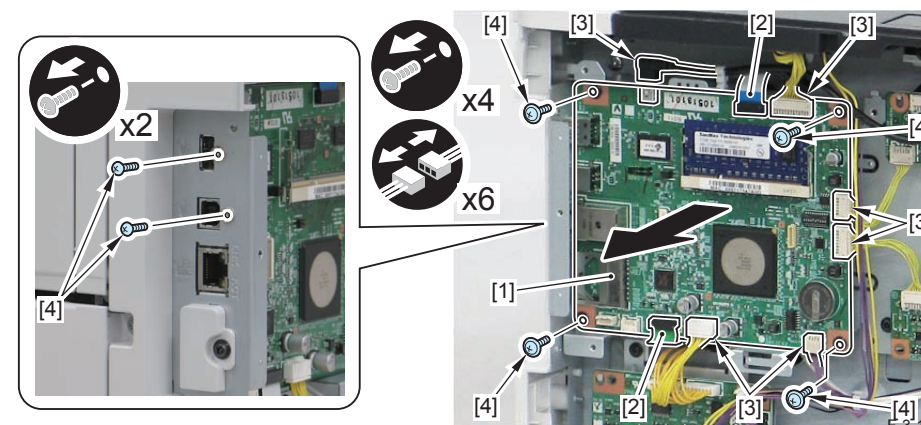

## Remove the Duplex Reverse Sensor Unit

### Preparations

- 1) Remove Left Cover.(Refer to page 3-9)
- 2) Remove Right Cover.(Refer to page 3-9)
- 3) Remove Rear Cover Unit.(Refer to page 3-10)

### Procedure

- 1) Remove Duplex Reverse Sensor Unit [1].
  - 1 Screw [2]
  - 1 Connector [3]

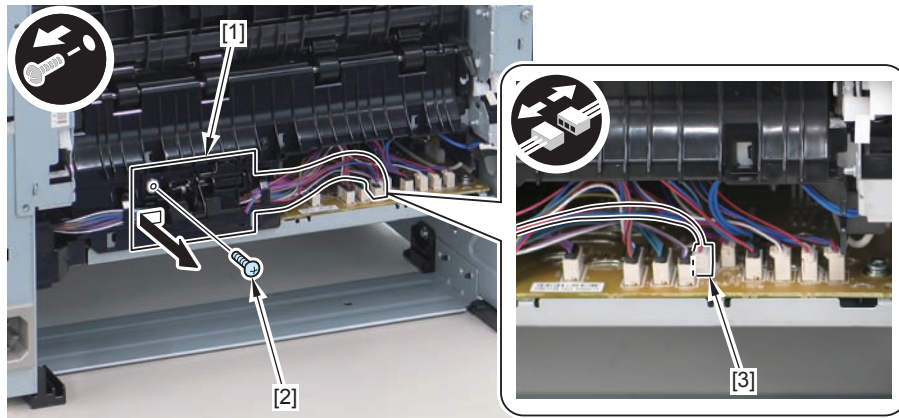

F-3-17

## Remove the All-Night Power Supply PCB

### Preparations

- 1) Remove Right Cover.(Refer to page 3-9)

### Procedure

- 1) Remove All-Night Power Supply PCB [1].
  - 2 Connector [2]
  - 1 Screw [3]

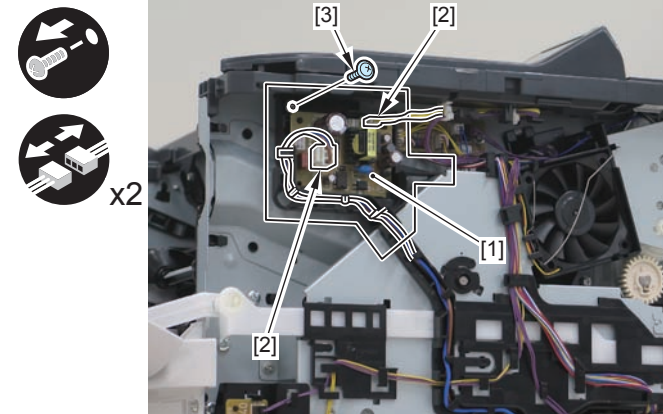

F-3-18

## Remove the Power Supply PCB

### Preparations

- 1) Remove Right Cover. (Refer to page 3-9)

### Procedure

- 1) Remove Power Supply PCB [1].
  - 2 Connectors [2]
  - 1 Screw [3]
  - 1 Ring Core [4]

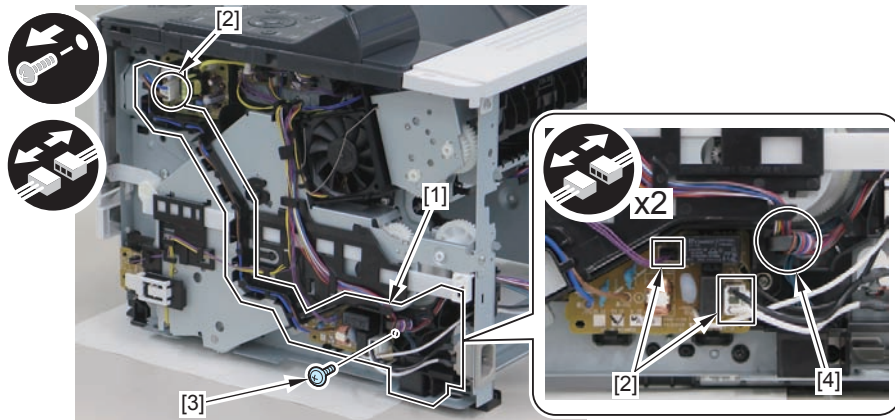

F-3-19

## Removing the Engine Controller Board

### Preparations

- 1) Remove Left Cover. (Refer to page 3-9)
- 2) Remove Right Cover. (Refer to page 3-9)
- 3) Remove Rear Cover Unit. (Refer to page 3-10)

### Procedure

- 1) Remove 6 connectors [3] from harness guide [2].

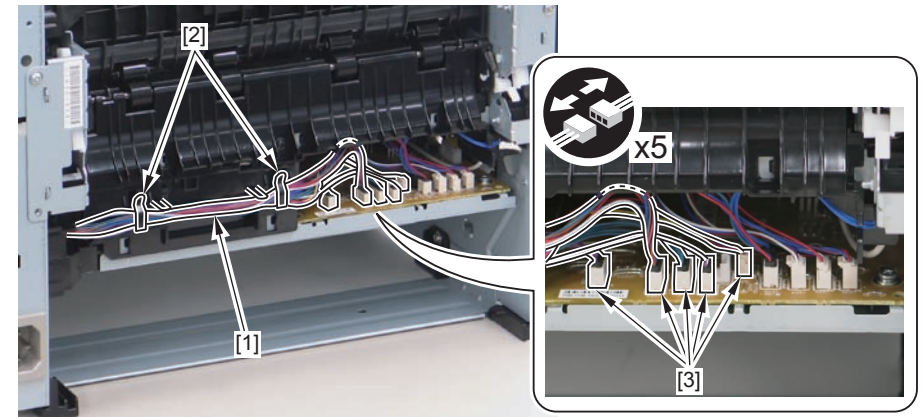

F-3-20

- 2) Remove Feed guide [1].

- 1 Screw [2]

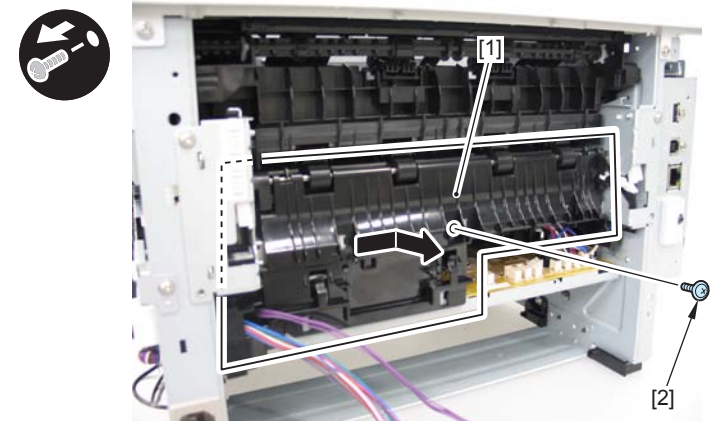

F-3-21

3) Remove 7 connectors [1] and Terminal [2].

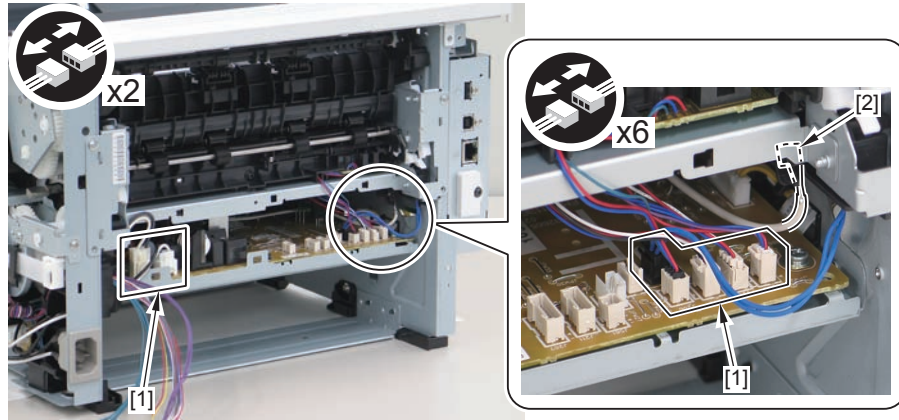

F-3-22

4) Remove 1 screw [1].

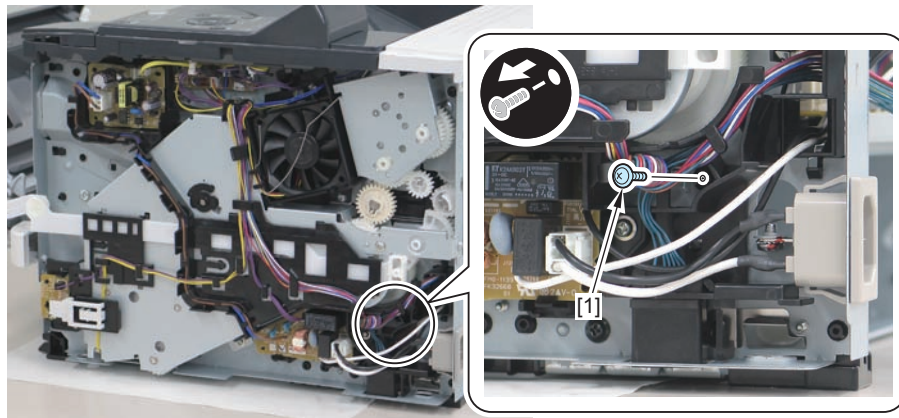

F-3-23

5) Disconnect flat cable [1].

6) Disengage harness [3] from 3 harness guide [2].

• 2 Connector [4]

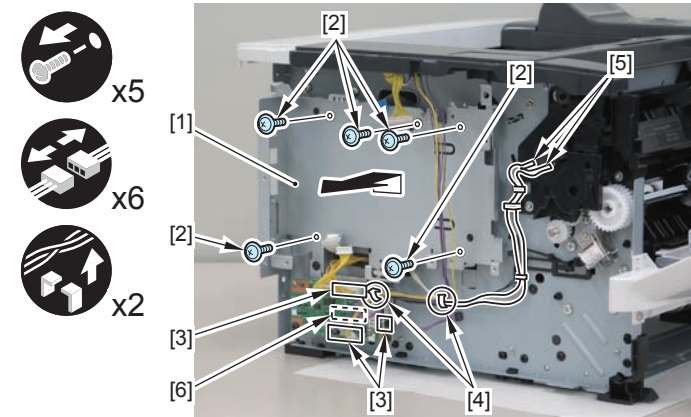

F-3-24

7) Remove 2 screw [1].

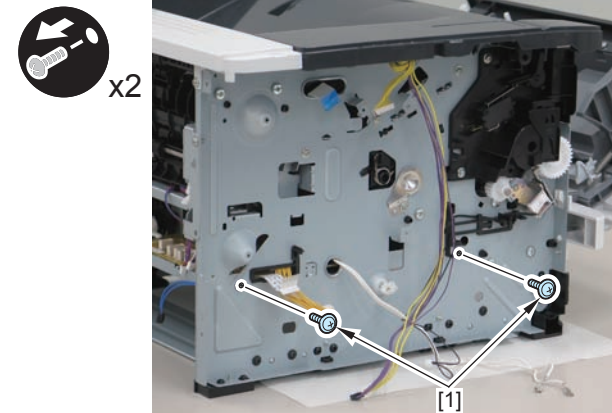

F-3-25

8) Disengage 2 latch [1] on left and right side of frame, and move Engine Controller Board [2] downwards.

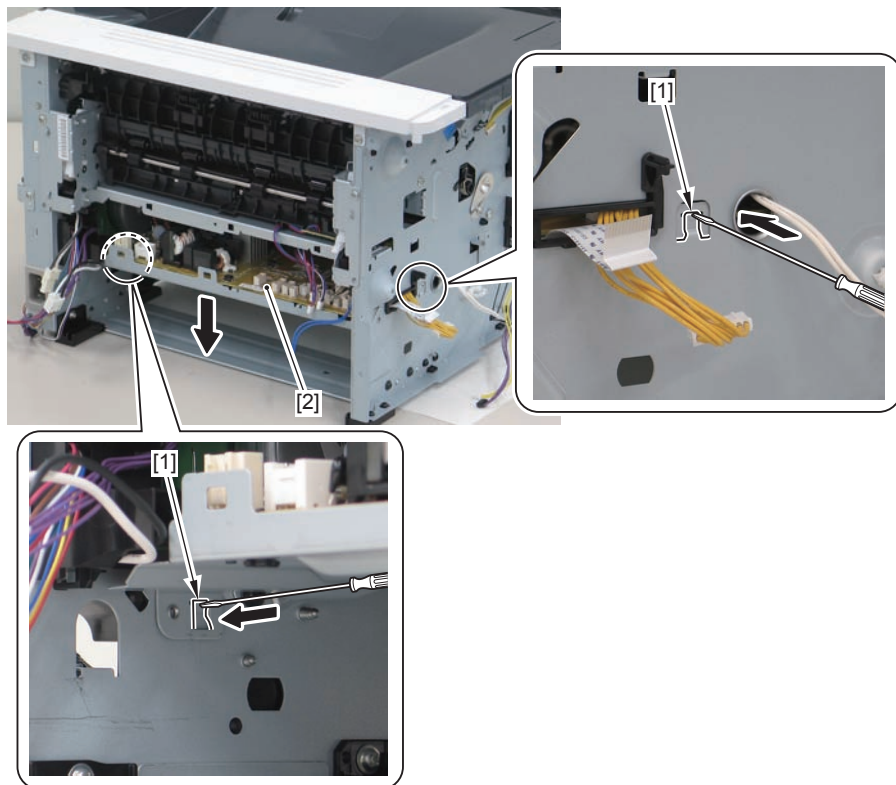

F-3-26

9) Pull 1 harness [1] and 1 flat cable [2] out towards the inside.  
10) Remove Engine Controller Board [3].

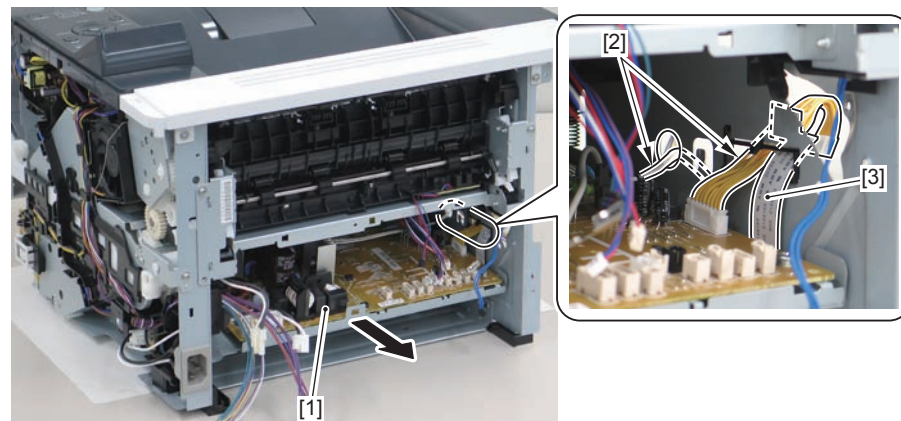

F-3-27

## Removing the Control Panel Unit

### Preparations

- 1) Remove Left Cover.(Refer to page 3-9)
- 2) Remove Right Cover.(Refer to page 3-9)
- 3) Remove Rear Cover Unit.(Refer to page 3-10)
- 4) Remove Upper Cover Unit.(Refer to page 3-11)

### Procedure

- 1) Disengage harness [2] from guide [1].

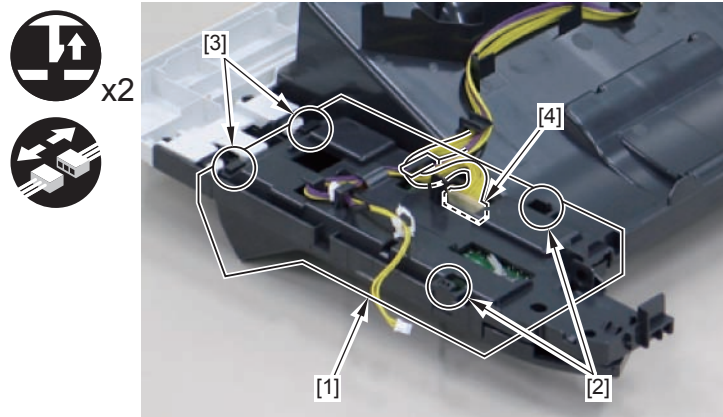

F-3-28

## Removing the Main Motor

### Preparations

- 1) Remove Left Cover.(Refer to page 3-9)
- 2) Remove Right Cover.(Refer to page 3-9)
- 3) Remove Rear Cover Unit.(Refer to page 3-10)
- 4) Remove Engine Controller Board.(Refer to page 3-14)
- 5) Remove Fixing Unit.(Refer to page 3-25)

### Procedure

- 1) Remove Main Motor [2].
- 2) Pull Transport Unit [3] towards the front.

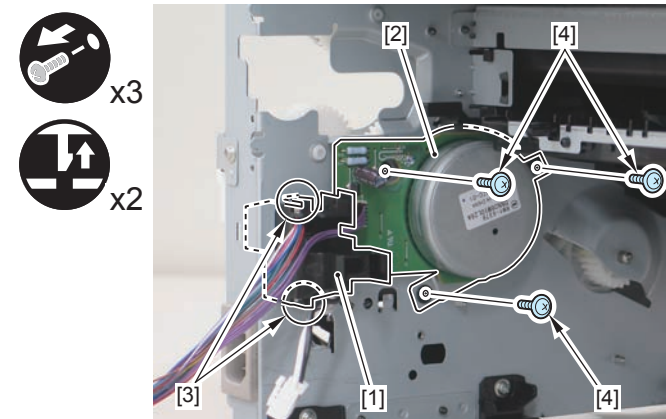

F-3-29

## Removing the Main Fan

### Preparations

- 1) Remove Left Cover.(Refer to page 3-9)
- 2) Remove Right Cover.(Refer to page 3-9)
- 3) Remove Rear Cover Unit.(Refer to page 3-10)
- 4) Remove Upper Cover Unit.(Refer to page 3-11)

### Procedure

- 1) Remove grounding spring [1].
- 2) Remove Main Fan [4].
  - 2 screws [2]
  - 1 Connector [3]

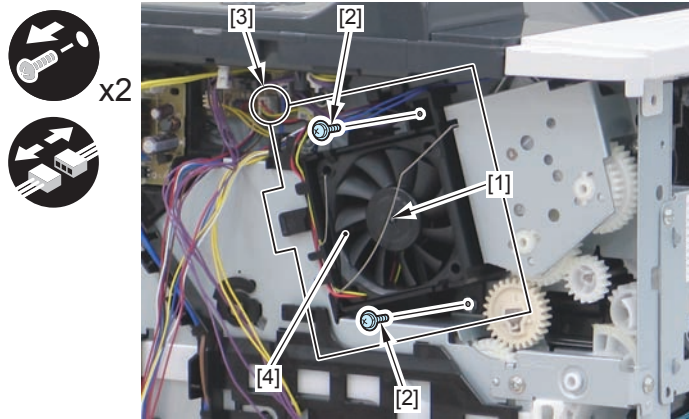

F-3-30

## Removing the Main Drive Unit

### Preparations

- 1) Remove Left Cover.(Refer to page 3-9)
- 2) Remove Right Cover.(Refer to page 3-9)
- 3) Remove Rear Cover Unit.(Refer to page 3-10)
- 4) Remove All-Night Power PCB.
- 5) Remove Main Fan Unit.(Refer to page 3-18)
- 5) Remove Duplex Reverse Sensor Unit.

### Procedure

- 1) Remove the Harnesses [1].
  - 1 harness guide [2]
  - 5 Connectors [3]

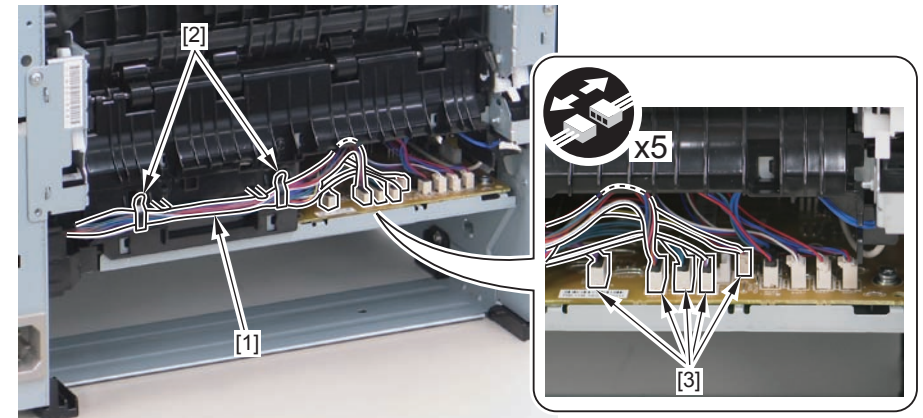

F-3-31



2) Remove harnesses from the guide [3].

- 3 Connectors [1]
- 1 Wire Saddle [2]

3) Remove main switch unit [4].

- 1 Screw [2]

4) Remove Link Arm [5].

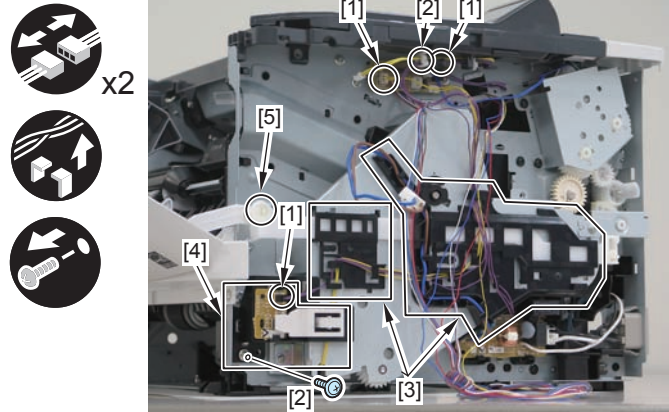

F-3-32

5) Remove Power Supply PCB Unit [1].

- 1 Connector [2]
- 1 Screw [3]

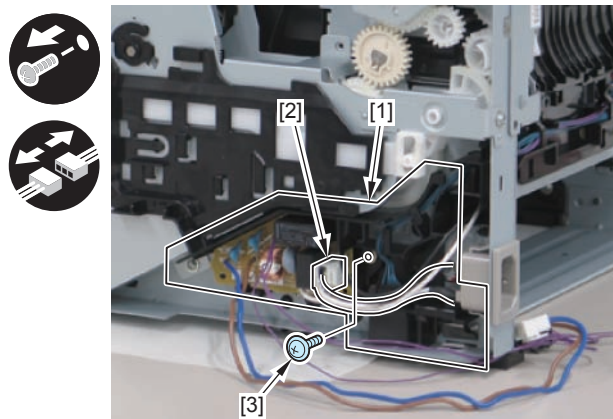

F-3-33

6) Remove Platei [1].

- 2 Screws [2]

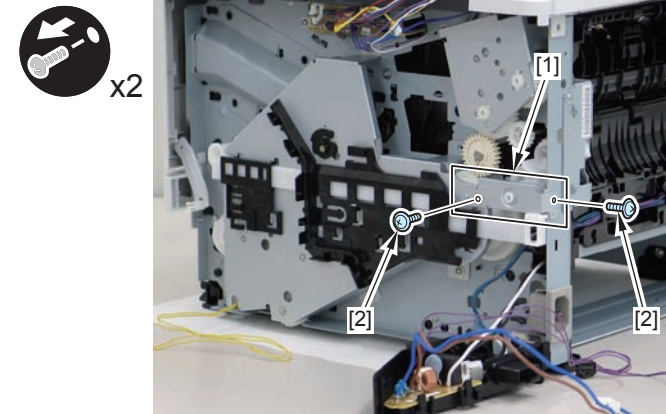

F-3-34

7) Remove Link guide [3] and remove Link Arm [4].

8) Remove Main Drive Unit [2].

- 4 Screw [1]

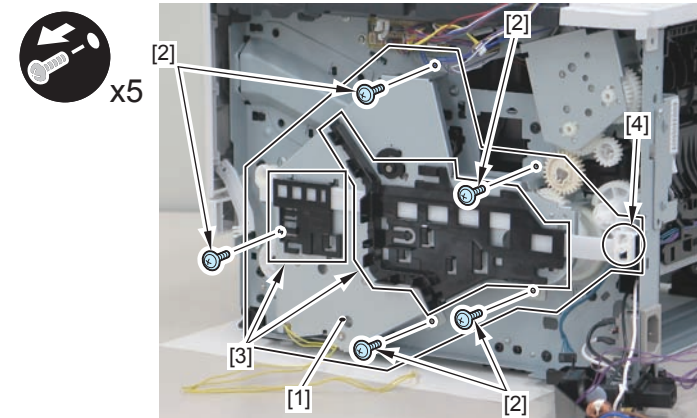

F-3-35

**CAUTION:**

The main drive gears are not fastened to the metal plate. Take care that the gears do not come apart.

## Removing the Duplex Drive Unit

### Preparations

- 1) Remove Left Cover.(Refer to page 3-9)
- 2) Remove Right Cover.(Refer to page 3-9)
- 3) Remove Rear Cover Unit.(Refer to page 3-10)
- 4) Remove Main Fan Unit.(Refer to page 3-11)

### Procedure

- 1) Remove Duplex Drive Unit [1].
  - 3 Screw [2]

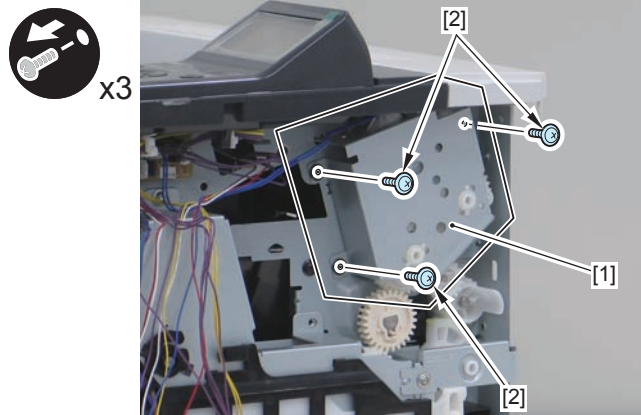

F-3-36

### CAUTION:

Be sure to install the black gear[2] to the side where a left-direction arrow[1] is marked.

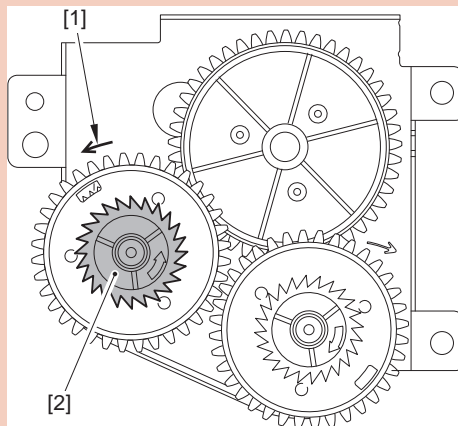

## Removing the Cassette Pickup Solenoid

### Preparations

- 1) Remove Right Cover.(Refer to page 3-9)

### Procedure

- 1) Remove main switch unit [1].
  - 1 Screw [2]
  - 1 Connector [3]

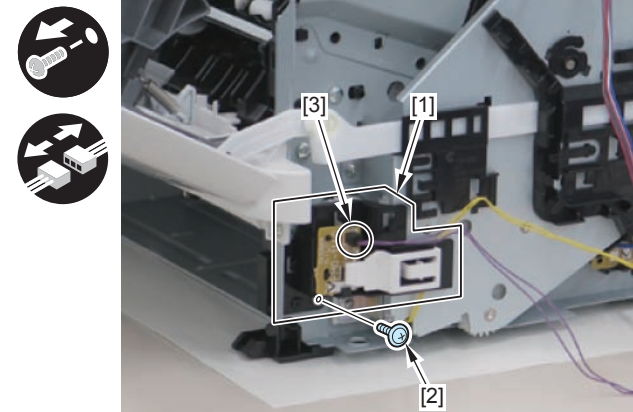

F-3-37

- 2) Remove Cassette Pickup Solenoid [1].
  - 1 Screw [2]
  - 1 Connector [3]

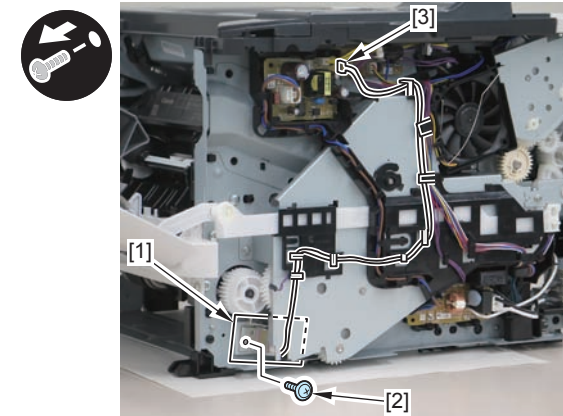

F-3-38

## Removing the Multi-purpose Solenoid

### Preparations

1) Remove Left Cover. (Refer to page 3-9)

### Procedure

1) Remove Multi-purpose Solenoid [1].

- 1 Screw [2]
- 1 Connector [3]
- 2 Wire Saddle [4]

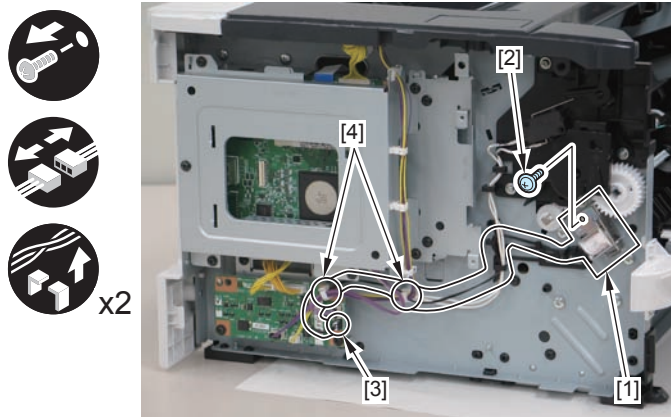

F-3-39

## Removing the Duplex Reversal Solenoid

### Preparations

1) Remove Left Cover. (Refer to page 3-9)

2) Remove Right Cover. (Refer to page 3-9)

3) Remove Rear Cover Unit. (Refer to page 3-10)

4) Remove Main Fan. (Refer to page 3-18)

5) Remove Duplex Drive Unit. (Refer to page 3-20)

### Procedure

1) Remove Duplex Reversal Solenoid [1].

- 1 Connector [2]
- 1 Screw [3]

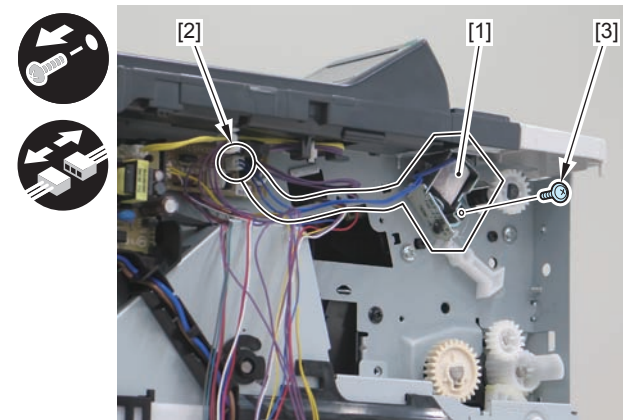

F-3-40

## Laser Exposure System

### Removing the Laser Scanner Unit

#### Preparations

- 1) Remove Right Cover.(Refer to page 3-9)
- 2) Remove Left Cover.(Refer to page 3-9)
- 3) Remove Rear Cover Unit.(Refer to page 3-10)
- 4) Remove Upper Cover Unit.(Refer to page 3-11)

#### Procedure

- 1) Remove Laser Scanner Unit [1].
  - 1 Sponge [2]
  - 1 Connector [3]
  - 1 Flat cable [4]
  - 4 Screw [5]

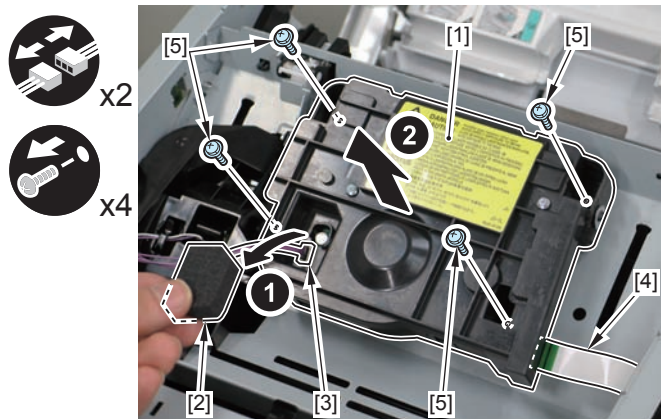

F-3-41

#### CAUTION:

Do not disassemble the laser scanner unit at a field.  
It may cause a malfunction.



F-3-42

## Image Forming System

### Removing the Transfer Roller

#### Procedure

#### CAUTION:

When assembling / disassembling the transfer charging roller, hold the shaft or bushing of the transfer charging roller and do not touch the sponge parts.

- 1) Press Release Button [1] and open Front Cover Unit [2].
- 2) Pinch the Holder [1] and Remove It In the Direction Of the Arrow.
- 3) Remove the Transfer Roller [2] In the Direction Of the Arrow.

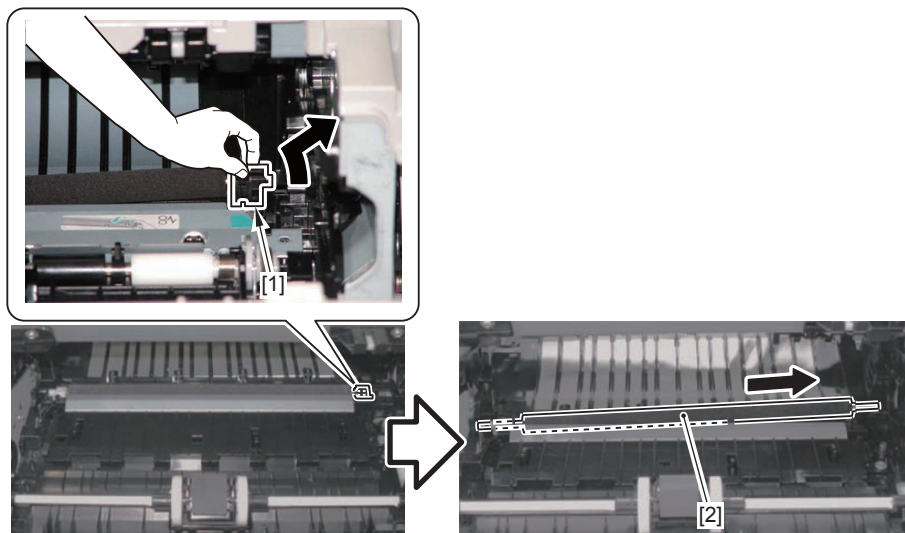

F-3-43

### Removing the Registration Unit

#### Preparations

- 1) Remove Left Cover. (Refer to page 3-9)
- 2) Remove Right Cover. (Refer to page 3-9)
- 3) Remove Rear Cover Unit. (Refer to page 3-10)
- 4) Remove Upper Cover Unit. (Refer to page 3-11)

#### Procedure

- 1) Remove tab [1] and gear [2].

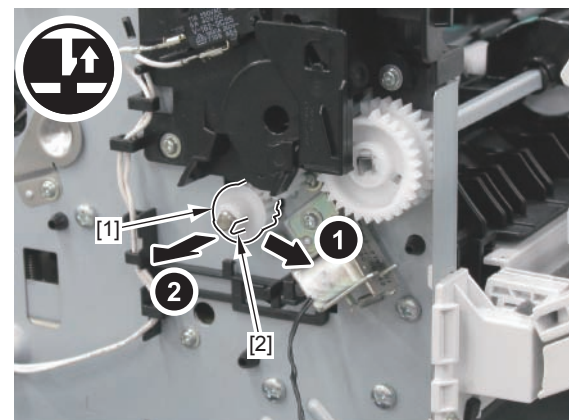

F-3-44

- 2) Lift guide [1] up to remove.

- 2 Hook [2]

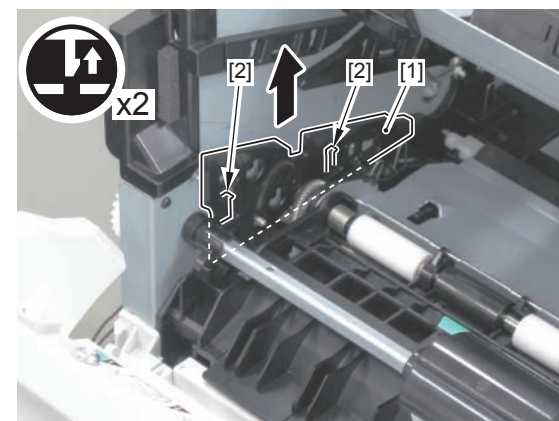

F-3-45

3) Remove gear cover [3] and Registration Unit [1].

- 5 Screw [2]

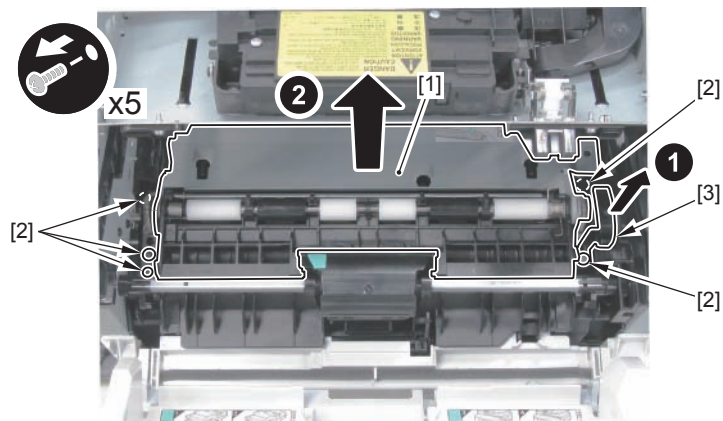

F-3-46

## Fixing System

### Removing the Fixing Unit

#### Preparations

- 1) Remove Left Cover. (Refer to page 3-9)
- 2) Remove Right Cover. (Refer to page 3-9)
- 3) Remove Rear Cover Unit. (Refer to page 3-10)
- 4) Remove Duplex Reverse Sensor Unit.

#### Procedure

##### CAUTION:

When removing the fixing assembly, perform the operation after the fixing assembly is surely cooled.

The fixing assembly just after printing may cause burn injury.

- 1) Close Front Cover and remove 3 gears.



F-3-47

#### Points to Note at Installation:

Fit the Protrusion [2] of the Gear [1] With the Cut-off of the Gear [3] and Install it.

Fit the Cut-off [4] of the Gear [1] With the Teeth of the Fan Gear [5] and Install it.

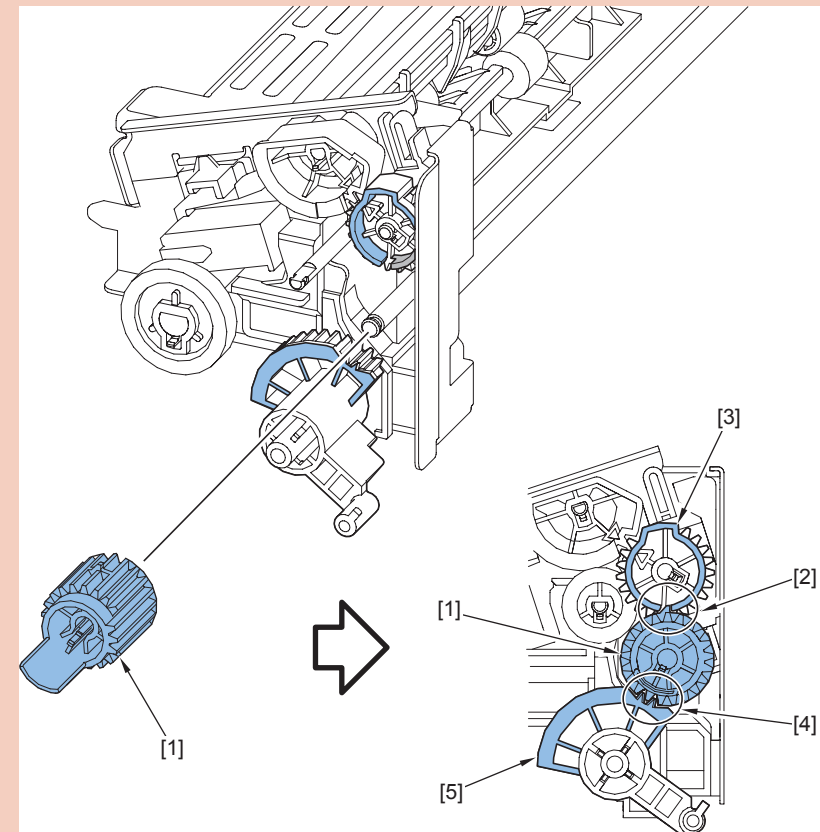

F-3-48

## 2) Remove transport guide [1].

- 2 harness guide [2]
- 5 Connector [3]

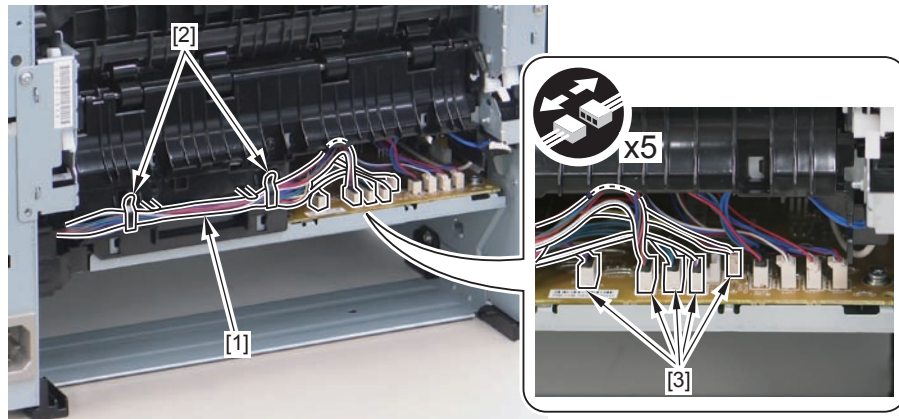

F-3-49

## 3) Remove Feed guide [1].

- 1 Screw

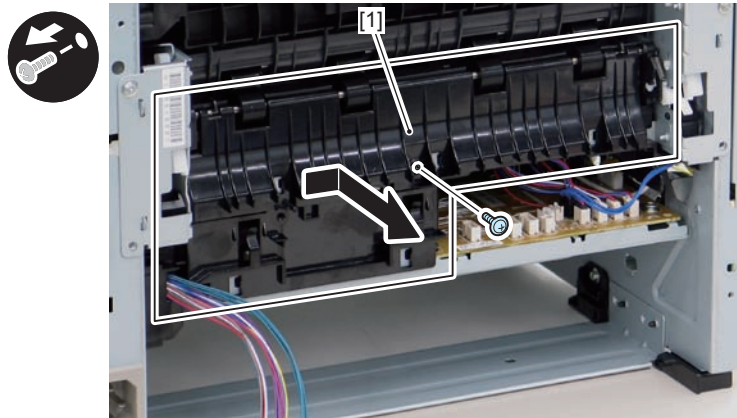

F-3-50

## 4) Remove Fixing Unit [1].

- 3 Connectors [2]
- 1 Terminal [3]
- 2 Screws [4]

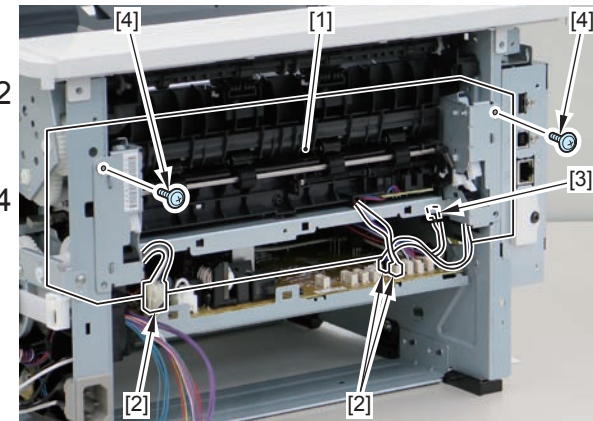

F-3-51

## CAUTION:

Do not disassemble the Fixing Unit at a field.  
It may cause a malfunction.

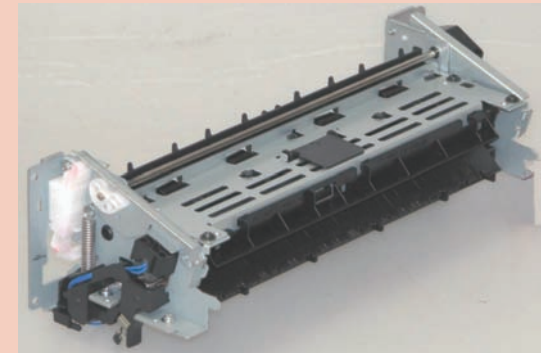

F-3-52



## Paper Pickup/Transport/Output System

### Removing the Cassette Pickup Roller

**CAUTION:**

Do not touch the surface of the Cassette Pickup Roller when removing or mounting it.

- 1) Remove Cassette.
- 2) Lift Lever [1] and move Duplex Feed Unit [2] downwards.

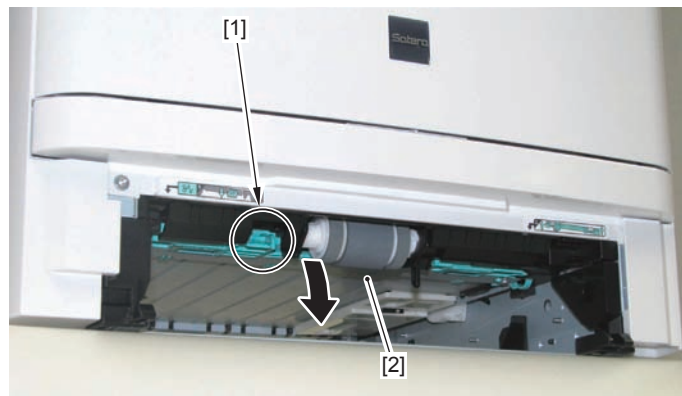

F-3-53

**CAUTION:**

During reassembly, 2 raise Lever [1] of Duplex Feed Unit and attach Duplex Feed Unit [3] to Main Unit by using 2 magnet [2] on each side.

- 3) Rotate left-side bushing [1] in arrow direction.

- 1 Tab [2]

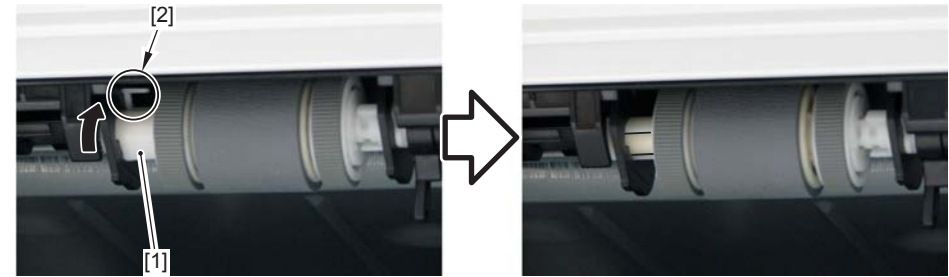

F-3-54

- 4) Remove Cassette Pickup Roller [1] in arrow direction.

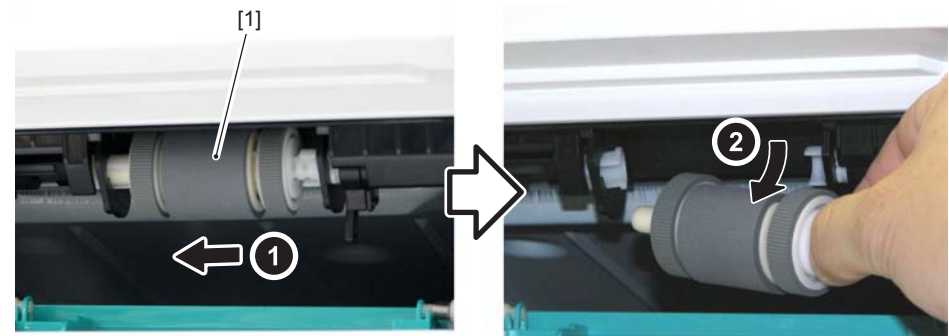

F-3-55

- 5) Remove 2 Pickup Toller [2] from Cassette Pickup Roller [1].

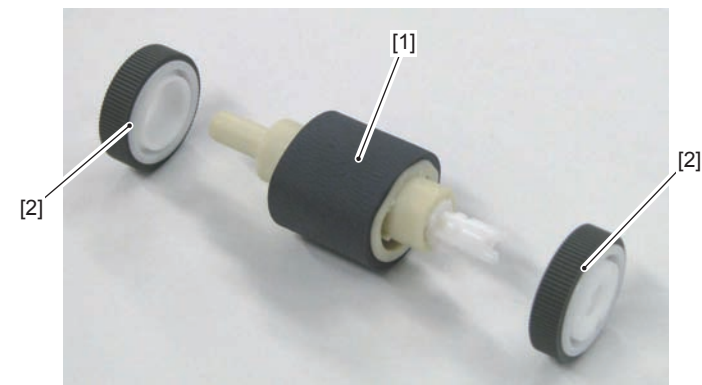

F-3-56

## Removing the Cassette Separation Pad

### CAUTION:

Do not touch the surface of the Cassette Separation Pad when removing or mounting it.

- 1) Remove Cassette.
  - 2) Remove Cassette Separation Pad [1].
- 2 Screw [2]

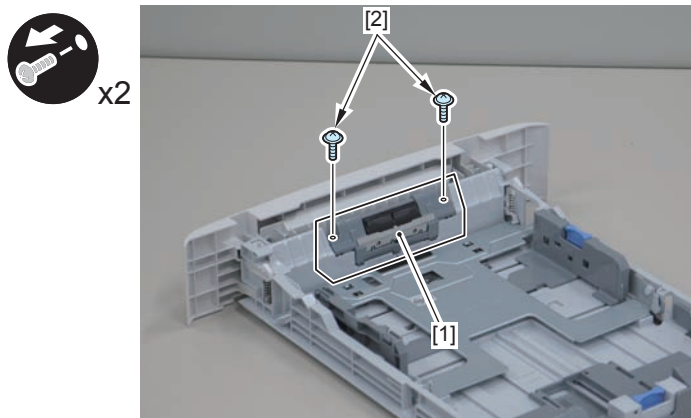

F-3-57

## Removing the Multi-purpose Pickup Roller

### CAUTION:

Do not touch the surface of the Multi-purpose Pickup Roller when removing or mounting it.

- 1) Press Release Button [1] and open Front Cover Unit [2].

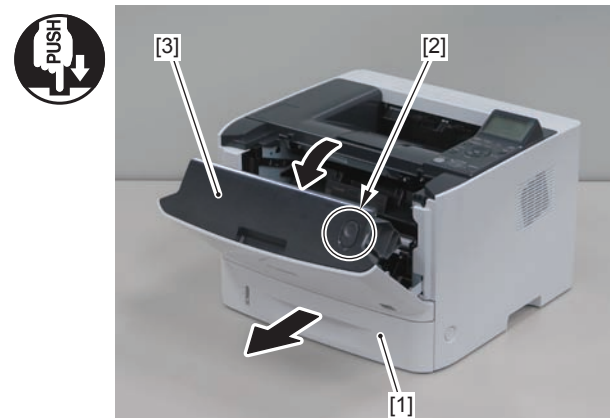

F-3-58

- 2) Open pickup roller cover [1].
- 3) Open pickup roller holder [2] and remove Multi-purpose Pickup Roller [3].

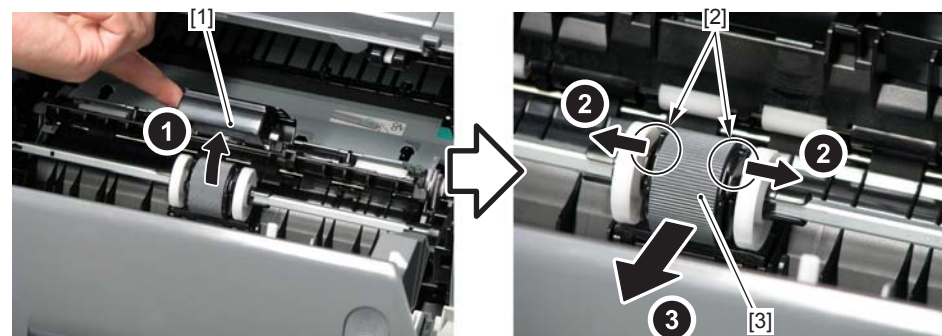

F-3-59

## Removing the Multi-purpose Separation Pad

### Preparation

- 1) Removing the Multi-purpose Pickup Roller. (Refer to page 3-28)

### Procedure

#### CAUTION:

Do not touch the surface of the Multi-purpose Separation Pad when removing or mounting it.

- 1) Open Front Cover [1].
- 2) While pushing down the manual tray [1], insert a flatblade screwdriver into the Multi-purpose Separation Pad [2] clearance and prize it open.

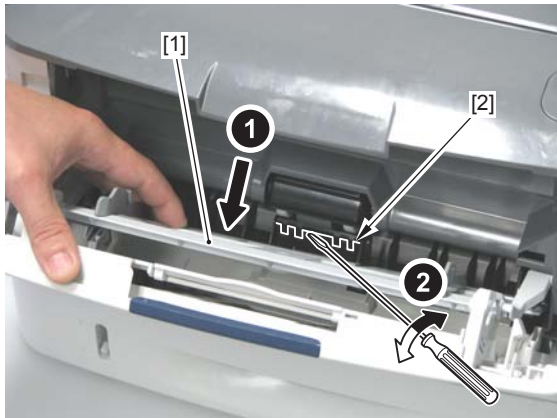

F-3-60

- 3) Press Release Button [1] and open Front Cover Unit [2].
- 4) Remove Multi-purpose Separation Pad [3].

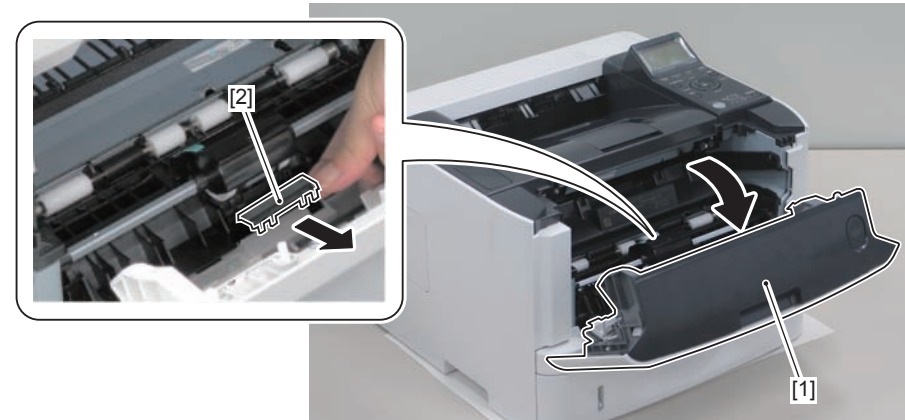

F-3-61

# 4

## Maintenance and Inspection

- Periodically Replaced Parts
- Consumable Parts
- Periodical Service
- Cleaning

## Periodically Replaced Parts

### Periodically Replaced Parts

- Periodic replacement parts are not required in this printer.

## Consumable Parts

### Durables Replaced by the Service Person

- Consumable parts are not required in this printer.

## Periodical Service

### Periodical Service

- No periodic services are required to this printer.

## Cleaning

### Cleaning at Service Visit

Follow the procedure blow when cleaning the printer during service visit.

Component	Cleaning Method
Pickup Roller / Sepalation Pad	Wipe With A Lint-free Cloth.
Registration Roller / Registration Arm Unit	Wipe With A Lint-Free Cloth.
Transfer Guide Unit	Wipe With A Soft and Dry Flannel Cloth.
Media Feed Belt / Media Feed Guide Unit	Wipe With A Lint-Free Cloth.
Fixing Inlet Guide	Wipe With Alcohol Dampened Flannel Cloth.

T-4-1

Do not clean the following components:

- Photosensitive drum
- Transfer roller

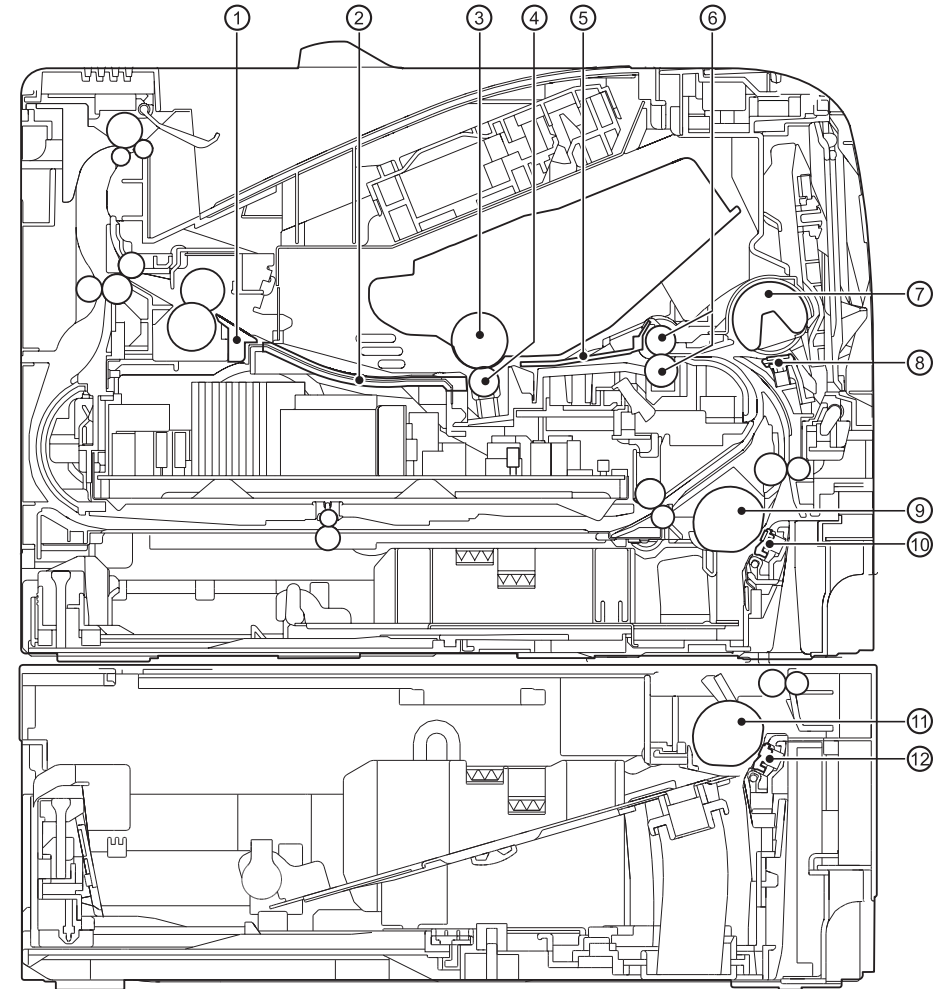

F-4-1

No.	Name	No.	Name
[1]	Fixing Inlet Guide	[7]	Multi-purpose Tray Pickup Roller
[2]	Media Feed Guide	[8]	Multi-purpose Tray Separation Pad
[3]	Photosensitive Drum	[9]	Cassette Pickup Roller
[4]	Transfer Roller	[10]	Cassette Separation Pad
[5]	Transfer Guide Unit	[11]	PF Pickup Roller
[6]	Registration Roller Unit	[12]	PF Separation Pad

T-4-2

# 5

## Troubleshooting

- Troubleshooting
- Error Codes
- Service Mode
- Version Upgrade
- Updater
- Debug log
- Backup/Restoration by Expansion ROM for servicing and Sublog Board

## Troubleshooting

### Test Pages

Printing test pages helps determine if the printer is functioning.

#### CAUTION:

There are two types of test pages: engine-test page and Main Controller-test page. Print a test page to make sure the printer engine and the Main Controller are functioning.

#### Engine-test page

There are two types of engine-test pages simplex print and duplex print.

##### a. Simplex print

Open and close the cartridge door three times continuously within 2 seconds during the standby period. The engine-test page should have a test print pattern on one side of media as shown below.

##### b. Duplex print

Open and close the cartridge door five times continuously within 2 seconds during the standby period. The engine-test page should have a test print pattern on both sides of media as shown below.

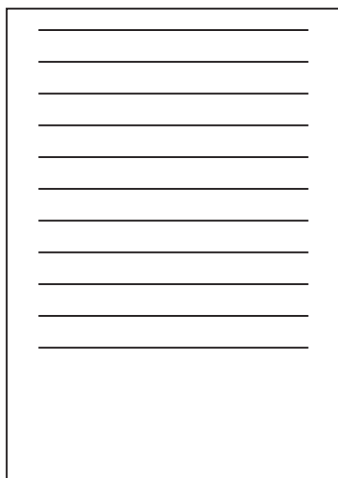

F-5-1

#### Controller-Test page

The data for test charts are created in the main controller. If no problem is found on the output test charts, the cause may lie in the PDL input or the reader.

NOTE: Method to display the test print  
It appears in the menu by pressing [Status Monitor/Cancel key] + [Utility] simultaneously.

Test Print	Pattern	image check item
B	Grid chart	Right angle accuracy Straight line accuracy
D	Print "E" in the entire area.	--
D1	--	The followings can be checked. • Firmware version • Service counter • PDL mode counter • Service mode setting value
I	Solid black	Transfer failure, White line, Margin
J	Halftone (dark)	Transfer failure, Black line, White line, Margin
K	Halftone (light)	Transfer failure, Black line, White line, Margin
L	Grid chart	Right angle accuracy Straight line accuracy
X	Halftone/Grid chart	Right angle accuracy Straight line accuracy
Z	Solid white	Fogging
AW	--	Print details of various service counters.
BH	--	Print product information.

T-5-1

## Device Log List

Print jam and error logs.

NOTE: Method to display the test print  
It appears in the menu by pressing [Status Monitor/Cancel key] + [Utility]  
simultaneously.

	Purpose of use
Log1	Jam log list Print 5 logs at a maximum.
Log2	Jam log list stored in the controller Print 5 logs at a maximum.
Log3	Error log list
Log4	Alarm log list Since there is no alarm code for this machine, alarm log list is not printed.

T-5-2

## Adjustment of Fixing System

### Nip-width specifications

The nip-width of the fixing unit is not adjustable in this printer, however the improper nip-width may cause the poor fixing.

Follow the procedures below to check the nip width.

- 1) Prepare an all-black print of letter size that is printed with the cartridge for this printer before visiting the user.
- 2) Load the printed sheet facing UP in the printer cassette.
- 3) Open the face-up cover.
- 4) Print a Testprint Z.
- 5) Measure the width of the glossy band across the paper and check if it meets the requirements below:
- 6) Turn off the power switch when the leading edge of media comes out of the face-up delivery slot. Wait for 20 seconds and turn on the power switch. Then open the jam removal cover and pull the paper out.

- Center (a): 6 to 9 mm
- Left (b): 6 to 9 mm
- Right (c): 6 to 9 mm

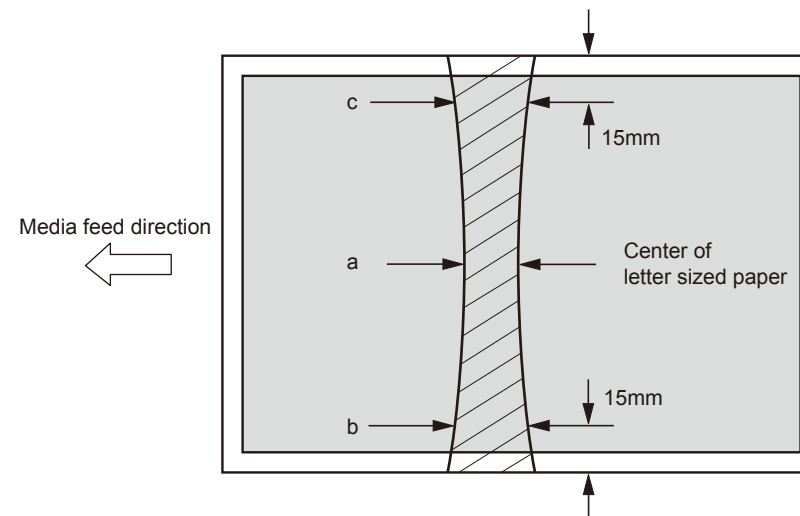

F-5-2



## Error Codes

### Error Code Details

E Code	Detail Code	Item	Description
E000	0000	Title	Error in temperature rising of Fixing Assembly
		Detection description	Temperature of the Fixing Assembly did not reach a certain temperature within the specified period of time.
		Remedy	1. Check the connection of connectors between the Fixing Assembly and the Engine Controller PCB. 2. If the connector at the Fixing Assembly side does not have induction while the assembly is removed, replace the assembly. 3. Replace the Engine Controller PCB.
E001	0000	Title	Abnormal high temperature of Fixing Assembly
		Detection description	It was detected that the temperature of the Fixing Assembly was abnormally high.
		Remedy	1. Check the connection of connectors between the Fixing Assembly and the Engine Controller PCB. 2. If the connector at the Fixing Assembly side does not have induction while the assembly is removed, replace the assembly. 3. Replace the Engine Controller PCB.
E003	0000	Title	Abnormal low temperature of Fixing Assembly
		Detection description	After Heater turns on, Main Thermistor detected a temperature of 120 deg C or lower for more than 20 seconds.
		Remedy	1. Check the connection of connectors between the Fixing Assembly and the Engine Controller PCB. 2. If the connector at the Fixing Assembly side does not have induction while the assembly is removed, replace the assembly. 3. Replace the Engine Controller PCB.
E004	0000	Title	Error in fixing power supply drive circuit
		Detection description	Error in either the Fixing Heater or the Main Motor
		Remedy	1. Check the connection of connectors between the Fixing Assembly and the Engine Controller PCB. 2. If the connector at the Fixing Assembly side does not have induction while the assembly is removed, replace the assembly. 3. Reconnect the connector on the Main Motor. 4. Replace the Main Motor. 5. Replace the Engine Controller PCB.
E014	0000	Title	Main motor error
		Detection description	Main motor failure is detected.
		Remedy	1. Reconnect the connector on the Main Motor. 2. Replace the Main Motor.

E Code	Detail Code	Item	Description
E06F	0068	Title	EEPROM communication error
		Detection description	EEPROM communication error
		Remedy	1. Reconnect the connector on the Engine Controller PCB. 2. Replace the Engine Controller PCB.
E100	0000	Title	Laser Scanner error
		Detection description	Error is detected in the Laser Scanner or the Scanner Motor.
		Remedy	1. Reconnect the connector on Laser Scanner Unit. 2. Replace the Laser Scanner Unit.
E245	2012	Title	System error
		Detection description	System error
		Remedy	Contact the service company office
E245	2022	Title	System error
		Detection description	System error
		Remedy	Contact the service company office
E247	0002	Title	System error
		Detection description	System error
		Remedy	Contact the service company office
E247	0003	Title	System error
		Detection description	System error
		Remedy	Contact the service company office
E247	0004	Title	System error
		Detection description	System error
		Remedy	Contact the service company office
E602	0002	Title	Firmware error
		Detection description	Bootable load failure
		Remedy	1. Install the set of the controller firmware. 2. Replace the Main Controller PCB.
E602	0008	Title	Memory area in the flash is depleted.
		Detection description	Remaining memory area in the flash is small.
		Remedy	* Turning OFF and then ON the main power stops the error code to be displayed, but the continuous use causes the memory area in the flash to be completely lost or causes symptoms as such as machine freeze. 1. Turning OFF and then ON the main power stops the error code to be displayed. 2. Export user information. 3. Replace the Main Controller PCB. 4. Import user information.

E Code	Detail Code	Item	Description
E602	0009	Title	MEAP cannot be started.
		Detection description	MEAP cannot be started due to an error caused by invalid power down.
		Remedy	Select Function.gr > MEAP > MEAP FUNCTION = ON, and turn OFF and then ON the main power. * Since the installed MEAP application and its management information are all cleared after reboot, MEAP needs to be reinstalled.
E602	1102	Title	File system could not be initialized normally (MEAP-related).
		Detection description	File system could not be initialized normally (MEAP-related).
		Remedy	Turning OFF and then ON the main power executes auto recovery. Since E616-0001 may be displayed in some cases, execute the remedy for E616-0001. * When this error occurs, the firmware downloaded by the CDS Updator will be lost.
E602	1112	Title	Device access error (MEAP-related).
		Detection description	Device access error (MEAP-related).
		Remedy	Turning OFF and then ON the main power executes auto recovery. Since E616-0001 may be displayed in some cases, execute the remedy for E616-0001. * When this error occurs, the firmware downloaded by the CDS Updator will be lost.
E602	1113	Title	Device access error (MEAP-related).
		Detection description	Device access error (MEAP-related).
		Remedy	Turning OFF and then ON the main power executes auto recovery. Since E616-0001 may be displayed in some cases, execute the remedy for E616-0001. * When this error occurs, the firmware downloaded by the CDS Updator will be lost.
E602	1302	Title	File system could not be initialized normally.
		Detection description	File system could not be initialized normally.
		Remedy	Turning OFF and then ON the main power executes auto recovery. * When this error occurs, the firmware downloaded by the CDS Updator will be lost.
E602	1312	Title	Device access error
		Detection description	Device access error
		Remedy	Turning OFF and then ON the main power executes auto recovery. * When this error occurs, the firmware downloaded by the CDS Updator will be lost.

E Code	Detail Code	Item	Description
E602	1313	Title	Device access error
		Detection description	Device access error
		Remedy	Turning OFF and then ON the main power executes auto recovery. * When this error occurs, the firmware downloaded by the CDS Updator will be lost.
E602	1602	Title	File system could not be initialized normally (CDS-related).
		Detection description	File system could not be initialized normally (CDS-related).
		Remedy	Turning OFF and then ON the main power executes auto recovery. * When this error occurs, the firmware downloaded by the CDS Updator will be lost.
E602	1612	Title	Device access error (CDS-related).
		Detection description	Device access error (CDS-related).
		Remedy	Turning OFF and then ON the main power executes auto recovery. * When this error occurs, the firmware downloaded by the CDS Updator will be lost.
E602	1613	Title	Device access error (CDS-related).
		Detection description	Device access error (CDS-related).
		Remedy	Turning OFF and then ON the main power executes auto recovery. * When this error occurs, the firmware downloaded by the CDS Updator will be lost.
E604	0000	Title	Lack of memory capacity
		Detection description	Lack of memory capacity
		Remedy	Check the memory capacity of ROM mounted on the Main Controller.
E604	0001	Title	Memory error
		Detection description	Failed to allocate the memory required to start PDL.
		Remedy	Check the installed memory, remove and then install the memory, and replace the memory.
E616	0001	Title	MEAP application is lost.
		Detection description	MEAP application is lost.
		Remedy	Select Function.gr > MEAP > MEAP FUNCTION = ON, and turn OFF and then ON the main power. * The setting is switched to the following after reboot. Initial screen setting: Native MEAP authentication: Off USB-Host setting: Native CDS-related: Off
E616	0002	Title	System error
		Detection description	System error
		Remedy	Execute Setup > Initialize Panel Setting to initialize NVRAM.

E Code	Detail Code	Item	Description
E730	100A	Title	System error
		Detection description	System error
		Remedy	1. Turn OFF and then ON the main power. 2. Replace the Main Controller PCB.
E730	C000	Title	An error, such as failure in memory retrieval at initialization, occurred.
		Detection description	An error, such as failure in memory retrieval at initialization, occurred.
		Remedy	Turning OFF and then ON the main power executes auto recovery.
E730	C001	Title	An error occurred when accessing the controller.
		Detection description	An error occurred when accessing the controller.
		Remedy	Turning OFF and then ON the main power executes auto recovery.
E730	D000	Title	An error, such as failure in memory retrieval at initialization, occurred.
		Detection description	An error, such as failure in memory retrieval at initialization, occurred.
		Remedy	Turning OFF and then ON the main power executes auto recovery.
E730	D001	Title	System error
		Detection description	System error
		Remedy	Turning OFF and then ON the main power executes auto recovery.
E733	0000	Title	Printer communication error
		Detection description	Communication error at initial communication, and packet error
		Remedy	1. Turn OFF and then ON the main power. 2. Replace the Main Controller PCB.
E733	0001	Title	Printer communication error
		Detection description	Communication error occurred after normal startup.
		Remedy	1. Turn OFF and then ON the main power. 2. Replace the Main Controller PCB.
E733	0004	Title	Printer communication error
		Detection description	Command error
		Remedy	1. Turn OFF and then ON the main power. 2. Replace the Main Controller PCB.
E733	0006	Title	Printer communication error
		Detection description	An unknown communication error
		Remedy	1. Turn OFF and then ON the main power. 2. Replace the Main Controller PCB.
E740	0002	Title	Detected the injustice of the Mac address
		Detection description	Detected the injustice of the Mac address
		Remedy	1. Check the Mac address. 2. Replace the Main Controller PCB.

E Code	Detail Code	Item	Description
E744	1000	Title	Firmware error
		Detection description	Mismatch of the model for which the firmware was downloaded is detected.
		Remedy	Install the firmware according to the model.
E744	1100	Title	System error
		Detection description	System error
		Remedy	1. Turn OFF and then ON the main power. 2. Replace the Main Controller PCB.
E748	2012	Title	System error
		Detection description	System error
		Remedy	Contact the service company office
E760	0000	Title	Firmware error
		Detection description	An error due to the controller software occurred so that print could not be proceeded.
		Remedy	Due to firmware error, the possibility of solving the error by replacing the Main Controller PCB is low. Check the downloaded firmware again.
E805	0000	Title	Main Fan error
		Detection description	Main Fan failure is detected.
		Remedy	1. Check the Main Fan or the connector. 2. Replace the Main Fan 3. Replace the Main Controller PCB.
E808	0001	Title	Failure detection of Low Voltage Power Supply PCB
		Detection description	Failure detection of Low Voltage Power Supply PCB
		Remedy	1. Check the connection of the Engine Controller or the connector. 2. Replace the Engine Controller PCB.

T-5-3

 Jam Codes

Jam Code		Cause	Jam Position
High Order	Low Order		
84		Paper feed delay jam 1	–
88		Paper feed retention jam 1	–
8C		Fixing output delay jam 1	–
90		Fixing output retention jam 1	–
94		Internal paper jam 1	–
98		Door open jam 1	–
9C		Wind-up jam 1	–
A0		Reversal unit jam 1	–
A1		Reversal unit jam 2	–
	00	–	Unknown area
	01	–	Feed slot 1 – resist position area
	02	–	Feed slot 2 – resist position area
	03	–	Feed slot 3 – resist position area
	07	–	Resist position – cartridge area
	08	–	Cartridge – fixing roller area
	09	–	Fixing unit roller – paper output unit area
	0C	–	Duplex reverse unit and adjacent area
	0D	–	Duplex Feed unit and adjacent area
	0E	–	Duplex reload unit and adjacent area

T-5-4

## Service Mode

### ADJUST GR.

Item	Description	Setting Range
ENGINE DENSITY CORR.	To execute density correction by setting the developing bias on the engine side.	0 <sup>+</sup> to 15
SUBTLE DENSITY CORR.	To adjust fine density at 1200dpi.	-1, 0 <sup>+</sup> , 1

T-5-5

### OPTION GR.

Item	Description
B4-L-CNT	Not use
SCT-ALL-CLR	To set whether clearing of all counts can be executed from the "Dept ID control setting" screen of RUI. ON: Clearing of all counts can be executed. OFF: Clearing of all counts cannot be executed.
SCT-IDV-CLR	To set whether clearing of counts can be executed from the "Dept editing" screen of RUI. ON: Clearing of counts can be executed. OFF: Clearing of counts cannot be executed.
PS-MODE	For R&D
COUNTER-SW	To switch the counter. MODEL1: Setting value 1 MODEL2: Setting value 2
TONEROUTCONT.PRINT	Not use

T-5-6

### FUNCTION GR.

Item	Description
ECONF	EXPORT To export device setting data in the following priority order. USB memory > SD card > RAM
	GENERAL Whether to set items whose device settings do not depend on the PCB, but can be performed commonly within the same device as the target
	DEPEND Whether to set items whose device settings change depending on the PCB as the target
	SECURITY Whether to set items related to security as the target
	ALL Whether to set all items exported in GENERAL/DEPEND/SECURITY as the target
IMPORT	To import device setting data in the following priority order USB memory > SD card > RAM

Item	Description
USB-H	To set to enable/disable the USB host function. By turning ON the host function, USB memory can be used.  (Note) Points to note when pulling out the USB memory <ul style="list-style-type: none"> <li>• Be sure to pull out the USB memory after turning USB-H to OFF because the USB memory is in the connected state when USB-H is ON.</li> <li>• Pulling out the USB memory while it is being accessed causes an error.</li> </ul> ON: Use the USB host function. (* default) OFF: Do not use the USB host function.
SUBLOG TO USB	To output sublog to the USB memory. It can be used regardless of the USB-H setting.  (Note) It cannot be executed more than 2 times consecutively. Since automatic recording of sublog can no longer be performed when executed once, be sure to turn OFF and then ON the main power after execution.
MEAP	MEAP-PN To specify the port number of MEAP HTTP.
	MEAP-SSL To specify the port number of MEAP HTTPS.
	CDS-MEAP To set whether to permit the user administrator to install MEAP application
	CDS-FIRM To set whether to permit the user administrator to update firmware
	CDS-UGW To set whether to permit firmware update from UGW
	CDS-LVUP To set whether to permit service technician or user administrator to use the periodical update function.
	CDS-CTL It is a menu to switch countries for obtaining firmware via CDS. Use this item to switch countries when obtaining firmware from another country due to the distance to the location server.
	MEAP FUNCTION Use this item when "E602-0009" occurs. It is a menu to clear the error code and recover MEAP. ON: Recover MEAP. OFF: Do not recover MEAP. (default)
DDNSINTY To change DDNS periodical update interval. 0: Do not perform periodical update. 1 to 48: 1 to 48 hours (default value: 24) [Description of terminology] DDNS (Dynamic Domain Name System): A system to dynamically register and manage the IP addresses which are dynamically allocated and their host names	
IPMTU To change MTU size of network packet. Use this item when performing communications between locations (such as SEND) connected with Ethernet in a field environment where MTU black hole problem occurs 1 to 10 [Description of terminology] MTU: A unit of transmission showing the maximum value of data which can be sent per 1 transfer (1 frame) in a network MTU black hole: A problem which occurs when ICMP packet is being filtered by firewall, etc. (Since the message does not reach the sender, the sender is not aware of the packet being lost, which then results in time-out.)	
PDL Z Logic	Not use

T-5-7

## LOG GR.

Item	Description
SYSTEM LOG	To set whether to use the system log function. ON: Use the system log function. OFF: Do not use the system log function.
SUBLOG FTP GET	To obtain sublog without using the serial console. For details on how to obtain sublog, refer to Chapter 5 “Debug Log”. * This item can only be executed when no job is in progress.
LOGGING UTILITY	To set whether to use the “Logging Utility” function in the utility menu. ON: Use the logging utility function. OFF: Do not use the logging utility function.
DEBUGLOG-SW	To set whether to perform sublog auto output when error code/exception/service call occurs. ON: Output automatically. OFF: Do not output automatically.  <ul style="list-style-type: none"> <li>■ Basic procedure: <ul style="list-style-type: none"> <li>● In the case of manual setting by service technicians (LUI) <ol style="list-style-type: none"> <li>1) Insert the USB memory.</li> <li>2) Set the service switch [USB-H] to ON.</li> <li>3) Set the service switch [DEBUGLOG-SW] to ON.</li> <li>4) After an error occurs, record the debug log from the menu (LUI) to the USB memory.</li> <li>5) Turn OFF and then ON the device power.</li> </ol> </li> <li>● In the case of remote setting from RDS <ol style="list-style-type: none"> <li>1) Insert the USB memory.</li> <li>2) Set the service switch [DEBUGLOG-SW] to ON from RDS.</li> <li>3) After an error occurs, record the debug log to the USB memory.</li> <li>4) Turn OFF and then ON the power.</li> </ol> </li> </ul> </li> </ul>

T-5-8

## PANEL GR

Item	Description
PANEL LOCK	To perform access restriction for each key on the Control Panel. ON: Enable the panel lock function. OFF: Disable the panel lock function.

T-5-9

## F/W UPDATE GR.

Item	Description
USB	To upgrade all firmware using the USB.
NETWORK	To upgrade all firmware via network.
USB STRAGE	To update the host machine to the firmware stored in the USB. ALL: All firmware CONT: Controller firmware BOOT: Startup firmware ROM: Firmware for control ROM DCON: Engine firmware
CDS	Firmware auto/manual update function by MEAP application (updater). ON: Update automatically/manually. OFF: Do not update automatically/manually. Update procedure is as follows. <ol style="list-style-type: none"> <li>1. Start MEAP (Updater).</li> <li>2. The Updater downloads the firmware via network.</li> <li>3. The Updater calls the program, and interrupts job input or user operation.</li> <li>4. The Updater decompress the firmware.</li> <li>5. The Updater calls the program and instructs to reboot.</li> <li>6. The machine reboots, and the new firmware starts operation.</li> </ol> Before executing this menu, service technicians should perform up to step 2.

T-5-10

## NETWORK GR.

Item	Description
DNSTRANS	To determine priority order of the protocol (IPv4/IPv6) to be used for DNS query. IPV4, IPV 6 (default)
FTP SYSLOG	To set the function to obtain various system log files. ON: Obtain the function. OFF: Do not obtain the function.
JOB SERIALIZE	To set connection serialize function. ON: Use the function. OFF: Do not use. the function.
BUFFER LIMIT	To clear the buffer acquisition limit of PSS. ON: Clear the buffer acquisition limit. OFF: Limit the buffer acquisition.

Item	Description	
E-RDS	E-RDS SWITCH	ON: Use Embedded-RDS. OFF: Do not use Embedded-RDS.
	RGW-ADDRESS	To check and set the server URL. Use the “up, down, left and right keys, Job Status/Cancel key and Feeder selection key” to enter URL, and “OK key” to determine it. “↓” is displayed at the end of the character string. The number of characters which can be entered is 128. The default value is the server URL. Characters which can be set are as follows. 0123456789ABCDEFGHIJKLMNPOQRSTUVWXYZabcdefghijklmnopqrstuvwxyz!#\$%&'()*+,-./:;<=>@[¥]^_`{ }~ (Note) If “ugwdevice.net/” is not included in the character string when entering an URL, it is judged as an authentication error and an error message is displayed.
	RGW-PORT	To set the port number of the server.
	COM-TEST	To execute a communication test, and display the result.
	COM-LOG	To display the detail of the communication test result. Communication with the server is attempted, and the time, error codes and error information at error occurrence up to the present date are displayed. Maximum of 5 logs are saved, and the latest log is displayed. Error information is 130 byte maximum.
	CLEAR	To clear the schedule information, alarm error and filtering information besides the eRDS setting value in service mode by executing this item.
CA-KEY	CLEAR	To change CA certificate to the default by executing this item and turning ON and then OFF the power.
TCP DELAYED ACK	ON: Enable ACK delay function of TCP. OFF: Disable ACK delay function of TCP. [Remarks] ACK: Text sent by the reception side to the sending side to notify that reception was performed correctly.	
WOLtrans	To set recovery from sleep mode. 1: Recover from sleep by WSD, and do not recover from sleep by the old utility using the broadcast packet. (default) 2: Recover from sleep by WSD, and do not have the function to recover from sleep by the old utility using the SNMP search broadcast packet. 3: Enable recovery from sleep by the old utility, and do not recover from sleep by WSD. [Description of terminology] WSD (Web services on devices): A protocol to easily set up connection and use of various devices connected to the network	

Item	Description	
SLEEP ADVERTISE	SWITCH	To set whether to use the sleep notification. ON: Notify sleep. OFF: Do not notify sleep.
	PORT	To set the port number as the destination of sleep notification. Setting value: 1 to 65535 Default value: 11427
	TTL	To set the number of routers which can send sleep notification messages. Setting value: 0 to 254 Default value: 3
	INTERVAL	To set the notification interval (seconds) of sleep notification. Setting value: 60 to 65535 Default value: 600
PROXYRES	To set proxy response function. ON*: Perform proxy response. OFF: Do not perform a proxy response.	
IPSEC SETTING	IKERETRY	To set the IKE retry times. 0 to 3 (default 1)
	IKEINTVL	To set the IKE retry interval (seconds). 1 to 30 (default value: 5)
	SPDALDEL	To set whether to initialize the device at next startup. Be sure to return this value to “0” after initialization is completed. 0: Initialize the device. 1: Do not initialize the device.
	IPSDREBLY	Since IPsec operates by a different process from the main program, log information is not kept in the Sublog Board. Therefore, change the value when obtaining the IPsec log. The setting is enabled after restart, and this value becomes “0” internally after restart. When this log is enabled, a file named “/APL_LOG/ipsec/ipseclog.txt” is generated, in which the log information is stored. However, this file is cleared when turning ON and then OFF the power. 0: Do not keep logs. 1 to 3: Log level 1 to 3, fatal error information 4 to 6: Log level 4 to 6, warning information 7: Log level 7, important log information 8 to 10: Log level 8, all logs

Item	Description	
PFW SETTING	ILOGKEEP	The time is saved when an address is blocked by packet filtering. The log is not notified to UI when an access is made from the same address within the specified period of time. The specified period of time mentioned above can be set. 0: 1 minute 1: 1 hour, 2: 2 hours, 3: 3 hours, ... 47: 47 hours, 48: 48 hours Restart is necessary to reflect the setting.
	ILOGMODE	Since packet filtering becomes enabled for all protocols, it blocks packets not related to this machine, for which logs can be kept. Therefore, logs of devices which are not malicious are kept as well, causing the log volume to become large. Use this item for users who want to keep logs precisely. 0: Keep unicast to the own machine only. (default) 1: Keep all filter logs.
	IPTBROAD	Transmission to IPv4 multicast address, broadcast address and subnet broadcast address is allowed even if the default policy is set to "Reject" in the IPv4 transmission setting. In addition, IPv6 multicast address transmission is allowed even if the default policy is set to "Reject" in the IPv6 transmission setting. When setting to reject multicast transmission also, the setting can be changed by switching the service mode value. 0: Allow multicast transmission. (default value) 1: Reject multicast address transmission when the transmission default policy is set to "Reject". 2 to 10: Not used

T-5-11

## ■ SP.ADMIN.MODE

Item	Description	Setting Range
MAINTENANCE C.	Not use	----

T-5-12



## Version Upgrade

### Overview

#### Overview of Version Upgrade

1. Download via the user support tool (hereinafter referred to as "UST")

The system software is downloaded from a PC connected with the machine by a USB cable.

2. Only LBP6680 (LBP3480 in the US), download via Contents Delivery System (hereinafter referred to as "CDS")

Download the system software directly to the machine from CDS via Internet.

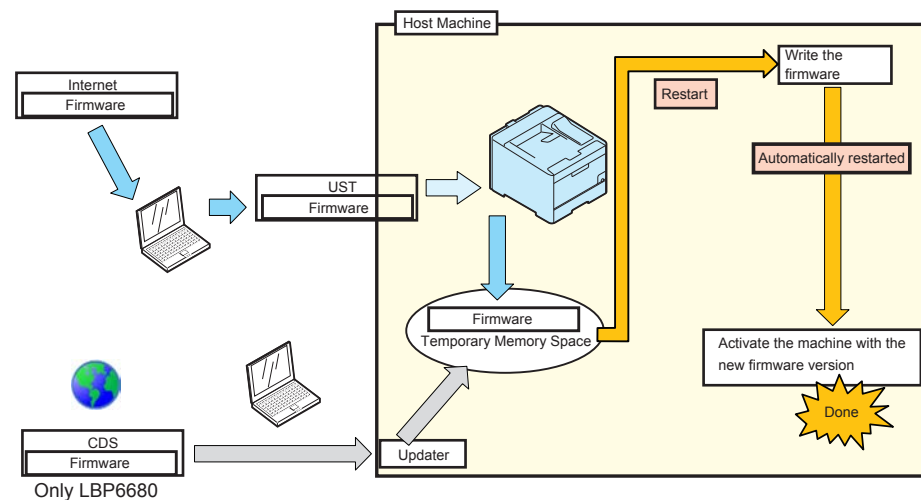

F-5-3

#### Checking the Version

In order to check the model name and the version, it is necessary to output a status print.

1) Utility Menu > Configuration Page

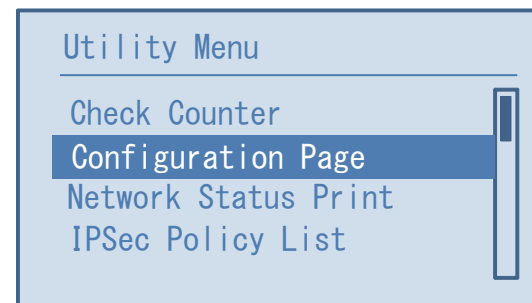

F-5-4

2) Check the printed status. You can upgrade the machine when the downloaded UST is later than the machine's version.

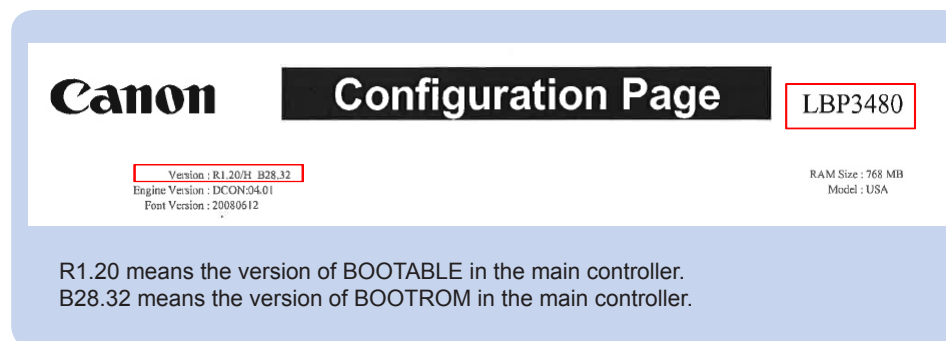

## Version Upgrade Using UST

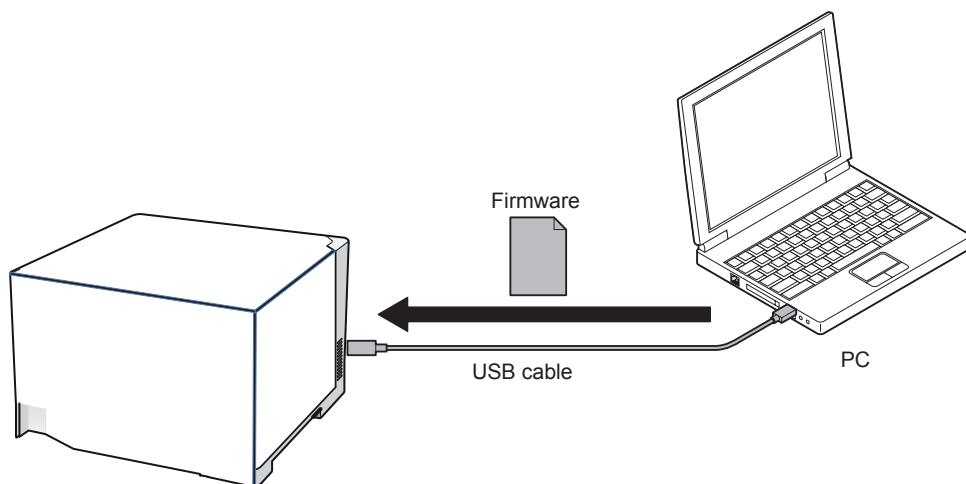

F-5-5

### Firmware Configuration

Firmware	Function	Storage area
BOOTROM	Startup of the main controller	Main controller PCB
BOOTABLE	Overall control	Main controller PCB

T-5-13

A number of firmware may be less than the above depending on the UST version.

## Preparation

### Necessary System Environment

- OS (Any of the following)
  - Microsoft Windows 2000 Server/Professional Edition
  - Microsoft Windows XP Professional/Home Edition\*
  - Microsoft Windows Server 2003 Edition\*
  - Microsoft Windows Server 2008 Edition\*
  - Microsoft Windows Vista\*
  - Microsoft Windows 7\*
  - Mac OS X 10.4.x
  - Mac OS X 10.5 and later

\* : 32-bit /64-bit processor version available
- PC
  - The OS listed above operates.
  - Memory (RAM): 128MB or greater
  - Hard disk: 100MB or greater
  - Display: Resolution 640 x 480 pixel or greater, 256-color or greater
  - Equipped with USB port
- UST file\* of this machine
  - \* : Download the file from website. (It differs depending on the sales company.)
- USB cable (USB1.1/2.0)

### Before Downloading the System Software

- 1) Start up the PC.
- 2) Connect the host machine and the PC with a USB cable.
- 3) Turn on the host machine, and place it in the standby status.

## ■ Downloading the Firmware

1) Select Setup > User Maintenance > Update Firmware

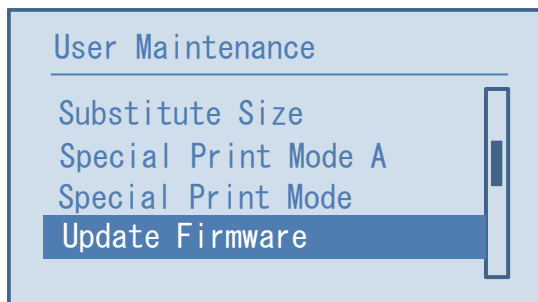

F-5-6

2) Select [USB].

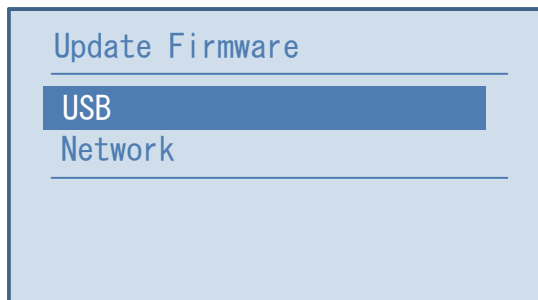

F-5-7

3) Select [Yes].

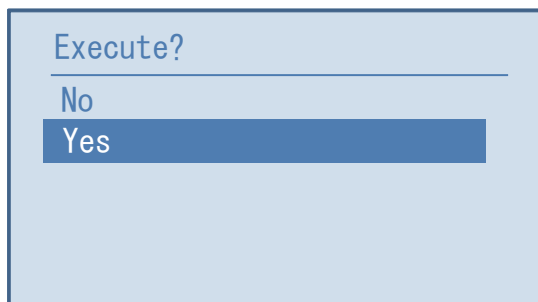

F-5-8

4) A reset starts and [UPDATEMODE READY] is displayed.

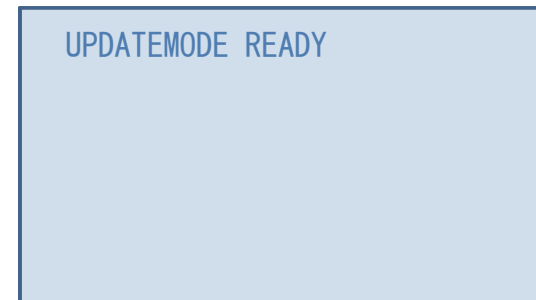

F-5-9

5) Carrying out the file of UST in the connected PC side.



F-5-10

6) Write down the firmware version to upgrade, and click the "Next" button.

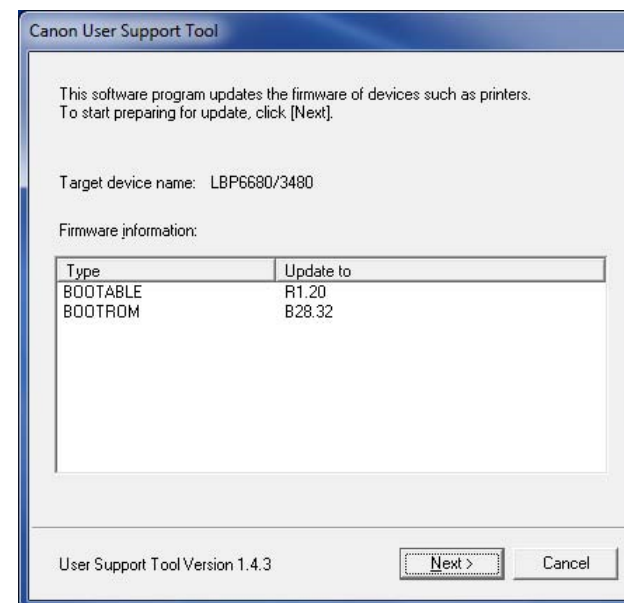

F-5-11

7) Click the "Next" button.

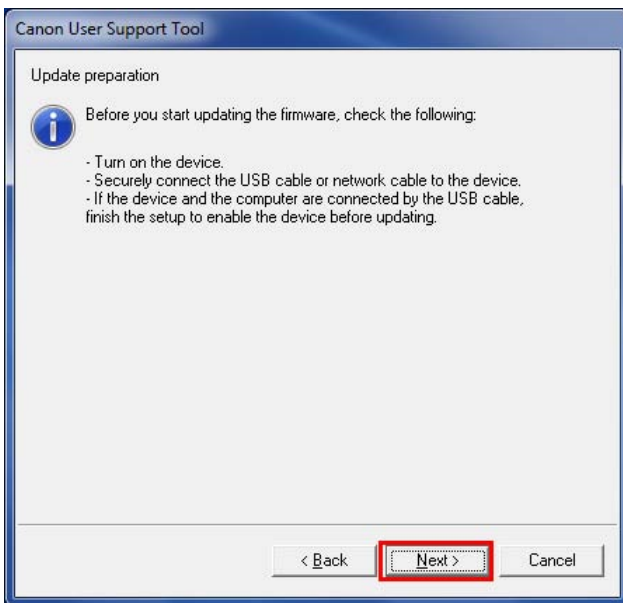

F-5-12

9) Click the "Start" button.

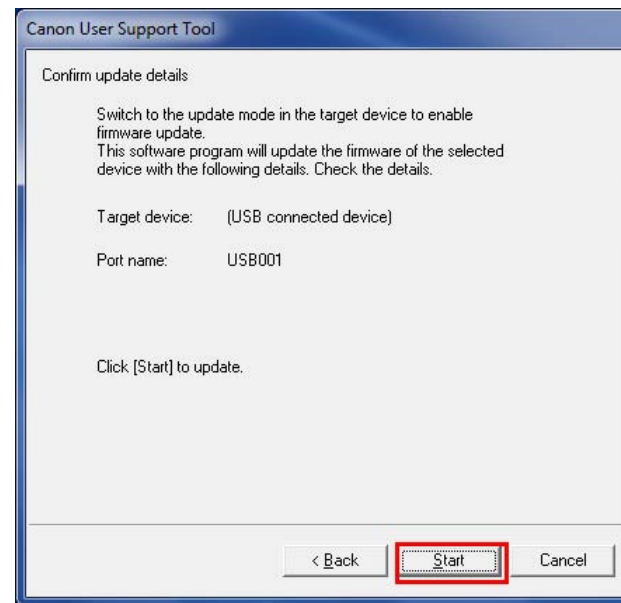

F-5-14

8) Select the USB connection device, and click the "Next" button.

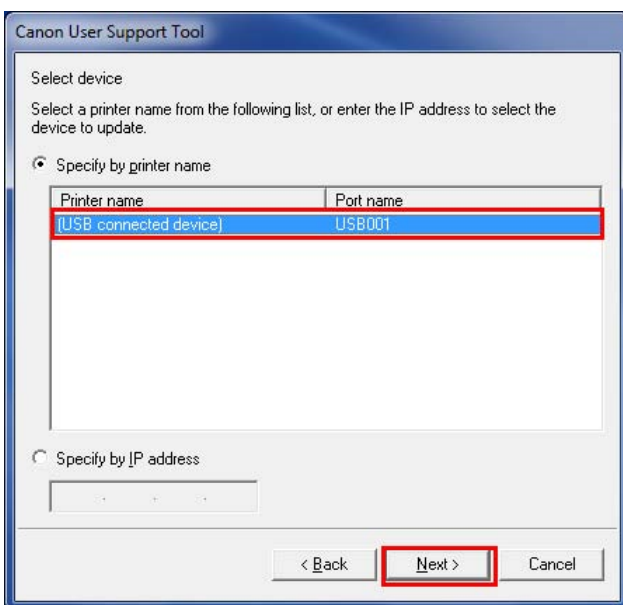

F-5-13

10) When the warning screen is displayed, click the "Yes" button.

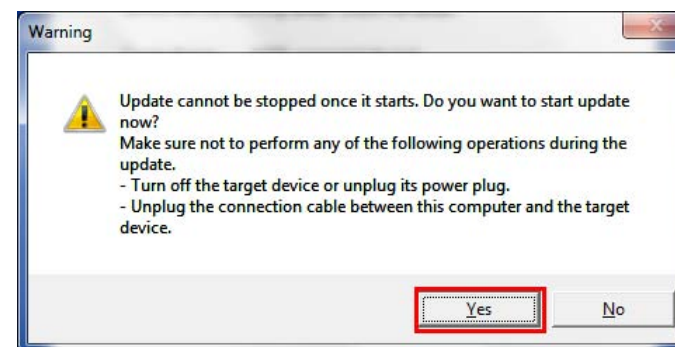

F-5-15

Then start downloading.



F-5-16

Note:  
"DOWNLOADING XX%" and "UPDATING XX%" are displayed in the display of the host machine during downloading. (XX shows the progress degree.)

11) When downloading is completed, click the "OK" button.

The host machine automatically restarts up



F-5-17

12) Perform Configuration Page print via the user mode, and make sure that the firmware version matches the information written down in Procedure 2).

Utility Menu > Configuration Page

# Updater

## Overview

### Outline

Updater provides functions that enable network communication with Content Delivery System V1.0 (hereinafter CDS) to install firmware, MEAP applications and system options.

- **Firmware Installation**  
Updater function enables users to distribute firmware through CDS via Internet. Particularly on e-Maintenance/UGW (called NETEYE in Japan)-enabled devices, firmware can be updated remotely, which effectively slashes costs incurred in field services.
- **MEAP Application**  
By linking devices to CDS and License Management System (providing the function to manage licenses; hereinafter LMS), applications can be installed in devices via Updater.

#### Caution:

LBP6670 non-supports CDS.

### Installing Firmware

With link to Updater, service technicians provide firmware install services in the following 3 methods.

Distribution Method	Download Commanded by:	Update Timing	Downloadable Firmware Versions		
			Previous Ver	Current Ver	Newer Ver
a. UGW-linked Download / Update (Full-remote update)	UGW	Auto	No	Yes	Yes*1
b. UGW-linked Download (Remote Distribution / Update)	UGW	Manual	Yes	Yes	Yes
c. Update via SST	SST	-	Yes	Yes	Yes

\*1: You can select the version allowed Remote Update.

T-5-14

#### a. UGW-linked Download and Update (Full-Remote Update)

If the device is linked to UGW and the distribution schedule and update setting are registered on UGW in advance, full remote firmware update is available. Upon downloaded from CDS, the firmware is updated on the device.

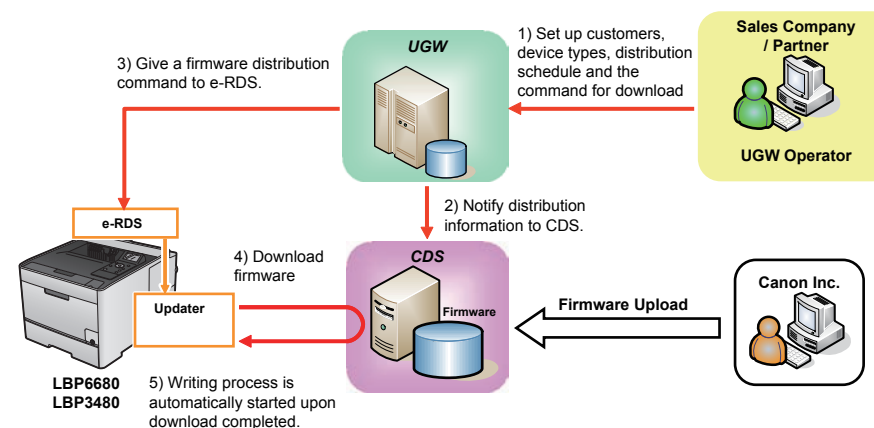

F-5-18

#### b. UGW-linked Download (Remote Distribution / Update)

If the device is linked to UGW and the distribution schedule is registered on UGW in advance, firmware can be distributed to the device before a service technician actually visits the customer site. This allows the service technician to update the firmware manually immediately after completing device inspection.

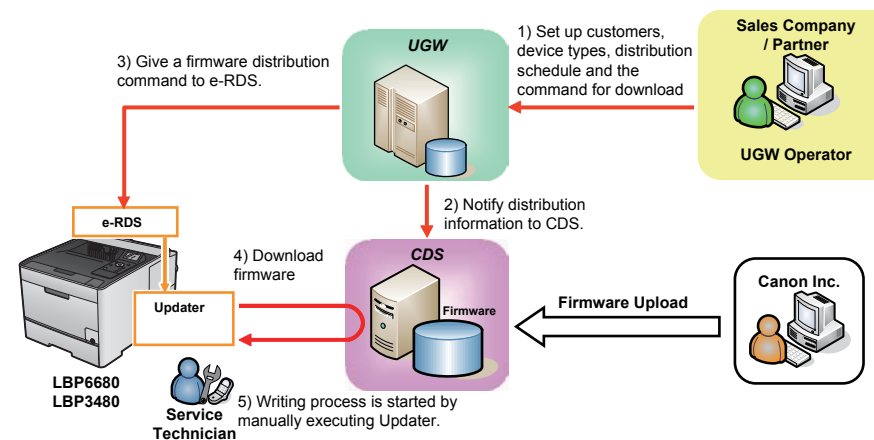

F-5-19

## System Configuration

The figure below schematically shows the system configuration.

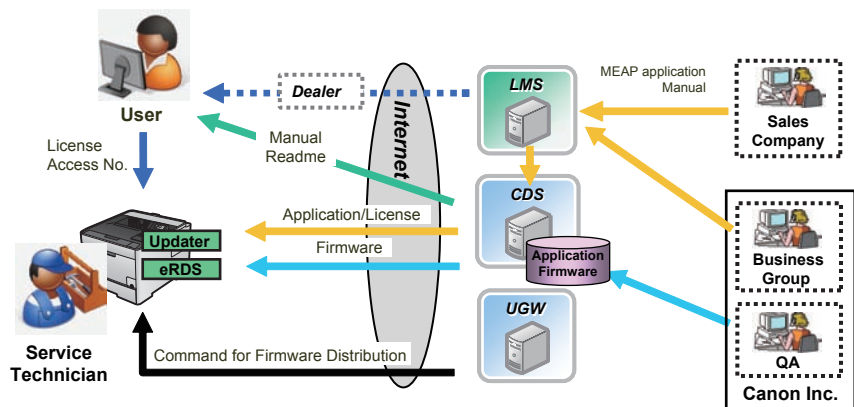

F-5-20

## List of Functions

The matrix below shows the list of functions provided by Updater.

Category	Function	Remote UI	UGW-linked
Firmware	Checking firmware compatibility	-	Yes
	Checking special firmware	-	Yes
	Checking latest firmware version	Yes	-
	Registering/deleting firmware distribution schedule	Yes	-
	Confirming and downloading firmware	Yes	Yes
	Updating downloaded firmware	Yes	-
	Cancelling downloaded firmware	Yes	-
	Acquiring firmware distribution information registered from UGW	-	Yes
	Notifying firmware version information	-	Yes
	Periodical update	-	-
MEAP application/system option	Inquiring license for MEAP application option	Yes	-
	Installing MEAP application / system option	Yes	-
System Management	Settings	Yes*	-
	Testing communications	Yes	-
	Displaying update logs	Yes	-
Internal system error notification	Displaying system logs	Yes	-
	Notifying internal system error occurrence to distribution server	Yes	Yes

T-5-15

\*Remote UI's Service Mode

## Distribution Flow

### Firmware Installation Flow

Service technicians provide firmware install services in the following 4 methods.

- a: UGW-linked download and update
- b: UGW-linked download
- c: Update via SST

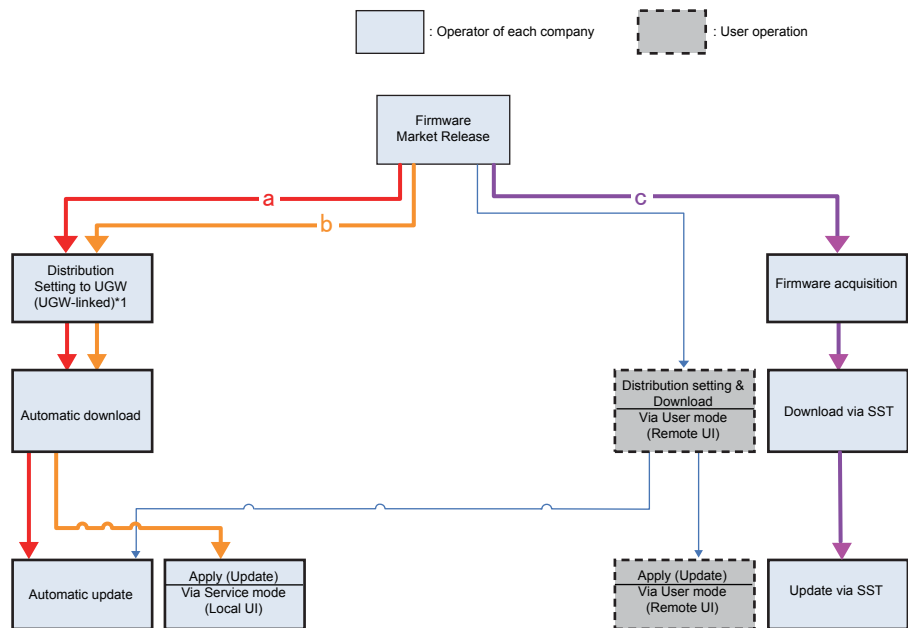

F-5-21

\*1: Schedules for UGW-linked distribution are maintained on CDS.

### MEAP Application Installation Flow

MEAP application installation method using service mode is not provided.

Be sure to use the user mode to install.

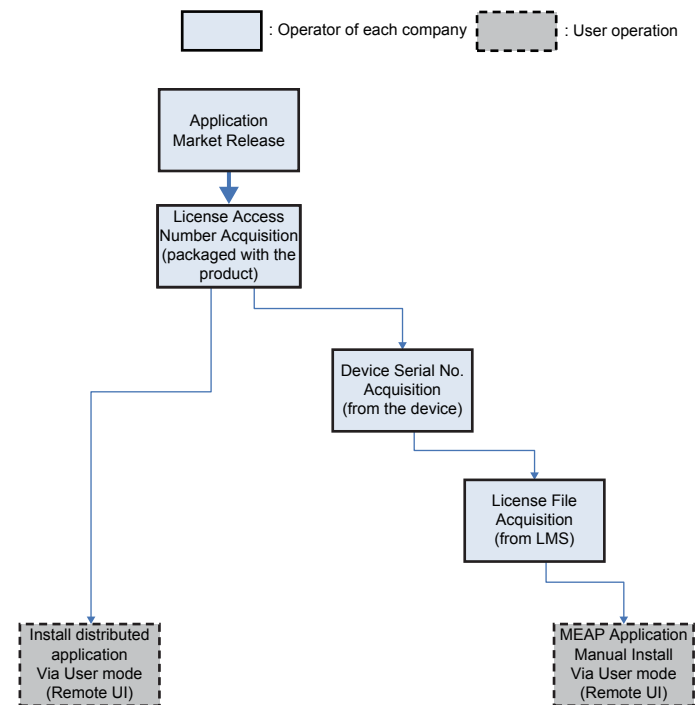

F-5-22



## ■ Limitations and Cautions

### ● Limitations

#### Changing Date/Time on Device

When a user changes the date/time setting on the device (including change of the setting according to daylight saving time), the firmware distribution may not be performed as scheduled.

But there is not the problem if it is time adjustment of several minutes with NTP servers.

#### Change of Setting from Service mode

Any settings from Service mode will be enabled after restarting the device.

### ● Cautions

#### Concurrent use of Updater functions

Multiple users cannot use Updater functions on a device concurrently by using it together with Remote UI.

#### Coexistence of Remote UI and other tools

Users logged in SMS (Service Management Service) are unable to use Update functions from Remote UI.

#### Using Updater function from Remote UI

Upon the following operations done, Updater functions are suspended from Remote UI for certain duration.

- When a user exits Web browser without clicking [Portal] or [Log Out] button in the setting of Remote Login Service via SMS
- When a user exits Web browser without clicking [Portal] button in the setting of not to use Remote Login Service via SMS.
- When a user exits Web browser without clicking [Log out from SMS] or [To Remote UI] button.

#### Wait for EOJ (end of job) Function

Firmware update will be triggered only after the following jobs are completed.

This is the Updater-specific specification.

Job/Function type	Receiving	Printing	Queued print jobs
PRINT	Wait for EOJ (end of job)	Wait for EOJ	Wait for EOJ
I-FAX Receipt	Cancel processing to trigger update *	Wait for EOJ	Wait for EOJ
Report Print	-	Wait for EOJ	Wait for EOJ

T-5-16

\*The data are guaranteed even if cut off in the middle of a job. It becomes the recovery object after the device reboot and carry out send / reception again.

Even during transfer, Pull SCAN job processing is cancelled soon after scanning is completed.

Firmware update is cancelled if the jobs are not completed within 10 minutes. If this occurs, the error code, 8x001106, will be returned (different numbers will be shown for x depending on the execution modes).

Firmware update is executed if the jobs stated above are not in the queue.

Follow the shutdown sequence to reboot the device after the firmware is updated.

## ■ Preparation

### ● Overview of Preparation

The following should be prepared before using Updater.

- For updating of firmware

Installation Method	Setting Sales Company's HQ	Network Settings	Enabling UGW Link	Enabling [Update Firmware] Button of User Mode	Enabling [Manual Update] Button of User Mode (Remote UI)
UGW-linked Download and Update	Yes	Yes	Yes	-	-
UGW-linked Download	Yes	Yes	Yes	-	-

T-5-17

### ● Setting Sales Company's HQ

When using devices input in the markets listed below, the default setting of Sales Company's HQ should be changed before obtaining firmware distributed from CDS. Unless the setting is changed properly, the desired firmware may not be able to be selected.

Market	Default Setting of Sales Company's HQ	Setting of Sales Company's HQ after Change
Canada	US	CA
Latin America	US	LA

T-5-18

Go to the following screen to change the setting of Sales Company's HQ.

Service Technician	Setting of Device Service Mode	SERVICE MODE > FUNCTION GR. > MEAP:2 > CDS-CTL
--------------------	--------------------------------	--

#### NOTE:

The list below shows the setting of Sales Company's HQ for CDS-CTS by market. Check and adhere to the appropriate setting for your market.

<List of Sales Company's HQ and the settings for CDS-CTL>

Japan = JP	China = CN
USA = US	Hong Kong = HK
Singapore = SG	Australia = AU
Europe = NL	Canada = CA
Korea = KR	Latin America = LA

## Network Settings

### Connecting to External Network

The method of connecting to external network is similar to a normal network connection method. Refer to user manual of the device for details.

#### NOTE:

- Before using UGW link or User mode, see the sections below to prepare as required. "Enabling UGW Link"

#### NOTE:

"External Network" here means the network connecting the device to CDS via Internet.

### Confirming URL Setting of Distribution Server

This section describes how to confirm the URL setting of the distribution server. One of the MEAP system service, [Register/Update Software(Management Settings)] is available.

1. You can log in it from a browser on a PC connected in a network.

Type the address [https://machine's IP address:8443/svm].

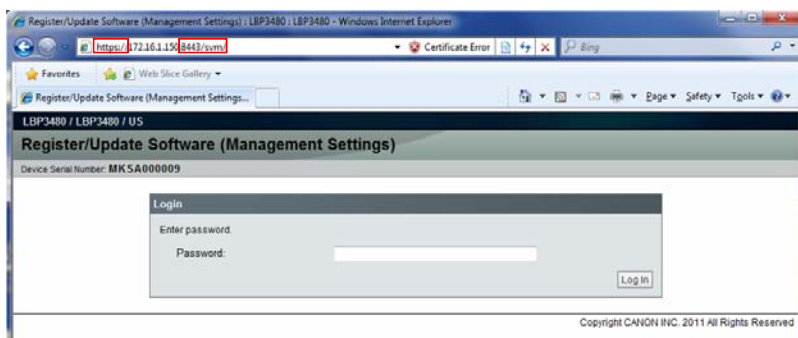

F-5-23

2. Type the password [\*28\*] then log in it.

#### Caution:

In the case of the following, you cannot log in even if you input a right password.

- The other user is using "Register/Update Software (Management Settings)" .
- The other user is using "Register/Update Software" in normal Remote UI.
- Because you have closed a browser without logging out definitely, you are still logging in it. Waiting for time-out.

3. After login, select [System Settings] > [Edit].



F-5-24

4. Confirm that "https://device.c-cdsknn.net/cds\_soap/updaterif" is typed in [Delivery Server URL].

If the URL is not entered or wrong URL is entered, enter the right URL in [Delivery Server URL].

When you set output level of the log, input numerical value (0-4). Setting the bigger numerical value, you can get more detailed output log.



F-5-25

**Caution:**

The setting change of the output level influences a performance.

Refer to System Management Operations> Various Setting> Setting Log Level in detail.

5. When you have changed the settings, press [Configure] button. The confirmation dialog is displayed. If there is no problem, select [Yes]. In this, the URL of the delivery server and setting editing of the log output level are the end.

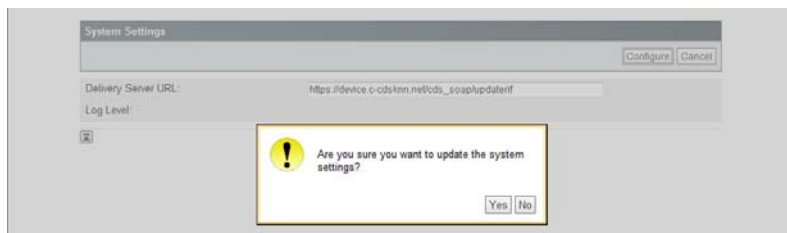

F-5-26

**Communication Test**

This section describes how to check if the communication is normally done to the distribution server and/or the file server.

**Note:**

CDS Server and RDS Server are different. So carry out the communication test with both Embedded RDS and CDS.

1. Enter [Register / Updater Software (Management Settings)].
2. Select [Display Logs / Communication Test] > [Communication Test].

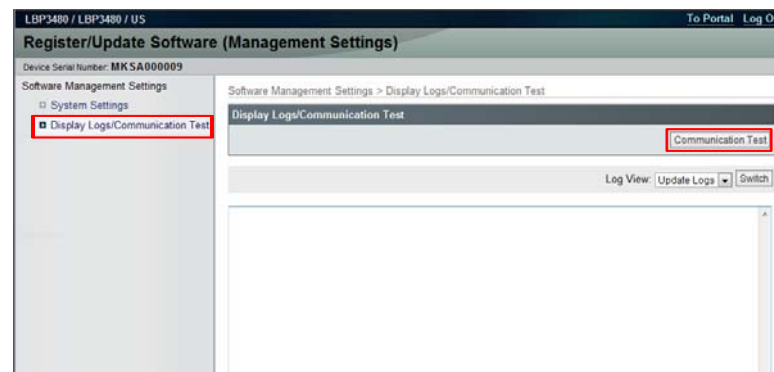

F-5-27

3. The Communication Test is carried out.

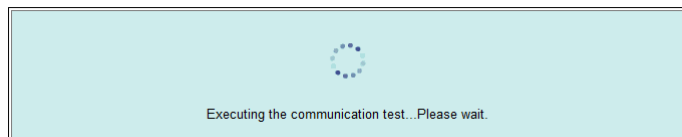

F-5-28

Obtain the download file information for communication test from the distribution server (to execute the communication test to the distribution server).

Using the download file information for communication test, the contents for test are downloaded from the file server (for the communication test to the file server).

4. Upon the communication test completed, the communication test result screen is shown. Press [OK] button to exit this operation.



F-5-29

## ● Enabling UGW Link

When installing the firmware in the method of “UGW-linked Download and Update” or “UGW-linked Download”, the following should be set before actually using UGW link.

Service Technician	Setting of Device Service Mode	SERVICE MODE >FUNCTION GR. >MEAP >CDS-UGW (Off -> On)
	Setting of UGW WebPortal	In [Customer Management] screen, set [Do not distribute firmware] to [Distribute firmware].
Sales Company's HQ	Setting of Authorities on UGW WebPortal	See "Analysis>Firmware Distribution Information" to grant the appropriate authorities to each account.

### NOTE:

- See “imageWARE Remote Operator's Manual / e-Maintenance Business Operation Manual” for how to operate UGW WebPortal.
- [Distribute Firmware] should be set on [Customer Management] screen for staff in charge of setting for [Enter customer information] or [Command for firmware distribution] in order to allow them to select the desired device on [Firmware Distribution Information] screen.
- If [Distribute Firmware] is not shown on [Customer Management] screen of UGW WebPortal, appropriate authorities may not be set to each account in Firmware Distribution Information. Contact the Sales Company HQ concerned for confirmation.

## ● Enabling [Install Application/Options] Button of User Mode (Remote UI)

To allow users to install applications using Updater, the setting of application installation should be set to ON for users in advance.

Service Technician	Setting of Device Service Mode	SERVICE MODE >FUNCTION GR. >MEAP >CDS-MEAP (Off -> On)
--------------------	--------------------------------	--

- Remote UI screen of Updater when the setting is not enabled (CDS-MEAP(Off)):

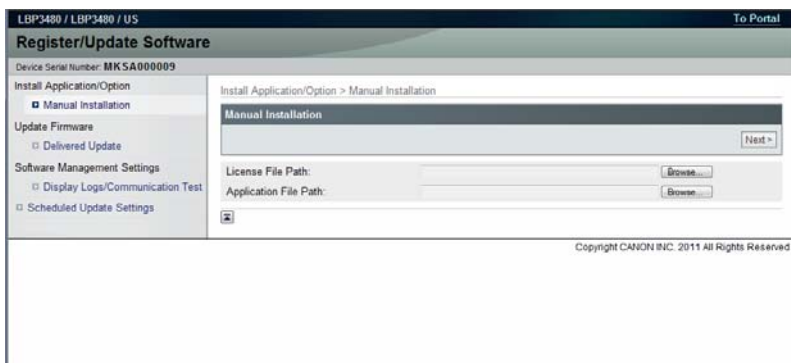

F-5-30

- Remote UI screen of Updater when the setting is enabled (CDS-MEAP(On)):

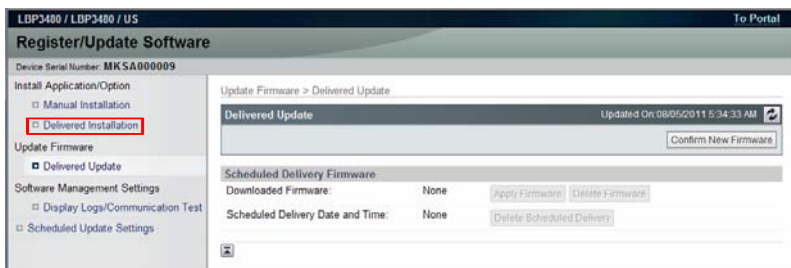

F-5-31

## ● Enabling [Manual Update] Button of User Mode (Remote UI)

To allow users to install firmware from Updater using the file on Local PCs, the setting of firmware installation should be set to ON for users in advance.

Service Technician	Setting of Device Service Mode	SERVICE MODE >FUNCTION GR. >MEAP >CDS-FIRM (Off -> On)
--------------------	--------------------------------	--

- Remote UI screen of Updater when the setting is not enabled (CDS-FIRM (Off)):



F-5-32

- Remote UI screen of Updater when the setting is enabled (CDS-FIRM (On)):

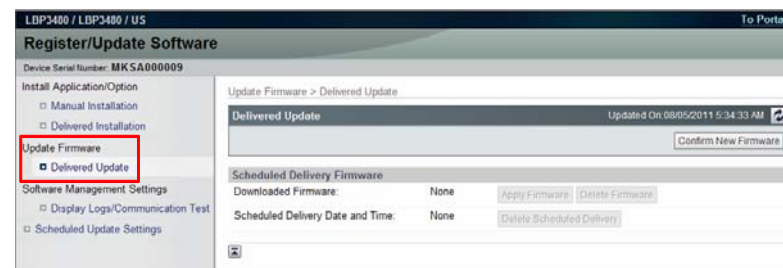

F-5-33

### Caution:

CDS-FIRM

CDS-FIRM is default On in LBP6680C (EU model).

It is default Off in LBP3480 (US model).

## ● Enabling [Scheduled Update] Button of User Mode

Service Technician	Setting of Device Service Mode	SERVICE MODE >FUNCTION GR. >MEAP >CDS-LVUP (On -> Off)
--------------------	--------------------------------	--

- Remote UI screen of Updater when the setting is not enabled (CDS-LVUP (Off)):

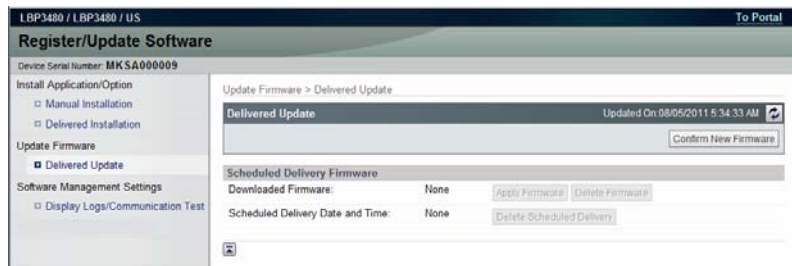

F-5-34

- Remote UI screen of Updater when the setting is enabled (CDS-LVUP (On)):

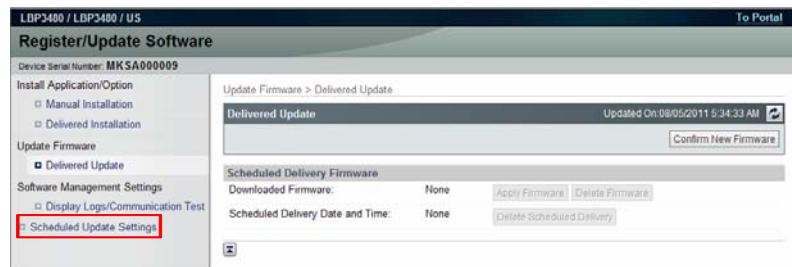

F-5-35

### Caution:

CDS-LVUP

CDS-LVUP is default On in LBP6680 (EU model).

It is default Off in LBP3480 (US model).

## System Management Operations

### Various Setting

#### Setting Log Level

This section describes how to set system log levels.

1. Activate [Register/Updater Software (Management Settings)] from browser.
  - 1). Enter [https://machine's IP address:8443/svm/] to the URL of browser.
  - 2). Type the password [\*28\*] then log in it.
  - 3). After login, select [System Settings] > [Edit].



F-5-36

2. Select a log level from [Log Level] dropdown list.

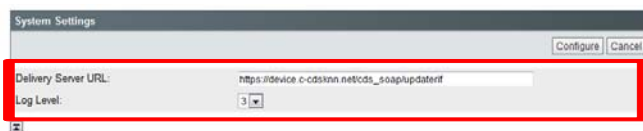

F-5-37

- [Log Level]:  
Select one of 5 levels ranging from [0] to [4]. (The default [3].)  
See the table below for logs output in each level.

Log Level	Log Output				
	Trace	Information	Important Message	Ordinary Error	System Error
0	-	-	-	-	Yes
1	-	-	-	Yes	Yes
2	-	-	Yes	Yes	Yes
3	-	Yes	Yes	Yes	Yes
4	Yes	Yes	Yes	Yes	Yes

T-5-19

#### NOTE:

This list shows the contents of the Log Output.

Log Output	Description
Trace	Detailed logs for debug
Information	Logs related to operations done on the system
Important Message	Update logs output by firmware type Installation logs by MEAP application Logs related to enabled functions by system option
Ordinary Error	Logs for ordinary errors
System Error	Logs for internal system errors

3. Press [Configure] button to set the selected log level. Now the log level is successfully set.

#### Caution:

When you set it to log level 4, a performance falls, and the log acquisition takes time remarkably .



## ● Displaying Logs

### Update Logs

This section describes how to confirm System Option/MEAP Application Installation Logs and Firmware Update Logs.

1. Select [Settings/Registration] > [License/Other] > [Register/Update Software] > [Display Logs/Communication Test] from management mode of Remote UI.

#### Note:

You can also access from [Register/Updater Software (Management Settings)] > [Display Logs/Communication Test]

2. Press [Update Logs] button.

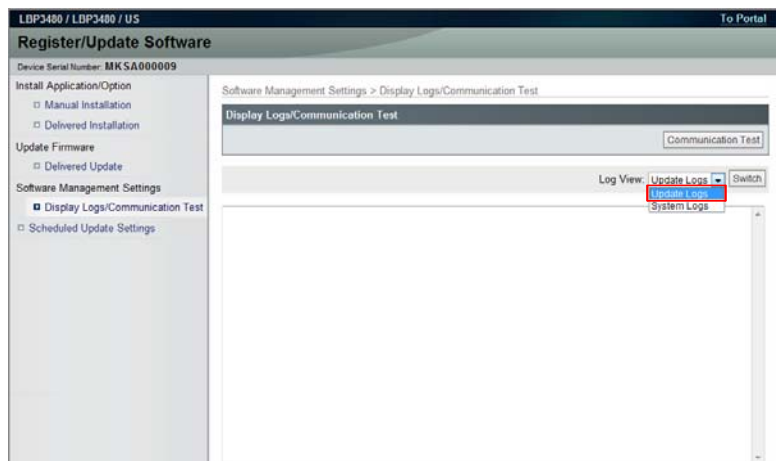

F-5-38

3. Press [Switch] button.

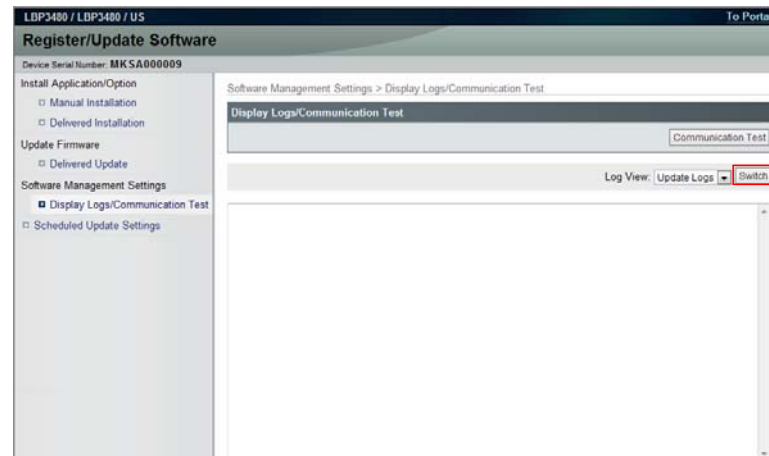

F-5-39

4. System Option/MEAP Application Installation Logs and Firmware Update Logs are shown.

## System Logs

This section describes how to confirm System Logs.

1. Select [Settings/Registration] > [License/Other] > [Register/Update Software] > [Display Logs/Communication Test] from management mode of Remote UI.

**Note:**

You can also access from [Register/Updater Software (Management Settings)] > [Display Logs/Communication Test]

2. Press [System Logs] button.

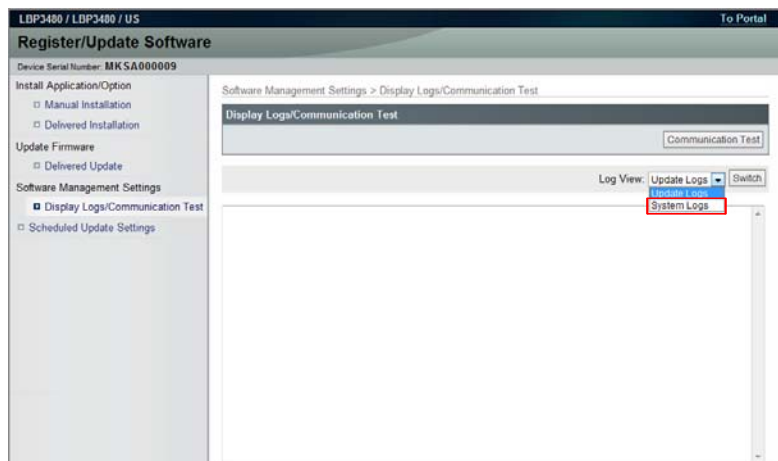

F-5-40

3. Press [Switch] button.

4. Updater internal logs are displayed.

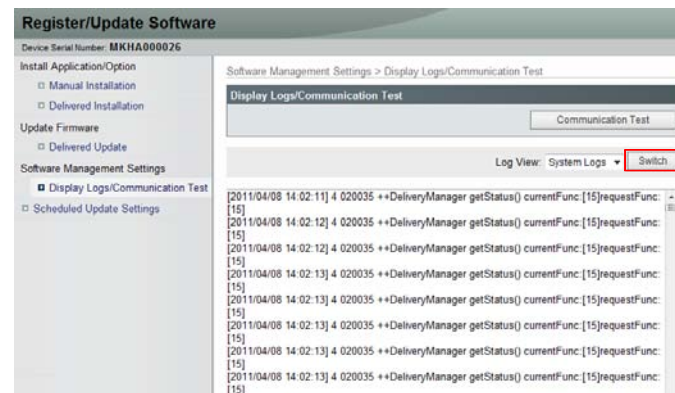

F-5-41

**Note:**

When you acquire the logs, do copy and paste of it.

## a. UGW-linked Download and Update (Full-remote Update)

See the figure below for the operational flow of “UGW-linked Download and Update”.

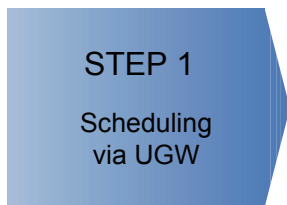

F-5-42

### STEP1: Scheduling via UGW

The firmware distribution schedule to the certain device should be set on UGW.

See “UGW-linked Download and Update” in Operation Manual of Content Delivery System for Firmware Distribution for details.

The device checks the schedule concerned every 12 hours on UGW. This allows the device to register the firmware distribution setting, enabling automatic firmware download and update.

#### CAUTION:

[Device without the function to wait for job completion]

- Explain to the user in advance that a job cannot be accepted during firmware update. Also, it is recommended to execute the operation during the period of time when no print job is accepted.

[Device with the function to wait for job completion]

- When the following jobs exist at the time of firmware update, firmware update processing is not executed until job completion.(When the firmware update processing is not executed more than 10 minutes, it will be timeout error.)

- Printing
- I-FAX

#### NOTE:

To contacts registered for E-mail notification on UGW, the E-mail is sent from UGW upon completing firmware update.

## b. UGW-linked Download (Remote Distribution Update)

See the figure below for the operational flow of “UGW-linked download”.



F-5-43

### STEP 1: Scheduling via UGW

The firmware distribution schedule to the certain device should be set on UGW.

See “UGW-linked Download” in Operation Manual of Content Delivery System (for Firmware Distribution) for details.

#### NOTE:

The firmware downloaded by scheduling via UGW can be checked/deleted from User mode, but cannot be updated. If a user download the other firmware, the firmware downloaded with "UGW-linked Download" is overwritten.

### STEP 2: Update using Updater

The firmware downloaded on the device can be updated using Updater functions.

- 1) Enter service mode. Select [F/W UPDATE].
- 2) Select CDS.

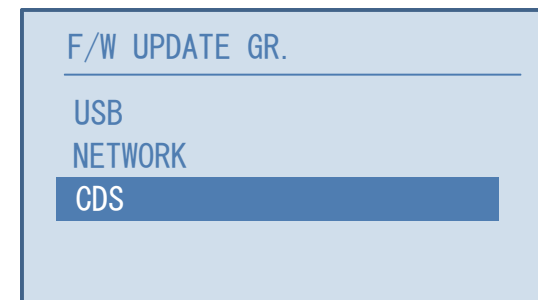

F-5-44

3) Press the [Yes] button in response to the confirmation to execute the operation.

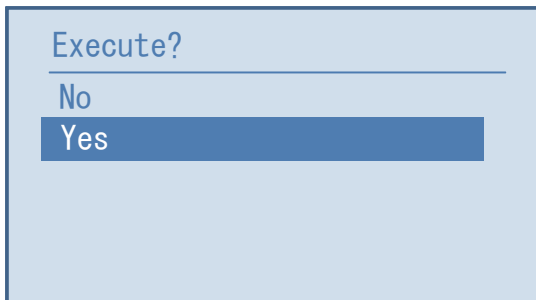

F-5-45

4) The firmware is applied to the device. The device is automatically restarted when the application is completed.

5) After the device is restarted, check the firmware version.

- Select [Utility Menu] from the Control Panel.
- Press the [Configuration Page] button.
- Check by the printed status that the version is the same as that of the updated firmware.

## ■ Deleting the Scheduled Firmware Delivery

Here is explained the method to delete the scheduled firmware delivery set by the Updater.

1) From the administrator mode of the remote UI, select [Settings/Registration] > [License/Other] > [Register/Update Software] > [Delivered Update].

2) Press the [Delete Scheduled Delivery] button.

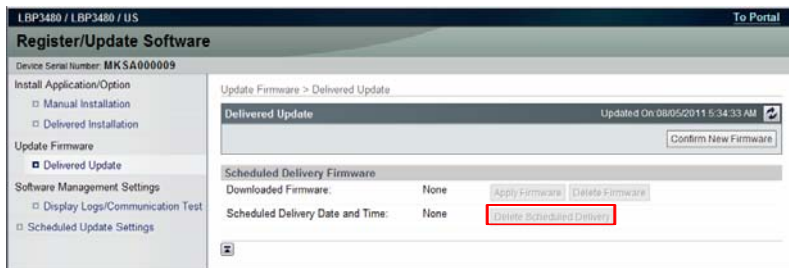

F-5-46

3) Check the description of the scheduled delivery, and execute the operation.

4) As the deletion result is displayed, check that it has been deleted, and then press the [OK] button. This concludes "Deleting the Scheduled Firmware Delivery".

## ■ Updating the Downloaded Firmware (Application of Firmware)

Here is explained the method to update firmware from the remote UI which has been downloaded by the Updater.

1) From the administrator mode of the remote UI, select [Settings/Registration] > [License/Other] > [Register/Update Software] > [Delivered Update].

2) Press the [Apply Firmware] button.

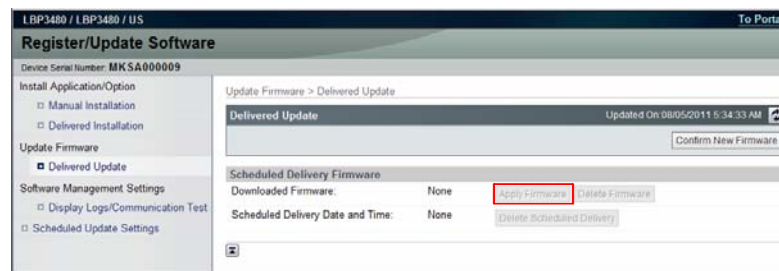

F-5-47

3) Check the downloaded firmware, and press the [Yes] button.

4) The firmware is applied to the device. The device is automatically restarted when the application is completed.

5) After the device is restarted, check the firmware version.

- Select [Utility Menu] from the Control Panel.
- Press the [Configuration Page] button.
- Check by the printed status that the version is the same as that of the updated firmware.

## ■ Deleting the Downloaded Firmware

Here is explained the method to delete the firmware downloaded by the Updater.

1) From the administrator mode of the remote UI, select [Settings/Registration] > [License/Other] > [Register/Update Software] > [Delivered Update].

2) Press the [Delete Firmware] button.

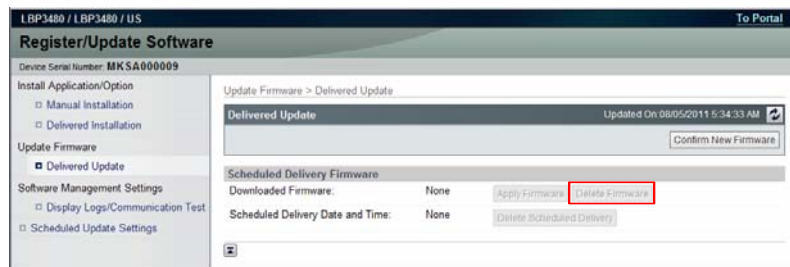

F-5-48

3) Check the downloaded firmware to be deleted, and execute the operation.

4) As the deletion result is displayed, check that it has been deleted, and then press the [OK] button. This concludes "Deleting the Downloaded Firmware".

## ■ Maintenance

### ● Upgrading Updater

The firmware installed in the device should be also upgraded when upgrading Updater. The setting information and logs (update logs/system logs) are inherited in the upgraded version.

### ● How to Replace Controller Boards

- Main Controller Board PCB (including SRAM)

The network and service mode setting should be set again after initialization. See "Preparation" in "Version Upgrade" of this manual for details.

### ● How to Replace Devices

All settings should be set again because no data are inherited. See "Preparation" in "Version Upgrade" of this manual for details.

## FAQ

### FAQ on Installing Firmware

No.1

Q: Is it also possible to downgrade firmware with using CDS?

A: Firmware can be downgraded in some methods shown in the table below.

If download and update are performed consecutively, firmware can't be downgraded.

Distribution Method	Downgrade Possibility
UGW-linked Download and Update	No
UGW-linked Download	Yes

T-5-20

No.2

Q: How can we confirm that the firmware is properly updated after "UGW-linked download and update" done?

A: You can confirm this in E-mail or the Device List on UGW-linked screen.

E-mail to notify firmware update will be sent from CDS server to the addresses set as destinations at the time of distribution setting to notify update completion.

On UGW-linked screen, search the device of your interest on [Select Device] screen to find the distribution status per device as shown in the search result.

No.3

Q: In the course of "UGW-linked download", what will happen if the user downloads the firmware before the service technician update the firmware downloaded with "UGW-linked download" before?

A: The previously downloaded firmware in the method of "UGW-linked download" will be overridden by the subsequently downloaded one.

This is because only one downloaded firmware can be held on the device.

The firmware downloaded in the method of "Service mode-linked download" and "UGW-linked download" can be checked/deleted from User mode, but cannot be updated, so it cannot be updated by the user unnoticed by the service technician.

No.4

Q: How is an individual response edition of firmware distributed?

A: Any individual response edition of firmware can be installed in all the methods provided by service technicians. Before installing the individual response edition, ensure to obtain the ID and password separately.

No.5

Q: If the device is down during firmware update, can the device be started using the older firmware version?

A: No, it is impossible to start the device using older versions. If this occurs, the service technician in charge should reinstall the firmware via SST. See "Troubleshooting on Firmware Installation" in chapter 6 of this manual for details.

No.6

Q: If the device is down during firmware download, is it possible to download the firmware again?

A: Firmware cannot be downloaded again automatically. Instead, the error is notified in E-mail. The user should register the firmware distribution schedule again accordingly.

## No.7

Q: Can we cancel the operation during firmware download?

A: Yes. [Cancel] button is shown.

(You cannot cancel UGW-linked Download.)

## No.8

Q: E-mail is sent to users to notify update completion. Can service technicians also receive such a notification?

A: Yes. The notification E-mail is also set for the service technician in charge if the user enters his/her E-mail address at the time of firmware distribution setting.

Multiple E-mail addresses can be entered in the field. Delimit each E-mail address with “,” (comma) or “;” (semicolon) when you enter multiple E-mail addresses in the field.

## No.9

Q: How long does the firmware update take?

A: Approx. 10 min. However, this does not include the download time. Download time relies on the network environment.

## ● FAQ on Installing MEAP Application/System Option

## No.1

Q: What happens if a MEAP application is installed in the system with insufficient storage free space?

A: An error message is shown. Upon starting installation, the MEAP application checks the required space against free space to judge installation availability.

## No.2

Q: Can we cancel the operation during installation of MEAP application?

A: Yes. [Cancel] button is shown.

## No.3

Q: Is the device automatically restarted after the system option is enabled?

A: The device is not automatically restarted. Users should restart the device manually.



## ● FAQ on General Matters of Updater

### No.1

Q: What preparation is needed in each installation method?

A: See the table below for preparation required in each installation method.

- For updating firmware

Installation Method	Setting Sales Company's HQ	Network Settings	Enabling UGW Link	Enabling [Update Firmware] Button of User Mode	Enabling [Manual Update] Button of User Mode (Remote UI)
UGW-linked Download and Update	Yes	Yes	Yes	-	-
UGW-linked Download	Yes	Yes	Yes	-	-

T-5-21

- For install Application

Installation Method	Network Settings	Enabling [Install Application/ Options] Button of User Mode (Remote UI)
LMS-linked Installation	Yes	-
LMS-linked installation via Remote UI	Yes	Yes

T-5-22

### No.2

Q: How can operations using Updater be masked on the users' side?

A: Be sure to perform the following from the service mode.

- Masking Firmware Installation

Setting Device Service Mode	SERVICE MODE >FUNCTION GR. >MEAP >CDS-FIRM (On -> Off)
-----------------------------	---

- Masking Application Installation

Setting Device Service Mode	SERVICE MODE >FUNCTION GR.>MEAP >CDS-MEAP (On -> Off)
-----------------------------	--

### No.3

Q: Can the communication be cancelled during the communication test?

A: No. During the communication test, there is no "Cancel" button.

## Error Messages

Error messages displayed in Remote UI are shown below. As to error codes, see the next list.

No.	Messages	Timing of display	Cause	Remedy
1	An error occurred with the delivery server. Contact your sales representative. Error Code: [xxx]	In communicating with the delivery server.	System error occurred in server.	Obtain the log etc. (Refer to "System Management Operations" under "Version Upgrade" of "Updater" in Chapter 6 "Troubleshooting" of this manual.) and contact Support Div. of the sales company.
2	Delivery server is stopped. Wait a while and then try to perform the operation again. Check the following URL for details. <Stopped Delivery Server URL>	In communicating with the delivery server.	Delivery server stopped.	Check the delivery server stop information. After the delivery server starts, perform the operation from this application. When the delivery server stop information is not available, contact the sales company's Support Department.
3	Failed to connect to delivery server. Check the delivery server and network.	In communicating with the delivery server.	Communication error due to incorrect settings of CDS URL. Excluding delivery server stop, communication error to the delivery server occurred.	Set correct CDS URL in the Updater settings.  Check if the network environment is correct to solve the cause of the error occurrence. If the network environment of the device is correct, obtain the log etc. (Refer to "System Management Operations" under "Version Upgrade" of "Updater" in Chapter 6 "Troubleshooting" of this manual.) and contact Support Div. of the sales company.
4	Download was stopped because an error occurred with the file server. Check the network.	At the time of file download	Communication error to the delivery server occurred.	Check if the network environment is correct to solve the cause of the error occurrence. If the network environment of the device is correct, obtain the log etc. (Refer to "System Management Operations" under "Version Upgrade" of "Updater" in Chapter 6 "Troubleshooting" of this manual.) and contact Support Div. of the sales company.
5	Downloaded files are invalid. Check the network.	At the time of file download	The received file is broken.	After checking the network environment of the device, re-execute the job. If it recurs, obtain the log etc. (Refer to "System Management Operations" under "Version Upgrade" of "Updater" in Chapter 6 "Troubleshooting" of this manual.) and contact Support Div. of the sales company.
6	Failed to retrieve information of special firmware. Check the retrieval ID and password.	Acquisition of applicable firmware information	No information exists about firmware for special firmware retrieval ID or Password is invalid.	Enter the correct firmware ID or Password applicable to the firmware information. If it recurs, obtain the log etc. (Refer to "System Management Operations" under "Version Upgrade" of "Updater" in Chapter 6 "Troubleshooting" of this manual.) and contact Support Div. of the sales company.
7	Scheduled delivery information of firmware does not exist. Check it because it may already have been deleted.	Acquisition of applicable firmware information	Delivery information with specified delivery ID does not exist.	Register the delivery schedule again. If this occurs at the time of canceling file download, deleting downloaded firmware or deleting scheduled delivery, no remedy is required.
8	Failed to apply firmware.	Firmware application error	Error due to the application (NLM)	Obtain the log etc. (Refer to "System Management Operations" under "Version Upgrade" of "Updater" in Chapter 6 "Troubleshooting" of this manual.) and contact Support Div. of the sales company.

No.	Messages	Timing of display	Cause	Remedy
9	Delivery Server : Connect Failed File Server : Retrieve Failed Error Code: [xxxx]	Communication test, etc. (communication test result dialogue)	In the communication test, failed to connect to the delivery server.	Check the network environment of the device, and re-execute the job. If it recurs, obtain the log etc. (Refer to "System Management Operations" under "Version Upgrade" of "Updater" in Chapter 6 "Troubleshooting" of this manual.) and contact Support Div. of the sales company.
			In SOAP communication, failed to success after 1 min retry.	Set proxy and restart the communication test. If it recurs, obtain the log etc. (Refer to "System Management Operations" under "Version Upgrade" of "Updater" in Chapter 6 "Troubleshooting" of this manual.) and contact Support Div. of the sales company.
			ID and Password required for proxy to connect to the internet are not configured in device.	Set the user environment to make the access to the following domain available. <a href="https://device.cdsknn.net/">https://device.cdsknn.net/</a> <a href="http://cdsknn.net.edgesuite.net/">http://cdsknn.net.edgesuite.net/</a> If it recurs, obtain the log etc. (Refer to "System Management Operations" under "Version Upgrade" of "Updater" in Chapter 6 "Troubleshooting" of this manual.) and contact Support Div. of the sales company.
			The access to the network is limited.	Contact Field Support Group in the sale company. After confirmation that the delivery server has been restored, restart the communication test. If it recurs, obtain the log etc. (Refer to "System Management Operations" under "Version Upgrade" of "Updater" in Chapter 6 "Troubleshooting" of this manual.) and contact Support Div. of the sales company again.
10	Delivery Server : Connect OK File Server : Retrieve Failed Error Code: [XXXX]	Delivery Server : Connect OK File Server : Retrieve Failed Error Code: [XXXX]	Due to no return of data for the communication test, time-out (in HTTP communication, no response for 1min) occurred. After that, retried but failed to connect to server.	Check the network environment of the device and re-execute the job. If it recurs, obtain the log etc. (Refer to "System Management Operations" under "Version Upgrade" of "Updater" in Chapter 6 "Troubleshooting" of this manual.) and contact Support Div. of the sales company.
			The network cable was disconnected during data download in the communication test.	Reconnect the network cable and then restart the communication test. If it recurs, obtain the log etc. (Refer to "System Management Operations" under "Version Upgrade" of "Updater" in Chapter 6 "Troubleshooting" of this manual.) and contact Support Div. of the sales company.
			The file server stopped during data download in the communication test.	Contact the sales company's Support Department. After confirmation that the delivery server has been restored, restart the communication test. If it recurs, obtain the log etc. (Refer to "System Management Operations" under "Version Upgrade" of "Updater" in Chapter 6 "Troubleshooting" of this manual.) and contact Support Div. of the sales company again.
			Hash value in the communication test file is incorrect.	Check the network environment and re-execute the job. If it recurs, obtain the log etc. (Refer to "System Management Operations" under "Version Upgrade" of "Updater" in Chapter 6 "Troubleshooting" of this manual.) and contact Support Div. of the sales company.

No.	Messages	Timing of display	Cause	Remedy
11	An error occurred. Error Code: [xxx]	communication test, etc. (main screen)	The max value (space/file) was exceeded and new log was not accepted. Normally an old log file is deleted before the max value (space/file) is exceeded, but error may occur due to other element (e.g. I/O error).	Check if the log file exceeded the max value. <Update log> Max space: 128KB/file Max file number: 4  <System log> Max space: 512KB/file Max file number: 4  If it recurs, obtain the log etc. (Refer to "System Management Operations" under "Version Upgrade" of "Updater" in Chapter 6 "Troubleshooting" of this manual.) and contact Support Div. of the sales company.
			Notice of version information (main screen)	Failed to acquire version information of device due to no CDS registration of firmware version of device.
		At the time of notifying version information, failed to connect to the delivery server.	Check if the network environment is correct to solve the cause of the error occurrence. If the network environment of the device is correct, obtain the log etc. (Refer to "System Management Operations" under "Version Upgrade" of "Updater" in Chapter 6 "Troubleshooting" of this manual.) and contact Support Div. of the sales company.	
		No return of notifying version information	Re-connect the network cable and re-execute the job. If it recurs, obtain the log etc. (Refer to "System Management Operations" under "Version Upgrade" of "Updater" in Chapter 6 "Troubleshooting" of this manual.) and contact Support Div. of the sales company.	
		Network cable was disconnected during notice of version information.	Re-execute the job. If it recurs, obtain the log etc. (Refer to "System Management Operations" under "Version Upgrade" of "Updater" in Chapter 6 "Troubleshooting" of this manual.) and contact Support Div. of the sales company.	
		Failed to send notice of version information since the main power was turned OFF and then ON during the sending.	Check the network environment of the device and re-execute the job. If it recurs, obtain the log etc. (Refer to "System Management Operations" under "Version Upgrade" of "Updater" in Chapter 6 "Troubleshooting" of this manual.) and contact Support Div. of the sales company.	
		Server stopped at the time of sending notice of version information.	Obtain the log etc. (Refer to "System Management Operations" under "Version Upgrade" of "Updater" in Chapter 6 "Troubleshooting" of this manual.) and contact Support Div. of the sales company.	
		An internal error occurred at the time of sending notice of version information.	Obtain the log etc. (Refer to "System Management Operations" under "Version Upgrade" of "Updater" in Chapter 6 "Troubleshooting" of this manual.) and contact Support Div. of the sales company.	

No.	Messages	Timing of display	Cause	Remedy
11	An error occurred. Error Code: [xxx]	UGW linkage (main screen)	UGW linkage was turned ON when eRDS was OFF.	For a device using eRDS, turn ON the eRDS. For a device not using eRDS, turn OFF the UGW linkage. If it recurs, obtain the log etc. (Refer to "System Management Operations" under "Version Upgrade" of "Updater" in Chapter 6 "Troubleshooting" of this manual.) and contact Support Div. of the sales company.
			An internal error occurred at the time of acquiring delivery information.	Re-execute the job. If it recurs, obtain the log etc. (Refer to "System Management Operations" under "Version Upgrade" of "Updater" in Chapter 6 "Troubleshooting" of this manual.) and contact Support Div. of the sales company.
		On-site (error dialogue)	An internal error occurred at the time of acquiring applicable firmware information.	Re-execute the job. If it recurs, obtain the log etc. (Refer to "System Management Operations" under "Version Upgrade" of "Updater" in Chapter 6 "Troubleshooting" of this manual.) and contact Support Div. of the sales company.
			An internal error occurred at the time of sending approval information.	Re-execute the job. If it recurs, obtain the log etc. (Refer to "System Management Operations" under "Version Upgrade" of "Updater" in Chapter 6 "Troubleshooting" of this manual.) and contact Support Div. of the sales company.
			An internal error occurred at the time of delivery order	Re-execute the job. If it recurs, obtain the log etc. (Refer to "System Management Operations" under "Version Upgrade" of "Updater" in Chapter 6 "Troubleshooting" of this manual.) and contact Support Div. of the sales company.
		Immediate download (error dialogue)	An internal error occurred at the time of requesting firmware delivery information.	Re-execute the job. If it recurs, obtain the log etc. (Refer to "System Management Operations" under "Version Upgrade" of "Updater" in Chapter 6 "Troubleshooting" of this manual.) and contact Support Div. of the sales company.
			During the download, all space in the storage disk was occupied. (DiskFull)	After adding vacant space of the storage disk, re-execute the job. If it recurs, obtain the log etc. (Refer to "System Management Operations" under "Version Upgrade" of "Updater" in Chapter 6 "Troubleshooting" of this manual.) and contact Support Div. of the sales company.
			At the end of receipt, an internal error occurred.	Re-execute the job. If it recurs, obtain the log etc. (Refer to "System Management Operations" under "Version Upgrade" of "Updater" in Chapter 6 "Troubleshooting" of this manual.) and contact Support Div. of the sales company.
		Manual update (error dialogue)	At the update start, an internal error occurred.	Re-execute the job. If it recurs, obtain the log etc. (Refer to "System Management Operations" under "Version Upgrade" of "Updater" in Chapter 6 "Troubleshooting" of this manual.) and contact Support Div. of the sales company
		Automatic update (error dialogue)	At the update start, an internal error occurred.	Re-execute the job. If it recurs, obtain the log etc. (Refer to "System Management Operations" under "Version Upgrade" of "Updater" in Chapter 6 "Troubleshooting" of this manual.) and contact Support Div. of the sales company.
		Deletion of downloaded firmware	At the time of notifying cancellation, an internal error occurred.	Re-execute the job. If it recurs, obtain the log etc. (Refer to "System Management Operations" under "Version Upgrade" of "Updater" in Chapter 6 "Troubleshooting" of this manual.) and contact Support Div. of the sales company.

No.	Messages	Timing of display	Cause	Remedy
12	An error occurred. Check the Update Firmware screen.	UGW linkage (main screen)	eRDS sent an order but Updater failed to connect to server.	Conduct a communication test to analyze the cause of the error. After solving the cause, resend the order from the eRDS. If it recurs, obtain the log etc. (Refer to "System Management Operations" under "Version Upgrade" of "Updater" in Chapter 6 "Troubleshooting" of this manual.) and contact Support Div. of the sales company.
			Delivery server stopped.	Contact the sales company's Support Department. After confirming restoration of the delivery server, re-execute the job. If it recurs, obtain the log etc. (Refer to "System Management Operations" under "Version Upgrade" of "Updater" in Chapter 6 "Troubleshooting" of this manual.) and contact Support Div. of the sales company.
			Scheduled date and time acquired from the delivery server was before current time (15 or more min had passed.)	Do the delivery setting from UGW again. If it recurs, obtain the log etc. (Refer to "System Management Operations" under "Version Upgrade" of "Updater" in Chapter 6 "Troubleshooting" of this manual.) and contact Support Div. of the sales company.
			Scheduled data and time acquired from the delivery server did not exist.	Do the delivery setting from UGW again. If it recurs, obtain the log etc. (Refer to "System Management Operations" under "Version Upgrade" of "Updater" in Chapter 6 "Troubleshooting" of this manual.) and contact Support Div. of the sales company.
		Immediate download (main screen)	At the time of immediate download, turned OFF and then ON the power of device main body.	Re-execute the job. If it recurs, obtain the log etc. (Refer to "System Management Operations" under "Version Upgrade" of "Updater" in Chapter 6 "Troubleshooting" of this manual.) and contact Support Div. of the sales company.
		Manual update (main screen) Automatic update (main screen)	Updated version was different from the ordered version.	Re-execute the job. If it recurs, obtain the log etc. (Refer to "System Management Operations" under "Version Upgrade" of "Updater" in Chapter 6 "Troubleshooting" of this manual.) and contact Support Div. of the sales company.
			After the update, failed to connect to the delivery server.	Check the network environment and re-execute the job. If it recurs, obtain the log etc. (Refer to "System Management Operations" under "Version Upgrade" of "Updater" in Chapter 6 "Troubleshooting" of this manual.) and contact Support Div. of the sales company.
			After the update, delivery server stopped.	Contact the sales company's Support Department. After confirming restoration of the delivery server, re-execute the job. If it recurs, obtain the log etc. (Refer to "System Management Operations" under "Version Upgrade" of "Updater" in Chapter 6 "Troubleshooting" of this manual.) and contact Support Div. of the sales company.
			After the update, the network cable was disconnected.	Re-connect the network cable and re-execute the job. If it recurs, obtain the log etc. (Refer to "System Management Operations" under "Version Upgrade" of "Updater" in Chapter 6 "Troubleshooting" of this manual.) and contact Support Div. of the sales company.
			After the update, server returned an error.	Obtain the log etc. (Refer to "System Management Operations" under "Version Upgrade" of "Updater" in Chapter 6 "Troubleshooting" of this manual.) and contact Support Div. of the sales company.
			After the update, an internal error occurred.	If it recurs, obtain the log etc. (Refer to "System Management Operations" under "Version Upgrade" of "Updater" in Chapter 6 "Troubleshooting" of this manual.) and contact Support Div. of the sales company.

No.	Messages	Timing of display	Cause	Remedy
13	Delivery Error Error Code: [xxx]	UGW linkage (Update Firmware screen)	eRDS sent an order but Updater failed to connect to the server.	Conduct a communication test to analyze the cause of the error. After solving the cause, resend the order from the eRDS. If it recurs, obtain the log etc. (Refer to "System Management Operations" under "Version Upgrade" of "Updater" in Chapter 6 "Troubleshooting" of this manual.) and contact Support Div. of the sales company.
			The delivery server stopped.	Contact the sales company's Support Department. After confirming restoration of the delivery server, re-execute the job. If it recurs, obtain the log etc. (Refer to "System Management Operations" under "Version Upgrade" of "Updater" in Chapter 6 "Troubleshooting" of this manual.) and contact Support Div. of the sales company.
			The scheduled data and time acquired from delivery server does not exist.	Do the delivery setting from UGW again. If it recurs, obtain the log etc. (Refer to "System Management Operations" under "Version Upgrade" of "Updater" in Chapter 6 "Troubleshooting" of this manual.) and contact Support Div. of the sales company.
14	Delivery Error Delivery Time Delivery Firmware Label Delivery Firmware version Error Code: [ xxx ]	UGW linkage (Update Firmware screen)  Immediate download (Update Firmware screen)	The scheduled date and time acquired from delivery server was before current time (15 or more min had passed).	Do the delivery setting from UGW again. If it recurs, obtain the log etc. (Refer to "System Management Operations" under "Version Upgrade" of "Updater" in Chapter 6 "Troubleshooting" of this manual.) and contact Support Div. of the sales company.
			At the time of immediate download, turned OFF and then ON the power of device main body.	Re-execute the job. If it recurs, obtain the log etc. (Refer to "System Management Operations" under "Version Upgrade" of "Updater" in Chapter 6 "Troubleshooting" of this manual.) and contact Support Div. of the sales company.
15	Applicable firmware is not registered.	On-site (error dialogue)	At the user site, no latest firmware exists.	This means the current firmware is the latest, so this error has no impact. But when the latest firmware to be retrieved must exist e.g. released new firmware information has been notified, contact Field Support Group in the sales company.
			No applicable firmware exists on CDS, so the service person can't select any applicable firmware.	Contact the sales company's Support Department.
16	Restart failed. Turn the main power OFF and ON.	Manual update (error dialogue)	An error occurred at the time of the device restart.	After turning OFF and then ON the main power of the device, re-execute the job. If it recurs, obtain the log etc. (Refer to "System Management Operations" under "Version Upgrade" of "Updater" in Chapter 6 "Troubleshooting" of this manual.) and contact Support Div. of the sales company.
		Automatic update (error dialogue)	An error occurred at the time of the device restart.	After turning OFF and then ON the main power of the device, re-execute the job. If it recurs, obtain the log etc. (Refer to "System Management Operations" under "Version Upgrade" of "Updater" in Chapter 6 "Troubleshooting" of this manual.) and contact Support Div. of the sales company.
17	Specify [E-Mail Address] with up to 64 characters.	At the time of periodical update setting	The specified E-mail address exceeded 64 characters.	Specify E-mail address within 64 characters.
18	The following characters cannot be used for the [E-Mail Address]: .;"()[]<>\	At the time of periodical update setting	The E-mail address was including the characters which could not be used.	Do not specify E-mail address with characters which cannot be used.
19	Specify [Comments] with up to 128 characters.	At the time of periodical update setting	Comments exceeded 128 characters.	Specify comments within 128 characters.
20	The [Delivery Server URL] is incorrect.	In setting with the deliver server URL.	The specified deliver server URL is wrong.	Enter the right URL( <a href="https://device.c-cdsknn.net/cds_soap/updaterif">https://device.c-cdsknn.net/cds_soap/updaterif</a> )

T-5-23

## Error Codes

Error Codes displayed on Remote UI and how to read them.

### How to read an error code

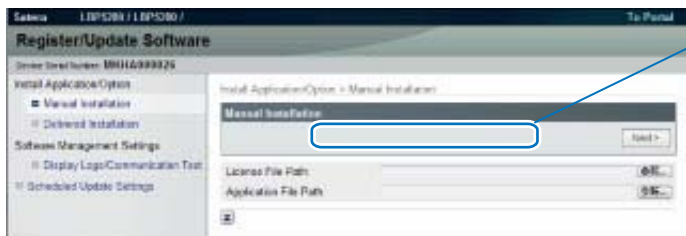

84014206

Code	Value	Contents
The first digit Error field	8	Error
The second digit Operator	0 1 2 3 4 5	Not defined. CDS server Updater UGW Service person IT administrator (User)
The 3rd - 4th digits Method category	xx	Method
The 5th digit Category code	0 1 2 3 4 5 6 7	Category code
The 6 - 8th digits Description code	000-	See Error code list

F-5-49

### Error Code

The error code list is shown below. Remedy are error codes of "-", and for all the error codes out of the list, contact Field Support Group in the sales company.

Error Code (hex number)					Description	Remedy	Cause of error							
The first digit Error field	The second digit Operator	The 3rd - 4th digits Method category	The 5th digit Category code	The 6 - 8th digits Description code			CDS delivery server	UP DATER	CDS file server	Network				
8	Error													
	0													
	1													
		x	x		Relating method code									
				0	Not categorized									
				0	0	1				No value is set in a mandatory data entry item	-	-	-	-
				0	0	2				In a string type of a data entry item, digit number and/or character type is/are set against the regulations	-	-	-	-



Error Code (hex number)					Description	Remedy	Cause of error					
The first digit Error field	The second digit Operator	The 3rd - 4th digits Method category	The 5th digit Category code	The 6 - 8th digits Description code			CDS delivery server	UP DATER	CDS file server	Network		
				0 0 3	In an data entry item, the value is set against the regulations (E.g. the set value is other than "Operator: 4. Service person, 5. User")		-	✓	-	-		
				0 0 4	No applicable delivery information exists		✓	-	-	-		
				0 0 5	The setting of the system is imperfect		✓	-	-	-		
			1	Operation								
				0 0 1	Inconsistency between the current firmware component in the data entry item and delivery information (E.g. the conditions for automatic update are not met. The settings of a mandatory additional set are invalid)		✓	✓	-	-		
				0 0 2	In a notice of delivery-allowed information, an install-set was release to the market, but the market release was stopped during the delivery		✓	-	-	-		
				0 0 3	No mail template file exists		✓	-	-	-		
				0 0 4	The device serial number in the data entry item differs from that in delivery information		✓	-	-	-		
				0 0 5	User is selected as Operator in the data entry items and the retrieval type is other than the latest		✓	-	-	-		
				0 0 6	The retrieval type in the data entry item is special and registration ID and individual Password are not set (* Operator did not enter registration ID and individual Password)		✓	-	-	-		
				0 0 7	The retrieval type in the data entry item is special and Operator is not Service person		✓	-	-	-		
				0 0 8	As to the device serial number in the data entry items, there is no applicable device code product		✓	-	-	-		
				0 0 9	The retrieval type in the data entry items is special and there are no basic-set applicable to the registration ID and Password (* When wrong registration ID or Password was entered by an operator)		✓	-	-	-		
				0 0 A	The delivery status is Applying		✓	-	-	-		
				0 0 B	No approval information exists about EULA or the export criteria when the delivery is determined		✓	-	-	-		
				0 0 C	The delivery status is Distributing/Distributed/Applying/Finished/Failed		✓	-	-	-		
				0 0 D	The delivery status is Distributing/Distributed/Applying/Finished/Failed		✓	-	-	-		
				0 0 E	The delivery status is New/Waiting to Distribute/Distributed/Applying/Finished/Failed		✓	-	-	-		
				0 0 F	The delivery code is other than Distributing. (Firmware delivery)		✓	-	-	-		
				0 1 0	The delivery status is New/Waiting to Distribute/Distributing/Applying/Finished/Failed		✓	-	-	-		
				0 1 1	The delivery status is Distributing/Distributed/Applying/Finished/Failed		✓	-	-	-		
				0 1 2	Device is "Not applicable to CDS" (Firmware delivery)		✓	-	-	-		

Error Code (hex number)					Description	Remedy	Cause of error			
The first digit Error field	The second digit Operator	The 3rd - 4th digits Method category	The 5th digit Category code	The 6 - 8th digits Description code			CDS delivery server	UP DATER	CDS file server	Network
				0 1 3	The delivery time which specified is in CDS delivery stop time	-	✓	-	-	
				0 1 4	The firmware reservation status of confirmation time-out	-	✓	-	-	
				0 1 5	The firmware delivery time-out	-	✓	-	-	
				0 1 6	The version upgrade of firmware is time-out	-	✓	-	-	
			2	I/O						
				0 0 1	The specified license access number does not exist in LMS	-	✓	-	-	
				0 0 2	The specified license access number has been deauthorized	-	✓	-	-	
				0 0 3	The package product of the entered license access number doesn't include MEAP application/System Option	-	✓	-	-	
				0 0 4	The sales company for the MEAP application isn't identical with the sale company for the package product	-	✓	-	-	
				0 0 5	The number of licenses to be issued will exceed the limit number allowed to register	-	✓	-	-	
				0 0 6	As for System Option for the same function, the license keys were issued more than the defined number of times for the same device serial number	-	✓	-	-	
				0 0 7	No device product exists applicable to the optional product	-	✓	-	-	
				0 0 8	No product exists applicable to the device serial number	-	✓	-	-	
				0 0 9	The product of the entered license access number cannot be used with this device because the settings of the sales company are incorrect	-	✓	-	-	
				0 0 A	No product linked to the license access number is registered in CDS for delivery	-	✓	-	-	
				0 0 B	Although the product linked to the license access number is registered in CDS for delivery, the delivery is stopped now	-	✓	-	-	
				0 0 C	No existence of optional product applicable to the device serial number.	-	✓	-	-	
				0 0 D	The license access number has been registered for another device	-	✓	-	-	
				0 0 E	For the device product applicable to the device serial number, no available software (MEAP application, System Option) exists	-	✓	-	-	
				0 1 0	LMS system error	-	✓	-	-	
			2~5							
		x	x		Relating method code					
				0	Not cartelized					
				0 0 0	Not defined	Normally not indicated				
				1 0 0	Unknown error	Normally not indicated				
			1		Operation					
				0 0 1	Processing exclusively	Start the operation again after terminating other Updater operations being executed simultaneously	-	✓	-	
				1 0 1	Failed to process preparation for use		-	✓	-	
				1 0 2	Failed to process use end		-	✓	-	
				1 0 3	Time out during restart of readiness preparation		-	✓	-	

Error Code (hex number)					Description	Remedy	Cause of error					
The first digit Error field	The second digit Operator	The 3rd - 4th digits Method category	The 5th digit Category code	The 6 - 8th digits Description code			CDS delivery server	UP DATER	CDS file server	Network		
				1 0 4	Session time-out excluding after application inquiry (after issuing delivery ID)	Start the operation again from the beginning		✓	-	-		
				1 0 5	CDS URL is not set	Set CDS URL	-	✓	-	-		
				1 0 6	There is another job	Start the operation again after terminating the job of the device	-	✓	-	-		
				2 0 1	Appointment of the periodical update for the periodical update non-support model		✓	-	-	-		
			2	I/O								
				1 x x	An internal error about file operation	-	-	✓	-	-		
				2 x x	An internal error about XML file operation	-	-	✓	-	-		
				3 0 1	Failed to output the license file	-	-	✓	-	-		
			3	Device								
				1 x x	An internal error in CPCA	-	-	✓	-	-		
				2 x x	An internal error in IMI	-	-	✓	-	-		
				3 x x	An internal error in SMS	-	-	✓	-	-		
				4 x x	An internal error in NLM	-	-	✓	-	-		
				6 0 1	A permit acquisition error in APL CDS partition		-	✓	-	-		
			4	SOAP communication								
				1 0 1	The processing thread stopped	-	-	✓	-	-		
				1 0 2	Processing SOAP communication now	-	-	✓	-	-		
				1 0 3	The function type is not matched	-	-	✓	-	-		
				1 0 4	An invalid SOAP response error	-	✓	-	-	-		
				2 0 1	An internal error about application information	-	-	✓	-	-		
				2 0 2	config.xml is NOT FOUND	-	-	✓	-	-		
				2 0 3	type.xml is NOT FOUND	-	-	✓	-	-		
				2 0 4	An error in binding type.xml	-	-	✓	-	-		
				2 0 5	An error in creating a service tab	-	-	✓	-	-		
				2 0 6	A runtime error in performing the web method	-	-	✓	-	✓		
				2 0 7	An unknown host error in performing the web method	<ul style="list-style-type: none"> <li>Check the network environment of the device and start the operation again</li> <li>Check if the URL settings of the CDS server are correct, and start the operation again after resetting</li> </ul>	✓	✓	-	✓		
				3 0 1	The delivery server is stopped	-	✓	-	-	-		
				3 0 2	An error occurrence in the delivery server	-	✓	✓	-	-		
			5	HTTP communication								
				1 0 1	Specified Hash Algorithm is unknown	-	-	✓	-	-		
				2 0 1	Invalid HTTP request	-	-	✓	✓	✓		
				2 0 2	Failed to connect to the server	Check the network environment of the device and start the operation again	-	✓	✓	✓		
				2 0 3	Failed to find the server	Check the network environment of the device and start the operation again	-	✓	✓	✓		
				2 0 4	An input/output error occurred during the connecting process to the server	-	-	✓	✓	✓		
				2 0 5	Failed to read a HTTP response	-	-	✓	✓	✓		
				2 0 6	Error in a HTTP response	-	-	✓	✓	✓		
				3 0 1	Failed to retrieve the data stream	-	-	✓	-	✓		
				3 0 2	Failed to create the file object for receipt	-	-	✓	-	✓		
				3 0 3	Failed to create the data stream of the file for receipt	-	-	✓	-	✓		

Error Code (hex number)					Description	Remedy	Cause of error					
The first digit Error field	The second digit Operator	The 3rd - 4th digits Method category	The 5th digit Category code	The 6 - 8th digits Description code			CDS delivery server	UP DATER	CDS file server	Network		
				3 0 4	Failed to receive the data	Check the network environment of the device and start the operation again	-	✓	✓	✓		
				3 0 5	An error about reserving the file data for receipt	-	-	✓	-	-		
				3 0 6	Failed to close the data stream	-	-	✓	-	-		
				3 0 7	Failed to close the file data for receipt	-	-	✓	-	-		
				3 0 8	Invalid hash code of the download file	Check the network environment of the device and start the operation again	✓	✓	✓	✓		
				3 0 9	The proxy authorization method is not applicable	Check the proxy authentication method used, and start the operation again after changing the settings to use the corresponding proxy authentication	-	✓	-	✓		
			6	Socket communication								
				1 0 1	Failed to connect the eRDS	-	-	✓	-	✓		
				1 0 2	No response from eRDS	-	-	✓	-	✓		
				1 0 3	No notice of start from the eRDS	-	-	✓	-	✓		
				1 0 4	Error of socket reading	-	-	✓	-	✓		
				1 0 5	Socket communication time-out	-	-	✓	-	✓		
			7	Other internal codes								
				0 0 2	One of installation, start or authorization failed (When installation or authorization failed, it is regarded as an error) *	-	-	✓	-	-		
				0 3 x	An internal error in processing the installation	-	-	✓	-	-		
				1 x x	An error by using invalid API	-	-	✓	-	-		
				2 x x	An internal error in SMS	-	-	✓	-	-		
				3 0 1	No existence of delivery ID	-	-	✓	-	-		
				3 0 2	Invalid delivery ID	-	-	✓	-	-		
				3 0 3	The updated firmware information is not identical with the firmware information after activation of the Updater	-	-	✓	-	-		
				3 0 4	The process of firmware download is incomplete	-	-	✓	-	-		
				3 0 5	The update process is incomplete	-	-	✓	-	-		
				3 0 6	The installment process is incomplete	-	-	✓	-	-		
				4 0 1	Failed to retrieve delivery information	-	-	✓	-	-		
				5 0 1	Failed to execute the delivery process	-	-	✓	-	-		
				5 0 2	The scheduled delivery was not executed within the defined period of time	Scheduled deliveries not executed within the defined period of time are abandoned, so register a scheduled delivery again. When setting the date and time of the scheduled delivery, be sure to designate a time when the device is ON	-	✓	-	-		

T-5-24

\* Not displayed on a device UI

## Debug log

### Sublog

#### Function Overview

Sublog is the record of behavior inside the Main Controller PCB.

In the case of a field failure that is hard to be reproduced, this measure is intended to improve efficiency in failure analysis and reduce the time for failure support by collecting debug log at the user site (which was created immediately after the failure) and sending it to the R&D.

When the Canon staff who is in charge of quality follow-up determines the need for an analysis of firmware debug log by the R&D department, we ask the field to collect log for an investigation to determine the cause.

### Sublog

It is available only when the Sublog Board is installed on the Main Controller PCB.

When the Sublog Board is not installed, log is not saved anywhere.

It is stored in the Sublog Board and its content is stored even when the power is turned OFF to be displayable when the power is turned ON again.

The Sublog Board has a limited capacity and when the log exceeding this storage number is attempted to be stored, the log is deleted in the order of length of time stored.

### Effective Instances of Collecting Debug Log

- The error occurs only at the customer site and cannot be reproduced by the sales company or the Canon staff who is in charge of quality follow-up.
- When the error frequency is low.
- When the error is suspected of links with firmware rather than a mechanical/electrical failure.

\* Collection of Sublog is not necessary when the reproduction procedure is identified and the error can be reproduced by the sales company HQ or the Canon staff who is in charge of quality follow-up.

### How the log is written

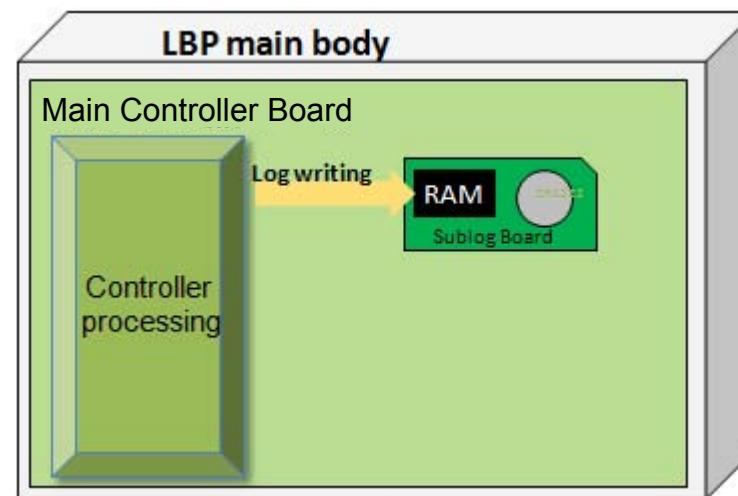

F-5-50

- In case of using the Sublog Board:
  - Write the log directly to RAM on the Sublog Board.
  - The on-board battery prevents data from being erased when the power is turned OFF.

## Collecting Sublog

### Flow of collecting Sublog

Installing the Sublog Board	Install the board to the host machine.
Generating the log	When the Sublog Board is installed, it records the log all time.
Collecting log	Set SUBLOG FTP GET in service mode to start FTP server function of the host machine. Connect a PC to the host machine by network connection to download the log via FTP client.

T-5-25

### Installing the Sublog Board

#### Note:

The battery on Sublog board is located at BATS1 CR2032.  
Push SW1 on the board and confirm that LED1 turns on.  
If LED1 does not turn on, You need change battery.

#### CAUTION:

There is danger of explosion if the battery is replaced with an incorrect type.  
Replace it only with the same type of battery.  
Dispose of used batteries according to the manufacturer's instructions.

1) Check that the power supply of the host machine is OFF. Remove the cover on the right side of the host machine.



F-5-51

2) Install the Sublog Expansion Board into the slot over the controller.



F-5-52

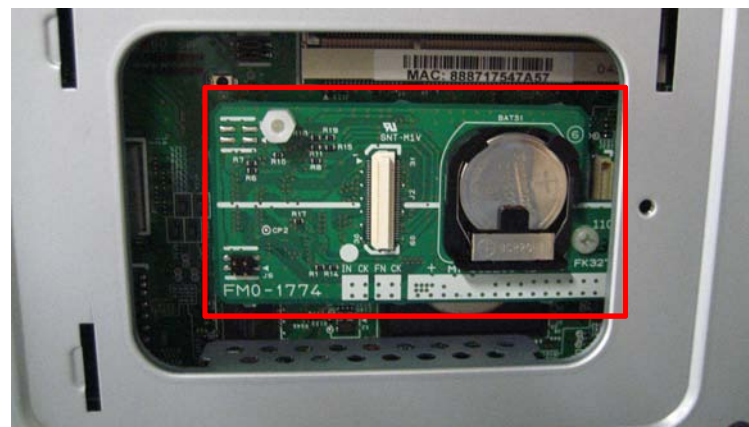

F-5-53

### Generating the log

Generation of the log starts as soon as the Sublog Board is installed.

For example, when collecting the log of error, take the following steps immediately after the error occurred.

If the log is not swiftly collected, it is possible for the log written on the schedule to overwrite the target behavior log.

## Collecting log

- 1) Connect the PC and the host machine by a network cable and check that communication is available.
  - a. When directly connecting a PC and the host machine, connect by a cross cable.
  - b. Check the IP address of the host machine by the Control Panel.
  - c. Check that a ping is sent to the IP address of the host machine from the command prompt of PC.

- 2) Enter service mode of the host machine. Select [LOG Gr.].

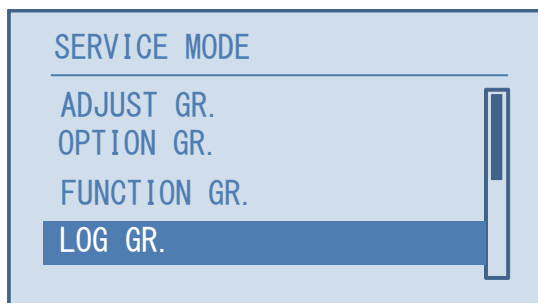

F-5-54

- 3) Select [SUBLOG FTP GET].

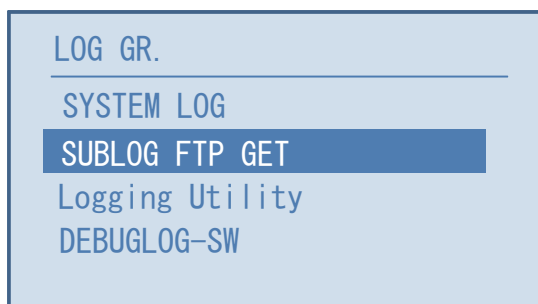

F-5-55

- 4) Select [YES].

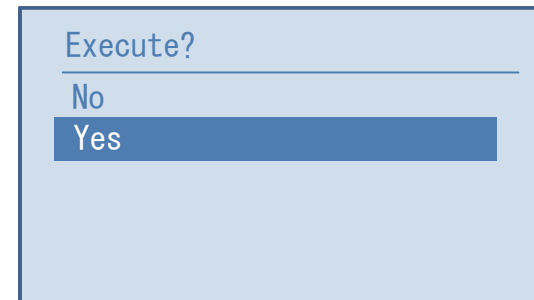

F-5-56

- 5) The host machine restarts and after blinking [STARTING] is displayed on the panel, [DL-T FTPD OK] is displayed.

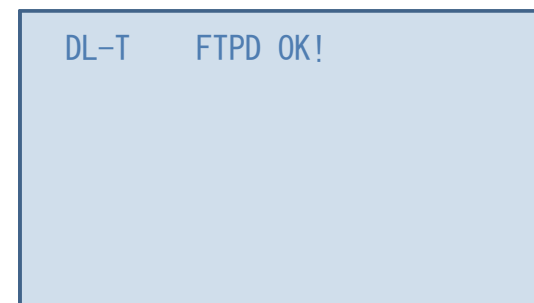

F-5-57

- 6) From the PC to receive the file, start FTP from command prompt. Enter the IP address of the device (or the host name) to connect and log in. Example: [ftp xxx.xxx.xxx.xxx (IP address)]

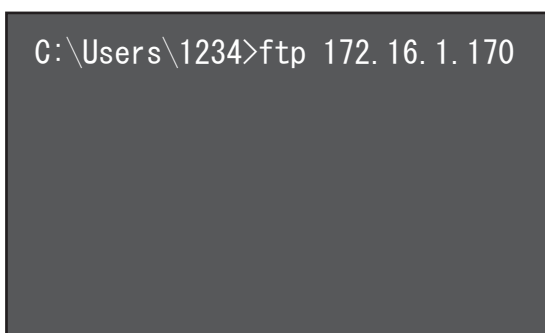

F-5-58

7) Enter the user name [guest] and password [welcome.].

```
C:\Users\1234>ftp 172.16.1.170
Connected to 172.16.1.170.
220 DRY FTP server ready.
User (172.16.1.170:(none)):guest
331 Password required for guest.
Password :
```

F-5-59

**Note:**

Do not forget to enter the period at the end of password [welcome.].  
Also note that no text appears when the password is typed in.

8) Receive the text file [/BOOTDEV/BOOT/SUBLOG.BIN] with the started FTP.

- Change bin -> Binary mode (do not forget to prevent the log from becoming garbled).
- cd /BOOTDEV/BOOT
- get SUBLOG.BIN

**Note:**

To change the name of Sublog, enter [get SUBLOG.BIN Any\_name].

```
C:\Users\1234>ftp 172.16.1.170
Connected to 172.16.1.170.
220 DRY FTP server ready.
User (172.16.1.170:(none)):guest
331 Password required for guest.
Password :
230 User logged in.
ftp> bin
200 Type set to I.
ftp> cd /BOOTDEV/BOOT
250 CWD command successful.
ftp> get SUBLOG.BIN
```

F-5-60

9) When received by the PC side, SUBLOG.BIN has been received.

```
200 Type set to I.
ftp> cd /BOOTDEV/BOOT
250 CWD command successful.
ftp> get SUBLOG.BIN
200 PORT command successful
150 Opening binary mode data connection
226 Transfer complete.
ftp: 2509954 bytes received in 0.75Seconds 3351.07Kbytes/sec.
ftp>_
```

F-5-61

10) Input the [bye] command and end the FTP client function of the PC.



(12) Check that the log is stored at the specific location on the PC.

Windows (C:) > Users > User name

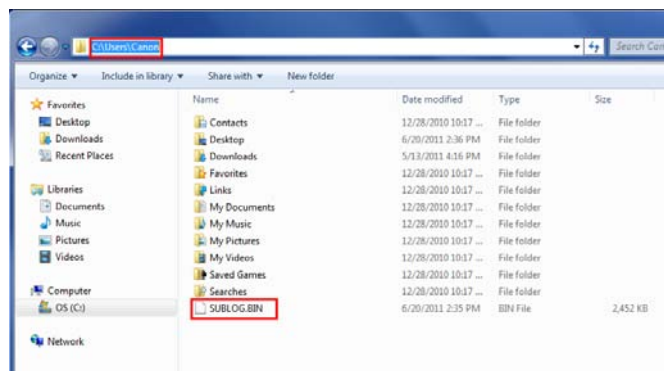

F-5-62

## Backup/Restoration by Expansion ROM for servicing and Sublog Board

### Function Overview

Data can be migrated to an unused Main Controller PCB by using the Expansion ROM for servicing + Sublog Board when the Main Controller PCB becomes faulty.

#### What to Prepare

- Sublog Board
- Expansion ROM for servicing
- Unused Main Controller PCB

#### CAUTION:

Install the Sublog Board to which data was backed up (exported) and Expansion ROM PCB to an unused Main Controller PCB which has not been installed to the machine.

Data cannot be migrated to a Main Controller PCB which has ever been used, even if only once.

#### Prerequisites

#### NOTE:

The battery on Sublog Board is located at BATS1 CR2032.  
Push SW1 on the board and confirm that LED1 turns on.  
If LED1 does not turn on, You need change battery.

#### CAUTION:

There is danger of explosion if the battery is replaced with an incorrect type.

Replace it only with the same type of battery.

Dispose of used batteries according to the manufacturer's instructions.

#### Target Data for Backup

LBP7660C
User mode setting values
Service mode setting values
Page counter
Device serial number

T-5-26

LBP7680C
User mode setting values
Service mode setting values

T-5-27

## Backup and Restoration (Export and Import)

### Flow of Export and Import

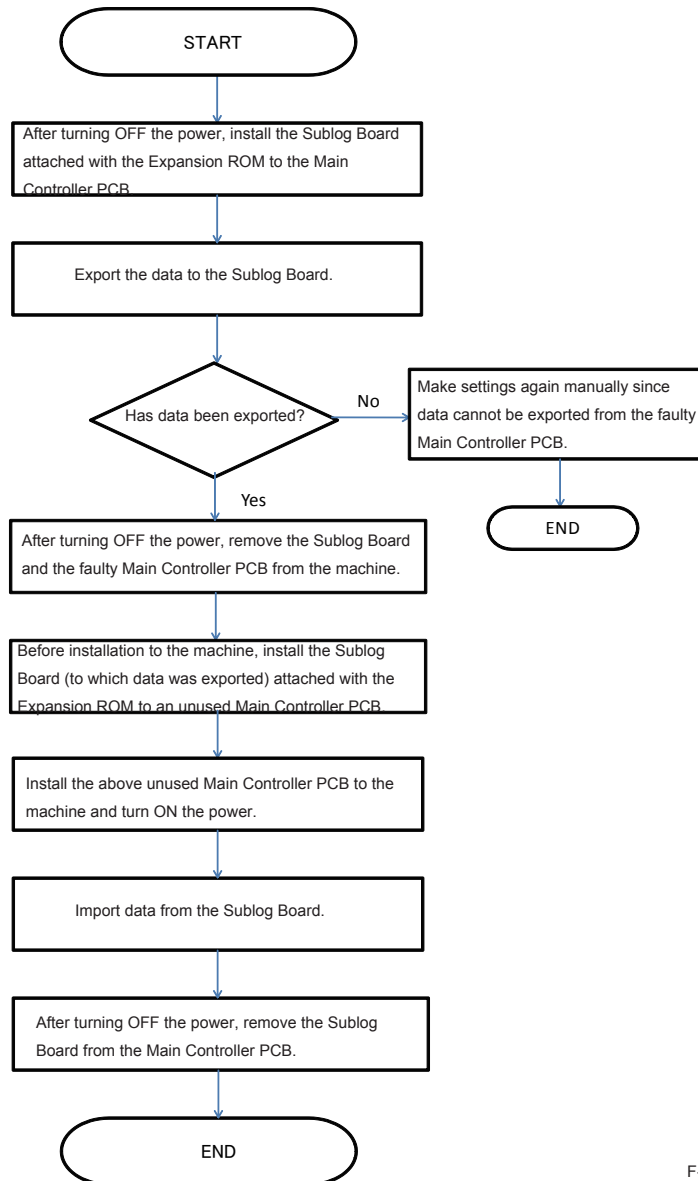

F-5-63

### Installing the Expansion ROM for servicing and Sublog Board

1) Install the Expansion ROM for servicing to the Sublog Board.

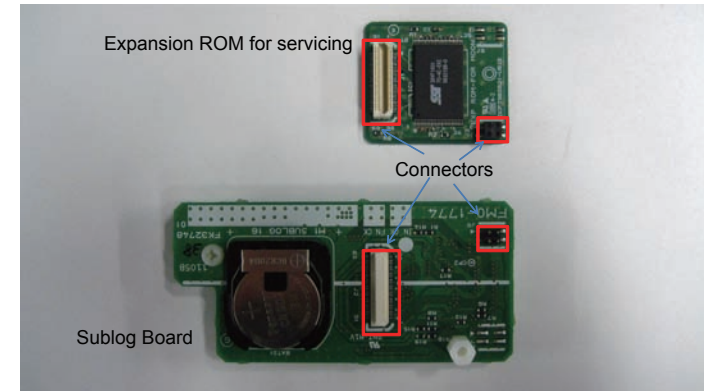

F-5-64

2) Install the above Sublog Board to the machine.

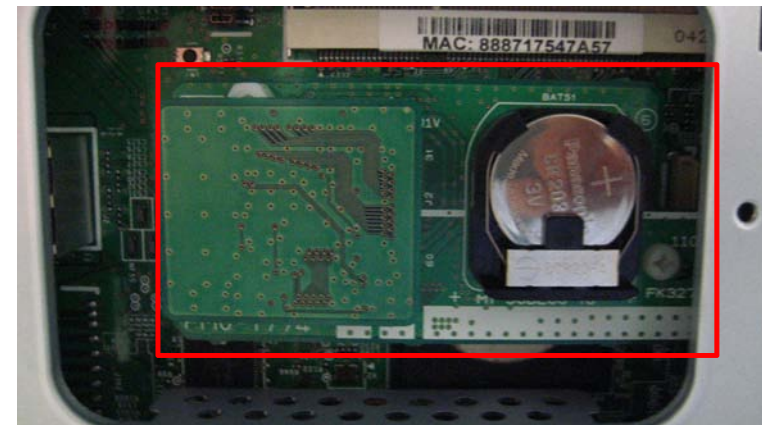

F-5-65



F-5-66

## Backup Procedure (Export)

1) The menu is displayed when turning ON the power while the Sublog Board attached with the Expansion ROM for servicing is installed.



F-5-67

2) Use the right and left arrow keys to select [NVRAM export].

3) Press the down arrow key. This operation causes the information stored in the machine to be exported to the Sublog Board.

4) The following message is displayed when backup is completed successfully.

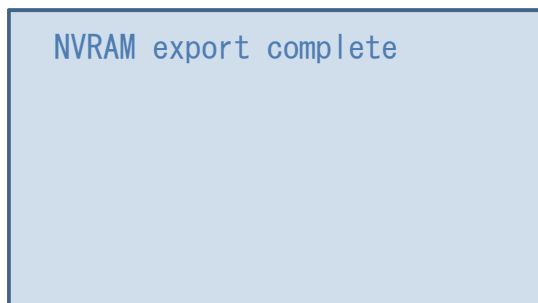

F-5-68

5) Turn OFF the power, and remove the faulty Main Controller PCB and the Sublog Board to which data was exported.

### CAUTION:

Install the Sublog Board to which data was backed up (exported) and Expansion ROM PCB to an unused Main Controller PCB which has not been installed to the machine.

Data cannot be migrated to a Main Controller PCB which has ever been used, even if only once.

## Restoration Procedure (Import)

1) Install the unused Main Controller PCB which has been installed with the Sublog Board (to which data was exported) attached with the Expansion ROM to the machine.

2) Turn ON the power and select [NVRAM import] in the menu, and then press the down arrow key. The information stored in the Sublog Board is written back to the machine.

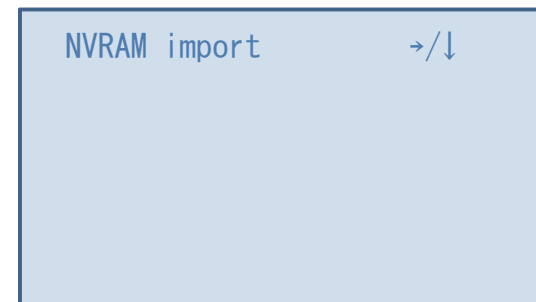

F-5-69

### CAUTION:

When not replacing with an unused Main Controller PCB, the following message is displayed and the operation is stopped. In this case, turn OFF the power and replace with an unused Main Controller PCB.

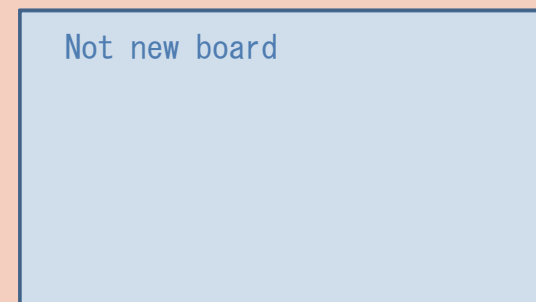

3) The data in the Sublog Board is deleted and the following message is displayed in the case of successful completion.

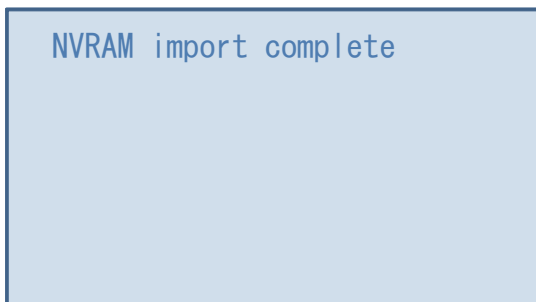

F-5-70

4) Turn OFF the power and remove the Sublog Board.

## Others

### Deletion (Erase)

When the data is not imported although it was exported, it needs to be deleted to prevent leakage of information.

1) Install the Sublog Board (containing data to be deleted) attached with the Expansion ROM to the Main Controller PCB.

2) Turn ON the power and select [NVRAM erase], and then delete the information stored in the Sublog Board.

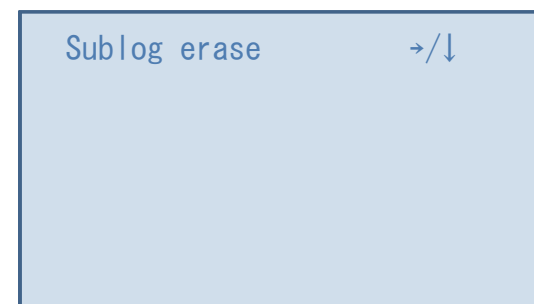

F-5-71

3) The following message is displayed in the case of successful completion.

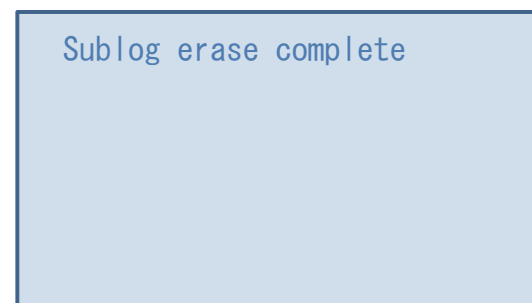

F-5-72

4) Turn OFF the power and remove the Sublog Board.

## List of Error Messages

The following messages are displayed when certain failures occur during operation.

List of Messages	Detail
Sublog board not found	Sublog Board is not installed.
NVRAM read error	Export cannot be executed because the faulty Main Controller PCB is too damaged to retrieve information.
Sublog R/W error	When the same data cannot be read 3 consecutive times due to Sublog Board error, the error message is displayed and the operation is stopped.
NVRAM write error	When information cannot be written to an unused Main Controller PCB for some reasons, the error message is displayed and the operation is stopped.
Sublog data not found	When the export data is not stored in the Sublog Board (including checksum check error), import process or erase process cannot be executed.
Not new board	Import cannot be executed since the Main Controller PCB is not unused or the one to which no serial number has been written.
Different product	Data is attempted to be imported to a model different from the one from which data was exported.

T-5-28

# Appendix

- General Timing Chart
- General Circuit Diagram
- Backup Data

## Service Tools

### Special Tools

No special tools are required for servicing this printer other than the standard tools.

### Solvents and Oil List

No.	Type	Purpose	Remark
1	Lubricant	Apply to gear	<ul style="list-style-type: none"><li>• MOLYKOTE® EM-50L (Dow Corning Corporation)</li><li>• Tool No. HY9-0007</li></ul>

T-6-1



# General Timing Chart

## General Timing Chart

Timing chart two consecutive prints on LTR paper

Power switch ON



Operation		WAIT	STBY	INTR	PRINT	LASTR	STBY
1	TOP sensor (PS912)				████████████████████		
2	Fixing delivery sensor (PS915)				████████████████████		
3	Print start command (EEC12)				████████████████████		
4	Scanner Motor	████████████████████			████████████████████		
5	Laser Diode	████████████████████			████████████████████		
6	BD Output signal (BDO)				████████████████████		
7	Main Motor (M1)	████████████████████			████████████████████		
8	Primary Charging Bias (AC)	████████████████████			████████████████████		
9	Primary Charging Bias (DC)	████████████████████			████████████████████		
10	Developing Bias	████████████████████			████████████████████		
11	Transfer Charging Bias	████████████████████			████████████████████		
12	Fixing Heater	████████████████████			████████████████████		
13	Cassette pickup solenoid (SL2)			████████	████████		
14	Main Fan (FM1)	████████████████████			████████████████████		████████████████████
15							
16							
17							
18							
19							
20							

F-6-1

# General Circuit Diagram

## General Circuit Diagram

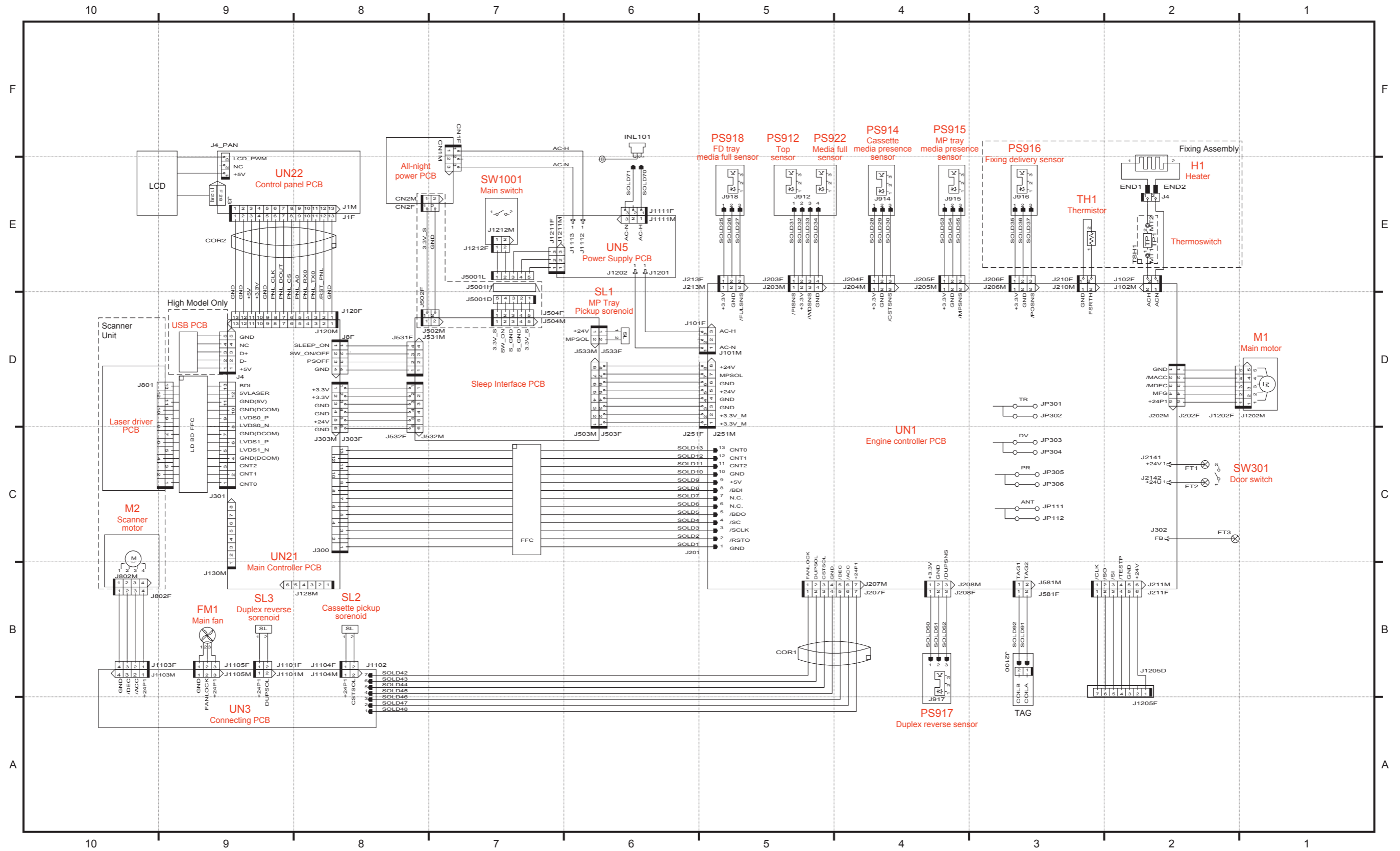

# Backup Data

Data to Be Stored	Data Location	Replacement		Delete									User Backup			Service Backup				
		When Replacing Main PCB	DC Controller PCB	User function					Service function				Can Data Be Backed up?	Method	Location to Be Stored	Can Data Be Backed up?	Method 1	Location to Be Stored	Method 2	Location to Be Stored
				Initializing the [Setup] Menu(Settings)	Initializing the Network Settings(Settings)	IPSec Policy settings delete*1	SD Card Data All Erase Function	(Fixing unit/ITB unit) Initializing the Service counter	FLASH MEMORY initialization Initializing the [Setup] Menu	DC Controller PCB FLASH MEMORY Clear	E-RDS > CLEAR	CA-KEY								
Control Panel set value (Except in network and IPSec Policy Settings*1)	Main Controller PCB	Clear	-	Clear	-	-	-	/	Clear	-	-	-	Yes	Setup > User Maintenance > IMPORT/EXPORT > EXPORT	USB memory	Yes	FUNCTION GR. > ECONF > EXPORT (GENERAL/DEPEND/ SECURITY/ALL)	USB memory	Sublog Expansion Board	Sublog Board
Control Panel set value(Network)		Clear	-	-	Clear	-	-	/	-	-	-	-	-	-	-	-	-	-	-	-
Control Panel set value(IPSec Policy Settings) *1		Clear	-	-	-	Clear	-	/	-	-	-	-	No	-	-	No	-	-	-	-
SSL Keys		Clear	-	-	-	-	-	/	-	-	-	Clear *5	No	-	-	No	-	-	-	-
CA Certificates		Clear	-	-	-	-	-	/	-	-	-	Clear *5	No	-	-	No	-	-	-	-
MEAP(Application/ Settings/Data)		Clear	-	-	-	-	-	/	-	-	-	-	No	-	-	No	-	-	-	-
e-RDS		Clear	-	-	-	-	-	/	-	-	Clear	-	Yes *4	Setup > User Maintenance > IMPORT/EXPORT > EXPORT	USB memory	Yes	FUNCTION GR. > ECONF > EXPORT (GENERAL/DEPEND/ SECURITY/ALL)	USB memory	Sublog Expansion Board	Sublog Board
SERVICE DATA(Main Controller PCB)		Clear	-	-	-	-	-	/	-	-	Clear *3	-	-	-	-	-	-	-	-	-
Serial Number (Only non-counter charge model)	Main Controller PCB	Clear	-	-	-	-	/	-	-	-	-	No	-	-	-	Yes	-	-	Sublog Expansion Board	Sublog Board
Number of the printed pages (Only non-counter charge model)		Clear	-	-	-	-	-	/	-	-	-	-	No	-	-	No *6	-	-	-	-
Main Controller service counter *2	/	/	/	/	/	/	/	/	/	/	/	/	/	/	/	/	/	/	/	/
Stored Job	SD Card	-	-	-	-	Clear	/	-	-	-	-	No	-	-	-	No	-	-	-	-

\*1. To delete IPSec Policy settings, select the following in service mode: Network.gr >IPSEC SETTING > SPDALDEL.  
 \*2. It belongs to counter gr. in service mode. Since counter gr. items are not available with this model, it is not applicable.  
 \*3. It is initialized by selecting the following in service mode: Network gr. > E-RDS > CLEAR.  
 \*4. Service mode setting values are stored in FLASH MEMORY. When importing/exporting user settings, the service mode items are included.  
 \*5. It is initialized by selecting the following in service mode: Network gr. > CA-KEY.  
 it is carried over automatically after replacing the PCB.  
 \*6. Required Sublog Board & Sublog Expansion Board.