



Lexmark™

CX730, CX735, CX737, XC4342, XC4352 MFPs

7530-236, -239, -678, -679, -878

Service Manual

- [Start diagnostics](#)
- [Maintenance](#)
- [Safety and notices](#)
- [Trademarks](#)
- [Index](#)

April 17, 2023

www.lexmark.com

Product information

Product name:

Lexmark CX730de, Lexmark CX735adse, Lexmark CX737adzse, Lexmark XC4342, Lexmark XC4352 MFPs

Machine type:

7530

Model(s):

236, 239, 678, 679, 878

Edition notice

April 17, 2023

The following paragraph does not apply to any country where such provisions are inconsistent with local law: LEXMARK INTERNATIONAL, INC., PROVIDES THIS PUBLICATION “AS IS” WITHOUT WARRANTY OF ANY KIND, EITHER EXPRESS OR IMPLIED, INCLUDING, BUT NOT LIMITED TO, THE IMPLIED WARRANTIES OF MERCHANTABILITY OR FITNESS FOR A PARTICULAR PURPOSE. Some states do not allow disclaimer of express or implied warranties in certain transactions; therefore, this statement may not apply to you.

This publication could include technical inaccuracies or typographical errors. Changes are periodically made to the information herein; these changes will be incorporated in later editions. Improvements or changes in the products or the programs described may be made at any time.

References in this publication to products, programs, or services do not imply that the manufacturer intends to make these available in all countries in which it operates. Any reference to a product, program, or service is not intended to state or imply that only that product, program, or service may be used. Any functionally equivalent product, program, or service that does not infringe any existing intellectual property right may be used instead. Evaluation and verification of operation in conjunction with other products, programs, or services, except those expressly designated by the manufacturer, are the user's responsibility.

Trademarks

Lexmark and the Lexmark logo are trademarks of Lexmark International, Inc., registered in the United States and/or other countries. PCL® is a registered trademark of the Hewlett-Packard Company. PCL is Hewlett-Packard Company's designation of a set of printer commands (language) and functions included in its printer products. This printer is intended to be compatible with the PCL language. This means the printer recognizes PCL commands used in various application programs, and that the printer emulates the functions corresponding to the commands.

PostScript is a registered trademark of Adobe Systems Incorporated in the United States and/or other countries.

All other trademarks are the property of their respective owners.

© 2022 Lexmark International, Inc.

All rights reserved.

P/N

Table of contents

Product information.....	2
Edition notice.....	2
Notices, conventions, and safety information.....	13
Laser notice.....	13
Avis relatif à l'utilisation du laser.....	13
Aviso de láser.....	13
Laser-Hinweis.....	14
Conventions.....	14
Safety information.....	16
Change history.....	21
Change history.....	21
General information.....	27
Printer model configurations.....	27
Finding the printer serial number.....	27
Selecting paper.....	27
Paper guidelines.....	27
Paper characteristics	28
Unacceptable paper	29
Storing paper.....	29
Selecting preprinted forms and letterhead	29
Supported paper sizes.....	30
Supported paper types.....	33
Supported paper weights	34
Tools required for service.....	34
Diagnostics and troubleshooting.....	35
Troubleshooting precautions.....	35
Troubleshooting overview.....	37
Performing the initial troubleshooting check.....	37
Securing the printer.....	37
Resetting the printer without admin credentials	37
Using the security reset jumper	38
Fixing print quality issues.....	39

Initial print quality check.....	39
Blank or white pages check	40
Dark print check.....	44
Ghost images check	46
Gray or colored background check.....	48
Horizontal colored lines or banding check	49
Light print check	51
Marks on leading or trailing edges check	56
Mottled print and dots check	57
Print crooked or skewed check.....	59
Repeating defects check.....	62
Solid color or black image check.....	65
Text or images cut off check	67
Toner easily rubs off check.....	69
Uneven print density check.....	70
Vertical colored lines or banding check.....	72
Vertical white lines check.....	72
Blurred print or misaligned color check	74
Gapping or half color page check	76
Image void process direction check	77
Image void scan direction check	80
Missing color check	82
Random marks check.....	86
Fixing scan quality issues.....	87
Dark image quality (using the ADF or scanner) check	87
Vertical lines (process direction using the ADF) check.....	88
Spots (using the flatbed scanner) check.....	89
ADF skew check.....	90
Media damage (using the ADF) check.....	92
Blank page copy check	92
Black page copy check.....	94
Paper jams.....	95
Avoiding jams	95
Identifying jam locations.....	96
200 paper jams.....	98
201 paper jams	106
202 paper jams.....	107
221 paper jams	116
230 paper jams	121
231 paper jams	126
232 paper jams	133
240 paper jams	139
241 paper jams	153
242–245 paper jams	162

280–295 paper jams.....	196
User attendance messages.....	202
0y user attendance errors.....	202
1y user attendance errors.....	206
3y user attendance errors.....	208
4y user attendance errors.....	218
5y user attendance errors.....	221
6y user attendance errors.....	224
7y user attendance errors.....	225
8y user attendance errors.....	228
Printer hardware errors.....	236
100 errors.....	236
101 errors.....	237
110 errors.....	238
120 errors.....	240
121 errors.....	242
126–127 errors.....	245
142 errors.....	247
145 errors.....	249
147 errors.....	250
149 errors.....	252
150 errors.....	253
151 errors.....	254
153 errors.....	256
160 errors.....	257
161–164 errors.....	258
162–165 errors.....	259
166–169 errors.....	262
171–172 errors.....	263
600–661 errors.....	265
662–669 errors.....	269
680 errors.....	273
84y errors.....	273
Procedure before starting the 9yy service checks.....	281
900–901 errors.....	282
912–992 errors.....	288
Other symptoms.....	293
Base printer symptoms.....	293
Scan, fax, and copy symptoms.....	303
Service menus.....	321
Understanding the printer control panel.....	321
Using the control panel.....	321
Understanding the status of the indicator light.....	321

Configuring the door interlock bypass jumpers.....	321
Diagnostics menu.....	323
Entering the Diagnostics Menu	323
Reports	324
Advanced Print Quality Samples.....	325
Format Fax Storage	325
Scanner Diagnostics.....	325
Printer Setup	331
Printer diagnostics and adjustments.....	333
Out of service erase	343
Event Log.....	343
Input tray quick print.....	344
Additional input trays adjustments/tests	344
Configuration menu.....	346
Entering the Configuration Menu	346
Configuration Menu	346
Entering Invalid engine mode.....	351
Entering Recovery mode.....	352
Service Engineer menu.....	354
Entering the Service Engineer (SE) menu	354
General SE	354
Network SE	354
Fax SE.....	355
Scanner SE.....	356
Parts removal.....	357
Data security notice.....	357
Removal precautions.....	358
Handling ESD-sensitive parts.....	360
Critical information for controller board or engine board replacement.....	360
Restoring the printer configuration after replacing the controller board	361
Restoring solutions, licenses, and configuration settings	364
Updating the printer firmware	365
Backing up eSF solutions and settings	366
Adjustments.....	367
Printhead alignment adjustment	367
Registration adjustment.....	369
Scanner Manual Registration	372
ADF registration adjustment.....	373
Flatbed registration adjustment	373
TPS characterization data entry	373
Removal procedures.....	374

Left side removals.....	374
Left cover removal	374
LVPS removal.....	377
Main fan removal	379
Fuser fan removal.....	380
Motor (EP drive) removal	382
EP drive gearbox removal.....	384
Motor (BOR) removal	386
Motor (deskew) removal.....	387
Power cable removal.....	388
Motor (exit/redrive) removal	390
LVPS cage removal.....	392
Fuser interconnect cable removal	395
Right side removals.....	397
Waste toner bottle removal	397
Imaging kit removal.....	399
Right cover removal.....	401
Toner door removal.....	402
Toner door mount bracket removal.....	404
USB cover removal	405
Headphone and USB socket cables removals.....	405
TMC card removal	409
Sensor (paper size) removal.....	411
Motor (fuser) removal	413
Waste toner bottle idler gear removal	415
Motor (duplex/MPF) removal	415
Sensor (weather station) removal	416
HVPS removal	417
Sensor (waste toner) removal	420
Sensor (MPF paper present) removal	420
Sensor (TPS) removal.....	422
Entering the sensor (TPS) characterization data.....	423
Front side removals.....	425
Front door removal	425
Motor cover removal	427
Scanner front cover removal.....	429
Transfer module removal.....	431
Transfer module retainer removal.....	433
Sensor (input) removal	434
Fuser removal.....	436
Redrive guide removal.....	437
Diverter removal	439
Sensor (redrive) removal	439
Sensor (fuser nip) removal	441

Control panel display (10-inch) removal	442
Control panel display (7-inch) removal	444
Control panel base (10-inch) removal	446
Control panel base (7-inch) removal	447
Control panel hinge removal.....	448
Control panel rear cover removal.....	449
Speaker removal	450
Front door hinges removal	451
Control panel arms removal	452
Transfer module guide rail removal.....	455
Aligner rollers removal.....	458
Pivot shaft removal.....	466
Duplex inner guide removal	466
Sensor (duplex staging) removal.....	467
Sensors (fuser buckle and narrow media) removal.....	468
Tensioner belt removal	469
Duplex outer guide removal.....	470
Front door cover removal.....	472
Rear side removals.....	474
Controller board shield removal.....	474
Scanner rear right cover removal	475
Scanner rear left cover removal	475
ISD card removal	476
TPM card removal	477
Controller board removal	478
Engine board removal.....	479
Top side removals.....	482
Bin cover removal	482
Top frame cover removal.....	483
Top frame base cover removal	483
Upper front door removal	484
Printhead removal	484
Top cover removal.....	486
Sensor (bin full) removal	489
Exit roller gear removal.....	492
Exit roller removal.....	493
Control panel FFC removal.....	494
Facade cover removal	496
Bin exit cover removal.....	496
Bin flag removal.....	497
Developer hold down arm removal.....	498
Bottom side removals.....	500
550-sheet tray insert removal.....	500
Separator bracket removal	500

Pick roller removals.....	502
Tray rail removal.....	504
Paper feeder removal.....	507
Paper out actuator spring removal	508
Isolation unit removal	509
ADF and flatbed scanner removals.....	512
Scanner glass pad removal	512
ADF rollers removal	514
ADF tray removal.....	517
ADF removal	517
Flatbed scanner removal.....	519
Scanner cables removal	526
ADF top cover removal.....	528
ADF right hinge removal	530
ADF left hinge removal	531
Tilting the ADF and flatbed scanner to access parts.....	532
Optional 550-sheet tray removals.....	536
Optional 550-sheet tray removal.....	536
Component locations.....	537
Printer configurations.....	537
Port locations.....	538
Controller board and engine board connectors.....	539
LVPS board connectors.....	543
Sensor locations.....	545
Motor locations.....	548
Maintenance.....	549
Inspection guide.....	549
Scheduled maintenance.....	549
Maintenance kits.....	549
Resetting counters	551
Cleaning the printer.....	552
Cleaning the printer	552
Cleaning the touch screen.....	553
Cleaning the scanner	554
Cleaning the pick roller.....	556
Cleaning the pick roller in the multipurpose feeder	557
Cleaning the ADF rollers	560
Cleaning the printhead lenses.....	563
Cleaning the tray 1 duplex turnaround.....	564

Parts catalog.....	566
Legend.....	566
Assembly 1: Covers 1.....	567
Assembly 2: Covers 2.....	569
Assembly 3: Control panel.....	571
Assembly 4: Fuser.....	573
Assembly 5: Transfer module.....	575
Assembly 6: Paper feed.....	577
Assembly 7: Paper path 1.....	579
Assembly 8: Paper path 2.....	581
Assembly 9: Duplex.....	583
Assembly 10: Electrical.....	585
Assembly 11: ADF and flatbed scanner.....	589
Assembly 12: Optional 550-sheet tray.....	591
Assembly 13: Convenience stapler.....	593
Assembly 14: Printer stand.....	595
Assembly 15: Miscellaneous.....	597
Assembly 16: Maintenance kits.....	599
Assembly 17: Power cords.....	601
Printer specifications.....	603
Power consumption.....	603
Product power consumption.....	603
Sleep Mode.....	603
Hibernate Mode.....	604
Off mode.....	604
Total energy usage.....	604
Applicability of Regulation (EU) 2019/2015 and (EU) 2019/2020.....	604
Selecting a location for the printer.....	604
Noise emission levels.....	605
Temperature information.....	606
Options and features.....	607
Available internal options.....	607
Theory of operation.....	609
Electrophotographic (EP) process.....	609
Print engine layout.....	609

Flowchart	610
EP process.....	611
Printer operation.....	619
Printer paper path rollers	619
Printer paper path sensors	621
Pick drive	623
Isolation drive	625
Aligner drive.....	626
Transfer drive.....	627
Fuser drive	628
Exit and redrive drive	630
Duplex drive.....	631
ADF and scanner operation.....	632
Flatbed scanner drive	632
ADF paper path rollers.....	633
ADF paper path sensors.....	633
ADF pick and feed drive.....	634
ADF transport and scan drive	635
ADF exit drive.....	639
Index.....	640
Part number index.....	647
Part name index.....	653

Notices, conventions, and safety information

Laser notice

The printer is certified in the U.S. to conform to the requirements of DHHS 21 CFR, Chapter I, Subchapter J for Class I (1) laser products, and elsewhere is certified as a Class 1 consumer laser product conforming to the requirements of IEC 60825-1:2014, EN 60825-1:2014+A11:2021, and EN 50689:2021.

Class I laser products are not considered to be hazardous. The laser system and printer are designed so there is never any human access to laser radiation above a Class I level during normal operation, user maintenance, or prescribed service conditions. The printer has a non-serviceable printhead assembly that contains a laser with the following specifications:

Class: IIIb (3b) AlGaAs

Nominal output power (milliwatts): 12

Wavelength (nanometers): 770–800

Avis relatif à l'utilisation du laser

Cette imprimante est certifiée conforme aux exigences de la réglementation des Etats-Unis relative aux produits laser de classe I (1) (DHHS 21 CFR, Chapitre I, Sous-chapitre J). Pour les autres pays, elle est certifiée conforme aux exigences relatives aux produits laser de classe 1 des normes CEI 60825-1:2014, EN 60825-1:2014+A11:2021 et EN 50689:2021.

Les produits laser de Classe I ne sont pas considérés comme dangereux. Le système laser ainsi que l'imprimante ont été conçus de manière à ce que personne ne soit jamais exposé à des radiations laser dépassant le niveau de classe I dans le cadre d'un fonctionnement normal, de l'entretien par l'utilisateur ou de la maintenance. L'imprimante dispose d'un ensemble de têtes d'impression non réparable contenant un laser doté des caractéristiques suivantes :

Classe : IIIb (3b) AlGaAs

Puissance de sortie nominale (milliwatts) : 12

Longueur d'onde (nanomètres) : 770-800

Aviso de láser

Esta impresora se ha certificado en EE.UU. cumpliendo con los requisitos de DHHS 21 CFR, capítulo I, subcapítulo J para los productos láser de Clase I (1) y en otros países está certificada como un producto láser de Clase I de acuerdo con los requisitos de IEC 60825-1:2014, EN 60825-1:2014+A11:2021 y EN 50689:2021.

Los productos láser de Clase I no se consideran peligrosos. El sistema láser y la impresora se han diseñado para que el ser humano no acceda nunca a las radiaciones láser por encima del nivel de Clase I durante su uso normal, ni en tareas de mantenimiento o intervenciones de servicio técnico prescritas. El conjunto de cabezal de impresión de la impresora no se puede reparar y contiene un láser con las siguientes especificaciones:

Clase: IIIb (3b) AlGaAs

Potencia nominal de salida (milivatios): 12

Longitud de onda (nanómetros): 770-800

Laser-Hinweis

Der Drucker wurde in den USA zertifiziert und entspricht den Anforderungen der Vorschriften DHHS 21 CFR Kapitel I, Unterkapitel J für Laserprodukte der Klasse I (1), andernorts ist er als Verbraucher-Laserprodukt der Klasse 1 zertifiziert, das den Anforderungen von IEC 60825-1 entspricht:2014, EN 60825-1:2014+A11:2021 und EN 50689:2021.

Laserprodukte der Klasse I werden nicht als gefährlich betrachtet. Das Lasersystem und der Drucker sind so konstruiert, dass unter normalen Betriebsbedingungen, bei der Wartung durch den Benutzer oder bei den vorgeschriebenen Wartungsbedingungen Menschen keiner Laserstrahlung ausgesetzt sind, die die Werte für Klasse I überschreitet. Der Drucker verfügt über eine Druckkopfeinheit, die nicht gewartet werden kann und mit einem Laser mit den folgenden Spezifikationen ausgestattet ist:

Klasse: IIIb (3b) AlGaAs

Nennausgangsleistung (Milliwatt): 12

Wellenlänge (Nanometer): 770–800

Conventions

Note: A *note* identifies information that could help you.

Warning: A *warning* identifies something that could damage the product hardware or software.

CAUTION: A *caution* indicates a potentially hazardous situation that could injure you.

Different types of caution statements include:

 **CAUTION—POTENTIAL INJURY:** Indicates a risk of injury.

 **CAUTION—SHOCK HAZARD:** Indicates a risk of electrical shock.

 **CAUTION—HOT SURFACE:** Indicates a risk of burn if touched.

 **CAUTION—TIPPING HAZARD:** Indicates a crush hazard.

 **CAUTION—PINCH HAZARD:** Indicates a risk of being caught between moving parts.

Conventions

Remarque : Une *Remarque* fournit des informations pouvant vous être utiles.

Avertissement : Un *Avertissement* signale un danger susceptible d'endommager le logiciel ou le matériel.

ATTENTION : La mention *Attention* vous signale un risque de blessure corporelle.

Il existe différentes mises en garde :

 **ATTENTION—RISQUE DE BLESSURE :** Signale un risque de blessure.

 **ATTENTION—RISQUE D'ELECTROCUTION :** Signale un risque d'électrocution.

 **ATTENTION—SURFACE CHAUDE** : Signale un risque de brûlure de contact.

 **ATTENTION—RISQUE DE BASCULEMENT** : Signale un risque d'écrasement.

 **ATTENTION : RISQUE DE PINCEMENT** : Signale un risque de pincement entre des pièces mobiles.

Convenciones

Nota: Las *notas* señalan información que puede serle útil.

Aviso: Las *advertencias* indican algo que podría dañar el software o el hardware del producto.

PRECAUCIÓN: Las *precauciones* indican una situación de posible peligro que puede implicar lesiones para el usuario.

Estos son los tipos de avisos de precaución que existen:

 **PRECAUCIÓN: POSIBLES DAÑOS PERSONALES:** Indica que existe riesgo de lesiones.

 **PRECAUCIÓN: PELIGRO DE DESCARGAS ELÉCTRICAS:** Indica que existe riesgo de descarga eléctrica.

 **PRECAUCIÓN: SUPERFICIE CALIENTE:** Indica que existe riesgo de sufrir quemaduras por contacto.

 **PRECAUCIÓN: RIESGO DE CAÍDA:** Indica que existe peligro de aplastamiento.

 **PRECAUCIÓN: PELIGRO DE ATRAPAMIENTO:** Existe riesgo de atrapamiento entre las piezas en movimiento.

Konventionen

Hinweis: Ein *Hinweis* enthält nützliche Informationen.

Warnung: Durch eine *Warnung* werden Sie auf einen Umstand hingewiesen, durch den die Produkthardware oder -software beschädigt werden könnte.

VORSICHT: *Vorsicht* weist auf eine mögliche gefährliche Situation hin, die ein Verletzungsrisiko birgt.

Verschiedene Vorsichtshinweise:

 **VORSICHT – MÖGLICHE VERLETZUNGSGEFAHR** Weist auf ein Verletzungsrisiko hin.

 **VORSICHT – STROMSCHLAGGEFAHR:** Weist auf das Risiko eines elektrischen Schlags hin.

 **VORSICHT – HEISSE OBERFLÄCHE:** Weist auf das Risiko von Verbrennungen bei Berührung hin.

 **VORSICHT – KIPPGEFAHR:** Weist auf Quetschgefahr hin.

 **VORSICHT – QUETSCHGEFAHR:** Weist auf das Risiko hin, zwischen beweglichen Komponenten eingequetscht zu werden.

Safety information

- The safety of this product is based on testing and approvals of the original design and specific components. The manufacturer is not responsible for safety in the event of use of unauthorized replacement parts.
- The maintenance information for this product has been prepared for use by a professional service person and is not intended to be used by others.
- There may be an increased risk of electrical shock and personal injury during disassembly and servicing of this product. Professional service personnel should understand this risk and take necessary precautions.

 **CAUTION—SHOCK HAZARD:** When you see this symbol on the product, there is a danger from hazardous voltage in the area of the product where you are working. Unplug the product before you begin, or use caution if the product must receive power in order to perform the task.

 **CAUTION—POTENTIAL INJURY:** The lithium battery in this product is not intended to be replaced. There is a danger of explosion if a lithium battery is incorrectly replaced. Do not recharge, disassemble, or incinerate a lithium battery. Discard used lithium batteries according to the manufacturer's instructions and local regulations.

 **CAUTION—POTENTIAL INJURY:** To avoid the risk of fire or electrical shock, connect the power cord to an appropriately rated and properly grounded electrical outlet that is near the product and easily accessible.

 **CAUTION—POTENTIAL INJURY:** To avoid the risk of fire or electrical shock, use only the power cord provided with this product or the manufacturer's authorized replacement.

 **CAUTION—POTENTIAL INJURY:** Do not use this product with extension cords, multioutlet power strips, multioutlet extenders, or UPS devices. The power capacity of these types of accessories can be easily overloaded by a laser printer and may result in a risk of fire, property damage, or poor printer performance.







 **CAUTION—POTENTIAL INJURY:** Only a Lexmark Inline Surge Protector that is properly connected between the printer and the power cord provided with the printer may be used with this product. The use of non-Lexmark surge protection devices may result in a risk of fire, property damage, or poor printer performance.

 **CAUTION—POTENTIAL INJURY:** If the printer weight is greater than 20 kg (44 lb), then it may require two or more people to lift it safely.

Consignes de sécurité

- La sécurité de ce produit est basée sur des tests et certifications de sa conception d'origine et de ses composants spécifiques. Le fabricant décline toute responsabilité en cas d'utilisation de pièces de rechange non autorisées.
- Les informations de maintenance de ce produit sont destinées à des professionnels qualifiés et ne sont pas conçues pour être utilisées par d'autres personnes.
- Il existe un risque potentiel de choc électrique et de blessures lors du démontage et de la maintenance de ce produit. Le personnel professionnel de maintenance doit comprendre les risques et prendre les précautions nécessaires.

 **ATTENTION—RISQUE D'ELECTROCUTION :** Ce symbole indique un danger lié à des niveaux de tension dangereux dans la zone du produit à manipuler. Débranchez le produit avant de commencer, ou agissez avec prudence si le produit doit être alimenté pour effectuer l'opération.

-  **ATTENTION—RISQUE DE BLESSURE** : La batterie lithium de ce produit n'est pas destinée à être remplacée. Si vous ne respectez pas les instructions de remplacement de la batterie, vous risquez de provoquer une explosion. Ne rechargez pas, ne désassemblez pas et ne brûlez pas la batterie au lithium. Mettez les batteries lithium usagées au rebut selon les instructions du fabricant et les réglementations locales.
-  **ATTENTION—RISQUE DE BLESSURE** : Pour éviter tout risque d'électrocution ou d'incendie, branchez le câble d'alimentation directement à une prise électrique répondant aux exigences requises et correctement mise à la terre, proche du produit et facile d'accès.
-  **ATTENTION—RISQUE DE BLESSURE** : Pour éviter tout risque d'incendie ou d'électrocution, utilisez uniquement le câble d'alimentation fourni avec ce produit ou un câble de remplacement autorisé par le fabricant.
-  **ATTENTION—RISQUE DE BLESSURE** : Ce produit ne doit pas être utilisé avec des rallonges, des barres multiprises, des rallonges multiprises ou des périphériques UPS. La capacité de ces types d'accessoires peut être facilement dépassée par une imprimante laser, d'où un risque de dégâts matériels, d'incendie ou de performances d'impression amoindries.
-  **ATTENTION—RISQUE DE BLESSURE** : Utilisez uniquement un parasurtenseur correctement raccordé à l'imprimante et au câble d'alimentation fourni avec la machine. L'utilisation de parasurtenseurs non fabriqués par Lexmark comporte un risque d'incendie et de dégâts matériels, et peut amoindrir les performances de l'imprimante.
-  **ATTENTION—RISQUE DE BLESSURE** : Si votre imprimante pèse plus de 20 kg (44 lb), l'intervention d'au moins deux personnes est nécessaire pour la soulever sans risque.

Información de seguridad



- La seguridad de este producto se basa en las pruebas y comprobaciones del diseño original y los componentes específicos. El fabricante no se hace responsable de la seguridad en caso de uso de piezas de repuesto no autorizadas.
- La información de mantenimiento de este producto se ha preparado para su uso por parte de un profesional de asistencia técnica y no está diseñada para su uso por parte de otros usuarios.
- Es posible que haya un mayor riesgo de descarga eléctrica y daños personales durante el desmontaje y el mantenimiento de este producto. El personal de asistencia profesional debe conocer este riesgo y tomar las precauciones necesarias.

 **PRECAUCIÓN: PELIGRO DE DESCARGAS ELÉCTRICAS:** Cuando vea este símbolo en el producto, existe peligro de tensiones peligrosas en el área del producto en la que está trabajando. Desconecte el producto antes de empezar o tenga cuidado si el producto debe recibir alimentación a fin de realizar la tarea.

 **PRECAUCIÓN: POSIBLES DAÑOS PERSONALES:** La batería de litio de este producto no debe reemplazarse. Existe riesgo de explosión si se sustituye incorrectamente una batería de litio. No recargue, desmonte ni incinere una batería de litio. Deseche las baterías de litio usadas según las instrucciones del fabricante y las normativas locales.

 **PRECAUCIÓN: POSIBLES DAÑOS PERSONALES:** Para evitar el riesgo de incendio o descarga eléctrica, conecte el cable de alimentación a una toma de corriente debidamente conectada a tierra con la potencia adecuada que se encuentre cerca del dispositivo y resulte fácilmente accesible.

 **PRECAUCIÓN: POSIBLES DAÑOS PERSONALES:** Para evitar el riesgo de incendio o descarga eléctrica, utilice exclusivamente el cable de alimentación que se suministra junto con este producto o el repuesto autorizado por el fabricante.

-  **PRECAUCIÓN: POSIBLES DAÑOS PERSONALES:** No utilice este producto con cables alargadores, regletas de varias tomas, cables alargadores de varias tomas o sistemas de alimentación ininterrumpida. La potencia de este tipo de accesorios puede sobrecargarse fácilmente si se utiliza una impresora láser, lo que puede dar lugar a que el rendimiento de la impresora sea bajo, a daños materiales o a posibles incendios.
-  **PRECAUCIÓN: POSIBLES DAÑOS PERSONALES:** Solo debe usarse con este producto un protector de sobretensión insertable Lexmark debidamente conectado entre la impresora y el cable de alimentación que con ella se suministra. El uso de protectores de sobretensión de marcas distintas a Lexmark puede dar lugar a que el rendimiento de la impresora sea bajo, a daños materiales o a posibles incendios.
-  **PRECAUCIÓN: POSIBLES DAÑOS PERSONALES:** si el peso de la impresora es superior a 20 kg (44 lb), pueden ser necesarias dos o más personas para levantarla de forma segura.

Sicherheitshinweise

- Die Sicherheit dieses Produkts basiert auf Tests und Zulassungen des Originaldesigns und der spezifischen Komponenten. Sofern nicht autorisierte Ersatzteile eingesetzt werden, übernimmt der Hersteller keinerlei Verantwortung in Bezug auf die Sicherheit dieses Produkts.
 - Die Wartungsinformationen für dieses Produkt wurden für ausgebildete Servicemitarbeiter zusammengestellt und dürfen nicht von anderen verwendet werden.
 - Möglicherweise besteht bei der Demontage und Wartung dieses Produkts eine erhöhte Stromschlag- und Verletzungsgefahr. Ausgebildete Servicemitarbeiter sollten sich dieser Gefahr bewusst sein und die notwendigen Vorsichtsmaßnahmen ergreifen.
-  **VORSICHT – STROMSCHLAGGEFAHR:** Wenn Sie dieses Symbol sehen, besteht eine Gefahr durch gefährliche Spannungen in dem Produktbereich, in dem Sie arbeiten. Trennen Sie das Produkt von seiner Stromverbindung, bevor Sie beginnen, oder gehen Sie vorsichtig vor, wenn das Produkt für die Durchführung der Aufgabe mit Strom versorgt werden muss.
 -  **VORSICHT – MÖGLICHE VERLETZUNGSGEFAHR** Die Lithiumbatterie in diesem Produkt darf nicht ausgetauscht werden. Wird eine Lithiumbatterie nicht ordnungsgemäß ausgetauscht, besteht Explosionsgefahr. Lithiumbatterien dürfen auf keinen Fall wieder aufgeladen, auseinander genommen oder verbrannt werden. Befolgen Sie zum Entsorgen verbrauchter Lithiumbatterien die Anweisungen des Herstellers und die örtlichen Bestimmungen.
 -  **VORSICHT – MÖGLICHE VERLETZUNGSGEFAHR** Um Feuer- und Stromschlaggefahr zu vermeiden, schließen Sie das Netzkabel direkt an eine ordnungsgemäß geerdete Steckdose an, die sich in der Nähe des Geräts befindet und leicht zugänglich ist.
 -  **VORSICHT – MÖGLICHE VERLETZUNGSGEFAHR** Um das Risiko eines Feuers oder elektrischen Schlags zu vermeiden, verwenden Sie ausschließlich das diesem Produkt beiliegende Netzkabel bzw. ein durch den Hersteller zugelassenes Ersatzkabel.
 -  **VORSICHT – MÖGLICHE VERLETZUNGSGEFAHR** Verwenden Sie das Produkt nicht mit Verlängerungskabeln, Mehrfachsteckdosen, Mehrfachverlängerungen oder Geräten für unterbrechungsfreie Stromversorgung. Die Belastbarkeit solcher Zubehörteile kann durch Laserdrucker schnell überschritten werden, was zu Brandgefahr, Beschädigung von Eigentum oder einer eingeschränkten Druckerleistung führen kann.

 **VORSICHT – MÖGLICHE VERLETZUNGSGEFAHR** Mit diesem Produkt darf nur ein Lexmark Inline Surge Protector verwendet werden, der vorschriftsgemäß zwischen dem Drucker und dem mitgelieferten Netzkabel angeschlossen ist. Die Verwendung von nicht von Lexmark stammenden Überspannungsschutzgeräten kann zu Brandgefahr, Beschädigung von Eigentum oder einer eingeschränkten Druckerleistung führen.

 **VORSICHT – MÖGLICHE VERLETZUNGSGEFAHR** Wenn der Drucker mehr als 20 kg wiegt, sind zum sicheren Anheben mindestens zwei Personen notwendig.

Change history

Change history

April 17, 2023

- Removed PN 41X2831 from the Control panel assembly in the Parts catalog chapter. See [“Control panel” on page 571](#).
- Updated the following topics in the Diagnostics and troubleshooting chapter:
 - Print crooked or skewed check. See [“Print crooked or skewed check” on page 59](#).
 - Image void scan direction check. See [“Image void scan direction check” on page 80](#).

March 30, 2023

- Updated the topic Configuring the door interlock bypass jumpers in the Service menus chapter. See [“Configuring the door interlock bypass jumpers” on page 321](#).
- Updated the following topics in the Diagnostics and troubleshooting chapter:
 - LVPS service check. See [“LVPS service check” on page 246](#).
 - HVPS service check. See [“HVPS service check” on page 247](#).
 - Fuser service check. See [“Fuser service check” on page 244](#).
 - Sensor (ADF multifeed) jam service check. See [“Sensor \(ADF multifeed\) jam service check” on page 200](#).
 - Scanner cover open service check. See [“Scanner cover open service check” on page 202](#).
 - Engine software error service check. See [“Engine software error service check” on page 291](#).
 - ADF paper jam service check. See [“ADF paper jam service check” on page 198](#).
 - 31 user attendance error messages. See [“31 user attendance error messages” on page 208](#).
 - 32 user attendance error messages. See [“32 user attendance error messages” on page 212](#).
 - 121 error messages. See [“121 error messages” on page 242](#).
 - 126-127 error messages. See [“126–127 error messages” on page 245](#).
 - 200 paper jam messages. See [“200 paper jam messages” on page 98](#).
 - 912-992 error messages. See [“912–992 error messages” on page 288](#).
- Updated the following topics in the Removals chapter:
 - Registration adjustment. See [“Registration adjustment” on page 369](#).
 - ADF registration adjustment. See [“ADF registration adjustment” on page 373](#).
 - Headphone and USB socket cables removals. See [“Headphone and USB socket cables removals” on page 405](#).
 - Headphone socket cable removal. See [“Headphone and USB socket cables removals” on page 405](#).
 - Motor (BOR) removal. See [“Motor \(BOR\) removal” on page 386](#).
 - Scanner glass pad removal. See [“Scanner glass pad removal” on page 512](#).
 - Left cover removal. See [“Left cover removal” on page 374](#).
 - HVPS removal. See [“HVPS removal” on page 417](#).
 - Paper out actuator spring removal. See [“Paper out actuator spring removal” on page 508](#).
 - Control panel display (7-inch) removal. See [“Control panel display \(7-inch\) removal” on page 444](#).

- Control panel base (7-inch) removal. See [“Control panel base \(7-inch\) removal” on page 447.](#)
- ADF tray removal. See [“ADF tray removal” on page 517.](#)
- Flatbed scanner removal. See [“Flatbed scanner removal” on page 519.](#)
- Scanner cables removal. See [“Scanner cables removal” on page 526.](#)
- Tilting the ADF and flatbed scanner to access parts. See [“Tilting the ADF and flatbed scanner to access parts” on page 532.](#)
- Updated the following topics in the Maintenance chapter:
 - Maintenance kits. See [“Maintenance kits” on page 549.](#)
 - Cleaning the pick roller in the multipurpose feeder. See [“Cleaning the pick roller in the multipurpose feeder” on page 557.](#)
- Updated the following topics in the Parts catalog chapter:
 - Fuser. See [“Fuser” on page 573.](#)
 - Maintenance kits. See [“Maintenance kits” on page 599.](#)
 - Electrical. See [“Electrical” on page 585.](#)
- Updated the topic Exit and redrive drive in the Theory of operation chapter. See [“Exit and redrive drive” on page 630.](#)

March 8, 2023

- Updated the following topics in the Diagnostics and troubleshooting chapter:
 - Blank or white pages check. See [“Blank or white pages check” on page 40.](#)
 - Gray or colored background check. See [“Gray or colored background check” on page 48.](#)
 - Horizontal colored lines or banding check. See [“Horizontal colored lines or banding check” on page 49.](#)
 - Light print check. See [“Light print check” on page 51.](#)
 - Print crooked or skewed check. See [“Print crooked or skewed check” on page 59.](#)
 - Repeating defects check. See [“Repeating defects check” on page 62.](#)
 - 32 user attendance error messages. See [“32 user attendance error messages” on page 212.](#)
 - 33 user attendance error messages. See [“33 user attendance error messages” on page 214.](#)
- Updated the following topics in the Service menus chapter:
 - Sensor tests. See [“Sensor tests” on page 333.](#)
 - Configuration menu. See [“Configuration Menu” on page 346.](#)
 - General SE. See [“General SE” on page 354.](#)
 - Network SE. See [“Network SE” on page 354.](#)
 - Fax SE. See [“Fax SE” on page 355.](#)
- Added the following topics in the Service menus chapter:
 - Memory tests. See [“Memory tests” on page 343.](#)
 - Controller Calibration. See [“Controller Calibration” on page 331.](#)
- Updated the following topics in the Removals chapter:
 - Imaging kit removal. See [“Imaging kit removal” on page 399.](#)
 - Transfer module removal. See [“Transfer module removal” on page 431.](#)

- Entering the sensor (TPS) characterization data. See [“Entering the sensor \(TPS\) characterization data” on page 423](#).
- HVPS removal. See [“HVPS removal” on page 417](#).
- Updated the topic Controller board and engine board connectors in the Component locations chapter. See [“Controller board and engine board connectors” on page 539](#).
- Updated the topic Cleaning the pick roller in the Maintenance chapter. See [“Cleaning the pick roller” on page 556](#).
- Updated the topic Fuser drive in the Theory of Operations chapter. See [“Fuser drive” on page 628](#).
- Updated the Wiring Diagram.

February 1, 2023

- Changed the P/N for fax card from 41X1374 to 41X4916. See [“Miscellaneous” on page 597](#).

December 22, 2022

- Added the topic Entering the sensor (TPS) characterization data in the Removals chapter. See [“Entering the sensor \(TPS\) characterization data” on page 423](#).

November 29, 2022

- Added the topic group Securing the printer in the Diagnostics and troubleshooting chapter. It includes these topics:
 - Resetting the printer without admin credentials. See [“Resetting the printer without admin credentials” on page 37](#).
 - Using the security reset jumper. See [“Using the security reset jumper” on page 38](#).

November 10, 2022

- Added PN 41X1374 Fax card in the Miscellaneous parts topic of the Parts catalog chapter. See [“Miscellaneous” on page 597](#).
- Changed the part number from 41X3899 to 41X0435 in the Covers 2 topic of the Parts catalog chapter. See [“Covers 2” on page 569](#).

October 20, 2022

- Updated the topic title from Sensor (fuser present) removal to Sensor (fuser nip) removal of the Parts removal chapter. See [“Sensor \(fuser nip\) removal” on page 441](#).
- Added the 121.42 error code in the 121 error messages topic of the Diagnostics and troubleshooting chapter. See [“121 error messages” on page 242](#).
- Added the 32.xy fuser unsupported codes in the 32 user attendance error messages of the Diagnostics and troubleshooting chapter. See [“32 user attendance error messages” on page 212](#).
- Added the new sensor (fuser nip) art and updated the content of the Fuser nip subtopic under the Fuser drive topic of the Theory of operation chapter. See [“Fuser drive” on page 628](#).
- Added PN 41X1083 Sensor (fuser nip) in the Fuser topic of the Parts catalog chapter. See [“Fuser” on page 573](#).

August 2, 2022

- Added the following topics in the Parts Removal chapter:
 - Control panel display (7-inch) removal. See [“Control panel display \(7-inch\) removal” on page 444.](#)
 - Control panel base (7-inch) removal. See [“Control panel base \(7-inch\) removal” on page 447.](#)
 - Transfer module retainer removal. See [“Transfer module retainer removal” on page 433.](#)
- Added the Resetting the ADF rollers maintenance counter topic in the Maintenance chapter. See [“Resetting the ADF rollers maintenance counter” on page 551.](#)
- Updated the following topics:
 - Motor (duplex/MPF) removal topic in the Parts removals chapter. See [“Motor \(duplex/MPF\) removal” on page 415.](#)
 - Isolation unit removal topic of the Parts removals chapter. See [“Isolation unit removal” on page 509.](#)
 - Print crooked or skewed check topic in the Diagnostics and troubleshooting chapter. See [“Print crooked or skewed check” on page 59.](#)
 - Light print check topic of the Diagnostics and troubleshooting chapter. See [“Light print check” on page 51.](#)
- Updated the titles of the following topics:
 - From Resetting the maintenance counters to Resetting the fuser maintenance counter. See [“Resetting the fuser maintenance counter” on page 551.](#)
 - From Transfer module reset to Resetting the transfer module counter. See [“Resetting the transfer module counter” on page 552.](#)
- Added PN 41X2848 to the Maintenance kits topic of the Maintenance chapter. See [“Maintenance kits” on page 549.](#)
- Changed the part number of Bin exit cover from 41X3896 to 41X3895 in the **Assembly 1: Covers 1** topic of the Parts Catalog chapter. See [“Covers 1” on page 567.](#)
- Removed PN 41X0578 (TPS wipers) from the **Assembly 10: Electrical** topic of the Parts Catalog chapter. See [“Electrical” on page 585](#)

July 7, 2022

- Added the **Applicability of Regulation (EU) 2019/2015 and (EU) 2019/2020** topic to the Printer Specifications chapter.
- Applied the following changes in the **Assembly 1: Covers 1** topic of the Parts Catalog chapter:
 - Changed Units/FRU of PN 41X0380 from 1 to 2.
 - Changed Units/FRU of PN 41X2032 from 1 to 4.
 See [“Covers 1” on page 567.](#)
- Applied the following changes in the **Assembly 3: Control panel** topic of the Parts Catalog chapter:
 - Updated the description for PN 41X2831 to control panel cable bracket, which includes the following components:
 - Headphones and USB cable bracket
 - Control panel FFC.
 - Added PN 41X4466 (Control panel cables)
 - Headphone and USB cable bracket
 - Headphone cable
 - Control panel FFC).

See [“Control panel” on page 571](#).

- Changed Units/mach of PN 41X0372 from 2 to 1 in the **Assembly 6: Paper feed** topic of the Parts Catalog chapter. See [“Paper feed” on page 577](#).
- Added PN 41X4463 (Left side cables
 - LVPS cable
 - AC line in cable
 - CMY motor cable
 - Fuser AC cable
 - BOR motor cable
 - Fuser DC cable
 - K motor cable
 - Exit/redrive motor cable).

to the **Assembly 7: Paper path 1** topic of the Parts Catalog chapter. See [“Paper path 1” on page 579](#).

- Changed Units/FRU of PN 41X4460 from 2 to 1 in the **Assembly 8: Paper path 2** topic of the Parts Catalog chapter. See [“Paper path 2” on page 581](#).
- Changed Units/FRU of PN 41X0379 from 1 to 2 in the **Assembly 9: Duplex** topic of the Parts Catalog chapter. See [“Duplex” on page 583](#).
- Added the following parts to the **Assembly 10: Electrical** topic of the Parts Catalog chapter:
 - Added PN 41X4465 (Right side cables
 - Front door sensor cables
 - TMC card cable
 - Weather station sensor cable
 - Interlock switch cables
 - Optional tray cables).
 - Added PN 41X4464 (Middle section cables
 - HVPS cable
 - Aligner sensor cables, waste toner sensor cable
 - Upper paper path sensor cables
 - Fuser buckle sensor cable
 - TPS cable
 - Paper path motor cables
 - Fuser motor cables).

See [“Electrical” on page 585](#).

- Updated the description for PN 41X3709 to Scanner cables in the **Assembly 11: ADF and flatbed scanner** topic of the Parts Catalog chapter. This part includes the following components:
 - ADF cables
 - ADF cable covers.

See [“ADF and flatbed scanner” on page 589](#).

- Changed the note for PN 40X8149 in the **Assembly 13: Convenience stapler** topic of the Parts Catalog chapter. PN 40X8149 has a CRU sheet, not FRU sheet. See [“Convenience stapler” on page 593](#).
- Added PN 41X1007 (Cleaning kit) in the **Assembly 15: Miscellaneous parts** topic of the Parts Catalog chapter. See [“Miscellaneous” on page 597](#).

- Applied the following image updates:
 - Updated the image in the **Assembly 1: Covers 1** topic of the Parts Catalog chapter.
 - Updated the image in the **Assembly 7: Paper path 1** topic of the Parts Catalog chapter.
 - Updated the image of the invalid engine code error in the **Critical information for controller board or engine board replacement** topic. See [“Critical information for controller board or engine board replacement” on page 360](#).
- Indicated that all parts in the **Assembly 16: Maintenance kits** topic of the Parts Catalog chapter have CRU sheets. See [“Maintenance kits” on page 599](#).
- Updated the wiring diagram to include the part numbers.

April 26, 2022

- Product announce

General information

Printer model configurations

The Lexmark™ CX730, CX735 and Lexmark XC4342, XC4352 MFPs are color, network-capable laser printers. All information in this *Service Manual* pertains to all models unless explicitly noted.

The printer is available in the following models:

Model name	Configuration / description	Machine type / model number
CX730de	7-in. color touch screen display, duplex print, duplex scan, networking, ISD and hard disk support, optional tray support, wireless module support	7530-236
XC4342	7-in. color touch screen display, duplex print, duplex scan, networking, ISD and hard disk support, optional tray support, wireless module support	7530-239
CX735adse	10-in. color touch screen display, duplex print, duplex scan, networking, fax, multi-feed detection, ISD and hard disk support, optional tray support, wireless module support	7530-678
XC4352	10-in. color touch screen display, duplex print, duplex scan, networking, fax, multi-feed detection, ISD and hard disk support, optional tray support, wireless module support	7530-679

Finding the printer serial number

- 1 Open door A.
- 2 Locate the serial number.

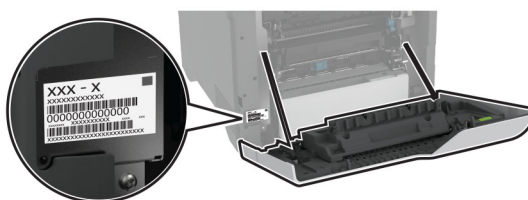

Selecting paper

Paper guidelines

Use the appropriate paper to prevent jams and help ensure trouble-free printing.

- Always use new, undamaged paper.
- Before loading paper, know the recommended printable side of the paper. This information is usually indicated on the paper package.
- Do not use paper that has been cut or trimmed by hand.

- Do not mix paper sizes, types, or weights in the same tray; mixing results in jams.
- Do not use coated papers unless they are specifically designed for electrophotographic printing.

For more information, see the *Paper and Specialty Media Guide*.

Paper characteristics

The following paper characteristics affect print quality and reliability. Consider these factors before printing on them.

Weight

Trays can feed paper of varying weights. Paper lighter than 60 g/m² (16 lb) may not be stiff enough to feed properly, and may cause jams. For more information, see the “Supported paper weights” topic.

Curl

Curl is the tendency for paper to curl at its edges. Excessive curl can cause paper feeding problems. Curl can occur after the paper passes through the printer, where it is exposed to high temperatures. Storing paper unwrapped in hot, humid, cold, or dry conditions can contribute to paper curling before printing and can cause feeding problems.

Smoothness

Paper smoothness directly affects print quality. If paper is too rough, toner cannot fuse to it properly. If paper is too smooth, it can cause paper feeding or print quality issues. We recommend the use of paper with 50 Sheffield points.

Moisture content

The amount of moisture in paper affects both print quality and the printer ability to feed the paper correctly. Leave paper in its original wrapper until you use it. Exposure of paper to moisture changes can degrade its performance.

Before printing, store paper in its original wrapper for 24 to 48 hours. The environment in which the paper is stored must be the same as the printer. Extend the time several days if the storage or transportation environment is very different from the printer environment. Thick paper may also require a longer conditioning period.

Grain direction

Grain refers to the alignment of the paper fibers in a sheet of paper. Grain is either *grain long* which runs the length of the paper, or *grain short* which runs the width of the paper. For recommended grain direction, see the “Supported paper weights” topic.

Fiber content

Most high-quality xerographic paper is made from 100 percent chemically treated pulped wood. This content provides the paper with a high degree of stability, resulting in fewer paper feeding problems and better print quality. Paper containing fibers such as cotton can negatively affect paper handling.

Unacceptable paper

The following paper types are not recommended for use with the printer:

- Chemically treated papers that are used to make copies without carbon paper. They are also known as carbonless papers, carbonless copy paper (CCP), or no carbon required (NCR) paper.
- Preprinted papers with chemicals that may contaminate the printer.
- Preprinted papers that can be affected by the temperature in the printer fuser.
- Preprinted papers that require a registration (the precise print location on the page) greater than ± 2.3 mm (± 0.09 in.). For example, optical character recognition (OCR) forms.

Sometimes, registration can be adjusted with a software app to print successfully on these forms.

- Coated papers (erasable bond), synthetic papers, or thermal papers.
- Rough-edged, rough or heavily textured surface papers, or curled papers.
- Recycled papers that fail EN12281:2002 (European).
- Paper weighing less than 60 g/m^2 (16 lb).
- Multiple-part forms or documents.

Storing paper

Use these paper storage guidelines to help avoid jams and uneven print quality:

- Store paper in its original wrapper in the same environment as the printer for 24 to 48 hours before printing.
- Extend the time several days if the storage or transportation environment is very different from the printer environment. Thick paper may also require a longer conditioning period.
- For best results, store paper where the temperature is 21°C (70°F) and the relative humidity is 40 percent.
- Most label manufacturers recommend printing in a temperature range of $18\text{--}24^\circ\text{C}$ ($65\text{--}75^\circ\text{F}$) with relative humidity between 40 and 60 percent.
- Store paper in cartons, on a pallet or shelf, rather than on the floor.
- Store individual packages on a flat surface.
- Do not store anything on top of individual paper packages.
- Take paper out of the carton or wrapper only when you are ready to load it in the printer. The carton and wrapper help keep the paper clean, dry, and flat.

Selecting preprinted forms and letterhead

- Use grain long paper.
- Use only forms and letterhead printed using an offset lithographic or engraved printing process.
- Avoid paper with rough or heavily textured surfaces.
- Use inks that are not affected by the resin in toner. Inks that are oxidation-set or oil-based generally meet these requirements; latex inks might not.
- Print samples on preprinted forms and letterheads considered for use before buying large quantities. This action determines whether the ink in the preprinted form or letterhead affects print quality.
- When in doubt, contact your paper supplier.
- When printing on letterhead, load the paper in the proper orientation for your printer. For more information, see the *Paper and Specialty Media Guide*.

Supported paper sizes

Paper size	650-sheet duo tray		Optional 550-sheet tray	Two-sided printing	Scanner	ADF
	550-sheet tray	100-sheet multipurpose feeder				
A4 210 x 297 mm (8.27 x 11.7 in.)	✓	✓	✓	✓	✓	✓
A5 landscape¹ 210 x 148 mm (8.27 x 5.83 in.)	✓	✓	✓	✓	✓	✓
A5 portrait¹ 148 x 210 mm (5.83 x 8.27 in.)	✓	✓	✓	✓	✓	✓
A6 105 x 148 mm (4.13 x 5.83 in.)	✓	✓	✓	✓	✓	✓
Banner 215.9 x 1320.8 mm (8.5 x 52 in.)	x	✓	x	x	x	x
Executive 184.2 x 266.7 mm (7.25 x 10.5 in.)	✓	✓	✓	✓	✓	✓
Folio 215.9 x 330.2 mm (8.5 x 13 in.)	✓	✓	✓	✓	✓	✓
Hagaki 100 x 148 mm (3.94 x 5.83 in.)	x	✓	x	x	✓	x
JIS B5 182 x 257 mm (7.17 x 10.1 in.)	✓	✓	✓	✓	✓	✓

¹ Supported in both the portrait and landscape orientations. When fed in the portrait orientation, A5 is treated as narrow paper. When fed in landscape orientation, it is treated as a regular width paper.

² When Universal is selected, the page is formatted for 215.9 x 355.6 mm (8.5 x 14 in.) unless the size is specified by the software application.

³ Load narrow paper in portrait orientation.

⁴ When Other Envelope is selected, the page is formatted for 215.9 x 355.6 mm (8.5 x 14 in.) unless a size is specified by the software application.

Paper size	650-sheet duo tray		Optional 550-sheet tray	Two-sided printing	Scanner	ADF
	550-sheet tray	100-sheet multipurpose feeder				
Legal 215.9 x 355.6 mm (8.5 x 14 in.)	✓	✓	✓	✓	✓	✓
Letter 215.9 x 279.4 mm (8.5 x 11 in.)	✓	✓	✓	✓	✓	✓
Oficio (Mexico) 216 x 340 mm (8.5 x 13.4 in.)	✓	✓	✓	✓	✓	✓
Statement 139.7 x 215.9 mm (5.5 x 8.5 in.)	✓	✓	✓	✓	✓	✓
Universal^{2, 3} 76.2 x 127 mm to 215.9 x 355.6 mm (3 x 5 in. to 8.5 x 14 in.)	X	✓	X	X	X	X
Universal^{2, 3} 105 x 148 mm to 215.9 x 355.6 mm (4.13 x 5.83 in. to 8.5 x 14 in.)	✓	✓	✓	✓	X	X
7 3/4 Envelope 98.4 x 190.5 mm (3.875 x 7.5 in.)	X	✓	X	X	✓	X
9 Envelope 98.4 x 225.4 mm (3.875 x 8.9 in.)	X	✓	X	X	✓	X
10 Envelope 104.8 x 241.3 mm (4.12 x 9.5 in.)	✓	✓	✓	X	✓	X

¹ Supported in both the portrait and landscape orientations. When fed in the portrait orientation, A5 is treated as narrow paper. When fed in landscape orientation, it is treated as a regular width paper.

² When Universal is selected, the page is formatted for 215.9 x 355.6 mm (8.5 x 14 in.) unless the size is specified by the software application.

³ Load narrow paper in portrait orientation.

⁴ When Other Envelope is selected, the page is formatted for 215.9 x 355.6 mm (8.5 x 14 in.) unless a size is specified by the software application.

Paper size	650-sheet duo tray		Optional 550-sheet tray	Two-sided printing	Scanner	ADF
	550-sheet tray	100-sheet multipurpose feeder				
11 Envelope 114.3 x 263.525 mm (4.5 x 10.375 in.)	✓	✓	✓	X	✓	X
12 Envelope 120.65 x 279.4 mm (4.75 x 11 in.)	✓	✓	✓	X	✓	X
B5 Envelope 176 x 250 mm (6.93 x 9.84 in.)	✓	✓	✓	X	✓	X
B6 Envelope 125 x 176 mm (4.92 x 6.92 in.)	✓	✓	✓	X	✓	X
C5 Envelope 162 x 229 mm (6.38 x 9.01 in.)	✓	✓	✓	X	✓	X
C6 Envelope 114 x 162 mm (4.48 x 6.37 in.)	✓	✓	✓	X	✓	X
DL Envelope 110 x 220 mm (4.33 x 8.66 in.)	✓	✓	✓	X	✓	X
Monarch 98.4 x 190.5 mm (3.875 x 7.5 in.)	X	✓	X	X	✓	X
Other Envelope⁴ 98.4 x 162 mm to 176 x 250 mm (3.87 x 6.38 in. to 6.93 x 9.84 in.)	X	✓	X	X	✓	X

¹ Supported in both the portrait and landscape orientations. When fed in the portrait orientation, A5 is treated as narrow paper. When fed in landscape orientation, it is treated as a regular width paper.

² When Universal is selected, the page is formatted for 215.9 x 355.6 mm (8.5 x 14 in.) unless the size is specified by the software application.

³ Load narrow paper in portrait orientation.

⁴ When Other Envelope is selected, the page is formatted for 215.9 x 355.6 mm (8.5 x 14 in.) unless a size is specified by the software application.

Supported paper types

Paper type	650-sheet duo tray		Optional 550-sheet tray	Two-sided printing	Scanner	ADF
	550-sheet tray	100-sheet multipurpose feeder				
Plain	✓	✓	✓	✓	✓	✓
Card stock	✓	✓	✓	✓	✓	x
Recycled	✓	✓	✓	✓	✓	✓
Glossy	✓	✓	✓	✓	✓	x
Labels	✓	✓	✓	✓	✓	x
Vinyl Labels	✓	✓	✓	x	✓	x
Bond	✓	✓	✓	✓	✓	✓
Envelope	✓	✓	✓	x	✓	x
Letterhead	✓	✓	✓	✓	✓	✓
Preprinted	✓	✓	✓	✓	✓	✓
Colored Paper	✓	✓	✓	✓	✓	✓
Light	✓	✓	✓	✓	✓	✓
Heavy	✓	✓	✓	✓	✓	✓
Rough/Cotton	✓	✓	✓	✓	✓	x
Custom Type [x]	✓	✓	✓	✓	✓	✓

Notes:

- Labels, envelopes, and card stock always print at reduced speed.
- Card stock is supported in two-sided printing only up to 163 g/m² (90-lb bond). Anything heavier is supported only in one-sided printing.
- Vinyl labels are supported for occasional use only and must be tested for acceptability. Some vinyl labels may feed more reliably from the multipurpose feeder.

Supported paper weights

650-sheet duo tray		Optional 550-sheet tray	Two-sided printing	ADF
550-sheet tray	100-sheet multipurpose feeder			
60–218 g/m ² (16–58-lb bond)	60–218 g/m ² (16–58-lb bond)	60–218 g/m ² (16–58-lb bond)	60–162 g/m ² (16–43-lb bond)	52–120 g/m ² (14–32-lb bond)

Notes:







- For 60 to 176 g/m² (16–47-lb bond) paper, grain long fibers are recommended.
- Paper less than 75 g/m² (20-lb bond) must be printed with Paper Type set to Light Paper. Failure to do so may cause excessive curl which can lead to feeding errors, especially in more humid environments.
- Two-sided printing supports paper weight from 60-162 g/m² (16–43-lb bond) paper.
- 100% cotton content maximum weight is 90 g/m² (24-lb bond).

Tools required for service







- Flat-blade screwdrivers, magnetic, various sizes
- #1 Phillips screwdriver, magnetic
- #2 Phillips screwdriver, magnetic
- #2 Phillips screwdriver, magnetic short-blade
- 7/32 inch (5.5 mm) nut driver
- Needle-nose pliers
- Diagonal side cutters
- Spring hook
- Analog or digital multimeter
- Flash light (optional)
- Approved toner vacuum (optional)

Diagnostics and troubleshooting







Troubleshooting precautions

-  **CAUTION—SHOCK HAZARD:** When you see this symbol on the product, there is a danger from hazardous voltage in the area of the product where you are working. Unplug the product before you begin, or use caution if the product must receive power in order to perform the task.
-  **CAUTION—SHOCK HAZARD:** This product uses an electronic power switch. It does not physically disconnect the input AC voltage. To avoid the risk of electrical shock, always remove the power cord from the printer when removal of the input AC voltage is required.
-  **CAUTION—SHOCK HAZARD:** To avoid the risk of electrical shock while troubleshooting with covers removed or doors open, do not touch the exposed wires or circuits while the printer is connected to an electrical outlet.
-  **CAUTION—SHOCK HAZARD:** To avoid the risk of electrical shock and to prevent damage to the printer, remove the power cord from the electrical outlet and disconnect all connections to any external devices before you connect or disconnect any cable, electronic board, or assembly.
-  **CAUTION—HOT SURFACE:** The inside of the printer might be hot. To reduce the risk of injury from a hot component, allow the surface to cool before touching it.
-  **CAUTION—PINCH HAZARD:** To avoid the risk of a pinch injury, use caution in areas marked with this label. Pinch injuries may occur around moving parts, such as gears, doors, trays, and covers.





Précautions de dépannage

-  **ATTENTION—RISQUE D'ELECTROCUTION :** Ce symbole indique un danger lié à des niveaux de tension dangereux dans la zone du produit à manipuler. Débranchez le produit avant de commencer, ou agissez avec prudence si le produit doit être alimenté pour effectuer l'opération.
-  **ATTENTION—RISQUE D'ELECTROCUTION :** Ce produit utilise un commutateur d'alimentation électronique. Il ne déconnecte pas physiquement la tension d'alimentation CA. Pour éviter tout risque d'électrocution, débranchez toujours le cordon d'alimentation de l'imprimante lorsque vous devez déconnecter la tension d'alimentation CA.
-  **ATTENTION—RISQUE D'ELECTROCUTION :** Pour éviter tout risque d'électrocution lors du dépannage de l'imprimante avec les capots retirés ou les portes ouvertes, prenez garde de ne pas toucher les fils ou circuits dénudés si l'imprimante est connectée à une prise électrique.
-  **ATTENTION—RISQUE D'ELECTROCUTION :** Pour éviter tout risque d'électrocution et éviter d'endommager l'imprimante, débranchez le cordon d'alimentation de la prise électrique et déconnectez toute connexion à tout périphérique externe avant de brancher ou débrancher des câbles ou circuits et assemblages électroniques.
-  **ATTENTION—SURFACE CHAUDE :** L'intérieur de l'imprimante risque d'être brûlant. Pour réduire le risque de brûlure, laissez la surface ou le composant refroidir avant d'y toucher.
-  **ATTENTION : RISQUE DE PINCEMENT :** Pour éviter tout risque de blessure par pincement, agissez avec précaution au niveau des zones signalées par cette étiquette. Les blessures par pincement peuvent se produire autour des pièces mobiles telles que les engrenages, portes, tiroirs et capots.

Precauciones durante la solución de problemas

-  **PRECAUCIÓN: PELIGRO DE DESCARGAS ELÉCTRICAS:** Cuando vea este símbolo en el producto, existe peligro de tensiones peligrosas en el área del producto en la que está trabajando. Desconecte el producto antes de empezar o tenga cuidado si el producto debe recibir alimentación a fin de realizar la tarea.
-  **PRECAUCIÓN: PELIGRO DE DESCARGAS ELÉCTRICAS:** Este producto utiliza un interruptor de corriente electrónico. No desconecta físicamente la entrada de voltaje de CA. Para evitar el riesgo de descarga eléctrica, desenchufe siempre el cable de alimentación de la impresora cuando sea necesario retirar la entrada de voltaje de CA.
-  **PRECAUCIÓN: PELIGRO DE DESCARGAS ELÉCTRICAS:** Para evitar el riesgo de descarga eléctrica al solucionar problemas sin las cubiertas o con las puertas abiertas, no toque los cables ni los circuitos expuestos mientras la impresora está conectada a una toma de corriente.
-  **PRECAUCIÓN: PELIGRO DE DESCARGAS ELÉCTRICAS:** Para evitar el riesgo de descargas eléctricas y daños en la impresora, retire el cable de alimentación de la toma eléctrica y desconecte todas las conexiones a dispositivos externos antes de conectar o desconectar cualquier cable, placa electrónica o conjunto.
-  **PRECAUCIÓN: SUPERFICIE CALIENTE:** El interior de la impresora podría estar caliente. Para evitar el riesgo de heridas producidas por el contacto con un componente caliente, deje que la superficie se enfríe antes de tocarlo.
-  **PRECAUCIÓN: PELIGRO DE ATRAPAMIENTO:** Para evitar el riesgo de lesión por atrapamiento, preste atención en las áreas marcadas con esta etiqueta. Las lesiones por atrapamiento se pueden producir en torno a partes móviles, tales como engranajes, puertas, bandejas y cubiertas.

Vorsichtsmaßnahmen bei der Fehlerbehebung

-  **VORSICHT – STROMSCHLAGGEFAHR:** Wenn Sie dieses Symbol sehen, besteht eine Gefahr durch gefährliche Spannungen in dem Produktbereich, in dem Sie arbeiten. Trennen Sie das Produkt von seiner Stromverbindung, bevor Sie beginnen, oder gehen Sie vorsichtig vor, wenn das Produkt für die Durchführung der Aufgabe mit Strom versorgt werden muss.
-  **VORSICHT – STROMSCHLAGGEFAHR:** Dieses Produkt verwendet einen elektronischen Leistungsschalter. Er trennt die Eingangswchselspannung nicht physikalisch. Um das Risiko eines elektrischen Schlags zu vermeiden, ziehen Sie stets das Netzkabel vom Drucker ab, wenn eine Abtrennung der Eingangswchselspannung erforderlich ist.
-  **VORSICHT – STROMSCHLAGGEFAHR:** Um die Gefahr eines Stromschlags während der Fehlerbehebung bei entfernten Abdeckungen oder offenen Klappen zu vermeiden, berühren Sie die freiliegenden Drähte oder Stromkreise nicht, wenn der Drucker an eine Steckdose angeschlossen ist.
-  **VORSICHT – STROMSCHLAGGEFAHR:** Um das Risiko eines elektrischen Schlags und Schäden am Drucker zu vermeiden, ziehen Sie das Netzkabel aus der Steckdose und trennen Sie alle Verbindungen zu jeglichen externen Geräten, bevor Sie Kabel, Elektronikplatinen oder Baugruppen einstecken oder abziehen.
-  **VORSICHT – HEISSE OBERFLÄCHE:** Das Innere des Druckers kann sehr heiß sein. Vermeiden Sie Verletzungen, indem Sie heiße Komponenten stets abkühlen lassen, bevor Sie ihre Oberfläche berühren.



VORSICHT – QUETSCHGEFAHR: Um das Risiko einer Quetschung zu vermeiden, gehen Sie in Bereichen, die mit diesem Etikett gekennzeichnet sind, mit Vorsicht vor. Quetschungen können im Bereich von beweglichen Komponenten auftreten, wie z. B. Zahnrädern, Klappen, Fächern und Abdeckungen.

Troubleshooting overview

Performing the initial troubleshooting check

- With the power cord unplugged from the electrical outlet, check if the cord is free from breakage, short circuits, disconnected wires, or incorrect connections.
- Make sure that the printer is properly grounded.
- Make sure that the power supply line voltage is within 10% of the rated line voltage.
- Make sure that the printer is securely installed on a level surface in a well-ventilated area.
- Make sure that the temperature and relative humidity are within the specifications. See [“Temperature information” on page 606](#).
- Avoid locations that:
 - Generate ammonia gas
 - Are exposed to direct sunlight
 - Are near open flames
 - Are dusty
- Make sure that the recommended paper for this printer is used.
- Do a test print with paper from a newly opened package, and then check the result.

Securing the printer

Resetting the printer without admin credentials

Notes:

- Resetting the printer or replacing the controller board deletes all security settings.

- Before changing the security settings, ask permission from your administrator.
- 1 Perform an Out of Service Erase to reset the printer to factory defaults without using admin credentials. For more information, see [“Erasing printer memory” on page 357](#).

Warning—Potential Damage: This method makes the device vulnerable to hacking because it allows the creation of an admin account afterwards. By default, newer firmware versions restrict Out of Service Erase to admin users only, making the printer more secure and remembering the admin password more important.

- 2 If Out of Service Erase is unavailable, then use the security reset jumper to reset the printer to factory defaults. For more information, see [“Using the security reset jumper” on page 38](#).
- 3 If the effect of the jumper reset is disabled, then replace the controller board. For more information, see [“Controller board removal” on page 478](#).

Using the security reset jumper

The security reset jumper is on the controller board. It can be used if the admin password is lost or forgotten, and Out of Service Erase is not available.

Notes:

- To enable the effect of the security reset jumper, from the home screen navigate to: **Security > Miscellaneous > Security Reset Jumper > Enable “Guest” Access**.
- To disable the effect of the jumper, select **No Effect** from the Security Reset Jumper section in the Security menu. If the password is forgotten or lost, perform an Out of Service Erase or replace the controller board. See [“Resetting the printer without admin credentials” on page 37](#) or [“Controller board removal” on page 478](#).

- 1 Turn off the printer.
- 2 Remove the controller board shield.
- 3 Locate the security jumper (A) on the controller board.

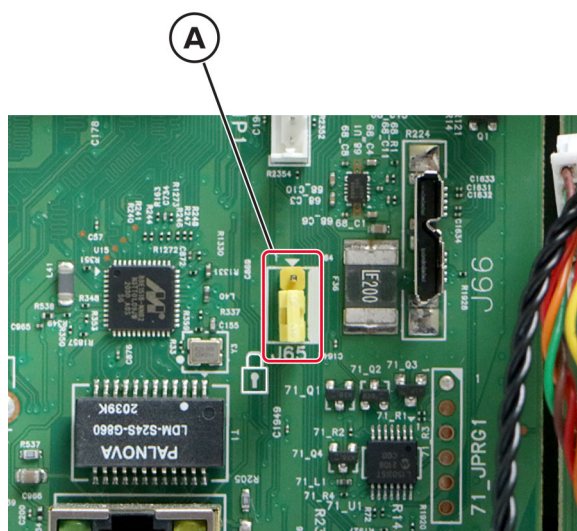

4 Move the jumper to cover the middle and exposed prongs.

Note: The movement of the jumper triggers the reset, not the jumper position.

5 Attach the controller board shield.

6 Turn on the printer.

Notes:

- The security framework remains in place after the reset. Public permissions are reset to default and now include Out of Service Erase as an option.
- If LDAP is used to authenticate the copy function in MFPs, then the LDAP configuration and copy function are no longer protected.
- If Enable Audit is activated in the Security Audit Log, then the printer logs a message each time the jumper is reset.
- Physical access to the printer is required to use the jumper, making it more secure against hacking. To prevent tampering of the jumper, secure the controller board cage with a Kensington lock.

Fixing print quality issues

Initial print quality check

Before troubleshooting print problems, perform the following:

- Make sure that the printer is located in an area that follows the recommended operating environment and power requirement specifications.
- Check the status of supplies. Replace supplies that are low or empty.
- Load 20-lb (75 to 80 gsm) plain letter or A4-size paper. Make sure that the paper guides are properly set and locked. From the control panel, set the paper size and type to match the paper loaded in the tray.
- Print and keep the menu settings page. The original menu settings page will be used to restore the custom settings if necessary.
- Make sure that the Print resolution, Toner darkness, and Color saver are set to their default values.
 - Print resolution: 4800 CQ
 - Toner darkness: 4
 - Color saver: Off
- Check the toner cartridge for damage, and replace if necessary.
- Print the advanced print quality samples to see if the problem remains. Use tray 1 to test print quality problems. Look for variations in the print from what is expected. On the last page of the advanced print quality samples, check the Print quality and EP setup section for non-default settings.
- Make sure that the correct print driver is used to prevent print problems. If the wrong print driver is installed, incorrect characters could print and the copy may not fit the page correctly.

Blank or white pages check

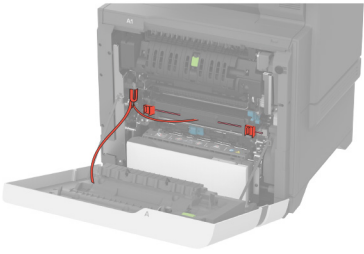
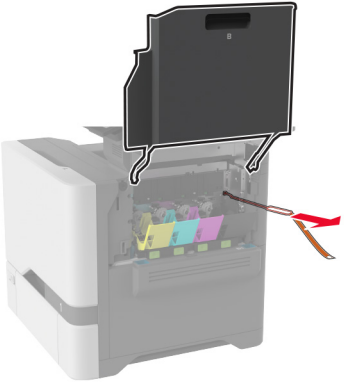
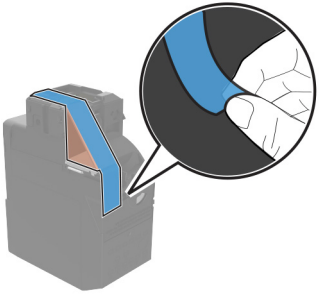
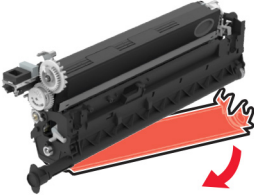

Note: Before performing this print quality check, print the Print Quality Test Pages. From the control panel, navigate to **Settings > Troubleshooting > Print Quality Test Pages**, and then perform the initial print quality check. See [“Initial print quality check” on page 39](#).

Action	Yes	No
<p>Step 1 Make sure to remove all the packing material in the following areas:</p> <ul style="list-style-type: none"> • Inside the printer   <ul style="list-style-type: none"> • Toner cartridges and imaging unit   <p>Does the problem remain?</p>	Go to step 2.	The problem is solved.

Action	Yes	No
<p>Step 2</p> <p>a Enter the Diagnostics menu, and then navigate to: Advanced Print Quality Samples > Advanced Print Quality Test Pages</p> <p>b Check the test page.</p> <p>Is only one color missing?</p>	Go to step 3.	Go to step 5.
<p>Step 3</p> <p>Check the toner cartridge and imaging unit contacts of the affected color.</p> <p>Are the contacts clean?</p>	Go to step 5.	Go to step 4.
<p>Step 4</p> <p>Clean the contacts.</p> <p>Does the problem remain?</p>	Go to step 5.	The problem is solved.
<p>Step 5</p> <p>Replace the affected imaging kit or imaging unit.</p> <p>Does the problem remain?</p>	Go to step 6.	The problem is solved.
<p>Step 6</p> <p>a Remove the transfer module. See “Transfer module removal” on page 431.</p> <p>b Close the front door or bypass the door interlock switch.</p> <p>c Enter the Diagnostics menu, and then navigate to: Printer diagnostics & adjustments > Motor tests</p> <p>d Select the motor of the affected color, and then touch Start.</p> <p>Does the motor run?</p>	Go to step 8.	Go to step 7.
<p>Step 7</p> <p>Replace the affected motor (EP drive). See “Motor (EP drive) removal” on page 382.</p> <p>Does the problem remain?</p>	Go to step 8.	The problem is solved.
<p>Step 8</p> <p>a Manually turn the motor (EP drive).</p> <p>b While turning the motor, check if the corresponding couplers that drive the affected toner cartridge or imaging unit move.</p> <p>Do the couplers move?</p>	Go to step 10.	Go to step 9.

Action	Yes	No
<p>Step 9 Replace the EP drive gearbox. See “EP drive gearbox removal” on page 384.</p> <p>Does the problem remain?</p>	Go to step 10.	The problem is solved.
<p>Step 10 Check if the pins on the HVPS freely move.</p> <p>Do the pins freely move?</p>	Go to step 12.	Go to step 11.
<p>Step 11 Replace the HVPS. See “HVPS removal” on page 417.</p> <p>Does the problem remain?</p>	Go to step 12.	The problem is solved.
<p>Step 12 Check the continuity of the cable on the JWTH_SC1 connector on the engine board.</p> <p>Does the cable have continuity?</p>	Go to step 14.	Go to step 13.
<p>Step 13 Replace the cable.</p> <p>Does the problem remain?</p>	Go to step 14.	The problem is solved.
<p>Step 14 Make sure that the printhead cables on the engine board are properly connected.</p> <p>Does the problem remain?</p>	Go to step 15.	The problem is solved.
<p>Step 15 Make sure that the JTH1 and JPWR1 cables are properly connected to the controller board and engine board.</p> <p>Does the problem remain?</p>	Go to step 16.	The problem is solved.
<p>Step 16 Replace the printhead. See “Printhead removal” on page 484.</p> <p>Does the problem remain?</p>	Go to step 17.	The problem is solved.
<p>Step 17 Replace the engine board. See “Engine board removal” on page 479.</p> <p>Does the problem remain?</p>	Contact the next level of support.	The problem is solved.

Dark print check



Note: Before performing this print quality check, print the Print Quality Test Pages. From the control panel, navigate to **Settings > Troubleshooting > Print Quality Test Pages**, and then perform the initial print quality check. See [“Initial print quality check” on page 39](#).

Action	Yes	No
<p>Step 1</p> <p>a From the home screen, touch Settings > Print > Quality > Toner Darkness.</p> <p>b Check the toner darkness setting value.</p> <p>Note: The default value for toner darkness is 4.</p> <p>Is the darkness setting too high?</p>	Go to step 2.	Go to step 3.
<p>Step 2</p> <p>Adjust the darkness setting to the proper value.</p> <p>Does the problem remain?</p>	Go to step 3.	The problem is solved.
<p>Step 3</p> <p>a Enter the Diagnostics menu, and then navigate to: Printer Setup > EP Setup > Toner Patch Sensor Adjust</p> <p>b Make sure that Calibration reference values are set to default.</p> <p>Note: Default value for Black and CMY settings is 0.</p> <p>Does the problem remain?</p>	Go to step 4.	The problem is solved.
<p>Step 4</p> <p>a Enter the Diagnostics menu, and then navigate to: Advanced Print Quality Samples > Advanced Print Quality Test Pages</p> <p>b Check the test page.</p> <p>Is only color affected?</p>	Go to step 5.	Go to step 7.

Action	Yes	No
<p>Step 5</p> <p>If the affected color is black, then do the following:</p> <ul style="list-style-type: none"> a Remove the black imaging unit from the imaging kit. b Reinstall the black imaging unit. <p>If the affected color is C, M, or Y, then do the following:</p> <ul style="list-style-type: none"> a Remove the affected color developer unit from the imaging kit. b Reinstall the affected color developer unit. <p>Does the problem remain?</p>	Go to step 6.	The problem is solved.
<p>Step 6</p> <p>Replace the affected black imaging unit or the whole color imaging kit.</p> <p>Does the problem remain?</p>	Go to step 7.	The problem is solved.
<p>Step 7</p> <ul style="list-style-type: none"> a Enter the Diagnostics menu, and then navigate to: Color alignment adjust b On the AA adjustment row, touch Start. c From the home screen, touch Settings > Print > Quality > Advanced Imaging > Color Adjust. <p>Does the problem remain?</p>	Go to step 8.	The problem is solved.
<p>Step 8</p> <p>Perform the toner patch sensing service check. See “Toner patch sensing service check” on page 300.</p> <p>Does the problem remain?</p>	Go to step 9.	The problem is solved.
<p>Step 9</p> <p>Reseat the HVPS cable on the engine board.</p> <p>Does the problem remain?</p>	Go to step 10.	The problem is solved.
<p>Step 10</p> <p>Replace the HVPS. See “HVPS removal” on page 417.</p> <p>Does the problem remain?</p>	Contact the next level of support.	The problem is solved.

Ghost images check

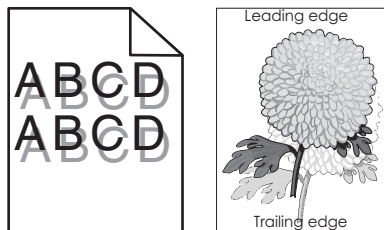

Note: Before performing this print quality check, print the Print Quality Test Pages. From the control panel, navigate to **Settings > Troubleshooting > Print Quality Test Pages**, and then perform the initial print quality check. See [“Initial print quality check” on page 39](#).

Action	Yes	No
<p>Step 1</p> <p>a From the home screen, touch Settings > Paper > Tray Configuration > Default Source.</p> <p>b Select the paper source.</p> <p>c Check if the paper type and size settings match the paper type and size set on the tray.</p> <p>Do the settings match?</p>	Go to step 3.	Go to step 2.
<p>Step 2</p> <p>Change the paper size and type, or adjust the size settings in the tray to match the paper size.</p> <p>Does the problem remain?</p>	Go to step 3.	The problem is solved.
<p>Step 3</p> <p>Note: Ghost images may occur when printing to a full-width media immediately after printing long jobs on narrow media.</p> <p>Did the issue occur right after printing a long job on narrow media?</p>	Go to step 4.	Go to step 5.
<p>Step 4</p> <p>Wait longer after printing long narrow media jobs before printing on full-width media. If necessary, contact the next level of support for the engine setting to make the printer wait longer automatically.</p> <p>Does the problem remain?</p>	Go to step 5.	The problem is solved.
<p>Step 5</p> <p>a From the home screen, touch Status/Supplies.</p> <p>b Check the status of the black and color supplies.</p> <p>Are any of the supplies low?</p>	Go to step 6.	Go to step 7.

Action	Yes	No
<p>Step 6 Replace the affected supply.</p> <p>Does the problem remain?</p>	Go to step 7.	The problem is solved.
<p>Step 7 Measure the distance from one point of the original image to the same point on the ghost image.</p> <p>Note: Defects that repeat after 43.6 mm are most likely caused by the developer roller.</p> <p>Is the distance 43.6 mm?</p>	Go to step 8.	Go to step 9.
<p>Step 8 Replace the affected imaging kit or imaging unit.</p> <p>Does the problem remain?</p>	Go to step 9.	The problem is solved.
<p>Step 9 Measure the distance from one point of the original image to the same point on the ghost image.</p> <p>Note: Defects that repeat after 94.5 mm are most likely caused by the photoconductor drum.</p> <p>Is the distance 94.5 mm?</p>	Go to step 10.	Go to step 11.
<p>Step 10 Replace the affected imaging kit or imaging unit.</p> <p>Does the problem remain?</p>	Go to step 11.	The problem is solved.
<p>Step 11</p> <p>a From the home screen, touch Settings > Reports > Menu Settings Page.</p> <p>Note: Perform this step twice to clear any debris.</p> <p>b Check the fuser area for toner contamination.</p> <p>Is there toner contamination?</p>	Go to step 12.	Contact the next level of support.
<p>Step 12 Replace the fuser. See “Fuser removal” on page 436.</p> <p>Does the problem remain?</p>	Contact the next level of support.	The problem is solved.

Gray or colored background check

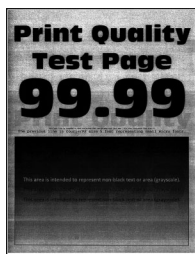

Note: Before performing this print quality check, print the Print Quality Test Pages. From the control panel, navigate to **Settings > Troubleshooting > Print Quality Test Pages**, and then perform the initial print quality check. See [“Initial print quality check” on page 39](#).

Action	Yes	No
<p>Step 1</p> <p>a Place a narrow strip of paper over the gap between the developer rollers.</p> <p>Note: Make sure that the paper stays in place when reinstalling the imaging unit to prevent the laser from discharging the photoconductor.</p> <p>b From the home screen, touch Settings > Troubleshooting > Print Quality Pages.</p> <p>c Check the test page.</p> <p>Is there vertical banding?</p>	Go to step 10.	Go to step 2.
<p>Step 2</p> <p>a From the home screen, touch Status/Supplies.</p> <p>b Check the status of the toner cartridges or imaging unit if any were recently replaced.</p> <p>Were any of the toner cartridges or imaging unit recently replaced?</p>	Go to step 3.	Go to step 4.
<p>Step 3</p> <p>Reinstall the toner cartridges or imaging unit.</p> <p>Does the problem remain?</p>	Go to step 4.	The problem is solved.
<p>Step 4</p> <p>Check if black is the only color producing the background of the print job.</p> <p>Is black the only color producing the background?</p>	Go to step 5.	Go to step 6.
<p>Step 5</p> <p>Replace the black imaging unit.</p> <p>Does the problem remain?</p>	Go to step 6.	The problem is solved.

Action	Yes	No
<p>Step 6</p> <p>Replace the imaging kit. See “Imaging kit removal” on page 399.</p> <p>Does the problem remain?</p>	Go to step 7.	The problem is solved.
<p>Step 7</p> <p>Reseat the HVPS cable on the HVPS and on the JHVPS1 connector on the engine board.</p> <p>Does the problem remain?</p>	Go to step 8.	The problem is solved.
<p>Step 8</p> <p>Check the contact pins connecting the HVPS to the transfer module for damage.</p> <p>Are the contact pins damaged?</p>	Go to step 9.	Go to step 10.
<p>Step 9</p> <p>Replace the HVPS. See “HVPS removal” on page 417.</p> <p>Does the problem remain?</p>	Contact the next level of support.	The problem is solved.
<p>Step 10</p> <p>Make sure that the printhead cables on the engine board are properly connected.</p> <p>Does the problem remain?</p>	Go to step 11.	The problem is solved.
<p>Step 11</p> <p>Replace the printhead. See “Printhead removal” on page 484.</p> <p>Does the problem remain?</p>	Contact the next level of support.	The problem is solved.

Horizontal colored lines or banding check



Note: Before performing this print quality check, print the Print Quality Test Pages. From the control panel, navigate to **Settings > Troubleshooting > Print Quality Test Pages**, and then perform the initial print quality check. See [“Initial print quality check” on page 39](#).

Actions	Yes	No
<p>Step 1 Check if the lines on the print quality test page are white.</p> <p>Are the lines white?</p>	Go to step 2.	Go to step 3.
<p>Step 2 Perform the repeating defects check. See “Repeating defects check” on page 62.</p> <p>Does the problem remain?</p>	Go to step 3.	The problem is solved.
<p>Step 3 Check if the lines appear only on the leading or trailing edge.</p> <p>Does the issue only occur on the leading or trailing edge?</p>	Go to step 4.	Go to step 5.
<p>Step 4 Perform the Marks on leading or trailing edges check. See “Marks on leading or trailing edges check” on page 56.</p> <p>Does the problem remain?</p>	Go to step 5.	The problem is solved.
<p>Step 5</p> <p>a Enter the Diagnostics menu, and then navigate to: Advanced Print Quality Samples > Advanced Print Quality Test Pages</p> <p>b Check if the lines appear on the same area of the page.</p> <p>Do the lines appear on the same area?</p>	Go to step 6.	Go to step 7.
<p>Step 6 Perform the repeating defects check. See “Repeating defects check” on page 62.</p> <p>Does the problem remain?</p>	Go to step 7.	The problem is solved.
<p>Step 7 Remove and reinstall the imaging kit. See “Imaging kit removal” on page 399.</p> <p>Does the problem remain?</p>	Go to step 8.	The problem is solved.
<p>Step 8 Check the pages right after the defective page.</p> <p>Do the lines appear after two consecutive normal pages were printed?</p>	Go to step 9.	The problem is solved.

Actions	Yes	No
<p>Step 9 Check the transfer module for contamination.</p> <p>Is the transfer module free of contamination?</p>	Contact the next level of support.	Go to step 10.
<p>Step 10 Clean or replace the transfer module. See “Transfer module removal” on page 431.</p> <p>Does the problem remain?</p>	Contact the next level of support.	The problem is solved.

Light print check



Note: Before performing this print quality check, print the Print Quality Test Pages. From the control panel, touch **Settings** > **Troubleshooting** > **Print Quality Test Pages**, and then perform the initial print quality check. See [“Initial print quality check” on page 39](#).

Action	Yes	No
<p>Step 1</p> <p>a From the home screen, touch Settings > Print > Quality.</p> <p>b Check the toner darkness setting value.</p> <p>Note: The default toner darkness value is 4.</p> <p>Is the darkness setting too low?</p>	Go to step 2.	Go to step 3.
<p>Step 2</p> <p>Adjust the darkness setting to the correct value.</p> <p>Does the problem remain?</p>	Go to step 3.	The problem is solved.
<p>Step 3</p> <p>a From the home screen, touch Device > Eco-mode > Print.</p> <p>b Make sure that Color saver is set to Off.</p> <p>Does the problem remain?</p>	Go to step 4.	The problem is solved.

Action	Yes	No
<p>Step 4</p> <p>a Enter the Diagnostics menu, and then navigate to: Printer Setup > EP Setup > Toner Patch Sensor Adjust</p> <p>b Make sure that Calibration reference values are set to default. Note: Default value for Black and CMY settings is 0.</p> <p>Does the problem remain?</p>	Go to step 5.	The problem is solved.
<p>Step 5</p> <p>Make sure that no paper is wrapping around the second transfer roller.</p> <p>Does the problem remain?</p>	Go to step 6.	The problem is solved.
<p>Step 6</p> <p>a From the home screen, navigate to: Settings > Print > Quality > Advanced Imaging > Color Adjust</p> <p>b Touch Color Adjust.</p> <p>Does the problem remain?</p>	Go to step 7.	The problem is solved.

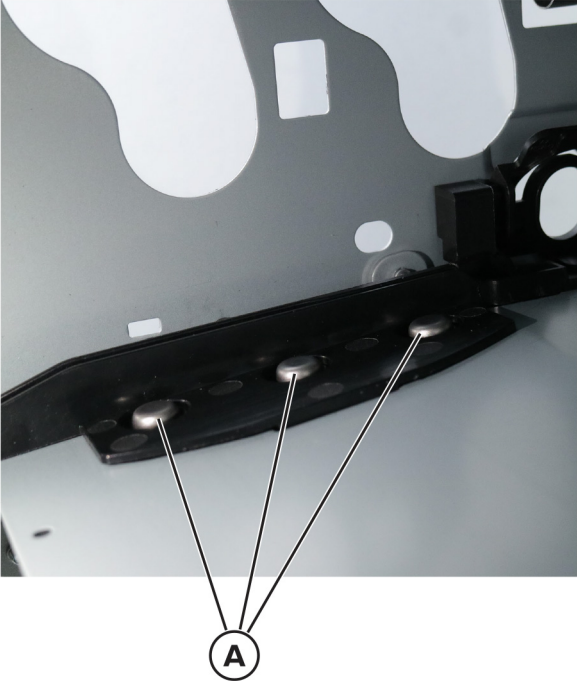
Action	Yes	No
<p>Step 7</p> <p>a Remove the transfer module. See “Transfer module removal” on page 431.</p> <p>b Check if the three contacts (A) are visible and if they freely move.</p>  <p>Are the contacts visible and do they freely move?</p>	Go to step 9.	Go to step 8.

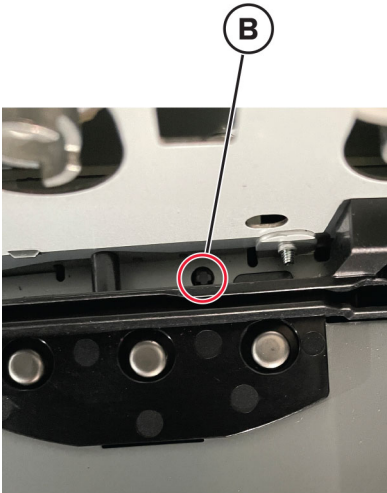
Action	Yes	No
<p>Step 8 Check if the index pin behind the transfer contact plate (B) is visible and properly aligned.</p>  <p>Is the index pin visible and properly aligned?</p>	Go to step 10.	Go to step 9.
<p>Step 9 a Reseat the HVPS. b Make sure that the contacts are visible and can freely move. c Make sure that the index pin is properly aligned.</p> <p>Does the problem remain?</p>	Go to step 10.	The problem is solved.
<p>Step 10 a Enter the Diagnostics menu, and then touch Advanced Print Quality Samples > Advanced Print Quality Test Pages. b Check the test page.</p> <p>Is only one color affected?</p>	Go to step 11.	Go to step 19.
<p>Step 11 Check the toner cartridge of the affected color for proper installation.</p> <ul style="list-style-type: none"> • Make sure that all packing materials are removed. • Check for misalignment. <p>Is the toner cartridge properly inserted?</p>	Go to step 13.	Go to step 12.
<p>Step 12 Insert the toner cartridge properly.</p> <p>Does the problem remain?</p>	Go to step 13.	The problem is solved.

Action	Yes	No
<p>Step 13 Check the cartridge toner level.</p> <p>Is the cartridge empty?</p>	Go to step 14.	Go to step 15.
<p>Step 14 Replace the toner cartridge.</p> <p>Does the problem remain?</p>	Go to step 15.	The problem is solved.
<p>Step 15 Remove, and then insert the imaging kit or imaging unit of the affected color.</p> <p>Does the problem remain?</p>	Go to step 16.	The problem is solved.
<p>Step 16</p> <p>a Remove the transfer module. See “Transfer module removal” on page 431.</p> <p>b Close the front door or bypass the door interlock switch.</p> <p>c Enter the Diagnostics menu, and then touch Printer diagnostics & adjustments > Motor tests.</p> <p>d Select the motor of the affected color, and then touch Start.</p> <p>Does the motor run?</p>	Go to step 19.	Go to step 17.
<p>Step 17 Reseat the motor cable.</p> <p>Does the problem remain?</p>	Go to step 18.	The problem is solved.
<p>Step 18 Replace the affected motor (EP drive). See “Motor (EP drive) removal” on page 382.</p> <p>Does the problem remain?</p>	Go to step 19.	The problem is solved.
<p>Step 19 Remove the imaging kit, and then check the printhead lenses for dust or debris. See “Imaging kit removal” on page 399.</p> <p>Are the lenses free of dust or debris?</p>	Go to step 21.	Go to step 20.
<p>Step 20 Clean the printhead lenses.</p> <p>Does the problem remain?</p>	Go to step 21.	The problem is solved.

Action	Yes	No
<p>Step 21</p> <p>Check the HVPS cable on the HVPS and on the JHVPS1 connector on the engine board for proper connection.</p> <p>Is the cable properly connected at both ends?</p>	Go to step 23.	Go to step 22.
<p>Step 22</p> <p>Reconnect the cable.</p> <p>Does the problem remain?</p>	Go to step 23.	The problem is solved.
<p>Step 23</p> <p>Replace the transfer module. See “Transfer module removal” on page 431.</p> <p>Does the problem remain?</p>	Go to step 24.	The problem is solved.
<p>Step 24</p> <p>Replace the HVPS. See “HVPS removal” on page 417.</p> <p>Does the problem remain?</p>	Contact the next level of support.	The problem is solved.

Marks on leading or trailing edges check

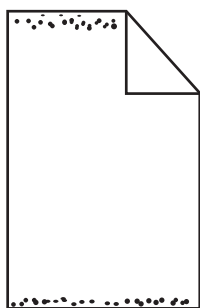

Note: Before performing this print quality check, print the Print Quality Test Pages. From the control panel, navigate to **Settings > Troubleshooting > Print Quality Test Pages**, and then perform the initial print quality check. See [“Initial print quality check” on page 39](#).

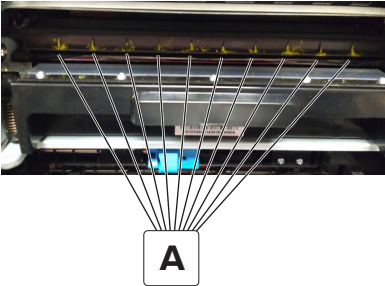
Action	Yes	No
<p>a Use a dry and lint-free cloth to clean the ribs (A) on the transfer module cleaning assembly housing.</p> <p>Note: Do not remove the transfer belt to clean the housing.</p>  <p>b Use a toner vacuum to remove the remaining toner. c Perform a print job.</p> <p>Does the problem remain?</p>	Contact the next level of support.	The problem is solved.

Mottled print and dots check



Note: Before performing this print quality check, print the Print Quality Test Pages. From the control panel, navigate to **Settings > Troubleshooting > Print Quality Test Pages**, and then perform the initial print quality check. See [“Initial print quality check” on page 39](#).

Action	Yes	No
<p>Step 1</p> <p>a From the home screen, touch Settings > Device > Preferences.</p> <p>b Check if the paper type and size settings match the paper type and size set on the tray.</p> <p>Do the settings match?</p>	Go to step 3.	Go to step 2.
<p>Step 2</p> <p>Change the paper size and type, or adjust the size settings in the tray to match the paper size.</p> <p>Does the problem remain?</p>	Go to step 3.	The problem is solved.

Action	Yes	No
<p>Step 3 Check the paper for texture or rough finish.</p> <p>Is the paper textured or rough?</p>	Go to step 4.	Go to step 5.
<p>Step 4 Replace the textured or rough paper with plain paper.</p> <p>Does the problem remain?</p>	Go to step 5.	The problem is solved.
<p>Step 5 Check the printer for toner leaks.</p> <p>Are there toner leaks?</p>	Go to step 6.	Go to step 7.
<p>Step 6</p> <ul style="list-style-type: none"> a Clean the printer thoroughly using a toner vacuum. b Perform a print job to clear the remaining toner from the imaging components. <p>Does the problem remain?</p>	Go to step 7.	The problem is solved.
<p>Step 7 Replace the affected imaging kit or imaging unit.</p> <p>Does the problem remain?</p>	Go to step 8.	The problem is solved.
<p>Step 8 Check the transfer module for improper installation and damage.</p> <p>Is the transfer module properly installed and free of damage?</p>	Go to step 10.	Go to step 9.
<p>Step 9 Reinstall or replace the transfer module. See “Transfer module removal” on page 431.</p> <p>Does the problem remain?</p>	Go to step 10.	The problem is solved.
<p>Step 10</p> <ul style="list-style-type: none"> a Remove the fuser. See “Fuser removal” on page 436. b Check the fuser for debris and damage. <p>Is the fuser free of debris and damage?</p>	Contact the next level of support.	Go to step 11.
<p>Step 11 Clean or replace the fuser.</p> <p>Does the problem remain?</p>	Contact the next level of support.	The problem is solved.

Print crooked or skewed check



Note: Before performing this print quality check, print the Print Quality Test Pages. From the control panel, navigate to **Settings > Troubleshooting > Print Quality Test Pages**, and then perform the initial print quality check. See [“Initial print quality check” on page 39](#).

Action	Yes	No
<p>Step 1</p> <p>Make sure that the paper is properly loaded and free of damage.</p> <p>Does the problem remain?</p>	Go to step 2.	The problem is solved.
<p>Step 2</p> <p>a From the home screen, touch Settings > Device > Preferences.</p> <p>b Check if the paper type and size settings match the paper type and size set on the tray.</p> <p>Do the settings match?</p>	Go to step 4.	Go to step 3.
<p>Step 3</p> <p>a Change the paper size and type, or adjust the size settings in the tray to match the paper size.</p> <p>b Make sure that the tray or MPF paper guides are properly set and flush with the sides of the paper loaded.</p> <p>Does the problem remain?</p>	Go to step 4.	The problem is solved.

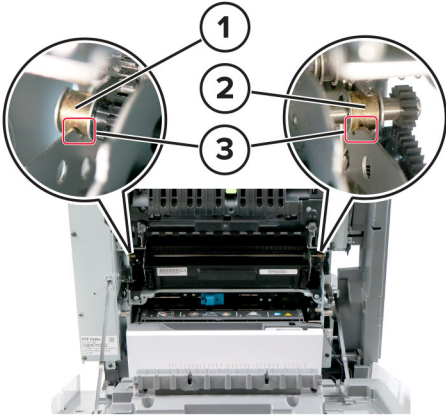
Action	Yes	No								
<p>Step 4</p> <p>a Check if the transfer module bearings are properly seated on the frame. Make sure that the bearings sit down into their vees.</p>  <table border="1" data-bbox="233 789 480 978"> <thead> <tr> <th>#</th> <th>Part</th> </tr> </thead> <tbody> <tr> <td>1</td> <td>Left bearing</td> </tr> <tr> <td>2</td> <td>Right bearing</td> </tr> <tr> <td>3</td> <td>Frame</td> </tr> </tbody> </table> <p>b If necessary, reinstall the transfer module. See “Transfer module removal” on page 431.</p> <p>Does the problem remain?</p>	#	Part	1	Left bearing	2	Right bearing	3	Frame	Go to step 5.	The problem is solved.
#	Part									
1	Left bearing									
2	Right bearing									
3	Frame									

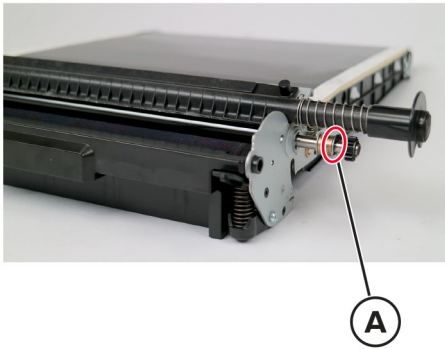
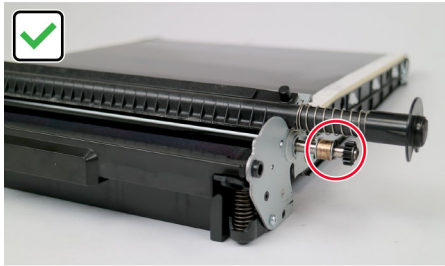
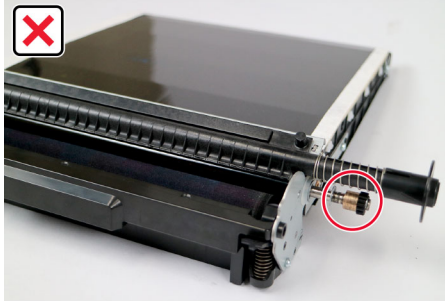
Action	Yes	No
<p>Step 5</p> <p>a Make sure that the transfer module E-clip (A) is not missing.</p>  <p>b Make sure that the transfer module bearing (B) is properly seated.</p>   <p>Does the problem remain?</p>	<p>Go to step 6.</p>	<p>The problem is solved.</p>
<p>Step 6</p> <p>Check the isolation unit for dust or debris.</p> <p>Is the isolation unit free of dust or debris?</p>	<p>Go to step 8.</p>	<p>Go to step 7.</p>
<p>Step 7</p> <p>Remove the dust or debris.</p> <p>Does the problem remain?</p>	<p>Go to step 8.</p>	<p>The problem is solved.</p>

Action	Yes	No
<p>Step 8</p> <p>a Enter the Diagnostics menu, and then navigate to: Printer diagnostics & adjustments > Motor tests > Deskew</p> <p>b Touch Start.</p> <p>Does the motor run?</p>	Go to step 11.	Go to step 9.
<p>Step 9</p> <p>Check the cable on the JMTR1 connector on the engine board for proper connection and damage, and replace if necessary.</p> <p>Does the problem remain?</p>	Go to step 10.	The problem is solved.
<p>Step 10</p> <p>Replace the motor (deskew). See “Motor (deskew) removal” on page 387.</p> <p>Does the problem remain?</p>	Go to step 11.	The problem is solved.
<p>Step 11</p> <p>Check the condition of the aligner rollers.</p> <p>Are the rollers free from excess wear, contamination, and damage?</p>	Contact the next level of support.	Go to step 12.
<p>Step 12</p> <p>Clean or replace the rollers. See “Aligner rollers removal” on page 458.</p> <p>Does the problem remain?</p>	Contact the next level of support.	The problem is solved.

Repeating defects check

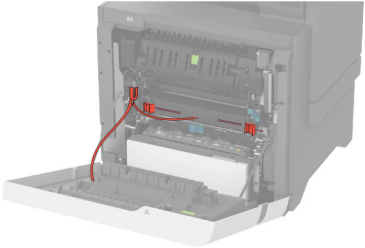
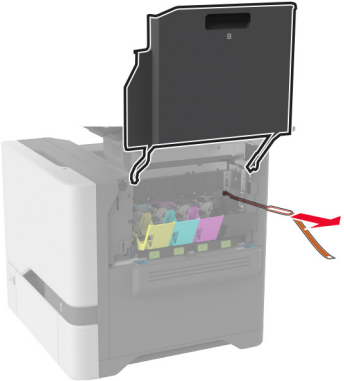
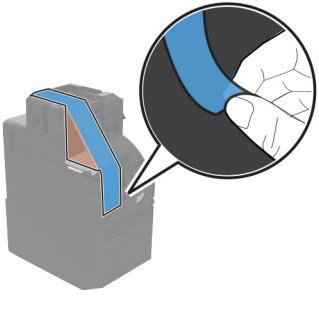
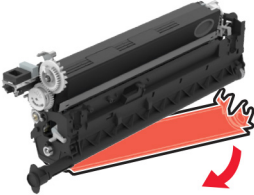

Note: Before performing this print quality check, print the Print Quality Test Pages. From the control panel, navigate to **Settings > Troubleshooting > Print Quality Test Pages**, and then perform the initial print quality check. See [“Initial print quality check” on page 39](#).

Action	Yes	No
<p>Step 1</p> <p>Make sure that the printer is free from dust and debris, and that the packing materials on the printer have been removed.</p> <ul style="list-style-type: none"> • Inside the printer  <hr/>  <ul style="list-style-type: none"> • Toner cartridges and imaging unit  <hr/>  <p>Is the printer free from dust, debris, and packing materials?</p>	Go to step 3.	Go to step 2.

Action	Yes	No
<p>Step 2 Remove the packing materials, dust, or debris.</p> <p>Does the problem remain?</p>	Go to step 3.	The problem is solved.
<p>Step 3 Measure the distance between the repeating marks.</p> <p>Note: A distance of 43.6 mm is likely caused by the developer roller. A distance of 45 mm is likely caused by the toner add roller.</p> <p>Is the distance between the marks either 43.6 mm or 45 mm?</p>	Go to step 4.	Go to step 5.
<p>Step 4 Replace the affected imaging kit or imaging unit.</p> <p>Does the problem remain?</p>	Contact the next level of support.	The problem is solved.
<p>Step 5 Measure the distance between the repeating marks.</p> <p>Note: A distance of 29.9 mm is likely caused by the charge roller. A distance of 23.2 mm is likely caused by the charge roller cleaner. A distance of 94.5 mm is likely caused by the photoconductor drum.</p> <p>Is the distance between the marks either 29.9 mm, 23.2 mm, or 94.5 mm?</p>	Go to step 6.	Go to step 7.
<p>Step 6 Replace the affected imaging kit or imaging unit.</p> <p>Does the problem remain?</p>	Contact the next level of support.	The problem is solved.
<p>Step 7 Measure the distance between the repeating marks.</p> <p>Note: A distance of 95 mm is likely caused by the fuser belt.</p> <p>Is the distance between the marks 95 mm or 110 mm?</p>	Go to step 8.	Go to step 9.
<p>Step 8 Replace the fuser. See “Fuser removal” on page 436.</p> <p>Does the problem remain?</p>	Contact the next level of support.	The problem is solved.

Action	Yes	No
<p>Step 9 Measure the distance between the repeating marks.</p> <p>Note: Distances of 37.7 mm, 54.6 mm, and 78.5 mm points to the transfer module as the likely cause.</p> <p>Is the distance between the marks either 37.7 mm, 54.6 mm, or 78.5 mm?</p>	Go to step 11.	Go to step 10.
<p>Step 10 Check the marks that appear on a multi-page print job.</p> <p>Do the marks appear on every other page?</p>	Go to step 11.	Contact the next level of support.
<p>Step 11 Replace the transfer module. See “Transfer module removal” on page 431.</p> <p>Does the problem remain?</p>	Contact the next level of support.	The problem is solved.

Solid color or black image check

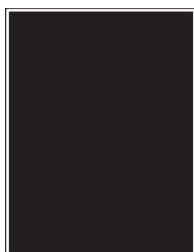

Note: Before performing this print quality check, print the Print Quality Test Pages. From the control panel, navigate to **Settings > Troubleshooting > Print Quality Test Pages**, and then perform the initial print quality check. See [“Initial print quality check” on page 39](#).

Action	Yes	No
<p>Step 1</p> <p>a Place a narrow strip of paper over the gap between the developer rollers.</p> <p>Note: Make sure that the paper stays in place when reinstalling the imaging unit to prevent the laser from discharging the photoconductor.</p> <p>b From the home screen, touch Settings > Troubleshooting > Print Quality Pages.</p> <p>c Check the test page.</p> <p>Is there vertical banding?</p>	Go to step 2.	Go to step 6.

Action	Yes	No
<p>Step 2</p> <p>a Make sure that the cables are properly connected on the printhead and engine board.</p> <p>b Make sure that the cables from the engine board are properly connected to the controller board.</p> <p>Does the problem remain?</p>	Go to step 3.	The problem is solved.
<p>Step 3</p> <p>Replace the printhead. See “Printhead removal” on page 484.</p> <p>Does the problem remain?</p>	Go to step 4.	The problem is solved.
<p>Step 4</p> <p>Replace the engine board. See “Engine board removal” on page 479.</p> <p>Does the problem remain?</p>	Go to step 5.	The problem is solved.
<p>Step 5</p> <p>Replace the controller board. See “Controller board removal” on page 478.</p> <p>Does the problem remain?</p>	Contact the next level of support.	The problem is solved.
<p>Step 6</p> <p>Replace the affected imaging unit or imaging kit.</p> <p>Does the problem remain?</p>	Go to step 7.	The problem is solved.
<p>Step 7</p> <p>Turn off the printer.</p> <p>Check the cable connection at both ends.</p> <p>Check the continuity of the HVPS cable.</p> <p>Is the cable connected at both ends, and has continuity?</p>	Go to step 9.	Go to step 8.
<p>Step 8</p> <p>Replace the HVPS cable.</p> <p>Does the problem remain?</p>	Go to step 9.	The problem is solved.
<p>Step 9</p> <p>Replace the HVPS. See “HVPS removal” on page 417.</p> <p>Does the problem remain?</p>	Contact the next level of support.	The problem is solved.

Text or images cut off check

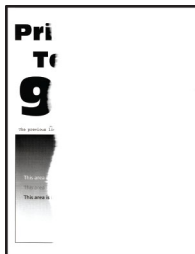

Note: Before performing this print quality check, print the Print Quality Test Pages. From the control panel, navigate to **Settings > Troubleshooting > Print Quality Test Pages**, and then perform the initial print quality check. See [“Initial print quality check” on page 39](#).

Actions	Yes	No
<p>Step 1</p> <p>a From the home screen, touch Settings > Device > Preferences.</p> <p>b Check if the paper type and size settings match the paper type and size set on the tray.</p> <p>Do the settings match?</p>	Go to step 3.	Go to step 2.
<p>Step 2</p> <p>Change the paper size and type, or adjust the size settings in the tray to match the paper size.</p> <p>Does the problem remain?</p>	Go to step 3.	The problem is solved.

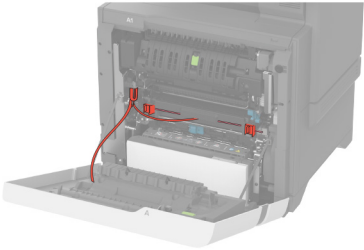
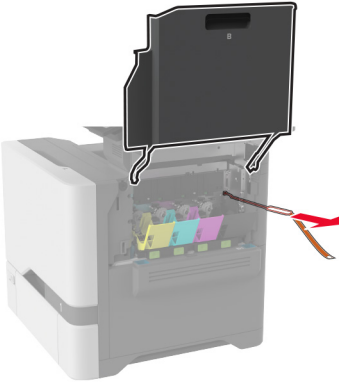
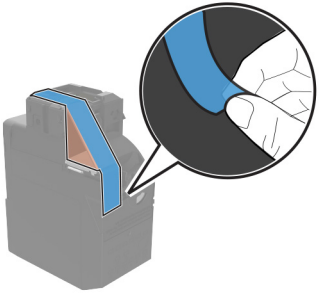
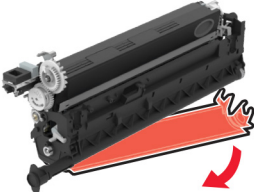
Actions	Yes	No
<p>Step 3</p> <p>Make sure to remove all the packing material in the following areas:</p> <ul style="list-style-type: none"> • Inside the printer  <hr/>  <ul style="list-style-type: none"> • Toner cartridges and imaging unit  <hr/>  <p>Does the problem remain?</p>	Go to step 4.	The problem is solved.

Actions	Yes	No
<p>Step 4 Make sure that the black imaging unit and CMY imaging kit have not reached end-of-life.</p> <p>Does the problem remain?</p>	Contact the next level of support.	The problem is solved.

Toner easily rubs off check

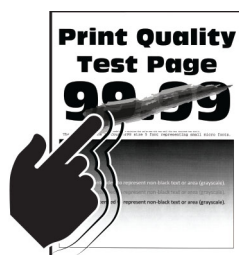

Note: Before performing this print quality check, print the Print Quality Test Pages. From the control panel, navigate to **Settings > Troubleshooting > Print Quality Test Pages**, and then perform the initial print quality check. See [“Initial print quality check” on page 39](#).

Actions	Yes	No
<p>Step 1</p> <p>a From the home screen, touch Settings > Device > Preferences.</p> <p>b Check if the paper type and size settings match the paper type and size set on the tray.</p> <p>Do the settings match?</p>	Go to step 3.	Go to step 2.
<p>Step 2</p> <p>Change the paper size and type, or adjust the size settings in the tray to match the paper size.</p> <p>Does the problem remain?</p>	Go to step 3.	The problem is solved.
<p>Step 3</p> <p>Check the paper for texture or rough finish.</p> <p>Is the paper textured or rough?</p>	Go to step 4.	Go to step 5.
<p>Step 4</p> <p>Replace the textured or rough paper with plain paper.</p> <p>Does the problem remain?</p>	Go to step 5.	The problem is solved.

Actions	Yes	No
<p>Step 5 Remove, and then reinstall the fuser. See “Fuser removal” on page 436.</p> <p>Does the problem remain?</p>	Go to step 6.	The problem is solved.
<p>Step 6 Replace the fuser. See “Fuser removal” on page 436.</p> <p>Does the problem remain?</p>	Go to step 7.	The problem is solved.
<p>Step 7</p> <p>a From the home screen, touch Settings > Device > Maintenance > Configuration Menu > Reports > Event Log.</p> <p>b Check the log history for fuser error codes.</p> <p>Are there fuser error codes on the event log?</p>	Go to step 8.	Go to step 9.
<p>Step 8 Perform the service check for the error code found.</p> <p>Does the problem remain?</p>	Go to step 9.	The problem is solved.
<p>Step 9 Replace the LVPS. See “LVPS removal” on page 377.</p> <p>Does the problem remain?</p>	Contact the next level of support.	The problem is solved.

Uneven print density check



Note: Before performing this print quality check, print the Print Quality Test Pages. From the control panel, navigate to **Settings > Troubleshooting > Print Quality Test Pages**, and then perform the initial print quality check. See [“Initial print quality check” on page 39](#).

Action	Yes	No
<p>Step 1</p> <p>a From the home screen, touch Settings > Device > Preferences.</p> <p>b Check if the paper type and size settings match the paper type and size set on the tray.</p> <p>Do the settings match?</p>	Go to step 3.	Go to step 2.
<p>Step 2</p> <p>Change the paper size and type, or adjust the size settings in the tray to match the paper size.</p> <p>Does the problem remain?</p>	Go to step 3.	The problem is solved.
<p>Step 3</p> <p>Check the paper for texture or rough finish.</p> <p>Is the paper textured or rough?</p>	Go to step 4.	Go to step 5.
<p>Step 4</p> <p>Replace the textured or rough paper with plain paper.</p> <p>Does the problem remain?</p>	Go to step 5.	The problem is solved.
<p>Step 5</p> <p>a Remove the imaging kit. See “Imaging kit removal” on page 399.</p> <p>b Inspect and clean the printhead lenses.</p> <p>c Print a test page.</p> <p>Does the problem remain?</p>	Go to step 6.	The problem is solved.
<p>Step 6</p> <p>a Remove the CMY developer units from the imaging kit, and then install them back to the imaging kit.</p> <p>b Remove the black imaging unit from the imaging kit, and then install it back to the imaging kit.</p> <p>Does the problem remain?</p>	Go to step 7.	The problem is solved.
<p>Step 7</p> <p>Replace the affected imaging unit or imaging kit.</p> <p>Does the problem remain?</p>	Contact the next level of support.	The problem is solved.

Vertical colored lines or banding check



Note: Before performing this print quality check, print the Print Quality Test Pages. From the control panel, navigate to **Settings > Troubleshooting > Print Quality Test Pages**, and then perform the initial print quality check. See [“Initial print quality check” on page 39](#).

Action	Yes	No
<p>Step 1</p> <p>a Enter the Diagnostics menu, and then navigate to: Advanced Print Quality Samples > Advanced Print Quality Test Pages</p> <p>b Check the test page.</p> <p>Is only one color producing the defect?</p>	Go to step 2.	Go to step 3.
<p>Step 2</p> <p>Replace the affected imaging kit or imaging unit.</p> <p>Does the problem remain?</p>	Go to step 3.	The problem is solved.
<p>Step 3</p> <p>Replace the transfer module. See “Transfer module removal” on page 431.</p> <p>Does the problem remain?</p>	Go to step 4.	The problem is solved.
<p>Step 4</p> <p>Replace the fuser. See “Fuser removal” on page 436.</p> <p>Does the problem remain?</p>	Contact the next level of support.	The problem is solved.

Vertical white lines check



Note: Before performing this print quality check, print the Print Quality Test Pages. From the control panel, navigate to **Settings > Troubleshooting > Print Quality Test Pages**, and then perform the initial print quality check. See [“Initial print quality check” on page 39](#).

Action	Yes	No
<p>Step 1</p> <p>a Remove the imaging kit. See “Imaging kit removal” on page 399.</p> <p>b Inspect and clean the printhead lenses.</p> <p>c Print a test page.</p> <p>Does the problem remain?</p>	Go to step 2.	The problem is solved.
<p>Step 2</p> <p>a Enter the Diagnostics menu, and then navigate to: Advanced Print Quality Samples > Advanced Print Quality Test Pages</p> <p>b Check the test page.</p> <p>Did the print defect appear on all the pages?</p>	Go to step 3.	Go to step 3.
<p>Step 3</p> <p>Replace the affected imaging kit or imaging unit.</p> <p>Does the problem remain?</p>	Go to step 4.	The problem is solved.
<p>Step 4</p> <p>Check the transfer module for improper installation and damage.</p> <p>Is the transfer module properly installed and free of damage?</p>	Go to step 5.	Go to step 5.
<p>Step 5</p> <p>Reinstall or replace the transfer module. See “Transfer module removal” on page 431.</p> <p>Does the problem remain?</p>	Go to step 6.	The problem is solved.
<p>Step 6</p> <p>Replace the printhead. See “Printhead removal” on page 484.</p> <p>Does the problem remain?</p>	Contact the next level of support.	The problem is solved.

Blurred print or misaligned color check

Note: Before performing this print quality check, print the Print Quality Test Pages. From the control panel, navigate to **Settings > Troubleshooting > Print Quality Test Pages**, and then perform the initial print quality check. See [“Initial print quality check” on page 39](#).

Actions	Yes	No
<p>Step 1 Check the print quality test page if it has one color that is blurred or misaligned.</p> <p>Is only one color blurred or misaligned?</p>	Go to step 2.	Go to step 3.
<p>Step 2 Perform the color alignment adjustment on the misaligned color. See “Color alignment adjust” on page 342.</p> <p>Does the problem remain?</p>	Go to step 3.	The problem is solved.
<p>Step 3 Perform color alignment adjustment on all colors. See “Color alignment adjust” on page 342.</p> <p>Does the problem remain?</p>	Go to step 4.	The problem is solved.
<p>Step 4 Perform the Auto alignment service check. See “Auto alignment service check” on page 302.</p> <p>Does the problem remain?</p>	Go to step 5.	The problem is solved.
<p>Step 5 Enter the Diagnostics menu, and then navigate to: Advanced Print Quality Samples > Advanced Print Quality Test Pages</p> <p>Does the problem remain?</p>	Go to step 6.	The problem is solved.
<p>Step 6 Remove the imaging kit, and then clean the printhead lenses. See “Cleaning the printhead lenses” on page 563.</p> <p>Does the problem remain?</p>	Go to step 7.	The problem is solved.
<p>Step 7 Replace the motor (K/transfer belt). See “Motor (EP drive) removal” on page 382.</p> <p>Does the problem remain?</p>	Go to step 8.	The problem is solved.

Actions	Yes	No
<p>Step 8 Replace the printhead. See “Printhead removal” on page 484. Does the problem remain?</p>	Go to step 9.	The problem is solved.
<p>Step 9 Replace the engine board. See “Engine board removal” on page 479. Does the problem remain?</p>	Contact the next level of support.	The problem is solved.

Gapping or half color page check

Note: Before performing this print quality check, print the Print Quality Test Pages. From the control panel, navigate to **Settings > Troubleshooting > Print Quality Test Pages**, and then perform the initial print quality check. See [“Initial print quality check” on page 39](#).

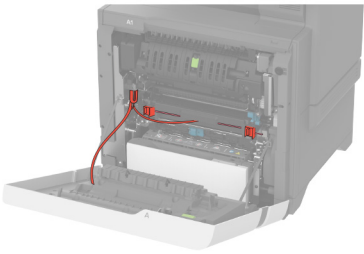
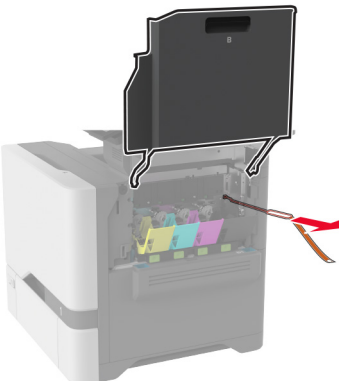
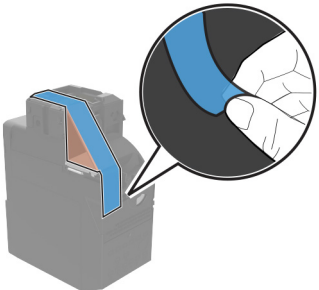
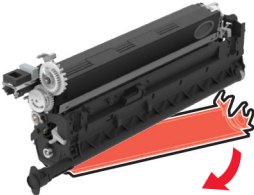
Action	Yes	No
<p>Step 1</p> <p>Make sure to remove all the packing material in the following areas:</p> <ul style="list-style-type: none"> • Inside the printer  <hr/>  <ul style="list-style-type: none"> • Toner cartridges and imaging unit  <hr/> 	Go to step 2.	The problem is solved.
Does the problem remain?	Diagnostics and troubleshooting	

Action	Yes	No
<p>Step 2</p> <p>a Reinstall the toner cartridges and imaging unit.</p> <p>b Reinstall the imaging kit.</p> <p>c Enter the Diagnostics menu, and then navigate to: Advanced Print Quality Samples > Advanced Print Quality Test Pages</p> <p>d Check the test page.</p> <p>Does the problem remain?</p>	Go to step 3.	The problem is solved.
<p>Step 3</p> <p>Check the developer hold down arms and their springs for damage.</p> <p>Are the developer hold down arms damaged?</p>	Go to step 4.	Go to step 5.
<p>Step 4</p> <p>Replace the affected developer hold down arm. See “Developer hold down arm removal” on page 498.</p> <p>Does the problem remain?</p>	Go to step 5.	The problem is solved.
<p>Step 5</p> <p>Replace the affected imaging kit or imaging unit.</p> <p>Does the problem remain?</p>	Contact the next level of support.	The problem is solved.

Image void process direction check

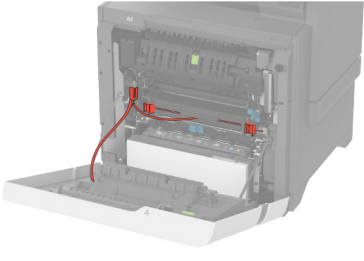
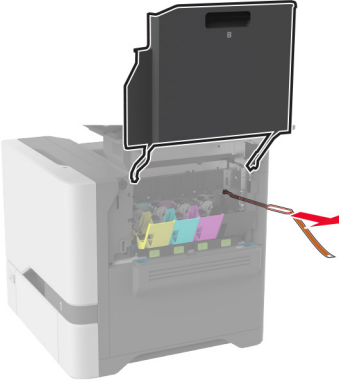
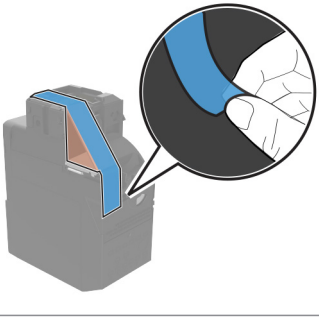
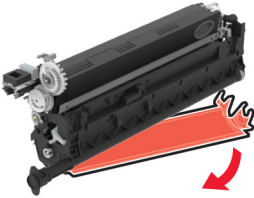

Note: Before performing this print quality check, print the Print Quality Test Pages. From the control panel, navigate to **Settings > Troubleshooting > Print Quality Test Pages**, and then perform the initial print quality check. See [“Initial print quality check” on page 39](#).

Action	Yes	No
<p>Step 1</p> <p>Load paper from a fresh package.</p> <p>Note: Paper may absorb moisture due to high humidity. Store paper in its original wrapper until it is ready to be used.</p> <p>Does the problem remain?</p>	Go to step 2.	The problem is solved.
<p>Step 2</p> <p>Make sure to remove all the packing material in the following areas:</p> <ul style="list-style-type: none"> • Inside the printer   <ul style="list-style-type: none"> • Toner cartridges and imaging unit   <p>Does the problem remain?</p>	Go to step 3.	The problem is solved.

Action	Yes	No
<p>Step 3</p> <p>a Reseat the imaging kit.</p> <p>b Perform a print job.</p> <p>Does the problem remain?</p>	Go to step 4.	The problem is solved.
<p>Step 4</p> <p>Check if the problem appears only on one side of the page.</p> <p>Does the problem appear only on one side?</p>	Go to step 5.	Go to step 8.
<p>Step 5</p> <p>Check the developer hold down arms for damage or loose springs.</p> <p>Are the developer hold down arms free of damage and loose springs?</p>	Go to step 7.	The problem is solved.
<p>Step 6</p> <p>Replace the developer hold down arms. See “Developer hold down arm removal” on page 498.</p> <p>Does the problem remain?</p>	Go to step 7.	The problem is solved.
<p>Step 7</p> <p>Check for missing colors.</p> <p>Is only one color missing?</p>	Go to step 9.	Go to step 8.
<p>Step 8</p> <p>Remove the imaging kit, and then clean the printhead lenses. See “Cleaning the printhead lenses” on page 563.</p> <p>Does the problem remain?</p>	Go to step 9.	The problem is solved.
<p>Step 9</p> <ul style="list-style-type: none"> • If the affected color is cyan, magenta, or yellow, then replace the developer unit of the affected color. • If the affected color is black, then replace the imaging unit. <p>Does the problem remain?</p>	Go to step 10.	The problem is solved.
<p>Step 10</p> <p>Replace the printhead. See “Printhead removal” on page 484.</p> <p>Does the problem remain?</p>	Go to step 11.	The problem is solved.
<p>Step 11</p> <p>Replace the engine board. See “Engine board removal” on page 479.</p> <p>Does the problem remain?</p>	Contact the next level of support.	The problem is solved.

Image void scan direction check



Note: Before performing this print quality check, print the Print Quality Test Pages. From the control panel, navigate to **Settings > Troubleshooting > Print Quality Test Pages**, and then perform the initial print quality check. See [“Initial print quality check” on page 39](#).

Action	Yes	No
<p>Step 1 Load paper from a fresh package.</p> <p>Note: Paper may absorb moisture due to high humidity. Store paper in its original wrapper until it is ready to be used.</p> <p>Does the problem remain?</p>	Go to step 2.	The problem is solved.
<p>Step 2 Reseat the imaging kit, and then perform a print job.</p> <p>Does the problem remain?</p>	Go to step 3.	The problem is solved.
<p>Step 3 Check if the problem affects only one color.</p> <p>Does the problem affect only one color?</p>	Go to step 4.	Go to step 5.
<p>Step 4 Replace the affected imaging kit or imaging unit.</p> <p>Does the problem remain?</p>	Go to step 5.	The problem is solved.
<p>Step 5 Measure the interval between every defect.</p> <p>Does the defect occur in 55-mm intervals?</p>	Contact the next level of support.	Go to step 6.
<p>Step 6 Replace the transfer module. See “Transfer module removal” on page 431.</p> <p>Does the problem remain?</p>	Go to step 7.	Go to step 5.

Action	Yes	No
<p>Step 7 Reseat the HVPS cable on the engine board.</p> <p>Does the problem remain?</p>	Go to step 8.	The problem is solved.
<p>Step 8 Replace the HVPS. See “HVPS removal” on page 417.</p> <p>Does the problem remain?</p>	Go to step 9.	The problem is solved.
<p>Step 9 Replace the engine board. See “Engine board removal” on page 479.</p> <p>Does the problem remain?</p>	Go to step 10.	The problem is solved.
<p>Step 10 Replace the printhead. See “Printhead removal” on page 484.</p> <p>Does the problem remain?</p>	Contact the next level of support.	The problem is solved.

Missing color check

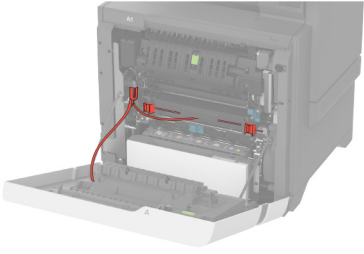
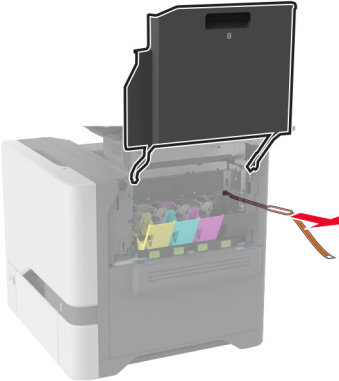
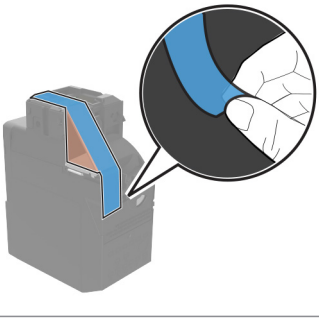
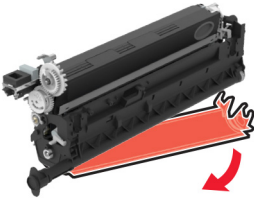
Action	Yes	No
<p>Step 1 Make sure to remove all the packing material in the following areas:</p> <ul style="list-style-type: none"> • Inside the printer  <hr/>  <ul style="list-style-type: none"> • Toner cartridges and imaging unit  <hr/>  <p>Does the problem remain?</p>	Go to step 2.	The problem is solved.

Action	Yes	No
<p>Step 2 Make sure that all supplies are properly installed.</p> <p>Does the problem remain?</p>	Go to step 3.	The problem is solved.
<p>Step 3 Reinstall the imaging unit and imaging kit.</p> <p>Does the problem remain?</p>	Go to step 4.	The problem is solved.
<p>Step 4 Reseat the printhead cable on the engine board.</p> <p>Does the problem remain?</p>	Go to step 5.	The problem is solved.
<p>Step 5 Check the contacts on the imaging unit or imaging kit of the missing color for dust or debris.</p> <p>Are the contacts free of dust or debris?</p>	Go to step 7.	Go to step 6.
<p>Step 6 Clean the contacts.</p> <p>Does the problem remain?</p>	Go to step 7.	The problem is solved.
<p>Step 7 Check if the missing color is yellow.</p> <p>Is the affected color yellow?</p>	Go to step 8.	Go to step 9.

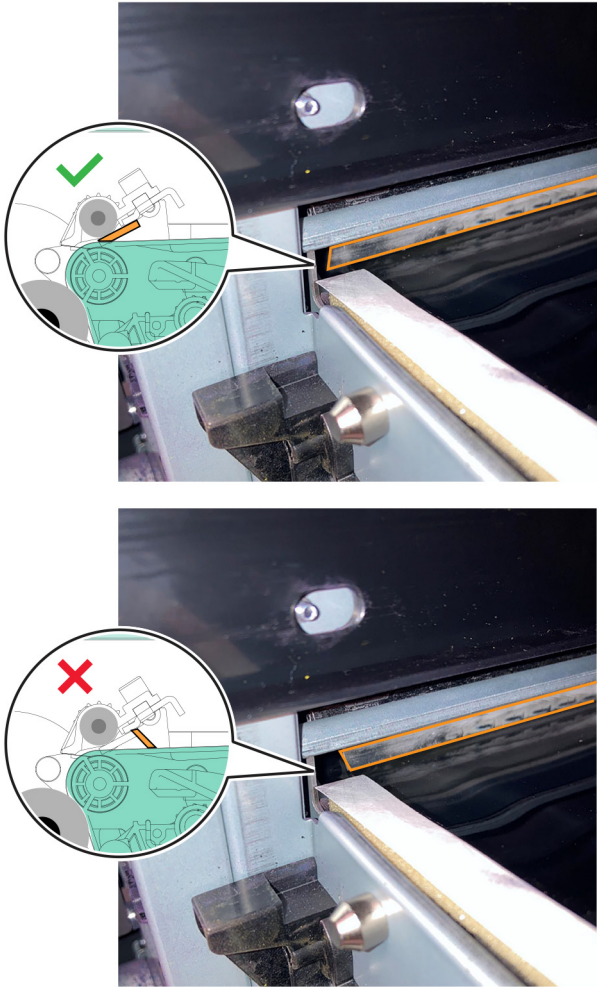
Action	Yes	No
<p>Step 8 Make sure that the cleaning blade on the transfer belt is facing the proper direction.</p> <p>Note: Look at the corner edge of the blade to determine the direction.</p>  <p>If the blade has flipped (and is now facing the wrong direction), replace the transfer module.</p> <p>Does the problem remain?</p>	Go to step 9.	The problem is solved.
<p>Step 9 Replace the affected imaging kit or imaging unit.</p> <p>Does the problem remain?</p>	Go to step 10.	The problem is solved.

Action	Yes	No
<p>Step 10</p> <p>Check if the spring-loaded pins in the HVPS freely move in and out with an equal amount of spring force.</p> <p>Do the pins freely move?</p>	Go to step 12.	Go to step 11.
<p>Step 11</p> <p>Replace the HVPS. See “HVPS removal” on page 417.</p> <p>Does the problem remain?</p>	Go to step 12.	The problem is solved.
<p>Step 12</p> <p>a Remove the transfer module. See “Transfer module removal” on page 431.</p> <p>b Close the front door or bypass the door interlock switch.</p> <p>c Enter the Diagnostics menu, and then navigate to: Printer diagnostics & adjustments > Motor tests</p> <p>d Select the motor of the affected color, and then touch Start.</p> <p>Does the motor run?</p>	Go to step 14.	Go to step 13.
<p>Step 13</p> <p>Replace the affected motor (EP drive). See “Motor (EP drive) removal” on page 382.</p> <p>Does the problem remain?</p>	Go to step 14.	The problem is solved.
<p>Step 14</p> <p>While manually turning the motors, check if the corresponding couplers move.</p> <p>Do the couplers move?</p>	Go to step 16.	Go to step 15.
<p>Step 15</p> <p>Replace the EP drive gearbox. See “EP drive gearbox removal” on page 384.</p> <p>Does the problem remain?</p>	Go to step 16.	The problem is solved.
<p>Step 16</p> <p>a Make sure that the printhead cables are properly connected to the engine board.</p> <p>b Make sure that the JTH1 and JPWR1 cables are properly connected to the controller board and engine board.</p> <p>Does the problem remain?</p>	Go to step 17.	The problem is solved.
<p>Step 17</p> <p>Replace the printhead. See “Printhead removal” on page 484.</p> <p>Does the problem remain?</p>	Go to step 18.	The problem is solved.

Action	Yes	No
<p>Step 18 Replace the engine board. See “Engine board removal” on page 479.</p> <p>Does the problem remain?</p>	Contact the next level of support.	The problem is solved.

Random marks check

Note: Before performing this print quality check, print the Print Quality Test Pages. From the control panel, navigate to **Settings > Troubleshooting > Print Quality Test Pages**, and then perform the initial print quality check. See [“Initial print quality check” on page 39](#).

Action	Yes	No
<p>Step 1 Check the printer for toner leaks.</p> <p>Are there toner leaks?</p>	Go to step 2.	Go to step 3.
<p>Step 2 a Clean the printer thoroughly using a toner vacuum. b Perform a print job to clear the remaining toner from the imaging components.</p> <p>Does the problem remain?</p>	Go to step 3.	The problem is solved.
<p>Step 3 Remove the imaging kit, and then check it for debris and fragments. See “Imaging kit removal” on page 399.</p> <p>Is the imaging kit free of debris and fragments?</p>	Go to step 5.	Go to step 4.
<p>Step 4 Remove the debris and fragments.</p> <p>Does the problem remain?</p>	Go to step 5.	The problem is solved.
<p>Step 5 a Remove the transfer module. See “Transfer module removal” on page 431. b Check the transfer module for debris and fragments.</p> <p>Is the transfer module free of debris and fragments?</p>	Go to step 7.	Go to step 6.
<p>Step 6 Remove the debris and fragments.</p> <p>Does the problem remain?</p>	Contact the next level of support.	The problem is solved.

Action	Yes	No
<p>Step 7</p> <p>a Remove the fuser. See “Fuser removal” on page 436.</p> <p>b Check the fuser for debris and damage.</p> <p>Is the fuser free of debris and damage?</p>	Contact the next level of support.	Go to step 8.
<p>Step 8</p> <p>Replace the fuser. See “Fuser removal” on page 436.</p> <p>Does the problem remain?</p>	Contact the next level of support.	The problem is solved.

Fixing scan quality issues

Dark image quality (using the ADF or scanner) check

Actions	Yes	No
<p>Step 1</p> <p>Enter the Diagnostics menu, and then navigate to: Advanced Print Quality Samples > Advanced Print Quality Test Pages</p> <p>Is the scan defect seen on the print quality samples?</p>	Go to step 2.	Go to step 3.
<p>Step 2</p> <p>Identify, and then resolve the print quality defect. See the “Fixing print quality issues” section..</p> <p>Does the problem remain?</p>	Go to step 3.	The problem is solved.
<p>Step 3</p> <p>From the home screen, touch Settings > Print > Quality > Advanced Imaging > Color Adjust.</p> <p>Does the problem remain?</p>	Go to step 4.	The problem is solved.
<p>Step 4</p> <p>Clean the following parts. See “Cleaning the scanner” on page 554.</p> <ul style="list-style-type: none"> • ADF glass • Scanner glass • ADF glass pad • Scanner glass pad • ADF glass pad in door C • ADF glass in door C <p>Does the problem remain?</p>	Go to step 5.	The problem is solved.

Actions	Yes	No
<p>Step 5</p> <p>a Perform a copy job using the ADF.</p> <p>b Perform a copy job using the scanner.</p> <p>Does the problem remain?</p>	Go to step 6.	The problem is solved.
<p>Step 6</p> <p>Replace the printer controller board. See “Controller board removal” on page 478.</p> <p>Does the problem remain?</p>	Contact the next level of support.	The problem is solved.

Vertical lines (process direction using the ADF) check

Actions	Yes	No
<p>Step 1</p> <p>Enter the Diagnostics menu, and then navigate to:</p> <p>Advanced Print Quality Samples > Advanced Print Quality Test Pages</p> <p>Is the scan defect seen on the print quality samples?</p>	Go to step 2.	Go to step 3.
<p>Step 2</p> <p>Identify, and then resolve the print quality defect. See the “Fixing print quality issues” section.</p> <p>Does the problem remain?</p>	Go to step 3.	The problem is solved.
<p>Step 3</p> <p>Clean the following parts. See “Cleaning the scanner” on page 554.</p> <ul style="list-style-type: none"> • ADF glass • Scanner glass • ADF glass pad • Scanner glass pad • ADF glass pad in door C • ADF glass in door C <p>Does the problem remain?</p>	Go to step 4.	The problem is solved.
<p>Step 4</p> <p>Check the ADF glass on the scanner for cracks or damage.</p> <p>Is the scanner free of cracks and damage?</p>	Go to step 5.	Go to step 8.

Actions	Yes	No
<p>Step 5 Check inside the flatbed scanner for dust and contamination.</p> <p>Is the flatbed scanner free of dust and contamination?</p>	Contact the next level of support.	Go to step 8.
<p>Step 6 Perform a two-sided copy job using the ADF, and then check if the issue occurs on the front side.</p> <p>Does the issue occur on the front side?</p>	Go to step 8.	Go to step 7.
<p>Step 7 Check if the issue occurs on the back side.</p> <p>Does the issue occur on the back side?</p>	Go to step 9.	The problem is solved.
<p>Step 8 Replace the flatbed scanner. See “Flatbed scanner removal” on page 519.</p> <p>Does the problem remain?</p>	Contact the next level of support.	The problem is solved.
<p>Step 9 Replace the ADF. See “ADF removal” on page 517.</p> <p>Does the problem remain?</p>	Contact the next level of support.	The problem is solved.

Spots (using the flatbed scanner) check

Actions	Yes	No
<p>Step 1 Enter the Diagnostics menu, and then navigate to: Advanced Print Quality Samples > Advanced Print Quality Test Pages</p> <p>Is the scan defect seen on the print quality samples?</p>	Go to step 2.	Go to step 3.
<p>Step 2 Identify, and then resolve the print quality defect. See the “Fixing print quality issues” section.</p> <p>Does the problem remain?</p>	Go to step 3.	The problem is solved.

Actions	Yes	No
<p>Step 3 Clean the following parts. See “Cleaning the scanner” on page 554.</p> <ul style="list-style-type: none"> • Scanner glass • Scanner glass pad <p>Does the problem remain?</p>	Go to step 4.	The problem is solved.
<p>Step 4 a Replace the scanner glass pad. See “Scanner glass pad removal” on page 512. b Perform a copy job using the scanner.</p> <p>Does the problem remain?</p>	Go to step 5.	The problem is solved.
<p>Step 5 Check inside the flatbed scanner for dust and contamination.</p> <p>Is the flatbed scanner free of dust and contamination?</p>	Contact the next level of support.	Go to step 6.
<p>Step 6 a Replace the flatbed scanner. See “Flatbed scanner removal” on page 519. b Perform a copy job using the scanner.</p> <p>Does the problem remain?</p>	Contact the next level of support.	The problem is solved.

ADF skew check

Actions	Yes	No
<p>Step 1 Enter the Diagnostics menu, and then navigate to: Advanced Print Quality Samples > Advanced Print Quality Test Pages</p> <p>Is the scan defect seen on the print quality samples?</p>	Go to step 2.	Go to step 3.
<p>Step 2 Identify, and then resolve the print quality defect. See the “Fixing print quality issues” section.</p> <p>Does the problem remain?</p>	Go to step 3.	The problem is solved.
<p>Step 3 Make sure that the printer is placed on a flat, sturdy, and stable surface.</p> <p>Does the problem remain?</p>	Go to step 4.	The problem is solved.

Actions	Yes	No
<p>Step 4</p> <p>a Make sure that the document is properly loaded in the ADF tray. Note: The ADF guide positions should match the width of the document.</p> <p>b Perform a copy job using the ADF.</p> <p>Does the problem remain?</p>	Go to step 5.	The problem is solved.
<p>Step 5</p> <p>Clear the ADF paper path of obstructions.</p> <p>Does the problem remain?</p>	Go to step 6.	The problem is solved.
<p>Step 6</p> <p>Open, and then properly close the ADF top cover.</p> <p>Does the problem remain?</p>	Go to step 7.	The problem is solved.
<p>Step 7</p> <p>From the home screen, navigate to: Settings > Device > Maintenance > Configuration Menu > Scanner Configuration > ADF Deskew > ADF Electronic Deskew > On</p> <p>Does the problem remain?</p>	Go to step 8.	The problem is solved.
<p>Step 8</p> <p>Check the ADF pick roller and separator roller for wear and damage.</p> <p>Are the rollers free of wear and damage?</p>	Contact the next level of support.	Go to step 9.
<p>Step 9</p> <p>Replace the ADF rollers. See “ADF rollers removal” on page 514.</p> <p>Does the problem remain?</p>	Contact the next level of support.	The problem is solved.

Media damage (using the ADF) check

Actions	Yes	No
<p>Step 1 Make sure that the document is properly loaded in the ADF tray. Note: The ADF guide positions should match the width of the document.</p> <p>Does the problem remain?</p>	Go to step 2.	The problem is solved.
<p>Step 2 Clear the ADF paper path of any obstructions.</p> <p>Does the problem remain?</p>	Go to step 3.	The problem is solved.
<p>Step 3 Open, and then properly close the ADF top cover.</p> <p>Does the problem remain?</p>	Go to step 4.	The problem is solved.
<p>Step 4 Check the ADF pick roller and separator roller for wear and damage.</p> <p>Are the rollers free of wear and damage?</p>	Contact the next level of support.	Go to step 5.
<p>Step 5 Replace the ADF rollers. See “ADF rollers removal” on page 514.</p> <p>Does the problem remain?</p>	Contact the next level of support.	The problem is solved.

Blank page copy check

Actions	Yes	No
<p>Step 1 Print a test page.</p> <p>Is the page blank?</p>	Go to step 2.	Go to step 3.
<p>Step 2 Resolve the print quality issue. See “Blank or white pages check” on page 40.</p> <p>Does the problem remain?</p>	Go to step 3.	The problem is solved.

Actions	Yes	No
<p>Step 3 Make sure that the orientation of the original document is correct.</p> <p>Notes:</p> <ul style="list-style-type: none"> • When copying from the ADF, load the document faceup. • When copying from the flatbed scanner, load the document facedown. <p>Does the problem remain?</p>	Go to step 4.	The problem is solved.
<p>Step 4</p> <p>a Make sure that the ADF FFC is properly connected to the ADF and controller board.</p> <p>b Make sure that the flatbed scanner FFC is properly connected to the flatbed scanner and controller board.</p> <p>Does the problem remain?</p>	Go to step 5.	The problem is solved.
<p>Step 5 Check the ADF and flatbed scanner FFC cables for damage.</p> <p>Are the FFC cables free of damage?</p>	Go to step 7.	Go to step 6.
<p>Step 6 Replace the damaged cables.</p> <p>Does the problem remain?</p>	Go to step 7.	The problem is solved.
<p>Step 7 Replace the flatbed scanner. See “Flatbed scanner removal” on page 519.</p> <p>Note: If the backside scan is blank, replace the ADF.</p> <p>Does the problem remain?</p>	Go to step 8.	The problem is solved.
<p>Step 8 Replace the controller board. See “Controller board removal” on page 478.</p> <p>Does the problem remain?</p>	Contact the next level of support.	The problem is solved.

Black page copy check

Actions	Yes	No
<p>Step 1 Print a test page.</p> <p>Is the page black?</p>	Go to step 2.	Go to step 3.
<p>Step 2 Resolve the print quality issue. See “Solid color or black image check” on page 65.</p> <p>Does the problem remain?</p>	Go to step 3.	The problem is solved.
<p>Step 3 Clean the following parts. See “Cleaning the scanner” on page 554.</p> <ul style="list-style-type: none"> • ADF glass • Scanner glass • ADF glass pad • Scanner glass pad • ADF glass pad in door C • ADF glass in door C <p>Does the problem remain?</p>	Go to step 4.	The problem is solved.
<p>Step 4</p> <p>a Make sure that the ADF FFC is properly connected to the ADF and controller board.</p> <p>b Make sure that the flatbed scanner FFC is properly connected to the flatbed scanner and controller board.</p> <p>Does the problem remain?</p>	Go to step 5.	The problem is solved.
<p>Step 5 Check the ADF and flatbed scanner FFC cables for damage.</p> <p>Are the FFC cables free of damage?</p>	Go to step 7.	Go to step 6.
<p>Step 6 Replace the damaged cables.</p> <p>Does the problem remain?</p>	Go to step 7.	The problem is solved.
<p>Step 7 Replace the flatbed scanner. See “Flatbed scanner removal” on page 519.</p> <p>Note: If the backside scan is blank, replace the ADF.</p> <p>Does the problem remain?</p>	Go to step 8.	The problem is solved.

Actions	Yes	No
<p>Step 8 Replace the controller board. See “Controller board removal” on page 478.</p> <p>Does the problem remain?</p>	Contact the next level of support.	The problem is solved.

Paper jams

Avoiding jams

Load paper properly

- Make sure that the paper lies flat in the tray.

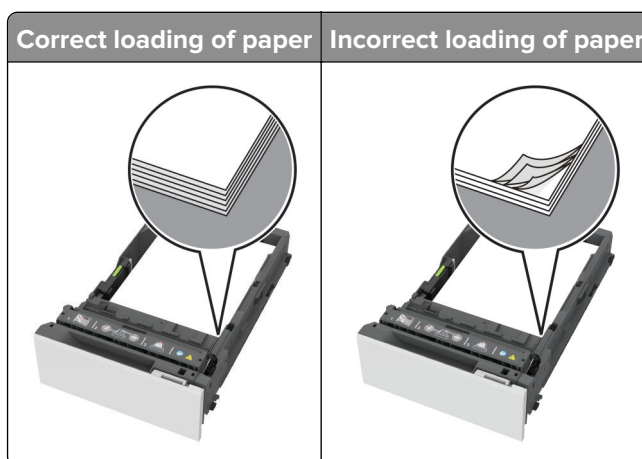

- Do not load or remove a tray while the printer is printing.
- Do not load too much paper. Make sure that the stack height is below the maximum paper fill indicator.

- Do not slide paper into the tray. Load paper as shown in the illustration.



- Make sure that the paper guides are positioned correctly and are not pressing tightly against the paper or envelopes.
- Push the tray firmly into the printer after loading paper.

Use recommended paper

- Use only recommended paper or specialty media.
- Do not load paper that is wrinkled, creased, damp, bent, or curled.
- Flex, fan, and align the paper edges before loading.

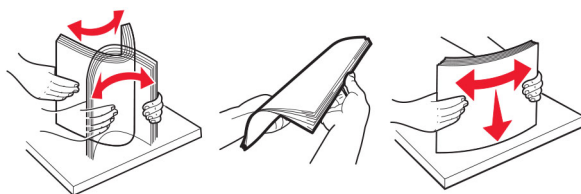

- Do not use paper that has been cut or trimmed by hand.
- Do not mix paper sizes, weights, or types in the same tray.
- Make sure that the paper size and type are set correctly on the computer or printer control panel.
- Store paper according to manufacturer recommendations.

Identifying jam locations

Notes:

- When Jam Assist is set to On, the printer flushes blank pages or pages with partial prints after a jammed page has been cleared. Check your printed output for blank pages.
- When Jam Recovery is set to On or Auto, the printer reprints jammed pages.

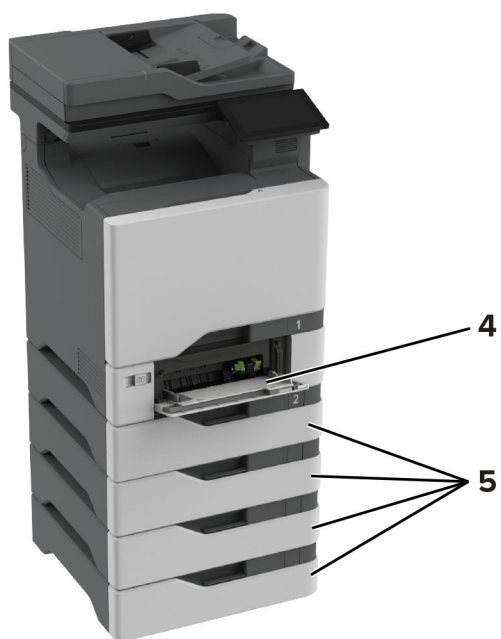
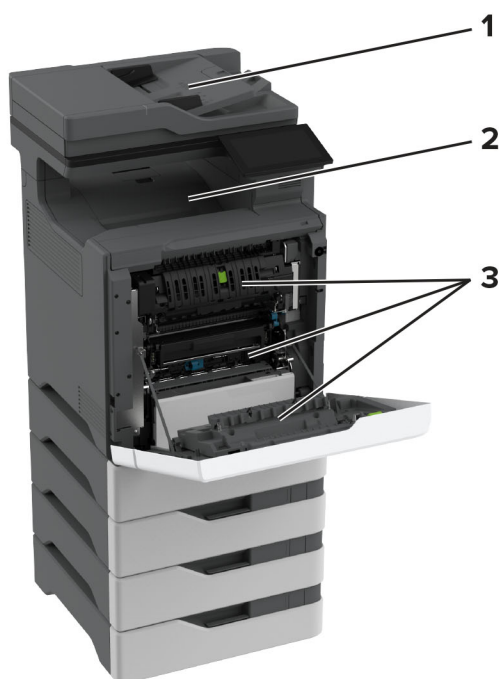

Jam locations	
1	ADF
2	Standard bin
3	Door A
4	Multipurpose feeder
5	Trays

200 paper jams

200 paper jam messages

Error code	Description	Action
200.03	Paper fed from the MPF never arrived at the sensor (input).	See “Sensor (input): Paper failed to arrive service check” on page 100.
200.05	Paper fed from the MPF never cleared the sensor (input).	See “Sensor (input): Paper failed to clear service check” on page 103.
200.12	Paper fed from tray 1 was detected earlier than expected at the sensor (input).	See “Sensor (input): Paper arrived too early service check” on page 99.
200.13	Paper fed from tray 1 never arrived at the sensor (input).	See “Sensor (input): Paper failed to arrive service check” on page 100.
200.14	Paper fed from tray 1 cleared the sensor (input) earlier than expected.	See “Sensor (input): Paper cleared too early service check” on page 104.
200.15	Paper fed from tray 1 never cleared the sensor (input).	See “Sensor (input): Paper failed to clear service check” on page 103.
200.22	Paper fed from tray 2 was detected earlier than expected at the sensor (input).	See “Sensor (input): Paper arrived too early service check” on page 99.
200.23	Paper fed from tray 2 did not reach the sensor (input).	See “Sensor (input): Paper failed to arrive service check” on page 100.
200.24	Paper fed from tray 2 cleared the sensor (input) earlier than expected.	See “Sensor (input): Paper cleared too early service check” on page 104.
200.25	Paper fed from tray 2 never cleared the sensor (input).	See “Sensor (input): Paper failed to clear service check” on page 103.
200.26	Paper fed from tray 2 was picked but it never reached the sensor (input).	See “Sensor (input): Paper failed to arrive service check” on page 100.
200.32	Paper fed from tray 3 was detected earlier than expected at the sensor (input).	See “Sensor (input): Paper arrived too early service check” on page 99.
200.33	Paper fed from tray 3 did not reach the sensor (input).	See “Sensor (input): Paper failed to arrive service check” on page 100.
200.34	Paper fed from tray 3 cleared the sensor (input) earlier than expected.	See “Sensor (input): Paper cleared too early service check” on page 104.
200.35	Paper fed from tray 3 never cleared the sensor (input).	See “Sensor (input): Paper failed to clear service check” on page 103.
200.36	Paper fed from tray 3 was picked but it never reached the sensor (input).	See “Sensor (input): Paper failed to arrive service check” on page 100.
200.42	Paper fed from tray 4 was detected earlier than expected at the sensor (input).	See “Sensor (input): Paper arrived too early service check” on page 99.
200.43	Paper fed from tray 4 did not reach the sensor (input).	See “Sensor (input): Paper failed to arrive service check” on page 100.
200.44	Paper fed from tray 4 cleared the sensor (input) earlier than expected.	See “Sensor (input): Paper cleared too early service check” on page 104.

Error code	Description	Action
200.45	Paper fed from tray 4 never cleared the sensor (input).	See “Sensor (input): Paper failed to clear service check” on page 103.
200.46	Paper fed from tray 4 was picked but it never reached the sensor (input).	See “Sensor (input): Paper failed to arrive service check” on page 100.
200.52	Paper fed from tray 5 was detected earlier than expected at the sensor (input).	See “Sensor (input): Paper arrived too early service check” on page 99.
200.53	Paper fed from tray 5 did not reach the sensor (input).	See “Sensor (input): Paper failed to arrive service check” on page 100.
200.54	Paper fed from tray 5 cleared the sensor (input) earlier than expected.	See “Sensor (input): Paper cleared too early service check” on page 104.
200.55	Paper fed from tray 5 never cleared the sensor (input).	See “Sensor (input): Paper failed to clear service check” on page 103.
200.56	Paper fed from tray 5 was picked but it never reached the sensor (input).	See “Sensor (input): Paper failed to arrive service check” on page 100.
200.91	Paper remains detected at the sensor (input) after the printer is turned on.	See “Sensor (input) static jam service check” on page 105.

Sensor (input): Paper arrived too early service check

Action	Yes	No
<p>Step 1</p> <p>a From the home screen, touch Settings > Device > Preferences.</p> <p>b Check if the paper size matches the size set on the tray guides.</p> <p>Does the paper size match the size set on the tray?</p>	Go to step 3.	Go to step 2.
<p>Step 2</p> <p>Change the paper size or adjust the size setting in the tray.</p> <p>Does the problem remain?</p>	Go to step 3.	The problem is solved.
<p>Step 3</p> <p>Check the tray for overfilling.</p> <p>Is the tray overfilled?</p>	Go to step 4.	Go to step 5.
<p>Step 4</p> <p>Remove the excess paper from the tray.</p> <p>Does the problem remain?</p>	Go to step 5.	The problem is solved.
<p>Step 5</p> <p>Check the paper path along the tray exit.</p> <p>Is the paper path free of fragments and contamination?</p>	Go to step 7.	Go to step 6.

Action	Yes	No
<p>Step 6 Clean the paper path.</p> <p>Does the problem remain?</p>	Go to step 7.	The problem is solved.
<p>Step 7 Perform a print job.</p> <p>Does the problem remain?</p>	Contact the next level of support.	The problem is solved.

Sensor (input): Paper failed to arrive service check

Action	Yes	No
<p>Step 1 a From the home screen, touch Settings > Device > Preferences. b Check if the paper type and size settings match the paper type and size set on the tray.</p> <p>Does the paper size match the size set on the tray?</p>	Go to step 3.	Go to step 2.
<p>Step 2 Change the paper size or adjust the size setting in the tray.</p> <p>Does the problem remain?</p>	Go to step 3.	The problem is solved.
<p>Step 3 Check the paper path for paper jams and fragments. Note: If necessary, remove the transfer module to properly see the paper path. See “Transfer module removal” on page 431.</p> <p>Is the paper path free of jams and fragments?</p>	Go to step 5.	Go to step 4.
<p>Step 4 Remove the jams and fragments.</p> <p>Does the problem remain?</p>	Go to step 5.	The problem is solved.
<p>Step 5 Check the tray insert and its paper path guides and drive gears for damage.</p> <p>Is the tray insert free of damage?</p>	Go to step 7.	Go to step 6.
<p>Step 6 Replace the tray insert. See “550-sheet tray insert removal” on page 500.</p> <p>Does the problem remain?</p>	Go to step 7.	The problem is solved.

Action	Yes	No
<p>Step 7</p> <p>a Make sure that the pick roller is properly installed.</p> <p>Note: Firmly press the pick roller to its shaft to make sure that it is properly engaged.</p> <p>b Check the pick roller for excess wear, contamination, and damage.</p> <p>Is the pick roller free from excess wear, contamination, and damage?</p>	Go to step 9.	Go to step 8.
<p>Step 8</p> <p>Replace the pick roller. See “Pick roller removals” on page 502.</p> <p>Does the problem remain?</p>	Go to step 9.	The problem is solved.
<p>Step 9</p> <p>a Enter the Diagnostics menu, and then navigate to: Printer diagnostics and adjustments > Motor tests > Pick (tray 1)</p> <p>b Select a setting, and then touch Start.</p> <p>Does the motor run?</p>	Go to step 12.	Go to step 10.
<p>Step 10</p> <p>a Make sure that the motor cable is properly connected.</p> <p>b Check the motor and the other paper feeder components for damage.</p> <p>Are the motor and paper feeder free of damage?</p>	Go to step 12.	Go to step 11.
<p>Step 11</p> <p>a Replace the paper feeder. See “Paper feeder removal” on page 507.</p> <p>b Perform a print job.</p> <p>Does the problem remain?</p>	Go to step 12.	The problem is solved.
<p>Step 12</p> <p>a Enter the Diagnostics menu, and then navigate to: Printer diagnostics & adjustments > Sensor tests</p> <p>b Find the sensor (Input).</p> <p>Does the sensor status change while toggling the sensor?</p>	Go to step 15.	Go to step 13.
<p>Step 13</p> <p>a Make sure that the sensor cable is properly connected.</p> <p>b Check the sensor for damage.</p> <p>Is the sensor free of damage?</p>	Go to step 15.	Go to step 14.

Action	Yes	No
<p>Step 14</p> <p>Replace the sensor. See “Sensor (input) removal” on page 434.</p> <p>Does the problem remain?</p>	Go to step 15.	The problem is solved.
<p>Step 15</p> <p>a Enter the Diagnostics menu, and then navigate to: Printer diagnostics & adjustments > Motor tests > Isolation</p> <p>b Touch Start, and then listen to the sound of the motor.</p> <p>c Check if the sound of the motor (isolation) is similar to this: https://contentdelivery.lexmark.com/webcontent/kbase/articles/SO8339/Bad_Isolation_Motor.mp3.</p> <p>Does the motor create a similar grinding sound?</p>	Go to step 17.	Go to step 16.
<p>Step 16</p> <p>Check the motor and its cable for damage.</p> <p>Are the motor and its cable free of damage?</p>	Go to step 18.	Go to step 17.
<p>Step 17</p> <p>Replace the isolation unit. See “Isolation unit removal” on page 509.</p> <p>Does the problem remain?</p>	Contact the next level of support.	The problem is solved.
<p>Step 18</p> <p>a Enter the Diagnostics menu, and then navigate to: Printer diagnostics & adjustments > Motor tests > Deskew</p> <p>b Touch Start.</p> <p>Does the motor run?</p>	Contact the next level of support.	Go to step 19.
<p>Step 19</p> <p>a Make sure that the motor cable is properly connected.</p> <p>b Check the motor (deskew) for damage.</p> <p>Is the motor free of damage?</p>	Contact the next level of support.	Go to step 20.
<p>Step 20</p> <p>Replace the motor (deskew). See “Motor (deskew) removal” on page 387.</p> <p>Does the problem remain?</p>	Contact the next level of support.	The problem is solved.

Sensor (input): Paper failed to clear service check

Action	Yes	No
<p>Step 1</p> <p>a From the home screen, touch Settings > Device > Preferences.</p> <p>b Check if the paper size matches the size set on the tray guides.</p> <p>Does the paper size match the size set on the tray?</p>	Go to step 3.	Go to step 2.
<p>Step 2</p> <p>Change the paper size or adjust the size setting in the tray.</p> <p>Does the problem remain?</p>	Go to step 3.	The problem is solved.
<p>Step 3</p> <p>Check the paper path for paper jams and obstructions.</p> <p>Note: If necessary, remove the transfer module to properly see the paper path. See “Transfer module removal” on page 431.</p> <p>Is the paper path free of jams and obstructions?</p>	Go to step 5.	Go to step 4.
<p>Step 4</p> <p>Remove the jams and obstructions.</p> <p>Does the problem remain?</p>	Go to step 5.	The problem is solved.
<p>Step 5</p> <p>a Enter the Diagnostics menu, and then navigate to: Printer diagnostics & adjustments > Sensor tests</p> <p>b Find the sensor (Input).</p> <p>Does the sensor status change while toggling the sensor?</p>	Go to step 8.	Go to step 6.
<p>Step 6</p> <p>a Make sure that the sensor cable is properly connected.</p> <p>b Check the sensor for damage.</p> <p>Is the sensor free of damage?</p>	Go to step 8.	Go to step 7.
<p>Step 7</p> <p>Replace the sensor. See “Sensor (input) removal” on page 434.</p> <p>Does the problem remain?</p>	Go to step 8.	The problem is solved.
<p>Step 8</p> <p>a Enter the Diagnostics menu, and then navigate to: Printer diagnostics & adjustments > Motor tests > Deskew</p> <p>b Touch Start.</p> <p>Does the motor run?</p>	Contact the next level of support.	Go to step 9.

Action	Yes	No
<p>Step 9</p> <p>a Make sure that the motor cable is properly connected.</p> <p>b Check the motor (deskew) for damage.</p> <p>Is the motor free of damage?</p>	Contact the next level of support.	Go to step 10.
<p>Step 10</p> <p>Replace the motor (deskew). See “Motor (deskew) removal” on page 387.</p> <p>Does the problem remain?</p>	Contact the next level of support.	The problem is solved.

Sensor (input): Paper cleared too early service check

Action	Yes	No
<p>Step 1</p> <p>a From the home screen, touch Settings > Device > Preferences.</p> <p>b Check if the paper size matches the size set on the tray guides.</p> <p>Does the paper size match the size set on the tray?</p>	Go to step 3.	Go to step 2.
<p>Step 2</p> <p>Change the paper size or adjust the size setting in the tray.</p> <p>Does the problem remain?</p>	Go to step 3.	The problem is solved.
<p>Step 3</p> <p>Check the tray for overfilling.</p> <p>Is the tray overfilled?</p>	Go to step 4.	Go to step 5.
<p>Step 4</p> <p>Remove the excess paper from the tray.</p> <p>Does the problem remain?</p>	Go to step 5.	The problem is solved.
<p>Step 5</p> <p>Check the paper condition in the tray.</p> <p>Is the paper crumpled or damaged?</p>	Go to step 6.	Go to step 7.
<p>Step 6</p> <p>Replace the crumpled or damaged paper.</p> <p>Does the problem remain?</p>	Go to step 7.	The problem is solved.

Action	Yes	No
<p>Step 7</p> <p>a Enter the Diagnostics menu, and then navigate to: Printer diagnostics & adjustments > Sensor tests</p> <p>b Find the sensor (Input).</p> <p>Does the sensor status change while toggling the sensor?</p>	Go to step 9.	The problem is solved.
<p>Step 8</p> <p>a Make sure that the sensor cable is properly connected.</p> <p>b Check the sensor for damage.</p> <p>Is the sensor free of damage?</p>	Go to step 9.	Go to step 9.
<p>Step 9</p> <p>Replace the sensor. See “Sensor (input) removal” on page 434.</p> <p>Does the problem remain?</p>	Go to step 10.	The problem is solved.
<p>Step 10</p> <p>Perform a print job.</p> <p>Does the problem remain?</p>	Contact the next level of support.	The problem is solved.

Sensor (input) static jam service check

Action	Yes	No
<p>Step 1</p> <p>a From the home screen, touch Settings > Device > Preferences.</p> <p>b Check if the paper size matches the size set on the tray guides.</p> <p>Does the paper size match the size set on the tray?</p>	Go to step 3.	Go to step 2.
<p>Step 2</p> <p>Change the paper size or adjust the size setting in the tray.</p> <p>Does the problem remain?</p>	Go to step 3.	The problem is solved.
<p>Step 3</p> <p>Check the paper path for partially fed or jammed paper.</p> <p>Note: If necessary, remove the transfer module to properly see the paper path. See “Transfer module removal” on page 431.</p> <p>Is the paper path free of partially fed or jammed paper?</p>	Go to step 5.	Go to step 4.
<p>Step 4</p> <p>Remove the partially fed or jammed paper.</p> <p>Does the problem remain?</p>	Go to step 5.	The problem is solved.

Action	Yes	No
<p>Step 5</p> <p>a Enter the Diagnostics menu, and then navigate to: Printer diagnostics & adjustments > Sensor tests</p> <p>b Find the sensor (Input).</p> <p>Does the sensor status change while toggling the sensor?</p>	Go to step 8.	Go to step 6.
<p>Step 6</p> <p>a Make sure that the sensor cable is properly connected.</p> <p>b Check the sensor for damage.</p> <p>Is the sensor free of damage?</p>	Go to step 8.	Go to step 7.
<p>Step 7</p> <p>Replace the sensor. See “Sensor (input) removal” on page 434.</p> <p>Does the problem remain?</p>	Go to step 8.	The problem is solved.
<p>Step 8</p> <p>Perform a print job.</p> <p>Does the problem remain?</p>	Contact the next level of support.	The problem is solved.

201 paper jams

201 paper jam messages

Error code	Description	Action
201.91	Paper remains detected at the sensor (fuser buckle) after the printer is turned on.	See “Sensor (fuser buckle) jam service check” on page 106 .

Sensor (fuser buckle) jam service check

Action	Yes	No
<p>Step 1</p> <p>a From the home screen, touch Settings > Device > Preferences.</p> <p>b Check if the paper size matches the size set on the tray guides.</p> <p>Does the paper size match the size set on the tray?</p>	Go to step 3.	Go to step 2.
<p>Step 2</p> <p>Change the paper size or adjust the size setting in the tray.</p> <p>Does the problem remain?</p>	Go to step 3.	The problem is solved.

Action	Yes	No
<p>Step 3</p> <p>Check the paper path for partially fed or jammed paper.</p> <p>Is the paper path free of partially fed or jammed paper?</p>	Go to step 5.	Go to step 4.
<p>Step 4</p> <p>Remove the partially fed or jammed paper.</p> <p>Note: The fuser nip may not release if the printer is still powered on. Make sure to close all doors, install the waste toner bottle, and then turn off the printer to release the fuser nip.</p> <p>Does the problem remain?</p>	Go to step 5.	The problem is solved.
<p>Step 5</p> <p>a Enter the Diagnostics menu, and then navigate to: Printer diagnostics & adjustments > Sensor tests</p> <p>b Find the sensor (Fuser buckle).</p> <p>Does the sensor status change while toggling the sensor?</p>	Contact the next level of support.	Go to step 6.
<p>Step 6</p> <p>a Make sure that the sensor cable is properly connected.</p> <p>b Check the sensor for damage.</p> <p>Is the sensor free of damage?</p>	Go to step 8.	Go to step 7.
<p>Step 7</p> <p>Replace the sensor. See “Sensors (fuser buckle and narrow media) removal” on page 468.</p> <p>Does the problem remain?</p>	Go to step 8.	The problem is solved.
<p>Step 8</p> <p>Perform a print job.</p> <p>Does the problem remain?</p>	Contact the next level of support.	The problem is solved.

202 paper jams

202 paper jam messages

Error code	Description	Action
202.02	Paper fed from the MPF was detected earlier than expected at the sensor (fuser exit).	See “Sensor (fuser exit): Paper arrived too early service check” on page 109.
202.03	Paper fed from the MPF never arrived at the sensor (fuser exit).	See “Sensor (fuser exit): Paper failed to arrive service check” on page 110.
202.04	Paper fed from the MPF cleared the sensor (fuser exit) earlier than expected.	See “Sensor (fuser exit): Paper cleared too early service check” on page 114.

Error code	Description	Action
202.05	Paper fed from the MPF never cleared the sensor (fuser exit).	See “Sensor (fuser exit): Paper failed to clear service check” on page 112.
202.12	Paper fed from tray 1 was detected earlier than expected at the sensor (fuser exit).	See “Sensor (fuser exit): Paper arrived too early service check” on page 109.
202.13	Paper fed from tray 1 never arrived at the sensor (fuser exit).	See “Sensor (fuser exit): Paper failed to arrive service check” on page 110.
202.14	Paper fed from tray 1 cleared the sensor (fuser exit) earlier than expected.	See “Sensor (fuser exit): Paper cleared too early service check” on page 114.
202.15	Paper fed from tray 1 never cleared the sensor (fuser exit).	See “Sensor (fuser exit): Paper failed to clear service check” on page 112.
202.22	Paper fed from tray 2 was detected earlier than expected at the sensor (fuser exit).	See “Sensor (fuser exit): Paper arrived too early service check” on page 109.
202.23	Paper fed from tray 2 never arrived at the sensor (fuser exit).	See “Sensor (fuser exit): Paper failed to arrive service check” on page 110.
202.24	Paper fed from tray 2 cleared the sensor (fuser exit) earlier than expected.	See “Sensor (fuser exit): Paper cleared too early service check” on page 114.
202.25	Paper fed from tray 2 never cleared the sensor (fuser exit).	See “Sensor (fuser exit): Paper failed to clear service check” on page 112.
202.32	Paper fed from tray 3 was detected earlier than expected at the sensor (fuser exit).	See “Sensor (fuser exit): Paper arrived too early service check” on page 109.
202.33	Paper fed from tray 3 never arrived at the sensor (fuser exit).	See “Sensor (fuser exit): Paper failed to arrive service check” on page 110.
202.34	Paper fed from tray 3 cleared the sensor (fuser exit) earlier than expected.	See “Sensor (fuser exit): Paper cleared too early service check” on page 114.
202.35	Paper fed from tray 3 never cleared the sensor (fuser exit).	See “Sensor (fuser exit): Paper failed to clear service check” on page 112.
202.42	Paper fed from tray 4 was detected earlier than expected at the sensor (fuser exit).	See “Sensor (fuser exit): Paper arrived too early service check” on page 109.
202.43	Paper fed from tray 4 never arrived at the sensor (fuser exit).	See “Sensor (fuser exit): Paper failed to arrive service check” on page 110.
202.44	Paper fed from tray 4 cleared the sensor (fuser exit) earlier than expected.	See “Sensor (fuser exit): Paper cleared too early service check” on page 114.
202.45	Paper fed from tray 4 never cleared the sensor (fuser exit).	See “Sensor (fuser exit): Paper failed to clear service check” on page 112.
202.52	Paper fed from tray 5 was detected earlier than expected at the sensor (fuser exit).	See “Sensor (fuser exit): Paper arrived too early service check” on page 109.
202.53	Paper fed from tray 5 never arrived at the sensor (fuser exit).	See “Sensor (fuser exit): Paper failed to arrive service check” on page 110.
202.54	Paper fed from tray 5 cleared the sensor (fuser exit) earlier than expected.	See “Sensor (fuser exit): Paper cleared too early service check” on page 114.
202.55	Paper fed from tray 5 never cleared the sensor (fuser exit).	See “Sensor (fuser exit): Paper failed to clear service check” on page 112.

Error code	Description	Action
202.91	Paper remains detected at the sensor (fuser exit) after the printer is turned on.	See “Sensor (fuser exit) static jam service check” on page 115.

Sensor (fuser exit): Paper arrived too early service check

Action	Yes	No
<p>Step 1</p> <p>a From the home screen, touch Settings > Device > Preferences.</p> <p>b Check if the paper size matches the size set on the tray guides.</p> <p>Does the paper size match the size set on the tray?</p>	Go to step 3.	Go to step 2.
<p>Step 2</p> <p>Change the paper size or adjust the size setting in the tray.</p> <p>Does the problem remain?</p>	Go to step 3.	The problem is solved.
<p>Step 3</p> <p>Check the paper path just before the fuser for paper jams and fragments.</p> <p>Is the paper path free of fragments and contamination?</p>	Go to step 5.	Go to step 4.
<p>Step 4</p> <p>Remove the paper jams and fragments.</p> <p>Note: The fuser nip may not release if the printer is still powered on. Make sure to close all doors, install the waste toner bottle, and then turn off the printer to release the fuser nip.</p> <p>Does the problem remain?</p>	Go to step 5.	The problem is solved.
<p>Step 5</p> <p>Check the fuser rollers for damage.</p> <p>Are the rollers free of damage?</p>	Go to step 7.	Go to step 6.
<p>Step 6</p> <p>Replace the fuser. See “Fuser removal” on page 436.</p> <p>Does the problem remain?</p>	Go to step 7.	The problem is solved.
<p>Step 7</p> <p>Perform a print job.</p> <p>Does the problem remain?</p>	Contact the next level of support.	The problem is solved.

Sensor (fuser exit): Paper failed to arrive service check

Action	Yes	No
<p>Step 1</p> <p>a From the home screen, touch Settings > Device > Preferences.</p> <p>b Check if the paper size matches the size set on the tray guides.</p> <p>Does the paper size match the size set on the tray?</p>	Go to step 3.	Go to step 2.
<p>Step 2</p> <p>Change the paper size or adjust the size setting in the tray.</p> <p>Does the problem remain?</p>	Go to step 3.	The problem is solved.
<p>Step 3</p> <p>Check the paper path for paper jams and fragments.</p> <p>Is the paper path free of jams and fragments?</p>	Go to step 5.	Go to step 4.
<p>Step 4</p> <p>Remove the jams and fragments.</p> <p>Note: The fuser nip may not release if the printer is still powered on. Make sure to close all doors, install the waste toner bottle, and then turn off the printer to release the fuser nip.</p> <p>Does the problem remain?</p>	Go to step 5.	The problem is solved.
<p>Step 5</p> <p>Check the fuser for obstructions.</p> <p>Is the fuser free from obstructions?</p>	Go to step 7.	Go to step 6.
<p>Step 6</p> <p>Remove the obstructions in the fuser area.</p> <p>Does the problem remain?</p>	Go to step 7.	The problem is solved.
<p>Step 7</p> <p>a Make sure that the fuser life has not ended.</p> <p>b Check the fuser for damage.</p> <p>Is the fuser free of damage?</p>	Go to step 9.	Go to step 8.
<p>Step 8</p> <p>Replace the fuser. See “Fuser removal” on page 436.</p> <p>Does the problem remain?</p>	Go to step 9.	The problem is solved.

Action	Yes	No
<p>Step 9</p> <p>a Enter the Diagnostics menu, and then navigate to: Printer diagnostics & adjustments > Sensor tests</p> <p>b Find the sensor (Fuser exit).</p> <p>Does the sensor status change while toggling the sensor?</p>	Go to step 12.	Go to step 10.
<p>Step 10</p> <p>a Make sure that the fuser is properly seated.</p> <p>b Make sure that the JFSNS1 connector on the engine board is properly connected.</p> <p>c Check the sensor for damage.</p> <p>Is the sensor free of damage?</p>	Go to step 12.	Go to step 11.
<p>Step 11</p> <p>Replace the fuser. See “Fuser removal” on page 436.</p> <p>Does the problem remain?</p>	Go to step 12.	The problem is solved.
<p>Step 12</p> <p>Check the transfer module for damage.</p> <p>Is the transfer module free of damage?</p>	Go to step 14.	Go to step 13.
<p>Step 13</p> <p>Replace the transfer module. See “Transfer module removal” on page 431.</p> <p>Does the problem remain?</p>	Go to step 14.	The problem is solved.
<p>Step 14</p> <p>a Enter the Diagnostics menu, and then navigate to: Printer diagnostics & adjustments > Motor tests > Fuser</p> <p>b Select a setting, and then touch Start.</p> <p>Does the motor run?</p>	Go to step 17.	Go to step 15.
<p>Step 15</p> <p>Make sure that the JFDRV1 connector on the engine board is properly connected.</p> <p>Does the problem remain?</p>	Go to step 16.	The problem is solved.
<p>Step 16</p> <p>a Replace the motor. See “Motor (fuser) removal” on page 413.</p> <p>b Perform a print job.</p> <p>Does the problem remain?</p>	Go to step 17.	The problem is solved.

Action	Yes	No
<p>Step 17</p> <p>a Remove the transfer module. See “Transfer module removal” on page 431.</p> <p>b Close the front door or bypass the door interlock switch.</p> <p>c Enter the Diagnostics menu, and then navigate to: Printer diagnostics & adjustments > Motor tests > K developer/transfer</p> <p>d Touch Start.</p> <p>Does the motor run?</p>	Contact the next level of support.	Go to step 18.
<p>Step 18</p> <p>Make sure that the JKDRV1 connector on the engine board is properly connected.</p> <p>Does the problem remain?</p>	Go to step 19.	The problem is solved.
<p>Step 19</p> <p>a Replace the motor (K/transfer belt). See “Motor (EP drive) removal” on page 382.</p> <p>b Perform a print job.</p> <p>Does the problem remain?</p>	Contact the next level of support.	The problem is solved.

Sensor (fuser exit): Paper failed to clear service check

Action	Yes	No
<p>Step 1</p> <p>a From the home screen, touch Settings > Device > Preferences.</p> <p>b Check if the paper size matches the size set on the tray guides.</p> <p>Does the paper size match the size set on the tray?</p>	Go to step 3.	Go to step 2.
<p>Step 2</p> <p>Change the paper size or adjust the size setting in the tray.</p> <p>Does the problem remain?</p>	Go to step 3.	The problem is solved.
<p>Step 3</p> <p>Check the paper path for paper jams and fragments.</p> <p>Is the paper path free of jams and fragments?</p>	Go to step 5.	Go to step 4.

Action	Yes	No
<p>Step 4 Remove the jams and fragments.</p> <p>Note: The fuser nip may not release if the printer is still powered on. Make sure to close all doors, install the waste toner bottle, and then turn off the printer to release the fuser nip.</p> <p>Does the problem remain?</p>	Go to step 5.	The problem is solved.
<p>Step 5 Check the fuser for obstructions.</p> <p>Is the fuser free from obstructions?</p>	Go to step 7.	Go to step 6.
<p>Step 6 Remove the obstructions in the fuser area.</p> <p>Does the problem remain?</p>	Go to step 7.	The problem is solved.
<p>Step 7 Check the fuser for damage or life expiration, and replace if necessary. See “Fuser removal” on page 436.</p> <p>Does the problem remain?</p>	Go to step 8.	The problem is solved.
<p>Step 8</p> <p>a Enter the Diagnostics menu, and then navigate to: Printer diagnostics & adjustments > Sensor tests</p> <p>b Find the sensor (Fuser exit).</p> <p>Does the sensor status change while toggling the sensor?</p>	Go to step 11.	Go to step 9.
<p>Step 9</p> <p>a Make sure that the fuser is properly seated.</p> <p>b Make sure that the JFSNS1 connector on the engine board is properly connected.</p> <p>c Check the sensor for damage.</p> <p>Is the sensor free of damage?</p>	Go to step 11.	Go to step 10.
<p>Step 10 Replace the fuser. See “Fuser removal” on page 436.</p> <p>Does the problem remain?</p>	Go to step 11.	The problem is solved.
<p>Step 11</p> <p>a Enter the Diagnostics menu, and then navigate to: Printer diagnostics & adjustments > Motor tests > Fuser</p> <p>b Select a setting, and then touch Start.</p> <p>Does the motor run?</p>	Contact the next level of support.	Go to step 12.

Action	Yes	No
<p>Step 12 Make sure that the motor cable is properly connected.</p> <p>Does the problem remain?</p>	Go to step 13.	The problem is solved.
<p>Step 13 a Replace the motor. See “Motor (fuser) removal” on page 413. b Perform a print job.</p> <p>Does the problem remain?</p>	Contact the next level of support.	The problem is solved.

Sensor (fuser exit): Paper cleared too early service check

Action	Yes	No
<p>Step 1 a From the home screen, touch Settings > Device > Preferences. b Check if the paper size matches the size set on the tray guides.</p> <p>Does the paper size match the size set on the tray?</p>	Go to step 3.	Go to step 2.
<p>Step 2 Change the paper size or adjust the size setting in the tray.</p> <p>Does the problem remain?</p>	Go to step 3.	The problem is solved.
<p>Step 3 Check the fuser rollers for damage.</p> <p>Are the rollers free of damage?</p>	Go to step 5.	Go to step 4.
<p>Step 4 Replace the fuser. See “Fuser removal” on page 436.</p> <p>Does the problem remain?</p>	Go to step 5.	The problem is solved.
<p>Step 5 a Enter the Diagnostics menu, and then navigate to: Printer diagnostics & adjustments > Sensor tests b Find the sensor (Fuser exit).</p> <p>Does the sensor status change while toggling the sensor?</p>	Go to step 8.	Go to step 6.
<p>Step 6 Make sure that the sensor cable is properly connected.</p> <p>Does the problem remain?</p>	Go to step 7.	The problem is solved.

Action	Yes	No
<p>Step 7 Replace the fuser. See “Fuser removal” on page 436.</p> <p>Does the problem remain?</p>	Go to step 8.	The problem is solved.
<p>Step 8 Perform a print job.</p> <p>Does the problem remain?</p>	Contact the next level of support.	The problem is solved.

Sensor (fuser exit) static jam service check

Action	Yes	No
<p>Step 1 a From the home screen, touch Settings > Device > Preferences. b Check if the paper size matches the size set on the tray guides.</p> <p>Does the paper size match the size set on the tray?</p>	Go to step 3.	Go to step 2.
<p>Step 2 Change the paper size or adjust the size setting in the tray.</p> <p>Does the problem remain?</p>	Go to step 3.	The problem is solved.
<p>Step 3 Check the paper path for partially fed or jammed paper.</p> <p>Is the paper path free of partially fed or jammed paper?</p>	Go to step 5.	Go to step 4.
<p>Step 4 Remove the partially fed or jammed paper.</p> <p>Note: The fuser nip may not release if the printer is still powered on. Make sure to close all doors, install the waste toner bottle, and then turn off the printer to release the fuser nip.</p> <p>Does the problem remain?</p>	Go to step 5.	The problem is solved.
<p>Step 5 a Enter the Diagnostics menu, and then navigate to: Printer diagnostics & adjustments > Sensor tests b Find the sensor (Fuser exit).</p> <p>Does the sensor status change while toggling the sensor?</p>	Contact the next level of support.	Go to step 6.

Action	Yes	No
<p>Step 6</p> <p>a Make sure that the fuser is properly seated.</p> <p>b Make sure that the JFSNS1 connector on the engine board is properly connected.</p> <p>c Check the sensor for damage.</p> <p>Is the sensor free of damage?</p>	Go to step 7.	The problem is solved.
<p>Step 7</p> <p>Replace the fuser. See “Fuser removal” on page 436.</p> <p>Does the problem remain?</p>	Contact the next level of support.	The problem is solved.

221 paper jams

221 paper jam messages

Error code	Description	Action
221.03	Paper fed from the MPF never arrived at the sensor (redrive).	See “Sensor (redrive): Paper failed to arrive service check” on page 117 .
221.04	Paper fed from the MPF cleared the sensor (redrive) earlier than expected.	See “Sensor (redrive): Paper cleared too early service check” on page 120 .
221.05	Paper fed from the MPF never cleared the sensor (redrive).	See “Sensor (redrive): Paper failed to clear service check” on page 119 .
221.13	Paper fed from tray 1 never arrived at the sensor (redrive).	See “Sensor (redrive): Paper failed to arrive service check” on page 117 .
221.14	Paper fed from tray 1 cleared the sensor (redrive) earlier than expected.	See “Sensor (redrive): Paper cleared too early service check” on page 120 .
221.15	Paper fed from tray 1 never cleared the sensor (redrive).	See “Sensor (redrive): Paper failed to clear service check” on page 119 .
221.23	Paper fed from tray 2 never arrived at the sensor (redrive).	See “Sensor (redrive): Paper failed to arrive service check” on page 117 .
221.24	Paper fed from tray 2 cleared the sensor (redrive) earlier than expected.	See “Sensor (redrive): Paper cleared too early service check” on page 120 .
221.25	Paper fed from tray 2 never cleared the sensor (redrive).	See “Sensor (redrive): Paper failed to clear service check” on page 119 .
221.33	Paper fed from tray 3 never arrived at the sensor (redrive).	See “Sensor (redrive): Paper failed to arrive service check” on page 117 .
221.34	Paper fed from tray 3 cleared the sensor (redrive) earlier than expected.	See “Sensor (redrive): Paper cleared too early service check” on page 120 .
221.35	Paper fed from tray 3 never cleared the sensor (redrive).	See “Sensor (redrive): Paper failed to clear service check” on page 119 .

Error code	Description	Action
221.43	Paper fed from tray 4 never arrived at the sensor (redrive).	See “Sensor (redrive): Paper failed to arrive service check” on page 117.
221.44	Paper fed from tray 4 cleared the sensor (redrive) earlier than expected.	See “Sensor (redrive): Paper cleared too early service check” on page 120.
221.45	Paper fed from tray 4 never cleared the sensor (redrive).	See “Sensor (redrive): Paper failed to clear service check” on page 119.
221.53	Paper fed from tray 5 never arrived at the sensor (redrive).	See “Sensor (redrive): Paper failed to arrive service check” on page 117.
221.54	Paper fed from tray 5 cleared the sensor (redrive) earlier than expected.	See “Sensor (redrive): Paper cleared too early service check” on page 120.
221.55	Paper fed from tray 5 never cleared the sensor (redrive).	See “Sensor (redrive): Paper failed to clear service check” on page 119.
221.94	Paper cleared the sensor (redrive) earlier than expected. Paper source is undetermined.	See “Sensor (redrive): Paper cleared too early service check” on page 120.

Sensor (redrive): Paper failed to arrive service check

Action	Yes	No
<p>Step 1</p> <p>Check the fuser and exit paper path for paper jams and obstructions.</p> <p>Is the paper path free of jams and obstructions?</p>	Go to step 3.	Go to step 2.
<p>Step 2</p> <p>Remove the jams and obstructions.</p> <p>Does the problem remain?</p>	Go to step 3.	The problem is solved.
<p>Step 3</p> <p>Check the duplex paper path for paper jams and obstructions.</p> <p>Is the paper path free of jams and obstructions?</p>	Go to step 5.	Go to step 4.
<p>Step 4</p> <p>Remove the jams and obstructions.</p> <p>Does the problem remain?</p>	Go to step 5.	The problem is solved.
<p>Step 5</p> <p>Inspect the ribs on the top frame base cover for wear, nicks, or other damage that could obstruct the paper path.</p> <p>Is there any damage?</p>	Go to step 6.	Go to step 9.

Action	Yes	No
<p>Step 6 Replace the top frame base cover. See “Top frame base cover removal” on page 483.</p> <p>Does the problem remain?</p>	Go to step 7.	The problem is solved.
<p>Step 7 a Enter the Diagnostics menu, and then navigate to: Printer diagnostics & adjustments > Sensor tests b Find the sensor (Redrive/Duplex Path 1).</p> <p>Does the sensor status change while toggling the sensor?</p>	Go to step 9.	Go to step 8.
<p>Step 8 Replace the sensor. See “Sensor (redrive) removal” on page 439.</p> <p>Does the problem remain?</p>	Go to step 9.	The problem is solved.
<p>Step 9 a Enter the Diagnostics menu, and then navigate to: Printer diagnostics & adjustments > Motor tests > Fuser b Select a setting, and then touch Start.</p> <p>Does the motor run?</p>	Contact the next level of support.	Go to step 10.
<p>Step 10 Make sure that the JFDRV1 connector on the engine board is properly connected.</p> <p>Does the problem remain?</p>	Go to step 11.	The problem is solved.
<p>Step 11 a Replace the motor. See “Motor (fuser) removal” on page 413. b Perform a print job.</p> <p>Does the problem remain?</p>	Contact the next level of support.	The problem is solved.

Sensor (redrive): Paper failed to clear service check

Action	Yes	No
<p>Step 1 Check the fuser and exit paper path for paper jams and obstructions.</p> <p>Is the paper path free of jams and obstructions?</p>	Go to step 3.	Go to step 2.
<p>Step 2 Remove the jams and obstructions.</p> <p>Does the problem remain?</p>	Go to step 3.	The problem is solved.
<p>Step 3 a Enter the Diagnostics menu, and then navigate to: Printer diagnostics & adjustments > Sensor tests b Find the sensor (Redrive/Duplex path 1).</p> <p>Does the sensor status change while toggling the sensor?</p>	Go to step 6.	Go to step 4.
<p>Step 4 a Make sure that the sensor cable is properly connected. b Check the sensor for damage.</p> <p>Is the sensor free of damage?</p>	Go to step 6.	Go to step 5.
<p>Step 5 Replace the sensor. See “Sensor (redrive) removal” on page 439.</p> <p>Does the problem remain?</p>	Go to step 6.	The problem is solved.
<p>Step 6 a Enter the Diagnostics menu, and then navigate to: Printer diagnostics & adjustments > Motor tests > Redrive b Select a setting, and then touch Start.</p> <p>Does the motor run?</p>	Contact the next level of support.	Go to step 7.
<p>Step 7 a Make sure that the motor cable is properly connected. b Check the motor for damage.</p> <p>Is the motor free of damage?</p>	Contact the next level of support.	Go to step 8.

Action	Yes	No
<p>Step 8</p> <p>a Replace the motor. See “Motor (exit/redrive) removal” on page 390.</p> <p>b Perform a print job.</p> <p>Does the problem remain?</p>	Contact the next level of support.	The problem is solved.

Sensor (redrive): Paper cleared too early service check

Action	Yes	No
<p>Step 1</p> <p>Check the fuser and exit paper path for paper jams and obstructions.</p> <p>Is the paper path free of jams and obstructions?</p>	Go to step 3.	Go to step 2.
<p>Step 2</p> <p>Remove the jams and obstructions.</p> <p>Does the problem remain?</p>	Go to step 3.	The problem is solved.
<p>Step 3</p> <p>Check the duplex paper path for paper jams and obstructions.</p> <p>Is the paper path free of jams and obstructions?</p>	Go to step 5.	Go to step 4.
<p>Step 4</p> <p>Remove the jams and obstructions.</p> <p>Does the problem remain?</p>	Go to step 5.	The problem is solved.
<p>Step 5</p> <p>a Enter the Diagnostics menu, and then navigate to: Printer diagnostics & adjustments > Sensor tests</p> <p>b Find the sensor (Redrive/Duplex Path 1).</p> <p>Does the sensor status change while toggling the sensor?</p>	Go to step 7.	Go to step 6.
<p>Step 6</p> <p>Replace the sensor. See “Sensor (redrive) removal” on page 439.</p> <p>Does the problem remain?</p>	Go to step 7.	The problem is solved.

Action	Yes	No
<p>Step 7</p> <p>a Enter the Diagnostics menu, and then navigate to: Printer diagnostics & adjustments > Motor tests > Redrive</p> <p>b Select a setting, and then touch Start.</p> <p>Does the motor run?</p>	Go to step 10.	Go to step 8.
<p>Step 8</p> <p>Make sure that the JOUTDC1 connector on the engine board is properly connected.</p> <p>Does the problem remain?</p>	Go to step 9.	The problem is solved.
<p>Step 9</p> <p>Replace the motor (exit/redrive). See “Motor (exit/redrive) removal” on page 390.</p> <p>Does the problem remain?</p>	Contact the next level of support.	The problem is solved.

230 paper jams

230 paper jam messages

Error code	Description	Action
230.03	Paper fed from the MPF never arrived at the sensor (redrive).	See “Sensor (redrive): Paper (duplex job) failed to arrive service check” on page 122 .
230.05	Paper fed from the MPF never cleared the sensor (redrive).	See “Sensor (redrive): Paper (duplex job) failed to clear service check” on page 124 .
230.13	Paper fed from tray 1 never arrived at the sensor (redrive).	See “Sensor (redrive): Paper (duplex job) failed to arrive service check” on page 122 .
230.15	Paper fed from tray 1 never cleared the sensor (redrive).	See “Sensor (redrive): Paper (duplex job) failed to clear service check” on page 124 .
230.23	Paper fed from tray 2 never arrived at the sensor (redrive).	See “Sensor (redrive): Paper (duplex job) failed to arrive service check” on page 122 .
230.25	Paper fed from tray 2 never cleared the sensor (redrive).	See “Sensor (redrive): Paper (duplex job) failed to clear service check” on page 124 .
230.33	Paper fed from tray 3 never arrived at the sensor (redrive).	See “Sensor (redrive): Paper (duplex job) failed to arrive service check” on page 122 .
230.35	Paper fed from tray 3 never cleared the sensor (redrive).	See “Sensor (redrive): Paper (duplex job) failed to clear service check” on page 124 .
230.43	Paper fed from tray 4 never arrived at the sensor (redrive).	See “Sensor (redrive): Paper (duplex job) failed to arrive service check” on page 122 .
230.45	Paper fed from tray 4 never cleared the sensor (redrive).	See “Sensor (redrive): Paper (duplex job) failed to clear service check” on page 124 .

Error code	Description	Action
230.53	Paper fed from tray 5 never arrived at the sensor (redrive).	See “Sensor (redrive): Paper (duplex job) failed to arrive service check” on page 122.
230.55	Paper fed from tray 5 never cleared the sensor (redrive).	See “Sensor (redrive): Paper (duplex job) failed to clear service check” on page 124.
230.91	Paper remains detected at the sensor (duplex path 1) after the printer is turned on.	See “Sensor (redrive) static jam service check” on page 125.

Sensor (redrive): Paper (duplex job) failed to arrive service check

Action	Yes	No
<p>Step 1</p> <p>a From the home screen, touch Settings > Device > Preferences.</p> <p>b Check if the paper size matches the size set on the tray guides.</p> <p>Does the paper size match the size set on the tray?</p>	Go to step 3.	Go to step 2.
<p>Step 2</p> <p>Change the paper size or adjust the size setting in the tray.</p> <p>Does the problem remain?</p>	Go to step 3.	The problem is solved.
<p>Step 3</p> <p>Check the redrive paper path for paper jams and obstructions.</p> <p>Is the paper path free of jams and obstructions?</p>	Go to step 5.	Go to step 4.
<p>Step 4</p> <p>Remove the jams and obstructions.</p> <p>Does the problem remain?</p>	Go to step 5.	The problem is solved.
<p>Step 5</p> <p>Check the duplex paper path for paper jams and obstructions.</p> <p>Is the paper path free of jams and obstructions?</p>	Go to step 7.	Go to step 6.
<p>Step 6</p> <p>Remove the jams and obstructions.</p> <p>Does the problem remain?</p>	Go to step 7.	The problem is solved.
<p>Step 7</p> <p>Inspect the ribs on the top frame base cover for wear, nicks, or other damage that could obstruct the paper path.</p> <p>Is there any damage?</p>	Go to step 8.	Go to step 9.

Action	Yes	No
<p>Step 8 Replace the top frame base cover. See “Top frame base cover removal” on page 483.</p> <p>Does the problem remain?</p>	Go to step 9.	The problem is solved.
<p>Step 9 Check the diverter for smooth movement.</p> <p>Does the diverter freely move without interference?</p>	Go to step 11.	Go to step 10.
<p>Step 10 Replace the diverter. See “Diverter removal” on page 439.</p> <p>Does the problem remain?</p>	Go to step 11.	The problem is solved.
<p>Step 11</p> <p>a Enter the Diagnostics menu, and then navigate to: Printer diagnostics & adjustments > Sensor tests</p> <p>b Find the sensor (Redrive/Duplex Path 1).</p> <p>Does the sensor status change while toggling the sensor?</p>	Go to step 13.	Go to step 12.
<p>Step 12 Replace the sensor. See “Sensor (redrive) removal” on page 439.</p> <p>Does the problem remain?</p>	Go to step 13.	The problem is solved.
<p>Step 13</p> <p>a Enter the Diagnostics menu, and then navigate to: Printer diagnostics & adjustments > Motor tests > Redrive</p> <p>b Select a setting, and then touch Start.</p> <p>Does the motor run?</p>	Go to step 15.	Go to step 14.
<p>Step 14 Make sure that the JOUTDC1 connector on the engine board is properly connected.</p> <p>Does the problem remain?</p>	Go to step 15.	The problem is solved.
<p>Step 15 Replace the motor (exit/redrive). See “Motor (exit/redrive) removal” on page 390.</p> <p>Does the problem remain?</p>	Contact the next level of support.	The problem is solved.

Sensor (redrive): Paper (duplex job) failed to clear service check

Action	Yes	No
<p>Step 1</p> <p>a From the home screen, touch Settings > Device > Preferences.</p> <p>b Check if the paper size matches the size set on the tray guides.</p> <p>Does the paper size match the size set on the tray?</p>	Go to step 3.	Go to step 2.
<p>Step 2</p> <p>Change the paper size or adjust the size setting in the tray.</p> <p>Does the problem remain?</p>	Go to step 3.	The problem is solved.
<p>Step 3</p> <p>Check if the paper size matches the size set on the tray guides.</p> <p>Does the paper size match the size set on the tray?</p>	Go to step 5.	Go to step 4.
<p>Step 4</p> <p>Change the paper size or adjust the size setting in the tray.</p> <p>Does the problem remain?</p>	Go to step 5.	The problem is solved.
<p>Step 5</p> <p>Check the paper path for paper jams and obstructions.</p> <p>Is the paper path free of jams and obstructions?</p>	Go to step 7.	Go to step 6.
<p>Step 6</p> <p>Remove the jams and obstructions.</p> <p>Does the problem remain?</p>	Go to step 7.	The problem is solved.
<p>Step 7</p> <p>a Enter the Diagnostics menu, and then navigate to: Printer diagnostics & adjustments > Sensor tests</p> <p>b Find the sensor (Redrive/Duplex path 1).</p> <p>Does the sensor status change while toggling the sensor?</p>	Go to step 10.	Go to step 8.
<p>Step 8</p> <p>a Make sure that the sensor cable is properly connected.</p> <p>b Check the sensor for damage.</p> <p>Is the sensor free of damage?</p>	Go to step 10.	Go to step 9.
<p>Step 9</p> <p>Replace the sensor. See “Sensor (redrive) removal” on page 439.</p> <p>Does the problem remain?</p>	Go to step 10.	The problem is solved.

Action	Yes	No
<p>Step 10</p> <p>a Enter the Diagnostics menu, and then navigate to: Printer diagnostics & adjustments > Motor tests > Duplex/MPF</p> <p>b Select a setting, and then touch Start.</p> <p>Does the motor run?</p>	Contact the next level of support.	Go to step 11.
<p>Step 11</p> <p>a Make sure that the motor cable is properly connected.</p> <p>b Check the motor for damage.</p> <p>Is the motor free of damage?</p>	Contact the next level of support.	Go to step 12.
<p>Step 12</p> <p>a Replace the motor. See “Motor (duplex/MPF) removal” on page 415.</p> <p>b Perform a print job.</p> <p>Does the problem remain?</p>	Contact the next level of support.	The problem is solved.

Sensor (redrive) static jam service check

Action	Yes	No
<p>Step 1</p> <p>a From the home screen, touch Settings > Device > Preferences.</p> <p>b Check if the paper size matches the size set on the tray guides.</p> <p>Does the paper size match the size set on the tray?</p>	Go to step 3.	Go to step 2.
<p>Step 2</p> <p>Change the paper size or adjust the size setting in the tray.</p> <p>Does the problem remain?</p>	Go to step 3.	The problem is solved.
<p>Step 3</p> <p>Check the paper path for partially fed or jammed paper.</p> <p>Is the paper path free of partially fed or jammed paper?</p>	Go to step 5.	Go to step 4.
<p>Step 4</p> <p>Remove the partially fed or jammed paper.</p> <p>Does the problem remain?</p>	Go to step 5.	The problem is solved.

Action	Yes	No
<p>Step 5</p> <p>a Enter the Diagnostics menu, and then navigate to: Printer diagnostics & adjustments > Sensor tests</p> <p>b Find the sensor (Redrive/Duplex path 1).</p> <p>Does the sensor status change while toggling the sensor?</p>	Contact the next level of support.	Go to step 6.
<p>Step 6</p> <p>a Make sure that the JDSNS1 connector on the engine board is properly connected.</p> <p>b Check the sensor for damage.</p> <p>Is the sensor free of damage?</p>	Go to step 7.	The problem is solved.
<p>Step 7</p> <p>Replace the sensor. See “Sensor (redrive) removal” on page 439.</p> <p>Does the problem remain?</p>	Contact the next level of support.	The problem is solved.

231 paper jams

231 paper jam messages

Error code	Description	Action
231.03	Paper fed from the MPF never arrived at the sensor (duplex staging).	See “Sensor (duplex staging): Paper failed to arrive service check” on page 128 .
231.05	Paper fed from tray 1 never cleared the sensor (duplex staging).	See “Sensor (duplex staging): Paper failed to clear service check” on page 130 .
231.13	Paper fed from tray 1 never arrived at the sensor (duplex staging).	See “Sensor (duplex staging): Paper failed to arrive service check” on page 128 .
231.14	Paper fed from tray 1 cleared the sensor (duplex staging) earlier than expected.	See “Sensor (duplex staging): Paper (duplex job) cleared too early service check” on page 131 .
231.15	Paper fed from tray 1 never cleared the sensor (duplex staging).	See “Sensor (duplex staging): Paper failed to clear service check” on page 130 .
231.23	Paper fed from tray 2 never arrived at the sensor (duplex staging).	See “Sensor (duplex staging): Paper failed to arrive service check” on page 128 .
231.24	Paper fed from tray 2 cleared the sensor (duplex staging) earlier than expected.	See “Sensor (duplex staging): Paper (duplex job) cleared too early service check” on page 131 .
231.25	Paper fed from tray 2 never cleared the sensor (duplex staging).	See “Sensor (duplex staging): Paper failed to clear service check” on page 130 .
231.32	Paper fed from tray 3 was detected earlier than expected at the sensor (duplex staging).	See “Sensor (duplex staging): Paper arrived too early service check” on page 127 .

Error code	Description	Action
231.33	Paper fed from tray 3 never arrived at the sensor (duplex staging).	See “Sensor (duplex staging): Paper failed to arrive service check” on page 128.
231.34	Paper fed from tray 3 cleared the sensor (duplex staging) earlier than expected.	See “Sensor (duplex staging): Paper (duplex job) cleared too early service check” on page 131.
231.35	Paper fed from tray 3 never cleared the sensor (duplex staging).	See “Sensor (duplex staging): Paper failed to clear service check” on page 130.
231.42	Paper fed from tray 4 was detected earlier than expected at the sensor (duplex staging).	See “Sensor (duplex staging): Paper arrived too early service check” on page 127.
231.43	Paper fed from tray 4 never arrived at the sensor (duplex staging).	See “Sensor (duplex staging): Paper failed to arrive service check” on page 128.
231.44	Paper fed from tray 4 cleared the sensor (duplex staging) earlier than expected.	See “Sensor (duplex staging): Paper (duplex job) cleared too early service check” on page 131.
231.45	Paper fed from tray 4 never cleared the sensor (duplex staging).	See “Sensor (duplex staging): Paper failed to clear service check” on page 130.
231.52	Paper fed from tray 5 was detected earlier than expected at the sensor (duplex staging).	See “Sensor (duplex staging): Paper arrived too early service check” on page 127.
231.53	Paper fed from tray 5 never arrived at the sensor (duplex staging).	See “Sensor (duplex staging): Paper failed to arrive service check” on page 128.
231.54	Paper fed from tray 5 cleared the sensor (duplex staging) earlier than expected.	See “Sensor (duplex staging): Paper (duplex job) cleared too early service check” on page 131.
231.55	Paper fed from tray 5 never cleared the sensor (duplex staging).	See “Sensor (duplex staging): Paper failed to clear service check” on page 130.
231.91	Paper remains detected at the sensor (duplex staging) after the printer is turned on.	See “Sensor (duplex staging) static jam service check” on page 132.

Sensor (duplex staging): Paper arrived too early service check

Action	Yes	No
<p>Step 1</p> <p>a From the home screen, touch Settings > Device > Preferences.</p> <p>b Check if the paper size matches the size set on the tray guides.</p> <p>Does the paper size match the size set on the tray?</p>	Go to step 3.	Go to step 2.
<p>Step 2</p> <p>Change the paper size or adjust the size settings in the tray.</p> <p>Does the problem remain?</p>	Go to step 3.	The problem is solved.

Action	Yes	No
<p>Step 3</p> <p>a From the home screen, touch Settings > Device > Preferences.</p> <p>b Check if the paper settings matches the paper in the tray guides.</p> <p>Do the paper settings match the paper in the tray?</p>	Go to step 5.	Go to step 4.
<p>Step 4</p> <p>Change the paper size and type, or adjust the size settings in the tray to match the paper size.</p> <p>Does the problem remain?</p>	Go to step 5.	The problem is solved.
<p>Step 5</p> <p>Check the duplex paper path for paper jams and obstructions.</p> <p>Is the paper path free of jams and obstructions?</p>	Go to step 6.	Go to step 6.
<p>Step 6</p> <p>Remove the jams and obstructions.</p> <p>Does the problem remain?</p>	Contact the next level of support.	The problem is solved.

Sensor (duplex staging): Paper failed to arrive service check

Action	Yes	No
<p>Step 1</p> <p>a From the home screen, touch Settings > Device > Preferences.</p> <p>b Check if the paper size matches the size set on the tray guides.</p> <p>Does the paper size match the size set on the tray?</p>	Go to step 3.	Go to step 2.
<p>Step 2</p> <p>Change the paper size or adjust the size setting in the tray.</p> <p>Does the problem remain?</p>	Go to step 3.	The problem is solved.
<p>Step 3</p> <p>Check the duplex paper path for paper jams and obstructions.</p> <p>Is the paper path free of jams and obstructions?</p>	Go to step 5.	Go to step 4.
<p>Step 4</p> <p>Remove the jams and obstructions.</p> <p>Does the problem remain?</p>	Go to step 5.	The problem is solved.

Action	Yes	No
<p>Step 5</p> <p>a Enter the Diagnostics menu, and then navigate to: Printer diagnostics & adjustments > Sensor tests</p> <p>b Find the sensor (Duplex path 2).</p> <p>Does the sensor status change while toggling the sensor?</p>	Go to step 8.	Go to step 6.
<p>Step 6</p> <p>a Make sure that the sensor cable is properly connected.</p> <p>b Check the sensor for damage.</p> <p>Is the sensor free of damage?</p>	Go to step 8.	Go to step 7.
<p>Step 7</p> <p>Replace the sensor (duplex staging).</p> <p>Does the problem remain?</p>	Go to step 8.	The problem is solved.
<p>Step 8</p> <p>a Enter the Diagnostics menu, and then navigate to: Printer diagnostics & adjustments > Motor tests > Duplex/MPF</p> <p>b Select a setting, and then touch Start.</p> <p>Does the motor run?</p>	Go to step 11.	Go to step 9.
<p>Step 9</p> <p>a Make sure that the motor cable is properly connected.</p> <p>b Check the motor for damage.</p> <p>Is the motor free of damage?</p>	Go to step 11.	Go to step 10.
<p>Step 10</p> <p>a Replace the motor. See “Motor (duplex/MPF) removal” on page 415.</p> <p>b Perform a print job.</p> <p>Does the problem remain?</p>	Go to step 11.	The problem is solved.
<p>Step 11</p> <p>Check the duplex inner guide and its gears, belts, and rollers for damage.</p> <p>Are the duplex inner guide and its components free of damage?</p>	Contact the next level of support.	The problem is solved.

Action	Yes	No
<p>Step 12</p> <p>a Replace the duplex inner guide. See “Duplex inner guide removal” on page 466.</p> <p>b Perform a print job.</p> <p>Does the problem remain?</p>	Contact the next level of support.	The problem is solved.

Sensor (duplex staging): Paper failed to clear service check

Action	Yes	No
<p>Step 1</p> <p>a From the home screen, touch Settings > Device > Preferences.</p> <p>b Check if the paper size matches the size set on the tray guides.</p> <p>Does the paper size match the size set on the tray?</p>	Go to step 3.	Go to step 2.
<p>Step 2</p> <p>Change the paper size or adjust the size setting in the tray.</p> <p>Does the problem remain?</p>	Go to step 3.	The problem is solved.
<p>Step 3</p> <p>Check if the paper size matches the size set on the tray guides.</p> <p>Does the paper size match the size set on the tray?</p>	Go to step 5.	Go to step 4.
<p>Step 4</p> <p>Change the paper size or adjust the size setting in the tray.</p> <p>Does the problem remain?</p>	Go to step 5.	The problem is solved.
<p>Step 5</p> <p>Check the paper path for paper jams and obstructions.</p> <p>Is the paper path free of jams and obstructions?</p>	Go to step 7.	Go to step 6.
<p>Step 6</p> <p>Remove the jams and obstructions.</p> <p>Does the problem remain?</p>	Go to step 7.	The problem is solved.
<p>Step 7</p> <p>a Enter the Diagnostics menu, and then navigate to: Printer diagnostics & adjustments > Sensor tests</p> <p>b Find the sensor (Duplex path 2).</p> <p>Does the sensor status change while toggling the sensor?</p>	Go to step 10.	Go to step 8.

Action	Yes	No
<p>Step 8</p> <p>a Make sure that the sensor cable is properly connected.</p> <p>b Check the sensor for damage.</p> <p>Is the sensor free of damage?</p>	Go to step 10.	Go to step 9.
<p>Step 9</p> <p>Replace the sensor (duplex staging).</p> <p>Does the problem remain?</p>	Go to step 10.	The problem is solved.
<p>Step 10</p> <p>a Enter the Diagnostics menu, and then navigate to: Printer diagnostics & adjustments > Motor tests > Isolation</p> <p>b Touch Start.</p> <p>Does the motor run?</p>	Contact the next level of support.	Go to step 11.
<p>Step 11</p> <p>a Make sure that the motor cable is properly connected.</p> <p>b Check the motor and isolation unit for damage.</p> <p>Are the motor and isolation unit free of damage?</p>	Contact the next level of support.	Go to step 12.
<p>Step 12</p> <p>a Replace the isolation unit. See “Isolation unit removal” on page 509.</p> <p>b Perform a print job.</p> <p>Does the problem remain?</p>	Contact the next level of support.	The problem is solved.

Sensor (duplex staging): Paper (duplex job) cleared too early service check

Action	Yes	No
<p>Step 1</p> <p>a From the home screen, touch Settings > Device > Preferences.</p> <p>b Check if the paper size matches the size set on the tray guides.</p> <p>Does the paper size match the size set on the tray?</p>	Go to step 3.	Go to step 2.
<p>Step 2</p> <p>Change the paper size or adjust the size setting in the tray.</p> <p>Does the problem remain?</p>	Go to step 3.	The problem is solved.

Action	Yes	No
<p>Step 3 Check the duplex inner guide and its gears, belts, and rollers for damage.</p> <p>Are the duplex inner guide and its components free of damage?</p>	Go to step 5.	Go to step 4.
<p>Step 4 a Replace the duplex inner guide. See “Duplex inner guide removal” on page 466. b Perform a print job.</p> <p>Does the problem remain?</p>	Go to step 5.	The problem is solved.
<p>Step 5 a Enter the Diagnostics menu, and then navigate to: Printer diagnostics & adjustments > Sensor tests b Find the sensor (Duplex path 2).</p> <p>Does the sensor status change while toggling the sensor?</p>	Go to step 8.	Go to step 6.
<p>Step 6 a Make sure that the sensor cable is properly connected. b Check the sensor for damage.</p> <p>Is the sensor free of damage?</p>	Go to step 8.	Go to step 7.
<p>Step 7 Replace the sensor (duplex staging).</p> <p>Does the problem remain?</p>	Go to step 8.	The problem is solved.
<p>Step 8 Perform a print job.</p> <p>Does the problem remain?</p>	Contact the next level of support.	The problem is solved.

Sensor (duplex staging) static jam service check

Action	Yes	No
<p>Step 1 a From the home screen, touch Settings > Device > Preferences. b Check if the paper size matches the size set on the tray guides.</p> <p>Does the paper size match the size set on the tray?</p>	Go to step 3.	Go to step 2.
<p>Step 2 Change the paper size or adjust the size setting in the tray.</p> <p>Does the problem remain?</p>	Go to step 3.	The problem is solved.

Action	Yes	No
<p>Step 3</p> <p>Check the paper path for partially fed or jammed paper.</p> <p>Is the paper path free of partially fed or jammed paper?</p>	Go to step 5.	Go to step 4.
<p>Step 4</p> <p>Remove the partially fed or jammed paper.</p> <p>Does the problem remain?</p>	Go to step 5.	The problem is solved.
<p>Step 5</p> <p>a Enter the Diagnostics menu, and then navigate to: Printer diagnostics & adjustments > Sensor tests</p> <p>b Find the sensor (Duplex path 2).</p> <p>Does the sensor status change while toggling the sensor?</p>	Contact the next level of support.	Go to step 6.
<p>Step 6</p> <p>a Make sure that the sensor cable is properly connected.</p> <p>b Check the sensor for damage.</p> <p>Is the sensor free of damage?</p>	Contact the next level of support.	Go to step 7.
<p>Step 7</p> <p>a Replace the sensor (duplex staging).</p> <p>b Perform a print job.</p> <p>Does the problem remain?</p>	Contact the next level of support.	The problem is solved.

232 paper jams

232 paper jam messages

Error code	Description	Action
232.03	During a duplex print job, paper fed from the MPF never arrived at the sensor (MPF/pass-through).	See “Sensor (MPF/pass-through): Paper (duplex job) failed to arrive service check” on page 135.
232.04	During a duplex print job, paper fed from the MPF cleared the sensor (MPF/pass-through) earlier than expected.	See “Sensor (MPF/pass-through): Paper (duplex job) cleared too early service check” on page 138.
232.05	During a duplex print job, paper fed from the MPF never cleared the sensor (MPF/pass-through).	See “Sensor (MPF/pass-through): Paper (duplex job) failed to clear service check” on page 137.
232.13	During a duplex print job, paper fed from tray 1 never arrived at the sensor (MPF/pass-through).	See “Sensor (MPF/pass-through): Paper (duplex job) failed to arrive service check” on page 135.

Error code	Description	Action
232.14	During a duplex print job, paper fed from tray 1 cleared the sensor (MPF/pass-through) earlier than expected.	See “Sensor (MPF/pass-through): Paper (duplex job) cleared too early service check” on page 138.
232.15	During a duplex print job, paper fed from tray 1 never cleared the sensor (MPF/pass-through).	See “Sensor (MPF/pass-through): Paper (duplex job) failed to clear service check” on page 137.
232.23	During a duplex print job, paper fed from tray 2 never arrived at the sensor (MPF/pass-through).	See “Sensor (MPF/pass-through): Paper (duplex job) failed to arrive service check” on page 135.
232.24	During a duplex print job, paper fed from tray 2 cleared the sensor (MPF/pass-through) earlier than expected.	See “Sensor (MPF/pass-through): Paper (duplex job) cleared too early service check” on page 138.
232.25	During a duplex print job, paper fed from tray 2 never cleared the sensor (MPF/pass-through).	See “Sensor (MPF/pass-through): Paper (duplex job) failed to clear service check” on page 137.
232.33	During a duplex print job, paper fed from tray 3 never arrived at the sensor (MPF/pass-through).	See “Sensor (MPF/pass-through): Paper (duplex job) failed to arrive service check” on page 135.
232.34	During a duplex print job, paper fed from tray 3 cleared the sensor (MPF/pass-through) earlier than expected.	See “Sensor (MPF/pass-through): Paper (duplex job) cleared too early service check” on page 138.
232.35	During a duplex print job, paper fed from tray 3 never cleared the sensor (MPF/pass-through).	See “Sensor (MPF/pass-through): Paper (duplex job) failed to clear service check” on page 137.
232.43	During a duplex print job, paper fed from tray 4 never arrived at the sensor (MPF/pass-through).	See “Sensor (MPF/pass-through): Paper (duplex job) failed to arrive service check” on page 135.
232.44	During a duplex print job, paper fed from tray 4 cleared the sensor (MPF/pass-through) earlier than expected.	See “Sensor (MPF/pass-through): Paper (duplex job) cleared too early service check” on page 138.
232.45	During a duplex print job, paper fed from tray 4 never cleared the sensor (MPF/pass-through).	See “Sensor (MPF/pass-through): Paper (duplex job) failed to clear service check” on page 137.
232.53	During a duplex print job, paper fed from tray 5 never arrived at the sensor (MPF/pass-through).	See “Sensor (MPF/pass-through): Paper (duplex job) failed to arrive service check” on page 135.
232.54	During a duplex print job, paper fed from tray 5 cleared the sensor (MPF/pass-through) earlier than expected.	See “Sensor (MPF/pass-through): Paper (duplex job) cleared too early service check” on page 138.
232.55	During a duplex print job, paper fed from tray 5 never cleared the sensor (MPF/pass-through).	See “Sensor (MPF/pass-through): Paper (duplex job) failed to clear service check” on page 137.
232.93	During a duplex print job, paper never arrived at the sensor (MPF/pass-through). Paper source is undetermined.	See “Sensor (MPF/pass-through): Paper (duplex job) failed to arrive service check” on page 135.

Error code	Description	Action
232.94	During a duplex print job, paper cleared the sensor (MPF/pass-through) earlier than expected. Paper source is undetermined.	See “Sensor (MPF/pass-through): Paper (duplex job) cleared too early service check” on page 138.
232.95	During a duplex print job, paper never cleared the sensor (MPF/pass-through). Paper source is undetermined.	See “Sensor (MPF/pass-through): Paper (duplex job) failed to clear service check” on page 137.

Sensor (MPF/pass-through): Paper (duplex job) failed to arrive service check

Action	Yes	No
<p>Step 1</p> <p>Check the duplex paper path for paper jams and obstructions.</p> <p>Is the paper path free of jams and obstructions?</p>	Go to step 3.	Go to step 2.
<p>Step 2</p> <p>Remove the jams and obstructions.</p> <p>Does the problem remain?</p>	Go to step 3.	The problem is solved.
<p>Step 3</p> <p>Check the sensor (MPF/pass-through) area for paper jams and obstructions.</p> <p>Is the paper path free of jams and obstructions?</p>	Go to step 5.	Go to step 4.
<p>Step 4</p> <p>Remove the jams and obstructions.</p> <p>Does the problem remain?</p>	Go to step 5.	The problem is solved.
<p>Step 5</p> <p>a Enter the Diagnostics menu, and then navigate to: Printer diagnostics & adjustments > Sensor tests</p> <p>b Find the sensor (MPF/pass-through).</p> <p>Does the sensor status change while toggling the sensor?</p>	Go to step 8.	Go to step 6.
<p>Step 6</p> <p>a Make sure that the sensor cable is properly connected.</p> <p>b Check the sensor and its flag for damage.</p> <p>c Check the isolation unit components for damage.</p> <p>Are the sensor and isolation unit components free of damage?</p>	Go to step 8.	Go to step 7.

Action	Yes	No
<p>Step 7 Replace the isolation unit. See “Isolation unit removal” on page 509.</p> <p>Does the problem remain?</p>	Go to step 8.	The problem is solved.
<p>Step 8 a Enter the Diagnostics menu, and then navigate to: Printer diagnostics & adjustments > Motor tests > Duplex/MPF b Select a setting, and then touch Start.</p> <p>Does the motor run?</p>	Go to step 11.	Go to step 9.
<p>Step 9 a Make sure that the motor cable is properly connected. b Check the motor for damage.</p> <p>Is the motor free of damage?</p>	Go to step 11.	Go to step 10.
<p>Step 10 a Replace the motor. See “Motor (duplex/MPF) removal” on page 415. b Perform a print job.</p> <p>Does the problem remain?</p>	Go to step 11.	The problem is solved.
<p>Step 11 Check the duplex inner guide and its gears, belts, and rollers for damage.</p> <p>Are the duplex inner guide and its components free of damage?</p>	Contact the next level of support.	Go to step 12.
<p>Step 12 a Replace the duplex inner guide. See “Duplex inner guide removal” on page 466. b Perform a print job.</p> <p>Does the problem remain?</p>	Contact the next level of support.	The problem is solved.

Sensor (MPF/pass-through): Paper (duplex job) failed to clear service check

Action	Yes	No
<p>Step 1 Check the duplex paper path for paper jams and obstructions.</p> <p>Is the paper path free of jams and obstructions?</p>	Go to step 3.	Go to step 2.
<p>Step 2 Remove the jams and obstructions.</p> <p>Does the problem remain?</p>	Go to step 3.	The problem is solved.
<p>Step 3 a Enter the Diagnostics menu, and then navigate to: Printer diagnostics & adjustments > Sensor tests b Find the sensor (MPF/pass-through).</p> <p>Does the sensor status change while toggling the sensor?</p>	Go to step 6.	Go to step 4.
<p>Step 4 a Make sure that the sensor cable is properly connected. b Check the sensor and its flag for damage. c Check the isolation unit components for damage.</p> <p>Are the sensor and isolation unit components free of damage?</p>	Go to step 6.	Go to step 5.
<p>Step 5 Replace the isolation unit. See “Isolation unit removal” on page 509.</p> <p>Does the problem remain?</p>	Go to step 6.	The problem is solved.
<p>Step 6 a Enter the Diagnostics menu, and then navigate to: Printer diagnostics & adjustments > Motor tests > Deskew b Touch Start.</p> <p>Does the motor run?</p>	Contact the next level of support.	Go to step 7.
<p>Step 7 a Make sure that the motor cable is properly connected. b Check the motor for damage.</p> <p>Does the problem remain?</p>	Contact the next level of support.	Go to step 8.

Action	Yes	No
<p>Step 8</p> <p>a Replace the motor (deskew). See “Motor (deskew) removal” on page 387.</p> <p>b Perform a print job.</p> <p>Does the problem remain?</p>	Contact the next level of support.	The problem is solved.

Sensor (MPF/pass-through): Paper (duplex job) cleared too early service check

Action	Yes	No
<p>Step 1</p> <p>Check the duplex inner guide and its gears, belts, and rollers for damage.</p> <p>Are the duplex inner guide and its components free of damage?</p>	Go to step 3.	Go to step 2.
<p>Step 2</p> <p>a Replace the duplex inner guide. See “Duplex inner guide removal” on page 466.</p> <p>b Perform a print job.</p> <p>Does the problem remain?</p>	Go to step 3.	The problem is solved.
<p>Step 3</p> <p>a Enter the Diagnostics menu, and then navigate to: Printer diagnostics & adjustments > Sensor tests</p> <p>b Find the sensor (MPF/pass-through).</p> <p>Does the sensor status change while toggling the sensor?</p>	Go to step 6.	Go to step 4.
<p>Step 4</p> <p>a Make sure that the sensor cable is properly connected.</p> <p>b Check the sensor for damage.</p> <p>Is the sensor free of damage?</p>	Go to step 6.	Go to step 5.
<p>Step 5</p> <p>Replace the isolation unit. See “Isolation unit removal” on page 509.</p> <p>Does the problem remain?</p>	Go to step 6.	The problem is solved.
<p>Step 6</p> <p>Perform a print job.</p> <p>Does the problem remain?</p>	Contact the next level of support.	The problem is solved.

240 paper jams

240 paper jam messages

Error code	Description	Action
240.05	Paper fed from the MPF was picked but it never cleared the sensor (MPF/pass-through).	See “Sensor (MPF/pass-through): Paper failed to clear service check” on page 139.
240.06	Paper fed from the MPF was picked but it never arrived at the sensor (MPF/pass-through).	See “Sensor (MPF/pass-through): Paper (MPF) failed to arrive service check” on page 141.
240.23	Paper fed from tray 2 was picked but it never arrived at the sensor (MPF/pass-through).	See “Sensor (MPF/pass-through): Paper (tray 2) failed to arrive service check” on page 143.
240.25	Paper fed from tray 2 was picked but it never cleared the sensor (MPF/pass-through).	See “Sensor (MPF/pass-through): Paper failed to clear service check” on page 139.
240.33	Paper fed from tray 3 was picked but it never arrived at the sensor (MPF/pass-through).	See “Sensor (MPF/pass-through): Paper (tray 3) failed to arrive service check” on page 145.
240.35	Paper fed from tray 3 was picked but it never cleared the sensor (MPF/pass-through).	See “Sensor (MPF/pass-through): Paper failed to clear service check” on page 139.
240.43	Paper fed from tray 4 was picked but it never arrived at the sensor (MPF/pass-through).	See “Sensor (MPF/pass-through): Paper (tray 4) failed to arrive service check” on page 147.
240.45	Paper fed from tray 4 was picked but it never cleared the sensor (MPF/pass-through).	See “Sensor (MPF/pass-through): Paper failed to clear service check” on page 139.
240.53	Paper fed from tray 5 was picked but it never arrived at the sensor (MPF/pass-through).	See “Sensor (MPF/pass-through): Paper (tray 5) failed to arrive service check” on page 149.
240.55	Paper fed from tray 5 was picked but it never cleared the sensor (MPF/pass-through).	See “Sensor (MPF/pass-through): Paper failed to clear service check” on page 139.
240.82	The motor (duplex/MPF) has stalled.	See “Motor (duplex/MPF) jam service check” on page 152.
240.84	The motor (duplex/MPF) failed to achieve expected speed or has stalled.	
240.91	Paper remains detected at the sensor (MPF/pass-through) after the printer is turned on.	See “Sensor (MPF/pass-through) static jam service check” on page 151.

Sensor (MPF/pass-through): Paper failed to clear service check

Action	Yes	No
<p>Step 1</p> <p>a From the home screen, touch Settings > Device > Preferences.</p> <p>b Check if the paper size matches the size set on the tray guides.</p> <p>Does the paper size match the size set on the tray?</p>	Go to step 3.	Go to step 2.

Action	Yes	No
<p>Step 2 Change the paper size or adjust the size setting in the tray.</p> <p>Does the problem remain?</p>	Go to step 3.	The problem is solved.
<p>Step 3 Check the duplex and MPF paper paths for paper jams and obstructions.</p> <p>Are the paper paths free of jams and obstructions?</p>	Go to step 5.	Go to step 4.
<p>Step 4 Remove the paper jams and obstructions.</p> <p>Does the problem remain?</p>	Go to step 5.	The problem is solved.
<p>Step 5 Check the tray insert and its paper path guides and drive gears for damage.</p> <p>Is the tray insert free of damage?</p>	Go to step 7.	Go to step 6.
<p>Step 6 Replace the tray insert. See “550-sheet tray insert removal” on page 500.</p> <p>Does the problem remain?</p>	Go to step 7.	The problem is solved.
<p>Step 7</p> <p>a Enter the Diagnostics menu, and then navigate to: Printer diagnostics & adjustments > Sensor tests</p> <p>b Find the sensor (MPF/pass-through).</p> <p>Does the sensor status change while toggling the sensor?</p>	Contact the next level of support.	Go to step 8.
<p>Step 8</p> <p>a Make sure that the sensor cable is properly connected.</p> <p>b Check the sensor and its flag for damage.</p> <p>c Check the isolation unit components for damage.</p> <p>Are the sensor and isolation unit components free of damage?</p>	Contact the next level of support.	Go to step 9.
<p>Step 9 Replace the isolation unit. See “Isolation unit removal” on page 509.</p> <p>Does the problem remain?</p>	Contact the next level of support.	The problem is solved.

Sensor (MPF/pass-through): Paper (MPF) failed to arrive service check

Action	Yes	No
<p>Step 1</p> <p>a From the home screen, touch Settings > Device > Preferences.</p> <p>b Check if the paper size matches the size set on the MPF guides.</p> <p>Does the paper size match the size set on the MPF?</p>	Go to step 3.	Go to step 2.
<p>Step 2</p> <p>Change the paper size or adjust the size setting in the MPF.</p> <p>Does the problem remain?</p>	Go to step 3.	The problem is solved.
<p>Step 3</p> <p>Check the MPF for overfilling.</p> <p>Is the MPF overfilled?</p>	Go to step 4.	Go to step 5.
<p>Step 4</p> <p>Remove the excess paper from the MPF.</p> <p>Does the problem remain?</p>	Go to step 5.	The problem is solved.
<p>Step 5</p> <p>Check the paper condition in the MPF.</p> <p>Is the paper crumpled or damaged?</p>	Go to step 6.	Go to step 7.
<p>Step 6</p> <p>Replace the crumpled or damaged paper.</p> <p>Does the problem remain?</p>	Go to step 7.	The problem is solved.
<p>Step 7</p> <p>a Make sure that the MPF pick roller is properly installed.</p> <p>Note: Firmly press the pick roller to its shaft to make sure that is properly engaged.</p> <p>b Check the MPF pick roller for excess wear, contamination, and damage.</p> <p>Is the MPF pick roller free from excess wear, contamination, and damage?</p>	Go to step 9.	Go to step 8.
<p>Step 8</p> <p>Replace the MPF pick roller. See “MPF pick roller removal” on page 503.</p> <p>Does the problem remain?</p>	Go to step 9.	The problem is solved.

Action	Yes	No
<p>Step 9 Check the tray exit paper path for paper fragments and contamination.</p> <p>Is the paper path free of fragments and contamination?</p>	Go to step 11.	Go to step 10.
<p>Step 10 Clean the paper path.</p> <p>Does the problem remain?</p>	Go to step 11.	The problem is solved.
<p>Step 11 Check the tray insert and its paper path guides and drive gears for damage.</p> <p>Is the tray insert free of damage?</p>	Go to step 13.	Go to step 12.
<p>Step 12 Replace the tray insert. See “550-sheet tray insert removal” on page 500.</p> <p>Does the problem remain?</p>	Go to step 13.	The problem is solved.
<p>Step 13</p> <p>a Enter the Diagnostics menu, and then navigate to: Printer diagnostics & adjustments > Sensor tests</p> <p>b Find the sensor (MPF/pass-through).</p> <p>Does the sensor status change while toggling the sensor?</p>	Go to step 16.	Go to step 14.
<p>Step 14</p> <p>a Make sure that the sensor cable is properly connected.</p> <p>b Check the sensor and its flag for damage.</p> <p>c Check the isolation unit components for damage.</p> <p>Are the sensor and isolation unit components free of damage?</p>	Go to step 16.	Go to step 15.
<p>Step 15 Replace the isolation unit. See “Isolation unit removal” on page 509.</p> <p>Does the problem remain?</p>	Go to step 16.	The problem is solved.
<p>Step 16</p> <p>a Enter the Diagnostics menu, and then navigate to: Printer diagnostics & adjustments > Motor tests > Duplex/MPF</p> <p>b Select a setting, and then touch Start.</p> <p>Does the motor run?</p>	Contact the next level of support.	Go to step 17.

Action	Yes	No
<p>Step 17</p> <p>a Make sure that the motor cable is properly connected.</p> <p>b Check the motor for damage.</p> <p>Is the motor free of damage?</p>	Contact the next level of support.	The problem is solved.
<p>Step 18</p> <p>a Replace the motor. See “Motor (duplex/MPF) removal” on page 415.</p> <p>b Perform a print job.</p> <p>Does the problem remain?</p>	Contact the next level of support.	The problem is solved.

Sensor (MPF/pass-through): Paper (tray 2) failed to arrive service check

Action	Yes	No
<p>Step 1</p> <p>a From the home screen, touch Settings > Device > Preferences.</p> <p>b Check if the paper size matches the size set on the tray guides.</p> <p>Does the paper size match the size set on the tray?</p>	Go to step 3.	Go to step 2.
<p>Step 2</p> <p>Change the paper size or adjust the size setting in the tray.</p> <p>Does the problem remain?</p>	Go to step 3.	The problem is solved.
<p>Step 3</p> <p>Check the tray for overfilling.</p> <p>Is the tray overfilled?</p>	Go to step 4.	Go to step 5.
<p>Step 4</p> <p>Remove the excess paper from the tray.</p> <p>Does the problem remain?</p>	Go to step 5.	The problem is solved.
<p>Step 5</p> <p>Check the paper condition in the tray.</p> <p>Is the paper crumpled or damaged?</p>	Go to step 6.	Go to step 7.
<p>Step 6</p> <p>Replace the crumpled or damaged paper.</p> <p>Does the problem remain?</p>	Go to step 7.	The problem is solved.

Action	Yes	No
<p>Step 7</p> <p>a Make sure that the tray 2 pick roller is properly installed.</p> <p>Note: Firmly press the pick roller to its shaft to make sure that it is properly engaged.</p> <p>b Check the tray 2 pick roller for excess wear, contamination, and damage.</p> <p>Is the tray 2 pick roller free from excess wear, contamination, and damage?</p>	Go to step 9.	Go to step 8.
<p>Step 8</p> <p>Replace the tray 2 pick roller. See “Pick roller removals” on page 502.</p> <p>Does the problem remain?</p>	Go to step 9.	The problem is solved.
<p>Step 9</p> <p>Check the tray exit paper path for fragments and contamination.</p> <p>Is the paper path free of fragments and contamination?</p>	Go to step 11.	Go to step 10.
<p>Step 10</p> <p>Clean the paper path.</p> <p>Does the problem remain?</p>	Go to step 11.	The problem is solved.
<p>Step 11</p> <p>a Enter the Diagnostics menu, and then navigate to: Printer diagnostics & adjustments > Sensor tests</p> <p>b Find the sensor (MPF/pass-through).</p> <p>Does the sensor status change while toggling the sensor?</p>	Go to step 14.	Go to step 12.
<p>Step 12</p> <p>a Make sure that the sensor cable is properly connected.</p> <p>b Check the sensor and its flag for damage.</p> <p>c Check the isolation unit components for damage.</p> <p>Are the sensor and isolation unit components free of damage?</p>	Go to step 14.	Go to step 13.
<p>Step 13</p> <p>Replace the isolation unit. See “Isolation unit removal” on page 509.</p> <p>Does the problem remain?</p>	Go to step 14.	The problem is solved.

Action	Yes	No
<p>Step 14</p> <p>a Enter the Diagnostics menu, and then navigate to: Additional input trays adjustments/tests > Additional input tray motors > Pick (tray 2)</p> <p>b Select a setting, and then touch Start.</p> <p>Does the motor run?</p>	Go to step 16.	Go to step 15.
<p>Step 15</p> <p>a Make sure that the motor cable is properly connected.</p> <p>b Check the motor and the other optional tray components for damage.</p> <p>Are the motor and the optional tray free of damage?</p>	Go to step 16.	Go to step 17.
<p>Step 16</p> <p>Replace the tray insert. See “550-sheet tray insert removal” on page 500.</p> <p>Does the problem remain?</p>	Go to step 17.	The problem is solved.
<p>Step 17</p> <p>a Replace the optional tray. See “Optional 550-sheet tray removal” on page 536.</p> <p>b Perform a print job.</p> <p>Does the problem remain?</p>	Contact the next level of support.	The problem is solved.

Sensor (MPF/pass-through): Paper (tray 3) failed to arrive service check

Action	Yes	No
<p>Step 1</p> <p>a From the home screen, touch Settings > Device > Preferences.</p> <p>b Check if the paper size matches the size set on the tray guides.</p> <p>Does the paper size match the size set on the tray?</p>	Go to step 3.	Go to step 2.
<p>Step 2</p> <p>Change the paper size or adjust the size setting in the tray.</p> <p>Does the problem remain?</p>	Go to step 3.	The problem is solved.
<p>Step 3</p> <p>a Enter the Diagnostics menu, and then navigate to: Printer diagnostics & adjustments > Sensor tests</p> <p>b Find the sensor (MPF/pass-through).</p> <p>Does the sensor status change while toggling the sensor?</p>	Go to step 6.	Go to step 4.

Action	Yes	No
<p>Step 4</p> <p>a Make sure that the sensor cable is properly connected.</p> <p>b Check the sensor and its flag for damage.</p> <p>c Check the isolation unit components for damage.</p> <p>Are the sensor and isolation unit free of damage?</p>	Go to step 6.	Go to step 5.
<p>Step 5</p> <p>Replace the isolation unit. See “Isolation unit removal” on page 509.</p> <p>Does the problem remain?</p>	Go to step 6.	The problem is solved.
<p>Step 6</p> <p>a Enter the Diagnostics menu, and then navigate to: Additional input trays adjustments/tests > Additional input tray sensors</p> <p>b Find the sensor (Pass-through (tray 2)).</p> <p>Does the sensor status change while toggling the sensor?</p>	Go to step 8.	Go to step 7.
<p>Step 7</p> <p>a Make sure that the sensor cable is properly connected.</p> <p>b Check the sensor and the other optional tray components for damage.</p> <p>Are the sensor and the optional tray free of damage?</p>	Go to step 8.	Go to step 10.
<p>Step 8</p> <p>a Enter the Diagnostics menu, and then navigate to: Additional input trays adjustments/tests > Additional input tray motors > Pass-through (tray 2)</p> <p>b Select a setting, and then touch Start.</p> <p>Does the motor run?</p>	Contact the next level of support.	Go to step 9.
<p>Step 9</p> <p>a Make sure that the motor cable is properly connected.</p> <p>b Check the motor and the other optional tray components for damage.</p> <p>Are the motor and the optional tray free of damage?</p>	Contact the next level of support.	Go to step 10.
<p>Step 10</p> <p>a Replace the optional tray. See “Optional 550-sheet tray removal” on page 536.</p> <p>b Perform a print job.</p> <p>Does the problem remain?</p>	Contact the next level of support.	The problem is solved.

Sensor (MPF/pass-through): Paper (tray 4) failed to arrive service check

Action	Yes	No
<p>Step 1</p> <p>a From the home screen, touch Settings > Device > Preferences.</p> <p>b Check if the paper size matches the size set on the tray guides.</p> <p>Does the paper size match the size set on the tray?</p>	Go to step 3.	Go to step 2.
<p>Step 2</p> <p>Change the paper size or adjust the size setting in the tray.</p> <p>Does the problem remain?</p>	Go to step 3.	The problem is solved.
<p>Step 3</p> <p>Check the paper path in tray 3 for paper jams and fragments.</p> <p>Is the paper path free of jams and fragments?</p>	Go to step 5.	Go to step 4.
<p>Step 4</p> <p>Remove the paper jams and fragments.</p> <p>Does the problem remain?</p>	Go to step 5.	The problem is solved.
<p>Step 5</p> <p>a Enter the Diagnostics menu, and then navigate to: Printer diagnostics & adjustments > Sensor tests</p> <p>b Find the sensor (MPF/pass-through).</p> <p>Does the sensor status change while toggling the sensor?</p>	Go to step 8.	Go to step 6.
<p>Step 6</p> <p>a Make sure that the sensor cable is properly connected.</p> <p>b Check the sensor and its flag for damage.</p> <p>c Check the isolation unit components for damage.</p> <p>Are the sensor and isolation unit free of damage?</p>	Go to step 8.	Go to step 7.
<p>Step 7</p> <p>Replace the isolation unit. See “Isolation unit removal” on page 509.</p> <p>Does the problem remain?</p>	Go to step 8.	The problem is solved.
<p>Step 8</p> <p>a Enter the Diagnostics menu, and then navigate to: Additional input trays adjustments/tests > Additional input tray sensors</p> <p>b Find the sensor (Pass-through (tray 2)).</p> <p>Does the sensor status change while toggling the sensor?</p>	Go to step 10.	Go to step 9.

Action	Yes	No
<p>Step 9</p> <p>a Make sure that the sensor cable is properly connected.</p> <p>b Check the sensor and the other optional tray components for damage.</p> <p>Are the sensor and the optional tray free of damage?</p>	Go to step 10.	Go to step 12.
<p>Step 10</p> <p>a Enter the Diagnostics menu, and then navigate to: Additional input trays adjustments/tests > Additional input tray motors > Pass-through (tray 2)</p> <p>b Select a setting, and then touch Start.</p> <p>Does the motor run?</p>	Go to step 13.	Go to step 11.
<p>Step 11</p> <p>a Make sure that the motor cable is properly connected.</p> <p>b Check the motor and the other optional tray components for damage.</p> <p>Are the motor and the optional tray free of damage?</p>	Go to step 13.	Go to step 12.
<p>Step 12</p> <p>Replace the optional tray. See “Optional 550-sheet tray removal” on page 536.</p> <p>Does the problem remain?</p>	Go to step 13.	The problem is solved.
<p>Step 13</p> <p>a Enter the Diagnostics menu, and then navigate to: Additional input trays adjustments/tests > Additional input tray sensors</p> <p>b Find the sensor (Pass-through (tray 3)).</p> <p>Does the sensor status change while toggling the sensor?</p>	Go to step 15.	Go to step 14.
<p>Step 14</p> <p>a Make sure that the sensor cable is properly connected.</p> <p>b Check the sensor and the other optional tray components for damage.</p> <p>Are the sensor and the optional tray free of damage?</p>	Go to step 15.	Go to step 17.
<p>Step 15</p> <p>a Enter the Diagnostics menu, and then navigate to: Additional input trays adjustments/tests > Additional input tray motors > Pass-through (tray 3)</p> <p>b Select a setting, and then touch Start.</p> <p>Does the motor run?</p>	Contact the next level of support.	Go to step 16.

Action	Yes	No
<p>Step 16</p> <p>a Make sure that the motor cable is properly connected.</p> <p>b Check the motor and the other optional tray components for damage.</p> <p>Are the motor and the optional tray free of damage?</p>	Contact the next level of support.	Go to step 17.
<p>Step 17</p> <p>Replace the optional tray. See “Optional 550-sheet tray removal” on page 536.</p> <p>Does the problem remain?</p>	Contact the next level of support.	The problem is solved.

Sensor (MPF/pass-through): Paper (tray 5) failed to arrive service check

Action	Yes	No
<p>Step 1</p> <p>a From the home screen, touch Settings > Device > Preferences.</p> <p>b Check if the paper size matches the size set on the tray guides.</p> <p>Does the paper size match the size set on the tray?</p>	Go to step 3.	Go to step 2.
<p>Step 2</p> <p>Change the paper size or adjust the size setting in the tray.</p> <p>Does the problem remain?</p>	Go to step 3.	The problem is solved.
<p>Step 3</p> <p>Check the paper path in tray 4 for paper jams and fragments.</p> <p>Is the paper path free of jams and fragments?</p>	Go to step 5.	Go to step 4.
<p>Step 4</p> <p>Remove the paper jams and fragments.</p> <p>Does the problem remain?</p>	Go to step 5.	The problem is solved.
<p>Step 5</p> <p>a Enter the Diagnostics menu, and then navigate to: Printer diagnostics & adjustments > Sensor tests</p> <p>b Find the sensor (MPF/pass-through).</p> <p>Does the sensor status change while toggling the sensor?</p>	Go to step 8.	Go to step 6.

Action	Yes	No
<p>Step 6</p> <p>a Make sure that the sensor cable is properly connected.</p> <p>b Check the sensor and its flag for damage.</p> <p>c Check the isolation unit components for damage.</p> <p>Are the sensor and isolation unit free of damage?</p>	Go to step 8.	Go to step 7.
<p>Step 7</p> <p>Replace the isolation unit. See “Isolation unit removal” on page 509.</p> <p>Does the problem remain?</p>	Go to step 8.	The problem is solved.
<p>Step 8</p> <p>a Enter the Diagnostics menu, and then navigate to: Additional input trays adjustments/tests > Additional input tray sensors</p> <p>b Find the sensor (Pass-through (tray 3)).</p> <p>Does the sensor status change while toggling the sensor?</p>	Go to step 10.	Go to step 9.
<p>Step 9</p> <p>a Make sure that the sensor cable is properly connected.</p> <p>b Check the sensor and the other optional tray components for damage.</p> <p>Are the sensor and the optional tray free of damage?</p>	Go to step 10.	Go to step 12.
<p>Step 10</p> <p>a Enter the Diagnostics menu, and then navigate to: Additional input trays adjustments/tests > Additional input tray motors > Pass-through (tray 3)</p> <p>b Select a setting, and then touch Start.</p> <p>Does the motor run?</p>	Go to step 13.	Go to step 11.
<p>Step 11</p> <p>a Make sure that the motor cable is properly connected.</p> <p>b Check the motor and the other optional tray components for damage.</p> <p>Are the motor and the optional tray free of damage?</p>	Go to step 13.	Go to step 12.
<p>Step 12</p> <p>Replace the optional tray. See “Optional 550-sheet tray removal” on page 536.</p> <p>Does the problem remain?</p>	Go to step 13.	The problem is solved.

Action	Yes	No
<p>Step 13</p> <p>a Enter the Diagnostics menu, and then navigate to: Additional input trays adjustments/tests > Additional input tray sensors</p> <p>b Find the sensor (Pass-through (tray 4)).</p> <p>Does the sensor status change while toggling the sensor?</p>	Go to step 15.	Go to step 14.
<p>Step 14</p> <p>a Make sure that the sensor cable is properly connected.</p> <p>b Check the sensor and the other optional tray components for damage.</p> <p>Are the sensor and the optional tray free of damage?</p>	Go to step 15.	Go to step 17.
<p>Step 15</p> <p>a Enter the Diagnostics menu, and then navigate to: Additional input trays adjustments/tests > Additional input tray motors > Pass-through (tray 4)</p> <p>b Select a setting, and then touch Start.</p> <p>Does the motor run?</p>	Contact the next level of support.	Go to step 16.
<p>Step 16</p> <p>a Make sure that the motor cable is properly connected.</p> <p>b Check the motor and the other optional tray components for damage.</p> <p>Are the motor and the optional tray free of damage?</p>	Contact the next level of support.	Go to step 17.
<p>Step 17</p> <p>Replace the optional tray. See “Optional 550-sheet tray removal” on page 536.</p> <p>Does the problem remain?</p>	Contact the next level of support.	The problem is solved.

Sensor (MPF/pass-through) static jam service check

Action	Yes	No
<p>Step 1</p> <p>a From the home screen, touch Settings > Device > Preferences.</p> <p>b Check if the paper size matches the size set on the tray guides.</p> <p>Does the paper size match the size set on the tray?</p>	Go to step 3.	Go to step 2.

Action	Yes	No
<p>Step 2 Change the paper size or adjust the size setting in the tray.</p> <p>Does the problem remain?</p>	Go to step 3.	The problem is solved.
<p>Step 3 a Enter the Diagnostics menu, and then navigate to: Printer diagnostics & adjustments > Sensor tests b Find the sensor (MPF/pass-through).</p> <p>Does the sensor status change while toggling the sensor?</p>	Contact the next level of support.	Go to step 4.
<p>Step 4 a Make sure that the sensor cable is properly connected. b Check the sensor and its flag for damage. c Check the isolation unit components for damage.</p> <p>Are the sensor and isolation unit free of damage?</p>	Contact the next level of support.	Go to step 5.
<p>Step 5 a Replace the isolation unit. See “Isolation unit removal” on page 509. b Perform a print job.</p> <p>Does the problem remain?</p>	Contact the next level of support.	The problem is solved.

Motor (duplex/MPF) jam service check

Action	Yes	No
<p>Step 1 Check if the MPF is the source tray used during the error.</p> <p>Is the MPF the source tray?</p>	Go to step 2.	Go to step 6.
<p>Step 2 Check the MPF for overfilling.</p> <p>Is the tray overfilled?</p>	Go to step 3.	Go to step 4.
<p>Step 3 Remove the excess paper from the MPF.</p> <p>Does the problem remain?</p>	Go to step 4.	The problem is solved.
<p>Step 4 Check the paper condition in the MPF.</p> <p>Is the paper crumpled or damaged?</p>	Go to step 5.	Go to step 6.

Action	Yes	No
<p>Step 5 Replace the crumpled or damaged paper.</p> <p>Does the problem remain?</p>	Go to step 6.	The problem is solved.
<p>Step 6 Check the duplex and MPF paper path guides along the tray 1 exit area.</p> <p>Is the paper path free of paper fragments and contamination?</p>	Go to step 7.	Go to step 8.
<p>Step 7 Clean the paper path.</p> <p>Does the problem remain?</p>	Go to step 8.	The problem is solved.
<p>Step 8</p> <p>a Enter the Diagnostics menu, and then navigate to: Printer diagnostics & adjustments > Motor tests > Duplex/MPF</p> <p>b Select a setting, and then touch Start.</p> <p>Does the motor run?</p>	Contact the next level of support.	Go to step 9.
<p>Step 9</p> <p>a Make sure that the motor cable JMTR1 on the engine board is properly connected.</p> <p>b Check the motor for damage.</p> <p>Is the motor free of damage?</p>	Contact the next level of support.	Go to step 10.
<p>Step 10</p> <p>a Replace the motor. See “Motor (duplex/MPF) removal” on page 415.</p> <p>b Perform a print job.</p> <p>Does the problem remain?</p>	Contact the next level of support.	The problem is solved.

241 paper jams

241 paper jam messages

Error code	Description	Action
241.12	Paper fed from tray 1 arrived at the sensor (tray 1 pick) earlier than expected.	See “Sensor (tray 1 pick): Paper arrived too early service check” on page 156 .
241.14	Paper fed from tray 1 cleared the sensor (tray 1 pick) earlier than expected.	See “Sensor (tray 1 pick): Paper cleared too early service check” on page 156 .

Error code	Description	Action
241.15	Paper fed from tray 1 never cleared the sensor (tray 1 pick).	See “Sensor (tray 1 pick): Paper failed to clear service check” on page 154.
241.16	Paper fed from tray 1 was picked but it never arrived at the sensor (tray 1 pick).	See “Sensor (input): tray 1 failed to pick service check” on page 158.
241.82	The motor (tray 1 pick) stalled or did not reach the expected speed.	See “Motor (tray 1 pick) jam service check” on page 161.
241.83	The motor (tray 1 pick) stalled or did not reach the expected speed.	
241.84	The motor (tray 1 pick) stalled or did not reach the expected speed.	
241.91	Paper remains detected at the sensor (tray 1 pick) after the printer is turned on.	See “Sensor (tray 1 pick) static jam service check” on page 160.

Sensor (tray 1 pick): Paper failed to clear service check

Action	Yes	No
<p>Step 1</p> <p>a From the home screen, touch Settings > Device > Preferences.</p> <p>b Check if the paper size matches the size set on the tray guides.</p> <p>Does the paper size match the size set on the tray?</p>	Go to step 3.	Go to step 2.
<p>Step 2</p> <p>Change the paper size or adjust the size setting in the tray.</p> <p>Does the problem remain?</p>	Go to step 3.	The problem is solved.
<p>Step 3</p> <p>Check the paper path for paper jams and fragments.</p> <p>Is the paper path free of jams and fragments?</p>	Go to step 5.	Go to step 4.
<p>Step 4</p> <p>Remove the paper jams and fragments.</p> <p>Does the problem remain?</p>	Go to step 5.	The problem is solved.
<p>Step 5</p> <p>Check the tray insert and its paper path guides and drive gears for damage.</p> <p>Is the tray insert free of damage?</p>	Go to step 7.	Go to step 6.

Action	Yes	No
<p>Step 6 Replace the tray insert. See “550-sheet tray insert removal” on page 500.</p> <p>Does the problem remain?</p>	Go to step 7.	The problem is solved.
<p>Step 7 a Enter the Diagnostics menu, and then navigate to: Printer diagnostics & adjustments > Sensor tests b Find the sensor (Input).</p> <p>Does the sensor status change while toggling the sensor?</p>	Go to step 10.	Go to step 8.
<p>Step 8 a Make sure that the sensor cable is properly connected. b Check the sensor for damage.</p> <p>Is the sensor free of damage?</p>	Go to step 10.	Go to step 9.
<p>Step 9 Replace the sensor. See “Sensor (input) removal” on page 434.</p> <p>Does the problem remain?</p>	Go to step 10.	The problem is solved.
<p>Step 10 a Enter the Diagnostics menu, and then navigate to: Printer diagnostics & adjustments > Motor tests > Isolation b Touch Start.</p> <p>Does the motor run?</p>	Contact the next level of support.	Go to step 11.
<p>Step 11 a Make sure that the motor cable is properly connected. b Check the motor and isolation unit for damage.</p> <p>Are the motor and isolation unit free of damage?</p>	Contact the next level of support.	Go to step 12.
<p>Step 12 a Replace the isolation unit. See “Isolation unit removal” on page 509. b Perform a print job.</p> <p>Does the problem remain?</p>	Contact the next level of support.	The problem is solved.

Sensor (tray 1 pick): Paper arrived too early service check

Action	Yes	No
<p>Step 1</p> <p>a From the home screen, touch Settings > Device > Preferences.</p> <p>b Check if the paper size matches the size set on the tray guides.</p> <p>Does the paper size match the size set on the tray?</p>	Go to step 3.	Go to step 2.
<p>Step 2</p> <p>Change the paper size or adjust the size setting in the tray.</p> <p>Does the problem remain?</p>	Go to step 3.	The problem is solved.
<p>Step 3</p> <p>Check the tray for overfilling.</p> <p>Is the tray overfilled?</p>	Go to step 4.	Go to step 5.
<p>Step 4</p> <p>Remove the excess paper from the tray.</p> <p>Does the problem remain?</p>	Go to step 5.	The problem is solved.
<p>Step 5</p> <p>Check the tray exit paper path for fragments and contamination.</p> <p>Is the paper path free of fragments and contamination?</p>	Go to step 7.	Go to step 6.
<p>Step 6</p> <p>Clean the paper path.</p> <p>Does the problem remain?</p>	Go to step 7.	The problem is solved.
<p>Step 7</p> <p>Perform a print job.</p> <p>Does the problem remain?</p>	Contact the next level of support.	The problem is solved.

Sensor (tray 1 pick): Paper cleared too early service check

Action	Yes	No
<p>Step 1</p> <p>a From the home screen, touch Settings > Device > Preferences.</p> <p>b Check if the paper size matches the size set on the tray guides.</p> <p>Does the paper size match the size set on the tray?</p>	Go to step 3.	Go to step 2.

Action	Yes	No
<p>Step 2 Change the paper size or adjust the size setting in the tray.</p> <p>Does the problem remain?</p>	Go to step 3.	The problem is solved.
<p>Step 3 Check the tray for overfilling.</p> <p>Is the tray overfilled?</p>	Go to step 4.	Go to step 5.
<p>Step 4 Remove the excess paper from the tray.</p> <p>Does the problem remain?</p>	Go to step 5.	The problem is solved.
<p>Step 5 Check the paper condition in the tray.</p> <p>Is the paper crumpled or damaged?</p>	Go to step 6.	Go to step 7.
<p>Step 6 Replace the crumpled or damaged paper.</p> <p>Does the problem remain?</p>	Go to step 7.	The problem is solved.
<p>Step 7 a Enter the Diagnostics menu, and then navigate to: Printer diagnostics & adjustments > Sensor tests b Find the sensor (Input).</p> <p>Does the sensor status change while toggling the sensor?</p>	Go to step 9.	The problem is solved.
<p>Step 8 a Make sure that the sensor cable is properly connected. b Check the sensor for damage.</p> <p>Is the sensor free of damage?</p>	Go to step 9.	Go to step 9.
<p>Step 9 Replace the sensor. See “Sensor (input) removal” on page 434.</p> <p>Does the problem remain?</p>	Go to step 10.	The problem is solved.
<p>Step 10 Perform a print job.</p> <p>Does the problem remain?</p>	Contact the next level of support.	The problem is solved.

Sensor (input): tray 1 failed to pick service check

Action	Yes	No
<p>Step 1</p> <p>a From the home screen, touch Settings > Device > Preferences.</p> <p>b Check if the paper size matches the size set on the tray guides.</p> <p>Does the paper size match the size set on the tray?</p>	Go to step 3.	Go to step 2.
<p>Step 2</p> <p>Change the paper size or adjust the size setting in the tray.</p> <p>Does the problem remain?</p>	Go to step 3.	The problem is solved.
<p>Step 3</p> <p>Check if the paper size matches the size set on the tray guides.</p> <p>Does the paper size match the size set on the tray?</p>	Go to step 5.	Go to step 4.
<p>Step 4</p> <p>Replace the paper or change the paper size setting in the tray.</p> <p>Does the problem remain?</p>	Go to step 5.	The problem is solved.
<p>Step 5</p> <p>Check the paper tray for overfilling.</p> <p>Is the paper tray overfilled?</p>	Go to step 6.	Go to step 7.
<p>Step 6</p> <p>Remove the excess paper from the tray.</p> <p>Does the problem remain?</p>	Go to step 7.	The problem is solved.
<p>Step 7</p> <p>Check the paper condition in the tray.</p> <p>Is the paper crumpled or damaged?</p>	Go to step 8.	Go to step 9.
<p>Step 8</p> <p>Replace the crumpled or damaged paper.</p> <p>Does the problem remain?</p>	Go to step 9.	The problem is solved.

Action	Yes	No
<p>Step 9</p> <p>a Make sure that the tray pick roller is properly installed.</p> <p>Note: Firmly press the pick roller to its shaft to make sure that it is properly engaged.</p> <p>b Check the tray pick roller for excess wear, contamination, and damage.</p> <p>Is the tray pick roller free from excess wear, contamination, and damage?</p>	Go to step 11.	Go to step 10.
<p>Step 10</p> <p>Replace the pick roller. See “Pick roller removals” on page 502.</p> <p>Does the problem remain?</p>	Go to step 11.	The problem is solved.
<p>Step 11</p> <p>Check the tray exit paper path for paper fragments and contamination.</p> <p>Is the paper path free of paper fragments and contamination?</p>	Go to step 15.	Go to step 12.
<p>Step 12</p> <p>Clean the paper path.</p> <p>Does the problem remain?</p>	Go to step 13.	The problem is solved.
<p>Step 13</p> <p>a Enter the Diagnostics menu, and then navigate to: Printer diagnostics & adjustments > Sensor tests</p> <p>b Find the sensor (Tray 1 pick).</p> <p>Does the sensor status change while toggling the sensor?</p>	Go to step 15.	Go to step 14.
<p>Step 14</p> <p>a Make sure that the sensor cable is properly connected.</p> <p>b Make sure that the sensor is properly installed.</p> <p>c Check the sensor and the other optional tray components for damage.</p> <p>Are the sensor and optional tray free of damage?</p>	Go to step 15.	Go to step 17.
<p>Step 15</p> <p>a Enter the Diagnostics menu, and then navigate to: Printer diagnostics and adjustments > Motor tests > Pick (tray 1)</p> <p>b Select a setting, and then touch Start.</p> <p>Does the motor run?</p>	Go to step 18.	Go to step 16.

Action	Yes	No
<p>Step 16</p> <p>a Make sure that the motor cable is properly connected.</p> <p>b Check the motor and the other paper feeder components for damage.</p> <p>Are the motor and paper feeder free of damage?</p>	Go to step 18.	Go to step 17.
<p>Step 17</p> <p>a Replace the paper feeder. See “Paper feeder removal” on page 507.</p> <p>b Perform a print job.</p> <p>Does the problem remain?</p>	Go to step 18.	The problem is solved.
<p>Step 18</p> <p>Perform a print test.</p> <p>Does the problem remain?</p>	Contact the next level of support.	The problem is solved.

Sensor (tray 1 pick) static jam service check

Action	Yes	No
<p>Step 1</p> <p>a From the home screen, touch Settings > Device > Preferences.</p> <p>b Check if the paper size matches the size set on the tray guides.</p> <p>Does the paper size match the size set on the tray?</p>	Go to step 3.	Go to step 2.
<p>Step 2</p> <p>Change the paper size or adjust the size setting in the tray.</p> <p>Does the problem remain?</p>	Go to step 3.	The problem is solved.
<p>Step 3</p> <p>a Enter the Diagnostics menu, and then navigate to: Printer diagnostics & adjustments > Sensor tests</p> <p>b Find the sensor (Tray 1 pick).</p> <p>Does the sensor status change while toggling the sensor?</p>	Contact the next level of support.	Go to step 4.
<p>Step 4</p> <p>a Make sure that the sensor cable is properly connected.</p> <p>b Check the sensor and the other isolation units for damage.</p> <p>Are the sensor and isolation unit free of damage?</p>	Contact the next level of support.	Go to step 5.

Action	Yes	No
<p>Step 5</p> <p>a Replace the isolation unit. See “Isolation unit removal” on page 509.</p> <p>b Perform a print job.</p> <p>Does the problem remain?</p>	Contact the next level of support.	The problem is solved.

Motor (tray 1 pick) jam service check

Action	Yes	No
<p>Step 1</p> <p>Check the tray for overfilling.</p> <p>Is the tray overfilled?</p>	Go to step 2.	Go to step 3.
<p>Step 2</p> <p>Remove the excess paper from the tray.</p> <p>Does the problem remain?</p>	Go to step 3.	The problem is solved.
<p>Step 3</p> <p>Check the paper condition in the tray.</p> <p>Is the paper crumpled or damaged?</p>	Go to step 4.	Go to step 5.
<p>Step 4</p> <p>Replace the crumpled or damaged paper.</p> <p>Does the problem remain?</p>	Go to step 5.	The problem is solved.
<p>Step 5</p> <p>Check the tray exit paper path for fragments and contamination.</p> <p>Is the paper path free of fragments and contamination?</p>	Go to step 7.	Go to step 6.
<p>Step 6</p> <p>Clean the paper path.</p> <p>Does the problem remain?</p>	Go to step 7.	The problem is solved.
<p>Step 7</p> <p>a Enter the Diagnostics menu, and then navigate to: Printer diagnostics and adjustments > Motor tests > Pick (tray 1)</p> <p>b Select a setting, and then touch Start.</p> <p>Does the motor run?</p>	Contact the next level of support.	Go to step 8.

Action	Yes	No
<p>Step 8</p> <p>a Make sure that the motor cable is properly connected.</p> <p>b Check the motor and the other paper feeder components for damage.</p> <p>Are the motor and paper feeder free of damage?</p>	Contact the next level of support.	Go to step 9.
<p>Step 9</p> <p>a Replace the paper feeder. See “Paper feeder removal” on page 507.</p> <p>b Perform a print job.</p> <p>Does the problem remain?</p>	Contact the next level of support.	The problem is solved.

242–245 paper jams

242 paper jam messages

Error code	Description	Action
242.21	Paper fed from tray 2 remains detected at the sensor (tray 2 pass-through) or at the sensor (tray 2 trailing edge) after the printer is turned on.	See “Sensors (optional tray trailing edge and pass-through) static jam service check” on page 170.
242.22	Paper fed from tray 2 was detected earlier than expected at the sensor (tray 2 pass-through) or at the sensor (tray 2 trailing edge).	See “Sensors (optional tray trailing edge and pass-through): Paper arrived too early service check” on page 172.
242.23	Paper fed from tray 2 never arrived at the sensor (tray 2 pass-through).	See “Sensor (tray 2 pass-through): Paper failed to arrive service check” on page 173.
242.24	Paper fed from tray 2 cleared the sensor (tray 2 pass-through) or the sensor (tray 2 trailing edge) earlier than expected.	See “Sensors (optional tray trailing edge and pass-through): Paper cleared too early service check” on page 181.
242.25	Paper fed from tray 2 cleared the sensor (tray 2 pass-through) or the sensor (tray 2 trailing edge) later than expected.	See “Sensors (optional tray trailing edge and pass-through): Paper cleared too late service check” on page 183.
242.26	Paper fed from tray 2 was picked but it never arrived at the sensor (tray 2 pass-through).	See “Sensor (optional tray pass-through): optional tray failed to pick service check” on page 185.
242.31	Paper fed from tray 3 remains detected at the sensor (tray 2 pass-through) or at the sensor (tray 2 trailing edge) after the printer is turned on.	See “Sensors (optional tray trailing edge and pass-through) static jam service check” on page 170.
242.32	Paper fed from tray 3 was detected earlier than expected at the sensor (tray 2 pass-through) or at the sensor (tray 2 trailing edge).	See “Sensors (optional tray trailing edge and pass-through): Paper arrived too early service check” on page 172.
242.33	Paper fed from tray 3 never arrived at the sensor (tray 2 pass-through).	See “Sensor (tray 2 pass-through): Paper failed to arrive service check” on page 173.

Error code	Description	Action
242.34	Paper fed from tray 3 cleared the sensor (tray 2 pass-through) or the sensor (tray 2 trailing edge) earlier than expected.	See “Sensors (optional tray trailing edge and pass-through): Paper cleared too early service check” on page 181.
242.35	Paper fed from tray 3 cleared the sensor (tray 2 pass-through) or the sensor (tray 2 trailing edge) later than expected.	See “Sensors (optional tray trailing edge and pass-through): Paper cleared too late service check” on page 183.
242.36	Paper fed from tray 3 was picked but it never arrived at the sensor (tray 2 pass-through).	See “Sensor (optional tray pass-through): optional tray failed to pick service check” on page 185.
242.41	Paper fed from tray 4 remains detected at the sensor (tray 2 pass-through) or at the sensor (tray 2 trailing edge) after the printer is turned on.	See “Sensors (optional tray trailing edge and pass-through) static jam service check” on page 170.
242.42	Paper fed from tray 4 was detected earlier than expected at the sensor (tray 2 pass-through) or at the sensor (tray 2 trailing edge).	See “Sensors (optional tray trailing edge and pass-through): Paper arrived too early service check” on page 172.
242.43	Paper fed from tray 4 never arrived at the sensor (tray 2 pass-through).	See “Sensor (tray 2 pass-through): Paper failed to arrive service check” on page 173.
242.44	Paper fed from tray 4 cleared the sensor (tray 2 pass-through) or the sensor (tray 2 trailing edge) earlier than expected.	See “Sensors (optional tray trailing edge and pass-through): Paper cleared too early service check” on page 181.
242.45	Paper fed from tray 4 cleared the sensor (tray 2 pass-through) or the sensor (tray 2 trailing edge) later than expected.	See “Sensors (optional tray trailing edge and pass-through): Paper cleared too late service check” on page 183.
242.46	Paper fed from tray 4 was picked but it never arrived at the sensor (tray 2 pass-through).	See “Sensor (optional tray pass-through): optional tray failed to pick service check” on page 185.
242.51	Paper fed from tray 5 remains detected at the sensor (tray 2 pass-through) or at the sensor (tray 2 trailing edge) after the printer is turned on.	See “Sensors (optional tray trailing edge and pass-through) static jam service check” on page 170.
242.52	Paper fed from tray 5 was detected earlier than expected at the sensor (tray 2 pass-through) or at the sensor (tray 2 trailing edge).	See “Sensors (optional tray trailing edge and pass-through): Paper arrived too early service check” on page 172.
242.53	Paper fed from tray 5 never arrived at the sensor (tray 2 pass-through).	See “Sensor (tray 2 pass-through): Paper failed to arrive service check” on page 173.
242.54	Paper fed from tray 5 cleared the sensor (tray 2 pass-through) or the sensor (tray 2 trailing edge) earlier than expected.	See “Sensors (optional tray trailing edge and pass-through): Paper cleared too early service check” on page 181.
242.55	Paper fed from tray 5 cleared the sensor (tray 2 pass-through) or the sensor (tray 2 trailing edge) later than expected.	See “Sensors (optional tray trailing edge and pass-through): Paper cleared too late service check” on page 183.
242.56	Paper fed from tray 5 was picked but it never arrived at the sensor (tray 2 pass-through).	See “Sensor (optional tray pass-through): optional tray failed to pick service check” on page 185.

Error code	Description	Action
242.70	Motor (550-sheet tray 2 transport) does not turn on.	See “Optional tray transport drive jam service check” on page 193.
242.71	Motor (550-sheet tray 2 transport) does not turn off.	
242.72	Motor (550-sheet tray 2 transport) speed did not ramp up to expected level.	
242.73	Motor (550-sheet tray 2 transport) stalled.	
242.74	Motor (550-sheet tray 2 transport) ran too slow.	
242.75	Motor (550-sheet tray 2 transport) ran too fast.	
242.76	Motor (550-sheet tray 2 transport) ran too long.	
242.80	Motor (550-sheet tray 2 pick/lift) does not turn on.	See “Optional tray pick drive failure service check” on page 195.
242.81	Motor (550-sheet tray 2 pick/lift) does not turn off.	
242.82	Motor (550-sheet tray 2 pick/lift) speed did not ramp up to expected level.	
242.83	Motor (550-sheet tray 2 pick/lift) stalled.	
242.84	Motor (550-sheet tray 2 pick/lift) ran too slow.	
242.85	Motor (550-sheet tray 2 pick/lift) ran too fast.	
242.86	Motor (550-sheet tray 2 pick/lift) ran too long.	
242.91	Paper remains detected at the sensor (tray 2 pass-through) or at the sensor (tray 2 trailing edge) after the printer is turned on. Paper source is undetermined.	See “Sensors (optional tray trailing edge and pass-through) static jam service check” on page 170.
242.92	Paper was detected earlier than expected at the sensor (tray 2 pass-through) or at the sensor (tray 2 trailing edge). Paper source is undetermined.	See “Sensors (optional tray trailing edge and pass-through): Paper arrived too early service check” on page 172.
242.93	Paper never arrived at the sensor (tray 2 pass-through). Paper source is undetermined.	See “Sensor (tray 2 pass-through): Paper failed to arrive service check” on page 173.
242.94	Paper cleared the sensor (tray 2 pass-through) or the sensor (tray 2 trailing edge) earlier than expected. Paper source is undetermined.	See “Sensors (optional tray trailing edge and pass-through): Paper cleared too early service check” on page 181.
242.95	Paper cleared the sensor (tray 2 pass-through) or the sensor (tray 2 trailing edge) later than expected. Paper source is undetermined.	See “Sensors (optional tray trailing edge and pass-through): Paper cleared too late service check” on page 183.
242.96	Paper was picked but it never arrived at the sensor (tray 2 pass-through). Paper source is undetermined.	See “Sensor (optional tray pass-through): optional tray failed to pick service check” on page 185.

243 paper jam messages

Error code	Description	Action
243.31	Paper fed from tray 3 remains detected at the sensor (tray 3 pass-through) or at the sensor (tray 3 trailing edge) after the printer is turned on.	See “Sensors (optional tray trailing edge and pass-through) static jam service check” on page 170.
243.32	Paper fed from tray 3 was detected earlier than expected at the sensor (tray 3 pass-through) or at the sensor (tray 3 trailing edge).	See “Sensors (optional tray trailing edge and pass-through): Paper arrived too early service check” on page 172.
243.33	Paper fed from tray 3 never arrived at the sensor (tray 3 pass-through).	See “Sensor (tray 3 pass-through): Paper failed to arrive service check” on page 176.
243.34	Paper fed from tray 3 cleared the sensor (tray 3 pass-through) or the sensor (tray 3 trailing edge) earlier than expected.	See “Sensors (optional tray trailing edge and pass-through): Paper cleared too early service check” on page 181.
243.35	Paper fed from tray 3 cleared the sensor (tray 3 pass-through) or the sensor (tray 3 trailing edge) later than expected.	See “Sensors (optional tray trailing edge and pass-through): Paper cleared too late service check” on page 183.
243.36	Paper fed from tray 3 was picked but it never arrived at the sensor (tray 3 pass-through).	See “Sensor (optional tray pass-through): optional tray failed to pick service check” on page 185.
243.41	Paper fed from tray 4 remains detected at the sensor (tray 3 pass-through) or at the sensor (tray 3 trailing edge) after the printer is turned on.	See “Sensors (optional tray trailing edge and pass-through) static jam service check” on page 170.
243.42	Paper fed from tray 4 was detected earlier than expected at the sensor (tray 3 pass-through) or at the sensor (tray 3 trailing edge).	See “Sensors (optional tray trailing edge and pass-through): Paper arrived too early service check” on page 172.
243.43	Paper fed from tray 4 never arrived at the sensor (tray 3 pass-through).	See “Sensor (tray 3 pass-through): Paper failed to arrive service check” on page 176.
243.44	Paper fed from tray 4 cleared the sensor (tray 3 pass-through) or the sensor (tray 3 trailing edge) earlier than expected.	See “Sensors (optional tray trailing edge and pass-through): Paper cleared too early service check” on page 181.
243.45	Paper fed from tray 4 cleared the sensor (tray 3 pass-through) or the sensor (tray 3 trailing edge) later than expected.	See “Sensors (optional tray trailing edge and pass-through): Paper cleared too late service check” on page 183.
243.46	Paper fed from tray 4 was picked but it never arrived at the sensor (tray 3 pass-through).	See “Sensor (optional tray pass-through): optional tray failed to pick service check” on page 185.
243.51	Paper fed from tray 5 remains detected at the sensor (tray 3 pass-through) or at the sensor (tray 3 trailing edge) after the printer is turned on.	See “Sensors (optional tray trailing edge and pass-through) static jam service check” on page 170.
243.52	Paper fed from tray 5 was detected earlier than expected at the sensor (tray 3 pass-through) or at the sensor (tray 3 trailing edge).	See “Sensors (optional tray trailing edge and pass-through): Paper arrived too early service check” on page 172.

Error code	Description	Action
243.53	Paper fed from tray 5 never arrived at the sensor (tray 3 pass-through).	See “Sensor (tray 3 pass-through): Paper failed to arrive service check” on page 176.
243.54	Paper fed from tray 5 cleared the sensor (tray 3 pass-through) or the sensor (tray 3 trailing edge) earlier than expected.	See “Sensors (optional tray trailing edge and pass-through): Paper cleared too early service check” on page 181.
243.55	Paper fed from tray 5 cleared the sensor (tray 3 pass-through) or the sensor (tray 3 trailing edge) later than expected.	See “Sensors (optional tray trailing edge and pass-through): Paper cleared too late service check” on page 183.
243.56	Paper fed from tray 5 was picked but it never arrived at the sensor (tray 3 pass-through).	See “Sensor (optional tray pass-through): optional tray failed to pick service check” on page 185.
243.70	Motor (550-sheet tray 3 transport) does not turn on.	See “Optional tray transport drive jam service check” on page 193.
243.71	Motor (550-sheet tray 3 transport) does not turn off.	
243.72	Motor (550-sheet tray 3 transport) speed did not ramp up to expected level.	
243.73	Motor (550-sheet tray 3 transport) stalled.	
243.74	Motor (550-sheet tray 3 transport) ran too slow.	
243.75	Motor (550-sheet tray 3 transport) ran too fast.	
243.76	Motor (550-sheet tray 3 transport) ran too long.	
243.80	Motor (550-sheet tray 3 pick/lift) does not turn on.	
243.81	Motor (550-sheet tray 3 pick/lift) does not turn off.	
243.82	Motor (550-sheet tray 3 pick/lift) speed did not ramp up to expected level.	
243.83	Motor (550-sheet tray 3 pick/lift) stalled.	
243.84	Motor (550-sheet tray 3 pick/lift) ran too slow.	
243.85	Motor (550-sheet tray 3 pick/lift) ran too fast.	
243.86	Motor (550-sheet tray 3 pick/lift) ran too long.	
243.91	Paper remains detected at the sensor (tray 3 pass-through) or at the sensor (tray 3 trailing edge) after the printer is turned on. Paper source is undetermined.	See “Sensors (optional tray trailing edge and pass-through) static jam service check” on page 170.
243.92	Paper was detected earlier than expected at the sensor (tray 3 pass-through) or at the sensor (tray 3 trailing edge). Paper source is undetermined.	See “Sensors (optional tray trailing edge and pass-through): Paper arrived too early service check” on page 172.
243.93	Paper never arrived at the sensor (tray 3 pass-through). Paper source is undetermined.	See “Sensor (tray 3 pass-through): Paper failed to arrive service check” on page 176.

Error code	Description	Action
243.94	Paper cleared the sensor (tray 3 pass-through) or the sensor (tray 3 trailing edge) earlier than expected. Paper source is undetermined.	See “Sensors (optional tray trailing edge and pass-through): Paper cleared too early service check” on page 181.
243.95	Paper cleared the sensor (tray 3 pass-through) or the sensor (tray 3 trailing edge) later than expected. Paper source is undetermined.	See “Sensors (optional tray trailing edge and pass-through): Paper cleared too late service check” on page 183.
243.96	Paper was picked but it never arrived at the sensor (tray 3 pass-through). Paper source is undetermined.	See “Sensor (optional tray pass-through): optional tray failed to pick service check” on page 185.

244 paper jam messages

Error code	Description	Action
244.41	Paper fed from tray 4 remains detected at the sensor (tray 4 pass-through) or at the sensor (tray 4 trailing edge) after the printer is turned on.	See “Sensors (optional tray trailing edge and pass-through) static jam service check” on page 170.
244.42	Paper fed from tray 4 was detected earlier than expected at the sensor (tray 4 pass-through) or at the sensor (tray 4 trailing edge).	See “Sensors (optional tray trailing edge and pass-through): Paper arrived too early service check” on page 172.
244.43	Paper fed from tray 4 never arrived at the sensor (tray 4 pass-through).	See “Sensor (tray 4 pass-through): Paper failed to arrive service check” on page 178.
244.44	Paper fed from tray 4 cleared the sensor (tray 4 pass-through) or the sensor (tray 4 trailing edge) earlier than expected.	See “Sensors (optional tray trailing edge and pass-through): Paper cleared too early service check” on page 181.
244.45	Paper fed from tray 4 cleared the sensor (tray 4 pass-through) or the sensor (tray 4 trailing edge) later than expected.	See “Sensors (optional tray trailing edge and pass-through): Paper cleared too late service check” on page 183.
244.46	Paper fed from tray 4 was picked but it never arrived at the sensor (tray 4 trailing edge).	See “Sensor (optional tray pass-through): optional tray failed to pick service check” on page 185.
244.51	Paper fed from tray 5 remains detected at the sensor (tray 4 pass-through) or at the sensor (tray 4 trailing edge) after the printer is turned on.	See “Sensors (optional tray trailing edge and pass-through) static jam service check” on page 170.
244.52	Paper fed from tray 5 was detected earlier than expected at the sensor (tray 4 pass-through) or at the sensor (tray 4 trailing edge).	See “Sensors (optional tray trailing edge and pass-through): Paper arrived too early service check” on page 172.
244.53	Paper fed from tray 5 never arrived at the sensor (tray 4 pass-through).	See “Sensor (tray 4 pass-through): Paper failed to arrive service check” on page 178.
244.54	Paper fed from tray 5 cleared the sensor (tray 4 pass-through) or the sensor (tray 4 trailing edge) earlier than expected.	See “Sensors (optional tray trailing edge and pass-through): Paper cleared too early service check” on page 181.
244.55	Paper fed from tray 5 cleared the sensor (tray 4 pass-through) or the sensor (tray 4 trailing edge) later than expected.	See “Sensors (optional tray trailing edge and pass-through): Paper cleared too late service check” on page 183.

Error code	Description	Action
244.56	Paper fed from tray 5 was picked but it never arrived at the sensor (tray 4 trailing edge).	See “Sensor (optional tray pass-through): optional tray failed to pick service check” on page 185.
244.70	Motor (550-sheet tray 4 transport) does not turn on.	See “Optional tray transport drive jam service check” on page 193.
244.71	Motor (550-sheet tray 4 transport) does not turn off.	
244.72	Motor (550-sheet tray 4 transport) speed did not ramp up to expected level.	
244.73	Motor (550-sheet tray 4 transport) stalled.	
244.74	Motor (550-sheet tray 4 transport) ran too slow.	
244.75	Motor (550-sheet tray 4 transport) ran too fast.	
244.76	Motor (550-sheet tray 4 transport) ran too long.	
244.80	Motor (550-sheet tray 4 pick/lift) does not turn on.	See “Optional tray pick drive failure service check” on page 195.
244.81	Motor (550-sheet tray 4 pick/lift) does not turn off.	
244.82	Motor (550-sheet tray 4 pick/lift) speed did not ramp up to expected level.	
244.83	Motor (550-sheet tray 4 pick/lift) stalled.	
244.84	Motor (550-sheet tray 4 pick/lift) ran too slow.	
244.85	Motor (550-sheet tray 4 pick/lift) ran too fast.	
244.86	Motor (550-sheet tray 4 pick/lift) ran too long.	
244.91	Paper remains detected at the sensor (tray 4 pass-through) or at the sensor (tray 4 trailing edge) after the printer is turned on. Paper source is undetermined.	See “Sensors (optional tray trailing edge and pass-through) static jam service check” on page 170.
244.92	Paper was detected earlier than expected at the sensor (tray 4 pass-through) or at the sensor (tray 4 trailing edge). Paper source is undetermined.	See “Sensors (optional tray trailing edge and pass-through): Paper arrived too early service check” on page 172.
244.93	Paper fed from tray 4 never arrived at the sensor (tray 4 pass-through). Paper source is undetermined.	See “Sensor (tray 4 pass-through): Paper failed to arrive service check” on page 178.
244.94	Paper cleared the sensor (tray 4 pass-through) or the sensor (tray 4 trailing edge) earlier than expected. Paper source is undetermined.	See “Sensors (optional tray trailing edge and pass-through): Paper cleared too early service check” on page 181.
244.95	Paper cleared the sensor (tray 4 pass-through) or the sensor (tray 4 trailing edge) later than expected. Paper source is undetermined.	See “Sensors (optional tray trailing edge and pass-through): Paper cleared too late service check” on page 183.
244.96	Paper was picked but it never arrived at the sensor (tray 4 pass-through). Paper source is undetermined.	See “Sensor (optional tray pass-through): optional tray failed to pick service check” on page 185.

Error code	Description	Action
244.97	Paper never cleared the sensor (tray 4 pass-through) or at the sensor (tray 4 trailing edge). Paper source is undetermined.	See “Sensors (optional tray trailing edge and pass-through): Paper failed to clear service check” on page 188.
244.98	Paper was detected later than expected at the sensor (tray 4 pass-through) or at the sensor (tray 4 trailing edge). Paper source is undetermined.	See “Sensors (optional tray trailing edge and pass-through): Paper arrived too late service check” on page 190.

245 paper jam messages

Error code	Description	Action
245.51	Paper fed from tray 5 remains detected at the sensor (tray 5 pass-through) or at the sensor (tray 5 trailing edge) after the printer is turned on.	See “Sensors (optional tray trailing edge and pass-through) static jam service check” on page 170.
245.52	Paper fed from tray 5 was detected earlier than expected at the sensor (tray 5 pass-through) or at the sensor (tray 5 trailing edge).	See “Sensors (optional tray trailing edge and pass-through): Paper arrived too early service check” on page 172.
245.53	Paper fed from tray 5 never arrived at the sensor (tray 5 pass-through).	See “Sensor (tray 4 pass-through): Paper failed to arrive service check” on page 178.
245.54	Paper fed from tray 5 cleared the sensor (tray 5 pass-through) or the sensor (tray 5 trailing edge) earlier than expected.	See “Sensors (optional tray trailing edge and pass-through): Paper cleared too early service check” on page 181.
245.55	Paper fed from tray 5 cleared the sensor (tray 5 pass-through) or the sensor (tray 5 trailing edge) later than expected.	See “Sensors (optional tray trailing edge and pass-through): Paper cleared too late service check” on page 183.
245.56	Paper fed from tray 5 was picked but it never arrived at the sensor (tray 5 trailing edge).	See “Sensor (optional tray pass-through): optional tray failed to pick service check” on page 185.
245.70	Motor (550-sheet tray 5 transport) does not turn on.	See “Optional tray transport drive jam service check” on page 193.
245.71	Motor (550-sheet tray 5 transport) does not turn off.	
245.72	Motor (550-sheet tray 5 transport) speed did not ramp up to expected level.	
245.73	Motor (550-sheet tray 5 transport) stalled.	
245.74	Motor (550-sheet tray 5 transport) ran too slow.	
245.75	Motor (550-sheet tray 5 transport) ran too fast.	
245.76	Motor (550-sheet tray 5 transport) ran too long.	

Error code	Description	Action
245.80	Motor (550-sheet tray 5 pick/lift) does not turn on.	See “Optional tray pick drive failure service check” on page 195.
245.81	Motor (550-sheet tray 5 pick/lift) does not turn off.	
245.82	Motor (550-sheet tray 5 pick/lift) speed did not ramp up to expected level.	
245.83	Motor (550-sheet tray 5 pick/lift) stalled.	
245.84	Motor (550-sheet tray 5 pick/lift) ran too slow.	
245.85	Motor (550-sheet tray 5 pick/lift) ran too fast.	
245.86	Motor (550-sheet tray 5 pick/lift) ran too long.	
245.91	Paper remains detected at the sensor (tray 5 pass-through) or at the sensor (tray 5 trailing edge) after the printer is turned on. Paper source is undetermined.	See “Sensors (optional tray trailing edge and pass-through) static jam service check” on page 170.
245.92	Paper was detected earlier than expected at the sensor (tray 5 pass-through) or at the sensor (tray 5 trailing edge). Paper source is undetermined.	See “Sensors (optional tray trailing edge and pass-through): Paper arrived too early service check” on page 172.
245.93	Paper fed from tray 5 never arrived at the sensor (tray 5 pass-through). Paper source is undetermined.	See “Sensor (tray 4 pass-through): Paper failed to arrive service check” on page 178.
245.94	Paper cleared the sensor (tray 5 pass-through) or the sensor (tray 5 trailing edge) earlier than expected. Paper source is undetermined.	See “Sensors (optional tray trailing edge and pass-through): Paper cleared too early service check” on page 181.
245.95	Paper cleared the sensor (tray 5 pass-through) or the sensor (tray 5 trailing edge) later than expected. Paper source is undetermined.	See “Sensors (optional tray trailing edge and pass-through): Paper cleared too late service check” on page 183.
245.96	Paper was picked but it never arrived at the sensor (tray 5 pass-through). Paper source is undetermined.	See “Sensor (optional tray pass-through): optional tray failed to pick service check” on page 185.
245.97	Paper never cleared the sensor (tray 5 pass-through) or at the sensor (tray 5 trailing edge). Paper source is undetermined.	See “Sensors (optional tray trailing edge and pass-through): Paper failed to clear service check” on page 188.
245.98	Paper was detected later than expected at the sensor (tray 5 pass-through) or at the sensor (tray 5 trailing edge). Paper source is undetermined.	See “Sensors (optional tray trailing edge and pass-through): Paper arrived too late service check” on page 190.

Sensors (optional tray trailing edge and pass-through) static jam service check

Action	Yes	No
<p>Step 1</p> <p>a From the home screen, touch Settings > Device > Preferences.</p> <p>b Check if the paper size matches the size set on the tray guides.</p> <p>Does the paper size match the size set on the tray?</p>	Go to step 3.	Go to step 2.

Action	Yes	No
<p>Step 2 Change the paper size or adjust the size setting in the tray.</p> <p>Does the problem remain?</p>	Go to step 3.	The problem is solved.
<p>Step 3 Check the paper path for partially fed or jammed paper.</p> <p>Is the paper path free of partially fed or jammed paper?</p>	Go to step 5.	Go to step 4.
<p>Step 4 Remove the partially fed or jammed paper.</p> <p>Does the problem remain?</p>	Go to step 5.	The problem is solved.
<p>Step 5</p> <p>a Enter the Diagnostics menu, and then navigate to: Additional input trays adjustments/tests > Additional input tray sensors</p> <p>b Find the sensor (Trailing edge (tray [x])). Note: [x] is the tray number.</p> <p>Does the sensor status change while toggling the sensor?</p>	Go to step 7.	Go to step 6.
<p>Step 6</p> <p>a Make sure that the sensor cable is properly connected.</p> <p>b Make sure that the sensor is properly installed.</p> <p>c Check the sensor for damage.</p> <p>Is the sensor free of damage?</p>	Go to step 7.	Go to step 9.
<p>Step 7</p> <p>a Enter the Diagnostics menu, and then navigate to: Additional input trays adjustments/tests > Additional input tray sensors</p> <p>b Find the sensor (Pass-through (tray [x])). Note: [x] is the tray number.</p> <p>Does the sensor status change while toggling the sensor?</p>	Go to step 10.	Go to step 8.
<p>Step 8</p> <p>a Make sure that the sensor cable is properly connected.</p> <p>b Make sure that the sensor is properly installed.</p> <p>c Check the sensor and the other optional tray components for damage.</p> <p>Is the sensor free of damage?</p>	Go to step 10.	Go to step 9.

Action	Yes	No
<p>Step 9 Replace the optional tray. See “Optional 550-sheet tray removal” on page 536.</p> <p>Does the problem remain?</p>	Go to step 10.	The problem is solved.
<p>Step 10 Perform a print test.</p> <p>Does the problem remain?</p>	Contact the next level of support.	The problem is solved.

Sensors (optional tray trailing edge and pass-through): Paper arrived too early service check

Action	Yes	No
<p>Step 1 a From the home screen, touch Settings > Device > Preferences. b Check if the paper size matches the size set on the tray guides.</p> <p>Does the paper size match the size set on the tray?</p>	Go to step 3.	Go to step 2.
<p>Step 2 Change the paper size or adjust the size setting in the tray.</p> <p>Does the problem remain?</p>	Go to step 3.	The problem is solved.
<p>Step 3 Check the paper path for partially fed or jammed paper.</p> <p>Is the paper path free of partially fed or jammed paper?</p>	Go to step 5.	Go to step 4.
<p>Step 4 Remove the partially fed or jammed paper.</p> <p>Does the problem remain?</p>	Go to step 5.	The problem is solved.
<p>Step 5 a Enter the Diagnostics menu, and then navigate to: Additional input trays adjustments/tests > Additional input tray sensors b Find the sensor (Trailing edge (tray [x])). Note: [x] is the tray number.</p> <p>Does the sensor status change while toggling the sensor?</p>	Go to step 7.	Go to step 6.

Action	Yes	No
<p>Step 6</p> <p>a Make sure that the sensor cable is properly connected.</p> <p>b Make sure that the sensor is properly installed.</p> <p>c Check the sensor for damage.</p> <p>Is the sensor free of damage?</p>	Go to step 7.	Go to step 9.
<p>Step 7</p> <p>a Enter the Diagnostics menu, and then navigate to: Additional input trays adjustments/tests > Additional input tray sensors</p> <p>b Find the sensor (Pass-through (tray [x])). Note: [x] is the tray number.</p> <p>Does the sensor status change while toggling the sensor?</p>	Go to step 10.	Go to step 8.
<p>Step 8</p> <p>a Make sure that the sensor cable is properly connected.</p> <p>b Make sure that the sensor is properly installed.</p> <p>c Check the sensor and the other optional tray components for damage.</p> <p>Is the sensor free of damage?</p>	Go to step 10.	Go to step 9.
<p>Step 9</p> <p>Replace the optional tray. See “Optional 550-sheet tray removal” on page 536.</p> <p>Does the problem remain?</p>	Go to step 10.	The problem is solved.
<p>Step 10</p> <p>Perform a print test.</p> <p>Does the problem remain?</p>	Contact the next level of support.	The problem is solved.

Sensor (tray 2 pass-through): Paper failed to arrive service check

Action	Yes	No
<p>Step 1</p> <p>a From the home screen, touch Settings > Device > Preferences.</p> <p>b Check if the paper size matches the size set on the tray guides.</p> <p>Does the paper size match the size set on the tray?</p>	Go to step 3.	Go to step 2.
<p>Step 2</p> <p>Change the paper size or adjust the size setting in the tray.</p> <p>Does the problem remain?</p>	Go to step 3.	The problem is solved.

Action	Yes	No
<p>Step 3 Check if the paper size matches the size set on the tray guides.</p> <p>Does the paper size match the size set on the tray?</p>	Go to step 5.	Go to step 4.
<p>Step 4 Replace the paper or change the paper size setting in the tray.</p> <p>Does the problem remain?</p>	Go to step 5.	The problem is solved.
<p>Step 5 Check the paper tray for overfilling.</p> <p>Is the paper tray overfilled?</p>	Go to step 6.	Go to step 7.
<p>Step 6 Remove the excess paper from the tray.</p> <p>Does the problem remain?</p>	Go to step 7.	The problem is solved.
<p>Step 7 Check the paper condition in the tray.</p> <p>Is the paper crumpled or damaged?</p>	Go to step 8.	Go to step 9.
<p>Step 8 Replace the crumpled or damaged paper.</p> <p>Does the problem remain?</p>	Go to step 9.	The problem is solved.
<p>Step 9 Check the paper path for partially fed or jammed paper.</p> <p>Is the paper path free of partially fed or jammed paper?</p>	Go to step 11.	Go to step 10.
<p>Step 10 Remove the partially fed or jammed paper.</p> <p>Does the problem remain?</p>	Go to step 11.	The problem is solved.
<p>Step 11 a Enter the Diagnostics menu, and then navigate to: Additional input trays adjustments/tests > Additional input tray sensors b Find the sensor (Pass-through (tray 2)).</p> <p>Does the sensor status change while toggling the sensor?</p>	Go to step 13.	Go to step 12.

Action	Yes	No
<p>Step 12</p> <p>a Make sure that the sensor cable is properly connected.</p> <p>b Make sure that the sensor is properly installed.</p> <p>c Check the sensor and the other optional tray components for damage.</p> <p>Is the sensor free of damage?</p>	Go to step 13.	Go to step 15.
<p>Step 13</p> <p>a Enter the Diagnostics menu, and then navigate to: Additional input trays adjustments/tests > Additional input tray motors</p> <p>b Select Pass-through (tray 2), and then touch Start.</p> <p>Does the motor run?</p>	Go to step 16.	Go to step 14.
<p>Step 14</p> <p>a Make sure that the motor cable is properly connected.</p> <p>b Make sure that the motor is properly installed.</p> <p>c Check the motor and the other optional tray components for damage.</p> <p>Are the motor and the optional tray free of damage?</p>	Go to step 16.	Go to step 15.
<p>Step 15</p> <p>Replace the optional tray. See “Optional 550-sheet tray removal” on page 536.</p> <p>Does the problem remain?</p>	Go to step 16.	The problem is solved.
<p>Step 16</p> <p>a Enter the Diagnostics menu, and then navigate to: Additional input trays adjustments/tests > Additional input tray motors</p> <p>b Select Pass-through (tray 3), and then touch Start.</p> <p>Does the motor run?</p>	Go to step 19.	Go to step 17.
<p>Step 17</p> <p>a Make sure that the motor cable is properly connected.</p> <p>b Make sure that the motor is properly installed.</p> <p>c Check the motor and the other optional tray components for damage.</p> <p>Are the motor and optional tray free of damage?</p>	Go to step 19.	Go to step 18.

Action	Yes	No
<p>Step 18 Replace the optional tray. See “Optional 550-sheet tray removal” on page 536.</p> <p>Does the problem remain?</p>	Go to step 19.	The problem is solved.
<p>Step 19 Perform a print test.</p> <p>Does the problem remain?</p>	Contact the next level of support.	The problem is solved.

Sensor (tray 3 pass-through): Paper failed to arrive service check

Action	Yes	No
<p>Step 1 a From the home screen, touch Settings > Device > Preferences. b Check if the paper size matches the size set on the tray guides.</p> <p>Does the paper size match the size set on the tray?</p>	Go to step 3.	Go to step 2.
<p>Step 2 Change the paper size or adjust the size setting in the tray.</p> <p>Does the problem remain?</p>	Go to step 3.	The problem is solved.
<p>Step 3 Check if the paper size matches the size set on the tray guides.</p> <p>Does the paper size match the size set on the tray?</p>	Go to step 5.	Go to step 4.
<p>Step 4 Replace the paper or change the paper size setting in the tray.</p> <p>Does the problem remain?</p>	Go to step 5.	The problem is solved.
<p>Step 5 Check the paper tray for overfilling.</p> <p>Is the paper tray overfilled?</p>	Go to step 6.	Go to step 7.
<p>Step 6 Remove the excess paper from the tray.</p> <p>Does the problem remain?</p>	Go to step 7.	The problem is solved.
<p>Step 7 Check the paper condition in the tray.</p> <p>Is the paper crumpled or damaged?</p>	Go to step 8.	Go to step 9.

Action	Yes	No
<p>Step 8 Replace the crumpled or damaged paper.</p> <p>Does the problem remain?</p>	Go to step 9.	The problem is solved.
<p>Step 9 Check the paper path for partially fed or jammed paper.</p> <p>Is the paper path free of partially fed or jammed paper?</p>	Go to step 11.	Go to step 10.
<p>Step 10 Remove the partially fed or jammed paper.</p> <p>Does the problem remain?</p>	Go to step 11.	The problem is solved.
<p>Step 11</p> <p>a Enter the Diagnostics menu, and then navigate to: Additional input trays adjustments/tests > Additional input tray sensors</p> <p>b Find the sensor (Pass-through (tray 3)).</p> <p>Does the sensor status change while toggling the sensor?</p>	Go to step 13.	Go to step 12.
<p>Step 12</p> <p>a Make sure that the sensor cable is properly connected.</p> <p>b Make sure that the sensor is properly installed.</p> <p>c Check the sensor and the other optional tray components for damage.</p> <p>Is the sensor free of damage?</p>	Go to step 13.	Go to step 15.
<p>Step 13</p> <p>a Enter the Diagnostics menu, and then navigate to: Additional input trays adjustments/tests > Additional input tray motors</p> <p>b Select Pass-through (tray 3), and then touch Start.</p> <p>Does the motor run?</p>	Go to step 16.	Go to step 14.
<p>Step 14</p> <p>a Make sure that the motor cable is properly connected.</p> <p>b Make sure that the motor is properly installed.</p> <p>c Check the motor and the other optional tray components for damage.</p> <p>Are the motor and the optional tray free of damage?</p>	Go to step 16.	Go to step 15.

Action	Yes	No
<p>Step 15 Replace the optional tray. See “Optional 550-sheet tray removal” on page 536.</p> <p>Does the problem remain?</p>	Go to step 16.	The problem is solved.
<p>Step 16 a Enter the Diagnostics menu, and then navigate to: Additional input trays adjustments/tests > Additional input tray motors b Select Pass-through (tray 4), and then touch Start.</p> <p>Does the motor run?</p>	Go to step 19.	Go to step 17.
<p>Step 17 a Make sure that the motor cable is properly connected. b Make sure that the motor is properly installed. c Check the motor and the other optional tray components for damage.</p> <p>Are the motor and optional tray free of damage?</p>	Go to step 19.	Go to step 18.
<p>Step 18 Replace the optional tray. See “Optional 550-sheet tray removal” on page 536.</p> <p>Does the problem remain?</p>	Go to step 19.	The problem is solved.
<p>Step 19 Perform a print test.</p> <p>Does the problem remain?</p>	Contact the next level of support.	The problem is solved.

Sensor (tray 4 pass-through): Paper failed to arrive service check

Action	Yes	No
<p>Step 1 a From the home screen, touch Settings > Device > Preferences. b Check if the paper size matches the size set on the tray guides.</p> <p>Does the paper size match the size set on the tray?</p>	Go to step 3.	Go to step 2.
<p>Step 2 Change the paper size or adjust the size setting in the tray.</p> <p>Does the problem remain?</p>	Go to step 3.	The problem is solved.

Action	Yes	No
<p>Step 3 Check if the paper size matches the size set on the tray guides.</p> <p>Does the paper size match the size set on the tray?</p>	Go to step 5.	Go to step 4.
<p>Step 4 Replace the paper or change the paper size setting in the tray.</p> <p>Does the problem remain?</p>	Go to step 5.	The problem is solved.
<p>Step 5 Check the paper tray for overfilling.</p> <p>Is the paper tray overfilled?</p>	Go to step 6.	Go to step 7.
<p>Step 6 Remove the excess paper from the tray.</p> <p>Does the problem remain?</p>	Go to step 7.	The problem is solved.
<p>Step 7 Check the paper condition in the tray.</p> <p>Is the paper crumpled or damaged?</p>	Go to step 8.	Go to step 9.
<p>Step 8 Replace the crumpled or damaged paper.</p> <p>Does the problem remain?</p>	Go to step 9.	The problem is solved.
<p>Step 9 Check the paper path for partially fed or jammed paper.</p> <p>Is the paper path free of partially fed or jammed paper?</p>	Go to step 11.	Go to step 10.
<p>Step 10 Remove the partially fed or jammed paper.</p> <p>Does the problem remain?</p>	Go to step 11.	The problem is solved.
<p>Step 11 a Enter the Diagnostics menu, and then navigate to: Additional input trays adjustments/tests > Additional input tray sensors b Find the sensor (Pass-through (tray 4)).</p> <p>Does the sensor status change while toggling the sensor?</p>	Go to step 13.	Go to step 12.

Action	Yes	No
<p>Step 12</p> <p>a Make sure that the sensor cable is properly connected.</p> <p>b Make sure that the sensor is properly installed.</p> <p>c Check the sensor and the other optional tray components for damage.</p> <p>Is the sensor free of damage?</p>	Go to step 13.	Go to step 15.
<p>Step 13</p> <p>a Enter the Diagnostics menu, and then navigate to: Additional input trays adjustments/tests > Additional input tray motors</p> <p>b Select Pass-through (tray 4), and then touch Start.</p> <p>Does the motor run?</p>	Go to step 16.	Go to step 14.
<p>Step 14</p> <p>a Make sure that the motor cable is properly connected.</p> <p>b Make sure that the motor is properly installed.</p> <p>c Check the motor and the other optional tray components for damage.</p> <p>Are the motor and the optional tray free of damage?</p>	Go to step 16.	Go to step 15.
<p>Step 15</p> <p>Replace the optional tray. See “Optional 550-sheet tray removal” on page 536.</p> <p>Does the problem remain?</p>	Go to step 16.	The problem is solved.
<p>Step 16</p> <p>a Enter the Diagnostics menu, and then navigate to: Additional input trays adjustments/tests > Additional input tray motors</p> <p>b Select Pass-through (tray 5), and then touch Start.</p> <p>Does the motor run?</p>	Go to step 19.	Go to step 17.
<p>Step 17</p> <p>a Make sure that the motor cable is properly connected.</p> <p>b Make sure that the motor is properly installed.</p> <p>c Check the motor and the other optional tray components for damage.</p> <p>Are the motor and optional tray free of damage?</p>	Go to step 19.	Go to step 18.

Action	Yes	No
<p>Step 18 Replace the optional tray. See “Optional 550-sheet tray removal” on page 536.</p> <p>Does the problem remain?</p>	Go to step 19.	The problem is solved.
<p>Step 19 Perform a print test.</p> <p>Does the problem remain?</p>	Contact the next level of support.	The problem is solved.

Sensors (optional tray trailing edge and pass-through): Paper cleared too early service check

Action	Yes	No
<p>Step 1 a From the home screen, touch Settings > Device > Preferences. b Check if the paper size matches the size set on the tray guides.</p> <p>Does the paper size match the size set on the tray?</p>	Go to step 3.	Go to step 2.
<p>Step 2 Change the paper size or adjust the size setting in the tray.</p> <p>Does the problem remain?</p>	Go to step 3.	The problem is solved.
<p>Step 3 Check if the paper size matches the size set on the tray guides.</p> <p>Does the paper size match the size set on the tray?</p>	Go to step 5.	Go to step 4.
<p>Step 4 Replace the paper or change the paper size setting in the tray.</p> <p>Does the problem remain?</p>	Go to step 5.	The problem is solved.
<p>Step 5 Check the paper tray for overfilling.</p> <p>Is the paper tray overfilled?</p>	Go to step 6.	Go to step 7.
<p>Step 6 Remove the excess paper from the tray.</p> <p>Does the problem remain?</p>	Go to step 7.	The problem is solved.

Action	Yes	No
<p>Step 7 Check the paper condition in the tray.</p> <p>Is the paper crumpled or damaged?</p>	Go to step 8.	Go to step 9.
<p>Step 8 Replace the crumpled or damaged paper.</p> <p>Does the problem remain?</p>	Go to step 9.	The problem is solved.
<p>Step 9 a Enter the Diagnostics menu, and then navigate to: Additional input trays adjustments/tests > Additional input tray sensors b Find the sensor (Trailing edge (tray [x])). Note: [x] is the tray number.</p> <p>Does the sensor status change while toggling the sensor?</p>	Go to step 11.	Go to step 10.
<p>Step 10 a Make sure that the sensor cable is properly connected. b Make sure that the sensor is properly installed. c Check the sensor for damage.</p> <p>Is the sensor free of damage?</p>	Go to step 11.	Go to step 13.
<p>Step 11 a Enter the Diagnostics menu, and then navigate to: Additional input trays adjustments/tests > Additional input tray sensors b Find the sensor (Pass-through (tray [x])). Note: [x] is the tray number.</p> <p>Does the sensor status change while toggling the sensor?</p>	Go to step 14.	Go to step 12.
<p>Step 12 a Make sure that the sensor cable is properly connected. b Make sure that the sensor is properly installed. c Check the sensor and the other optional tray components for damage.</p> <p>Is the sensor free of damage?</p>	Go to step 14.	Go to step 13.
<p>Step 13 Replace the optional tray. See “Optional 550-sheet tray removal” on page 536.</p> <p>Does the problem remain?</p>	Go to step 14.	The problem is solved.

Action	Yes	No
<p>Step 14 Perform a print test.</p> <p>Does the problem remain?</p>	Contact the next level of support.	The problem is solved.

Sensors (optional tray trailing edge and pass-through): Paper cleared too late service check

Action	Yes	No
<p>Step 1 a From the home screen, touch Settings > Device > Preferences. b Check if the paper size matches the size set on the tray guides.</p> <p>Does the paper size match the size set on the tray?</p>	Go to step 3.	Go to step 2.
<p>Step 2 Change the paper size or adjust the size setting in the tray.</p> <p>Does the problem remain?</p>	Go to step 3.	The problem is solved.
<p>Step 3 Check if the paper size matches the size set on the tray guides.</p> <p>Does the paper size match the size set on the tray?</p>	Go to step 5.	Go to step 4.
<p>Step 4 Replace the paper or change the paper size setting in the tray.</p> <p>Does the problem remain?</p>	Go to step 5.	The problem is solved.
<p>Step 5 Check the primary paper path for paper jams and obstructions.</p> <p>Is the paper path free of jams and obstructions?</p>	Go to step 7.	Go to step 6.
<p>Step 6 Remove the paper jams and obstructions.</p> <p>Does the problem remain?</p>	Go to step 7.	The problem is solved.
<p>Step 7 a Enter the Diagnostics menu, and then navigate to: Additional input trays adjustments/tests > Additional input tray sensors b Find the sensor (Trailing edge (tray [x])). Note: [x] is the tray number.</p> <p>Does the sensor status change while toggling the sensor?</p>	Go to step 9.	Go to step 8.

Action	Yes	No
<p>Step 8</p> <p>a Make sure that the sensor cable is properly connected.</p> <p>b Make sure that the sensor is properly installed.</p> <p>c Check the sensor and the other optional tray components for damage.</p> <p>Is the sensor free of damage?</p>	Go to step 9.	Go to step 13.
<p>Step 9</p> <p>a Enter the Diagnostics menu, and then navigate to: Additional input trays adjustments/tests > Additional input tray sensors</p> <p>b Find the sensor (Pass-through (tray [x])). Note: [x] is the tray number.</p> <p>Does the sensor status change while toggling the sensor?</p>	Go to step 11.	Go to step 10.
<p>Step 10</p> <p>a Make sure that the sensor cable is properly connected.</p> <p>b Make sure that the sensor is properly installed.</p> <p>c Check the sensor and the other optional tray components for damage.</p> <p>Are the sensor and the optional tray free of damage?</p>	Go to step 11.	Go to step 11.
<p>Step 11</p> <p>a Enter the Diagnostics menu, and then navigate to: Additional input trays adjustments/tests > Additional input tray motors</p> <p>b Select Pass-through (tray [x]), and then touch Start. Note: [x] is the tray number.</p> <p>Does the motor run?</p>	Go to step 14.	Go to step 12.
<p>Step 12</p> <p>a Make sure that the motor cable is properly connected.</p> <p>b Make sure that the motor is properly installed.</p> <p>c Check the motor and the other optional tray components for damage.</p> <p>Are the motor and the optional tray free of damage?</p>	Go to step 14.	Go to step 13.
<p>Step 13</p> <p>Replace the optional tray. See “Optional 550-sheet tray removal” on page 536.</p> <p>Does the problem remain?</p>	Go to step 14.	The problem is solved.

Action	Yes	No
<p>Step 14</p> <p>a Enter the Diagnostics menu, and then navigate to: Printer diagnostics & adjustments > Motor tests</p> <p>b Select Duplex/MPF, and then touch Start.</p> <p>Does the motor run?</p>	Go to step 17.	Go to step 15.
<p>Step 15</p> <p>Reseat the motor cable, and then check the motor for misalignment and damage.</p> <p>Is the motor properly installed and free of damage?</p>	Go to step 17.	Go to step 16.
<p>Step 16</p> <p>Reinstall or replace the motor. See “Motor (duplex/MPF) removal” on page 415.</p> <p>Does the problem remain?</p>	Go to step 17.	The problem is solved.
<p>Step 17</p> <p>Perform a print test.</p> <p>Does the problem remain?</p>	Contact the next level of support.	The problem is solved.

Sensor (optional tray pass-through): optional tray failed to pick service check

Action	Yes	No
<p>Step 1</p> <p>a From the home screen, touch Settings > Device > Preferences.</p> <p>b Check if the paper size matches the size set on the tray guides.</p> <p>Does the paper size match the size set on the tray?</p>	Go to step 3.	Go to step 2.
<p>Step 2</p> <p>Change the paper size or adjust the size setting in the tray.</p> <p>Does the problem remain?</p>	Go to step 3.	The problem is solved.
<p>Step 3</p> <p>Check if the paper size matches the size set on the tray guides.</p> <p>Does the paper size match the size set on the tray?</p>	Go to step 5.	Go to step 4.
<p>Step 4</p> <p>Replace the paper or change the paper size setting in the tray.</p> <p>Does the problem remain?</p>	Go to step 5.	The problem is solved.

Action	Yes	No
<p>Step 5 Check the paper tray for overfilling.</p> <p>Is the paper tray overfilled?</p>	Go to step 6.	Go to step 7.
<p>Step 6 Remove the excess paper from the tray.</p> <p>Does the problem remain?</p>	Go to step 7.	The problem is solved.
<p>Step 7 Check the paper condition in the tray.</p> <p>Is the paper crumpled or damaged?</p>	Go to step 8.	Go to step 9.
<p>Step 8 Replace the crumpled or damaged paper.</p> <p>Does the problem remain?</p>	Go to step 9.	The problem is solved.
<p>Step 9</p> <p>a Make sure that the optional tray pick roller is properly installed. Note: Firmly press the pick roller to its shaft to make sure that it is properly engaged.</p> <p>b Check the optional tray pick roller for excess wear, contamination, and damage.</p> <p>Is the optional tray pick roller free from excess wear, contamination, and damage?</p>	Go to step 11.	Go to step 10.
<p>Step 10 Replace the pick roller. See “Pick roller removals” on page 502.</p> <p>Does the problem remain?</p>	Go to step 11.	The problem is solved.
<p>Step 11 Check the tray exit paper path for paper fragments and contamination.</p> <p>Is the paper path free of paper fragments and contamination?</p>	Go to step 15.	Go to step 12.
<p>Step 12 Clean the paper path.</p> <p>Does the problem remain?</p>	Go to step 13.	The problem is solved.

Action	Yes	No
<p>Step 13</p> <p>a Enter the Diagnostics menu, and then navigate to: Additional input trays adjustments/tests > Additional input tray sensors</p> <p>b Find the sensor (Trailing edge (tray [x])). Note: [x] is the tray number.</p> <p>Does the sensor status change while toggling the sensor?</p>	Go to step 15.	Go to step 14.
<p>Step 14</p> <p>a Make sure that the sensor cable is properly connected.</p> <p>b Make sure that the sensor is properly installed.</p> <p>c Check the sensor and the other optional tray components for damage.</p> <p>Are the sensor and optional tray free of damage?</p>	Go to step 15.	Go to step 17.
<p>Step 15</p> <p>a Enter the Diagnostics menu, and then navigate to: Additional input tray diagnostics > Motor tests</p> <p>b Select Pick (tray [x]), and then touch Start.</p> <p>Does the motor run?</p>	Go to step 18.	Go to step 16.
<p>Step 16</p> <p>a Make sure that the motor cable is properly connected.</p> <p>b Make sure that the motor is properly installed.</p> <p>c Check the motor and the other optional tray components for damage.</p> <p>Are the motor and the optional tray free of damage?</p>	Go to step 18.	Go to step 17.
<p>Step 17</p> <p>Replace the optional tray. See “Optional 550-sheet tray removal” on page 536.</p> <p>Does the problem remain?</p>	Go to step 18.	The problem is solved.
<p>Step 18</p> <p>Perform a print test.</p> <p>Does the problem remain?</p>	Contact the next level of support.	The problem is solved.

Sensors (optional tray trailing edge and pass-through): Paper failed to clear service check

Action	Yes	No
<p>Step 1</p> <p>a From the home screen, touch Settings > Device > Preferences.</p> <p>b Check if the paper size matches the size set on the tray guides.</p> <p>Does the paper size match the size set on the tray?</p>	Go to step 3.	Go to step 2.
<p>Step 2</p> <p>Change the paper size or adjust the size setting in the tray.</p> <p>Does the problem remain?</p>	Go to step 3.	The problem is solved.
<p>Step 3</p> <p>Check the paper path for partially fed or jammed paper.</p> <p>Is the paper path free of partially fed or jammed paper?</p>	Go to step 5.	Go to step 4.
<p>Step 4</p> <p>Remove the partially fed or jammed paper.</p> <p>Does the problem remain?</p>	Go to step 5.	The problem is solved.
<p>Step 5</p> <p>a Enter the Diagnostics menu, and then navigate to: Additional input trays adjustments/tests > Additional input tray sensors</p> <p>b Find the sensor (Trailing edge (tray [x])). Note: [x] is the tray number.</p> <p>Does the sensor status change while toggling the sensor?</p>	Go to step 7.	Go to step 6.
<p>Step 6</p> <p>a Make sure that the sensor cable is properly connected.</p> <p>b Make sure that the sensor is properly installed.</p> <p>c Check the sensor for damage.</p> <p>Is the sensor free of damage?</p>	Go to step 7.	Go to step 11.
<p>Step 7</p> <p>a Enter the Diagnostics menu, and then navigate to: Additional input trays adjustments/tests > Additional input tray sensors</p> <p>b Find the sensor (Pass-through (tray [x])). Note: [x] is the tray number.</p> <p>Does the sensor status change while toggling the sensor?</p>	Go to step 9.	Go to step 8.

Action	Yes	No
<p>Step 8</p> <p>a Make sure that the sensor cable is properly connected.</p> <p>b Make sure that the sensor is properly installed.</p> <p>c Check the sensor and the other optional tray components for damage.</p> <p>Is the sensor free of damage?</p>	Go to step 9.	Go to step 11.
<p>Step 9</p> <p>a Enter the Diagnostics menu, and then navigate to: Additional input trays adjustments/tests > Additional input tray motors</p> <p>b Select Pass-through (tray [x]), and then touch Start.</p> <p>Note: [x] is the tray number.</p> <p>Does the motor run?</p>	Go to step 12.	Go to step 10.
<p>Step 10</p> <p>a Make sure that the motor cable is properly connected.</p> <p>b Make sure that the motor is properly installed.</p> <p>c Check the motor and the other optional tray components for damage.</p> <p>Are the motor and optional tray free of damage?</p>	Go to step 12.	Go to step 11.
<p>Step 11</p> <p>Replace the optional tray. See “Optional 550-sheet tray removal” on page 536.</p> <p>Does the problem remain?</p>	Go to step 12.	The problem is solved.
<p>Step 12</p> <p>a Enter the Diagnostics menu, and then navigate to: Printer diagnostics & adjustments > Motor tests</p> <p>b Find the motor (Duplex/MPF), and then touch Start.</p> <p>Does the motor run?</p>	Go to step 15.	Go to step 13.
<p>Step 13</p> <p>Reseat the motor cable, and then check the motor for misalignment and damage.</p> <p>Is the motor properly installed and free of damage?</p>	Go to step 15.	Go to step 14.
<p>Step 14</p> <p>Reinstall or replace the motor. See “Motor (duplex/MPF) removal” on page 415.</p> <p>Does the problem remain?</p>	Go to step 15.	The problem is solved.

Action	Yes	No
<p>Step 15 Perform a print test.</p> <p>Does the problem remain?</p>	Contact the next level of support.	The problem is solved.

Sensors (optional tray trailing edge and pass-through): Paper arrived too late service check

Action	Yes	No
<p>Step 1 a From the home screen, touch Settings > Device > Preferences. b Check if the paper size matches the size set on the tray guides.</p> <p>Does the paper size match the size set on the tray?</p>	Go to step 3.	Go to step 2.
<p>Step 2 Change the paper size or adjust the size setting in the tray.</p> <p>Does the problem remain?</p>	Go to step 3.	The problem is solved.
<p>Step 3 Check if the paper size matches the size set on the tray guides.</p> <p>Does the paper size match the size set on the tray?</p>	Go to step 5.	Go to step 4.
<p>Step 4 Replace the paper or change the paper size setting in the tray.</p> <p>Does the problem remain?</p>	Go to step 5.	The problem is solved.
<p>Step 5 Check the paper tray for overfilling.</p> <p>Is the paper tray overfilled?</p>	Go to step 6.	Go to step 7.
<p>Step 6 Remove the excess paper from the tray.</p> <p>Does the problem remain?</p>	Go to step 7.	The problem is solved.
<p>Step 7 Check the paper condition in the tray.</p> <p>Is the paper crumpled or damaged?</p>	Go to step 8.	Go to step 9.
<p>Step 8 Replace the crumpled or damaged paper.</p> <p>Does the problem remain?</p>	Go to step 9.	The problem is solved.

Action	Yes	No
<p>Step 9</p> <p>a Make sure that the separator bracket is properly installed.</p> <p>b Check the separator bracket for damage.</p> <p>Is the separator bracket free of damage?</p>	Go to step 11.	Go to step 10.
<p>Step 10</p> <p>Replace the separator bracket. See “Separator bracket removal” on page 500.</p> <p>Does the problem remain?</p>	Go to step 11.	The problem is solved.
<p>Step 11</p> <p>a Make sure that the optional tray pick roller is properly installed.</p> <p>Note: Firmly press the pick roller to its shaft to make sure that it is properly engaged.</p> <p>b Check the optional tray pick roller for excess wear, contamination, and damage.</p> <p>Is the optional tray pick roller free from excess wear, contamination, and damage?</p>	Go to step 13.	Go to step 12.
<p>Step 12</p> <p>Replace the pick roller. See “Pick roller removals” on page 502.</p> <p>Does the problem remain?</p>	Go to step 13.	The problem is solved.
<p>Step 13</p> <p>Check the tray exit paper path for paper fragments and contamination.</p> <p>Is the paper path free of paper fragments and contamination?</p>	Go to step 15.	Go to step 14.
<p>Step 14</p> <p>Clean the paper path.</p> <p>Does the problem remain?</p>	Go to step 15.	The problem is solved.
<p>Step 15</p> <p>a Enter the Diagnostics menu, and then navigate to: Additional input trays adjustments/tests > Additional input tray sensors</p> <p>b Find the sensor (Trailing edge (tray [x])).</p> <p>Note: [x] is the tray number.</p> <p>Does the sensor status change while toggling the sensor?</p>	Go to step 17.	Go to step 16.

Action	Yes	No
<p>Step 16</p> <p>a Make sure that the sensor cable is properly connected.</p> <p>b Make sure that the sensor is properly installed.</p> <p>c Check the sensor for damage.</p> <p>Is the sensor free of damage?</p>	Go to step 17.	Go to step 23.
<p>Step 17</p> <p>a Enter the Diagnostics menu, and then navigate to: Additional input trays adjustments/tests > Additional input tray motors</p> <p>b Select Pick (tray [x]), and then touch Start.</p> <p>Note: [x] is the tray number.</p> <p>Does the motor run?</p>	Go to step 19.	Go to step 18.
<p>Step 18</p> <p>a Make sure that the motor cable is properly connected.</p> <p>b Make sure that the motor is properly installed.</p> <p>c Check the motor and the other optional tray components for damage.</p> <p>Are the motor and the optional tray free of damage?</p>	Go to step 19.	Go to step 23.
<p>Step 19</p> <p>a Enter the Diagnostics menu, and then navigate to: Additional input trays adjustments/tests > Additional input tray sensors</p> <p>b Find the sensor (Pass-through (tray [x])).</p> <p>Note: [x] is the tray number.</p> <p>Does the sensor status change while toggling the sensor?</p>	Go to step 21.	Go to step 20.
<p>Step 20</p> <p>a Make sure that the sensor cable is properly connected.</p> <p>b Make sure that the sensor is properly installed.</p> <p>c Check the sensor and the other optional tray components for damage.</p> <p>Are the sensor and optional tray free of damage?</p>	Go to step 21.	Go to step 23.

Action	Yes	No
<p>Step 21</p> <p>a Enter the Diagnostics menu, and then navigate to: Additional input trays adjustments/tests > Additional input tray motors</p> <p>b Select Pass-through (tray [x]), and then touch Start. Note: [x] is the tray number.</p> <p>Does the motor run?</p>	Go to step 24.	Go to step 22.
<p>Step 22</p> <p>a Make sure that the motor cable is properly connected.</p> <p>b Make sure that the motor is properly installed.</p> <p>c Check the motor and the other optional tray components for damage.</p> <p>Are the motor and optional tray free of damage?</p>	Go to step 24.	Go to step 23.
<p>Step 23</p> <p>Replace the optional tray. See “Optional 550-sheet tray removal” on page 536.</p> <p>Does the problem remain?</p>	Go to step 24.	The problem is solved.
<p>Step 24</p> <p>Perform a print test.</p> <p>Does the problem remain?</p>	Contact the next level of support.	The problem is solved.

Optional tray transport drive jam service check

Action	Yes	No
<p>Step 1</p> <p>Check the paper path and trays for paper fragments and partially fed paper.</p> <p>Is the paper path free of paper fragments and partially fed paper?</p>	Go to step 3.	Go to step 2.
<p>Step 2</p> <p>Remove the paper fragments and partially fed paper.</p> <p>Does the problem remain?</p>	Go to step 3.	The problem is solved.
<p>Step 3</p> <p>Make sure that all the trays and tray inserts are properly installed.</p> <p>Does the problem remain?</p>	Go to step 4.	The problem is solved.

Action	Yes	No
<p>Step 4 Enter the Diagnostics menu, and then navigate to: Input tray quick print >select source tray > Single</p> <p>Does the problem remain?</p>	Go to step 5.	The problem is solved.
<p>Step 5 a Enter the Diagnostics menu, and then navigate to: Additional input tray adjustments/tests > Additional input tray motors b Select Pass-through (tray [x]), and then touch Start. Note: [x] is the tray number.</p> <p>Does the motor run?</p>	Go to step 7.	Go to step 6.
<p>Step 6 Reseat the cable on the motor and on the optional tray controller board.</p> <p>Does the problem remain?</p>	Go to step 7.	The problem is solved.
<p>Step 7 Remove the source tray insert, and then check if the following components are functional and free of damage:</p> <ul style="list-style-type: none"> • Paper guides • Lift plate <p>Note: Move the components or turn gears to check for proper mechanisms.</p> <p>Are the tray insert and its components functional and free of damage?</p>	Go to step 9.	Go to step 8.
<p>Step 8 Replace the tray insert.</p> <p>Does the problem remain?</p>	Go to step 9.	The problem is solved.
<p>Step 9 Make sure that the controller board of the affected tray is properly installed. Reseat all the cables on the controller board.</p> <p>Does the problem remain?</p>	Go to step 10.	The problem is solved.
<p>Step 10 Check the affected tray controller board and its connector pins for damage.</p> <p>Are the tray controller board and its connectors free of damage?</p>	Contact the next level of support.	The problem is solved.

Action	Yes	No
<p>Step 11 Replace the optional tray. See “Optional 550-sheet tray removal” on page 536.</p> <p>Does the problem remain?</p>	Contact the next level of support.	The problem is solved.

Optional tray pick drive failure service check

Action	Yes	No
<p>Step 1 Check the paper path and trays for paper fragments and partially fed paper.</p> <p>Is the paper path free of paper fragments and partially fed paper?</p>	Go to step 3.	Go to step 2.
<p>Step 2 Remove the paper fragments and partially fed paper.</p> <p>Does the problem remain?</p>	Go to step 3.	The problem is solved.
<p>Step 3 Make sure that all the trays and tray inserts are properly installed.</p> <p>Does the problem remain?</p>	Go to step 4.	The problem is solved.
<p>Step 4 Enter the Diagnostics menu, and then navigate to: Input tray quick print >select source tray > Single</p> <p>Does the problem remain?</p>	Go to step 5.	The problem is solved.
<p>Step 5 a Enter the Diagnostics menu, and then navigate to: Additional input tray diagnostics > Motor tests b Select Pick (tray [x]), and then touch Start. Note: [x] is the tray number.</p> <p>Does the motor run?</p>	Go to step 7.	Go to step 6.
<p>Step 6 Reseat the cable on the motor and on the optional tray controller board.</p> <p>Does the problem remain?</p>	Go to step 7.	The problem is solved.

Action	Yes	No
<p>Step 7</p> <p>Check the source tray controller board and its connector pins for damage.</p> <p>Are the tray controller board and its connectors free of damage?</p>	Contact the next level of support.	The problem is solved.
<p>Step 8</p> <p>Replace the optional tray. See “Optional 550-sheet tray removal” on page 536.</p> <p>Does the problem remain?</p>	Contact the next level of support.	The problem is solved.

280–295 paper jams

280–295 paper jam messages

Error code	Description	Action
280.06	No paper was detected in the ADF tray during an ADF scan job.	See “ADF paper undetected service check” on page 197 .
280.11	Paper remains detected at the sensor (ADF scan 1) after the printer is turned on.	See “ADF paper jam service check” on page 198 .
280.13	Paper did not reach the sensor (ADF scan 1).	
280.15	Paper did not clear the sensor (ADF scan 1).	
280.91	Paper remains detected at the sensor (ADF scan 1) after the printer is turned on.	
280.93	Paper did not reach the sensor (ADF scan 1).	
280.95	Paper did not clear the sensor (ADF scan 1).	
284.11	Paper remains detected at the sensor (ADF scan 2) during a duplex scan job.	
284.13	Paper did not reach the sensor (ADF scan 2) during a duplex scan job.	
284.15	Paper did not clear the sensor (ADF scan 2) during a duplex scan job.	

Error code	Description	Action
284.91	Paper remains detected at the sensor (ADF scan 2) during a duplex scan job.	See “ADF paper jam service check” on page 198.
284.93	Paper did not reach the sensor (ADF scan 2) during a duplex scan job.	
284.95	Paper did not clear the sensor (ADF scan 2) during a duplex scan job.	
288.10	The sensor (ADF multifeed) detected a double-feed.	See “Sensor (ADF multifeed) jam service check” on page 200.
288.90	The sensor (ADF multifeed) detected a double-feed.	
291.06	The scanner cover was open during an ADF job.	See “Scanner cover open service check” on page 202.
295.01	Imagepipe Error—Page gap is too small.	See “ADF feed errors service check” on page 305.

ADF paper undetected service check

Actions	Yes	No
<p>Step 1 Make sure that the paper is properly loaded in the ADF tray.</p> <p>Does the problem remain?</p>	Go to step 2.	The problem is solved.
<p>Step 2 a Enter the Diagnostics menu, and then navigate to: Scanner diagnostics > Sensor tests b Find the sensor (ADF media present).</p> <p>Does the status of each sensor change while toggling the sensors?</p>	Go to step 6.	Go to step 3.
<p>Step 3 Check the sensor for dirt and debris.</p> <p>Is the sensor free of dirt and debris?</p>	Go to step 5.	Go to step 4.
<p>Step 4 Clean the sensor.</p> <p>Does the problem remain?</p>	Go to step 5.	The problem is solved.
<p>Step 5 Check if the actuator is stuck or damaged.</p> <p>Is the actuator stuck or damaged?</p>	Go to step 8.	Go to step 6.

Actions	Yes	No
Step 6 Reseat the JADF2 connector on the controller board. Does the problem remain?	Go to step 7.	The problem is solved.
Step 7 Reseat the ADF cables on the ADF. Does the problem remain?	Go to step 8.	The problem is solved.
Step 8 Replace the ADF. See “ADF removal” on page 517 . Does the problem remain?	Contact the next level of support.	The problem is solved.

ADF paper jam service check

Notes:

- Before performing this check, update the scanner firmware. For more information on the correct firmware version, contact the next level of support.
- If the paper does not feed into the ADF, then see [“ADF feed errors service check” on page 305](#).

Actions	Yes	No
Step 1 Check the paper path for paper jams and fragments. Is the paper path free of fragments and debris?	Go to step 3.	Go to step 2.
Step 2 Remove the paper jams and fragments. Does the problem remain?	Go to step 3.	The problem is solved.
Step 3 Check if the paper feeds into the ADF. Does the paper feed into the ADF?	Go to step 5.	Go to step 4.
Step 4 Perform the ADF feed error service check. See “ADF feed errors service check” on page 305 . Does the problem remain?	Go to step 5.	The problem is solved.
Step 5 Check if the paper has a bent or curled leading edge. Does the paper have a bent or curled leading edge?	Go to step 6.	Go to step 9.

Actions	Yes	No
<p>Step 6 Replace the paper, and then resend the scan job.</p> <p>Does the problem remain?</p>	Go to step 7.	The problem is solved.
<p>Step 7 Check if the paper is damp or heavy.</p> <p>Is the paper damp or heavy?</p>	Go to step 8.	Go to step 9.
<p>Step 8 Replace the paper, and then resend the scan job.</p> <p>Does the problem remain?</p>	Go to step 9.	The problem is solved.
<p>Step 9</p> <p>a Enter the Diagnostics menu, and then navigate to: Scanner diagnostics > Motor tests > ADF pick</p> <p>b Touch Start.</p> <p>c Enter the Diagnostics menu, and then navigate to: Scanner diagnostics > Motor tests > ADF transport</p> <p>d Touch Start.</p> <p>Do the motors run?</p>	Go to step 11.	Go to step 10.
<p>Step 10</p> <p>a Reseat the JADF2 connector on the controller board.</p> <p>b Reseat the ADF cables on the ADF.</p> <p>Does the problem remain?</p>	Go to step 11.	The problem is solved.
<p>Step 11</p> <p>a Enter the Diagnostics menu, and then navigate to: Scanner diagnostics > Sensor tests</p> <p>b Find the following sensors:</p> <ol style="list-style-type: none"> 1 Sensor (ADF media present) 2 Sensor (ADF 1st scan) 3 Sensor (ADF 2nd scan) <p>Does the status of each sensor change while toggling the sensors?</p>	Go to step 15.	Go to step 12.
<p>Step 12 Check the affected sensor for dirt and debris.</p> <p>Is the sensor free of dirt and debris?</p>	Go to step 15.	Go to step 13.

Actions	Yes	No
Step 13 Clean the sensor. Does the problem remain?	Go to step 14.	The problem is solved.
Step 14 Check if the actuator is stuck or damaged. Is the actuator stuck or damaged?	Go to step 16.	Go to step 15.
Step 15 a Reseat the JADF2 connector on the controller board. b Reseat the ADF cables on the ADF. Does the problem remain?	Go to step 16.	The problem is solved.
Step 16 Replace the ADF. See “ADF removal” on page 517 . Does the problem remain?	Contact the next level of support.	The problem is solved.

Sensor (ADF multifeed) jam service check

Action	Yes	No
Step 1 Check the original document: <ul style="list-style-type: none"> Remove sticky notes, tape, paper clips, staples, and other objects that could cause or contribute to jams. Check the document for damage such as creases, tears, holes, and excess wear. Is the original document free of contaminations and damage?	Go to step 3.	Go to step 2.
Step 2 Remove the contaminations or replace the damaged original document. Does the problem remain?	Go to step 3.	The problem is solved.
Step 3 Enter the Diagnostics menu, and then navigate to: Scanner diagnostics > Feed test Does the problem remain?	Go to step 4.	The problem is solved.

Action	Yes	No
<p>Step 4</p> <p>Check the ADF paper path and sensor (ADF multifeed) for paper fragments and contaminations such as pieces of tape, paper clips and staples.</p> <p>Are the paper path and sensor free of obstructions and contaminations?</p>	Go to step 6.	Go to step 5.
<p>Step 5</p> <p>Remove the obstructions and contaminations.</p> <p>Does the problem remain?</p>	Go to step 6.	The problem is solved.
<p>Step 6</p> <p>a Make sure that the cable of the sensor (ADF multifeed) is properly connected to the sensor and controller board.</p> <p>b Load an undamaged document into the ADF tray, and then perform a copy job.</p> <p>Does the problem remain?</p>	Go to step 7.	The problem is solved.
<p>Step 7</p> <p>Check the condition of the ADF rollers.</p> <ul style="list-style-type: none"> • ADF pick roller • ADF feed roller • ADF separator roller <p>Are the ADF rollers free from excess wear, contamination, and damage?</p>	Go to step 9.	Go to step 8.
<p>Step 8</p> <p>Clean or replace the ADF rollers. See “ADF rollers removal” on page 514.</p> <p>Does the problem remain?</p>	Go to step 9.	The problem is solved.
<p>Step 9</p> <p>a Make sure that the cable of the sensor (ADF multifeed) is properly connected to the sensor and controller board.</p> <p>b Load an undamaged document into the ADF tray, and then perform a copy job.</p> <p>Does the problem remain?</p>	Go to step 10.	The problem is solved.
<p>Step 10</p> <p>Replace the ADF. See “ADF removal” on page 517.</p> <p>Does the problem remain?</p>	Contact the next level of support.	The problem is solved.

Scanner cover open service check

Actions	Yes	No
<p>Step 1 Make sure that the scanner cover is properly closed.</p> <p>Does the problem remain?</p>	Go to step 2.	The problem is solved.
<p>Step 2 a Enter the Diagnostics menu, and then navigate to: Scanner diagnostics > Sensor tests b Find the sensor (ADF closed).</p> <p>Does the sensor status change while toggling the sensor?</p>	Go to step 4.	Go to step 3.
<p>Step 3 Check the sensor actuator for misalignment and damage.</p> <p>Is the actuator misaligned or damaged?</p>	Go to step 4.	Go to step 5.
<p>Step 4 a Reseat the JADF2 connector on the controller board. b Reseat the ADF cables on the ADF.</p> <p>Does the problem remain?</p>	Go to step 5.	The problem is solved.
<p>Step 5 Replace the ADF. See “ADF removal” on page 517.</p> <p>Does the problem remain?</p>	Go to step 6.	The problem is solved.
<p>Step 6 Perform an ADF scan job.</p> <p>Does the problem remain?</p>	Contact the next level of support.	The problem is solved.

User attendance messages

0y user attendance errors

8 user attendance messages

Error code	Description	Action
8.01	A door is detected as open.	See “Door interlock switch service check” on page 203 .
8.03	ADF top cover was detected as open.	See “ADF top cover open service check” on page 204 .

Supply error service check

Action	Yes	No
<p>Make sure that the supplies are properly and completely installed.</p> <p>Does the problem remain?</p>	Contact the next level of support.	The problem is solved.

Door interlock switch service check

Action	Yes	No
<p>Step 1</p> <p>a Enter the Diagnostics menu, and then navigate to: Printer diagnostics & adjustments > Sensor tests</p> <p>b Find the sensor (Door interlock).</p> <p>Does the sensor status change while toggling the sensor?</p>	The problem is solved.	Go to step 2.
<p>Step 2</p> <p>Make sure that the sensor cable is properly connected.</p> <p>Does the problem remain?</p>	Go to step 3.	The problem is solved.
<p>Step 3</p> <p>a Remove the motor cover. See “Motor cover removal” on page 427.</p> <p>b Make sure that the interlock sensor cable relay is properly connected.</p> <p>Does the problem remain?</p>	Go to step 4.	The problem is solved.
<p>Step 4</p> <p>Check the front door interlock switch actuator for damage.</p> <p>Is the actuator free of damage?</p>	Go to step 6.	Go to step 5.
<p>Step 5</p> <p>Replace the duplex outer guide. See “Duplex outer guide removal” on page 470.</p> <p>Does the problem remain?</p>	Go to step 6.	The problem is solved.
<p>Step 6</p> <p>Check the toner door interlock switch actuator for damage.</p> <p>Is the actuator free of damage?</p>	Go to step 8.	Go to step 7.
<p>Step 7</p> <p>Replace the toner door. See “Toner door removal” on page 402.</p> <p>Does the problem remain?</p>	Go to step 8.	The problem is solved.

Action	Yes	No
<p>Step 8 Replace the motor cover. See “Motor cover removal” on page 427.</p> <p>Does the problem remain?</p>	Go to step 9.	The problem is solved.
<p>Step 9 Replace the engine board. See “Engine board removal” on page 479.</p> <p>Does the problem remain?</p>	Contact the next level of support.	The problem is solved.

ADF top cover open service check

Actions	Yes	No
<p>Step 1 Check if the ADF top cover is completely closed.</p> <p>Is the ADF top cover completely closed?</p>	Go to step 3.	Go to step 2.
<p>Step 2 Close the ADF top cover completely.</p> <p>Does the problem remain?</p>	Go to step 3.	The problem is solved.
<p>Step 3 Reset the printer, and then perform an ADF scan job.</p> <p>Does the problem remain?</p>	Go to step 4.	The problem is solved.
<p>Step 4</p> <p>a Enter the Diagnostics menu, and then navigate to: Scanner diagnostics > Sensor tests</p> <p>b Find the sensor (ADF top door interlock).</p> <p>Does the sensor status change while toggling the sensor?</p>	Go to step 7.	Go to step 5.
<p>Step 5 Check the actuator for misalignment and damage.</p> <p>Is the actuator misaligned or damaged?</p>	Go to step 6.	Go to step 7.
<p>Step 6 Replace the ADF. See “ADF removal” on page 517.</p> <p>Does the problem remain?</p>	Go to step 7.	The problem is solved.

Actions	Yes	No
<p>Step 7 Perform an ADF scan job.</p> <p>Does the problem remain?</p>	Contact the next level of support.	The problem is solved.

Auto reboot error service check

Action	Yes	No
<p>Step 1 Turn off the printer, wait for about 10 seconds, and then turn on the printer.</p> <p>Does the problem remain?</p>	Go to step 2.	The problem is solved.
<p>Step 2</p> <ul style="list-style-type: none"> a Turn off the printer. b Turn on the printer and enter the Diagnostics menu. c Do a print test. d Restart the printer. <p>Does the problem remain?</p>	Go to step 3.	The problem is solved.
<p>Step 3 Make sure that the controller board is properly installed. Reseat all the cables on the controller board.</p> <p>Does the problem remain?</p>	Go to step 4.	The problem is solved.
<p>Step 4 Check the firmware version.</p> <p>Is the firmware updated to the latest version?</p>	Go to step 6.	Go to step 5.
<p>Step 5 Update the firmware.</p> <p>Does the problem remain?</p>	Go to step 6.	The problem is solved.
<p>Step 6 Check the controller board and its connector pins for damage.</p> <p>Are the controller board and its connectors free of damage?</p>	Contact the next level of support.	Go to step 7.
<p>Step 7 Replace the controller board. See “Controller board removal” on page 478.</p> <p>Does the problem remain?</p>	Contact the next level of support.	The problem is solved.

1y user attendance errors

11–12 user attendance messages

Error code	Description	Action
11.11	A wrong paper type or size was detected on tray 1.	See “Mismatched paper size service check” on page 207.
11.12	A wrong paper type, size, or orientation was detected on tray 1.	
11.21	A wrong paper type or size was detected on tray 2.	
11.22	A wrong paper type, size, or orientation was detected on tray 2.	
11.31	A wrong paper type or size was detected on tray 3.	
11.32	A wrong paper type, size, or orientation was detected on tray 3.	
11.41	A wrong paper type or size was detected on tray 4.	
11.42	A wrong paper type, size, or orientation was detected on tray 4.	
11.51	A wrong paper type or size was detected on tray 5.	
11.52	A wrong paper type, size, or orientation was detected on tray 5.	
11.81	A wrong paper type or size was detected on the MPF.	
11.82	A wrong paper type, size, or orientation was detected on the MPF.	
11.91	A wrong paper type or size was detected on the MPF.	
11.92	A wrong paper type, size, or orientation was detected on the MPF.	

Error code	Description	Action
12.11	A wrong setting for paper type or size was detected on tray 1.	See “Mismatched paper size service check” on page 207.
12.12	A wrong setting for paper type, size, or orientation was detected on tray 1.	
12.21	A wrong setting for paper type or size was detected on tray 2.	
12.22	A wrong setting for paper type, size, or orientation was detected on tray 2.	
12.31	A wrong setting for paper type or size was detected on tray 3.	
12.32	A wrong setting for paper type, size, or orientation was detected on tray 3.	
12.41	A wrong setting for paper type or size was detected on tray 4.	
12.42	A wrong setting for paper type, size, or orientation was detected on tray 4.	
12.51	A wrong setting for paper type or size was detected on tray 5.	
12.52	A wrong setting for paper type, size, or orientation was detected on tray 5.	
12.81	A wrong setting for paper type or size was detected on the MPF.	
12.82	A wrong setting for paper type, size, or orientation was detected on the MPF.	
12.91	A wrong setting for paper type or size was detected on the MPF.	
12.92	A wrong setting for paper type, size, or orientation was detected on the MPF.	

Mismatched paper size service check

Action	Yes	No
<p>Step 1</p> <p>a From the home screen, touch Settings > Device > Preferences.</p> <p>b Check if the paper size matches the size set on the tray guides.</p> <p>Does the paper size match the size set on the tray?</p>	Go to step 3.	Go to step 2.
<p>Step 2</p> <p>Change the paper size or adjust the size setting in the tray.</p> <p>Does the problem remain?</p>	Go to step 3.	The problem is solved.

Action	Yes	No
<p>Step 3</p> <p>Check the engine board and its pins for damage.</p> <p>Is the engine board free of damage?</p>	Contact the next level of support.	Go to step 4.
<p>Step 4</p> <p>Replace the engine board. See “Engine board removal” on page 479.</p> <p>Does the problem remain?</p>	Contact the next level of support.	The problem is solved.

3y user attendance errors

31 user attendance error messages

Error code	Description	Action
31.35A	A waste toner bottle smart chip or sensor communication error was detected.	See “Waste toner bottle service check” on page 234 .
31.35B	A waste toner bottle smart chip or sensor communication error was detected.	
31.35C	A waste toner bottle smart chip or sensor communication error was detected.	
31.35D	A waste toner bottle smart chip or sensor communication error was detected.	
31.35E	A waste toner bottle smart chip or sensor communication error was detected.	
31.35F	A waste toner bottle smart chip or sensor communication error was detected.	
31.35G	A waste toner bottle smart chip or sensor communication error was detected.	
31.35H	A waste toner bottle smart chip or sensor communication error was detected.	

Error code	Description	Action
31.40A	A black toner cartridge smart chip or sensor communication error was detected.	See “Missing toner cartridge, imaging unit, or imaging kit service check” on page 215.
31.40B	A black toner cartridge smart chip or sensor communication error was detected.	
31.40C	A black toner cartridge smart chip or sensor communication error was detected.	
31.40D	A black toner cartridge smart chip or sensor communication error was detected.	
31.40E	A black toner cartridge smart chip or sensor communication error was detected.	
31.40F	A black toner cartridge smart chip or sensor communication error was detected.	
31.40G	A black toner cartridge smart chip or sensor communication error was detected.	
31.40H	A black toner cartridge smart chip or sensor communication error was detected.	
31.41A	A cyan toner cartridge smart chip or sensor communication error was detected.	See “Missing toner cartridge, imaging unit, or imaging kit service check” on page 215.
31.41B	A cyan toner cartridge smart chip or sensor communication error was detected.	
31.41C	A cyan toner cartridge smart chip or sensor communication error was detected.	
31.41D	A cyan toner cartridge smart chip or sensor communication error was detected.	
31.41E	A cyan toner cartridge smart chip or sensor communication error was detected.	
31.41F	A cyan toner cartridge smart chip or sensor communication error was detected.	
31.41G	A cyan toner cartridge smart chip or sensor communication error was detected.	
31.41H	A cyan toner cartridge smart chip or sensor communication error was detected.	

Error code	Description	Action
31.42A	A magenta toner cartridge smart chip or sensor communication error was detected.	See “Missing toner cartridge, imaging unit, or imaging kit service check” on page 215.
31.42B	A magenta toner cartridge smart chip or sensor communication error was detected.	
31.42C	A magenta toner cartridge smart chip or sensor communication error was detected.	
31.42D	A magenta toner cartridge smart chip or sensor communication error was detected.	
31.42E	A magenta toner cartridge smart chip or sensor communication error was detected.	
31.42G	A magenta toner cartridge smart chip or sensor communication error was detected.	
31.43A	A yellow toner cartridge smart chip or sensor communication error was detected.	
31.43B	A yellow toner cartridge smart chip or sensor communication error was detected.	
31.43C	A yellow toner cartridge smart chip or sensor communication error was detected.	
31.43D	A yellow toner cartridge smart chip or sensor communication error was detected.	
31.43E	A yellow toner cartridge smart chip or sensor communication error was detected.	
31.43F	A yellow toner cartridge smart chip or sensor communication error was detected.	
31.43G	A yellow toner cartridge smart chip or sensor communication error was detected.	
31.43H	A yellow toner cartridge smart chip or sensor communication error was detected.	

Error code	Description	Action
31.60A	A black imaging unit smart chip or sensor communication error was detected.	See “Missing toner cartridge, imaging unit, or imaging kit service check” on page 215.
31.60B	A black imaging unit smart chip or sensor communication error was detected.	
31.60C	A black imaging unit smart chip or sensor communication error was detected.	
31.60D	A black imaging unit smart chip or sensor communication error was detected.	
31.60E	A black imaging unit smart chip or sensor communication error was detected.	
31.60F	A black imaging unit smart chip or sensor communication error was detected.	
31.60G	A black imaging unit smart chip or sensor communication error was detected.	
31.60H	A black imaging unit smart chip or sensor communication error was detected.	
31.64A	A CMY imaging kit smart chip or sensor communication error was detected.	See “Missing toner cartridge, imaging unit, or imaging kit service check” on page 215.
31.64B	A CMY imaging kit smart chip or sensor communication error was detected.	
31.64C	A CMY imaging kit smart chip or sensor communication error was detected.	
31.64D	A CMY imaging kit smart chip or sensor communication error was detected.	
31.64E	A CMY imaging kit smart chip or sensor communication error was detected.	
31.64F	A CMY imaging kit smart chip or sensor communication error was detected.	
31.64G	A CMY imaging kit smart chip or sensor communication error was detected.	
31.64H	A CMY imaging kit smart chip or sensor communication error was detected.	
31.80A	A fuser smart chip or sensor communication error was detected.	See “Fuser service check” on page 244.
31.80Y		
31.80Z		

32 user attendance error messages

Error code	Description	Action
32.40A	The black toner cartridge is unsupported.	See “Missing toner cartridge, imaging unit, or imaging kit service check” on page 215.
32.40B	The black toner cartridge is unsupported.	
32.40C	The black toner cartridge is unsupported.	
32.40D	The black toner cartridge is unsupported.	
32.40E	The black toner cartridge is unsupported.	
32.40F	The black toner cartridge is unsupported.	
32.41A	The cyan toner cartridge is unsupported.	See “Missing toner cartridge, imaging unit, or imaging kit service check” on page 215.
32.41B	The cyan toner cartridge is unsupported.	
32.41C	The cyan toner cartridge is unsupported.	
32.41D	The cyan toner cartridge is unsupported.	
32.41E	The cyan toner cartridge is unsupported.	
32.41F	The cyan toner cartridge is unsupported.	
32.42A	The magenta toner cartridge is unsupported.	See “Missing toner cartridge, imaging unit, or imaging kit service check” on page 215.
32.42B	The magenta toner cartridge is unsupported.	
32.42C	The magenta toner cartridge is unsupported.	
32.42D	The magenta toner cartridge is unsupported.	
32.42E	The magenta toner cartridge is unsupported.	
32.42F	The magenta toner cartridge is unsupported.	
32.43A	The yellow toner cartridge is unsupported.	See “Missing toner cartridge, imaging unit, or imaging kit service check” on page 215.
32.43B	The yellow toner cartridge is unsupported.	
32.43C	The yellow toner cartridge is unsupported.	
32.43D	The yellow toner cartridge is unsupported.	
32.43E	The yellow toner cartridge is unsupported.	
32.43F	The yellow toner cartridge is unsupported.	

Error code	Description	Action
32.60A	The black imaging unit is unsupported.	See “Missing toner cartridge, imaging unit, or imaging kit service check” on page 215.
32.60B	The black imaging unit is unsupported.	
32.60C	The black imaging unit is unsupported.	
32.60D	The black imaging unit is unsupported. Notes: <ul style="list-style-type: none"> • An imaging unit that ships with the printer or equipment (SWE) cannot be switched with another SWE imaging unit. • Make sure to replace the SWE imaging unit only when prompted to do so. • Replace the used SWE imaging unit only with a newly ordered imaging unit compatible with the printer. 	
32.60E	The black imaging unit is unsupported.	
32.60F	The black imaging unit is unsupported.	
32.64A	The CMY imaging kit is unsupported.	
32.64B	The CMY imaging kit is unsupported.	
32.64C	The CMY imaging kit is unsupported.	
32.64D	The CMY imaging kit is unsupported. Notes: <ul style="list-style-type: none"> • An imaging kit that ships with the printer or equipment (SWE) cannot be switched with another SWE imaging kit. • Make sure to replace the SWE imaging kit only when prompted to do so. • Replace the used SWE imaging kit only with a newly ordered imaging kit compatible with the printer. 	
32.64E	The CMY imaging kit is unsupported.	
32.64F	The CMY imaging kit is unsupported.	
32.80x	The fuser is unsupported.	CS/CX730/735 fuser is installed in a CS/CX737 machine or vice versa. Remove the fuser, and then install a supported one. For more information, see the instruction sheet that came with the part.

33 user attendance error messages

Error code	Description	Action
33.40	An inauthentic black toner cartridge was detected.	See “Non-Lexmark supply” on page 214.
33.41	An inauthentic cyan toner cartridge was detected.	
33.42	An inauthentic magenta toner cartridge was detected.	
33.43	An inauthentic yellow toner cartridge was detected.	
33.60	An inauthentic black imaging unit was detected.	
33.64	An inauthentic CMY imaging kit was detected.	

37–39 user attendance messages

Error code	Description	Action
37.03	The memory is insufficient to collate the job.	See “Insufficient memory service check” on page 217.
38.00	The memory is full.	
38.01	The memory is full.	
39.01	The page is too complex to print.	See “Complex page service check” on page 217.
39.02	The page is too complex to print.	

Non-Lexmark supply

The printer has detected a non-Lexmark supply or part installed in the printer.

The Lexmark printer is designed to function best with genuine Lexmark supplies and parts. Use of third-party supplies or parts may affect the performance, reliability, or life of the printer and its imaging components.

All life indicators are designed to function with Lexmark supplies and parts and may deliver unpredictable results if third-party supplies or parts are used. Imaging component usage beyond the intended life may damage the Lexmark printer or associated components.

Warning—Potential Damage: Use of third-party supplies or parts can affect warranty coverage. Damage caused by the use of third-party supplies or parts may not be covered by the warranty.

To accept any and all of these risks and to proceed with the use of non-genuine supplies or parts in your printer, instruct the customer to touch and hold the error message on the display using two fingers for 15 seconds. When a confirmation dialog box appears, touch **Continue**.

If the customer does not want to accept these risks, then remove the third-party supply or part from the printer and install a genuine Lexmark supply or part.

If the printer does not print after clearing the error message, then instruct the customer to reset the supply usage counter.

Resetting the supply usage counter

- 1 From the home screen, touch **Settings** > **Device** > **Maintenance** > **Configuration Menu** > **Supply Usage And Counters** > **Reset Maintenance Counter**.
- 2 Touch **Start**.

Note: If resetting the supply usage counter fails, then the customer should return the supply item to the place of purchase.

Missing toner cartridge, imaging unit, or imaging kit service check

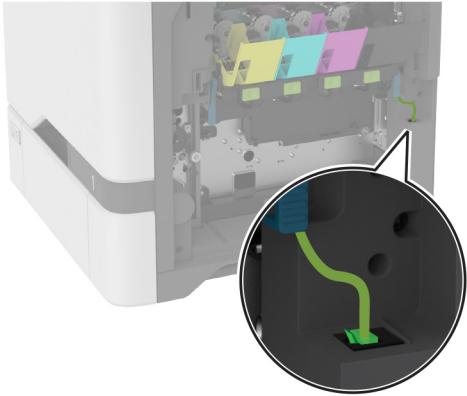
Action	Yes	No
<p>Step 1</p> <p>a Make sure that the toner cartridge or imaging unit is properly installed.</p> <p>b Make sure that the supply is genuine and supported.</p> <p>Does the problem remain?</p>	Go to step 2.	The problem is solved.
<p>Step 2</p> <p>Make sure that the imaging kit cable is properly connected.</p>  <p>Does the problem remain?</p>	Go to step 3.	The problem is solved.
<p>Step 3</p> <p>a Remove the imaging kit. See “Imaging kit removal” on page 399. Make sure that the springs allow for proper contact. If the imaging kit is damaged, then go to step 4.</p> <p>b Make sure that the imaging kit cable is properly connected.</p> <p>Does the problem remain?</p>	Go to step 4.	The problem is solved.
<p>Step 4</p> <p>Replace the imaging kit. See “Imaging kit removal” on page 399. Reuse the current supplies.</p> <p>Does the problem remain?</p>	Go to step 5.	The problem is solved.

Action	Yes	No
<p>Step 5 Make sure that the HVPS pogo pin cables are properly connected.</p> <p>Does the problem remain?</p>	Go to step 6.	The problem is solved.
<p>Step 6 Check the pogo pin contacts for dust or debris.</p> <p>Are the contacts free of dust or debris?</p>	Go to step 8.	Go to step 7.
<p>Step 7 Remove the dust or debris.</p> <p>Does the problem remain?</p>	Go to step 8.	The problem is solved.
<p>Step 8 Check the HVPS and its pogo pin contacts for damage.</p> <p>Is the HVPS free of damage?</p>	Go to step 10.	Go to step 9.
<p>Step 9 Replace the HVPS. See “HVPS removal” on page 417.</p> <p>Does the problem remain?</p>	Go to step 10.	The problem is solved.
<p>Step 10</p> <p>a Enter the Diagnostics menu, and then navigate to: Printer diagnostics & adjustments > Sensor tests</p> <p>b Find, and then test the sensor of the affected supply.</p> <ul style="list-style-type: none"> • K Toner Meter • C Toner Meter • M Toner Meter • Y Toner Meter <p>Does the sensor status change while toggling the sensor?</p>	Go to step 12.	Go to step 11.
<p>Step 11 Replace the TMC card. See “TMC card removal” on page 409.</p> <p>Does the problem remain?</p>	Go to step 12.	The problem is solved.
<p>Step 12 Replace the engine board. See “Engine board removal” on page 479.</p> <p>Does the problem remain?</p>	Contact the next level of support.	The problem is solved.

Insufficient memory service check

Action	Yes	No
<p>a Perform a POR.</p> <p>b From the home screen, navigate to Settings > Print > Setup > Download Target > Disk.</p> <p>Does the problem remain?</p>	Contact the next level of support.	The problem is solved.

Complex page service check

Action	Yes	No
<p>Step 1</p> <p>Reset the printer, and then navigate to: Settings > Print > Setup > Download Target > Disk</p> <p>Does the problem remain?</p>	Go to step 2.	The problem is solved.
<p>Step 2</p> <p>Enter the Diagnostics menu, and then navigate to: Input tray quick print > Tray 1 > Single</p> <p>Does the problem remain?</p>	Go to step 3.	The problem is solved.
<p>Step 3</p> <p>Check the controller board pins for damage, and replace if necessary. See “Controller board removal” on page 478.</p> <p>Does the problem remain?</p>	Contact the next level of support.	The problem is solved.

4y user attendance errors

42 user attendance messages

Error code	Description	Action
42.01	The toner cartridge and printer regions are mismatched.	See “Region mismatch service check” on page 220.
42.02	The toner cartridge and printer regions are mismatched.	
42.03	The toner cartridge and printer regions are mismatched.	
42.04	The toner cartridge and printer regions are mismatched.	
42.05	The toner cartridge and printer regions are mismatched.	
42.09	The toner cartridge and printer regions are mismatched.	
42.10	The toner cartridge and printer regions are mismatched.	See “Region mismatch service check” on page 220.
42.12	The toner cartridge and printer regions are mismatched.	
42.13	The toner cartridge and printer regions are mismatched.	
42.14	The toner cartridge and printer regions are mismatched.	
42.15	The toner cartridge and printer regions are mismatched.	
42.19	The toner cartridge and printer regions are mismatched.	
42.20	The toner cartridge and printer regions are mismatched.	See “Region mismatch service check” on page 220.
42.21	The toner cartridge and printer regions are mismatched.	
42.23	The toner cartridge and printer regions are mismatched.	
42.24	The toner cartridge and printer regions are mismatched.	
42.25	The toner cartridge and printer regions are mismatched.	
42.29	The toner cartridge and printer regions are mismatched.	

Error code	Description	Action
42.30	The toner cartridge and printer regions are mismatched.	See “Region mismatch service check” on page 220.
42.31	The toner cartridge and printer regions are mismatched.	
42.32	The toner cartridge and printer regions are mismatched.	
42.34	The toner cartridge and printer regions are mismatched.	
42.35	The toner cartridge and printer regions are mismatched.	
42.39	The toner cartridge and printer regions are mismatched.	
42.40	The toner cartridge and printer regions are mismatched.	See “Region mismatch service check” on page 220.
42.41	The toner cartridge and printer regions are mismatched.	
42.42	The toner cartridge and printer regions are mismatched.	
42.43	The toner cartridge and printer regions are mismatched.	
42.45	The toner cartridge and printer regions are mismatched.	
42.49	The toner cartridge and printer regions are mismatched.	
42.50	The toner cartridge and printer regions are mismatched.	See “Region mismatch service check” on page 220.
42.51	The toner cartridge and printer regions are mismatched.	
42.52	The toner cartridge and printer regions are mismatched.	
42.53	The toner cartridge and printer regions are mismatched.	
42.54	The toner cartridge and printer regions are mismatched.	
42.59	The toner cartridge and printer regions are mismatched.	

Error code	Description	Action
42.90	The toner cartridge and printer regions are mismatched.	See “Region mismatch service check” on page 220.
42.91	The toner cartridge and printer regions are mismatched.	
42.92	The toner cartridge and printer regions are mismatched.	
42.93	The toner cartridge and printer regions are mismatched.	
42.94	The toner cartridge and printer regions are mismatched.	
42.95	The toner cartridge and printer regions are mismatched.	

43 user attendance error messages

Error code	Description	Action
43.40Y	A black TMC error was detected.	See “Toner meter cycle (TMC) card service check” on page 221.
43.40Z	A black TMC error was detected.	
43.41Y	A cyan TMC error was detected.	
43.41Z	A cyan TMC error was detected.	
43.42Y	A magenta TMC error was detected.	
43.42Z	A magenta TMC error was detected.	
43.43Y	A yellow TMC error was detected.	
43.43Z	A yellow TMC error was detected.	

Region mismatch service check

Notes:

- The 42 errors occur due to a region mismatch.
- The first digit after 42 indicates the region code of the printer.
- The second digit after 42 indicates the region code of the cartridge.
- A worldwide cartridge is compatible with all printer regions.

Numeric code	Region
0	Worldwide or Undefined region
1	North America (United States, Canada)
2	European Economic Area, Western Europe, Nordic countries, Switzerland
3	Asia Pacific

Numeric code	Region
4	Latin America
5	Rest of Europe, Middle East, Africa
6	Australia, New Zealand
9	Invalid region

Action	Yes	No
Step 1 Check the region number of the cartridge and the printer. Do the numbers match?	Contact the next level of support.	Go to step 2.
Step 2 Install the appropriate cartridge. Does the problem remain?	Contact the next level of support.	The problem is solved.

Toner meter cycle (TMC) card service check

Actions	Yes	No
Step 1 a Enter the Diagnostics menu, and then navigate to: Printer diagnostics & adjustments > Sensor tests b Find the sensor (toner meter) of the affected color. Does the sensor status change while toggling the sensor?	Go to step 2.	Go to step 3.
Step 2 Replace the toner cartridge. Does the problem remain?	Go to step 3.	The problem is solved.
Step 3 Replace the TMC card. See “TMC card removal” on page 409 . Does the problem remain?	Contact the next level of support.	The problem is solved.

5y user attendance errors

55–59 user attendance error messages

Error code	Description	Action
55.1	An unsupported USB device was detected.	See “Unsupported USB device or hub service check” on page 222 .
55.2	An unsupported USB hub was detected.	

Error code	Description	Action
58A	Too many optional trays were detected.	See “Excess options service check” on page 223.
58B	Too many optional trays were detected.	
58C	Too many optional trays were detected.	
58D	Too many optional trays were detected.	
59C	An unsupported option was detected.	See “Incompatible option service check” on page 223.
59D	An unsupported option was detected.	

Unsupported USB device or hub service check

Action	Yes	No
<p>Step 1</p> <p>Make sure that the flash drive supports the File Allocation Table (FAT) system.</p> <p>Does the problem remain?</p>	Go to step 2.	The problem is solved.
<p>Step 2</p> <p>Try another flash drive.</p> <p>Does the problem remain?</p>	Go to step 3.	The problem is not with the printer. Replace the unsupported or defective flash drive.
<p>Step 3</p> <p>Check the firmware version.</p> <p>Is the firmware updated to the latest version?</p>	Go to step 5.	Go to step 4.
<p>Step 4</p> <p>Update the firmware.</p> <p>Does the problem remain?</p>	Go to step 5.	The problem is solved.
<p>Step 5</p> <p>Make sure that the controller board is properly installed. Reseat all the cables on the controller board.</p> <p>Does the problem remain?</p>	Go to step 6.	The problem is solved.
<p>Step 6</p> <p>Check the controller board and its connector pins for damage.</p> <p>Are the controller board and its connectors free of damage?</p>	Contact the next level of support.	Go to step 7.
<p>Step 7</p> <p>Replace the controller board. See “Controller board removal” on page 478.</p> <p>Does the problem remain?</p>	Contact the next level of support.	The problem is solved.

Excess options service check

Action	Yes	No
<p>Step 1 Perform a POR, and then resend the print job.</p> <p>Does the problem remain?</p>	Go to step 2.	The problem is solved.
<p>Step 2 Check the number of optional trays allowed, and then remove the excess optional trays.</p> <p>Does the problem remain?</p>	Go to step 3.	The problem is solved.
<p>Step 3 Check the engine board pins for damage.</p> <p>Are the pins free of damage?</p>	Contact the next level of support.	Go to step 4.
<p>Step 4 Replace the engine board. See “Engine board removal” on page 479.</p> <p>Does the problem remain?</p>	Contact the next level of support.	The problem is solved.

Incompatible option service check

Action	Yes	No
<p>Step 1</p> <p>a Unplug the printer, and then reseal the optional tray interface cable.</p> <p>b Plug the printer.</p> <p>Does the problem remain?</p>	Go to step 2.	The problem is solved.
<p>Step 2 Check if the engine firmware supports the optional tray, and update the firmware if necessary.</p> <p>Note: Contact the next level of support for the correct firmware version.</p> <p>Does the problem remain?</p>	Go to step 3.	The problem is solved.
<p>Step 3 Check the optional tray and its controller board for damage.</p> <p>Are the optional tray and its controller board free of damage?</p>	Contact the next level of support.	The problem is solved.

Action	Yes	No
<p>Step 4 Replace the optional tray. See “Optional 550-sheet tray removal” on page 536.</p> <p>Does the problem remain?</p>	Contact the next level of support.	The problem is solved.

6y user attendance errors

61–66 user attendance error messages

Error code	Description	Action
61	The hard disk is defective.	See “Hard disk failure service check” on page 224 .
62	The hard disk is full.	
63	The hard disk is not formatted.	
64	The hard disk format is unsupported.	
66	The hard disk needs to be formatted.	

Hard disk failure service check

Action	Yes	No
<p>Step 1 Delete unnecessary files.</p> <ul style="list-style-type: none"> From the home screen, navigate to Settings > Device > Maintenance > Out-of-Service Erase > Erase Hard Disk > Sanitize all information on hard disk > Erase downloads. From the home screen, navigate to Settings > Maintenance > Configuration Menu > Out-of-Service Erase > Erase Hard Disk > Sanitize all information on hard disk, and erase the jobs. <p>Does the problem remain?</p>	Go to step 2.	The problem is solved.
<p>Step 2 Make sure that the printer is using the latest firmware version.</p> <p>Does the problem remain?</p>	Go to step 3.	The problem is solved.
<p>Step 3</p> <ol style="list-style-type: none"> Make sure that the hard disk cable is properly connected. Make sure that the hard disk is properly installed. Check the hard disk for damage. <p>Is the hard disk free of damage?</p>	Go to step 5.	Go to step 4.

Action	Yes	No
Step 4 Replace the hard disk. Does the problem remain?	Go to step 5.	The problem is solved.
Step 5 Check the controller board pins for damage. Are the pins free of damage?	Contact the next level of support.	Go to step 6.
Step 6 Replace the controller board. See “Controller board removal” on page 478 . Does the problem remain?	Contact the next level of support.	The problem is solved.

7y user attendance errors

71–72 user attendance error messages

Error code	Description	Action
71.01	The fax station name is not set up.	See “Fax station error service check” on page 226 .
71.02	The fax station number is not set up.	
71.03	The analog phone line is not found.	See “Fax failure service check” on page 227 .
71.04	The analog phone line is incorrectly connected.	See “Modem/fax card service check” on page 307 .
71.05	An invalid FoIP license was detected.	
71.06	The fax server is not found.	
71.12	The printer cannot print faxes because the fax memory is full.	See “Fax failure service check” on page 227 .
71.13	The printer cannot send faxes because the fax memory is full.	
71.20	The fax partition is not working.	See “Modem/fax card service check” on page 307 .
72.01	The SMTP server is not set up.	

Fax station error service check

Action	Yes	No
<p>Step 1 Turn off the printer, wait for about 10 seconds, and then turn on the printer.</p> <p>Does the problem remain?</p>	Go to step 2.	The problem is solved.
<p>Step 2 a From the control panel, navigate to: Settings > Fax > Fax defaults > Fax setup > General fax settings b Set the fax name and fax number.</p> <p>Does the problem remain?</p>	Go to step 3.	The problem is solved.
<p>Step 3 Check the firmware version.</p> <p>Is the firmware updated to the latest version?</p>	Go to step 5.	Go to step 4.
<p>Step 4 Update the firmware.</p> <p>Does the problem remain?</p>	Go to step 5.	The problem is solved.
<p>Step 5 Make sure that the controller board is properly installed. Reseat all the cables on the controller board.</p> <p>Does the problem remain?</p>	Go to step 6.	The problem is solved.
<p>Step 6 Check the controller board and its connector pins for damage.</p> <p>Are the controller board and its connectors free of damage?</p>	Contact the next level of support.	Go to step 7.
<p>Step 7 Replace the controller board. See “Controller board removal” on page 478.</p> <p>Does the problem remain?</p>	Contact the next level of support.	The problem is solved.

Fax failure service check

Action	Yes	No
<p>Step 1 Turn off the printer, wait for about 10 seconds, and then turn on the printer.</p> <p>Does the problem remain?</p>	Go to step 2.	The problem is solved.
<p>Step 2</p> <p>a Make sure that the telephone cable is properly connected to the line port of the printer.</p> <p>b Make sure that the other end of the cable is connected to an active analog wall jack. Contact the analog phone service provider if necessary.</p> <p>Does the problem remain?</p>	Go to step 3.	The problem is solved.
<p>Step 3 Check the line port connector pins of the fax card for corrosion and damage.</p> <p>Note: The telephone cable must properly fit with the line port.</p> <p>Is the fax card connector free of damage?</p>	Go to step 4.	The problem is solved.
<p>Step 4 Check the firmware version.</p> <p>Is the firmware updated to the latest version?</p>	Go to step 6.	Go to step 5.
<p>Step 5 Update the firmware.</p> <p>Does the problem remain?</p>	Go to step 6.	The problem is solved.
<p>Step 6 Make sure that the controller board is properly installed. Reseat all the cables on the controller board.</p> <p>Does the problem remain?</p>	Go to step 7.	The problem is solved.
<p>Step 7 Check the controller board and its connector pins for damage.</p> <p>Are the controller board and its connectors free of damage?</p>	Contact the next level of support.	Go to step 8.
<p>Step 8 Replace the controller board. See “Controller board removal” on page 478.</p> <p>Does the problem remain?</p>	Contact the next level of support.	The problem is solved.

8y user attendance errors

80 user attendance error messages

Error code	Description	Action
80.01	The maintenance kit is nearly low. The backup roll or fuser page count threshold has been reached.	See “Maintenance kit service check” on page 233 .
80.09	The maintenance kit is nearly low. The user-selected EWS set point has been reached.	
80.11	The maintenance kit is low. The backup roll or fuser page count threshold has been reached.	
80.19	The maintenance kit is low. The user-selected EWS set point has been reached.	
80.21	The maintenance kit is very low. The backup roll or fuser page count threshold has been reached.	
80.29	The maintenance kit is very low. The user-selected EWS set point has been reached.	
80.31	Replace the maintenance kit. The backup roll or fuser page count threshold has been reached. The fuser may continue to function beyond end of life.	
80.39	Replace the maintenance kit. The user-selected EWS set point has been reached. The fuser may continue to function beyond end of life.	

82 user attendance error messages

Error code	Description	Action
82.00	The waste toner bottle has a nearly low remaining life.	See “Waste toner bottle service check” on page 234.
82.02	The waste toner bottle has a nearly low remaining life. The waste toner counter set point has been reached.	
82.09	The waste toner bottle has a nearly low remaining life. The user-selected EWS set point has been reached.	
82.12	The waste toner bottle has a low remaining life. The waste toner counter set point has been reached..	
82.13	The waste toner bottle has a low remaining life.	
82.19	The waste toner bottle has a low remaining life. The user-selected EWS set point has been reached.	
82.20	The waste toner bottle has a very low remaining life.	
82.22	The waste toner bottle has a very low remaining life. The waste toner counter set point has been reached.	
82.23	The waste toner bottle has a very low remaining life.	
82.29	The waste toner bottle has a very low remaining life. The user-selected EWS set point has been reached.	
82.30	The waste toner bottle has no remaining life.	
82.32	The waste toner bottle has no remaining life. The waste toner counter set point has been reached.	
82.33	The waste toner bottle has no remaining life.	
82.39	The waste toner bottle has no remaining life. The user-selected EWS set point has been reached.	
82.40	The waste toner bottle is already beyond end-of-life.	
82.42	The waste toner bottle is already beyond end-of-life. The waste toner counter set point has been reached.	
82.49	The waste toner bottle is already beyond end-of-life. The user-selected EWS set point has been reached.	

84 user attendance error messages

Error code	Description	Action
84.00	The black imaging unit or CMY imaging kit is nearly low.	See “Toner cartridge, imaging unit, or imaging kit error service check” on page 235.
84.01	The black imaging unit or CMY imaging kit is nearly low.	
84.03	The black imaging unit or CMY imaging kit is nearly low. The side count set point has been reached.	
84.09	The black imaging unit or CMY imaging kit is nearly low. The user-selected EWS set point has been reached.	
84.11	The black imaging unit or CMY imaging kit is low.	
84.13	The black imaging unit or CMY imaging kit is low. The side count set point has been reached.	
84.19	The black imaging unit or CMY imaging kit is low. The user-selected EWS set point has been reached.	
84.21	The black imaging unit or CMY imaging kit is very low.	
84.23	The black imaging unit or CMY imaging kit is very low. The side count set point has been reached.	
84.29	The black imaging unit or CMY imaging kit is very low. The user-selected EWS set point has been reached.	
84.31	The black imaging unit or CMY imaging kit has reached end-of-life.	
84.33	The black imaging unit or CMY imaging kit has reached end-of-life.	
84.41	The black imaging unit or CMY imaging kit has reached beyond end-of-life.	
84.43	The black imaging unit or CMY imaging kit has reached beyond end-of-life.	
84.48	The black imaging unit or CMY imaging kit has reached beyond end-of-life.	

88 user attendance error messages

Error code	Description	Action
88.00K	The black toner cartridge is nearly low.	See “Toner cartridge, imaging unit, or imaging kit error service check” on page 235.
88.00C	The cyan toner cartridge is nearly low.	
88.00M	The magenta toner cartridge is nearly low.	
88.00Y	The yellow toner cartridge is nearly low.	
88.01K	The black toner cartridge is nearly low.	
88.01C	The cyan toner cartridge is nearly low.	
88.01M	The magenta toner cartridge is nearly low.	
88.01Y	The yellow toner cartridge is nearly low.	
88.08K	The black toner cartridge is nearly low.	
88.08C	The cyan toner cartridge is nearly low.	
88.08M	The magenta toner cartridge is nearly low.	
88.08Y	The yellow toner cartridge is nearly low.	
88.09K	The black toner cartridge is nearly low. The user-selected EWS set point has been reached.	
88.09C	The cyan toner cartridge is nearly low. The user-selected EWS set point has been reached.	
88.09M	The magenta toner cartridge is nearly low. The user-selected EWS set point has been reached.	
88.09Y	The yellow toner cartridge is nearly low. The user-selected EWS set point has been reached.	
88.10K	The black toner cartridge is low.	See “Toner cartridge, imaging unit, or imaging kit error service check” on page 235.
88.10C	The cyan toner cartridge is low.	
88.10M	The magenta toner cartridge is low.	
88.10Y	The yellow toner cartridge is low.	
88.18K	The black toner cartridge is low.	
88.18C	The cyan toner cartridge is low.	
88.18M	The magenta toner cartridge is low.	
88.18Y	The yellow toner cartridge is low.	
88.19K	The black toner cartridge is low. The user-selected EWS set point has been reached.	
88.19C	The cyan toner cartridge is low. The user-selected EWS set point has been reached.	
88.19M	The magenta toner cartridge is low. The user-selected EWS set point has been reached.	
88.19Y	The yellow toner cartridge is low. The user-selected EWS set point has been reached.	

Error code	Description	Action
88.20K	The black toner cartridge is very low.	See “Toner cartridge, imaging unit, or imaging kit error service check” on page 235.
88.20C	The cyan toner cartridge is very low.	
88.20M	The magenta toner cartridge is very low.	
88.20Y	The yellow toner cartridge is very low.	
88.28K	The black toner cartridge is very low.	
88.28C	The cyan toner cartridge is very low.	
88.28M	The magenta toner cartridge is very low.	
88.28Y	The yellow toner cartridge is very low.	
88.29K	The black toner cartridge is very low. The user-selected EWS set point has been reached.	
88.29C	The cyan toner cartridge is very low. The user-selected EWS set point has been reached.	
88.29M	The magenta toner cartridge is very low. The user-selected EWS set point has been reached.	
88.29Y	The yellow toner cartridge is very low. The user-selected EWS set point has been reached.	
88.30K	The black toner cartridge is at end-of-life.	See “Toner cartridge, imaging unit, or imaging kit error service check” on page 235.
88.30C	The cyan toner cartridge is at end-of-life.	
88.30M	The magenta toner cartridge is at end-of-life.	
88.30Y	The yellow toner cartridge is at end-of-life.	
88.37K	The black toner cartridge is at end-of-life.	
88.37C	The cyan toner cartridge is at end-of-life.	
88.37M	The magenta toner cartridge is at end-of-life.	
88.37Y	The yellow toner cartridge is at end-of-life.	
88.38K	The black toner cartridge is at end-of-life.	
88.38C	The cyan toner cartridge is at end-of-life.	
88.38M	The magenta toner cartridge is at end-of-life.	
88.38Y	The yellow toner cartridge is at end-of-life.	

Error code	Description	Action
88.40K	The black toner cartridge is beyond end-of-life.	See “Toner cartridge, imaging unit, or imaging kit error service check” on page 235.
88.40C	The cyan toner cartridge is beyond end-of-life.	
88.40M	The magenta toner cartridge is beyond end-of-life.	
88.40Y	The yellow toner cartridge is beyond end-of-life.	
88.47K	The black toner cartridge is beyond end-of-life.	
88.47C	The cyan toner cartridge is beyond end-of-life.	
88.47M	The magenta toner cartridge is beyond end-of-life.	
88.47Y	The yellow toner cartridge is beyond end-of-life.	
88.48K	The black toner cartridge is beyond end-of-life.	
88.48C	The cyan toner cartridge is beyond end-of-life.	
88.48M	The magenta toner cartridge is beyond end-of-life.	
88.48Y	The yellow toner cartridge is beyond end-of-life.	

Maintenance kit service check

Warning—Potential Damage: Do not perform these steps if the printer is on.

- 1 Replace the required maintenance kit.
- 2 Reset the maintenance counter. See the “Resetting counters” section.

Waste toner bottle service check

Action	Yes	No
<p>Step 1 Reinstall the waste toner bottle.</p> <p>Note: Make sure that the waste toner bottle is upright. If it is tilted, then the sensor may get a false reading on the amount of toner.</p> <p>Does the problem remain?</p>	Go to step 2.	The problem is solved.
<p>Step 2</p> <p>a Tap the waste toner bottle to dislodge the toner particles from its walls.</p> <p>b Check if the waste toner bottle is full.</p> <p>Note: If the level of the waste toner reaches the sensor detection area, then the waste toner bottle is already full.</p> <p>c Check the waste toner bottle for damage.</p> <p>Is the waste toner bottle full or damaged?</p>	Go to step 3.	Go to step 4.
<p>Step 3 Replace the waste toner bottle.</p> <p>Does the problem remain?</p>	Go to step 4.	The problem is solved.
<p>Step 4</p> <p>a Enter the Diagnostics menu, and then navigate to: Printer diagnostics and adjustments > Sensor tests</p> <p>b Find the sensor (Waste toner bottle).</p> <p>Does the sensor status change while toggling the sensor?</p>	Go to step 8.	Go to step 5.
<p>Step 5 Make sure that the sensor cable is properly connected.</p> <p>Does the problem remain?</p>	Go to step 6.	The problem is solved.
<p>Step 6 Check the sensor and its flag for improper installation, contamination, and damage.</p> <p>Is the sensor properly installed and free of contamination and damage?</p>	Go to step 8.	Go to step 7.
<p>Step 7 Reinstall, clean, or replace the sensor.</p> <p>Does the problem remain?</p>	Go to step 8.	The problem is solved.

Action	Yes	No
<p>Step 8 Perform the sensor (waste toner bottle) calibration. See “Waste toner sensor calibration” on page 332.</p> <p>Does the problem remain?</p>	Contact the next level of support.	The problem is solved.

Toner cartridge, imaging unit, or imaging kit error service check

Action	Yes	No
<p>Step 1 a Make sure that the toner cartridges, black imaging unit, and CMY imaging kit are all completely installed. b Make sure that the toner cartridges, black imaging unit, and CMY imaging kit are genuine and supported.</p> <p>Does the problem remain?</p>	Go to step 2.	The problem is solved.
<p>Step 2 a Make sure that the toner cartridges, black imaging unit, and CMY imaging kit are properly installed. b Make sure that the imaging kit cable is properly connected.</p> <p>Does the problem remain?</p>	Go to step 3.	The problem is solved.
<p>Step 3 Check the TMC card contacts for damage.</p> <p>Are the TMC card contacts free of damage?</p>	Go to step 5.	Go to step 4.
<p>Step 4 Replace the TMC card. See “TMC card removal” on page 409.</p> <p>Does the problem remain?</p>	Go to step 5.	The problem is solved.
<p>Step 5 Check the engine board and its pins for damage.</p> <p>Is the engine board free of damage?</p>	Contact the next level of support.	Go to step 6.
<p>Step 6 Replace the engine board. See “Engine board removal” on page 479.</p> <p>Does the problem remain?</p>	Contact the next level of support.	The problem is solved.

Printer hardware errors

100 errors

100 error messages

Error code	Description	Action
100.01	The weather station data is not valid.	See “Sensor (weather station) service check” on page 236.
100.04D	The printhead thermistor reading is out of range.	See “Printhead service check” on page 239.
100.25	The TPS thermistor reading is out of range.	See “TPS thermistor service check” on page 236.

Sensor (weather station) service check

Action	Yes	No
Step 1 Check the sensor cable for proper connection and damage, and replace if necessary. Does the problem remain?	Go to step 2.	The problem is solved.
Step 2 Replace the sensor. See “Sensor (weather station) removal ” on page 416. Does the problem remain?	Contact the next level of support.	The problem is solved.

TPS thermistor service check

Action	Yes	No
Step 1 Make sure that the sensor (TPS) is properly connected. Does the problem remain?	Go to step 2.	The problem is solved.
Step 2 Replace the sensor (TPS). See “Sensor (TPS) removal” on page 422. Does the problem remain?	Contact the next level of support.	The problem is solved.

101 errors

101 error messages

Error code	Description	Action
101.20	Tray 2 product ID is invalid.	See “Invalid input option type or ID is detected service check” on page 237.
101.21	Tray 2 board ID is invalid.	
101.22	Tray 2 type is invalid.	
101.30	Tray 3 product ID is invalid.	
101.31	Tray 3 board ID is invalid.	
101.32	Tray 3 type is invalid.	
101.40	Tray 4 product ID is invalid.	
101.41	Tray 4 board ID is invalid.	
101.42	Tray 4 type is invalid.	
101.50	Tray 5 product ID is invalid.	
101.51	Tray 5 board ID is invalid.	
101.52	Tray 5 type is invalid.	

Invalid input option type or ID is detected service check

Action	Yes	No
<p>Step 1</p> <p>a Make sure that the latest firmware is installed.</p> <p>b Make sure that the options configuration is supported. See the <i>Printer, Option, and Stand Compatibility Guide</i>.</p> <p>c Restart the printer.</p> <p>Does the problem remain?</p>	Go to step 2.	The problem is solved.
<p>Step 2</p> <p>Reinstall the optional tray.</p> <p>Does the problem remain?</p>	Go to step 3.	The problem is solved.
<p>Step 3</p> <p>Replace the optional tray. See “Optional 550-sheet tray removal” on page 536.</p> <p>Does the problem remain?</p>	Go to step 4.	The problem is solved.
<p>Step 4</p> <p>Restart the printer.</p> <p>Does the problem remain?</p>	Contact the next level of support.	The problem is solved.

110 errors

110 error messages

Error code	Description	Action
110.20	A printhead error was detected before the motor was turned on.	See “Printhead service check” on page 239.
110.21	The printhead power was off when the laser servo started.	
110.31	A printhead error (no first Hysnc) was detected.	
110.32	A printhead error (lost first Hysnc) was detected.	
110.33	A printhead error (lost first Hysnc) was detected during servo.	
110.34	A printhead error (mirror motor lost lock) was detected.	
110.35	A printhead error (mirror motor no first lock) was detected.	
110.36	A printhead error (mirror motor never stabilized) was detected.	
110.37	The pinthead type was undetermined.	
110.41	A printhead NVRAM read failure occurred.	
110.70	The printhead NVRAM values were incorrect.	
110.71	A printhead timing measurement error was detected.	
110.91	A printhead timing reading error was detected.	
110.92	A printhead NVRAM checksum mismatch occurred.	

Printhead service check

Action	Yes	No
<p>Step 1 Restart the printer.</p> <p>Does the problem remain?</p>	Go to step 2.	The problem is solved.
<p>Step 2</p> <p>a Make sure that the printhead cable is properly connected.</p> <p>b Make sure that the following connectors on the engine board are properly connected.</p> <ul style="list-style-type: none"> • JMIRR1 or JMIRR2 • JPH1 <p>Does the problem remain?</p>	Go to step 3.	The problem is solved.
<p>Step 3 Replace the printhead. See “Printhead removal” on page 484.</p> <p>Does the problem remain?</p>	Go to step 4.	The problem is solved.
<p>Step 4 Replace the engine board. See “Engine board removal” on page 479.</p> <p>Does the problem remain?</p>	Contact the next level of support.	The problem is solved.

120 errors

120 error messages

Error code	Description	Action
120.80	<p>The motor (fuser) did not turn on.</p> <p>Notes:</p> <ul style="list-style-type: none"> • A 120.80 error may unexpectedly occur while performing motor tests in the Diagnostics mode, most likely if a door is open or has been opened. This might not indicate a problem with the fuser or fuser motor. • To check if the fuser and fuser motor are working properly, perform a POR and then a basic print test. If the error still occurs afterwards, then additional troubleshooting of the fuser or fuser motor should be done. 	See “Motor (fuser) service check” on page 240.
120.81	The motor (fuser) did not turn off.	
120.82	The motor (fuser) speed did not ramp up to the required level.	
120.83	The motor (fuser) stalled.	
120.84	The motor (fuser) ran too slow.	
120.85	The motor (fuser) ran too fast.	
120.86	The motor (fuser) did not run at the correct timing.	

Motor (fuser) service check

Action	Yes	No
<p>Step 1</p> <p>Restart the printer.</p> <p>Does the problem remain?</p>	Go to step 2.	The problem is solved.
<p>Step 2</p> <p>a Check if the fuser has reached end-of-life.</p> <p>b Check the fuser for damage.</p> <p>Is the fuser still functional and free of damage?</p>	Go to step 4.	Go to step 3.
<p>Step 3</p> <p>Replace the fuser. See “Fuser removal” on page 436.</p> <p>Does the problem remain?</p>	Go to step 4.	Go to step 4.

Action	Yes	No
<p>Step 4 Make sure that the JFDRV1 connector is properly connected to the engine board and motor (fuser).</p> <p>Does the problem remain?</p>	Go to step 5.	The problem is solved.
<p>Step 5 Remove the fuser, and then manually turn the fuser drive gear.</p> <p>Does the gear freely turn?</p>	Go to step 7.	Go to step 6.
<p>Step 6 Replace the fuser drive gear.</p> <p>Does the problem remain?</p>	Go to step 7.	The problem is solved.
<p>Step 7 Replace the motor (fuser). See “Motor (fuser) removal” on page 413.</p> <p>Does the problem remain?</p>	Go to step 8.	The problem is solved.
<p>Step 8 Replace the engine board. See “Engine board removal” on page 479.</p> <p>Does the problem remain?</p>	Contact the next level of support.	The problem is solved.

121 errors

121 error messages

Error code	Description	Action
121.00	Fuser failed to reach the temperature during warm-up.	See “Fuser service check” on page 244.
121.01	There was an attempt to heat fuser, but it was not installed.	
121.02	Fuser went over the required temperature during EWC/line voltage detection.	
121.03	Fuser hardware and driver mismatch.	
121.04	There was an attempt to heat fuser, but fuser relay was open and fuser PIC microcontroller did not report an error or did not respond. Notes: <ul style="list-style-type: none"> • A 121.04 error may unexpectedly occur while performing motor tests in the Diagnostics mode, most likely if a door is open or has been opened. This might not indicate a problem with the fuser or fuser motor. • To check if the fuser and fuser motor are working properly, perform a POR and then a basic print test. If the error still occurs afterwards, then additional troubleshooting of the fuser or fuser motor should be done. 	
121.05	There was an attempt to heat fuser, but fuser relay was open and fuser PIC microcontroller reported an error.	
121.08	Fuser did not reach the required temperature while the page is in the fuser.	
121.09	Fuser did not reach the required temperature for motors. Note: Not applicable to standby mode.	
121.10	Fuser did not reach the required temperature during start of EWC/line voltage detection.	
121.11	Fuser reached the required temperature during final EWC/line voltage detection too late.	
121.12	Fuser did not reach the required temperature during final EWC/line voltage detection.	
121.13	Fuser reached the required temperature during final EWC/line voltage detection too fast.	

Error code	Description	Action
121.22	Open fuser relay was detected.	See “Fuser service check” on page 244.
121.32	Fuser did not reach the required temperature at 100% power. Notes: <ul style="list-style-type: none"> • A 121.32 error may unexpectedly occur while performing motor tests in the Diagnostics mode, most likely if a door is open or has been opened. This might not indicate a problem with the fuser or fuser motor. • To check if the fuser and fuser motor are working properly, perform a POR and then a basic print test. If the error still occurs afterwards, then additional troubleshooting of the fuser or fuser motor should be done. 	
121.33	Fuser did not reach the required temperature while the page is in the fuser.	
121.34	Fuser did not reach the required temperature during steady state control.	
121.35	Fuser too warm to power up and execute EWC/line voltage detection after a wrong fuser was installed.	
121.36	Open fuser relay was detected in very cold or unknown ambient temperature.	
121.41	Fuser mechanism did not detect the expected cam sensor signal.	
121.42	Fuser gate time is increasingly out of range.	
121.43	The motor (fuser) current exceeded the limit.	

Error code	Description	Action
121.50	Fuser went over the required temperature during global over temperature check.	See “Fuser service check” on page 244.
121.52	Fuser main heater thermistor temperature is out of range.	
121.53	Fuser main heater thermistor temperature change rate is out of range.	
121.56	Fuser middle heater thermistor temperature is out of range (or narrow thermistor for CS/CX737).	
121.57	Fuser middle heater thermistor temperature change rate is out of range (or narrow thermistor for CS/CX737).	
121.58	Fuser edge thermistor temperature is out of range.	
121.59	Fuser edge thermistor temperature change rate is out of range.	
121.67	Fuser narrow media backup roll thermistor temperature change rate is out of range.	
121.71	Open fuser main heater thermistor was detected.	
121.73	Open fuser middle heater thermistor was detected (or narrow thermistor for CS/CX737).	
121.74	Open fuser edge thermistor was detected.	

Fuser service check

Action	Yes	No
<p>Step 1</p> <p>Make sure that the fuser has the correct fuser type. A 121.05 or 126.11 error may occur if the wrong fuser type is installed.</p> <p>Notes:</p> <ul style="list-style-type: none"> • The fuser type number can be found on the fuser sticker. • The fuser types supported are 00, 01, and 02 for all models except CS/CX737. • For CS/CX737, the only supported fuser type is 05. <p>Does the problem remain?</p>	Go to step 2.	The problem is solved.
<p>Step 2</p> <p>Make sure that the JLVPS1 connector is properly connected to the engine board and LVPS.</p> <p>Does the problem remain?</p>	Go to step 3.	The problem is solved.

Action	Yes	No
<p>Step 3</p> <p>Make sure that the JFSNS1 connector is properly connected to the engine board and fuser.</p> <p>Does the problem remain?</p>	Go to step 4.	The problem is solved.
<p>Step 4</p> <p>Replace the fuser. See “Fuser removal” on page 436.</p> <p>Does the problem remain?</p>	Go to step 5.	The problem is solved.
<p>Step 5</p> <p>Make sure that the sensor (fuser nip) is properly installed. See “Sensor (fuser nip) removal” on page 441.</p> <p>Notes:</p> <ul style="list-style-type: none"> • Check if the actuator and the sensor are not dislodged. • Check if the cable is not disconnected. <p>Does the problem remain?</p>	Go to step 6.	The problem is solved.
<p>Step 6</p> <p>Replace the sensor (fuser nip).</p> <p>Does the problem remain?</p>	Go to step 7.	The problem is solved.
<p>Step 7</p> <p>Replace the LVPS. See “LVPS removal” on page 377.</p> <p>Does the problem remain?</p>	Go to step 8.	The problem is solved.
<p>Step 8</p> <p>Replace the engine board. See “Engine board removal” on page 479.</p> <p>Does the problem remain?</p>	Contact the next level of support.	The problem is solved.

126–127 errors

126–127 error messages

Error code	Description	Action
126.05	The LVPS power rail dropped, but printer is not in sleep mode.	See “LVPS service check” on page 246 .
126.06	The LVPS power rail was down after POR.	
126.07	The LVPS sensor rail was down during POR.	

Error code	Description	Action
126.10	No LVPS line frequency was detected.	1 See step 1 (only) of “Fuser service check” on page 244. 2 See “LVPS service check” on page 246.
126.11	The LVPS line frequency has gone outside the operating range.	
126.14	The LVPS relay is stuck in close position.	See “LVPS service check” on page 246.
127.01	HVPS was not detected.	See “HVPS service check” on page 247.

LVPS service check

Action	Yes	No
<p>Step 1</p> <p>Make sure that the fuser has the correct fuser type. A 121.05 or 126.11 error may occur if the wrong fuser type is installed.</p> <p>Notes:</p> <ul style="list-style-type: none"> • The fuser type number can be found on the fuser sticker. • The fuser types supported are 00, 01, and 02 for all models except CS/CX737. • For CS/CX737, the only supported fuser type is 05. <p>Does the problem remain?</p>	Go to step 2.	The problem is solved.
<p>Step 2</p> <p>a Turn off the printer, and then disconnect it from the electrical outlet for more than five seconds.</p> <p>b Reconnect and restart the printer.</p> <p>Does the problem remain?</p>	Go to step 3.	The problem is solved.
<p>Step 3</p> <p>Make sure that the JLVP1 connector on the engine board and LVPS is properly connected.</p> <p>Does the problem remain?</p>	Go to step 4.	The problem is solved.
<p>Step 4</p> <p>Replace the LVPS. See “LVPS removal” on page 377.</p> <p>Does the problem remain?</p>	Go to step 5.	The problem is solved.
<p>Step 5</p> <p>Replace the engine board. See “Engine board removal” on page 479.</p> <p>Does the problem remain?</p>	Contact the next level of support.	The problem is solved.

HVPS service check

Action	Yes	No
<p>Step 1 Restart the printer.</p> <p>Does the problem remain?</p>	Go to step 2.	The problem is solved.
<p>Step 2 Make sure that the JHVPS1 connector on the engine board is properly connected to the HVPS.</p> <p>Does the problem remain?</p>	Go to step 3.	The problem is solved.
<p>Step 3 Replace the HVPS. See “HVPS removal” on page 417.</p> <p>Does the problem remain?</p>	Go to step 4.	The problem is solved.
<p>Step 4 Replace the engine board. See “Engine board removal” on page 479.</p> <p>Does the problem remain?</p>	Contact the next level of support.	The problem is solved.

142 errors

142 error messages

Error code	Description	Action
142.80	The motor (CMY) did not turn on.	See “Motor (CMY) service check” on page 248.
142.81	The motor (CMY) did not turn off.	
142.82	The motor (CMY) speed did not ramp up to the required level.	
142.83	The motor (CMY) stalled.	
142.84	The motor (CMY) ran too slow.	
142.85	The motor (CMY) ran too fast.	
142.86	The motor (CMY) did not run at the correct timing.	

Motor (CMY) service check

Action	Yes	No
<p>Step 1 Restart the printer.</p> <p>Does the problem remain?</p>	Go to step 2.	The problem is solved.
<p>Step 2</p> <p>a Remove the imaging kit. See “Imaging kit removal” on page 399.</p> <p>b Remove the transfer module. See “Transfer module removal” on page 431.</p> <p>c Enter the Diagnostics menu, and then navigate to: Printer diagnostics & adjustments > Motor tests > CMY developer</p> <p>d Touch Start.</p> <p>Does the motor run?</p>	Go to step 5.	Go to step 3.
<p>Step 3 Make sure that the JCDRV1 connector on the engine board is properly connected to the motor (CMY).</p> <p>Does the problem remain?</p>	Go to step 4.	The problem is solved.
<p>Step 4 Replace the motor (CMY). See “Motor (EP drive) removal” on page 382.</p> <p>Does the problem remain?</p>	Go to step 5.	The problem is solved.
<p>Step 5</p> <p>a Check if the CMY imaging kit has reached end-of-life.</p> <p>b Check the CMY imaging kit for damage.</p> <p>Is the CMY imaging kit functional and free of damage?</p>	Go to step 7.	Go to step 6.
<p>Step 6 Replace the affected CMY imaging kit. See “Imaging kit removal” on page 399.</p> <p>Does the problem remain?</p>	Go to step 7.	The problem is solved.
<p>Step 7 Manually turn the drive gears.</p> <p>Do the CMY drive gears freely turn?</p>	Go to step 9.	Go to step 8.

Action	Yes	No
<p>Step 8 Replace the EP drive gearbox. See “EP drive gearbox removal” on page 384.</p> <p>Does the problem remain?</p>	Go to step 9.	The problem is solved.
<p>Step 9 Replace the engine board. See “Engine board removal” on page 479.</p> <p>Does the problem remain?</p>	Contact the next level of support.	The problem is solved.

145 errors

145 error messages

Error code	Description	Action
145.80	The motor (BOR) did not turn on.	See “Motor (BOR) service check” on page 249.
145.81	The motor (BOR) did not turn off.	
145.82	The motor (BOR) speed did not ramp up to the required level.	
145.83	The motor (BOR) stalled.	
145.84	The motor (BOR) ran too slow.	
145.85	The motor (BOR) ran too fast.	
145.86	The motor (BOR) did not run at the correct timing.	

Motor (BOR) service check

Action	Yes	No
<p>Step 1 Restart the printer.</p> <p>Does the problem remain?</p>	Go to step 2.	The problem is solved.
<p>Step 2 a Remove the transfer module. See “Transfer module removal” on page 431. b Enter the Diagnostics menu, and then navigate to: Printer diagnostics & adjustments > Motor tests > Black only retract c Touch Start.</p> <p>Does the motor run?</p>	Go to step 5.	Go to step 3.

Action	Yes	No
<p>Step 3 Make sure that the JBOR1 connector on the engine board is properly connected to the motor.</p> <p>Does the problem remain?</p>	Go to step 4.	The problem is solved.
<p>Step 4 Replace the motor. See “Motor (BOR) removal” on page 386.</p> <p>Does the problem remain?</p>	Go to step 5.	The problem is solved.
<p>Step 5 Manually turn the BOR gear on the transfer module.</p> <p>Does the gear freely turn?</p>	Contact the next level of support.	Go to step 6.
<p>Step 6 Replace the transfer module. See “Transfer module removal” on page 431.</p> <p>Does the problem remain?</p>	Go to step 7.	The problem is solved.
<p>Step 7 Replace the engine board. See “Engine board removal” on page 479.</p> <p>Does the problem remain?</p>	Contact the next level of support.	The problem is solved.

147 errors

147 error messages

Error code	Description	Action
147.80	The motor (deskew) did not turn on.	See “Motor (deskew) service check” on page 251.
147.81	The motor (deskew) did not turn off.	
147.82	The motor (deskew) speed did not ramp up to the required level.	
147.83	The motor (deskew) stalled.	
147.84	The motor (deskew) ran too slow.	
147.85	The motor (deskew) ran too fast.	
147.86	The motor (deskew) did not run at the correct timing.	

Motor (deskew) service check

Action	Yes	No
<p>Step 1 Restart the printer.</p> <p>Does the problem remain?</p>	Go to step 2.	The problem is solved.
<p>Step 2 a Enter the Diagnostics menu, and then navigate to: Printer diagnostics & adjustments > Motor tests > Deskew b Touch Start.</p> <p>Does the motor run?</p>	Go to step 5.	Go to step 3.
<p>Step 3 Make sure that the JMTR1 connector on the engine board is properly connected to the motor.</p> <p>Does the problem remain?</p>	Go to step 4.	Contact the next level of support.
<p>Step 4 Replace the motor. See “Motor (deskew) removal” on page 387.</p> <p>Does the problem remain?</p>	Go to step 5.	Contact the next level of support.
<p>Step 5 Manually turn the aligner rollers.</p> <p>Is there binding or uneven movement when turning the rollers?</p>	Go to step 6.	Go to step 7.
<p>Step 6 Check the aligner rollers and drivetrain for damage.</p> <p>Are the aligner roller and drivetrain free of damage?</p>	Go to step 8.	Go to step 7.
<p>Step 7 Replace the affected aligner roller or drivetrain. See “Aligner rollers removal” on page 458.</p> <p>Does the problem remain?</p>	Go to step 8.	The problem is solved.
<p>Step 8 Replace the engine board. See “Engine board removal” on page 479.</p> <p>Does the problem remain?</p>	Contact the next level of support.	The problem is solved.

149 errors

149 error messages

Error code	Description	Action
149.80	The motor (exit/redrive) did not turn on.	See “Motor (exit/redrive) service check” on page 252.
149.81	The motor (exit/redrive) did not turn off.	
149.82	The motor (exit/redrive) speed did not ramp up to the required level.	
149.83	The motor (exit/redrive) stalled.	
149.84	The motor (exit/redrive) ran too slow.	
149.85	The motor (exit/redrive) ran too fast.	
149.86	The motor (exit/redrive) did not run at the correct timing.	

Motor (exit/redrive) service check

Action	Yes	No
<p>Step 1 Restart the printer.</p> <p>Does the problem remain?</p>	Go to step 2.	The problem is solved.
<p>Step 2 Make sure that the JOUTDC1 connector on the engine board is properly connected to the motor.</p> <p>Does the problem remain?</p>	Go to step 3.	The problem is solved.
<p>Step 3 Restart the printer.</p> <p>Does the problem remain?</p>	Go to step 4.	The problem is solved.
<p>Step 4 Replace the motor. See “Motor (exit/redrive) removal” on page 390.</p> <p>Does the problem remain?</p>	Go to step 5.	The problem is solved.
<p>Step 5 Restart the printer.</p> <p>Does the problem remain?</p>	Go to step 6.	The problem is solved.

Action	Yes	No
<p>Step 6 Replace the engine board. See “Engine board removal” on page 479.</p> <p>Does the problem remain?</p>	Contact the next level of support.	The problem is solved.

150 errors

150 error messages

Error code	Description	Action
150.80	The motor (duplex/MPF) did not turn on.	See “Motor (duplex/MPF) service check” on page 253 .
150.81	The motor (duplex/MPF) did not turn off.	
150.82	The motor (duplex/MPF) speed did not ramp up to the required level.	
150.83	The motor (duplex/MPF) stalled.	
150.84	The motor (duplex/MPF) ran too slow.	
150.85	The motor (duplex/MPF) ran too fast.	
150.86	The motor (duplex/MPF) did not run at the correct timing.	

Motor (duplex/MPF) service check

Action	Yes	No
<p>Step 1 Restart the printer.</p> <p>Does the problem remain?</p>	Go to step 2.	The problem is solved.
<p>Step 2 a Enter the Diagnostics menu, and then navigate to: Printer diagnostics & adjustments > Motor tests > Duplex/MPF b Touch Start.</p> <p>Does the motor run?</p>	Go to step 6.	Go to step 3.
<p>Step 3 Make sure that the JMTR1 connector is properly connected to the engine board.</p> <p>Does the problem remain?</p>	Go to step 4.	The problem is solved.

Action	Yes	No
<p>Step 4</p> <p>Open the front door, and then manually turn the duplex/MPF drive gears.</p> <p>Do the gears move freely?</p>	Go to step 6.	Go to step 5.
<p>Step 5</p> <p>Replace the motor. See “Motor (duplex/MPF) removal” on page 415.</p> <p>Does the problem remain?</p>	Go to step 6.	The problem is solved.
<p>Step 6</p> <p>Replace the engine board. See “Engine board removal” on page 479.</p> <p>Does the problem remain?</p>	Contact the next level of support.	The problem is solved.

151 errors

151 error messages

Error code	Description	Action
151.80	The motor (K/transfer belt) did not turn on.	See “Motor (K/transfer belt) service check” on page 255.
151.81	The motor (K/transfer belt) did not turn off.	
151.82	The motor (K/transfer belt) speed did not ramp up to the required level.	
151.83	The motor (K/transfer belt) stalled.	
151.84	The motor (K/transfer belt) ran too slow.	
151.85	The motor (K/transfer belt) ran too fast.	
151.86	The motor (K/transfer belt) did not run at the correct timing.	

Motor (K/transfer belt) service check

Action	Yes	No
<p>Step 1 Restart the printer.</p> <p>Does the problem remain?</p>	Go to step 2.	The problem is solved.
<p>Step 2</p> <p>a Remove the imaging kit. See “Imaging kit removal” on page 399.</p> <p>b Remove the transfer module. See “Transfer module removal” on page 431.</p> <p>c Enter the Diagnostics menu, and then navigate to: Printer diagnostics & adjustments > Motor tests > K developer/Transfer</p> <p>d Touch Start.</p> <p>Does the motor run?</p>	Go to step 5.	Go to step 3.
<p>Step 3 Make sure that the JKDRV1 connector on the engine board is properly connected to the motor (K/transfer belt).</p> <p>Does the problem remain?</p>	Go to step 4.	The problem is solved.
<p>Step 4 Replace the motor (K/transfer belt). See “Motor (EP drive) removal” on page 382.</p> <p>Does the problem remain?</p>	Go to step 5.	The problem is solved.
<p>Step 5</p> <p>a Check if the black imaging unit and transfer module have reached end-of-life.</p> <p>b Check the black imaging unit and transfer module for damage.</p> <p>Are the black imaging unit and transfer module functional and free of damage?</p>	Go to step 7.	Go to step 6.
<p>Step 6 Replace the affected black imaging unit or transfer module. See “Transfer module removal” on page 431.</p> <p>Does the problem remain?</p>	Go to step 7.	The problem is solved.
<p>Step 7 Manually turn the drive gears.</p> <p>Do the black imaging unit and transfer module drive gears freely turn?</p>	Go to step 9.	Go to step 8.

Action	Yes	No
<p>Step 8 Replace the EP drive gearbox. See “EP drive gearbox removal” on page 384.</p> <p>Does the problem remain?</p>	Go to step 9.	The problem is solved.
<p>Step 9 Replace the engine board. See “Engine board removal” on page 479.</p> <p>Does the problem remain?</p>	Contact the next level of support.	The problem is solved.

153 errors

153 error messages

Error code	Description	Action
153.80	The motor (isolation) unit did not turn on.	See “Isolation unit service check” on page 256.
153.81	The motor (isolation) unit did not turn off.	
153.82	The motor (isolation) unit speed did not ramp up to the required level.	
153.83	The motor (isolation) stalled.	
153.84	The motor (isolation) ran too slow.	
153.85	The motor (isolation) ran too fast.	
153.86	The motor (isolation) did not run at the correct timing.	

Isolation unit service check

Action	Yes	No
<p>Step 1 Reset the printer.</p> <p>Does the problem remain?</p>	Go to step 2.	The problem is solved.
<p>Step 2 a Enter the Diagnostics menu, and then navigate to: Printer diagnostics & adjustments > Motor tests > Isolation b Touch Start.</p> <p>Does the motor run?</p>	Go to step 3.	Go to step 4.

Action	Yes	No
<p>Step 3</p> <p>Make sure that the JMTR1 connector on the engine board is properly connected to the motor.</p> <p>Does the problem remain?</p>	Go to step 4.	The problem is solved.
<p>Step 4</p> <p>Manually turn the isolation rollers and the alternate isolation rollers.</p> <p>Do the rollers move freely?</p>	Go to step 6.	Go to step 5.
<p>Step 5</p> <p>Replace the isolation unit. See “Isolation unit removal” on page 509.</p> <p>Does the problem remain?</p>	Go to step 6.	The problem is solved.
<p>Step 6</p> <p>Replace the engine board. See “Engine board removal” on page 479.</p> <p>Does the problem remain?</p>	Contact the next level of support.	The problem is solved.

160 errors

160 error messages

Error code	Description	Action
160.80	The motor (duplex/MPF) did not turn on.	See “Motor (duplex/MPF) service check” on page 253 .
160.81	The motor (duplex/MPF) did not turn off.	
160.82	The motor (duplex/MPF) speed did not ramp up to the required level.	
160.83	The motor (duplex/MPF) stalled.	
160.84	The motor (duplex/MPF) ran too slow.	
160.85	The motor (duplex/MPF) ran too fast.	
160.86	The motor (duplex/MPF) did not run at the correct timing.	

161–164 errors

161 error messages

Error code	Description	Action
161.80	The motor (tray 1 pick/lift) did not turn on.	See “Motor (tray 1 pick/lift) lifting error service check” on page 258.
161.81	The motor (tray 1 pick/lift) did not turn off.	
161.82	The motor (tray 1 pick/lift) speed did not ramp up to the required level.	
161.83	The motor (tray 1 pick/lift) stalled.	
161.84	The motor (tray 1 pick/lift) ran too slow.	
161.85	The motor (tray 1 pick/lift) ran too fast.	
161.86	The motor (tray 1 pick/lift) did not run at the correct timing.	

Motor (tray 1 pick/lift) lifting error service check

Action	Yes	No
<p>Step 1 Restart the printer.</p> <p>Does the problem remain?</p>	Go to step 2.	The problem is solved.
<p>Step 2 Make sure that the tray insert is properly seated or fully inserted.</p> <p>Does the problem remain?</p>	Go to step 3.	The problem is solved.
<p>Step 3 a Enter the Diagnostics menu, and then navigate to: Printer diagnostics & adjustments > Sensor tests b Find the sensor (Pick roller index (tray 1)).</p> <p>Does the sensor status change while toggling the sensor?</p>	Go to step 5.	Go to step 4.
<p>Step 4 Make sure that the JMTR1 connector on the engine board is properly connected to the sensor.</p> <p>Does the problem remain?</p>	Go to step 5.	The problem is solved.

Action	Yes	No
<p>Step 5 Check the motor (tray 1 pick) for proper operation and noise.</p> <p>a Remove the tray insert.</p> <p>b Enter the Diagnostics menu, and then navigate to: Printer diagnostics & adjustments > Motor tests > Pick (tray 1)</p> <p>c Select Pick (tray 1) lifting, and then touch Start.</p> <p>Does the motor run or does it sound normal?</p>	Go to step 8.	Go to step 6.
<p>Step 6 Make sure that the JMTR1 connector on the engine board is properly connected to the motor.</p> <p>Does the problem remain?</p>	Go to step 7.	The problem is solved.
<p>Step 7 Replace the paper feeder. See “Paper feeder removal” on page 507.</p> <p>Does the problem remain?</p>	Go to step 8.	The problem is solved.
<p>Step 8 Restart the printer.</p> <p>Does the problem remain?</p>	Contact the next level of support.	The problem is solved.

162–165 errors

162–165 error messages

Error code	Description	Action
162.80	The motor (tray 2 pick/lift) did not turn on.	See “Motor (optional tray pick/lift) service check” on page 260 .
162.81	The motor (tray 2 pick/lift) did not turn off.	
162.82	The motor (tray 2 pick/lift) speed did not ramp up to the required level.	
162.83	The motor (tray 2 pick/lift) stalled.	
162.84	The motor (tray 2 pick/lift) ran too slow.	
162.85	The motor (tray 2 pick/lift) ran too fast.	
162.86	The motor (tray 2 pick/lift) did not run at the correct timing.	

Error code	Description	Action
163.80	The motor (tray 3 pick/lift) did not turn on.	See “Motor (optional tray pick/lift) service check” on page 260.
163.81	The motor (tray 3 pick/lift) did not turn off.	
163.82	The motor (tray 3 pick/lift) speed did not ramp up to the required level.	
163.83	The motor (tray 3 pick/lift) stalled.	
163.84	The motor (tray 3 pick/lift) ran too slow.	
163.85	The motor (tray 3 pick/lift) ran too fast.	
163.86	The motor (tray 3 pick/lift) did not run at the correct timing.	
164.80	The motor (tray 4 pick/lift) did not turn on.	See “Motor (optional tray pick/lift) service check” on page 260.
164.81	The motor (tray 4 pick/lift) did not turn off.	
164.82	The motor (tray 4 pick/lift) speed did not ramp up to the required level.	
164.83	The motor (tray 4 pick/lift) stalled.	
164.84	The motor (tray 4 pick/lift) ran too slow.	
164.85	The motor (tray 4 pick/lift) ran too fast.	
164.86	The motor (tray 4 pick/lift) did not run at the correct timing.	
165.80	The motor (tray 5 pick/lift) did not turn on.	See “Motor (optional tray pick/lift) service check” on page 260.
165.81	The motor (tray 5 pick/lift) did not turn off.	
165.82	The motor (tray 5 pick/lift) speed did not ramp up to the required level.	
165.83	The motor (tray 5 pick/lift) stalled.	
165.84	The motor (tray 5 pick/lift) ran too slow.	
165.85	The motor (tray 5 pick/lift) ran too fast.	
165.86	The motor (tray 5 pick/lift) did not run at the correct timing.	

Motor (optional tray pick/lift) service check

Action	Yes	No
<p>Step 1</p> <p>Check the pick roller for misalignment and damage.</p> <p>Is the pick roller properly installed and free of damage?</p>	Go to step 3.	Go to step 2.
<p>Step 2</p> <p>Make sure that the motor cable is properly connected.</p> <p>Does the problem remain?</p>	Go to step 3.	The problem is solved.

Action	Yes	No
<p>Step 3 Restart the printer.</p> <p>Does the problem remain?</p>	Go to step 4.	The problem is solved.
<p>Step 4 Replace the optional tray. See “Optional 550-sheet tray removal” on page 536.</p> <p>Does the problem remain?</p>	Contact the next level of support.	The problem is solved.

166–169 errors

166–169 error messages

166.80	The motor (tray 2 pass-through) did not turn on.	See “Motor (optional tray pass-through) failure service check” on page 263.
166.81	The motor (tray 2 pass-through) did not turn off.	
166.82	The motor (tray 2 pass-through) speed did not ramp up to the required level.	
166.83	The motor (tray 2 pass-through) stalled.	
166.84	The motor (tray 2 pass-through) ran too slow.	
166.85	The motor (tray 2 pass-through) ran too fast.	
166.86	The motor (tray 2 pass-through) did not run at the correct timing.	
167.80	The motor (tray 3 pass-through) did not turn on.	
167.81	The motor (tray 3 pass-through) did not turn off.	
167.82	The motor (tray 3 pass-through) speed did not ramp up to the required level.	
167.83	The motor (tray 3 pass-through) stalled.	
167.84	The motor (tray 3 pass-through) ran too slow.	
167.85	The motor (tray 3 pass-through) ran too fast.	
167.86	The motor (tray 3 pass-through) did not run at the correct timing.	
168.80	The motor (tray 4 pass-through) did not turn on.	
168.81	The motor (tray 4 pass-through) did not turn off.	
168.82	The motor (tray 4 pass-through) speed did not ramp up to the required level.	
168.83	The motor (tray 4 pass-through) stalled.	
168.84	The motor (tray 4 pass-through) ran too slow.	
168.85	The motor (tray 4 pass-through) ran too fast.	
168.86	The motor (tray 4 pass-through) did not run at the correct timing.	

169.80	The motor (tray 5 pass-through) did not turn on.	See “Motor (optional tray pass-through) failure service check” on page 263.
169.81	The motor (tray 5 pass-through) did not turn off.	
169.82	The motor (tray 5 pass-through) speed did not ramp up to the required level.	
169.83	The motor (tray 5 pass-through) stalled.	
169.84	The motor (tray 5 pass-through) ran too slow.	
169.85	The motor (tray 5 pass-through) ran too fast.	
169.86	The motor (tray 5 pass-through) did not run at the correct timing.	

Motor (optional tray pass-through) failure service check

Action	Yes	No
Step 1 Restart the printer Does the problem remain?	Go to step 2.	The problem is solved.
Step 2 Make sure that the motor cable is properly connected. Does the problem remain?	Go to step 3.	The problem is solved.
Step 3 Restart the printer. Does the problem remain?	Go to step 4.	The problem is solved.
Step 4 Replace the optional tray. See “Optional 550-sheet tray removal” on page 536. Does the problem remain?	Contact the next level of support.	The problem is solved.

171–172 errors

171–172 error messages

Error code	Description	Action
171.82	The main fan speed did not ramp up to the required level.	See “Main fan service check” on page 264.
171.83	The main fan stalled.	
171.84	The main fan ran too slow.	
171.85	The main fan ran too fast.	

Error code	Description	Action
172.82	The LVPS/fuser fan speed did not ramp up to the required level.	See “LVPS/fuser fan service check” on page 264.
172.83	The LVPS/fuser fan stalled.	
172.84	The LVPS/fuser fan ran too slow.	
172.85	The LVPS fuser fan ran too fast.	

LVPS/fuser fan service check

Action	Yes	No
<p>Step 1</p> <p>Make sure that the fuser fan area is clear of obstructions.</p> <p>Does the problem remain?</p>	Go to step 2.	The problem is solved.
<p>Step 2</p> <p>Make sure that the JFAN1 connector on the engine board is properly connected to the fan.</p> <p>Does the problem remain?</p>	Go to step 3.	The problem is solved.
<p>Step 3</p> <p>Replace the fuser fan. See “Fuser fan removal” on page 380.</p> <p>Does the problem remain?</p>	Go to step 4.	The problem is solved.
<p>Step 4</p> <p>Replace the engine board. See “Engine board removal” on page 479.</p> <p>Does the problem remain?</p>	Contact the next level of support.	The problem is solved.

Main fan service check

Action	Yes	No
<p>Step 1</p> <p>Make sure that the main fan area is clear of obstructions.</p> <p>Does the problem remain?</p>	Go to step 2.	The problem is solved.
<p>Step 2</p> <p>Make sure that the JFAN2 connector on the engine board is properly connected to the fan.</p> <p>Does the problem remain?</p>	Go to step 3.	The problem is solved.

Action	Yes	No
Step 3 Replace the main fan. See “Main fan removal” on page 379 . Does the problem remain?	Go to step 4.	The problem is solved.
Step 4 Replace the engine board. See “Engine board removal” on page 479 . Does the problem remain?	Contact the next level of support.	The problem is solved.

600–661 errors

600–661 error messages

Error code	Description	Action	
600.95	RIP intentionally declared a jam error, usually to prevent a kiosk user from printing free pages.	See “RIP error service check” on page 267 .	
602.19	Tray 1 was unable to be ready for picking.	See “Unknown error service check” on page 268 .	
602.29	Tray 2 was unable to be ready for picking.		
602.39	Tray 3 was unable to be ready for picking.		
602.49	Tray 4 was unable to be ready for picking.		
602.59	Tray 5 was unable to be ready for picking.		
611.32	Lost HSYNC errors were detected. Laser safety interlock system may be the cause.		
611.34	A mirror motor lock error was detected.	See “Fuser service check” on page 244 .	
611.72	A facet map failure error occurred.		
621.01	The fuser heater was not hot enough when the paper entered the fuser nip.		
647.80	The motor (deskew) did not turn on.		See “Motor (deskew) service check” on page 251 .
647.81	The motor (deskew) did not turn off.		
647.82	The motor (deskew) speed did not ramp up to the required level.		
647.83	The motor (deskew) stalled.		
647.84	The motor (deskew) ran too slow.		
647.85	The motor (deskew) ran too fast.		
647.86	The motor (deskew) did not run at the correct timing.		

Error code	Description	Action
649.80	The motor (redrive) did not turn on.	See “Motor (exit/redrive) service check” on page 252.
649.81	The motor (redrive) did not turn off.	
649.82	The motor (redrive) speed did not ramp up to the required level.	
649.83	The motor (redrive) stalled.	
649.84	The motor (redrive) ran too slow.	
649.85	The motor (redrive) ran too fast.	
649.86	The motor (redrive) did not run at the correct timing.	
650.80	The motor (duplex/MPF) did not turn on.	See “Motor (duplex/MPF) service check” on page 253.
650.81	The motor (duplex/MPF) did not turn off.	
650.82	The motor (duplex/MPF) speed did not ramp up to the required level.	
650.83	The motor (duplex/MPF) stalled.	
650.84	The motor (duplex/MPF) ran too slow.	
650.85	The motor (duplex/MPF) ran too fast.	
650.86	The motor (duplex/MPF) did not run at the correct timing.	
653.80	The motor (isolation) unit did not turn on.	See “Isolation unit service check” on page 256.
653.81	The motor (isolation) unit did not turn off.	
653.82	The motor (isolation) unit speed did not ramp up to the required level.	
653.83	The motor (isolation) stalled.	
653.84	The motor (isolation) ran too slow.	
653.85	The motor (isolation) ran too fast.	
653.86	The motor (isolation) did not run at the correct timing.	
660.80	The motor (duplex/MPF) did not turn on.	See “Motor (duplex/MPF) service check” on page 253.
660.81	The motor (duplex/MPF) did not turn off.	
660.82	The motor (duplex/MPF) speed did not ramp up to the required level.	
660.83	The motor (duplex/MPF) stalled.	
660.84	The motor (duplex/MPF) ran too slow.	
660.85	The motor (duplex/MPF) ran too fast.	
660.86	The motor (duplex/MPF) did not run at the correct timing.	

Error code	Description	Action
661.13	The tray 1 lift plate failed to lift.	See “Motor (tray 1 pick/lift) lifting error service check” on page 258.
661.80	The motor (tray 1 pick/lift) did not turn on.	
661.81	The motor (tray 1 pick/lift) did not turn off.	
661.82	The motor (tray 1 pick/lift) speed did not ramp up to the required level.	
661.83	The motor (tray 1 pick/lift) stalled.	
661.84	The motor (tray 1 pick/lift) ran too slow.	
661.85	The motor (tray 1 pick/lift) ran too fast.	
661.86	The motor (tray 1 pick/lift) did not run at the correct timing.	

RIP error service check

Action	Yes	No
<p>Step 1</p> <p>a Open all printer doors, and then remove the manual feeder and tray.</p> <p>b Check the paper path, tray, and bin for paper fragments and partially fed paper.</p> <p>Are the paper path, bin, and tray free of paper fragments and partially fed paper?</p>	Go to step 3.	Go to step 2.
<p>Step 2</p> <p>Remove the paper fragments and partially fed paper.</p> <p>Does the problem remain?</p>	Go to step 3.	The problem is solved.
<p>Step 3</p> <p>Reseat the HVPS flat cables.</p> <p>Does the problem remain?</p>	Go to step 4.	The problem is solved.
<p>Step 4</p> <p>Make sure that the controller board is properly installed. Reseat all the cables on the controller board.</p> <p>Does the problem remain?</p>	Go to step 5.	The problem is solved.
<p>Step 5</p> <p>Check the controller board and its connector pins for damage.</p> <p>Are the controller board and its connectors free of damage?</p>	Contact the next level of support.	Go to step 6.

Action	Yes	No
<p>Step 6 Replace the controller board. See “Controller board removal” on page 478.</p> <p>Does the problem remain?</p>	Contact the next level of support.	The problem is solved.

Unknown error service check

Action	Yes	No
<p>Restart the print job.</p> <p>Does the problem remain?</p>	Contact the next level of support.	The problem is solved.

662–669 errors

662–669 error messages

Error code	Description	Action
662.23	The tray 2 lift plate failed to lift.	See “Motor (optional tray pick/lift) lifting error service check” on page 271.
662.80	The motor (tray 2 pick/lift) did not turn on.	
662.81	The motor (tray 2 pick/lift) did not turn off.	
662.82	The motor (tray 2 pick/lift) speed did not ramp up to the required level.	
662.83	The motor (tray 2 pick/lift) stalled.	
662.84	The motor (tray 2 pick/lift) ran too slow.	
662.85	The motor (tray 2 pick/lift) ran too fast.	
662.86	The motor (tray 2 pick/lift) did not run at the correct timing.	
663.33	The tray 3 lift plate failed to lift.	
663.80	The motor (tray 3 pick/lift) did not turn on.	
663.81	The motor (tray 3 pick/lift) did not turn off.	
663.82	The motor (tray 3 pick/lift) speed did not ramp up to the required level.	
663.83	The motor (tray 3 pick/lift) stalled.	
663.84	The motor (tray 3 pick/lift) ran too slow.	
663.85	The motor (tray 3 pick/lift) ran too fast.	
663.86	The motor (tray 3 pick/lift) did not run at the correct timing.	
664.43	The tray 4 lift plate failed to lift.	
664.80	The motor (tray 4 pick/lift) did not turn on.	
664.81	The motor (tray 4 pick/lift) did not turn off.	
664.82	The motor (tray 4 pick/lift) speed did not ramp up to the required level.	
664.83	The motor (tray 4 pick/lift) stalled.	
664.84	The motor (tray 4 pick/lift) ran too slow.	
664.85	The motor (tray 4 pick/lift) ran too fast.	
664.86	The motor (tray 4 pick/lift) did not run at the correct timing.	

Error code	Description	Action
665.53	The tray 5 lift plate failed to lift.	See “Motor (optional tray pick/lift) lifting error service check” on page 271.
665.80	The motor (tray 5 pick/lift) did not turn on.	
665.81	The motor (tray 5 pick/lift) did not turn off.	
665.82	The motor (tray 5 pick/lift) speed did not ramp up to the required level.	
665.83	The motor (tray 5 pick/lift) stalled.	
665.84	The motor (tray 5 pick/lift) ran too slow.	
665.85	The motor (tray 5 pick/lift) ran too fast.	
665.86	The motor (tray 5 pick/lift) did not run at the correct timing.	
666.80	The motor (tray 2 pass-through) did not turn on.	See “Motor (optional tray pass-through) stalled service check” on page 272.
666.81	The motor (tray 2 pass-through) did not turn off.	
666.82	The motor (tray 2 pass-through) speed did not ramp up to the required level.	
666.83	The motor (tray 2 pass-through) stalled.	
666.84	The motor (tray 2 pass-through) ran too slow.	
666.85	The motor (tray 2 pass-through) ran too fast.	
666.86	The motor (tray 2 pass-through) did not run at the correct timing.	
667.80	The motor (tray 3 pass-through) did not turn on.	
667.81	The motor (tray 3 pass-through) did not turn off.	
667.82	The motor (tray 3 pass-through) speed did not ramp up to the required level.	
667.83	The motor (tray 3 pass-through) stalled.	
667.84	The motor (tray 3 pass-through) ran too slow.	
667.85	The motor (tray 3 pass-through) ran too fast.	
667.86	The motor (tray 3 pass-through) did not run at the correct timing.	
668.80	The motor (tray 4 pass-through) did not turn on.	
668.81	The motor (tray 4 pass-through) did not turn off.	
668.82	The motor (tray 4 pass-through) speed did not ramp up to the required level.	
668.83	The motor (tray 4 pass-through) stalled.	
668.84	The motor (tray 4 pass-through) ran too slow.	
668.85	The motor (tray 4 pass-through) ran too fast.	
668.86	The motor (tray 4 pass-through) did not run at the correct timing.	

Error code	Description	Action
669.80	The motor (tray 5 pass-through) did not turn on.	See “Motor (optional tray pass-through) stalled service check” on page 272.
669.81	The motor (tray 5 pass-through) did not turn off.	
669.82	The motor (tray 5 pass-through) speed did not ramp up to the required level.	
669.83	The motor (tray 5 pass-through) stalled.	
669.84	The motor (tray 5 pass-through) ran too slow.	
669.85	The motor (tray 5 pass-through) ran too fast.	
669.86	The motor (tray 5 pass-through) did not run at the correct timing.	

Motor (optional tray pick/lift) lifting error service check

Action	Yes	No
<p>Step 1 Restart the printer.</p> <p>Does the problem remain?</p>	Go to step 2.	The problem is solved.
<p>Step 2 Make sure that the tray insert is properly seated or fully inserted.</p> <p>Does the problem remain?</p>	Go to step 3.	The problem is solved.
<p>Step 3</p> <p>a Enter the Diagnostics menu, and then navigate to: Additional input trays adjustments/tests > Additional input tray sensors</p> <p>b Find the sensor (Pick roller index (tray [x])). Note: [x] is the tray number.</p> <p>Does the sensor status change while toggling the sensor?</p>	Go to step 5.	Go to step 4.
<p>Step 4 Make sure that the sensor cable is properly connected.</p> <p>Does the problem remain?</p>	Go to step 5.	The problem is solved.

Action	Yes	No
<p>Step 5 Check the affected motor for proper operation and noise.</p> <p>a Remove the tray insert.</p> <p>b Enter the Diagnostics menu, and then navigate to: Additional input trays adjustments/tests > Additional input tray motors</p> <p>c Select Pick (tray [x]), and then touch Start. Note: [x] is the tray number.</p> <p>Does the motor run or does it sound normal?</p>	Go to step 8.	Go to step 6.
<p>Step 6 Make sure that the motor cable is properly connected.</p> <p>Does the problem remain?</p>	Go to step 7.	The problem is solved.
<p>Step 7 Replace the optional tray. See “Optional 550-sheet tray removal” on page 536.</p> <p>Does the problem remain?</p>	Go to step 8.	The problem is solved.
<p>Step 8 Restart the printer.</p> <p>Does the problem remain?</p>	Contact the next level of support.	The problem is solved.

Motor (optional tray pass-through) stalled service check

Action	Yes	No
<p>Step 1</p> <p>a Enter the Diagnostics menu, and then navigate to: Additional input trays adjustments/tests > Additional input tray motors</p> <p>b Select Pass-through (tray [x]), and then touch Start. Note: [x] is the tray number.</p> <p>Does the motor run?</p>	Go to step 4.	Go to step 2.
<p>Step 2 Make sure that the motor cable is properly connected.</p> <p>Does the problem remain?</p>	Go to step 3.	The problem is solved.

Action	Yes	No
<p>Step 3 Check the motor for noise.</p> <p>Does the motor sound abnormal or do the gears make a grinding sound?</p>	Go to step 5.	Go to step 4.
<p>Step 4 Perform a print job.</p> <p>Does the problem remain?</p>	Go to step 5.	The problem is solved.
<p>Step 5 Replace the optional tray. See “Optional 550-sheet tray removal” on page 536.</p> <p>Does the problem remain?</p>	Contact the next level of support.	The problem is solved.

680 errors

680 error messages

Error code	Description	Action
680.10	During an ADF job, the ADF top cover was detected as open.	See “ADF top cover open service check” on page 204.
680.20	During an ADF job, no paper was detected on the ADF tray.	See “ADF paper undetected service check” on page 197.
680.40	During a scan job, a communication error occurred.	See “Scanner communication failure service check” on page 275.

84y errors

840–845 error messages

Error code	Description	Action
840.01	The scanner was manually disabled by the user.	See “Scanner disabled error service check” on page 274.
840.02	The scanner was automatically disabled by the printer after two consecutive hardware failures.	
842.00	A scanner communication error (no response) was detected.	See “Scanner communication failure service check” on page 275.
842.01	A scanner communication error (HW protocol) was detected.	
842.02	A scanner communication error (logical protocol) was detected.	

Error code	Description	Action
843.00	The CIS scanner failed to reach its home position.	See “Flatbed CIS scanner home position service check” on page 276.
843.01	An ADF mechanical failure occurred.	See “ADF feed/exit drive service check” on page 277.
845.02	The scanner front side scan module was detected as unplugged.	See “Front side scan error service check” on page 279.
845.03	The ADF back side scan module was detected as unplugged.	See “Duplex scan error service check” on page 277.

Scanner disabled error service check

Actions	Yes	No
<p>Step 1</p> <p>a From the home screen, navigate to: Settings > Device > Maintenance > Configuration Menu > Scanner Configuration > Disable Scanner > No</p> <p>b Reset the printer, and then perform an ADF scan job.</p> <p>Does the problem remain?</p>	Go to step 2.	The problem is solved.
<p>Step 2</p> <p>a From the home screen, navigate to: Settings > Device > Maintenance > Configuration Menu > Scanner Configuration > Disable Scanner > Yes</p> <p>b Restart the printer, and then perform an ADF scan job.</p> <p>Does the display indicate that the ADF is disabled?</p>	Go to step 3.	Go to step 4.
<p>Step 3</p> <p>a Reseat the JADF1 connector on the controller board.</p> <p>b Reseat the ADF cables on the ADF.</p> <p>c Repeat step 1.</p> <p>Does the problem remain?</p>	Go to step 4.	The problem is solved.
<p>Step 4</p> <p>a Replace the ADF. See “ADF removal” on page 517.</p> <p>b Repeat step 1.</p> <p>Does the problem remain?</p>	Go to step 5.	The problem is solved.
<p>Step 5</p> <p>Reseat the JFB1, JFBM1, and JHS1 connectors on the controller board.</p> <p>Does the problem remain?</p>	Go to step 6.	The problem is solved.

Actions	Yes	No
<p>Step 6</p> <p>a Replace the scanner. See “Flatbed scanner removal” on page 519.</p> <p>b Repeat step 1.</p> <p>Does the problem remain?</p>	Go to step 7.	The problem is solved.
<p>Step 7</p> <p>Replace the controller board. See “Controller board removal” on page 478.</p> <p>Does the problem remain?</p>	Contact the next level of support.	The problem is solved.

Scanner communication failure service check

Actions	Yes	No
<p>Step 1</p> <p>Reseat the JADF1 connector on the controller board.</p> <p>Does the problem remain?</p>	Go to step 2.	The problem is solved.
<p>Step 2</p> <p>Reseat the JFB1 connector on the controller board.</p> <p>Does the problem remain?</p>	Go to step 3.	The problem is solved.
<p>Step 3</p> <p>Replace the ADF. See “ADF removal” on page 517.</p> <p>Does the problem remain?</p>	Go to step 4.	The problem is solved.
<p>Step 4</p> <p>Replace the scanner. See “Flatbed scanner removal” on page 519.</p> <p>Does the problem remain?</p>	Go to step 5.	The problem is solved.
<p>Step 5</p> <p>Replace the controller board. See “Controller board removal” on page 478.</p> <p>Does the problem remain?</p>	Contact the next level of support.	The problem is solved.

Flatbed CIS scanner home position service check

Actions	Yes	No
<p>Step 1 Turn off the printer.</p> <p>Does the CIS scanner move and return to the home position?</p>	The problem is solved.	Go to step 2.
<p>Step 2 a Enter the Diagnostics menu, and then navigate to: Scanner diagnostics > Sensor tests b Find the sensor (FB CCD home).</p> <p>Does the sensor status change while toggling the sensor?</p>	Go to step 4.	Go to step 3.
<p>Step 3 Reseat the JHS1 connector on the controller board.</p> <p>Does the problem remain?</p>	Go to step 4.	The problem is solved.
<p>Step 4 Reseat the JFBM1 connector on the controller board.</p> <p>Does the problem remain?</p>	Go to step 5.	The problem is solved.
<p>Step 5 Measure the voltage of pin 1 of the JFBM1 connector on the controller board.</p> <p>Is the voltage equal to +24 V AC?</p>	Go to step 6.	Go to step 7.
<p>Step 6 Measure the voltage of pin 1 of the JHS1 connector on the controller board. Note: Pin 2 is GND.</p> <p>Is the voltage equal to +5 V AC?</p>	Contact the next level of support.	Go to step 7.
<p>Step 7 Replace the scanner. See “Flatbed scanner removal” on page 519.</p> <p>Does the problem remain?</p>	Contact the next level of support.	The problem is solved.

ADF feed/exit drive service check

Actions	Yes	No
<p>Step 1 Manually turn the ADF feed/exit roller.</p> <p>Does the problem remain?</p>	Go to step 2.	The problem is solved.
<p>Step 2 a Enter the Diagnostics menu, and then navigate to: Scanner diagnostics > Motor tests b Select ADF transport, and then touch Start.</p> <p>Do the motors run?</p>	Go to step 4.	Go to step 3.
<p>Step 3 a Reseat the JADF2 connector on the controller board. b Reseat the ADF cables on the ADF.</p> <p>Does the problem remain?</p>	Go to step 4.	The problem is solved.
<p>Step 4 Replace the ADF. See “ADF removal” on page 517.</p> <p>Does the problem remain?</p>	Contact the next level of support.	The problem is solved.

Duplex scan error service check

Action	Yes	No
<p>Step 1 Check the ADF paper path for paper fragments, partially fed paper, and obstructions.</p> <ul style="list-style-type: none"> • Under the ADF top cover • Under the ADF • ADF bin <p>Is the paper path free of paper fragments, partially fed paper, and obstructions?</p>	Go to step 3.	Go to step 2.
<p>Step 2 Remove the paper fragments, partially fed paper, and obstructions.</p> <p>Does the problem remain?</p>	Go to step 3.	The problem is solved.

Action	Yes	No
<p>Step 3</p> <p>a Enter the Diagnostics menu, and then navigate to: Scanner diagnostics > Motor tests</p> <p>b Select ADF transport, and then start the test.</p> <p>Does the motor run?</p>	Go to step 5.	Go to step 4.
<p>Step 4</p> <p>a Make sure that the ADF is properly installed. Lift the ADF, and then check if it closes properly.</p> <p>b Check the ADF for damage.</p> <p>Is the ADF free of damage?</p>	Go to step 5.	Go to step 7.
<p>Step 5</p> <p>a Enter the Diagnostics menu, and then navigate to: Scanner diagnostics > Sensor tests</p> <p>b Run the test on the following sensors:</p> <ul style="list-style-type: none"> • ADF media present • ADF 1st scan <p>Does the sensor status change while toggling the sensors?</p>	Go to step 8.	Go to step 6.
<p>Step 6</p> <p>Check the affected sensor and its flag for damage.</p> <p>Is the sensor free of damage?</p>	Go to step 8.	Go to step 7.
<p>Step 7</p> <p>a Reseat the scanner cables and JADF1 connector on the controller board.</p> <p>b Reseat the ADF cables on the ADF.</p> <p>Does the problem remain?</p>	Go to step 8.	The problem is solved.
<p>Step 8</p> <p>Check the cables for damage.</p> <p>Are the cables free of damage?</p>	Go to step 10.	Go to step 9.
<p>Step 9</p> <p>Replace the affected scanner or ADF cable.</p> <p>Does the problem remain?</p>	Go to step 10.	The problem is solved.
<p>Step 10</p> <p>Check if the scanner lamp lights up during scanning.</p> <p>Is the scanner lamp functional?</p>	Go to step 12.	Go to step 11.

Action	Yes	No
<p>Step 11 Replace the scanner. See “Flatbed scanner removal” on page 519.</p> <p>Does the problem remain?</p>	Contact the next level of support.	The problem is solved.
<p>Step 12 Replace the ADF. See “ADF removal” on page 517.</p> <p>Does the problem remain?</p>	Contact the next level of support.	The problem is solved.

Front side scan error service check

Action	Yes	No
<p>Step 1 Check the ADF paper path for paper fragments, partially fed paper, and obstructions.</p> <ul style="list-style-type: none"> • Under the ADF top cover • Under the ADF • ADF bin <p>Is the paper path free of paper fragments, partially fed paper, and obstructions?</p>	Go to step 3.	Go to step 2.
<p>Step 2 Remove the paper fragments, partially fed paper, and obstructions.</p> <p>Does the problem remain?</p>	Go to step 3.	The problem is solved.
<p>Step 3</p> <p>a Enter the Diagnostics menu, and then navigate to: Scanner diagnostics > Motor tests</p> <p>b Select ADF transport, and then start the test.</p> <p>Does the motor run?</p>	Go to step 5.	Go to step 4.
<p>Step 4</p> <p>a Make sure that the ADF is properly installed. Lift the ADF, and then check if it closes properly.</p> <p>b Check the ADF for damage.</p> <p>Is the ADF free of damage?</p>	Go to step 5.	Go to step 7.

Action	Yes	No
<p>Step 5</p> <p>a Enter the Diagnostics menu, and then navigate to: Scanner diagnostics > Sensor tests</p> <p>b Run the test on the following sensors:</p> <ul style="list-style-type: none"> • ADF media present • ADF 1st scan <p>Does the sensor status change while toggling the sensors?</p>	Go to step 8.	Go to step 6.
<p>Step 6</p> <p>Check the affected sensor and its flag for damage.</p> <p>Is the sensor free of damage?</p>	Go to step 8.	Go to step 7.
<p>Step 7</p> <p>a Reseat the scanner cables and JFB1 connector on the controller board.</p> <p>b Reseat the ADF cables on the ADF.</p> <p>Does the problem remain?</p>	Go to step 8.	The problem is solved.
<p>Step 8</p> <p>Check the cables for damage.</p> <p>Are the cables free of damage?</p>	Go to step 10.	Go to step 9.
<p>Step 9</p> <p>Replace the affected scanner or ADF cable.</p> <p>Does the problem remain?</p>	Go to step 10.	The problem is solved.
<p>Step 10</p> <p>Check if the scanner lamp lights up during scanning.</p> <p>Is the scanner lamp functional?</p>	Go to step 12.	Go to step 11.
<p>Step 11</p> <p>Replace the scanner. See “Flatbed scanner removal” on page 519.</p> <p>Does the problem remain?</p>	Contact the next level of support.	The problem is solved.
<p>Step 12</p> <p>Replace the ADF. See “ADF removal” on page 517.</p> <p>Does the problem remain?</p>	Contact the next level of support.	The problem is solved.

Procedure before starting the 9yy service checks

Retrieve certain information that helps your next level of support in diagnosing the problem before replacing the controller board.

Warning—Potential Damage: Do not replace the controller board unless instructed by your next level of support.

- 1 Collect the history information and firmware logs (Fwdebug and logs.tar.gz) from the SE menu.
- 2 Collect the settings from the Menu Settings Page.
- 3 Collect information from the user.

Note: Not all of the items are retrievable from the printer that you are working on.

A. Collecting the history information from the SE menu

Note: Make sure that your printer is connected to a network or to a print server.

- 1 Open a web browser, type **http://printer_IP_address/se**, and then press **Enter**.

Notes:

- **printer_IP_address** is the TCP/IP address of the printer.
- **se** is required to access the printer diagnostic information.

- 2 Click **History Information**, copy all information, and then save it as a text file.
- 3 Email the text file to your next level of support.

B. Collecting the firmware logs (Fwdebug and logs.tar.gz) from the SE menu

Notes:

- Make sure that your printer is connected to a network or to a print server.
- Some printers are designed to restart automatically after a 9yy error. On these printers, you can retrieve the secondary crash code information using the SE menu.

- 1 Open a web browser, type **http://printer_IP_address/se**, and then press **Enter**.
- 2 Click **Logs Gzip Compressed**.

Note: A logs.tar.gz file is saved to the Downloads folder. The file may take several minutes to save. You may rename the file if a logs.tar.gz already exists in the Downloads folder.

- 3 Email the logs to your next level of support.

Note: To download the FWdebug log to a flash drive, see [“General SE” on page 354](#).

C. Collecting the settings from the Menu Settings Page

Note: The Menu Settings Page is different for each printer. For more information, see the *User's Guide*. Your next level of support will tell you which page they want to see.

Copying the Menu Settings Page from the Embedded Web Server (EWS)

Note: Make sure that your printer is connected to a network or to a print server.

- 1 Open a web browser, type **http://printer_IP_address**, and then press **Enter**.
- 2 Click **Settings**, and then select one of the settings pages from the links shown on the page.
- 3 Copy all the information, and then save it as a text file.
- 4 Email the text file to your next level of support.

Printing the Menu Settings Page

- 1 From the home screen, navigate to:
Reports > Menu Settings Page
- 2 Print the Menu Settings Page, and then email a scanned copy of the page to your next level of support.

D. Collecting information from the user

Ask the user for information about the following:

- Print job being run
- Operating system being used
- Print driver being used
- Other information on what was happening when the 9yy error occurred

900–901 errors

900–901 error messages

Error code	Description	Action
900.00	A RIP firmware error occurred.	See “System software error service check” on page 282.
900.70	A RIP firmware error occurred.	
901.01	A RIP firmware error occurred.	
901.02	A RIP firmware error occurred.	

System software error service check

Different types of 900.xx errors can occur. There may be a communication problem (bad cable, network connection, and software issues), or a hardware problem with the controller board or ISP (internal solutions port). Check the communication and software problems first. Determine if the problem is constant or intermittent. Use the following troubleshooting procedure to isolate the issue. Take notes as instructed. You will need that information in the event that you need to contact your next level of support.

Before troubleshooting:

- 1 Perform the [“Procedure before starting the 9yy service checks” on page 281.](#)
- 2 Determine the operating system used when the error occurred. If possible, determine whether a PostScript or PCL file was sent to the printer when the error occurred. Ask the customer which Lexmark Solutions applications are installed on the printer.

Action	Yes	No
<p>Step 1 Perform a POR.</p> <p>Does the error remain?</p>	Go to step 2.	The problem is solved.
<p>Step 2</p> <ul style="list-style-type: none"> a Write down the exact 900.xx error code that appears on the display. b Turn off the printer. c Clear the print queues. d Disconnect all communication cables, and then remove all memory options. e Remove any installed ISP. f Reset the printer into the Diagnostics menu. <p>Does the problem remain?</p>	Go to step 3.	Go to step 6.
<p>Step 3 Check all the cables on the controller board for proper connection.</p> <p>Are the cables properly connected?</p>	Go to step 5.	Go to step 4.
<p>Step 4</p> <ul style="list-style-type: none"> a Reconnect the cables. b Reset the printer into the Diagnostics menu. <p>Does the problem remain?</p>	Go to step 5.	Go to step 6.
<p>Step 5</p> <ul style="list-style-type: none"> a Replace the controller board. See “Controller board removal” on page 478. b Reset the printer. <p>Note: If a different error code displays, then go to the service check for that error code.</p> <p>Does the problem remain?</p>	Go to step 28.	The problem is solved.
<p>Step 6 Print the following:</p> <ul style="list-style-type: none"> • Error Log • Menu Settings Page • Network Settings Page <p>Does the problem remain while printing these pages?</p>	Go to step 28.	Go to step 7.

Action	Yes	No
<p>Step 7</p> <p>Note: Before performing this step, write down the following information about the file being sent to the printer:</p> <ul style="list-style-type: none"> • Application used • Operating system • Driver type • File type (PCL, PostScript, XPS, etc.) <p>a Reattach the communications cable.</p> <p>b Reset the printer.</p> <p>c Perform a print job.</p> <p>Does the problem remain?</p>	Go to step 8.	Go to step 10.
<p>Step 8</p> <p>a Reset the printer.</p> <p>b Perform a different print job.</p> <p>Does the problem remain?</p>	Go to step 9.	Go to step 10.
<p>Step 9</p> <p>a Upgrade the firmware.</p> <p>Note: Contact your next level of support for the correct firmware level to use.</p> <p>b Reset the printer.</p> <p>c Perform a print job.</p> <p>Does the problem remain?</p>	Go to step 28.	Go to step 10.
<p>Step 10</p> <p>Verify if the printer is an MFP.</p> <p>Is the printer an MFP?</p>	Go to step 11.	Go to step 18.
<p>Step 11</p> <p>Perform a copy job.</p> <p>Does the problem remain?</p>	Go to step 28.	Go to step 12.
<p>Step 12</p> <p>Perform a scan to PC job.</p> <p>Does the problem remain?</p>	Go to step 28.	Go to step 13.
<p>Step 13</p> <p>Verify if a fax card is installed.</p> <p>Is a fax card installed?</p>	Go to step 14.	Go to step 18.

Action	Yes	No
<p>Step 14</p> <p>a Reinstall the fax card.</p> <p>b Reset the printer.</p> <p>Does the problem remain?</p>	Go to step 15.	Go to step 17.
<p>Step 15</p> <p>a Upgrade the firmware if it was not upgraded in a previous step.</p> <p>Note: Contact your next level of support for the correct firmware level to use.</p> <p>b Reset the printer.</p> <p>c Perform a print job.</p> <p>Does the problem remain?</p>	Go to step 16.	The problem is solved.
<p>Step 16</p> <p>a Replace the fax card.</p> <p>b Reset the printer.</p> <p>Does the problem remain?</p>	Go to step 28.	The problem is solved.
<p>Step 17</p> <p>Perform a fax job.</p> <p>Does the problem remain?</p>	Go to step 28.	Go to step 18.
<p>Step 18</p> <p>Verify if an ISP option is installed.</p> <p>Is an ISP option installed?</p>	Go to step 19.	The problem is solved.
<p>Step 19</p> <p>a Reinstall the first ISP option.</p> <p>b Reset the printer.</p> <p>Does the problem remain?</p>	Go to step 21.	Go to step 20.
<p>Step 20</p> <p>Perform a job to test the option.</p> <p>Does the problem remain?</p>	Go to step 21.	Go to step 26.

Action	Yes	No
<p>Step 21</p> <p>a Upgrade the firmware if it was not upgraded in a previous step. Note: Contact your next level of support for the correct firmware level to use.</p> <p>b Reset the printer.</p> <p>c Perform a print job.</p> <p>Does the problem remain?</p>	Go to step 22.	The problem is solved.
<p>Step 22</p> <p>a Replace the faulty ISP option.</p> <p>b Reset the printer.</p> <p>Does the problem remain?</p>	Go to step 28.	Go to step 23.
<p>Step 23</p> <p>Verify if there are more ISP options to install.</p> <p>Are there more ISP options to install?</p>	Go to step 24.	Go to step 28.
<p>Step 24</p> <p>a Install the next ISP option.</p> <p>b Reset the printer.</p> <p>Does the problem remain?</p>	Go to step 25.	The problem is solved.
<p>Step 25</p> <p>Perform a job to test the option.</p> <p>Does the problem remain?</p>	Go to step 26.	The problem is solved.
<p>Step 26</p> <p>a Upgrade the firmware if it was not upgraded in a previous step. Note: Contact your next level of support for the correct firmware level to use.</p> <p>b Reset the printer.</p> <p>c Send a print job.</p> <p>Does the problem remain?</p>	Go to step 27.	The problem is solved.
<p>Step 27</p> <p>a Replace the faulty ISP option.</p> <p>b Reset the printer.</p> <p>Does the problem remain?</p>	Go to step 28.	The problem is solved.

Action	Yes	No
<p>Step 28</p> <p>Contact your next level of support.</p> <p>Provide the following information:</p> <ul style="list-style-type: none">• Exact 900.xx error digits and complete error message• Printed menu settings page• Printed network settings page• Device error log• A sample print file if the error appears to be isolated to a single file• File/Application used if the error is related to specific print file• Device operating system• Driver used (PCL/PS)• Frequency of the occurrence of the error		

912–992 errors

912–992 error messages

Error code	Description	Action
912.05	An engine error occurred.	See “Engine software error service check” on page 291.
912.08	An engine error occurred.	
912.09	An engine error occurred.	
912.15	An engine error occurred.	
912.16	An engine error occurred.	
912.17	An engine error occurred.	
912.19	An engine error occurred.	
912.28	An engine error occurred.	
912.32	An engine error occurred.	
912.33	An engine error occurred.	
912.34	An engine error occurred.	
912.35	An engine error occurred.	
912.38	An engine error occurred.	
912.40	An engine error occurred.	
912.42	An engine error occurred.	
912.44	An engine error occurred.	
912.45	An engine error occurred.	
912.46	An engine error occurred.	
912.48	An engine error occurred.	
912.49	An engine error occurred.	
912.50	An engine error occurred.	
912.52	An engine error occurred.	
912.58	An engine error occurred.	

Error code	Description	Action
912.60	An engine error occurred.	See “Engine software error service check” on page 291.
912.61	An engine error occurred.	
912.66	An engine error occurred.	
912.69	An engine error occurred.	
912.70	An engine error occurred.	
912.72	An engine error occurred.	
912.74	An engine error occurred.	
912.76	An engine error occurred.	
912.77	An engine error occurred.	
912.79	An engine error occurred.	
912.80	An engine error occurred.	
912.81	An engine error occurred.	
912.82	An engine error occurred.	
912.85	An engine error occurred.	
912.86	An engine error occurred.	
912.88	An engine error occurred.	
938.04	Supplies security is not enabled.	See “Engine software error service check” on page 291.
941.01	An engine communication error occurred.	
941.02	An engine communication error occurred.	
941.03	An engine communication error occurred.	See “Engine software error service check” on page 291.
940.00	Serial communication failure between the controller board and engine board.	
950.10	An NVRAM mismatch error occurred.	See “NVRAM failure service check” on page 291.
953.99	An NVRAM chip error occurred on the mirrored part.	
958.99	A controller board NAND error occurred.	

Error code	Description	Action	
980.01	A validation failure was detected by the Paperport communication device.	See “Options communication error service check” on page 292.	
980.02	A framing error or receive buffer overflow was detected by the Paperport communication device.		
980.03	A timeout error was detected by the Paperport communication device.		
980.04	An option failed to echo the last sent communication byte on time.		
980.05	An option declared a link reset.		
980.11	A Paperport command response was detected. Response was too large for the communications buffer.		
980.13	An optional device hot plug was detected by the printer. Low-level error occurred at the Paperport.		
980.14	An engine timeout error occurred while waiting for the following: <ul style="list-style-type: none"> • A mechanical reset • An intervention required (IR) message to clear after inserting a tray 		
980.15	An engine timeout error occurred while waiting for an option to become idle.		
981.91	An Invalid Paperport protocol error occurred.		
982.92	A Paperport framing error occurred.		See “Options communication error service check” on page 292.
982.93	A Paperport overrun error occurred.		
982.94	A Paperport parity error occurred.		
982.95	An Other Paperport error occurred.		
982.96	The Paperport encountered multiple communication errors.		
982.97	An invalid Paperport Echo occurred.		
983.98	An unsupported Paperport command error occurred.		
984.99	An invalid Paperport parameter error occurred.		
992.01	An option device software error occurred.	See “Options communication error service check” on page 292.	

Engine software error service check

Actions	Yes	No
<p>Step 1</p> <p>a Perform a POR.</p> <p>b Wait for 10 seconds, and then turn on the printer.</p> <p>Does the problem remain?</p>	Go to step 2.	The problem is solved.
<p>Step 2</p> <p>a Remove the controller board shield. See “Controller board shield removal” on page 474.</p> <p>b Make sure that the controller board and engine board cables are properly connected.</p> <p>Does the problem remain?</p>	Go to step 3.	The problem is solved.
<p>Step 3</p> <p>Replace the engine board. See “Engine board removal” on page 479.</p> <p>Does the problem remain?</p>	Go to step 4.	The problem is solved.
<p>Step 4</p> <p>Replace the controller board. See “Controller board removal” on page 478.</p> <p>Does the problem remain?</p>	Contact the next level of support.	The problem is solved.

NVRAM failure service check

Warning—Potential Damage: When replacing any of the following components, replace only one component at a time or the printer will be rendered inoperable:

Replace the required component, bring the printer up in Diagnostics mode, and then verify that the problem is fixed before performing a POR.

This error indicates a mismatch between the engine board and the controller board.

Actions	Yes	No
<p>Step 1</p> <p>Verify if the engine board has been replaced.</p> <p>Has the engine board been replaced?</p>	Go to step 2.	Go to step 3.
<p>Step 2</p> <p>Replace the engine board with a new engine board that has not undergone installation or use. See “Engine board removal” on page 479.</p> <p>Does the problem remain?</p>	Go to step 3.	The problem is solved.

Actions	Yes	No
<p>Step 3 Verify if the controller board has been replaced.</p> <p>Has the controller board been replaced?</p>	Go to step 4.	Go to step 5.
<p>Step 4 Replace the controller board with a new controller board that has not undergone installation or use. See “Controller board removal” on page 478.</p> <p>Does the problem remain?</p>	Go to step 5.	The problem is solved.
<p>Step 5 a Turn the printer off for ten or more seconds. b Turn the printer back on.</p> <p>Does the problem remain?</p>	Go to step 6.	The problem is solved.
<p>Step 6 Restore the printer to factory defaults to clear the NVRAM.</p> <p>Does the problem remain?</p>	Go to step 7.	The problem is solved.
<p>Step 7 Replace the engine board. See “Engine board removal” on page 479.</p> <p>Does the problem remain?</p>	Go to step 8.	The problem is solved.
<p>Step 8 Replace the controller board. See “Controller board removal” on page 478.</p> <p>Does the problem remain?</p>	Contact the next level of support.	The problem is solved.

Options communication error service check

Action	Yes	No
<p>Step 1 a Check if the firmware is updated, and then update the firmware if necessary. b Make sure that the printer supports the option. See the <i>Printer, Option, and Stand Compatibility Guide</i>. c Make sure that the option is properly attached to the printer or adjacent option. d Reset the printer.</p> <p>Does the problem remain?</p>	Go to step 2.	The problem is solved.

Action	Yes	No
<p>Step 2 Reseat the option interface cable on the engine board.</p> <p>Does the problem remain?</p>	Go to step 3.	The problem is solved.
<p>Step 3 Do the following to each option: a Reinstall the option. b Print a test page, and then check if the option is defective.</p> <p>Are all options properly working?</p>	Go to step 4.	Contact the next level of support
<p>Step 4 Replace the option.</p> <p>Does the problem remain?</p>	Contact the next level of support	The problem is solved.

Other symptoms

Base printer symptoms

Base printer symptoms

Symptom	Action
Printer has no power.	See “Dead machine service check” on page 294.
Control panel is not functioning.	See “Control panel service check” on page 295.
Toner out message appears on the display.	See “Toner meter cycle (TMC) card service check” on page 221.
Printer is not communicating with host (USB).	See “USB service check” on page 296.
Printer is not communicating with host (network).	See “Network service check” on page 296.
Bin paper jam or bin full message appears on the display.	See “Sensor (bin full) static jam service check” on page 299.
Invalid engine code message appears on the display.	See “Engine board removal” on page 479.

Dead machine service check

Action	Yes	No
<p>Step 1 Check the AC line for proper voltage.</p> <p>Does the AC line have proper voltage?</p>	Go to step 3.	Go to step 2.
<p>Step 2 Use an electrical outlet that has proper voltage.</p> <p>Does the problem remain?</p>	Go to step 3.	The problem is solved.
<p>Step 3 Check the power cord for damage.</p> <p>Is the power cord free of damage?</p>	Go to step 5.	Go to step 4.
<p>Step 4 Replace the power cord.</p> <p>Does the problem remain?</p>	Go to step 5.	The problem is solved.
<p>Step 5 Make sure that the JLVP51 connector on the engine board is properly connected to the LVPS.</p> <p>Does the problem remain?</p>	Go to step 6.	The problem is solved.
<p>Step 6 Measure the values of pin 4, 6, 8, and 11 to 26 of the JLVP5 connector on the controller board. See “Controller board and engine board connectors” on page 539.</p> <p>Are the values approximately correct?</p>	Go to step 8.	Go to step 7.
<p>Step 7 Replace the LVPS. See “LVPS removal” on page 377.</p> <p>Does the problem remain?</p>	Go to step 8.	The problem is solved.
<p>Step 8 Replace the engine board. See “Engine board removal” on page 479.</p> <p>Does the problem remain?</p>	Contact the next level of support.	The problem is solved.

Control panel service check

Action	Yes	No
<p>Step 1 Restart the printer.</p> <p>Does the problem remain?</p>	Go to step 2.	The problem is solved.
<p>Step 2 Check the LED on the control panel.</p> <p>Is the LED on?</p>	Go to step 3.	Go to step 4.
<p>Step 3 Check the ethernet connection LEDs on the controller board.</p> <p>Are the LEDs on?</p>	Go to step 4.	Go to step 8.
<p>Step 4 Make sure that the control panel FFC is properly connected to the control panel and controller board.</p> <p>Does the problem remain?</p>	Go to step 5.	The problem is solved.
<p>Step 5 Check the control panel FFC for damage.</p> <p>Is the FFC free of damage?</p>	Go to step 7.	Go to step 6.
<p>Step 6 Replace the control panel FFC. See “Control panel FFC removal” on page 494.</p> <p>Does the problem remain?</p>	Go to step 7.	The problem is solved.
<p>Step 7 Replace the control panel display. See “Control panel display (10-inch) removal” on page 442 or “Control panel display (7-inch) removal” on page 444.</p> <p>Does the problem remain?</p>	Go to step 8.	The problem is solved.
<p>Step 8 Disconnect the LVPS cable from the engine board, and then measure the voltages of the red and orange wires.</p> <p>Is the reading on the red wire +6.5 V, and the orange wire +25 V?</p>	Go to step 10.	Go to step 9.
<p>Step 9 Replace the LVPS. See “LVPS removal” on page 377.</p> <p>Does the problem remain?</p>	Go to step 10.	The problem is solved.

Action	Yes	No
<p>Step 10 Replace the controller board. See “Controller board removal” on page 478.</p> <p>Does the problem remain?</p>	Contact the next level of support.	The problem is solved.

USB service check

Actions	Yes	No
<p>Step 1 Make sure that the USB cable is properly connected to the printer and host PC.</p> <p>Does the problem remain?</p>	Go to step 2.	The problem is solved.
<p>Step 2 Use a different USB cable.</p> <p>Does the problem remain?</p>	Go to step 3.	The problem is solved.
<p>Step 3 Connect a different device to the USB cable.</p> <p>Did the host PC see the device?</p>	Go to step 4.	The issue is with the host machine.
<p>Step 4 Replace the controller board. See “Controller board removal” on page 478.</p> <p>Does the problem remain?</p>	Contact the next level of support.	The problem is solved.

Network service check

Notes:

- Before starting this service check, print out the network setup page. From the home screen, touch **Settings > Reports > Network > Network Setup Page**.
- Consult the network administrator to verify that the physical and wireless network settings displayed on the network settings page for the device are properly configured.
- If a wireless network is used, then verify that the printer is in range of the host computer or wireless access point, and there is no electronic interference.
- Have the network administrator verify that the device is using the correct SSID, and wireless security protocols.
- For more network troubleshooting information, consult the Lexmark Network Setup Guide.

Actions	Yes	No
<p>Step 1 If the printer is physically connected to the network, make sure that the Ethernet cable is properly connected on both ends.</p> <p>Does the problem remain?</p>	Go to step 2.	The problem is solved.
<p>Step 2 If the network is wireless, check the online status of the printer under Printers and Faxes on the host computer. Delete all print jobs in the print queue.</p> <p>Is the printer online and in Ready state?</p>	Go to step 4.	Go to step 3.
<p>Step 3 Change the printer status to online.</p> <p>Does the problem remain?</p>	Go to step 4.	The problem is solved.
<p>Step 4 Check the IP address displayed on the network settings page.</p> <p>Does it match the IP address in the port of the drivers using the printer?</p>	Go to step 9.	Go to step 5.
<p>Step 5 Note: A printer should use a static IP address on a network.</p> <p>Does the LAN use DHCP?</p>	Go to step 6.	Go to step 8.
<p>Step 6 Check the first two segments of the IP address.</p> <p>Does the IP address start with 169.254?</p>	Go to step 7.	Go to step 8.
<p>Step 7 Restart the printer.</p> <p>Does the problem remain?</p>	Go to step 9.	The problem is solved.
<p>Step 8 Reset the address on the printer to match the IP address on the driver.</p> <p>Does the problem remain?</p>	Go to step 9.	The problem is solved.
<p>Step 9 Have the network administrator check if the printer and computer IP address have identical subnet addresses.</p> <p>Are the subnet addresses the same?</p>	Go to step 11.	Go to step 10.

Actions	Yes	No
<p>Step 10 Using the subnet address supplied by the network administrator, assign a unique IP address to the printer.</p> <p>Note: The printer IP address should match the IP address on the print driver.</p> <p>Does the problem remain?</p>	Go to step 11.	The problem is solved.
<p>Step 11</p> <p>Is the printer physically connected (Ethernet cable) to the network?</p>	Go to step 12.	Go to step 15.
<p>Step 12</p> <p>Try using a different Ethernet cable.</p> <p>Does the problem remain?</p>	Go to step 13.	The problem is solved.
<p>Step 13</p> <p>Have the network administrator check the network drop for activity.</p> <p>Is the network drop functioning properly?</p>	Go to step 14.	Contact the network administrator.
<p>Step 14</p> <p>Replace the controller board. See “Controller board removal” on page 478.</p> <p>Does the problem remain?</p>	Go to step 15.	The problem is solved.
<p>Step 15</p> <p>Is the printer on the same wireless network as the other devices?</p>	Go to step 17.	Go to step 16.
<p>Step 16</p> <p>Assign the correct wireless network to the printer.</p> <p>Does the problem remain?</p>	Go to step 17.	The problem is solved.
<p>Step 17</p> <p>Are the other devices on the wireless network communicating properly?</p>	Go to step 18.	Contact the network administrator.
<p>Step 18</p> <p>Make sure that the wireless card on the controller board is properly installed.</p> <p>Does the problem remain?</p>	Go to step 19.	The problem is solved.

Actions	Yes	No
<p>Step 19 If there is an attached antenna, check it for damage, and replace if necessary.</p> <p>Does the problem remain?</p>	Go to step 20.	The problem is solved.
<p>Step 20 Make sure that the antenna is properly connected to the wireless card.</p> <p>Does the problem remain?</p>	Go to step 21.	The problem is solved.
<p>Step 21 Replace the wireless card.</p> <p>Does the problem remain?</p>	Go to step 22.	The problem is solved.
<p>Step 22 Replace the controller board. See “Controller board removal” on page 478.</p> <p>Does the problem remain?</p>	Contact the next level of support.	The problem is solved.

Sensor (bin full) static jam service check

Action	Yes	No
<p>Step 1 a From the home screen, touch Settings > Device > Preferences. b Check if the paper size matches the size set on the tray guides.</p> <p>Does the paper size match the size set on the tray?</p>	Go to step 3.	Go to step 2.
<p>Step 2 Change the paper size or adjust the size setting in the tray.</p> <p>Does the problem remain?</p>	Go to step 3.	The problem is solved.
<p>Step 3 Check the paper path for partially fed or jammed paper.</p> <p>Is the paper path free of partially fed or jammed paper?</p>	Go to step 5.	Go to step 4.
<p>Step 4 Remove the partially fed or jammed paper.</p> <p>Does the problem remain?</p>	Go to step 5.	The problem is solved.

Action	Yes	No
<p>Step 5</p> <p>a Enter the Diagnostics menu, and then navigate to: Printer diagnostics & adjustments > Sensor tests</p> <p>b Find the sensor (Output bin full).</p> <p>Does the sensor status change while toggling the sensor?</p>	Contact the next level of support.	Go to step 6.
<p>Step 6</p> <p>Make sure that the JDSNS1 connector on the engine board is properly connected.</p> <p>Does the problem remain?</p>	Go to step 7.	The problem is solved.
<p>Step 7</p> <p>Check the sensor for damage.</p> <p>Is the sensor free of damage?</p>	Contact the next level of support.	Go to step 8.
<p>Step 8</p> <p>a Replace the sensor. See “Sensor (bin full) removal” on page 489.</p> <p>b Perform a print job.</p> <p>Does the problem remain?</p>	Contact the next level of support.	The problem is solved.

Toner patch sensing service check

Pre-check procedure

- 1 Enter the Diagnostics menu, and then navigate to:
Printer diagnostics & adjustments > Color alignment adjust

- 2 On the AA adjustment row, touch **Start**.

Note: This triggers the auto align routine which performs the color alignment error corrections (0.42 mm, 0.84 mm, and 3 mm range).

Note: If the AA adjustment is successful, an **AA adjustment passed** message appears on the screen. If an **AA adjustment passed** message does not appear, skip the next pre-check step, and then go directly to step 4 in the service check.

- 3 Enter the Diagnostics menu, and then navigate to:
Printer setup > EP setup > Toner patch sensor adjust > Full calibration

Note: This triggers the auto align routine (0.42 mm range only) and the solid area and linearization adjustments.

Action	Yes	No
<p>Step 1</p> <p>a From the home screen, touch Settings > Troubleshooting > Print Quality Test Pages.</p> <p>b On the Device information section of the print quality test page, check the CalSet values of the following:</p> <ul style="list-style-type: none"> • C Developer operating point • C Laser operating point • C Linearization stat • M Developer operating point • M Laser operating point • M Linearization stat • Y Developer operating point • Y Laser operating point • Y Linearization stat • K Developer operating point • K Laser operating point • K Linearization stat <p>Are the values 0?</p>	Go to step 2.	The problem is solved.
<p>Step 2</p> <p>Perform the blank or white pages service check. See “Blank or white pages check” on page 40.</p> <p>Was an issue found and resolved?</p>	Go to step 3.	Go to step 4.
<p>Step 3</p> <p>Perform the auto alignment service check. See “Auto alignment service check” on page 302.</p> <p>Does the problem remain?</p>	Go to step 4.	The problem is solved.
<p>Step 4</p> <p>a Enter the Diagnostics menu, and then navigate to: Printer setup > EP setup > Toner patch sensor adjust</p> <p>b On the sensor gain characterization row, touch Start.</p> <p>c On the sensor gain verification row, touch Start.</p> <p>d On the sensor gain verification section of the test page, check the average signal values of the patch number.</p> <p>Are the values within the requirement?</p>	The problem is solved.	Go to step 5.
<p>Step 5</p> <p>Perform the auto alignment service check. See “Auto alignment service check” on page 302.</p> <p>Does the problem remain?</p>	Go to step 6.	The problem is solved.

Action	Yes	No
<p>Step 6</p> <p>Make sure that the JTPS_C1 connector on the engine board is properly connected to the sensor (TPS).</p> <p>Does the problem remain?</p>	Go to step 7.	The problem is solved.
<p>Step 7</p> <p>a Replace the sensor (TPS). See “Sensor (TPS) removal” on page 422.</p> <p>b Enter the Diagnostics menu, and then navigate to: Printer setup > EP setup > Toner patch sensor adjust</p> <p>c On the sensor gain characterization row, touch Start.</p> <p>d On the sensor gain verification row, touch Start.</p> <p>e On the sensor gain verification section of the test page, check the average signal values of the patch number.</p> <p>Are the values within the requirement?</p>	The problem is solved.	Contact the next level of support.

Auto alignment service check

Pre-check procedure

- Enter the Diagnostics menu, and then navigate to:
Printer diagnostics & adjustments > Color alignment adjust
- On the AA adjustment row, touch **Start**.

Note: This triggers the auto align routine which performs the color alignment error corrections (0.42 mm, 0.84 mm, and 3 mm range).

Note: If the AA adjustment is successful, an **AA adjustment passed** message appears on the screen. If an **AA adjustment passed** message does not appear, skip the next pre-check step, and then go directly to step 3 in the service check.
- Enter the Diagnostics menu, and then navigate to:
Printer setup > EP setup > Toner patch sensor adjust > Full calibration

Note: This triggers the auto align routine (0.42 mm range only).

Action	Yes	No
<p>Step 1</p> <p>a From the home screen, touch Settings > Troubleshooting > Print Quality Test Pages.</p> <p>b On the CalSet section of the test page, check the color alignment stat value.</p> <p>Is the value 0?</p>	Go to step 2.	The problem is solved.

Action	Yes	No
<p>Step 2</p> <p>Perform the blank or white pages service check or missing color service check. See “Blank or white pages check” on page 40 or “Missing color check” on page 82.</p> <p>Does the problem remain?</p>	Go to step 3.	The problem is solved.
<p>Step 3</p> <p>Make sure that the JTPS_C1 connector on the engine board is properly connected to the sensor (TPS).</p> <p>Does the problem remain?</p>	Go to step 4.	The problem is solved.
<p>Step 4</p> <p>Replace the sensor (TPS). See “Sensor (TPS) removal” on page 422.</p> <p>Does the problem remain?</p>	The problem is solved.	Contact the next level of support.

Scan, fax, and copy symptoms

Scan, fax, and copy symptoms

Symptom	Action
The ADF does not scan both sides of the document.	See “ADF duplex service check” on page 304 .
The scanned image using the ADF is skewed.	See “ADF feed errors service check” on page 305 .
Multiple documents feed into the ADF.	
Documents do not feed into the ADF.	
The scanner makes a buzzing noise on startup or during a scan.	See “Flatbed CIS scanner home position service check” on page 276 .
The copied page is blank.	See “Blank page copy check” on page 92 .
The copied page is black.	See “Black page copy check” on page 94 .
There is no dial tone.	See “Modem/fax card service check” on page 307 .
The printer does not connect to a fax machine.	The fax machine is turned off. Ask the fax recipient to check the machine.
Incoming fax has blank spaces or poor quality.	See “Blank spaces on incoming fax service check” on page 308 .
Incoming fax has stretched words.	See “Stretched words on incoming fax service check” on page 308 .
The printer does not transmit faxes.	See “Fax transmission service check” on page 308 .

Symptom	Action
The printer does not receive faxes.	See “Fax reception service check” on page 310.
The ADF makes a rattling noise.	See “ADF rattling noise service check” on page 313.
The scanner does not scan a legal-size document.	See “Scanner legal-size scan service check” on page 313.

ADF duplex service check

Actions	Yes	No
<p>Step 1 Check if all the ADF motors run. See “Motor tests” on page 325.</p> <p>Does each motor run?</p>	Go to step 2.	Go to step 5.
<p>Step 2 Check if the status of each ADF sensor changes while toggling the sensor. See “Sensor test” on page 327.</p> <p>Does the sensor status change while toggling the sensor?</p>	Go to step 3.	Go to step 5.
<p>Step 3 Check if the actuator of each sensor is dirty or stuck.</p> <p>Is the actuator dirty or stuck?</p>	Go to step 4.	Go to step 5.
<p>Step 4 Clean the actuator.</p> <p>Does the problem remain?</p>	Go to step 5.	The problem is solved.
<p>Step 5</p> <ul style="list-style-type: none"> a Reseat the JADF1 connector on the controller board. b Reseat the ADF cables on the ADF. <p>Does the problem remain?</p>	Go to step 6.	The problem is solved.
<p>Step 6 Replace the ADF. See “ADF removal” on page 517.</p> <p>Does the problem remain?</p>	Contact the next level of support.	The problem is solved.

ADF feed errors service check

Actions	Yes	No
<p>Step 1 Check if multiple pages can feed into the ADF.</p> <p>Can multiple pages feed into the ADF?</p>	Go to step 5.	Go to step 2.
<p>Step 2 Check the ADF separator roller and ADF pick roller for dirt.</p> <p>Are the ADF rollers clean?</p>	Go to step 4.	Go to step 3.
<p>Step 3 Using a lint-free cloth and isopropyl alcohol, clean the separator roller and pick roller.</p> <p>Does the problem remain?</p>	Go to step 4.	The problem is solved.
<p>Step 4 Replace the ADF rollers. See “ADF rollers removal” on page 514.</p> <p>Does the problem remain?</p>	Go to step 5.	The problem is solved.
<p>Step 5 Check if the document that fed into the ADF is skewed.</p> <p>Is the document skewed?</p>	Go to step 6.	Go to step 7.
<p>Step 6 Set the ADF tray guides correctly.</p> <p>Does the problem remain?</p>	Go to step 7.	The problem is solved.
<p>Step 7 Make sure that the ADF top cover is closed completely.</p> <p>Does the problem remain?</p>	Go to step 8.	The problem is solved.
<p>Step 8 Check if the document has a wrinkled or torn leading edge.</p> <p>Does the document have a wrinkled or torn leading edge?</p>	Go to step 9.	Go to step 10.
<p>Step 9 Replace the document, and then resend the scan job.</p> <p>Does the problem remain?</p>	Go to step 10.	The problem is solved.

Actions	Yes	No
<p>Step 10</p> <p>a Enter the Diagnostics menu, and then navigate to: Scanner diagnostics > Motor tests</p> <p>b Test the following motors.</p> <ul style="list-style-type: none"> • ADF pick • ADF transport <p>Do the motors run?</p>	Go to step 12.	Go to step 11.
<p>Step 11</p> <p>a Reseat the JADF1 connector on the controller board.</p> <p>b Reseat the ADF cables on the ADF.</p> <p>Does the problem remain?</p>	Go to step 12.	The problem is solved.
<p>Step 12</p> <p>a Enter the Diagnostics menu, and then navigate to: Scanner diagnostics > Sensor tests</p> <p>b Find the sensor (ADF media present).</p> <p>Does the sensor status change while toggling the sensor?</p>	Go to step 16.	Go to step 13.
<p>Step 13</p> <p>Check if the actuator is dirty or stuck.</p> <p>Is the actuator dirty or stuck?</p>	Go to step 14.	Go to step 15.
<p>Step 14</p> <p>Clean the actuator.</p> <p>Does the problem remain?</p>	Go to step 15.	The problem is solved.
<p>Step 15</p> <p>a Reseat the JADF1 connector on the controller board.</p> <p>b Reseat the ADF cables on the ADF.</p> <p>Does the problem remain?</p>	Go to step 16.	The problem is solved.
<p>Step 16</p> <p>Replace the ADF. See “ADF removal” on page 517.</p> <p>Does the problem remain?</p>	Go to step 17.	The problem is solved.
<p>Step 17</p> <p>Replace the controller board. See “Controller board removal” on page 478.</p> <p>Does the problem remain?</p>	Contact the next level of support.	The problem is solved.

Modem/fax card service check

Actions	Yes	No
<p>Step 1 Reseat the telephone cable on the LINE port of the printer and on the wall jack.</p> <p>Does the problem remain?</p>	Go to step 2.	The problem is solved.
<p>Step 2 Check if the telephone cable sends and receives calls.</p> <p>Does the cable send and receive calls?</p>	Go to step 4.	Go to step 3.
<p>Step 3 Connect the telephone cable to a working wall jack.</p> <p>Does the problem remain?</p>	Go to step 4.	The problem is solved.
<p>Step 4 Reseat the modem card ribbon cable on the modem card and on the JFAX1 connector on the controller board.</p> <p>Does the problem remain?</p>	Go to step 5.	The problem is solved.
<p>Step 5 Check the modem card ribbon cable for continuity.</p> <p>Does the cable have continuity?</p>	Go to step 7.	Go to step 6.
<p>Step 6 Replace the modem card ribbon cable.</p> <p>Does the problem remain?</p>	Go to step 7.	The problem is solved.
<p>Step 7 Measure the voltages of pins 4, 5, and 7 of the JFAX1 connector on the controller board.</p> <p>Note: Pins 9, 11, 13, 15, 17, and 19 are GND.</p> <p>Are the voltages of pins 4 and 5 equal to +3.3 V DC and pin 7 equal to +5 V DC?</p>	Go to step 8.	Go to step 9.
<p>Step 8 Replace the fax card.</p> <p>Does the problem remain?</p>	Go to step 9.	The problem is solved.
<p>Step 9 Replace the controller board. See “Controller board removal” on page 478.</p> <p>Does the problem remain?</p>	Contact the next level of support.	The problem is solved.

Blank spaces on incoming fax service check

Actions	Yes	No
Step 1 Have a fax sent from another machine. Does the problem remain?	Go to step 2.	The problem is solved.
Step 2 Attach the MFP to a different phone line. Does the problem remain?	Go to step 3.	The problem is solved.
Step 3 Print a test page. Does the image quality issue remain?	Go to step 4.	The problem is solved.
Step 4 Install a new toner cartridge. Does the problem remain?	Contact the next level of support.	The problem is solved.

Stretched words on incoming fax service check

Actions	Yes	No
Have a fax sent from another machine. Does the problem remain?	Contact the next level of support.	The problem is solved.

Fax transmission service check

Actions	Yes	No
Step 1 Reseat the telephone cable on the LINE port of the printer and on the wall jack. Does the problem remain?	Go to step 2.	The problem is solved.
Step 2 Check for a dial tone. Is there a dial tone?	Go to step 3.	Go to step 5.
Step 3 Use a telephone to check if the telephone line sends and receives calls. Does the line send and receive calls?	Go to step 6.	Go to step 4.

Actions	Yes	No
<p>Step 4 Use a telephone handset to check if the telephone line is free of static or external noise.</p> <p>Is the line free of static or external noise?</p>	Go to step 6.	Go to step 5.
<p>Step 5 Connect the telephone cable to a working wall jack.</p> <p>Does the problem remain?</p>	Go to step 6.	The problem is solved.
<p>Step 6 a From the home screen, navigate to: Settings > Fax > Fax defaults > Fax setup > Fax Receive Settings > Admin Controls > Enable Fax Receive b Touch On.</p> <p>Does the problem remain?</p>	Go to step 7.	The problem is solved.
<p>Step 7 a From the home screen, navigate to: Settings > Fax > Fax defaults > Fax setup > Fax Receive Settings > Admin Controls > Answer on b Select a ring pattern.</p> <p>Does the problem remain?</p>	Go to step 8.	The problem is solved.
<p>Step 8 Check if the telephone line is analog.</p> <p>Is the line analog?</p>	Go to step 11.	Go to step 9.
<p>Step 9 Check if the telephone line is a VOIP line.</p> <p>Is the line VOIP?</p>	Go to step 11.	Go to step 10.
<p>Step 10 Ask the system administrator to check if the VOIP server is configured to receive faxes.</p> <p>Is the server configured to receive faxes?</p>	Go to step 11.	Contact the next level of support.
<p>Step 11 Check if the printer receives a fax from one specific remote device.</p> <p>Does the printer receive a fax from one specific remote device?</p>	Go to step 13.	Go to step 12.

Actions	Yes	No
<p>Step 12 Check if a different device can send a fax.</p> <p>Does the device send a fax?</p>	Contact the next level of support.	Go to step 13.
<p>Step 13</p> <p>a From the home screen, navigate to: Settings > Fax > Fax defaults > Fax setup > Fax Receive Settings > Admin Controls > Block no name fax</p> <p>b Touch Off.</p> <p>Does the problem remain?</p>	Go to step 14.	The problem is solved.
<p>Step 14</p> <p>a From the home screen, navigate to: Settings > Fax > Fax defaults > Fax setup > Fax Receive Settings > Admin Controls > Banned fax list</p> <p>b Check if the remote device number is on the list.</p> <p>Is the number on the list?</p>	Go to step 15.	Go to step 16.
<p>Step 15</p> <p>Remove the remote device number from the list.</p> <p>Does the problem remain?</p>	Go to step 16.	The problem is solved.
<p>Step 16</p> <p>a Enter the Service Engineer menu, and then navigate to: Fax SE > Modem Settings > Receive Thresh</p> <p>b Adjust the setting in steps of 2 dB.</p> <p>Note: The recommended adjustment range is between -33 dB and -48dB.</p> <p>Does the problem remain?</p>	Go to step 17.	The problem is solved.
<p>Step 17</p> <p>a Enter the Service Engineer menu, and then navigate to: Fax SE > Fax Settings > AutoPrint T30 Logs</p> <p>b Check the reported error code. See “Fax error log codes” on page 314.</p> <p>c Perform the action suggested for the error.</p> <p>Does the problem remain?</p>	Contact the next level of support.	The problem is solved.

Fax reception service check

Note: Before performing this service check, make sure that the correct country code is selected.

Actions	Yes	No
<p>Step 1 Reseat the telephone cable on the LINE port of the printer and on the wall jack.</p> <p>Does the problem remain?</p>	Go to step 2.	The problem is solved.
<p>Step 2 Check if the telephone cable sends and receives calls.</p> <p>Does the cable send and receive calls?</p>	Go to step 4.	Go to step 3.
<p>Step 3 Connect the telephone cable to a working wall jack.</p> <p>Does the problem remain?</p>	Go to step 4.	The problem is solved.
<p>Step 4 Check if the telephone line is analog.</p> <p>Is the telephone line analog?</p>	Go to step 7.	Go to step 5.
<p>Step 5 Check if the telephone line is a VOIP line.</p> <p>Is the line VOIP?</p>	Go to step 6.	Go to step 7.
<p>Step 6 Ask the system administrator to verify if the VOIP server is configured to receive faxes.</p> <p>Is the server configured to receive faxes?</p>	Go to step 7.	Contact the next level of support.
<p>Step 7 Check if the printer is on a PABX.</p> <p>Is the printer on a PABX?</p>	Go to step 9.	Go to step 8.
<p>Step 8</p> <p>a From the home screen, navigate to: Settings > Fax > Fax defaults > Fax setup > Fax Send Settings > Behind a PABX</p> <p>b Touch Yes.</p> <p>Does the problem remain?</p>	Go to step 9.	The problem is solved.

Actions	Yes	No
<p>Step 9</p> <p>a From the home screen, navigate to: Settings > Fax > Fax defaults > Fax setup > Fax Send Settings > Behind a PABX</p> <p>b Touch No.</p> <p>c Check if access to an outside line needs a dial prefix.</p> <p>Does access need a dial prefix?</p>	Go to step 10.	Go to step 11.
<p>Step 10</p> <p>Send a fax using a dial prefix.</p> <p>Does the problem remain?</p>	Go to step 11.	The problem is solved.
<p>Step 11</p> <p>Check if the printer sends a fax to one specific destination.</p> <p>Does the printer send a fax to one specific destination?</p>	Go to step 13.	Go to step 12.
<p>Step 12</p> <p>Check if the device that does not receive a fax can send a fax.</p> <p>Does the device send a fax?</p>	Go to step 13.	Contact the next level of support.
<p>Step 13</p> <p>a Enter the Service Engineer menu, and then navigate to: Fax SE > Fax Settings > AutoPrint T30 Logs</p> <p>b Check the reported error code. See “Fax error log codes” on page 314.</p> <p>c Perform the action suggested for the error.</p> <p>Does the problem remain?</p>	Go to step 14.	The problem is solved.
<p>Step 14</p> <p>a Enter the Service Engineer menu, and then navigate to: Fax SE > Modem Settings > Transmit Level</p> <p>b Adjust the setting in steps of 1 dB.</p> <p>Note: The recommended adjustment range is ± 5 dB from the default value.</p> <p>Does the problem remain?</p>	Contact the next level of support.	The problem is solved.

ADF rattling noise service check

Actions	Yes	No
<p>Step 1 Reinstall the ADF pick roller and ADF separator roller.</p> <p>Does the problem remain?</p>	Go to step 2.	The problem is solved.
<p>Step 2 Replace the ADF pick roller and ADF separator roller. See “ADF rollers removal” on page 514.</p> <p>Does the problem remain?</p>	Go to step 3.	The problem is solved.
<p>Step 3 Reinstall the ADF top cover.</p> <p>Does the problem remain?</p>	Go to step 4.	The problem is solved.
<p>Step 4 Replace the ADF top cover. See “ADF top cover removal” on page 528.</p> <p>Does the problem remain?</p>	Contact the next level of support.	The problem is solved.

Scanner legal-size scan service check

Actions	Yes	No
<p>Step 1</p> <p>a Open the scanner cover.</p> <p>b Check if the X mark on the scanner glass pad is visible and free of damage.</p> <p>Is the X mark visible and free of damage?</p>	Go to step 3.	Go to step 2.
<p>Step 2 Replace the scanner glass pad. See “Scanner glass pad removal” on page 512.</p> <p>Does the problem remain?</p>	Go to step 3.	The problem is solved.
<p>Step 3</p> <p>a Open the scanner cover.</p> <p>b Check if the X mark is in the rear right of the scanner glass pad.</p> <p>Is the X mark in the rear right of the scanner glass pad?</p>	Go to step 5.	Go to step 4.
<p>Step 4 Reinstall the scanner glass pad in the correct orientation.</p> <p>Does the problem remain?</p>	Go to step 5.	The problem is solved.

Actions	Yes	No
<p>Step 5</p> <p>a Perform scanner calibration. See “Scanner Calibration Reset” on page 331.</p> <p>b Send a scan job.</p> <p>Does the problem remain?</p>	Go to step 6.	The problem is solved.
<p>Step 6</p> <p>a Replace the scanner. See “Flatbed scanner removal” on page 519.</p> <p>b Send a scan job.</p> <p>Does the problem remain?</p>	Go to step 7.	The problem is solved.
<p>Step 7</p> <p>Replace the controller board. See “Controller board removal” on page 478.</p> <p>Does the problem remain?</p>	Contact the next level of support.	The problem is solved.

Fax error log codes

Error code	Description	Action
000	No error occurred during fax transmission.	No action is needed.
200	Error occurred when transmitting training.	<ul style="list-style-type: none"> • Check line quality. • Select a lower Max Speed value under Fax Send settings. • Adjust the transmit level.
3XX	Error occurred when receiving image data.	<ul style="list-style-type: none"> • Check line quality. • Adjust Receive Threshold. • Select a lower Max Speed value under Fax Receive settings.
4XX	Error occurred when sending image data.	<ul style="list-style-type: none"> • Check line quality. • Adjust ‘Transmit Level’. • Select a lower ‘Max Speed’ value under Fax Receive settings.
5XX	Received unknown response from remote fax device.	No action needed. Issue is with the other device.
6XX	Error occurred when receiving a frame.	<ul style="list-style-type: none"> • Check line quality. • Adjust ‘Receive Threshold’.
7XX	Error occurred when sending a frame.	<ul style="list-style-type: none"> • Check line quality. • Adjust ‘Transmit Level’. • Select a lower ‘Max Speed’ value under Fax Send settings.

Error code	Description	Action
800	Received EOT unexpectedly from the modem in V34 mode.	If error persists, then disable V34 modulation scheme.
802	Too many timeouts occurred during ECM reception.	If error persists, then disable ECM mode.
803	Fax cancelled by user	No action needed.
804	Unexpectedly received a disconnect command from the remote end.	<ul style="list-style-type: none"> • Check line quality. • Adjust Transmit Level/Receive Threshold values. • Remote device could be requesting an unsupported feature.
805	Remote fax device failed to respond to the DCS command.	<ul style="list-style-type: none"> • Adjust Transmit Level/Receive Threshold values. • Remote device could be malfunctioning.
808	T1 timeout occurred when trying to establish a connection with a remote fax device.	Adjust Transmit Level/Receive Threshold values.
809	T2 Timeout occurred due to loss of command/response synchronization.	Adjust Transmit Level/Receive Threshold values.
80A	T5 Timeout occurred when transmitting image data to remote fax device.	<ul style="list-style-type: none"> • Check line quality. • Adjust 'Transmit Level'. • Select a lower 'Max Speed' value under Fax Send settings.
80B	Too many errors when transmitting in ECM mode.	<ul style="list-style-type: none"> • Check line quality. • Adjust 'Transmit Level'. • Select a lower 'Max Speed' value under Fax Send settings.
80C	Remote device failed to respond to the CTC command.	<ul style="list-style-type: none"> • Select a lower 'Max Speed' value under Fax Send settings. • Adjust 'Transmit Level'.
80D	Received too many requests from remote end to repeat the previous command sent.	<ul style="list-style-type: none"> • Check line quality. • Adjust 'Transmit Level'. • Check if line conditions on remote end will facilitate a good connection.
80E	Functional limitation-Remote fax device does not support G3 receive capability.	No action needed. Issue with the remote device.
811	Failed to detect a fax device at the remote end.	<ul style="list-style-type: none"> • Verify MFD is answering to fax call and not a voice call. • Decrease value of 'Rings To Answer' setting.
812	No more data rates available in V34 modulation scheme.	Adjust to a lower modulation scheme.

Error code	Description	Action
813	Timeout occurred after waiting too long to receive a good frame.	Adjust "Receive Threshold".
814	Tried too many times at selected speed using V34 modulation scheme.	<ul style="list-style-type: none"> • Adjust 'Transmit Level'. • Adjust to a lower modulation scheme.
815	Fax transmission was interrupted due to power failure.	Troubleshoot MFP if error persists. See "Modem/fax card service check" on page 307 .
818	Fax transmission failed due to insufficient memory to store scanned image.	Adjust 'Memory Use' setting to allocate more memory for send jobs.
819	Fax transmission failed due to insufficient memory to store received image.	Adjust 'Memory Use' setting to allocate more memory for receive jobs.
81A	A timeout occurred during transmission of a page in ECM mode.	Select a lower 'Max Speed' value under Fax Send settings.
880	Failure to transmit training successfully in V17, V29, V27 terminal modulation schemes.	<ul style="list-style-type: none"> • Select a lower "Max Speed" under Fax Send settings. • Adjust the "Transmit Level". • Check line quality.
881	Failure to transmit training successfully in V33, V29, V27 terminal modulation schemes.	<ul style="list-style-type: none"> • Select a lower "Max Speed" under Fax Send settings. • Adjust the "Transmit Level". • Check line quality.
882	Failure to transmit training successfully in V17, V29 terminal modulation schemes.	<ul style="list-style-type: none"> • Select a lower "Max Speed" under Fax Send settings. • Adjust the "Transmit Level". • Check line quality.
883	Failure to transmit training successfully in V17, V27 terminal modulation schemes.	<ul style="list-style-type: none"> • Select a lower "Max Speed" under Fax Send settings. • Adjust the "Transmit Level". • Check line quality.
884	Failure to transmit training successfully in V29, V27 terminal modulation schemes.	<ul style="list-style-type: none"> • Select a lower "Max Speed" under Fax Send settings. • Adjust the "Transmit Level". • Check line quality.
885	Failure to transmit training successfully in V17 terminal modulation scheme.	<ul style="list-style-type: none"> • Select a lower "Max Speed" under Fax Send settings. • Adjust the "Transmit Level". • Check line quality.
886	Failure to transmit training successfully in V29 terminal modulation scheme.	<ul style="list-style-type: none"> • Select a lower "Max Speed" under Fax Send settings. • Adjust the "Transmit Level". • Check line quality.

Error code	Description	Action
887	Failure to transmit training successfully in V27 terminal modulation scheme.	<ul style="list-style-type: none"> • Select a lower “Max Speed” under Fax Send settings. • Adjust the “Transmit Level”. • Check line quality.
888	Failure to transmit training successfully at 2400 bps in V27 terminal modulation scheme.	<ul style="list-style-type: none"> • Adjust “Transmit Level”. • Check line quality.
889	Failed to connect at the minimum speed supported by the MFP.	<ul style="list-style-type: none"> • Adjust “Transmit Level”. • Incompatible connection.
88A	Failed to connect using V.34 modulation scheme.	<ul style="list-style-type: none"> • Check line quality. • Adjust to a lower modulation scheme. • Adjust Transmit Level Receive Threshold values.
901	No fax tones detected from remote end.	<ul style="list-style-type: none"> • Verify destination phone number. • Verify that the remote fax is authorized to receive faxes.
902	No dial tone detected.	<ul style="list-style-type: none"> • Check by enabling ‘Behind a PABX’ setting. • Check phone line. • Check MFD modem hardware.
903	Busy tone detected.	Check with remote end if successive attempts fail.
904	Hardware error detected.	See “Modem/fax card service check” on page 307.
905	A timeout occurred after dialing the number and waiting for a response.	Check with remote end if successive attempts fail.
906	Fax cancelled by user.	No action needed.
907	Modem detected a digital line connection.	Verify the MFP is connected to an analog line. See “Fax transmission service check” on page 308.
908	Phone line was disconnected	Restore phone line connection.
A00	Received request for unsupported function from remote fax device.	No action needed.
A01	Received request for unsupported image width from remote fax device.	No action needed.
A02	Received request for unsupported image resolution from remote fax device.	No action needed.
A03	Received request for unsupported compression type from remote fax device.	No action needed.
A04	Received request for unsupported image length from remote fax device.	No action needed.

Error code	Description	Action
F00	Unknown error occurred.	No action needed.

Escalating a fax issue to second-level support

Before contacting the second-level support, go to the SE menu on the MFP, and then generate a Fax error file. This file contains machine settings information and debug information that will help second-level support determine the cause of a failure.

To generate the fax error file, perform the following steps:

- 1 In a Web browser, type **http://MFP/<IP address>/se**.
- 2 The MFP's SE menu page will display. Click the "Dump Job History" link. The following displays:

Fax Job Log							
Wednesday, 2006-02-08 11:25							
Action	Date	Time	Job #	Length	Station Name/Number	Pages	Status
SCAN	1969-12-31	19:00				9	OK
SEND	2006-02-01	13:55	73	17:53	4039	2	CANCELED
SEND	2006-02-01	13:56	74	17:53	4039	0	CANCELED

- 3 Write down the type of connection, the type of error, and the job in which the error occurred.
- 4 In the Web browser address bar, type **http://MFP/<IP address>/se**.
- 5 Click **Report a Fax Problem**. The fax check list displays.
- 6 Fill in the requested information. This is where you will type in the information you retrieved in step 3. Second-level support can assist you if you have questions about the information requested on the page.

Title/Name of Tester	<input type="text" value="Your Name"/>	Date of Event	<input type="text" value="Date of Event"/>	mm/dd/yyyy
Customer	<input type="text" value="Customer Name"/>	Time of Event	<input type="text" value="Time of Event"/>	hh:mm [A,P]M
Job ID	<input type="text" value="Job ID"/>			#####
Describe the Physical Connection:				
Type:	Description:	Channel Quality:		
<input checked="" type="radio"/> Analog	<input type="checkbox"/> VoIP/FoIP	<input checked="" type="radio"/> Clear		
<input type="radio"/> Digital	<input type="checkbox"/> PAB	<input type="radio"/> OK		
	<input type="checkbox"/> ISD	<input type="radio"/> Some Noise		
		<input type="radio"/> Very Noisy		

Note: The fields requesting the code levels, model number, type of problem are auto-filled. If the information is not in the fields, it can be retrieved from the SE menu. The SE menu can be accessed by pressing ****411** or typing **http://MFP/<IP address>/se** in a Web browser.

- 7 After all the requested information is entered into the Fax Checklist Web page, press the **Submit** button on the bottom of the page. A dialogue asking you to save the file appears.

Note: The file generated by the MFP is not automatically transmitted to second-level support. It is placed on the computer desktop.

- 8 Enter a name for the file, and indicated where you want to save the file.
- 9 Press **OK**. The file appears on the desktop.
- 10 E-mail the file to second-level support.

Service menus

Understanding the printer control panel

Using the control panel

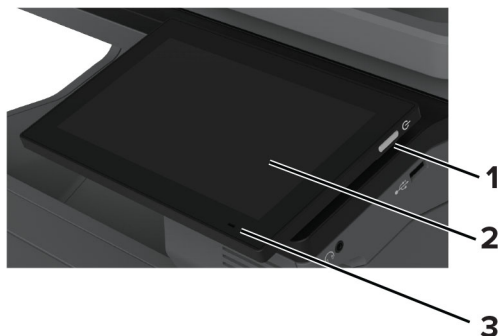

	Control panel part	Function
1	Power button	<ul style="list-style-type: none"> Turn on or turn off the printer. Note: To turn off the printer, press and hold the power button for five seconds. Set the printer to Sleep mode. Wake the printer from Sleep or Hibernate mode.
2	Display	<ul style="list-style-type: none"> View the printer messages and supply status. Set up and operate the printer.
3	Indicator light	Check the status of the printer.

Understanding the status of the indicator light

Indicator light	Printer status
Off	The printer is off.
Solid blue	The printer is ready.
Blinking blue	The printer is printing or processing data.
Blinking red	The printer requires user intervention.
Solid amber	The printer is in Sleep mode.
Blinking amber	The printer is in Deep Sleep or Hibernate mode.

Configuring the door interlock bypass jumpers

Note: The interlock bypass jumpers are only used with the following motors:

- Motor (fuser)
- Motor (K/transfer belt)
- Motor (tray 1 pick/lift)
- Motor (duplex/MPF)

The engine board has two door interlock bypass jumpers. These jumpers allow you to leave the doors open to see the motors in operation while being tested in diagnostics mode.

The J72 jumper connector enables the motor (fuser) and motor (K/transfer belt) for diagnostic tests.

The JMTREN2 jumper connector enables the motor (tray1 pick/lift) and motor (duplex/MPF) for diagnostic tests.

Note: If the jumpers are not set to the bypass position and a motor test is performed while a door is open, then a 1yy.80 or other error can occur.

The following are the jumper configurations:

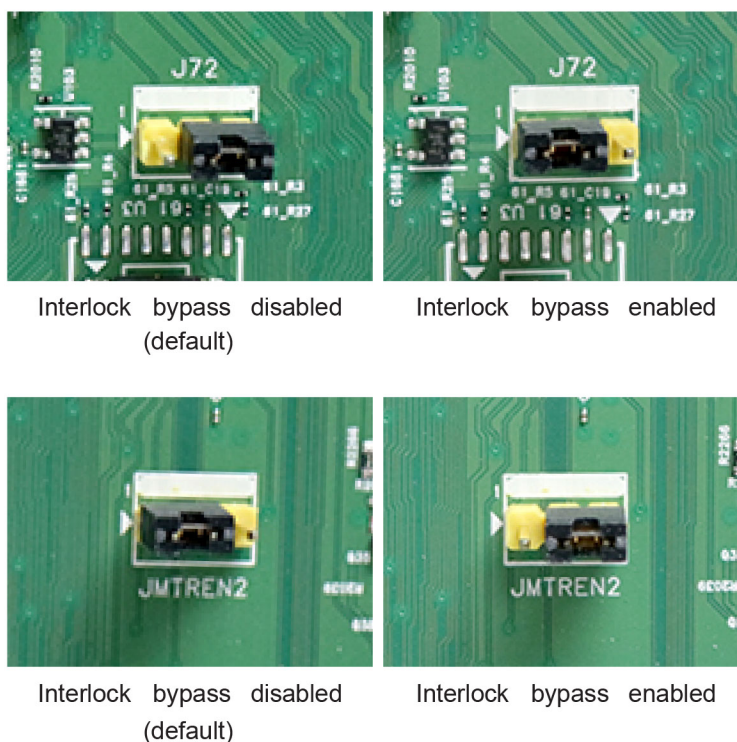

To set the jumpers:

- 1 Turn off the printer.
- 2 Remove the controller board shield. See [“Controller board shield removal” on page 474](#).
- 3 Locate the jumper connectors on the engine board.
- 4 Move the jumper of the motor being tested to the bypass position.

Note: If no jumper is available on the header, borrow the jumper from the JSHUNT1 connector (A) on the upper right side of the engine board.

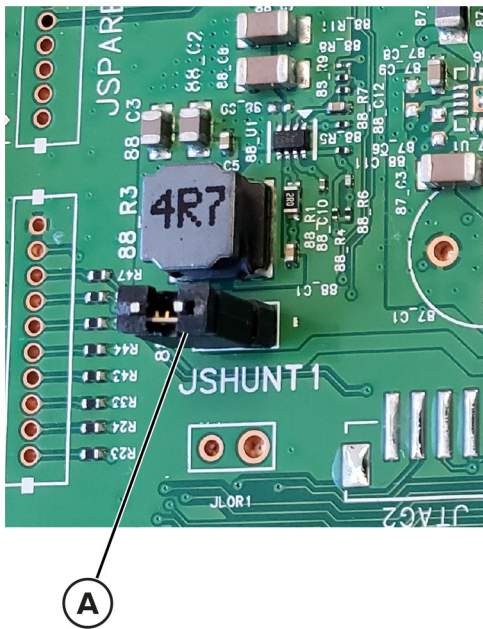

- 5 Enter the Diagnostics menu, and then navigate to: **Printer diagnostics & adjustments > Motor tests.**
- 6 Observe precautions for motor tests. See [“Motor tests” on page 338.](#)
- 7 Select a motor, and then touch **Start.**
- 8 After the test, turn off the printer, and then move the jumpers back to the default position.
Note: If the JSHUNT1 jumper was borrowed, restore it to the JSHUNT1 connector.

Diagnostics menu

Entering the Diagnostics Menu

The Diagnostics Menu contains tests that are used to help isolate printer issues.

- To access the menu from POST, do the following:
 - 1 Unplug the power cord from the electrical outlet.
 - 2 Open tray 1.
 - 3 Connect the power cord to the electrical outlet.

When the display shows the following icon, close tray 1.

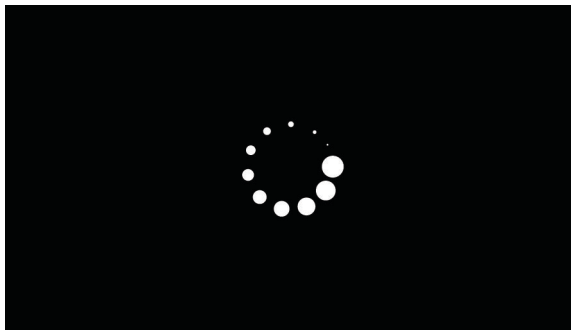

4 From the menu that appears on the display, select **Diagnostics_Mode**.

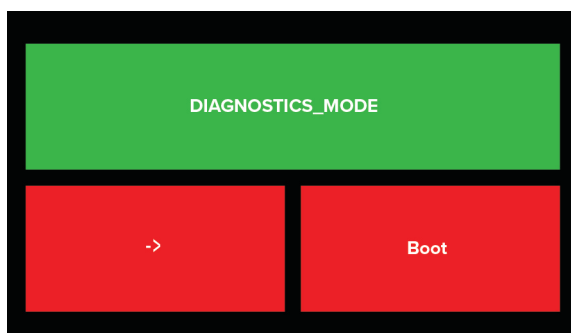

Notes:

- Make sure that the selected menu turns green.
- If the **Diagnostics_Mode** option does not show on the display, touch -> repeatedly until it appears.

5 Select **Boot**.

- To access the Diagnostics Menu from the home screen, do the following:

- 1** From the home screen, touch .
- 2** Touch ****36**, and then touch **OK**.

Reports

Device

This report lists all the current printer settings.

Enter the Diagnostics menu, and then navigate to:

Reports > Device

Licenses

This setting lists all the installed licenses and their feature data.

Enter the Diagnostics menu, and then navigate to:

Reports > Licenses

Advanced Print Quality Samples

This setting prints a list of the printer settings and sample pages to check print quality.

Enter the Diagnostics menu, and then navigate to:

Advanced Print Quality Samples > Advanced Print Quality Test Pages

Format Fax Storage

This setting deletes stored fax jobs.

1 Enter the Diagnostics menu, and then navigate to:

Format Fax Storage

2 Touch **Start**.

Note: If the device is registered to etherFAX™, it must be unregistered and then registered again for etherFAX to work. For more information, visit <https://www.etherfax.net/lexmark>.

Scanner Diagnostics

Motor tests

Note: For a video demonstration, see [Performing the scanner motor tests](#).

1 Enter the Diagnostics menu, and then select navigate to:

Scanner diagnostics > Motor tests

2 Select a motor, and then touch **Start**.

Notes:

- If the motor is activated, then it is properly working.
- Some motors require automatic deactivation in order to avoid secondary issues such as possible damage and contamination.
- Some tests require a special action to activate a motor such as removing a major component.
- If the motor fails, the test failure may not indicate a failed motor. Further troubleshooting may be required. Check the boards and cables for possible issues.

List of motor tests

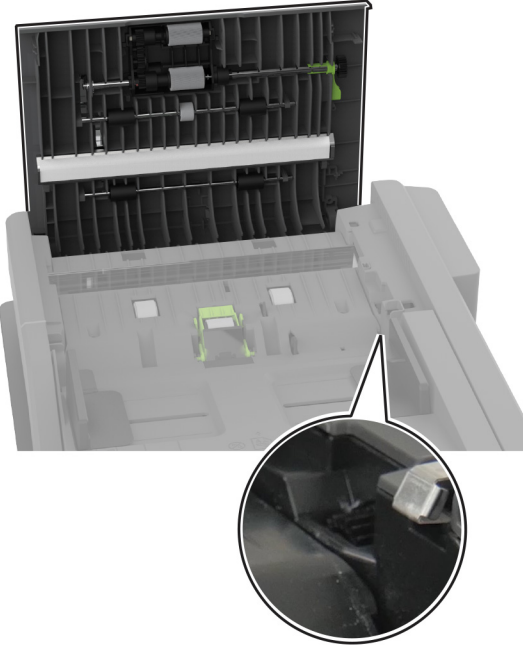
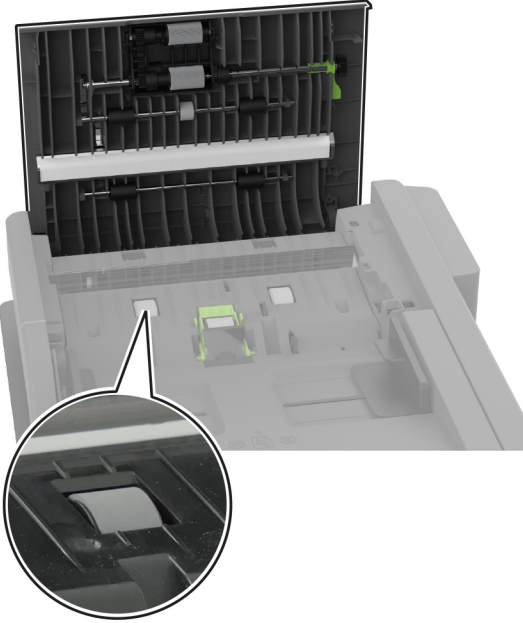
Test	Notes
ADF pick	<p data-bbox="383 254 992 281">Open the ADF top cover to view the pick drive gear.</p> 
ADF transport	<p data-bbox="383 1060 1040 1087">Open the ADF top cover to view the ADF feed/exit roller.</p> 

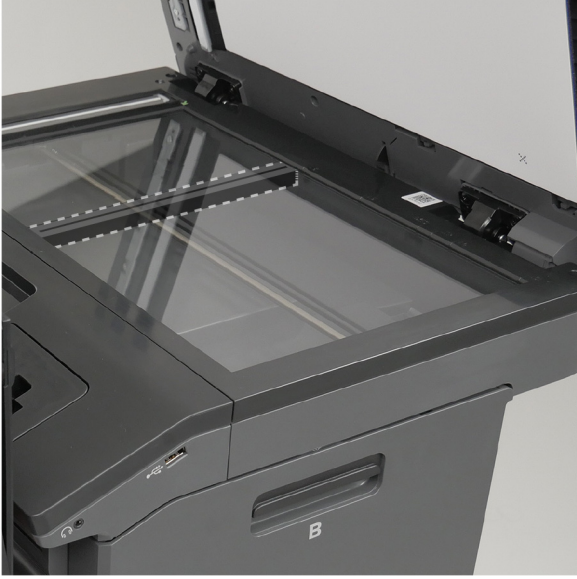
Test	Notes
Flatbed scanner	<p data-bbox="383 205 1040 233">Open the scanner cover to view the flatbed CIS scanner.</p> 

Sensor test

Note: For a video demonstration, see [Performing the scanner sensor tests](#).

This test verifies the status of the scanner sensors.

- 1** Enter the Diagnostics menu, and then touch **Scanner diagnostics**.
- 2** From the Sensor test row, touch **Start**.
A list of sensors appears.

3 Find, and then manually toggle the sensor.

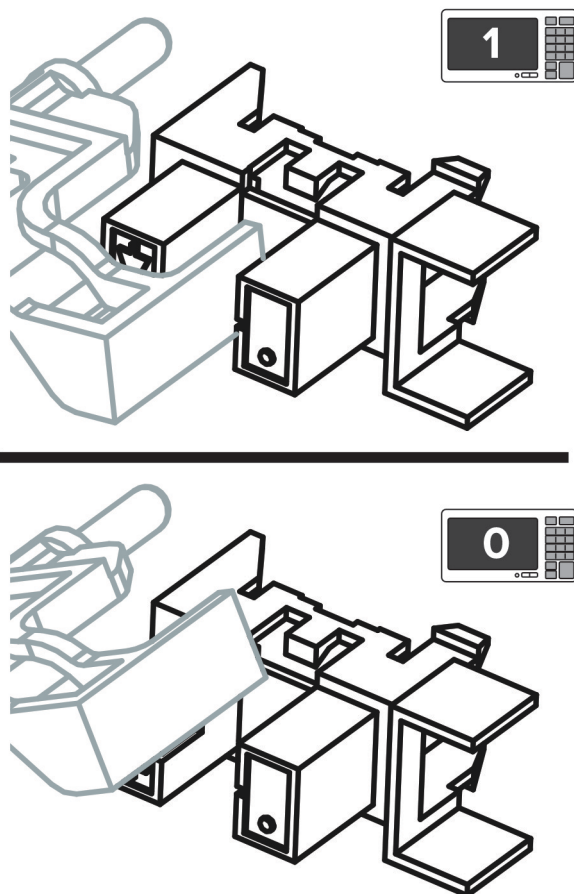

Notes:

- The sensor status on the screen toggles between **1** and **0** when the sensor is properly working.
- If a sensor test fails, the test failure may not indicate a failed sensor. Further troubleshooting may be required. Check the boards and cables for possible issues.

List of sensor tests

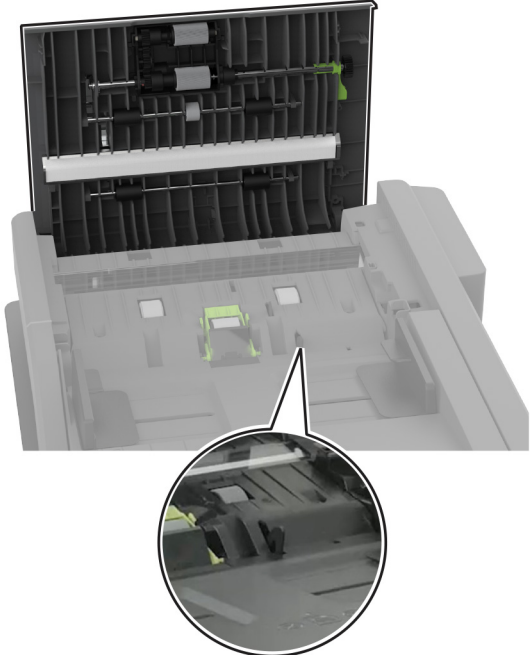
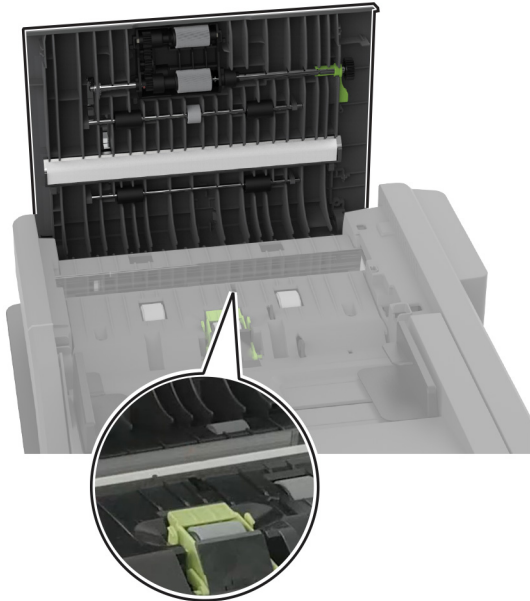
Tests	Notes
ADF media present	<p data-bbox="732 254 1271 281">Open the ADF top cover to access the sensor.</p> 
ADF 1st scan	<p data-bbox="732 1073 1271 1100">Open the ADF top cover to access the sensor.</p> 

Tests	Notes
ADF 2nd scan	<ol style="list-style-type: none"> 1 Open the scanner cover. 2 Insert a sheet of paper to toggle the sensor. 
ADF closed	Open or close the scanner cover to toggle the sensor.
ADF top door interlock	Open or close the ADF top cover to toggle the sensor.
ADF calibration strip home	--
FB CCD home	--

Multifeed calibration

Note: For a video demonstration, see [Performing the scanner multifeed calibration](#).

- 1 Load a single letter or A4 size paper on the ADF tray.
- 2 Enter the Diagnostics menu, and then touch **Scanner diagnostics**.
- 3 Select Multifeed Calibration, and then touch **Start**.

Feed Test

Note: For a video demonstration, see [Performing the scanner feed test](#).

This test allows for a continuous feed from the ADF or flatbed.

- 1 Enter the Diagnostics menu, and then navigate to:
Scanner diagnostics > Feed Test
- 2 Select a paper size.
- 3 From the Feed Test row, touch **Start**.

Scanner Calibration Reset

Before starting the test, make sure that the scanner glass and scanner pad are clean. For more information, see [“Cleaning the scanner” on page 554](#).

- 1 Enter the Diagnostics menu, and then touch **Scanner diagnostics**.
- 2 From the Sensor Calibration Reset row, touch **Start**.

To verify the result, do the following:

- 1 Load the ADF with a document containing light and dark content.
- 2 Print a two-sided copy of the document.

Notes:

- If the back side of the copy has vertical streaks, then clean the scanner glass and backing material, and then print another copy.
- If the streaks still appear, then repeat the cleaning and verification procedure or replace the ADF.

Controller Calibration

Warning—Potential Damage: Do not perform this operation without specific instructions from the next level of support.

- 1 Enter the Diagnostics menu, and then touch **Scanner diagnostics**.
- 2 From the Controller Calibration row, touch **Start**.

Printer Setup

Printed page count (mono)

This setting displays the amount of pages printed in mono.

- 1 Enter the Diagnostics menu, and then touch **Printer Setup**.
- 2 View the printed page count for mono.

Printed page count (color)

This setting displays the amount of pages printed in color.

- 1 Enter the Diagnostics menu, and then touch **Printer Setup**.
- 2 View the printed page count for color.

Permanent page count

This setting displays the total number of pages printed in mono and color. After all the print tests are completed, this value resets to zero.

- 1 Enter the Diagnostics menu, and then touch **Printer Setup**.
- 2 View the permanent page count.

Processor ID

This setting indicates the ID of the processor on the controller board.

- 1 Enter the Diagnostics menu, and then touch **Printer Setup**.
- 2 View the processor ID.

Serial number

This setting displays a read-only value of the serial number.

- 1 Enter the Diagnostics menu, and then touch **Printer Setup**.
- 2 View the serial number.

Model name

This setting displays the model name of the printer.

- 1 Enter the Diagnostics menu, and then touch **Printer Setup**.
- 2 View the model name.

Engine setting [x]

Warning—Potential Damage: Do not change this setting without specific instructions from the next level of support.

This setting allows you to select a printer engine setting. Possible values are 0–255. 0 is the default.

- 1 Enter the Diagnostics menu, and then navigate to:
Printer Setup > Engine setting [x]
- 2 Select a setting, enter a value, and then touch **OK**.

EP setup

Warning—Potential Damage: Do not change this setting without specific instructions from the next level of support.

This setting allows you to adjust the EP setup of the printer.

- 1 Enter the Diagnostics menu, and then navigate to:
Printer Setup > EP setup
- 2 Select a setting.

Waste toner sensor calibration

This procedure ensures the accuracy of the waste toner level detection.

- 1 Enter the Diagnostics menu, and then navigate to:
Printer Setup > Waste toner sensor calibration
- 2 Remove the waste toner bottle.

3 Touch **Start**.

Printer diagnostics and adjustments

Sensor tests

Note: For a video demonstration, see [Performing the printer sensor tests](#).

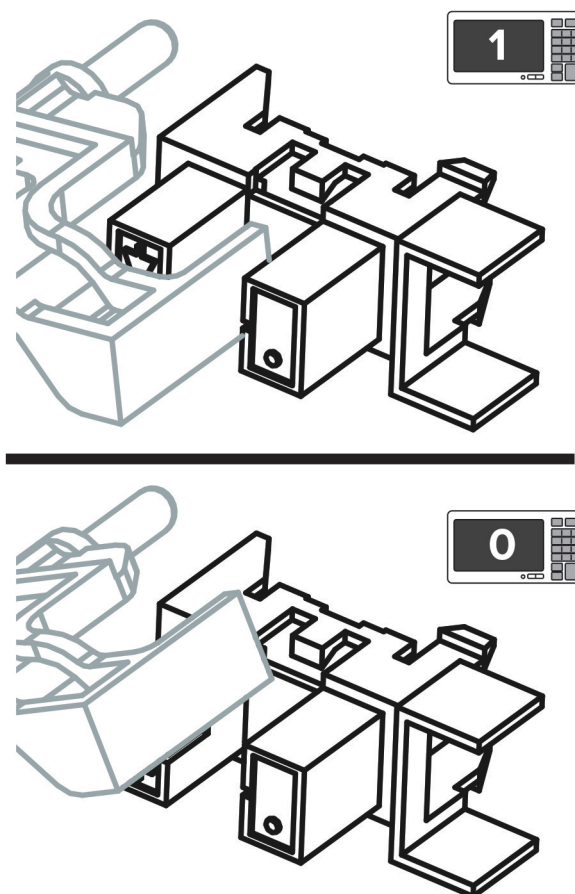

- 1 Enter the Diagnostics menu, and then touch **Printer diagnostics & adjustments**.
- 2 From the Sensor tests row, touch **Start**.
A list of sensors appears.
- 3 Find, and then manually toggle the sensor.



Notes:



- The sensor status on the screen toggles between **1** and **0** when the sensor is properly working.
- If a sensor test fails, the test failure may not indicate a failed sensor. Further troubleshooting may be required. Check the boards and cables for possible issues.

List of sensor tests

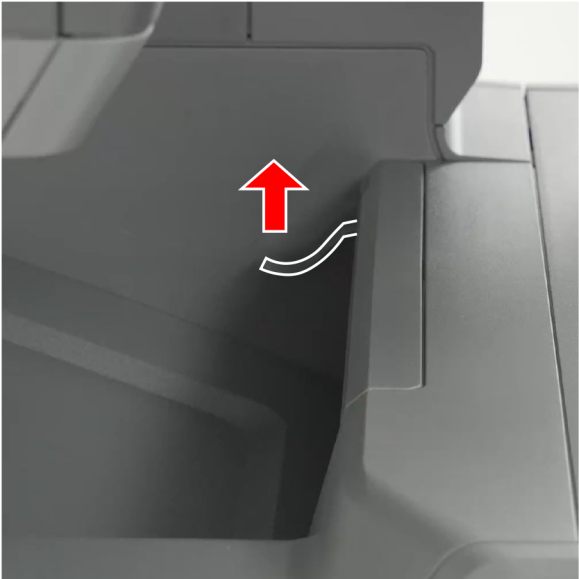
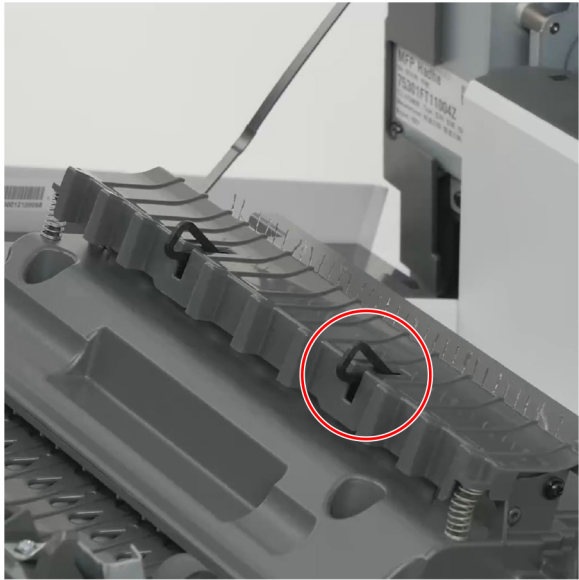
Tests	Notes
Pick roller index (tray 1)	<ol style="list-style-type: none"> 1 Remove the tray insert.
Paper present (tray 1)	<ol style="list-style-type: none"> 2 Lower the pick roller to toggle the sensor. 
MPF media present	Load or remove paper on the MPF to toggle the sensor.
Tray 1 pick	--
MPF/pass-through	--
Input	--
Narrow media	<p>Open the front door to access the sensor.</p> 

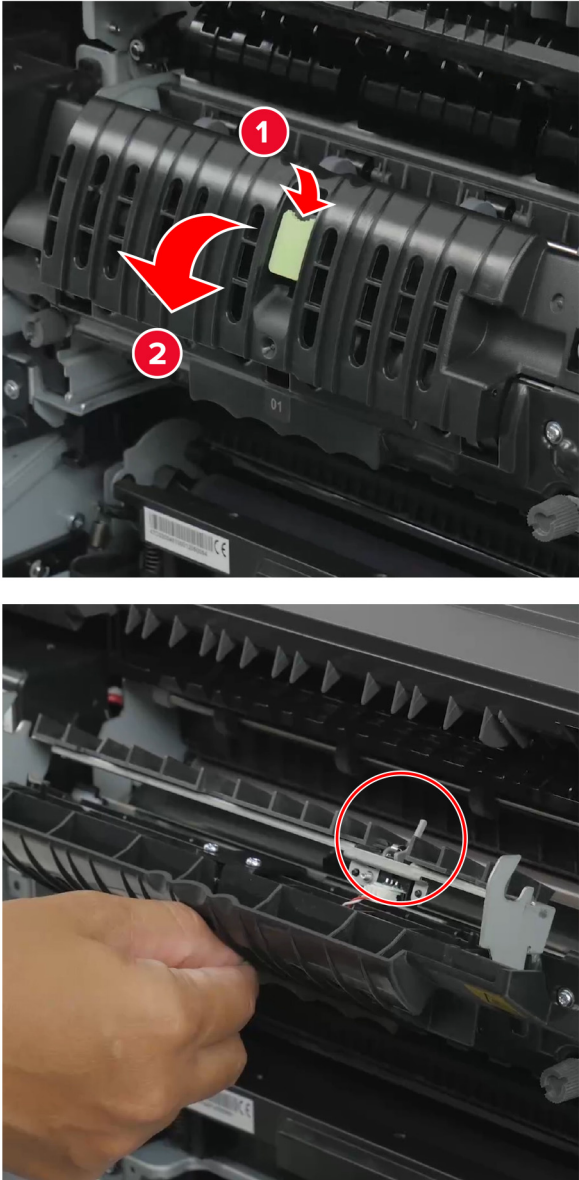
Tests	Notes
Output bin full	<p data-bbox="610 201 1032 233">Lift the bin flag to toggle the sensor.</p>  <p data-bbox="753 281 1328 856">A close-up photograph of the output bin's internal mechanism. A red arrow points upwards from a small, curved white flag, indicating the direction to lift it to toggle the sensor.</p>
Redrive/Duplex path 1	--
Duplex path 2	--
Fuser buckle	<p data-bbox="610 1001 1097 1033">Open the front door to access the sensor.</p>  <p data-bbox="753 1083 1328 1659">A close-up photograph of the fuser buckle mechanism. A red circle highlights a small black component, which is the sensor mentioned in the notes. A metal tool is visible in the background, used to access this area.</p>

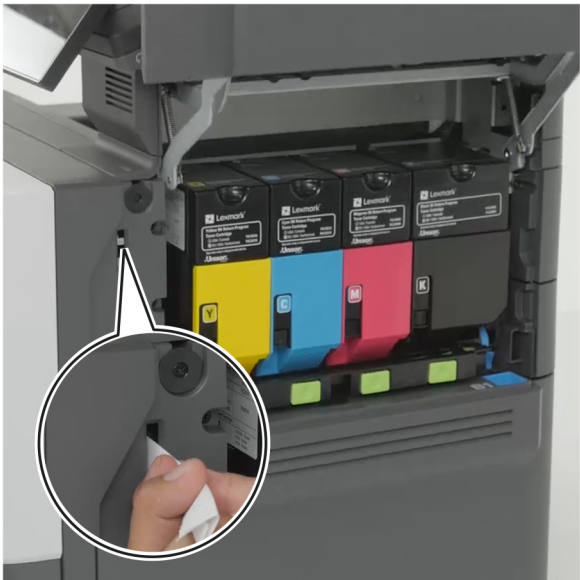
Tests	Notes
Fuser exit	<p data-bbox="610 201 1190 233">Open the fuser access door to access the sensor.</p>  <p>The top photograph shows the fuser assembly with a door handle being pulled. Red arrows and numbers 1 and 2 indicate the direction of movement. The bottom photograph shows the door open, with a red circle highlighting a sensor component.</p>
Fuser nip release home	--

Tests	Notes
Door interlock	<ol style="list-style-type: none"><li data-bbox="626 205 948 237">1 Open the cartridge door.<li data-bbox="626 247 1208 279">2 Toggle the sensor with a folded sheet of paper. 
Pass/Fail Cables	--
Waste Toner Bottle	<ol style="list-style-type: none"><li data-bbox="626 997 1024 1029">1 Remove the waste toner bottle.<li data-bbox="626 1039 1208 1071">2 Toggle the sensor with a folded sheet of paper. 

Tests	Notes
Media size (tray 1) switch 1	Remove the tray insert to access the switches. 
Media size (tray 1) switch 2	
Media size (tray 1) switch 3	
Media size (tray 1) switch 4	
K Toner meter	--
C Toner meter	--
M Toner meter	--
Y Toner meter	--

Motor tests

1 Enter the Diagnostics menu, and then navigate to:

Printer diagnostics & adjustments > Motor tests



2 Select a motor, and then touch **Start**.

Notes:

- If the motor is activated, then it is properly working.
- Some motors require automatic deactivation in order to avoid secondary issues such as possible damage and contamination.
- Some tests require a special action to activate a motor such as removing a major component.
- If the motor fails, the test failure may not indicate a failed motor. Further troubleshooting may be required. Check the boards and cables for possible issues.

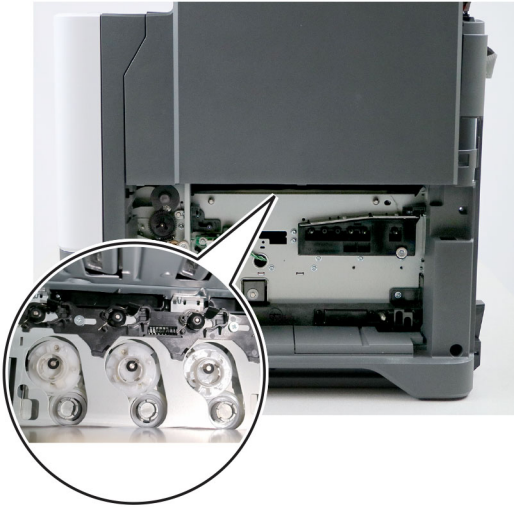
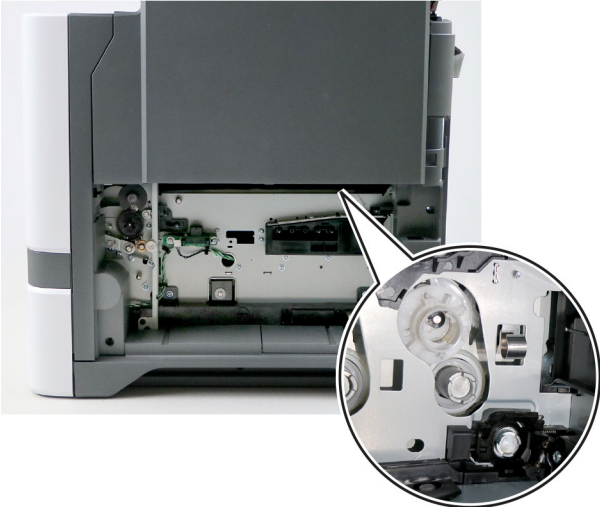
List of motor tests

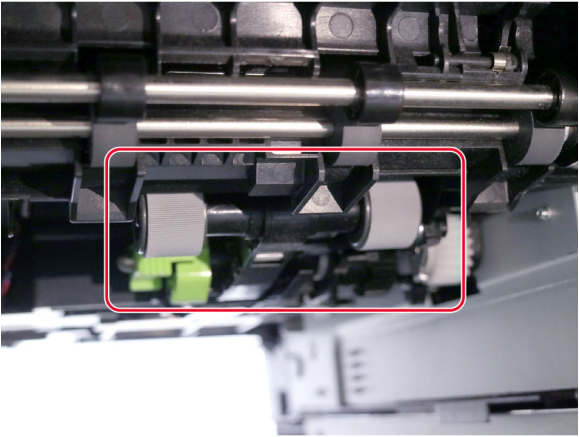
Test	Notes
CMY developer	<ol style="list-style-type: none"> 1 Remove the imaging kit. 2 Close all doors. <p>The test is successful if the couplings rotate.</p> 
K developer-transfer	<ol style="list-style-type: none"> 1 Remove the imaging kit. 2 Remove the transfer module. See “Transfer module removal” on page 431. 3 Close all doors. <p>The test is successful if the coupling rotates.</p> 

Test	Notes
Pick (tray 1)	<p>Remove the tray insert. The test is successful if the pick roller activates.</p> 
Isolation	--
Deskew	--
Fuser	Close all doors.
Redrive	<p>The test is successful if the rollers activate.</p> 
Duplex/MPF	--
Black only retract	<ol style="list-style-type: none"> 1 Remove the imaging kit. 2 Remove the transfer module. See “Transfer module removal” on page 431. 3 Close all doors.

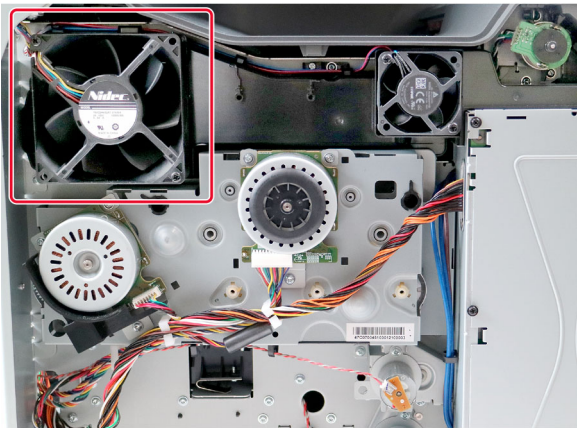
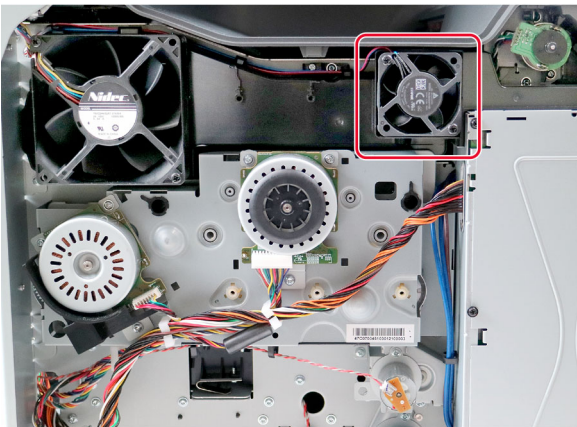
Test	Notes
Fan (main)	<p>Remove the left cover.</p> <p>The test is successful if the main fan activates.</p> 
Fan (fuser)	<p>Remove the left cover.</p> <p>The test is successful if the fuser fan activates.</p> 

Registration adjust

This setting lets you adjust the skew, margins, or perform a Quick Test. For more information, see [“Registration adjustment” on page 369](#).

- 1 Enter the Diagnostics menu, and then navigate to:
Printer diagnostics & adjustments > Registration adjust
- 2 Select a setting to adjust.

Color alignment adjust

This setting allows you to adjust the color alignments and to print or reset the default settings.

- 1 Enter the Diagnostics menu, and then navigate to:
Printer diagnostics & adjustments > Color alignment adjust
- 2 Select a setting.

Supply reset

The setting resets the transfer module counter values to zero.

- 1 Enter the Diagnostics menu, and then navigate to:
Printer diagnostics & adjustments > Supply reset
- 2 Select a setting, and then touch **Start**.

Add-on cards tests

This setting allows you to test the add-on cards installed on the printer.

- 1 Enter the Diagnostics menu, and then navigate to:
Printer diagnostics & adjustments > Add-on cards tests
- 2 Select a card.

Weather station

This setting lets you view the temperature and humidity of the weather station sensor.

- 1 Enter the Diagnostics menu, and then touch **Printer diagnostics & adjustments**.
- 2 From the Weather station row, touch **Start**.

Fuser temperature

This setting lets you view the fuser temperature.

- 1 Enter the Diagnostics menu, and then touch **Printer diagnostics & adjustments**.
- 2 From the Fuser temperature row, touch **Start**.

Universal Override

This setting allows the user to load custom paper sizes into a paper source.

- 1 Enter the Diagnostics menu, and then navigate to:
Printer diagnostics & adjustments > Universal Override
- 2 Select a setting to adjust.

Memory tests

This setting lets you test or flash the printer memory or test or format the printer hard disk.

- 1 Enter the Diagnostics menu, and then navigate to:
Printer diagnostics & adjustments > Memory tests
- 2 Select a setting.

Out of service erase

This setting deletes nonvolatile memory and information on the storage drive.

- 1 Enter the Diagnostics menu, and then navigate to:
Out of service erase
- 2 Touch **Start**.

Event Log

Display Log

This setting displays the panel text that appears when the event occurs.

Enter the Diagnostics menu, and then navigate to:

Event Log > Display Log

Print Log

This setting lists an extended version of the various printer events.

- 1 Enter the Diagnostics menu, and then navigate to:
Event Log > Print Log
- 2 Touch **Start**.

Note: The events that appear in the report vary depending on the operational history of the printer.

Print Log Summary

This setting lists a brief summary of the various printer events.

- 1 Enter the Diagnostics menu, and then navigate to:
Event Log > Print Log Summary
- 2 Touch **Start**.

Note: The events that appear in the report vary depending on the operational history of the printer.

Mark Log

This setting allows you to create a service, maintenance, or custom log entry. Each log entry is added in the printer event log.

- 1 Enter the Diagnostics menu, and then navigate to:
Event Log > Mark Log
- 2 Select a log that you want to create, and then touch **Start**.

Input tray quick print

Note: For a video demonstration, see [Performing the input tray quick print](#).

This setting lets you print a single or continuous Quick Test page in either duplex or simplex mode.

- 1 Enter the Diagnostics menu, and then touch **Input tray quick print**.
- 2 Select where you want to print the pages from.
- 3 Select whether to print a single or continuous test page, and then touch **Start**.

Additional input trays adjustments/tests

Sensor tests

- 1 Enter the Diagnostics menu, and then touch **Additional input trays adjustments/tests**.
- 2 From the Additional input tray sensors row, touch **Start**.
A list of sensors appears.
- 3 Find, and then manually toggle the sensor.

Notes:

- The sensor status on the screen toggles between **1** and **0** when the sensor is properly working.
- If a sensor test fails, the test failure may not indicate a failed sensor. Further troubleshooting may be required. Check the boards and cables for possible issues.

List of sensor tests

Media size (tray 2) switch 1
Media size (tray 2) switch 2
Media size (tray 2) switch 3
Media size (tray 2) switch 4
Media size (tray 3) switch 1
Media size (tray 3) switch 2
Media size (tray 3) switch 3
Media size (tray 3) switch 4
Media size (tray 4) switch 1

Media size (tray 4) switch 2
Media size (tray 4) switch 3
Media size (tray 4) switch 4
Media size (tray 5) switch 1
Media size (tray 5) switch 2
Media size (tray 5) switch 3
Media size (tray 5) switch 4
Pass-through (tray 2)
Pass-through (tray 3)
Pass-through (tray 4)
Pass-through (tray 5)
Trailing edge (tray 2)
Trailing edge (tray 3)
Trailing edge (tray 4)
Trailing edge (tray 5)
Pick roller index (tray 2)
Pick roller index (tray 3)
Pick roller index (tray 4)
Pick roller index (tray 5)
Paper present (tray 2)
Paper present (tray 3)
Paper present (tray 4)
Paper present (tray 5)

Motor tests

1 Enter the Diagnostics menu, and then navigate to:

Additional input trays adjustments/tests > Additional input tray motors

2 Select a motor, and then touch **Start**.

Notes:

- If the motor is activated, then it is properly working.
- Some motors require automatic deactivation in order to avoid secondary issues such as possible damage and contamination.
- Some tests require a special action to activate a motor such as removing a major component.
- If the motor fails, the test failure may not indicate a failed motor. Further troubleshooting may be required. Check the boards and cables for possible issues.

List of motor tests

Pick (tray 2)
Pick (tray 3)
Pick (tray 4)
Pick (tray 5)
Pass-through (tray 2)
Pass-through (tray 3)
Pass-through (tray 4)
Pass-through (tray 5)

Configuration menu

Entering the Configuration Menu

From the control panel, navigate to:

Settings > Device > Maintenance > Configuration Menu

Configuration Menu

Menu item	Description
USB Configuration USB PnP 1* 2	Change the USB driver mode of the printer to improve its compatibility with a personal computer.
USB Configuration USB Scan to Local On* Off	Set whether the USB device driver enumerates as a USB Simple device (single interface) or as a USB Composite device (multiple interfaces).
USB Configuration USB Speed Full Auto*	Set the USB port to run at full speed and disable its high-speed capabilities.
Tray Configuration Size Sensing Tray [x] Sensing Off On*	Set the tray to sense automatically the paper size loaded into it.
Note: An asterisk (*) next to a value indicates the factory default setting.	

Menu item	Description
Tray Configuration Tray Linking Automatic* Off	Set the printer to link the trays that have the same paper type and paper size settings.
Tray Configuration Show Tray Insert Message Off Only for unknown sizes* Always	Display a message that lets the user change the paper size and paper type settings after inserting the tray.
Tray Configuration A5 Loading Short Edge Long Edge*	Determine the default loading orientation for the A5 size paper in all paper sources.
Tray Configuration Paper Prompts Auto* Multipurpose Feeder Manual Paper	Set the paper source that the user fills when a prompt to load paper appears. Note: For Multipurpose Feeder to appear, in the Paper menu, set Configure MP to Cassette.
Tray Configuration Envelope Prompts Auto* Multipurpose Feeder Manual Envelope	Set the paper source that the user fills when a prompt to load envelope appears. Note: For Multipurpose Feeder to appear, in the Paper menu, set Configure MP to Cassette.
Tray Configuration Action for Prompts Prompt user* Continue Use current	Set the printer to resolve paper- or envelope-related change prompts.
Tray Configuration Multiple Universal Sizes Off On*	Set the tray to support multiple universal paper sizes.
Reports Menu Settings Page Event Log Event Log Summary	Print reports about printer menu settings, status, and event logs.
Supply Usage And Counters Clear Supply Usage History	Reset the supply usage history, such as number of pages and days remaining, to the factory shipped level.
Note: An asterisk (*) next to a value indicates the factory default setting.	

Menu item	Description
Supply Usage And Counters ITM Reset Reset Black Cartridge Counter Reset Cyan Cartridge Counter Reset Magenta Cartridge Counter Reset Yellow Cartridge Counter Reset Maintenance Counter	Reset the counter after installing a new supply item or maintenance kit.
Supply Usage And Counters Tiered Coverage Ranges	Adjust the amount of color coverage for each printing range.
Printer Emulations PPDS Emulation Off* On	Set the printer to recognize and use the PPDS data stream.
Printer Emulations PS Emulation Off On*	Set the printer to recognize and use the PS data stream.
Printer Emulations Enable Formsmerge Off* On	Activate formsmerge to store the forms into the hard disk or intelligent storage drive (ISD). Note: The printer must have a hard disk or an ISD installed.
Printer Emulations Enable Prescribe Off* On	Activate Prescribe. Note: The Prescribe license must be installed.
Printer Emulations Emulator Security Page Timeout 0–60 (60*)	Set the page timeout during emulation.
Printer Emulations Emulator Security Reset Emulator After Job Off* On	Reset the emulator after a print job.
Printer Emulations Emulator Security Disable Printer Message Access Off On*	Disable access to printer message during emulation.
Note: An asterisk (*) next to a value indicates the factory default setting.	

Menu item	Description
Fax Configuration Fax Low Power Support Disable Sleep Permit Sleep Auto*	Set fax to enter Sleep mode whenever the printer determines that it must.
Fax Configuration Fax Storage Location NAND Disk*	Set the storage location for all faxes. Note: This menu item appears only when a hard disk or an ISD is installed.
Print Configuration Black Only Mode Off* On	Print non-copy jobs in grayscale.
Print Configuration Color Trapping Off 1 2* 3 4 5	Enhance the printed output to compensate for misregistration in the printer.
Print Configuration Font Sharpening 0–150 (24*)	Set a text point-size value below which the high-frequency screens are used when printing font data. For example, if the value is 24, then all fonts sized 24 points or less use the high-frequency screens.
Device Operations Quiet Mode Off* On	Set the printer to operate in Quiet Mode. Note: Enabling this setting slows down the overall performance of the printer.
Device Operations Panel Menus Off On*	Enable access to the printer menus from the control panel.
Device Operations Safe Mode Off* On	Set the printer to operate in a special mode, in which it attempts to continue offering as much functionality as possible, despite known issues. For example, when set to On, and the duplex motor is nonfunctional, the printer performs one-sided printing of the documents even if the job is two-sided printing.
Note: An asterisk (*) next to a value indicates the factory default setting.	

Menu item	Description
Device Operations Minimum Copy Memory 80 MB* 100 MB	Set the minimum memory allocation for storing copy jobs.
Device Operations Clear Custom Status	Erase user-defined strings for the Default or Alternate custom messages.
Device Operations Clear all remotely-installed messages	Erase messages that were remotely installed.
Device Operations Automatically Display Error Screens Off On*	Show existing error messages on the display after the printer remains inactive on the home screen for a length of time.
Device Operations Honor orientation on fast path copy Off* On	Enable the printer to use the orientation setting under the Copy menu when sending quick copy jobs.
Toner patch sensor setup Calibration frequency preference Disabled Fewest color adjustments Fewer color adjustments Normal* Better color accuracy Best color accuracy	Set how often color calibration and color alignment is performed.
Toner patch sensor setup Full calibration	Optimize print darkness, print linearization, and color alignment.
Toner patch sensor setup Print TPS information page	Print a diagnostic page that contains information on toner patch sensor calibration.
App Configuration LES Applications Off On*	Enable Lexmark Embedded Solutions (LES) applications.
Scanner Configuration Scanner Manual Registration Print Quick Test	Print a Quick Test target page. Note: Make sure that the margin spacing on the target page is uniform all the way around the target. If it is not, then the printer margins must be reset.
Scanner Configuration Scanner Manual Registration Front ADF Registration Rear ADF Registration Flatbed Registration	Manually register the flatbed and ADF after replacing the ADF, scanner glass, or controller board.
Note: An asterisk (*) next to a value indicates the factory default setting.	

Menu item	Description
Scanner Configuration Reset Maintenance Counter	Reset the counter after replacing the ADF maintenance kit.
Scanner Configuration Edge Erase Flatbed Edge Erase (3*) ADF Edge Erase (3*)	Set the size, in millimeters, of the no-print area around an ADF or flatbed scan job.
Scanner Configuration ADF Deskew ADF Electronic Deskew (On*)	Reduce skewing of documents that are scanned from the ADF.
Scanner Configuration Disable Scanner No* Yes ADF Only	Disable the scanner when it is not working properly.
Scanner Configuration Tiff Byte Order CPU Endianness* Little Endian Big Endian	Set the byte order of a TIFF-formatted scan output.
Scanner Configuration Exact Tiff Rows Per Strip On* Off	Set the RowsPerStrip tag value of a TIFF-formatted scan output.
Note: An asterisk (*) next to a value indicates the factory default setting.	

Entering Invalid engine mode

This mode allows the printer to load the correct firmware code. For more information, see [“Updating the printer firmware ” on page 365](#).

- 1 Unplug the power cord from the electrical outlet.
- 2 Open tray 1.
- 3 Connect the power cord to the electrical outlet.

When the display shows the following icon, close tray 1.

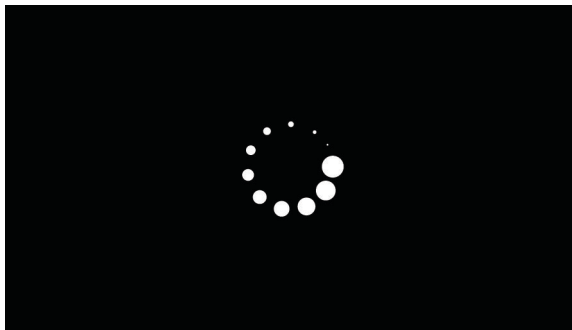

4 Touch -> to navigate the menu that appears on the display, and then select **ENGINE_FLASH**.

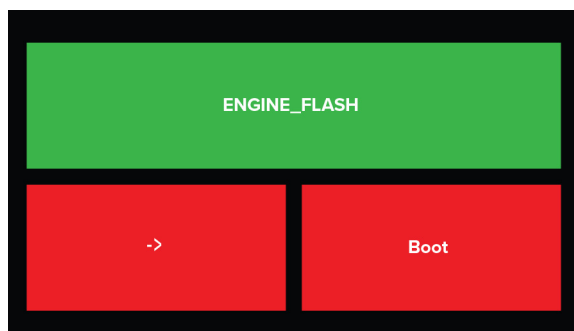

Note: The selected menu turns green.

5 Touch **Boot**.

Entering Recovery mode

This mode allows the printer to boot from a secondary set of instructions and flash firmware code. While in this mode, you can only flash firmware code through a USB cable directly connected to a PC.

Depending on your printer model, do any of the following:

For LED display

- 1 Turn off the printer.
- 2 Open the front door.
- 3 Press and hold the **Stop** button.
- 4 Turn on the printer.
- 5 When all the icons flash, release the button.

For 2-line display

- 1 Turn off the printer.
- 2 Press and hold the **OK** and **Back** buttons.
- 3 Turn on the printer.

- 4 When the display shows the following icon, release the buttons.

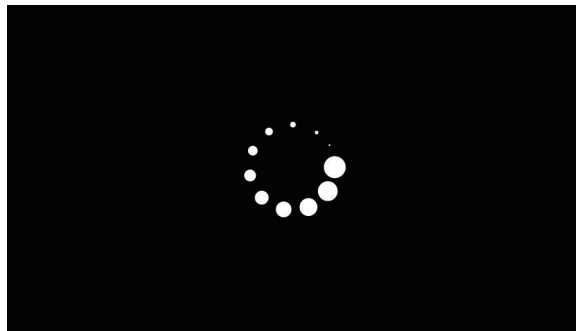

For 2.4-, 4.3-, 7-, and 10-inch displays with number pads

- 1 Turn off the printer.
- 2 Press and hold the **2**, **7**, and **8** buttons.
- 3 Turn on the printer.
- 4 When the display shows the following icon, release the buttons.

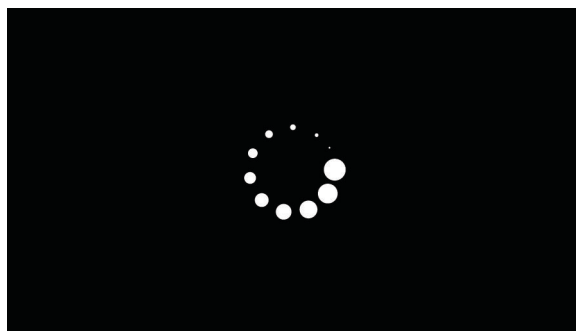

For 2.8-, 4.3-, 7-, and 10-inch displays without number pads

- 1 Turn off the printer.
- 2 Open tray 1.
Note: Make sure that paper is loaded in the tray.
- 3 Turn on the printer.
- 4 When an ellipses appears on the upper-left corner of the display, close tray 1.
Note: If tray 1 is not closed, then the printer boots normally.

Service Engineer menu

Entering the Service Engineer (SE) menu

- 1 From the home screen, touch .
- 2 Touch ****411**, and then touch **OK**.

General SE

Enter the Service Engineer (SE) menu, and then select **General SE**.

The following settings are available:

- Capture Logs to USB drive
- Capture Logs to Internal Storage
- Code Versions
- Debug Level

Network SE

Enter the Service Engineer (SE) menu, and then select **Network SE**.

Note: Use these settings as directed by the next level of support.

Top level menu	Intermediate menu
History	<ul style="list-style-type: none"> • Print History • Mark History
MAC	<ul style="list-style-type: none"> • Set Card Speed • LAA • Keep Alive
NPAP	Print Alerts
TCP/IP	<ul style="list-style-type: none"> • DHCP Request Options • netstat • arp • Allow SNMP Set • MTU • Meditech Mode • RAW LPR Mode • Garp Interval
Wireless Settings Note: This setting is only available if a wireless module is installed.	<ul style="list-style-type: none"> • Wireless Performance Enhancement • Unset Wireless Region • Disable Wireless 11n • Disable PMF

Top level menu	Intermediate menu
Ping Test	<ul style="list-style-type: none"> • Ping Address • Attempts • Packet Size • Ping
Other Actions	<ul style="list-style-type: none"> • ifconfig • IPtables [Firewall Dump] • IP6tables [Firewall Dump] • IPsec Dump
Enable DHCPD Debugging	N/A
Enable WPA-suplicant Debugging	N/A
Enable Ethernet Gigabit	N/A
Enable Dual-NIC	N/A
Enable BLE	N/A
Netconfig Debug Level	N/A
IPP ICONS	<ul style="list-style-type: none"> • Delete intermediate icons • Delete current icons

Fax SE

Use this menu for the fax transmission and fax reception service checks.

Enter the Service Engineer (SE) menu, and then select **Fax SE**.

Note: Use these settings as directed by the next level of support.

Top level menu	Intermediate menu
Agency Test Menu	<ul style="list-style-type: none"> • Go Off Hook • Ring Detect • Generate Tones • Modulations
Fax Settings	<ul style="list-style-type: none"> • Fax Modulations • FOIP Settings • Miscellaneous Settings • Reset Fax Settings
Modem Settings	<ul style="list-style-type: none"> • Caller ID Pattern <ul style="list-style-type: none"> Note: Changing the value of this setting also changes the value of the Caller ID setting in the Fax Settings. • Pulse Dial Type • Disable Sending CRP • Dial Wait Time • ANSam Transmit Time

Top level menu	Intermediate menu
Fax Logs	<ul style="list-style-type: none"> • Print All T30 Logs • Print CallerID Log • Print Call Log • Print Fax Settings • Print Job Log • Print All T30 Error Logs • Print T30 Log • Print T38 Trace Log • Clear T38 Trace Log • Reboot System
Reboot System	N/A

Scanner SE

Use this setting to view the scanner calibration data.

Enter the Service Engineer (SE) menu, and then select **Scanner SE**.

Parts removal

Data security notice

Identifying printer memory

- **Volatile memory**—The printer uses standard random access memory (RAM) to buffer user data temporarily during simple print and copy jobs.
- **Nonvolatile memory**—The printer may use two forms of nonvolatile memory: EEPROM and NAND (flash memory). Both types are used to store the operating system, printer settings, network information, scanner and bookmark settings, and embedded solutions.
- **Hard disk memory**—Some printers have a hard disk drive installed. The hard disk is designed for printer-specific functionality and cannot be used for long-term storage of data that is not print-related. The hard disk does not let users extract information, create folders, create disk or network file shares, or transfer FTP information directly from a client device. The hard disk can retain buffered user data from complex print jobs, form data, and font data.

The following parts can store memory:

- Printer control panel
- User interface controller card (UICC)
- Controller board
- Optional hard disks

Note: The printer control panel and controller board contain NVRAM.

Erasing printer memory

To erase volatile memory, turn off the printer.

To erase nonvolatile memory, do the following:

- 1 From the control panel, navigate to **Settings > Device > Maintenance > Out of Service Erase > Sanitize all information on nonvolatile memory**.
- 2 Select **Sanitize all information on nonvolatile memory**, and then select **ERASE**.
- 3 Follow the instructions on the screen.

To erase hard disk memory, do the following:

- 1 From the control panel, navigate to **Settings > Device > Maintenance > Out of Service Erase > Sanitize all information on hard disk**.
- 2 Select **Sanitize all information on hard disk**, and then select **ERASE**.
- 3 Follow the instructions on the screen.





Note: This process can take from several minutes to more than an hour, making the printer unavailable for other tasks.

If a hard disk is replaced, then do the following:





- 1 Remove the hard disk, and then return it to the customer.
- 2 Request the customer to sign the *Customer Retention* form.

Note: You can get printed copies of the form from your Lexmark partner manager.
- 3 Take a photo of the signed form, and then upload it to the Service Request debrief tool.
- 4 Fax or e-mail the signed form to the number or e-mail address shown at the bottom of the form.

Removal precautions

-  **CAUTION—SHOCK HAZARD:** The low-voltage power supply (LVPS) and the high-voltage power supply (HVPS) may have residual voltage present. To avoid the risk of electrical shock, do not touch their circuit components or the solder side of the board. Only handle them by their outer edges or metal housing.
-  **CAUTION—SHOCK HAZARD:** This product uses an electronic power switch. It does not physically disconnect the input AC voltage. To avoid the risk of electrical shock, always remove the power cord from the printer when removal of the input AC voltage is required.
-  **CAUTION—SHOCK HAZARD:** To avoid the risk of electrical shock and to prevent damage to the printer, remove the power cord from the electrical outlet and disconnect all connections to any external devices before you connect or disconnect any cable, electronic board, or assembly.
-  **CAUTION—HOT SURFACE:** The inside of the printer might be hot. To reduce the risk of injury from a hot component, allow the surface to cool before touching it.
-  **CAUTION—PINCH HAZARD:** To avoid the risk of a pinch injury, use caution in areas marked with this label. Pinch injuries may occur around moving parts, such as gears, doors, trays, and covers.





Précautions de retrait

-  **ATTENTION—RISQUE D'ELECTROCUTION :** Une tension résiduelle peut être présente dans le bloc d'alimentation basse tension (LVPS) et le bloc d'alimentation haute tension (HVPS). Pour éviter tout risque d'électrocution, ne touchez pas les composants du circuit ou le côté soudure de la carte. Tenez-les uniquement par leurs extrémités ou le boîtier en métal.
-  **ATTENTION—RISQUE D'ELECTROCUTION :** Ce produit utilise un commutateur d'alimentation électronique. Il ne déconnecte pas physiquement la tension d'alimentation CA. Pour éviter tout risque d'électrocution, débranchez toujours le cordon d'alimentation de l'imprimante lorsque vous devez déconnecter la tension d'alimentation CA.
-  **ATTENTION—RISQUE D'ELECTROCUTION :** Pour éviter tout risque d'électrocution et éviter d'endommager l'imprimante, débranchez le cordon d'alimentation de la prise électrique et déconnectez toute connexion à tout périphérique externe avant de brancher ou débrancher des câbles ou circuits et assemblages électroniques.
-  **ATTENTION—SURFACE CHAUDE :** L'intérieur de l'imprimante risque d'être brûlant. Pour réduire le risque de brûlure, laissez la surface ou le composant refroidir avant d'y toucher.
-  **ATTENTION : RISQUE DE PINCEMENT :** Pour éviter tout risque de blessure par pincement, agissez avec précaution au niveau des zones signalées par cette étiquette. Les blessures par pincement peuvent se produire autour des pièces mobiles telles que les engrenages, portes, tiroirs et capots.

Precauciones durante la extracción

-  **PRECAUCIÓN: PELIGRO DE DESCARGAS ELÉCTRICAS:** La fuente de alimentación de bajo voltaje (LVPS) y la fuente de alimentación de alto voltaje (HVPS) pueden presentar voltaje residual. Para evitar el riesgo de descarga eléctrica, no toque los componentes del circuito ni el lateral soldado de la placa. Manipule solo los bordes exteriores o la carcasa metálica.
-  **PRECAUCIÓN: PELIGRO DE DESCARGAS ELÉCTRICAS:** Este producto utiliza un interruptor de corriente electrónico. No desconecta físicamente la entrada de voltaje de CA. Para evitar el riesgo de descarga eléctrica, desenchufe siempre el cable de alimentación de la impresora cuando sea necesario retirar la entrada de voltaje de CA.
-  **PRECAUCIÓN: PELIGRO DE DESCARGAS ELÉCTRICAS:** Para evitar el riesgo de descargas eléctricas y daños en la impresora, retire el cable de alimentación de la toma eléctrica y desconecte todas las conexiones a dispositivos externos antes de conectar o desconectar cualquier cable, placa electrónica o conjunto.
-  **PRECAUCIÓN: SUPERFICIE CALIENTE:** El interior de la impresora podría estar caliente. Para evitar el riesgo de heridas producidas por el contacto con un componente caliente, deje que la superficie se enfríe antes de tocarlo.
-  **PRECAUCIÓN: PELIGRO DE ATRAPAMIENTO:** Para evitar el riesgo de lesión por atrapamiento, preste atención en las áreas marcadas con esta etiqueta. Las lesiones por atrapamiento se pueden producir en torno a partes móviles, tales como engranajes, puertas, bandejas y cubiertas.

Vorsichtsmaßnahmen bei der Demontage

-  **VORSICHT – STROMSCHLAGGEFAHR:** Im Niederspannungsnetzteil (LVPS) und Hochspannungsnetzteil (HVPS) liegt unter Umständen Restspannung vor. Um das Risiko eines elektrischen Schlags zu vermeiden, berühren Sie keine umliegenden Bauteile oder die Lötseite der Platine. Fassen Sie sie nur an den Außenkanten oder am Metallgehäuse an.
-  **VORSICHT – STROMSCHLAGGEFAHR:** Dieses Produkt verwendet einen elektronischen Leistungsschalter. Er trennt die Eingangswchselspannung nicht physikalisch. Um das Risiko eines elektrischen Schlags zu vermeiden, ziehen Sie stets das Netzkabel vom Drucker ab, wenn eine Abtrennung der Eingangswchselspannung erforderlich ist.
-  **VORSICHT – STROMSCHLAGGEFAHR:** Um das Risiko eines elektrischen Schlags und Schäden am Drucker zu vermeiden, ziehen Sie das Netzkabel aus der Steckdose und trennen Sie alle Verbindungen zu jeglichen externen Geräten, bevor Sie Kabel, Elektronikplatinen oder Baugruppen einstecken oder abziehen.
-  **VORSICHT – HEISSE OBERFLÄCHE:** Das Innere des Druckers kann sehr heiß sein. Vermeiden Sie Verletzungen, indem Sie heiße Komponenten stets abkühlen lassen, bevor Sie ihre Oberfläche berühren.
-  **VORSICHT – QUETSCHGEFAHR:** Um das Risiko einer Quetschung zu vermeiden, gehen Sie in Bereichen, die mit diesem Etikett gekennzeichnet sind, mit Vorsicht vor. Quetschungen können im Bereich von beweglichen Komponenten auftreten, wie z. B. Zahnrädern, Klappen, Fächern und Abdeckungen.

Handling ESD-sensitive parts

To prevent damage to the electrostatic discharge (ESD)-sensitive parts in the printer, do the following:

- Turn off the printer before removing logic boards.
- Keep the parts in their original packing material until you are ready to install them into the printer.
- Make the least-possible movements with your body to prevent an increase of static electricity from clothing fibers, carpets, and furniture.
- Use the ESD wrist strap. Connect the wrist band to the system ground point. This action discharges any static electricity in your body to the printer.
- Hold the parts by their edge connector shroud. Do not touch its pins. If you are removing a pluggable module, then use the correct tool.
- If possible, keep all parts in a grounded metal cabinet.
- Do not place the parts on the printer cover or on a metal table. If you need to put down the parts, then put them in their packing material.
- Prevent parts from being accidentally touched by other personnel. Cover the printer when you are not working on it.
- Be careful while working with the parts when cold-weather heating is used. Low humidity increases static electricity.

Critical information for controller board or engine board replacement

 **CAUTION—POTENTIAL INJURY:** The lithium battery in this product is not intended to be replaced. There is a danger of explosion if a lithium battery is incorrectly replaced. Do not recharge, disassemble, or incinerate a lithium battery. Discard used lithium batteries according to the manufacturer's instructions and local regulations.

 **ATTENTION—RISQUE DE BLESSURE :** La batterie lithium de ce produit n'est pas destinée à être remplacée. Il existe un risque d'explosion si une batterie lithium est placée de façon incorrecte. Ne rechargez pas, ne démontez pas et n'incinerez pas une batterie lithium. Mettez les batteries lithium usagées au rebut selon les instructions du fabricant et les réglementations locales.

 **PRECAUCIÓN: POSIBLES DAÑOS PERSONALES:** La batería de litio de este producto no debe reemplazarse. Existe riesgo de explosión si se sustituye incorrectamente una batería de litio. No recargue, desmonte ni incinere una batería de litio. Deseche las baterías de litio según las instrucciones del fabricante y las normativas locales.

 **VORSICHT – MÖGLICHE VERLETZUNGSGEFAHR** Die Lithiumbatterie in diesem Produkt darf nicht ausgetauscht werden. Wird eine Lithiumbatterie nicht ordnungsgemäß ausgetauscht, besteht Explosionsgefahr. Lithiumbatterien dürfen auf keinen Fall wieder aufgeladen, auseinander genommen oder verbrannt werden. Befolgen Sie zum Entsorgen verbrauchter Lithiumbatterien die Anweisungen des Herstellers und die örtlichen Bestimmungen.

Read the following instructions carefully before performing them. Practice accessing DIAGNOSTICS_MODE first before replacing the part. See [“Entering the Diagnostics Menu” on page 323](#).

Warning—Potential Damage: An invalid engine code error occurs if the controller board and engine board are not on the same firmware level. Resolve the error shown with firmware updates. For more information, see [“Entering Invalid engine mode” on page 351](#) and [“Updating the printer firmware ” on page 365](#).

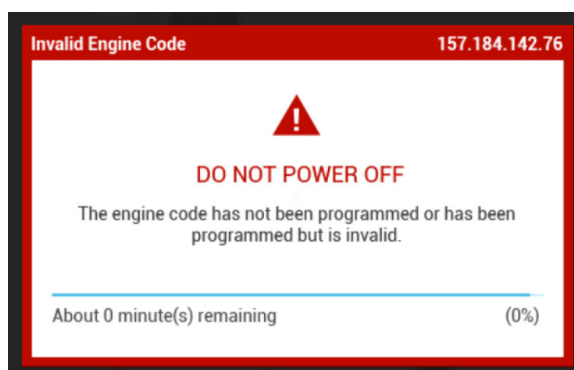

Warning—Potential Damage: To avoid NVRAM mismatch issues, replace only one of the following components at a time:

- Engine board
- Controller board

To replace a component and to test whether the problem is resolved:

1 Replace the affected component.

Warning—Potential Damage: Do not perform a Power-On Reset (POR) until the problem is resolved. If a POR is performed at this point, then the replacement part can no longer be used in another printer and must be returned to the manufacturer.

2 Enter the Diagnostics Menu. The Diagnostics Menu allows you to temporarily use the replacement part.

Warning—Potential Damage: Some printers will perform a POR automatically if the Diagnostics Menu is not opened within five seconds. If a POR is performed at this point, then the replacement part can no longer be used in another printer and must be returned to the manufacturer.

3 Use the Diagnostics Menu to test the replacement part. Do a feed test to check if the problem is resolved.

- If the problem is not resolved—Turn off the printer, and then reinstall the old part.
- If the problem is resolved—Perform a POR.

Restoring the printer configuration after replacing the controller board

Restore the printer to its correct configuration to complete the replacement service. Use the Service Restore Tool to download the software bundle, and then flash the printer settings and embedded solutions.

Note: The software bundle contains the latest version of the firmware, applications, and software licenses from the Lexmark Virtual Solutions Center (VSC). The printer firmware may be at a different level from what was used before replacing the controller board.

Using the Service Restore Tool

- 1** Go to <https://cdp.lexmark.com/service-restore-tool/> to access the tool.
- 2** Log in using your Lexmark or partner login.
If your login fails, then contact your next level of support.

- 3 Enter the printer serial number, and then submit the information.

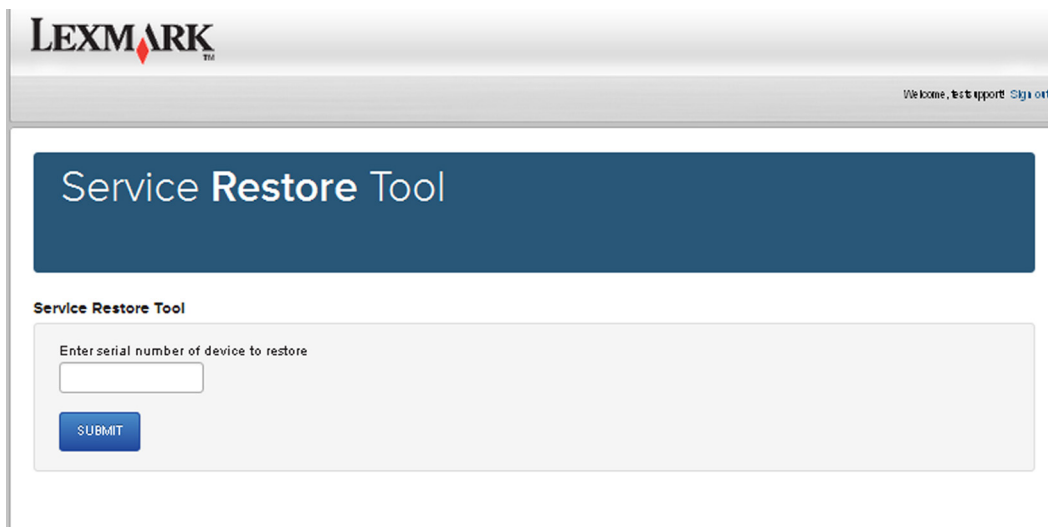

The screenshot shows the Lexmark Service Restore Tool interface. At the top left is the Lexmark logo. At the top right, there is a navigation bar with the text "Welcome, test support" and a "Sign out" link. Below this is a large blue header with the text "Service Restore Tool". Underneath the header, the text "Service Restore Tool" is repeated. A form area contains the instruction "Enter serial number of device to restore" above a text input field. Below the input field is a blue "SUBMIT" button.

Note: Make sure that the serial number that appears on the verification screen is correct.

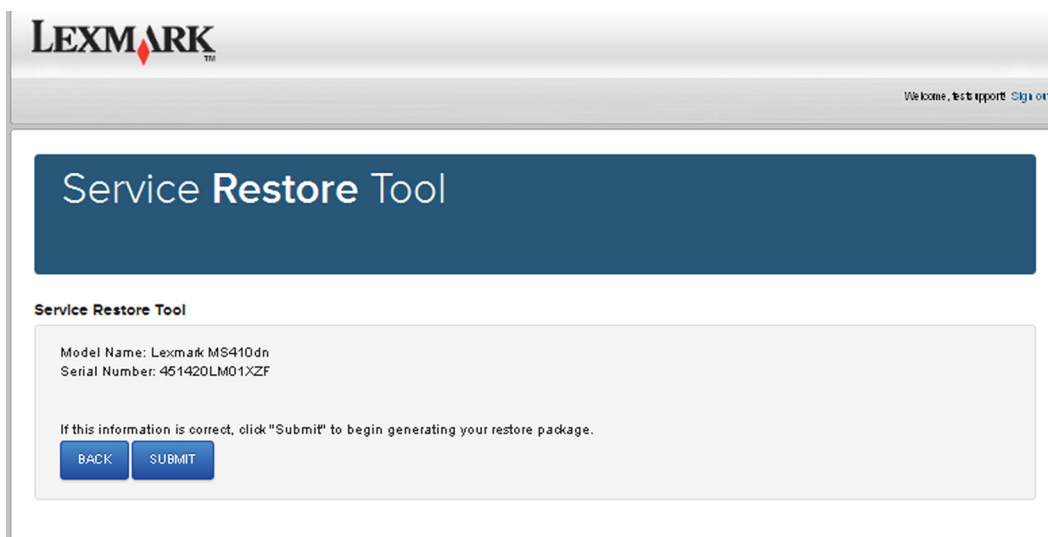

The screenshot shows the Lexmark Service Restore Tool interface at the verification stage. At the top left is the Lexmark logo. At the top right, there is a navigation bar with the text "Welcome, test support" and a "Sign out" link. Below this is a large blue header with the text "Service Restore Tool". Underneath the header, the text "Service Restore Tool" is repeated. A form area displays the following information: "Model Name: Lexmark MS410dn" and "Serial Number: 451420LM01XZF". Below this information is the instruction "If this information is correct, click 'Submit' to begin generating your restore package." At the bottom of the form area are two blue buttons: "BACK" and "SUBMIT".

- 4 Save the zip file.

Note: Make sure that the serial number in the zip file matches the serial number of the printer being restored.

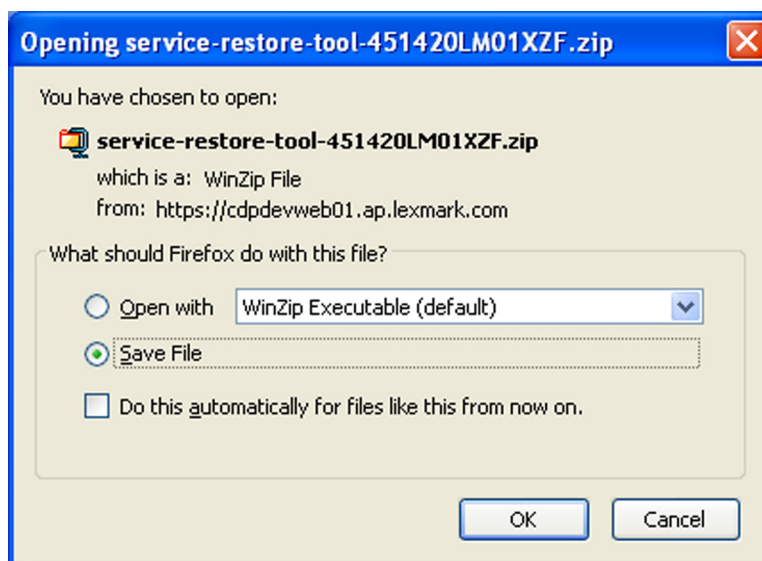

- 5 Extract the contents of the zip file, open the *Readme* file, and then follow the instructions in the file.

Notes:

- Perform the install instructions on the *Readme* file in the exact order shown. Restart the printer only if the file says so.
- For more information on how to flash the downloaded files, see [“Updating the printer firmware” on page 365](#).
- To load the zip files that are extracted from the Service Restore Tool, see [“Restoring solutions, licenses, and configuration settings” on page 364](#).

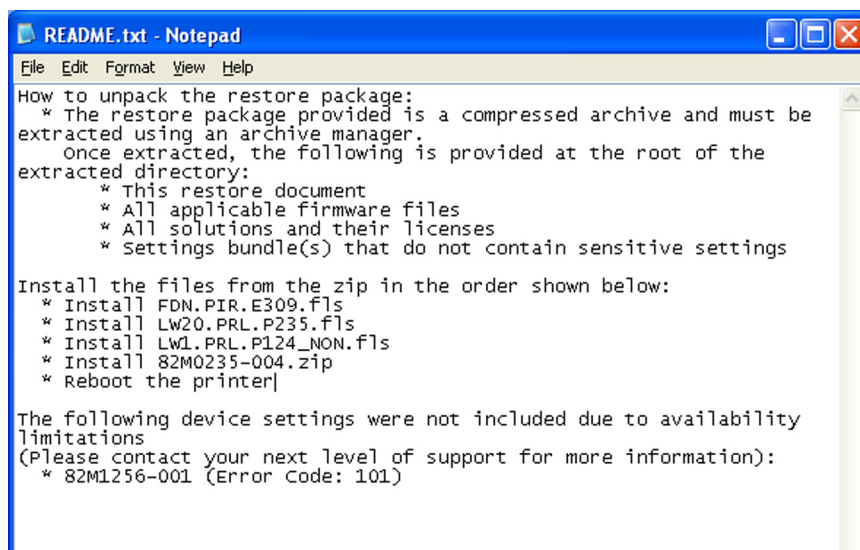

- 6 After performing the installation instructions in the *Readme* file, confirm from the customer if all the eSF apps have been installed.

Notes:

- If you are unable to access the administrative menus to verify that the printer is restored, then ask the customer for access rights.
- If a 10.00 error appears after you restart the printer, then contact the next level of support.

Restoring solutions, licenses, and configuration settings

To load the zip files that are extracted from the Service Restore Tool, do the following:

- 1 Open a web browser, and then type the printer IP address.

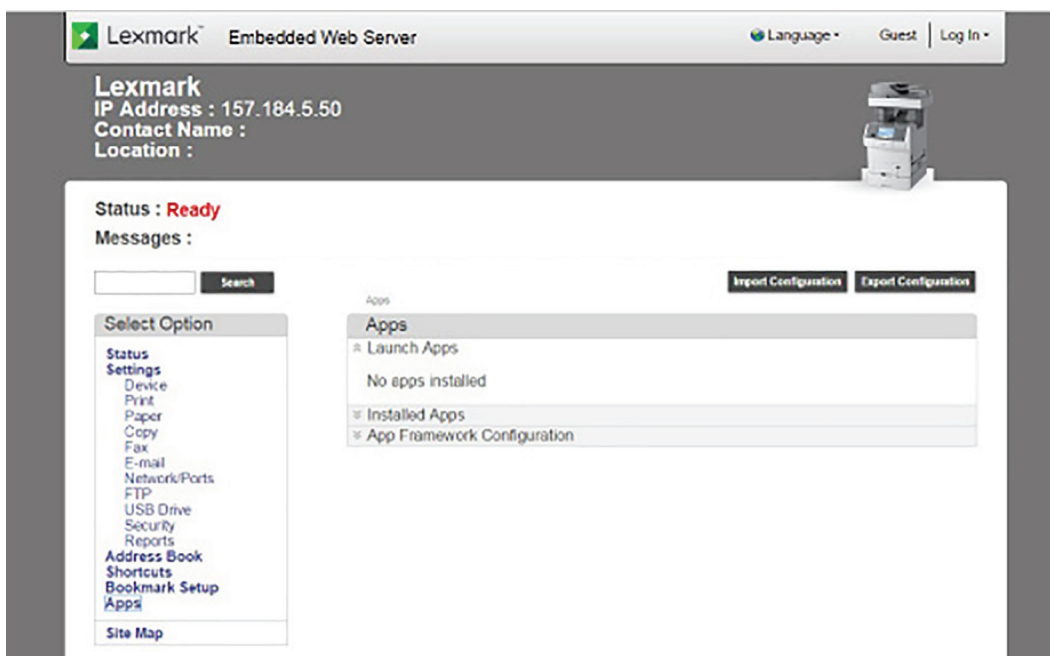

- 2 Click **Import Configuration**, and then click **Browse**.

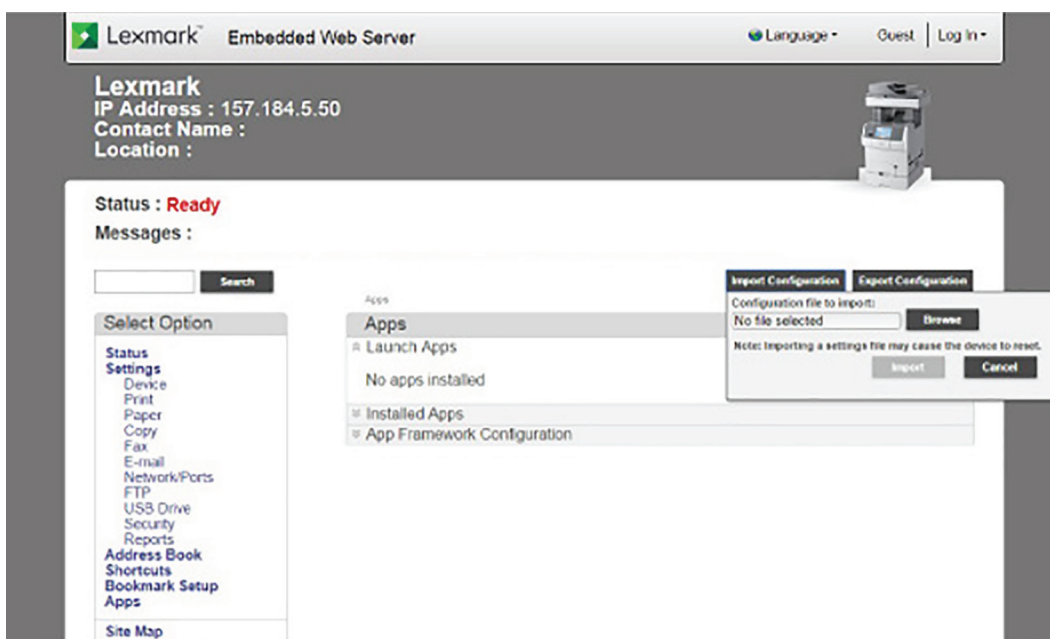

- 3 Navigate to the folder where the zip files are extracted from the Service Restore Tool.

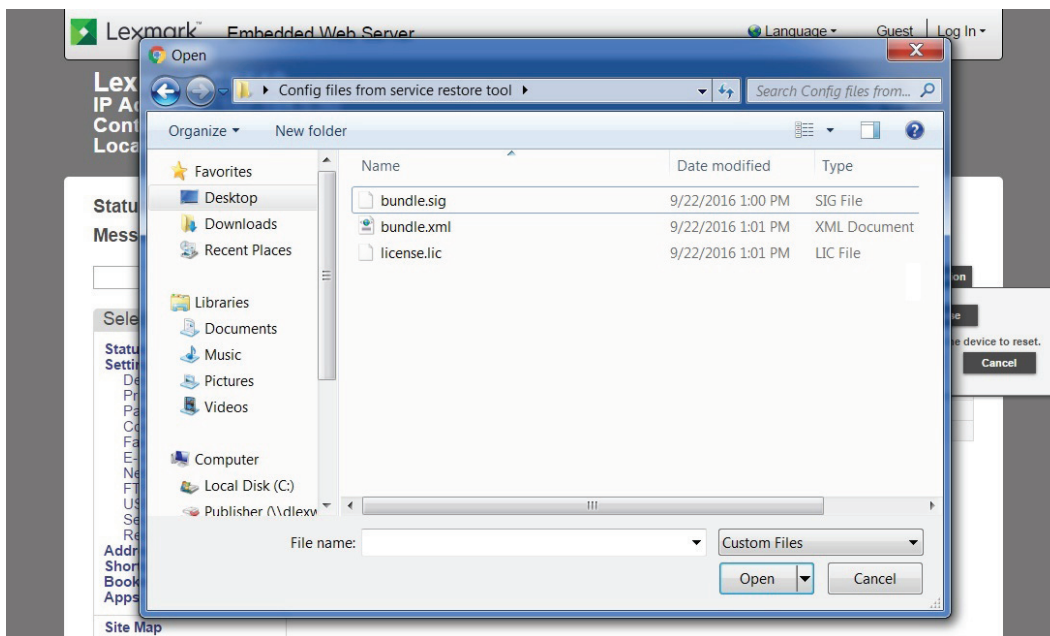

- 4 Select the file to import, and then click **Import**.
- 5 Repeat step 2 through step 4 for the other files that are included in the extracted zip file.

Updating the printer firmware

Warning—Potential Damage: Before updating the printer firmware, ask the next level of support for the correct code. Using an incorrect code level may damage the printer.

The printer must be in ready state in order to update the firmware. For more information, see [“Entering Invalid engine mode” on page 351](#).

Using a flash drive

This option is available only in printer models with front USB port.

Make sure to enable the Enable Drive and Update Code settings. You can find the settings in the Flash drive menu under the Settings menu.

- 1 Insert the flash drive.
The display lists the files on the thumbdrive.

- 2 Select the file that you need to flash.

Note: Do not turn off the printer while the update is going on.

Using a network computer

Using the File Transfer Protocol (FTP)

Make sure that the printer is in ready state before flashing.

- 1 Turn on the printer.
- 2 Obtain the IP address:
 - From the home screen
 - From the TCP/IP section of the Network/Ports menu
- 3 From the command prompt of a network computer, open an FTP session to the printer IP address.
- 4 Use a PUT command to place the firmware file on the printer.
The printer performs a POR sequence and terminates the FTP session.
- 5 Repeat step 2 through to step 4 for the other files.

Using the Embedded Web Server

Make sure that the printer is in ready state before flashing.

- 1 Open a web browser, and then type the printer IP address.
- 2 From the home page, navigate to **Configuration > Update Firmware**.
- 3 Select the file to use.
The printer performs a POR sequence and terminates the FTP session.
- 4 Repeat step 2 through to step 4 for the other files.

Backing up eSF solutions and settings

Note: Export the eSF solutions and settings from the printer before replacing the controller board.

Exporting eSF solutions and settings file

- 1 Reset the printer into Invalid engine mode. See [“Entering Invalid engine mode” on page 351](#).
- 2 Open a web browser, and then type the printer IP address.
Note: If the web page cannot be accessed or an error occurs when starting the printer into Invalid engine mode, then data backup is not an option. Inform the customer that the data cannot be saved.
- 3 Click **Apps**, click **Export Configuration**, and then select one of the options in the dropdown menu.
- 4 Click **Export**.
Note: The size limit of the export file is 128 KB.

Adjustments

Printhead alignment adjustment

Printhead misalignment may cause crooked or skewed print. Perform this procedure after replacing the printhead or if there are skewed print issues.

Checking the test page for alignment

- 1 Enter the Diagnostics menu, and then navigate to:
Printer diagnostics & adjustments > Registration adjust > Quick test

- 2 Check the test page.

The following test page result shows a properly aligned printhead:

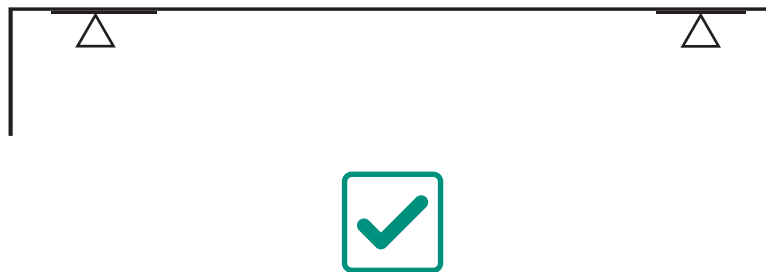

Aligning a printhead skewed in the counterclockwise direction

In most cases, the printhead is skewed counterclockwise, as shown in the following test page result.

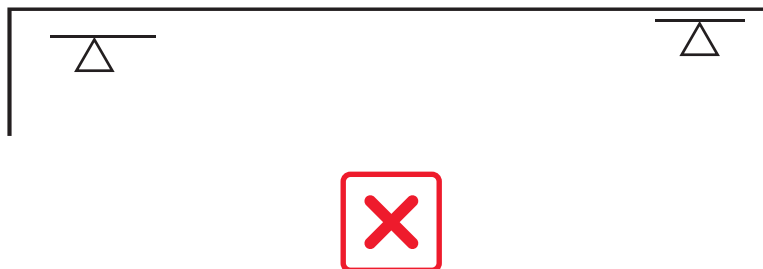

- 1 Tilt the ADF and flatbed scanner. See [“Tilting the ADF and flatbed scanner to access parts” on page 532](#).
- 2 Remove the bin cover. See [“Bin cover removal” on page 482](#).

3 Loosen the three screws.

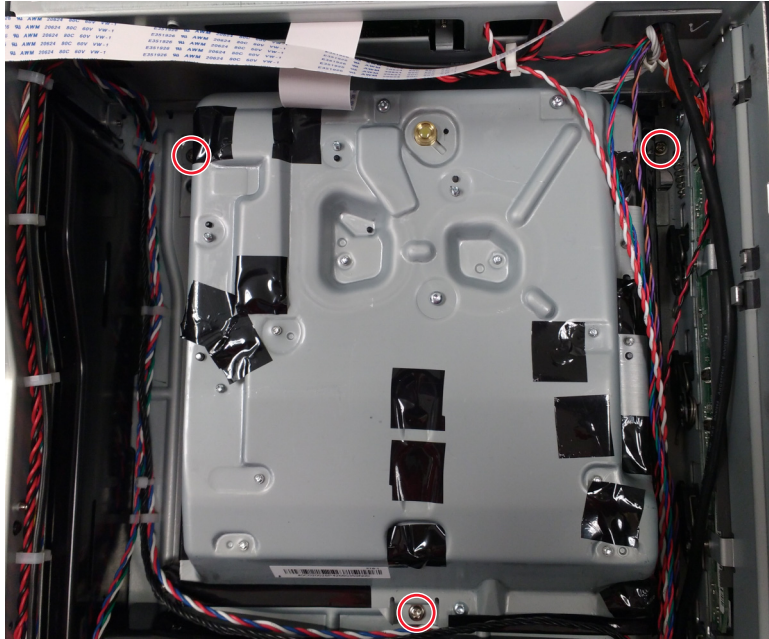

Parts removal

- 4 Adjust the printhead until the front left corner of the printhead touches the printhead stop (A).



A

- 5 Print another test page, and then check if the printhead is aligned.
- 6 Repeat step 4 through step 5 until the printhead is aligned.
- 7 Tighten the three screws.

Registration adjustment

Image misalignments can occur after printhead replacement. Perform the succeeding procedures to correct the position of the image relative to the paper edges.

Notes:

- You cannot perform mechanical registration or skew adjustments on the printhead.
- Before performing the procedures, make sure that the tray guides are properly set and the paper settings on the printer match the size of the paper loaded in the tray.

Adjusting the skew

The skew adjustment changes the angle of the horizontal lines so that the lines are aligned with the leading edge of the page. As the skew setting is changed, the top line on the test page stays in place at the left end, while its right end tilts up or down. All horizontal lines on the page tilt at that same angle while the vertical lines remain at the same angle.

Changing the skew setting moves the right edge of the page up or down, and changes the angle of the top and bottom lines. If the skew is properly adjusted, the horizontal line at the top of the page is parallel to the leading edge of the page.

To check for skew:

- 1 Enter the Diagnostics menu.
 - a From the home screen, touch .
 - b Touch ****36**, and then touch **OK**.
- 2 Navigate to:
Printer diagnostics & adjustments > Registration adjust
- 3 Select **Quick Test**, and then touch **Start**.
The printer prints a test page.

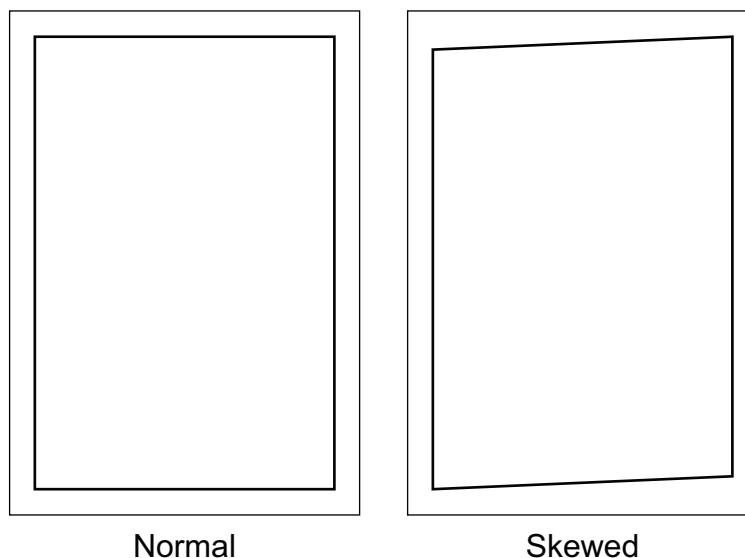

Note: If there is no skew on the page, then see [“Adjusting the top and bottom margins” on page 371](#).

To adjust the skew:

- 1 Enter the Diagnostics menu.
 - a From the home screen, touch .
 - b Touch ****36**, and then touch **OK**.

2 Navigate to:

Printer diagnostics & adjustments > Registration adjust > Top skew

3 Specify the value. The value range is from -100 to 100.

Notes:

- Raising the value of the skew rotates the horizontal lines clockwise. The left end of the line remains in the same place and the right end moves downward.
- Decreasing the value of the skew rotates the horizontal lines counterclockwise. The left end of the line remains in the same place and the right end moves upward.

4 Touch **OK**.

5 Print a Quick test page to verify the change.

6 Repeat step 1 through step 4 until the horizontal line is properly aligned with the leading edge of the page.

7 Check for proper margin alignment. See [“Adjusting the top and bottom margins” on page 371](#).

Adjusting the top and bottom margins

1 Load Letter- or A4-size paper into tray 1.

2 From the home screen, touch **Settings > Paper > Tray Configuration > Default Source > Tray 1**.

3 Verify that the paper type and size settings match the type and size of the paper loaded in the tray.

4 Enter the Diagnostics menu, and then navigate to **Printer diagnostics & adjustments > Registration adjust**.

5 Touch **Quick Test**, and then touch **Start**.

The printer prints a test page.

6 Check the top and bottom margins of the test page for correct alignment.

Notes:

- The arrows should be completely visible along the edges.
- The tip of the arrows should point to the edges of the paper.

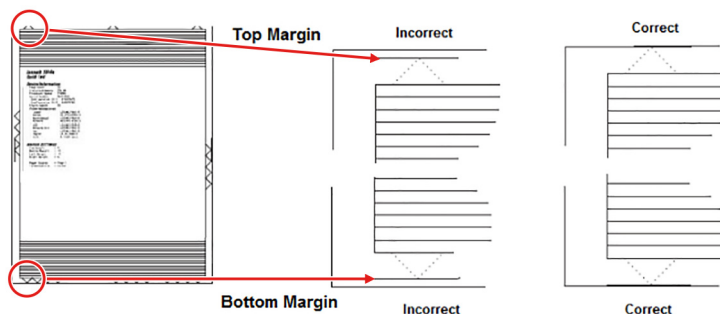

7 Change the value of the top margin or bottom margin as needed.

- Select the margin that needs adjustment.
- Enter a value in the field.

Notes:

- The value range is from -80 to 80.

- Increasing the value of the top margin pushes the top edge of the image downward. Increasing the value of the bottom margin pushes the bottom edge of the image upward.

c Touch **Start**.

- 8 Print a test page to verify the changes.
- 9 Repeat step 7 through step 8 as needed.
- 10 Check for proper color alignment. See [“Adjusting the color alignment” on page 372](#).

Adjusting the color alignment

The Color alignment procedure is performed on the cyan, magenta, and yellow colors only.

- 1 Enter the Diagnostics menu.
 - a From the home screen, touch .
 - b Touch ****36**, and then touch **OK**.
- 2 Navigate to:
Printer diagnostics & adjustments > Color alignment adjust
On the AA Adjustment row, touch **Start**.
- 3 Enter the Diagnostics menu, and then navigate to:
Printer diagnostics & adjustments > Color alignment adjust > Cyan > Quick test
Check the alignment markings on the test page generated. Follow the instructions on the test page to correct the color misalignment.
- 4 Enter the Diagnostics menu, and then navigate to:
Printer diagnostics & adjustments > Color alignment adjust > Yellow > Quick test
Check the alignment markings on the test page generated. Follow the instructions on the test page to correct the color misalignment.
- 5 Enter the Diagnostics menu, and then navigate to:
Printer diagnostics & adjustments > Color alignment adjust > Magenta > Quick test
Check the alignment markings on the test page generated. Follow the instructions on the test page to correct the color misalignment.
- 6 If color misalignment still occurs, then repeat step 1 through step 4.

Scanner Manual Registration

Use this setting to register the flatbed and ADF on the scanner. Perform a registration adjustment whenever the ADF, flatbed, or controller board is replaced.

Note: This setting does not appear if the Disable Scanner setting is set to Auto Disabled.

For more information on adjusting the scanner registration, see [“ADF registration adjustment” on page 373](#) and [“Flatbed registration adjustment” on page 373](#).

ADF registration adjustment

- 1 From the home screen, navigate to:
Settings > Device > Maintenance > Configuration Menu > Scanner Configuration > Scanner Manual Registration
- 2 From the Print Quick Test section, touch **Start**.
- 3 Place the test page faceup on the ADF, and then select **Front ADF Registration**.
- 4 From the Copy Quick Test section, touch **Start**.
- 5 Compare the pages from the print quick and copy quick tests.
- 6 Adjust the value of the top margin and vertical magnification settings.
- 7 Apply the changes.
- 8 Repeat step 2 through step 7 to make further adjustments.
- 9 From the Print Quick Test section, touch **Start**.
- 10 Place the quick test page facedown on the ADF, and then select **Rear ADF Registration**.
- 11 From the Copy Quick Test section, touch **Start**.
- 12 Compare the pages from the print quick and copy quick tests.
- 13 Adjust the value of the top margin settings.
- 14 Apply the changes.
- 15 Repeat step 9 through step 14 to make further adjustments.

Flatbed registration adjustment

- 1 From the home screen, navigate to:
Settings > Device > Maintenance > Configuration Menu > Scanner Configuration > Scanner Manual Registration
- 2 From the Print Quick Test section, touch **Start**.
- 3 Place the test page on the flatbed, and then select **Flatbed Registration**.
- 4 From the Copy Quick Test section, touch **Start**.
- 5 Compare the pages from the print quick and copy quick tests.
- 6 Adjust the value of the top margin, left margin, and vertical magnification settings.
- 7 Apply the changes.
- 8 Repeat steps 2 through step 7 to make further adjustments.

TPS characterization data entry

Note: This procedure only applies to a new sensor (TPS).

Follow the instructions on the accompanying FRU sheet of the sensor (TPS).

Removal procedures

Keep the following tips in mind as you replace parts:

- Some removal procedures require removing cable ties. Do not forget to install these cable ties during reassembly to avoid pinching wires, obstructing the paper path, or restricting mechanical movement.
- Remove the imaging unit and imaging kit before removing other printer parts. Carefully set the imaging unit and imaging kit on a clean, smooth, and flat surface. Protect the imaging unit and imaging kit from light while out of the printer.
- Disconnect all external cables from the printer to prevent possible damage during service.
- Unless otherwise stated, install the parts in reverse order of removal.
- When installing a part held with several screws, start all screws before the final tightening.
- For printers that have an electronic power switch, make sure to unplug the power cord after powering off.

Left side removals

Left cover removal

- 1 Remove the screw (A).

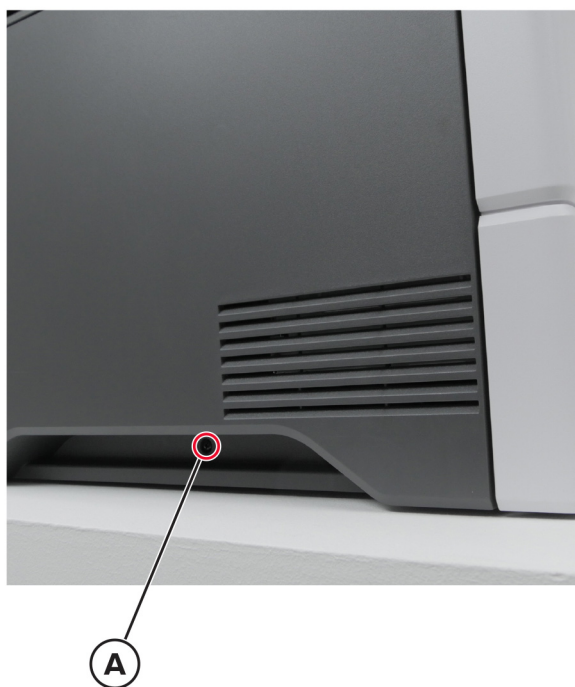

2 Remove the three screws (B).

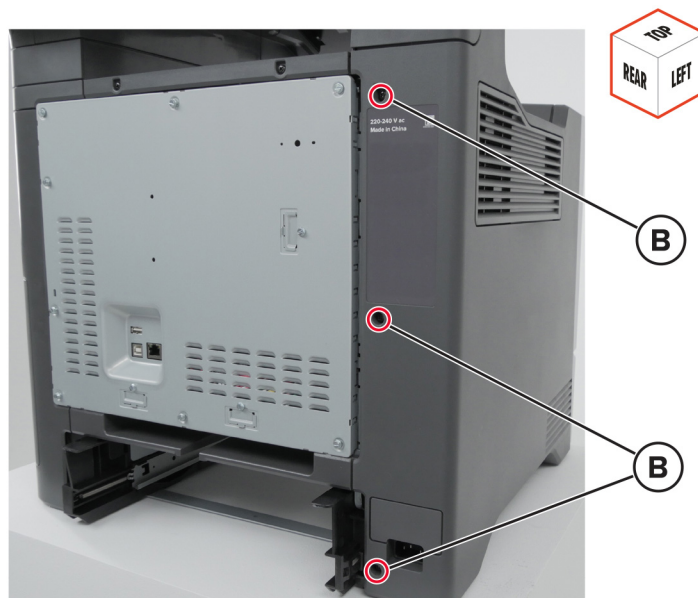

3 Remove the four screws (C).

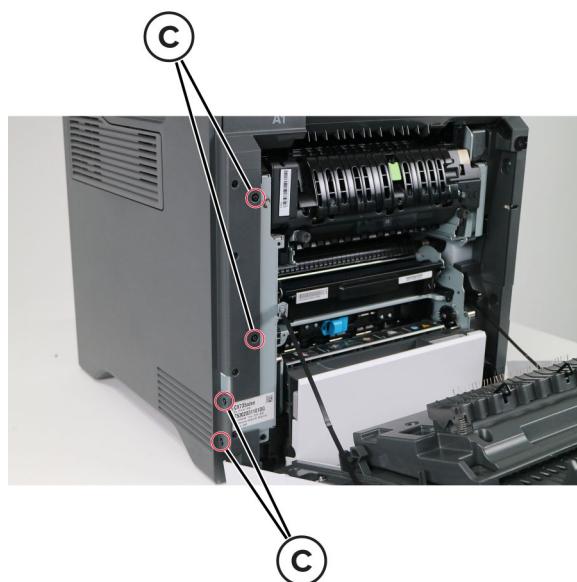

4 Release the straps (D) to loosen the door.

Warning—Potential Damage: Make sure that the door does not fall.

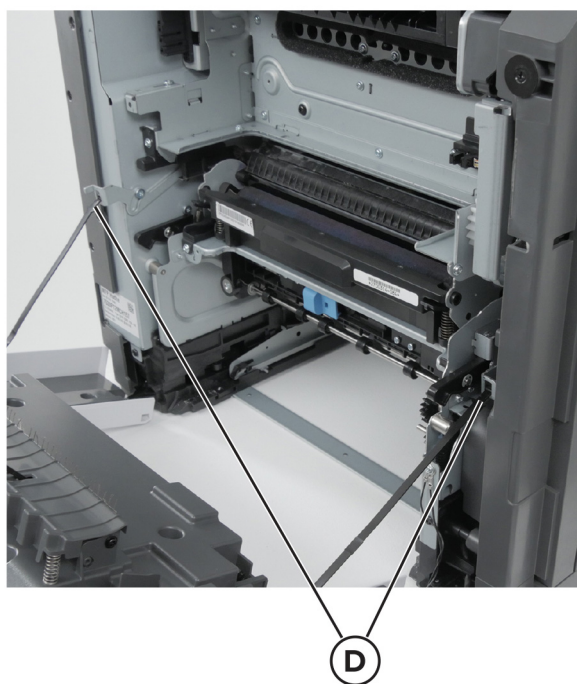

5 Remove the left cover.

LVPS removal

Note: For a video demonstration, see [Replacing the LVPS](#).

- 1 Remove the left cover. See [“Left cover removal”](#) on page 374.
- 2 Disconnect the cable (A).

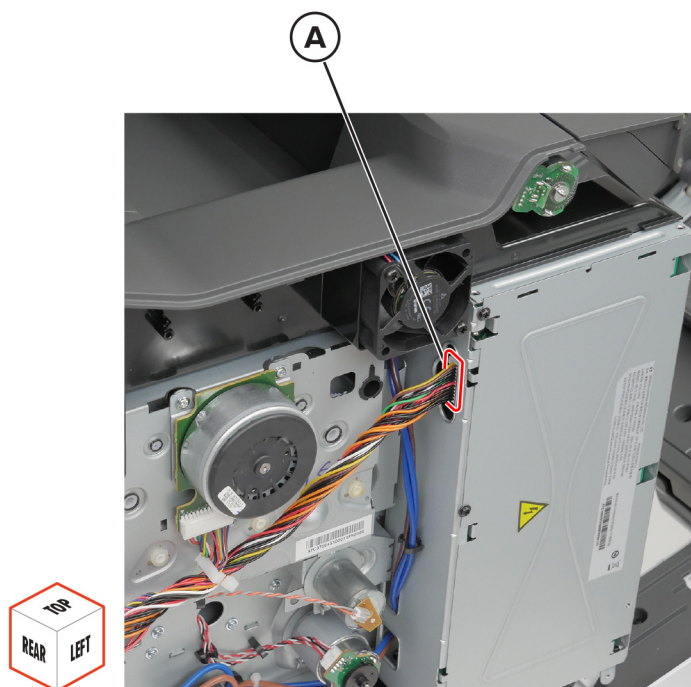

3 Remove the seven screws (B), and then pull the LVPS.

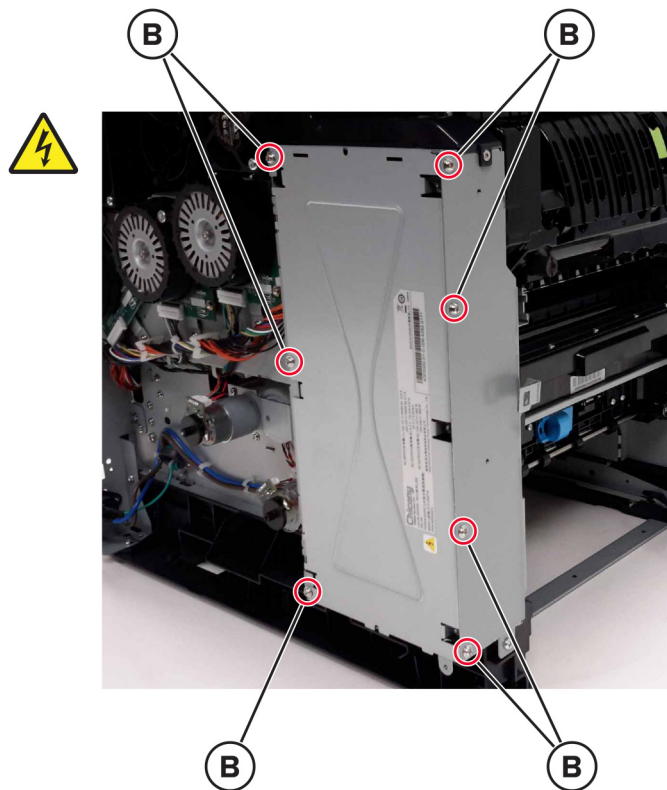

4 Disconnect the cables (C).

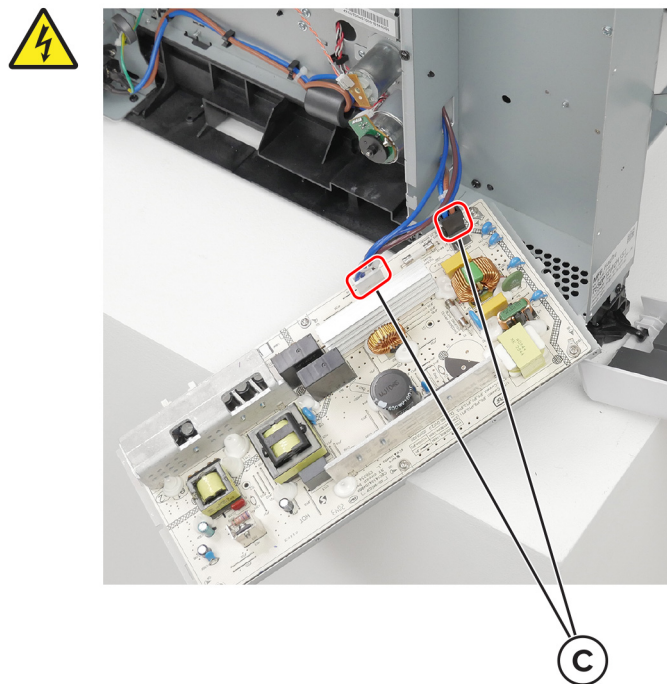

5 Remove the LVPS.

Main fan removal

- 1 Remove the left cover. See [“Left cover removal” on page 374.](#)
- 2 Remove the controller board shield. See [“Controller board shield removal” on page 474.](#)
- 3 Disconnect the cable (A).



4 Remove the two screws (B).



5 Remove the fan.

Fuser fan removal

- 1 Remove the left cover. See [“Left cover removal” on page 374.](#)
- 2 Remove the controller board shield. See [“Controller board shield removal” on page 474.](#)

3 Disconnect the cable (A).



4 Remove the two screws (B).

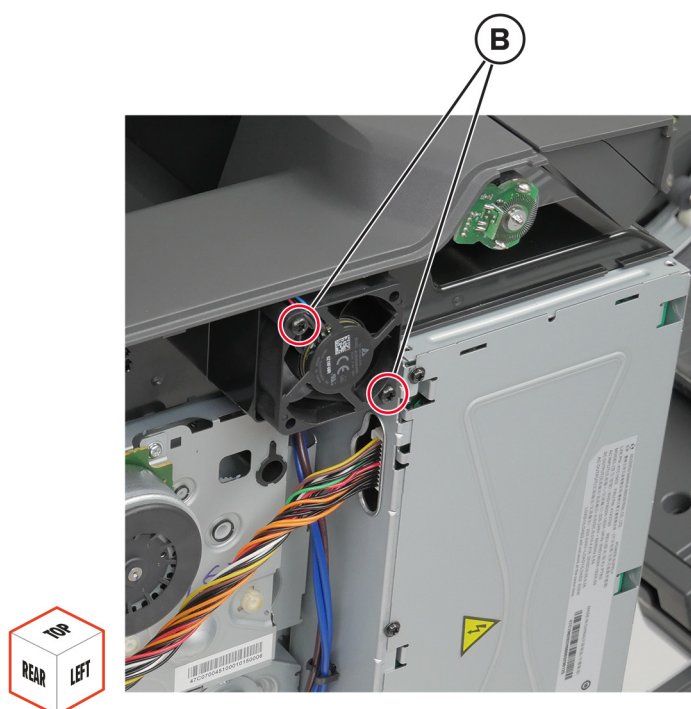

5 Release the cable from its guides, and then remove the fan.

Installation note: Pay attention to the cable route.



Motor (EP drive) removal

- 1 Remove the left cover. See [“Left cover removal” on page 374](#).
- 2 Disconnect the cable (A), and then remove the screws (B).
 - Motor (K/transfer belt)

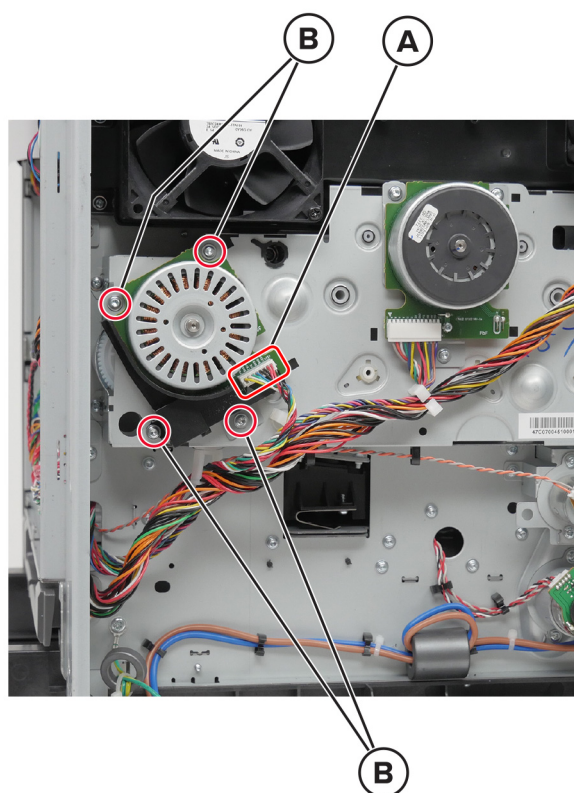

- Motor (CMY)

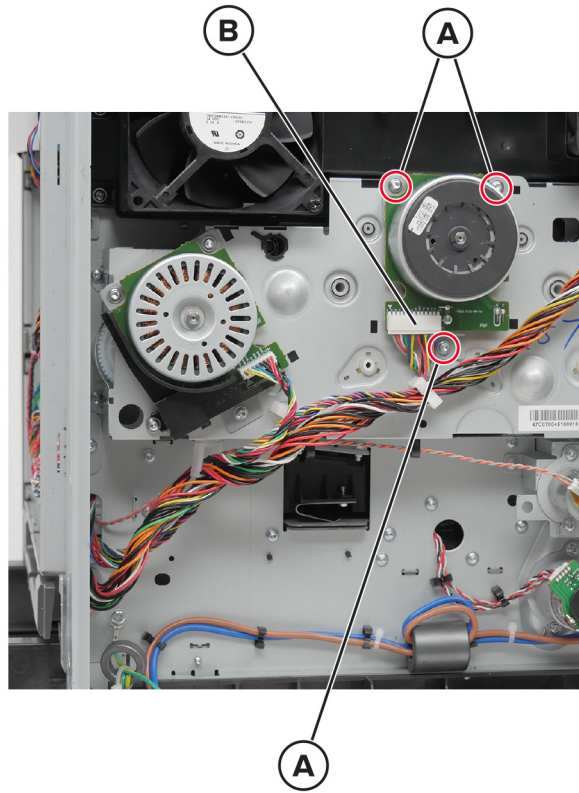

3 Remove the motor.

EP drive gearbox removal

Note: For a video demonstration, see [Replacing the EP drive gearbox](#).

- 1 Remove the left cover. See [“Left cover removal” on page 374](#).
- 2 Disconnect the cables (A), and then remove the five screws (B).

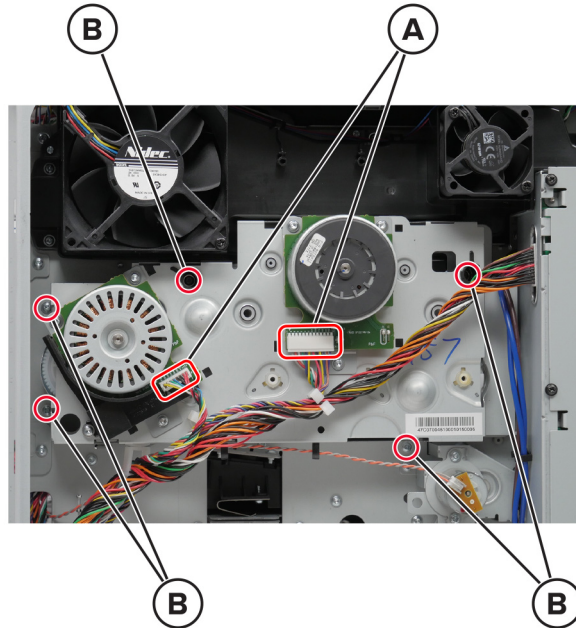

- 3 Lift up the gearbox to free the hooks from the frame, and then slowly remove the gearbox.

Warning—Potential Damage: The right edge of the gearbox may be sharp. Be careful not to cut the cables (A).

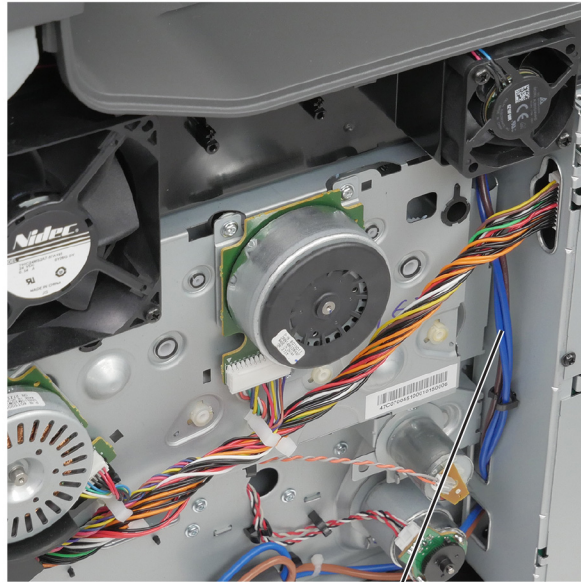

A

Installation note: Make sure to align the locating tabs with their corresponding slots.

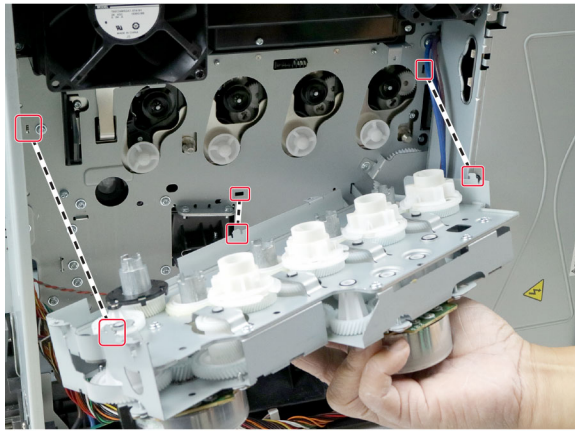

Motor (BOR) removal

- 1 Remove the left cover. See [“Left cover removal” on page 374](#).
- 2 Disconnect the cable (A), and then remove the two screws (B).

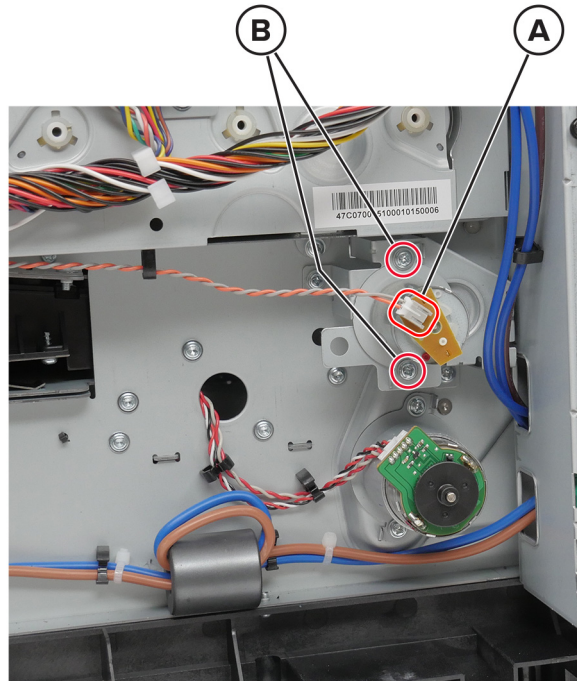

- 3 Remove the motor.

Installation note: Align the motor to the center hole to correctly install it.

Motor (deskew) removal

- 1 Remove the left cover. See [“Left cover removal” on page 374.](#)
- 2 Disconnect the cable (A), and then remove the two screws (B).

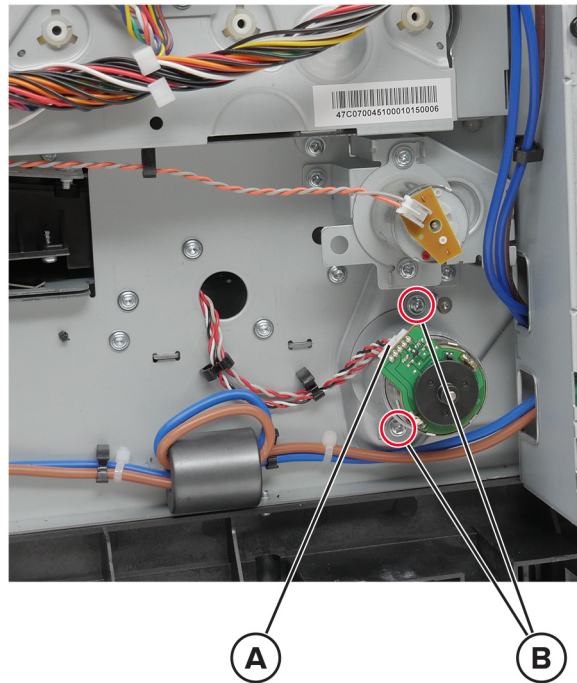

- 3 Remove the motor.

Power cable removal

- 1 Remove the left cover. See [“Left cover removal” on page 374](#).
- 2 Remove the two screws (A), and then release the socket.

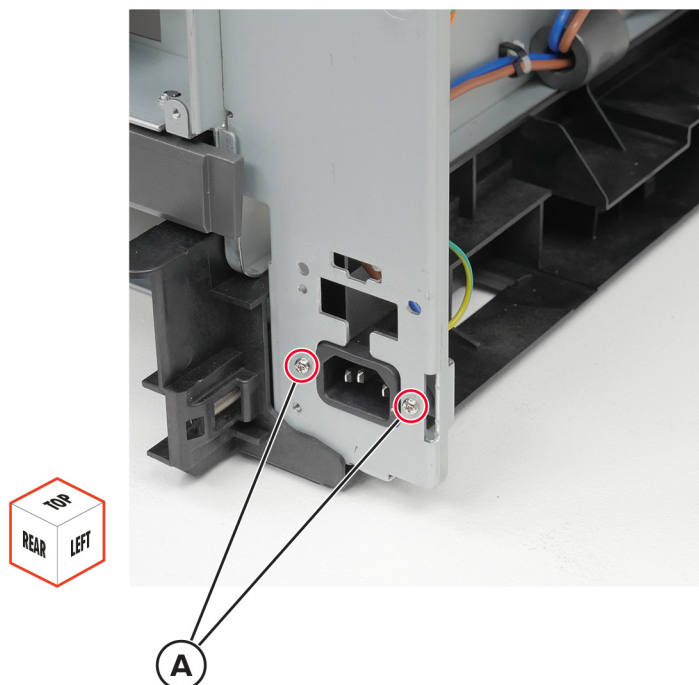

3 Remove the seven screws (B), and then pull the LVPS.

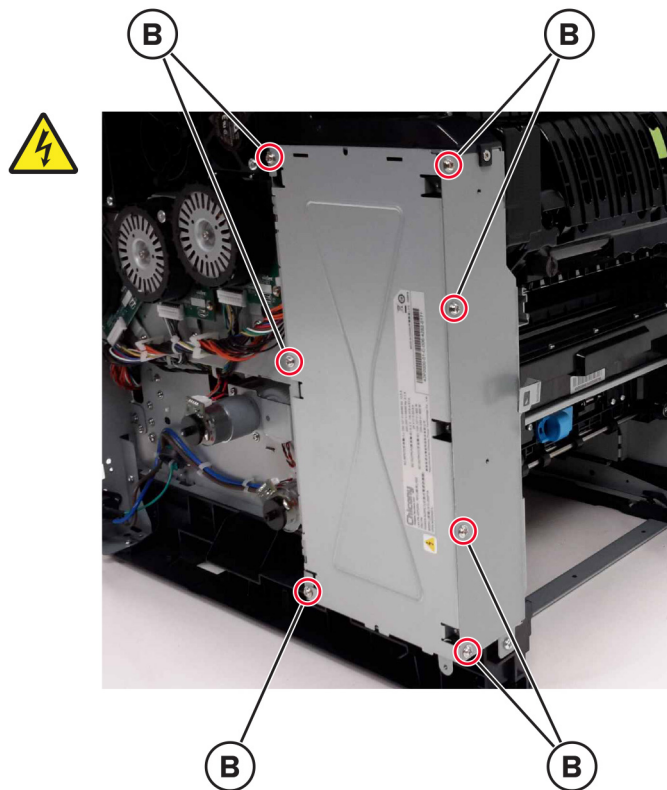

4 Disconnect the cable (C).

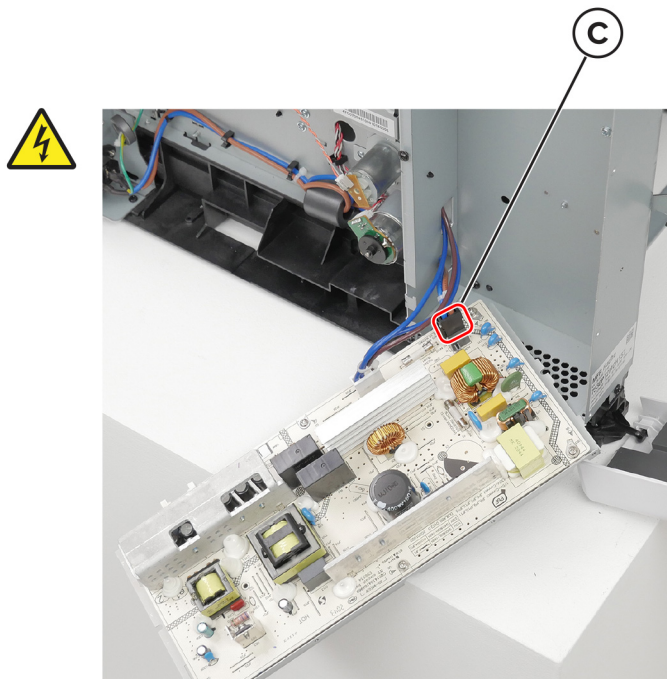

5 Remove the ground screw (D), and then remove the cable from its guides.

Installation note: Pay attention to the cable route.

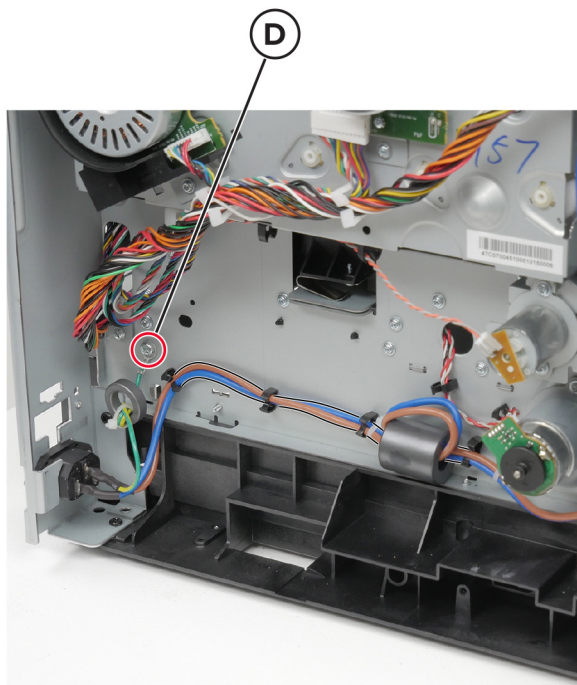

Motor (exit/redrive) removal

- 1 Remove the left cover. See [“Left cover removal” on page 374](#).
- 2 Open door A1, and then remove the three screws (A).

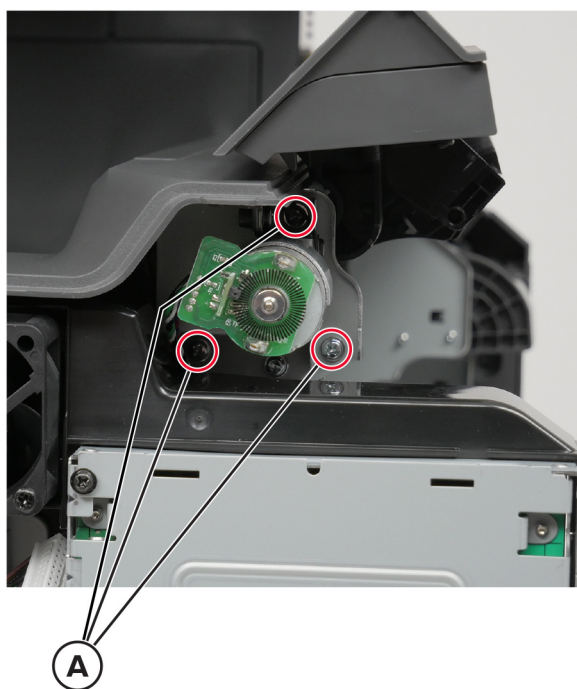

Parts removal

3 Remove the ground screw (B) and the other screw (C).

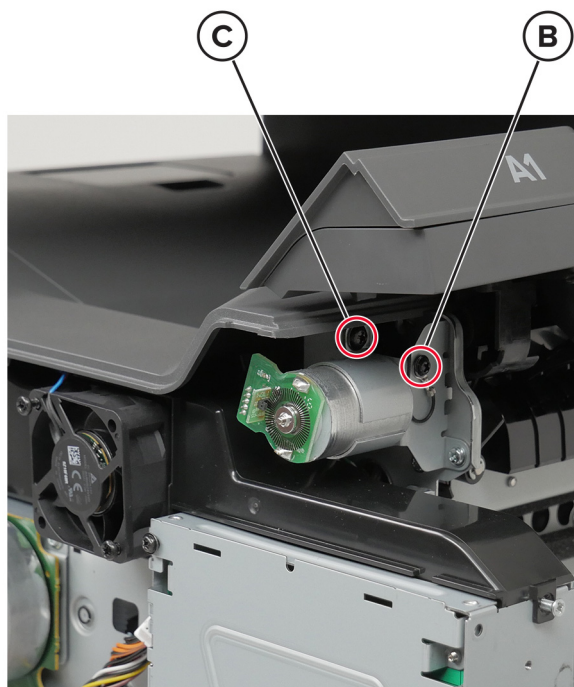

4 Disconnect the cable (D), and then remove the motor.

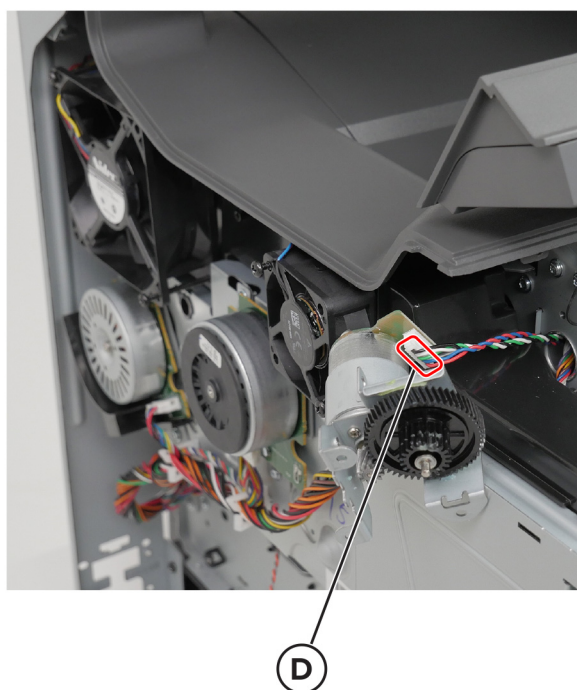

LVPS cage removal

- 1 Remove the fuser. See [“Fuser removal” on page 436](#).
- 2 Remove the transfer module. See [“Transfer module removal” on page 431](#).
- 3 Remove the left cover. See [“Left cover removal” on page 374](#).
- 4 Remove the LVPS. See [“LVPS removal” on page 377](#).
- 5 Remove the two screws (A).

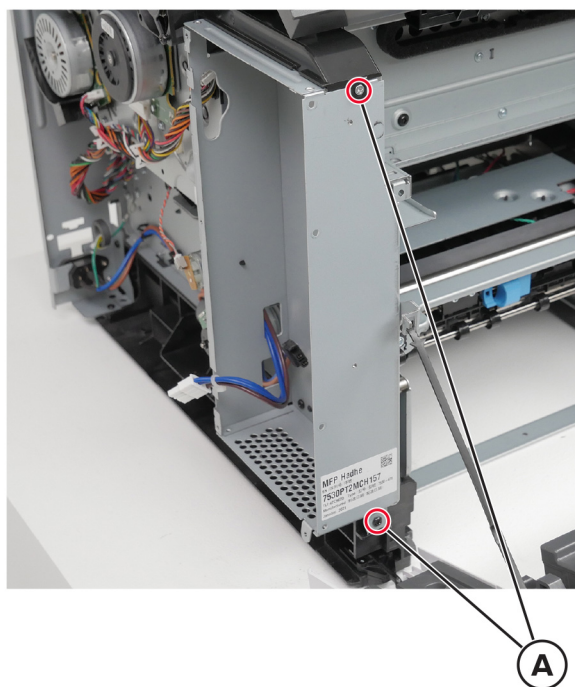

6 Remove the six screws (B).

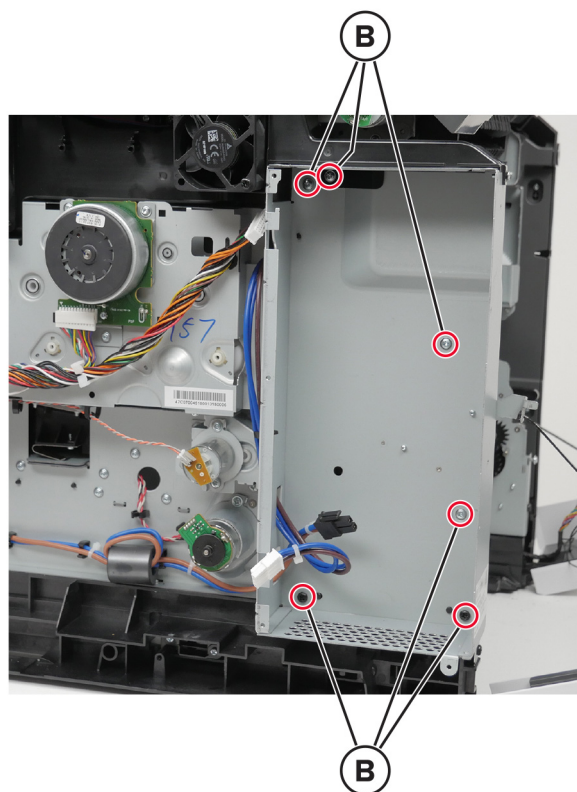

7 Remove the screw (C), and then release the strap (D).



- 8 Release the cable from its guides, and then remove the cage.

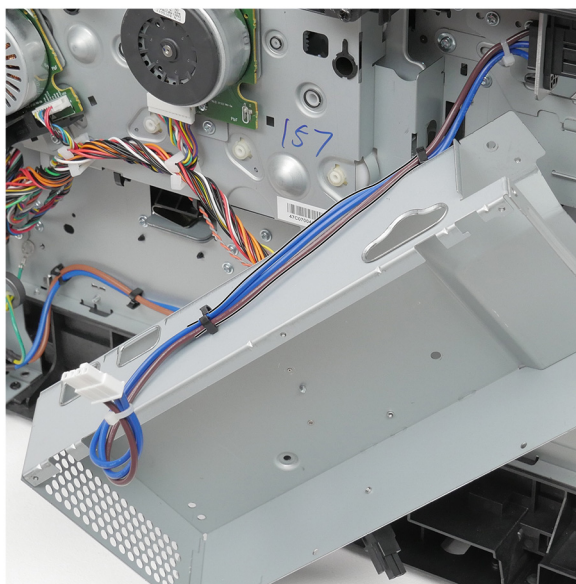

- 9 Remove the screw (E), E-clip (F), spring (G), and guides (H) from the cage.

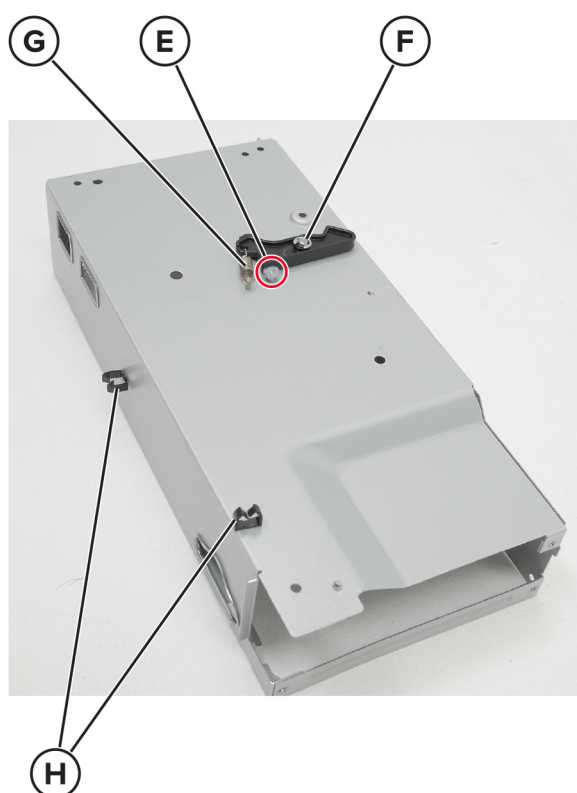

Fuser interconnect cable removal

- 1 Remove the fuser. See [“Fuser removal” on page 436](#).
- 2 Remove the transfer module. See [“Transfer module removal” on page 431](#).
- 3 Remove the left cover. See [“Left cover removal” on page 374](#).
- 4 Remove the LVPS. See [“LVPS removal” on page 377](#).
- 5 Remove the LVPS cage. See [“LVPS cage removal” on page 392](#).
- 6 Remove the two screws (A), and then pull the bracket.

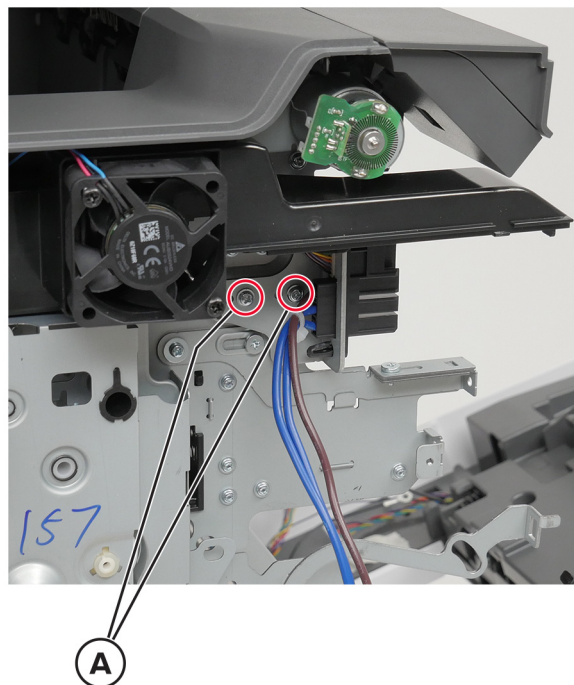

7 Disconnect the cable (B), and then remove the bracket.

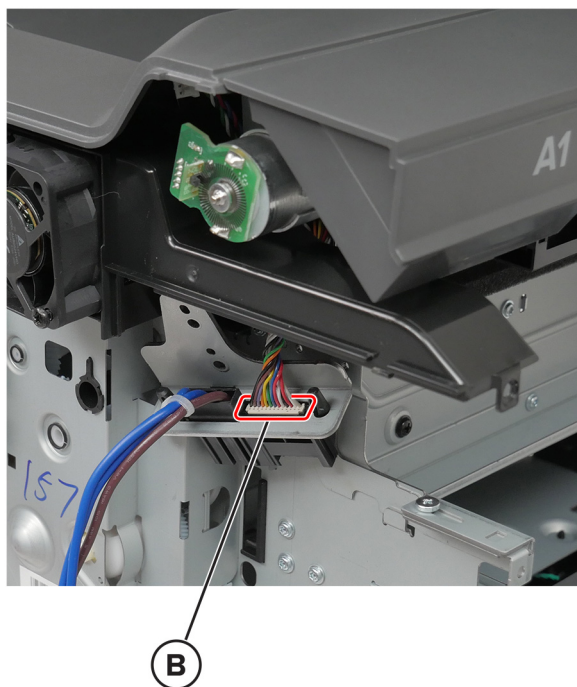

8 Release the pins (C) from the bracket using a pair of pliers, and then remove the cable.

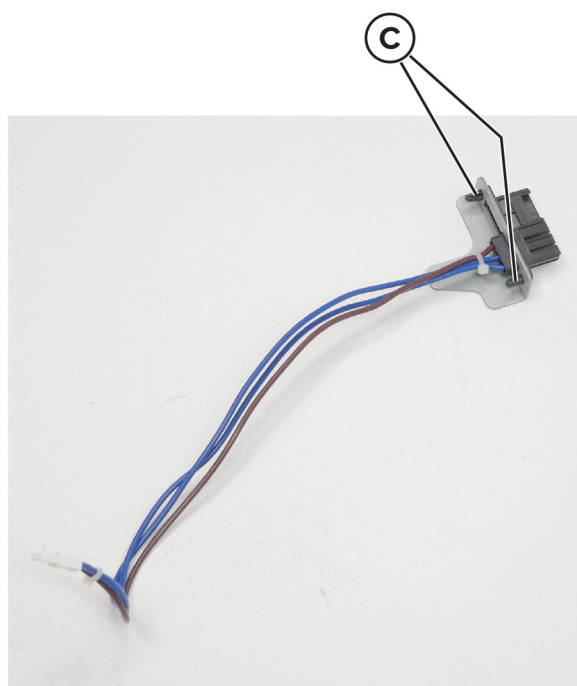

Right side removals

Waste toner bottle removal

- 1 Open door B.

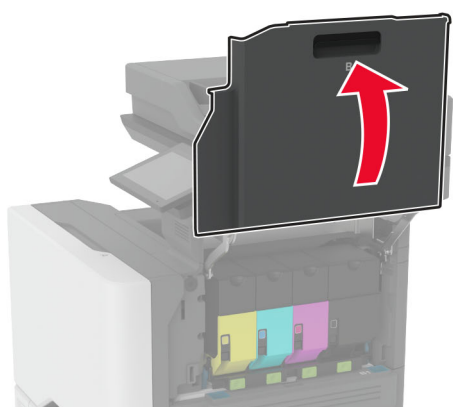
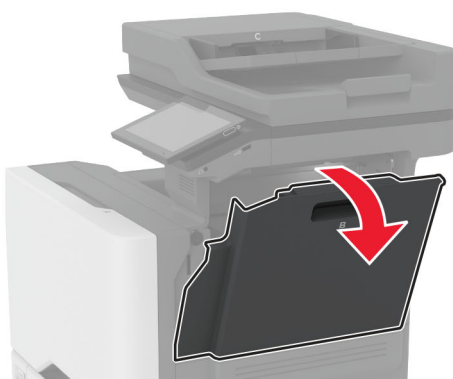
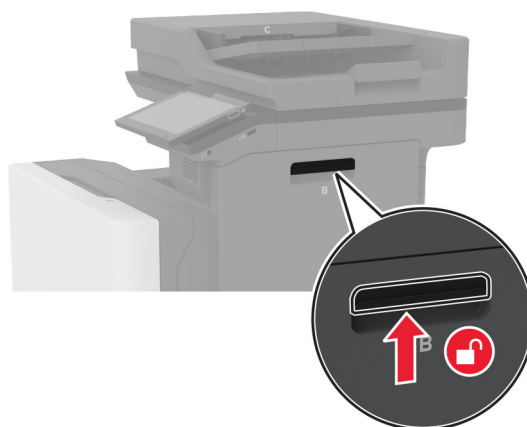

2 Remove the waste toner bottle.

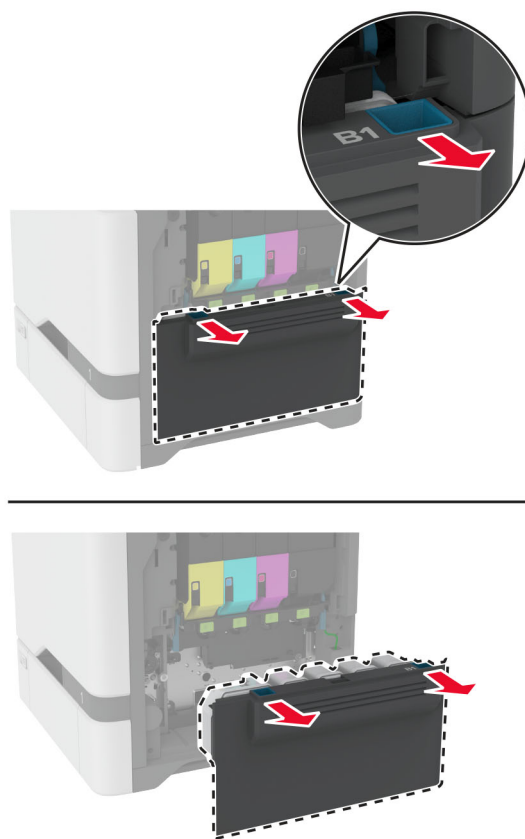

Note: To avoid spilling the toner, place the bottle in an upright position.

Imaging kit removal

- 1 Remove the waste toner bottle. See [“Waste toner bottle removal” on page 397](#).
- 2 Disconnect the imaging kit cable.

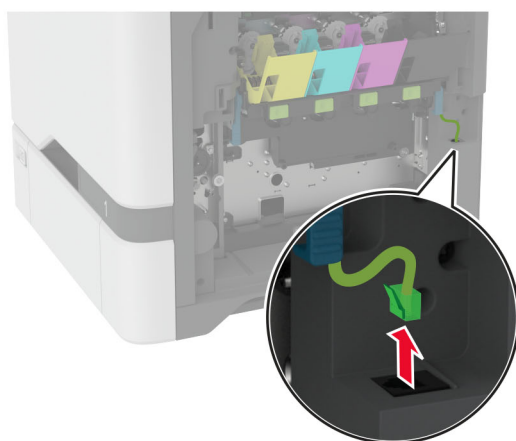
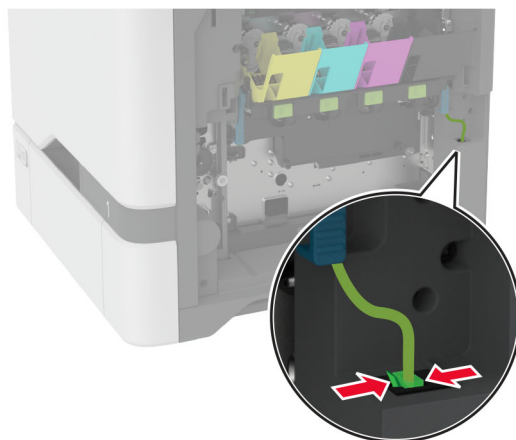

3 Remove the imaging kit.

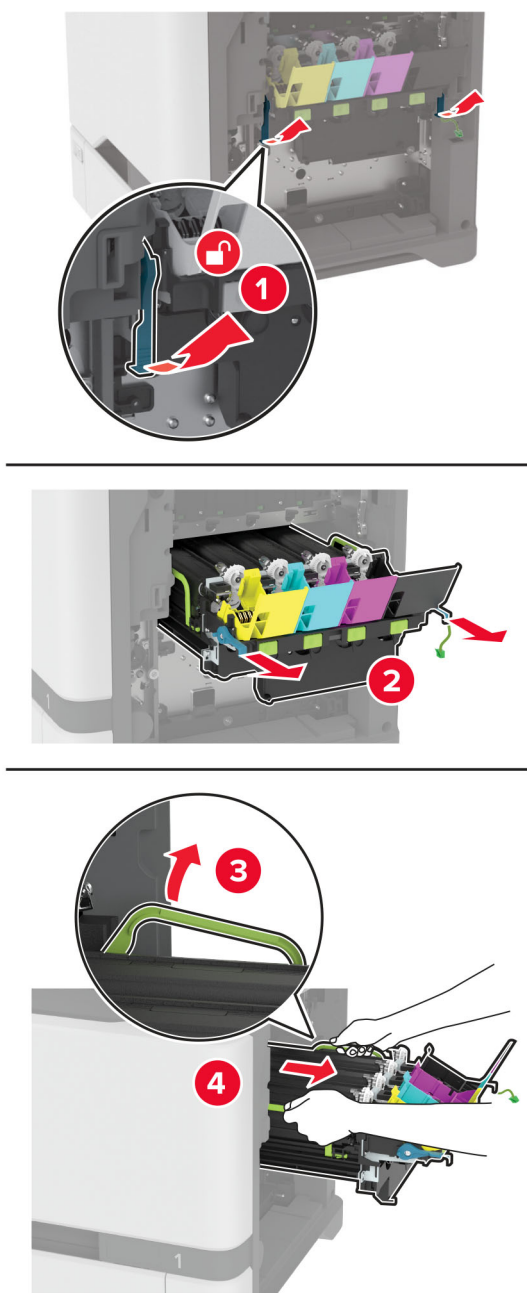

Note: To avoid scratching the imaging kit or damaging the photoconductor drum, place the imaging kit in an uplifted position.



Warning—Potential Damage: Do not expose the photoconductor unit to direct light for more than 10 minutes. Extended exposure to light may cause print quality problems.

Right cover removal

- 1 Remove the waste toner bottle. See [“Waste toner bottle removal” on page 397.](#)
- 2 Remove the motor cover. See [“Motor cover removal” on page 427.](#)
- 3 Disconnect the cable (A), and then remove the five screws (B).

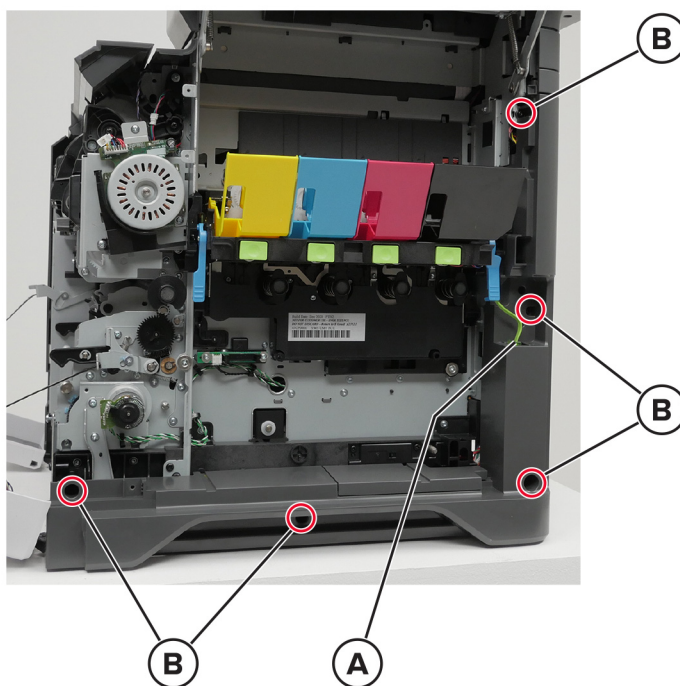

- 4 Pull the cover, and then disconnect the cable (C).

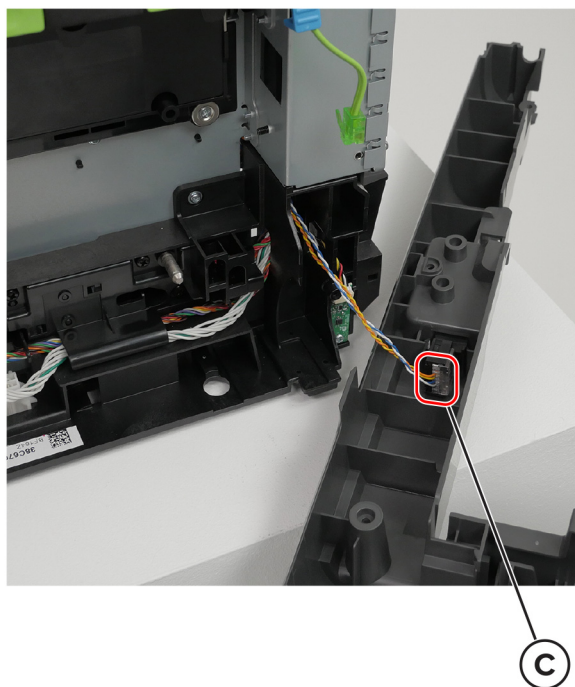

- 5 Remove the cover.

Toner door removal

- 1 Open the toner door.
- 2 Release the springs (A).

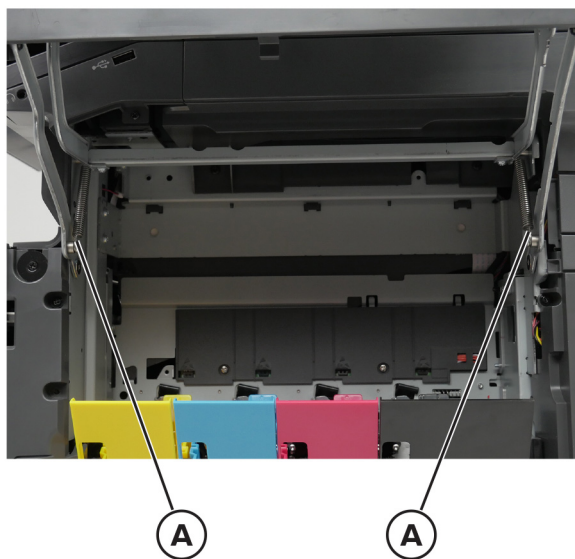

3 Remove the two screws (B).

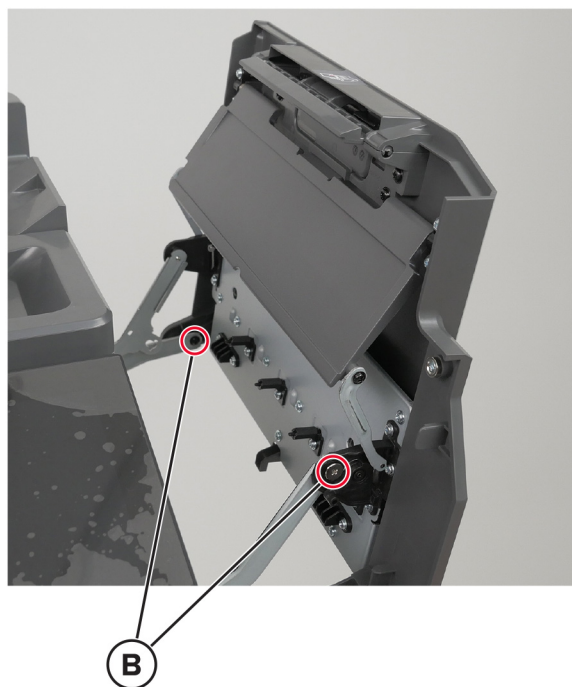

4 Remove the two screws (C).

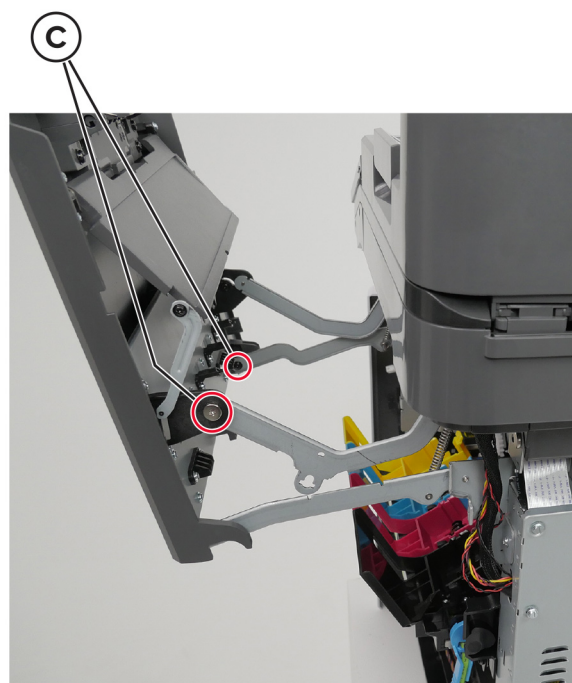

5 Remove the door.

Toner door mount bracket removal

- 1 Remove the toner door. See [“Toner door removal” on page 402](#).
- 2 Remove the eight screws (A).

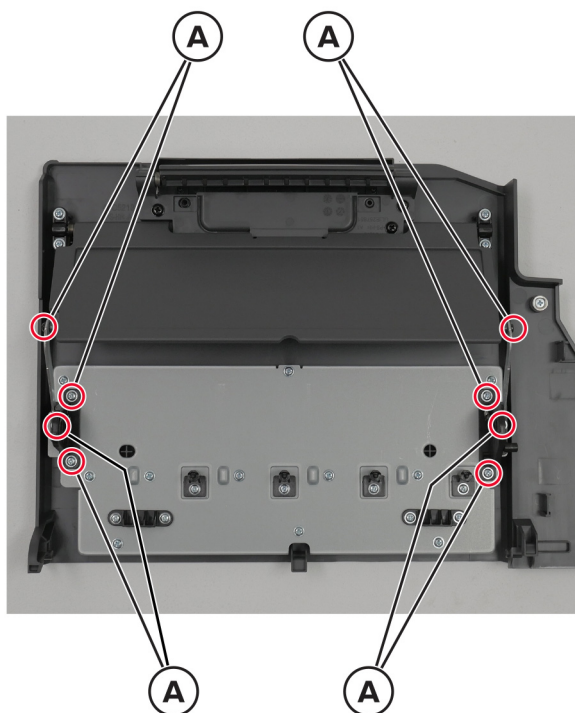

- 3 Remove the brackets.

USB cover removal

- 1 Open the cartridge door.
- 2 Remove the screw (A), and then remove the cover.



Headphone and USB socket cables removals

Headphone socket cable removal

- 1 Remove the scanner rear right cover. See [“Scanner rear right cover removal” on page 475.](#)
- 2 Remove the scanner rear left cover. See [“Scanner rear left cover removal” on page 475.](#)
- 3 Remove the ADF. See [“ADF removal” on page 517.](#)
- 4 Remove the controller board shield. See [“Controller board shield removal” on page 474.](#)
- 5 Remove the flatbed scanner. See [“Flatbed scanner removal” on page 519.](#)
- 6 Remove the output bin door.
- 7 Remove or loosen the top cover. See [“Top cover removal” on page 486.](#)

- 8 Remove the screw (A), and then remove the cover.



- 9 Remove the screw (B), and then release the headphone socket.



10 Disconnect the cable (C).

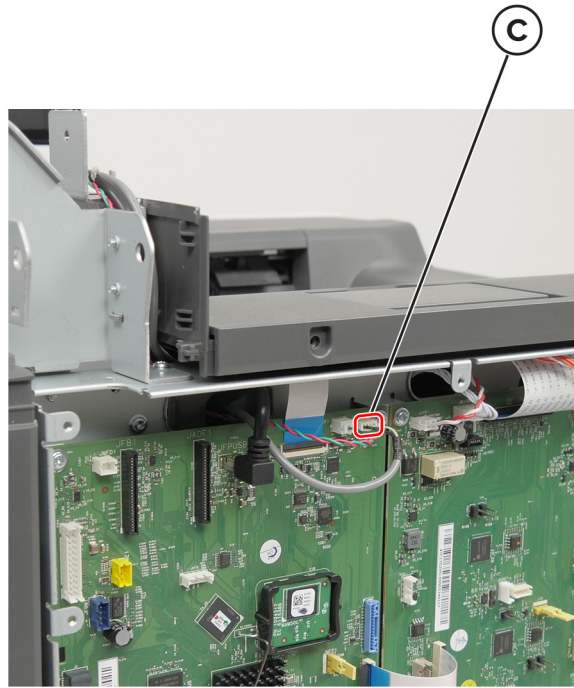

11 Remove the cable.

USB socket cable removal

- 1** Remove the scanner rear right cover. See [“Scanner rear right cover removal” on page 475.](#)
- 2** Remove the scanner rear left cover. See [“Scanner rear left cover removal” on page 475.](#)
- 3** Remove the ADF. See [“ADF removal” on page 517.](#)
- 4** Remove the controller board shield. See [“Controller board shield removal” on page 474.](#)
- 5** Remove the flatbed scanner. See [“Flatbed scanner removal” on page 519.](#)
- 6** Remove the output bin door.
- 7** Remove or loosen the top cover. See [“Top cover removal” on page 486.](#)

- 8 Remove the screw (A), and then remove the cover.



- 9 Remove the two screws (B), and then release the USB socket.



- 10 Disconnect the cable (C).



- 11 Remove the cable.

TMC card removal

- 1 Remove the waste toner bottle. See [“Waste toner bottle removal” on page 397.](#)
- 2 Remove the imaging kit. See [“Imaging kit removal” on page 399.](#)

3 Remove the two screws (A), and then pull the cover.

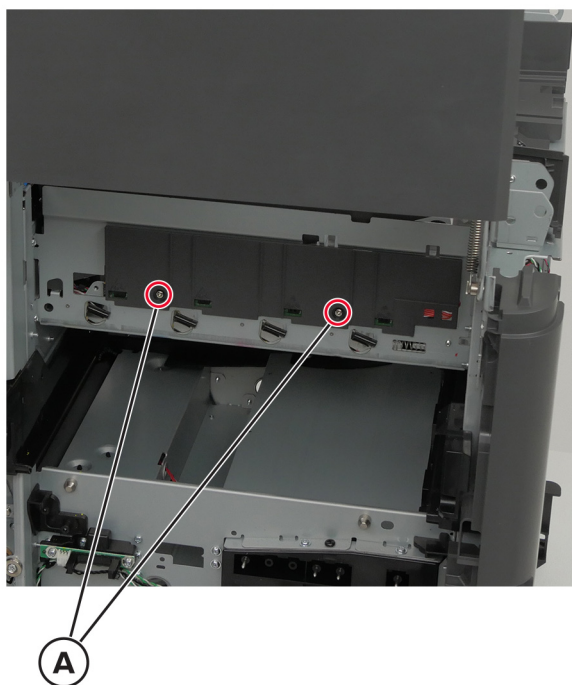

4 Disconnect the cable (B), and then remove the card.

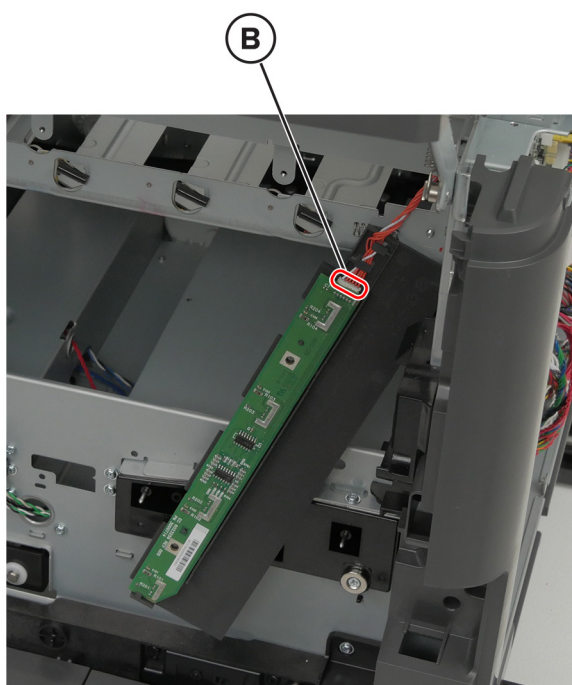

Sensor (paper size) removal

- 1 Remove the waste toner bottle. See [“Waste toner bottle removal” on page 397.](#)
- 2 Remove the motor cover. See [“Motor cover removal” on page 427.](#)
- 3 Remove the right cover. See [“Right cover removal” on page 401.](#)
- 4 Remove the three screws (A).

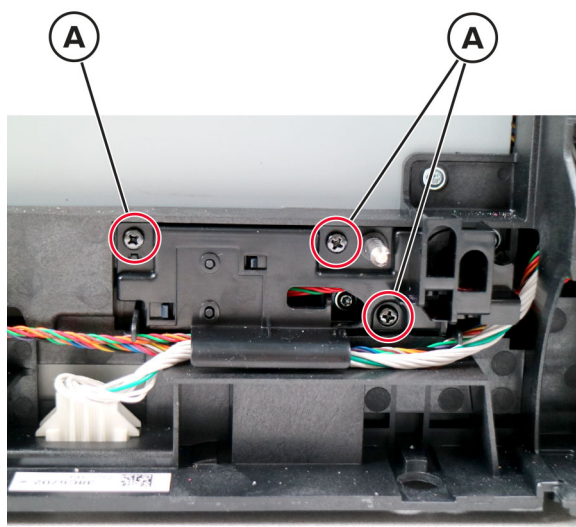

- 5 Pull the mounting assembly away from the printer.

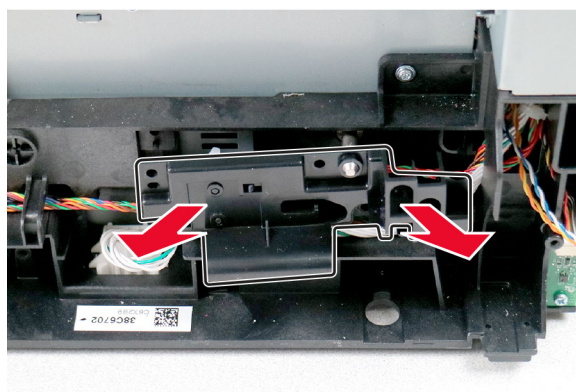

6 Disconnect the sensor cable (B).

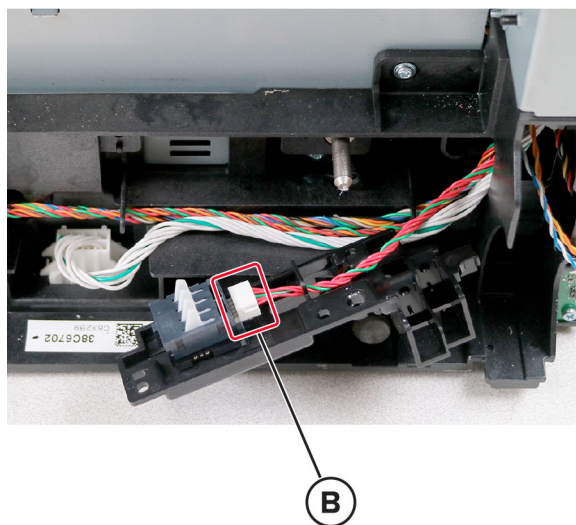

7 Release the two tabs (C) from the mounting assembly, and then remove the sensor.

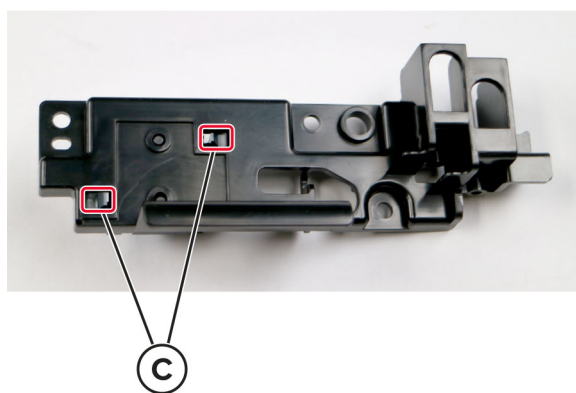

Motor (fuser) removal

- 1 Remove the motor cover. See [“Motor cover removal” on page 427](#).
- 2 Disconnect the motor cable (A), and then release the toroid (B).

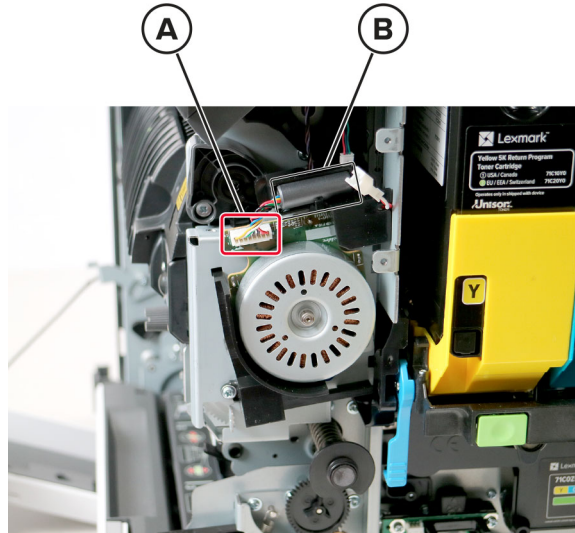

- 3 Remove the two screws (C), and then remove the two covers (D).

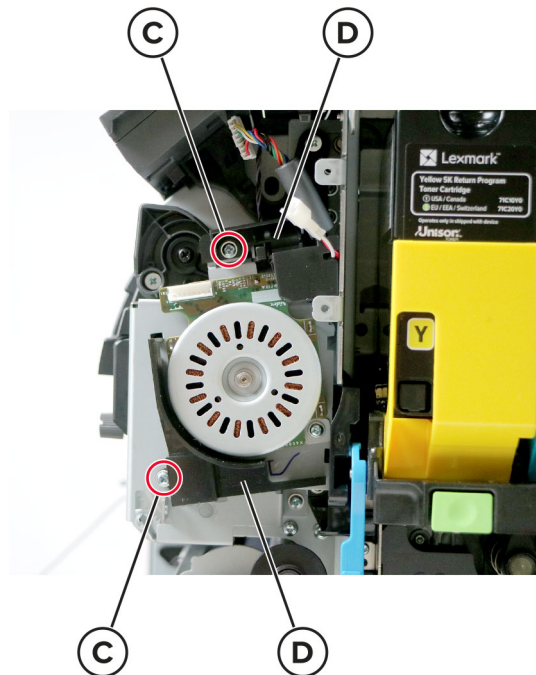

Note: Pry the latch of the bottom cover to release it.

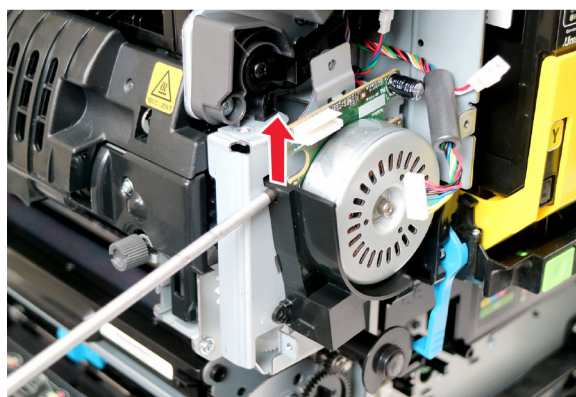

4 Remove the two screws (E), and then remove the motor.

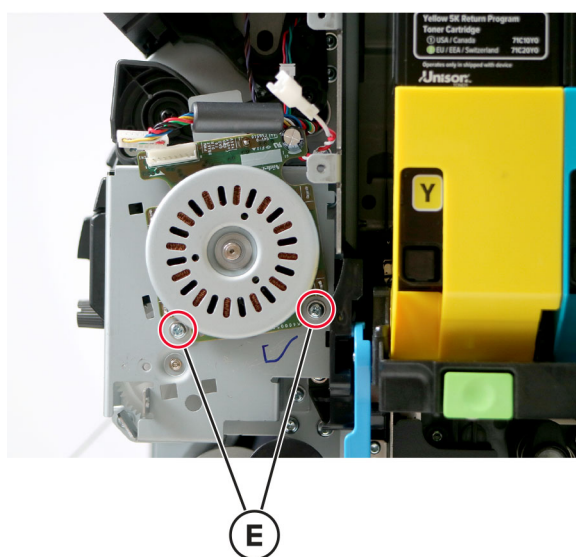

Waste toner bottle idler gear removal

- 1 Remove the waste toner bottle. See [“Waste toner bottle removal” on page 397.](#)
- 2 Remove the gear.

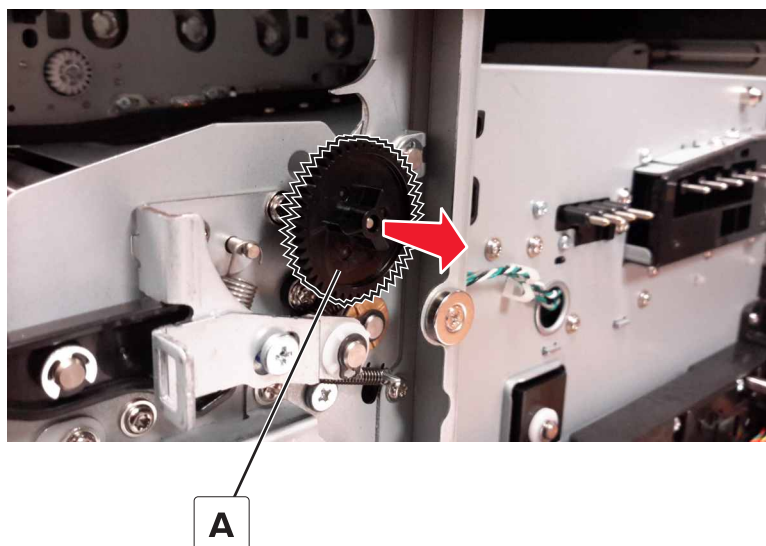

Motor (duplex/MPF) removal

- 1 Remove the motor cover. See [“Motor cover removal” on page 427.](#)
- 2 Remove the right cover. See [“Right cover removal” on page 401.](#)
- 3 Remove the screws (A and then B), and then remove the bracket.

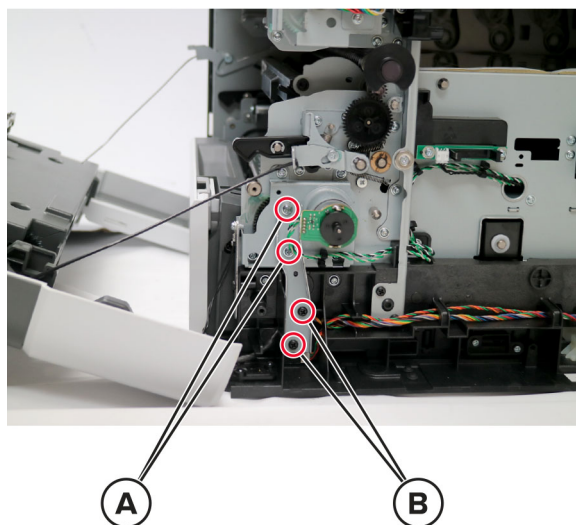

- 4 Disconnect the cable (C), remove the four screws (D), and then remove the motor.

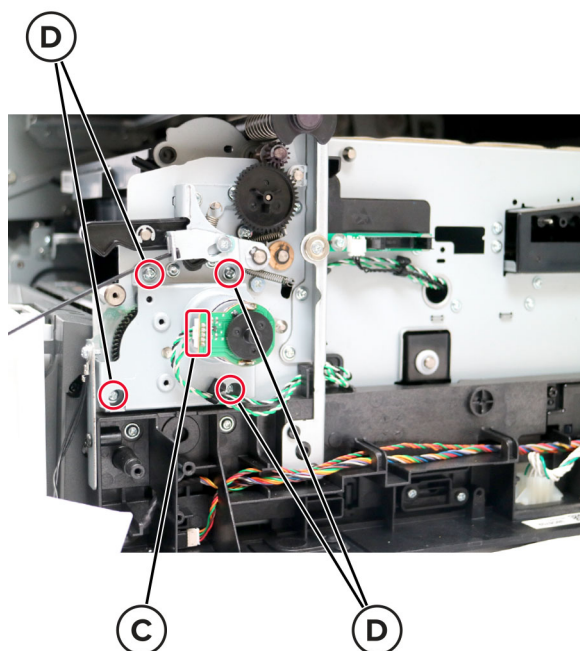

Sensor (weather station) removal

- 1 Remove the waste toner bottle. See [“Waste toner bottle removal” on page 397.](#)
- 2 Remove the motor cover. See [“Motor cover removal” on page 427.](#)
- 3 Remove the right cover. See [“Right cover removal” on page 401.](#)
- 4 Remove the screw (A), disconnect the cable (B), and then remove the sensor.

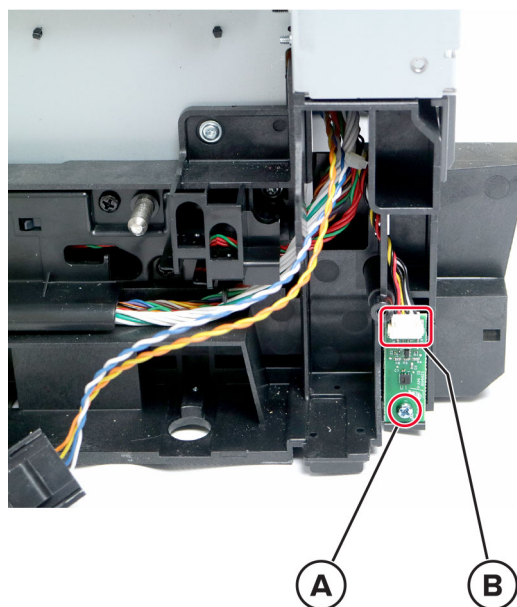

Parts removal

HVPS removal

Note: For a video demonstration, see [Replacing the HVPS](#).

- 1 Remove the imaging kit. See [“Imaging kit removal” on page 399](#).
- 2 Remove the waste toner bottle. See [“Waste toner bottle removal” on page 397](#).
- 3 Remove the left cover. See [“Left cover removal” on page 374](#).
- 4 Remove the controller board shield. See [“Controller board shield removal” on page 474](#).
- 5 Remove the engine board. See [“Engine board removal” on page 479](#).
- 6 Remove the retainer (A).

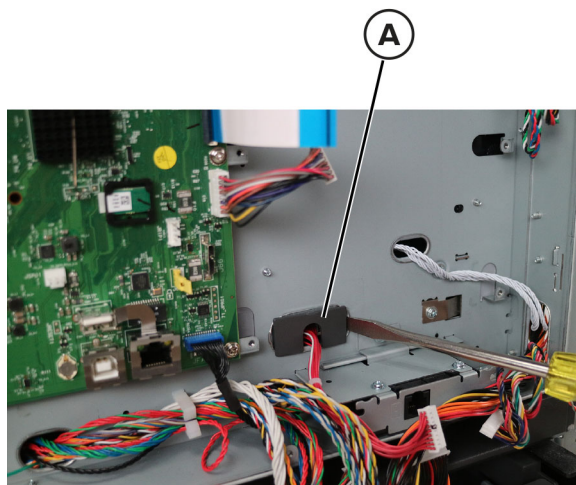

- 7 Press the latch to release it, and then disconnect the cable (B).

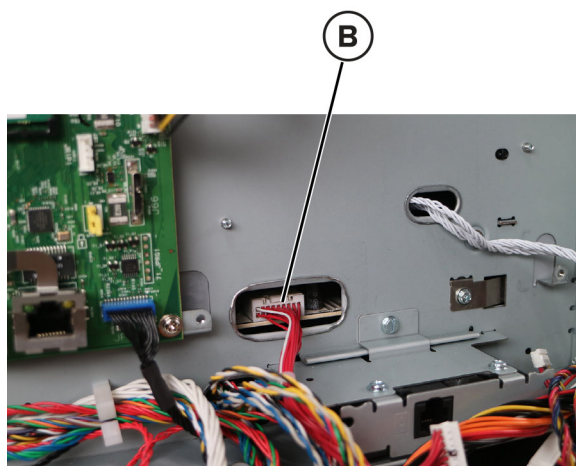

- 8 Remove the screw (C) securing the HVPS.

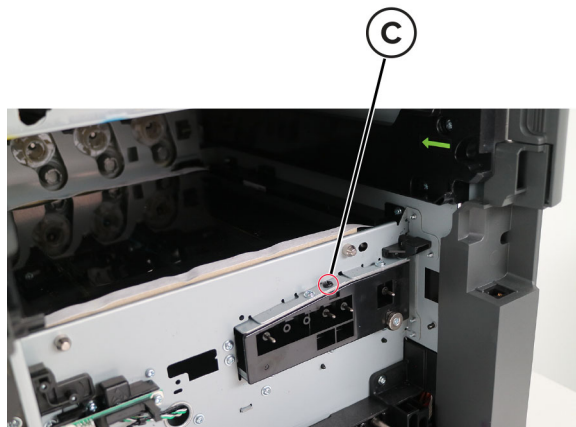

- 9 At the opposite end of the HVPS, press down on the latch (D), and then slide the HVPS inward to release it.

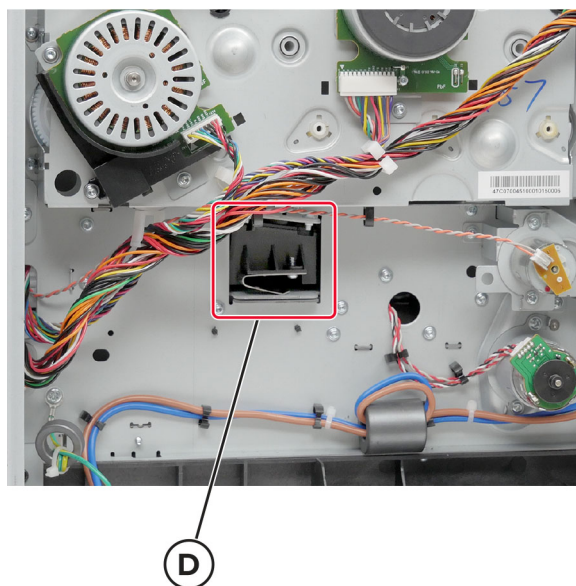

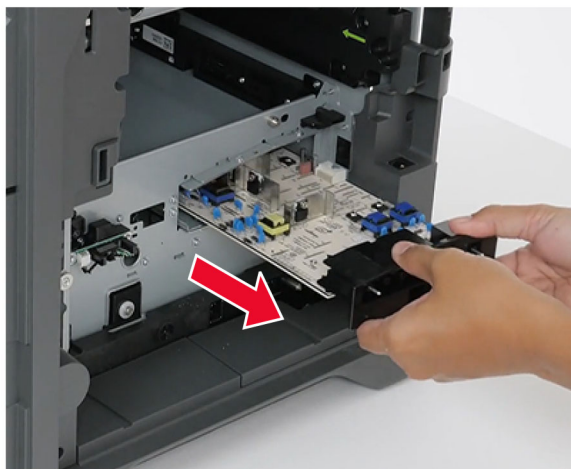
10 Remove the HVPS.**Installation notes:**

- Press on the three toner contacts (location shown in E) while inserting the HVPS.
- Make sure that the three toner contacts freely move and are fully extended after installation.

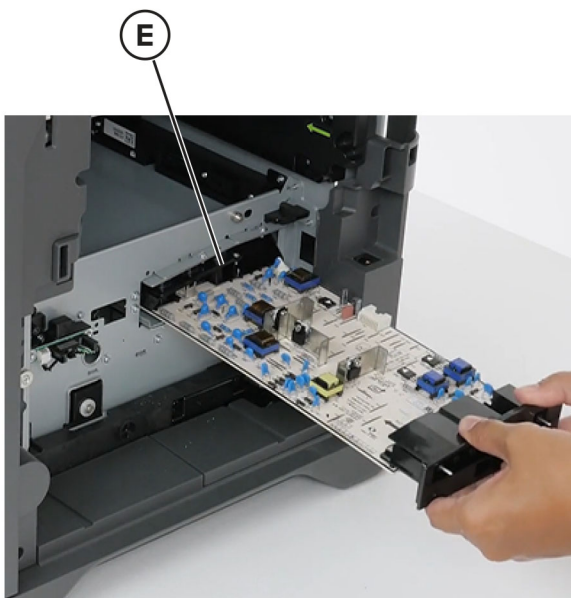

Sensor (waste toner) removal

- 1 Remove the waste toner bottle. See [“Waste toner bottle removal” on page 397.](#)
- 2 Disconnect the cable (A), and then remove the two screws (B).

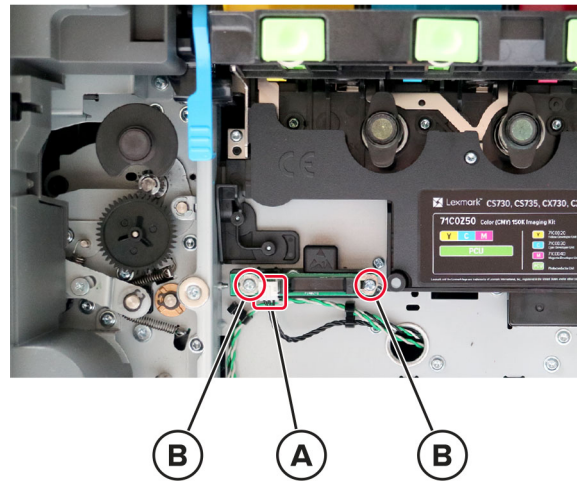

- 3 Remove the sensor (waste toner).

Sensor (MPF paper present) removal

- 1 Remove the waste toner bottle. See [“Waste toner bottle removal” on page 397.](#)
- 2 Remove the motor cover. See [“Motor cover removal” on page 427.](#)
- 3 Remove the right cover. See [“Right cover removal” on page 401.](#)
- 4 Remove the four screws (A).

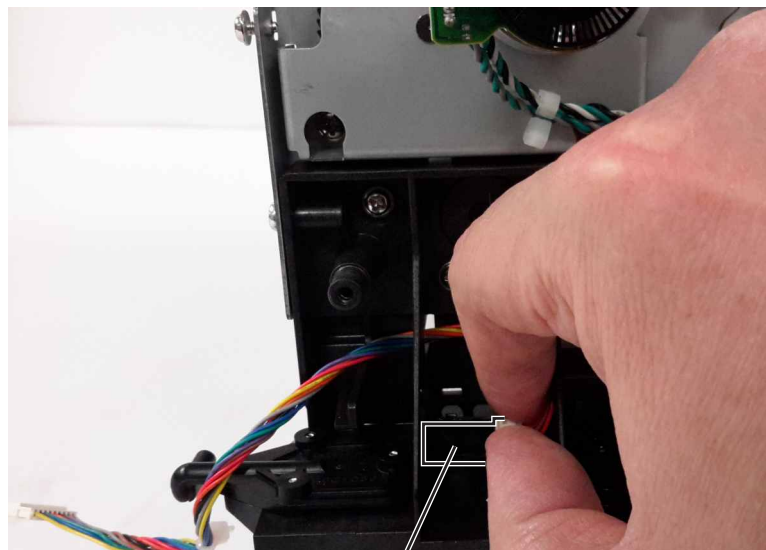

A

Parts removal

420

- 5 On the other side of the sensor, insert the prying tool into the hole (B) to release the sensor.

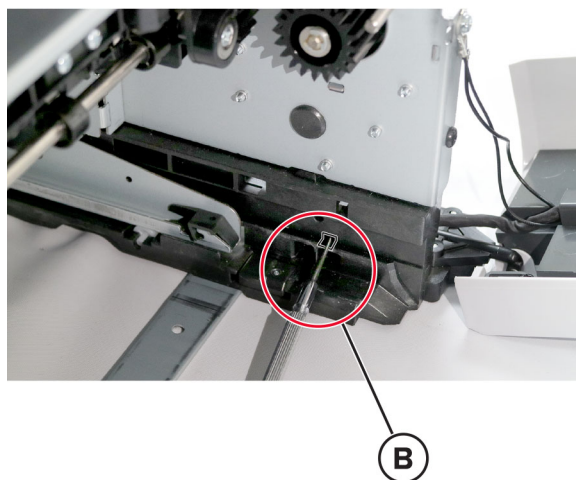

- 6 Pry the sensor (C) out of the printer.

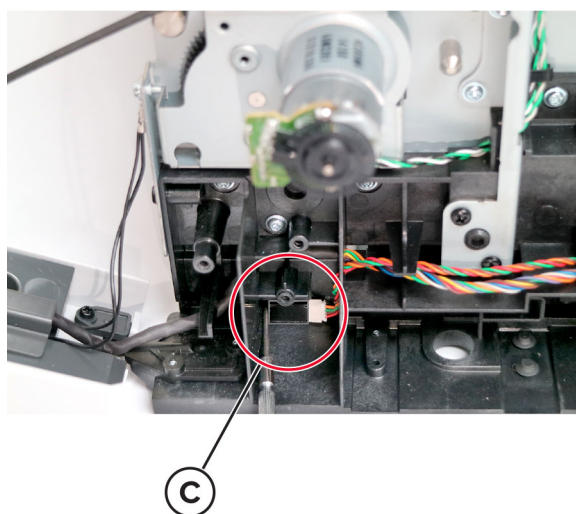

- 7 Disconnect the sensor cable (D), and then remove the sensor.

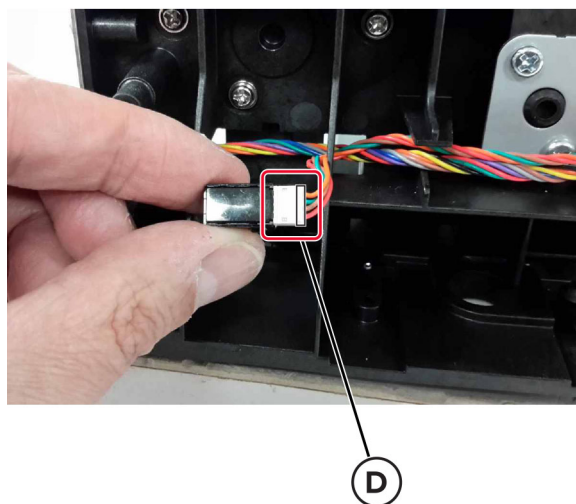

Sensor (TPS) removal

- 1 Remove the waste toner bottle. See [“Waste toner bottle removal” on page 397.](#)
- 2 Remove the imaging kit. See [“Imaging kit removal” on page 399.](#)
- 3 Remove the transfer module. See [“Transfer module removal” on page 431.](#)
- 4 Remove the three screws (A).

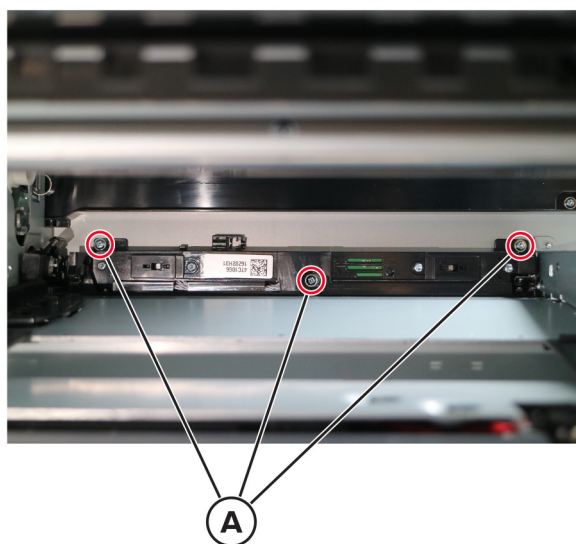

- 5 Disconnect the two cables (B).

Warning—Potential Damage: Press the tab, before disconnecting the cable

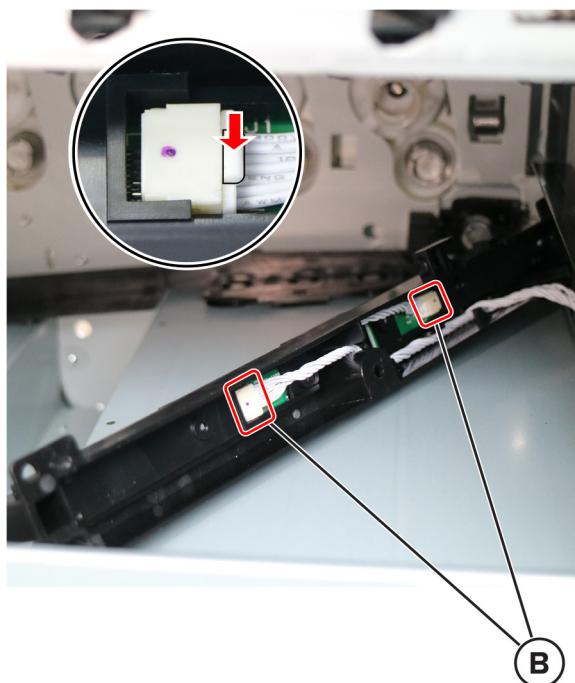

6 Remove the sensor.

Installation note: When installing a new sensor (TPS), perform the TPS characterization data entry as instructed in the accompanying FRU sheet. For more information, see [“Entering the sensor \(TPS\) characterization data” on page 423](#).

Entering the sensor (TPS) characterization data

Entering data automatically from the flash drive

Notes:

- A new sensor (TPS) includes a flash drive that contains the characterization data. Entering data automatically from the flash drive is the easier method.
- The characterization data cannot be used on another sensor.

After installing a new sensor (TPS), do the following:

1 Insert the flash drive into the front USB port.

Note: The printer copies automatically the required data from the flash drive.

2 Remove the flash drive.

3 Enter the Diagnostics menu.

- From the home screen, touch .
- Touch ****36**, and then touch **OK**.

4 Navigate to: **Printer setup > EP setup > Toner patch sensor adjust**

5 Perform the following procedures:

- Full calibration
- Sensor gain characterization
- Sensor gain verification

Note: Check the results for errors (in red). Contact the next level of support if needed.

6 From the home screen, navigate to: **Settings > Print > Quality > Advanced Imaging > Color Adjust**

7 Touch **Color Adjust**.

Entering data manually

Notes:

- Perform this method if it is not possible to access the data using the flash drive.
- The characterization data cannot be used on another sensor.

After installing a new sensor (TPS), do the following:

1 Enter the Diagnostics menu.

- a** From the home screen, touch .
- b** Touch ****36**, and then touch **OK**.

2 Navigate to: **Printer setup > EP setup > Toner patch sensor adjust > TPS characterization data**

3 Enter the characterization data from the FRU sheet.

- a** Select **Left sensor data**, and then enter the corresponding strings.
- b** Select **Right sensor data**, and then enter the corresponding strings.
- c** Select **Shared sensor data**, and then enter the corresponding strings.
- d** Select **Serial number**, and then enter the corresponding strings.
- e** Select **Save all TPS sensor data**, and then touch **Start**.

4 Enter the Diagnostics menu, and then navigate to: **Printer setup > EP setup > Toner patch sensor adjust**

5 Perform the following procedures:

- Full calibration
- Sensor gain characterization
- Sensor gain verification

Note: Check the results for errors (in red). Contact the next level of support if needed.

6 From the home screen, navigate to: **Settings > Print > Quality > Advanced Imaging > Color Adjust**

7 Touch **Color Adjust**.

Front side removals

Front door removal

- 1 Remove the screw, and then remove the cover.

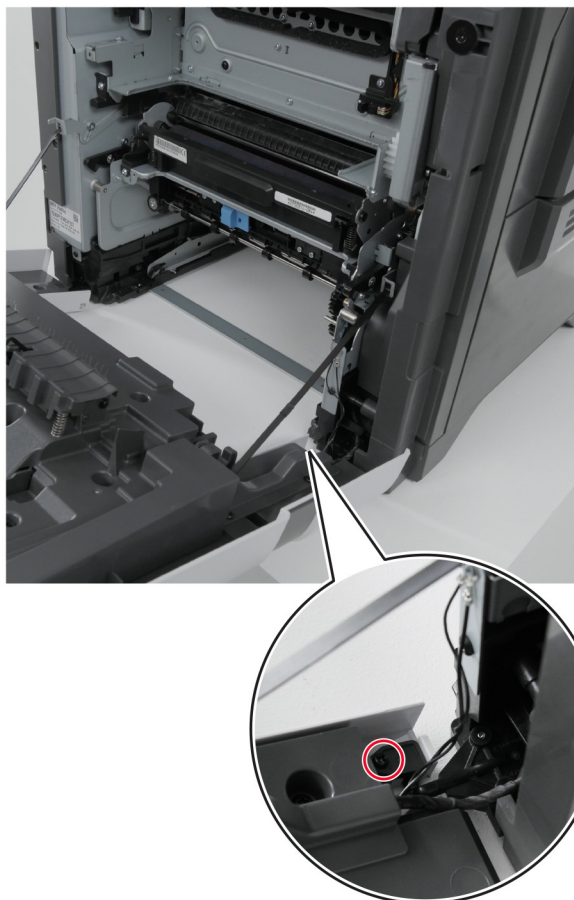

- 2** Remove the two screws (A), and then remove the cable cover.

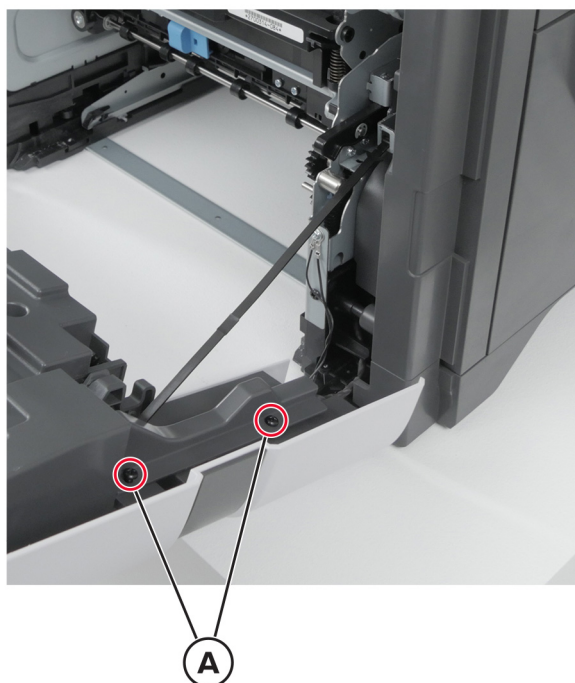

- 3** Disconnect the cable (B), and then remove the ground screw (C).

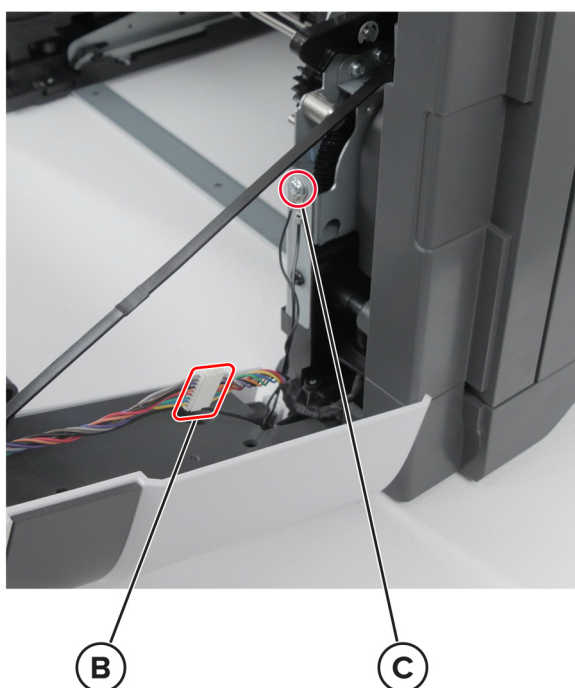

- 4** Release the straps (D), and then remove the door.

Warning—Potential Damage: Make sure that the door does not fall.

**D**

Motor cover removal

- 1 Open the front door and cartridge door.
- 2 Remove the screw (A).

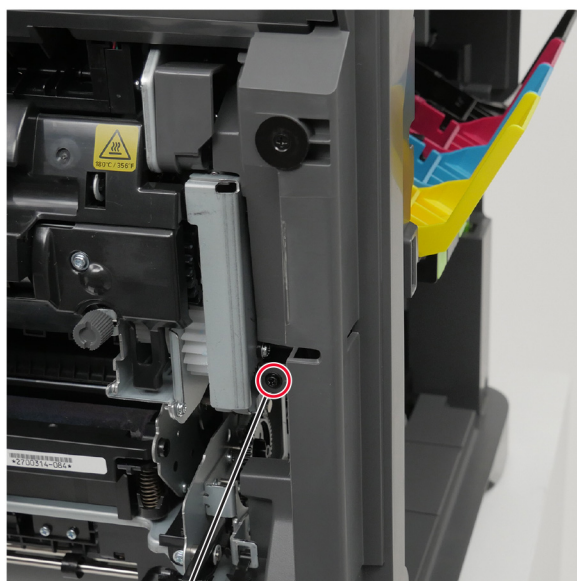
**A**

Parts removal

427

3 Remove the three screws (B).

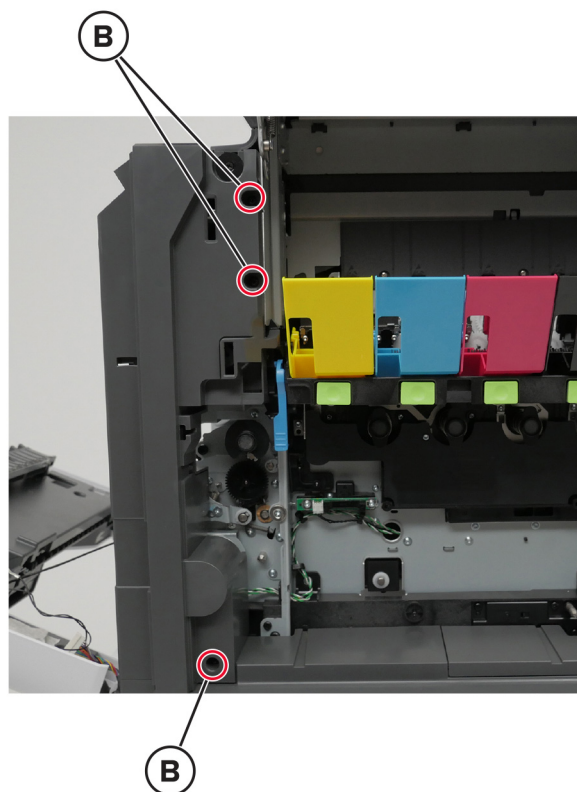

4 Disconnect the switch cable (C).

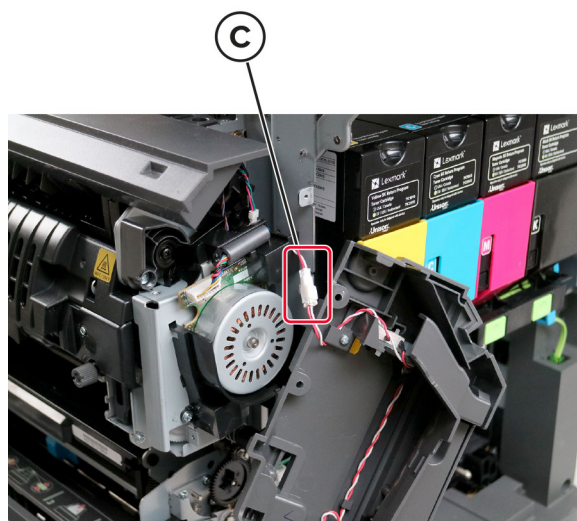

5 Remove the cover.

Scanner front cover removal

- 1 Remove the USB cover. See [“USB cover removal” on page 405.](#)
- 2 Remove the badge cover.



- 3 Remove the screw (A).



A

4 Remove the screw (B).

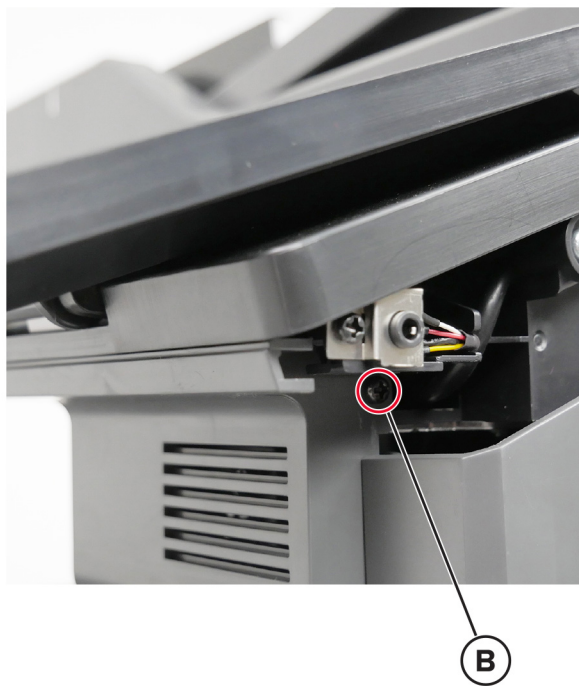

5 Open the cartridge door, and then remove the screw (C).

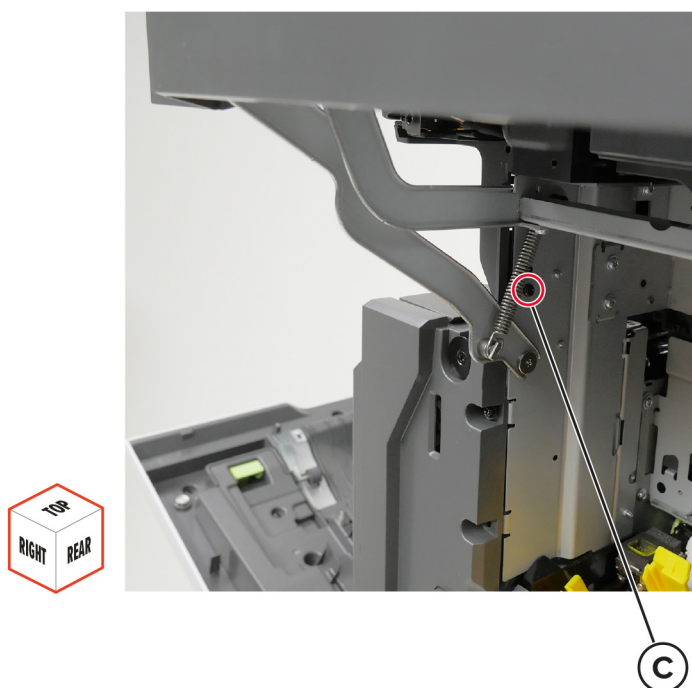

6 Remove the cover.

Transfer module removal

- 1 Remove the waste toner bottle. See [“Waste toner bottle removal” on page 397](#).
- 2 Remove the imaging kit. See [“Imaging kit removal” on page 399](#).
- 3 Open the front door.
- 4 Remove the screw (A), and then remove the transfer module retainer.

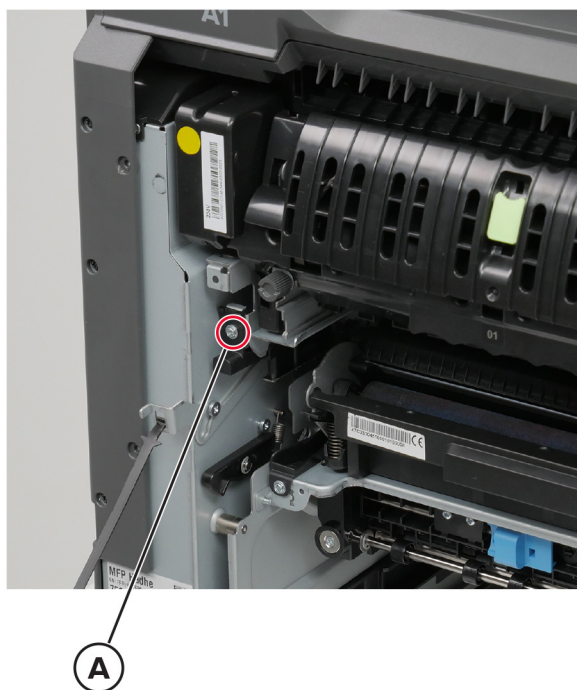

- 5 Open the cartridge door, and then remove the screw (B).

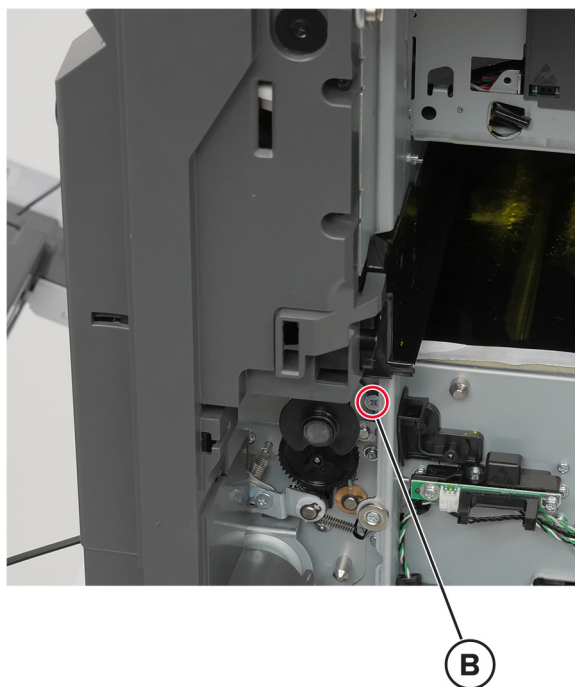

- 6 Remove the transfer module.

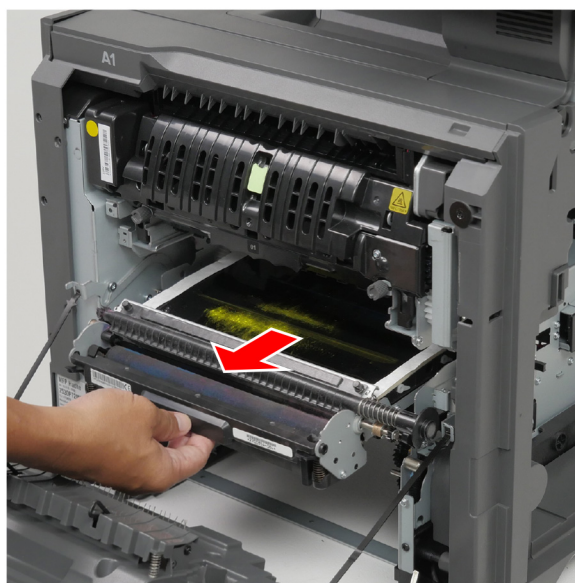

Installation notes:

- Check if the transfer module bearings are properly seated on the frame. Make sure that the bearings sit down into their vees.

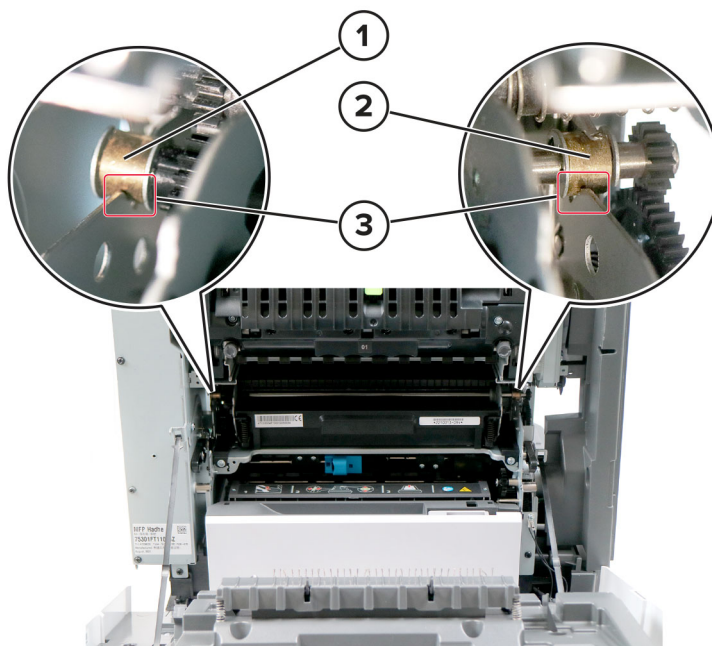

#	Part
1	Left bearing
2	Right bearing
3	Frame

- Reset the transfer module counter. See [“Resetting the transfer module counter” on page 552.](#)
- Align the top and bottom margins. See [“Registration adjustment” on page 369.](#)

Transfer module retainer removal

- 1 Remove the waste toner bottle. See [“Waste toner bottle removal” on page 397.](#)
- 2 Remove the imaging kit. See [“Imaging kit removal” on page 399.](#)
- 3 Open the front door.

- 4 Remove the screw (A), and then remove the transfer module retainer.

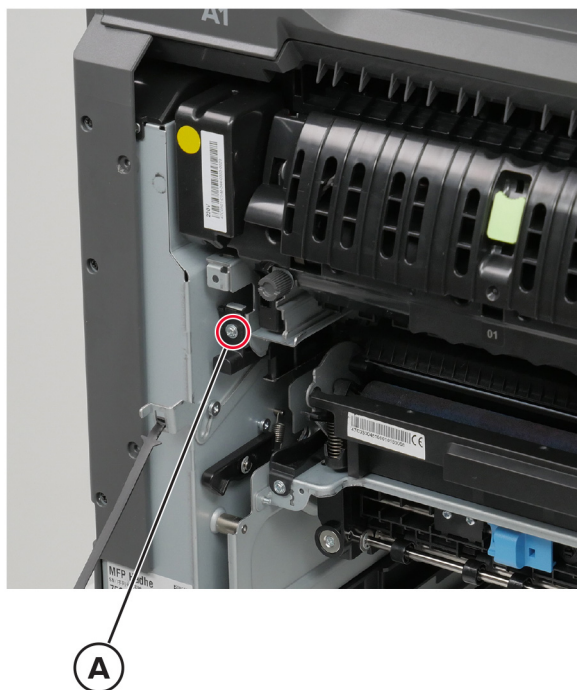

Installation note: Slide the transfer module retainer into the printer.

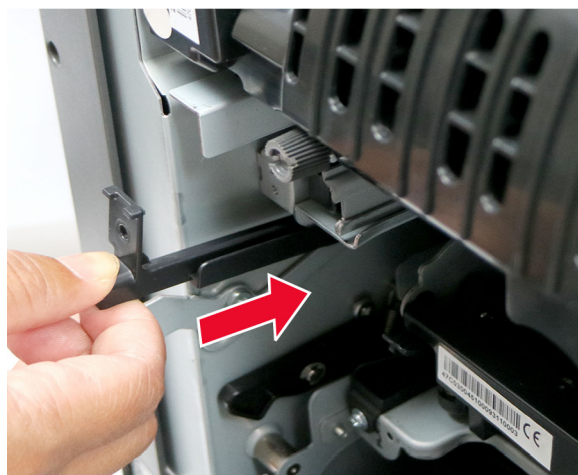

Sensor (input) removal

- 1 Remove the waste toner bottle. See [“Waste toner bottle removal” on page 397.](#)
- 2 Remove the imaging kit. See [“Imaging kit removal” on page 399.](#)
- 3 Remove the transfer module. See [“Transfer module removal” on page 431.](#)

4 Remove the screw (A), and then lift the sensor.

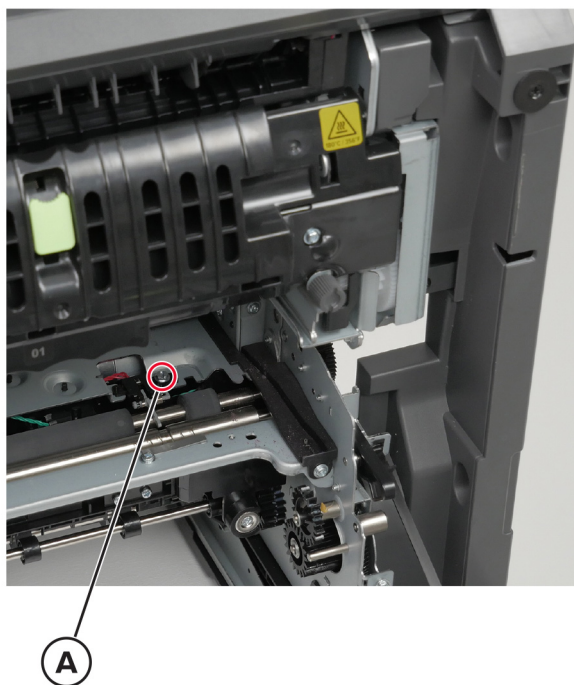

5 Disconnect the cable (B), and then remove the sensor.

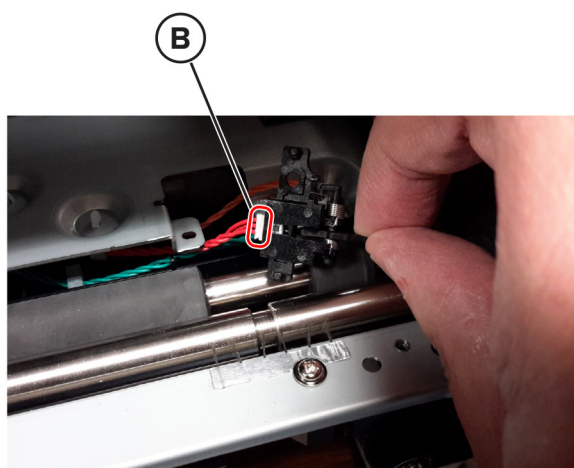

Fuser removal

- 1 Open door A, and then open door A1.

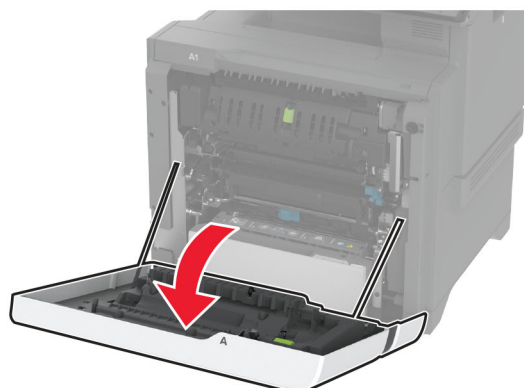

- 2 Remove the fuser.

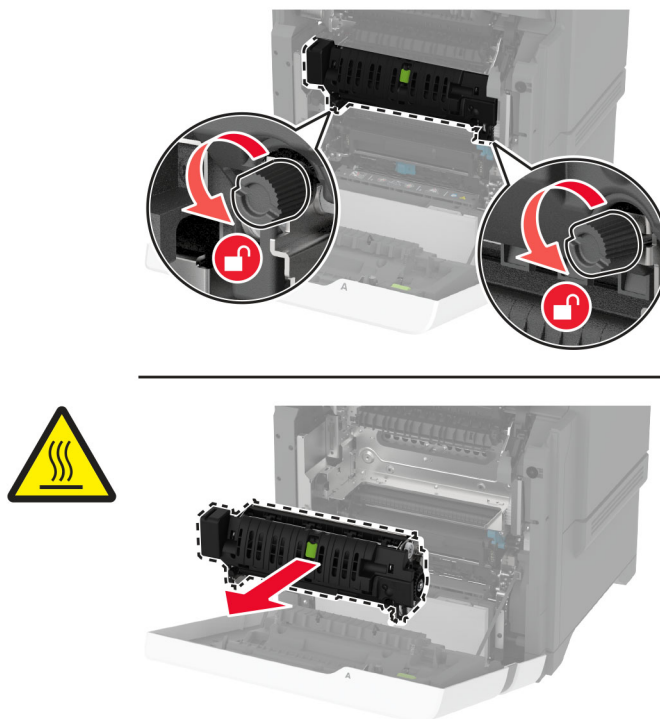

Installation note: After installing a new fuser, reset the fuser maintenance counter. See [“Resetting the fuser maintenance counter” on page 551](#).

Redrive guide removal

- 1 Remove the fuser. See [“Fuser removal” on page 436](#).
- 2 Remove the four screws (A).

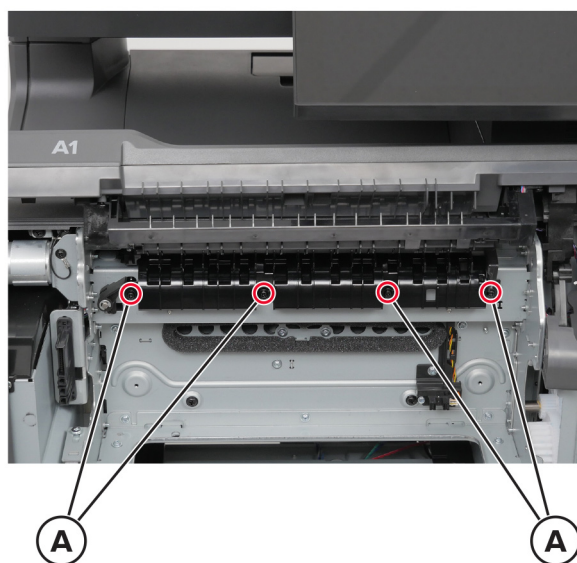

Parts removal

- 3 Move the diverter (B) out of the way, and then release the cover from its frame.

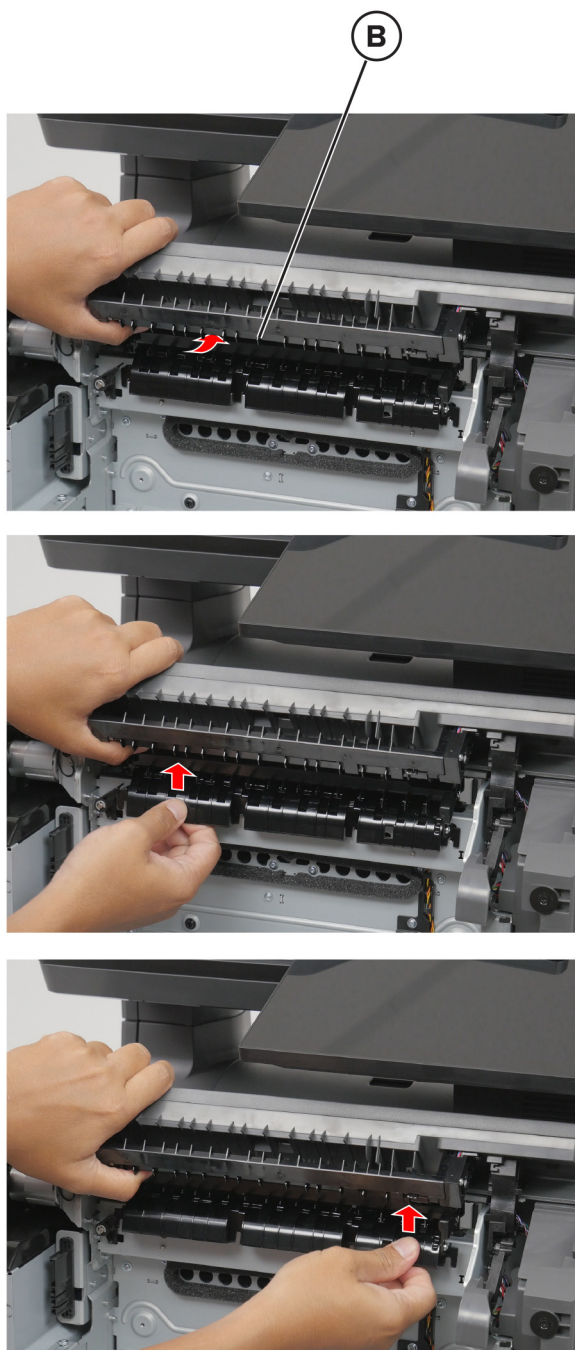

- 4 Remove the cover.

Note: If necessary, turn the lever to make way for the cover.

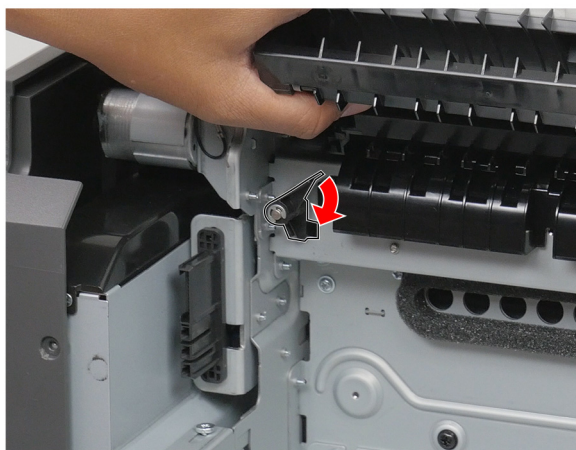

Diverter removal

- 1 Remove the fuser. See [“Fuser removal” on page 436](#).
- 2 Remove the top frame cover. See [“Top frame cover removal” on page 483](#).
- 3 Remove the top frame base cover. See [“Top frame base cover removal” on page 483](#).
- 4 Remove the three screws (A).

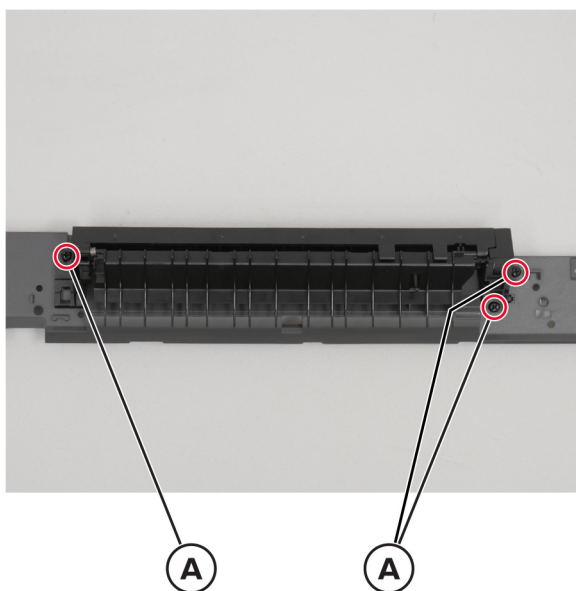

- 5 Remove the diverter.

Sensor (redrive) removal

- 1 Remove the fuser. See [“Fuser removal” on page 436](#).
- 2 Remove the top frame cover. See [“Top frame cover removal” on page 483](#).

- 3 Remove the top frame base cover. See [“Top frame base cover removal” on page 483.](#)
- 4 Remove the diverter. See [“Diverter removal” on page 439.](#)
- 5 Remove the screw (A), and then remove the sensor bracket.

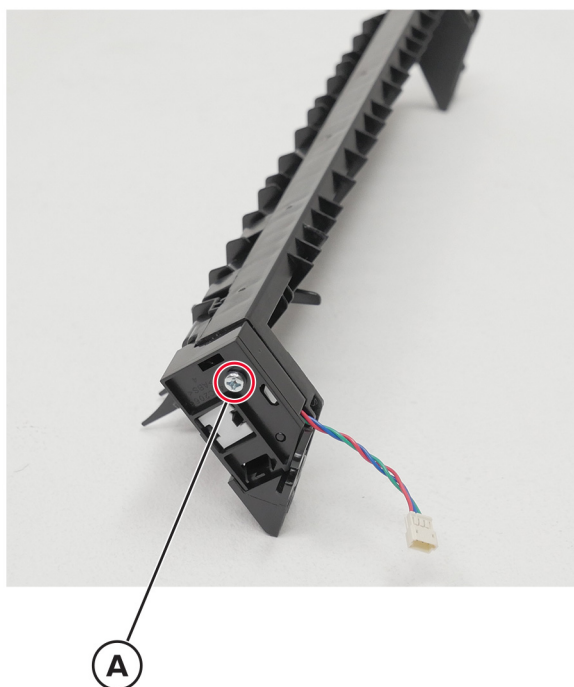

- 6 Remove the retainer (B), and then remove the sensor from its bracket.

Installation note: Make sure that the retainer is installed with the replacement sensor.

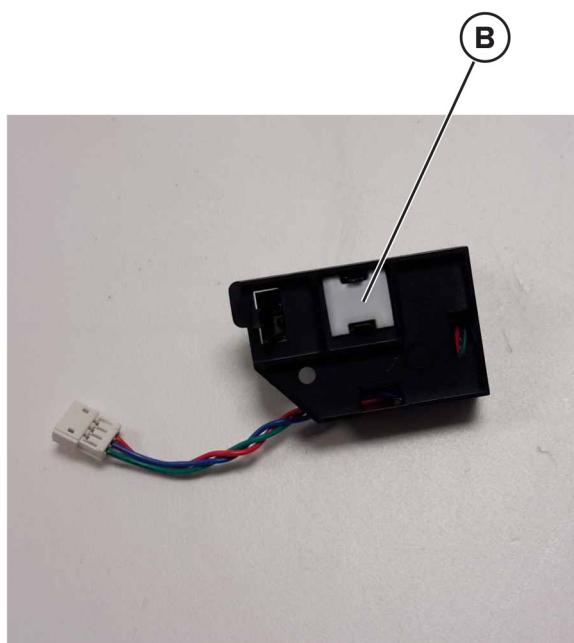

Sensor (fuser nip) removal

- 1 Remove the fuser. See [“Fuser removal” on page 436](#).
- 2 Remove the two screws (A).

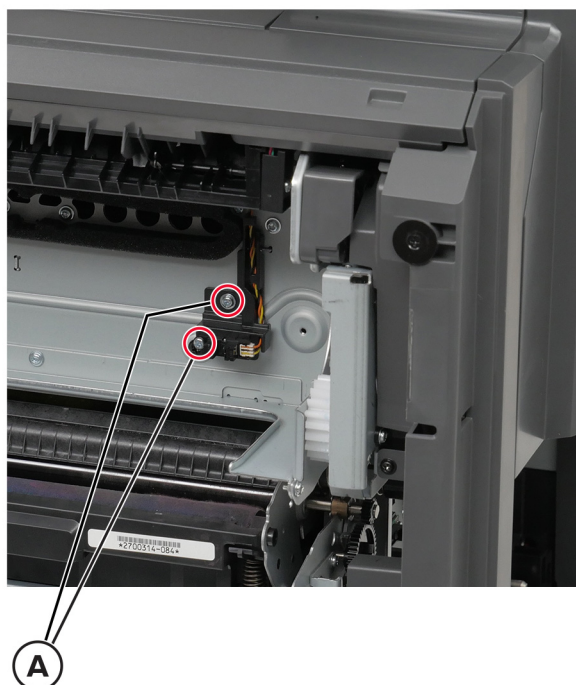

- 3 Disconnect the cable (B), and then remove the sensor.



Control panel display (10-inch) removal

Note: For a video demonstration, see [Replacing the control panel display and control panel base](#).

- 1 Remove the six screws (A) behind the control panel.

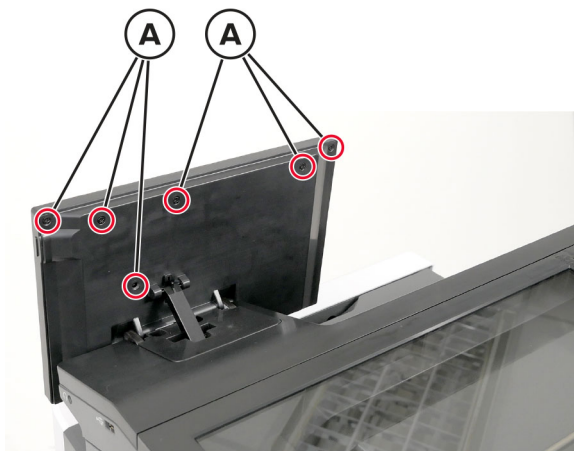

- 2 Pry the control panel display to release, and then pull it to access the cable.

Warning—Potential Damage: The FFC may get damaged if the control panel display is dropped. Make sure to hold the control panel display after releasing it.



- 3** Unlock the clip, and then disconnect the cable.

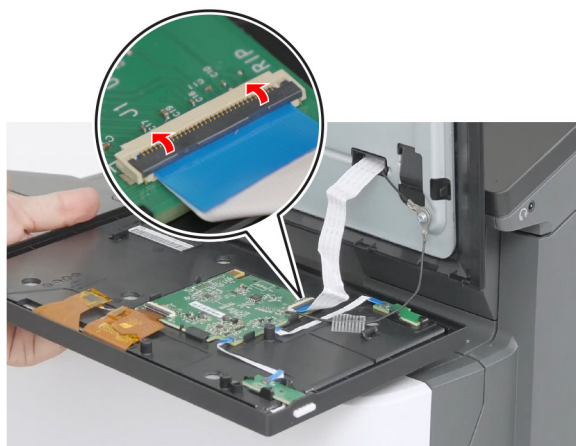

- 4** Remove the ground screw (B), and then remove the control panel display.



Control panel display (7-inch) removal

- 1 Remove the screws (A) behind the control panel.

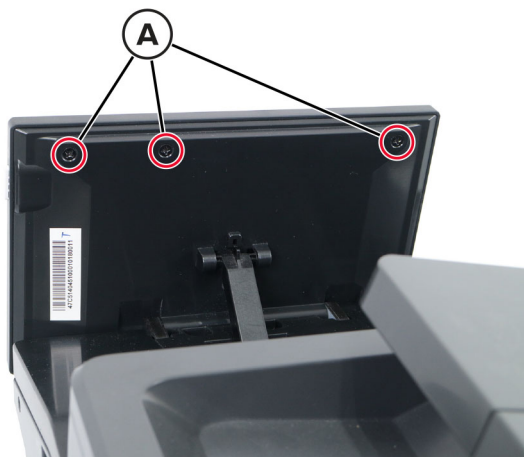

- 2 Pry the control panel display to release it, and then pull the panel to access the cable.

Warning—Potential Damage: To avoid damaging the cable, make sure to hold the control panel display after releasing it.



3 Remove the cable (B).

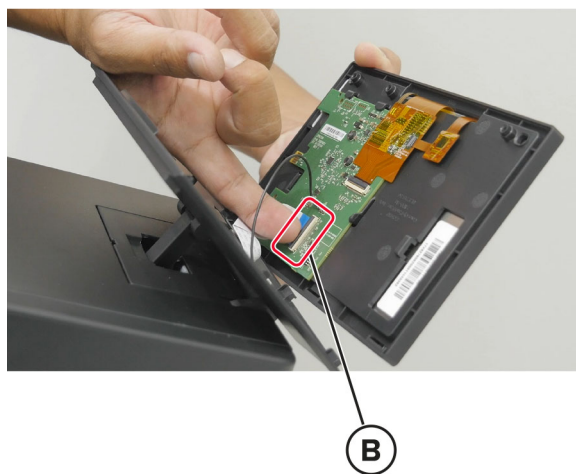

4 Remove the screw (C).

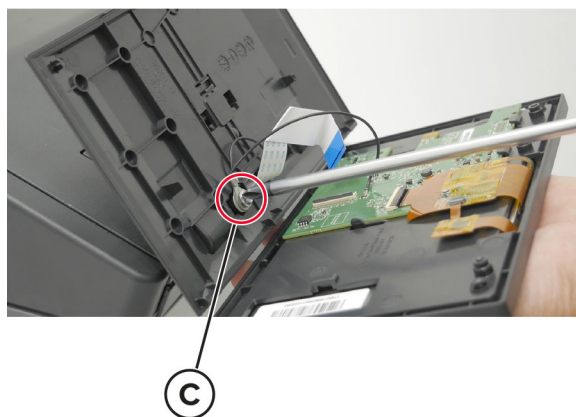

5 Remove the control panel.

Control panel base (10-inch) removal

- 1 Remove the control panel. See [“Control panel display \(10-inch\) removal” on page 442](#).
- 2 Remove the three screws (A) under the control panel.

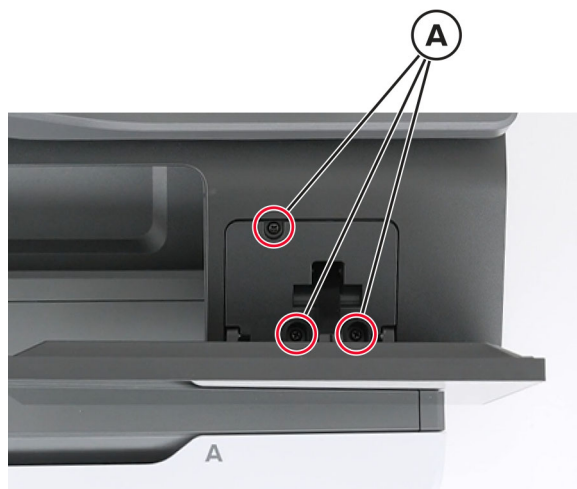

- 3 Release the control panel hinge.



- 4 Release the flat flex and ground cables from the control panel rear cover to remove the control panel base with rear cover.



Control panel base (7-inch) removal

- 1 Remove the control panel. See [“Control panel display \(7-inch\) removal” on page 444](#).
- 2 Remove the screws (A) under the control panel.

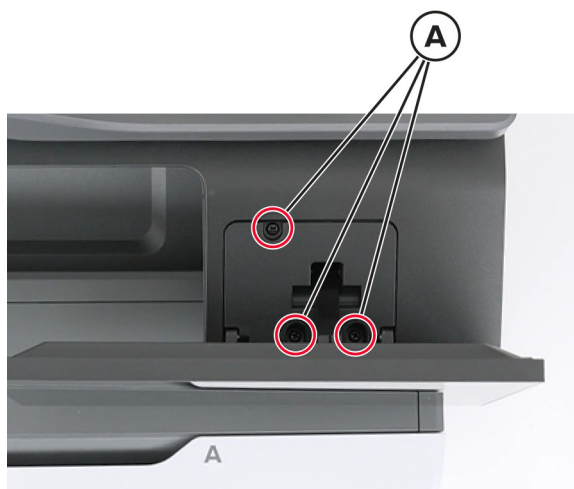

- 3 Release the control panel hinge.



- 4 Release the FFC (B) from the control panel rear cover to remove the control panel base with rear cover.

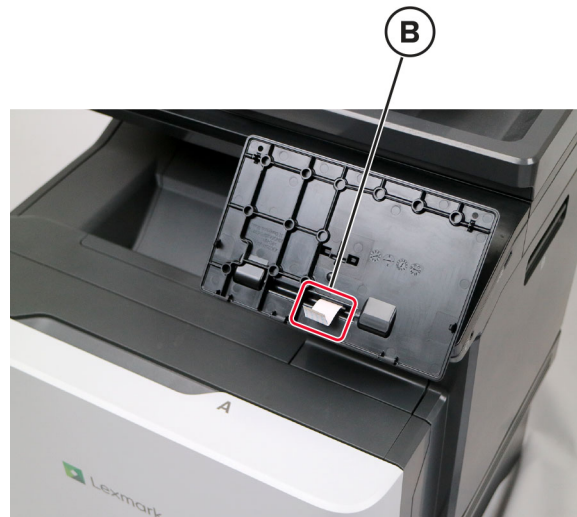

Control panel hinge removal

- 1 Remove the control panel. See [“Control panel display \(10-inch\) removal” on page 442](#) or [“Control panel display \(7-inch\) removal” on page 444](#).
- 2 Remove the control panel base. See [“Control panel base \(10-inch\) removal” on page 446](#) or [“Control panel base \(7-inch\) removal” on page 447](#).

- 3 Remove the two screws (A), and then remove the control panel hinge from the rear cover.

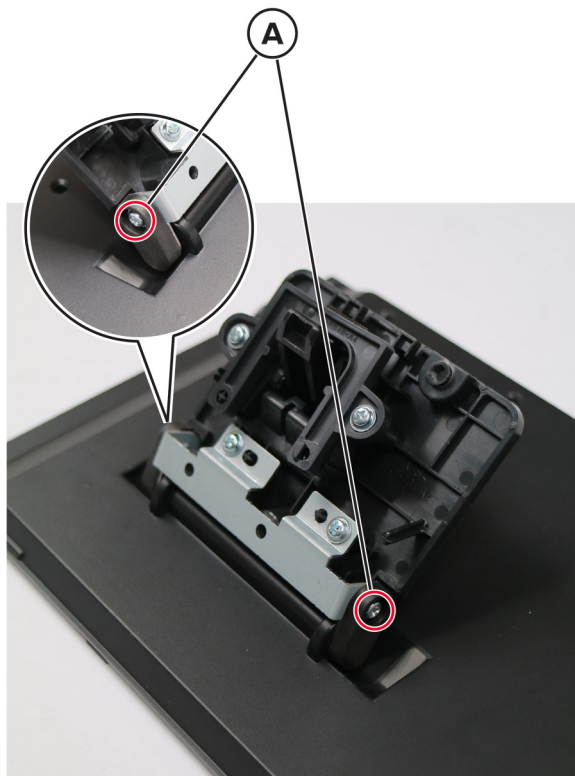

Control panel rear cover removal

- 1 Remove the control panel. See [“Control panel display \(10-inch\) removal” on page 442](#) or [“Control panel display \(7-inch\) removal” on page 444](#).
- 2 Remove the control panel base. See [“Control panel base \(10-inch\) removal” on page 446](#) or [“Control panel base \(7-inch\) removal” on page 447](#).

- 3 Remove the two screws (A), and then remove the control panel rear cover from the hinge.

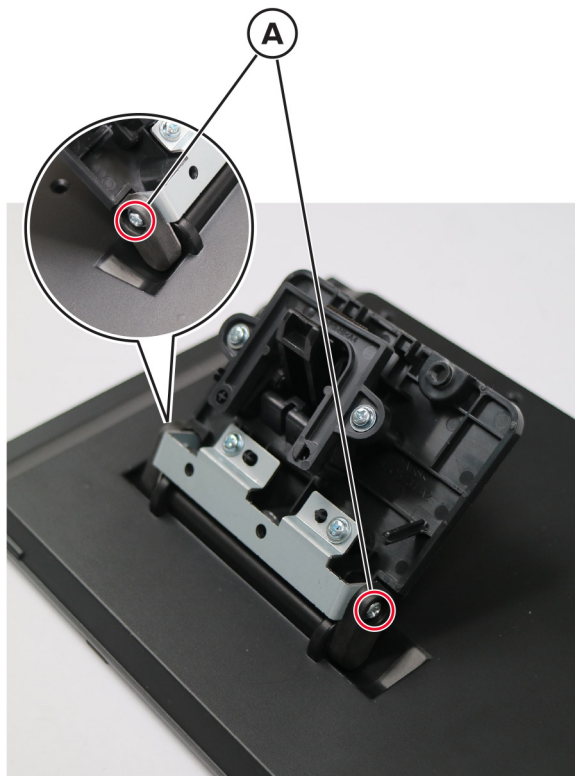

Speaker removal

- 1 Remove the USB cover. See [“USB cover removal” on page 405.](#)
- 2 Remove the scanner front cover. See [“Scanner front cover removal” on page 429.](#)

- 3 Remove the two screws (A).

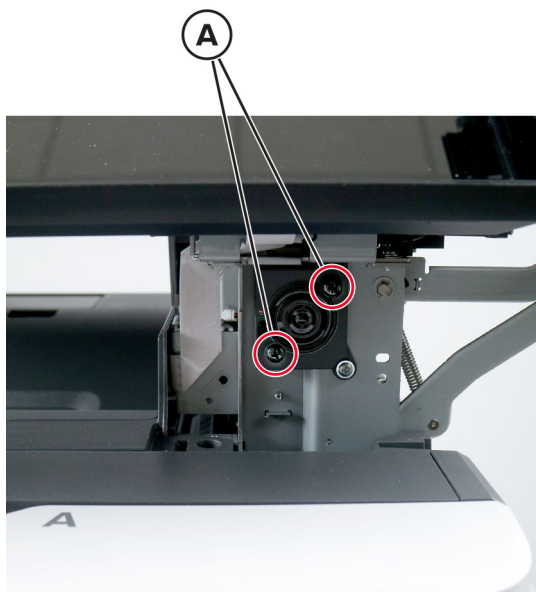

- 4 Disconnect the cable (B).

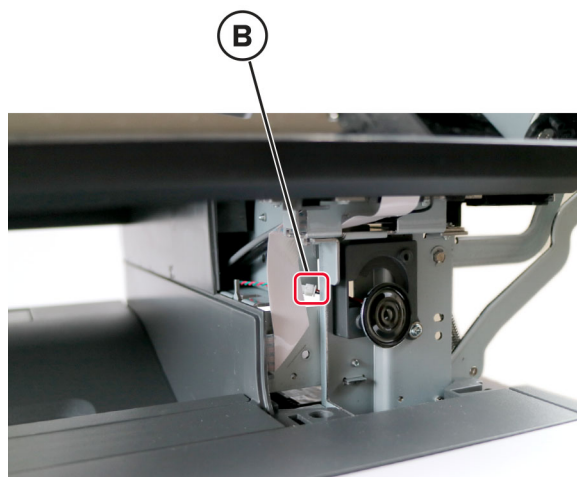

- 5 Remove the speaker.

Front door hinges removal

Warning—Potential Damage: Remove the waste toner bottle and imaging kit first before removing the hinges. Failure to do this can lead to toner spillage and damage to the printer.

Note: This procedure is applicable to the left and right hinges.

- 1 Remove the waste toner bottle. See [“Waste toner bottle removal” on page 397](#).
- 2 Remove the imaging kit. See [“Imaging kit removal” on page 399](#).
- 3 Remove the front door. See [“Front door removal” on page 425](#).

- 4 Place the printer on its side.
- 5 Remove the three screws (A) securing the hinge, and then remove the hinge.

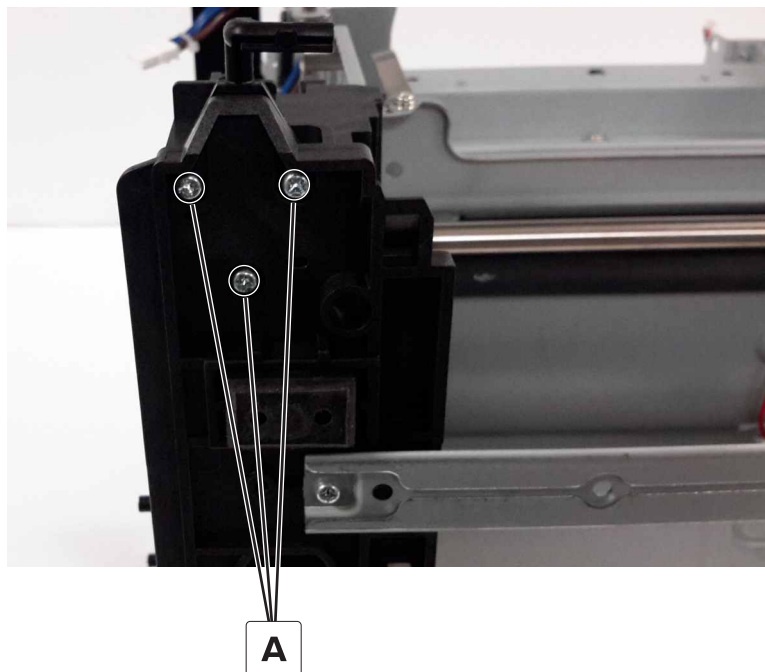

Control panel arms removal

Note: The control panel arms are two separate FRUs. This procedure shows how to remove both arms.

- 1 Remove the fuser. See [“Fuser removal” on page 436](#).
- 2 Remove the top frame cover. See [“Top frame cover removal” on page 483](#).
- 3 Remove the four screws (A).

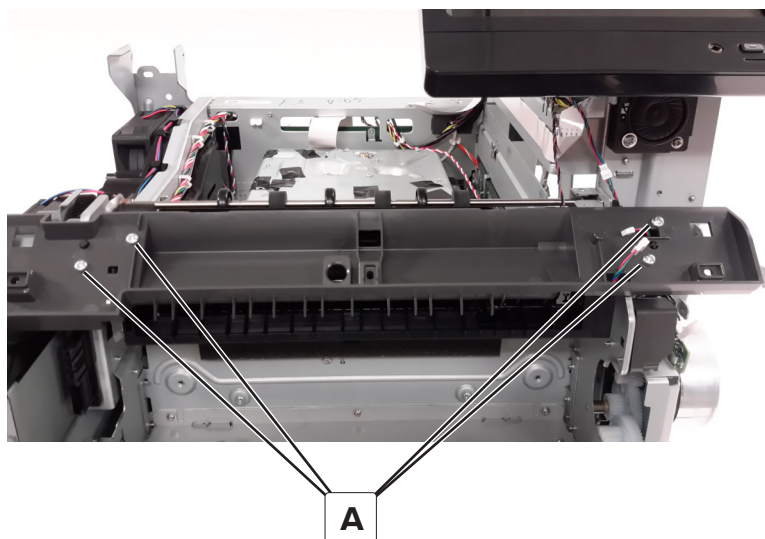

- 4 Disconnect the cable (B).

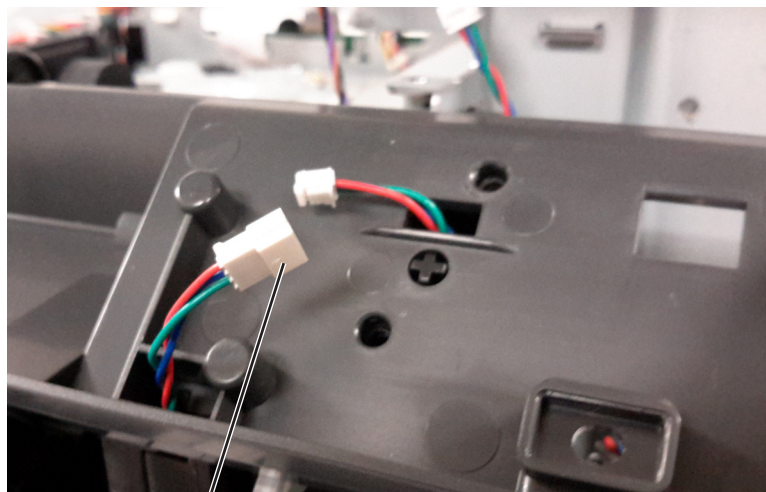

B

- 5 Remove the redrive guide. See [“Redrive guide removal” on page 437.](#)
- 6 Remove the control panel left arm (C) from the mounting pin.

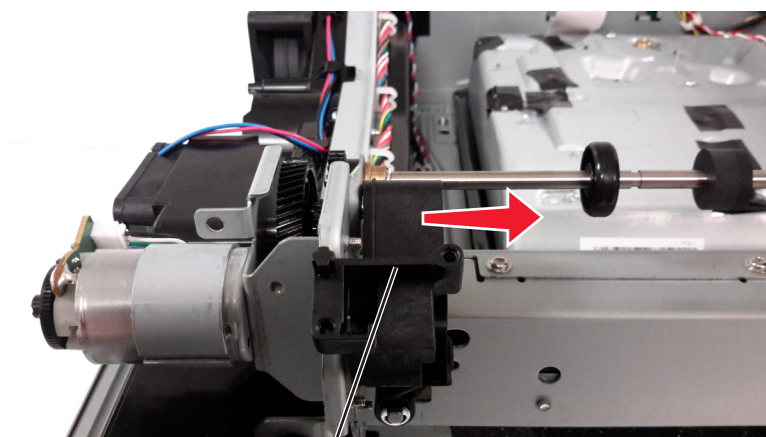

C

7 Disconnect the cable (D).

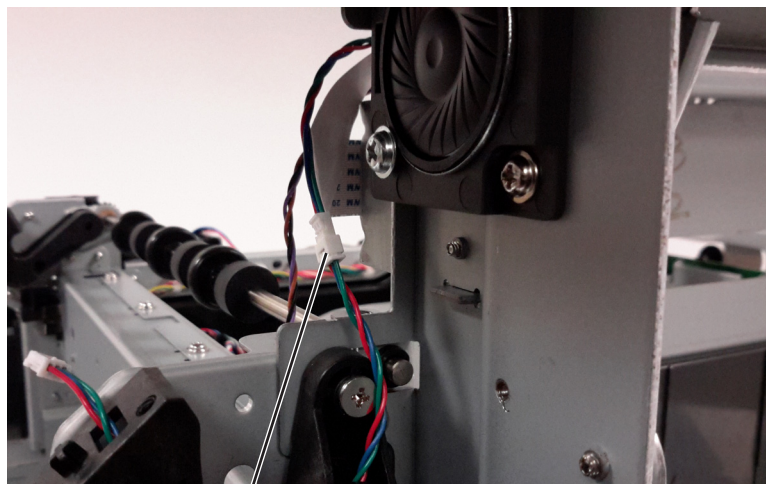

D

8 Remove the two screws (E), and then remove the right arm.

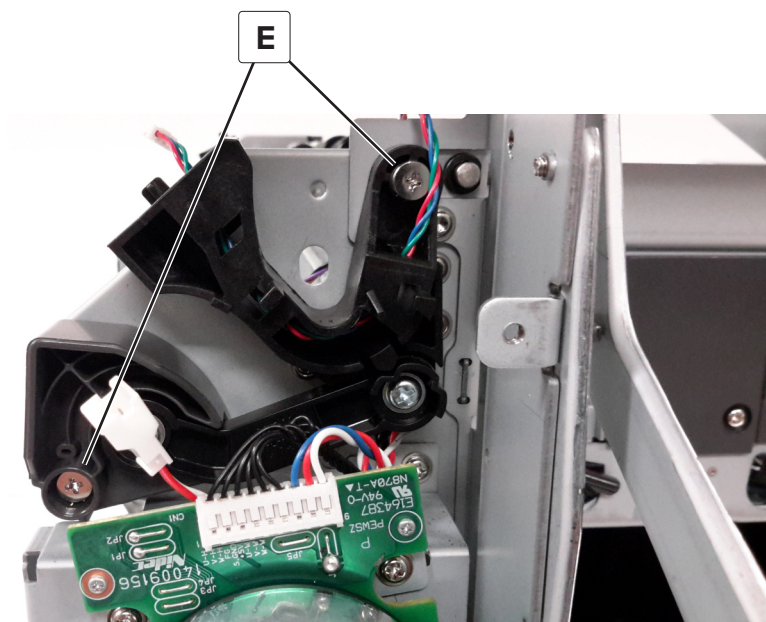

E

- 9 Remove the cable (F) from the right arm.



Transfer module guide rail removal

- 1 Remove the waste toner bottle. See [“Waste toner bottle removal” on page 397.](#)
- 2 Remove the imaging kit. See [“Imaging kit removal” on page 399.](#)
- 3 Remove the transfer module. See [“Transfer module removal” on page 431.](#)
- 4 Remove the left cover. See [“Left cover removal” on page 374.](#)
- 5 Remove the EP drive gearbox. See [“EP drive gearbox removal” on page 384.](#)

6 Remove the three screws (A).

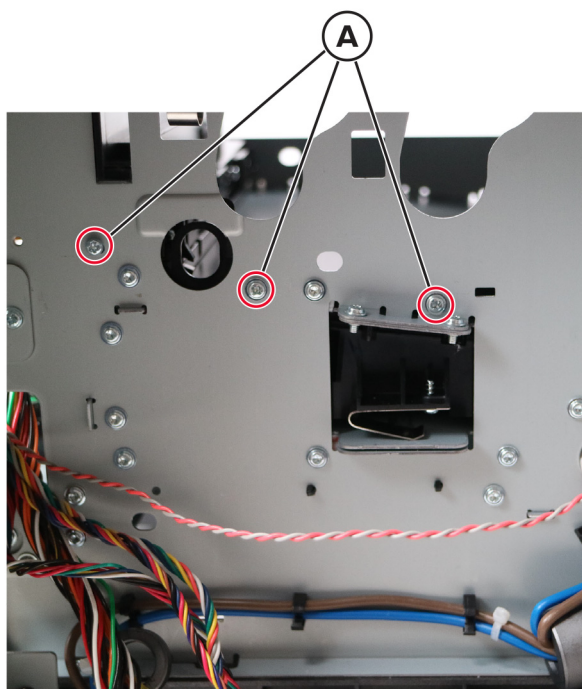

7 Remove the screw (B).

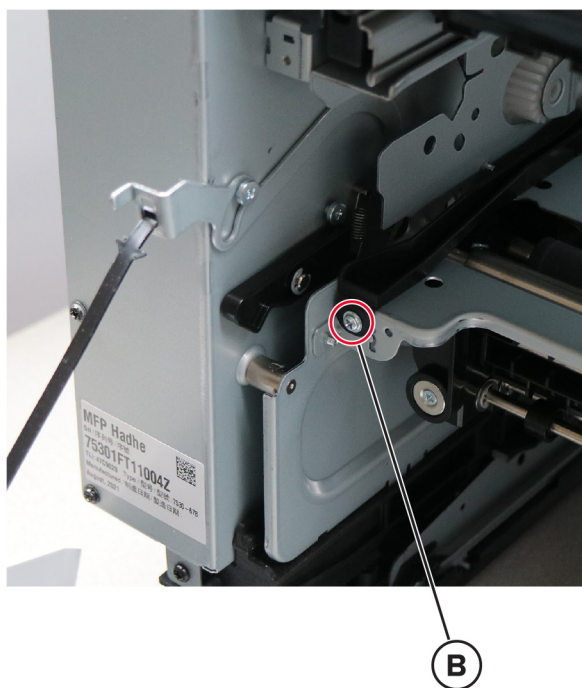

8 Gently release the guide rail from the frame.

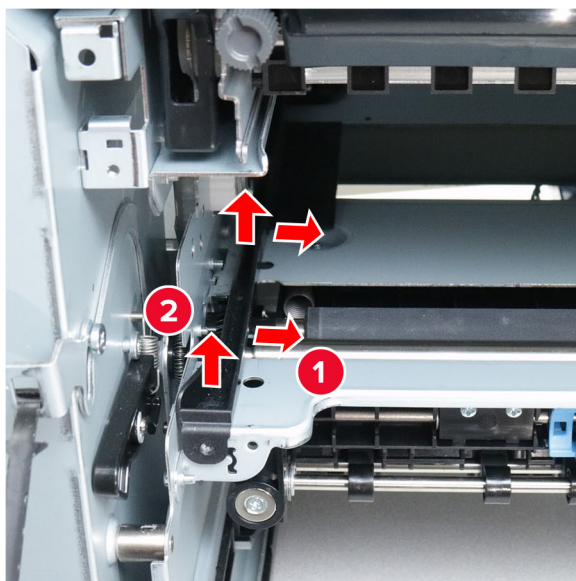

9 Release the spring (C), and then remove the spring and coupling (D) from the guide rail.



Installation note: Make sure that the HVPS contacts (A) are aligned and unblocked.

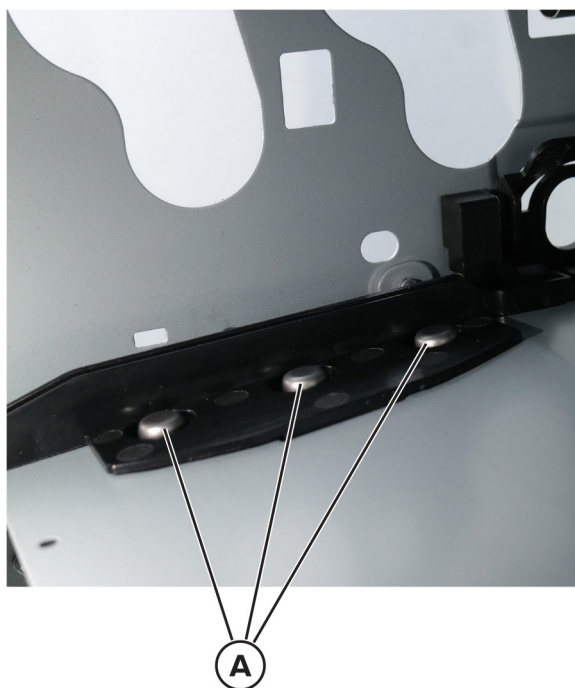

Aligner rollers removal

- 1 Remove the fuser. See [“Fuser removal” on page 436.](#)
- 2 Remove the waste toner bottle. See [“Waste toner bottle removal” on page 397.](#)
- 3 Remove the imaging kit. See [“Imaging kit removal” on page 399.](#)
- 4 Remove the transfer module. See [“Transfer module removal” on page 431.](#)
- 5 Remove the left cover. See [“Left cover removal” on page 374.](#)
- 6 Remove the LVPS. See [“LVPS removal” on page 377.](#)
- 7 Remove the LVPS cage. See [“LVPS cage removal” on page 392.](#)
- 8 Remove the motor cover. See [“Motor cover removal” on page 427.](#)
- 9 Remove the right cover. See [“Right cover removal” on page 401.](#)
- 10 Remove the sensor (input). See [“Sensor \(input\) removal” on page 434.](#)

- 11 On the right side of the printer, remove the gear (A), and then remove the screw (B).

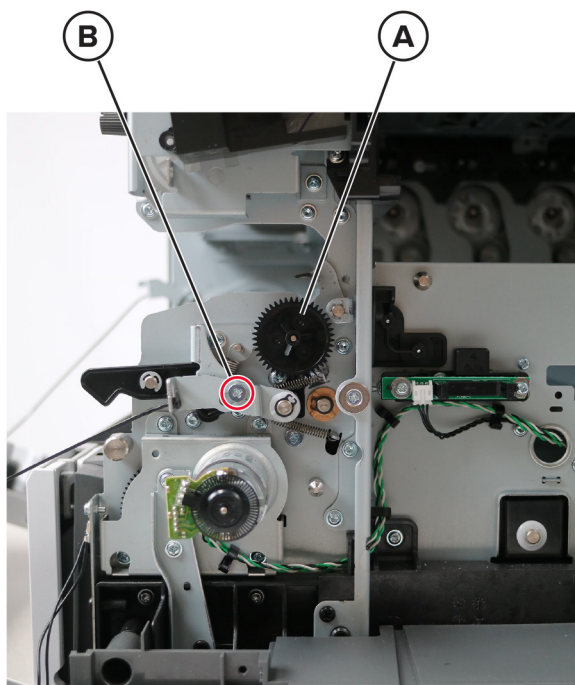

- 12 Remove the C-clip (C), and then remove the spacer.

Warning—Potential Damage: Be careful not to overextend the clip when removing or installing.

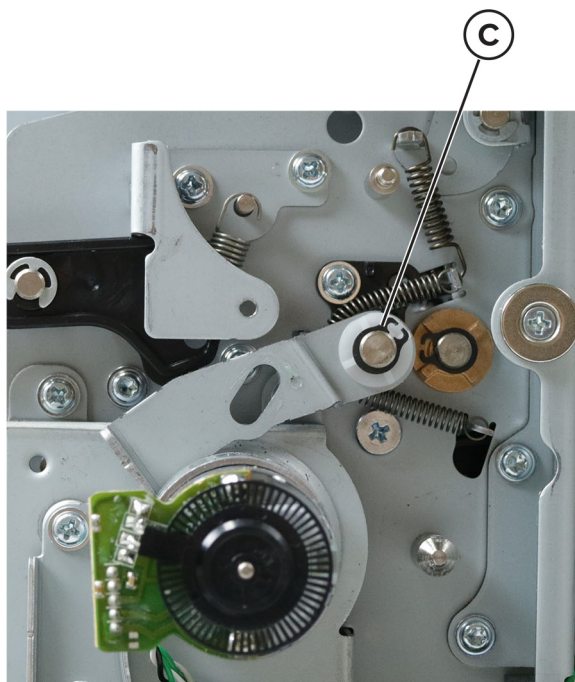

13 Remove the bracket (D), and then release the spring (E).

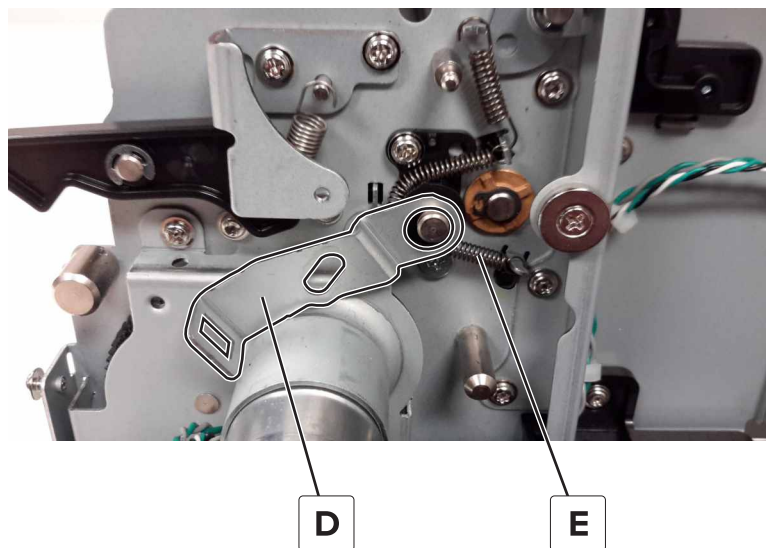

14 Remove the spacer (F).

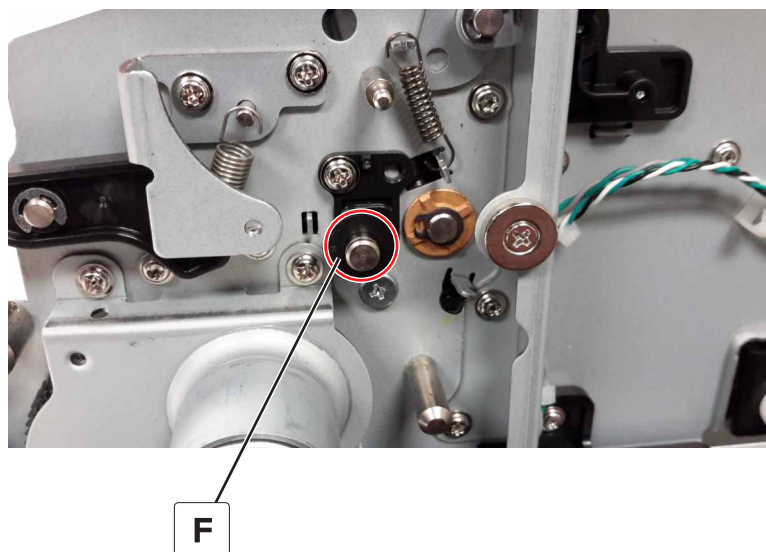

15 Remove the screw (G), and then remove the guide (H).

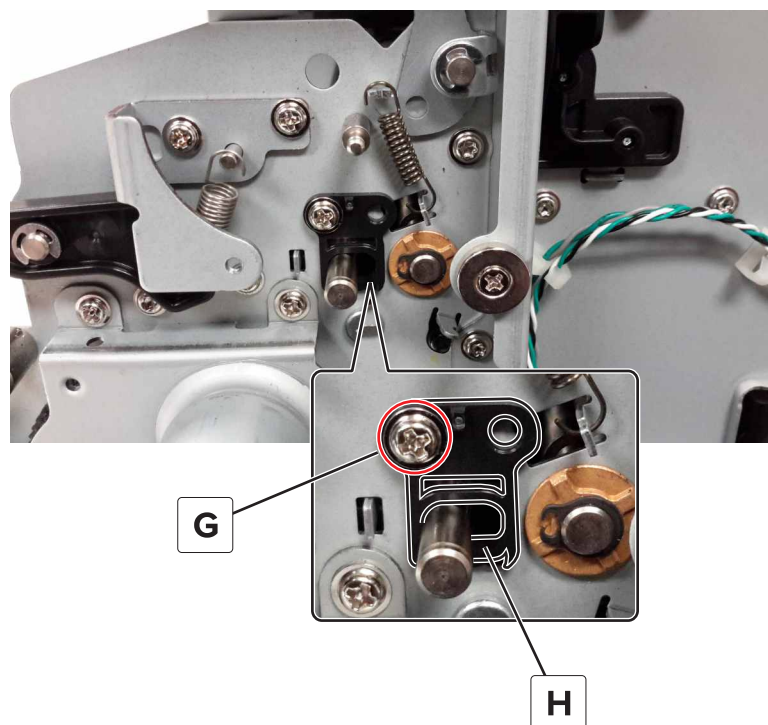

16 Remove the C-clip (J), and then remove the bushing.

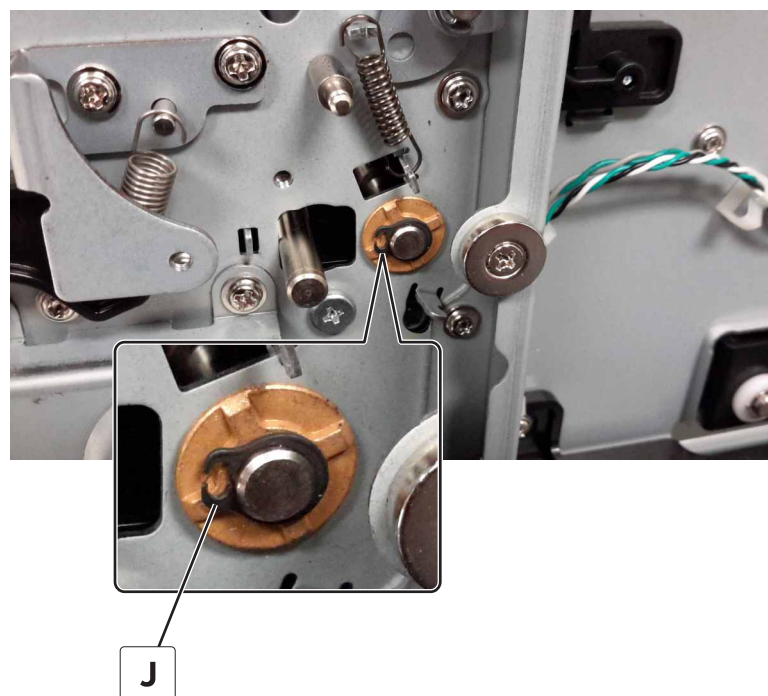

17 Remove the C-clip (K), and then remove the spacer.

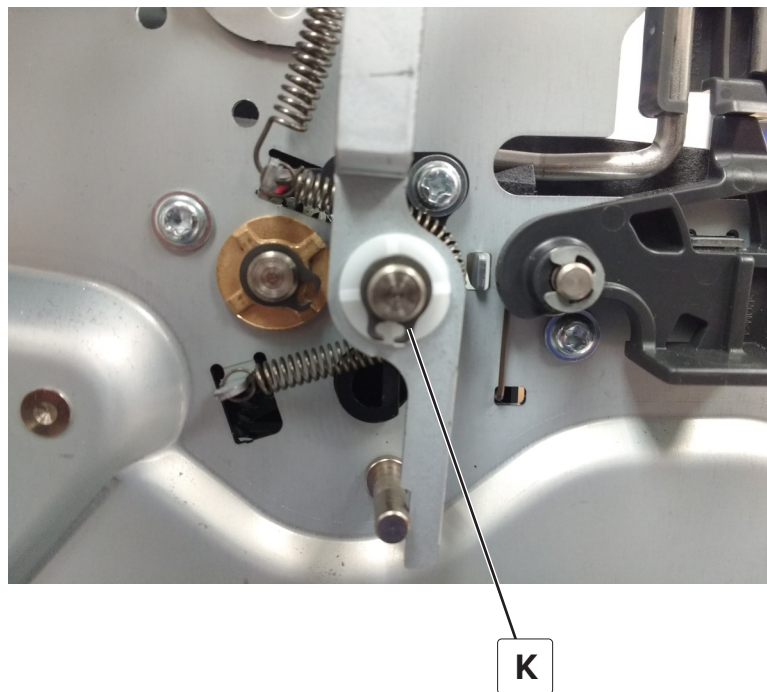

18 Remove the spring (L), and then remove the spacer (M).

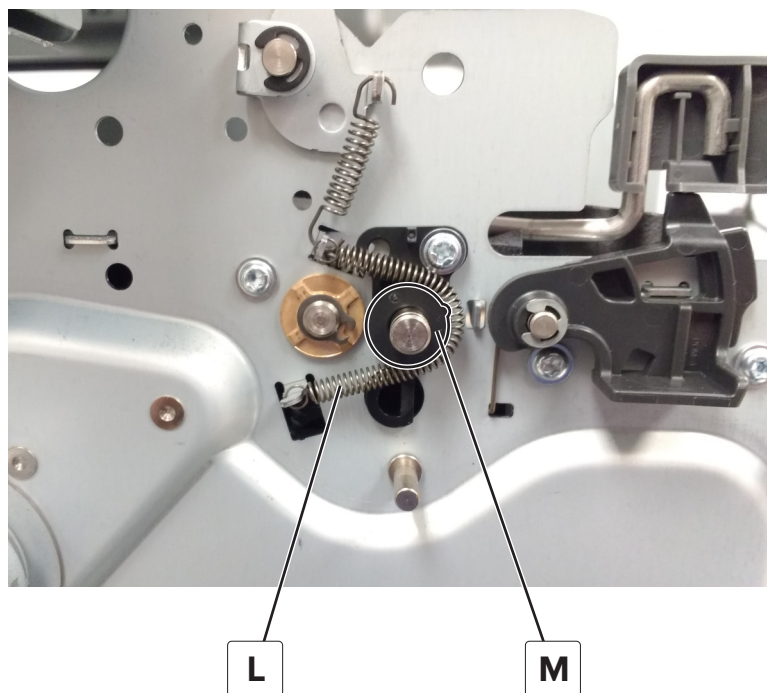

19 Remove the screw (N), and then remove the guide (P).

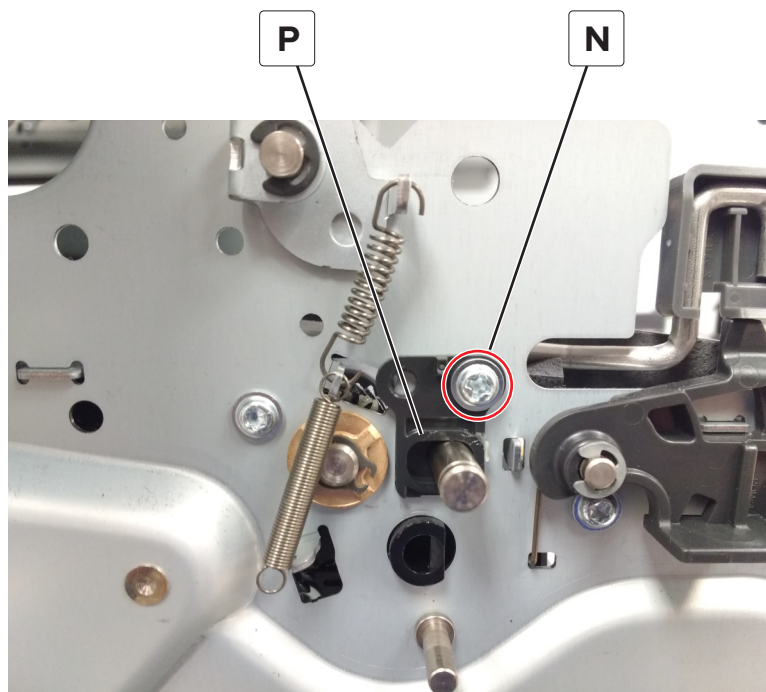

20 Remove the C-clip (Q), and then remove the bushing.

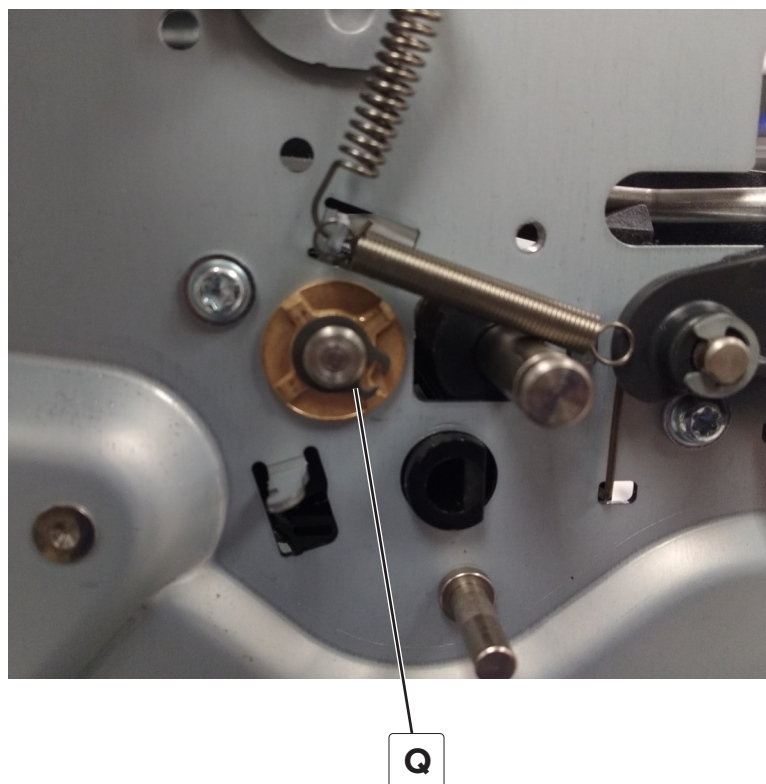

21 Slide the front aligner roller to the right to remove.

Note: Be careful not to drop or lose the washer on the left side of the shaft.

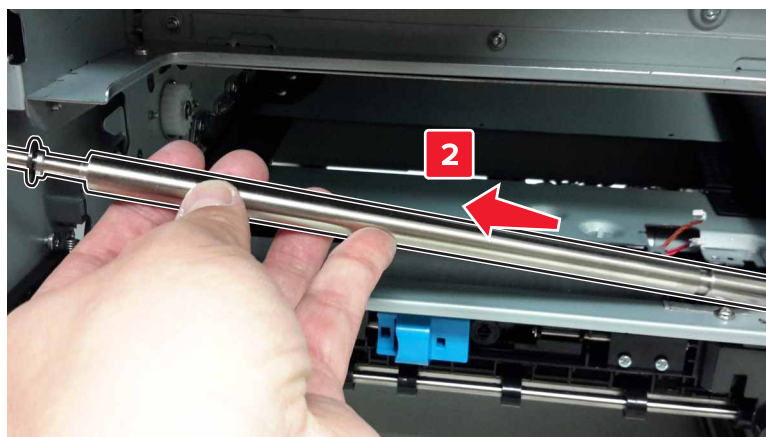
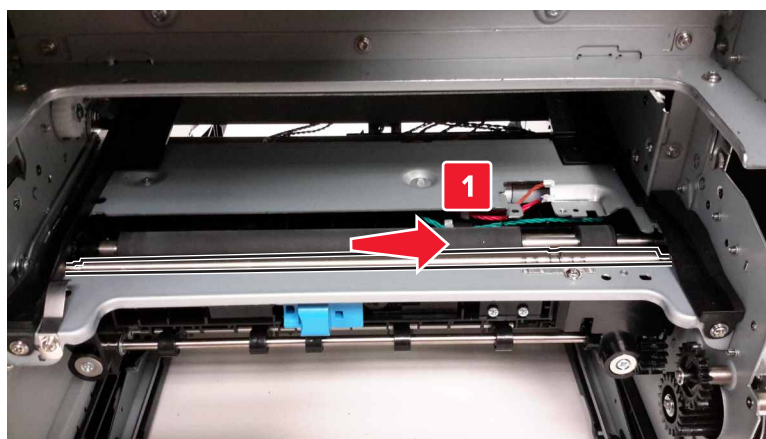

Parts removal

22 Slide the rear aligner roller to the right to remove.

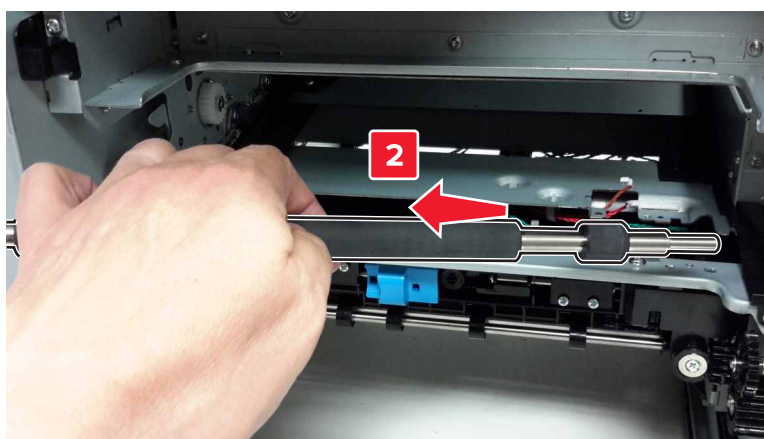
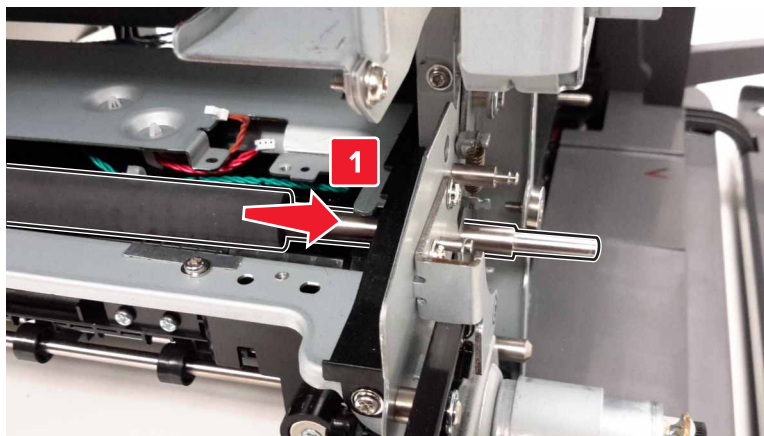

Pivot shaft removal

- 1 Remove the front door. See [“Front door removal” on page 425](#).
- 2 Remove the two E-clips (A), and then remove the shaft (B).

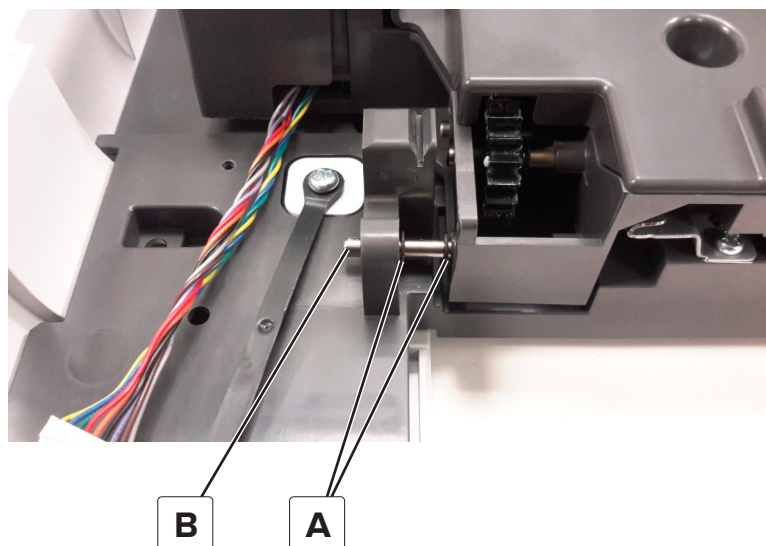

Duplex inner guide removal

- 1 Remove the front door. See [“Front door removal” on page 425](#).
- 2 Remove the pivot shaft. See [“Pivot shaft removal” on page 466](#).
- 3 Release the latch (A), and then slide the guide to remove.

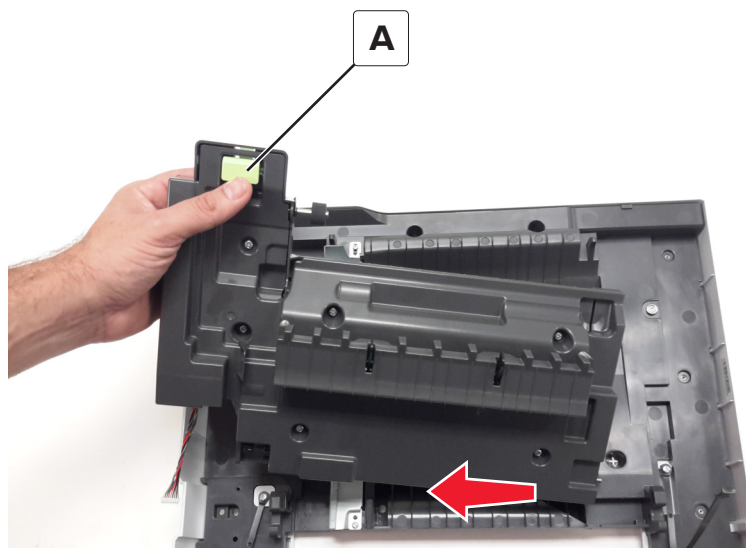

Sensor (duplex staging) removal

- 1 Remove the front door. See [“Front door removal” on page 425](#).
- 2 Remove the pivot shaft. See [“Pivot shaft removal” on page 466](#).
- 3 Remove the duplex inner guide. See [“Duplex inner guide removal” on page 466](#).
- 4 Remove the six screws (A).

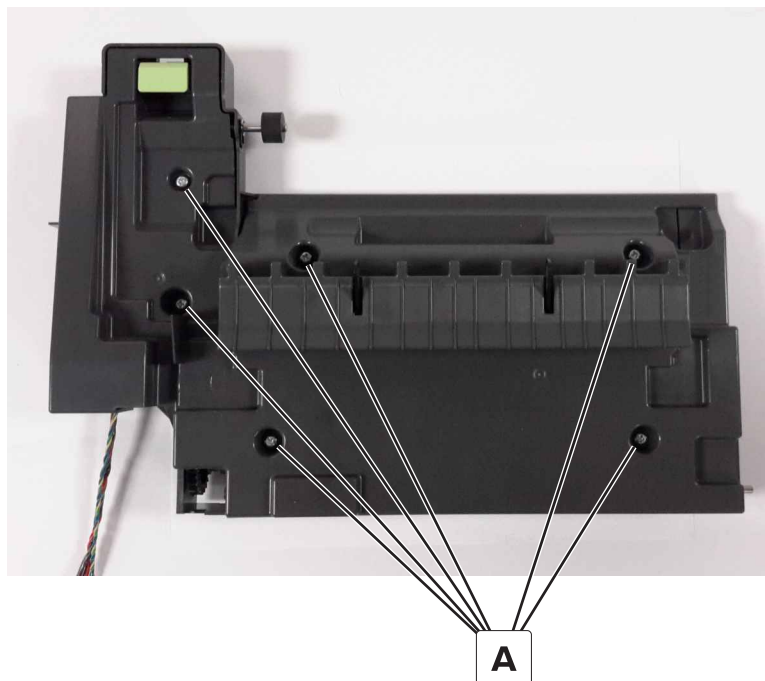

- 5 Disconnect the cable (B), and then remove the sensor (C).

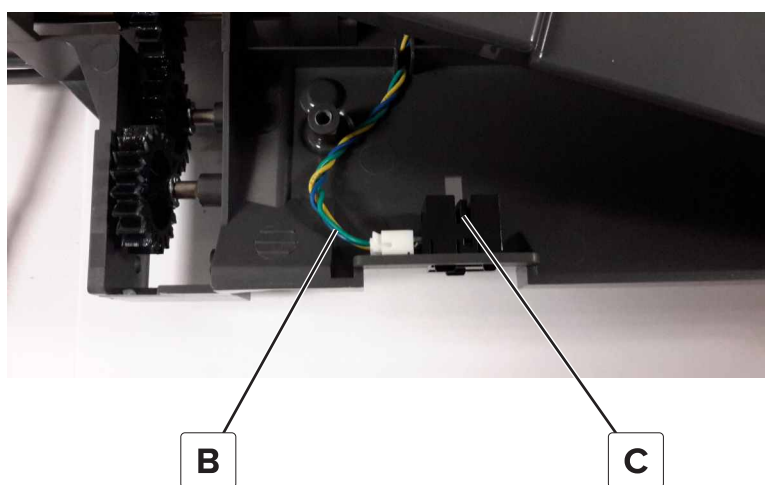

Sensors (fuser buckle and narrow media) removal

- 1 Open the front door.
- 2 Remove the screw (A).

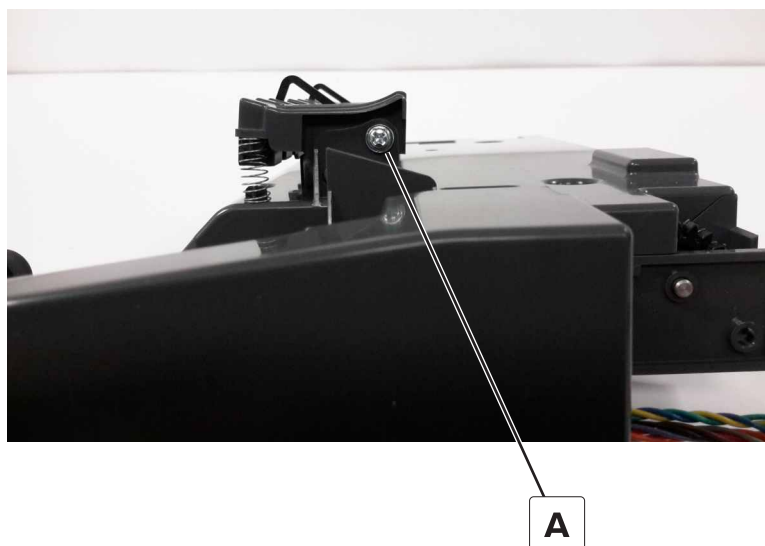

- 3 Slide the paper guide to the right to remove.

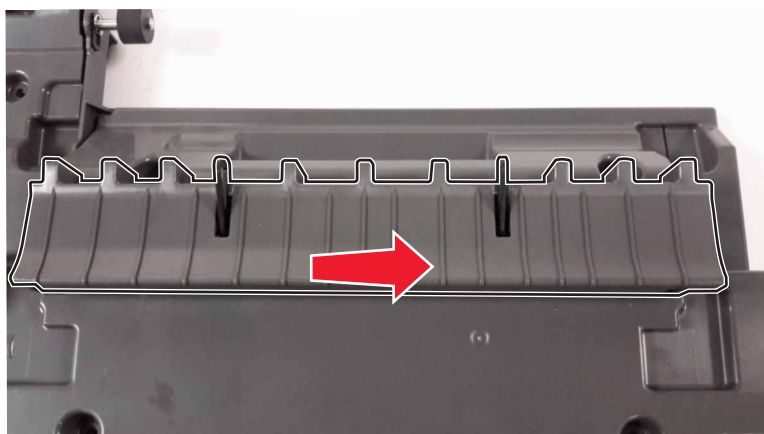

- 4 Disconnect the sensor cable (B), remove the screw (C), and then remove the sensors.

Note: The left sensor is the sensor (fuser buckle). The right sensor is the sensor (narrow media). For more information, see [“Fuser drive” on page 628](#).

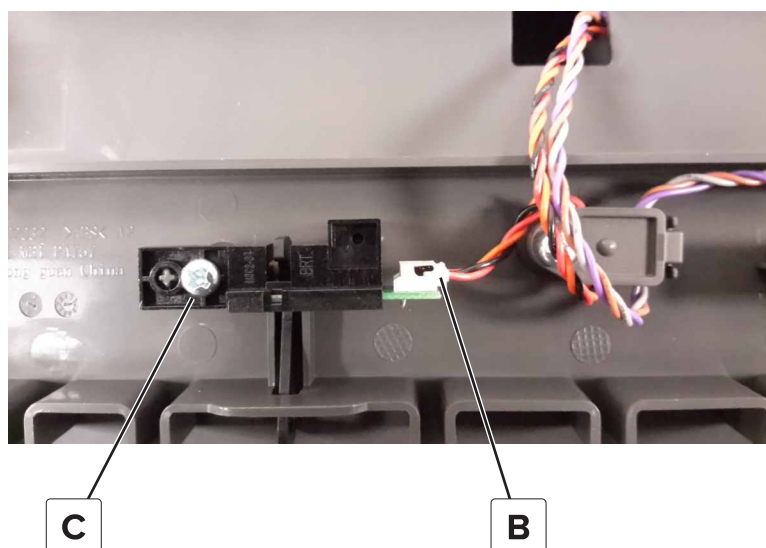

Tensioner belt removal

- 1 Remove the front door. See [“Front door removal” on page 425.](#)
- 2 Remove the pivot shaft. See [“Pivot shaft removal” on page 466.](#)
- 3 Remove the duplex inner guide. See [“Duplex inner guide removal” on page 466.](#)
- 4 Remove the six screws (A), and then remove the cover.

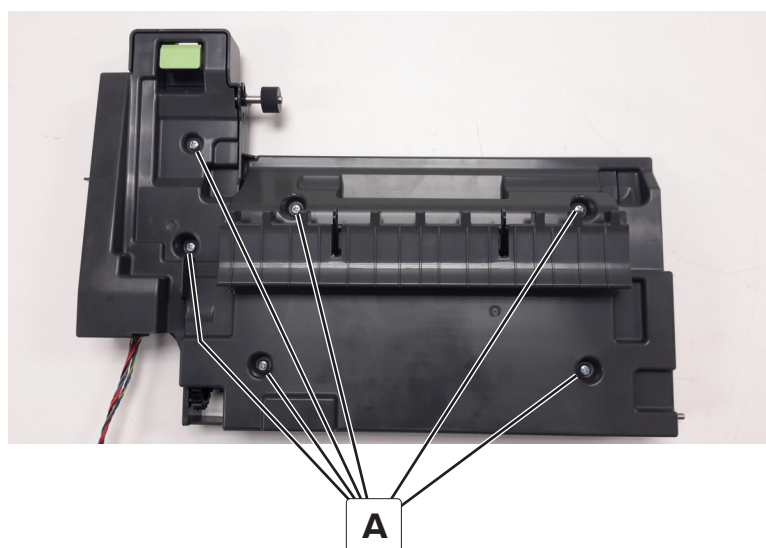

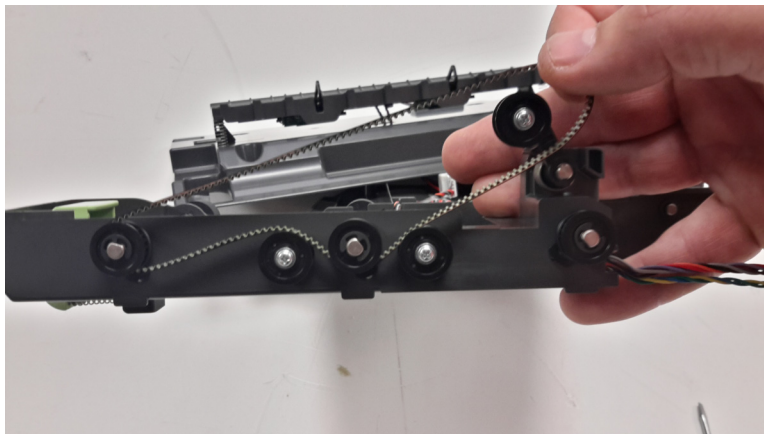
5 Remove the belt.

Note: Pay attention to the belt path before removing the belt.

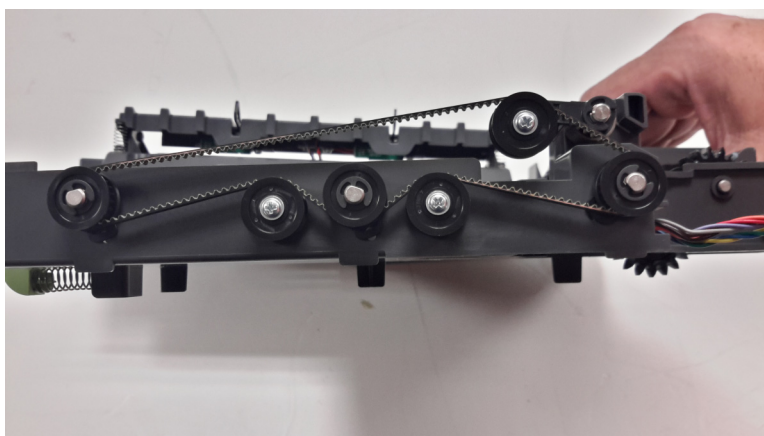

Duplex outer guide removal

- 1 Remove the front door. See [“Front door removal” on page 425.](#)
- 2 Remove the pivot shaft. See [“Pivot shaft removal” on page 466.](#)
- 3 Remove duplex inner guide. See [“Duplex inner guide removal” on page 466.](#)

4 Remove the tray indicator (A).

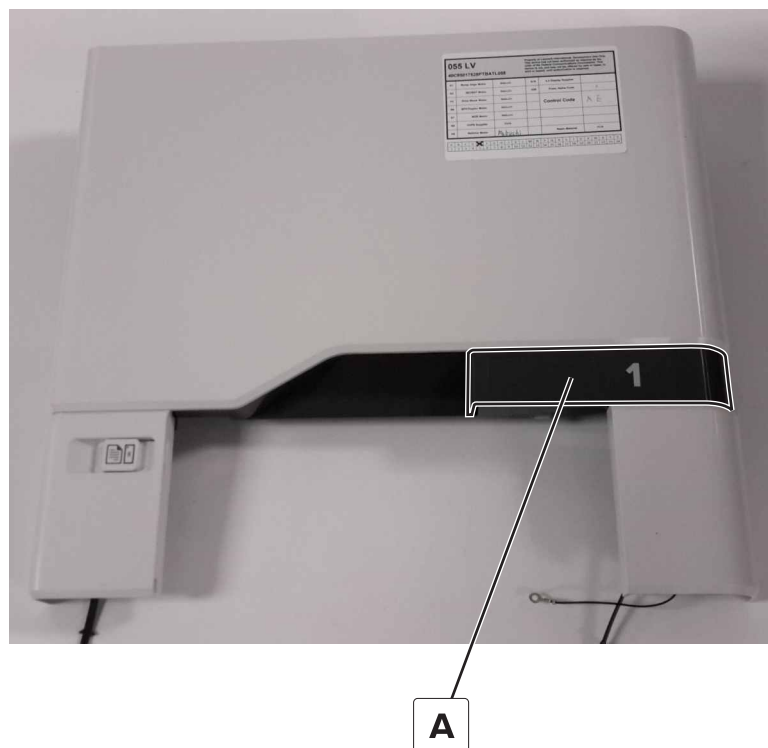

5 Remove the 12 screws (B), and then remove the duplex outer guide.

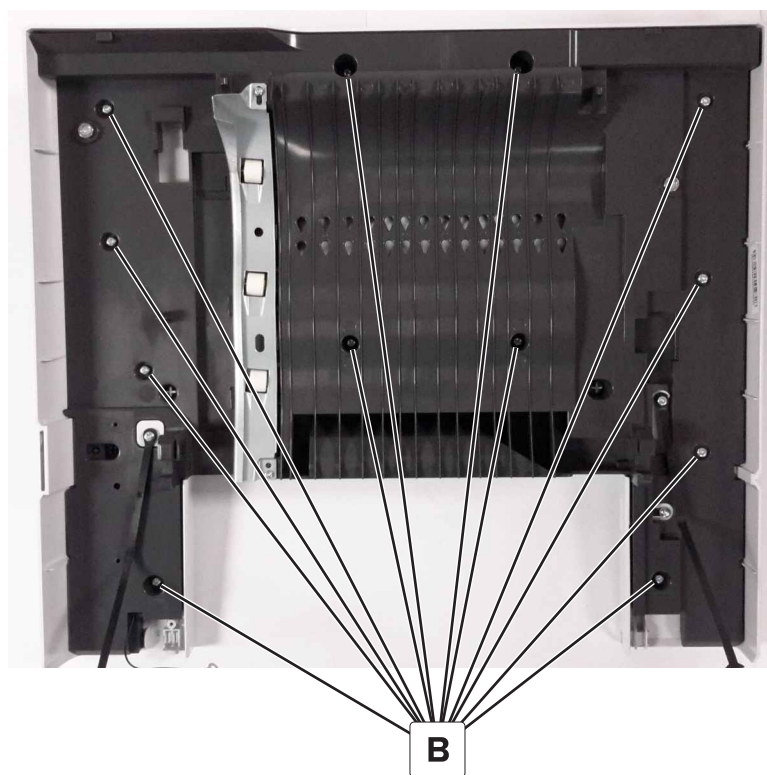

Parts removal

471

Front door cover removal

- 1 Remove the front door. See [“Front door removal” on page 425](#).
- 2 Remove the pivot shaft. See [“Pivot shaft removal” on page 466](#).
- 3 Remove duplex inner guide. See [“Duplex inner guide removal” on page 466](#).
- 4 Remove the tray indicator (A).

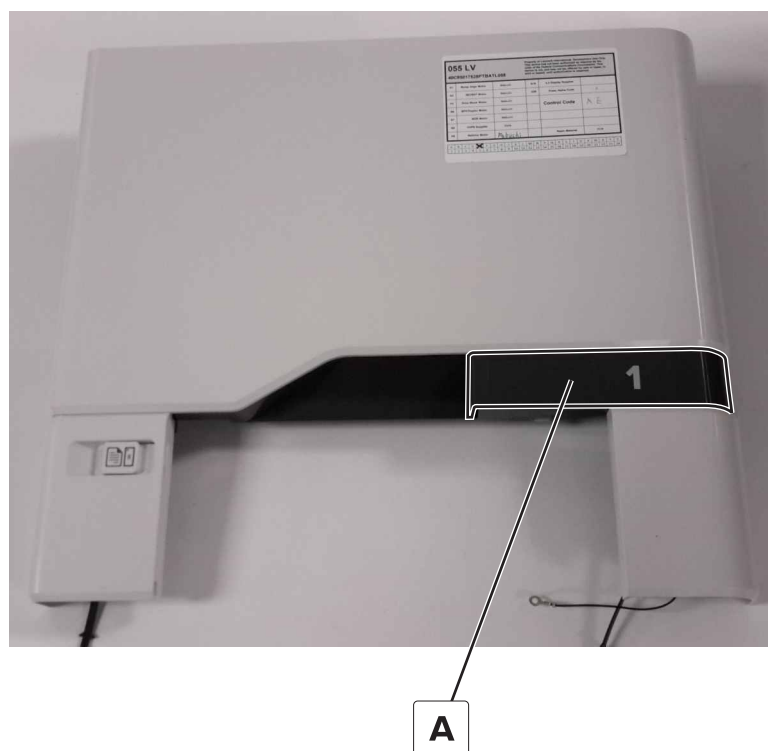

- 5 Remove the 12 screws (B), and then remove the front door cover from the duplex outer guide.

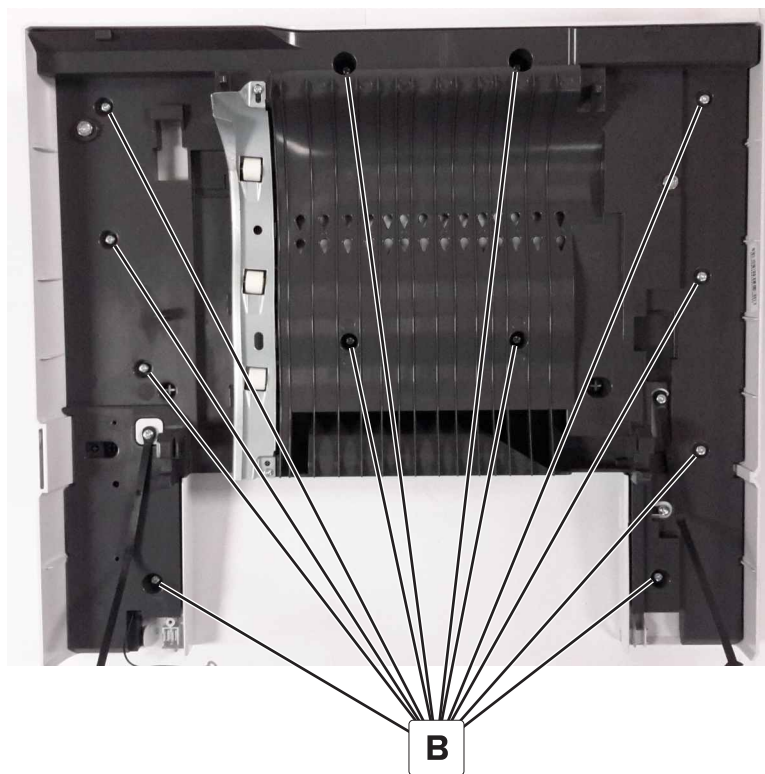

Parts removal

Rear side removals

Controller board shield removal

- 1 Remove the eight screws (A).

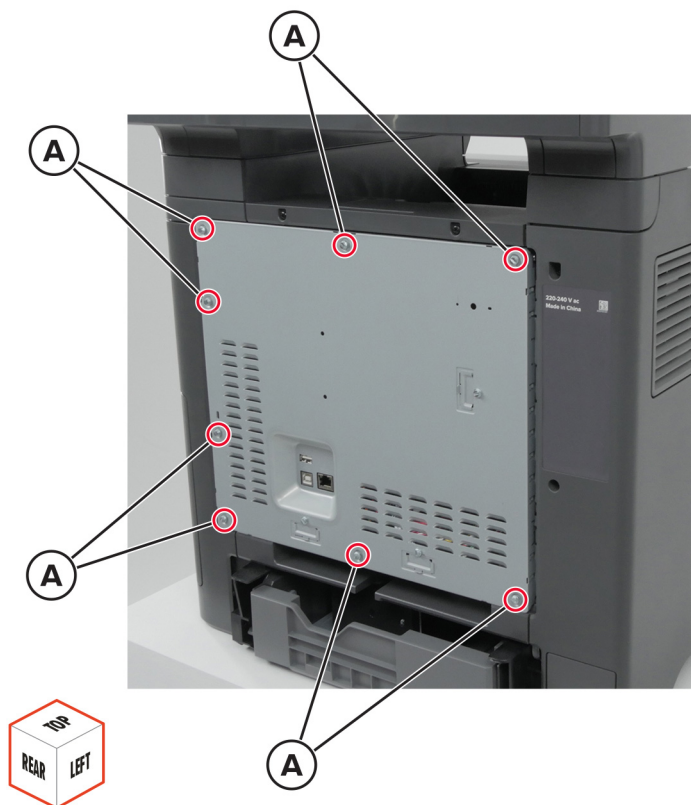

- 2 Remove the shield.

Installation warning: The screws may damage the board cables. Make sure that the board cables are out of the way before screwing the shield in place.

Scanner rear right cover removal

Remove the cover (A).



Scanner rear left cover removal

Remove the cover (A).



Parts removal

ISD card removal

- 1 Remove the controller board shield. See [“Controller board shield removal” on page 474](#).
- 2 Release the latches, and then remove the card.

Warning—Potential Damage: To avoid electrical damage, make sure that the printer is unplugged.

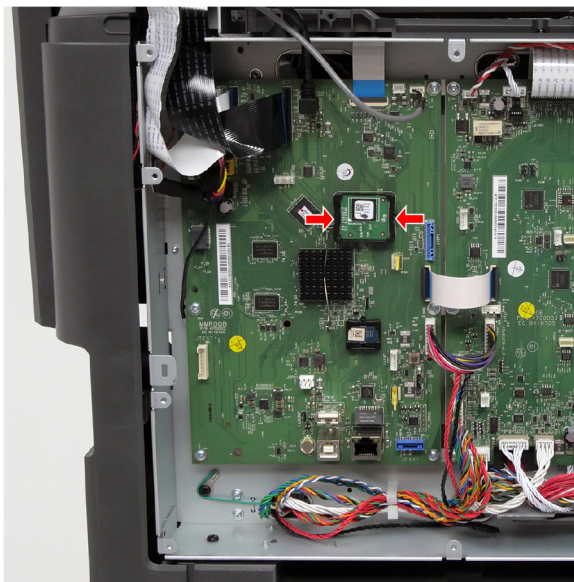

Installation note: Make sure that the connector is plugged.

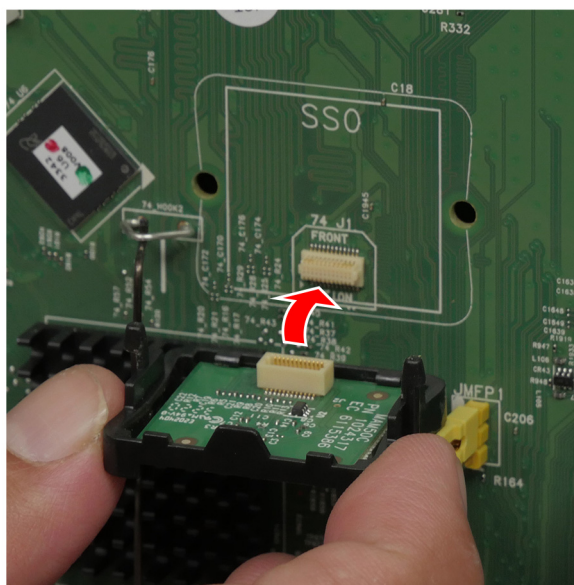

TPM card removal

- 1 Remove the controller board shield. See [“Controller board shield removal” on page 474](#).
- 2 Release the latches, and then remove the card.

Warning—Potential Damage: To avoid electrical damage, make sure that the printer is unplugged.

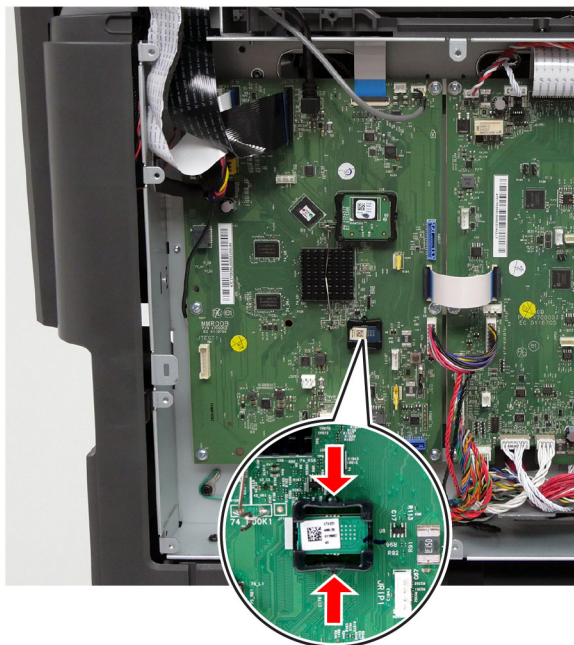

Installation note: Make sure that the connector is plugged in.

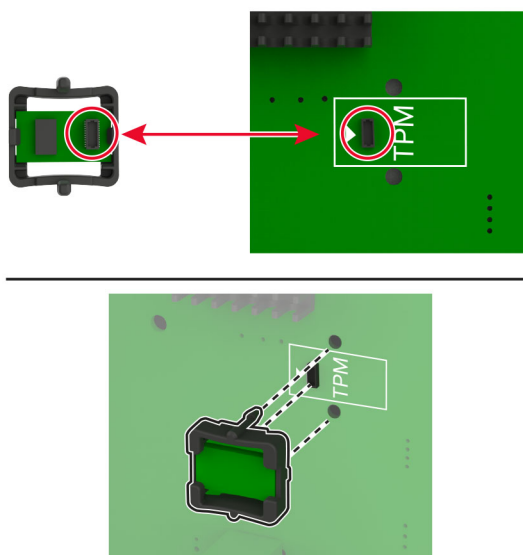

Controller board removal

Critical information for controller board or engine board replacement

Read the following instructions carefully before performing them. Practice accessing DIAGNOSTICS_MODE first before replacing the part. See [“Entering the Diagnostics Menu” on page 323](#).

Warning—Potential Damage: An invalid engine code error occurs if the controller board and engine board are not on the same firmware level. Resolve the error shown with firmware updates. For more information, see [“Entering Invalid engine mode” on page 351](#) and [“Updating the printer firmware ” on page 365](#).

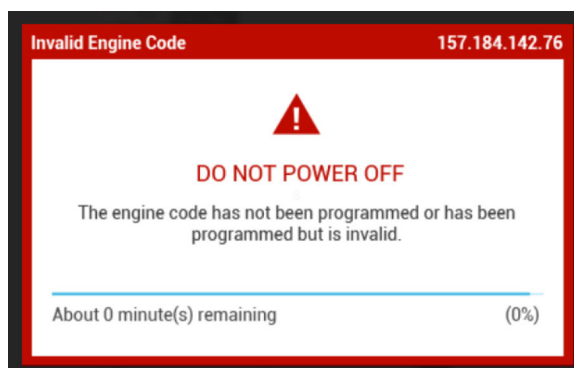

Warning—Potential Damage: To avoid NVRAM mismatch issues, replace only one of the following components at a time:

- Engine board
- Controller board

To replace a component and to test whether the problem is resolved:

- 1 Replace the affected component.

Warning—Potential Damage: Do not perform a Power-On Reset (POR) until the problem is resolved. If a POR is performed at this point, then the replacement part can no longer be used in another printer and must be returned to the manufacturer.

- 2 Enter the Diagnostics Menu. The Diagnostics Menu allows you to temporarily use the replacement part.

Warning—Potential Damage: Some printers will automatically perform a POR if the Diagnostics Menu is not opened within five seconds. If a POR is performed at this point, then the replacement part can no longer be used in another printer and must be returned to the manufacturer.

- 3 Use the Diagnostics Menu to test the replacement part. Perform a feed test to check if the problem is resolved.
 - If the problem is not resolved—Turn off the printer, and then reinstall the old part.
 - If the problem is resolved—Perform a POR.

Removal procedure

Note: For a video demonstration, see [Replacing the controller board](#).

- 1 Remove the controller board shield. See [“Controller board shield removal” on page 474](#).
- 2 Disconnect all the cables, and then remove the six screws (A).

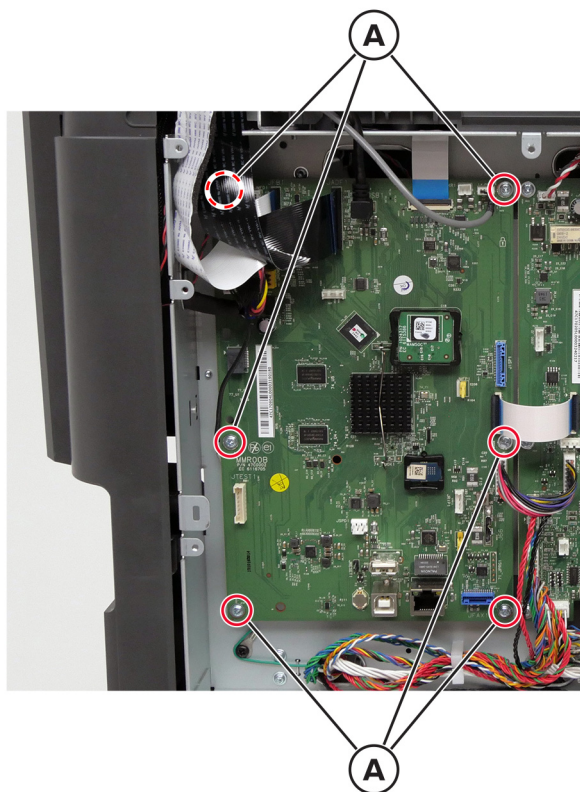

- 3 Remove the board.

Installation notes:

- a Some controller boards have a TPM card or ISD card attached. Make sure to install these cards to the new controller board. See [“ISD card removal” on page 476](#) and [“TPM card removal” on page 477](#).
- b After the new controller board is installed, restore the printer configuration. See [“Restoring the printer configuration after replacing the controller board” on page 361](#).

Engine board removal

Critical information for controller board or engine board replacement

Read the following instructions carefully before performing them. Practice accessing DIAGNOSTICS_MODE first before replacing the part. See [“Entering the Diagnostics Menu” on page 323](#).

Warning—Potential Damage: An invalid engine code error occurs if the controller board and engine board are not on the same firmware level. Resolve the error shown with firmware updates. For more information, see [“Entering Invalid engine mode” on page 351](#) and [“Updating the printer firmware ” on page 365](#).

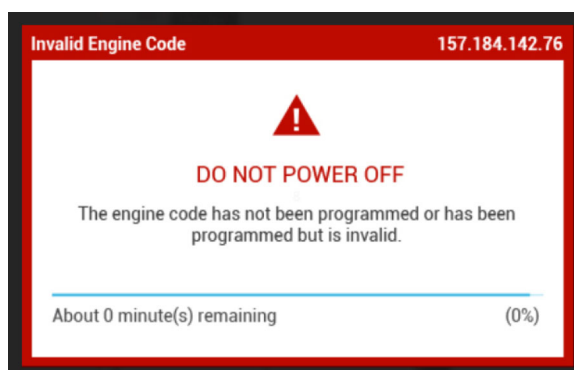

Warning—Potential Damage: To avoid NVRAM mismatch issues, replace only one of the following components at a time:

- Engine board
- Controller board

To replace a component and to test whether the problem is resolved:

- 1 Replace the affected component.

Warning—Potential Damage: Do not perform a Power-On Reset (POR) until the problem is resolved. If a POR is performed at this point, then the replacement part can no longer be used in another printer and must be returned to the manufacturer.

- 2 Enter the Diagnostics Menu. The Diagnostics Menu allows you to temporarily use the replacement part.

Warning—Potential Damage: Some printers will automatically perform a POR if the Diagnostics Menu is not opened within five seconds. If a POR is performed at this point, then the replacement part can no longer be used in another printer and must be returned to the manufacturer.

- 3 Use the Diagnostics Menu to test the replacement part. Perform a feed test to check if the problem is resolved.
 - If the problem is not resolved—Turn off the printer, and then reinstall the old part.
 - If the problem is resolved—Perform a POR.

Removal procedure

Note: For a video demonstration, see [Replacing the engine board](#).

- 1 Remove the controller board shield. See [“Controller board shield removal” on page 474](#).
- 2 Disconnect all the cables, and then remove the six screws (A).

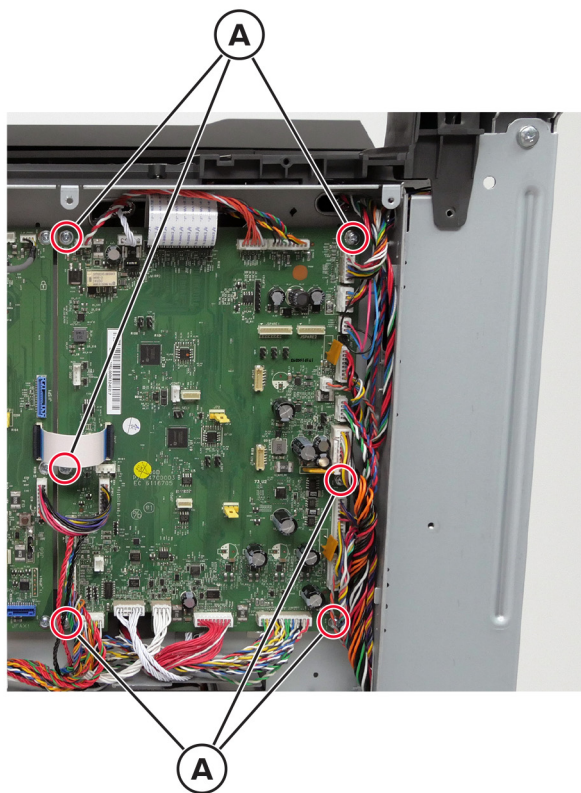

- 3 Remove the board.

Top side removals

Bin cover removal

- 1 From the rear, remove the two screws (A).

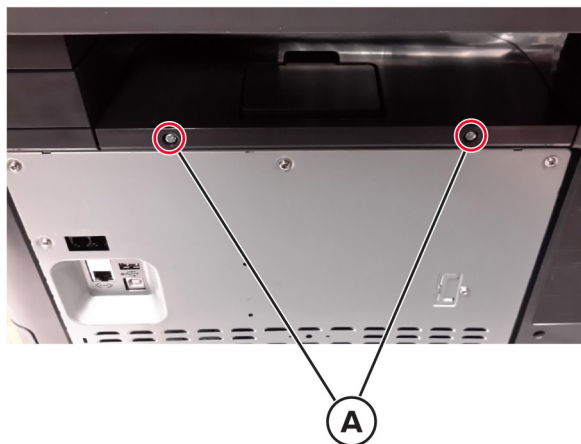

- 2 Remove the cover.

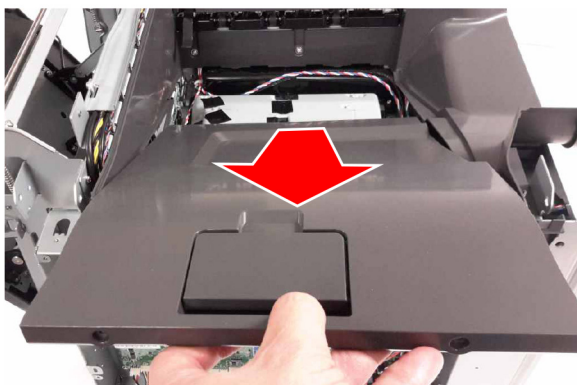

Top frame cover removal

- 1 Open the front door and door A1.
- 2 Remove the two screws (A), and then release the two latches (B).

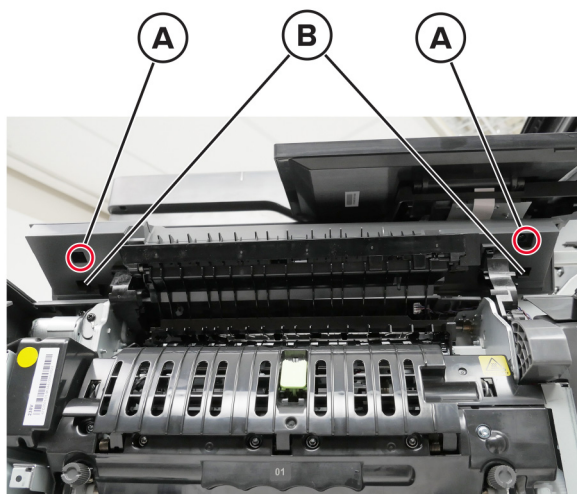

- 3 Remove the cover.

Top frame base cover removal

- 1 Remove the top frame cover. See [“Top frame cover removal” on page 483](#).
- 2 Disconnect the cable (A), and then remove the four screws (B).

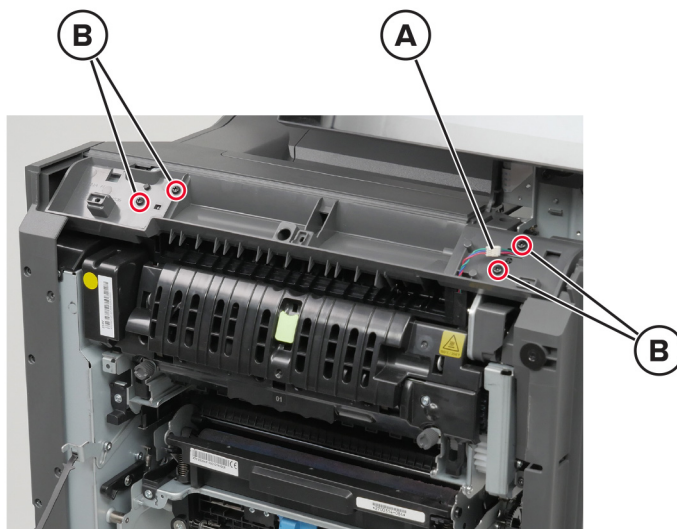

- 3 Remove the cover.

Upper front door removal

Note: The upper front door consists of the top frame cover and top frame base cover.

- 1 Remove the top frame cover. See [“Top frame cover removal” on page 483.](#)
- 2 Remove the top frame base cover. See [“Top frame base cover removal” on page 483.](#)

Printhead removal

Note: For a video demonstration, see [Replacing the printhead.](#)

- 1 Tilt the ADF and flatbed scanner. See [“Tilting the ADF and flatbed scanner to access parts” on page 532.](#)
- 2 Remove the controller board shield. See [“Controller board shield removal” on page 474.](#)
- 3 Remove the bin cover. See [“Bin cover removal” on page 482.](#)
- 4 Before removing the printhead, do the following:
 - a Check if a printhead stop is installed on the old printhead. If there is none, a printhead stop is included with the new printhead.

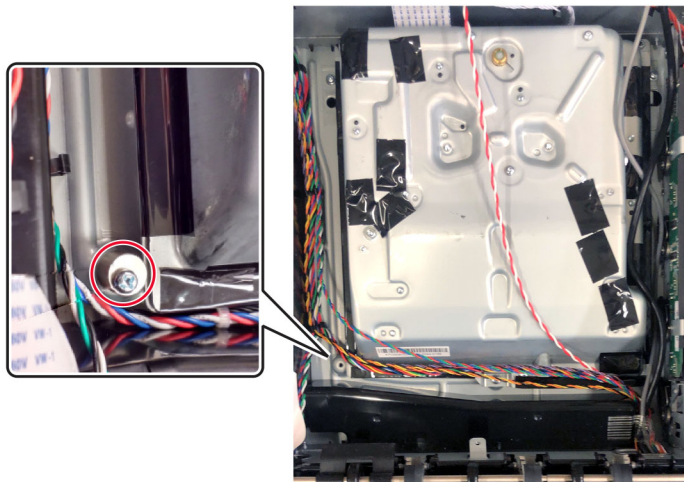

- b If no stop is installed, then place the stop (A) next to the printhead and turn the stop until it touches the printhead.

- c Fasten the stop with the screw (B).

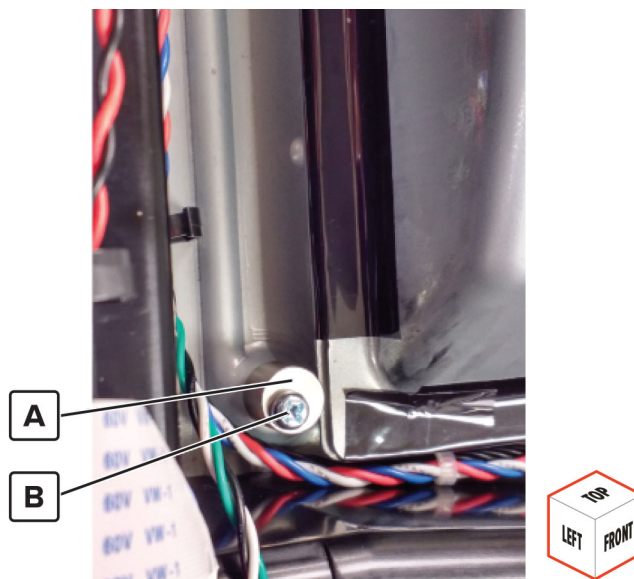

- 5 Remove the three screws (A).

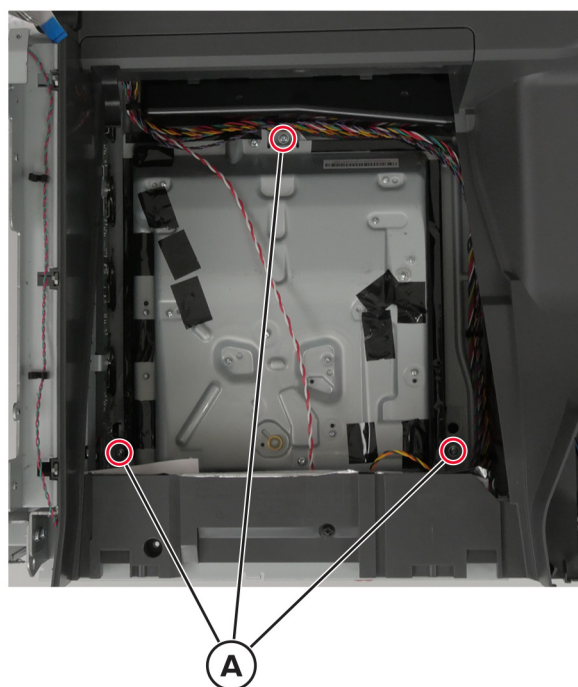

Parts removal

- 6 Disconnect the cables (B).



- 7 Remove the printhead.

Installation notes:

- a When installing the printhead, replace the screws but do not tighten them right away. After installing the screws, turn the printhead clockwise until it stops.
- b Enter the Diagnostics menu, and then navigate to:
Printer diagnostics & adjustments > Registration adjust > Quick test
- c If the printhead needs alignment, perform a printhead alignment adjustment. See [“Printhead alignment adjustment” on page 367](#).
- d Tighten the screws.
- e Perform a color alignment adjustment. See [“Color alignment adjust” on page 342](#).

Top cover removal

- 1 Remove the scanner rear right cover. See [“Scanner rear right cover removal” on page 475](#).
- 2 Remove the scanner rear left cover. See [“Scanner rear left cover removal” on page 475](#).
- 3 Remove the waste toner bottle. See [“Waste toner bottle removal” on page 397](#).
- 4 Remove the imaging kit. See [“Imaging kit removal” on page 399](#).
- 5 Remove the motor cover. See [“Motor cover removal” on page 427](#).
- 6 Remove or loosen the right cover. See [“Right cover removal” on page 401](#).
- 7 Remove the controller board shield. See [“Controller board shield removal” on page 474](#).
- 8 Remove the USB cover. See [“USB cover removal” on page 405](#).

- 9 Remove the scanner front cover. See [“Scanner front cover removal” on page 429](#).
- 10 Remove the control panel. See [“Control panel display \(10-inch\) removal” on page 442](#) or [“Control panel display \(7-inch\) removal” on page 444](#).
- 11 Remove the control panel base. See [“Control panel base \(10-inch\) removal” on page 446](#) or [“Control panel base \(7-inch\) removal” on page 447](#).
- 12 Remove the façade cover. See [“Facade cover removal” on page 496](#).
- 13 Remove the ADF and flatbed scanner. See [“Flatbed scanner removal” on page 519](#).
- 14 Remove the bin cover. See [“Bin cover removal” on page 482](#).
- 15 Remove the two screws (A).

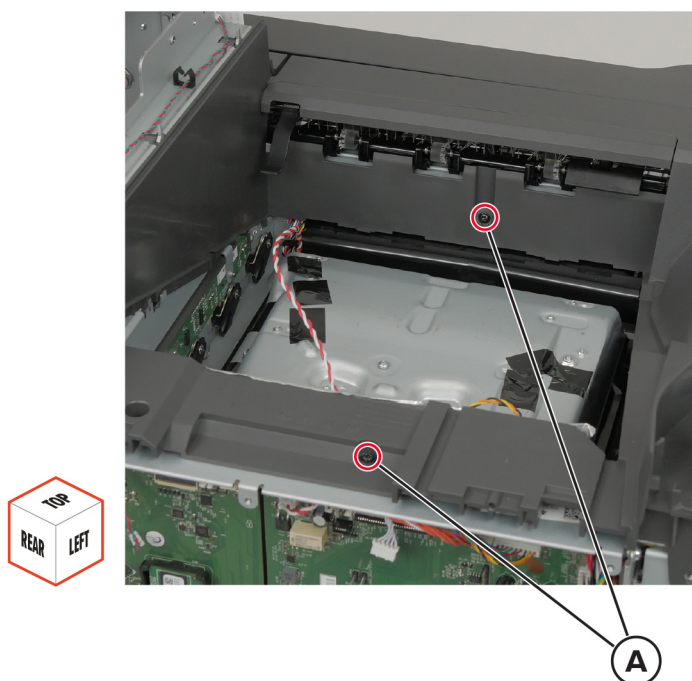

16 Remove the screw (B).

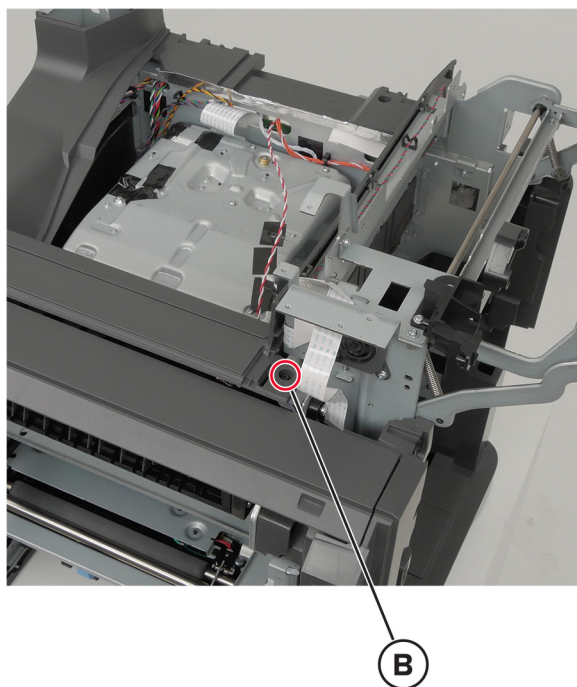

17 Lift the cover, and then disconnect the sensor cable (C).

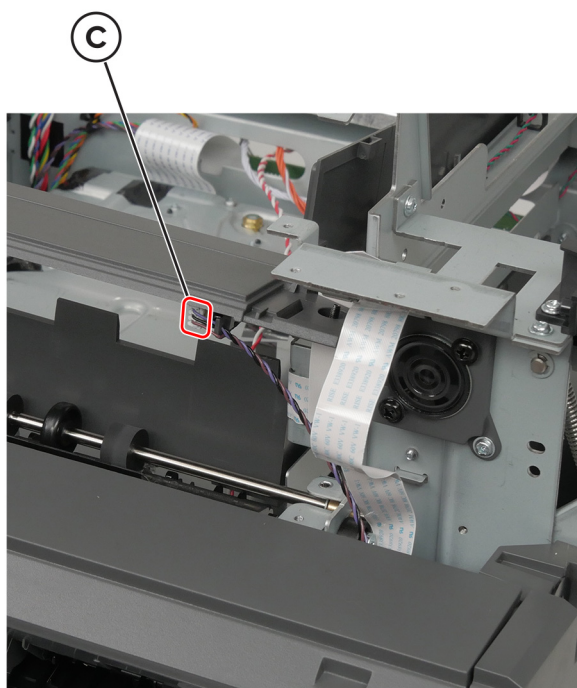

Parts removal

- 18** Remove the sensor retainer (D), and then remove the sensor from the cover.

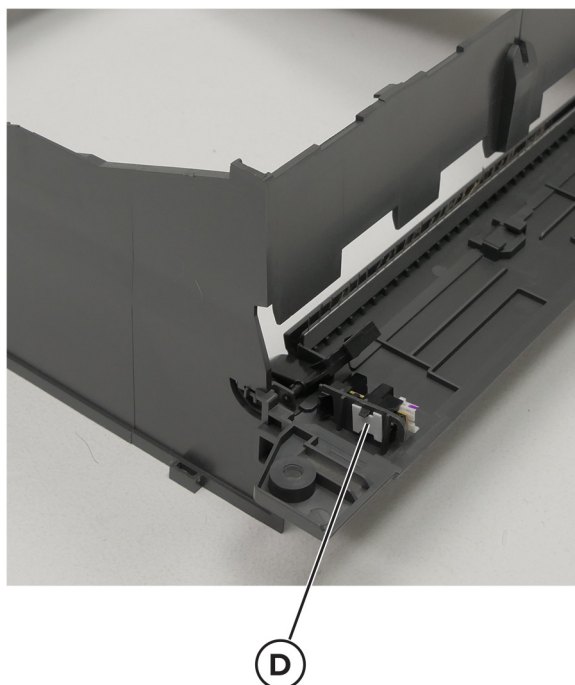

Sensor (bin full) removal

- 1** Remove the scanner rear right cover. See [“Scanner rear right cover removal” on page 475.](#)
- 2** Remove the scanner rear left cover. See [“Scanner rear left cover removal” on page 475.](#)
- 3** Remove the waste toner bottle. See [“Waste toner bottle removal” on page 397.](#)
- 4** Remove the imaging kit. See [“Imaging kit removal” on page 399.](#)
- 5** Remove the motor cover. See [“Motor cover removal” on page 427.](#)
- 6** Remove or loosen the right cover. See [“Right cover removal” on page 401.](#)
- 7** Remove the controller board shield. See [“Controller board shield removal” on page 474.](#)
- 8** Remove the USB cover. See [“USB cover removal” on page 405.](#)
- 9** Remove the scanner front cover. See [“Scanner front cover removal” on page 429.](#)
- 10** Remove the control panel. See [“Control panel display \(10-inch\) removal” on page 442](#) or [“Control panel display \(7-inch\) removal” on page 444.](#)
- 11** Remove the control panel base. See [“Control panel base \(10-inch\) removal” on page 446](#) or [“Control panel base \(7-inch\) removal” on page 447.](#)
- 12** Remove the façade cover. See [“Facade cover removal” on page 496.](#)
- 13** Remove the ADF and flatbed scanner. See [“Flatbed scanner removal” on page 519.](#)
- 14** Remove the bin cover. See [“Bin cover removal” on page 482.](#)

15 Remove the two screws (A).

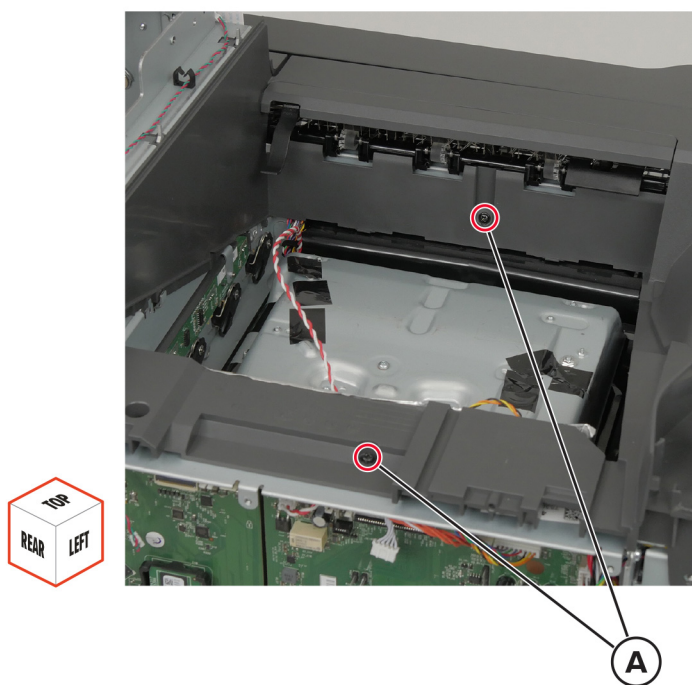

16 Remove the screw (B).

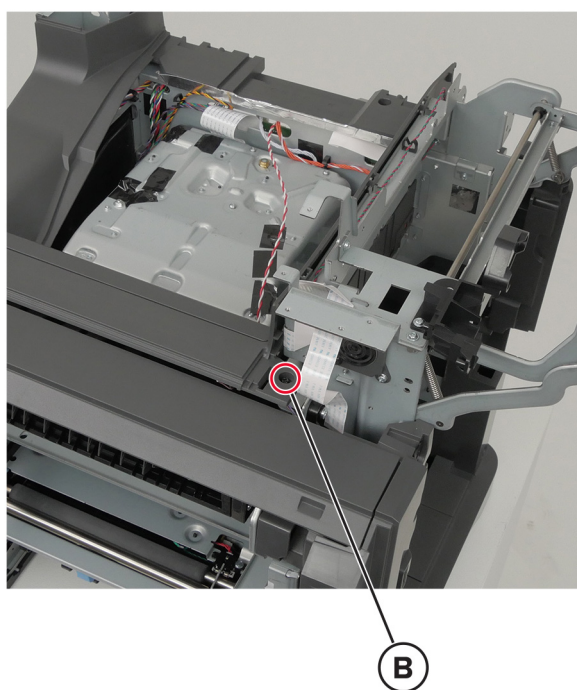

17 Lift the cover, and then disconnect the sensor cable (C).

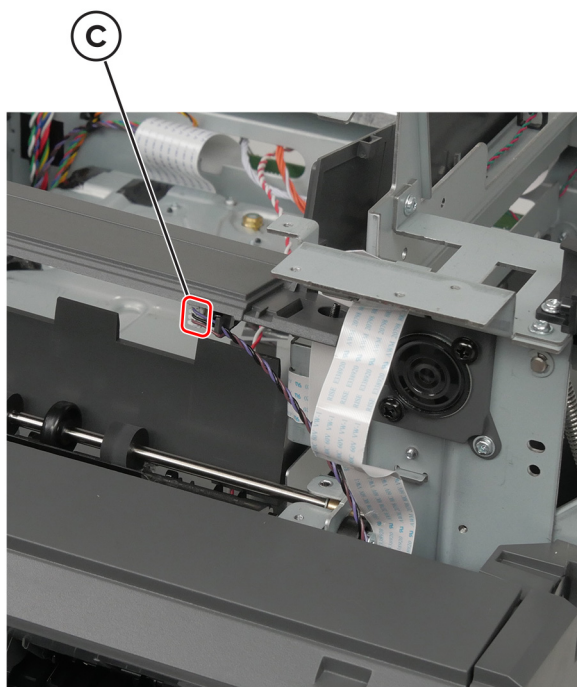

18 Remove the sensor retainer (D), and then remove the sensor from the cover.

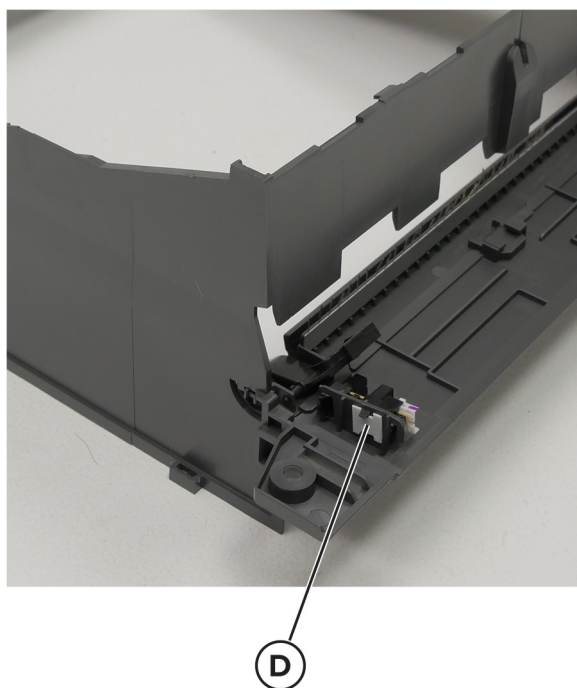

Exit roller gear removal

- 1 Remove the scanner rear right cover. See [“Scanner rear right cover removal” on page 475](#).
- 2 Remove the scanner rear left cover. See [“Scanner rear left cover removal” on page 475](#).
- 3 Remove the waste toner bottle. See [“Waste toner bottle removal” on page 397](#).
- 4 Remove the imaging kit. See [“Imaging kit removal” on page 399](#).
- 5 Remove the motor cover. See [“Motor cover removal” on page 427](#).
- 6 Remove or loosen the right cover. See [“Right cover removal” on page 401](#).
- 7 Remove the controller board shield. See [“Controller board shield removal” on page 474](#).
- 8 Remove the USB cover. See [“USB cover removal” on page 405](#).
- 9 Remove the scanner front cover. See [“Scanner front cover removal” on page 429](#).
- 10 Remove the control panel. See [“Control panel display \(10-inch\) removal” on page 442](#) or [“Control panel display \(7-inch\) removal” on page 444](#).
- 11 Remove the control panel base. See [“Control panel base \(10-inch\) removal” on page 446](#) or [“Control panel base \(7-inch\) removal” on page 447](#).
- 12 Remove the façade cover. See [“Facade cover removal” on page 496](#).
- 13 Remove the ADF and flatbed scanner. See [“Flatbed scanner removal” on page 519](#).
- 14 Remove the bin cover. See [“Bin cover removal” on page 482](#).
- 15 Remove the top cover. See [“Top cover removal” on page 486](#).
- 16 Remove the E-clip (A), and then remove the gear.

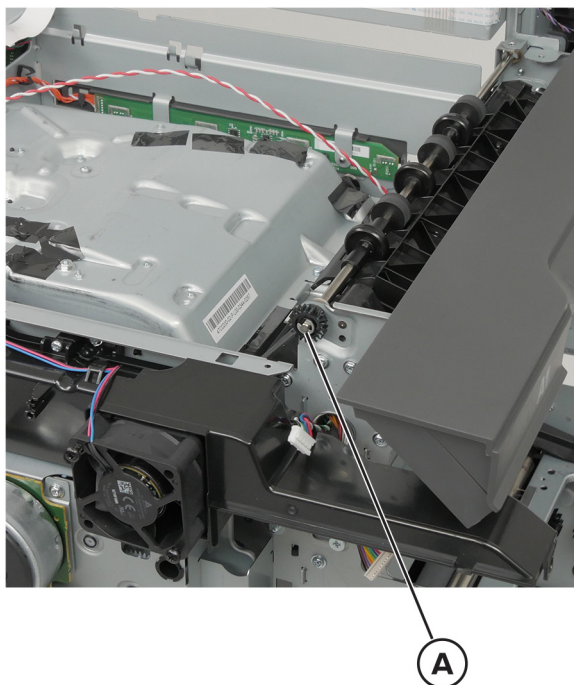

Exit roller removal

- 1 Remove the scanner rear right cover. See [“Scanner rear right cover removal” on page 475](#).
- 2 Remove the scanner rear left cover. See [“Scanner rear left cover removal” on page 475](#).
- 3 Remove the waste toner bottle. See [“Waste toner bottle removal” on page 397](#).
- 4 Remove the imaging kit. See [“Imaging kit removal” on page 399](#).
- 5 Remove the motor cover. See [“Motor cover removal” on page 427](#).
- 6 Remove or loosen the right cover. See [“Right cover removal” on page 401](#).
- 7 Remove the controller board shield. See [“Controller board shield removal” on page 474](#).
- 8 Remove the USB cover. See [“USB cover removal” on page 405](#).
- 9 Remove the scanner front cover. See [“Scanner front cover removal” on page 429](#).
- 10 Remove the control panel. See [“Control panel display \(10-inch\) removal” on page 442](#) or [“Control panel display \(7-inch\) removal” on page 444](#).
- 11 Remove the control panel base. See [“Control panel base \(10-inch\) removal” on page 446](#) or [“Control panel base \(7-inch\) removal” on page 447](#).
- 12 Remove the façade cover. See [“Facade cover removal” on page 496](#).
- 13 Remove the ADF and flatbed scanner. See [“Flatbed scanner removal” on page 519](#).
- 14 Remove the bin cover. See [“Bin cover removal” on page 482](#).
- 15 Remove the top cover. See [“Top cover removal” on page 486](#).

- 16** Remove the two E-clips (A), and then remove the gear (B) and bushing (C).

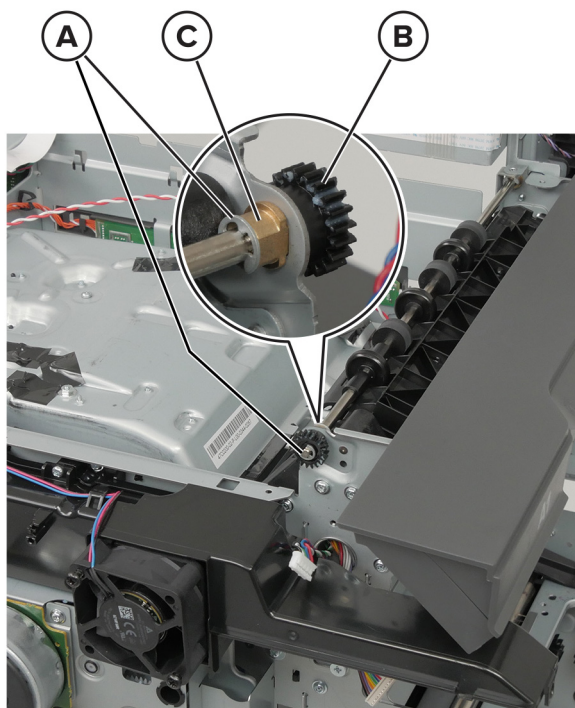

- 17** Remove the roller.

Control panel FFC removal

- 1** Remove the scanner rear right cover. See [“Scanner rear right cover removal” on page 475.](#)
- 2** Remove the scanner rear left cover. See [“Scanner rear left cover removal” on page 475.](#)
- 3** Remove the waste toner bottle. See [“Waste toner bottle removal” on page 397.](#)
- 4** Remove the imaging kit. See [“Imaging kit removal” on page 399.](#)
- 5** Remove the motor cover. See [“Motor cover removal” on page 427.](#)
- 6** Remove or loosen the right cover. See [“Right cover removal” on page 401.](#)
- 7** Remove the controller board shield. See [“Controller board shield removal” on page 474.](#)
- 8** Remove the USB cover. See [“USB cover removal” on page 405.](#)
- 9** Remove the scanner front cover. See [“Scanner front cover removal” on page 429.](#)
- 10** Remove the control panel. See [“Control panel display \(10-inch\) removal” on page 442](#) or [“Control panel display \(7-inch\) removal” on page 444.](#)
- 11** Remove the control panel base. See [“Control panel base \(10-inch\) removal” on page 446](#) or [“Control panel base \(7-inch\) removal” on page 447.](#)
- 12** Remove the façade cover. See [“Facade cover removal” on page 496.](#)
- 13** Remove the ADF and flatbed scanner. See [“Flatbed scanner removal” on page 519.](#)

- 14 Remove the bin cover. See [“Bin cover removal” on page 482.](#)
- 15 Remove the top cover. See [“Top cover removal” on page 486.](#)
- 16 Disconnect the cable (A).

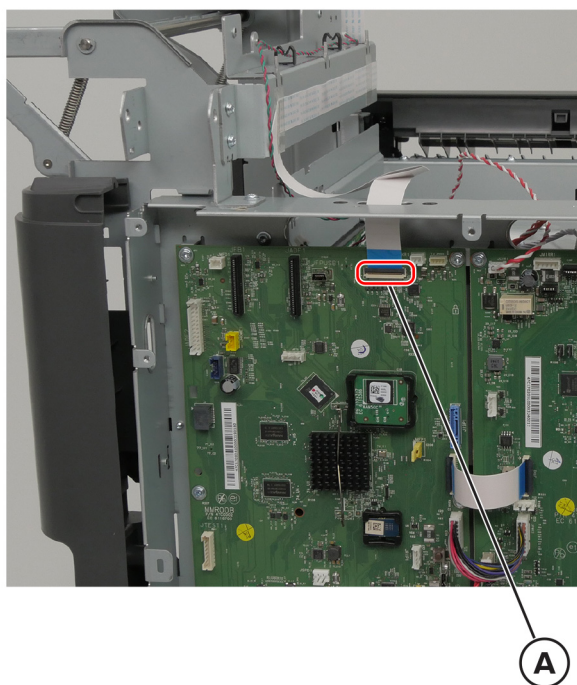

- 17 Remove the cable (B).

Installation note: Pay attention to the cable route.

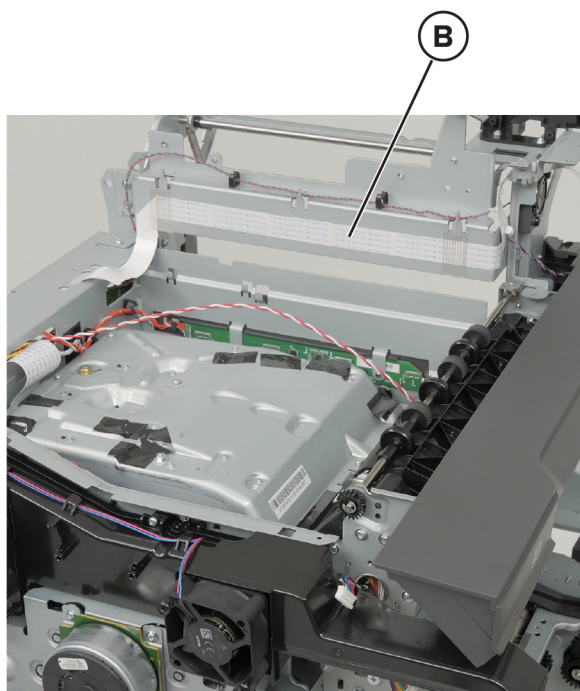

Facade cover removal

- 1 Remove the USB cover. See [“USB cover removal” on page 405](#).
- 2 Remove the scanner front cover. See [“Scanner front cover removal” on page 429](#).
- 3 Remove the control panel. See [“Control panel display \(10-inch\) removal” on page 442](#) or [“Control panel display \(7-inch\) removal” on page 444](#).
- 4 Remove the control panel base. See [“Control panel base \(10-inch\) removal” on page 446](#) or [“Control panel base \(7-inch\) removal” on page 447](#).
- 5 Remove the two screws (A).

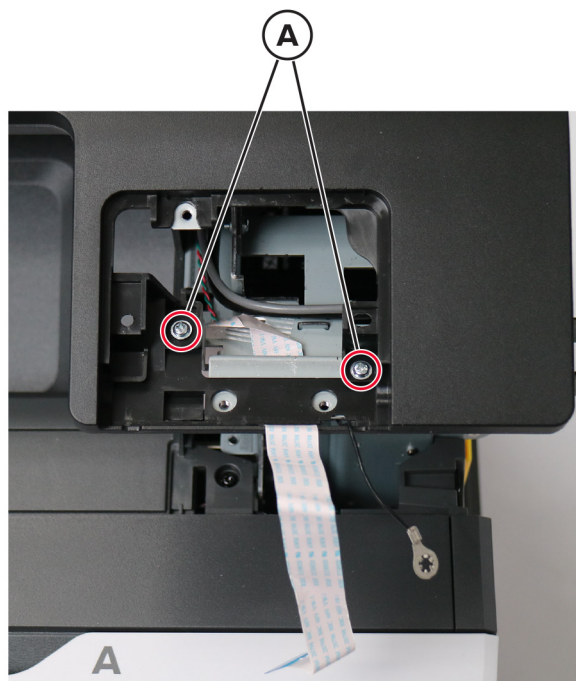

- 6 Remove the cover.

Bin exit cover removal

- 1 Remove the scanner rear right cover. See [“Scanner rear right cover removal” on page 475](#).
- 2 Remove the scanner rear left cover. See [“Scanner rear left cover removal” on page 475](#).
- 3 Remove the waste toner bottle. See [“Waste toner bottle removal” on page 397](#).
- 4 Remove the imaging kit. See [“Imaging kit removal” on page 399](#).
- 5 Remove the motor cover. See [“Motor cover removal” on page 427](#).
- 6 Remove or loosen the right cover. See [“Right cover removal” on page 401](#).
- 7 Remove the controller board shield. See [“Controller board shield removal” on page 474](#).
- 8 Remove the USB cover. See [“USB cover removal” on page 405](#).
- 9 Remove the scanner front cover. See [“Scanner front cover removal” on page 429](#).

- 10 Remove the control panel. See [“Control panel display \(10-inch\) removal” on page 442](#) or [“Control panel display \(7-inch\) removal” on page 444](#).
- 11 Remove the control panel base. See [“Control panel base \(10-inch\) removal” on page 446](#) or [“Control panel base \(7-inch\) removal” on page 447](#).
- 12 Remove the façade cover. See [“Façade cover removal” on page 496](#).
- 13 Remove the ADF and flatbed scanner. See [“Flatbed scanner removal” on page 519](#).
- 14 Remove the bin cover. See [“Bin cover removal” on page 482](#).
- 15 Remove the top cover. See [“Top cover removal” on page 486](#).
- 16 Disengage the tab (A), and then remove the cable from the tabs.

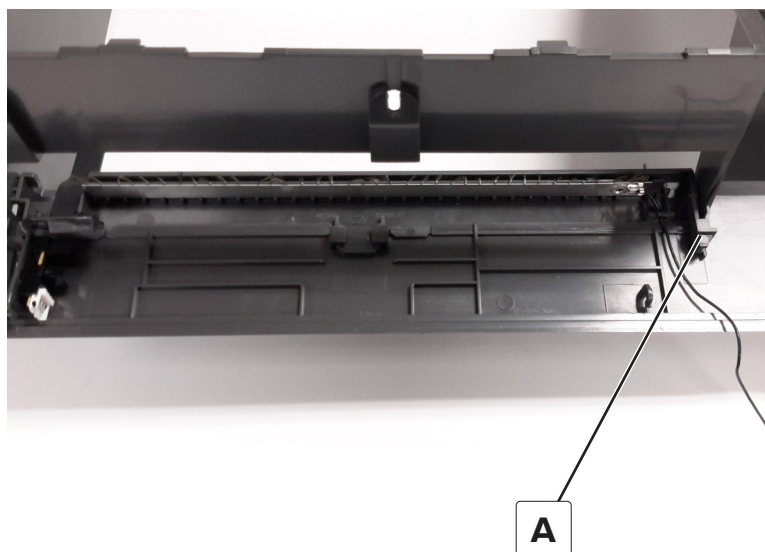

- 17 Remove the cover.

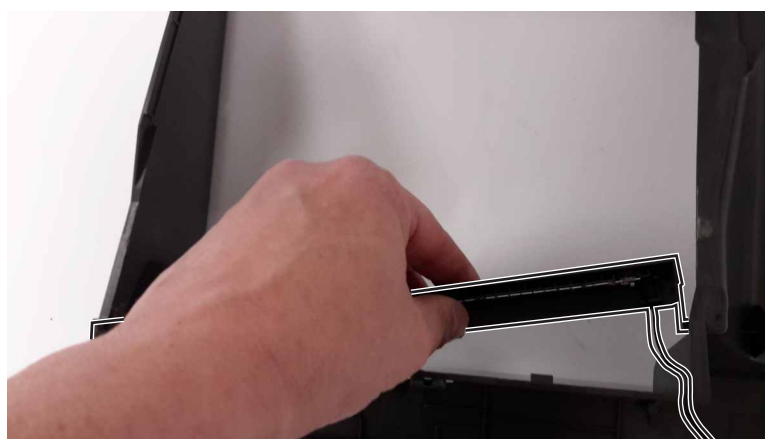

Bin flag removal

- 1 Remove the scanner rear right cover. See [“Scanner rear right cover removal” on page 475](#).
- 2 Remove the scanner rear left cover. See [“Scanner rear left cover removal” on page 475](#).

- 3 Remove the waste toner bottle. See [“Waste toner bottle removal” on page 397](#).
- 4 Remove the imaging kit. See [“Imaging kit removal” on page 399](#).
- 5 Remove the motor cover. See [“Motor cover removal” on page 427](#).
- 6 Remove or loosen the right cover. See [“Right cover removal” on page 401](#).
- 7 Remove the controller board shield. See [“Controller board shield removal” on page 474](#).
- 8 Remove the USB cover. See [“USB cover removal” on page 405](#).
- 9 Remove the scanner front cover. See [“Scanner front cover removal” on page 429](#).
- 10 Remove the control panel. See [“Control panel display \(10-inch\) removal” on page 442](#) or [“Control panel display \(7-inch\) removal” on page 444](#).
- 11 Remove the control panel base. See [“Control panel base \(10-inch\) removal” on page 446](#) or [“Control panel base \(7-inch\) removal” on page 447](#).
- 12 Remove the façade cover. See [“Facade cover removal” on page 496](#).
- 13 Remove the ADF and flatbed scanner. See [“Flatbed scanner removal” on page 519](#).
- 14 Remove the bin cover. See [“Bin cover removal” on page 482](#).
- 15 Remove the top cover. See [“Top cover removal” on page 486](#).
- 16 Remove the bin exit cover. See [“Bin exit cover removal” on page 496](#).
- 17 Slide the flag to the left to remove.

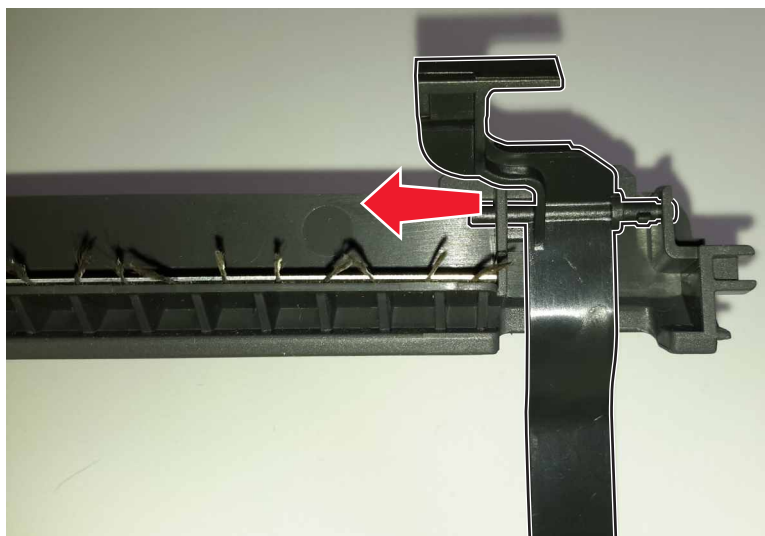

Developer hold down arm removal

- 1 Tilt the ADF and flatbed scanner. See [“Tilting the ADF and flatbed scanner to access parts” on page 532](#).
- 2 Remove the controller board shield. See [“Controller board shield removal” on page 474](#).
- 3 Remove the bin cover. See [“Bin cover removal” on page 482](#).
- 4 Remove the printhead. See [“Printhead removal” on page 484](#).

5 Remove the E-clip (A).

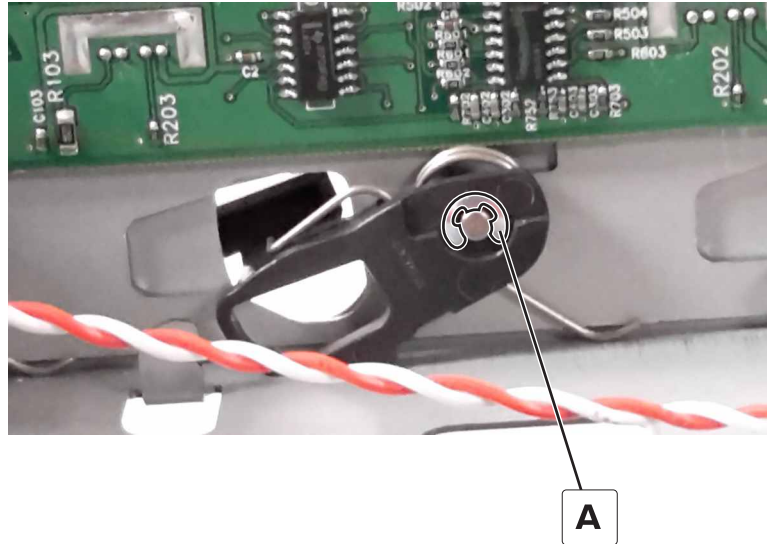

6 Pull the bell crank (B) and spring (C) off the mounting pin, and then remove the developer hold down arm.

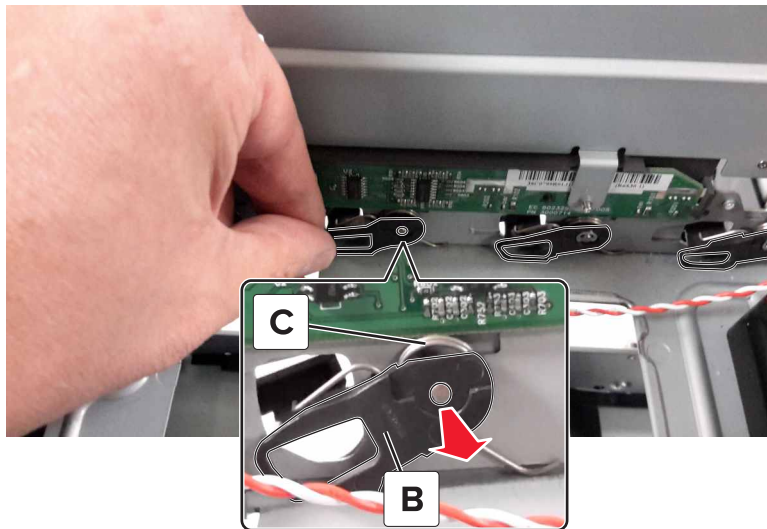

Bottom side removals

550-sheet tray insert removal

Remove the tray.

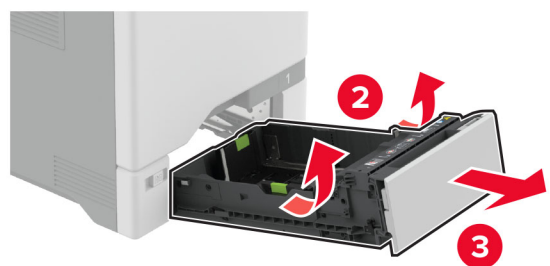

Separator bracket removal

1 Pull out the tray.

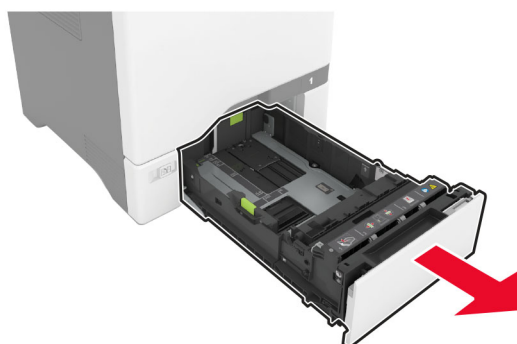

2 Remove the separator bracket.

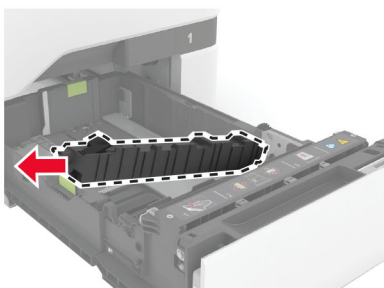
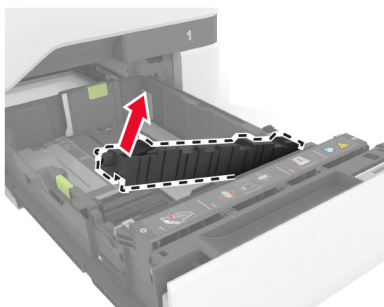
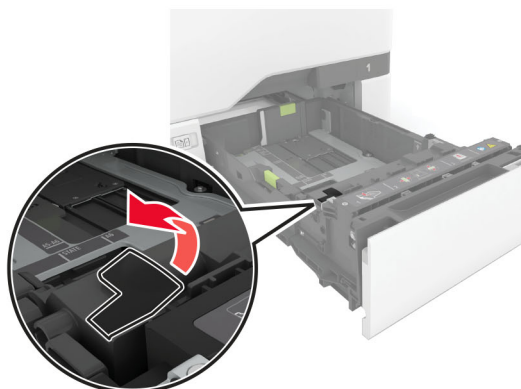

Pick roller removals

Tray 1 pick roller removal

- 1 Remove the tray.

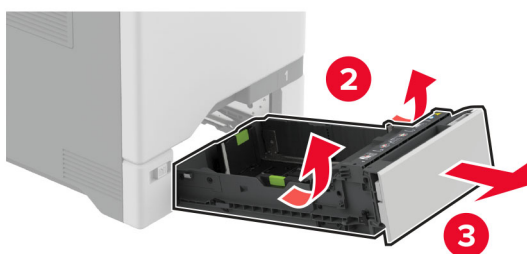

2 Remove the pick roller.

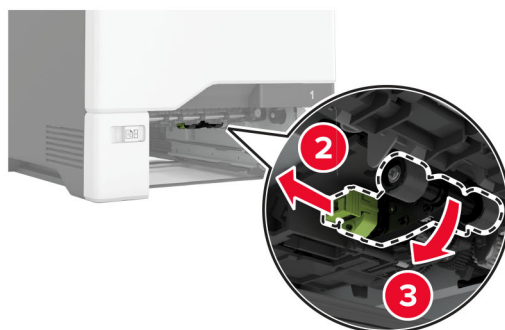

MPF pick roller removal

1 Open the multipurpose feeder.

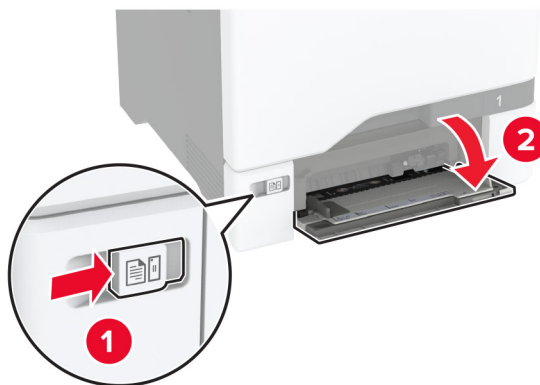

Parts removal

- 2 Remove the pick roller.

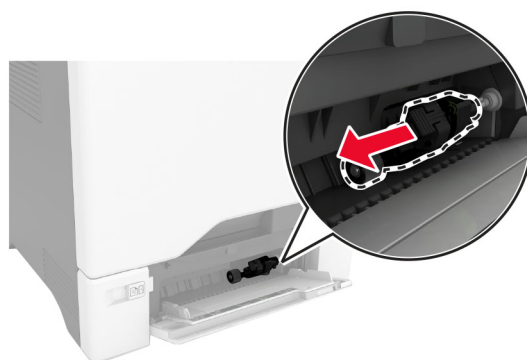
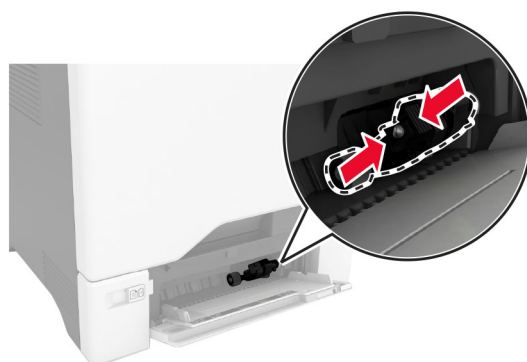

Tray rail removal

- 1 Remove the waste toner bottle. See [“Waste toner bottle removal” on page 397.](#)
- 2 Remove the tray insert. See [“550-sheet tray insert removal” on page 500.](#)
- 3 Remove the left cover. See [“Left cover removal” on page 374.](#)
- 4 Remove the motor cover. See [“Motor cover removal” on page 427.](#)
- 5 Remove the right cover. See [“Right cover removal” on page 401.](#)

6 Remove the screws (A), and then remove the tray rail stops.

- Right side

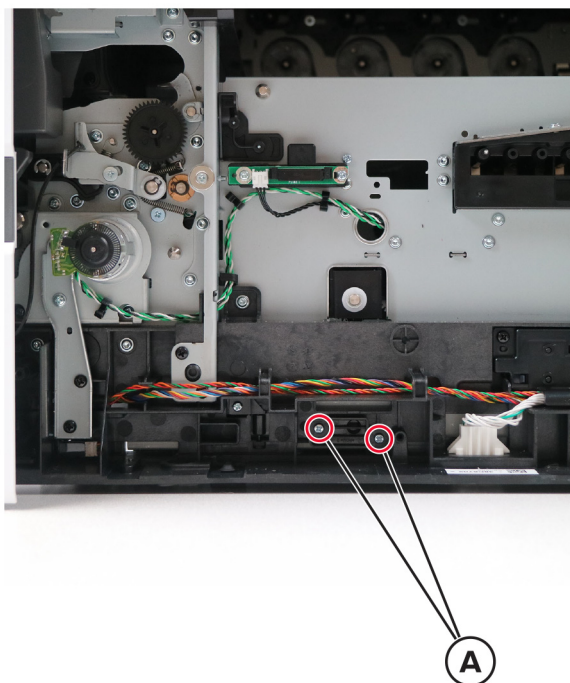

- Left side

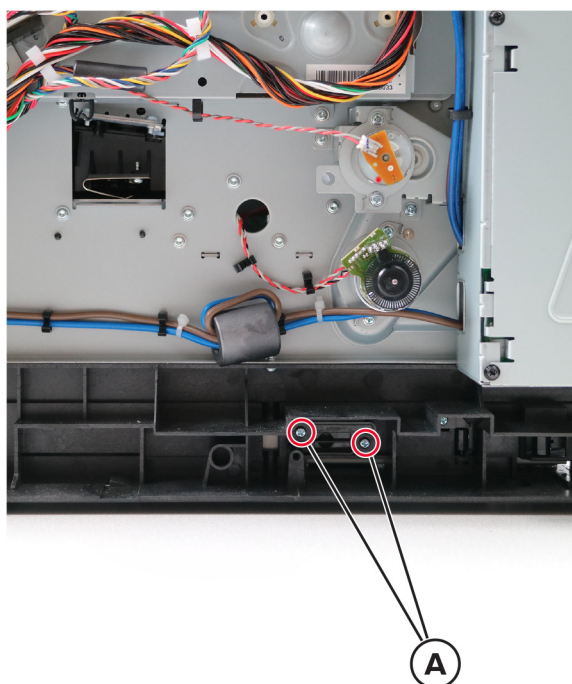

Parts removal

7 Release the springs (B).

- Right side

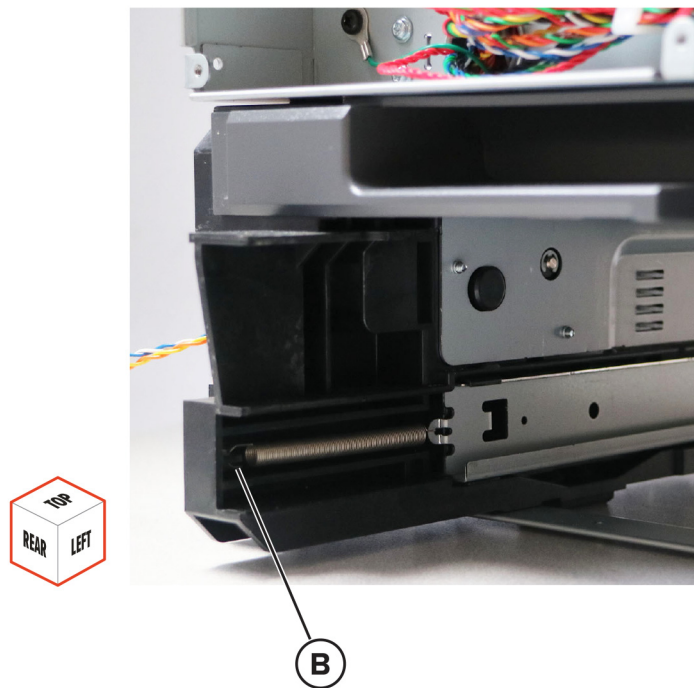

- Left side

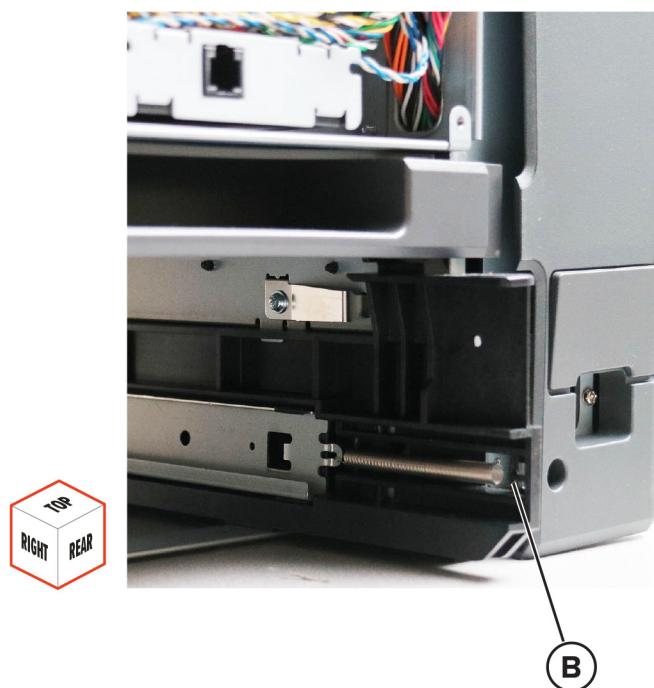
**8** Remove the tray rails.

Paper feeder removal

Warning—Potential Damage: Remove the waste toner bottle and imaging kit first before removing the paper feeder. Failure to do this can lead to toner spillage and damage to the printer.

- 1 Remove the waste toner bottle. See [“Waste toner bottle removal” on page 397.](#)
- 2 Remove the imaging kit. See [“Imaging kit removal” on page 399.](#)
- 3 Remove the tray insert. See [“550-sheet tray insert removal” on page 500.](#)
- 4 Remove the tray 1 pick roller. See [“Pick roller removals” on page 502.](#)
- 5 Place the printer on its back, and then disconnect the cables.
- 6 Remove the four screws (A).

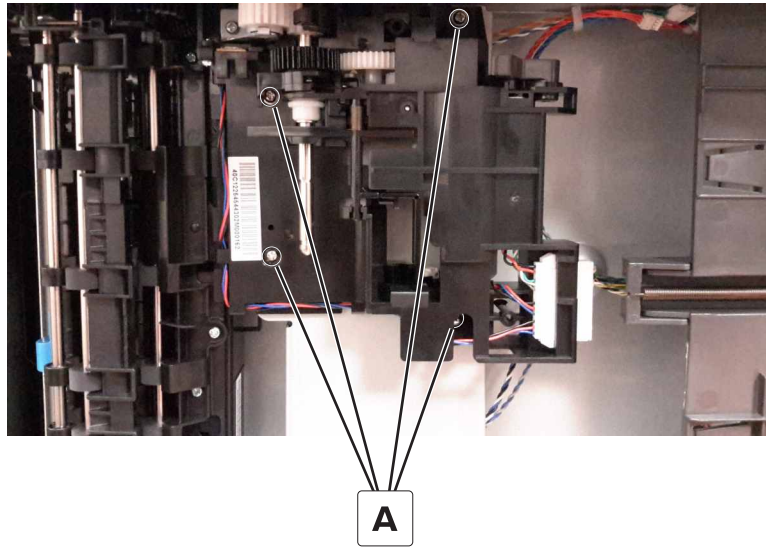

- 7 Disconnect the cable (B), and then remove the paper feeder.

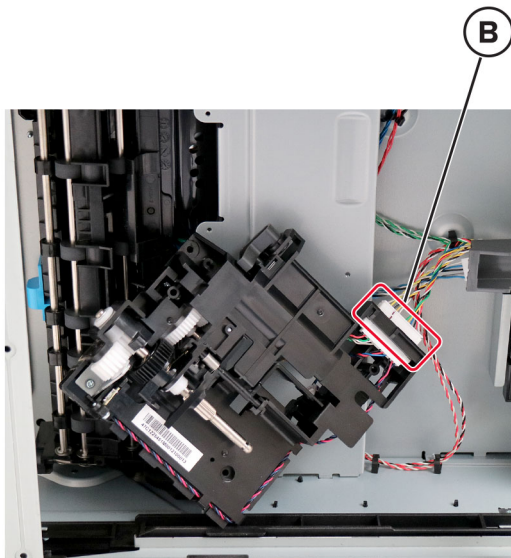

Parts removal

Paper out actuator spring removal

- 1 Remove the paper feeder. See [“Paper feeder removal” on page 507](#).

Warning—Potential Damage: Remove the waste toner bottle and imaging kit first before removing the paper feeder. Failure to do this can lead to toner spillage and damage to the printer.

- 2 Pay attention to the position of the paper out actuator spring (A).

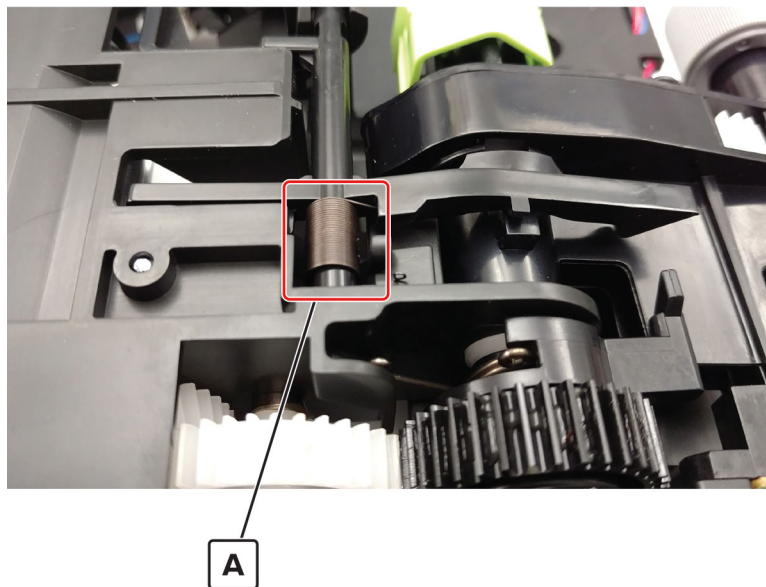

- 3 Move the actuator to the right, and then release it.

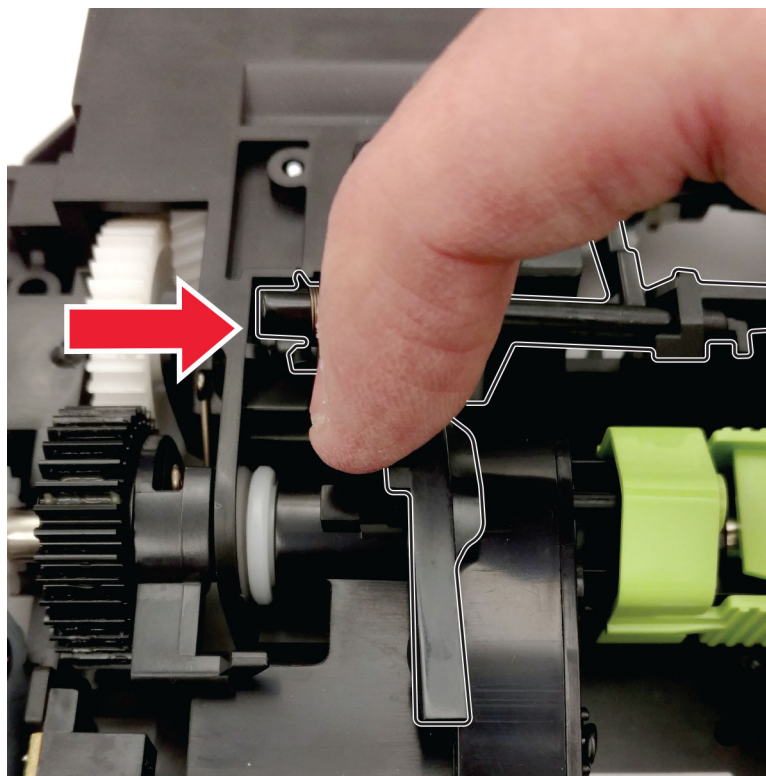

4 Remove the actuator.

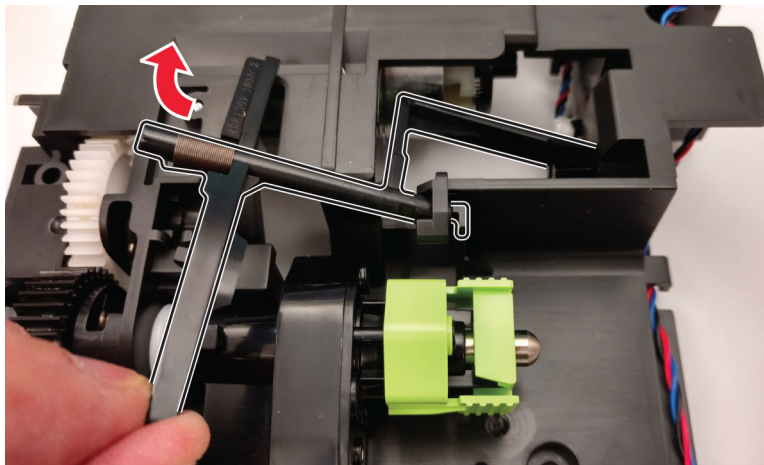

5 Remove the spring.

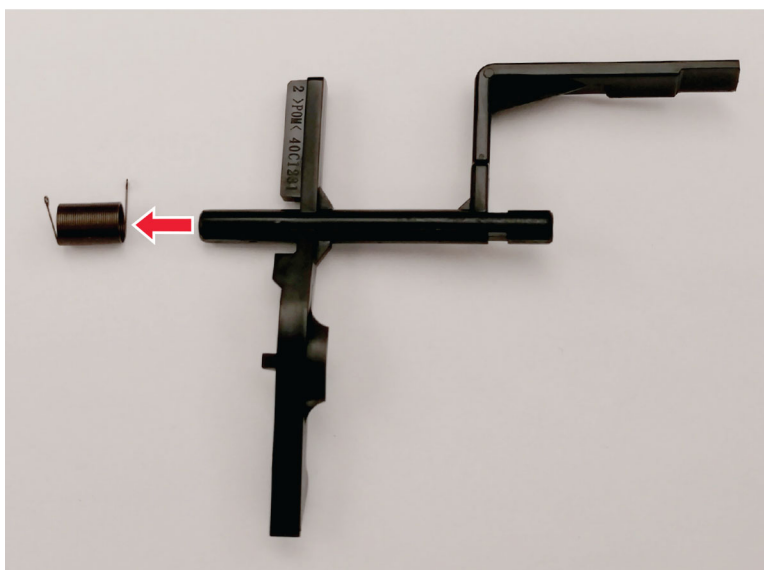

Installation note: When installing the spring, make sure to install it as shown in step 6.

Isolation unit removal

Warning—Potential Damage: To avoid toner spillage and printer damage, remove the waste toner bottle and imaging kit first before removing the isolation unit.

- 1 Remove the waste toner bottle. See [“Waste toner bottle removal” on page 397.](#)
- 2 Remove the imaging kit. See [“Imaging kit removal” on page 399.](#)

- 3 Remove the tray insert. See [“550-sheet tray insert removal” on page 500.](#)
- 4 Remove the tray 1 pick roller. See [“Pick roller removals” on page 502.](#)
- 5 Remove the paper feeder. See [“Paper feeder removal” on page 507.](#)
- 6 Remove the motor cover. See [“Motor cover removal” on page 427.](#)
- 7 Remove the right cover. See [“Right cover removal” on page 401.](#)
- 8 Remove the motor (duplex/MPF). See [“Motor \(duplex/MPF\) removal” on page 415.](#)
- 9 Remove the three screws (A) that are securing the isolation unit.

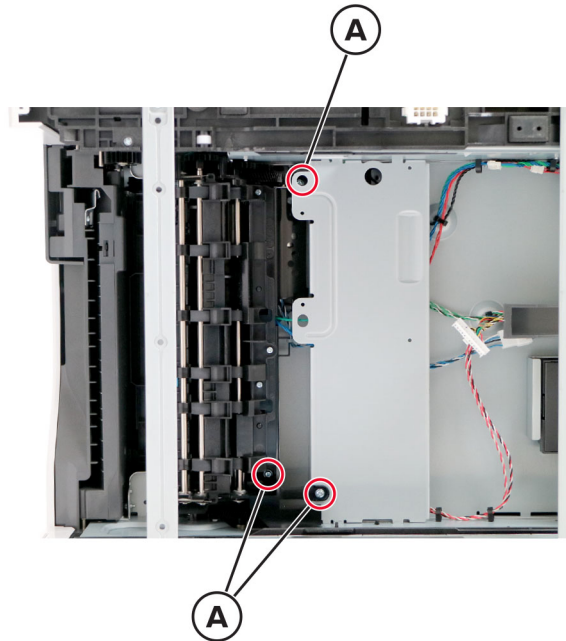

- 10 Remove the biasing screw (B).

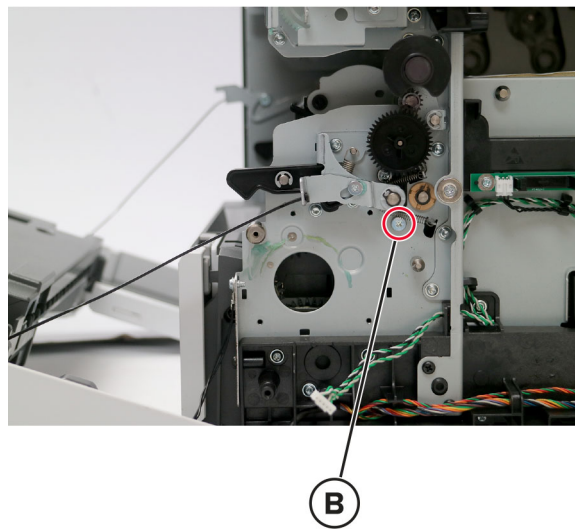

Installation note: Make sure to install the biasing screw first before installing the other three screws.

- 11** Disconnect the motor cable (C) and sensor cable (D).

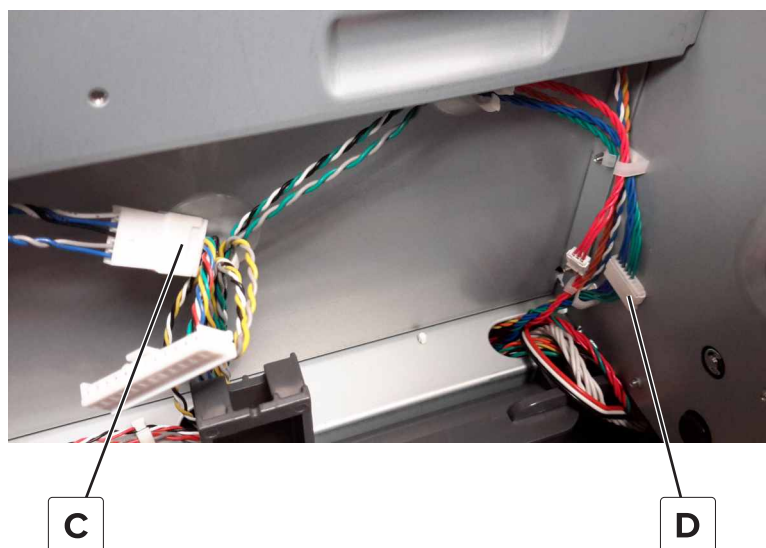

- 12** Tilt the right portion of the isolation unit to the front, and then remove the unit.

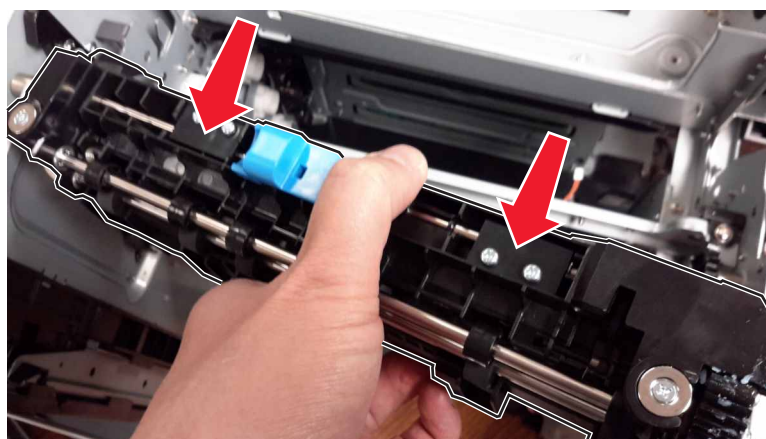

- 13** Release the isolation unit cables from the printer.

ADF and flatbed scanner removals

Scanner glass pad removal

- 1 Open the scanner cover.

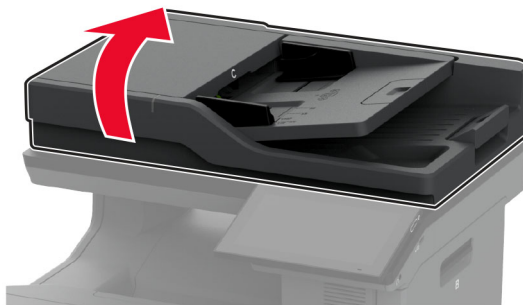

- 2 Slowly remove the scanner glass pad.

Note: Make sure to avoid tearing the adhesive from the foam pad, or tear the foam itself.

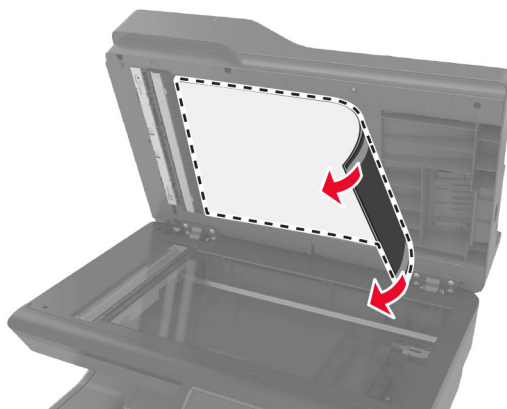

Installation notes:

- a Place the white area of the new scanner glass pad facedown on the scanner glass, and then remove the backing on the tape.

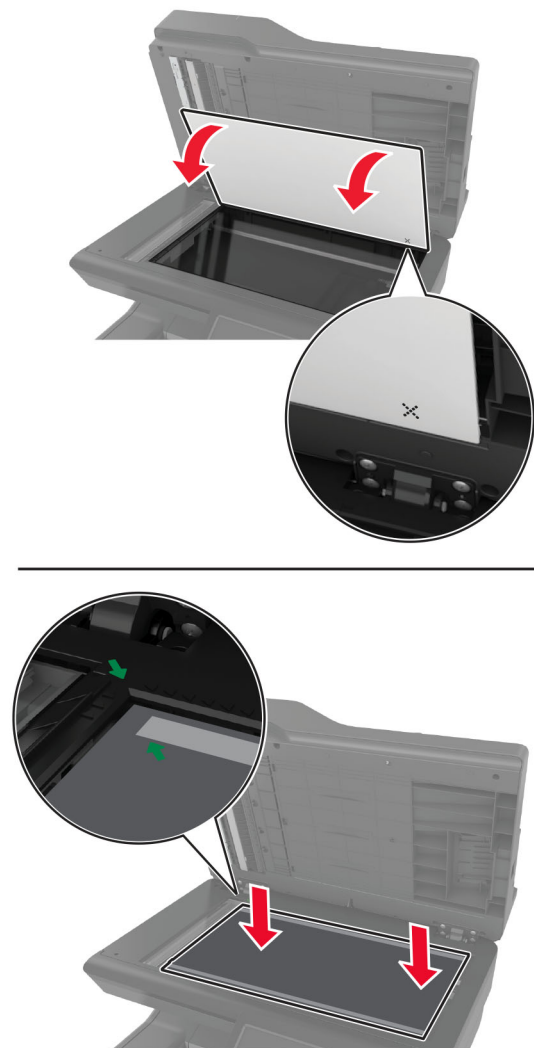

Note: Make sure that the scanner glass pad is aligned correctly on the edges of the scanner glass.

- b** Close the scanner cover to stick the new scanner glass pad to the cover.

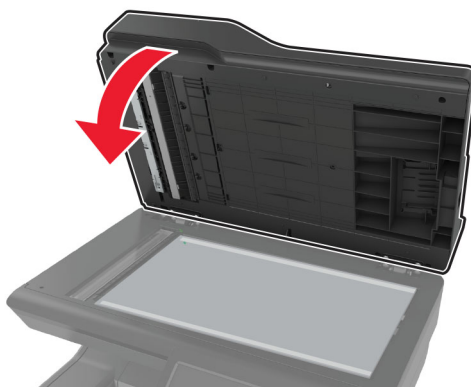

- c** Open the scanner cover to check if the new scanner glass pad is properly attached to the cover.

ADF rollers removal

- 1** Open door C.

Warning—Potential Damage: To prevent damage from electrostatic discharge, touch any exposed metal frame of the printer before accessing or touching interior areas of the printer.

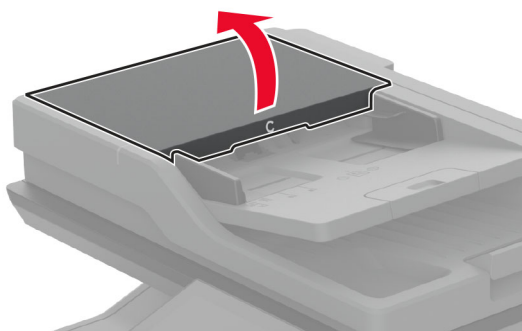

2 Remove the ADF pick roller.

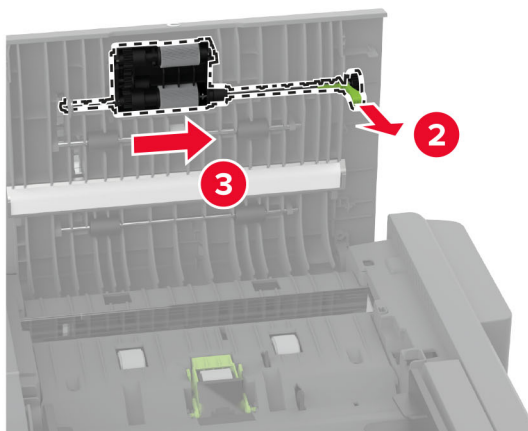
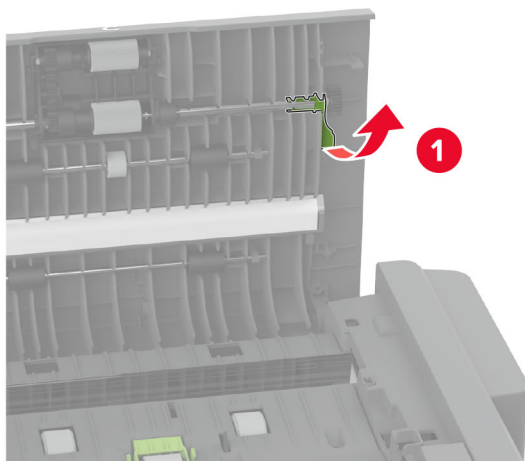

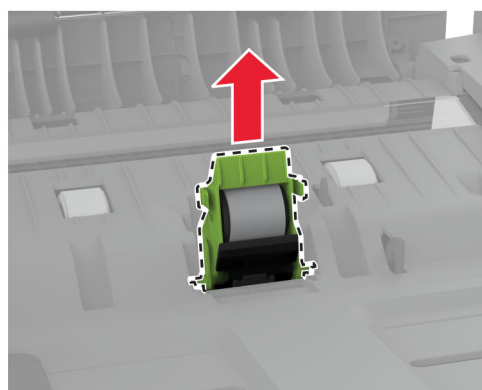
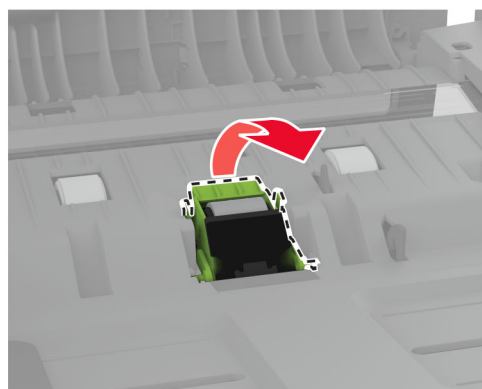
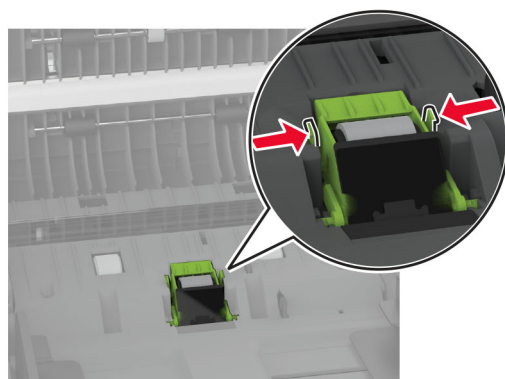
3 Remove the ADF separator roller.

ADF tray removal

- 1 Release the front hinge.



- 2 Remove the ADF tray.

ADF removal

- 1 Release the latches, and then remove the cover.

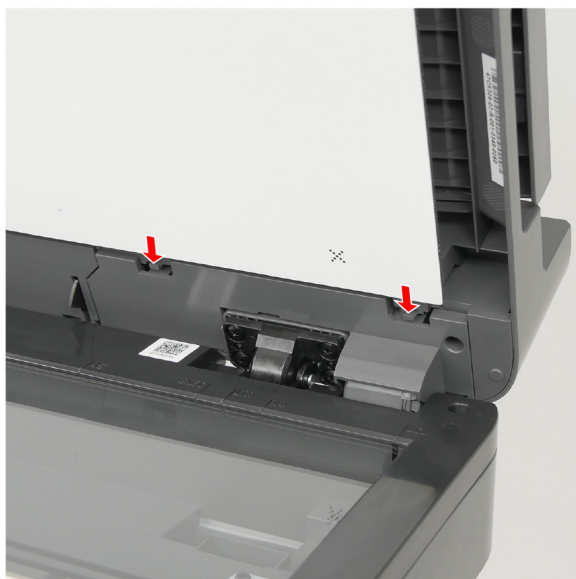

2 Disconnect the FFC (A).

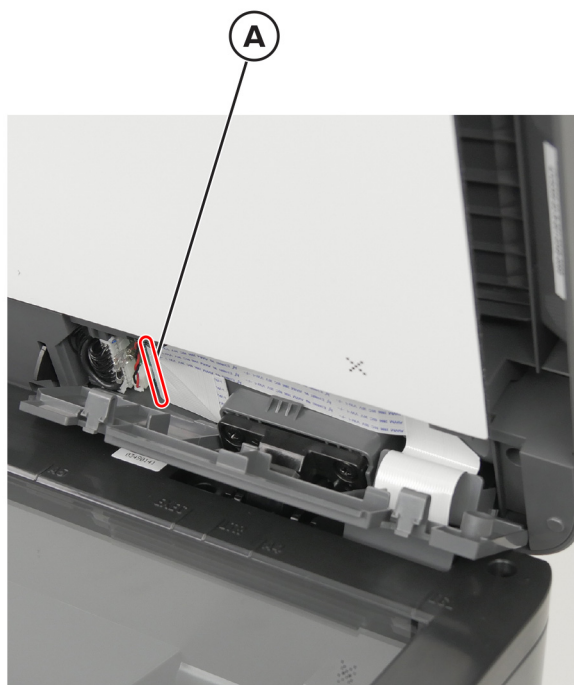

3 Slightly lift the ADF, and then disconnect the cables (B).

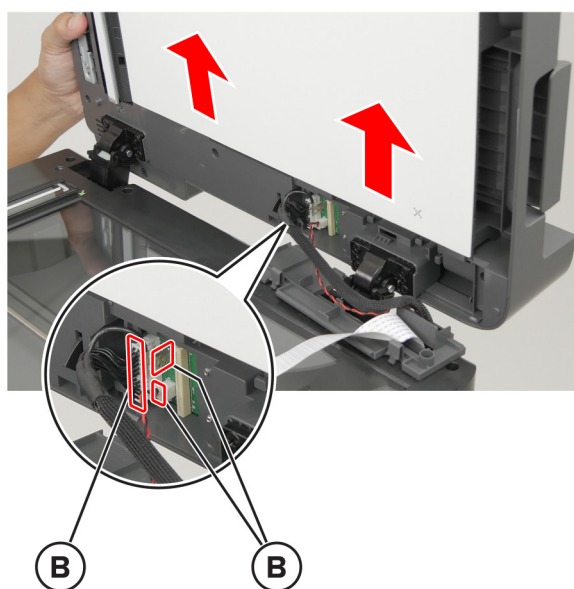

4 Remove the ADF.

Flatbed scanner removal

Note: For a video demonstration, see [Replacing the scanner](#).

- 1 Remove the ADF. See [“ADF removal” on page 517](#).
- 2 Remove the scanner rear left cover. See [“Scanner rear left cover removal” on page 475](#).
- 3 Remove the controller board shield. See [“Controller board shield removal” on page 474](#).
- 4 Disconnect the two cables (A).



5 Disconnect the four connectors (B).

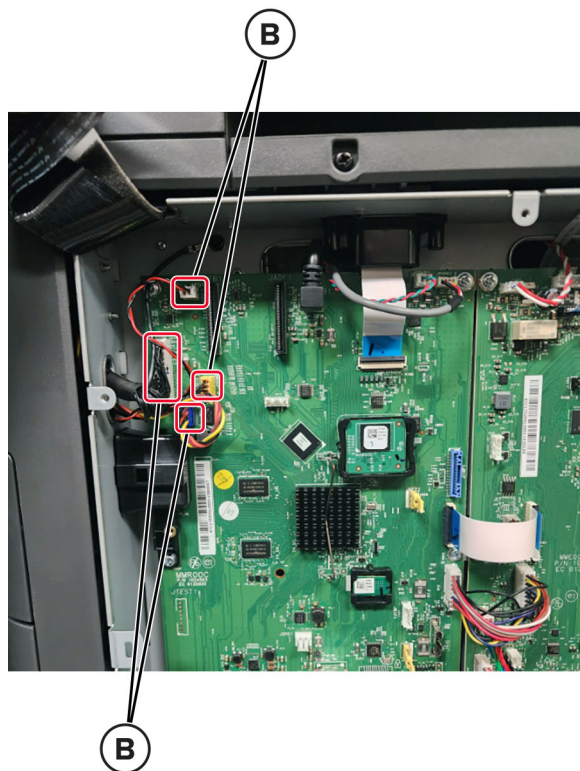

6 Remove the ground screw (C).

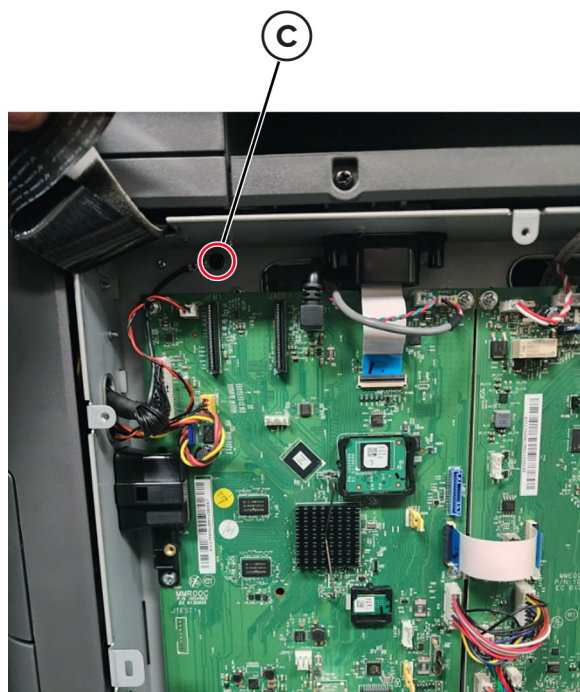

- 7 Remove the three screws (D), and then remove the control panel base cover.

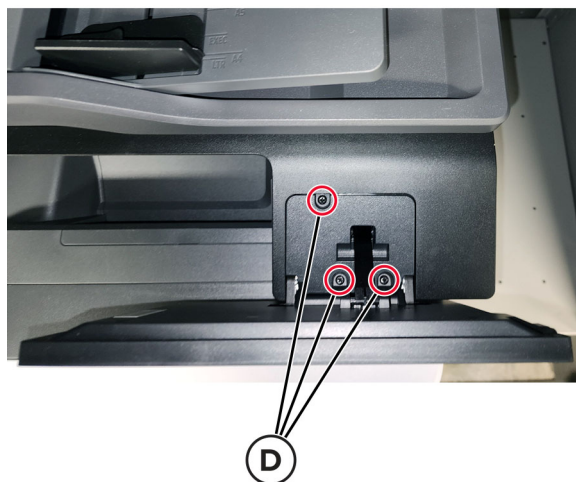

Warning—Potential Damage: Do not allow the control panel display to fall. Place a ream of paper or a similar object under the display to support it once it is detached.



- 8 Remove the two screws (E).

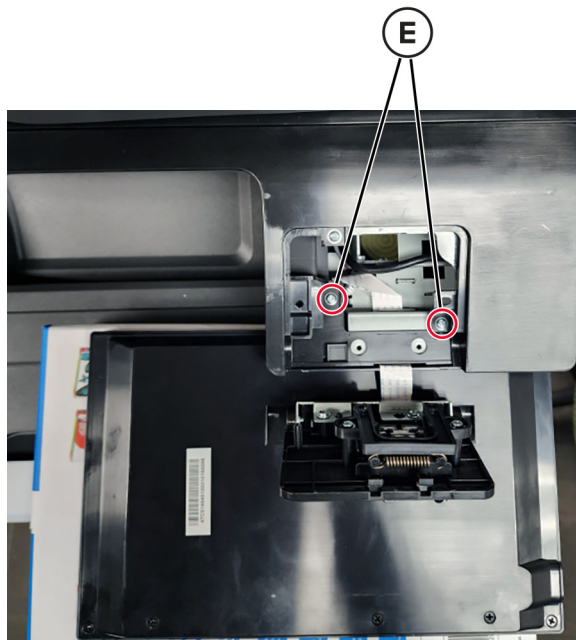

- 9 Gently insert a flat-tipped screwdriver under the left side of the cover, and then lift upwards to release the fastening hook.



10 Remove the two screws (F).

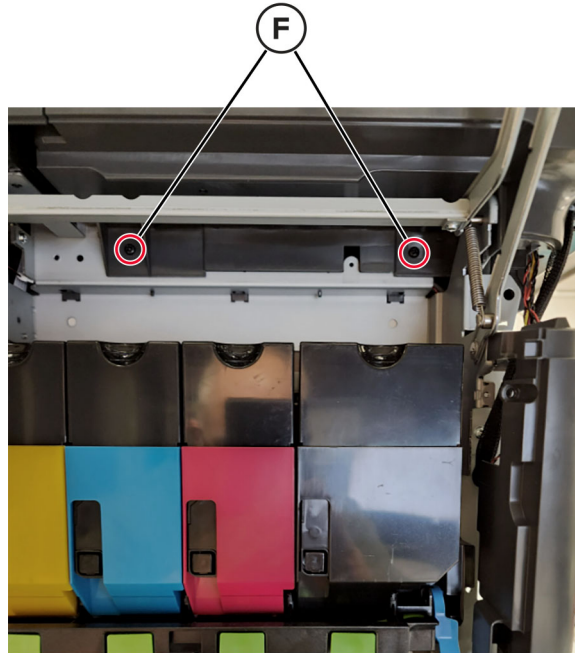

11 Remove the scanner rear right cover. See [“Scanner rear right cover removal” on page 475.](#)

12 Remove the waste toner cover and bottle.

13 Remove the screw (G).



14 Remove the two screws (H).

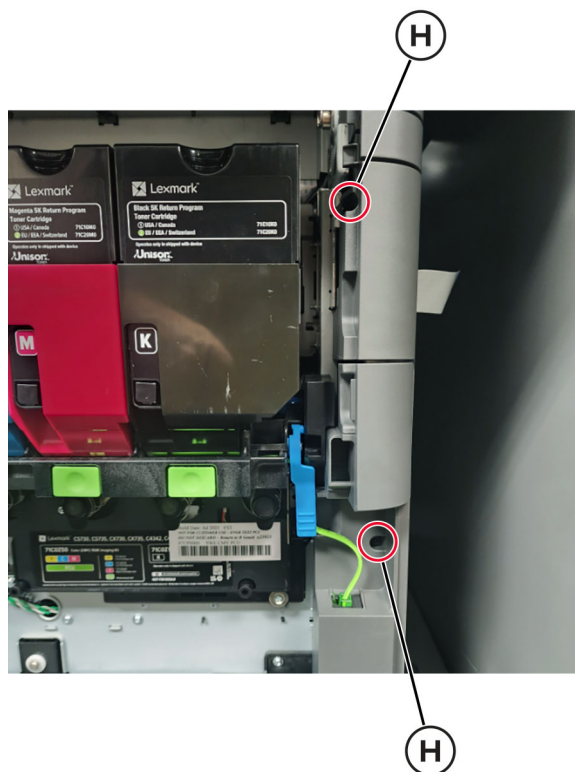

15 Gently flex the right cover, and then remove the cables (I) from the hole in the controller board cage.



Parts removal

16 Remove the pin (J) and the clip (K).

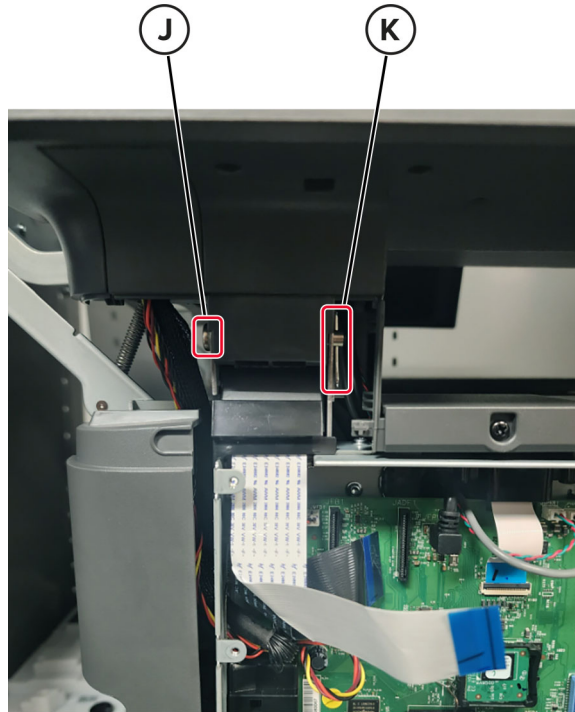

17 Remove the clip (L) and the pin (M).



18 Gently remove the scanner from the frame.

Note: Ensure the scanner cables are free from their routings before removing the scanner.

Scanner cables removal

- 1 Remove the ADF. See [“ADF removal” on page 517](#).
- 2 Remove the scanner. See [“Flatbed scanner removal” on page 519](#).
- 3 Place the scanner upside down on a table, lift the hook (A), and then remove the cable cover.

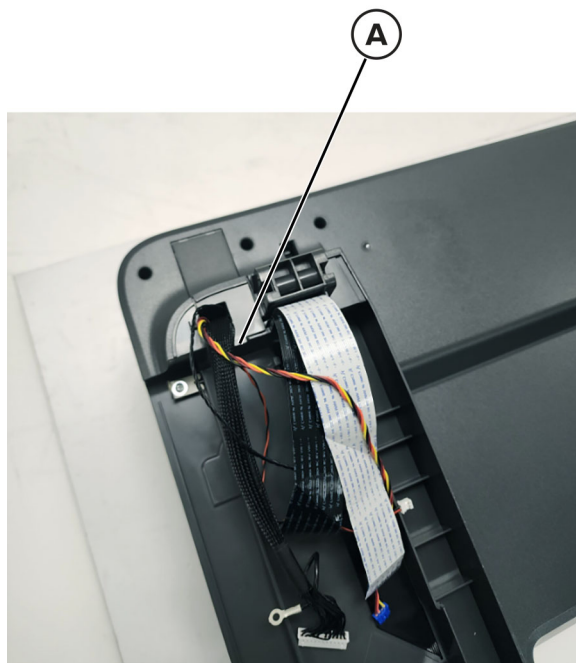

4 Detach the cables (B) from their retainers (C).

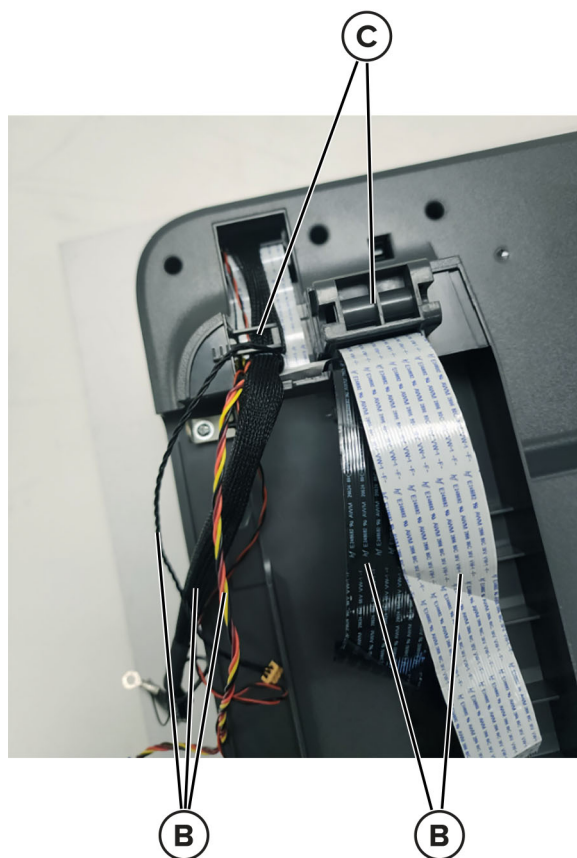

5 Turn the scanner the right side up, and then remove the scanner cables (D).

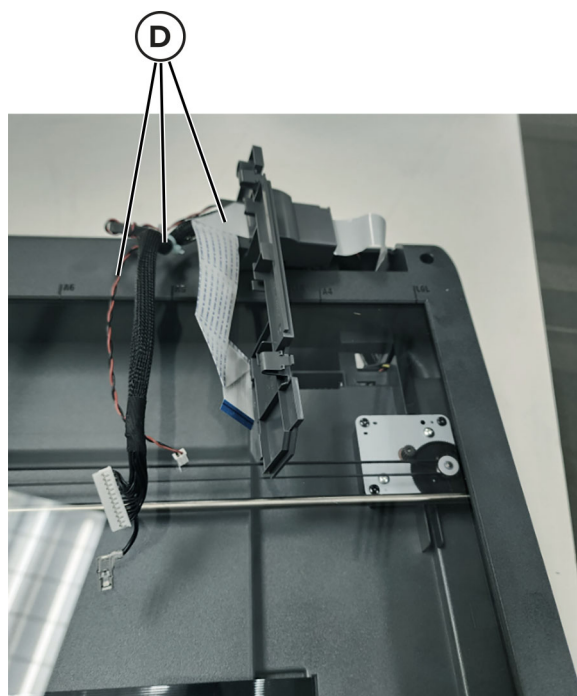

Parts removal

ADF top cover removal

- 1 Open door C.

Warning—Potential Damage: To prevent damage from electrostatic discharge, touch any exposed metal frame of the printer before accessing or touching interior areas of the printer.

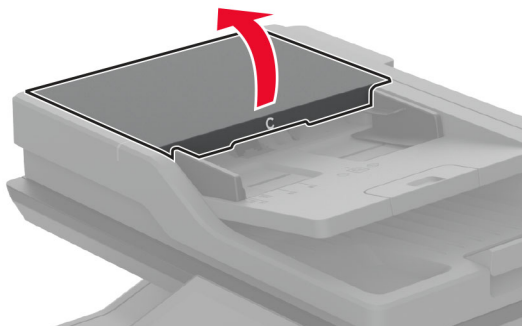

- 2 Disconnect the cable (A).



- 3 Using a flat-blade screwdriver, release the hinges (B).

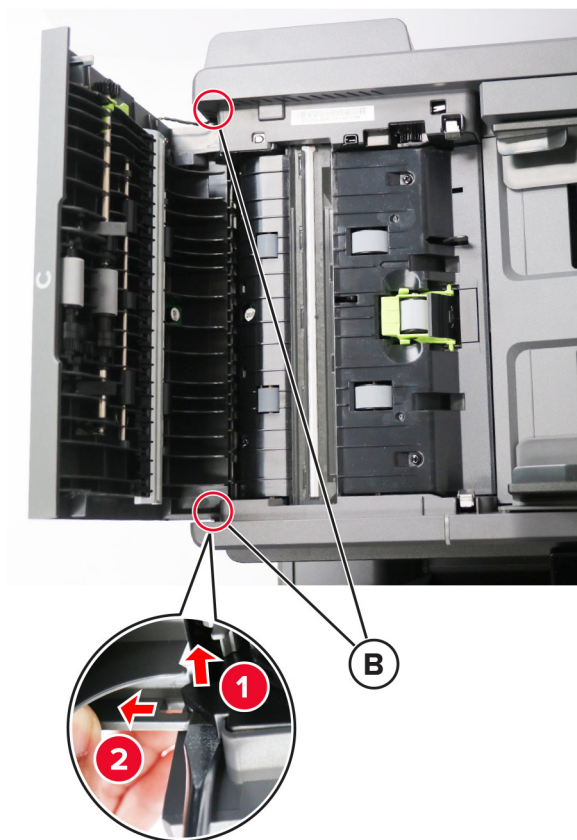

- 4 Remove the cover.

ADF right hinge removal

- 1 Remove the ADF. See [“ADF removal” on page 517](#).
- 2 Remove the four screws (A), and then remove the hinge.



ADF left hinge removal

- 1 Remove the ADF. See [“ADF removal” on page 517](#).
- 2 Remove the four screws (A), and then remove the hinge.



Tilting the ADF and flatbed scanner to access parts

- 1 Open the toner door.
- 2 Remove the two screws (A).

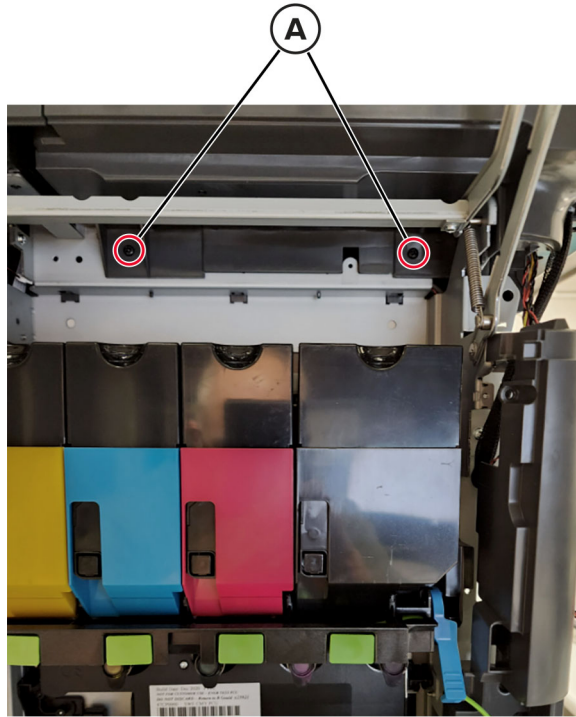

- 3 Remove the three screws (B), and then remove the control panel base cover.

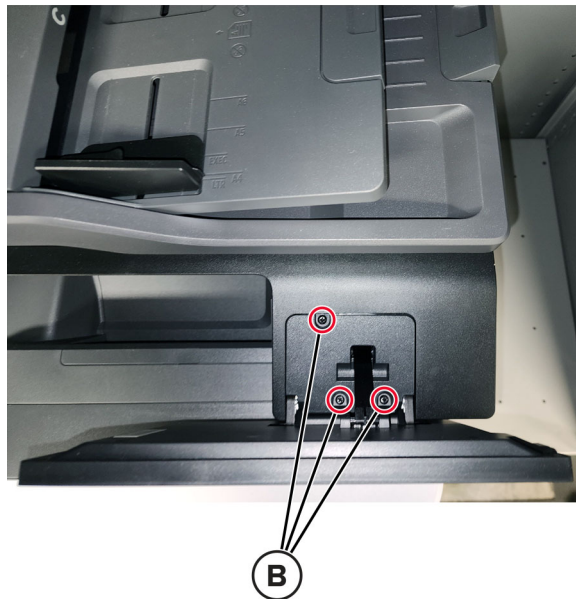

Warning—Potential Damage: Do not allow the control panel display to fall. Place a ream of paper or a similar object under the display to support the panel once it is detached.



4 Remove the two screws (C).

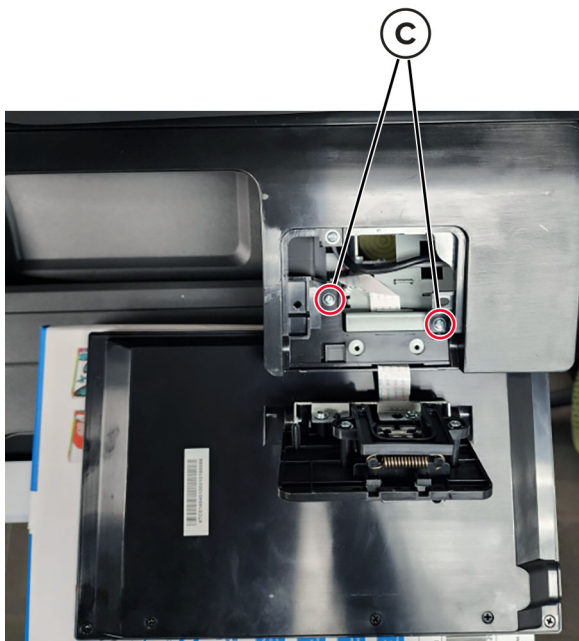

Parts removal

533

- 5** Gently insert a flat-tipped screwdriver under the left side of the cover, and then lift upwards to release the fastening hook.



- 6** Remove the scanner rear left cover. See [“Scanner rear left cover removal” on page 475.](#)
- 7** Remove the scanner rear right cover. See [“Scanner rear right cover removal” on page 475.](#)

8 Remove the screw (D).



9 Lower the ADF, then gently lift the flatbed scanner up and rotate it back.



Parts removal

Optional 550-sheet tray removals

Optional 550-sheet tray removal

Unlock, and then remove the tray.

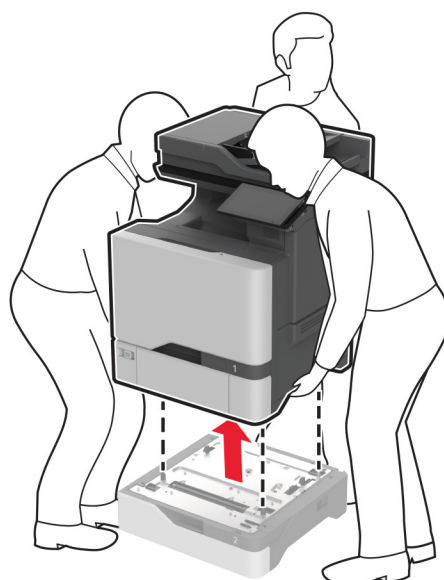

Component locations

Printer configurations

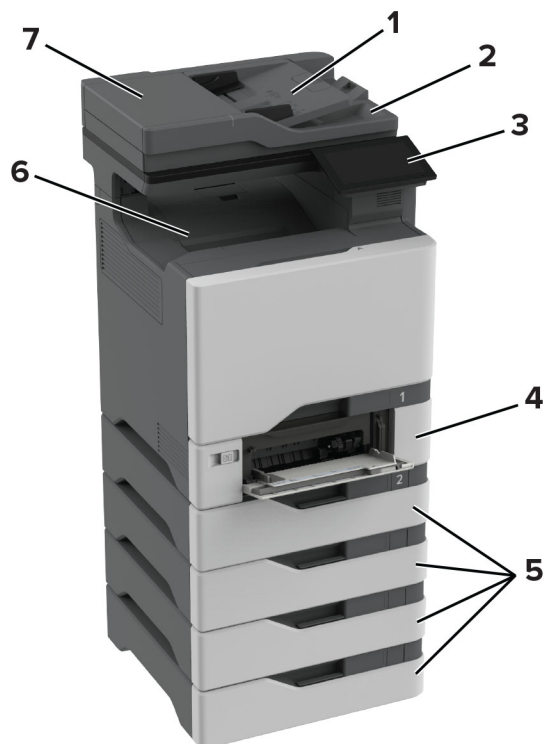

1	ADF tray
2	ADF bin
3	Control panel
4	650-sheet duo tray Note: The tray is composed of a 550-sheet tray and a 100-sheet multipurpose feeder.
5	Optional 550-sheet trays Note: Up to four optional trays can be installed.
6	Standard bin
7	Automatic document feeder (ADF)

Port locations

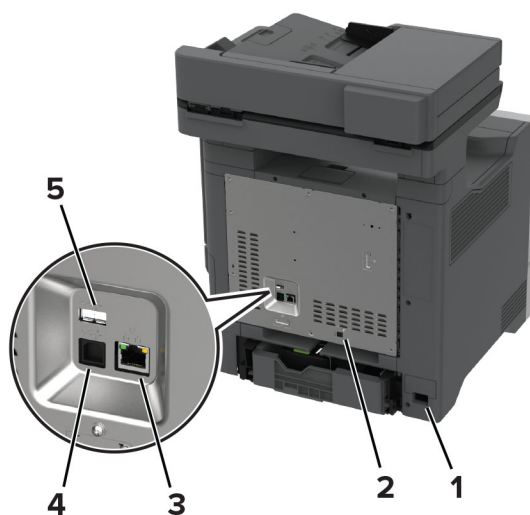

	Printer port	Function
1	Power cord socket	Connect the printer to a properly grounded electrical outlet.
2	LINE port Note: Available only in some printer models.	Connect the printer to an active telephone line through a standard wall jack (RJ-11), DSL filter, or VoIP adapter, or any other adapter that allows you to access the telephone line to send and receive faxes.
3	Ethernet port	Connect the printer to a network.
4	USB printer port	Connect the printer to a computer.
5	USB port	Attach a keyboard or any compatible option.

Controller board connectors

Connector	Connects to
J2	Wireless module
J65	Connector jumper
JADF1	ADF back side scan module
JADF2	<ul style="list-style-type: none"> • ADF sensors • Motor (ADF pick) • Motor (ADF transport)
JBUSB1	Rear USB port
J1	Ethernet port
JFAX1	Fax card
JFB1	Scanner front side scan module
JFBM1	Motor (flatbed CIS scanner)
JFPUSB1	Front USB port
JHOME1	Sensor (flatbed CIS scanner)
JISP1	Internal Solutions Port
JLCD1	Control panel display
JMFD1	Sensor (ADF multifeed)
JMFP1	Connector jumper
JPHONE2	Headphones
JPWR1	Engine board, power connection
JSPKR1	Speaker
JTH1	Engine board, data connection
JTPM1	Trusted Platform Module
JUSB1	USB printer port
J66	HDD Connector (internal or external)

Engine board

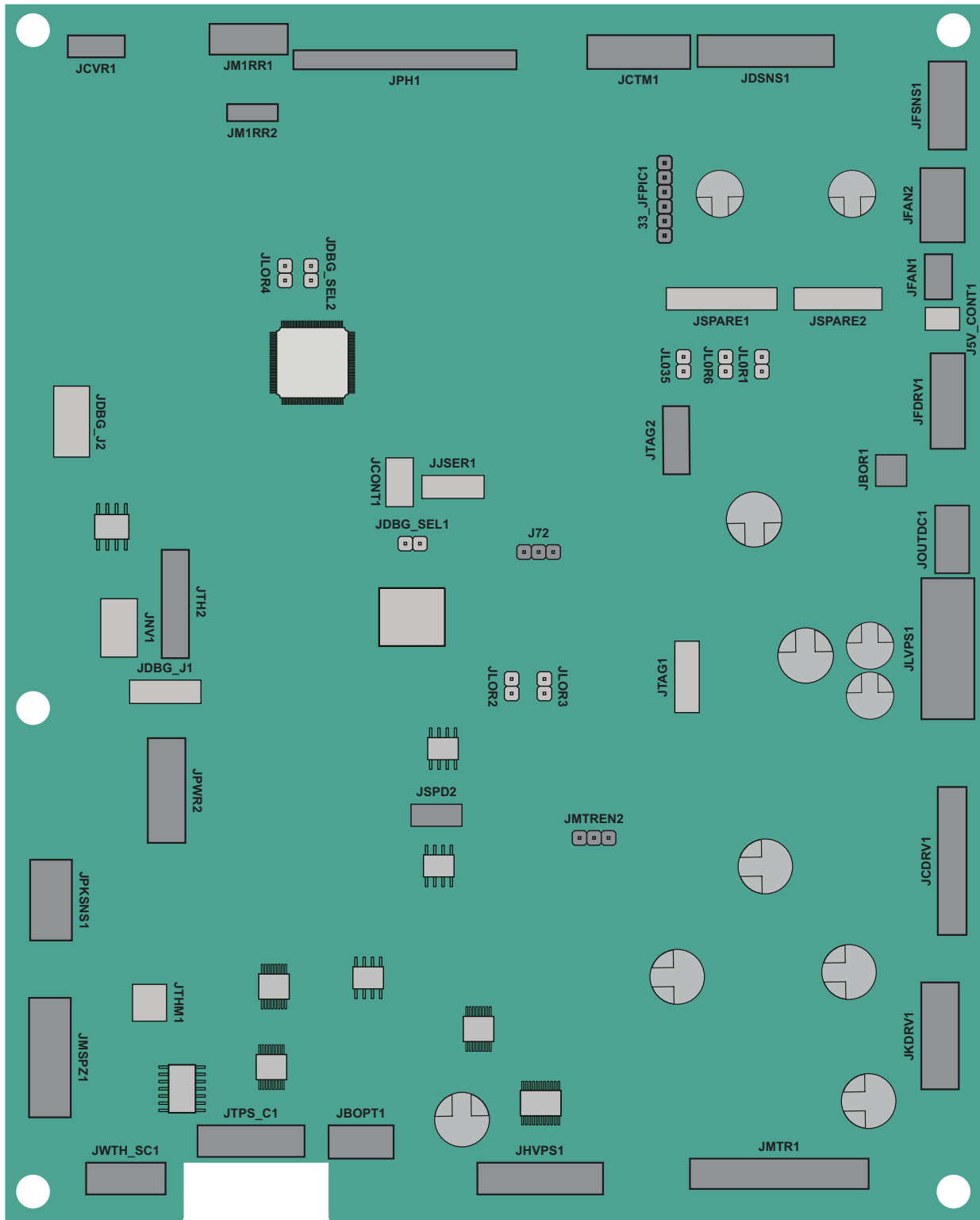

Component locations

Engine board connectors

Connector	Connects to
J72	Connector jumper
JBOR1	Motor (BOR)
JCDRV1	Motor (CMY)
JCTM1	TMC card
JCVR1	Interlock switches
JDSNS1	<ul style="list-style-type: none"> • Sensor (redrive) • Sensor (exit/bin full)
JFAN2	Main fan
JFDRV1	Motor (fuser)
JFSNS1	Sensor (fuser nip)
JHVPS1	HVPS
JKDRV1	Motor (K/transfer belt)
JLVPS1	LVPS
JMIRR1	Printhead mirror
JMIRR2	Printhead mirror
JMSPZ1	<ul style="list-style-type: none"> • Sensor (tray 1 paper size) • Sensor (MPF paper present) • Front door sensors <ul style="list-style-type: none"> – Sensor (duplex staging) – Sensor (fuser buckle) – Sensor (narrow media)
JMTR1	<ul style="list-style-type: none"> • Pick drive <ul style="list-style-type: none"> – Motor (tray 1 pick) – Sensor (tray 1 pick position) – Sensor (tray 1 paper present) • Motor (deskew) • Motor (duplex/MPF) • Isolation unit <ul style="list-style-type: none"> – Motor (isolation)
JMTREN2	Connector jumper
JBOPT1	Optional tray
JOUTDC1	Motor (exit/redrive)
JPH1	Printhead

Connector	Connects to
JPKSNS1	<ul style="list-style-type: none"> • Sensor (waste toner contact) • Sensor (input) • Isolation unit <ul style="list-style-type: none"> – Sensor (tray 1 pick) – Sensor (MPF/pass-through)
JPWR2	Controller board, power connection
JTH2	Controller board, data connection
JTPS_C1	Sensor (TPS)
JWTH_SC1	<ul style="list-style-type: none"> • Sensor (weather station) • Imaging unit and imaging kit
JFAN1	Fuser fan

LVPS board connectors

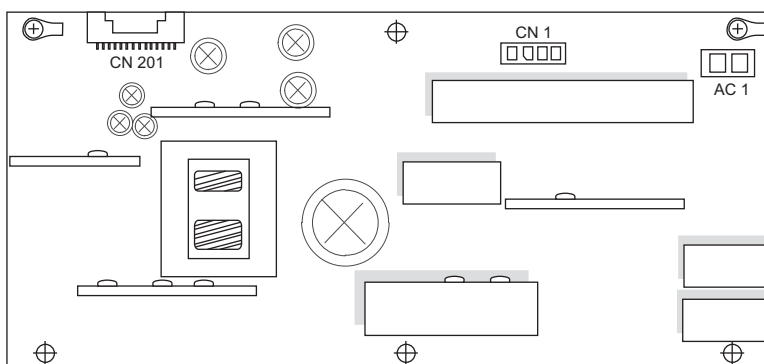

Connector	Connects to	Pin no.	Signal
CN201	Engine board	1	+25V
		2	GND
		3	+25V
		4	GND
		5	+25V
		6	GND
		7	+25V
		8	GND
		9	+25V
		10	GND
		11	+25V
		12	GND
		13	+25V
		14	GND
		15	+25V
		16	GND
		17	GND
		18	GND
		19	Zero_Cross
		20	Heat_On2
		21	Heat_On1
		22	Main_On_Off
		23	Tx_PwrMtr
		24	Relay_Drive
		25	Ground
		26	+6.5V
		27	+6.5V
		28	+6.5V
		29	Rx_PwrMtr
		30	Heat_On3
CN1	Fuser	1	AC Common
		2	AC Out 3
		3	AC Out 2
		4	AC Out 1

Component locations

Connector	Connects to	Pin no.	Signal
AC1	AC line in	1	Phase
		2	Neutral

Sensor locations

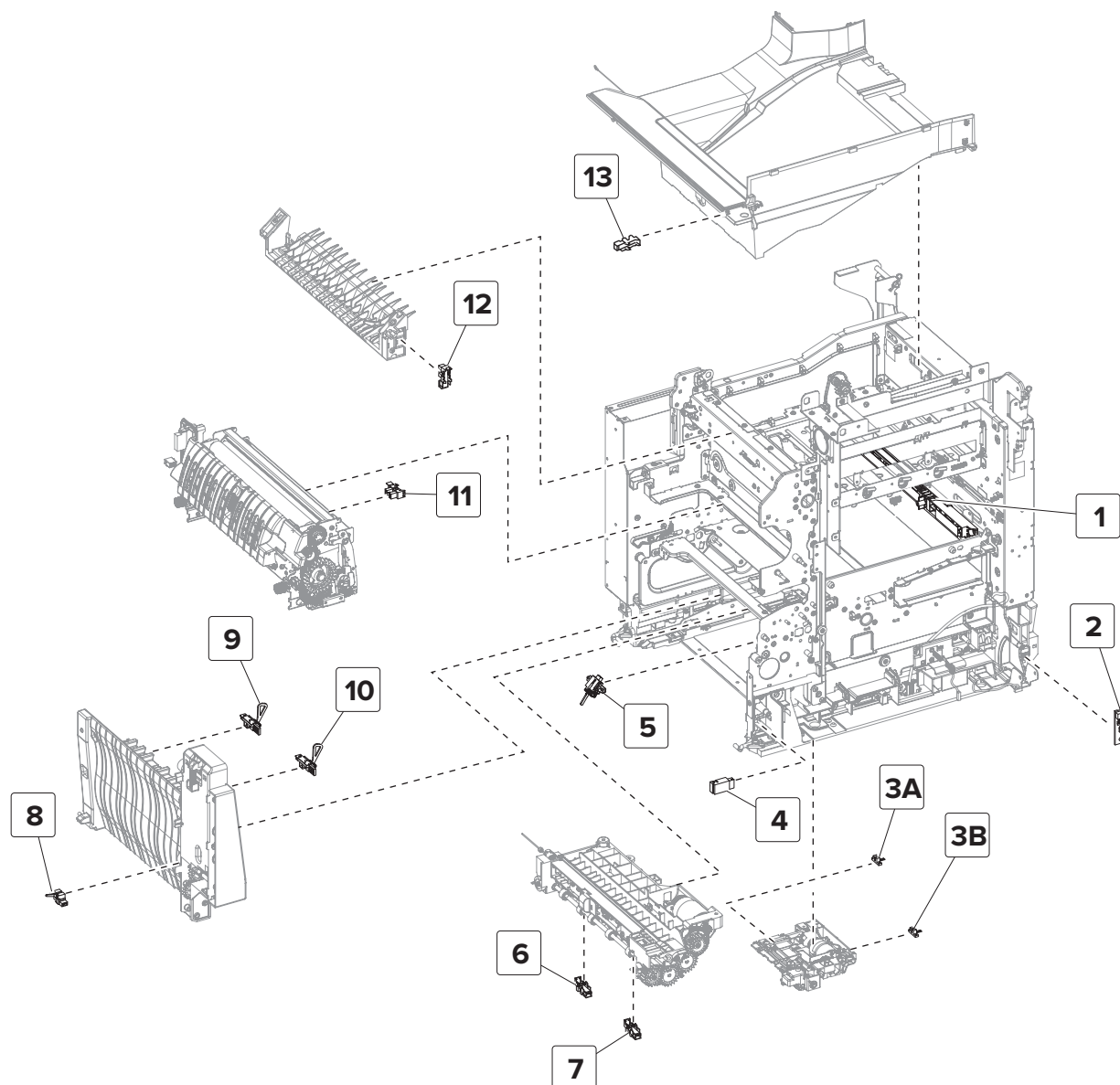

Component locations

1	Sensor (TPS)
2	Sensor (weather station)
3A	Sensor (tray 1 paper present)
3B	Sensor (pick position)
4	Sensor (MPF paper present)
5	Sensor (input)
6	Sensor (tray 1 pick)
7	Sensor (MPF/pass-through)
8	Sensor (duplex staging)
9	Sensor (narrow media)
10	Sensor (fuser buckle)
11	Sensor (fuser exit)
12	Sensor (redrive)
13	Sensor (exit/bin full)

Standard paper path sensors

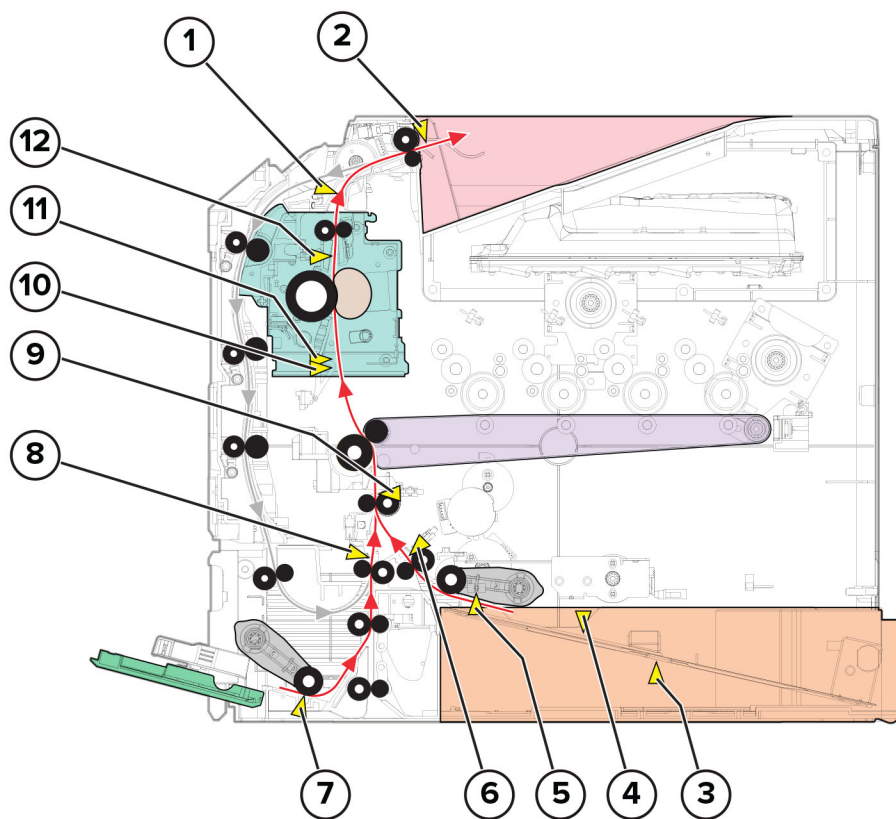

Component locations

1	Sensor (redrive)
2	Sensor (exit/bin full)
3	Sensor (paper size)
4	Sensor (tray 1 paper present)
5	Sensor (pick position)
6	Sensor (tray 1 pick)
7	Sensor (MPF paper present)
8	Sensor (MPF/pass-through)
9	Sensor (input)
10	Sensor (fuser buckle)
11	Sensor (narrow media)
12	Sensor (fuser exit)

Duplex paper path sensors

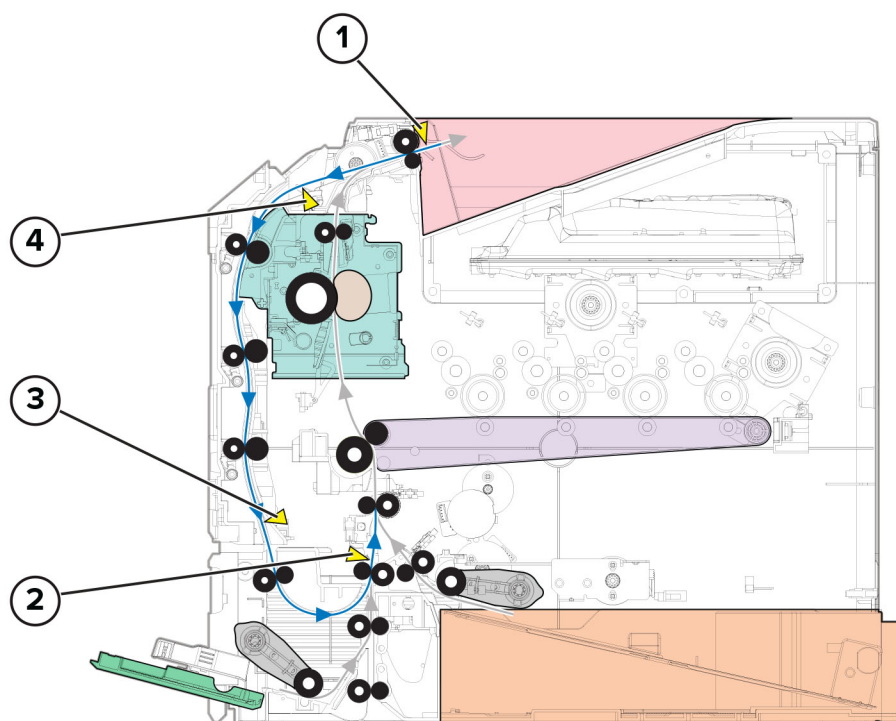

1	Sensor (exit/bin full)
2	Sensor (MPF/pass-through)
3	Sensor (duplex staging)
4	Sensor (redrive)

Component locations

Motor locations

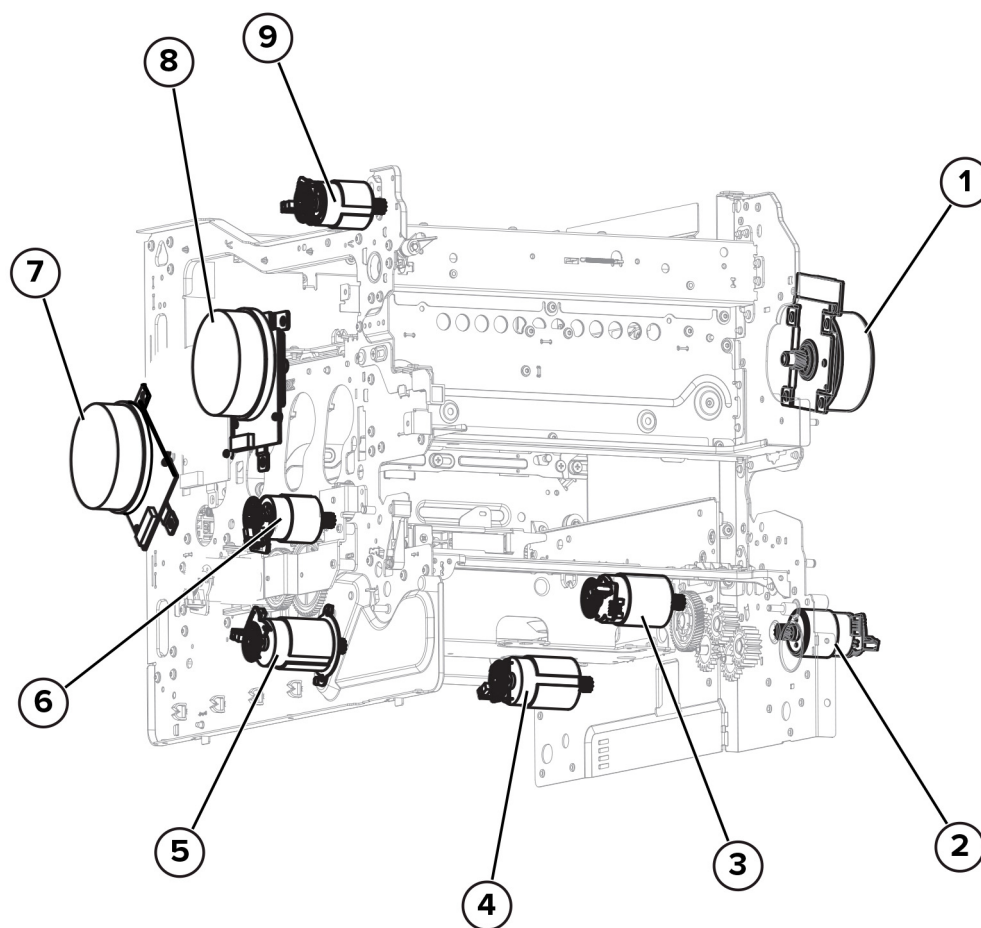

1	Motor (fuser)
2	Motor (duplex/MPF)
3	Motor (isolation)
4	Motor (tray 1 pick/lift)
5	Motor (deskew)
6	Motor (BOR)
7	Motor (K/transfer belt)
8	Motor (CMY)
9	Motor (exit/redrive)

Maintenance

Inspection guide

Use this guide in identifying the parts that must be inspected, cleaned, or replaced based on the page count.

If any unsafe condition exists, find out how serious the hazard is and if you can continue before you correct the hazard.

As you service the machine, check for the following:

- Damaged, missing, or altered parts, especially in the area of the power switch and the power supply
- Damaged, missing, or altered covers, especially in the area of the top cover and power supply cover
- Possible safety exposure from any non-Lexmark attachments

Use the following table to determine when to inspect the specified parts:

Printer parts	Every service call	Every 150K	Every 360K	Notes
Tray insert <ul style="list-style-type: none"> • Width guides • Length guides 	Inspect	Inspect	Inspect	Check for correct positioning.
Transfer module	Inspect	Inspect	Inspect	Ensure correct installation.
Fuser	Inspect	Replace	Inspect	Ensure correct installation.
Pick rollers <ul style="list-style-type: none"> • Tray pick roller • MPF pick roller • Separator bracket 	Inspect and clean if needed.	Inspect and clean if needed.	Replace	Clean with a damp cloth.
Paper path rollers	Inspect	Inspect	Inspect	<ul style="list-style-type: none"> • Check for paper fragments. • Check for excessive toner build-up on rollers. • Clean with damp cloth if needed.
Others <ul style="list-style-type: none"> • Toner spillage 	Clean	Clean	Clean	Use a toner vacuum and cloth to remove all toner spillage from the printer.

Scheduled maintenance

Maintenance kits

The control panel displays an **80 .xxx** error when it reaches certain page counts. It is necessary to replace the appropriate maintenance kit to maintain print quality and printer reliability. For more information, see [“80 user attendance error messages” on page 228](#).

Note: When replacing the maintenance kit, install all the parts that are included in the box, and then reset the maintenance counter.

The printer may stop printing when the fuser rated life is reached. After 150K printed pages (sides) a maintenance kit may be required.

The parts are available as a maintenance kit with the following part numbers:

Kit	Contents	Page count	Notes
41X3884—Maintenance kit, 100 V	<ul style="list-style-type: none"> • 41X2932—Fuser, 100 V • 41X0956—Pick roller • 41X0374—Separator bracket 	150K	Reset the fuser maintenance counter after replacing the fuser maintenance kit. See “Resetting the fuser maintenance counter” on page 551.
41X3882—Maintenance kit, 110 V	<ul style="list-style-type: none"> • 41X2930—Fuser, 115 V • 41X0956—Pick roller • 41X0374—Separator bracket 	150K	Reset the fuser maintenance counter after replacing the fuser maintenance kit. See “Resetting the fuser maintenance counter” on page 551.
41X3883—Maintenance kit, 220 V	<ul style="list-style-type: none"> • 41X2931—Fuser, 220 V • 41X0956—Pick roller • 41X0374—Separator bracket 	150K	Reset the fuser maintenance counter after replacing the fuser maintenance kit. See “Resetting the fuser maintenance counter” on page 551.

Kit	Contents	Page count	Notes
41X4512—Maintenance kit, 115 V (narrow media; for CS/CX737 models only)	<ul style="list-style-type: none"> • 41X4511—Fuser, 115 V (narrow media; for CS/CX737 models only) • 41X0956—Pick roller • 41X0374—Separator bracket 	150K	Reset the fuser maintenance counter after replacing the fuser maintenance kit. See “Resetting the fuser maintenance counter” on page 551.
41X2848—Maintenance kit ADF	ADF rollers <ul style="list-style-type: none"> • ADF pick roller • ADF separator roller 	110K (scanned pages)	Reset the ADF rollers maintenance counter after replacing the ADF rollers. See “Resetting the ADF rollers maintenance counter” on page 551.

When performing the scheduled maintenance procedure, remove paper dust and toner contamination from the following areas:

- Trays
- Imaging kit and imaging unit areas
- Transfer roller area
- Duplex area
- Standard bin

Resetting counters

Resetting the fuser maintenance counter

- 1 From the home screen, touch **Settings > Device > Maintenance > Configuration Menu > Supply Usage and Counters > Reset Maintenance Counter.**
- 2 Touch **Start.**

Resetting the ADF rollers maintenance counter





- 1 From the home screen, touch **Settings > Device > Maintenance > Configuration Menu > Scanner Configuration > Reset Maintenance Counter.**

Resetting the transfer module counter

- 1 From the home screen, touch **Settings > Device > Maintenance > Configuration Menu > Supply Usage and Counters > ITM Reset.**
- 2 Touch **Start.**

Cleaning the printer

Cleaning the printer

-  **CAUTION—SHOCK HAZARD:** To avoid the risk of electrical shock when cleaning the exterior of the printer, unplug the power cord from the electrical outlet and disconnect all cables from the printer before proceeding.
-  **ATTENTION—RISQUE D'ELECTROCUTION :** Pour éviter tout risque d'électrocution lors du nettoyage de l'extérieur de l'imprimante, débranchez le cordon d'alimentation électrique de la prise et déconnectez tous les câbles de l'imprimante avant de continuer.
-  **PRECAUCIÓN: PELIGRO DE DESCARGAS ELÉCTRICAS:** Para evitar el riesgo de descarga eléctrica al limpiar el exterior de la impresora, desconecte el cable de alimentación de la toma eléctrica y desconecte todos los cables de la impresora antes de realizar la operación.
-  **VORSICHT – STROMSCHLAGGEFAHR:** Um das Risiko eines elektrischen Schlags beim Reinigen des Druckergehäuses zu vermeiden, ziehen Sie das Netzkabel aus der Steckdose, und ziehen Sie alle Kabel vom Drucker ab, bevor Sie fortfahren.

Notes:

- Perform this task after every few months.
 - Damage to the printer caused by improper handling is not covered by the printer warranty.
- 1 Turn off the printer, and then unplug the power cord from the electrical outlet.
 - 2 Remove paper from the standard bin and multipurpose feeder.
 - 3 Remove any dust, lint, and pieces of paper around the printer using a soft brush or vacuum.
 - 4 Wipe the outside of the printer with a damp, soft, lint-free cloth.

Notes:

- Do not use household cleaners or detergents, as they may damage the finish of the printer.

- Make sure that all areas of the printer are dry after cleaning.

5 Connect the power cord to the electrical outlet, and then turn on the printer.

 **CAUTION—POTENTIAL INJURY:** To avoid the risk of fire or electrical shock, connect the power cord to an appropriately rated and properly grounded electrical outlet that is near the product and easily accessible.

 **ATTENTION—RISQUE DE BLESSURE :** Pour éviter tout risque d'électrocution ou d'incendie, branchez le câble d'alimentation directement à une prise électrique répondant aux exigences requises et correctement mise à la terre, proche du produit et facile d'accès.

 **PRECAUCIÓN: POSIBLES DAÑOS PERSONALES:** Para evitar el riesgo de incendio o descarga eléctrica, conecte el cable de alimentación a una toma de corriente debidamente conectada a tierra con la potencia adecuada que se encuentre cerca del dispositivo y resulte fácilmente accesible.

 **VORSICHT – MÖGLICHE VERLETZUNGSGEFAHR** Um das Risiko eines Feuers oder eines elektrischen Schlags zu vermeiden, schließen Sie das Netzkabel an eine ordnungsgemäß geerdete Steckdose an, die sich in der Nähe des Geräts befindet und leicht zugänglich ist.

Cleaning the touch screen

 **CAUTION—SHOCK HAZARD:** To avoid the risk of electrical shock when cleaning the exterior of the printer, unplug the power cord from the electrical outlet and disconnect all cables from the printer before proceeding.

 **ATTENTION—RISQUE D'ELECTROCUTION :** Pour éviter tout risque d'électrocution lors du nettoyage de l'extérieur de l'imprimante, débranchez le cordon d'alimentation électrique de la prise et déconnectez tous les câbles de l'imprimante avant de continuer.

 **PRECAUCIÓN: PELIGRO DE DESCARGAS ELÉCTRICAS:** Para evitar el riesgo de descarga eléctrica al limpiar el exterior de la impresora, desconecte el cable de alimentación de la toma eléctrica y desconecte todos los cables de la impresora antes de realizar la operación.

 **VORSICHT – STROMSCHLAGGEFAHR:** Um das Risiko eines elektrischen Schlags beim Reinigen des Druckergehäuses zu vermeiden, ziehen Sie das Netzkabel aus der Steckdose, und ziehen Sie alle Kabel vom Drucker ab, bevor Sie fortfahren.

1 Turn off the printer, and then unplug the power cord from the electrical outlet.

2 Using a damp, soft, lint-free cloth, wipe the touch screen.

Notes:

- Do not use household cleaners or detergents, as they may damage the touch screen.
- Make sure that the touch screen is dry after cleaning.

3 Connect the power cord to the electrical outlet, and then turn on the printer.

⚠ CAUTION—POTENTIAL INJURY: To avoid the risk of fire or electrical shock, connect the power cord to an appropriately rated and properly grounded electrical outlet that is near the product and easily accessible.

⚠ ATTENTION—RISQUE DE BLESSURE : Pour éviter tout risque d'électrocution ou d'incendie, branchez le câble d'alimentation directement à une prise électrique répondant aux exigences requises et correctement mise à la terre, proche du produit et facile d'accès.

⚠ PRECAUCIÓN: POSIBLES DAÑOS PERSONALES: Para evitar el riesgo de incendio o descarga eléctrica, conecte el cable de alimentación a una toma de corriente debidamente conectada a tierra con la potencia adecuada que se encuentre cerca del dispositivo y resulte fácilmente accesible.

⚠ VORSICHT – MÖGLICHE VERLETZUNGSGEFAHR Um das Risiko eines Feuers oder eines elektrischen Schlags zu vermeiden, schließen Sie das Netzkabel an eine ordnungsgemäß geerdete Steckdose an, die sich in der Nähe des Geräts befindet und leicht zugänglich ist.

Cleaning the scanner

1 Open the scanner cover.

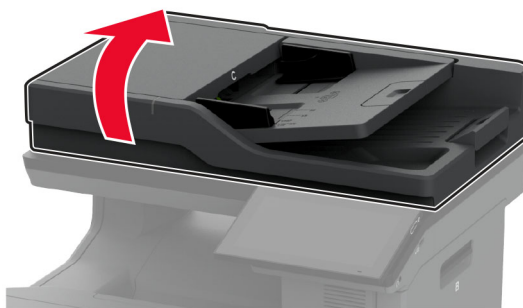

2 Using a damp, soft, lint-free cloth, wipe the following areas:

- ADF glass pad



- Scanner glass pad

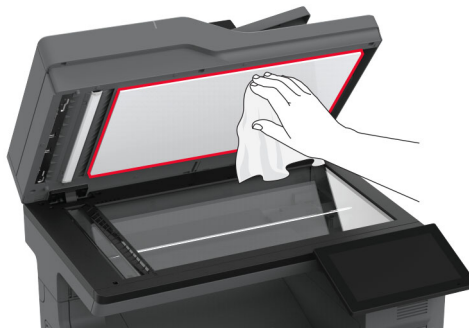

- ADF glass



- Scanner glass



- 3** Close the scanner cover.
- 4** Open door C.

5 Using a damp, soft, lint-free cloth, wipe the following areas:

- ADF glass pad in door C

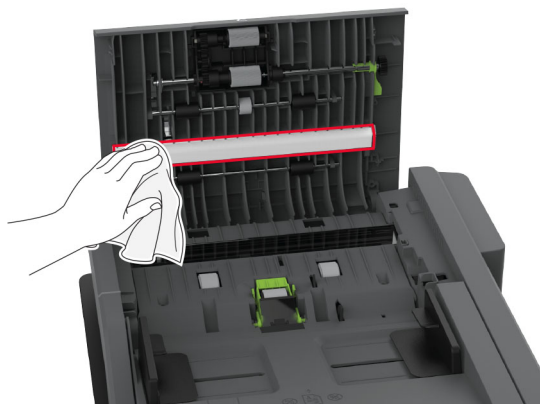

- ADF glass in door C



6 Close door C.

Cleaning the pick roller

- 1** Turn off the printer, and then unplug the power cord from the electrical outlet.
- 2** Remove the pick roller. See [“Pick roller removals” on page 502](#) or [“MPF pick roller removal” on page 503](#).

3 Apply isopropyl alcohol to a soft, lint-free cloth, and then wipe the pick tires.

4 Connect the power cord to the electrical outlet, and then turn on the printer.

⚠ CAUTION—POTENTIAL INJURY: To avoid the risk of fire or electrical shock, connect the power cord to an appropriately rated and properly grounded electrical outlet that is near the product and easily accessible.

⚠ ATTENTION—RISQUE DE BLESSURE : Pour éviter tout risque d'électrocution ou d'incendie, branchez le câble d'alimentation directement à une prise électrique répondant aux exigences requises et correctement mise à la terre, proche du produit et facile d'accès.

⚠ PRECAUCIÓN: POSIBLES DAÑOS PERSONALES: Para evitar el riesgo de incendio o descarga eléctrica, conecte el cable de alimentación a una toma de corriente debidamente conectada a tierra con la potencia adecuada que se encuentre cerca del dispositivo y resulte fácilmente accesible.

⚠ VORSICHT – MÖGLICHE VERLETZUNGSGEFAHR Um das Risiko eines Feuers oder eines elektrischen Schlags zu vermeiden, schließen Sie das Netzkabel an eine ordnungsgemäß geerdete Steckdose an, die sich in der Nähe des Geräts befindet und leicht zugänglich ist.

Cleaning the pick roller in the multipurpose feeder

1 Turn off the printer, and then unplug the power cord from the electrical outlet.

2 Open the multipurpose feeder.

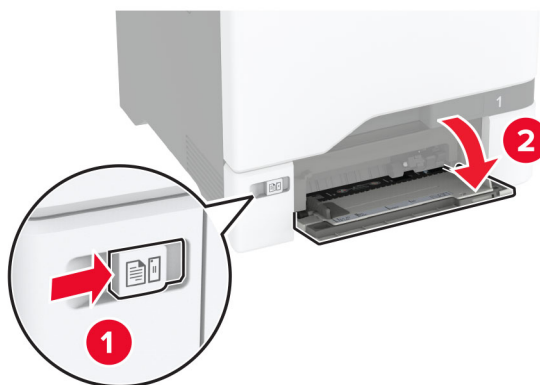

3 Remove the pick roller.

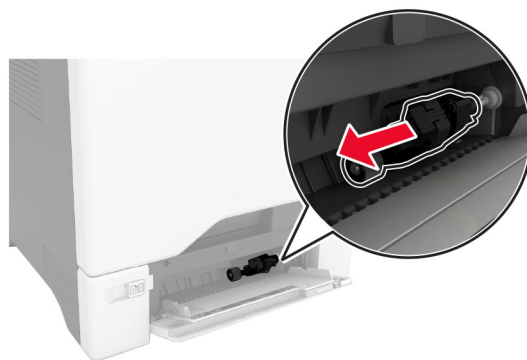

4 Apply isopropyl alcohol to a soft, lint-free cloth, and then wipe the pick roller.

5 Insert the pick roller.

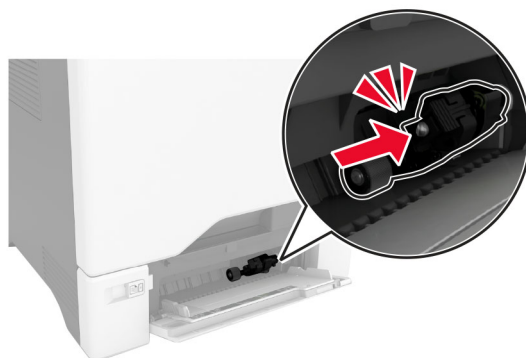
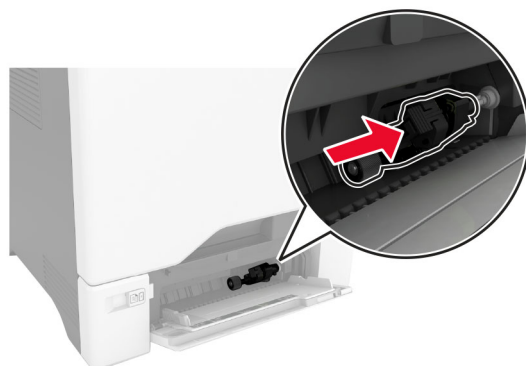

6 Close the multipurpose feeder.

7 Connect the power cord to the electrical outlet, and then turn on the printer.

⚠ CAUTION—POTENTIAL INJURY: To avoid the risk of fire or electrical shock, connect the power cord to an appropriately rated and properly grounded electrical outlet that is near the product and easily accessible.

⚠ ATTENTION—RISQUE DE BLESSURE : Pour éviter tout risque d'électrocution ou d'incendie, branchez le câble d'alimentation directement à une prise électrique répondant aux exigences requises et correctement mise à la terre, proche du produit et facile d'accès.

⚠ PRECAUCIÓN: POSIBLES DAÑOS PERSONALES: Para evitar el riesgo de incendio o descarga eléctrica, conecte el cable de alimentación a una toma de corriente debidamente conectada a tierra con la potencia adecuada que se encuentre cerca del dispositivo y resulte fácilmente accesible.

⚠ VORSICHT – MÖGLICHE VERLETZUNGSGEFAHR Um das Risiko eines Feuers oder eines elektrischen Schlags zu vermeiden, schließen Sie das Netzkabel an eine ordnungsgemäß geerdete Steckdose an, die sich in der Nähe des Geräts befindet und leicht zugänglich ist.

Cleaning the ADF rollers

1 Open door C.

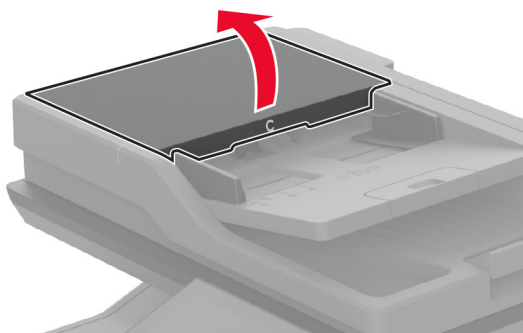

2 Remove the ADF pick roller.

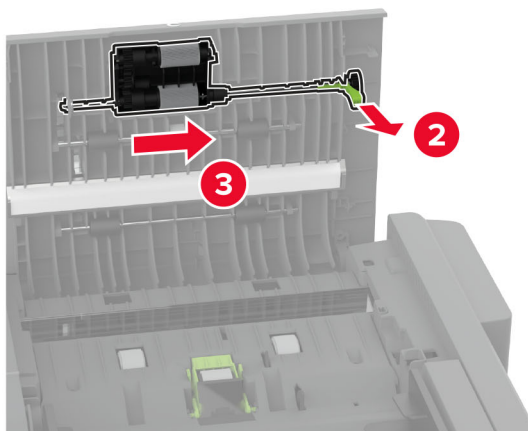
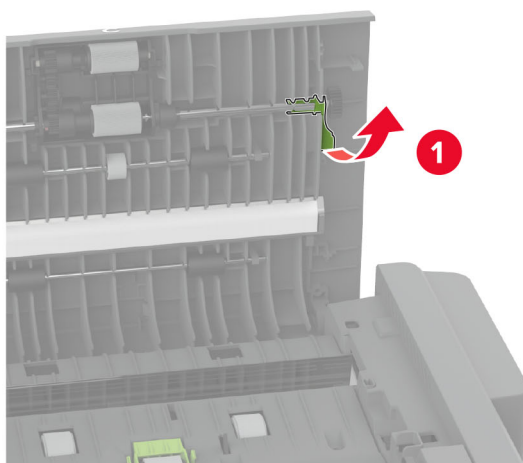

3 Remove the ADF separator roller.

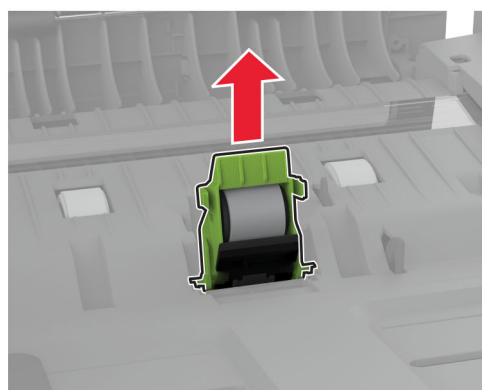
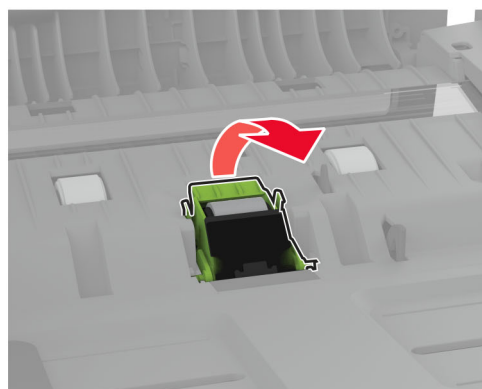
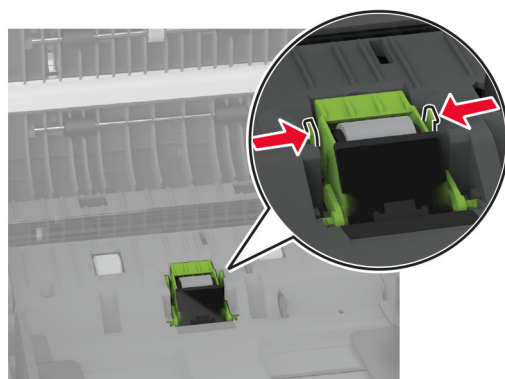

4 Apply isopropyl alcohol to a soft, lint-free cloth, and then wipe the ADF pick roller and ADF separator roller.

5 Insert the ADF separator roller until it *clicks* into place.

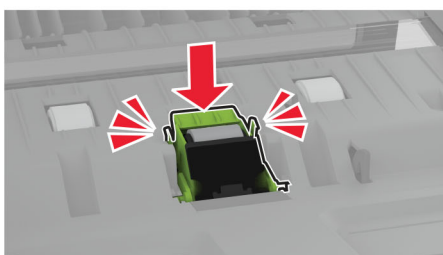
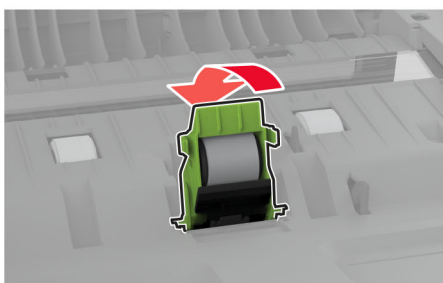
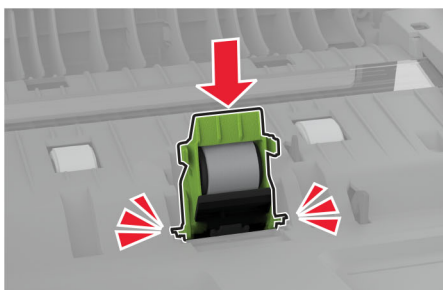
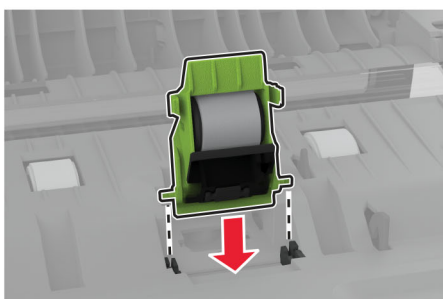

6 Insert the ADF pick roller until it *clicks* into place.

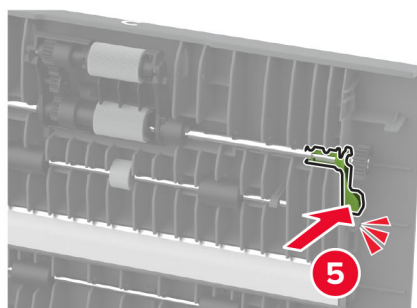
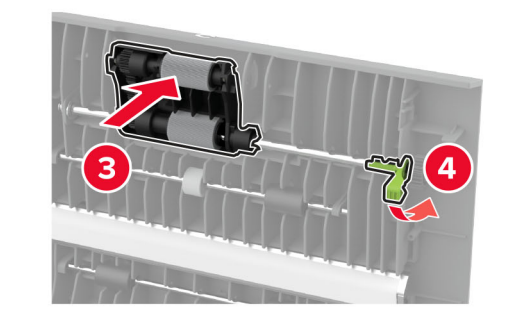
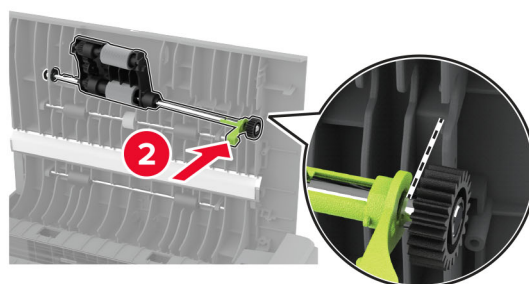
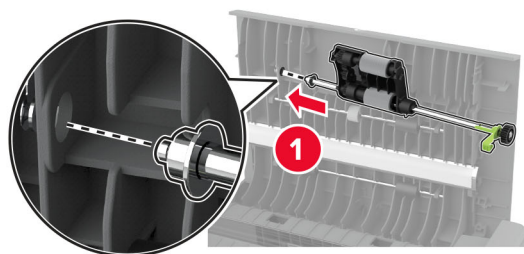

7 Close door C.

Cleaning the printhead lenses

- 1 Remove the waste toner bottle. See [“Waste toner bottle removal” on page 397](#).
- 2 Remove the imaging kit. See [“Imaging kit removal” on page 399](#).

- 3 Using a lint-free cloth, wipe the printhead lenses (A).

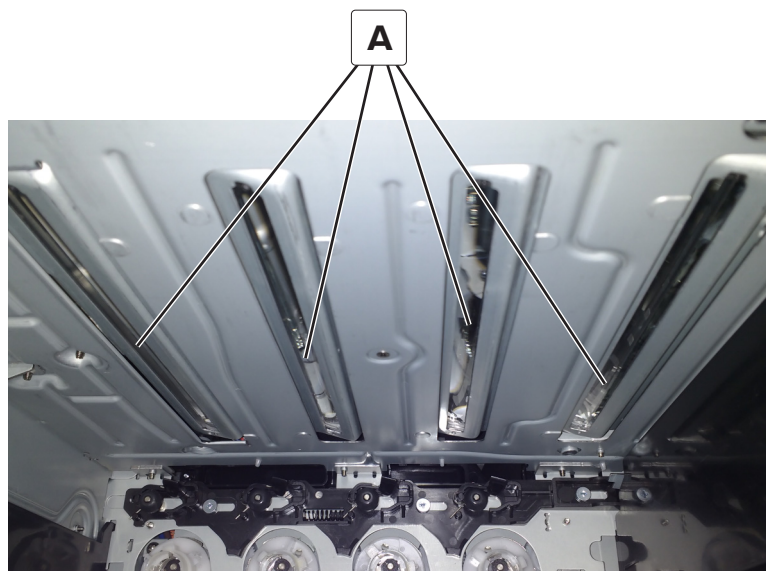

Cleaning the tray 1 duplex turnaround

- 1 Pull tray 1, and then remove the two screws (A).

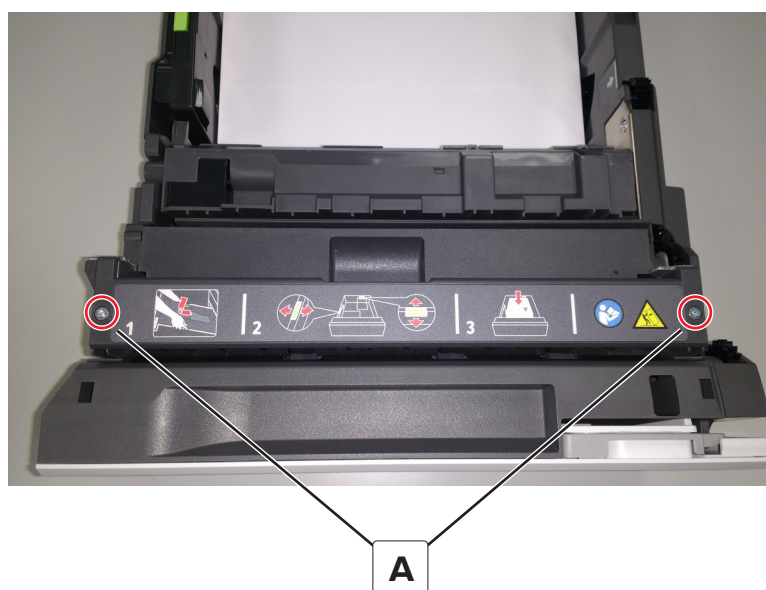

2 Open the turnaround cover.

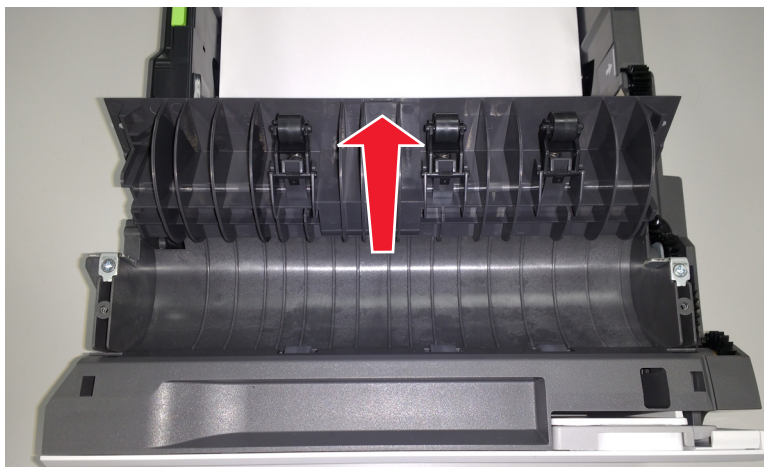

3 Remove the debris in the duplex turnaround area.

4 Close the cover, and then screw it back in place.

Parts catalog

Legend

The following column headings are used in the parts catalog:

- **Asm-index**—Identifies the item in the illustration
- **P/N**—Identifies the part number of a FRU
- **Units/mach**—Refers to the number of units in a printer
- **Units/opt**—Refers to the number of units in an option
- **Units/FRU**—Refers to the number of units in a FRU
- **Description**—A brief description of the part

The following abbreviations are used in the parts catalog:

- **NS** (not shown) in the Asm-index column indicates that the part is procurable but is not shown in the illustration.
- **PP** (parts packet) in the Description column indicates that the part is contained in a parts packet.

Assembly 1: Covers 1

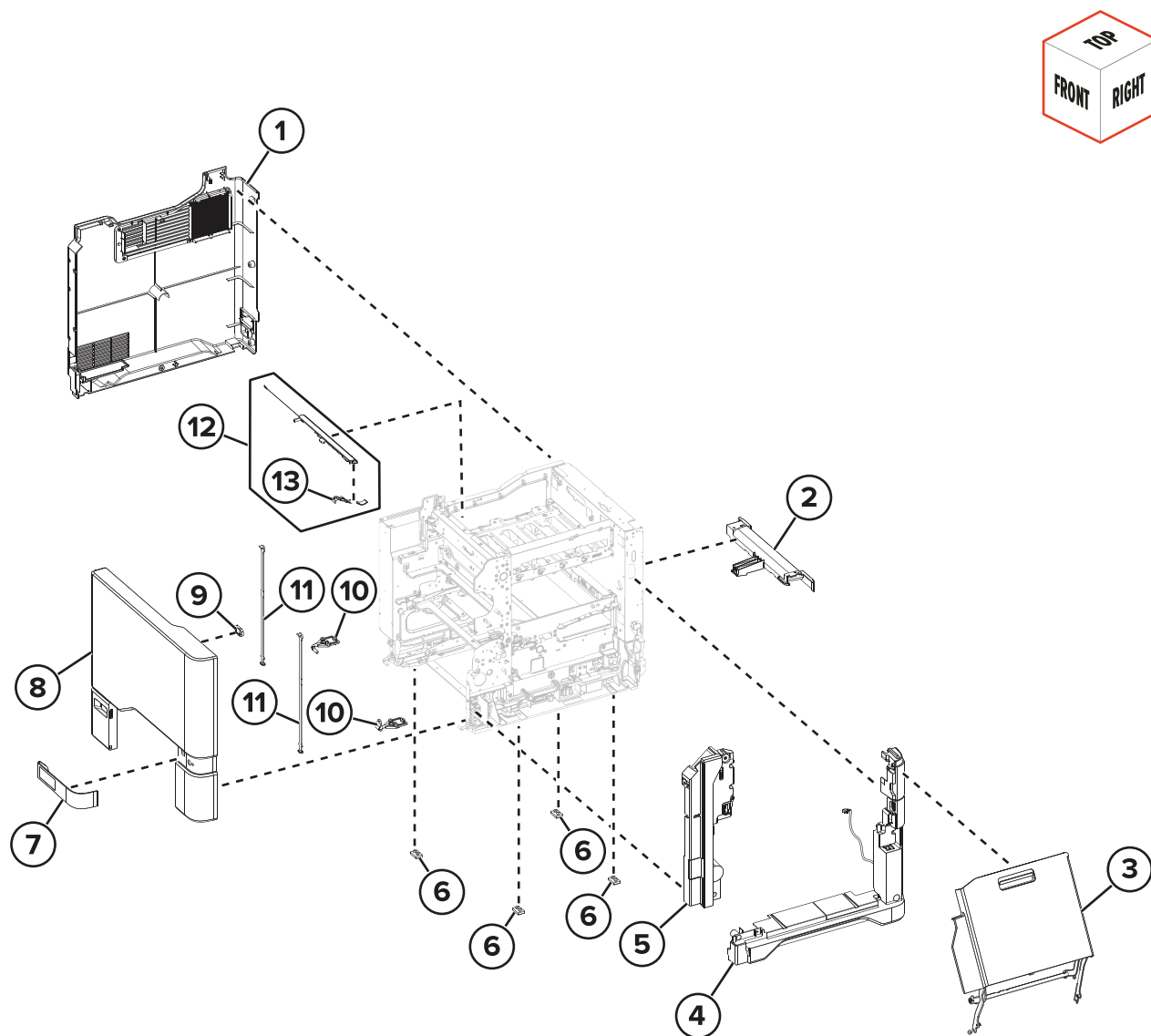

Assembly 1: Covers 1

Asm-index	P/N	Units/mach	Units/FRU	Description	Removal procedure
1	41X2889	1	1	Left cover	“Left cover removal” on page 374
2	41X0424	1	1	Rear handle cover	--
3	41X2918	1	1	Toner door with linkages	“Toner door removal” on page 402
4	41X2827	1	1	Right cover	“Right cover removal” on page 401
5	41X2897	1	1	Motor cover	“Motor cover removal” on page 427
6	41X2032	4	4	Rubber feet	--
7	41X0401	1	1	Tray indicator	--
8	41X0442	1	1	Front door cover	“Front door cover removal” on page 472
9	41X0560	1	1	Front door bracket	--
10	41X0567	1	1	Front door hinges	“Front door hinges removal” on page 451
11	41X0380	2	2	Front door straps	--
12	41X3895	1	1	Bin exit cover	“Bin exit cover removal” on page 496
13	41X0772	1	1	Bin flag	“Bin flag removal” on page 497

Assembly 2: Covers 2

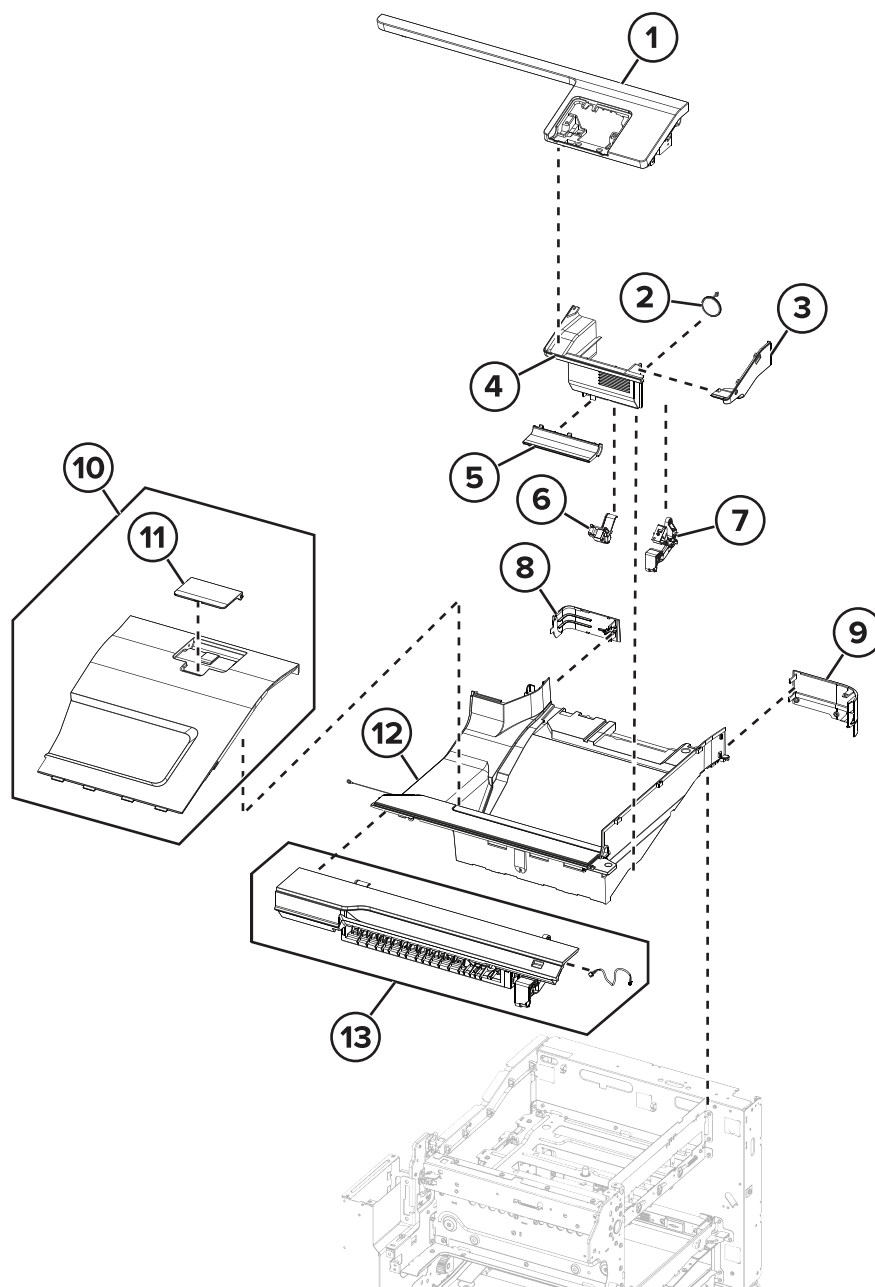

Assembly 2: Covers 2

Asm-index	P/N	Units/mach	Units/FRU	Description	Removal procedure
1	41X2830	1	1	Façade cover	“Facade cover removal” on page 496
2	41X4224	1	1	Speaker	“Speaker removal” on page 450
3	41X2837	1	1	USB cover	“USB cover removal” on page 405
4	41X2829	1	1	Scanner front cover	“Scanner front cover removal” on page 429
5	41X4316	1	1	Badge cover	“Scanner front cover removal” on page 429
6	41X0561	1	1	Control panel left arm	“Control panel arms removal” on page 452
7	41X0562	1	1	Control panel right arm	“Control panel arms removal” on page 452
8	41X3898	1	1	Scanner rear left cover	“Scanner rear left cover removal” on page 475
9	41X0435	1	1	Scanner rear right cover	“Scanner rear right cover removal” on page 475
10	41X3897	1	1	Bin cover	“Bin cover removal” on page 482
11	41X0410	1	1	Bin extender	--
12	41X2898	1	1	Top cover	“Top cover removal” on page 486
13	41X2919	1	1	Upper front door (with cable)	“Upper front door removal” on page 484

Assembly 3: Control panel

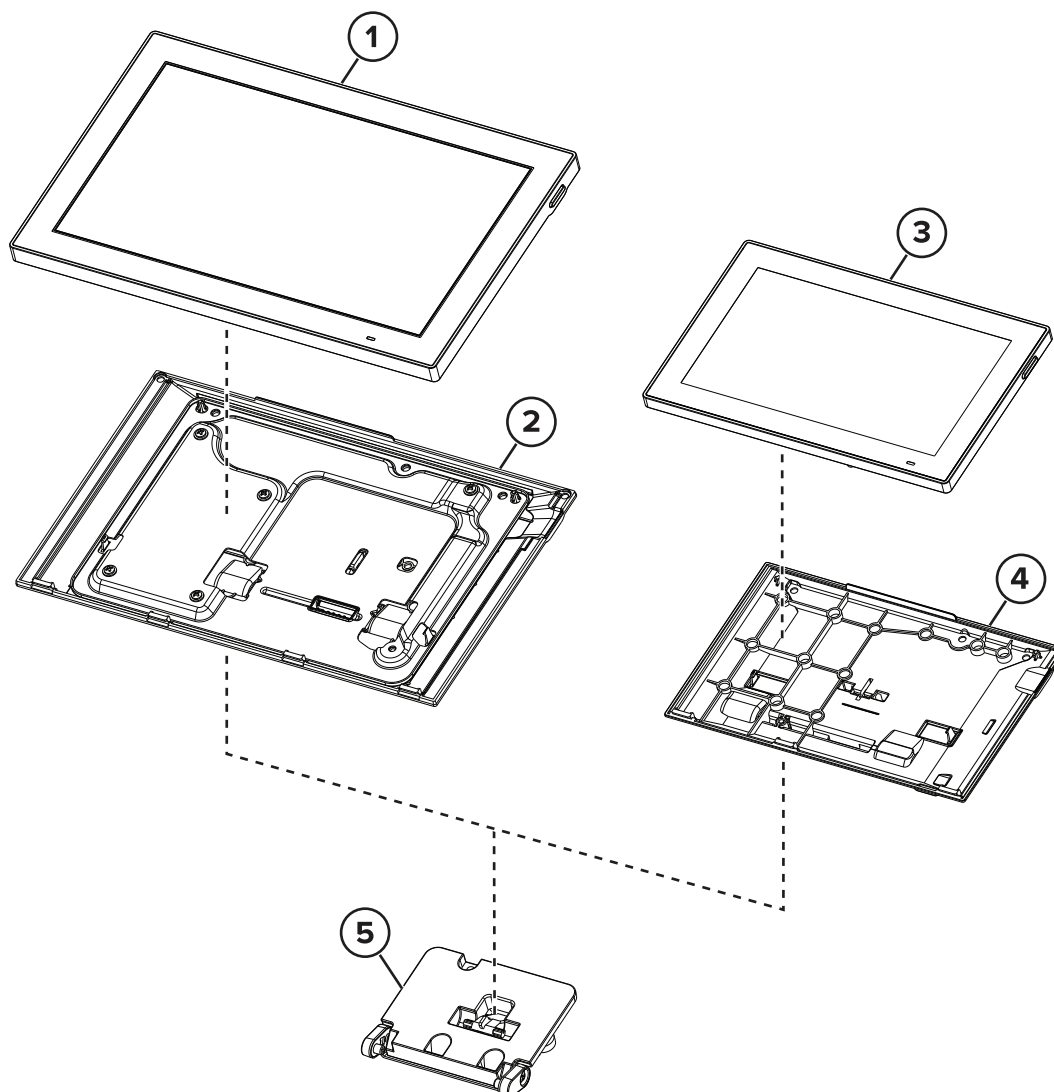

Assembly 3: Control panel

Asm-index	P/N	Units/mach	Units/FRU	Description	Removal procedure
1	41X2881	1	1	Control panel display, 10-inch Note: This part has a FRU sheet.	“Control panel display (10-inch) removal” on page 442
2	41X2884	1	1	Control panel (10-inch display) rear cover	“Control panel rear cover removal” on page 449
3	41X2880	1	1	Control panel display, 7-inch Note: This part has a FRU sheet.	--
4	41X2883	1	1	Control panel (7-inch display) rear cover	--
5	41X2835	1	1	Control panel hinge	“Control panel hinge removal” on page 448
NS	41X4466	1	1	Control panel cables	--

Assembly 4: Fuser

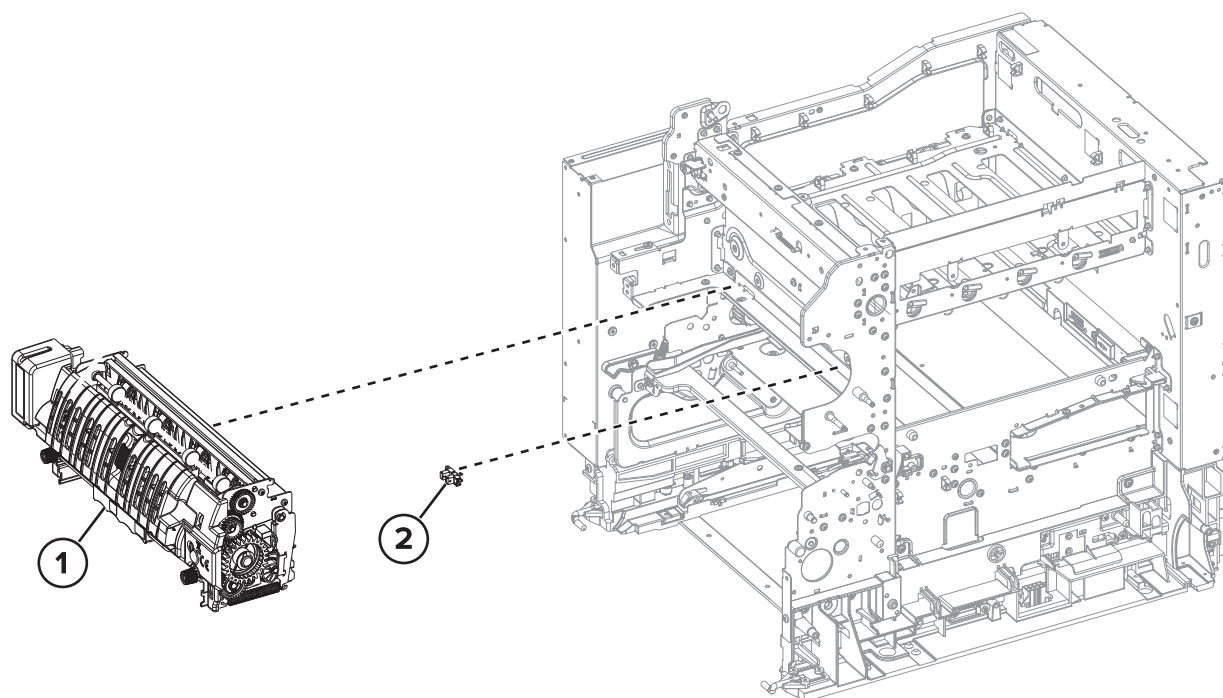

Assembly 4: Fuser

Asm-index	P/N	Units/mach	Units/FRU	Description	Removal procedure
1	41X2930	1	1	Fuser, 115 V Note: This part has a CRU sheet.	“Fuser removal” on page 436
1	41X2931	1	1	Fuser, 220 V Note: This part has a CRU sheet.	“Fuser removal” on page 436
1	41X2932	1	1	Fuser, 100 V Note: This part has a CRU sheet.	“Fuser removal” on page 436
1	41X4511	1	1	Fuser, 115 V (narrow media; for CS/CX737 models only) Note: This part has a CRU sheet.	“Fuser removal” on page 436
2	41X1083	1	1	Sensor (fuser nip)	“Sensor (fuser nip) removal” on page 441

Assembly 5: Transfer module

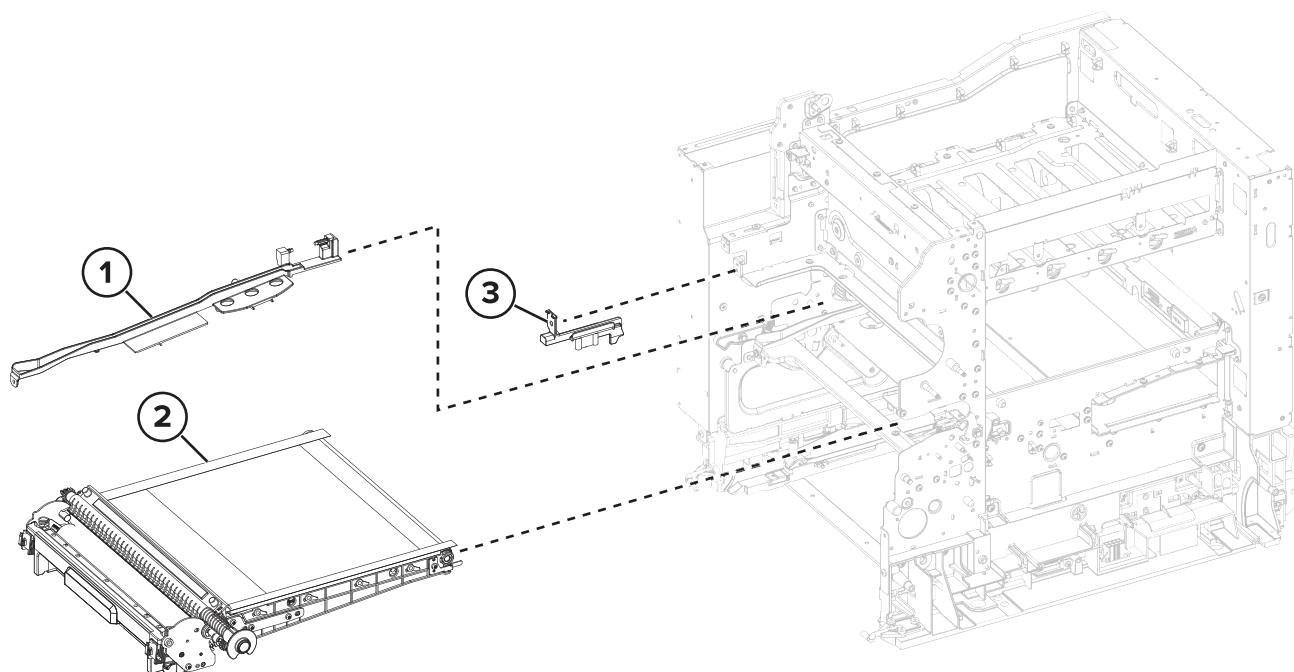

Assembly 5: Transfer module

Asm-index	P/N	Units/mach	Units/FRU	Description	Removal procedure
1	41X2900	1	1	Transfer module guide rail	“Transfer module guide rail removal” on page 455
2	41X2689	1	1	Transfer module Note: This part has a FRU sheet.	“Transfer module removal” on page 431
3	41X2833	1	1	Transfer module retainer	“Transfer module removal” on page 431

Assembly 6: Paper feed

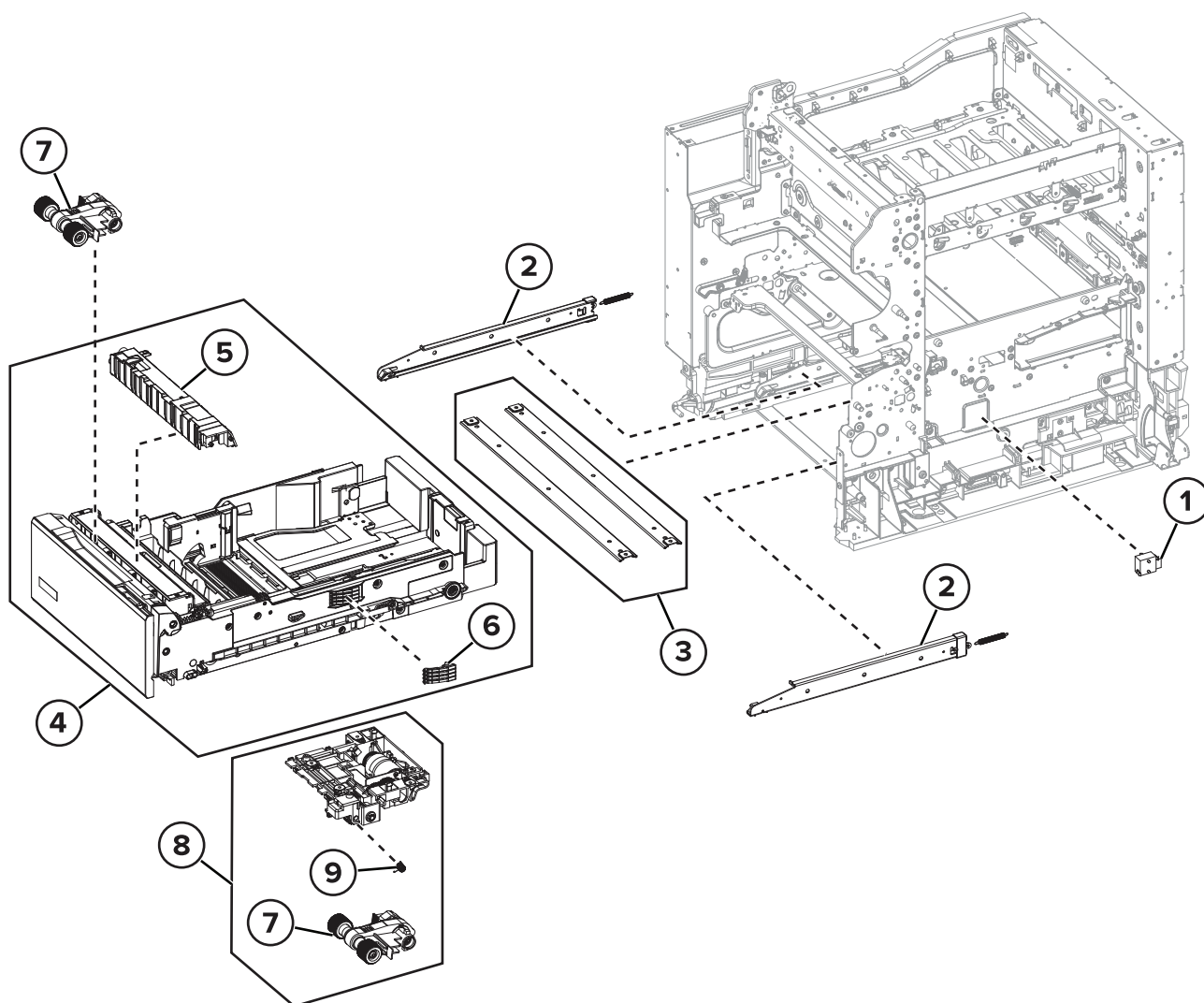

Assembly 6: Paper feed

Asm-index	P/N	Units/mach	Units/FRU	Description	Removal procedure
1	40X7911	1	1	Sensor (paper size)	“Sensor (paper size) removal” on page 411
2	41X0372	1	1	Tray rails	“Tray rail removal” on page 504
3	41X0825	2	2	Support straps	--
4	41X0268	1	1	550-sheet tray insert Note: This part has a CRU sheet.	“550-sheet tray insert removal” on page 500
5	41X0374	1	1	Separator bracket Note: This part has a CRU sheet.	“Separator bracket removal” on page 500
6	41X0373	1	1	Paper size sensor actuators	--
7	41X0956	2	1	Pick roller Note: This part has a CRU sheet.	“Pick roller removals” on page 502
8	41X4450	1	1	Paper feeder	“Paper feeder removal” on page 507
9	41X2034	1	1	Paper actuator spring Note: This part has a FRU sheet.	“Paper out actuator spring removal” on page 508

Assembly 7: Paper path 1

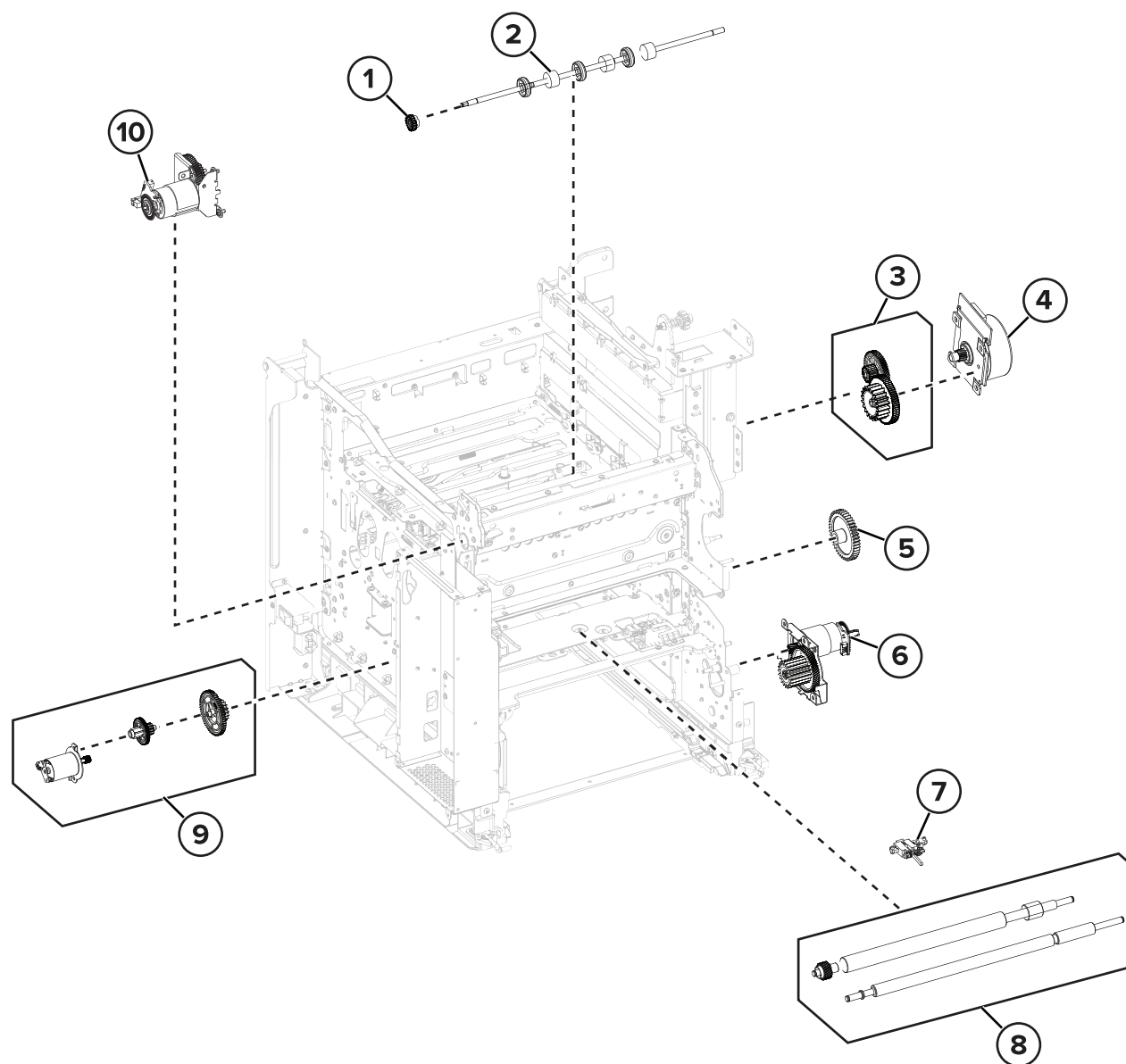

Assembly 7: Paper path 1

Asm-index	P/N	Units/mach	Units/FRU	Description	Removal procedure
1	41X0391	1	1	Exit roller gear	“Exit roller gear removal” on page 492
2	41X0390	1	1	Exit roller	“Exit roller removal” on page 493
3	41X0395	1	1	Fuser drive gear	--
4	41X4460	1	1	Motor (fuser)	“Motor (fuser) removal” on page 413
5	41X0757	1	1	Waste toner bottle idler gear	“Waste toner bottle idler gear removal” on page 415
6	41X0381	1	1	Motor (duplex/MPF)	“Motor (duplex/MPF) removal” on page 415
7	41X0385	1	1	Sensor (input)	“Sensor (input) removal” on page 434
8	41X0386	1	1	Aligner rollers	“Aligner rollers removal” on page 458
9	41X2825	1	1	Motor (BOR)	“Motor (BOR) removal” on page 386
10	41X0392	1	1	Motor (exit/redrive)	“Motor (exit/redrive) removal” on page 390
NS	41X4463	1	1	Left side cables <ul style="list-style-type: none"> • LVPS cable • AC line in cable • CMY motor cable • Fuser AC cable • BOR motor cable • Fuser DC cable • K motor cable • Exit/redrive motor cable 	--

Assembly 8: Paper path 2

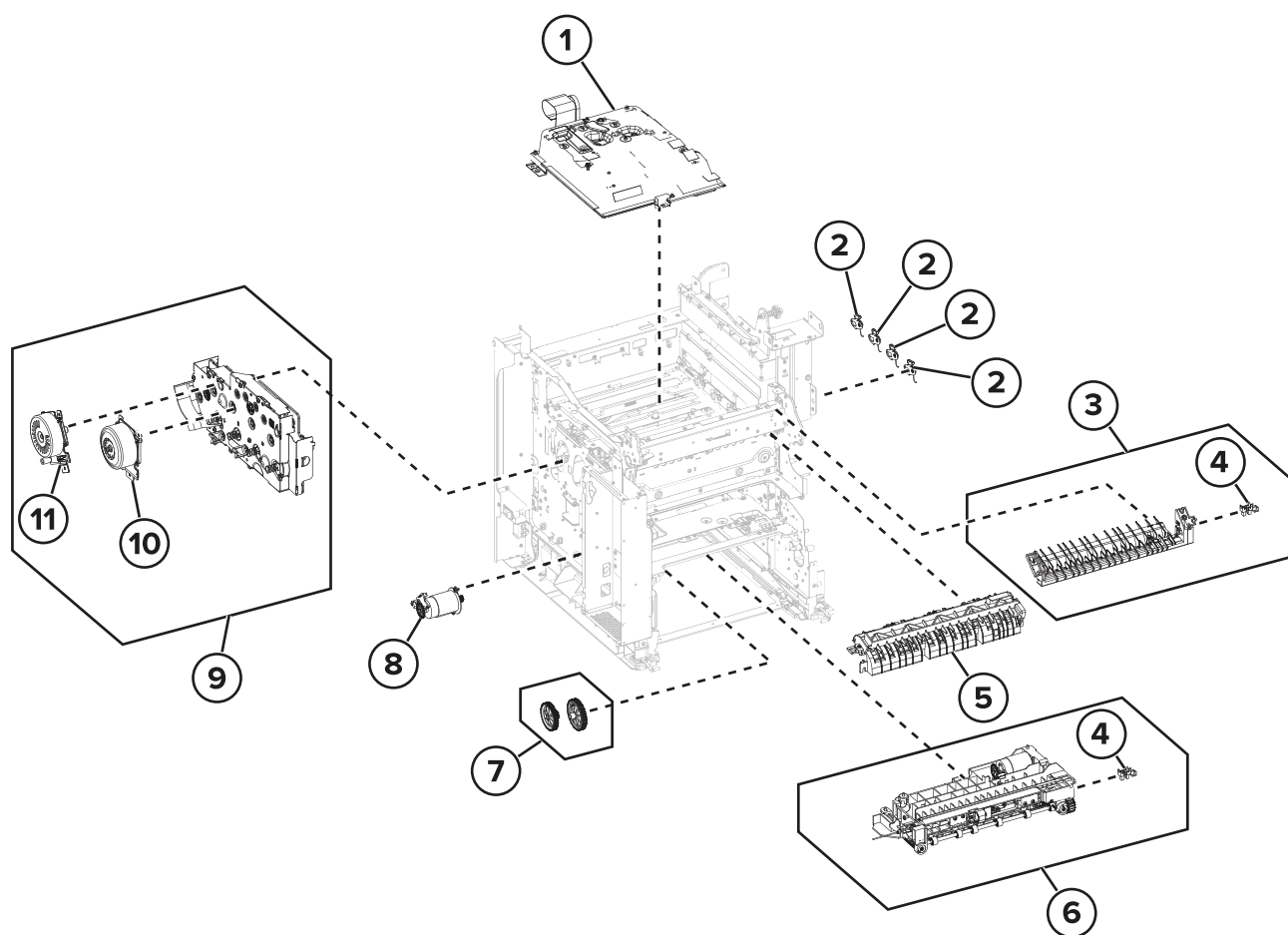

Assembly 8: Paper path 2

Asm-index	P/N	Units/mach	Units/FRU	Description	Removal procedure
1	41X2844	1	1	Print head Note: This part has a FRU sheet.	“Printhead removal” on page 484
2	41X0897	4	1	Developer hold down arm	“Developer hold down arm removal” on page 498
3	41X0389	1	1	Diverter	“Diverter removal” on page 439
4	41X0570	1	1	Sensor (redrive)	“Sensor (redrive) removal” on page 439
4	41X0570	1	1	Sensor (MPF/pass-through)	--
5	41X0388	1	1	Redrive guide	“Redrive guide removal” on page 437
6	41X0384	1	1	Isolation unit	“Isolation unit removal” on page 509
7	41X0758	1	1	Aligner drivetrain kit	--
8	41X0387	1	1	Motor (deskew)	“Motor (deskew) removal” on page 387
9	41X2768	1	1	EP drive gearbox	“EP drive gearbox removal” on page 384
10	41X4461	1	1	Motor (CMY)	“Motor (EP drive) removal” on page 382
11	41X4460	1	1	Motor (K/transfer belt)	“Motor (EP drive) removal” on page 382

Assembly 9: Duplex

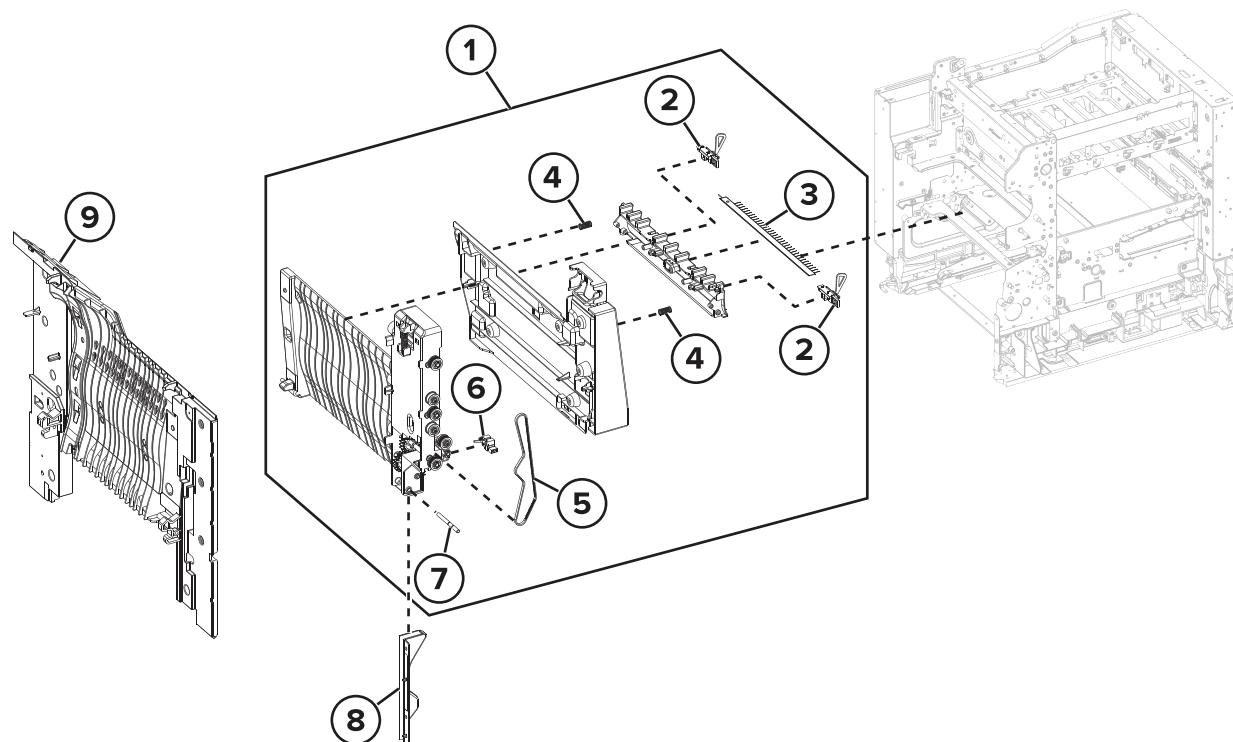

Assembly 9: Duplex

Asm-index	P/N	Units/mach	Units/FRU	Description	Removal procedure
1	41X0376	1	1	Duplex inner guide	“Duplex inner guide removal” on page 466
2	41X0447	1	1	Sensor (fuser buckle)	“Sensors (fuser buckle and narrow media) removal” on page 468
2	41X0447	1	1	Sensor (narrow media)	“Sensors (fuser buckle and narrow media) removal” on page 468
3	41X0824	1	1	Static brush	--
4	41X0379	2	2	Guide springs	--
5	41X0378	1	1	Tensioner belt	“Tensioner belt removal” on page 469
6	41X0446	1	1	Sensor (duplex staging)	“Sensor (duplex staging) removal” on page 467
7	41X0377	1	1	Pivot shaft	“Pivot shaft removal” on page 466
8	41X0400	1	1	Cable cover	“Front door removal” on page 425
9	41X0407	1	1	Duplex outer guide	“Duplex outer guide removal” on page 470

Assembly 10: Electrical

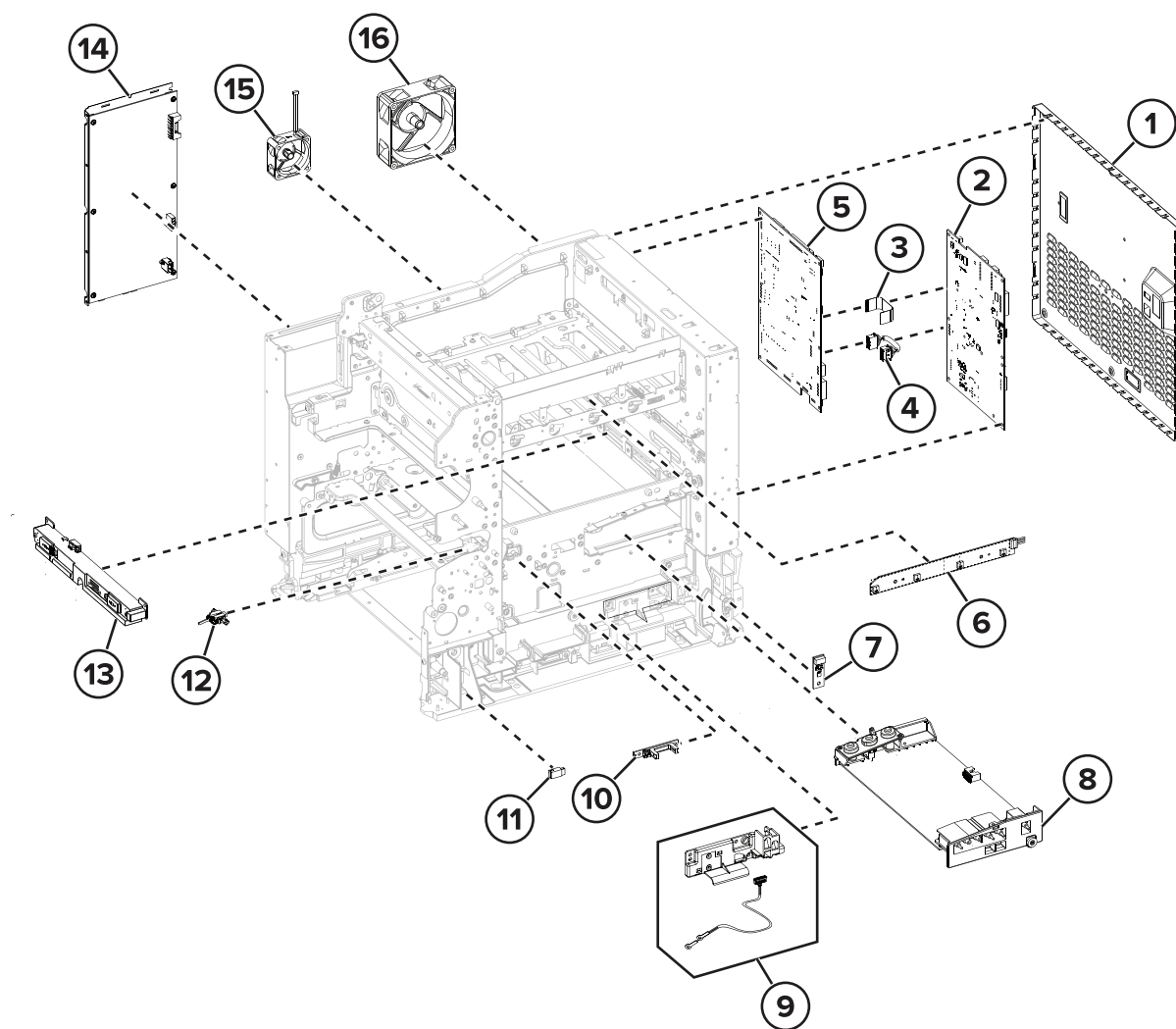

Assembly 10: Electrical

Asm-index	P/N	Units/mach	Units/FRU	Description	Removal procedure
1	41X1907	1	1	Controller board shield	“Controller board shield removal” on page 474
2	41X2875	1	1	Controller board Note: This part has a FRU sheet.	“Controller board removal” on page 478
3	41X2878	1	1	Print data cable	--
4	41X2877	1	1	Controller power cable	--
5	41X2876	1	1	Engine board Note: This part has a FRU sheet.	“Engine board removal” on page 479
5	41X4581	1	1	Engine board (for CS/CX737 models only) Note: This part has a FRU sheet.	“Engine board removal” on page 479
6	41X0394	1	1	TMC Card	“TMC card removal” on page 409
7	41X0785	1	1	Sensor (weather station)	“Sensor (weather station) removal ” on page 416
8	41X2777	1	1	HVPS	“HVPS removal” on page 417
9	41X0486	1	1	Sensor (waste toner contact)	--
10	41X4488	1	1	Sensor (waste toner) ¹	“Sensor (waste toner) removal” on page 420
11	41X0566	1	1	Sensor (MPF paper present)	“Sensor (MPF paper present) removal” on page 420
12	41X0385	1	1	Sensor (input)	“Sensor (input) removal” on page 434
13	41X2832	1	1	Sensor (TPS) ¹	“Sensor (TPS) removal” on page 422
14	41X2794	1	1	LVPS, 110 V	“LVPS removal” on page 377
14	41X2795	1	1	LVPS, 220 V	“LVPS removal” on page 377
15	41X0398	1	1	Fuser fan	“Fuser fan removal” on page 380
16	41X0397	1	1	Main fan	“Main fan removal” on page 379

Asm-index	P/N	Units/mach	Units/FRU	Description	Removal procedure
NS	41X4465	1	1	Right side cables <ul style="list-style-type: none"> • Front door sensor cables • TMC card cable • Weather station sensor cable • Interlock switch cables • Optional tray cables 	--
NS	41X4464	1	1	Middle section cables <ul style="list-style-type: none"> • HVPS cable • Aligner sensor cables, waste toner sensor cable • Upper paper path sensor cables • Fuser buckle sensor cable • TPS cable • Paper path motor cables • Fuser motor cables 	--

Assembly 11: ADF and flatbed scanner

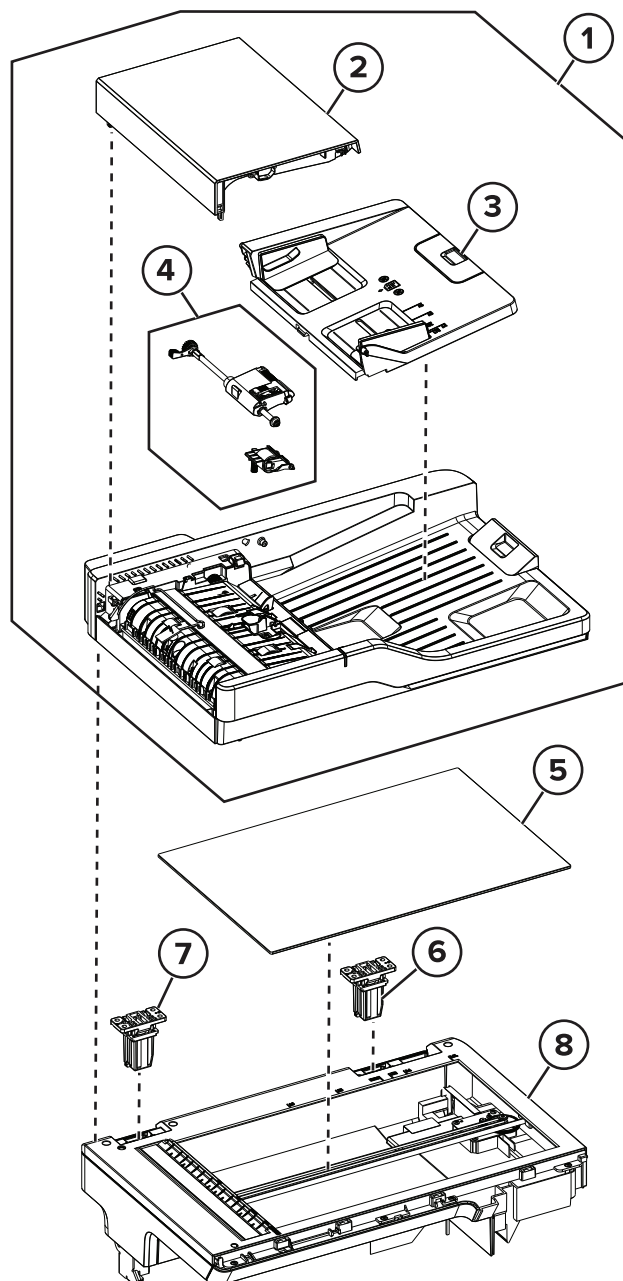

Assembly 11: ADF and flatbed scanner

Asm-index	P/N	Units/mach	Units/FRU	Description	Removal procedure
1	41X2850	1	1	ADF	“ADF removal” on page 517
2	41X2846	1	1	ADF top cover	“ADF top cover removal” on page 528
3	41X2847	1	1	ADF tray	--
4	41X2848	1	1	ADF rollers Note: This part has a CRU sheet.	“ADF rollers removal” on page 514
5	41X2853	1	1	Scanner glass pad Note: This part has a CRU sheet.	“Scanner glass pad removal” on page 512
6	40X7546	1	1	ADF right hinge	“ADF right hinge removal” on page 530
7	41X2845	1	1	ADF left hinge	“ADF left hinge removal” on page 531
8	41X2849	1	1	Flatbed scanner	“Flatbed scanner removal” on page 519
NS	41X3709	1	1	ADF and scanner cables <ul style="list-style-type: none"> • ADF and scanner cables • Cable covers 	“Scanner cables removal” on page 526

Assembly 12: Optional 550-sheet tray

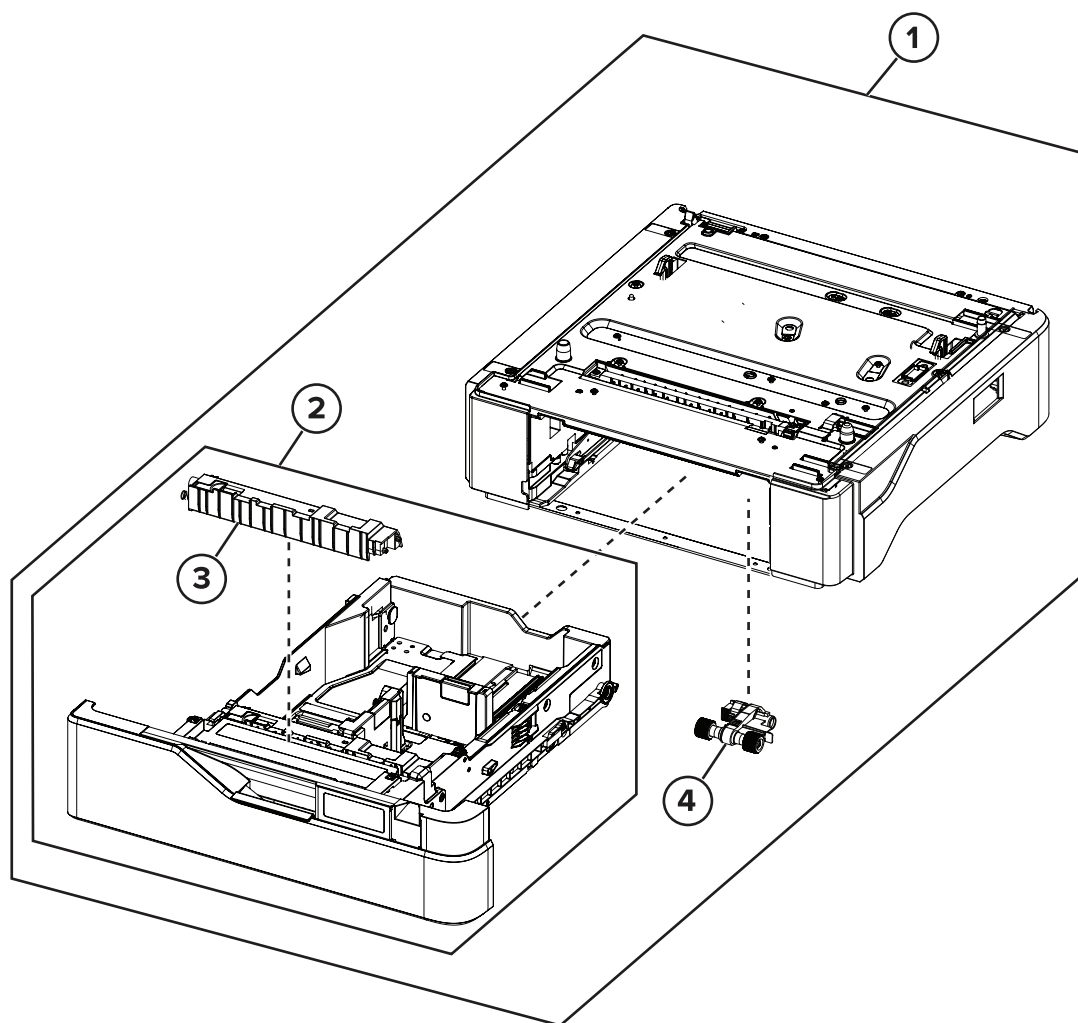

Assembly 12: Optional 550-sheet tray

Asm-index	P/N	Units/opt	Units/FRU	Description	Removal procedure
1	41X0271	1	1	Optional 550-sheet tray Note: This part has a CRU sheet.	“Optional 550-sheet tray removal” on page 536
2	41X0361	1	1	Optional 550-sheet tray insert Note: This part has a CRU sheet.	“550-sheet tray insert removal” on page 500
3	41X0374	1	1	Separator bracket Note: This part has a CRU sheet.	“Separator bracket removal” on page 500
4	41X0956	1	1	Pick roller Note: This part has a CRU sheet.	“Waste toner bottle removal” on page 397

Assembly 13: Convenience stapler

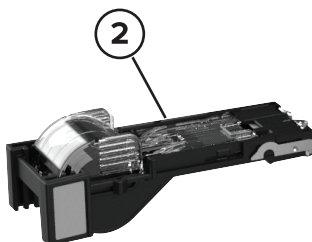
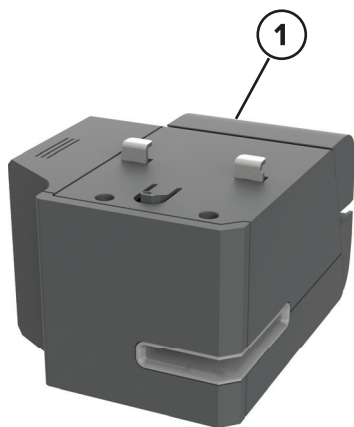

Assembly 13: Convenience stapler

Asm-index	P/N	Units/opt	Units/FRU	Description	Removal procedure
1	41X4236	1	1	Convenience stapler Note: This part has a CRU sheet.	--
2	40X8149	1	1	Staple cartridge holder Note: This part has a CRU sheet.	--
3	41X4237	1	1	Universal AC power adapter Note: This part has a CRU sheet.	--

Assembly 14: Printer stand

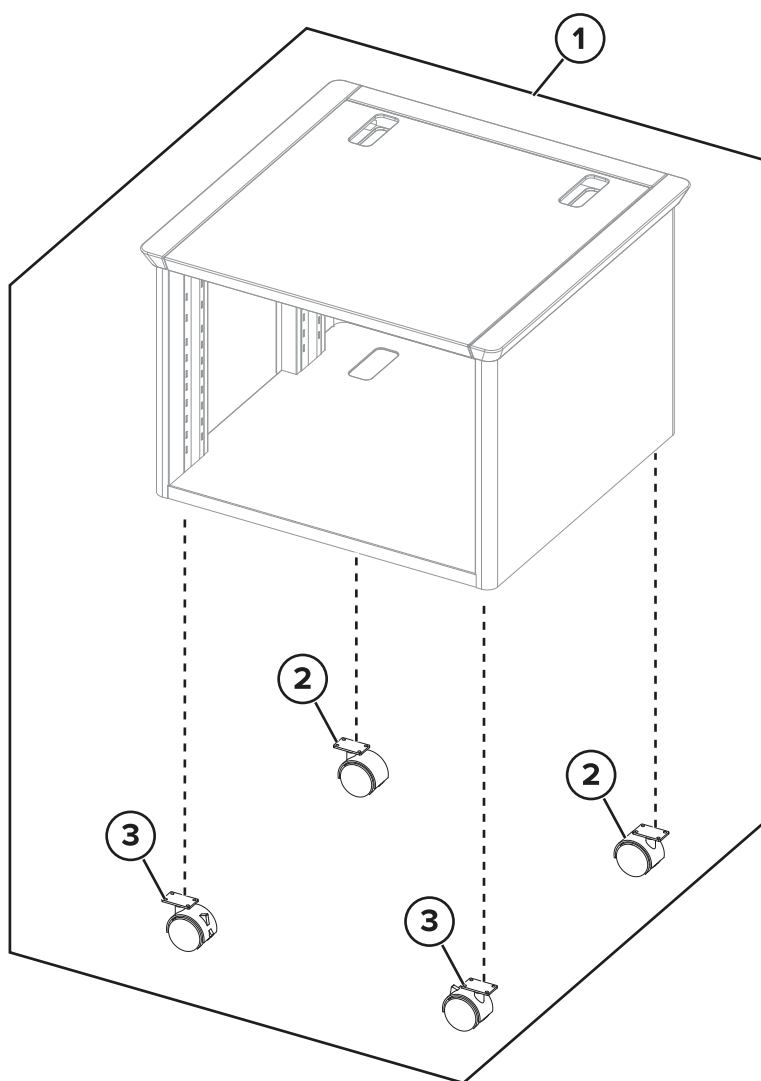

Assembly 14: Printer stand

Asm-index	P/N	Units/opt	Units/FRU	Description	Removal procedure
1	41X0764	1	1	Printer stand	--
2	41X0775	2	1	Nonlocking caster	--
3	41X0774	2	1	Locking caster	--

Assembly 15: Miscellaneous

Asm-index	P/N	Units/mach	Units/FRU	Description	Removal procedure
NS	41X2543	1	1	MarkNet N8370 wireless print server	--
NS	40X9652	1	1	Adapter–Fiber gigabit ISP	--
NS	40X8671	1	1	Cover kit, removable hard disk drive	--
NS	40X9934	1	1	Hard disk drive, 320+ GB	--
NS	41X1872	1	1	MarkNet N8372 802.11 a/b/g/n/ac wireless print server	--
NS	40X4819	1	1	RS-232C serial interface card	--
NS	41X1945	1	1	MarkNet N8230 fiber ISP with side cover	--
NS	41X0357	1	1	Surge protective device, 110-120 V	--
NS	41X0370	1	1	Surge protective device, 220-240 V	--
NS	40X1368	1	1	USB cable, 2 m	--
NS	41X2854	1	1	Intelligent storage drive	“ISD card removal” on page 476
NS	41X2873	1	1	Trusted platform module (TPM) card Note: This part has a FRU sheet.	“TPM card removal” on page 477
NS	41X0021	1	1	Parallel ISP backpack kit	--
NS	41X0020	1	1	Serial ISP backpack kit	--
NS	41X0045	1	1	Keyboard	--
NS	41X1007	1	1	Cleaning kit	--
NS	41X4916	1	1	Fax card	--

Assembly 16: Maintenance kits

Asm-index	P/N	Units/mach	Units/FRU	Description	Removal procedure
NS	41X3882	1	1	Maintenance kit, 110 V <ul style="list-style-type: none"> • Fuser, 115 V • Pick roller • Separator bracket Note: This part has a CRU sheet.	--
NS	41X3883	1	1	Maintenance kit, 220 V <ul style="list-style-type: none"> • Fuser, 220 V • Pick roller • Separator bracket Note: This part has a CRU sheet.	--
NS	41X3884	1	1	Maintenance kit, 100 V <ul style="list-style-type: none"> • Fuser, 100 V • Pick roller • Separator bracket Note: This part has a CRU sheet.	--
NS	41X4512	1	1	Maintenance kit, 115 V (narrow media; for CS/CX737 models only) <ul style="list-style-type: none"> • Fuser, 115 V (narrow media; for CS/CX737 models only) • Pick roller • Separator bracket Note: This part has a CRU sheet.	--
NS	41X2848	1	1	ADF rollers <ul style="list-style-type: none"> • ADF pick roller • ADF separator roller Note: This part has a CRU sheet.	--

Assembly 17: Power cords

Asm-index	P/N	Units/mach	Units/FRU	Description	Removal procedure
NS	40X7104	1	1	US, Canada, Latin America LV	--
NS	40X0288	1	1	Argentina	--
NS	40X0259	1	1	Brazil LV	--
NS	40X0273	1	1	Chile, Uruguay	--
NS	40X0297	1	1	Bolivia, Peru, Paraguay	--
NS	40X0301	1	1	Australia, New Zealand	--
NS	40X3609	1	1	Japan	--
NS	40X1792	1	1	Korea	--
NS	40X0303	1	1	PRC	--
NS	40X1791	1	1	Taiwan	--
NS	40X0271	1	1	Hong Kong	--
NS	40X0279	1	1	Philippines, Thailand	--
NS	40X1767	1	1	Indonesia, Vietnam, Cambodia, Laos	--
NS	40X1773	1	1	Bangladesh, Nepal, Bhutan	--
NS	40X0271	1	1	Singapore, Malaysia, Pakistan, Sri Lanka, Myanmar, Brunei, India	--
NS	40X1767	1	1	Algeria, Austria, Benelux (Belgium, Luxembourg, Netherlands), Bosnia, Bulgaria, Croatia, Czech Republic, Egypt, Estonia, France, Germany, Greece, Hungary, Iceland, Italy, Latvia, Lithuania, Morocco, Poland, Portugal, Romania, Russia (CIS), Serbia, Slovakia, Spain, Turkey	--
NS	40X1774	1	1	Nordics	--
NS	40X0275	1	1	Israel	--
NS	40X1773	1	1	South Africa	--
NS	40X1772	1	1	Switzerland	--
NS	40X0271	1	1	UK, Saudi Arabia	--

Printer specifications

Power consumption

Product power consumption

The following table documents the power consumption characteristics of the product.

Note: Some modes may not apply to your product.

Mode	Description	Power consumption (Watts)
Printing	The product is generating hard-copy output from electronic inputs.	One-sided: 630 (CX730, XC4342); 760 (CX735, CX737, XC4352) Two-sided: 520 (CX730, XC4342); 640 (CX735, CX737, XC4352)
Copy	The product is generating hard-copy output from hard-copy original documents.	640 (CX730, XC4342); 800 (CX735, CX737, XC4352)
Scan	The product is scanning hard-copy documents.	44.5 (CX730, XC4342); 45.0 (CX735, CX737, XC4352)
Ready	The product is waiting for a print job.	31.5 (CX730, XC4342); 32.0 (CX735, CX737, XC4352)
Sleep Mode	The product is in a high-level energy-saving mode.	1.0 (CX730, XC4342); 1.2 (CX735, CX737, XC4352)
Hibernate	The product is in a low-level energy-saving mode.	0.1
Off	The product is plugged into an electrical outlet, but the power switch is turned off.	0.1

The power consumption levels listed in the previous table represent time-averaged measurements. Instantaneous power draws may be substantially higher than the average.

Values are subject to change. See www.lexmark.com for current values.

Sleep Mode

This product is designed with an energy-saving mode called *Sleep Mode*. The Sleep Mode saves energy by lowering power consumption during extended periods of inactivity. The Sleep Mode is automatically engaged after this product is not used for a specified period of time, called the *Sleep Mode Timeout*.

Factory default Sleep Mode Timeout for this product (in minutes):	15
---	----

By using the configuration menus, the Sleep Mode Timeout can be modified between 1 minute and 120 minutes, or between 1 minute and 114 minutes, depending on the printer model. If the printer speed is less than or equal to 30 pages per minute, then you can set the timeout only up to 60 minutes or 54 minutes, depending on the printer model. Setting the Sleep Mode Timeout to a low value reduces energy consumption, but may increase the response time of the product. Setting the Sleep Mode Timeout to a high value maintains a fast response, but uses more energy.

Some models support a *Deep Sleep Mode*, which further reduces power consumption after longer periods of inactivity.

Hibernate Mode

This product is designed with an ultra-low power operating mode called *Hibernate mode*. When operating in Hibernate Mode, all other systems and devices are powered down safely.

The Hibernate mode can be entered in any of the following methods:

- Using the Hibernate Timeout
- Using the Schedule Power modes

Factory default Hibernate Timeout for this product in all countries or regions	3 days
--	--------

The amount of time the printer waits after a job is printed before it enters Hibernate mode can be modified between one hour and one month.

Notes on EPEAT-registered imaging equipment products:

- Standby power level occurs in Hibernate or Off mode.
- The product shall automatically power down to a standby power level of ≤ 1 W. The auto standby function (Hibernate or Off) shall be enabled at product shipment.

Off mode

If this product has an off mode which still consumes a small amount of power, then to completely stop product power consumption, disconnect the power supply cord from the electrical outlet.

Total energy usage

It is sometimes helpful to estimate the total product energy usage. Since power consumption claims are provided in power units of Watts, the power consumption should be multiplied by the time the product spends in each mode in order to calculate energy usage. The total product energy usage is the sum of each mode's energy usage.

Applicability of Regulation (EU) 2019/2015 and (EU) 2019/2020

Per Commission Regulation (EU) 2019/2015 and (EU) 2019/2020, the light source contained within this product or its component is intended to be used for Image Capture or Image Projection only, and is not intended for use in other applications.

Selecting a location for the printer

- Set up the printer near an appropriately rated and properly grounded electrical outlet.
- Leave enough room to open trays, covers, and doors and to install hardware options.
- Make sure that airflow in the room meets the latest revision of the ASHRAE 62 standard or the CEN Technical Committee 156 standard.

- Provide a flat, sturdy, and stable surface.
- Keep the printer:
 - Clean, dry, and free of dust.
 - Away from water or wet locations.
 - Away from stray staples and paper clips.
 - Away from the direct airflow of air conditioners, heaters, or ventilators.
 - Free from direct sunlight and humidity extremes.
- Observe the recommended temperatures and avoid fluctuations:

Ambient temperature	10 to 32.2°C (50 to 90°F)
Storage temperature	15.6 to 32.2°C (60 to 90°F)

- Allow the following recommended amount of space around the printer for proper ventilation:

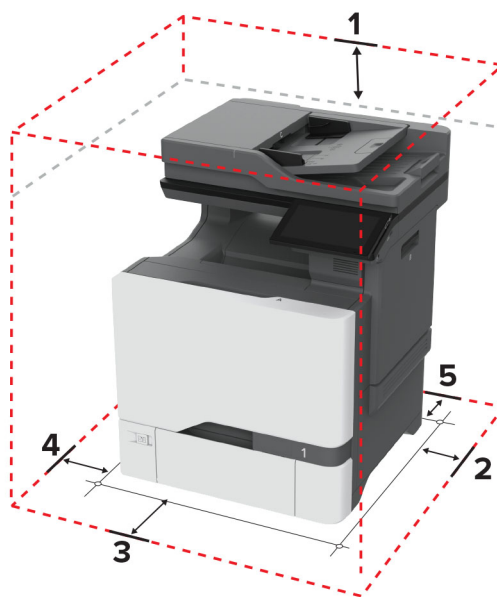

1	Top	229 mm (9 in.)
2	Rear	101.6 mm (4 in.)
3	Right side	178 mm (7 in.)
4	Front	508 mm (20 in.)
5	Left side	127 mm (5 in.)

Noise emission levels

The following measurements were made in accordance with ISO 7779 and reported in conformance with ISO 9296.

Note: Some modes may not apply to your product.

1-meter average sound pressure, dBA	
Printing	One-sided: 52 (CX730de, XC4342); 53 (CX735, CX737, XC4352) Two-sided: 53 (CX730, XC4342); 55 (CX735, CX737, XC4352)
Scanning	51
Copying	Mono: 55 (CX730, XC4342); 56 (CX735, CX737, XC4352) Color: 51 (CX730, XC4342); 52 (CX735, CX737, XC4352)
Ready	14

Values are subject to change. See www.lexmark.com for current values.

Temperature information

Operating temperature and relative humidity	10 to 32.2°C (50 to 90°F) and 15 to 80% RH 15.6 to 32.2°C (60 to 90°F) and 8 to 80% RH Maximum wet-bulb temperature ² : 22.8°C (73°F) Non-condensing environment
Printer / cartridge / imaging unit long-term storage ¹	15.6 to 32.2°C (60 to 90°F) and 8 to 80% RH Maximum wet-bulb temperature ² : 22.8°C (73°F)
Printer / cartridge / imaging unit short-term shipping	-40 to 40°C (-40 to 104°F)
<p>¹ Supplies shelf life is approximately 2 years. This is based on storage in a standard office environment at 22°C (72°F) and 45% humidity.</p> <p>² Wet-bulb temperature is determined by the air temperature and the relative humidity.</p>	

Options and features

Available internal options

- Intelligent storage drive (ISD)
 - Fonts
 - Simplified Chinese
 - Traditional Chinese
 - Japanese
 - Korean
 - Arabic
 - Mass storage
- Printer hard disk
- Licensed features
 - IPDS
 - Bar Code
- Lexmark Internal solutions port (ISP)
 - IEEE 1284-B Parallel Card
 - RS-232C Serial Card
 - Fiber Port
- Wireless module
 - MarkNet™ N8370
 - MarkNet N8372

Notes:

- An ISD or a hard disk is required to activate formsmerge and other features.
- Some IPDS features require an ISD or a hard disk.

Theory of operation

Electrophotographic (EP) process

Print engine layout

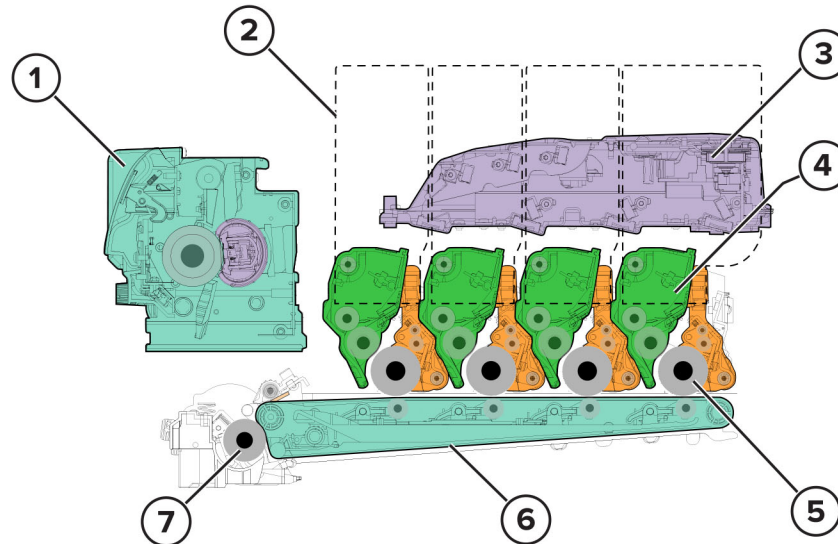

1	Fuser
2	Toner cartridges (Y, C, M, K)
3	Printhead
4	Developer unit
5	Photoconductor drum
6	Transfer belt
7	Second transfer roller

Flowchart

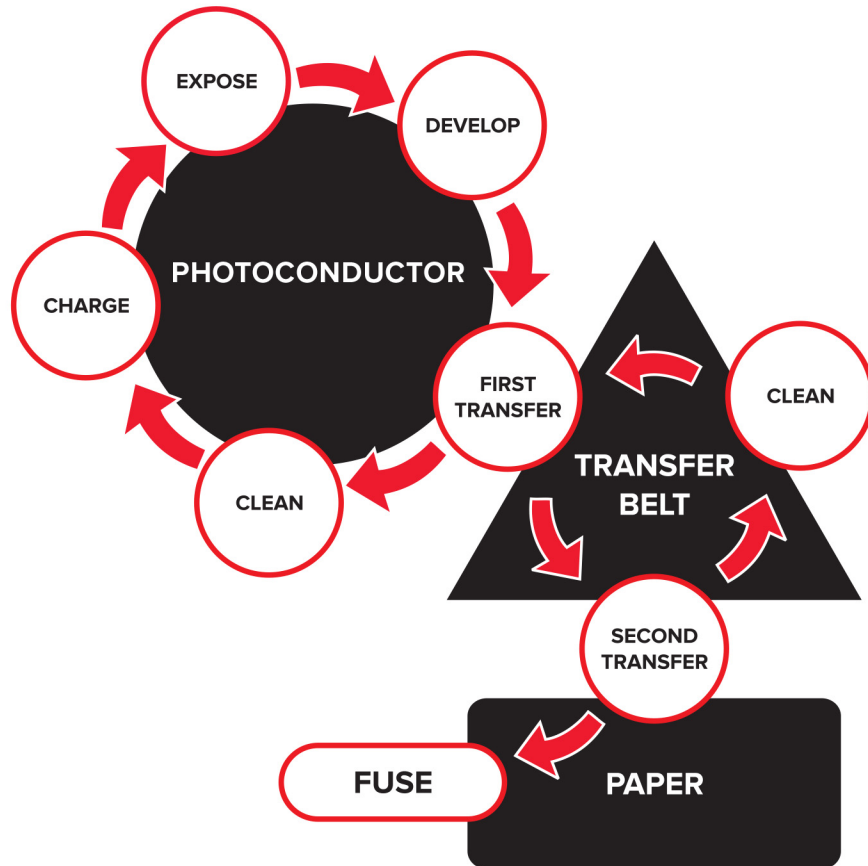

EP process

Charge

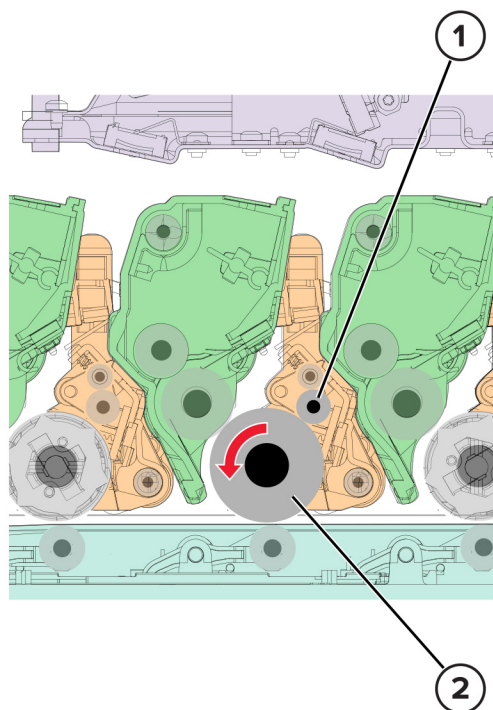

1	Charge roller
2	Photoconductor drum

The charge roller applies a uniform negative electrical charge to the surface of the photoconductor drum. The photoconductor drum, because of its photoconductive properties, holds the charge as long as it is not exposed to light.

Service tips

- If the surface of the charge roller is damaged, such as having a nick or pit, then the charge on the photoconductor drum is uneven. A repeating mark may appear on the printed page. For more information, see [“Repeating defects check” on page 62](#).
- If the charge roller is severely damaged, then the surface of the photoconductor drum is not properly charged. Excessive amounts of toner particles are deposited on the photoconductor drum. The printed page becomes saturated with 100% of the color from the supply with the defective charge roller. The affected imaging unit or kit must be replaced immediately.

Expose

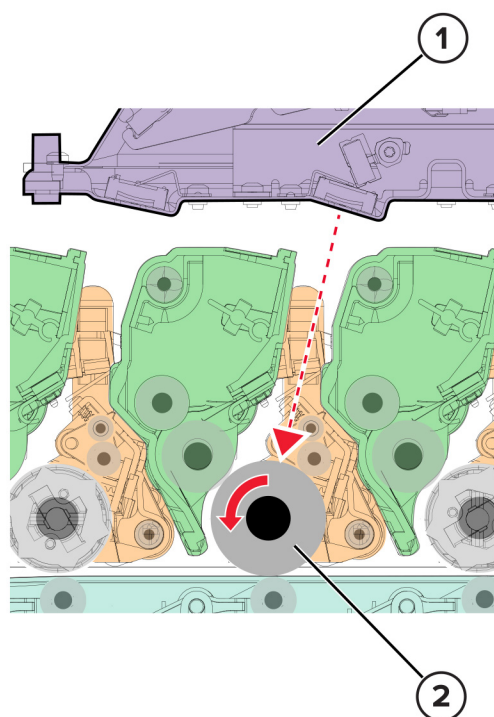

1	Printhead
2	Photoconductor drum

The printhead lasers emit the light that contacts the surface of the photoconductor drum. An invisible image, called *digital latent image*, is written as the light turns on or off. The light causes areas of the photoconductor drum surface to lose charge, resulting in a relative opposite polarity.

Service tips

- Do not touch the surface of the photoconductor drum with your bare hand. The oil from your skin may cause a charge disparity on the surface, and the toner may no longer stick properly. The result can be repeating blotches or voids on the printed page or patches of light print. The affected imaging unit or kit may need to be replaced.
- The surface of the photoconductor drum is coated with an organic substance that makes it sensitive to light. Make sure to cover the photoconductor drum when you are working on the printer. If it is exposed to light for too long, then light or dark print quality problems may occur. The imaging unit or imaging kit may need to be replaced.
- Toner particles or dirt that get stuck on the printhead lens may obstruct the path of the laser beam. The result can be vertical light streaks on the printed page. If cleaning is not possible, then the printhead may need to be replaced.

Develop

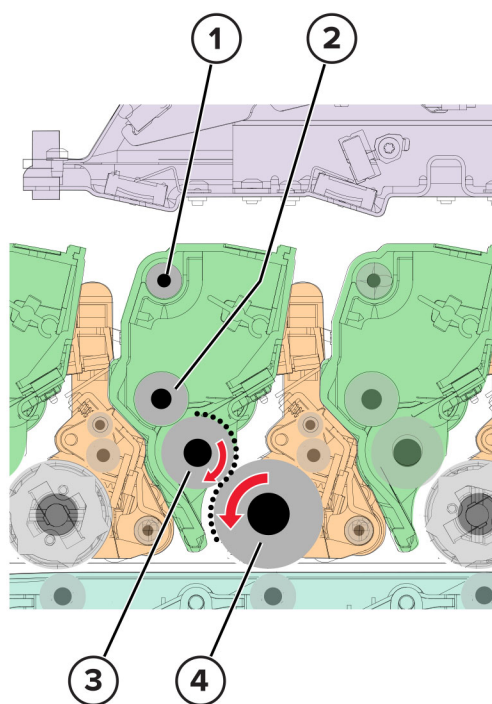

1	Auger
2	Toner add roller
3	Developer roller
4	Photoconductor drum

The developer roller applies the toner from the toner cartridge to the photoconductor drum. The relative opposite polarity in charge causes the toner particles to attract to the photoconductor drum areas which were exposed to light. In the process, the digital latent image is developed.

This process is similar to using glue to write on a can, and then rolling the can over glitter. The glitter sticks to the glue but does not stick to the rest of the can.

Service tips

- Do not touch the surface of the developer roller with your bare hand. The oil from your skin may cause a charge disparity on the surface, and the toner may no longer stick properly. The result can be repeating blotches or voids on the printed page or patches of light print. The affected developer unit may need to be replaced.
- If the developer roller is damaged, then it cannot contact the surface of the photoconductor drum properly. The result can be repeating marks, thin vertical voids, or thin vertical lines of color on the printed page. Check the surface of the developer roller for damage. For more information, see [“Repeating defects check” on page 62.](#)

First transfer

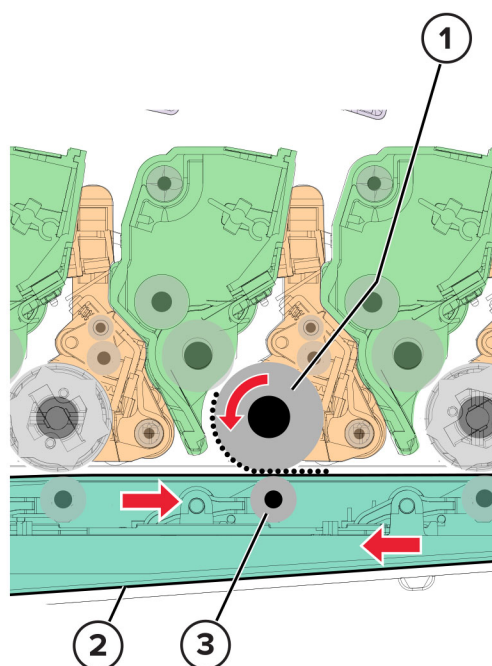

1	Photoconductor drum
2	Transfer belt
3	First transfer roller

For each color, there is a charge difference between the developed toner image on the photoconductor drum surface and the first transfer roller. This difference causes the image to transfer to the surface of the transfer belt. This transfer occurs during a direct surface-to-surface contact between the photoconductor drum and the transfer belt.

Service tips

- Do not touch the surface of the transfer belt with your bare hand. The oil from your skin may cause a charge disparity on the surface, and the toner may no longer stick properly. The result can be repeating blotches or voids on the printed page or patches of light print. The transfer module may need to be replaced. For more information, see [“Repeating defects check” on page 62](#).
- Do not use solvents or other cleaners to clean the transfer belt surface. Their chemicals may result to scratches or charge disparities. Voids on the printed page or blotches of light print may occur. The transfer module may need to be replaced.
- Sharp and hard objects can damage the transfer belt surface. Be careful when using a screwdriver or prying tool near the transfer module. If the transfer belt has tears or cracks, then the transfer module may need to be replaced.

Second transfer

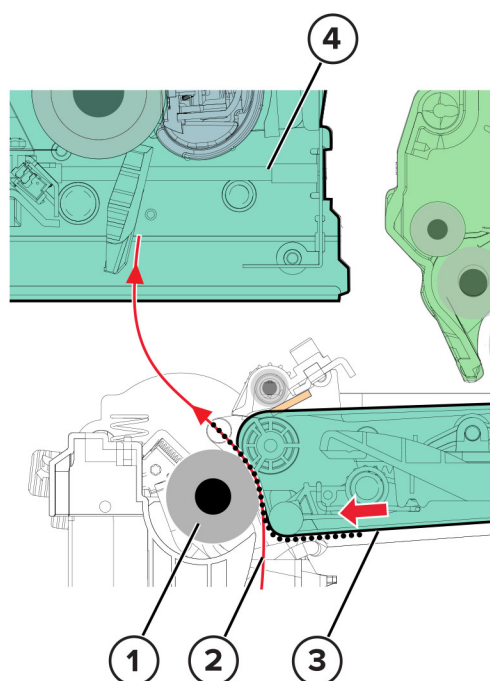

1	Second transfer roller
2	Paper
3	Transfer belt
4	Fuser

On the transfer belt, the four-color image is carried toward the second transfer roller until it reaches a set point. The paper pick is timed when the paper is at the exact position between the transfer belt and second transfer roller.

When the image on the transfer belt reaches the second transfer roller, the negatively charged toner clings to the paper. The entire image is then transferred from the transfer belt to the paper.

Service tips

- If the second transfer roller has nicks, pits, or flat spots, then its surface cannot come into contact with the paper and transfer belt. The result can be voids on the printed page or spots of light print (or repeating voids or spots). For more information, see [“Repeating defects check” on page 62](#).
- If the toner does not fully transfer, then the entire page may be very light or blank due to the following:
 - The second transfer roller does not properly engage the transfer belt.
 - The HVPS does not have voltage. Any toner that does transfer, is due to contact alone (without charge). Check the HVPS contacts to the second transfer roller.

Fuse

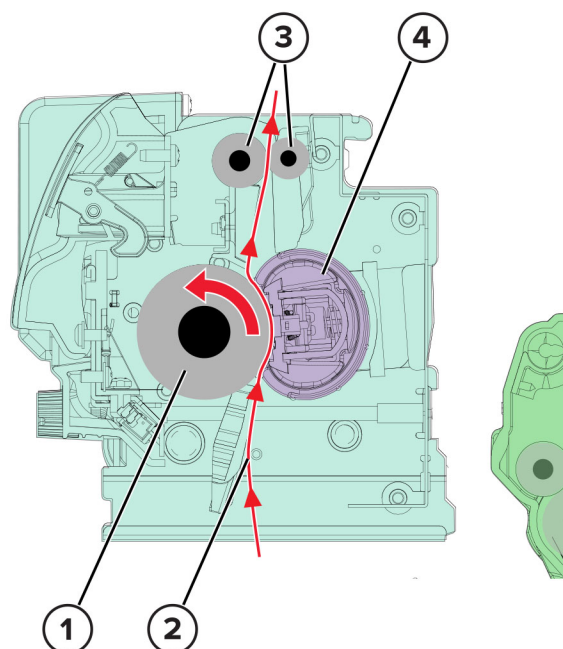

1	Pressure roller
2	Paper
3	Fuser decurl rollers
4	Heat belt

Even if the toner image is already on the paper, the toner particles are not yet permanently bonded to the surface. Paper is transported from the second transfer roller to the fuser where heat and pressure are applied to it. As a result, the toner particles melt and permanently fuse with the paper, completing the print process. The cycle repeats for the succeeding pages.

Service tips

- If the pressure roller or heat belt is damaged, then the toner may be pulled off the page. Paper jams may also occur.
- Toner rubbing off a printed page indicates a malfunctioning fuser or an incorrect paper type setting. Always check the paper type setting before replacing the fuser. A common mistake is to print on heavier paper, such as card stock, with the paper type set to plain paper.
- After a jam is called on the fuser area, the fuser roller automatically releases to relieve the pressure on the paper. If possible, never pull paper with unfused toner through the fuser. Try to pull the jammed paper out of the fuser in the opposite direction it was traveling.

Clean

Two cleaning processes take place during the EP process. Both processes remove the residual toner from the system.

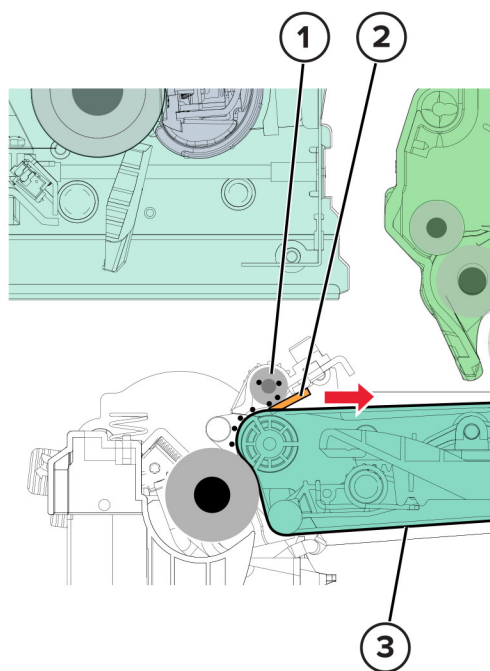

1	Auger
2	Cleaning blade
3	Transfer belt

When the toner image on the transfer belt is transferred to the page, the transfer belt rotates and gets cleaned by the cleaning blade. The cleaning occurs for every page that is printed.

The removed toner is moved to the waste toner bottle using a rotating auger.

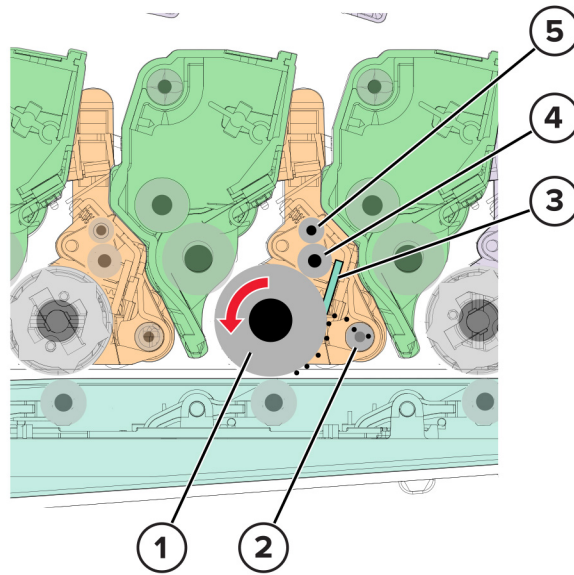

1	Photoconductor drum
2	Auger
3	Cleaning blade
4	Charge roller
5	Charge roller cleaner

After each plane of color is transferred to the transfer belt from the photoconductor drums, a cleaning blade scrapes the remaining toner from the drums.

The photoconductor drum surface is prepared to restart the EP process.

Printer operation

Printer paper path rollers

Standard paper path

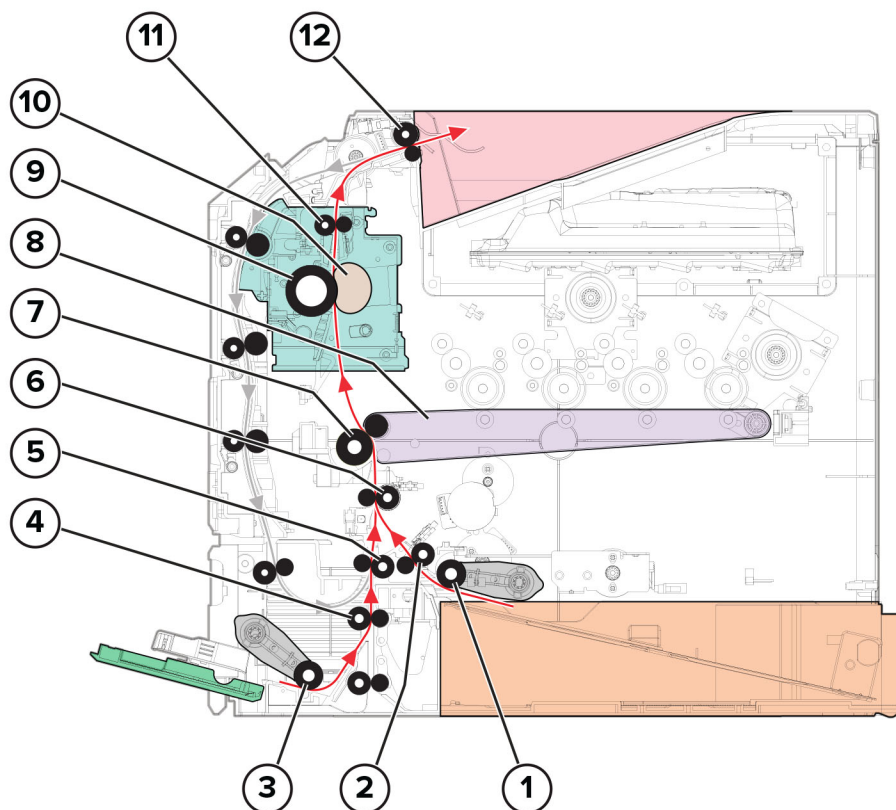

1	Tray 1 pick roller
2	Isolation roller
3	MPF pick roller
4	MPF reference edge roller
5	Alternate isolation roller
6	Aligner roller
7	Second transfer roller
8	Transfer belt
9	Fuser pressure roller
10	Fuser belt
11	Fuser decurl roller
12	Exit roller

Theory of operation

Duplex paper path

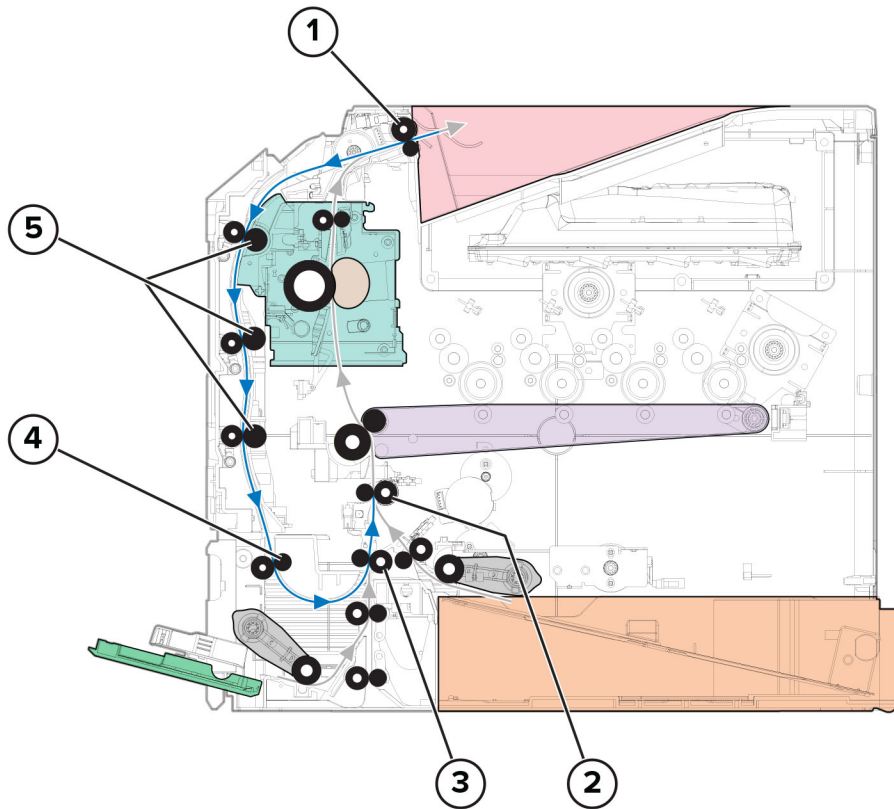

1	Exit roller
2	Aligner roller
3	Alternate isolation roller
4	Duplex feed roller
5	Duplex aligner rollers

Printer paper path sensors

Standard paper path

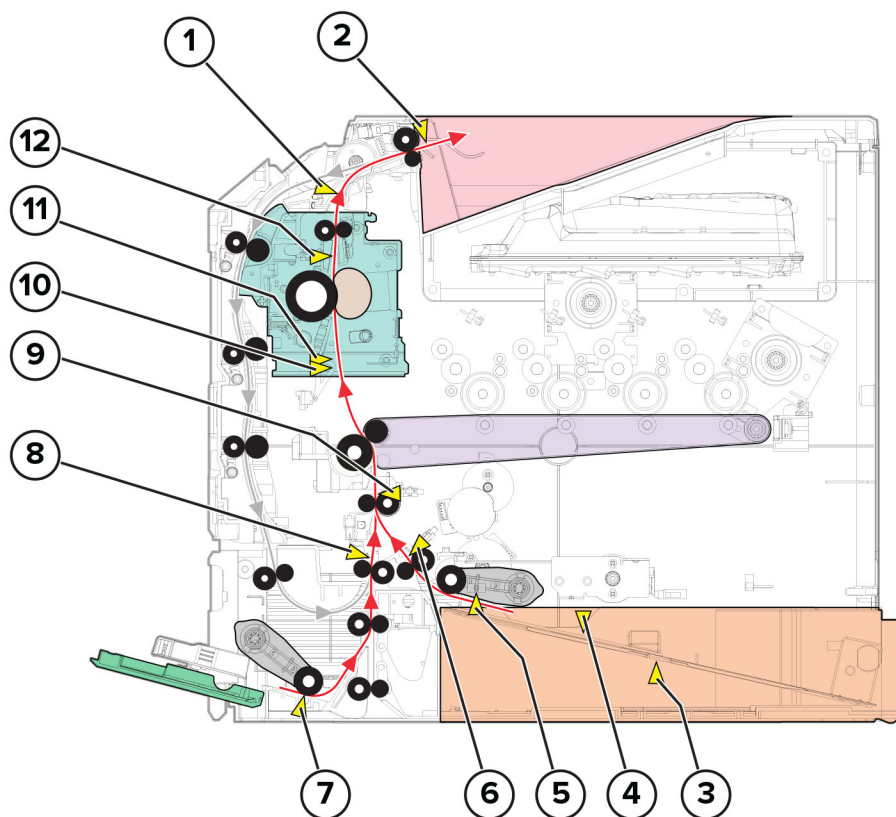

#	Sensor	Functions
1	Sensor (redrive)	<ul style="list-style-type: none"> • Detects the paper as it exits the printer. • Detects the paper as it enters the duplex paper path.
2	Sensor (bin full)	Detects if the bin is full.
3	Sensor (paper size)	Detects the position of the rear paper guide for determining the paper length.
4	Sensor (tray 1 paper present)	Detects the presence or absence of paper in the tray.
5	Sensor (pick position)	Detects if the pick roller is in position to pick.
6	Sensor (tray 1 pick)	Detects the paper as it is picked and fed to the printer.
7	Sensor (MPF paper present)	Detects the paper that is loaded in the MPF.
8	Sensor (MPF/pass-through)	<ul style="list-style-type: none"> • Detects the paper that is fed from the MPF or duplex path. • Detects the paper that is transferred from the optional trays.
9	Sensor (input)	Detects the paper as it approaches the transfer belt. The movements of the transfer belt and aligner roller are exactly timed to ensure the proper placement of the image on the paper.
10	Sensor (fuser buckle)	Detects the paper as it buckles at the fuser entrance. To prevent jams, the rollers slow down or speed up depending on the size of the buckle.

#	Sensor	Functions
11	Sensor (narrow media)	Detects if the paper width is narrow.
12	Sensor (fuser exit)	Detects the paper exiting the fuser.

Duplex paper path

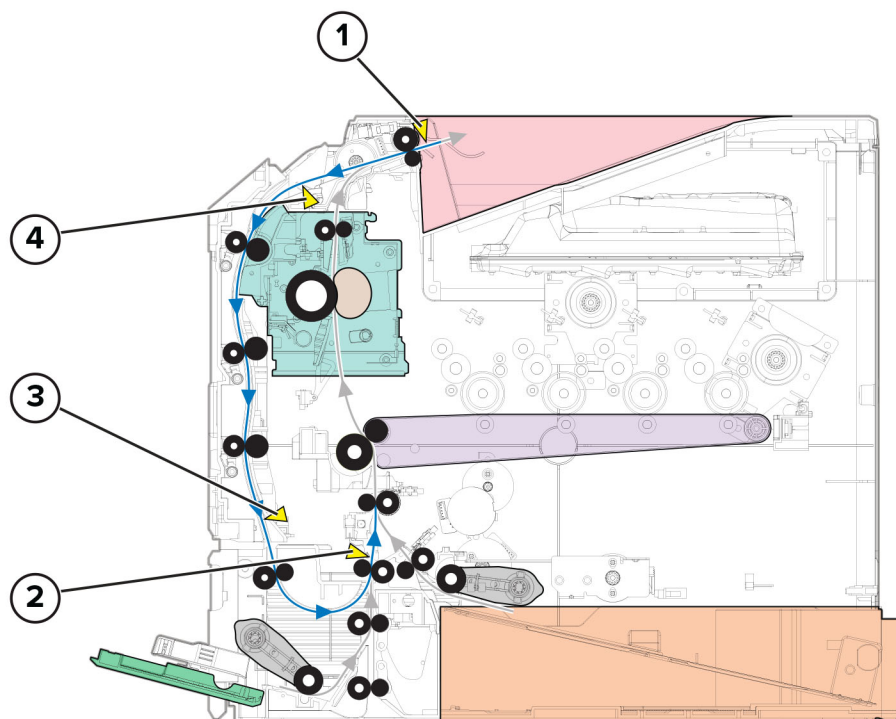

#	Sensor	Functions
1	Sensor (bin full)	Detects if the bin is full.
2	Sensor (MPF/pass-through)	<ul style="list-style-type: none"> • Detects the paper that is fed from the MPF or duplex path. • Detects the paper that is transported from the optional trays.
3	Sensor (duplex staging)	Detects the paper from the duplex path as it is realigned at its reference edge.
4	Sensor (redrive)	<ul style="list-style-type: none"> • Detects the paper as it exits the printer. • Detects the paper as it enters the duplex paper path.

Pick drive

Tray 1

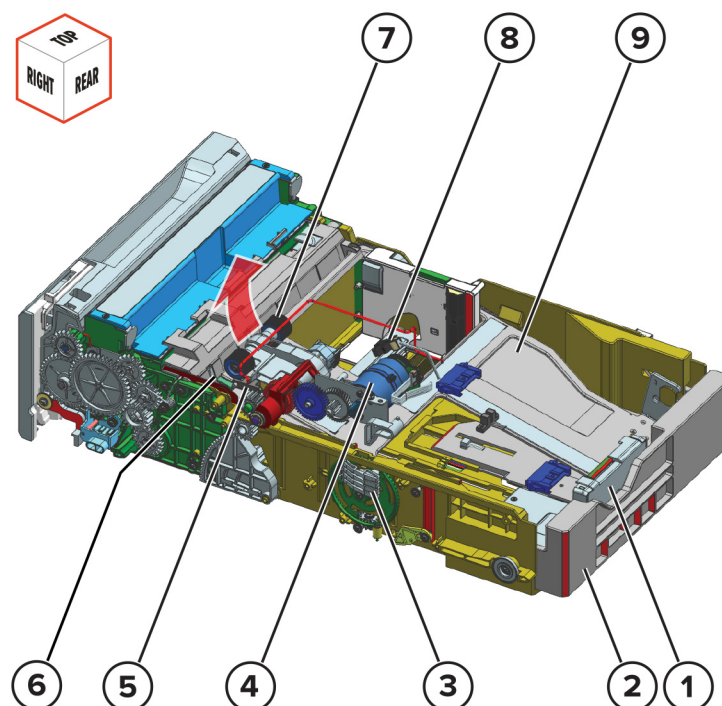

1	Length guide
2	Tray
3	Paper size sensor actuator
4	Motor (tray 1 pick/lift)
5	Sensor (pick position)
6	Separator pad
7	Tray 1 pick roller
8	Sensor (tray 1 paper present)
9	Lift plate

Paper is lifted by the lift plate until the sensor (pick position) is triggered. The motor (pick/lift) starts, and then enables the pick roller to feed the paper into the printer.

Note: The motor (pick/lift) also drives the lift plate when rotating in reverse.

To avoid multiple-sheet picking, the friction from the separator pad prevents the extra paper from entering the printer.

The sensor (paper present) detects if the tray is empty.

The paper size is only detected based on the setting of the length guide. The paper size information is decoded using the paper size sensor actuator, and then sent to the controller board.

MPF

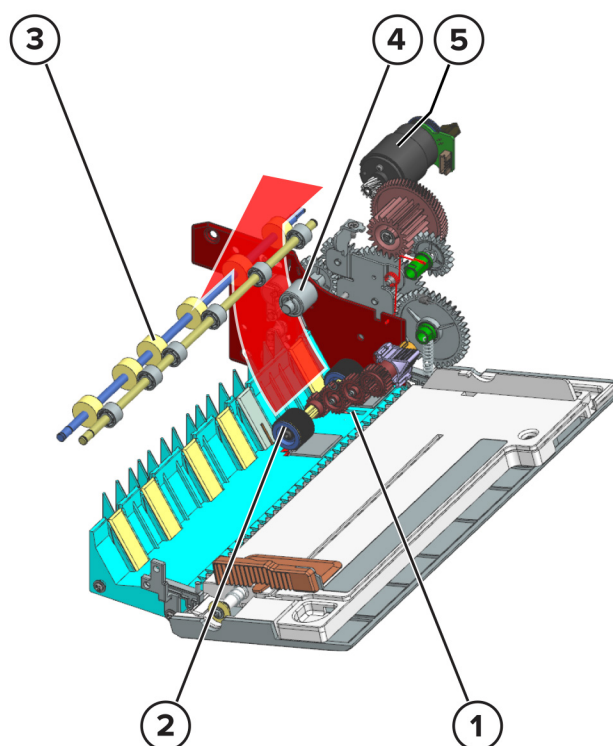

1	Sensor (MPF paper present)
2	MPF pick roller
3	Alternate isolation roller
4	MPF reference edge roller
5	Motor (duplex/MPF)

The MPF pick roller feeds the paper into the printer. At the MPF reference edge roller, paper is aligned along the reference edge and transported to the alternate isolation roller.

The motor (duplex/MPF) drives the MPF pick roller and reference edge roller. During duplex transport, a clutch in the gear mechanism prevents the MPF pick roller from picking paper.

The sensor (MPF paper present) detects if paper is loaded in the MPF.

Isolation drive

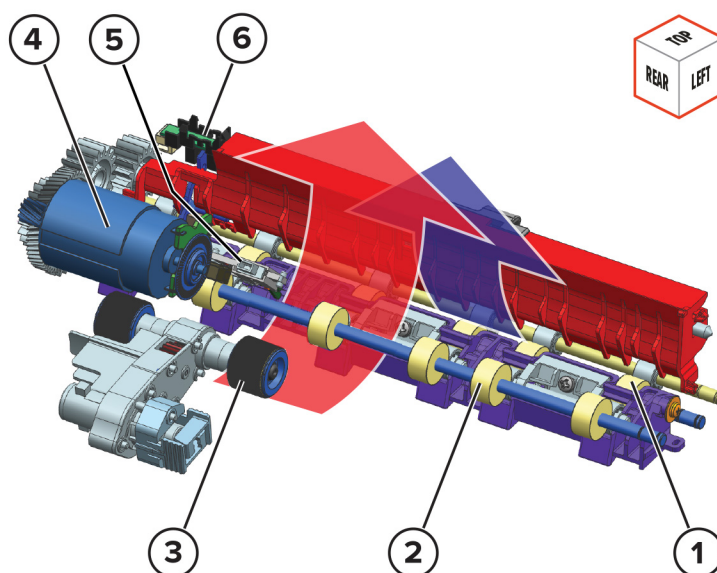

1	Alternate isolation roller
2	Isolation roller
3	Tray 1 pick roller
4	Motor (isolation)
5	Sensor (tray 1 pick)
6	Sensor (MPF/pass-through)

Isolation rollers receive the paper from different paths. For tray 1 print jobs, the path direction is indicated by the red arrow. For MPF, optional tray, or duplex print jobs, the path direction is indicated by the blue arrow. Sensors along the path detect the paper being transported.

The motor (isolation) drives the isolation rollers.

Aligner drive

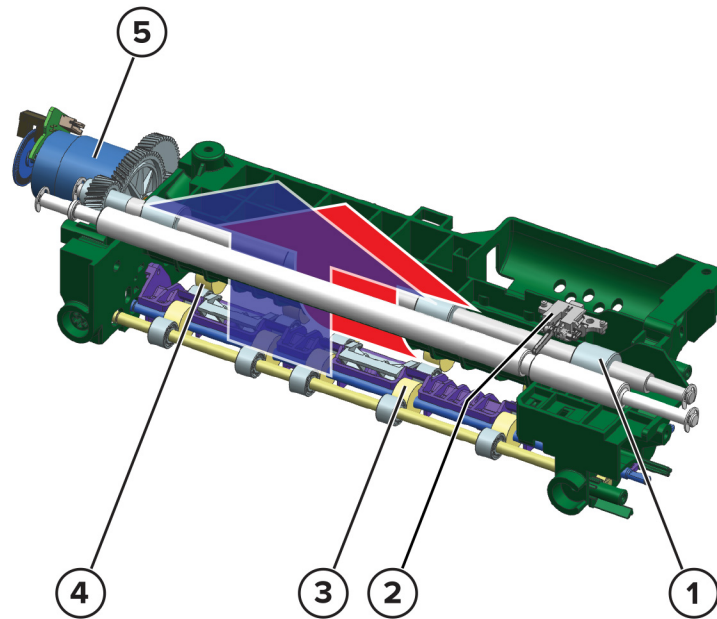

1	Aligner roller
2	Sensor (input)
3	Alternate isolation roller
4	Isolation roller
5	Motor (deskew)

Paper stops at the aligner roller to undergo skew correction. The isolation roller pushes the paper against the aligner roller. As the paper buckles, its leading edge aligns with the aligner roller. Paper then passes the aligner rollers, where it is detected by the sensor (input). The movements of the transfer belt and aligner roller are exactly timed to ensure the proper placement of the image on the paper.

The motor (deskew) drives the aligner roller.

Transfer drive

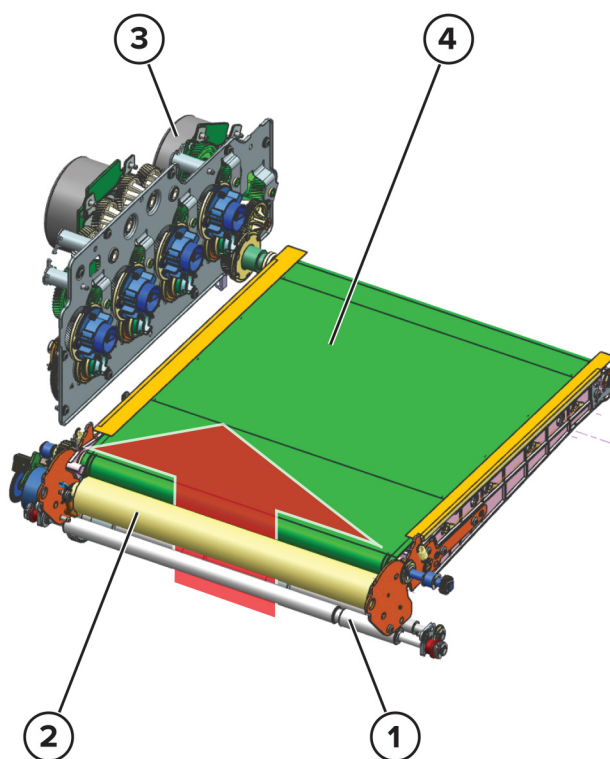

1	Aligner roller
2	Second transfer roller
3	Motor (K/transfer belt)
4	Transfer belt

After the paper is aligned, it passes between the second transfer roller and transfer belt. At this point, the four-color image is transferred to the paper.

The motor (K/transfer belt) drives the transfer belt. The movements of the transfer belt and aligner roller are exactly timed to ensure the proper placement of the image on the paper.

Fuser drive

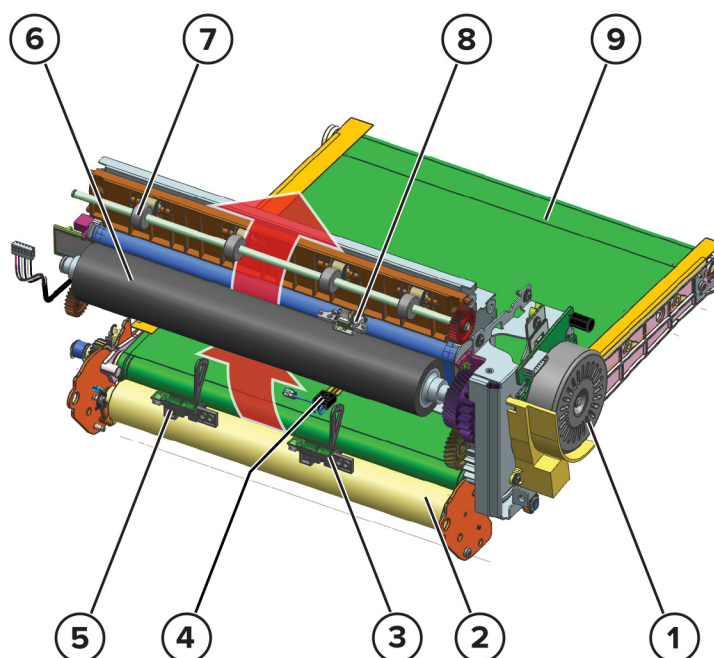

1	Motor (fuser)
2	Second transfer roller
3	Sensor (fuser buckle)
4	Sensor (fuser temperature)
5	Sensor (narrow media)
6	Fuser pressure roller
7	Fuser decurl roller
8	Sensor (fuser exit)
9	Transfer belt

The paper buckles when it reaches the fuser roller. If the buckle is small, then the fuser roller slows down to avoid pulling the paper from the transfer belt nip. If the buckle is big, then the roller speeds up to avoid smearing the image. The sensor (fuser buckle) detects the buckle.

As the paper passes the fuser, heat and pressure are applied to permanently bond the toner to the paper.

To counteract the paper curl after fusing, the fuser decurl roller applies a curl in the opposite direction. The roller also transports the paper to the exit path.

The sensor (fuser exit) detects the paper. The sensor (narrow media) determines if the paper is narrow.

The motor (fuser) drives the fuser rollers.

Fuser nip

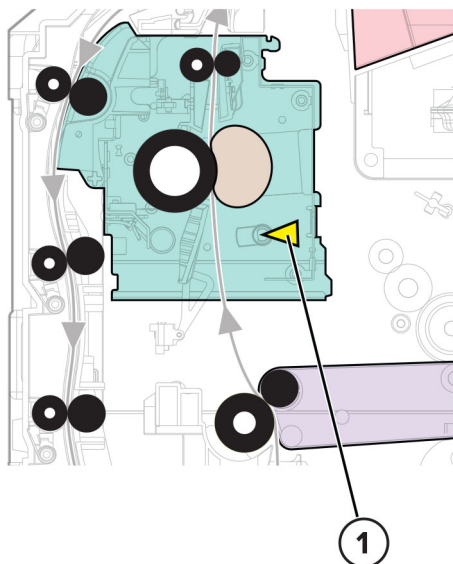

1	Sensor (fuser nip)
---	--------------------

The sensor (fuser nip) detects if the rollers are squeezing the paper.

The fuser nip may not release if the printer is still powered on. The fuser nip will not release if the doors are open or the waste toner bottle is missing because the fuser motor is interlocked. In some cases, the printer may need to be turned off first before removing jams in the fuser nip.

Exit and redrive drive

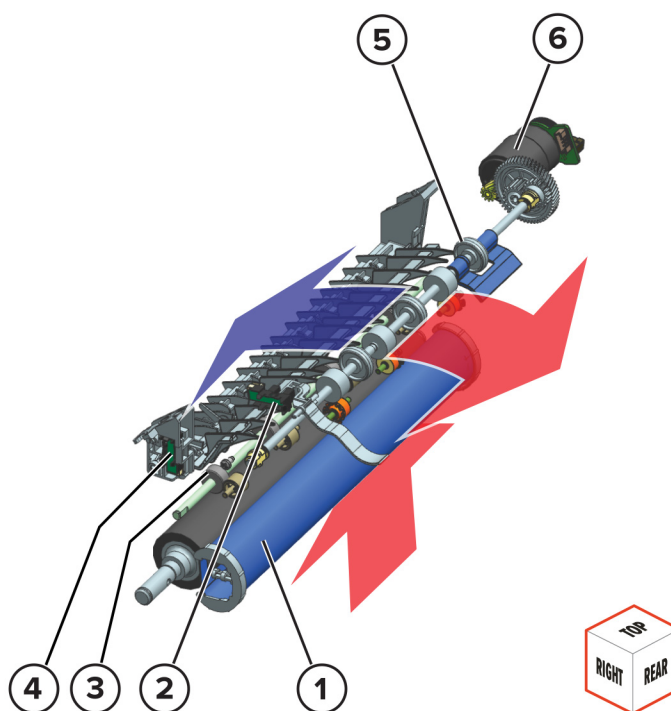

1	Fuser belt
2	Sensor (bin full)
3	Fuser decurl roller
4	Sensor (redrive)
5	Exit roller
6	Motor (exit/redrive)

Paper is ejected by the exit roller to the bin. The exit roller is controlled by the motor (exit/redrive).

The sensor (redrive) detects the paper going to the bin. (It also detects paper entering the duplex path.)

The sensor (bin full) detects if the bin is full.

For duplex print jobs, the exit roller reverses its rotation to feed the paper back to the printer following the duplex paper path.

Note: The duplex paper path moves in the direction indicated by the blue arrow.

Duplex drive

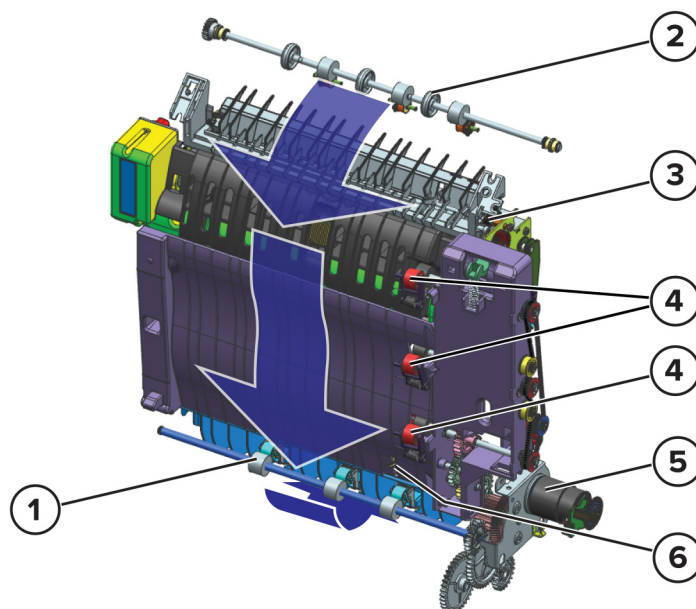

1	Duplex feed roller
2	Exit roller
3	Sensor (redrive)
4	Duplex aligner roller.
5	Motor (duplex/MPF)
6	Sensor (duplex staging)

For duplex print jobs, paper from the exit roller travels along the duplex aligner rollers. The aligner rollers also push the paper to the right, to align the side edge of the paper along the reference edge. As paper reaches the duplex feed roller, it is fed to the alternate isolation roller (see [“Isolation drive” on page 625](#)). Paper is then fed back to the standard paper path to print on the opposite side.

Sensors along the duplex path detect the paper. The motor (duplex/MPF) drives the duplex rollers.

ADF and scanner operation

Flatbed scanner drive

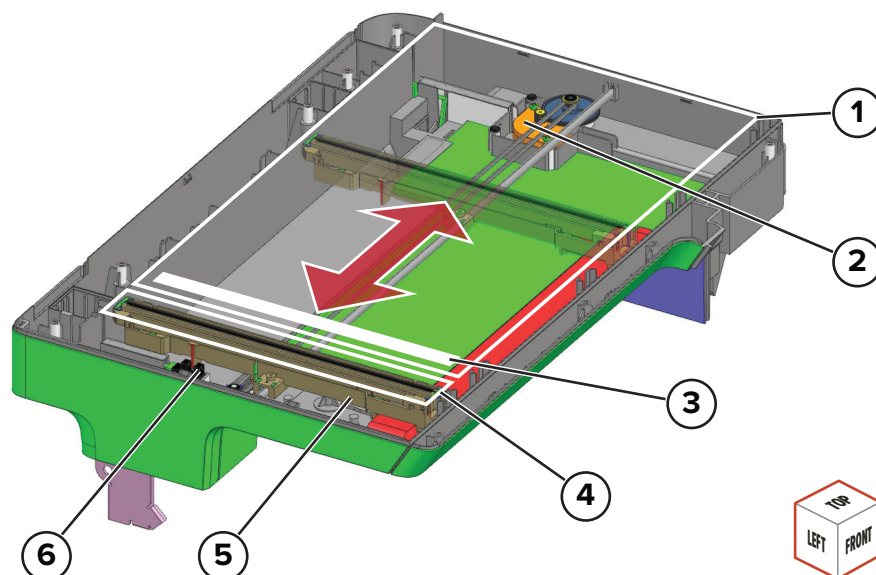

1	Scanner glass area
2	Motor (flatbed CIS scanner)
3	Calibration reference strip
4	ADF glass area
5	Flatbed CIS scanner
6	Sensor (flatbed CIS scanner)

The flatbed scanner has a contact image sensor (CIS) scan module that illuminates the surface of the document. The reflections produced are detected by the CIS scanner to create the scan image.

For flatbed scan jobs, the CIS scanner moves across the scanner glass area to scan the front side of the document (facedown). The motor (flatbed CIS scanner) controls the CIS scanner position. The CIS scanner is detected at its home position by the sensor (flatbed CIS scanner). The position of the CIS scanner is also detected based on the computed distance relative to the calibration reference strip. To maintain the correct shading levels if needed, the CIS scanner scans the white surface of the calibration reference strip.

During ADF scan jobs, the CIS scanner stays at the ADF glass area to scan the front side of the document.

ADF paper path rollers

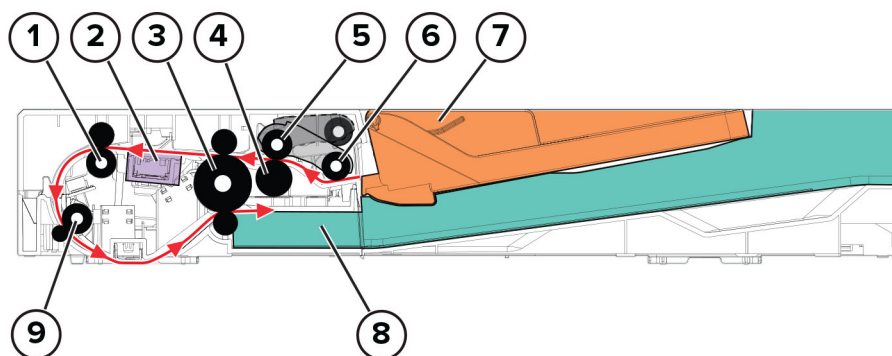

1	ADF transport roller
2	ADF CIS scanner
3	ADF feed/exit roller
4	ADF separator roller
5	ADF feed roller
6	ADF pick roller
7	ADF tray
8	ADF bin
9	ADF scan roller

Paper from the ADF tray enters the ADF through the pick roller, feed roller, and separator roller.

The back side of the paper is scanned after the paper passes the ADF feed/exit roller. The front side of the paper is scanned after the paper passes the ADF scan roller.

After the paper is scanned, it is ejected by the feed/exit roller to the ADF bin.

ADF paper path sensors

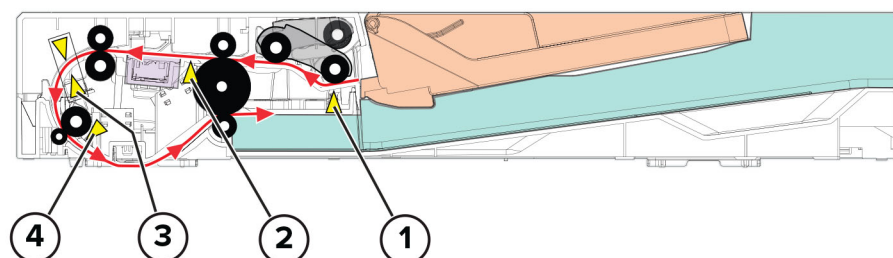

#	Sensor	Function
1	Sensor (ADF paper present)	Detects paper presence in the ADF tray
2	Sensor (ADF scan 2)	Detects the paper that is about to be scanned at its back side
3	Sensor (ADF multifeed)	Detects multiple paper feed
4	Sensor (ADF scan 1)	Detects the paper that is about to be scanned at its front side

ADF pick and feed drive

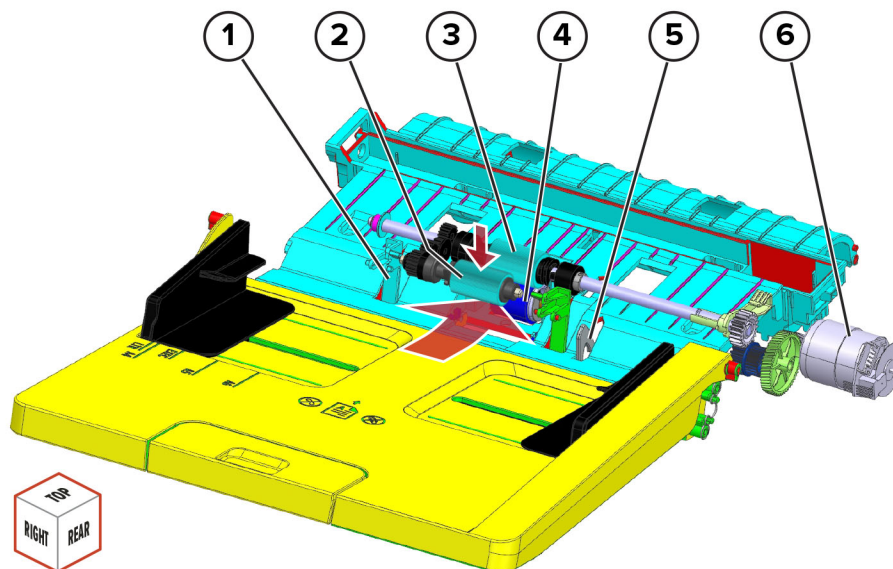

1	Paper stop
2	ADF pick roller
3	ADF feed roller
4	ADF separator roller
5	Sensor (ADF paper present)
6	Motor (ADF pick)

The sensor (ADF paper present) detects if paper is loaded in the ADF tray. When the scan job command is signaled, the pick roller lowers to pick the paper from the ADF tray.

Note: When the pick roller is raised, the leading edges of the paper in the tray are aligned by the paper stops.

When paper reaches the feed roller, the resistance of the separator roller allows only the topmost sheet to feed.

The motor (ADF pick) drives the ADF pick and feed rollers.

ADF transport and scan drive

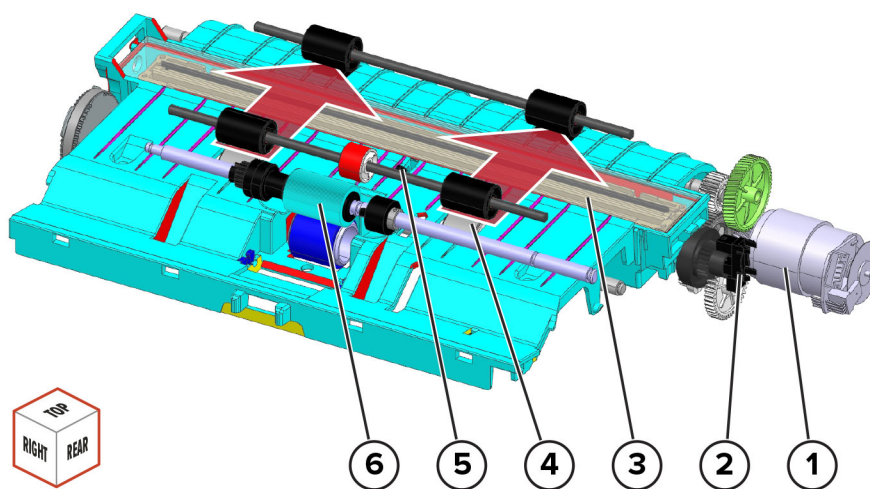

1	Motor (ADF transport)
2	Sensor (ADF calibration)
3	ADF CIS scanner
4	ADF feed/exit roller
5	Sensor (ADF scan 2)
6	ADF feed roller

As paper enters the ADF, the ADF feed/exit roller receives it. The sensor (ADF scan 2) detects the paper to begin the scan. The ADF CIS scanner scans the back side of the document.

The motor (ADF transport) drives the ADF feed/exit roller.

Note: If needed, calibration for the ADF CIS scanner occurs automatically before a job to adjust shading levels. During calibration, the ADF CIS scanner moves laterally to scan a reference white surface on the opposite side. The ADF CIS scanner is detected at its home position by the sensor (ADF calibration).

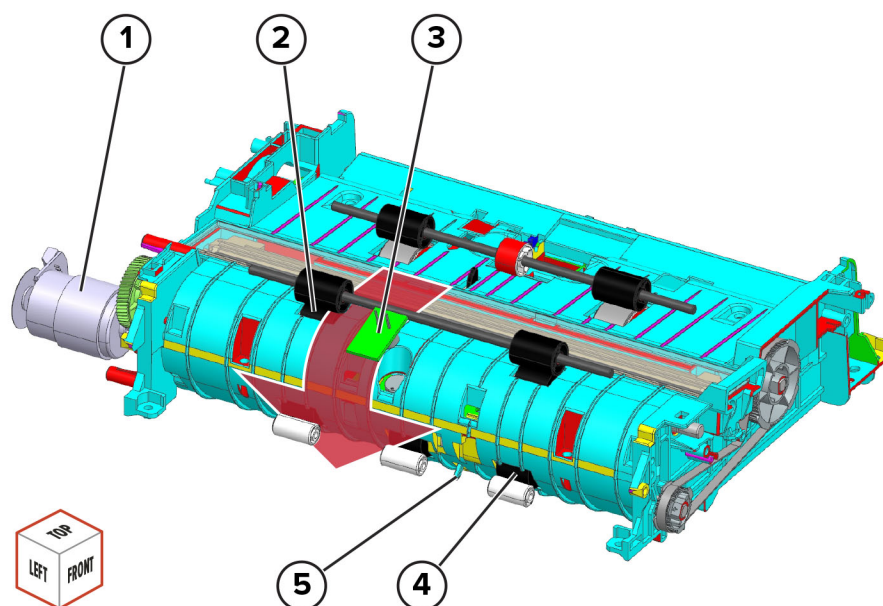

1	Motor (ADF transport)
2	ADF transport roller
3	Sensor (ADF multifeed)
4	ADF scan roller
5	Sensor (ADF scan 1)

After the back side is scanned, the ADF transport roller transports paper to the ADF scan roller. At this point, the sensor (ADF multifeed) detects if the document has multiple sheets.

The motor (ADF transport) drives the ADF transport and scan rollers.

Multifeed detection

Note: Multifeed detection is supported only in some printer models.

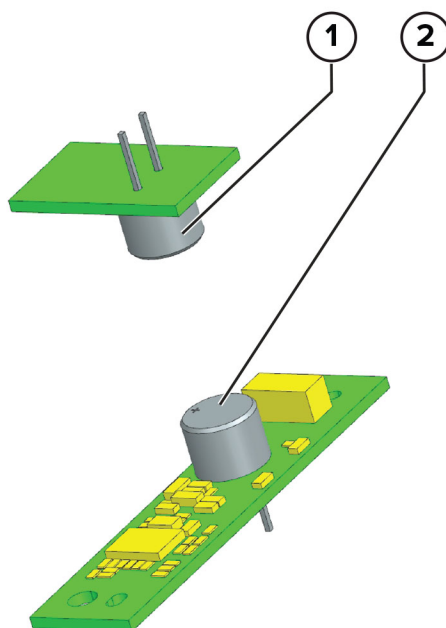

1	Transmitter
2	Receiver

The sensor (ADF multifeed) consists of a transmitter and a receiver. The sensor detects the presence of an air gap between sheets of paper passing between the transmitter and receiver. The transmitter emits an ultrasonic frequency in the direction of the receiver. The signal that arrives at the receiver drops to nearly nothing when multiple sheets are in the path.

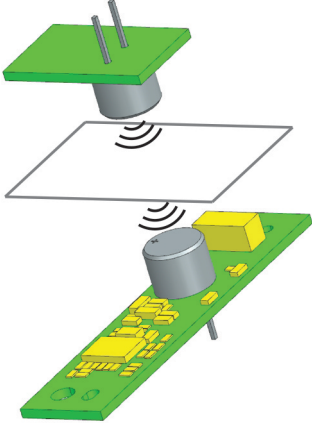
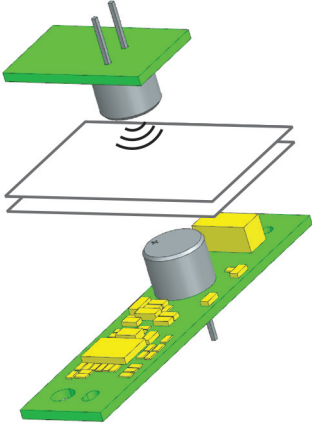
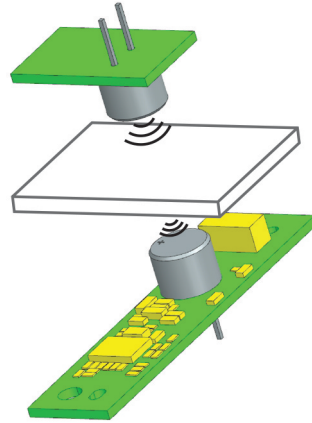
<p>Single sheet (normal)</p>	 <p>The diagram shows a green PCB with a yellow component and a grey cylindrical component. A white sheet is positioned between the PCB and a green top plate. The top plate has two silver pins. The PCB is mounted on a grey base. The white sheet is shown with a wavy line indicating its position relative to the PCB and the top plate.</p>
<p>Multiple sheets</p>	 <p>The diagram shows a green PCB with a yellow component and a grey cylindrical component. Two white sheets are positioned between the PCB and a green top plate. The top plate has two silver pins. The PCB is mounted on a grey base. The two white sheets are shown with a wavy line indicating their position relative to the PCB and the top plate.</p>
<p>Single sheet (thick)</p>	 <p>The diagram shows a green PCB with a yellow component and a grey cylindrical component. A single thick white sheet is positioned between the PCB and a green top plate. The top plate has two silver pins. The PCB is mounted on a grey base. The thick white sheet is shown with a wavy line indicating its position relative to the PCB and the top plate.</p>

ADF exit drive

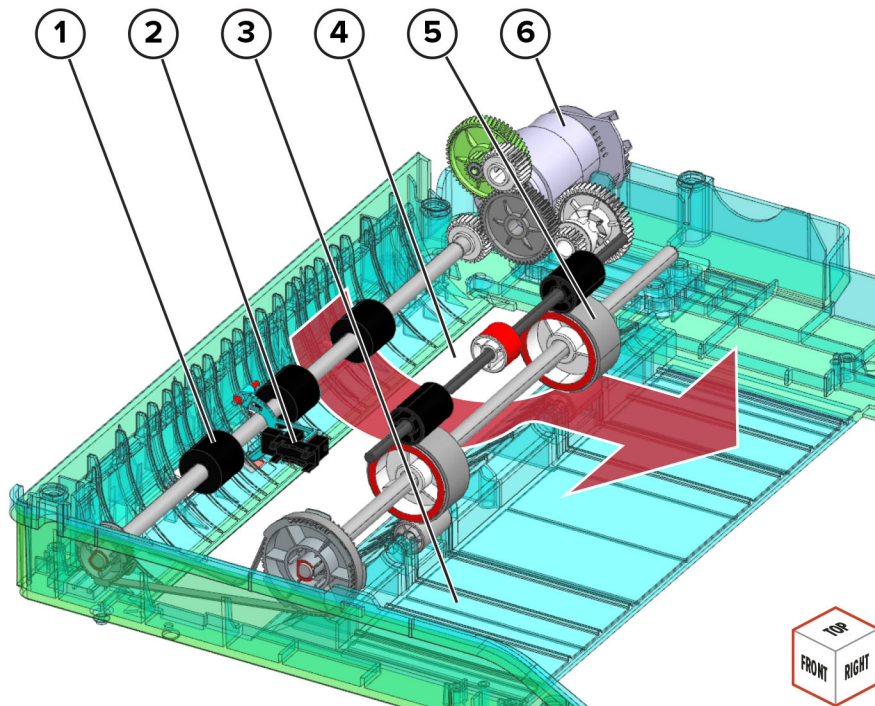

1	ADF scan roller
2	Sensor (ADF scan 1)
3	ADF bin
4	ADF glass
5	ADF feed/exit roller
6	Motor (ADF transport)

Paper is fed to the ADF scan roller for front-side scanning. At the ADF glass area, the flatbed scanner does the scan. The ADF feed/exit roller ejects the scanned document to the ADF bin.

The motor (ADF transport) drives the scan and exit rollers. The sensor (ADF scan 1) detects the paper entering the ADF glass area.

Index

A

- additional input tray diagnostics
 - motor tests 345
- additional input trays adjustments/tests
 - sensor tests 344
- ADF maintenance counter
 - printer maintenance counter reset 0
- ADF maintenance kit
 - resetting the counter 0
- ADF pick roller
 - cleaning 560
- ADF rollers
 - cleaning 560
- ADF separator roller
 - cleaning 560
- ADF skew check
 - troubleshooting 90
- ADF theory
 - double-feed detection 635
 - exit drive 639
 - paper path 633
 - paper path sensors 633
 - pick and feed drive 634
 - transport and scan drive 635
- adjustment
 - ADF registration 373
 - flatbed registration 373
 - printhead 367
 - registration adjustment 369
 - TPS characterization data entry 373
- advanced print quality samples 325
- attaching cables 538
- available internal options 607
- avoiding paper jams 95

B

- blurred print 74

C

- change history 21
- charge 611
- clean/erase 611
- cleaning
 - exterior of the printer 552
 - interior of the printer 552
 - pick tires 556
 - printhead lenses 563

- tray 1 duplex turnaround 564
- cleaning pick roller in the multipurpose feeder 557
- cleaning the ADF pick roller 560
- cleaning the ADF rollers 560
- cleaning the ADF separator roller 560
- cleaning the printer 552
- cleaning the scanner 554
- cleaning the touch screen 553
- configuration menu
 - accessing 346
 - scanner manual registration 372
- configurations
 - printer models 27
- configuring the door interlock bypass jumpers 321
- connectors
 - controller board 539
 - engine board 539
 - LVPS controller board 543
- control panel
 - using 321
- controller board
 - critical information 360
- controller board, restoring configuration 361

D

- dark image quality 87
- data security notice 357
- develop 611
- diagnostics menu
 - accessing 323
 - controller calibration 331
 - feed test 330
 - multifeed calibration 330
 - scanner calibration reset 331

E

- electrostatic-sensitive parts 360
- embedded solutions 366
- emission notices 605
- engine board
 - critical information 360
- EP process 611
 - charge 611
 - clean/erase 611
 - develop 611
 - expose 611
 - first transfer 611
 - fuser 611

- second transfer 611
 - error codes
 - 100 error messages 236
 - 101 error messages 237
 - 11 206
 - 110 error messages 238
 - 12 206
 - 120 error messages 240
 - 121 error messages 242
 - 126 error messages 245
 - 127 error messages 245
 - 142 error messages 247
 - 145 error messages 249
 - 147 error messages 250
 - 149 error messages 252
 - 150 error messages 253
 - 151 error messages 254
 - 153 error messages 256
 - 160 error messages 257
 - 161 error messages 258
 - 162 error messages 259
 - 163 error messages 259
 - 164 error messages 259
 - 165 error messages 259
 - 166 error messages 262
 - 167 error messages 262
 - 168 error messages 262
 - 169 error messages 262
 - 17y error messages 263
 - 200 paper jam messages 98
 - 201 paper jam messages 106
 - 202 paper jam messages 107
 - 221 paper jam messages 116
 - 230 paper jam messages 121
 - 231 paper jam messages 126
 - 232 paper jam messages 133
 - 240 paper jam messages 139
 - 241 paper jam messages 153
 - 242 paper jam messages 162
 - 243 paper jam messages 165
 - 244 paper jam messages 167
 - 42 218
 - 600 error messages 265
 - 602 error messages 265
 - 611 error messages 265
 - 621 error messages 265
 - 647 error messages 265
 - 649 error messages 265
 - 650 error messages 265
 - 653 error messages 265
 - 660 error messages 265
 - 661 error messages 265
 - 662 error messages 269
 - 663 error messages 269
 - 664 error messages 269
 - 665 error messages 269
 - 666 error messages 269
 - 667 error messages 269
 - 668 error messages 269
 - 669 error messages 269
 - 8 202
 - 840 error messages 273
 - 842 error messages 273
 - 843 error messages 273
 - 845 error messages 273
 - 912 error messages 288
 - 938 error messages 288
 - 941 error messages 288
 - 950 error messages 288
 - 953 error messages 288
 - 958 error messages 288
 - 980 error messages 288
 - 981 error messages 288
 - 982 error messages 288
 - 983 error messages 288
 - 984 error messages 288
 - 985 error messages 288
 - 992 error messages 288
 - ESD-sensitive parts 360
 - eSF solutions 366
 - Ethernet cable 538
 - Ethernet port 538
 - event log
 - display log 343
 - mark log 344
 - print log 343
 - print log summary 343
 - expose 611
- ## F
- fax error log codes 314
 - fax issue, escalating 318
 - finding the printer serial number 27
 - firmware card 607
 - first transfer 611
 - format fax storage 325
 - fuser 611
- ## H
- humidity around the printer 606

I

indicator light
 understanding the status 321
 inspection guide 549
 internal options 607
 invalid code, fixing 351
 invalid engine mode
 accessing 351

J

jam areas
 locating 96
 jams, paper
 avoiding 95

L

letterhead
 selecting 29
 locating jam areas 96
 locations
 motor 548
 sensor 545

M

maintenance counter
 printer maintenance counter reset 0
 transfer module reset 552
 maintenance kit
 resetting the counter 0
 maintenance kits 549
 media damage (using the ADF) 92
 menu
 Configuration Menu 346
 misaligned color 74
 moving the printer 604

N

noise emission levels 605
 Non-Lexmark supply 214
 notices 603, 604, 605

O

options
 firmware cards 607
 out of service erase 343

P

paper
 letterhead 29

preprinted forms 29
 selecting 27
 unacceptable 29
 paper characteristics 28
 paper guidelines 27
 paper jams
 28y 196
 avoiding 95
 paper sizes
 supported 30
 paper types
 supported 33
 paper weights
 supported 34
 parts catalog legend 566
 pick roller in the multipurpose feeder
 cleaning 557
 pick tires
 cleaning 556
 power cord socket 538
 preprinted forms
 selecting 29
 print cycle 610
 flowchart 610
 print engine layout 609
 print quality
 initial check 39
 print quality troubleshooting
 adf duplex service check 304
 adf feed errors service check 305
 ADF feed/exit drive service check 277
 ADF open service check 202
 ADF paper jam service check 198
 ADF top cover open service check 204
 blank or white pages 40
 blurred print 74
 colored background 48
 dark print 44
 fax reception service check 310
 fax transmission service check 308
 flatbed home position service check 276
 flatbed legal-size scan service check 313
 gapping or half color page 76
 ghost images 46
 horizontal colored lines or banding 49
 image void process direction 77
 image void scan direction 80
 light print 51
 misaligned color 74
 modem/fax card service check 307
 mottled print and dots 57
 random marks 86

- scanner communication failure service check 275
 - scanner disabled error service check 274
 - solid color or black image 65
 - text or images cut off 67
 - toner easily rubs off 69
 - uneven print density 70
 - vertical colored lines or banding 72
 - vertical white lines 72
 - printer
 - aligner drive 626
 - duplex drive 631
 - exit and redrive drive 630
 - fuser drive 628
 - isolation drive 625
 - minimum clearances 604
 - MPPF pick drive 623
 - paper path rollers 619
 - paper path sensors 621
 - selecting a location for 604
 - transfer drive 627
 - tray 1 pick drive 623
 - printer configurations 537
 - printer diagnostics
 - input tray quick print 344
 - printer diagnostics & adjustments
 - motor tests 338
 - sensor tests 333
 - universal override 342
 - printer diagnostics and adjustments
 - add-on cards tests 342
 - color alignment adjust 342
 - fuser temperature 342
 - memory tests 343
 - registration adjust 341
 - supply reset 342
 - weather station 342
 - printer messages
 - Non-Lexmark supply 214
 - printer models
 - configurations 27
 - printer ports 538
 - printer setup
 - engine setting [x] 332
 - EP setup 332
 - model name 332
 - permanent page count 331
 - printed page count (color) 331
 - printed page count (mono) 331
 - process ID 332
 - serial number 332
 - waste toner sensor calibration 332
 - printer status 321
 - printhead lenses
 - cleaning 563
- ## R
- recovery mode
 - accessing 352
 - removal
 - 550-sheet tray insert 500
 - ADF 517
 - ADF pick roller 514
 - ADF rollers 514
 - ADF separator roller 514
 - ADF tray 517
 - assembly drive 384
 - badge cover 429
 - bin cover 482
 - control panel base (10-inch) **O**
 - control panel base (7-inch) 447
 - control panel display (10-inch) 442
 - control panel display (7-inch) 444
 - control panel FFC 494
 - control panel hinge 448
 - control panel left arm 452
 - control panel rear cover 449
 - control panel right arm 452
 - controller board 478
 - controller board shield 474
 - developer hold down arm 498
 - diverter 439
 - duplex inner guide 466
 - duplex outer guide 470
 - engine board 479
 - exit roller 493
 - exit roller gear 492
 - façade cover 496
 - flatbed scanner 519
 - front door 425
 - front door cover 472
 - fuser 436
 - fuser fan 380
 - fuser interconnect cable 395
 - headphone and USB socket cables 405
 - imaging kit 399
 - ISD card 476
 - left cover 374
 - LVPS 377
 - LVPS cage 392
 - main fan 379
 - motor (BOR) 386
 - motor (CMY) 382
 - motor (deskew) 387
 - motor (EP drive) 382

- motor (exit/redrive) 390
 - motor (K/transfer belt) 382
 - motor cover 427
 - optional 550-sheet tray 536
 - pick roller 502
 - power cable 388
 - printhead 484
 - redrive guide 437
 - right cover 401
 - scanner cables 526
 - scanner front cover 429
 - scanner rear left cover 475
 - scanner rear right cover 475
 - sensor (bin full) 489
 - sensor (fuser buckle) 468
 - sensor (fuser nip) 441
 - sensor (input) 434
 - sensor (narrow media) 468
 - sensor (redrive) 439
 - speaker 450
 - tensioner belt 469
 - tilting the ADF and flatbed scanner 532
 - TMC card 409
 - toner door 402
 - toner door mount bracket 404
 - top cover 486
 - top frame base cover 483
 - top frame cover 483
 - TPM card 477
 - transfer module 431
 - transfer module retainer 431
 - tray rail 504
 - upper front door 484
 - usb cover 405
 - waste toner bottle 397
 - waste toner bottle idler gear 415
 - removal procedures
 - tips 374
 - removals
 - ADF left hinge 531
 - ADF right hinge 530
 - ADF top cover 528
 - aligner roller 458
 - Bin exit cover 496
 - bin flag 497
 - front door hinges 451
 - high voltage power supply (HVPS) 417
 - isolation unit 509
 - motor (duplex/MPF) 415
 - motor (fuser) 413
 - paper feeder 507
 - paper out actuator spring 508
 - pivot shaft 466
 - scanner glass pad 512
 - sensor (duplex staging) 467
 - sensor (MPF paper present) 420
 - sensor (paper size) 411
 - sensor (TPS) 422
 - sensor (waste toner) 420
 - sensor (weather station) 416
 - separator bracket 500
 - transfer module guide rail 455
 - reports
 - device settings 324
 - installed licenses 324
 - resetting
 - supply usage counters 214
 - resetting the printer
 - without admin credentials 37
 - resetting the supply usage counters 214
 - restoring
 - configuration file 364
 - license file 364
- ## S
- scan quality troubleshooting
 - ADF skew 90
 - black page copy service check 94
 - blank page copy service check 92
 - dark image 87
 - media damage (using the ADF) 92
 - spots 89
 - vertical lines 88
 - scanner
 - cleaning 554
 - scanner diagnostics
 - controller calibration 331
 - feed test 330
 - motor tests 325
 - multifeed calibration 330
 - scanner calibration reset 331
 - sensor test 327
 - scanner manual registration 372
 - scanner theory
 - flatbed 632
 - scheduled maintenance 549
 - second transfer 611
 - security reset jumper
 - using 38
 - selecting location
 - for the printer 604
 - sensor (TPS)
 - characterization data 423

- serial number, printer
 - finding 27
 - service checks troubleshooting
 - 900 service error messages 282
 - 901 service error messages 282
 - network service check 296
 - USB service check 296
 - service engineer (SE) menu
 - accessing 354
 - fax SE 355
 - general SE 354
 - network SE 354
 - scanner SE 356
 - spots 89
 - storing paper 29
 - supply reset
 - fuser reset 342
 - ITM reset 342
 - supply usage counters
 - resetting 214
 - supported paper sizes 30
 - supported paper types 33
 - supported paper weights 34
 - symptoms
 - printer 293
- T**
- temperature around the printer 606
 - theory
 - aligner drive 626
 - duplex drive 631
 - exit and redrive drive 630
 - fuser drive 628
 - isolation drive 625
 - MPF pick drive 623
 - printer paper path 619
 - printer paper path sensors 621
 - transfer drive 627
 - tray 1 pick drive 623
 - theory, ADF paper path 633
 - theory, ADF paper path sensors 633
 - theory, flatbed scanner 632
 - tools, required 34
 - touch screen
 - cleaning 553
 - troubleshooting
 - copy symptoms 303
 - fax symptoms 303
 - initial check 37
 - scan symptoms 303
 - troubleshooting, print quality
 - adf duplex service check 304
 - adf feed errors service check 305
 - ADF feed/exit drive service check 277
 - ADF paper jam service check 198
 - ADF top cover open service check 204
 - blank or white pages 40
 - blurred print 74
 - dark print 44
 - fax reception service check 310
 - fax transmission service check 308
 - flatbed home position service check 276
 - flatbed legal-size scan service check 313
 - gapping or half color page 76
 - ghost images 46
 - gray background 48
 - horizontal colored lines or banding 49
 - image void process direction 77
 - image void scan direction 80
 - light print 51
 - misaligned color 74
 - modem/fax card service check 307
 - mottled print and dots 57
 - random marks 86
 - scanner communication failure service check 275
 - scanner cover open service check 202
 - scanner disabled error service check 274
 - solid color or black image 65
 - text or images cut off 67
 - toner easily rubs off 69
 - uneven print density 70
 - vertical colored lines or banding 72
 - vertical white lines 72
 - troubleshooting, scan quality
 - ADF skew 90
 - black page copy service check 94
 - blank page copy service check 92
 - dark image 87
 - media damage (using the ADF) 92
 - spots 89
 - vertical lines 88
 - troubleshooting, service checks
 - 900 service error messages 282
 - 901 service error messages 282
 - network service check 296
 - USB service check 296
- U**
- updating the printer firmware
 - using a flash drive 365
 - using a network computer 365
 - USB cable 538
 - USB port 538

user attendance messages

- 31 user attendance error messages 208
- 32 user attendance error messages 212
- 33 user attendance error messages 214
- 43 user attendance error messages 220
- 55 user attendance error messages 221
- 58 user attendance error messages 221
- 59 user attendance error messages 221
- 61 user attendance error messages 224
- 62 user attendance error messages 224
- 63 user attendance error messages 224
- 64 user attendance error messages 224
- 66 user attendance error messages 224
- 71 user attendance error messages 224
- 72 user attendance error messages 224
- 80 user attendance error messages 228
- 82 user attendance error messages 229
- 84 user attendance error messages 230
- 88 user attendance error messages 231

using the control panel 321

V

vertical lines 88

Part number index

P/N	Part name	Page
40X0259	Brazil LV.....	601
40X0271	Hong Kong.....	601
40X0271	Singapore, Malaysia, Pakistan, Sri Lanka, Myanmar, Brunei, India.....	601
40X0271	UK, Saudi Arabia.....	601
40X0273	Chile, Uruguay.....	601
40X0275	Israel.....	601
40X0279	Philippines, Thailand.....	601
40X0288	Argentina.....	601
40X0297	Bolivia, Peru, Paraguay.....	601
40X0301	Australia, New Zealand	601
40X0303	PRC.....	601
40X1368	USB cable, 2 m.....	597
40X1767	Algeria, Austria, Benelux (Belgium, Luxembourg, Netherlands), Bosnia, Bulgaria, Croatia, Czech Republic, Egypt, Estonia, France, Germany, Greece, Hungary, Iceland, Italy, Latvia, Lithuania, Morocco, Poland, Portugal, Romania, Russia (CIS), Serbia, Slovakia, Spain, Turkey.....	601
40X1767	Indonesia, Vietnam, Cambodia, Laos.....	601
40X1772	Switzerland.....	601
40X1773	Bangladesh, Nepal, Bhutan.....	601
40X1773	South Africa.....	601
40X1774	Nordics.....	601
40X1791	Taiwan.....	601
40X1792	Korea.....	601
40X3609	Japan.....	601
40X4819	RS-232C serial interface card.....	597
40X7104	US, Canada, Latin America LV	601
40X7546	ADF right hinge.....	590
40X7911	Sensor (paper size).....	578
40X8149	Staple cartridge holder.....	594
40X8671	Cover kit, removable hard disk drive.....	597
40X9652	Adapter–Fiber gigabit ISP.....	597
40X9934	Hard disk drive, 320+ GB.....	597
41X0020	Serial ISP backpack kit.....	597

P/N	Part name	Page
41X0021	Parallel ISP backpack kit.....	597
41X0045	Keyboard.....	597
41X0268	550-sheet tray insert.....	578
41X0271	Optional 550-sheet tray.....	592
41X0357	Surge protective device, 110-120 V.....	597
41X0361	Optional 550-sheet tray insert.....	592
41X0370	Surge protective device, 220-240 V.....	597
41X0372	Tray rails.....	578
41X0373	Paper size sensor actuators.....	578
41X0374	Separator bracket.....	578, 592
41X0376	Duplex inner guide.....	584
41X0377	Pivot shaft.....	584
41X0378	Tensioner belt.....	584
41X0379	Guide springs.....	584
41X0380	Front door straps.....	568
41X0381	Motor (duplex/MPF).....	580
41X0384	Isolation unit.....	582
41X0385	Sensor (input).....	580, 586
41X0386	Aligner rollers.....	580
41X0387	Motor (deskew).....	582
41X0388	Redrive guide.....	582
41X0389	Diverter.....	582
41X0390	Exit roller.....	580
41X0391	Exit roller gear.....	580
41X0392	Motor (exit/redrive).....	580
41X0394	TMC Card.....	586
41X0395	Fuser drive gear.....	580
41X0397	Main fan.....	586
41X0398	Fuser fan.....	586
41X0400	Cable cover.....	584
41X0401	Tray indicator.....	568
41X0407	Duplex outer guide.....	584
41X0410	Bin extender.....	570
41X0424	Rear handle cover.....	568

P/N	Part name	Page
41X0435	Scanner rear right cover.....	570
41X0442	Front door cover.....	568
41X0446	Sensor (duplex staging).....	584
41X0447	Sensor (fuser buckle).....	584
41X0447	Sensor (narrow media).....	584
41X0486	Sensor (waste toner contact).....	586
41X0560	Front door bracket.....	568
41X0561	Control panel left arm.....	570
41X0562	Control panel right arm.....	570
41X0566	Sensor (MPF paper present).....	586
41X0567	Front door hinges.....	568
41X0570	Sensor (MPF/pass-through).....	582
41X0570	Sensor (redrive).....	582
41X0757	Waste toner bottle idler gear.....	580
41X0758	Aligner drivetrain kit.....	582
41X0764	Printer stand.....	596
41X0772	Bin flag.....	568
41X0774	Locking caster.....	596
41X0775	Nonlocking caster.....	596
41X0785	Sensor (weather station).....	586
41X0824	Static brush.....	584
41X0825	Support straps.....	578
41X0897	Developer hold down arm.....	582
41X0956	Pick roller.....	578, 592
41X1007	Cleaning kit.....	597
41X1083	Sensor (fuser nip).....	574
41X1872	MarkNet N8372 802.11 a/b/g/n/ac wireless print server.....	597
41X1907	Controller board shield.....	586
41X1945	MarkNet N8230 fiber ISP with side cover.....	597
41X2032	Rubber feet.....	568
41X2034	Paper out actuator spring.....	578
41X2543	MarkNet N8370 wireless print server.....	597
41X2689	Transfer module.....	576
41X2768	EP drive gearbox.....	582

P/N	Part name	Page
41X2777	HVPS.....	586
41X2794	LVPS, 110 V.....	586
41X2795	LVPS, 220 V.....	586
41X2825	Motor (BOR).....	580
41X2827	Right cover.....	568
41X2829	Scanner front cover.....	570
41X2830	Façade cover.....	570
41X2832	Sensor (TPS).....	586
41X2833	Transfer module retainer.....	576
41X2835	Control panel hinge.....	572
41X2837	USB cover.....	570
41X2844	Printhead.....	582
41X2845	ADF left hinge.....	590
41X2846	ADF top cover.....	590
41X2847	ADF tray.....	590
41X2848	ADF rollers.....	590, 599
41X2849	Flatbed scanner.....	590
41X2850	ADF.....	590
41X2853	Scanner glass pad.....	590
41X2854	Intelligent storage drive.....	597
41X2873	TPM card.....	597
41X2875	Controller board.....	586
41X2876	Engine board.....	586
41X2877	Controller power cable.....	586
41X2878	Print data cable.....	586
41X2880	Control panel display, 7-inch.....	572
41X2881	Control panel display, 10-inch.....	572
41X2883	Control panel (7-inch display) rear cover.....	572
41X2884	Control panel (10-inch display) rear cover.....	572
41X2889	Left cover.....	568
41X2897	Motor cover.....	568
41X2898	Top cover.....	570
41X2900	Transfer module guide rail.....	576
41X2918	Toner door with linkages.....	568

P/N	Part name	Page
41X2919	Upper front door (with cable).....	570
41X2930	Fuser, 115 V.....	574
41X2931	Fuser, 220 V.....	574
41X2932	Fuser, 100 V.....	574
41X3709	ADF and scanner cables.....	590
41X3882	Maintenance kit, 110 V.....	599
41X3883	Maintenance kit, 220 V.....	599
41X3884	Maintenance kit, 100 V.....	599
41X3895	Bin exit cover.....	568
41X3897	Bin cover.....	570
41X3898	Scanner rear left cover.....	570
41X4224	Speaker.....	570
41X4236	Convenience stapler.....	594
41X4237	Universal AC power adapter.....	594
41X4316	Badge cover.....	570
41X4450	Paper feeder.....	578
41X4460	Motor (fuser).....	580
41X4460	Motor (K/transfer belt).....	582
41X4461	Motor (CMY).....	582
41X4463	Left side cables.....	580
41X4464	Middle section cables.....	587
41X4465	Right side cables.....	587
41X4466	Control panel cables.....	572
41X4488	Sensor (waste toner).....	586
41X4511	Fuser, 115 V (narrow media; for CS/CX737 models only).....	574
41X4512	Maintenance kit, 115 V (narrow media; for CS/CX737 models only).....	599
41X4581	Engine board (for CS/CX737 models only).....	586
41X4916	Fax card.....	597

Part name index

P/N	Part name	Page
41X0268	550-sheet tray insert.....	578
40X9652	Adapter–Fiber gigabit ISP.....	597
41X2850	ADF.....	590
41X3709	ADF and scanner cables.....	590
41X2845	ADF left hinge.....	590
40X7546	ADF right hinge.....	590
41X2848	ADF rollers.....	590, 599
41X2846	ADF top cover.....	590
41X2847	ADF tray.....	590
40X1767	Algeria, Austria, Benelux (Belgium, Luxembourg, Netherlands), Bosnia, Bulgaria, Croatia, Czech Republic, Egypt, Estonia, France, Germany, Greece, Hungary, Iceland, Italy, Latvia, Lithuania, Morocco, Poland, Portugal, Romania, Russia (CIS), Serbia, Slovakia, Spain, Turkey.....	601
41X0758	Aligner drivetrain kit.....	582
41X0386	Aligner rollers.....	580
40X0288	Argentina.....	601
40X0301	Australia, New Zealand	601
41X4316	Badge cover.....	570
40X1773	Bangladesh, Nepal, Bhutan.....	601
41X3897	Bin cover.....	570
41X3895	Bin exit cover.....	568
41X0410	Bin extender.....	570
41X0772	Bin flag.....	568
40X0297	Bolivia, Peru, Paraguay.....	601
40X0259	Brazil LV.....	601
41X0400	Cable cover.....	584
40X0273	Chile, Uruguay.....	601
41X1007	Cleaning kit.....	597
41X2884	Control panel (10-inch display) rear cover.....	572
41X2883	Control panel (7-inch display) rear cover.....	572
41X4466	Control panel cables.....	572
41X2881	Control panel display, 10-inch.....	572
41X2880	Control panel display, 7-inch.....	572

P/N	Part name	Page
41X2835	Control panel hinge.....	572
41X0561	Control panel left arm.....	570
41X0562	Control panel right arm.....	570
41X2875	Controller board.....	586
41X1907	Controller board shield.....	586
41X2877	Controller power cable.....	586
41X4236	Convenience stapler.....	594
40X8671	Cover kit, removable hard disk drive.....	597
41X0897	Developer hold down arm.....	582
41X0389	Diverter.....	582
41X0376	Duplex inner guide.....	584
41X0407	Duplex outer guide.....	584
41X2876	Engine board.....	586
41X4581	Engine board (for CS/CX737 models only).....	586
41X2768	EP drive gearbox.....	582
41X0390	Exit roller.....	580
41X0391	Exit roller gear.....	580
41X2830	Façade cover.....	570
41X4916	Fax card.....	597
41X2849	Flatbed scanner.....	590
41X0560	Front door bracket.....	568
41X0442	Front door cover.....	568
41X0567	Front door hinges.....	568
41X0380	Front door straps.....	568
41X0395	Fuser drive gear.....	580
41X0398	Fuser fan.....	586
41X2932	Fuser, 100 V.....	574
41X2930	Fuser, 115 V.....	574
41X4511	Fuser, 115 V (narrow media; for CS/CX737 models only).....	574
41X2931	Fuser, 220 V.....	574
41X0379	Guide springs.....	584
40X9934	Hard disk drive, 320+ GB.....	597
40X0271	Hong Kong.....	601
41X2777	HVPS.....	586

P/N	Part name	Page
40X1767	Indonesia, Vietnam, Cambodia, Laos.....	601
41X2854	Intelligent storage drive.....	597
41X0384	Isolation unit.....	582
40X0275	Israel.....	601
40X3609	Japan.....	601
41X0045	Keyboard.....	597
40X1792	Korea.....	601
41X2889	Left cover.....	568
41X4463	Left side cables.....	580
41X0774	Locking caster.....	596
41X2794	LVPS, 110 V.....	586
41X2795	LVPS, 220 V.....	586
41X0397	Main fan.....	586
41X3884	Maintenance kit, 100 V.....	599
41X3882	Maintenance kit, 110 V.....	599
41X4512	Maintenance kit, 115 V (narrow media; for CS/CX737 models only).....	599
41X3883	Maintenance kit, 220 V.....	599
41X1945	MarkNet N8230 fiber ISP with side cover.....	597
41X2543	MarkNet N8370 wireless print server.....	597
41X1872	MarkNet N8372 802.11 a/b/g/n/ac wireless print server.....	597
41X4464	Middle section cables.....	587
41X2825	Motor (BOR).....	580
41X4461	Motor (CMY).....	582
41X0387	Motor (deskew).....	582
41X0381	Motor (duplex/MPF).....	580
41X0392	Motor (exit/redrive).....	580
41X4460	Motor (fuser).....	580
41X4460	Motor (K/transfer belt).....	582
41X2897	Motor cover.....	568
41X0775	Nonlocking caster.....	596
40X1774	Nordics.....	601
41X0271	Optional 550-sheet tray.....	592
41X0361	Optional 550-sheet tray insert.....	592
41X4450	Paper feeder.....	578

P/N	Part name	Page
41X2034	Paper out actuator spring.....	578
41X0373	Paper size sensor actuators.....	578
41X0021	Parallel ISP backpack kit.....	597
40X0279	Philippines, Thailand.....	601
41X0956	Pick roller.....	578, 592
41X0377	Pivot shaft.....	584
40X0303	PRC.....	601
41X2878	Print data cable.....	586
41X0764	Printer stand.....	596
41X2844	Printhead.....	582
41X0424	Rear handle cover.....	568
41X0388	Redrive guide.....	582
41X2827	Right cover.....	568
41X4465	Right side cables.....	587
40X4819	RS-232C serial interface card.....	597
41X2032	Rubber feet.....	568
41X2829	Scanner front cover.....	570
41X2853	Scanner glass pad.....	590
41X3898	Scanner rear left cover.....	570
41X0435	Scanner rear right cover.....	570
41X0446	Sensor (duplex staging).....	584
41X0447	Sensor (fuser buckle).....	584
41X1083	Sensor (fuser nip).....	574
41X0385	Sensor (input).....	580, 586
41X0566	Sensor (MPF paper present).....	586
41X0570	Sensor (MPF/pass-through).....	582
41X0447	Sensor (narrow media).....	584
40X7911	Sensor (paper size).....	578
41X0570	Sensor (redrive).....	582
41X2832	Sensor (TPS).....	586
41X0486	Sensor (waste toner contact).....	586
41X4488	Sensor (waste toner).....	586
41X0785	Sensor (weather station).....	586
41X0374	Separator bracket.....	578, 592

P/N	Part name	Page
41X0020	Serial ISP backpack kit.....	597
40X0271	Singapore, Malaysia, Pakistan, Sri Lanka, Myanmar, Brunei, India.....	601
40X1773	South Africa.....	601
41X4224	Speaker.....	570
40X8149	Staple cartridge holder.....	594
41X0824	Static brush.....	584
41X0825	Support straps.....	578
41X0357	Surge protective device, 110-120 V.....	597
41X0370	Surge protective device, 220-240 V.....	597
40X1772	Switzerland.....	601
40X1791	Taiwan.....	601
41X0378	Tensioner belt.....	584
41X0394	TMC Card.....	586
41X2918	Toner door with linkages.....	568
41X2898	Top cover.....	570
41X2873	TPM card.....	597
41X2689	Transfer module.....	576
41X2900	Transfer module guide rail.....	576
41X2833	Transfer module retainer.....	576
41X0401	Tray indicator.....	568
41X0372	Tray rails.....	578
40X0271	UK, Saudi Arabia.....	601
41X4237	Universal AC power adapter.....	594
41X2919	Upper front door (with cable).....	570
40X7104	US, Canada, Latin America LV	601
40X1368	USB cable, 2 m.....	597
41X2837	USB cover.....	570
41X0757	Waste toner bottle idler gear.....	580

CX730, CX735, CX737, XC4342, XC4352

WIRING DIAGRAM

