

Version 1.0  
January 2022  
702P08673

# Xerox® B305/B315 Multifunction Printer Service Manual

**Publication Information**

Product: Xerox® B305/B315 Multifunction Printer

Title: Xerox® B305/B315 Multifunction Printer Service Manual

Part Number: 702P08673

Publication Status: Launch release

Publication Date: January 2022

**Preparation Notes:**

Prepared for:

Xerox Corporation

800 Phillips Road

Webster, New York, 14580

**Copyright Statement:**

© 2022 Xerox Corporation. All Rights Reserved. Xerox®, and Xerox are trademarks of Xerox Corporation in the United States and/or other countries.

Registered Trademarks:

Other company trademarks are also acknowledged.

**NOTICE**

While every care has been taken in the preparation of this manual, no liability will be accepted by Xerox arising out of any inaccuracies or omissions.

All service documentation is supplied to Xerox external customers for informational purposes only. Xerox service documentation is intended for use by certified, product trained service personnel only. Xerox does not warrant or represent that it will notify or provide to such customer any future change to this documentation. Customer performed service of equipment, or modules, components or parts of such equipment may affect whether Xerox is responsible to fix machine defects under the warranty offered by Xerox with respect to such equipment. You should consult the applicable warranty for its terms regarding customer or third-party provided service.

# Table of Contents

1 Notices, Conventions, and Safety Information.....	9
Laser Notice.....	10
Avis Relatif À L'utilisation Du Laser .....	10
Aviso De Láser .....	10
Laser-hinweis .....	11
Avvertenza sui prodotti laser .....	11
Conventions.....	12
Conventions.....	12
Convenciones.....	12
Konventionen .....	13
Convenzioni .....	13
Safety Information .....	15
Consignes De Sécurité.....	15
Información De Seguridad.....	16
Sicherheitshinweise.....	17
Informazioni sulla sicurezza .....	18
Health and Safety Incident Reporting .....	20
2 Change History.....	23
January 2022.....	24
3 General Information .....	25
Printer Model Configurations .....	26
Locating the Printer Serial Number.....	27
Supported Paper Sizes, Types, and Weights .....	28
Supported Paper Sizes.....	28
Supported Paper Types .....	31
Supported Paper Weights.....	31
Tools Required For Service .....	32
4 Diagnostics and Troubleshooting.....	33
Troubleshooting Precautions .....	34
Précautions De Dépannage.....	34
Precauciones Durante La Solución De Problemas.....	35
Vorsichtsmaßnahmen Bei Der Fehlerbehebung .....	35
Precauzioni per gli interventi di riparazione .....	36
Troubleshooting Overview .....	38
Performing The Initial Troubleshooting Check .....	38
Using Safe Mode .....	38

## Table of Contents

Fixing Print Quality Issues .....	39
Supplies Used to Resolve Print Quality Issues .....	39
Gray Background or Toner Fog Check .....	39
Blank Page Check.....	41
Print Is Too Dark Check .....	43
Print Is Too Light Check.....	45
Paper Curl Check.....	47
Folded or Wrinkled Paper Check .....	48
Solid Black Pages Check .....	50
Skewed Print Check .....	52
Streaked Vertical Lines Appear On Prints During A Print Job Check .....	53
Streaked Vertical Lines Appear On Prints During A Copy Job Check.....	55
Horizontal Light Bands Check.....	57
Vertical Light Bands Check.....	58
Vertical Dark Bands Check.....	59
Vertical Dark Streaks With Print Missing Check .....	60
White Streaks and Voided Areas Check .....	62
Clipped Pages or Images Check .....	63
Incorrect Margins On Prints Check.....	65
Toner Rubs Off Check.....	65
Toner Specks Appear On Prints During A Print Job Check .....	67
Toner Specks Appear On Prints During A Copy Job Check .....	68
Repeating Defects Check .....	69
Paper Jams .....	72
200 Paper Jams .....	72
202 Paper Jams .....	80
232 Paper Jams .....	86
242 Paper Jams .....	88
280–295 Paper Jams .....	89
User Attendance Messages .....	94
Non-Xerox Supply .....	94
Metered Supply Installed in Printer Configured For Sold .....	94
User Attendance Messages.....	96
Unsupported or Unresponsive Toner Cartridge Service Check.....	98
Unsupported or Unresponsive Imaging Unit Service Check.....	99
Mismatched Supplies Error Service Check .....	100
Supplies Low Service Check .....	101
Printer Hardware Errors .....	102
111 Errors .....	102
121 Errors .....	103
126 Errors.....	106
140 Errors.....	108
162 Errors .....	109
6yy Errors .....	111
84y Errors .....	116
Procedure Before Starting The 9yy Service Checks.....	122
900 Errors .....	123
912 Errors.....	127

938–992 Errors .....	130
Other Symptoms.....	133
Base Printer Symptoms .....	133
Tray Near Empty Service Check.....	133
False Bin Full Error Service Check.....	134
5 Service Menus.....	135
Understanding The Printer Control Panel.....	136
Using The Control Panel.....	136
Understanding The Status Of The Indicator Light .....	136
Diagnostics Menu .....	137
Entering The Diagnostics Menu.....	137
Reports .....	137
Advanced Print Quality Samples.....	138
Format Fax Storage.....	138
Event Log.....	138
Input Tray Quick Print .....	139
Output Bin Quick Feed .....	139
Printer Setup.....	139
Printer Diagnostics & Adjustments .....	141
Scanner Diagnostics.....	143
Config Menu.....	146
Entering The Config Menu .....	146
Config Menu.....	146
Service Engineer (SE) Menu.....	151
Entering The SE Menu.....	151
Fax SE Menu .....	151
General SE Menu .....	152
Network SE Menu .....	152
Scanner SE Menu .....	153
EWS SE Menu .....	153
Entering Invalid Engine Mode .....	154
Entering Recovery Mode .....	155
For LED Display .....	155
For 2.8-inch Display.....	155
6 Parts Removal .....	157
Data Security Notice.....	158
Identifying Printer Memory.....	158
Erasing Printer Memory.....	158
Removal Precautions.....	159
Précautions De Retrait.....	159
Precauciones Durante La Extracción.....	160
Vorsichtsmaßnahmen Bei Der Demontage.....	160
Precauzioni per la rimozione.....	161

## Table of Contents

Handling ESD-sensitive Parts .....	161
Critical Information For Controller Board or Control Panel Replacement .....	162
Restoring The Printer Configuration After Replacing The Controller Board .....	163
Restoring Licenses and Configuration Settings .....	163
Updating The Printer Firmware .....	165
Ribbon Cable Connectors .....	167
Removal Procedures .....	169
Left Side Removals .....	170
Left Cover Removal .....	170
Main Drive Gears Removal .....	171
Imaging Unit Coupling Removal .....	175
Pick Roller Clutch Removal .....	175
Left Front Door Link Removal .....	177
Right Side Removals .....	179
Right Cover Removal .....	179
Controller Board Removal .....	181
LVPS Removal .....	182
HVPS Removal .....	183
Sensor (MPF Paper Present) Removal .....	185
Right Front Door Link Removal .....	185
MPF Solenoid Cable Removal .....	186
Main Fan Removal .....	187
Speaker Removal .....	188
Front Removals .....	189
Control Panel Removal .....	189
Upper Front Cover Removal .....	190
Front Door Removal .....	191
Transfer Roller Removal .....	192
MPF Pick Roller Removal .....	192
Pick Separator Roller Removal .....	193
Rear Removals .....	195
Rear Door Removal .....	195
Fuser Removal .....	196
Top Removals .....	198
Printhead Removal .....	198
Redrive Removal .....	199
Bin Full Sensor Actuator Removal .....	200
Bottom Removals .....	203
Duplex Guide Removal .....	203
ADF and Scanner Removals .....	206
ADF Cover Removal .....	206
ADF Tray Removal .....	206
ADF Separator Pad Removal .....	206
ADF and Scanner Removal .....	207
Scanner Pivot Arm Removal .....	209
Fax Card Removal .....	211

7 Component Locations.....	213
Printer Configuration .....	214
Controller Board Connectors.....	215
8 Maintenance .....	221
Cleaning Printer Parts.....	222
Cleaning The Printer .....	222
Cleaning The Scanner .....	222
9 Parts Catalog .....	225
Legend .....	226
Assembly 1: Covers .....	227
Assembly 2: Control Panel.....	229
Assembly 3: Electronics .....	230
Assembly 4: Gears.....	232
Assembly 5: Paper Path.....	233
Assembly 6: 550-sheet Optional Tray .....	235
Assembly 7: ADF and Scanner .....	236
10 Printer Specifications .....	239
Power Consumption .....	240
Product Power Consumption .....	240
Sleep Mode.....	240
Hibernate Mode.....	241
Off Mode.....	241
Total Energy Usage.....	241
Selecting A Location For The Printer .....	242
Noise Emission Levels.....	244
Temperature Information.....	245
11 Theory Of Operation.....	247
POR Sequence.....	248
Print Cycle Operation .....	249
Print Engine Layout.....	249
Print Cycle.....	250
Printer Operation .....	256
Printer Sections.....	256
Printer Paper Path.....	257
Printer Paper Path Sensors .....	259
Main Drive.....	260
Tray Drive .....	261
ADF Theory.....	262

## Table of Contents

<b>ADF Paper Path</b> .....	<b>262</b>
12 Part Number Index .....	263
13 Part Name Index.....	265
14 Wiring Diagram .....	267
<b>Wiring Diagram (B305/B315)</b> .....	<b>268</b>



# Notices, Conventions, and Safety Information

## Laser Notice

The printer is certified in the U.S. to conform to the requirements of DHHS 21 CFR, Chapter I, Subchapter J for Class I (1) laser products, and elsewhere is certified as a Class I laser product conforming to the requirements of IEC 60825-1: 2014.

Class I laser products are not considered to be hazardous. The laser system and printer are designed so there is never any human access to laser radiation above a Class I level during normal operation, user maintenance, or prescribed service conditions. The printer has a non-serviceable printhead assembly that contains a laser with the following specifications:

Class: IIIb (3b) AlGaInP

Nominal output power (milliwatts): 25

Wavelength (nanometers): 775–800

## Avis Relatif À L'utilisation Du Laser

Cette imprimante est certifiée conforme aux exigences de la réglementation des Etats-Unis relative aux produits laser de classe I (1) (DHHS 21 CFR, Chapitre I, Sous-chapitre J). Pour les autres pays, elle est certifiée conforme aux exigences des normes CEI 60825-1:2014 relatives aux produits laser de classe I.

Les produits laser de classe I ne sont pas considérés comme dangereux. Le système laser ainsi que l'imprimante ont été conçus de manière à ce que personne ne soit jamais exposé à des radiations laser dépassant le niveau de classe I dans le cadre d'un fonctionnement normal, de l'entretien par l'utilisateur ou de la maintenance. L'imprimante dispose d'un ensemble de têtes d'impression non réparable contenant un laser doté des caractéristiques suivantes:

Class: IIIb (3b) AlGaInP

Nominal output power (milliwatts): 25

Wavelength (nanometers): 775–800

## Aviso De Láser

Esta impresora se ha certificado en EE.UU. cumpliendo con los requisitos de DHHS 21 CFR, capítulo I, subcapítulo J para los productos láser de Clase I (1) y en otros países está certificada como un producto láser de Clase I de acuerdo con los requisitos de IEC 60825-1: 2014.

Los productos láser de Clase I no se consideran peligrosos. El sistema láser y la impresora se han diseñado para que el ser humano no acceda nunca a las radiaciones láser por encima del nivel de Clase I durante su uso normal, ni en tareas de mantenimiento o intervenciones de servicio técnico prescritas. El conjunto de cabezal de impresión de la impresora no se puede reparar y contiene un láser con las siguientes especificaciones:

Class: IIIb (3b) AlGaInP

Nominal output power (milliwatts): 25

Wavelength (nanometers): 775–800

## Laser-hinweis

Der Drucker wurde in den USA zertifiziert und entspricht den Anforderungen der Vorschriften DHHS21CFR KapitelI für Laserprodukte der KlasseI(1), andernorts ist er als Laserprodukt der KlasseI zertifiziert, das den Anforderungen von IEC60825-1 entspricht: 2014.

Laserprodukte der KlasseI werden nicht als gefährlich betrachtet. Das Lasersystem und der Drucker sind so konstruiert, dass unter normalen Betriebsbedingungen, bei der Wartung durch den Benutzer oder bei den vorgeschriebenen Wartungsbedingungen Menschen keiner Laserstrahlung ausgesetzt sind, die die Werte für KlasseI überschreitet. Der Drucker verfügt über eine Druckkopfeinheit, die nicht gewartet werden kann und mit einem Laser mit den folgenden Spezifikationen ausgestattet ist.

Class: IIIb (3b) AlGaInP

Nominal output power (milliwatts): 25

Wavelength (nanometers): 775–800

## Avvertenza sui prodotti laser

La stampante è certificata negli Stati Uniti come prodotto conforme ai requisiti DHHS 21 CFR Capitolo I, Sottocapitolo J per i prodotti laser di Classe I (1), mentre in altri paesi è certificata come prodotto laser di Classe I conforme ai requisiti IEC 60825-1: 2014.

I prodotti laser di Classe I non sono considerati pericolosi. Il sistema laser e la stampante sono stati progettati in modo da impedire l'esposizione a radiazioni laser superiori al livello previsto dalla Classe I durante le normali operazioni di stampa, manutenzione o assistenza. La stampante è dotata di un gruppo testina di stampa non riparabile che contiene un laser con le seguenti specifiche:

Classe: IIIb (3b) AlGaInP

Potenza di uscita nominale (milliwatt): 25

Lunghezza d'onda (nanometri): 775-800







## Conventions

**Note:** A *note* identifies information that could help you.

**Warning:** A *warning* identifies something that could damage the product hardware or software.

**CAUTION:** A *caution* indicates a potentially hazardous situation that could injure you.

Different types of caution statements include:

-  **CAUTION—POTENTIAL INJURY:** Indicates a risk of injury.
-  **CAUTION—SHOCK HAZARD:** Indicates a risk of electrical shock.
-  **CAUTION—HOT SURFACE:** Indicates a risk of burn if touched.
-  **CAUTION—TIPPING HAZARD:** Indicates a crush hazard.
-  **CAUTION—PINCH HAZARD:** Indicates a risk of being caught between moving parts.
-  **CAUTION—MOVING PARTS:** Indicates a risk of laceration or abrasion injuries from rotating parts.







## Conventions

**Remarque:** Une *Remarque* fournit des informations pouvant vous être utiles.

**Avertissement:** Un *Avertissement* signale un danger susceptible d'endommager le logiciel ou le matériel.

**ATTENTION:** La mention *Attention* vous signale un risque de blessure corporelle.

Il existe différentes mises en garde:

-  **ATTENTION ! DOMMAGE POTENTIEL :** Signale un risque de blessure.
-  **ATTENTION ! RISQUE D'ÉLECTROCUTION :** Signale un risque d'électrocution.
-  **ATTENTION ! SURFACE CHAUDE :** Signale un risque de brûlure de contact.
-  **ATTENTION ! RISQUE DE BASCULEMENT :** Signale un risque d'écrasement.
-  **ATTENTION ! RISQUE DE PINCEMENT :** Signale un risque de pincement entre des pièces mobiles.
-  **ATTENTION ! PIÈCES MOBILES :** Signale un risque de coupures ou de frottements à cause des pièces rotatives.







## Convenciones

**Nota:** Las *notas* señalan información que puede serle útil.

**Aviso:** Las *advertencias* indican algo que podría dañar el software o el hardware del producto.

**PRECAUCIÓN:** Las *precauciones* indican una situación de posible peligro que puede implicar lesiones para el usuario.

Estos son los tipos de avisos de precaución que existen:

-  **PRECAUCIÓN—RIESGO DE LESIONES:** Indica que existe riesgo de lesiones.
-  **PRECAUCIÓN—RIESGO DE DESCARGA:** Indica que existe riesgo de descarga eléctrica.
-  **PRECAUCIÓN—SUPERFICIE CALIENTE:** Indica que existe riesgo de sufrir quemaduras por contacto.
-  **PRECAUCIÓN—RIESGO DE CAÍDA:** Indica que existe peligro de aplastamiento.
-  **PRECAUCIÓN—RIESGO DE DESCARGA ELÉCTRICA:** Existe riesgo de atrapamiento entre las piezas en movimiento.
-  **PRECAUCIÓN—PARTES MÓVILES:** Indica que existe riesgo de lesiones por laceración o abrasión causadas por piezas giratorias.







## Konventionen

**Hinweis:** Ein *Hinweis* enthält nützliche Informationen.

**Warnung:** Durch eine *Warnung* werden Sie auf einen Umstand hingewiesen, durch den die Produkthardware oder -software beschädigt werden könnte.

**VORSICHT:** *Vorsicht* weist auf eine mögliche gefährliche Situation hin, die ein Verletzungsrisiko birgt.

Verschiedene Vorsichtshinweise:

-  **VORSICHT – VERLETZUNGSGEFAHR:** Weist auf ein Verletzungsrisiko hin.
-  **VORSICHT – STROMSCHLAGGEFAHR:** Weist auf das Risiko eines elektrischen Schlags hin.
-  **VORSICHT – HEISS:** Weist auf das Risiko von Verbrennungen bei Berührung hin.
-  **VORSICHT – KIPPGEFAHR:** Weist auf Quetschgefahr hin.
-  **VORSICHT – QUETSCHGEFAHR:** Weist auf das Risiko hin, zwischen beweglichen Komponenten eingequetscht zu werden.
-  **VORSICHT – BEWEGLICHE TEILE:** Weist auf das Risiko von Verletzungen und Abschürfungen durch sich drehende Teile hin.







## Convenzioni

**Nota:** Una *nota* identifica informazioni che potrebbero essere di aiuto.

**Avvertenza:** Un messaggio di *avvertenza* segnala qualcosa che potrebbe danneggiare l'hardware o il software del prodotto.

**ATTENZIONE:** Un messaggio di *attenzione* segnala una situazione potenzialmente pericolosa che potrebbe causare lesioni all'utente.

I diversi tipi di messaggi di attenzione sono:

-  **ATTENZIONE – PERICOLO DI LESIONI:** Indica il rischio di ferirsi.
-  **ATTENZIONE – PERICOLO DI SCOSSA ELETTRICA:** Indica il rischio di scosse elettriche.
-  **ATTENZIONE – SUPERFICIE SURRISCALDATA:**Indica il rischio di bruciarsi al contatto.
-  **ATTENZIONE – PERICOLO DI RIBALTAMENTO:** Indica il pericolo di essere schiacciati.
-  **ATTENZIONE – PERICOLO DI SCHIACCIAMENTO:** Indica il rischio di intrappolamento tra parti in movimento.
-  **ATTENZIONE – PARTI MOBILI:** Indica il rischio di lesioni da lacerazione o abrasione dovute a parti rotanti.

## Safety Information

- The safety of this product is based on testing and approvals of the original design and specific components. The manufacturer is not responsible for safety in the event of use of unauthorized replacement parts.
- The maintenance information for this product has been prepared for use by a professional service person and is not intended to be used by others.
- There may be an increased risk of electrical shock and personal injury during disassembly and servicing of this product. Professional service personnel should understand this risk and take necessary precautions.

 **CAUTION—SHOCK HAZARD:** When you see this symbol on the product, there is a danger from hazardous voltage in the area of the product where you are working. Unplug the product before you begin, or use caution if the product must receive power in order to perform the task.

 **CAUTION—POTENTIAL INJURY:** The lithium battery in this product is not intended to be replaced. There is a danger of explosion if a lithium battery is incorrectly replaced. Do not recharge, disassemble, or incinerate a lithium battery. Discard used lithium batteries according to the manufacturer's instructions and local regulations.

 **CAUTION—POTENTIAL INJURY:** To avoid the risk of fire or electrical shock, connect the power cord to an appropriately rated and properly grounded electrical outlet that is near the product and easily accessible.

 **CAUTION—POTENTIAL INJURY:** To avoid the risk of fire or electrical shock, use only the power cord provided with this product or the manufacturer's authorized replacement.







 **CAUTION—POTENTIAL INJURY:** Do not use this product with extension cords, multioutlet power strips, multioutlet extenders, or UPS devices. The power capacity of these types of accessories can be easily overloaded by a laser printer and may result in a risk of fire, property damage, or poor printer performance.

 **CAUTION—POTENTIAL INJURY:** Only a Xerox Inline Surge Protector that is properly connected between the printer and the power cord provided with the printer may be used with this product. The use of non-Xerox surge protection devices may result in a risk of fire, property damage, or poor printer performance.



 **CAUTION—POTENTIAL INJURY:** If the printer weight is greater than 20kg (44lb), then it may require two or more people to lift it safely.

## Consignes De Sécurité





- La sécurité de ce produit est basée sur des tests et certifications de sa conception d'origine et de ses composants spécifiques. Le fabricant décline toute responsabilité en cas d'utilisation de pièces de rechange non autorisées.
- Les informations de maintenance de ce produit sont destinées à des professionnels qualifiés et ne sont pas conçues pour être utilisées par d'autres personnes.
- Il existe un risque potentiel de choc électrique et de blessures lors du démontage et de la maintenance de ce produit. Le personnel professionnel de maintenance doit comprendre les risques et prendre les précautions nécessaires.

-  **ATTENTION ! RISQUE D'ÉLECTROCUTION :** Ce symbole indique un danger lié à des niveaux de tension dangereux dans la zone du produit à manipuler. Débranchez le produit avant de commencer, ou agissez avec prudence si le produit doit être alimenté pour effectuer l'opération.
-  **ATTENTION ! DOMMAGE POTENTIEL :** La batterie lithium de ce produit n'est pas destinée à être remplacée. Si vous ne respectez pas les instructions de remplacement de la batterie, vous risquez de provoquer une explosion. Ne rechargez pas, ne désassemblez pas et ne brûlez pas la batterie au lithium. Mettez les batteries lithium usagées au rebut selon les instructions du fabricant et les réglementations locales.
-  **ATTENTION ! DOMMAGE POTENTIEL :** Pour éviter tout risque d'électrocution ou d'incendie, branchez le câble d'alimentation directement à une prise électrique répondant aux exigences requises et correctement mise à la terre, proche du produit et facile d'accès.
-  **ATTENTION ! DOMMAGE POTENTIEL :** Pour éviter tout risque d'incendie ou d'électrocution, utilisez uniquement le câble d'alimentation fourni avec ce produit ou un câble de remplacement autorisé par le fabricant.
-  **ATTENTION ! DOMMAGE POTENTIEL :** Ce produit ne doit pas être utilisé avec des rallonges, des barres multiprises, des rallonges multiprises ou des périphériques UPS. La capacité de ces types d'accessoires peut être facilement dépassée par une imprimante laser, d'où un risque de dégâts matériels, d'incendie ou de performances d'impression amoindries.
-  **ATTENTION ! DOMMAGE POTENTIEL :** Utilisez uniquement un parasurtenseur correctement raccordé à l'imprimante et au câble d'alimentation fourni avec la machine. L'utilisation de parasurtenseurs non fabriqués par Xerox comporte un risque d'incendie et de dégâts matériels, et peut amoindrir les performances de l'imprimante.
-  **ATTENTION ! DOMMAGE POTENTIEL :** Si votre imprimante pèse plus de 20kg (44lb), l'intervention d'au moins deux personnes est nécessaire pour la soulever sans risque.





## Información De Seguridad



- La seguridad de este producto se basa en las pruebas y comprobaciones del diseño original y los componentes específicos. El fabricante no se hace responsable de la seguridad en caso de uso de piezas de repuesto no autorizadas.
- La información de mantenimiento de este producto se ha preparado para su uso por parte de un profesional de asistencia técnica y no está diseñada para su uso por parte de otros usuarios.
- Es posible que haya un mayor riesgo de descarga eléctrica y daños personales durante el desmontaje y el mantenimiento de este producto. El personal de asistencia profesional debe conocer este riesgo y tomar las precauciones necesarias.
-  **PRECAUCIÓN—RIESGO DE DESCARGA:** Cuando vea este símbolo en el producto, existe peligro de tensiones peligrosas en el área del producto en la que está trabajando. Desconecte el producto antes de empezar o tenga cuidado si el producto debe recibir alimentación a fin de realizar la tarea.
-  **PRECAUCIÓN—RIESGO DE LESIONES:** La batería de litio de este producto no debe reemplazarse. Existe riesgo de explosión si se sustituye incorrectamente una batería de litio. No recargue, desmonte ni incinere una batería de litio. Deseche las baterías de litio usadas según las instrucciones del fabricante y las normativas locales.









-  **PRECAUCIÓN—RIESGO DE LESIONES:** Para evitar el riesgo de incendio o descarga eléctrica, conecte el cable de alimentación a una toma de corriente debidamente conectada a tierra con la potencia adecuada que se encuentre cerca del dispositivo y resulte fácilmente accesible.
-  **PRECAUCIÓN—RIESGO DE LESIONES:** Para evitar el riesgo de incendio o descarga eléctrica, utilice exclusivamente el cable de alimentación que se suministra junto con este producto o el repuesto autorizado por el fabricante.
-  **PRECAUCIÓN—RIESGO DE LESIONES:** No utilice este producto con cables alargadores, regletas de varias tomas, cables alargadores de varias tomas o sistemas de alimentación ininterrumpida. La potencia de este tipo de accesorios puede sobrecargarse fácilmente si se utiliza una impresora láser, lo que puede dar lugar a que el rendimiento de la impresora sea bajo, a daños materiales o a posibles incendios.
-  **PRECAUCIÓN—RIESGO DE LESIONES:** Solo debe usarse con este producto un protector de sobretensión insertable Xerox debidamente conectado entre la impresora y el cable de alimentación que con ella se suministra. El uso de protectores de sobretensión de marcas distintas a Xerox puede dar lugar a que el rendimiento de la impresora sea bajo, a daños materiales o a posibles incendios.
-  **PRECAUCIÓN—RIESGO DE LESIONES:** si el peso de la impresora es superior a 20kg (44lb), pueden ser necesarias dos o más personas para levantarla de forma segura.

## Sicherheitshinweise

- Die Sicherheit dieses Produkts basiert auf Tests und Zulassungen des Originaldesigns und der spezifischen Komponenten. Sofern nicht autorisierte Ersatzteile eingesetzt werden, übernimmt der Hersteller keinerlei Verantwortung in Bezug auf die Sicherheit dieses Produkts.
- Die Wartungsinformationen für dieses Produkt wurden für ausgebildete Servicemitarbeiter zusammengestellt und dürfen nicht von anderen verwendet werden.
- Möglicherweise besteht bei der Demontage und Wartung dieses Produkts eine erhöhte Stromschlag- und Verletzungsgefahr. Ausgebildete Servicemitarbeiter sollten sich dieser Gefahr bewusst sein und die notwendigen Vorsichtsmaßnahmen ergreifen.
-  **VORSICHT – STROMSCHLAGEFAHR:** Wenn Sie dieses Symbol sehen, besteht eine Gefahr durch gefährliche Spannungen in dem Produktbereich, in dem Sie arbeiten. Trennen Sie das Produkt von seiner Stromverbindung, bevor Sie beginnen, oder gehen Sie vorsichtig vor, wenn das Produkt für die Durchführung der Aufgabe mit Strom versorgt werden muss.
-  **VORSICHT – VERLETZUNGSGEFAHR:** Die Lithiumbatterie in diesem Produkt darf nicht ausgetauscht werden. Wird eine Lithiumbatterie nicht ordnungsgemäß ausgetauscht, besteht Explosionsgefahr. Lithiumbatterien dürfen auf keinen Fall wieder aufgeladen, auseinander genommen oder verbrannt werden. Befolgen Sie zum Entsorgen verbrauchter Lithiumbatterien die Anweisungen des Herstellers und die örtlichen Bestimmungen.
-  **VORSICHT – VERLETZUNGSGEFAHR:** Um Feuer- und Stromschlaggefahr zu vermeiden, schließen Sie das Netzkabel direkt an eine ordnungsgemäß geerdete Steckdose an, die sich in der Nähe des Geräts befindet und leicht zugänglich ist.
-  **VORSICHT – VERLETZUNGSGEFAHR:** Um das Risiko eines Feuers oder elektrischen Schlags zu vermeiden, verwenden Sie ausschließlich das diesem Produkt beiliegende Netzkabel bzw. ein durch den Hersteller zugelassenes Ersatzkabel.

-  **VORSICHT – VERLETZUNGSGEFAHR:** Verwenden Sie das Produkt nicht mit Verlängerungskabeln, Mehrfachsteckdosen, Mehrfachverlängerungen oder Geräten für unterbrechungsfreie Stromversorgung. Die Belastbarkeit solcher Zubehörteile kann durch Laserdrucker schnell überschritten werden, was zu Brandgefahr, Beschädigung von Eigentum oder einer eingeschränkten Druckerleistung führen kann.
-  **VORSICHT – VERLETZUNGSGEFAHR:** Mit diesem Produkt darf nur ein Xerox Inline Surge Protector verwendet werden, der vorschriftsgemäß zwischen dem Drucker und dem mitgelieferten Netzkabel angeschlossen ist. Die Verwendung von nicht von Xerox stammenden Überspannungsschutzgeräten kann zu Brandgefahr, Beschädigung von Eigentum oder einer eingeschränkten Druckerleistung führen.
-  **VORSICHT – VERLETZUNGSGEFAHR:** Wenn der Drucker mehr als 20kg wiegt, sind zum sicheren Anheben mindestens zwei Personen notwendig.

## Informazioni sulla sicurezza

- La sicurezza di questo prodotto è basata sul collaudo e le approvazioni del progetto tecnico originale e di specifici componenti. Il produttore non è responsabile per la sicurezza in caso di utilizzo di parti di ricambio non autorizzate.
- Le informazioni sulla manutenzione di questo prodotto sono rivolte esclusivamente a personale di manutenzione e assistenza specializzato.
- L'intervento di smontaggio e manutenzione/riparazione di questo dispositivo potrebbe comportare un maggiore rischio di scossa elettrica o lesioni personali. Il personale di assistenza specializzato deve essere consapevole di tale rischio e assumere le necessarie precauzioni.
-  **ATTENZIONE – PERICOLO DI SCOSSA ELETTRICA:** La presenza di questo simbolo sul prodotto significa che è presente tensione pericolosa nell'area del prodotto su cui si sta lavorando. Scollegare il prodotto prima di iniziare, o prestare cautela se l'intervento richiede che il prodotto debba ricevere alimentazione.
-  **ATTENZIONE – PERICOLO DI LESIONI:** La batteria al litio presente nel prodotto non deve essere sostituita. In caso di sostituzione errata della batteria al litio, potrebbe verificarsi un'esplosione. Non ricaricare, smontare o bruciare batterie al litio. Smaltire le batterie al litio usate seguendo le istruzioni del produttore e le norme locali.
-  **ATTENZIONE – PERICOLO DI LESIONI:** Per evitare il rischio di incendio o scosse elettriche, collegare il cavo di alimentazione a una presa elettrica dotata di messa a terra e con le specifiche adeguate, situata in prossimità del prodotto e facilmente accessibile.
-  **ATTENZIONE – PERICOLO DI LESIONI:** Per evitare il rischio di incendi o scosse elettriche, utilizzare solo il cavo di alimentazione fornito con il prodotto o componenti sostitutivi autorizzati dal produttore.
-  **ATTENZIONE – PERICOLO DI LESIONI:** Non utilizzare il prodotto con cavi di prolunga, prese multiple, prolunghe multipresa o gruppi di continuità. La capacità di potenza di questi tipi di accessori può essere facilmente sovraccaricata da una stampante laser e può comportare incendi, danni o scarse prestazioni della stampante.
-  **ATTENZIONE – PERICOLO DI LESIONI:** Con questo prodotto può essere utilizzato solo un protettore di sovratensione in linea Xerox fornito con la stampante, correttamente collegato alla stampante e al cavo di alimentazione. L'utilizzo di protettori di sovratensione non Xerox può comportare il rischio di incendi, danni o scarse prestazioni della stampante.



**ATTENZIONE – PERICOLO DI LESIONI:** Se la stampante pesa più di 20 kg (44 lb), potrebbe richiedere due o più persone per essere sollevata in modo sicuro.

# Health and Safety Incident Reporting

## I. Summary

This section defines requirements for notification of health and safety incidents involving Xerox products (equipment and materials) at customer locations.

## II. Scope

Xerox Corporation and subsidiaries worldwide.

## III. Objective

To enable prompt resolution of health and safety incidents involving Xerox products and to ensure Xerox regulatory compliance.

## IV. Definitions

Incident:

An event or condition occurring in a customer account that has resulted in injury, illness or property damage. Examples of incidents include machine fires, smoke generation, physical injury to an operator or service representative. Alleged events and product conditions are included in this definition.

## V. Requirements

Initial Report:

1. Xerox organizations shall establish a process for individuals to report product incidents to Xerox Environment Health and Safety within 24 hours of becoming aware of the event.
2. The information to be provided at the time of reporting is contained in Appendix A (Health and Safety Incident Report involving a Xerox product).
3. The initial notification may be made by the method that follows:
  - Email Xerox EH&S at: [usa.product.incident@xerox.com](mailto:usa.product.incident@xerox.com).
  - Fax Xerox EH&S at: 585-422-2249.



**Note:** If sending a fax, please also send the original via internal mail.

Responsibilities for resolution:

1. Business Groups/Product Design Teams responsible for the product involved in the incident shall:
  - a. Manage field bulletins, customer correspondence, product recalls, safety retrofits.
  - b. Fund all field retrofits.
2. Field Service Operations shall:
  - a. Preserve the Xerox product involved and the scene of the incident inclusive of any associated equipment located in the vicinity of the incident.
  - b. Return any affected equipment/part(s) to the location designated by Xerox EH&S and/or the Business Division.
  - c. Implement all safety retrofits.
3. Xerox EH&S shall:
  - a. Manage and report all incident investigation activities.
  - b. Review and approve proposed product corrective actions and retrofits, if necessary.
  - c. Manage all communications and correspondence with government agencies.
  - d. Define actions to correct confirmed incidents.

## VI. Appendices

The Health and Safety Incident Report involving a Xerox Product (Form # EH&S-700) is available in the following location:

- [GSN Library 1789](#)



# Change History

Change History

## January 2022

This is the launch version of the service manual.



# General Information

## Printer Model Configurations

The Xerox B305 and B315 MFPs are small, monochrome, network-capable, laser printers.

Model	Configurations
B305	Network-ready monochrome laser four-in-one MFP with 2.8-inch touch screen, 40 ppm, 10/100 Ethernet, front USB, internal duplex printing, and simplex scanning for small workgroups.
B315	Network-ready monochrome laser four-in-one MFP with 2.8-inch touch screen, 42 ppm, wireless, Gigabit Ethernet, front USB, internal duplex printing, and duplex scanning for small workgroups.

## Locating the Printer Serial Number

Follow the below steps to locate the serial number of the printer.

1. Open the front door.

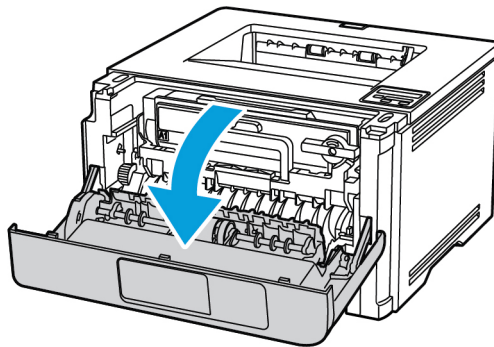
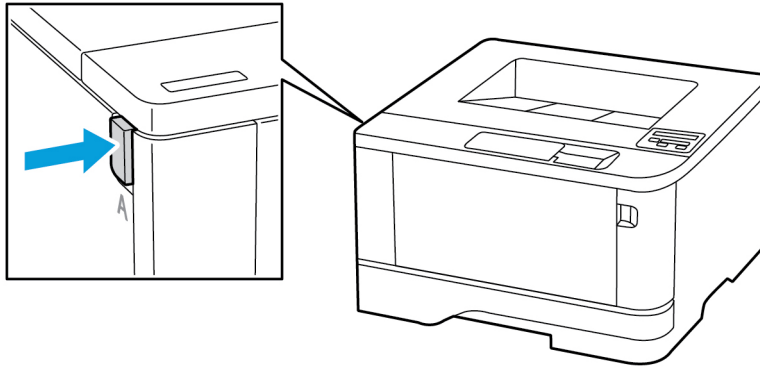

2. Locate the printer serial number behind the front door

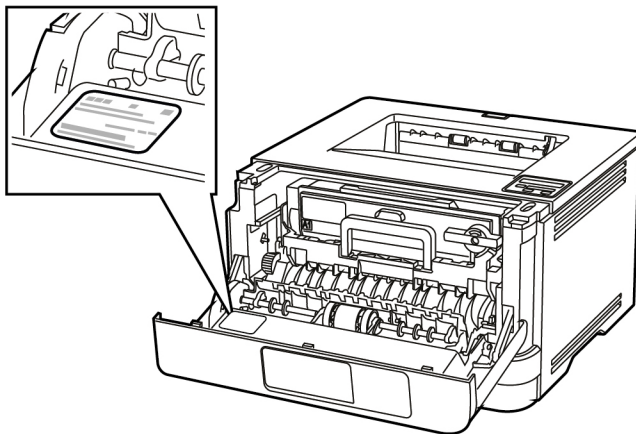

## Supported Paper Sizes, Types, and Weights

### Supported Paper Sizes

Paper size	Standard 250-sheet tray	Optional 550-sheet tray	Multipurpose feeder	Two-sided printing	Scanner	ADF
<b>A4</b> 210x297mm (8.27x11.7i-n.)	✓	✓	✓	✓	✓	✓
<b>A5 Portrait (SEF)</b> 148x210mm (5.83x8.27i-n.)	✓	✓	✓	X	✓	✓
<b>A5 Landscape (LEF)<sup>1</sup></b> 210x148mm (8.27x5.83i-n.)	✓	✓	✓	X	✓	✓
<b>A6</b> 105x148mm (4.13x5.83i-n.)	✓	✓	✓	X	✓	✓
<b>JIS B5</b> 182x257mm (7.17x10.1i-n.)	✓	✓	✓	X	✓	✓
<b>Oficio (Mexico)</b> 215.9x340.4-mm (8.5x13.4in.)	✓	✓	✓	✓	X	✓
<b>Hagaki</b> 100x148mm (3.94x5.83i-n.)	✓	X	✓	X	✓	X

Paper size	Standard 250-sheet tray	Optional 550-sheet tray	Multipurpose feeder	Two-sided printing	Scanner	ADF
<b>Statement</b> 139.7x215.9-mm (5.5x8.5in.)	✓	✓	✓	X	✓	✓
<b>Executive</b> 184.2x266.7-mm (7.25x10.5in.)	✓	✓	✓	X	✓	✓
<b>Letter</b> 215.9x279.4-mm (8.5x11in.)	✓	✓	✓	✓	✓	✓
<b>Legal</b> 215.9x355.6-mm (8.5x14in.)	✓	✓	✓	✓	X	✓
<b>Folio</b> 215.9x330.2-mm (8.5x13in.)	✓	✓	✓	✓	X	✓
<b>Universal<sup>3</sup></b> 99x148mm to 215.9x359.9-2mm (3.9x5.83in. to 8.5x14.17in.)	✓	✓	✓	✓ <sub>2</sub>	X	✓
<b>73/4 Envelope</b> 98.4x190.5-mm (3.875x7.5in.)	X	X	✓	X	✓	X
<b>9Envelope</b>	X	X	✓	X	✓	X

## General Information

Paper size	Standard 250-sheet tray	Optional 550-sheet tray	Multipurpose feeder	Two-sided printing	Scanner	ADF
98.4x225.4-mm (3.875x8.9in.)						
<b>10Envelope</b> 104.8x241.3-mm (4.12x9.5in.)	X	X	✓	X	✓	X
<b>DLEnvelope</b> 110x220mm (4.33x8.66in.)	X	X	✓	X	✓	X
<b>C5Envelope</b> 162x229mm (6.38x9.01in.)	X	X	✓	X	✓	X
<b>B5Envelope</b> 176x250mm (6.93x9.84in.)	X	X	✓	X	✓	X
<b>OtherEnvelope</b> 98.4x162mm to 176x250mm (3.87x6.38in. to 6.93x9.84in.)	X	X	✓	X	✓	X
<p><sup>1</sup> The default support is long-edge feed.</p> <p><sup>2</sup> Paper must at least be 210mm (8.27in.) wide and 279.4mm (11in.) long for two-sided printing.</p> <p><sup>3</sup> When Universal is selected, the page is formatted for 215.90x355.60mm (8.5x14in.) unless specified by the application.</p>						

## Supported Paper Types

Paper type	Standard 250-sheet tray	Optional 550-sheet tray	Multipurpose feeder	Two-sided printing	Automatic document feeder
Plain paper	✓	✓	✓	✓	✓
Card stock	X	X	✓	X	X
Recycled	✓	✓	✓	✓	X
Paper labels*	✓	✓	✓	X	X
Bond	✓	✓	✓	✓	X
Letterhead	✓	✓	✓	✓	X
Preprinted	✓	✓	✓	✓	X
Colored Paper	✓	✓	✓	✓	X
Light Paper	✓	✓	✓	✓	X
Heavy Paper	✓	✓	✓	✓	X
Rough/Cotton	✓	✓	✓	✓	X
Envelope	X	X	✓	X	X
Rough envelope	X	X	✓	X	X

\* One-sided paper labels are supported for occasional use of less than 20 pages per month. Vinyl, pharmacy, or two-sided labels are not supported.

## Supported Paper Weights

	Standard 250-sheet tray	Optional 550-sheet tray	Multipurpose feeder	Two-sided printing	Automatic document feeder
Paper weight	60–120g/m <sup>2</sup> (16–32lb)	60–120g/m <sup>2</sup> (16–32lb)	60–217g/m <sup>2</sup> (16–58lb)	60–90g/m <sup>2</sup> (16–24lb)	60–90g/m <sup>2</sup> (16–24lb)







## Tools Required For Service

- Flat-blade screwdrivers, various sizes
- #1 Phillips screwdriver, magnetic
- #2 Phillips screwdriver, magnetic
- #2 Phillips screwdriver, magnetic short-blade
- Torx screwdriver (T20 head)
- Needle-nose pliers
- Diagonal side cutters
- Spring hook
- Feeler gauges
- Analog or digital multimeter
- 3-mm ball hex wrench
- Toner vacuum
- Flashlight









# Diagnostics and Troubleshooting

## Troubleshooting Precautions

-  **CAUTION—SHOCK HAZARD:** When you see this symbol on the product, there is a danger from hazardous voltage in the area of the product where you are working. Unplug the product before you begin, or use caution if the product must receive power in order to perform the task.
-  **CAUTION—SHOCK HAZARD:** This product uses an electronic power switch. It does not physically disconnect the input AC voltage. To avoid the risk of electrical shock, always remove the power cord from the printer when removal of the input AC voltage is required.
-  **CAUTION—SHOCK HAZARD:** To avoid the risk of electrical shock while troubleshooting with covers removed or doors open, do not touch the exposed wires or circuits while the printer is connected to an electrical outlet.
-  **CAUTION—SHOCK HAZARD:** To avoid the risk of electrical shock and to prevent damage to the printer, remove the power cord from the electrical outlet and disconnect all connections to any external devices before you connect or disconnect any cable, electronic board, or assembly.
-  **CAUTION—HOT SURFACE:** The inside of the printer might be hot. To reduce the risk of injury from a hot component, allow the surface to cool before touching it.
-  **CAUTION—PINCH HAZARD:** To avoid the risk of a pinch injury, use caution in areas marked with this label. Pinch injuries may occur around moving parts, such as gears, doors, trays, and covers.
-  **CAUTION—MOVING PARTS:** To avoid the risk of laceration or abrasion injuries, keep hands away from moving parts in areas marked with this label. Injuries from moving parts may occur around gears and other rotating parts.

## Précautions De Dépannage

-  **ATTENTION ! RISQUE D'ÉLECTROCUTION :** Ce symbole indique un danger lié à des niveaux de tension dangereux dans la zone du produit à manipuler. Débranchez le produit avant de commencer, ou agissez avec prudence si le produit doit être alimenté pour effectuer l'opération.
-  **ATTENTION ! RISQUE D'ÉLECTROCUTION :** Ce produit utilise un commutateur d'alimentation électronique. Il ne déconnecte pas physiquement la tension d'alimentation CA. Pour éviter tout risque d'électrocution, débranchez toujours le cordon d'alimentation de l'imprimante lorsque vous devez déconnecter la tension d'alimentation CA.
-  **ATTENTION ! RISQUE D'ÉLECTROCUTION :** Pour éviter tout risque d'électrocution lors du dépannage de l'imprimante avec les capots retirés ou les portes ouvertes, prenez garde de ne pas toucher les fils ou circuits dénudés si l'imprimante est connectée à une prise électrique.
-  **ATTENTION ! RISQUE D'ÉLECTROCUTION :** Pour éviter tout risque d'électrocution et éviter d'endommager l'imprimante, débranchez le cordon d'alimentation de la prise électrique et déconnectez toute connexion à tout périphérique externe avant de brancher ou débrancher des câbles ou circuits et assemblages électroniques.
-  **ATTENTION ! SURFACE CHAUDE :** L'intérieur de l'imprimante risque d'être brûlant. pour réduire le risque de brûlure, laissez la surface ou le composant refroidir avant d'y toucher.

 **ATTENTION ! RISQUE DE PINCEMENT :** Pour éviter tout risque de blessure par pincement, agissez avec précaution au niveau des zones signalées par cette étiquette. Les blessures par pincement peuvent se produire autour des pièces mobiles telles que les engrenages, portes, tiroirs et capots.

 **ATTENTION ! PIÈCES MOBILES :** Pour éviter tout risque de coupures ou de frottements, éloignez les mains des pièces en mouvement dans les zones signalées par cette étiquette. Les pièces en mouvement autour des engrenages et autres pièces rotatives peuvent causer des blessures.

## Precauciones Durante La Solución De Problemas

 **PRECAUCIÓN—RIESGO DE DESCARGA:** Cuando vea este símbolo en el producto, existe peligro de tensiones peligrosas en el área del producto en la que está trabajando. Desconecte el producto antes de empezar o tenga cuidado si el producto debe recibir alimentación a fin de realizar la tarea.

 **PRECAUCIÓN—RIESGO DE DESCARGA:** Este producto utiliza un interruptor de corriente electrónico. No desconecta físicamente la entrada de voltaje de CA. Para evitar el riesgo de descarga eléctrica, desenchufe siempre el cable de alimentación de la impresora cuando sea necesario retirar la entrada de voltaje de CA.

 **PRECAUCIÓN—RIESGO DE DESCARGA:** Para evitar el riesgo de descarga eléctrica al solucionar problemas sin las cubiertas o con las puertas abiertas, no toque los cables ni los circuitos expuestos mientras la impresora está conectada a una toma de corriente.

 **PRECAUCIÓN—RIESGO DE DESCARGA:** Para evitar el riesgo de descargas eléctricas y daños en la impresora, retire el cable de alimentación de la toma eléctrica y desconecte todas las conexiones a dispositivos externos antes de conectar o desconectar cualquier cable, placa electrónica o conjunto.







 **PRECAUCIÓN—SUPERFICIE CALIENTE:** El interior de la impresora podría estar caliente. Para evitar el riesgo de heridas producidas por el contacto con un componente caliente, deje que la superficie se enfríe antes de tocarlo.

 **PRECAUCIÓN—RIESGO DE DESCARGA ELÉCTRICA:** Para evitar el riesgo de lesión por atrapamiento, preste atención en las áreas marcadas con esta etiqueta. Las lesiones por atrapamiento se pueden producir en torno a partes móviles, tales como engranajes, puertas, bandejas y cubiertas.





 **PRECAUCIÓN—PARTES MÓVILES:** Para evitar el riesgo de lesiones por laceración o abrasión, mantenga las manos lejos de las partes móviles en las zonas marcadas con esta etiqueta. Las lesiones causadas por partes móviles pueden producirse cerca de los engranajes u otras piezas giratorias.

## Vorsichtsmaßnahmen Bei Der Fehlerbehebung

 **VORSICHT – STROMSCHLAGGEFAHR:** Wenn Sie dieses Symbol sehen, besteht eine Gefahr durch gefährliche Spannungen in dem Produktbereich, in dem Sie arbeiten. Trennen Sie das Produkt von seiner Stromverbindung, bevor Sie beginnen, oder gehen Sie vorsichtig vor, wenn das Produkt für die Durchführung der Aufgabe mit Strom versorgt werden muss.

-  **VORSICHT – STROMSCHLAGGEFAHR:** Dieses Produkt verwendet einen elektronischen Leistungsschalter. Er trennt die Eingangswchselspannung nicht physikalisch. Um das Risiko eines elektrischen Schlags zu vermeiden, ziehen Sie stets das Netzkabel vom Drucker ab, wenn eine Abtrennung der Eingangswchselspannung erforderlich ist.
-  **VORSICHT – STROMSCHLAGGEFAHR:** Um die Gefahr eines Stromschlags während der Fehlerbehebung bei entfernten Abdeckungen oder offenen Klappen zu vermeiden, berühren Sie die freiliegenden Drähte oder Stromkreise nicht, wenn der Drucker an eine Steckdose angeschlossen ist.
-  **VORSICHT – STROMSCHLAGGEFAHR:** Um das Risiko eines elektrischen Schlags und Schäden am Drucker zu vermeiden, ziehen Sie das Netzkabel aus der Steckdose und trennen Sie alle Verbindungen zu jeglichen externen Geräten, bevor Sie Kabel, Elektronikplatinen oder Baugruppen einstecken oder abziehen.
-  **VORSICHT – HEISS:** Das Innere des Druckers kann sehr heiß sein. Vermeiden Sie Verletzungen, indem Sie heiße Komponenten stets abkühlen lassen, bevor Sie ihre Oberfläche berühren.
-  **VORSICHT – QUETSCHGEFAHR:** Um das Risiko einer Quetschung zu vermeiden, gehen Sie in Bereichen, die mit diesem Etikett gekennzeichnet sind, mit Vorsicht vor. Quetschungen können im Bereich von beweglichen Komponenten auftreten, wie z.B. Zahnrädern, Klappen, Fächern und Abdeckungen.
-  **VORSICHT – BEWEGLICHE TEILE:** Um das Risiko von Verletzungen und Abschürfungen zu vermeiden, halten Sie Ihre Hände von sich bewegenden Teilen in Bereichen fern, die mit diesem Hinweis gekennzeichnet sind. Verletzungen durch sich bewegende Teile treten unter Umständen im Bereich von Zahnrädern und anderen sich drehenden Teilen auf.

## Precauzioni per gli interventi di riparazione

-  **ATTENZIONE – PERICOLO DI SCOSSA ELETTRICA:** La presenza di questo simbolo sul prodotto significa che è presente tensione pericolosa nell'area del prodotto su cui si sta lavorando. Scollegare il prodotto prima di iniziare, o prestare cautela se l'intervento richiede che il prodotto debba ricevere alimentazione.
-  **ATTENZIONE – PERICOLO DI SCOSSA ELETTRICA:** Questo prodotto utilizza un interruttore di alimentazione elettronico. Tale interruttore non scollega fisicamente la tensione CA in entrata. Per evitare il rischio di scossa elettrica, rimuovere sempre il cavo di alimentazione dalla stampante quando è necessario rimuovere la tensione CA in entrata.
-  **ATTENZIONE – PERICOLO DI SCOSSA ELETTRICA:** Per evitare il rischio di scossa elettrica quando si eseguono interventi sulla macchina con coperture rimosse e sportelli aperti, non toccare cavi o circuiti esposti quando la stampante è collegata a una presa elettrica.
-  **ATTENZIONE – PERICOLO DI SCOSSA ELETTRICA:** Per evitare il rischio di scossa elettrica e per impedire danni alla stampante, rimuovere il cavo di alimentazione dalla presa elettrica e scollegare tutti i collegamenti a eventuali dispositivi esterni prima di collegare o scollegare qualsiasi cavo, scheda elettronica o gruppo.
-  **ATTENZIONE – SUPERFICIE SURRISCALDATA:** L'area interna della stampante potrebbe surriscaldarsi. Per evitare infortuni, lasciare raffreddare la superficie dei componenti prima di toccarla.



**ATTENZIONE – PERICOLO DI SCHIACCIAMENTO:** Per evitare il rischio di lesioni, prestare la massima cautela quando si accede alle aree contrassegnate con questa etichetta. Potrebbero infatti verificarsi lesioni da schiacciamento in prossimità di parti in movimento, quali ad esempio ingranaggi, porte, vassoi e coperchi.



**ATTENZIONE – PARTI MOBILI:** Per evitare il rischio di lesioni da lacerazione o abrasione, tenere le mani lontano da parti in movimento nelle aree contrassegnate con questa etichetta. Le lesioni dovute a parti in movimento possono verificarsi intorno a ingranaggi e altre parti rotanti.

## Troubleshooting Overview

### Performing The Initial Troubleshooting Check

- With the power cord unplugged from the electrical outlet, check if the cord is free from breakage, short circuits, disconnected wires, or incorrect connections.
- Make sure that the printer is properly grounded.
- Make sure that the power supply line voltage is within 10 % of the rated line voltage.
- Make sure that the printer is securely installed on a level surface in a well-ventilated area.
- Make sure that the temperature and relative humidity are within the specifications. See [Temperature information](#).
- Avoid locations that:
  - Generate ammonia gas
  - Are exposed to direct sunlight
  - Are near open flames
  - Are dusty
- Make sure that the recommended paper for this printer is used.
- Do a test print with paper from a newly opened package, and then check the result.

### Using Safe Mode

Safe Mode lets the printer continue to operate in a special limited mode in which it attempts to continue offering as much functionality as possible despite known issues.

 **Note:**

- When in Safe Mode, the printer only prints in simplex mode from tray 1 at the slowest operating point.
- This setting cannot be used if the sensor (tray present) is damaged.

#### **warning**

Safe Mode is intended as a short-term workaround and must be used only in the case of a non-critical error when a print job must be completed before service can be arranged to repair the printer. The printer must be returned to standard operating mode before diagnostics can be run or full-function printing can continue.

Enter Safe Mode from the Configuration menu, and then POR the printer. See [Config Menu](#).

Return the printer to standard operating mode to service the printer and return to full-function printing.

## Fixing Print Quality Issues

### Supplies Used to Resolve Print Quality Issues

For this family of printers, the following supplies are available to resolve print quality issues:

Supply Item	P/N
Standard-Capacity Toner Cartridge (3K) NA/XE Sold	006R04376
High-Capacity Toner Cartridge (8K) NA/XE Sold	006R04377
Extra High-Capacity Toner Cartridge (20K) NA/XE Sold	006R04378
Standard-Capacity Toner Cartridge (3K) DMO Sold	006R04379
High-Capacity Toner Cartridge (8K) DMO Sold	006R04380
Extra High-Capacity Toner Cartridge (20K) DMO Sold	006R04381
World Wide Metered Toner Cartridge (15K)	006R04382
Imaging Kit (40K) Universal World Wide	013R00690

### Gray Background or Toner Fog Check

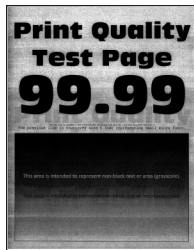

 **Note:** Before performing this print quality check, print the Print Quality Test Pages. From the control panel, navigate to **Settings > Troubleshooting > Print Quality Test Pages**, and then perform the initial print quality check. See [Performing the initial troubleshooting check](#) .

## Diagnostics and Troubleshooting

Action	Yes	No
<p><b>Step 1</b></p> <p>1 Remove any packing material left on the imaging unit.</p> <p>You may need a pair of pliers to remove pieces of plastic inside the imaging unit.</p> <p>2 Make sure that there are no obstructions between the charge roller and photoconductor drum.</p> <p>Does the problem remain?</p>	Go to step 2.	The problem is solved.
<p><b>Step 2</b></p> <p>1 Turn off the printer, wait for 10 seconds, and then turn on the printer.</p> <p>2 Set the toner darkness to a lighter setting.</p> <p>From the control panel, navigate to <b>Settings &gt; Print &gt; Quality &gt; Toner Darkness</b>.</p> <p>Does the problem remain?</p>	Go to step 3.	The problem is solved.
<p><b>Step 3</b></p> <p>Check if the printer is using a genuine and supported Xerox toner cartridge.</p> <p>If the printer is using a third-party cartridge, then refer the users to their cartridge supplier.</p> <p>Is the printer using a genuine and supported Xerox toner cartridge?</p>	Go to step 5.	Go to step 4.
<p><b>Step 4</b></p> <p>Insert a genuine and supported Xerox toner cartridge.</p> <p>Does the problem remain?</p>	Go to step 5.	The problem is solved.
<p><b>Step 5</b></p> <p>Remove any packing material left on the imaging unit.</p> <p>You may need a pair of pliers to remove pieces of plastic inside the imaging unit.</p> <p>Does the problem remain?</p>	Go to step 6.	The problem is solved.
<p><b>Step 6</b></p>	Go to step 7.	The problem is solved.



Action	Yes	No
Replace the toner cartridge. Does the problem remain?		
<b>Step 7</b> 1 Remove the right cover. See <a href="#">Right cover removal</a> . 2 Make sure that the HVPS1 cable on the controller board and HVPS is properly connected. Does the problem remain?	Go to step 8.	The problem is solved.
<b>Step 8</b> Replace the HVPS. See <a href="#">HVPS removal</a> . Does the problem remain?	Contact the next level of support.	The problem is solved.

## Blank Page Check



 **Note:** Before performing this print quality check, print the Print Quality Test Pages. From the control panel, navigate to **Settings > Troubleshooting > Print Quality Test Pages**, and then perform the initial print quality check. See [Performing the initial troubleshooting check](#).

Action	Yes	No
<b>Step 1</b> Verify that the toner cartridge is not empty. Is the toner cartridge empty?	Go to step 2.	Go to step 3.
<b>Step 2</b> Replace the toner cartridge. Does the problem remain?	Go to step 3.	The problem is solved.
<b>Step 3</b> Check if the printer is using a genuine and supported Xerox toner cartridge.	Go to step 5.	Go to step 4.

## Diagnostics and Troubleshooting

Action	Yes	No
<p>If the printer is using a third-party cartridge, then refer the users to their cartridge supplier.</p> <p>Is the printer using a genuine and supported Xerox toner cartridge?</p>		
<p><b>Step 4</b></p> <p>Insert a genuine and supported Xerox toner cartridge.</p> <p>Does the problem remain?</p>	Go to step 5.	The problem is solved.
<p><b>Step 5</b></p> <p>1 Remove any packing material left on the imaging unit.</p> <p>You may need a pair of pliers to remove pieces of plastic inside the imaging unit.</p> <p>2 Firmly shake the imaging unit to redistribute the toner, and then insert it.</p> <p>Does the problem remain?</p>	Go to step 6.	The problem is solved.
<p><b>Step 6</b></p> <p>1 Make sure that the transfer roller is properly installed.</p> <p>2 Check the transfer roller for contamination and damage.</p> <p>Is the transfer roller free of contamination and damage?</p>	Go to step 9.	Go to step 7.
<p><b>Step 7</b></p> <p>Remove, and then install the transfer roller. See <a href="#">Transfer roller removal</a>.</p> <p>Does the problem remain?</p>	Go to step 8.	The problem is solved.
<p><b>Step 8</b></p> <p>Replace the transfer roller.</p> <p>Does the problem remain?</p>	Go to step 9.	The problem is solved.
<p><b>Step 9</b></p> <p>1 Remove the right cover. See <a href="#">Right cover removal</a>.</p> <p>2 Make sure that the HVPS1 cable on the controller board and HVPS is properly connected.</p>	Go to step 10.	The problem is solved.

Action	Yes	No
Does the problem remain?		
<b>Step 10</b> Replace the HVPS. See <a href="#">HVPS removal</a> . Does the problem remain?	Go to step 11.	The problem is solved.
<b>Step 11</b> Replace the printhead. See <a href="#">Printhead removal</a> . Does the problem remain?	Contact the next level of support.	The problem is solved.

## Print Is Too Dark Check

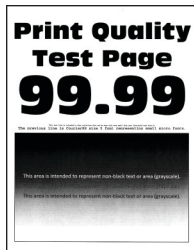

**Note:** Before performing this print quality check, print the Print Quality Test Pages. From the control panel, navigate to **Settings > Troubleshooting > Print Quality Test Pages**, and then perform the initial print quality check. See [Performing the initial troubleshooting check](#).

Action	Yes	No
<b>Step 1</b> Check if the printer is using a genuine and supported Xerox toner cartridge. If the printer is using a third-party cartridge, then refer the users to their cartridge supplier. Is the printer using a genuine and supported Xerox toner cartridge?	Go to step 3.	Go to step 2.
<b>Step 2</b> Insert a genuine and supported Xerox toner cartridge. Does the problem remain?	Go to step 3.	The problem is solved.
<b>Step 3</b> 1 Remove any packing material left on the imaging unit.	Go to step 4.	The problem is solved.

## Diagnostics and Troubleshooting

Action	Yes	No
<p>You may need a pair of pliers to remove pieces of plastic inside the imaging unit.</p> <p>2 Make sure that there are no obstructions between the charge roller and photoconductor drum.</p> <p>Does the problem remain?</p>		
<p><b>Step 4</b></p> <p>1 Turn off the printer, wait for 10 seconds, and then turn on the printer.</p> <p>2 Set the toner darkness to a lighter setting.</p> <p>From the control panel, navigate to <b>Settings &gt; Print &gt; Quality &gt; Toner Darkness</b>.</p> <p>Does the problem remain?</p>	Go to step 5.	The problem is solved.
<p><b>Step 5</b></p> <p>Replace the imaging unit.</p> <p>Does the problem remain?</p>	Go to step 6.	The problem is solved.
<p><b>Step 6</b></p> <p>1 Remove the right cover. See <a href="#">Right cover removal</a>.</p> <p>2 Make sure that the HVPS1 cable on the controller board and HVPS is properly connected.</p> <p>Does the problem?</p>	Go to step 7.	The problem is solved.
<p><b>Step 7</b></p> <p>Replace the HVPS. See <a href="#">HVPS removal</a>.</p> <p>Does the problem remain?</p>	Contact the next level of support.	The problem is solved.

# Print Is Too Light Check

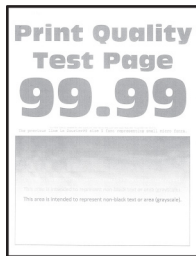

**Note:** Before performing this print quality check, print the Print Quality Test Pages. From the control panel, navigate to **Settings > Troubleshooting > Print Quality Test Pages**, and then perform the initial print quality check. See [Performing the initial troubleshooting check](#).

Action	Yes	No
<p><b>Step 1</b></p> <p>Check if the toner cartridge is empty or if it has reached its end of life.</p> <p>Is the toner cartridge empty or has reached its end of life?</p>	Go to step 2.	Go to step 3.
<p><b>Step 2</b></p> <p>Replace the toner cartridge.</p> <p>Does the problem remain?</p>	Go to step 3.	The problem is solved.
<p><b>Step 3</b></p> <p>Check if the printer is using a genuine and supported Xerox toner cartridge.</p> <p>If the printer is using a third-party cartridge, then refer the users to their cartridge supplier.</p> <p>Is the printer using a genuine and supported Xerox toner cartridge?</p>	Go to step 5.	Go to step 4.
<p><b>Step 4</b></p> <p>Insert a genuine and supported Xerox toner cartridge.</p> <p>Does the problem remain?</p>	Go to step 5.	The problem is solved.
<p><b>Step 5</b></p> <ol style="list-style-type: none"> <li>1 Turn off the printer, wait for 10 seconds, and then turn on the printer.</li> <li>2 Do the following:             <ol style="list-style-type: none"> <li>a Set the toner darkness to a darker setting.</li> </ol> </li> </ol>	Go to step 6.	The problem is solved.

Action	Yes	No
<p>From the control panel, navigate to <b>Settings &gt; Print &gt; Quality &gt; Toner Darkness</b>.</p> <p>b Set the paper type, texture, and weight to match the paper loaded.</p> <p>From the control panel, navigate to <b>Settings &gt; Paper &gt; Media Configuration &gt; Media Types</b>.</p> <p>Does the problem remain?</p>		
<p><b>Step 6</b></p> <ol style="list-style-type: none"> <li>1 Remove the imaging unit.</li> <li>2 Push either side of the transfer roller, and then check if it depresses and bounces back into place.</li> <li>3 If the transfer roller does not depress and bounce back into place, then reinstall the transfer roller.</li> <li>4 Firmly shake the toner cartridge to redistribute the toner, and then insert it.</li> <li>5 Turn off the printer, wait for 10 seconds, and then turn on the printer.</li> </ol> <p>Does the problem remain?</p>	Go to step 7.	The problem is solved.
<p><b>Step 7</b></p> <ol style="list-style-type: none"> <li>1 Make sure that the transfer roller is properly installed.</li> <li>2 Check the transfer roller for contamination and damage.</li> </ol> <p>Is the transfer roller free of contamination and damage?</p>	Go to step 9.	Go to step 8.
<p><b>Step 8</b></p> <p>Reinstall or replace the transfer roller. See <a href="#">Transfer roller removal</a>.</p> <p>Does the problem remain?</p>	Go to step 9.	The problem is solved.
<p><b>Step 9</b></p> <p>Replace the imaging unit. See <a href="#">Transfer roller removal</a>.</p> <p>Does the problem remain?</p>	Go to step 10.	The problem is solved.

Action	Yes	No
<b>Step 10</b> 1 Remove the right cover. See <a href="#">Right cover removal</a> . 2 Make sure that the HVPS1 cable on the controller board and HVPS is properly connected.  Does the problem remain?	Go to step 11.	The problem is solved.
<b>Step 11</b> Replace the HVPS. See <a href="#">HVPS removal</a> .  Does the problem remain?	Contact the next level of support.	The problem is solved.

## Paper Curl Check



 **Note:** Before performing this print quality check, print the Print Quality Test Pages. From the control panel, navigate to **Settings > Troubleshooting > Print Quality Test Pages**, and then perform the initial print quality check. See [Performing the initial troubleshooting check](#).

Action	Yes	No
<b>Step 1</b> Check if the printer is using a genuine and supported Xerox toner cartridge.  If the printer is using a third-party cartridge, then refer the users to their cartridge supplier.  Is the printer using a genuine and supported Xerox toner cartridge?	Go to step 3.	Go to step 2.
<b>Step 2</b> Insert a genuine and supported Xerox toner cartridge.  Does the problem remain?	Go to step 3.	The problem is solved.
<b>Step 3</b>	Go to step 5.	Go to step 4.

Action	Yes	No
<p>Check if the printer is using a genuine and supported Xerox fuser.</p> <p>Is the printer using a genuine and supported Xerox fuser?</p>		
<p><b>Step 4</b></p> <p>Insert a genuine and supported Xerox fuser.</p> <p>Does the problem remain?</p>	Go to step 5.	The problem is solved.
<p><b>Step 5</b></p> <p>Make sure that the paper guide setting matches the size of the paper loaded.</p> <p>Does the problem remain?</p>	Go to step 6.	The problem is solved.
<p><b>Step 6</b></p> <p>Set the paper type, texture, and weight to match the paper loaded.</p> <p>From the control panel, navigate to <b>Settings &gt; Paper &gt; Media Configuration &gt; Media Types</b>.</p> <p>Does the problem remain?</p>	Go to step 7.	The problem is solved.
<p><b>Step 7</b></p> <p>1 Make sure that the paper loaded is from a fresh package.</p> <p>Paper absorbs moisture due to high humidity. Store paper in its original wrapper until you use it.</p> <p>2 Make sure that the printer supports the paper loaded.</p> <p>Does the problem remain?</p>	Contact the next level of support.	The problem is solved.

## Folded or Wrinkled Paper Check





 **Note:** Before performing this print quality check, print the Print Quality Test Pages. From the control panel, navigate to **Settings > Troubleshooting > Print Quality Test Pages**, and then perform the initial print quality check. See [Performing the initial troubleshooting check](#) .

Action	Yes	No
<p><b>Step 1</b></p> <p>1 Check if the printer is using a non-Xerox toner cartridge.</p> <p>If the printer is using a third-party cartridge, then refer the users to their cartridge supplier.</p> <p>2 Make sure that the toner cartridge is compatible with the imaging unit.</p> <p>Does the problem remain?</p>	Go to step 2.	The problem is solved.
<p><b>Step 2</b></p> <p>1 Check if the paper loaded is from a fresh package.</p> <p>Paper absorbs moisture due to high humidity. Store paper in its original wrapper until you use it.</p> <p>2 Make sure that the printer supports the paper loaded.</p> <p>Does the problem remain?</p>	Go to step 3.	The problem is solved.
<p><b>Step 3</b></p> <p>1 Check the toner cartridge for leaks.</p> <p>2 Using an approved toner vacuum, completely remove the stray toner from the printer, toner cartridge, and imaging unit.</p> <p>Does the problem remain?</p>	Go to step 4.	The problem is solved.

Action	Yes	No
<p><b>Step 4</b></p> <p>1 Remove the fuser. See <a href="#">Fuser removal</a>.</p> <p>2 Make sure that the fuser entry guide is free of waste toner and dust.</p> <p>Clean the fuser entry guide with a toner vacuum and cloth. Do not use compressed air.</p> <p>Does the problem remain?</p>	Go to step 5.	The problem is solved.
<p><b>Step 5</b></p> <p>Replace the fuser.</p> <p>Does the problem remain?</p>	Contact the next level of support.	The problem is solved.

## Solid Black Pages Check



 **Note:** Before performing this print quality check, print the Print Quality Test Pages. From the control panel, navigate to **Settings > Troubleshooting > Print Quality Test Pages**, and then perform the initial print quality check. See [Performing the initial troubleshooting check](#) .

Action	Yes	No
<p><b>Step 1</b></p> <p>Check if the printer is using a genuine and supported Xerox toner cartridge.</p> <p>If the printer is using a third-party cartridge, then refer the users to their cartridge supplier.</p> <p>Is the printer using a genuine and supported Xerox toner cartridge?</p>	Go to step 3.	Go to step 2.
<p><b>Step 2</b></p> <p>Insert a genuine and supported Xerox toner cartridge.</p> <p>Does the problem remain?</p>	Go to step 3.	The problem is solved.

Action	Yes	No
<p><b>Step 3</b></p> <p>1 Remove any packing material left on the imaging unit.</p> <p>You may need a pair of pliers to remove pieces of plastic inside the imaging unit.</p> <p>2 Check the charge roller contact on the right side of the imaging unit for damage and contamination.</p>  <p>Is the charge roller contact free of damage and contamination?</p>	Go to step 6.	Go to step 4.
<p><b>Step 4</b></p> <p>1 Perform a POR.</p> <p>2 Perform a print test.</p> <p>Does the problem remain?</p>	Go to step 5.	The problem is solved.
<p><b>Step 5</b></p> <p>Replace the imaging unit.</p> <p>Does the problem remain?</p>	Go to step 6.	The problem is solved.
<p><b>Step 6</b></p> <p>1 Remove the right cover. See <a href="#">Right cover removal</a>.</p> <p>2 Make sure that the HVPS1 cable on the controller board and HVPS is properly connected.</p> <p>Does the problem remain?</p>	Go to step 7.	The problem is solved.
<p><b>Step 7</b></p> <p>Replace the HVPS. See <a href="#">HVPS removal</a>.</p> <p>Does the problem remain?</p>	Contact the next level of support.	The problem is solved.

## Skewed Print Check



 **Note:** Before performing this print quality check, print the Print Quality Test Pages. From the control panel, navigate to **Settings > Troubleshooting > Print Quality Test Pages**, and then perform the initial print quality check. See [Performing the initial troubleshooting check](#) .

Action	Yes	No
<p><b>Step 1</b></p> <p>Check the guides in the tray where the skewed prints are printed from.</p> <p>If the paper source is the MPF, then proceed to step 6.</p> <p>Does the position of the guides match the paper loaded?</p>	Go to step 3.	Go to step 2.
<p><b>Step 2</b></p> <p>Adjust the guides to match the paper loaded.</p> <p>Does the problem remain?</p>	Go to step 3.	The problem is solved.
<p><b>Step 3</b></p> <p>Check if the printer supports the paper loaded.</p> <p>Is the paper supported?</p>	Go to step 5.	Go to step 4.
<p><b>Step 4</b></p> <p>Remove the paper, and then load a supported one.</p> <p>Does the problem remain?</p>	Go to step 5.	The problem is solved.
<p><b>Step 5</b></p> <p>Perform a print test.</p> <p>Does the problem remain?</p>	Go to step 6.	The problem is solved.
<p><b>Step 6</b></p> <p>Check the guides in the MPF tray.</p> <p>Does the position of the guides match the paper loaded?</p>	Go to step 8.	Go to step 7.

Action	Yes	No
<b>Step 7</b> Adjust the guides to match the paper loaded. Does the problem remain?	Go to step 8.	The problem is solved.
<b>Step 8</b> Make sure that the printer supports the paper loaded. Does the problem remain?	Go to step 9.	The problem is solved.
<b>Step 9</b> Check the MPF pick roller for excess wear and contamination. Is the MPF pick roller free from excess wear and contamination?	Go to step 11.	Go to step 10.
<b>Step 10</b> Replace the front door with MPF pick roller. See <a href="#">Front door removal</a> . Does the problem remain?	Go to step 11.	The problem is solved.
<b>Step 11</b> Reinstall or replace the transfer roller. See <a href="#">Transfer roller removal</a> . Does the problem remain?	Go to step 12.	The problem is solved.
<b>Step 12</b> Replace the imaging unit. Does the problem remain?	Contact the next level of support.	The problem is solved.

## Streaked Vertical Lines Appear On Prints During A Print Job Check



 **Note:** Before performing this print quality check, print the Print Quality Test Pages. From the control panel, navigate to **Settings > Troubleshooting > Print Quality Test Pages**, and then perform the initial print quality check. See [Performing the initial troubleshooting check](#).

## Diagnostics and Troubleshooting

Action	Yes	No
<p><b>Step 1</b></p> <p>1 Make sure that the printer is not placed in a cold and damp area.</p> <p>2 Print 15 simplex pages to dry the transfer roller.</p> <p>Does the problem remain?</p>	Go to step 2.	The problem is solved.
<p><b>Step 2</b></p> <p>Check if the printer is using a genuine and supported Xerox toner cartridge.</p> <p>If the printer is using a third-party cartridge, then refer the users to their cartridge supplier.</p> <p>Is the printer using a genuine and supported Xerox toner cartridge?</p>	Go to step 4.	Go to step 3.
<p><b>Step 3</b></p> <p>Insert a genuine and supported Xerox toner cartridge.</p> <p>Does the problem remain?</p>	Go to step 4.	The problem is solved.
<p><b>Step 4</b></p> <p>Check the status of the imaging unit.</p> <p>Is the imaging unit near its end of life?</p>	Go to step 6.	Go to step 5.
<p><b>Step 5</b></p> <p>Remove, and then insert the imaging unit.</p> <p>Does the problem remain?</p>	Go to step 6.	The problem is solved.
<p><b>Step 6</b></p> <p>Replace the imaging unit.</p> <p>Does the problem remain?</p>	Contact the next level of support.	The problem is solved.

# Streaked Vertical Lines Appear On Prints During A Copy Job Check



**Note:** Before performing this print quality check, print the Print Quality Test Pages. From the control panel, navigate to **Settings > Troubleshooting > Print Quality Test Pages**, and then perform the initial print quality check. See [Performing the initial troubleshooting check](#).

Action	Yes	No
<p><b>Step 1</b></p> <p>1 Make sure that the printer is not placed in a cold and damp area.</p> <p>2 Print 15 simplex pages to dry the transfer roller.</p> <p>Does the problem remain?</p>	Go to step 2.	The problem is solved.
<p><b>Step 2</b></p> <p>Clean the scanner. See .</p> <p>Does the problem remain?</p>	Go to step 3.	The problem is solved.
<p><b>Step 3</b></p> <p>Open the scanner cover, and then check if it closes properly.</p> <p>Does the cover close properly?</p>	Go to step 5.	Go to step 4.
<p><b>Step 4</b></p> <p>Make sure that the scanner glass pad is clean and properly installed.</p> <p>Does the problem remain?</p>	Go to step 5.	The problem is solved.
<p><b>Step 5</b></p> <p>With the scanner cover open, perform a copy job to check the scanner lamp.</p> <p>The scanner lamp must light up and move along the scan area.</p> <p>Is the scanner lamp functional?</p>	Go to step 7.	Go to step 6.
<p><b>Step 6</b></p>	Go to step 7.	The problem is solved.

## Diagnostics and Troubleshooting

Action	Yes	No
<p>1 Remove the right cover. See <a href="#">Right cover removal</a>.</p> <p>2 Reseat the scanner cables.</p> <p>Does the problem remain?</p>		
<p><b>Step 7</b></p> <p>Check the scanner and its components for damage.</p> <ul style="list-style-type: none"> <li>• Scanner lamp</li> <li>• Motor (scanner)</li> <li>• Scanner belt</li> <li>• Glass panes</li> <li>• Cables</li> </ul> <p>Are the scanner and its components free of damage?</p>	Go to step 9.	Go to step 8.
<p><b>Step 8</b></p> <p>Replace the ADF and scanner. See <a href="#">ADF and Scanner Removal</a>.</p> <p>Does the problem remain?</p>	Go to step 9.	The problem is solved.
<p><b>Step 9</b></p> <p>Check the firmware version.</p> <p>Is the firmware updated to the latest version?</p>	Go to step 11.	Go to step 10.
<p><b>Step 10</b></p> <p>Update the firmware.</p> <p>Does the problem remain?</p>	Go to step 11.	The problem is solved.
<p><b>Step 11</b></p> <p>1 Make sure that the controller board is properly installed.</p> <p>2 Reseat all the cables on the controller board.</p> <p>Does the problem remain?</p>	Go to step 12.	The problem is solved.
<p><b>Step 12</b></p> <p>Replace the controller board. See <a href="#">Controller Board Removal</a>.</p> <p>Does the problem remain?</p>	Contact the next level of support.	The problem is solved.



# Horizontal Light Bands Check

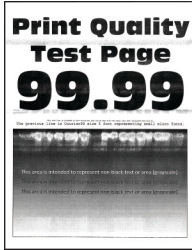

**Note:** Before performing this print quality check, print the Print Quality Test Pages. From the control panel, navigate to **Settings > Troubleshooting > Print Quality Test Pages**, and then perform the initial print quality check. See [Performing the initial troubleshooting check](#).

Action	Yes	No
<b>Step 1</b> Check if the banding is along the edge of the paper. Is the banding along the edge of the paper?	Go to step 2.	Go to step 3.
<b>Step 2</b> Replace the fuser. See <a href="#">Fuser removal</a> . Does the problem remain?	Go to step 3.	The problem is solved.
<b>Step 3</b> Check if the toner cartridge is empty or if it has reached its end of life. Is the toner cartridge empty or has reached its end of life?	Go to step 4.	Go to step 5
<b>Step 4</b> Replace the toner cartridge. Does the problem remain?	Go to step 5.	The problem is solved.

Action	Yes	No
<p><b>Step 5</b></p> <p>Check if the printer is using a genuine and supported Xerox toner cartridge.</p> <p>If the printer is using a third-party cartridge, then refer the users to their cartridge supplier.</p> <p>Is the printer using a genuine and supported Xerox toner cartridge?</p>	Contact the next level of support.	Go to step 6.
<p><b>Step 6</b></p> <p>Insert a genuine and supported Xerox toner cartridge.</p> <p>Does the problem remain?</p>	Contact the next level of support.	The problem is solved.

## Vertical Light Bands Check



**Note:** Before performing this print quality check, print the Print Quality Test Pages. From the control panel, navigate to **Settings > Troubleshooting > Print Quality Test Pages**, and then perform the initial print quality check. See [Performing the initial troubleshooting check](#) .

Action	Yes	No
<p><b>Step 1</b></p> <p>Check if the banding is along the edge of the paper.</p> <p>Is the banding along the edge of the paper?</p>	Go to step 2.	Go to step 3.
<p><b>Step 2</b></p> <p>Replace the fuser. See <a href="#">Fuser removal</a>.</p> <p>Does the problem remain?</p>	Go to step 3.	The problem is solved.
<p><b>Step 3</b></p> <p>Check if the printer is using a genuine and supported Xerox toner cartridge.</p>	Go to step 5.	Go to step 4.

Action	Yes	No
<p>If the printer is using a third-party cartridge, then refer the users to their cartridge supplier.</p> <p>Is the printer using a genuine and supported Xerox toner cartridge?</p>		
<p><b>Step 4</b></p> <p>Insert a genuine and supported Xerox toner cartridge.</p> <p>Does the problem remain?</p>	Go to step 5.	The problem is solved.
<p><b>Step 5</b></p> <p>1 Remove the imaging unit.</p> <p>2 Clean the printhead laser glass window with a soft cloth.</p> <p>Does the problem remain?</p>	Contact the next level of support.	The problem is solved.

## Vertical Dark Bands Check

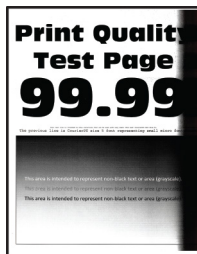

**Note:** Before performing this print quality check, print the Print Quality Test Pages. From the control panel, navigate to **Settings > Troubleshooting > Print Quality Test Pages**, and then perform the initial print quality check. See [Performing the initial troubleshooting check](#).

Action	Yes	No
<p><b>Step 1</b></p> <p>Check if the banding is along the edge of the paper.</p> <p>Is the banding along the edge of the paper?</p>	Go to step 2.	Go to step 3.
<p><b>Step 2</b></p> <p>Replace the fuser. See <a href="#">Fuser removal</a>.</p> <p>Does the problem remain?</p>	Go to step 3.	The problem is solved.
<p><b>Step 3</b></p> <p>1 Remove any packing material left on the imaging unit.</p>	Go to step 4.	The problem is solved.

Action	Yes	No
<p>You may need a pair of pliers to remove pieces of plastic inside the imaging unit.</p> <p>2 Make sure that there are no obstructions between the charge roller and photoconductor drum.</p> <p>Does the problem remain?</p>		
<p><b>Step 4</b></p> <p>Check if the printer is using a genuine and supported Xerox toner cartridge.</p> <p>If the printer is using a third-party cartridge, then refer the users to their cartridge supplier.</p> <p>Is the printer using a genuine and supported Xerox toner cartridge?</p>	Go to step 6.	Go to step 5.
<p><b>Step 5</b></p> <p>Insert a genuine and supported Xerox toner cartridge.</p> <p>Does the problem remain?</p>	Go to step 6.	The problem is solved.
<p><b>Step 6</b></p> <p>Remove, and then insert the imaging unit.</p> <p>Does the problem remain?</p>	Contact the next level of support.	The problem is solved.

## Vertical Dark Streaks With Print Missing Check

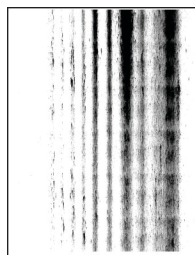

**Note:** Before performing this print quality check, print the Print Quality Test Pages. From the control panel, navigate to **Settings > Troubleshooting > Print Quality Test Pages**, and then perform the initial print quality check. See [Performing the initial troubleshooting check](#).

Action	Yes	No
<p><b>Step 1</b></p> <p>Check if the toner cartridge is empty or if it has reached its end of life.</p> <p>Is the toner cartridge empty or has reached its end of life?</p>	Go to step 2.	Go to step 3.
<p><b>Step 2</b></p> <p>Replace the toner cartridge.</p> <p>Does the problem remain?</p>	Go to step 3.	The problem is solved.
<p><b>Step 3</b></p> <p>Check if the printer is using a genuine and supported Xerox toner cartridge.</p> <p>If the printer is using a third-party cartridge, then refer the users to their cartridge supplier.</p> <p>Is the printer using a genuine and supported Xerox toner cartridge?</p>	Go to step 5.	Go to step 4.
<p><b>Step 4</b></p> <p>Insert a genuine and supported Xerox toner cartridge.</p> <p>Does the problem remain?</p>	Go to step 5.	The problem is solved.

Action	Yes	No
<p><b>Step 5</b></p> <p>1 Remove any packing material left on the imaging unit.</p> <p>You may need a pair of pliers to remove pieces of plastic inside the imaging unit.</p> <p>2 Check the charge roller contact on the right side of the imaging unit for damage and contamination.</p>  <p>Is the charge roller contact free of damage and contamination?</p>	Contact the next level of support.	Go to step 6.
<p><b>Step 6</b></p> <p>Replace the imaging unit.</p> <p>Does the problem remain?</p>	Contact the next level of support.	The problem is solved.

## White Streaks and Voided Areas Check



**Note:** Before performing this print quality check, print the Print Quality Test Pages. From the control panel, navigate to **Settings > Troubleshooting > Print Quality Test Pages**, and then perform the initial print quality check. See [Performing the initial troubleshooting check](#) .

Action	Yes	No
<p><b>Step 1</b></p> <p>Check if the printer is using a genuine and supported Xerox toner cartridge.</p> <p>If the printer is using a third-party cartridge, then refer the users to their cartridge supplier.</p> <p>Is the printer using a genuine and supported Xerox toner cartridge?</p>	Go to step 3.	Go to step 2.
<p><b>Step 2</b></p> <p>Insert a genuine and supported Xerox toner cartridge.</p> <p>Does the problem remain?</p>	Go to step 3.	The problem is solved.
<p><b>Step 3</b></p> <p>1 Perform a POR.</p> <p>2 Perform a print test.</p> <p>Does the problem remain?</p>	Go to step 4.	The problem is solved.
<p><b>Step 4</b></p> <p>Check the status of the imaging unit.</p> <p>Is the imaging unit near its end of life?</p>	Go to step 5.	Contact the next level of support.
<p><b>Step 5</b></p> <p>Replace the imaging unit.</p> <p>Does the problem remain?</p>	Contact the next level of support.	The problem is solved.

## Clipped Pages or Images Check



**Note:** Before performing this print quality check, print the Print Quality Test Pages. From the control panel, navigate to **Settings > Troubleshooting > Print Quality Test Pages**, and then perform the initial print quality check. See [Performing the initial troubleshooting check](#).

## Diagnostics and Troubleshooting

Action	Yes	No
<p><b>Step 1</b></p> <p>1 Remove any packing material left on the imaging unit.</p> <p>You may need a pair of pliers to remove pieces of plastic inside the imaging unit.</p> <p>2 Make sure that there are no obstructions between the charge roller and photoconductor drum.</p> <p>Does the problem remain?</p>	Go to step 2.	The problem is solved.
<p><b>Step 2</b></p> <p>Remove, and then insert the toner cartridge.</p> <p>Does the problem remain?</p>	Go to step 3.	The problem is solved.
<p><b>Step 3</b></p> <p>Check if the printer is using a genuine and supported Xerox toner cartridge.</p> <p>If the printer is using a third-party cartridge, then refer the users to their cartridge supplier.</p> <p>Is the printer using a genuine and supported Xerox toner cartridge?</p>	Go to step 5.	Go to step 4.
<p><b>Step 4</b></p> <p>Insert a genuine and supported Xerox toner cartridge.</p> <p>Does the problem remain?</p>	Go to step 5.	The problem is solved.
<p><b>Step 5</b></p> <p>Remove, and then insert the imaging unit.</p> <p>Does the problem remain?</p>	Go to step 6.	The problem is solved.
<p><b>Step 6</b></p> <p>Replace the imaging unit.</p> <p>Does the problem remain?</p>	Go to step 7.	The problem is solved.
<p><b>Step 7</b></p> <p>1 Remove the imaging unit.</p> <p>2 Clean the printhead laser glass window with a soft cloth.</p> <p>Does the problem remain?</p>	Contact the next level of support.	The problem is solved.



# Incorrect Margins On Prints Check



 **Note:** Before performing this print quality check, print the Print Quality Test Pages. From the control panel, navigate to **Settings > Troubleshooting > Print Quality Test Pages**, and then perform the initial print quality check. See [Performing the initial troubleshooting check](#).

Action	Yes	No
<p><b>Step 1</b></p> <p>Adjust the guides in the tray to match the size of the paper loaded.</p> <p>Does the problem remain?</p>	<p>Go to step 2.</p>	<p>The problem is solved.</p>
<p><b>Step 2</b></p> <p>Do either of the following:</p> <ul style="list-style-type: none"> <li>Set the paper size to match the paper loaded in the tray.</li> </ul> <p>Enter the Diagnostics menu, and then navigate to:</p> <p><b>Printer diagnostics &amp; adjustments &gt; Printer registration adjustments</b></p> <ul style="list-style-type: none"> <li>Change the paper loaded in the tray to match the paper size set in the tray.</li> </ul> <p>Does the problem remain?</p>	<p>Contact the next level of support.</p>	<p>The problem is solved.</p>

# Toner Rubs Off Check



 **Note:** Before performing this print quality check, print the Print Quality Test Pages. From the control panel, navigate to **Settings > Troubleshooting > Print Quality Test Pages**, and then perform the initial print quality check. See [Performing the initial troubleshooting check](#) .

Action	Yes	No
<p><b>Step 1</b></p> <p>Check if the printer is using a genuine and supported Xerox toner cartridge.</p> <p>If the printer is using a third-party cartridge, then refer the users to their cartridge supplier.</p> <p>Is the printer using a genuine and supported Xerox toner cartridge?</p>	Go to step 3.	Go to step 2.
<p><b>Step 2</b></p> <p>Insert a genuine and supported Xerox toner cartridge.</p> <p>Does the problem remain?</p>	Go to step 3.	The problem is solved.
<p><b>Step 3</b></p> <p>Set the paper type, texture, and weight to match the paper loaded.</p> <p>From the control panel, navigate to <b>Settings &gt; Paper &gt; Media Configuration &gt; Media Types</b>.</p> <p>Does the problem remain?</p>	Go to step 4.	The problem is solved.
<p><b>Step 4</b></p> <p>Remove, and then install the fuser. See <a href="#">Fuser removal</a>.</p> <p>Does the problem remain?</p>	Go to step 5.	The problem is solved.
<p><b>Step 5</b></p> <p>Replace the fuser.</p> <p>Does the problem remain?</p>	Contact the next level of support.	The problem is solved.

# Toner Specks Appear On Prints During A Print Job Check

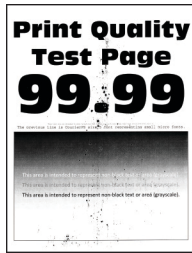

 **Note:** Before performing this print quality check, print the Print Quality Test Pages. From the control panel, navigate to **Settings > Troubleshooting > Print Quality Test Pages**, and then perform the initial print quality check. See [Performing the initial troubleshooting check](#) .

Action	Yes	No
<p><b>Step 1</b></p> <p>Check if the printer is using a genuine and supported Lexmark toner cartridge.</p> <p>If the printer is using a third-party cartridge, then refer the users to their cartridge supplier.</p> <p>Is the printer using a genuine and supported Lexmark toner cartridge?</p>	Go to step 3.	Go to step 2.
<p><b>Step 2</b></p> <p>Insert a genuine and supported Lexmark toner cartridge.</p> <p>Does the problem remain?</p>	Go to step 3.	The problem is solved.
<p><b>Step 3</b></p> <ol style="list-style-type: none"> <li>From the control panel, navigate to <b>Status/Supplies &gt; Supplies</b>.</li> <li>Check the status of the imaging unit.</li> </ol> <p>Is the imaging unit near its end of life or showing signs of toner leakage?</p>	Go to step 4.	Go to step 5.
<p><b>Step 4</b></p> <p>Replace the imaging unit.</p> <p>Does the problem remain?</p>	Go to step 5.	The problem is solved.
<p><b>Step 5</b></p>	Go to step 6.	Go to step 7.

Action	Yes	No
<p>Check if toner specks appear only on the edges or back side of the paper.</p> <p>Do toner specks appear only on the edges or back side of the paper?</p>		
<p><b>Step 6</b></p> <p>Replace the transfer roller. See <a href="#">Transfer roller removal</a>.</p> <p>Does the problem remain?</p>	Go to step 7.	The problem is solved.
<p><b>Step 7</b></p> <p>Check the printer for stray toner contamination.</p> <p>Is the printer contaminated with stray toner?</p>	Go to step 8.	Contact the next level of support.
<p><b>Step 8</b></p> <p>Using an approved toner vacuum, completely remove the stray toner from the printer, toner cartridge, and imaging unit.</p> <p>Does the problem remain?</p>	Contact the next level of support.	The problem is solved.

## Toner Specks Appear On Prints During A Copy Job Check



**Note:** Before performing this print quality check, print the Print Quality Test Pages. From the control panel, navigate to **Settings > Troubleshooting > Print Quality Test Pages**, and then perform the initial print quality check. See [Performing the initial troubleshooting check](#).

Action	Yes	No
<b>Step 1</b> Clean the scanner. See . Does the problem remain?	Go to step 2.	The problem is solved.
<b>Step 2</b> Check the firmware version. Is the firmware updated to the latest version?	Go to step 4.	Go to step 3.
<b>Step 3</b> Update the firmware. Does the problem remain?	Go to step 4.	The problem is solved.
<b>Step 4</b> Replace the ADF and scanner. See <a href="#">ADF and Scanner Removal</a> . Does the problem remain?	Go to step 5.	The problem is solved.
<b>Step 5</b> 1 Make sure that the controller board is properly installed. 2 Reseat all the cables on the controller board. Does the problem remain?	Go to step 6.	The problem is solved.
<b>Step 6</b> Replace the controller board. See <a href="#">Controller Board Removal</a> . Does the problem remain?	Contact the next level of support.	The problem is solved.

## Repeating Defects Check



**Note:** Before performing this print quality check, print the Print Quality Test Pages. From the control panel, navigate to **Settings > Troubleshooting > Print Quality Test Pages**, and then perform the initial print quality check. See [Performing the initial troubleshooting check](#) .

## Diagnostics and Troubleshooting

Action	Yes	No
<p><b>Step 1</b></p> <p>Using the Print Quality Test Pages, check if the distance between the repeating defects is equal to any of the following:</p> <ul style="list-style-type: none"> <li>• 37.7mm (1.48in.)</li> <li>• 96mm (3.78in.)</li> </ul> <p>Does the distance between the repeating defects match any of the measurements?</p>	Go to step 2.	Go to step 3.
<p><b>Step 2</b></p> <p>Replace the imaging unit.</p> <p>Does the problem remain?</p>	Go to step 3.	The problem is solved.
<p><b>Step 3</b></p> <p>Check if the distance between the repeating defects is equal to any of the following:</p> <ul style="list-style-type: none"> <li>• 37.5mm (1.48in.)</li> <li>• 43.5mm (1.71in.)</li> </ul> <p>Does the distance between the repeating defects match any of the measurements?</p>	Go to step 4.	Go to step 5.
<p><b>Step 4</b></p> <p>Replace the toner cartridge.</p> <p>Does the problem remain?</p>	Go to step 5.	The problem is solved.
<p><b>Step 5</b></p> <p>Check if the distance between the repeating defects is equal to 52mm (2.05in.).</p> <p>Does the distance between the repeating defects match the measurement?</p>	Go to step 6.	Go to step 7.
<p><b>Step 6</b></p> <p>Replace the transfer roller. See <a href="#">Transfer roller removal</a>.</p> <p>Does the problem remain?</p>	Go to step 7.	The problem is solved.

Action	Yes	No
<p><b>Step 7</b></p> <p>Check if the distance between the repeating defects is equal to any of the following:</p> <ul style="list-style-type: none"> <li>• 62.5mm (2.46in.)</li> <li>• 79.8mm (3.14in.)</li> </ul> <p>Does the distance between the repeating defects match any of the measurements?</p>	Go to step 8.	Contact the next level of support.
<p><b>Step 8</b></p> <p>Replace the fuser. See <a href="#">Fuser removal</a>.</p> <p>Does the problem remain?</p>	Contact the next level of support.	The problem is solved.

# Paper Jams

## 200 Paper Jams

### 200 Paper Jam Messages

Error code	Description	Action
200.02	Paper fed from the MPF was detected earlier than expected at the sensor (input).	See <a href="#">Sensor (input): Paper arrived too early jam service check</a> .
200.04	Paper fed from the MPF cleared the sensor (input) earlier than expected.	See <a href="#">Sensor (input): Paper cleared too early jam service check</a> .
200.05	Paper fed from the MPF never cleared the sensor (input).	See <a href="#">Sensor (input): Paper failed to clear jam service check</a> .
200.06	Paper fed from the MPF was detected later than expected or was never detected at the sensor (input).	See <a href="#">Sensor (input): Paper failed to arrive jam service check</a> .
200.12	Paper fed from tray 1 was detected earlier than expected at the sensor (input).	See <a href="#">Sensor (input): Paper arrived too early jam service check</a> .
200.13	Paper fed from tray 1 was detected later than expected or was never detected at the sensor (input).	See <a href="#">Sensor (input): Paper failed to arrive jam service check</a> .
200.14	Paper fed from tray 1 cleared the sensor (input) earlier than expected.	See <a href="#">Sensor (input): Paper cleared too early jam service check</a> .
200.15	Paper fed from tray 1 never cleared the sensor (input).	See <a href="#">Sensor (input): Paper failed to clear jam service check</a> .
200.22	Paper fed from tray 2 was detected earlier than expected at the sensor (input).	See <a href="#">Sensor (input): Paper arrived too early jam service check</a> .
200.23	Paper fed from tray 2 was detected later than expected or was never detected at the sensor (input).	See <a href="#">Sensor (input): Paper failed to arrive jam service check</a> .
200.24	Paper fed from tray 2 cleared the sensor (input) earlier than expected.	See <a href="#">Sensor (input): Paper cleared too early jam service check</a> .



Error code	Description	Action
200.25	Paper fed from tray 2 never cleared the sensor (input).	See <a href="#">Sensor (input): Paper failed to clear jam service check</a> .
200.91	Paper remains detected at the sensor (input) after the printer is turned on.	See <a href="#">Sensor (input): Static jam service check</a> .

## Sensor (Input): Paper Arrived Too Early Jam Service Check

Action	Yes	No
<b>Step 1</b> Identify the source tray. Is MPF the source tray?	Go to step 2.	Go to step 4.
<b>Step 2</b> 1 Make sure that the MPF pick roller is free of contamination. 2 Clean the MPF pick roller. Does the problem remain?	Go to step 3.	The problem is solved.
<b>Step 3</b> Replace the front door. See <a href="#">Front door removal</a> . Does the problem remain?	Contact the next level of support.	The problem is solved.
<b>Step 4</b> Make sure that the paper is properly loaded in the tray. Does the problem remain?	Go to step 5.	The problem is solved.
<b>Step 5</b> Make sure that each tray is free of paper fragments and partially fed paper. Does the problem remain?	Go to step 6.	The problem is solved.
<b>Step 6</b> 1 Make sure that the pick roller and separator roller are free from contamination. 2 Clean the pick roller and separator roller. Does the problem remain?	Go to step 7.	The problem is solved.
<b>Step 7</b>	Go to step 9.	Go to step 8.

Action	Yes	No
<p>1 Enter the Diagnostics menu, and then navigate to:</p> <p><b>Printer diagnostics &amp; adjustments &gt; Sensor tests</b></p> <p>2 Find the sensor (input).</p> <p>3 Make sure that the sensor actuator freely moves and is not stuck.</p> <p>Does the sensor status change while toggling the sensor?</p>		
<p><b>Step 8</b></p> <p>1 Remove the right cover. See <a href="#">Right cover removal</a>.</p> <p>2 Make sure that the JMTR1 sensor cable is properly connected to the controller board.</p> <p>Does the problem remain?</p>	Go to step 9.	The problem is solved.
<p><b>Step 9</b></p> <p>Perform a print test.</p> <p>Does the problem remain?</p>	Contact the next level of support.	The problem is solved.

## Sensor (Input): Paper Cleared Too Early Jam Service Check

Action	Yes	No
<p><b>Step 1</b></p> <p>1 Remove the tray insert.</p> <p>2 Make sure that the paper is properly loaded in the tray.</p> <p>3 From the printer control panel or Printing Preferences or Print dialog, verify the paper size settings.</p> <p>The tray has no size sensing mechanism. Manually set the paper size through the printer control panel or Printing Preferences or Print dialog.</p> <p>Does the paper size match the settings that you want?</p>	Go to step 3.	Go to step 2.
<p><b>Step 2</b></p> <p>Change the paper size or adjust the size setting in the tray.</p>	Go to step 3.	The problem is solved.

Action	Yes	No
Does the problem remain?		
<b>Step 3</b> 1 Make sure that the tray is not overfilled. 2 Make sure that the paper guides are not set too tight against the paper. Does the problem remain?	Go to step 4.	The problem is solved.
<b>Step 4</b> Check the tray for crumpled, damaged, or deformed paper. Are there crumpled, damaged, or deformed paper in the tray?	Go to step 5.	Go to step 6.
<b>Step 5</b> Replace the crumpled, damaged, or deformed paper. Does the problem remain?	Go to step 6.	The problem is solved.
<b>Step 6</b> 1 Enter theDiagnostics menu, and then navigate to: <b>Printer diagnostics &amp; adjustments &gt; Sensor tests</b> 2 Find the sensor (input). 3 Make sure that the sensor actuator freely moves and is not stuck. Does the sensor status change while toggling the sensor?	Go to step 8.	Go to step 7.
<b>Step 7</b> 1 Remove the right cover. See <a href="#">Right cover removal</a> . 2 Make sure that the JMTR1 sensor cable is properly connected to the controller board. Does the problem remain?	Go to step 8.	The problem is solved.
<b>Step 8</b> Perform a print test. Does the problem remain?	Contact the next level of support.	The problem is solved.

## Sensor (Input): Paper Failed To Arrive Jam Service Check

 **Note:** This service check is not applicable to tray 2.

Action	Yes	No
<p><b>Step 1</b></p> <ol style="list-style-type: none"> <li>1 Remove the tray insert.</li> <li>2 Make sure that the paper is properly loaded in the tray.</li> <li>3 From the printer control panel or Printing Preferences or Print dialog, verify the paper size settings.</li> </ol> <p>The tray has no size sensing mechanism. Manually set the paper size through the printer control panel or Printing Preferences or Print dialog.</p> <p>Does the paper size match the settings that you want?</p>	Go to step 3.	Go to step 2.
<p><b>Step 2</b></p> <p>Change the paper size or adjust the size setting in the tray.</p> <p>Does the problem remain?</p>	Go to step 3.	The problem is solved.
<p><b>Step 3</b></p> <ol style="list-style-type: none"> <li>1 Make sure that the tray is not overfilled.</li> <li>2 Make sure that the paper guides are not set too tight against the paper.</li> </ol> <p>Does the problem remain?</p>	Go to step 4.	The problem is solved.
<p><b>Step 4</b></p> <p>Check the tray for crumpled, damaged, or deformed paper.</p> <p>Are there crumpled, damaged, or deformed paper in the tray?</p>	Go to step 5.	Go to step 6.
<p><b>Step 5</b></p> <p>Replace the crumpled, damaged, or deformed paper.</p> <p>Does the problem remain?</p>	Go to step 6.	The problem is solved.
<p><b>Step 6</b></p> <ol style="list-style-type: none"> <li>1 Enter theDiagnostics menu, and then navigate to:</li> </ol>	Go to step 8.	Go to step 7.

Action	Yes	No
<p><b>Printer diagnostics &amp; adjustments &gt; Sensor tests</b></p> <p>2 Find the sensor (input). 3 Make sure that the sensor actuator freely moves and is not stuck.</p> <p>Does the sensor status change while toggling the sensor?</p>		
<p><b>Step 7</b></p> <p>1 Remove the right cover. See <a href="#">Right cover removal</a>. 2 Make sure that the JMTR1 sensor cable is properly connected to the controller board.</p> <p>Does the problem remain?</p>	Go to step 8.	The problem is solved.
<p><b>Step 8</b></p> <p>Perform a print test.</p> <p>Does the problem remain?</p>	Contact the next level of support.	The problem is solved.

## Sensor Input): Paper Failed To Clear Jam Service Check

Action	Yes	No
<p><b>Step 1</b></p> <p>1 Remove the tray insert. 2 Make sure that the paper is properly loaded in the tray. 3 From the printer control panel or Printing Preferences or Print dialog, verify the paper size settings.</p> <p>The tray has no size sensing mechanism. Manually set the paper size through the printer control panel or Printing Preferences or Print dialog.</p> <p>Does the paper size match the settings that you want?</p>	Go to step 3.	Go to step 2.
<p><b>Step 2</b></p> <p>Change the paper size or adjust the size setting in the tray.</p> <p>Does the problem remain?</p>	Go to step 3.	The problem is solved.

## Diagnostics and Troubleshooting

Action	Yes	No
<p><b>Step 3</b></p> <p>1 Make sure that the tray is not overfilled.</p> <p>2 Make sure that the paper guides are not set too tight against the paper.</p> <p>Does the problem remain?</p>	Go to step 4.	The problem is solved.
<p><b>Step 4</b></p> <p>Check the tray for crumpled, damaged, or deformed paper.</p> <p>Are there crumpled, damaged, or deformed paper in the tray?</p>	Go to step 5.	Go to step 6.
<p><b>Step 5</b></p> <p>Replace the crumpled, damaged, or deformed paper.</p> <p>Does the problem remain?</p>	Go to step 6.	The problem is solved.
<p><b>Step 6</b></p> <p>Identify the source tray.</p> <p>Is MPF the source tray?</p>	Go to step 7.	Go to step 9.
<p><b>Step 7</b></p> <p>Make sure that the MPF pick roller is free of contamination.</p> <p>Does the problem remain?</p>	Go to step 8.	The problem is solved.
<p><b>Step 8</b></p> <p>Replace the front door. See <a href="#">Front door removal</a>.</p> <p>Does the problem remain?</p>	Go to step 9.	The problem is solved.
<p><b>Step 9</b></p> <p>Make sure that the pick roller is free of contamination.</p> <p>Does the problem remain?</p>	Go to step 10.	The problem is solved.
<p><b>Step 10</b></p> <p>1 Replace the pick roller.</p> <p>2 Replace the separator roller.</p> <p>Does the problem remain?</p>	Go to step 11.	The problem is solved.
<p><b>Step 11</b></p> <p>1 Enter the Diagnostics menu, and then navigate to:</p>	Go to step 13.	Go to step 12.

Action	Yes	No
<p><b>Printer diagnostics &amp; adjustments &gt; Sensor tests</b></p> <p>2 Find the sensor (input). 3 Make sure that the sensor actuator freely moves and is not stuck.</p> <p>Does the sensor status change while toggling the sensor?</p>		
<p><b>Step 12</b></p> <p>1 Remove the right cover. See <a href="#">Right cover removal</a>. 2 Make sure that the JMTR1 sensor cable is properly connected to the controller board.</p> <p>Does the problem remain?</p>	Go to step 13.	The problem is solved.
<p><b>Step 13</b></p> <p>Perform a print test.</p> <p>Does the problem remain?</p>	Contact the next level of support.	The problem is solved.

## Sensor (Input): Static Jam Service Check

Action	Yes	No
<p><b>Step 1</b></p> <p>Check the paper path for paper fragments and partially fed paper.</p> <p>Is the paper path free of paper fragments and partially fed paper?</p>	Go to step 3.	Go to step 2.
<p><b>Step 2</b></p> <p>Remove the paper fragments and partially fed paper.</p> <p>Does the problem remain?</p>	Go to step 3.	The problem is solved.
<p><b>Step 3</b></p> <p>1 Enter the Diagnostics menu, and then navigate to:</p> <p><b>Printer diagnostics &amp; adjustments &gt; Sensor tests</b></p> <p>2 Find the sensor (input). 3 Make sure that the sensor actuator freely moves and is not stuck.</p>	Go to step 5.	Go to step 4.

Action	Yes	No
Does the sensor status change while toggling the sensor?		
<b>Step 4</b> 1 Remove the right cover. See <a href="#">Right cover removal</a> . 2 Make sure that the JMTR1 sensor cable is properly connected to the controller board. Does the problem remain?	Go to step 5.	The problem is solved.
<b>Step 5</b> Perform a print test. Does the problem remain?	Contact the next level of support.	The problem is solved.

## 202 Paper Jams

### 202 Paper Jam Messages

Error code	Description	Action
202.03	Paper fed from the MPF never arrived at the sensor (fuser exit).	See <a href="#">Sensor (fuser exit): Paper failed to arrive jam service check</a> .
202.13	Paper fed from tray 1 never arrived at the sensor (fuser exit).	
202.23	Paper fed from tray 2 never arrived at the sensor (fuser exit).	
202.x4	Paper cleared the sensor (fuser exit) too soon.	See <a href="#">Sensor (fuser exit): Paper cleared too early jam service check</a> .
202.05	Paper fed from the MPF never cleared the sensor (fuser exit).	See <a href="#">Sensor (fuser exit): Paper failed to clear jam service check</a> .
202.15	Paper fed from tray 1 never cleared the sensor (fuser exit).	
202.25	Paper fed from tray 2 never cleared the sensor (fuser exit).	
202.91	Paper remains detected at the sensor (fuser exit) after the printer is turned on.	See <a href="#">Sensor (fuser exit): Static jam service check</a> .
202.93	The sensor (fuser exit) detected a jam during or after a flush action.	



Error code	Description	Action
202.95	Paper fed from an unknown tray never cleared the sensor (fuser exit).	

## Sensor (Fuser Exit): Paper Failed To Arrive Jam Service Check

Action	Yes	No
<p><b>Step 1</b></p> <p>Check the fuser paper path for paper fragments and partially fed paper.</p> <p>Is the fuser paper path free of paper fragments and partially fed paper?</p>	Go to step 3.	Go to step 2.
<p><b>Step 2</b></p> <p>Remove the paper fragments and partially fed paper.</p> <p>Do not remove any paper or paper fragments from the fuser using tools.</p> <p>Does the problem remain?</p>	Go to step 3.	The problem is solved.
<p><b>Step 3</b></p> <p>1 Remove paper in the tray, flip it over, and then reload paper.</p> <p>2 Resend the print job.</p> <p>Does the problem remain?</p>	Go to step 4.	The problem is solved.
<p><b>Step 4</b></p> <p>Replace the paper in the tray, and then resend the print job.</p> <p>Does the problem remain?</p>	Go to step 5.	The problem is solved.
<p><b>Step 5</b></p> <p>1 Enter the Diagnostics menu, and then navigate to:</p> <p><b>Printer diagnostics &amp; adjustments &gt; Sensor tests</b></p> <p>2 Find the sensor (fuser exit).</p> <p>3 Make sure that the sensor actuator freely moves and is not stuck.</p> <p>Does the sensor status change while toggling the sensor?</p>	Go to step 7.	Go to step 6.

## Diagnostics and Troubleshooting

Action	Yes	No
<p><b>Step 6</b></p> <ol style="list-style-type: none"> <li>1 Remove the right cover. See <a href="#">Right cover removal</a>.</li> <li>2 Make sure that the JEXIT1 sensor cable is properly connected to the controller board.</li> </ol> <p>Does the problem remain?</p>	Go to step 7.	The problem is solved.
<p><b>Step 7</b></p> <ol style="list-style-type: none"> <li>1 Enter the Diagnostics menu, and then navigate to: <b>Printer diagnostics &amp; adjustments &gt; Motor tests</b></li> <li>2 Find the main motor (forward).</li> <li>3 Open the front door, remove the imaging unit, and then close the front door.</li> <li>4 Activate the motor test.</li> <li>5 Open the rear door, and then check if the fuser belt is properly rotating.</li> </ol> <p>Is the fuser belt properly rotating?</p>	Go to step 9.	Go to step 8.
<p><b>Step 8</b></p> <ol style="list-style-type: none"> <li>1 Remove the right cover. See <a href="#">Right cover removal</a>.</li> <li>2 Make sure that the JMTR1 sensor cable is properly connected to the controller board.</li> </ol> <p>Does the problem remain?</p>	Go to step 9.	The problem is solved.
<p><b>Step 9</b></p> <p>Replace the fuser. See <a href="#">Fuser removal</a>.</p> <p>Does the problem remain?</p>	Go to step 10.	The problem is solved.
<p><b>Step 10</b></p> <p>Perform a print job.</p> <p>Does the problem remain?</p>	Go to step 11.	The problem is solved.

Action	Yes	No
<b>Step 11</b> Replace the main drive gears. See <a href="#">Main drive gears removal</a> . Does the problem remain?	Go to step 12.	The problem is solved.
<b>Step 12</b> 1 Make sure that the metal shutter in the printer frame is not stuck. 2 Check the metal shutter for fuser entry. Does the metal shutter freely move?	Contact the next level of support.	The problem is solved.

### Sensor (Fuser Exit): Paper Cleared Too Early Jam Service Check

Action	Yes	No
<b>Step 1</b> Remove all paper from the bin. Does the problem remain?	Go to step 2.	The problem is solved.
<b>Step 2</b> Check the fuser exit area, rear door, and redrive area for jammed paper or paper fragments. Are there jammed paper or paper fragments?	Go to step 3.	Contact the next level of support.
<b>Step 3</b> Remove the jammed paper or paper fragments. Does the problem remain?	Contact the next level of support.	The problem is solved.

## Sensor (Fuser Exit): Paper Failed To Clear Jam Service Check

Action	Yes	No
<p><b>Step 1</b></p> <ol style="list-style-type: none"> <li>1 Make sure that the fuser exit area, rear door, and redrive area are free of jammed paper or paper fragments</li> <li>2 Make sure that the rear door can properly close.</li> <li>3 Check the rear door for damage.</li> </ol> <p>Is the rear door functional and free of damage?</p>	Go to step 3.	Go to step 2.
<p><b>Step 2</b></p> <ol style="list-style-type: none"> <li>1 Enter the Diagnostics menu, and then navigate to: <b>Printer diagnostics &amp; adjustments &gt; Sensor tests</b></li> <li>2 Find the sensor (fuser exit).</li> <li>3 Make sure that the sensor actuator freely moves and is not stuck.</li> </ol> <p>Does the sensor status change while toggling the sensor?</p>	Go to step 5.	Go to step 3.
<p><b>Step 3</b></p> <ol style="list-style-type: none"> <li>1 Remove the right cover. See <a href="#">Right cover removal</a>.</li> <li>2 Make sure that the JEXIT1 sensor cable is properly connected to the controller board.</li> </ol> <p>Does the problem remain?</p>	Go to step 4.	The problem is solved.
<p><b>Step 4</b></p> <p>Replace the rear door. See <a href="#">Rear door removal</a>.</p> <p>Does the problem remain?</p>	Go to step 5.	The problem is solved.
<p><b>Step 5</b></p> <p>Replace the fuser. See <a href="#">Fuser removal</a>.</p> <p>Does the problem remain?</p>	Go to step 6.	The problem is solved.
<p><b>Step 6</b></p> <p>Check the redrive for damage.</p> <p>Is the redrive free of damage?</p>	Go to step 8.	Go to step 7.

Action	Yes	No
<b>Step 7</b> Replace the redrive. See <a href="#">Redrive removal</a> . Does the problem remain?	Go to step 8.	The problem is solved.
<b>Step 8</b> Perform a print test. Does the problem remain?	Contact the next level of support.	The problem is solved.

## Sensor (Fuser Exit): Static Jam Service Check

Action	Yes	No
<b>Step 1</b> Remove paper fragments and partially fed paper. Does the problem remain?	Go to step 2.	The problem is solved.
<b>Step 2</b> 1 Enter the Diagnostics menu, and then navigate to: <b>Printer diagnostics &amp; adjustments &gt; Sensor tests</b> 2 Find the sensor (fuser exit). 3 Make sure that the sensor actuator freely moves and is not stuck. Does the sensor status change while toggling the sensor?	Go to step 4.	Go to step 3.
<b>Step 3</b> 1 Remove the right cover. See <a href="#">Right cover removal</a> . 2 Make sure that the JEXIT1 sensor cable is properly connected to the controller board. Does the problem remain?	Go to step 4.	The problem is solved.
<b>Step 4</b> Perform a print test. Does the problem remain?	Contact the next level of support.	The problem is solved.

## 232 Paper Jams

### 232 Paper Jam Messages

Error code	Description	Action
232.03	Paper fed from MPF was detected later than expected or was never detected at the sensor (input) during a duplex print job.	See <a href="#">Sensor (input): Paper (duplex job) failed to arrive jam service check</a> .
232.13	Paper fed from tray 1 was detected later than expected or was never detected at the sensor (input) during a duplex print job.	
232.23	Paper fed from tray 2 was detected later than expected or was never detected at the sensor (input) during a duplex print job.	
232.05	Paper fed from the MPF never cleared the sensor (input) during a duplex print job.	
232.15	Paper fed from tray 1 never cleared the sensor (input) during a duplex print job.	
232.25	Paper fed from tray 2 never cleared the sensor (input) during a duplex print job.	
232.93	Paper fed from an unknown tray was detected later than expected or was never detected at the sensor (input) during a duplex print job.	
232.95	Paper fed from an unknown tray never cleared the sensor (input) during a duplex print job.	

## Sensor (Input): Paper (Duplex Job) Failed To Arrive Jam Service Check

Action	Yes	No
<b>Step 1</b> Remove all paper from the bin, and then resend the print job. Does the problem remain?	Go to step 2.	The problem is solved.
<b>Step 2</b> Check the fuser access area for jammed paper and obstructions. Is the fuser access area free of jammed paper and obstructions?	Go to step 4.	Go to step 3.
<b>Step 3</b> Remove the jammed paper and obstructions. Does the problem remain?	Go to step 4.	The problem is solved.
<b>Step 4</b> Check the duplex path area for jammed paper and obstructions. Is the duplex path area free of jammed paper and obstructions?	Go to step 6.	Go to step 5.
<b>Step 5</b> Remove the jammed paper and obstructions. Does the problem remain?	Go to step 6.	The problem is solved.
<b>Step 6</b> Check the duplex guide for proper installation. Is the duplex guide properly installed?	Go to step 8.	Go to step 7.
<b>Step 7</b> Reseat the duplex guide, and then make sure that it is properly closed. Does the problem remain?	Go to step 8.	The problem is solved.
<b>Step 8</b> Check the duplex guide for damage.	Go to step 10.	Go to step 9.

Action	Yes	No
Is the duplex guide free of damage?		
<b>Step 9</b> Replace the duplex guide. See <a href="#">Duplex guide removal</a> . Does the problem remain?	Go to step 10.	The problem is solved.
<b>Step 10</b> 1 Enter the Diagnostics menu, and then navigate to: <b>Printer diagnostics &amp; adjustments &gt; Sensor tests</b> 2 Find the sensor (input). 3 Make sure that the sensor actuator freely moves and is not stuck. Does the sensor status change while toggling the sensor?	Go to step 12.	Go to step 11.
<b>Step 11</b> 1 Remove the right cover. See <a href="#">Right cover removal</a> . 2 Make sure that the JMTR1 sensor cable is properly connected to the controller board. Does the problem remain?	Go to step 12.	The problem is solved.
<b>Step 12</b> Perform a print test. Does the problem remain?	Contact the next level of support.	The problem is solved.

## 242 Paper Jams

### 242 Paper Jam Messages

Error code	Description	Action
242.26	Paper fed from tray 2 was picked but it never reached the sensor (input).	See <a href="#">Optional tray pick drive failure service check</a> .
242.80	Paper jam caused by the motor (tray 2) not turning on.	



Error code	Description	Action
242.81	Paper jam caused by the motor (tray 2) not turning off.	
242.82	Paper jam caused by the motor (tray 2) speed not ramping up to the required level.	
242.83	Paper jam caused by the motor (tray 2) stalling.	
242.84	Paper jam caused by the motor (tray 2) running too slow.	
242.85	Paper jam caused by the motor (tray 2) running too fast.	
242.86	Paper jam caused by the motor (tray 2) running too long.	

## 280–295 Paper Jams

### 280–295 Paper Jam Messages

Error code	Description	Action
280.11	Paper remains detected at the sensor (ADF scan) after the printer is turned on.	See .
280.13	Paper never arrived at the sensor (ADF scan).	
280.15	Paper never cleared the sensor (ADF scan).	
295.01	An imagepipe error occurred. Gap between scanned pages is too small.	

## ADF Jam Service Check

Action	Yes	No
<p><b>Step 1</b></p> <p>Check the ADF paper path for paper fragments, partially fed paper, and obstructions.</p> <ul style="list-style-type: none"> <li>• Under the ADF cover</li> <li>• Under the ADF</li> <li>• ADF bin</li> </ul> <p>Is the paper path free of paper fragments, partially fed paper, and obstructions?</p>	Go to step 3.	Go to step 2.
<p><b>Step 2</b></p> <p>Remove the paper fragments, partially fed paper, and obstructions.</p> <p>Does the problem remain?</p>	Go to step 3.	The problem is solved.
<p><b>Step 3</b></p> <ol style="list-style-type: none"> <li>1 Open the ADF cover, and then check if it closes properly.</li> <li>2 Check the cover for improper installation.</li> </ol> <p>Is the ADF cover functional and properly installed?</p>	Go to step 5.	Go to step 4.
<p><b>Step 4</b></p> <ol style="list-style-type: none"> <li>1 Reinstall the ADF cover.</li> <li>2 Check the ADF cover for damage.</li> </ol> <p>Is the ADF cover free of damage?</p>	Go to step 5.	Go to step 6.
<p><b>Step 5</b></p> <ol style="list-style-type: none"> <li>1 Check the ADF cover pick mechanism for improper operation.</li> <li>2 Check the ADF pick roller and feed roller for wear, damage, and contamination.</li> </ol> <p>Are the pick components functional and free of wear, damage, and contamination?</p>	Go to step 7.	Go to step 6.
<p><b>Step 6</b></p> <p>Clean the affected components or replace the ADF cover. See <a href="#">ADF Cover Removal</a>.</p> <p>Does the problem remain?</p>	Go to step 7.	The problem is solved.

Action	Yes	No
<p><b>Step 7</b></p> <ol style="list-style-type: none"> <li>1 Check the ADF separator pad for improper installation.</li> <li>2 Check the separator pad for wear, damage, and contamination.</li> </ol> <p>Is the ADF separator pad properly installed and free of wear, damage, and contamination?</p>	Go to step 9.	Go to step 8.
<p><b>Step 8</b></p> <p>Reinstall, clean, or replace the ADF separator pad. See <a href="#">ADF Separator Pad Removal</a> .</p> <p>Does the problem remain?</p>	Go to step 9.	The problem is solved.
<p><b>Step 9</b></p> <ol style="list-style-type: none"> <li>1 Enter the Diagnostics menu, and then navigate to: <b>Scanner diagnostics &gt; Motor tests</b></li> <li>2 Select <b>ADF transport</b>, and then start the test.</li> </ol> <p>Does the motor run?</p>	Go to step 11.	Go to step 10.
<p><b>Step 10</b></p> <ol style="list-style-type: none"> <li>1 Make sure that the ADF is properly installed. Lift the ADF, and then check if it closes properly.</li> <li>2 Check the ADF for damage.</li> </ol> <p>Is the ADF free of damage?</p>	Go to step 11.	Go to step 16.
<p><b>Step 11</b></p> <ol style="list-style-type: none"> <li>1 Enter the Diagnostics menu, and then navigate to: <b>Scanner diagnostics &gt; Sensor tests</b></li> <li>2 Run the test on the following sensors: <ul style="list-style-type: none"> <li>• ADF paper present</li> <li>• ADF scan</li> </ul> </li> </ol> <p>Do the status of the sensors change while toggling the sensors?</p>	Go to step 13.	Go to step 12.
<p><b>Step 12</b></p> <p>Check the affected sensor and its flag for damage.</p>	Go to step 13.	Go to step 16.

## Diagnostics and Troubleshooting

Action	Yes	No
Is the sensor free of damage?		
<p><b>Step 13</b></p> <p>1 Enter the Diagnostics menu, and then navigate to:</p> <p style="padding-left: 20px;"><b>Scanner diagnostics &gt; Motor tests</b></p> <p>2 Select <b>Scanner</b>, and then start the test.</p> <p>Does the motor run?</p>	Go to step 17.	Go to step 14.
<p><b>Step 14</b></p> <p>1 Remove the right cover. See <a href="#">Right cover removal</a>.</p> <p>2 Reseat the following cables on the controller board:</p> <ul style="list-style-type: none"> <li>• JADFM1</li> <li>• JFBM1</li> <li>• JSCANSNS1</li> <li>• scanner ground cable</li> </ul> <p>Does the problem remain?</p>	Go to step 15.	The problem is solved.
<p><b>Step 15</b></p> <p>Check the scanner and its components for damage.</p> <ul style="list-style-type: none"> <li>• Belt</li> <li>• Cables</li> </ul> <p>Is the scanner free of damage?</p>	Go to step 17.	Go to step 16.
<p><b>Step 16</b></p> <p>Replace the ADF and scanner. See <a href="#">ADF and Scanner Removal</a>.</p> <p>Does the problem remain?</p>	Go to step 17.	The problem is solved.
<p><b>Step 17</b></p> <p>Make sure that the controller board is properly installed. Reseat all the cables on the controller board.</p> <p>Does the problem remain?</p>	Go to step 18.	The problem is solved.

Action	Yes	No
<p><b>Step 18</b></p> <p>Check the controller board and its connector pins for damage.</p> <p>Are the controller board and its connectors free of damage?</p>	Contact the next level of support.	Go to step 19.
<p><b>Step 19</b></p> <p>Replace the controller board. See <a href="#">Controller Board Removal</a>.</p> <p>Does the problem remain?</p>	Contact the next level of support.	The problem is solved.

## User Attendance Messages

### Non-Xerox Supply

The printer has detected a non-Xerox supply or part installed in the printer.

The Xerox printer is designed to function best with genuine Xerox supplies and parts. Use of third-party supplies or parts may affect the performance, reliability, or life of the printer and its imaging components.

All life indicators are designed to function with Xerox supplies and parts and may deliver unpredictable results if third-party supplies or parts are used. Imaging component usage beyond the intended life may damage the Xerox printer or associated components.

 **Warning:** Use of third-party supplies or parts can affect warranty coverage. Damage caused by the use of third-party supplies or parts may not be covered by the warranty.

If a customer accepts any and all of these risks and proceeds with the use of non-genuine supplies or parts in the printer, then instruct the customer to press and hold **X** and **#** simultaneously from the control panel for 15 seconds. Do not perform this action yourself.

If a customer does not want to accept these risks, then remove the third-party supply or part from the printer and install a genuine Xerox supply or part.

If the printer does not print after pressing and holding **X** and **#** simultaneously for 15 seconds, then instruct the customer to reset the supply usage counter.

1. From the control panel, navigate to:  
**Settings > Device > Maintenance > Configuration Menu > Supply Usage And Counters**
2. Select the part or supply to reset, and then select **Start**.
3. Read the warning message, and then select **Continue**.
4. Press and hold **X** and **#** simultaneously for 15 seconds to clear the message.

 **Note:** If the customer is unable to reset the supply usage counters, then the customer should return the item to the place of purchase.

### Metered Supply Installed in Printer Configured For Sold

The printer has detected a metered supply installed in the printer configured to use sold supply.

The printers ship with worldwide neutral toner cartridges. Initial installation of these cartridges sets the printer to worldwide neutral configuration. The first toner cartridge replacement sets the geographic differentiation code and toner cartridge type in NVM to that of the replacement cartridge. To change these NVM, a supplies plan conversion code (non-PagePack) or activation code (PagePack) code is required.

See [Supplies used to resolve print quality issues](#) for part numbers.

If an incorrect type of toner cartridge is installed, an error code is generated indicating toner incompatibility.

## Changing The Service Plan (Non-PagePack)

Contact the relevant OpCo to obtain a conversion code:

- **US:** Provide the printer Serial Number and Total Meter Read using the email template provided in Eureka Tip 1465824. A conversion PIN code is provided within 10 minutes. For any service plan conversion issues or special requests, phone Xerox Corporate Licensing Systems (XDSS), 1-800-890-3260.
- **Xerox Business Solutions (XBS):** All requests for service plan conversions must be approved by the XBS VP of Service. Request your field service manager to contact your XBS company VP of Service for direction. The XBS Core Company VP of Service will require authorization to convert the printer from sold to metered, and will provide a status of your request. Do not phone Field Engineering to request a conversion code.
- **US Authorized Service Provider (ASP):** Provide the printer Serial Number and Total Meter Read using the email template provided in Eureka Tip 1465824. A conversion PIN code is provided within 10 minutes. For any service plan conversion issues or special requests, phone Xerox Corporate Licensing Systems (XDSS), 1-800-890-3260.
- **Canada:** Provide the printer Serial Number and Total Meter Read using the email template provided in Eureka Tip 1465824. A conversion PIN code is provided within 10 minutes. For any service plan conversion issues or special requests, phone Customer Delivery Organization (CDO) field support, 1-800-647-1331.



**Note:** The service plan conversion code must be entered within 500 Total Impression counts. If this count is exceeded, a new code is required.

### Using The Control Panel

1. From the control panel, navigate to **Settings > Supplies Plan > Plan Conversion**.
2. Record the **Total Impressions** and **Device Serial Number**.
3. Contact the relevant OpCo to obtain the conversion code.
4. After receiving the conversion code, on the control panel, navigate to **Supplies Plan > Plan Conversion > Conversion Code**.
5. Enter the conversion code provided, then select **Convert Plan**.
6. Navigate to **Supplies Plan > Plan Conversion > Current Plan** to confirm the conversion is successful.

### Using The Embedded Web Server

1. Open a web browser, and then type the printer IP address. If necessary, ask the customer to enter the Admin password.
2. From the home page, navigate to **Settings > Supplies Plan > Plan Conversion**.
3. Record the **Total Impressions** and **Device Serial Number**.
4. Contact the relevant OpCo to obtain the conversion code.
5. After receiving the conversion code, on the embedded web server, navigate to **Settings > Supplies Plan > Plan Conversion > Conversion Code**.

6. Enter the conversion code provided, then click **Convert Plan**.
7. Check the **Current Plan** status to confirm the conversion is successful.

## Changing The Service Plan (PagePack)

Contact the relevant OpCo to obtain an activation code. Provide the Sequence Number and Device Serial Number.

- **EMEA (XE):** Email office.europe.page.pack.pin@xerox.com
- **EMEA (DMO-E):** Follow your local process.
- **LATAM (Latin America):** Follow your local process.

 **Note:** The service plan activation code must be entered within 1000 Total Impression counts. If this count is exceeded, a new code is required.

### Using The Control Panel

1. From the control panel, navigate to **Supplies Plan > Plan Activation**.
2. Record the **Sequence Number** and **Device Serial Number**.
3. Contact the relevant OpCo to obtain the activation code.
4. After receiving the activation code, on the control panel, navigate to **Settings > Supplies Plan > Plan Activation > Activation Code**.
5. Enter the activation code provided, then select **Activate Plan**.

### Using The Embedded Web Server

1. Open a web browser, and then type the printer IP address. If necessary, ask the customer to enter the Admin password.
2. From the home page, navigate to **Settings > Supplies Plan > Plan Activation**.
3. Record the **Sequence Number** and **Device Serial Number**.
4. Contact the relevant OpCo to obtain the activation code.
5. After receiving the activation code, on the embedded web server, navigate to **Settings > Supplies Plan > Plan Activation > Activation Code**.
6. Enter the activation code provided, then click **Activate Plan**.

## User Attendance Messages

Error code	Description	Action
29.xx	Packing material present on supplies.	Remove the packing material from the supplies.
31.40	The toner cartridge is missing or unresponsive.	See <a href="#">Unsupported or unresponsive toner cartridge service check</a> .



Error code	Description	Action
31.60	The imaging unit is missing or unresponsive.	See <a href="#">Unsupported or unresponsive imaging unit service check</a> .
32.40	The toner cartridge is unsupported.	See <a href="#">Unsupported or unresponsive toner cartridge service check</a> .
32.40J	Metered toner cartridge installed in printer configured for Sold.	See <a href="#">Metered supply installed in printer configured for sold</a>
32.60	The imaging unit is unsupported.	See <a href="#">Unsupported or unresponsive imaging unit service check</a> .
33.40	A non-Xerox black toner cartridge was detected.	See <a href="#">Unsupported or unresponsive toner cartridge service check</a> .
33.60		
41.60	The imaging unit and toner cartridge are mismatched or incompatible.	See <a href="#">Mismatched supplies error service check</a> .
42.xx	The toner cartridge is incompatible due to printer region mismatch.	Install the correct toner cartridge for the region.
43.40	A toner cartridge sensor error was detected.	
80.0x	The remaining life of the fuser, pick roller, or transfer roller are nearly low.	See <a href="#">Supplies low service check</a> .
80.1x	The remaining life of the fuser, pick roller, or transfer roller are low.	
80.2x	The remaining life of the fuser, pick roller, or transfer roller are very low.	
80.3x	The life of the fuser, pick roller, or transfer roller has ended.	
84.0x	The remaining life of the imaging unit is nearly low.	
84.1x	The remaining life of the imaging unit is low.	
84.2x	The remaining life of the imaging unit is very low.	
84.3x	The imaging unit life has ended.	
84.4x	The imaging unit life has ended. The printer forces a hard stop on the imaging unit.	
88.0x	The remaining life of the toner cartridge is nearly low.	

Error code	Description	Action
88.1x	The remaining life of the toner cartridge is low.	
88.2x	The remaining life of the toner cartridge is very low.	
88.3x	The toner cartridge life has ended.	
88.4x	The toner cartridge life has ended. The printer forces a hard stop on the toner cartridge.	

## Unsupported or Unresponsive Toner Cartridge Service Check

Action	Yes	No
<b>Step 1</b> Check whether the toner cartridge installed is genuine. Is the cartridge a genuine and supported Xerox unit?	Go to step 3.	Go to step 2.
<b>Step 2</b> Install a genuine and supported Xerox toner cartridge. Does the problem remain?	Go to step 3.	The problem is solved.
<b>Step 3</b> 1 Check the toner cartridge contacts for contamination. 2 Check the toner cartridge for leaks and damage. Are the toner cartridge and its contacts free of contamination and damage?	Go to step 5.	Go to step 4.
<b>Step 4</b> Clean or replace the toner cartridge. Does the problem remain?	Go to step 5.	The problem is solved.
<b>Step 5</b> Check the toner cartridge smart chip contacts for contamination. Are the contacts free of contamination?	Go to step 7.	Go to step 6.

Action	Yes	No
<b>Step 6</b> Clean the smart chip contact. Does the problem remain?	Go to step 7.	The problem is solved.
<b>Step 7</b> Reseat the smart chip contact cable on the controller board. Does the problem remain?	Contact the next level of support.	The problem is solved.

## Unsupported or Unresponsive Imaging Unit Service Check

Action	Yes	No
<b>Step 1</b> Check whether the imaging unit installed is genuine and supported by the printer model. Is the imaging unit a genuine and supported Xerox unit?	Go to step 3.	Go to step 2.
<b>Step 2</b> Install a genuine and supported Xerox imaging unit. Does the problem remain?	Go to step 3.	The problem is solved.
<b>Step 3</b> 1 Check the imaging unit contacts for contamination. 2 Check the imaging unit for leaks and damage. Are the imaging unit and its contacts free of contamination and damage?	Go to step 5.	Go to step 4.
<b>Step 4</b> Clean or replace the imaging unit. Does the problem remain?	Go to step 5.	The problem is solved.
<b>Step 5</b> 1 Check the imaging unit smart chip contacts for contamination. 2 Check if the contacts are bent or damaged.	Go to step 7.	Go to step 6.

Action	Yes	No
Are the contacts free of contamination and damage?		
<b>Step 6</b> Clean or repair the smart chip contact. Does the problem remain?	Go to step 7.	The problem is solved.
<b>Step 7</b> Reseat the smart chip contact cable on the controller board. Does the problem remain?	Contact the next level of support.	The problem is solved.

## Mismatched Supplies Error Service Check

Action	Yes	No
<b>Step 1</b> Check whether the supplies installed are genuine and supported by the printer model. Are the supplies genuine and supported Xerox units?	Go to step 3.	Go to step 2.
<b>Step 2</b> Install genuine and supported Xerox units. Does the problem remain?	Go to step 3.	The problem is solved.
<b>Step 3</b> Replace the affected supply with the correct unit. Does the problem remain?	Contact the next level of support.	The problem is solved.

## Supplies Low Service Check

Action	Yes	No
<p><b>Step 1</b></p> <p>Perform a print test on paper from a fresh package, and then check the result.</p> <p>Are there print quality defects on the test page?</p>	Go to step 2.	Go to step 3.
<p><b>Step 2</b></p> <p>Identify, and then resolve the print quality defects. See <a href="#">Fixing print quality issues</a>.</p> <p>If a supply was replaced, then make sure that the maintenance kit counter is reset.</p> <p>Does the problem remain?</p>	Go to step 3.	The problem is solved.
<p><b>Step 3</b></p> <p>Perform a feed test to check if the printer has paper feed problems.</p> <p>Does the printer have a problem feeding paper during the test?</p>	Go to step 4.	Go to step 5.
<p><b>Step 4</b></p> <p>Resolve the feed problem.</p> <p>If a transfer roller was replaced, then make sure that the maintenance kit counter is reset.</p> <p>Does the problem remain?</p>	Go to step 5.	The problem is solved.
<p><b>Step 5</b></p> <p>Replace the affected part with a new one.</p> <ul style="list-style-type: none"> <li>• Fuser</li> <li>• Pick roller</li> <li>• Transfer roller</li> </ul> <p>Does the problem remain?</p>	Contact the next level of support.	The problem is solved.

# Printer Hardware Errors

## 111 Errors

### 111 Error Messages

Error code	Description	Action
111.20	Printhead error (mirror motor lock) was detected before the motor was turned on.	See <a href="#">Printhead service check</a> .
111.21	No printhead power (+5 V) when the laser servo started.	
111.30	The printhead failed during power-on tests.	
111.31	Printhead error (no first HSYNC) was detected.	
111.32	Printhead error (lost HSYNC) was detected.	
111.33	Printhead error (lost HSYNC) was detected during servo.	
111.34	Printhead error (mirror motor lost lock) was detected.	
111.35	Printhead error (mirror motor never got first lock) was detected.	
111.36	Printhead error (mirror motor lock never stabilized) was detected.	
111.37	Paper reached the sensor but the mirror motor was not locked.	
111.38	Paper reached the sensor (input) but the printhead startup was not complete.	
111.40	The wrong printhead is installed.	
111.91	Printhead error (bad facet time reading).	

## Printhead Service Check

Action	Yes	No
<b>Step 1</b> Perform a POR. Does the problem remain?	Go to step 2.	The problem is solved.
<b>Step 2</b> 1 Make sure that the JVD01 and JMIR1 cables are properly connected on the controller board. 2 Check the cables for damage. Are the cables properly connected and free of damage?	Go to step 4.	Go to step 3.
<b>Step 3</b> Replace the printhead. See <a href="#">Printhead removal</a> . Does the problem remain?	Go to step 4.	The problem is solved.
<b>Step 4</b> Perform a POR. Does the problem remain?	Go to step 5.	The problem is solved.
<b>Step 5</b> Replace the controller board. See <a href="#">Controller Board Removal</a> . Does the problem remain?	Contact the next level of support.	The problem is solved.

## 121 Errors

### 121 Error Messages

Error code	Description	Action
121.00	Fuser did not reach the required temperature.	See <a href="#">Fuser service check</a> .
121.02	Fuser went over the required temperature during EWC/line voltage detection.	
121.04	During an attempt to heat up, the fuser relay was open and the micro-controller was not reporting an error.	

## Diagnostics and Troubleshooting

Error code	Description	Action
121.05	During an attempt to heat up, the fuser relay was open and the micro-controller was reporting an error.	
121.10	Fuser did not reach the required temperature during the start of EWC/line voltage detection.	
121.11	Fuser reached the required temperature too late during the final EWC/line voltage detection.	
121.12	Fuser did not reach the required temperature during the final EWC/line voltage detection.	
121.13	Fuser reached the required temperature too fast during the final EWC/line voltage detection.	
121.14	Fuser is heating too fast.	
121.20	Fuser did not reach the required temperature during steady state control. This can occur during printing or in standby mode.	
121.22	Open fuser relay was detected.	
121.23	Fuser relay was turned off, but the feedback to the engine code indicated that it was still open.	
121.24	Fuser did not reach the required temperature during the final EWC/line voltage detection.	
121.28	Fuser did not reach the required temperature during EP warm-up.	
121.32	Fuser did not reach the required temperature at 100 % power.	
121.33	Fuser did not reach the required temperature while page is in the fuser).	
121.34	Fuser did not reach the required temperature during steady state control.	
121.50	Fuser went over the required temperature during global over-temp check.	
121.52	Main thermistor temperature is out of range.	



Error code	Description	Action
121.53	Main thermistor temperature change rate is out of range.	
121.71	Open fuser main heater thermistor was detected.	

## Fuser Service Check

Action	Yes	No
<b>Step 1</b> Make sure that the fuser is properly installed. Does the problem remain?	Go to step 2.	The problem is solved.
<b>Step 2</b> Check whether the fuser installed is genuine and supported by the printer model. Is the fuser a genuine and supported Xerox unit?	Go to step 3.	Go to step 5.
<b>Step 3</b> Check if the fuser type is compatible with the printer model. Are the fuser and printer compatible?	Go to step 4.	Go to step 5.
<b>Step 4</b> Check the fuser life. Has the fuser reached its end of life?	Go to step 5.	Go to step 6.
<b>Step 5</b> Replace the fuser. See <a href="#">Fuser removal</a> . Make sure that the new fuser is supported by the printer model. Does the problem remain?	Go to step 6.	The problem is solved.
<b>Step 6</b> Make sure that the voltage output of the electrical outlet matches the voltage rating of the printer. Does the problem remain?	Go to step 7.	The problem is solved.

Action	Yes	No
<b>Step 7</b> Make sure that the JFUSER1 and JEXIT1 cables are properly connected on the controller board. Does the problem remain?	Go to step 8.	The problem is solved.
<b>Step 8</b> Make sure that the high voltage cable is properly connected to the LVPS. Does the problem remain?	Go to step 9.	The problem is solved.
<b>Step 9</b> Perform a POR. Does the problem remain?	Go to step 10.	The problem is solved.
<b>Step 10</b> Replace the LVPS. See <a href="#">LVPS removal</a> . Does the problem remain?	Go to step 11.	The problem is solved.
<b>Step 11</b> Replace the fuser. See <a href="#">Fuser removal</a> . Does the problem remain?	Contact the next level of support.	The problem is solved.

## 126 Errors

### 126 Error Messages

Error code	Description	Action
126.01	Line frequency has gone outside the operating range.	See <a href="#">LVPS service check</a> .
126.02	No line frequency was detected.	
126.05	The LVPS power dropped but the printer was not in sleep mode.	
126.06	LVPS 25 V line error was detected.	
126.07	LVPS 5 V rail was down during power-on.	
126.10	No line frequency was detected.	

Error code	Description	Action
126.11	Line frequency exceeded the operating range.	
126.14	LVPS relay is stuck or closed.	

## LVPS Service Check

Action	Yes	No
<p><b>Step 1</b></p> <p>Make sure that the printer is directly plugged into the electrical outlet.</p> <p>Does the problem remain?</p>	Go to step 2.	The problem is solved.
<p><b>Step 2</b></p> <p>Make sure that the voltage output of the electrical outlet matches the voltage rating of the printer.</p> <p>Does the problem remain?</p>	Go to step 3.	The problem is solved.
<p><b>Step 3</b></p> <p>1 Make sure that the PCN1 cable on the LVPS is properly connected.</p> <p>2 Make sure that the JLVPS1 cable on the controller board is properly connected.</p> <p>Does the problem remain?</p>	Go to step 4.	The problem is solved.
<p><b>Step 4</b></p> <p>Make sure that the voltage output of the electrical outlet matches the voltage rating of the LVPS.</p> <p>Does the problem remain?</p>	Go to step 5.	The problem is solved.
<p><b>Step 5</b></p> <p>Perform a POR.</p> <p>Does the problem remain?</p>	Go to step 6.	The problem is solved.

Action	Yes	No
<b>Step 6</b> Replace the LVPS. See <a href="#">LVPS removal</a> . Does the problem remain?	Go to step 7.	The problem is solved.
<b>Step 7</b> Perform a POR. Does the problem remain?	Contact the next level of support.	The problem is solved.

## 140 Errors

### 140 Error Messages

Error code	Description	Action
140.80	Motor (main drive) does not turn on.	See <a href="#">Motor (main drive) service check</a> .
140.81	Motor (main drive) does not turn off.	
140.82	Motor (main drive) speed did not ramp up to the required level.	
140.83	Motor (main drive) stalled.	
140.85	Motor (main drive) ran too fast.	
140.86	Motor (main drive) ran too long.	

### Motor (Main Drive) Service Check

Action	Yes	No
<b>Step 1</b> 1 Remove the imaging unit. 2 Manually turn the photoconductor gear, and then check the cleaning blade for damage or failure. Does the photoconductor drum rotate?	Go to step 3.	Go to step 2.
<b>Step 2</b> Replace the imaging unit. Does the problem remain?	Go to step 3.	The problem is solved.

Action	Yes	No
<b>Step 3</b> 1 Make sure that the JMTR1 cable is properly connected to the controller board. 2 Check the cable for damage. Is the cable free of damage?	Go to step 5.	Go to step 4.
<b>Step 4</b> Replace the JMTR1 cable. Does the problem remain?	Go to step 5.	The problem is solved.
<b>Step 5</b> Perform a POR. Does the problem remain?	Contact the next level of support.	The problem is solved.

## 162 Errors

### 162 Error Messages

Error code	Description	Action
162.80	The motor (tray 2 pick) does not turn on.	See <a href="#">Optional tray pick drive failure service check</a> .
162.81	The motor (tray 2 pick) does not turn off.	
162.82	The motor (tray 2 pick) speed did not ramp up to the required level.	
162.83	The motor (tray 2 pick) stalled.	
162.84	The motor (tray 2 pick) ran too slow.	
162.85	The motor (tray 2 pick) ran too fast.	
162.86	The motor (tray 2 pick) ran too long.	

## Optional Tray Pick Drive Failure Service Check

Action	Yes	No
<b>Step 1</b> Check if the optional tray motor (pick) runs. Does the motor run?	Go to step 3.	Go to step 2.
<b>Step 2</b> Reseat the motor cable, and then reseat the cable on the optional tray controller board. Does the problem remain?	Go to step 3.	The problem is solved.
<b>Step 3</b> 1 Remove the optional tray. 2 Under the printer, check the interconnect cable for damage. Is the cable free of damage?	Go to step 5.	Go to step 4.
<b>Step 4</b> Insert the optional tray. Make sure that the interconnect cable properly fits with the socket on the optional tray. Does the problem remain?	Go to step 5.	The problem is solved.
<b>Step 5</b> 1 Remove the tray insert from the optional tray. 2 Check if the lift plate moves properly. 3 Check the lift plate gears for damage. Is the tray insert functional and free of damage?	Contact the next level of support.	Go to step 6.
<b>Step 6</b> Replace the tray insert. Does the problem remain?	Contact the next level of support.	The problem is solved.

# 6yy Errors

## 600-680 Error Messages

Error code	Description	Action	
600.01	Toner tally from the RIP was not received.	Resend the print job. If the problem remains, then contact the next level of support.	
600.02	Video did not start.		
600.04	Duplex page was not picked.		
600.05	Invalid PH NVRAM Type error was detected.		
600.06	Paper port driver is unresponsive.		
600.07	Page is at image point before EP is ready.		
600.09	EP update error was detected.		
600.10	EP late run-in error was detected.		
600.11	Packing material was detected by the sensor (toner density).		Remove the imaging unit and toner cartridge, and then make sure that all packing material are properly removed.
600.95	RIP intentionally declared a jam error, usually to prevent a kiosk user from printing free pages.		Resend the print job. If the problem remains, then contact the next level of support.
602.29	Tray 2 was not ready for picking.	See <a href="#">Optional tray pick drive failure service check</a> .	
611.02	An Input ISR error occurred and the printhead was not ready.	See <a href="#">Printhead service check</a> .	
611.32	Lost Hsync errors were detected. Laser safety interlock system may be the cause.		
611.33	Lost Hsync errors were detected during servo.		
611.34	A mirror motor lock error was detected.		
611.35	Mirror motor never got first lock.		
611.36	Mirror motor lock never stabilized.		
611.37	Paper reached the sensor (input) but the mirror motor was not locked.		

## Diagnostics and Troubleshooting

Error code	Description	Action
611.38	Paper reached the sensor (input) but the printhead startup was not complete.	
621.01	Fuser heater was too cold when paper entered the fuser nip.	Resend the print job. If the problem remains, then contact the next level of support.
640.84	The motor (main drive) stalled or ran too slow.	See <a href="#">Motor (main drive) service check</a> .
662.23	The tray 2 lift plate failed to lift.	See <a href="#">Optional tray pick drive failure service check</a> .
662.80	Jam detection caused by motor (tray 2) not turning on.	
662.81	Jam detection caused by motor (tray 2) not turning off.	
662.82	Jam detection caused by motor (tray 2) speed not ramping up to the required level.	
662.83	Jam detection caused by motor (tray 2) stalling.	
662.84	Jam detection caused by motor (tray 2) running too slow.	
662.85	Jam detection caused by motor (tray 2) running too fast.	
662.86	Jam detection caused by motor (tray 2) running too long.	
680.20	During an ADF job, there was no paper detected on the ADF tray.	See .
680.40	During a scan job, a communication error occurred.	See .



## Fuser Overheated Service Check

Action	Yes	No
<b>Step 1</b> 1 Allow fuser to cool for three minutes. 2 Resend the print job. Does the problem remain?	Go to step 2.	The problem is solved.
<b>Step 2</b> Replace the fuser. See <a href="#">Fuser removal</a> . Does the problem remain?	Contact the next level of support.	The problem is solved.

## ADF Failure Service Check

Action	Yes	No
<b>Step 1</b> Check the ADF paper path for paper fragments, partially fed paper, and obstructions. <ul style="list-style-type: none"> <li>• Under the ADF cover</li> <li>• Under the ADF</li> <li>• ADF bin</li> </ul> Is the paper path free of paper fragments, partially fed paper, and obstructions?	Go to step 3.	Go to step 2.
<b>Step 2</b> Remove the paper fragments, partially fed paper, and obstructions. Does the problem remain?	Go to step 3.	The problem is solved.
<b>Step 3</b> 1 Enter the Diagnostics menu, and then navigate to: <b>Scanner diagnostics &gt; Motor tests</b> 2 Select <b>ADF transport</b> , and then start the test. Does the motor run?	Go to step 5.	Go to step 4.
<b>Step 4</b> 1 Make sure that the ADF is properly installed. Lift the ADF,	Go to step 5.	Go to step 9.

## Diagnostics and Troubleshooting

Action	Yes	No
<p>and then check if it closes properly.</p> <p>2 Check the ADF for damage.</p> <p>Is the ADF free of damage?</p>		
<p><b>Step 5</b></p> <p>1 Enter the Diagnostics menu, and then navigate to:</p> <p><b>Scanner diagnostics &gt; Sensor tests</b></p> <p>2 Run the test on the following sensors:</p> <ul style="list-style-type: none"> <li>• ADF paper present</li> <li>• ADF scan</li> </ul> <p>Does the sensor status change while toggling the sensors?</p>	Go to step 10.	Go to step 6.
<p><b>Step 6</b></p> <p>Check the affected sensor and its flag for damage.</p> <p>Is the sensor free of damage?</p>	Go to step 7.	Go to step 9.
<p><b>Step 7</b></p> <p>1 Remove the right cover. See <a href="#">Right cover removal</a>.</p> <p>2 Reseat the scanner cables.</p> <p>Does the problem remain?</p>	Go to step 8.	The problem is solved.
<p><b>Step 8</b></p> <p>Check the cable for damage.</p> <p>Is the cable free of damage?</p>	Go to step 10.	Go to step 9.
<p><b>Step 9</b></p> <p>Replace the ADF and scanner. See <a href="#">ADF and Scanner Removal</a>.</p> <p>Does the problem remain?</p>	Go to step 10.	The problem is solved.
<p><b>Step 10</b></p> <p>Make sure that the controller board is properly installed. Reseat all the cables on the controller board.</p> <p>Does the problem remain?</p>	Go to step 11.	The problem is solved.

Action	Yes	No
<b>Step 11</b> Check the controller board and its connector pins for damage.  Are the controller board and its connectors free of damage?	Contact the next level of support.	Go to step 12.
<b>Step 12</b> Replace the controller board. See <a href="#">Controller Board Removal</a> .  Does the problem remain?	Contact the next level of support.	The problem is solved.

## Scanner Communication Error Service Check

Action	Yes	No
<b>Step 1</b> 1 Remove the right cover. See <a href="#">Right cover removal</a> . 2 Reseat the following cables on the controller board: <ul style="list-style-type: none"> <li>• JADFM1</li> <li>• JFBM1</li> <li>• JSCANSNS1</li> <li>• scanner ground cable</li> </ul> Does the problem remain?	Go to step 2.	The problem is solved.
<b>Step 2</b> Make sure that the scanner ground cable is properly connected to the controller board.  Does the problem remain?	Go to step 3.	The problem is solved.
<b>Step 3</b> Replace the ADF and scanner. See <a href="#">ADF and Scanner Removal</a> .  Does the problem remain?	Go to step 4.	The problem is solved.
<b>Step 4</b> Replace the controller board. See <a href="#">Controller Board Removal</a> .  Does the problem remain?	Contact the next level of support.	The problem is solved.

## 84y Errors

### 840–845 Error Messages

Error code	Description	Action
840.01	The scanner was manually disabled by the user.	See .
840.02	The scanner was automatically disabled by the printer after two consecutive hardware failures.	
842.00	A scanner communication error (no response) was detected.	
842.01	A scanner communication error (HW protocol) was detected.	
842.02	A scanner communication error (logical protocol) was detected.	
843.00	The scanner CIS failed to reach its home position.	
845.03	A back side scan error occurred.	See .

### Scanner Communication Failure Service Check

Action	Yes	No
<p><b>Step 1</b></p> <p>Check the ADF paper path for paper fragments, partially fed paper, and obstructions.</p> <ul style="list-style-type: none"> <li>• Under the ADF cover</li> <li>• Under the ADF</li> <li>• ADF bin</li> </ul> <p>Is the paper path free of paper fragments, partially fed paper, and obstructions?</p>	Go to step 3.	Go to step 2.
<p><b>Step 2</b></p> <p>Remove the paper fragments, partially fed paper, and obstructions.</p> <p>Does the problem remain?</p>	Go to step 3.	The problem is solved.
<p><b>Step 3</b></p> <p>1 Remove the right cover. See <a href="#">Right cover removal</a>.</p>	Go to step 4.	The problem is solved.

Action	Yes	No
<p>2 Reseat the scanner cables on the controller board.</p> <p>Does the problem remain?</p>		
<p><b>Step 4</b></p> <p>Check the cables for damage.</p> <p>Is the cable free of damage?</p>	Go to step 5.	Go to step 12.
<p><b>Step 5</b></p> <p>1 From the control panel, navigate to:</p> <p><b>Settings &gt; Device &gt; Maintenance &gt; Config Menu &gt; Scanner Configuration &gt; Disable Scanner</b></p> <p>2 Select <b>Enable</b>.</p> <p>Does the problem remain?</p>	Go to step 6.	The problem is solved.
<p><b>Step 6</b></p> <p>1 Enter the Diagnostics menu, and then navigate to:</p> <p><b>Scanner diagnostics &gt; Motor tests</b></p> <p>2 Select <b>ADF transport</b>, and then start the test.</p> <p>Does the motor run?</p>	Go to step 8.	Go to step 7.
<p><b>Step 7</b></p> <p>1 Make sure that the ADF is properly installed. Lift the ADF, and then check if it closes properly.</p> <p>2 Check the ADF for damage.</p> <p>Is the ADF free of damage?</p>	Go to step 8.	Go to step 13.
<p><b>Step 8</b></p> <p>1 Enter the Diagnostics menu, and then navigate to:</p> <p><b>Scanner diagnostics &gt; Sensor tests</b></p> <p>2 Run the test on the following sensors:</p> <ul style="list-style-type: none"> <li>• ADF paper present</li> <li>• ADF scan</li> </ul> <p>Does the sensor status change while toggling the sensors?</p>	Go to step 10.	Go to step 9.

## Diagnostics and Troubleshooting

Action	Yes	No
<p><b>Step 9</b></p> <p>Check the affected sensor and its flag for damage.</p> <p>Is the sensor free of damage?</p>	Go to step 10.	Go to step 13.
<p><b>Step 10</b></p> <p>1 Enter the Diagnostics menu, and then navigate to:</p> <p style="padding-left: 20px;"><b>Scanner diagnostics &gt; Motor tests</b></p> <p>2 Select <b>Scanner</b>, and then start the test.</p> <p>Does the motor run?</p>	Go to step 14.	Go to step 11.
<p><b>Step 11</b></p> <p>1 Remove the right cover. See <a href="#">Right cover removal</a>.</p> <p>2 Reseat the scanner cables.</p> <p>Does the problem remain?</p>	Go to step 12.	The problem is solved.
<p><b>Step 12</b></p> <p>Check the scanner and its components for damage.</p> <ul style="list-style-type: none"> <li>• CIS</li> <li>• Belt</li> <li>• Cables</li> </ul> <p>Is the scanner free of damage?</p>	Go to step 14.	Go to step 13.
<p><b>Step 13</b></p> <p>Replace the ADF and scanner. See <a href="#">ADF and Scanner Removal</a>.</p> <p>Does the problem remain?</p>	Go to step 14.	The problem is solved.
<p><b>Step 14</b></p> <p>Make sure that the controller board is properly installed. Reseat all the cables on the controller board.</p> <p>Does the problem remain?</p>	Go to step 15.	The problem is solved.

Action	Yes	No
<b>Step 15</b> Check the controller board and its connector pins for damage.  Are the controller board and its connectors free of damage?	Contact the next level of support.	Go to step 16.
<b>Step 16</b> Replace the controller board. See <a href="#">Controller Board Removal</a> .  Does the problem remain?	Contact the next level of support.	The problem is solved.

## Scanner Noise Service Check

Action	Yes	No
<b>Step 1</b> With the scanner cover open, do a copy job to check the scanner lamp.  The scanner lamp must light up and move along the scan area.  Is the scanner lamp functional?	Go to step 3.	Go to step 2.
<b>Step 2</b> 1 Remove the right cover. See <a href="#">Right cover removal</a> . 2 Reseat the scanner cables on the controller board.  Does the problem remain?	Go to step 3.	The problem is solved.
<b>Step 3</b> Check the scanner and its components for damage. <ul style="list-style-type: none"> <li>• Scanner lamp</li> <li>• Motor (scanner)</li> <li>• Scanner belt</li> <li>• Glass panes</li> <li>• Cables</li> </ul> Are the scanner and its components free of damage?	Go to step 5.	Go to step 4.
<b>Step 4</b> Replace the ADF and scanner. See <a href="#">ADF and Scanner Removal</a> .  Does the problem remain?	Go to step 5.	The problem is solved.

## Diagnostics and Troubleshooting

Action	Yes	No
<b>Step 5</b> Check the firmware version. Is the firmware updated to the latest version?	Go to step 7.	Go to step 6.
<b>Step 6</b> Update the firmware. Does the problem remain?	Go to step 7.	The problem is solved.
<b>Step 7</b> Make sure that the controller board is properly installed. Reseat all the cables on the controller board. Does the problem remain?	Go to step 8.	The problem is solved.
<b>Step 8</b> Replace the controller board. See <a href="#">Controller Board Removal</a> . Does the problem remain?	Contact the next level of support.	The problem is solved.

## Duplex Scan Error Service Check

Action	Yes	No
<b>Step 1</b> Check the ADF paper path for paper fragments, partially fed paper, and obstructions. <ul style="list-style-type: none"> <li>• Under the ADF cover</li> <li>• Under the ADF</li> <li>• ADF bin</li> </ul> Is the paper path free of paper fragments, partially fed paper, and obstructions?	Go to step 3.	Go to step 2.
<b>Step 2</b> Remove the paper fragments, partially fed paper, and obstructions. Does the problem remain?	Go to step 3.	The problem is solved.
<b>Step 3</b> 1 Enter the Diagnostics menu, and then navigate to:	Go to step 5.	Go to step 4.



Action	Yes	No
<p><b>Scanner diagnostics &gt; Motor tests</b></p> <p>2 Select <b>ADF transport</b>, and then start the test.</p> <p>Does the motor run?</p>		
<p><b>Step 4</b></p> <p>1 Make sure that the ADF is properly installed. Lift the ADF, and then check if it closes properly.</p> <p>2 Check the ADF for damage.</p> <p>Is the ADF free of damage?</p>	Go to step 5.	Go to step 7.
<p><b>Step 5</b></p> <p>1 Enter the Diagnostics menu, and then navigate to:</p> <p><b>Scanner diagnostics &gt; Sensor tests</b></p> <p>2 Run the test on the following sensors:</p> <ul style="list-style-type: none"> <li>• ADF paper present</li> <li>• ADF scan</li> </ul> <p>Does the sensor status change while toggling the sensors?</p>	Go to step 8.	Go to step 6.
<p><b>Step 6</b></p> <p>Check the affected sensor and its flag for damage.</p> <p>Is the sensor free of damage?</p>	Go to step 8.	Go to step 7.
<p><b>Step 7</b></p> <p>1 Remove the right cover. See <a href="#">Right cover removal</a>.</p> <p>2 Reseat the scanner cables on the controller board.</p> <p>Does the problem remain?</p>	Go to step 8.	The problem is solved.
<p><b>Step 8</b></p> <p>Check the cable for damage.</p> <p>Is the cable free of damage?</p>	Go to step 9.	Go to step 10.

Action	Yes	No
<p><b>Step 9</b></p> <p>With the scanner cover open, do a duplex copy job to check the ADF scanner lamp.</p> <p>The scanner lamp must light up.</p> <p>Is the scanner lamp functional?</p>	Contact the next level of support.	Go to step 10.
<p><b>Step 10</b></p> <p>Replace the ADF and scanner. See <a href="#">ADF and Scanner Removal</a>.</p> <p>Does the problem remain?</p>	Contact the next level of support.	The problem is solved.

## Procedure Before Starting The 9yy Service Checks

Retrieve certain information that helps your next level of support in diagnosing the problem before replacing the controller board.

 **Warning:** Do not replace the controller board unless instructed by your next level of support.

1. Collect the history information and firmware logs (Fwdebug and logs.tar.gz) from the SE menu.
2. Collect the settings from the Menu Settings Page.
3. Collect information from the user.

 **Note:** Not all of the items are retrievable from the printer that you are working on.

### A. Collecting The History Information From The SE Menu

 **Note:** Make sure that your printer is connected to a network or to a print server.

1. Open a web browser, type `http://printer_IP_address/se`, and then press **Enter**.

 **Note:**

- printer\_IP\_address is the TCP/IP address of the printer.
  - se is required to access the printer diagnostic information.
2. Click **History Information**, copy all information, and then save it as a text file.
  3. E-mail the text file to your next level of support.

## B. Collecting The Firmware Logs (fwdebug and Logs.tar.gz) From The SE Menu

### Note:

- Make sure that your printer is connected to a network or to a print server.
  - Some printers are designed to restart automatically after a 9yy error. On these printers, you can retrieve the secondary crash code information using the SE menu.
1. Open a web browser, type `http://printer_IP_address/se`, and then press **Enter**.
  2. Click **Logs Gzip Compressed**.

 **Note:** A logs.tar.gz file is saved to the Downloads folder. The file may take several minutes to save. You may rename the file if a logs.tar.gz already exists in the Downloads folder.

3. E-mail the logs to your next level of support.

 **Note:** To download the FWdebug log to a flash drive, see [General SE Menu](#).

## C. Collecting The Settings From The Menu Settings Page

 **Note:** The Menu Settings Page is different for each printer. For more information, see the printer User's Guide. Your next level of support will tell you which page they want to see.

## D. Collecting Information From The User

Ask the user for information about the following:

- Print job being run
- Operating system being used
- Print driver being used
- Other information on what was happening when the 9yy error occurred

## 900 Errors

### 900 Error Messages

Error code	Description	Action
900.xx	Unrecoverable RIP software error/ illegal trap.	See <a href="#">900 service error check</a> .

## 900 Error Service Check

Action	Yes	No
<p><b>Step 1</b></p> <ul style="list-style-type: none"> <li>Perform a POR.</li> <li>Check if a 900.xx error code appears on the display.</li> </ul> <p>Does a 900.xx error code appear?</p>	Go to step 4.	Go to step 2.
<p><b>Step 2</b></p> <p>Check if another type of error code appears instead of the 900.xx error code.</p> <p>Does a different error code appear?</p>	Go to step 3.	Go to step 4.
<p><b>Step 3</b></p> <p>See the error code and its service instructions in the printer service manual.</p> <p>Does the problem remain?</p>	Go to step 4.	The problem is solved.
<p><b>Step 4</b></p> <ul style="list-style-type: none"> <li>Turn off the printer.</li> <li>At the rear of the printer, disconnect the network cable, USB cable, and the fax line.</li> <li>Turn on the printer.</li> </ul> <p>Does the problem remain?</p>	Go to step 12.	Go to step 5.
<p><b>Step 5</b></p> <ul style="list-style-type: none"> <li>From the control panel, navigate to the <b>Reports</b> menu.</li> <li>Select <b>Device Statistics</b> and <b>Device Settings</b>.</li> </ul> <p>Does the problem remain?</p>	Go to step 12.	Go to step 6.
<p><b>Step 6</b></p> <p>Check if the printer has a scanner.</p> <p>Does the printer have a scanner?</p>	Go to step 7.	Go to step 8.
<p><b>Step 7</b></p> <p>Using the scanner, perform a one-page copy job in color.</p> <p>Does the problem remain?</p>	Go to step 12.	Go to step 8.
<p><b>Step 8</b></p> <ul style="list-style-type: none"> <li>Turn off the printer.</li> </ul>	Go to step 9.	Go to step 10.

Action	Yes	No
<ul style="list-style-type: none"> <li>At the rear of the printer, connect the network cable, USB cable, and the fax line.</li> <li>Turn on the printer.</li> </ul> <p>Does the problem remain?</p>		
<p><b>Step 9</b></p> <ul style="list-style-type: none"> <li>Start the printer in <b>Invalid engine mode</b>. See <a href="#">Entering invalid engine mode</a>.</li> <li>Check if an <b>Invalid Engine Code</b> message appears.</li> </ul> <p>Does the Invalid Engine Code message appear?</p>	Go to step 10.	Contact the next level of support.
<p><b>Step 10</b></p> <p>Using the Device Settings report that is printed in step 5, check if the firmware level is older than the latest available version.</p> <p>Is the firmware version older, and does the customer agree to update the firmware?</p>	Go to step 11.	Contact the next level of support.
<p><b>Step 11</b></p> <p>Update the firmware to the latest version.</p> <p>Does the problem remain?</p>	Go to step 12.	The problem is solved.
<p><b>Step 12</b></p> <ul style="list-style-type: none"> <li>Turn off the printer.</li> <li>Make sure that all the cables on the controller board and scanner are properly connected.</li> <li>Turn on the printer.</li> <li>From the control panel, navigate to the <b>Reports</b> menu, and then select <b>Device Statistics</b> and <b>Device Settings</b>.</li> <li>For MFPs, perform a one-page copy and scan job in color.</li> </ul> <p>Does the problem remain?</p>	Go to step 13.	The problem is solved.
<p><b>Step 13</b></p> <p>Check if a hard disk is installed.</p> <p>Is a hard disk installed?</p>	Go to step 14.	Go to step 17.
<p><b>Step 14</b></p>	Go to step 15.	The problem is solved.

## Diagnostics and Troubleshooting

Action	Yes	No
<ul style="list-style-type: none"> <li>• Check for buffered print jobs, and then delete them.</li> <li>• Perform a POR.</li> </ul> <p>Does the problem remain?</p>		
<p><b>Step 15</b></p> <ul style="list-style-type: none"> <li>• Turn off the printer.</li> <li>• Uninstall the hard disk drive.</li> <li>• Perform a POR.</li> </ul> <p>Does the problem remain?</p>	Go to step 17.	Go to step 16.
<p><b>Step 16</b></p> <p>Replace the hard disk.</p> <p>Does the problem remain?</p>	Go to step 17.	The problem is solved.
<p><b>Step 17</b></p> <p>Check if the printer has any of the following components installed:</p> <ul style="list-style-type: none"> <li>• Memory options</li> <li>• Fax card</li> <li>• Modem</li> <li>• Wireless and network option cards</li> </ul> <p>Is any of the components installed?</p>	Go to step 18.	Go to step 21.
<p><b>Step 18</b></p> <ul style="list-style-type: none"> <li>• Turn off the printer.</li> <li>• Remove all the installed components.</li> <li>• Turn on the printer.</li> </ul> <p>Does the problem remain?</p>	Go to step 21.	Go to step 19.
<p><b>Step 19</b></p> <ul style="list-style-type: none"> <li>• Turn off the printer.</li> <li>• Install the following components one at a time: <ul style="list-style-type: none"> <li>– Memory options</li> <li>– Fax card</li> <li>– Modem</li> <li>– Wireless and network option cards</li> </ul> </li> </ul> <p> <b>Note:</b> Make sure to perform a POR after installing each component.</p>	Go to step 20.	The problem is solved.

Action	Yes	No
Does the problem remain?		
<b>Step 20</b> <ul style="list-style-type: none"> <li>Turn off the printer.</li> <li>Replace the components that caused the error.</li> <li>Turn on the printer.</li> </ul> Does the problem remain?	Go to step 21.	The problem is solved.
<b>Step 21</b> Replace the controller board. See <a href="#">Controller Board Removal</a> Does the problem remain?	Contact the next level of support.	The problem is solved.

## 912 Errors

### 912 Error Messages

Error code	Description	Action
912.01	An engine error occurred.	Resend the print job. If the problem remains, then contact the next level of support.
912.02	An engine error occurred.	
912.04	An engine error occurred.	
912.05	An engine error occurred.	
912.06	An engine error occurred.	
912.07	An engine error occurred.	
912.08	An engine error occurred.	Resend the print job. If the problem remains, then contact the next level of support.
912.09	An engine error occurred.	
912.10	An engine error occurred.	
912.13	An engine error occurred.	
912.14	An engine error occurred.	
912.15	An engine error occurred.	
912.16	An engine error occurred.	
912.17	An engine error occurred.	
912.18	An engine error occurred.	

## Diagnostics and Troubleshooting

Error code	Description	Action
912.19	An engine error occurred.	
912.20	An engine error occurred.	
912.21	An engine error occurred.	
912.28	An engine error occurred.	
912.30	An engine error occurred.	
912.31	An engine error occurred.	
912.32	An engine error occurred.	
912.33	An engine error occurred.	
912.34	An engine error occurred.	
912.35	An engine error occurred.	
912.36	An engine error occurred.	
912.38	An engine error occurred.	
912.39	An engine error occurred.	Resend the print job. If the problem remains, then contact the next level of support.
912.40	An engine error occurred.	
912.42	An engine error occurred.	
912.43	An engine error occurred.	
912.44	An engine error occurred.	
912.45	An engine error occurred.	
912.46	An engine error occurred.	
912.48	An engine error occurred.	
912.49	An engine error occurred.	
912.51	An engine error occurred.	
912.52	An engine error occurred.	
912.53	An engine error occurred.	
912.54	An engine error occurred.	
912.55	An engine error occurred.	
912.56	An engine error occurred.	
912.57	An engine error occurred.	
912.58	An engine error occurred.	



Error code	Description	Action
912.60	An engine error occurred.	
912.61	An engine error occurred.	
912.64	An engine error occurred.	
912.65	An engine error occurred.	
912.66	An engine error occurred.	
912.69	An engine error occurred.	
912.70	An engine error occurred.	
912.72	An engine error occurred.	
912.73	An engine error occurred.	
912.74	An engine error occurred.	
912.75	An engine error occurred.	
912.77	An engine error occurred.	
912.86	An engine error occurred.	

## Optional Tray Communication Error Service Check

Action	Yes	No
<p><b>Step 1</b></p> <p>Check the paper path and trays for paper fragments and partially fed paper.</p> <p>Is the paper path free of paper fragments and partially fed paper?</p>	Go to step 3.	Go to step 2.
<p><b>Step 2</b></p> <p>Remove the paper fragments and partially fed paper.</p> <p>Does the problem remain?</p>	Go to step 3.	The problem is solved.
<p><b>Step 3</b></p> <p>Make sure that all the trays and tray inserts are properly inserted.</p> <p>Does the problem remain?</p>	Go to step 4.	The problem is solved.
<p><b>Step 4</b></p> <p>Enter the Diagnostics menu, and then select <b>Input tray quick print</b>.</p>	Go to step 5.	Contact the next level of support.

Action	Yes	No
<p>Perform a print test on the optional tray.</p> <p>Does the error occur in the optional tray?</p>		
<p><b>Step 5</b></p> <ol style="list-style-type: none"> <li>1 Remove the optional tray.</li> <li>2 Make sure that the interconnect cable of the tray is properly installed.</li> <li>3 Check the interconnect cable and its connector pins for damage.</li> <li>4 Make sure that the tray controller board is properly installed.</li> <li>5 Reseat all the cables on the tray controller board.</li> <li>6 Check the optional tray controller board and its connector pins for damage.</li> </ol> <p>Are the tray interconnect cable and controller board free of damage?</p>	Contact the next level of support.	Go to step 6.
<p><b>Step 6</b></p> <p>Replace the optional tray.</p> <p>Does the problem remain?</p>	Contact the next level of support.	The problem is solved.

## 938–992 Errors

### 938–992 Error Messages

Error code	Description	Action
938.yy	Supplies security is not enabled.	Restart the printer. If the problem remains, then contact the next level of support.
950.10	<p>Non-Generic FRU installed.</p> <p>Mismatch between system NVRAM part and mirror NVRAM part.</p> <p>.xx points to the setting that does not match.</p>	See <a href="#">NVRAM mismatch failure service check</a> .

Error code	Description	Action
953.99	NVRAM chip failure with mirror part.	
980.yy	An option communication error occurred.	See <a href="#">Optional tray communication error service check</a> .
981.yy	An invalid paper port protocol error occurred.	
982.yy	A paper port error occurred.	
983.yy	An unsupported paper port command error occurred.	
984.yy	An invalid paper port parameter error occurred.	
992.yy	An option device software error occurred.	

## NVRAM Mismatch Failure Service Check

 **Warning:** To avoid NVRAM mismatch issues, replace only one of the following components at a time:

- Control panel
- Controller board

To replace a component and to test whether the problem is resolved:

1. Replace the affected component.

 **Warning:** Do not perform a Power-On Reset (POR) until the problem is resolved. If a POR is performed at this point, then the replacement part can no longer be used in another printer and must be returned to the manufacturer.

2. Enter the Diagnostics menu. The Diagnostics menu allows you to use temporarily the replacement part.

 **Warning:** Some printers perform automatically a POR if the Diagnostics menu is not opened within five seconds. If a POR is performed at this point, then the replacement part can no longer be used in another printer and must be returned to the manufacturer.

3. Use the Diagnostics menu to test the replacement part. Perform a feed test to check if the problem is resolved.
  - If the problem is not resolved—Turn off the printer, and then install the old part.
  - If the problem is resolved—Perform a POR.

## Diagnostics and Troubleshooting

Action	Yes	No
<p><b>Step 1</b></p> <p>Check if the control panel was recently replaced.</p> <p>Was the control panel recently replaced?</p>	Go to step 2.	Go to step 4.
<p><b>Step 2</b></p> <p>Replace the current control panel with the original control panel. See <a href="#">Control Panel Removal</a>.</p> <p>Does the problem remain?</p>	Go to step 3.	The problem is solved.
<p><b>Step 3</b></p> <p>Replace the original control panel with a new control panel.</p> <p>Make sure that the new control panel is not previously installed from another printer.</p> <p>Does the problem remain?</p>	Contact the next level of support.	The problem is solved.
<p><b>Step 4</b></p> <p>Check if the controller board was recently replaced.</p> <p>Was the controller board recently replaced?</p>	Go to step 5.	Contact the next level of support.
<p><b>Step 5</b></p> <p>Replace the current controller board with the original controller board. See <a href="#">Controller Board Removal</a>.</p> <p>Does the problem remain?</p>	Go to step 6.	The problem is solved.
<p><b>Step 6</b></p> <p>Replace the original controller board with a new controller board.</p> <p>Make sure that the new controller board is not previously installed from another printer.</p> <p>Does the problem remain?</p>	Contact the next level of support.	The problem is solved.

## Other Symptoms

### Base Printer Symptoms

Symptom	Action
A false tray paper low message appears.	See <a href="#">Tray near empty service check</a> .
A false bin full message appears	See <a href="#">False bin full error service check</a> .

### Tray Near Empty Service Check

Action	Yes	No
<b>Step 1</b> Check the actuator in the tray insert for damage. Is the actuator free of damage?	Go to step 3.	Go to step 2.
<b>Step 2</b> Replace the tray insert. Does the problem remain?	Go to step 3.	The problem is solved.
<b>Step 3</b> 1 Make sure that the sensor (tray near empty) is properly installed. 2 Check the sensor for damage. Is the sensor free of damage?	Go to step 5.	Go to step 4.
<b>Step 4</b> Replace the sensor (tray near empty) assembly. Does the problem remain?	Go to step 5.	The problem is solved.
<b>Step 5</b> 1 Make sure that the sensor cable is properly connected to the controller board. 2 Check the sensor cable for damage. Is the sensor cable free of damage?	Go to step 7.	Go to step 6.

Action	Yes	No
<b>Step 6</b> Replace the sensor cable. Does the problem remain?	Go to step 7.	The problem is solved.
<b>Step 7</b> Perform a POR. Does the problem remain?	Contact the next level of support.	The problem is solved.

## False Bin Full Error Service Check

Action	Yes	No
<b>Step 1</b> Remove, and then install the bin full sensor actuator. See <a href="#">Bin full sensor actuator removal</a> . Does the problem remain?	Go to step 2.	The problem is solved.
<b>Step 2</b> Check the bin full sensor actuator for damage, and replace if necessary Does the problem remain?	Go to step 3.	The problem is solved.
<b>Step 3</b> Check the sensor (bin full) for damage, and replace if necessary. Does the problem remain?	Contact the next level of support.	The problem is solved.

# Service Menus

# Understanding The Printer Control Panel

## Using The Control Panel



	Control panel part	Function
1	Display	<ul style="list-style-type: none"> <li>View printer messages and supply status.</li> <li>Set up and operate the printer.</li> </ul>
2	Power button	Turn on or turn off the printer. To turn off the printer, press and hold the power button for five seconds.
3	Home button	Go to the home screen.
4	Back button	Return to the previous screen.
5	Start button	Start a job, depending on which mode is selected.
6	Indicator light	Check the status of the printer.

## Understanding The Status Of The Indicator Light

Indicator light	Printer status
Off	The printer is off or in Hibernate mode.
Blue	The printer is ready or processing data.
Blinking red	The printer requires user intervention.
Solid amber	The printer is in Sleep mode.



# Diagnostics Menu

## Entering The Diagnostics Menu

The Diagnostics Menu contains tests that are used to help isolate printer issues.

- To access the menu from POST, do the following:
  1. Unplug the power cord from the electrical outlet.
  2. Open tray 1.
  3. Connect the power cord to the electrical outlet.

When the display shows the following icon, close tray 1.

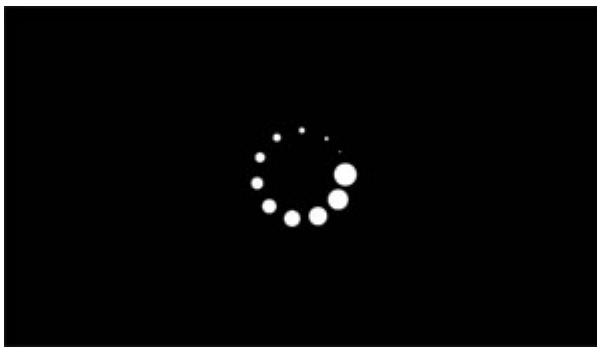

4. From the menu that appears on the display, select **Diagnostics\_Mode**, and then select **Boot**.
- To access the Diagnostics Menu from the home screen, on the control panel, press the following buttons in this sequence: **Back, Back, Start, Start**

## Reports

### Device Settings

This report lists all the current printer settings.

Enter the Diagnostics menu, and then navigate to:

**Reports > Device > Device Settings**

For non-touch-screen printer models, press **OK** to navigate through the settings.

### Installed Licenses

This setting lists all the installed licenses and their feature data.

Enter the Diagnostics menu, and then navigate to:

**Reports > Licenses > Installed Licenses**

For non-touch-screen printer models, press **OK** to navigate through the settings.

## Advanced Print Quality Samples

This setting prints the Print Quality Test Pages.

Enter the Diagnostics menu, and then select **Advanced Print Quality Samples**.

## Format Fax Storage

This setting allows formatting of non-volatile fax storage.

Enter the Diagnostics menu, and then navigate to:

**Format Fax Storage > Format Fax Storage**

## Event Log

### Display Log

This setting shows a history of printer events.

Enter the Diagnostics menu, and then navigate to:

**Event Log > Display Log**

For non-touch-screen printer models, press **OK** to navigate through the settings.

### Print Log

This setting shows additional information about the printer events.

Enter the Diagnostics menu, and then navigate to:

**Event Log > Print Log**

For non-touch-screen printer models, press **OK** to navigate through the settings.

 **Note:** The events that appear in the report vary depending on the operational history of the printer.

### Print Log Summary

This setting lists a brief summary of the various printer events.

Enter the Diagnostics menu, and then navigate to:

**Event Log > Print Log Summary**

For non-touch-screen printer models, press **OK** to navigate through the settings.

 **Note:** The events that appear in the report vary depending on the operational history of the printer.

## Mark Log

This setting allows you to create a service, maintenance, or custom log entry. Each log entry is added in the printer event log.

1. Enter the Diagnostics menu, and then navigate to:

**Event Log > Mark Log**

For non-touch-screen printer models, press **OK** to navigate through the settings.

2. Select a log that you want to create.

## Input Tray Quick Print

This setting lets you print a single or continuous Quick Test page in either duplex or simplex mode.

1. Enter the Diagnostics menu, and then select **Input tray quick print**.
2. Select a paper source.
3. Select whether to print a single or continuous test page.

## Output Bin Quick Feed

This setting lets you feed a single or continuous page from the standard bin.

1. Enter the Diagnostics menu, and then navigate to:

**Output bin quick feed > Standard bin**

For non-touch-screen printer models, press **OK** to navigate through the settings.

2. Select whether to print a single or continuous test page.

## Printer Setup

### Printed Page Count (mono)

This setting displays the amount of pages printed in mono.

1. Enter the Diagnostics menu, and then navigate to:

**Printer Setup > Printed page count (mono)**

2. View the printed page count for mono.

### Permanent Page Count

This setting displays the total number of pages printed. After all the print tests are completed, this value resets to zero.

1. Enter the Diagnostics menu, and then navigate to:

**Printer Setup > Permanent page count**

## Service Menus

2. View the permanent page count.

### Enable Edge-to-edge (printing)

This setting allows print jobs to include the edges of the page.

1. Enter the Diagnostics menu, and then navigate to:  
**Printer Setup > Enable edge-to-edge (printing)**
2. Select a setting.

### Enable Edge-to-edge (copy)

This setting allows copy jobs to include the edges of the page.

1. Enter the Diagnostics menu, and then navigate to:  
**Printer Setup > Enable edge-to-edge (copy)**
2. Select a setting.

### Processor ID

This setting indicates the ID of the processor on the controller board.

1. Enter the Diagnostics menu, and then navigate to:  
**Printer Setup > Processor ID**
2. View the processor ID.

### Serial Number

This setting shows the printer serial number.

1. Enter the Diagnostics menu, and then navigate to:  
**Printer Setup > Serial number**

For non-touch-screen printer models, press **OK** to navigate through the settings.

2. View the serial number.

### Model Name

This setting shows the model name of the printer.

1. Enter the Diagnostics menu, and then navigate to:  
**Printer Setup > Model name**

For non-touch-screen printer models, press **OK** to navigate through the settings.

2. View the model name.

## Engine Setting [x]

 **Warning:** Do not change this setting without specific instructions from the next level of support.

This setting allows you to select a printer engine setting. Possible values are 0–255. 0 is the default.

For non-touch-screen printer models, press **OK** to navigate through the settings.

1. Enter the Diagnostics menu, and then navigate to:

**Printer Setup > Engine setting [x]**

2. Select a setting, and then enter a value.

## EP Setup

 **Warning:** Do not change this setting without specific instructions from the next level of support.

This setting allows you to adjust the EP setup of the printer.

For non-touch-screen printer models, press **OK** to navigate through the settings.

1. Enter the Diagnostics menu, and then navigate to:

**Printer Setup > EP setup**

2. Select a setting.

# Printer Diagnostics & Adjustments

## Sensor Tests

1. Enter the Diagnostics menu, and then select **Printer diagnostics & adjustments**.

A list of sensor tests appears.

2. Find, and then manually toggle the sensor.

 **Note:**

- The sensor status on the screen toggles between **1** and **0** when the sensor is properly working.
- If a sensor test fails, the test failure may not indicate a failed sensor. Further troubleshooting may be required. Check the boards and cables for possible issues.
- For the fuser exit sensor actuator, toggle it toward the rear door.

### List Of Sensor Tests

MPF media present
Tray1 present
Input
Output bin/Narrow media

Fuser exit
Front door interlock

## Motor Tests

1. Enter the Diagnostics menu, and then navigate to:

**Printer diagnostics & adjustments > Motor tests**

For non-touch-screen printer models, press **OK** to navigate through the settings.

2. Select a motor.

 **Note:**

- If the motor is activated, then it is properly working.
- Some motors require automatic deactivation to avoid secondary issues such as possible damage and contamination.
- Some tests require a special action to activate a motor such as removing a major component.
- If the motor fails, the test failure may not indicate a failed motor. Further troubleshooting may be required. Check the boards and cables for possible issues.
- To stop a running motor in non-touch-screen printer models, press **OK**.

### List Of Motor Tests

Main Motor
MPF Pick Solenoid
Media Pick Clutch
Fan (main)

## Registration Adjust

This setting lets you adjust the skew and margins or print a Quick Test page.

For non-touch-screen printer models, press **OK** to navigate through the settings.

1. Enter the Diagnostics menu, and then navigate to:

**Printer diagnostics and adjustments > Registration adjust**

2. Select a setting to adjust.

## Margin Offset

This setting allows you to adjust the margin offset and to print or reset the default settings.

For non-touch-screen printer models, press **OK** to navigate through the settings.

1. Enter the Diagnostics menu, and then navigate to:  
**Printer diagnostics & adjustments > Margin Offset**
2. Select a setting.

## Universal Override

This setting allows the user to load custom paper sizes into a paper source.

For non-touch-screen printer models, press **OK** to navigate through the settings.

1. Enter the Diagnostics menu, and then navigate to:  
**Printer diagnostics and adjustments > Universal Override**
2. Select a setting to adjust.

## Scanner Diagnostics

### Motor Tests

1. Enter the Diagnostics menu, and then navigate to:  
**Scanner Diagnostics > Motor Tests**

For non-touch-screen printer models, press **OK** to navigate through the settings.

2. Select a motor.

#### Note:

- If the motor is activated, then it is properly working.
- Some motors require automatic deactivation to avoid secondary issues such as possible damage and contamination.
- Some tests require a special action to activate a motor such as removing a major component.
- If the motor fails, the test failure may not indicate a failed motor. Further troubleshooting may be required. Check the boards and cables for possible issues.

### List Of Motor Tests

Scanner
ADF transport

### Sensor Test

This test verifies the status of the scanner sensors.

## Service Menus

1. Enter the Diagnostics menu, and then navigate to:

### **Scanner diagnostics > Sensor test**

A list of sensor tests appears.

2. Find, and then manually toggle the sensor.

#### **Note:**

- The sensor status on the screen toggles between **1** and **0** when the sensor is properly working.
- If a sensor test fails, the test failure may not indicate a failed sensor. Further troubleshooting may be required. Check the boards and cables for possible issues.

## List Of Sensor Tests

ADF paper present
ADF scan

## Feed Test

This test allows for a continuous feed from the ADF or flatbed.

1. Enter the Diagnostics menu, and then navigate to:

### **Scanner Diagnostics > Feed Test**

 **Note:** Set the paper size to match the paper loaded in the ADF tray if necessary.

2. Touch **Feed Test**.

## Scanner Calibration Reset

Before starting the test, clean the scanner. For more information, see .

1. Enter the Diagnostics menu, and then select **Scanner Diagnostics**.
2. Touch **Scanner Calibration Reset**.

To verify the result, do the following:

 **Note:** The following procedure only applies to models with ADF.

1. Load the ADF with a document containing light and dark content.
2. Print a two-sided copy of the document.

#### **Note:**

- If the back side of the copy has vertical streaks, then clean the scanner glass and scanner glass pad, and then print another copy.
- If the streaks still appear, then repeat the cleaning and verification procedure or replace the scanner cover.



## Controller Calibration

This test must be done when the scanner controller or flatbed scanner is changed.

1. Enter the Diagnostics menu, and then navigate to:  
**Scanner Diagnostics > Controller Calibration**
2. Touch **Start**.

## Config Menu

### Entering The Config Menu

The Config menu consists of menus, settings, and operations that are used to configure the printer.

To access the Config menu, press and hold **Right arrow** and **OK** on the control panel, and then turn on the printer.

### Config Menu

Menu item	Description
<b>USB Configuration</b> USB PnP 1* 2	Change the USB driver mode of the printer to improve its compatibility with a personal computer.
<b>USB Configuration</b> USB Scan to Local On* Off	Set whether the USB device driver enumerates as a USB Simple device (single interface) or as a USB Composite device (multiple interfaces).
<b>USB Configuration</b> USB Speed Full Auto*	Set the USB port to run at full speed and disable its high-speed capabilities.
<b>Tray Configuration</b> Tray Linking Automatic* Off	Set the printer to link the trays that have the same paper type and paper size settings.
<b>Tray Configuration</b> Show Tray Insert Message Off Only for unknown sizes* Always	Show the Tray Insertmessage.
<b>Tray Configuration</b> A5 Loading Short Edge Long Edge*	Specify the page orientation when loading A5 paper size.

Menu item	Description
<b>Tray Configuration</b> Paper Prompts Auto* MP Feeder Manual Paper	Set the paper source that the user fills when a prompt to load paper appears.
<b>Tray Configuration</b> Envelope Prompts Auto* MP Feeder Manual Envelope	Set the paper source that the user fills when a prompt to load envelope appears.
<b>Tray Configuration</b> Action for Prompts Prompt user* Continue Use current	Set the printer to resolve paper- or envelope-related change prompts.
<b>Reports</b> Menu Settings Page Event Log Event Log Summary	Print reports about printer menu settings, status, and event logs.
<b>Supply Usage And Counters</b> Clear Supply Usage History Reset Black Imaging Unit Counter Reset Maintenance Counter	Reset the supply page counter or view the total printed pages.
<b>Printer Emulations</b> PS Emulation Off On*	Set the printer to recognize and use the PS data stream.
<b>Printer Emulations</b> Emulator Security Page Timeout 0–60 (60*)	Set the page timeout during emulation.
<b>Printer Emulations</b> Emulator Security Reset Emulator After Job	Reset the emulator after a print job.

Menu item	Description
Off* On	
<b>Printer Emulations</b> Emulator Security Disable Printer Message Access On* Off	Disable access to the printer message during emulation.
<b>Print Configuration</b> Font Sharpening 0–150 (24*)	Set a text point-size value below which the high-frequency screens are used when printing font data.
<b>Fax Configuration</b> Fax Low Power Support Disable Sleep Permit Sleep Auto*	Set fax to enter Sleep mode whenever the printer determines that it should.
<b>Print Configuration</b> Print Density Disabled* 1–5 Copy Density Disabled* 1–5	Adjust the toner density when printing or copying documents.
<b>Device Operations</b> Quiet Mode Off* On	Set the printer to reduce the amount of noise that it makes when printing.  Enabling this setting slows down the overall performance of the printer.
<b>Device Operations</b> Panel Menus Enable* Disable	Set the printer to show the control panel menus.  This menu item appears only in the Embedded Web Server.
<b>Device Operations</b> Safe Mode Off*	Set the printer to operate in a special mode, in which it attempts to continue offering as much functionality as possible, despite known issues.  For example, when set to On, and the duplex motor is nonfunctional, the printer performs one-sided

Menu item	Description
On	printing of the documents even if the job is two-sided printing.  This setting cannot be used when the tray is not fully inserted or the tray sensor is damaged.
<b>Device Operations</b> Clear Custom Status	Erase all custom messages.
<b>Device Operations</b> Clear all remotely-installed messages	Erase all remotely-installed messages.
<b>Device Operations</b> Automatically Display Error Screens On* Off	Show existing error messages on the display after the printer remains inactive on the home screen for a length of time equal to the Screen Timeout setting.
<b>Scanner Configuration</b> Scanner Manual Registration Print Quick Test	Print a Quick Test target page.  Make sure that the margin spacing on the target page is uniform all the way around the target. If it is not, then the printer margins may need to be reset.
<b>Scanner Configuration</b> Scanner Manual Registration Front ADF Registration Flatbed Registration	Manually register the flatbed and ADF after replacing the ADF, scanner glass, or controller board.
<b>Scanner Configuration</b> Edge Erase Flatbed Edge Erase (3*) ADF Edge Erase (3*)	Set the size, in millimeters, of the no-print area around an ADF or flatbed scan job.
<b>Scanner Configuration</b> Disable Scanner Enabled* Disabled ADF Disabled	Disable the scanner if it is not working properly.
<b>Scanner Configuration</b> Tiff Byte Order CPU Endianness* Little Endian Big Endian	Set the byte order of a TIFF-formatted scan output.

## Service Menus

Menu item	Description
<b>Scanner Configuration</b> Exact Tiff Rows Per Strip On* Off	Set the RowsPerStrip tag value of a TIFF-formatted scan output.
An asterisk (*) next to a value indicates the factory default setting.	

# Service Engineer (SE) Menu

## Entering The SE Menu

To access the menu from the home screen, on the control panel, press the following buttons in this sequence:

**Back, Back, Home, Home**

## Fax SE Menu

Use this menu to help resolve fax transmission and reception issues.

Enter the SE menu, and then touch **Fax SE Menu**.

 **Note:** Use these settings as directed by the next level of support.

Top-level menu	Intermediate menu
Agency Test Menu	<ul style="list-style-type: none"> <li>Go Off Hook</li> <li>Ring Detect</li> <li>Generate Tones</li> <li>Modulations</li> </ul>
Fax Settings	<ul style="list-style-type: none"> <li>Fax Modulations</li> <li>FOIP Settings</li> <li>Miscellaneous Settings</li> <li>Reset Fax Settings</li> </ul>
Modem Settings	<ul style="list-style-type: none"> <li>Caller ID Pattern</li> </ul> <p>Changing the value of this setting also changes the value of the Caller ID setting in the Fax Settings.</p> <ul style="list-style-type: none"> <li>Pulse Dial Type</li> <li>Disable Sending CRP</li> </ul>
Fax logs	<ul style="list-style-type: none"> <li>Print all T30 Logs</li> <li>Print CallerID Log</li> <li>Print Call Log</li> <li>Print Fax Settings</li> <li>Print Job Log</li> <li>Print All T30 Log Errors</li> <li>Print All Auto Captured Logs On</li> <li>Print T38 Trace Log</li> <li>Clear T38 Trace Log</li> </ul>
Reboot System	N/A

## General SE Menu

- Capture Logs to USB Drive

 **Note:** This setting allows you to save a log file to a USB drive.

- Code Versions
- Debug Level

## Network SE Menu

Enter the SE menu, and then select **Network SE Menu**.

 **Note:** Use these settings as directed by the next level of support.

Top-level menu	Intermediate menu
HISTORY	<ul style="list-style-type: none"> <li>• Print History</li> <li>• Mark History</li> </ul>
MAC	<ul style="list-style-type: none"> <li>• Set Card Speed</li> <li>• LAA</li> <li>• Keep Alive</li> </ul>
NPAP	Print Alerts
TCP/IP	<ul style="list-style-type: none"> <li>• DHCP Request Options</li> <li>• netstat</li> <li>• arp</li> <li>• Allow SNMP Set</li> <li>• MTU</li> <li>• Meditech Mode</li> <li>• RAW LPR Mode</li> <li>• Garp Interval</li> </ul>
Wireless Settings	<ul style="list-style-type: none"> <li>• Wireless Performance Enhancement</li> <li>• Unset Wireless Region</li> </ul>
Ping Test	<ul style="list-style-type: none"> <li>• Ping Address</li> <li>• Attempts</li> <li>• Packet Size</li> <li>• Ping</li> </ul>
Other Actions	<ul style="list-style-type: none"> <li>• ifconfig</li> <li>• IPtables [Firewall Dump]</li> <li>• IP6tables [Firewall Dump]</li> <li>• IPsec Dump</li> </ul>
Enable DHCPD Debugging	N/A
Enable wpa-suplicant Debugging	N/A
Enable Ethernet Gigabit	N/A



## Scanner SE Menu

Enter this setting to view the calibration data.

## EWS SE Menu

Enter this setting to help resolve customer communication related printing issues.

To access the Silabs configuration:

1. Open a web browser and then type `https://<IP address>/se`.
2. Navigate to **Fax > Settings > Silabs Configuration**

## Entering Invalid Engine Mode

This mode allows the printer to load the correct firmware code.

1. Unplug the power cord from the electrical outlet.
2. Open tray 1.
3. Connect the power cord to the electrical outlet.

When the display shows the following icon, close tray 1.

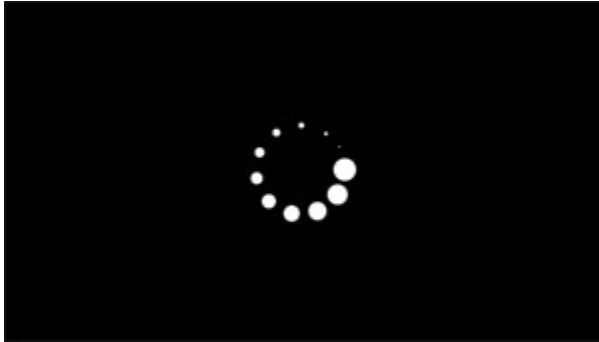

4. From the menu that appears on the display, select ->, and then select **ENGINE\_FLASH**.

## Entering Recovery Mode

This mode allows the printer to boot from a secondary set of instructions and flash firmware code. While in this mode, you can only flash firmware code through a USB cable directly connected to a PC.

Depending on your printer model, do any of the following:

### For LED Display

1. Turn off the printer.
2. Open the front door.
3. Press and hold the **Stop** button.
4. Turn on the printer.
5. When all the icons flash, release the button.

### For 2.8-inch Display

1. Turn off the printer.
2. Open tray 1.
3. Make sure that paper is loaded in tray 1.
4. Turn on the printer.
5. When the display shows the following icon, close tray 1.



 **Note:** If tray 1 is not closed, then the printer will boot normally.

6. A screen with red selection items appears.  
Touch -> to navigate to Recovery mode.
7. Touch **Boot** or **RECOVERY**.

## Service Menus

# Parts Removal

## Data Security Notice

### Identifying Printer Memory

- **Volatile memory**—The printer uses standard random access memory (RAM) to buffer user data temporarily during simple print and copy jobs.
- **Nonvolatile memory**—The printer may use two forms of nonvolatile memory: EEPROM and NAND (flash memory). Both types are used to store the operating system, printer settings, network information, scanner and bookmark settings, and embedded solutions.
- **Hard disk memory**—Some printers have a hard disk drive installed. The hard disk is designed for printer-specific functionality and cannot be used for long-term storage of data that is not print-related. The hard disk does not let users extract information, create folders, create disk or network file shares, or transfer FTP information directly from a client device. The hard disk can retain buffered user data from complex print jobs, form data, and font data.

The following parts can store memory:

- Printer control panel
- User interface controller card (UICC)
- Controller board
- Optional hard disks

 **Note:** The printer control panel and controller board contain NVRAM.





### Erasing Printer Memory

To erase volatile memory or buffered data, turn off the printer.





To erase non-volatile memory or individual settings, device and network settings, security settings, and embedded solutions, do the following:

1. From the control panel, navigate to:  
**Settings > Device > Maintenance > Out of Service Erase > Sanitize all information on nonvolatile memory > Yes**
2. Select either **Start initial setup** or **Leave printer offline**.





## Removal Precautions

-  **CAUTION—SHOCK HAZARD:** The low-voltage power supply (LVPS) and the high-voltage power supply (HVPS) may have residual voltage present. To avoid the risk of electrical shock, do not touch their circuit components or the solder side of the board. Only handle them by their outer edges or metal housing.
-  **CAUTION—SHOCK HAZARD:** This product uses an electronic power switch. It does not physically disconnect the input AC voltage. To avoid the risk of electrical shock, always remove the power cord from the printer when removal of the input AC voltage is required.
-  **CAUTION—SHOCK HAZARD:** To avoid the risk of electrical shock and to prevent damage to the printer, remove the power cord from the electrical outlet and disconnect all connections to any external devices before you connect or disconnect any cable, electronic board, or assembly.
-  **CAUTION—HOT SURFACE:** The inside of the printer might be hot. To reduce the risk of injury from a hot component, allow the surface to cool before touching it.
-  **CAUTION—PINCH HAZARD:** To avoid the risk of a pinch injury, use caution in areas marked with this label. Pinch injuries may occur around moving parts, such as gears, doors, trays, and covers.





## Précautions De Retrait

-  **ATTENTION ! RISQUE D'ÉLECTROCUTION :** Une tension résiduelle peut être présente dans le bloc d'alimentation basse tension (LVPS) et le bloc d'alimentation haute tension (HVPS). Pour éviter tout risque d'électrocution, ne touchez pas les composants du circuit ou le côté soudure de la carte. Tenez-les uniquement par leurs extrémités ou le boîtier en métal.
-  **ATTENTION ! RISQUE D'ÉLECTROCUTION :** Ce produit utilise un commutateur d'alimentation électronique. Il ne déconnecte pas physiquement la tension d'alimentation CA. Pour éviter tout risque d'électrocution, débranchez toujours le cordon d'alimentation de l'imprimante lorsque vous devez déconnecter la tension d'alimentation CA.
-  **ATTENTION ! RISQUE D'ÉLECTROCUTION :** Pour éviter tout risque d'électrocution et éviter d'endommager l'imprimante, débranchez le cordon d'alimentation de la prise électrique et déconnectez toute connexion à tout périphérique externe avant de brancher ou débrancher des câbles ou circuits et assemblages électroniques.
-  **ATTENTION ! SURFACE CHAUDE :** L'intérieur de l'imprimante risque d'être brûlant. pour réduire le risque de brûlure, laissez la surface ou le composant refroidir avant d'y toucher.
-  **ATTENTION ! RISQUE DE PINCEMENT :** Pour éviter tout risque de blessure par pincement, agissez avec précaution au niveau des zones signalées par cette étiquette. Les blessures par pincement peuvent se produire autour des pièces mobiles telles que les engrenages, portes, tiroirs et capots.

## Precauciones Durante La Extracción





-  **PRECAUCIÓN—RIESGO DE DESCARGA:** La fuente de alimentación de bajo voltaje (LVPS) y la fuente de alimentación de alto voltaje (HVPS) pueden presentar voltaje residual. Para evitar el riesgo de descarga eléctrica, no toque los componentes del circuito ni el lateral soldado de la placa. Manipule solo los bordes exteriores o la carcasa metálica.
-  **PRECAUCIÓN—RIESGO DE DESCARGA:** Este producto utiliza un interruptor de corriente electrónico. No desconecta físicamente la entrada de voltaje de CA. Para evitar el riesgo de descarga eléctrica, desenchufe siempre el cable de alimentación de la impresora cuando sea necesario retirar la entrada de voltaje de CA.
-  **PRECAUCIÓN—RIESGO DE DESCARGA:** Para evitar el riesgo de descargas eléctricas y daños en la impresora, retire el cable de alimentación de la toma eléctrica y desconecte todas las conexiones a dispositivos externos antes de conectar o desconectar cualquier cable, placa electrónica o conjunto.
-  **PRECAUCIÓN—SUPERFICIE CALIENTE:** El interior de la impresora podría estar caliente. Para evitar el riesgo de heridas producidas por el contacto con un componente caliente, deje que la superficie se enfríe antes de tocarlo.
-  **PRECAUCIÓN—RIESGO DE DESCARGA ELÉCTRICA:** Para evitar el riesgo de lesión por atrapamiento, preste atención en las áreas marcadas con esta etiqueta. Las lesiones por atrapamiento se pueden producir en torno a partes móviles, tales como engranajes, puertas, bandejas y cubiertas.

## Vorsichtsmaßnahmen Bei Der Demontage

-  **VORSICHT – STROMSCHLAGGEFAHR:** Im Niederspannungsnetzteil (LVPS) und Hochspannungsnetzteil (HVPS) liegt unter Umständen Restspannung vor. Um das Risiko eines elektrischen Schlags zu vermeiden, berühren Sie keine umliegenden Bauteile oder die Lötseite der Platine. Fassen Sie sie nur an den Außenkanten oder am Metallgehäuse an.
-  **VORSICHT – STROMSCHLAGGEFAHR:** Dieses Produkt verwendet einen elektronischen Leistungsschalter. Er trennt die Eingangswchselspannung nicht physikalisch. Um das Risiko eines elektrischen Schlags zu vermeiden, ziehen Sie stets das Netzkabel vom Drucker ab, wenn eine Abtrennung der Eingangswchselspannung erforderlich ist.
-  **VORSICHT – STROMSCHLAGGEFAHR:** Um das Risiko eines elektrischen Schlags und Schäden am Drucker zu vermeiden, ziehen Sie das Netzkabel aus der Steckdose und trennen Sie alle Verbindungen zu jeglichen externen Geräten, bevor Sie Kabel, Elektronikplatinen oder Baugruppen einstecken oder abziehen.
-  **VORSICHT – HEISS:** Das Innere des Druckers kann sehr heiß sein. Vermeiden Sie Verletzungen, indem Sie heiße Komponenten stets abkühlen lassen, bevor Sie ihre Oberfläche berühren.
-  **VORSICHT – QUETSCHGEFAHR:** Um das Risiko einer Quetschung zu vermeiden, gehen Sie in Bereichen, die mit diesem Etikett gekennzeichnet sind, mit Vorsicht vor. Quetschungen können im Bereich von beweglichen Komponenten auftreten, wie z.B. Zahnrädern, Klappen, Fächern und Abdeckungen.



## Precauzioni per la rimozione

-  **ATTENZIONE – PERICOLO DI SCOSSA ELETTRICA:** Sull'alimentatore a bassa tensione (LVPS) e l'alimentatore ad alta tensione (HVPS) può essere presente tensione residua. Per evitare il rischio di scossa elettrica, non toccare i loro componenti elettrici o il lato saldatura della scheda. Toccarli soltanto dai bordi esterni o dall'alloggiamento in metallo.
-  **ATTENZIONE – PERICOLO DI SCOSSA ELETTRICA:** Questo prodotto utilizza un interruttore di alimentazione elettronico. Tale interruttore non scollega fisicamente la tensione CA in entrata. Per evitare il rischio di scossa elettrica, rimuovere sempre il cavo di alimentazione dalla stampante quando è necessario rimuovere la tensione CA in entrata.
-  **ATTENZIONE – PERICOLO DI SCOSSA ELETTRICA:** Per evitare il rischio di scossa elettrica e per impedire danni alla stampante, rimuovere il cavo di alimentazione dalla presa elettrica e scollegare tutti i collegamenti a eventuali dispositivi esterni prima di collegare o scollegare qualsiasi cavo, scheda elettronica o gruppo.
-  **ATTENZIONE – SUPERFICIE SURRISCALDATA:** L'area interna della stampante potrebbe surriscaldarsi. Per evitare infortuni, lasciare raffreddare la superficie dei componenti prima di toccarla.
-  **ATTENZIONE – PERICOLO DI SCHIACCIAMENTO:** Per evitare il rischio di lesioni, prestare la massima cautela quando si accede alle aree contrassegnate con questa etichetta. Potrebbero infatti verificarsi lesioni da schiacciamento in prossimità di parti in movimento, quali ad esempio ingranaggi, porte, vassoi e coperchi.



## Handling ESD-sensitive Parts



Many electronic products use parts that are known to be sensitive to electrostatic discharge (ESD). To prevent damage to ESD-sensitive parts, do the following:



- Turn off the printer before removing logic boards.
- Keep the parts in their original packing material until you are ready to install them into the printer.
- Make the least possible movements with your body to prevent an increase of static electricity from clothing fibers, carpets, and furniture.
- Put the ESD wrist strap on your wrist. Connect the wrist band to the system ground point. This action discharges any static electricity in your body to the printer.
- Hold the parts by their edge connector shroud. Do not touch its pins. If you are removing a pluggable module, then use the correct tool.
- If possible, keep all parts in a grounded metal cabinet.
- Do not place the parts on the printer cover or on a metal table. If you need to put down the parts, then put them into their packing material.
- Prevent parts from being accidentally touched by other personnel. Cover the printer when you are not working on it.
- Be careful while working with the parts when cold-weather heating is used. Low humidity increases static electricity.

## Critical Information For Controller Board or Control Panel Replacement

 **CAUTION—POTENTIAL INJURY:** The lithium battery in this product is not intended to be replaced. There is a danger of explosion if a lithium battery is incorrectly replaced. Do not recharge, disassemble, or incinerate a lithium battery. Discard used lithium batteries according to the manufacturer's instructions and local regulations.

 **ATTENTION ! DOMMAGE POTENTIEL :**  La batterie lithium de ce produit n'est pas destinée à être remplacée. Il existe un risque d'explosion si une batterie lithium est placée de façon incorrecte. Ne rechargez pas, ne démontez pas et n'incinerez pas une batterie lithium. Mettez les batteries lithium usagées au rebut selon les instructions du fabricant et les réglementations locales.

 **PRECAUCIÓN—RIESGO DE LESIONES:**  La batería de litio de este producto no debe reemplazarse. Existe riesgo de explosión si se sustituye incorrectamente una batería de litio. No recargue, desmonte ni incinere una batería de litio. Deseche las baterías de litio según las instrucciones del fabricante y las normativas locales.

 **VORSICHT – VERLETZUNGSGEFAHR:**  Die Lithiumbatterie in diesem Produkt darf nicht ausgetauscht werden. Wird eine Lithiumbatterie nicht ordnungsgemäß ausgetauscht, besteht Explosionsgefahr. Lithiumbatterien dürfen auf keinen Fall wieder aufgeladen, auseinander genommen oder verbrannt werden. Befolgen Sie zum Entsorgen verbrauchter Lithiumbatterien die Anweisungen des Herstellers und die örtlichen Bestimmungen.

 **ATTENZIONE – PERICOLO DI LESIONI:** La batteria al litio presente nel prodotto non deve essere sostituita. In caso di sostituzione errata della batteria al litio, potrebbe verificarsi un'esplosione. Non ricaricare, smontare o bruciare batterie al litio. Smaltire le batterie al litio usate seguendo le istruzioni del produttore e le norme locali.

 **Warning:** Observe all precautions when handling ESD sensitive parts. See .

 **Warning:** Carefully remove cables and connectors. Make sure they are not damaged.

 **Warning:** To avoid damaging the part or experience NVRAM mismatch issues, replace only one of the following components at a time:

- Control panel
- Controller board

To replace a component and to test whether the problem is resolved:

1. Replace the affected component.

 **Warning:** Do not perform a Power-On Reset (POR) until the problem is resolved. If a POR is performed at this point, then the replacement part can no longer be used in another printer and must be returned to the manufacturer.

2. Enter the Diagnostics menu. The menu allows you to temporarily use the replacement part.

 **Warning:** Some printers perform a POR automatically if the Diagnostics menu is not opened within five seconds. If a POR is performed at this point, then the replacement part can no longer be used in another printer and must be returned to the manufacturer.

3. Use the Diagnostics menu to test the replacement part. Do a feed test to check if the problem is resolved.
  - If the problem is not resolved—Turn off the printer, and then install the old part.
  - If the problem is resolved—Perform a POR.
  - If NVRAM error occurs during the replacement, then see [NVRAM mismatch failure service check](#).

## Restoring The Printer Configuration After Replacing The Controller Board

Restore the printer to its correct configuration. Contact your Hardware Support Line to obtain the applicable zip file. Flash the printer settings and embedded solutions..

 **Note:** The software bundle contains the latest version of the firmware, applications, and software licenses from the Lexmark Virtual Solutions Center (VSC). The printer firmware may be at a different level from what was used before replacing the controller board.

Extract the contents of the zip file.

- Perform the install instructions on the Readme file in the exact order shown. Restart the printer only if the file says so.
- For more information on how to flash the downloaded files, see [Updating the printer firmware](#).
- To load the zip file, see [Restoring licenses and configuration settings](#).

After performing the installation instructions in the Readme file, confirm that the printer is restored.

- If you are unable to access the administrative menus to verify that the printer is restored, then ask the customer for access rights.
- If a 10.00 error appears after you restart the printer, then contact the next level of support.

## Restoring Licenses and Configuration Settings

To load the zip files that you received from Hardware Support, do the following:

## Parts Removal

1. Open a web browser, and then type the printer IP address.

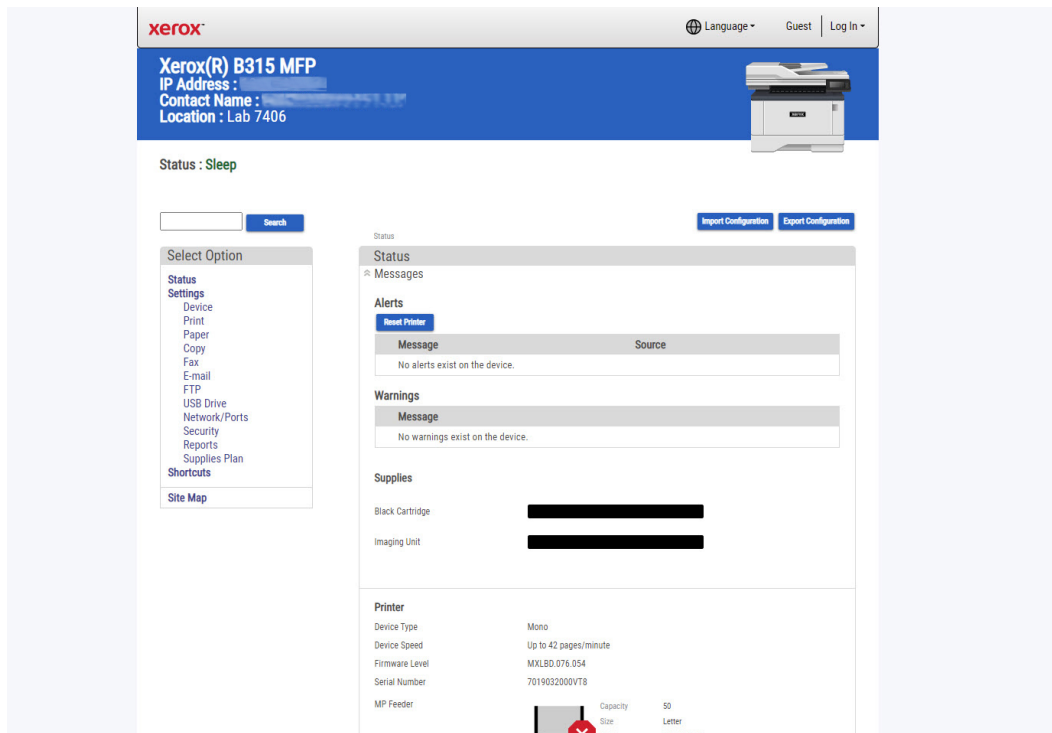

2. Click **Import Configuration**, and then click **Browse**.

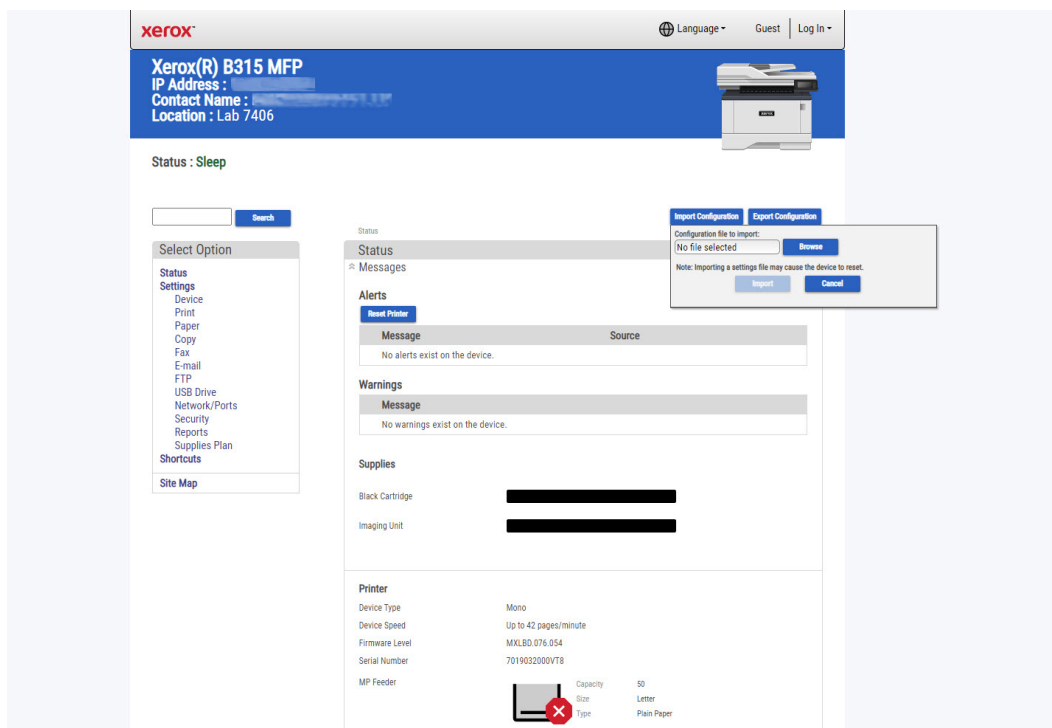

3. Navigate to the folder where the zip files are extracted.

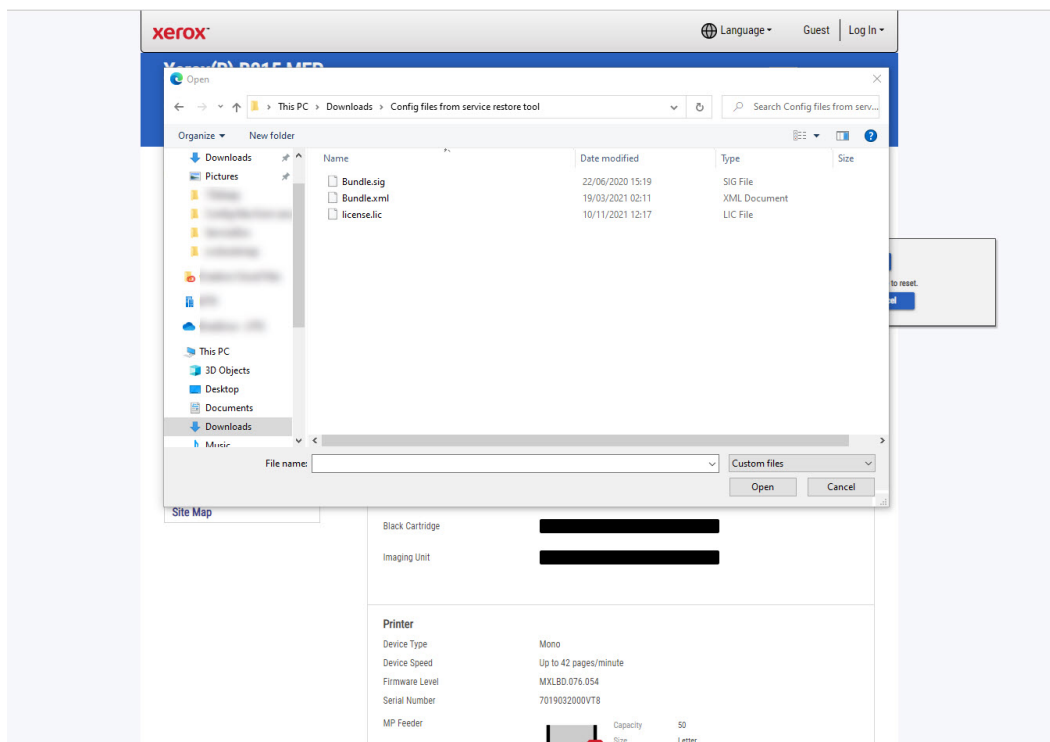

4. Select the file to import, and then click **Import**.
5. Repeat step 2 through step 4 for the other files that are included in the extracted zip file.

## Updating The Printer Firmware

**Warning:** Before updating the printer firmware, ask the next level of support for the correct code. Using an incorrect code level may damage the printer.

### Using A Flash Drive

**Note:** The printer must be in ready state to update the firmware.

This option is available only in printer models with front USB port.

1. Insert the flash drive into the USB port.
2. Depending on the printer model, do any of the following:
  - From the control panel, navigate to **USB Menu: Print from USB > Accept** or **OK**, and then select the file that you need to flash.
  - Select the firmware file.

**Note:** Do not turn off the printer while the update is going on.

## Using A Network Computer

### Using the File Transfer Protocol (FTP)

 **Note:** The printer must be in ready state to update the firmware.

1. Turn on the printer.
2. Obtain the IP address from the home screen.
3. From the command prompt of a network computer, open an FTP session to the printer IP address.
4. Use a PUT command to place the firmware file on the printer.

The printer performs a POR sequence and terminates the FTP session.

### Using the Embedded Web Server

 **Note:** The printer must be in ready state to update the firmware.

1. Open a web browser, and then type the printer IP address.
2. Click **Settings > Device > Update Firmware**.
3. Select the file to use.

The printer performs a POR sequence and terminates the EWS session.

## Using A USB Cable Connection

 **Note:** Make sure that the cable is connected to the rear USB port.

### Using USB Flash Utility

1. Go to [support.lexmark.com](http://support.lexmark.com), and then download USB Flash Utility.
2. Extract, and then run the utility.
3. Click **Browse Files**, and then browse to the firmware file directory.
4. Select the firmware file.
5. Select the source printer.
6. Click **Start**.

### Using USButil

1. Go to [support.lexmark.com](http://support.lexmark.com), and then download USButil.
2. Extract, and then drag and drop the firmware file onto the USButil icon.
3. A command prompt window appears briefly.

 **Note:** Make sure to disconnect other USB devices when using USButil.

# Ribbon Cable Connectors

## Low Insertion Force (LIF) Connector

 **Warning:** When installing a cable into an LIF connector, avoid bending the edges of the cables and damaging the contacts on the cables.

## Inserting the cable

1. Make sure that the contacts of the controller board and connectors are on the same side.

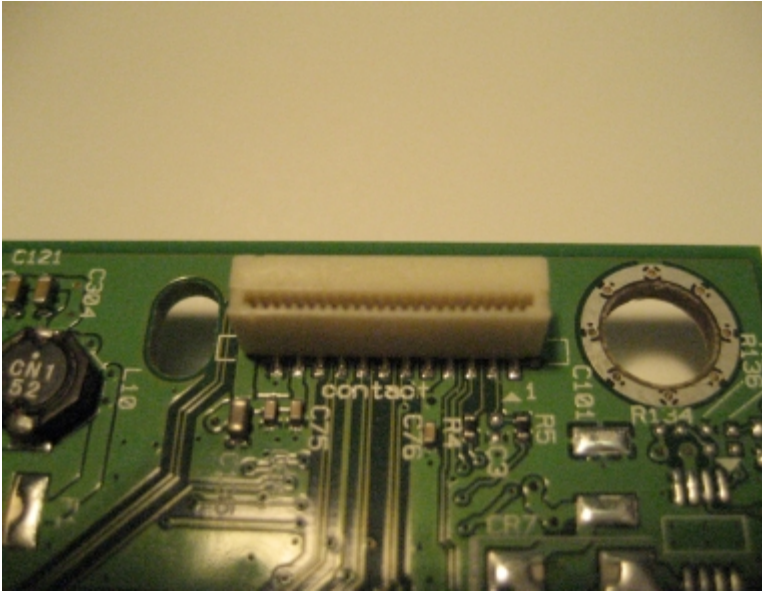

2. Insert the cable.

 **Note:** Make sure that the cable is installed straight into the connector to avoid intermittent failures.

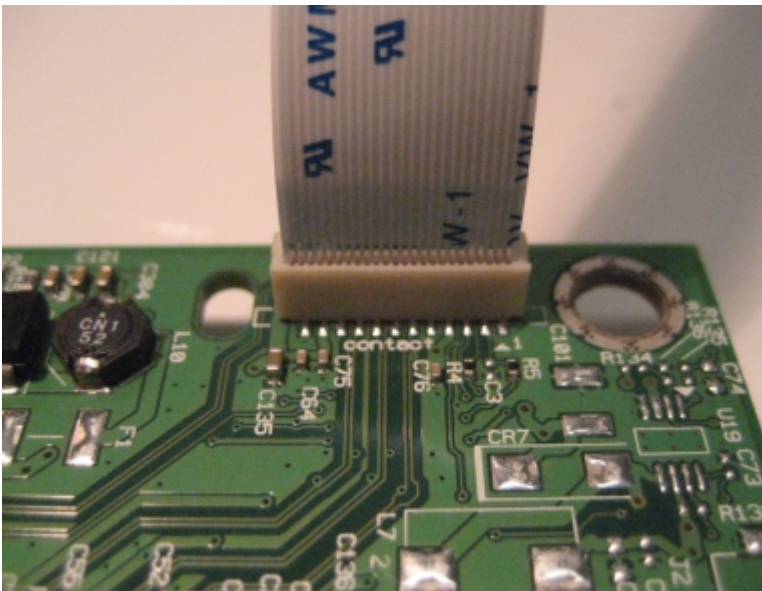



## Removal Procedures

Keep the following tips in mind as you replace parts:

- Some removal procedures require removing cable ties. You must replace cable ties during reassembly to avoid pinching wires, obstructing the paper path, or restricting mechanical movement.
- Remove the toner cartridges, imaging unit, and trays before removing other printer parts. The imaging kit must be carefully set on a clean, smooth, and flat surface. It must also be protected from light while out of the printer.
- Disconnect all external cables from the printer to prevent possible damage during service.
- Unless otherwise stated, install the parts in reverse order of removal.
- When installing a part held with several screws, start all screws before the final tightening.
- For printers that have an electronic power switch, make sure to unplug the power cord after powering off.

## Left Side Removals

### Left Cover Removal

1. Remove the screw at the front, and then remove the screw at the rear of the cover.



2. Open the front door, and then release the left front door link.

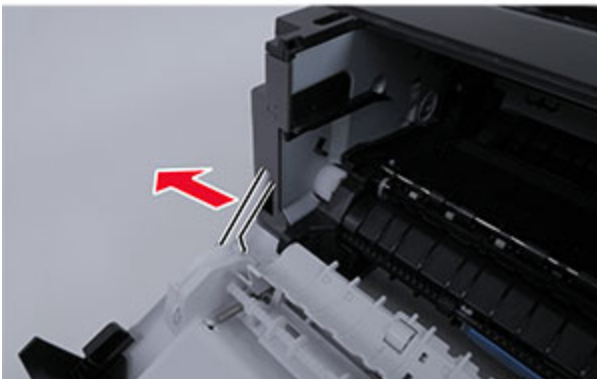

3. Place the printer on its right side.
4. Release the three latches (A) at the bottom of the cover, and then remove the cover.



## Main Drive Gears Removal

 **Note:** For a video demonstration, see [Main drive gears removal](#).

1. Remove the left cover. See [Left cover removal](#).
2. Place the printer on its right side.

 **Warning:** If the printer is not placed on its right side, then the gears fall out of place when the gear plates are removed.

## Parts Removal

3. Remove the 12 screws, remove the gear covers, and then remove the gears.

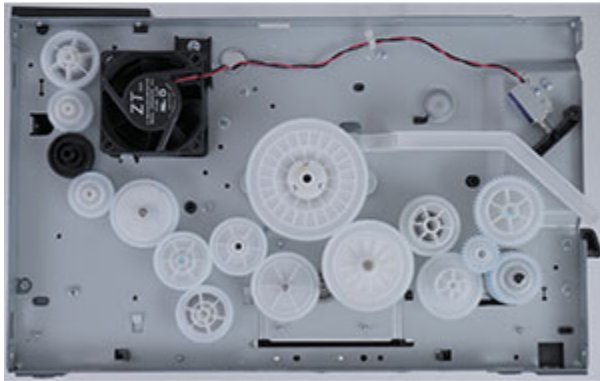
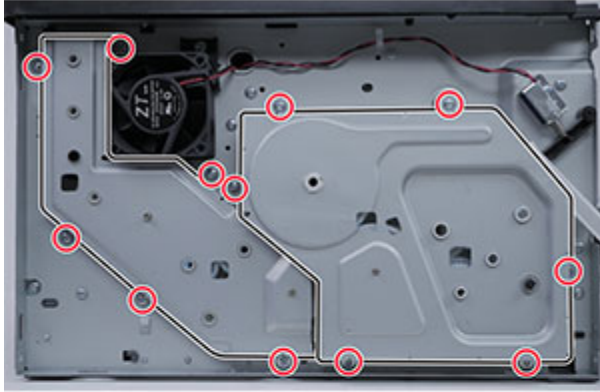

### Installation notes:

- Pay attention to the position of the gears.
- Most gears have a molded letter for identification.

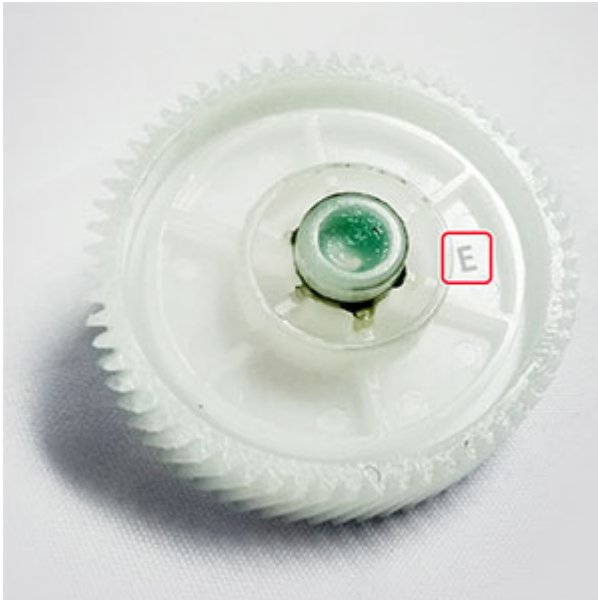

- Note the letter or number on the gears, and then use the following illustration to match their proper location and position in the printer.
- Some locations have multiple gears stacked on top of each other.

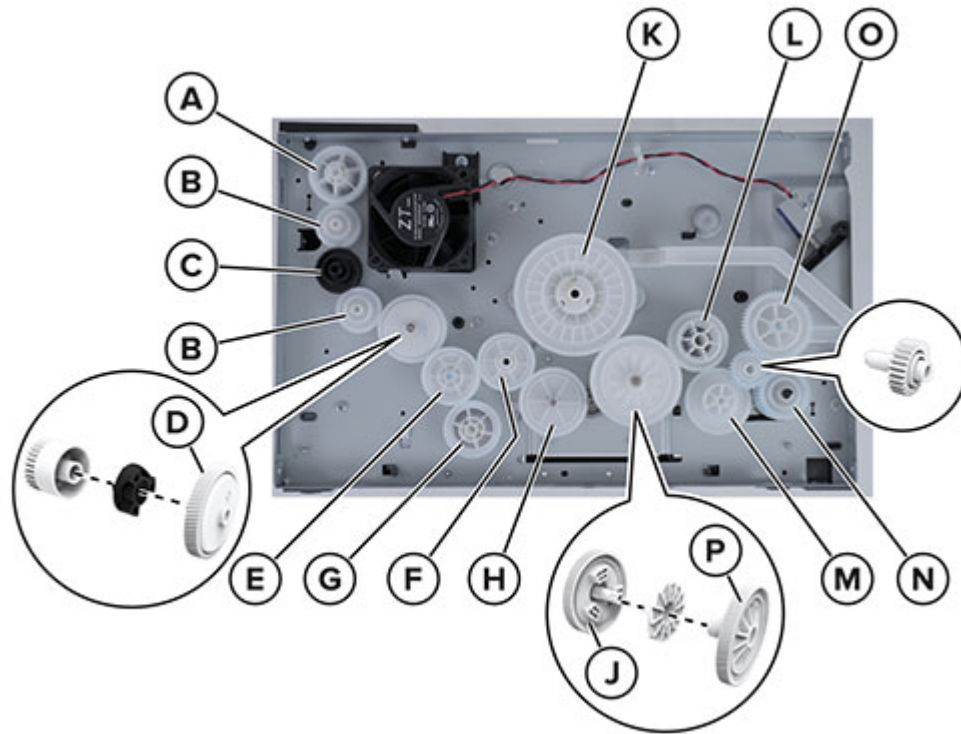

4. Remove the left front door link. See [Left front door link removal](#).
5. Remove the two screws (A), and then remove the coupling (B).

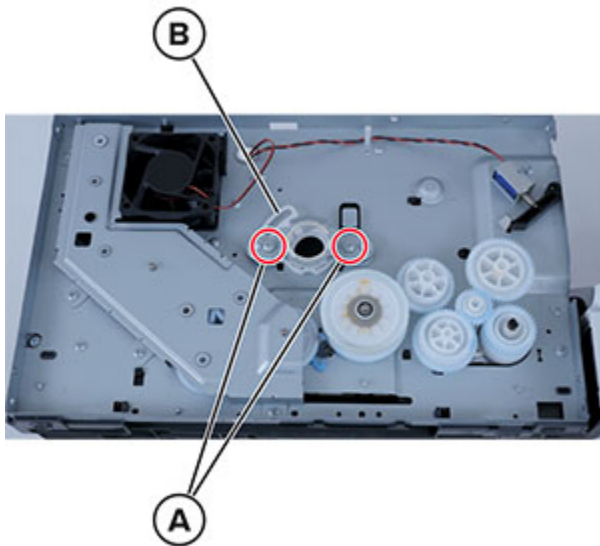

## Parts Removal

6. Place the printer on its left side, remove the screw (C), and then remove the duplex swing arm assembly (D).

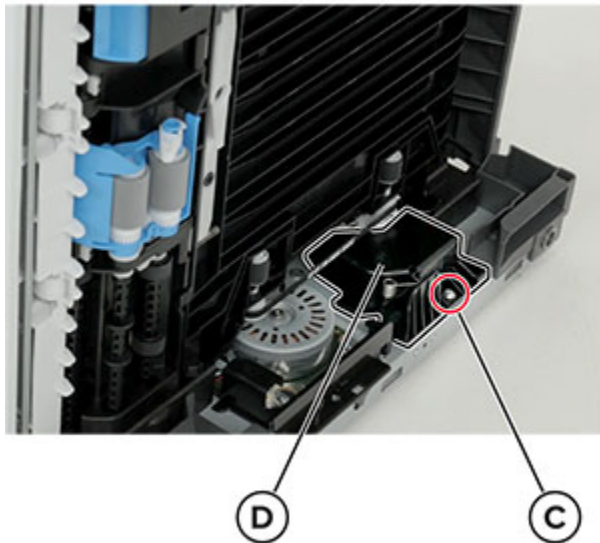

### Installation notes:

- a. Make sure that the gears assembly is properly installed in the housing.

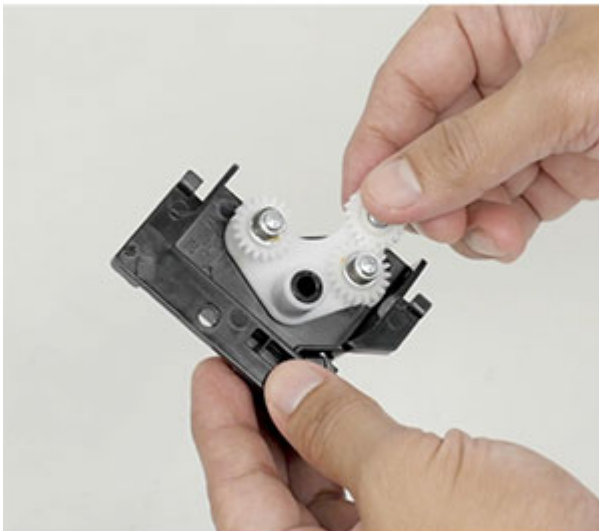

- b. Align the tab on the housing to the notch in the frame, and then install the duplex swing arm assembly.



## Imaging Unit Coupling Removal

1. Remove the left cover. See [Left cover removal](#).
2. Remove the left front door link. See [Left front door link removal](#).
3. Remove the two screws (A), and then remove the imaging unit coupling (B).

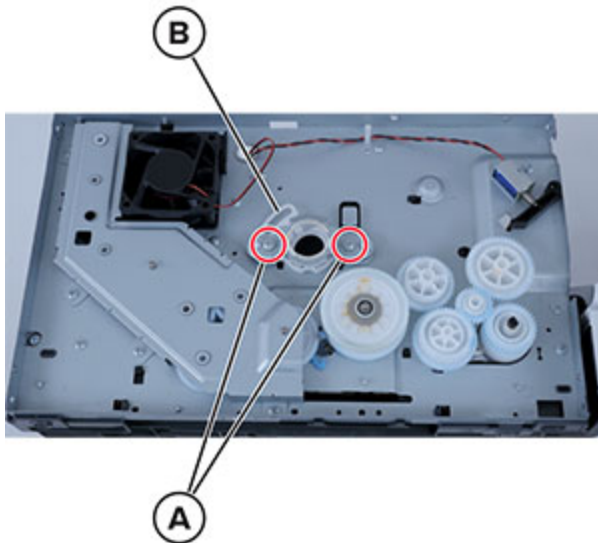

## Pick Roller Clutch Removal

1. Remove the left cover. See [Left cover removal](#).

## Parts Removal

2. Remove the six screws, and then remove the gear cover.

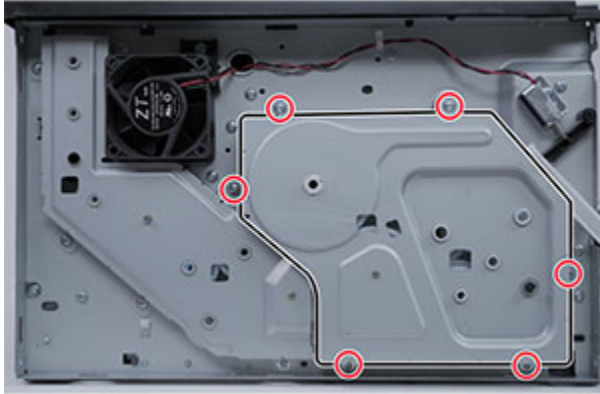

3. Remove the three gears.

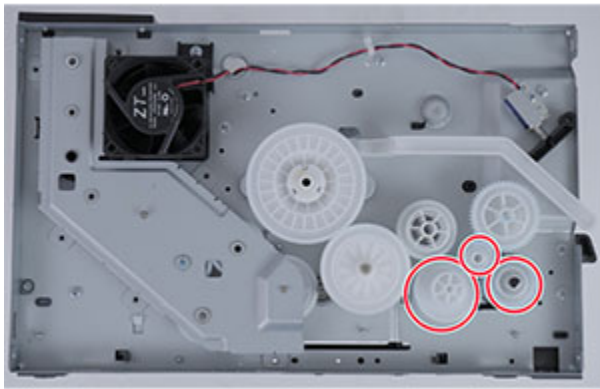

 **Note:** Installation note: Pay attention to the position of the gears.



4. Remove the clutch (A), and then disconnect the cable (B).

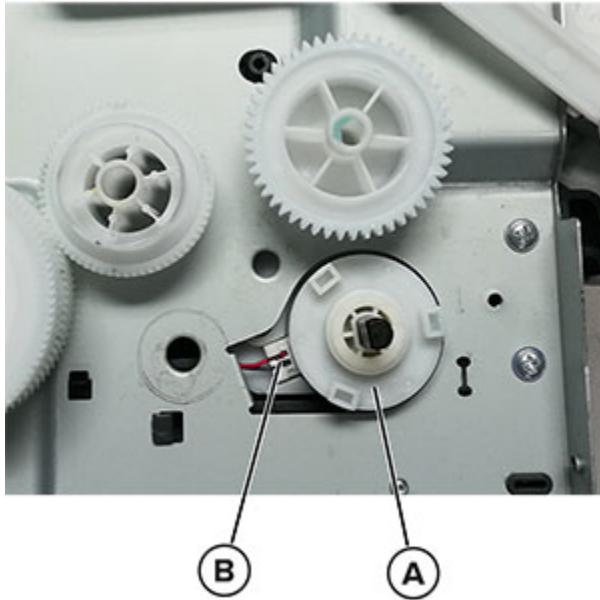

## Left Front Door Link Removal

1. Remove the left cover. See [Left cover removal](#).
2. Remove the six screws, and then remove the gear cover.

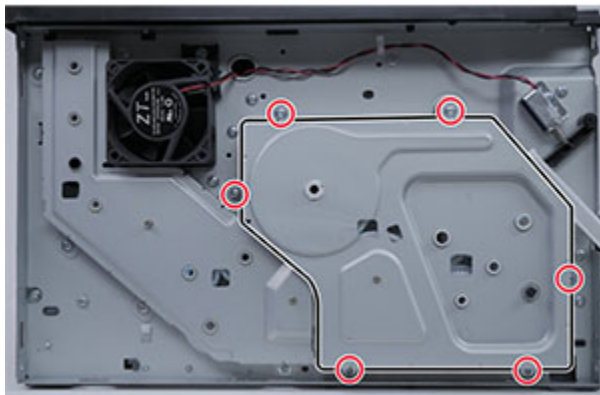

## Parts Removal

3. Remove the gear.

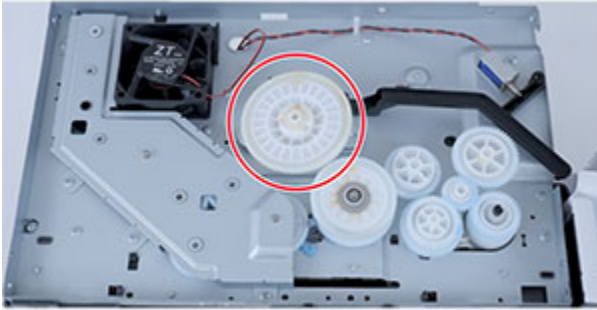

4. Release the left front door link (A) from the retainer (B), and then remove the left front door link.

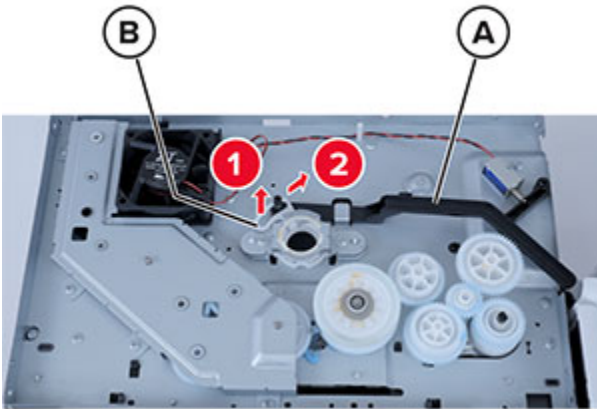

## Right Side Removals

### Right Cover Removal

1. Remove the screw at the front, and then remove the screw at the rear of the cover.



2. Open the front door, and then place the printer on its left side.

## Parts Removal

3. Release the three latches at the bottom (A).



4. Release the latch at the front, and then remove the cover.



## Controller Board Removal

 **Note:** For a video demonstration, see [Controller board removal](#).

1. Remove the right cover. See [Right cover removal](#).

## Parts Removal

2. Disconnect all the cables from the controller board.

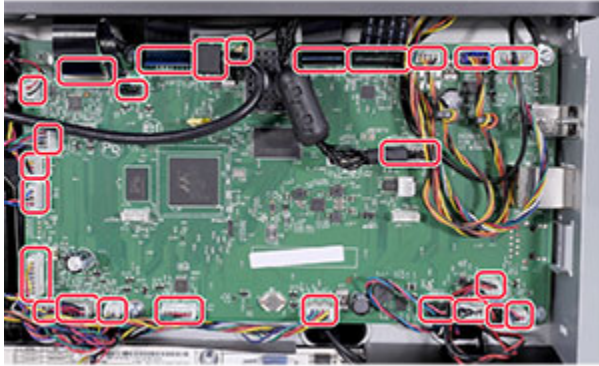

3. Remove the five screws, and then remove the controller board.

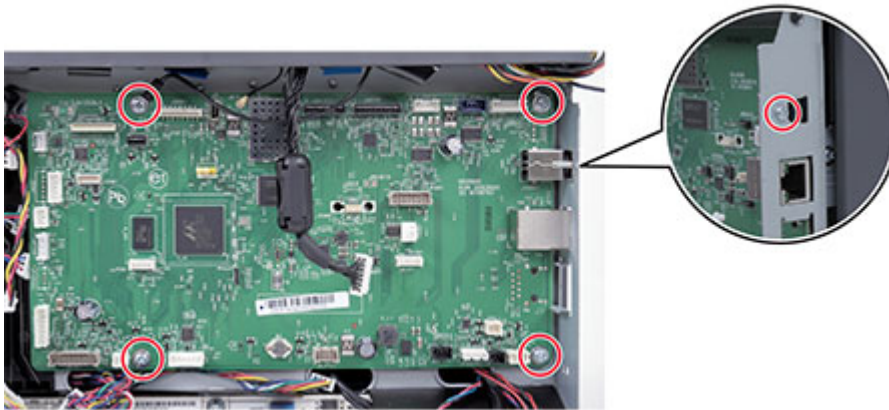

## LVPS Removal

 **Note:** For a video demonstration, see [LVPS removal](#).

1. Remove the right cover. See [Right cover removal](#).

2. Disconnect the two cables (A), remove the six screws (B), and then remove the LVPS.

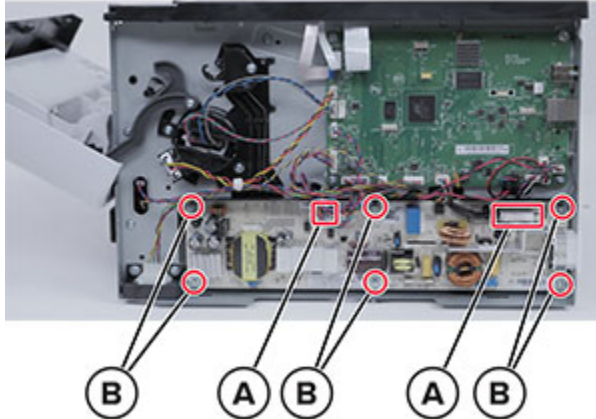

- ⚠ **CAUTION—SHOCK HAZARD:** To avoid the risk of electrical shock, do not remove the shield from the back of the LVPS.
- ⚠ **ATTENTION ! RISQUE D'ÉLECTROCUTION :** Pour éviter tout risque d'électrocution, ne retirez pas la protection de l'arrière du bloc d'alimentation basse tension (LVPS).
- ⚠ **PRECAUCIÓN—RIESGO DE DESCARGA:** Para evitar el riesgo de descarga eléctrica, no retire la protección de la parte trasera de la fuente de alimentación de bajo voltaje (LVPS).
- ⚠ **VORSICHT – STROMSCHLAGGEFAHR:** Um die Gefahr eines elektrischen Schlags zu vermeiden, entfernen Sie die Abdeckung nicht von der Rückseite des Niederspannungsnetzteils.
- ⚠ **ATTENZIONE – PERICOLO DI SCOSSA ELETTRICA:** Per evitare il rischio di scosse elettriche, non rimuovere la protezione dal retro dell'alimentazione a bassa tensione (LVPS).

## HVPS Removal

 **Note:** For a video demonstration, see [HVPS removal](#).

1. Remove the left cover. See [Left cover removal](#).
2. Remove the right cover. See [Right cover removal](#).
3. Remove the rear door. See [Rear door removal](#).
4. Place the printer on its left side.

## Parts Removal

5. Remove the three screws (A), release the HVPS, and then disconnect the cable (B).

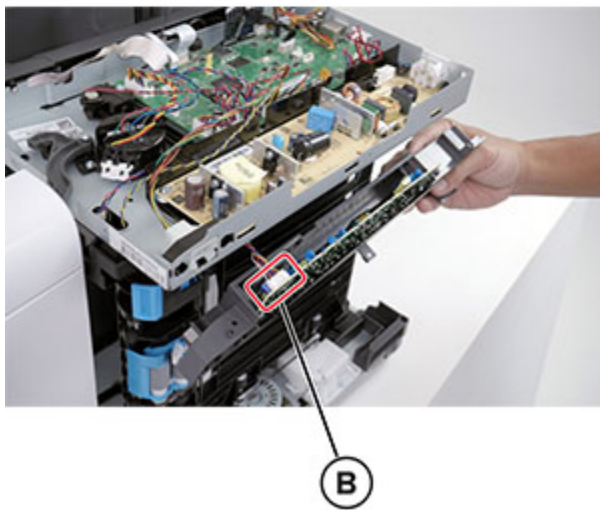
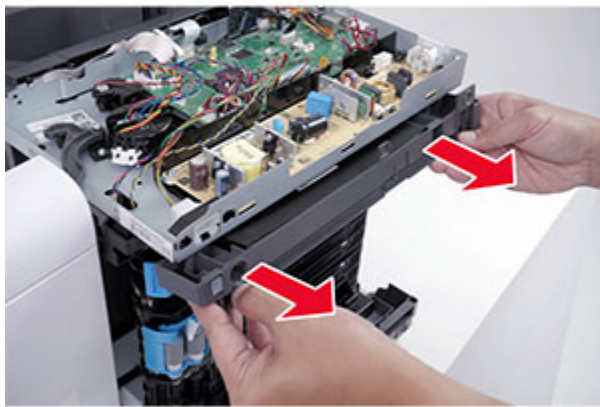
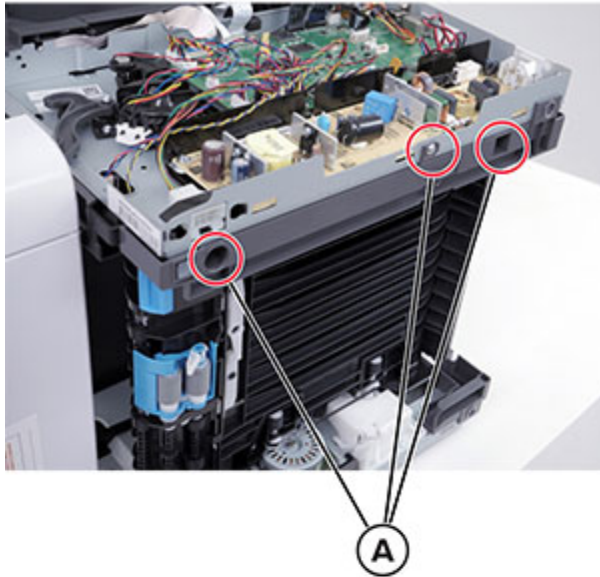



## Sensor (MPF Paper Present) Removal

 **Note:** For a video demonstration, see [Sensor \(MPF paper present\) removal](#).

1. Remove the right cover. See [Right cover removal](#).
2. Open the front door, and then remove the screw.

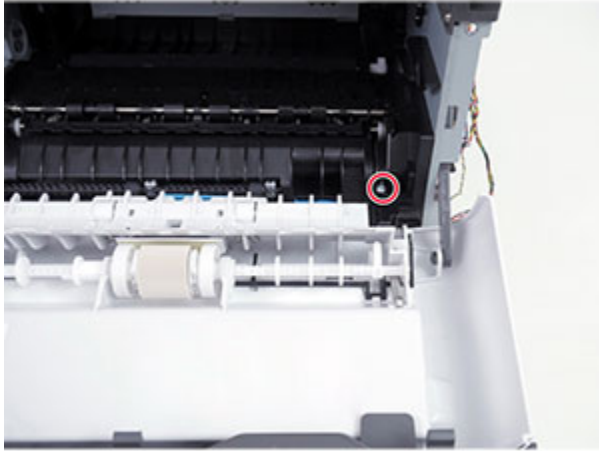

3. Release the latches securing the sensor, and then disconnect the sensor cable.

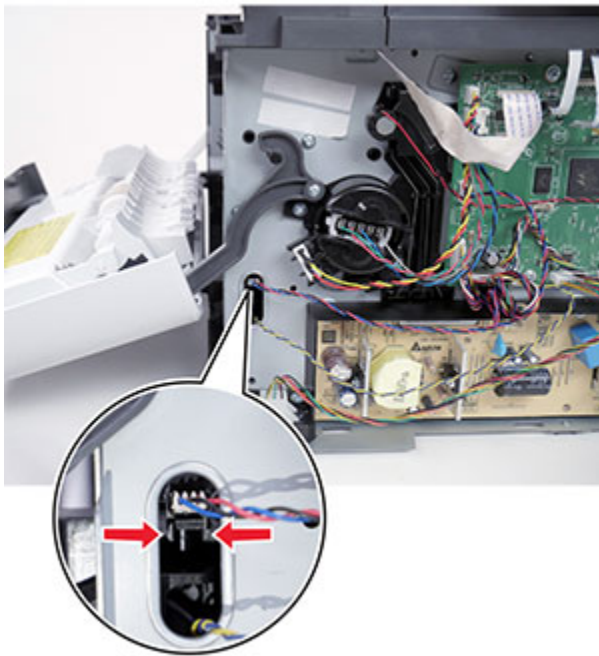

## Right Front Door Link Removal

1. Remove the right cover. See [Right cover removal](#).

## Parts Removal

2. Remove the screw, and then remove the link from the front door.

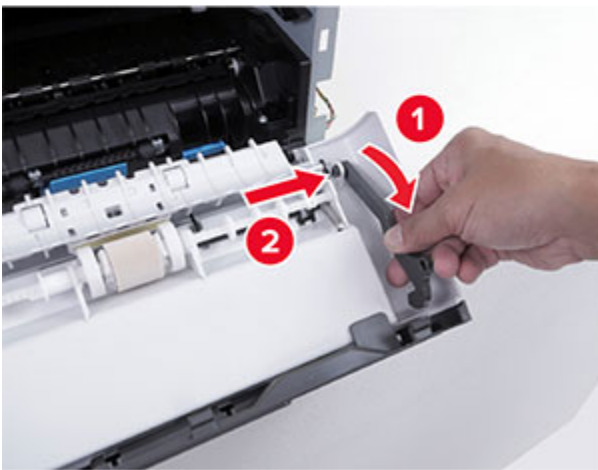
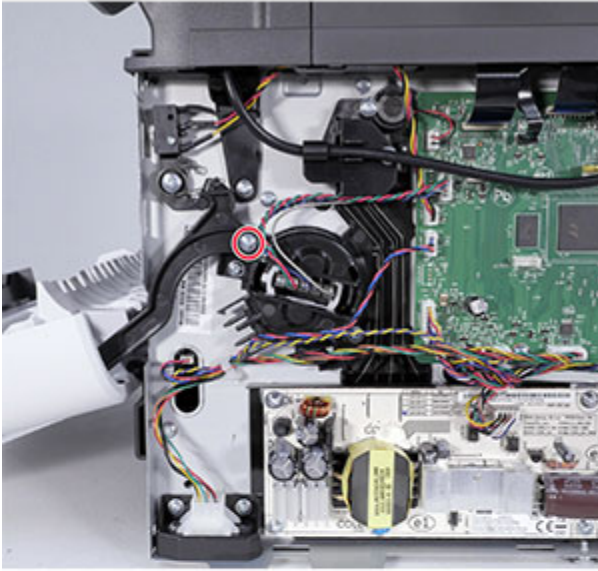

## MPF Solenoid Cable Removal

 **Note:** For a video demonstration, see [MPF Solenoid Cable Removal](#).

1. Remove the left cover. See [Left cover removal](#).
2. Remove the right cover. See [Right cover removal](#).
3. Remove the ADF and scanner. See [ADF and Scanner Removal](#).

4. Disconnect the cable, and then remove the screw to remove the solenoid cable.

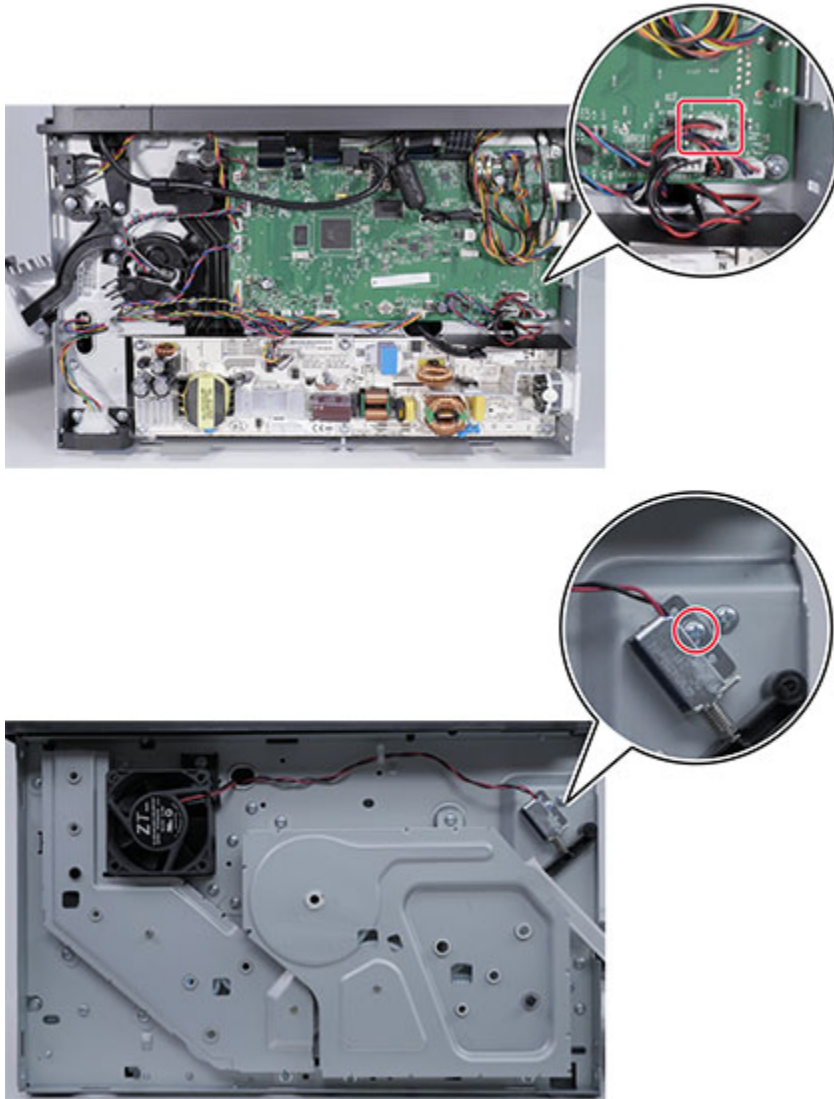

## Main Fan Removal

 **Note:** For a video demonstration, see [Main Fan Removal](#).

1. Remove the left cover. See [Left cover removal](#).
2. Remove the right cover. See [Right cover removal](#).
3. Remove the ADF and scanner. See [ADF and Scanner Removal](#).

## Parts Removal

4. Disconnect the cable, and then remove the screw to remove the fan.

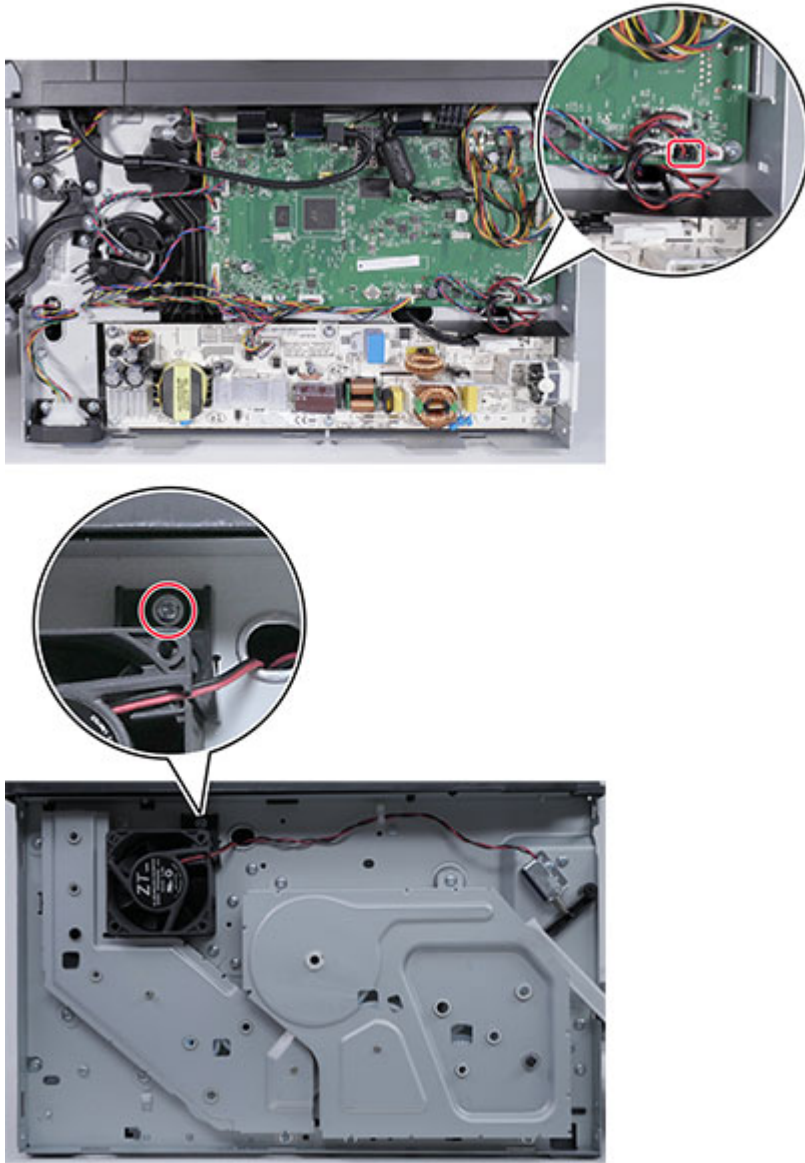

## Speaker Removal

1. Remove the right cover. See [Right cover removal](#).
2. Disconnect the cable (A), remove the screw (B), and then remove the speaker.

## Front Removals

### Control Panel Removal

1. Remove the right cover. See [Right cover removal](#).
2. Disconnect the two cables.



3. Remove the ADF and scanner. See [ADF and Scanner Removal](#).
4. Remove the control panel cables from the top right frame of the printer.

## Parts Removal

5. Remove the screw, and then remove the control panel.



## Upper Front Cover Removal

 **Note:** For a video demonstration, see [Upper front cover removal](#).

1. Open the front door.
2. Release the two latches.



3. Remove the cover.



## Front Door Removal

 **Note:** For a video demonstration, see [Front door removal](#).

1. Remove the right cover. See [Right cover removal](#).
2. Remove the right front door link. See [Right front door link removal](#).
3. Release the left front door link, and then remove the front door.

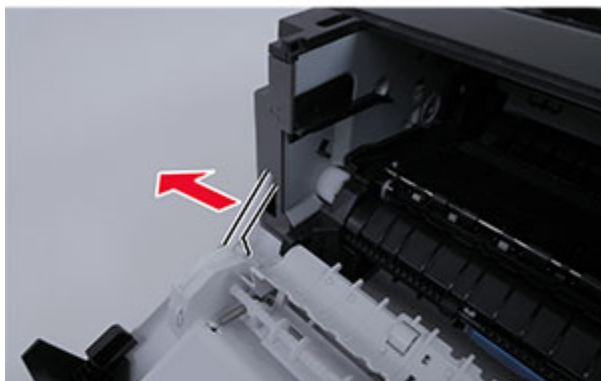

## Transfer Roller Removal

 **Note:** For a video demonstration, see [Transfer roller removal](#).

1. Open the front door.
2. Release the two latches, and then remove the transfer roller.



### Installation notes:

- Do not touch the foam on the roller.
- The shaft has grease. To avoid contaminating the roller, do not touch the shaft.
- Make sure that the spring is properly installed on the left side of the roller.

## MPF Pick Roller Removal

1. Open the front door.



2. Remove the MPF pick roller.



## Pick Separator Roller Removal

1. Remove the tray insert.

## Parts Removal

2. Remove the pick separator roller.

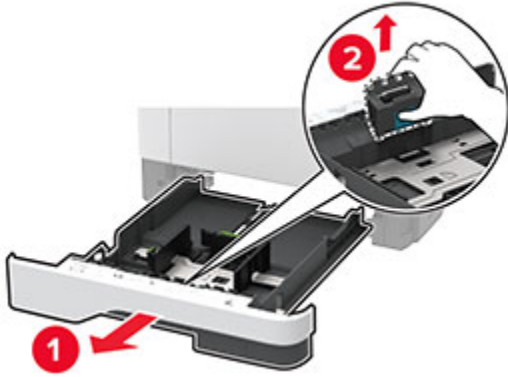

## Rear Removals

### Rear Door Removal

1. Remove the left cover. See [Left cover removal](#).

## Parts Removal

2. Remove the screw, and then remove the rear door.

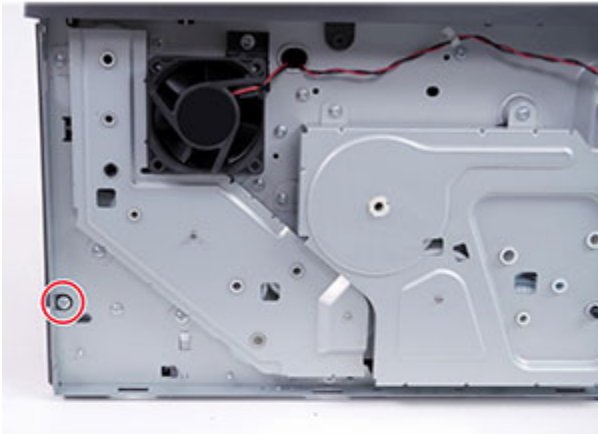

 **Note:** Pay attention to the position of the locating feature on the right side before removing the door.



## Fuser Removal

 **Note:** For a video demonstration, see [Fuser removal](#).

1. Remove the right cover. See [Right cover removal](#).
2. Disconnect the three cables.

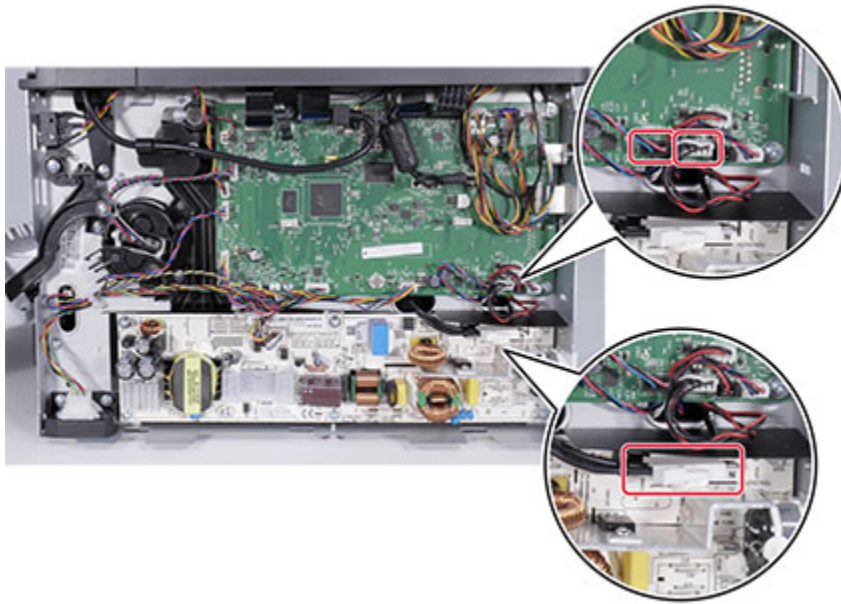

3. Open the rear door, remove the four screws, and then remove the fuser.

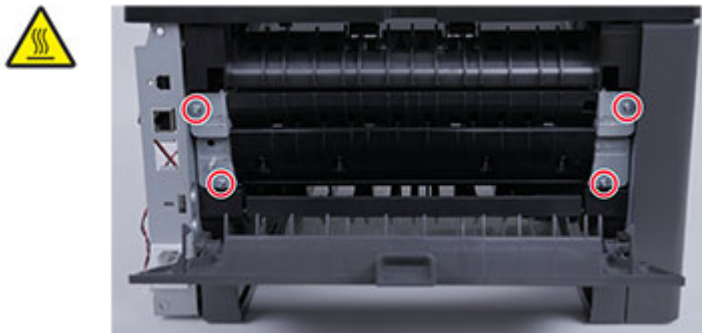

## Top Removals

### Printhead Removal

 **Note:** For a video demonstration, see [Printhead Removal](#).

1. Remove the right cover. See [Right cover removal](#).
2. Remove the left cover. See [Left cover removal](#).
3. Remove the ADF and scanner. See [ADF and Scanner Removal](#).
4. Disconnect the two cables.

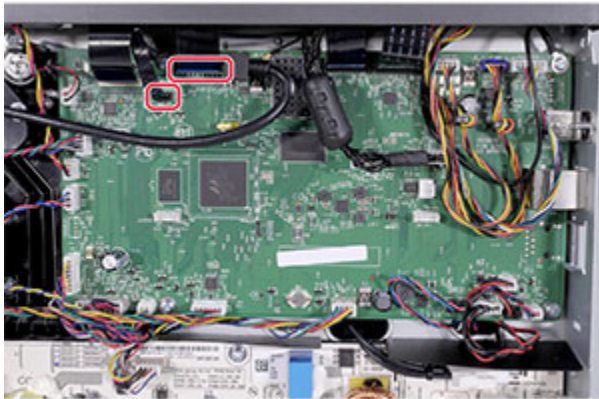

- Remove the three screws (A), remove the two cables (B) from the toroid (C), and then remove the printhead.

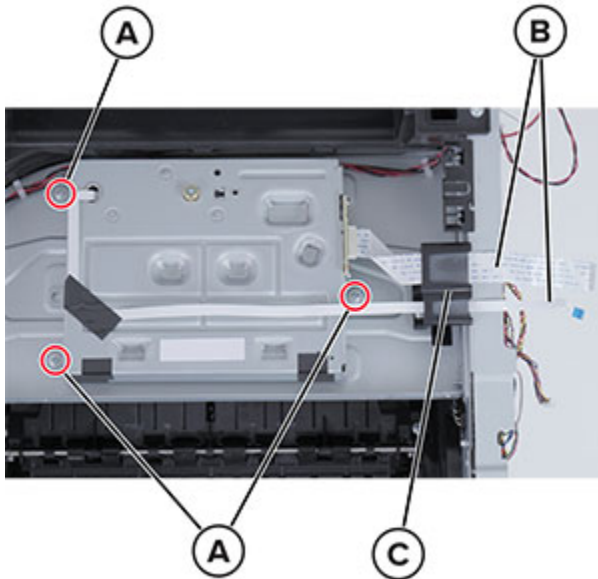

 **Note:** Installation note: When installing the printhead, tighten the screws in the following the order:

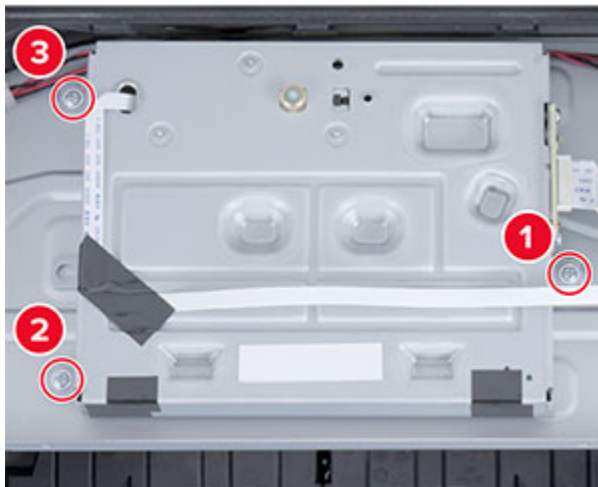

## Redrive Removal

 **Note:** For a video demonstration, see [Redrive Removal](#).

- Remove the right cover. See [Right cover removal](#).
- Remove the left cover. See [Left cover removal](#).
- Remove the ADF and scanner. See [ADF and Scanner Removal](#).

## Parts Removal

4. Remove the four screws.



5. Lift the redrive, and then disconnect the cable from the redrive.

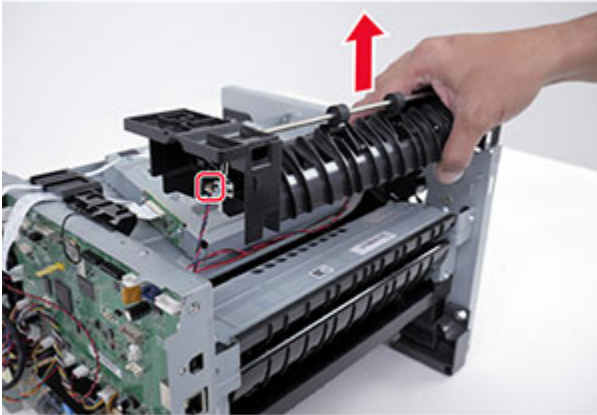

## Bin Full Sensor Actuator Removal

1. Remove the ADF and scanner. See [ADF and Scanner Removal](#).



2. Firmly pull the bin full actuator to the left until it is disengaged from the printer frame.

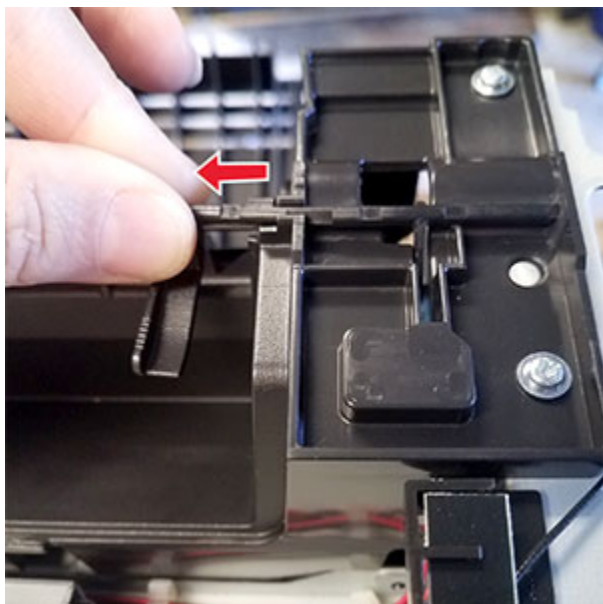

3. Remove the actuator.

**Installation notes:**

- a. Make sure that the actuator is properly positioned as shown.

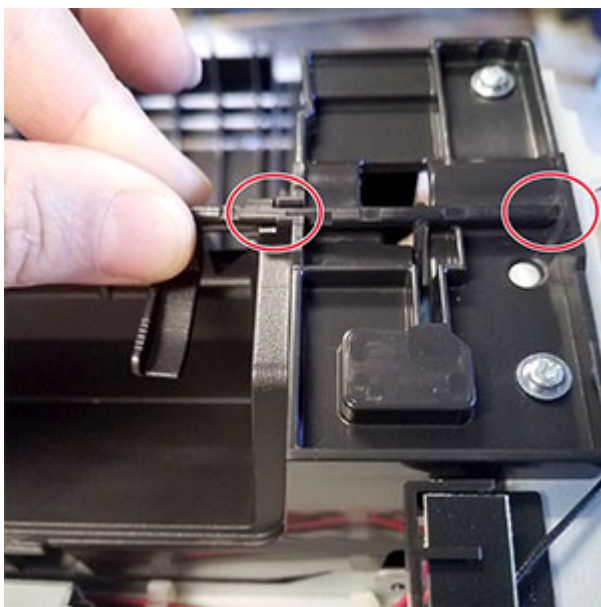

## Parts Removal

- b. Carefully rotate the actuator upward until it is engaged to the printer frame.

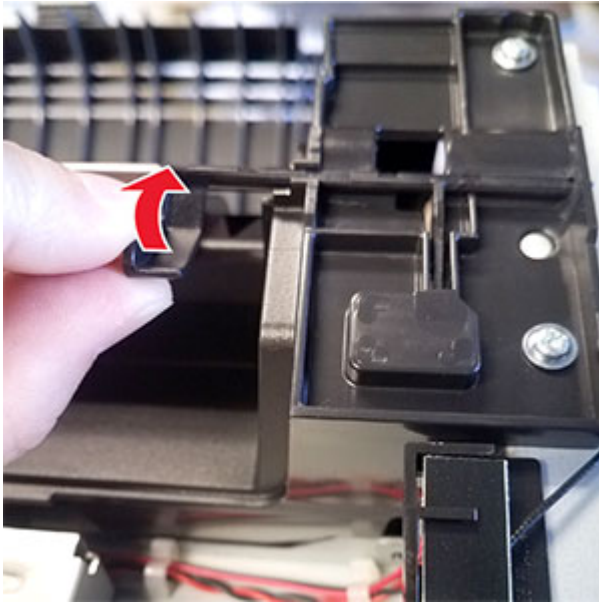

- c. Make sure that the actuator is properly installed and freely rotates without binding.

## Bottom Removals

### Duplex Guide Removal

1. Place the printer on its left side.

## Parts Removal

2. Remove the duplex guide.

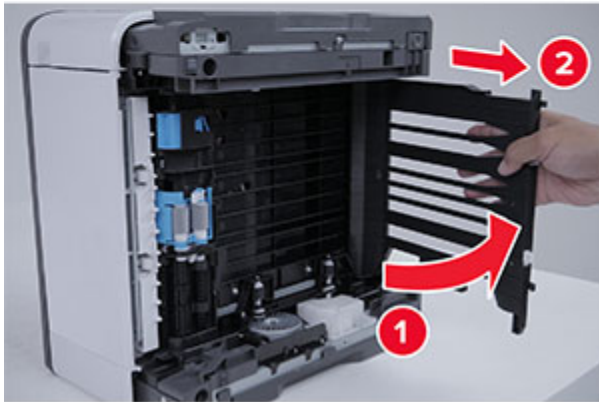
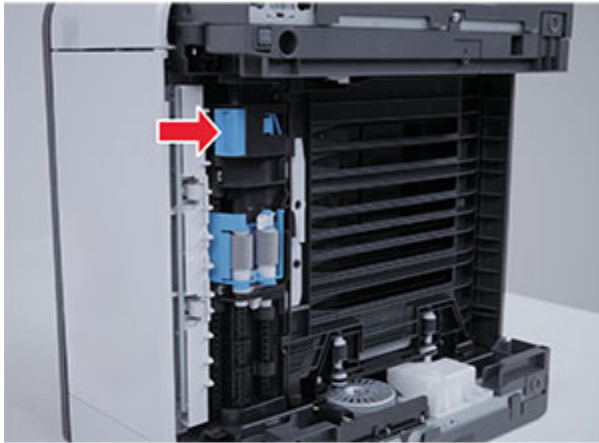

 **Note:** Installation note: Make sure that the duplex guide is properly inserted into the locating features inside the printer.

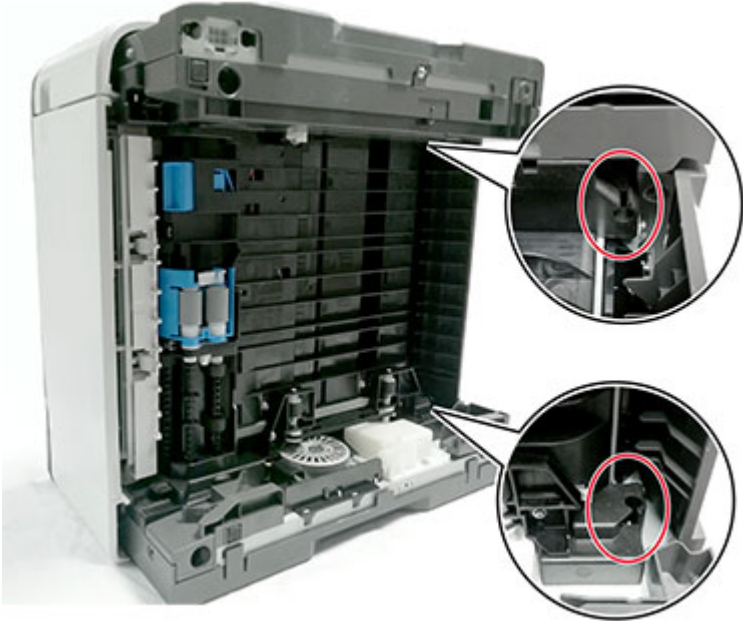

## ADF and Scanner Removals

### ADF Cover Removal

1. Open the ADF cover.
2. Remove the ADF cover.



### ADF Tray Removal

1. Open the ADF cover.
2. Remove the ADF tray.



### ADF Separator Pad Removal

1. Open the ADF cover.

2. Release the latch to remove the ADF separator pad.

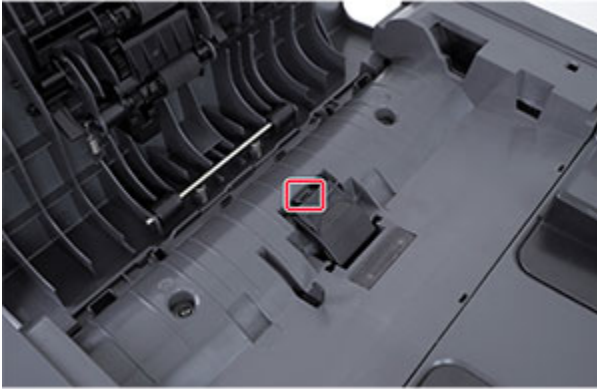

 **Note:** Installation note: Do not lose the spring under the ADF separator pad.

## ADF and Scanner Removal

 **Note:** For a video demonstration, see [ADF and Scanner Removal](#).

1. Remove the right cover. See [Right cover removal](#).
2. Remove the left cover. See [Left cover removal](#).
3. Remove the control panel. See [Control Panel Removal](#).
4. Disconnect the six cables (A), and then remove the two screws (B).

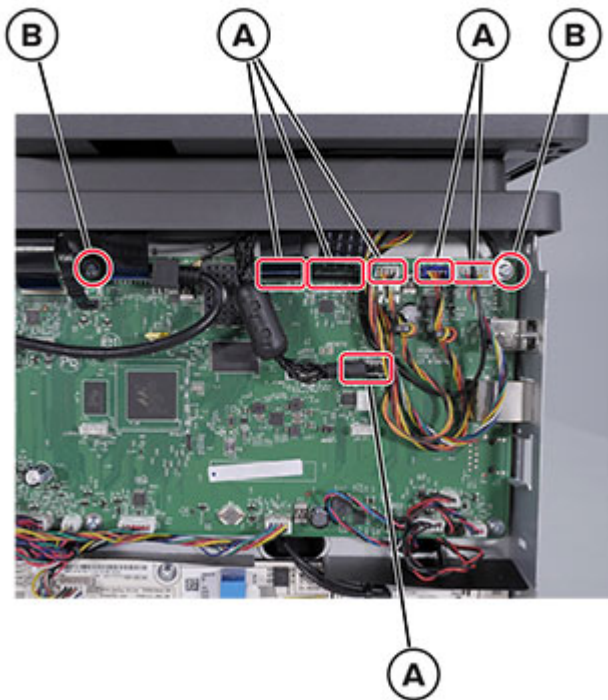

## Parts Removal

5. Remove the three screws from the printer frame.

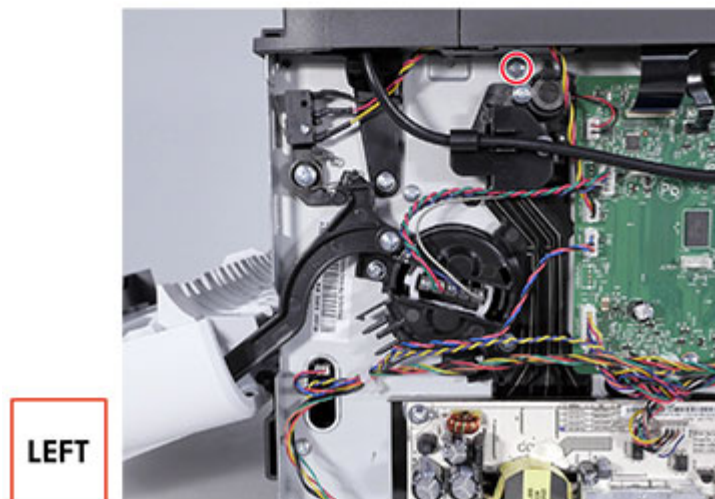
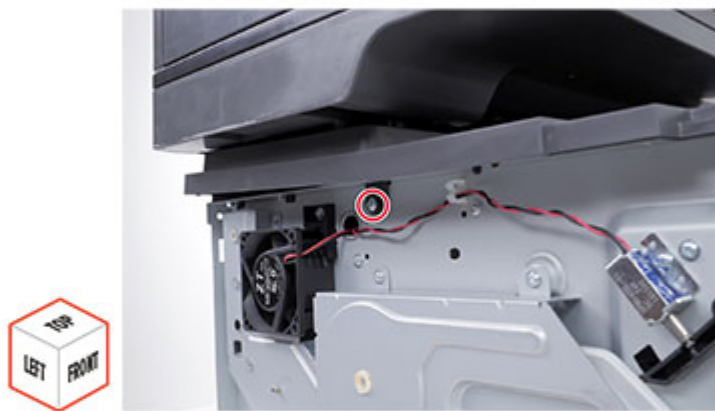



6. Remove the ADF and scanner.

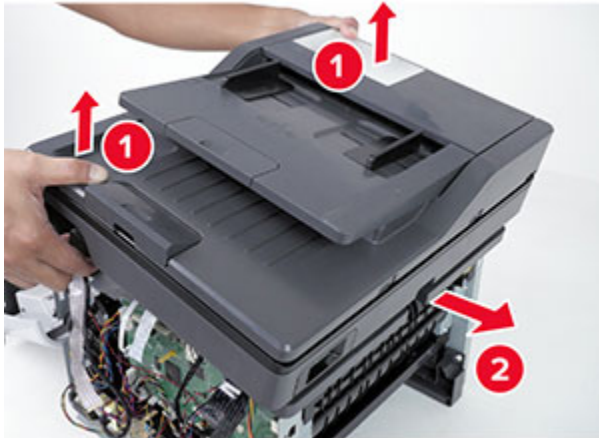

 **Note:** Installation note: Make sure to perform the ADF scanner calibration after replacing the ADF and scanner.

To perform the ADF scanner calibration:

1. Load the calibration sheet into the ADF tray.

 **Note:** Adjust the guides to match the size of the calibration sheet.

2. Enter the Diagnostics menu, and then select **Scanner Diagnostics**.
3. Touch **Scanner Calibration Reset**.
4. Wait for about 45 seconds for the calibration to finish.

 **Note:** A Test Completed message appears on the display when the calibration is finished.

## Scanner Pivot Arm Removal

1. Slightly raise the ADF and scanner assembly.

## Parts Removal

2. While pulling on the scanner pivot arm latch, completely raise the ADF and scanner assembly to release the latch.



3. Remove the two screws, and then remove the scanner pivot arm.



## Fax Card Removal

 **Note:** For a video demonstration, see [Fax Card Removal](#).

1. Remove the right cover. See [Right cover removal](#).
2. Remove the left cover. See [Left cover removal](#).
3. Remove the ADF and scanner. See [ADF and Scanner Removal](#).
4. Release the scanner pivot arm latch.



5. Place the ADF and scanner assembly on its left side.

## Parts Removal

6. Remove the toroid from the fax card cable.



7. Release the three latches, and then remove the fax card.

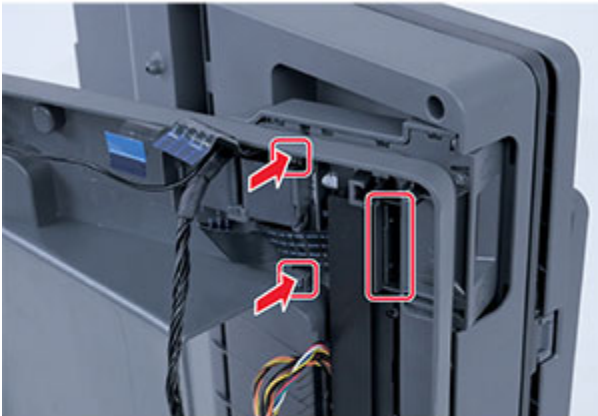

# Component Locations

## Printer Configuration



1	Automatic document feeder (ADF)
2	ADF tray
3	ADF bin
4	Control panel
5	Standard bin
6	Multipurpose feeder
7	Standard 250-sheet tray
8	Optional 550-sheet tray

## Controller Board Connectors

Connector	Connects to	Pin number	Signal
JSCANSNS1	Sensor (ADF paper present)	1	SNS_ADF_DOC
		2	SNS_ADF_DOC_LED
		3	GND
		4	SNS_ADF_SCAN
		5	PWR_ADF_SCAN_LED
		6	GND
JFBM1	Motor (scanner flatbed)	1	FBM_BOUT1
		2	FBM_BOUT2
		3	FBM_AOUT2
		4	FBM_AOUT1
JADFM1	Motor (ADF scanner)	1	ADFM_BOUT1
		2	ADFM_BOUT2
		3	ADFM_AOUT2
		4	ADFM_AOUT1
JACIS1	Scanner flatbed analog CIS bar	1	OS1_AFE
		2	GND
		3	OS2_AFE
		4	GND
		5	OS3_AFE
		6	GND
		7	+3.3 V_FB_C
		8	AFE_REV_ID1
		9	AFE_REV_ID2
		10	A_SOL
		11	GND
		12	A_CIS_PCLK
		13	+5 V_AWAKE
		14	SCAN_LEDB
		15	SCAN_LEDG
		16	SCAN_LEDR

## Component Locations

Connector	Connects to	Pin number	Signal
JDCIS1	Scanner ADF digital CIS bar	1	GND
		2	SCAN_RXIN_P(0)
		3	SCAN_RXIN_N(0)
		4	GND
		5	SCAN_RXCLK_P
		6	SCAN_RXCLK_N
		7	GND
		8	D_SOL
		9	D_AFE_SEN
		10	D_AFE_SDIO
		11	D_AFE_SCK
		12	GND
		13	D_CIS_PCLK
		14	+3.3 V_ADF
JWIFI1	Wi-Fi antenna	1	WIFI_ANT
		2	GND
J3	USB front port cable	1	+5 V_FUSB
		2	USB_N
		3	USB_P
		4	NC
		5	GND
JVDO1	Printhead video	1	VDO_HSYNC-
		2	GND
		3	VDO_K1+
		4	VDO_K1-
		5	GND
		6	VDO_LPOW_K
		7	VDO_LADJ_K1
		8	VDO_BOOST_K
		9	+3.3 V_PHRAIL_SW
		10	GND
		11	VDO_LEN_K-



Connector	Connects to	Pin number	Signal
		12	+3.3 V_PHRAIL_SW
		13	VDO_K0+
		14	VDO_K0-
		15	GND
		16	VDO_LADJ_K0
JMIR1	Motor (printhead mirror)	1	+25 V_SW
		2	GND
		3	MM_START
		4	MM_LOCK
		5	MM_REFCLK
JUICC28	2.8-in. control panel LCD	1	LED_DRIVE
		2	+5 V_CONT
		3	MIR_TXD
		4	MIR_CS-
		5	POWER_BUTTON
		6	LCD_RS
		7	LCD_TE
		8	MIR_RXD
		9	GND
		10	MIR_CLK
		11	GND
		12	I2C_DAT
		13	I2C_CLK
		14	+5 V_UI
		15	RESET-
		16	IRQ-
		17	GND
18	LCD_WR		
19	LCD_RD		
20	+5 V_UI		
21	D0		

## Component Locations

Connector	Connects to	Pin number	Signal
		22	D1
		23	GND
		24	D2
		25	D3
		26	+5 V_UI
		27	D4
		28	D5
		29	GND
		30	D6
		31	D7
		32	+5 V_UI
JSPKR1	Speaker	1	Speaker+
		2	Speaker -
JSCHIP1	Toner cartridge and imaging unit smart chip	1	I2C_DAT
		2	+3.3 V_SCHIP
		3	I2C_CLK
		4	GND
		5	TONER_EMPTY
JCVR1	Front door laser safety switch	1	+3.3 V_PHRAIL
		2	+3.3 V
		3	GND
JMPSNS1	Sensor (MPF paper present)	1	SNS_MPS
		2	GND
		3	PWR_MPF
JHVPS1	HVPS	1	+25 V_SW
		2	DEV_PWM
		3	ADC_HV_SERVO
		4	XFER_EN
		5	TX_PWM
		6	GND
		7	CHG_PWM
JMTR1	Motor (main drive)	1	+25 V_SW

Connector	Connects to	Pin number	Signal
		2	GND
		3	BRAKE
		4	PWM
		5	DIR
		6	FG
		7	+25 V_SW
		8	GND
		Sensor (toner density)	9
	10		THERM_TDS
	11		SNS_TDS
	12		GND
	13		PWR_TDS
	Pick clutch	14	+25 V_SW
		15	CLUTCH_SINK
	Sensor (input)	16	SNS_INPUT
		17	GND
		18	PWR_INPUT
	JTRAY1	Tray present switch	1
2			TRAY_DETECT
JOPT1	Paper handling option	1	+25 V_SW
		2	TXD_OPT
		3	TRAY_PULLED_N
		4	RXD_OPT
		5	GND
		6	5 V_OPT
JLVPS1	LVPS	1	RELAY_ON
		2	HEAT_ON
		3	ZERO_CROSS
		4	+25 V_SW_ON
		5	+25 V_CONT_RAIL
		6	GND
		7	+25 V_SW_RAIL

## Component Locations

Connector	Connects to	Pin number	Signal
		8	GND
JEXIT1	Sensor (fuser exit)	1	SNS_EXIT
		2	GND
		3	PWR_EXIT
JFUSER1	Fuser thermistor	1	THERM_FUSER
		2	GND
		3	AC_RELAY_ON_TCO
		4	AC_RELAY_ON
JFAN1	Fan	1	+25 V_SW
		2	FAN_SINK
JBIN1	Sensor (bin full)	1	SNS_BF
		2	GND
		3	PWR_BF
JSOL1	MPF pick solenoid	1	+25 V_SW
		2	SOL_SINK
JFAX1	Fax  <b>Note:</b> This connector is only applicable for the B315.	1	TONE
		2	FAX_PWR
		3	FAX_PWR
		4	RES
		5	+5V
		6	IRQ
		7	GND
		8	SCK
		9	GND
		10	MOSI
		11	GND
		12	MISO
		13	GND
		14	CS

# Maintenance

## Cleaning Printer Parts

### Cleaning The Printer

 **CAUTION—SHOCK HAZARD:** To avoid the risk of electrical shock when cleaning the exterior of the printer, unplug the power cord from the electrical outlet and disconnect all cables from the printer before proceeding.

 **Note:**

- Perform this task after every few months.
  - Damage to the printer caused by improper handling is not covered by the printer warranty.
1. Turn off the printer, and then unplug the power cord from the electrical outlet.
  2. Remove paper from the standard bin and multipurpose feeder.
  3. Remove any dust, lint, and pieces of paper around the printer using a soft brush or vacuum.
  4. Wipe the outside of the printer with a damp, soft, lint-free cloth.

 **Note:**

- Do not use household cleaners or detergents, as they may damage the finish of the printer.
  - Make sure that all areas of the printer are dry after cleaning.
5. Connect the power cord to the electrical outlet, and then turn on the printer.

 **CAUTION—POTENTIAL INJURY:** To avoid the risk of fire or electrical shock, connect the power cord to an appropriately rated and properly grounded electrical outlet that is near the product and easily accessible.

### Cleaning The Scanner

1. Open the scanner cover.



2. Using a damp, soft, lint-free cloth, wipe the following areas:

- ADF glass pad

 **Note:** In some printer models, this location has an ADF glass instead of a pad.



- Scanner glass pad



- ADF glass



## Maintenance

- Scanner glass



3. Close the scanner cover.



# Parts Catalog

## Legend

The following column headings are used in the parts catalog:

- **Asm-index**—Identifies the item in the illustration.
- **Part number**—Identifies the unique number that correlates with the part.
- **Units/mach**—Refers to the number of units actually used in the base machine or product.
- **Units/FRU**—Refers to the number of units in a particular FRU.
- **Description**—Describes the part.

The following abbreviations are used in the parts catalog:

- **NS** (not shown) in the Asm-index column indicates that the part is procurable but is not pictured in the illustration.
- **PP** (parts packet) in the Description column indicates that the part is contained in a parts packet.

# Assembly 1: Covers

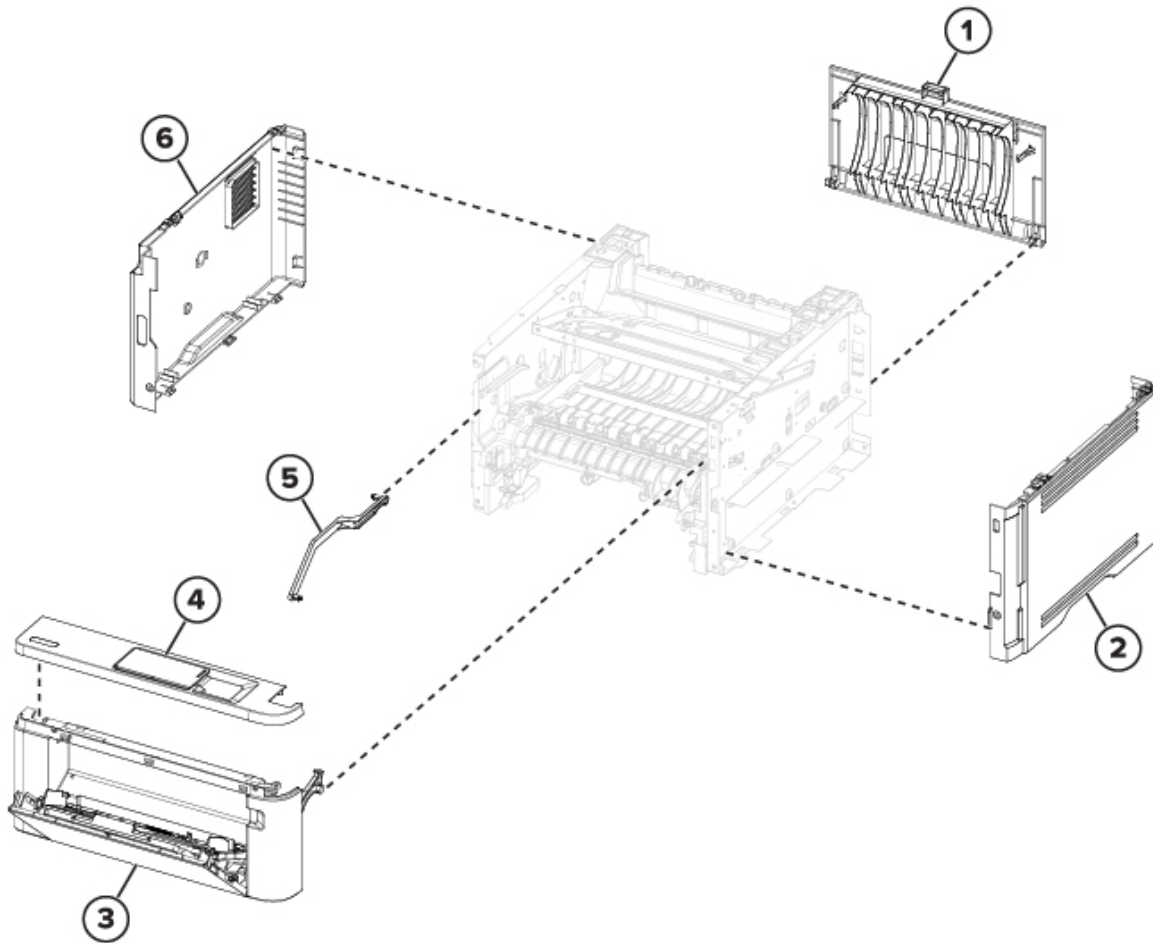

Asm-index	P/N	Units/mach	Units/FRU	Description	Removal procedure
1	002N03427	1	1	Rear door	<a href="#">Rear door removal</a>
2	002N03399	1	1	Right cover	<a href="#">Right cover removal</a>
3	002N03424	1	1	Front door with MPF pick roller	<a href="#">Front door removal</a>

Parts Catalog

Asm-index	P/N	Units/mach	Units/FRU	Description	Removal procedure
4	002N03413	1	12	Upper front cover with decals	<a href="#">Upper Front Cover Removal</a>
5	002N03428	1	1	Left front door link	<a href="#">Left front door link removal</a>
6	002N03400	1	1	Left cover	<a href="#">Left cover removal</a>

## Assembly 2: Control Panel

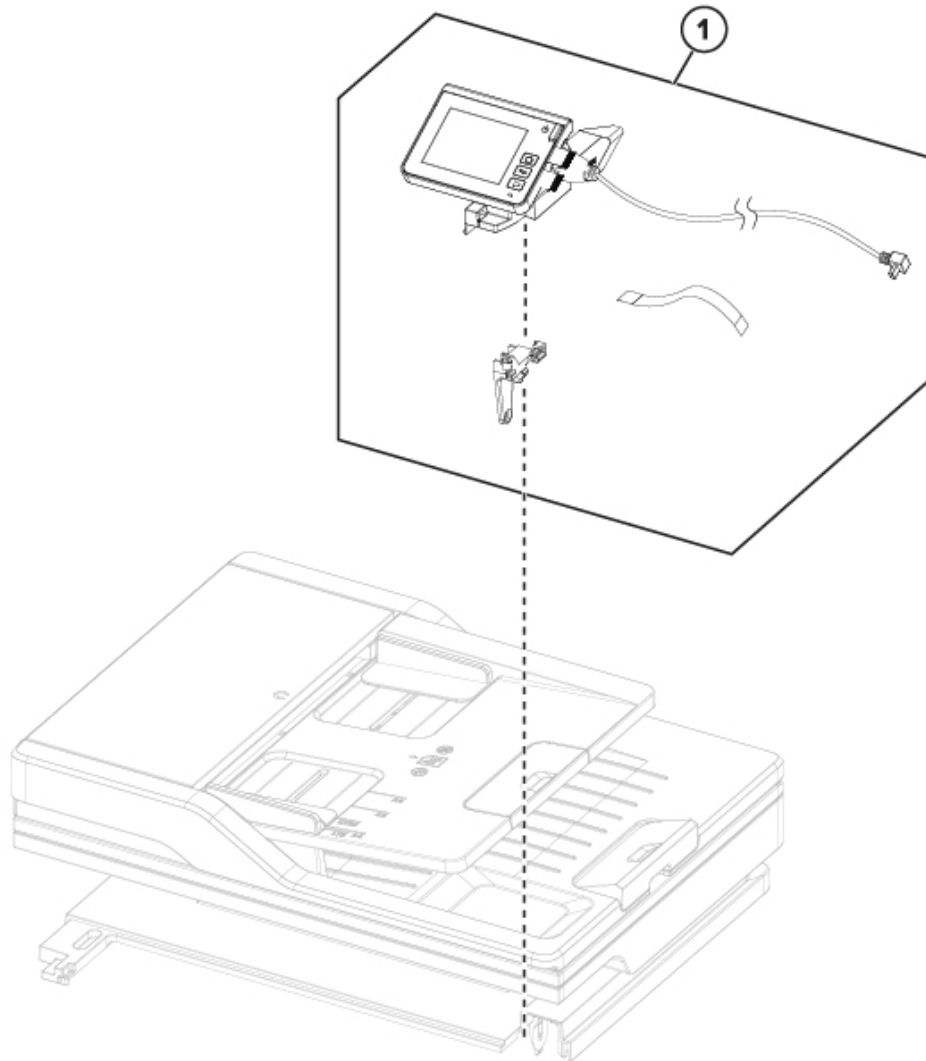

Asm-index	P/N	Units/mach	Units/FRU	Description	Removal procedure
1	002N03397	1	1	Control panel assembly	<a href="#">Control Panel Removal</a>

## Assembly 3: Electronics

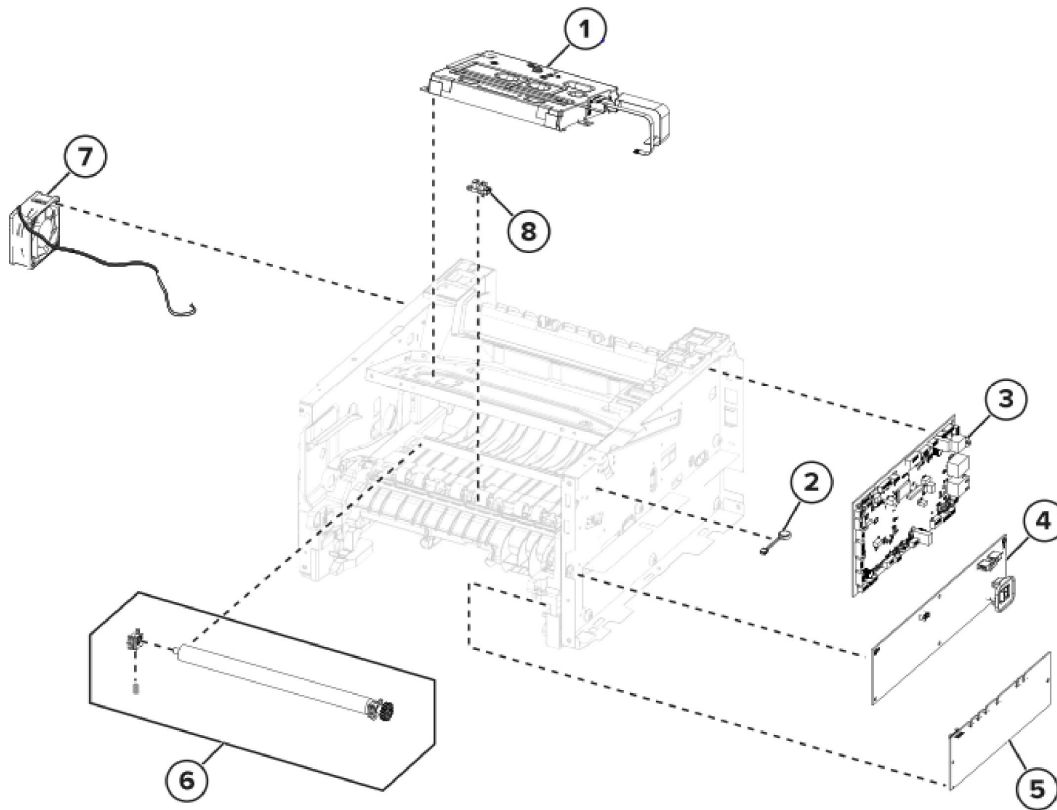

Asm-index	P/N	Units/mach	Units/FRU	Description	Removal procedure
1	046N00243	1	1	Printhead	<a href="#">Printhead removal</a>
2	130N01911	1	1	Speaker	<a href="#">Speaker removal</a>
3	109N00872	1	1	Controller board	<a href="#">Controller Board Removal</a>
4	112N00267	1	1	LVPS, 110V	<a href="#">LVPS removal</a>
4	112N00268	1	1	LVPS, 220V	<a href="#">LVPS removal</a>
5	112N00269	1	1	HVPS	<a href="#">HVPS removal</a>
6	022N02903	1	3	Transfer roller, bearing and spring	<a href="#">Transfer roller removal</a>

Asm-index	P/N	Units/mach	Units/FRU	Description	Removal procedure
7	127N07968	1	1	Main fan	<a href="#">Main Fan Removal</a>
8	130N01897	1	1	Sensor (input)	

## Assembly 4: Gears

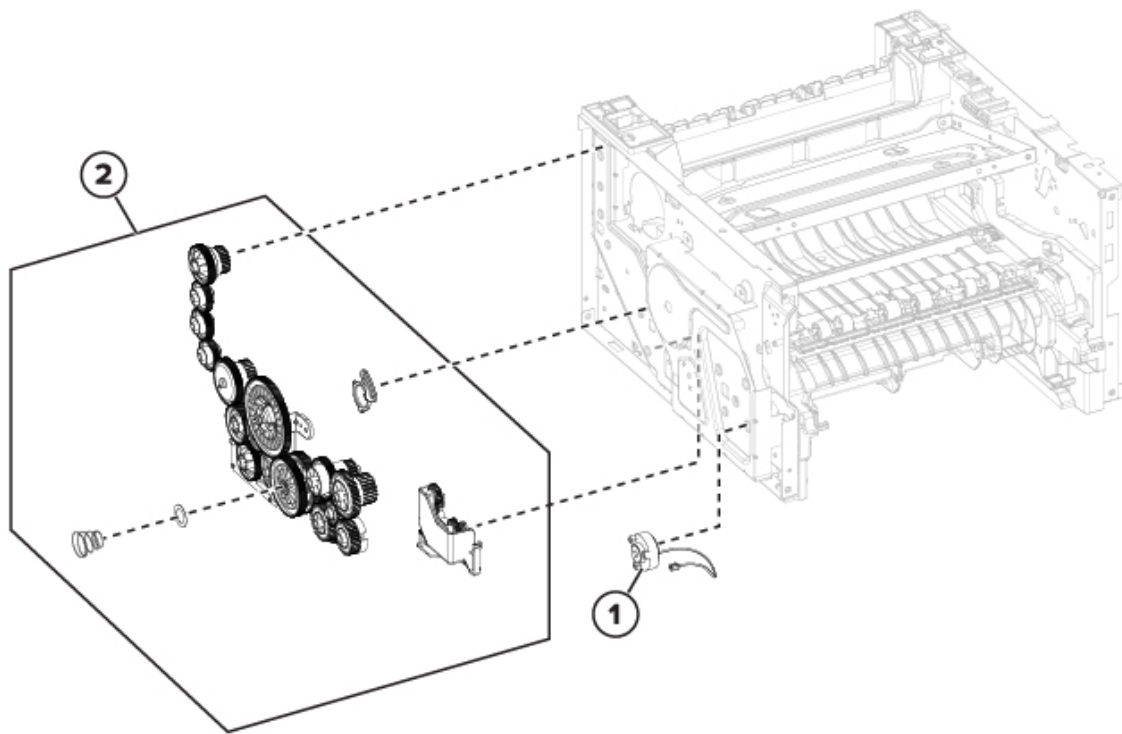

Asm-index	P/N	Units/mach	Units/FRU	Description	Removal procedure
1	005N01213	1	1	Pick roller clutch	<a href="#">Pick Roller Clutch Removal</a>
2	007N01855	1	24	Main drive gears kit	<a href="#">Main drive gears removal</a>



## Assembly 5: Paper Path

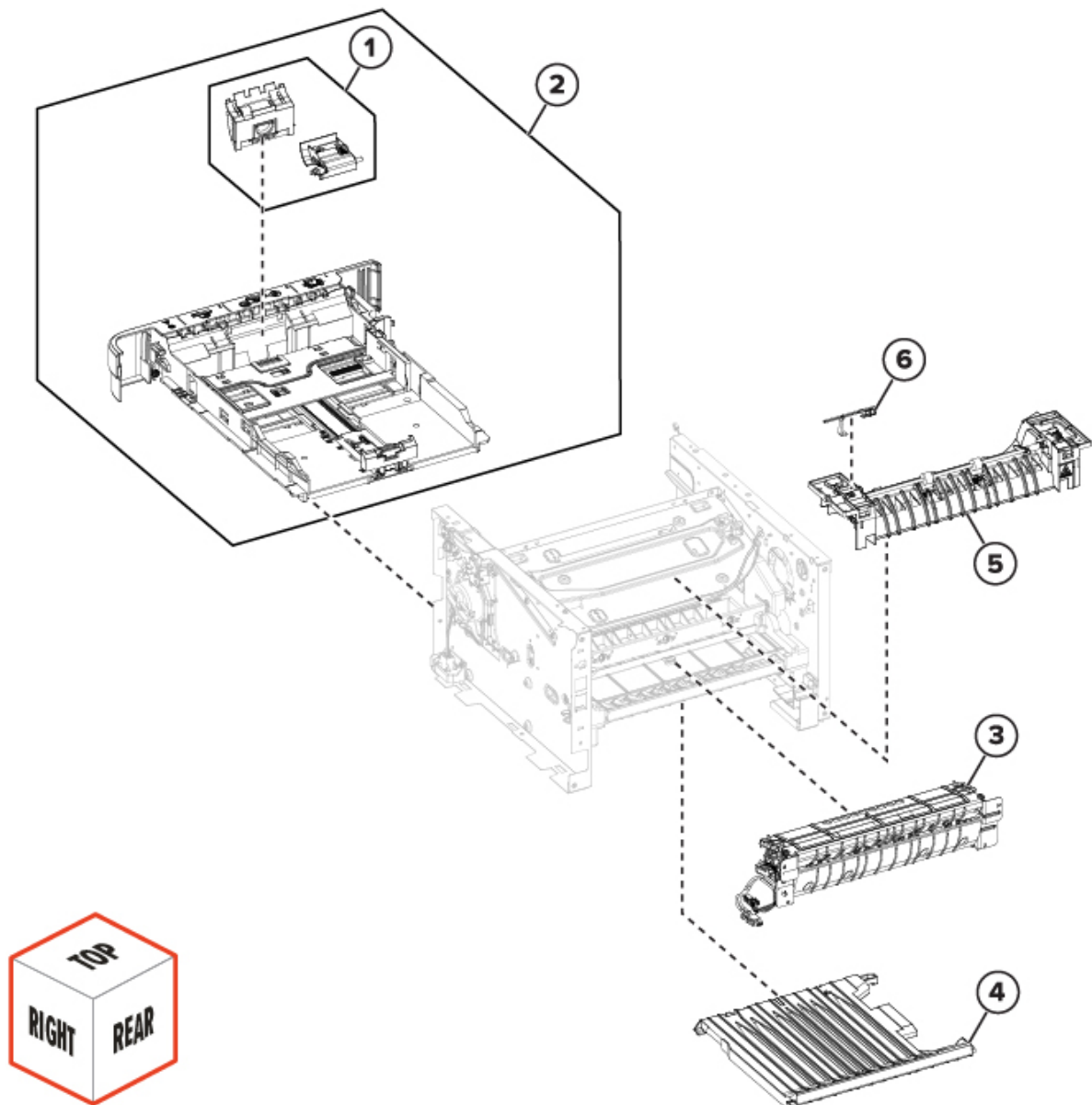

Asm-index	P/N	Units/mach	Units/FRU	Description	Removal procedure
1	022N02902	1	1	Pick separator roller	<a href="#">Pick Separator Roller Removal</a>
2	050N00717	1	1	250-sheet tray	–
3	126N00458	1	1	Fuser, 110 V	<a href="#">Fuser removal</a>
3	126N00459	1	1	Fuser, 220 V	<a href="#">Fuser removal</a>

## Parts Catalog

Asm-index	P/N	Units/mach	Units/FRU	Description	Removal procedure
4	032N00557	1	1	Duplex guide	Duplex guide removal
5	007N01857	1	1	Redrive	
6	120N00574	1	1	Bin full sensor actuator	

## Assembly 6: 550-sheet Optional Tray

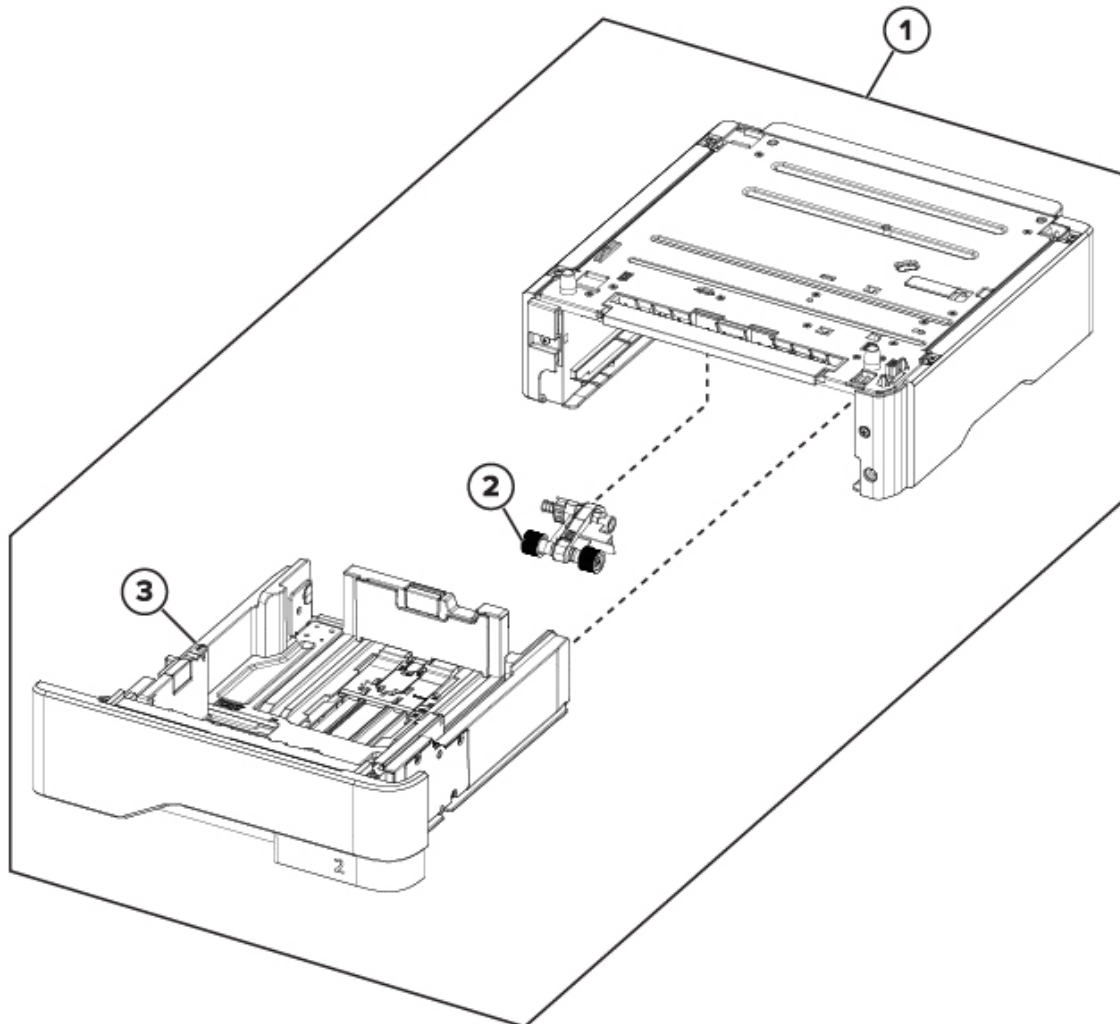

Asm-index	P/N	Units/mach	Units/FRU	Description	Removal procedure
1	–	1	1	Optional 550-sheet tray	–
2	022N02904	1	1	550-sheet tray pick roller	–
3	050N00722	1	1	550-sheet tray insert	–

## Assembly 7: ADF and Scanner

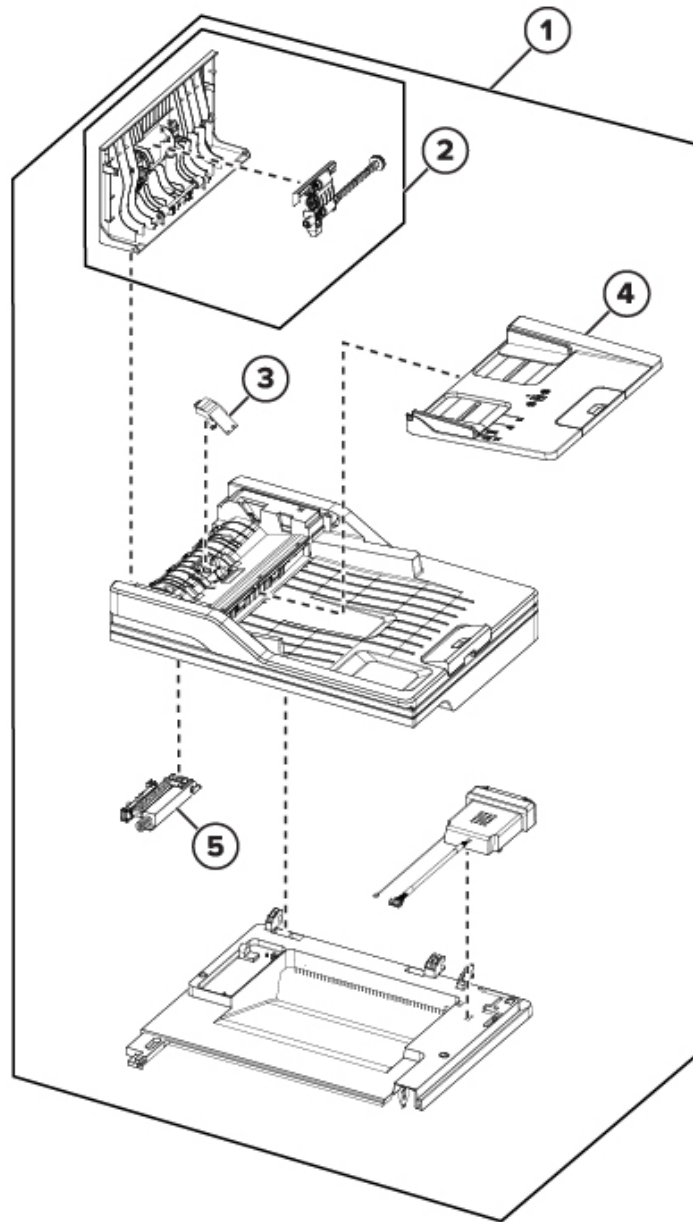

Asm-index	P/N	Units/mach	Units/FRU	Description	Removal procedure
1	109N00875	1	1	Scanner without fax card (B305)	<a href="#">ADF and Scanner Removal</a>
1	109N00876	1	1	Scanner with fax card (B315)	<a href="#">ADF and Scanner Removal</a>

Asm-index	P/N	Units/mach	Units/FRU	Description	Removal procedure
2	002N03410	1	1	ADF cover	<a href="#">ADF Cover Removal</a>
3	019N01154	1	1	ADF separator pad	<a href="#">ADF Separator Pad Removal</a>
4	050N00716	1	1	ADF tray	<a href="#">ADF Tray Removal</a>
5	109N00851	1	1	Scanner pivot arm	<a href="#">Scanner Pivot Arm Removal</a>



# Printer Specifications

## Power Consumption

### Product Power Consumption

The following table documents the power consumption characteristics of the product.

 **Note:** Some modes may not apply to your product.

Mode	Description	Power consumption (Watts)
Printing	The product is generating hard-copy output from electronic inputs.	One-sided: 530 (B305), 580 (B315); Two-sided: 315 (B305), 330 (B315)
Copy	The product is generating hard-copy output from hard-copy original documents.	550 (B305); 600 (B315)
Scan	The product is scanning hard-copy documents.	13 (B305); 14 (B315)
Ready	The product is waiting for a print job.	6.5 (B305); 7.5 (B315)
Sleep Mode	The product is in a high-level energy-saving mode.	0.8 (B305); 1.1 (B315)
Hibernate	The product is in a low-level energy-saving mode.	0.1
Off	The product is plugged into an electrical outlet, but the power switch is turned off.	0.1

The power consumption levels listed in the previous table represent time-averaged measurements. Instantaneous power draws may be substantially higher than the average.

Values are subject to change. See [www.xerox.com](http://www.xerox.com) for current values.

### Sleep Mode

This product is designed with an energy-saving mode called *Sleep Mode*. The Sleep Mode saves energy by lowering power consumption during extended periods of inactivity. The Sleep Mode is automatically engaged after this product is not used for a specified period of time, called the *Sleep Mode Timeout*.

Factory default Sleep Mode Timeout for this product (in minutes):	15
---	----

By using the configuration menus, the Sleep Mode Timeout can be modified between 1 minute and 120 minutes. If the print speed is less than or equal to 30 pages per minute, then you can set the timeout only up to 60 minutes. Setting the Sleep Mode Timeout to a low value reduces energy consumption, but may increase the response time of the product. Setting the Sleep Mode Timeout to a high value maintains a fast response, but uses more energy.



## Hibernate Mode

This product is designed with an ultra-low power operating mode called *Hibernate mode*. When operating in Hibernate Mode, all other systems and devices are powered down safely.

The Hibernate mode can be entered in any of the following methods:

- Using the Hibernate Timeout
- Using the Schedule Power modes

Factory default Hibernate Timeout for this product in all countries or regions	3 days
--	--------

The amount of time the printer waits after a job is printed before it enters Hibernate mode can be modified between one hour and one month.

## Off Mode

If this product has an off mode which still consumes a small amount of power, then to completely stop product power consumption, disconnect the power supply cord from the electrical outlet.

## Total Energy Usage

It is sometimes helpful to estimate the total product energy usage. Since power consumption claims are provided in power units of Watts, the power consumption should be multiplied by the time the product spends in each mode in order to calculate energy usage. The total product energy usage is the sum of each mode's energy usage.

## Selecting A Location For The Printer

- Leave enough room to open trays, covers, and doors and to install hardware options.
- Set up the printer near an electrical outlet.
- ⚠ **CAUTION—POTENTIAL INJURY:** To avoid the risk of fire or electrical shock, connect the power cord to an appropriately rated and properly grounded electrical outlet that is near the product and easily accessible.
- ⚠ **ATTENTION ! DOMMAGE POTENTIEL :** Pour éviter tout risque d'électrocution ou d'incendie, branchez le câble d'alimentation directement à une prise électrique répondant aux exigences requises et correctement mise à la terre, proche du produit et facile d'accès.
- ⚠ **PRECAUCIÓN—RIESGO DE LESIONES:** Para evitar el riesgo de incendio o descarga eléctrica, conecte el cable de alimentación a una toma de corriente debidamente conectada a tierra con la potencia adecuada que se encuentre cerca del dispositivo y resulte fácilmente accesible.
- ⚠ **VORSICHT – VERLETZUNGSGEFAHR:** Um Feuer- und Stromschlaggefahr zu vermeiden, schließen Sie das Netzkabel direkt an eine ordnungsgemäß geerdete Steckdose an, die sich in der Nähe des Geräts befindet und leicht zugänglich ist.
- ⚠ **ATTENZIONE – PERICOLO DI LESIONI:** Per evitare il rischio di incendio o scosse elettriche, collegare il cavo di alimentazione a una presa elettrica dotata di messa a terra e con le specifiche adeguate, situata in prossimità del prodotto e facilmente accessibile.
- ⚡ **CAUTION—SHOCK HAZARD:** To avoid the risk of electrical shock, do not place or use this product near water or wet locations.
- ⚡ **ATTENTION ! RISQUE D'ÉLECTROCUTION :** pour éviter tout risque d'électrocution, n'installez pas la machine à proximité d'un point d'eau ou dans un environnement humide.
- ⚡ **PRECAUCIÓN—RIESGO DE DESCARGA:** Para evitar el riesgo de descargas eléctricas, no instale este producto cerca de agua o donde haya humedad.
- ⚡ **VORSICHT – STROMSCHLAGGEFAHR:** Um das Risiko eines elektrischen Schlags zu vermeiden, dieses Produkt nicht in der Nähe von Wasser oder an feuchten Standorten aufstellen oder verwenden.
- ⚡ **ATTENZIONE – PERICOLO DI SCOSSA ELETTRICA:** Per evitare il rischio di scosse elettriche, non posizionare o utilizzare questo prodotto in prossimità di acqua o superfici bagnate.
- Make sure that airflow in the room meets the latest revision of theASHRAE 62 standard or the CEN Technical Committee 156 standard.
- Provide a flat, sturdy, and stable surface.
- Keep the printer:
  - Clean, dry, and free of dust
  - Away from stray staples and paper clips
  - Away from the direct airflow of air conditioners, heaters, or ventilators
  - Free from direct sunlight and humidity extremes

- Observe the recommended temperatures and avoid fluctuations.

Ambient temperature	10 to 32.2°C (50 to 90°F)
Storage temperature	-40 to 40°C (-40 to 104°F)

- Allow the following recommended amount of space around the printer for proper ventilation:



1	Top	305 mm (12 in.)
2	Rear	100 mm (3.94 in.)
3	Right side	76.2 mm (3 in.)
4	Front	305 mm (12 in.) The minimum space needed in front of the printer is 76 mm (3 in.).
5	Left side	110 mm (4.33 in.)

## Noise Emission Levels

The following measurements were made in accordance with ISO 7779 and reported in conformance with ISO 9296.

 **Note:** Some modes may not apply to your product.

1-meter average sound pressure, dBA	
Printing	One-sided: 53; Two-sided: 50
Ready	14

Values are subject to change. See <https://www.xerox.com> for current values.

## Temperature Information

Operating temperature and relative humidity	10° to 32.2° C (50° to 90° F) and 15 to 80 % RH 15.6° to 32.2° C (60° to 90° F) and 8 to 80 % RH Maximum wet-bulb temperature <sup>2</sup> : 22.8° C (73° F) Non-condensing environment
Printer / cartridge / imaging unit long-term storage <sup>1</sup>	15.6° to 32.2° C (60° to 90° F) and 8 to 80 % RH Maximum wet-bulb temperature <sup>2</sup> : 22.8° C (73° F)
Printer / cartridge / imaging unit short-term shipping	-40° to 40° C (-40° to 104° F)
<p><sup>1</sup> Supplies shelf life is approximately 2 years. This is based on storage in a standard office environment at 22° C (72° F) and 45 % humidity.</p> <p><sup>2</sup> Wet-bulb temperature is determined by the air temperature and the relative humidity.</p>	

## Printer Specifications

# Theory Of Operation

## POR Sequence

As the printer is turned on, the engine code goes through a series of tests to verify hardware integrity. If a hardware failure is detected, then it is reported to the printer. If the POR sequence cannot be completed successfully, then the printer may post an error message. The message states that service may be needed.



# Print Cycle Operation

## Print Engine Layout

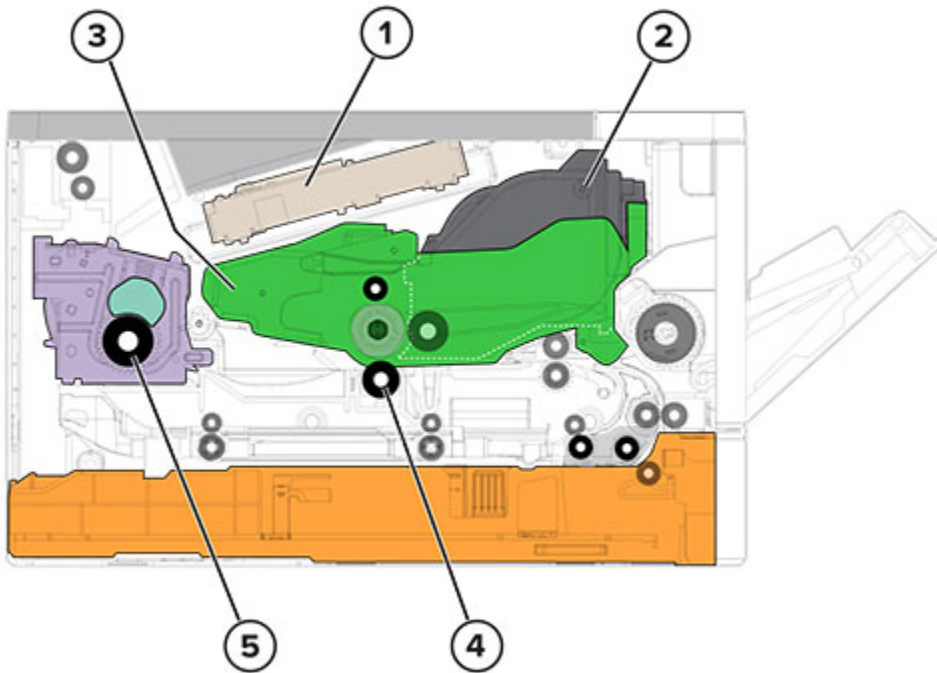

1	Printhead
2	Toner cartridge
3	Imaging unit
4	Transfer roller
5	Fuser

# Print Cycle

## Flowchart

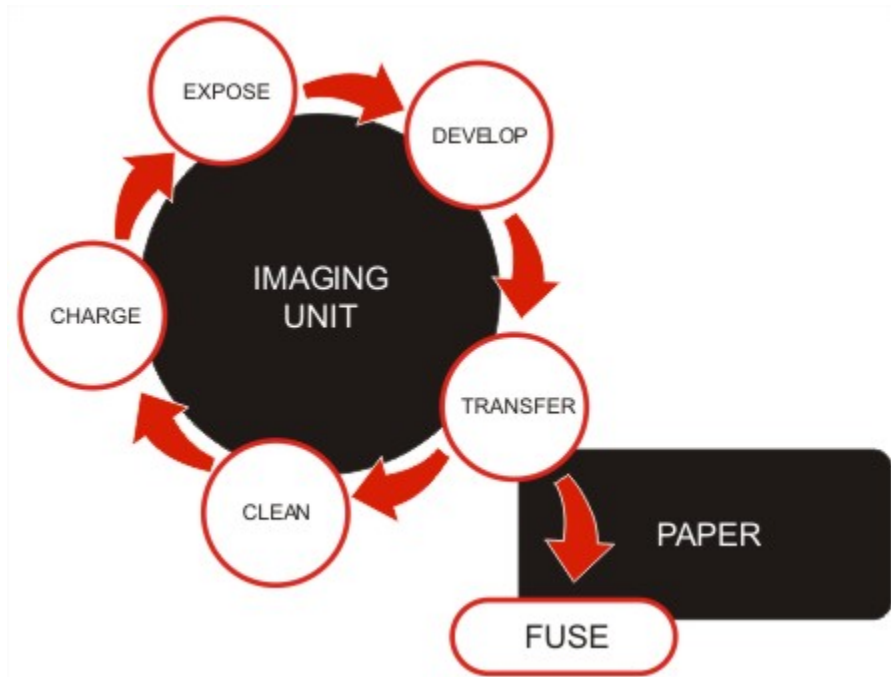

## Charge

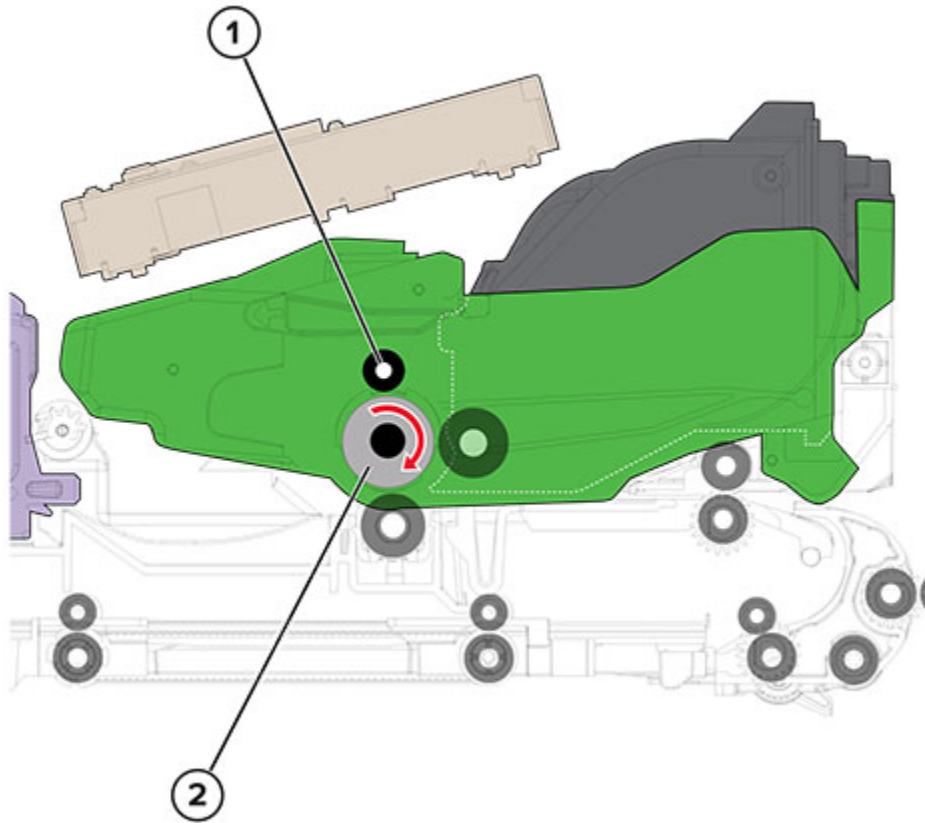

1	Charge roller
2	Photoconductor

The charge roller applies a uniform negative electrical charge to the surface of the photoconductor. The insulative properties of the photoconductor allow it to hold a charge and its photoconductive properties allow it to discharge when exposed to light.

## Expose

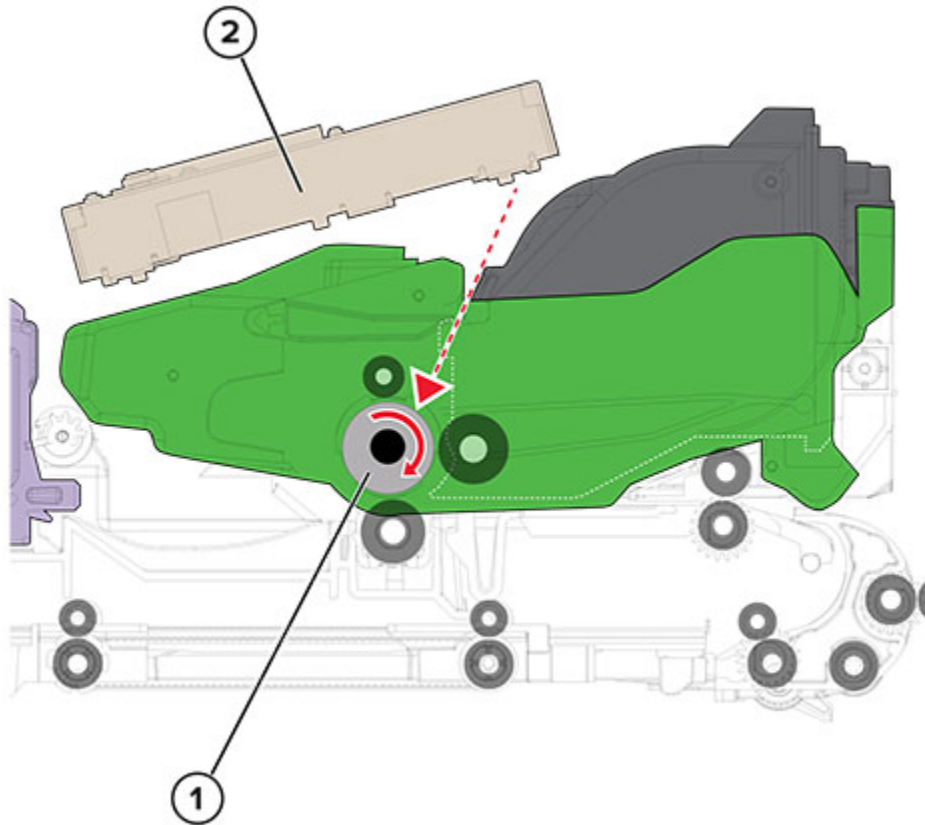

1	Photoconductor
2	Printhead

The printhead emits a laser that exposes the surface of the photoconductor. The laser pulses coincide with the digital latent image. The exposed areas of the photoconductor surface are discharged, resulting in a photoconductor surface potential that is less negative than the non-exposed areas.

# Develop

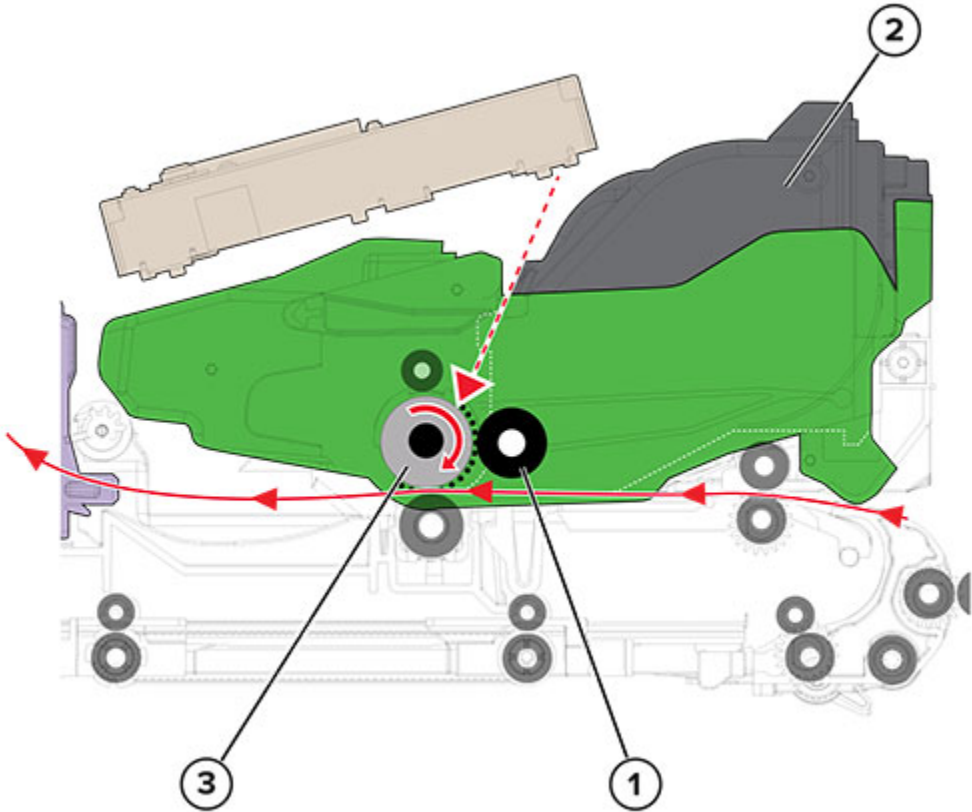

1	Developer roller
2	Toner cartridge
3	Photoconductor

The developer roller applies the toner from the toner cartridge to the photoconductor during the development process. The difference in surface potential creates an electric field that causes the toner particles to move to the photoconductor according to the pattern of the latent image.

## Transfer

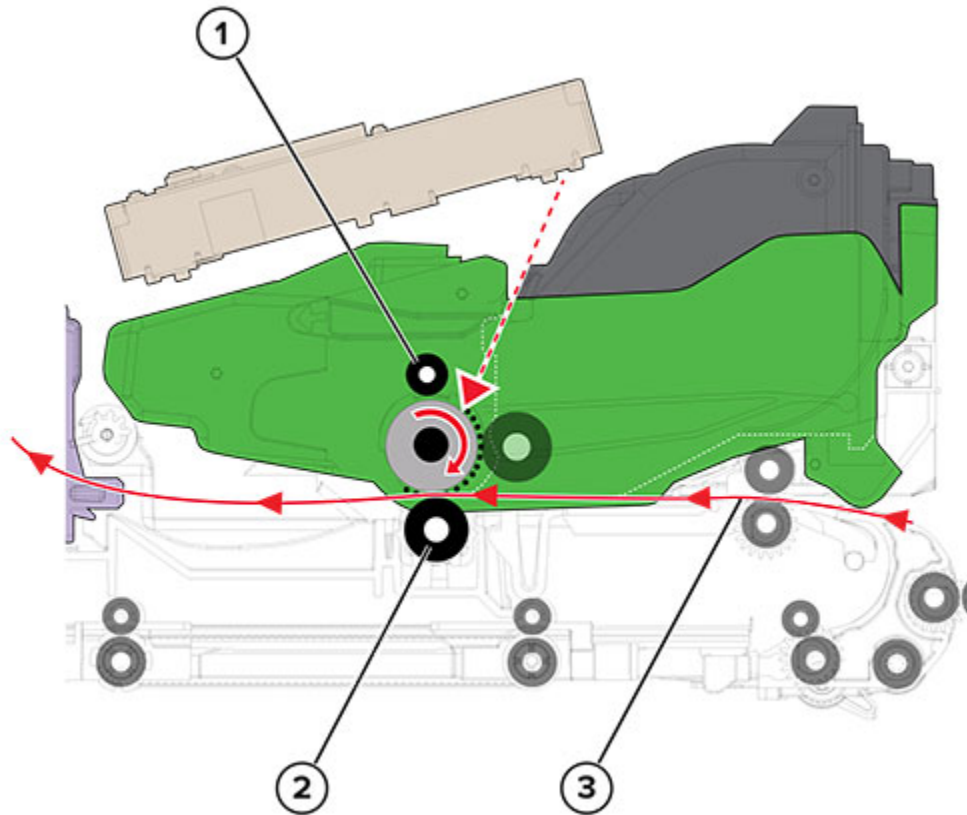

1	Charge roller
2	Transfer roller
3	Paper

A positive potential relative to the toned image formed on the photoconductor is applied to the transfer roller. This allows the transfer roller to move the developed toner from the surface of the photoconductor to the paper as the paper is passed between the transfer roller and photoconductor.

## Clean

The cleaning blade removes the residual toner from the photoconductor after the transfer. After cleaning, the process moves again to the charge process and repeats each cycle until the entire image is transferred to a side of the paper.

## Fuse

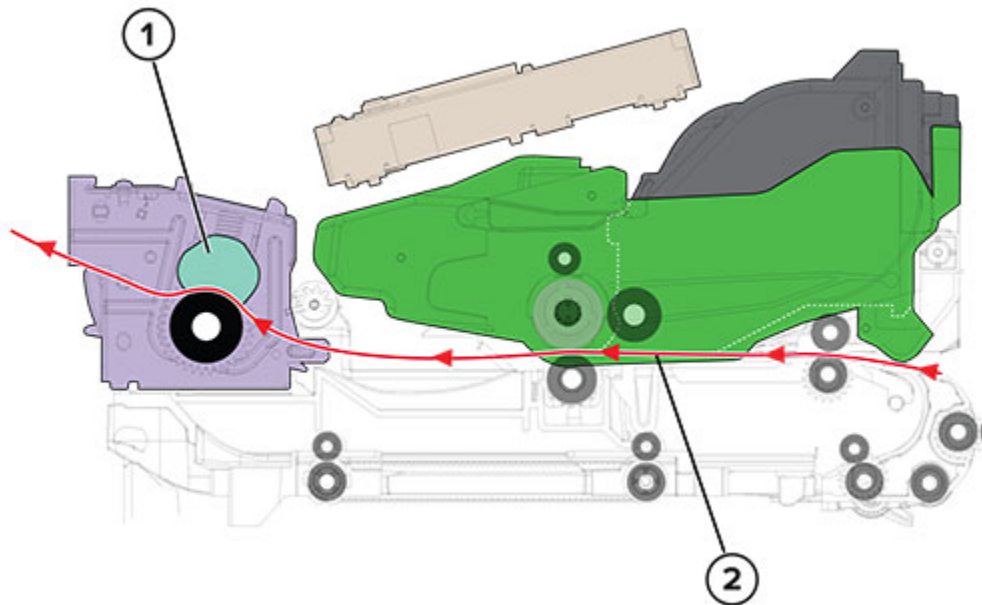

1	Fuser
2	Paper

After the toner image is transferred to the paper, the toner particles are not yet permanently bonded to the paper. For the final step in the print process, paper is transported to the fuser where heat and pressure are applied to it. As a result, the toner particles melt and are permanently fused to the paper, completing the print process. The print cycle repeats for the succeeding pages.

# Printer Operation

## Printer Sections

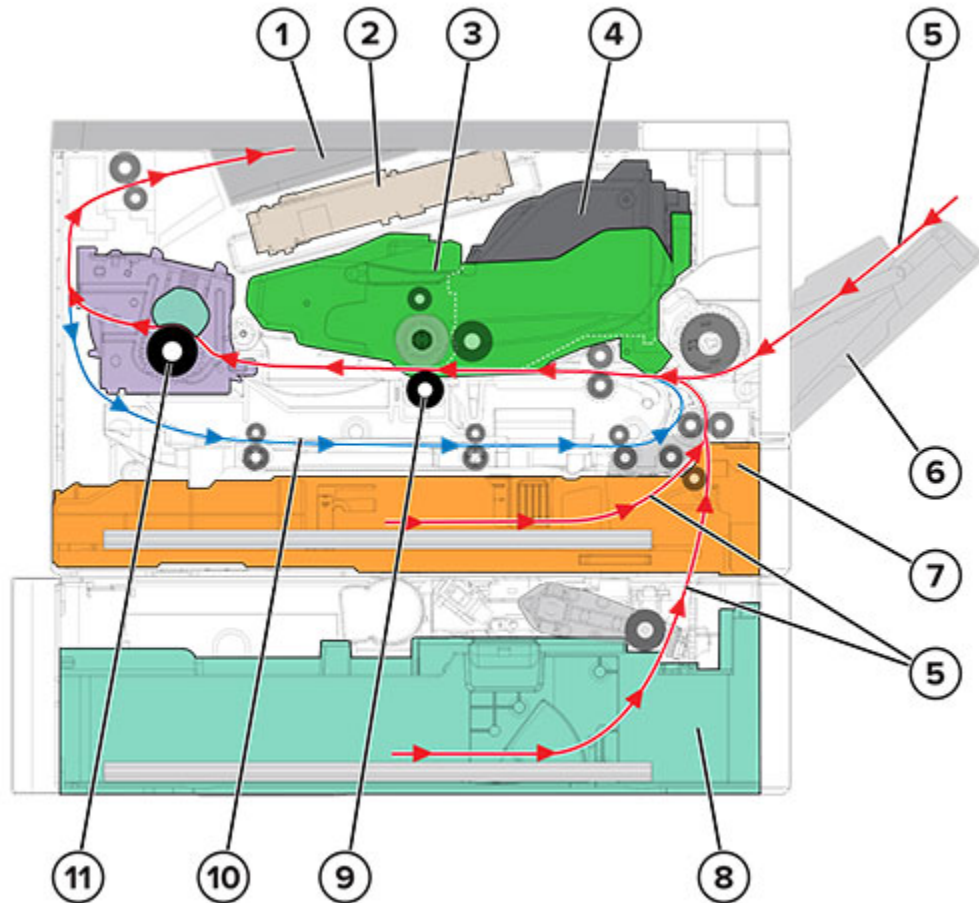

1	Output bin
2	Printhead
3	Imaging unit
4	Toner cartridge
5	Simplex paper path
6	MPF
7	Standard tray
8	Optional tray
9	Transfer roller



10	Duplex paper path
11	Fuser

## Printer Paper Path

### Simplex Print Job

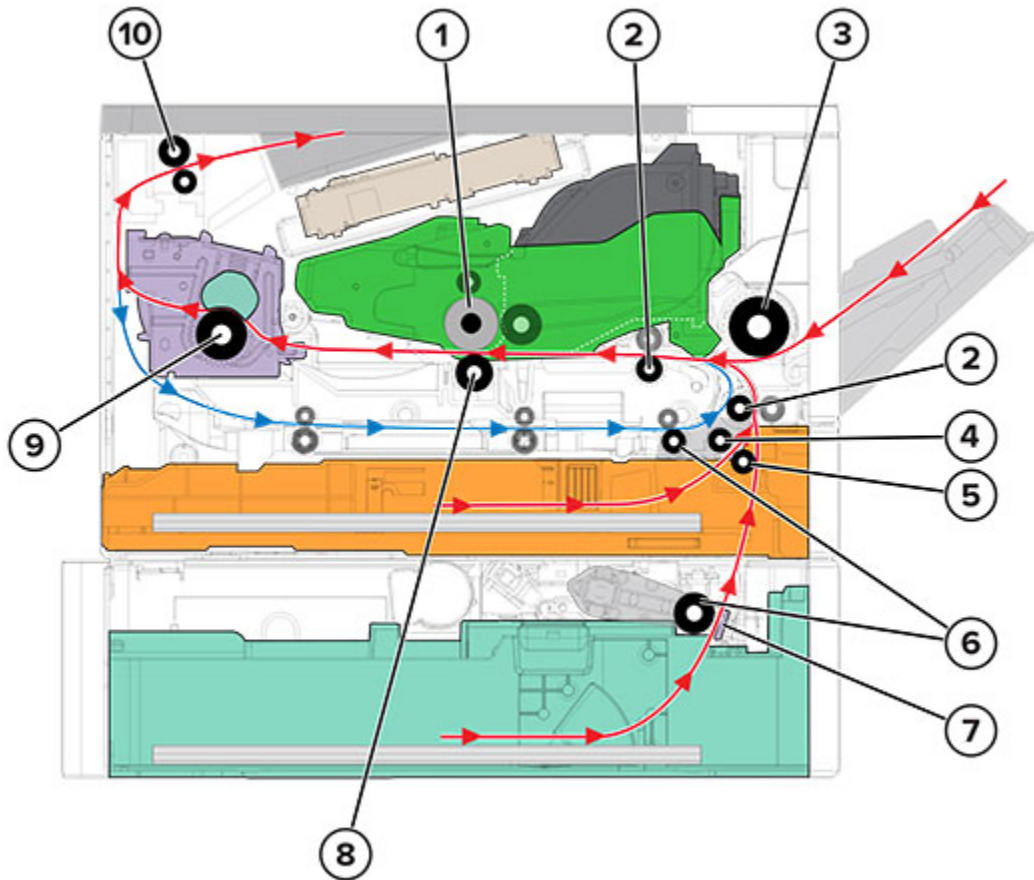

1	Photoconductor
2	Transport roller
3	MPF pick roller
4	Feed roller
5	Separator roller
6	Pick roller
7	Separator pad
8	Transfer roller

## Theory Of Operation

9	Fuser
10	Paper exit roller

The pick roller picks and the feed roller feeds the paper to the separator roller or separator pad. The feed roller feeds the paper to the transport roller. For MPF print jobs, the MPF pick roller picks and feeds the paper to the transport roller.

The transport rollers feed the paper to the transfer roller. At the transfer roller, the photoconductor transfers the developed image to the paper to create the printed image.

As the paper passes the fuser, heat and pressure are applied to permanently bond the toner to the paper.

After printing, the paper exit roller ejects the paper to the output bin.

## Duplex Print Job

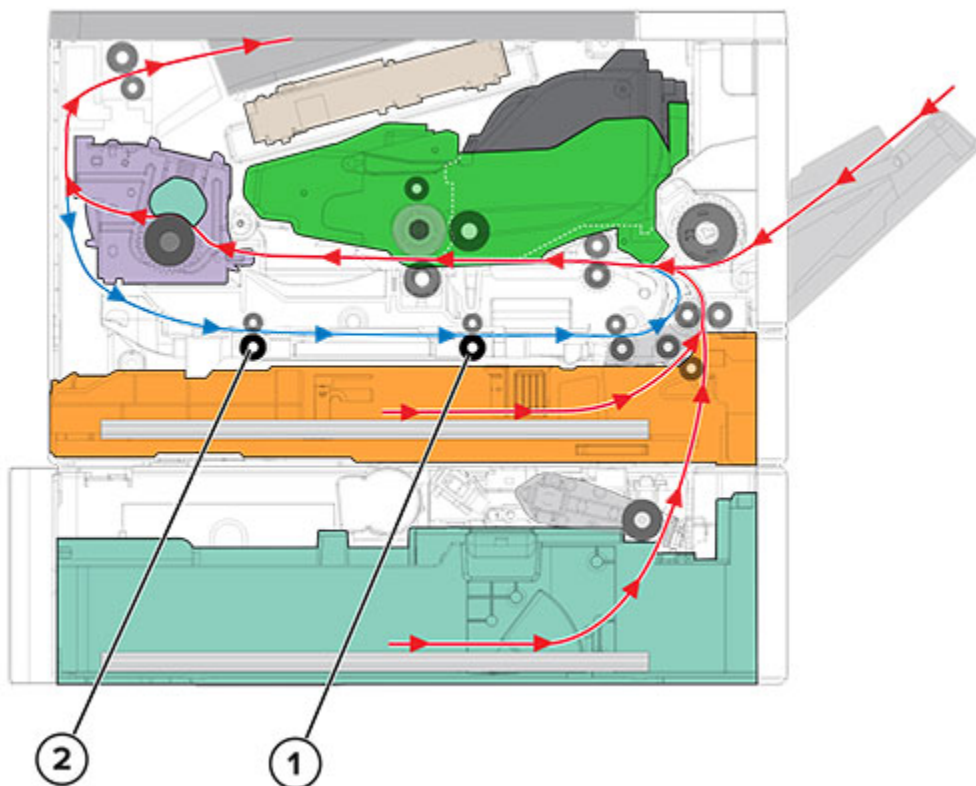

1	Duplex rear roller
2	Duplex front roller

After the first side is printed, the paper stops at the output bin while still in the paper exit roller. The paper is fed again into the duplex paper path to have the opposite side printed.

The paper travels along the duplex path until it enters again the transport roller. From there, the paper continues its path until the print job is done.

## Printer Paper Path Sensors

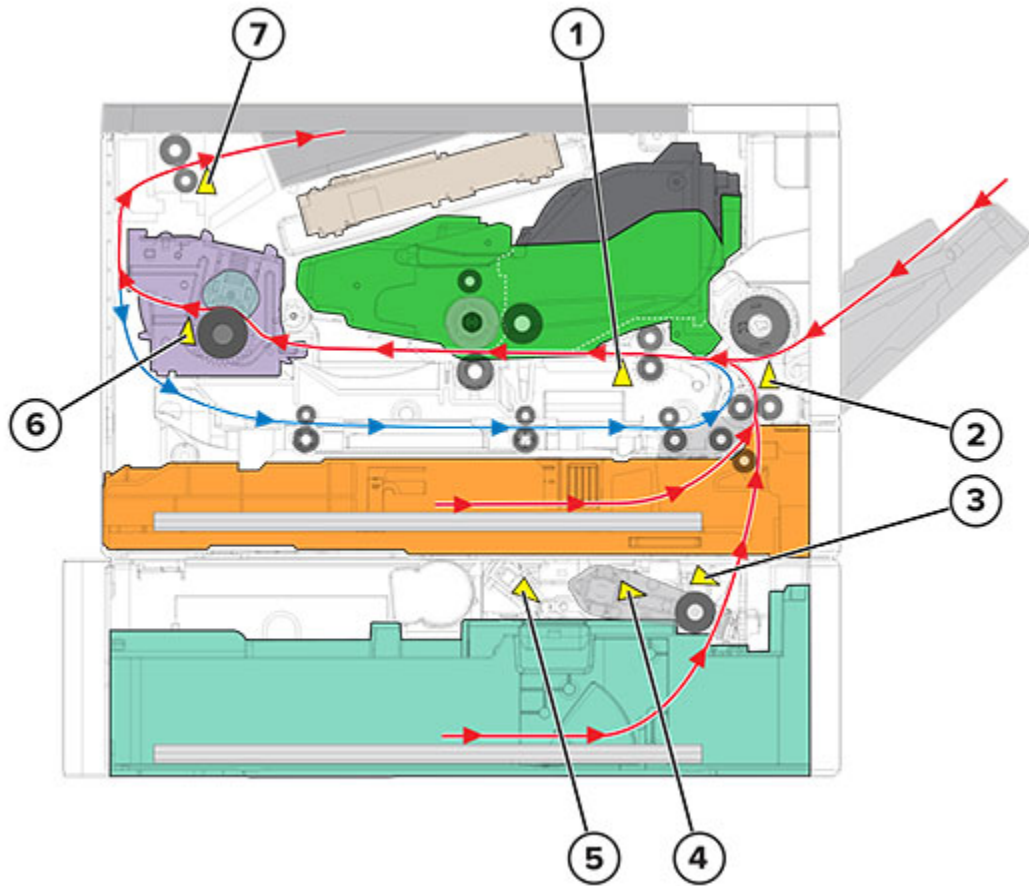

#	Sensor	Function
1	Sensor (input)	Detects paper that is traveling from the transport roller
2	Sensor (MPF paper present)	Detects paper presence in the MPF
3	Sensor (trailing edge)	Detects the trailing edge of the paper that is fed from the optional tray
4	Sensor (index)	Detects if the pick roller is at the correct height to pick paper from the optional tray
5	Sensor (paper present)	Detects paper presence in the optional tray
6	Sensor (fuser exit)	Detects paper that is exiting the fuser
7	Sensor (narrow media/bin full)	<ul style="list-style-type: none"> <li>• Detects if paper is narrow</li> <li>• Detects if the bin is full</li> </ul>

## Main Drive

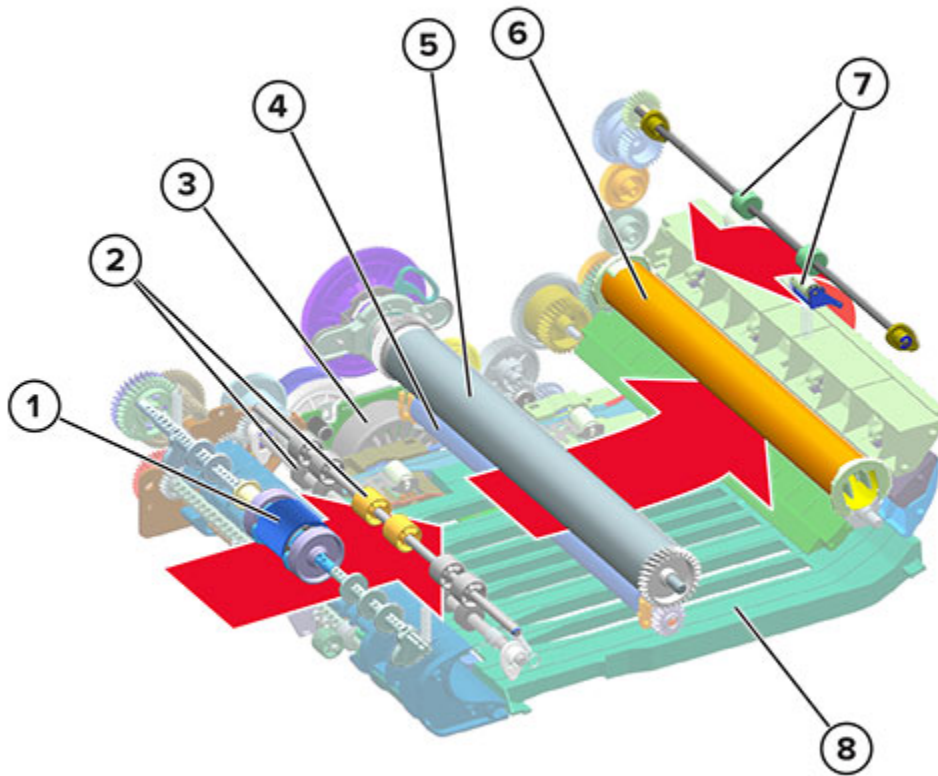

1	MPF pick roller
2	Transport roller
3	Motor (main drive)
4	Transfer roller
5	Photoconductor
6	Fuser
7	Paper exit roller
8	Duplex

The motor (main drive) provides mechanical power to the printer.

The motor transfers power through several gears to the following parts:

- MPF pick roller
- Transport roller

- Transfer roller
- Photoconductor
- Fuser
- Paper exit roller
- Duplex

## Tray Drive

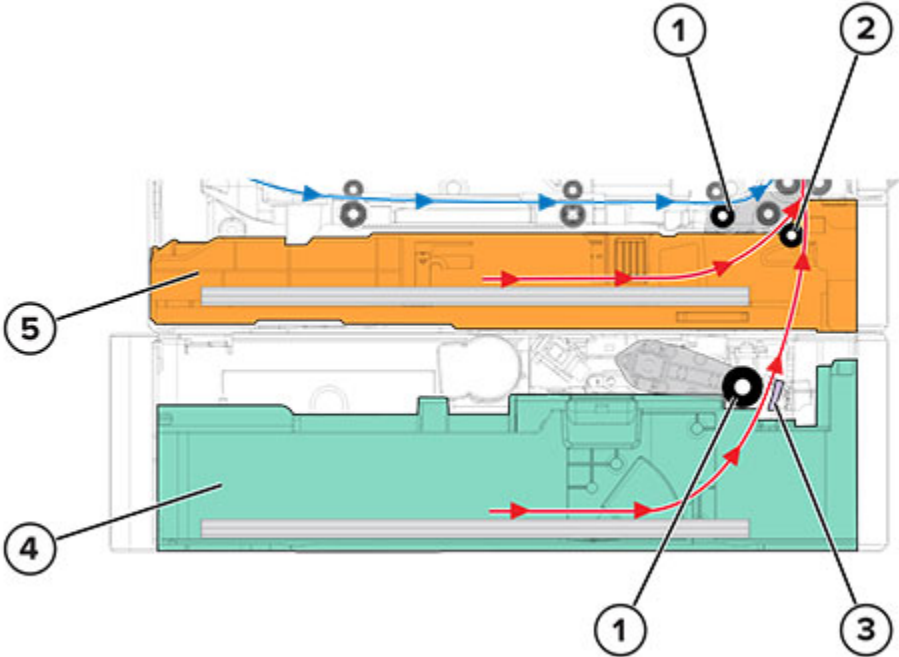

1	Pick roller
2	Separator roller
3	Separator pad
4	Optional tray
5	Standard tray

The motor (main drive) in the printer drives the standard tray. The lift plate in the tray is spring loaded and is not driven by a motor. The spring raises the lift plate until the paper is in contact with the pick roller.

The motor inside the optional tray drives the optional tray. The motor drives the lift plate to a specified height in the tray.

To prepare for feeding, the lift plate raises to push the paper against the pick roller. The lift plate stops pushing at the point where the pick roller is at the proper height for picking. After the pick roller is in position, it feeds the topmost paper. The separator roller and separator pad ensures that only one sheet is fed at a time.

## ADF Theory

### ADF Paper Path

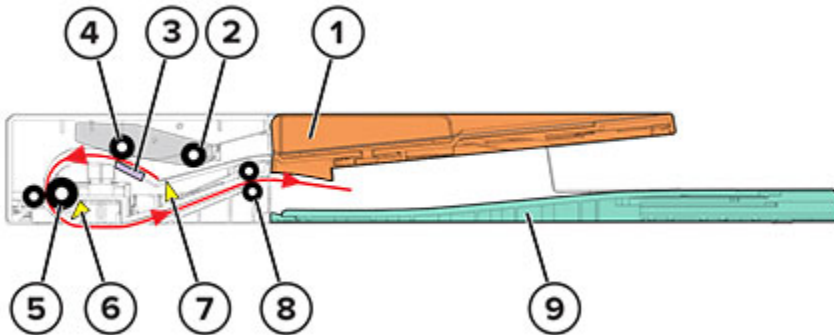

1	ADF tray
2	ADF pick roller
3	ADF separator pad
4	ADF feed roller
5	ADF scan roller
6	Sensor (ADF scan)
7	Sensor (ADF paper present)
8	ADF exit roller
9	ADF bin

Paper from the ADF tray enters the ADF through the ADF pick roller, ADF feed roller, and ADF separator pad. On the ADF tray, the sensor (ADF paper present) detects if paper is loaded.

After the paper is fed, it travels to the ADF scan roller for scanning. As the paper passes the sensor (ADF scan), the scanner under the ADF obtains the image from the sheet. If equipped, a CIS unit obtains the image from the other side of the sheet in a duplex scan job.

After the paper is scanned, the ADF exit roller ejects the paper to the ADF bin.

## Part Number Index

P/N	Part name
002N03397	Control panel assembly
002N03399	Right cover
002N03400	Left cover
002N03410	ADF cover
002N03413	Upper front cover with decals
002N03424	Front door with MPF pick roller
002N03427	Rear door
005N01213	Pick roller clutch
007N01855	Main drive gears kit
007N01857	Redrive
019N01154	ADF separator pad
022N02902	Pick separator roller
022N02903	Transfer roller, bearing and spring
022N02904	550-sheet tray pick roller
032N00557	Duplex guide
046N00243	Printhead
050N00716	ADF tray
002N03428	Left front door link
050N00717	250-sheet tray
050N00722	550-sheet tray insert
109N00851	Scanner pivot arm
109N00872	Controller board
109N00875	Scanner without fax card (B305)
109N00876	Scanner with fax card (B315)
112N00267	LVPS, 110 V
112N00268	LVPS, 220 V
112N00269	HVPS
120N00574	Bin full sensor actuator

## Part Number Index

P/N	Part name
126N00458	Fuser, 110 V
126N00459	Fuser, 220 V
127N07968	Main fan
130N01897	Sensor (input)
130N01911	Speaker



## Part Name Index

P/N	Part name
050N00717	250-sheet tray
050N00722	550-sheet tray insert
022N02904	550-sheet tray pick roller
002N03410	ADF cover
019N01154	ADF separator pad
050N00716	ADF tray
120N00574	Bin full sensor actuator
002N03397	Control panel assembly
109N00872	Controller board
032N00557	Duplex guide
002N03424	Front door with MPF pick roller
126N00458	Fuser, 110 V
126N00459	Fuser, 220 V
112N00269	HVPS
002N03400	Left cover
002N03428	Left front door link
112N00267	LVPS, 110V
112N00268	LVPS, 220V
007N01855	Main drive gears kit
127N07968	Main fan
005N01213	Pick roller clutch
022N02902	Pick separator roller
046N00243	Printhead
002N03427	Rear door
007N01857	Redrive
002N03399	Right cover
109N00851	Scanner pivot arm
109N00875	Scanner without fax card (B305)

## Part Name Index

P/N	Part name
109N00876	Scanner with fax card (B315)
130N01897	Sensor (input)
130N01911	Speaker
022N02903	Transfer roller, bearing and spring
002N03413	Upper front cover with decals

14

# Wiring Diagram

# Wiring Diagram (B305/B315)

