

SP C260DNw/SP C262DNw
SP C260SFNw/SP C262SFNw
Machine
Code:M0AR/M0AS/M0AW/M0AX
Field Service Manual
Ver 1.1

Latest Release: August, 2017
Initial Release: April, 2017
(c) 2017 Ricoh Co.,Ltd.

Important Safety Notices

Warnings, Cautions, Notes

In this manual, the following important symbols and notations are used.

WARNING

- A Warning indicates a potentially hazardous situation. Failure to obey a Warning could result in death or serious injury.

CAUTION

- A Caution indicates a potentially hazardous situation. Failure to obey a Caution could result in minor or moderate injury or damage to the machine or other property.

Important

- Obey these guidelines to avoid problems such as misfeeds, damage to originals, loss of valuable data and to prevent damage to the machine.

Note

- This information provides tips and advice about how to best service the machine.

General Safety Instructions

For your safety, please read this manual carefully before you use this product. Keep this manual handy for future reference.

Safety Information

Always obey the following safety precautions when using this product.

Safety During Operation

In this manual, the following important symbols and notations are used.

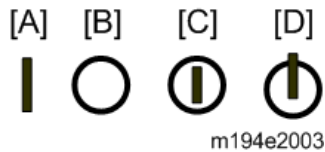

[A]: ON

[B]: OFF

[C]: Push ON/Push OFF

[D]: Standby

Switches and Symbols

Where symbols are used on or near switches on machines for Europe and other areas, the meaning of each symbol conforms with IEC60417.

Safety

Prevention of Physical Injury

1. Before disassembling or assembling parts of the machine and peripherals, make sure that the machine and peripheral power cords are unplugged.
2. The plug should be near the machine and easily accessible.
3. Note that some components of the machine and the paper tray unit are supplied with electrical voltage even if the main power switch is turned off.
4. Always unplug the power cord from the power source before you move the product. Before you move the machine, arrange the power cord so it will not fall under the machine.
5. Disconnect all peripheral units (finisher, LCT, etc.) from the mainframe before you move the machine.
6. If any adjustment or operation check has to be made with exterior covers off or open while the main switch is turned on, keep hands away from electrified or mechanically driven components.
7. The machine drives some of its components when it completes the warm-up period. Be careful to keep hands away from the mechanical and electrical components as the machine starts operation.
8. The inside and the metal parts of the fusing unit become extremely hot while the machine is operating. Be careful to avoid touching those components with your bare hands.
9. To prevent a fire or explosion, keep the machine away from flammable liquids, gases, and aerosols.
10. Do not use flammable sprays or solvent in the vicinity of the machine. Also, avoid placing these items in the vicinity of the machine. Doing so could result in fire or electric shock.
11. To avoid fire or explosion, never use an organic cleaner near any part that generates heat.
12. Clean the floor completely after accidental spillage of silicone oil or other materials to prevent slippery surfaces that could cause accidents leading to hand or leg injuries.
13. Never remove any safety device unless it requires replacement. Always replace safety devices immediately.
14. Never do any procedure that defeats the function of any safety device.
15. Modification or removal of a safety device (fuse, switch, etc.) could lead to a fire and personal injury. Always test the operation of the machine to ensure that it is operating normally and safely after removal and replacement of any safety device.
16. For replacements use only the correct fuses or circuit breakers rated for use with the machine. Using replacement devices not designed for use with the machine could lead to a fire and personal injuries.
17. For machines installed with the ADF/ARDF:
When a thick book or three-dimensional original is placed on the exposure glass and the ARDF cover is lowered, the back side of the ARDF rises up to accommodate the original. Therefore, when closing the ARDF, please be sure to keep your hands away from the hinges at the back of the ARDF.
18. When using a vacuum cleaner around the machine, keep others away from the cleaner, especially

small children.

19. For machines installed with the anti-tip components:

The anti-tip components are necessary for meeting the requirements of IEC60950-1, the international standard for safety. The aim of these components is to prevent the products, which are heavy in weight, from toppling as a result of people running into or leaning onto the products, which can lead to serious accidents such as persons becoming trapped under the product. (U.S.: UL60950-1, Europe: EN60950-1) Therefore, removal of such components must always be with the consent of the customer. Do not remove them at your own judgment.

20. **NEVER touch** the AC circuits on the PSU board to prevent electric shock caused by residual charge. Residual charge of about 100V-400V remains in the AC circuits on the PSU board for several months even when the board has been removed from the machine after turning off the machine power and unplugging the power cord.

Health Safety Conditions

1. For the machines installed with the ozone filters:
 - Never operate the machine without the ozone filters installed.
 - Always replace the ozone filters with the specified types at the proper intervals.
2. The machine, which use high voltage power source, can generate ozone gas. High ozone density is harmful to human health. Therefore, locate the machine in a large well ventilated room that has an air turnover rate of more than 50m³/hr/person.
3. Toner and developer are non-toxic, but if you get either of them in your eyes by accident, it may cause temporary eye discomfort. Try to remove with eye drops or flush with water as first aid. If unsuccessful, get medical attention.

Observance of Electrical Safety Standards

1. The machine and its peripherals must be installed and maintained by a customer service representative who has completed the training course on those models with exceptions on some machines where the installation can be handled by the user.

Safety and Ecological Notes for Disposal

- Do not incinerate toner bottles or used toner. Toner dust may ignite suddenly when exposed to an open flame.
- Dispose of used toner, developer, organic photoconductors, and AIO unit in accordance with local regulations. (These are non-toxic supplies.)
- Dispose of replaced parts in accordance with local regulations.
- When keeping used lithium batteries in order to dispose of them later, do not put more than 100 batteries per sealed box. Storing larger numbers or not sealing them apart may lead to chemical reactions and heat build-up.

CAUTION

The danger of explosion exists if a battery of this type is incorrectly replaced. Replace only with the same or an equivalent type recommended by the manufacturer. Discard used batteries in accordance with the manufacturer's instructions.

Handling Toner

- Work carefully when removing paper jams or replacing toner bottles or cartridges to avoid spilling toner on clothing or the hands.
- If toner is inhaled, immediately gargle with large amounts of cold water and move to a well-ventilated location. If there are signs of irritation or other problems, seek medical attention.
- If toner gets on the skin, wash immediately with soap and cold running water.
- If toner gets into the eyes, flush the eyes with cold running water or eye wash. If there are signs of irritation or other problems, seek medical attention.
- If toner is swallowed, drink a large amount of cold water to dilute the ingested toner. If there are signs of any problem, seek medical attention.
- If toner spills on clothing, wash the affected area immediately with soap and cold water. Never use hot water! Hot water can cause toner to set and permanently stain fabric.
- Always store toner and developer supplies such as toner and developer packages, cartridges, bottles (including used toner and empty bottles and cartridges), and AIO unit out of the reach of children.
- Always store fresh toner supplies or empty bottles or cartridges in a cool, dry location that is not exposed to direct sunlight.
- Do not use a vacuum cleaner to remove spilled toner (including used toner). Vacuumed toner may cause a fire or explosion due to sparks or electrical contact inside the cleaner. However, it is possible to use a cleaner designed to be dust explosion-proof. If toner is spilled over the floor, sweep up spilled toner slowly and clean up any remaining toner with a wet cloth.

Handling the development unit cooling system

For the machines installed the development cooling system:

1. The development unit cooling system circulates propylene glycol from a sealed tank through hoses that pass behind cooling plates on the sides of each development unit.
2. The coolant tank is located at the bottom of the cooling box on the back of the main machine.
3. Always obey local laws and regulations if you need to dispose of a tank or the propylene glycol coolant.
4. The tank must never be emptied directly into a local drainage system, river, pond, or lake.
5. Contact a professional industrial waste disposal organization and ask them to dispose of the tank.

Lithium Batteries for Taiwan

警告

本機器內的鋰電池如果更換不正確型號會有爆炸的危險。
只能使用相同或製造商推薦同等類型的電池進行更換。
請依製造商說明書處理用過之廢棄電池。

Laser Safety

The Center for Devices and Radiological Health (CDRH) prohibits the repair of laser-based optical units in the field. The optical housing unit can only be repaired in a factory or at a location with the requisite equipment. The laser subsystem is replaceable in the field by a qualified Customer Engineer. The laser chassis is not repairable in the field. Customer engineers are therefore directed to return all chassis and laser subsystems to the factory or service depot when replacement of the optical subsystem is required.

⚠ WARNING

- Use of controls, or adjustment, or performance of procedures other than those specified in this manual may result in hazardous radiation exposure.

WARNING FOR LASER UNIT

WARNING:

Turn off the main switch before attempting any of the procedures in the Laser Unit section. Laser beams can seriously damage your eyes.

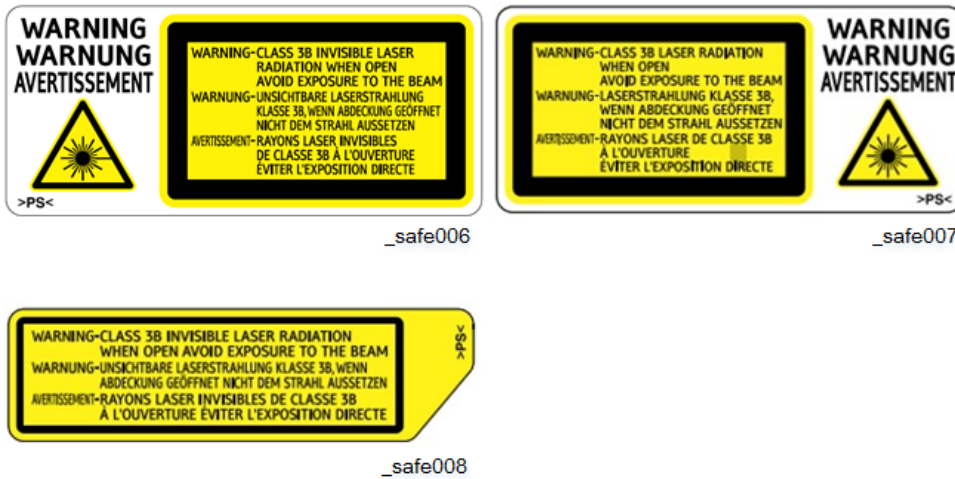

Safety Instructions for the Color Controller

Fuse

The color controller uses a double pole fuse. If this fuse blows, be sure to replace it with an identical fuse.

Batteries

CAUTION







Always replace a battery with the same type of battery prescribed for use with the color controller unit. Replacing a battery with any type other than the one prescribed for use could cause an explosion.

- Never discard used batteries by mixing them with other batteries or other refuse.
- Always remove used batteries from the work site and dispose of them in accordance with local laws and regulations regarding the disposal of such items.

Symbols, Abbreviations and Trademarks

Symbols, Abbreviations

This manual uses several symbols and abbreviations. The meaning of those symbols and abbreviations are as follows:

Symbol	What it means
	Clip ring
	Screw
	Connector
	Clamp
	E-ring
	Flat Flexible Cable
	Timing Belt
SEF	Short Edge Feed
LEF	Long Edge Feed
K	Black
C	Cyan
M	Magenta
Y	Yellow
B/W, BW	Black and White
FC	Full color

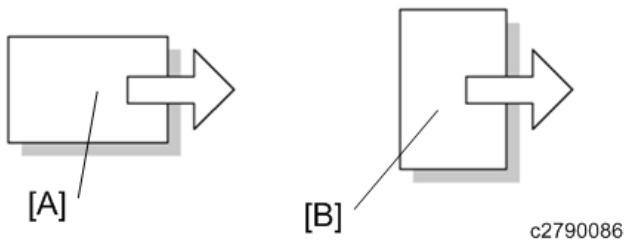

[A] Short Edge Feed (SEF)

[B] Long Edge Feed (LEF)

Trademarks

Adobe, Acrobat, PageMaker, PostScript, and PostScript 3 are either registered trademarks or trademarks of Adobe Systems Incorporated in the United States and/or other countries.

The Bluetooth® word mark and logos are registered trademarks owned by Bluetooth SIG, Inc. and any use of such marks by Ricoh Company, Ltd. is under license.

Firefox and Thunderbird are registered trademarks of the Mozilla Foundation.

Google, Android, and Chrome are trademarks of Google Inc.

iOS® is a registered trademark or trademark of Cisco Systems, Inc. and/or its affiliates in the United States and certain other countries.

Java is a registered trademark of Oracle and/or its affiliates.

JAWS® is a registered trademark of Freedom Scientific, Inc., St. Petersburg, Florida and/or other countries.

Kerberos is a trademark of the Massachusetts Institute of Technology (MIT).

Linux is a registered trademark of Linus Torvalds.

Macintosh, OS X, Bonjour, Safari, and TrueType are trademarks of Apple Inc., registered in the U.S. and other countries.

Microsoft, Windows, Windows Server, Windows Vista, Internet Explorer, and Outlook are either registered trademarks or trademarks of Microsoft Corp. in the United States and/or other countries.

PictBridge is a trademark.

QR Code is a registered trademark of DENSO WAVE INCORPORATED in Japan and in other countries.

"Red Hat" is a registered trademark of Red Hat, Inc.

The SD and SD logo are trademarks of SD-3C, LLC.

UNIX is a registered trademark of The Open Group.

UPnP is a trademark of UPnP Implementers Corporation.



This product includes RSA BSAFE® Cryptographic software of EMC Corporation. RSA and BSAFE are registered trademarks or trademarks of EMC Corporation in the United States and other countries.

The proper names of Internet Explorer 6, 7, and 8 are as follows:

- Microsoft® Internet Explorer® 6
- Windows® Internet Explorer® 7
- Windows® Internet Explorer® 8

The proper names of the Windows operating systems are as follows:

- The product names of Windows Vista are as follows:

Microsoft® Windows Vista® Ultimate

Microsoft® Windows Vista® Business

Microsoft® Windows Vista® Home Premium

Microsoft® Windows Vista® Home Basic

Microsoft® Windows Vista® Enterprise

- The product names of Windows 7 are as follows:

Microsoft® Windows® 7 Home Premium

Microsoft® Windows® 7 Professional

Microsoft® Windows® 7 Ultimate

Microsoft® Windows® 7 Enterprise

- The product names of Windows 8 are as follows:

Microsoft® Windows® 8

Microsoft® Windows® 8 Pro

Microsoft® Windows® 8 Enterprise

- The product names of Windows 8.1 are as follows:

Microsoft® Windows® 8.1

Microsoft® Windows® 8.1 Pro

Microsoft® Windows® 8.1 Enterprise

- The product names of Windows 10 are as follows:

Microsoft® Windows® 10 Home Premium

Microsoft® Windows® 10 Pro

Microsoft® Windows® 10 Enterprise

Microsoft® Windows® 10 Education

- The product names of Windows Server 2003 are as follows:

Microsoft® Windows Server® 2003 Standard Edition

Microsoft® Windows Server® 2003 Enterprise Edition

- The product names of Windows Server 2003 R2 are as follows:

Microsoft® Windows Server® 2003 R2 Standard Edition

Microsoft® Windows Server® 2003 R2 Enterprise Edition

- The product names of Windows Server 2008 are as follows:

Microsoft® Windows Server® 2008 Standard

Microsoft® Windows Server® 2008 Enterprise

- The product names of Windows Server 2008 R2 are as follows:

Microsoft® Windows Server® 2008 R2 Standard

Microsoft® Windows Server® 2008 R2 Enterprise

- The product names of Windows Server 2012 are as follows:

Microsoft® Windows Server® 2012 Foundation

Microsoft® Windows Server® 2012 Essentials

Microsoft® Windows Server® 2012 Standard

- The product names of Windows Server 2012 R2 are as follows:

Microsoft® Windows Server® 2012 R2 Foundation

Microsoft® Windows Server® 2012 R2 Essentials

Microsoft® Windows Server® 2012 R2 Standard

Other product names used herein are for identification purposes only and might be trademarks of their respective companies. We disclaim any and all rights to those marks.

Microsoft product screen shots reprinted with permission from Microsoft Corporation.

Table of Contents

1. Product Information	7
General Specifications	7
Supported Paper Sizes	8
Machine Overview	9
Component Layout	9
Paper Path	12
Drive Layout	13
Machine Configuration	15
Printer Models	15
MF Models	15
Option	15
Guidance for Those Who are Familiar with Predecessor Products	17
2. Installation	19
Installation Requirements	19
Environment	19
Machine level	19
Machine Space Requirements	20
Power Requirements	21
Installation Procedure	21
3. Preventive Maintenance	22
Preventive Maintenance	22
4. Replacement and Adjustment	23
Before You Start	23
General Precautions	23
Releasing Plastic Latches	25
After Servicing the Machine	25
Lithium Batteries (MF Models)	25
Special Tools	26
Exterior Covers	27
Rear Cover	27
Right Cover	28
Left Cover	29
Front Cover Unit	30
Laser Unit	32
Caution Decal Locations	32
Laser Optics Housing Unit	32
AIO Cartridge (All In One Cartridge)	36

AIO Cartridge.....	36
Black AIO Motor	36
Color AIO Motor.....	39
Image Transfer	41
Image Transfer Belt Unit.....	41
ITB (Image Transfer Belt) Cleaning Unit	42
Agitator Motor.....	43
ITB (Image Transfer Belt) Contact Motor	44
ITB (Image Transfer Belt) Contact Sensor	45
TM (Toner Mark) Sensor Base	46
Waste Toner Bottle Set Sensor.....	47
Waste Toner Overflow Sensor	48
Image Fusing	49
Fusing Unit.....	49
Fusing Lamp.....	51
Transport/Fusing Motor	54
Paper Transfer	56
Transfer Unit.....	56
Transfer Roller	57
Registration Roller	58
Registration Sensor	59
Registration Clutch.....	60
Paper Feed	61
Paper Feed Clutch	61
Paper Feed Roller.....	61
Separation Pad.....	62
Paper End Sensor	63
Paper Exit.....	64
Paper Exit Roller	64
Paper Exit Sensor	64
Electrical Components.....	66
Controller Board.....	66
EGB (Engine Board)	70
FCU (only for MF Models).....	73
Operation Panel.....	74
OPU, NFC (only for Printer Models).....	78
Wi-Fi Board	80
Interlock Switches	81
Fusing Fan Motor.....	82

Fusing Stripper Pawl Solenoid	83
Fusing Pressure Release Sensor	84
LSU Fan Motor	85
ID Chip Board	85
PSU	86
High Voltage Power Supply Board	88
Temperature/Humidity Sensor	89
Duplex Motor	90
Speaker (only for MF Models)	91
EEPROM	92
ADF (for SP C260SFNw)	94
ADF Unit	94
Original Tray	94
ADF Pick-Up Roller	95
ADF Feed Roller	96
ADF Separation Pad	96
ADF Front Cover	96
ADF Rear Cover	97
ADF Motor	98
ADF Top Cover	99
Original Set Sensor	99
ADF Registration Sensor	101
DADF (for SP C262SFNw)	103
DADF/Scanner Assembly	103
Adjustment after replacing the DADF/Scanner Assembly	105
Extension Tray/Original Tray	107
DADF Front Cover	108
DADF Rear Cover	109
DADF Separation Pad	110
DADF Feed Roller	111
DADF Pick-Up Roller	111
Reverse Roller	112
Back CIS/Back DF Exposure Glass	114
Adjustment after Replacing the Back CIS	116
Scanner Unit (for SP C260SFNw)	120
Scanner Unit (for SP C262SFNw)	123
5. System Maintenance Reference	124
Service Menu	124
Overview	124

MF Models	124
Printer Models	138
Configuration, Maintenance and Test Page Information	142
Overview	142
Error Log	142
Counter and Coverage (only for Printer Models)	143
Firmware Updating	144
Checking the Machine Firmware Version	144
Updating the Controller Firmware	144
Updating the Engine Firmware	147
Bootloader Firmware	150
6. Troubleshooting	151
Service Call Conditions	151
Summary	151
Engine SC	151
Controller SC	158
Fax Error Code Definition (only for MF Models)	159
Basic error code structure	159
Error code table	160
Fax Error Clear Principle (only for MF Models)	164
RX	164
TX	164
Image Problems	165
Overview	165
Image Problem	165
7. Detailed Descriptions	166
Machine Overview	166
Component Layout	166
Paper Path	167
Drive Layout	167
Electrical Component Layout	168
Board Structure	176
Printing Process	178
Process Control	180
Overview	180
Process Control Flow	180
Process Control Self-check	181
Laser Exposure	183
Overview	183

Optical Path.....	184
LD Safety Switch.....	184
MUSIC (Mirror Unit Skew and Interval Correction).....	185
Paper Feed.....	186
Overview.....	186
Drive and Paper End Detection.....	186
Tray Lift.....	187
By-pass Feed.....	188
Duplex.....	188
AIO (All In One) Cartridge.....	190
Overview.....	190
Drive.....	191
OPC Charge and Cleaning.....	192
Waste Toner Collection from the OPC.....	192
Toner Mixing and Transport.....	193
Development Mechanism.....	193
Toner Near End and End Detection.....	194
Image Transfer.....	195
Overview.....	195
Drive and Transfer Belt Roller Bias.....	195
Transfer Belt Contact.....	196
ITB (Image Transfer Belt) Cleaning Unit.....	197
Transfer Roller Overview.....	197
Paper Transfer and Discharge.....	198
Waste Toner Collection.....	199
Fusing and Exit.....	200
Overview.....	200
Drive.....	201
Pressure Release Mechanism.....	202
Envelope Lever (Pressure Release Lever).....	202
Temperature Control.....	203
ADF/DADF (for MF models).....	206
Overview.....	206
Paper Path.....	207
Timing Chart.....	208
Scanner (for MF models).....	210
Overview.....	210
Drive.....	210
Energy Saving.....	211

Energy Saver Modes 211

1. Product Information

General Specifications

See “Appendices” for the following information:

- General Specifications
- Controller Specifications

1.Product Information

Supported Paper Sizes

See “Appendices” for the following information:

- Supported Paper Sizes

Machine Overview

Component Layout

Engine (Printer Models)

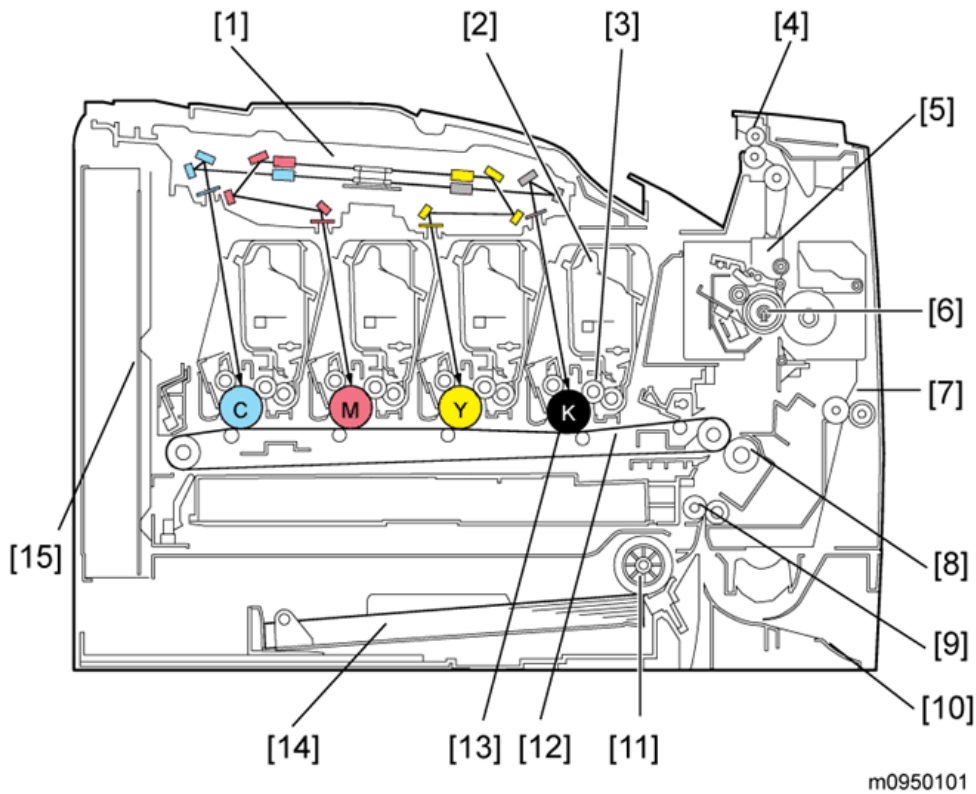

1. Laser Optics Housing Unit	9. Registration Roller
2. Print Cartridge (AIO)	10. By-pass
3. Development Roller (AIO)	11. Paper Feed Roller
4. Paper Exit	12. ITB (Image Transfer Belt) Unit
5. Fusing Unit	13. OPC (AIO)
6. Fusing Lamp	14. Tray 1
7. Duplex Path	15. EGB/Controller
8. Transfer Roller	

1.Product Information

Engine (MF Models)

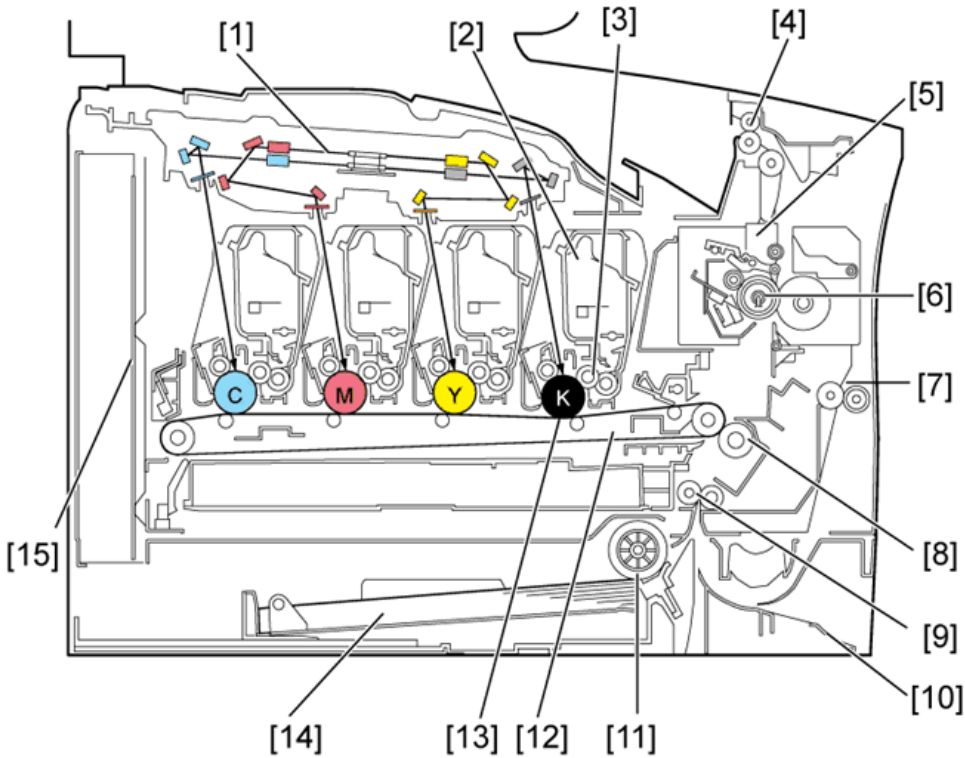

m0990101

<p>1. Laser Optics Housing Unit</p> <p>2. Print Cartridge (AIO)</p> <p>3. Development Roller (AIO)</p> <p>4. Paper Exit</p> <p>5. Fusing Unit</p> <p>6. Fusing Lamp</p> <p>7. Duplex Path</p> <p>8. Transfer Roller</p>	<p>9. Registration Roller</p> <p>10. By-pass</p> <p>11. Paper Feed Roller</p> <p>12. ITB (Image Transfer Belt) Unit</p> <p>13. OPC (AIO)</p> <p>14. Tray 1</p> <p>15. EGB/Controller</p>
---	--

ADF (SP C260SFNw only)

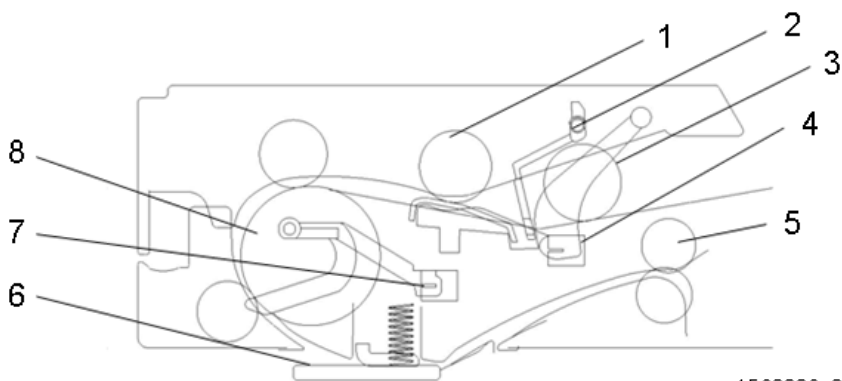

m1562026_2

<p>1. Feed Roller</p> <p>2. Media Stopper</p>	<p>5. Original Exit Roller</p> <p>6. DF Exposure Glass</p>
---	--

3. Pick-up Roller	7. Registration Sensor
4. Original Set Sensor	8. Transport Roller

DADF (SP C262SFNw only)

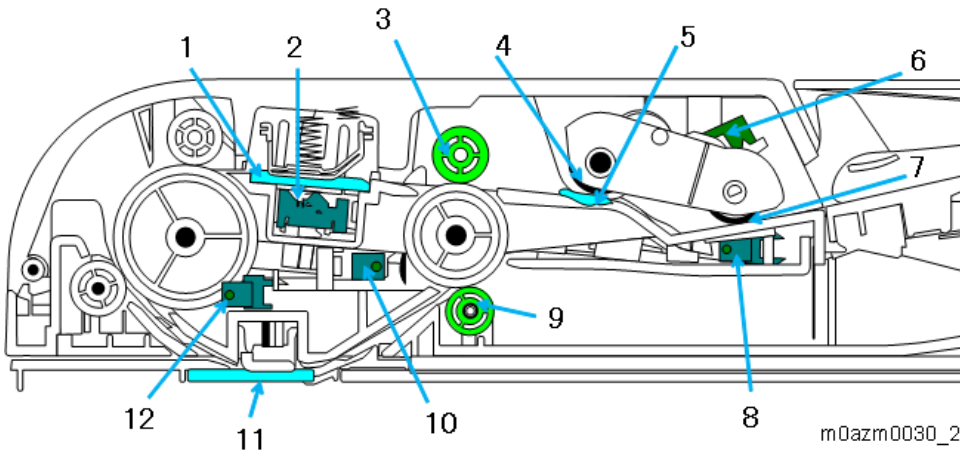

1. Back DF Exposure Glass	7. DADF Pick-Up Roller
2. Back CIS	8. Original Set Sensor
3. Transport Roller	9. Original Exit Roller
4. DADF Feed Roller	10. Back Registration Sensor
5. DADF Separation Pad	11. Exposure Glass
6. Original Set Sensor Feeler	12. Front Registration Sensor

Scanner (MF Models)

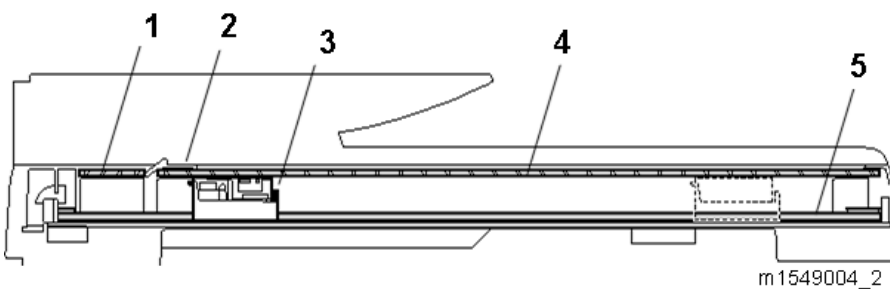

1. DF Exposure Glass	4. Scanner Exposure Glass
2. White Sheet	5. Carriage Drive Shaft
3. CIS Carriage Unit	

Paper Path

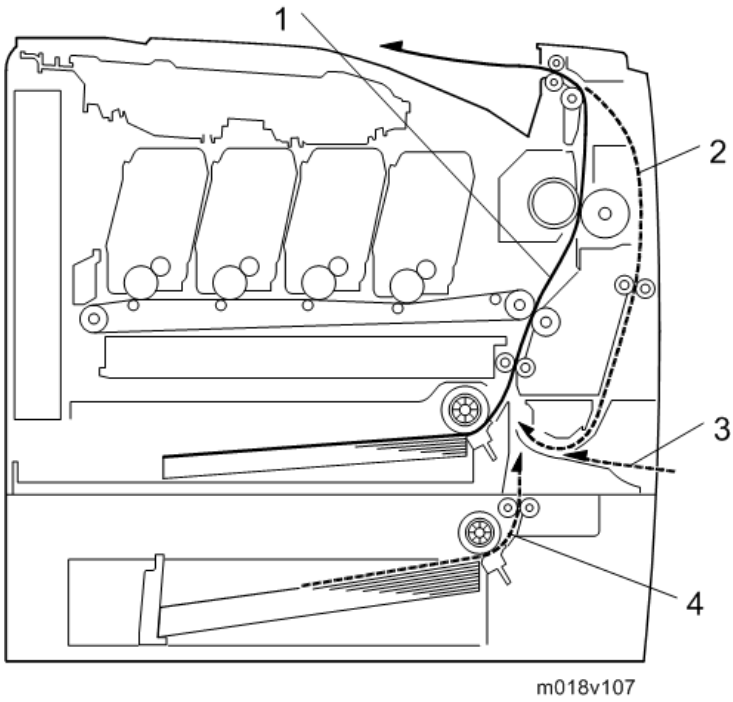

- 1. Paper path from tray 1
- 2. Duplex path
- 3. By-pass tray
- 4. Paper path from tray 2 (optional)

ADF (SP C260SFNw only)

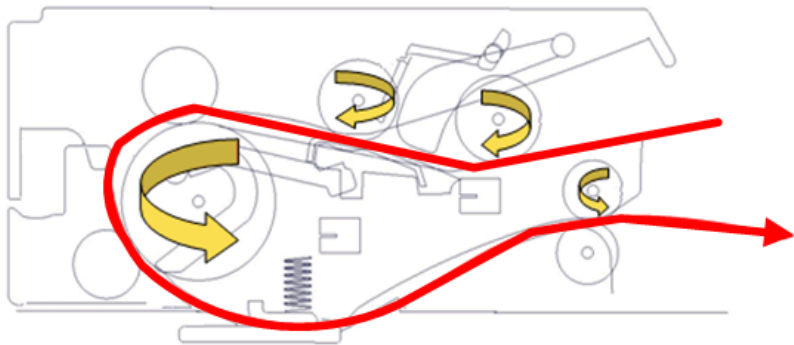

DADF (SP C262SFNw only)

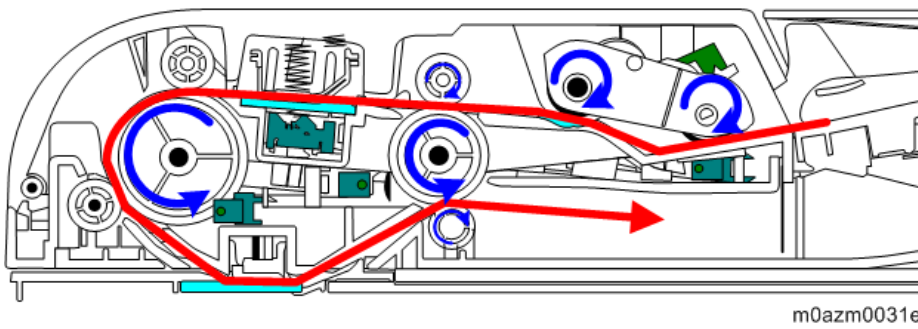

Drive Layout

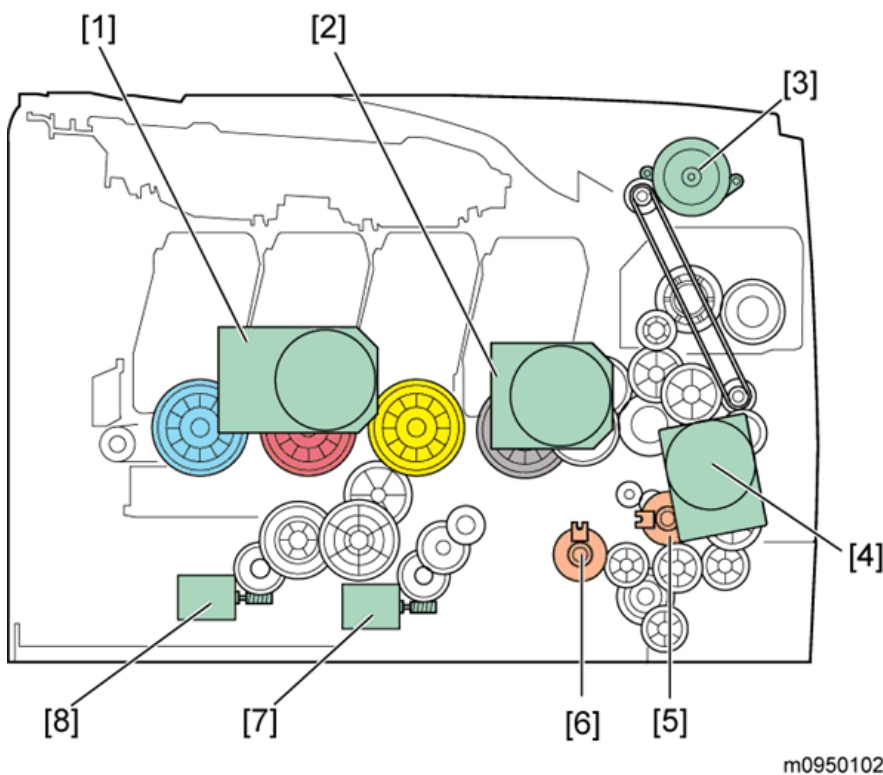

1. Color AIO Motor	5. Registration Clutch
2. Black AIO Motor	6. Paper Feed Clutch
3. Duplex Motor	7. Agitator Motor
4. Transport/Fusing Motor	8. ITB (Image Transfer Belt) Contact Motor

- **Color AIO Motor:**
This drives the color AIOs (Cyan, Magenta and Yellow)
- **Black AIO Motor:**
This drives the black AIO and the ITB (Image Transfer Belt).
- **Duplex Motor :**
This drives the paper exit roller and the duplex roller.
- **Transport/Fusing Motor:**
This drives the fusing unit, paper feed roller, registration roller and paper exit roller via the paper feed clutch,

1.Product Information

registration clutch and gears.

- **Registration Clutch:**

This transfers drive from the transport/ fusing motor to the registration roller.

- **Paper Feed Clutch:**

This transfers drive from the transport/ fusing motor to the paper feed roller.

- **Agitator Motor:**

This moves the agitators in the waste toner bottle.

- **ITB Contact Motor:**

This moves the ITB into contact with and away from the color OPCs.

Machine Configuration

Printer Models

Name	Machine Code	PPM (Single-sided mode)	Optional Memory	Printer Language	Operation Panel	Fax
SP C260DNw	M0AR-27	BW/FC: 20/21ppm (A4/LT)	Not Supported	GDI	Two-line LCD	Not Supported
SP C262DNw	M0AS-17	BW/FC: 20/21ppm (A4/LT)	Not Supported	PS/PCL	Two-line LCD	Not Supported
SP C262DNw	M0AS-27	BW/FC: 20/21ppm (A4/LT)	Not Supported	PS/PCL	Two-line LCD	Not Supported

MF Models

Name	Machine Code	PPM (Single-sided mode)	Optional Memory	Printer Language	Operation Panel	Fax
SP C260SFNw	M0AW-27	BW/FC: 20/21ppm (A4/LT)	Not Supported	GDI	4.3 inch touch panel	Supported
SP C262SFNw	M0AX-17	BW/FC: 20/21ppm (A4/LT)	Not Supported	PS/PCL	4.3 inch touch panel	Supported
SP C262SFNw	M0AX-27	BW/FC: 20/21ppm (A4/LT)	Not Supported	PS/PCL	4.3 inch touch panel	Supported

Option

No.	Name	Machine Code	Paper Capacity (80 g/m2)	Remarks
1	Paper Feed Unit TK1220	G849-50	500 sheets	Common (Md-P3)

1.Product Information

Diagram

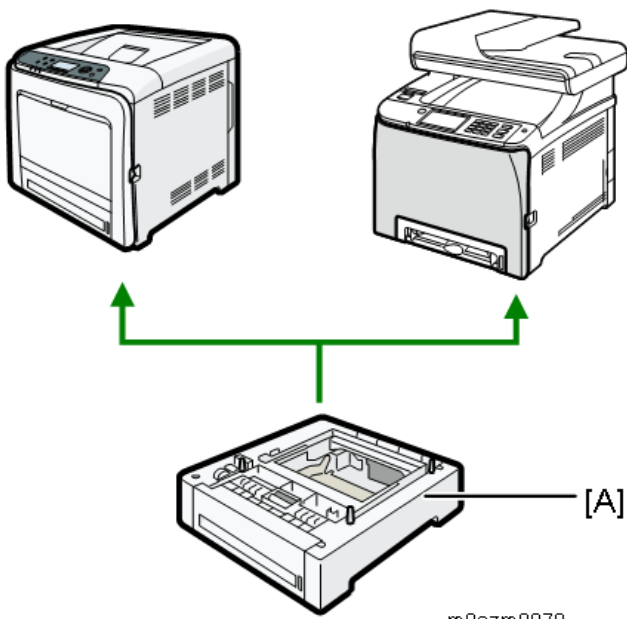

No.	Name	Machine Code
[A]	Paper Feed Unit TK1220	G849-50

Guidance for Those Who are Familiar with Predecessor Products

The SP C260 series models are similar to the SP C250 series. If you have experience with those products, the following information will be of help when you read this manual.

Different Points from Previous Products

Printer Models:

Function	Previous C250 series		New C260 series	
	SP C250DN	SP C252DN	SP C260DNw	SP C262DNw
Operation panel	Two-line LCD		Two-line LCD	
Exterior color of printer	"Urban light gray"		"Intelligent gray"	
Optional Paper Feed unit and its exterior color	TK1010		TK1220 (Common with MD-P3)	
	"Urban light gray"		"Intelligent gray"	
AIO	Common (*see note below)		Common(*see note below)	
OS	Win,Mac		Win, Mac, Linux	
PDL	PCL/PS		GDI	PCL/PS
Wi-Fi Direct	Not Supported		Supported	
Mobile printing	RSDP		AirPrint Mopria GCP, RSDP	
NFC	Not Supported		Supported	
Driver language for Arabic	Not Supported		Supported	
Log Store via USB drive and Web Image Monitor	Not Supported		Supported	

MF Models:

Function	Previous C250 series		New C260 series		Remarks
	SP C250SF	SP C252SF	SP C260SFNw	SP C262SFNw	
ADF type/capacity	ADF / 35 pages		ADF / 35 pages	DADF / 50 pages	
Operation panel	Four-line BW LCD		4.3 inch touch panel		
Exterior color of main frame	"Urban light gray"		"Intelligent gray"		
Optional Paper Feed unit and its exterior	TK1010 "Urban light gray"		TK1220 "Intelligent gray"		

1.Product Information

Function	Previous C250 series		New C260 series		Remarks
	SP C250SF	SP C252SF	SP C260SFNw	SP C262SFNw	
color			(Common with MD-P3)		
AIO	Common (*see note below)		Common (*see note below)		
OS	Windows, Mac		Windows, Mac, Linux		
PDL	PCL/PS		GDI	PCL/PS	
Wi-Fi Direct	Not Supported		Supported		
Mobile printing	RSDP		AirPrint Mopria GCP, RSDP Scanning app		<ul style="list-style-type: none"> • Mobile scan app (RICOH SP C260 series Scan) for iOS and Android • Easy-scan app (RICOH Scan Utility) for PC
NFC	Not Supported		Supported		
Driver language for Arabic	Not Supported		Supported		
Log Store via USB drive and Web Image Monitor	Supported		Supported		

Note: AIO Interchangeability

Black /Color AIO	C250 series		C260 series	
	SP C250DN SP C250SF	SP C252DN SP C252SF	SP C260DNw SP C260SFNw	SP C262SNw SP C262SFNw
6.5K/6.0K AIO	No	Yes	No	Yes
4.5K /4.0K AIO	No	Yes	No	Yes
2.3K/2.3K AIO (only for NA)	Yes	No	Yes	No
2.0K/1.6K AIO (all regions excluding NA)	Yes	No	Yes	No

- Yes: This AIO can be used.
- No: This AIO cannot be used.

2. Installation

Installation Requirements

Environment

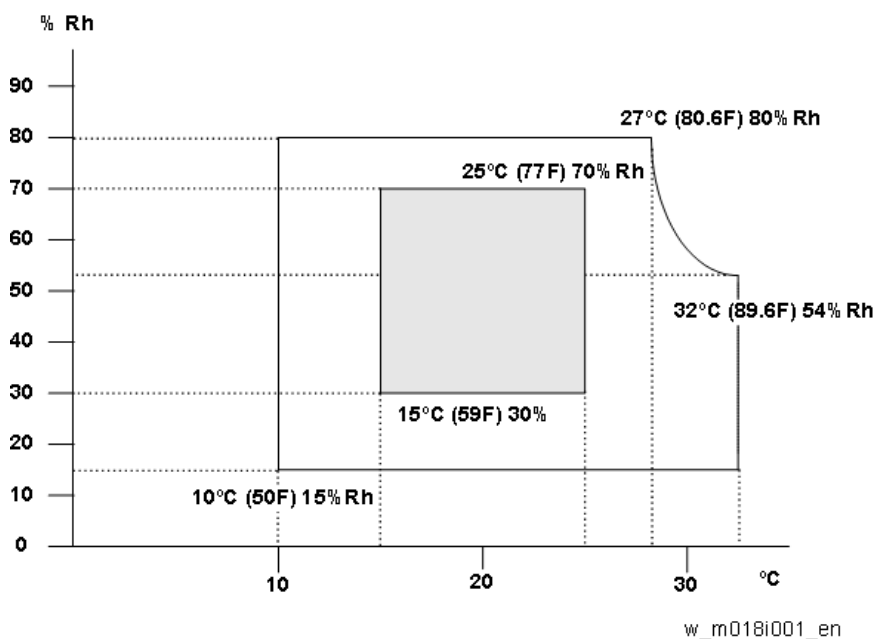

1. Temperature Range: 10C to 32C (50F to 89.6F)
2. Humidity Range: 15% to 80% RH
3. Ambient Illumination: Less than 2,000 lux (do not expose to direct sunlight)
4. Ventilation: 30 m³/hr/person
5. Do not put the machine in areas that get sudden temperature changes. This includes:
 - Areas directly exposed to cool air from an air conditioner
 - Areas directly exposed to heat from a heater.
6. Do not put the machine in areas that get exposed to corrosive gas.
7. Do not install the machine at locations over 2,500 m (8,202 ft.) above sea level.
For Chinese model: 2,000 m (6,561 ft.)
8. Put the machine on a strong, level base. (Inclination on any side must be no more than 3 mm.)
9. Do not put the machine in areas with strong vibrations.

Machine level

Front to back: Within 3 mm (0.12") of level

Right to left: Within 3 mm (0.12") of level

2.Installation

Machine Space Requirements

Put the machine near the power source with these clearances:

Printer Models

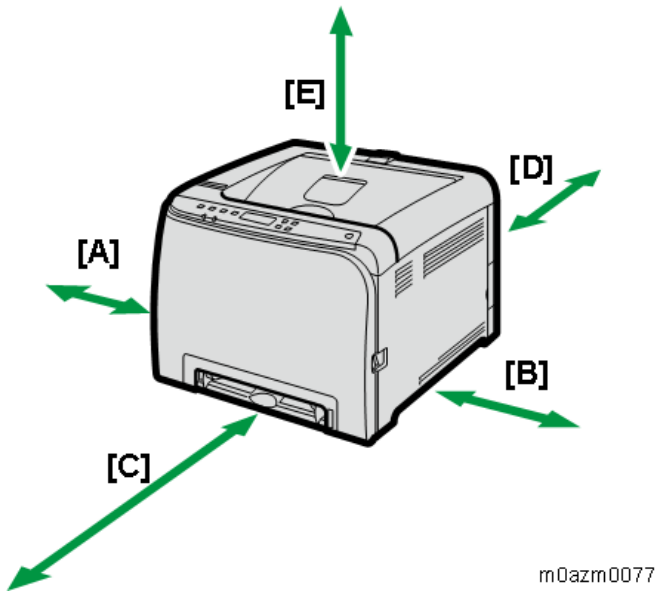

m0azm0077

[A]: Left side: Over 10 cm (4.0")

[B]: Right side: Over 20 cm (7.9")

[C]: Front: Over 70 cm (27.6")

[D]: Rear: Over 20 cm (7.9")

[E]: Top: Over 33 cm (13")

MF Models

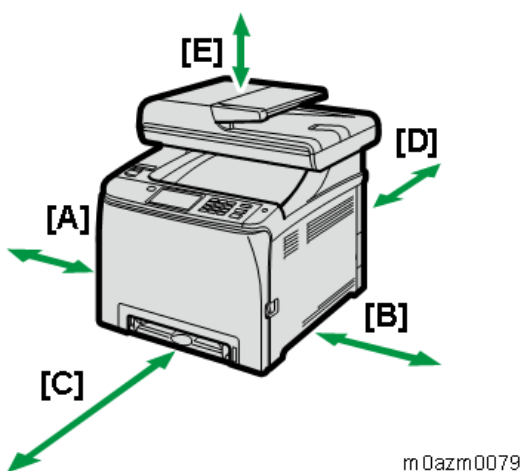

m0azm0079

[A]: Left side: Over 10 cm (4.0")

[B]: Right side: Over 20 cm (7.9")

[C]: Front: Over 70 cm (27.6")

[D]: Rear: Over 20 cm (7.9")

[E]: Top: Over 24 cm (9.5")

Power Requirements

CAUTION

- Make sure that the plug is tightly in the outlet.
- Avoid multi-wiring.
- Make sure that you ground the machine.

Input voltage level	120 V to 127 V, 60 Hz: Less than 11 A (for North America) 220 V to 240 V, 50 Hz/60 Hz: Less than 6 A (for Europe/ Asia) 110 V, 60 Hz: Less than 12 A (for Taiwan)
Permitted voltage fluctuation: 10%	
Do not set anything on the power cord.	

Installation Procedure

Refer to the Quick Installation Guide for details about installing the machine.

3. Preventive Maintenance

Preventive Maintenance

See “Appendices” for the following information:

- Preventive Maintenance

4. Replacement and Adjustment

Before You Start

General Precautions

CAUTION

- If there are printer jobs in the machine, print out all jobs in the printer buffer.
- Turn off the main power switch and unplug the machine before you do the procedures in this section.

Use extreme caution when removing and replacing components. The cables in the machine are located very close to moving parts; proper routing is a must.

After components have been removed, any cables that have been displaced during the procedure must be restored as close as possible to their original positions. Before removing any component from the machine, note any cable routings that may be affected.

Before servicing the machine:

1. Verify that documents are not stored in memory.
2. Remove the print cartridge before you remove parts.
3. Unplug the power cord.
4. Work on a flat and clean surface.
5. Replace with authorized components only.
6. Do not force plastic material components.

Make sure all components are returned to their original positions.

AIO

The AIO consists of the OPC drum, charge roller, development unit, cleaning components and toner tank. Observe the following precautions when handling the AIO.

1. Never touch the drum surface with bare hands. If the drum surface is dirty or if you have accidentally touched it, wipe it with a dry cloth, or clean it with wet cotton and then wipe it dry with a cloth.
2. Never use alcohol to clean the drum. Alcohol will dissolve the drum surface.
3. Store the AIO in a cool dry place.
4. Do not expose the drum to corrosive gases (ammonia, etc.).
5. Do not shake a used AIO, as this may cause toner to spill out.
6. Dispose of used AIO components in accordance with local regulations.

Laser Unit

1. Do not loosen or adjust the screws securing the LD drive board on the LD unit. Doing so will put the LD unit out of adjustment.
2. Do not adjust the variable resistors on the LD unit, as these are permanently adjusted at the factory. If replacement of the LD drive board is necessary, replace the entire LD unit.

4.Replacement and Adjustment

3. Keep the polygon mirror and toroidal lens free of dust. Laser performance is very sensitive to dust on these components.
4. Do not touch the shield glass or the surface of the polygon mirror with bare hands.
5. Do not adjust the Laser Synchronization detector on the LD unit, as these are permanently adjusted at the factory.

Transfer Roller

1. Never touch the surface of the transfer roller with bare hands.
2. Be careful not to scratch the transfer roller, as the surface is easily damaged.

Fusing

1. After installing the fusing thermistor, make sure that it is in contact with the hot roller and that the roller can rotate freely.
2. Be careful to avoid damage to the hot roller stripper pawls and their tension springs.
3. Do not touch the fusing lamp and rollers with bare hands.
4. Make sure that the fusing lamp is positioned correctly and that it does not touch the inner surface of the hot roller.

Paper Feed

1. Do not touch the surface of paper feed rollers.
2. To avoid misfeeds, the side and end fences in each paper tray must be positioned correctly so as to align with loaded paper size.

DADF (only for SP C262SFNw)

1. Clean the parts indicated by arrows with a soft damp cloth and then wipe the same parts with a dry cloth to remove any remaining moisture.

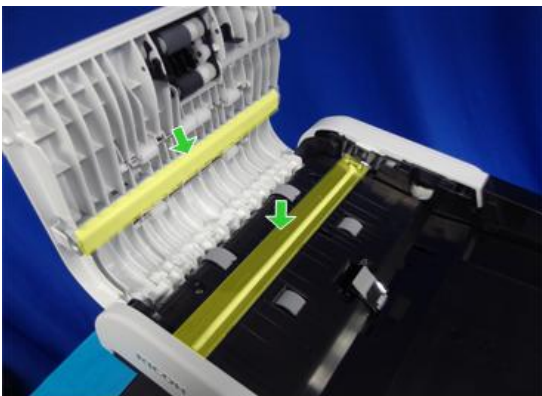

m0azm0003

Scanner Unit (MF Models)

1. Clean the parts indicated by arrows with a soft damp cloth and then wipe the same parts with a dry cloth to

remove any remaining moisture.

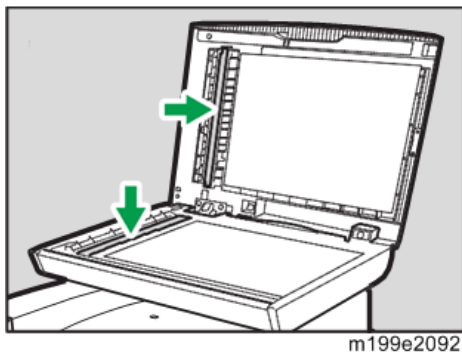

2. Do not disassemble the scanner unit.

Releasing Plastic Latches

Many of the parts are held in place with plastic latches. The latches break easily, so release them carefully. To release a latch, press the hook end of the latch away from the part to which it is latched.

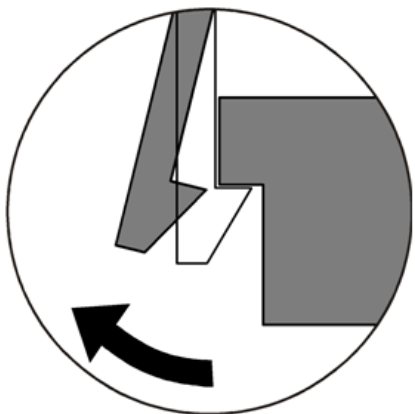

After Servicing the Machine

1. Make sure all parts that require grounding are properly grounded.
2. Make sure the interlock switch is functioning.
3. Do not leave unused parts inside the machine.
4. Do not leave any tools inside the machine.
5. Make sure all wires are properly connected and routed.
6. Make sure wires are not jammed between parts of the machine.

Lithium Batteries (MF Models)

⚠ CAUTION

- Incorrect replacement of lithium battery(s) on the controller or on the fax unit poses risk of explosion. Replace only with the same type or with an equivalent type recommended by the manufacturer. Discard used batteries in accordance with the manufacturer's instructions.

4.Replacement and Adjustment

Special Tools

- PC: Windows Vista/7/8.1/10 or Windows Server 2008/2008 R2/2012/2012 R2.
- USB cable

Exterior Covers

⚠ CAUTION

- Turn off the main power switch and unplug the printer before you do the procedures in this section.

Rear Cover

Rear Cover (Printer Models)

1. Rear tray cover [A]
2. Interface cover [B] (hook × 1)

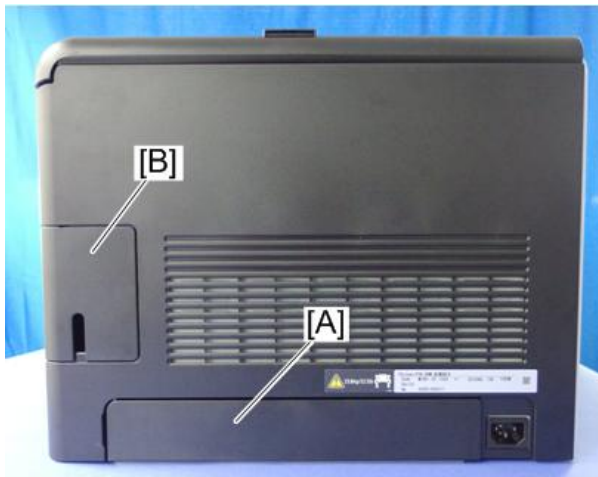

m199e2003

3. Rear cover [C] (⚙ × 3)

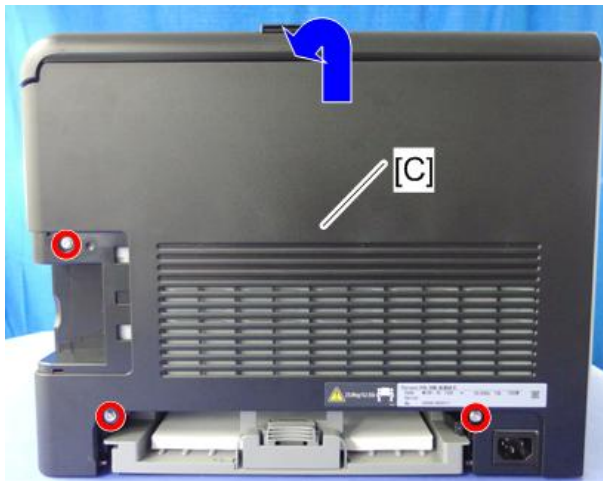

m199e2004

ⓘ Note

- The screw in the Interface cover: M3 x 8, others: M4 x 10

4.Replacement and Adjustment

Rear Cover (MF Models)

1. Rear tray cover [A]



m199e2005

2. Rear cover [B] (× 2)

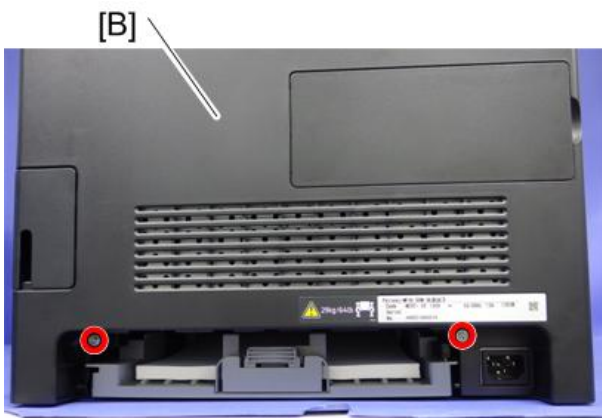

m199e2006

Right Cover

1. Rear cover ([Rear Cover](#))

2. Operation panel ([Operation Panel](#), [NFC \(MF Models\)](#))

3. Right cover [A] ( × 4)



Note

- Top front screw: M3 x 8, others: M4 x 10

Left Cover

1. Open the top cover.

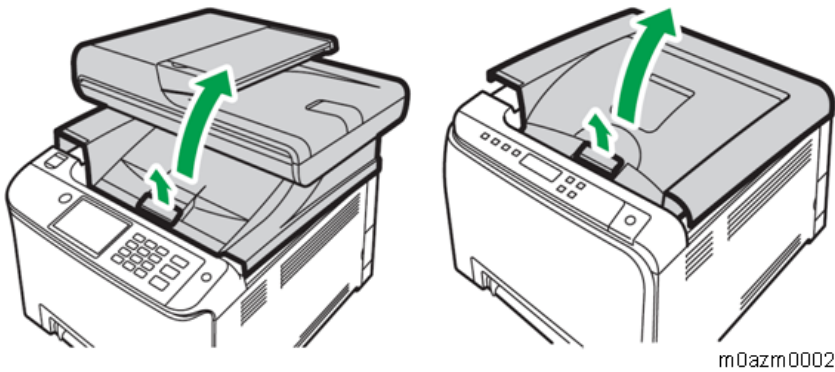

2. Pull the front cover open lever (1), and open the front cover (2).



4.Replacement and Adjustment

- 3.** Left cover [A] ( × 3, hook at the arrow mark below)



Note

- Top front screw: M3 x 8, others: M4 x 10
- Remove the rear cover and the operation panel in advance when you meet difficulties in removing the left cover.

Front Cover Unit

- 1.** Rear cover ([Rear Cover](#))
- 2.** Operation panel ([Operation Panel, NFC \(MF Models\)](#))
- 3.** Transfer unit ([Transfer Unit](#))
- 4.** Right cover ([Right Cover](#))
- 5.** Cover link gear unit [A] ( × 2)

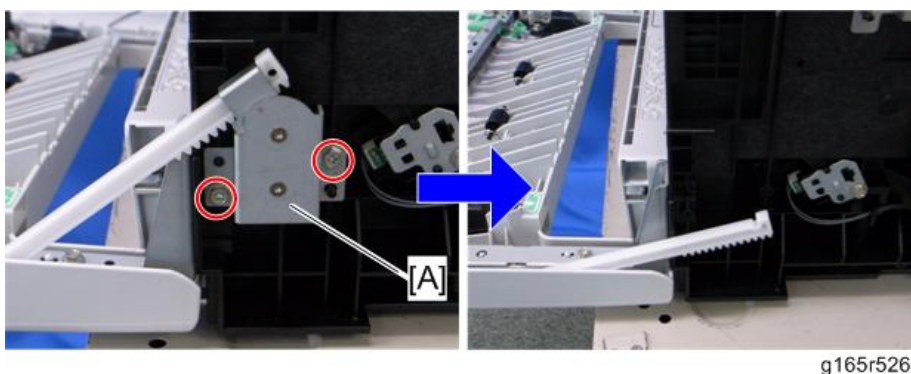

- 6.** Release the belt [B]

7. Front cover unit [C] ( × 4)

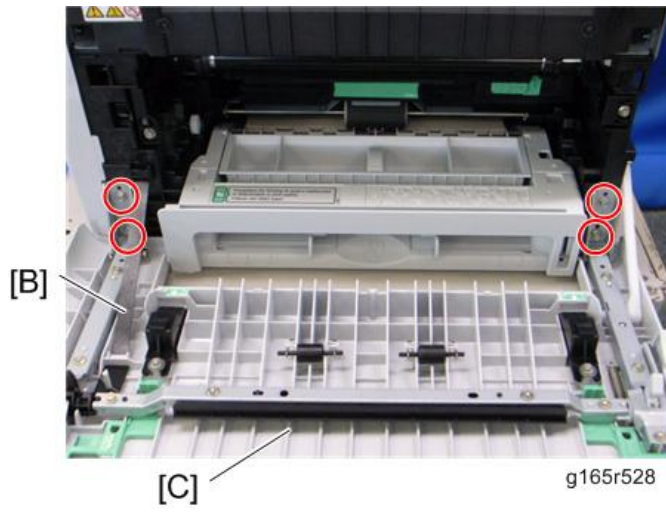

4.Replacement and Adjustment

Laser Unit

⚠ WARNING

- Turn off the main power switch and unplug the printer before beginning any of the procedures in this section. Laser beams can cause serious eye injury.

Caution Decal Locations

⚠ WARNING

- Be sure to turn off the main power switch and disconnect the power plug from the power outlet before beginning any disassembly or adjustment of the laser unit. This printer uses a class IIIb laser beam with a wavelength of 655 nm and an output of 7 mW. The laser can cause serious eye injury.

Caution decals are attached as shown below.

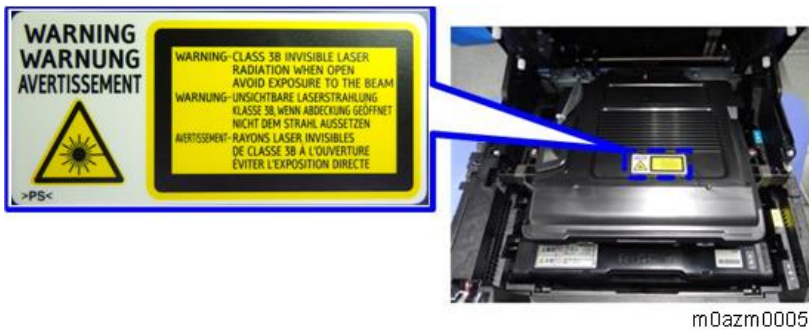

Laser Optics Housing Unit

- 1.** Rear cover ([Rear Cover](#))
- 2.** Controller box cover ([Controller Board](#))
- 3.** Only for MF Models: Interface bracket ([Controller Board](#))
- 4.** Disconnect the three harnesses from CN301, 302 and 303 on the EGB. ( × 3)



5. Open the top cover.

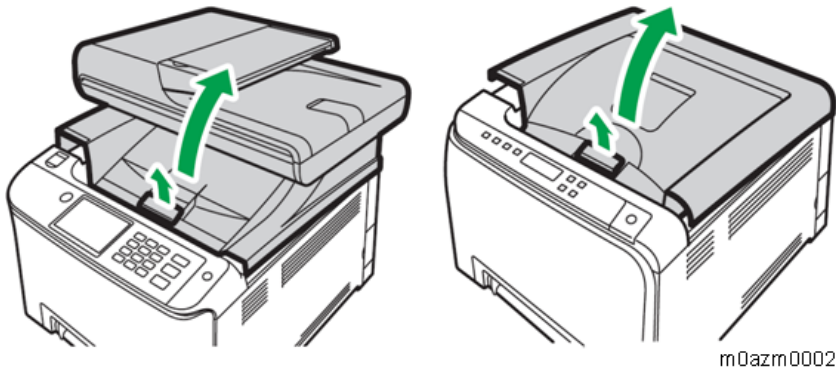

m0azm0002

6. Remove the harness guide [A] on the rear-left frame.
Lift up the hook [B] of the harness guide and slide the harness guide to the right.

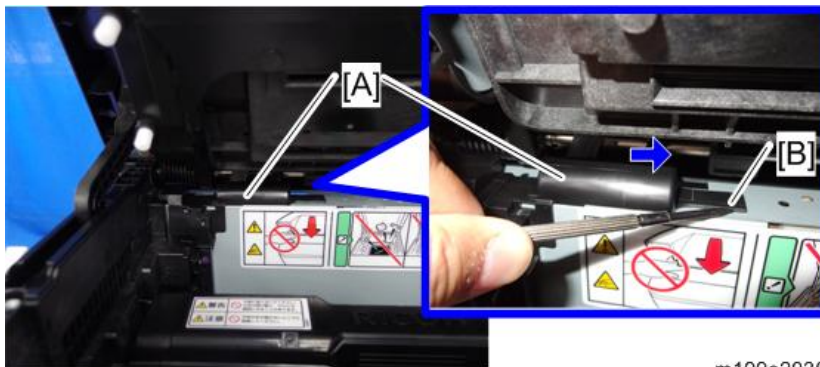

m199e2030

7. Stoppers [C] ( × 2 each: left side and right side)
8. Remove the springs [D] (left side and right side).

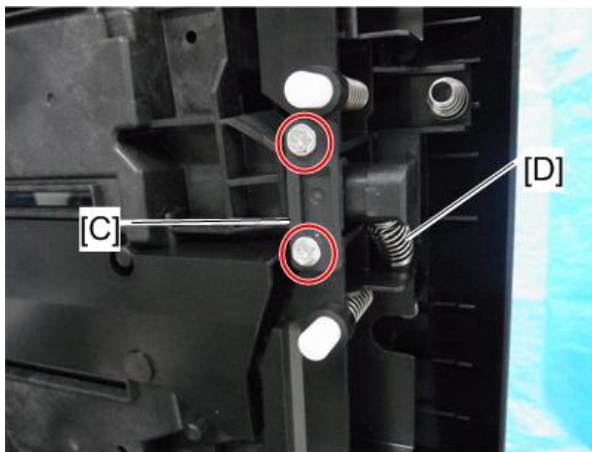

m199z009

9. Remove the laser optics housing unit [E] from the top cover and place it on the main body.

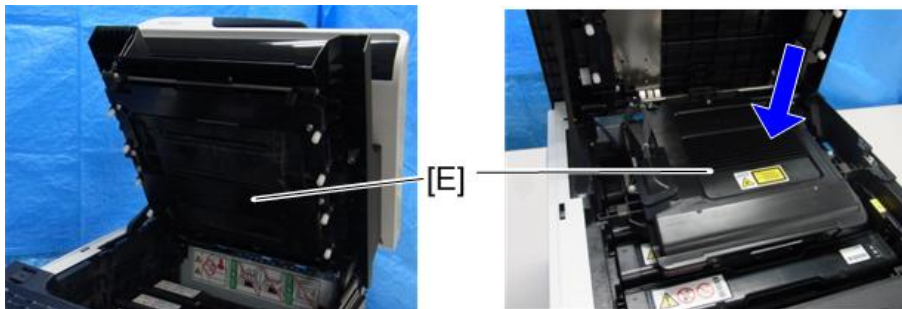

m203z010

4.Replacement and Adjustment

Note

- Always use two hands when carrying the laser optics housing unit. Be sure not to drop the laser optics housing unit.

10. Take out the harnesses [F]. (× 1)

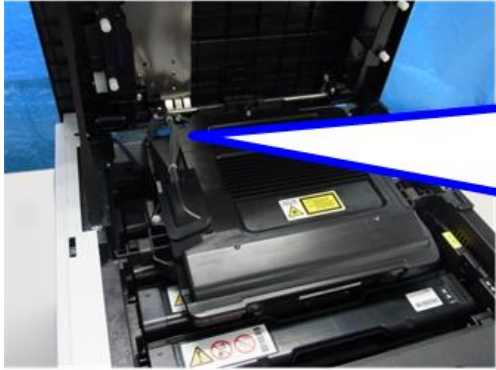

m203z011

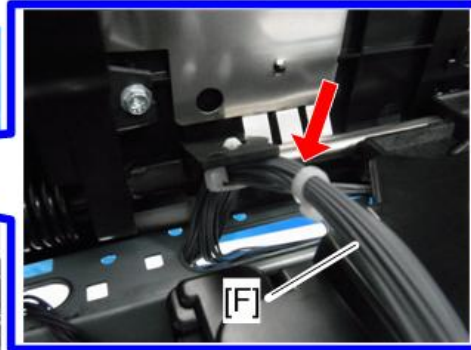

m199z011

11. Laser optics housing unit [G].



m199z012

After replacing the laser optics housing unit

After replacing the laser optics housing unit, it is necessary to enter the LD parameters and adjust color registration.

1. Open the front cover.
2. Turn on the machine.
3. Check if the machine is "READY" status.
4. Enter the SP mode.
5. Select [Engine Service Setting] > [Init. LSU Data].

In the printer models, select [Engine Maintenance] > [Init. LSU Data].

Appropriate LD parameters to match the replaced laser optics housing unit are written on the EEPROM of the engine board.

6. Close the front cover.
7. Perform "Color Registration" in [Engine Service Setting].

In the printer models, perform "Color Registration" in [Engine Maintenance].
MUSIC is performed.

- 8.** If necessary, adjust the registration settings for each tray and for the front and rear sides of the paper with the SP mode.

 **Note**

- If the MUSIC error persists, contact your supervisor , and get a set of LD parameters for the unit. After that, enter them with “LSU Adjustment” in the SP mode.

AIO Cartridge (All In One Cartridge)

AIO Cartridge

1. Open the top cover.
2. AIO cartridge [A]



m199e2031

Black AIO Motor

1. Left cover ([Left Cover](#))
2. Disconnect the fusing connector [A] and remove the fusing relay harness [B] (2 hooks).

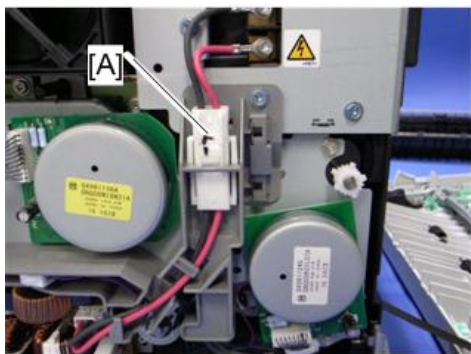

m018r531

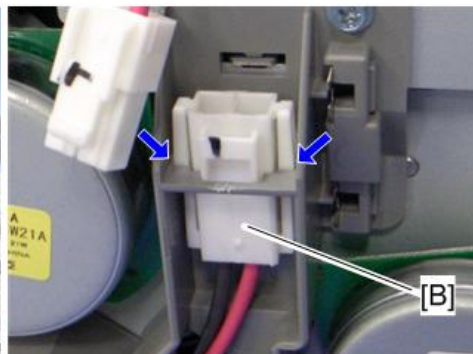

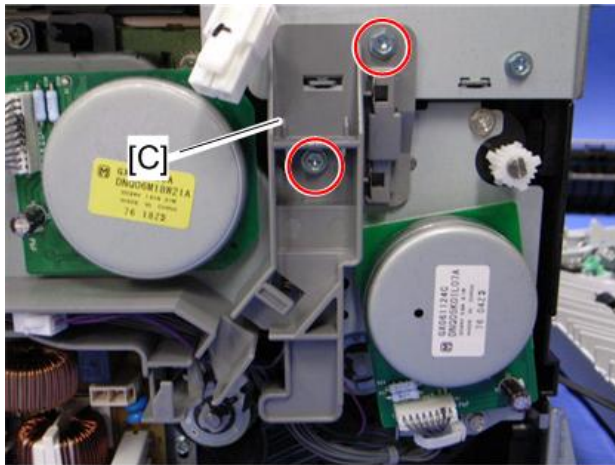

m018r532

3. Fusing harness guide [C] ( × 2)



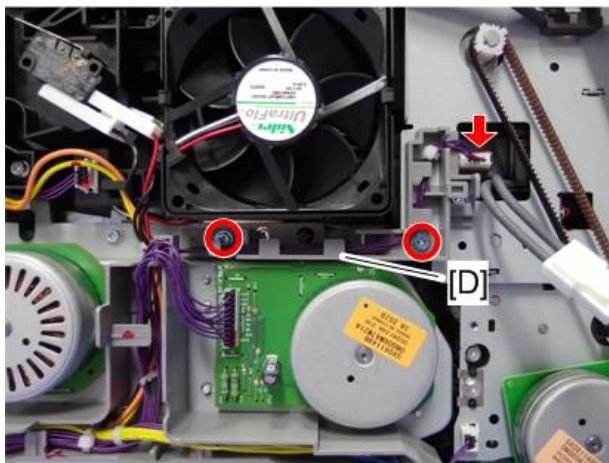

m018r533

4. Fusing thermistor harness guide [D] ( × 2,  × 1)



m199e2068

5. Disconnect the connectors shown by arrows in the picture below and release all harnesses on the harness guide [E]. ( × 4,  × 1)

6. Harness guide [E] ( × 4, hook × 1)

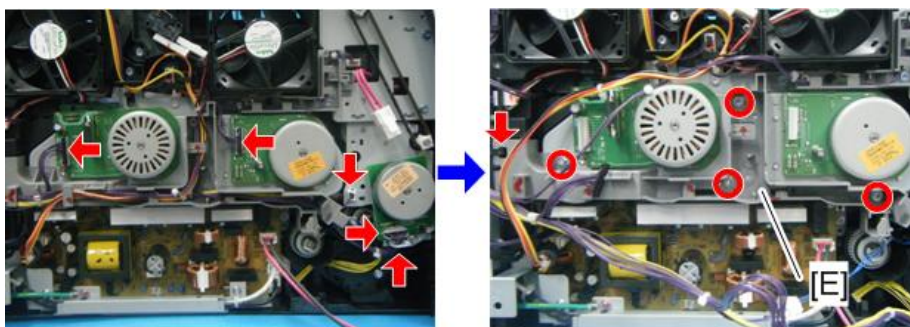

m199e2069

4.Replacement and Adjustment

7. Drive unit [F] ( × 4)

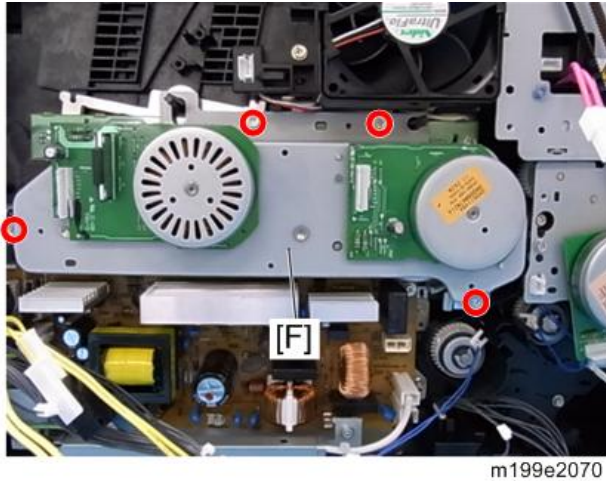

m199e2070

8. Black AIO gear [G], Yellow AIO gear [H], and Cyan AIO gear [I] (snap ring × 1 each)

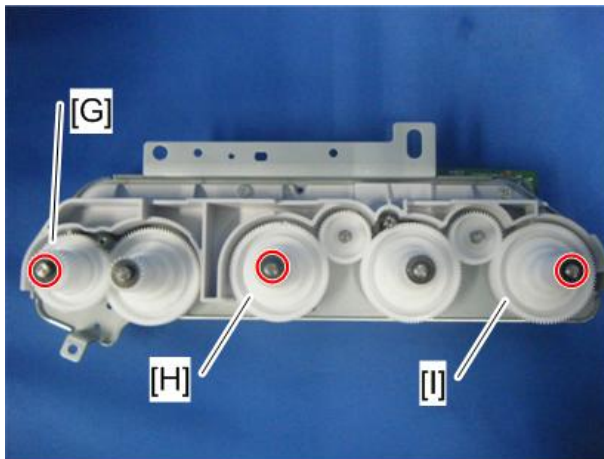

m199e2071

9. Drive unit guide [J] ( × 3)

10. The other back AIO gear [K] (snap ring × 1)

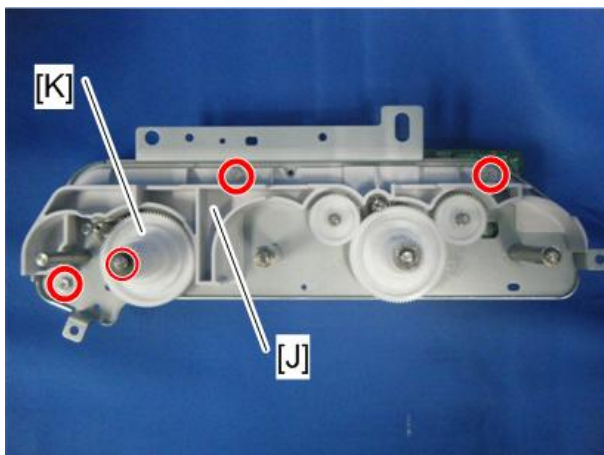

m199e2072

- 11.** Black AIO motor [L] ( × 3)

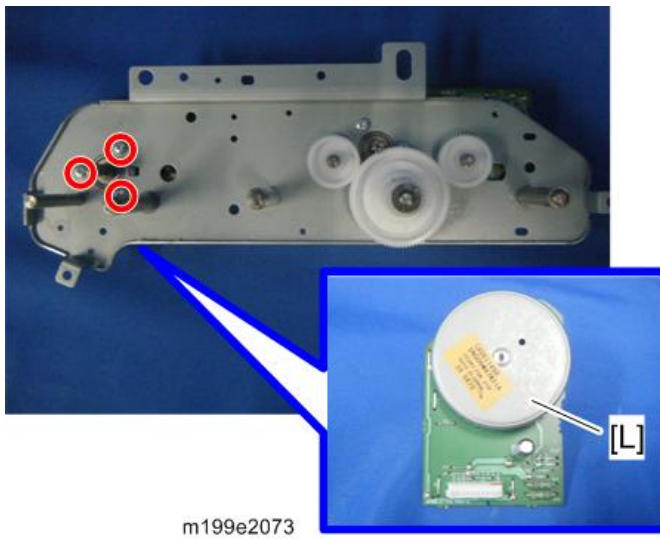

Color AIO Motor

- 1.** Drive unit (Black AIO Motor)
2. Black AIO gear [A], yellow AIO gear [B], and cyan AIO gear [C] (snap ring × 1 each)

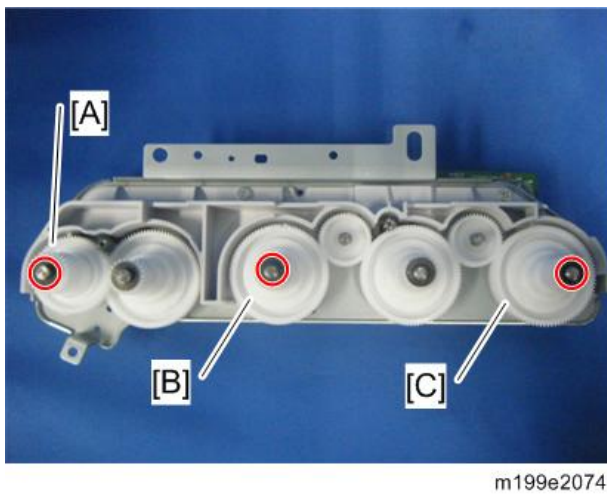

- 3.** Drive unit guide [D] ( × 3)

4.Replacement and Adjustment

4. Idler gear [E], and Magenta AIO gear [F] (snap ring × 1)

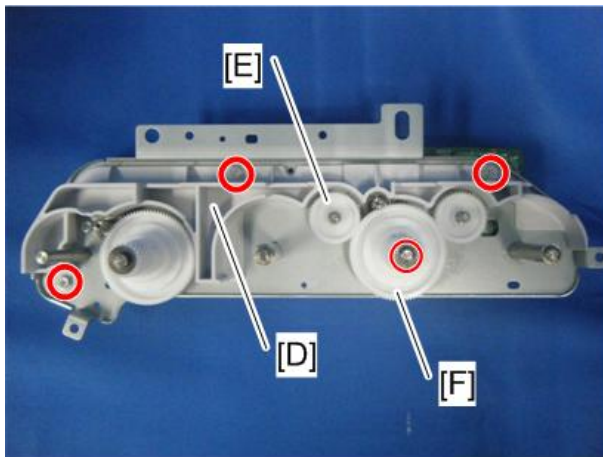

m199e2075

5. Color AIO motor [G] ( × 3)

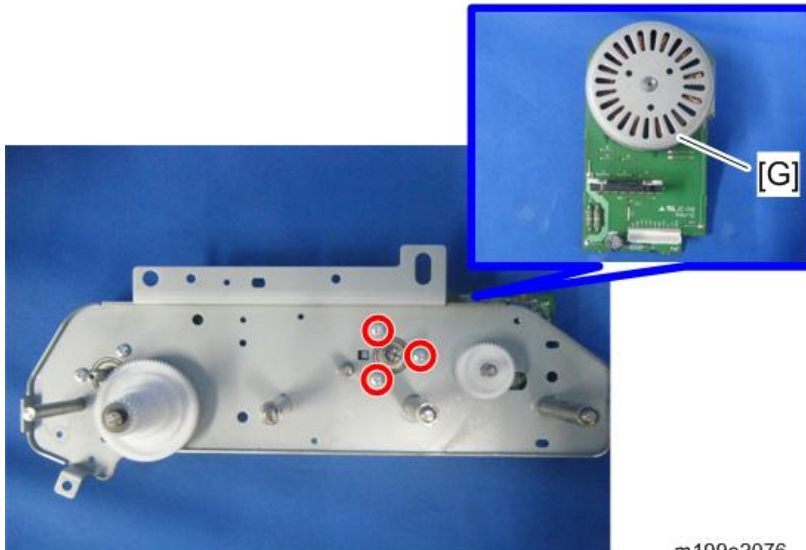

m199e2076

Image Transfer

Image Transfer Belt Unit

1. Remove all the AIO cartridges (AIO Cartridge).
2. Transfer unit (Transfer Unit)
3. Pull out the waste toner bottle [A].

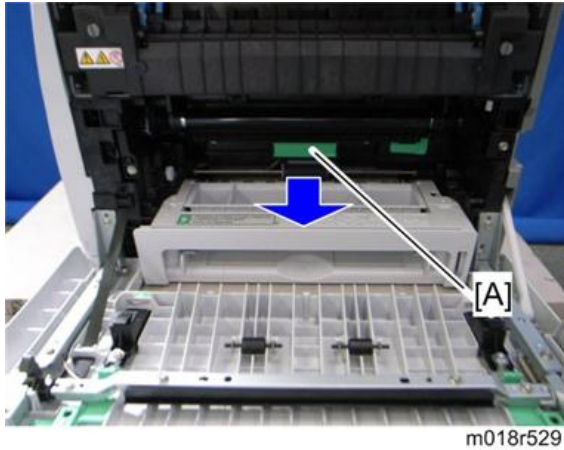

4. Release the hook [B] under the guide plate.
5. Move the guide plate [C] underneath the fusing unit to the left, and then remove it.

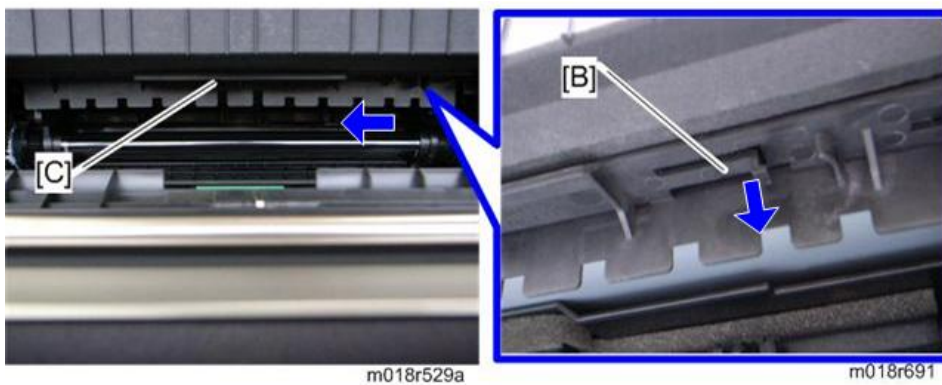

6. Pull out the image transfer belt unit [D]. ( × 2)

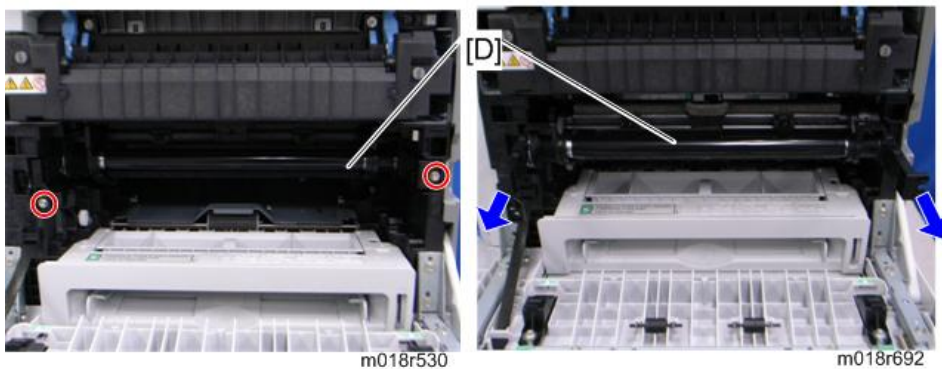

4.Replacement and Adjustment

After replacing the image transfer belt unit

★ Important

- Do the following step 3 with the front cover of the machine open.
- 1.** Open the front cover and turn on the machine.
 - 2.** Enter the SP mode.
 - 3.** Execute "Reset Transfer Unit" in [Engine Service Setting].
In the printer models, execute "Reset Transfer" in [Engine Maintenance].
 - 4.** Close the front cover.
 - 5.** Execute "Trans. Belt Adjust" in [Engine Service Setting].
In the printer models, execute "Trans Belt Adj." in [Engine Maintenance].
 - 6.** If necessary, adjust the registration settings for each tray and for the front and rear sides of the paper with the SP mode.

ITB (Image Transfer Belt) Cleaning Unit

↓ Note

- The ITB cleaning unit contains waste toner. When removing the ITB cleaning unit, put it on a sheet of paper.
- 1.** Image transfer belt unit ([Image Transfer Belt Unit](#))
 - 2.** Left handle [A] (hook, bushing × 1)
 - 3.** Right handle [B] (hook, bushing × 1)

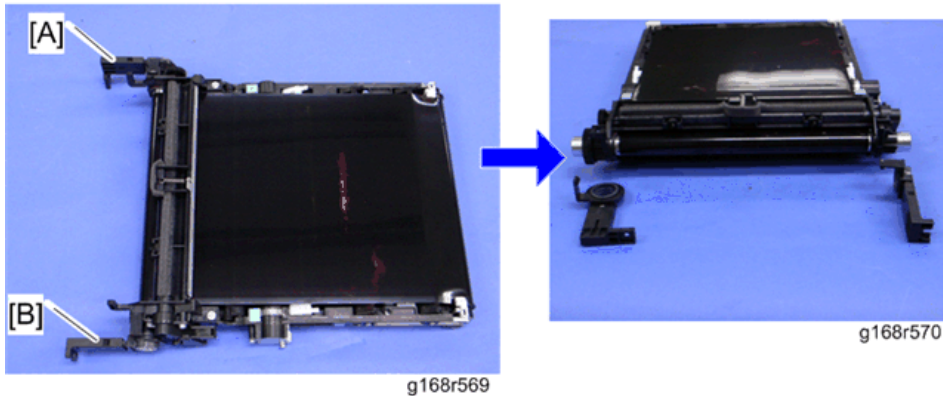

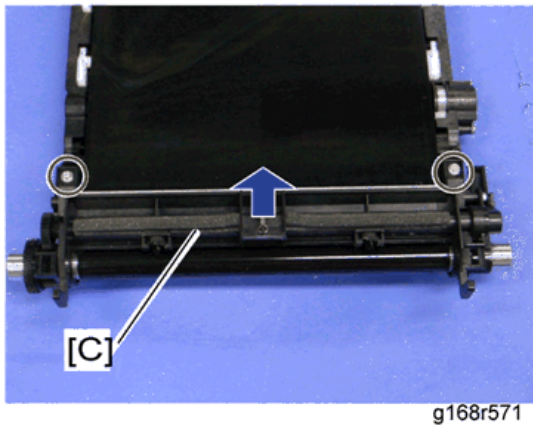

4. ITB cleaning unit [C] ( × 2)

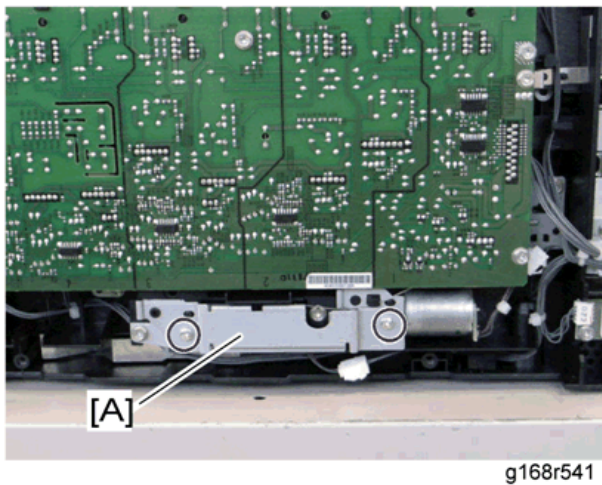

Agitator Motor

1. Rear cover (Rear Cover)
2. Operation panel (Operation Panel, NFC (MF Models))
3. Right cover (Right Cover)
4. Motor bracket [A] ( × 2)



5. Agitator motor assembly [A] ( × 1,  × 1)

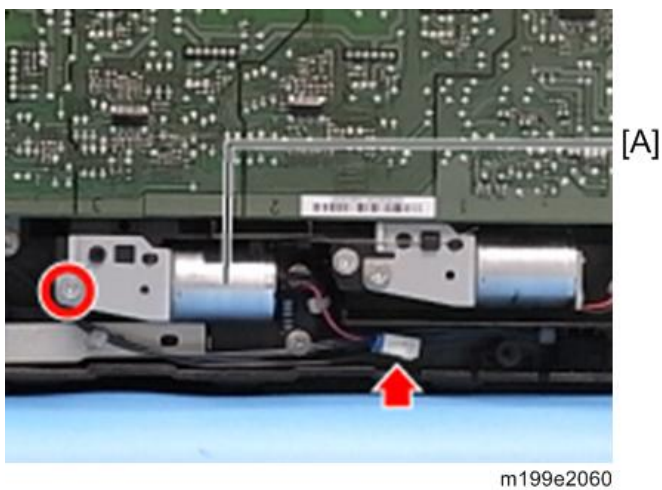

4.Replacement and Adjustment

- 6.** Agitator motor [C] ( × 2)

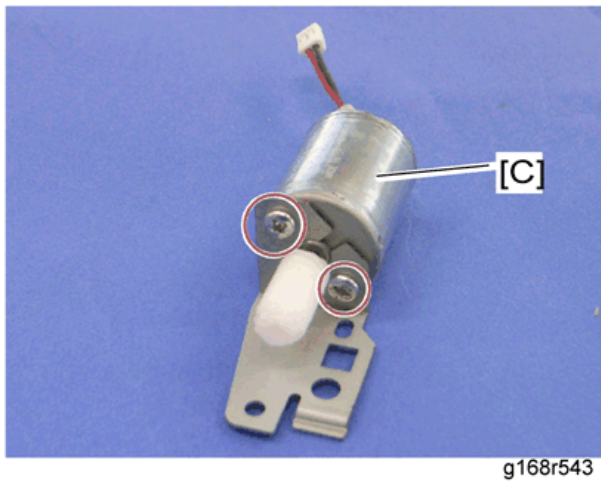

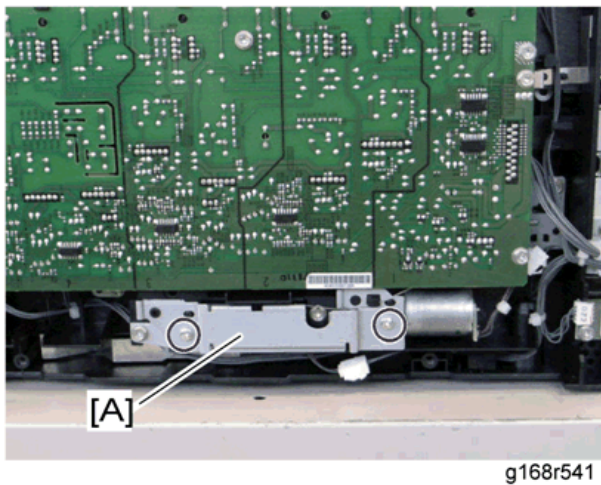

ITB (Image Transfer Belt) Contact Motor

- 1.** Rear cover ([Rear Cover](#))
- 2.** Operation panel ([Operation Panel, NFC \(MF Models\)](#))
- 3.** Right cover ([Right Cover](#))
- 4.** Motor bracket [A] ( × 2)



- 5.** Release the wire [B].

- 6.** ITB contact motor assembly [C] ( × 1,  × 1)

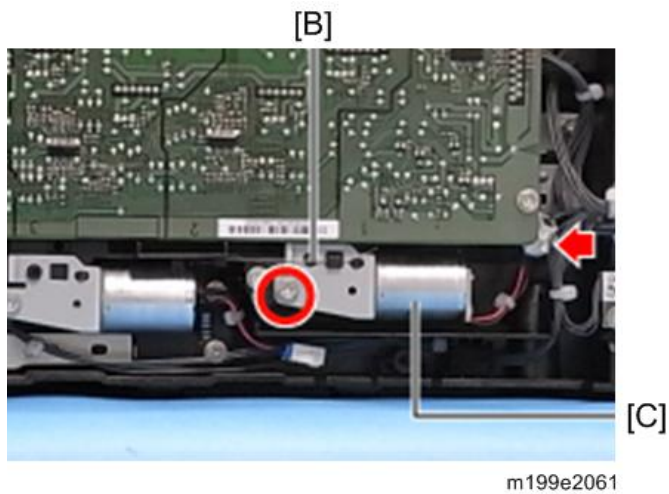

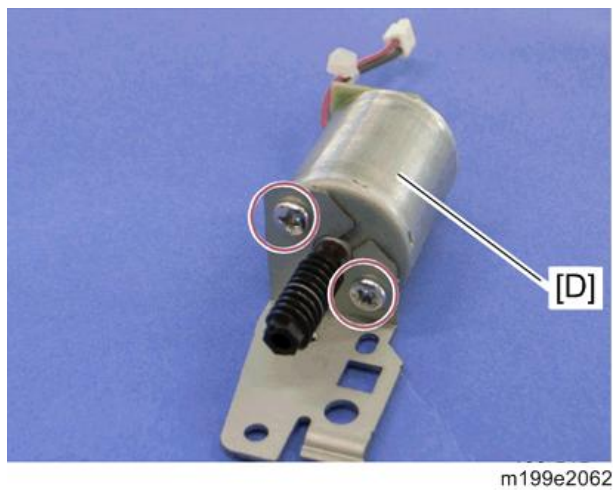

- 7.** ITB contact motor [D] ( × 2)



ITB (Image Transfer Belt) Contact Sensor

- 1.** Rear cover ([Rear Cover](#))
- 2.** Operation panel ([Operation Panel, NFC \(MF Models\)](#))
- 3.** Right cover ([Right Cover](#))
- 4.** High voltage power supply board ([High Voltage Power Supply Board](#))

4.Replacement and Adjustment

5. ITB contact sensor assembly [A] ( × 1,  × 1)

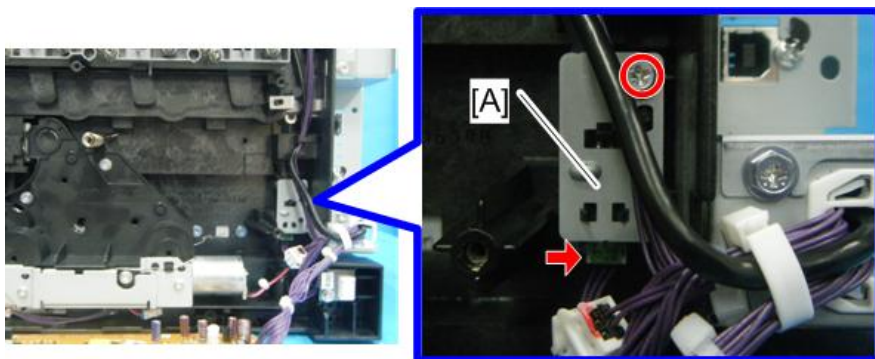

m199e2077

6. ITB contact sensor [B] (3hooks)

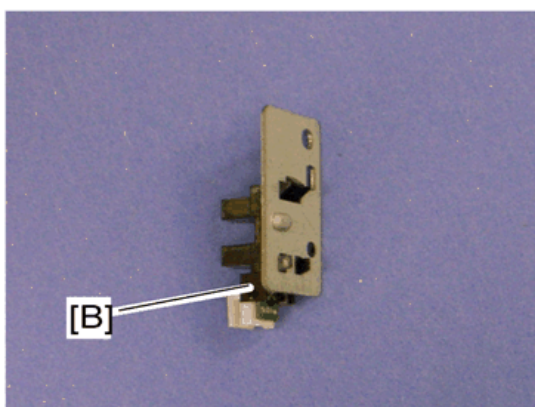

g168r548

TM (Toner Mark) Sensor Base

1. Rear cover ([Rear Cover](#))
2. Controller box cover ([Controller Board](#))
3. Only for MF models: FCU and Speaker bracket ([Controller Board](#))
4. Disconnect CN306 on the EGB. ( × 1)

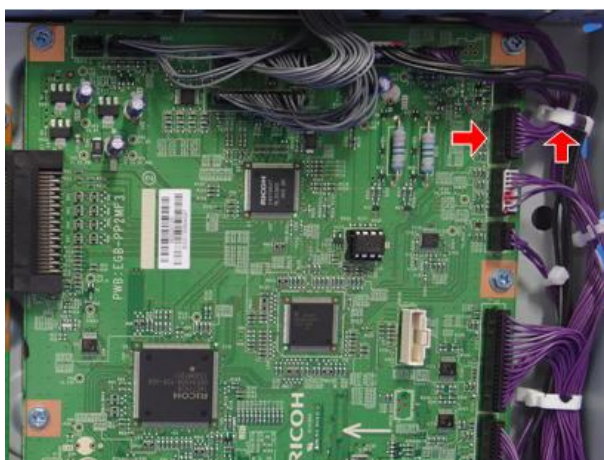

m199e2063

5. Remove all the AIO cartridges ([AIO Cartridge](#)).
6. Image Transfer Belt Unit ([Image Transfer Belt Unit](#))

7. Harness cover [A] (hook)
8. TM sensor base [B]

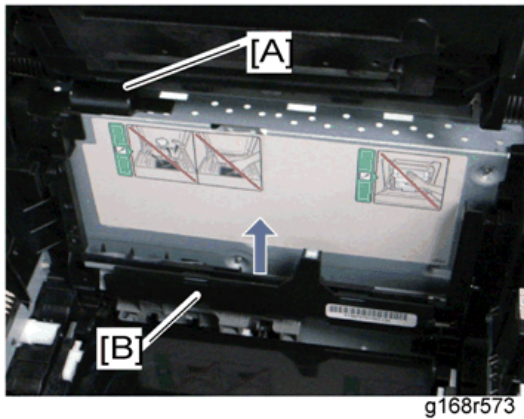

Waste Toner Bottle Set Sensor

1. Rear cover ([Rear Cover](#))
2. Controller box cover ([Controller Board](#))
3. Only for MF models: FCU and Speaker bracket ([Controller Board](#))
4. Disconnect CN315 on the EGB
5. Remove two screws [A] for the waste toner sensor base.

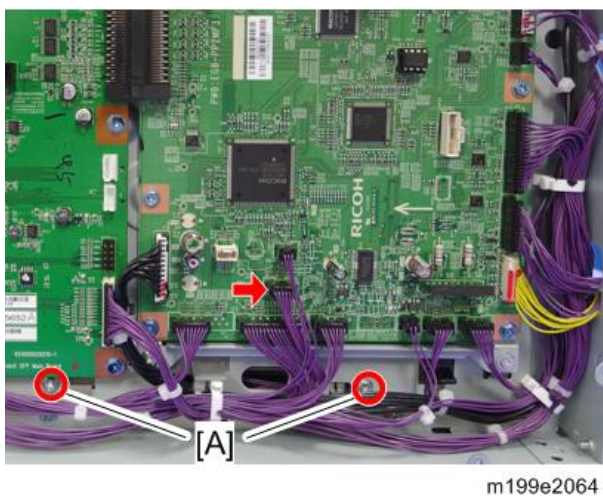

6. Remove all the AIO cartridges. ([AIO Cartridge](#))
7. Image transfer belt unit ([Image Transfer Belt Unit](#))

4.Replacement and Adjustment

8. Waste toner sensor base [B]

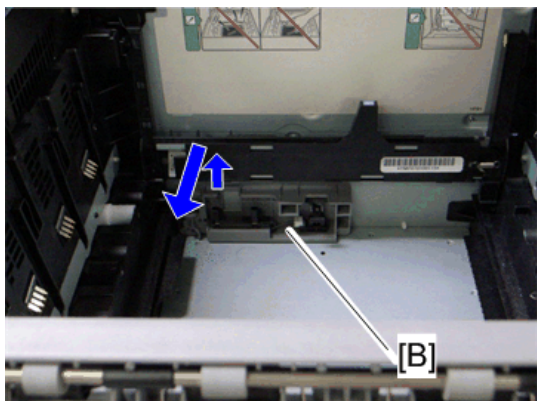

g165r608

9. Waste toner bottle set sensor [C] (3hooks, × 1)

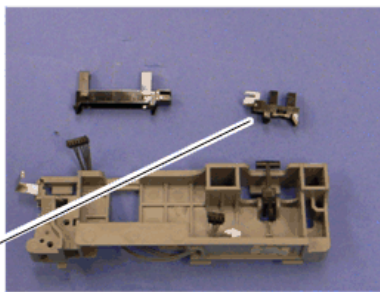
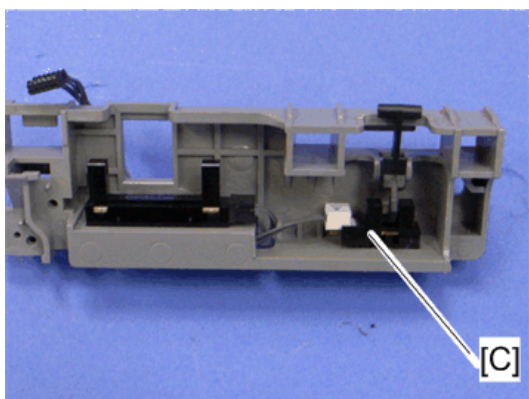

g165r609

Note

- When reinstalling the waste toner bottle set sensor, connect it to the white connector of the harness.

Waste Toner Overflow Sensor

1. Waste toner sensor base (Waste Toner Bottle Set Sensor)

2. Waste toner overflow sensor [A] (3hooks, × 1)

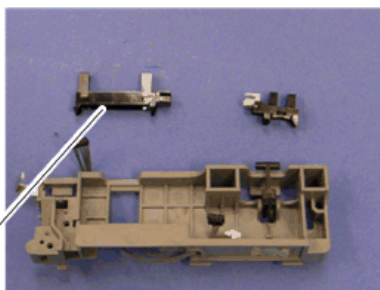
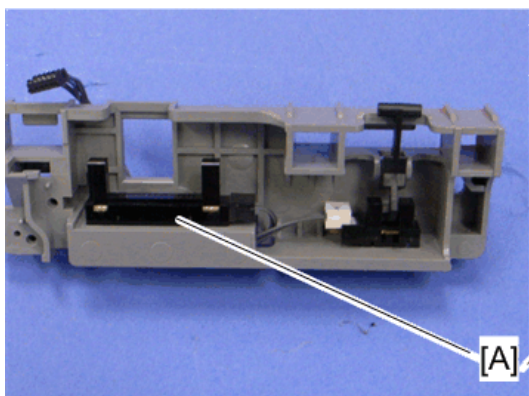

g165r609a

Note

- When reinstalling the waste toner overflow sensor, connect it to the black connector of the harness.

Image Fusing

⚠ CAUTION

- Make sure that the fusing unit is cool before you touch it. The fusing unit can be very hot.
- Make sure to restore the insulators, shields, etc after you service the fusing unit.

Fusing Unit

★ Important

- Execute "Reset Fuser Unit" with the SP mode after you replace the fusing unit, otherwise a fusing error may occur.

1. Pull the front cover open lever (1), and open the front cover (2).



2. Left cover ([Left Cover](#))
3. Disconnect the connectors [A], [B].

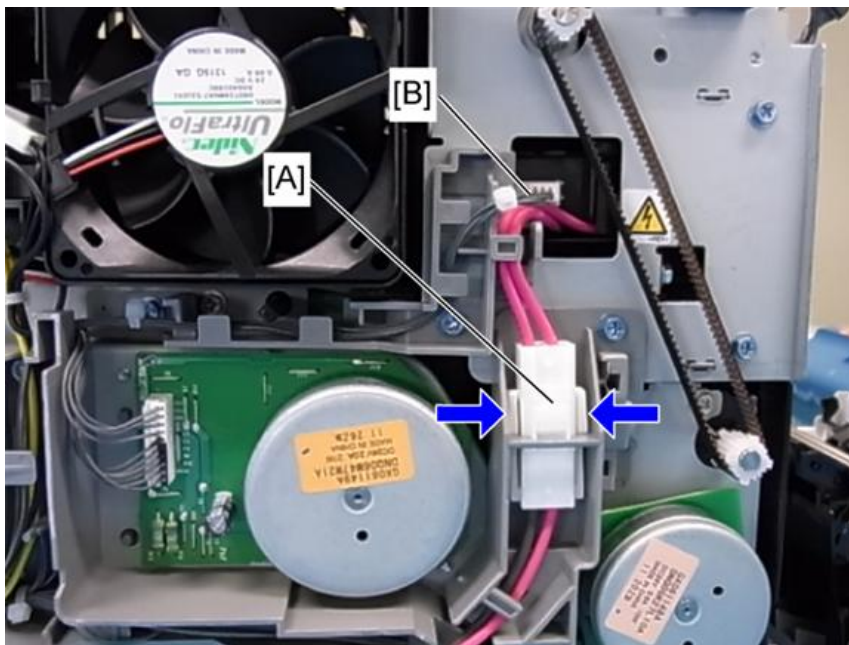

4.Replacement and Adjustment

4. Fusing unit [C] (× 3)

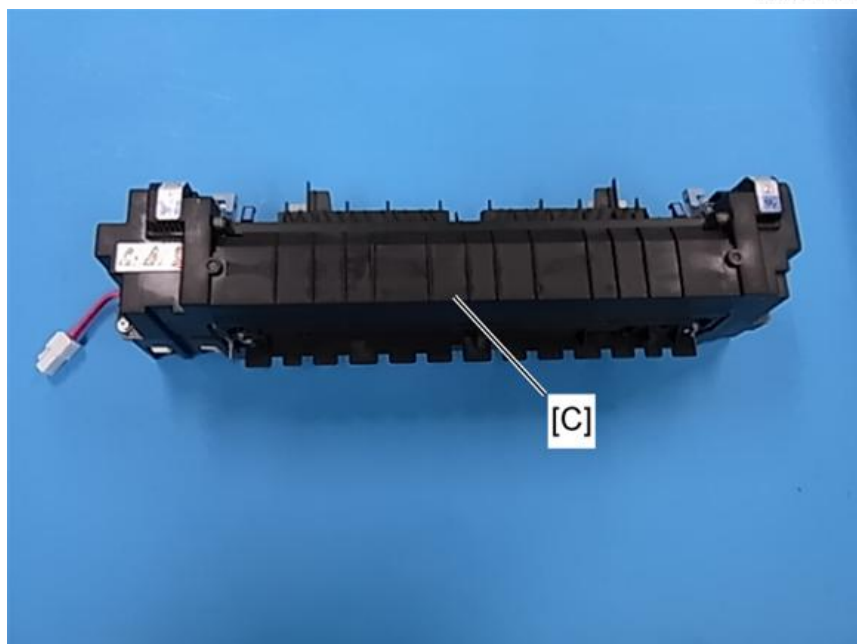
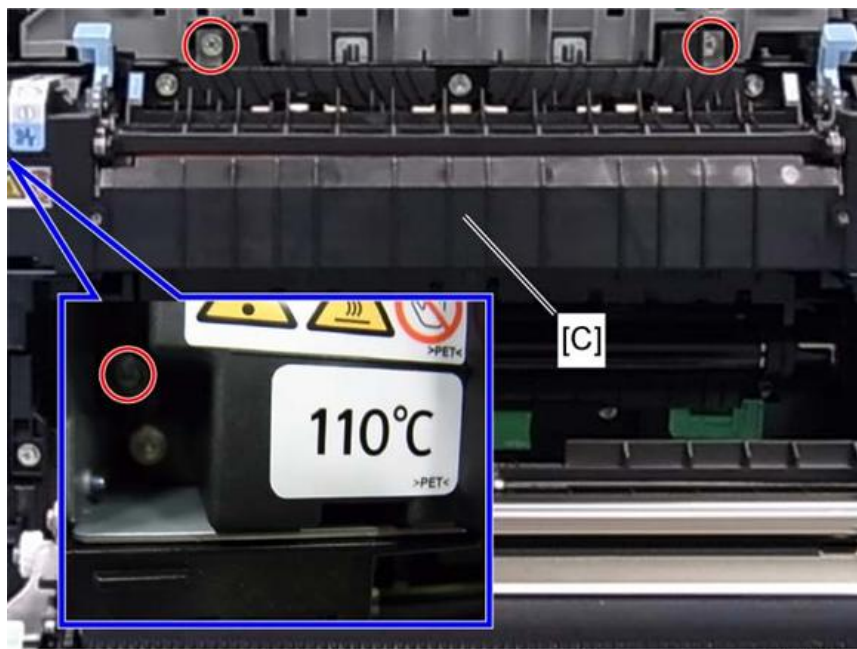

Note

- It is likely to remove a fusing unit cover screw instead of the lower left fixing screw by mistake. Make sure which screw should be removed before you do this step.

5. After replacing the fusing unit, turn on the machine.

6. Enter the SP mode.

7. Execute "Reset Fuser Unit" in [Engine Service Setting] ([SP Menu \(only for MF Models\)](#)).

In the printer models, execute "Reset Fuser" in [Engine Maintenance] ([Service Mode \(only for Printer Models\)](#)).

Fusing Lamp

1. Fusing unit (Fusing Unit)
2. Fusing front cover [A] ( × 3)

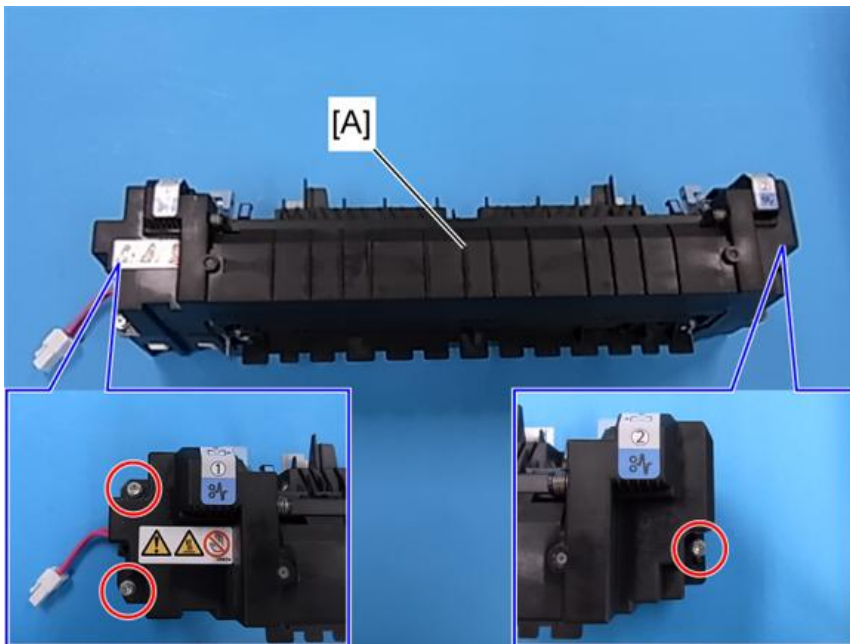

m0950008

3. Fusing back cover [B] ( × 2)

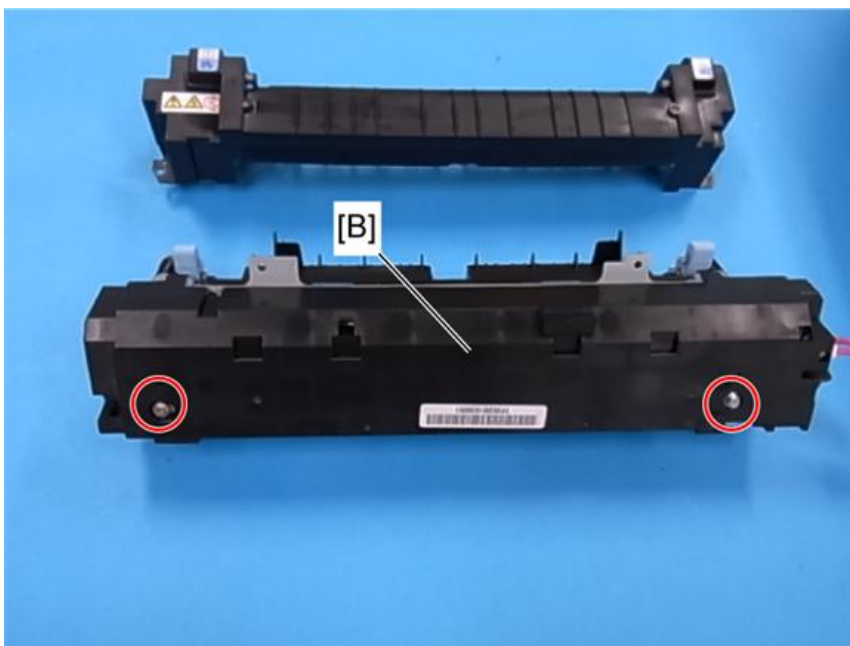

m0950009

4.Replacement and Adjustment

4. Fusing lamp cable [C] (× 2)

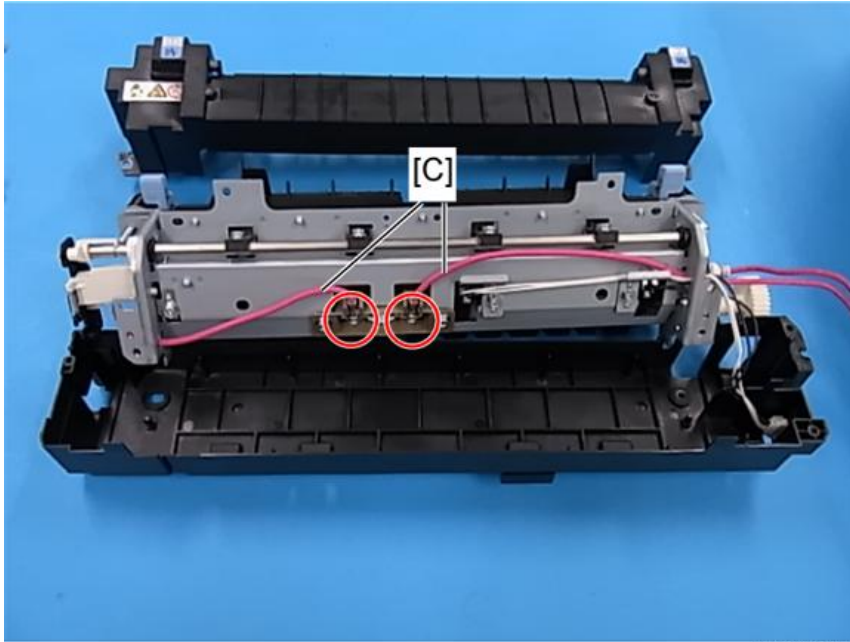

m0950010

5. Lamp right stay [E] (× 1)

6. Lamp left stay [D] (× 1)

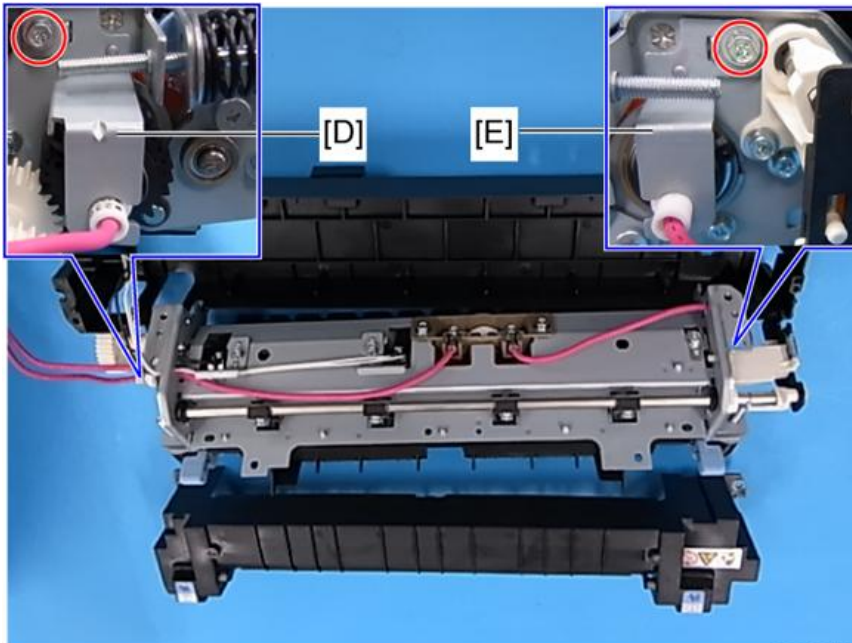

m0950011

7. Fusing lamp [E]

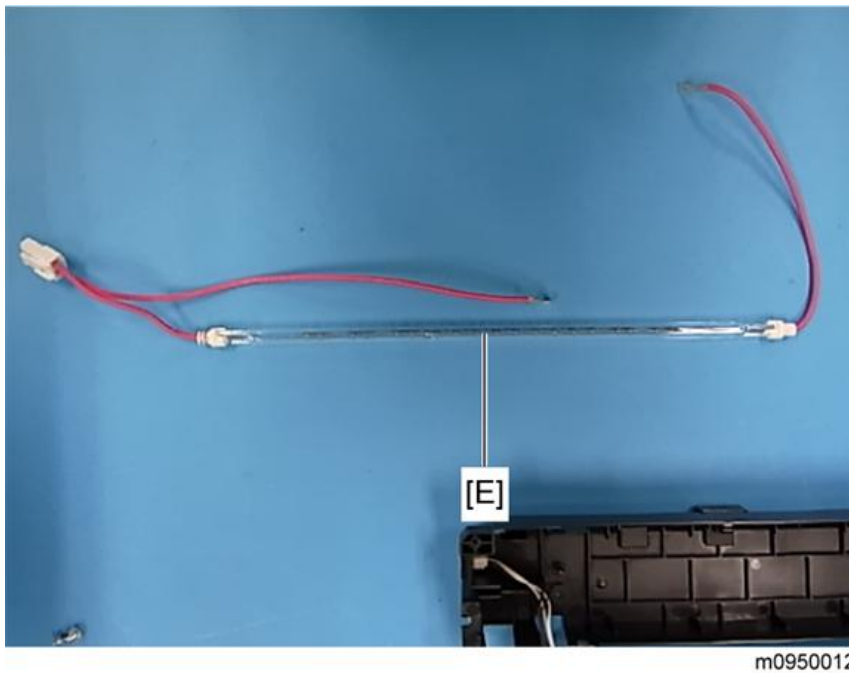

When Reinstalling the Fusing Lamp

The end of the fusing lamp [A], which shows the voltage and power ratings, must be placed at the left side of the fusing unit (fusing cable side).

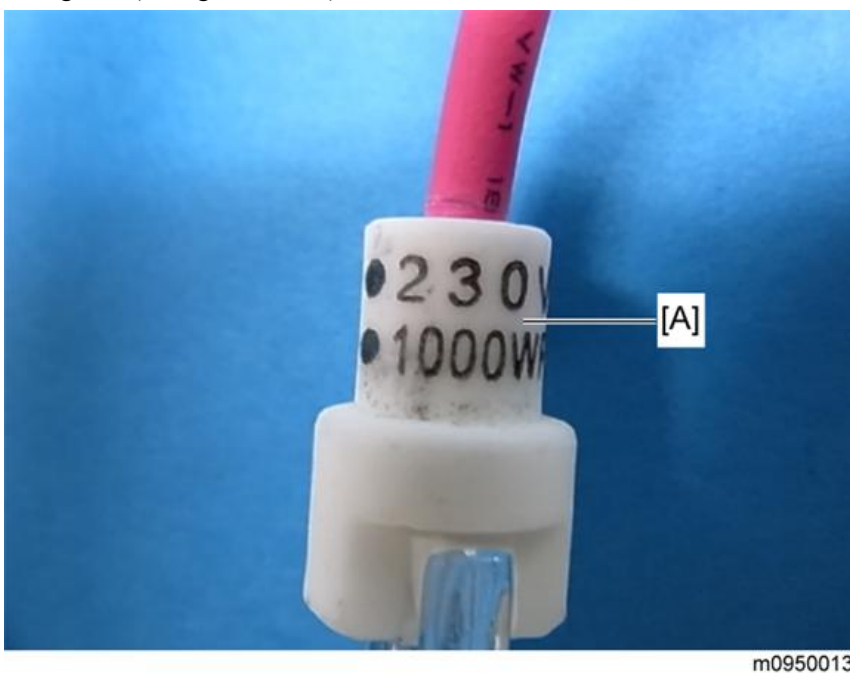

When Reassembling the Fusing Unit

Route the harness [A] as shown below when reinstalling the back cover [B].

4.Replacement and Adjustment

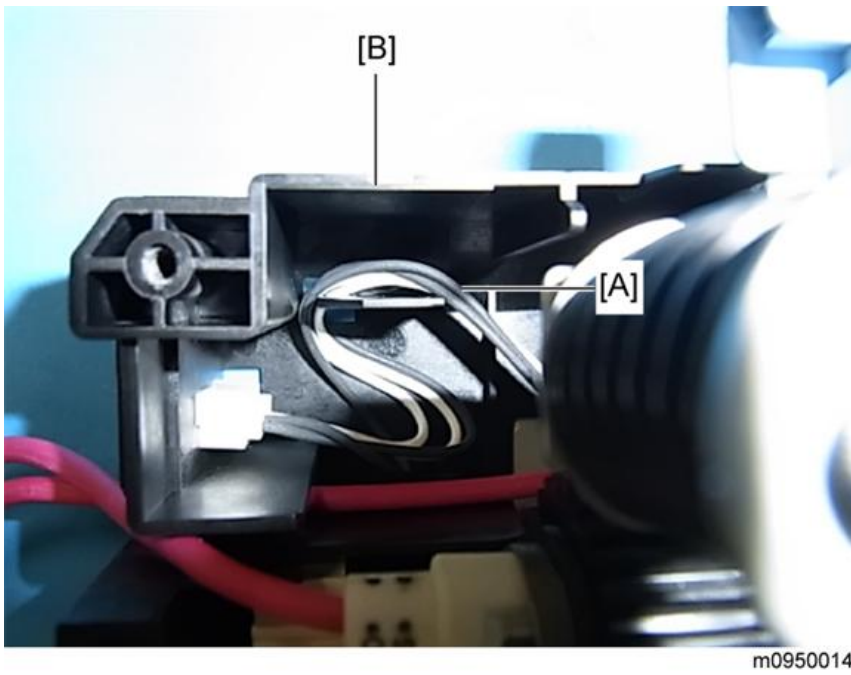

Transport/Fusing Motor

1. Rear cover ([Rear Cover](#))
2. Left cover ([Left Cover](#))
3. Disconnect the fusing connector [A] and remove the fusing relay harness [B] (2 hooks).

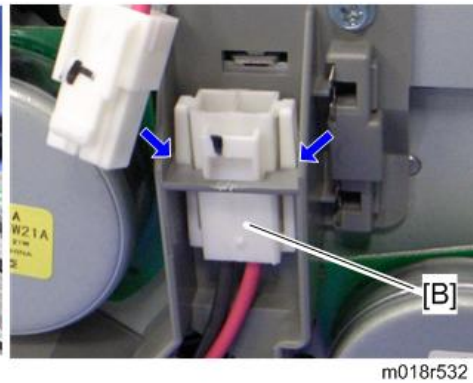
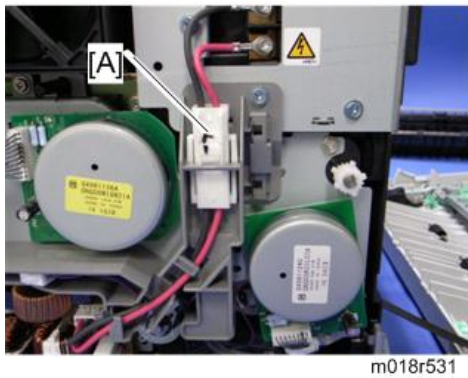

4. Fusing harness guide [C] ( × 2)

5. Duplex timing belt [D]

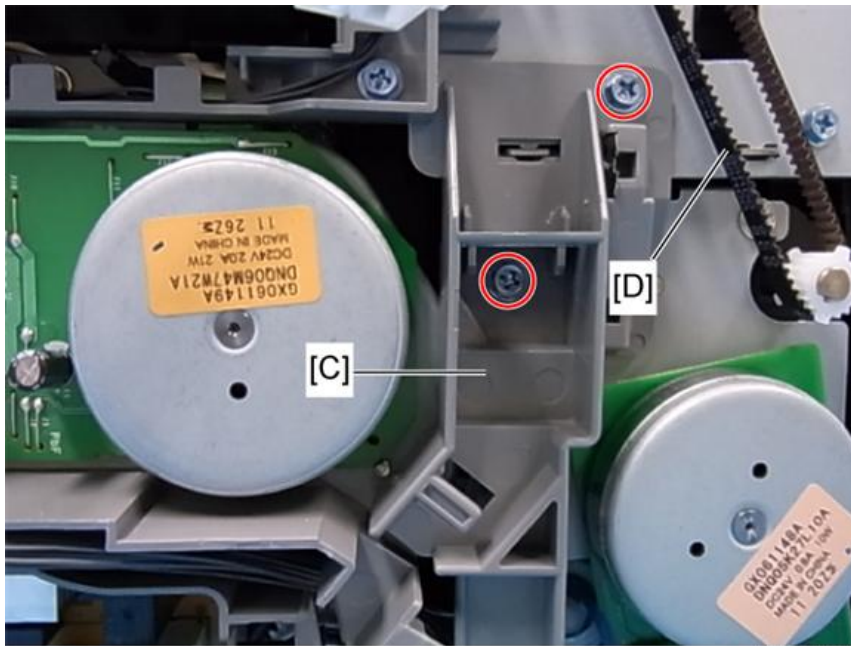

m0950016

6. Transport/Fusing motor assembly [E] ( × 3,  × 3,  × 1, grounding plate [F] × 1)

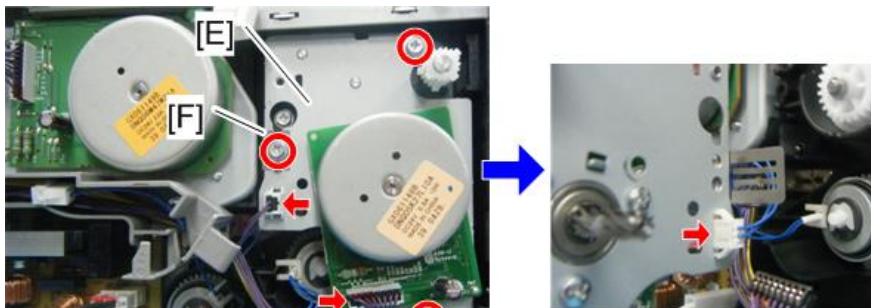

m199e2079

7. Transport/Fusing motor [G] ( × 3)

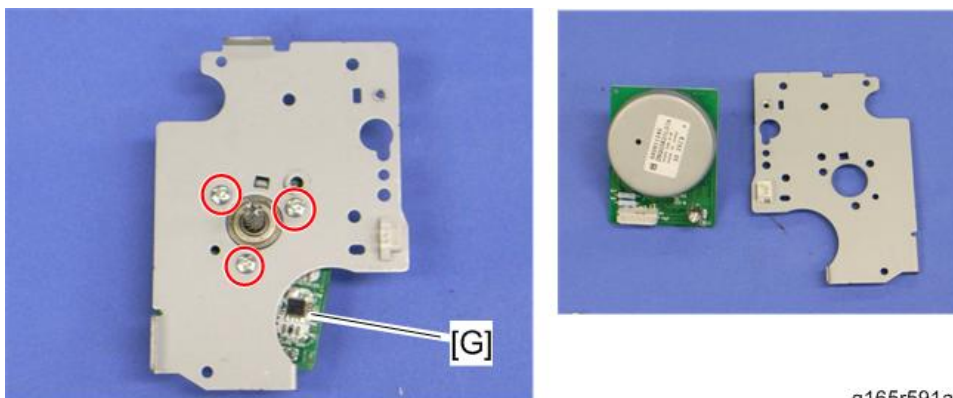

g165r591a

Paper Transfer

Transfer Unit

★ Important

- If you install a complete new unit, execute "Reset 2nd Transfer Unit" with the SP mode, otherwise a paper transfer error may occur.

- 1.** Pull the front cover open lever (1), and open the front cover (2).



- 2.** Release the locks [A].
- 3.** Transfer unit [B]

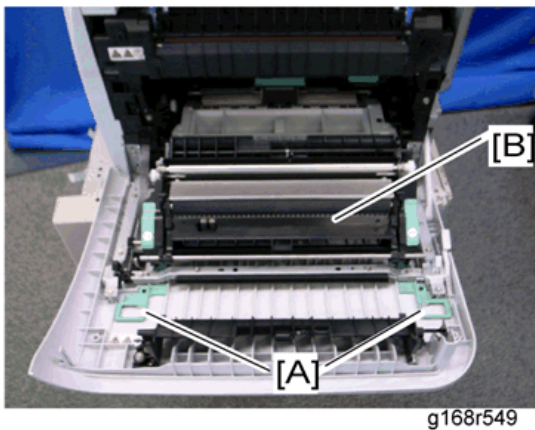

- 4.** If you install a complete new unit, turn on the machine.
- 5.** Enter the SP mode.
- 6.** Execute "Reset 2nd Transfer Unit" in [Engine Service Setting] ([SP Menu \(only for MF Models\)](#))
In the printer models, execute "Reset 2nd" in [Engine Maintenance] ([Service Mode \(only for Printer Models\)](#)).

 Transfer Roller

★ Important

- If you install a new roller, execute "Reset 2nd Transfer Unit" with the SP mode, otherwise a paper transfer error may occur.

1. Transfer Unit (Transfer Unit)
2. Release the two hooks [A] at both sides of the transfer unit.



3. Open the transfer roller unit [B] and remove it.

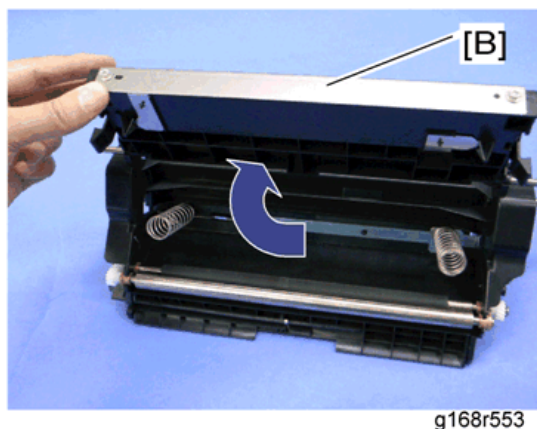

4. Transfer roller assembly [C] ( × 2)

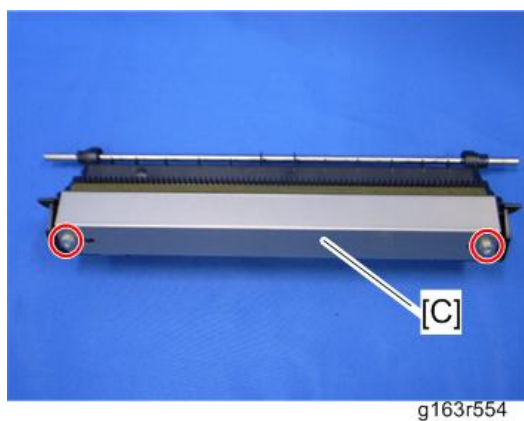

5. Release the holder [D] at the left side of the transfer roller unit (hook).

4.Replacement and Adjustment

6. Transfer roller [E]

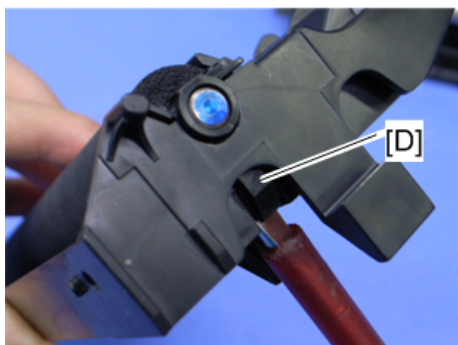

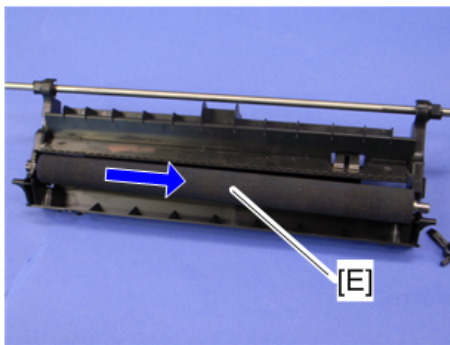

g168r555



g168r556

7. After installing a new roller, turn on the machine.
8. Enter the SP mode.
9. Execute "Reset 2nd Transfer Unit" in [Engine Service Setting] ([SP Menu \(only for MF Models\)](#))
In the printer models, execute "Reset 2nd" in [Engine Maintenance] ([Service Mode \(only for Printer Models\)](#)).

Registration Roller

1. Transfer unit ([Transfer Unit](#))
2. Transfer roller unit ([Transfer Roller](#))
3. Tension springs [A] (both sides)
4. Registration idle roller [B] ( $\times 2$, gear $\times 1$, bushing $\times 2$)
5. Registration roller [C] ( $\times 2$, gear $\times 2$, bushing $\times 2$)

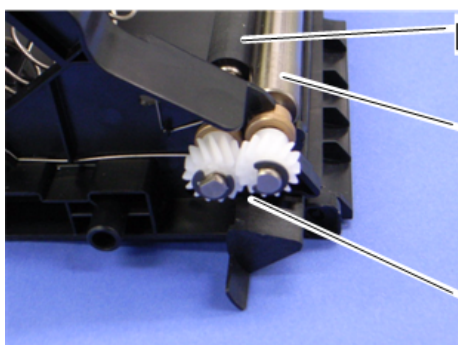

g168r557

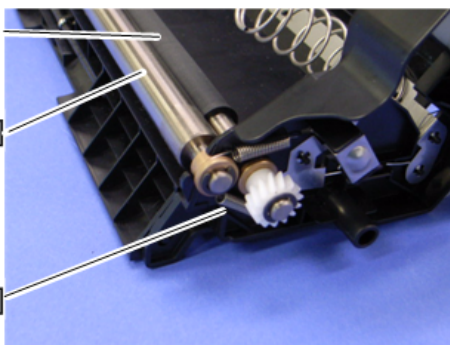



g168r558

Reassembling the registration roller unit

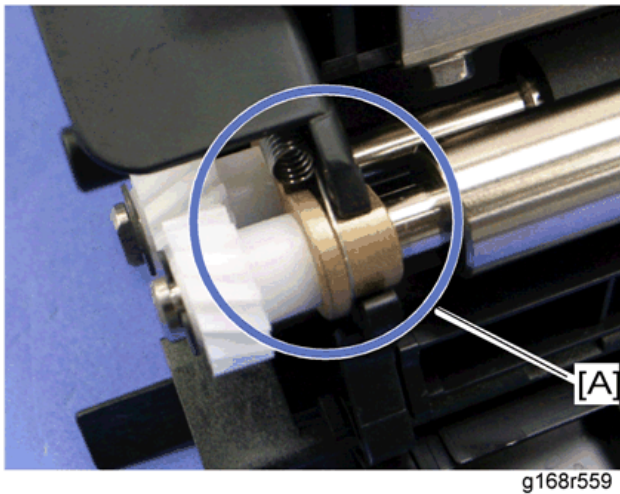
When installing the tension spring, make sure that the tension spring correctly hooks onto the bushing of the registration idle roller as shown below [A].



Registration Sensor

1. Rear cover (Rear Cover)
2. Operation panel (Operation Panel, NFC (MF Models))
3. Right Cover (Right Cover)
4. Registration sensor assembly [A] ( × 1,  × 1)

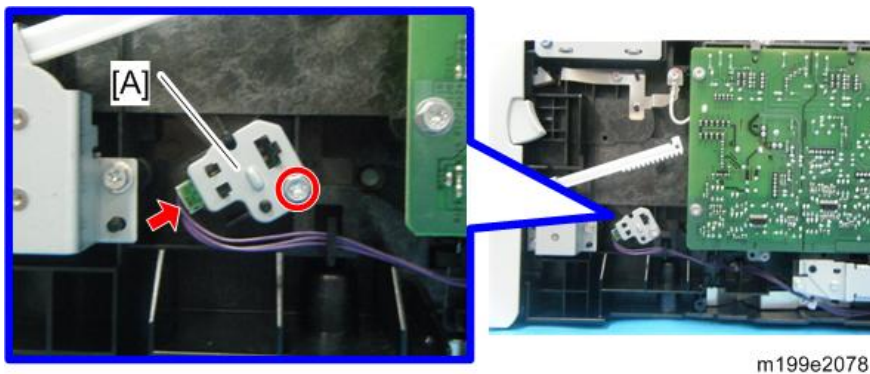

5. Registration sensor [B] (hooks)

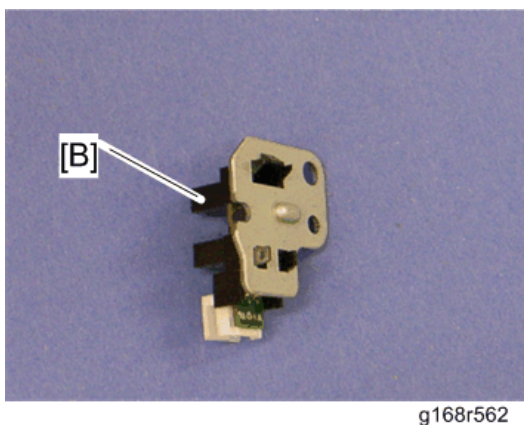

4.Replacement and Adjustment

Registration Clutch

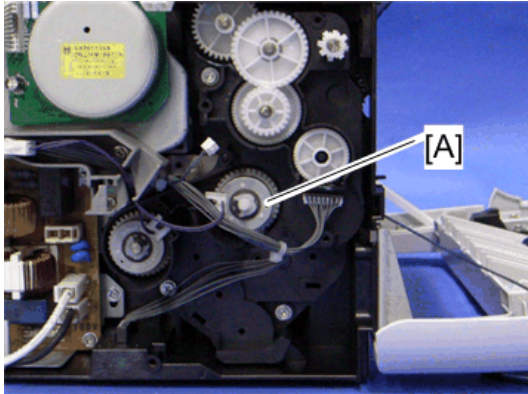

1. Rear cover ([Rear Cover](#))
2. Left cover ([Left Cover](#))
3. Transport/Fusing motor ([Transport/Fusing Motor](#))
4. Registration clutch [A] ( × 1)



g165d592

Paper Feed

Paper Feed Clutch

1. Rear cover ([Rear Cover](#))
2. Left cover ([Left Cover](#))
3. Paper feed clutch [A] ( × 1,  × 1)

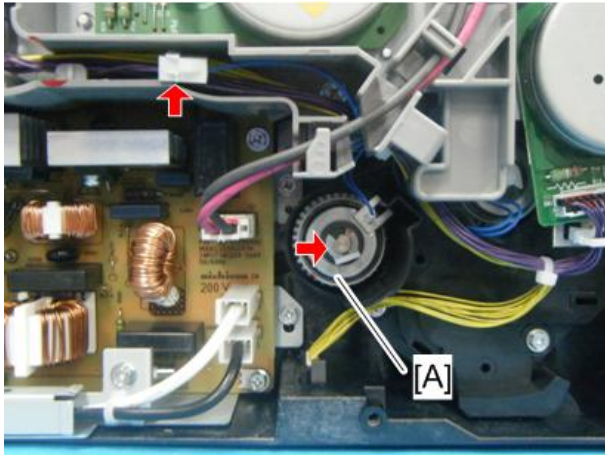

m199e2080

Paper Feed Roller

1. Remove all the AIO cartridges.
2. Remove the waste toner bottle.
3. Rear cover ([Rear Cover](#))
4. Left cover ([Left Cover](#))
5. Paper feed clutch ([Paper Feed Clutch](#))
6. Close the top cover and front cover.
7. Pull out the tray.
8. Stand the machine with the rear side facing the table.



g165r597

4.Replacement and Adjustment

- 9.** Slide the paper feed shaft [A] to the left side. ( × 2)

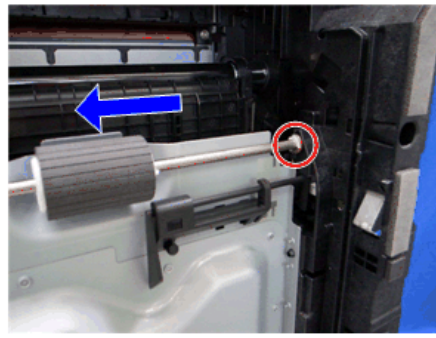
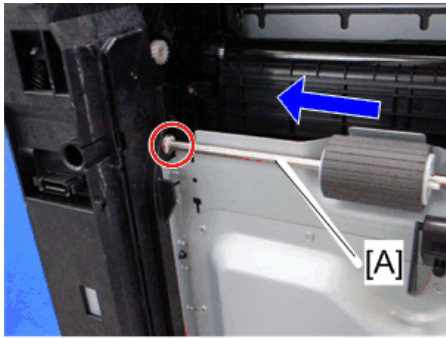

g165r598

- 10.** Paper feed roller [B] (hook)

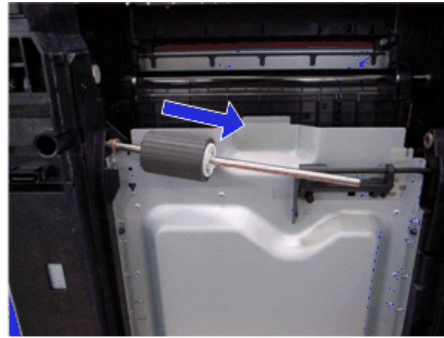
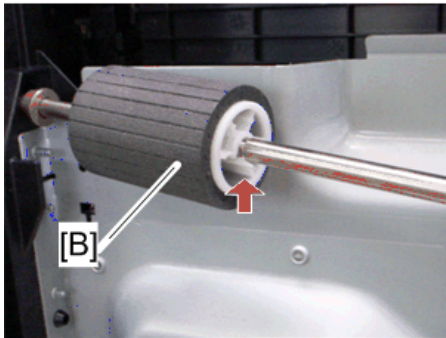

g165r600

Separation Pad

- 1.** Pull out the tray.
- 2.** Push down the bottom plate [A].
- 3.** Separation pad [B] (2hooks, spring × 1)

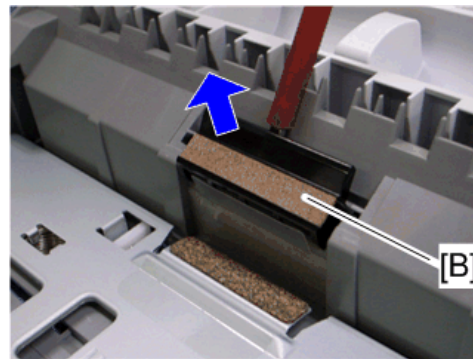
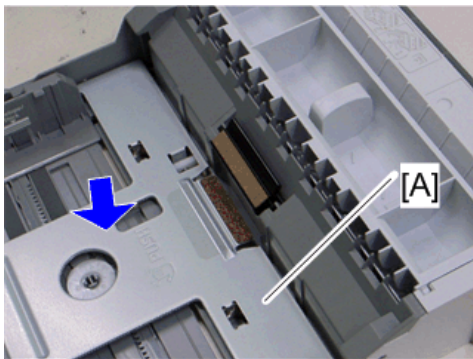

g165r602



Note

- When reinstalling the separation pad, make sure that the Mylar [C] is not placed under the separation

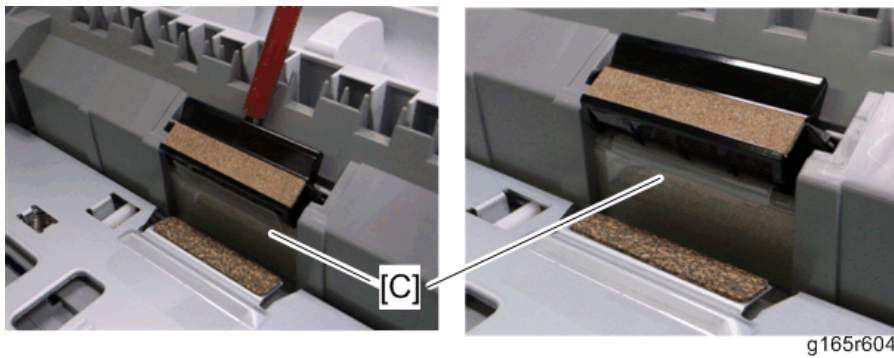
pad. The right side image below shows incorrect installation.



Paper End Sensor

1. Rear cover ([Rear Cover](#))
2. Operation panel ([Operation Panel, NFC \(MF Models\)](#))
3. Right cover ([Right Cover](#))
4. High voltage power supply board ([High Voltage Power Supply Board](#))
5. Paper end sensor assembly [A] ( × 1,  × 1)

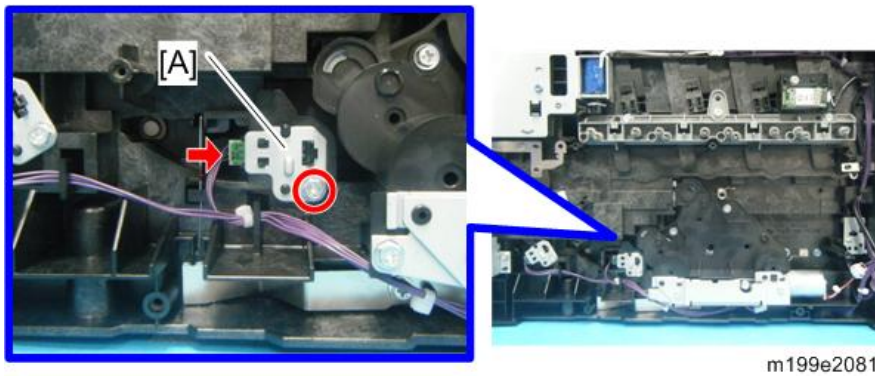

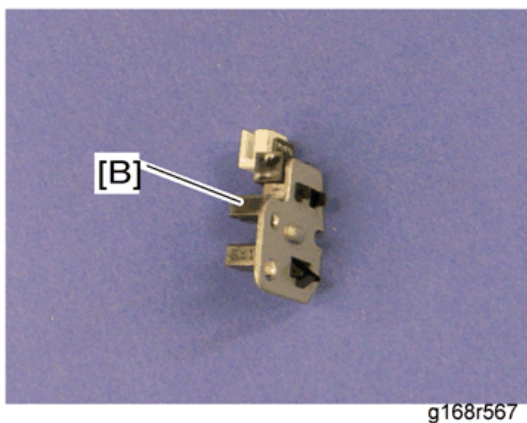

6. Paper end sensor [B] (3hooks)



Paper Exit

Paper Exit Roller

1. Operation panel ([Operation Panel, NFC \(MF Models\)](#))
2. Remove the bushing [A] ( × 1)
3. Pull out the paper exit roller [B] from the right stay, and move its left side towards the front slightly, and then remove it from the mainframe. ( × 1)

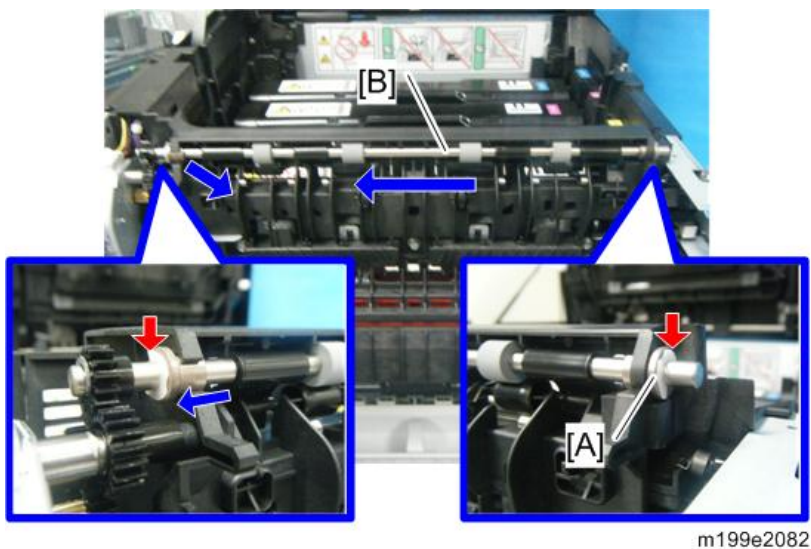

4. Remove the four exit guides [C] and gear [D]. ( × 1, bushing × 1)

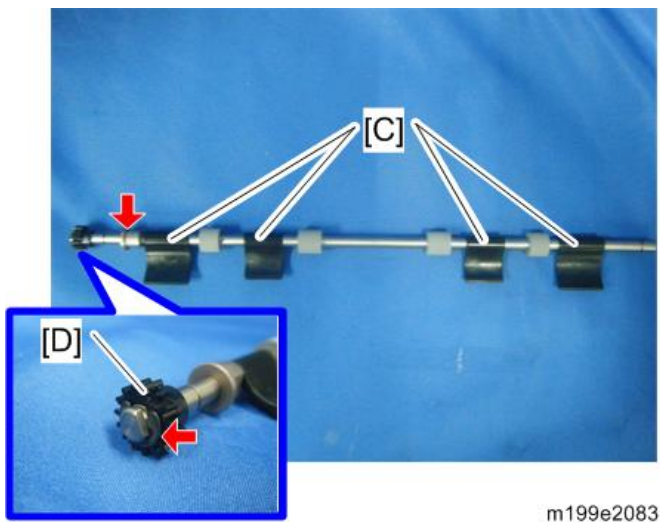

Paper Exit Sensor

1. Rear cover ([Rear Cover](#))
2. Operation panel ([Operation Panel, NFC \(MF Models\)](#))
3. Right cover ([Right Cover](#))

4. Fusing stripper pawl solenoid assembly [A] ( × 4)

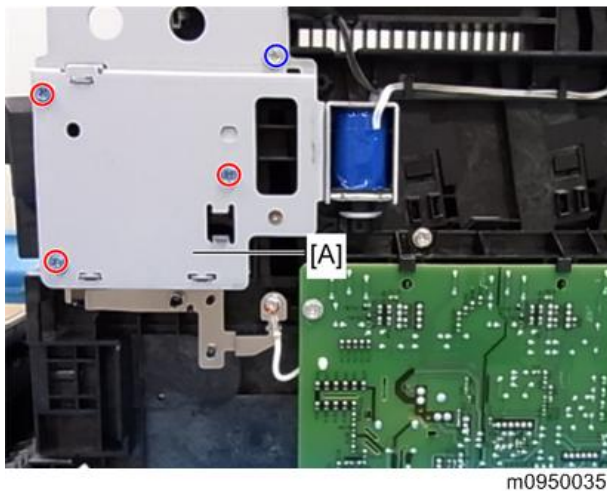

 Note

- The upper right screw in the above photo is different from other 3 screws.

5. Remove the paper exit sensor [C] while lightly pressing the feeler [B] in the direction shown by the arrow (4 hooks,  × 1).

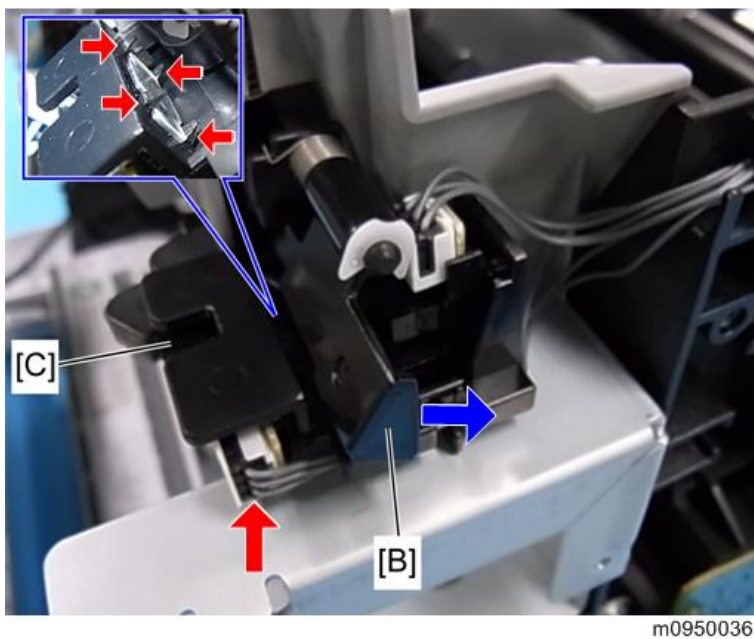

Electrical Components

Controller Board

★ Important

When you replace the controller board, the following counters stored on the controller board are cleared:

- Copier counter
- Scanner counter
- Facsimile counter
- Coverage counter
- Jam counter
- Economy color print counter

The printer counter does not clear.

Controller Board (Printer Models)

- 1.** Rear cover (Rear Cover)
- 2.** Controller box cover [A] ( × 6)

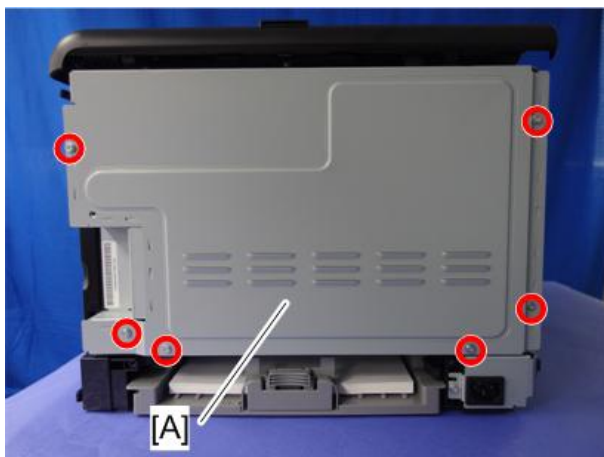

m199e2032

- 3.** Interface bracket [B] ( × 3)

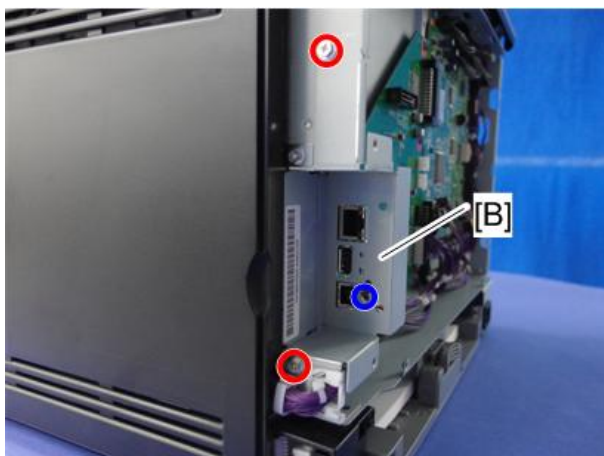

m199e2033

Note

- The middle screw in the above photo is different from the other 2 screws.

4. Controller board [C] ( × 5,  × 2)



m199e2034

Controller Board (MF Models)

- 1.** Rear cover (Rear Cover)
- 2.** Controller box cover [A] ( × 7)

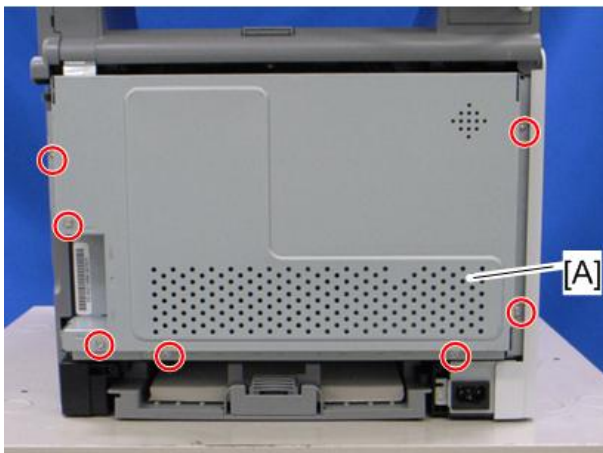

g165r505a

4.Replacement and Adjustment

3. Interface bracket [B] (× 3)

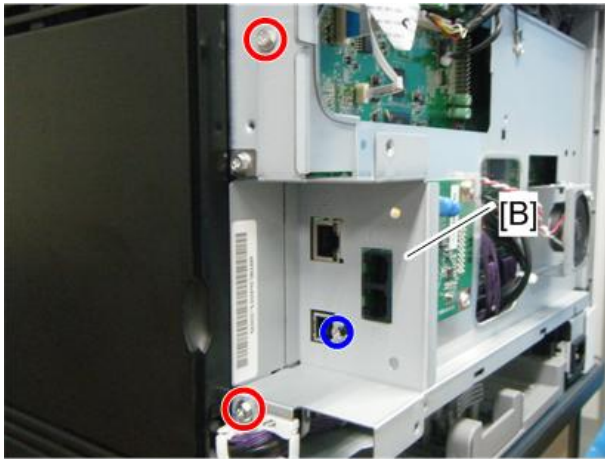

m199e2035

Note

- The middle screw in the above photo is different from the other 2 screws.

4. Disconnect the FFCs, and then remove the ferrite core [A].

SP C260SFNw: two FFCs

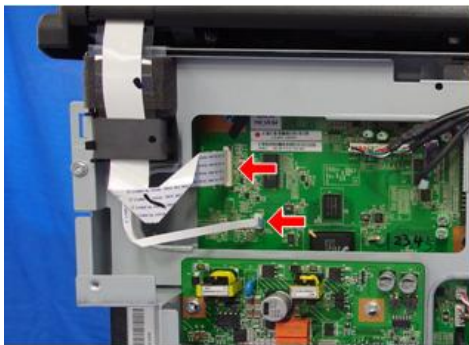

 x2

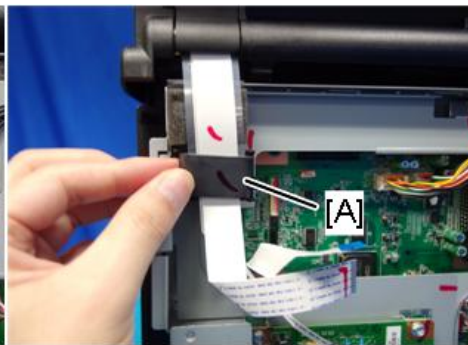

m0azm0006_2

SP C262SFNw: three FFCs



 x3

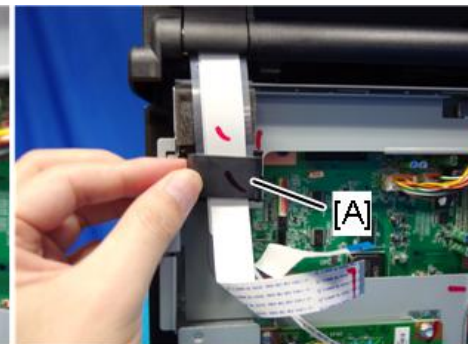

m0azm0006

5. Disconnect the speaker harness.

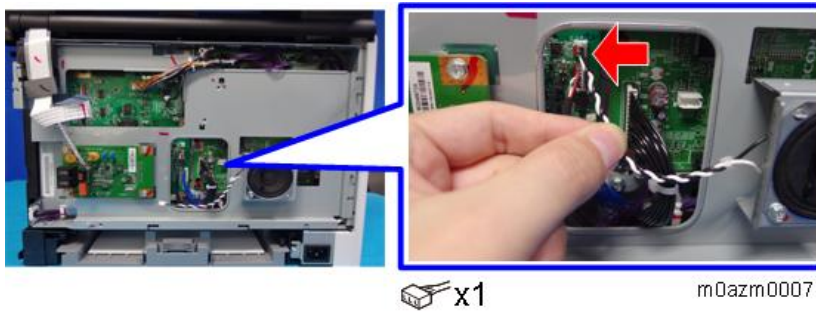

6. Ground wire.

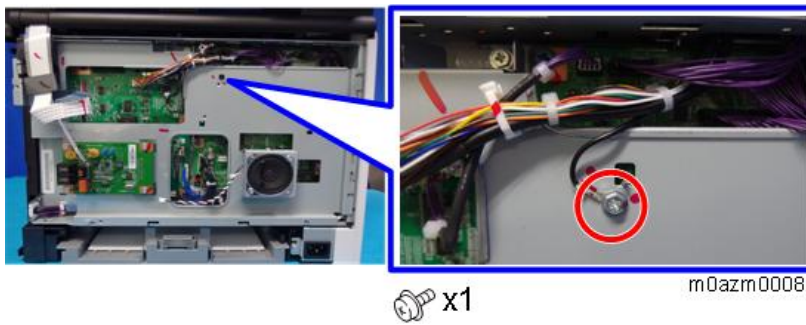

7. Controller board bracket with the speaker [A].

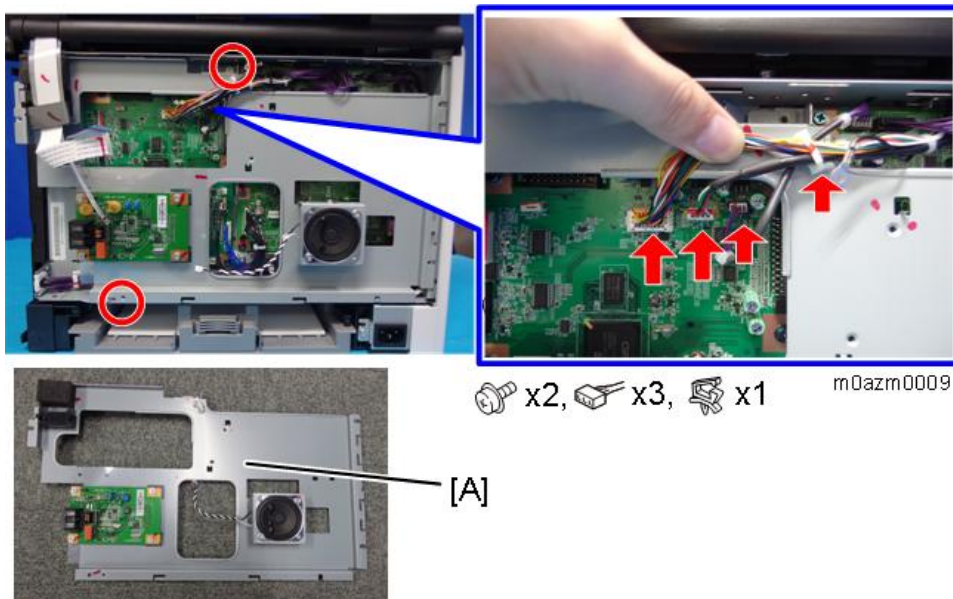

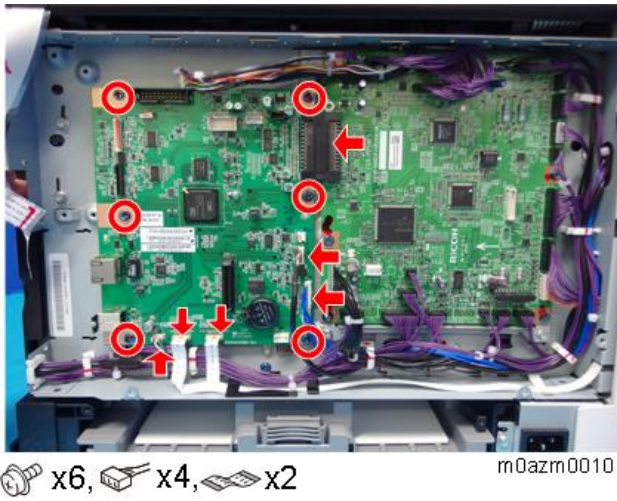

4.Replacement and Adjustment

8. Controller board



EGB (Engine Board)

EGB (Printer Models)

1. Rear cover ([Rear Cover](#))
2. Controller box cover ([Controller Board](#))
3. EGB [A] ( × 6, all  s)



4. EEPROM [B]



m0950024

When installing the new EGB

1. Remove the EEPROM from the old EGB.
2. Install it on the new EGB with the mark [A] pointing to the right side of the board after you replace the EGB.

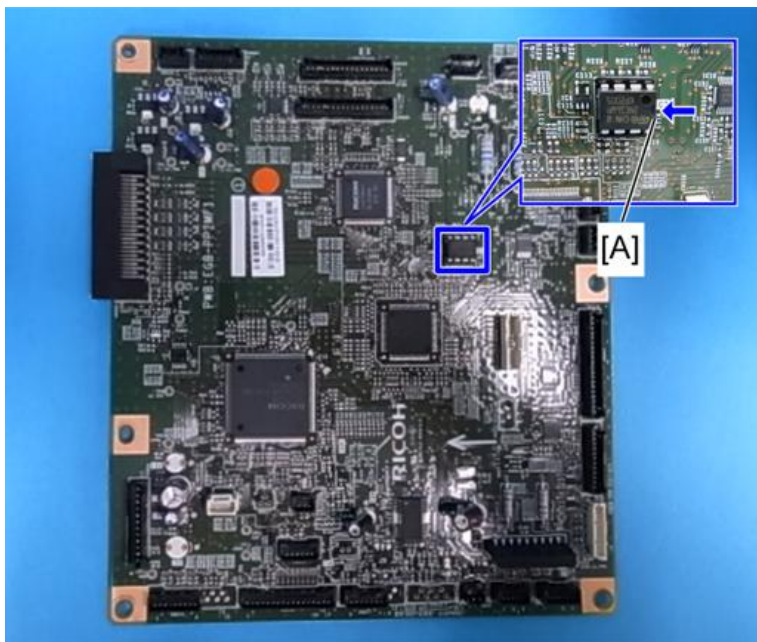

m0950025



3. Replace the EEPROM if the EEPROM on the old EGB is defective.
For detailed information such as which items are cleared, refer to “[EEPROM](#)”.

⚠ CAUTION

- Keep the EEPROM away from objects that can cause static electricity. Static electricity can damage EEPROM data.
- Make sure that the EEPROM is correctly installed on the EGB.

4.Replacement and Adjustment

EGB (MF Models)

1. Rear cover ([Rear Cover](#))
2. Controller box cover ([Controller Board](#))
3. FCU and Speaker bracket ([Controller Board](#))
4. EGB [A] (all s,  × 6)

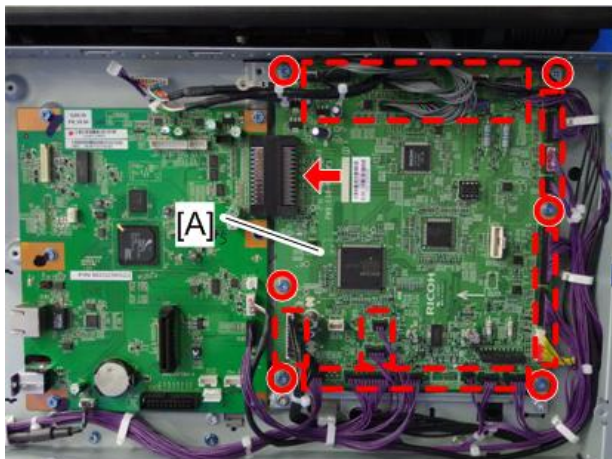

m199e2040

5. EEPROM [B]

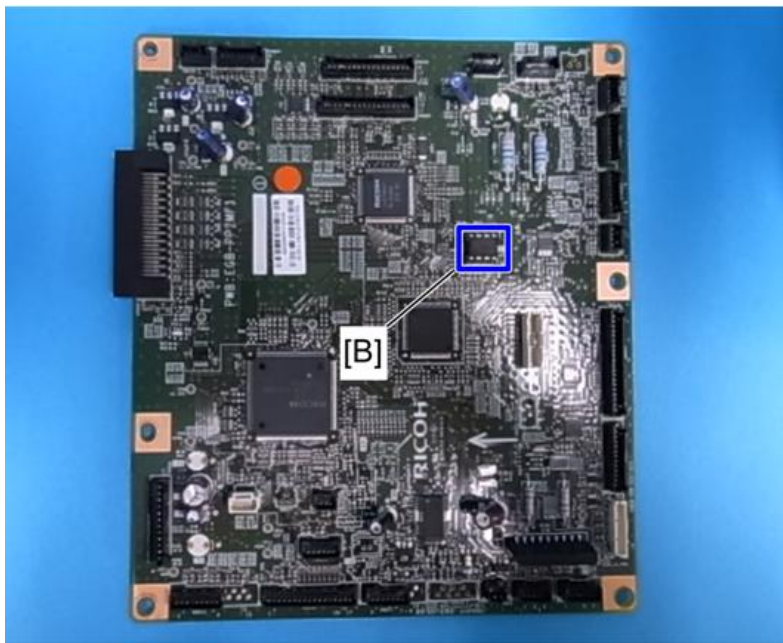

m0950024

When installing the new EGB

1. Remove the EEPROM from the old EGB.

2. Install it on the new EGB with the mark [A] pointing to the right side of the board after you replace the EGB.

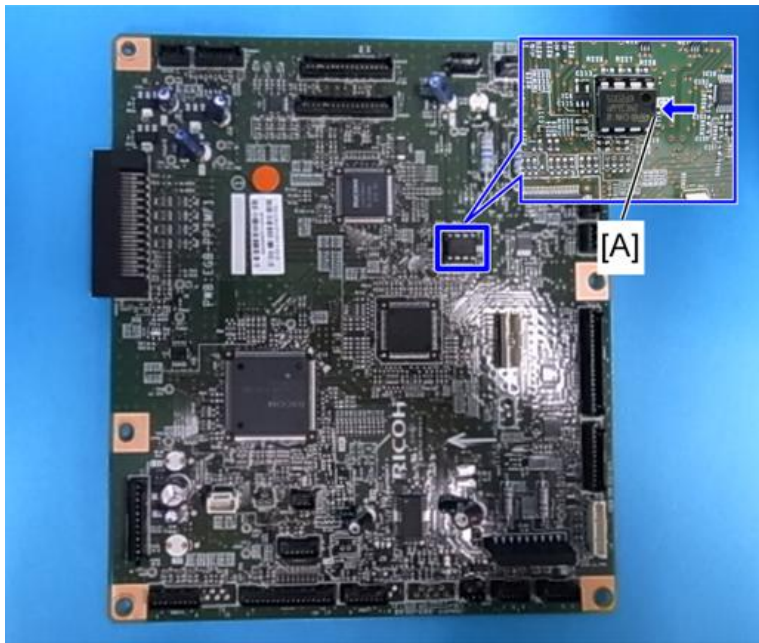

m0950025

3. Replace the EEPROM if the EEPROM on the old EGB is defective.
For detailed information such as which items are cleared, refer to “EEPROM”.

⚠ CAUTION

- Keep the EEPROM away from any objects that can cause static electricity. Static electricity can damage EEPROM data.
- Make sure that the EEPROM is correctly installed on the EGB.

FCU (only for MF Models)

1. Rear cover (Rear Cover)
2. Controller box cover (Controller Board)
3. Interface bracket (Controller Board)
4. FCU [A] ( × 4)

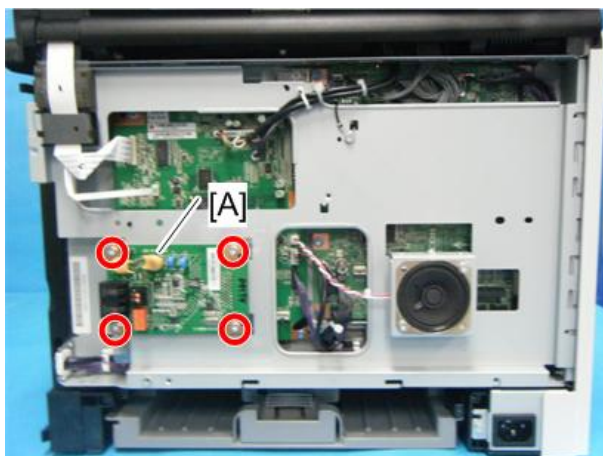

m199e2041

4.Replacement and Adjustment

Operation Panel

Operation Panel (Printer Models)

- 1.** Open the top cover.

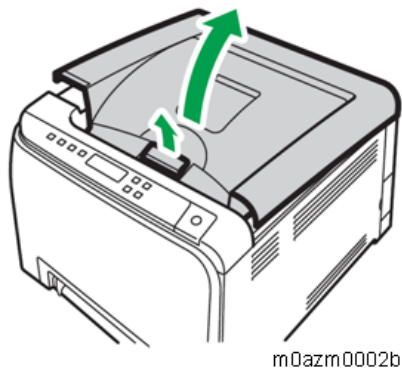

- 2.** Pull the front cover open lever (1), and open the front cover (2).

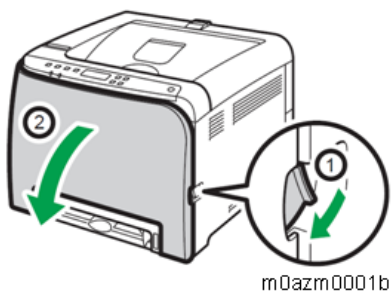

- 3.** Front harness cover [A].

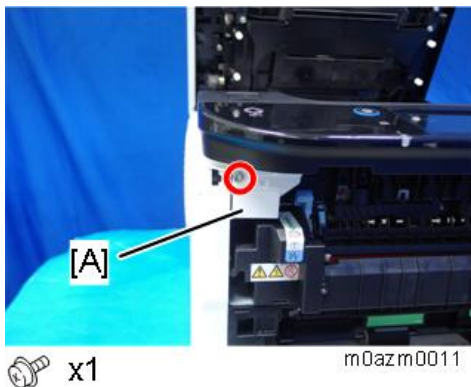

- 4.** Remove the screw securing the operation panel on the machine's right side.



- 5.** Disconnect the harness on the back of the operation panel (🔌 x 1).



m198d4907



m0azm1002

Operation Panel, NFC (MF Models)

1. Open the top cover.

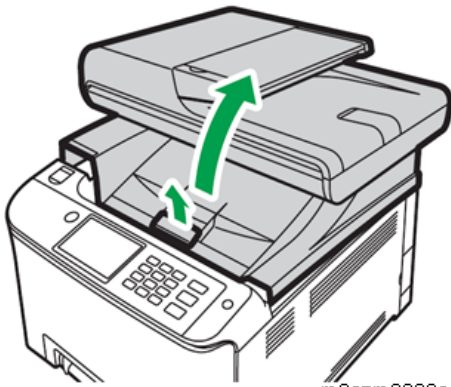

m0azm0002a

2. Pull the front cover open lever (1), and open the front cover (2).



m0azm0001a

4.Replacement and Adjustment

3. Front harness cover [A].

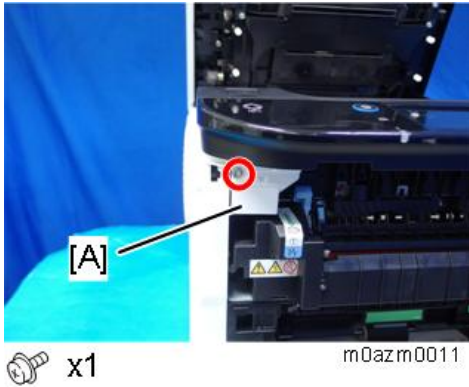

4. Remove the screw securing the operation panel on the machine's right side.



5. Standing at the front of the machine, pull and slide the operation panel toward you so it turns over, remove the 1 connector and 2 FFCs at the left side, and then remove the operation panel.

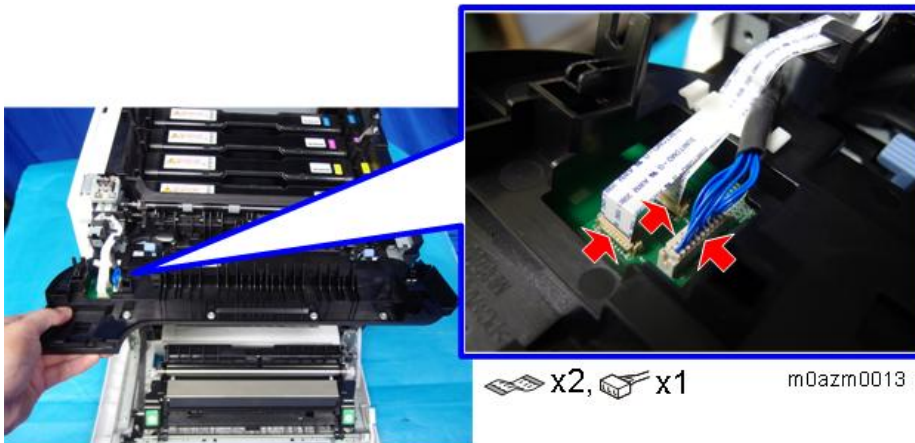

Note

The FFCs are locked. Lift the tabs on their connectors to unlock them, and then remove them.

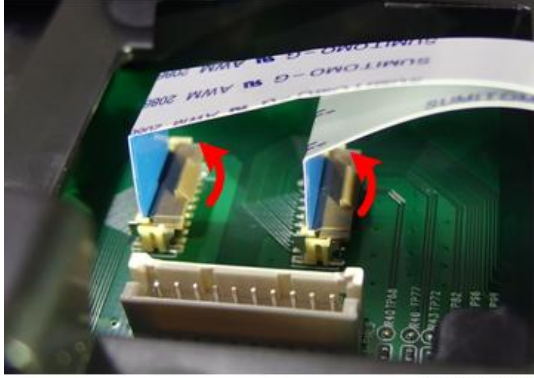

m0azm0013

- 6.** Turn the operation panel over, and then remove its back cover [A].

4.Replacement and Adjustment



m0azm0014

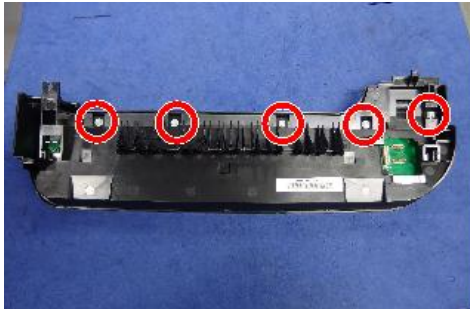

 x5

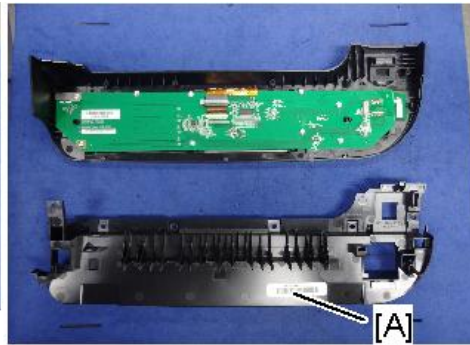

m0azm0016

7. Remove the NFC board [A].

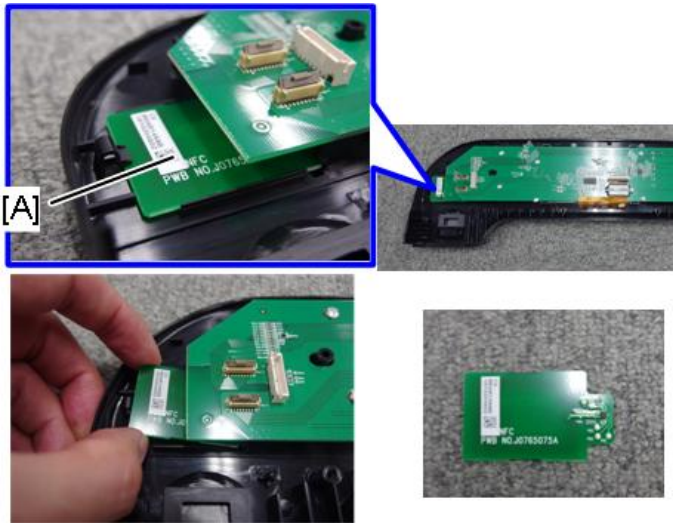

m0azm0082

OPU, NFC (only for Printer Models)

1. Operation panel (Operation Panel (Printer Models))

2. Remove the key and display assembly [A] from the operation panel.

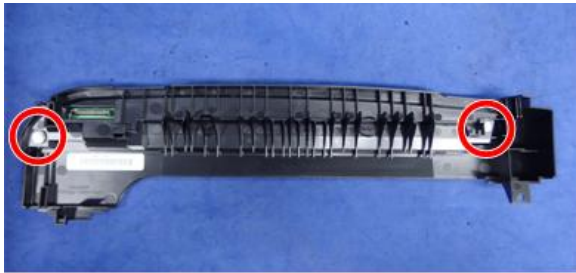

 x2

m0azm1003

3. Separate the operation panel [B] and its back cover [A].

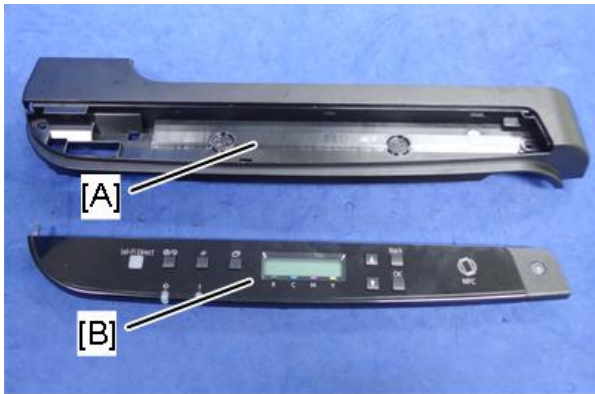

m0azm1005

Note

Before separating them, be sure to disengage all 3 hooks.



m0azm1004

4.Replacement and Adjustment

4. OPU [A]

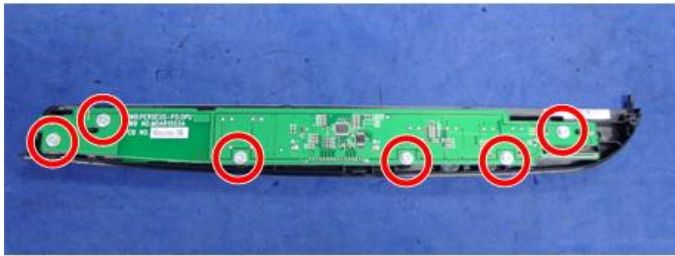

 x6



m0azm1006

5. NFC [A]





m0azm1007

6. After assembly, check that you can press all the keys smoothly without them catching.

Wi-Fi Board

1. Rear cover ([Rear Cover](#))
2. Operation panel ([Operation Panel](#), [NFC \(MF Models\)](#))
3. Right cover ([Right Cover](#))

4. Remove the Wi-Fi Board [A] with the bracket. ( × 1,  × 1)

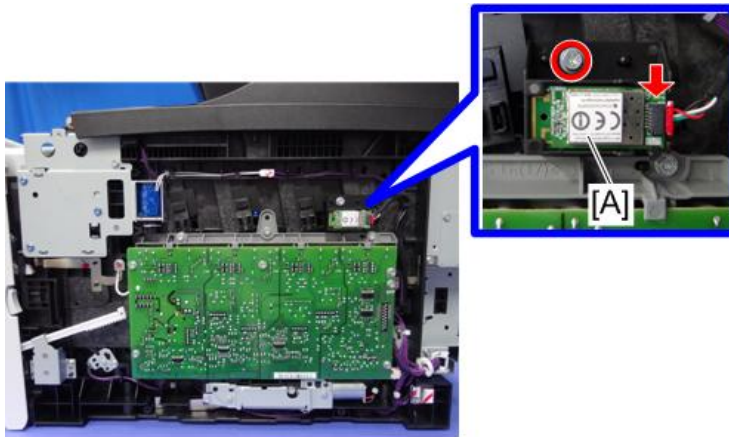

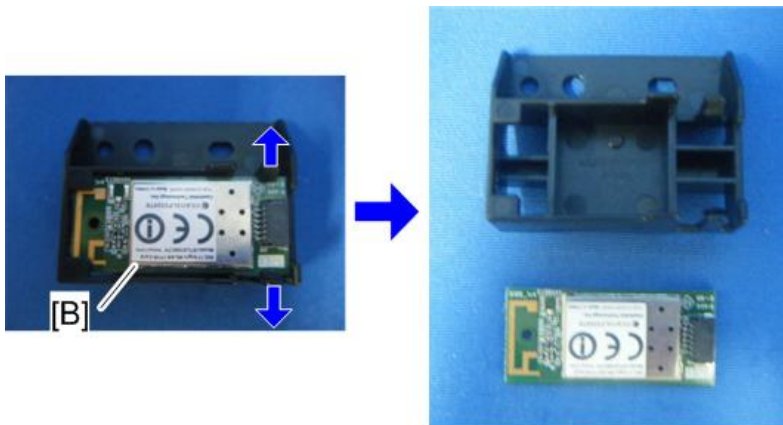

m199e2038

5. Remove the Wi-Fi Board [B] from the bracket.



m199e2084

Interlock Switches

1. Left cover (Left Cover)
2. Interlock switch base [A] ( × 4,  × 4)

Note

- Removing the spring [B] first makes this procedure easier.
- Remove all the connectors after the interlock switch base has been removed.

4.Replacement and Adjustment

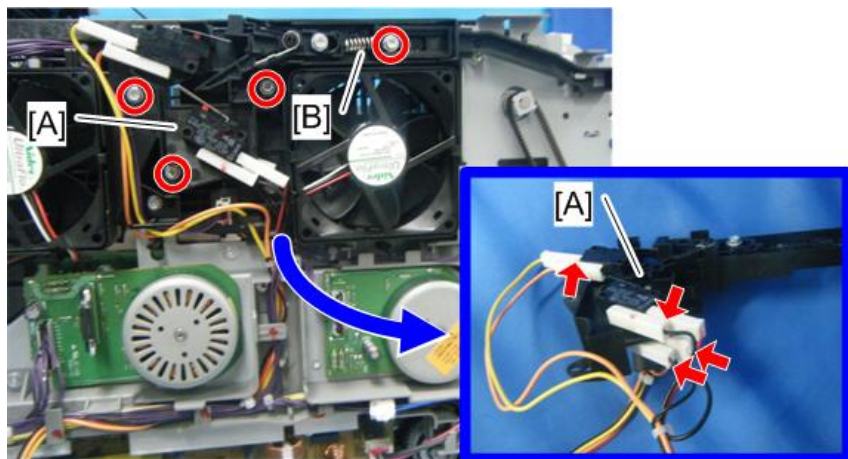

m199e2085

3. Two interlock switches [C] and [D] at the outside of the base and one interlock switch [E] at the inside of the base (hook ×1 each)

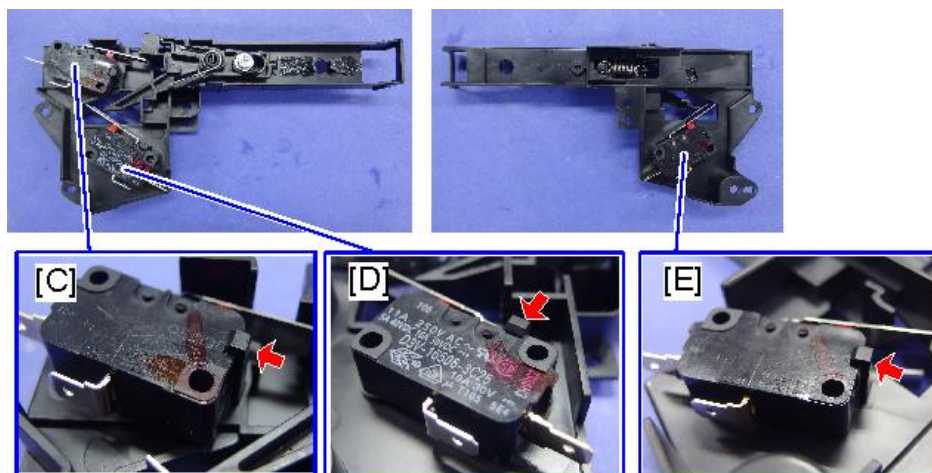

m0azm0086

Fusing Fan Motor

1. Left cover (Left Cover)
2. Interlock switch base (Interlock Switches)
3. Fusing fan base [A] (⚙ × 2, 📦 × 1)

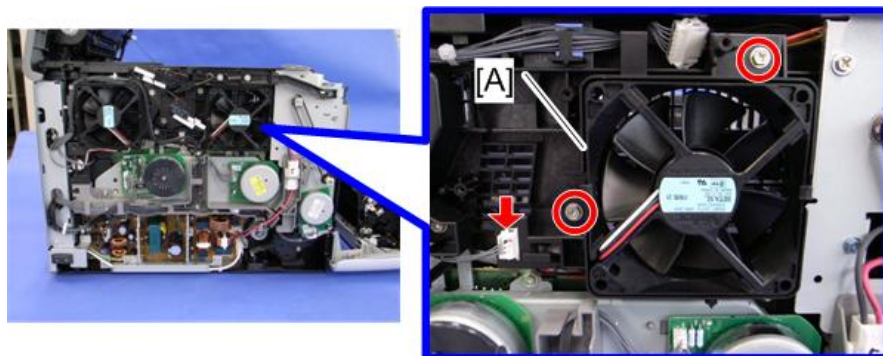

m199e2049

4. Fusing fan motor [B] (2hooks,  × 1)

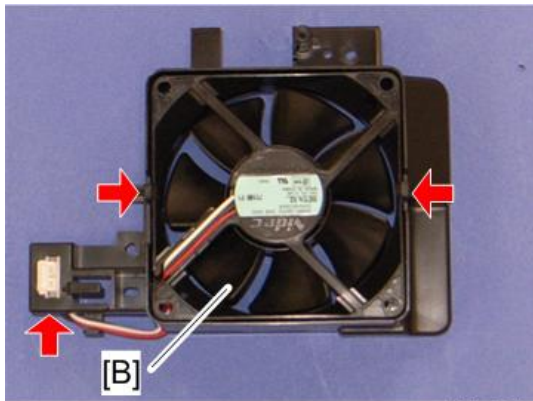



g165r624

⚠ CAUTION

- Install the fusing fan motor with its decal facing the outside of the machine.

Fusing Stripper Pawl Solenoid

1. Open the front cover.
2. Open the top cover.
3. Rear cover ([Rear Cover](#))
4. Operation panel ([Operation Panel, NFC \(MF Models\)](#))
5. Right cover ([Right Cover](#))
6. Fusing stripper pawl solenoid assembly [A] ( × 4,  × 1)

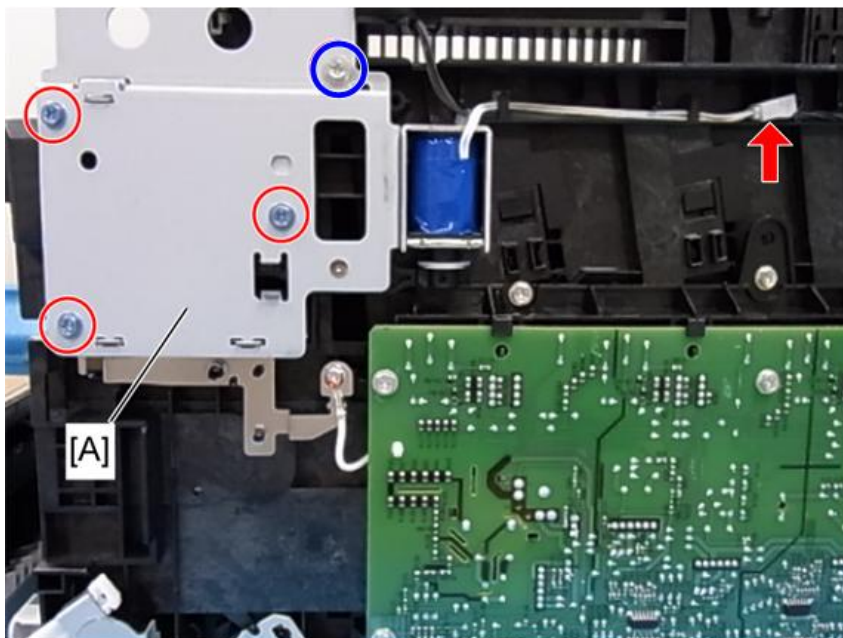

m199e2086

Note

- The upper right screw in the above photo is different from other 3 screws.

4.Replacement and Adjustment

7. Fusing stripper pawl solenoid [B] (× 2)

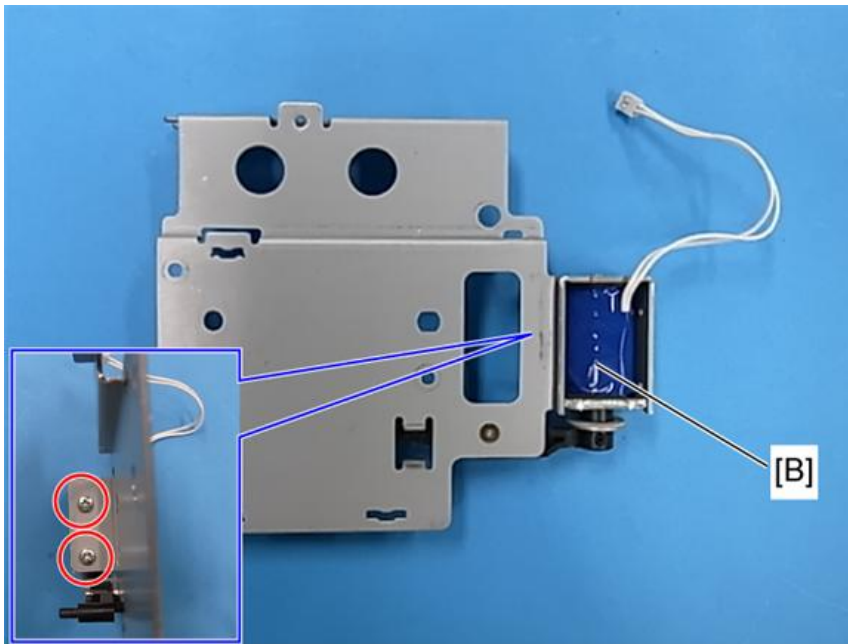

m0950019

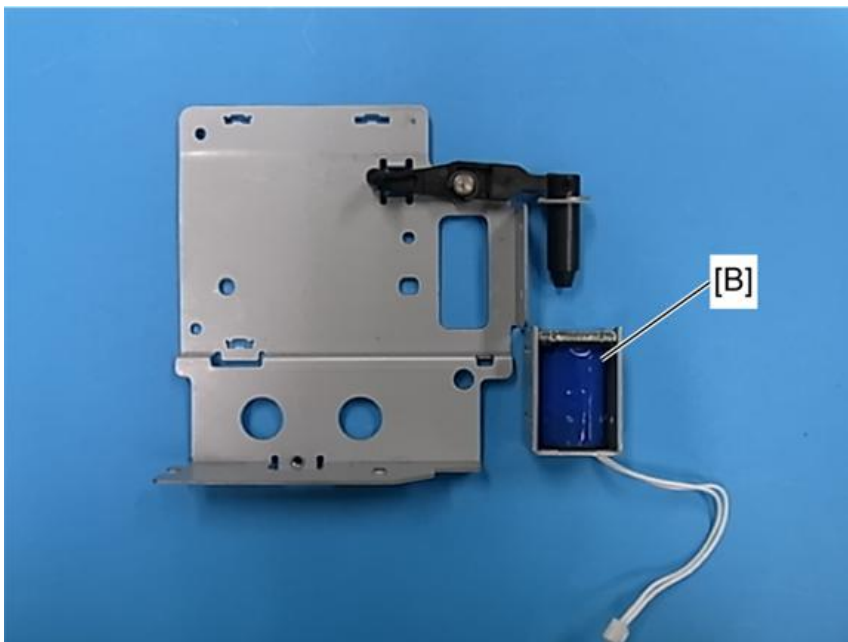

m0950020

Fusing Pressure Release Sensor

1. Fusing stripper pawl solenoid assembly (Fusing Stripper Pawl Solenoid)

2. Fusing pressure release sensor ( [A] × 1, 4hooks)

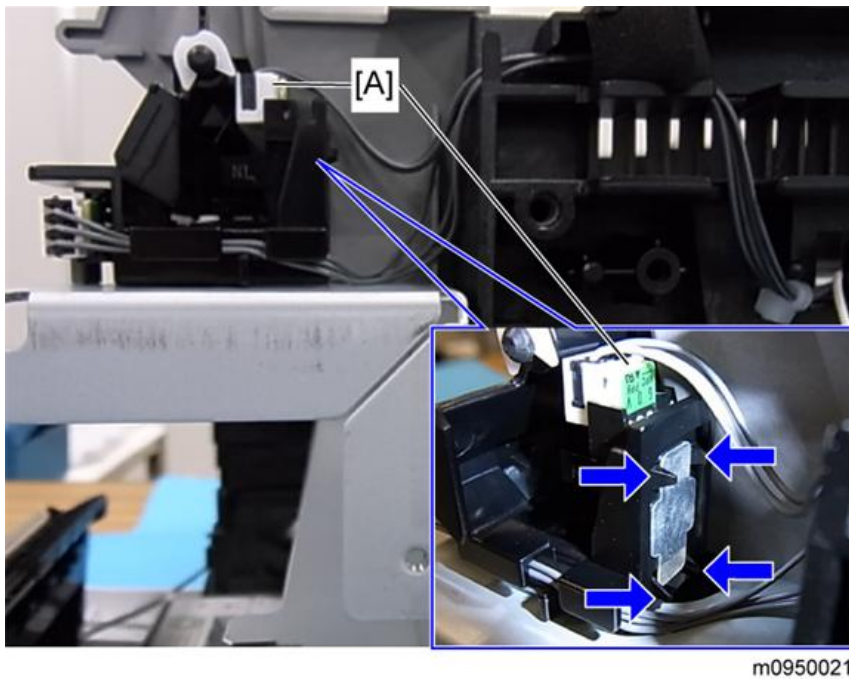

LSU Fan Motor

1. Left cover ([Left Cover](#))
2. LSU fan motor [A] (2hooks,  × 1)

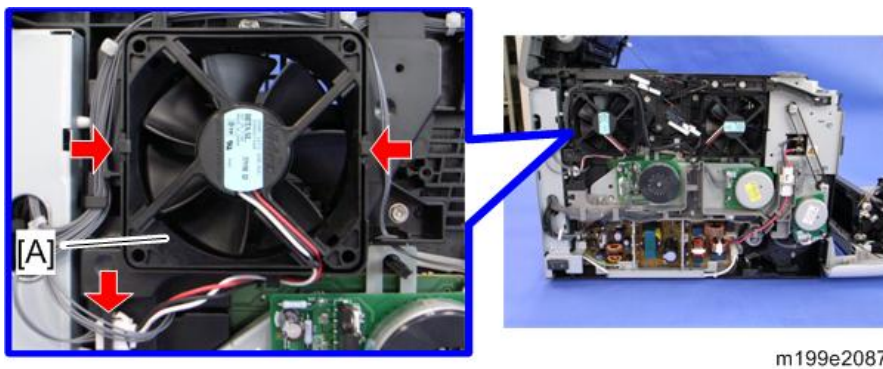

CAUTION

- Install the LSU fan motor with its decal facing the outside of the machine.

ID Chip Board

1. Rear cover ([Rear Cover](#))
2. Left cover ([Left Cover](#))
3. Controller box cover ([Controller Board](#))
4. Only for MF Models: FCU and Speaker bracket ([Controller Board](#))
5. Disconnect the connector (CN305) on the EGB.
6. Interlock switch base ([Interlock Switches](#))

4.Replacement and Adjustment

7. Fusing fan base (Fusing Fan Motor)

8. Drive unit (Black AIO Motor)

9. Take the harnesses aside around the LSU fan base [A].

10. LSU fan base [A] ( × 2,  × 1)

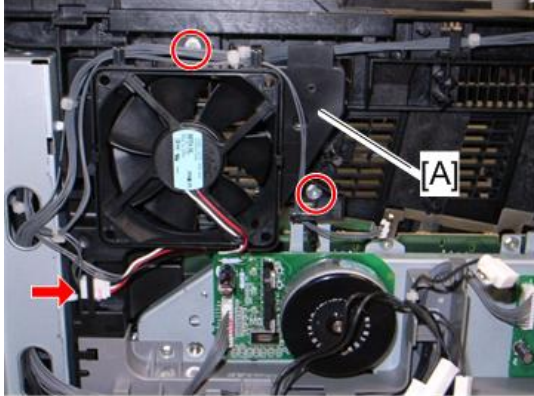

g165r626

11. ID Chip Board [B] ( × 3)

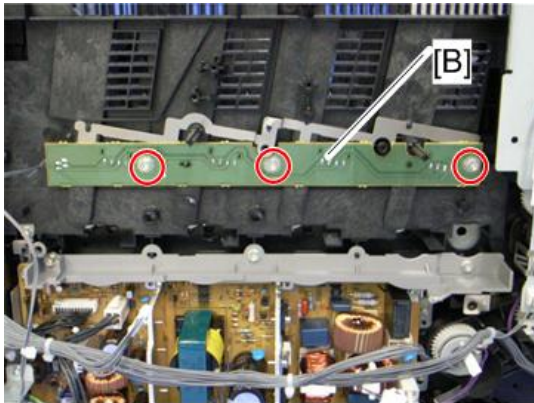

g165r627

PSU

DANGER

- Turn off the main power switch and unplug the power cord before replacing the PSU.
- Do not touch the areas outlined in red [A] in the following diagrams when replacing the PSU. Residual charge on the board may cause electric shock.

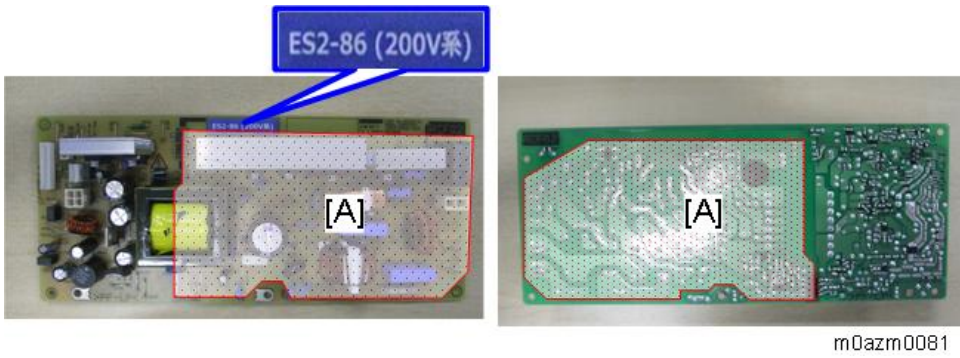
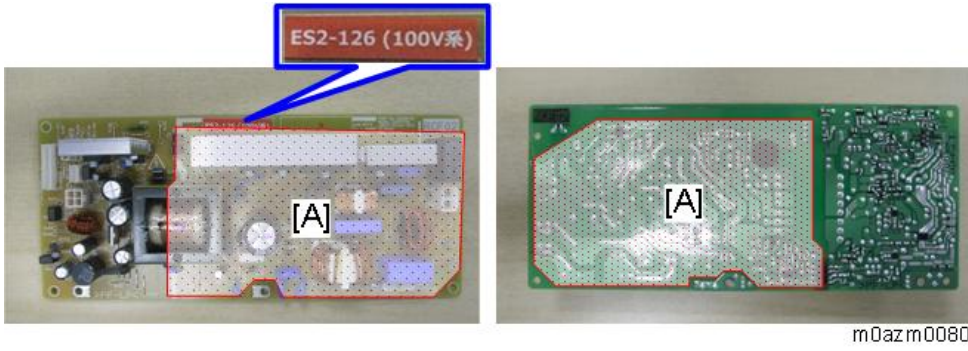

1. Left cover (Left Cover)
2. Harness guide (Black AIO Motor)
3. Power cord bracket [A].

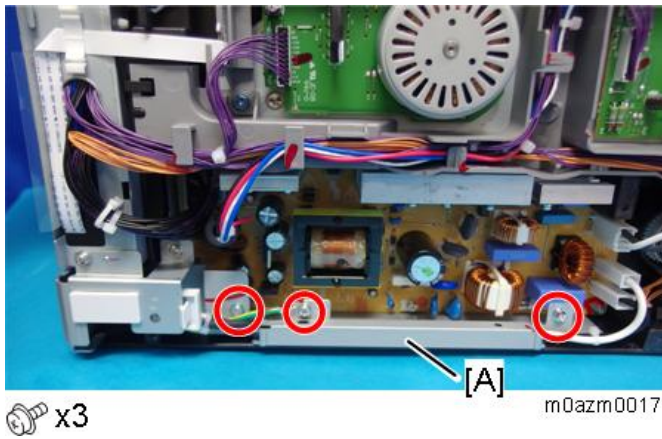

4.Replacement and Adjustment

4. Power switch bracket [A]

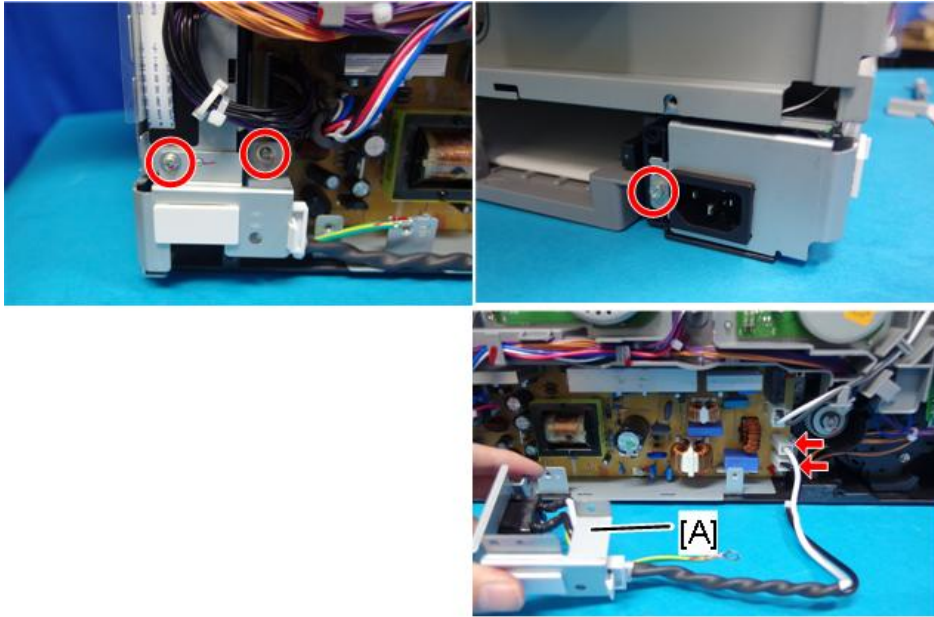

⚙️ x3, 📦 x2

m0azm0019

5. PSU assembly [D] (⚙️ × 4, 📦 × 5)

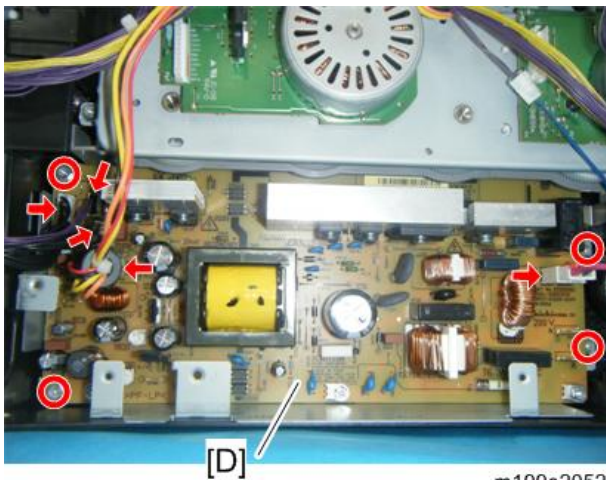

m199e2052

6. PSU [E] (⚙️ × 4)

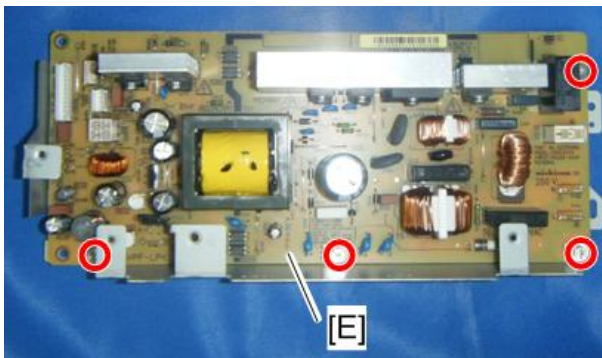

m199e2053

High Voltage Power Supply Board

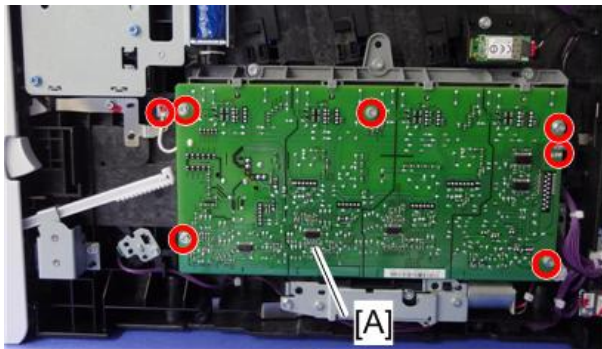

1. Rear cover (Rear Cover)

2. Operation panel (Operation Panel, NFC (MF Models))
3. Right cover (Right Cover)
4. High Voltage Power Supply Board [A] ( × 6, High voltage line × 1)



m199e2054

Temperature/Humidity Sensor

1. Rear cover (Rear Cover)
2. Operation panel (Operation Panel, NFC (MF Models))
3. Right cover (Right Cover)
4. Temperature/Humidity sensor [A] ( × 1,  × 1)

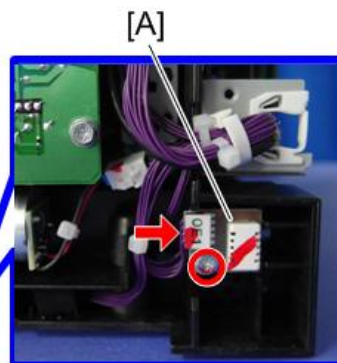
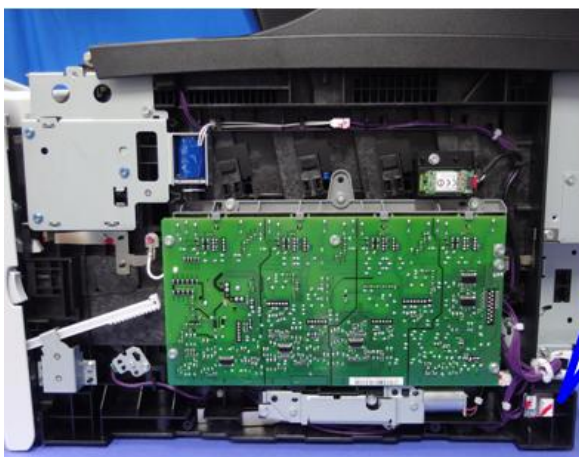

m199e2055

4.Replacement and Adjustment



Duplex Motor

1. Operation panel (Operation Panel, NFC (MF Models))
2. Left cover (Left Cover)
3. Interlock switch base (Interlock Switches)
4. Disconnect the fusing connector [A] and remove the fusing relay harness [B] (2hooks).

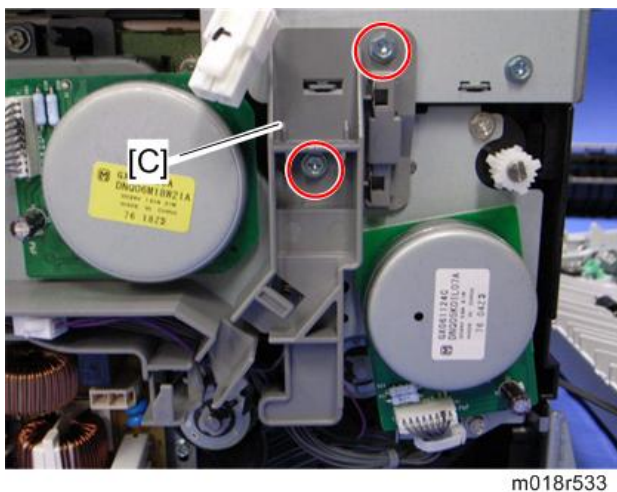

5. Fusing harness guide [C] ( × 2)



6. Fusing thermistor harness guide [D] ( × 2,  × 1)

7. Duplex timing belt [E]

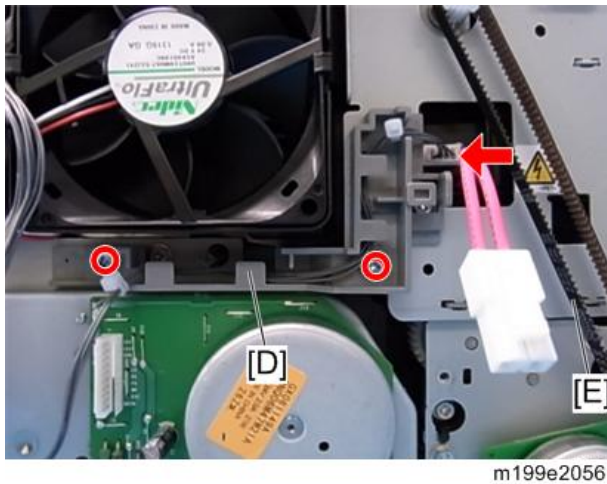

8. Left bracket [F] (Printer models:  × 5, MF Models:  × 6 including [G])

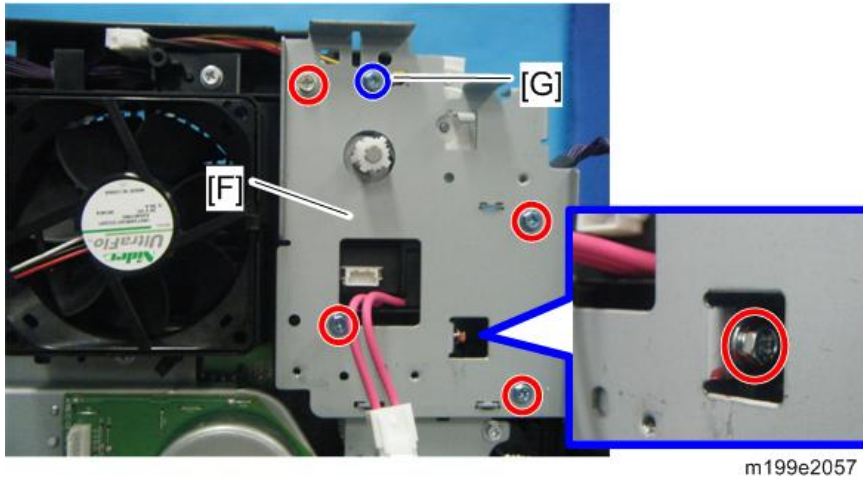

9. Duplex motor [H] ( × 2,  × 1)

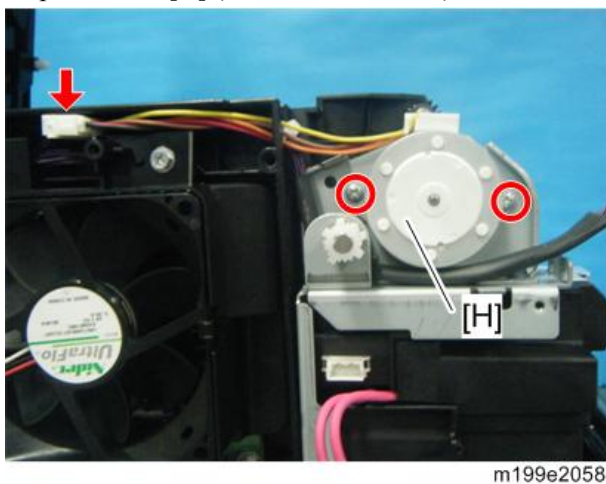

Speaker (only for MF Models)

- 1.** Rear cover (Rear Cover)
- 2.** Controller box cover (Controller Board)

4.Replacement and Adjustment

3. Speaker [A]



EEPROM

Note

- Replacement and Reinstallation procedures for the EEPROM are included in the [EGB \(Engine Board\)](#) replacement procedure. Refer to [EGB \(Engine Board\)](#) for details.

When replacing an old EEPROM with a new EEPROM, EEPROM setting is required. Follow the EEPROM setting procedure described below.

Important

- When you replace the EEPROM, the following counters stored on the EEPROM are cleared:
 - Machine total counter (total page, full color, and B&W)
 - Error log (listed as “Call Service” on Maintenance Page)
 - Duplex page counter
- Do the following steps 1 to 14 with the front cover of the machine open.

1. Open the front cover and turn on the machine.

Note

- The machine may issue an error code (because the cover is open), but continue this procedure.

2. Enter the SP mode.

3. Execute "Init Engine EEPROM" in [Engine Service Setting].

In the printer models, execute "Init. Eng. ROM" in [Engine Maintenance].

EEPROM Initialization starts.

4. Exit the SP mode.

5. Enter the mode for inputting a machine serial number.

Note

- Ask your supervisor about how to access the serial number input display.

6. Input the machine serial number.

7. Exit the serial number input display, and then enter the SP mode again.

8. Select a destination.

- MF model: [SP Menu] > [Engine Service Setting] > [Destination]
- Printer Model: [Service Mode] > [Engine Maintenance] > [Destination]

- 9.** Select a model.
- MF model: [SP Menu] > [Engine Service Setting] > [Model]
 - Printer Model: [Service Mode] > [Engine Maintenance] > [Model]
- 10.** Enter a plug and play name.
- MF model: [SP Menu] > [Engine Service Setting] > [PnP Name]
 - Printer Model: [Service Mode] > [Engine Maintenance] > [PnP Name]
- Enter the following plug and play name according to the model:
- SP C260SFNw/SP C260DNw: 0x10
- SP C262SFNw/C262SFNw/SP C262DNw/C262DNw: 0x14
- 11.** Write the LD parameters of the laser optics housing unit to the new EEPROM.
- MF model: [SP Menu] > [Engine Service Setting] > [Init. LSU Data]
 - Printer Model: [Service Mode] > [Engine Maintenance] > [Init. LSU Data]
- 12.** Turn off the machine.
- 13.** Turn on the machine with the front cover open.
- 14.** Enter the SP mode again.
- 15.** Close the front cover.
- 16.** Execute "Trans. Belt Adjust" in [Engine Service Setting] to adjust the ITB (Image Transfer Belt) unit.
In the printer models, execute "Trans. Belt Adj," in [Engine Maintenance].
- 17.** Select [Fuser SC Detect], and then select "ON" or "OFF" for consecutive fusing jam detection.
- MF model: [SP Menu] > [Engine Service Setting] > [Fuser SC Detect]
 - Printer Model: [Service Mode] > [Engine Maintenance] > [Fuser SC Detect]
-  **Note**
- The default setting is "OFF". Select "ON" only if the customer wants to use this feature.
- 18.** Adjust the registration for each direction (vertical and horizontal directions) and tray if necessary.
- MF model: [SP Menu] > [Engine Service Setting] > [Registration]
 - Printer Model: [Service Mode] > [Engine Maintenance] > [Registration]
- 19.** Adjust the transfer roller bias and the temperature reduction of the fusing unit for each paper type and for the front and back sides. The default settings for normal operation are all '0'.
- MF model: [SP Menu] > [Engine Service Setting] > [2nd Transfer Fuser Temp]
 - Printer Model: [Service Mode] > [Engine Maintenance] > [2nd Transfer]
- 20.** Perform the color registration.
- MF model: [SP Menu] > [Engine Service Setting] > [Color Registration]
 - Printer Model: [Service Mode] > [Engine Maintenance] > [Color Regist]
- MUSIC is performed.
- 21.** If necessary, adjust the registration settings for the front and rear sides of each paper tray with the SP mode.

ADF (for SP C260SFNw)

ADF Unit

1. Left stand cover [A]. (hook × 1)
2. Disconnect the 2 harnesses from the left stand. ( × 2)

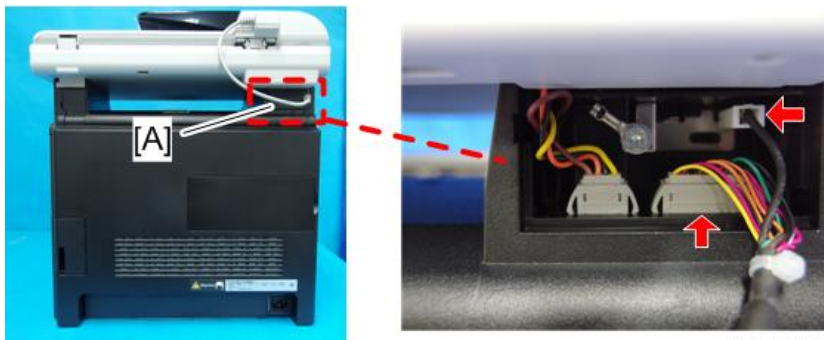

m199e2018

3. Open the ADF unit [B] and remove it in the direction of the blue arrow. (hooks)

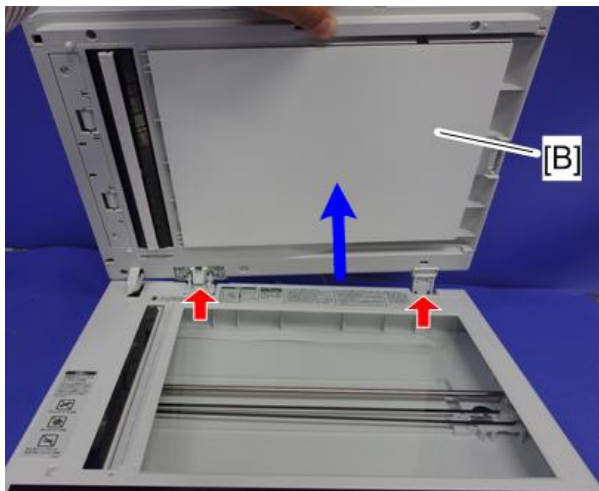

m199e2019

Original Tray

1. Open the extension tray [A] and then open the ADF top cover [B].

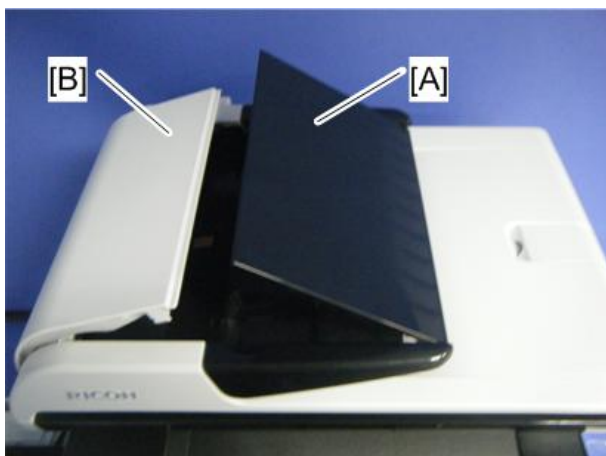

m199e2020

2. Original tray [C] (2 tabs)

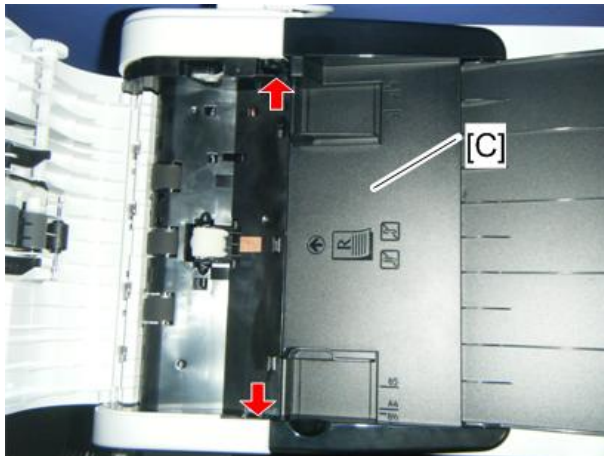

m199e2021

ADF Pick-Up Roller

1. Open the ADF top cover [A].
2. ADF feed unit [B] (tab)

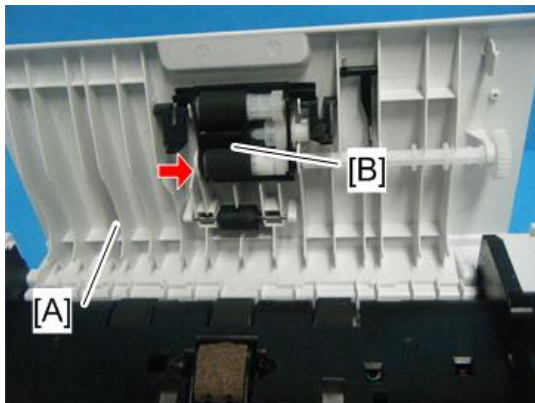

m1562032

3. ADF pick-up roller [C]

Note

- Be careful not to lose the spring.

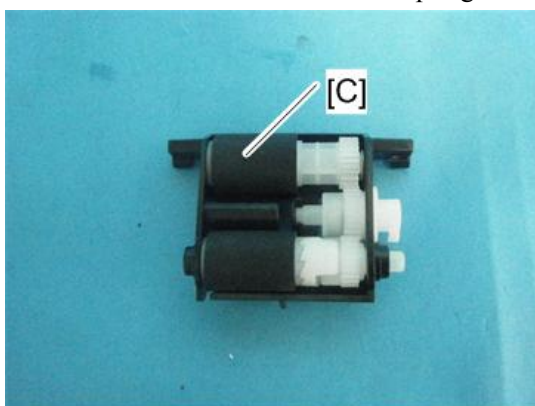

m1562033

4.Replacement and Adjustment

ADF Feed Roller

1. ADF feed unit (ADF Pick-Up Roller)
2. ADF feed roller [A]

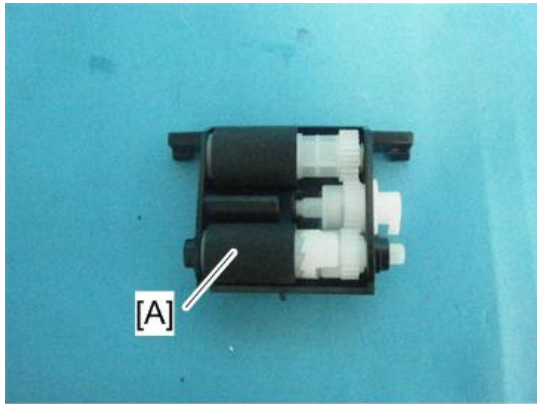

m1562034

ADF Separation Pad

1. Open the ADF top cover.
2. ADF separation pad [A] (2 hooks, spring × 1)

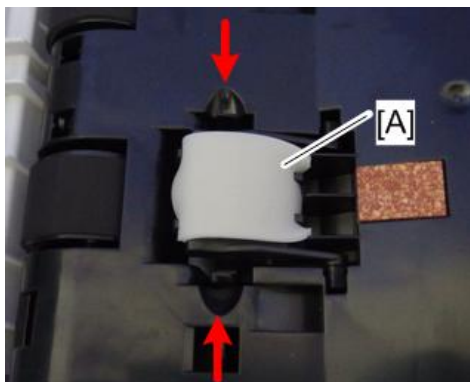

m199e2022

ADF Front Cover

1. ADF unit (ADF Unit)
2. Original tray (Original Tray)
3. Turn the ADF unit over.

4. ADF front cover [A] ( × 2, 2hooks)

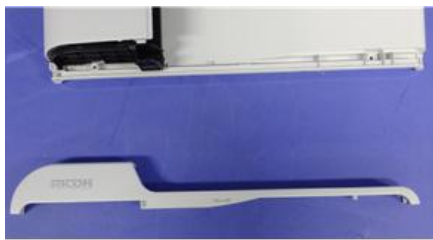
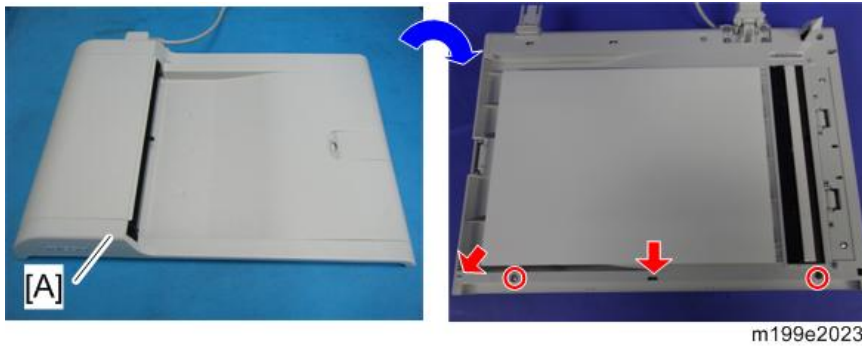

m202d4704

ADF Rear Cover

- 1.** ADF unit (ADF Unit)
- 2.** Original tray (Original Tray)
- 3.** Turn the ADF unit over.
- 4.** ADF rear cover [A] ( × 2, 2hooks)

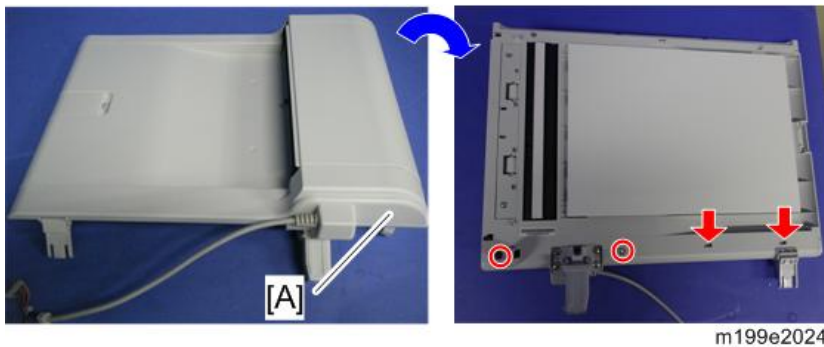



m202d4706

4.Replacement and Adjustment

ADF Motor

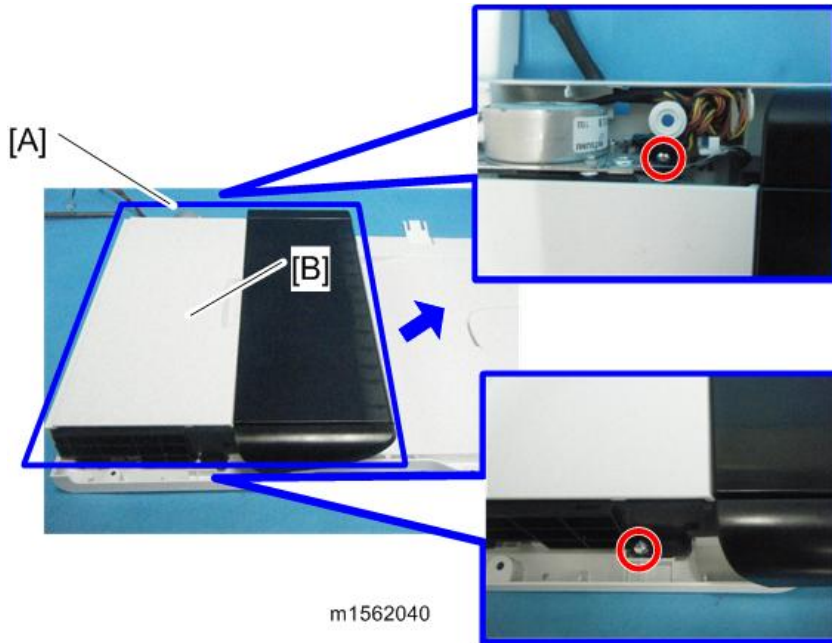
1. ADF unit (ADF Unit)
2. ADF front cover (ADF Front Cover)
3. ADF rear cover (ADF Rear Cover)
4. Remove the ADF drive unit [A] while the ADF top cover [B] remains closed. ( × 2)



5. ADF motor assembly [C] ( × 2, ground screw × 1,  × 1, ground plate, discharge brush)

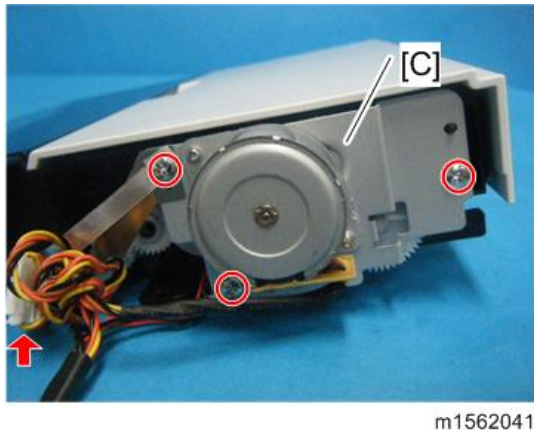

6. ADF motor [D] ( × 2)

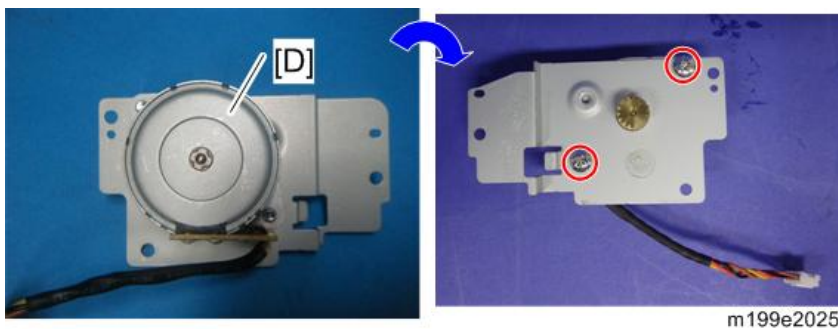

ADF Top Cover

1. ADF drive unit (ADF Motor)
2. Open the ADF top cover [A] and remove it. (two tabs)

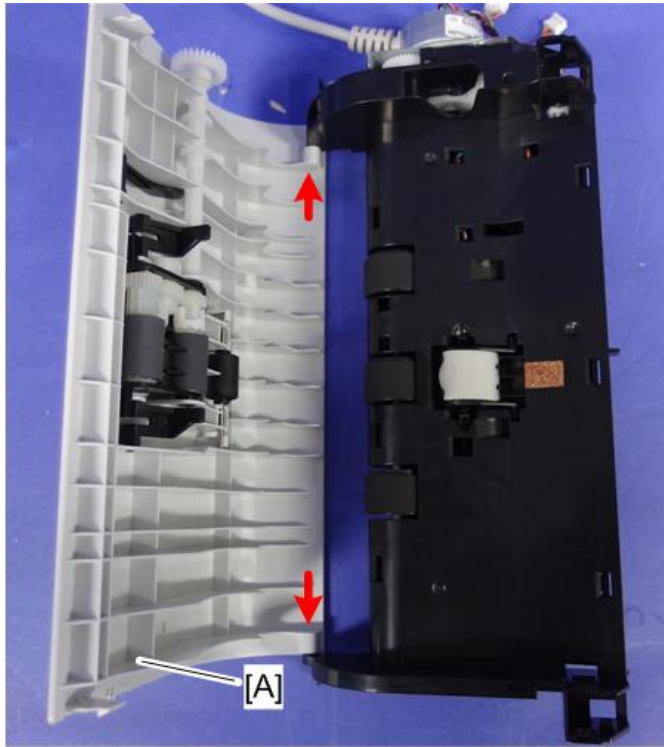

m199e2026

Original Set Sensor

1. ADF drive unit (ADF Motor)
2. Turn the ADF drive unit over.

4.Replacement and Adjustment

3. Pressure plate [A] (4 hooks, 2 springs)

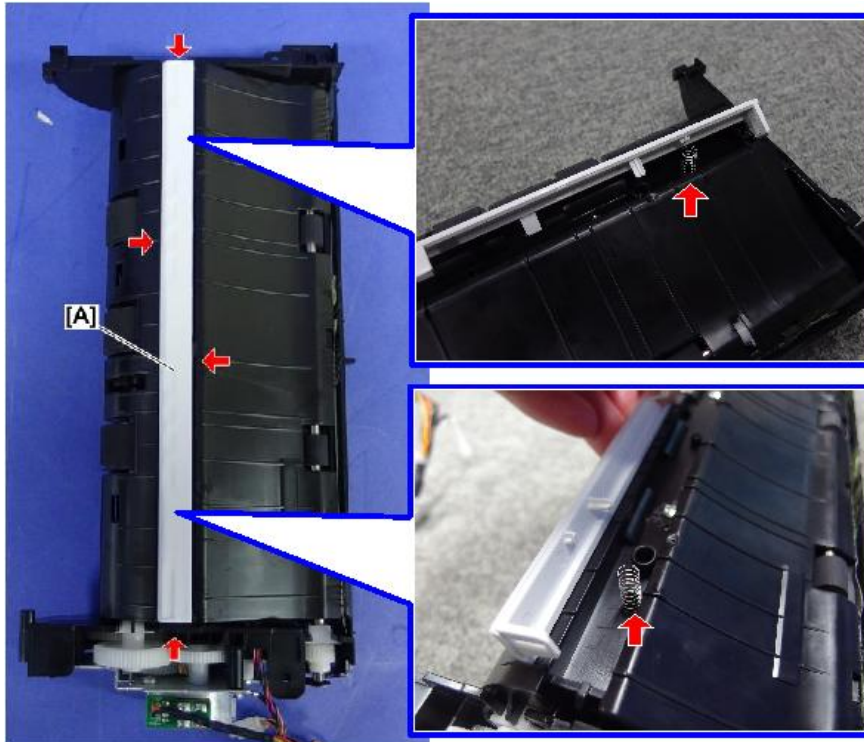

m0azm0085

4. Lower guide [B] ( × 2, 6 hooks, 2 tabs)

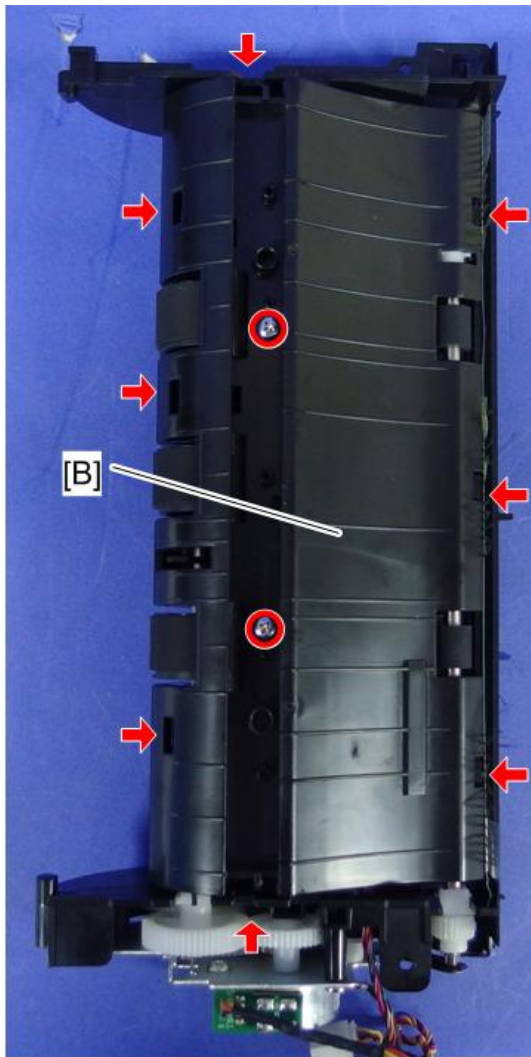

m199e2027

5. Original set sensor [C] (4 hooks,  ×1)

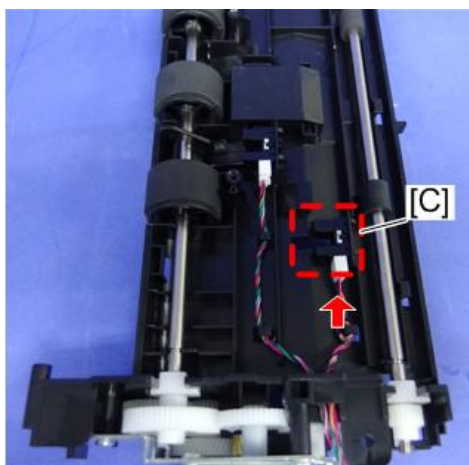

m199e2028

ADF Registration Sensor

1. ADF drive unit (ADF Motor)

4.Replacement and Adjustment

2. Lower guide (Original Set Sensor)

3. ADF registration sensor [A] (4 hooks,  × 1)

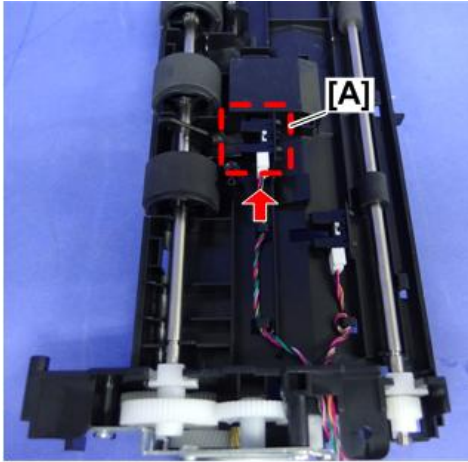

m202d4713

DADF (for SP C262SFNw)

DADF/Scanner Assembly

★ Important

- The DADF unit and scanner unit are connected by an FFC [A], so they cannot be separated.

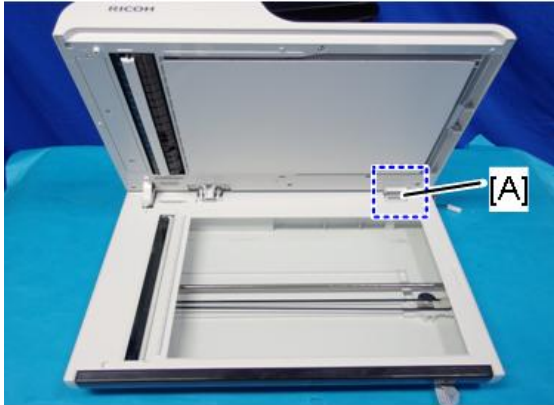

m0azm0023

- Replace the DADF unit and scanner unit together as the DADF/Scanner Assembly.

- Rear Cover ([Rear Cover](#))
- Controller box cover ([Controller Board](#))
- Disconnect the three FFCs, and then remove the ferrite core [A].

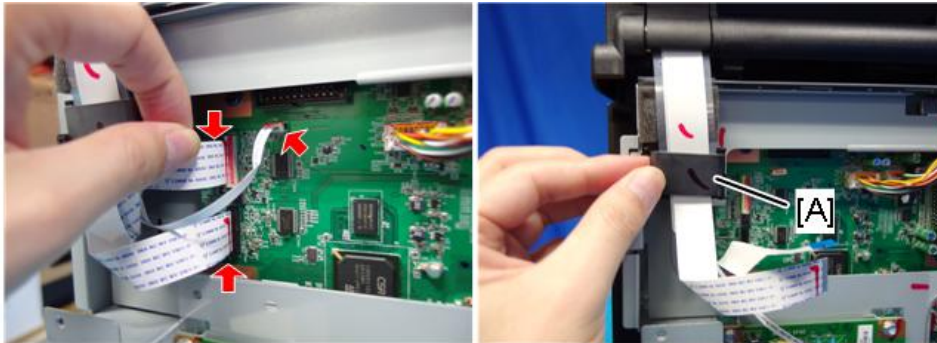

x3

m0azm0006

- Remove the left stand cover [A] and right stand cover [B]. (hook × 1 each)

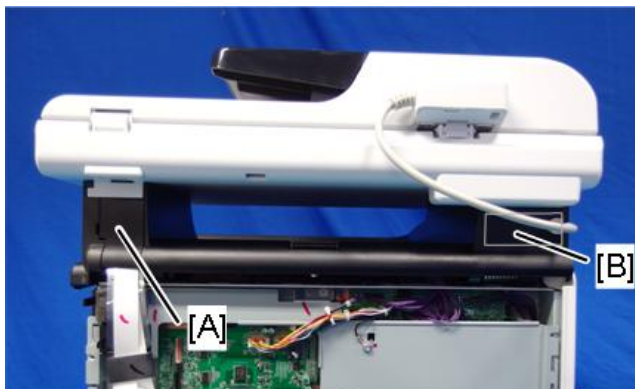

m0azm0022

4.Replacement and Adjustment

5. Disconnect the three harnesses and ground wire from the left stand.

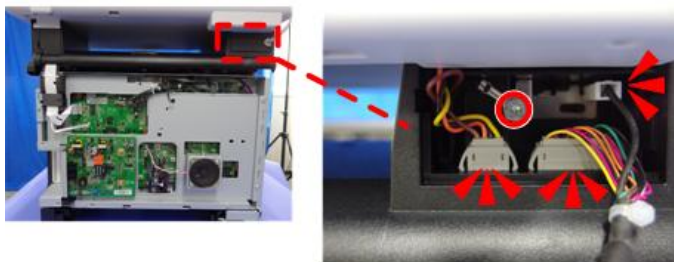

m202d4802

Note

- When disconnecting the ground wire, use a tool such as radio pliers to hold it.

6. Open the top cover and remove the stepped screw [E].



m199e2015

Note

- The stepped screw is a plastic screw with an anchor.
- Pull it out by grasping the anchor with pliers, etc after loosening it halfway.



m202d4810

7. Close the top cover.

8. Slide the scanner unit [F] in the direction of the blue arrow and pull it out while pushing the lock button [G].

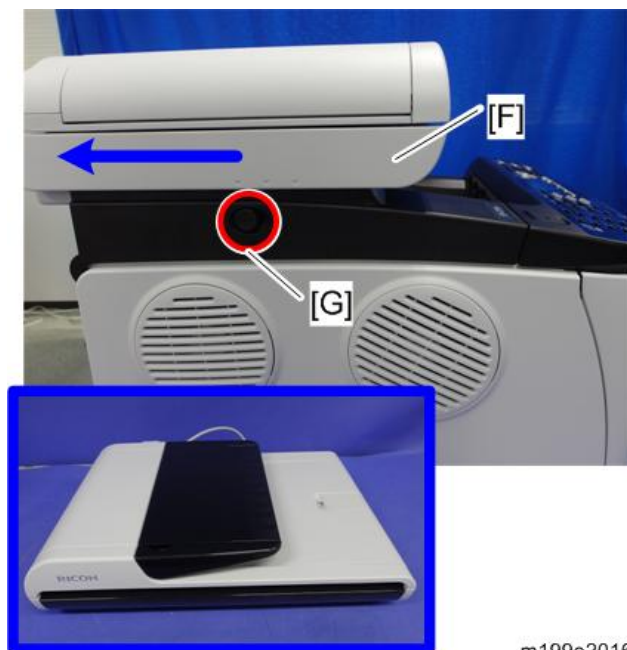

m199e2016

Adjustment after replacing the DADF/Scanner Assembly

After replacing the DADF/scanner assembly, adjust the contact image sensor (CIS) for the front and back. Because of differences in each individual DADF/scanner assembly, go into the SP mode, and enter the values on the barcode on the assembly to adjust the difference in the color balance between front and back. Be sure to perform this adjustment each time you replace the DADF/scanner assembly.

1. Check the barcode.



m0azm0032

Note

- The barcode values are, from the left, red (3), green (3), blue (3), gray (2), 0, 0, 0, 0.



m0azm0033

4.Replacement and Adjustment

2. Enter the Maintenance Mode Menu.
3. Press [Scanner Service Setting].

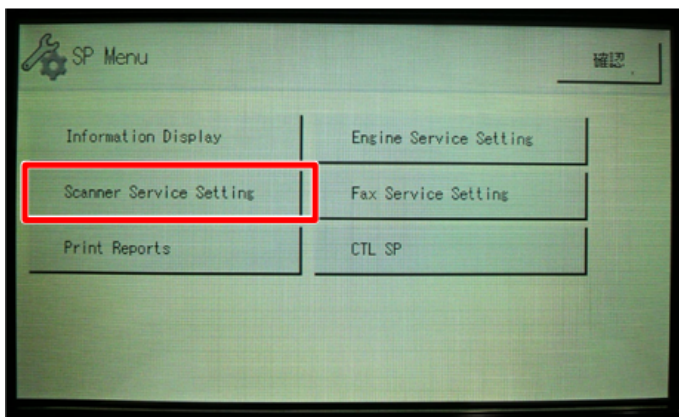

m0azm0034

4. Press [Image Adjust].

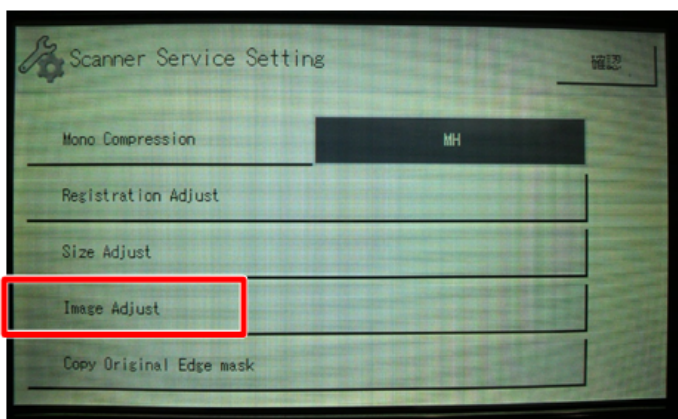

m0azm0035

5. Select the following settings and set them to the values on the barcode.

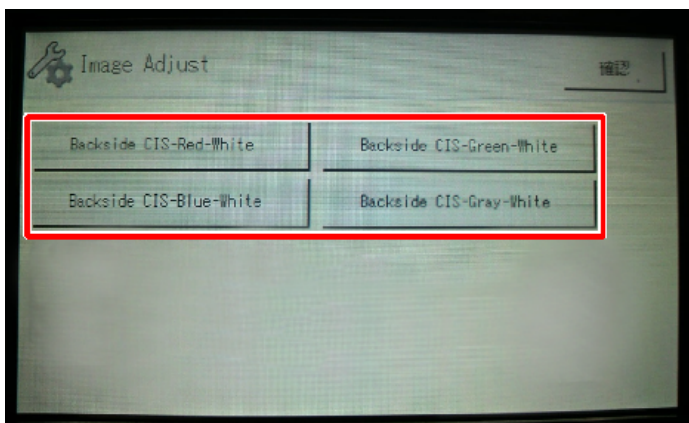

m0azm0036

Setting	Initial value	Range (steps)	Description
Backside CIS-Red-White	0	-15 to 15 (1)	Adjusts the difference in color balance between the front and back for red.
Backside CIS-Green-	0	-15 to 15	Adjusts the difference in color balance between the front

Setting	Initial value	Range (steps)	Description
White		(1)	and back for green.
Backside CIS-Blue-White	0	-15 to 15 (1)	Adjusts the difference in color balance between the front and back for blue.
Backside CIS-Gray-White	0	-15 to 15 (1)	Adjusts the difference in color balance between the front and back for gray.

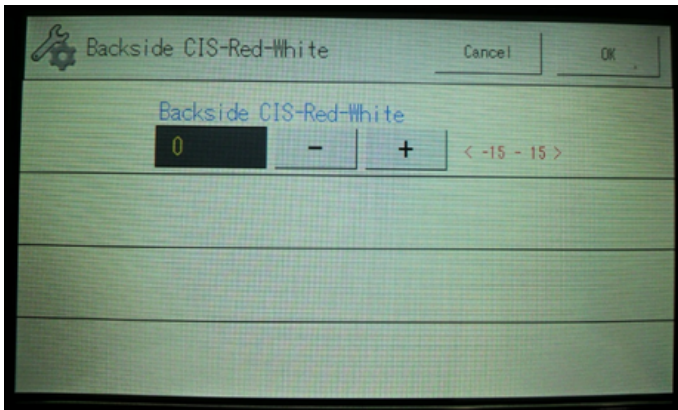

m0azm0037

Extension Tray/Original Tray

1. Open the extension tray [A], and then, bending it slightly, disengage the hooks on the sides and then remove the extension tray.



m0azm0050

2. Open the DADF cover, disengage the hooks on the sides of the original tray [A], and then remove the tray.



m0azm0051

DADF Front Cover

- 1.** While pressing the DADF release bar [A] on the back of the scanner unit, open the DADF.



- 2.** Cover the scanner exposure glass with a mat or something to prevent it from being damaged.

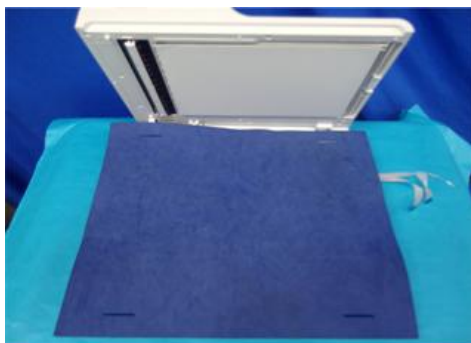

- 3.** Open the DADF cover, and then remove the DADF front cover [A].



 x2

DADF Rear Cover

1. While pressing the DADF release bar [A] on the back of the scanner unit, open the DADF.



2. Cover the scanner exposure glass with a mat or something to prevent it from being damaged.

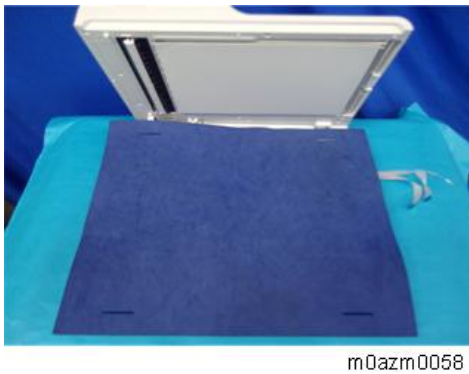

3. Remove the screws on the DADF rear cover.

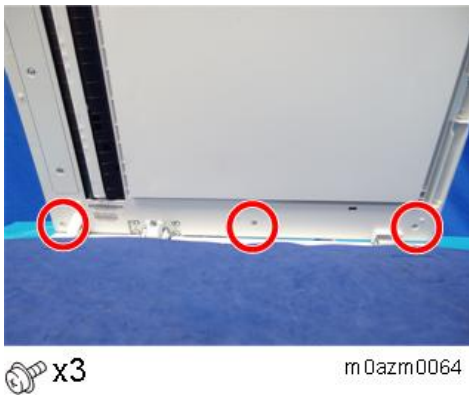

4. Remove the screw on the back of the scanner unit.



4.Replacement and Adjustment

- 5.** Open the DADF cover, and then remove the DADF rear cover [A].

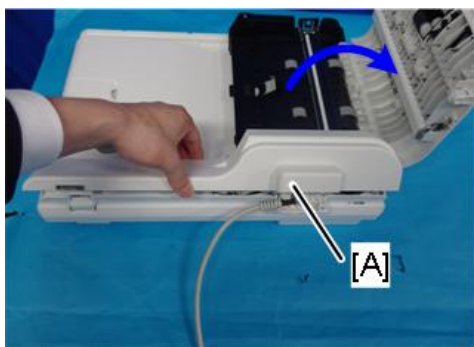

m0azm0062

Note

- There are 4 hooks on the DADF rear cover. Be sure to disengage all the hooks when you remove the cover.

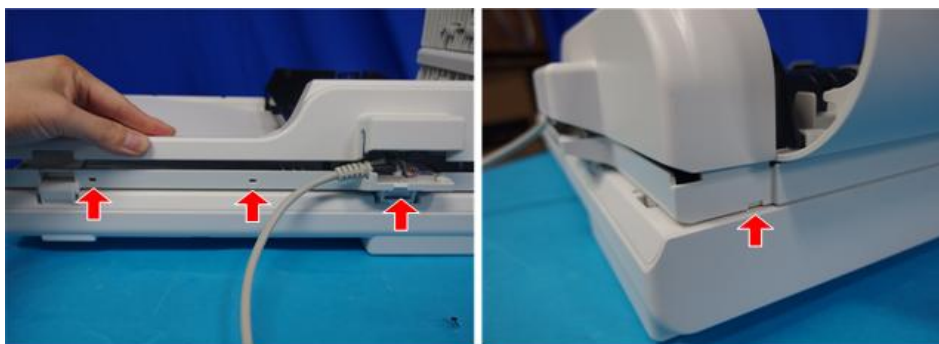

m0azm0063

DADF Separation Pad

- 1.** Open the DADF top cover.
- 2.** While pressing the parts indicated by red arrows, remove the DADF separation pad [A]. (2 hooks, spring × 1)

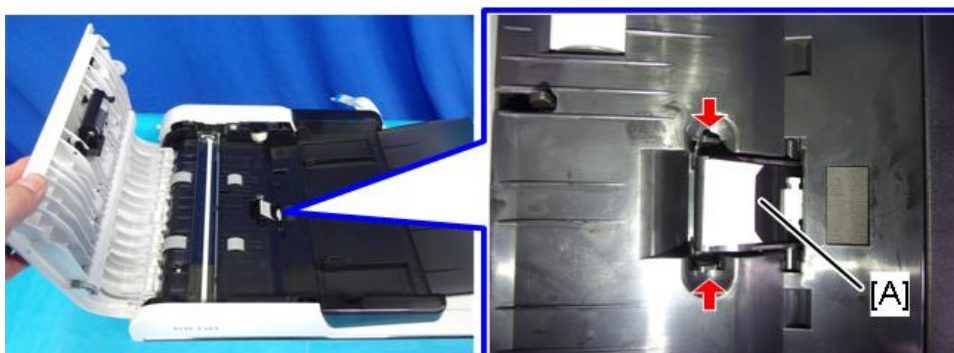

m0azm0052

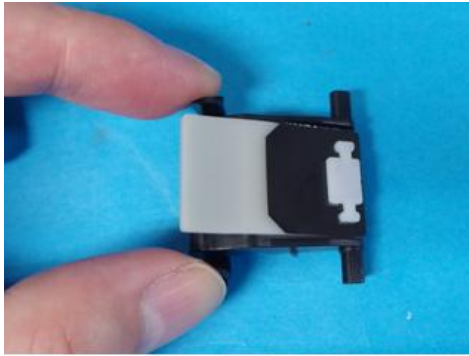

m0azm0053

DADF Feed Roller

1. Open the DADF top cover.
2. Bend the rib [A] out slightly and then remove the DADF feed unit [B].

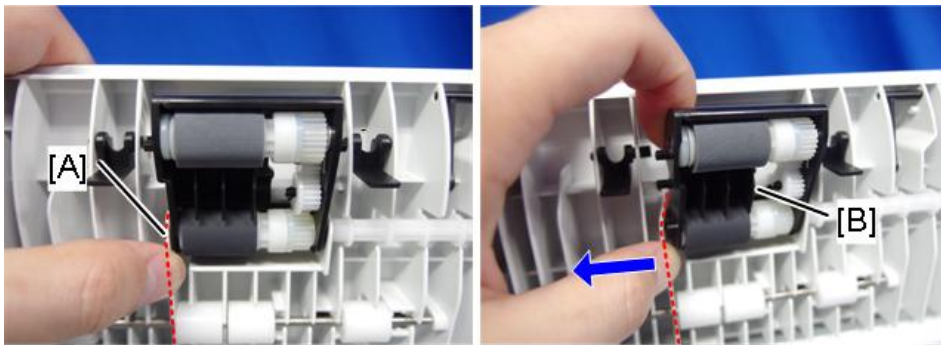

m0azm0054

3. DADF Feed Roller [A]

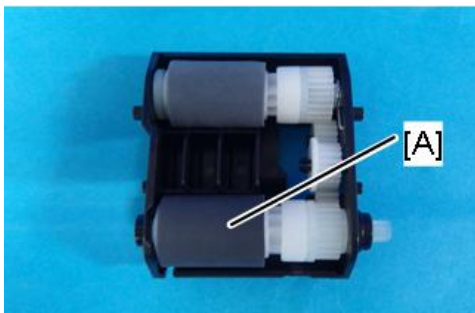

m0azm0056

★ Important

- After the installation, make sure that the gear turns properly.

DADF Pick-Up Roller

1. Open the DADF top cover.
2. Bend the rib [A] out slightly and then remove the DADF feed unit [B].

4.Replacement and Adjustment

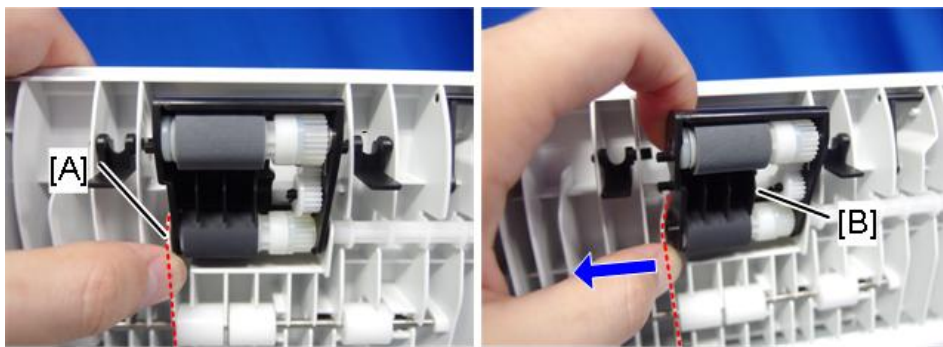

m0azm0054

3. Slide the DADF pick-up roller [A] towards the gear and remove it from the DADF feed unit.

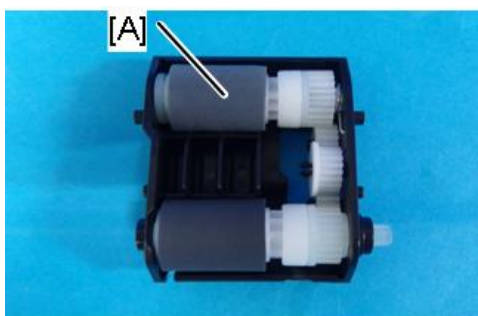

m0azm0055

★ Important

- Be careful: the gear contains a spring.

Reverse Roller

1. While pressing the DADF release bar [A] on the back of the scanner unit, open the DADF.



m0azm0057

- 2.** Cover the scanner exposure glass with a mat or something to prevent it from being damaged.

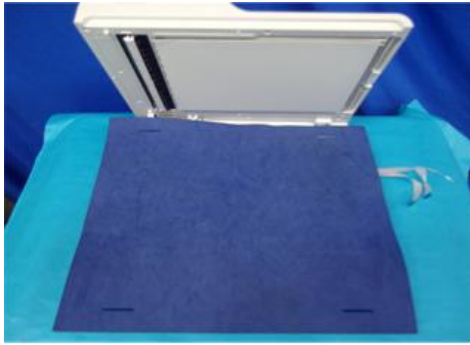

m0azm0058

- 3.** Remove the cover for the reverse roller [A].

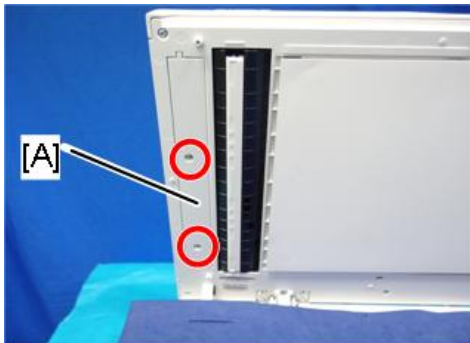

 x2

m0azm0068

- 4.** Pull up the reverse roller's shaft.

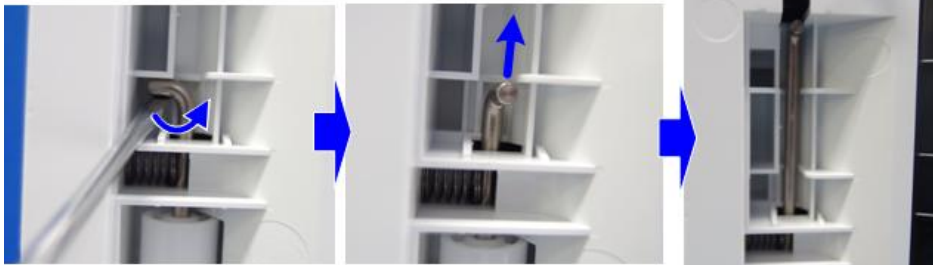

m0azm0069

- 5.** Remove the DADF Front Cover. ([DADF Front Cover](#))
6. Remove the DADF Rear Cover. ([DADF Rear Cover](#))
7. Remove the screws at the front side of the DADF drive unit [A].



 x2

m0azm0065

4.Replacement and Adjustment

8. Lifting the DADF drive unit [A] slightly, pull the reverse roller's shaft [B] out through the gap.

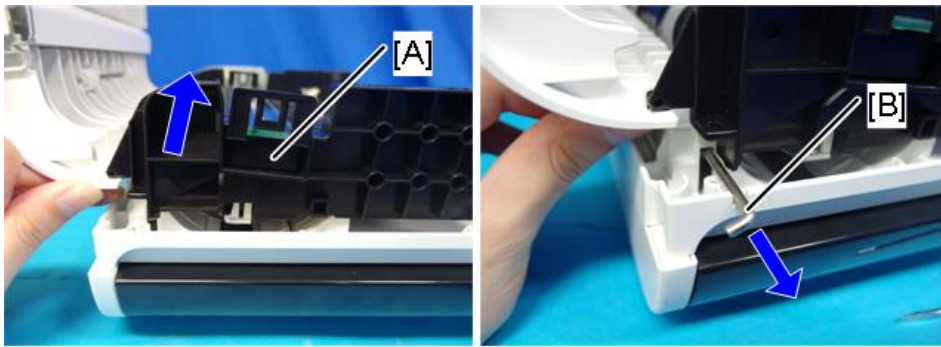

m0azm0066

9. Open the DADF and then remove the springs and rollers.



m0azm0066

Back CIS/Back DF Exposure Glass

1. Remove the DADF front cover. ([DADF Front Cover](#))
2. Remove the DADF rear cover. ([DADF Rear Cover](#))
3. Open the DADF upper cover and then remove the back DF exposure glass [A].

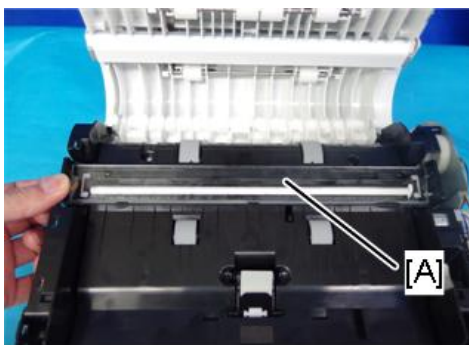

m0azm0070

Removing the Back DF Exposure Glass

1. Pressing the hooks [A] at the sides of the back DF exposure glass outward, insert your forefingers

through the gaps [B] and then push up the back DF exposure glass [C].

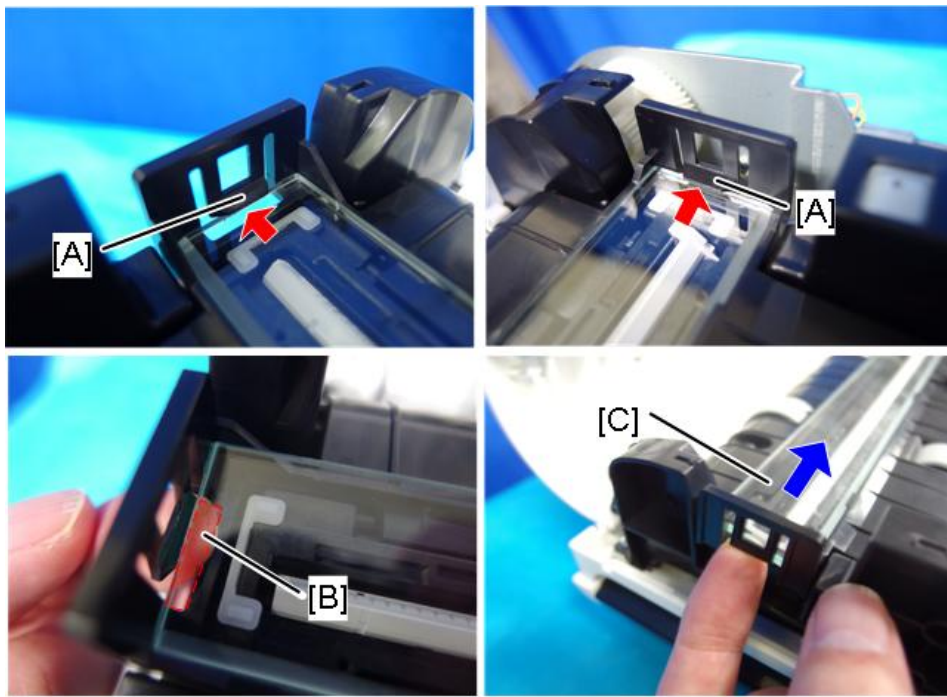

m0azm0071

2. Check that the hooks have been disengaged and then remove the back DF exposure glass [B].

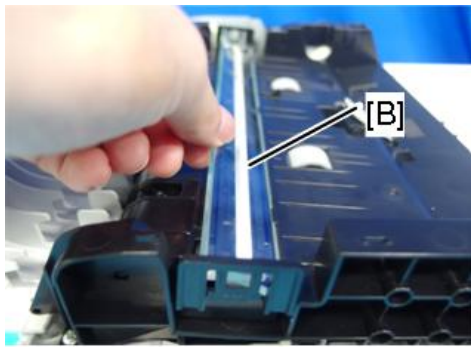

m0azm0073

4. Remove the back CIS [A].

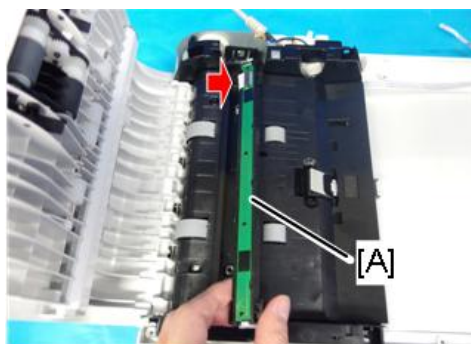

m0azm0074

4.Replacement and Adjustment



m0azm0075

5. After replacing the back CIS, adjust the difference in image quality between the front and back. (See [Adjustment after Replacing the Back CIS.](#))

Attaching the Back DF Exposure Glass

1. Position the back DF exposure glass with the side with the tilt facing up to come in contact with the original.
2. Engage the 3 hooks (as indicated by red arrows) (1), and then push in the rear part (2).

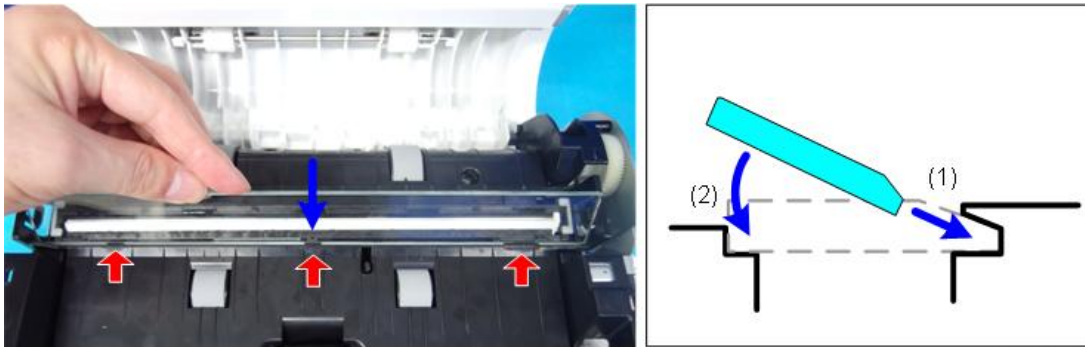

m0azm0076

3. Check that the back DF exposure glass has engaged with the hooks [A].

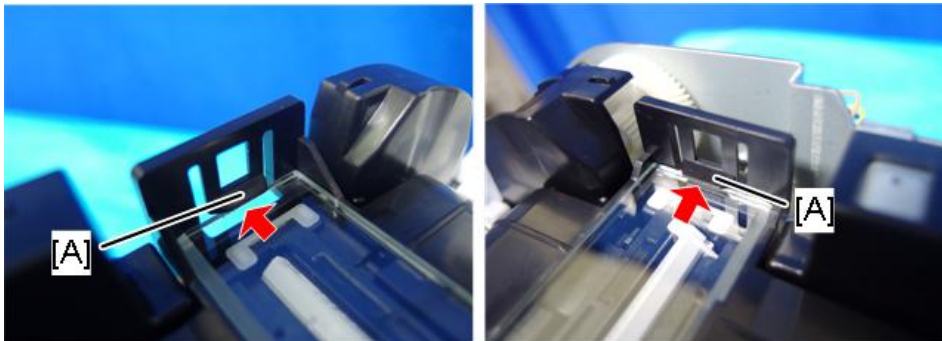

m0azm0071a

Adjustment after Replacing the Back CIS

After replacing the back CIS on its own, and not the complete DADF/scanner assembly, adjust the difference in the color balance between front and back as follows.

If you replaced the DADF/scanner assembly, go into the Maintenance Mode Menu, and enter the values on the barcode on the unit in accordance with “[Adjustment after replacing the DADF/Scanner Assembly](#)”.

↓ Note



- You cannot change the color balance on the front. Adjust the color balance on the back compared with that on the front depending on whether the front is gray, reddish, greenish, or bluish.

1. After changing the back CIS, enter the Maintenance Mode Menu.
2. Press [Scanner Service Setting].
3. Press [Image Adjust].
4. Check that the following settings are set to the initial value of "0".

If not, change the values to "0".

Setting	Initial value	Range (steps)	Description
Backside CIS-Red-White	0	-15 to 15 (1)	Adjusts the difference in color balance between the front and back for red.
Backside CIS-Green-White	0	-15 to 15 (1)	Adjusts the difference in color balance between the front and back for green.
Backside CIS-Blue-White	0	-15 to 15 (1)	Adjusts the difference in color balance between the front and back for blue.
Backside CIS-Gray-White	0	-15 to 15 (1)	Adjusts the difference in color balance between the front and back for gray.

5. Place an original that has gray parts on both sides on the DADF, and then make a duplex color copy.
6. Check that the gray parts on the copy appear the same on both sides.
7. If they are the same (targeted gray), there is no need for adjustment.
8. If adjustment is necessary, check which color in the following list looks the most similar to the results.

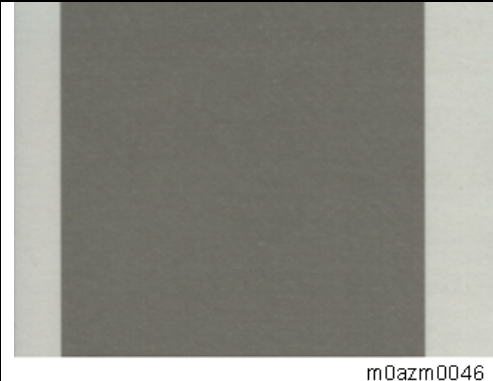
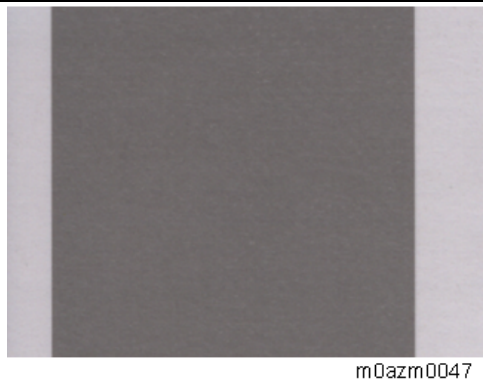
Targeted gray (normal color)	Reddish
 m0azm0044	 m0azm0045
Greenish	Bluish
 m0azm0046	 m0azm0047

9. Check which is the applicable case from cases 1 to 4 below, and then enter the adjustment values

4.Replacement and Adjustment

accordingly.

Examples:

a) The image on the front is 'targeted gray', and the image on the back is 'greenish'

Applicable to case 1. The adjustment values are (4, -4, 4, -4).

b) The image on the front is 'reddish' and the image on the back is 'bluish'

Applicable to case 2. The adjustment values are (8, 0, -8, 0).

Case 1: Adjustment values when the image on the front is "targeted gray"

	Image on the front	Image on the back		
	Targeted gray	Reddish	Greenish (Adjustment example a)	Bluish
Red	0	-4	4	4
Green	0	4	-4	4
Blue	0	4	4	-4
Gray	0	4	-4	4

Case 2: Adjustment values when the image on the front is "reddish"

	Image on the back	Image on the front	Image on the back	
	Targeted gray	Reddish	Greenish	Bluish (Adjustment example b)
Red	4	0	8	8
Green	-4	0	-8	0
Blue	-4	0	0	-8
Gray	-4	0	-8	0

Case 3: Adjustment values when the image on the front is "greenish"

	Image on the back		Image on the front	Image on the back
	Targeted gray	Reddish	Greenish	Bluish
Red	-4	-8	0	0
Green	4	8	0	8
Blue	-4	0	0	-8
Gray	4	8	0	8

Case 4: Adjustment values when the image on the front is "bluish"

	Image on the back			Image on the front
	Targeted gray	Reddish	Greenish	Bluish
Red	-4	-8	0	0
Green	-4	0	-8	0
Blue	4	8	8	0
Gray	-4	0	-8	0

- 10.** After the adjustment, make a duplex color copy and then check that the colors are the same on both sides.

Scanner Unit (for SP C260SFNw)

★ Important

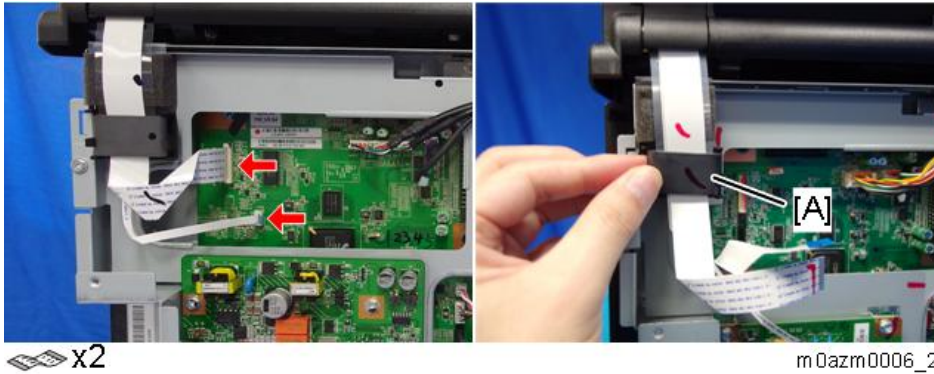

- Before removing the scanner unit, check that the ADF is installed on the scanner unit. If you attempt to remove the scanner unit without the ADF, the scanner unit is locked by the ADF release bar.

1. Rear cover ([Rear Cover](#))
2. Controller box cover ([Controller Board](#))
3. Disconnect the two FFCs, and then remove the ferrite core [A].

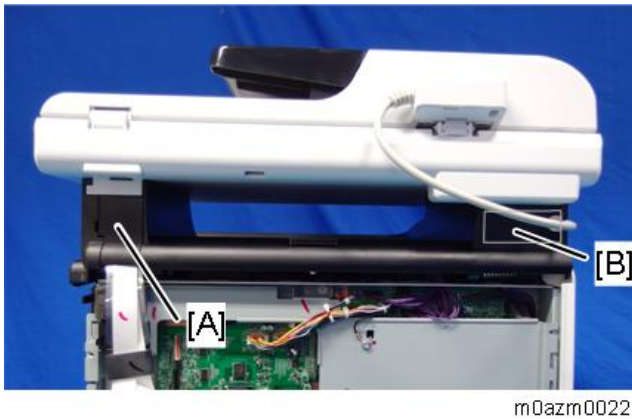

4. Remove the left stand cover [A] and right stand cover [B]. (hook × 1 each)



5. Disconnect the three harnesses and the ground wire from the left stand. ( × 3,  × 1)

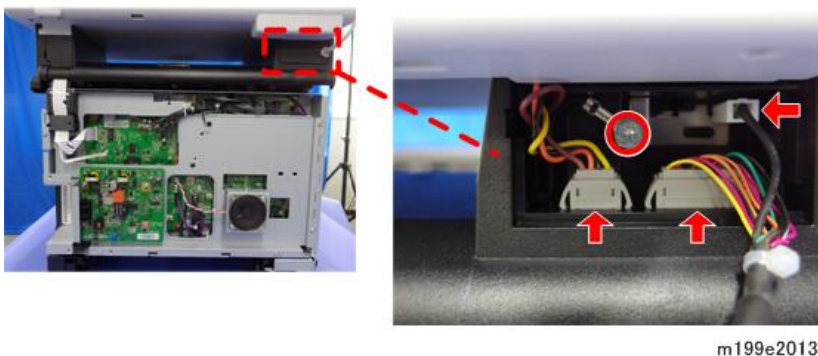

6. Open the top cover and remove the stepped screw [E].

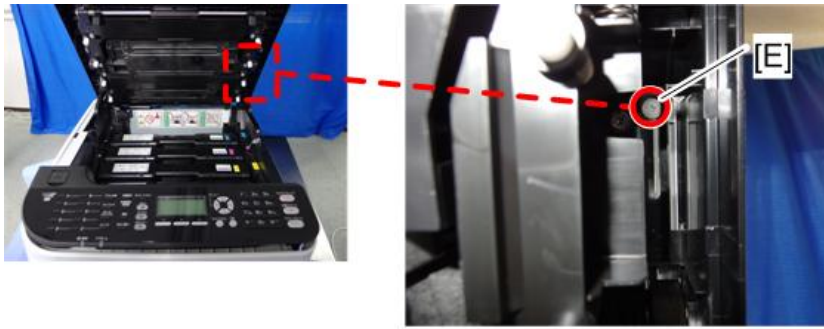

m199e2015

Note

- The stepped screw is a plastic screw with an anchor.
- Pull it out grasping the anchor with pliers, etc after loosening it halfway.



m199e2014

7. Close the top cover.

8. Slide the scanner unit [F] in the direction of the blue arrow and pull it out while pushing the lock button [G].

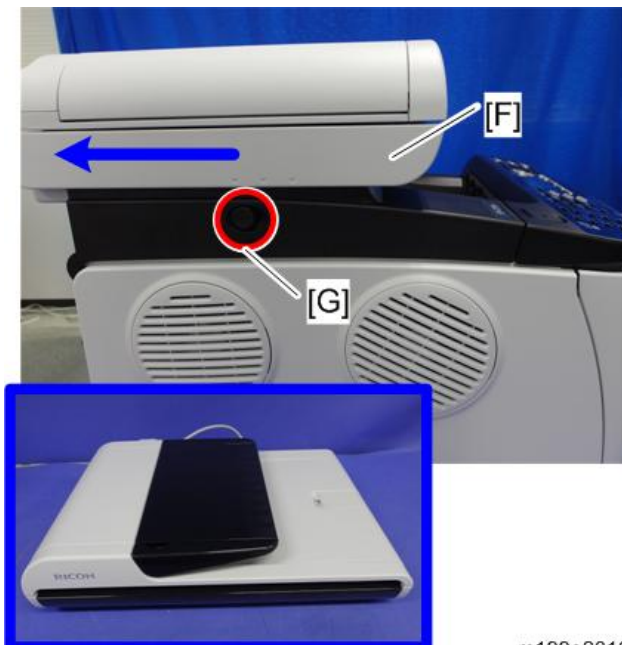

m199e2016

4.Replacement and Adjustment

- 9.** Open the ADF while pressing the ADF release bar [H] on the rear of the scanner unit.

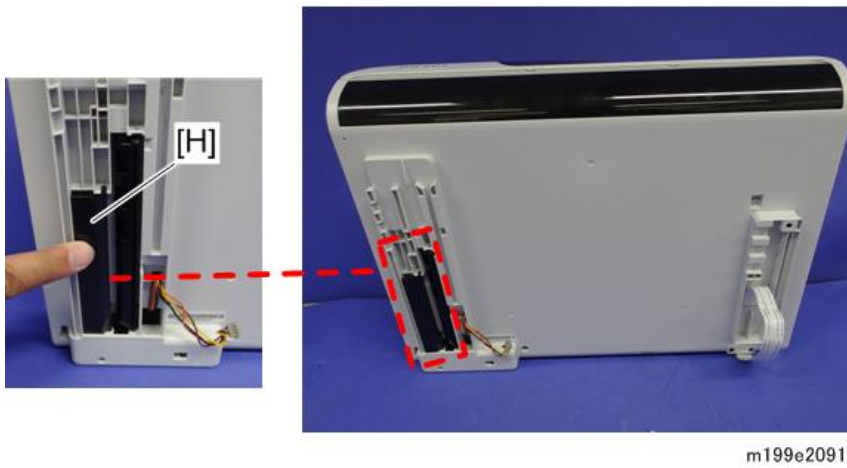

- 10.** Remove the ADF unit [I] from the scanner unit in the direction of the blue arrow. (hooks)

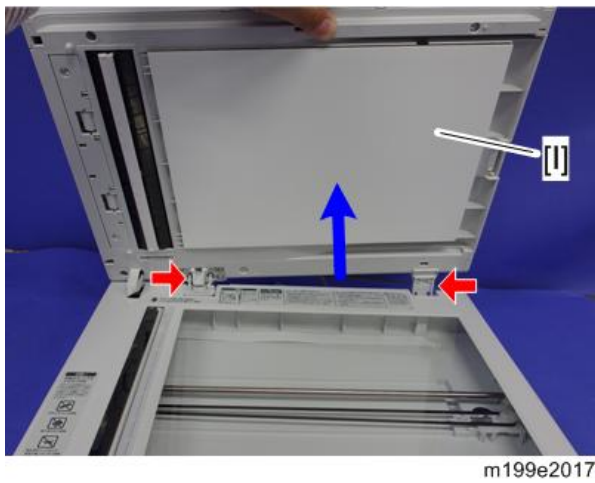

Scanner Unit (for SP C262SFNw)

The DADF unit and scanner unit are connected by an FFC [A], so they cannot be separated.

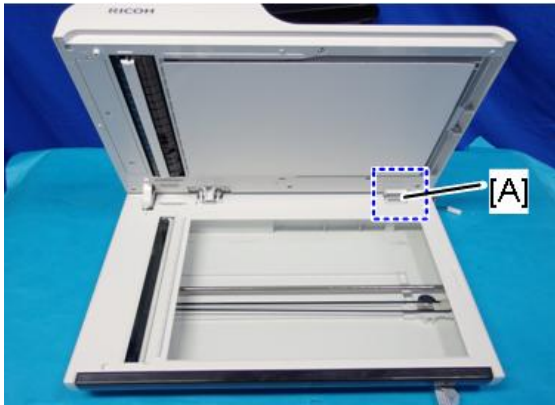

m0azm0023

With the SP C262SFNw, replace the DADF unit and scanner unit together as the DADF/Scanner Assembly.

For details about how to replace them, see [DADF/Scanner Assembly](#).

5. System Maintenance Reference

Service Menu

Overview

These models have several service menus. Each service menu has several adjustment items. This section explains what you can do in each service menu.

MF Models

Mode	Description	Reference
SP Mode (SP Menu)	This is a menu for maintenance and service.	SP Menu (only for MF Models)
Special Maintenance Menu	This is a menu for initializing all information stored in the controller, except for some counters.	Special Maintenance Menu (only for MF Models)
User Special Maintenance Menu	Specifies whether to detect paper size mismatches.	User Special Maintenance Menu (only for MF Models)
Fax Service Test Menu	This is a menu for checking the fax mode.	Fax Service Test Menu (only for MF Models)
LCD Coordinate Maintenance Mode	Calibrates the touch panel screen.	LCD Coordinate Maintenance Mode

Printer Models

Mode	Description	Reference
SP Mode (Service Mode)	This is a menu for maintenance and service.	Service Mode (only for Printer Models)
Size Detection SP Menu	Specifies whether to detect paper size mismatches.	Size Detection SP Menu (only for Printer Models)
Serial No. SP Menu	You can enter the machine serial number.	Serial No. SP Menu (only for Printer Models)

MF Models

SP Menu (only for MF Models)

Note

- For information on how to enter the SP Menu, contact the supervisor in your branch office.

Information Display		
Model Name	Displays the Model Name, Depends on Engine Firmware Settings	
FW Version	CTL FW	Displays the Firmware Version

	Version	
	FAX FW Version	Displays the Facsimile Firmware Version.
	Engine FW Version	Displays the Engine Firmware Version
Printer Counter	Color Image	Displays the number of sheets printed in color.
	Black Image	Displays the number of sheets printed in black and white.
	Color Print Detail	Displays the number of sheets printed in color using the printer driver (with the Economy color mode disabled).
	B&W Print Detail	Displays the number of sheets printed in black and white using the printer driver.
	Economy Print	Displays the number of sheets printed in color using the printer driver (with the Economy color mode enabled).
Scanner Counter	Total Page	Displays the total number of sheets scanned.
	Black Image	Displays the number of sheets scanned in black and white.
	Color Image	Displays the number of sheets scanned in color.
	ADF/DADF Used	Displays the number of sheets scanned using ADF/DADF.
Jam Counter	Jam Total	Displays the total number of paper jams.
	ADF/DADF	Displays the number of paper jams in the ADF/DADF.
	Printer Out	Displays the number of paper jams in the output tray.
	Internal	Displays the number of paper jams in the machine's interior.
	Tray1	Displays the number of paper jams in Tray 1.
	Tray2	Displays the number of paper jams in (optional) Tray 2.
	Duplex	Displays the number of paper jams at the paper feed/delivery for duplex printing.
Coverage	Coverage1 (Tray 1)	Displays the print coverage on the sheets fed from Tray 1.
	Coverage2 (Tray2)	Displays the print coverage on the sheets fed from Tray 2.

Engine Service Setting	
PnP Name	Sets the Plug and Play name. SP C260SFNw: 0x10 SP C262SFNw: 0x14 C262SFNw: 0x14 [0x00 to 0x7F / - / -]
Destination	Sets the destination and updates the engine setting.

5.System Maintenance Reference

	DOM/ NA (Default)/ EU/ CHN/ TAIWAN/ ASIA / LA	
Model	DFU (Designed for Factory Use) Do not change this setting. Displays the current model.	
Brand ID	DFU (Designed for Factory Use) Do not change this setting. [0x00 to 0x7F / - / -] Displays the current brand ID number.	
Maintenance ID	DFU (Designed for Factory Use) Do not change this setting. [0x00 to 0x7F / - / -] Displays the current maintenance ID number.	
2nd Transfer Fuser Temp.	Media Type	Sets the Media type. Plain paper (Default), Thick Paper 2, Middle Thick Paper, Thick Paper 1, Recycled Paper, Color Paper, Letterhead, Preprinted Paper, Prepunched Paper, Label Paper, Bond Paper, Cardstock, Envelope, Thick Post, Thin Paper
	2nd Transfer Front	Adjusts the transfer roller current, based on the default value. [-15 to 15 / 0 (Default) / 1µA/step]
	2nd Transfer Back	Adjusts the transfer roller current, based on the default value. [-15 to 15 / 0 (Default) / 1µA/step]
	Fuser Temperature	Adjusts the temperature of the fusing unit, based on the default value. [-30 to 0 / 0 (Default) / 2°C/step]
Toner Limit	Text	Determines the maximum amount of ink/toner you can use in any area of your text. This is where you are controlling exactly how much ink will be used during printing. [200 to 400 / 250 (Default)/ 10/step]
	Graphic	Determines the maximum amount of ink/toner you can use in any area of your graphic. This is where you are controlling exactly how much ink will be used during printing. [200 to 400 / 250 (Default)/ 10/step]
	Image	Determines the maximum amount of ink/toner you can use in any area of your image. This is where you are controlling exactly how much ink will be used during printing. [200 to 400 / 250 (Default)/ 10/step]
Registration	Horiz. Tray1	Adjusts the horizontal registration for tray 1. If the machine settings are reset to the factory defaults, this value does not change. [-15 to 15 / 0 (Default) / 1 mm/step]
	Vert. Tray1	Adjusts the vertical registration for tray 1. If the machine settings are reset to the factory defaults, this value does not change.

		[-15 to 15 / 0 (Default) / 1 mm/step]
	Horiz.Tray2	Adjusts the horizontal registration for tray 2. If the machine settings are reset to the factory defaults, this value does not change. [-15 to 15 / 0 (Default) / 1 mm/step]
	Vert.Tray2	Adjusts the vertical registration for tray 2. If the machine settings are reset to the factory defaults, this value does not change. [-15 to 15 / 0 (Default) / 1 mm/step]
	Horiz Bypass Tray	Adjusts the horizontal registration for the bypass tray. If the machine settings are reset to the factory defaults, this value does not change. [-15 to 15 / 0 (Default) / 1 mm/step]
	Vert Bypass Tray	Adjusts the vertical registration for the bypass tray. If the machine settings are reset to the factory defaults, this value does not change. [-15 to 15 / 0 (Default) / 1 mm/step]
	Horiz.Dup. Back	Adjusts the horizontal registration for the back side in duplex mode. If the machine settings are reset to the factory defaults, this value does not change. [-15 to 15 / 0 (Default) / 1 mm/step]
	Vert.Dup. Back	Adjusts the vertical registration for the back side in duplex mode. If the machine settings are reset to the factory defaults, this value does not change. [-15 to 15 / 0 (Default) / 1 mm/step]
LSU Adjustment	Input 160 bytes setting.	Character: alphanumeric "0-9", "a-f", "A-F", only valid data can be input. Input length: 160 bytes
Init. LSU data	Appropriate LD parameters to match the replaced laser optics housing unit are written to the EEPROM of the engine board.	
Trans. Belt Adjustment	When you execute "Trans. Belt Adjustment", the transfer belt adjustment is done. This calibrates the motor speed to match the length of the new transfer belt.	
Color Registration	The engine will do color registration and density tuning automatically. The printer will warm up automatically after this setting is changed.	
Reset Transfer Unit	Resets the transfer unit life counter.	
Reset Fuser Unit	Resets the fusing unit life counter.	
Reset 2nd Transfer unit	Resets the 2nd transfer unit (transfer roller) life counter.	
Fuser SC Detect	On/Off	If On, the engine detects SC559. If Off, the engine does not detect "Fusing SC Reset".
Fuser SC Reset	Resets the Fusing related SC.	

5. System Maintenance Reference

Init Engine EEPROM	Execute this to initialize a new EEPROM. Turn the machine power off/on after you execute this setting. Also, the following items are cleared by the EEPROM initialization: <ul style="list-style-type: none"> Machine total counter (total page, full color, and B&W) Error log (listed as “Call Service” on Maintenance Page) Duplex page counter 	
Special Mode	DFU (Designed for Factory Use) Do not change this setting.	
PM Parts Rep Notice	0	At near end: No Notice / Not Stopped
		At life end: Notice “Replace Now” / Not Stopped
	1	At near end: No Notice / Not Stopped
		At life end: No Notice / Not Stopped
	2 (default)	At near end: Notice / Not Stopped
		At life end: Notice “Replace Now” / Not Stopped
3	At near end: Notice “Replace Soon” / Not Stopped	
	At life end: Notice “Replace Now” / Stopped	
Energy Saver Mode 3	Specifies whether to have the machine switch to Energy Saver Mode 3 instead of Energy Saver Mode 2 when the machine has been idle for 10 minutes. [ON/OFF (Default: ON)]	

Scanner Service Setting		
Mono Compression	Sets the monochrome compression type for scanning. MH (Default)/ MR/ MMR	
Registration Adjust	ADF Main Reg.	Adjusts the ADF main-scan registration. [-1.0 to 1.5 / 0 (Default)/ 0.1 mm/step]
	ADF Sub Reg.	Adjusts the ADF sub-scan registration. [-1.0 to 1.5 / 0 (Default)/ 0.1 mm/step]
	Flatbed Main Reg.	Adjusts the Flatbed main-scan registration. [-1.0 to 1.5 / 0 (Default)/ 0.1 mm/step]
	Flatbed Sub Reg.	Adjusts the Flatbed sub-scan registration. [-1.0 to 1.5 / 0 (Default)/ 0.1 mm/step]
	DADF backside Main Reg.	Adjusts the DADF main-scan registration on the back. [-1.0 to 1.5 / 0 (Default)/ 0.1 mm/step]
	DADF backside Sub Reg.	Adjusts the DADF sub-scan registration on the back. [-1.0 to 1.5 / 0 (Default)/ 0.1 mm/step]
Size Adjust	ADF/DADF Sub Reg.	Adjusts the ADF/DADF sub-scan magnification. [-0.9 to 0.9 / 0 (Default)/ 0.1 %/step]

	Flatbed Sub Reg.	Adjusts the Flatbed sub-scan magnification. [-0.9 to 0.9 / 0 (Default)/ 0.1 %/step]
Image Adjust	Backside CIS-Red-White	Adjusts the DADF difference between front and back for red. [-15 to 15 / 0 (Default)/ 1 /step]
	Backside CIS-Green-White	Adjusts the DADF difference between front and back for green. [-15 to 15 / 0 (Default)/ 1 /step]
	Backside CIS-Blue-White	Adjusts the DADF difference between front and back for blue. [-15 to 15 / 0 (Default)/ 1 /step]
	Backside CIS-Gray-White	Adjusts the DADF difference between front and back for gray. [-15 to 15 / 0 (Default)/ 1 /step]
Copy Original Edge mask	Flatbed Top	Adjusts the leading-edge margin for flatbed scanning. [-3.0 to 3.0 / 0 (Default)/ 0.1 mm/step]
	Flatbed Bottom	Adjusts the trailing-edge margin for flatbed scanning. [-3.0 to 3.0 / 0 (Default)/ 0.1 mm/step]
	Flatbed Left	Adjusts the left margin for flatbed scanning. [-3.0 to 3.0 / 0 (Default)/ 0.1 mm/step]
	Flatbed Right	Adjusts the right margin for flatbed scanning. [-3.0 to 3.0 / 0 (Default)/ 0.1 mm/step]
	ADF/DADF Top	Adjusts the leading-edge margin for ADF/DADF scanning. [-3.0 to 3.0 / 0 (Default)/ 0.1 mm/step]
	ADF/DADF Bottom	Adjusts the trailing-edge margin for ADF/DADF scanning. [-3.0 to 3.0 / 0 (Default)/ 0.1 mm/step]
	ADF/DADF Left	Adjusts the left margin for ADF/DADF scanning. [-3.0 to 3.0 / 0 (Default)/ 0.1 mm/step]
	ADF/DADF Right	Adjusts the right margin for ADF/DADF scanning. [-3.0 to 3.0 / 0 (Default)/ 0.1 mm/step]

Fax Service Setting		
Modem Settings	RX Level	Sets the reception level. [-43 dBm (Default)/ -33 dBm/ -26 dBm / -16 dBm]
	TX Level	Sets the transmission level.

5.System Maintenance Reference

		[0 dBm/ -1 dBm/ -2 dBm/ -3 dBm/ -4 dBm / -5 dBm/ -6 dBm/ -7 dBm/ -8 dBm/ -9 dBm / -10 dBm/ -11 dBm/ -12 dBm/ -13 dBm / -14 dBm/ -15 dBm]
	Cable Equalizer	These selectors are used to improve the pass-band characteristics of analogue signals on the telephone line. [0Km (Default)/ 1.8Km/ 3.6Km/ 7.2Km]
Protocol Definition	Training Retries	This sets the number of training retries to be repeated before automatic fallback. [1 Time/ 2 Times (Default)/ 3 Times/ 4 Times]
	Encoding	Sets the compression method for Tx/Rx. [MMR+MR+MH (Default)/ MR+MH/ MH]
Protocol Definition Timer	T0 Timer	Timeout for response from the called station in automatic sending mode [35 Sec/ 45 Sec/ 55 Sec/ 60 Sec(Default)/ 90 Sec/ 140 Sec]
	T1 Timer	Set the time length for the T1 timer. [40 Sec (Default)/ 50 Sec]
	T4 Timer	Set the time length for the T4 timer. [3 Sec (Default)/ 4.5 Sec]
RX Settings	Silence Detection	Silence (No tone) detection time (Rx mode : FAX/ TAD Only) After the line is connected via the external telephone, the machine can detect silence (no tone) for the time length specified by this setting. [30 sec (Default)]
	CNG Tone Detection Time	CNG tone detection time (RX mode : FAX / TEL, FAX / TAD Only) After the line is connected via the external telephone, the machine can detect a CNG signal for the time length specified by this setting. [5 Sec (Default)/ 10 Sec]
	CNG Cycles	Number of CNG cycles to be detected This setting is only effective for FAX/TAD mode. [1.5 Cycle (Default)/ 2.0 Cycle]
	Tone Sound Monitoring	Determines the period when tones from the line are monitored. [No Monitoring/ Up To Phase B (Default)/ All TX Phases]
RX Settings	Stop/Clear key	Pressing the Stop/Clear key can stop the current receiving operation. Received data is lost. [No Functional (Default)/ Functional]
	Off-Hook Level	DFU (Designed for Factory Use)

		Do not change this setting. [10V (Default)/ 15V/ 20V/ 25V]
	Off-Hook Detection Period	Sets the Off-Hook detection period. 200 ms (default) 800 ms
	Number for Remote Switch	- [0 to 9 / - / 1step]
	Number of time to press	- [1 to 3 / - / 1step]
	Period for TEL to FAX	- [Limitless / 10 sec / 20 sec / 30 sec/ 40 sec]
TX Settings	Redial Interval	Sets the redial interval when Tx fails. [5 Min/ 6 Min]
	Redialings	Sets the number of redials when Tx fails. [2 times/ 3 Times/ 4 Times/ 5 Times]
Overseas Comm Mode Settings	Overseas Comm Mode	This sets the machine to ignore a DIS signal sent from the called station once in a sending operation. [Off (Default)/ Ignore DIS Once]
	Minimum Time Length	If this setting is set to "On", the machine detects the CNG signal after the line is connected. If it is set to "Off", the machine detects the CNG signal as long as the line is connected. [100 Ms/ 200 Ms/ 300 Ms/ 400 Ms (Default)]
Dial Pulse Setting	Dial Pulse Type	This sets the number of pulses that are generated during dialing. <ul style="list-style-type: none"> • N: Dialing '0' generates 10 pulses --- Dialing '9' generates 9 pulses. • N+1: Dialing '0' generates 1 pulses --- Dialing '9' generates 10 pulses. • 10-N: Dialing '0' generates 10 pulses --- Dialing '9' generates 1 pulse.
Tone Signal Settings	Tone Signal Transmission Time Length	Sets the tone signal transmission time length [100 ms (Default)]
	Minimum Pause in Tone Dialing	Sets the minimum pause during tone dialing [100 ms (Default)/ 150 ms/ 200 ms]
	Attenuator For Pseudo RingBack tone To the Line	Sets the attenuator for pseudo ringback tone to the line [0 to 15 / 10 (Default)/ 1 dB/step]
	DTMF Level	Sets the transmission level of DTMF tones.

5.System Maintenance Reference

		[-12 dBu / -11 dBu/ -10 dBu/ -8 dBu/ -6 dBu]
	DTMF Delta	Sets the level difference between high band frequency signals and low band frequency signals when sending DTMF tones. [2 dBu/ 3 dBu]
1Dial Tone Detection	Wait Time	The machine starts dialing after the specified interval without detection of a dial tone when Dial tone detection is set to "No detection". [3.5 Sec (Default)/ 7.0 Sec/ 10.5 Sec / 14.0 Sec]
	Timeout Length	This setting sets the time-out length for the 1st dial tone detection. The machine waits for a dial tone for the specified time and disconnects itself from the line when no dial tone is input. [10 Sec (Default)/ 15 Sec/ 20 Sec/ 30 Sec]
BT (Busy Tone) Detection	BT Setting	DFU (Designed for Factory Use) Do not change this setting. [Off/ On] BT: Busy tone
	BT Frequency	DFU (Designed for Factory Use) Do not change this setting. [300-550 Hz/ 300-650 Hz/ 325-525 Hz/ 340-550 Hz/ 350-500 Hz/ 350-550 Hz/ 375-475 Hz/ 380-520 Hz]
	BT Level	DFU (Designed for Factory Use) Do not change this setting. [-35 dB/ -36 dB/ -37 dB/ -38 dB/ -39 dB]
	BT Cadence	DFU (Designed for Factory Use) Do not change this setting. [0.10/ 0.15/ 0.20/ 0.25/ 0.30/ 0.35/ 0.40/ 0.45/ 0.50/ 0.75]
Comm Settings	RTN Rate	The machine checks the actual data reconstruction errors and then transmits an RTN depending on the decoding error rate that is set by this setting (Number of lines containing an error per page / Total number of lines per page). [10%/ 15%]
	V34 Modem	DFU (Designed for Factory Use) Do not change this setting. [Permitted (Default)/ Prohibited]
	V17 Modem	DFU (Designed for Factory Use) Do not change this setting. [Permitted (Default)/ Prohibited]
V34 Settings	Equalizer	These selectors set the equalizer's training level to be applied if

		training fails due to poor line connection. [Automatic (Default)/ 4 Point/ 16 Point]
	Redialing	Resend when a communication error occurs. [Disabled (Default)/ Not Disabled]
	First TX Speed	Sets the first transmission speed choice, before fallback. [2400 Bps/ 4800 Bps/ 7200 Bps/ 9600 Bps / 12000 Bps/ 14400 Bps/ 16800 Bps/ 19200 Bps/ 21600 Bps/ 24000 Bps/ 26400 Bps/ 28800 Bps/ 31200 Bps/ 33600 Bps (Default)]
	Symbol Rate	This setting limits the transmission speed range in V.34 mode by masking the desired symbol rate(s). [Not Used (Default)/ 3429 Sym/Sec / 3200 Sym/Sec/ 3000 Sym/Sec / 2800 Sym/Sec/ 2400 Sym/Sec]
Internet Fax Function (only for SP C262SFNw)	Disable/Enable	Decides whether the Internet Fax function is used or not. Default: Enabled
	Reply-To Setting	Sets “Reply-To” in the SMTP authentication. Yes: Sets the e-mail address that is usually set in the “From” field in the “Reply-To” field, and sets the “Administrator e-mail Address” in the “From” field. No: Not set. Default: No
	Prt Rec Txt Mail Header	Selects whether or not to print the header part of E-mail. Default: No
All Document Transfer		If the machine cannot print faxes due to a printer malfunction or for any other reason, transfer the data to another fax machine for printing. This feature is for both TX/RX jobs of fax and Internet Fax, and excludes reports. Below is a list of target data that should be transferred: <ol style="list-style-type: none"> 1. Fax RX image data (receive/forward) 2. Fax TX image data (redial) 3. Internet Fax RX image data (receive/forward) 4. Internet Fax TX image data (redial) 5. PC fax jobs (redial) Max. 40 characters (one byte)

Print Reports	
G3 Protocol dump list	G3 protocol dump of the latest communication is printed.

5.System Maintenance Reference

	(M203 doesn't support this) Off (Default)/ Error/ On
--	---

(6) CTL SP		
Economy Color Print	Tentative Denstiy-Text	DFU (Designed for Factory Use) Do not change this setting.
	Tentative Denstiy-Graphic	
	Tentative Denstiy-Image	
	Conversion Mode	
AirPrint		Specifies whether to enable or disable the AirPrint function. [Disable(Default) / Enable]
Debug Tool		Specifies whether to send the debug log via the Ethernet port or USB port or to disable the Debug Tool function. [OFF(Default) / NIC / USB]

User Special Maintenance Menu (only for MF Models)

Note

- For information on how to enter the User Special Maintenance Menu, contact the supervisor in your branch office.

Size Mismatch Detection	Specifies whether to detect paper size mismatches. Yes: The error recovery procedure is performed after a paper size mismatch is detected. No: The error recovery procedure will not be performed regardless of the size mismatch. Default: Yes Machine Reboot: Not required
-------------------------	--

Fax Service Test Menu (only for MF Models)

Note

- For information on how to enter the Fax Service Test Menu, contact the supervisor in your branch office.

Fax Test		
Off-Hook Test	On Hook	Executes the on hook test.
	Off Hook	Executes the off hook test
CED Test		Executes the CED test.
CNG Test	1100 Hz	Executes the CNG test

ANSam		Executes the ANSam test.
Ring Tone Test		Executes the ring tone test.
DTMF Test	Tone [0] to [9]	Executes the DTMF tone 0 to 9 test.
	Tone [*]	Executes the DTMF tone * test.
	Tone [#]	Executes the DTMF tone # test.
	Tone Stop	Executes the Stop DTMF tone test.
Modem Test	[V34] 33600 bps	Generates the [V34] 33600 bps signal.
	[V34] 28800 bps	Generates the [V34] 28800 bps signal.
	[V17] 14400 bps	Generates the [V17] 14400 bps signal.
	[V17] 12000 bps	Generates the [V17] 12000 bps signal.
	[V17] 9600 bps	Generates the [V17] 9600 bps signal.
	[V17] 7200 bps	Generates the [V17] 7200 bps signal.
	[V29] 9600 bps	Generates the [V29] 9600 bps signal.
	[V29] 7200 bps	Generates the [V29] 7200 bps signal.
	[V27] 4800 bps	Generates the [V27] 4800 bps signal.
	[V27] 2400 bps	Generates the [V27] 2400 bps signal.
	[V21] 300 bps	Generates the [V21] 300 bps signal.
	Signal Stop	Generates the Stop signal.

Special Maintenance Menu (only for MF Models)

Note

- For information on how to enter the Special Maintenance Menu, contact the supervisor in your branch office.

Engine SN. SP	You can enter the machine serial number.
Factory Default (DFU)	Resets all the settings to factory defaults. After executing, the initial setup menu appears after power-on. Executing this setting clears the following counters: <ul style="list-style-type: none"> Counters of the each functions (copier, facsimile, printer, and scanner) Coverage counter Jam counter Economy color print counter
Reset Menu Setting	Resets the user mode menu to factory defaults except for the following items: <ul style="list-style-type: none"> - Display Language - Country - Network Settings (Includes the settings made with WIM.) - Fax Directory (Quick Dial and Speed Dial and Special sender list)

LCD Coordinate Maintenance Mode

You can calibrate the touch screen with the LCD Coordinate Maintenance Mode.

Note

- For information on how to enter the LCD Coordinate Maintenance Mode, contact the supervisor in your branch office.

1.Set operation panel coordinate	Set the calibration coordinates for the touch panel.
2. Check operation panel coordinate	Check the position of the coordinates for the touch panel with the 5 marks on the screen.

Procedure

- Enter the LCD Coordinate Maintenance Mode.
- Press [1.Set operation panel coordinate] (or press the [1] key on the number keys).

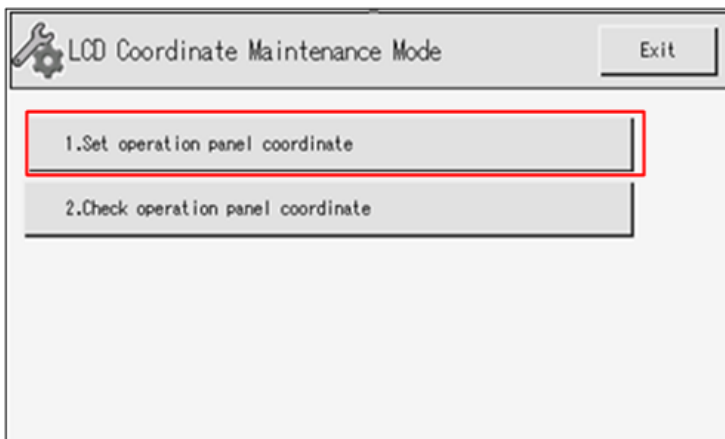

m0azm0105

- Press the black mark (+) at the upper left of the screen. Press the center of the black mark (+).

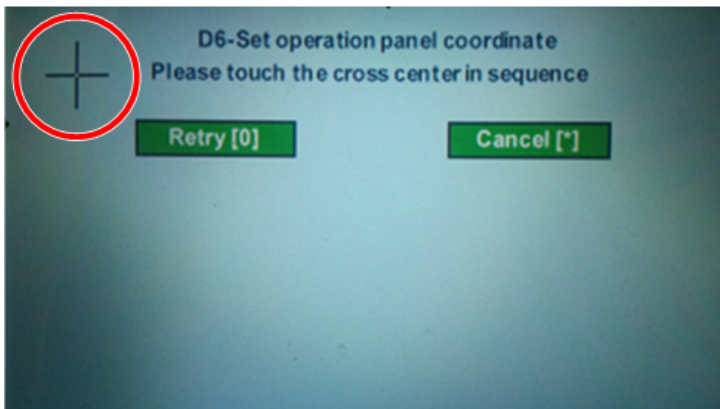

m0azm0107

- The black marks (+) appear in the following order: top right, bottom right, bottom left, and the center. Press

the black marks (+) in this order.

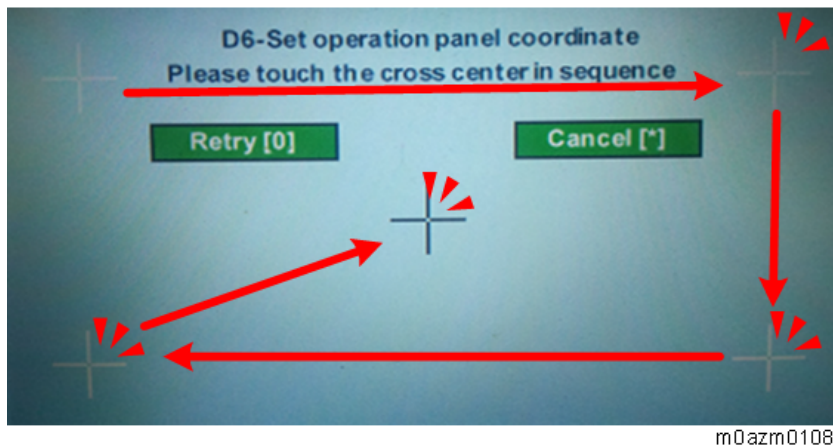

m0azm0108

5. Press [OK[#]] on the screen (or press [#] on the number keys) to save.

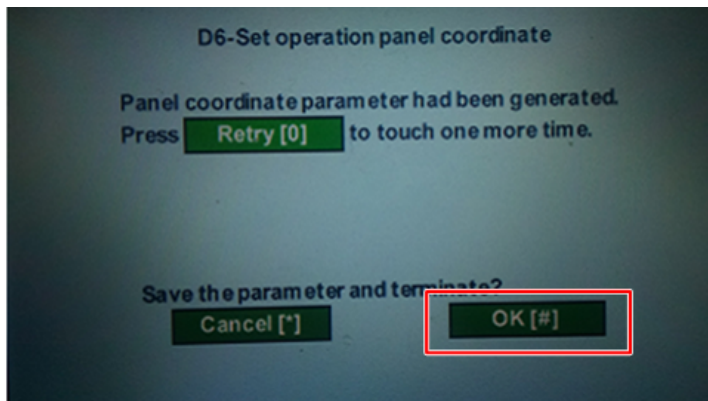

m0azm0109

6. Press [2. Check operation panel coordinate] (or press the [2] key on the number keys).

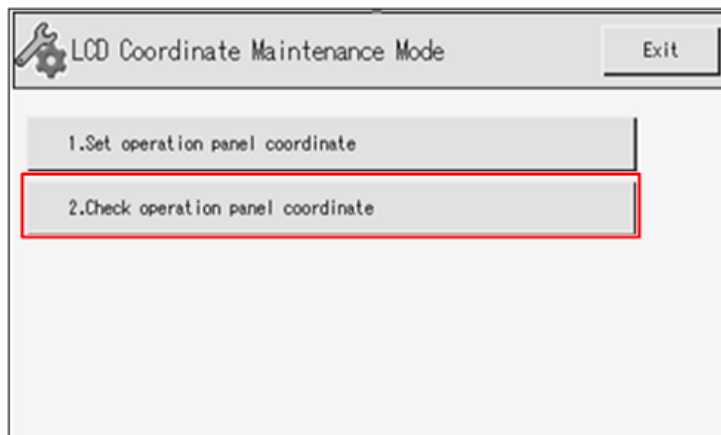

m0azm0106

7. Press 9 black marks (+) displayed on the screen, and then check that the position of the coordinates is within an acceptable range.

Repeat step 2 through step 5 if it is not within an acceptable range, then press precisely at the center of the black mark in step 4.

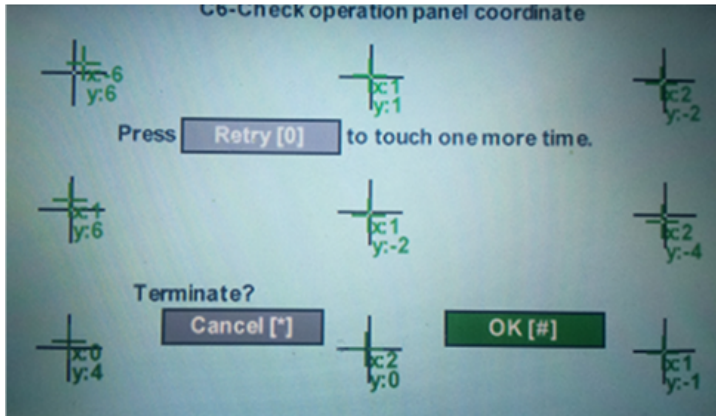

m0azm0110

8. Press [OK[#]] on the screen (or press [#] on the number keys) to exit.

Printer Models

Service Mode (only for Printer Models)

Note

- For information on how to enter the Service Mode, contact the supervisor in your branch office.

Service Menu		
Toner Limit	Toner Limit Tex	Determines the maximum amount of ink/toner you can use in any area of your text. This is where you are controlling exactly how much ink will be used during printing. [200 to 400 / 250 (Default)/ 10/step] Setting 0: Off
	Toner Limit Gra	Determines the maximum amount of ink/toner you can use in any area of your graphic. This is where you are controlling exactly how much ink will be used during printing. [200 to 400 / 250 (Default)/ 10/step] Setting 0: Off
	Toner Limit Ima	Determines the maximum amount of ink/toner you can use in any area of your image. This is where you are controlling exactly how much ink will be used during printing. [200 to 400 / 250 (Default)/ 10/step] Setting 0: Off

Engine Maintenance	
Model	Displays only Displays the current model in a dropdown list. Do not change this setting (Designed for Factory Use).
Brand	Displays the current brand ID number. Do not change this setting (Designed for Factory Use). [0x00 to 0x7F / - / -]

Destination	Sets the destination and updates the engine setting. DOM/ NA (Default)/ EU/ CHN/ TAIWAN/ ASIA / LA	
PnP Name	Sets the Plug and Play name. SP C260DNw:0x10 SP C262DNw: 0x14 C262DNw: 0x14 [0x00 to 0x7F / - / -]	
2nd Transfer	Media Type	Sets the Media type. Plain paper, Thin Paper, Thick Paper 2, Thick Paper 1, Envelope, Cardstock, Bond Paper, Label Paper, Prepunched, Preprinted, Letterhead, Color Paper, Recycled Paper, Middle Thick
	2nd Front	Adjusts the transfer roller current, based on the default value. [-15 to 15 / 0 (Default) / 1 μ A/step]
	2nd Back	Adjusts the transfer roller current, based on the default value. [-15 to 15 / 0 (Default) / 1 μ A/step]
	Fuser Temp.	Adjusts the temperature of the fusing unit, based on the default value. [-30 to 0 / 0 (Default) / 2 $^{\circ}$ C/step]
Registration	Horiz. Tray1	Adjusts the horizontal registration for tray 1. If the machine settings are reset to the factory defaults, this value does not change. [-15 to 15 / 0 (Default) / 1 mm/step]
	Vert.Tray1	Adjusts the vertical registration for tray 1. If the machine settings are reset to the factory defaults, this value does not change. [-15 to 15 / 0 (Default) / 1 mm/step]
	Horiz Bypass Tray	Adjusts the horizontal registration for the bypass tray. If the machine settings are reset to the factory defaults, this value does not change. [-15 to 15 / 0 (Default) / 1 mm/step]
	Vert Bypass Tray	Adjusts the vertical registration for the bypass tray. If the machine settings are reset to the factory defaults, this value does not change. [-15 to 15 / 0 (Default) / 1 mm/step]
	Horiz.Dup Back	Adjusts the horizontal registration for the back side in duplex mode. If the machine settings are reset to the factory defaults, this value does not change. [-15 to 15 / 0 (Default) / 1 mm/step]
	Vert.Dup Back	Adjusts the vertical registration for the back side in duplex mode. If the machine settings are reset to the factory defaults, this value does not change. [-15 to 15 / 0 (Default) / 1 mm/step]
Init. Eng. ROM	Execute this to initialize a new EEPROM. Turn the machine power off/on after you execute this setting. Also, the following items are cleared by EEPROM initialization: <ul style="list-style-type: none"> Machine total counter (total page, full color, and B&W) 	

5. System Maintenance Reference

	<ul style="list-style-type: none"> • Error log (listed as “Call Service” on Maintenance Page) • Duplex page counter 	
Clear log	Clears the failure analysis log. After the failure is cleared, this clears the unnecessary log to record the next log.	
Reset Transfer	Resets the transfer unit life counter.	
Reset Fuser	Resets the fusing unit life counter.	
Reset 2nd	Resets the 2nd transfer unit (transfer roller) life counter.	
Maintenance ID	Displays the current maintenance ID number. Do not change this setting (Designed for Factory Use). [0x00 to 0x7F / - / -]	
LSU Adjustment	Input 160 bytes setting.	Character: alphanumeric "0-9", "a-f", "A-F", only valid data can be input. Input length: 160 bytes
Init. LSU data	Appropriate LD parameters to match the replaced laser optics housing unit are written to the EEPROM of the engine board.	
Trans. Belt Adj	When you execute "Trans. Belt Adj", the transfer belt adjustment is done. This calibrates the motor speed to match the length of the new transfer belt.	
Fuser SC Detect	On/Off*	If On, the engine detects SC559. If Off, the engine does not detect "Fusing SC Reset".
Fuser SC Reset	Resets the Fusing related SC.	
Color Regist	The engine will do color registration and density tuning automatically. The printer will warm up automatically after this setting is changed.	
Special Mode	DFU (Designed for Factory Use) Do not change this setting.	

PM Parts Notice	Sets whether to display the PM parts replacement notice and whether to stop the engine.	
	0	At near end: No Notice / Not Stopped
		At life end: Notice “Replace Now” / Not Stopped
	1	At near end: No Notice / Not Stopped
		At life end: No Notice / Not Stopped
	2 (default)	At near end: Notice / Not Stopped
		At life end: Notice “Replace Now” / Not Stopped
	3	At near end: Notice “Replace Soon” / Not Stopped
		At life end: Notice “Replace Now” / Stopped

Economy Color	
Conversion Mode	Sets the conversion mode for the economy color print.

	<p>No: No conversion is executed.</p> <p>Color Up Mode: Converts into economy color. The image density is decreased.</p> <p>B&W Up Mode: Converts into Economy Black and white.</p>
--	---

System Maint.	
AirPrint	<p>Specifies whether to enable or disable the AirPrint function.</p> <p>[Disable(Default) / Enable]</p>
Debug Tool	<p>Specifies whether to send the debug log via the Ethernet port or USB port or to disable the Debug Tool function.</p> <p>[OFF(Default) / NIC / USB]</p>

Size Detection SP Menu (only for Printer Models)

Note

- For information on how to enter the Size Detection SP Menu, contact the supervisor in your branch office.

Size Mism. Dect.	<p>Specifies whether to detect paper size mismatches.</p> <p>Yes: The error recovery procedure is performed after a paper size mismatch is detected.</p> <p>No: The error recovery procedure will not be performed regardless of the size mismatch.</p> <p>Default: Yes</p> <p>Machine Reboot: Not required</p>
------------------	---

Serial No. SP Menu (only for Printer Models)

Note

- For information on how to enter the Serial No. SP Menu, contact the supervisor in your branch office.

Engine SN. SP	You can enter the machine serial number.
---------------	--

Configuration, Maintenance and Test Page Information

Overview

The configuration page, maintenance page and test page for these models have information about the machine's status. Print this sheet as shown below. Check the configuration page, maintenance page or test page when doing machine maintenance.

To Print the Configuration Page/ Test Page/ Maintenance Page (Printer Models)

1. Turn on the machine.
2. Press the "Menu" key.
3. Press the "▲" or "▼" key to select "List/Test Print", and then press the "OK" key.
4. Press the "▲" or "▼" key to select "Config. Page" or "Test Page" or "Maintenance Pg", and then press the "OK" key.
5. The configuration page or test page or maintenance page is printed.

Note

- Press "Back" to return to the previous menu.

To Print the Configuration Page/ Maintenance Page (MF Models)

1. Turn on the machine.
2. Press the [HOME] key.
3. Press the [Setting] icon on the home screen.
4. Press [Print List/Report].
5. Press [Configuration Page], or [Maintenance Page].
6. Press "Yes" in the confirmation screen.
7. The configuration page or maintenance page is printed.

Note

- Press "Exit" to return to the previous menu.

Error Log

The Error Log on the configuration page has the error logs (SC codes) and the following information. However, the following error codes cannot be stored after turning off the machine.

Error Code	Description
Code 3	<ul style="list-style-type: none"> • Paper misfeed • Paper is not detected in the tray. • The loaded paper size does not match the setting. • Some unit(s) is (are) not correctly installed.
Code 4	Print/Data Error

Error Code	Description
Code 5	A consumable supply has run out
Code 6	Warning; Toner near end, Waste toner bottle near full, TM sensor cleaning, Fusing belt near end or Transfer belt near end
Code 7	Alert; Diagnostic Error

Counter and Coverage (only for Printer Models)

Configuration Page

The configuration page for the printer models has the paper jam, coverage and consumed AIO counters in the bottom line, but these counter names are not printed on the configuration page. These counters give the following information;

Three counters [A]:	Feed jam counter, inner jam counter, duplex jam counter
Four counters [B]:	Recent coverage of K, C, M, Y
Four counters [C]:	Accumulated Coverage of K, C, M, Y
Four counters [D]:	Consumed High Yield AIO counter of K, C, M, Y
Four counters [E]:	Consumed Short Yield AIO counter of K, C, M, Y
Four counters [F]:	High yield AIO Replacement counter of K, C, M, Y
Four counters [G]:	Short yield AIO Replacement counter of K, C, M, Y

The symbols [H] printed beside the remaining toner counter indicate the type of the AIO.

- S: Short Yield AIO
- H: High Yield AIO

Configuration Page (1/2) RICOH Aficio SP C742DN

0,0,0 / 48,0,0,5 / 13,0,0,5
 0,0,0,0 / 0,0,0,0 / 0,0,0,0 / 0,0,0,0

[A] [B] [C]
 [D] [E] [F] [G]

[H]

m0950039

Firmware Updating

CAUTION

- Do not turn off the main power of the machine during the firmware updating. If doing so, the engine board or controller board may be damaged.
- Never disconnect the cable you are using for the updates during the update process.
- When the controller firmware is updated, the fax firmware is also updated at the same time. There is no way to update the fax firmware by itself. The fax firmware is not listed in the configuration page, and so check it by selecting SP mode > Information Display > FW Version > FAX FW".

Checking the Machine Firmware Version

Print the configuration page and take note of the current firmware version (shown under "System Reference" on the configuration page).

To Print the Configuration Page (Printer Models)

1. Turn the machine on.
2. Press the "Menu" key.
3. Press the "▲" or "▼" key to select "List/Test Print", and press the "OK" key.
4. Press the "▲" or "▼" key to select "Config. Page", and then press the "OK" key.

To Print the Configuration Page (MF Models)

1. Turn on the machine.
2. Press the [HOME] key.
3. Press the [Setting] icon on the home screen.
4. Press [Print List/Report].
5. Press [Configuration Page], or [Maintenance Page].
6. Press "Yes" in the confirmation screen.
7. The configuration page or maintenance page is printed.

Updating the Controller Firmware

Using the following procedure to update the controller firmware, be sure to print the configuration page both before and after the update. Comparing pre- and post-update configuration pages allows you to check whether or not the update was successful.

Procedure

When updating firmware, always disconnect any cable(s) other than the one being used for the update operation.

- 1.** Download the firmware files to your computer.
 - FwUpdateTool.exe (Service mode execute file)
 - Setting.ini (Parameter setting)
 - xxx.brn (Controller Firmware)

2. Make a folder on a local drive of your computer and save the files there.
3. Turn the machine on.
4. Connect the computer and the machine through a network or directly by USB.
5. Double-click the "FWUpdateTool.exe" file to execute the updating program.
A dialog box with cautionary statements appears.
6. Read the cautionary statements carefully, and then click "OK".

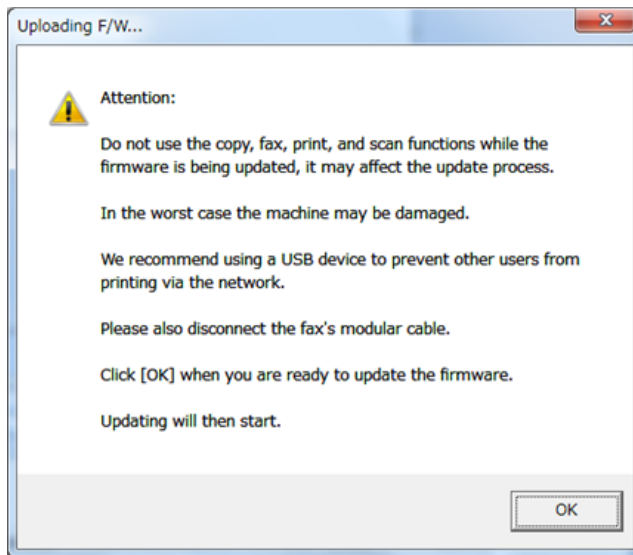

m0azm0088

The firmware update tool opens.

7. For a USB connection, click "Firmware Update (USB)" [A].
For a network connection, enter the machine's IP address in "Machine IP address" [B], and then click "Firmware Update (LAN)" [C].

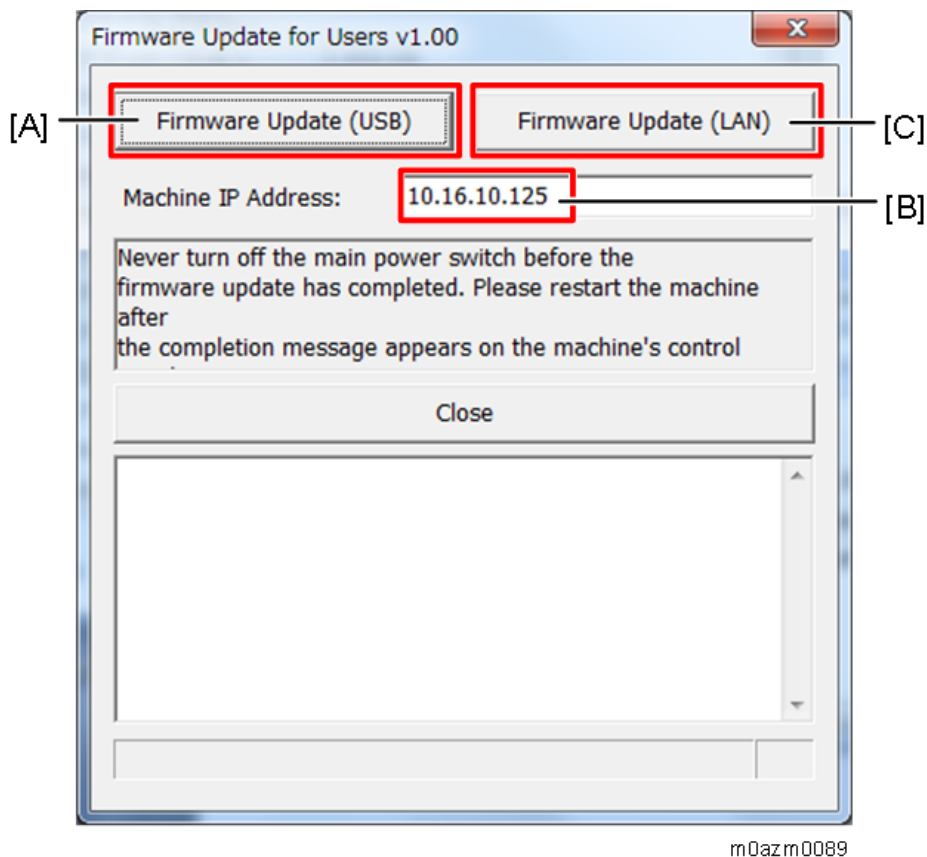

The firmware update starts.

Note

- When the firmware update starts:
 - For Printer models: The alert LED starts to light up.
 - For MF models: The alert LED starts to light up and machine makes a beep sound.

8. Check the machine's control panel for messages and the update's current percentage of completion.

Note

- Do not turn the main power off from this point until the update procedure is completed.

9. Wait until the update completion message appears on the machine's control panel.

Note

- When the firmware update is completed:
 - For Printer models: The alert LED starts
 - For MF models: The alert LED starts flashing and machine makes a beep sound.

- 10.** Click “Close” [A] to close the update tool.

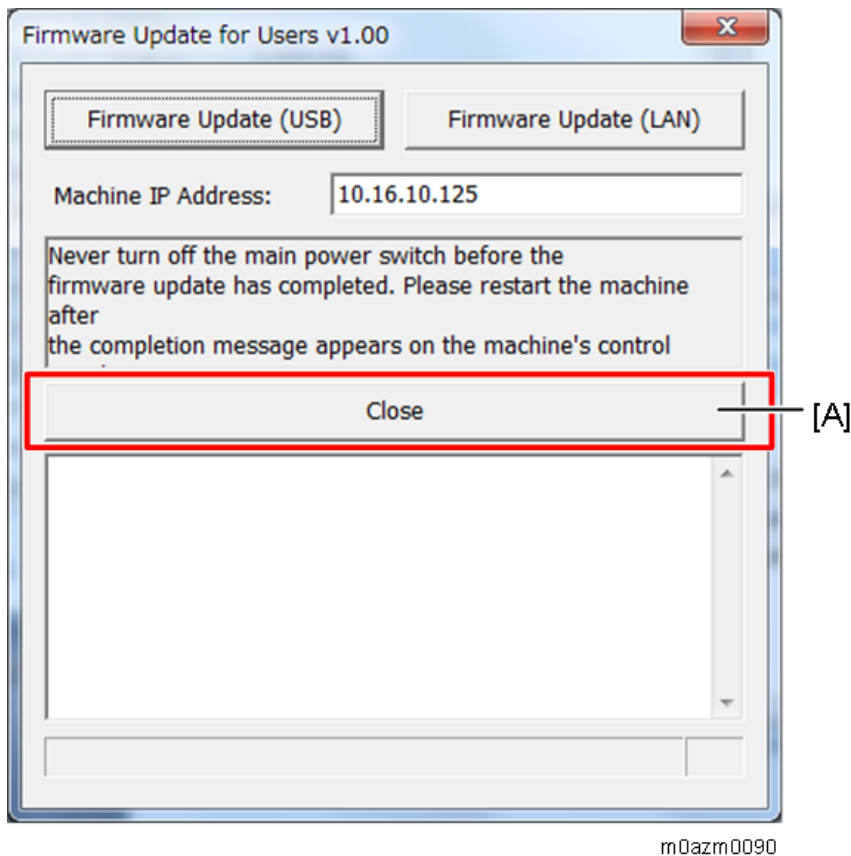

m0azm0090

- 11.** Turn off the power of the machine, and then turn it back on.
12. Print a configuration or maintenance page to check the machine's firmware version.

⚠ CAUTION

- Do not turn off the machine until the update completion message appears on the machine’s control panel. Otherwise, the controller board will be damaged.
- If the update completion message does not appear, the download failed. Try again. You can also switch from an Ethernet connection to a USB connection and see if that works. If you still cannot download the firmware, it may be necessary to change the EGB and/or the controller board.
- If power failed during the download, try again. If you still cannot download the firmware, it may be necessary to change the EGB and/or the controller board.

Updating the Engine Firmware

When updating firmware, always disconnect any other cable(s) than the one being used for the update operation.

- 1.** Download the firmware files to your computer.
 - UsbToolSP.exe (Service mode execute file)
 - Setting.ini (Parameter setting)
 - yyy.bin (Engine Firmware)
- 2.** Make a folder on a local drive of your computer and save the files there.
- 3.** Turn the machine on.
- 4.** Connect the computer and the machine through a network or directly by USB.

5. System Maintenance Reference

5. Open the top cover.
6. Double-click the "UsbToolSP.exe" file to execute the updating program.
A dialog box with cautionary statements appears.
7. Read the cautionary statements carefully, and then click "OK".

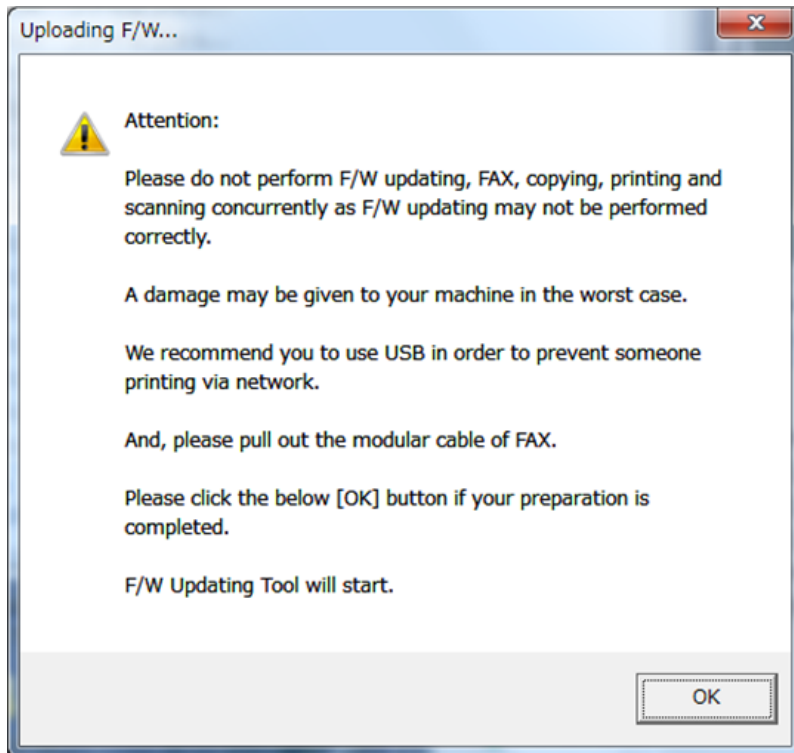

m0azm0091

The firmware update tool opens.

8. For a USB connection, click "Eng. F/W Update (USB)" [A].
For a network connection, enter the machine's IP address in "Machine IP address" [B], and then click "Eng. F/W Update (NET)" [C].

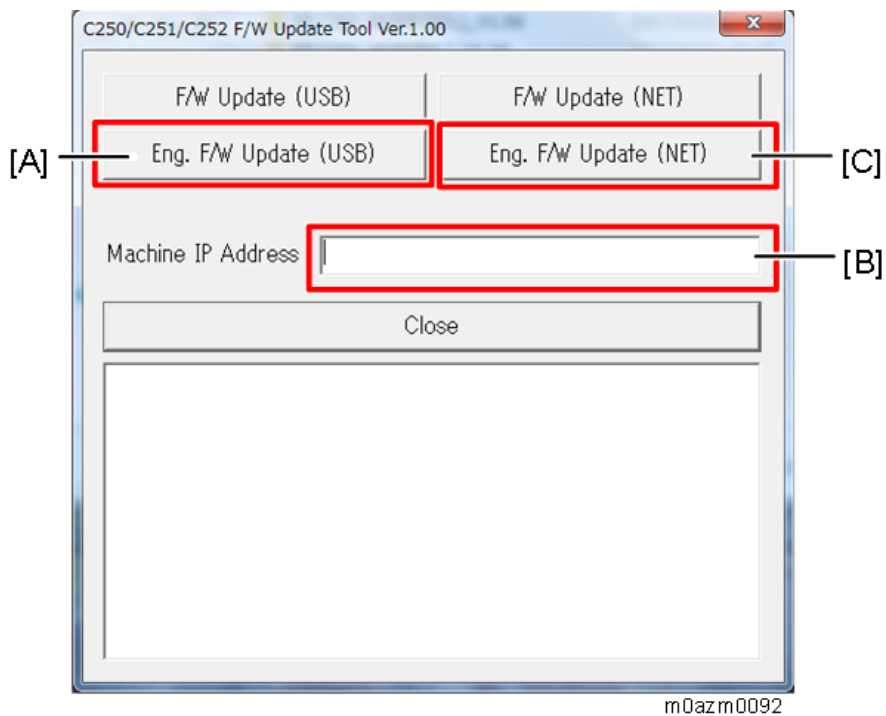

The firmware update starts.

Note

- When the firmware update starts:
For Printer models: The alert LED starts to light up.
- For MF models: The alert LED starts to light up and machine makes a beep sound.

Note

- Do not turn the main power off from this point until the update procedure is completed.

9. Wait until the update completion message appears on the machine's control panel.

Note

- When the firmware update is completed:
 - For Printer models: The alert LED starts flashing.
 - For MF models: The alert LED starts flashing and machine makes a beep sound.

10. Click “Close” [A] to close the update tool.

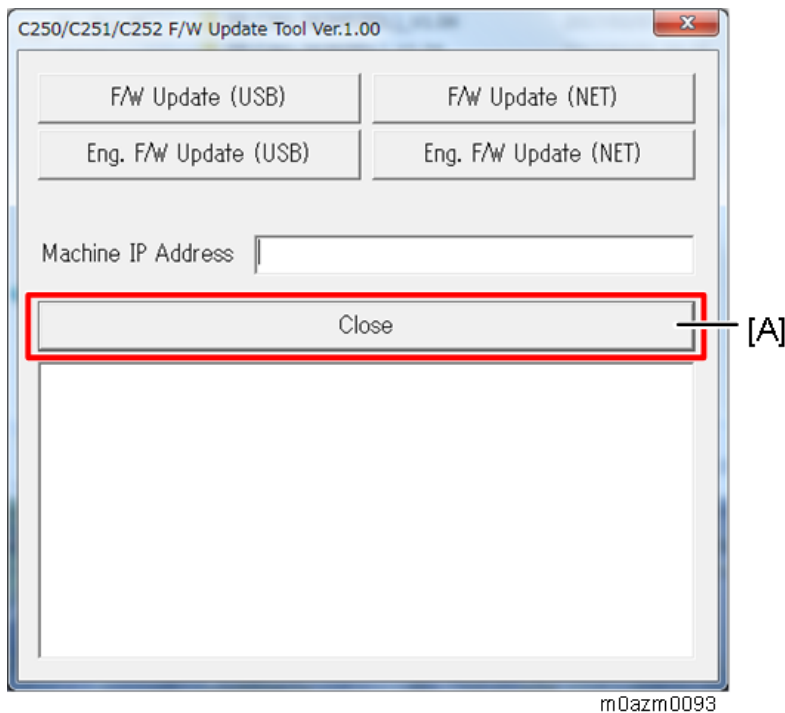

11. Close the top cover.

12. Turn off the power of the machine, and then turn it back on.

13. Print a configuration or maintenance page to check the machine's firmware version.

⚠ CAUTION

- Do not turn off the machine until the update completion message appears on the machine’s control panel. Otherwise, the controller board will be damaged.
- If the update completion message does not appear, the download failed. Try again. You can also switch from an Ethernet connection to a USB connection and see if that works. If you still cannot download the firmware, it may be necessary to change the EGB and/or the controller board.
- If power failed during the download, try again. If you still cannot download the firmware, it may be necessary to change the EGB and/or the controller board.

Bootloader Firmware

This is also listed on the configuration page, but this firmware is not updated in the field.

6. Troubleshooting

Service Call Conditions

Summary

This machine issues an SC (Service Call) code if an error occurs on the machine. The error code can be seen on the operation panel.

Make sure that you understand the following points;

1. All SCs are logged.
2. At first, always turn the main switch off and on if an SC code is issued.
3. First, disconnect then reconnect the connectors before you replace the PCBs, if the problem concerns electrical circuit boards.
4. First, check the mechanical load before you replace motors or sensors, if the problem concerns a motor lock.
5. Fusing related SCs: To prevent damage to the machine, the main machine cannot be operated until the fusing related SC has been reset by a service representative.
 - Enter the engine maintenance mode.
 - Press "O.K" in "Fuser SC Reset" with the SP mode (MF models: SP Menu, Printer models: Service Mode), and then turn the main power switch off and on.

Engine SC

SC 1xx (Other Error)

SC195	Serial Number Error
	The serial number stored in the memory (EGB) is not correct.
	<ul style="list-style-type: none"> • EEPROM defective • EGB replaced without original EEPROM <ol style="list-style-type: none"> 1. Check the serial number. 2. If the stored serial number is incorrect, contact your supervisor.

SC 2xx (Laser Optics Error)

SC202	Polygon motor error 1: ON timeout
	The polygon mirror motor does not reach the targeted operating speed within 5 sec. after turning on or changing speed.
SC203	Polygon motor error 2: OFF timeout
	The polygon mirror motor does not leave the READY status within 3 sec. after the polygon motor switched off.
SC204	Polygon motor error 3: XSCRDY signal error
	The SCRDY_N signal remains HIGH for 200 ms while the LD unit is firing.

6. Troubleshooting

	<ul style="list-style-type: none"> • Polygon motor/driver board harness loose or disconnected • Polygon motor/driver board defective • Laser optics unit defective • IPU (EGB) defective <ol style="list-style-type: none"> 1. Replace the interface harness of the laser optics unit. 2. Replace the laser optics unit. 3. Replace the EGB (Engine Board).
--	---

SC220	Laser Synchronizing Detection Error: [K]/[Y]
	The laser synchronizing detection signal for LDB [K]/[Y] is not output after the LDB unit has turned on while the polygon motor is rotating normally.
SC222	Laser Synchronizing Detection Error: [M]/[C]
	The laser synchronizing detection signal for LDB [M]/[C] is not output after the LDB unit has turned on while the polygon motor is rotating normally.
	<ul style="list-style-type: none"> • Disconnected cable from the laser synchronizing detection unit or defective connection • Defective laser synchronizing detector • Defective LDB • Defective EGB <ol style="list-style-type: none"> 1. Check the connectors. 2. Replace the laser optics unit. 3. Replace the EGB.

SC240	LD error
	The IPU (EGB) detects a problem at the LD unit.
	<ul style="list-style-type: none"> • Worn-out LD • Disconnected or broken harness of the LD. <ol style="list-style-type: none"> 1. Replace the laser optics unit.

SC 3xx (Charge Error)

SC300	High voltage power output error
	The measured voltage is not correct when the EGB measures each charge output (charge, development, image transfer belt unit, and transfer unit).
	<ul style="list-style-type: none"> • Disconnected or defective high voltage harness • Defective high voltage power supply • Defective EGB <ol style="list-style-type: none"> 1. Check or replace the harnesses. 2. Replace the high voltage power supply board 3. Replace the EGB.

SC396	Black drum motor error
	The LOCK signal error is detected when the EGB monitors the black drum motor state. (This monitoring is done immediately after power-on, when the motor starts rotating, and immediately after the motor stops.)
	<ul style="list-style-type: none"> • Disconnected or defective motor harness. • Motor slips due to excessive load <ol style="list-style-type: none"> 1. Check the harness from the black drum motor. Replace it if necessary.
SC397	Color drum motor error
	The LOCK signal error is detected when the EGB monitors the color drum motor state. (This monitoring is done immediately after power-on, when the motor starts rotating, and immediately after the motor stops.)
	<ul style="list-style-type: none"> • Disconnected or defective motor harness. • Motor slips due to excessive load <ol style="list-style-type: none"> 1. Check the harness from the color drum motor. Replace it if necessary.

SC 4xx (Image Transfer and Transfer Error)

SC400	TM sensor error
	The CPU detected a low voltage of the positive reflection output under the threshold in the TM sensor.
	<ul style="list-style-type: none"> • TM sensors are dirty. • A solid print out due to an electrostatic charging error • The TM sensor is defective. <ol style="list-style-type: none"> 1. Clean the TM sensors. 2. Replace the TM sensors. 3. Check the image transfer unit. 4. Turn the power Off and On.
SC445	ITB (Image Transfer Belt) Unit: Home Position Error
	The ITB contact sensor does not detect the home position of the ITB for 5 seconds after the ITB unit initialization has been done.
	ITB (Image Transfer Belt) Unit: Contact Position Error
	The ITB contact sensor does not detect the contact position of the ITB for 5 seconds after the ITB unit has moved to the contact position.
	ITB (Image Transfer Belt) Unit: No-contact Position Error
	The ITB contact sensor does not detect the home position of the ITB for 5 seconds after the ITB unit has moved to no-contact position.
	<ul style="list-style-type: none"> • Defective ITB contact motor • Defective ITB contact sensor • Defective ITB unit <ol style="list-style-type: none"> 1. Replace the ITB contact motor. 2. Replace the ITB contact sensor.

6. Troubleshooting

	3. Replace the ITB unit.
--	--------------------------

SC480	Agitator Motor Error
	The agitator motor error is detected twice for 10 msec during the initialization at power-on or after the cover is closed.
	<ul style="list-style-type: none"> • Disconnected or defective harness • Defective agitator motor <ol style="list-style-type: none"> 1. Check or replace the harness. 2. Replace the agitator motor.

SC490	ITB (Image Transfer Belt) Unit Set Error
	The TM sensor does not detect the reflection from the ITB.
	<ul style="list-style-type: none"> • No ITB unit in the machine • Dirty TM sensor <ol style="list-style-type: none"> 1. Check the installation of the ITB unit. 2. Clean the TM sensor.

SC 5xx (Motor and Fusing Error)

SC500	Transport/Fusing Motor Error
	The LOCK signal error is detected when the EGB monitors the transport/fusing motor state. (This monitoring is done immediately after power-on, when the motor starts rotating, and immediately after the motor stops.)
	<ul style="list-style-type: none"> • Disconnected or defective motor harness. • Motor slips due to excessive load <ol style="list-style-type: none"> 1. Check the harness from the transport/fusing motor. Replace it if necessary.

SC530	LSU Fan Motor Error
	A LOCK signal is not detected for more than ten seconds while the motor START signal is on and if this error occurs twice consecutively, this SC is issued.
	<ul style="list-style-type: none"> • Disconnected or defective motor harness. • Defective LSU fan motor <ol style="list-style-type: none"> 1. Check or replace the motor harness. 2. Replace the LSU fan motor.

SC531	Fusing Fan Motor Error
	A LOCK signal is not detected for more than ten seconds while the motor START signal is on and if this error occurs twice consecutively, this SC is issued.
	<ul style="list-style-type: none"> • Disconnected or defective motor harness.

	<ul style="list-style-type: none"> • Defective LSU fan motor <ol style="list-style-type: none"> 1. Check or replace the motor harness. 2. Replace the fusing fan motor.
SC541	<p>Thermistor Error</p> <p>The thermistor output is less than 0°C for 7 seconds.</p> <ul style="list-style-type: none"> • Disconnected thermistor • Defective harness connection <ol style="list-style-type: none"> 1. Check the harness connection of the thermistor. 2. Replace the fusing unit. <p>★ Important</p> <ul style="list-style-type: none"> • Execute "Fuser SC Reset" to recover the machine after completing the recovery procedure. Otherwise, the machine continues to issue this SC code and cannot be operated.
SC542	<p>Print Ready Temperature Error</p> <ul style="list-style-type: none"> • The heating roller temperature increase during a set time is not correct. • The fusing temperature does not reach the print ready temperature within a set time after the fusing lamp has turned on. <ul style="list-style-type: none"> • Defective thermistor • Incorrect power supply input at the main power socket • Defective fusing lamp <ol style="list-style-type: none"> 1. Check the voltage of the wall outlet. 2. Replace the fusing unit 3. Replace the fusing lamp. <p>★ Important</p> <ul style="list-style-type: none"> • Execute Fuser SC Reset" to recover the machine after completing the recovery procedure. Otherwise, the machine continues to issue this SC code and cannot be operated.
SC543	<p>High Temperature Detection Error</p> <p>This SC is issued if one of following conditions occurs:</p> <ul style="list-style-type: none"> • The thermistor (center) detects 255°C or thermistor (end) detects 245°C. • The thermistor (center) detects a 3°C increment or more for five seconds at 220°C or more or the thermistor (end) detects a 4°C increment or more for five seconds at 210°C or more. <ul style="list-style-type: none"> • Defective I/O control (EGB) • Defective EGB <ol style="list-style-type: none"> 1. Replace the EGB <p>★ Important</p> <ul style="list-style-type: none"> • Execute "Fuser SC Reset" to recover the machine after completing the recovery procedure. Otherwise, the machine continues to issue this SC code and cannot be operated.

6.Troubleshooting

SC545	Heating Lamp Full-Power Error
	The fusing lamp is fully-powered for a certain time while the fusing unit stays in the stand-by mode and is not rotating.
	<ul style="list-style-type: none"> • Deformed thermistor • Thermistor not in the correct position • Defective fusing lamp <ol style="list-style-type: none"> 1. Replace the fusing unit. 2. Replace the fusing lamp. <p>★ Important</p> <ul style="list-style-type: none"> • Execute "Fuser SC Reset" to recover the machine after completing the recovery procedure. Otherwise, the machine continues to issue this SC code and cannot be operated.

SC547	Zero Cross Error
	The zero cross signal is not detected for three seconds even though the fusing lamp relay is on after turning on the main power or closing the front door.
	<ul style="list-style-type: none"> • Defective fusing lamp relay <ol style="list-style-type: none"> 1. Turn the main power switch off and on. <p>★ Important</p> <ul style="list-style-type: none"> • Execute "Fuser SC Reset" to recover the machine after completing the recovery procedure. Otherwise, the machine continues to issue this SC code and cannot be operated. The power should be turned off and on after the recovery procedure.

SC548	Low Temperature Error
	The center thermistor detects 100°C or less for 4 seconds.
	<ul style="list-style-type: none"> • Defective fusing lamp • Defective thermistor <ol style="list-style-type: none"> 1. Replace the fusing unit. 2. Replace the fusing lamp. <p>★ Important</p> <ul style="list-style-type: none"> • Execute "Fuser SC Reset" to recover the machine after completing the recovery procedure. Otherwise, the machine continues to issue this SC code and cannot be operated.

SC557	Zero Cross Frequency Error
	The detection error occurs ten times consecutively in ten zero cross signal detections. This error is defined when the detected zero cross signal is 17 or less/27 or more for 0.2 seconds.
	<ul style="list-style-type: none"> • Defective fusing lamp relay • Unstable input power source

	<ol style="list-style-type: none"> 1. Check the power supply source. 2. Replace the fusing unit. 3. Turn the main power switch off and on. <p>★ Important</p> <ul style="list-style-type: none"> • Execute "Fuser SC Reset" to recover the machine after completing the recovery procedure. Otherwise, the machine continues to issue this SC code and cannot be operated. The power should be turned off and on after the recovery procedure.
--	---

SC559	Consecutive Fusing Jam
	<p>The paper jam counter for the fusing unit reaches 3. The paper jam counter is cleared if the paper is fed correctly.</p> <p>This SC is activated only when this function (Fuser SC Detect) is enabled with the SP mode (default "OFF").</p>
	<ul style="list-style-type: none"> • Defective fusing unit • Defective fusing control <ol style="list-style-type: none"> 1. Clear this SC to send a command after a jam removal. 2. Turn off this function after a jam removal. <p>★ Important</p> <ul style="list-style-type: none"> • Execute "Fuser SC Reset" to recover the machine after completing the recovery procedure. Otherwise, the machine continues to issue this SC code and cannot be operated.

SC 6xx (Communication and Other Error)

SC669	EEPROM Error
	An unexpected value exists in the initialization flag of the EEPROM
	<ul style="list-style-type: none"> • EEPROM not initialized • Defective EEPROM <ol style="list-style-type: none"> 1. Initialize the EEPROM. 2. Replace the EEPROM. 3. Replace the EGB.

SC690	GAVD Communication Error
	The ID of the GAVD is not identified during initialization.
	The chip ID of the GAVD cannot be detected by the machine at power-on.
	<ul style="list-style-type: none"> • Defective EGB <ol style="list-style-type: none"> 1. Replace the EGB.

Controller SC

SC8xx

SC819	Service Cycle Power
	<ul style="list-style-type: none"> • Incorrect combination of EGB and controller board. • An unexpected error occurs in the EEPROM on the controller board.
	<ul style="list-style-type: none"> • Controller board defective <ol style="list-style-type: none"> 1. Install the correct EGB and controller boards for this machine. 2. Replace the controller board

SC823	USB/ Network Device Error
	An interface error in the USB connection or NIB connection occurs.
	<ul style="list-style-type: none"> • Controller board defective <ol style="list-style-type: none"> 1. Replace the controller board.

SC824	EEPROM Error
	An EEPROM check error at power-on occurs.
	<ul style="list-style-type: none"> • Controller board defective <ol style="list-style-type: none"> 1. Replace the controller board.

SC827	On-Board Memory Check Error
	An on-board memory check error at power-on occurs.
	<ul style="list-style-type: none"> • Controller board defective <ol style="list-style-type: none"> 1. Replace the controller board.

SC828	ROM Checksum Error
	A ROM checksum error at power-on occurs.
	<ol style="list-style-type: none"> 1. Replace the controller board.

Fax Error Code Definition (only for MF Models)

This error code definition is for dial errors, TX communication errors, and RX communication errors.

The Error Code is printed on the TX Report/Activity Report/G3 Protocol dump list.

Basic error code structure

Error codes consist of six hexadecimal digits (0–5).

Digit 5 (far left): TX or RX

TX:	1xxxxx
RX:	2xxxxx
Internet Fax TX:	3xxxxx
Internet Fax RX:	4xxxxx

Digit 4: Coding (MH/MR/MMR/JBIG)

MH:	x1xxxx
MR:	x2xxxx
MMR:	x3xxxx
JBIG:	x4xxxx

Digit 3: Modem mode

V27ter nonECM	xx1xxx
V29 nonECM	xx2xxx
V17 nonECM	xx3xxx
V33 nonECM	xx4xxx
V34	xx5xxx
V27ter ECM	xx9xxx
V29 ECM	xxaxxx
V17 ECM	xxbxxx
V33 ECM	xxcxxx

Digit 2: Modem speed

2400	xxx1xx
4800	xxx2xx
7200	xxx3xx
9600	xxx4xx
12000	xxx5xx
14400	xxx6xx
16800	xxx7xx
19200	xxx8xx

6. Troubleshooting

21600	xxx9xx
24000	xxxaxx
26400	xxxbxx
28800	xxxcxx
31200	xxxdx
33600	xxxexx

Digits 1-0 are assigned to indicate detailed error descriptions.

Error code table

Error Type	Error Description	Error Code
General	Normal (No Error)	0
	STOP	xxxx01
	Unknown Error	xxxxFF
	RX T1 Time Out	Not logged in activity report
Local Mechanical error	Scanner Error during TX	1xxx11
	Memory Full during RX	2xxx14
	Authorized Reception = Enable, Since received TSI was not match, reception was refused.	xxxx06
Dial failure	Connection Fail	xxxx21
	Dial Fail	xxxx22
	Redial All Failed	xxxx23
Comm. Error	TX T1 Time Out	xxxx31
	V8 negotiation Fail	xxxx32
	Retry Out	xxxx40
	Too many FTT	xxxx41
	Too many CRP	xxxx42
	T2 Time Out	xxxx43
	DCN received	xxxx44
	Command Rec Error	xxxx45
	Resp Rec Error	xxxx46
	Invalid Command/Response RX	xxxx47
	Remoter No RX capability	xxxx48
	T1 time out after EOM	xxxx49
	T2 Time Out	xxxx50
	Image Data not ready	xxxx51
Phase-C Time Out	xxxx52	

Error Type	Error Description	Error Code
	JBIG Buffer Full	xxxx53
	Retry Out	xxxx60
	T2 Time Out	xxxx61
	DCN received	xxxx62
	Too many CRP	xxxx63
	Too many PPR	xxxx64
	RNR time Out	xxxx65
	RTN/PIN Received, EOR/ERR/DCN	xxxx66
	Invalid Command/Response RX	xxxx67
Comm. Error	Command Rec Error	xxxx68
	Resp Rec Error	xxxx69
	Time Out	xxxx70
	Modem hang-up	xxxx80
	V34 abort received	xxxx81
	V34 t1 timeout, control channel error	xxxx82
	V34 t1 timeout, primary channel error	xxxx83
	Data not sent until guard timer expired	xxxx84

The following information is also included in the User Guide.

Error Code	Solution
1XXX11	<p>An original has been jammed inside the ADF while sending a fax in Immediate Transmission mode.</p> <ul style="list-style-type: none"> Remove jammed originals, and then place them again. Check the originals are suitable for scanning.
1XXX21	<p>The line could not be connected correctly.</p> <ul style="list-style-type: none"> Check if the telephone line is properly connected to the machine. Disconnect the telephone line cord from the machine, and connect the cord to a telephone. Check if you can make calls using the telephone. If you cannot make calls this way, contact your telephone company.
1XXX22 to 1XXX23	<p>Dial fails when trying to send faxes.</p> <ul style="list-style-type: none"> Check if that the fax number you dialed is correct. Check if that the destination is a fax machine. Check if that the line is not busy. You may need to insert a pause between dial digits. Press the [Pause/Redial] key after, for example, the area code. Check if [PSTN / PBX] under [Admin. Tools] has been specified properly for your connection method to the telephone network.

6. Troubleshooting

Error Code	Solution
1XXX32 to 1XXX84	<p>An error occurred while sending a fax.</p> <ul style="list-style-type: none"> • Check if the telephone line is properly connected to the machine. • Disconnect the telephone line cord from the machine, and connect the cord to a telephone. Check if you can make calls using the telephone. If you cannot make calls this way, contact your telephone company.
2XXX14	<p>The machine was not able to print the received fax, or the machine's memory reached its capacity while receiving a fax because the document was too large.</p> <ul style="list-style-type: none"> • The paper tray was empty. Load paper in the paper tray. • The tray selected in [Select Paper Tray] under [Fax Features] did not contain A4, Letter, or Legal size paper. Load valid size paper in the tray, and configure the paper size settings under [Tray Paper Settings] accordingly. • A cover or tray was open. Close the cover or tray. • There was a paper jam. Remove the jammed paper. • A print cartridge was empty. Replace the print cartridge. • The received fax was too large. Ask the sender to re-send the document in parts as several smaller faxes, or to send the fax at a lower resolution.
2XXX32 to 2XXX84	<p>An error occurred while receiving a fax.</p> <ul style="list-style-type: none"> • Check if the telephone line is properly connected to the machine. • Disconnect the telephone line cord from the machine, and connect the cord to a telephone. Check if you can make calls using the telephone. If you cannot make calls this way, contact your telephone company.
3XXX11	<p>Connection to the server failed while sending an Internet Fax.</p> <ul style="list-style-type: none"> • Check if the network cable is properly connected to the machine. • Check if the network settings such as the IP address, DNS, and SMTP settings have been configured properly (make sure that no double-byte character is used).
3XXX12	<p>E-mail transmission failed while sending an Internet Fax.</p> <ul style="list-style-type: none"> • There was an error in the header of the e-mail. Check if the network settings such as the IP address, DNS, and SMTP settings have been configured properly (make sure that no double-byte character is used).
3XXX13	<p>E-mail transmission failed while sending an Internet Fax.</p> <ul style="list-style-type: none"> • There was an error in the part header of the e-mail. Check if the network settings such as the IP address, DNS, and SMTP settings have been configured properly (make sure that no double-byte character is used).
3XXX14	<p>E-mail transmission failed while sending an Internet Fax.</p> <ul style="list-style-type: none"> • There was an error in the converted TIFF file. Check if the network settings such as the IP address, DNS, and SMTP settings have been configured properly (make sure that no double-byte character is used).
3XXX33	<p>The machine memory reached capacity while sending an Internet Fax.</p>

Error Code	Solution
	<ul style="list-style-type: none"> The fax was too large. Resend the document in parts as several smaller faxes, or send the fax at a lower resolution.
4XXX21	<p>Connection to the server failed while receiving an Internet Fax.</p> <ul style="list-style-type: none"> Check if the network cable is properly connected to the machine. Check if the network settings such as the IP address, DNS, and POP3 settings have been configured properly (make sure that no double-byte character is used).
4XXX22	<p>E-mail reception failed while receiving an Internet Fax.</p> <ul style="list-style-type: none"> LIST command to the POP3 server failed. Ask the sender to check the e-mail settings.
4XXX23	<p>E-mail reception failed while receiving an Internet Fax.</p> <ul style="list-style-type: none"> There was an error in the header of the e-mail. Ask the sender to check the e-mail settings.
4XXX24	<p>E-mail reception failed while receiving an Internet Fax.</p> <ul style="list-style-type: none"> There was an error in the part header of the e-mail. Ask the sender to check the e-mail settings. The e-mail had an invalid Content-Type, or an unsupported type of file (such as PDF or JPEG) was received. Ask the sender to check the file type.
4XXX25	<p>E-mail reception failed while receiving an Internet Fax.</p> <ul style="list-style-type: none"> There was an error in the text part of the part body of the e-mail. Ask the sender to check the e-mail settings.
4XXX26	<p>E-mail reception failed while receiving an Internet Fax.</p> <ul style="list-style-type: none"> There was an error in the received TIFF file (which resulted from a condition not indicated by the error codes 4XXX43 to 4XXX45). Ask the sender to check the TIFF file.
4XXX42	<p>E-mail reception failed while receiving an Internet Fax.</p> <ul style="list-style-type: none"> There was an error in the part header of the e-mail. Ask the sender to check the e-mail settings.
4XXX43	<p>A TIFF file could not be received via Internet Fax properly.</p> <ul style="list-style-type: none"> The compression method of the received TIFF file was other than MH/MR/MMR. Ask the sender to check the TIFF file.
4XXX44	<p>A TIFF file could not be received via Internet Fax properly.</p> <ul style="list-style-type: none"> The resolution of the TIFF file was not supported, or the width of the TIFF file was that of A3 or B4 paper. Ask the sender to check the TIFF file.
4XXX45	<p>A TIFF file could not be received via Internet Fax properly.</p> <ul style="list-style-type: none"> The format of the TIFF file was other than TIFF-S/F. Ask the sender to check the TIFF file.
4XXX46	<p>The machine memory reached its capacity while receiving an Internet Fax.</p> <ul style="list-style-type: none"> The fax was too large. Ask the sender to resend the document in parts as several smaller faxes, or send at a lower resolution.

Fax Error Clear Principle (only for MF Models)

RX

1. When the RX communication Error occurs, the display shows "RX Comm Error".
 2. During the display shows "RX Comm Error", any job can be accepted same as the normal status.
 3. The "RX Comm Error" to be cleared by receiving any jobs (Fax, Copy, Print, Scan) or pressing any button.
-

TX

1. When the TX communication Error occurs, the display shows the "TX Comm Error".
2. If the auto redial is on, This machine (M203/M204) retry the TX, This machine (M203/M204) doesn't show the error message during the retry.
 - If the retry finish successfully, then return to the normal status.
 - If the retry fail as the number set by user, the message remains as "TX Comm Error".
 - If the auto redial is off, the message is remain.
3. During the display shows "TX Comm Error", any job can be accepted same as the normal status.
4. The "TX Comm Error" to be cleared by receiving any jobs (Fax, Copy, Print, Scan) or pressing any button.

Image Problems

Overview

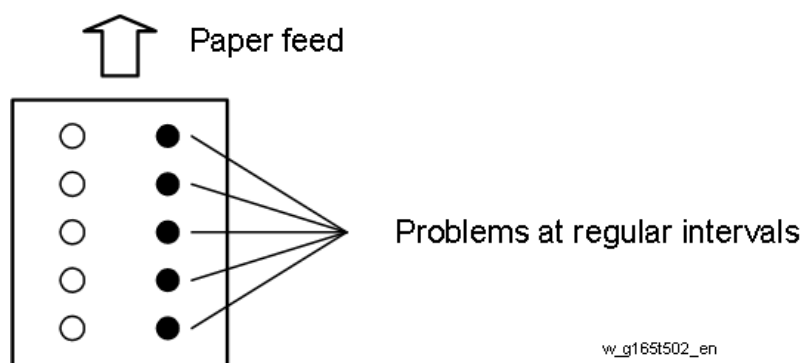

Image problems may appear at regular intervals that depend on the circumference of certain components. The following diagram shows the possible symptoms (black or white dots at regular intervals).

- Abnormal image at 23.5 mm intervals: Paper feed roller.
- Abnormal image at 59 mm intervals: Paper transfer roller
- Abnormal image at 25 mm intervals: Image transfer belt unit (Transfer roller)
- Abnormal image at 30 mm intervals: Charge roller.
- Abnormal image at 38 mm intervals: Registration roller
- Colored spots at 27 mm intervals: AIO cartridge (Development roller)
- Abnormal image at 61 mm intervals: Image transfer belt unit (Drive roller)
- Colored spots at 76 mm intervals: AIO cartridge (OPC drum)
- Abnormal image at 95 mm intervals: Fusing unit (Pressure roller)
- Abnormal image at 76 mm intervals: Fusing unit (Heat roller)

Image Problem

Print out a “maintenance page” (all K, C, M, or Y), which will clarify if the cause is a problem with one of the AIOs, Image transfer belt, image transfer roller, or the fusing unit ([Configuration, Maintenance and Test Page Information](#)).

- Occurs with 1-3 colors: AIO unit(s) failure
- Occurs with all four colors: Image transfer belt, transfer roller or fusing unit failure

7. Detailed Descriptions

Machine Overview

Component Layout

Engine

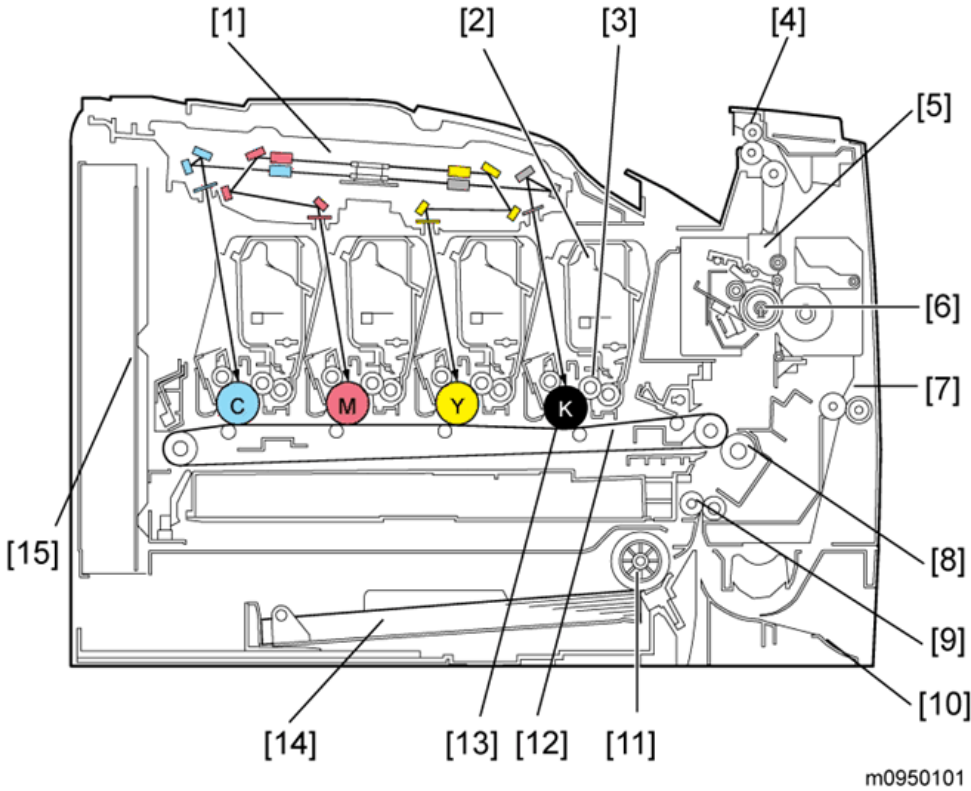

1. Laser Optics Housing Unit	9. Registration Roller
2. Print Cartridge (AIO)	10. By-pass
3. Development Roller (AIO)	11. Paper Feed Roller
4. Paper Exit	12. ITB (Image Transfer Belt) Unit
5. Fusing Unit	13. OPC (AIO)
6. Fusing Lamp	14. Tray 1
7. Duplex Path	15. EGB/Controller
8. Transfer Roller	

Paper Path

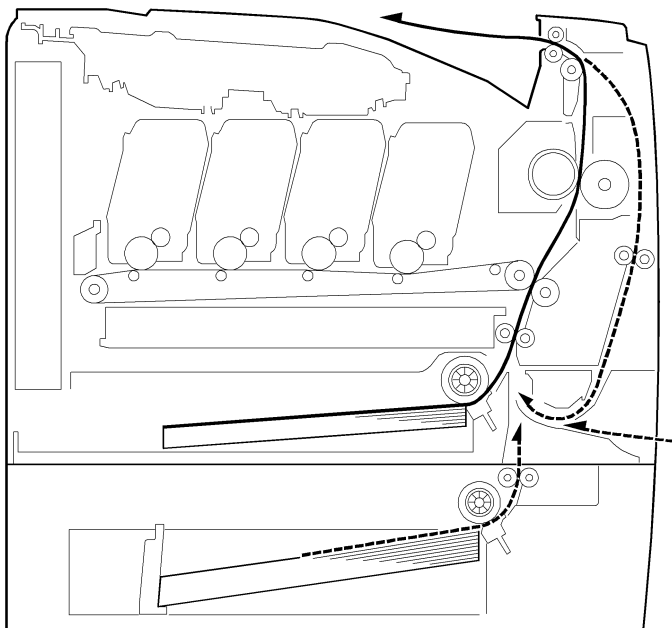

g165v107

Drive Layout

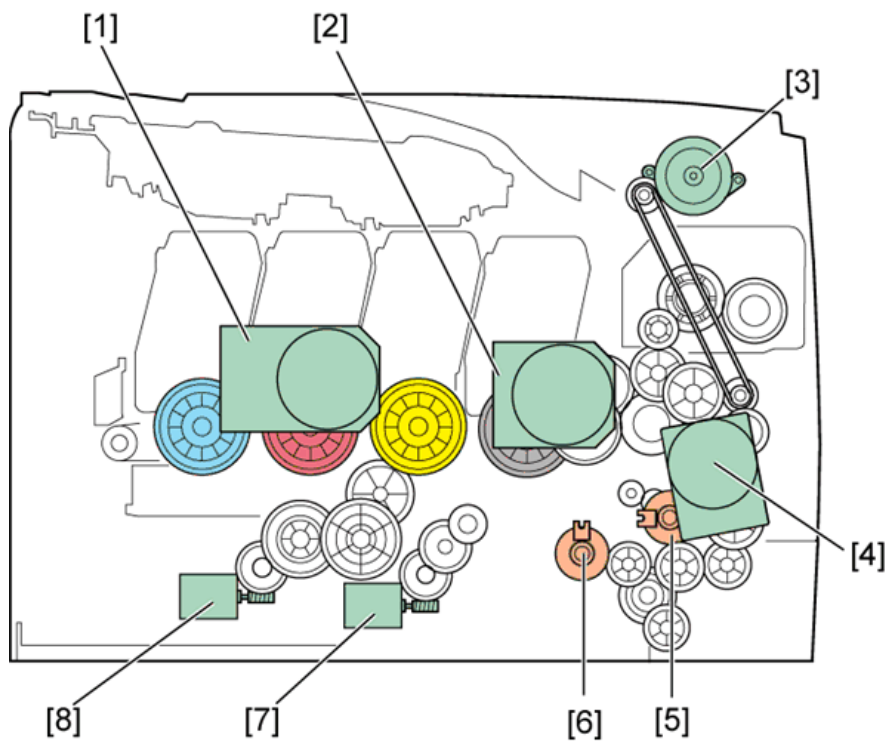

m0950102

<p>1. Color AIO Motor 2. Black AIO Motor 3. Duplex Motor</p>	<p>5. Registration Clutch 6. Paper Feed Clutch 7. Agitator Motor</p>
--	--

7.Detailed Descriptions

4. Transport/Fusing Motor	8. ITB (Image Transfer Belt) Contact Motor
---------------------------	--

- **Color AIO Motor:**
This drives the color AIOs (Cyan, Magenta and Yellow)
- **Black AIO Motor:**
This drives the black AIO and the ITB (Image Transfer Belt).
- **Duplex Motor:**
This drives the paper exit roller and the duplex roller.
- **Transport/Fusing Motor:**
This drives the fusing unit, paper feed roller, registration roller and paper exit roller* via the paper feed clutch, registration clutch and gears. (*: This motor only drives the paper exit roller in non-duplex mode.)
- **Registration Clutch:**
This transfers drive from the transport/ fusing motor to the registration roller.
- **Paper Feed Clutch:**
This transfers drive from the transport/ fusing motor to the paper feed roller.
- **Agitator Motor:**
This moves the agitators in the waste toner bottle.
- **ITB Contact Motor:**
This moves the ITB into contact with and away from the color OPCs.

Electrical Component Layout

ADF/DADF

ADF

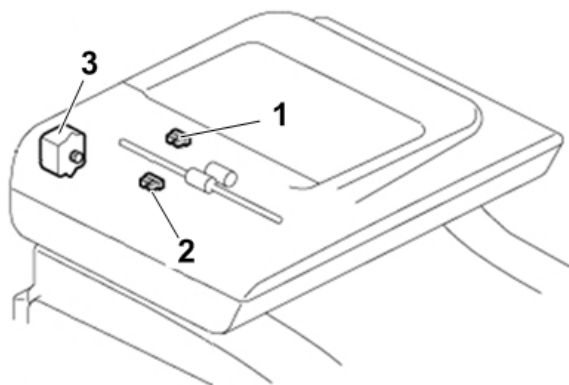

m202d7002

No.	Parts Name	Reference
1	Original set sensor	Original Set Sensor
2	ADF registration sensor	ADF Registration Sensor
3	ADF motor	ADF Motor

DADF

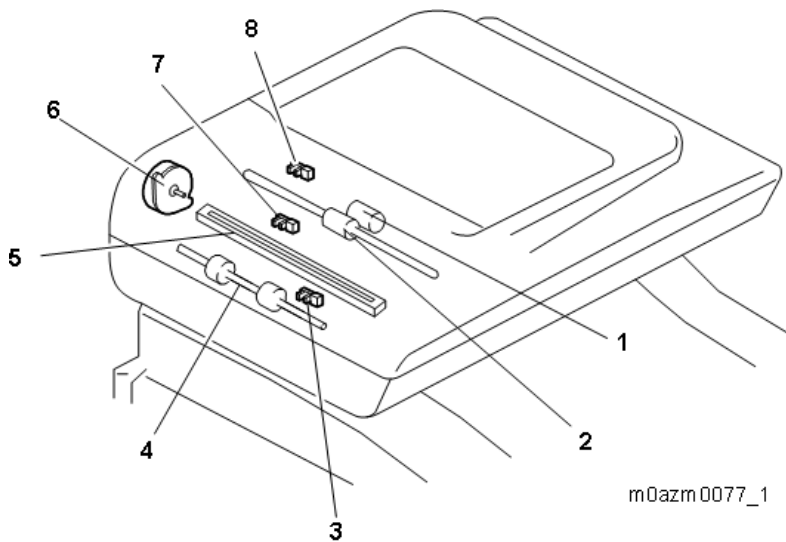

No.	Parts Name	Reference
1	DADF pick-up roller	DADF Pick-Up Roller
2	DADF feed roller	DADF Feed Roller
3	Front registration sensor	-
4	Reverse roller	Reverse Roller
5	Back CIS	Back CIS/Back DF Exposure Glass
6	DADF motor	-
7	Registration sensor	-
8	Original set sensor	-

Scanner

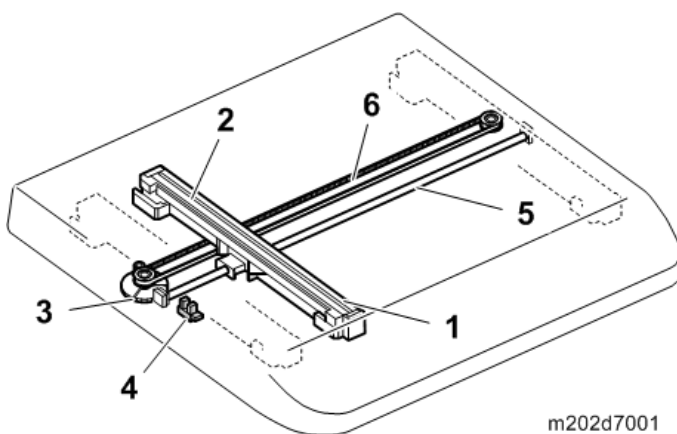

No.	Parts Name	Reference
1	Carriage	-
2	CIS	-
3	Scanner motor	-

7.Detailed Descriptions

No.	Parts Name	Reference
4	CIS carriage HP sensor	-
5	Shaft	-
6	Timing belt	-

Engine

MF Models 1

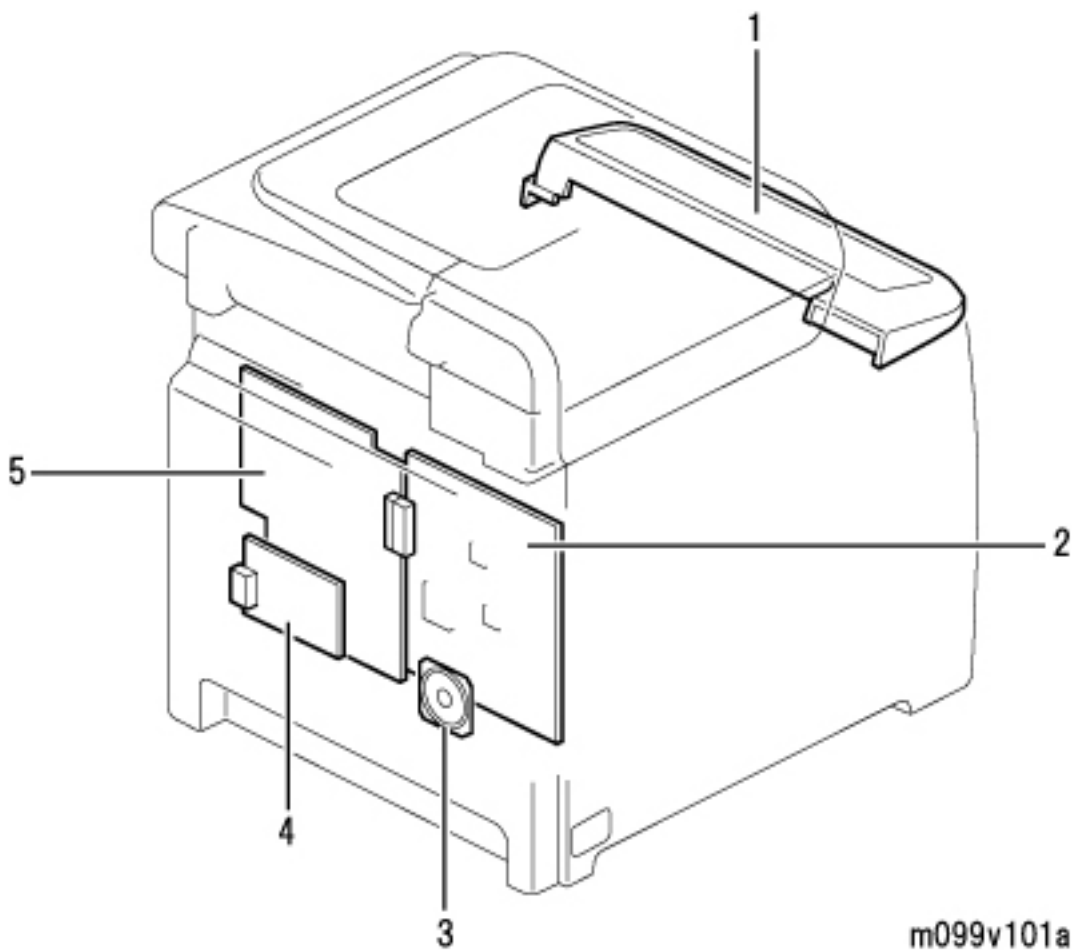

No.	Parts Name	Description/Reference
1	Operation Panel Board	This board controls the operation of the operation panel keys, LCD and LEDs. Operation Panel, NFC (MF Models)
2	EGB (Engine Board)	This board controls all of the machine, input/output, drivers and input/output connections and the handshake with the Controller. EGB (MF Models)
3	Speaker	Speaker (only for MF Models)
4	FCU	FCU (only for MF Models)
5	Controller Board	This board controls the memory, all applications and all peripheral devices.

No.	Parts Name	Description/Reference
		Controller Board (MF Models)

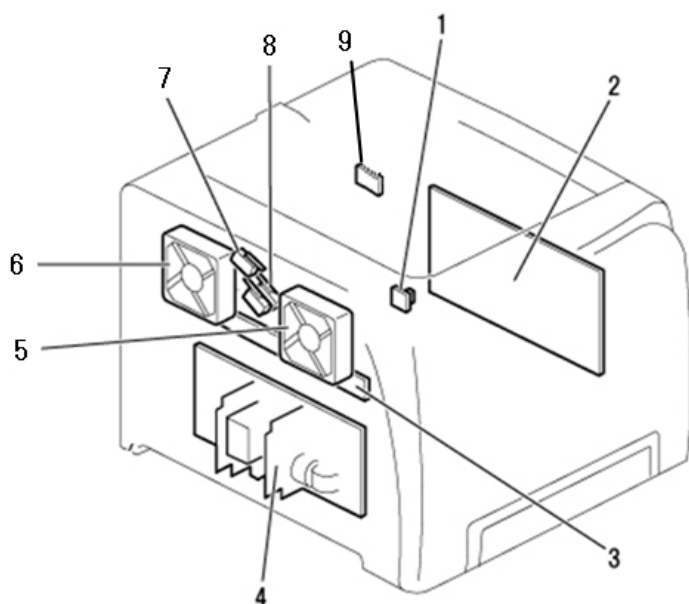
MF Models 2

m0azm0048

No.	Parts Name	Description/Reference
1	Temperature/Humidity Sensor	This sensor detects the relative temperature and humidity around the machine. Temperature/Humidity Sensor
2	High Voltage Power Supply Board	This board supplies the charge to the image transfer roller and high voltage for the charge roller, transfer roller and the development roller. High Voltage Power Supply Board
3	ID Chip Board	This board relays the ID chip data of each AIO from/to the EGB. ID Chip Board
4	PSU (Power Supply Unit)	This supplies DC power for the EGB, fusing unit and interlock switches. PSU
5	Fusing Fan Motor	This motor exhausts air around the fusing unit. Fusing Fan Motor
6	LSU Fan Motor	This motor exhausts air around the laser optics housing unit. LSU Fan Motor
7	Interlock Switch	These switches turn off DC power when the front cover or top cover is open. Interlock Switches
8	Interlock Switch	
9	Wi-Fi Board	Wi-Fi Board

7.Detailed Descriptions

Printer Models

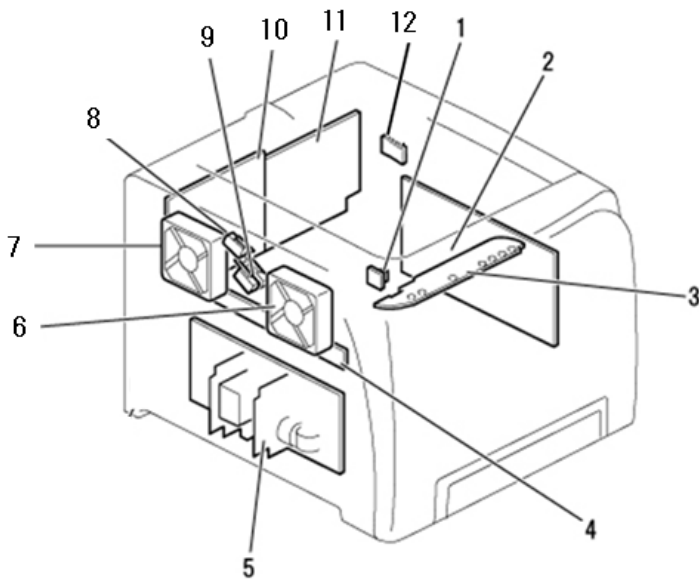

m0azm0049

No.	Parts Name	Description/Reference
1	Temperature/Humidity Sensor	Temperature/Humidity Sensor
2	High Voltage Power Supply Board	High Voltage Power Supply Board
3	Operation Panel Board	Operation Panel (Printer Models)
4	ID Chip Board	ID Chip Board
5	PSU (Power Supply Unit)	PSU
6	Fusing Fan Motor	Fusing Fan Motor
7	LSU Fan Motor	LSU Fan Motor
8	Interlock Switch	Interlock Switches
9	Interlock Switch	
10	EGB (Engine Board)	EGB (Printer Models)
11	Controller Board	Controller Board (Printer Models)
12	Wi-Fi Board	Wi-Fi Board

Common Parts 1

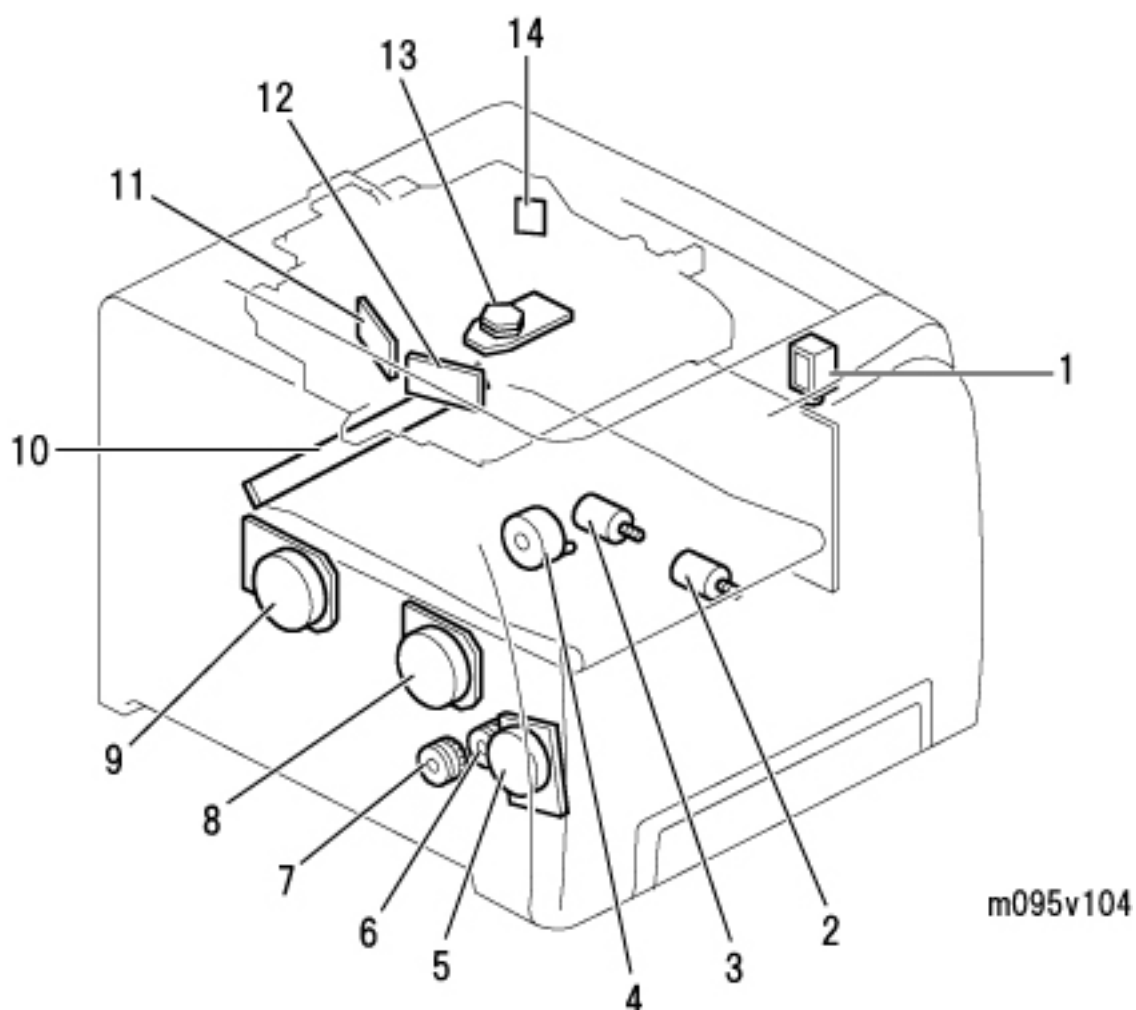

No.	Parts Name	Description/Reference
1	Fusing stripper pawl solenoid	This solenoid is connected to the stripper pawl, and it detaches the stripper pawl from the hot roller unless it is necessary to contact. Fusing Stripper Pawl Solenoid
2	Agitator motor	Agitator Motor
3	ITB (Image Transfer Belt) contact motor	ITB (Image Transfer Belt) Contact Motor
4	Duplex motor	Duplex Motor
5	Transport/Fusing motor	Transport/Fusing Motor
6	Registration clutch	Registration Clutch
7	Paper feed clutch	Paper Feed Clutch
8	Black AIO motor	Black AIO Motor
9	Color AIO motor	Color AIO Motor
10	TM (Toner Mark) Sensor Base	TM (Toner Mark) Sensor Base
11	LDB(C,M)	-

7.Detailed Descriptions

No.	Parts Name	Description/Reference
12	LDB(Y,K)	-
13	Polygon motor	-
14	Laser Synchronization detector	-

Common Parts 2

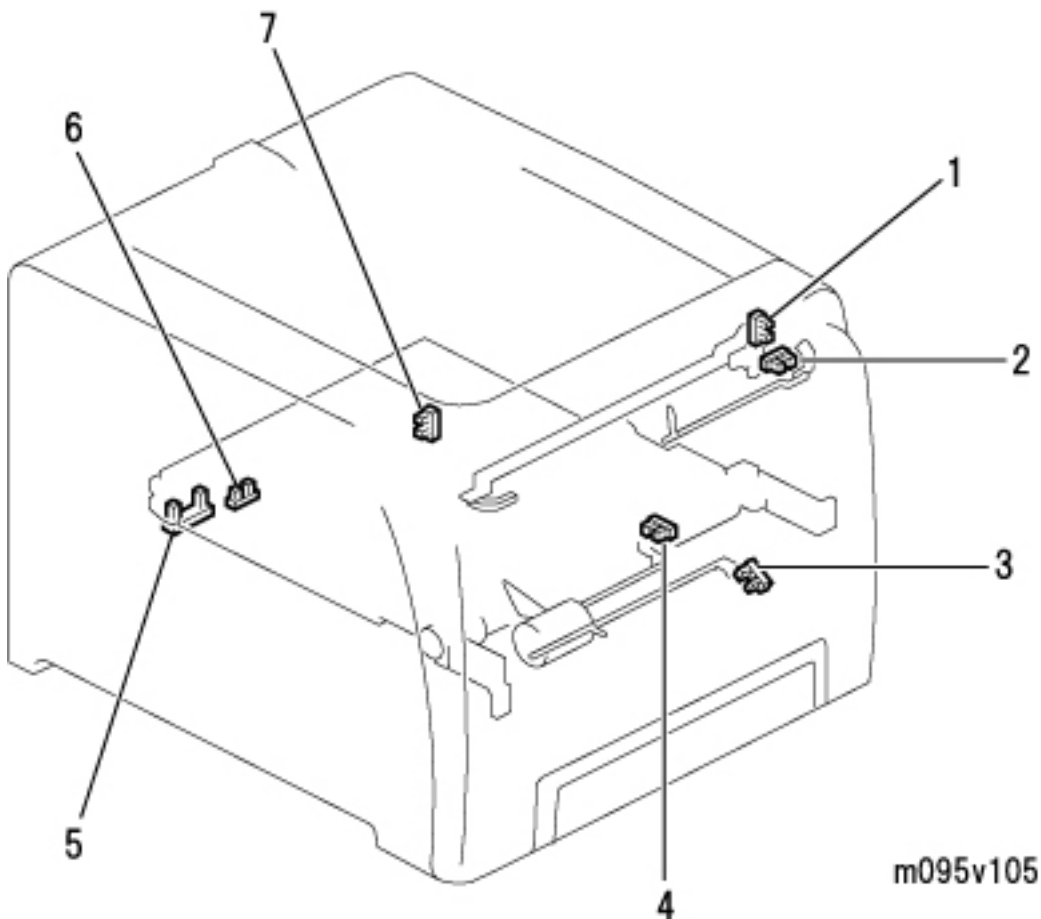

No.	Parts Name	Description/Reference
1	Fusing Pressure Release Sensor	This sensor detects whether the envelope lever is set to the envelope position. Fusing Pressure Release Sensor
2	Paper Exit Sensor	This sensor detects a paper jam in the fusing unit, paper exit path and duplex path. Paper Exit Sensor
3	Paper End Sensor	This sensor detects paper end and whether the tray is set. Paper End Sensor
4	Registration Sensor	This sensor detects a paper jam at the paper feed, by-pass feed and registration roller, and also determines the paper size based on the sensor on-off time. Registration Sensor
5	Waste Toner	This sensor detects whether the waste toner bottle is full.

No.	Parts Name	Description/Reference
	Overflow Sensor	Waste Toner Overflow Sensor
6	Waste Toner Bottle Set Sensor	This sensor detects whether the waste toner bottle is set. Waste Toner Bottle Set Sensor
7	ITB Contact Sensor	This sensor detects whether the image transfer belt is in contact with the color OPCs (C, M, Y). ITB (Image Transfer Belt) Contact Sensor

Common Parts 3

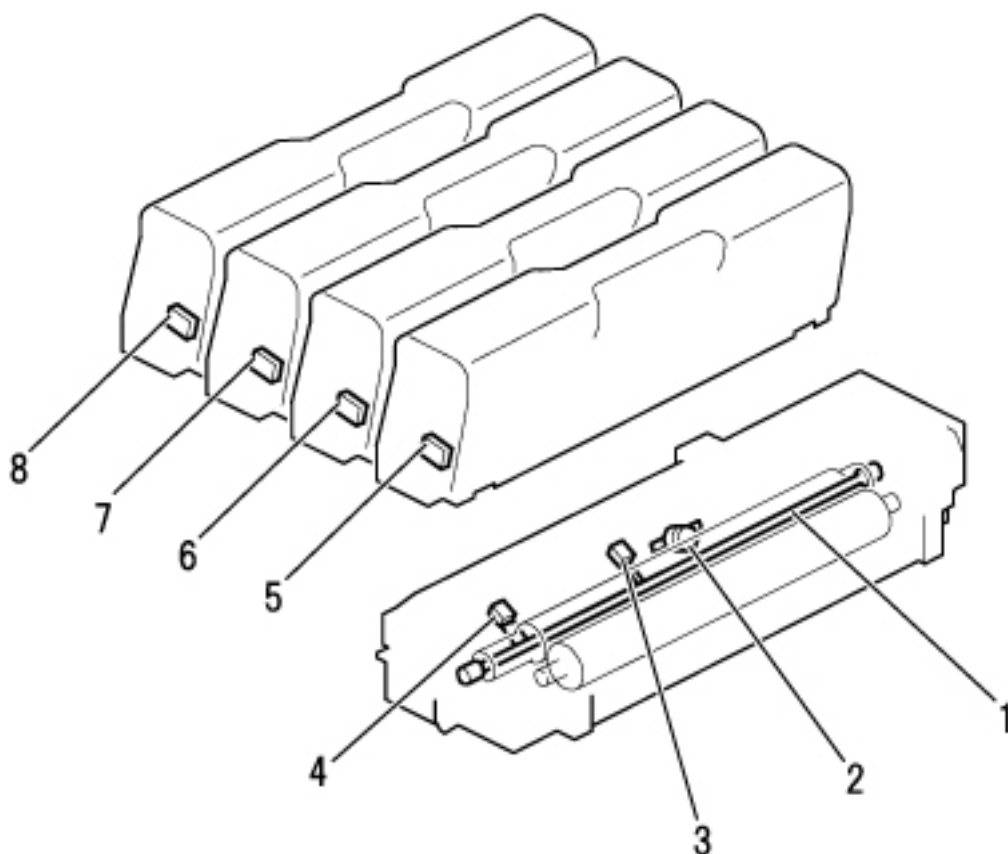

m095v106

No.	Parts Name	Description/Reference
1	Fusing lamp	Fusing Lamp
2	Thermostat	-
3	Thermistor (center)	-
4	Thermistor (edge)	-
5	ID chip (Bk)	-
6	ID chip (Y)	-
7	ID chip (M)	-
8	ID chip (C)	-

Board Structure

Printer Model

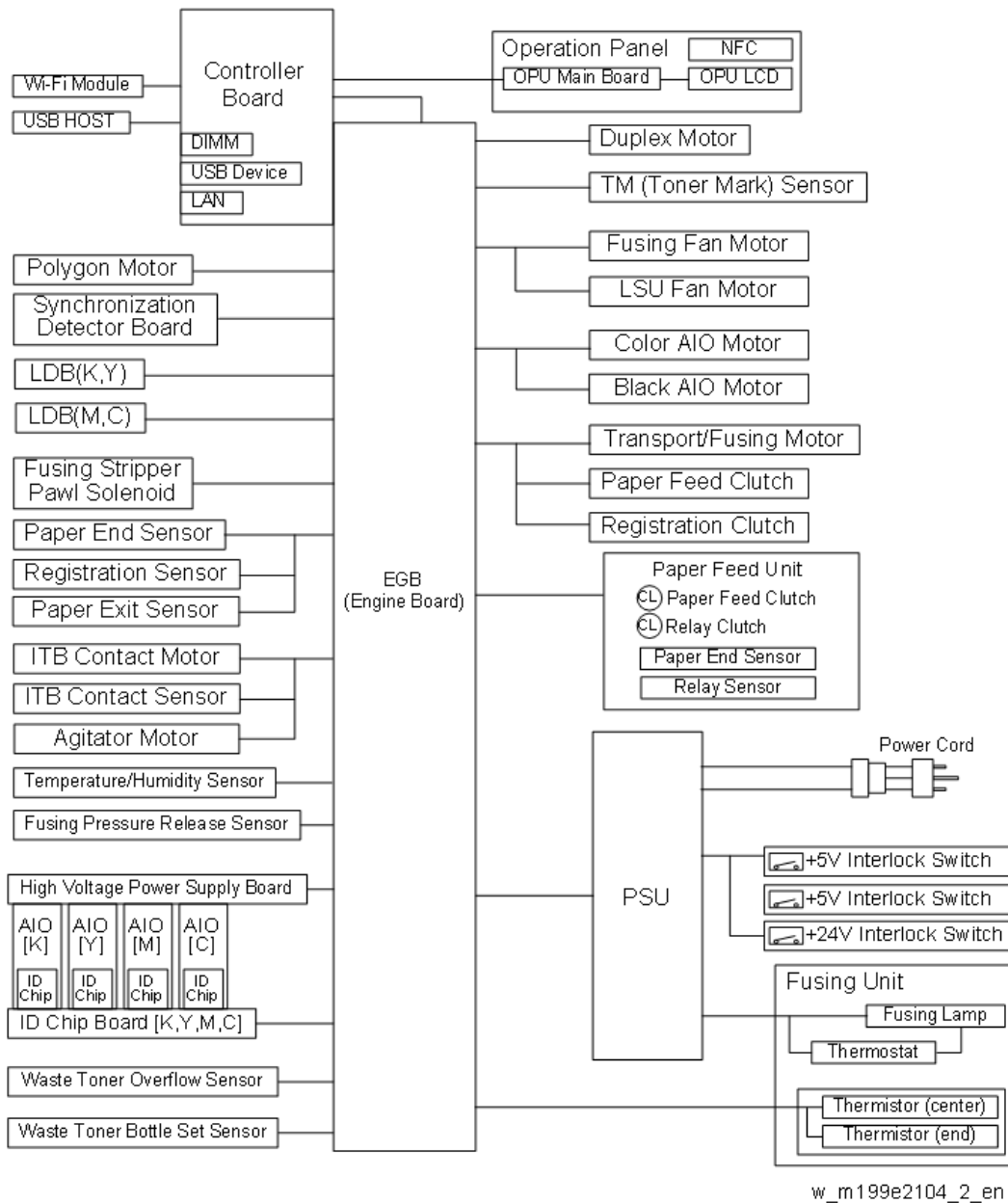

- **EGB (Engine Board):**
This controls the Engine, the controller interface, image processing, MUSIC (Mirror Unit for Skew and Interval Correction), input/output, interfaces with the optional units. MUSIC is also called Automatic Line Position Adjustment.
- **Controller:**
This controls the interface between the OPU and EGB, wireless LAN (IEEE802.11b/g/n) and applications. The controller connects to the EGB through the PCI Bus (Peripheral Component Interconnect Bus).
- **LD Drive Board:**
This is the laser diode drive circuit board.
- **Memory DIMM: 128MB**

This is for more printer processing memory, and is also used for collation and for soft fonts.

- OPU (Operation Panel Unit):

This controls the display panel, the LED, and the keypad.

MF Model

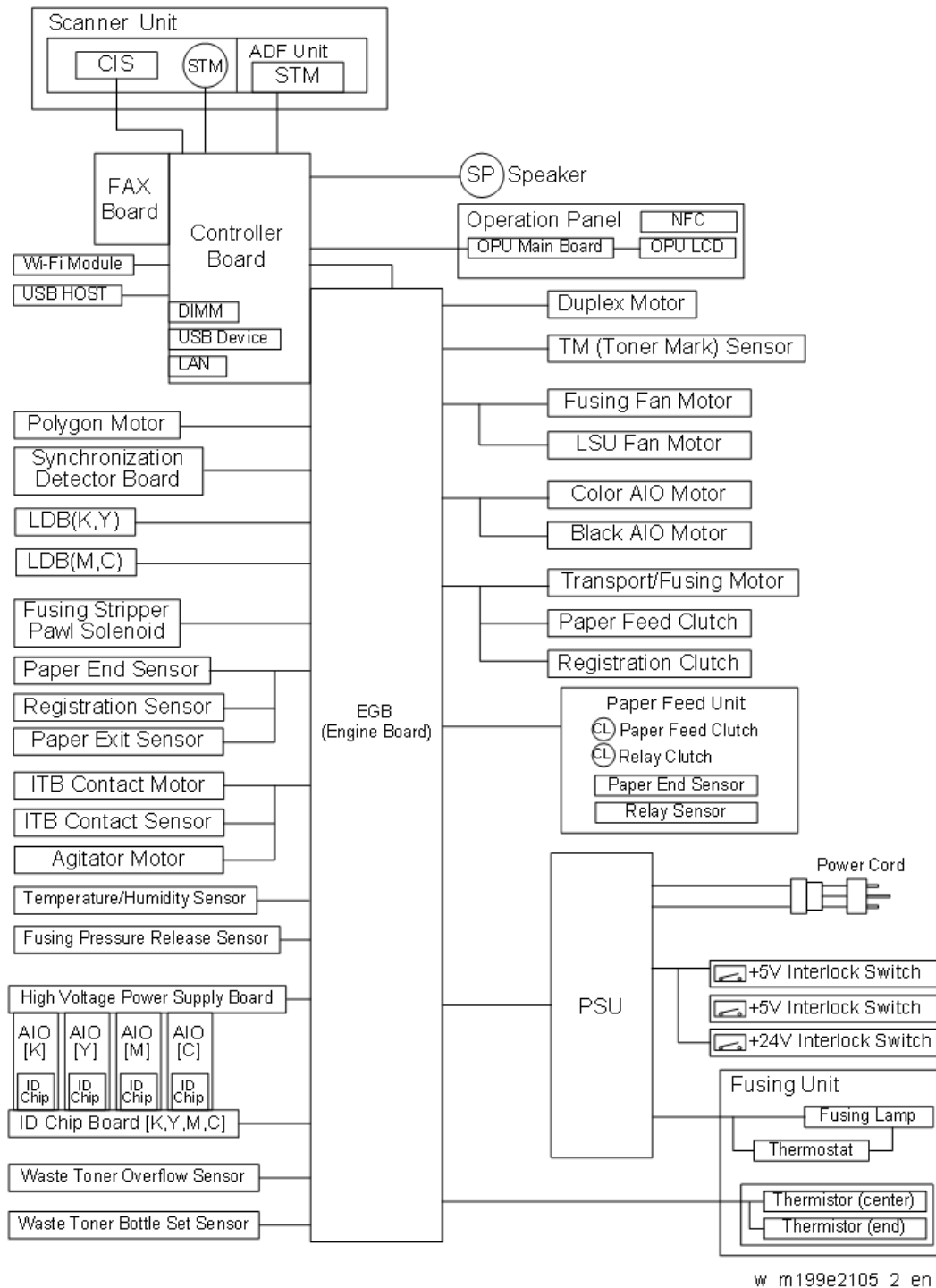

- EGB (Engine Board):

This controls the Engine, the controller interface, image processing, MUSIC (Mirror Unit for Skew and Interval Correction), input/output, interfaces with the optional units. MUSIC is also called Automatic Line Position Adjustment.

7.Detailed Descriptions

- **Controller:**
This controls the interface between the OPU and EGB, wireless LAN (IEEE802.11b/g/n), ADF, Scanner unit and applications. The controller connects to the EGB through the PCI Bus (Peripheral Component Interconnect Bus).
- **LD Drive Board:**
This is the laser diode drive circuit board.
- **Memory DIMM: 256MB**
This is for more printer processing memory, and is also used for collation and for soft fonts.
- **OPU (Operation Panel Unit):**
This controls the display panel, the LED, and the keypad.

Printing Process

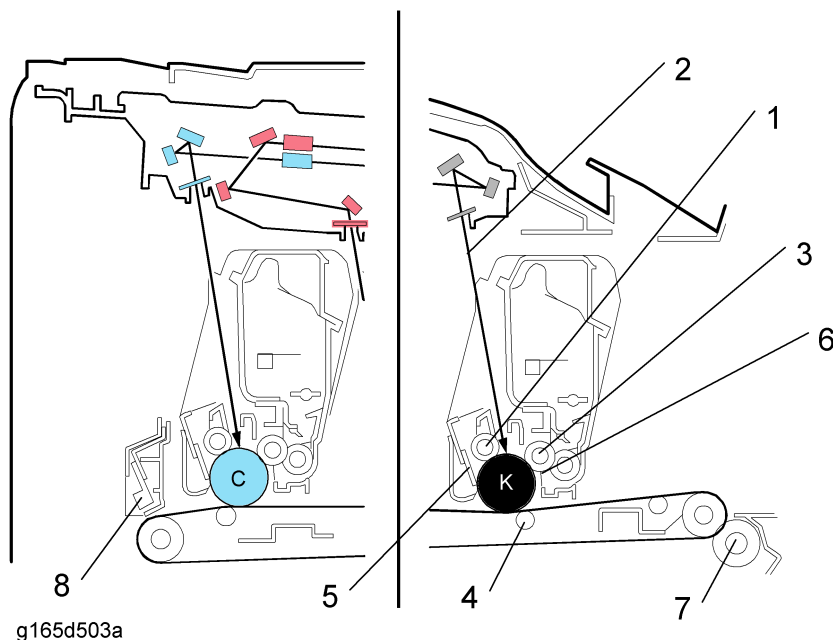

This machine uses four AIOs and four laser beams for color printing. Each AIO contains a drum, charge roller, cleaning brush, blade, development roller and mixing auger.

The toner image on each drum is moved to the image transfer belt. The four colors are put on the belt. All four toners are put on the belt at the same time. Then the completed four-color image is moved to the paper.

1. **OPC charge (AIO):**

The charge roller gives the OPC a negative charge.

2. **Laser exposure:**

The laser beam from the laser diode (LD) goes through the lens and mirrors and to the drum. To make a latent image on the drum, the machine turns the laser beam on and off.

3. **Development (AIO):**

The development roller moves negatively-charged toner to the latent image on the drum surface. This machine uses four development units (one for each color).

4. **Image transfer:**

The charge that is applied to the image transfer roller pulls the toner from the drum to the transfer belt. Four toner images are put on the paper at the same time.

5. Cleaning for the OPC:

The cleaning blade removes remaining toner on the drum surface after image transfer to the paper.

6. Quenching for the Development Roller:

Charge is removed from the development roller with a quenching sheet in the AIO. There is no quenching for the OPC drum.

7. Paper Transfer and Separation:

Toner transfers from the image transfer belt to the paper when the paper is fed between the image transfer belt and transfer roller. After transfer, the paper separates from the image transfer belt, because of a discharge plate immediately after the transfer roller.

8. TM (Toner Mark) sensor:

The TM sensor board contains three TM sensors (one at the left, one at the center, and one at the right). The center TM sensor detects the density of the sensor patterns on the transfer belt. The TM sensor output is used for process control and for automatic line-position adjustment, skew, and color registration adjustments for the latent image.

Process Control

Overview

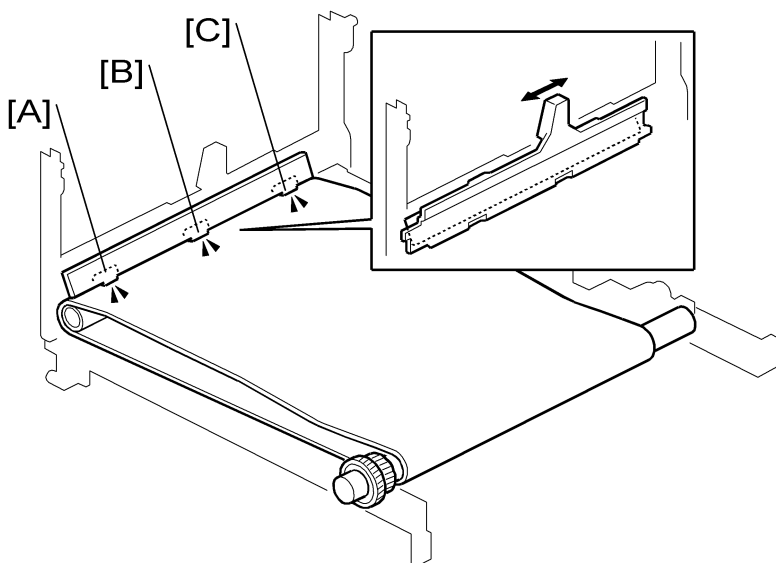

g165d305

This machine has these two forms of process control:

- Potential control
- Toner supply control

Process control uses these components:

- Three TM (Toner Mark) sensors (left [A], center [B], and right [C]). Only the center TM sensor (direct-reflection and diffusion type) is used for process control. The left and right TM sensors (direct-reflection type) are used for line positioning and other adjustments.
- Temperature/humidity sensor at the rear right of the machine.

Process Control Flow

1. TM sensor correction (Vsg adjustment)

The center TM sensor checks the bare transfer belt's reflectivity and the machine calibrates the TM sensors.

2. Development bias control

The machine makes a 7-gradation pattern on the transfer belt for each toner color. The pattern has 9 squares (the sequence is as follows: 7 yellow squares, 7 cyan squares, 7 magenta squares and 7 black squares). Each of the squares is 10 mm x 17 mm, and is a solid-color square. To make the squares, the machine changes the development bias and charge roller voltage. The difference between development bias and charge roller voltage is always the same.

The center TM sensor detects the densities of the 7 solid-color squares for each color. The machine calculates an appropriate development bias from this data.

This control takes about 33 seconds to be completed.

3. LD power control

For LD power control, the machine does the same sequence described in "2 Development bias control".

Finally, the machine calculates an appropriate LD power.

4. MUSIC (Mirror Unit Skew and Interval Control)

The machine uses the TM sensors to measure sample lines deposited on the ITB, and corrects color image registration adjustment based on the sensor readings. Sample lines are made on the left, center and right of the ITB.

This control takes about 22 seconds to be completed.

Process Control Self-check

This machine does potential control with a procedure that is known as the process control self-check. This procedure is done at these 7 times.

Timing	Execution Mode
1. Initial Power-ON	<ul style="list-style-type: none"> • Development Bias Control and MUSIC (approx. 55 seconds) • MUSIC only (approx. 22 seconds) • No Execution One of the control modes is executed at each timing. What control mode is done depend(s) on some conditions as described in the text that follows this table.
2. Recovery form Sleep Mode	
3. Front or Top Cover Open/Close	
4. Ready Status	
5. Before Job	
6. Page End	
7. Job End	

1. Initial

- Toner amount control and MUSIC start automatically immediately after the power is turned on, if one of the following conditions occurs.
 - 1) New AIO detection
 - 2) New ITB (Image Transfer Belt) unit detection (after transfer unit life counter is reset with SP mode)
 - 3) Environment (temperature and humidity) change detection.
- MUSIC starts automatically immediately after the power is turned on (there is toner amount control) if conditions other than described above occur.

2. Recovery from Sleep Mode

- Toner amount control and MUSIC start automatically when the machine comes back from energy saver mode, if one of following conditions occurs.
 - 1) New AIO detection
 - 2) New ITB (Image Transfer Belt) unit detection (after transfer unit life counter is reset with SP mode)
 - 3) Environment (temperature and humidity) change detection.
- MUSIC starts automatically (there is toner amount control) when the machine comes back from energy saver mode, if the following condition occurs.
 - 1) The previous MUSIC was done if there was a high temperature inside the machine.

7.Detailed Descriptions

3. Immediately after the front or top cover is closed
 - No adjustment is done when the front or top cover is closed, if one of following conditions occurs.
 - 1) After paper jam detection and New AIO detection
 - 2) New ITB unit detection (after transfer unit life counter is reset with SP mode)
 - 3) No environment change
 - Toner amount control and MUSIC start automatically when the front or top cover is closed, if conditions other than described above occur.
4. Ready status:
 - Toner amount control and MUSIC start automatically when the machine stays in the ready condition and the environment has changed.
5. Before a job:
 - MUSIC starts automatically before a job if the previous MUSIC was done when there was a high temperature inside the machine and a specified time has elapsed.
 - MUSIC starts automatically before a job if the machine is turned on in a low temperature condition and a specified time has elapsed.
6. Page end:
 - Toner amount control and MUSIC start automatically between pages when the machine detects an environment change.
 - Toner amount control and MUSIC start automatically between pages when the machine has copied/printed 200 pages since the previous process control.
 - Toner amount control and MUSIC interrupt a job and start automatically between pages when the machine has copied/printed 250 pages since the previous process control.
 - MUSIC starts automatically between pages when the machine has copied/printed 100 pages in the same job since the previous process control.
 - MUSIC starts automatically between pages when the polygon motor has been rotating for 180 seconds.
 - MUSIC interrupts a job and starts automatically between pages when the polygon motor has been rotating for 300 seconds.
7. Job end:
 - Toner amount control and MUSIC start automatically after a job when the machine gets a request to execute the toner amount control and MUSIC.
 - MUSIC starts automatically after a job when the machine gets a request to execute MUSIC.

Laser Exposure

Overview

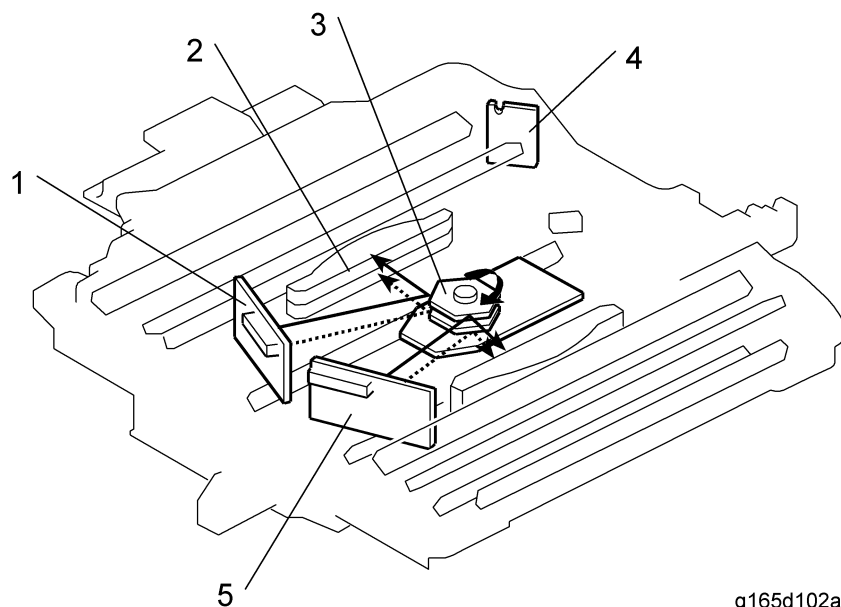

g165d102a

1. LD unit - C/M	4. Synchronizing Detector Board
2. $F\theta$ Lens	5. LD unit - K/Y
3. Polygon Mirror Motor	

This machine uses two LDB units and one polygon mirror motor to produce latent images on four OPC drums (one drum for each color toner).

There are two hexagonal mirrors. The polygon mirror motor rotates the mirrors clockwise and each mirror reflects beams from LD unit.

The laser beam from the LD unit - C/M is directed to the $F\theta$ lens at rear side by the polygon mirrors. The laser beam from the LD unit - K/Y is directed to the $F\theta$ lens at front side by the polygon mirrors.

Laser exposure for magenta and cyan starts from the left side of the drum, but for yellow and black it starts from the right side of the drum. This is because the units for magenta and cyan are on the other side of the polygon mirror from the units for yellow and black.

The machine has one laser synchronizing detector board (LSD) as shown above. The board detects four colors. The LSD detects the start of the main scan.

Optical Path

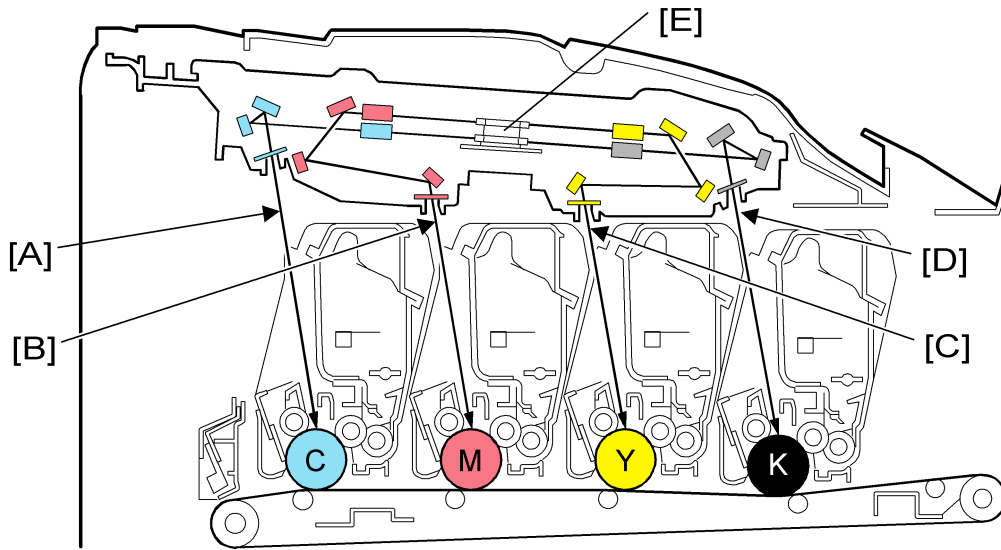

g165d101

The laser beams for magenta [B] and yellow [C] are sent to the upper part of the polygon mirror [E]. The laser beams for cyan [A] and black [D] are sent to the lower part of the polygon mirror.

LD Safety Switch

A safety switch turns off when the front cover or the top cover is opened. As a result, the relay on the PSU cuts off the power supply (+5V) to the two LD boards. (The circuits go through the EGB.) This system prevents unexpected laser emission, and ensures user safety and technician safety.

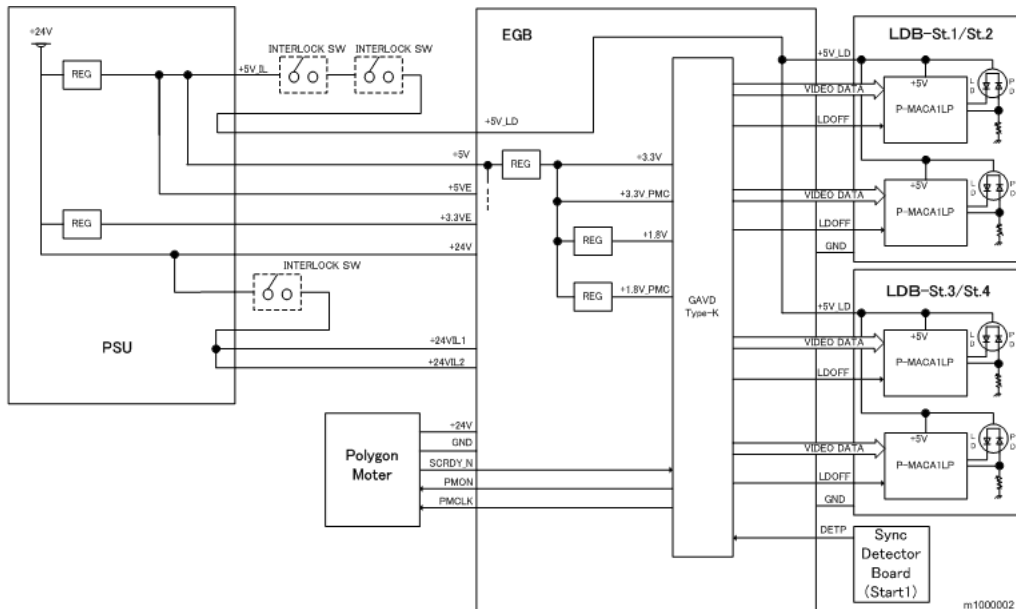

m1000002

MUSIC (Mirror Unit Skew and Interval Correction)

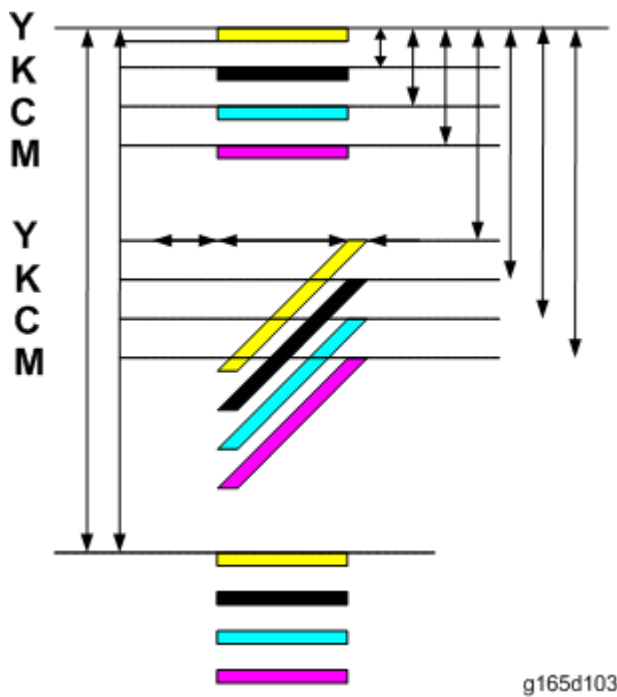

During MUSIC, the line patterns above are made 16 times for fine adjustment or 8 times for the rough adjustment on the transfer belt. The spaces between the lines (YY, KK, CC, MM, KY, KC, KM) are measured by the front, center, and rear TM sensors. The controller reads the average of the spaces, and adjusts these items:

- Sub scan line position for YCM
- Main scan line position for KYCM
- Magnification ratio for KYCM
- Phase control

The transfer-belt-cleaning unit cleans the transfer belt after the patterns are measured.

The execution timing for MUSIC follows the sequence of the process control ("Process Control").

Paper Feed

Overview

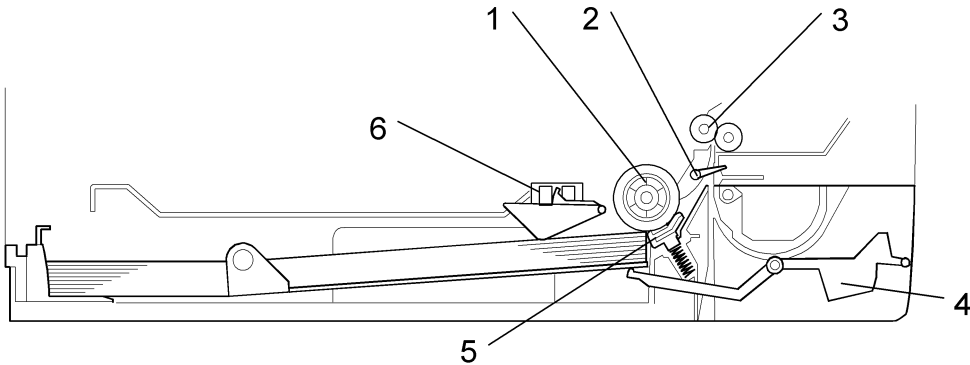

g165d701

1. Paper Feed Roller	4. Paper Height Lever
2. Registration Sensor	5. Separation Pad
3. Registration Roller	6. Paper End Sensor

This machine has a paper tray (250 sheets) and a by-pass paper feed (single sheet).

The paper feed mechanism uses a friction pad system.

The paper end sensor detects whether paper is installed in the tray and whether the tray is set in the machine, because this machine does not have a tray set sensor.

This machine also does not have automatic paper size detection. The machine determines the paper size from the on-off timing of the registration sensor. If the paper type which is selected at the PC does not match the paper size measured by the registration sensor, the machine issues a paper jam alert and stops the motors.

Drive and Paper End Detection

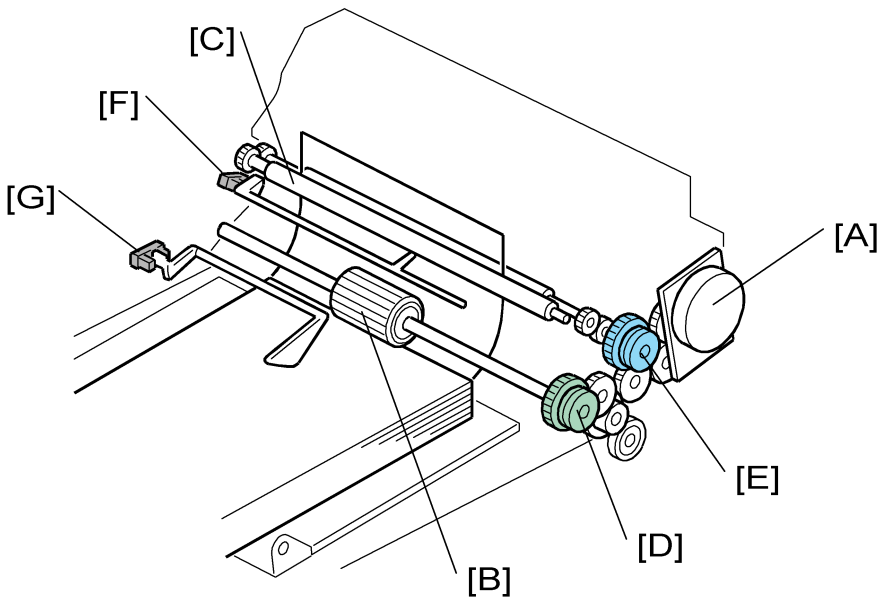

g165d702

Paper Feed

The transport/fusing motor [A] controls the paper feed roller [B] and registration roller [C] with the paper feed clutch [D], registration clutch [E] and gears. (The transport/fusing motor also controls the fusing unit and paper exit roller.) The paper feed roller feeds a sheet of paper to the registration roller [C].

When the registration sensor [F] detects a sheet of paper, the machine makes a paper buckle at the registration roller to correct paper skew. After that, the registration clutch turns on, and then the registration roller transports a sheet of paper to the transfer roller unit.

Paper End Detection

There is a paper end sensor [G] in the tray. The feeler drops into the cutout in the bottom plate and the actuator interrupts the paper end sensor. This sensor also detects whether the tray is set.

Tray Lift

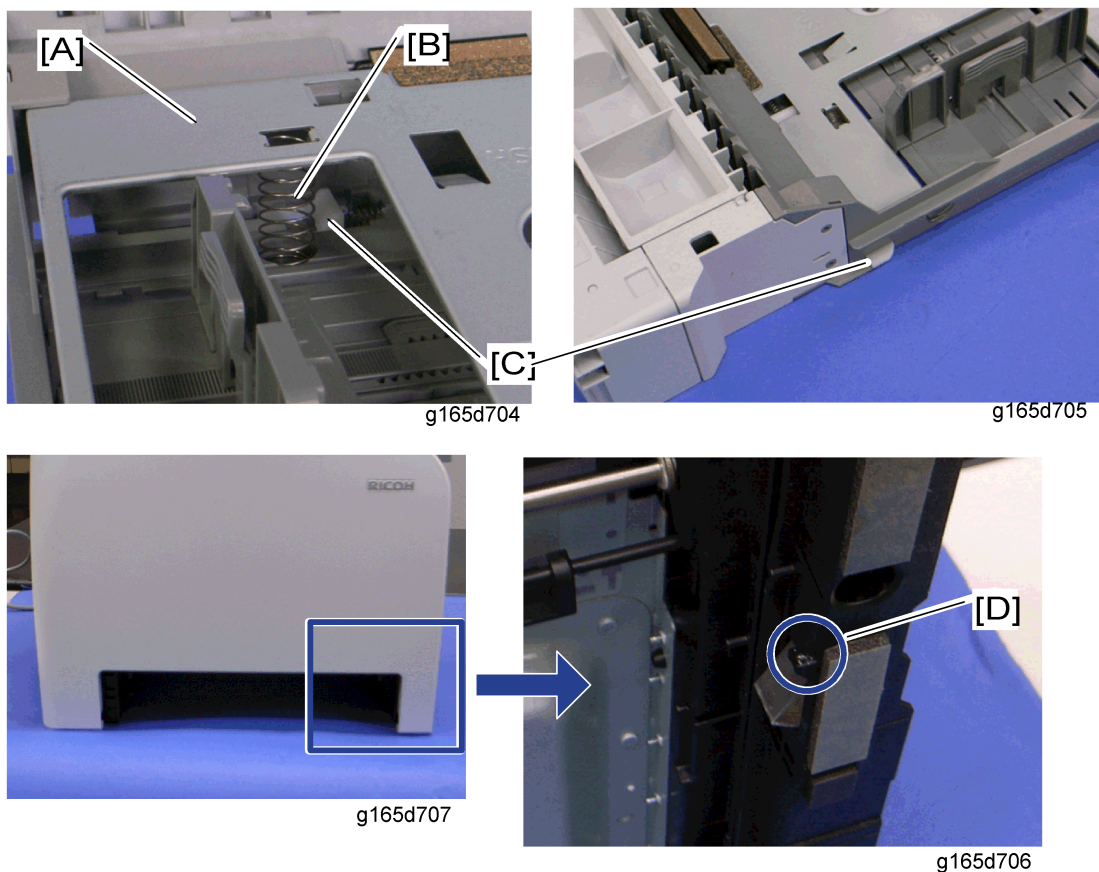

The bottom plate [A] is lifted by the springs [B] in the tray when the tray is inserted in the machine, and the bottom tray lock lever [C] is released by the projection [D] at the right side of the tray set location. There is no tray lowering mechanism for these models. Therefore, you must press down the bottom plate when you insert the tray in the machine.

By-pass Feed

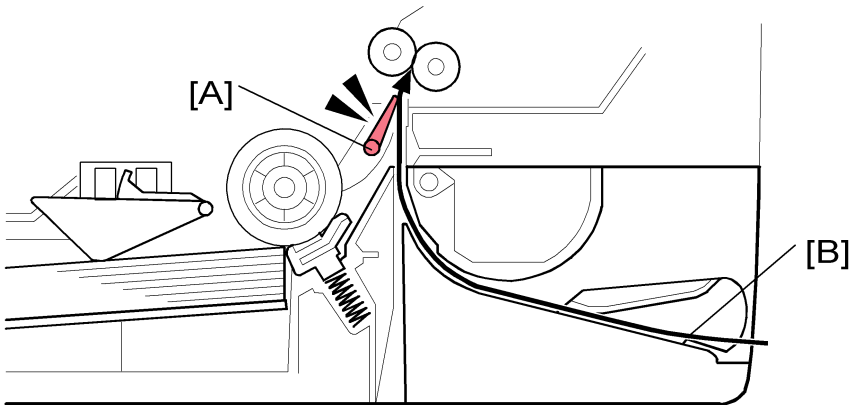

g165d703

This machine uses a manual by-pass feed system. When the registration sensor [A] detects a sheet of paper [B] but no job has come in from a PC, the machine determines that the user has put a sheet of paper in the by-pass tray.

Duplex

Drive

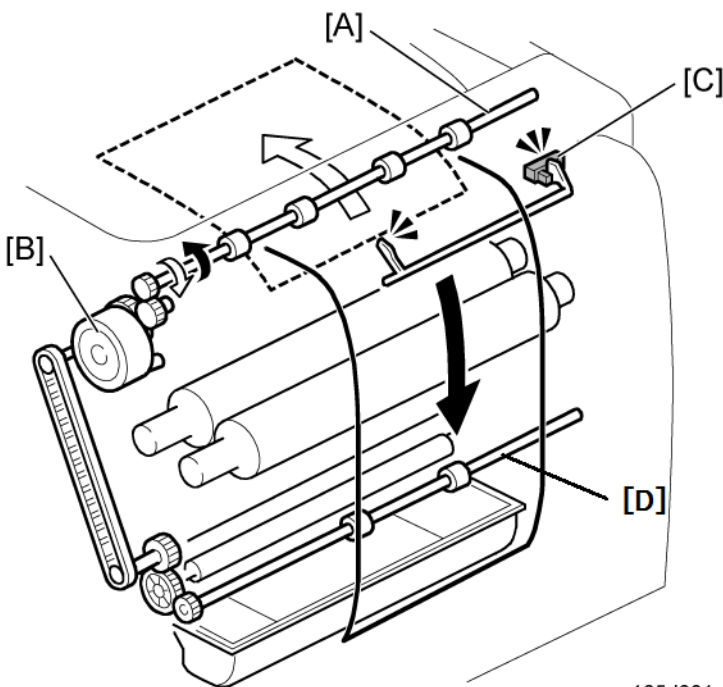

g165d801

The duplex motor [B] feeds out paper to the output tray in single-sided mode and also feeds paper to the duplex path in duplex mode. When a sheet of paper is detected by the paper exit sensor [C] in duplex mode, the duplex motor stops and rotates in reverse. The paper exit roller [A] feeds the sheet of paper to the duplex path. The duplex transport roller [D], which is driven by the duplex motor through the timing belt, transports the sheet of paper to the registration roller.

Duplex Operation

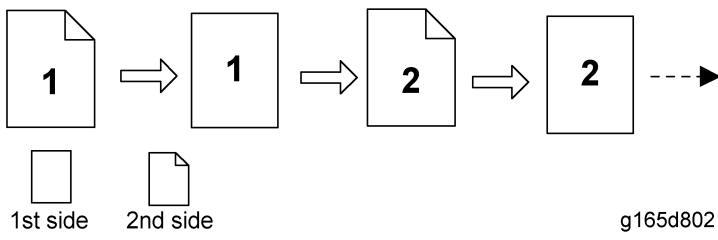

There is no interleaving. The printing is done as shown above: 2nd side of 1st page → 1st side of 1st page → 2nd side of 2nd page → 1st side of 2nd page → ----.

AIO (All In One) Cartridge

Overview

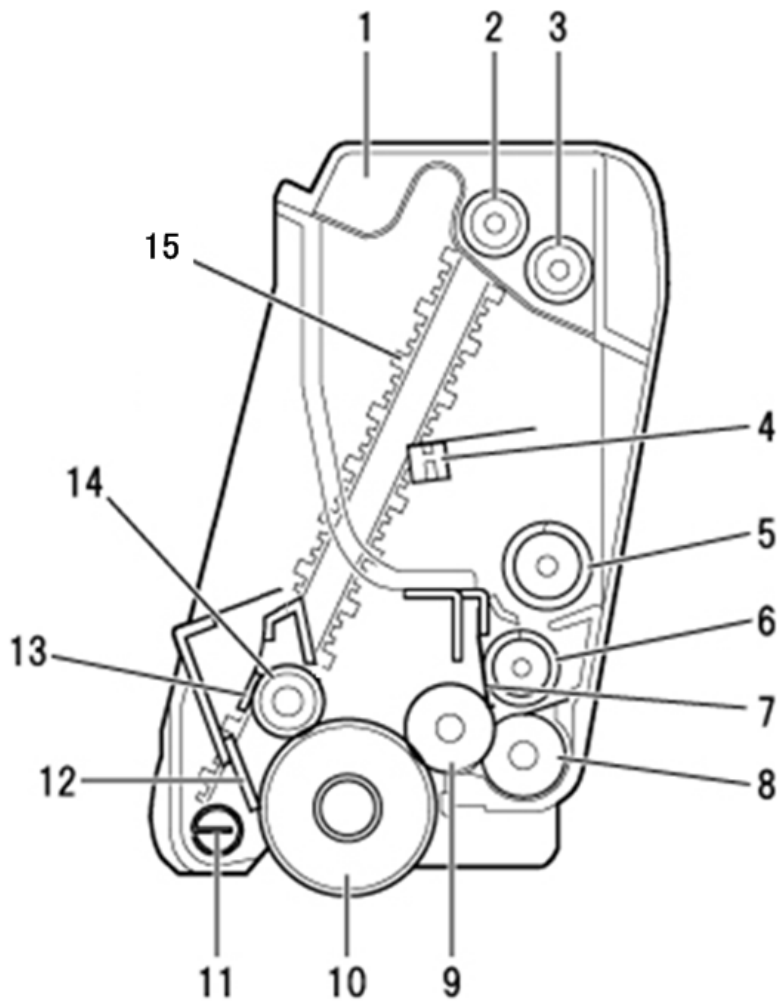

m202d7201

1. Waste Toner Container	9. Development Roller
2. Transport Belt Shaft	10. OPC
3. Waste Toner Collection Coil	11. Waste Toner Collection Coil
4. Toner Agitator	12. OPC Cleaning Blade
5. Upper Mixing Roller	13. Charge Roller Cleaner
6. Lower Mixing Roller	14. Charge Roller
7. Development Blade	15. Waste Toner Transport Belt
8. Toner Supply Roller	

This machine uses the AIO system. Each AIO consists of the waste toner tank, print cartridge part, development unit part, and OPC part. This gives the user easy replacement procedures and helps to make the engine module more compact. The waste toner bottle is smaller than other full-color printers because the waste toner from the OPC is collected in the waste toner tank of each AIO.

The diameter of the OPC is 24 mm and the diameter of the development roller is 12 mm.

Drive

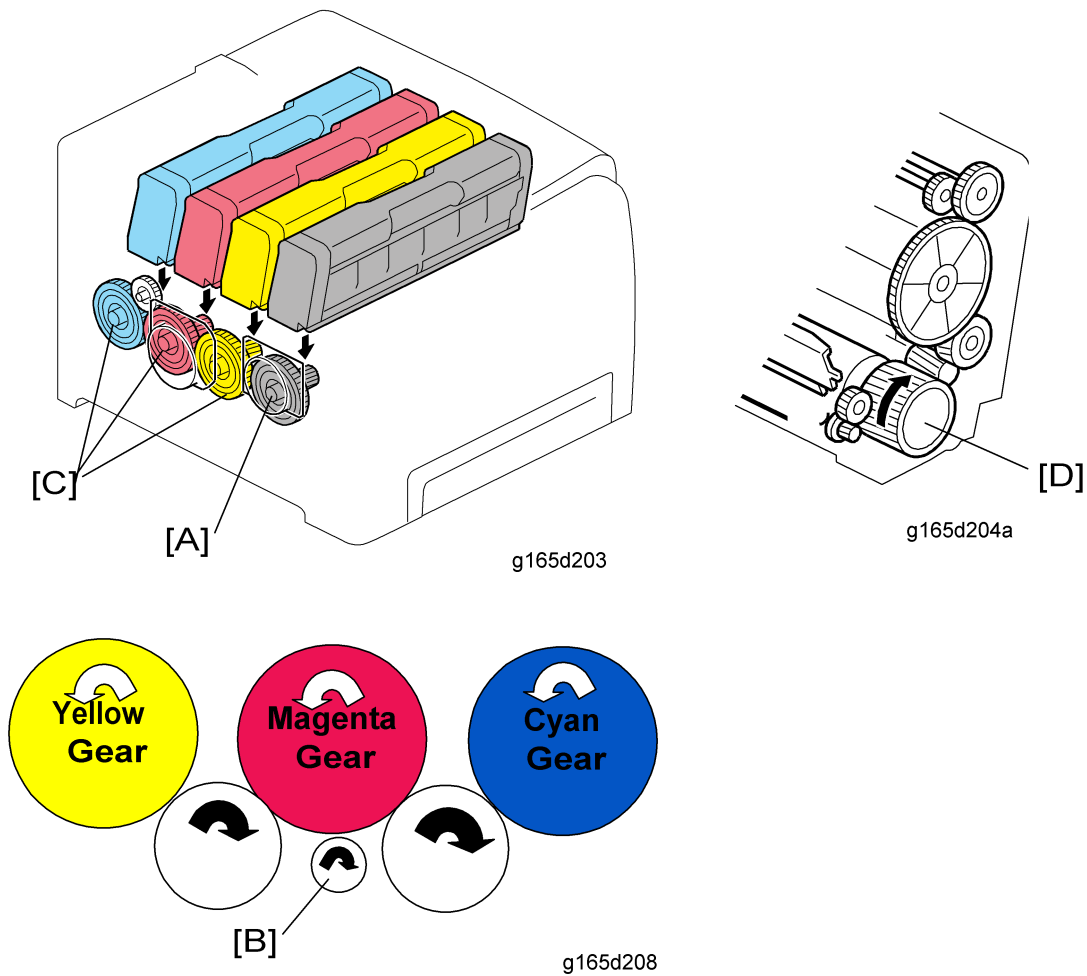

The black AIO motor drives the gear [A] for the black AIO. The color AIO motor drives the gears [B] and color gears [C] for the cyan, magenta and yellow AIOs through gears. Each of these gears engages with a gear [D] in the OPC, and this gear drives the rollers in the AIO through other gears.

OPC Charge and Cleaning

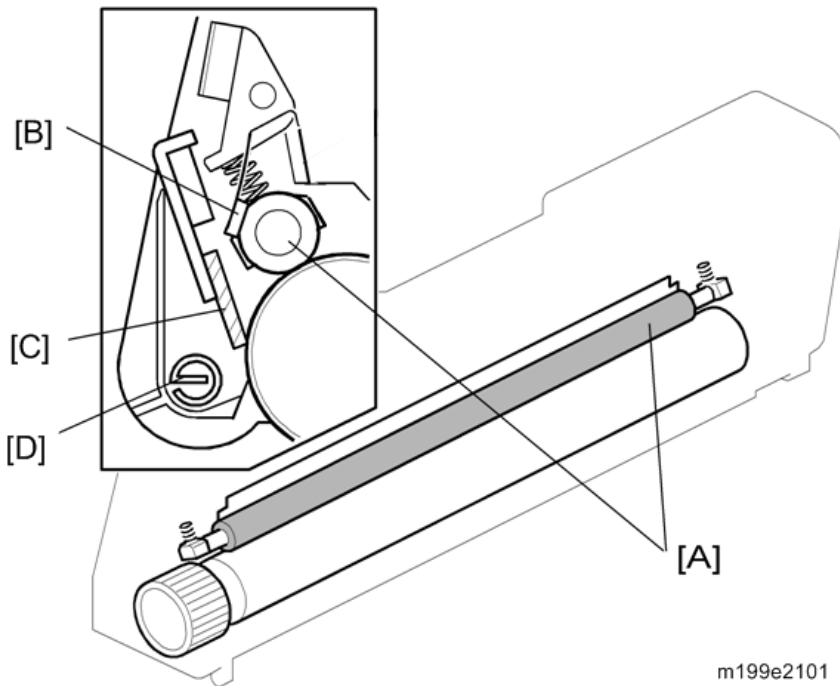

This machine uses a charge roller [A]. The charge roller gives the drum surface a negative charge. The high voltage supply board, which is at the left side of the machine, applies a dc and ac voltage (at a constant current) to the roller. The ac voltage helps to make sure that the charge given to the drum is as constant as possible. The machine automatically controls the charge roller voltage when process control is done. The charge roller cleaner [B], which always touch the charge roller, clean the charge roller. The OPC cleaning blade [C] removes the waste toner on the OPC. The toner collection coil [D] moves the toner to the waste toner transport belt.

Waste Toner Collection from the OPC

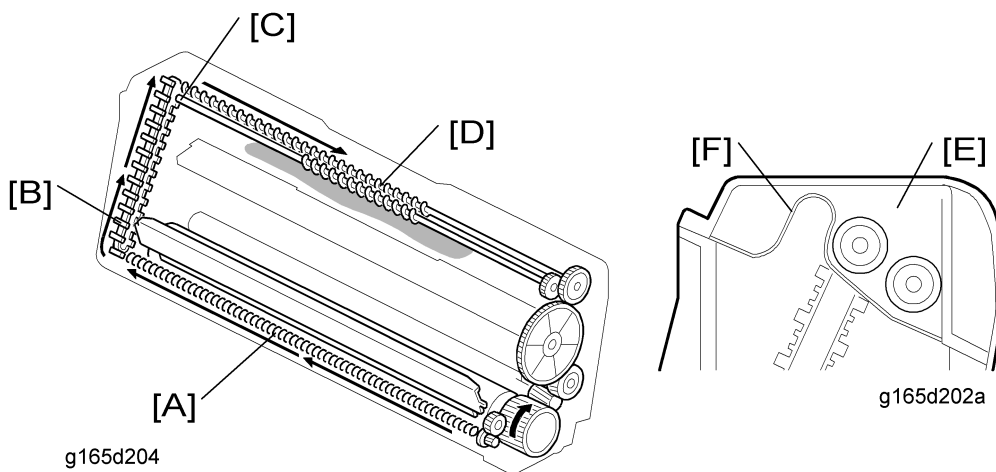

The waste toner collection coil [A] transports waste toner from the OPC to the right side of the AIO. After that, the waste toner transport belt [B], which is driven by the transport belt shaft [C], lifts waste toner up to the waste

toner tank [E].

The collected waste toner is moved to the left side of the AIO by the waste toner collection coil [D] and transport belt shaft [C].

A flexible sheet [F] separates the unused toner area from the waste toner area. The waste toner area becomes larger when toner is consumed.

Toner Mixing and Transport

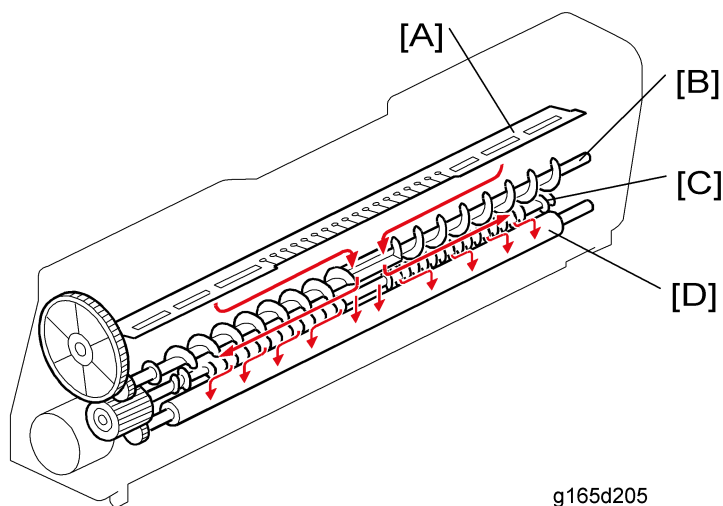

g165d205

The toner moves as shown in the above drawing. The toner agitator [A] mixes the toner so that it is transported evenly to the mixing rollers. The upper mixing roller [B] moves toner to the center, then the lower mixing roller [C] moves toner to the right and left sides. Finally, the toner supply roller [D] supplies toner to the development roller. This mixing mechanism prevents toner hardening and uneven image density in the outputs.

Development Mechanism

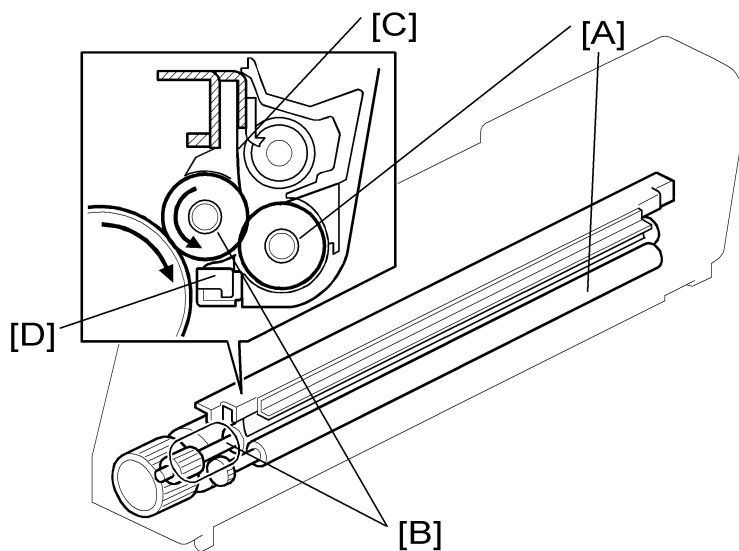

g165d206

This machine does not use developer, so a TD sensor is not necessary. In each AIO unit, the toner supply roller

7.Detailed Descriptions

[A] supplies toner to the development roller [B]. Electrostatic attraction generated by the friction between the toner supply roller and development roller moves toner to the surface of the development roller, and the development blade [C] makes sure that the layer of toner on the development roller has an even thickness. The discharge sheet [D] removes development roller bias.

Toner Near End and End Detection

Toner Near End and Toner End

To detect the toner near-end and the toner end, the machine uses:

- Pixel count (memory chip on the AIO)
- AIO rotation distance (memory chip on the AIO)

Toner End

After near-end, it is estimated that 200 pages (A4, 5% coverage) can be printed until toner end occurs.

Image Transfer

Overview

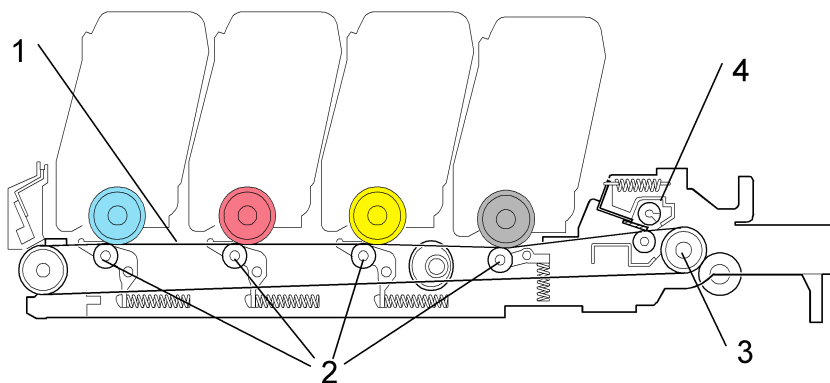

g165d301

1. Image Transfer Belt	3. ITB Drive Roller
2. ITB (Image Transfer Belt) Roller	4. ITB Cleaning Unit

The toner is moved from the four OPC drums to the image transfer belt. For a full color print, all four colors are moved from the OPCs to the transfer belt at the same time. The transfer roller then moves the four-color toner image from the transfer belt to the paper.

The ITB cleaning unit removes remaining toner from the surface of the ITB after image transfer.

Drive and Transfer Belt Roller Bias

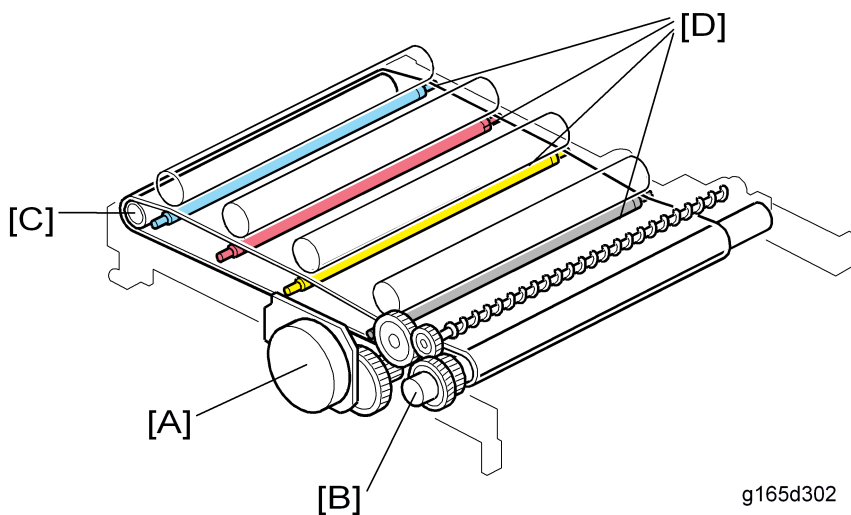

g165d302

The black AIO motor [A] controls the transfer belt drive roller [B]. The belt tension roller [C] adds tension to the transfer belt to help to turn this belt.

The image transfer belt rollers [D] are charged from terminal plates to move the toner from the OPCs to the image transfer belt.

 Transfer Belt Contact

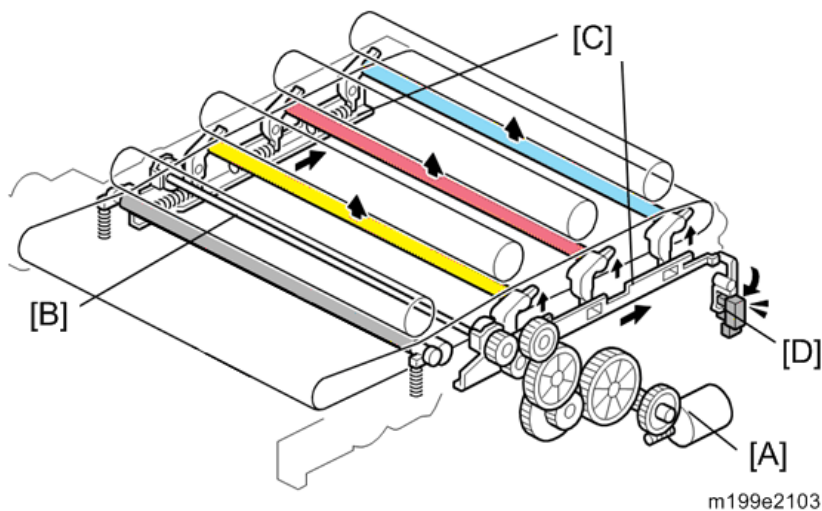

The transfer belt does not touch the color OPC drums (cyan, magenta and yellow) when the machine makes a black and white print.

The transfer belt contact motor [A] turns the CMY contact cam shaft [B] when the machine starts to make a color print. The CMY contact cams slide the right and left sliders [C] and these sliders lift the belt transfer rollers for each OPC drum (CMY) to the transfer belt. Because of this mechanism, the life of the transfer belt is longer (it is not necessary for the transfer belt to touch the color OPC drums when the machine makes a black and white print). However, if the customer selects "Off" with the "ACS" setting, the four OPC drums always touch the image transfer belt.

The ITB (image transfer belt) contact sensor [D] detects if the image transfer rollers for each OPC drum (CMY) touch the transfer belt.

If one of the following problems with transfer belt contact occur, SC445 is displayed.

- Home position shift abnormality (ITB contact sensor does not detect the home position at the time of power on / cover opening and shutting)
- Spaced position shift abnormality (ITB contact sensor does not detect that the transfer belt moves away from the color OPC drums when the machine makes a black and white print)
- Contact position shift abnormality (ITB contact sensor does not detect that the transfer belt touches the color OPC drums when the machine makes a color print)

ITB (Image Transfer Belt) Cleaning Unit

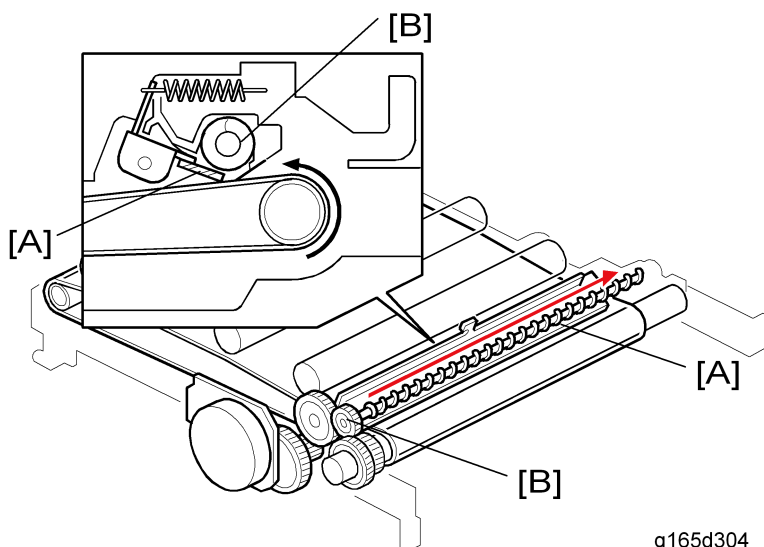

The ITB cleaning blade [A] in the cleaning unit removes remaining toner on the image transfer belt after image transfer to the paper. The toner collection coil [B] moves the collected waste toner to the outlet for the waste toner bottle.

The ITB cleaning unit has a shutter mechanism at the outlet for the waste toner bottle. When the ITB unit is removed, the shutter closes the outlet to prevent waste toner from falling.

Transfer Roller Overview

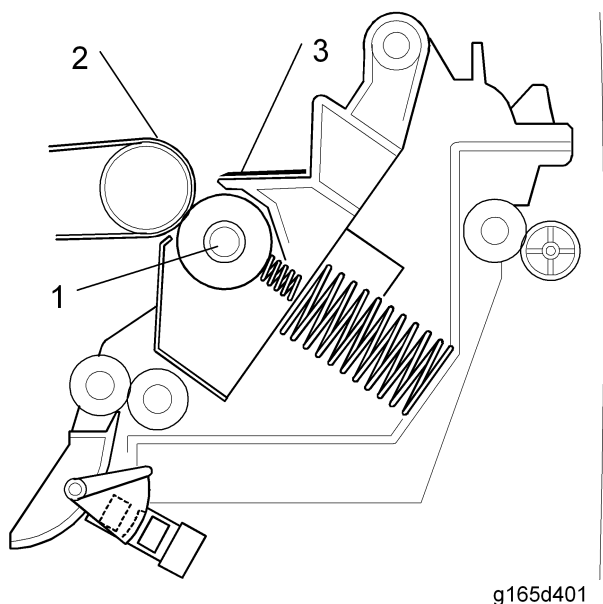

1. Transfer Roller
2. Image Transfer Belt
3. Discharge Plate

Paper Transfer and Discharge

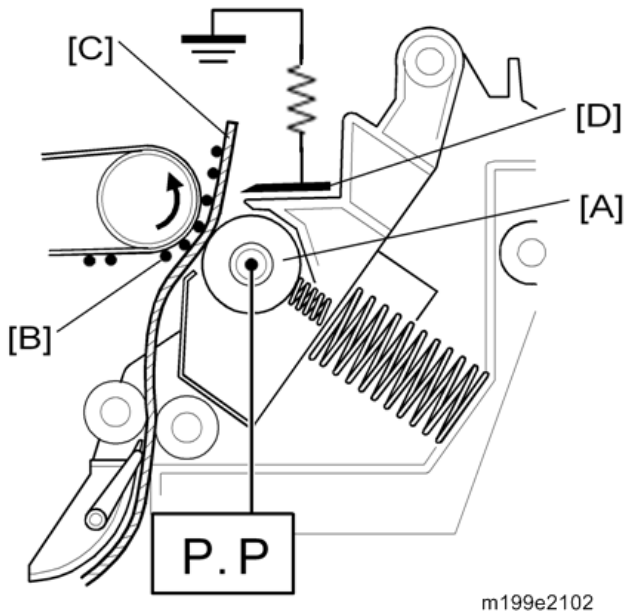

Transfer Roller

The transfer roller [A] is always pressed against the image transfer belt by pressure from a spring. The transfer roller moves toner images [B] from the transfer belt to the paper. When a sheet of paper [C] goes between the transfer roller and the transfer belt, the transfer roller turns with the paper.

Paper Transfer Bias

The high voltage power supply (HVPS) supplies electricity to the transfer roller. The transfer roller is positively charged. The right end of the transfer unit is attached to the terminal from the HVPS when you close the front cover.

Discharge Plate

The transfer unit has a discharge plate [D] above the transfer roller. The discharge plate removes charge that was applied to the paper during paper transfer. This helps paper move away from the transfer roller.

Waste Toner Collection

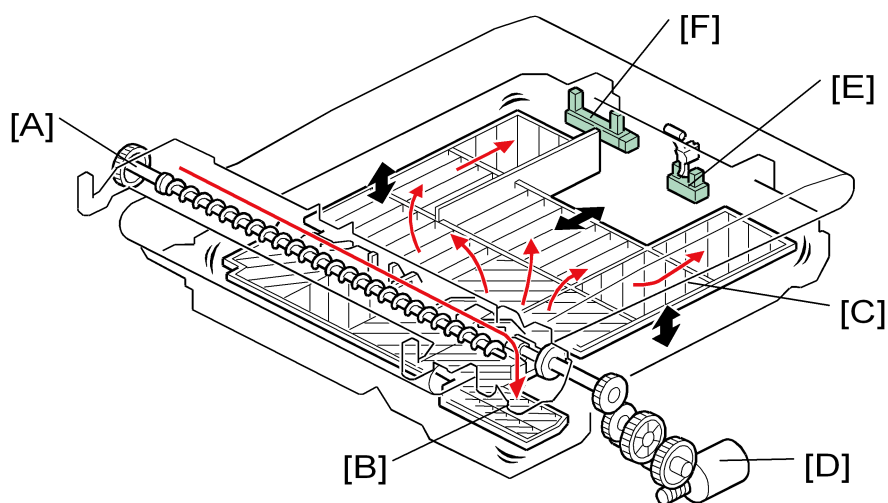

g165d451

The waste toner collection coil [A] moves collected waste toner from the ITB (image transfer belt) unit to the entrance [B] of the waste toner bottle. The agitator plate [C] levels the collected waste toner in the waste toner bottle. It is driven by the agitator motor [D].

The waste toner bottle set sensor [E] detects whether the waste toner bottle is set. If it is not set, "Waste Toner Bottle" appears on the LCD on the machine.

The waste toner overflow sensor [F] detects whether the waste toner bottle is full. If it is full, "Replace the Waste Toner Bottle" appears on the LCD on the machine. 400 more pages can be printed, then the machine stops.

Fusing and Exit

Overview

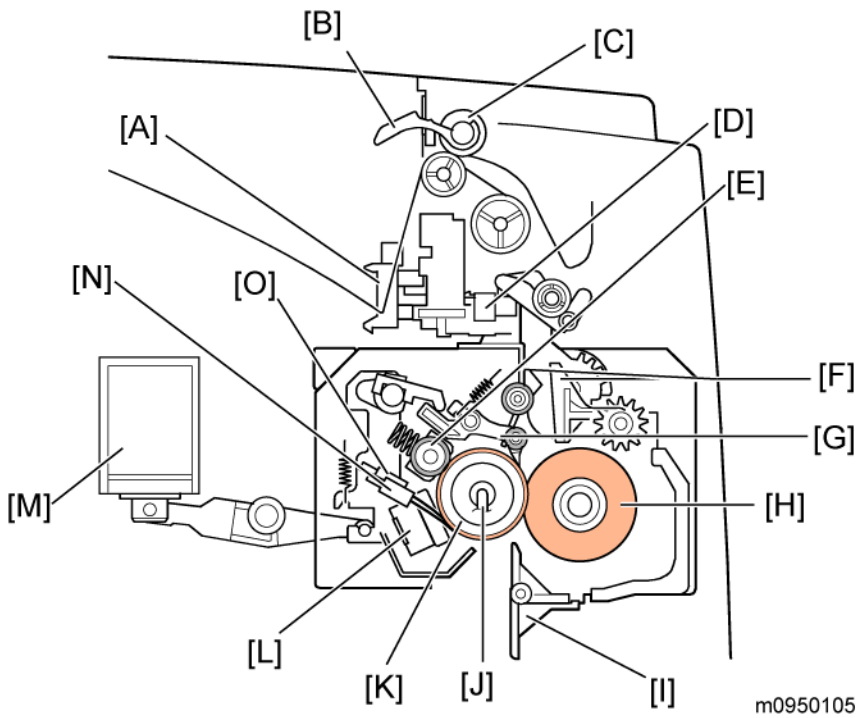

A. Fusing Pressure Release Sensor	H. Pressure Roller
B. Paper Exit Pressure Guide	I. Fusing Entrance Guide Plate
C. Paper Exit Roller	J. Fusing Lamp
D. Paper Exit Sensor	K. Hot Roller
E. Cleaning Roller	L. Thermostat
F. Fusing Exit Guide Plate	M. Fusing Stripper Pawl Solenoid
G. Stripper Pawl	N. Thermistor (Left)
	O. Thermistor (Center)

Drive

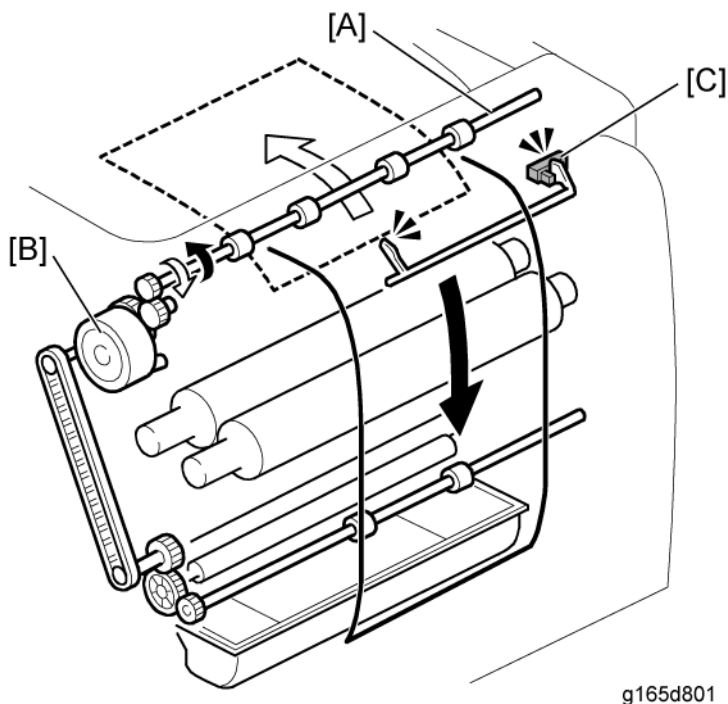

g165d801

The transport/fusing motor drives the hot roller. However, the paper exit roller [A] is controlled by the duplex motor [B]. This is because the duplex motor controls paper exit and feed in the duplex.

The paper exit sensor [C] detects the trailing edge of the paper to determine the stop timing for the transport/fusing motor, reverse timing, and stop timing for the duplex motor. It also checks whether a paper jam occurs at the fusing unit or paper exit.

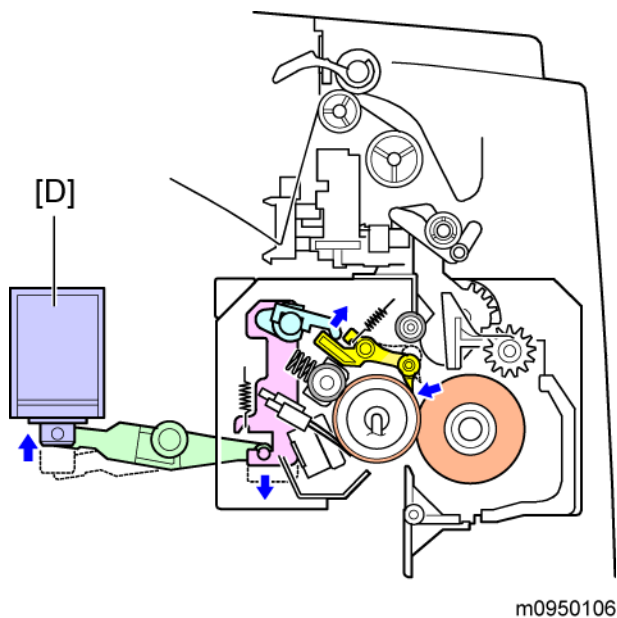

m0950106

The fusing stripper pawl solenoid [D] is connected to the stripper pawl, and it detaches the stripper pawl from the hot roller unless it is necessary to contact. This function makes the warm-up time shorter because the fusing lamp does not have to heat up both the hot roller and the fusing stripper pawl. At the same time, this solenoid and pawl can decrease the probability that a paper twists about the hot roller because the stripper pawl can detach the paper

7.Detailed Descriptions

from the hot roller steady due to the fusing pawl solenoid operation.

Pressure Release Mechanism

The springs always apply the correct pressure to the nip between the pressure roller and hot roller. When releasing the pressure release levers (same as the envelope lever in this model), the pressure roller moves away from the hot roller. If a paper jam occurs in the fusing unit, releasing these levers make it easy to remove jammed paper.

Envelope Lever (Pressure Release Lever)

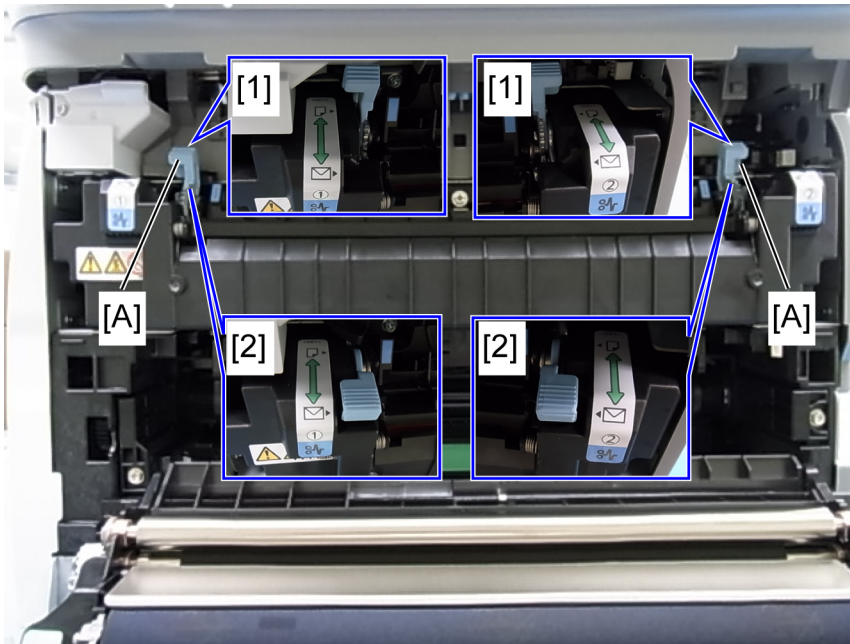

m0990007

The envelope lever (Pressure release lever) [A] is also used by the operator to adjust the size of the gap between the pressure roller and hot roller. A larger gap is needed for envelopes, which are thicker than paper.

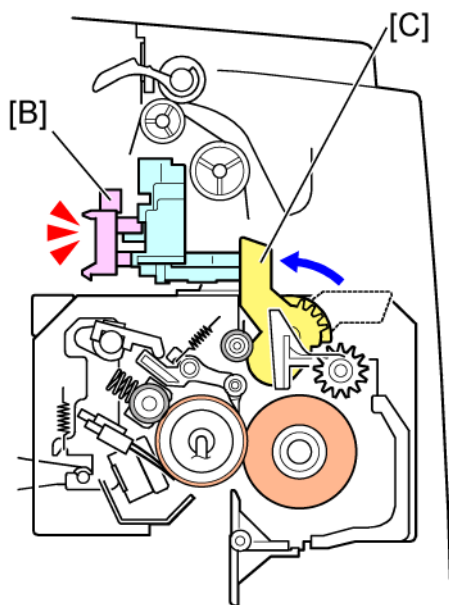

m0950107

The fusing pressure release sensor [B] detects whether the envelope lever [C] is set to the envelope position. A warning will be shown on the LCD if the envelope lever is set when normal paper is being fed, and vice versa.

- Lower the lever [2] to increase the size of the gap between the hot roller and pressure roller. This prevents jams and wrinkling when printing on envelopes.
- Raise the lever [1] to reduce the gap for all other print jobs. Normally this lever should be up.

Note

- Both envelope levers should be set to the same position at the same time, Otherwise a warning will be shown on the LCD to prevent paper jams.

Temperature Control

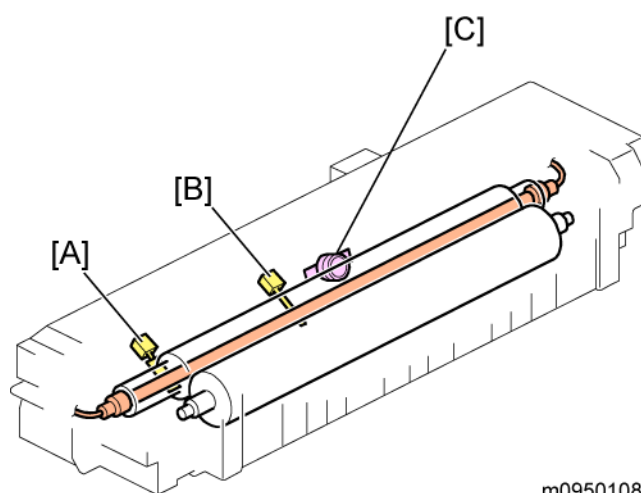

m0950108

The fusing unit has these components for temperature control:

- The fusing thermistors [A] [B] send a signal when the fusing temperature goes past the threshold.
- The central thermistor [B] is the one that is used for fusing temperature control.
- The fusing thermostat [C] breaks the electric circuit when the fusing temperature goes past the threshold. The thermostat is on the same electrical circuit as the fusing lamp, so the fusing lamp goes off if the fusing thermostat breaks the electrical circuit.

7.Detailed Descriptions

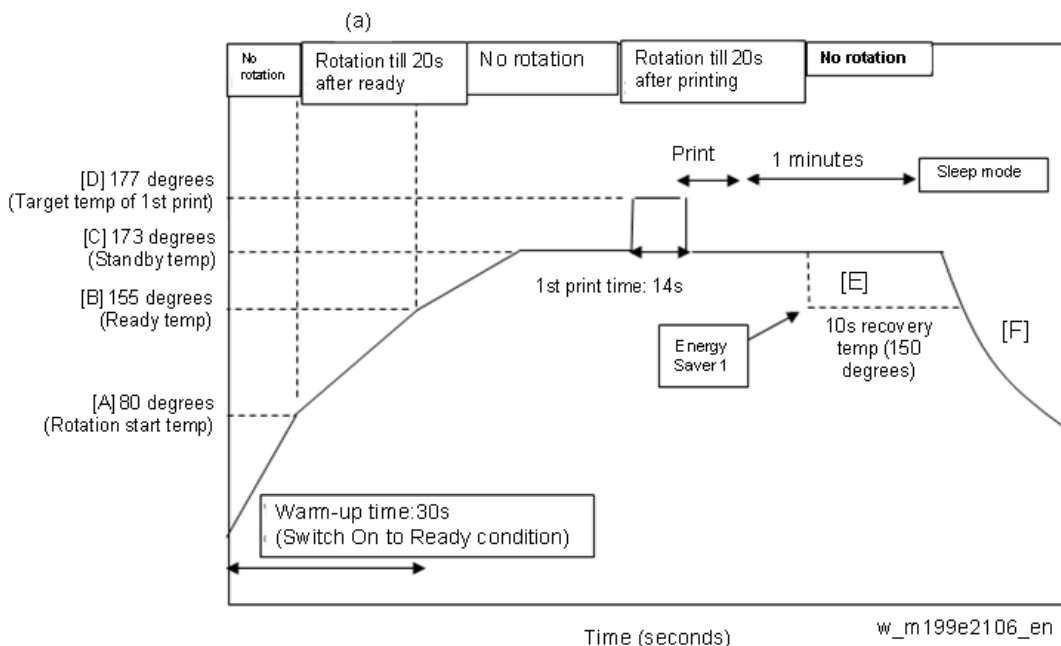

- [A]: Idling ready temperature (80°C)
The fusing unit starts to rotate (idling) until 3 seconds after stand by (a).
- [B]: Ready temperature (155°C)
This is the temperature finish warm-up condition.
- [C]: Standby temperature (173°C)
This is the temperature to wait for a print job.
- [D]: target temperature of 1st print (This depends on the target temperature of each paper type; see the table below)
The machine keeps this temperature during printing.
- [E]: 10 seconds recovery temperature (150°C)
This is the low power mode for printing. This temperature is lower than the stand by temperature [C] and saves power.
- [F]: Sleep mode
The machine turns off power to the engine unit for sleep mode after the machine has not got a print job for 10 minutes (at the default setting).

Target Temperature for Each Paper Type

Paper	Speed	Temp
Thin (60 to 65g/m ²)	1	170°C
Plain (60 to 74g/m ²)	1	173°C
Middle thick (75 to 90g/m ²)	1	177°C
Recycled	1	177°C
Plain /Middle thick/ recycled	1	177°C
Color paper	1	177°C
Preprinted	1	177°C

Letterhead	1	177°C
Prepunched	1	177°C
Thick 1 (91 to 105g/m ²)	1/2	160°C
Thick 2 (106 to 160g/m ²)	1/2	165°C
Cardstock	1/2	165°C
Bond	1/2	160°C
Envelope	1/2	196°C

Fusing unit related SC codes

If one of the fusing unit components (such as thermistors, thermostat, fusing lamp etc.) is defective, the following SC codes may be issued. For details, refer to the SC code list in the chapter "Troubleshooting".

- SC541, 542, 543 and 545

If one of these SC codes is issued:

- Enter the SP mode.
- Press "O.K" in "Fuser SC Reset", and then turn the main power switch off and on.

Anti-Humidity Mode

To reduce paper curl in high temperature and humidity environments, the fusing unit does idle rotation before a job, if the customer enables this function in the user mode.

- Mode 1: No fusing idling, transfer roller voltage is increased
- Mode 2: Fusing unit rotates for 30 seconds before a job, transfer roller voltage is increased.
- Mode 3: Fusing unit rotates for 60 seconds before a job, transfer roller voltage is increased.

ADF/DADF (for MF models)

Overview

ADF

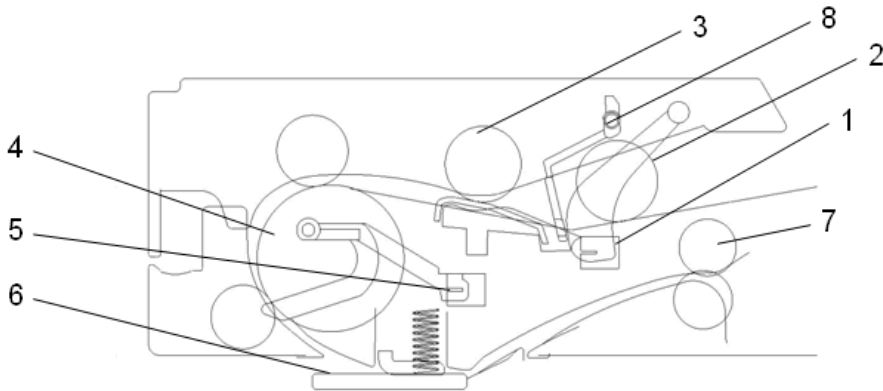

m1562026

1. Original Set Sensor	5. Registration Sensor
2. Pick-up Roller	6. DF Exposure Glass
3. Feed Roller	7. Original Exit Roller
4. Transport Roller	8. Media Stopper

DADF

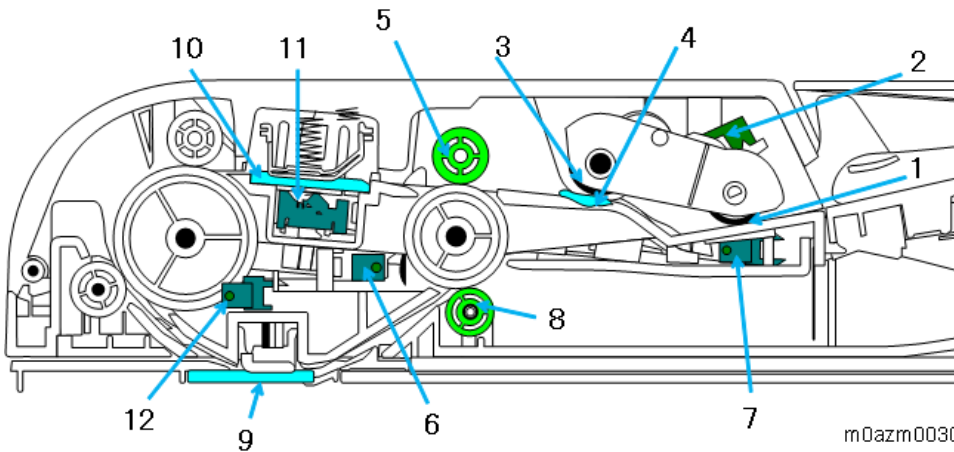

m0azm0030

1. DADF Pick-Up Roller	7. Original Set Sensor
2. Original Set Sensor Feeler	8. Original Exit Roller
3. DADF Feed Roller	9. Exposure Glass
4. DADF Separation Pad	10. Back DF Exposure Glass
5. Transport Roller	11. Back CIS
6. Back Registration Sensor	12. Front Registration Sensor

Paper Path

Paper Path (ADF)

The ADF feed unit, comprising the pick-up roller [2] and feed roller [3], waits in a raised position to allow the original to be loaded easily.

When you load the original, the feeler of the original set sensor [1] is lifted, and the machine detects that the original has been loaded.

When you press the [B&W Start] key or [Color Start] key, the ADF motor drives the pick-up roller and feed roller, and the ADF feed unit descends to pick up the original.

During the continuous scanning of multiple sheets, the ADF feed unit stays down to feed the original further through the original feed path while preventing double feeding with the media stopper. If the registration sensor [5] does not detect the original within a certain period after original feeding starts, the machine determines that the original has jammed.

The original fed by the transport roller [4] is scanned by the CIS at the DF exposure glass [6] and then finally delivered to the output tray by the original exit roller [7].

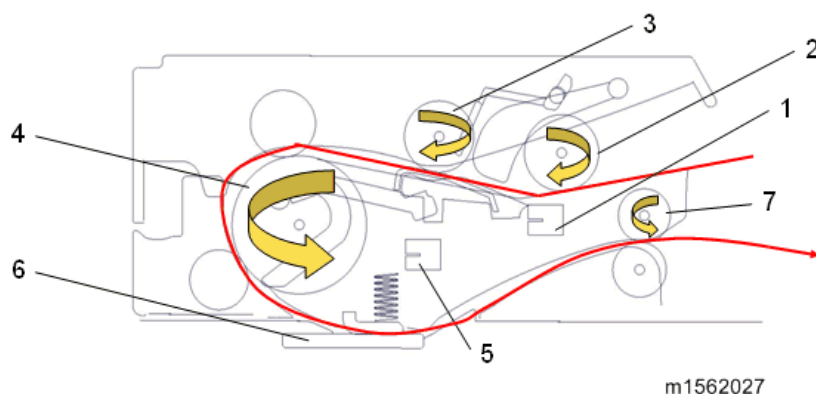

Paper Path (DADF)

The DADF feed unit, comprising the pick-up roller [2] and feed roller [3], waits in a raised position to allow the original to be loaded easily.

When you load the original, the feeler of the original set sensor [1] is lifted, and the machine detects that the original has been loaded.

When you press the [B&W Start] key or [Color Start] key, the DADF motor drives the pick-up roller and feed roller, and the DADF feed unit descends to pick up the original.

During the continuous scanning of multiple sheets, the ADF feed unit stays down to feed the original further through the original feed path while preventing double feeding with the media stopper. If the front registration sensor [5] or the back registration sensor [9] does not detect the original within a certain period after original feeding starts, the machine determines that the original has jammed.

In the case of duplex scanning, the original fed by the transport roller [4] is scanned by the back CIS [7] located under the back DF exposure glass [6], passes the transport roller [8], has its front scanned by the CIS at the front DF exposure glass [10], and then is finally delivered to the output tray by the original exit roller [11].

7.Detailed Descriptions

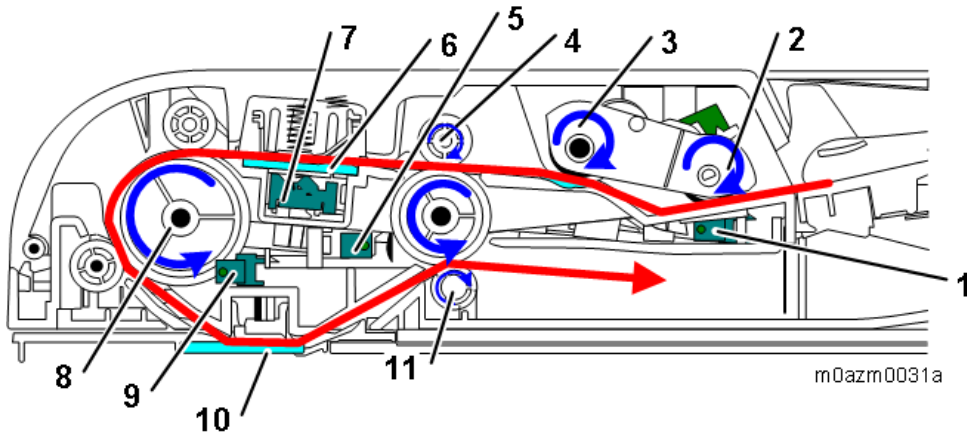

Timing Chart

Single page

(Upper line: ON, Lower line: OFF)

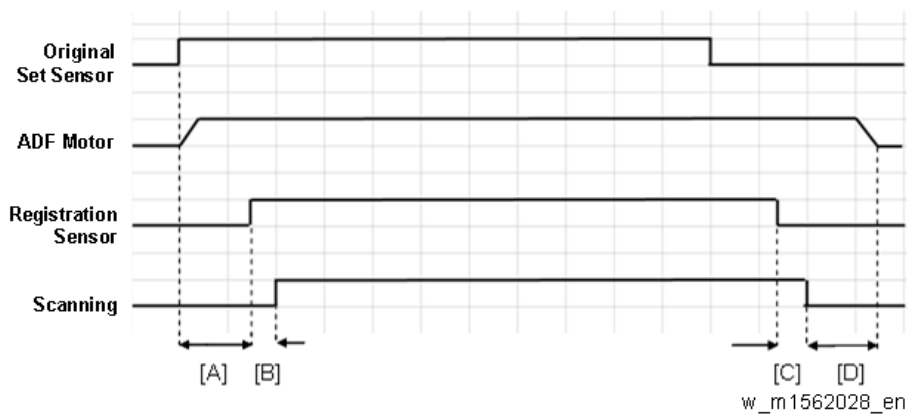

- [A]: Check for Feed-in jam
- [B]: Number of pulses for motor start to Start Scanning
- [C]: Number of pulses for Registration Sensor off to Stop Scanning
- [D]: Number of pulses for Paper feed out

Multi Page

(Upper line: ON, Lower line: OFF)

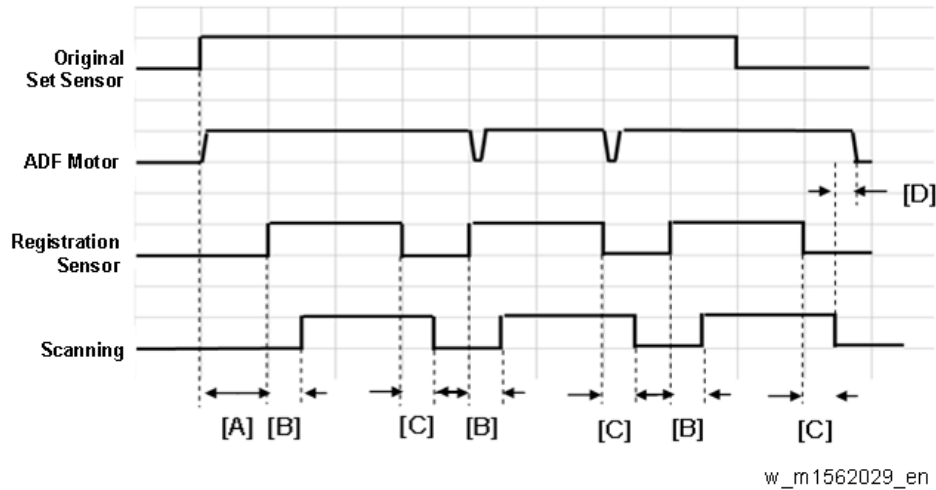

- [A]: Check for Feed-in jam
- [B]: Number of pulses for motor start to Start Scanning
- [C]: Number of pulses for Registration Sensor off to Stop Scanning
- [D]: Number of pulses for last Paper feed out

DADF Duplex Scanning

(Upper line: ON, Lower line: OFF)

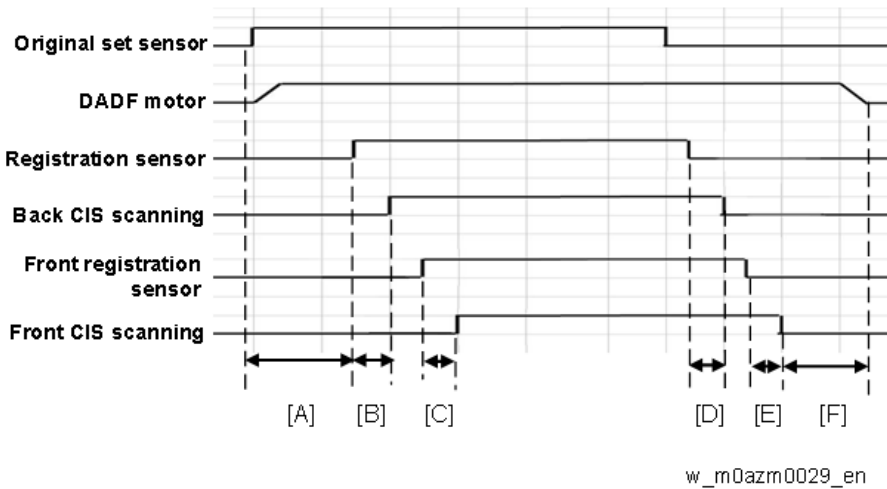

- [A]: Check for Feed-in jam
- [B]: Number of pulses for Registration Sensor on to start scanning the back of the original.
- [C]: Number of pulses for Front Registration Sensor on to start scanning the front of the original.
- [D]: Number of pulses for Registration Sensor off to stop scanning the back of the original.
- [E]: Number of pulses for Front Registration Sensor off to stop scanning the front of the original.
- [F]: Number of pulses for Paper feed out

Scanner (for MF models)

Overview

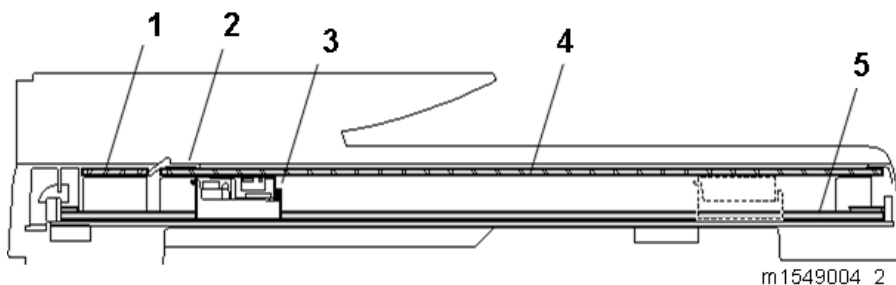

1. DF Exposure Glass	4. Scanner Exposure Glass
2. White Sheet	5. Carriage Drive Shaft
3. CIS Carriage Unit	

Drive

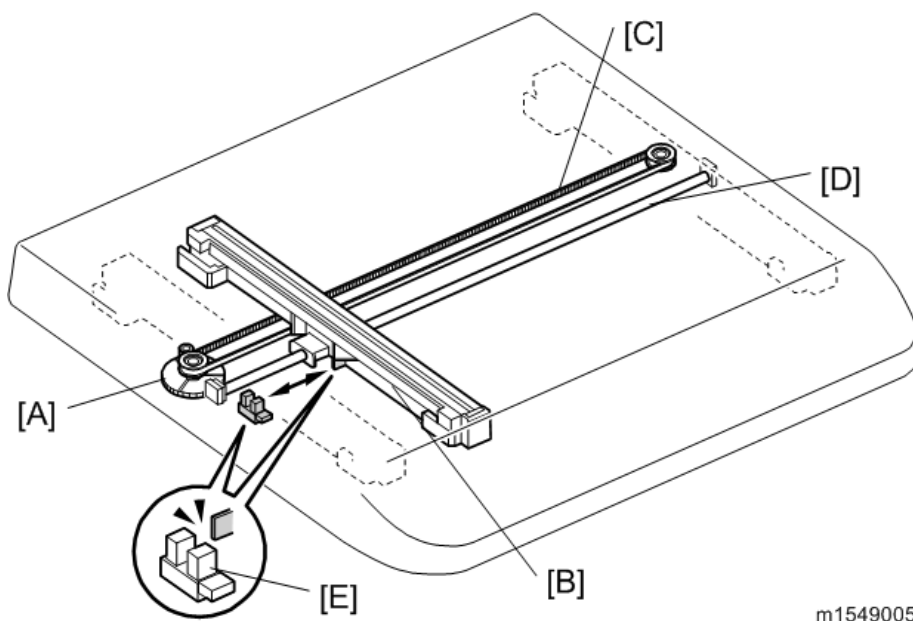

The scanner motor [A] drives the CIS carriage unit [B] through gears and a timing belt [C]. The CIS carriage unit moves along the carriage drive shaft [D]. The carriage home position sensor [E] in the scanner detects the home position of carriage unit when initializing the scanner or before/after scanning. The CIS carriage unit moves to read the white sheet before every scan mode to adjust white level.

Energy Saving

Energy Saver Modes

Customers should use energy saver modes properly, to save energy and protect the environment.

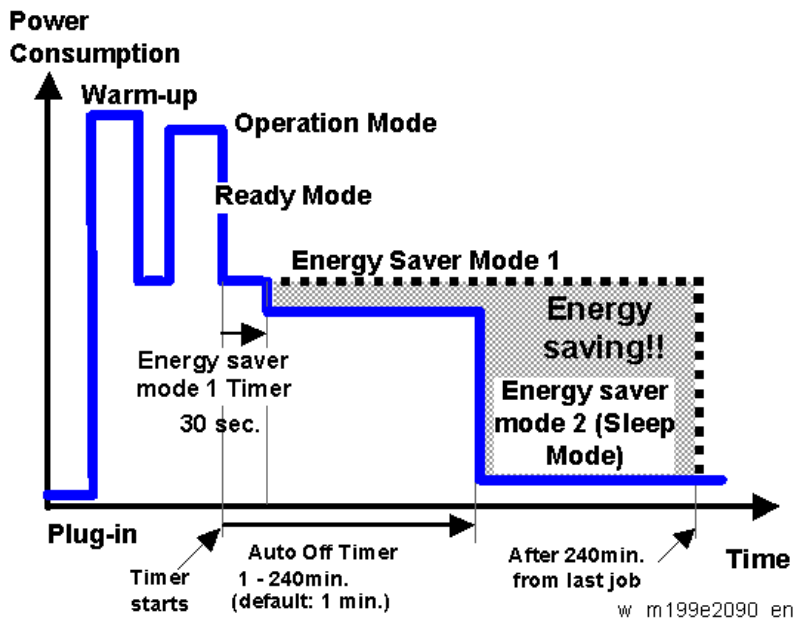

Energy Saver Modes	Description
Energy Saver Mode 1	Lowers the fusing temperature.
Energy Saver Mode 2 (Sleep Mode)	No power is supplied to the printing engine, and almost none to the controller.
Energy Saver Mode 3	Lowers the fusing temperature more than that of Energy Saver Mode 1 (Engine is powered on). This mode extends the fusing unit life. You can specify in SP mode whether to have the machine switch to Energy Saver Mode 3 instead of Energy Saver Mode 2 when the machine has been idle for 10 minutes.

When the machine is not being used, the machine enters energy saver mode to reduce the power consumption by lowering the fusing temperature.

The area shaded gray in this diagram represents the amount of energy that is saved when the timers are at the default settings (1 minute). If the timers are changed, then the energy saved will be different. For example, if the timers are all set to 240 minutes, the gray area will disappear, and no energy is saved before 240 minutes expires.

Timer Settings (Printer Models)

- The user can set this timer with the menu mode.
- Press [Menu].
 - Press [▼] or [▲] to scroll through the menu listing and press [OK] to select.

7.Detailed Descriptions

- 1.** [System] → [Energy Saver 2] → [On/Off] > [On]
- 2.** [System] → [Energy Saver 2] → [E.Saver2 Timer] → [1] to [240] min (Select the time with [▼] / [▲] keys.)
- 3.** Press [Back] to return to the previous menu.
 - The default setting of Sleep mode is 1 minute.

Timer Settings (MF Models)

- The user can set this timer with the User Tools mode.
- 1.** Press the [HOME] key.
 - 2.** Press [Administrator Tools].
 - 3.** Press [Energy Saver Mode].
 - 4.** Press [EnergySaverMode 2].
 - 5.** Select "On", and specify the time to elapse before Energy Saver Mode 2 (input the time with number keyboard screen).
 - 6.** Press [OK] to return to the previous menu.
 - The default setting of Sleep mode is 1 minute.

Power Consumption

Energy Saver Mode 2 (Sleep Mode)

- MF models:1.3 W*
- Printer models:1.2 W*

Energy Saver Mode 1

- MF models (EU version): 44.2 W*
- MF models (NA version): 42.6 W*
- Printer models (EU version): 40.8 W*
- Printer models (NA version): 40.9 W*

* Recovery time and power consumption may differ depending on the conditions and environment of the machine.

Return to Stand-by Mode

Energy Saver Mode 2 (Sleep Mode)

Recovery time

- 30 seconds or less*

Energy Saver Mode 1

Recovery time

- 10 seconds or less*

* Recovery time and power consumption may differ depending on the conditions and environment of the machine.

Recommendation

We recommend that the default settings should be kept.

- If the customer requests that these settings should be changed, please explain that their energy costs could increase, and that they should consider the effects on the environment of extra energy use.
- If it is necessary to change the settings, please try to make sure that the Auto Off timer is not too long. Try with a shorter setting first, such as 12 minutes, then go to a longer one (such as 15 minutes) if the customer is not satisfied.
- If the timers are all set to the maximum value, the machine will not begin saving energy until 240 minutes has expired after the last job. This means that after the customer has finished using the machine for the day, energy will be consumed that could otherwise be saved.

SP C260DNw/SP C262DNw
SP C260SFNw/SP C262SFNw
Machine
Code:M0AR/M0AS/M0AW/M0AX
Appendices
Ver 1.0

Latest Release: April, 2017
Initial Release: April, 2017
(c) 2017 Ricoh Co.,Ltd.

Table of Contents

1. General Specifications.....	2
Printer Model (SP C260DNw/SP C262DNw).....	2
MF Model (SP C260SFNw/SP C262SFNw).....	5
Engine	5
Copier.....	7
Scanner.....	9
Fax.....	9
Option.....	11
Paper Feed Unit.....	11
2. Controller Specifications.....	12
Printer Model (SP C260DNw/SP C262DNw).....	12
MF Model (SP C260SFNw/SP C262SFNw).....	14
3. Supported Paper Sizes/Types	16
4. Preventive Maintenance	19
User Replaceable Items	19
Yield items and Service Maintenance	20
5. Exchange and Replace Procedure	21
Instruction.....	21
Cleaning Points after Machine Arrival at Depot	22
6. FAQs/Knowledge Base.....	23

1. General Specifications

Printer Model (SP C260DNw/SP C262DNw)

Item		Description	
Configuration		Desktop	
Print process		Laser electrostatic transfer	
Maximum paper size for printing		Legal	
Resolution	Speed Mode		600x600 dpi 1bit (600x600 dpi)
	Standard Mode		600x600 dpi 2 bit (1200 x 600 dpi equivalent)
	Fine Mode		600x600 dpi 4 bit (2400 x 600dpi equivalent)
Printing Speed	Plain Paper	1-Sided	BW/FC: 20/21ppm (A4/LT SEF)
		2-Sided	BW/FC: 12ppm (A4/LT SEF)
First Print Speed (Standard Tray)	BW		14 sec. or less(A4/LT SEF)
	FC		14 sec. or less(A4/LT SEF)
Dimensions (W x D x H)	Main Frame		400 x 450 x 320 mm (15.7 × 17.8 × 12.8")
Weight		23.8 kg (52.5lb.) or less *Includes consumables.	
Input capacity (80 g/m ²)	Standard	Standard Tray	250 sheets
		Bypass tray	1 sheet
	Op. Paper Tray	Paper Feed Unit	500 sheets x 1
	Max		Up to 751 sheets
Output capacity	Standard Tray	Face down	up to 150 sheets (A4/LT or 80g/m ² , 20lb)
Input Paper Size	Standard Tray		A4, B5 JIS, A5 LEF, A5 SEF, B6JIS, A6, 8 1/2 × 14, 8 1/2 × 11, 5 1/2 × 8 1/2, 7 1/4 × 10 1/2, 8 × 13, 8 1/2 × 13, 8 1/4 × 13, 16K, 4 1/8 × 9 1/2, 3 7/8 × 7 1/2, C5 Env, C6 Env, DL Env, 8 1/2 × 13 2/5, 8 1/2 × 13 3/5 Custom size: Min. 90 x 148mm (3.54x 5.83") Max. 216 x 356mm (8.50x 14.0")
	Bypass Tray		A4, B5 JIS, A5 LEF, A5 SEF, B6JIS, A6, 8 1/2 × 14, 8 1/2 × 11, 5 1/2 × 8 1/2, 7 1/4 × 10 1/2, 8 × 13, 8 1/2 × 13, 8 1/4 × 13, 16K, 4 1/8 × 9 1/2, 3 7/8 × 7 1/2, C5 Env, C6 Env, DL Env,

1. General Specifications

Item		Description	
		$8\frac{1}{2} \times 13\frac{2}{5}$, $8\frac{1}{2} \times 13\frac{3}{5}$ Custom size: Min. 90 x 148mm (3.54"x 5.83") Max. 216 x 356mm (8.50"x 14.0")	
	Op. Paper Tray	A4, Letter	
Paper Type	Standard Tray	Plain Paper, Middle Thick Paper, Recycled Paper, Thick Paper 1, Thick Paper 2, Thin Paper, Letterhead, Preprinted Paper, Label Paper, Prepunched Paper, Bond Paper, Cardstock, Color Paper, Envelope	
	Bypass Tray	Plain Paper, Middle Thick Paper, Recycled Paper, Thick Paper 1, Thick Paper 2, Thin Paper, Letterhead, Preprinted Paper, Label Paper, Prepunched Paper, Bond Paper, Cardstock, Color Paper	
	Op. Paper Feed Unit / Duplex	Thin Paper, Plain Paper, Middle Thick Paper, Thick Paper 1, Recycled Paper, Color Paper, Preprinted Paper, Prepunched Paper, Letterhead	
Paper Weight	Standard Tray	60-160g/m ² (16-42lb)	
	Bypass tray	60-160g/m ² (16-42lb)	
	Automatic duplex	60-90g/m ² (16-24lb)	
	Op. Paper Tray	Paper Feed Unit	60-105g/m ² (16-28lb)
Power Requirement	NA version	120-127V/ 60Hz/ less than 11A	
	Taiwan version	110V/ 60Hz/ less than 12A	
	EU, Asia, China version	220-240V/ 50/60Hz/ less than 6A	
Power Consumption	NA	Max.	1300W or less
		Ready	58.9 W
		During printing	Color: 384W B&W: 321W
	EU version	Max.	1300W or less
		Ready	58.3 W
		During printing	Color: 384W B&W: 321W
Warm-up Time		30 sec or less (from power on) (At room temperature 23°C, humidity 50% and supplying the rated power)	
Energy Save Mode	Energy Saver mode	Power Consumption	NA: 40.9 W* EU version: 40.8 W*

1.General Specifications

Item		Description	
	1		* Recovery time and power consumption may differ depending on the conditions and environment of the machine.
		Default Time	30 seconds
	Energy Saver mode 2	Power Consumption	1.2 W* * Recovery time and power consumption may differ depending on the conditions and environment of the machine.
		Default Time	1 minute

MF Model (SP C260SFNw/SP C262SFNw)**Engine**

Item		Description	
Configuration		Desktop	
Print process		Laser electrostatic transfer	
Maximum paper size for printing		Legal	
Maximum paper size for scanning	Exposure Glass	A4, Letter	
	ADF / DADF	Legal	
Resolution	Speed Mode	600x600 dpi 1bit (600x600 dpi)	
	Standard Mode	600x600 dpi 2 bit (1200 x 600 dpi equivalent)	
	Fine Mode	600x600 dpi 4 bit (2400 x 600dpi equivalent)	
Printing Speed	Plain Paper	1-Sided	BW/FC: 20/21ppm (A4/LT SEF)
		2-Sided	BW/FC: 12ppm (A4/LT SEF)
First Print Speed (Standard Tray)	BW	14 sec. or less (A4/LT SEF)	
	FC	14 sec. or less (A4/LT SEF)	
Dimensions (W x D x H)	Main Frame	420 x 493 x 460mm (16.5 × 19.4 × 18.7")	
Weight		SP C260SFNw: 2 9 kg (64 lb.) or less SP C262SFNw: 30 kg (66.2 lb.) or less *Includes consumables.	
Input capacity (80 g/m ²)	Standard	Standard Tray	250 sheets
		Bypass tray	1 sheet
	Op. Paper Tray	Paper Feed Unit	500 sheets x 1
	Max		Up to 751 sheets
Output capacity	Standard Tray	Face down	up to 150 sheets (A4/LT or 80g/m ² , 20lb)
Input Paper Size	Standard Tray	A4, B5 JIS, A5 LEF, A5 SEF, B6JIS, A6, 8 1/2 × 14, 8 1/2 × 11, 5 1/2 × 8 1/2, 7 1/4 × 10 1/2, 8 × 13, 8 1/2 × 13, 8 1/4 × 13, 16K, 4 1/8 × 9 1/2, 3 7/8 × 7 1/2, C5 Env, C6 Env, DL Env, 8 1/2 × 13 2/5, 8 1/2 × 13 3/5 Custom size: Min. 90 x 148mm (3.54x 5.83") Max. 216 x 356mm (8.50x 14.0")	
	Bypass Tray	A4, B5 JIS, A5 LEF, A5 SEF, B6JIS, A6, 8 1/2 × 14, 8 1/2 × 11, 5 1/2 × 8 1/2, 7 1/4 × 10 1/2, 8 × 13, 8 1/2 × 13, 8 1/4 × 13, 16K, 4 1/8 × 9 1/2, 3 7/8 × 7 1/2, C5 Env, C6 Env, DL	

1.General Specifications

Item		Description	
		Env, 8 1/2 × 13 2/5, 8 1/2 × 13 3/5 Custom size: Min. 90 x 148mm (3.54"x 5.83") Max. 216 x 356mm (8.50"x 14.0")	
	Op. Paper Tray	A4, Letter	
	Duplex	A4, B5 JIS, Legal , Letter, Executive, 8 1/2 × 13 inches, Folio, 8 inches × 13 inches, 16K	
Paper Type	Standard Tray	Plain Paper, Middle Thick Paper, Recycled Paper, Thick Paper 1, Thick Paper 2, Thin Paper, Letterhead, Preprinted Paper, Label Paper, Prepunched Paper, Bond Paper, Cardstock, Color Paper, Envelope	
	Bypass Tray	Plain Paper, Middle Thick Paper, Recycled Paper, Thick Paper 1, Thick Paper 2, Thin Paper, Letterhead, Preprinted Paper, Label Paper, Prepunched Paper, Bond Paper, Cardstock, Color Paper	
	Op.Paper Feed Unit / Duplex	Thin Paper, Plain Paper, Middle Thick Paper, Thick Paper 1, Recycled Paper, Color Paper, Preprinted Paper, Prepunched Paper, Letterhead	
Paper Weight	Standard tray	60-160g/m ² (16-42lb)	
	Bypass tray	60-160g/m ² (16-42lb)	
	Automatic duplex	60-90g/m ² (16-24lb)	
	Op. Paper Tray	Paper Feed Unit	60-105g/m ² (16-28lb)
ADF/DADF	Capacity (80g/m ² , 20lb)	SP C260SFNw: 35 sheets SP C262SFNw: 50 sheets	
	Paper size	140 to 216 mm (5 1/2 to 8 1/2 inches) in width, 140 to 356 mm (5 1/2 to 14 inches) in width	
	Paper weight	52 to 105 g/m ² (13.8 to 28.0 lb.)	
Power Requirement	NA version	120-127V/ 60Hz/ less than 11A	
	Taiwan version	110V/ 60Hz/ less than 12A	
	EU, Asia, China version	220-240V/ 50/60Hz/ less than 6A	
Power Consumption	NA	Max.	1300W or less
		Ready	60.7 W
		During printing	Color: 404W B&W: 331W
	EU version	Max.	1300W or less
		Ready	58.2 W

1.General Specifications

Item			Description
		During printing	Color: 404W B&W: 331W
Warm-up Time			30 sec or less (from power on) (At room temperature 23°C, humidity 50% and supplying the rated power)
Energy Save Mode	Energy Saver mode 1	Power Consumption	EU version: 44.2 W* NA: 42.6 W* * Recovery time and power consumption may differ depending on the conditions and environment of the machine.
		Default Time	30 seconds
	Energy Saver mode 2	Power Consumption	1.3 W* * Recovery time and power consumption may differ depending on the conditions and environment of the machine.
		Default Time	1 minute

Copier

Item		Description
1st copy speed	Platen/ADF	BW: Less than 20 sec. (A4/LT SEF) FC: Less than 20 sec. (A4/LT SEF)
Maximum original size	Platen	A4 (210 x 297mm) / Letter (215.9 x 279.4mm)
	ADF	A4 (210 x 297mm) / Letter (215.9 x 279.4mm) / Legal (215.9 x 355.6mm)
Multiple Copy Speed	When copying multiple simplex originals (simplex printing)	BW: 20 cpm (A4)*, 21cpm (LT) FC: 20 cpm (A4) , 21cpm (LT) *14cpm in Germany and 9cpm in Belgium & Austria
	When making multiple copies of simplex originals one by one (simplex printing)	BW: 20 cpm* FC: 12 cpm *14cpm in Germany and 9cpm in Belgium & Austria

1.General Specifications

Item		Description
	When making multiple copies of two-sided originals one by one (duplex scanning, simplex printing) (only for SP C262SFNw)	BW: 20 cpm* FC: 12 cpm *14cpm in Germany and 9cpm in Belgium & Austria
	When making multiple copies of two-sided originals one by one (duplex scanning, duplex printing) (only for SP C262SFNw)	BW: 12 cpm FC: 12 cpm
Multiple copy		Up to 99
Resolution (H x V)	Exposure glass	Scanning: 600 × 600 dpi Printing: 600 × 600 dpi
	DF	Scanning: 300 × 600 dpi Printing: 600 × 600 dpi
Grayscale		256 levels
Reduction / Enlargement	Fix	NA: 50, 65, 78, 93, 129, 155, 200, 400% EU: 50, 71, 82, 93, 122, 141, 200, 400%
	Custom	Book: 25 - 400% in 1% step ARDF: 25 - 200% in 1% step
Image density adjustment		Yes, Manual only: 5 levels
Copy mode (Image quality mode)		Yes (Text / Photo / Text Photo)
Memory copy		Yes
Duplex copy		Yes (only for DADF model)
Interrupt copy		No
Combine copy		2 in 1, 4 in 1
ID Copy copy		Yes (only 2 in 1)
APS/AMS		No
Auto Tray Switch		No
Directional Magnification		No
Directional Size Magnification		No
Photo Mode		Yes
Auto Start		No
User Program		No
Electronic Sorting		Yes
Image Rotation		No

1.General Specifications

Item	Description
Series Copy	No

Scanner

Item	Description
Scanning Device	Contact Image Sensor (CIS)
Scan Mode	Color, B/W, Grayscale
Scanning Resolution	Control panel <ul style="list-style-type: none"> • Exposure glass 600 × 600 dpi • DF 300 × 300 dpi
	TWAIN <ul style="list-style-type: none"> • Exposure glass 19200 × 19200 dpi • DF 600 × 600 dpi
	WIA 600 × 600 dpi
Gray scale	256 levels
Scan speed	BW: Less than 5 sec. FC: Less than 10 sec.
Maximum scanning area (horizontal × vertical)	Platen 216 × 297 mm (8.5 × 11.7 inches)
	DF 216 × 356 mm (8.5 × 14 inches)
Gradation	Input 16 bit color processing
	Output 8 bit color processing
Interface	Scanning from the control panel <ul style="list-style-type: none"> • Ethernet (10BASE-T, 100BASE-TX) , USB2.0 (Scan to USB) Scanning from a computer <ul style="list-style-type: none"> • Ethernet (10BASE-T, 100BASE-TX), USB 2.0
Sendable file formats	TIFF, JPEG, PDF

Fax

Item	Description
Access line	PSTN/ PBX
Transmission mode	ITU-T Group 3 (G3)
Data compression method	MH, MR, MMR, JBIG
Transfer rate	33.6 kbps to 2400 bps (auto shift down system)
Resolution	8 x 3.85/ 8 x 7.7 lines/mm

1.General Specifications

Item		Description
		200 x 100/ 200 x 200 dpi
Scanning Speed		Less than 5 sec. (Platen/ADF)
Transmission Speed		G3: Approx.3 seconds (200x100 dpi, ,JBIGmb, ITUT #1 chart TTI off, memory transmission)
Scan Page per Minute(DF used)	A4/LT SEF	Less than 20 spm (A4/LT SEF) (8 x 3.85)
	A4/LT LEF Image Rotation	LEF not available
Page Memory Size	Std	2MB
	with Optional SAF Memory	No
SAF Memory Size	Std	8*3.85 line/mm (Approx. 100 pages) by ITUT#1 chart
	with Optional SAF Memory	-
Memory capacity		More than 100 sheets (8 dots per mm × 3.85 line per mm)
Address book		Speed dial <ul style="list-style-type: none"> • 200 items Quick dial <ul style="list-style-type: none"> • 20 items Number of redials for Fax <ul style="list-style-type: none"> • 1

Option

Paper Feed Unit

Item		Description
Paper Tray (500x1)	Paper Size	A4, Letter (8 1/2 × 11 inches)
	Paper Weight	60 to 105 g/m ² (16 to 28 lb.)
	Paper capacity	500 sheets
	Dimensions (W x D x H)	400 × 450 × 127 mm (15.8 × 17.8 × 5 inches)
	Weight	Less than 4 kg (8.9 lb.)

2. Controller Specifications

Printer Model (SP C260DNw/SP C262DNw)

Item	Description	
Processor	Quatro5305-350MHz	
Memory	Std.	128MB
Resolution	Speed Mode: 600x600 dpi 1bit (600x600 dpi) Standard Mode: 600x600 dpi 2 bit (1200 x 600 dpi equivalent) Fine Mode: 600x600 dpi 4 bit (2400 x 600dpi equivalent)	
Interface	Std.	USB2.0,100Base-TX/10Base-T, IEEE802.11b/g/n
Language	Std.	PCL6/5c, GDI, PostScript3, PictBridge
Font	PCL: 80 fonts	
Operating Systems	Windows Vista/7/8.1/10, Windows Server 2008/2008 R2/2012/2012 R2 Mac OS X 10.9 or later	
Network Protocols	TCP/IP, IPP, Bonjour	

Print Resolution		
Engine	Speed Mode: 600x600 dpi 1bit (600x600 dpi)	
PictBridge	Standard Mode: 600x600 dpi 2 bit (1200 x 600 dpi equivalent)	
Controller	PCL5c	Fine Mode: 600x600 dpi 4 bit (2400 x 600dpi equivalent)
	PCL6	
	PostScript3/PDF	
Drivers	PCL5c	
	PCL6	
	PostScript3	
Language		
Operation Panel (LCD)	1. English, 2. German, 3. French, 4. Italian, 5. Spanish, 6. Dutch, 7. Swedish, 8. Norwegian, 9. Danish, 10.Finnish, 11.Portuguese	
Drivers	PCL5c	1. English, 2. German, 3. French, 4. Italian, 5. Spanish, 6. Dutch, 7. Swedish, 8. Norwegian, 9. Danish, 10. Finnish, 11. Portuguese, 12. Czech, 13. Hungarian, 14. Polish, 15. Russian, 16. Turkish, 17. Brazilian Portuguese
	PCL6	
	PostScript3	
Test Page Print	Config. Map	1. English, 2. German, 3. French, 4. Italian, 5. Spanish, 6. Dutch, 7. Swedish, 8. Norwegian, 9. Danish, 10. Finnish, 11. Portuguese, 12. Czech, 13. Hungarian, 14. Polish, 15. Russian, 16. Turkish, 17. Brazilian Portuguese
	The others	1. English

Interface Specification

2.Controller Specifications

Network Interface Board (Standard)	Data Transmission Speed	10Mbps, 100Mbps, 1000Mbps
	Protocol	TCP/IP, IPX/SPX
	Supported OS	Windows Vista/7/8.1/10, Windows Server 2008/2008 R2/2012/2012 R2 Mac OS X 10.9 or later
	Distance between devices	100m
USB2.0 Interface (Standard)	Data Transmission Speed	480Mbps (High Speed:USB2.0), 12Mbps (Full Speed)
	Supported OS	Windows Vista/7/8.1/10, Windows Server 2008/2008 R2/2012/2012 R2 Mac OS X 10.9 or later

Note

- SPX protocol requires Netware option.

2.Controller Specifications

MF Model (SP C260SFNw/SP C262SFNw)

Item		Description
Processor		Quatro5310-400MHz
Memory	Std.	256MB
Resolution		Speed Mode: 600x600 dpi 1bit (600x600 dpi) Standard Mode: 600x600 dpi 2 bit (1200 x 600 dpi equivalent) Fine Mode: 600x600 dpi 4 bit (2400 x 600dpi equivalent)
Interface	Std.	USB2.0,100Base-TX/10Base-T, IEEE802.11b/g/n
Language	Std.	PCL6/5c, PostScript3, PictBridge
Font		PCL/PS: 80 fonts
Operating Systems		Windows Vista/7/8.1/10, Windows Server 2008/2008 R2/2012/2012 R2 Mac OS X 10.9 or later
Network Protocols		TCP/IP, IPP, Bonjour

Print Resolution		
Engine		Speed Mode: 600x600 dpi 1bit (600x600 dpi)
PictBridge		Standard Mode: 600x600 dpi 2 bit (1200 x 600 dpi equivalent)
Controller	PCL5c	Fine Mode: 600x600 dpi 4 bit (2400 x 600dpi equivalent)
	PCL6	
	PostScript3/PDF	
Drivers	PCL5c	
	PCL6	
	PostScript3	
Language		
Operation Panel (LCD)		1. English, 2. German, 3. French, 4. Italian, 5. Spanish, 6. Dutch, 7. Swedish, 8. Norwegian, 9. Danish, 10. Finnish, 11. Portuguese, 12. Czech, 13. Hungarian, 14. Polish, 15. Russian, 16. Turkish, 17. Brazilian Portuguese
Drivers	PCL5c	1. English, 2. German, 3. French, 4. Italian, 5. Spanish, 6. Dutch, 7. Swedish, 8. Norwegian, 9. Danish, 10. Finnish, 11. Portuguese, 12. Czech, 13. Hungarian, 14. Polish, 15. Russian, 16. Turkish, 17. Brazilian Portuguese
	PCL6	8. Norwegian, 9. Danish, 10. Finnish, 11. Portuguese, 12. Czech, 13. Hungarian, 14. Polish, 15. Russian, 16. Turkish, 17. Brazilian Portuguese
	PostScript3	Hungarian, 14. Polish, 15. Russian, 16. Turkish, 17. Brazilian Portuguese
Test Page Print	Config. Map	1. English, 2. German, 3. French, 4. Italian, 5. Spanish, 6. Dutch, 7. Swedish, 8. Norwegian, 9. Danish, 10. Finnish, 11. Portuguese, 12. Czech, 13. Hungarian, 14. Polish, 15. Russian, 16. Turkish, 17. Brazilian Portuguese
	The others	1. English

Interface Specification		
Network Interface Board (Standard)	Data Transmission Speed	10Mbps, 100Mbps, 1000Mbps

2.Controller Specifications

	Protocol	TCP/IP, IPX/SPX
	Supported OS	Windows Vista/7/8.1/10, Windows Server 2008/2008 R2/2012/2012 R2 Mac OS X 10.9 or later
	Distance between devices	100m
USB2.0 Interface (Standard)	Data Transmission Speed	480Mbps (High Speed:USB2.0), 12Mbps (Full Speed)
	Supported OS	Windows Vista/7/8.1/10, Windows Server 2008/2008 R2/2012/2012 R2 Mac OS X 10.9 or later

Note

- SPX protocol requires Netware option.

3. Supported Paper Sizes/Types

After loading paper in the tray, specify the paper type and size using the control panel. This machine does not detect the paper size automatically. Need to select paper size with operation panel/driver.

Paper Size

A	Supported and the size is molded in the tray.
B	Supported but size is not molded in the tray.
Y	Automatic duplex is possible
N	Not supported.

Paper Size	mm	inch	Standard Tray	Bypass Tray	Auto. Dup.	Option PFU
A4SEF	210 × 297	8.27 × 11.7	A	A	Y	A
B5SEF(JIS)	182 × 257	7.17 × 10.12	A	A	N	N
A5LEF	210 x 148	8.27 ×5.83	B	B	N	N
A5SEF	148 × 210	5.83 × 8.27	A	A	N	N
B6SEF(JIS)	128 × 257	5.04 × 7.17	B	B	N	N
A6SEF	105 × 148	4.13 × 5.83	B	B	N	N
Legal/Oficio(Brazil)	216 × 356	8.5 × 14	A	A	Y	N
Letter/Carta(Mexico)	216 × 279	8.5 × 11	A	A	Y	A
Foolscap/US Folio/Oficio	216 × 330	8.5 × 13	B	A	Y	N
Oficio(Mexico)/Government-Legal	216 × 340	8.5 × 13.4	B (only for NA)	B (only for NA)	B (only for NA)	N
Oficio	216 × 318	8.5 × 12.5	B	N	N	N
Envelope #10(com10)	105 x 241	4.1 x 9.5	B	N	N	N
Envelope Monarch	98 x	3.9 x 7.5	B	N	N	N

3.Supported Paper Sizes/Types

Paper Size	mm	inch	Standard Tray	Bypass Tray	Auto. Dup.	Option PFU
	191					
Envelope B5	176 x 250	6.9 x 9.8	N	N	N	N
Envelope C5	162 x 229	6.4 x 9	B	B	N	N
Envelope DL	110 x 220	4.3 x 8.7	B	B	N	N
Envelope C6	114 x 162	4.49 x 6.38	B	B	N	N
16K	195 x 267	7.7 x 10.5	B	B	Y	N
Indian Legal/FS	215 × 345	8.5 × 13.6	N	N	N	N
HLT/STMT	140 × 216	5.5 × 8.5	B	B	N	N
GLT	203 × 267	8.0 × 10.5	N	N	N	N
F/GL	203 × 330	8.0 × 13	B	B	Y	N
GovernmentLG	-	8.25 × 14	N	N	N	N
Australian-FOOLSCAP	206 × 338	8.0 × 13.3	N	N	N	N
4 x 6"	102 × 152	4 x 6	N	N	N	N
5 x 8"	127 × 203	5 x 8	N	N	N	N
Executive	-	7.25 x 10.5	A	A	Y	N
Folio/8.25 x 13"	-	8.25 x 13	B	B	Y	N
Eng Quatro	-	8 x 10	N	N	N	N

Paper Type

Y	Supported
N	Not supported

3.Supported Paper Sizes/Types

Type	Thickness	Standard Tray	Bypass Tray	Auto. Dup.
Plain/Middle Thick/Recycled	66-90g/m ²	Y	Y	Y
Plain	66-74g/m ²	Y	Y	Y
Thin	60-65g/m ²	Y	Y	Y
Middle Thick	75-90g/m ³	Y	Y	Y
Thick 1	91-105g/m ³	Y	Y	N
Thick 2	106-160g/m ⁴	Y	Y	N
Recycled		Y	Y	Y
Colored		Y	Y	N
Pre-printed		Y	N	Y
Pre-punched		Y	Y	Y
Letter-head		Y	Y	Y
Bond		Y	Y	N
Cardstock		Y	Y	N
Label		Y	Y	N
Transparency		N	N	N
Envelope		Y	Y	N
Postcard		Y	Y	N
Special media		N	N	N
Cotton		N	N	N

4. Preventive Maintenance

User Replaceable Items

Item	Yield	Note
Waste Toner Bottle	Approx. 25 k prints/ bottle (See condition 4)	Image Coverage Ratio: 5%, BK:CMY=5:5
AIO BK (1.8k)	Approx. 2.0 k prints/cartridge	For SP C260DNw/SP C260SFNw *Except for NA
AIO CMY (1.4k)	Approx. 1.6 k prints/cartridge	
AIO BK (2.0k)	Approx. 2.3 k prints/cartridge	For SP C260DNw/SP C260SFNw (NA only)
AIO CMY (2.0k)	Approx. 2.3 k prints/cartridge	
AIO BK (3.6k)	Approx. 4.5 k prints/cartridge	For SP C262DNw/C262SFNw
AIO CMY (3.4k)	Approx. 4.0 k prints/cartridge	
AIO BK (5k)	Approx. 6.5 k prints/cartridge	For SP C262DNw/C262SFNw
AIO CMY (5k)	Approx. 6.0 k prints/cartridge	

Condition:

1. The condition is standard temperature and humidity.
2. These yield values may change depending on the circumstances and printing conditions.
3. The Waste Toner Bottle's yield is measured when the printer is used 50% for color and 50% for black-and-white
4. Waste Toner Bottle yield was measured for 3P/J when the printer is used 50% for color and 50% for black-and-white.

Yield items and Service Maintenance

The machine default setting will show the messages “Replace Soon” at the near end condition and “Replace Now” at the end condition for yield parts. However, you can select the preferred machine action at near end and end for yield parts using SP mode “PM Parts Rep Notice” as shown in the following table.

There are 4 settings (0 to 3):

PM Parts Rep Notice	Sets whether to display the PM parts replacement notice and whether to stop the engine.	
	0	At near end: No Notice / Not Stopped
		At life end: Notice “Replace Now” / Not Stopped
	1	At near end: No Notice / Not Stopped
		At life end: No Notice / Not Stopped
	2 (default)	At near end: Notice / Not Stopped
		At life end: Notice “Replace Now” / Not Stopped
	3	At near end: Notice “Replace Soon” / Not Stopped
At life end: Notice “Replace Now” / Stopped		

Item	Yield
Image Transfer Unit	90 K
Fusing Unit	90 K
Transfer Roller	90 K
DF Separation Pad (for MF Models)	35 K

5. Exchange and Replace Procedure

If the machine exchange and replacement is required, arrange to send a machine without the four print cartridges (AIO) to the customer site.

Instruction

Instruct the customer to do the following procedure.

Before the substitute machine gets to the customer site

- Save the customer settings by using a web browser. For details, refer to the “User Guide”.
- Clear customer settings in the problem machine.

When the substitute machine gets to the customer site

1. Remove the four print cartridges (AIO) from the problem machine.
2. Install the four print cartridges (AIO) into the substitute machine.
3. Restore the customer settings which are printed on the configuration page by using a web browser.
4. Send back the problem machine to the repair center.

5.Exchange and Replace Procedure

Cleaning Points after Machine Arrival at Depot

1. Open the front cover.
2. Release the locks [A].
3. Transfer unit [B]

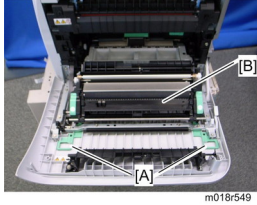

4. Pull out the waste toner bottle [A].

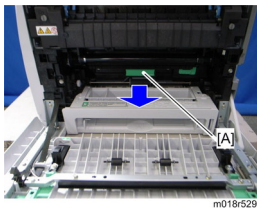

5. Release the hook [A] under the guide plate.
6. Move the guide plate [B] underneath the fusing unit to the left, and then remove it.

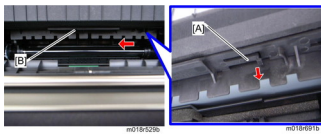

7. Pull out the image transfer belt unit [A] (⊙ x 2).

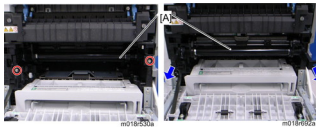

8. Clean inside the printer, especially around the circled area [A].

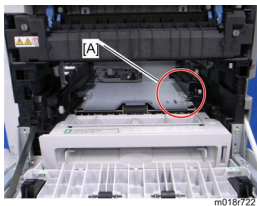

9. Clean the circled area at the waste toner bottle [A] and the circled area [B] on the image transfer belt unit.

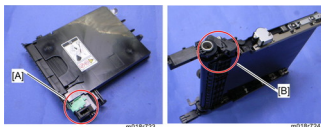

10. Reassemble the printer.

6. FAQs/Knowledge Base

You can access the FAQs and knowledge base for this model through Web Image Monitor.

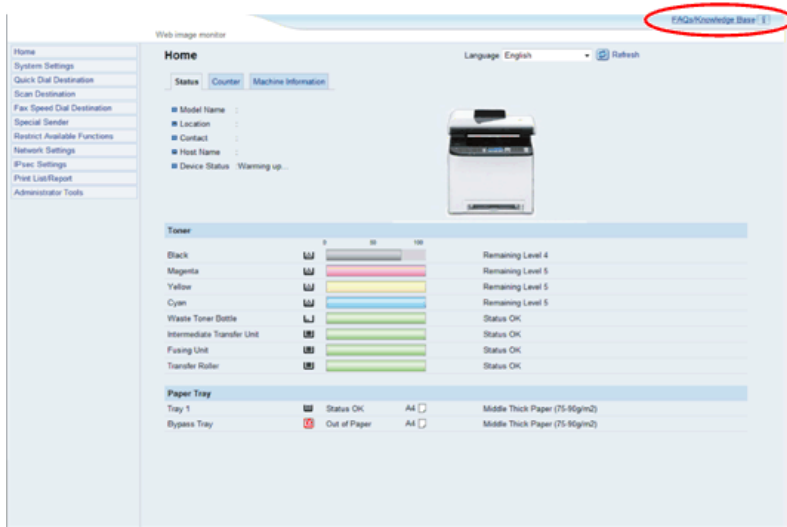

m204f0001

1. http://machine's_IP_address
2. Click 'FAQs/Knowledge Base' at the top right of the screen.