

SP 320SFN
(M0A9)
Parts Catalog

Model	Product Code	PC Style
SP 320DN	M0A7	3D
SP 325DNw	M287	3D
SP 377DNwX	M0BB	3D
SP 320SN	M0A8	3D
SP 325SNw	M288	3D
SP 377SNwX	M0BC	3D
SP 320SFN	M0A9	3D
SP 325SFNw	M289	3D
SP 377SFNwX	M0BD	3D
ARDF	M2891601	Traditional

Unit All



U001
EXTERIOR



U002
ADF/SCANNER



U003
OPERATION



U004
LASER UNIT

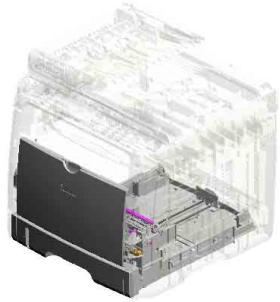

U005
PAPER FEED



U006
PCU

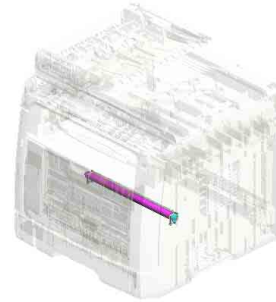

U007
TRANSFER/SEPARATION



U008
FUSING

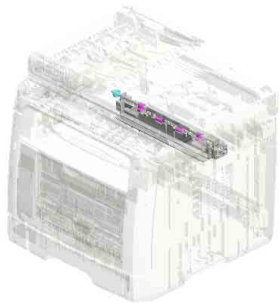

U009
PAPER EXIT

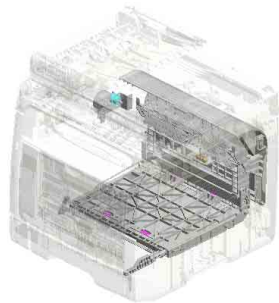

U010
DUPLEX

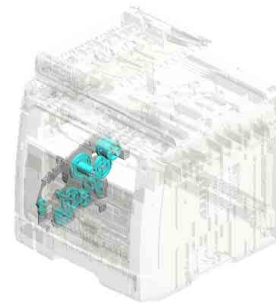

U011
MAIN DRIVE



U012
ELECTRICAL

Unit All

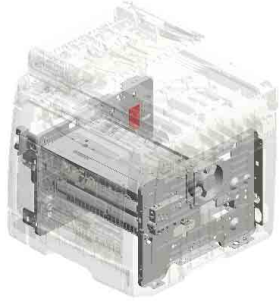

U013
MAIN FRAME

U001 EXTERIOR

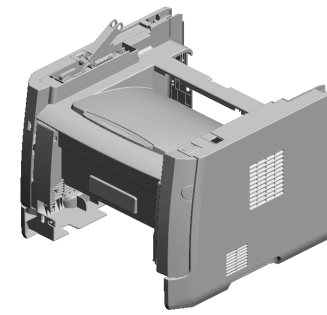

- 10.M1341382 RAIL:SCANNER:OPEN AND CLOSE
- 5.04523008N (x2) TAPPING SCREW - M3X8
- 11.M1341386 RAIL:STOPPER:SCANNER:OPEN AND CLOSE
- 19.M1561392 GUIDE PLATE:SCANNER:OPEN AND CLOSE
- 18.M1561272 COIL SPRING:SCANNER

1.04503008N (x2) TAPPING SCREW - M3X8

8.G0521518 SPRING - LOCK LEVER

9.M1180501 SPEAKER:M118

12.M1561240 EXTENSION TRAY:MF:ASSY

7.AG070514 MAGNET CATCH

4.04513008N (x4) TAPPING SCREW - M3X8

2.04503012N (x4) TAPPING SCREW: 3X12

15.M1561256 SHAFT:TURN:SCANNER:RIGHT

20.M2871370 COVER:REAR LOWER

17.M1561260 (CHN):COVER:REAR MIDDLE

14.M1561254 SHAFT:TURN:SCANNER:LEFT

13.M1561250 COVER:UPPER:MF

6.11050761 CLAMP:LWS-0511A

16.M1561259 (EU/AA):COVER:REAR MIDDLE

3.04513006N (x6) TAPPING SCREW - 3X6

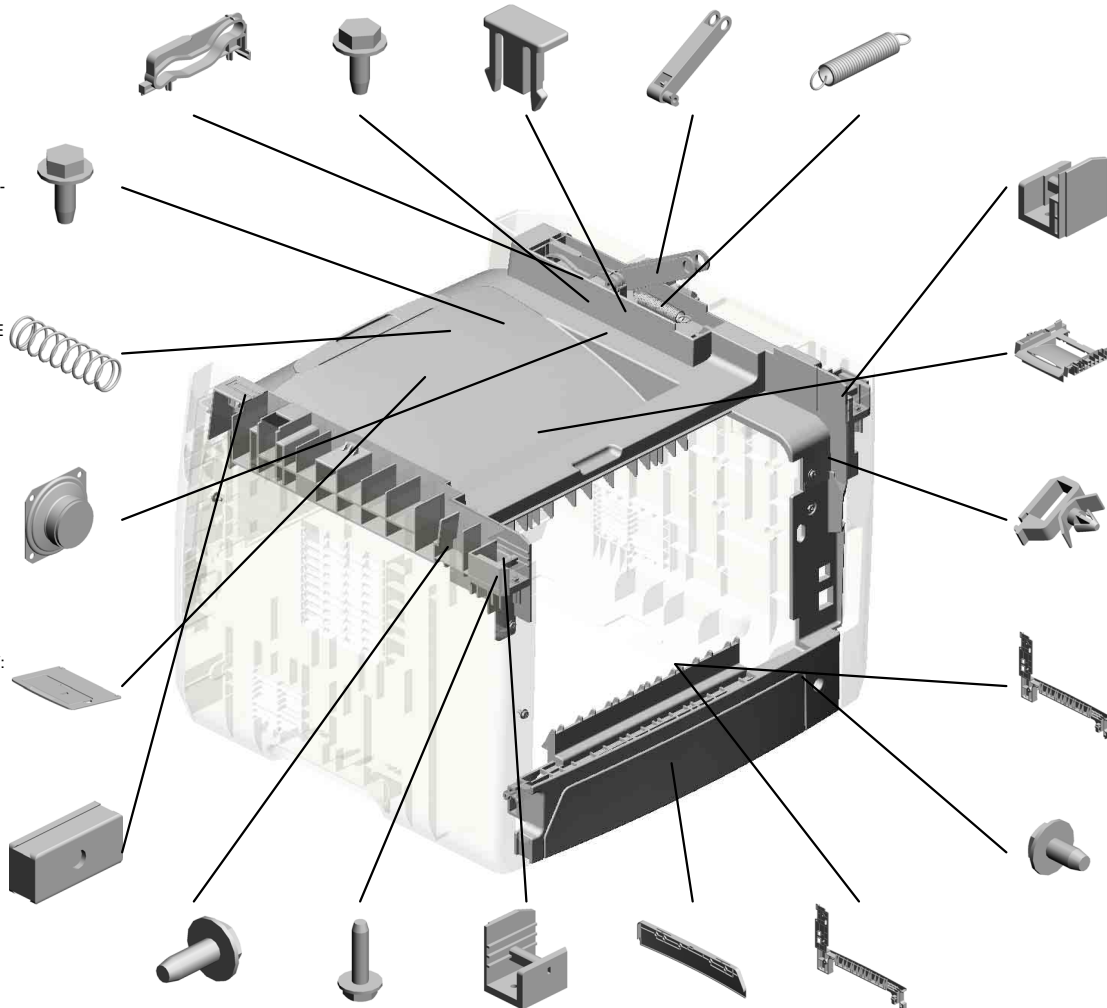

U001 EXTERIOR

23.M2891252
BUTTON

21.M2882632
DECAL:PICK-UP P
APER JAM

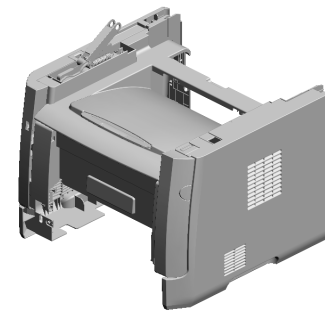

22.M2891251
COVER:FRONT

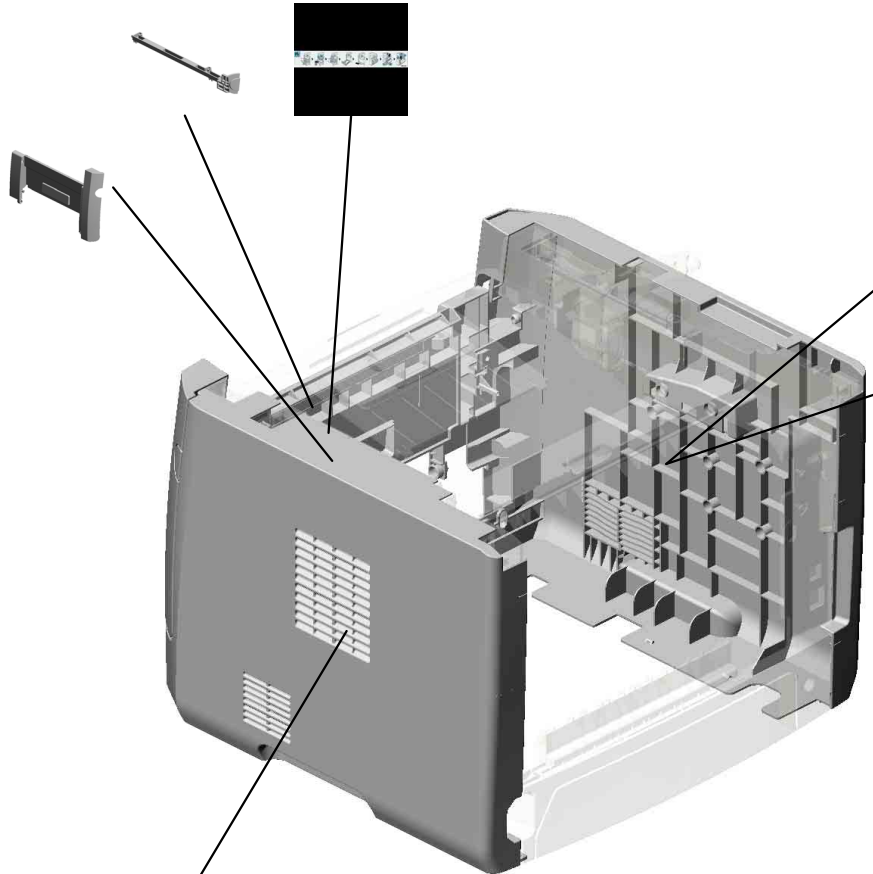

24.M2891253
(EU/AA):COVER:SI
DE PLATE:LEFT

26.M2891264
(CHN):COVER:SID
E PLATE:LEFT

25.M2891255
COVER:SIDE PLAT
E:RIGHT

U001	U002	U003	U004	U005	U006	U007	U008	U009	U010	U011	U012	U013
------	------	------	------	------	------	------	------	------	------	------	------	------

U002.ADF/SCANNER

U002_S001
M1561640
ADF:ASS'Y

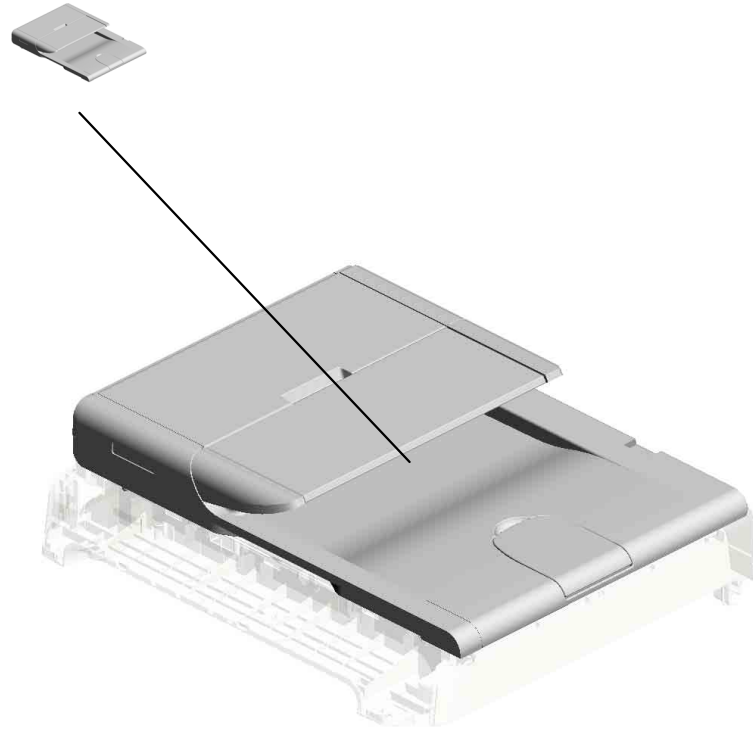

U001	U002	U003	U004	U005	U006	U007	U008	U009	U010	U011	U012	U013
------	-------------	------	------	------	------	------	------	------	------	------	------	------

U002
ADF/SCANNER

69.M2881600
SCANNER:ASSY

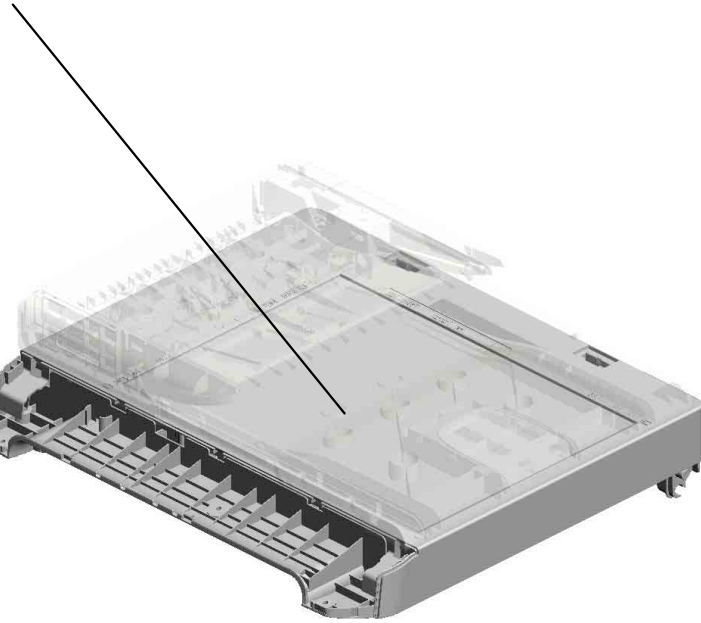
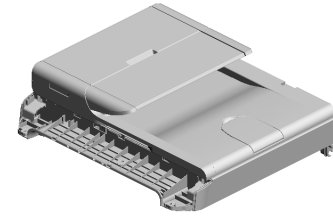

U001	U002	U003	U004	U005	U006	U007	U008	U009	U010	U011	U012	U013
------	-------------	------	------	------	------	------	------	------	------	------	------	------

U002_S001
ADF:ASS'Y

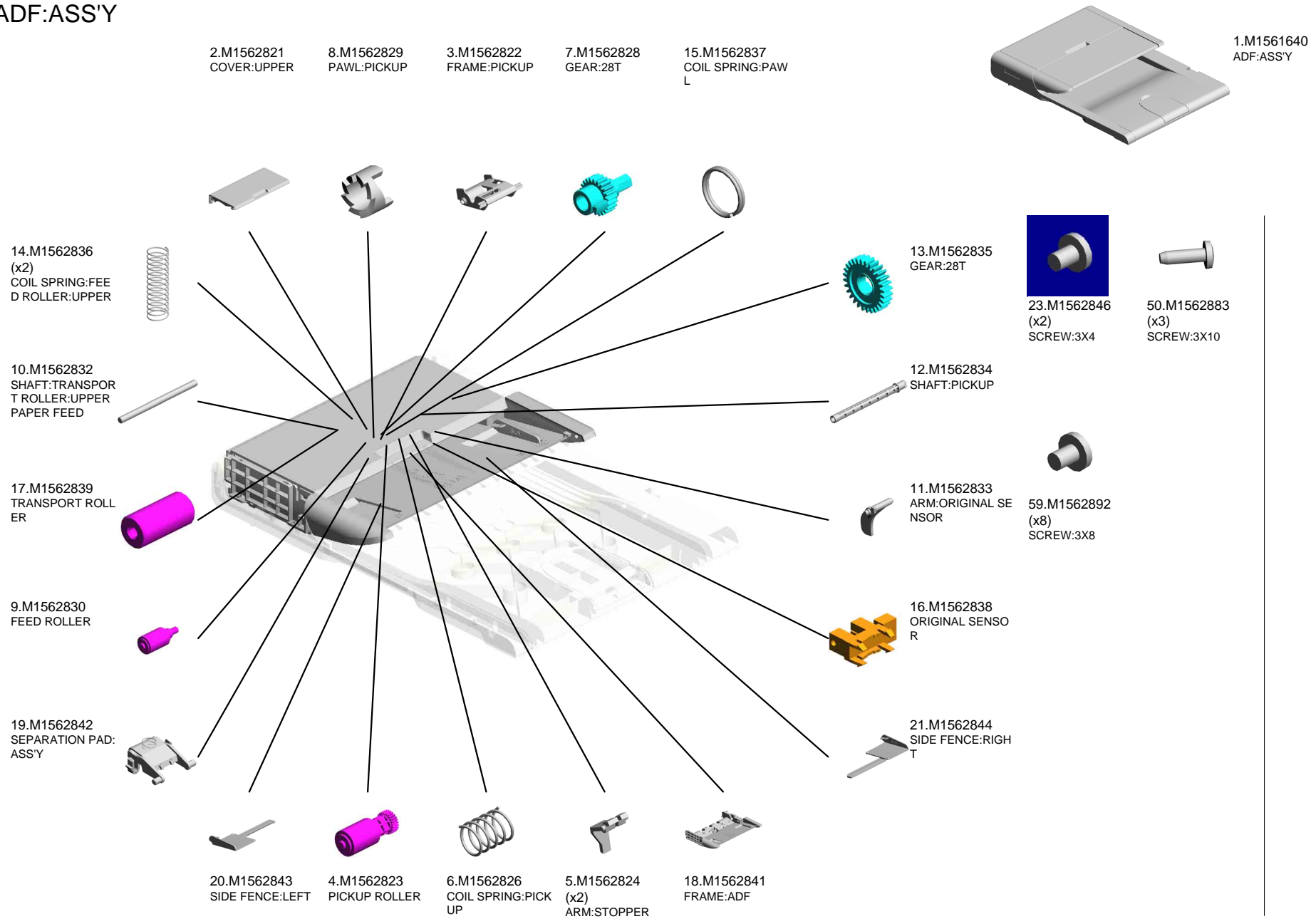

U002_S001
ADF:ASS'Y

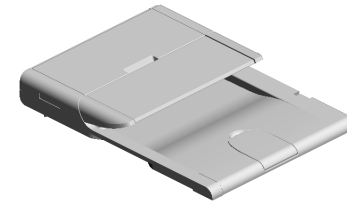

1.M1561640
ADF:ASS'Y

32.M1562855 REGISTRATION SENSOR
28.M1562851 GEAR:46T
37.M1562860 PLAIN SHAFT BEARING:RIGHT
30.M1562853 GEAR:53T
27.M1562850 GEAR:39T

38.M1562861 REGISTRATION ARM:ASSY

39.M1562862 ARM:REGISTRATION SENSOR

40.M1562863 FRAME:LOWER

35.M1562858 PLAIN SHAFT BEARING:RIGHT:EXIT ROLLER

34.M1562857 PLAIN SHAFT BEARING:LEFT:EXIT ROLLER

41.M1562864 DISCHARGE BRUSH

33.M1562856 EXIT ROLLER

31.M1562854 GEAR:18T

29.M1562852 GEAR:43T

36.M1562859 PLAIN SHAFT BEARING:LEFT:REGISTRATION ROLLER

42.M1562865 FRAME:MOTOR:ADF

26.M1562849 GEAR:37T

25.M1562848 GEAR:28T

22.M1562845 GROUND PLATE

24.M1562847 GEAR:21T

U002_S001
ADF:ASS'Y

58.M1562891 COVER:ADF:LOWE
R
45.M1562869 PLATE:ADF
63.M1562896 PAD:PICKUP
51.M1562884 HINGE:LEFT:ASSY
43.M1562866 MOTOR:ADF

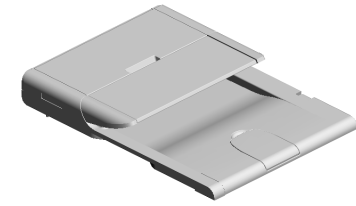

1.M1561640
ADF:ASS'Y

55.M1562888
SHAFT:PAPER FEE
D ROLLER:LOWER

57.M1562890
(x4)
COIL SPRING:REA
R

53.M1562886
(x2)
SHAFT:EXIT ROLL
ER

54.M1562887
(x2)
EXIT ROLLER:DRIV
EN

44.M1562868
(x2)
COIL SPRING:PLA
TE:ADF

56.M1562889
(x2)
PAPER FEED ROL
LER:LOWER

62.M1562895
COVER:FRONT

47.M1562872
COVER:ORIGINAL
TRAY:EXTENSION
TRAY:2

48.M1562881
COVER:MAIN

60.M1562893
SPONGE:ADF

59.M1562892
(x5)
SCREW:3X8

61.M1562894
COVER:REAR

46.M1562871
COVER:ORIGINAL
TRAY:EXTENSION
TRAY:1

52.M1562885
HINGE:RIGHT

49.M1562882
COVER:MAIN:EXT
ENSION TRAY

U002_S001
ADF:ASS'Y

67.M2021780
GEAR:22T

68.M2021781
PAWL:MECHANICA
L SPRING CLUTCH
:M202

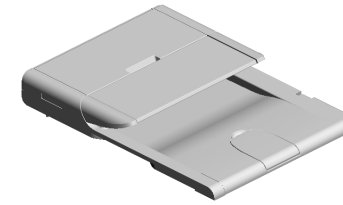

1.M1561640
ADF:ASS'Y

66.M2021779
DISCHARGE BRUS
H:MECHANICAL SP
RING CLUTCH

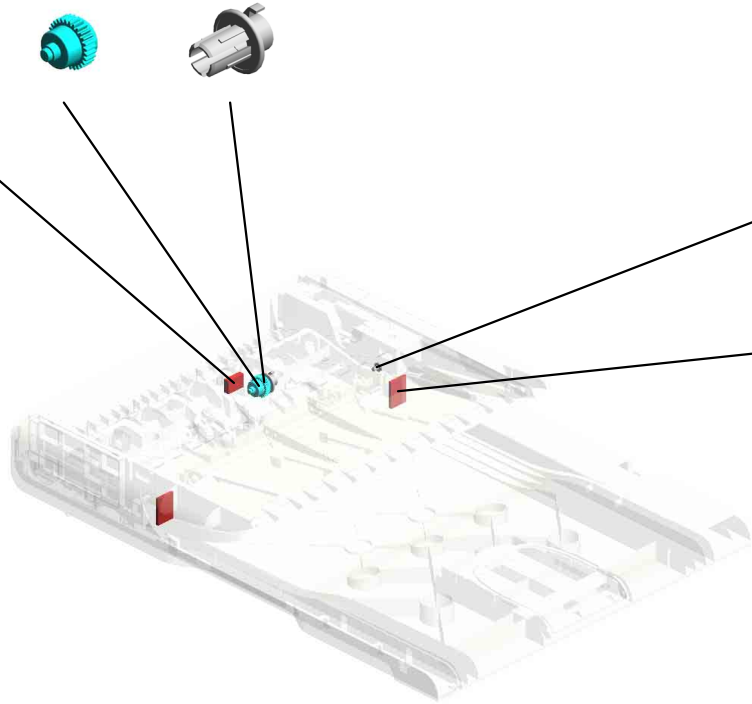
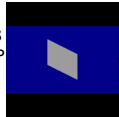

64.M1562898
SCREW:3X6

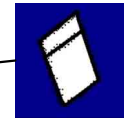

65.M1562899
(x2)
SHEET:OUTLET

U003 OPERATION

2.M0A91402
(EU/AA):OPERATIO
N PANEL:ASS'Y

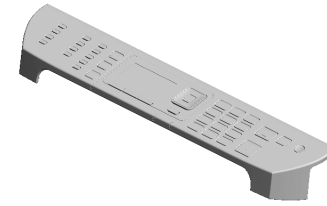

1.04503010N (x 3)
TAPPING SCREW - M3X10

3.M0A91404
(CHN):OPERATION
PANEL:ASS'Y

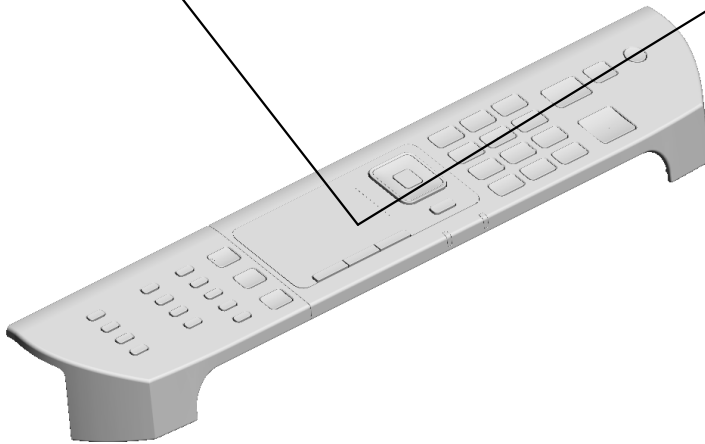

U001	U002	U003	U004	U005	U006	U007	U008	U009	U010	U011	U012	U013
------	------	------	------	------	------	------	------	------	------	------	------	------

U004.LASER UNIT

U004_S001
M0A71851
OPTICAL WRITING UNIT:ASS
Y

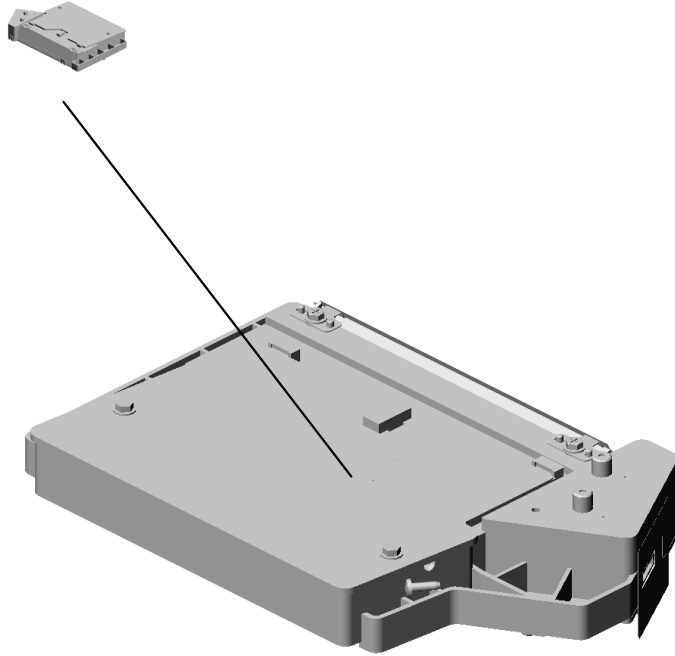

U001	U002	U003	U004	U005	U006	U007	U008	U009	U010	U011	U012	U013
------	------	------	------	------	------	------	------	------	------	------	------	------

U004
LASER UNIT

7.04543008Q
(x3)
TAPPING SCREW:
3X8

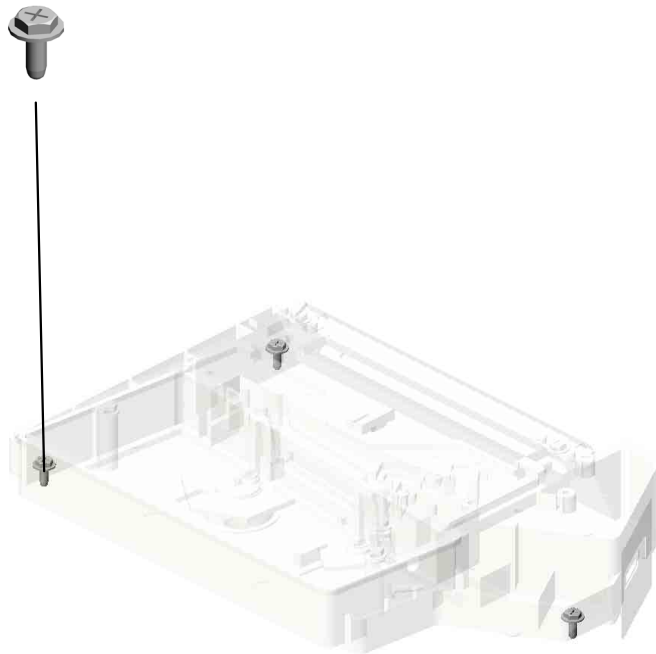
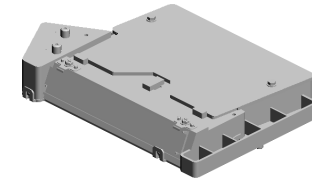

U001	U002	U003	U004	U005	U006	U007	U008	U009	U010	U011	U012	U013
------	------	------	-------------	------	------	------	------	------	------	------	------	------

U004_S001
OPTICAL WRITING UNIT:ASS'Y

3.04513006N
TAPPING SCREW -
3X6

1.04503008N
(x6)
TAPPING SCREW -
M3X8

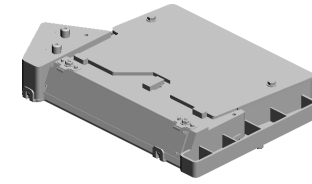

8.M0A71851
OPTICAL WRITING
UNIT:ASS'Y

5.04523010N
BINDING SELF-TA
PPING SCREW:3X
10

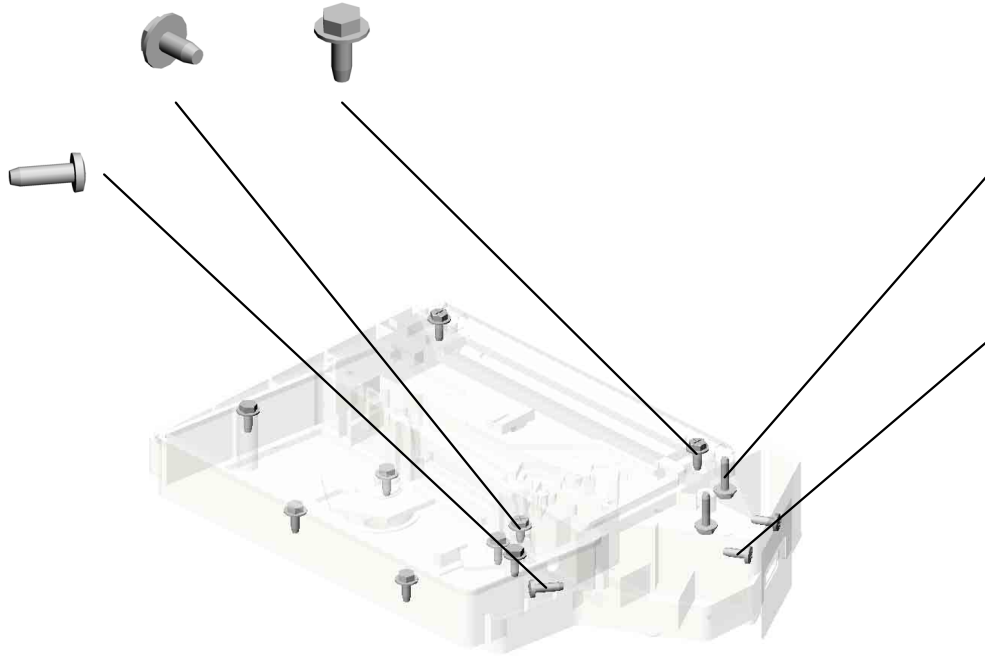

2.04503012N
(x2)
TAPPING SCREW:
3X12

6.04543006Q (x 2)
TAPPING SCREW - M3X6

4.04523008N
(x4)
TAPPING SCREW -
M3X8

U001	U002	U003	U004	U005	U006	U007	U008	U009	U010	U011	U012	U013
------	------	------	------	------	------	------	------	------	------	------	------	------

U005.PAPER FEED

U005_S001
M1542505
PAPER TRAY:ASSY

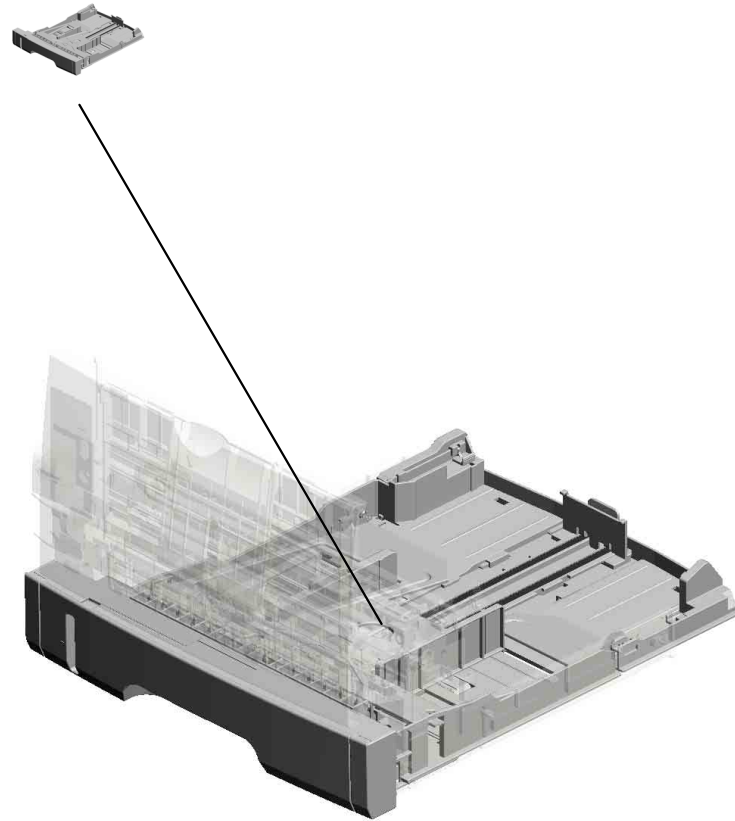

U001	U002	U003	U004	U005	U006	U007	U008	U009	U010	U011	U012	U013
------	------	------	------	-------------	------	------	------	------	------	------	------	------

U005_S001.PAPER TRAY:ASS'Y

U005_S001_S001
M0122610
TRAY BOTTOM PLATE

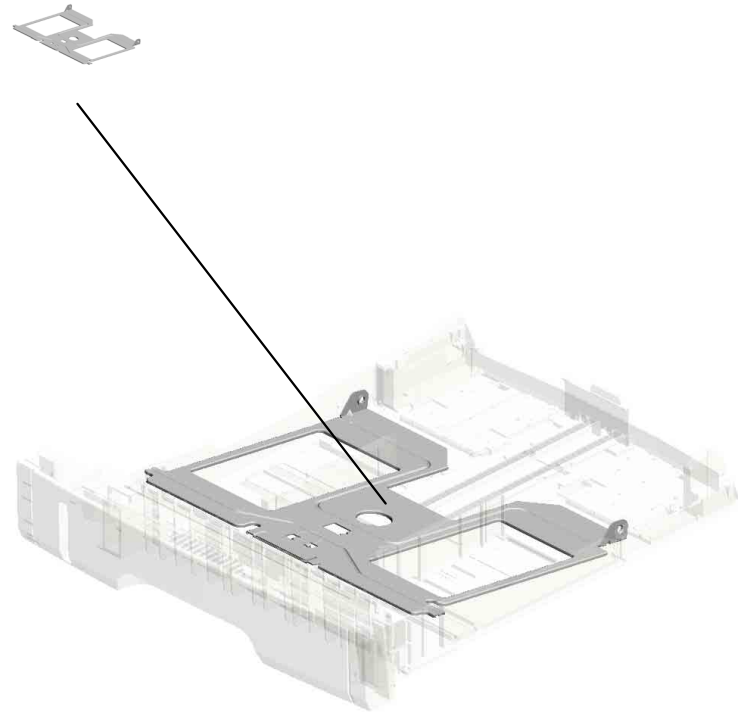

U001	U002	U003	U004	U005	U006	U007	U008	U009	U010	U011	U012	U013
------	------	------	------	------	------	------	------	------	------	------	------	------

U005 PAPER FEED

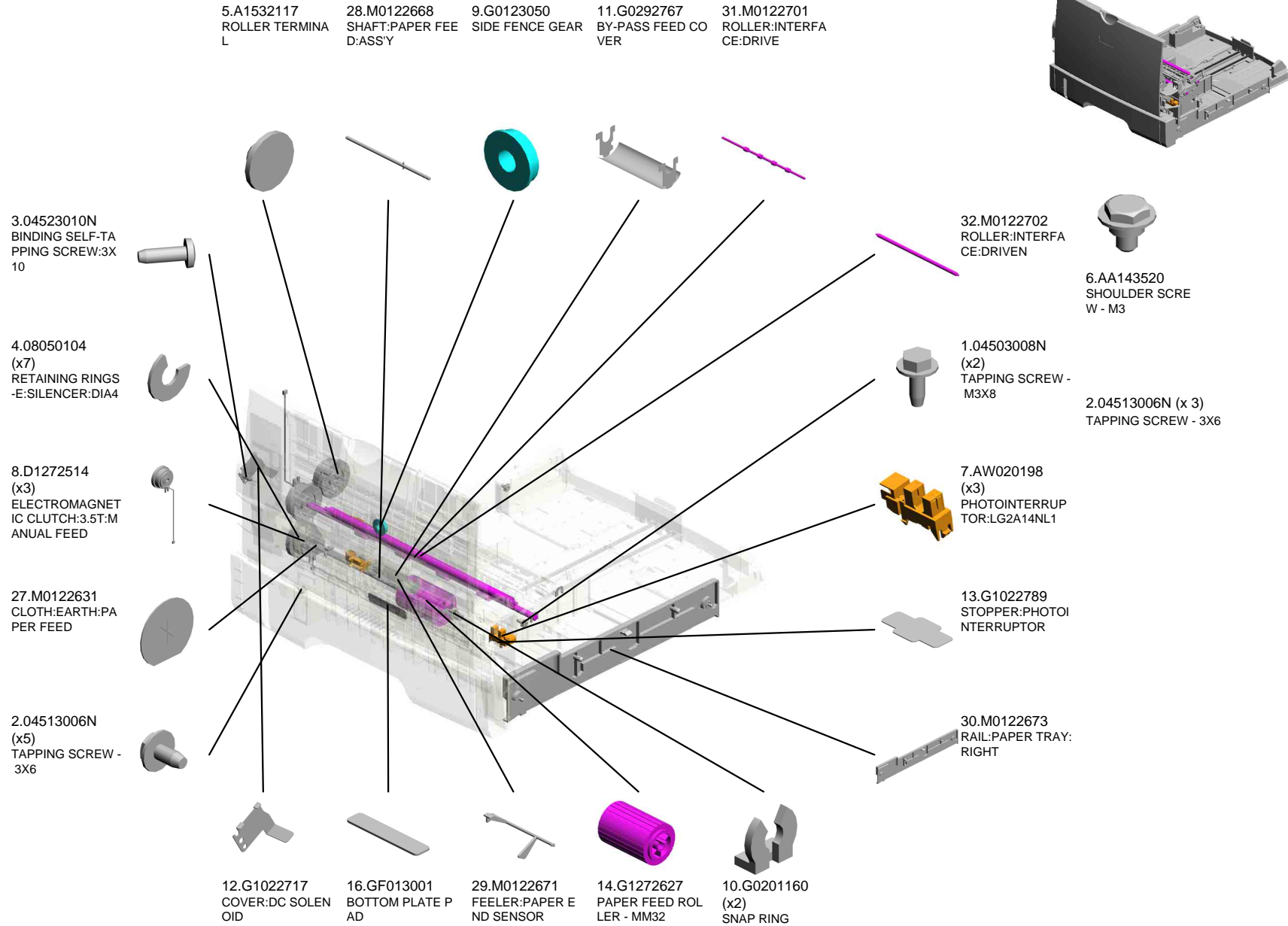

U001	U002	U003	U004	U005	U006	U007	U008	U009	U010	U011	U012	U013
------	------	------	------	------	------	------	------	------	------	------	------	------

U005 PAPER FEED

34.M0122711
BUSHING:REGISTRATION:DRIVEN:LEFT

45.M0122744
(x2)
GUIDE:REGISTRATION

52.M0122833
DECAL:SIDE FENCE:MANUAL FEED

35.M0122715
GUIDE PLATE:TRANSPORT:UPPER

36.M0122718
REGISTRATION ROLLER:DRIVE

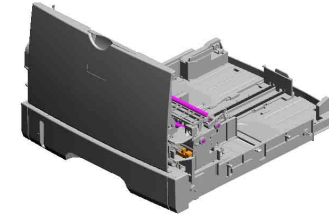

43.M0122742
GROUND PLATE:DRIVEN:REGISTRATION ROLLER

42.M0122741
GROUND PLATE:DRIVE:REGISTRATION ROLLER

51.M0122830
MECHANICAL SPRING CLUTCH:MANUAL FEED

47.M0122753
(x2)
BUSHING:ROLLER:DRIVEN

40.M0122725
SPRING:FEELER:REGISTRATION

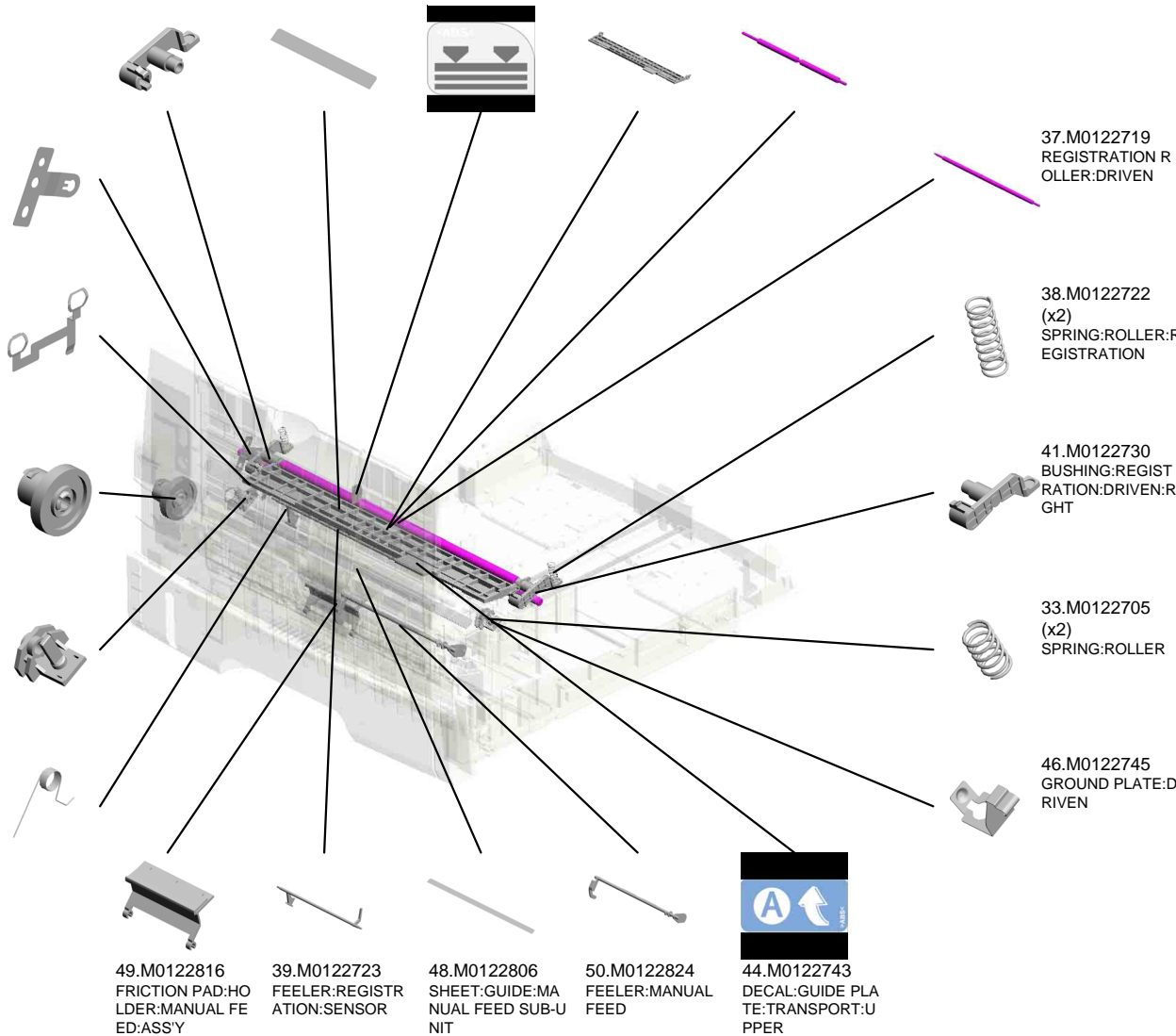

U005 PAPER FEED

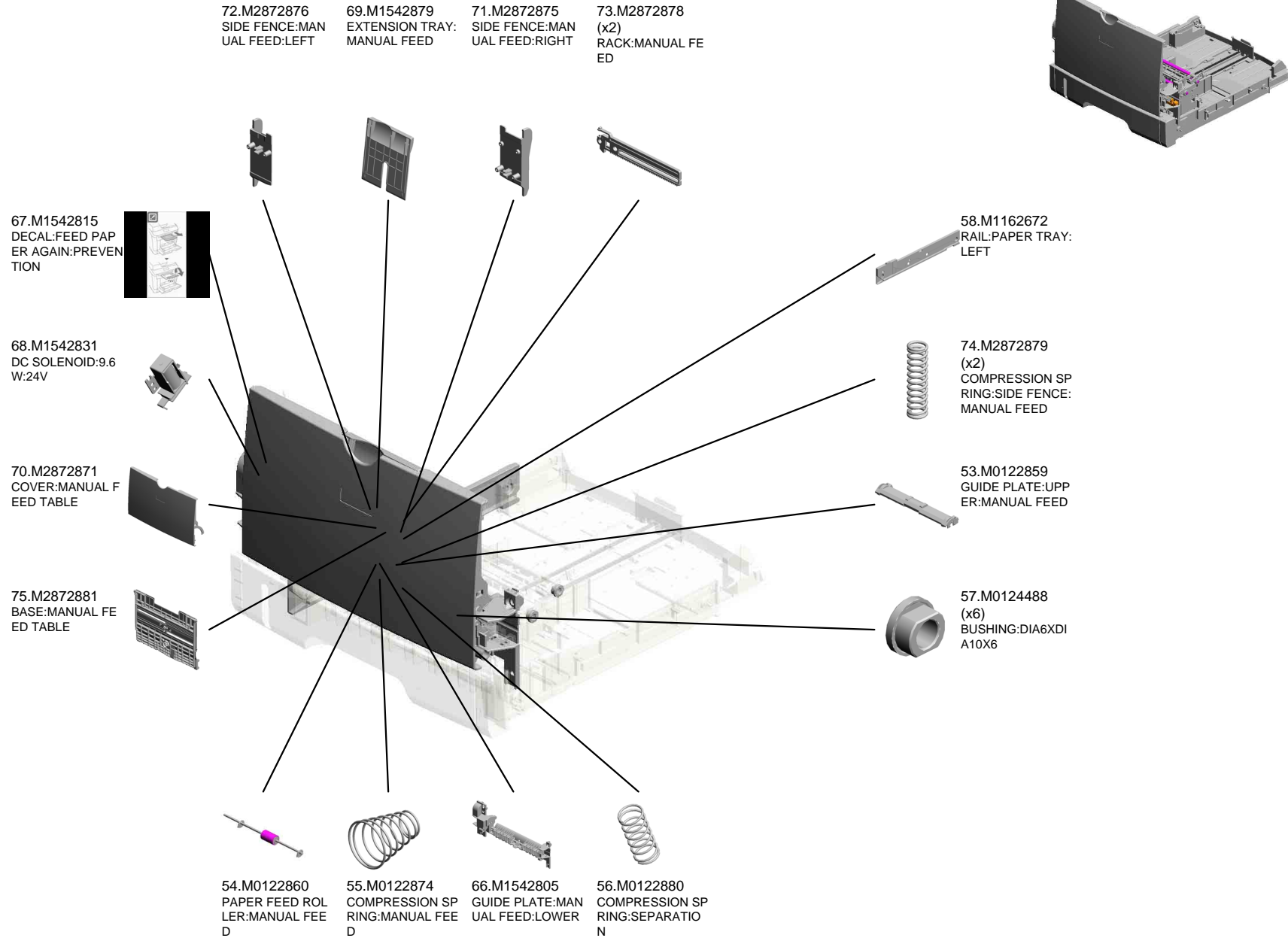

U001	U002	U003	U004	U005	U006	U007	U008	U009	U010	U011	U012	U013
------	------	------	------	------	------	------	------	------	------	------	------	------

U005_S001
PAPER TRAY:ASS'Y

25.M0122613 COMPRESSION SPRING:SEPARATION
 21.M0122605 FRICTION PAD:ADHESION
 20.M0122604 SPRING:RELEASE:TRAY BOTTOM PLATE
 18.M0122590 COIL SPRING:EAR TH

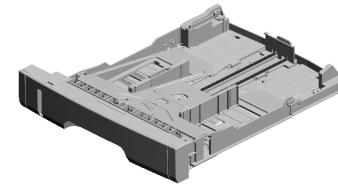

59.M1542505 PAPER TRAY:ASS'Y

64.M1542640 COVER:PAPER TRAY:LEFT



62.M1542618 DECAL:PAPER TRAY:FRONT

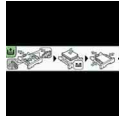

61.M1542616 LEVER:PAPER VOLUME SENSOR



63.M1542629 COVER:PAPER TRAY:MIDDLE

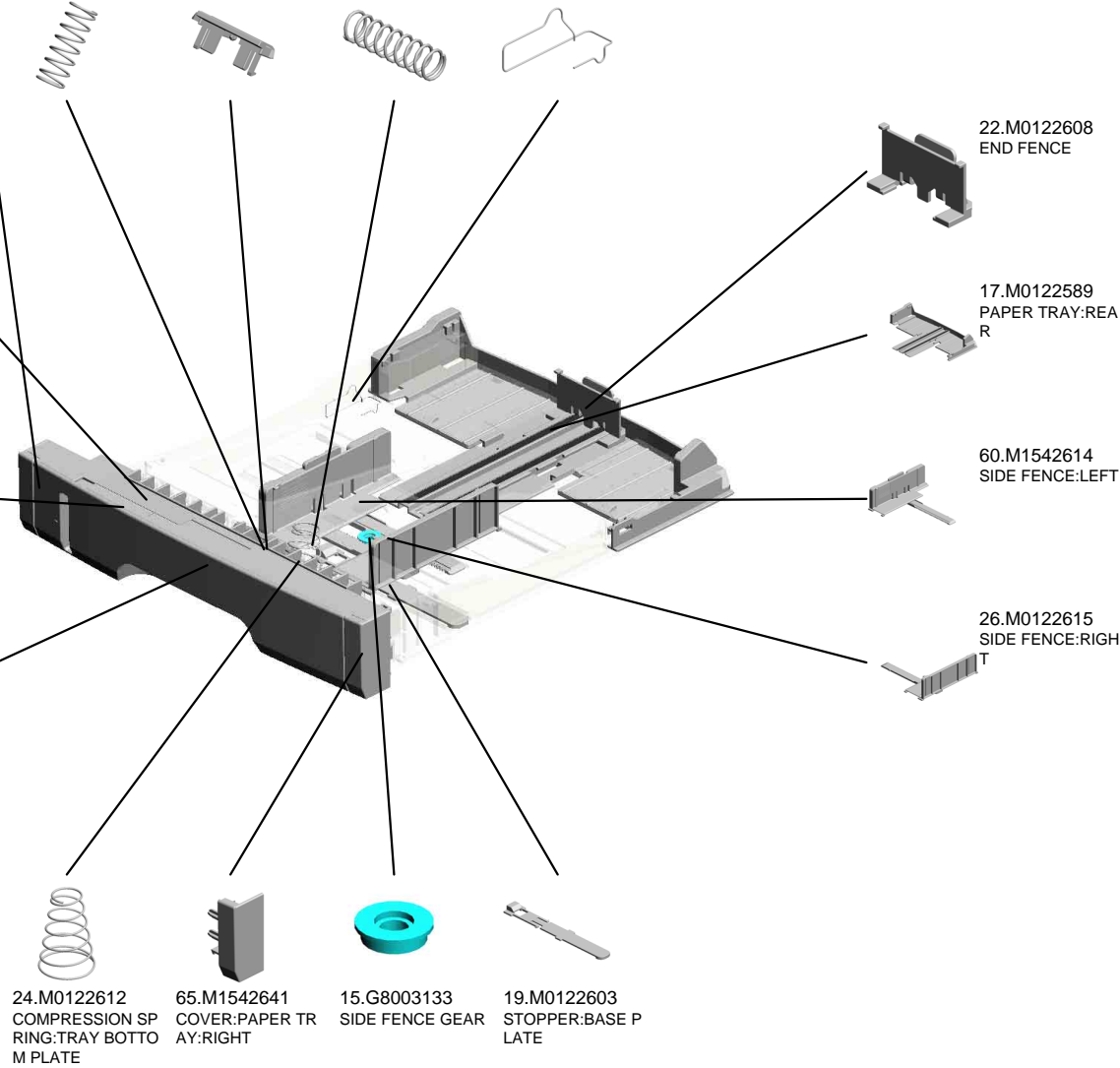

U005_S001_S001
TRAY BOTTOM PLATE

16.GF013001
BOTTOM PLATE P
AD



23.M0122610
TRAY BOTTOM PL
ATE

U001	U002	U003	U004	U005	U006	U007	U008	U009	U010	U011	U012	U013
------	------	------	------	------	------	------	------	------	------	------	------	------

U006
PCU

1.04503008N
(x2)
TAPPING SCREW -
M3X8

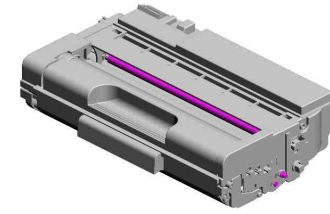
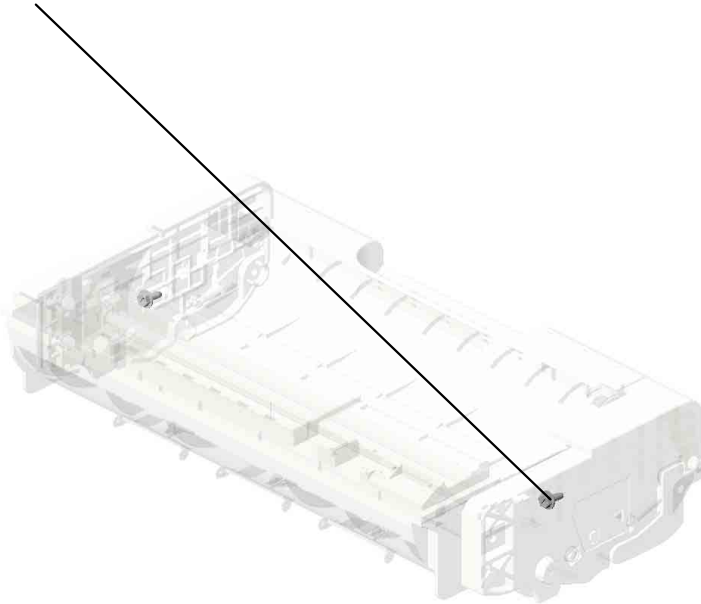

1.04503008N (x 4)
TAPPING SCREW - M3X8
2.04523010N (x 2)
BINDING SELF-TAPPING SCREW:3X10

U001	U002	U003	U004	U005	U006	U007	U008	U009	U010	U011	U012	U013
------	------	------	------	------	------	------	------	------	------	------	------	------

U007 TRANSFER/SEPARATION

7.M01016259 ELECTRODE PLAT
E:SEPARATION
5.M0126260 COVER:ELECTRO
DE PLATE
6.M01016250 TRANSFER ROLLE
R

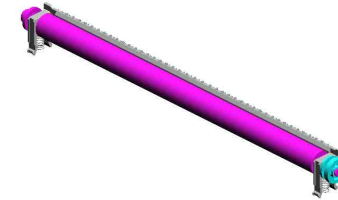

4.M0126256
ROLLER:POSITION
ING:TRANSFER R
OLLER

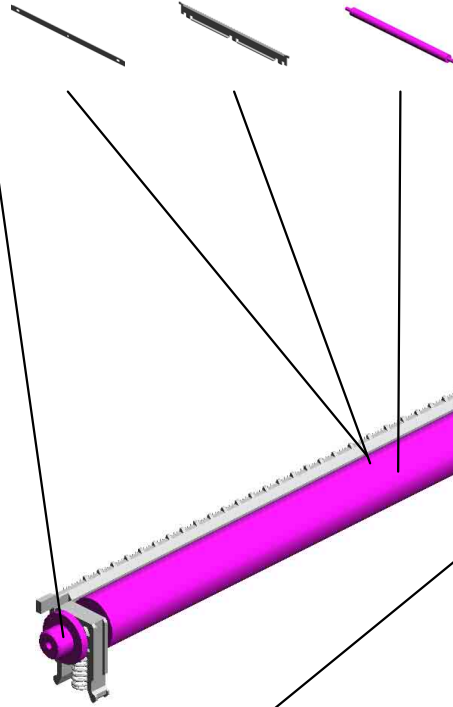

3.M0126255
GEAR:TRANSFER
ROLLER



1.M0126252
(x2)
BUSHING:TRANSF
ER ROLLER:RIGHT



2.M0126254
(x2)
SPRING:TRANSFE
R ROLLER



U001	U002	U003	U004	U005	U006	U007	U008	U009	U010	U011	U012	U013
------	------	------	------	------	------	------	------	------	------	------	------	------

U008.FUSING

U008_S001
M2874031
(EU/AA):FUSING UNIT:ASSY

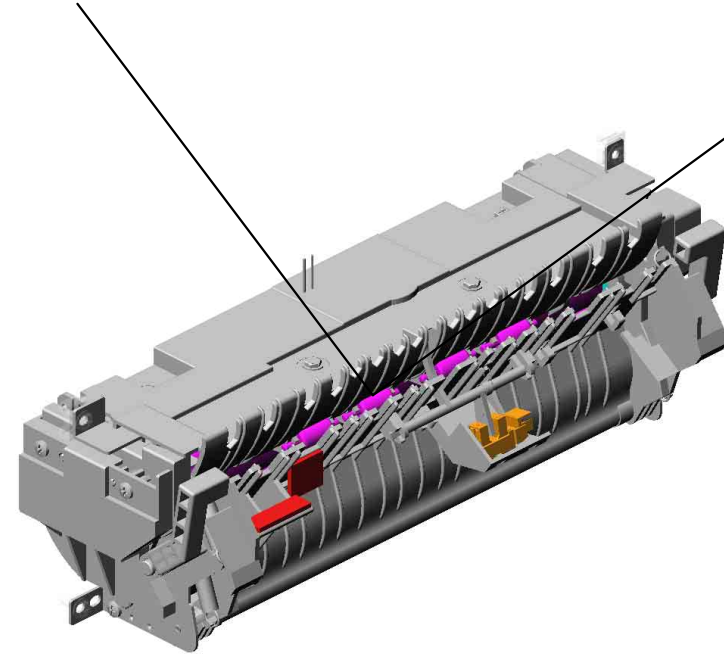
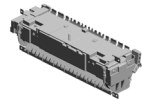

U008_S002
M2874033
(CHN):FUSING UNIT:ASSY

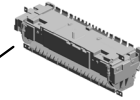

U001	U002	U003	U004	U005	U006	U007	U008	U009	U010	U011	U012	U013
------	------	------	------	------	------	------	------	------	------	------	------	------

U008 FUSING

35.M0124270 (x2)
THERMAL INSULATING BUSHING:FUSING UNIT

4.04513008N (x2)
TAPPING SCREW - M3X8

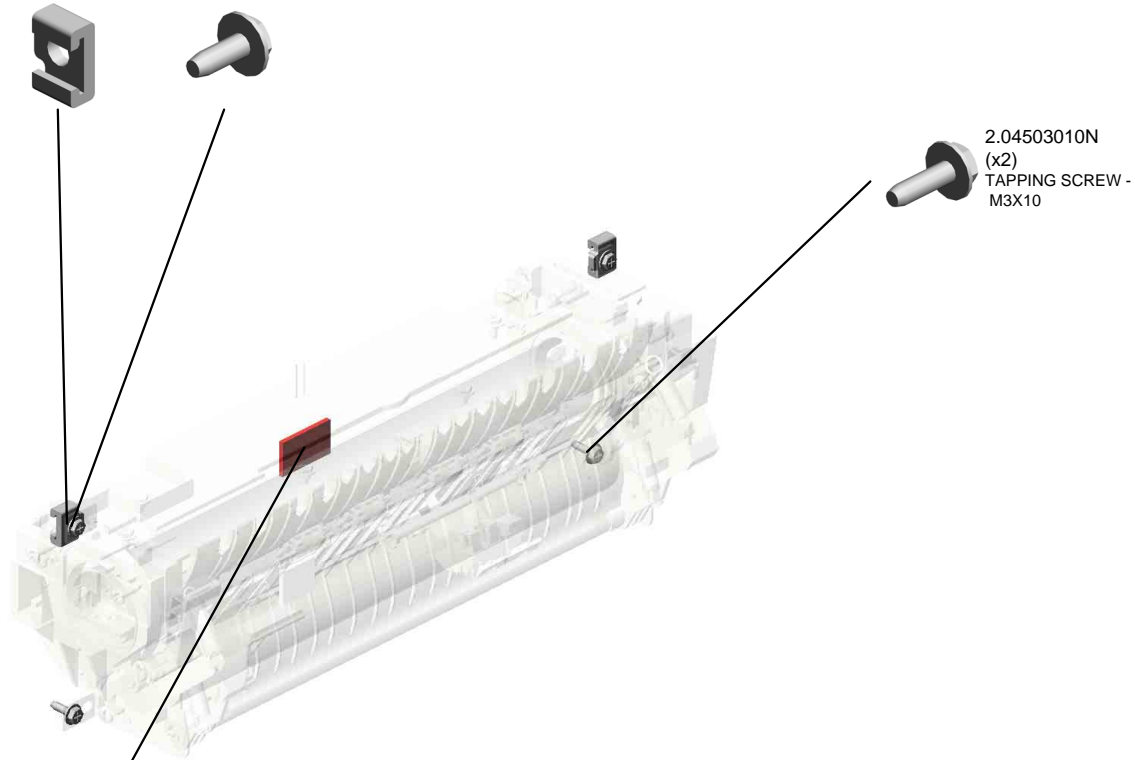
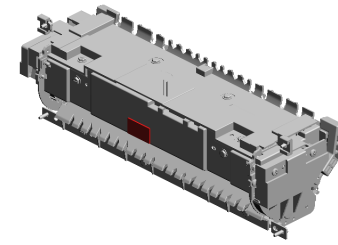

46.M0124699
DECAL:WARNING (HIGH TEMPERATURE):FRONT

U008_S001
(EU/AA):FUSING UNIT:ASS'Y

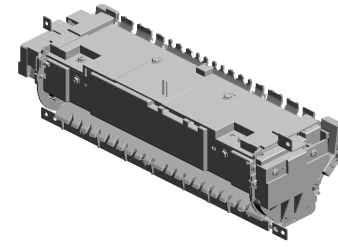

47.M2874031
(EU/AA):FUSING UNIT:ASSY

12.AW110116
THERMOSTAT

21.M0124204
LEVER:LEFT:FRAM
E:FUSING

17.M0124120
(x3)
TENSION SPRING:
PICKOFF PAWL

7.08025318
(x4)
BINDING HEAD TA
PPING SCREW:ES:
3X10

19.M0124186
COVER:LEFT UPP
ER:ASSY

8.08046127
(x4)
HEXAGONAL BOLT
:DOUBLE SCREW:
M3X8

9.09543010N
SCREW:POLISHED
ROUND/SPRING:M
3X10

10.AA143520
(x7)
SHOULDER SCRE
W - M3

1.03603006N
(x11)
SCREW - M3X6

13.G1274328
DECAL - HIGH TEM
PERATURE



18.M0124135
FEELER:PAPER FE
ED SENSOR

16.M0124109
SPRING:FEELER:E
XIT

11.AW020198
PHOTOINTERRUP
TOR:LG2A14NL1

4.04513008N
(x4)
TAPPING SCREW -
M3X8

20.M0124202
(x2)
LEVER:PRESSURE

3.04513006N
(x2)
TAPPING SCREW -
3X6

14.M0124053
GEAR:HOT ROLLE
R

15.M0124055
(x2)
RADIAL BALL BEA
RING:35X47X7

5.04533006N
(x6)
TAPPING SCREW -
M3X6

6.07200040E
(x2)
RETAINING RING -
M4

U008_S001
(EU/AA):FUSING UNIT:ASS'Y

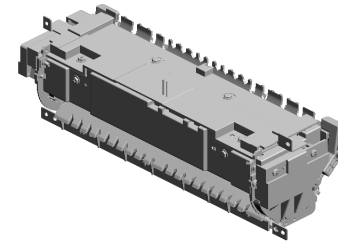

47.M2874031
(EU/AA):FUSING UNIT:ASSY

41.M0124287
COVER:RIGHT UP
PER:FUSING

38.M0124281
(x2)
RETAINING RINGS
-C:HOT ROLLER

39.M0124284
LEVER:PRESSURE
:LEFT

25.M0124212
FUSING ENTRANCE
GUIDE PLATE:UPPER

42.M0124292
FUSING COVER:UPPER

22.M0124205
LEVER:RIGHT FRAME:FUSING

31.M0124223
THERMAL INSULATING
BUSHING:HOT ROLLER

24.M0124211
PLATE NUT:HEATER

34.M0124266
COVER:RIGHT LOWER:FUSING

26.M0124213
(x2)
BUSHING:PRESSURE ROLLER

29.M0124217
FUSING ENTRANCE
GUIDE PLATE:LOWER

37.M0124279
CLEANING ROLLER:ASSY

30.M0124220
HOT ROLLER

33.M0124253
PRESSURE ROLLER:DIA30

27.M0124215
GUIDE PLATE:EXIT

36.M0124276
COVER:LEFT:LOWER:FUSING

23.M0124208
(x3)
BRACKET:GATE PLATE

40.M0124285
LEVER:PRESSURE:RIGHT

32.M0124229
(x2)
TENSION SPRING:FUSING:PRESSURE

28.M0124216
(x2)
TENSION SPRING:FUSING:GUIDE PLATE

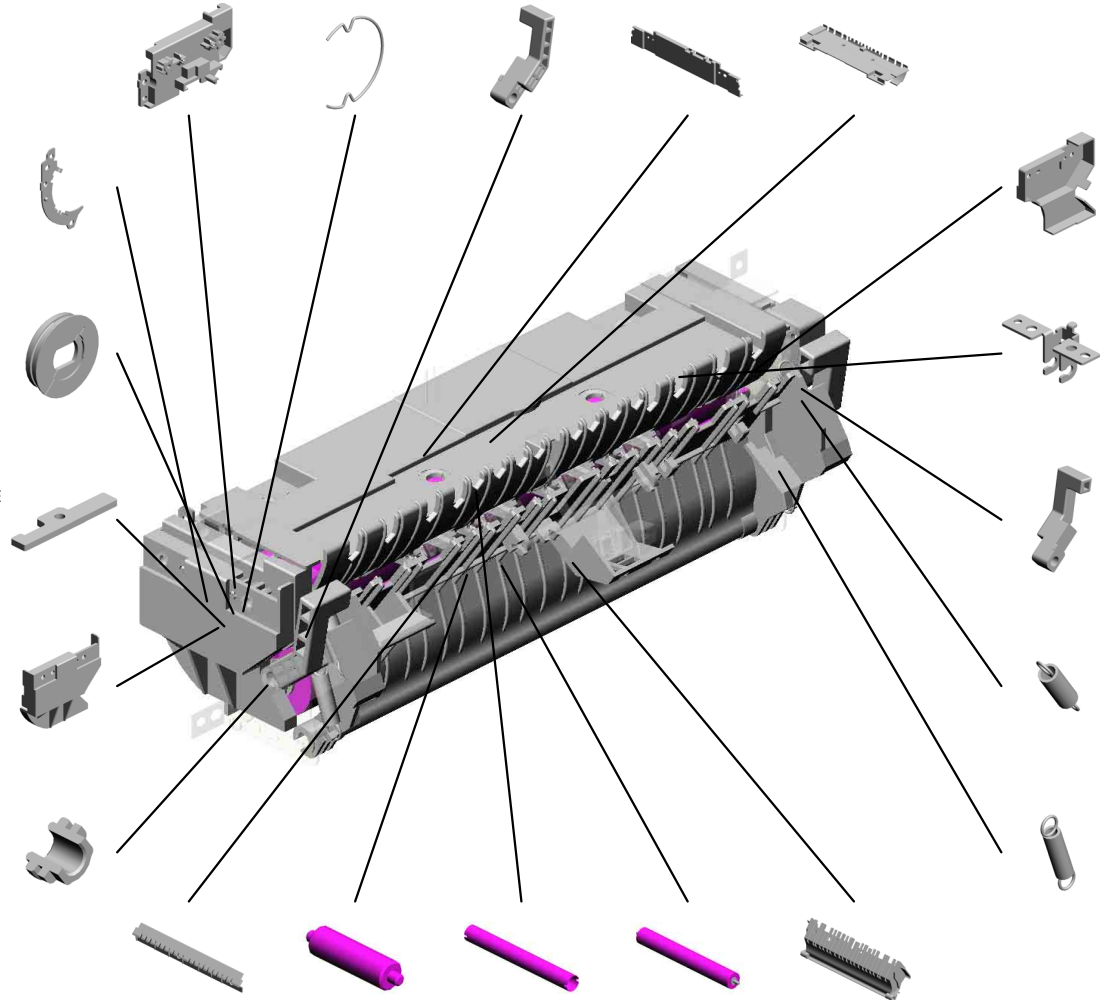

U008_S001
(EU/AA):FUSING UNIT:ASS'Y

51.M2874263
THERMISTOR

50.M2874234
HOUSING:THERM
OSTAT:ASS'Y

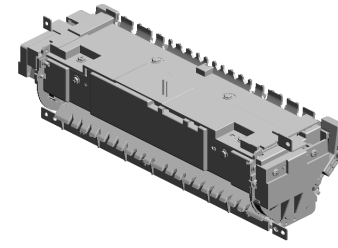

47.M2874031
(EU/AA):FUSING U
NIT:ASS'Y

44.M0124295
GROUND PLATE:A
SS'Y

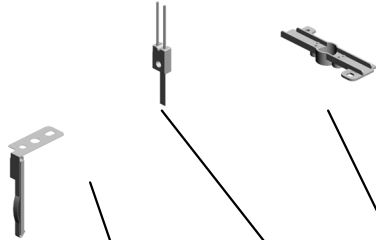

49.M2874206
(x3)
STRIPPER PAWLS



43.M0124293
(x4)
EXIT ROLLER:EXIT
:FUSING

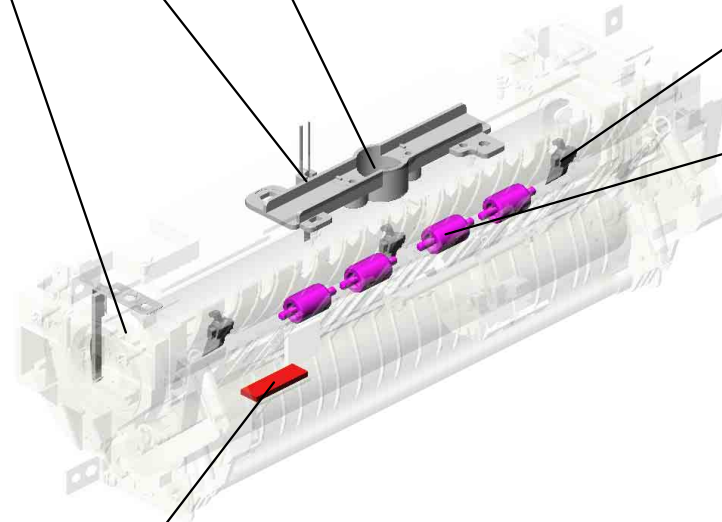

45.M0124603
DECAL:GUIDE PLA
TE:B

U001	U002	U003	U004	U005	U006	U007	U008	U009	U010	U011	U012	U013
------	------	------	------	------	------	------	------	------	------	------	------	------

U008_S002
(CHN):FUSING UNIT:ASS'Y

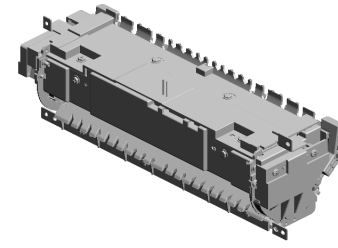

48.M2874033
(CHN):FUSING UNIT:ASS'Y

8.08046127 (x4) HEXAGONAL BOLT :DOUBLE SCREW: M3X8
 21.M0124204 LEVER:LEFT:FRAM E:FUSING
 17.M0124120 (x3) TENSION SPRING: PICKOFF PAWL
 7.08025318 (x4) BINDING HEAD TAPPING SCREW:ES: 3X10
 19.M0124186 COVER:LEFT UPPER:ASS'Y

12.AW110116 THERMOSTAT

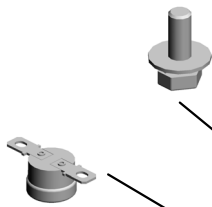

9.09543010N SCREW:POLISHED ROUND/SPRING:M 3X10



10.AA143520 (x7) SHOULDER SCREW - M3



1.03603006N (x11) SCREW - M3X6



13.G1274328 DECAL - HIGH TEMPERATURE



18.M0124135 FEELER:PAPER FEELER SENSOR



16.M0124109 SPRING:FEELER:EXIT



11.AW020198 PHOTOINTERRUPTOR:LG2A14NL1



4.04513008N (x4) TAPPING SCREW - M3X8



20.M0124202 (x2) LEVER:PRESSURE



3.04513006N (x2) TAPPING SCREW - 3X6



14.M0124053 GEAR:HOT ROLLER



15.M0124055 (x2) RADIAL BALL BEARING:35X47X7



5.04533006N (x6) TAPPING SCREW - M3X6



6.07200040E (x2) RETAINING RING - M4



U008_S002
(CHN):FUSING UNIT:ASS'Y

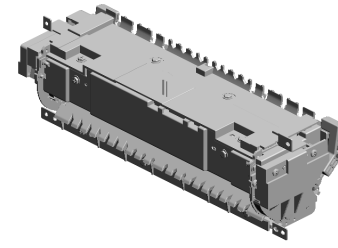

48.M2874033
(CHN):FUSING UNIT:ASS'Y

41.M0124287 COVER:RIGHT UPPER:FUSING
38.M0124281 (x2) RETAINING RINGS-C:HOT ROLLER
39.M0124284 LEVER:PRESSURE:LEFT
25.M0124212 FUSING ENTRANCE GUIDE PLATE:UPPER
42.M0124292 FUSING COVER:UPPER

22.M0124205 LEVER:RIGHT FRAME:FUSING

31.M0124223 THERMAL INSULATING BUSHING:HOT ROLLER

24.M0124211 PLATE NUT:HEATER

34.M0124266 COVER:RIGHT LOWER:FUSING

26.M0124213 (x2) BUSHING:PRESSURE ROLLER

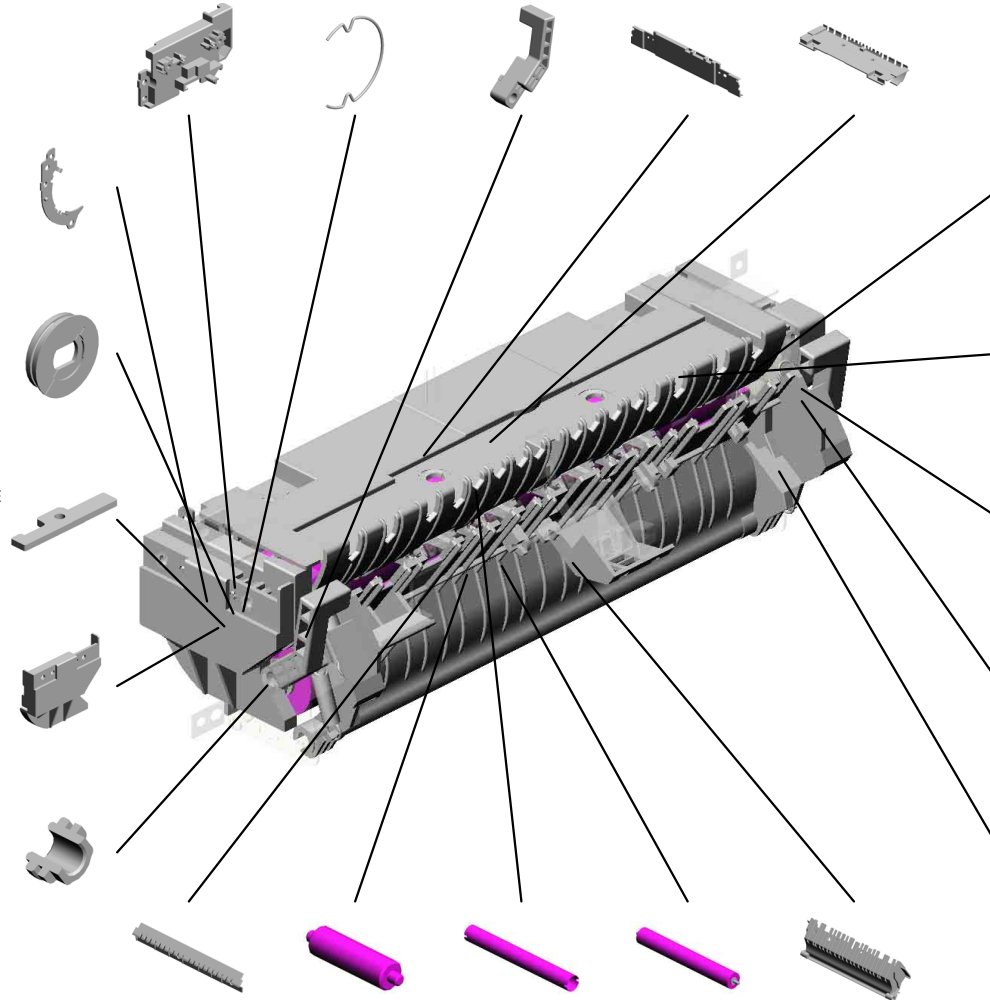

36.M0124276 COVER:LEFT:LOWER:FUSING

23.M0124208 (x3) BRACKET:GATE PLATE

40.M0124285 LEVER:PRESSURE:RIGHT

32.M0124229 (x2) TENSION SPRING:FUSING:PRESSURE

28.M0124216 (x2) TENSION SPRING:FUSING:GUIDE PLATE

29.M0124217 FUSING ENTRANCE GUIDE PLATE:LOWER
37.M0124279 CLEANING ROLLER:ASSY
30.M0124220 HOT ROLLER
33.M0124253 PRESSURE ROLLER:DIA30
27.M0124215 GUIDE PLATE:EXIT

U001	U002	U003	U004	U005	U006	U007	U008	U009	U010	U011	U012	U013
------	------	------	------	------	------	------	------	------	------	------	------	------

U008_S002
(CHN):FUSING UNIT:ASS'Y

51.M2874263
THERMISTOR

50.M2874234
HOUSING:THERM
OSTAT:ASS'Y

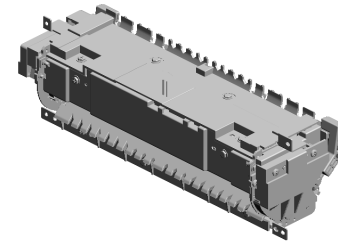

48.M2874033
(CHN):FUSING UNI
T:ASS'Y

44.M0124295
GROUND PLATE:A
SS'Y

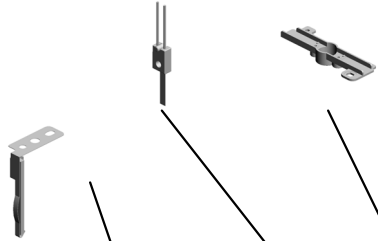

49.M2874206
(x3)
STRIPPER PAWLS



43.M0124293
(x4)
EXIT ROLLER:EXIT
:FUSING

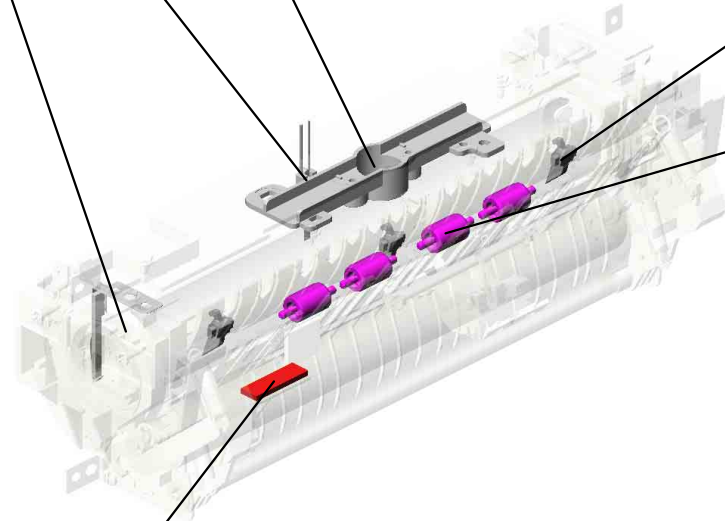

45.M0124603
DECAL:GUIDE PLA
TE:B

U001	U002	U003	U004	U005	U006	U007	U008	U009	U010	U011	U012	U013
------	------	------	------	------	------	------	------	------	------	------	------	------

U009 PAPER EXIT

2.07200040E (x2)
RETAINING RING - M4

6.M0124488 (x2)
BUSHING:DIA6XDI A10X6

8.M0134470 (x2)
EXIT ROLLER:DUPLEX

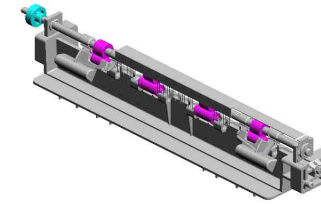

7.M0134455
GEAR:DRIVE:EXIT ROLLER



1.04503008N (x2)
TAPPING SCREW - M3X8



9.M1544499
GROUND PLATE:EXIT ROLLER

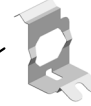

3.M0124453 (x4)
EXIT ROLLER



4.M0124454 (x4)
SPRING:EXIT ROLLER:EXIT



5.M0124458
DISCHARGE BRUSH:EXIT:ASS'Y DRAWING

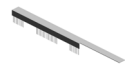

U001	U002	U003	U004	U005	U006	U007	U008	U009	U010	U011	U012	U013
------	------	------	------	------	------	------	------	------	------	------	------	------

U010 DUPLEX

- 4.04543006Q (x4) TAPPING SCREW - M3X6
- 10.M0134610 GEAR:DRIVE:DUPL EX
- 6.08050104 (x7) RETAINING RINGS -E:SILENCER:DIA4
- 11.M0134611 BRACKET:DRIVE:D UPLEX:ASS'Y
- 18.M0134664 GUIDE PLATE:VER TICAL TRANSPOR T:UPPER

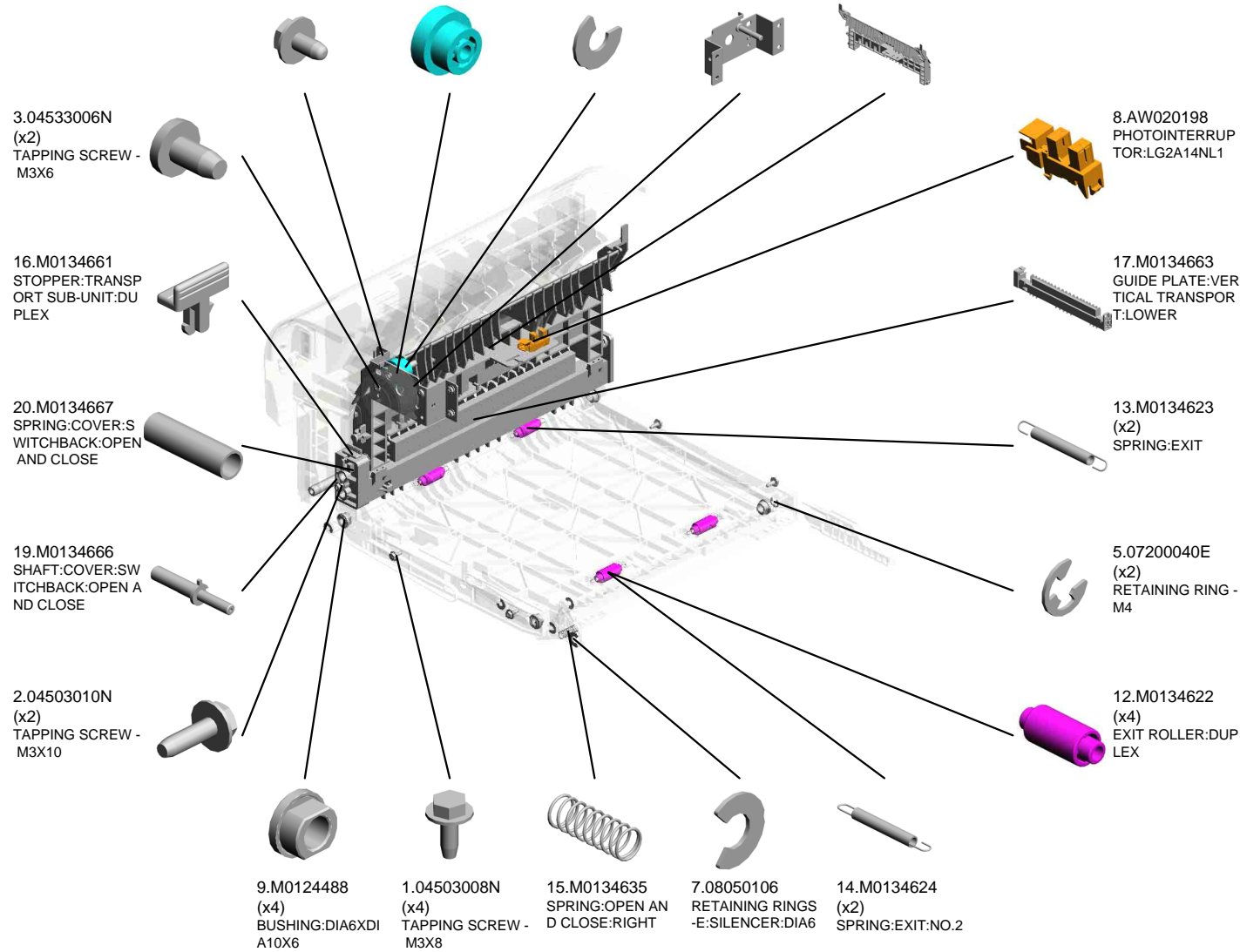
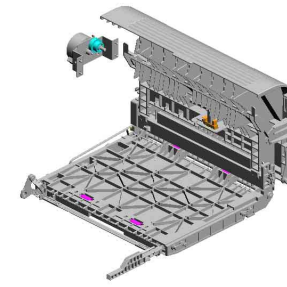

U010 DUPLEX

22.M0134669
(x2)
MAGNET CATCH:AS
SY

40.M0134794
DECAL:GUIDE PLA
TE:VERTICAL TRA
NSPORT:UPPER

34.M0134761
TRANSPORT ROLL
ER:DUPLEX:MIDDL
E

27.M0134684
SHEET:DUPLEX

23.M0134671
SHEET:HORIZONT
AL TRANSPORT:LE
FT

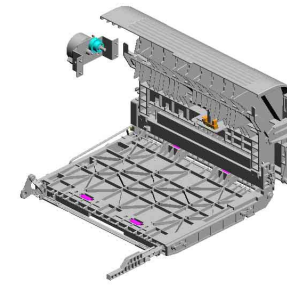

24.M0134672
SHEET:HORIZONT
AL TRANSPORT:RI
GHT

29.M0134688
GROUND PLATE:H
ORIZONTAL TRAN
SPORT:REAR

36.M0134765
(x3)
PULLEY:TRANSP
ORT

38.M0134772
TIMING BELT:DRIV
E

30.M0134691
LEVER:OPEN AND
CLOSE:LOWER

25.M0134673
LEVER:OPEN AND
CLOSE:NO.1

26.M0134674
LEVER:OPEN AND
CLOSE:NO.2

31.M0134696
LEVER:OPEN AND
CLOSE:LEFT

35.M0134762
TRANSPORT ROLL
ER:DUPLEX:EXIT

33.M0134698
BRACKET:OPEN A
ND CLOSE:LOWER

37.M0134771
TIMING BELT:HORI
ZONTAL TRANSP
ORT

21.M0134668
SHEET:GUIDE:HO
RIZONTAL TRAN
SPORT:LOWER

39.M0134785
SPRING:COVER:S
WITCHBACK:OPEN
AND CLOSE

32.M0134697
LEVER:OPEN AND
CLOSE:RIGHT

28.M0134685
BUTTON:OPEN AN
D CLOSE:LOWER

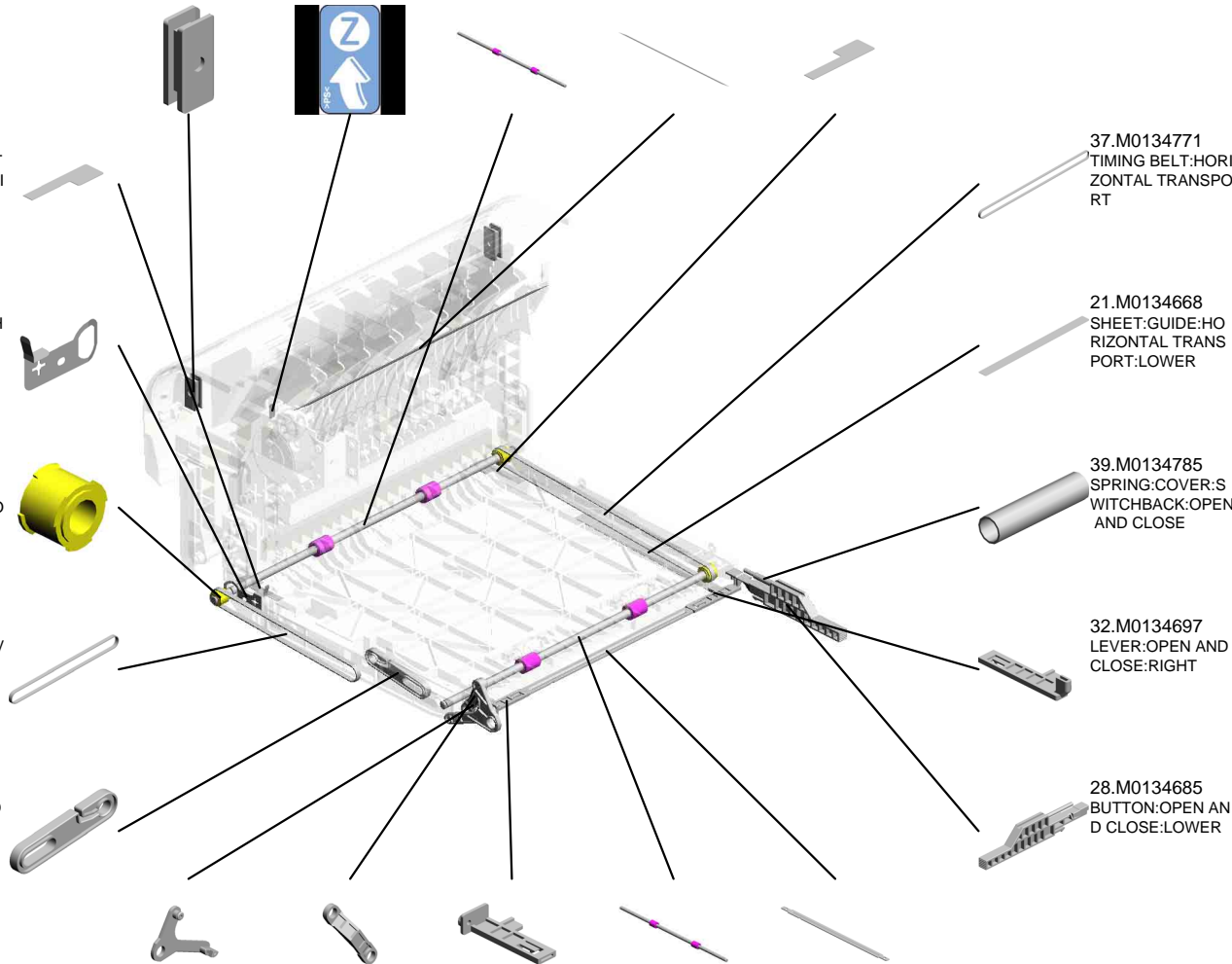

U010 DUPLEX

43.M1540265
STEPPER MOTOR

42.M1174662
COVER:SWITCHBA
CK:OPEN AND CL
OSE

41.M0134797
FEELER:SENSOR:
VERTICAL TRANS
PORT

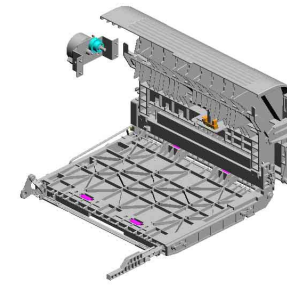

46.M2874719
(x2)
PIN:GUIDE:TRANS
PORT

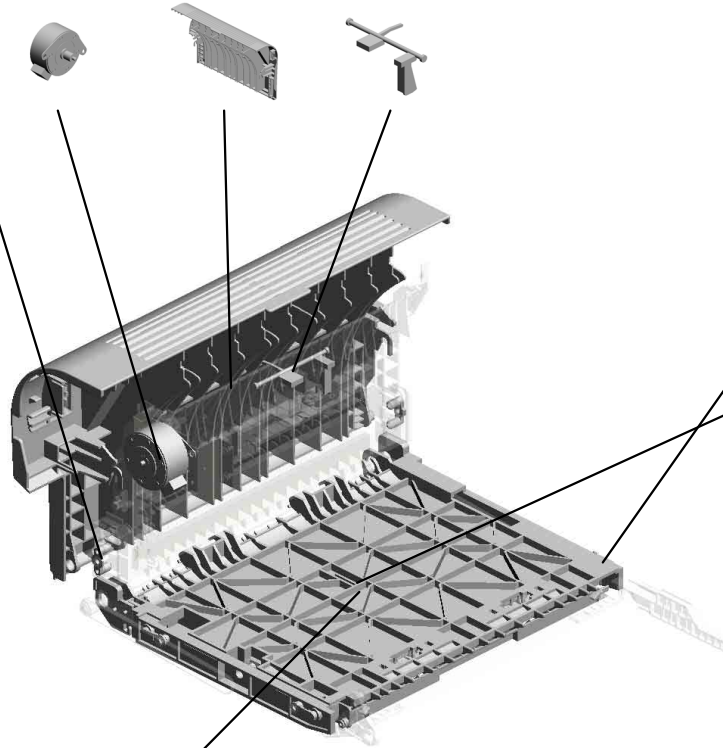

47.M2874895
(x4)
PIN:GUIDE:UPPER

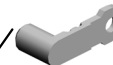

44.M1544694
GUIDE:HORIZONT
AL TRANSPORT:U
PPER

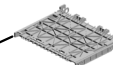

45.M1544695
GUIDE:HORIZONT
AL TRANSPORT:L
OWER



U001	U002	U003	U004	U005	U006	U007	U008	U009	U010	U011	U012	U013
------	------	------	------	------	------	------	------	------	------	------	------	------

U011 MAIN DRIVE

7.11050758 CLAMP:LWSM-030 6A
 11.M0121120 GEAR:DRIVE:FUSI NG:NO.3
 13.M0121128 GEAR:DRIVE:FUSI NG:NO.4
 3.07200040E RETAINING RING - M4
 2.04543006Q TAPPING SCREW - M3X6

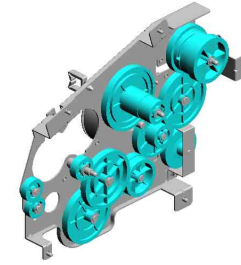

8.G0521120 SPRING - PAPER EXIT RELEASE



4.08050104 (x6) RETAINING RINGS -E:SILENCER:DIA4



10.M0121119 GEAR:DRIVE:FUSI NG:NO.2



9.M0121117 GEAR:DRIVE:DRUM



17.M0131178 BRACKET:DRIVE:DUPLIX



14.M0121150 BRUSHLESS MOTOR:DC 36.7W



18.M1161118 GEAR:DRIVE:FUSI NG:NO.1



19.M1161121 GEAR:DRIVE:PAPER FEED:NO.1



20.M1161122 GEAR:DRIVE:PAPER FEED:NO.2



6.11050568 CLAMP:LWSS-0504



5.11050197 WIRE SADDLE

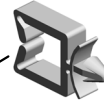

1.04513006N (x10) TAPPING SCREW - 3X6



12.M0121123 GEAR:DRIVE:PAPER FEED:NO.3

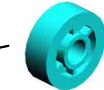

16.M0121172 GEAR:DRIVE:MANUAL FEED SECTION:NO.2



15.M0121171 GEAR:DRIVE:MANUAL FEED SECTION:NO.1

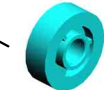

U011 MAIN DRIVE

22.M1171136 23.M1541177
GEAR:DRIVE:DUPL CASE:DRIVE:ASS'Y
EX SECTION

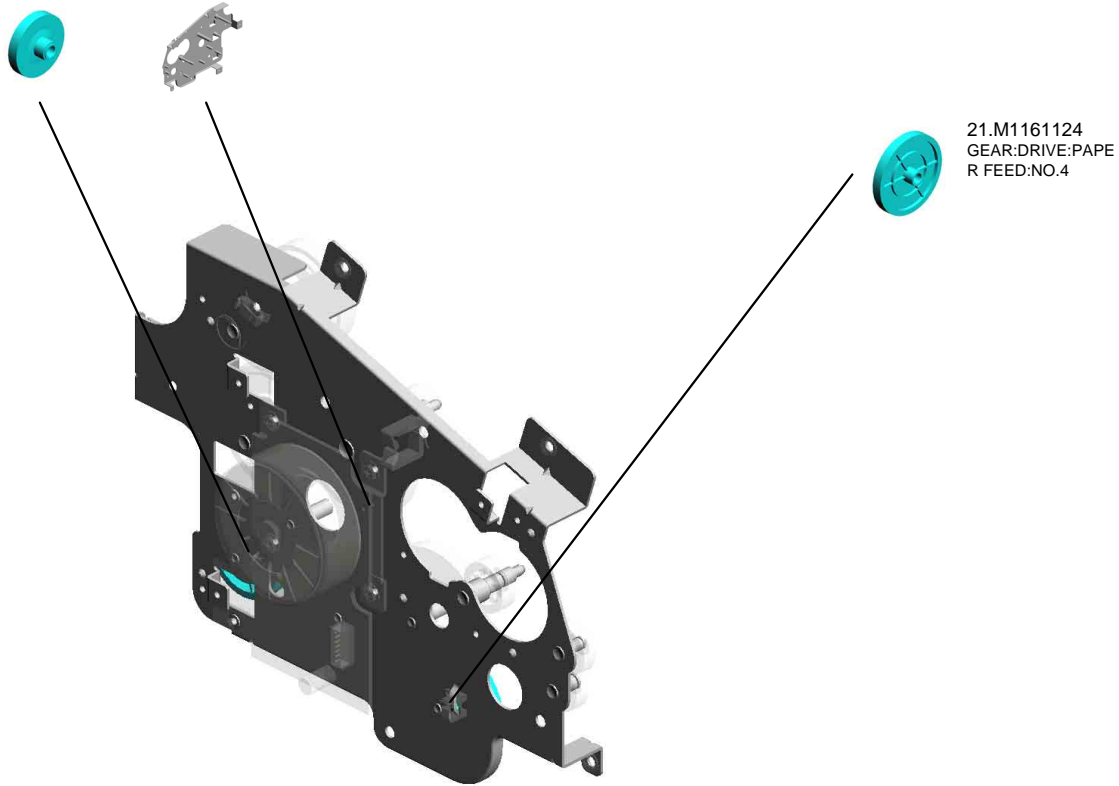
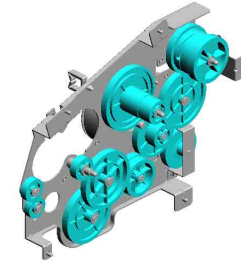

21.M1161124
GEAR:DRIVE:PAPE
R FEED:NO.4

U001	U002	U003	U004	U005	U006	U007	U008	U009	U010	U011	U012	U013
------	------	------	------	------	------	------	------	------	------	------	------	------

U012 ELECTRICAL

8.M2895061
(EU/AA):PCB:FAX:ASSY
9.M2895063
(CHN):PCB:FAX:ASSY

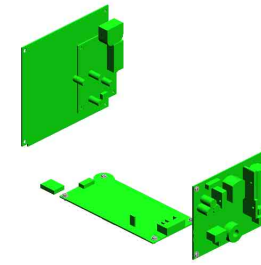

4.M0A95052
PCB:ECBCTL:4IN1:ASSY



1.04513006N
(x4)
TAPPING SCREW - M3X6

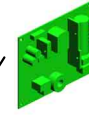
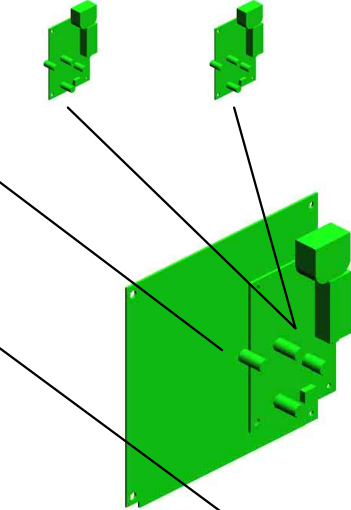

7.M2875312
(EU/AA):POWER SUPPLY UNIT:ASSY

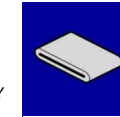

3.16072774
FERRITE CORE:K3FF

2.04543006Q
(x4)
TAPPING SCREW - M3X6

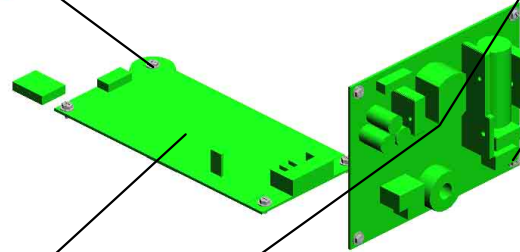

5.M1545402
POWER PACK:ASSY

6.M2875311
(CHN):POWER SUPPLY UNIT:ASSY

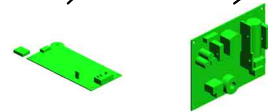

U001	U002	U003	U004	U005	U006	U007	U008	U009	U010	U011	U012	U013
------	------	------	------	------	------	------	------	------	------	------	------	------

U013 MAIN FRAME

- 2.04513006N (x21) TAPPING SCREW - 3X6
- 17.M0121037 TONER BOTTLE:CASE
- 18.M0121040 CASE:DISCHARGE LAMP
- 6.04543014Q TAPPING SCREW: 3X14
- 13.12042612 (x2) MICRO SWITCH:D3 V-16506-3C25

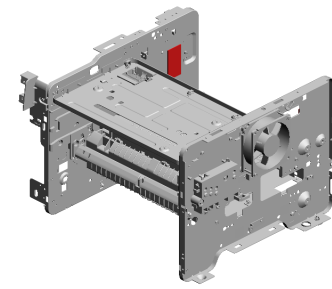

- 3.04513014N TAPPING SCREW: 3X14

- 16.GW010007 PHOTO REFLECTOR ON SENSOR:EXIT

- 8.11050568 CLAMP:LWSS-0504

- 1.04503008N (x12) TAPPING SCREW - M3X8

- 10.11050758 (x5) CLAMP:LWSS-030 6A

- 15.G0271180 (x2) RUBBER FOOT - GF

- 20.M0121065 CASE:TERMINAL

- 19.M0121063 (x4) TERMINAL:CHARGE

- 21.M0121066 (x4) SPRING:TERMINAL :CHARGE

- 9.11050598 CLAMP:LWSS-1N

- 11.11050760 (x5) CLAMP:LWSS-051 1A

- 10.11050758 (x3) CLAMP:LWSS-030 6A

- 11.11050760 (x3) CLAMP:LWSS-051 1A

- 5.04543006Q (x5) TAPPING SCREW - M3X6

- 14.AX640199 FAN:MM80:25MM:D C 2.16W

- 12.11050762 (x2) CLAMP:LWS-0711A

- 4.04513030N (x2) TAPPING SCREW: 3X30

- 7.09504006N SCREW - M4X6

U013 MAIN FRAME

25.M0124120 (x3)
TENSION SPRING:
PICKOFF PAWL

24.M0121097 (x3)
SUPPORTER:PAPE
R:TRANSPORT

26.M0124601
DECAL:LEVER:EN
VELOPE:LEFT

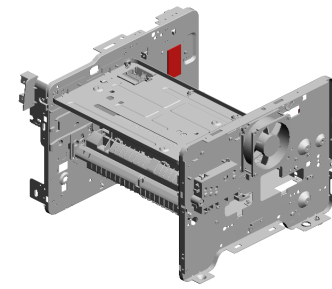

31.M2881089
CASE:USB

23.M0121089 (x3)
GUIDE:PAPER:LEA
DING EDGE

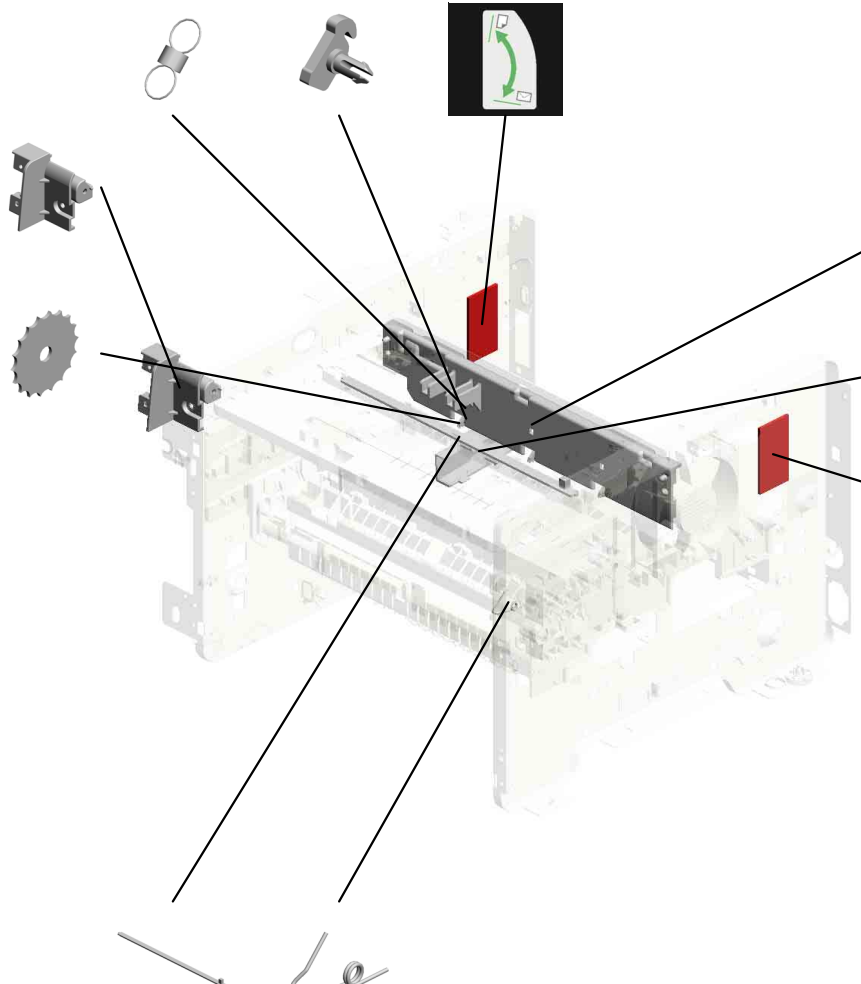

28.M1541099
HEAT INSULATING
PLATE:FUSING:FR
ONT:TYPE A

30.M2871043
COVER:U CONVEY
ER BELT:DUPLX

27.M0124602
DECAL:LEVER:FR
VELOPE:RIGHT

29.M1542056
DISCHARGE LAMP

22.M0121088
COIL SPRING:RAIL
:RIGHT

U001	U002	U003	U004	U005	U006	U007	U008	U009	U010	U011	U012	U013
------	------	------	------	------	------	------	------	------	------	------	------	-------------

ACCESSORIES

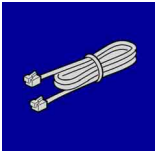

1.H4524105
MODULER CORD:6PIN-6PIN



2.M0A90431
MODEL NAME PLATE:SP320^SFN



3.M1011301
PLATE:LOGO:RIC

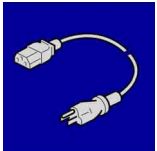

4.M1015799
(CHN):POWER SUPPLY CORD

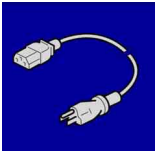

5.M1545699
(EU/AA):POWER SUPPLY CORD:250
V:10A



6.M1560452
(CHN):HOLDER:HAND SET



7.M1560462
(CHN):HAND SET:SUB-ASSY

Exclusive Parts

Number	Part Name	Group	ID
A1532117	ROLLER TERMINAL	U005	5
AA143520	SHOULDER SCREW - M3	U005	6
		U008_S001	10
		U008_S002	10
AG070514	MAGNET CATCH	U001	7
AW020198	PHOTOINTERRUPTOR:LG2A14NL 1	U005	7
		U008_S001	11
		U008_S002	11
		U010	8
AW110116	THERMOSTAT	U008_S001	12
		U008_S002	12
AX640199	FAN:MM80:25MM:DC 2.16W	U013	14
D1272514	ELECTROMAGNETIC CLUTCH:3.5 T:MANUAL FEED	U005	8
G0123050	SIDE FENCE GEAR	U005	9
G0201160	SNAP RING	U005	10
G0271180	RUBBER FOOT - GF	U013	15
G0292767	BY-PASS FEED COVER	U005	11
G0521120	SPRING - PAPER EXIT RELEASE	U011	8
G0521518	SPRING - LOCK LEVER	U001	8
G1022717	COVER:DC SOLENOID	U005	12
G1022789	STOPPER:PHOTOINTERRUPTOR	U005	13
G1272627	PAPER FEED ROLLER - MM32	U005	14
G1274328	DECAL - HIGH TEMPERATURE	U008_S001	13
		U008_S002	13
G8003133	SIDE FENCE GEAR	U005_S001	15
GF013001	BOTTOM PLATE PAD	U005	16
		U005_S001_S001	16
GW010007	PHOTO REFLECTION SENSOR:EXI T	U013	16
H4524105	MODULER CORD:6PIN-6PIN	ACCESSORIES	1
M0121037	TONER BOTTLE:CASE	U013	17
M0121040	CASE:DISCHARGE LAMP	U013	18
M0121063	TERMINAL:CHARGE	U013	19
M0121065	CASE:TERMINAL	U013	20
M0121066	SPRING:TERMINAL:CHARGE	U013	21
M0121088	COIL SPRING:RAIL:RIGHT	U013	22
M0121089	GUIDE:PAPER:LEADING EDGE	U013	23

Number	Part Name	Group	ID
M0121097	SUPPORTER:PAPER:TRANSPORT	U013	24
M0121117	GEAR:DRIVE:DRUM	U011	9
M0121119	GEAR:DRIVE:FUSING:NO.2	U011	10
M0121120	GEAR:DRIVE:FUSING:NO.3	U011	11
M0121123	GEAR:DRIVE:PAPER FEED:NO.3	U011	12
M0121128	GEAR:DRIVE:FUSING:NO.4	U011	13
M0121150	BRUSHLESS MOTOR:DC 36.7W	U011	14
M0121171	GEAR:DRIVE:MANUAL FEED SECT ION:NO.1	U011	15
M0121172	GEAR:DRIVE:MANUAL FEED SECT ION:NO.2	U011	16
M0122589	PAPER TRAY:REAR	U005_S001	17
M0122590	COIL SPRING:EARTH	U005_S001	18
M0122603	STOPPER:BASE PLATE	U005_S001	19
M0122604	SPRING:RELEASE:TRAY BOTTOM PLATE	U005_S001	20
M0122605	FRICTION PAD:ADHESION	U005_S001	21
M0122608	END FENCE	U005_S001	22
M0122610	TRAY BOTTOM PLATE	U005_S001_S001	23
M0122612	COMPRESSION SPRING:TRAY BO TTOM PLATE	U005_S001	24
M0122613	COMPRESSION SPRING:SEPARAT ION	U005_S001	25
M0122615	SIDE FENCE:RIGHT	U005_S001	26
M0122631	CLOTH:EARTH:PAPER FEED	U005	27
M0122668	SHAFT:PAPER FEED:ASS'Y	U005	28
M0122671	FEELER:PAPER END SENSOR	U005	29
M0122673	RAIL:PAPER TRAY:RIGHT	U005	30
M0122701	ROLLER:INTERFACE:DRIVE	U005	31
M0122702	ROLLER:INTERFACE:DRIVEN	U005	32
M0122705	SPRING:ROLLER	U005	33
M0122711	BUSHING:REGISTRATION:DRIVEN :LEFT	U005	34
M0122715	GUIDE PLATE:TRANSPORT:UPPE R	U005	35
M0122718	REGISTRATION ROLLER:DRIVE	U005	36
M0122719	REGISTRATION ROLLER:DRIVEN	U005	37
M0122722	SPRING:ROLLER:REGISTRATION	U005	38

Exclusive Parts

Number	Part Name	Group	ID
M0122723	FEELER:REGISTRATION:SENSOR	U005	39
M0122725	SPRING:FEELER:REGISTRATION	U005	40
M0122730	BUSHING:REGISTRATION:DRIVEN :RIGHT	U005	41
M0122741	GROUND PLATE:DRIVE:REGISTR ATION ROLLER	U005	42
M0122742	GROUND PLATE:DRIVEN:REGIST RATION ROLLER	U005	43
M0122743	DECAL:GUIDE PLATE:TRANSPOR T:UPPER	U005	44
M0122744	GUIDE:REGISTRATION	U005	45
M0122745	GROUND PLATE:DRIVEN	U005	46
M0122753	BUSHING:ROLLER:DRIVEN	U005	47
M0122806	SHEET:GUIDE:MANUAL FEED SUB -UNIT	U005	48
M0122816	FRICTION PAD:HOLDER:MANUAL FEED:ASS'Y	U005	49
M0122824	FEELER:MANUAL FEED	U005	50
M0122830	MECHANICAL SPRING CLUTCH:M ANUAL FEED	U005	51
M0122833	DECAL:SIDE FENCE:MANUAL FEE D	U005	52
M0122859	GUIDE PLATE:UPPER:MANUAL FE ED	U005	53
M0122860	PAPER FEED ROLLER:MANUAL F EED	U005	54
M0122874	COMPRESSION SPRING:MANUAL FEED	U005	55
M0122880	COMPRESSION SPRING:SEPARAT ION	U005	56
M0124053	GEAR:HOT ROLLER	U008_S001	14
		U008_S002	14
M0124055	RADIAL BALL BEARING:35X47X7	U008_S001	15
		U008_S002	15
M0124109	SPRING:FEELER:EXIT	U008_S001	16
		U008_S002	16
M0124120	TENSION SPRING:PICKOFF PAWL	U008_S001	17
		U008_S002	17

Number	Part Name	Group	ID
		U013	25
M0124135	FEELER:PAPER FEED SENSOR	U008_S001	18
		U008_S002	18
M0124186	COVER:LEFT UPPER:ASS'Y	U008_S001	19
		U008_S002	19
M0124202	LEVER:PRESSURE	U008_S001	20
		U008_S002	20
M0124204	LEVER:LEFT:FRAME:FUSING	U008_S001	21
		U008_S002	21
M0124205	LEVER:RIGHT:FRAME:FUSING	U008_S001	22
		U008_S002	22
M0124208	BRACKET:GATE PAWL	U008_S001	23
		U008_S002	23
M0124211	PLATE NUT:HEATER	U008_S001	24
		U008_S002	24
M0124212	FUSING ENTRANCE GUIDE PLATE :UPPER	U008_S001	25
		U008_S002	25
M0124213	BUSHING:PRESSURE ROLLER	U008_S001	26
		U008_S002	26
M0124215	GUIDE PLATE:EXIT	U008_S001	27
		U008_S002	27
M0124216	TENSION SPRING:FUSING:GUIDE PLATE	U008_S001	28
		U008_S002	28
M0124217	FUSING ENTRANCE GUIDE PLATE :LOWER	U008_S001	29
		U008_S002	29
M0124220	HOT ROLLER	U008_S001	30
		U008_S002	30
M0124223	THERMAL INSULATING BUSHING: HOT ROLLER	U008_S001	31
		U008_S002	31
M0124229	TENSION SPRING:FUSING:PRESS URE	U008_S001	32
		U008_S002	32
M0124253	PRESSURE ROLLER:DIA30	U008_S001	33
		U008_S002	33
M0124266	COVER:RIGHT LOWER:FUSING	U008_S001	34
		U008_S002	34
M0124270	THERMAL INSULATING BUSHING: FUSING UNIT	U008	35
M0124276	COVER:LEFT:LOWER:FUSING	U008_S001	36

Exclusive Parts

Number	Part Name	Group	ID
		U008_S002	36
M0124279	CLEANING ROLLER:ASS'Y	U008_S001	37
		U008_S002	37
M0124281	RETAINING RINGS-C:HOT ROLLER	U008_S001	38
		U008_S002	38
M0124284	LEVER:PRESSURE:LEFT	U008_S001	39
		U008_S002	39
M0124285	LEVER:PRESSURE:RIGHT	U008_S001	40
		U008_S002	40
M0124287	COVER:RIGHT UPPER:FUSING	U008_S001	41
		U008_S002	41
M0124292	FUSING COVER:UPPER	U008_S001	42
		U008_S002	42
M0124293	EXIT ROLLER:EXIT:FUSING	U008_S001	43
		U008_S002	43
M0124295	GROUND PLATE:ASS'Y	U008_S001	44
		U008_S002	44
M0124453	EXIT ROLLER	U009	3
M0124454	SPRING:EXIT ROLLER:EXIT	U009	4
M0124458	DISCHARGE BRUSH:EXIT:ASS'Y DRAWING	U009	5
M0124488	BUSHING:DIA6XDIA10X6	U005	57
		U009	6
		U010	9
M0124601	DECAL:LEVER:ENVELOPE:LEFT	U013	26
M0124602	DECAL:LEVER:ENVELOPE:RIGHT	U013	27
M0124603	DECAL:GUIDE PLATE:B	U008_S001	45
		U008_S002	45
M0124699	DECAL:WARNING (HIGH TEMPERATURE):FRONT	U008	46
M0126252	BUSHING:TRANSFER ROLLER:RIGHT	U007	1
M0126254	SPRING:TRANSFER ROLLER	U007	2
M0126255	GEAR:TRANSFER ROLLER	U007	3
M0126256	ROLLER:POSITIONING:TRANSFER ROLLER	U007	4
M0126260	COVER:ELECTRODE PLATE	U007	5
M0131178	BRACKET:DRIVE:DUPLEX	U011	17

Number	Part Name	Group	ID
M0134455	GEAR:DRIVE:EXIT ROLLER	U009	7
M0134470	EXIT ROLLER:DUPLEX	U009	8
M0134610	GEAR:DRIVE:DUPLEX	U010	10
M0134611	BRACKET:DRIVE:DUPLEX:ASS'Y	U010	11
M0134622	EXIT ROLLER:DUPLEX	U010	12
M0134623	SPRING:EXIT	U010	13
M0134624	SPRING:EXIT:NO.2	U010	14
M0134635	SPRING:OPEN AND CLOSE:RIGHT	U010	15
M0134661	STOPPER:TRANSPORT SUB-UNIT:DUPLEX	U010	16
M0134663	GUIDE PLATE:VERTICAL TRANSPORT:LOWER	U010	17
M0134664	GUIDE PLATE:VERTICAL TRANSPORT:UPPER	U010	18
M0134666	SHAFT:COVER:SWITCHBACK:OPEN AND CLOSE	U010	19
M0134667	SPRING:COVER:SWITCHBACK:OPEN AND CLOSE	U010	20
M0134668	SHEET:GUIDE:HORIZONTAL TRANSPORT:LOWER	U010	21
M0134669	MAGNET CATCH:ASS'Y	U010	22
M0134671	SHEET:HORIZONTAL TRANSPORT:LEFT	U010	23
M0134672	SHEET:HORIZONTAL TRANSPORT:RIGHT	U010	24
M0134673	LEVER:OPEN AND CLOSE:NO.1	U010	25
M0134674	LEVER:OPEN AND CLOSE:NO.2	U010	26
M0134684	SHEET:DUPLEX	U010	27
M0134685	BUTTON:OPEN AND CLOSE:LOWER	U010	28
M0134688	GROUND PLATE:HORIZONTAL TRANSPORT:REAR	U010	29
M0134691	LEVER:OPEN AND CLOSE:LOWER	U010	30
M0134696	LEVER:OPEN AND CLOSE:LEFT	U010	31
M0134697	LEVER:OPEN AND CLOSE:RIGHT	U010	32
M0134698	BRACKET:OPEN AND CLOSE:LOWER	U010	33
M0134761	TRANSPORT ROLLER:DUPLEX:MI	U010	34

Exclusive Parts

Number	Part Name	Group	ID
	DDLE		
M0134762	TRANSPORT ROLLER:DUPLEX:EX IT	U010	35
M0134765	PULLEY:TRANSPORT	U010	36
M0134771	TIMING BELT:HORIZONTAL TRAN SPORT	U010	37
M0134772	TIMING BELT:DRIVE	U010	38
M0134785	SPRING:COVER:SWITCHBACK:OP EN AND CLOSE	U010	39
M0134794	DECAL:GUIDE PLATE:VERTICAL T RANSPORT:UPPER	U010	40
M0134797	FEELER:SENSOR:VERTICAL TRAN SPORT	U010	41
M0A71851	OPTICAL WRITING UNIT:ASS'Y	U004_S001	8
M0A90431	MODEL NAME PLATE:SP320SFN	ACCESSORIES	2
M0A91402	(EU/AA):OPERATION PANEL:ASS'Y	U003	2
M0A91404	(CHN):OPERATION PANEL:ASS'Y	U003	3
M0A95052	PCB:ECBCTL:4IN1:ASS'Y	U012	4
M1011301	PLATE:LOGO:RIC	ACCESSORIES	3
M1015799	(CHN):POWER SUPPLY CORD	ACCESSORIES	4
M1016250	TRANSFER ROLLER	U007	6
M1016259	ELECTRODE PLATE:SEPARATION	U007	7
M1161118	GEAR:DRIVE:FUSING:NO.1	U011	18
M1161121	GEAR:DRIVE:PAPER FEED:NO.1	U011	19
M1161122	GEAR:DRIVE:PAPER FEED:NO.2	U011	20
M1161124	GEAR:DRIVE:PAPER FEED:NO.4	U011	21
M1162672	RAIL:PAPER TRAY:LEFT	U005	58
M1171136	GEAR:DRIVE:DUPLEX SECTION	U011	22
M1174662	COVER:SWITCHBACK:OPEN AND CLOSE	U010	42
M1180501	SPEAKER:M118	U001	9
M1341382	RAIL:SCANNER:OPEN AND CLOSE	U001	10
M1341386	RAIL:STOPPER:SCANNER:OPEN A ND CLOSE	U001	11
M1540265	STEPPER MOTOR	U010	43
M1541099	HEAT INSULATING PLATE:FUSING :FRONT:TYPE A	U013	28
M1541177	CASE:DRIVE:ASS'Y	U011	23

Number	Part Name	Group	ID
M1542056	DISCHARGE LAMP	U013	29
M1542505	PAPER TRAY:ASS'Y	U005_S001	59
M1542614	SIDE FENCE:LEFT	U005_S001	60
M1542616	LEVER:PAPER VOLUME SENSOR	U005_S001	61
M1542618	DECAL:PAPER TRAY:FRONT	U005_S001	62
M1542629	COVER:PAPER TRAY:MIDDLE	U005_S001	63
M1542640	COVER:PAPER TRAY:LEFT	U005_S001	64
M1542641	COVER:PAPER TRAY:RIGHT	U005_S001	65
M1542805	GUIDE PLATE:MANUAL FEED:LOW ER	U005	66
M1542815	DECAL:FEED PAPER AGAIN:PREV ENTION	U005	67
M1542831	DC SOLENOID:9.6W:24V	U005	68
M1542879	EXTENSION TRAY:MANUAL FEED	U005	69
M1544499	GROUND PLATE:EXIT ROLLER	U009	9
M1544694	GUIDE:HORIZONTAL TRANSPORT :UPPER	U010	44
M1544695	GUIDE:HORIZONTAL TRANSPORT :LOWER	U010	45
M1545402	POWER PACK:ASS'Y	U012	5
M1545699	(EU/AA):POWER SUPPLY CORD:25 0V:10A	ACCESSORIES	5
M1560452	(CHN):HOLDER:HAND SET	ACCESSORIES	6
M1560462	(CHN):HAND SET:SUB-ASS'Y	ACCESSORIES	7
M1561240	EXTENSION TRAY:MF:ASS'Y	U001	12
M1561250	COVER:UPPER:MFP	U001	13
M1561254	SHAFT:TURN:SCANNER:LEFT	U001	14
M1561256	SHAFT:TURN:SCANNER:RIGHT	U001	15
M1561259	(EU/AA):COVER:REAR MIDDLE	U001	16
M1561260	(CHN):COVER:REAR MIDDLE	U001	17
M1561272	COIL SPRING:SCANNER	U001	18
M1561392	GUIDE PLATE:SCANNER:OPEN AN D CLOSE	U001	19
M1561640	ADF:ASS'Y	U002_S001	1
M1562821	COVER:UPPER	U002_S001	2
M1562822	FRAME:PICKUP	U002_S001	3
M1562823	PICKUP ROLLER	U002_S001	4
M1562824	ARM:STOPPER	U002_S001	5

Exclusive Parts

Number	Part Name	Group	ID
M1562826	COIL SPRING:PICKUP	U002_S001	6
M1562828	GEAR:28T	U002_S001	7
M1562829	PAWL:PICKUP	U002_S001	8
M1562830	FEED ROLLER	U002_S001	9
M1562832	SHAFT:TRANSPORT ROLLER:UPPER PAPER FEED	U002_S001	10
M1562833	ARM:ORIGINAL SENSOR	U002_S001	11
M1562834	SHAFT:PICKUP	U002_S001	12
M1562835	GEAR:28T	U002_S001	13
M1562836	COIL SPRING:FEED ROLLER:UPPER	U002_S001	14
M1562837	COIL SPRING:PAWL	U002_S001	15
M1562838	ORIGINAL SENSOR	U002_S001	16
M1562839	TRANSPORT ROLLER	U002_S001	17
M1562841	FRAME:ADF	U002_S001	18
M1562842	SEPARATION PAD:ASS'Y	U002_S001	19
M1562843	SIDE FENCE:LEFT	U002_S001	20
M1562844	SIDE FENCE:RIGHT	U002_S001	21
M1562845	GROUND PLATE	U002_S001	22
M1562846	SCREW:3X4	U002_S001	23
M1562847	GEAR:21T	U002_S001	24
M1562848	GEAR:28T	U002_S001	25
M1562849	GEAR:37T	U002_S001	26
M1562850	GEAR:39T	U002_S001	27
M1562851	GEAR:46T	U002_S001	28
M1562852	GEAR:43T	U002_S001	29
M1562853	GEAR:53T	U002_S001	30
M1562854	GEAR:18T	U002_S001	31
M1562855	REGISTRATION SENSOR	U002_S001	32
M1562856	EXIT ROLLER	U002_S001	33
M1562857	PLAIN SHAFT BEARING:LEFT:EXIT ROLLER	U002_S001	34
M1562858	PLAIN SHAFT BEARING:RIGHT:EXIT ROLLER	U002_S001	35
M1562859	PLAIN SHAFT BEARING:LEFT:REGISTRATION ROLLER	U002_S001	36
M1562860	PLAIN SHAFT BEARING:RIGHT	U002_S001	37
M1562861	REGISTRATION ROLLER:ASS'Y	U002_S001	38

Number	Part Name	Group	ID
M1562862	ARM:REGISTRATION SENSOR	U002_S001	39
M1562863	FRAME:LOWER	U002_S001	40
M1562864	DISCHARGE BRUSH	U002_S001	41
M1562865	FRAME:MOTOR:ADF	U002_S001	42
M1562866	MOTOR:ADF	U002_S001	43
M1562868	COIL SPRING:PLATE:ADF	U002_S001	44
M1562869	PLATE:ADF	U002_S001	45
M1562871	COVER:ORIGINAL TRAY:EXTENSION TRAY:1	U002_S001	46
M1562872	COVER:ORIGINAL TRAY:EXTENSION TRAY:2	U002_S001	47
M1562881	COVER:MAIN	U002_S001	48
M1562882	COVER:MAIN:EXTENSION TRAY	U002_S001	49
M1562883	SCREW:3X10	U002_S001	50
M1562884	HINGE:LEFT:ASS'Y	U002_S001	51
M1562885	HINGE:RIGHT	U002_S001	52
M1562886	SHAFT:EXIT ROLLER	U002_S001	53
M1562887	EXIT ROLLER:DRIVEN	U002_S001	54
M1562888	SHAFT:PAPER FEED ROLLER:LOWER	U002_S001	55
M1562889	PAPER FEED ROLLER:LOWER	U002_S001	56
M1562890	COIL SPRING:REAR	U002_S001	57
M1562891	COVER:ADF:LOWER	U002_S001	58
M1562892	SCREW:3X8	U002_S001	59
M1562893	SPONGE:ADF	U002_S001	60
M1562894	COVER:REAR	U002_S001	61
M1562895	COVER:FRONT	U002_S001	62
M1562896	PAD:PICKUP	U002_S001	63
M1562898	SCREW:3X6	U002_S001	64
M1562899	SHEET:OUTLET	U002_S001	65
M2021779	DISCHARGE BRUSH:MECHANICAL SPRING CLUTCH	U002_S001	66
M2021780	GEAR:22T	U002_S001	67
M2021781	PAWL:MECHANICAL SPRING CLUTCH:M202	U002_S001	68
M2871043	COVER:U CONVEYER BELT:DUPLICATE	U013	30
M2871370	COVER:REAR LOWER	U001	20

Exclusive Parts

Number	Part Name	Group	ID
M2872871	COVER:MANUAL FEED TABLE	U005	70
M2872875	SIDE FENCE:MANUAL FEED:RIGH T	U005	71
M2872876	SIDE FENCE:MANUAL FEED:LEFT	U005	72
M2872878	RACK:MANUAL FEED	U005	73
M2872879	COMPRESSION SPRING:SIDE FEN CE:MANUAL FEED	U005	74
M2872881	BASE:MANUAL FEED TABLE	U005	75
M2874031	(EU/AA):FUSING UNIT:ASS'Y	U008_S001	47
M2874033	(CHN):FUSING UNIT:ASS'Y	U008_S002	48
M2874206	STRIPPER PAWLS	U008_S001	49
		U008_S002	49
M2874234	HOUSING:THERMOSTAT:ASS'Y	U008_S001	50
		U008_S002	50
M2874263	THERMISTOR	U008_S001	51
		U008_S002	51
M2874719	PIN:GUIDE:TRANSPORT	U010	46
M2874895	PIN:GUIDE:UPPER	U010	47
M2875311	(CHN):POWER SUPPLY UNIT:ASS' Y	U012	6
M2875312	(EU/AA):POWER SUPPLY UNIT:AS S'Y	U012	7
M2881089	CASE:USB	U013	31
M2881600	SCANNER:ASS'Y	U002	69
M2882632	DECAL:PICK-UP PAPER JAM	U001	21
M2891251	COVER:FRONT	U001	22
M2891252	BUTTON	U001	23
M2891253	(EU/AA):COVER:SIDE PLATE:LEFT	U001	24
M2891255	COVER:SIDE PLATE:RIGHT	U001	25
M2891264	(CHN):COVER:SIDE PLATE:LEFT	U001	26
M2895061	(EU/AA):PCB:FAX:ASS'Y	U012	8
M2895063	(CHN):PCB:FAX:ASS'Y	U012	9

Standard Parts



03603006N
SCREW - M3X6



04503008N
TAPPING SCREW - M3X8



04503010N
TAPPING SCREW - M3X10



04503012N
TAPPING SCREW:3X12



04513006N
TAPPING SCREW - 3X6



04513008N
TAPPING SCREW - M3X8

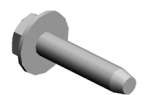

04513014N
TAPPING SCREW:3X14



04513030N
TAPPING SCREW:3X30



04523008N
TAPPING SCREW - M3X8



04523010N
BINDING SELF-TAPPING SCREW:3X10

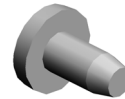

04533006N
TAPPING SCREW - M3X6



04543006Q
TAPPING SCREW - M3X6



04543008Q
TAPPING SCREW:3X8



04543014Q
TAPPING SCREW:3X14



07200040E
RETAINING RING - M4

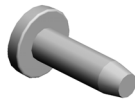

08025318
BINDING HEAD TAPPING SCREW:ES:3X10



08046127
HEXAGONAL BOLT:DOUBLE SCREW:M3X8



08050104
RETAINING RINGS-E:SILENCER:DIA4



08050106
RETAINING RINGS-E:SILENCER:DIA6



09504006N
SCREW - M4X6



09543010N
SCREW:POLISHED ROUND/SPRING:M3X10



11050197
WIRE SADDLE



11050568
CLAMP:LWSS-0504

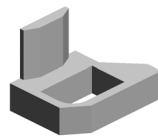

11050598
CLAMP:LWSS-1N



11050758
CLAMP:LWSM-0306A

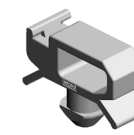

11050760
CLAMP:LWSM-0511A



11050761
CLAMP:LWS-0511A

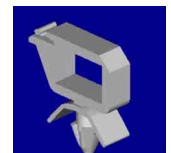

11050762
CLAMP:LWS-0711A

Standard Parts



12042612

MICRO SWITCH:D3V-16506-3
C25

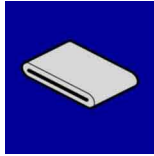

16072774

FERRITE CORE:K3 FF

