

Digital B&W Copiers
(M156/M157/M176/M177-NA)
Parts Catalog

Parts change information sample

 **Add**

 **Update**

 **Delete**

Unit All



U001
EXTERIOR



U002
ADF



U003
LASER UNIT



U004
PAPER FEED



U005
PCU



U006
TRANSFER/SEPARATION



U007
FUSING



U008
PAPER EXIT

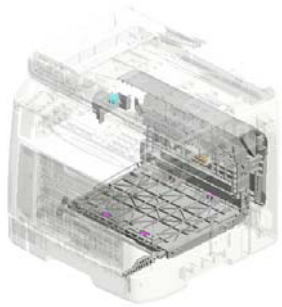

U009
DUPLEX



U010
MAIN DRIVE

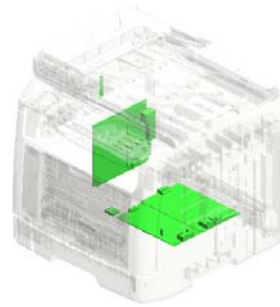

U011
ELECTRICAL

U001 EXTERIOR

3.AG070514
MAGNET CATCH

10.M1561240
EXTENSION TRAY:
MF:ASSY

13.M1561252
BUTTON

9.M1542632
DECAL:PICK-UP P
APER JAM

12.M1561251
COVER:FRONT



17.M1561256
SHAFT:TURN:SCA
NNER:RIGHT

11.M1561250
COVER:UPPER:MF
P

16.M1561255
COVER:SIDE PLAT
E:RIGHT:EU

15.M1561254
SHAFT:TURN:SCA
NNER:LEFT

1.04503008N
TAPPING SCREW -
M3X8

5.M1161370
COVER:REAR LO
WER

18.M1561259
COVER:REAR MID
DLE:EU

19.M1561272
COIL SPRING:SCA
NNER

14.M1561253
COVER:SIDE PLAT
E:LEFT:EU

20.M1561392
GUIDE PLATE:SCA
NNER:OPEN AND
CLOSE

4.G0521518
SPRING - LOCK LE
VER

7.M1341382
RAIL:SCANNER:OP
EN AND CLOSE

8.M1341386
RAIL:STOPPER:SC
ANNER:OPEN AND
CLOSE

2.04513006N
(x6)
TAPPING SCREW -
3X6

6.M1180501
SPEAKER:M118

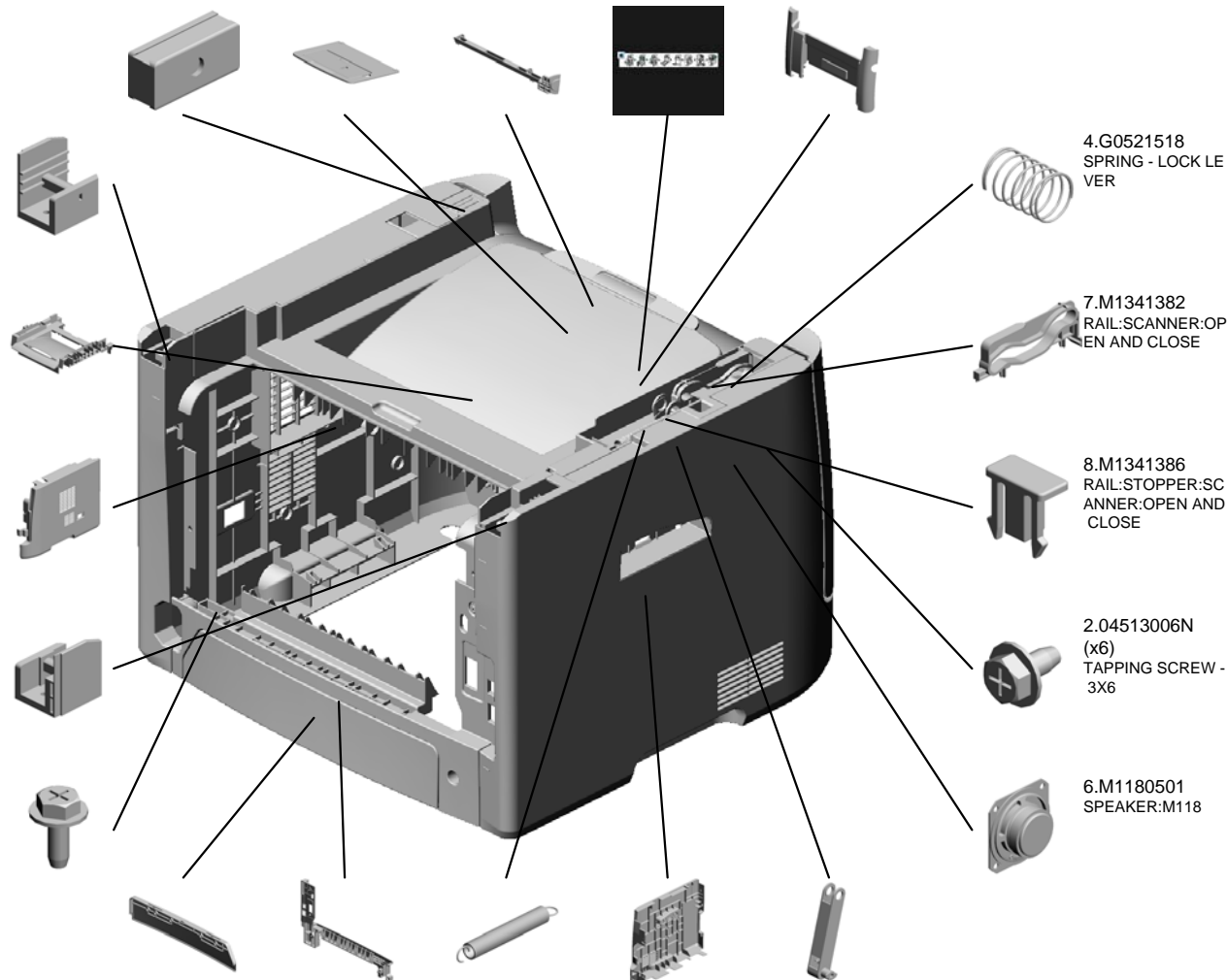

U002.ADF

U002_S001
M1561640
ADF:ASS'Y



U001	U002	U003	U004	U005	U006	U007	U008	U009	U010	U011
------	-------------	------	------	------	------	------	------	------	------	------

U002
ADF

1.M1561500
OPERATION PANE
L:ASSY:NA

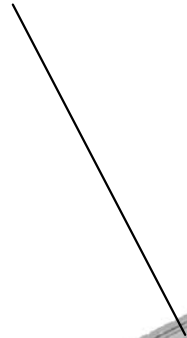

2.M1561600
SCANNER:ASSY

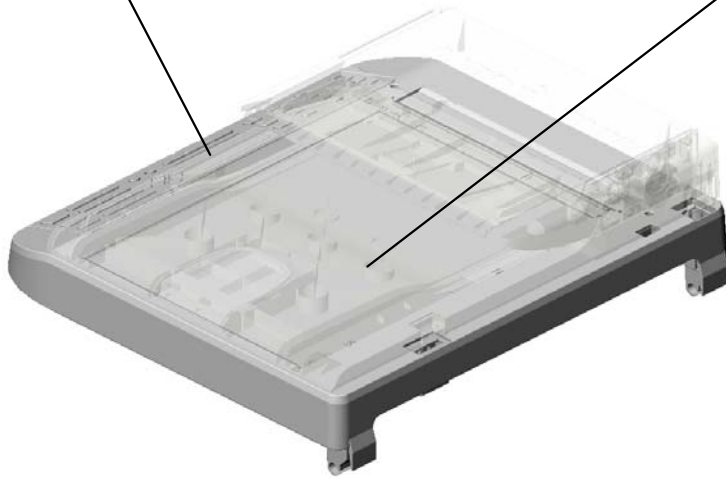

U002_S001
ADF:ASS'Y

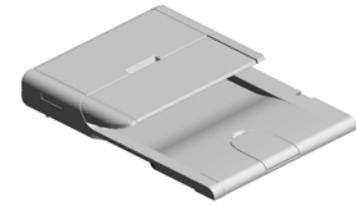

3.M1561640
[A]
ADF:ASS'Y
201501-01 X/O

4.M1562821 COVER:UPPER
5.M1562822 FRAME:PICKUP
11.M1562828 GEAR:28T
20.M1562837 COIL SPRING:PAWL
8.M2021780 GEAR:22T
201410-02 X/X

14.M1562831 TRANSPORT ROLLER

15.M1562832 SHAFT:TRANSPORT ROLLER:UPPER PAPER FEED

12.M1562829 PAWL:PICKUP

13.M1562830 FEED ROLLER

19.M1562836 COIL SPRING:FEED ROLLER:UPPER

23.M1562842 SEPARATION PAD: ASS'Y

24.M1562843 SIDE FENCE:LEFT

6.M1562823 PICKUP ROLLER

9.M1562826 COIL SPRING:PICKUP

22.M1562841 FRAME:ADF

18.M1562835 GEAR:28T

17.M1562834 SHAFT:PICKUP

10.M2021781 PAWL:MECHANICAL SPRING CLUTCH :M202
201410-01 X/X

16.M1562833 ARM:ORIGINAL SENSOR

7.M1562824 (x2)
ARM:STOPPER

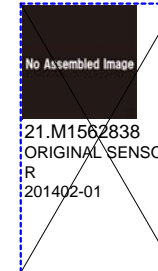

66.M1562899 (x2)
SHEET:OUTLET

U002_S001
ADF:ASS'Y

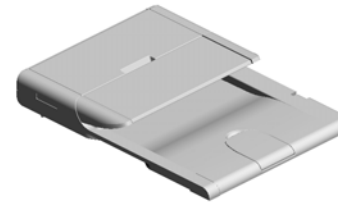

3.M1561640
[A]
ADF:ASS'Y
201501-01 X/O

35.M1562855 REGISTRATION SENSOR
31.M1562851 GEAR:46T
40.M1562860 PLAIN SHAFT BEARING:RIGHT
33.M1562853 GEAR:53T
30.M1562850 GEAR:39T

41.M1562861 REGISTRATION ROLLER:ASSY

42.M1562862 ARM:REGISTRATION SENSOR

43.M1562863 FRAME:LOWER

38.M1562858 PLAIN SHAFT BEARING:RIGHT:EXIT ROLLER

37.M1562857 PLAIN SHAFT BEARING:LEFT:EXIT ROLLER

36.M1562856 EXIT ROLLER

35.M1562855 REGISTRATION SENSOR
201402-02

34.M1562854 GEAR:18T

32.M1562852 GEAR:43T

25.M1562844 SIDE FENCE:RIGHT

29.M1562849 GEAR:37T

28.M1562848 GEAR:28T

26.M1562845 GROUND PLATE

27.M1562847 GEAR:21T

39.M1562859 PLAIN SHAFT BEARING:LEFT:REGISTRATION ROLLER

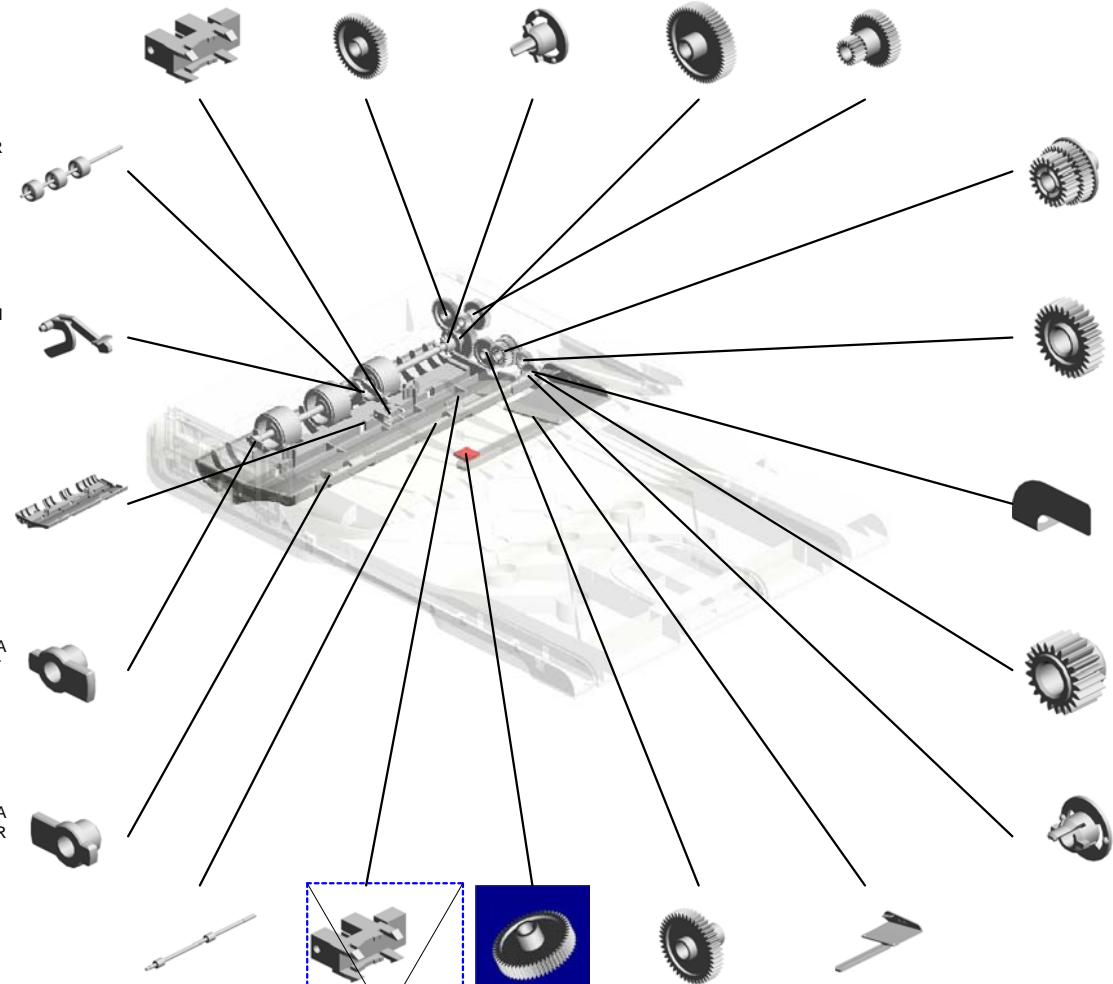

U002_S001
ADF:ASS'Y

58.M1562889
(x2)
PAPER FEED ROLLER:LOWER

48.M1562869
PLATE:ADF

53.M1562884
HINGE:LEFT:ASS'Y

45.M1562865
FRAME:MOTOR:ADF

46.M1562866
MOTOR:ADF

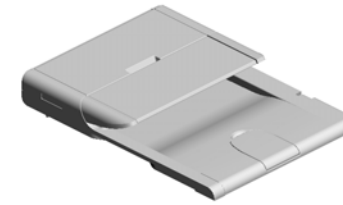

3.M1561640
[A]
ADF:ASS'Y
201501-01 X/O

57.M1562888
SHAFT:PAPER FEED ROLLER:LOWER

60.M1562891
COVER:ADF:LOWER

59.M1562890
(x4)
COIL SPRING:REAR

55.M1562886
(x2)
SHAFT:EXIT ROLLER

47.M1562868
(x2)
COIL SPRING:PLATE:ADF

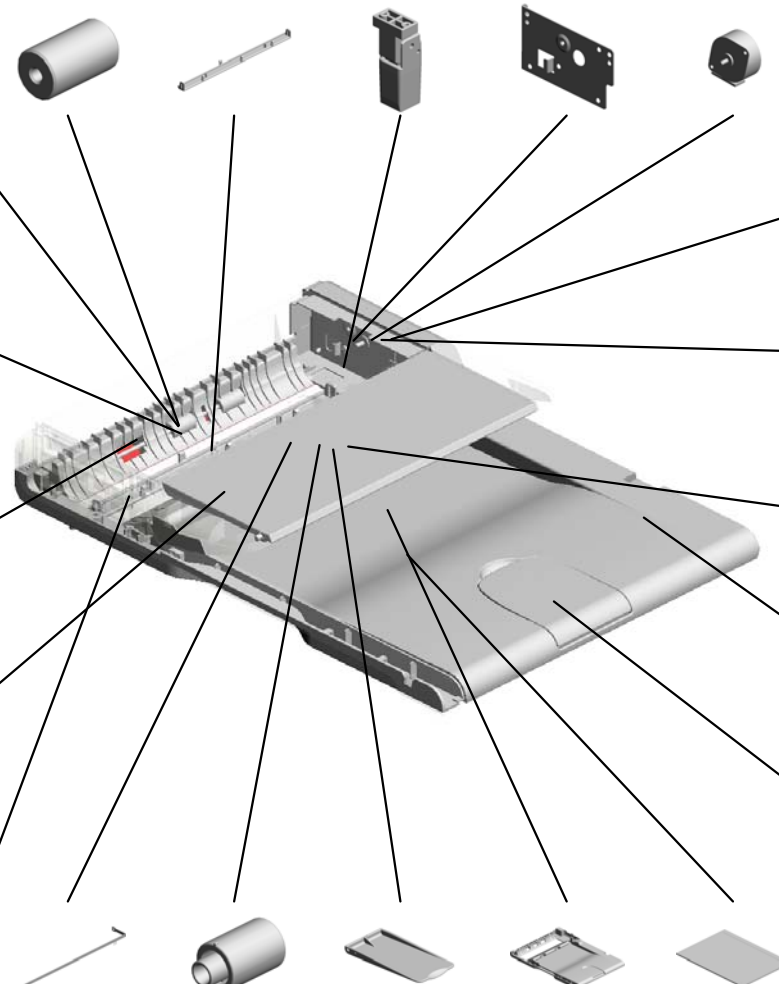

61.M1562892
(x5)
SCREW:3X8

63.M1562894
COVER:REAR

49.M1562871
COVER:ORIGINAL TRAY:EXTENSION TRAY:1

54.M1562885
HINGE:RIGHT

52.M1562882
COVER:MAIN:EXTENSION TRAY

44.M1562864
DISCHARGE BRUSH

56.M1562887
(x2)
EXIT ROLLER:DRIVEN

50.M1562872
COVER:ORIGINAL TRAY:EXTENSION TRAY:2

51.M1562881
COVER:MAIN

62.M1562893
SPONGE:ADF

U002_S001
ADF:ASS'Y

68.M2021779
DISCHARGE BRUS
H:MECHANICAL SP
RING CLUTCH
201410-03



67.M1562896
PAD:PICKUP
201405-01



65.M1562898
SCREW:3X6

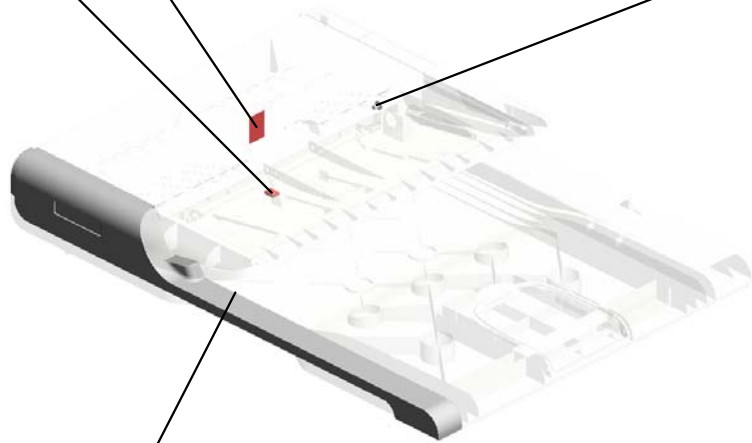

64.M1562895
COVER:FRONT

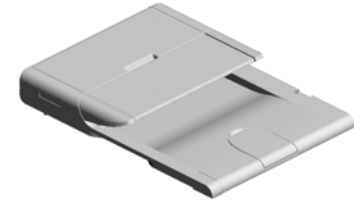

3.M1561640
[A]
ADF:ASS'Y
201501-01 X/O



M1561630
[A]
ADF:ASS'Y
201501-01 X/O

U003.LASER UNIT

U003_S001
M1541851
IMAGING UNIT:ASS'Y

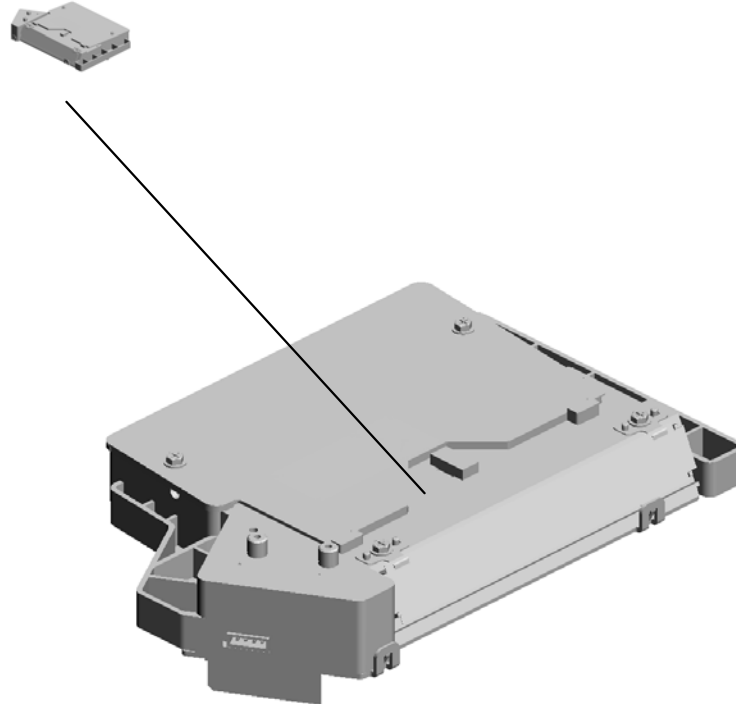

U001	U002	U003	U004	U005	U006	U007	U008	U009	U010	U011
------	------	------	------	------	------	------	------	------	------	------

U003
LASER UNIT

5.04543008Q
(x3)
TAPPING SCREW:
3X8

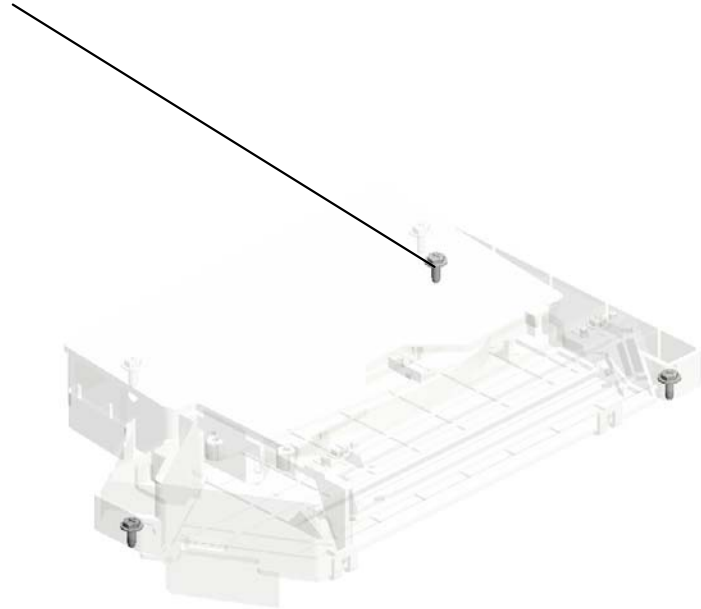
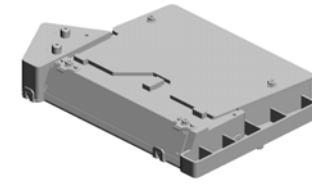

U001	U002	U003	U004	U005	U006	U007	U008	U009	U010	U011
------	------	------	------	------	------	------	------	------	------	------

U003_S001
IMAGING UNIT:ASS'Y

3.04523008N
(x4)
TAPPING SCREW -
M3X8

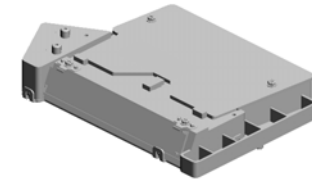

6.M1541851
IMAGING UNIT:AS
SY

4.04523010N
BINDING SELF-TA
PPING SCREW:3X
10

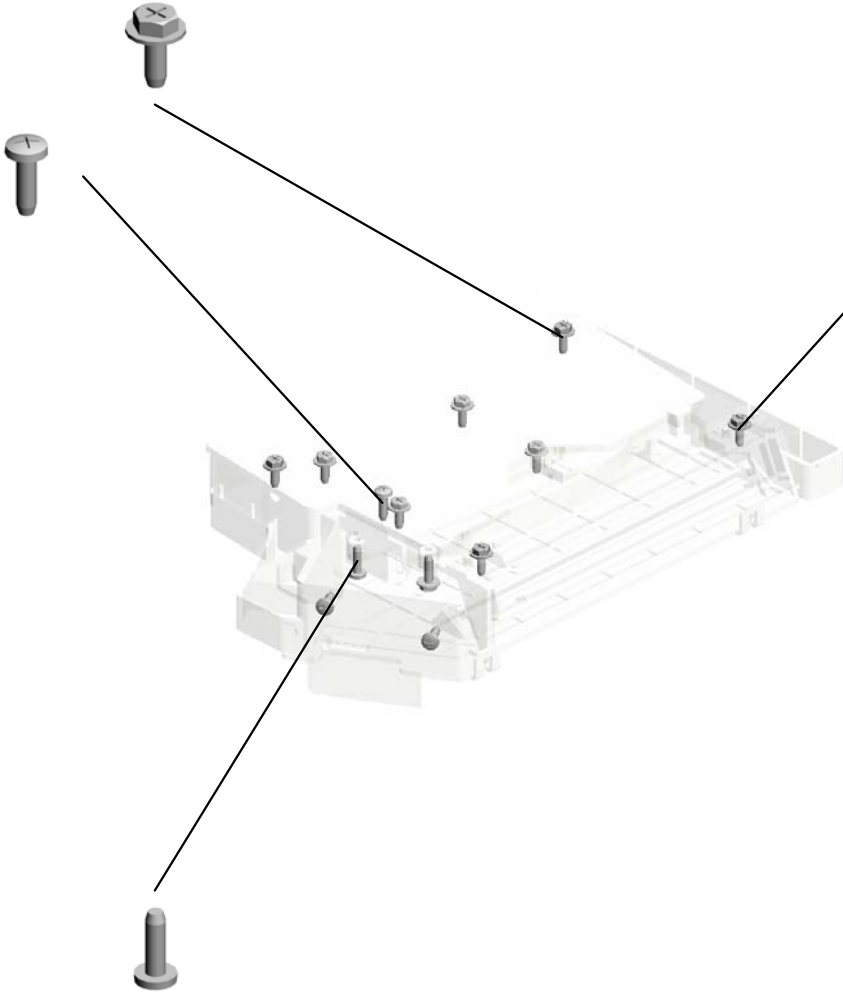

1.04503008N
(x6)
TAPPING SCREW -
M3X8

2.04503012N
(x2)
TAPPING SCREW:
3X12

U001	U002	U003	U004	U005	U006	U007	U008	U009	U010	U011
------	------	------	------	------	------	------	------	------	------	------

U004.PAPER FEED

U004_S002
M1542532
MANUAL FEED TABLE:ASS'Y

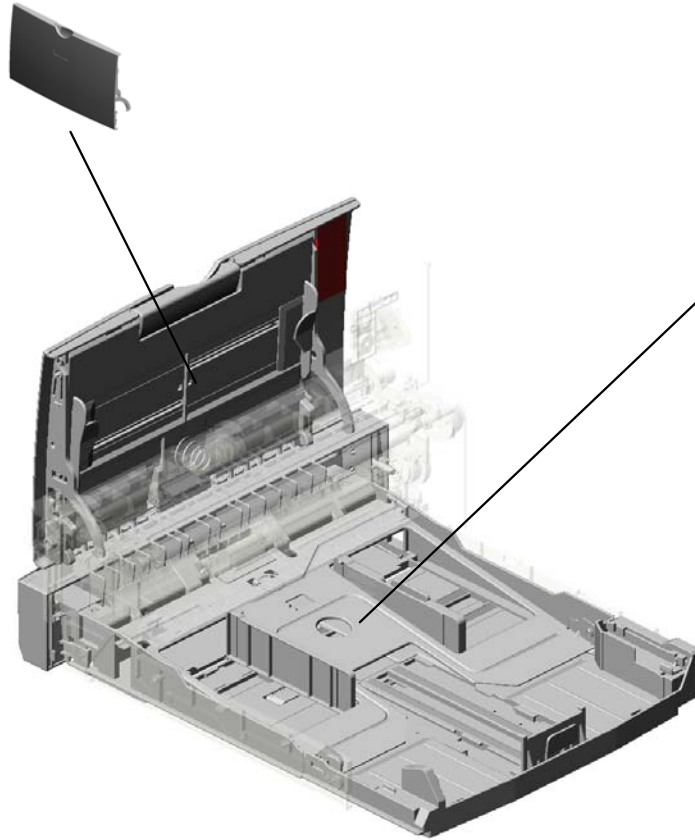

U004_S001
M1542505
PAPER TRAY:ASS'Y

U001	U002	U003	U004	U005	U006	U007	U008	U009	U010	U011
------	------	------	------	------	------	------	------	------	------	------

U004_S001.PAPER TRAY:ASS'Y

U004_S001_S001
M0122610
TRAY BOTTOM PLATE

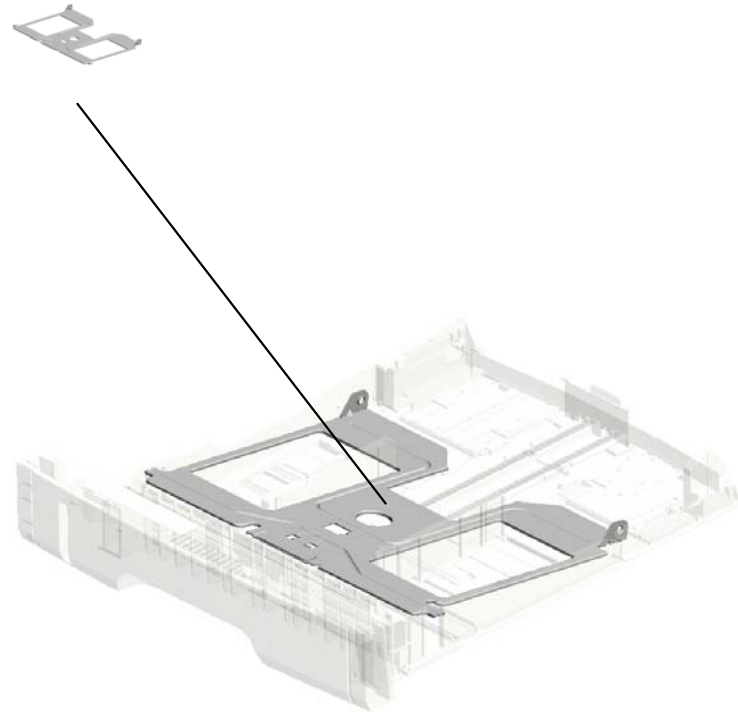

U001	U002	U003	U004	U005	U006	U007	U008	U009	U010	U011
------	------	------	------	------	------	------	------	------	------	------

U004 PAPER FEED

10.G0292767
BY-PASS FEED COVER

33.M0122702
ROLLER:INTERF
ACE:DRIVEN

32.M0122701
ROLLER:INTERF
ACE:DRIVE

3.04523010N
BINDING SELF-TA
PPING SCREW:3X
10

11.G1022717
COVER:DC SOLEN
OID



34.M0122705
(x2)
SPRING:ROLLER

13.G1022789
STOPPER:PHOTOI
NTERRUPTOR

1.04503008N
(x2)
TAPPING SCREW -
M3X8

28.M0122631
CLOTH:EARTH:PA
PER FEED

9.G0201160
(x2)
SNAP RING

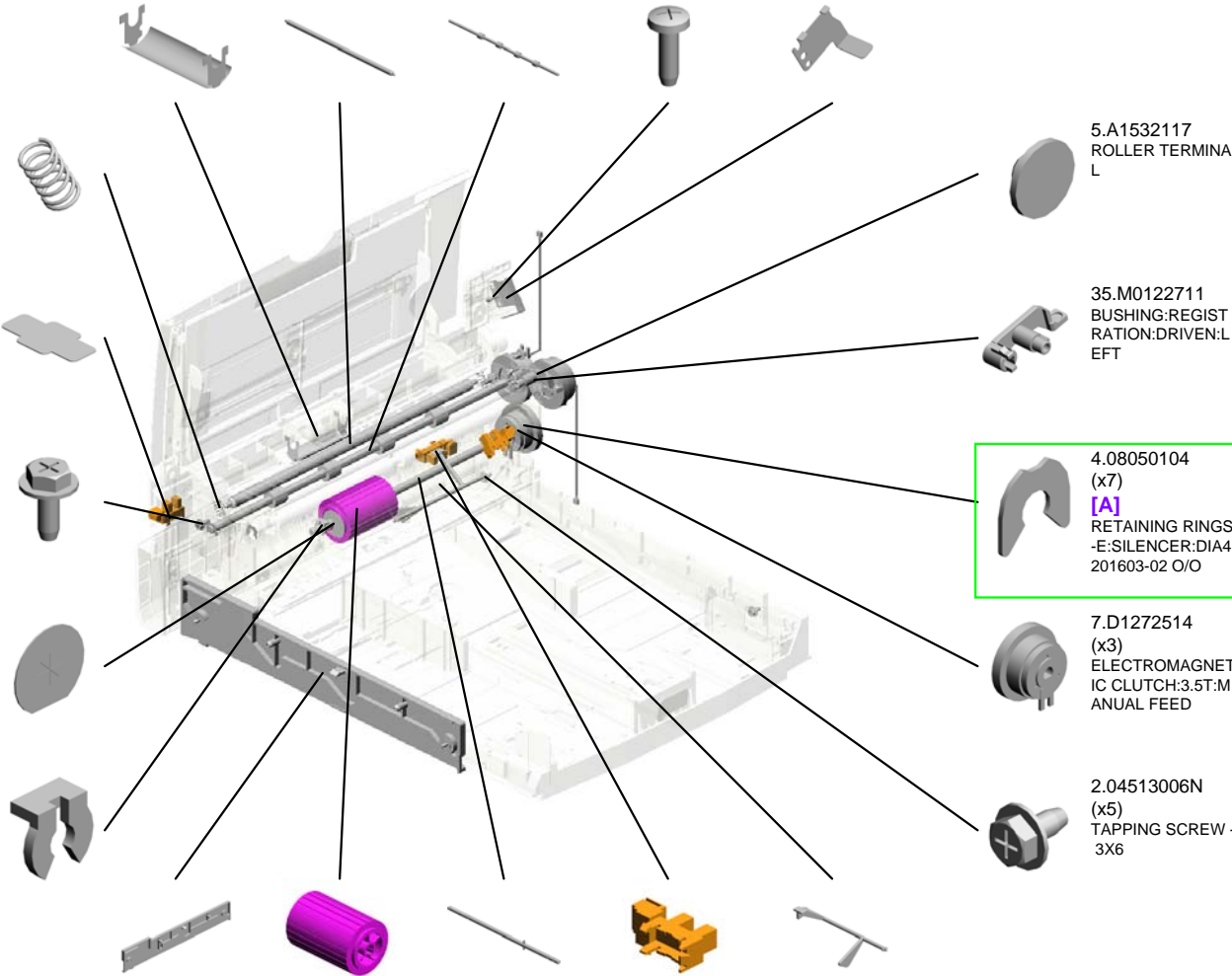

5.A1532117
ROLLER TERMINA
L

35.M0122711
BUSHING:REGIST
RATION:DRIVEN:L
EFT

4.08050104
(x7)
[A]
RETAINING RINGS
-E:SILENCER:DIA4
201603-02 O/O

7.D1272514
(x3)
ELECTROMAGNET
IC CLUTCH:3.5T:M
ANUAL FEED

2.04513006N
(x5)
TAPPING SCREW -
3X6

31.M0122673
RAIL:PAPER TRAY:
RIGHT

14.G1272627
PAPER FEED ROLL
ER - MM32

29.M0122668
SHAFT:PAPER FEE
D:ASSY

6.AW020198
(x3)
PHOTOINTERRUP
TOR:LG2A14NL1

30.M0122671
FEELER:PAPER E
ND SENSOR

U004 PAPER FEED

57.M0122880 COMPRESSION SPRING:SEPARATION
 54.M0122859 GUIDE PLATE:UPPER:MANUAL FEED
 50.M0122816 FRICTION PAD:HOLDER:MANUAL FEED:ASSY
 55.M0122860 PAPER FEED ROLLER:MANUAL FEED
 49.M0122806 SHEET:GUIDE:MANUAL FEED SUB-UNIT



45.M0122743 DECAL:GUIDE PLATE:TRANSPORT:UPPER

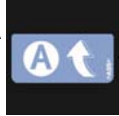

51.M0122824 FEELER:MANUAL FEED



47.M0122745 GROUND PLATE:DRIVEN



39.M0122722 (x2) SPRING:ROLLER:REGISTRATION



42.M0122730 BUSHING:REGISTRATION:DRIVEN:RIGHT



36.M0122715 GUIDE PLATE:TRANSPORT:UPPER

38.M0122719 REGISTRATION ROLLER:DRIVEN

37.M0122718 REGISTRATION ROLLER:DRIVE

40.M0122723 FEELER:REGISTRATION:SENSOR

46.M0122744 (x2) GUIDE:REGISTRATION

52.M0122830 MECHANICAL SPRING CLUTCH:MANUAL FEED



44.M0122742 GROUND PLATE:DRIVEN:REGISTRATION ROLLER



48.M0122753 (x2) BUSHING:ROLLER:DRIVEN



43.M0122741 GROUND PLATE:DRIVEN:REGISTRATION ROLLER



41.M0122725 SPRING:FEELER:REGISTRATION



U004 PAPER FEED

69.M1542831
DC SOLENOID:9.6
W:24V



67.M1542805
GUIDE PLATE:MAN
UAL FEED:LOWER

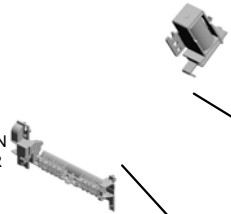

59.M1162672
RAIL:PAPER TRAY:
LEFT

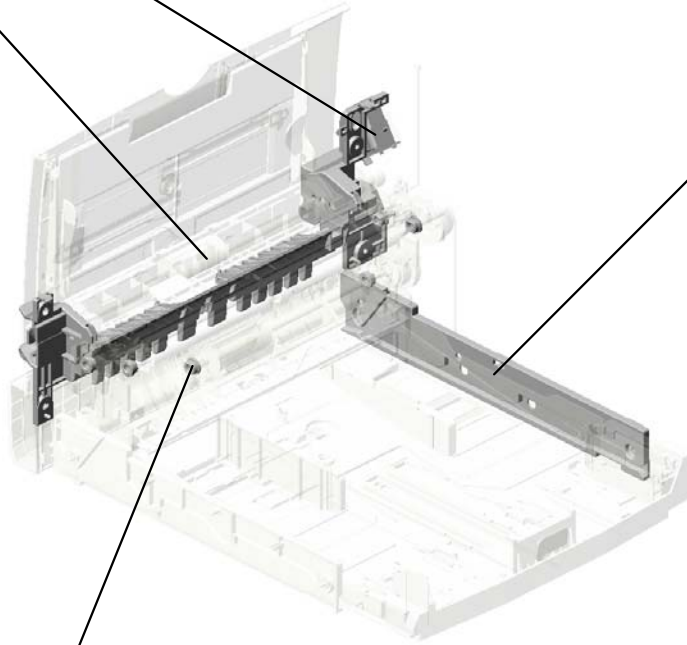

58.M0124488
(x6)
BUSHING:DIA6XDI
A10X6



08050089
[A]
RETAINING RING -
M4
201603-02 O/O

U001	U002	U003	U004	U005	U006	U007	U008	U009	U010	U011
------	------	------	------	------	------	------	------	------	------	------

U004_S001 PAPER TRAY:ASS'Y

25.M0122613 COMPRESSION SPRING:SEPARATION
 21.M0122605 FRICTION PAD:ADHESION
 20.M0122604 SPRING:RELEASE:TRAY BOTTOM PLATE
 18.M0122590 COIL SPRING:EAR TH

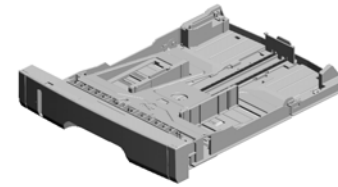

60.M1542505
[A]
 PAPER TRAY:ASS'Y
 201503-01 O/O

65.M1542640 COVER:PAPER TRAY:LEFT



63.M1542618 DECAL:PAPER TRAY:FRONT



62.M1542616 LEVER:PAPER VOLUME SENSOR



64.M1542629 COVER:PAPER TRAY:MIDDLE



22.M0122608 END FENCE

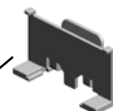

17.M0122589 PAPER TRAY:REAR



26.M1542614 SIDE FENCE:LEFT 201401-01



27.M0122615 SIDE FENCE:RIGHT



24.M0122612 COMPRESSION SPRING:TRAY BOTTOM PLATE
 66.M1542641 COVER:PAPER TRAY:RIGHT
 15.G8003133 SIDE FENCE GEAR
 19.M0122603 STOPPER:BASE PLATE

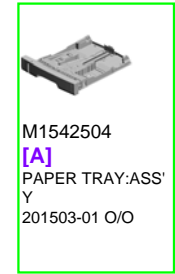
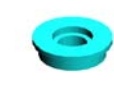

M1542504
[A]
 PAPER TRAY:ASS'Y
 201503-01 O/O

U004_S001_S001
TRAY BOTTOM PLATE

16.GF013001
BOTTOM PLATE P
AD

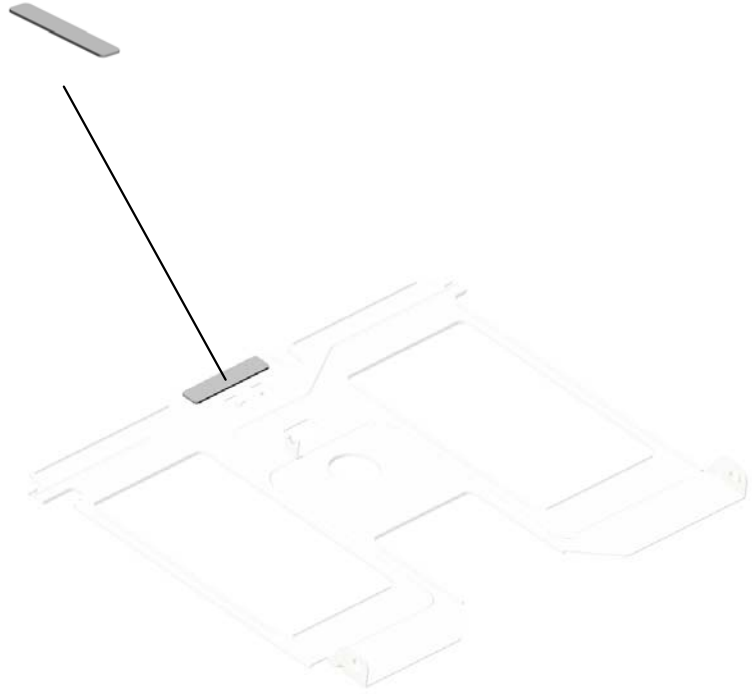

23.M0122610
TRAY BOTTOM PL
ATE

U001	U002	U003	U004	U005	U006	U007	U008	U009	U010	U011
------	------	------	------	------	------	------	------	------	------	------

U004_S002
MANUAL FEED TABLE:ASS'Y

73.M1542879 EXTENSION TRAY:MANUAL FEED
8.G0123050 SIDE FENCE GEAR
12.G1022755 (x2) RACK:SIDE FENCE:REAR

61.M1542532 MANUAL FEED TABLE:ASS'Y

53.M0122833 DECAL:SIDE FENCE:MANUAL FEED



71.M1542875 SIDE FENCE:MANUAL FEED:RIGHT



68.M1542815 DECAL:FEED PAPER AGAIN:PREVENTION:EXP



72.M1542877 SIDE FENCE:MANUAL FEED:LEFT



70.M1542870 COVER:MANUAL FEED TABLE



56.M0122874 COMPRESSION SPRING:MANUAL FEED
16.GF013001 BOTTOM PLATE PAD

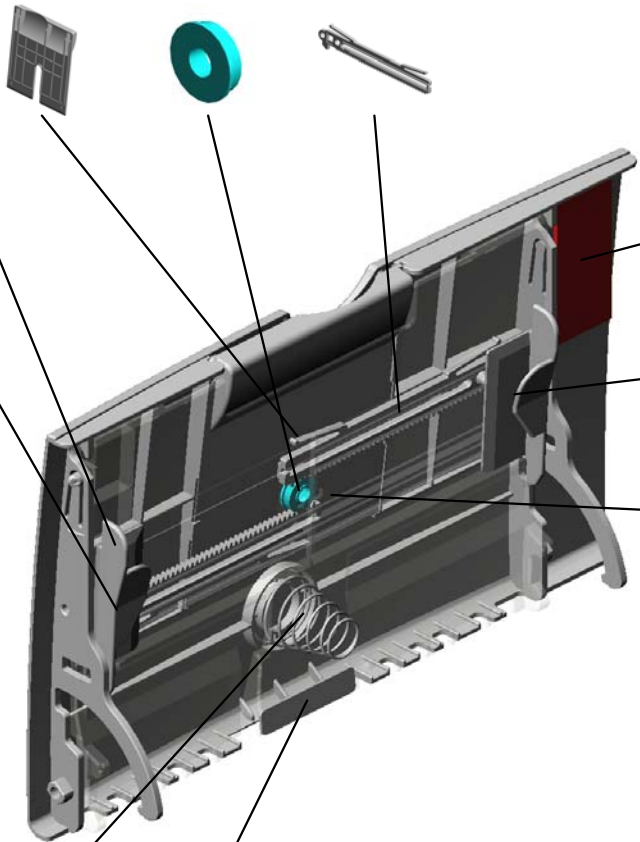

U005
PCU

2.04523010N
(x2)
BINDING SELF-TAP-
PING SCREW:3X
10

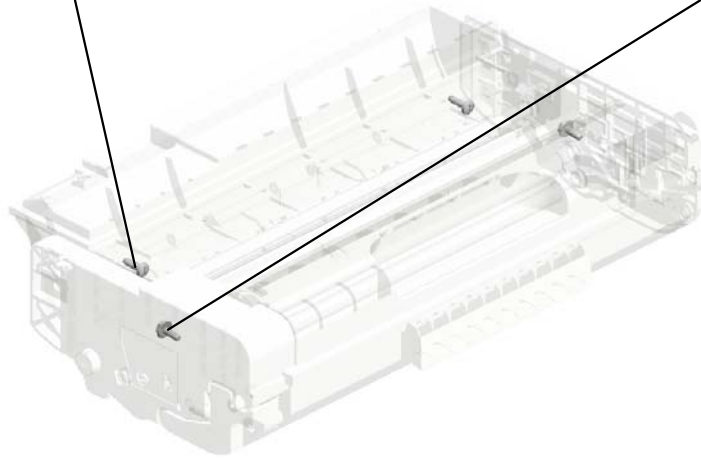

1.04503008N
(x2)
TAPPING SCREW -
M3X8



U001	U002	U003	U004	U005	U006	U007	U008	U009	U010	U011
------	------	------	------	------	------	------	------	------	------	------

U006 TRANSFER/SEPARATION

6.M1016250
TRANSFER ROLLER
R

5.M0126260
COVER:ELECTRO
DE PLATE

7.M1016259
ELECTRODE PLAT
E:SEPARATION



4.M0126256
ROLLER:POSITION
ING:TRANSFER R
OLLER

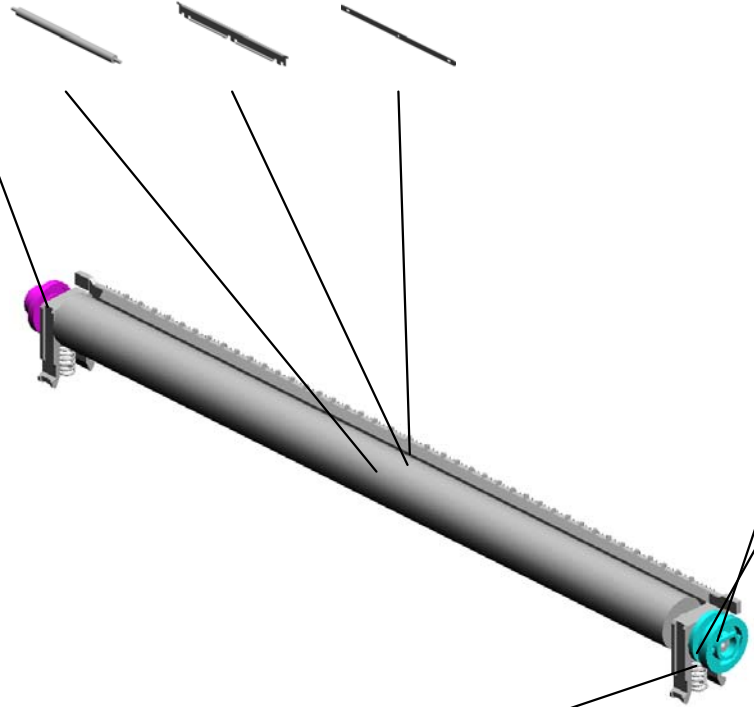

3.M0126255
GEAR:TRANSFER
ROLLER



1.M0126252
(x2)
BUSHING:TRANSF
ER ROLLER:RIGHT



2.M0126254
(x2)
SPRING:TRANSFE
R ROLLER



U001	U002	U003	U004	U005	U006	U007	U008	U009	U010	U011
------	------	------	------	------	------	------	------	------	------	------

U007.FUSING

U007_S001
M1544030
FUSING UNIT:NA:ASS'Y

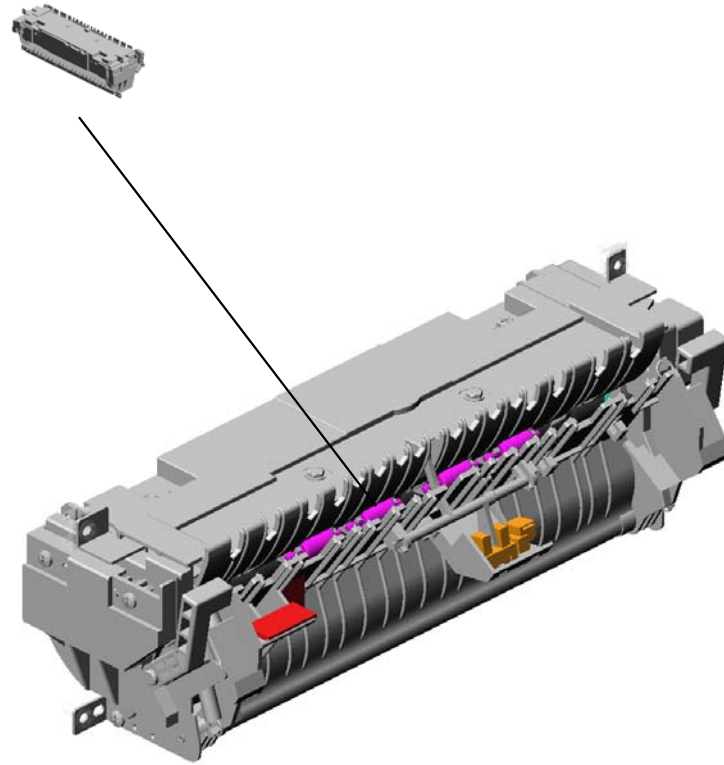

U001	U002	U003	U004	U005	U006	U007	U008	U009	U010	U011
------	------	------	------	------	------	------	------	------	------	------

U007 FUSING

4.04513008N
(x2)
TAPPING SCREW -
M3X8

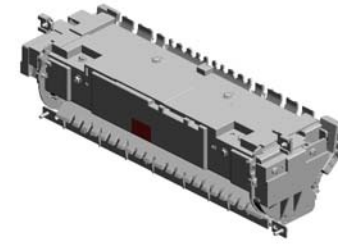

39.M0124270
(x2)
THERMAL INSULA
TING BUSHING:FU
SING UNIT

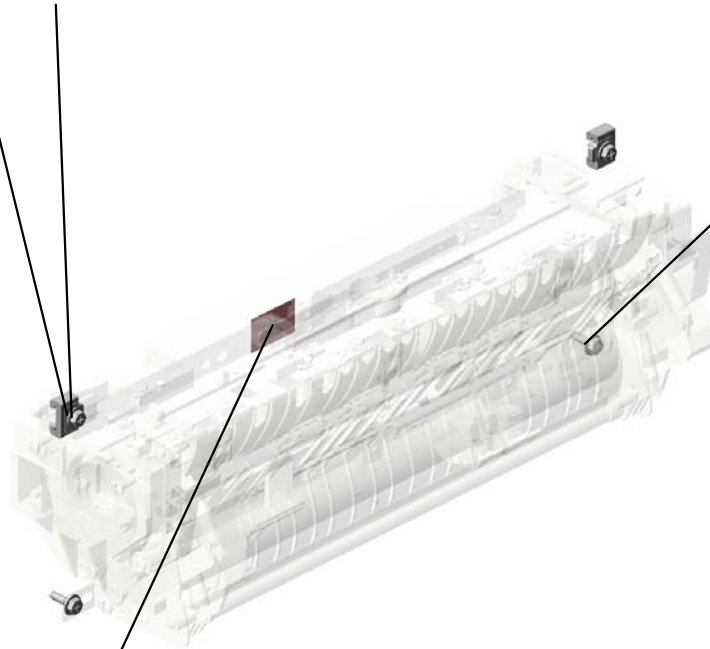

2.04503010N
(x2)
TAPPING SCREW -
M3X10



50.M0124699
DECAL:WARNING (HIGH TEMPERATU
RE):FRONT

U001	U002	U003	U004	U005	U006	U007	U008	U009	U010	U011
------	------	------	------	------	------	------	------	------	------	------

U007_S001
FUSING UNIT:NA:ASS'Y

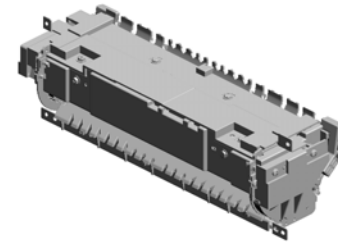

51.M1544030
FUSING UNIT:NA:ASS'Y

- 8.08046127 (x4) HEXAGONAL BOLT :DOUBLE SCREW: M3X8
- 12.AW110058 THERMOSTAT:177
- 1.03603006N (x11) SCREW - M3X6
- 7.08025318 (x4) BINDING HEAD TAPPING SCREW:ES: 3X10
- 20.M0124186 COVER:LEFT UPPER:ASS'Y

9.09543010N SCREW:POLISHED ROUND/SPRING:M 3X10

10.AA143520 (x7) SHOULDER SCREW - M3

18.M0124123 HEATER:700W:120V

13.G1274328 DECAL - HIGH TEMPERATURE

5.04533006N (x6) TAPPING SCREW - M3X6

19.M0124135 FEELER:PAPER FEELER SENSOR

16.M0124109 SPRING:FEELER:EXIT

11.AW020198 PHOTOINTERRUPTOR:LG2A14NL1

4.04513008N (x4) TAPPING SCREW - M3X8

21.M0124202 (x2) LEVER:PRESSURE

3.04513006N (x2) TAPPING SCREW - 3X6

14.M0124053 GEAR:HOT ROLLER

15.M0124055 (x2) RADIAL BALL BEARING:35X47X7

17.M0124120 (x3) TENSION SPRING: PICKOFF PAWL

6.07200040E (x2) RETAINING RING - M4



U007_S001
FUSING UNIT:NA:ASS'Y

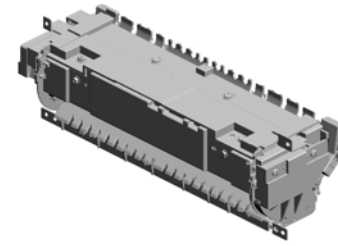

51.M1544030
FUSING UNIT:NA:ASS'Y

- 42.M0124281 (x2) RETAINING RINGS -C:HOT ROLLER
- 27.M0124212 FUSING ENTRANCE GUIDE PLATE:UPPER
- 37.M0124263 THERMISTOR:FUSING
- 32.M0124220 HOT ROLLER
- 35.M0124234 HOUSING:THERMOSTAT:ASS'Y

23.M0124205 LEVER:RIGHT:FRAME:FUSING

33.M0124223 THERMAL INSULATING BUSHING:HOT ROLLER

26.M0124211 PLATE NUT:HEATER

38.M0124266 COVER:RIGHT LOWER:FUSING

28.M0124213 (x2) BUSHING:PRESSURE ROLLER

31.M0124217 FUSING ENTRANCE GUIDE PLATE:LOWER

41.M0124279 CLEANING ROLLER:ASS'Y

36.M0124253 PRESSURE ROLLER:DIA30

29.M0124215 GUIDE PLATE:EXIT

24.M0124206 (x3) STRIPPER PAWLS

22.M0124204 LEVER:LEFT:FRAME:FUSING

40.M0124276 COVER:LEFT:LOWER:FUSING

25.M0124208 (x3) BRACKET:GATE PAWL

34.M0124229 (x2) TENSION SPRING:FUSING:PRESSURE

30.M0124216 (x2) TENSION SPRING:FUSING:GUIDE PLATE

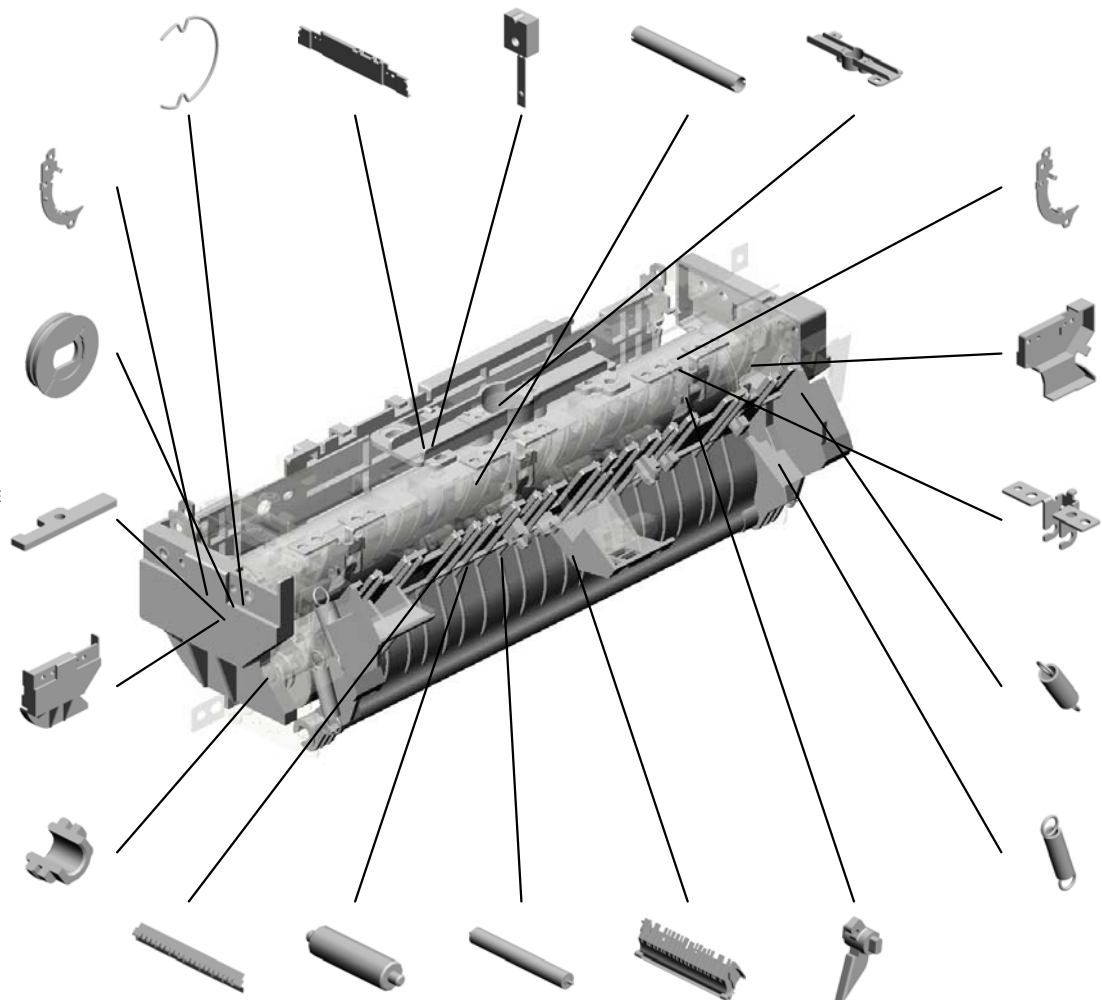

U007_S001
FUSING UNIT:NA:ASS'Y

48.M0124295 GROUND PLATE:ASS'Y
 43.M0124284 LEVER:PRESSURE:LEFT
 46.M0124292 FUSING COVER:UPPER

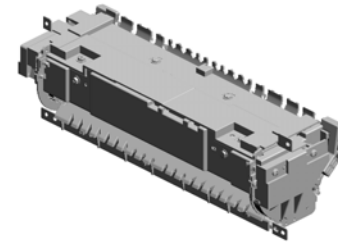

51.M1544030
FUSING UNIT:NA:ASS'Y

45.M0124287
COVER:RIGHT UPPER:FUSING



44.M0124285
LEVER:PRESSURE:RIGHT



47.M0124293
(x4)
EXIT ROLLER:EXIT:FUSING

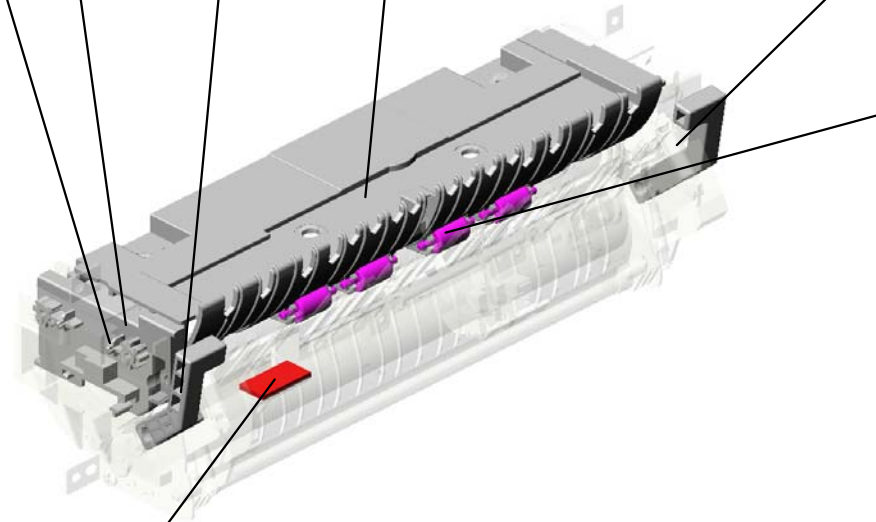

49.M0124603
DECAL:GUIDE PLATE:B

U001	U002	U003	U004	U005	U006	U007	U008	U009	U010	U011
------	------	------	------	------	------	------	------	------	------	------

U008 PAPER EXIT

8.M0134470
EXIT ROLLER:DUP
LEX

3.M0124453
EXIT ROLLER

4.M0124454
SPRING:EXIT ROL
LER:EXIT

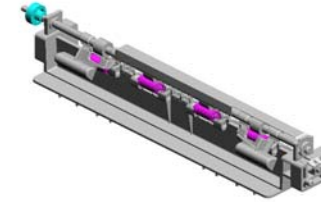

5.M0124458
DISCHARGE BRUS
H:EXIT:ASS'Y DRA
WING

9.M1544499
GROUND PLATE:E
XIT ROLLER



7.M0134455
GEAR:DRIVE:EXIT
ROLLER

2.07200040E
(x2)
RETAINING RING -
M4

6.M0124488
(x2)
BUSHING:DIA6XDI
A10X6

1.04503008N
(x2)
TAPPING SCREW -
M3X8

U001	U002	U003	U004	U005	U006	U007	U008	U009	U010	U011
------	------	------	------	------	------	------	------	------	------	------

U009 DUPLEX

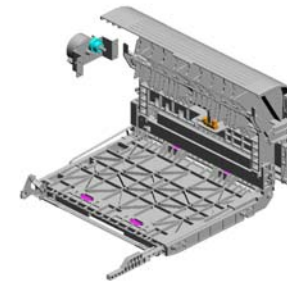

- 12.M0134611 BRACKET:DRIVE:DUPL
EX:ASS'Y
- 11.M0134610 GEAR:DRIVE:DUPL
EX
- 3.04533006N (x2)
TAPPING SCREW -
M3X6
- 4.04543006Q (x4)
TAPPING SCREW -
M3X6
- 17.M0134661 STOPPER:TRANSP
ORT SUB-UNIT:DU
PLEX

- 2.04503010N (x2)
TAPPING SCREW -
M3X10

- 5.07200040E (x2)
RETAINING RING -
M4

- 7.08050104 (x7)
[B]
RETAINING RINGS
-E:SILENCER:DIA4
201603-02 O/O

- 16.M0134635 SPRING:OPEN AN
D CLOSE:RIGHT

- 6.08050106 (x7)
[A]
RETAINING RINGS
-E:SILENCER:DIA6
201603-01 O/O

- 13.M0134622 (x4)
EXIT ROLLER:DUPL
EX

- 14.M0134623 (x2)
SPRING:EXIT

- 9.G0961019 (x2)
TRANSPORT GUID
E PIN

- 10.M0124488 (x4)
BUSHING:DIA6XDI
A10X6

- 1.04503008N (x4)
TAPPING SCREW -
M3X8

- 19.M0134664 GUIDE PLATE:VER
TICAL TRANSPOR
T:UPPER

- 20.M0134666 SHAFT:COVER:SW
ITCHBACK:OPEN A
ND CLOSE

- 8.AW020198 (x2)
PHOTOINTERRUP
TOR:LG2A14NL1

- 18.M0134663 GUIDE PLATE:VER
TICAL TRANSPOR
T:LOWER

- 15.M0134624 (x2)
SPRING:EXIT:NO.2

U009 DUPLEX

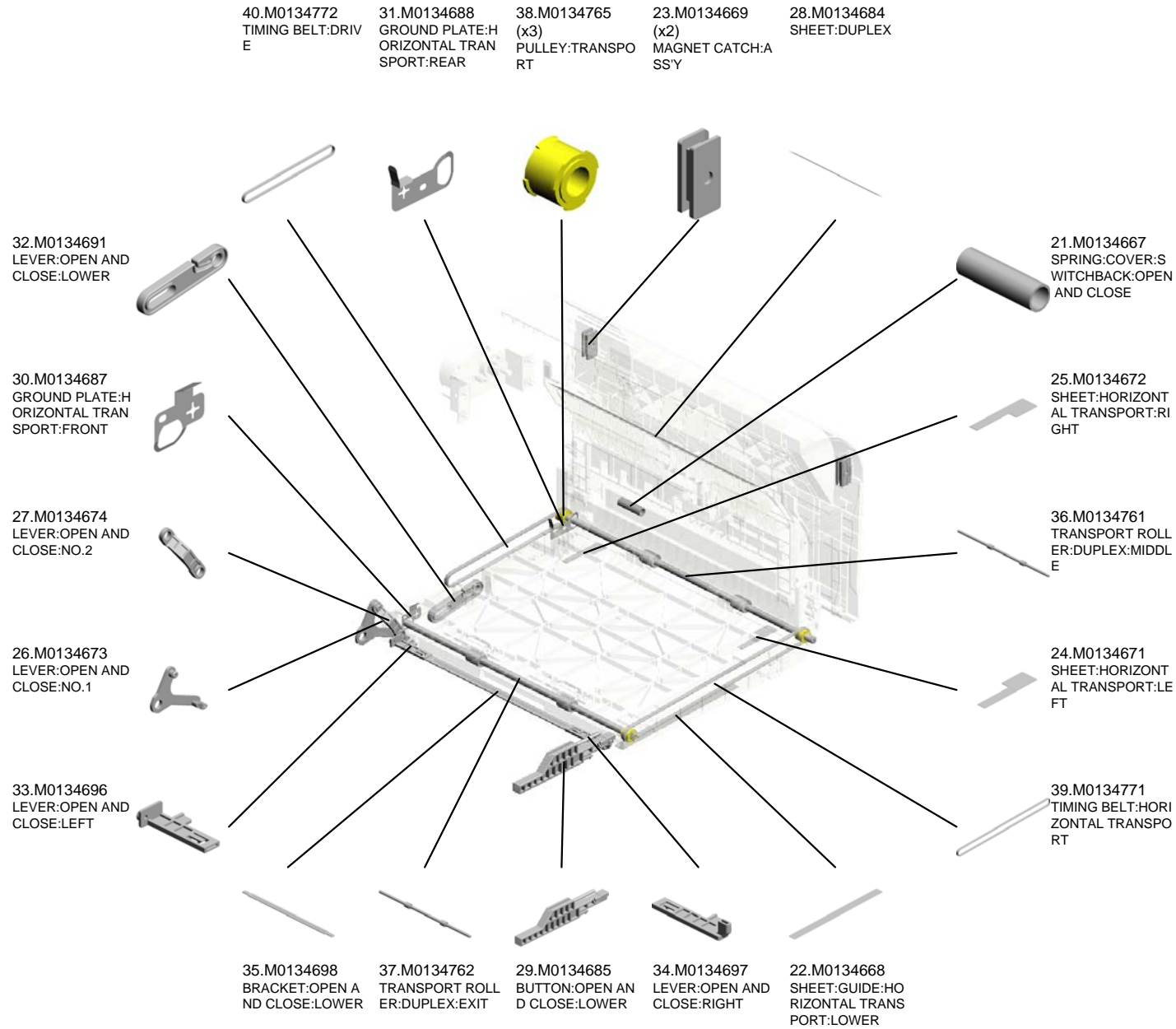

U009 DUPLEX

43.M0134794
DECAL:GUIDE PLATE:VERTICAL TRANSPORT:UPPER

46.M1174662
COVER:SWITCHBACK:OPEN AND CLOSE

45.M0134797
FEELER:SENSOR:VERTICAL TRANSPORT

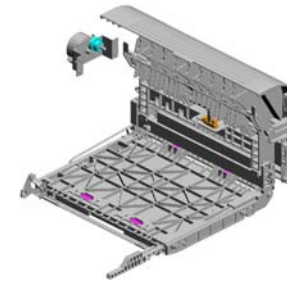

47.M1540265
STEPPER MOTOR



41.M0134778
FEELER:SENSOR:HORIZONTAL TRANSPORT

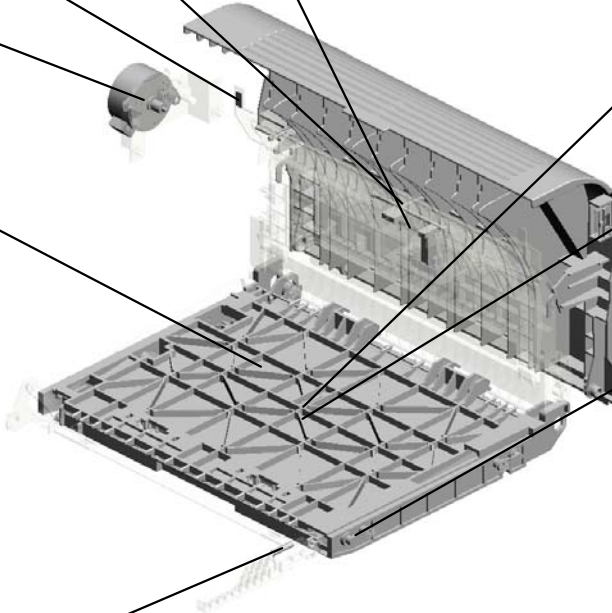

48.M1544694
GUIDE:HORIZONTAL TRANSPORT:UPPER

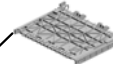

49.M1544695
GUIDE:HORIZONTAL TRANSPORT:LOWER



44.M0134795
(x4)
PIN:GUIDE:UPPER

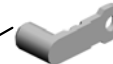

42.M0134785
SPRING:COVER:SWITCHBACK:OPEN AND CLOSE

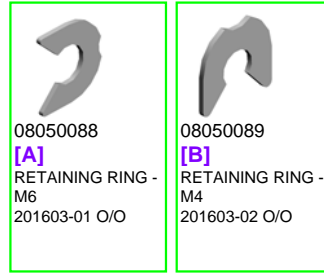

U010 MAIN DRIVE

- 17.AX640199 FAN:MM80:25MM:D C 2.16W
- 4.04513030N (x2) TAPPING SCREW: 3X30
- 1.04503008N (x12) TAPPING SCREW - M3X8
- 7.07200040E RETAINING RING - M4
- 2.04513006N (x31) TAPPING SCREW - 3X6

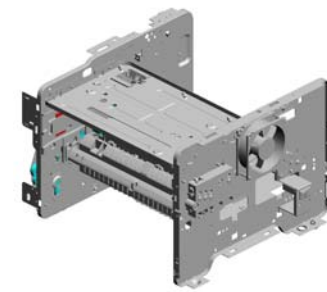

13.11050534
(x2)
CLAMP

9.09504006N
SCREW - M4X6

16.12042879
SWITCH:A8L-21-15
N2

3.04513014N
TAPPING SCREW:
3X14

18.G0271180
(x2)
RUBBER FOOT - G
F

11.11050762
(x2)
[C]
CLAMP:LWS-0711A
201603-03 O/O

8.08050104
(x6)
[A]
RETAINING RINGS
-E:SILENCER:DIA4
201603-02 O/O

19.G0521120
SPRING - PAPER E
XIT RELEASE

12.11050758
(x13)
[B]
CLAMP:LWSM-030
6A
201603-04 O/O

14.11050568
(x2)
CLAMP:LWSS-0504

15.12042612
(x2)
MICRO SWITCH:D3
V-16506-3C25

6.04543014Q
TAPPING SCREW:
3X14

20.GW010007
PHOTO REFLECTI
ON SENSOR:EXIT

10.11050197
WIRE SADDLE

5.04543006Q
(x6)
TAPPING SCREW -
M3X6

U001	U002	U003	U004	U005	U006	U007	U008	U009	U010	U011
------	------	------	------	------	------	------	------	------	------	------

U010 MAIN DRIVE

24.M0121065
CASE:TERMINAL

39.M0124602
DECAL:LEVER:EN
VELOPE:RIGHT

26.M0121088
COIL SPRING:RAIL
:RIGHT

22.M0121040
CASE:DISCHARGE
LAMP

21.M0121037
TONER BOTTLE:C
ASE

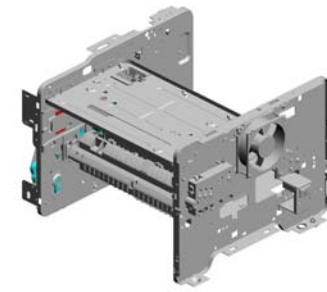

25.M0121066
(x4)
SPRING:TERMINAL
:CHARGE



23.M0121063
(x4)
TERMINAL:CHARG
E



37.M0124120
(x3)
TENSION SPRING:
PICKOFF PAWL



28.M0121097
(x3)
SUPPORTER:PAPE
R:TRANSPORT



27.M0121089
(x3)
GUIDE:PAPER:LEA
DING EDGE



33.M0121128
GEAR:DRIVE:FUSI
NG:NO.4



31.M0121120
GEAR:DRIVE:FUSI
NG:NO.3



30.M0121119
GEAR:DRIVE:FUSI
NG:NO.2



40.M0131178
BRACKET:DRIVE:D
UPLEX



34.M0121150
BRUSHLESS MOT
OR:DC 36.7W



38.M0124601
DECAL:LEVER:EN
VELOPE:LEFT

36.M0121172
GEAR:DRIVE:MAN
UAL FEED SECTIO
N:NO.2



29.M0121117
GEAR:DRIVE:DRU
M



32.M0121123
GEAR:DRIVE:PAPE
R FEED:NO.3



35.M0121171
GEAR:DRIVE:MAN
UAL FEED SECTIO
N:NO.1



U010 MAIN DRIVE

48.M1541099 HEAT INSULATING PLATE:FUSING:FRONT:TYPE A 201404-01
 47.M1542056 DISCHARGE LAMP
 46.M1541177 CASE:DRIVE:ASSY

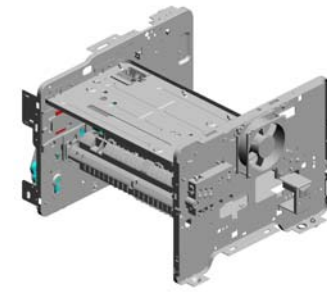

49.M1741091 HEAT INSULATING PLATE:FUSING:FRONT:TYPE B

41.M1161118 GEAR:DRIVE:FUSING:NO.1

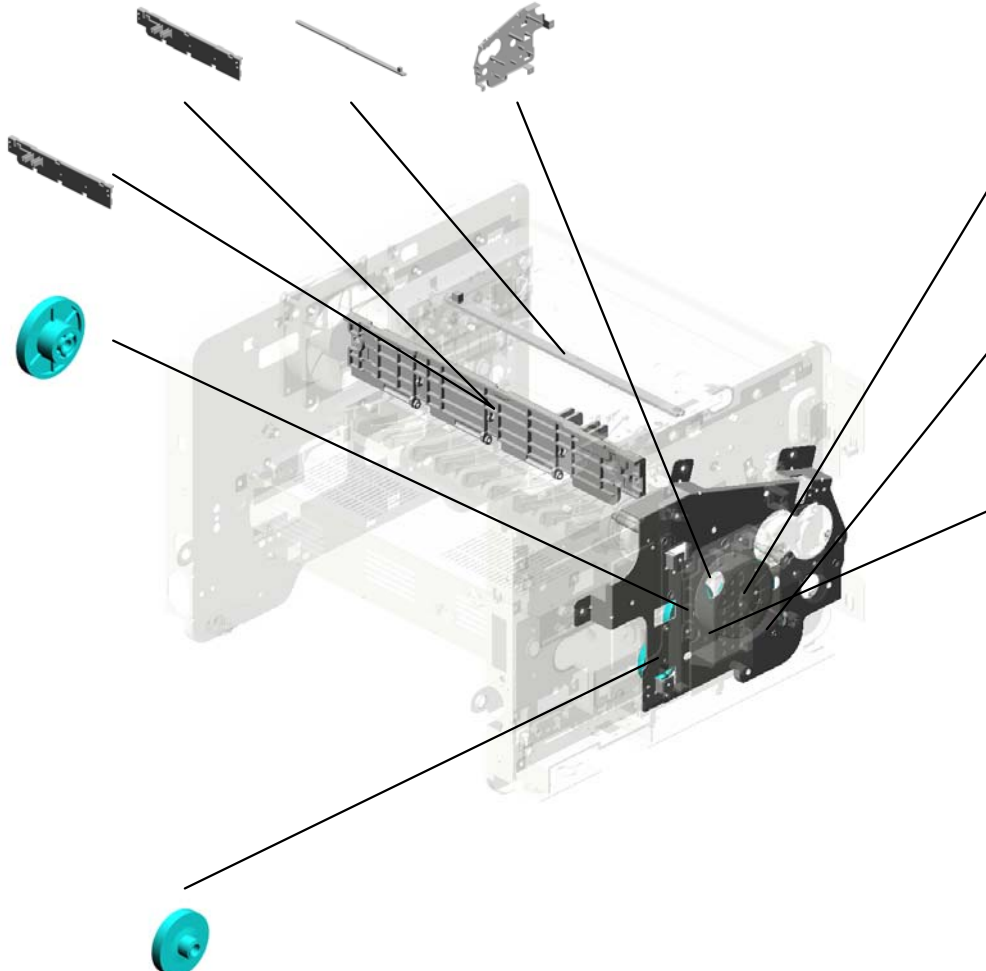



45.M1171136 GEAR:DRIVE:DUPL EX SECTION

43.M1161122 GEAR:DRIVE:PAPE R FEED:NO.2

44.M1161124 GEAR:DRIVE:PAPE R FEED:NO.4

42.M1161121 GEAR:DRIVE:PAPE R FEED:NO.1

 08050089 [A] RETAINING RING - M4 201603-02 O/O	 11050508 [C] HARNESS CLAMP - LWS-0711 201603-03 O/O
 11050511 [B] HARNESS CLAMP - LWS-0306ZC 201603-04 O/O	

U011 ELECTRICAL

3.M1555001
PCB:WIFI:(for M157
/M177)

5.M1565008
PCB:MAIN BOARD:
ASS'Y:(for M156/M1
76)

4.M1565003
PCB:FAX:NA:ASS'Y

6.M1575008
PCB:MAIN BOARD:
ASS'Y:(for M157/M1
77)

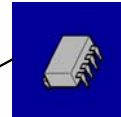
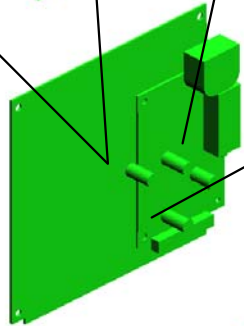

7.14077726
EEPROM:BR24T08-
W
201312-01

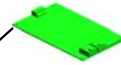

1.M1545313
POWER SUPPLY U
NIT:100V:ASS'Y:81.
7W



2.M1545402
POWER PACK:ASS
'Y

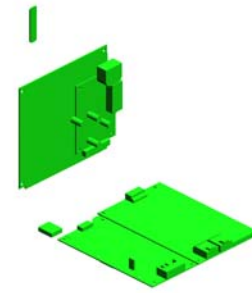

ACCESSORIES



1.H5235350
TELEPHONE CABLE



2.M1011301
PLATE:LOGO:RIC:(for M156/M157/M177)

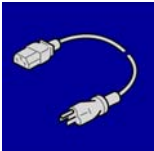

3.M1545697
POWER SUPPLY CORD:125V:10A:NA



4.M1560481
MODEL NAME PLATE:(for M156)



5.M1570481
MODEL NAME PLATE:(for M157)



6.M1760481
MODEL NAME PLATE:(for M176)



7.M1770481
MODEL NAME PLATE:(for M177)

Exclusive Parts

Number	Part Name	Group	ID
A1532117	ROLLER TERMINAL	U004	5
AA143520	SHOULDER SCREW - M3	U007_S001	10
AG070514	MAGNET CATCH	U001	3
AW020198	PHOTOINTERRUPTOR:LG2A14NL 1	U004	6
		U007_S001	11
		U009	8
AW110058	THERMOSTAT:177	U007_S001	12
AX640199	FAN:MM80:25MM:DC 2.16W	U010	17
D1272514	ELECTROMAGNETIC CLUTCH:3.5 T:MANUAL FEED	U004	7
G0123050	SIDE FENCE GEAR	U004_S002	8
G0201160	SNAP RING	U004	9
G0271180	RUBBER FOOT - GF	U010	18
G0292767	BY-PASS FEED COVER	U004	10
G0521120	SPRING - PAPER EXIT RELEASE	U010	19
G0521518	SPRING - LOCK LEVER	U001	4
G0961019	TRANSPORT GUIDE PIN	U009	9
G1022717	COVER:DC SOLENOID	U004	11
G1022755	RACK:SIDE FENCE:REAR	U004_S002	12
G1022789	STOPPER:PHOTOINTERRUPTOR	U004	13
G1272627	PAPER FEED ROLLER - MM32	U004	14
G1274328	DECAL - HIGH TEMPERATURE	U007_S001	13
G8003133	SIDE FENCE GEAR	U004_S001	15
GF013001	BOTTOM PLATE PAD	U004_S001_S001	16
		U004_S002	16
GW010007	PHOTO REFLECTION SENSOR:EXI T	U010	20
H5235350	TELEPHONE CABLE	ACCESSORIES	1
M0121037	TONER BOTTLE:CASE	U010	21
M0121040	CASE:DISCHARGE LAMP	U010	22
M0121063	TERMINAL:CHARGE	U010	23
M0121065	CASE:TERMINAL	U010	24
M0121066	SPRING:TERMINAL:CHARGE	U010	25
M0121088	COIL SPRING:RAIL:RIGHT	U010	26
M0121089	GUIDE:PAPER:LEADING EDGE	U010	27
M0121097	SUPPORTER:PAPER:TRANSPORT	U010	28
M0121117	GEAR:DRIVE:DRUM	U010	29
M0121119	GEAR:DRIVE:FUSING:NO.2	U010	30

Number	Part Name	Group	ID
M0121120	GEAR:DRIVE:FUSING:NO.3	U010	31
M0121123	GEAR:DRIVE:PAPER FEED:NO.3	U010	32
M0121128	GEAR:DRIVE:FUSING:NO.4	U010	33
M0121150	BRUSHLESS MOTOR:DC 36.7W	U010	34
M0121171	GEAR:DRIVE:MANUAL FEED SECT ION:NO.1	U010	35
		U010	36
M0121172	GEAR:DRIVE:MANUAL FEED SECT ION:NO.2	U010	36
M0122589	PAPER TRAY:REAR	U004_S001	17
M0122590	COIL SPRING:EARTH	U004_S001	18
M0122603	STOPPER:BASE PLATE	U004_S001	19
M0122604	SPRING:RELEASE:TRAY BOTTOM PLATE	U004_S001	20
M0122605	FRICTION PAD:ADHESION	U004_S001	21
M0122608	END FENCE	U004_S001	22
M0122610	TRAY BOTTOM PLATE	U004_S001_S001	23
M0122612	COMPRESSION SPRING:TRAY BO TTOM PLATE	U004_S001	24
M0122613	COMPRESSION SPRING:SEPARAT ION	U004_S001	25
M0122615	SIDE FENCE:RIGHT	U004_S001	27
M0122631	CLOTH:EARTH:PAPER FEED	U004	28
M0122668	SHAFT:PAPER FEED:ASS'Y	U004	29
M0122671	FEELER:PAPER END SENSOR	U004	30
M0122673	RAIL:PAPER TRAY:RIGHT	U004	31
M0122701	ROLLER:INTERFACE:DRIVE	U004	32
M0122702	ROLLER:INTERFACE:DRIVEN	U004	33
M0122705	SPRING:ROLLER	U004	34
M0122711	BUSHING:REGISTRATION:DRIVEN :LEFT	U004	35
M0122715	GUIDE PLATE:TRANSPORT:UPPE R	U004	36
M0122718	REGISTRATION ROLLER:DRIVE	U004	37
M0122719	REGISTRATION ROLLER:DRIVEN	U004	38
M0122722	SPRING:ROLLER:REGISTRATION	U004	39
M0122723	FEELER:REGISTRATION:SENSOR	U004	40
M0122725	SPRING:FEELER:REGISTRATION	U004	41
M0122730	BUSHING:REGISTRATION:DRIVEN	U004	42

Exclusive Parts

Number	Part Name	Group	ID
	:RIGHT		
M0122741	GROUND PLATE:DRIVE:REGISTRATION ROLLER	U004	43
M0122742	GROUND PLATE:DRIVEN:REGISTRATION ROLLER	U004	44
M0122743	DECAL:GUIDE PLATE:TRANSPORT:UPPER	U004	45
M0122744	GUIDE:REGISTRATION	U004	46
M0122745	GROUND PLATE:DRIVEN	U004	47
M0122753	BUSHING:ROLLER:DRIVEN	U004	48
M0122806	SHEET:GUIDE:MANUAL FEED SUB-UNIT	U004	49
M0122816	FRICTION PAD:HOLDER:MANUAL FEED:ASS'Y	U004	50
M0122824	FEELER:MANUAL FEED	U004	51
M0122830	MECHANICAL SPRING CLUTCH:MANUAL FEED	U004	52
M0122833	DECAL:SIDE FENCE:MANUAL FEED	U004_S002	53
M0122859	GUIDE PLATE:UPPER:MANUAL FEED	U004	54
M0122860	PAPER FEED ROLLER:MANUAL FEED	U004	55
M0122874	COMPRESSION SPRING:MANUAL FEED	U004_S002	56
M0122880	COMPRESSION SPRING:SEPARATION	U004	57
M0124053	GEAR:HOT ROLLER	U007_S001	14
M0124055	RADIAL BALL BEARING:35X47X7	U007_S001	15
M0124109	SPRING:FEELER:EXIT	U007_S001	16
M0124120	TENSION SPRING:PICKOFF PAWL	U007_S001	17
		U010	37
M0124123	HEATER:700W:120V	U007_S001	18
M0124135	FEELER:PAPER FEED SENSOR	U007_S001	19
M0124186	COVER:LEFT UPPER:ASS'Y	U007_S001	20
M0124202	LEVER:PRESSURE	U007_S001	21
M0124204	LEVER:LEFT:FRAME:FUSING	U007_S001	22
M0124205	LEVER:RIGHT:FRAME:FUSING	U007_S001	23

Number	Part Name	Group	ID
M0124206	STRIPPER PAWLS	U007_S001	24
M0124208	BRACKET:GATE PAWL	U007_S001	25
M0124211	PLATE NUT:HEATER	U007_S001	26
M0124212	FUSING ENTRANCE GUIDE PLATE:UPPER	U007_S001	27
M0124213	BUSHING:PRESSURE ROLLER	U007_S001	28
M0124215	GUIDE PLATE:EXIT	U007_S001	29
M0124216	TENSION SPRING:FUSING:GUIDE PLATE	U007_S001	30
M0124217	FUSING ENTRANCE GUIDE PLATE:LOWER	U007_S001	31
M0124220	HOT ROLLER	U007_S001	32
M0124223	THERMAL INSULATING BUSHING:HOT ROLLER	U007_S001	33
M0124229	TENSION SPRING:FUSING:PRESSURE	U007_S001	34
M0124234	HOUSING:THERMOSTAT:ASS'Y	U007_S001	35
M0124253	PRESSURE ROLLER:DIA30	U007_S001	36
M0124263	THERMISTOR:FUSING	U007_S001	37
M0124266	COVER:RIGHT LOWER:FUSING	U007_S001	38
M0124270	THERMAL INSULATING BUSHING:FUSING UNIT	U007	39
M0124276	COVER:LEFT:LOWER:FUSING	U007_S001	40
M0124279	CLEANING ROLLER:ASS'Y	U007_S001	41
M0124281	RETAINING RINGS-C:HOT ROLLER	U007_S001	42
M0124284	LEVER:PRESSURE:LEFT	U007_S001	43
M0124285	LEVER:PRESSURE:RIGHT	U007_S001	44
M0124287	COVER:RIGHT UPPER:FUSING	U007_S001	45
M0124292	FUSING COVER:UPPER	U007_S001	46
M0124293	EXIT ROLLER:EXIT:FUSING	U007_S001	47
M0124295	GROUND PLATE:ASS'Y	U007_S001	48
M0124453	EXIT ROLLER	U008	3
M0124454	SPRING:EXIT ROLLER:EXIT	U008	4
M0124458	DISCHARGE BRUSH:EXIT:ASS'Y DRAWING	U008	5
M0124488	BUSHING:DIA6XDIA10X6	U004	58
		U008	6

Exclusive Parts

Number	Part Name	Group	ID
		U009	10
M0124601	DECAL:LEVER:ENVELOPE:LEFT	U010	38
M0124602	DECAL:LEVER:ENVELOPE:RIGHT	U010	39
M0124603	DECAL:GUIDE PLATE:B	U007_S001	49
M0124699	DECAL:WARNING (HIGH TEMPERATURE):FRONT	U007	50
M0126252	BUSHING:TRANSFER ROLLER:RIGHT	U006	1
M0126254	SPRING:TRANSFER ROLLER	U006	2
M0126255	GEAR:TRANSFER ROLLER	U006	3
M0126256	ROLLER:POSITIONING:TRANSFER ROLLER	U006	4
M0126260	COVER:ELECTRODE PLATE	U006	5
M0131178	BRACKET:DRIVE:DUPLEX	U010	40
M0134455	GEAR:DRIVE:EXIT ROLLER	U008	7
M0134470	EXIT ROLLER:DUPLEX	U008	8
M0134610	GEAR:DRIVE:DUPLEX	U009	11
M0134611	BRACKET:DRIVE:DUPLEX:ASS'Y	U009	12
M0134622	EXIT ROLLER:DUPLEX	U009	13
M0134623	SPRING:EXIT	U009	14
M0134624	SPRING:EXIT:NO.2	U009	15
M0134635	SPRING:OPEN AND CLOSE:RIGHT	U009	16
M0134661	STOPPER:TRANSPORT SUB-UNIT:DUPLEX	U009	17
M0134663	GUIDE PLATE:VERTICAL TRANSPORT:LOWER	U009	18
M0134664	GUIDE PLATE:VERTICAL TRANSPORT:UPPER	U009	19
M0134666	SHAFT:COVER:SWITCHBACK:OPEN AND CLOSE	U009	20
M0134667	SPRING:COVER:SWITCHBACK:OPEN AND CLOSE	U009	21
M0134668	SHEET:GUIDE:HORIZONTAL TRANSPORT:LOWER	U009	22
M0134669	MAGNET CATCH:ASS'Y	U009	23
M0134671	SHEET:HORIZONTAL TRANSPORT:LEFT	U009	24
M0134672	SHEET:HORIZONTAL TRANSPORT	U009	25

Number	Part Name	Group	ID
	:RIGHT		
M0134673	LEVER:OPEN AND CLOSE:NO.1	U009	26
M0134674	LEVER:OPEN AND CLOSE:NO.2	U009	27
M0134684	SHEET:DUPLEX	U009	28
M0134685	BUTTON:OPEN AND CLOSE:LOWER	U009	29
M0134687	GROUND PLATE:HORIZONTAL TRANSPORT:FRONT	U009	30
M0134688	GROUND PLATE:HORIZONTAL TRANSPORT:REAR	U009	31
M0134691	LEVER:OPEN AND CLOSE:LOWER	U009	32
M0134696	LEVER:OPEN AND CLOSE:LEFT	U009	33
M0134697	LEVER:OPEN AND CLOSE:RIGHT	U009	34
M0134698	BRACKET:OPEN AND CLOSE:LOWER	U009	35
M0134761	TRANSPORT ROLLER:DUPLEX:MIDDLE	U009	36
M0134762	TRANSPORT ROLLER:DUPLEX:EXIT	U009	37
M0134765	PULLEY:TRANSPORT	U009	38
M0134771	TIMING BELT:HORIZONTAL TRANSPORT	U009	39
M0134772	TIMING BELT:DRIVE	U009	40
M0134778	FEELER:SENSOR:HORIZONTAL TRANSPORT	U009	41
M0134785	SPRING:COVER:SWITCHBACK:OPEN AND CLOSE	U009	42
M0134794	DECAL:GUIDE PLATE:VERTICAL TRANSPORT:UPPER	U009	43
M0134795	PIN:GUIDE:UPPER	U009	44
M0134797	FEELER:SENSOR:VERTICAL TRANSPORT	U009	45
M1011301	PLATE:LOGO:RIC:(for M156/M157/M177)	ACCESSORIES	2
M1016250	TRANSFER ROLLER	U006	6
M1016259	ELECTRODE PLATE:SEPARATION	U006	7
M1161118	GEAR:DRIVE:FUSING:NO.1	U010	41
M1161121	GEAR:DRIVE:PAPER FEED:NO.1	U010	42

Exclusive Parts

Number	Part Name	Group	ID
M1161122	GEAR:DRIVE:PAPER FEED:NO.2	U010	43
M1161124	GEAR:DRIVE:PAPER FEED:NO.4	U010	44
M1161370	COVER:REAR LOWER	U001	5
M1162672	RAIL:PAPER TRAY:LEFT	U004	59
M1171136	GEAR:DRIVE:DUPLEX SECTION	U010	45
M1174662	COVER:SWITCHBACK:OPEN AND CLOSE	U009	46
M1180501	SPEAKER:M118	U001	6
M1341382	RAIL:SCANNER:OPEN AND CLOSE	U001	7
M1341386	RAIL:STOPPER:SCANNER:OPEN AND CLOSE	U001	8
M1540265	STEPPER MOTOR	U009	47
M1541099	HEAT INSULATING PLATE:FUSING :FRONT:TYPE A	U010	48
M1541177	CASE:DRIVE:ASS'Y	U010	46
M1541851	IMAGING UNIT:ASS'Y	U003_S001	6
M1542056	DISCHARGE LAMP	U010	47
M1542505	PAPER TRAY:ASS'Y	U004_S001	60
M1542532	MANUAL FEED TABLE:ASS'Y	U004_S002	61
M1542614	SIDE FENCE:LEFT	U004_S001	26
M1542616	LEVER:PAPER VOLUME SENSOR	U004_S001	62
M1542618	DECAL:PAPER TRAY:FRONT	U004_S001	63
M1542629	COVER:PAPER TRAY:MIDDLE	U004_S001	64
M1542632	DECAL:PICK-UP PAPER JAM	U001	9
M1542640	COVER:PAPER TRAY:LEFT	U004_S001	65
M1542641	COVER:PAPER TRAY:RIGHT	U004_S001	66
M1542805	GUIDE PLATE:MANUAL FEED:LOWER	U004	67
M1542815	DECAL:FEED PAPER AGAIN:PREVENTION:EXP	U004_S002	68
M1542831	DC SOLENOID:9.6W:24V	U004	69
M1542870	COVER:MANUAL FEED TABLE	U004_S002	70
M1542875	SIDE FENCE:MANUAL FEED:RIGHT	U004_S002	71
M1542877	SIDE FENCE:MANUAL FEED:LEFT	U004_S002	72
M1542879	EXTENSION TRAY:MANUAL FEED	U004_S002	73
M1544030	FUSING UNIT:NA:ASS'Y	U007_S001	51
M1544499	GROUND PLATE:EXIT ROLLER	U008	9

Number	Part Name	Group	ID
M1544694	GUIDE:HORIZONTAL TRANSPORT :UPPER	U009	48
M1544695	GUIDE:HORIZONTAL TRANSPORT :LOWER	U009	49
M1545313	POWER SUPPLY UNIT:100V:ASS'Y :81.7W	U011	1
M1545402	POWER PACK:ASS'Y	U011	2
M1545697	POWER SUPPLY CORD:125V:10A:NA	ACCESSORIES	3
M1555001	PCB:WIFI:(for M157/M177)	U011	3
M1560481	MODEL NAME PLATE:(for M156)	ACCESSORIES	4
M1561240	EXTENSION TRAY:MF:ASS'Y	U001	10
M1561250	COVER:UPPER:MFP	U001	11
M1561251	COVER:FRONT	U001	12
M1561252	BUTTON	U001	13
M1561253	COVER:SIDE PLATE:LEFT:EU	U001	14
M1561254	SHAFT:TURN:SCANNER:LEFT	U001	15
M1561255	COVER:SIDE PLATE:RIGHT:EU	U001	16
M1561256	SHAFT:TURN:SCANNER:RIGHT	U001	17
M1561259	COVER:REAR MIDDLE:EU	U001	18
M1561272	COIL SPRING:SCANNER	U001	19
M1561392	GUIDE PLATE:SCANNER:OPEN AND CLOSE	U001	20
M1561500	OPERATION PANEL:ASS'Y:NA	U002	1
M1561600	SCANNER:ASS'Y	U002	2
M1561640	ADF:ASS'Y	U002_S001	3
M1562821	COVER:UPPER	U002_S001	4
M1562822	FRAME:PICKUP	U002_S001	5
M1562823	PICKUP ROLLER	U002_S001	6
M1562824	ARM:STOPPER	U002_S001	7
M1562826	COIL SPRING:PICKUP	U002_S001	9
M1562828	GEAR:28T	U002_S001	11
M1562829	PAWL:PICKUP	U002_S001	12
M1562830	FEED ROLLER	U002_S001	13
M1562831	TRANSPORT ROLLER	U002_S001	14
M1562832	SHAFT:TRANSPORT ROLLER:UPPER PAPER FEED	U002_S001	15
M1562833	ARM:ORIGINAL SENSOR	U002_S001	16

Exclusive Parts

Number	Part Name	Group	ID
M1562834	SHAFT:PICKUP	U002_S001	17
M1562835	GEAR:28T	U002_S001	18
M1562836	COIL SPRING:FEED ROLLER:UPPER	U002_S001	19
M1562837	COIL SPRING:PAWL	U002_S001	20
M1562838	ORIGINAL SENSOR	U002_S001	21
M1562841	FRAME:ADF	U002_S001	22
M1562842	SEPARATION PAD:ASS'Y	U002_S001	23
M1562843	SIDE FENCE:LEFT	U002_S001	24
M1562844	SIDE FENCE:RIGHT	U002_S001	25
M1562845	GROUND PLATE	U002_S001	26
M1562847	GEAR:21T	U002_S001	27
M1562848	GEAR:28T	U002_S001	28
M1562849	GEAR:37T	U002_S001	29
M1562850	GEAR:39T	U002_S001	30
M1562851	GEAR:46T	U002_S001	31
M1562852	GEAR:43T	U002_S001	32
M1562853	GEAR:53T	U002_S001	33
M1562854	GEAR:18T	U002_S001	34
M1562855	REGISTRATION SENSOR	U002_S001	35
M1562856	EXIT ROLLER	U002_S001	36
M1562857	PLAIN SHAFT BEARING:LEFT:EXIT ROLLER	U002_S001	37
M1562858	PLAIN SHAFT BEARING:RIGHT:EXIT ROLLER	U002_S001	38
M1562859	PLAIN SHAFT BEARING:LEFT:REGISTRATION ROLLER	U002_S001	39
M1562860	PLAIN SHAFT BEARING:RIGHT	U002_S001	40
M1562861	REGISTRATION ROLLER:ASS'Y	U002_S001	41
M1562862	ARM:REGISTRATION SENSOR	U002_S001	42
M1562863	FRAME:LOWER	U002_S001	43
M1562864	DISCHARGE BRUSH	U002_S001	44
M1562865	FRAME:MOTOR:ADF	U002_S001	45
M1562866	MOTOR:ADF	U002_S001	46
M1562868	COIL SPRING:PLATE:ADF	U002_S001	47
M1562869	PLATE:ADF	U002_S001	48
M1562871	COVER:ORIGINAL TRAY:EXTENSION TRAY:1	U002_S001	49

Number	Part Name	Group	ID
M1562872	COVER:ORIGINAL TRAY:EXTENSION TRAY:2	U002_S001	50
M1562881	COVER:MAIN	U002_S001	51
M1562882	COVER:MAIN:EXTENSION TRAY	U002_S001	52
M1562884	HINGE:LEFT:ASS'Y	U002_S001	53
M1562885	HINGE:RIGHT	U002_S001	54
M1562886	SHAFT:EXIT ROLLER	U002_S001	55
M1562887	EXIT ROLLER:DRIVEN	U002_S001	56
M1562888	SHAFT:PAPER FEED ROLLER:LOWER	U002_S001	57
M1562889	PAPER FEED ROLLER:LOWER	U002_S001	58
M1562890	COIL SPRING:REAR	U002_S001	59
M1562891	COVER:ADF:LOWER	U002_S001	60
M1562892	SCREW:3X8	U002_S001	61
M1562893	SPONGE:ADF	U002_S001	62
M1562894	COVER:REAR	U002_S001	63
M1562895	COVER:FRONT	U002_S001	64
M1562896	PAD:PICKUP	U002_S001	67
M1562898	SCREW:3X6	U002_S001	65
M1562899	SHEET:OUTLET	U002_S001	66
M1565003	PCB:FAX:NA:ASS'Y	U011	4
M1565008	PCB:MAIN BOARD:ASS'Y:(for M156/M176)	U011	5
M1570481	MODEL NAME PLATE:(for M157)	ACCESSORIES	5
M1575008	PCB:MAIN BOARD:ASS'Y:(for M157/M177)	U011	6
M1741091	HEAT INSULATING PLATE:FUSING:FRONT:TYPE B	U010	49
M1760481	MODEL NAME PLATE:(for M176)	ACCESSORIES	6
M1770481	MODEL NAME PLATE:(for M177)	ACCESSORIES	7
M2021779	DISCHARGE BRUSH:MECHANICAL SPRING CLUTCH	U002_S001	68
M2021780	GEAR:22T	U002_S001	8
M2021781	PAWL:MECHANICAL SPRING CLUTCH:M202	U002_S001	10

Standard Parts



03603006N
SCREW - M3X6



04503008N
TAPPING SCREW - M3X8



04503010N
TAPPING SCREW - M3X10



04503012N
TAPPING SCREW:3X12



04513006N
TAPPING SCREW - 3X6



04513008N
TAPPING SCREW - M3X8



04513014N
TAPPING SCREW:3X14



04513030N
TAPPING SCREW:3X30



04523008N
TAPPING SCREW - M3X8



04523010N
BINDING SELF-TAPPING SCREW:3X10



04533006N
TAPPING SCREW - M3X6



04543006Q
TAPPING SCREW - M3X6



04543008Q
TAPPING SCREW:3X8

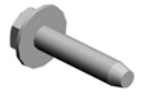

04543014Q
TAPPING SCREW:3X14



07200040E
RETAINING RING - M4



08025318
BINDING HEAD TAPPING SCREW:ES:3X10



08046127
HEXAGONAL BOLT:DOUBLE SCREW:M3X8



08050088
RETAINING RING - M6



08050089
RETAINING RING - M4



08050104
RETAINING RINGS-E:SILENCER:DIA4



08050106
RETAINING RINGS-E:SILENCER:DIA6



09504006N
SCREW - M4X6



09543010N
SCREW:POLISHED ROUND/SPRING:M3X10



11050197
WIRE SADDLE



11050508
HARNESS CLAMP - LWS-071



11050511
HARNESS CLAMP - LWS-030



11050534
CLAMP



11050568
CLAMP:LWSS-0504

Standard Parts



11050758
CLAMP:LWSM-0306A



11050762
CLAMP:LWS-0711A



12042612
MICRO SWITCH:D3V-16506-3
C25

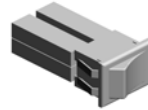

12042879
SWITCH:A8L-21-15N2

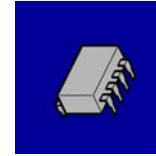

14077726
EEPROM:BR24T08-W

PM Part List

Number	Part Name	Num	Group	ID
G1272627	PAPER FEED ROLLER - MM3 2	1	U004	14
M1016250	TRANSFER ROLLER	1	U006	6
M1544030	FUSING UNIT:NA:ASS'Y	1	U007_S001	51

Design Change List

Number	Title	Set	Old Part		New Part		Index No.		Q'ty	Interchg		Reason	Cut-in S/N
			P/N	Name	P/N	Name	Group	ID		Indiv.	Set		
201603-01	1603 Modification	-	08050088	RETAINING RING - M6	08050106	RETAINING RING S-E:SILENCER:DI A6	U009	6	1	O/O			M17717:
201603-02	1603 Modification	-	08050089	RETAINING RING - M4	08050104	RETAINING RING S-E:SILENCER:DI A4	U004	4	7	O/O			M17717:
							U009	7	7				
							U010	8	6				
201603-03	1603 Modification	-	11050508	HARNESS CLAM P - LWS-0711	11050762	CLAMP:LWS-071 1A	U010	11	2	O/O			M17717:
201603-04	1603 Modification	-	11050511	HARNESS CLAM P - LWS-0306ZC	11050758	CLAMP:LWSM-03 06A	U010	12	13	O/O			M17717:
201503-01	1503 Modification	-	M1542504	PAPER TRAY:AS S'Y	M1542505	PAPER TRAY:AS S'Y	U004_S001	60	1	O/O			M17717:
201501-01	1501 Modification	-	M1561630	ADF:ASS'Y	M1561640	ADF:ASS'Y	U002_S001	3	1	X/O			M17717:
201410-01	1410 Modification	A	M1562827	PAWL:MECHANI CAL SPRING CL UTCH	M2021781	PAWL:MECHANI CAL SPRING CL UTCH:M202	U002_S001	10	1	X/X			M17717:
201410-02	1410 Modification	A	M1562825	GEAR:22T	M2021780	GEAR:22T	U002_S001	8	1	X/X			M17717:
201410-03	1410 Modification	A			M2021779	DISCHARGE BR USH:MECHANIC AL SPRING CLUT CH	U002_S001	68	1				M17717:
201405-01	1405 Modification	-			M1562896	PAD:PICKUP	U002_S001	67	1				M17717:
201404-01	1404 Modification	-			M1541099	HEAT INSULATIN G PLATE:FUSIN G:FRONT:TYPE A	U010	48	1				M17717:
201404-02	1404 Modification	-			M1741091	HEAT INSULATIN G PLATE:FUSIN G:FRONT:TYPE B	U010	49	1				M17717:

Design Change List

Number	Title	Set	Old Part		New Part		Index No.		Q'ty	Interchg		Reason	Cut-in S/N
			P/N	Name	P/N	Name	Group	ID		Indiv.	Set		
201402-01	1402 Modification	-	M1562838	ORIGINAL SENSOR			U002_S001	21	1				M17717:
201402-02	1402 Modification	-	M1562855	REGISTRATION SENSOR			U002_S001	35	1				M17717:
201312-01	1312 Modification	-			14077726	EEPROM:BR24T08-W	U011	7	1				M17717:
201401-01	1401 Modification	-	M0122614	SIDE FENCE:LEFT	M1542614	SIDE FENCE:LEFT	U004_S001	26	1				M17717:

