



RICOH UNIVERSITY

Learning ♦ Knowledge ♦ Performance



M044
PARTS CATALOG

LANIER RICOH SAVIN



M044
PARTS CATALOG

LANIER
RICOH
SAVIN



RICOH UNIVERSITY

Learning ♦ Knowledge ♦ Performance

M044 PARTS CATALOG

LANIER RICOH SAVIN®

It is the reader's responsibility when discussing the information contained within this document to maintain a level of confidentiality that is in the best interest of Ricoh Americas Corporation and its member companies.

**NO PART OF THIS DOCUMENT MAY BE REPRODUCED IN ANY
FASHION AND DISTRIBUTED WITHOUT THE PRIOR
PERMISSION OF RICOH AMERICAS CORPORATION.**

All product names, domain names or product illustrations, including desktop images, used in this document are trademarks, registered trademarks or the property of their respective companies.

They are used throughout this book in an informational or editorial fashion only and for the benefit of such companies. No such use, or the use of any trade name, or web site is intended to convey endorsement or other affiliation with Ricoh products.

LEGEND

PRODUCT CODE	COMPANY		
	LANIER	RICOH	SAVIN
M044	Pro C751	Pro C751	Pro C751
B331-14	A3/11"x17" Tray Unit TK5010		
B499-04	Tab Sheet Holder Type3260		
D449	Punch Unit PU5020		
D512	Booklet Finisher SR5040		
D513	Finisher SR5030		
D515	High Capacity Stacker SK5020		
D516	LCIT RT5060		
D517	Multi Bypass Tray BY5010		
D518	Cover Interposer Tray CI5020		
D519	Ring Binder RB5010		
D520	Trimmer Unit TR5040		
D521	Multi-Folding Unit FD5010		
D525-01,02	Color Controller E-41A		
D544	Decurler Unit DU5010		
D548	Buffer Pass Unit Type 5010		
D554-01,02,03	CTL option		

DOCUMENTATION HISTORY

REV. NO.	DATE	COMMENTS
*	08/2011	Original Printing

Unit All



U001
Exterior 1

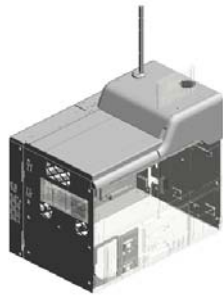

U002
Exterior 2



U003
Operation 1

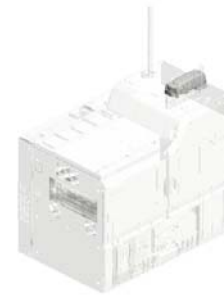

U004
Operation 2

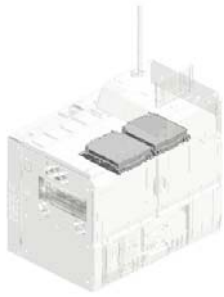

U005
Laser Unit

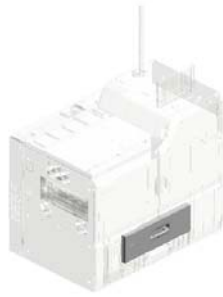

U006
Tandem Tray 1



U007
Tandem Tray 2 (Left)

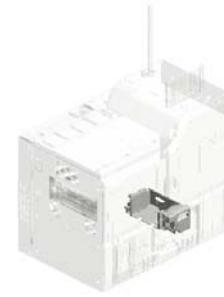

U008
Tandem Tray 3 (Right)



U009
Universal Tray 1

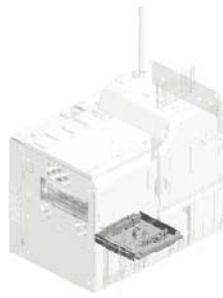

U010
Universal Tray 2

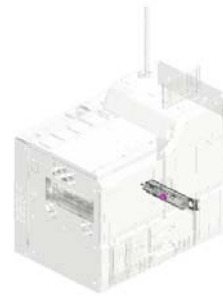

U011
Paper Feed 1 (1st)

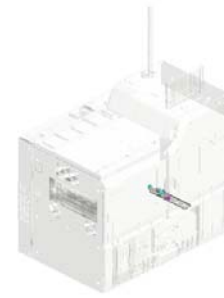

U012
Paper Feed 2 (1st)

Unit All



U013
Paper Feed 3 (1st)



U014
Paper Feed 1 (2nd)



U015
Paper Feed 2 (2nd)



U016
Paper Feed 3 (2nd)

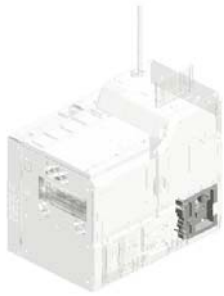

U017
Vertical Transport 1

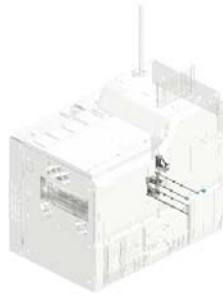

U018
Vertical Transport 2

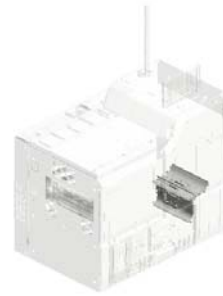

U019
Vertical Transport 3



U020
Vertical Transport 4

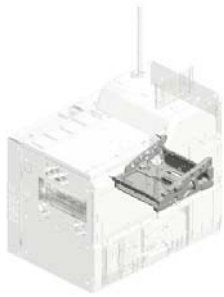

U021
Paper Registration 1



U022
Paper Registration 2

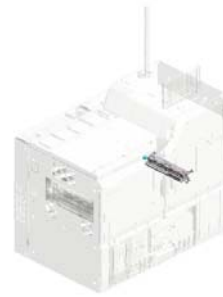

U023
Paper Registration 3



U024
Paper Registration 4

Unit All



U025
Paper Registration 5



U026
Paper Registration 6



U027
Toner Supply 1



U028
Toner Supply 2

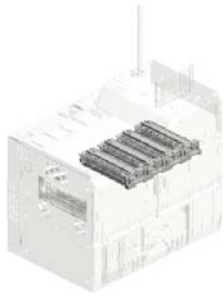

U029
PCDU



U030
ITB Unit 1



U031
ITB Unit 2

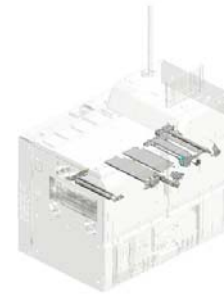

U032
ITB Unit 3



U033
ITB Cleaning

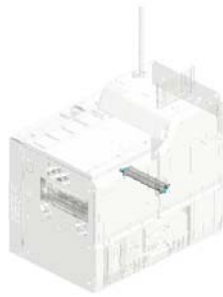

U034
Paper Transfer

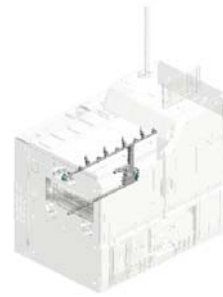

U035
Used Toner 1



U036
Used Toner 2

Unit All



U037
Used Toner 3

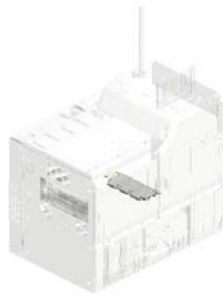

U038
Paper Transport



U039
Fusing 1



U040
Fusing 2

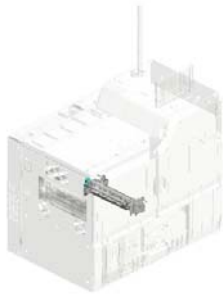

U041
Fusing 3



U042
Fusing Cleaning 1



U043
Fusing Cleaning 2

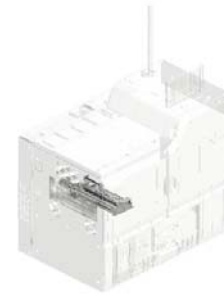

U044
Paper Exit 1



U045
Paper Exit 2



U046
Paper Exit 3



U047
Paper Exit 4



U048
Paper Exit 5

Unit All

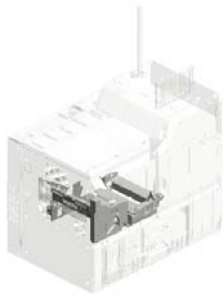

U049
Paper Exit 6

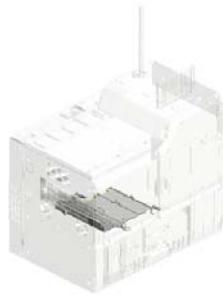

U050
Duplex 1



U051
Duplex 2

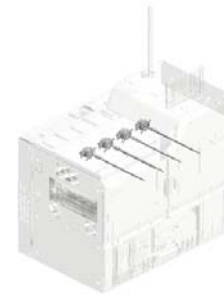

U052
Drive 1 (Drum)

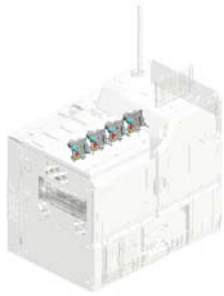

U053
Drive 2 (Cleaning/Development)

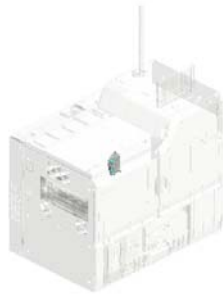

U054
Drive 3 (Paper Transfer)



U055
Drive 4 (Fusing)

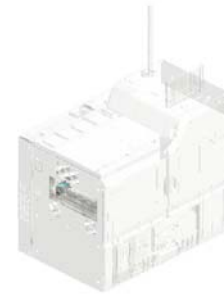

U056
Drive 5 (Paper Exit)



U057
Drive 6 (Used Toner)



U058
Drive 7 (Paper Feed)

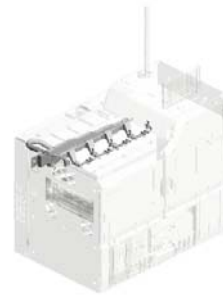

U059
Cooling 1

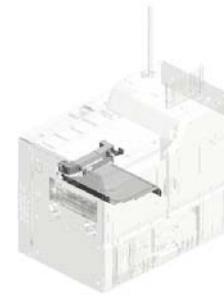

U060
Cooling 2

Unit All



U061
Cooling 3

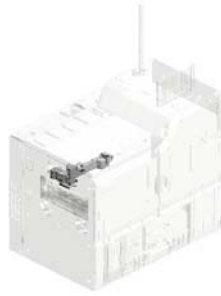

U062
Cooling 4

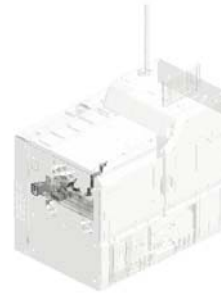

U063
Cooling 5



U064
Cooling 6

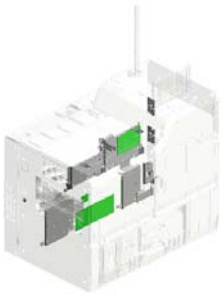

U065
Electrical 1 (Rear)

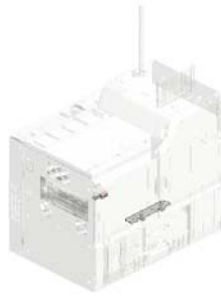

U066
Electrical 2 (Front)

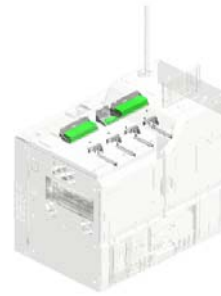

U067
Electrical 3 (Upper)

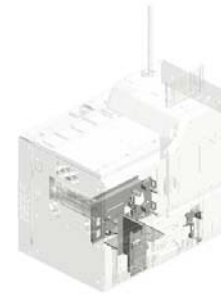

U068
Electrical 4 (Paper Feed)



U069
Electrical 5 (Control)

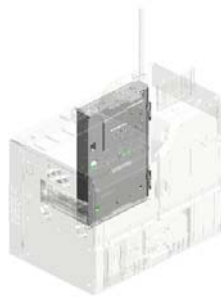

U070
Electrical 6 (Back 1)

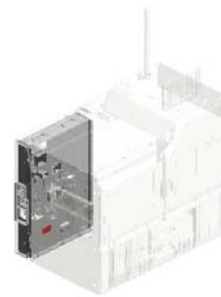

U071
Electrical 7 (Back 2)



U072
Main Frame

U001.Exterior 1

U001_S001
D0747791
DOOR:COLLECTION BOTTLE
:ASS'Y

U001_S002
D0747800
SUPPORTING PLATE:DOOR:
FRONT LEFT:ASS'Y

U001_S003
M0447816
SUPPORTING PLATE:DOOR:
FRONT RIGHT:ASS'Y

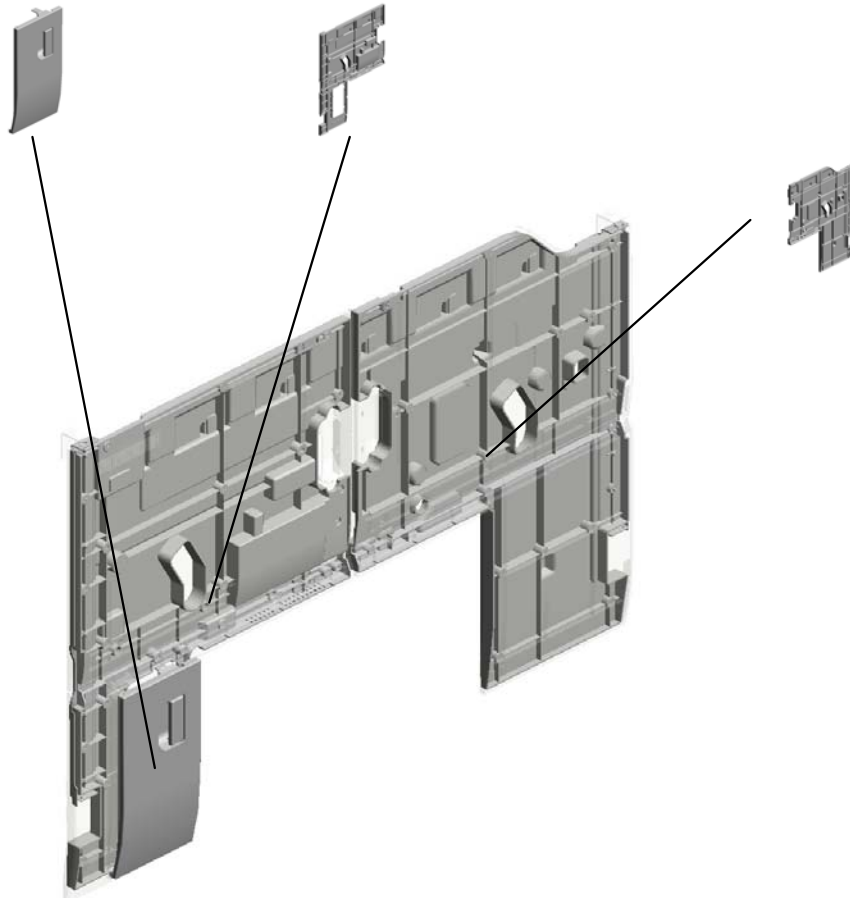

U001	U002	U003	U004	U005	U006	U007	U008	U009	U010	U011	U012	U013	U014	U015	U016	U017	U018	U019	U020	U021
------	------	------	------	------	------	------	------	------	------	------	------	------	------	------	------	------	------	------	------	------

U001
Exterior 1

7.D0747775
PLATE:LOGO:RICO
H

8.D0747780
DOOR:FRONT LEF
T:UPPER:ASS'Y

17.D0747810
DOOR:FRONT RIG
HT:UPPER:ASS'Y

25.D0747858
HINGE:RIGHT UPP
ER:ASS'Y



23.D0747850
HINGE:LEFT UPPE
R:ASS'Y

5.C1012360
(x2)
SNAP RING

10.D0747787
HINGE:DOOR:COL
LECTION BOTTLE:
ASS'Y

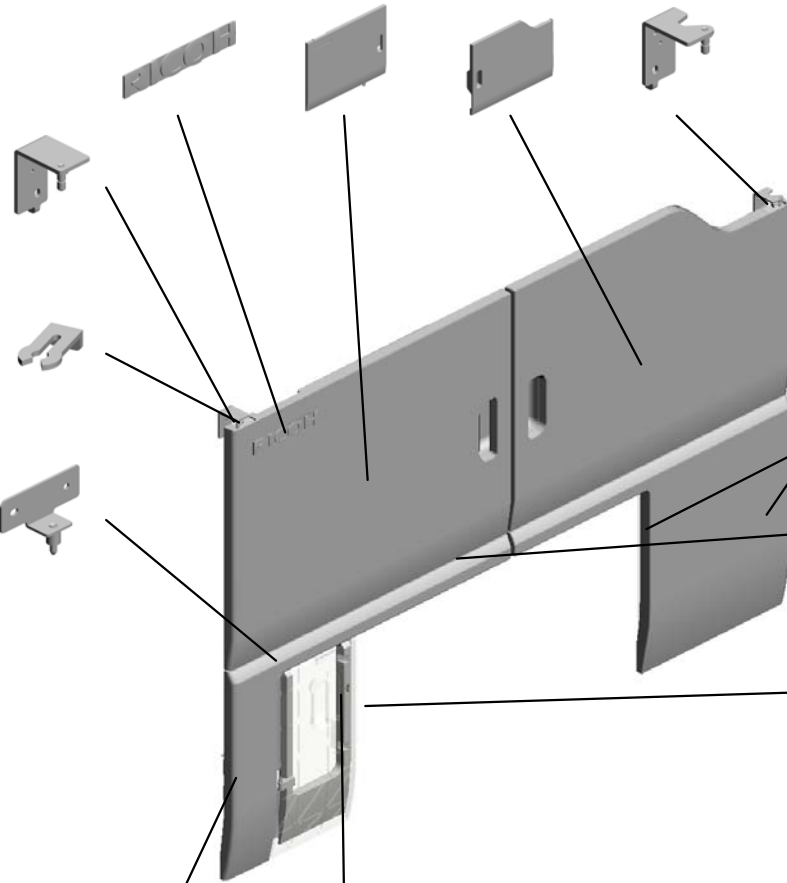

26.D0747861
HINGE:RIGHT LOW
ER:ASS'Y

18.D0747814
DOOR:FRONT RIG
HT:LOWER

1.08025324
(x46)
HEXAGON HEAD T
APPING SCREW:P
F:4X10

9.D0747785
DOOR:FRONT LEF
T:LOWER

24.D0747854
HINGE:LEFT LOWE
R:ASS'Y

15.D0747797
SPRING PLATE:DO
OR:LEFT LOWER

U001_S001
DOOR:COLLECTION BOTTLE:ASS'Y

2.54472681
(x2)
SNAP RING

1.08025324
HEXAGON HEAD T
APPING SCREW:P
F:4X10

4.B2341293
LEVER - SAFETY S
WITCH

11.D0747791
DOOR:COLLECTIO
N BOTTLE:ASS'Y

6.D0146458
(x2)
SPRING:BLADE:NO
.1

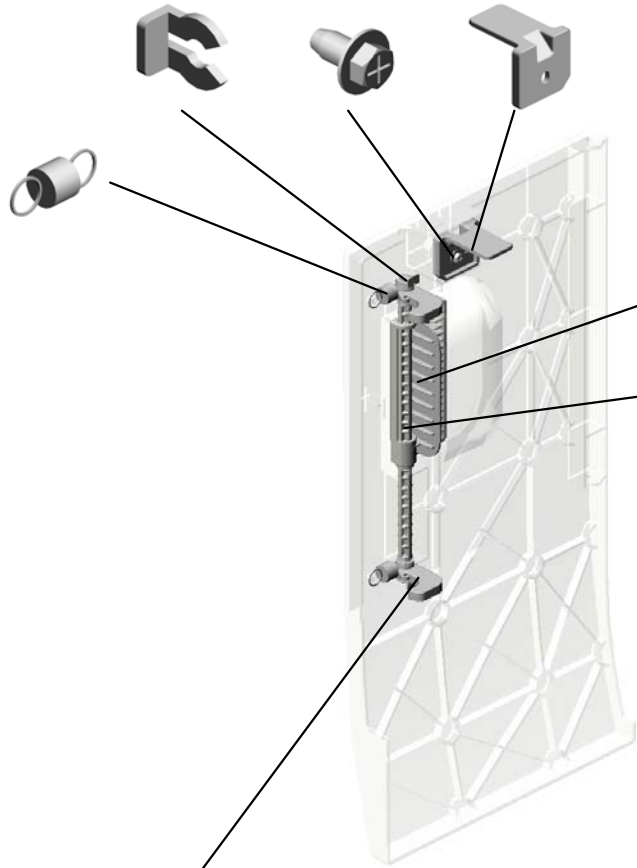

13.D0747794
(x2)
LEVER:RELEASE:D
OOR:COLLECTION
BOTTLE

12.D0747793
GRIP:DOOR:COLL
ECTION BOTTLE

14.D0747795
SHAFT:CONTACT
POINT:GRIP

U001_S002
SUPPORTING PLATE:DOOR:FRONT LEFT:ASS'Y

3.AG071013
(x2)
MAGNET CATCH:2
4.5N:ASS'Y

20.D0747837
DECAL:MISFEED R
EMOVAL:CDE

16.D0747800
SUPPORTING PLA
TE:DOOR:FRONT L
EFT:ASS'Y

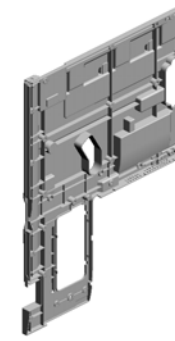

21.D0747838
DECAL:MISFEED R
EMOVAL:Z-1

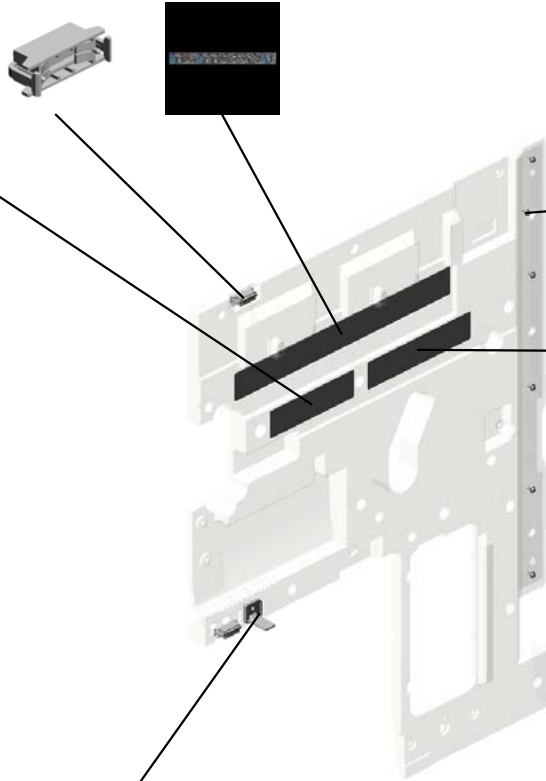

1.08025324
(x6)
HEXAGON HEAD T
APPING SCREW:P
F:4X10

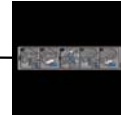

22.D0747839
DECAL:MISFEED R
EMOVAL:Z-2



4.B2341293
LEVER - SAFETY S
WITCH

U001	U002	U003	U004	U005	U006	U007	U008	U009	U010	U011	U012	U013	U014	U015	U016	U017	U018	U019	U020	U021
------	------	------	------	------	------	------	------	------	------	------	------	------	------	------	------	------	------	------	------	------

U001_S003

SUPPORTING PLATE:DOOR:FRONT RIGHT:ASS'Y

19.D0747836
DECAL:MISFEED R
EMOVAL:AB

28.M0447835
DECAL:MISFEED R
EMOVAL:LOCATIO
N

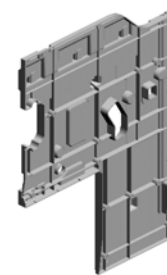

27.M0447816
SUPPORTING PLA
TE:DOOR:FRONT
RIGHT:ASS'Y

1.08025324
HEXAGON HEAD T
APPING SCREW:P
F:4X10

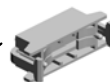
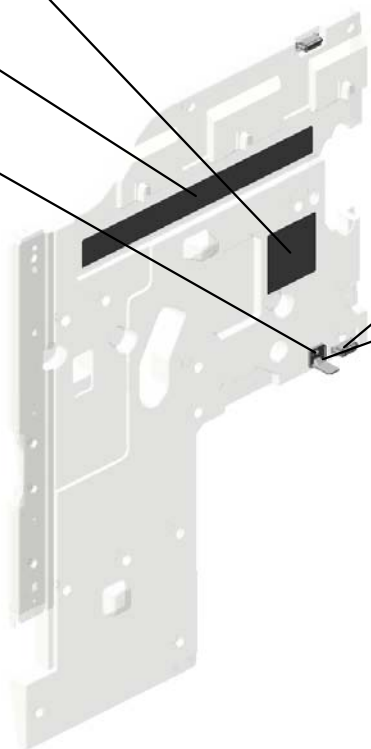

3.AG071013
(x2)
MAGNET CATCH:2
4.5N:ASS'Y



4.B2341293
LEVER - SAFETY S
WITCH

U002.Exterior 2

U002_S001
D0741293
COVER:MAIN:LEFT:ASS'Y

U002_S003
D0747768
COVER:FRONT LEFT:ASS'Y

U002_S002
D0747826
COVER:MAIN:RIGHT:ASS'Y

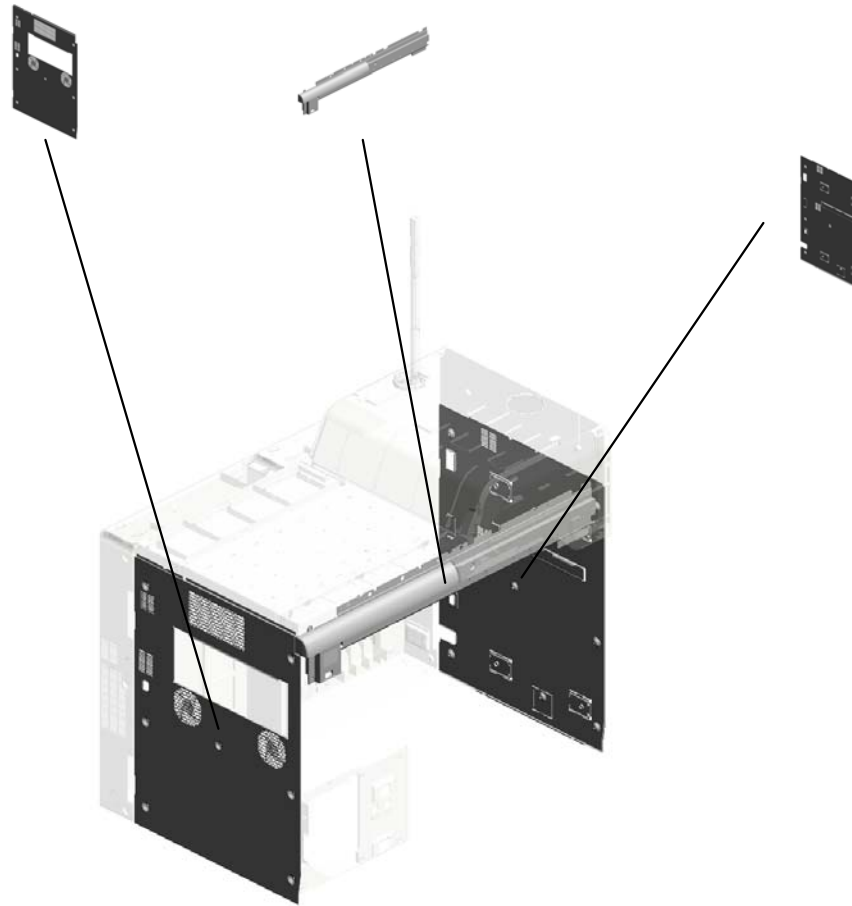

U001	U002	U003	U004	U005	U006	U007	U008	U009	U010	U011	U012	U013	U014	U015	U016	U017	U018	U019	U020	U021
------	-------------	------	------	------	------	------	------	------	------	------	------	------	------	------	------	------	------	------	------	------

U002 Exterior 2

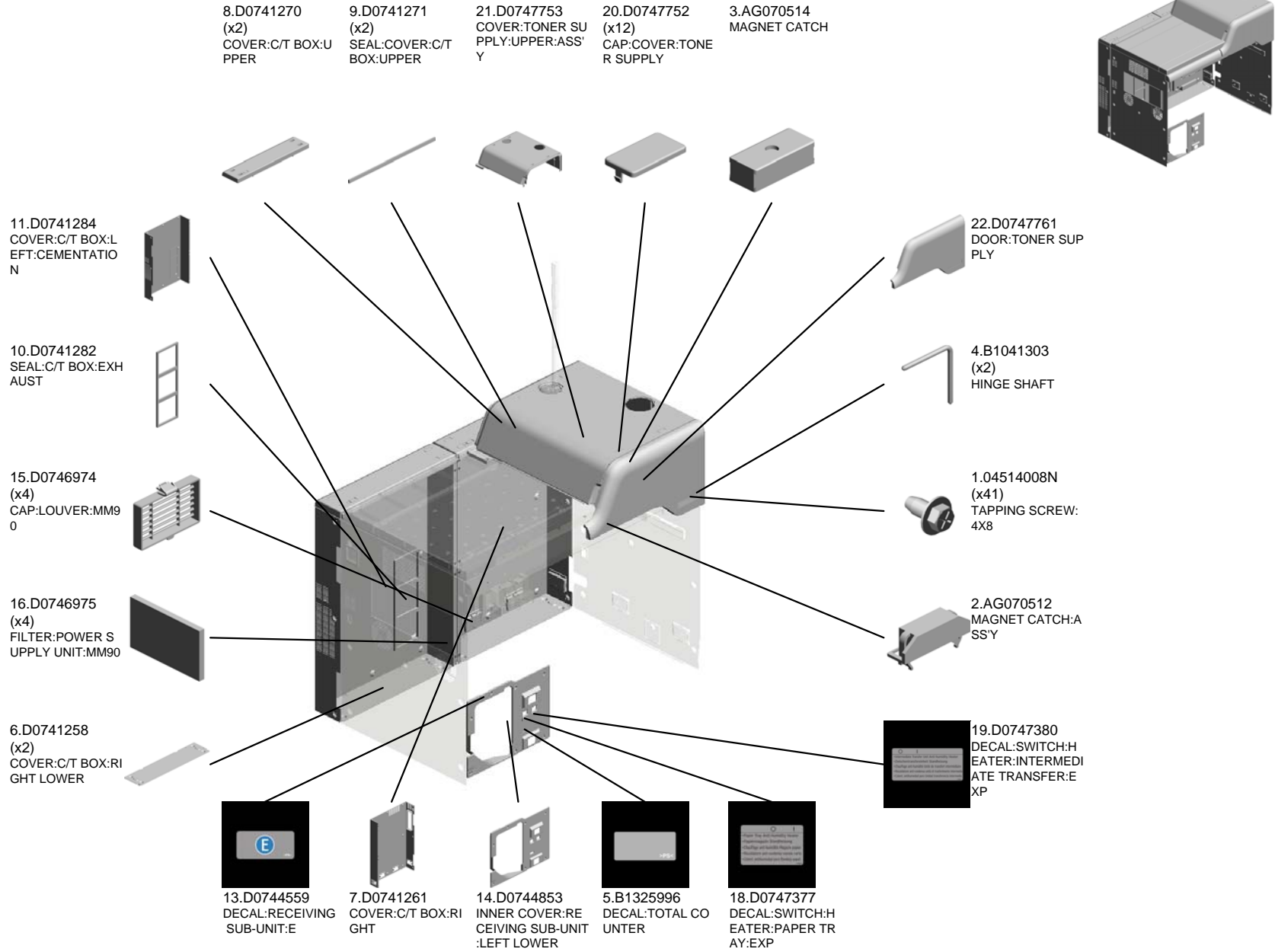

U002 Exterior 2

40.M0447746
COVER:UPPER RE
AR

41.M0447747
(x3)
CAP:COVER:REAR

37.M0447743
COVER:UPPER MI
DDLE

44.M0771861
TUBE TYPE LAMP:
TAC:ASS'Y

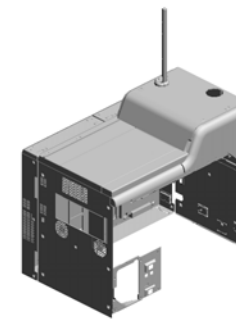

38.M0447744
(x4)
BRACKET:COVER:
UPPER MIDDLE:RE
AR

39.M0447745
(x4)
BRACKET:COVER:
UPPER MIDDLE:FR
ONT

23.D0747762
(x2)
BRACKET:HINGE:T
ONER SUPPLY

42.M0447880
MODEL NAME PLA
TE:PRO_C751

36.M0447741
COVER:UPPER FR
ONT

43.M0447898
DECAL:POWER SO
URCE:OFF:ENGLIS
H

33.D0747845
INNER COVER:5ST

U002_S001
COVER:MAIN:LEFT:ASS'Y

35.D0757884
(x2)
SEAL:EXHAUST:LE
FT UPPER

12.D0741293
COVER:MAIN:LEFT
:ASS'Y

27.D0747822
COVER:MAIN:LEFT
:WELDING

17.D0747152
SEAL:DUCT:EXHA
UST:LEFT REAR

34.D0757877
(x2)
SEAL:EXHAUST:LE
FT MIDDLE

U001	U002	U003	U004	U005	U006	U007	U008	U009	U010	U011	U012	U013	U014	U015	U016	U017	U018	U019	U020	U021
------	-------------	------	------	------	------	------	------	------	------	------	------	------	------	------	------	------	------	------	------	------

U002_S002
COVER:MAIN:RIGHT:ASS'Y

30.D0747829
(x4)
CAP:JOINT:LARGE
CAPACITY TRAY

31.D0747830
COVER:LARGE CA
PACITY TRAY

1.04514008N
TAPPING SCREW:
4X8

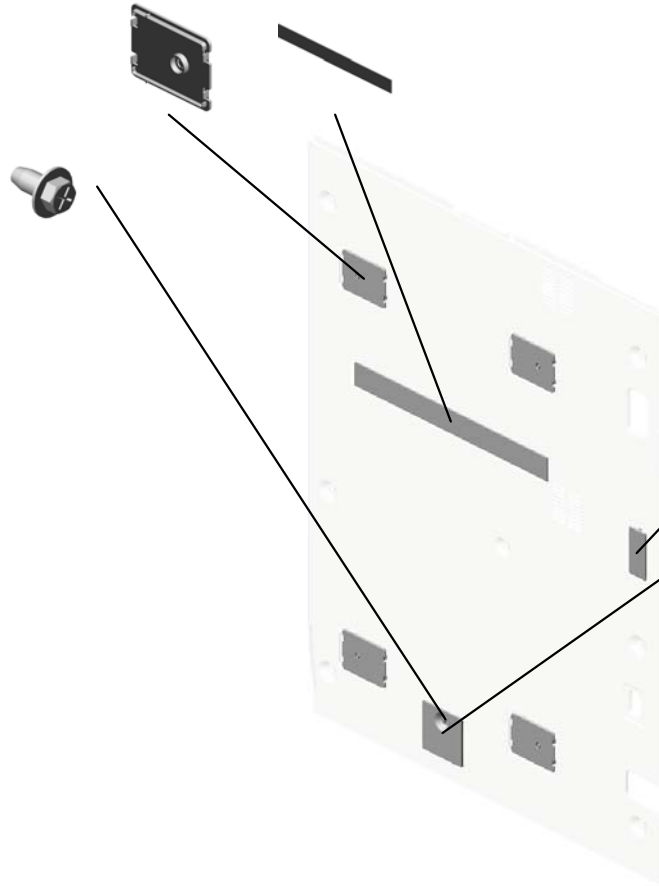

29.D0747828
CAP:CONNECTOR

32.D0747831
COVER:CONNECT
OR:LARGE CAPACI
TY TRAY



28.D0747826
COVER:MAIN:RIGH
T:ASS'Y

U002_S003
COVER:FRONT LEFT:ASS'Y

25.D0747773
DECAL:OPERATIO
N INSTRUCTIONS:
TONER SUPPLY

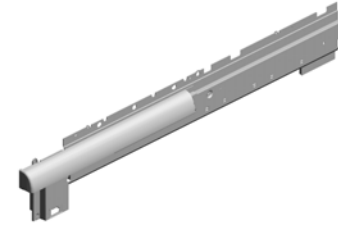
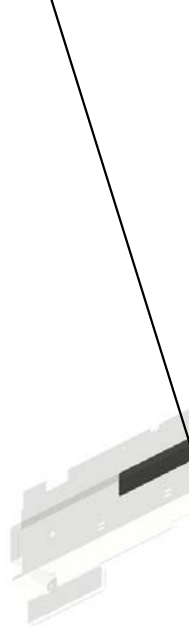

24.D0747768
COVER:FRONT LE
FT:ASS'Y

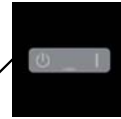

26.D0747774
DECAL:MAIN SWIT
CH



U003.Operation 1

U003_S001
D0746851
OPERATION SUB-UNIT:TAP:
NA:ASS'Y

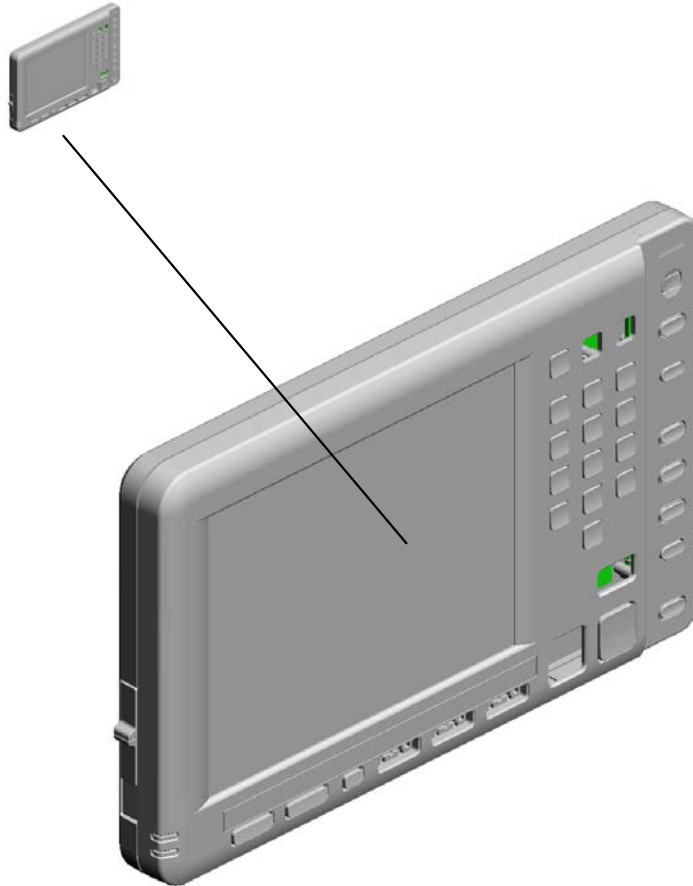

U001	U002	U003	U004	U005	U006	U007	U008	U009	U010	U011	U012	U013	U014	U015	U016	U017	U018	U019	U020	U021
------	------	------	------	------	------	------	------	------	------	------	------	------	------	------	------	------	------	------	------	------

U003
Operation 1

2.D0746735
COVER:OPERATIO
N PANEL:REAR UP
PER



1.D0746734
COVER:OPERATIO
N PANEL:REAR

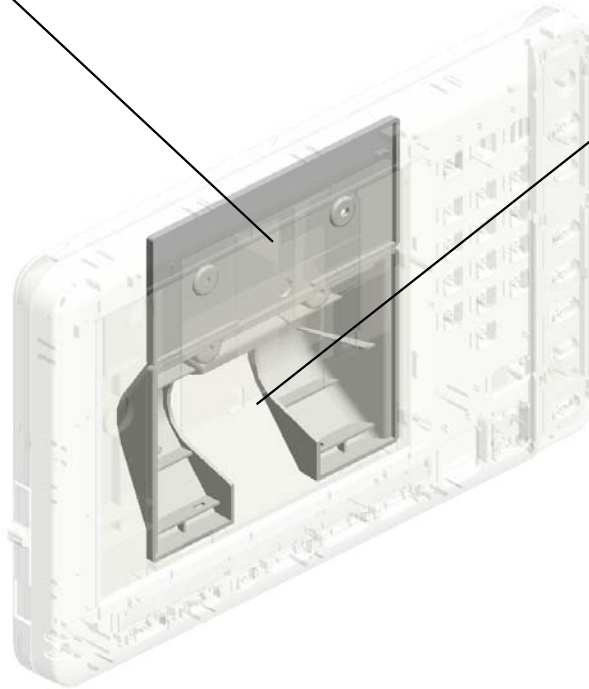

U003_S001
OPERATION SUB-UNIT:TAP:NA:ASS'Y

22.M0771800 TOUCH PANEL:10.4INCH
 17.M0771783 SHADEING PLATE: TOUCH PANEL
 23.M0771810 LCD:10.4SVGA-LED
 18.M0771785 BRACKET:STAY:ARM
 3.D0746831 PCB:OPU:P:NA:SERVICE



4.D0746851
OPERATION SUB-UNIT:TAP:NA:ASS'Y

16.M0771782
BRACKET:LCD

6.M0771766
KNOB:VARIABLE RESISTOR

15.M0771781
LENS:INPUT

13.M0771774
KEYTOP:PRINTER

14.M0771778
KEYTOP:BLANK

21.M0771790
PLATE:APPLICATION:NA

11.M0771772
SPACER:APPLICATION:P

19.M0771786
COVER:FRONT:PART:NA:ASSY

5.M0771765
COVER:REAR

7.M0771767
KEYTOP:START

20.M0771789
KEYTOP:RESET SWITCH:EXP

12.M0771773
SPACER:START:PART

9.M0771770
KEYTOP:POWER SOURCE

24.M0771812
PCB:PART:KEY:MAIN:ASSY

8.M0771768
KEYTOP:10KEY

10.M0771771
KEYTOP:OPTION:PART

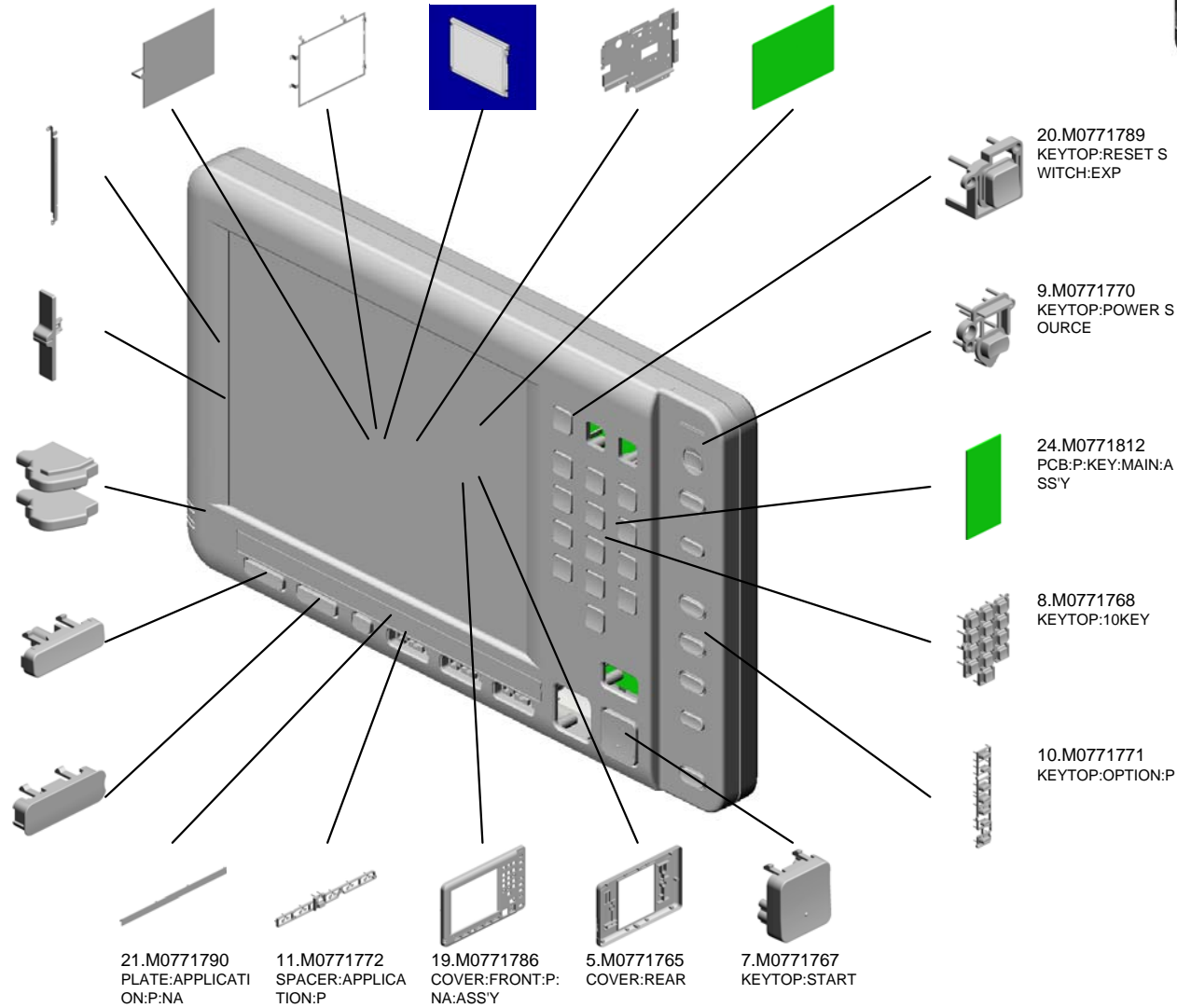

U003_S001
OPERATION SUB-UNIT:TAP:NA:ASS'Y

26.M0771814
PCB:P:KEY:APPLI:
ASS'Y



4.D0746851
OPERATION SUB-
UNIT:TAP:NA:ASS'
Y

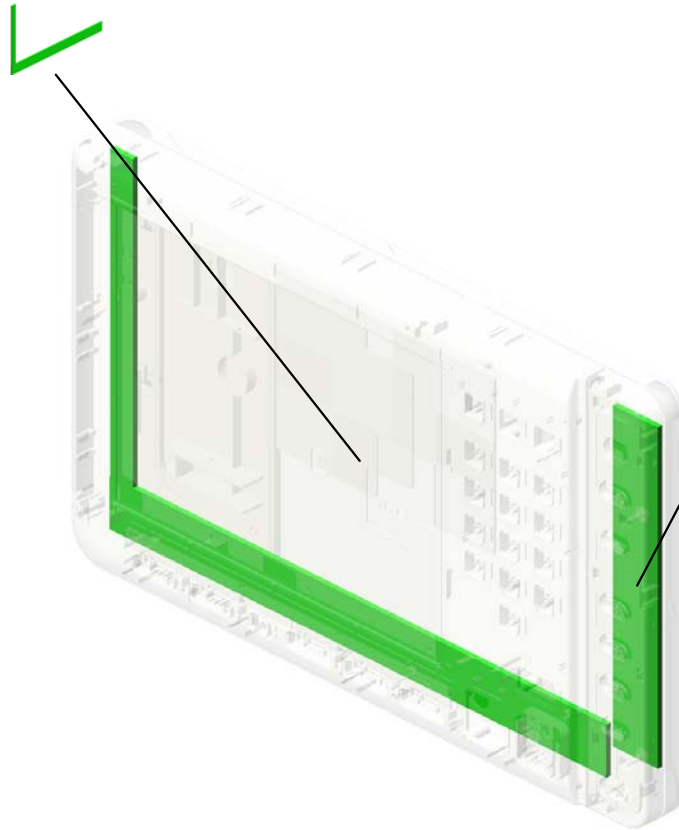

25.M0771813
PCB:P:KEY:SUB:AS
S'Y

U004 Operation 2

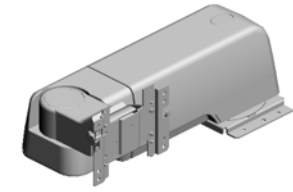
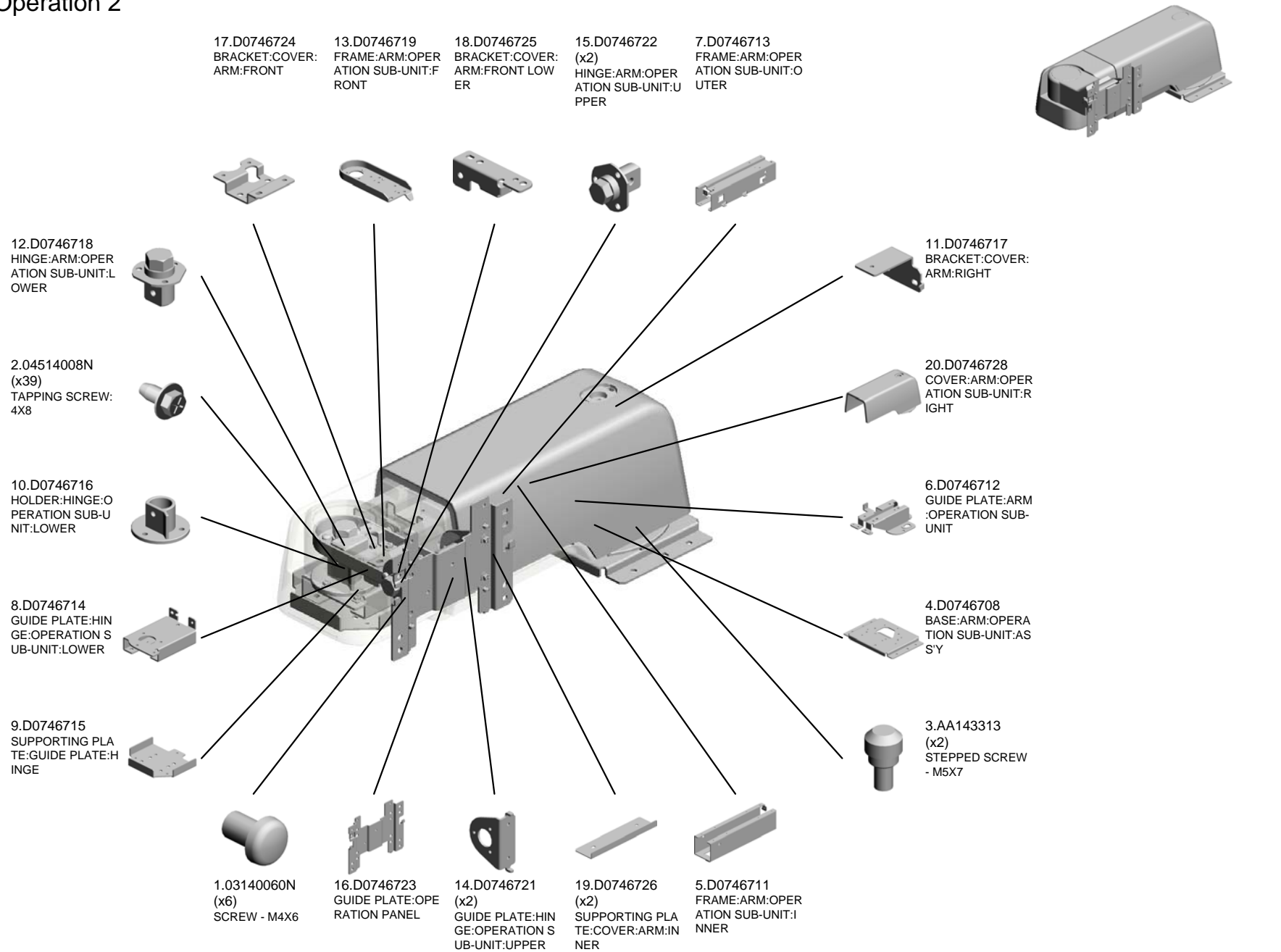

U001	U002	U003	U004	U005	U006	U007	U008	U009	U010	U011	U012	U013	U014	U015	U016	U017	U018	U019	U020	U021
------	------	------	------	------	------	------	------	------	------	------	------	------	------	------	------	------	------	------	------	------

U004 Operation 2

27.D0746737 CAP:COVER:ARM:FRONT
 25.D0746733 COVER:ARM:OPERATION SUB-UNIT:FRONT
 29.D0746739 HOLDER:HINGE:OPERATION SUB-UNIT:UPPER

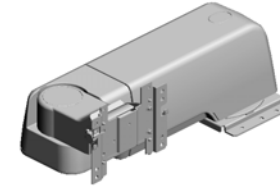

23.D0746731 COVER:ARM:OPERATION SUB-UNIT:LEFT



24.D0746732 COVER:ARM:OPERATION SUB-UNIT:LEFT LOWER

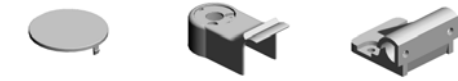

28.D0746738 CAP:COVER:ARM:RIGHT



21.D0746729 COVER:ARM:OPERATION SUB-UNIT:INNER



22.D0746730 COVER:ARM:OPERATION SUB-UNIT:RIGHT LOWER



26.D0746736 COVER:ARM:OPERATION SUB-UNIT:FRONT LOWER

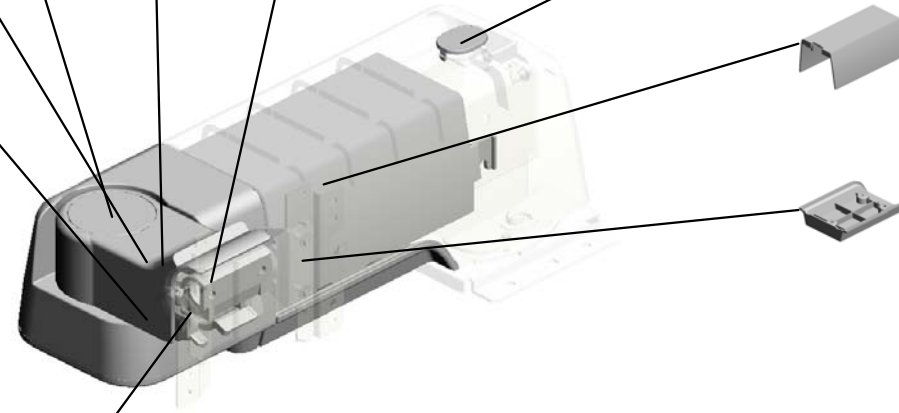

U005
Laser Unit

2.D0741801
(x2)
OPTICAL WRITING
UNIT:ASS'Y

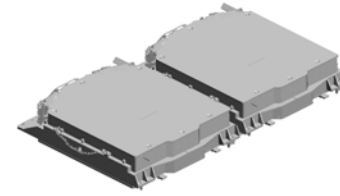
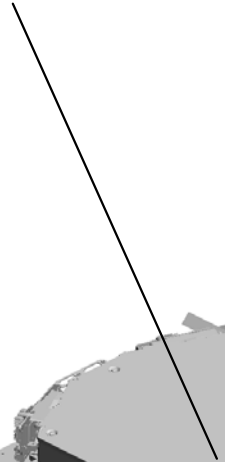

1.03604020N
(x8)
SCREW:M4X20

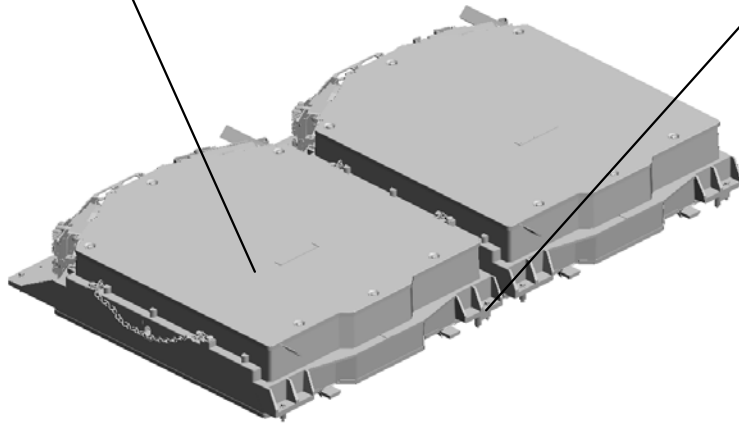
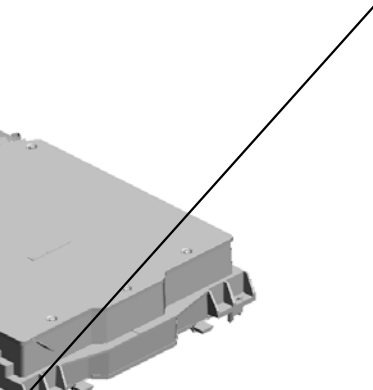

U001	U002	U003	U004	U005	U006	U007	U008	U009	U010	U011	U012	U013	U014	U015	U016	U017	U018	U019	U020	U021
------	------	------	------	------	------	------	------	------	------	------	------	------	------	------	------	------	------	------	------	------

U006 Tandem Tray 1

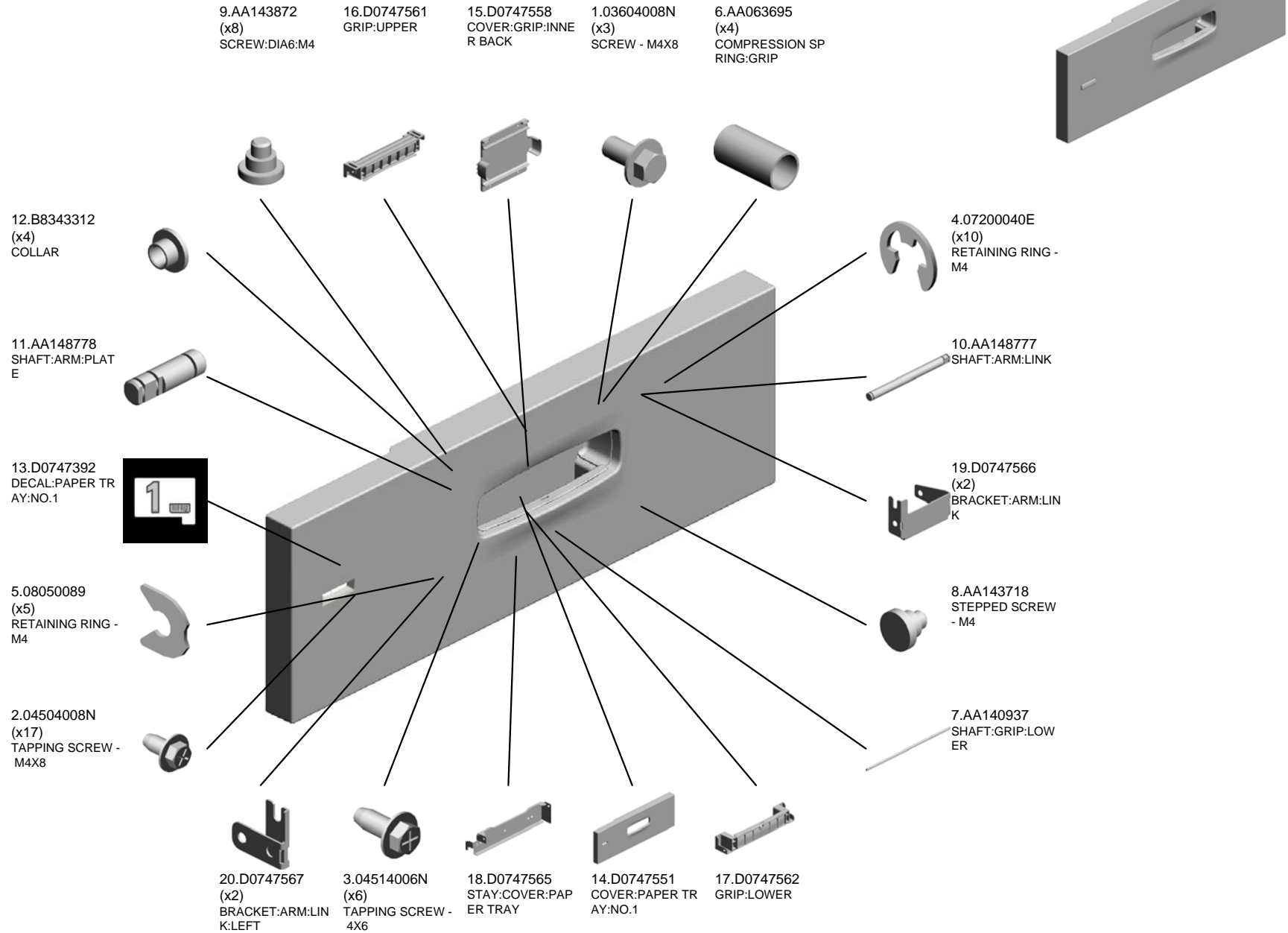

U001	U002	U003	U004	U005	U006	U007	U008	U009	U010	U011	U012	U013	U014	U015	U016	U017	U018	U019	U020	U021
------	------	------	------	------	-------------	------	------	------	------	------	------	------	------	------	------	------	------	------	------	------

U006 Tandem Tray 1

29.D5161453
DIFFUSION PLATE:
LED

24.D0747575
LINK:UPPER LOW
ER:LEFT:ASS'Y

23.D0747573
BRACKET:ARM:PL
ATE



27.D0747609
PROTECTION:COV
ER:LED

28.D5161261
COVER:LED

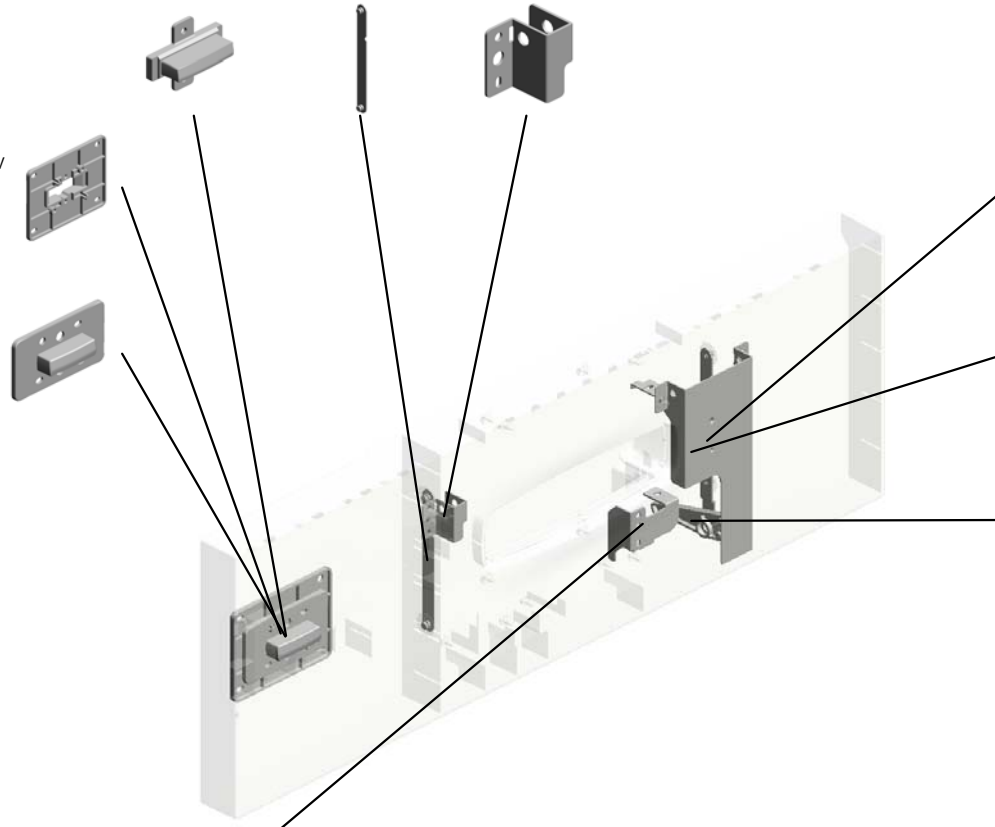

25.D0747577
LINK:UPPER LOW
ER:ASS'Y

22.D0747570
BASE:LINK:PAPER
TRAY:ASS'Y

26.D0747579
STOPPER:TANDE
M LCT

21.D0747568
BRACKET:FIX:AUXI
LIARY:COVER

U001	U002	U003	U004	U005	U006	U007	U008	U009	U010	U011	U012	U013	U014	U015	U016	U017	U018	U019	U020	U021
------	------	------	------	------	-------------	------	------	------	------	------	------	------	------	------	------	------	------	------	------	------

U007.Tandem Tray 2 (Left)

U007_S001
D0747546
TANDEM LCT:LEFT:NA:ASS'
Y

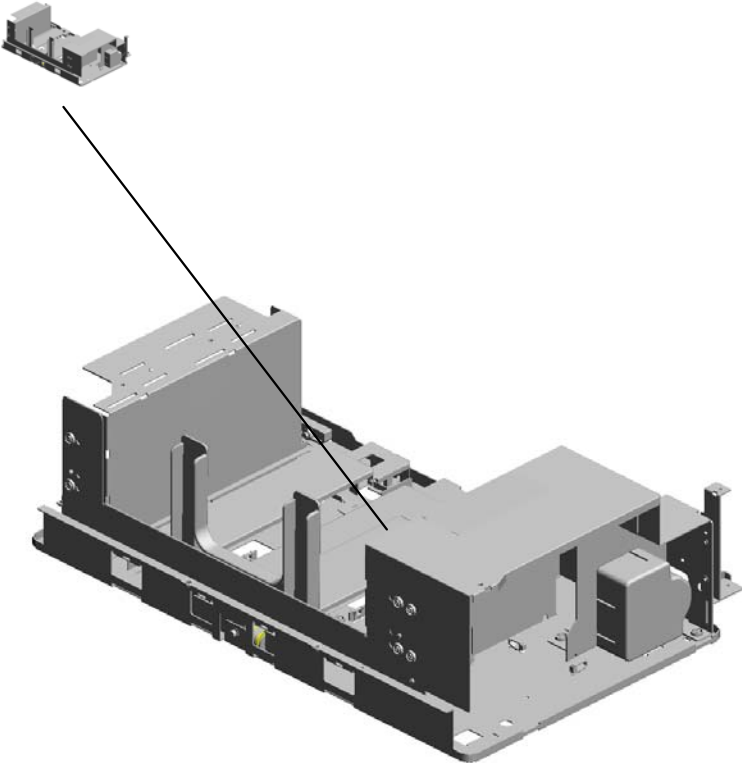

U001	U002	U003	U004	U005	U006	U007	U008	U009	U010	U011	U012	U013	U014	U015	U016	U017	U018	U019	U020	U021
------	------	------	------	------	------	------	------	------	------	------	------	------	------	------	------	------	------	------	------	------

U007_S001.TANDEM LCT:LEFT:NA:ASS'Y

U007_S001_S001
D0747596
TRAY BOTTOM PLATE:LEFT
MIDDLE:ASS'Y

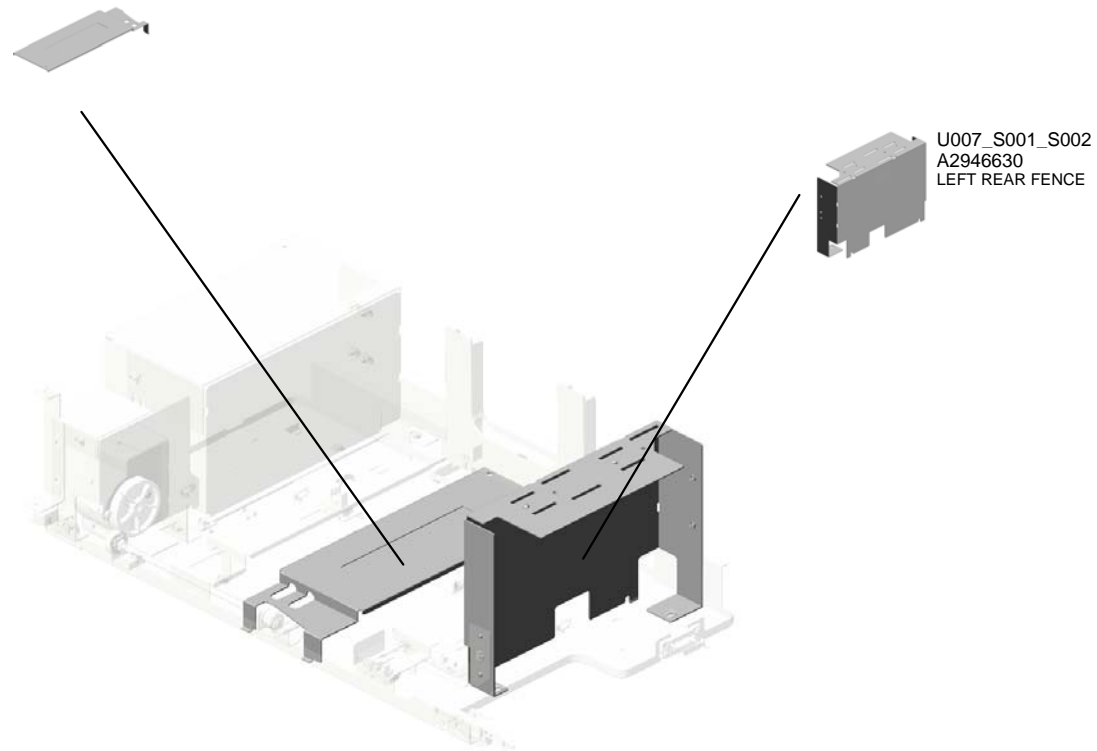

U001	U002	U003	U004	U005	U006	U007	U008	U009	U010	U011	U012	U013	U014	U015	U016	U017	U018	U019	U020	U021
------	------	------	------	------	------	------	------	------	------	------	------	------	------	------	------	------	------	------	------	------

U007
Tandem Tray 2 (Left)

3.03540060N
(x3)
SCREW-M4X6

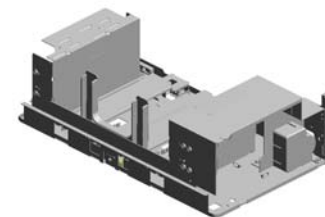
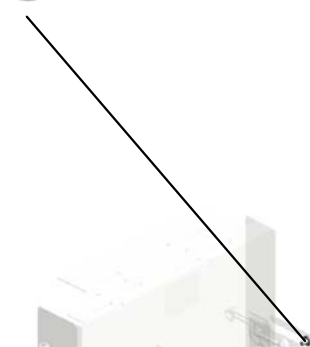

2.03540040N
(x2)
SCREW-M4X4

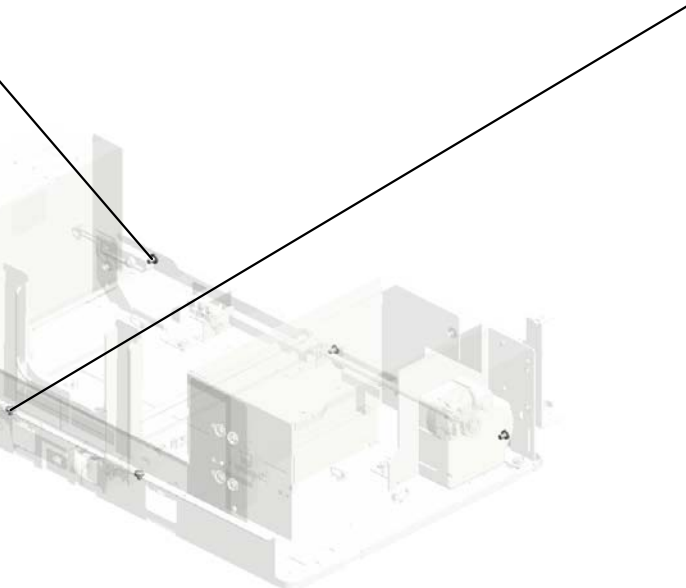

U001	U002	U003	U004	U005	U006	U007	U008	U009	U010	U011	U012	U013	U014	U015	U016	U017	U018	U019	U020	U021
------	------	------	------	------	------	------	------	------	------	------	------	------	------	------	------	------	------	------	------	------

U007_S001
TANDEM LCT:LEFT:NA:ASS'Y

- 4.04503008N (x3) TAPPING SCREW - M3X8
- 12.A2946643 LEFT FRONT FENCE
- 20.AB033084 TIMING PULLEY - 15T
- 8.04534006N BINDING SELF TAPPING SCREW:4X6
- 23.AW020163 PAPER FEED SENSOR

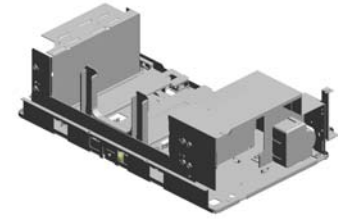

40.D0747546
TANDEM LCT:LEFT
:NA:ASS'Y

24.AX040145
DC MOTOR:TANDEM LCT



19.AB019475
GEAR - 48T



18.AB013798
GEAR - Z18



17.AA140686
SHAFT - TIMING PULLEY



10.50530447 (x2)
BUSHING - 6MM



22.AW020145 (x2)
PHOTOINTERRUPTOR:FLAT



15.AA043271
TIMING BELT S3M 196T



7.04514006N (x25)
TAPPING SCREW - 4X6



16.AA060987
TENSION SPRING: TIMING BELT:10N



5.04504008N (x2)
TAPPING SCREW - M4X8



13.A2946645
LEFT SIDE PLATE



6.04504010N (x2)
TAPPING SCREW: M4X10



21.AB033085
TIMING PULLEY - 15T

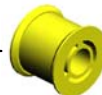

9.07200040E (x5)
RETAINING RING - M4



1.03130080N (x2)
PAN HEAD SCREW :M3X8



U001	U002	U003	U004	U005	U006	U007	U008	U009	U010	U011	U012	U013	U014	U015	U016	U017	U018	U019	U020	U021
------	------	------	------	------	------	------	------	------	------	------	------	------	------	------	------	------	------	------	------	------

U007_S001
TANDEM LCT:LEFT:NA:ASS'Y

35.D0596646
INNER COVER:TA
NDEM LCT:LEFT

39.D0747389
DECAL:PAPER SE
T DIRECTION:TAN
DEM LCT:LEFT

32.B2476950
SHAFT:SLIDER:BA
CK FENCE

29.B1327561
BACK FENCE:LEFT

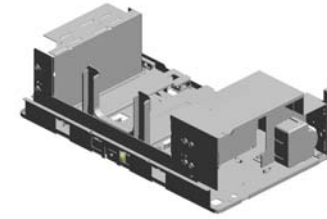

40.D0747546
TANDEM LCT:LEFT
:NA:ASS'Y

37.D0596665
BRACKET:DC MOT
OR:LEFT:ASS'Y

31.B2347540
TRAY BOTTOM PL
ATE:LEFT FRONT

26.B0656830
PULLEY BRACKET

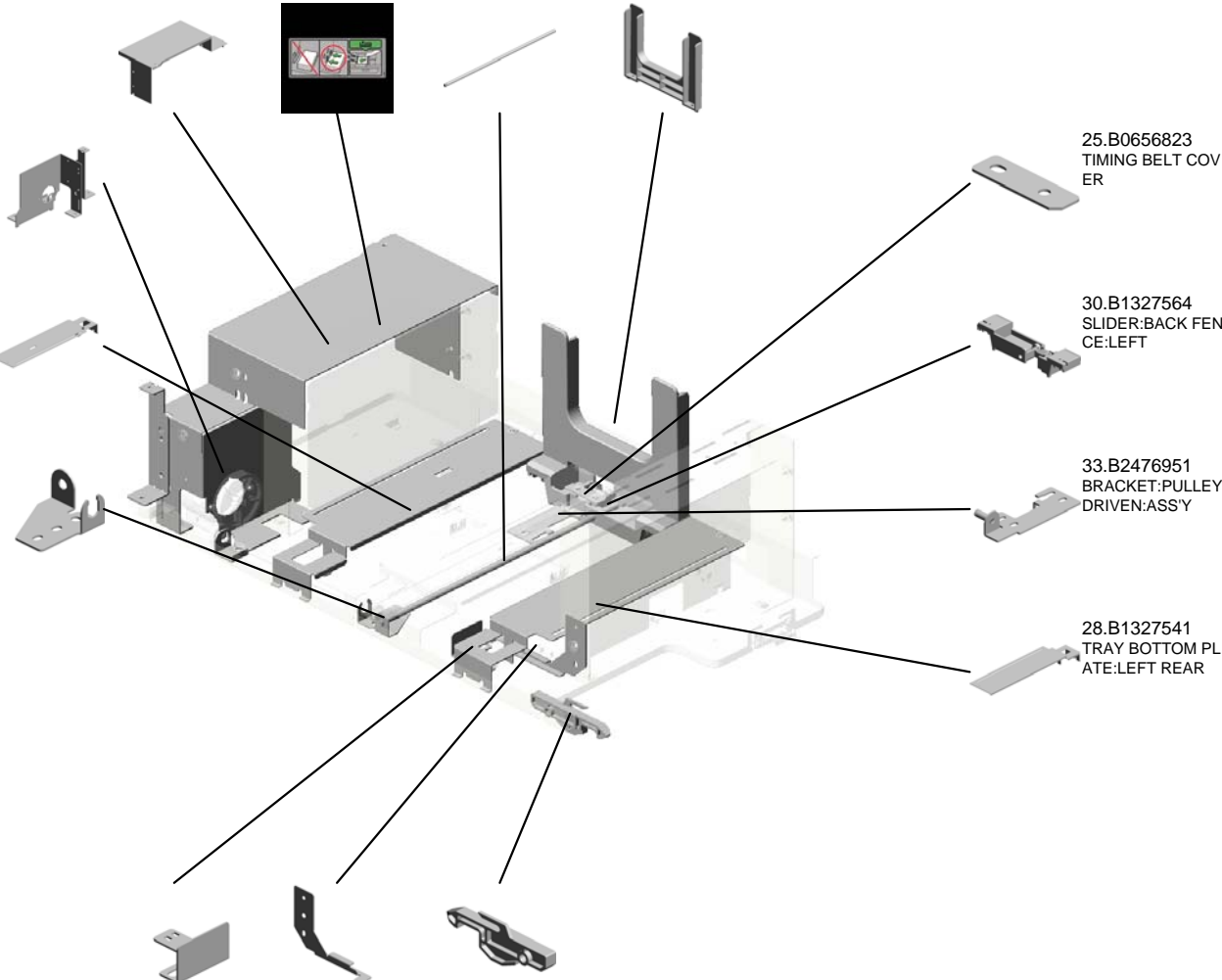

25.B0656823
TIMING BELT COV
ER

30.B1327564
SLIDER:BACK FEN
CE:LEFT

33.B2476951
BRACKET:PULLEY:
DRIVEN:ASS'Y

28.B1327541
TRAY BOTTOM PL
ATE:LEFT REAR

27.B0656831
SENSOR BRACKE
T

36.D0596659
SUPPORTING PLA
TE:SIDE FENCE:LE
FT

34.D0596620
LEVER:COUPLING:
LEFT

U001	U002	U003	U004	U005	U006	U007	U008	U009	U010	U011	U012	U013	U014	U015	U016	U017	U018	U019	U020	U021
------	------	------	------	------	------	------	------	------	------	------	------	------	------	------	------	------	------	------	------	------

U007_S001_S001
TRAY BOTTOM PLATE:LEFT MIDDLE:ASS'Y

38.D0747387
DECAL:BASE:TAN
DEM LCT:LEFT

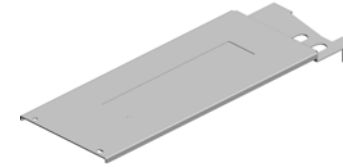
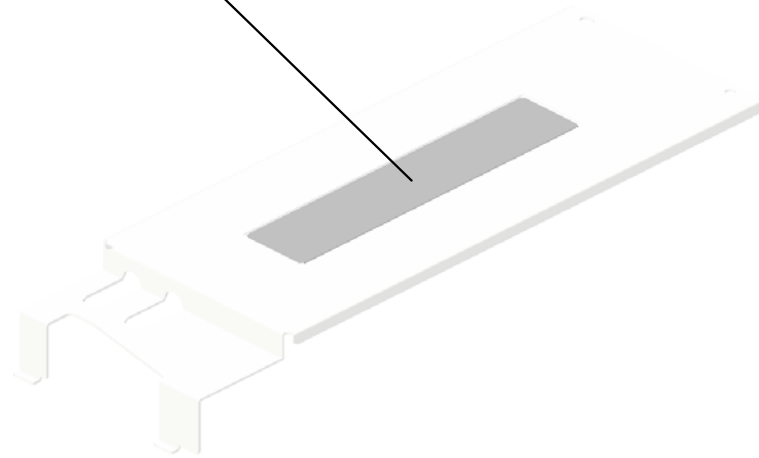

41.D0747596
TRAY BOTTOM PL
ATE:LEFT MIDDLE:
ASS'Y

U001	U002	U003	U004	U005	U006	U007	U008	U009	U010	U011	U012	U013	U014	U015	U016	U017	U018	U019	U020	U021
------	------	------	------	------	------	------	------	------	------	------	------	------	------	------	------	------	------	------	------	------

U007_S001_S002
LEFT REAR FENCE

14.AA001508
DECAL:SIDE FENC
E:40X30

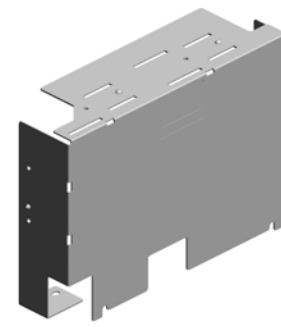
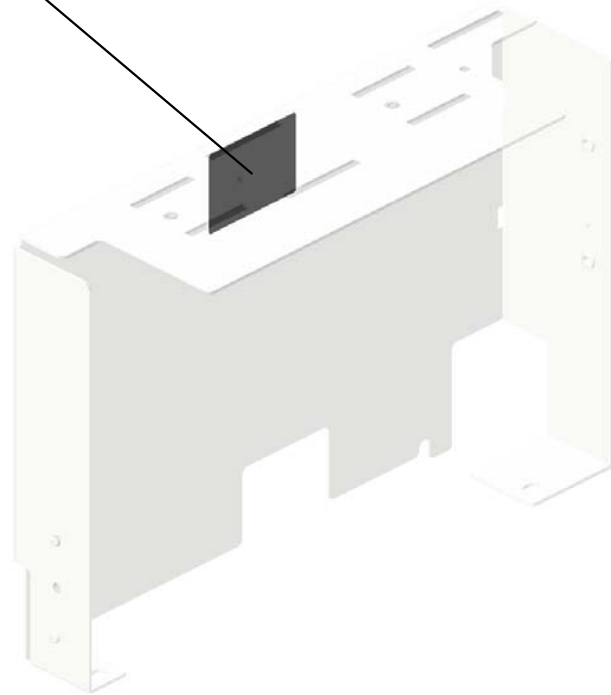

11.A2946630
LEFT REAR FENCE

U001	U002	U003	U004	U005	U006	U007	U008	U009	U010	U011	U012	U013	U014	U015	U016	U017	U018	U019	U020	U021
------	------	------	------	------	------	------	------	------	------	------	------	------	------	------	------	------	------	------	------	------

U008.Tandem Tray 3 (Right)

U008_S001
D0747541
TANDEM LCT:RIGHT:NA:ASS
Y

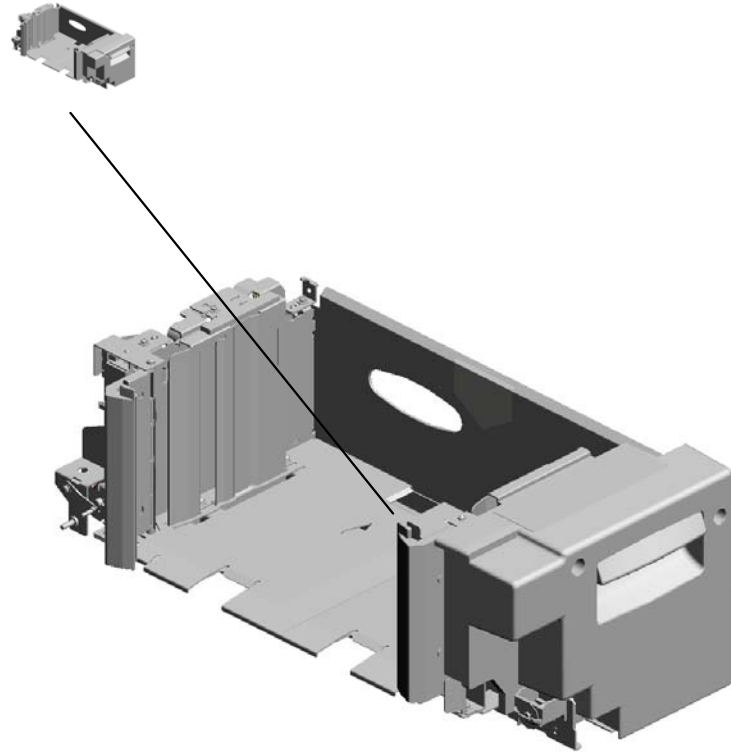

U001	U002	U003	U004	U005	U006	U007	U008	U009	U010	U011	U012	U013	U014	U015	U016	U017	U018	U019	U020	U021
------	------	------	------	------	------	------	------	------	------	------	------	------	------	------	------	------	------	------	------	------

U008_S001.TANDEM LCT:RIGHT:NA:ASS'Y

U008_S001_S001
B2346686
SIDE FENCE - RIGHT FRONT

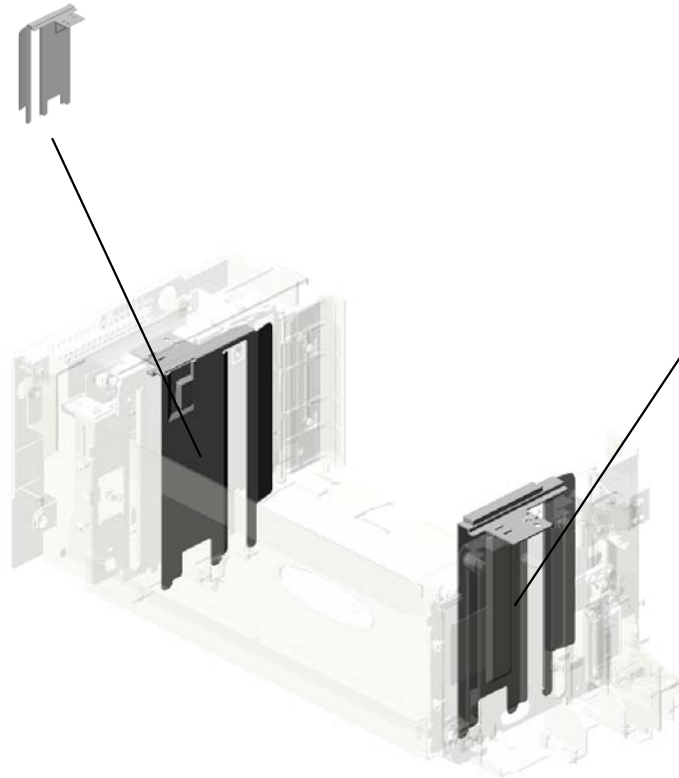

U008_S001_S002
B2346691
SIDE FENCE:TANDEM LCT:R
IGHT:ASS'Y

U001	U002	U003	U004	U005	U006	U007	U008	U009	U010	U011	U012	U013	U014	U015	U016	U017	U018	U019	U020	U021
------	------	------	------	------	------	------	------	------	------	------	------	------	------	------	------	------	------	------	------	------

U008
Tandem Tray 3 (Right)

58.D0596664
GUIDE:MIDDLE:PA
PER TRAY

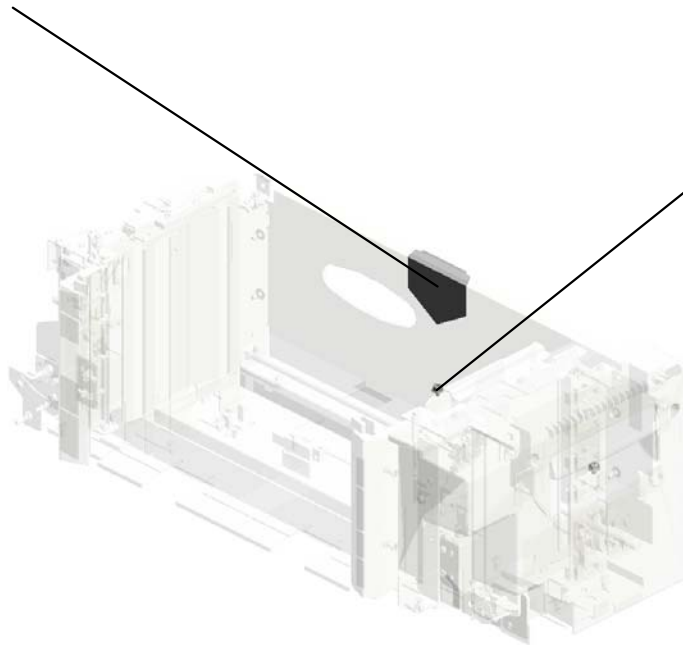
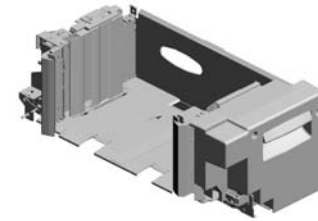

57.D0592399
(x2)
FLANGED HEXAG
ONAL HEAD BOLT:
M3*4

U001	U002	U003	U004	U005	U006	U007	U008	U009	U010	U011	U012	U013	U014	U015	U016	U017	U018	U019	U020	U021
------	------	------	------	------	------	------	-------------	------	------	------	------	------	------	------	------	------	------	------	------	------

U008_S001
TANDEM LCT:RIGHT:NA:ASS'Y

- | | | | | |
|--|---|---|---|---|
| 3.04504008N
(x2)
TAPPING SCREW -
M4X8 | 6.04544008Q
(x13)
TAPPING SCREW -
M4X8 | 22.AA060757
(x2)
TENSION SPRING -
LONG | 8.07200040E
(x8)
RETAINING RING -
M4 | 18.A2486713
(x2)
HOOK - TENSION
SPRING |
|--|---|---|---|---|

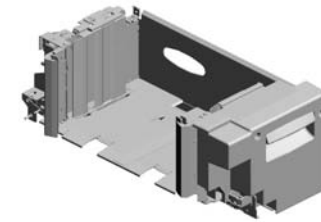

65.D0747541
TANDEM LCT:RIGH
T:NA:ASS'Y

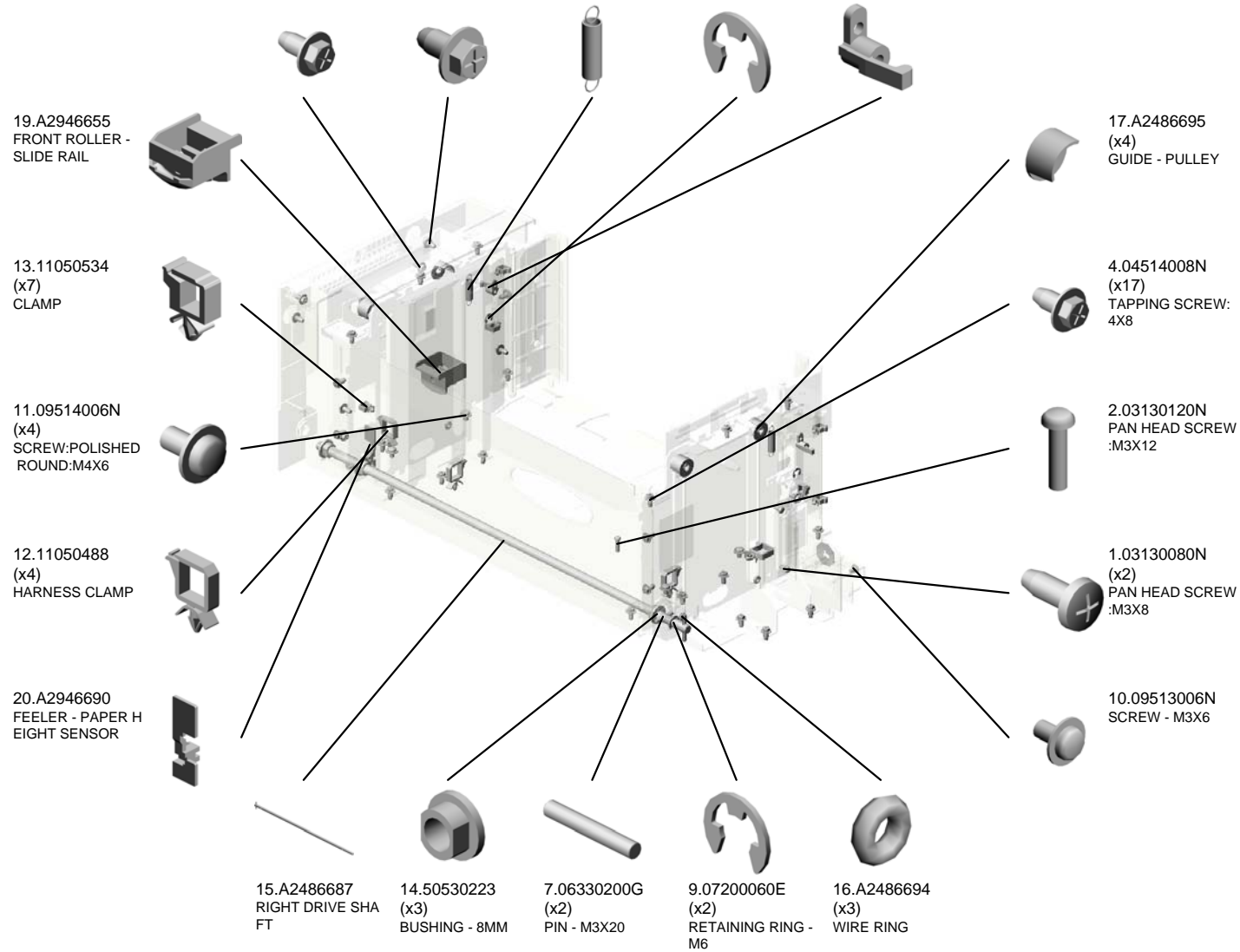

U008_S001
TANDEM LCT:RIGHT:NA:ASS'Y

- 28.AB032058 (x2) WIRE PULLEY - M10
- 23.AA060758 (x2) TENSION SPRING - SHORT
- 32.AW020145 (x9) PHOTOINTERRUPTOR:FLAT
- 40.B0706683 LEVER:RELEASE:FRONT
- 39.B0706667 END FENCE COVE R FRONT

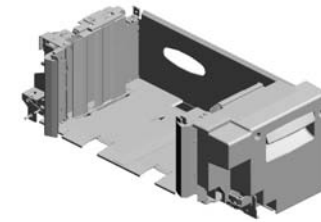

65.D0747541
TANDEM LCT:RIGHT:NA:ASS'Y

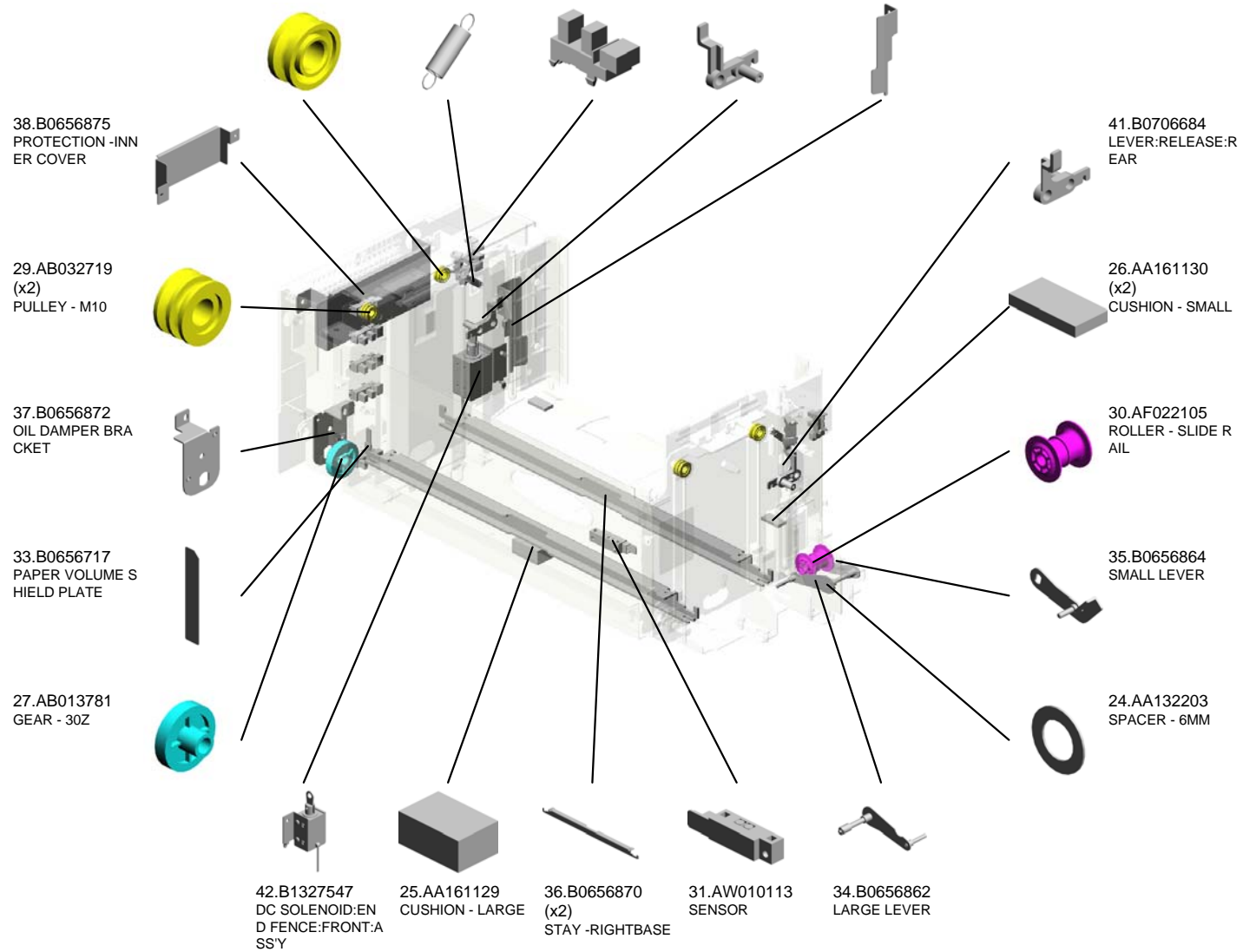

U001	U002	U003	U004	U005	U006	U007	U008	U009	U010	U011	U012	U013	U014	U015	U016	U017	U018	U019	U020	U021
------	------	------	------	------	------	------	------	------	------	------	------	------	------	------	------	------	------	------	------	------

U008_S001
TANDEM LCT:RIGHT:NA:ASS'Y

63.D0747385
DECAL:CAUTION C
HART:TANDEM LC
T

61.D0596712
INNER COVER:TA
NDEM LCT

64.D0747388
DECAL:PAPER SE
T DIRECTION:TAN
DEM LCT:RIGHT

55.D0146626
BRACKET:ON OFF
DETECTOR:FRON
T

48.B2346612
END FENCE - FRO
NT

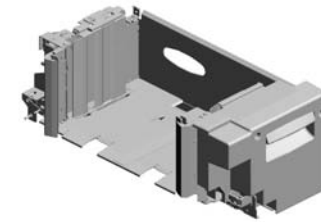

65.D0747541
TANDEM LCT:RIGH
T:NA:ASS'Y

47.B2346606
SENSOR BRACKE
T

46.B2346141
POSITIONING SLE
EVE - INNER BACK

53.B2476901
OIL DAMPER:FALL

62.D0746497
(x2)
DECAL:POSITIONI
NG DISPLAY:TCRU

59.D0596668
SIDE PLATE:SIDE:
TANDEM LCT

66.D0747595
BASE:TANDEM LC
T:RIGHT:ADHESIO
N

43.B1327550
(x2)
COVER:PULLEY:D
RIVE WERE

56.D0146627
BRACKET:ON OFF
DETECTOR:REAR

49.B2346625
END FENCE - REA
R

52.B2476695
GUIDE:MISFEED R
EMOVAL:PAPER T
RAY

44.B1327571
DC SOLENOID:EN
D FENCE:REAR:AS
S'Y

45.B1327575
BRACKET:CONNE
CTOR:TANDEM LC
T

U008_S001_S001
SIDE FENCE - RIGHT FRONT

60.D0596690
PLATE:PAPER:ASS
Y

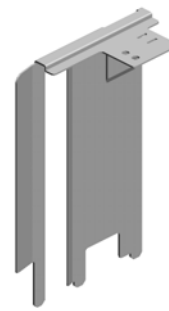
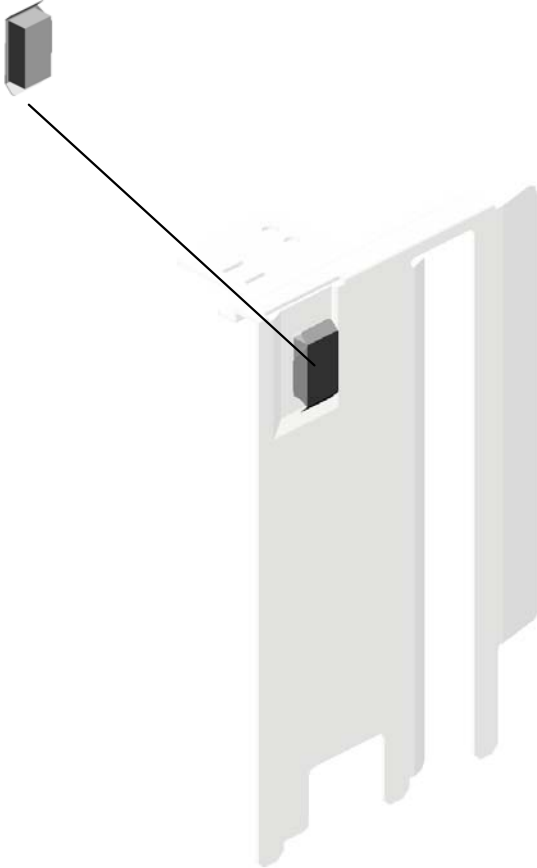

50.B2346686
SIDE FENCE - RIG
HT FRONT

U001	U002	U003	U004	U005	U006	U007	U008	U009	U010	U011	U012	U013	U014	U015	U016	U017	U018	U019	U020	U021
------	------	------	------	------	------	------	-------------	------	------	------	------	------	------	------	------	------	------	------	------	------

U008_S001_S002
SIDE FENCE:TANDEM LCT:RIGHT:ASS'Y

54.B4756855
SHIELD:TANDEM L
CT:REAR RIGHT

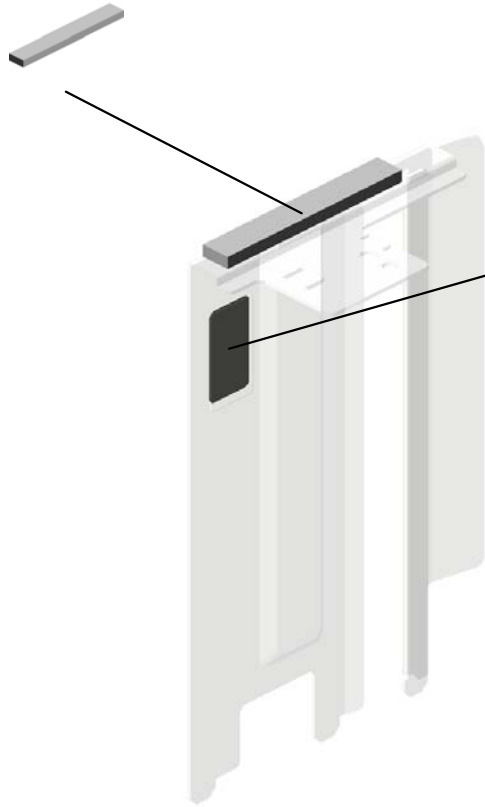

21.AA001509
DECAL:SIDE FENC
E:16X30



51.B2346691
SIDE FENCE:TAND
EM LCT:RIGHT:AS
SY

U001	U002	U003	U004	U005	U006	U007	U008	U009	U010	U011	U012	U013	U014	U015	U016	U017	U018	U019	U020	U021
------	------	------	------	------	------	------	-------------	------	------	------	------	------	------	------	------	------	------	------	------	------

U009 Universal Tray 1

10.D0747393
DECAL:PAPER TRAY:NO.2

7.D0596721
STOPPER:PAPER TRAY

4.04514008N
(x2)
TAPPING SCREW:
4X8

9.D0596728
(x2)
COMPRESSION SPRING:GRIP:PAPER TRAY

12.D0747603
PLATE:GRIP:PAPER TRAY:NO.2

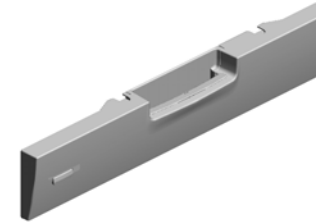

15.D0747609
PROTECTION COVER:LED



17.D5161453
DIFFUSION PLATE:LED

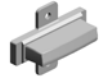

16.D5161261
COVER:LED



2.04504008N
(x15)
TAPPING SCREW - M4X8



8.D0596725
BRACKET:STOPPER:PAPER TRAY:RIGHT:PEEN



13.D0747606
GRIP:PAPER TRAY:NO.2



11.D0747601
COVER:PAPER TRAY:NO.2



14.D0747607
ARM:PAPER TRAY:GRIP



3.04513008N
(x2)
TAPPING SCREW - M3X8



5.07200040E
RETAINING RING - M4



6.AA143883
SHAFT:STOPPER:PAPER TRAY



1.03530080N
SCREW:M3X8



U010.Universal Tray 2

U010_S001
D0747631
PAPER TRAY:UNIVERSAL:D
OM:SUB-ASS'Y

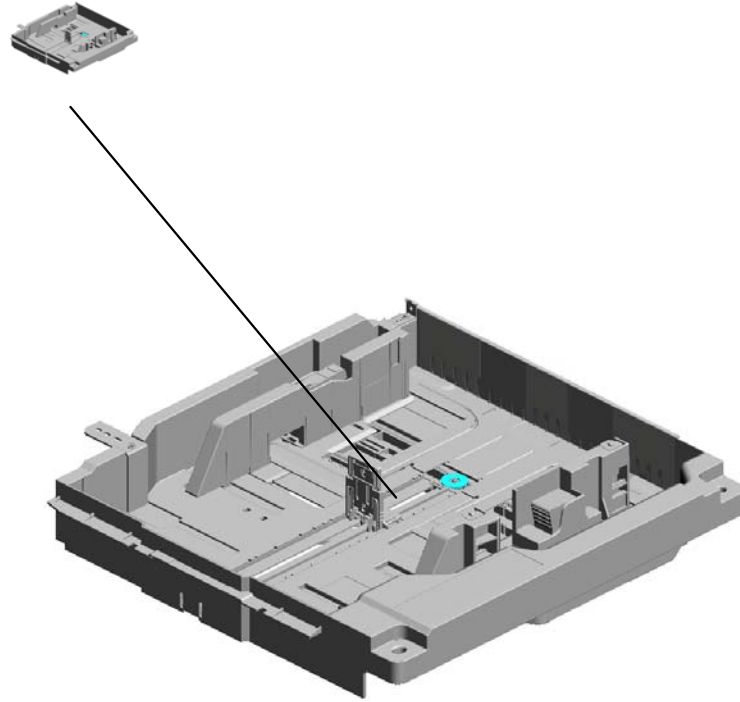

U001	U002	U003	U004	U005	U006	U007	U008	U009	U010	U011	U012	U013	U014	U015	U016	U017	U018	U019	U020	U021
------	------	------	------	------	------	------	------	------	------	------	------	------	------	------	------	------	------	------	------	------

U010_S001.PAPER TRAY:UNIVERSAL:DOM:SUB-ASS'Y

U010_S001_S001
B1326793
SIDE FENCE:FRONT:ASS'Y

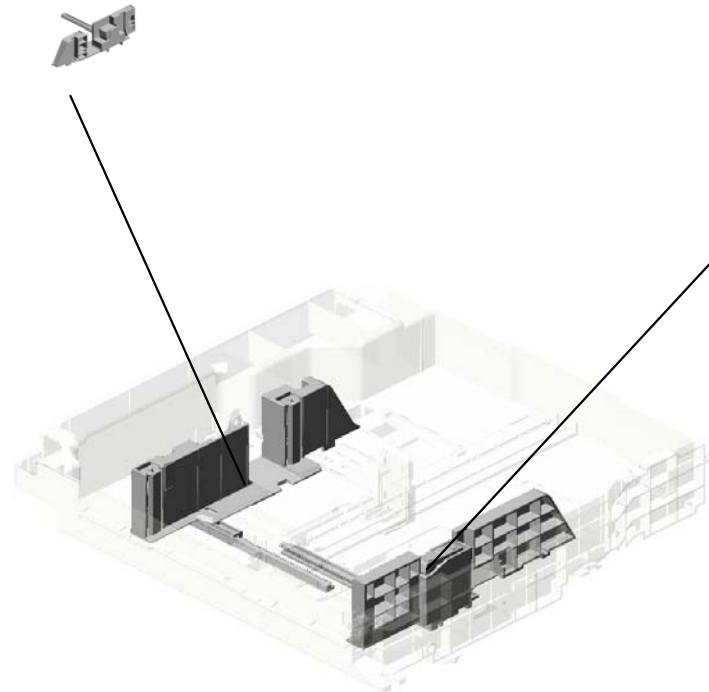

U010_S001_S002
B2346490
SIDE FENCE:REAR:ASS'Y

U001	U002	U003	U004	U005	U006	U007	U008	U009	U010	U011	U012	U013	U014	U015	U016	U017	U018	U019	U020	U021
------	------	------	------	------	------	------	------	------	------	------	------	------	------	------	------	------	------	------	------	------

U010 Universal Tray 2

26.B2346497
GUIDE:REAR:PAPER TRAY

33.D0596496
GUIDE:MIDDLE:PAPER TRAY

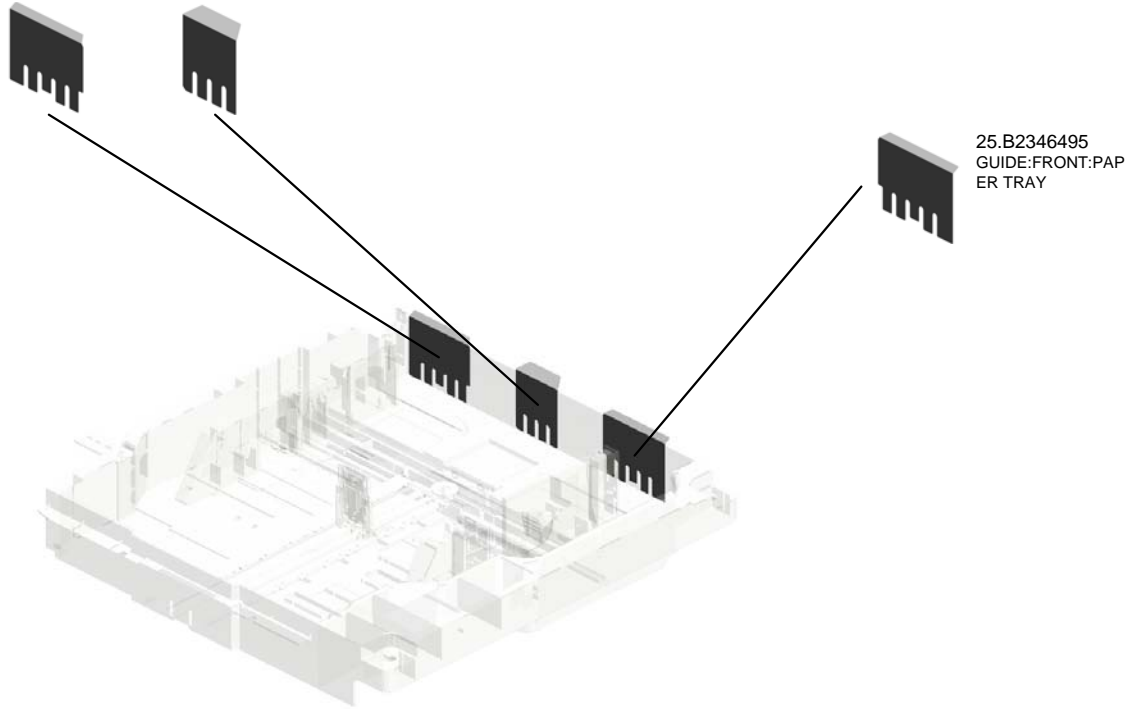
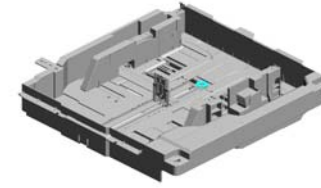

U010_S001

PAPER TRAY:UNIVERSAL:DOM:SUB-ASS'Y

19.B1326798
SPRING PLATE:PA
PER TRAY:EARTH

34.D0747390
DECAL:PAPER SE
T DIRECTION:PAP
ER TRAY

29.D0146780
TRAY BOTTOM PL
ATE:ASS'Y

11.AF017033
END FENCE

32.D0146785
SPRING PLATE:AR
M:END FENCE:LO
CK

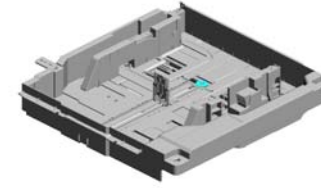

35.D0747631
PAPER TRAY:UNIV
ERSAL:DOM:SUB-
ASS'Y

9.AA060961
TENSION SPRING:
SIDE FENCE:REAR

4.07200060E
(x2)
RETAINING RING -
M6

10.AB012327
GEAR:16Z

3.04504008N
(x3)
TAPPING SCREW -
M4X8

13.B0656526
LIFT LEVER

1.03604008N
(x2)
SCREW - M4X8

12.B0656524
BOTTOM PLATE LI
FT SHAFT

28.B2476695
GUIDE:MISFEED R
EMOVAL:PAPER T
RAY

31.D0146784
SPRING PLATE:EN
D FENCE

27.B2346498
(x2)
SHEET:TRAY BOT
TOM PLATE

15.B0656545
(x2)
DECAL - POSITION
ING

30.D0146783
ARM:END FENCE:LO
CK

18.B1326797
SIDE FENCE:REAR
:AUXILIARY

20.B1816780
LINK:END FENCE:
PAPER SIZE SENS
OR:ASS'Y

21.B1816789
LINK:SIDE FENCE:
PAPER SIZE SENS
OR

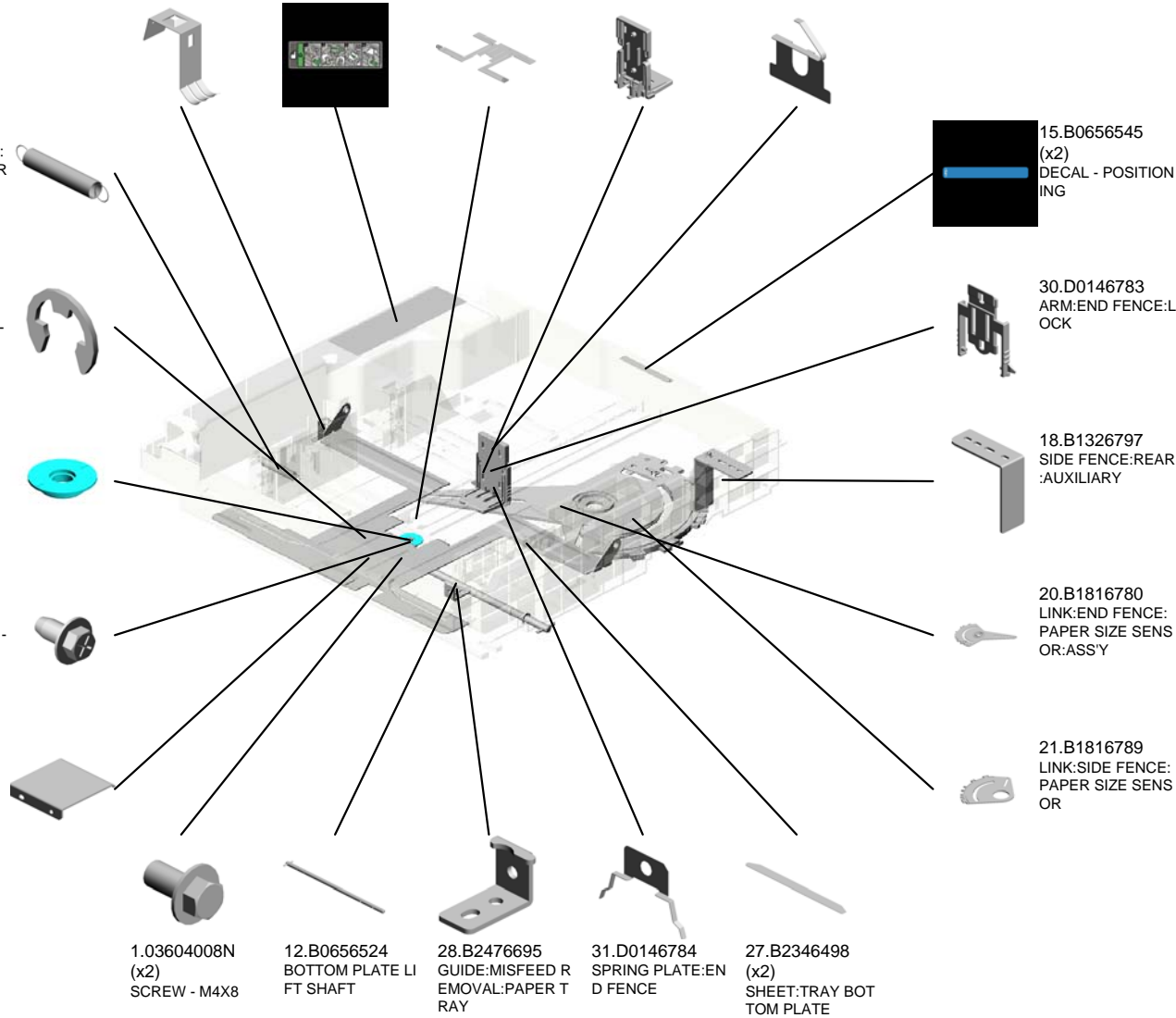

U010_S001_S001
SIDE FENCE:FRONT:ASS'Y

5.A1342978
SPRING PLATE

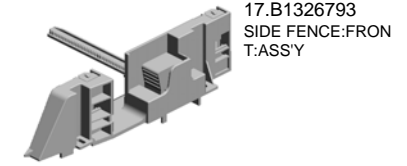

17.B1326793
SIDE FENCE:FRON
T:ASSY

23.B2342864
PAD:CLEANER

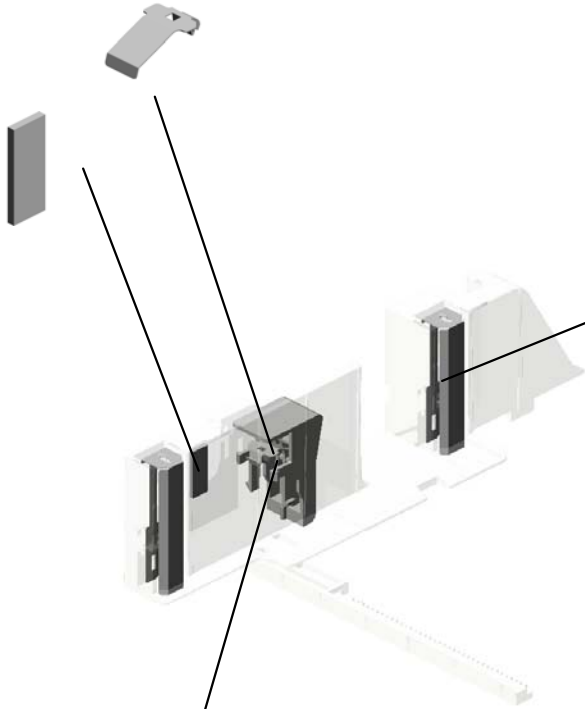

16.B1326791
(x2)
PLATE:SIDE FENC
E

14.B0656538
POSITIONING STO
PPER LEVER

U001	U002	U003	U004	U005	U006	U007	U008	U009	U010	U011	U012	U013	U014	U015	U016	U017	U018	U019	U020	U021
------	------	------	------	------	------	------	------	------	------	------	------	------	------	------	------	------	------	------	------	------

U010_S001_S002
SIDE FENCE:REAR:ASS'Y

22.B2232873
DECAL - SIDE FEN
CE REAR

8.A2672860
REAR LEVER STO
PPER

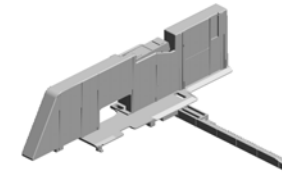

24.B2346490
SIDE FENCE:REAR
:ASS'Y

23.B2342864
PAD:CLEANER

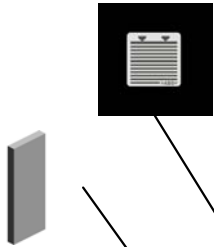

6.A2672857
SPRING PLATE - SI
DE FENCE



7.A2672859
SIDE FENCE STOP
PER



2.04503008N
(x2)
TAPPING SCREW -
M3X8

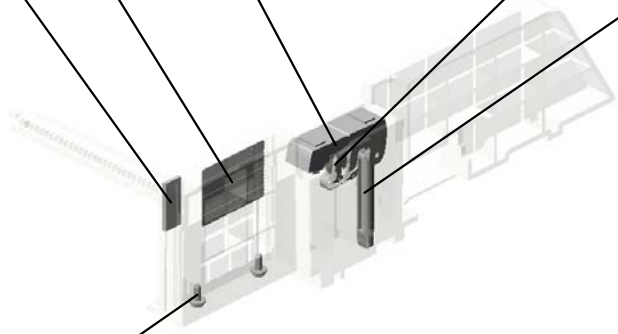

U001	U002	U003	U004	U005	U006	U007	U008	U009	U010	U011	U012	U013	U014	U015	U016	U017	U018	U019	U020	U021
------	------	------	------	------	------	------	------	------	------	------	------	------	------	------	------	------	------	------	------	------

U011.Paper Feed 1 (1st)

U011_S001
D0747500
PAPER FEED UNIT:PAPER B
ANK:ASS'Y

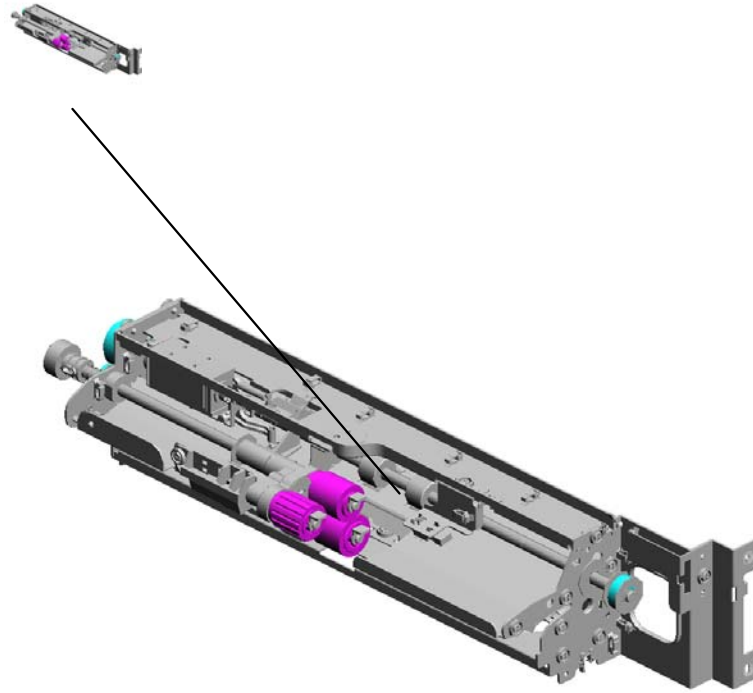

U001	U002	U003	U004	U005	U006	U007	U008	U009	U010	U011	U012	U013	U014	U015	U016	U017	U018	U019	U020	U021
------	------	------	------	------	------	------	------	------	------	------	------	------	------	------	------	------	------	------	------	------

U011
Paper Feed 1 (1st)

3.04514008N
(x2)
TAPPING SCREW:
4X8

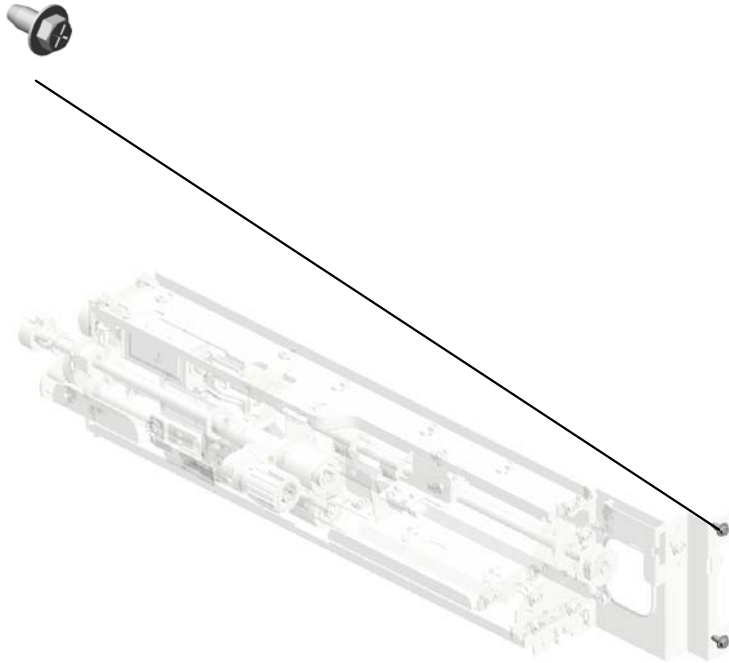

U001	U002	U003	U004	U005	U006	U007	U008	U009	U010	U011	U012	U013	U014	U015	U016	U017	U018	U019	U020	U021
------	------	------	------	------	------	------	------	------	------	------	------	------	------	------	------	------	------	------	------	------

U011_S001

PAPER FEED UNIT:PAPER BANK:ASS'Y

17.D0592620
(x2)
RETAINING RINGS
-C

4.07200040E
RETAINING RING -
M4

6.54472706
GEAR - 15T

9.AF030072
PAPER FEED ROLL
ER:PICKUP

18.D0596277
COVER:GEAR:PAP
ER FEED ROLLER

19.D0747500
PAPER FEED UNIT
:PAPER BANK:ASS'
Y



11.AW010107
PAPER FEED SEN
SOR



10.AF031080
PAPER FEED ROLL
ER:FEED



16.B2346288
BSENSOR BRACK
ET - SENSOR



13.B2342624
BALL BEARING - 8
X12X5



12.AW020145
PHOTOINTERRUP
TOR:FLAT



14.B2346275
PICKUP ARM



7.AA060523
PICK-UP PRESSUR
E SPING



5.08050088

(x2)
RETAINING RING -
M6



15.B2346282
PICKUP DC SOLEN
OID



20.D0747527
SHAFT:FEED:ASS'
Y



2.04514006N
(x4)
TAPPING SCREW -
4X6



8.AA083009
CLUTCH ROLLER -
8X18X11



U012 Paper Feed 2 (1st)

- 12.B2346222 REVERSE DRIVE S
HAFT
- 10.AB011591 GEAR:REVERSE
- 14.B2346233 DC SOLENOID:RE
VERSE:SUB-ASS'Y
- 1.03530040N
(x2)
SCREW - M3X4
- 9.AB011392
DRIVE REVERSE G
EAR - 24Z

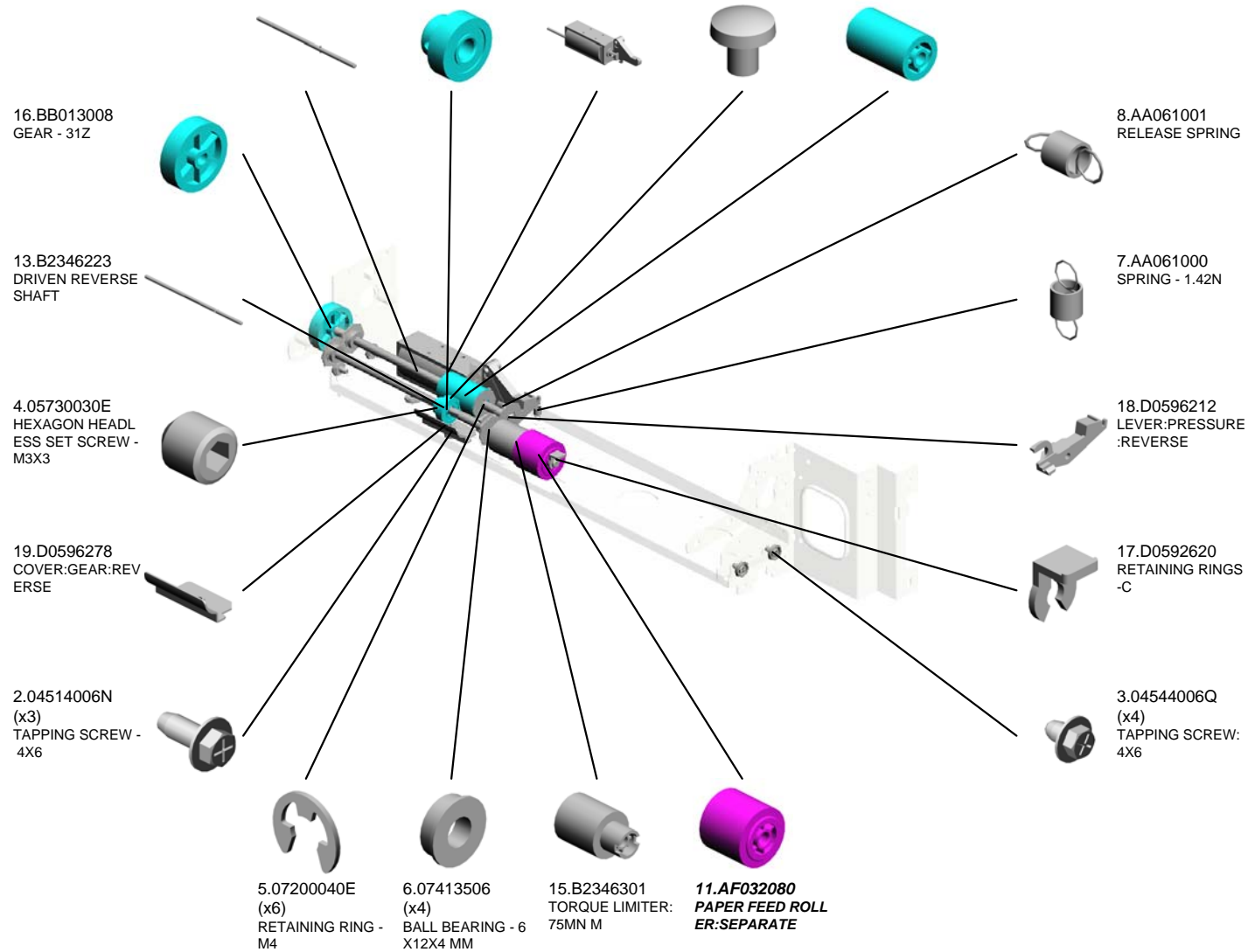
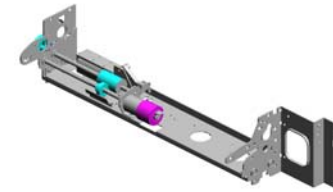

U013 Paper Feed 3 (1st)

- 3.07200060E (x4) RETAINING RING - M6
- 4.07423808 (x2) BALL BEARING - 8 X16X5
- 14.D0747521 GUIDE PLATE:UPP ER:PAPER FEED UNIT
- 6.AA084059 (x2) BALL BEARING HOLDER
- 15.D0747522 GUIDE PLATE:LOWER:PAPER FEED UNIT

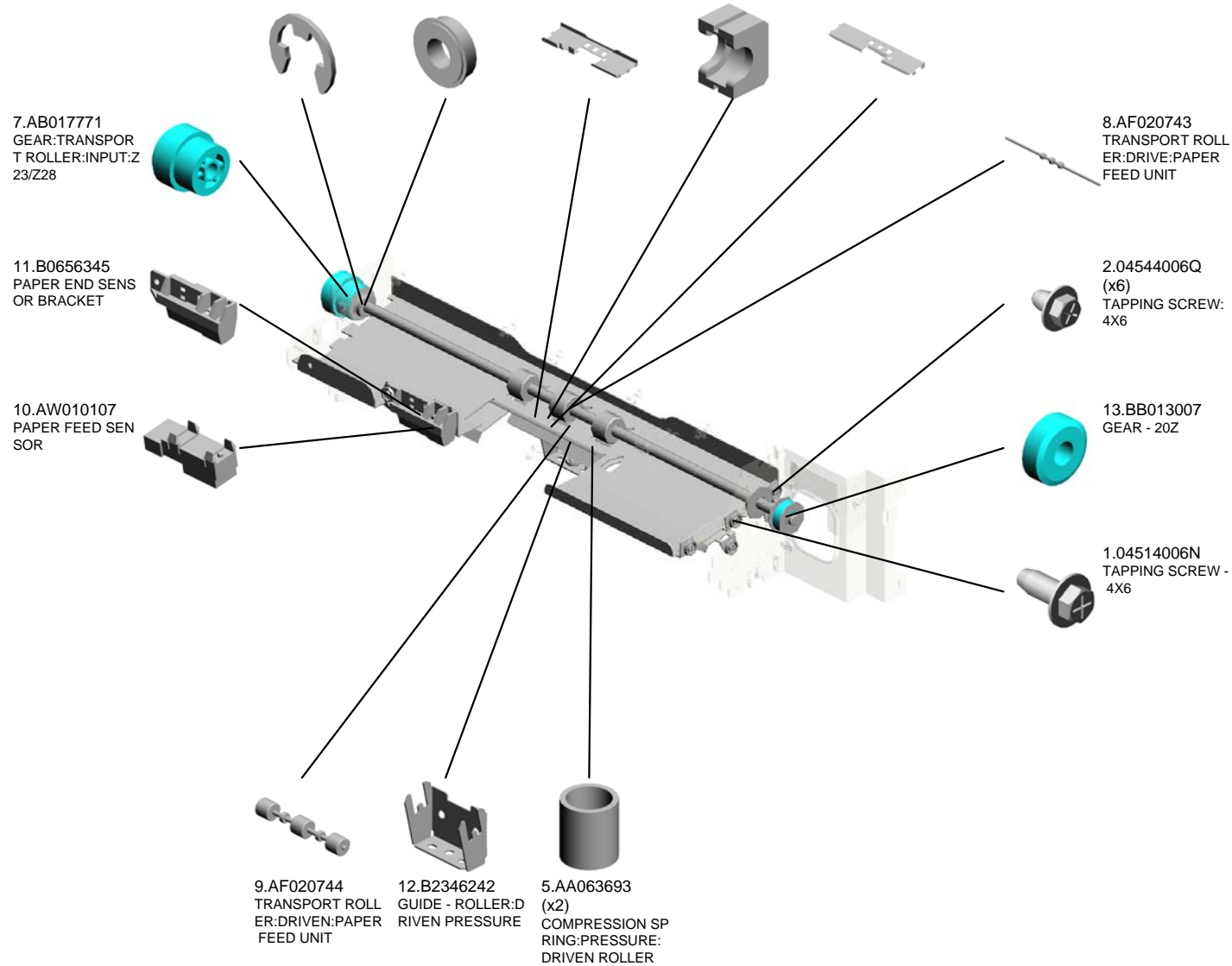
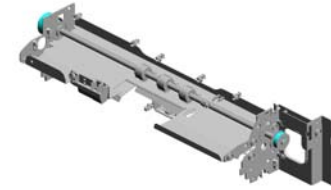

U001	U002	U003	U004	U005	U006	U007	U008	U009	U010	U011	U012	U013	U014	U015	U016	U017	U018	U019	U020	U021
------	------	------	------	------	------	------	------	------	------	------	------	------	------	------	------	------	------	------	------	------

U014.Paper Feed 1 (2nd)

U014_S001
D0747500
PAPER FEED UNIT:PAPER B
ANK:ASS'Y

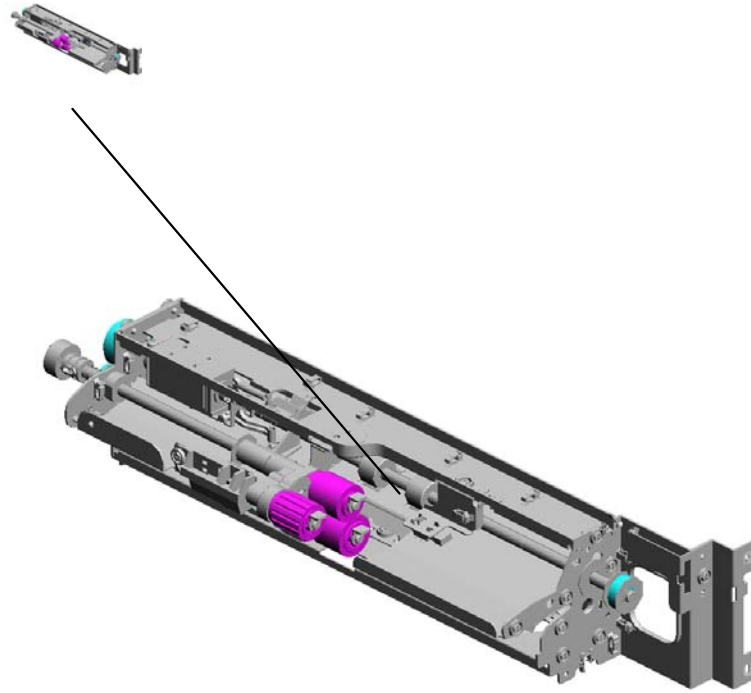

U001	U002	U003	U004	U005	U006	U007	U008	U009	U010	U011	U012	U013	U014	U015	U016	U017	U018	U019	U020	U021
------	------	------	------	------	------	------	------	------	------	------	------	------	------	------	------	------	------	------	------	------

U014
Paper Feed 1 (2nd)

3.04514008N
(x2)
TAPPING SCREW:
4X8

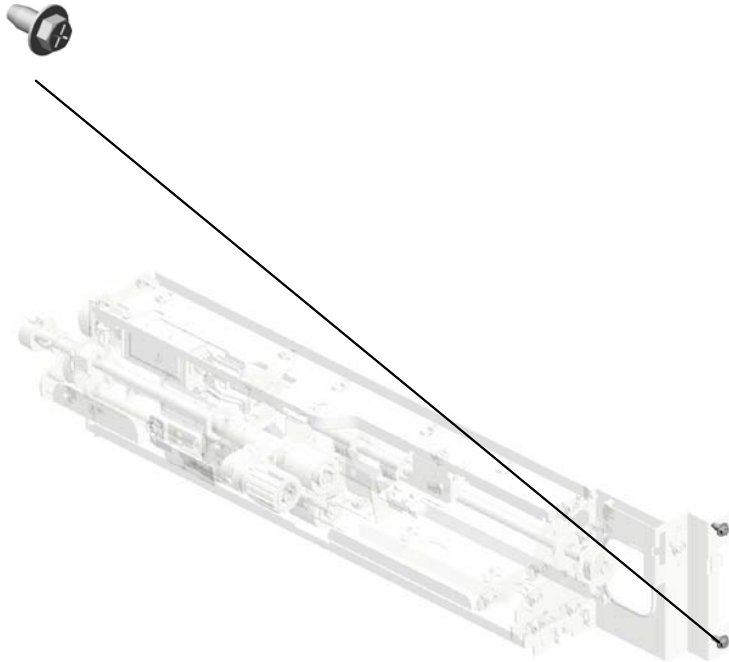
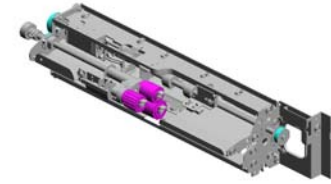

U001	U002	U003	U004	U005	U006	U007	U008	U009	U010	U011	U012	U013	U014	U015	U016	U017	U018	U019	U020	U021
------	------	------	------	------	------	------	------	------	------	------	------	------	------	------	------	------	------	------	------	------

U014_S001

PAPER FEED UNIT:PAPER BANK:ASS'Y

17.D0592620
(x2)
RETAINING RINGS
-C

4.07200040E
RETAINING RING -
M4

6.54472706
GEAR - 15T

9.AF030072
PAPER FEED ROLL
ER:PICKUP

18.D0596277
COVER:GEAR:PAP
ER FEED ROLLER



19.D0747500
PAPER FEED UNIT
:PAPER BANK:ASS'
Y

11.AW010107
PAPER FEED SEN
SOR



10.AF031080
PAPER FEED ROLL
ER:FEED



16.B2346288
BSENSOR BRACK
ET - SENSOR



13.B2342624
BALL BEARING - 8
X12X5



12.AW020145
PHOTOINTERRUP
TOR:FLAT



14.B2346275
PICKUP ARM



7.AA060523
PICK-UP PRESSUR
E SPING



5.08050088
(x2)
RETAINING RING -
M6



15.B2346282
PICKUP DC SOLEN
OID



20.D0747527
SHAFT:FEED:ASS'
Y



2.04514006N
(x4)
TAPPING SCREW -
4X6



8.AA083009
CLUTCH ROLLER -
8X18X11



U015 Paper Feed 2 (2nd)

- 12.B2346222 REVERSE DRIVE S
HAFT
- 10.AB011591 GEAR:REVERSE
- 14.B2346233 DC SOLENOID:RE
VERSE:SUB-ASS'Y
- 1.03530040N (x2)
SCREW - M3X4
- 9.AB011392 DRIVE REVERSE G
EAR - 24Z

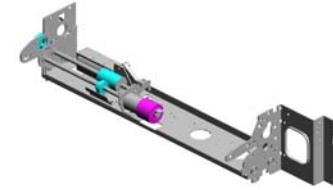

16.BB013008
GEAR - 31Z

13.B2346223
DRIVEN REVERSE
SHAFT

4.05730030E
HEXAGON HEADL
ESS SET SCREW -
M3X3

19.D0596278
COVER:GEAR:REV
ERSE

2.04514006N
(x3)
TAPPING SCREW -
4X6

5.07200040E
(x6)
RETAINING RING -
M4

6.07413506
(x4)
BALL BEARING - 6
X12X4 MM

15.B2346301
TORQUE LIMITER:
75MN M

11.AF032080
PAPER FEED ROLL
ER:SEPARATE

8.AA061001
RELEASE SPRING

7.AA061000
SPRING - 1.42N

18.D0596212
LEVER:PRESSURE
:REVERSE

17.D0592620
RETAINING RINGS
-C

3.04544006Q
(x4)
TAPPING SCREW:
4X6

U001	U002	U003	U004	U005	U006	U007	U008	U009	U010	U011	U012	U013	U014	U015	U016	U017	U018	U019	U020	U021
------	------	------	------	------	------	------	------	------	------	------	------	------	------	------	------	------	------	------	------	------

U016 Paper Feed 3 (2nd)

- 3.07200060E (x4) RETAINING RING - M6
- 4.07423808 (x2) BALL BEARING - 8 X16X5
- 14.D0747521 GUIDE PLATE:UPP ER:PAPER FEED UNIT
- 6.AA084059 (x2) BALL BEARING HOLDER
- 15.D0747522 GUIDE PLATE:LOWER:PAPER FEED UNIT

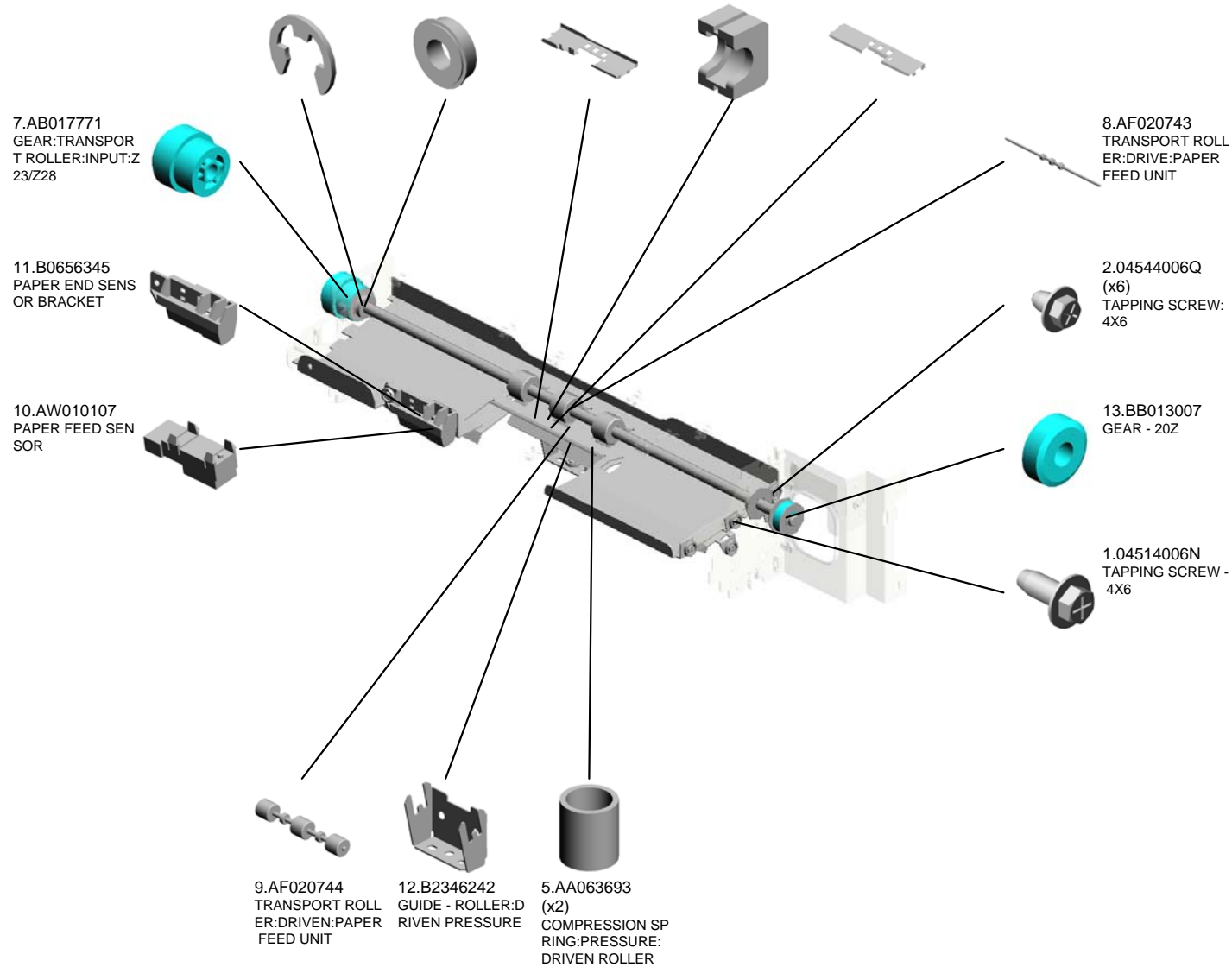
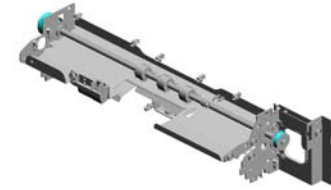

U017 Vertical Transport 1

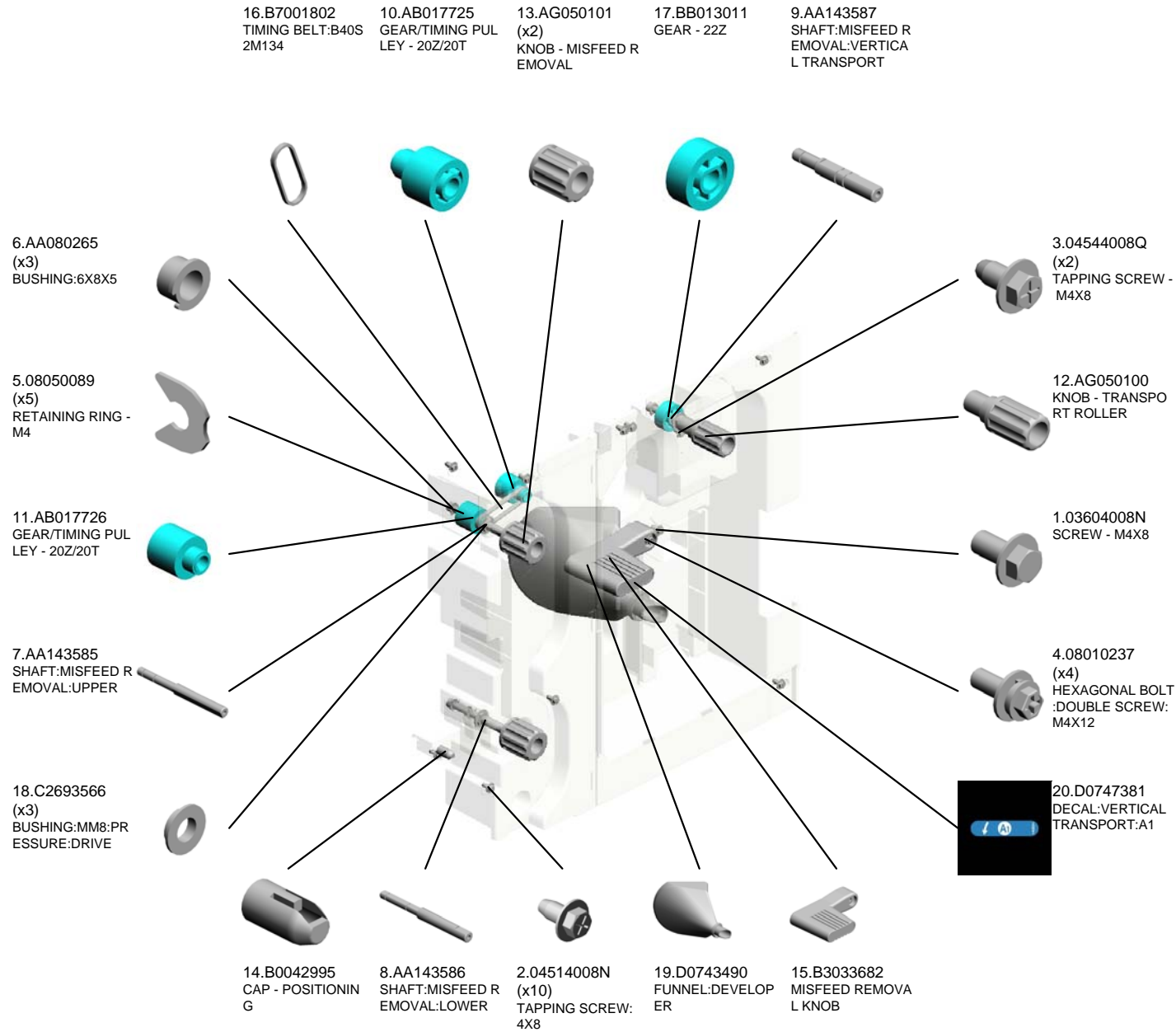
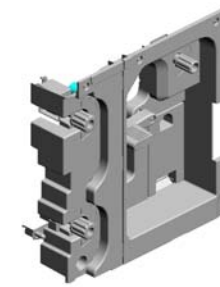

U001	U002	U003	U004	U005	U006	U007	U008	U009	U010	U011	U012	U013	U014	U015	U016	U017	U018	U019	U020	U021
------	------	------	------	------	------	------	------	------	------	------	------	------	------	------	------	-------------	------	------	------	------

U017 Vertical Transport 1

24.D0747654
INNER COVER:VE
RTICAL TRANSP
RT:LEFT

21.D0747382
DECAL:VERTICAL
TRANSPORT:A2

23.D0747384
DECAL:VERTICAL
TRANSPORT:B2

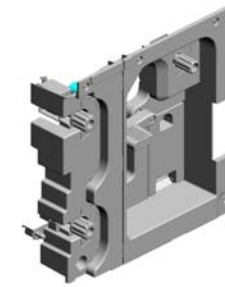

27.G1785029
GEAR:DECURA:Z2
0/M1



25.D0747656
INNER COVER:VE
RTICAL TRANSP
RT:RIGHT



26.D0747659
COVER:FUNNEL-D
EVELOPER



22.D0747383
DECAL:VERTICAL
TRANSPORT:A3

U018 Vertical Transport 2

1.03603006N
(x10)
SCREW - M3X6

15.D0743032
SHAFT:JOINT:PAP
ER FEED UNIT

2.07080080N
WASHER-DIA8

7.AA063470
COMPRESSION SP
RING:PAPER FEED
:DRIVE

8.AA148776
SHAFT:DRIVE

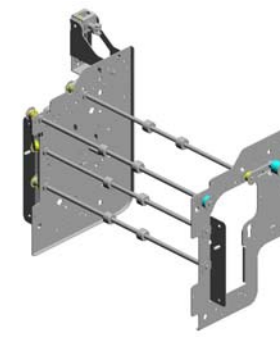

17.D0743173
(x11)
TIMING PULLEY:S2
M:25T



16.D0743108
(x2)
DC STEPPER MOT
OR:4.94W:ASS'Y



6.AA043647
(x6)
TIMING BELT:60S2
M188



4.07423808
(x12)
BALL BEARING - 8
X16X5



5.11050534
(x2)
CLAMP



11.AF020741
TRANSPORT ROLL
ER:GRIP:DRIVE



10.AF020740
(x2)
TRANSPORT ROLL
ER:VERTICAL TRA
NSPORT:DRIVE



12.AF020786
TRANSPORT ROLL
ER:EXIT:PAPER BA
NK:DRIVE



9.AB017725
GEAR/TIMING PUL
LEY - 20Z/20T

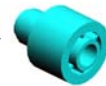

3.07200060E
(x20)
RETAINING RING -
M6



13.B7004428
TIMING BELT:B40S
2M158

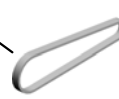

14.BB013007
GEAR - 20Z



U019 Vertical Transport 3



1.03603006N
(x27)
SCREW - M3X6

8.AA080346
(x2)
BUSHING:FLANGE
TYPE:DIA6

14.D0747455
GUIDE PLATE:GRI
P:UPPER

16.D0747465
GUIDE PLATE:FEE
D PAPER AGAIN

6.AA063471
(x2)
COMPRESSION SP
RING:PRESSURE:8
N

4.11050511
(x19)
HARNES CLAMP -
LWS-0306ZC

3.07200030E
(x2)
RETAINING RING -
M3

10.AA161172
CUSHION:GUIDE P
LATE

15.D0747461
GUIDE PLATE:GRI
P:LOWER

5.54472681
(x4)
SNAP RING

11.AF022165
(x3)
TRANSPORT ROLL
ER - DRIVEN

19.D0747476
GUIDE PLATE:OPE
N AND CLOSE:ASS
Y

12.AW010107
(x5)
PAPER FEED SEN
SOR

13.D0747450
GUIDE PLATE:VER
TICAL TRANSPOR
T:DRIVE

7.AA063693
(x6)
COMPRESSION SP
RING:PRESSURE:
DRIVEN ROLLER

18.D0747474
GUIDE PLATE:CON
NECTING:RIGHT

17.D0747470
GUIDE PLATE:CON
NECTING:UPPER

20.D0747481
GUIDE PLATE:OPE
N AND CLOSE:CO
NNECTING:ASS'Y

9.AA084059
(x8)
BALL BEARING HO
LDER

2.04534008N
(x2)
BINDING SELF TAP
PING SCREW:4X8

U019 Vertical Transport 3

21.D3553810
BRACKET:DETENT
:RIGHT:ASS'Y

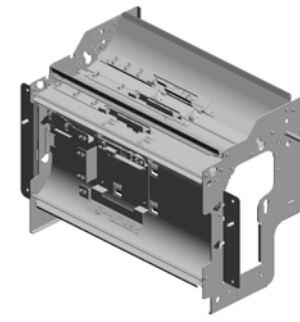

24.D3553858
(x2)
TORSION SPRING:
GUIDE PLATE:16N

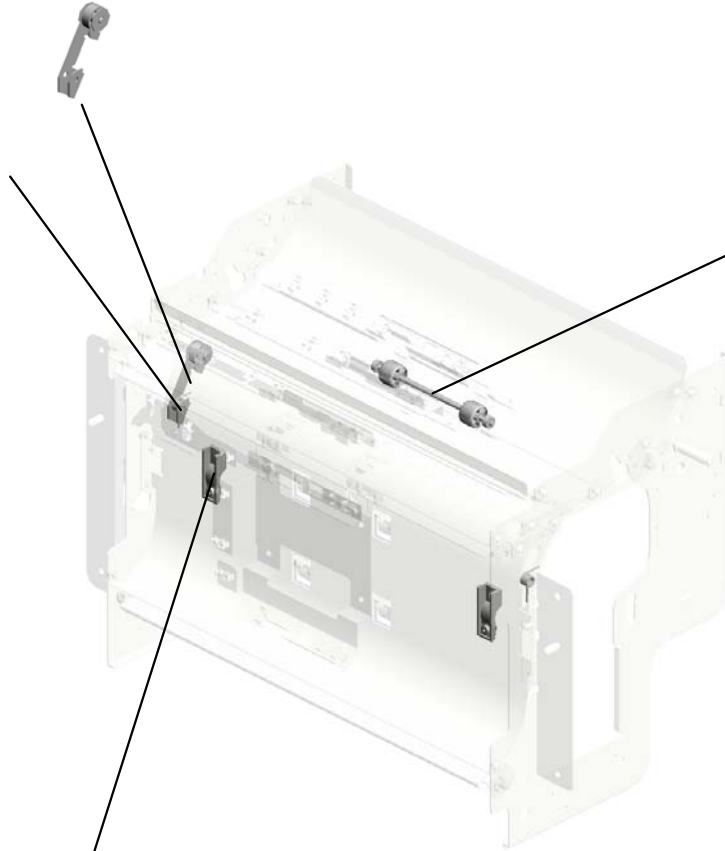

25.M0774862
TRANSPORT ROLL
ER:DRIVEN:DUPL
X:DIA18X2



22.D3553828
(x2)
HOLDER:STAY:GUI
DE PLATE



U020 Vertical Transport 4

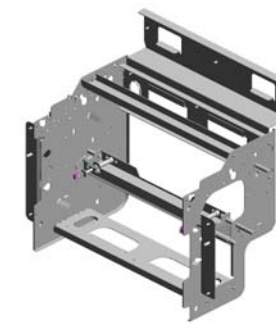

1.03603006N
(x16)
SCREW - M3X6

14.D0747433
(x2)
STUD:HANDLE:RE
LEASE:ASS'Y

10.AA063694
(x2)
COMPRESSION SP
RING:HANDLE

15.D3553844
(x4)
SHOE:HANDLE:RE
LEASE

3.04544008Q
(x8)
TAPPING SCREW -
M4X8

6.11050511
(x8)
HARNES CLAMP -
LWS-0306ZC

7.11050551
(x3)
CLAMP:LES-0505

2.04514008N
(x4)
TAPPING SCREW:
4X8

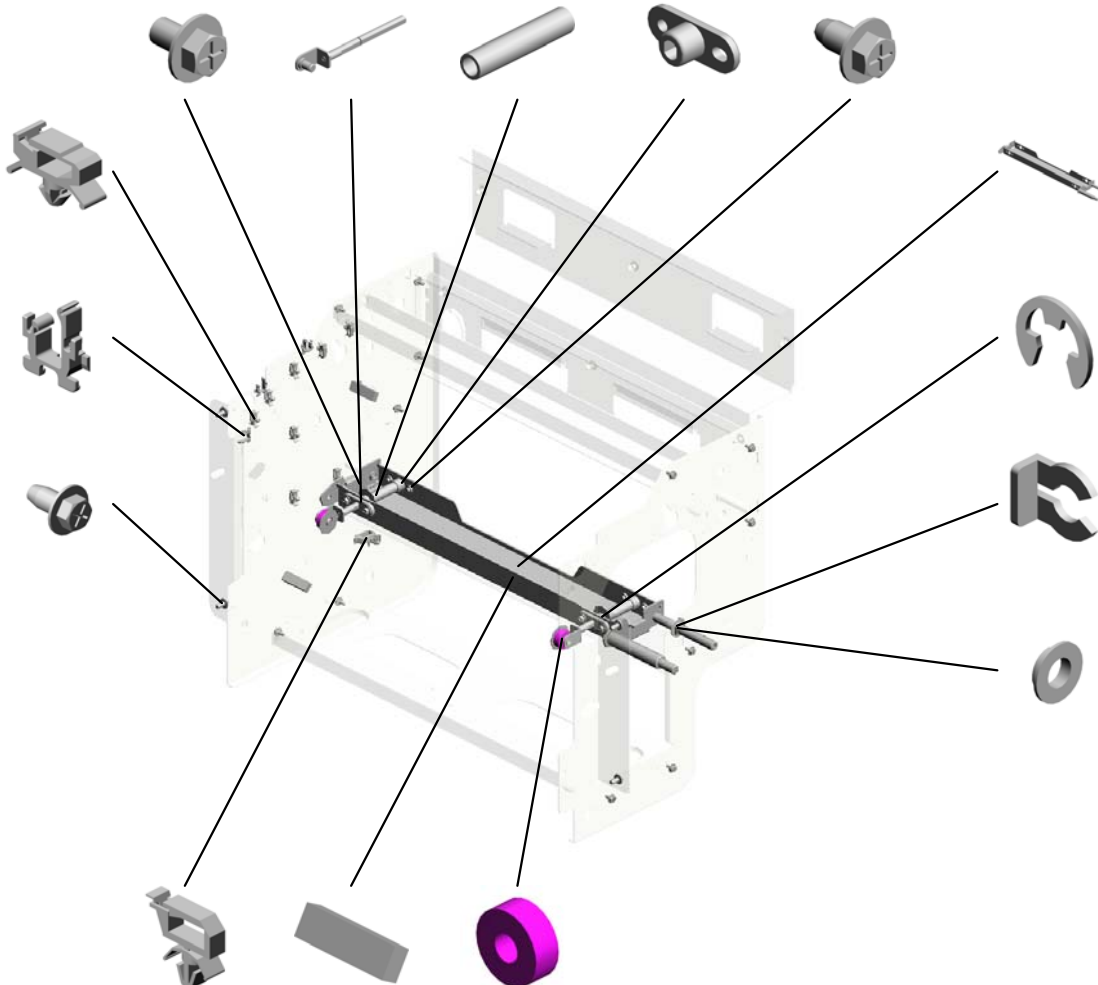

13.D0747431
STAY:HANDLE:AS
S'Y

4.07200040E
(x4)
RETAINING RING -
M4

8.52152621
SNAP RING - M6

12.C2693566
BUSHING:MM8:PR
ESSURE:DRIVE

5.11050487
(x2)
HARNES CLAMP

11.B8323909
(x3)
BRACKET CUSHIO
N

9.67542866
(x2)
ROLLER - POSITIO
NING GUIDE

U021.Paper Registration 1

U021_S001
D0742681
SHAFT:CAM:SHIFT

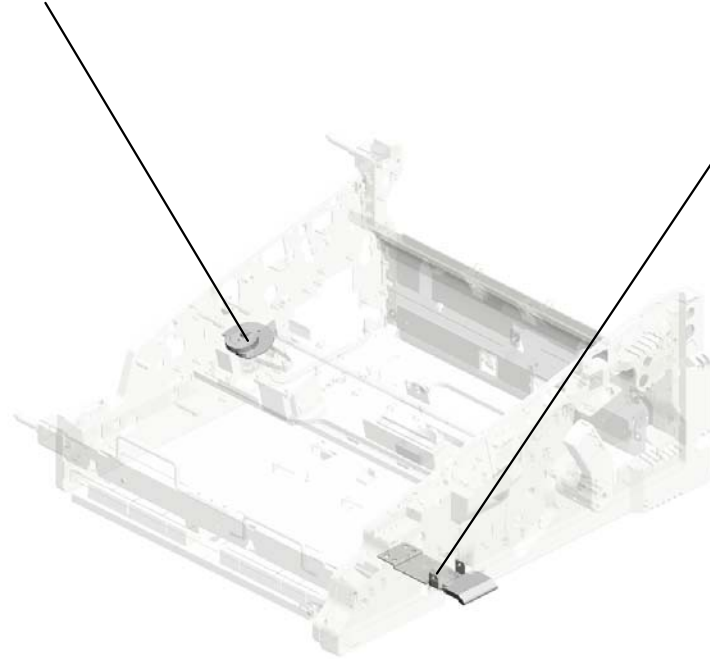

U021_S002
D0742979
LEVER:GUIDE PLATE



U001	U002	U003	U004	U005	U006	U007	U008	U009	U010	U011	U012	U013	U014	U015	U016	U017	U018	U019	U020	U021
------	------	------	------	------	------	------	------	------	------	------	------	------	------	------	------	------	------	------	------	------

U021 Paper Registration 1

18.AA082101 BUSHING - 6X10X6
 2.03604010N (x3) SCREW:M4X10
 12.11050723 (x2) CLAMPS:WES-0507
 10.08050089 (x4) RETAINING RING - M4
 17.AA063678 (x4) SPRING - 3.5N

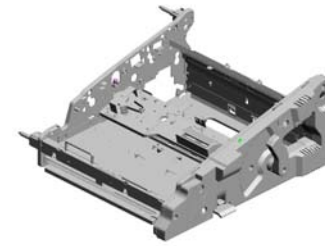

21.AA132300 (x2) ROLLER:LOCK:PU LL OUT



11.11050534 (x2) CLAMP



13.54472681 SNAP RING



16.AA061065 (x4) TENSION SPRING: DUPLX:DRIVEN ROLLER



4.04504008N (x8) TAPPING SCREW - M4X8



14.A2574493 BAND



1.03604008N (x47) SCREW - M4X8



22.AA143811 (x2) STEPPED SCREW - M3X4



3.04503008N (x4) TAPPING SCREW - M3X8



19.AA082104 (x7) BUSHING - 8X12X7



7.07200060E RETAINING RING - M6



20.AA084059 (x4) BALL BEARING HOLDER



5.04544008Q (x21) TAPPING SCREW - M4X8



9.08050088 (x2) RETAINING RING - M6



6.07200040E (x2) RETAINING RING - M4



U021 Paper Registration 1

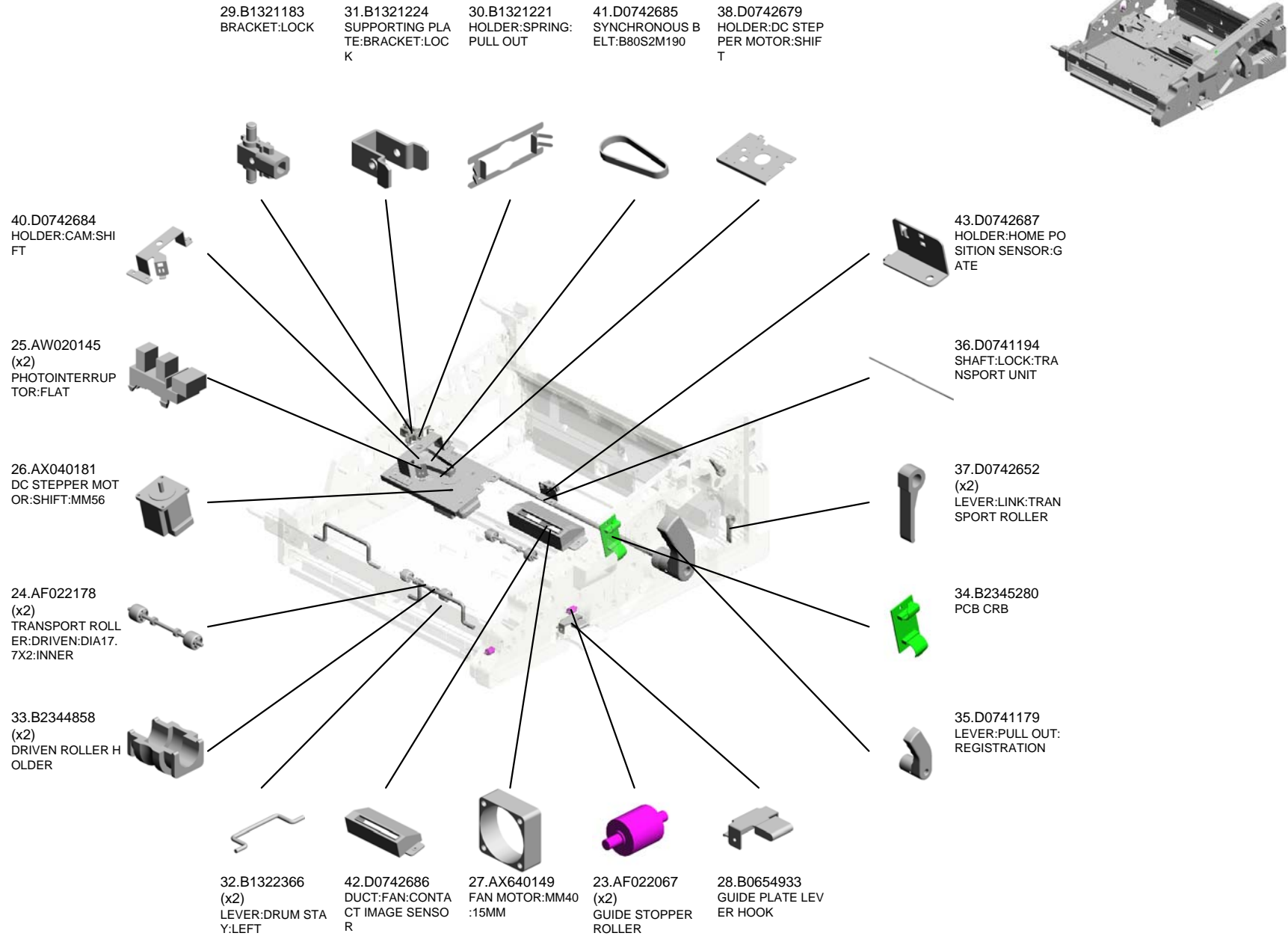

U021 Paper Registration 1

64.G1784818
(x2)
SPRING:PULL OUT
:LOCK:EXIT

44.D0742813
HOOK:COIL SPRIN
G:GATE

59.D0746497
(x6)
DECAL:POSITIONI
NG DISPLAY:TCRU

45.D0742850
GUIDE PLATE:VER
TICAL TRANSPOR
T:RIGHT

65.G1787453
(x2)
ARM:ON-OFF:TRA
NSPORT ROLLER

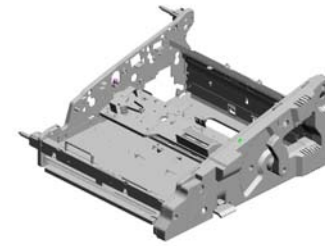

61.G1784759
BRACKET:LOCK:E
XIT

50.D0742965
HOLDER:PRESSU
RE:DRIVEN ROLLE
R:DUPLEX:EXIT

46.D0742864
GUIDE PLATE:DUP
LEX:RIGHT:UPPER

51.D0742974
STOPPER:LEVER:
TRANSPORT UNIT:
LEFT

49.D0742935
GUIDE:DUPLEX:OP
EN AND CLOSE:RI
GHT:LOWER

63.G1784817
(x4)
SPRING:PRESSUR
E:ROLLER:DUPLE
X

56.D0742987
DECAL:PULL OUT:
RIGHT:B6

57.D0742989
DECAL:PULL OUT:
RIGHT:Z2

62.G1784808
(x2)
BRACKET:PRESSU
RE:ROLLER

60.D0747844
INNER COVER:PUL
L OUT:RIGHT

48.D0742931
SHAFT:LINK:ON-O
FF:VERTICAL TRA
NSPORT:UPPER

54.D0742985
DECAL:PULL OUT:
RIGHT:B3

53.D0742984
DECAL:PULL OUT:
RIGHT:B1

55.D0742986
DECAL:PULL OUT:
RIGHT:B4

47.D0742930
SHAFT:LINK:ON-O
FF:VERTICAL TRA
NSPORT:LOWER

U021 Paper Registration 1

66.G1787618
PLATE:FIX:BAND

71.M0774862
(x2)
TRANSPORT ROLL
ER:DRIVEN:DUPLE
X:DIA18X2



70.G1787793
(x2)
SCREW:REGISTRA
TION:FIX

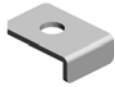

68.G1787743
BOSS:POSITIONIN
G PIN:TRANSPORT
UNIT:NO.1



67.G1787633
HOOK:GUIDE PLAT
E:DUPLEX:ASS'Y



69.G1787744
BOSS:POSITIONIN
G PIN:TRANSPORT
UNIT:NO.2



U021_S001
SHAFT:CAM:SHIFT

8.07413706
BALL BEARING - 6
X10X3

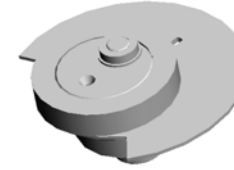

39.D0742681
SHAFT:CAM:SHIFT



15.A8592230
BALL BEARING - 6
X13X5



U001	U002	U003	U004	U005	U006	U007	U008	U009	U010	U011	U012	U013	U014	U015	U016	U017	U018	U019	U020	U021
------	------	------	------	------	------	------	------	------	------	------	------	------	------	------	------	------	------	------	------	------

U021_S002
LEVER:GUIDE PLATE

58.D0742990
DECAL:PULL OUT:
RIGHT:Z4

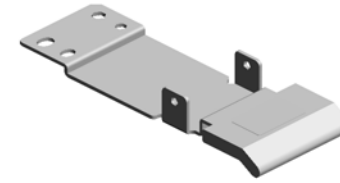

52.D0742979
LEVER:GUIDE PLA
TE

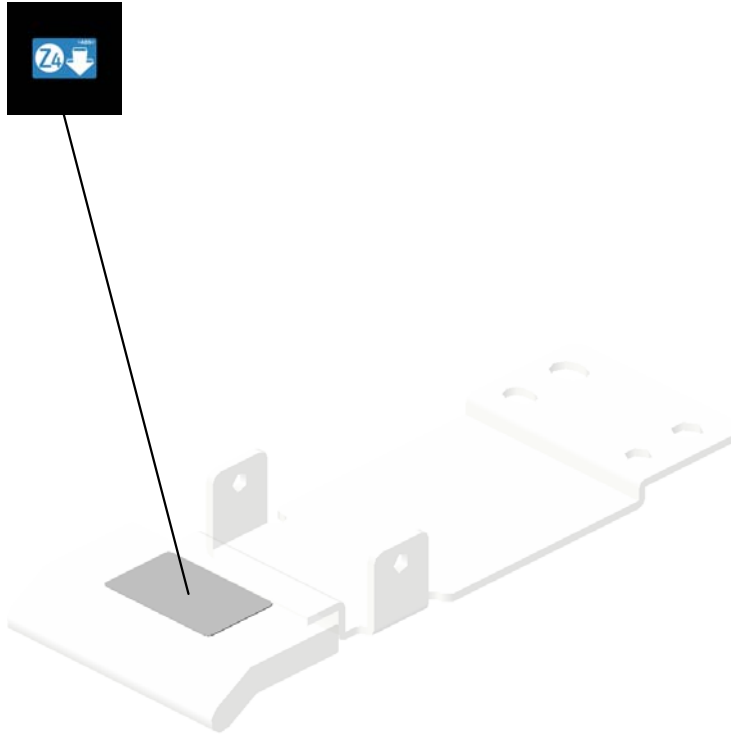

U022 Paper Registration 2

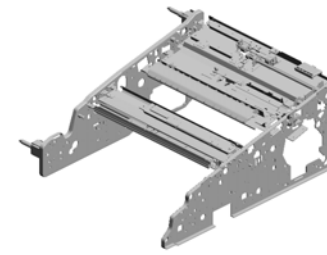
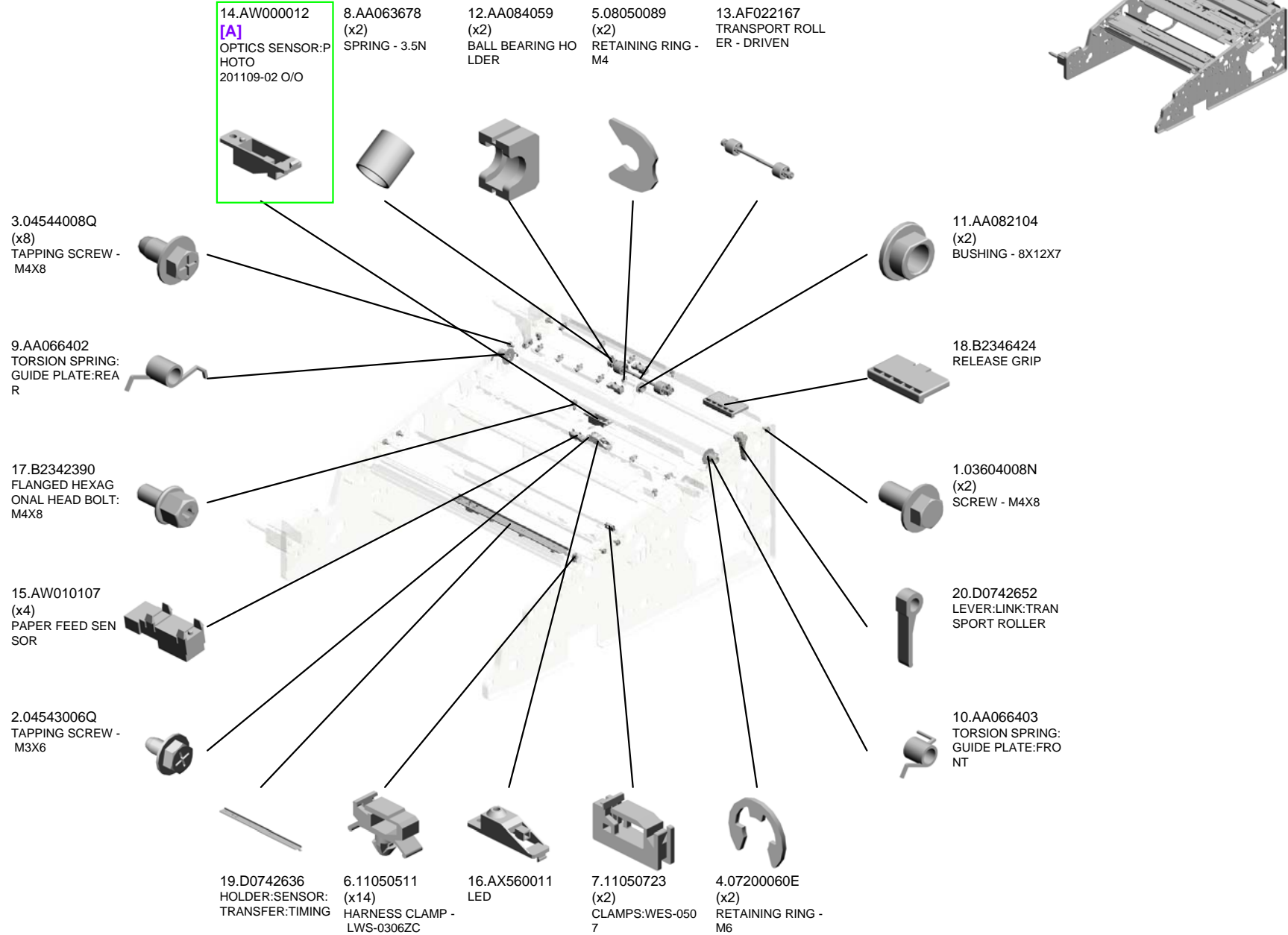

U022 Paper Registration 2

- 24.D0742757 HOLDER:SENSOR:CONNECTING:LCT:NO.2
- 37.D0742960 GUIDE PLATE:REGISTRATION:ENTRANCE:UPPER
- 29.D0742794 HOLDER:DOUBLE FEED SENSOR:PHOTO
- 23.D0742756 HOLDER:SENSOR:CONNECTING:LCT:NO.1
- 22.D0742753 GUIDE PLATE:CONNECTING:LARGE CAPACITY TRAY:UPPER

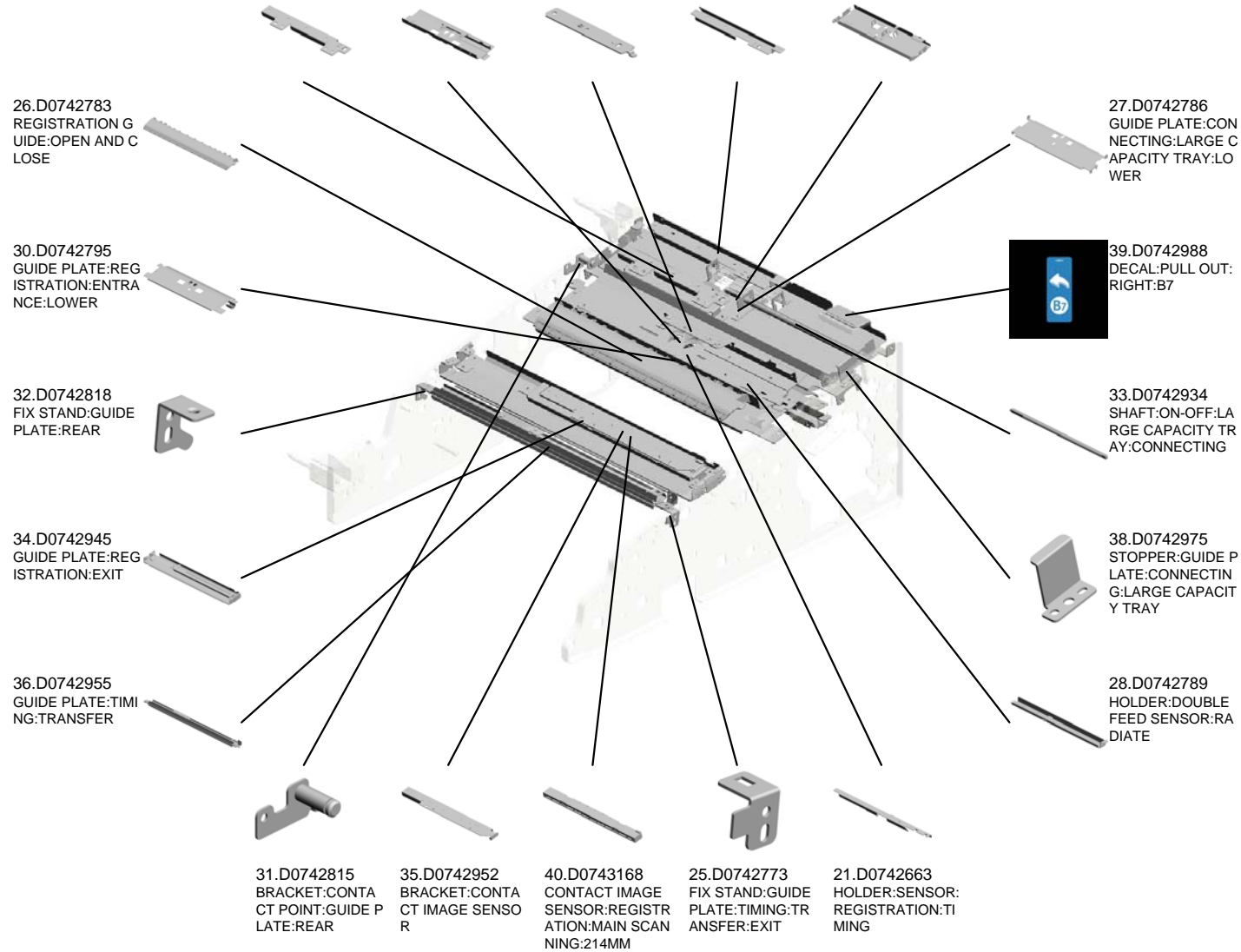
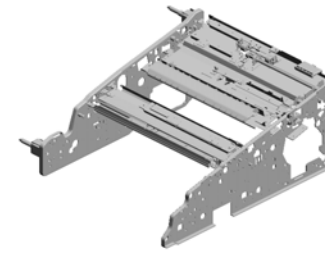

U001	U002	U003	U004	U005	U006	U007	U008	U009	U010	U011	U012	U013	U014	U015	U016	U017	U018	U019	U020	U021
------	------	------	------	------	------	------	------	------	------	------	------	------	------	------	------	------	------	------	------	------

U022
Paper Registration 2

42.G1787453
ARM:ON-OFF:TRA
NSPORT ROLLER

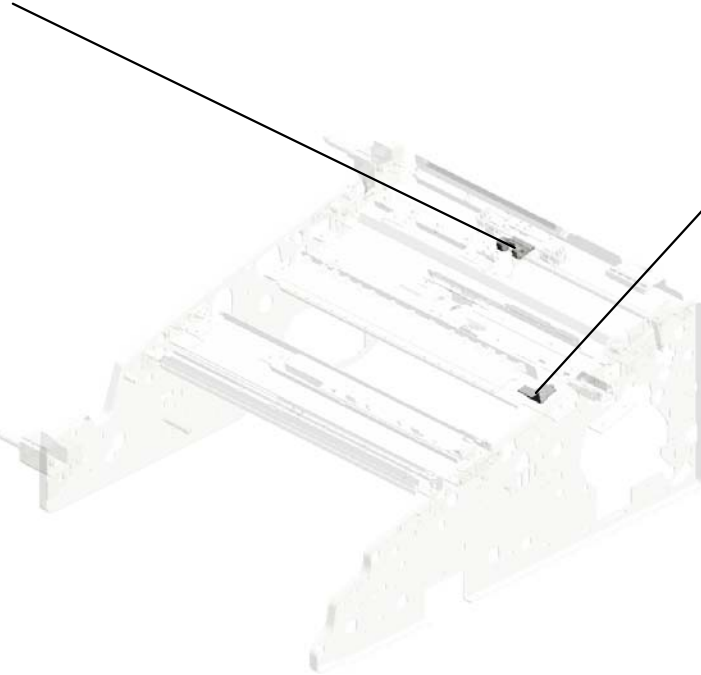
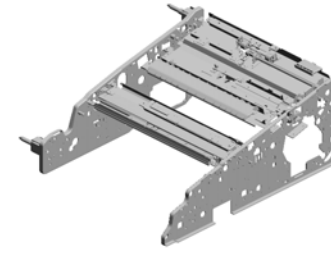

41.G1787421
BRACKET:BEARIN
G:GUIDE:REAR



AW000011
[A]
OPTICS SENSOR:PHOTO
201109-02 O/O

U023.Paper Registration 3

U023_S001
D0742702
SWING UNIT:ASS'Y

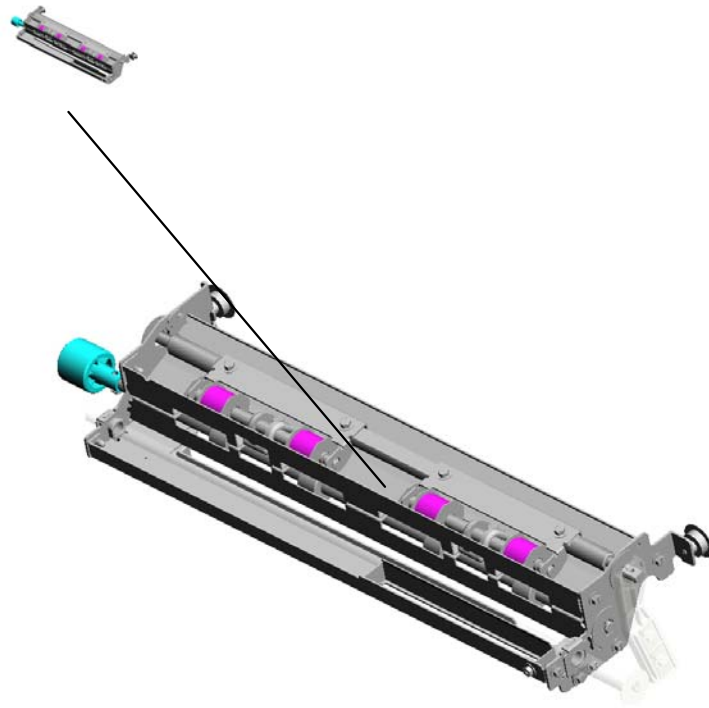

U001	U002	U003	U004	U005	U006	U007	U008	U009	U010	U011	U012	U013	U014	U015	U016	U017	U018	U019	U020	U021
------	------	------	------	------	------	------	------	------	------	------	------	------	------	------	------	------	------	------	------	------

U023 Paper Registration 3

10.AA063468
COMPRESSION SP
RING:SHIFT

2.03604008N
SCREW - M4X8

14.D0742721
ARM:TRANSPORT
ROLLER:SHIFT:TA
KE SHEJTER



13.D0742718
SHAFT:SHIFT

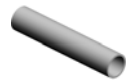

15.D0742722
PROTECTION:ARM
:TRANSPORT ROL
LER:SHIFT:TAKE S
HEJTER



8.08046123
(x2)
HEXAGONAL BOLT
:W/WASHER:M3X8



4.07200040E
RETAINING RING -
M4

U001	U002	U003	U004	U005	U006	U007	U008	U009	U010	U011	U012	U013	U014	U015	U016	U017	U018	U019	U020	U021
------	------	------	------	------	------	------	------	------	------	------	------	------	------	------	------	------	------	------	------	------

U023_S001
SWING UNIT:ASS'Y

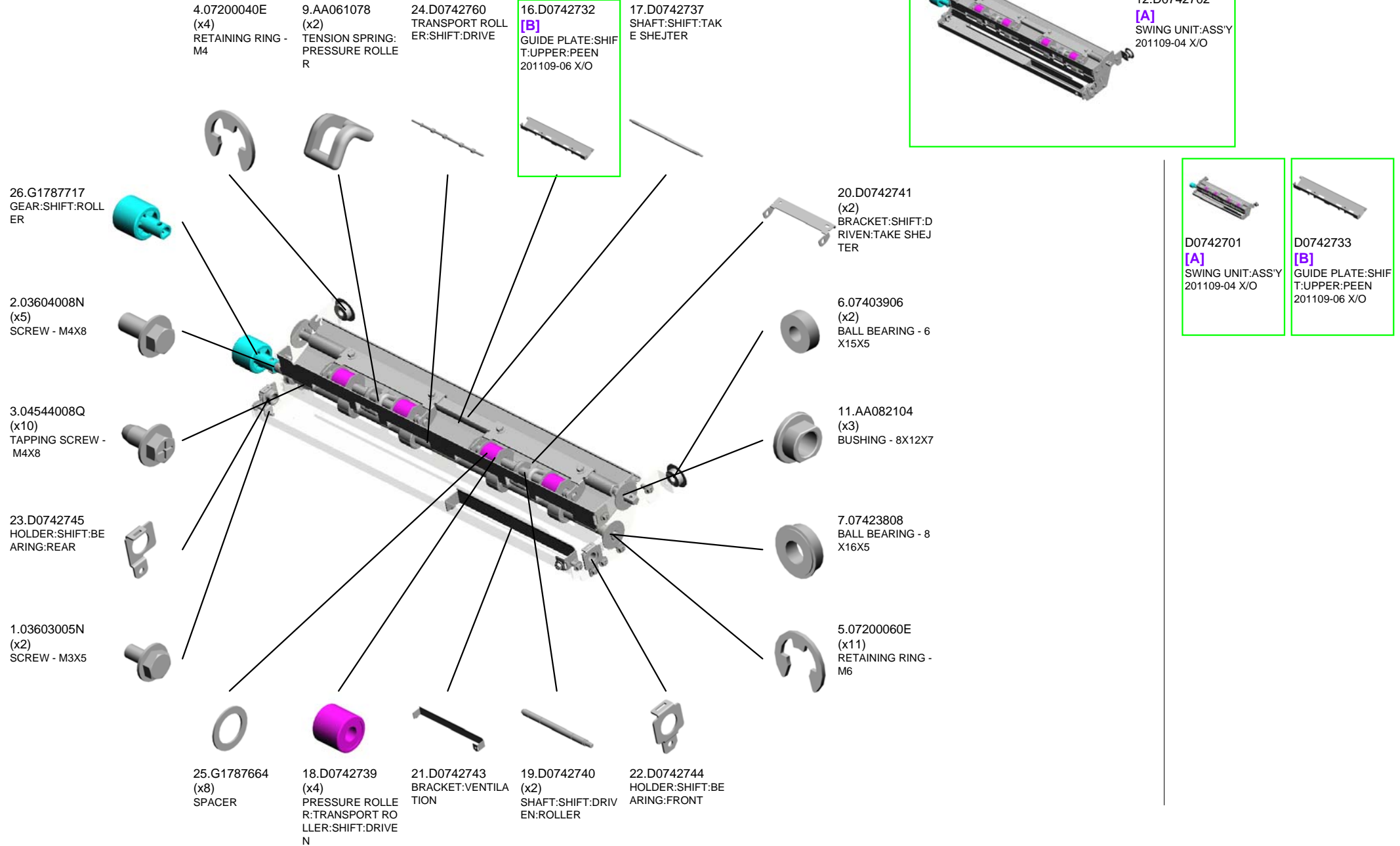

U001	U002	U003	U004	U005	U006	U007	U008	U009	U010	U011	U012	U013	U014	U015	U016	U017	U018	U019	U020	U021
------	------	------	------	------	------	------	------	------	------	------	------	------	------	------	------	------	------	------	------	------

U024 Paper Registration 4

5.03604010N (x6) SCREW:M4X10
 9.07200060E (x13) RETAINING RING - M6
 18.AA043621 TIMING BELT - 60S 2M156
 19.AA043639 SYNCHRONOUS B ELT:B60S2M192
 17.AA043312 TIMING BELT:60S2 M138

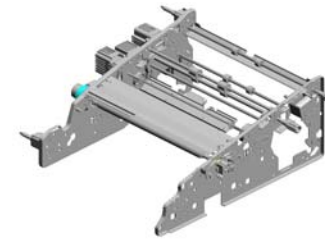

3.03604006N (x2) SCREW - M4X6



8.07200040E (x7) RETAINING RING - M4



11.07403906 (x2) BALL BEARING - 6 X15X5



4.03604008N (x7) SCREW - M4X8



16.11050511 (x9) HARNESS CLAMP - LWS-0306ZC



20.AA061066 COIL SPRING:GAT E



2.03603006N (x7) SCREW - M3X6



7.07200030E (x2) RETAINING RING - M3



10.07403804 BALL BEARING:DIA 4XDIA9X4



15.09543008N (x6) SCREW - M3X8



1.03530040N (x2) SCREW - M3X4



13.07423808 (x3) BALL BEARING - 8 X16X5



14.08010237 (x2) HEXAGONAL BOLT :DOUBLE SCREW: M4X12



6.04544008Q (x2) TAPPING SCREW - M4X8



12.07413006 BALL BEARING - 6 X17X6MM



U024 Paper Registration 4

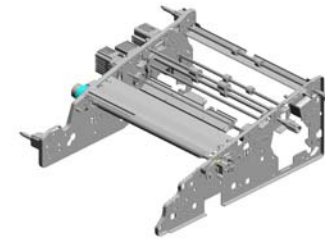

- 38.D0742629 BRACKET:DC STEPPER MOTOR:TRANSPORT ROLLER:SHIFT
- 25.AX040157 (x2) STEPPER MOTOR:DC1.68V 6.7W
- 22.AA161122 (x2) MOTOR CUSHION
- 39.D0742632 BRACKET:DC STEPPER MOTOR:MM56:CAM
- 28.B2342629 (x2) BALL BEARING - REAR

29.B8341648
TIMING BELT - B60
S2M120

37.D0742626
TIMING PULLEY:S2M:31T/31T

30.B8352889
TIMING BELT - B60
S2M144

35.D0742621
PLATE:DC MOTOR:
TIMING ROLLER:TRANSFER

36.D0742622
BRACKET:DC MOTOR:
TIMING ROLLER:TRANSFER

33.D0741369
COVER:ENCODER

31.D0396137
ENCODER:ASSY

26.B2236171
RUBBER BUSHING:
ENCODER

32.D0592399
(x4)
FLANGED HEXAGONAL
HEAD BOLT:
M3*4

24.AW020199
(x2)
OPTICS SENSOR:
ENCODER:300LPI

40.D0742634
BRACKET:DC STEPPER
MOTOR:MM42:REGISTRATION:
ENTRANCE

27.B2342628
(x2)
BALL BEARING - FRONT

21.AA082101
BUSHING - 6X10X6

23.AG050100
(x2)
KNOB - TRANSPORT
ROLLER

34.D0742601
PLATE:ADJUSTING
PIN

U001	U002	U003	U004	U005	U006	U007	U008	U009	U010	U011	U012	U013	U014	U015	U016	U017	U018	U019	U020	U021
------	------	------	------	------	------	------	------	------	------	------	------	------	------	------	------	------	------	------	------	------

U024 Paper Registration 4

53.D0742749
(x2)
ARM:REGISTRATI
ON ROLLER:TIMIN
G

55.D0742769
BRACKET:DC STE
PPER MOTOR:REG
ISTRATION ROLLE
R:TIMING

49.D0742697
GATE PAWL:PEEN

48.D0742696
SHAFT:GATE PAW
L

56.D0742771
SHAFT:REGISTRA
TION ROLLER:TIMI
NG:DRIVEN

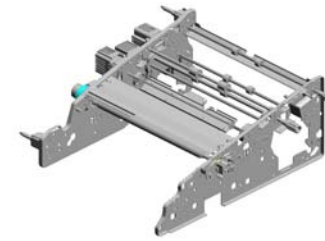

59.D0742777
(x2)
CAM:REGISTRATI
ON ROLLER:TIMIN
G



41.D0742642
GEAR:TIMING ROL
LER:TRANSFER:Z5
9



58.D0742774
COVER:TIMING:TR
ANSFER



43.D0742654
CASE:REMOVE PA
PER DUST:ASS'Y



42.D0742643
TIMING ROLLER:T
RANSFER:DRIVEN



45.D0742691
SHAFT:CAM

46.D0742693
CAM:GATE

52.D0742748
SHAFT:ARM:REGIS
TRATION ROLLER:
TIMING

47.D0742694
CAM:TRANSPORT
ROLLER:SHIFT

57.D0742772
COVER:BEARING

50.D0742711
TRANSPORT ROLL
ER:CONNECTING:
LARGE CAPACITY
TRAY

60.D0742881
TRANSPORT ROLL
ER:REGISTRATION
:ENTRANCE:DRIVE
:PRESS FIT

44.D0742665
REGISTRATION R
OLLER:TIMING:DRI
VE

54.D0742750
STAY:SOLENOID

51.D0742715
BRACKET:SOLENO
ID:PEEN

U001	U002	U003	U004	U005	U006	U007	U008	U009	U010	U011	U012	U013	U014	U015	U016	U017	U018	U019	U020	U021
------	------	------	------	------	------	------	------	------	------	------	------	------	------	------	------	------	------	------	------	------

U024 Paper Registration 4

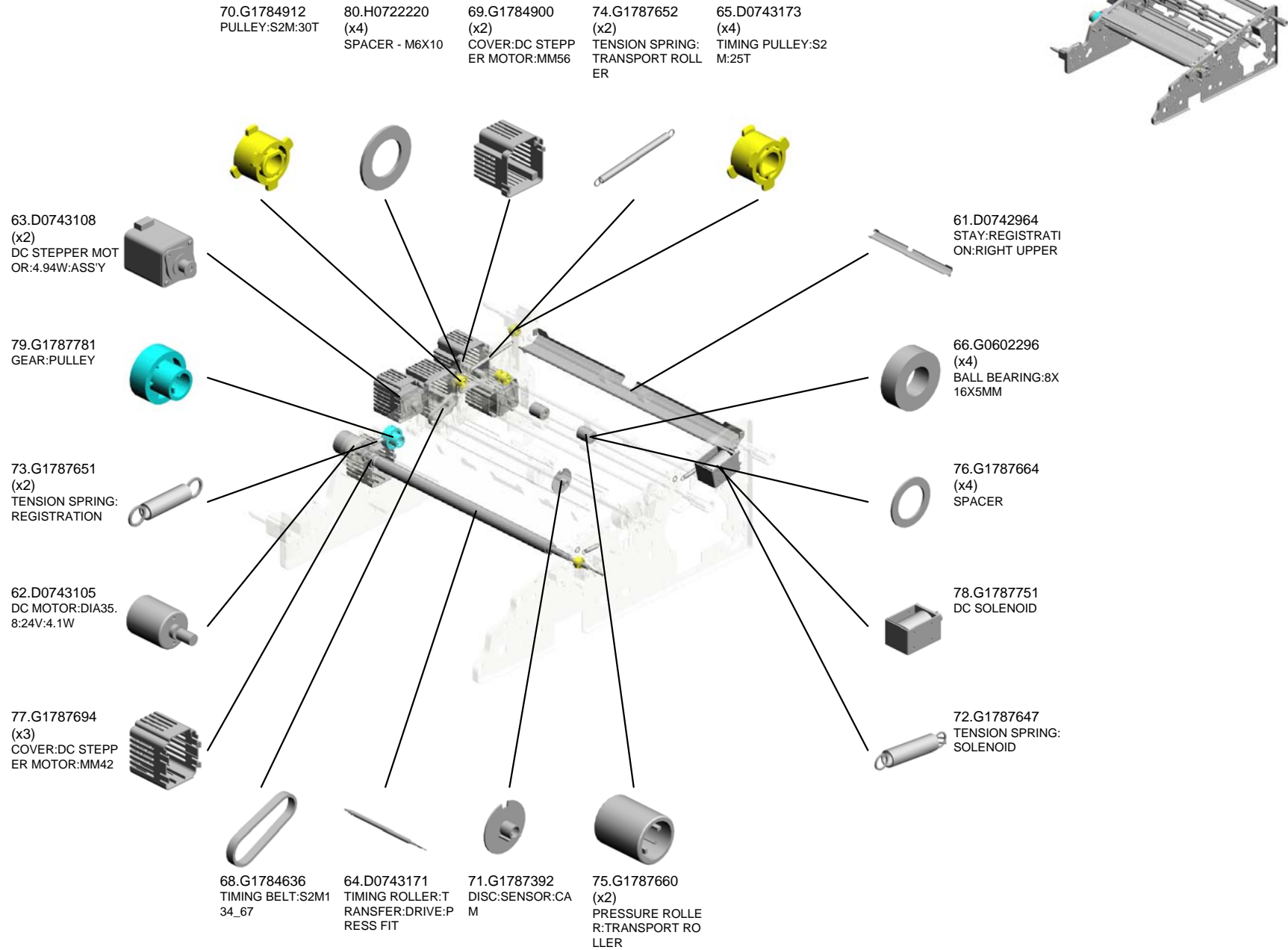

U025 Paper Registration 5

16.B1321220
COVER:BASE:PUL
L OUT

17.B1321228
INSULATING SHEE
T:PULL OUT

15.AZ310029
POWER PACK:D

6.07200060E
(x7)
RETAINING RING -
M6

1.03603006N
(x8)
SCREW - M3X6

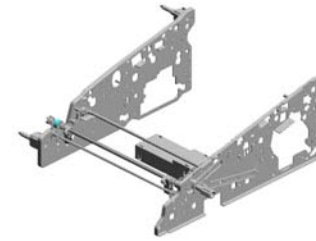

12.AA082104
(x2)
BUSHING - 8X12X7



2.03604008N
(x2)
SCREW - M4X8



3.03604014N
SCREW - M4X14



20.D0743427
(x2)
RADIAL BALL BEA
RING:DIA8XDIA16X
5



4.06330140G
PARALLEL PIN - 3X
14



7.07413706
BALL BEARING - 6
X10X3



9.08050089
(x2)
RETAINING RING -
M4



13.AB030846
TIMING PULLEY:S2
M:22T



19.D0742969
SHAFT:MISFEED R
EMOVAL:TIMING R
OLLER:TRANSFER



10.11050511
(x2)
HARNES CLAMP -
LWS-0306ZC



5.07200040E
(x2)
RETAINING RING -
M4



11.AA043638
TIMING BELT:40S2
M224



18.D0742962
BRACKET:MISFEE
D REMOVAL:TIMIN
G ROLLER:TRANS
FER



8.08010237
HEXAGONAL BOLT
:DOUBLE SCREW:
M4X12



14.AG050100
KNOB - TRANSPO
RT ROLLER



U025 Paper Registration 5

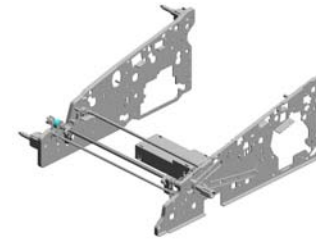
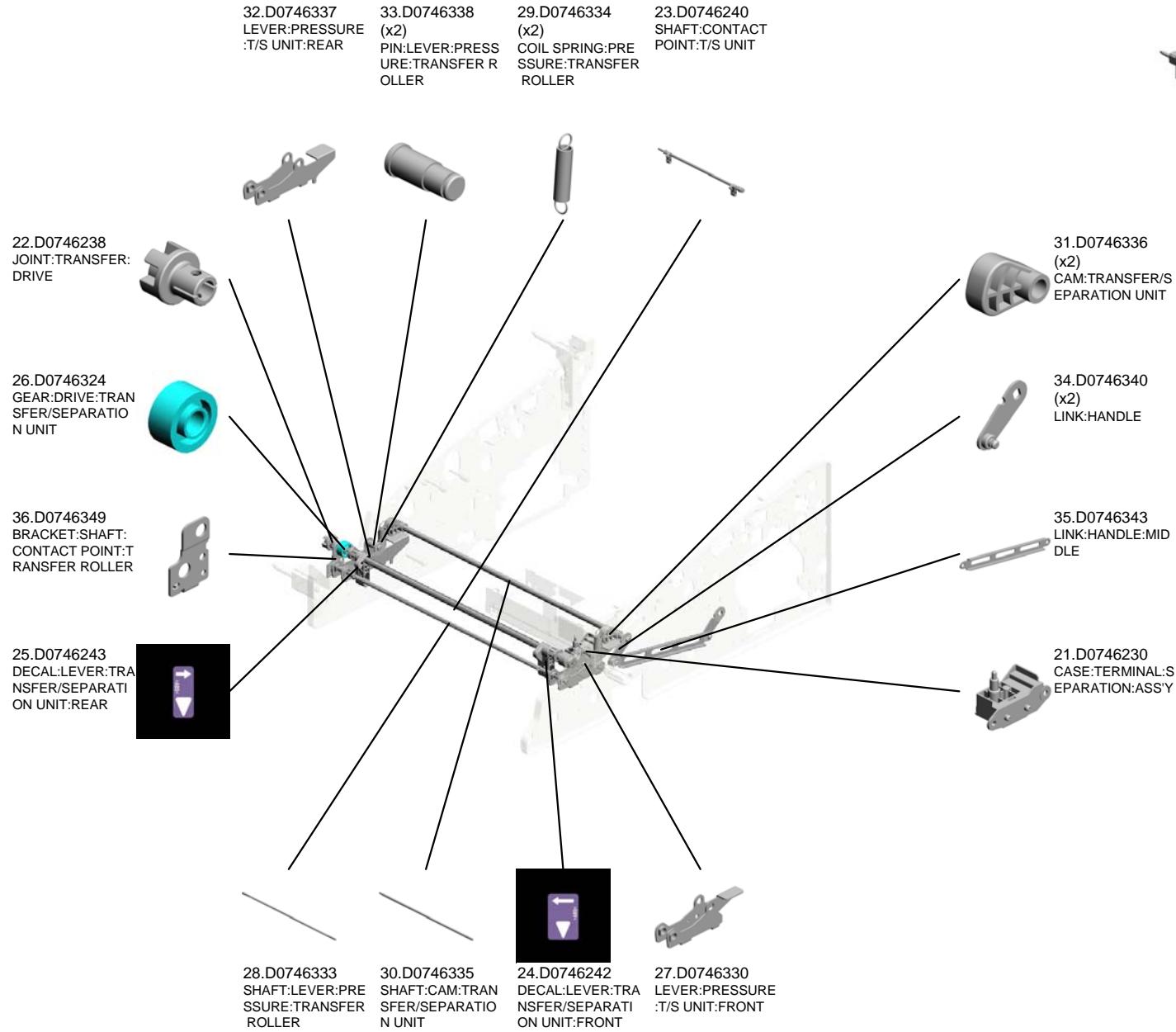

U026 Paper Registration 6

14.11050516
(x2)
CLAMP

3.03603008N
(x4)
SCREW:M3X8

19.AA063472
(x2)
COMPRESSION SP
RING:CONNECTO
R:UPPER

11.08050089
(x2)
RETAINING RING -
M4

20.AA066400
COIL SPRING:PAW
L:OPEN AND CLOS
E

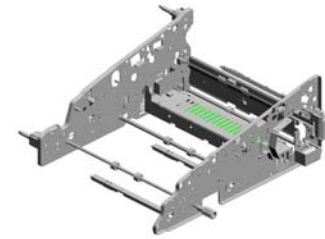

16.AA043609
TIMING BELT:60S2
M124



4.03604008N
(x3)
SCREW - M4X8



15.AA043608
TIMING BELT:40S2
M184



7.07200060E
(x9)
RETAINING RING -
M6



17.AA043634
TIMING BELT - 40S
2M296



10.08010237
HEXAGONAL BOLT
:DOUBLE SCREW:
M4X12



9.07423808
(x3)
BALL BEARING - 8
X16X5



2.03603006N
(x14)
SCREW - M3X6



12.08050092
(x2)
RETAINING RING -
3M



8.07413708
BALL BEARING - 8
X12X3.5MM



5.04543006Q
(x2)
TAPPING SCREW -
M3X6



18.AA061070
TENSION SPRING:
DC SOLENOID:LIN
K



6.07200030E
(x2)
RETAINING RING -
M3



13.11050511
(x9)
HARNESS CLAMP -
LWS-0306ZC



1.03530040N
(x5)
SCREW - M3X4



U026 Paper Registration 6

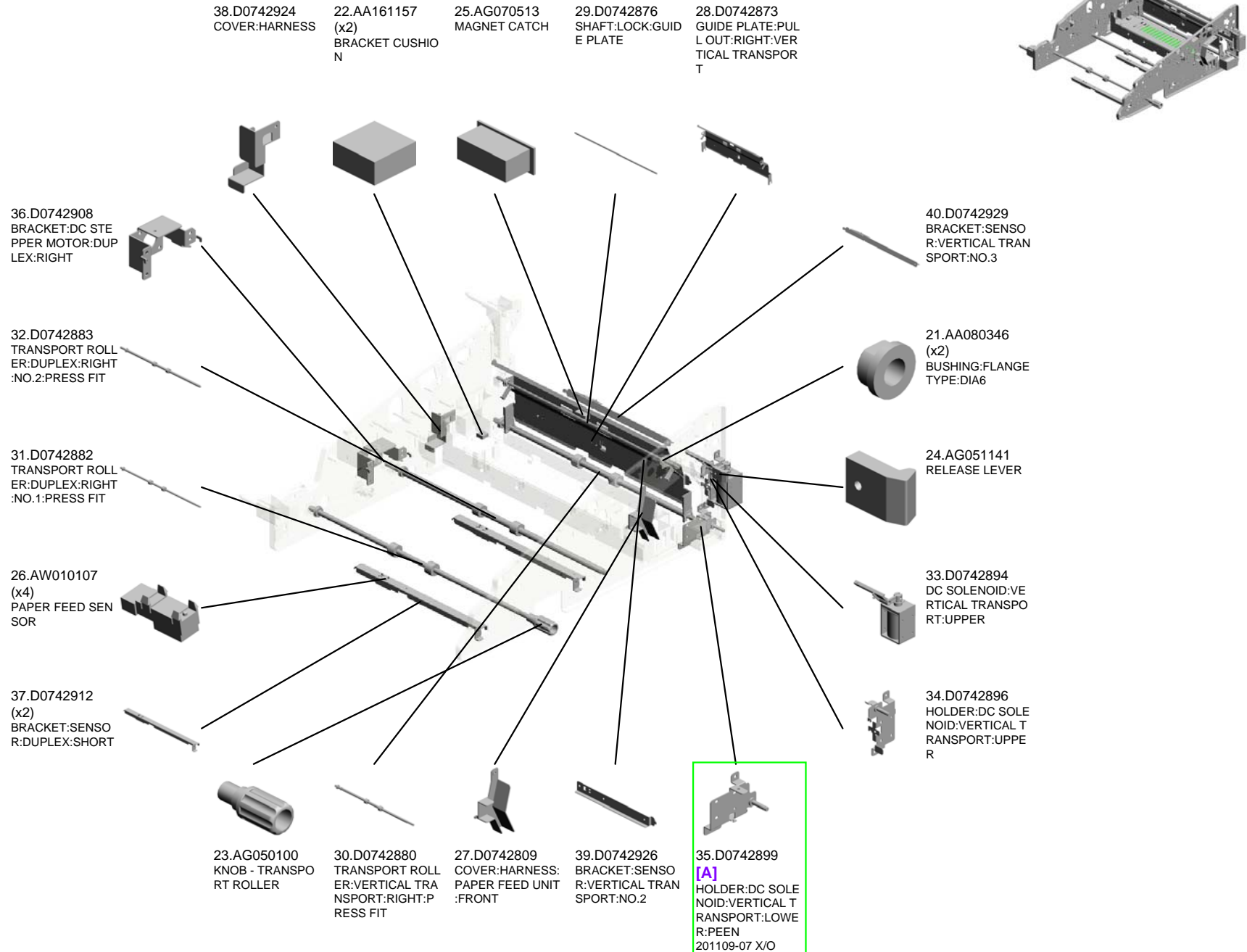

U001	U002	U003	U004	U005	U006	U007	U008	U009	U010	U011	U012	U013	U014	U015	U016	U017	U018	U019	U020	U021
------	------	------	------	------	------	------	------	------	------	------	------	------	------	------	------	------	------	------	------	------

U026 Paper Registration 6

50.G1784866 (x2)
COMPRESSION SPRING:EXIT:CONNECTOR

51.G1787515 (x4)
CONNECTOR GUIDE PIN:CONNECTOR

42.D0742970 (x2)
CAM:GUIDE PLATE:OPEN AND CLOSE

43.D0742971 (x4)
PLATE:LINK:OPEN AND CLOSE:REAR

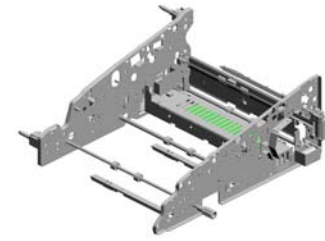

46.D0743108
DC STEPPER MOTOR:4.94W:ASS'Y



47.D0743173 (x3)
TIMING PULLEY:S2 M:25T



41.D0742941
TIMING PULLEY:S2 M:30T



48.D0744683
JOINT:EXIT:DRIVE



49.D0745532
PCB:DRB

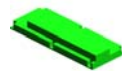

45.D0742977
COVER:HARNESS:FRONT UPPER



44.D0742972
LEVER:GUIDE PLATE:OPEN AND CLOSE:FRONT



53.G1787751
DC SOLENOID



52.G1787647
TENSION SPRING:SOLENOID

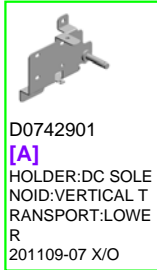

D0742901
[A]
HOLDER:DC SOLENOID:VERTICAL TRANSPORT:LOWER
201109-07 X/O

U027 Toner Supply 1

12.B2343372
(x4)
DC MOTOR:TONE
R BOTTLE:DC21V
5.85W

6.11050516
(x20)
CLAMP

1.03125050N
(x8)
SCREW - M2.5X5

16.D0743708
(x4)
SPRING LOCK WA
SHER:DRIVE SUB-
UNIT:TONER BOT
TLE

13.D0743702
(x4)
SHAFT:DRIVE SUB
-UNIT:TONER SUP
PLY UNIT:2

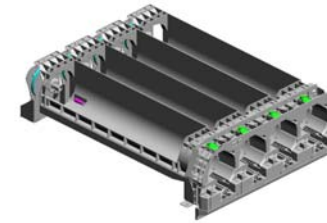

5.07200040E
(x16)
RETAINING RING -
M4

15.D0743707
(x4)
SHAFT:DRIVE SUB
-UNIT:TONER SUP
PLY UNIT:1

14.D0743703
(x4)
GEAR:TONER BOT
TLE:DIA92

9.AB012008
(x4)
GEAR - 23Z

17.D0743714
(x4)
BRACKET:DRIVE:T
ONER BOTTLE

18.D0743721
(x4)
JOINT:DRIVE:TONE
R SUPPLY UNIT

19.D0743722
(x4)
COIL SPRING:DRIV
E SUB-UNIT:TONE
R SUPPLY UNIT

8.AB012007
(x4)
GEAR - 14Z

7.AA082101
(x16)
BUSHING - 6X10X6

3.04503010N
(x33)
TAPPING SCREW -
M3X10

2.03603006N
(x9)
SCREW - M3X6

20.D0743736
(x4)
SEAL:NOZZLE:NOZ
ZLE COVER

4.04514008N
(x16)
TAPPING SCREW:
4X8

11.B2233485
(x4)
SEAL:HOLDER:ST
OPPER:SHUTTER:
1

10.AW020145
(x4)
PHOTOINTERRUP
TOR:FLAT

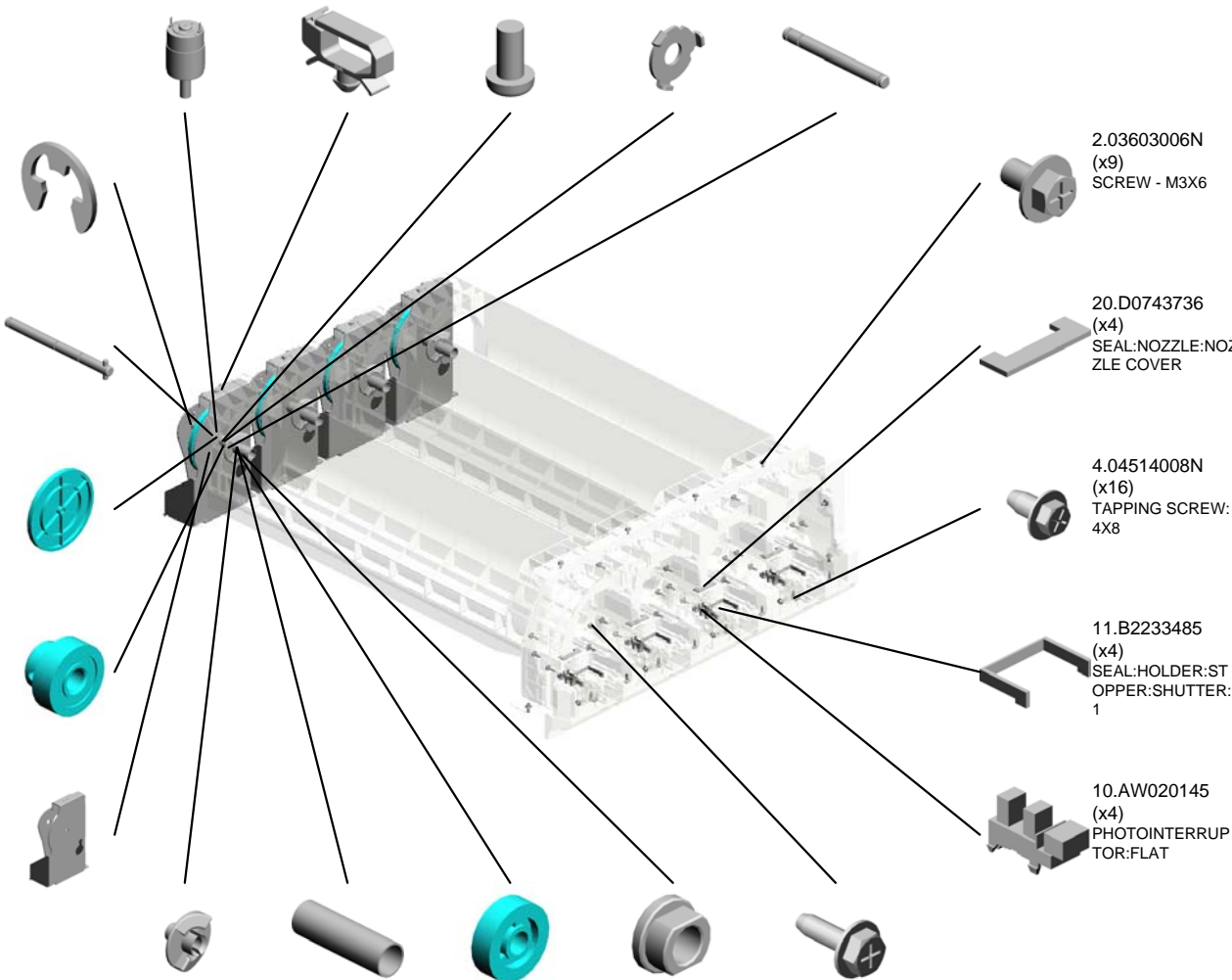

U027 Toner Supply 1



- 35.D0743768 (x8) TENSION SPRING: SHUTTER:TONER SUPPLY UNIT
- 30.D0743763 (x4) NOZZLE COVER:TONER SUPPLY SUB-UNIT
- 29.D0743762 (x4) NOZZLE:TONER SUPPLY:TAURUS
- 31.D0743764 (x4) LEVER:TONER BOTTLE
- 32.D0743765 (x4) CASE:LOWER FRONT:TONER SUPPLY UNIT

- 40.G1783543 (x8) ROLLER:PLATE:TONER BOTTLE

- 28.D0743756 (x4) SEAL:BLOCK LIGHT:LEVER

- 33.D0743766 (x4) PLATE:COIL SPRING

- 38.D0743772 DECAL:OPERATE:TONER BOTTLE:M

- 39.D0743773 DECAL:OPERATE:TONER BOTTLE:Y

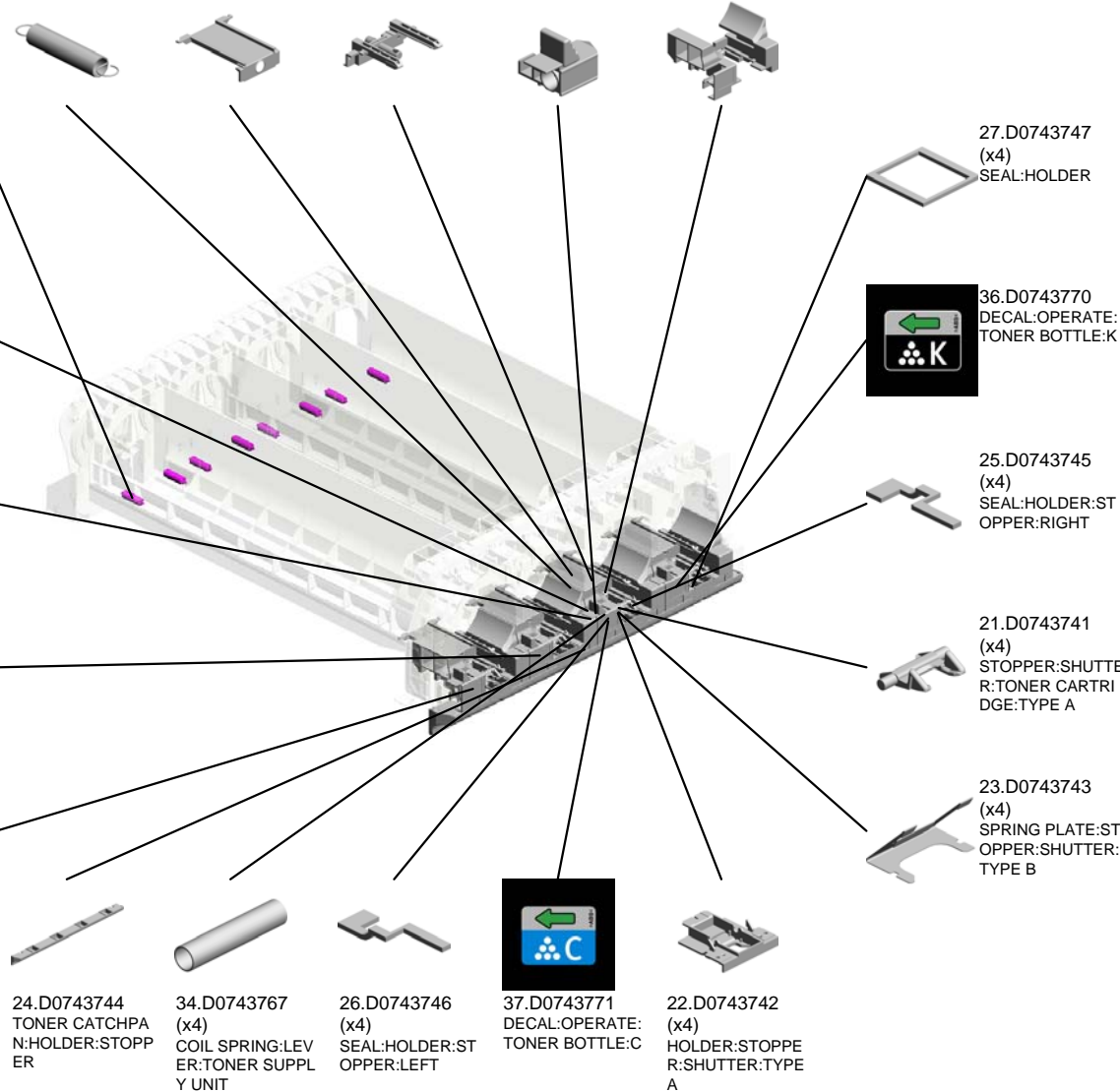

U027 Toner Supply 1

43.M0265158
PCB:RFID-AFE:M

44.M0265166
PCB:RFID-AFE:C



45.M0265168
PCB:RFID-AFE:Y

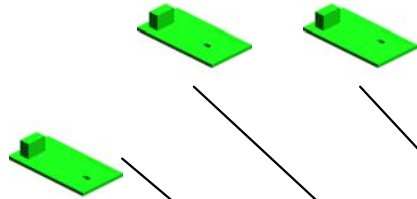

42.M0265152
PCB:RFID-AFE:K

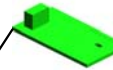

41.M0265108
PCB:RFID-CPU

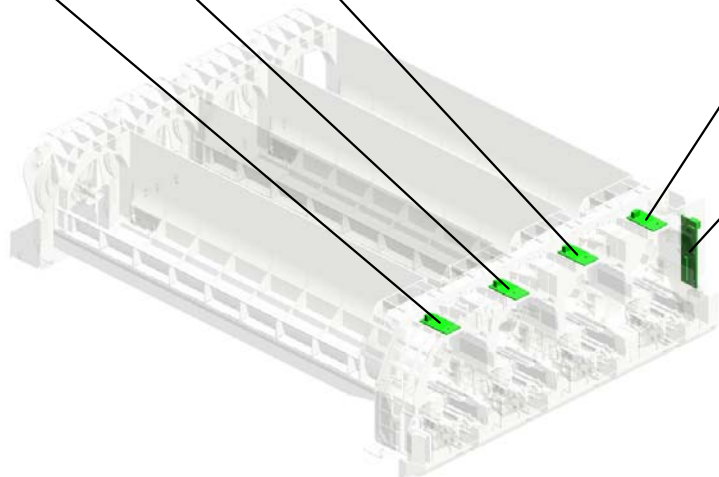

U001	U002	U003	U004	U005	U006	U007	U008	U009	U010	U011	U012	U013	U014	U015	U016	U017	U018	U019	U020	U021
------	------	------	------	------	------	------	------	------	------	------	------	------	------	------	------	------	------	------	------	------

U028 Toner Supply 2

17.D0743516
GEAR:DRIVE:TON
ER SUPPLY

6.07200060E
(x3)
RETAINING RING -
M6

10.11050516
(x9)
CLAMP

11.A2222724
(x4)
EXTERNAL CIRCLI
P - MM8

13.AA082151
(x4)
GUIDE:SHAFT:DRI
VE:TONER SUPPL
Y



4.04514008N
(x7)
TAPPING SCREW:
4X8

18.D0743517
GEAR:IDLER:TONE
R SUPPLY

19.D0743518
GEAR:TIMING PUL
LEY:DRIVEN:TONE
R SUPPLY

12.AA043983
SYNCHRONOUS B
ELT:60S3M243

20.D0743521
BRACKET:TIGHTE
NER:TONER SUPPL
Y

1.03603006N
(x11)
SCREW - M3X6

8.11050488
(x3)
HARNESS CLAMP

15.D0743513
SHAFT:DRIVE:TON
ER SUPPLY

9.11050511
(x12)
HARNESS CLAMP -
LWS-0306ZC

2.03604008N
(x8)
SCREW - M4X8

7.07423910
(x3)
BALL BEARING:10
X22X6

16.D0743514
(x4)
GEAR:DRIVE:ELEC
TROMAGNETIC CL
UTCH:TONER SUP
PLY

5.07200040E
(x4)
RETAINING RING -
M4

14.B0044438
(x4)
BUSHING

3.04503010N
(x16)
TAPPING SCREW -
M3X10

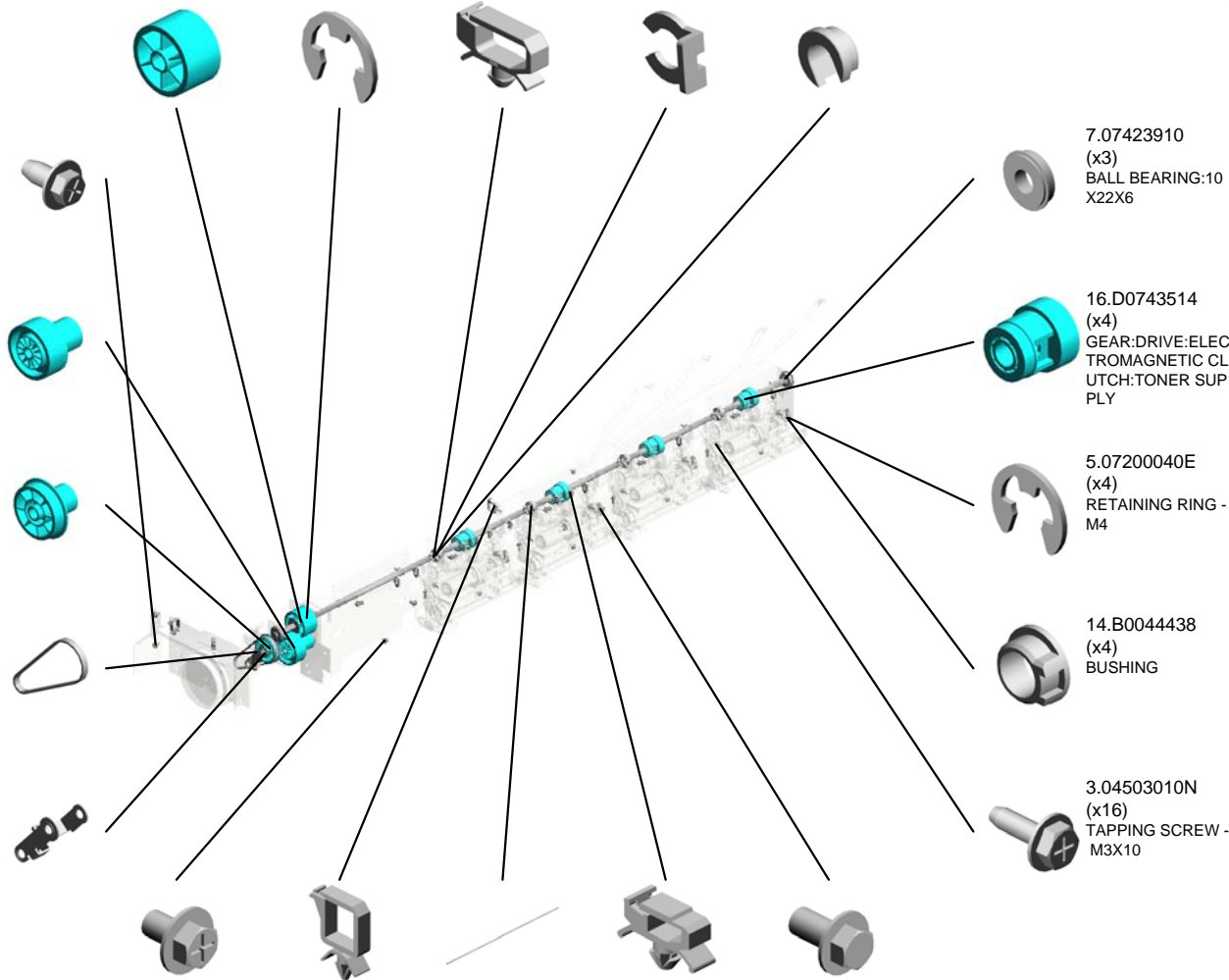

U028 Toner Supply 2

22.D0743525 TENSION SPRING:
TIGHTENER:TONE
R SUPPLY

23.D0743526 SUPPORTING PLA
TE:GEAR:TONER S
UPPLY

30.D0743624 TUBE:TONER SUP
PLY:Y



32.D0757188 COVER:MOTOR:T
ONER SUPPLY



31.D0743631 DC BRUSHLESS M
OTOR:TONER SUP
PLY:47.5W



21.D0743522 SHAFT:TIGHTENE
R:TONER SUPPLY

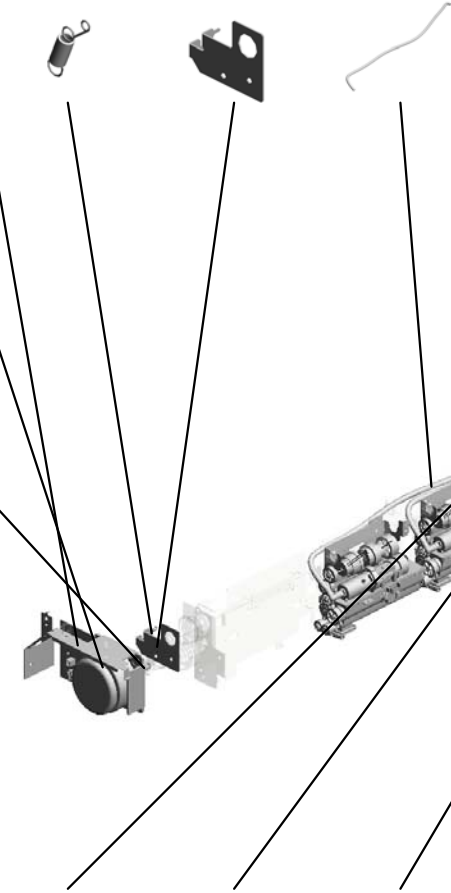

27.D0743621 TUBE:TONER SUP
PLY:BK



24.D0743531 (x4)
DRIVE SUB-UNIT:T
ONER SUPPLY:AS
S'Y

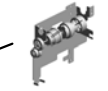

25.D0743551 (x4)
PUMP:TONER SUP
PLY:SUB-ASS'Y



29.D0743623 TUBE:TONER SUP
PLY:M



28.D0743622 TUBE:TONER SUP
PLY:C



26.D0743580 (x4)
CASE:TONER SUP
PLY:SUB-ASS'Y



U001	U002	U003	U004	U005	U006	U007	U008	U009	U010	U011	U012	U013	U014	U015	U016	U017	U018	U019	U020	U021
------	------	------	------	------	------	------	------	------	------	------	------	------	------	------	------	------	------	------	------	------

U029.PCDU

U029_S004
D0742195
CHARGE UNIT

U029_S005
D0742330
CLEANING UNIT:ASS'Y

U029_S007
D0742195
CHARGE UNIT

U029_S001
D0742195
CHARGE UNIT

U029_S010
D0742195
CHARGE UNIT

U029_S002
D0742330
CLEANING UNIT:ASS'Y

U029_S011
D0742330
CLEANING UNIT:ASS'Y

U029_S003
D0742301
PCU:TAURUS:ASS'Y

U029_S012
D0742301
PCU:TAURUS:ASS'Y

U029_S006
D0742301
PCU:TAURUS:ASS'Y

U029_S009
D0742301
PCU:TAURUS:ASS'Y

U029_S008
D0742330
CLEANING UNIT:ASS'Y

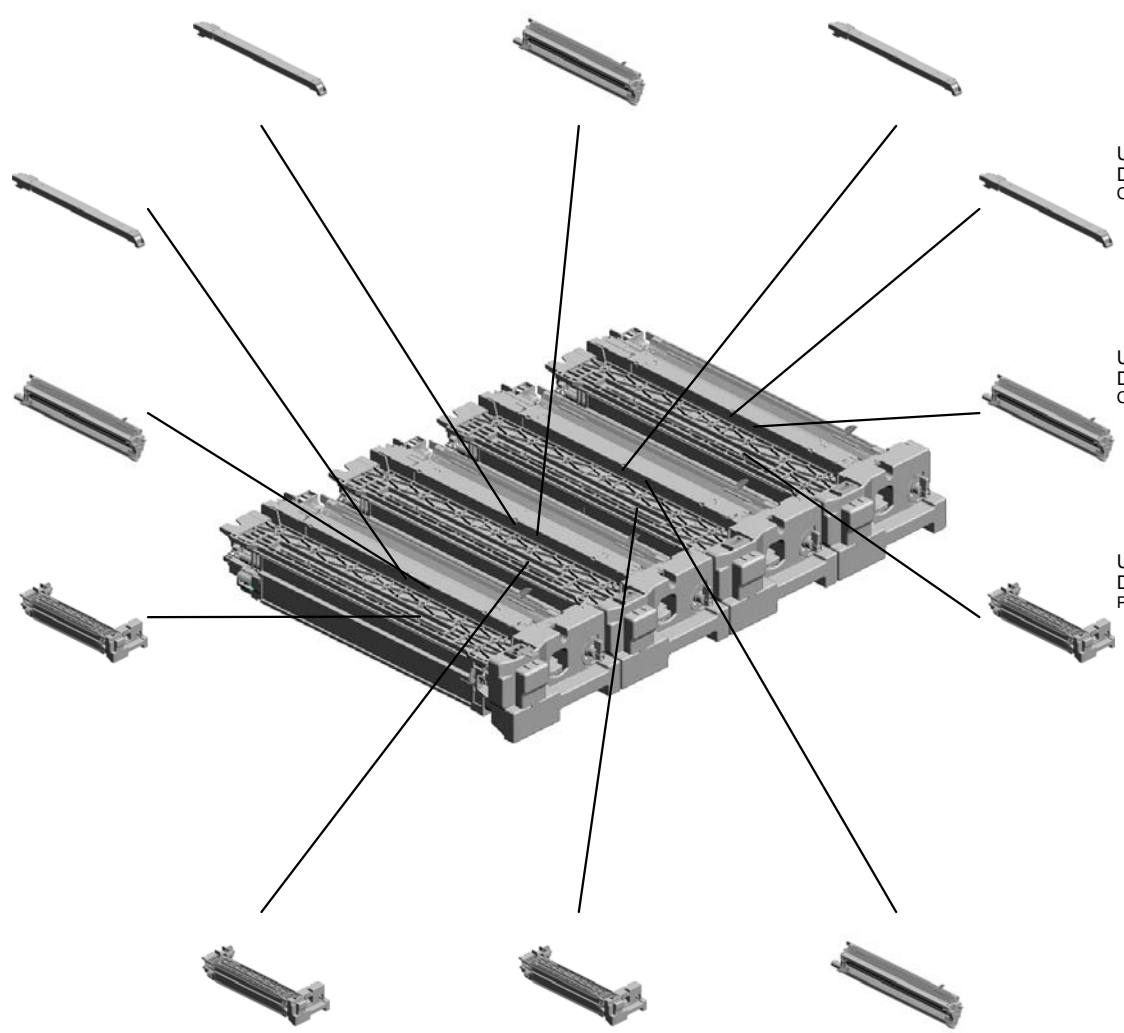

U001	U002	U003	U004	U005	U006	U007	U008	U009	U010	U011	U012	U013	U014	U015	U016	U017	U018	U019	U020	U021
------	------	------	------	------	------	------	------	------	------	------	------	------	------	------	------	------	------	------	------	------

U029_S002.CLEANING UNIT:ASS'Y

U029_S002_S001
D0742481
BLADE:APPLY:ASS'Y

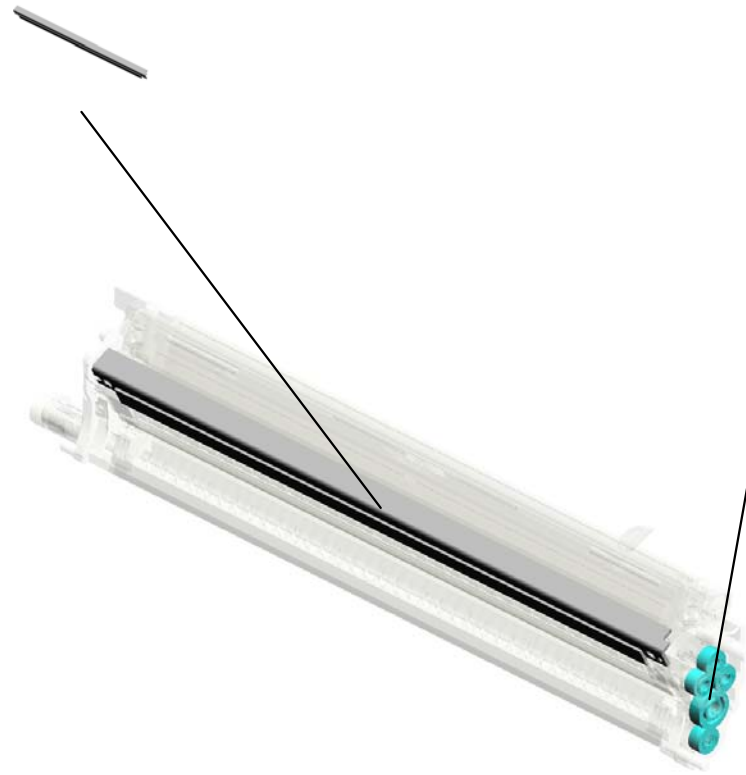

U029_S002_S002
D0758701
GEAR:CLEANING:DRUM:SER
VICE

U001	U002	U003	U004	U005	U006	U007	U008	U009	U010	U011	U012	U013	U014	U015	U016	U017	U018	U019	U020	U021
------	------	------	------	------	------	------	------	------	------	------	------	------	------	------	------	------	------	------	------	------

U029_S003.PCU:TAURUS:ASS'Y

U029_S003_S001
D0742392
COVER:PCU:FRONT:ASS'Y

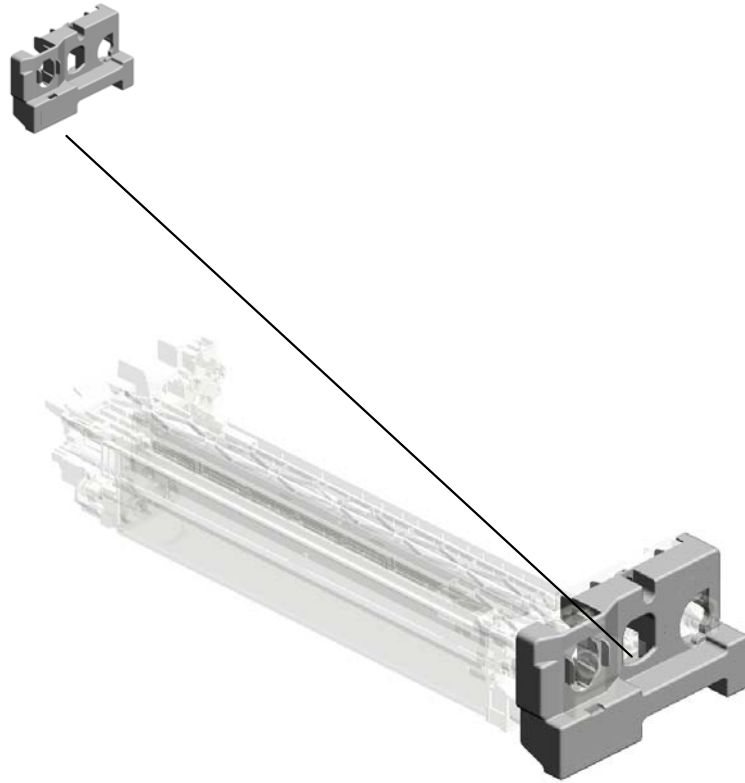

U001	U002	U003	U004	U005	U006	U007	U008	U009	U010	U011	U012	U013	U014	U015	U016	U017	U018	U019	U020	U021
------	------	------	------	------	------	------	------	------	------	------	------	------	------	------	------	------	------	------	------	------

U029_S005.CLEANING UNIT:ASS'Y

U029_S005_S001
D0742481
BLADE:APPLY:ASS'Y

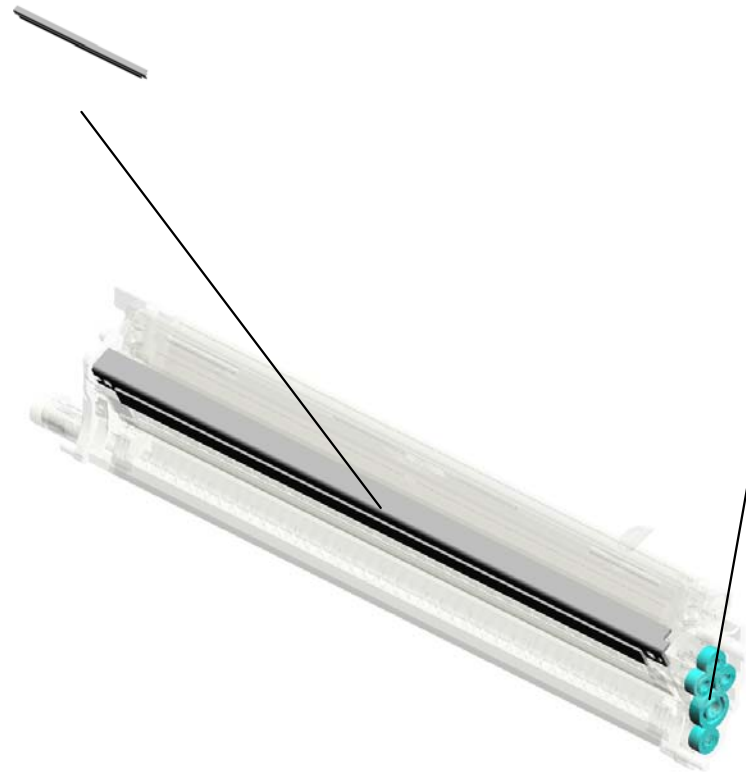

U029_S005_S002
D0758701
GEAR:CLEANING:DRUM:SER
VICE

U001	U002	U003	U004	U005	U006	U007	U008	U009	U010	U011	U012	U013	U014	U015	U016	U017	U018	U019	U020	U021
------	------	------	------	------	------	------	------	------	------	------	------	------	------	------	------	------	------	------	------	------

U029_S006.PCU:TAURUS:ASS'Y

U029_S006_S001
D0742392
COVER:PCU:FRONT:ASS'Y

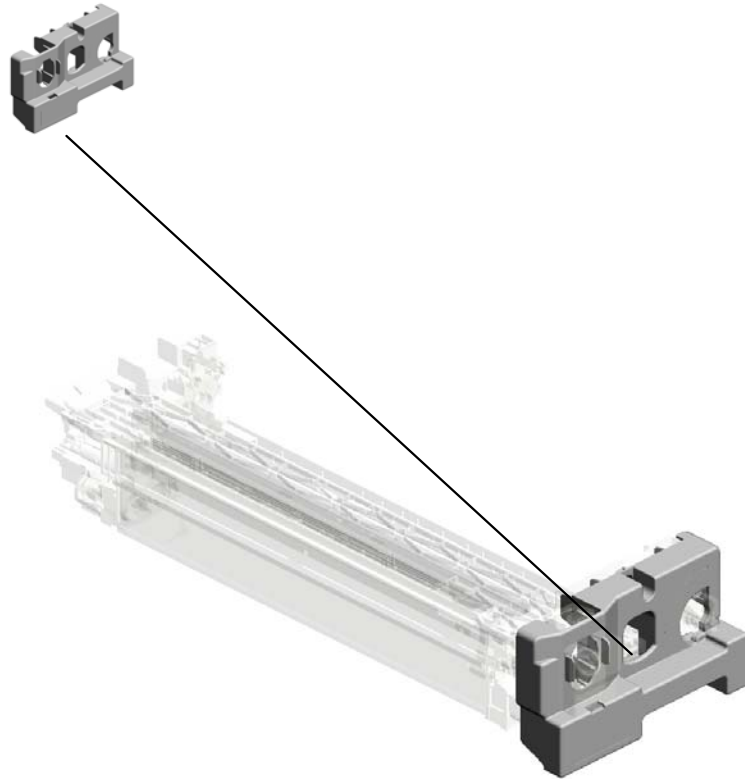

U001	U002	U003	U004	U005	U006	U007	U008	U009	U010	U011	U012	U013	U014	U015	U016	U017	U018	U019	U020	U021
------	------	------	------	------	------	------	------	------	------	------	------	------	------	------	------	------	------	------	------	------

U029_S008.CLEANING UNIT:ASS'Y

U029_S008_S001
D0742481
BLADE:APPLY:ASS'Y

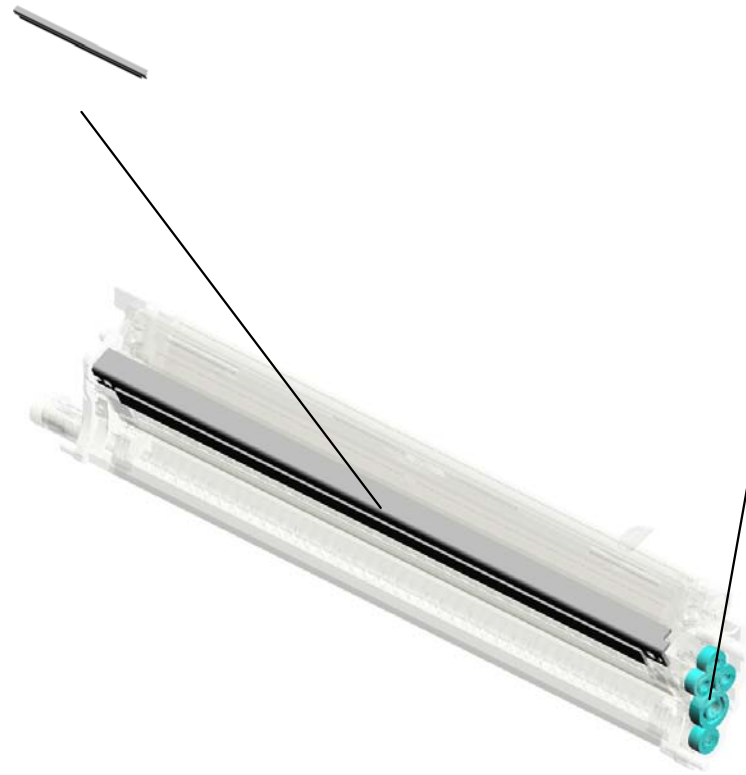

U029_S008_S002
D0758701
GEAR:CLEANING:DRUM:SER
VICE

U001	U002	U003	U004	U005	U006	U007	U008	U009	U010	U011	U012	U013	U014	U015	U016	U017	U018	U019	U020	U021
------	------	------	------	------	------	------	------	------	------	------	------	------	------	------	------	------	------	------	------	------

U029_S009.PCU:TAURUS:ASS'Y

U029_S009_S001
D0742392
COVER:PCU:FRONT:ASS'Y

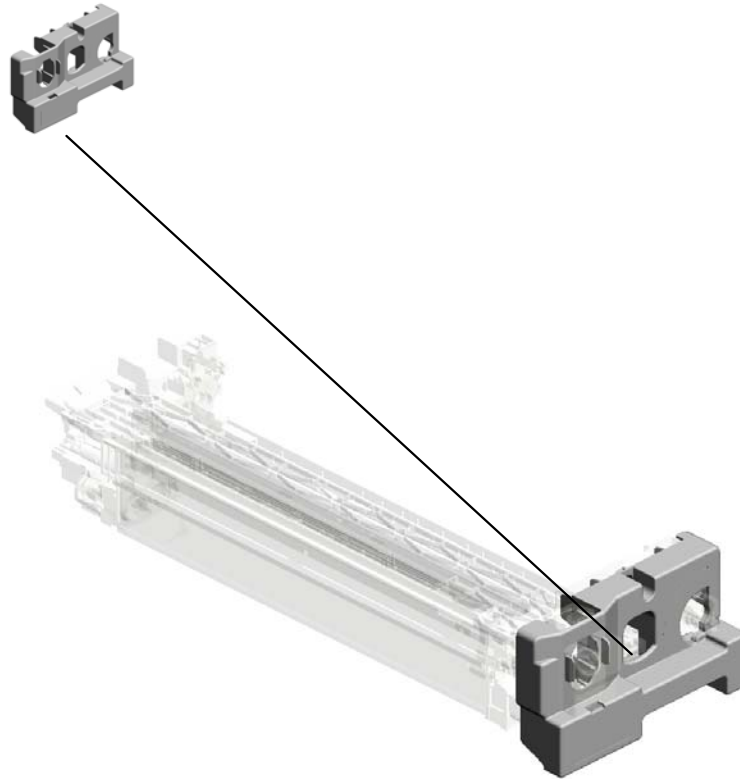

U001	U002	U003	U004	U005	U006	U007	U008	U009	U010	U011	U012	U013	U014	U015	U016	U017	U018	U019	U020	U021
------	------	------	------	------	------	------	------	------	------	------	------	------	------	------	------	------	------	------	------	------

U029_S011.CLEANING UNIT:ASS'Y

U029_S011_S001
D0742481
BLADE:APPLY:ASS'Y



U029_S011_S002
D0758701
GEAR:CLEANING:DRUM:SER
VICE

U001	U002	U003	U004	U005	U006	U007	U008	U009	U010	U011	U012	U013	U014	U015	U016	U017	U018	U019	U020	U021
------	------	------	------	------	------	------	------	------	------	------	------	------	------	------	------	------	------	------	------	------

U029_S012.PCU:TAURUS:ASS'Y

U029_S012_S001
D0742392
COVER:PCU:FRONT:ASS'Y

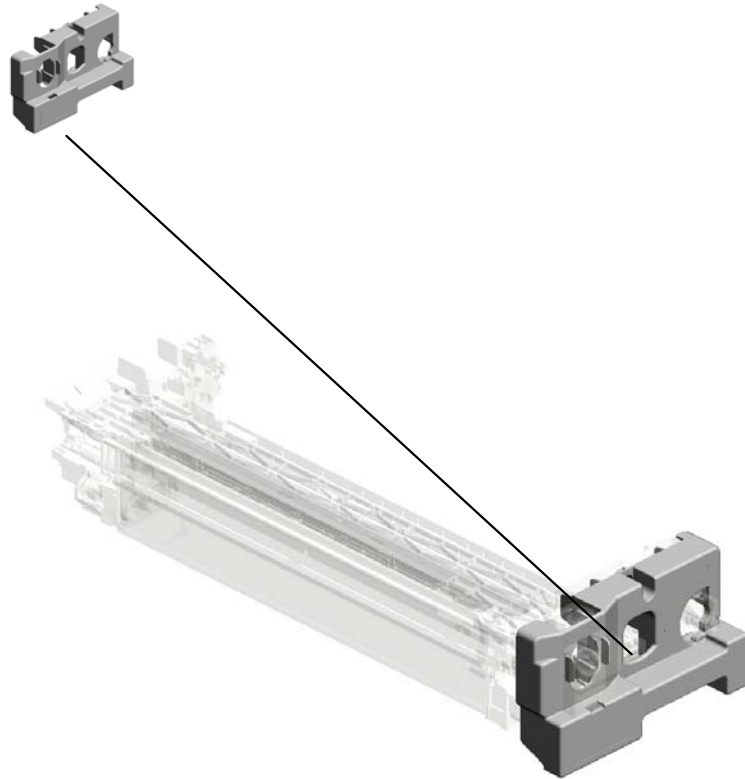

U001	U002	U003	U004	U005	U006	U007	U008	U009	U010	U011	U012	U013	U014	U015	U016	U017	U018	U019	U020	U021
------	------	------	------	------	------	------	------	------	------	------	------	------	------	------	------	------	------	------	------	------

U029
PCDU

53.D0742542
(x8)
DECAL:GRIP

68.D0749510
(x4)
OPC DRUM DIA60

11.D0742252
(x4)
FRAME:PHOTOCO
NDUCTOR



52.D0742541
(x8)
DECAL:ARROW LA
BEL

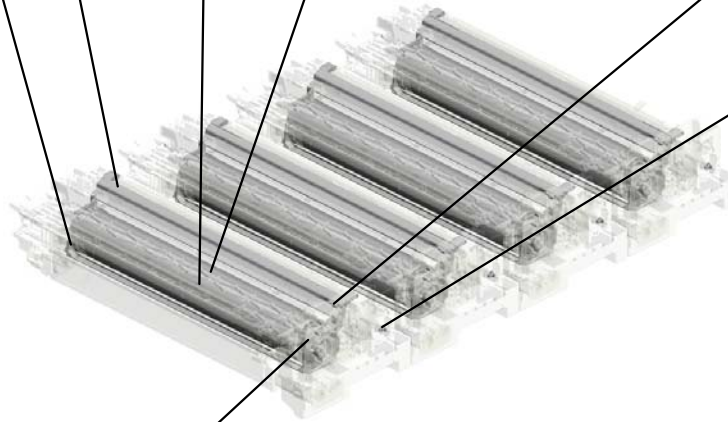
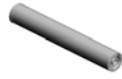

5.B2342390
(x4)
FLANGED HEXAG
ONAL HEAD BOLT:
M4X8



6.B2591131
(x4)
SCREW:PCU



69.D0749640
DEVELOPER BLAC
K



70.D0749660
DEVELOPER CYAN



71.D0749670
DEVELOPER MAG
ENTA



72.D0749680
DEVELOPER YELL
OW



7.D0142380
(x4)
COMPRESSION SP
RING - DRUM

U029_S001
CHARGE UNIT

54.D0742543
DECAL:GRIP

10.D0742195
CHARGE UNIT



U001	U002	U003	U004	U005	U006	U007	U008	U009	U010	U011	U012	U013	U014	U015	U016	U017	U018	U019	U020	U021
------	------	------	------	------	------	------	------	------	------	------	------	------	------	------	------	------	------	------	------	------

U029_S002
CLEANING UNIT:ASS'Y

2.03603006N
(x4)
SCREW - M3X6

39.D0742471
(x2)
ARM:COATING BAR

40.D0742473
(x2)
TENSION SPRING:
COATING BAR:9.0
N

41.D0742475
STAY:APPLY:ASS'Y

38.D0742466
COATING BAR:AS
S'Y

13.D0742330
CLEANING UNIT:AS
S'Y



37.D0742459
JOINT:CLEANING
UNIT

35.D0742457
PLAIN SHAFT BEA
RING:BRUSH ROLL
ER:APPLY:REAR

4.8025320
HEXAGON HEAD T
APPING SCREW:ES
S:3X10

1.03530060N
(x4)
BIND SCREW - M3
X6

31.D0742425
SEAL:BLADE:CLE
ANING:REAR

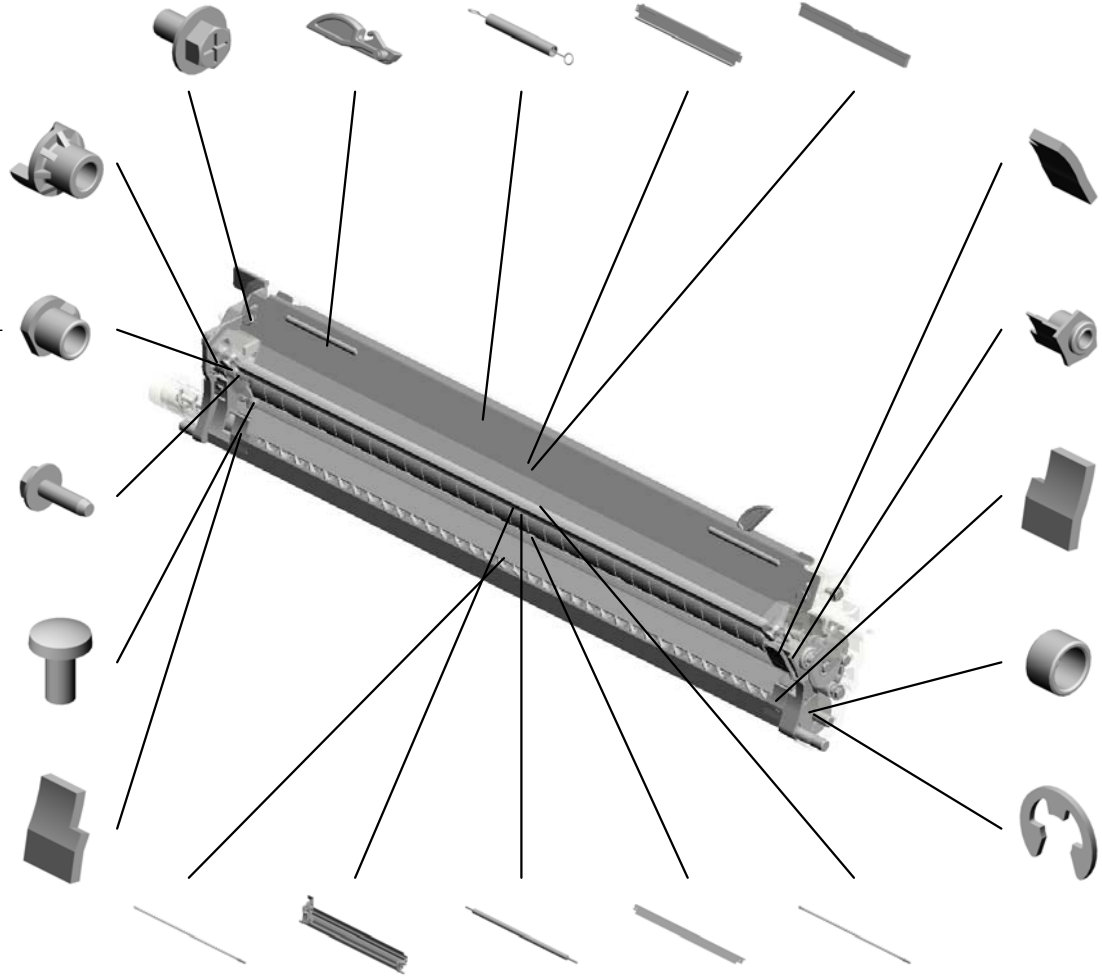

43.D0742485
SEAL:BLADE:APP
LY:FRONT

34.D0742456
PLAIN SHAFT BEA
RING:BRUSH ROLL
ER:APPLY:FRONT

30.D0742424
SEAL:BLADE:CLE
ANING:FRONT

28.D0742419
(x2)
PLAIN SHAFT BEA
RING:TRANSPORT
SCREW

3.07200040E
(x3)
RETAINING RING -
M4

27.D0742414
TRANSPORT SCR
EW:BASE:ASS'Y

26.D0742401
FRAME:BASE:ASS'
Y

33.D0742454
BRUSH ROLLER:A
PPLY:ASS'Y

29.D0742422
BLADE:CLEANING:
ASS'Y

32.D0742448
TRANSPORT SCR
EW:APPLY:ASS'Y

U029_S002
CLEANING UNIT:ASS'Y

46.D0742497
VIBRATING PLATE:
TONER OUTLET S
UB-UNIT

44.D0742486
SEAL:BLADE:APP
LY:REAR



13.D0742330
CLEANING UNIT:A
SS'Y

45.D0742491
COVER:TONER OU
TLET SUB-UNIT:CL
EANING UNIT:ASS'
Y

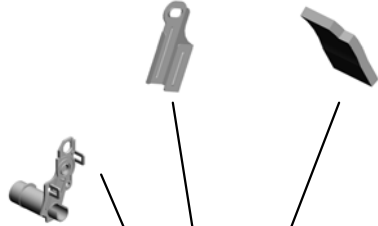

53.D0742542
(x2)
DECAL:GRIP



50.D0742504
DRUM STAY:CLEA
NING UNIT



U001	U002	U003	U004	U005	U006	U007	U008	U009	U010	U011	U012	U013	U014	U015	U016	U017	U018	U019	U020	U021
------	------	------	------	------	------	------	------	------	------	------	------	------	------	------	------	------	------	------	------	------

U029_S002_S001
BLADE:APPLY:ASS'Y

75.D0742487
(x2)
SEAL:BLADE
201109-20



42.D0742481
BLADE:APPLY:AS
S'Y

U001	U002	U003	U004	U005	U006	U007	U008	U009	U010	U011	U012	U013	U014	U015	U016	U017	U018	U019	U020	U021
------	------	------	------	------	------	------	------	------	------	------	------	------	------	------	------	------	------	------	------	------

U029_S002_S002
GEAR:CLEANING:DRUM:SERVICE

48.D0742502
GEAR:IDLER:20Z:L
EFT



73.D0758701
GEAR:CLEANING:
DRUM:SERVICE

36.D0742458
GEAR:19Z:RIGHT

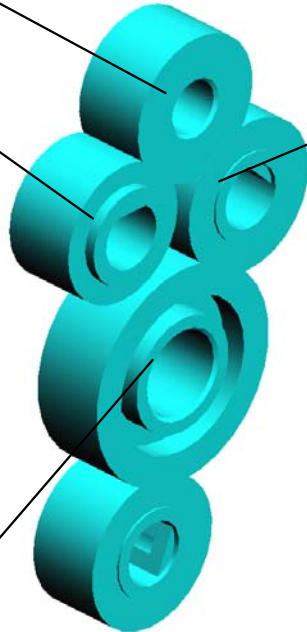

47.D0742501
(x2)
GEAR:21Z:RIGHT



49.D0742503
GEAR:IDLER:31Z:L
EFT



U001	U002	U003	U004	U005	U006	U007	U008	U009	U010	U011	U012	U013	U014	U015	U016	U017	U018	U019	U020	U021
------	------	------	------	------	------	------	------	------	------	------	------	------	------	------	------	------	------	------	------	------

U029_S003
PCU:TAURUS:ASS'Y

22.D0742386
HOLDER:LOCK:CLEANING UNIT:REAR

52.D0742541
(x4)
DECAL:ARROW LABEL

56.D0743322
FILTER:DEVELOPMENT

8.D0742191
DISCHARGE LAMP
:LED ARRAY

9.D0742192
SHEET:DISCHARGE LAMP

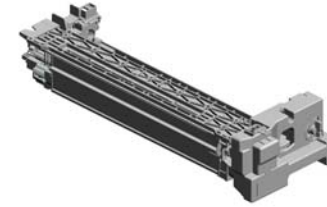

12.D0742301
PCU:TAURUS:ASS'Y

55.D0742544
DECAL:POSITIONING DISPLAY

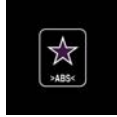

59.D0743367
ELECTRODE PLATE:DEVELOPMENT BIAS:REAR UPPER



61.D0743416
JOINT:DRIVE:DEVELOPMENT UNIT



60.D0743368
ELECTRODE PLATE:DEVELOPMENT BIAS:REAR LOWER



57.D0743340
JOINT:DRIVE:TRANSPORT SCREW



58.D0743362
ELECTRODE PLATE:DEVELOPMENT BIAS:FRONT

2.03603006N
(x3)
SCREW - M3X6

14.D0742366
LEVER:LOCK:CHARGE UNIT

15.D0742367
HOLDER:LOCK:CHARGE UNIT

16.D0742368
COMPRESSION SPRING:LOCK:CHARGE UNIT

18.D0742377
TENSION SPRING:LOCK:PCU



19.D0742381
(x2)
COMPRESSION SPRING:LOCK:CLEANING UNIT



20.D0742382
HOLDER:LOCK:CLEANING UNIT:FRONT



17.D0742376
LEVER:LOCK:PCU



21.D0742383
LEVER:LOCK:CLEANING UNIT:FRONT



U001	U002	U003	U004	U005	U006	U007	U008	U009	U010	U011	U012	U013	U014	U015	U016	U017	U018	U019	U020	U021
------	------	------	------	------	------	------	------	------	------	------	------	------	------	------	------	------	------	------	------	------

U029_S003
PCU:TAURUS:ASS'Y

63.D0743421
GEAR:TRANSPOR
T SCREW:UPPER

64.D0743422
GEAR:IDLER:DEVE
LOPMENT:UPPER:
ASSY



12.D0742301
PCU:TAURUS:ASS'
Y

62.D0743420
(x2)
GEAR:TRANSPOR
T SCREW

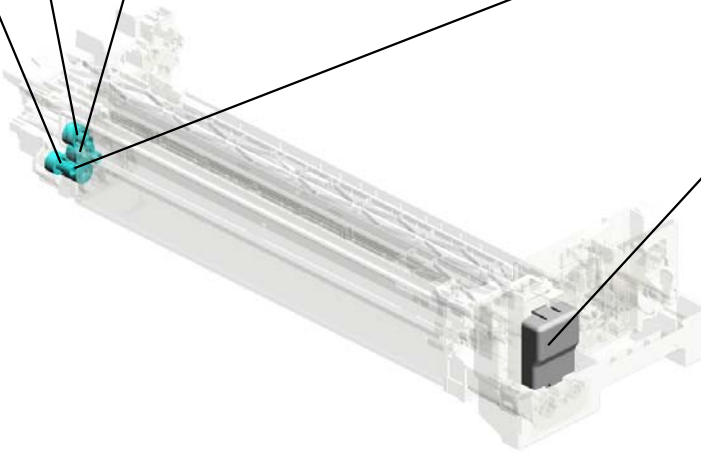
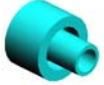
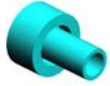

65.D0743425
GEAR:IDLER:DEVE
LOPMENT:LOWER:
ASSY

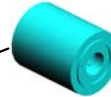

66.D0743440
COVER:INSERT:DE
VELOPER



U001	U002	U003	U004	U005	U006	U007	U008	U009	U010	U011	U012	U013	U014	U015	U016	U017	U018	U019	U020	U021
------	------	------	------	------	------	------	------	------	------	------	------	------	------	------	------	------	------	------	------	------

U029_S003_S001
COVER:PCU:FRONT:ASS'Y

67.D0743829
DECAL:POSITIONI
NG DISPLAY:TCRU

25.D0742395
GROUND PLATE:P
CU:ASS'Y

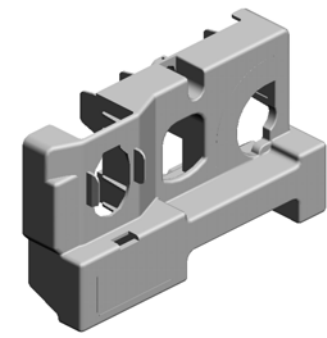

23.D0742392
COVER:PCU:FRON
T:ASS'Y

24.D0742393
COVER:PCU:FRON
T

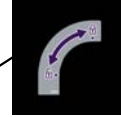
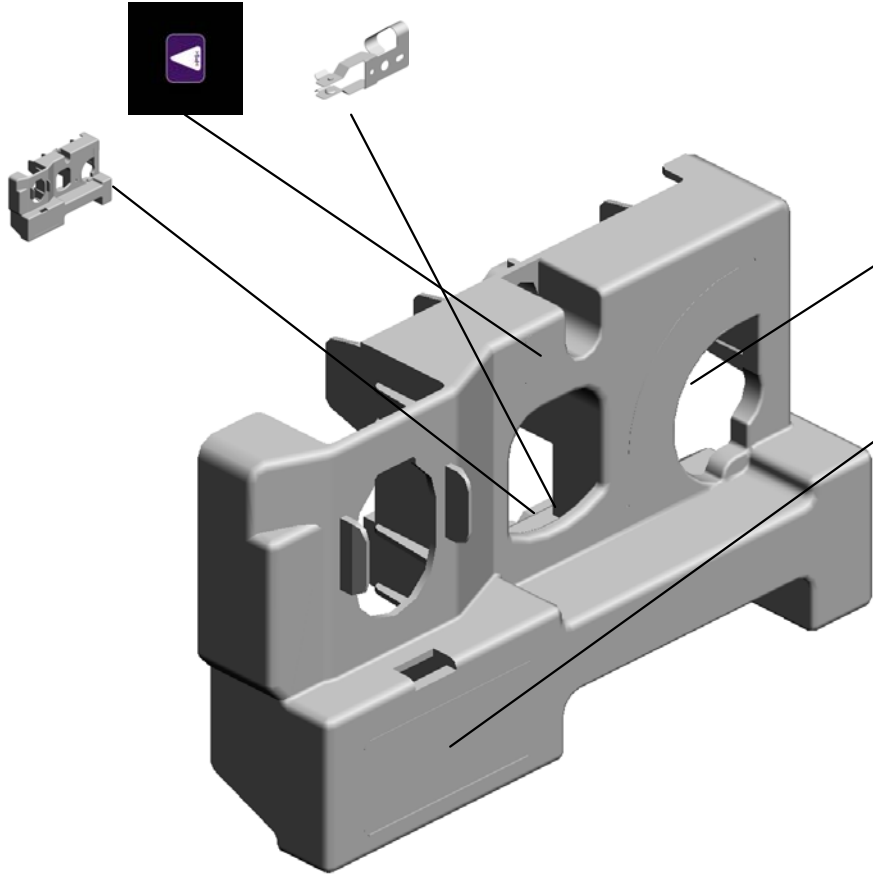

51.D0742540
DECAL:LOCK:CLE
ANING UNIT



74.G0291982
LD DECAL

U001	U002	U003	U004	U005	U006	U007	U008	U009	U010	U011	U012	U013	U014	U015	U016	U017	U018	U019	U020	U021
------	------	------	------	------	------	------	------	------	------	------	------	------	------	------	------	------	------	------	------	------

U029_S004
CHARGE UNIT

54.D0742543
DECAL:GRIP

10.D0742195
CHARGE UNIT



U001	U002	U003	U004	U005	U006	U007	U008	U009	U010	U011	U012	U013	U014	U015	U016	U017	U018	U019	U020	U021
------	------	------	------	------	------	------	------	------	------	------	------	------	------	------	------	------	------	------	------	------

U029_S005
CLEANING UNIT:ASS'Y

2.03603006N
(x4)
SCREW - M3X6

39.D0742471
(x2)
ARM:COATING BAR

40.D0742473
(x2)
TENSION SPRING:
COATING BAR:9.0
N

41.D0742475
STAY:APPLY:ASS'Y

38.D0742466
**COATING BAR:AS
S'Y**

13.D0742330
CLEANING UNIT:AS
S'Y



37.D0742459
**JOINT:CLEANING
UNIT**

35.D0742457
PLAIN SHAFT BEA
RING:BRUSH ROLL
ER:APPLY:REAR

4.8025320
HEXAGON HEAD T
APPING SCREW:ES
S:3X10

1.03530060N
(x4)
BIND SCREW - M3
X6

31.D0742425
**SEAL:BLADE:CLE
ANING:REAR**

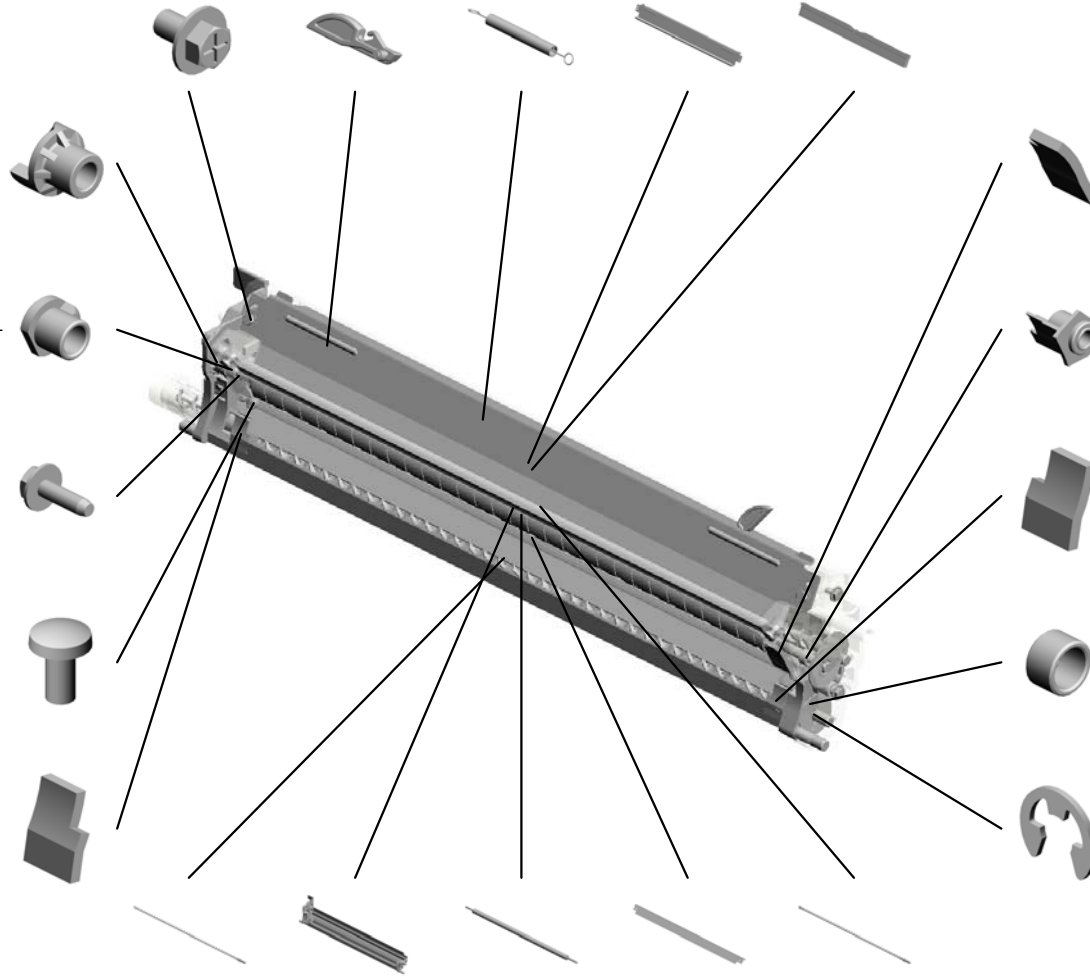

43.D0742485
**SEAL:BLADE:APP
LY:FRONT**

34.D0742456
PLAIN SHAFT BEA
RING:BRUSH ROLL
ER:APPLY:FRONT

30.D0742424
**SEAL:BLADE:CLE
ANING:FRONT**

28.D0742419
(x2)
PLAIN SHAFT BEA
RING:TRANSPORT
SCREW

3.07200040E
(x3)
RETAINING RING -
M4

27.D0742414
TRANSPORT SCR
EW:BASE:ASS'Y

26.D0742401
FRAME:BASE:ASS'
Y

33.D0742454
**BRUSH ROLLER:A
PPLY:ASS'Y**

29.D0742422
**BLADE:CLEANING:
ASS'Y**

32.D0742448
TRANSPORT SCR
EW:APPLY:ASS'Y

U001	U002	U003	U004	U005	U006	U007	U008	U009	U010	U011	U012	U013	U014	U015	U016	U017	U018	U019	U020	U021
------	------	------	------	------	------	------	------	------	------	------	------	------	------	------	------	------	------	------	------	------

U029_S005
CLEANING UNIT:ASS'Y

46.D0742497
VIBRATING PLATE:
TONER OUTLET S
UB-UNIT

44.D0742486
SEAL:BLADE:APP
LY:REAR



13.D0742330
CLEANING UNIT:A
SS'Y

45.D0742491
COVER:TONER OU
TLET SUB-UNIT:CL
EANING UNIT:ASS'
Y

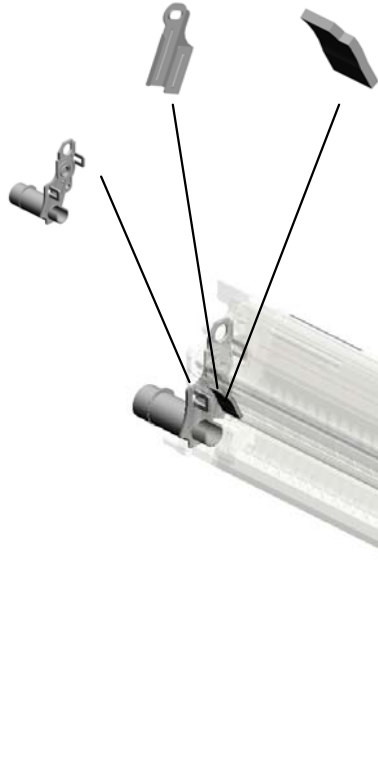

53.D0742542
(x2)
DECAL:GRIP

50.D0742504
DRUM STAY:CLEA
NING UNIT

U001	U002	U003	U004	U005	U006	U007	U008	U009	U010	U011	U012	U013	U014	U015	U016	U017	U018	U019	U020	U021
------	------	------	------	------	------	------	------	------	------	------	------	------	------	------	------	------	------	------	------	------

U029_S005_S001
BLADE:APPLY:ASS'Y

75.D0742487
(x2)
SEAL:BLADE
201109-20

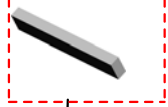

42.D0742481
BLADE:APPLY:AS
S'Y

U001	U002	U003	U004	U005	U006	U007	U008	U009	U010	U011	U012	U013	U014	U015	U016	U017	U018	U019	U020	U021
------	------	------	------	------	------	------	------	------	------	------	------	------	------	------	------	------	------	------	------	------

U029_S005_S002
GEAR:CLEANING:DRUM:SERVICE

48.D0742502
GEAR:IDLER:20Z:L
EFT



73.D0758701
GEAR:CLEANING:
DRUM:SERVICE

36.D0742458
GEAR:19Z:RIGHT

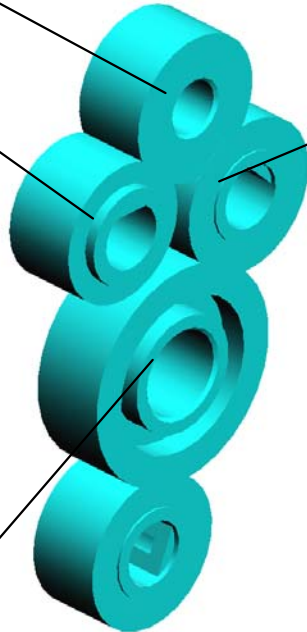

47.D0742501
(x2)
GEAR:21Z:RIGHT



49.D0742503
GEAR:IDLER:31Z:L
EFT



U001	U002	U003	U004	U005	U006	U007	U008	U009	U010	U011	U012	U013	U014	U015	U016	U017	U018	U019	U020	U021
------	------	------	------	------	------	------	------	------	------	------	------	------	------	------	------	------	------	------	------	------

U029_S006
PCU:TAURUS:ASS'Y

22.D0742386
HOLDER:LOCK:CLEANING UNIT:REAR

52.D0742541 (x4)
DECAL:ARROW LABEL

56.D0743322
FILTER:DEVELOPMENT

8.D0742191
DISCHARGE LAMP:LED ARRAY

9.D0742192
SHEET:DISCHARGE LAMP

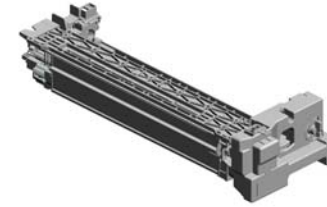

12.D0742301
PCU:TAURUS:ASS'Y

55.D0742544
DECAL:POSITIONING DISPLAY

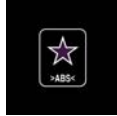

59.D0743367
ELECTRODE PLATE:DEVELOPMENT BIAS:REAR UPPER



61.D0743416
JOINT:DRIVE:DEVELOPMENT UNIT



60.D0743368
ELECTRODE PLATE:DEVELOPMENT BIAS:REAR LOWER



57.D0743340
JOINT:DRIVE:TRANSPORT SCREW



58.D0743362
ELECTRODE PLATE:DEVELOPMENT BIAS:FRONT

2.03603006N (x3)
SCREW - M3X6

14.D0742366
LEVER:LOCK:CHARGE UNIT

15.D0742367
HOLDER:LOCK:CHARGE UNIT

16.D0742368
COMPRESSION SPRING:LOCK:CHARGE UNIT

18.D0742377
TENSION SPRING:LOCK:PCU



19.D0742381 (x2)
COMPRESSION SPRING:LOCK:CLEANING UNIT



20.D0742382
HOLDER:LOCK:CLEANING UNIT:FRONT



21.D0742383
LEVER:LOCK:CLEANING UNIT:FRONT



17.D0742376
LEVER:LOCK:PCU



U001	U002	U003	U004	U005	U006	U007	U008	U009	U010	U011	U012	U013	U014	U015	U016	U017	U018	U019	U020	U021
------	------	------	------	------	------	------	------	------	------	------	------	------	------	------	------	------	------	------	------	------

U029_S006
PCU:TAURUS:ASS'Y

63.D0743421
GEAR:TRANSPOR
T SCREW:UPPER

64.D0743422
GEAR:IDLER:DEVE
LOPMENT:UPPER:
ASSY



12.D0742301
PCU:TAURUS:ASS'
Y

62.D0743420
(x2)
GEAR:TRANSPOR
T SCREW

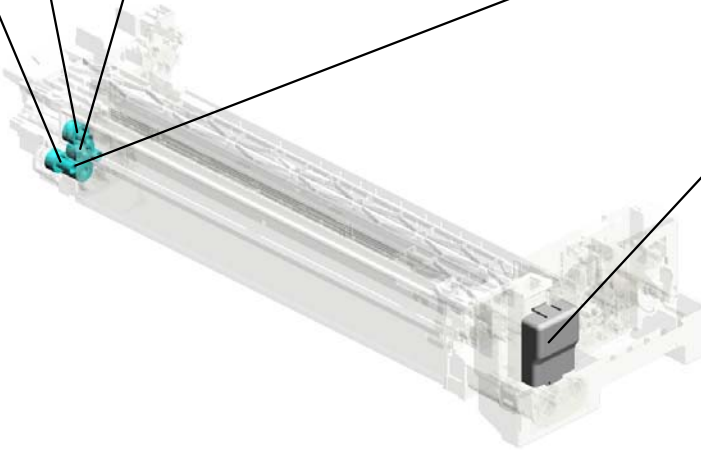
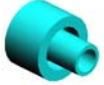
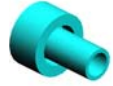

65.D0743425
GEAR:IDLER:DEVE
LOPMENT:LOWER:
ASSY

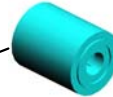

66.D0743440
COVER:INSERT:DE
VELOPER



U001	U002	U003	U004	U005	U006	U007	U008	U009	U010	U011	U012	U013	U014	U015	U016	U017	U018	U019	U020	U021
------	------	------	------	------	------	------	------	------	------	------	------	------	------	------	------	------	------	------	------	------

U029_S006_S001
COVER:PCU:FRONT:ASS'Y

67.D0743829
DECAL:POSITIONI
NG DISPLAY:TCRU

25.D0742395
GROUND PLATE:P
CU:ASS'Y

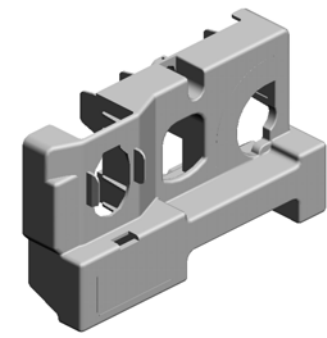

23.D0742392
COVER:PCU:FRON
T:ASS'Y

24.D0742393
COVER:PCU:FRON
T

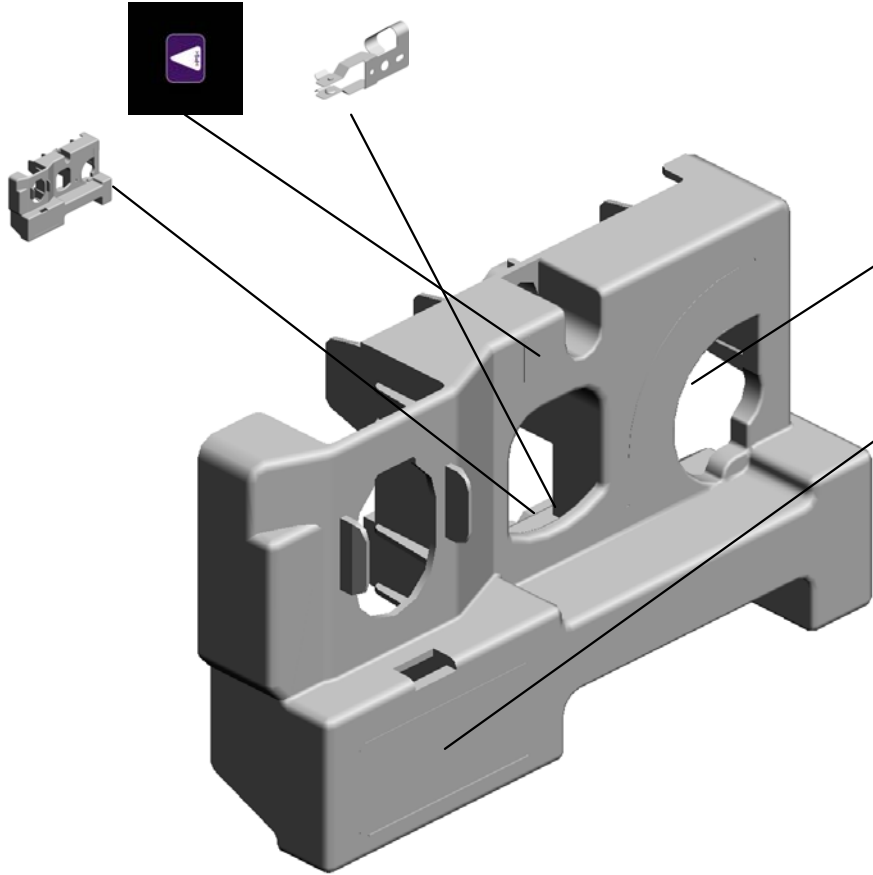

51.D0742540
DECAL:LOCK:CLE
ANING UNIT



74.G0291982
LD DECAL

U001	U002	U003	U004	U005	U006	U007	U008	U009	U010	U011	U012	U013	U014	U015	U016	U017	U018	U019	U020	U021
------	------	------	------	------	------	------	------	------	------	------	------	------	------	------	------	------	------	------	------	------

U029_S007
CHARGE UNIT

54.D0742543
DECAL:GRIP



10.D0742195
CHARGE UNIT



U001	U002	U003	U004	U005	U006	U007	U008	U009	U010	U011	U012	U013	U014	U015	U016	U017	U018	U019	U020	U021
------	------	------	------	------	------	------	------	------	------	------	------	------	------	------	------	------	------	------	------	------

U029_S008
CLEANING UNIT:ASS'Y

2.03603006N
(x4)
SCREW - M3X6

39.D0742471
(x2)
ARM:COATING BAR

40.D0742473
(x2)
TENSION SPRING:
COATING BAR:9.0
N

41.D0742475
STAY:APPLY:ASS'Y

38.D0742466
**COATING BAR:AS
S'Y**

13.D0742330
CLEANING UNIT:AS
S'Y



37.D0742459
**JOINT:CLEANING
UNIT**

35.D0742457
PLAIN SHAFT BEA
RING:BRUSH ROLL
ER:APPLY:REAR

4.8025320
HEXAGON HEAD T
APPING SCREW:ES
S:3X10

1.03530060N
(x4)
BIND SCREW - M3
X6

31.D0742425
**SEAL:BLADE:CLE
ANING:REAR**

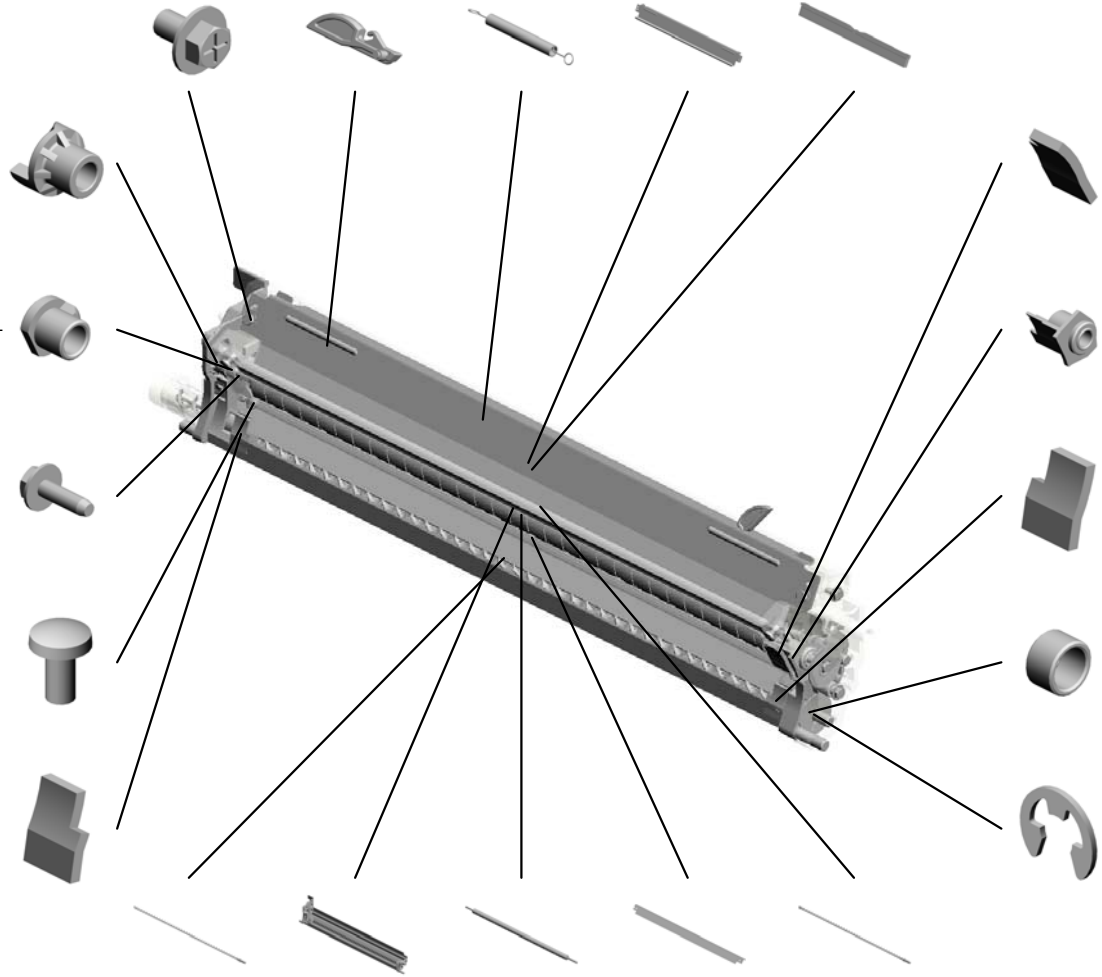

43.D0742485
**SEAL:BLADE:APP
LY:FRONT**

34.D0742456
PLAIN SHAFT BEA
RING:BRUSH ROLL
ER:APPLY:FRONT

30.D0742424
**SEAL:BLADE:CLE
ANING:FRONT**

28.D0742419
(x2)
PLAIN SHAFT BEA
RING:TRANSPORT
SCREW

3.07200040E
(x3)
RETAINING RING -
M4

27.D0742414
TRANSPORT SCR
EW:BASE:ASS'Y

26.D0742401
FRAME:BASE:ASS'
Y

33.D0742454
**BRUSH ROLLER:A
PPLY:ASS'Y**

29.D0742422
**BLADE:CLEANING:
ASS'Y**

32.D0742448
TRANSPORT SCR
EW:APPLY:ASS'Y

U029_S008
CLEANING UNIT:ASS'Y

46.D0742497
VIBRATING PLATE:
TONER OUTLET S
UB-UNIT

44.D0742486
SEAL:BLADE:APP
LY:REAR



13.D0742330
CLEANING UNIT:A
SS'Y

45.D0742491
COVER:TONER OU
TLET SUB-UNIT:CL
EANING UNIT:ASS'
Y

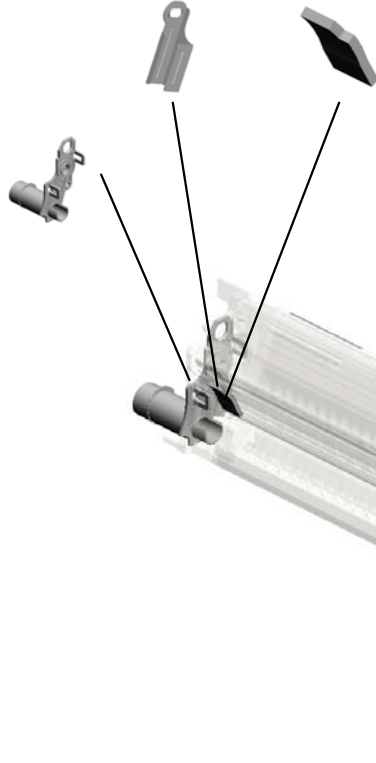

53.D0742542
(x2)
DECAL:GRIP



50.D0742504
DRUM STAY:CLEA
NING UNIT

U001	U002	U003	U004	U005	U006	U007	U008	U009	U010	U011	U012	U013	U014	U015	U016	U017	U018	U019	U020	U021
------	------	------	------	------	------	------	------	------	------	------	------	------	------	------	------	------	------	------	------	------

U029_S008_S001
BLADE:APPLY:ASS'Y

75.D0742487
(x2)
SEAL:BLADE
201109-20



42.D0742481
BLADE:APPLY:AS
S'Y

U001	U002	U003	U004	U005	U006	U007	U008	U009	U010	U011	U012	U013	U014	U015	U016	U017	U018	U019	U020	U021
------	------	------	------	------	------	------	------	------	------	------	------	------	------	------	------	------	------	------	------	------

U029_S008_S002
GEAR:CLEANING:DRUM:SERVICE

48.D0742502
GEAR:IDLER:20Z:L
EFT



73.D0758701
GEAR:CLEANING:
DRUM:SERVICE

36.D0742458
GEAR:19Z:RIGHT

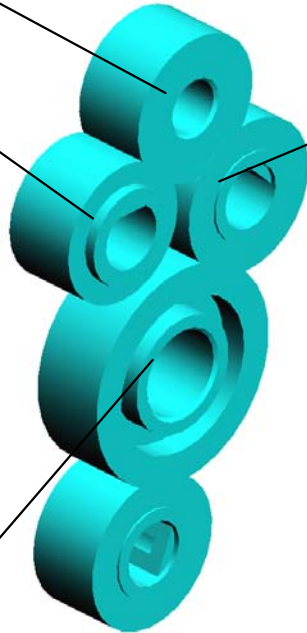

47.D0742501
(x2)
GEAR:21Z:RIGHT



49.D0742503
GEAR:IDLER:31Z:L
EFT



U001	U002	U003	U004	U005	U006	U007	U008	U009	U010	U011	U012	U013	U014	U015	U016	U017	U018	U019	U020	U021
------	------	------	------	------	------	------	------	------	------	------	------	------	------	------	------	------	------	------	------	------

U029_S009
PCU:TAURUS:ASS'Y

22.D0742386
HOLDER:LOCK:CLEANING UNIT:REAR

52.D0742541 (x4)
DECAL:ARROW LABEL

56.D0743322
FILTER:DEVELOPMENT

8.D0742191
DISCHARGE LAMP:LED ARRAY

9.D0742192
SHEET:DISCHARGE LAMP

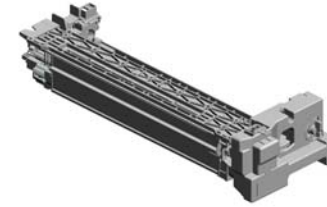

12.D0742301
PCU:TAURUS:ASS'Y

55.D0742544
DECAL:POSITIONING DISPLAY

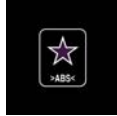

59.D0743367
ELECTRODE PLATE:DEVELOPMENT BIAS:REAR UPPER



61.D0743416
JOINT:DRIVE:DEVELOPMENT UNIT



60.D0743368
ELECTRODE PLATE:DEVELOPMENT BIAS:REAR LOWER



57.D0743340
JOINT:DRIVE:TRANSPORT SCREW



58.D0743362
ELECTRODE PLATE:DEVELOPMENT BIAS:FRONT

2.03603006N (x3)
SCREW - M3X6

14.D0742366
LEVER:LOCK:CHARGE UNIT

15.D0742367
HOLDER:LOCK:CHARGE UNIT

16.D0742368
COMPRESSION SPRING:LOCK:CHARGE UNIT

18.D0742377
TENSION SPRING:LOCK:PCU



19.D0742381 (x2)
COMPRESSION SPRING:LOCK:CLEANING UNIT



20.D0742382
HOLDER:LOCK:CLEANING UNIT:FRONT



21.D0742383
LEVER:LOCK:CLEANING UNIT:FRONT



17.D0742376
LEVER:LOCK:PCU



U001	U002	U003	U004	U005	U006	U007	U008	U009	U010	U011	U012	U013	U014	U015	U016	U017	U018	U019	U020	U021
------	------	------	------	------	------	------	------	------	------	------	------	------	------	------	------	------	------	------	------	------

U029_S009
 PCU:TAURUS:ASS'Y

63.D0743421
 GEAR:TRANSPOR
 T SCREW:UPPER

64.D0743422
 GEAR:IDLER:DEVE
 LOPMENT:UPPER:
 ASSY



12.D0742301
 PCU:TAURUS:ASS'
 Y

62.D0743420
 (x2)
 GEAR:TRANSPOR
 T SCREW

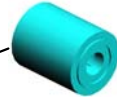
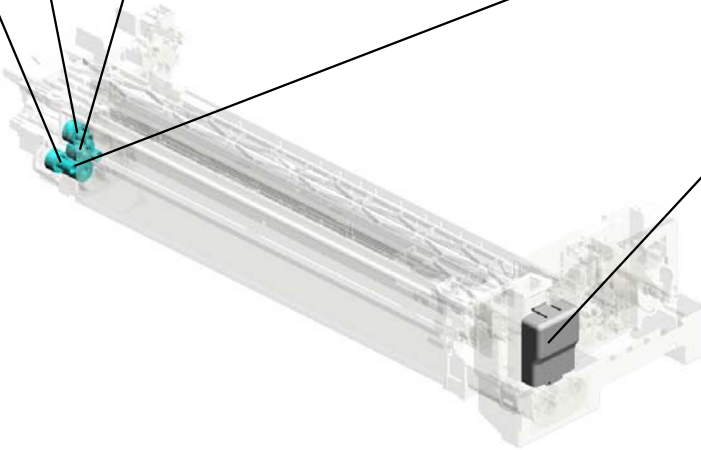
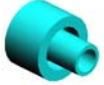
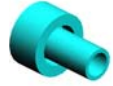

65.D0743425
 GEAR:IDLER:DEVE
 LOPMENT:LOWER:
 ASSY



66.D0743440
 COVER:INSERT:DE
 VELOPER

U001	U002	U003	U004	U005	U006	U007	U008	U009	U010	U011	U012	U013	U014	U015	U016	U017	U018	U019	U020	U021
------	------	------	------	------	------	------	------	------	------	------	------	------	------	------	------	------	------	------	------	------

U029_S009_S001
COVER:PCU:FRONT:ASS'Y

67.D0743829
DECAL:POSITIONI
NG DISPLAY:TCRU

25.D0742395
GROUND PLATE:P
CU:ASS'Y

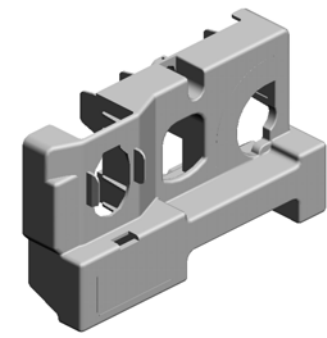

23.D0742392
COVER:PCU:FRON
T:ASS'Y

24.D0742393
COVER:PCU:FRON
T

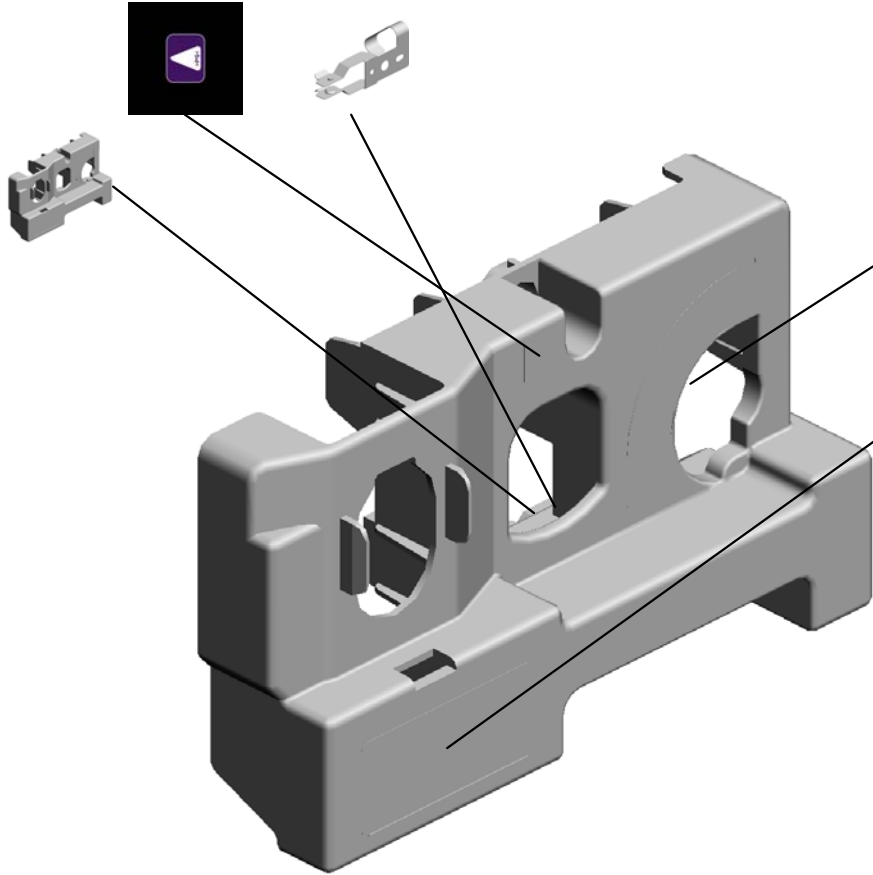

51.D0742540
DECAL:LOCK:CLE
ANING UNIT



74.G0291982
LD DECAL

U001	U002	U003	U004	U005	U006	U007	U008	U009	U010	U011	U012	U013	U014	U015	U016	U017	U018	U019	U020	U021
------	------	------	------	------	------	------	------	------	------	------	------	------	------	------	------	------	------	------	------	------

U029_S010
CHARGE UNIT

54.D0742543
DECAL:GRIP



10.D0742195
CHARGE UNIT

U001	U002	U003	U004	U005	U006	U007	U008	U009	U010	U011	U012	U013	U014	U015	U016	U017	U018	U019	U020	U021
------	------	------	------	------	------	------	------	------	------	------	------	------	------	------	------	------	------	------	------	------

U029_S011
CLEANING UNIT:ASS'Y

2.03603006N
(x4)
SCREW - M3X6

39.D0742471
(x2)
ARM:COATING BA
R

40.D0742473
(x2)
TENSION SPRING:
COATING BAR:9.0
N

41.D0742475
STAY:APPLY:ASS'Y

38.D0742466
COATING BAR:AS
S'Y

13.D0742330
CLEANING UNIT:AS
SS'Y



37.D0742459
JOINT:CLEANING
UNIT

35.D0742457
PLAIN SHAFT BEA
RING:BRUSH ROLL
ER:APPLY:REAR

4.8025320
HEXAGON HEAD T
APPING SCREW:ES
S:3X10

1.03530060N
(x4)
BIND SCREW - M3
X6

31.D0742425
SEAL:BLADE:CLE
ANING:REAR

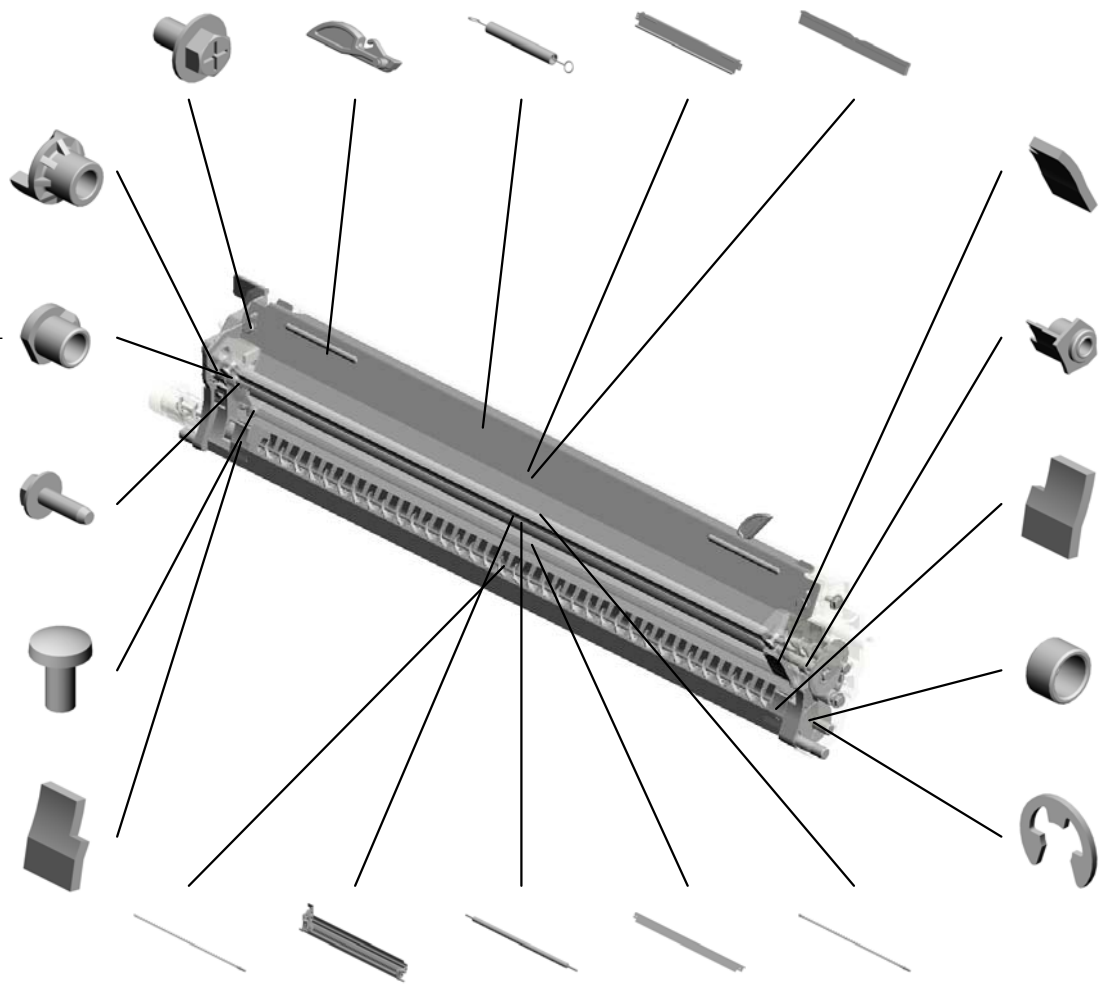

43.D0742485
SEAL:BLADE:APP
LY:FRONT

34.D0742456
PLAIN SHAFT BEA
RING:BRUSH ROLL
ER:APPLY:FRONT

30.D0742424
SEAL:BLADE:CLE
ANING:FRONT

28.D0742419
(x2)
PLAIN SHAFT BEA
RING:TRANSPORT
SCREW

3.07200040E
(x3)
RETAINING RING -
M4

27.D0742414
TRANSPORT SCR
EW:BASE:ASS'Y

26.D0742401
FRAME:BASE:ASS'
Y

33.D0742454
BRUSH ROLLER:A
PPLY:ASS'Y

29.D0742422
BLADE:CLEANING:
ASS'Y

32.D0742448
TRANSPORT SCR
EW:APPLY:ASS'Y

U029_S011
CLEANING UNIT:ASS'Y

46.D0742497
VIBRATING PLATE:
TONER OUTLET S
UB-UNIT

44.D0742486
SEAL:BLADE:APP
LY:REAR



13.D0742330
CLEANING UNIT:A
SS'Y

45.D0742491
COVER:TONER OU
TLET SUB-UNIT:CL
EANING UNIT:ASS'
Y

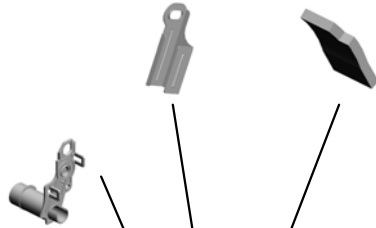

53.D0742542
(x2)
DECAL:GRIP



50.D0742504
DRUM STAY:CLEA
NING UNIT



U001	U002	U003	U004	U005	U006	U007	U008	U009	U010	U011	U012	U013	U014	U015	U016	U017	U018	U019	U020	U021
------	------	------	------	------	------	------	------	------	------	------	------	------	------	------	------	------	------	------	------	------

U029_S011_S001
BLADE:APPLY:ASS'Y

75.D0742487
(x2)
SEAL:BLADE
201109-20



42.D0742481
BLADE:APPLY:AS
S'Y

U001	U002	U003	U004	U005	U006	U007	U008	U009	U010	U011	U012	U013	U014	U015	U016	U017	U018	U019	U020	U021
------	------	------	------	------	------	------	------	------	------	------	------	------	------	------	------	------	------	------	------	------

U029_S011_S002
GEAR:CLEANING:DRUM:SERVICE

48.D0742502
GEAR:IDLER:20Z:L
EFT



73.D0758701
GEAR:CLEANING:
DRUM:SERVICE

36.D0742458
GEAR:19Z:RIGHT

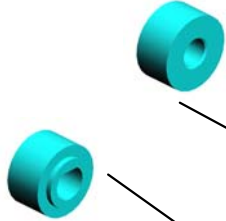

47.D0742501
(x2)
GEAR:21Z:RIGHT

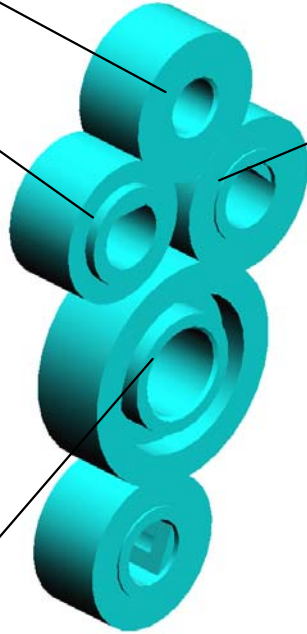

49.D0742503
GEAR:IDLER:31Z:L
EFT



U001	U002	U003	U004	U005	U006	U007	U008	U009	U010	U011	U012	U013	U014	U015	U016	U017	U018	U019	U020	U021
------	------	------	------	------	------	------	------	------	------	------	------	------	------	------	------	------	------	------	------	------

U029_S012
PCU:TAURUS:ASS'Y

22.D0742386
HOLDER:LOCK:CLEANING UNIT:REAR

52.D0742541
(x4)
DECAL:ARROW LABEL

56.D0743322
FILTER:DEVELOPMENT

8.D0742191
DISCHARGE LAMP
:LED ARRAY

9.D0742192
SHEET:DISCHARGE LAMP

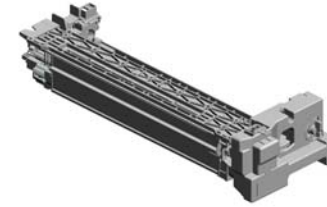

12.D0742301
PCU:TAURUS:ASS'Y

55.D0742544
DECAL:POSITIONING DISPLAY

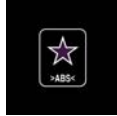

59.D0743367
ELECTRODE PLATE:DEVELOPMENT BIAS:REAR UPPER



61.D0743416
JOINT:DRIVE:DEVELOPMENT UNIT



60.D0743368
ELECTRODE PLATE:DEVELOPMENT BIAS:REAR LOWER



57.D0743340
JOINT:DRIVE:TRANSPORT SCREW



58.D0743362
ELECTRODE PLATE:DEVELOPMENT BIAS:FRONT

2.03603006N
(x3)
SCREW - M3X6

14.D0742366
LEVER:LOCK:CHARGE UNIT

15.D0742367
HOLDER:LOCK:CHARGE UNIT

16.D0742368
COMPRESSION SPRING:LOCK:CHARGE UNIT

18.D0742377
TENSION SPRING:LOCK:PCU

19.D0742381
(x2)
COMPRESSION SPRING:LOCK:CLEANING UNIT

20.D0742382
HOLDER:LOCK:CLEANING UNIT:FRONT

21.D0742383
LEVER:LOCK:CLEANING UNIT:FRONT

17.D0742376
LEVER:LOCK:PCU

U001	U002	U003	U004	U005	U006	U007	U008	U009	U010	U011	U012	U013	U014	U015	U016	U017	U018	U019	U020	U021
------	------	------	------	------	------	------	------	------	------	------	------	------	------	------	------	------	------	------	------	------

U029_S012
PCU:TAURUS:ASS'Y

63.D0743421
GEAR:TRANSPOR
T SCREW:UPPER

64.D0743422
GEAR:IDLER:DEVE
LOPMENT:UPPER:
ASSY



12.D0742301
PCU:TAURUS:ASS'
Y

62.D0743420
(x2)
GEAR:TRANSPOR
T SCREW

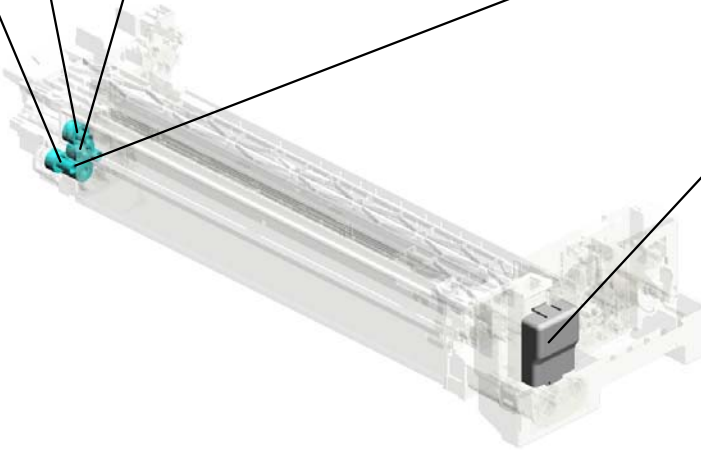
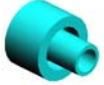
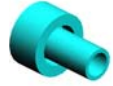

65.D0743425
GEAR:IDLER:DEVE
LOPMENT:LOWER:
ASSY

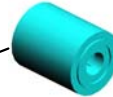

66.D0743440
COVER:INSERT:DE
VELOPER



U001	U002	U003	U004	U005	U006	U007	U008	U009	U010	U011	U012	U013	U014	U015	U016	U017	U018	U019	U020	U021
------	------	------	------	------	------	------	------	------	------	------	------	------	------	------	------	------	------	------	------	------

U029_S012_S001
COVER:PCU:FRONT:ASS'Y

67.D0743829
DECAL:POSITIONI
NG DISPLAY:TCRU

25.D0742395
GROUND PLATE:P
CU:ASS'Y

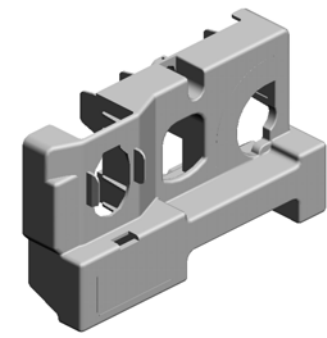

23.D0742392
COVER:PCU:FRON
T:ASS'Y

24.D0742393
COVER:PCU:FRON
T

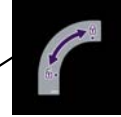
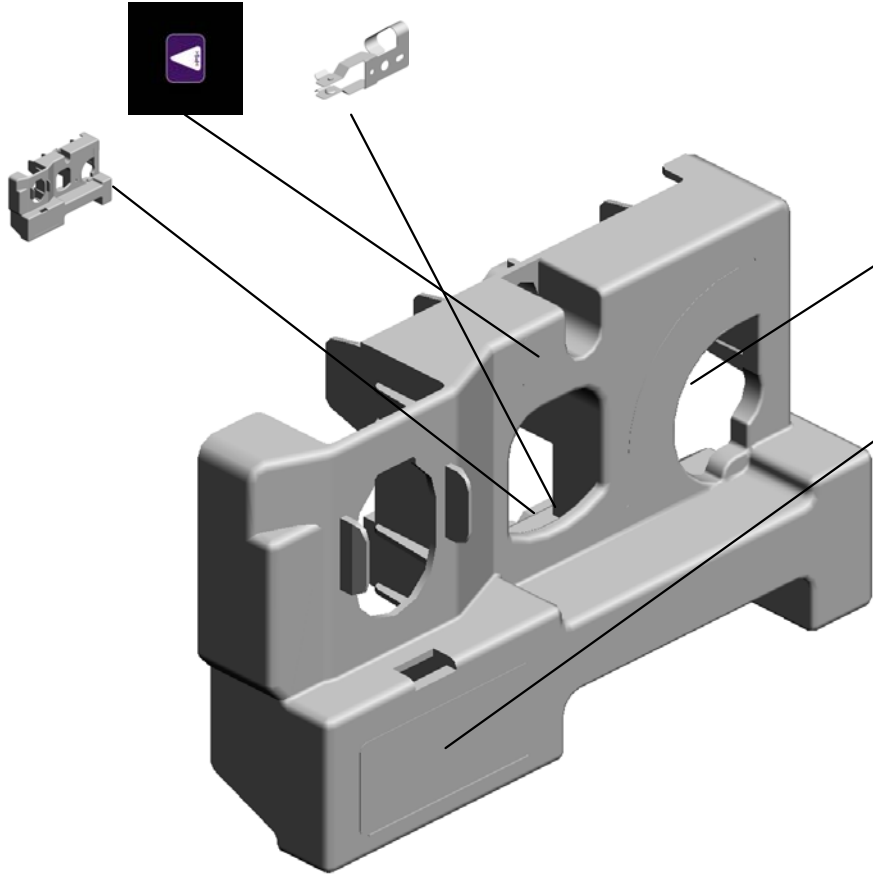

51.D0742540
DECAL:LOCK:CLE
ANING UNIT



74.G0291982
LD DECAL

U001	U002	U003	U004	U005	U006	U007	U008	U009	U010	U011	U012	U013	U014	U015	U016	U017	U018	U019	U020	U021
------	------	------	------	------	------	------	------	------	------	------	------	------	------	------	------	------	------	------	------	------

U030.ITB Unit 1

U030_S001
D0746381
CASE:TENSION:ROLLER:AS
SY



U001	U002	U003	U004	U005	U006	U007	U008	U009	U010	U011	U012	U013	U014	U015	U016	U017	U018	U019	U020	U021
------	------	------	------	------	------	------	------	------	------	------	------	------	------	------	------	------	------	------	------	------

U030
ITB Unit 1

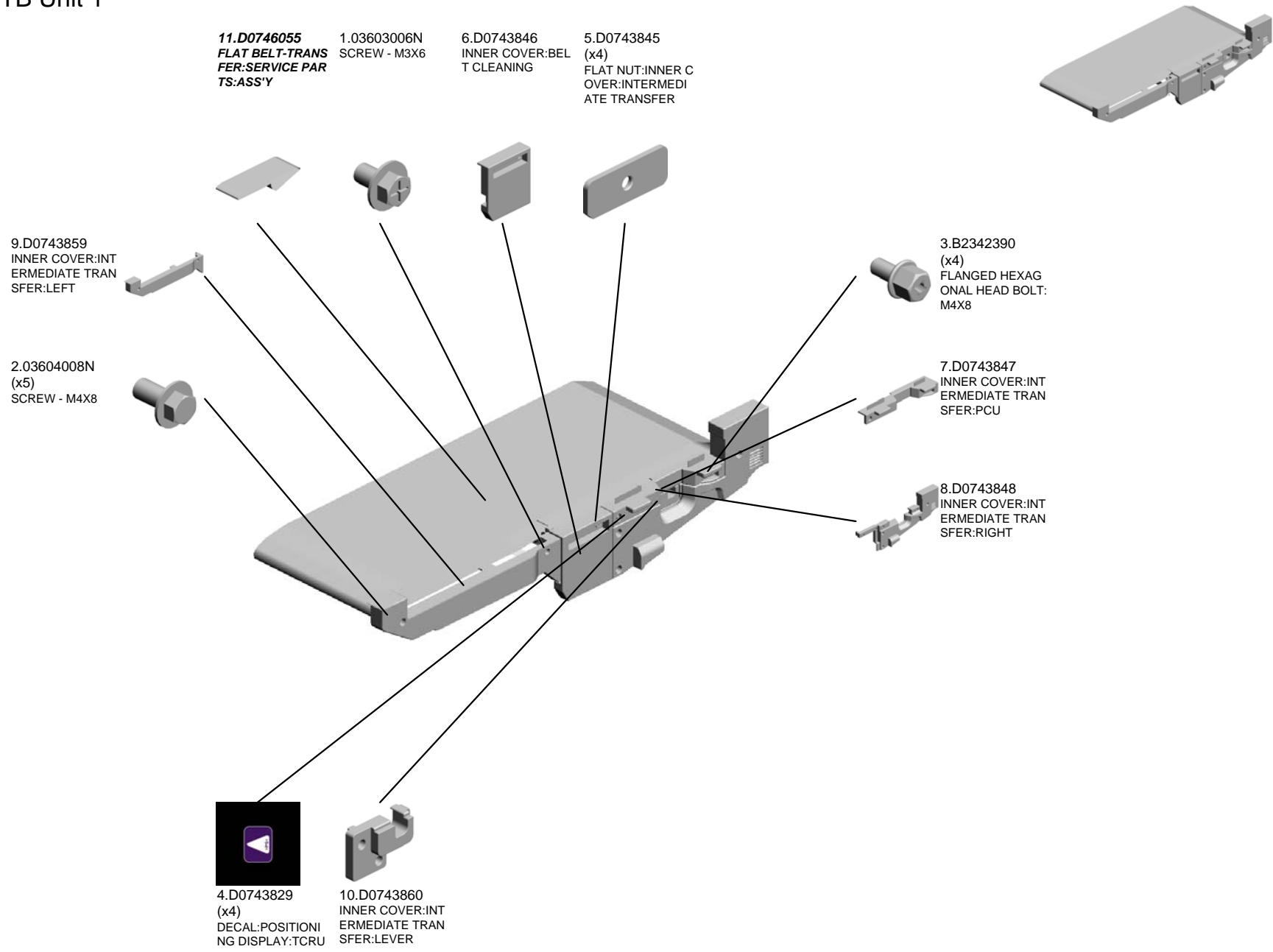

U001	U002	U003	U004	U005	U006	U007	U008	U009	U010	U011	U012	U013	U014	U015	U016	U017	U018	U019	U020	U021
------	------	------	------	------	------	------	------	------	------	------	------	------	------	------	------	------	------	------	------	------

U030_S001
CASE:TENSION:ROLLER:ASS'Y

13.D0746397
(x2)
COIL SPRING:TEN
SION:ROLLER



12.D0746381
CASE:TENSION:R
OLLER:ASS'Y

U001	U002	U003	U004	U005	U006	U007	U008	U009	U010	U011	U012	U013	U014	U015	U016	U017	U018	U019	U020	U021
------	------	------	------	------	------	------	------	------	------	------	------	------	------	------	------	------	------	------	------	------

U031
ITB Unit 2

4.03603006N
(x105)
SCREW - M3X6

13.08046123
(x7)
HEXAGONAL BOLT
:W/WASHER:M3X8

17.11029781
CONNECTOR:5140
5-3919

16.11029387
CONNECTOR:DRA
WER:51405-2611

20.AA083022
(x4)
BUSHING:DIA6:DIA
8



7.04503008N
(x5)
TAPPING SCREW -
M3X8

12.07403906
(x4)
BALL BEARING - 6
X15X5

15.08053566
(x2)
RADIAL BALL BEA
RING:DIA6XDIA12X
4

2.03530060N
(x2)
BIND SCREW - M3
X6

11.07403806
BALL BEARING - 6
X13X5

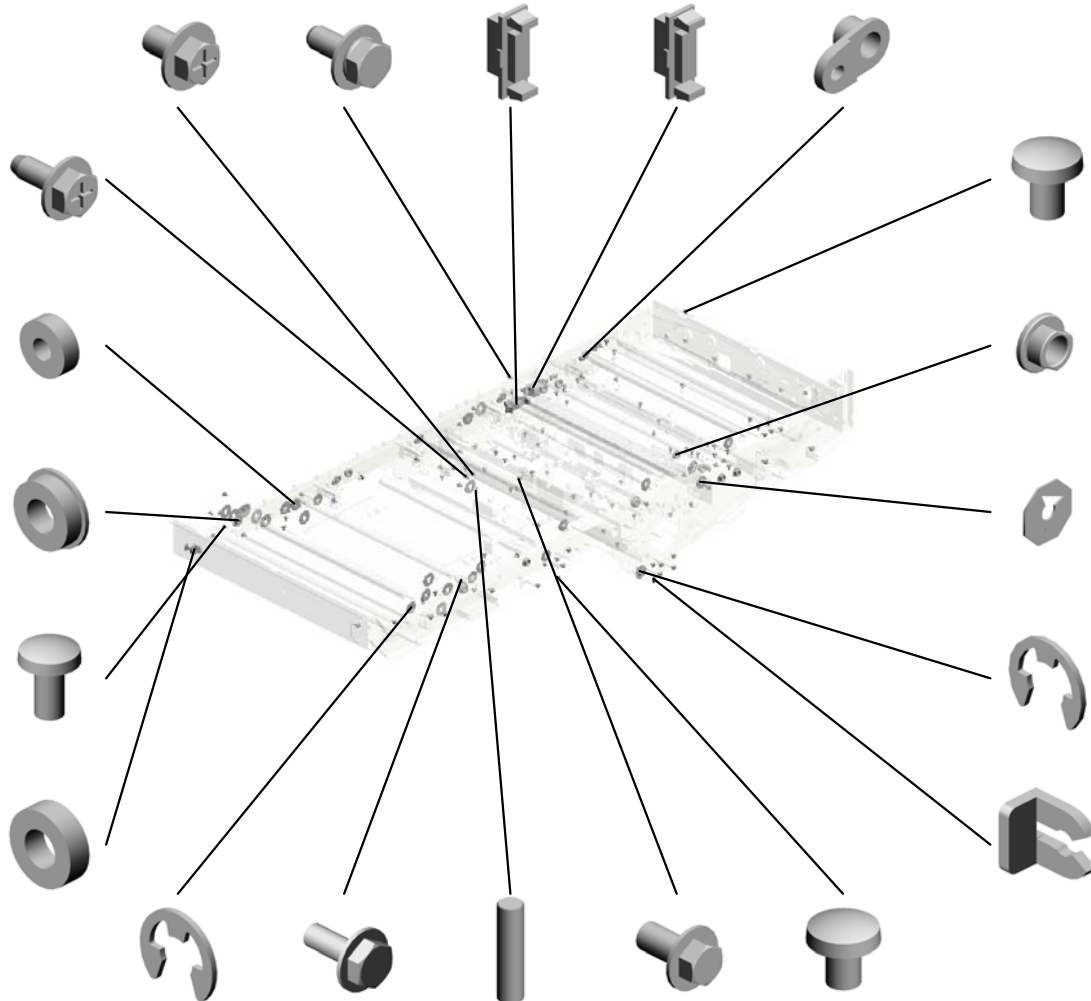

9.07200040E
(x15)
RETAINING RING -
M4

5.03603008N
SCREW:M3X8

8.06330140G
(x2)
PARALLEL PIN - 3X
14

6.03604008N
(x10)
SCREW - M4X8

1.03530040N
(x2)
SCREW - M3X4

3.03540060N
SCREW-M4X6

19.AA082144
(x8)
BUSHING - 8X12X7

14.08050088
(x2)
RETAINING RING -
M6

10.07200060E
(x14)
RETAINING RING -
M6

18.52062686
SNAP RING

U031
ITB Unit 2



- 28.D0743821 (x7) TENSION SPRING: PRESSURE:INTERMEDIATE TRANSFER:COLLAR
- 40.D0746093 COVER:INTERMEDIATE TRANSFER:NO.2
- 39.D0746092 (x2) BRACKET:HEATER:INTERMEDIATE TRANSFER
- 24.AX400194 (x2) HEATER - 230V/9W
- 33.D0743853 PLATE:FRAME:INTERMEDIATE TRANSFER

32.D0743842 COVER:HARNESS:SECOND:INTERMEDIATE TRANSFER

34.D0745542 PCB:TDRB

25.AZ320174 POWER PACK:T1/T2

30.D0743836 SEAL:MIDDLE:INTERMEDIATE TRANSFER

21.AA143744 (x2) STEPPED SCREW

23.AW500023 (x2) PUSH SWITCH

22.AW020145 PHOTOINTERRUPTOR:FLAT

38.D0746088 COVER:INTERMEDIATE TRANSFER:ASSY

26.C2693566 (x2) BUSHING:MM8:PRESSURE:DRIVE

29.D0743830 DECAL:OPERATE:LEVER:INTERMEDIATE TRANSFER

37.D0746076 DUCT:TM SENSOR:INTERMEDIATE TRANSFER

35.D0746074 TENSION SPRING:SLEEVE:WIRE:INTERMEDIATE TRANSFER

27.D0396327 (x6) SPACER:SENSOR:TM

31.D0743841 SEAL:RIGHT:INTERMEDIATE TRANSFER

36.D0746075 (x2) GRIP:INTERMEDIATE TRANSFER:LEFT

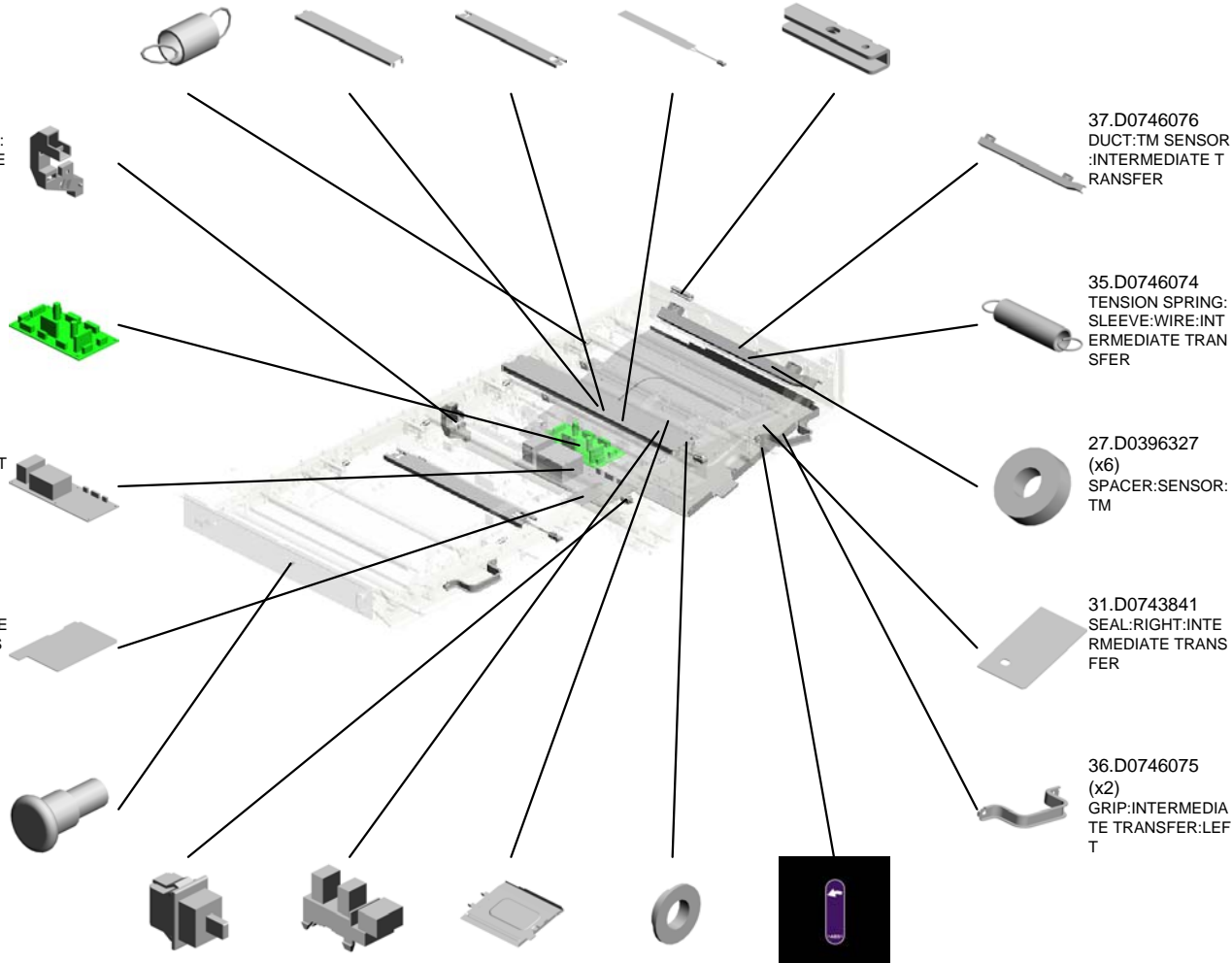

U031
ITB Unit 2



- 41.D0746097 THERMOSTAT:INTERMEDIATE TRANSFER
- 59.D0746180 (x4) COMPRESSION SPRING:BIAS:INTERMEDIATE TRANSFER
- 60.D0746197 (x4) TERMINAL:CONNECTING:BIAS:INTERMEDIATE TRANSFER
- 48.D0746147 (x4) TERMINAL:INTERMEDIATE TRANSFER
- 54.D0746161 (x4) COVER:BIAS:INTERMEDIATE TRANSFER

50.D0746155 SLIDE RAIL:ON-OFF:INTERMEDIATE TRANSFER:REAR:ASSY

47.D0746138 BRACKET:ROLLER:TRANSFER:LEFT REAR:ASSY

55.D0746169 ROLLER:FRONT:INTERMEDIATE TRANSFER:LEFT

52.D0746158 (x4) ROLLER:INTERMEDIATE TRANSFER:ASSY

57.D0746173 TENSION SPRING:PRESSURE:INTERMEDIATE TRANSFER



42.D0746100 DENSITY SENSOR

53.D0746160 (x2) ROLLER:FRONT:INTERMEDIATE TRANSFER:RIGHT:ASSY

45.D0746134 (x4) PLAIN SHAFT BEARING:INSULATE

58.D0746175 (x4) PLAIN SHAFT BEARING:SLIDE RAIL:ON-OFF

51.D0746156 (x2) TENSION SPRING:ON-OFF:SLIDE RAIL



44.D0746130 SPRING PLATE:EA RTH:INTERMEDIATE TRANSFER:ASSY

46.D0746136 BRACKET:ROLLER:TRANSFER:LEFT FRONT:ASSY

49.D0746153 SLIDE RAIL:ON-OFF:INTERMEDIATE TRANSFER:FRONT:ASSY

56.D0746171 GUIDE PLATE:COIL SPRING:PRESSURE:TIGHTENER

43.D0743820 [A] GUIDE:TRANSPORT:INTERMEDIATE TRANSFER:ASSY 201109-09 X/O

U001	U002	U003	U004	U005	U006	U007	U008	U009	U010	U011	U012	U013	U014	U015	U016	U017	U018	U019	U020	U021
------	------	------	------	------	------	------	------	------	------	------	------	------	------	------	------	------	------	------	------	------

U031
ITB Unit 2

61.D0746398
COVER:COIL SPRI
NG:INTERMEDIAT
E TRANSFER

63.G1786392
HOUSING:LOWER:
COVER



62.G0143291
(x6)
SNAP RING - PICK
UP



65.G1786394
WIRE:STOPPER:L
OWER:COVER

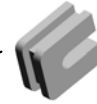

64.G1786393
SLEEVE:WIRE:LO
WER:COVER



D0746122
[A]
GUIDE:TRANSPOR
T:INTERMEDIATE
TRANSFER:ASS'Y
201109-09 X/O

U001	U002	U003	U004	U005	U006	U007	U008	U009	U010	U011	U012	U013	U014	U015	U016	U017	U018	U019	U020	U021
------	------	------	------	------	------	------	------	------	------	------	------	------	------	------	------	------	------	------	------	------

U032 ITB Unit 3

- 13.AA043976 TIMING BELT:40S2 M142
- 1.03603006N (x31) SCREW - M3X6
- 7.07403804 BALL BEARING: DIA 4XDIA9X4
- 5.07200030E (x2) RETAINING RING - M3
- 10.11050516 (x3) CLAMP

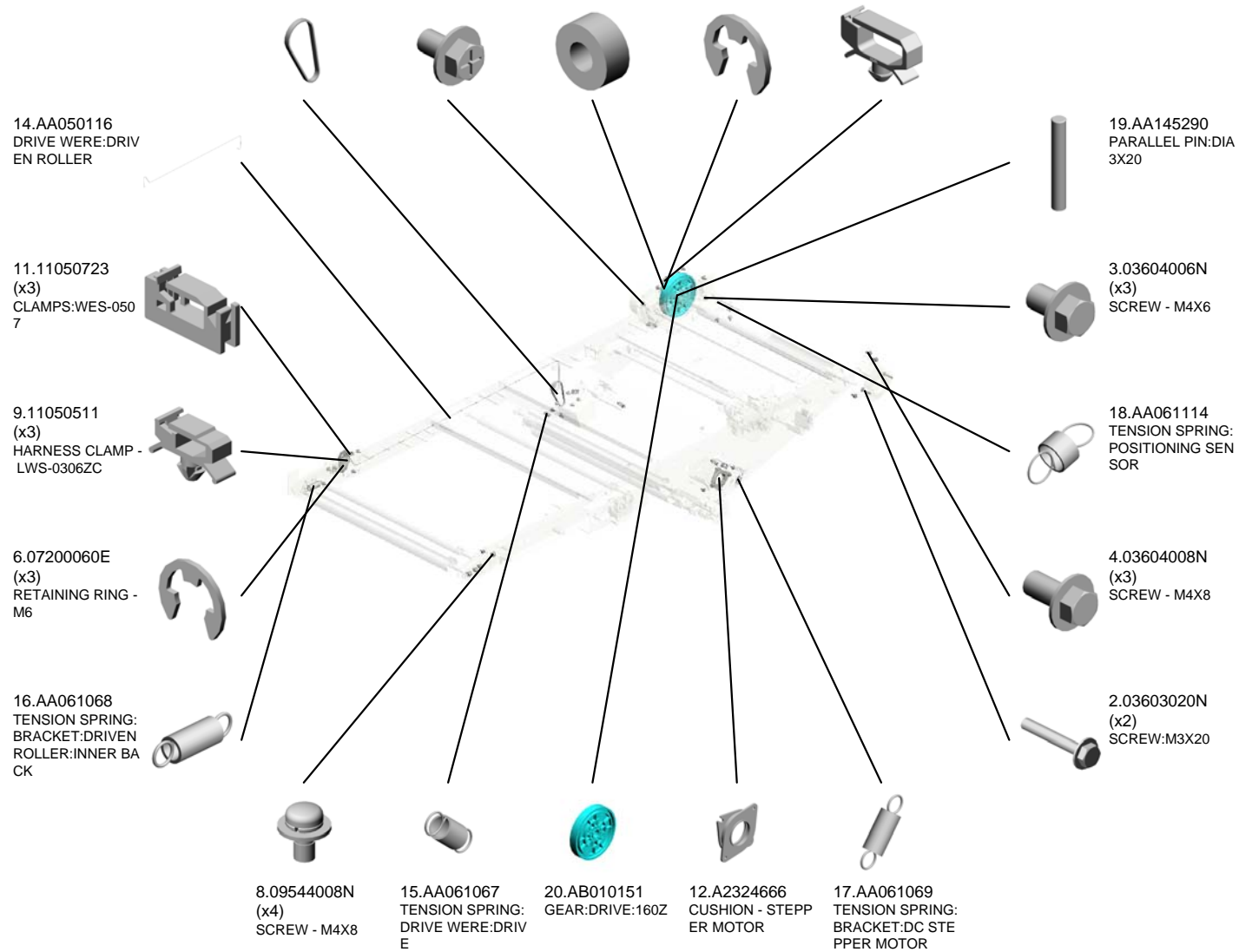

U032 ITB Unit 3

- 30.B2236171 RUBBER BUSHING :ENCODER
- 32.D0396137 ENCODER:ASS'Y
- 24.AW020199 (x2) OPTICS SENSOR:ENCODER:300LPI
- 35.D0741369 COVER:ENCODER
- 37.D0743805 HOUSING:DRIVE:INTERMEDIATE TRANSFER:PRESS FIT



33.D0741363
DRUM STAY:DC MOTOR:DRIVE

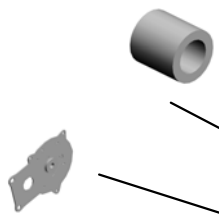

34.D0741365
DC MOTOR:DIA56:13W



21.AB032072 (x3)
PULLEY:DRIVEN:WIRE



40.D0743871
STOPPER:WIRE:PULLEY



22.AW020145 (x4)
PHOTOINTERRUPTOR:FLAT



26.AX060393
DC STEPPER MOTOR:MM42:1.3A:4.42V



38.D0743822 (x2)
ROLLER:OPPOSITE:BELT CLEANING:PRESS FIT



23.AW020149 (x2)
PAPER FEED SENSOR



39.D0743854
COVER:OPPOSITE:TRANSFER ROLLER



27.AX060394
DC STEPPER MOTOR:MM42:1.2A:3.60V



31.C6006119
SPRING WASHER: DIA12.3:T=0.2



25.AW020200
POSITIONING SENSOR:FLAT BELT-TRANSFER



36.D0743801
DRIVE ROLLER:INTERMEDIATE TRANSFER:ASS'Y



29.B1326114
CAM:ON-OFF:BLACK



28.AX650048
FAN:SIROCCO:1.44W



U032
ITB Unit 3

41.D0743872
PULLEY:DRIVE WE
RE:ASSY

43.D0743881
BRACKET:DC STE
PPER MOTOR:POS
ITIONING CONTRO
L

50.D0743898
(x2)
BRACKET:POSITIO
NING SENSOR:SLA
CK PREVENTION

51.D0743899
(x2)
LEVER:POSITIONI
NG SENSOR:SLAC
K PREVENTION

48.D0743892
LEVER:POSITIONI
NG SENSOR:FLAT
BELT-TTRANSFER



60.D0746114
CAM:ON-OFF:TRA
NSFER ROLLER:R
EAR

56.D0746103
(x2)
COVER:INTERMED
IATE TRANSFER:N
O.1

42.D0743873
FEELER:DRIVE WE
RE

53.D0746066
(x2)
ROLLER:DRIVEN:I
NTERMEDIATE TR
ANSFER:NO.2:ASS'
Y

55.D0746071
ROLLER:DRIVEN:I
NTERMEDIATE TR
ANSFER:ASS'Y

45.D0743884
SCALE:BRACKET:
DRIVEN ROLLER:F
RONT

44.D0743882
HOLDER:DRIVEN
ROLLER:FRONT

57.D0746110
ROLLER:OPPOSE
D:PAPER:ASS'Y

58.D0746112
CORE:OPPOSED:T
RANSFER ROLLER

54.D0746068
ROLLER:TRANSFE
R:FRONT:ASS'Y

49.D0743896
COVER:POSITIONI
NG SENSOR:FLAT
BELT-TTRANSFER

47.D0743889
BRACKET:POSITIO
NING SENSOR:FLA
T BELT-TTRANSFER

52.D0746008
POSITIONING SEN
SOR:SCALE:INTER
MEDIATE TRANSF
ER:ASS'Y

46.D0743887
BRACKET:ON-OFF:
TRANSFER ROLLE
R

59.D0746113
CAM:ON-OFF:TRA
NSFER ROLLER:F
RONT

U032
ITB Unit 3

63.D0746119 CASE:OPPOSED:TRANSFER ROLLER:REAR
 78.D0746165 PULLEY:ON-OFF:BELT TENSIONER
 79.D0746168 TIGHTENER:INTERMEDIATE TRANSFER:ASSY
 69.D0746140 SHAFT:CAM:INTERMEDIATE TRANSFER:BLACK:2
 70.D0746141 SHAFT:CAM:INTERMEDIATE TRANSFER:BLACK

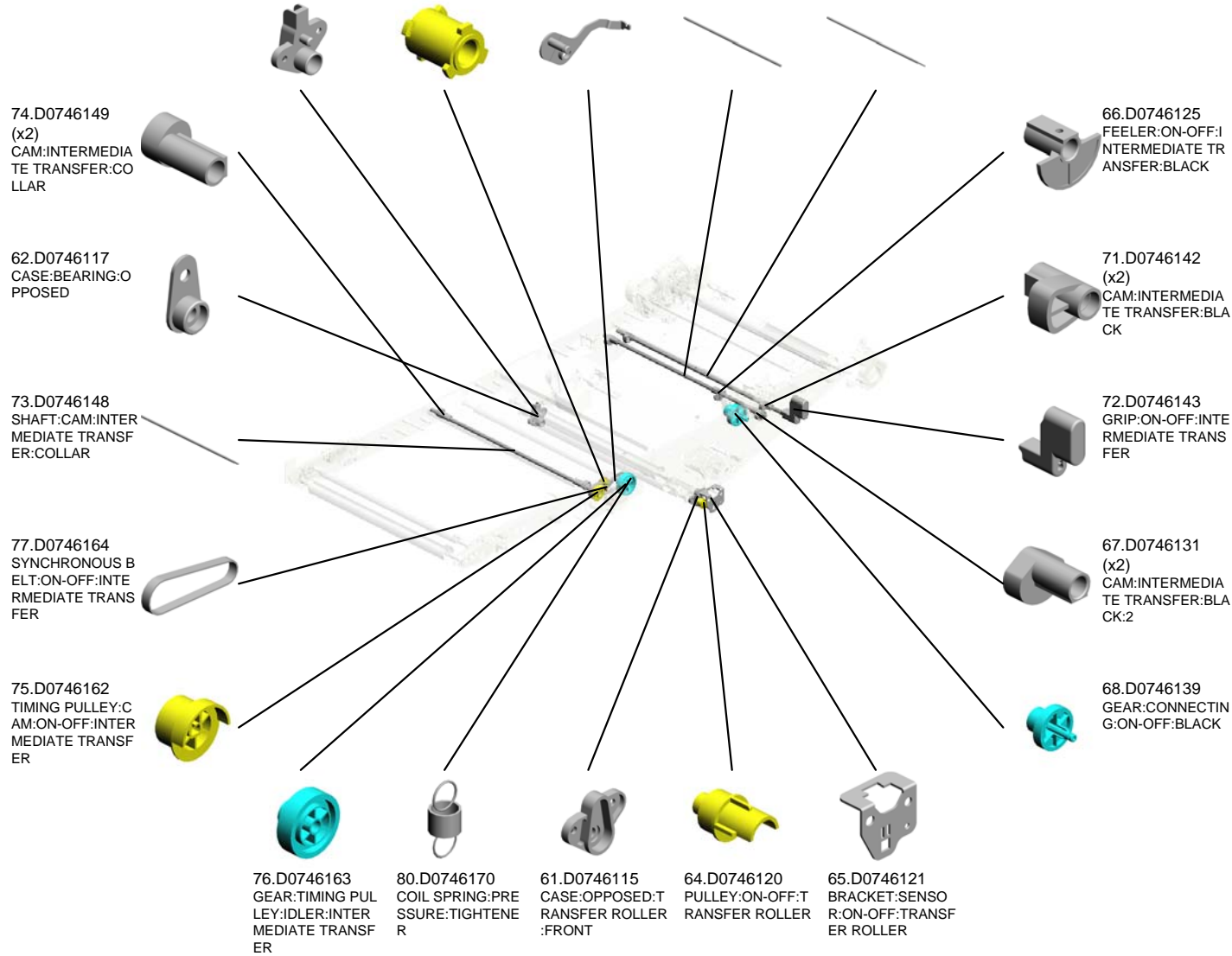

U032
ITB Unit 3

85.D0746187 BRACKET:ON-OFF:BLACK:REAR:ASSY
88.D0746198 GEAR:ON-OFF:BLACK
89.D0746199 COVER:GEAR:ON-OFF:BLACK
86.D0746195 GEAR:COUPLING:ON-OFF:BLACK



81.D0746172 COLLAR:ON-OFF:INTERMEDIATE TRANSFER



83.D0746179 GEAR:IDLER:INTERMEDIATE TRANSFER:Z17:Z53



82.D0746177 DC STEPPER MOTOR:24V:14.8W



91.D0747090 SEAL:VACUUM:POSITIONING SENSOR



92.D0747118 DUCT:INNER BACK:COOLING:POSITIONING SENSOR



90.D0747087 SEAL:DC FAN MOTOR:SIROCCO



93.D0747119 DUCT:FRONT:COOLING:POSITIONING SENSOR



95.G1785023 TIMING BELT:S2M190



87.D0746196 DC MOTOR:ON-OFF:F:5.28W:BRS



84.D0746184 BRACKET:ON-OFF:BLACK:FRONT:ASSY



U033.ITB Cleaning

U033_S001
D0746400
BELT CLEANING:ASS'Y

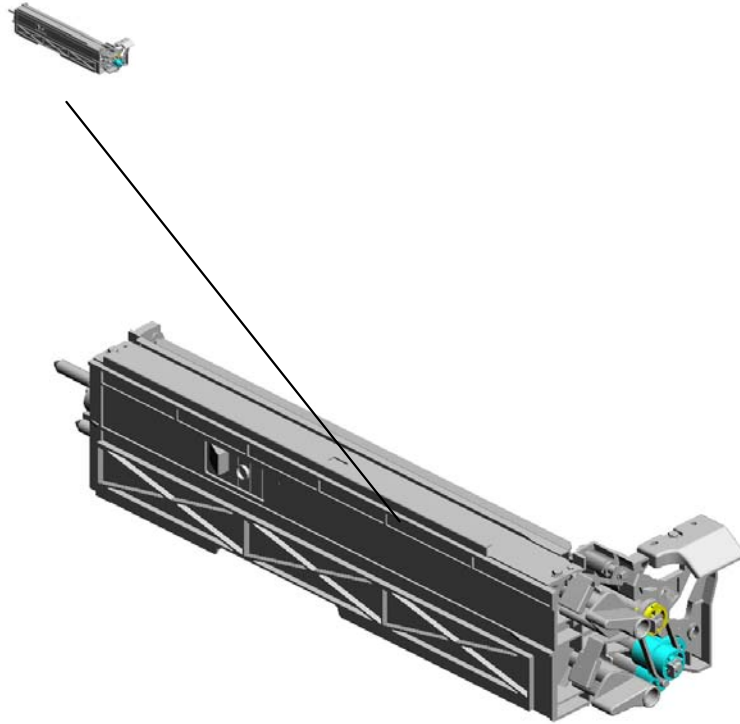

U001	U002	U003	U004	U005	U006	U007	U008	U009	U010	U011	U012	U013	U014	U015	U016	U017	U018	U019	U020	U021
------	------	------	------	------	------	------	------	------	------	------	------	------	------	------	------	------	------	------	------	------

U033_S001.BELT CLEANING:ASS'Y

U033_S001_S001
D0746450
COATING BAR:ASS'Y

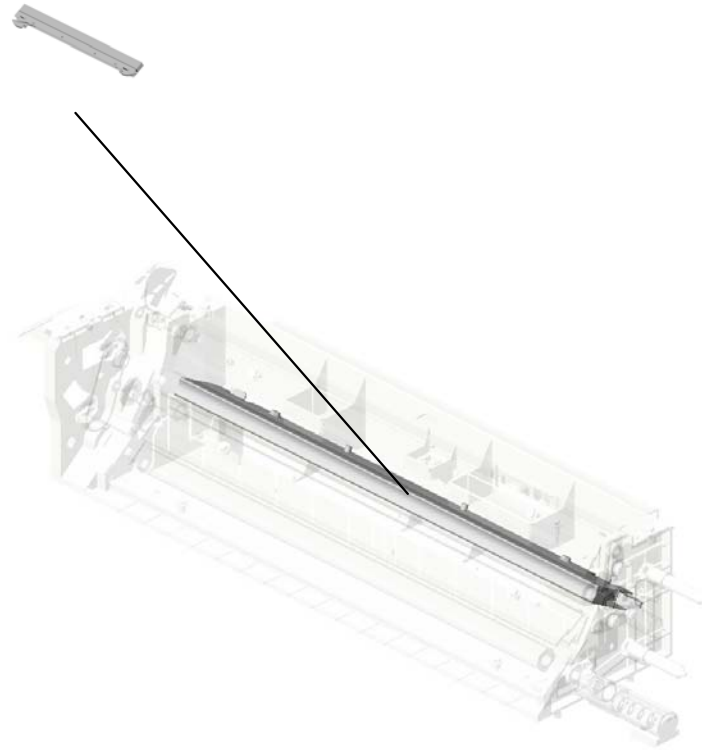

U001	U002	U003	U004	U005	U006	U007	U008	U009	U010	U011	U012	U013	U014	U015	U016	U017	U018	U019	U020	U021
------	------	------	------	------	------	------	------	------	------	------	------	------	------	------	------	------	------	------	------	------

U033
ITB Cleaning

9.B2342390
FLANGED HEXAG
ONAL HEAD BOLT:
M4X8

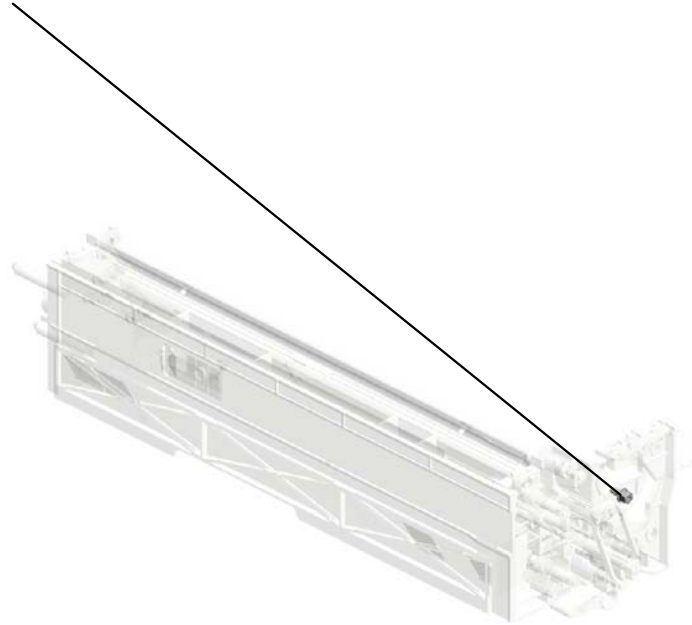

U001	U002	U003	U004	U005	U006	U007	U008	U009	U010	U011	U012	U013	U014	U015	U016	U017	U018	U019	U020	U021
------	------	------	------	------	------	------	------	------	------	------	------	------	------	------	------	------	------	------	------	------

U033_S001 BELT CLEANING:ASS'Y

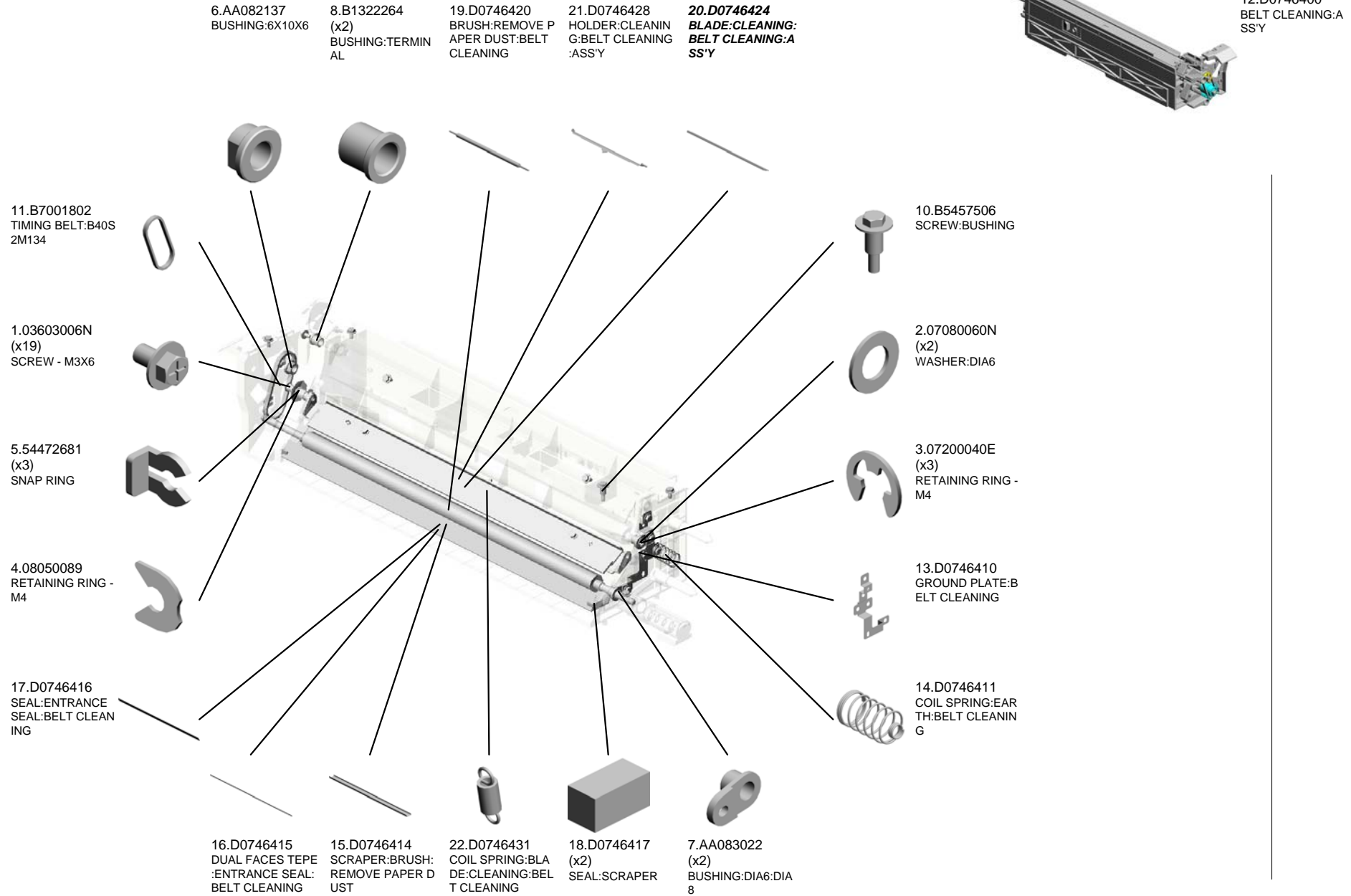

U001	U002	U003	U004	U005	U006	U007	U008	U009	U010	U011	U012	U013	U014	U015	U016	U017	U018	U019	U020	U021
------	------	------	------	------	------	------	------	------	------	------	------	------	------	------	------	------	------	------	------	------

U033_S001
BELT CLEANING:ASS'Y

44.D0746480
PULLEY:BRUSH:APPLY:Z30

40.D0746471
RELEASE PLATE:BLADE:APPLY

29.D0746446
BRUSH:APPLY:BELT CLEANING

34.D0746461
HOLDER:APPLY:BELT CLEANING:ASSY

33.D0746457
BLADE:APPLY:ASSY

12.D0746400
BELT CLEANING:ASSY



39.D0746470
RELEASE PLATE:BLADE:CLEANING

42.D0746478
GEAR:PULLEY:IDLER:BELT CLEANING

41.D0746477
GEAR:BRUSH:REMOVE PAPER DUST:Z17

24.D0746439
PLAIN SHAFT BEARING:REMOVE PAPER DUST:TRANSPORT SCREW

43.D0746479
GEAR:COLLECTOR OIL:Z19

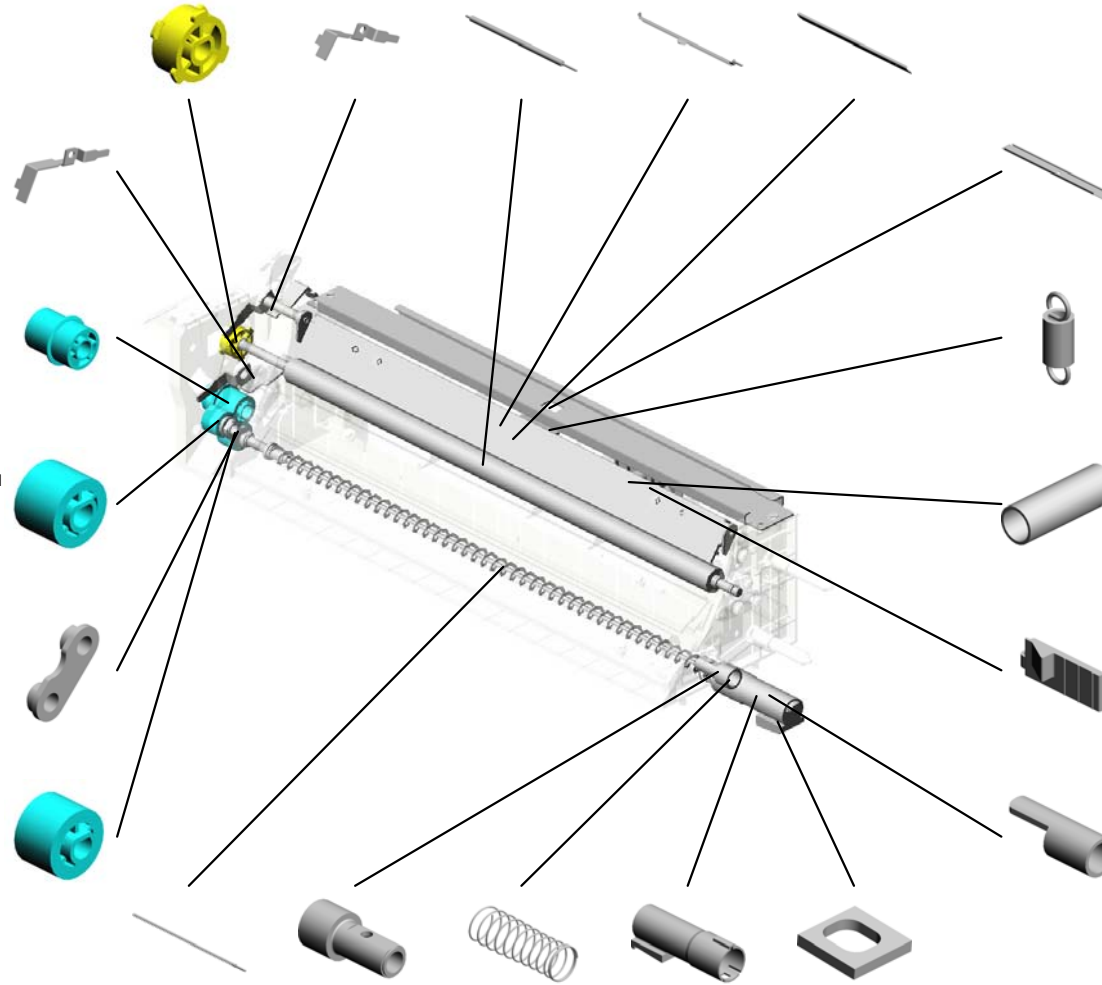

38.D0746469
SLIDE RAIL:UPPER:BELT CLEANING

35.D0746464
COIL SPRING:BLADE:APPLY:BELT CLEANING

36.D0746467
COIL SPRING:STOPPER:CASE:BELT CLEANING

37.D0746468
STOPPER:CASE:BELT CLEANING

26.D0746441
SHUTTER:TRANSPORT SCREW:BELT CLEANING

23.D0746434
TONER COLLECTOR ON COIL:BELT CLEANING:ASSY

45.D0746481
JOINT:BRUSH:REMOVE PAPER DUST:BELT CLEANING

27.D0746442
COIL SPRING:DISCHARGE USED TONER

25.D0746440
GUIDE:DISCHARGE USED TONER:BELT CLEANING

28.D0746443
SEAL:DISCHARGE USED TONER

U001	U002	U003	U004	U005	U006	U007	U008	U009	U010	U011	U012	U013	U014	U015	U016	U017	U018	U019	U020	U021
------	------	------	------	------	------	------	------	------	------	------	------	------	------	------	------	------	------	------	------	------

U033_S001
BELT CLEANING:ASS'Y

58.D0746496
GRIP:BELT CLEANING

55.D0746491
SEAL:CASE:CLEANING BLADE:FRONT

57.D0746495
(x2)
LEVER:RELEASE:BLADE

60.G1786621
(x2)
COVER:RELEASE:PLATE:BLADE

52.D0746488
SEAL:HOLDER:BEHIND:BELT CLEANING



12.D0746400
BELT CLEANING:ASS'Y

59.D0746497
(x2)
DECAL:POSITIONING DISPLAY:TCRU



47.D0746483
SEAL:HOLDER:CLEANING BLADE:FRONT LOWER

49.D0746485
SEAL:CASE:BRUSH:FRONT

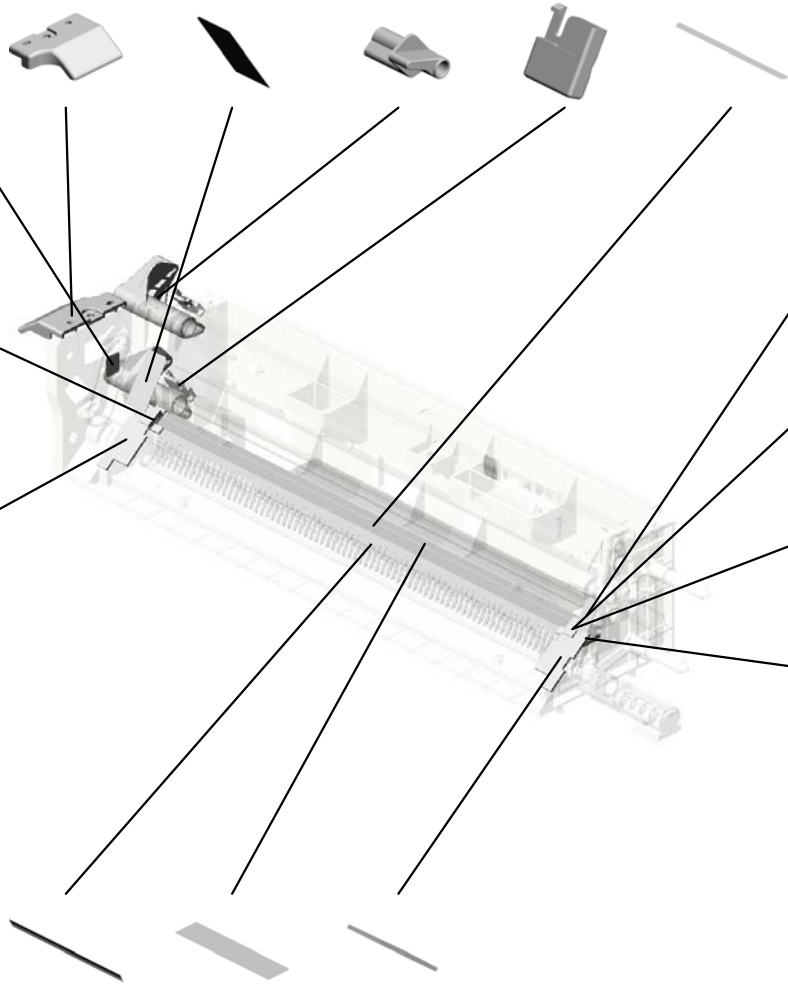

56.D0746492
SEAL:CASE:CLEANING BLADE:REAR

46.D0746482
(x2)
SEAL:HOLDER:CLEANING BLADE:UPPER

48.D0746484
SEAL:HOLDER:CLEANING BLADE:REAR LOWER

51.D0746487
(x2)
SEAL:HOLDER:CLEANING BLADE:LOWER

53.D0746489
VIBRATING PLATE:TRANSPORT SCREEN:BELT CLEANING

54.D0746490
SEAL:BASE:CASE:BELT CLEANING

50.D0746486
SEAL:CASE:BRUSH:REAR

U001	U002	U003	U004	U005	U006	U007	U008	U009	U010	U011	U012	U013	U014	U015	U016	U017	U018	U019	U020	U021
------	------	------	------	------	------	------	------	------	------	------	------	------	------	------	------	------	------	------	------	------

U033_S001_S001
COATING BAR:ASS'Y

31.D0746454
(x2)
ARM:COATING BA
R:BELT CLEANING



32.D0746455
COIL SPRING:COA
TING BAR



30.D0746450
COATING BAR:AS
S'Y

U001	U002	U003	U004	U005	U006	U007	U008	U009	U010	U011	U012	U013	U014	U015	U016	U017	U018	U019	U020	U021
------	------	------	------	------	------	------	------	------	------	------	------	------	------	------	------	------	------	------	------	------

U034.Paper Transfer

U034_S001
D0746201
TRANSFER/SEPARATION UN
IT:ASS'Y

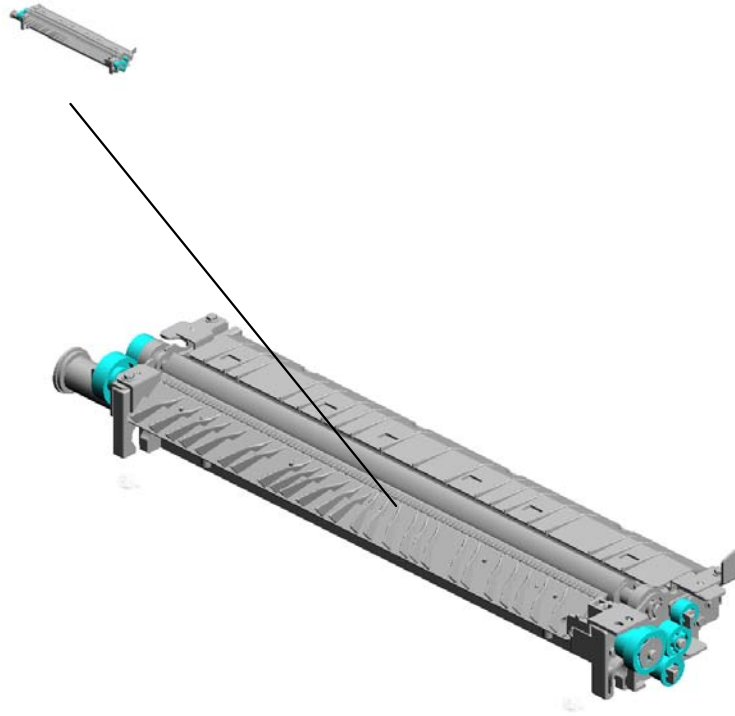

U001	U002	U003	U004	U005	U006	U007	U008	U009	U010	U011	U012	U013	U014	U015	U016	U017	U018	U019	U020	U021
------	------	------	------	------	------	------	------	------	------	------	------	------	------	------	------	------	------	------	------	------

U034 Paper Transfer

15.B2342390
(x2)
FLANGED HEXAG
ONAL HEAD BOLT:
M4X8



U001	U002	U003	U004	U005	U006	U007	U008	U009	U010	U011	U012	U013	U014	U015	U016	U017	U018	U019	U020	U021
------	------	------	------	------	------	------	------	------	------	------	------	------	------	------	------	------	------	------	------	------

U034_S001
TRANSFER/SEPARATION UNIT:ASS'Y

- 21.D0746241 (x2) DECAL:GRIP:TRANSFER/SEPARATION UNIT
- 16.D0146272 BUSHING:BRUSH:REAR
- 20.D0746228 ELECTRODE PLATE:FRAME
- 2.04503008N TAPPING SCREW - M3X8
- 1.03603006N (x14) SCREW - M3X6



17.D0746201
TRANSFER/SEPARATION UNIT:ASS'Y

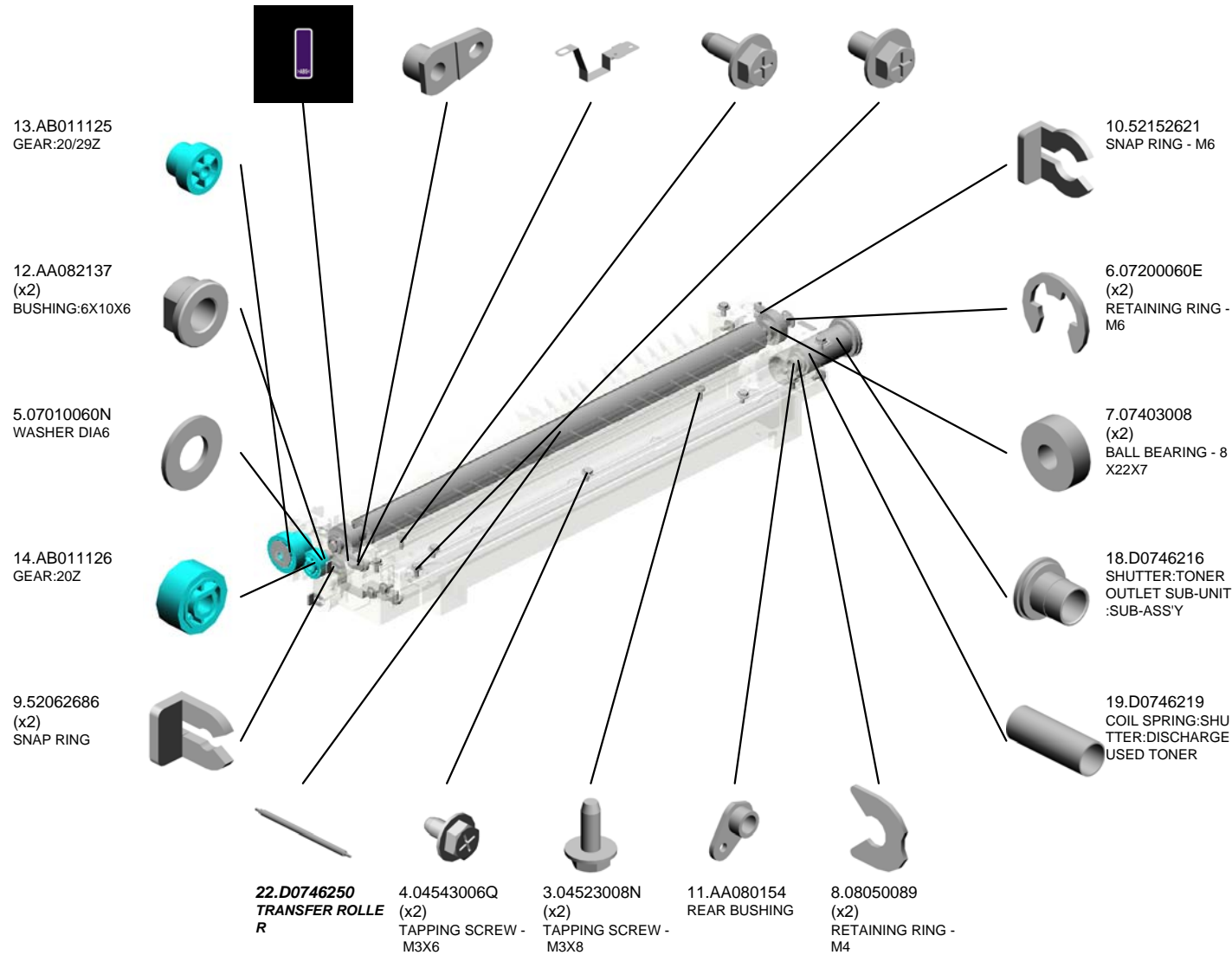

U001	U002	U003	U004	U005	U006	U007	U008	U009	U010	U011	U012	U013	U014	U015	U016	U017	U018	U019	U020	U021
------	------	------	------	------	------	------	------	------	------	------	------	------	------	------	------	------	------	------	------	------

U034_S001

TRANSFER/SEPARATION UNIT:ASS'Y

34.D0746300
SEPARATION COR
ONA:ASS'Y

23.D0746255
BRUSH ROLLER:T
RANSFER ROLLER
:ASS'Y

24.D0746257
BRUSH ROLLER:A
PPLY:ASS'Y

27.D0746273
SEAL:HOLDER

25.D0746265
BLADE:TRANSFER
ROLLER:ASS'Y



17.D0746201
TRANSFER/SEPAR
ATION UNIT:ASS'Y

31.D0746280
GUIDE PLATE:ENT
RANCE:TRANSFER
ROLLER:ASS'Y

39.D0746315
GEAR:BRUSH:APP
LY

37.D0746313
GEAR:IDLER:COLL
ECTION COIL

29.D0746276
PIN:POSITIONING
PLATE:BLADE:TRA
NSFER ROLLER:A
SS'Y

38.D0746314
GEAR:COLLECTIO
N COIL

32.D0746291
(x2)
COIL SPRING:COA
TING BAR

33.D0746294
TRANSPORT SCR
EW:TRANSFER RO
LLER:ASS'Y

26.D0746270
HOLDER:BLADE:A
SS'Y

41.G1786767
COATING BAR:TR
ANSFER ROLLER

36.D0746312
GEAR:IDLER:TRAN
SFER ROLLER

35.D0746311
GEAR:TRANSFER
ROLLER

28.D0746274
(x2)
SEAL:HOLDER:UP
PER

30.D0746279
(x2)
COIL SPRING:BLA
DE:TRANSFER RO
LLER

40.G1784018
CASE:COATING BA
R:TRANSFER ROL
LER

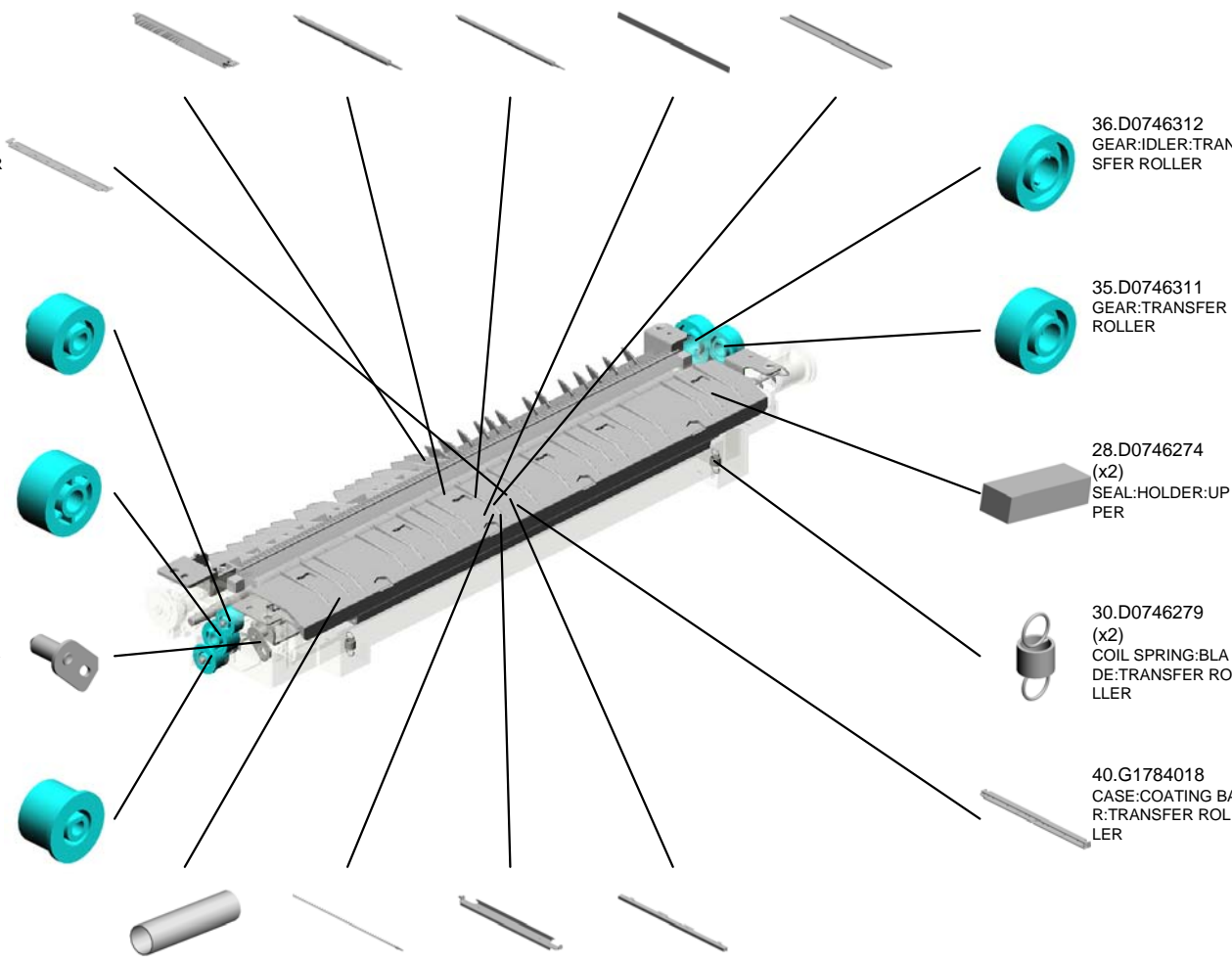

U001	U002	U003	U004	U005	U006	U007	U008	U009	U010	U011	U012	U013	U014	U015	U016	U017	U018	U019	U020	U021
------	------	------	------	------	------	------	------	------	------	------	------	------	------	------	------	------	------	------	------	------

U035.Used Toner 1

U035_S001
D0746501
TONER OUTLET SUB-UNIT:P
CU:MAIN:ASS'Y

U035_S002
D0746531
TONER OUTLET SUB-UNIT:B
ELT CLEANING:MAIN:ASS'Y

U035_S003
D0746551
TONER OUTLET SUB-UNIT:V
ERTICAL TRANSPORT:ASS'Y

U035_S004
D0746601
TONER OUTLET SUB-UNIT:L
OWER:ASS'Y

U001	U002	U003	U004	U005	U006	U007	U008	U009	U010	U011	U012	U013	U014	U015	U016	U017	U018	U019	U020	U021
------	------	------	------	------	------	------	------	------	------	------	------	------	------	------	------	------	------	------	------	------

U035 Used Toner 1

25.D0746572
BRACKET:VERTICAL TRANSPORT:ASSY

28.D0746577
CAM:VERTICAL TRANSPORT:DIA15

37.GA082010
BUSHING:DIA6:DIA10:9

27.D0746575
SHAFT:CAM:VERTICAL TRANSPORT

2.04514008N
(x25)
TAPPING SCREW:4X8



14.D0746520
(x4)
COVER:DISCHARGE USED TONER:DEVELOPMENT



4.D0143241
(x4)
SEAL:DISCHARGE USED TONER



5.D0143242
(x4)
SEAL:DISCHARGE USED TONER:LOWER



3.07200040E
(x3)
RETAINING RING - M4



29.D0746578
GEAR:Z37:CAM:VERTICAL TRANSPORT



31.D0746585
(x2)
GEAR:Z38/Z24:VERTICAL TRANSPORT



26.D0746574
COVER:CAM:VERTICAL TRANSPORT



30.D0746579
SEAL:COVER:CAM:VERTICAL TRANSPORT



1.04513006N
(x2)
TAPPING SCREW - 3X6



32.D0746586
GEAR:Z35:IDLER:VERTICAL TRANSPORT

U035_S001
 TONER OUTLET SUB-UNIT:PCU:MAIN:ASS'Y

10.D0746514 (x4)
 SEAL:TONER OUTLET SUB-UNIT:PCU

7.D0746504
 TRANSPORT SCR
 EW:PCU:MAIN:ASS'Y



6.D0746501
 TONER OUTLET SUB-UNIT:PCU:MAIN:ASS'Y

8.D0746511 (x2)
 PLAIN SHAFT BEARING:TONER RECYCLING SUB-UNIT



13.D0746517 (x8)
 STEEL BALL:TONER OUTLET SUB-UNIT



11.D0746515
 SEAL:COVER:5ST.:PCU



9.D0746512
 GEAR:Z35:TRANSPORT SCREW:PCU:MAIN



12.D0746516
 SEAL:COVER:5ST.:DEVELOPMENT



3.07200040E
 RETAINING RING - M4



U001	U002	U003	U004	U005	U006	U007	U008	U009	U010	U011	U012	U013	U014	U015	U016	U017	U018	U019	U020	U021
------	------	------	------	------	------	------	------	------	------	------	------	------	------	------	------	------	------	------	------	------

U035_S002

TONER OUTLET SUB-UNIT:BELT CLEANING:MAIN:ASS'Y

16.D0746534 TRANSPORT SCREW:BELT CLEANING:MAIN:ASS'Y
13.D0746517 STEEL BALL:TONER OUTLET SUB-UNIT
18.D0746540 SEAL:BELT CLEANING:MAIN

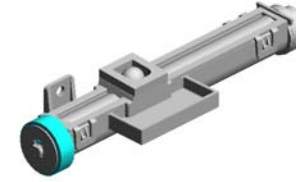

15.D0746531 TONER OUTLET SUB-UNIT:BELT CLEANING:MAIN:ASS'Y

19.D0746541 SEAL:RING:TONER OUTLET SUB-UNIT:BELT CLEANING

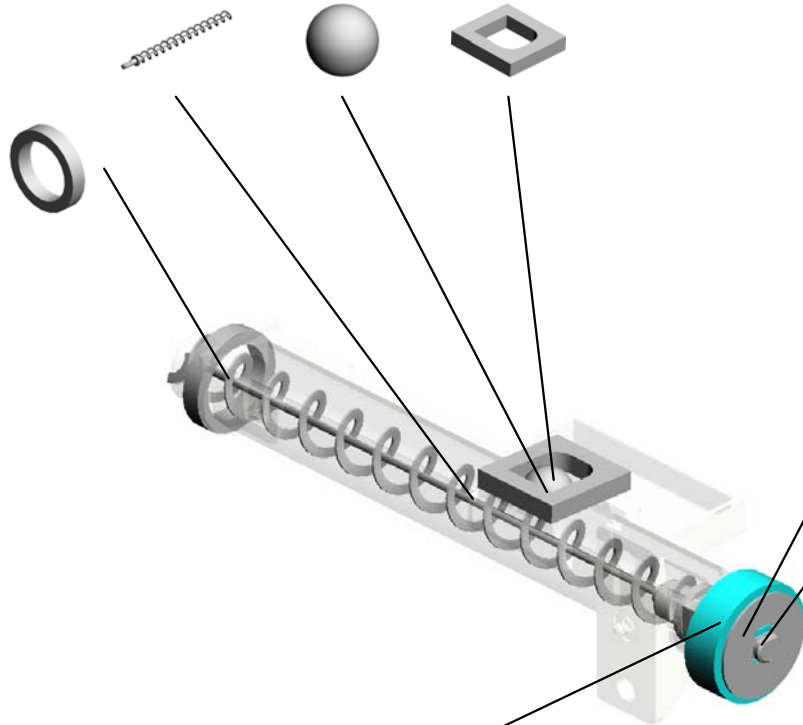

17.D0746539 GEAR:Z29:TRANSPORT SCREW:BELT CLEANING

3.07200040E RETAINING RING - M4

8.D0746511 PLAIN SHAFT BEARING:TONER RECYCLING SUB-UNIT

U001	U002	U003	U004	U005	U006	U007	U008	U009	U010	U011	U012	U013	U014	U015	U016	U017	U018	U019	U020	U021
------	------	------	------	------	------	------	------	------	------	------	------	------	------	------	------	------	------	------	------	------

U035_S003
TONER OUTLET SUB-UNIT:VERTICAL TRANSPORT:ASS'Y

24.D0746567
SEAL:VERTICAL T
RANSPORT:UPPE
R

21.D0746564
TONER OUTLET S
UB-UNIT:T/S UNIT:
SHUTTER:OUTER

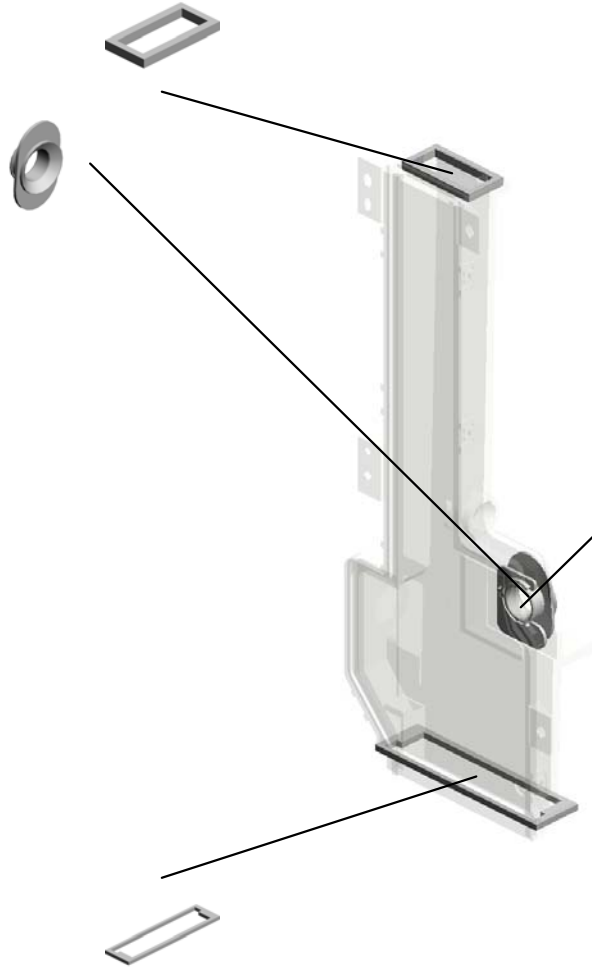

20.D0746551
TONER OUTLET S
UB-UNIT:VERTICA
L TRANSPORT:AS
SY

22.D0746565
TONER OUTLET S
UB-UNIT:T/S UNIT:
SHUTTER:INNER

23.D0746566
SEAL:VERTICAL T
RANSPORT:LOWE
R

U001	U002	U003	U004	U005	U006	U007	U008	U009	U010	U011	U012	U013	U014	U015	U016	U017	U018	U019	U020	U021
------	------	------	------	------	------	------	------	------	------	------	------	------	------	------	------	------	------	------	------	------

U035_S004

TONER OUTLET SUB-UNIT:LOWER:ASS'Y

35.D0746609 GEAR:Z3:TRANSP
ORT SCREW:LOW
ER
8.D0746511 PLAIN SHAFT BEA
RING:TONER REC
YCLING SUB-UNIT



33.D0746601
TONER OUTLET S
UB-UNIT:LOWER:A
SS'Y

3.07200040E
RETAINING RING -
M4

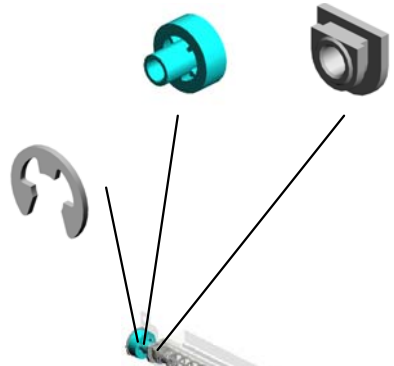

34.D0746604
TRANSPORT SCR
EW:TONER OUTLE
T SUB-UNIT:LOWE
R:ASSY



36.D0746610
SEAL:RING:TONER
OUTLET SUB-UNI
T:LOWER

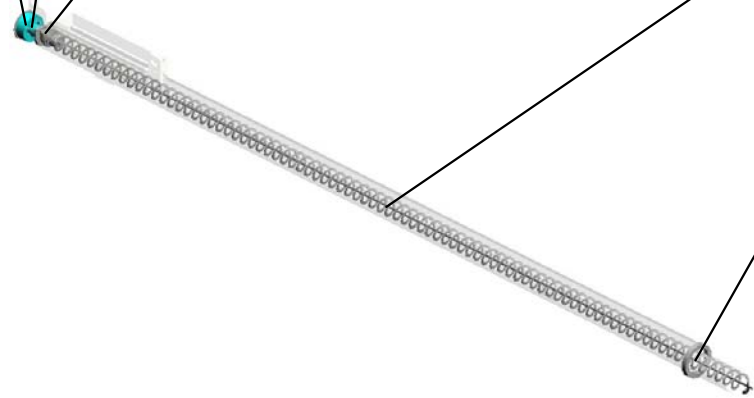

U001	U002	U003	U004	U005	U006	U007	U008	U009	U010	U011	U012	U013	U014	U015	U016	U017	U018	U019	U020	U021
------	------	------	------	------	------	------	------	------	------	------	------	------	------	------	------	------	------	------	------	------

U036.Used Toner 2

U036_S001
D0746627
COLLECTION BOTTLE:SMAL
L:ASSY

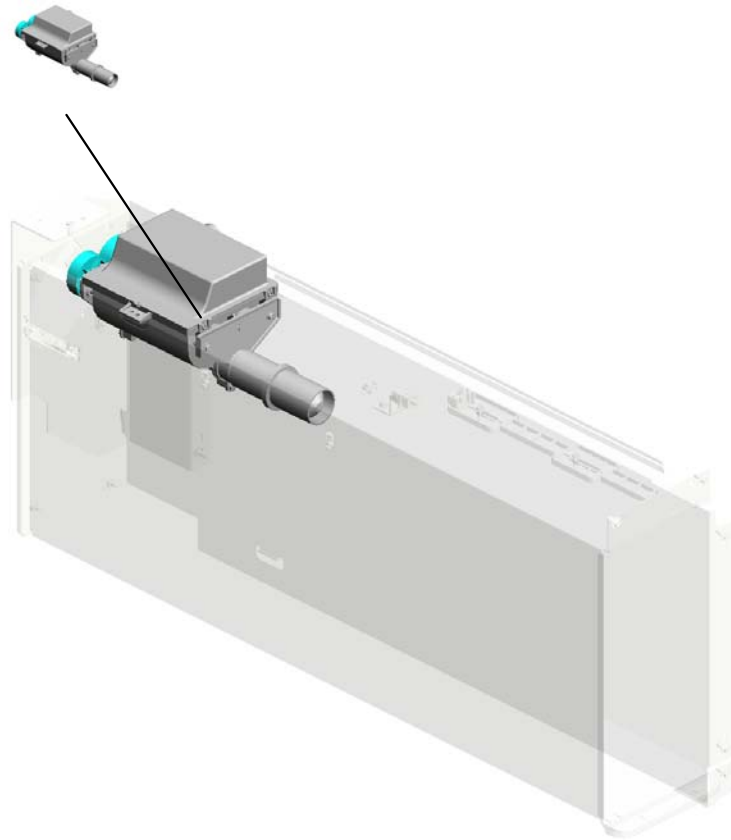

U001	U002	U003	U004	U005	U006	U007	U008	U009	U010	U011	U012	U013	U014	U015	U016	U017	U018	U019	U020	U021
------	------	------	------	------	------	------	------	------	------	------	------	------	------	------	------	------	------	------	------	------

U036 Used Toner 2

3.04513006N
(x13)
TAPPING SCREW -
3X6

16.D0741454
DC MOTOR:DIA49:
9.8W:BLS

13.AW020145
PHOTOINTERRUP
TOR:FLAT

1.03603006N
SCREW - M3X6

10.11050511
(x7)
HARNES CLAMP -
LWS-0306ZC

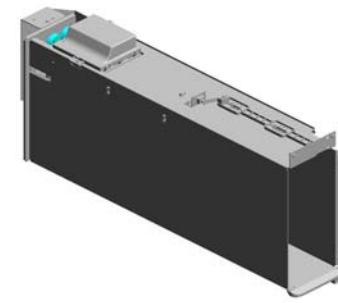

11.11050551
CLAMP:LES-0505

37.D0746663
TORQUE LIMITER
MECHANICAL CLU
TCH:GEAR:Z63

35.D0746656
COVER:GEAR:SID
E PLATE:PEEN

36.D0746659
SHAFT:JOINT:COL
LECTION BOTTLE:
ASS'Y

14.AW020164
(x2)
OIL END SENSOR

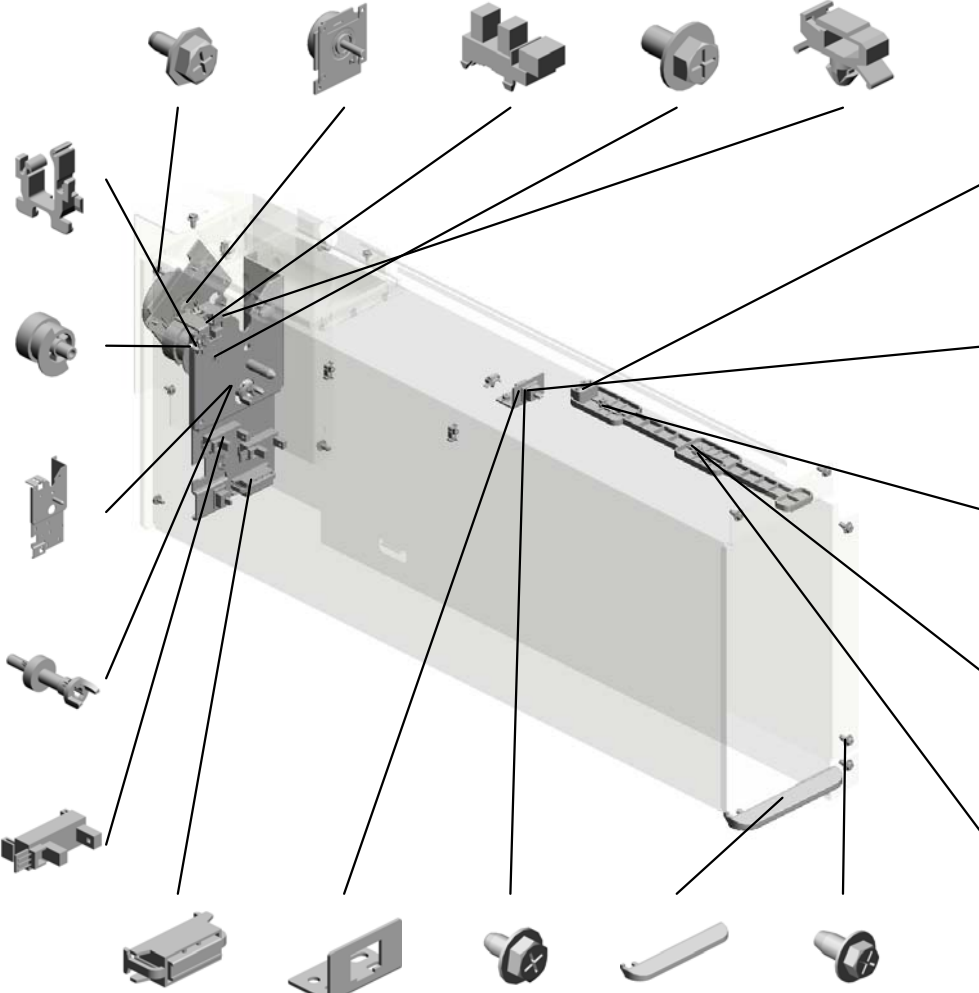

2.04503008N
TAPPING SCREW -
M3X8

15.AW500023
(x2)
PUSH SWITCH

6.04543010Q
(x2)
TAPPING SCREW:
3X10

34.D0746648
LINK:PUSH SWITC
H:TONER RECYCLI
NG SUB-UNIT

8.07073050N
(x2)
BUSHING:DIA3X5

12.AG071012
MAGNET CATCH:A
SS'Y

33.D0746647
BRACKET:PUSH S
WITCH

5.04543006Q
(x2)
TAPPING SCREW -
M3X6

17.D0746626
INNER COVER:TO
NER RECYCLING S
UB-UNIT

4.04514008N
(x8)
TAPPING SCREW:
4X8

U036
Used Toner 2

38.D0746664 GEAR:IDLER:Z49/Z
27
40.D0746666 GEAR:IDLER:Z37/Z
28

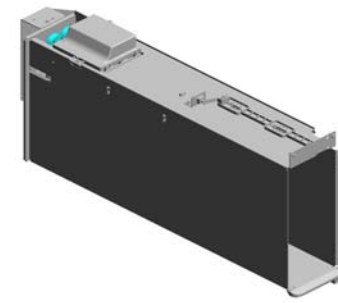

41.D0746667
HOLDER:RADIAL B
ALL BEARING:JOIN
T

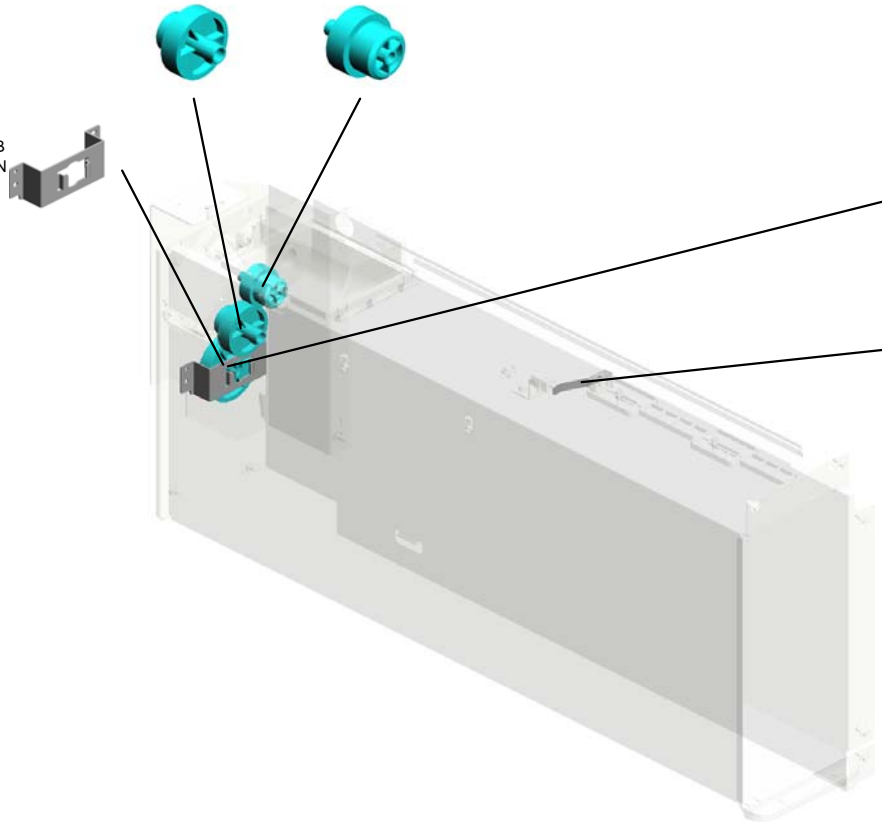

39.D0746665
GEAR:JOINT:COLL
ECTION BOTTLE:Z
65

43.D0746669
SPRING PLATE:PU
SH SWITCH

U001	U002	U003	U004	U005	U006	U007	U008	U009	U010	U011	U012	U013	U014	U015	U016	U017	U018	U019	U020	U021
------	------	------	------	------	------	------	------	------	------	------	------	------	------	------	------	------	------	------	------	------

U036_S001
COLLECTION BOTTLE:SMALL:ASS'Y



18.D0746627
COLLECTION BOT
TLE:SMALL:ASS'Y

31.D0746645
GEAR:AGITATOR:
COLLECTION BOT
TLE:SMALL:Z41

23.D0746633
COVER:BEARING:
SMALL

26.D0746640
PLAIN SHAFT BEA
RING:TRANSPORT
SCREW:SMALL

27.D0746641
(x2)
PLAIN SHAFT BEA
RING:SMALL:GEAR

19.D0746629
COVER:COLLECTI
ON BOTTLE:SMAL
L

30.D0746644
GEAR:AGITATOR:
COLLECTION BOT
TLE:SMALL:Z49/Z4
1

7.06320140G
PARALLEL PIN

29.D0746643
GEAR:TRANSPOR
T SCREW:COLLEC
TION BOTTLE:SMAL
L:Z31

9.08050089
RETAINING RING -
M4

24.D0746634
(x2)
AGITATOR:SMALL

25.D0746635
TRANSPORT SCR
EW:SMALL:ASS'Y

32.D0746646
(x2)
SEAL:TONER REC
YCLING SUB-UNIT:
SMALL

42.D0746668
SEAL:PIPE:TONER
RECYCLING SUB-
UNIT:SMALL

28.D0746642
(x2)
PLAIN SHAFT BEA
RING:SMALL

22.D0746632
COMPRESSION SP
RING:SHUTTER:S
MALL

2.04503008N
(x6)
TAPPING SCREW -
M3X8

20.D0746630
PIPE:COLLECTION
BOTTLE:SMALL

21.D0746631
SHUTTER:TONER
RECYCLING SUB-
UNIT:SMALL

U037.Used Toner 3

U037_S001
D0746590
COLLECTION BOTTLE:ASSY

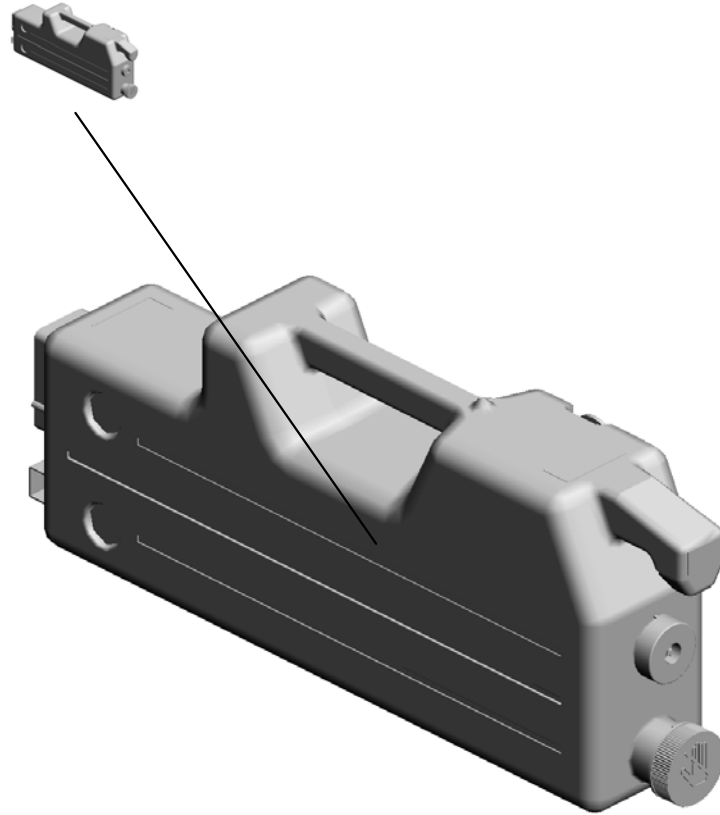

U001	U002	U003	U004	U005	U006	U007	U008	U009	U010	U011	U012	U013	U014	U015	U016	U017	U018	U019	U020	U021
------	------	------	------	------	------	------	------	------	------	------	------	------	------	------	------	------	------	------	------	------

U037
Used Toner 3

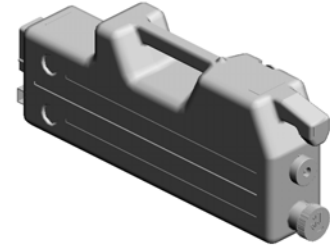

U001	U002	U003	U004	U005	U006	U007	U008	U009	U010	U011	U012	U013	U014	U015	U016	U017	U018	U019	U020	U021
------	------	------	------	------	------	------	------	------	------	------	------	------	------	------	------	------	------	------	------	------

U037_S001
COLLECTION BOTTLE:ASS'Y

3.D0746684
SEAL:TANK:USED
TONER:COLLECT
201109-24

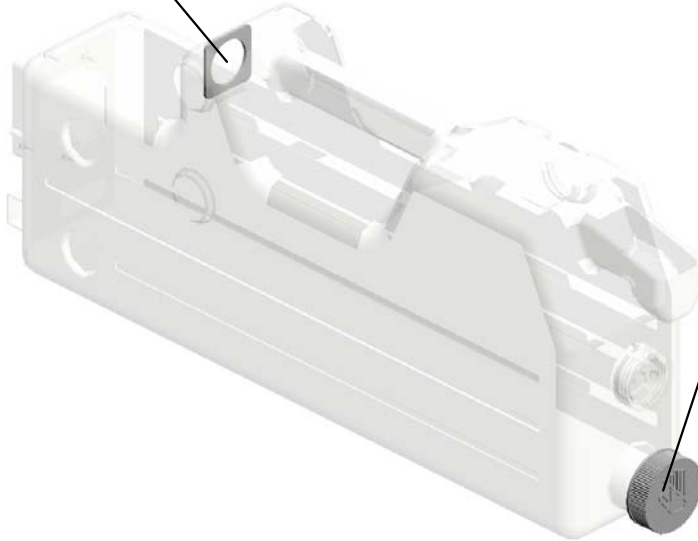

1.AA036015
CAP:COLLECTION
BOTTLE

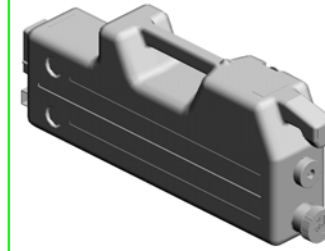

2.D0746590
[A]
COLLECTION BOT
TLE:ASS'Y
201109-10 X/O

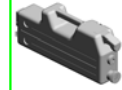

D0746670
[A]
COLLECTION BOT
TLE:ASS'Y
201109-10 X/O

U001	U002	U003	U004	U005	U006	U007	U008	U009	U010	U011	U012	U013	U014	U015	U016	U017	U018	U019	U020	U021
------	------	------	------	------	------	------	------	------	------	------	------	------	------	------	------	------	------	------	------	------

U038.Paper Transport

U038_S001
D0743850
TRANSPORT BELT UNIT:ASS
Y

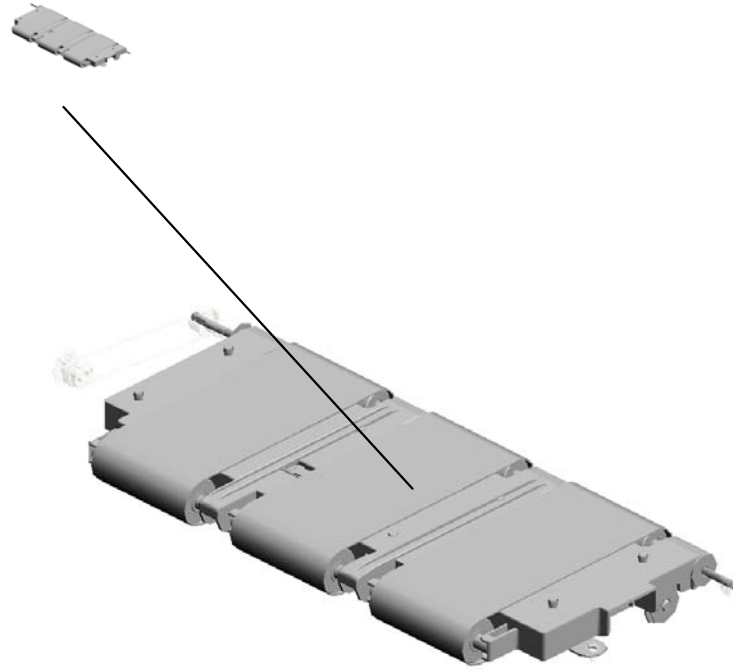

U001	U002	U003	U004	U005	U006	U007	U008	U009	U010	U011	U012	U013	U014	U015	U016	U017	U018	U019	U020	U021
------	------	------	------	------	------	------	------	------	------	------	------	------	------	------	------	------	------	------	------	------

U038 Paper Transport

15.D0741394
PULLEY:DRIVE:TR
ANSPORT UNIT

14.B7031166
TIMING BELT:B40S
2M274:

19.D0743858
PULLEY:DRIVE:VA
CUUM



4.07200040E
RETAINING RING -
M4

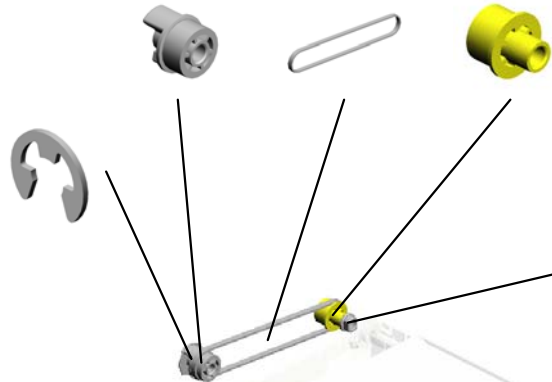

10.AA082101
(x2)
BUSHING - 6X10X6

8.54472681
SNAP RING

3.04514008N
(x2)
TAPPING SCREW:
4X8

U001	U002	U003	U004	U005	U006	U007	U008	U009	U010	U011	U012	U013	U014	U015	U016	U017	U018	U019	U020	U021
------	------	------	------	------	------	------	------	------	------	------	------	------	------	------	------	------	------	------	------	------

U038_S001
 TRANSPORT BELT UNIT:ASS'Y

2.03603020N
 (x6)
 SCREW:M3X20

18.D0743855
 BRACKET:SENSO
 R:VACUUM

1.03603006N
 SCREW - M3X6

12.AW010107
 PAPER FEED SEN
 SOR



16.D0743850
 TRANSPORT BELT
 UNIT:ASS'Y

11.AF022064
 (x3)
 TRANSPORT ROLL
 ER:DRIVEN



13.AX640201
 (x3)
 FAN:MM60:DC 3.12
 W



9.AA040034
 (x3)
 TRANSPORT BELT

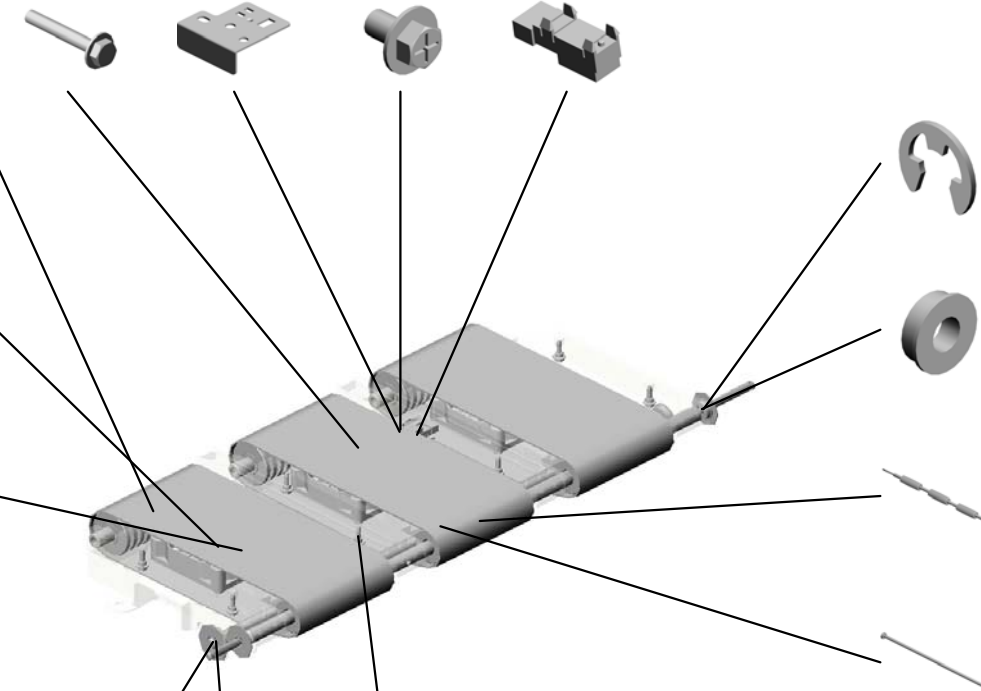
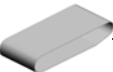

4.07200040E
 (x2)
 RETAINING RING -
 M4



6.07413506
 (x2)
 BALL BEARING - 6
 X12X4 MM



17.D0743851
 TRANSPORT ROLL
 ER:DRIVE



20.D0743863
 SHAFT:DRIVEN:FL
 AT CONVEYER BE
 LT



5.07200060E
 RETAINING RING -
 M6



7.07423808
 BALL BEARING - 8
 X16X5



21.GA143003
 (x7)
 SCREW:MM5:2.5M
 M



U039.Fusing 1

U039_S001
D0744487
FUSING UNIT:TAURUS:230V:
ASSY

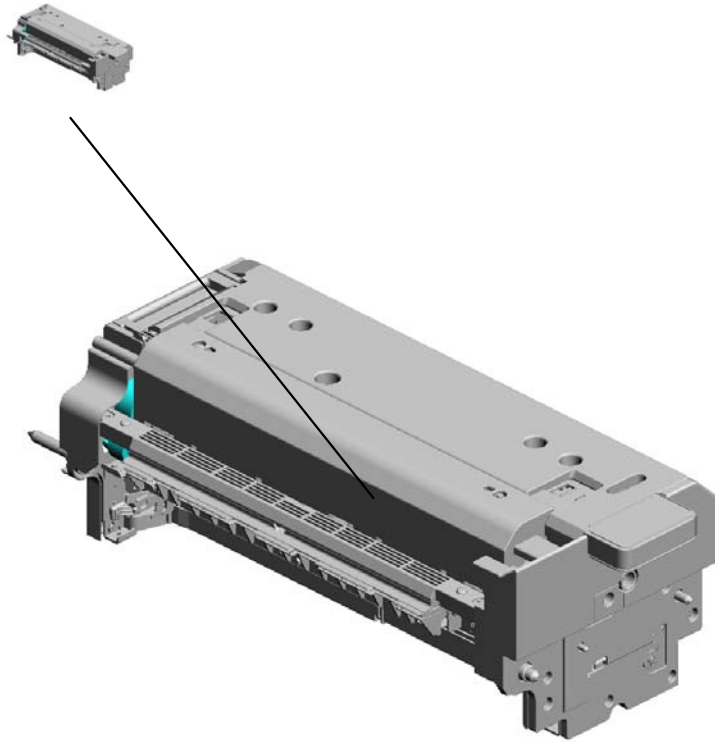

U001	U002	U003	U004	U005	U006	U007	U008	U009	U010	U011	U012	U013	U014	U015	U016	U017	U018	U019	U020	U021
------	------	------	------	------	------	------	------	------	------	------	------	------	------	------	------	------	------	------	------	------

U039_S001.FUSING UNIT:TAURUS:230V:ASS'Y

U039_S001_S001
D0744190
COVER:FUSING UNIT:UPPE
R:FIBER

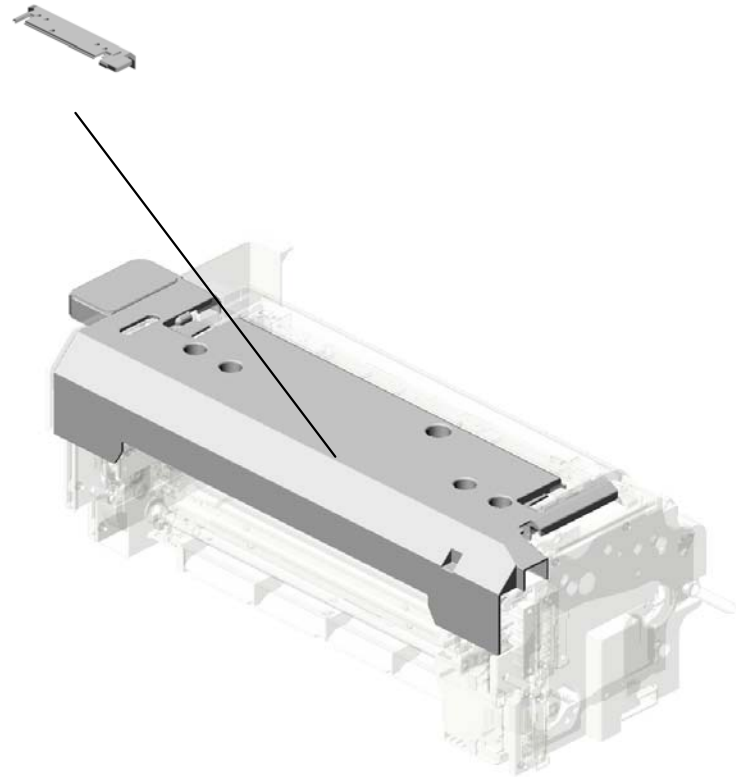

U001	U002	U003	U004	U005	U006	U007	U008	U009	U010	U011	U012	U013	U014	U015	U016	U017	U018	U019	U020	U021
------	------	------	------	------	------	------	------	------	------	------	------	------	------	------	------	------	------	------	------	------

U039
Fusing 1

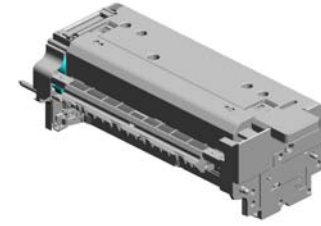

U001	U002	U003	U004	U005	U006	U007	U008	U009	U010	U011	U012	U013	U014	U015	U016	U017	U018	U019	U020	U021
------	------	------	------	------	------	------	------	------	------	------	------	------	------	------	------	------	------	------	------	------

U039_S001
FUSING UNIT:TAURUS:230V:ASS'Y

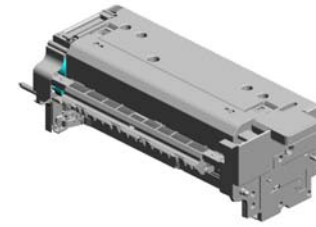

28.D0744487
FUSING UNIT:TAURUS:230V:ASS'Y

- 3.08046123 (x16) HEXAGONAL BOLT :W/WASHER:M3X8
- 9.D0744188 DUCT:HEAT ROLLER:UPPER
- 18.D0744280 COVER:GUIDE PLATE:EXIT:UPPER
- 17.D0744277 GUIDE PLATE:EXIT:CONNECTING:UPPER:SHEET
- 2.07200030E (x2) RETAINING RING - M3

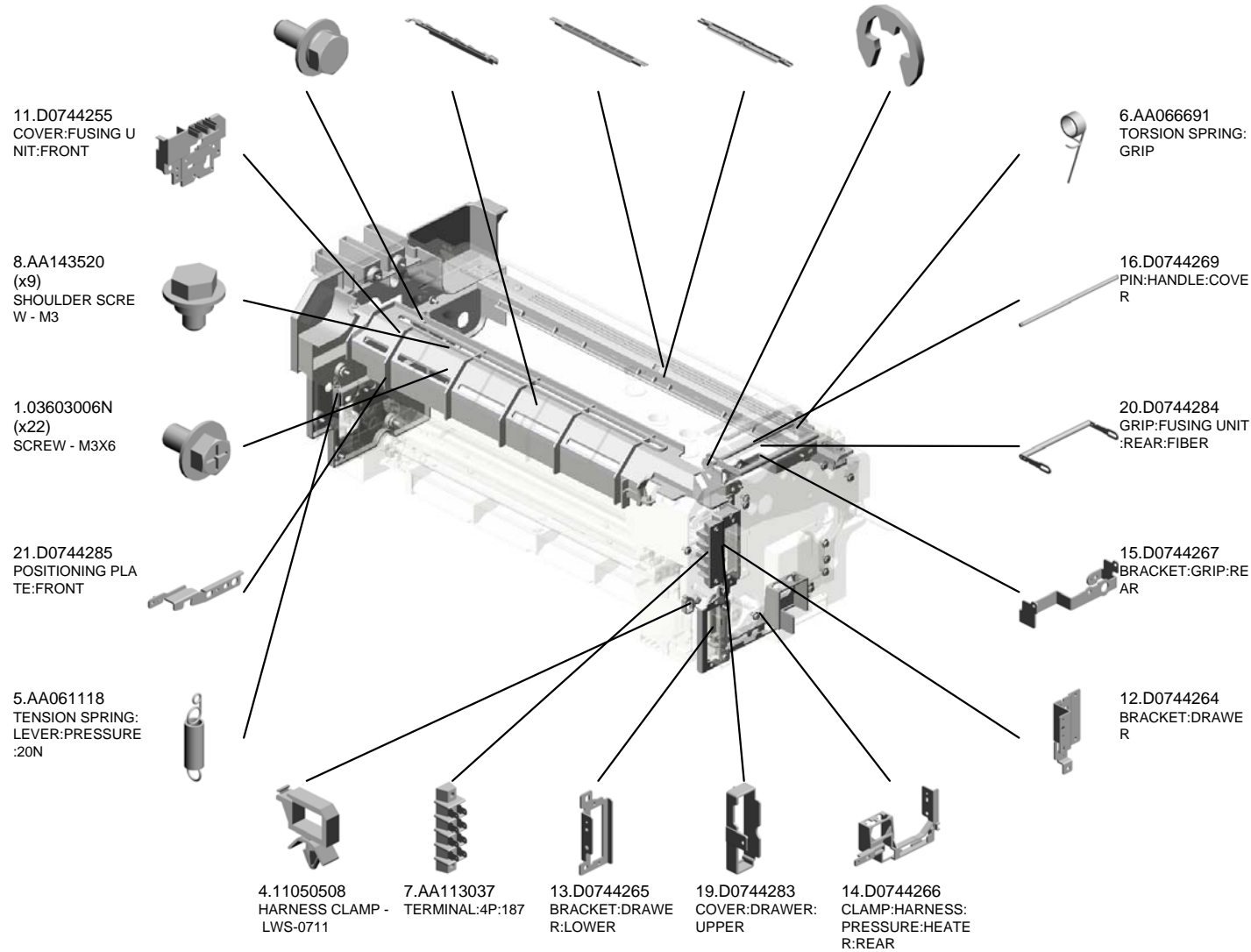

U001	U002	U003	U004	U005	U006	U007	U008	U009	U010	U011	U012	U013	U014	U015	U016	U017	U018	U019	U020	U021
------	------	------	------	------	------	------	------	------	------	------	------	------	------	------	------	------	------	------	------	------

U039_S001
 FUSING UNIT:TAURUS:230V:ASS'Y

23.D0744289 COVER:FUSING U
 NIT:FRONT:WINDO
 W
 27.D0744381 DECAL:FUSING UN
 IT:POSITIONING

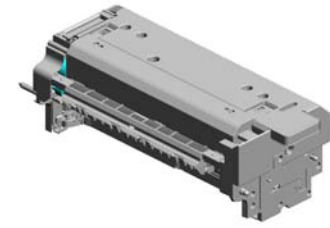

28.D0744487
 FUSING UNIT:TAU
 RUS:230V:ASS'Y

24.D0744293
 PLATE:LEVER:PRE
 SSURE

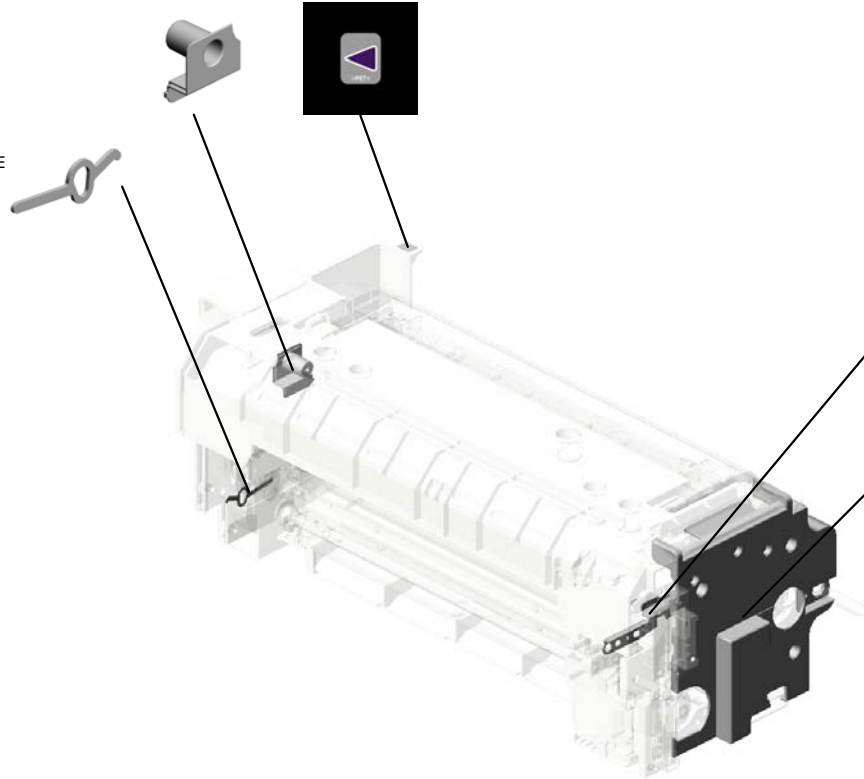

22.D0744287
 POSITIONING PLA
 TE:REAR

26.D0744342
 COVER:FUSING U
 NIT:REAR:PRINTIN
 G

U001	U002	U003	U004	U005	U006	U007	U008	U009	U010	U011	U012	U013	U014	U015	U016	U017	U018	U019	U020	U021
------	------	------	------	------	------	------	------	------	------	------	------	------	------	------	------	------	------	------	------	------

U039_S001_S001
COVER:FUSING UNIT:UPPER:FIBER

25.D0744336
DECAL:WARNING (REMOVAL AND INSTALLATION);FUSING

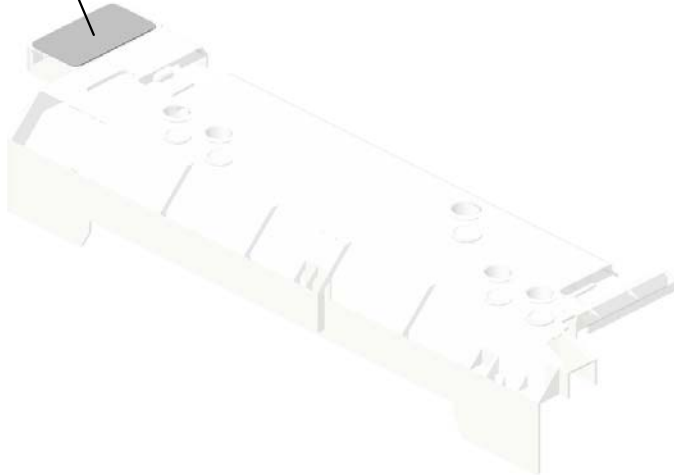

10.D0744190
COVER:FUSING UNIT:UPPER:FIBER

U001	U002	U003	U004	U005	U006	U007	U008	U009	U010	U011	U012	U013	U014	U015	U016	U017	U018	U019	U020	U021
------	------	------	------	------	------	------	------	------	------	------	------	------	------	------	------	------	------	------	------	------

U040.Fusing 2

U040_S001
D0744429
STRIPPER PLATE:UNI:FUSIN
G:ASS'Y



U001	U002	U003	U004	U005	U006	U007	U008	U009	U010	U011	U012	U013	U014	U015	U016	U017	U018	U019	U020	U021
------	------	------	------	------	------	------	------	------	------	------	------	------	------	------	------	------	------	------	------	------

U040 Fusing 2

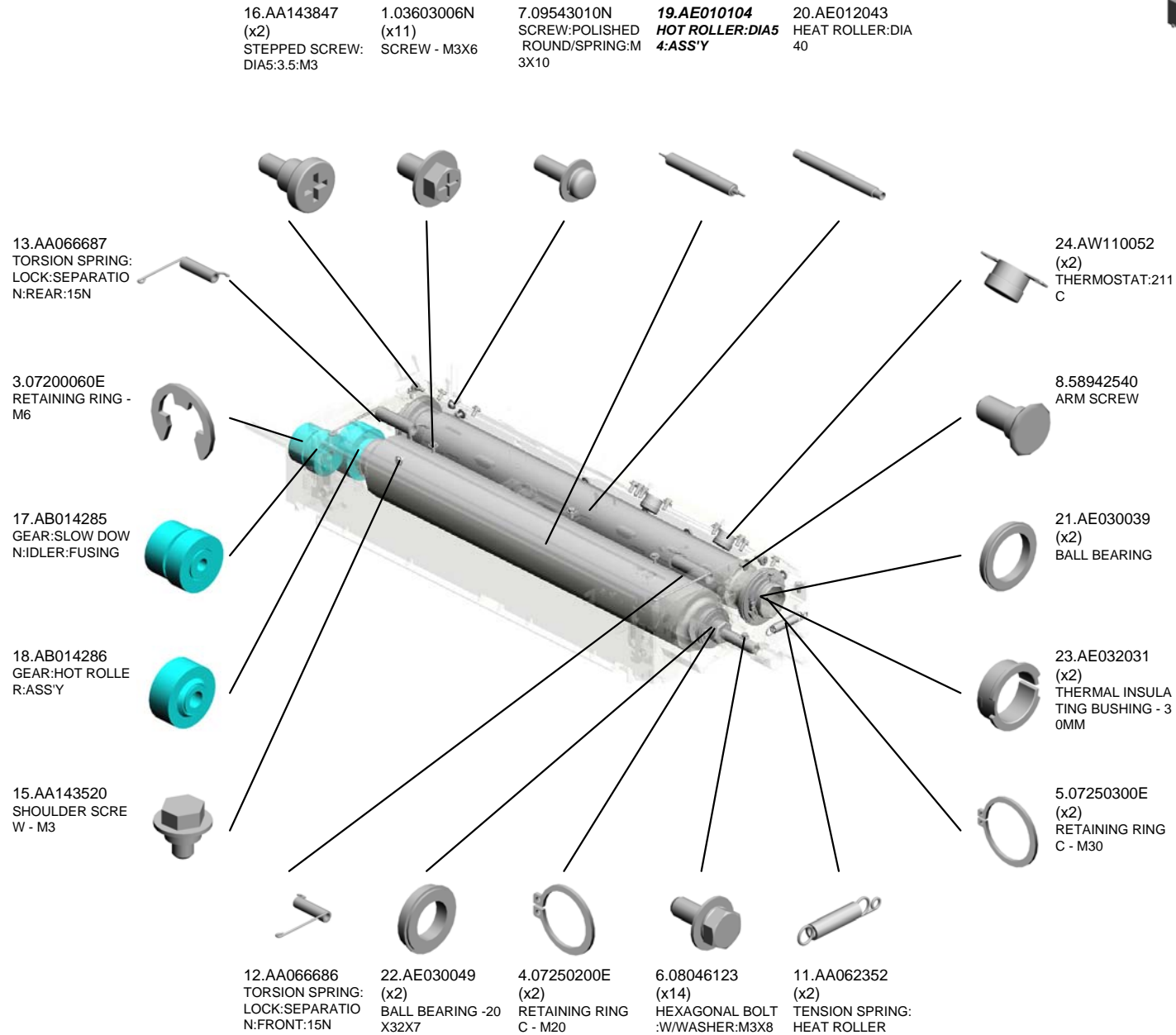
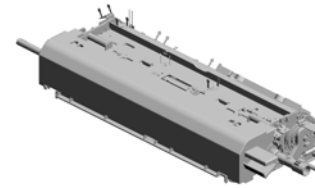

U001	U002	U003	U004	U005	U006	U007	U008	U009	U010	U011	U012	U013	U014	U015	U016	U017	U018	U019	U020	U021
------	------	------	------	------	------	------	------	------	------	------	------	------	------	------	------	------	------	------	------	------

U040 Fusing 2

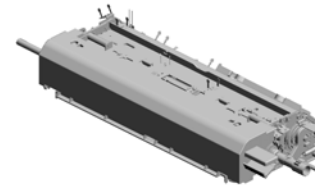

- 41.D0744179 HOLDER:THERMIS TOR:HEAT ROLLER:REAR
- 26.AX440323 HEATER:HEAT ROLLER:B:230V:1000W/400W
- 25.AX440322 HEATER:HEAT ROLLER:A:230V:650W/870W
- 54.D0744345 FUSING ENTRANCE GUIDE PLATE:UPPER:FIBER
- 44.D0744182 ELECTRODE PLATE:THERMOSTAT:HEAT ROLLER

48.D0744196 DISCHARGE BRUSH:HEAT ROLLER:PEEN

39.D0744174 HOLDER:HEATER:HEAT ROLLER:REAR

47.D0744185 (x2) RING:GUIDE:HEAT ROLLER:DIA40

37.D0744172 COVER:HARNESS:FIRST

49.D0744197 FLAT BELT-FUSING:SEAL

52.D0744281 (x2) BRACKET:TORSION SPRING:PEEN

29.D0144247 (x3) HOUSING - TEMPERATURE SENSOR

40.D0744176 HOLDER:THERMISTOR:HOT ROLLER

51.D0744224 JOINT:KNOB:FUSING

38.D0744173 HOLDER:HEATER:HEAT ROLLER:FRONT

42.D0744180 HOUSING:THERMOSTAT:HEAT ROLLER:ASSY

43.D0744181 ELECTRODE PLATE:THERMOSTAT:HEAT ROLLER:MIDDLE

45.D0744183 TAB:TERMINAL:187:2P:UPPER

46.D0744184 TAB:TERMINAL:187:2P:LOWER

53.D0744297 PLATE:RADIAL BALL BEARING:HEAT ROLLER

U040 Fusing 2

56.D0745363
TEMPERATURE SE
NSOR:FUSING UNI
T:UPPER:13PIN:AS
S'Y

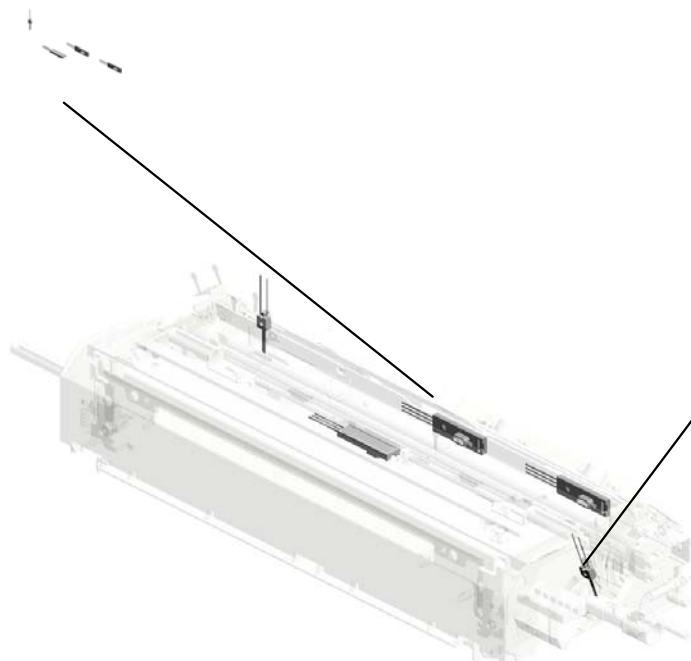
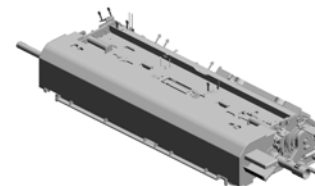

57.D0745364
TEMPERATURE SE
NSOR:FUSING UNI
T:UPPER:11PIN:AS
S'Y

U001	U002	U003	U004	U005	U006	U007	U008	U009	U010	U011	U012	U013	U014	U015	U016	U017	U018	U019	U020	U021
------	------	------	------	------	------	------	------	------	------	------	------	------	------	------	------	------	------	------	------	------

U040_S001
STRIPPER PLATE:UNI:FUSING:ASS'Y



55.D0744429
STRIPPER PLATE:
UNI:FUSING:ASS'Y

- 6.08046123 (x4) HEXAGONAL BOLT :W/WASHER:M3X8
- 10.AA061117 (x2) TENSION SPRING: STRIPPER PLATE: PLATE
- 58.G0294176 (x7) TURN ROLLER - EXIT SUB-UNIT
- 34.D0744143 SHAFT:STRIPPER PLATE
- 32.D0744127 SUPPORTING PLATE:FRAME:STRIPPER PLATE

27.B1324167 GRIP:OIL APPLICATION UNIT:FIBER

35.D0744144 LEVER:PAPER EXIT UNIT:FRONT

30.D0744123 (x2) LEVER:STRIPPER PLATE:PLATE

31.D0744124 (x2) BRACKET:STRIPPER PLATE:PLATE:PEEN

33.D0744128 COVER:STRIPPER PLATE:UNI:FUSING:ASS'Y

50.D0744200 GUIDE PLATE:FUSING EXIT:CONNECTING:UPPER:SHEET

2.07200040E (x3) RETAINING RING - M4

9.AA061116 (x4) TENSION SPRING: STRIPPER PLATE: 2N

15.AA143520 (x2) SHOULDER SCREW - M3

1.03603006N (x9) SCREW - M3X6

28.B1324197 TORSION SPRING: LEVER

14.AA082101 (x2) BUSHING - 6X10X6

36.D0744145 LEVER:PAPER EXIT UNIT:REAR

U041.Fusing 3

U041_S001
D0744478
GUIDE PLATE:FUSING EXIT:
LOWER:CONNECTING:ASS'Y

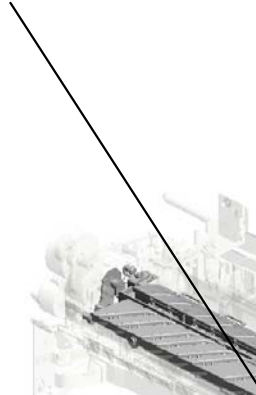

U041_S002
D0744467
PRESSURE SUB-UNIT:STRIP
PER PLATE:UNI:ASS'Y

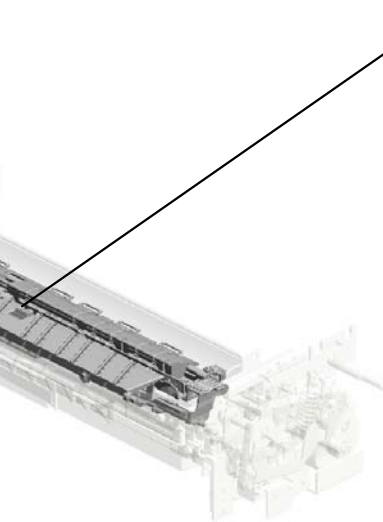

U001	U002	U003	U004	U005	U006	U007	U008	U009	U010	U011	U012	U013	U014	U015	U016	U017	U018	U019	U020	U021
------	------	------	------	------	------	------	------	------	------	------	------	------	------	------	------	------	------	------	------	------

U041 Fusing 3

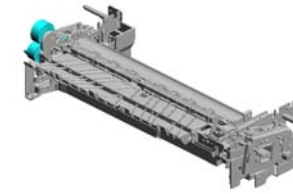

- 6.07270060E (x2) RETAINING RING - M6
- 11.AA064000 (x2) COMPRESSION SPRING:PRESSURE
- 2.07010060N WASHER DIA6
- 17.AE030044 (x2) BALL BEARING - 10X22X6
- 7.08046123 (x25) HEXAGONAL BOLT :W/WASHER:M3X8

5.07200060E (x13) RETAINING RING - M6

23.BB013025 GEAR:PRESSURE ROLLER

24.BB013026 GEAR:IDLER:25Z:ASSY

22.B1324313 (x2) PRESSURE SPRING HOLDER

13.AA066690 TORSION SPRING: DUCT:REAR

15.AE020200 PRESSURE ROLLER: DIA65

21.AX430193 HEATER:PRESSURE ROLLER:230V:400W/400W

20.AW110044 THERMOSTAT:150C:250V/17A

12.AA066689 TORSION SPRING: DUCT:FRONT

14.AA143520 (x9) SHOULDER SCREW - M3

1.03603006N (x41) SCREW - M3X6

9.09543010N SCREW:POLISHED ROUND/SPRING:M3X10

18.AE030058 (x2) BALL BEARING: DIA25:DIA37

16.AE030030 (x4) BALL BEARING - 8X19X6

8.09300404A (x2) PARALLEL KEY:4X4X25

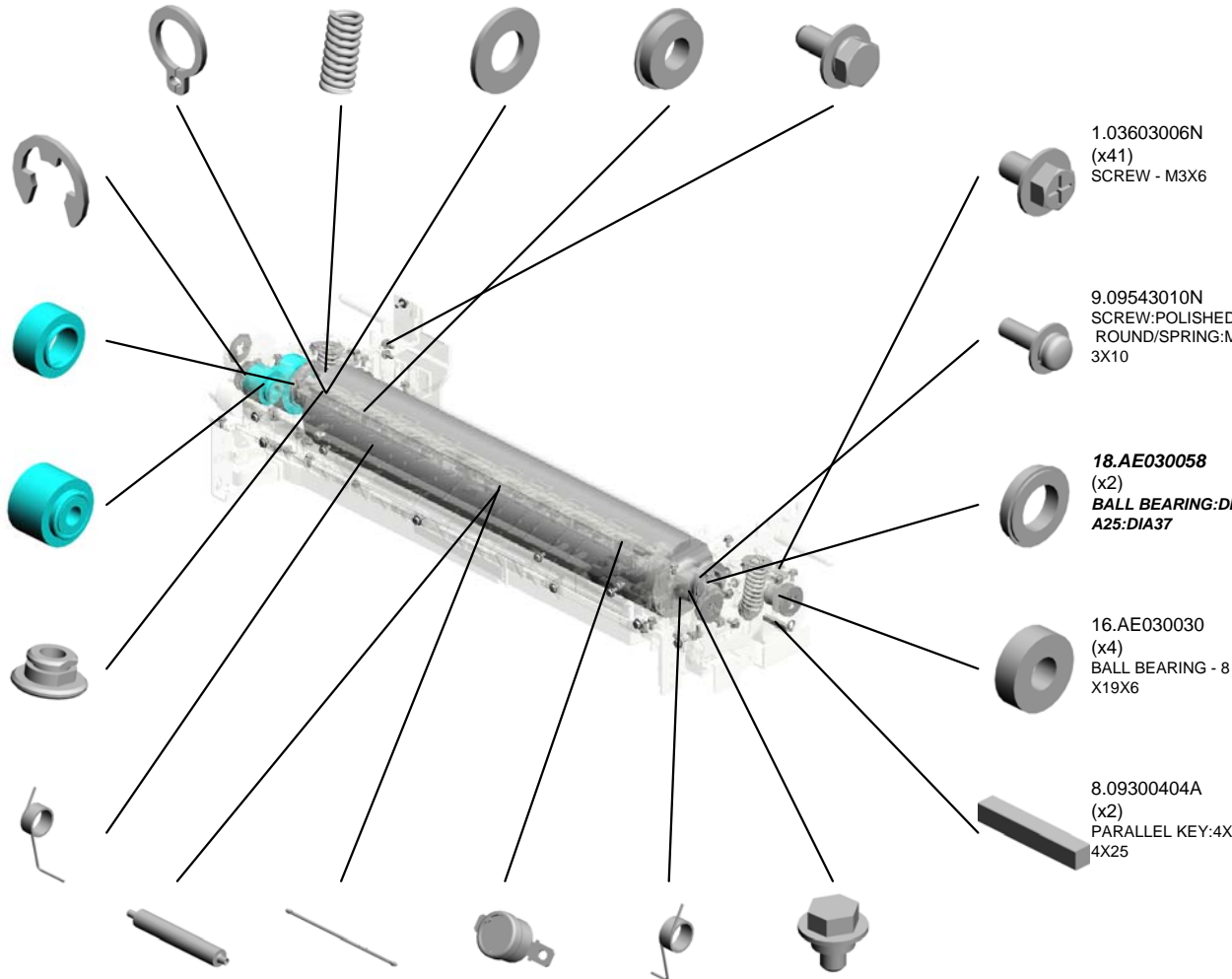

U041 Fusing 3

- 26.BB013028 GEAR:IDLER:35Z:ASSY
- 29.D0744000 (x2) SUPPORTING PLATE:LEVER:PRESSURE
- 31.D0744004 LEVER:PRESSURE:REAR:INNER
- 45.D0744060 SIDE PLATE:PRESSURE:REAR
- 46.D0744061 CLAMP:HARNES:PRESSURE

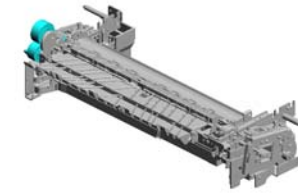

36.D0744015
HOLDER:HEATER:
PRESSURE:REAR

27.C2382873
ADJUSTING SCREW

34.D0744011
LEVER:PRESSURE:
:REAR:OUTER

25.BB013027
GEAR:JOINT:PRESSURE:ASSY

37.D0744016
LEVER:WEB:ASSY

28.D0144247
HOUSING - TEMPERATURE SENSOR

43.D0744056
FUSING ENTRANCE GUIDE PLATE:LOWER

48.D0744063
HOUSING:THERMOSTAT:ASSY

38.D0744026
ELECTRODE PLATE:HEATER:PRESSURE:FRONT

30.D0744001
LEVER:PRESSURE:FRONT:INNER

47.D0744062
BRACKET:THERMOSTOR:PRESSURE

32.D0744009
(x4)
HOLDER:M5

44.D0744059
SIDE PLATE:PRESSURE:FRONT

35.D0744014
HOLDER:HEATER:PRESSURE:FRONT

33.D0744010
LEVER:PRESSURE:FRONT:OUTER

U001	U002	U003	U004	U005	U006	U007	U008	U009	U010	U011	U012	U013	U014	U015	U016	U017	U018	U019	U020	U021
------	------	------	------	------	------	------	------	------	------	------	------	------	------	------	------	------	------	------	------	------

U041 Fusing 3

55.D0744072 (x2) STEPPED SCREW: M5
 65.D0744098 COVER:TERMINAL:CONNECTING
 63.D0744096 TERMINAL:CONNECTING
 66.D0744099 COVER:HARNESS:FIRST:LOWER
 64.D0744097 TAB:TERMINAL:CONNECTING

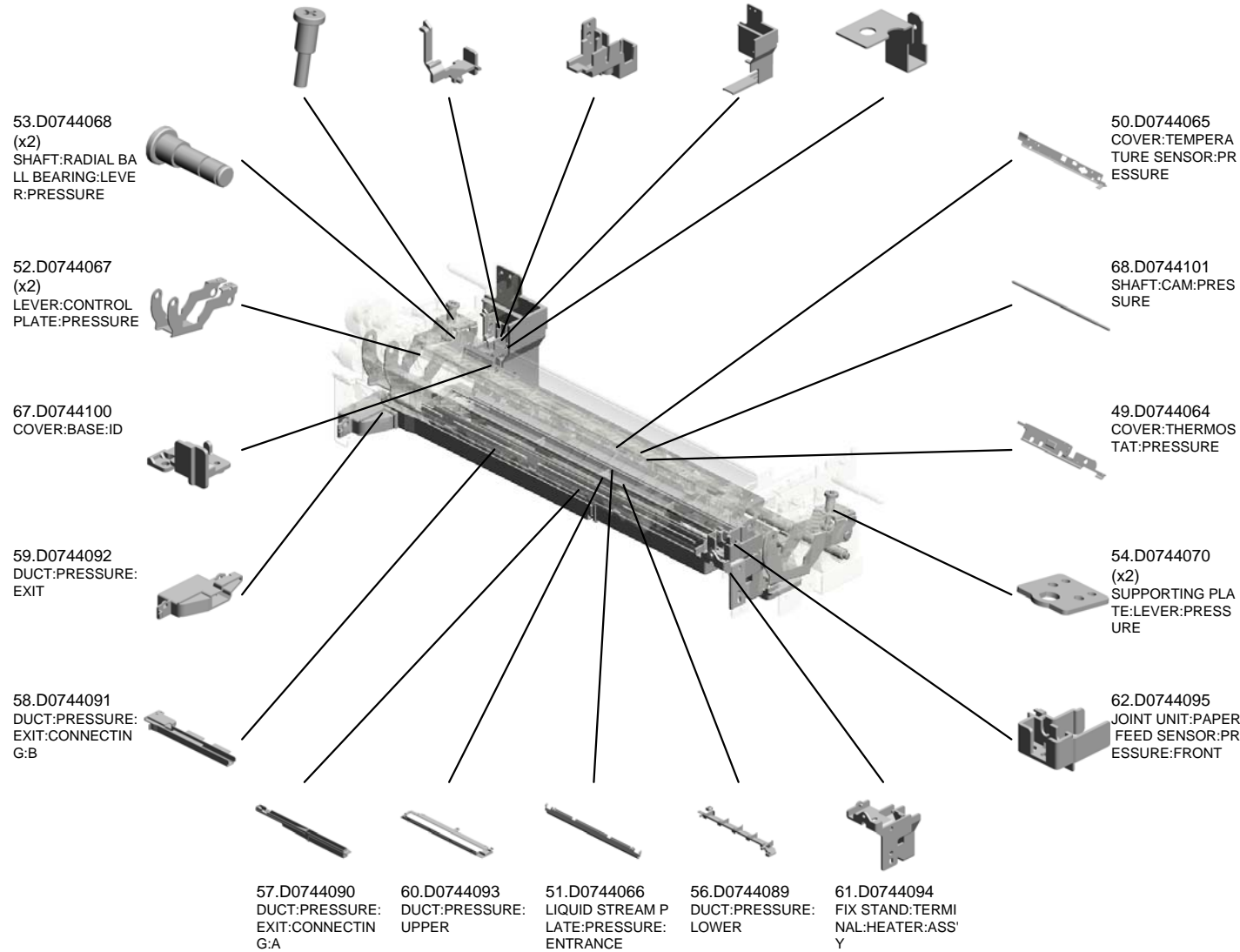
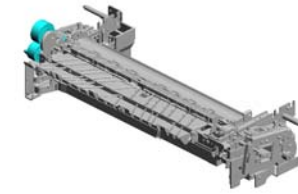

U001	U002	U003	U004	U005	U006	U007	U008	U009	U010	U011	U012	U013	U014	U015	U016	U017	U018	U019	U020	U021
------	------	------	------	------	------	------	------	------	------	------	------	------	------	------	------	------	------	------	------	------

U041 Fusing 3

77.D0744227 (x2)
BOLT:M5:ROUND POINT

69.D0744102 (x2)
COLLAR:DIA10X:DI
A14X:12

76.D0744208
COVER:GUARD:SI
DE PLATE:REAR

72.D0744105
FEELER:CAM:PRE
SSURE:REAR



73.D0744106
JOINT:CAM:PRESS
SURE:A

70.D0744103
(x2)
CAM:PRESSURE:A

75.D0744207
COVER:GREASE:G
EAR:JOINT:PRESS
SURE



83.D0745374
TEMPERATURE SE
NSOR:FUSING UNI
T:DRAWER:17PIN:
ASSY

71.D0744104
FEELER:CAM:PRE
SSURE:FRONT

85.GW020020
(x2)
PHOTOINTERRUP
TOR:LG248NL1

74.D0744107
COLLAR:DIA10XDI
A14X9.4

84.D0745414
PCB:TCRU-IDB

78.D0744230
GUIDE PLATE:FUSI
NG EXIT:LOWER:N
O.2:ASSY



U001	U002	U003	U004	U005	U006	U007	U008	U009	U010	U011	U012	U013	U014	U015	U016	U017	U018	U019	U020	U021
------	------	------	------	------	------	------	------	------	------	------	------	------	------	------	------	------	------	------	------	------

U041_S001
 GUIDE PLATE:FUSING EXIT:LOWER:CONNECTING:ASS'Y

14.AA143520 (x2)
 SHOULDER SCREW - M3
 79.D0744232
 GUIDE PLATE:FUSING EXIT:LOWER:CONNECTING:ASS'Y

82.D0744478
 GUIDE PLATE:FUSING EXIT:LOWER:CONNECTING:ASS'Y



10.AA061115 (x2)
 TENSION SPRING: 0.4N

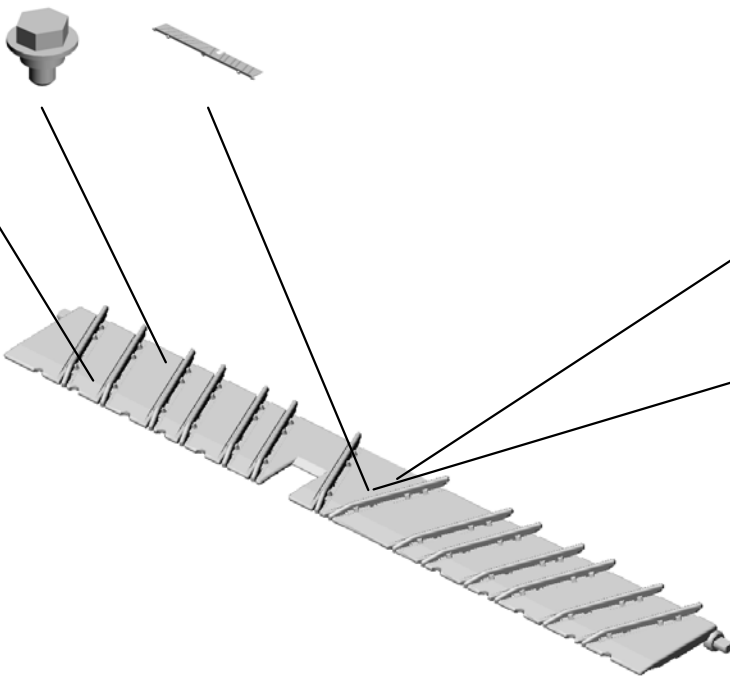

7.08046123
 HEXAGONAL BOLT :WASHER:M3X8

80.D0744235
 SUPPORTING PLATE:GUIDE PLATE:FUSING EXIT:LOWER

U001	U002	U003	U004	U005	U006	U007	U008	U009	U010	U011	U012	U013	U014	U015	U016	U017	U018	U019	U020	U021
------	------	------	------	------	------	------	------	------	------	------	------	------	------	------	------	------	------	------	------	------

U041_S002

PRESSURE SUB-UNIT:STRIPPER PLATE:UNI:ASS'Y

41.D0744053
LEVER:RELEASE:STRIPPER PLATE:PRESSURE

86.D0744236
GUIDE PLATE:FUSING EXIT:LOWER:ASSY
201109-21

42.D0744054
BRACKET:PAPER FEED SENSOR:FUSING EXIT



81.D0744467
PRESSURE SUB-UNIT:STRIPPER PLATE:UNI:ASSY

3.07200030E
RETAINING RING - M3

40.D0744049
LEVER:STRIPPER PLATE:RELEASE:PRESSURE

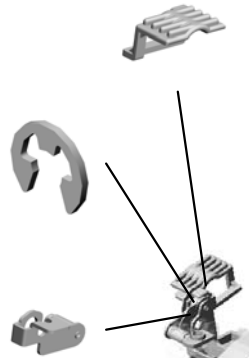

19.AW010200
(x3)
PAPER FEED SENSOR:FUSING EXIT

7.08046123
HEXAGONAL BOLT :W/WASHER:M3X8



4.07200040E
(x2)
RETAINING RING - M4



39.D0744028
HOLDER:STRIPPER PLATE:UNIT

14.AA143520
SHOULDER SCREW - M3



U001	U002	U003	U004	U005	U006	U007	U008	U009	U010	U011	U012	U013	U014	U015	U016	U017	U018	U019	U020	U021
------	------	------	------	------	------	------	------	------	------	------	------	------	------	------	------	------	------	------	------	------

U042.Fusing Cleaning 1

U042_S001
D0744450
WEB:CLEANING UNIT:ASSY

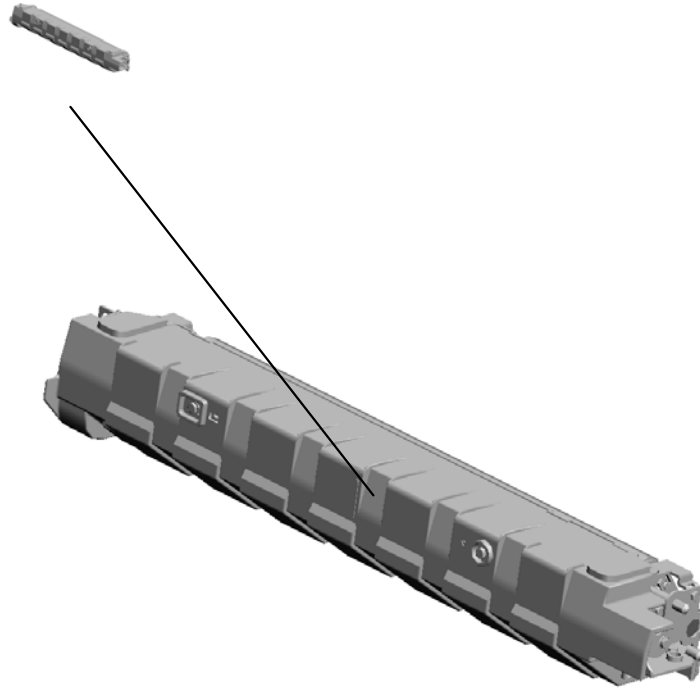

U001	U002	U003	U004	U005	U006	U007	U008	U009	U010	U011	U012	U013	U014	U015	U016	U017	U018	U019	U020	U021
------	------	------	------	------	------	------	------	------	------	------	------	------	------	------	------	------	------	------	------	------

U042_S001.WEB:CLEANING UNIT:ASS'Y

U042_S001_S002
D0744329
WEB:GEAR:ASSY

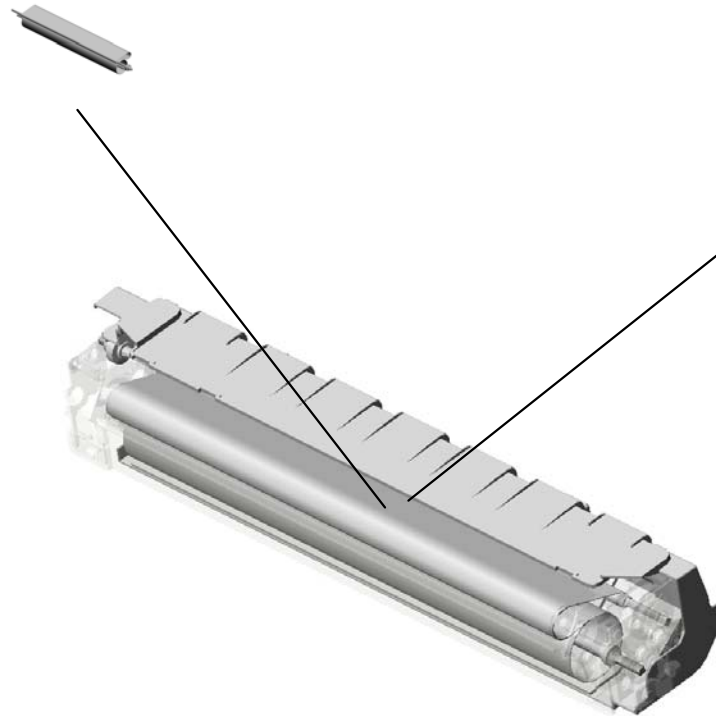

U042_S001_S001
D0744325
COVER:WEB:CLEANING FEL
T

U001	U002	U003	U004	U005	U006	U007	U008	U009	U010	U011	U012	U013	U014	U015	U016	U017	U018	U019	U020	U021
------	------	------	------	------	------	------	------	------	------	------	------	------	------	------	------	------	------	------	------	------

U042
Fusing Cleaning 1



U001	U002	U003	U004	U005	U006	U007	U008	U009	U010	U011	U012	U013	U014	U015	U016	U017	U018	U019	U020	U021
------	------	------	------	------	------	------	------	------	------	------	------	------	------	------	------	------	------	------	------	------

U042_S001
WEB:CLEANING UNIT:ASS'Y

3.05730030E
HEXAGON HEADL
ESS SET SCREW -
M3X3

10.AA080355
(x2)
BUSHING - 7MM

18.AB010178
WORM GEAR

11.AA080356
(x2)
BUSHING - 6MM

6.08046123
HEXAGONAL BOLT
:W/WASHER:M3X8



34.D0744450
WEB:CLEANING U
NIT:ASSY

5.07200040E
(x5)
RETAINING RING -
M4

9.AA080354
(x3)
BUSHING - 6MM

4.07200030E
(x2)
RETAINING RING -
M3

8.AA066401
TORSION SPRING:
FEELER

1.04543006Q
(x21)
TAPPING SCREW -
M3X6



12.AA143520
SHOULDER SCRE
W - M3

20.D0094388
ROLLER CLUTCH

13.AB010173
GEAR - 60Z

14.AB010174
GEAR - 20Z/50Z

19.B2342390
FLANGED HEXAG
ONAL HEAD BOLT:
M4X8

7.AA063465
(x2)
COMPRESSION SP
RING:CLEANING F
ELT:27N

16.AB010176
GEAR - 24Z

21.D0744300
SPRING PLATE:CL
EANING UNIT:FUSI
NG

2.04543008Q
TAPPING SCREW:
3X8

15.AB010175
GEAR - 24Z

U001	U002	U003	U004	U005	U006	U007	U008	U009	U010	U011	U012	U013	U014	U015	U016	U017	U018	U019	U020	U021
------	------	------	------	------	------	------	------	------	------	------	------	------	------	------	------	------	------	------	------	------

U042_S001
WEB:CLEANING UNIT:ASS'Y

25.D0744308 BRACKET:FRONT:WEB
23.D0744303 FEELER:CLEANING
24.D0744304 SHAFT:WORM GEAR:SUB-ASS'Y

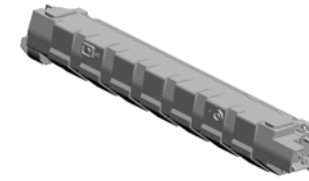

34.D0744450
WEB:CLEANING UNIT:ASS'Y

35.M0774200
MECHANICAL ROLLER CLUTCH:ROLLER

26.D0744309
BRACKET:FRONT:AUXILIARY

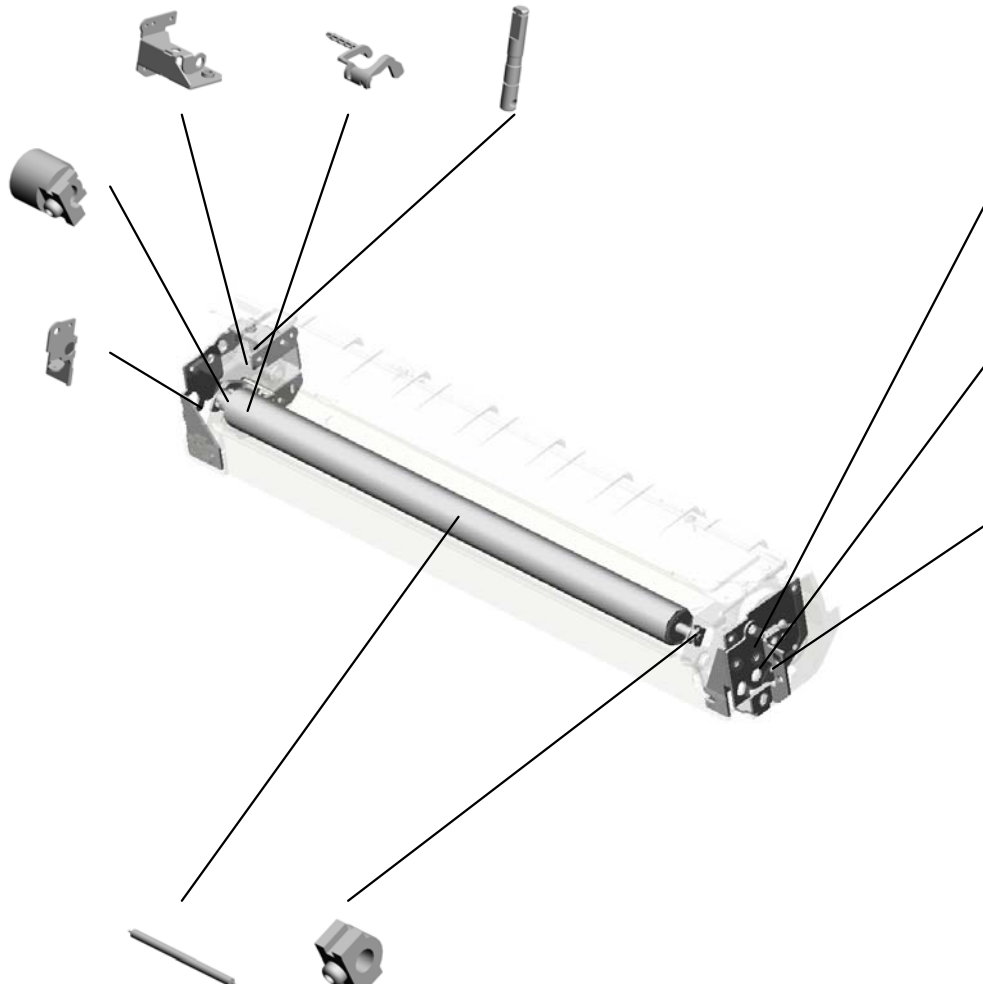

27.D0744310
BRACKET:REAR

28.D0744311
BRACKET:REAR:WEB

29.D0744314
BRACKET:REAR:PIN

32.D0744333
ROLLER:PLATE

22.D0744302
PLAIN SHAFT BEARING:ROLLER:REAR

U001	U002	U003	U004	U005	U006	U007	U008	U009	U010	U011	U012	U013	U014	U015	U016	U017	U018	U019	U020	U021
------	------	------	------	------	------	------	------	------	------	------	------	------	------	------	------	------	------	------	------	------

U042_S001_S001
COVER:WEB:CLEANING FELT

33.D0744380
DECAL:H-TEMP W
ARNING:FUSING:
WEB



30.D0744325
COVER:WEB:CLEA
NING FELT



U001	U002	U003	U004	U005	U006	U007	U008	U009	U010	U011	U012	U013	U014	U015	U016	U017	U018	U019	U020	U021
------	------	------	------	------	------	------	------	------	------	------	------	------	------	------	------	------	------	------	------	------

U042_S001_S002
WEB:GEAR:ASS'Y

3.05730030E 17.AB010177
HEXAGON HEADL GEAR - 32Z
ESS SET SCREW -
M3X3

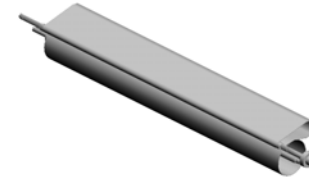

31.D0744329
WEB:GEAR:ASS'Y

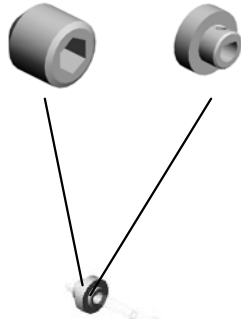

11.AA080356
BUSHING - 6MM



U001	U002	U003	U004	U005	U006	U007	U008	U009	U010	U011	U012	U013	U014	U015	U016	U017	U018	U019	U020	U021
------	------	------	------	------	------	------	------	------	------	------	------	------	------	------	------	------	------	------	------	------

U043

Fusing Cleaning 2

20.D0744351 (x4) STEPPED SCREW: DIA5.4DIA:DIA3.5:M3

2.04514008N (x3) TAPPING SCREW: 4X8

19.D0744350 BRACKET:DRAWER R:FUSING SECTIO N:24

6.08046123 HEXAGONAL BOLT :W/WASHER:M3X8

9.53041639 (x2) BUSHING - 8MM

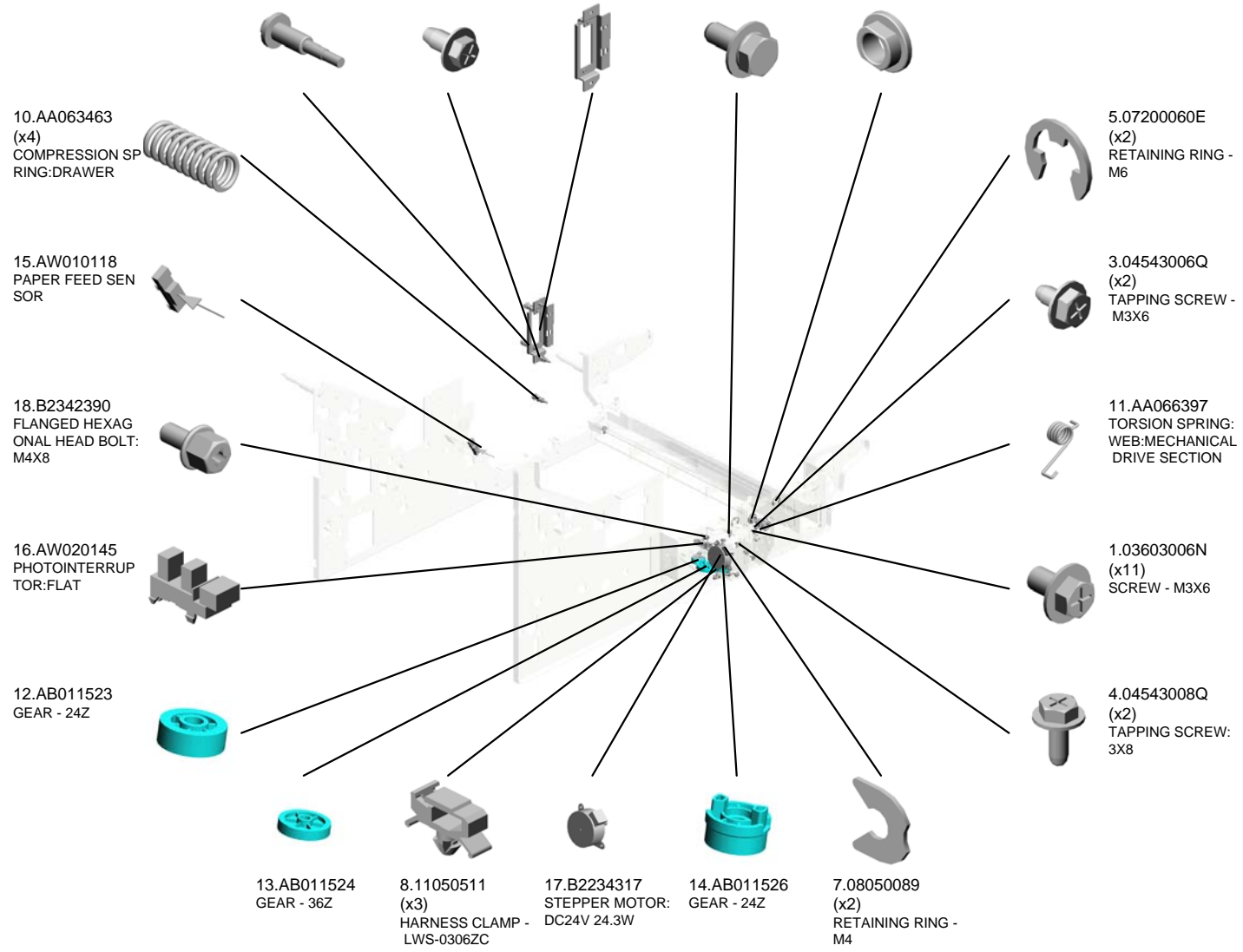
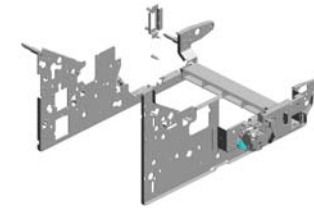

U043

Fusing Cleaning 2

22.D0744353
COVER:GEAR:JOI
NT

28.D0744398
DUCT:PRESSURE:
CONNECTING:A

29.D0744399
DUCT:PRESSURE:
CONNECTING:B

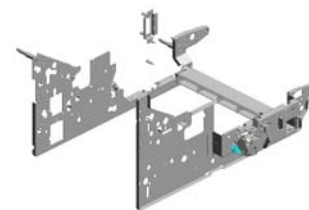

27.D0744372
BRACKET:WEB:PH
OTOINTERRUPTO
R:MAIN



21.D0744352
JOINT:GEAR:WEB:
DRIVE



26.D0744371
GRIP:SLIDER:FUSI
NG

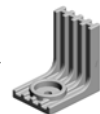

25.D0744364
BRACKET:WEB:CL
EANING



24.D0744356
BRACKET:LEVER:
WEB:DRIVE SUB-U
NIT



23.D0744354
GEAR:SLOW DOW
N:WORM GEAR



U001	U002	U003	U004	U005	U006	U007	U008	U009	U010	U011	U012	U013	U014	U015	U016	U017	U018	U019	U020	U021
------	------	------	------	------	------	------	------	------	------	------	------	------	------	------	------	------	------	------	------	------

U044 Paper Exit 1

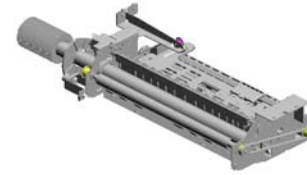

- 7.04544006Q (x3) TAPPING SCREW: 4X6
- 9.07200030E (x2) RETAINING RING - M3
- 19.AA063680 (x2) PRESSURE SPRING - 5X10.5
- 17.67542866 ROLLER - POSITIONING GUIDE
- 3.04503008N (x4) TAPPING SCREW - M3X8

- 8.04544008Q (x2) TAPPING SCREW - M4X8

- 18.AA062319 SPRING

- 6.04543008Q TAPPING SCREW: 3X8

- 4.04513006N (x2) TAPPING SCREW - 3X6

- 5.04514008N (x5) TAPPING SCREW: 4X8

- 11.07200060E (x5) RETAINING RING - M6

- 15.11050600 CLAMP:LWSM-030 6-2M

- 16.54472681 SNAP RING

- 13.07423808 (x3) BALL BEARING - 8 X16X5

- 12.07200080E (x2) RETAINING RING - M8

- 1.03603006N (x3) SCREW - M3X6

- 2.03604008N (x2) SCREW - M4X8

- 20.AA080240 (x2) BUSHING - MM5

- 14.11050511 (x4) HARNESS CLAMP - LWS-0306ZC

- 10.07200040E (x5) RETAINING RING - M4

U001	U002	U003	U004	U005	U006	U007	U008	U009	U010	U011	U012	U013	U014	U015	U016	U017	U018	U019	U020	U021
------	------	------	------	------	------	------	------	------	------	------	------	------	------	------	------	------	------	------	------	------

U044 Paper Exit 1

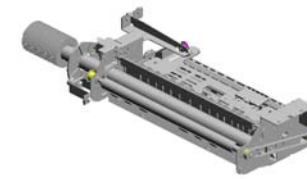
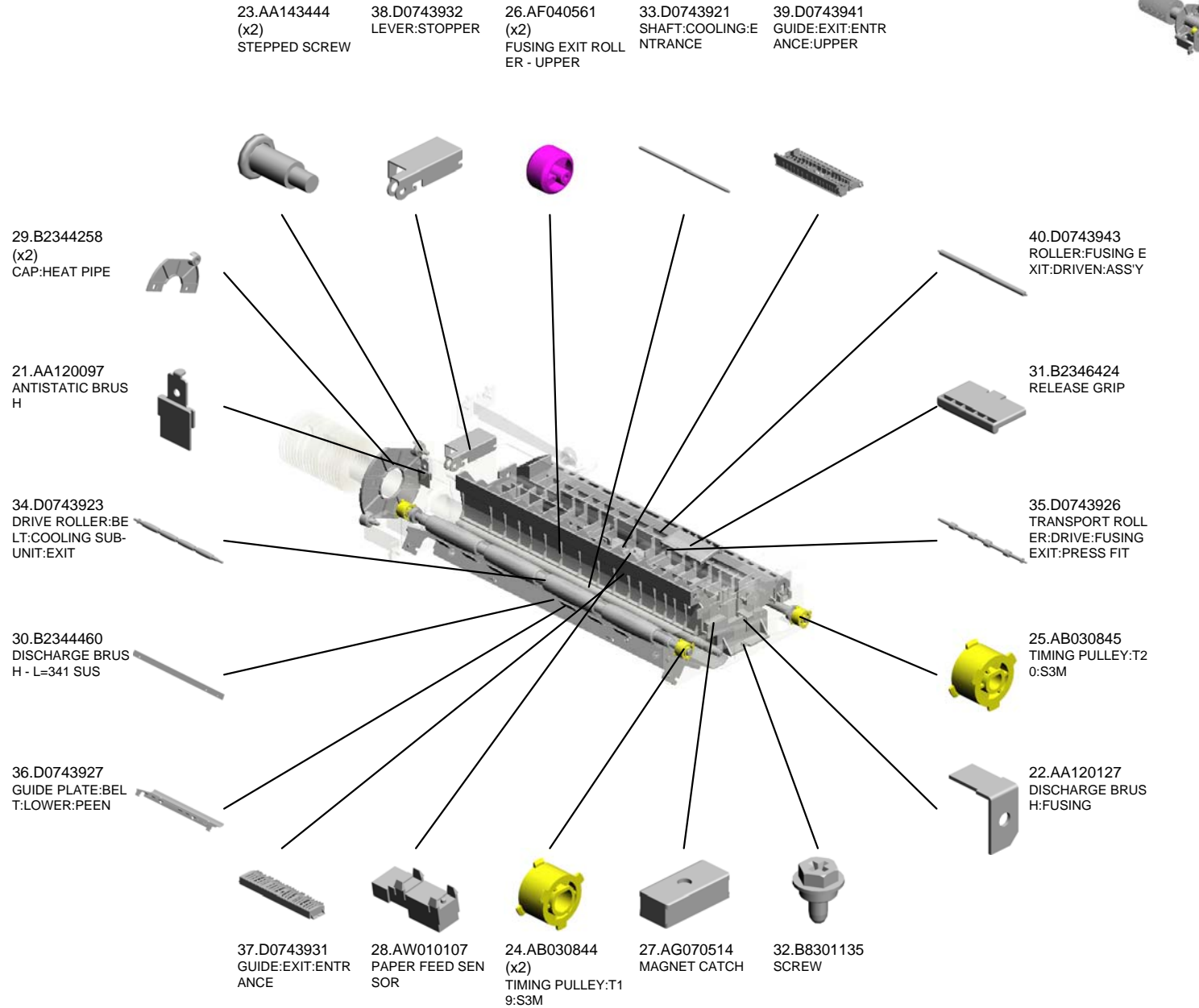

U001	U002	U003	U004	U005	U006	U007	U008	U009	U010	U011	U012	U013	U014	U015	U016	U017	U018	U019	U020	U021
------	------	------	------	------	------	------	------	------	------	------	------	------	------	------	------	------	------	------	------	------

U044 Paper Exit 1

- 55.G1784828 (x2) STAY:LOCK:LEVER:LEFT LOWER
- 54.G1784815 (x2) LEVER:LOCK:LEFT LOWER:FRAME
- 57.M0262872 (x2) TENSION SPRING:GRIP
- 50.D0743991 PLATE:EXIT:ENTRANCE
- 47.D0743963 SHEET:TRANSPORT:COOLING:INNER BACK

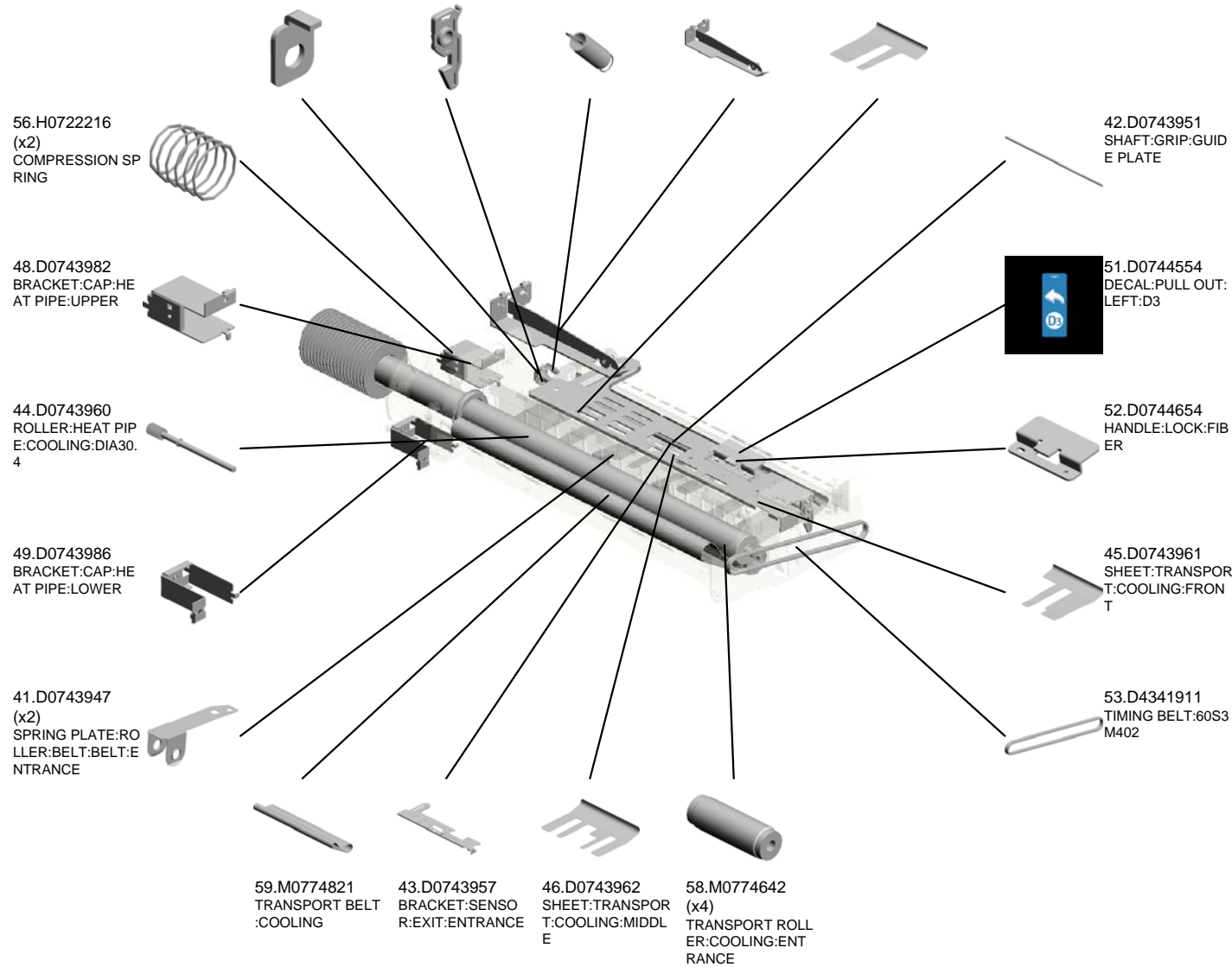
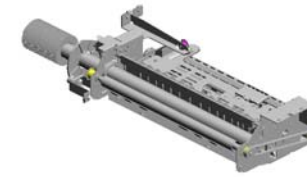

U001	U002	U003	U004	U005	U006	U007	U008	U009	U010	U011	U012	U013	U014	U015	U016	U017	U018	U019	U020	U021
------	------	------	------	------	------	------	------	------	------	------	------	------	------	------	------	------	------	------	------	------

U045 Paper Exit 2

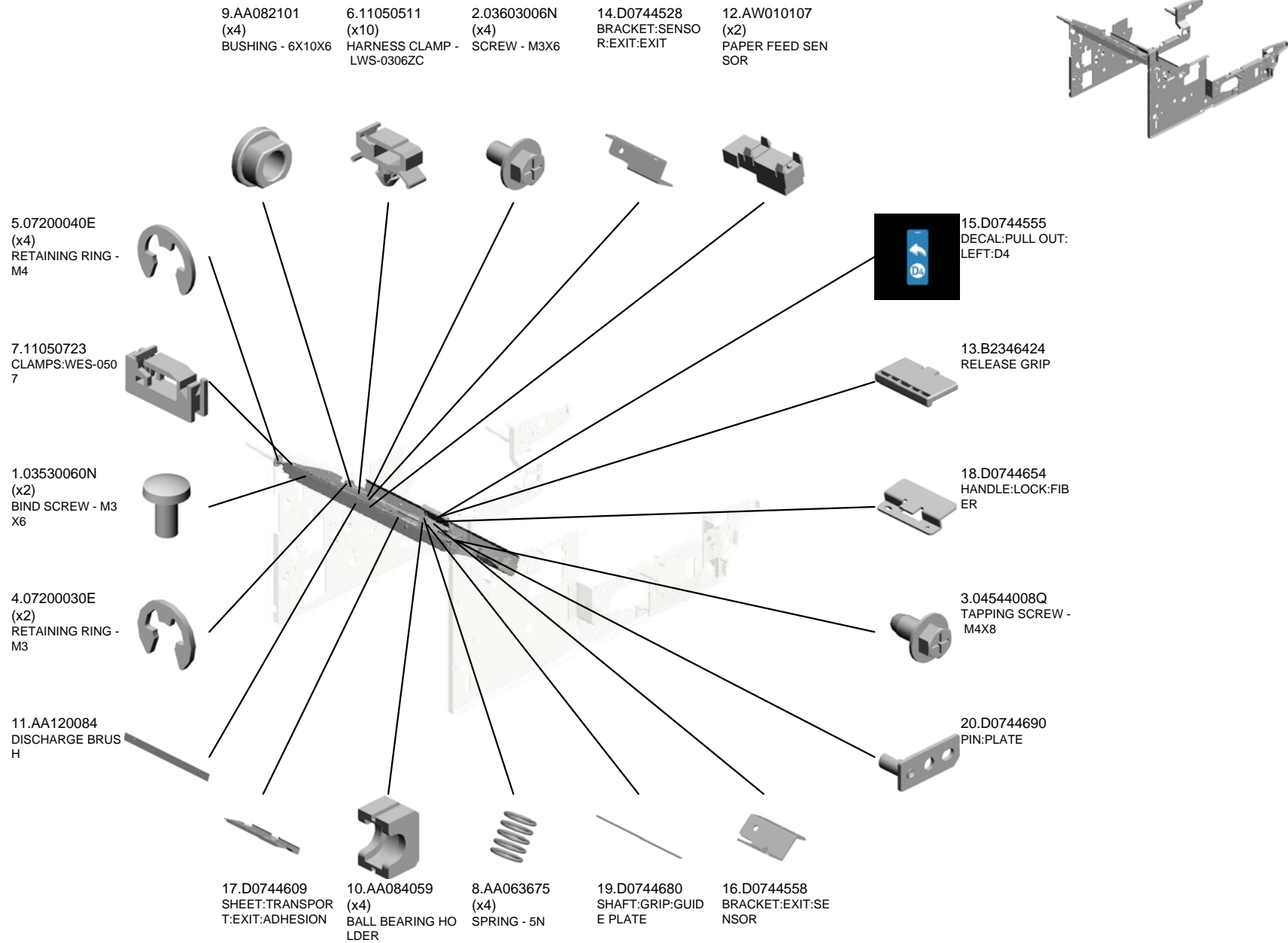

U001	U002	U003	U004	U005	U006	U007	U008	U009	U010	U011	U012	U013	U014	U015	U016	U017	U018	U019	U020	U021
------	------	------	------	------	------	------	------	------	------	------	------	------	------	------	------	------	------	------	------	------

U045
Paper Exit 2

21.G1784815 (x2)
LEVER:LOCK:LEFT
LOWER:FRAME

24.M3791627 (x2)
TRANSPORT ROLL
ER:DRIVEN

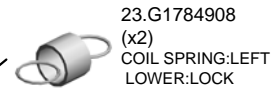
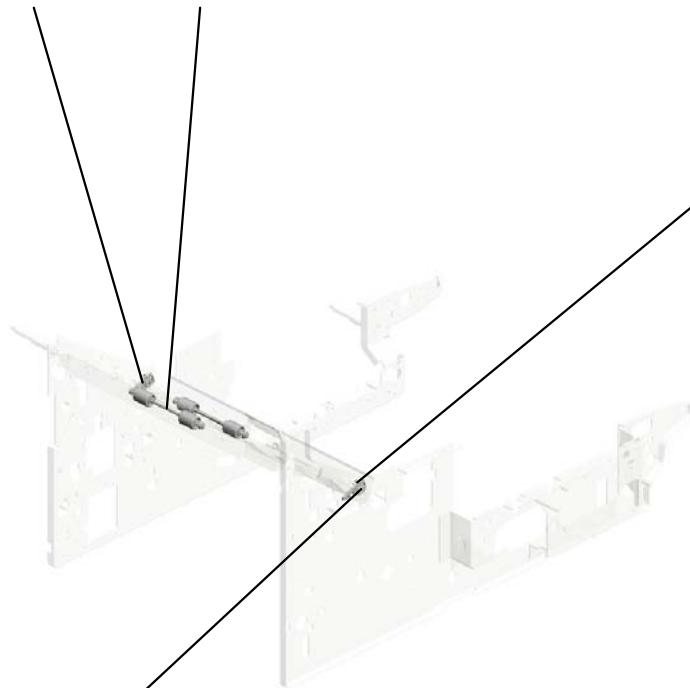
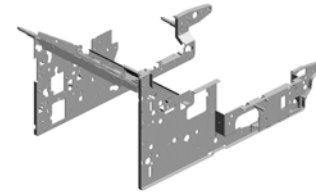

23.G1784908 (x2)
COIL SPRING:LEFT
LOWER:LOCK



22.G1784828 (x2)
STAY:LOCK:LEVER
:LEFT LOWER

U046.Paper Exit 3

U046_S003
D0744544
DAMPING INSULATION:REV
ERSE:ENTRANCE:ADHESIO
N

U046_S002
D0744541
DAMPING INSULATION:REV
ERSE:ADHESION

U046_S001
D0744540
DAMPING INSULATION:DUP
LEX:ENTRANCE:ADHESION

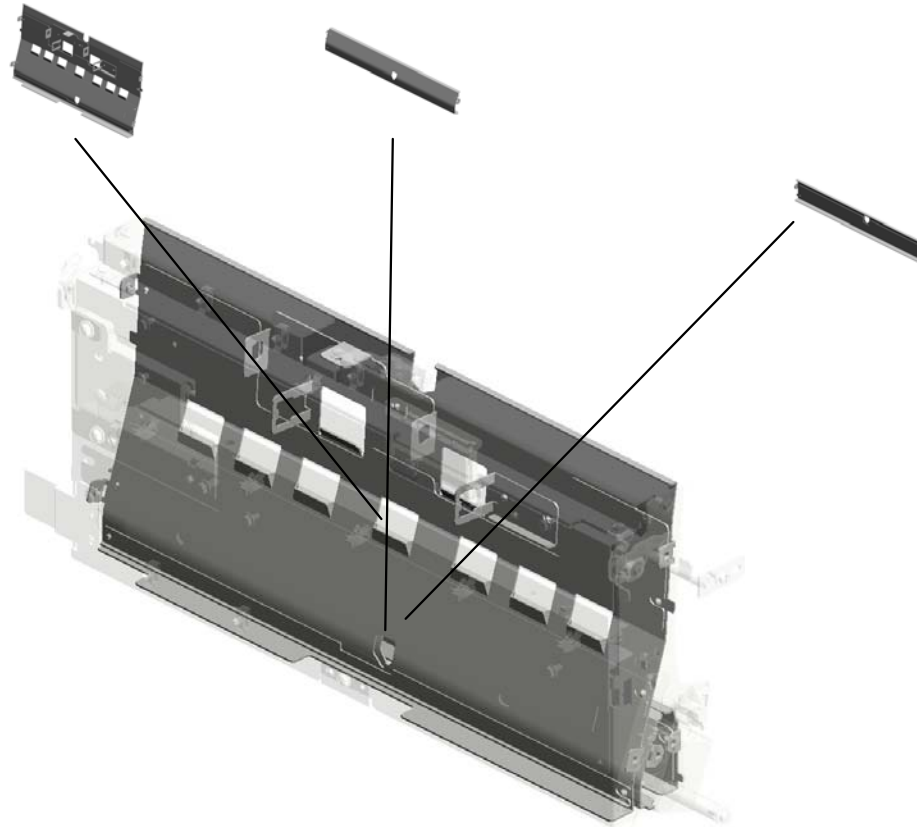

U001	U002	U003	U004	U005	U006	U007	U008	U009	U010	U011	U012	U013	U014	U015	U016	U017	U018	U019	U020	U021
------	------	------	------	------	------	------	------	------	------	------	------	------	------	------	------	------	------	------	------	------

U046 Paper Exit 3

- 4.07200040E (x7) RETAINING RING - M4
- 7.11050511 (x13) HARNESS CLAMP - LWS-0306ZC
- 21.D0744580 DC SOLENOID:REVERSE ROLLER:ASSY
- 1.03603006N (x28) SCREW - M3X6
- 6.08053384 (x2) BUSHING - 5MM

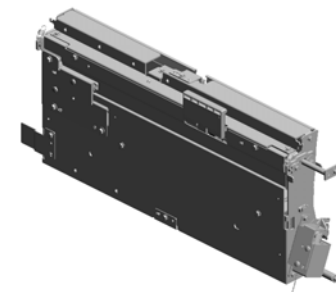

8.AA082101 (x2) BUSHING - 6X10X6

2.03604008N (x5) SCREW - M4X8

14.D0744519 COVER:HARNESS: SWITCHBACK:LEFT LOWER

5.07200060E (x2) RETAINING RING - M6

9.AA082104 (x2) BUSHING - 8X12X7

23.D0744625 COVER:REVERSE UNIT:LEFT LOWER

12.AW010107 (x2) PAPER FEED SENSOR

11.AA120145 DISCHARGE BRUSH:REVERSE:17MM

20.D0744577 GATE PAWL:SWITCHBACK

22.D0744611 DC SOLENOID:GATE PAWL:SWITCHBACK:ASSY

19.D0744567 SHAFT:LOCK:REVERSE

13.B2346424 RELEASE GRIP

18.D0744556 DECAL:PULL OUT:LEFT:D5

10.AA084059 (x2) BALL BEARING HOLDER

3.04544008Q TAPPING SCREW - M4X8

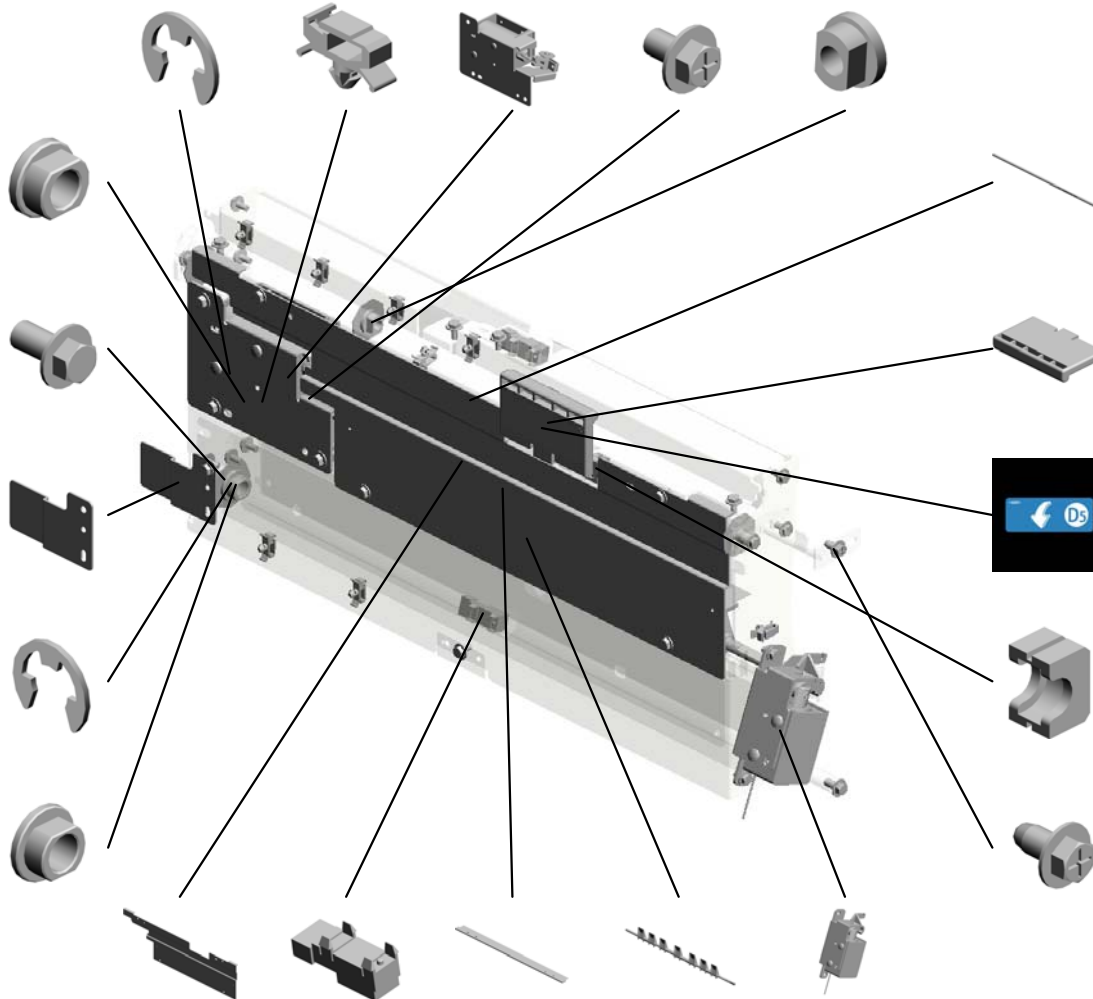

U046 Paper Exit 3

37.G1784908 (x2)
COIL SPRING:LEFT LOWER:LOCK

34.G1784815 (x2)
LEVER:LOCK:LEFT LOWER:FRAME

35.G1784822 (x2)
SPRING:PRESSURE:0.8N:DIA0.65

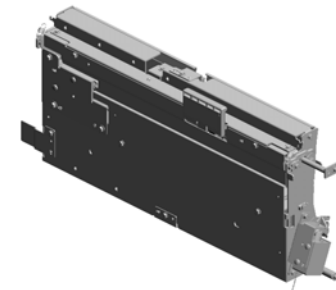

36.G1784828 (x2)
STAY:LOCK:LEVER:LEFT LOWER

33.G1784813
STOPPER:LEFT LOWER:FRAME

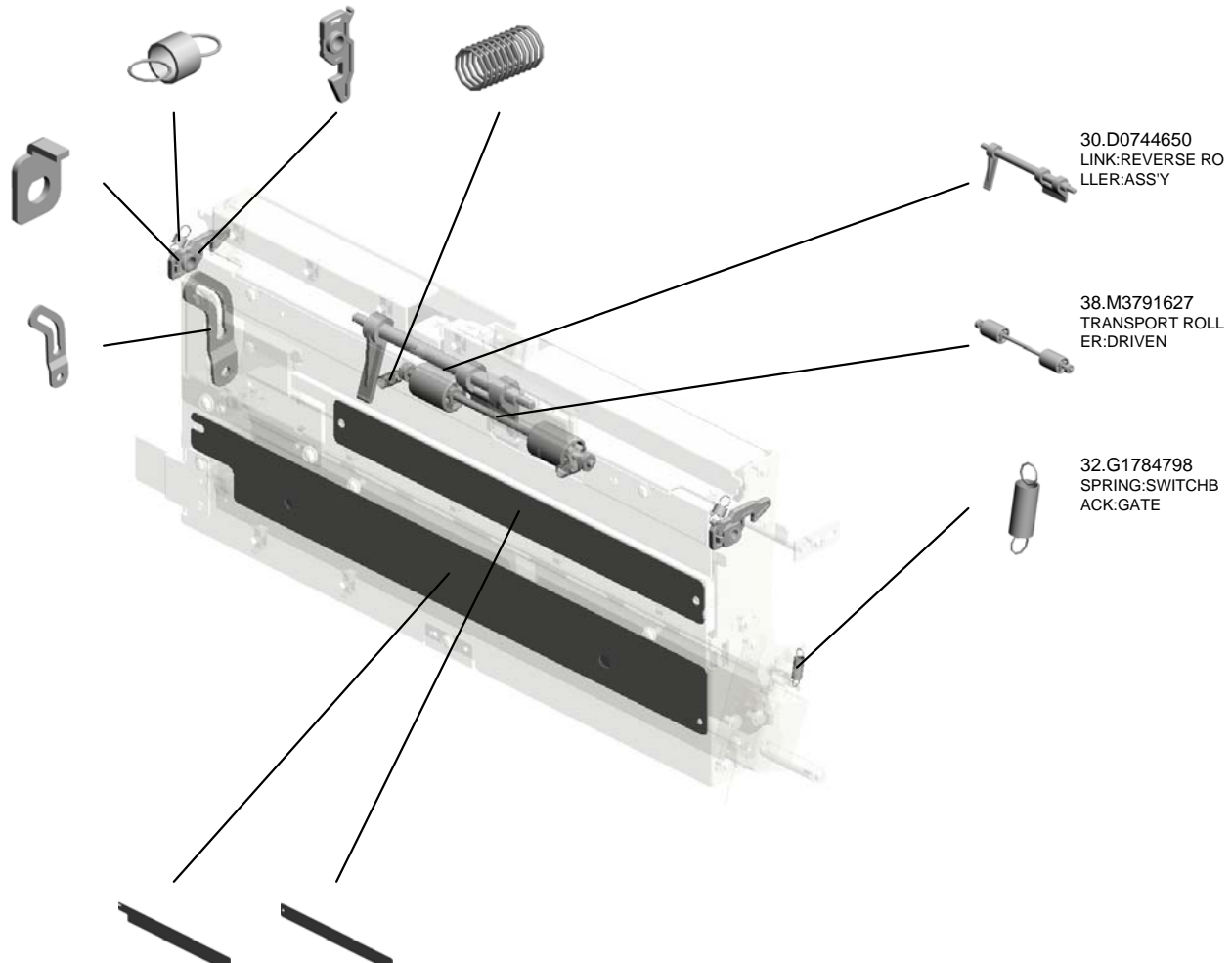

30.D0744650
LINK:REVERSE ROLLER:ASSY

38.M3791627
TRANSPORT ROLLER:DRIVEN

32.G1784798
SPRING:SWITCHBACK:GATE

25.D0744627
DAMPING INSULATION:REVERSE ENTRANCE:LOWER

28.D0744630
DAMPING INSULATION:COVER:REVERSE UNIT

U046_S001
DAMPING INSULATION:DUPLEX:ENTRANCE:ADHESION

27.D0744629
DAMPING INSULATION:DUPLEX:ENTRANCE

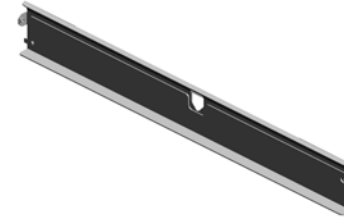
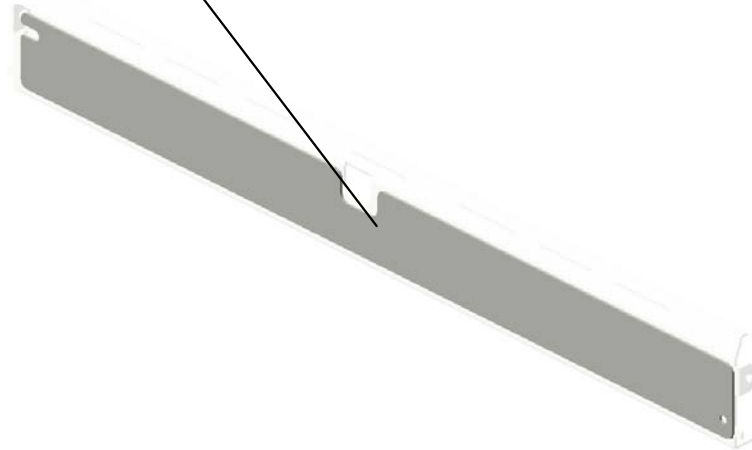

15.D0744540
DAMPING INSULATION:DUPLEX:ENTRANCE:ADHESION

U001	U002	U003	U004	U005	U006	U007	U008	U009	U010	U011	U012	U013	U014	U015	U016	U017	U018	U019	U020	U021
------	------	------	------	------	------	------	------	------	------	------	------	------	------	------	------	------	------	------	------	------

U046_S002
DAMPING INSULATION:REVERSE:ADHESION

26.D0744628
DAMPING INSULAT
ION:REVERSE:UPP
ER



29.D0744631
DAMPING INSULAT
ION:REVERSE:LO
WER

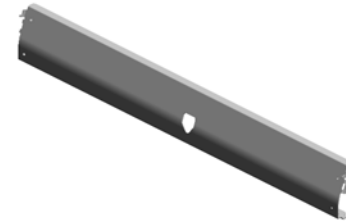
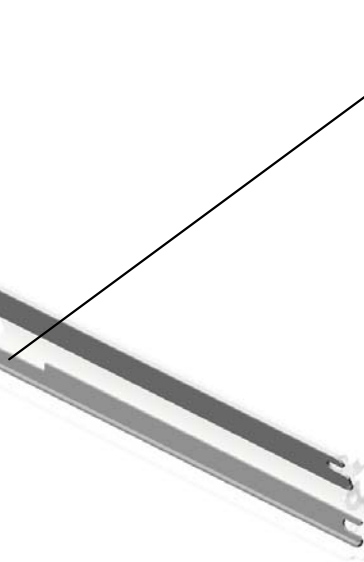

16.D0744541
DAMPING INSULAT
ION:REVERSE:AD
HESION

U001	U002	U003	U004	U005	U006	U007	U008	U009	U010	U011	U012	U013	U014	U015	U016	U017	U018	U019	U020	U021
------	------	------	------	------	------	------	------	------	------	------	------	------	------	------	------	------	------	------	------	------

U046_S003

DAMPING INSULATION:REVERSE:ENTRANCE:ADHESION

24.D0744626
DAMPING INSULAT
ION:REVERSE:ENT
RANCE:UPPER

25.D0744627
DAMPING INSULAT
ION:REVERSE:ENT
RANCE:LOWER

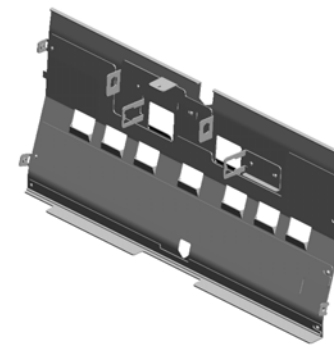

17.D0744544
DAMPING INSULAT
ION:REVERSE:ENT
RANCE:ADHESION

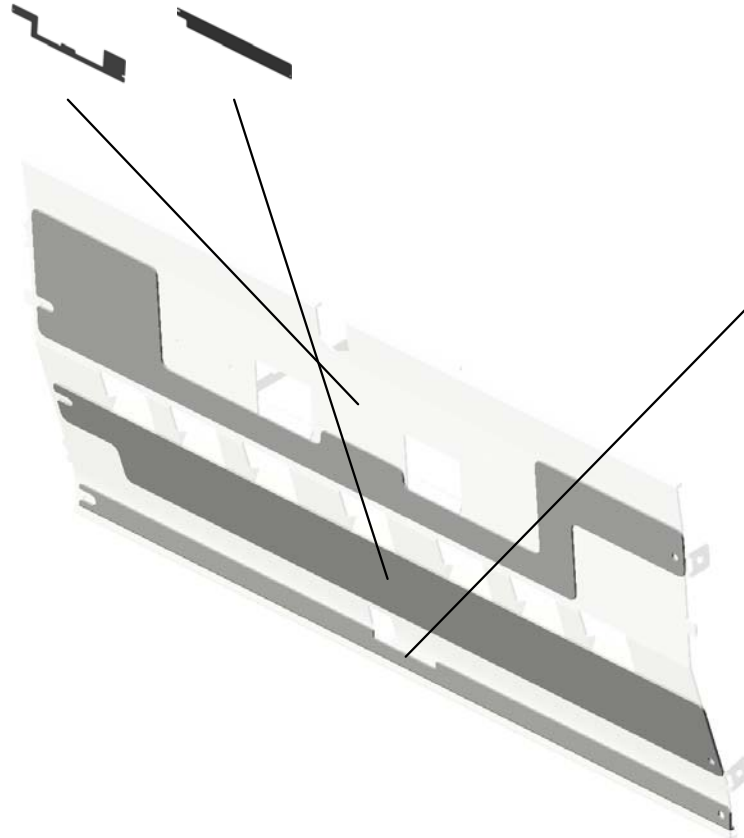

29.D0744631
DAMPING INSULAT
ION:REVERSE:LO
WER

U001	U002	U003	U004	U005	U006	U007	U008	U009	U010	U011	U012	U013	U014	U015	U016	U017	U018	U019	U020	U021
------	------	------	------	------	------	------	------	------	------	------	------	------	------	------	------	------	------	------	------	------

U047 Paper Exit 4

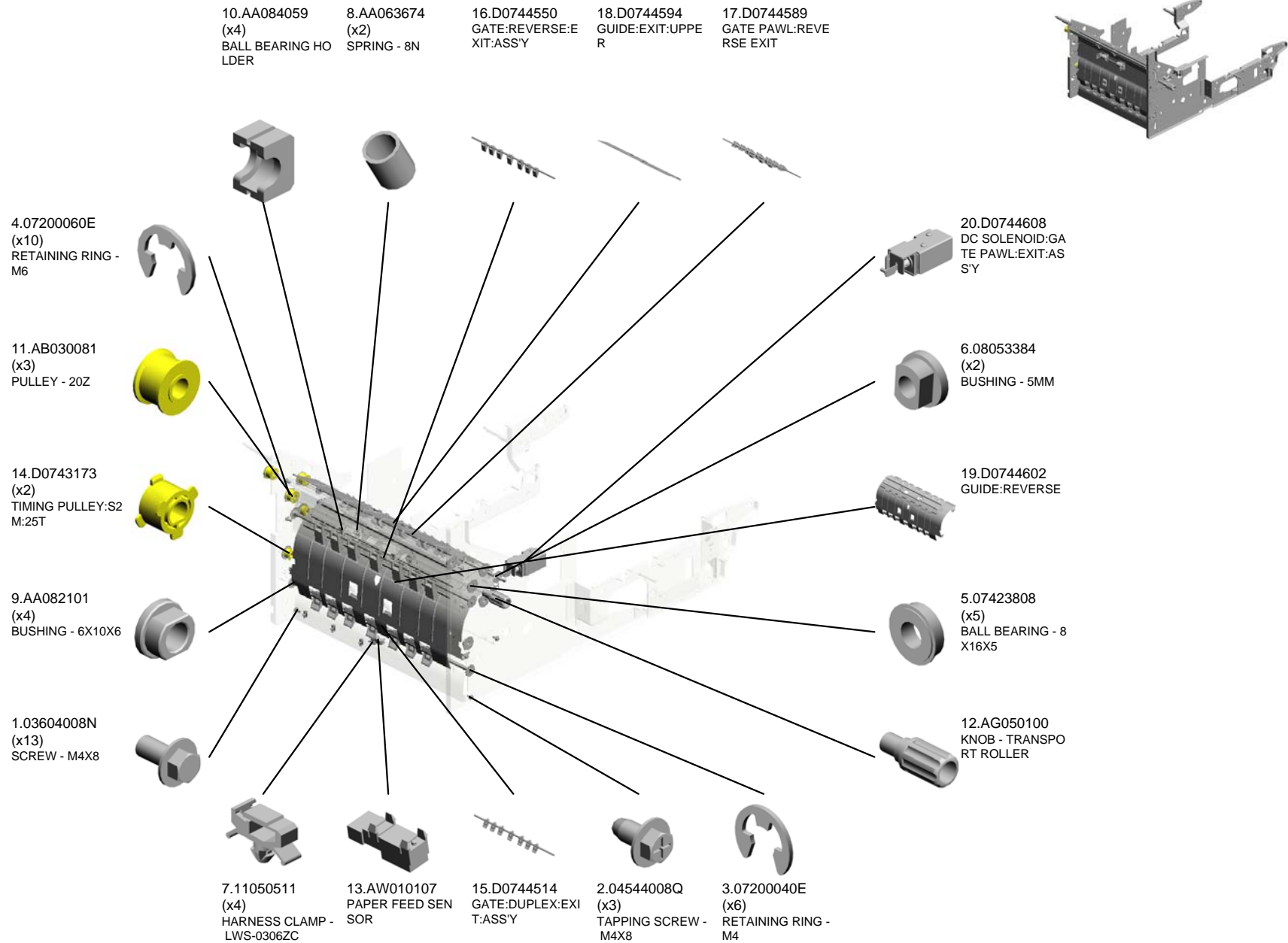

U001	U002	U003	U004	U005	U006	U007	U008	U009	U010	U011	U012	U013	U014	U015	U016	U017	U018	U019	U020	U021
------	------	------	------	------	------	------	------	------	------	------	------	------	------	------	------	------	------	------	------	------

U047 Paper Exit 4

23.D0744614
(x2)
TRANSPORT ROLL
ER:CONNECTING:
DRIVE:EXIT:PRES
S FIT

32.M3791627
(x2)
TRANSPORT ROLL
ER:DRIVEN

24.D0744615
GUIDE PLATE:REV
ERSE EXIT:ASSY

22.D0744613
EXIT ROLLER:DRIV
E:REVERSE:EXIT:P
RESS FIT

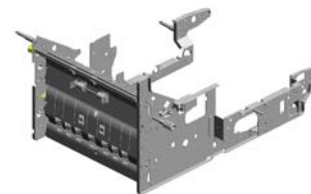

30.G1784822
(x2)
SPRING:PRESSUR
E:0.8N:DIA0.65

28.G1783593
(x14)
TENSION SPRING:
STOPPER



25.D0744656
LEVER:GATE PAW
L:REVERSE

29.G1784793
SPRING:REVERSE:
GATE

31.G1784852
RUBBER FOOT:708
6082

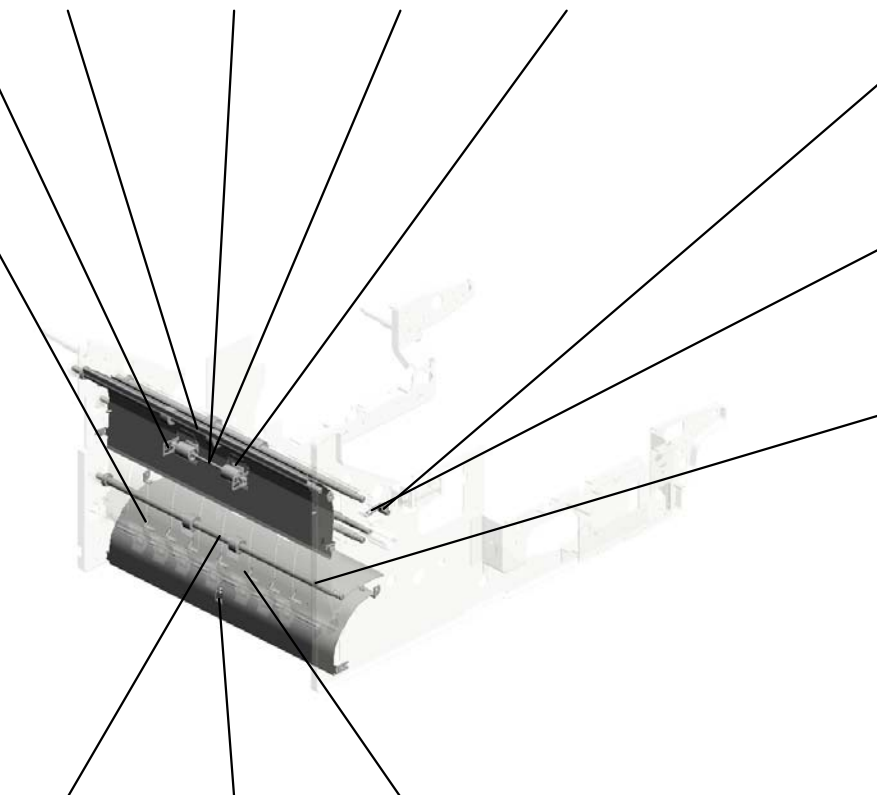

21.D0744612
(x2)
TRANSPORT ROLL
ER:DRIVE:REVERS
E:PRESS FIT

27.D0744670
BRACKET:DUPL
EX:REVERSE:SENSO
R

26.D0744667
GUIDE:DUPL
EX:EN
TRANCE



U048 Paper Exit 5

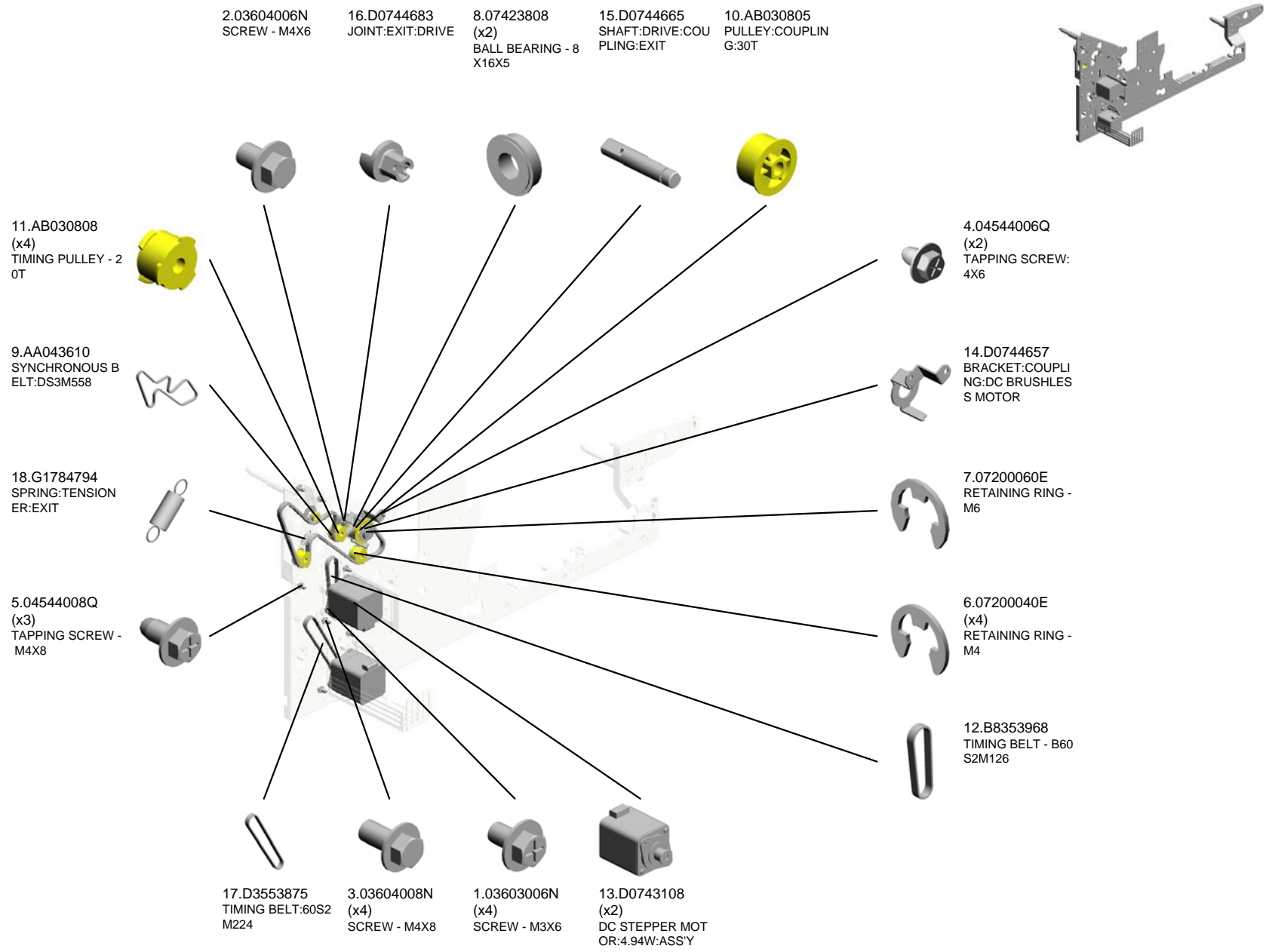

U001	U002	U003	U004	U005	U006	U007	U008	U009	U010	U011	U012	U013	U014	U015	U016	U017	U018	U019	U020	U021
------	------	------	------	------	------	------	------	------	------	------	------	------	------	------	------	------	------	------	------	------

U049 Paper Exit 6

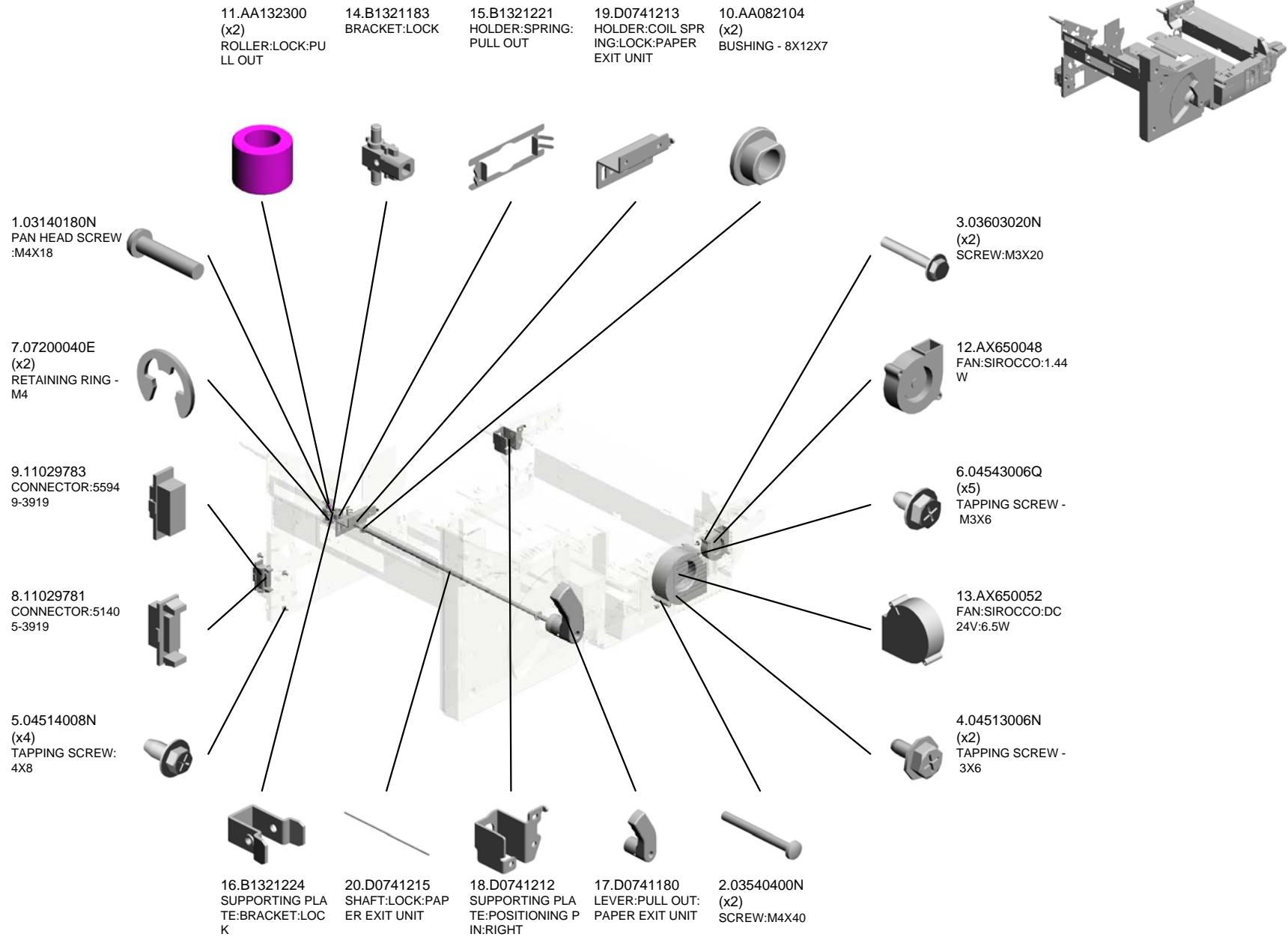

U001	U002	U003	U004	U005	U006	U007	U008	U009	U010	U011	U012	U013	U014	U015	U016	U017	U018	U019	U020	U021
------	------	------	------	------	------	------	------	------	------	------	------	------	------	------	------	------	------	------	------	------

U049 Paper Exit 6

37.G1784909
(x2)
SCREW:TRANSPORT

33.D0747848
DECAL:PULL OUT:
LEFT:FUSING UNIT
:SET

32.D0747843
INNER COVER:PUL
L OUT:LEFT

34.D0747849
DECAL:PULL OUT:
LEFT:FUSING UNIT
:TCRU

29.D0747086
SEAL:VACUUM:CO
OLING:INTERMEDI
ATE TRANSFER:P
ULL OUT

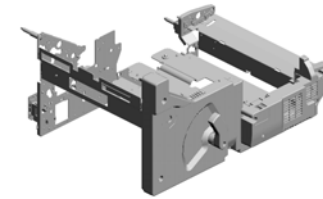

36.G1784818
(x2)
SPRING:PULL OUT
:LOCK:EXIT

35.G1784759
BRACKET:LOCK:EX
IT

38.G1787743
BOSS:POSITIONIN
G PIN:TRANSPORT
UNIT:NO.1

23.D0744557
DECAL:H-TEMP W
ARNING:EXIT

22.D0744553
DECAL:PULL OUT:
LEFT:D1

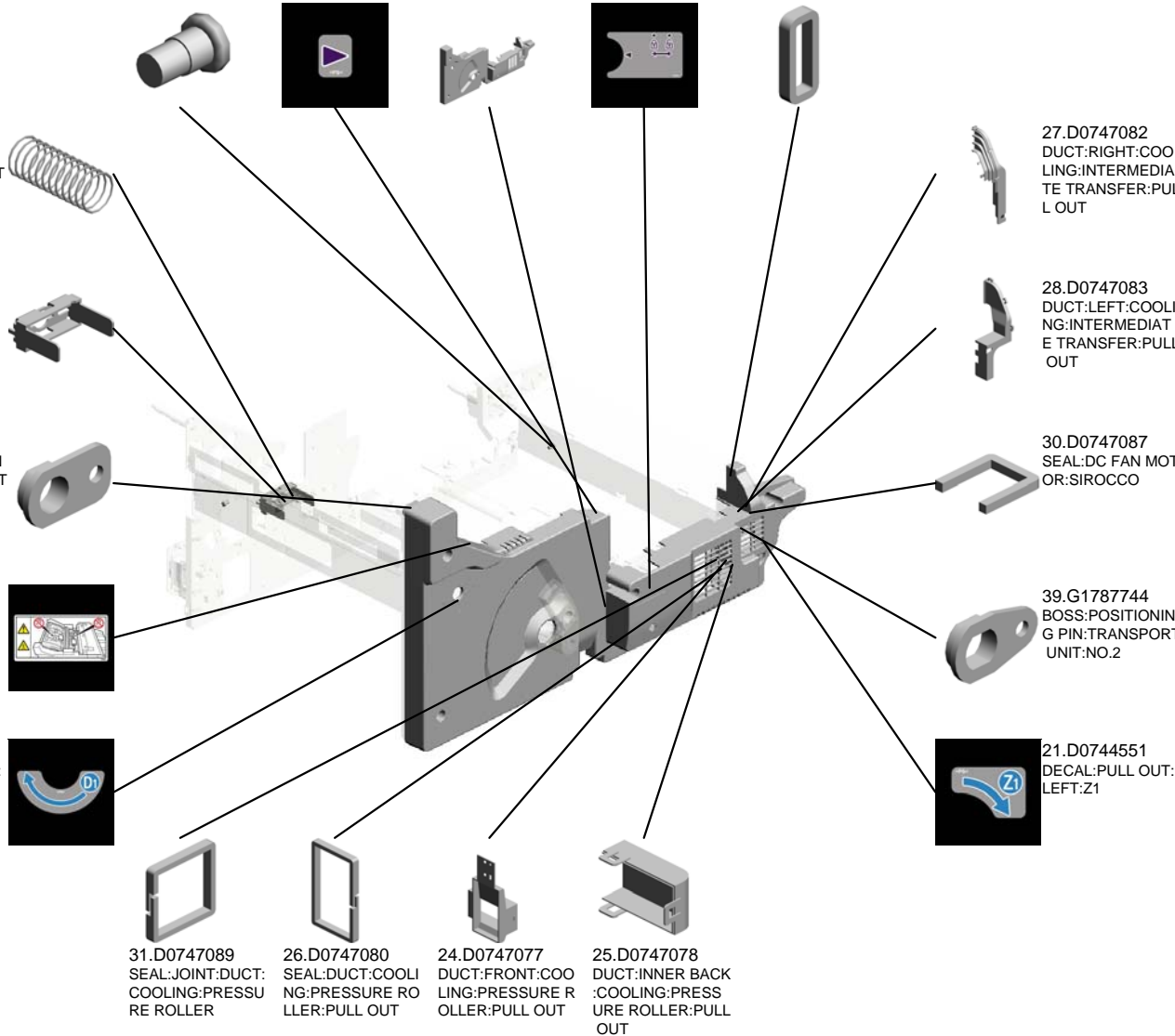

27.D0747082
DUCT:RIGHT:COO
LING:INTERMEDI
ATE TRANSFER:PUL
L OUT

28.D0747083
DUCT:LEFT:COOLI
NG:INTERMEDI
ATE TRANSFER:PULL
OUT

30.D0747087
SEAL:DC FAN MOT
OR:SIROCCO

39.G1787744
BOSS:POSITIONIN
G PIN:TRANSPORT
UNIT:NO.2

21.D0744551
DECAL:PULL OUT:
LEFT:Z1

31.D0747089
SEAL:JOINT:DUCT:
COOLING:PRESSU
RE ROLLER

26.D0747080
SEAL:DUCT:COOLI
NG:PRESSURE RO
LLER:PULL OUT

24.D0747077
DUCT:FRONT:COO
LING:PRESSURE R
OLLER:PULL OUT

25.D0747078
DUCT:INNER BACK
:COOLING:PRESS
URE ROLLER:PULL
OUT

U050.Duplex 1

U050_S001
D0744826
GRIP:DUPLX:GUIDE PLATE:
LEFT



U001	U002	U003	U004	U005	U006	U007	U008	U009	U010	U011	U012	U013	U014	U015	U016	U017	U018	U019	U020	U021
------	------	------	------	------	------	------	------	------	------	------	------	------	------	------	------	------	------	------	------	------

U050 Duplex 1

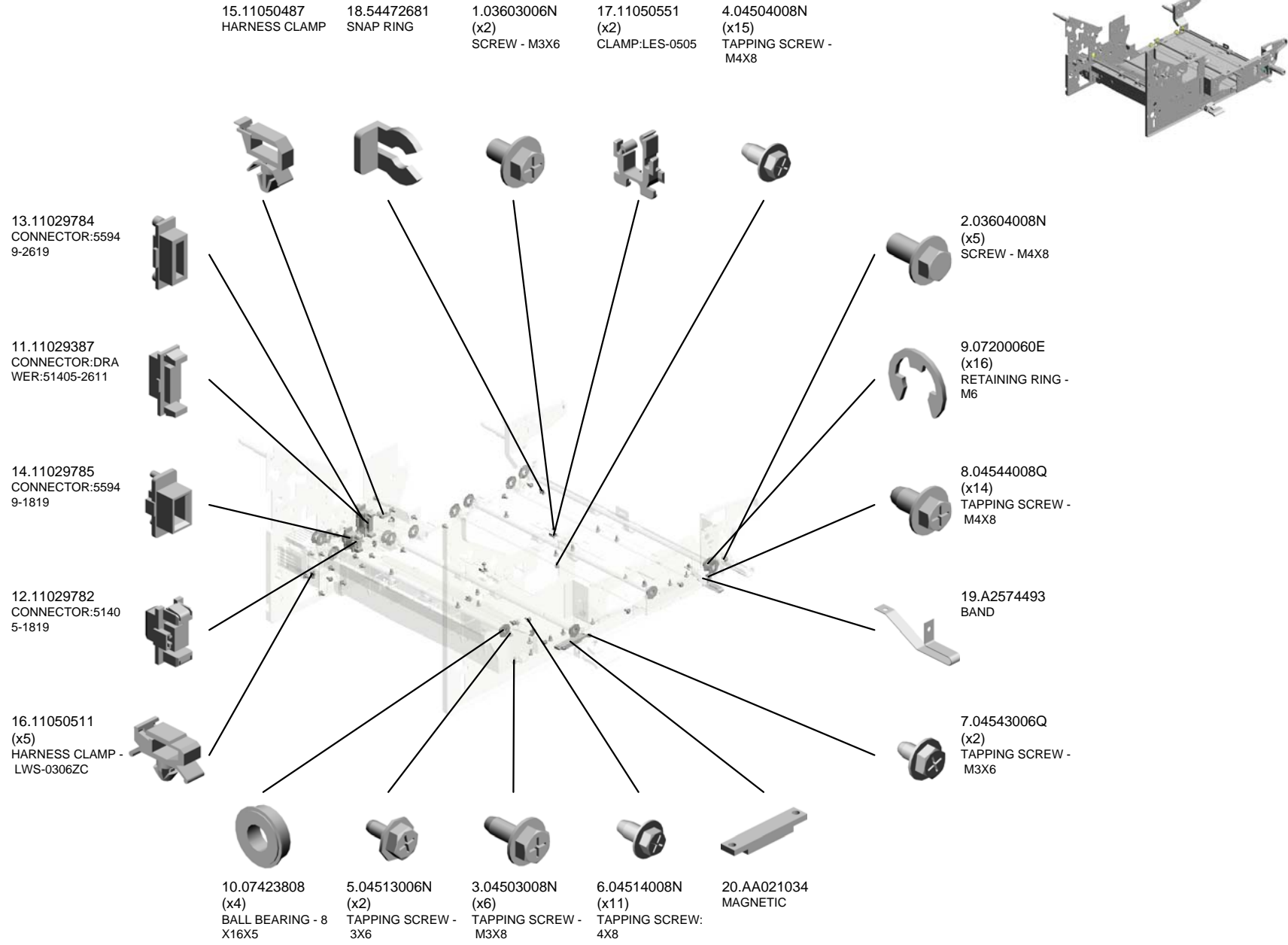

U001	U002	U003	U004	U005	U006	U007	U008	U009	U010	U011	U012	U013	U014	U015	U016	U017	U018	U019	U020	U021
------	------	------	------	------	------	------	------	------	------	------	------	------	------	------	------	------	------	------	------	------

U050 Duplex 1

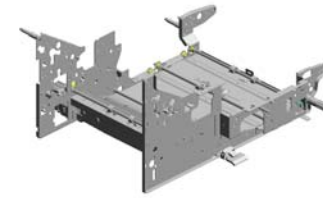
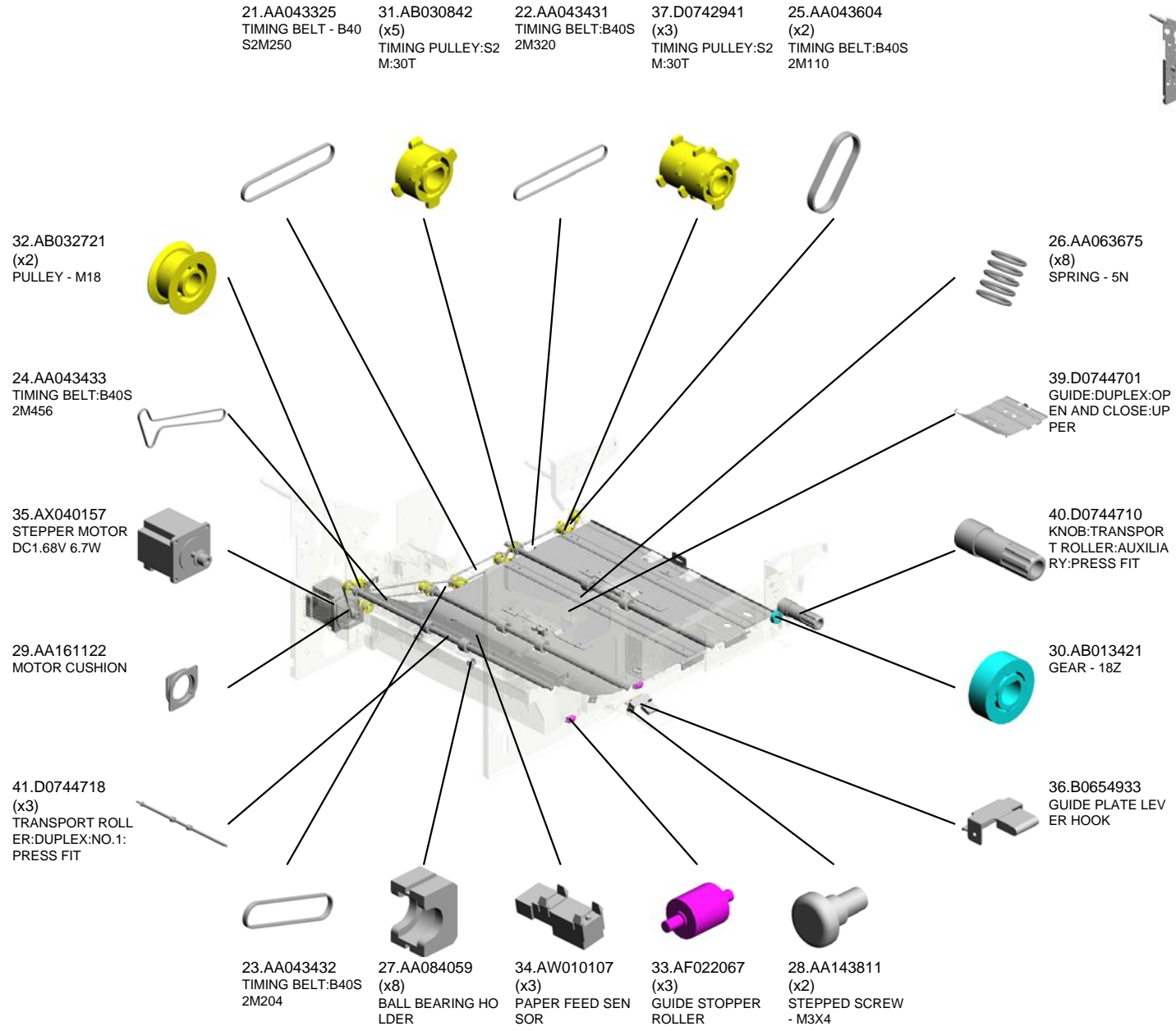

U050 Duplex 1

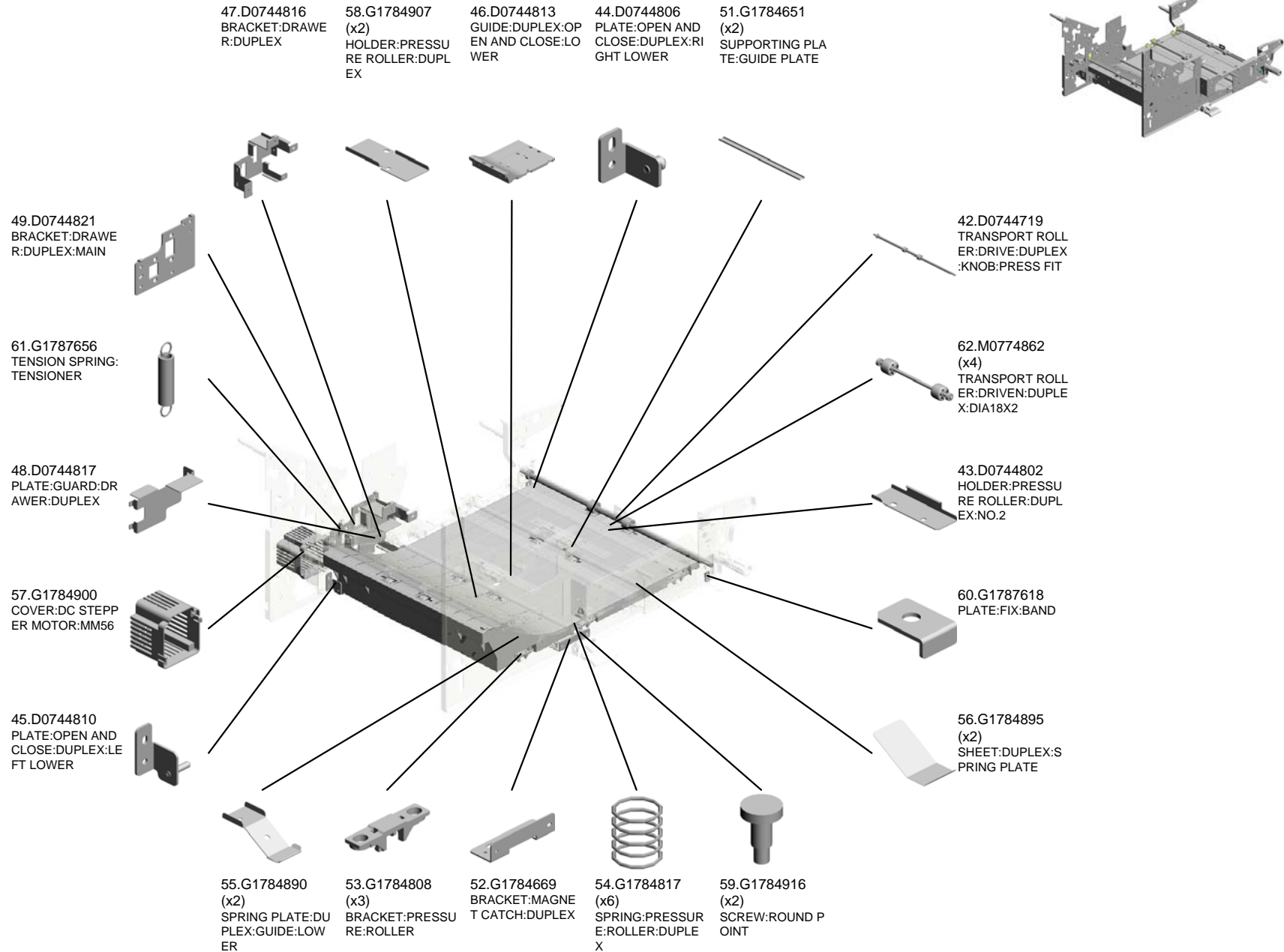

U001	U002	U003	U004	U005	U006	U007	U008	U009	U010	U011	U012	U013	U014	U015	U016	U017	U018	U019	U020	U021
------	------	------	------	------	------	------	------	------	------	------	------	------	------	------	------	------	------	------	------	------

U050_S001
GRIP:DUPLEX:GUIDE PLATE:LEFT

38.D0744552
DECAL:PULL OUT:
LEFT:Z3

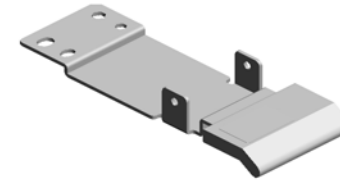

50.D0744826
GRIP:DUPLEX:GUI
DE PLATE:LEFT

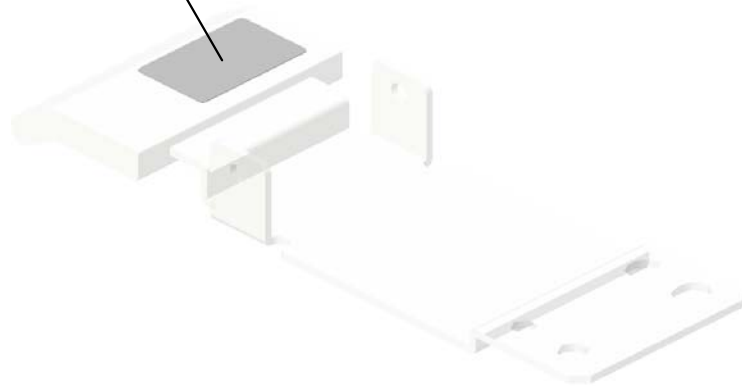

U001	U002	U003	U004	U005	U006	U007	U008	U009	U010	U011	U012	U013	U014	U015	U016	U017	U018	U019	U020	U021
------	------	------	------	------	------	------	------	------	------	------	------	------	------	------	------	------	------	------	------	------

U051 Duplex 2

8.AA043623
TIMING BELT - B40
S2M180

13.D0743173
TIMING PULLEY:S2
M:25T

9.AA063674
(x2)
SPRING - 8N

19.D0744872
BRACKET:TRANSP
ORT ROLLER:DUP
LEX:REVERSE:RIG
HT

14.D0744612
TRANSPORT ROLL
ER:DRIVE:REVERS
E:PRESS FIT

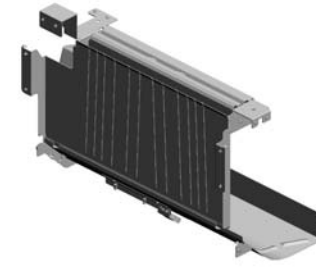

12.D0743108
DC STEPPER MOT
OR:4.94W:ASS'Y

3.04543006Q
(x7)
TAPPING SCREW -
M3X6

2.04514008N
(x13)
TAPPING SCREW:
4X8

4.04544008Q
(x2)
TAPPING SCREW -
M4X8

7.11050511
(x4)
HARNESS CLAMP -
LWS-0306ZC

15.D0744857
GUIDE PLATE:REC
EIVING SUB-UNIT:
LEFT LOWER:LEFT

1.04513006N
(x11)
TAPPING SCREW -
3X6

17.D0744865
BRACKET:SENSO
R:RECEIVING SUB-
UNIT:LEFT LOWER

11.AW010127
PAPER FEED SEN
SOR

16.D0744860
GUIDE PLATE:REC
EIVING SUB-UNIT:
LEFT LOWER:LOW
ER

18.D0744871
GUIDE PLATE:TRA
NSPORT ROLLER:
DUPLEX:REVERSE

20.D0744881
GUIDE PLATE:PRE
SSURE ROLLER:D
UPLEX:REVERSE

10.AA084059
(x2)
BALL BEARING HO
LDER

5.07200060E
(x2)
RETAINING RING -
M6

6.07423808
BALL BEARING - 8
X16X5

U051
Duplex 2

22.M0774862
TRANSPORT ROLL
ER:DRIVEN:DUPLE
X:DIA18X2

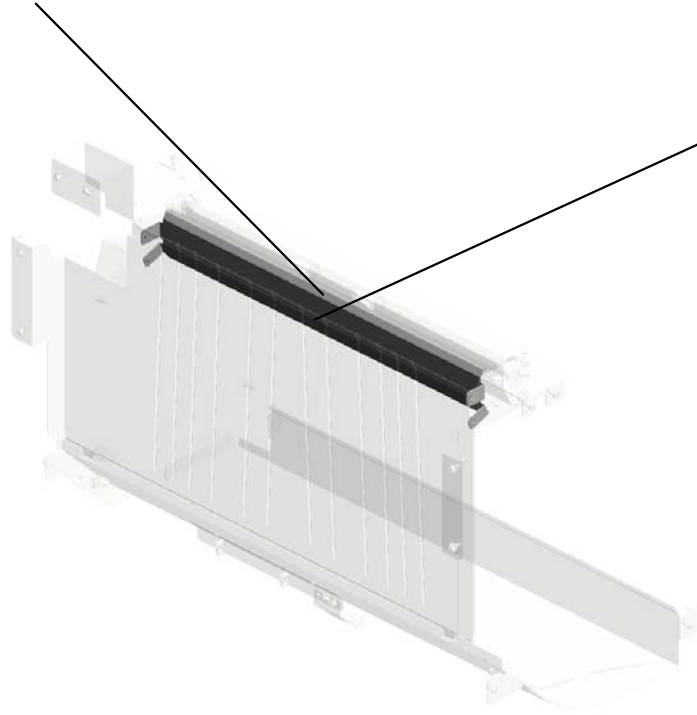

21.D0744885
GUIDE PLATE:PRE
SSURE ROLLER:D
UPLEX:REVERSE:L
EFT

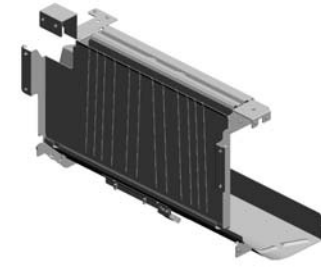

U001	U002	U003	U004	U005	U006	U007	U008	U009	U010	U011	U012	U013	U014	U015	U016	U017	U018	U019	U020	U021
------	------	------	------	------	------	------	------	------	------	------	------	------	------	------	------	------	------	------	------	------

U052 Drive 1 (Drum)

1.03603014N
(x4)
SCREW - M3X14



3.D0741315
(x4)
DC MOTOR:DIA65:
24V:15.3W



2.03604010N
(x12)
SCREW:M4X10

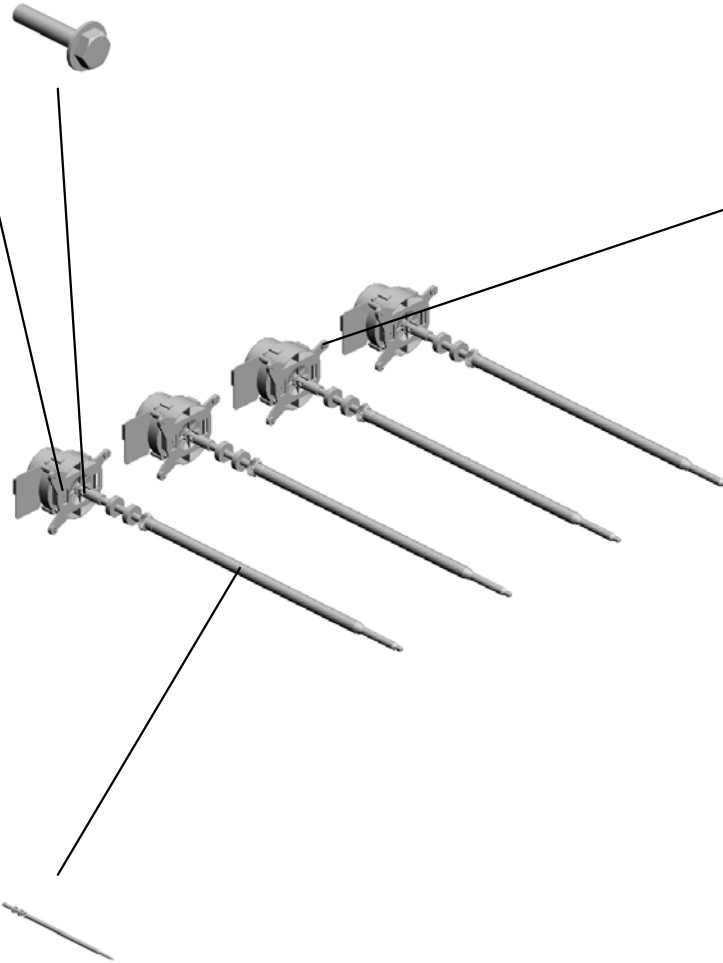

4.D0741316
(x4)
DRUM SHAFT:ASS'
Y

U001	U002	U003	U004	U005	U006	U007	U008	U009	U010	U011	U012	U013	U014	U015	U016	U017	U018	U019	U020	U021
------	------	------	------	------	------	------	------	------	------	------	------	------	------	------	------	------	------	------	------	------

U053

Drive 2 (Cleaning/Development)

18.D0741330 (x4) BRACKET:DRIVE:ASSY
 1.03130040N (x12) SCREW:M3X4
 17.D0741329 (x4) DC MOTOR:DIA49:24V:6.3W
 15.D0141265 (x4) BRACKET:DC MOTOR
 3.04513006N (x28) TAPPING SCREW - 3X6

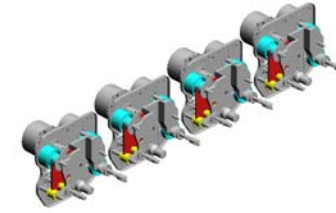

16.D0741327 (x4) DC MOTOR:DIA63:24V:21.8W



10.AB017836 (x4) [A] GEAR:PULLEY:DEVELOPMENT DRIVE UNIT:46Z/37T 201109-01 X/O

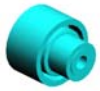

19.D0741338 (x4) TENSION SPRING:TIGHTENER:DRIVE



8.AA043981 (x4) SYNCHRONOUS BELT:60DS2M300



6.07403906 (x4) BALL BEARING - 6X15X5



2.03604006N (x12) SCREW - M4X6



14.AB030836 (x4) PULLEY:IDLER:DRIVE:AROUND THE PHOTOCONDUCTOR:PRESS FIT



4.07200060E (x8) RETAINING RING - M6



13.AB030833 (x4) TIMING PULLEY:DRIVE:TRANSPORT SCREW:23T



5.07250100E (x4) RETAINING RING - C - M10



7.09544008N (x4) SCREW - M4X8



11.AB017818 (x4) GEAR:SLOW DOWN:BRUSH ROLLER:83Z/68Z:PRESS FIT



9.AB010150 (x4) GEAR:DRIVE:BRUSH ROLLER:71Z



20.D0741341 (x4) BRACKET:AUXILIARY:DRIVE:AROUND THE PHOTOCONDUCTOR



12.AB030832 (x4) TIMING PULLEY:DRIVE:DEVELOPMENT SLEEVE:37T



U053 Drive 2 (Cleaning/Development)

22.D0741348
(x4)
TIGHTENER:DRIVE
:AROUND THE PH
OTOCONDUCTOR:
ASS'Y

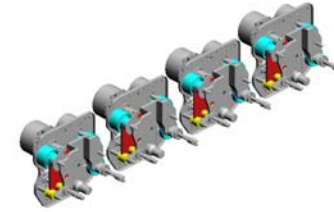

23.D0741352
(x4)
SHAFT:DRIVE:TRA
NSPORT SCREW:A
SS'Y



24.D0741356
(x4)
SHAFT:DRIVE:BRU
SH ROLLER:ASS'Y

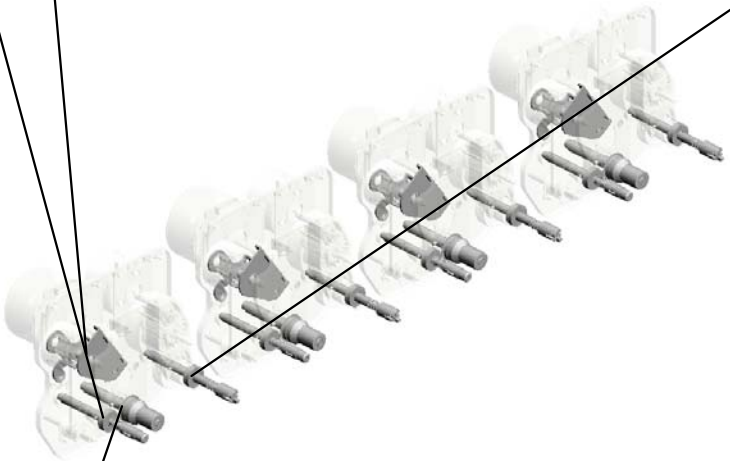

21.D0741343
(x4)
SHAFT:DRIVE:DEV
ELOPMENT SLEEV
E:ASS'Y



AB017817
[A]
GEAR:PULLEY:DE
VELOPMENT DRIV
E UNIT:46Z/37T
201109-01 X/O

U001	U002	U003	U004	U005	U006	U007	U008	U009	U010	U011	U012	U013	U014	U015	U016	U017	U018	U019	U020	U021
------	------	------	------	------	------	------	------	------	------	------	------	------	------	------	------	------	------	------	------	------

U054

Drive 3 (Paper Transfer)

6.AB010152 GEAR:DRIVE:63Z
 13.D0741371 DC MOTOR:DIA48:24V:17W
 15.D0741375 BRACKET:DC BRUSHLESS MOTOR:ASSY
 17.D0741380 SHAFT:DRIVE:BELT CLEANING:ASSY
 8.AB017820 GEAR:DRIVE:101Z/52Z

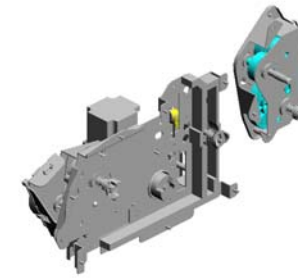

4.07403804 BALL BEARING:DIA 4XDIA9X4



3.07200030E RETAINING RING - M3



10.B2236171 RUBBER BUSHING :ENCODER



11.D0396137 ENCODER:ASSY



2.03604006N SCREW - M4X6



12.D0741369 COVER:ENCODER (x7)



1.03603006N SCREW - M3X6



5.11050516 (x4) CLAMP



16.D0741379 BRACKET:PLATE



9.AW020199 (x2) OPTICS SENSOR:ENCODER:300LPI



7.AB010153 GEAR:DRIVE:155Z



14.D0741372 SHAFT:DRIVE:TRANSFER:ASSY



U055.Drive 4 (Fusing)

U055_S001
D0741430
DRIVE UNIT:ON-OFF:FUSING
:ASS'Y

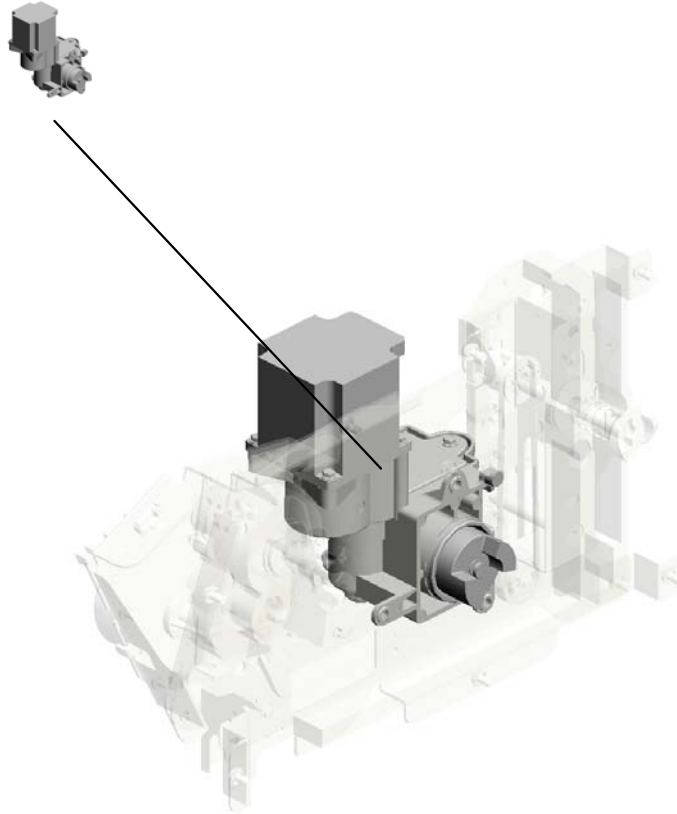

U001	U002	U003	U004	U005	U006	U007	U008	U009	U010	U011	U012	U013	U014	U015	U016	U017	U018	U019	U020	U021
------	------	------	------	------	------	------	------	------	------	------	------	------	------	------	------	------	------	------	------	------

U055 Drive 4 (Fusing)

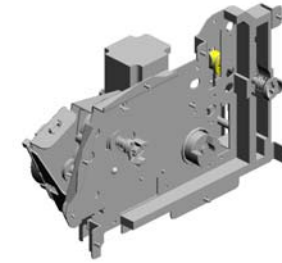

- 6.07200060E RETAINING RING - M6
- 14.AB030838 TIMING PULLEY:DRIVE:FLAT CONVEYER BELT
- 25.D0741418 (x3) RUBBER BUSHING :DIA7
- 3.04513006N (x7) TAPPING SCREW - 3X6
- 21.D0741405 SHAFT:OUTPUT:DRIVE:FUSING:ASS'Y

7.11050516
(x5)
CLAMP

20.D0741404
COVER:GEAR

22.D0741409
DC MOTOR:DIA55:
33W

19.D0741401
BRACKET:DRIVE:F
USING:ASS'Y

13.AB017804
GEAR:Z29:Z87

10.AA061112
TENSION SPRING:
TIGHTENER

1.03603006N
(x3)
SCREW - M3X6

8.AA043340
SYNCHRONOUS B
ELT:40S2M580

24.D0741412
BRACKET:DRIVE:V
ACUUM:UPPER:AS
S'Y

23.D0741411
BRACKET:DRIVE:V
ACUUM:LOWER
S'Y

16.AB030841
TIMING PULLEY:O
UTPUT:VACUUM:S
2M:32T

18.D0741390
SHAFT:OUTPUT:DRIVE:FUSING:ASS'Y

9.AA043584
TIMING BELT:S2M2
88

15.AB030840
TIMING PULLEY:S2
M:26T/40T

4.04514008N
(x10)
TAPPING SCREW:
4X8

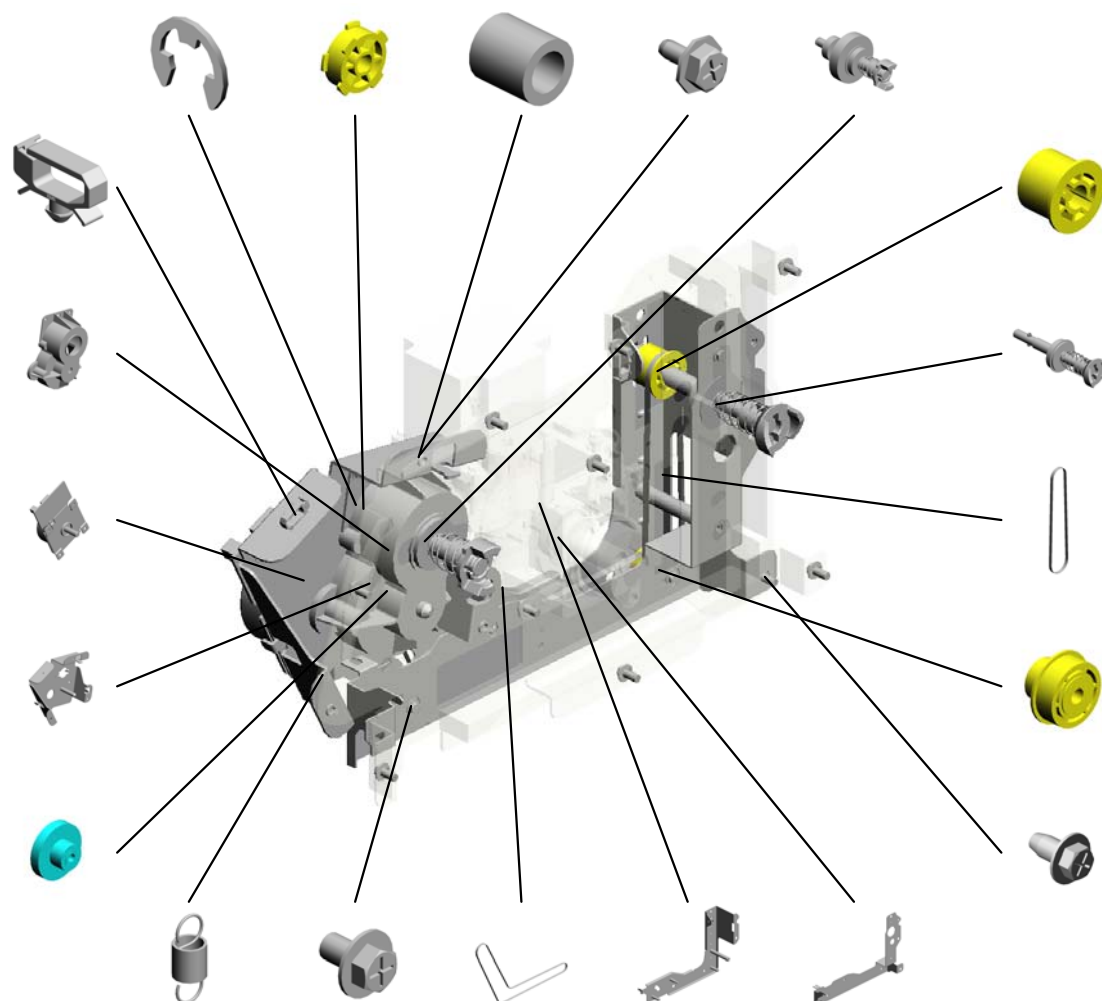

U001	U002	U003	U004	U005	U006	U007	U008	U009	U010	U011	U012	U013	U014	U015	U016	U017	U018	U019	U020	U021
------	------	------	------	------	------	------	------	------	------	------	------	------	------	------	------	------	------	------	------	------

U055
Drive 4 (Fusing)

26.D0741424
BRACKET:TIGHTE
NER:ASSY

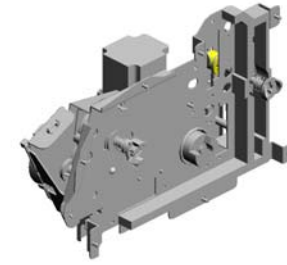

27.D0741426
PULLEY:IDLER

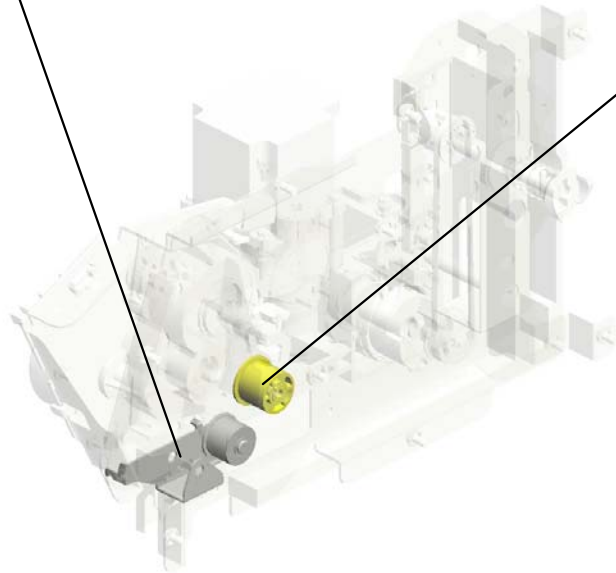

U001	U002	U003	U004	U005	U006	U007	U008	U009	U010	U011	U012	U013	U014	U015	U016	U017	U018	U019	U020	U021
------	------	------	------	------	------	------	------	------	------	------	------	------	------	------	------	------	------	------	------	------

U055_S001
DRIVE UNIT:ON-OFF:FUSING:ASS'Y

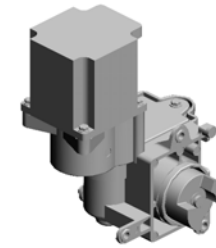

28.D0741430
DRIVE UNIT:ON-OFF:
F:FUSING:ASS'Y

17.AX050331 DC STEPPER MOT
OR:ON-OFF:FUSIN
G:7.2W
5.07200040E RETAINING RING -
M4
12.AB011299 GEAR:Z27
31.D0741449 COVER:HOUSING:
SIDE:PRESS FIT
36.D0741504 SHEET:ON-OFF:FU
SING DRIVE SUB-U
NIT

2.03603008N
(x10)
SCREW:M3X8

30.D0741445
COVER:HOUSING:
UPPER:PRESS FIT

32.D0741461
SHAFT:WORM GE
AR:ON-OFF:PRESS
FIT

33.D0741474
RING

34.D0741500
WORM WHEEL:ON
-OFF:FUSING

35.D0741501
SHAFT:OUTPUT:O
N-OFF:FUSING:PR
ESS FIT

11.AA063466
COMPRESSION SP
RING:JOINT:ON-O
FF

29.D0741439
JOINT:ON-OFF:FU
SING

U001	U002	U003	U004	U005	U006	U007	U008	U009	U010	U011	U012	U013	U014	U015	U016	U017	U018	U019	U020	U021
------	------	------	------	------	------	------	------	------	------	------	------	------	------	------	------	------	------	------	------	------

U056

Drive 5 (Paper Exit)

2.04514008N
(x3)
TAPPING SCREW:
4X8

5.AB017880
GEAR:IDLER:DRIV
E:EXIT:Z101/42

3.07200060E
RETAINING RING -
M6

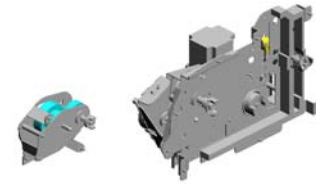

6.D0741451
BRACKET:DRIVE:EX
IT:ASS'Y

8.D0741454
DC MOTOR:DIA49:
9.8W:BLS

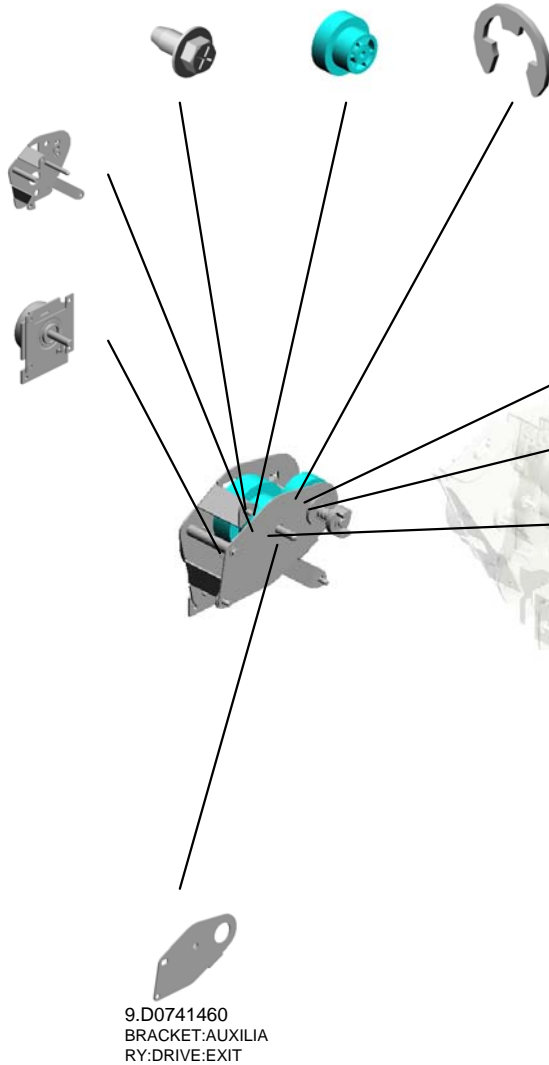

4.AB011551
GEAR:DRIVE:EXIT:
47Z

7.D0741452
SHAFT:DRIVE:EXIT
:ASS'Y

1.03603006N
(x6)
SCREW - M3X6

9.D0741460
BRACKET:AUXILIA
RY:DRIVE:EXIT

U001	U002	U003	U004	U005	U006	U007	U008	U009	U010	U011	U012	U013	U014	U015	U016	U017	U018	U019	U020	U021
------	------	------	------	------	------	------	------	------	------	------	------	------	------	------	------	------	------	------	------	------

U057 Drive 6 (Used Toner)



- 8.AA061111 TENSION SPRING: MIDDLE:DRIVE:USED TONER
- 17.AB030852 (x2) PULLEY:IDLER:DRIVE:USED TONER:32T
- 15.AB030850 PULLEY:TIGHTENER:DRIVE:USED TONER
- 16.AB030851 (x2) PULLEY:DRIVE:USED TONER:25T
- 4.07200040E (x7) RETAINING RING - M4

5.AA043645 SYNCHRONOUS BELT:40S2M426

20.D0741464 SHAFT:RIGHT:DRIVE:USED TONER:ASSY

2.04513006N TAPPING SCREW - 3X6

3.04514008N (x5) TAPPING SCREW: 4X8

10.AB013765 GEAR:DRIVE:USED TONER:36Z

11.AB017881 GEAR:PULLEY:DRIVE:USED TONER:44Z/32T

19.D0741454 DC MOTOR:DIA49:9.8W:BLS

18.AW020145 PHOTOINTERERRUPTOR:FLAT

14.AB017884 GEAR:PULLEY:DRIVE UNIT:USED TONER:36Z/32T

13.AB017883 GEAR:IDLER:DRIVE UNIT:USED TONER:77Z/23Z

6.AA043646 SYNCHRONOUS BELT:40S2M596

7.AA061110 TENSION SPRING: TIGHTENER:DRIVE UNIT:USED TONER

12.AB017882 GEAR:DRIVE UNIT:USED TONER:48Z/24Z

1.03603006N (x7) SCREW - M3X6

9.AB011550 GEAR:DRIVE UNIT:USED TONER:35Z

U057

Drive 6 (Used Toner)

22.D0741466 BRACKET:TIGHTENER:DRIVE:USED TONER:ASSY
 30.D0741496 JOINT:DRIVE:USED TONER
 24.D0741470 SHAFT:LEFT:DRIVE:USED TONER:ASSY
 27.D0741484 HOLDER:LEFT:DRIVE:USED TONER



21.D0741465 BRACKET:TENSION:DRIVE:USED TONER:ASSY

26.D0741476 HOLDER:RIGHT:DRIVE:USED TONER

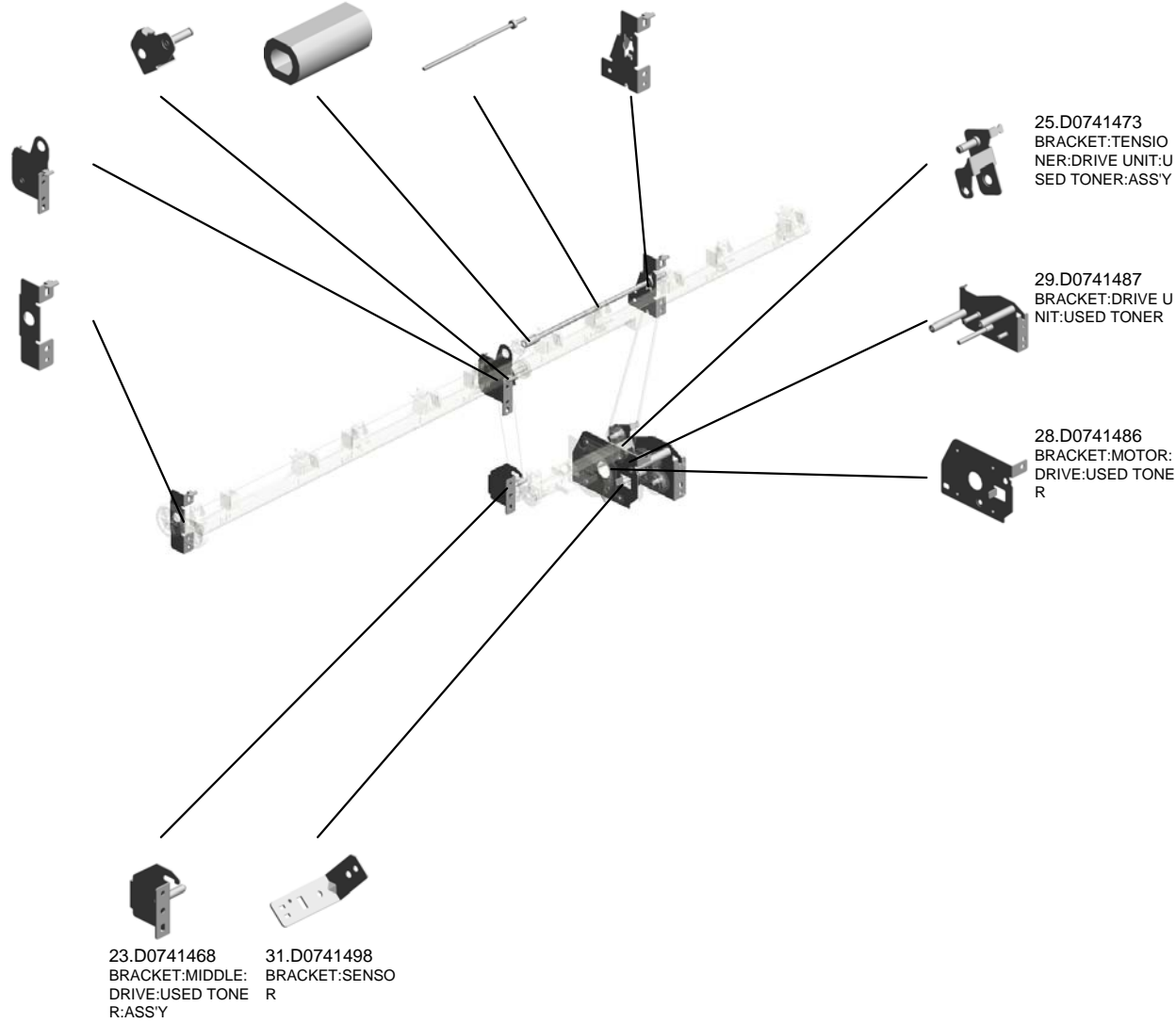

U001	U002	U003	U004	U005	U006	U007	U008	U009	U010	U011	U012	U013	U014	U015	U016	U017	U018	U019	U020	U021
------	------	------	------	------	------	------	------	------	------	------	------	------	------	------	------	------	------	------	------	------

U058

Drive 7 (Paper Feed)



- 12.B2346506 (x4) TIMING PULLEY - 30T
- 19.B2346541 (x2) FEED DRIVE SHAFT
- 4.07200060E (x4) RETAINING RING - M6
- 17.B2346532 (x2) TIGHTENER BRACKET
- 5.07413708 (x4) BALL BEARING - 8 X12X3.5MM

- 18.B2346533 (x2) TIMING BELT - S2 M152

- 9.AX040157 (x4) STEPPER MOTOR DC1.68V 6.7W

- 8.AA161122 (x4) MOTOR CUSHION

- 16.B2346531 (x2) TIGHTENER BRACKET

- 3.04514010N (x8) TAPPING SCREW: 4X10

- 10.AX040254 DC MOTOR: RISING TRAY: ASSY

- 1.04514006N (x8) TAPPING SCREW - 4X6

- 11.B1326759 DC MOTOR: RISE: TANDEM LCT: ASSY

- 7.09514006N (x12) SCREW: POLISHED ROUND: M4X6

- 2.04514008N (x11) TAPPING SCREW: 4X8

- 6.07423808 (x4) BALL BEARING - 8 X16X5

- 20.B2346542 (x2) GRIP DRIVE SHAFT

- 14.B2346514 (x2) TIMING BELT - S2 M126

- 15.B2346530 (x2) BRACKET

- 13.B2346508 (x4) TENSION SPRING

U059 Cooling 1

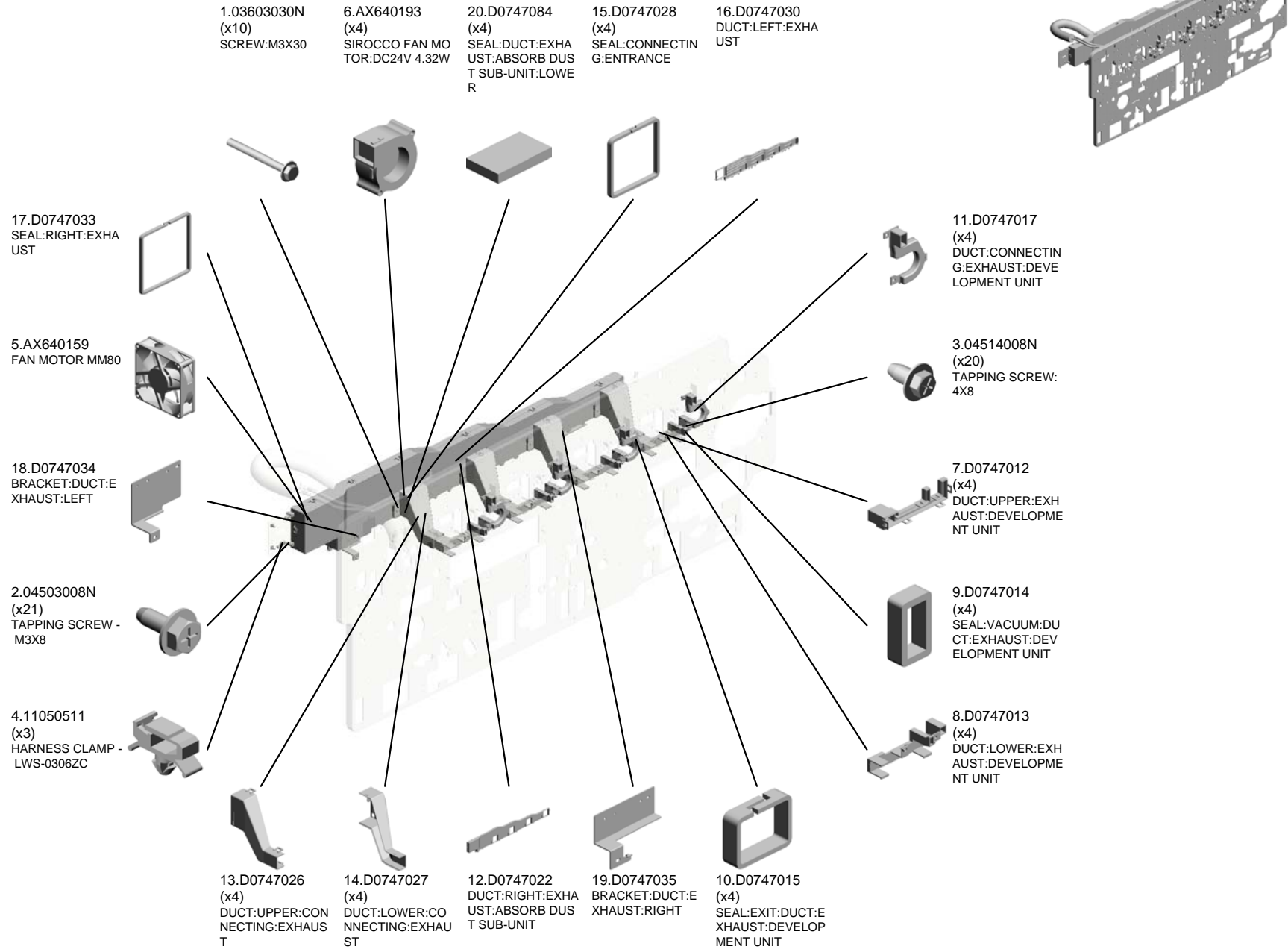

U001	U002	U003	U004	U005	U006	U007	U008	U009	U010	U011	U012	U013	U014	U015	U016	U017	U018	U019	U020	U021
------	------	------	------	------	------	------	------	------	------	------	------	------	------	------	------	------	------	------	------	------

U059
Cooling 1

22.D0747095 (x4)
SEAL:CONNECTIN
G:ABSORB DUST S
UB-UNIT:FAN:ENT
RANCE

21.D0747088 (x4)
SEAL:CONNECTIN
G:ABSORB DUST S
UB-UNIT:ENTRANC
E:SHORT

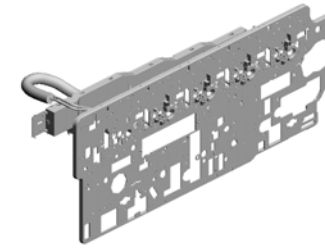

23.D0747099 (x8)
SEAL:CONNECTIN
G:ABSORB DUST S
UB-UNIT:UPPER L
OWER

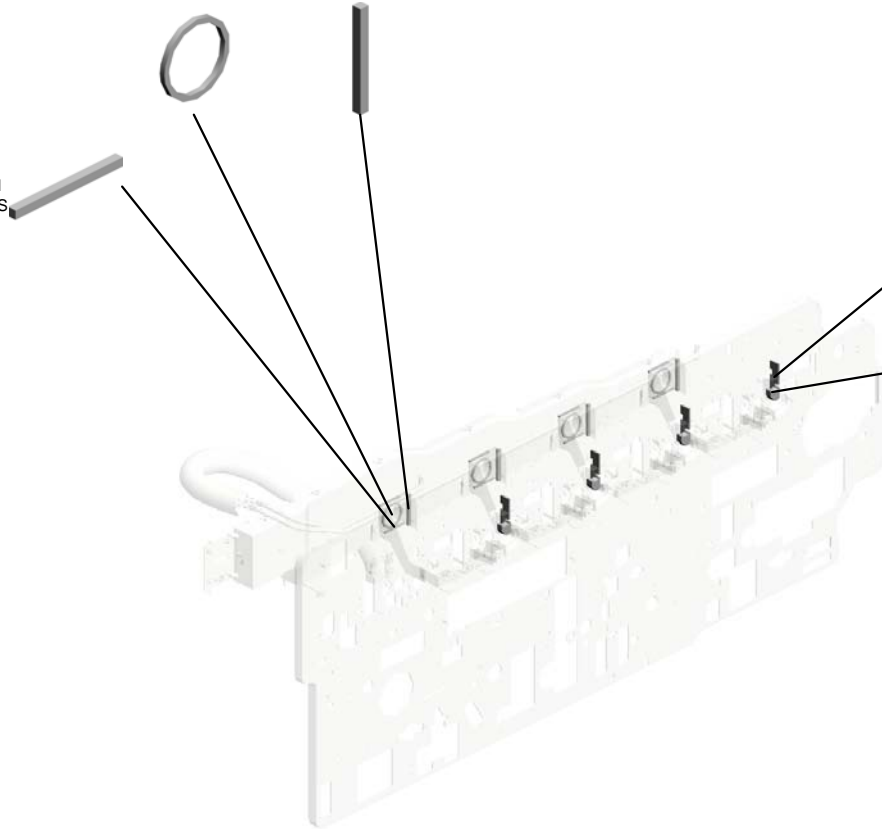

25.D0747103 (x4)
SEAL:UPPER:DUC
T:CONNECTING:D
EVELOPMENT UNI
T

24.D0747102 (x4)
SEAL:LOWER:DUC
T:CONNECTING:D
EVELOPMENT UNI
T

U060 Cooling 2

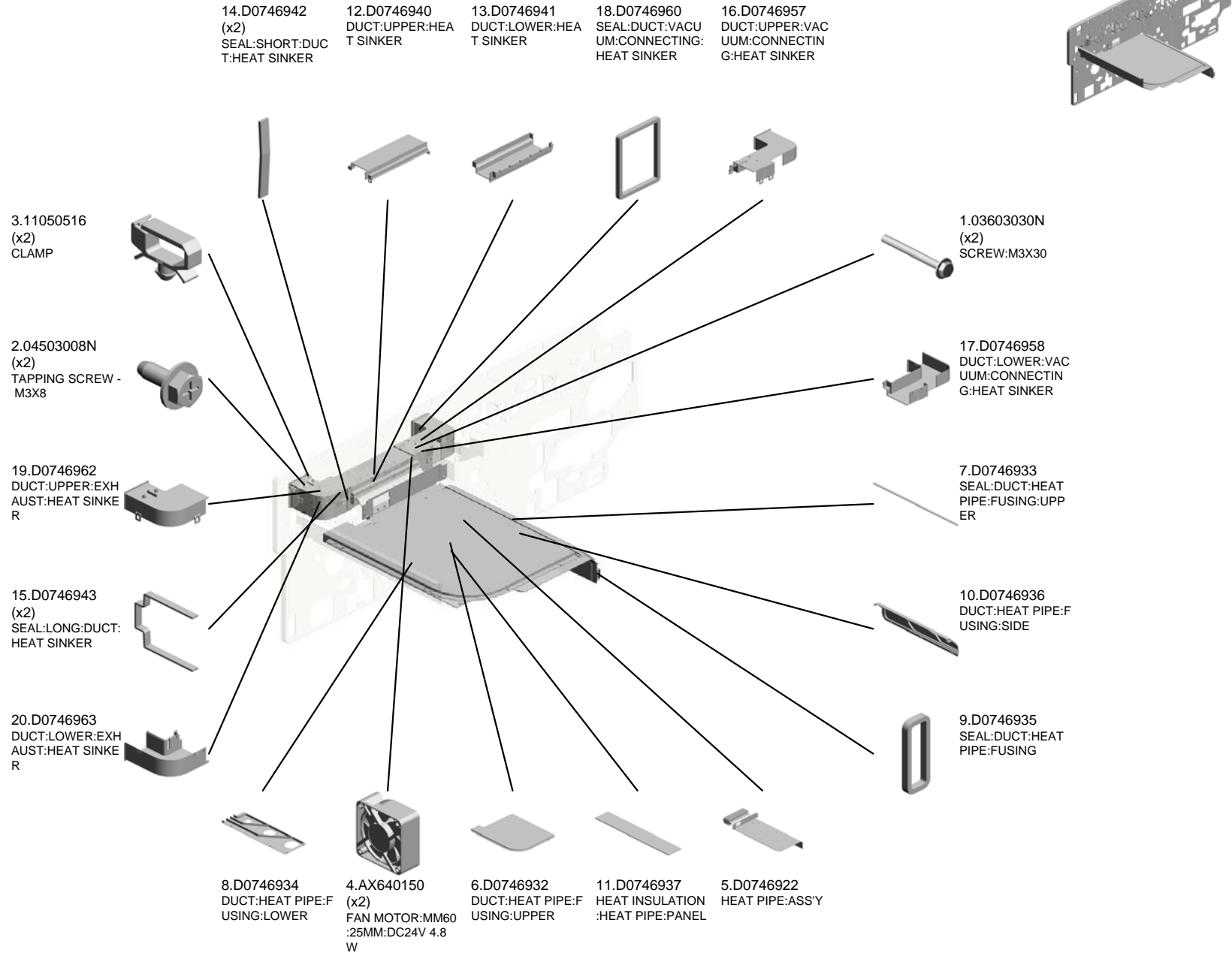

U001	U002	U003	U004	U005	U006	U007	U008	U009	U010	U011	U012	U013	U014	U015	U016	U017	U018	U019	U020	U021
------	------	------	------	------	------	------	------	------	------	------	------	------	------	------	------	------	------	------	------	------

U060
Cooling 2

22.D0746965
BRACKET:DUCT:EXHAUST:HEAT SINKER

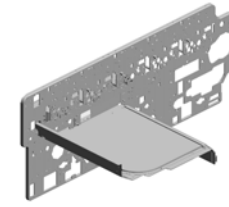

23.D0746972
SEAL:DUCT:EXHAUST:HEAT SINKER



24.D0747010
SEAL:LOWER:PAN
EL:HEAT PIPE



21.D0746964
BRACKET:FAN:DUCT:EXHAUST:HEAT SINKER

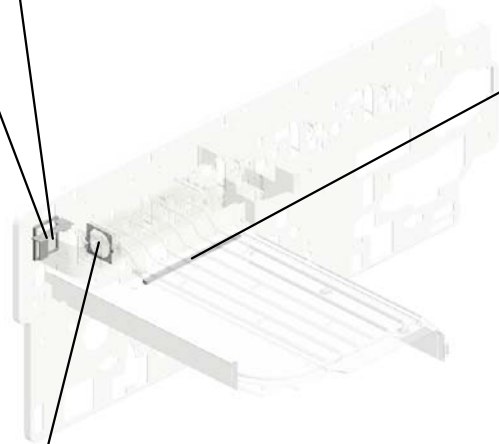

U001	U002	U003	U004	U005	U006	U007	U008	U009	U010	U011	U012	U013	U014	U015	U016	U017	U018	U019	U020	U021
------	------	------	------	------	------	------	------	------	------	------	------	------	------	------	------	------	------	------	------	------

U061 Cooling 3

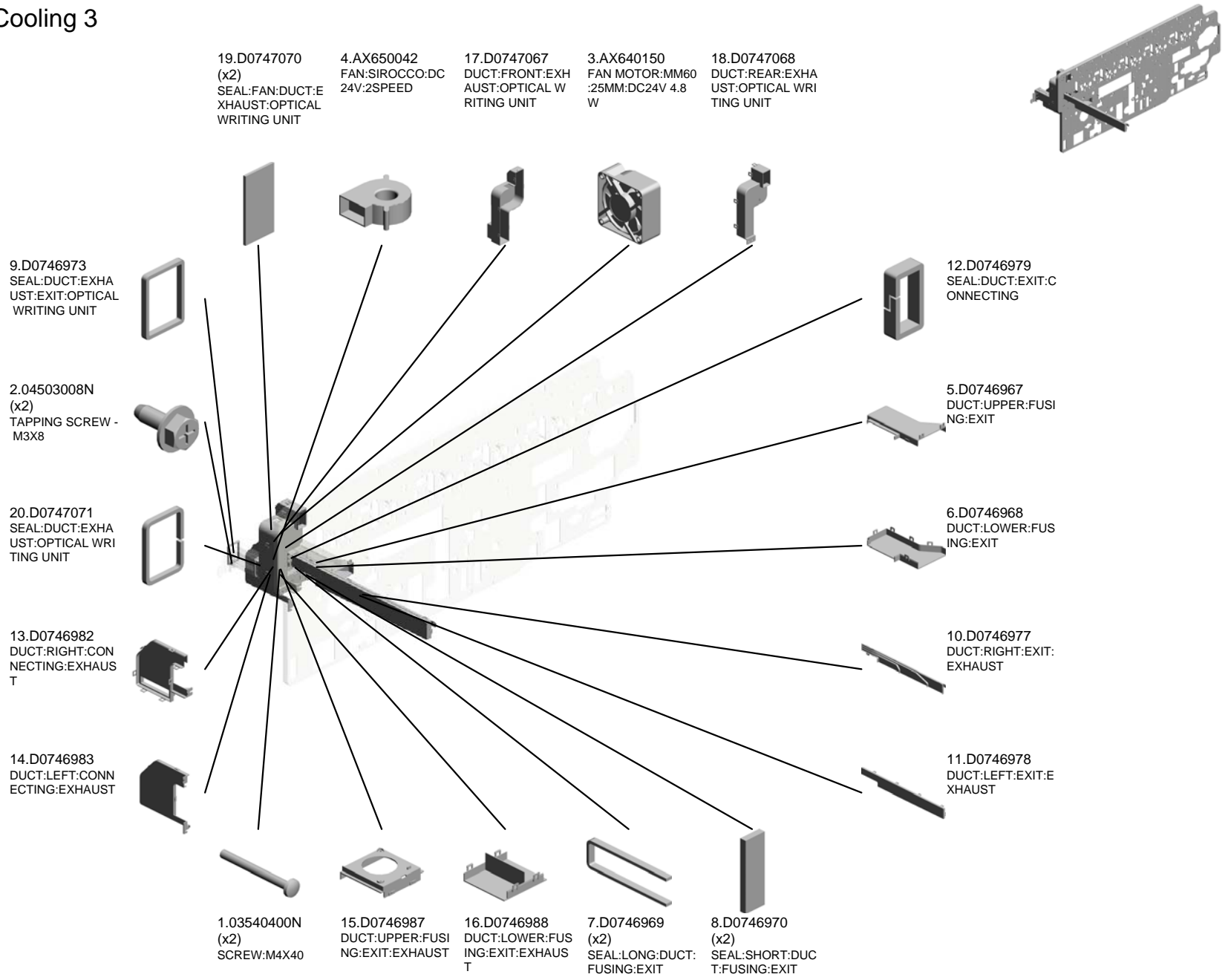

U001	U002	U003	U004	U005	U006	U007	U008	U009	U010	U011	U012	U013	U014	U015	U016	U017	U018	U019	U020	U021
------	------	------	------	------	------	------	------	------	------	------	------	------	------	------	------	------	------	------	------	------

U061
Cooling 3

21.D0747073
DUCT:RIGHT:EXHA
UST:EXIT:OPTICAL
WRITING UNIT

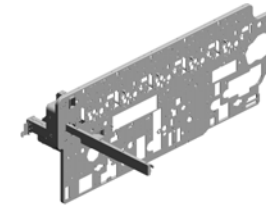

22.D0747074
DUCT:LEFT:EXHA
UST:EXIT:OPTICAL
WRITING UNIT

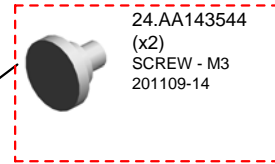
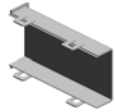

24.AA143544
(x2)
SCREW - M3
201109-14

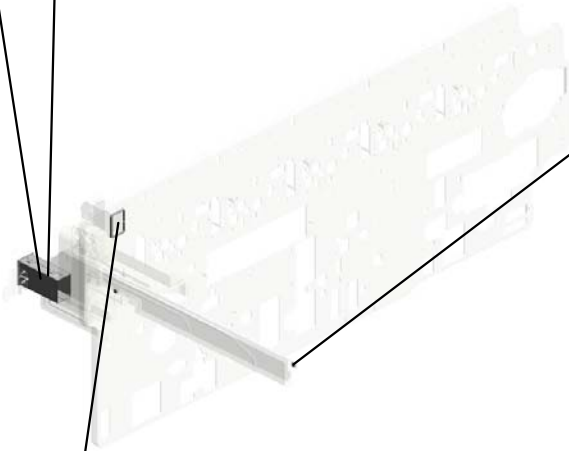

23.D0747165
SEAL:DUCT:EXHA
UST:OPTICAL WRI
TING UNIT

U062 Cooling 4

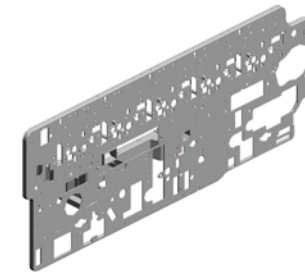
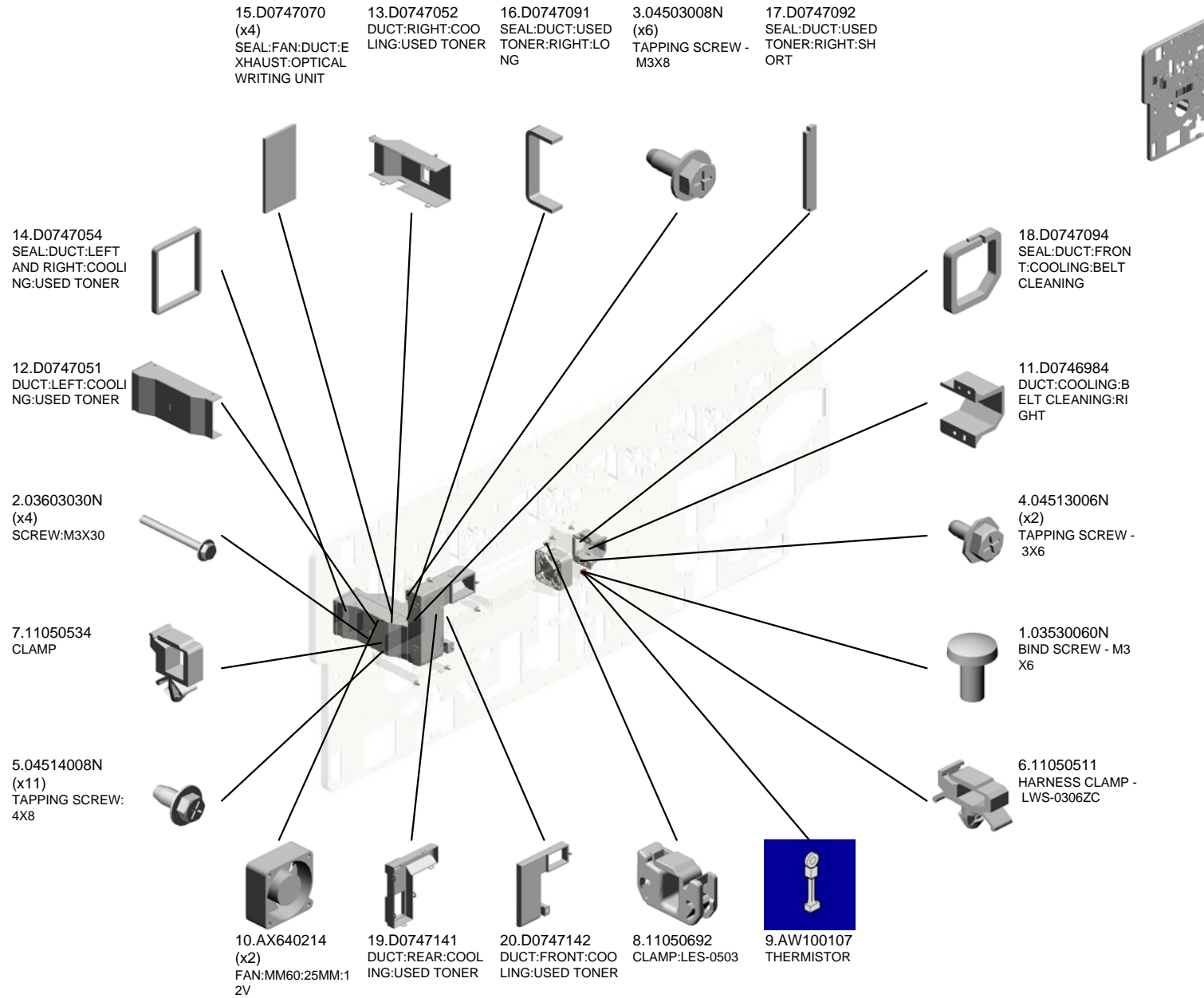

U062 Cooling 4

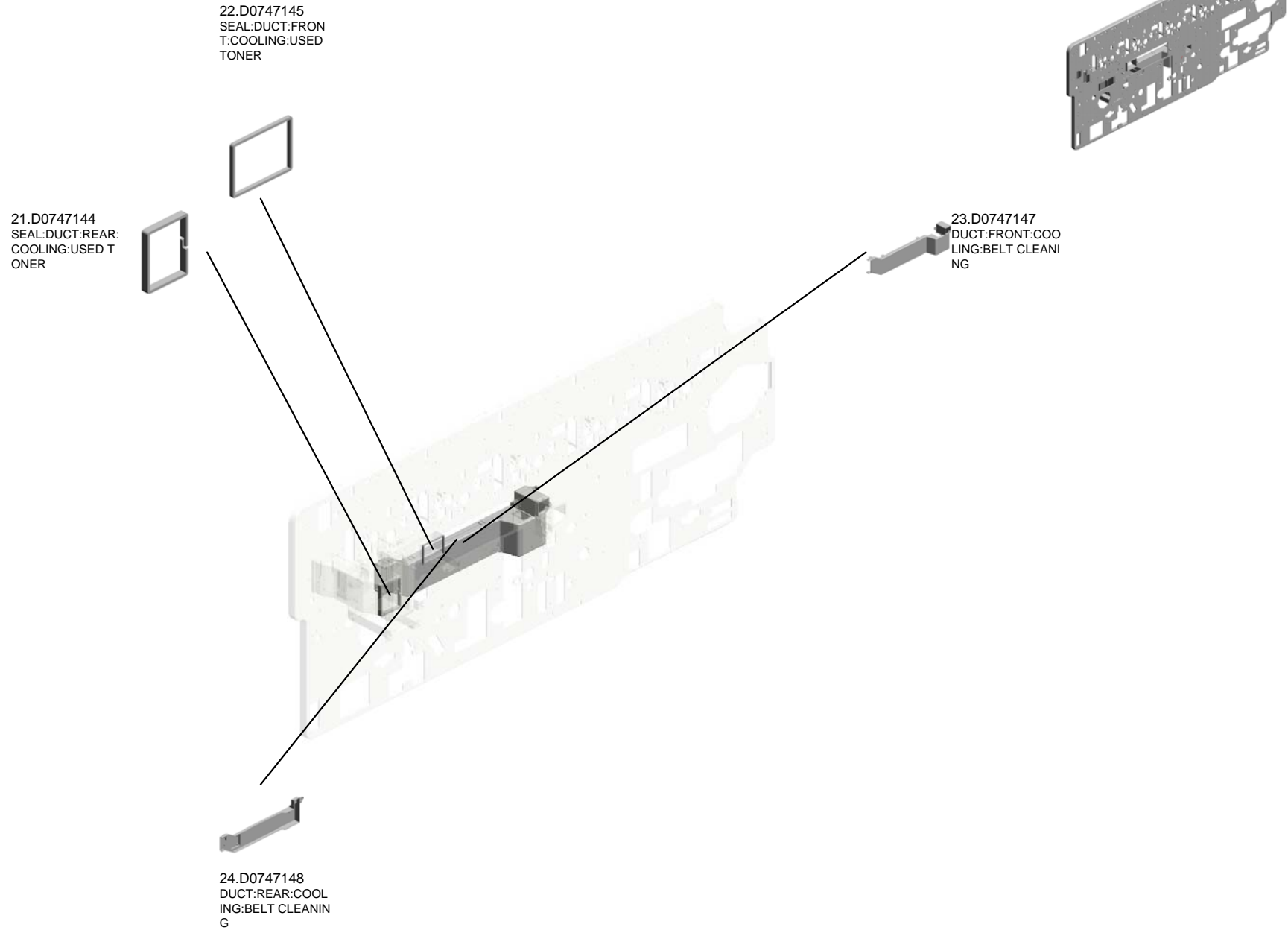

U001	U002	U003	U004	U005	U006	U007	U008	U009	U010	U011	U012	U013	U014	U015	U016	U017	U018	U019	U020	U021
------	------	------	------	------	------	------	------	------	------	------	------	------	------	------	------	------	------	------	------	------

U063 Cooling 5

5.AX640150
(x2)
FAN MOTOR:MM60
:25MM:DC24V 4.8
W

12.D0746996
SEAL:DUCT:HEAT
PIPE:ROLLER:FAN

9.D0746992
DUCT:HEAT PIPE:
ROLLER:FRONT

11.D0746995
SEAL:DUCT:HEAT
PIPE:ROLLER:VAC
UUM

6.AX650052
FAN:SIROCCO:DC
24V:6.5W

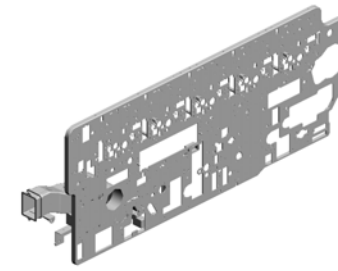

10.D0746993
DUCT:HEAT PIPE:
ROLLER:INNER BA
CK

2.04503008N
(x2)
TAPPING SCREW -
M3X8

13.D0746997
SEAL:DUCT:HEAT
PIPE:ROLLER:EXH
AUST

14.D0746998
DUCT:VACUUM:HE
AT PIPE:ROLLER

4.11050511
(x2)
HARNES CLAMP -
LWS-0306ZC

16.D0747001
DUCT:EXHAUST:H
EAT PIPE:ROLLER:
LEFT

15.D0747000
DUCT:EXHAUST:H
EAT PIPE:ROLLER:
RIGHT

3.04514008N
(x5)
TAPPING SCREW:
4X8

1.03540400N
(x2)
SCREW:M4X40

20.D0747042
DUCT:FRONT:EXIT
:COOLING:FUSING

8.D0746939
SEAL:DUCT:CONN
ECTING:COOLING:
FUSING EXIT

7.D0746938
DUCT:CONNECTIN
G:COOLING:FUSIN
G EXIT

19.D0747039
SEAL:DUCT:COOLI
NG:FUSING

18.D0747038
DUCT:REAR:COOL
ING:FUSING

17.D0747037
DUCT:FRONT:COO
LING:FUSING

U001	U002	U003	U004	U005	U006	U007	U008	U009	U010	U011	U012	U013	U014	U015	U016	U017	U018	U019	U020	U021
------	------	------	------	------	------	------	------	------	------	------	------	------	------	------	------	------	------	------	------	------

U063
Cooling 5

21.D0747043
DUCT:REAR:EXIT:
COOLING:FUSING

26.D0747105
SEAL:UPPER:DUC
T:COOLING:FUSIN
G

24.D0747048
SEAL:VACUUM:DU
CT:CONNECTING:
FUSING

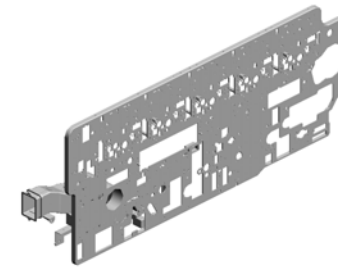

22.D0747045
SEAL:EXIT:SIROC
CO

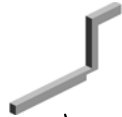

23.D0747047
DUCT:CONNECTIN
G:COOLING:FUSIN
G



27.D0747106
SEAL:LOWER:DUC
T:COOLING:FUSIN
G



25.D0747049
SEAL:EXHAUST:D
UCT:CONNECTING
:FUSING



U064 Cooling 6

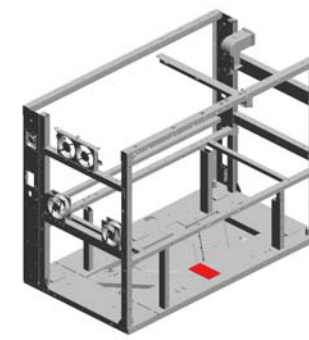
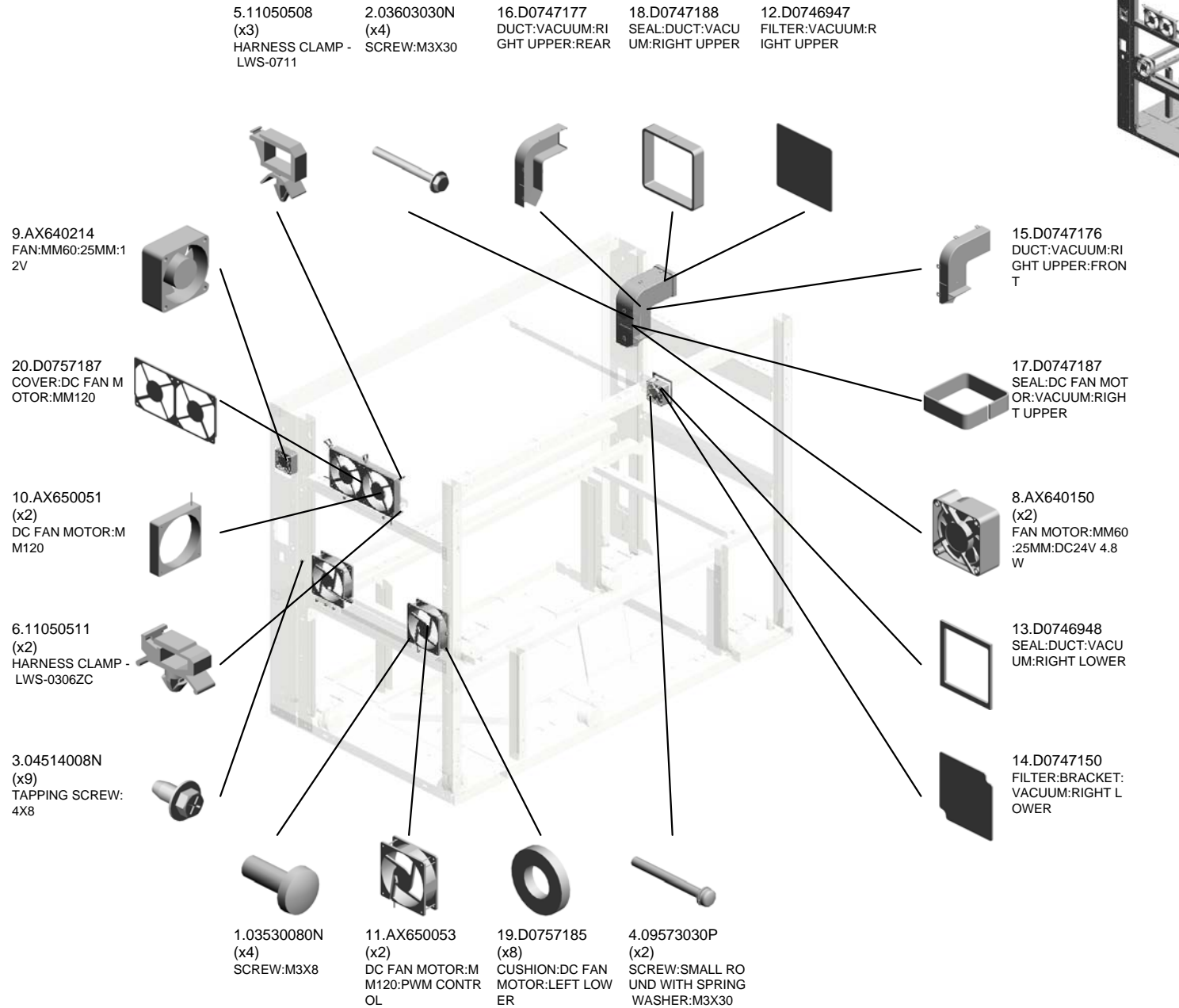

U001	U002	U003	U004	U005	U006	U007	U008	U009	U010	U011	U012	U013	U014	U015	U016	U017	U018	U019	U020	U021
------	------	------	------	------	------	------	------	------	------	------	------	------	------	------	------	------	------	------	------	------

U065 Electrical 1 (Rear)

4.04514008N
(x32)
TAPPING SCREW:
4X8

14.D0745506
PCB:IOB

17.M0445401
PCB:BCU:ASS'Y

1.03603006N
(x32)
SCREW - M3X6

2.03604008N
SCREW - M4X8

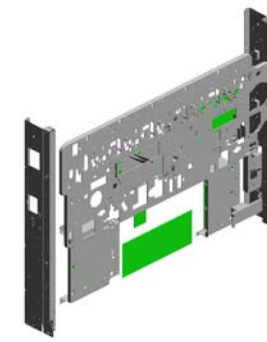

15.D0745520
PCB:TDCU:ASS'Y

5.11028502
CONNECTOR - 546
79-1615

3.04513008N
(x2)
TAPPING SCREW -
M3X8

12.D0745430
AC CONTROL BOA
RD

13.D0745440
PCB:RELAY:AC

9.AZ240166
POWER SUPPLY U
NIT:200-240V:395W

11.D0745424
PCB:RYB

7.14077036
EEPROM:AT24C12
8B-PU

6.11071281
FUSE:BJS2012F2

10.B2347587
POWER SUPPLY C
ORD BRACKET

16.D0745911
BRACKET:NOISE F
ILTER

8.16071799
FILTER - SUP-ET20
-ER-0

U001	U002	U003	U004	U005	U006	U007	U008	U009	U010	U011	U012	U013	U014	U015	U016	U017	U018	U019	U020	U021
------	------	------	------	------	------	------	------	------	------	------	------	------	------	------	------	------	------	------	------	------

U066 Electrical 2 (Front)

8.D0743636 SHEET:MAIN SWITCH
 2.03603014N (x4) SCREW - M3X14
 5.12042521 (x4) MICRO SWITCH



12.D0745920 BRACKET:MAIN SWITCH

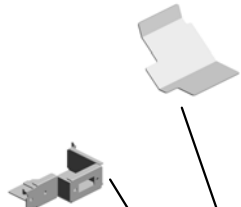

6.12042614 SWITCH AC250V/16A



3.04514008N (x2) TAPPING SCREW: 4X8



4.11050516 (x5) CLAMP



9.D0745914 BRACKET:SAFETY SWITCH



1.03603006N (x2) SCREW - M3X6



10.D0745916 (x2) SPRING PLATE:SAFETY SWITCH



11.D0745917 (x2) ARM:SAFETY SWITCH



7.C2182185 (x2) STEPPER SCREW



U001	U002	U003	U004	U005	U006	U007	U008	U009	U010	U011	U012	U013	U014	U015	U016	U017	U018	U019	U020	U021
------	------	------	------	------	------	------	------	------	------	------	------	------	------	------	------	------	------	------	------	------

U067 Electrical 3 (Upper)

- 5.07200030E (x4) RETAINING RING - M3
- 16.D0742178 (x4) TENSION SPRING: SOLENOID:ON-OFF
- 8.AW500023 (x4) PUSH SWITCH
- 19.D0742572 (x4) STAY:SET SENSOR:PCU
- 10.B1325415 BASE:ELECTRIC POTENTIAL SENSOR

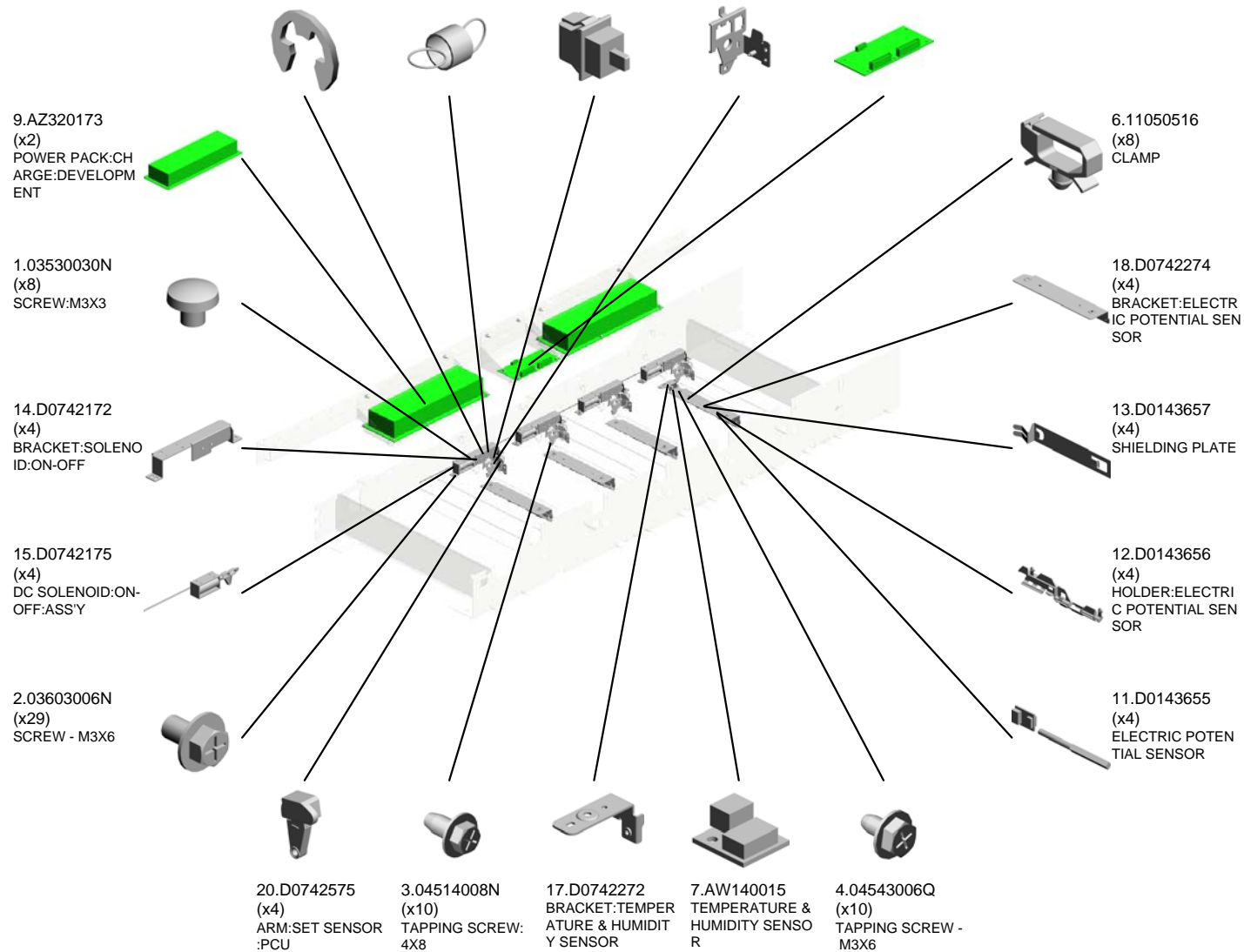
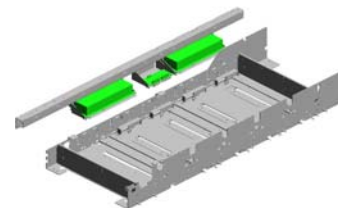

U001	U002	U003	U004	U005	U006	U007	U008	U009	U010	U011	U012	U013	U014	U015	U016	U017	U018	U019	U020	U021
------	------	------	------	------	------	------	------	------	------	------	------	------	------	------	------	------	------	------	------	------

U067
Electrical 3 (Upper)

23.D0742181
(x4)
CONNECTOR:1POL
E
201109-28



22.D0742577
(x4)
CONNECTOR:DRA
WER:4POLE:REC

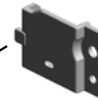
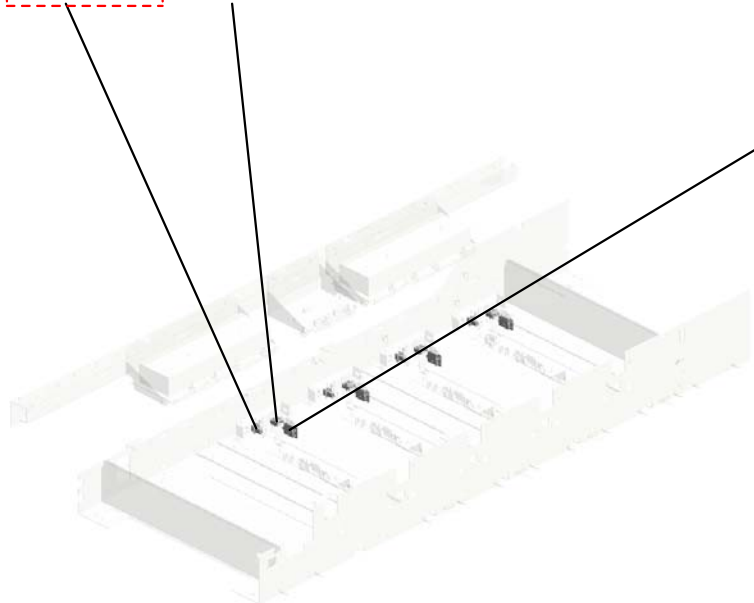
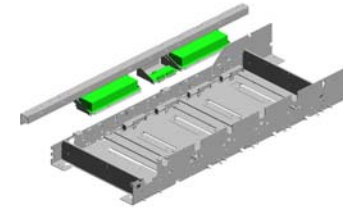

21.D0742576
(x4)
HOLDER:SET SEN
SOR:PCU

U068 Electrical 4 (Paper Feed)

10.11050692 (x2) CLAMP:LES-0503
 9.11050518 EDGE SADDLE - L ES-1010
 3.07200040E RETAINING RING - M4
 13.AA132203 SPACER - 6MM
 15.AA143550 (x2) SCREW:DIA4:M3

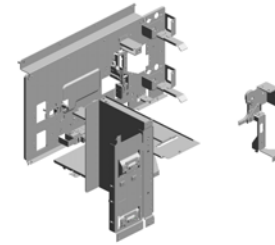

5.08030058 (x2) STEPPED SCREW

12.AA063268 (x2) CONNECTOR SPRING

4.08025220 (x2) TAPPING SCREW - M4X8

14.AA140912 SCREW - 8X14X2.8

6.08046123 HEXAGONAL BOLT :W/WASHER:M3X8

2.04514008N (x47) TAPPING SCREW: 4X8

7.11050487 (x7) HARNESS CLAMP

19.AX310045 TOTAL COUNTER: 7FIG:24V

1.03604006N (x6) SCREW - M4X6

8.11050516 (x14) CLAMP

20.B0042995 CAP - POSITIONING

18.AW500023 PUSH SWITCH

16.AA143569 (x2) SCREW

17.AW500010 PUSH SWITCH

11.12042570 (x2) ROCKER SWITCH: SDDJE13200

U068 Electrical 4 (Paper Feed)

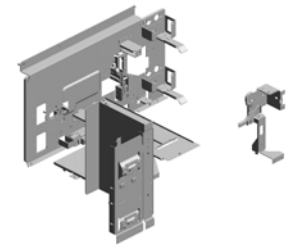
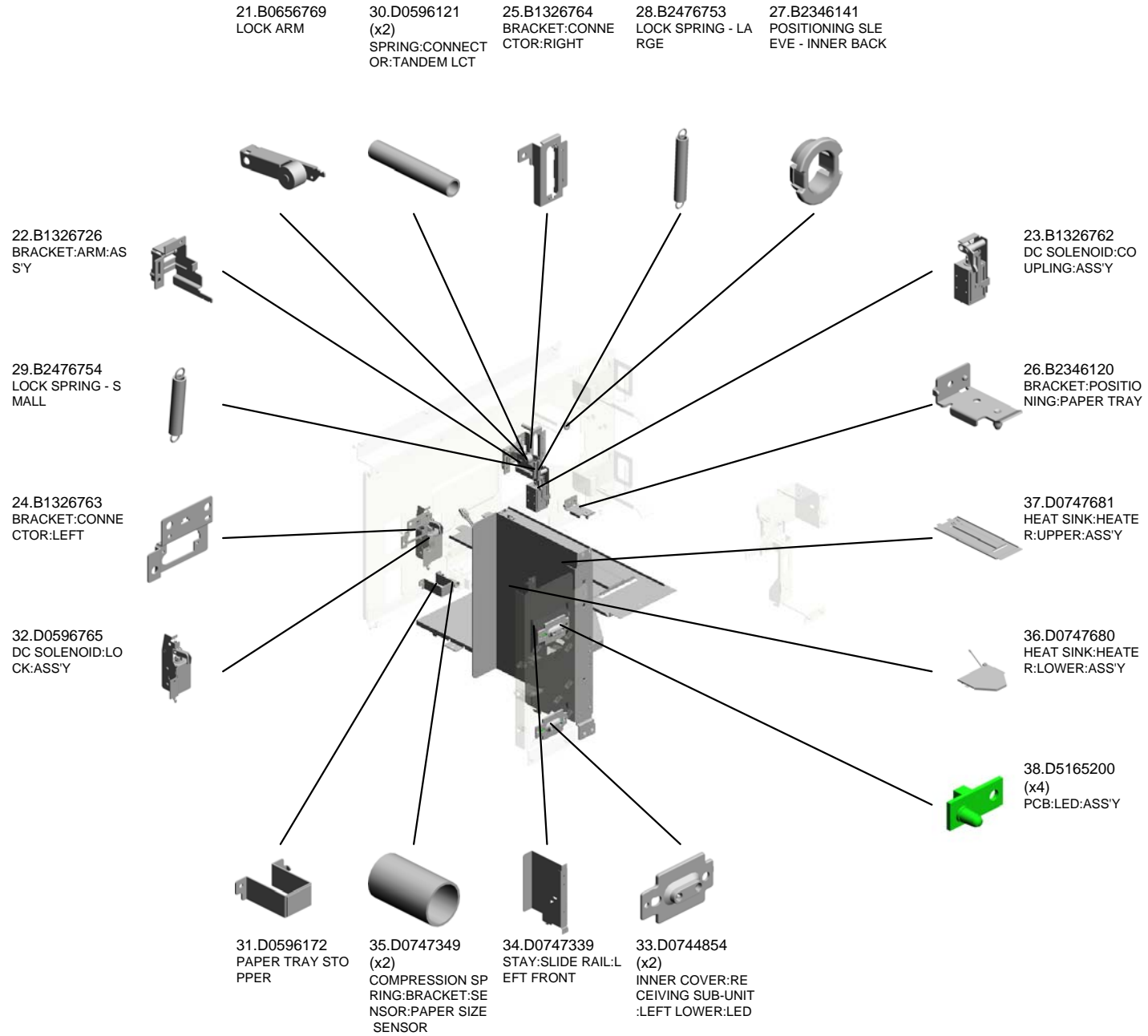

U001	U002	U003	U004	U005	U006	U007	U008	U009	U010	U011	U012	U013	U014	U015	U016	U017	U018	U019	U020	U021
------	------	------	------	------	------	------	------	------	------	------	------	------	------	------	------	------	------	------	------	------

U069 Electrical 5 (Control)

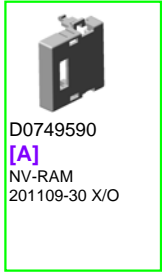
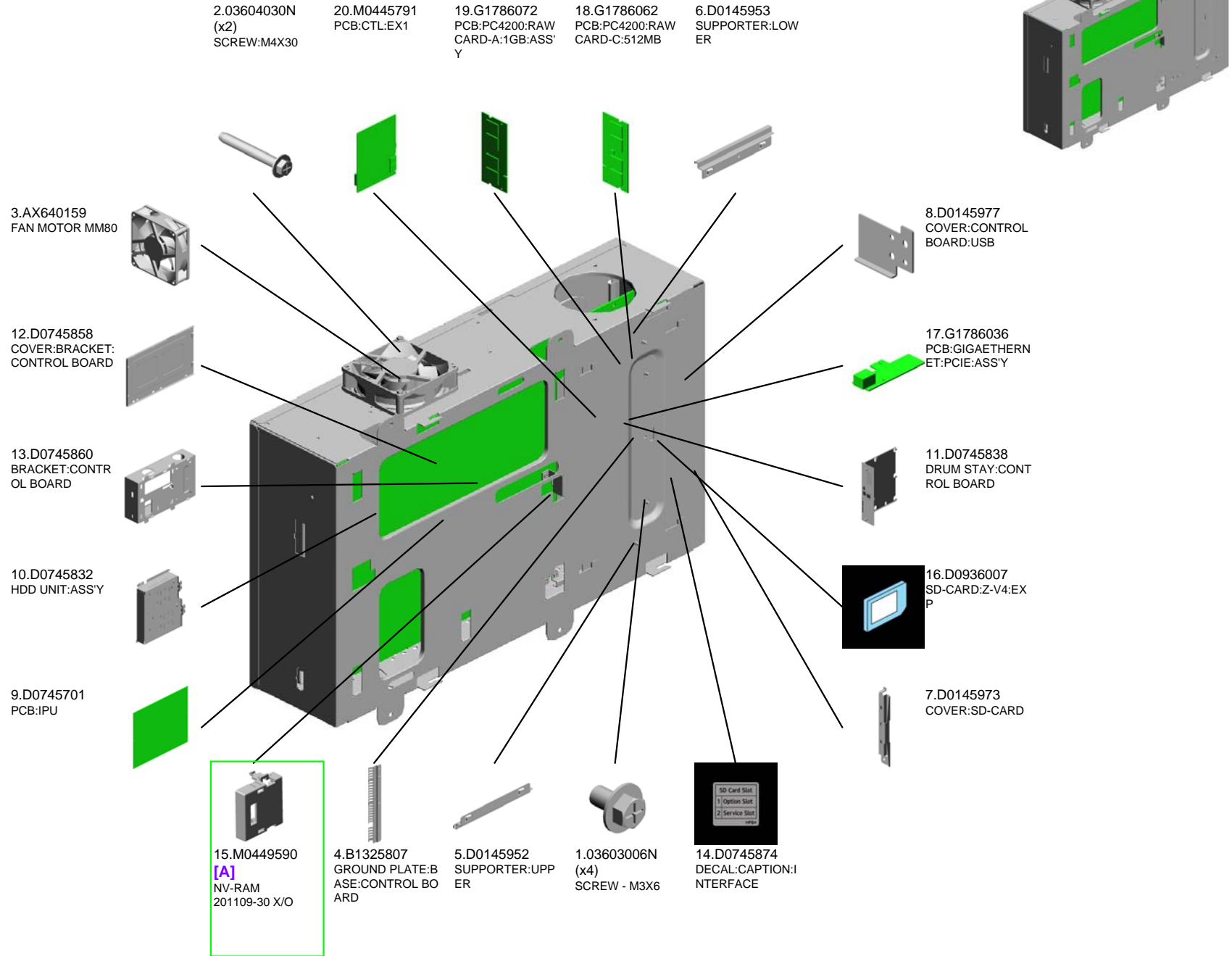

U001	U002	U003	U004	U005	U006	U007	U008	U009	U010	U011	U012	U013	U014	U015	U016	U017	U018	U019	U020	U021
------	------	------	------	------	------	------	------	------	------	------	------	------	------	------	------	------	------	------	------	------

U070

Electrical 6 (Back 1)

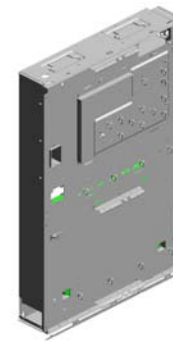

- 3.04543006Q (x6) TAPPING SCREW - M3X6
- 7.B1322366 (x2) LEVER:DRUM STAY:LEFT
- 12.D0741287 SEAL:C/T BOX:DUCT:UPPER
- 11.D0741286 SEAL:C/T BOX:DUCT:FRONT
- 19.D0747140 DUCT:FRONT:EXHAUST:AUST:C/T BOX

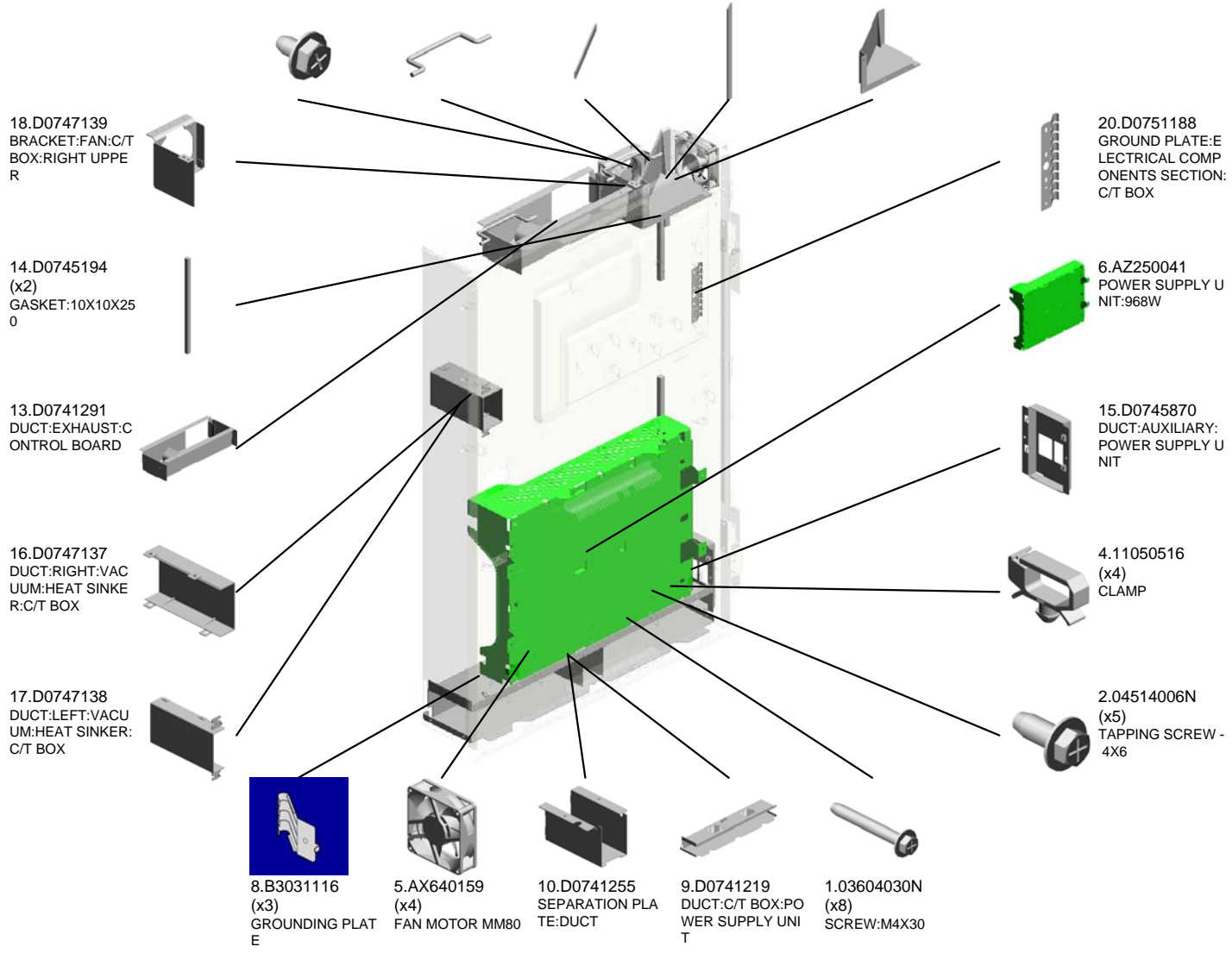

U001	U002	U003	U004	U005	U006	U007	U008	U009	U010	U011	U012	U013	U014	U015	U016	U017	U018	U019	U020	U021
------	------	------	------	------	------	------	------	------	------	------	------	------	------	------	------	------	------	------	------	------

U071.Electrical 7 (Back 2)

U071_S001
D0741251
DUCT:EXHAUST:EXIT:ASSY

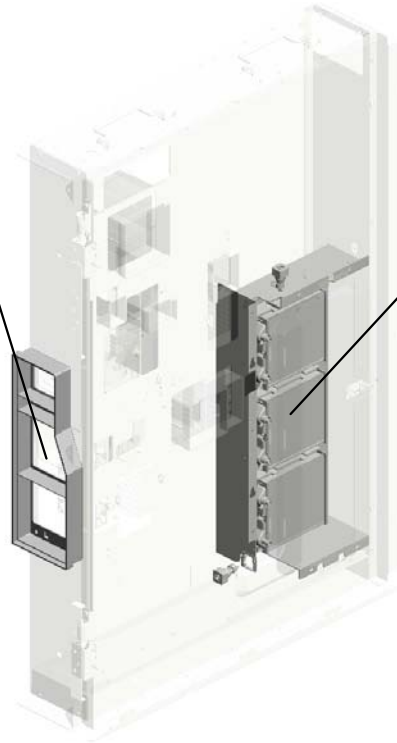

U071_S002
D0747250
LIQUID COOLING:FAN:ASSY

U001	U002	U003	U004	U005	U006	U007	U008	U009	U010	U011	U012	U013	U014	U015	U016	U017	U018	U019	U020	U021
------	------	------	------	------	------	------	------	------	------	------	------	------	------	------	------	------	------	------	------	------

U071

Electrical 7 (Back 2)

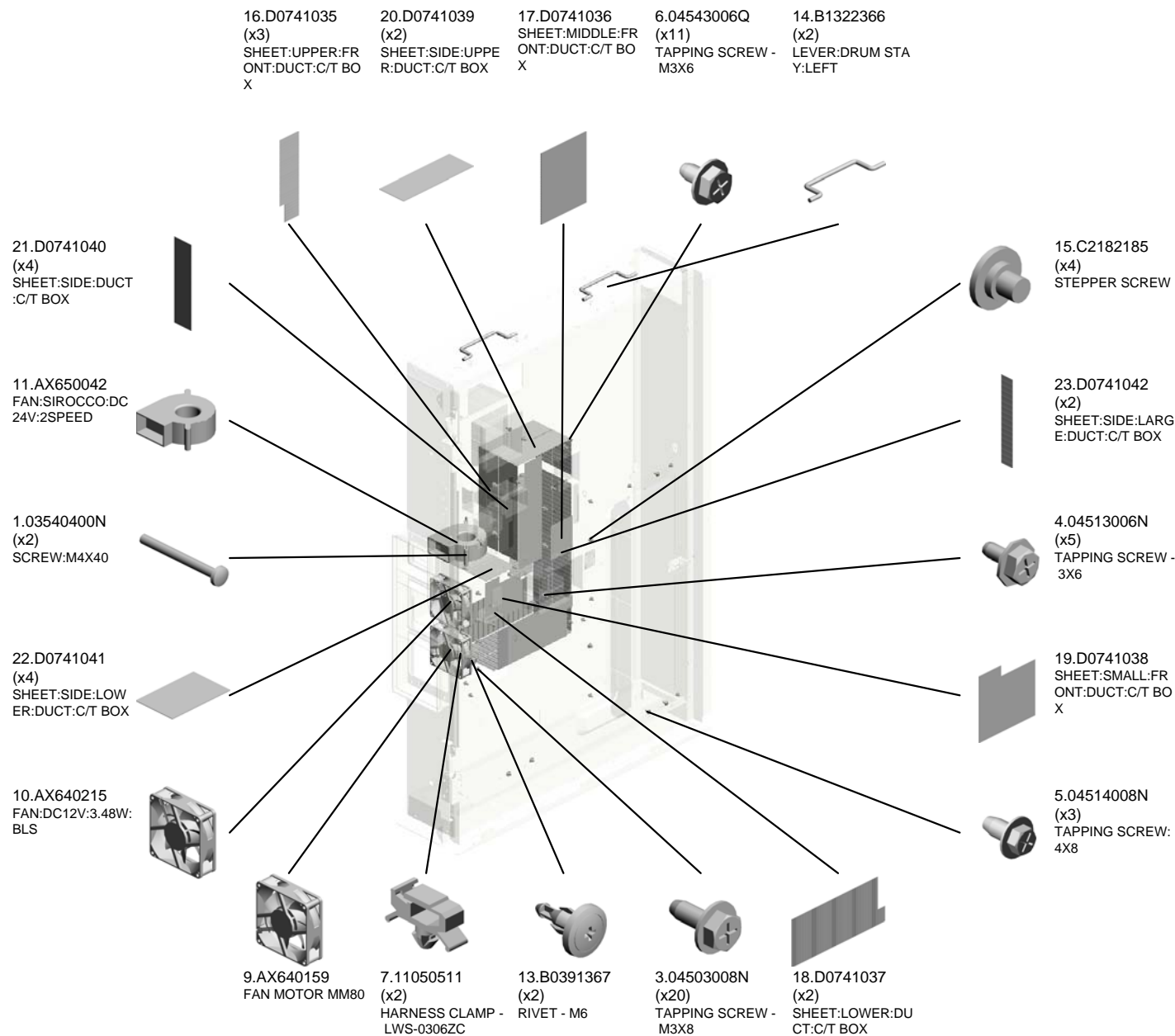

U001	U002	U003	U004	U005	U006	U007	U008	U009	U010	U011	U012	U013	U014	U015	U016	U017	U018	U019	U020	U021
------	------	------	------	------	------	------	------	------	------	------	------	------	------	------	------	------	------	------	------	------

U071

Electrical 7 (Back 2)



- 36.D0747114 (x4) BRACKET:FAN:DU CT:EXHAUST:C/T BOX
- 39.D0747122 DUCT:FRONT:OZONE UNIT:C/T BOX
- 44.D0747128 SEAL:LOWER:DUCT:OZONE FILTER:C/T BOX
- 27.D0741046 SHEET:UPPER:REAR:DUCT:C/T BOX
- 24.D0741043 (x2) SHEET:UPPER:BRACKET:DUCT:C/T BOX

40.D0747123 DUCT:REAR:OZONE UNIT:C/T BOX

43.D0747126 SEAL:COVER:DUCT:OZONE UNIT:C/T BOX

34.D0747110 OZONE FILTER

42.D0747125 COVER:DUCT:OZONE UNIT:C/T BOX

41.D0747124 BRACKET:FAN:DUCT:OZONE FILTER:C/T BOX

33.D0747109 SEAL:EXIT:EXHAUST:DUCT:C/T BOX

31.D0747104 BRACKET:FAN:DUCT:EXHAUST:C/T BOX

35.D0747111 (x5) FILTER:PREVENTENCE

26.D0741045 (x2) SHEET:LOWER:BRACKET:DUCT:C/T BOX

30.D0746945 SHEET:C/T BOX:LIQUID COOLING:LOWER

25.D0741044 (x2) SHEET:MIDDLE:BRACKET:DUCT:C/T BOX

28.D0741047 SHEET:LOWER:REAR:DUCT:C/T BOX

32.D0747107 SEAL:LOWER:DUCT:EXHAUST:C/T BOX

38.D0747116 SEAL:COVER:DUCT:EXHAUST:C/T BOX

37.D0747115 COVER:DUCT:EXHAUST:C/T BOX

U001	U002	U003	U004	U005	U006	U007	U008	U009	U010	U011	U012	U013	U014	U015	U016	U017	U018	U019	U020	U021
------	------	------	------	------	------	------	------	------	------	------	------	------	------	------	------	------	------	------	------	------

U071

Electrical 7 (Back 2)

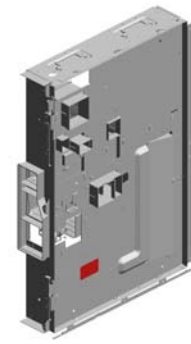

- 45.D0747129 SEAL:UPPER:DUCT:OZONE FILTER:C/T BOX
- 51.D0747189 DUCT:FRONT:EXHAUST:C/T BOX
- 57.D0747195 (x2) SEAL:DUCT:C/T BOX:MIDDLE UPPER
- 54.D0747192 BRACKET:MIDDLE:DUCT:EXHAUST:C/T BOX
- 53.D0747191 BRACKET:UPPER:DUCT:EXHAUST:C/T BOX

52.D0747190 DUCT:REAR:EXHAUST:C/T BOX

46.D0747130 SEAL:EXIT:DUCT:OZONE FILTER:C/T BOX

60.D0747198 SEAL:DUCT:C/T BOX:MIDDLE LOWER

58.D0747196 BRACKET:UPPER:FAN:DUCT:C/T BOX

49.D0747170 SEAL:EXIT:MIDDLE:DUCT:C/T BOX

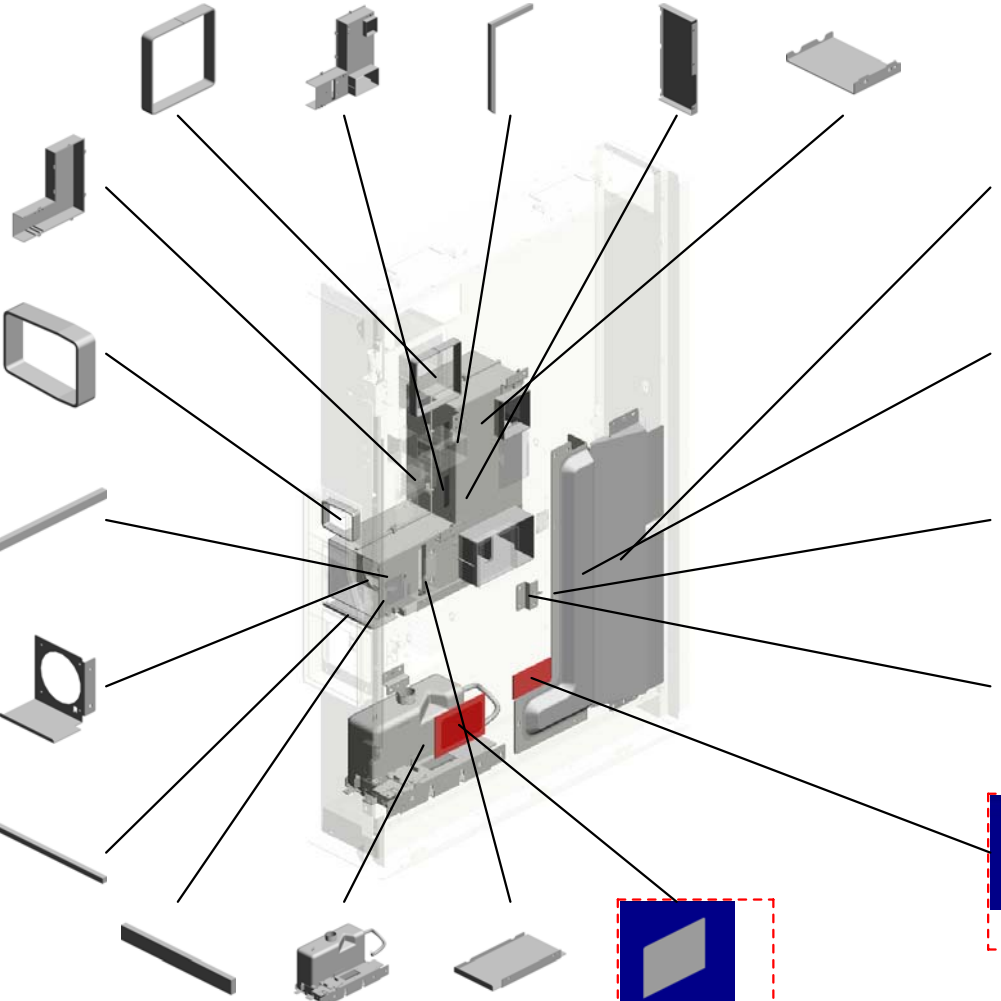

47.D0747134 BRACKET:FIN:RADIATOR

48.D0747135 SEAL:FIN

61.D0747199 COVER:LIQUID COOLING:BASE:C/T BOX

56.D0747194 (x5) BRACKET:DUCT:EXHAUST:C/T BOX

64.D0746944 SHEET:C/T BOX:LIQUID COOLING:UPPER
201109-25

59.D0747197 (x3) SEAL:DUCT:C/T BOX:MIDDLE SIDEWAYS

63.D0747261 LIQUID COOLING:PUMP:ASSY

55.D0747193 BRACKET:LOWER:DUCT:EXHAUST:C/T BOX



65.D0747207 SHEET:C/T BOX:LIQUID COOLING:WINDOW
201109-26

U001	U002	U003	U004	U005	U006	U007	U008	U009	U010	U011	U012	U013	U014	U015	U016	U017	U018	U019	U020	U021
------	------	------	------	------	------	------	------	------	------	------	------	------	------	------	------	------	------	------	------	------

U071_S001
DUCT:EXHAUST:EXIT:ASS'Y

50.D0747174
SEAL:DUCT:EXIT

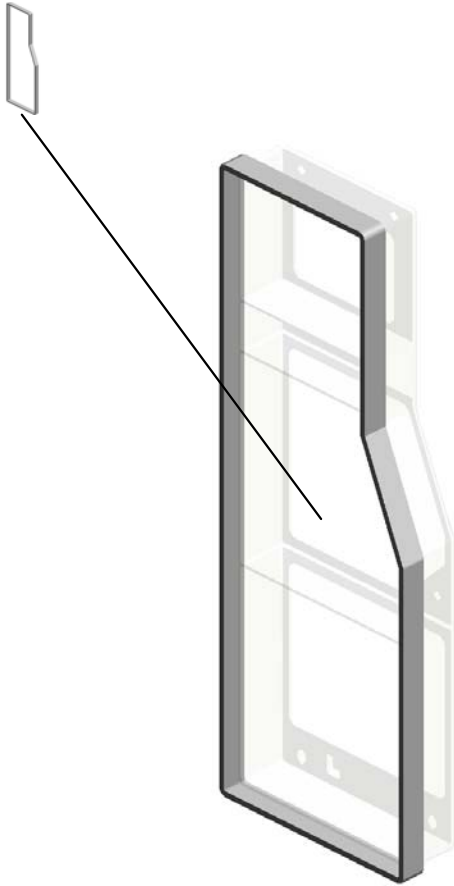

29.D0741251
DUCT:EXHAUST:E
XIT:ASS'Y

U001	U002	U003	U004	U005	U006	U007	U008	U009	U010	U011	U012	U013	U014	U015	U016	U017	U018	U019	U020	U021
------	------	------	------	------	------	------	------	------	------	------	------	------	------	------	------	------	------	------	------	------

U071_S002
LIQUID COOLING:FAN:ASS'Y

2.03603030N
(x6)
SCREW:M3X30

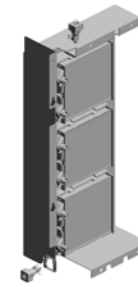

62.D0747250
LIQUID COOLING:F
AN:ASS'Y



12.AX650051
(x3)
DC FAN MOTOR:M
M120

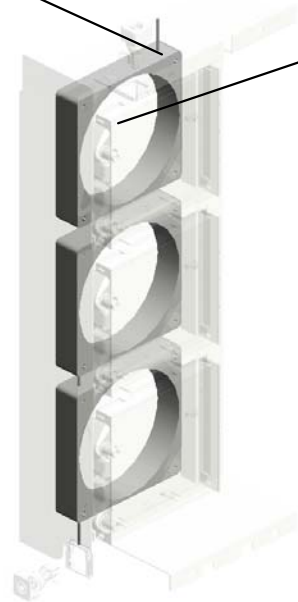

U001	U002	U003	U004	U005	U006	U007	U008	U009	U010	U011	U012	U013	U014	U015	U016	U017	U018	U019	U020	U021
------	------	------	------	------	------	------	------	------	------	------	------	------	------	------	------	------	------	------	------	------

U072.Main Frame

U072_S002
D0743446
RECEPTACLE:DEVELOPME
T BIAS:ASS'Y



U072_S001
D0743446
RECEPTACLE:DEVELOPME
T BIAS:ASS'Y



U072_S004
D0743446
RECEPTACLE:DEVELOPME
T BIAS:ASS'Y



U072_S003
D0743446
RECEPTACLE:DEVELOPME
T BIAS:ASS'Y



U001	U002	U003	U004	U005	U006	U007	U008	U009	U010	U011	U012	U013	U014	U015	U016	U017	U018	U019	U020	U021
------	------	------	------	------	------	------	------	------	------	------	------	------	------	------	------	------	------	------	------	------

U072 Main Frame

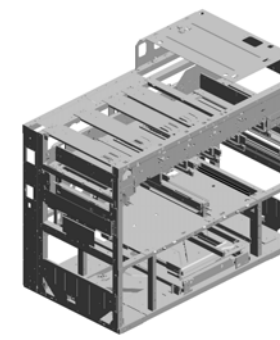

- 4.03604006N (x2) SCREW - M4X6
- 13.11050723 (x3) CLAMPS:WES-050 7
- 11.11050600 (x3) CLAMP:LWSM-030 6-2M
- 3.03540080N (x2) SCREW:M4X8
- 12.11050601 (x3) CLAMP:LWSM-051 1-2M

6.04514008N (x55) TAPPING SCREW: 4X8

10.07200040E (x2) RETAINING RING - M4

17.B0656136 (x2) TRAY LOCK ARM

5.03604008N (x12) SCREW - M4X8

2.03540060N (x8) SCREW-M4X6

16.AW140015 TEMPERATURE & HUMIDITY SENSOR

8.04544008Q (x5) TAPPING SCREW - M4X8

18.B0656591 PAPER TRAY HOLDER BASE

19.B1327591 RAIL:PAPER TRAY: ASS'Y

9.07200030E RETAINING RING - M3

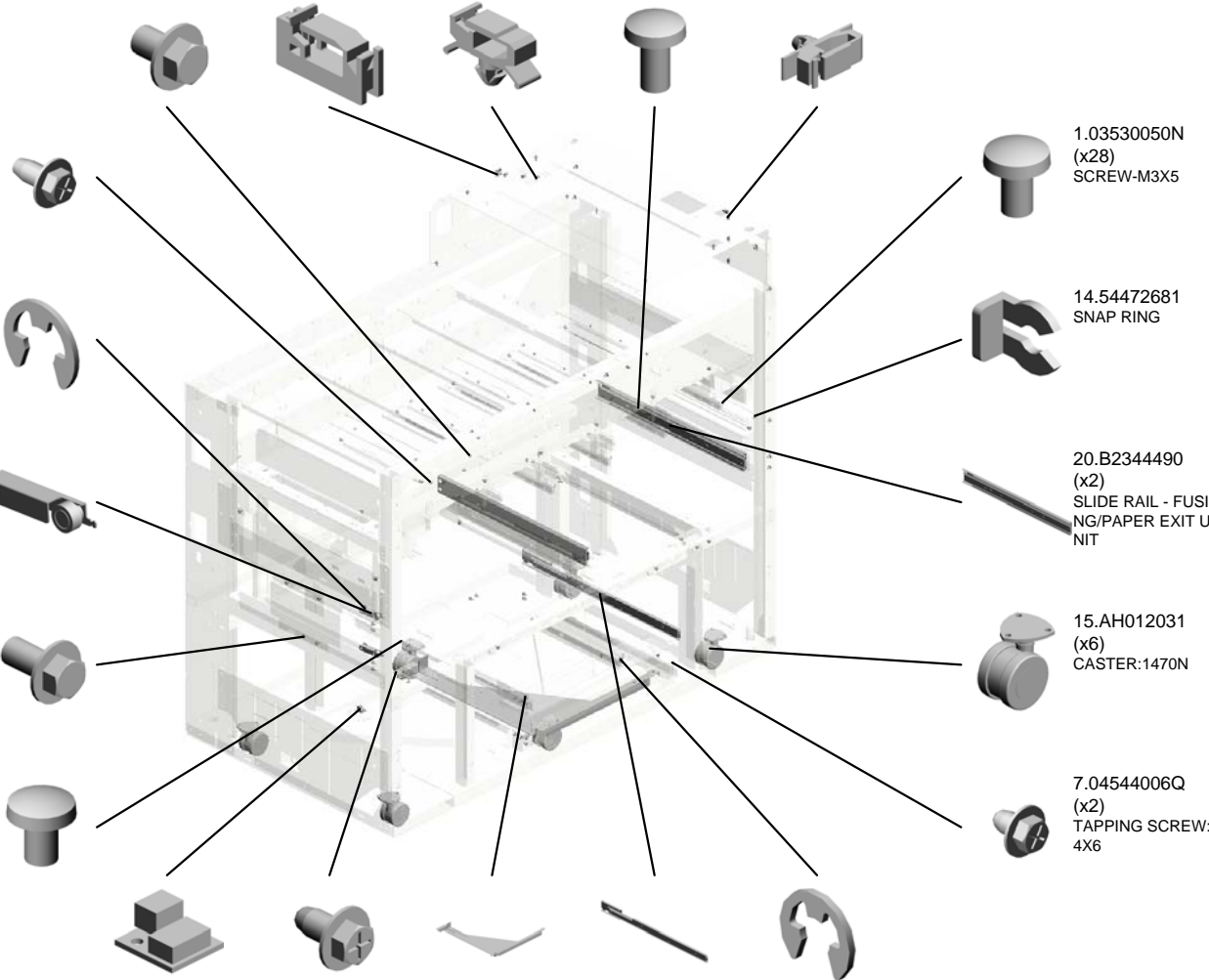

1.03530050N (x28) SCREW-M3X5

14.54472681 SNAP RING

20.B2344490 (x2) SLIDE RAIL - FUSI NG/PAPER EXIT UNIT

15.AH012031 (x6) CASTER:1470N

7.04544006Q (x2) TAPPING SCREW: 4X6

U072 Main Frame

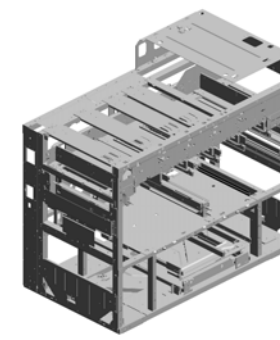

- 33.D0741173 BOSS:POSITIONING PIN:TRANSPORT UNIT:NO.2:10.3MM
- 30.D0741125 PLATE:RADIAL BALL BEARING:THRU ST
- 37.D0742558 (x4) SLIDE RAIL:PCU:LEFT
- 35.D0742552 (x5) GUIDE PLATE:SLIDE RAIL:PCU
- 36.D0742553 (x4) SLIDE RAIL:PCU:RIGHT

23.B2591131 (x8) SCREW:PCU

31.D0741128 PLAIN SHAFT BEARING:POSITIONING PIN:FUSING

34.D0741195 (x4) GUIDE:LOCK:TRANSPORT UNIT

32.D0741154 COVER:PAPER EXIT UNIT:EXIT

25.D0590761 SPRING:TANDEM TRAY:LOCK

27.D0596591 SPRING:PAPER TRAY:LOCK

29.D0626692 SLIDE RAIL:PAPER TRAY:LEFT:SUB-ASSY

26.D0596170 BRACKET:SLIDE RAIL:PAPER TRAY:2:ASSY

21.B2346138 RAIL - TANDEM LC T

24.BA146065 SHAFT:STOPPER:TANDEM LCT

39.D0742797 STAY:CONNECTOR:LARGE CAPACITY TRAY

40.D0742799 GUIDE PLATE:CONNECTION:LCT:LOWER

38.D0742561 (x4) LOCK:SLIDE RAIL:PCU:RIGHT

22.B2346188 SLIDE SLEEVE POSITIONING

28.D0596731 SHIELD:GUIDE:MISFEED REMOVAL

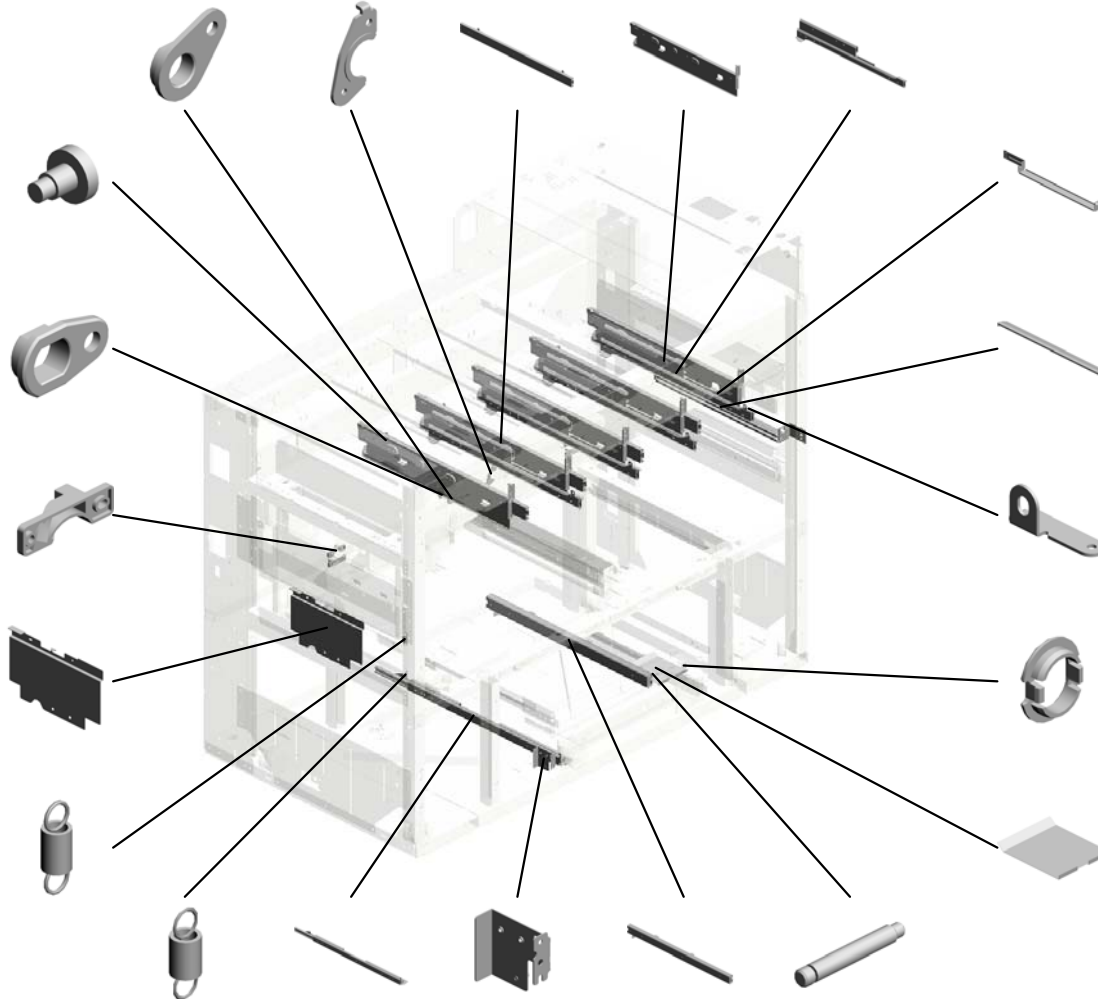

U072 Main Frame

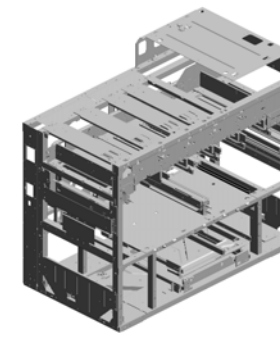

- 48.D0744351 (x2) STEPPED SCREW: DIA5.4DIA:3.5M3
- 50.D0746078 (x2) COMPRESSION SPRING:DRAWER:INTERMEDIATE TRANSFER
- 51.D0747172 (x8) SEAL:OPTICAL WRITING UNIT:LOWER
- 58.D0751184 (x8) SEAL:OPTICAL WRITING UNIT:UPPER
- 42.D0742942 PIN:GUIDE PLATE:CONNECTION:LARGE CAPACITY TRAY:UPPER

60.G1787744
BOSS:POSITIONING PIN:TRANSPORT UNIT:NO.2

59.G1787743 (x3)
BOSS:POSITIONING PIN:TRANSPORT UNIT:NO.1

49.D0744682
PAPER EXIT SUB-UNIT:EXIT:MAIN

54.D0747331
STAY:SLIDE RAIL:LEFT INNER REAR:NO.1:PEEN

56.D0747335
STAY:SLIDE RAIL:LEFT:NO.2

53.D0747330
SLIDE RAIL:LEFT:NO.1

55.D0747333
STAY:SLIDE RAIL:LEFT FRONT:NO.1

62.D0741088
SHEET:BASE:MAIN:FRONT
201109-16

52.D0747326
SLIDE RAIL:RIGHT:NO.2:ASS'Y

57.D0747367
BRACKET:STOPPER:TANDEM LCT

41.D0742938
[A]
GUIDE PLATE:CONNECTION:LARGE CAPACITY TRAY:UPPER
201109-29 X/O

44.D0743038
BRACKET:DUPLIX:EXIT

45.D0743039
GUIDE PLATE:DUPLIX:EXIT

43.D0743033
GUIDE PLATE:CONNECTING

46.D0743047 (x2)
BRACKET:HOLDER:DUPLIX:ASS'Y

D0742939
[A]
GUIDE PLATE:CONNECTION:LARGE CAPACITY TRAY:UPPER
201109-29 X/O



U001	U002	U003	U004	U005	U006	U007	U008	U009	U010	U011	U012	U013	U014	U015	U016	U017	U018	U019	U020	U021
------	------	------	------	------	------	------	------	------	------	------	------	------	------	------	------	------	------	------	------	------

U072_S001
RECEPTACLE:DEVELOPMENT BIAS:ASS'Y

61.AA063371
SPRING
201109-12



47.D0743446
RECEPTACLE:DEV
ELOPMENT BIAS:A
SS'Y

U001	U002	U003	U004	U005	U006	U007	U008	U009	U010	U011	U012	U013	U014	U015	U016	U017	U018	U019	U020	U021
------	------	------	------	------	------	------	------	------	------	------	------	------	------	------	------	------	------	------	------	------

U072_S002
RECEPTACLE:DEVELOPMENT BIAS:ASS'Y

61.AA063371
SPRING
201109-12



47.D0743446
RECEPTACLE:DEV
ELOPMENT BIAS:A
SS'Y

U001	U002	U003	U004	U005	U006	U007	U008	U009	U010	U011	U012	U013	U014	U015	U016	U017	U018	U019	U020	U021
------	------	------	------	------	------	------	------	------	------	------	------	------	------	------	------	------	------	------	------	------

U072_S003
RECEPTACLE:DEVELOPMENT BIAS:ASS'Y

61.AA063371
SPRING
201109-12

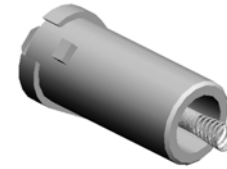

47.D0743446
RECEPTACLE:DEV
ELOPMENT BIAS:A
SS'Y

U001	U002	U003	U004	U005	U006	U007	U008	U009	U010	U011	U012	U013	U014	U015	U016	U017	U018	U019	U020	U021
------	------	------	------	------	------	------	------	------	------	------	------	------	------	------	------	------	------	------	------	------

U072_S004
RECEPTACLE:DEVELOPMENT BIAS:ASS'Y

61.AA063371
SPRING
201109-12

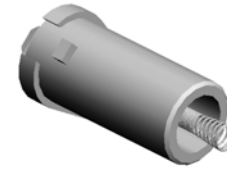

47.D0743446
RECEPTACLE:DEV
ELOPMENT BIAS:A
SS'Y

U001	U002	U003	U004	U005	U006	U007	U008	U009	U010	U011	U012	U013	U014	U015	U016	U017	U018	U019	U020	U021
------	------	------	------	------	------	------	------	------	------	------	------	------	------	------	------	------	------	------	------	------

Accessories



1.D0744225
KNOB:FUSING



2.D0744391
HOLDER:KNOB:FUSING:DUAL FACE
S TEPE

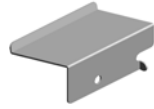

3.D0746727
COVER:HARNES:OPERATION PAN
EL

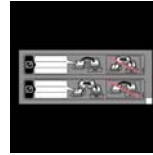

4.D0747391
(x2)
DECAL:PAPER SET DIRECTION



5.D0747847
DECAL:CAUTION CHART:INKJET:PA
PER:NA

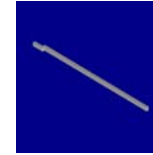

6.D0747905
SEAL:MAIN:FRONT LEFT:LOWER



7.D0747906
SEAL:MAIN:FRONT LEFT:UPPER



8.G1781141
(x4)
HOLDER:STAND:M20

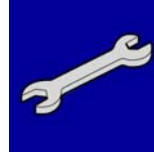

9.G1788350
WRENCH:HEXAGONAL BOLT



10.D0744390
ACCESSORY:KNOB:FUSING:ASSY
201109-22

Special Tools

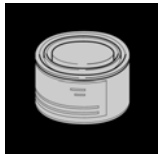

1.52039502
GREASE 501

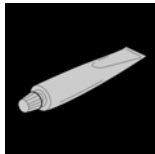

2.A2579300
GREASE - BARRIERTA S552R



3.B1329700
LUBRICANT POWDER

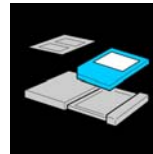

4.B6455010
SD-CARD:ASSY



5.VSSG9002
FLUOTRIBO MG GREASE : 100G



6.G0049668
GREASE:KS660:SHIN-ETSU
201109-11

Decals and Documents



1.AA001509
DECAL:SIDE FENCE:16X30



2.B0656545
DECAL - POSITIONING



3.B1325996
DECAL:TOTAL COUNTER



4.B2232873
DECAL - SIDE FENCE REAR



5.D0742540
DECAL:LOCK:CLEANING UNIT

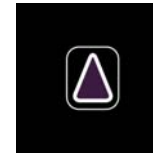

6.D0742541
DECAL:ARROW LABEL

Decals and Documents

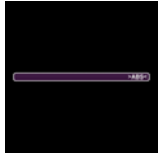

7.D0742542
DECAL:GRIP



8.D0742544
DECAL:POSITIONING DISPLAY

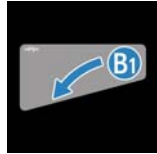

9.D0742984
DECAL:PULL OUT:RIGHT:B1



10.D0742985
DECAL:PULL OUT:RIGHT:B3



11.D0742986
DECAL:PULL OUT:RIGHT:B4



12.D0742987
DECAL:PULL OUT:RIGHT:B6



13.D0742988
DECAL:PULL OUT:RIGHT:B7



14.D0742989
DECAL:PULL OUT:RIGHT:Z2



15.D0742990
DECAL:PULL OUT:RIGHT:Z4

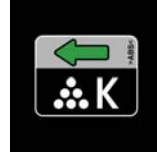

16.D0743770
DECAL:OPERATE:TONER BOTTLE:K

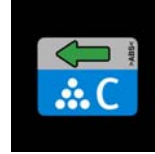

17.D0743771
DECAL:OPERATE:TONER BOTTLE:C



18.D0743772
DECAL:OPERATE:TONER BOTTLE:M



19.D0743773
DECAL:OPERATE:TONER BOTTLE:Y



20.D0743829
DECAL:POSITIONING DISPLAY:TCR
U



21.D0743830
DECAL:OPERATE:LEVER:INTERMED
IATE TRANSFER



22.D0744336
DECAL:WARNING (REMOVAL AND I
NSTALLATION):FUSING



23.D0744380
DECAL:H-TEMP WARNING:FUSING:
WEB

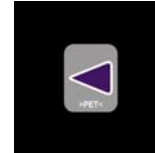

24.D0744381
DECAL:FUSING UNIT:POSITIONING



25.D0744551
DECAL:PULL OUT:LEFT:Z1



26.D0744552
DECAL:PULL OUT:LEFT:Z3



27.D0744553
DECAL:PULL OUT:LEFT:D1



28.D0744554
DECAL:PULL OUT:LEFT:D3



29.D0744555
DECAL:PULL OUT:LEFT:D4



30.D0744556
DECAL:PULL OUT:LEFT:D5

Decals and Documents



31.D0744557
DECAL:H-TEMP WARNING:EXIT



32.D0744559
DECAL:RECEIVING SUB-UNIT:E

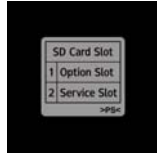

33.D0745874
DECAL:CAPTION:INTERFACE

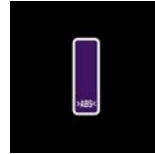

34.D0746241
DECAL:GRIP:TRANSFER/SEPARATI
ON UNIT



35.D0746242
DECAL:LEVER:TRANSFER/SEPARAT
ION UNIT:FRONT



36.D0746243
DECAL:LEVER:TRANSFER/SEPARAT
ION UNIT:REAR



37.D0746497
DECAL:POSITIONING DISPLAY:TCR
U

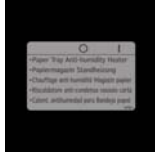

38.D0747377
DECAL:SWITCH:HEATER:PAPER TR
AY:EXP

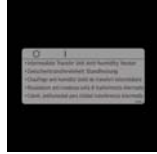

39.D0747380
DECAL:SWITCH:HEATER:INTERMED
IATE TRANSFER:EXP



40.D0747381
DECAL:VERTICAL TRANSPORT:A1



41.D0747382
DECAL:VERTICAL TRANSPORT:A2



42.D0747383
DECAL:VERTICAL TRANSPORT:A3



43.D0747385
DECAL:CAUTION CHART:TANDEM L
CT



44.D0747387
DECAL:BASE:TANDEM LCT:LEFT



45.D0747388
DECAL:PAPER SET DIRECTION:TAN
DEM LCT:RIGHT



46.D0747390
DECAL:PAPER SET DIRECTION:PAP
ER TRAY



47.D0747391
DECAL:PAPER SET DIRECTION



48.D0747392
DECAL:PAPER TRAY:NO.1



49.D0747393
DECAL:PAPER TRAY:NO.2



50.D0747773
DECAL:OPERATION INSTRUCTIONS:
TONER SUPPLY



51.D0747774
DECAL:MAIN SWITCH



52.D0747836
DECAL:MISFEED REMOVAL:AB



53.D0747837
DECAL:MISFEED REMOVAL:CDE



54.D0747838
DECAL:MISFEED REMOVAL:Z-1

Decals and Documents



55.D0747839
DECAL:MISFEED REMOVAL:Z-2

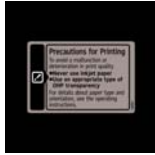

56.D0747847
DECAL:CAUTION CHART:INKJET:PA
PER:NA

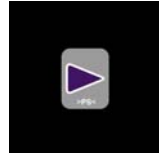

57.D0747848
DECAL:PULL OUT:LEFT:FUSING UNI
T:SET

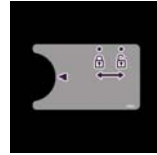

58.D0747849
DECAL:PULL OUT:LEFT:FUSING UNI
T:TCRU



59.G0291982
LD DECAL



60.M0447835
DECAL:MISFEED REMOVAL:LOCATI
ON



61.M0447898
DECAL:POWER SOURCE:OFF:ENGLI
SH

Exclusive Parts

Number	Part Name	Group	ID
50530223	BUSHING - 8MM	U008_S001	14
50530447	BUSHING - 6MM	U007_S001	10
52039502	GREASE 501	Special Tools	1
52062686	SNAP RING	U031	18
		U034_S001	9
52152621	SNAP RING - M6	U020	8
		U034_S001	10
53041639	BUSHING - 8MM	U043	9
54472681	SNAP RING	U001_S001	2
		U019	5
		U021	13
		U033_S001	5
		U038	8
		U044	16
		U050	18
54472706	GEAR - 15T	U011_S001	6
		U014_S001	6
58942540	ARM SCREW	U040	8
67542866	ROLLER - POSITIONING GUIDE	U020	9
		U044	17
8025320	HEXAGON HEAD TAPPING SCREW:ES:3X10	U029_S002	4
		U029_S005	4
		U029_S008	4
		U029_S011	4
A1342978	SPRING PLATE	U010_S001_S001	5
A2222724	EXTERNAL CIRCLIP - MM8	U028	11
A2324666	CUSHION - STEPPER MOTOR	U032	12
A2486687	RIGHT DRIVE SHAFT	U008_S001	15
A2486694	WIRE RING	U008_S001	16
A2486695	GUIDE - PULLEY	U008_S001	17
A2486713	HOOK - TENSION SPRING	U008_S001	18
A2574493	BAND	U021	14
		U050	19
A2579300	GREASE - BARRIERTA S552R	Special Tools	2
A2672857	SPRING PLATE - SIDE FENCE	U010_S001_S002	6
A2672859	SIDE FENCE STOPPER	U010_S001_S002	7
A2672860	REAR LEVER STOPPER	U010_S001_S002	8

Number	Part Name	Group	ID
A2946630	LEFT REAR FENCE	U007_S001_S002	11
A2946643	LEFT FRONT FENCE	U007_S001	12
A2946645	LEFT SIDE PLATE	U007_S001	13
A2946655	FRONT ROLLER - SLIDE RAIL	U008_S001	19
A2946690	FEELER - PAPER HEIGHT SENSOR	U008_S001	20
A8592230	BALL BEARING - 6X13X5	U021_S001	15
AA001508	DECAL:SIDE FENCE:40X30	U007_S001_S002	14
AA001509	DECAL:SIDE FENCE:16X30	Decals and Documents	1
		U008_S001_S002	21
AA021034	MAGNETIC	U050	20
AA036015	CAP:COLLECTION BOTTLE	U037_S001	1
AA040034	TRANSPORT BELT	U038_S001	9
AA043271	TIMING BELT S3M 196T	U007_S001	15
AA043312	TIMING BELT:60S2M138	U024	17
AA043325	TIMING BELT - B40S2M250	U050	21
AA043340	SYNCHRONOUS BELT:40S2M580	U055	8
AA043431	TIMING BELT:B40S2M320	U050	22
AA043432	TIMING BELT:B40S2M204	U050	23
AA043433	TIMING BELT:B40S2M456	U050	24
AA043584	TIMING BELT:S2M288	U055	9
AA043604	TIMING BELT:B40S2M110	U050	25
AA043608	TIMING BELT:40S2M184	U026	15
AA043609	TIMING BELT:60S2M124	U026	16
AA043610	SYNCHRONOUS BELT:DS3M558	U048	9
AA043621	TIMING BELT - 60S2M156	U024	18
AA043623	TIMING BELT - B40S2M180	U051	8
AA043634	TIMING BELT - 40S2M296	U026	17
AA043638	TIMING BELT:40S2M224	U025	11
AA043639	SYNCHRONOUS BELT:B60S2M192	U024	19
AA043645	SYNCHRONOUS BELT:40S2M426	U057	5
AA043646	SYNCHRONOUS BELT:40S2M596	U057	6
AA043647	TIMING BELT:60S2M188	U018	6
AA043976	TIMING BELT:40S2M142	U032	13
AA043981	SYNCHRONOUS BELT:60DS2M300	U053	8
AA043983	SYNCHRONOUS BELT:60S3M243	U028	12
AA050116	DRIVE WERE:DRIVEN ROLLER	U032	14

Exclusive Parts

Number	Part Name	Group	ID
AA060523	PICK-UP PRESSURE SPING	U011_S001	7
		U014_S001	7
AA060757	TENSION SPRING - LONG	U008_S001	22
AA060758	TENSION SPRING - SHORT	U008_S001	23
AA060961	TENSION SPRING:SIDE FENCE:REAR	U010_S001	9
AA060987	TENSION SPRING:TIMING BELT:10N	U007_S001	16
AA061000	SPRING - 1.42N	U012	7
		U015	7
AA061001	RELEASE SPRING	U012	8
		U015	8
AA061065	TENSION SPRING:DUPLEX:DRIVE N ROLLER	U021	16
AA061066	COIL SPRING:GATE	U024	20
AA061067	TENSION SPRING:DRIVE WERE:DRIVE	U032	15
AA061068	TENSION SPRING:BRACKET:DRIVEN ROLLER:INNER BACK	U032	16
AA061069	TENSION SPRING:BRACKET:DC STEPPER MOTOR	U032	17
AA061070	TENSION SPRING:DC SOLENOID:LINK	U026	18
AA061078	TENSION SPRING:PRESSURE ROLLER	U023_S001	9
AA061110	TENSION SPRING:TIGHTENER:DRIVE UNIT:USED TONER	U057	7
AA061111	TENSION SPRING:MIDDLE:DRIVE:USED TONER	U057	8
AA061112	TENSION SPRING:TIGHTENER	U055	10
AA061114	TENSION SPRING:POSITIONING SENSOR	U032	18
AA061115	TENSION SPRING:0.4N	U041_S001	10
AA061116	TENSION SPRING:STRIPPER PLATE:2N	U040_S001	9
AA061117	TENSION SPRING:STRIPPER PLATE:PLATE	U040_S001	10
AA061118	TENSION SPRING:LEVER:PRESSURE	U039_S001	5

Number	Part Name	Group	ID
	RE:20N		
AA062319	SPRING	U044	18
AA062352	TENSION SPRING:HEAT ROLLER	U040	11
AA063268	CONNECTOR SPRING	U068	12
AA063371	SPRING	U072_S001	61
		U072_S002	61
		U072_S003	61
		U072_S004	61
AA063463	COMPRESSION SPRING:DRAWER	U043	10
AA063465	COMPRESSION SPRING:CLEANING FELT:27N	U042_S001	7
AA063466	COMPRESSION SPRING:JOINT:ON-OFF	U055_S001	11
AA063468	COMPRESSION SPRING:SHIFT	U023	10
AA063470	COMPRESSION SPRING:PAPER FEED:DRIVE	U018	7
AA063471	COMPRESSION SPRING:PRESSURE:8N	U019	6
AA063472	COMPRESSION SPRING:CONNECTOR:UPPER	U026	19
AA063674	SPRING - 8N	U047	8
		U051	9
AA063675	SPRING - 5N	U045	8
		U050	26
AA063678	SPRING - 3.5N	U021	17
		U022	8
AA063680	PRESSURE SPRING - 5X10.5	U044	19
AA063693	COMPRESSION SPRING:PRESSURE:DRIVEN ROLLER	U013	5
		U016	5
		U019	7
AA063694	COMPRESSION SPRING:HANDLE	U020	10
AA063695	COMPRESSION SPRING:GRIP	U006	6
AA064000	COMPRESSION SPRING:PRESSURE	U041	11
AA066397	TORSION SPRING:WEB:MECHANICAL DRIVE SECTION	U043	11
AA066400	COIL SPRING:PAWL:OPEN AND CLOSE	U026	20

Exclusive Parts

Number	Part Name	Group	ID
AA066401	TORSION SPRING:FEELER	U042_S001	8
AA066402	TORSION SPRING:GUIDE PLATE:REAR	U022	9
AA066403	TORSION SPRING:GUIDE PLATE:FRONT	U022	10
AA066686	TORSION SPRING:LOCK:SEPARATION:FRONT:15N	U040	12
AA066687	TORSION SPRING:LOCK:SEPARATION:REAR:15N	U040	13
AA066689	TORSION SPRING:DUCT:FRONT	U041	12
AA066690	TORSION SPRING:DUCT:REAR	U041	13
AA066691	TORSION SPRING:GRIP	U039_S001	6
AA080154	REAR BUSHING	U034_S001	11
AA080240	BUSHING - MM5	U044	20
AA080265	BUSHING:6X8X5	U017	6
AA080346	BUSHING:FLANGE TYPE:DIA6	U019	8
		U026	21
AA080354	BUSHING - 6MM	U042_S001	9
AA080355	BUSHING - 7MM	U042_S001	10
AA080356	BUSHING - 6MM	U042_S001	11
		U042_S001_S002	11
AA082101	BUSHING - 6X10X6	U021	18
		U024	21
		U027	7
		U038	10
		U040_S001	14
		U045	9
		U046	8
		U047	9
AA082104	BUSHING - 8X12X7	U021	19
		U022	11
		U023_S001	11
		U025	12
		U046	9
		U049	10
AA082137	BUSHING:6X10X6	U033_S001	6
		U034_S001	12
AA082144	BUSHING - 8X12X7	U031	19

Number	Part Name	Group	ID
AA082151	GUIDE:SHAFT:DRIVE:TONER SUPPLY	U028	13
AA083009	CLUTCH ROLLER - 8X18X11	U011_S001	8
		U014_S001	8
AA083022	BUSHING:DIA6:DIA8	U031	20
		U033_S001	7
AA084059	BALL BEARING HOLDER	U013	6
		U016	6
		U019	9
		U021	20
		U022	12
		U045	10
		U046	10
		U047	10
		U050	27
		U051	10
AA113037	TERMINAL:4P:187	U039_S001	7
AA120084	DISCHARGE BRUSH	U045	11
AA120097	ANTISTATIC BRUSH	U044	21
AA120127	DISCHARGE BRUSH:FUSING	U044	22
AA120145	DISCHARGE BRUSH:REVERSE:17MM	U046	11
AA132203	SPACER - 6MM	U008_S001	24
		U068	13
AA132300	ROLLER:LOCK:PULL OUT	U021	21
		U049	11
AA140686	SHAFT - TIMING PULLEY	U007_S001	17
AA140912	SCREW - 8X14X2.8	U068	14
AA140937	SHAFT:GRIP:LOWER	U006	7
AA143313	STEPPED SCREW - M5X7	U004	3
AA143444	STEPPED SCREW	U044	23
AA143520	SHOULDER SCREW - M3	U039_S001	8
		U040	15
		U040_S001	15
		U041	14
		U041_S001	14
		U041_S002	14
		U042_S001	12

Exclusive Parts

Number	Part Name	Group	ID
AA143544	SCREW - M3	U061	24
AA143550	SCREW:DIA4:M3	U068	15
AA143569	SCREW	U068	16
AA143585	SHAFT:MISFEED REMOVAL:UPPER	U017	7
AA143586	SHAFT:MISFEED REMOVAL:LOWER	U017	8
AA143587	SHAFT:MISFEED REMOVAL:VERTICAL TRANSPORT	U017	9
AA143718	STEPPED SCREW - M4	U006	8
AA143744	STEPPED SCREW	U031	21
AA143811	STEPPED SCREW - M3X4	U021	22
		U050	28
AA143847	STEPPED SCREW:DIA5:3.5:M3	U040	16
AA143872	SCREW:DIA6:M4	U006	9
AA143883	SHAFT:STOPPER:PAPER TRAY	U009	6
AA145290	PARALLEL PIN:DIA3X20	U032	19
AA148776	SHAFT:DRIVE	U018	8
AA148777	SHAFT:ARM:LINK	U006	10
AA148778	SHAFT:ARM:PLATE	U006	11
AA161122	MOTOR CUSHION	U024	22
		U050	29
		U058	8
AA161129	CUSHION - LARGE	U008_S001	25
AA161130	CUSHION - SMALL	U008_S001	26
AA161157	BRACKET CUSHION	U026	22
AA161172	CUSHION:GUIDE PLATE	U019	10
AB010150	GEAR:DRIVE:BRUSH ROLLER:71Z	U053	9
AB010151	GEAR:DRIVE:160Z	U032	20
AB010152	GEAR:DRIVE:63Z	U054	6
AB010153	GEAR:DRIVE:155Z	U054	7
AB010173	GEAR - 60Z	U042_S001	13
AB010174	GEAR - 20Z/50Z	U042_S001	14
AB010175	GEAR - 24Z	U042_S001	15
AB010176	GEAR - 24Z	U042_S001	16
AB010177	GEAR - 32Z	U042_S001_S002	17
AB010178	WORM GEAR	U042_S001	18
AB011125	GEAR:20/29Z	U034_S001	13

Number	Part Name	Group	ID
AB011126	GEAR:20Z	U034_S001	14
AB011299	GEAR:Z27	U055_S001	12
AB011392	DRIVE REVERSE GEAR - 24Z	U012	9
		U015	9
AB011523	GEAR - 24Z	U043	12
AB011524	GEAR - 36Z	U043	13
AB011526	GEAR - 24Z	U043	14
AB011550	GEAR:DRIVE UNIT:USED TONER:35Z	U057	9
AB011551	GEAR:DRIVE:EXIT:47Z	U056	4
AB011591	GEAR:REVERSE	U012	10
		U015	10
AB012007	GEAR - 14Z	U027	8
AB012008	GEAR - 23Z	U027	9
AB012327	GEAR:16Z	U010_S001	10
AB013421	GEAR - 18Z	U050	30
AB013765	GEAR:DRIVE:USED TONER:36Z	U057	10
AB013781	GEAR - 30Z	U008_S001	27
AB013798	GEAR - Z18	U007_S001	18
AB014285	GEAR:SLOW DOWN:IDLER:FUSING	U040	17
AB014286	GEAR:HOT ROLLER:ASS'Y	U040	18
AB017725	GEAR/TIMING PULLEY - 20Z/20T	U017	10
		U018	9
AB017726	GEAR/TIMING PULLEY - 20Z/20T	U017	11
AB017771	GEAR:TRANSPORT ROLLER:INPUT:Z23/Z28	U013	7
		U016	7
AB017804	GEAR:Z29:Z87	U055	13
AB017818	GEAR:SLOW DOWN:BRUSH ROLLER:83Z/68Z:PRESS FIT	U053	11
AB017820	GEAR:DRIVE:101Z/52Z	U054	8
AB017836	GEAR:PULLEY:DEVELOPMENT DRIVE UNIT:46Z/37T	U053	10
AB017880	GEAR:IDLER:DRIVE:EXIT:Z101/42	U056	5
AB017881	GEAR:PULLEY:DRIVE:USED TONER:44Z/32T	U057	11
AB017882	GEAR:DRIVE UNIT:USED TONER:48Z/24Z	U057	12

Exclusive Parts

Number	Part Name	Group	ID
AB017883	GEAR:IDLER:DRIVE UNIT:USED TONER:77Z/23Z	U057	13
AB017884	GEAR:PULLEY:DRIVE UNIT:USED TONER:36Z/32T	U057	14
AB019475	GEAR - 48T	U007_S001	19
AB030081	PULLEY - 20Z	U047	11
AB030805	PULLEY:COUPLING:30T	U048	10
AB030808	TIMING PULLEY - 20T	U048	11
AB030832	TIMING PULLEY:DRIVE:DEVELOPMENT SLEEVE:37T	U053	12
AB030833	TIMING PULLEY:DRIVE:TRANSPORT SCREW:23T	U053	13
AB030836	PULLEY:IDLER:DRIVE:AROUND THE PHOTOCONDUCTOR:PRESS FIT	U053	14
AB030838	TIMING PULLEY:DRIVE:FLAT CONVEYER BELT	U055	14
AB030840	TIMING PULLEY:S2M:26T/40T	U055	15
AB030841	TIMING PULLEY:OUTPUT:VACUUM:S2M:32T	U055	16
AB030842	TIMING PULLEY:S2M:30T	U050	31
AB030844	TIMING PULLEY:T19:S3M	U044	24
AB030845	TIMING PULLEY:T20:S3M	U044	25
AB030846	TIMING PULLEY:S2M:22T	U025	13
AB030850	PULLEY:TIGHTENER:DRIVE:USED TONER	U057	15
AB030851	PULLEY:DRIVE:USED TONER:25T	U057	16
AB030852	PULLEY:IDLER:DRIVE:USED TONER:32T	U057	17
AB032058	WIRE PULLEY - M10	U008_S001	28
AB032072	PULLEY:DRIVEN:WIRE	U032	21
AB032719	PULLEY - M10	U008_S001	29
AB032721	PULLEY - M18	U050	32
AB033084	TIMING PULLEY - 15T	U007_S001	20
AB033085	TIMING PULLEY - 15T	U007_S001	21
AE010104	HOT ROLLER:DIA54:ASS'Y	U040	19
AE012043	HEAT ROLLER:DIA40	U040	20
AE020200	PRESSURE ROLLER:DIA65	U041	15

Number	Part Name	Group	ID
AE030030	BALL BEARING - 8X19X6	U041	16
AE030039	BALL BEARING	U040	21
AE030044	BALL BEARING - 10X22X6	U041	17
AE030049	BALL BEARING -20X32X7	U040	22
AE030058	BALL BEARING:DIA25:DIA37	U041	18
AE032031	THERMAL INSULATING BUSHING - 30MM	U040	23
AF017033	END FENCE	U010_S001	11
AF020740	TRANSPORT ROLLER:VERTICAL TRANSPORT:DRIVE	U018	10
AF020741	TRANSPORT ROLLER:GRIP:DRIVE	U018	11
AF020743	TRANSPORT ROLLER:DRIVE:PAPER FEED UNIT	U013	8
		U016	8
AF020744	TRANSPORT ROLLER:DRIVEN:PAPER FEED UNIT	U013	9
		U016	9
AF020786	TRANSPORT ROLLER:EXIT:PAPER BANK:DRIVE	U018	12
AF022064	TRANSPORT ROLLER:DRIVEN	U038_S001	11
AF022067	GUIDE STOPPER ROLLER	U021	23
		U050	33
AF022105	ROLLER - SLIDE RAIL	U008_S001	30
AF022165	TRANSPORT ROLLER - DRIVEN	U019	11
AF022167	TRANSPORT ROLLER - DRIVEN	U022	13
AF022178	TRANSPORT ROLLER:DRIVEN:DIA17.7X2:INNER	U021	24
AF030072	PAPER FEED ROLLER:PICKUP	U011_S001	9
		U014_S001	9
AF031080	PAPER FEED ROLLER:FEED	U011_S001	10
		U014_S001	10
AF032080	PAPER FEED ROLLER:SEPARATE	U012	11
		U015	11
AF040561	FUSING EXIT ROLLER - UPPER	U044	26
AG050100	KNOB - TRANSPORT ROLLER	U017	12
		U024	23
		U025	14
		U026	23
		U047	12
AG050101	KNOB - MISFEED REMOVAL	U017	13

Exclusive Parts

Number	Part Name	Group	ID
AG051141	RELEASE LEVER	U026	24
AG070512	MAGNET CATCH:ASS'Y	U002	2
AG070513	MAGNET CATCH	U026	25
AG070514	MAGNET CATCH	U002	3
		U044	27
AG071012	MAGNET CATCH:ASS'Y	U036	12
AG071013	MAGNET CATCH:24.5N:ASS'Y	U001_S002	3
		U001_S003	3
AH012031	CASTER:1470N	U072	15
AW000012	OPTICS SENSOR:PHOTO	U022	14
AW010107	PAPER FEED SENSOR	U011_S001	11
		U013	10
		U014_S001	11
		U016	10
		U019	12
		U022	15
		U026	26
		U038_S001	12
		U044	28
		U045	12
		U046	12
		U047	13
		U050	34
AW010113	SENSOR	U008_S001	31
AW010118	PAPER FEED SENSOR	U043	15
AW010127	PAPER FEED SENSOR	U051	11
AW010200	PAPER FEED SENSOR:FUSING EX IT	U041_S002	19
AW020145	PHOTOINTERRUPTOR:FLAT	U007_S001	22
		U008_S001	32
		U011_S001	12
		U014_S001	12
		U021	25
		U027	10
		U031	22
		U032	22
		U036	13
		U043	16

Number	Part Name	Group	ID
		U057	18
AW020149	PAPER FEED SENSOR	U032	23
AW020163	PAPER FEED SENSOR	U007_S001	23
AW020164	OIL END SENSOR	U036	14
AW020199	OPTICS SENSOR:ENCODER:300L PI	U024	24
		U032	24
		U054	9
AW020200	POSITIONING SENSOR:FLAT BELT -TRANSFER	U032	25
AW100107	THERMISTOR	U062	9
AW110044	THERMOSTAT:150C:250V/17A	U041	20
AW110052	THERMOSTAT:211C	U040	24
AW140015	TEMPERATURE & HUMIDITY SEN SOR	U067	7
		U072	16
AW500010	PUSH SWITCH	U068	17
AW500023	PUSH SWITCH	U031	23
		U036	15
		U067	8
		U068	18
AX040145	DC MOTOR:TANDEM LCT	U007_S001	24
AX040157	STEPPER MOTOR DC1.68V 6.7W	U024	25
		U050	35
		U058	9
AX040181	DC STEPPER MOTOR:SHIFT:MM5 6	U021	26
AX040254	DC MOTOR:RISING TRAY:ASS'Y	U058	10
AX050331	DC STEPPER MOTOR:ON-OFF:FU SING:7.2W	U055_S001	17
AX060393	DC STEPPER MOTOR:MM42:1.3A: 4.42V	U032	26
AX060394	DC STEPPER MOTOR:MM42:1.2A: 3.60V	U032	27
AX310045	TOTAL COUNTER:7FIG:24V	U068	19
AX400194	HEATER - 230V/9W	U031	24
AX430193	HEATER:PRESSURE ROLLER:230 V:400W/400W	U041	21
AX440322	HEATER:HEAT ROLLER:A:230V:65 0W/870W	U040	25

Exclusive Parts

Number	Part Name	Group	ID
AX440323	HEATER:HEAT ROLLER:B:230V:1000W/400W	U040	26
AX560011	LED	U022	16
AX640149	FAN MOTOR:MM40:15MM	U021	27
AX640150	FAN MOTOR:MM60:25MM:DC24V 4.8W	U060	4
		U061	3
		U063	5
		U064	8
AX640159	FAN MOTOR MM80	U059	5
		U069	3
		U070	5
		U071	9
AX640193	SIROCCO FAN MOTOR:DC24V 4.32W	U059	6
AX640201	FAN:MM60:DC 3.12W	U038_S001	13
AX640214	FAN:MM60:25MM:12V	U062	10
		U064	9
AX640215	FAN:DC12V:3.48W:BLS	U071	10
AX650042	FAN:SIROCCO:DC24V:2SPEED	U061	4
		U071	11
AX650048	FAN:SIROCCO:1.44W	U032	28
		U049	12
AX650051	DC FAN MOTOR:MM120	U064	10
		U071_S002	12
AX650052	FAN:SIROCCO:DC24V:6.5W	U049	13
		U063	6
AX650053	DC FAN MOTOR:MM120:PWM CONTROL	U064	11
AZ240166	POWER SUPPLY UNIT:200-240V:395W	U065	9
AZ250041	POWER SUPPLY UNIT:968W	U070	6
AZ310029	POWER PACK:D	U025	15
AZ320173	POWER PACK:CHARGE:DEVELOPMENT	U067	9
AZ320174	POWER PACK:T1/T2	U031	25
B0042995	CAP - POSITIONING	U017	14
		U068	20
B0044438	BUSHING	U028	14

Number	Part Name	Group	ID
B0391367	RIVET - M6	U071	13
B0654933	GUIDE PLATE LEVER HOOK	U021	28
		U050	36
B0656136	TRAY LOCK ARM	U072	17
B0656345	PAPER END SENSOR BRACKET	U013	11
		U016	11
B0656524	BOTTOM PLATE LIFT SHAFT	U010_S001	12
B0656526	LIFT LEVER	U010_S001	13
B0656538	POSITIONING STOPPER LEVER	U010_S001_S001	14
B0656545	DECAL - POSITIONING	Decals and Documents	2
		U010_S001	15
B0656591	PAPER TRAY HOLDER BASE	U072	18
B0656717	PAPER VOLUME SHIELD PLATE	U008_S001	33
B0656769	LOCK ARM	U068	21
B0656823	TIMING BELT COVER	U007_S001	25
B0656830	PULLEY BRACKET	U007_S001	26
B0656831	SENSOR BRACKET	U007_S001	27
B0656862	LARGE LEVER	U008_S001	34
B0656864	SMALL LEVER	U008_S001	35
B0656870	STAY -RIGHTBASE	U008_S001	36
B0656872	OIL DAMPER BRACKET	U008_S001	37
B0656875	PROTECTION -INNER COVER	U008_S001	38
B0706667	END FENCE COVER FRONT	U008_S001	39
B0706683	LEVER:RELEASE:FRONT	U008_S001	40
B0706684	LEVER:RELEASE:REAR	U008_S001	41
B1041303	HINGE SHAFT	U002	4
B1321183	BRACKET:LOCK	U021	29
		U049	14
B1321220	COVER:BASE:PULL OUT	U025	16
B1321221	HOLDER:SPRING:PULL OUT	U021	30
		U049	15
B1321224	SUPPORTING PLATE:BRACKET:LOCK	U021	31
		U049	16
B1321228	INSULATING SHEET:PULL OUT	U025	17
B1322264	BUSHING:TERMINAL	U033_S001	8
B1322366	LEVER:DRUM STAY:LEFT	U021	32
		U070	7

Exclusive Parts

Number	Part Name	Group	ID
		U071	14
B1324167	GRIP:OIL APPLICATION UNIT:FIBER	U040_S001	27
B1324197	TORSION SPRING:LEVER	U040_S001	28
B1324313	PRESSURE SPRING HOLDER	U041	22
B1325415	BASE:ELECTRIC POTENTIAL SENSOR	U067	10
B1325807	GROUND PLATE:BASE:CONTROL BOARD	U069	4
B1325996	DECAL:TOTAL COUNTER	Decals and Documents	3
		U002	5
B1326114	CAM:ON-OFF:BLACK	U032	29
B1326726	BRACKET:ARM:ASS'Y	U068	22
B1326759	DC MOTOR:RISE:TANDEM LCT:ASS'Y	U058	11
B1326762	DC SOLENOID:COUPLING:ASS'Y	U068	23
B1326763	BRACKET:CONNECTOR:LEFT	U068	24
B1326764	BRACKET:CONNECTOR:RIGHT	U068	25
B1326791	PLATE:SIDE FENCE	U010_S001_S001	16
B1326793	SIDE FENCE:FRONT:ASS'Y	U010_S001_S001	17
B1326797	SIDE FENCE:REAR:AUXILIARY	U010_S001	18
B1326798	SPRING PLATE:PAPER TRAY:EAR TH	U010_S001	19
B1327541	TRAY BOTTOM PLATE:LEFT REAR	U007_S001	28
B1327547	DC SOLENOID:END FENCE:FRONT:ASS'Y	U008_S001	42
B1327550	COVER:PULLEY:DRIVE WERE	U008_S001	43
B1327561	BACK FENCE:LEFT	U007_S001	29
B1327564	SLIDER:BACK FENCE:LEFT	U007_S001	30
B1327571	DC SOLENOID:END FENCE:REAR:ASS'Y	U008_S001	44
B1327575	BRACKET:CONNECTOR:TANDEM LCT	U008_S001	45
B1327591	RAIL:PAPER TRAY:ASS'Y	U072	19
B1329700	LUBRICANT POWDER	Special Tools	3
B1816780	LINK:END FENCE:PAPER SIZE SENSOR:ASS'Y	U010_S001	20

Number	Part Name	Group	ID
B1816789	LINK:SIDE FENCE:PAPER SIZE SENSOR	U010_S001	21
B2232873	DECAL - SIDE FENCE REAR	Decals and Documents	4
		U010_S001_S002	22
B2233485	SEAL:HOLDER:STOPPER:SHUTTER:1	U027	11
B2234317	STEPPER MOTOR:DC24V 24.3W	U043	17
B2236171	RUBBER BUSHING:ENCODER	U024	26
		U032	30
		U054	10
B2341293	LEVER - SAFETY SWITCH	U001_S001	4
		U001_S002	4
		U001_S003	4
B2342390	FLANGED HEXAGONAL HEAD BOLT:M4X8	U022	17
		U029	5
		U030	3
		U033	9
		U034	15
		U042_S001	19
		U043	18
B2342624	BALL BEARING - 8X12X5	U011_S001	13
		U014_S001	13
B2342628	BALL BEARING - FRONT	U024	27
B2342629	BALL BEARING - REAR	U024	28
B2342864	PAD:CLEANER	U010_S001_S001	23
		U010_S001_S002	23
B2343372	DC MOTOR:TONER BOTTLE:DC21V 5.85W	U027	12
B2344258	CAP:HEAT PIPE	U044	29
B2344460	DISCHARGE BRUSH - L=341 SUS	U044	30
B2344490	SLIDE RAIL - FUSING/PAPER EXIT UNIT	U072	20
B2344858	DRIVEN ROLLER HOLDER	U021	33
B2345280	PCB CRB	U021	34
B2346120	BRACKET:POSITIONING:PAPER TRAY	U068	26
B2346138	RAIL - TANDEM LCT	U072	21

Exclusive Parts

Number	Part Name	Group	ID
B2346141	POSITIONING SLEEVE - INNER BACK	U008_S001	46
		U068	27
B2346188	SLIDE SLEEVE POSITIONING	U072	22
B2346222	REVERSE DRIVE SHAFT	U012	12
		U015	12
B2346223	DRIVEN REVERSE SHAFT	U012	13
		U015	13
B2346233	DC SOLENOID:REVERSE:SUB-ASS'Y	U012	14
		U015	14
B2346242	GUIDE - ROLLER:DRIVEN PRESSURE	U013	12
		U016	12
B2346275	PICKUP ARM	U011_S001	14
		U014_S001	14
B2346282	PICKUP DC SOLENOID	U011_S001	15
		U014_S001	15
B2346288	BSENSOR BRACKET - SENSOR	U011_S001	16
		U014_S001	16
B2346301	TORQUE LIMITER:75MM M	U012	15
		U015	15
B2346424	RELEASE GRIP	U022	18
		U044	31
		U045	13
		U046	13
B2346490	SIDE FENCE:REAR:ASS'Y	U010_S001_S002	24
B2346495	GUIDE:FRONT:PAPER TRAY	U010	25
B2346497	GUIDE:REAR:PAPER TRAY	U010	26
B2346498	SHEET:TRAY BOTTOM PLATE	U010_S001	27
B2346506	TIMING PULLEY - 30T	U058	12
B2346508	TENSION SPRING	U058	13
B2346514	TIMING BELT - S2M126	U058	14
B2346530	BRACKET	U058	15
B2346531	TIGHTENER BRACKET	U058	16
B2346532	TIGHTENER BRACKET	U058	17
B2346533	TIMING BELT - S2M152	U058	18
B2346541	FEED DRIVE SHAFT	U058	19
B2346542	GRIP DRIVE SHAFT	U058	20
B2346606	SENSOR BRACKET	U008_S001	47
B2346612	END FENCE - FRONT	U008_S001	48

Number	Part Name	Group	ID
B2346625	END FENCE - REAR	U008_S001	49
B2346686	SIDE FENCE - RIGHT FRONT	U008_S001_S001	50
B2346691	SIDE FENCE:TANDEM LCT:RIGHT:ASS'Y	U008_S001_S002	51
B2347540	TRAY BOTTOM PLATE:LEFT FRONT	U007_S001	31
B2347587	POWER SUPPLY CORD BRACKET	U065	10
B2476695	GUIDE:MISFEED REMOVAL:PAPER TRAY	U008_S001	52
		U010_S001	28
B2476753	LOCK SPRING - LARGE	U068	28
B2476754	LOCK SPRING - SMALL	U068	29
B2476901	OIL DAMPER:FALL	U008_S001	53
B2476950	SHAFT:SLIDER:BACK FENCE	U007_S001	32
B2476951	BRACKET:PULLEY:DRIVEN:ASS'Y	U007_S001	33
B2591131	SCREW:PCU	U029	6
		U072	23
B3031116	GROUNDING PLATE	U070	8
B3033682	MISFEED REMOVAL KNOB	U017	15
B4756855	SHIELD:TANDEM LCT:REAR RIGHT	U008_S001_S002	54
B5457506	SCREW:BUSHING	U033_S001	10
B6455010	SD-CARD:ASS'Y	Special Tools	4
B7001802	TIMING BELT:B40S2M134	U017	16
		U033_S001	11
B7004428	TIMING BELT:B40S2M158	U018	13
B7031166	TIMING BELT:B40S2M274:	U038	14
B8301135	SCREW	U044	32
B8323909	BRACKET CUSHION	U020	11
B8341648	TIMING BELT - B60S2M120	U024	29
B8343312	COLLAR	U006	12
B8352889	TIMING BELT - B60S2M144	U024	30
B8353968	TIMING BELT - B60S2M126	U048	12
BA146065	SHAFT:STOPPER:TANDEM LCT	U072	24
BB013007	GEAR - 20Z	U013	13
		U016	13
		U018	14
BB013008	GEAR - 31Z	U012	16
		U015	16

Exclusive Parts

Number	Part Name	Group	ID
BB013011	GEAR - 22Z	U017	17
BB013025	GEAR:PRESSURE ROLLER	U041	23
BB013026	GEAR:IDLER:25Z:ASS'Y	U041	24
BB013027	GEAR:JOINT:PRESSURE:ASS'Y	U041	25
BB013028	GEAR:IDLER:35Z:ASS'Y	U041	26
C1012360	SNAP RING	U001	5
C2182185	STEPPER SCREW	U066	7
		U071	15
C2382873	ADJUSTING SCREW	U041	27
C2693566	BUSHING:MM8:PRESSURE:DRIVE	U017	18
		U020	12
		U031	26
C6006119	SPRING WASHER:DIA12.3:T=0.2	U032	31
D0094388	ROLLER CLUTCH	U042_S001	20
D0141265	BRACKET:DC MOTOR	U053	15
D0142380	COMPRESSION SPRING - DRUM	U029	7
D0143241	SEAL:DISCHARGE USED TONER	U035	4
D0143242	SEAL:DISCHARGE USED TONER:LOWER	U035	5
D0143655	ELECTRIC POTENTIAL SENSOR	U067	11
D0143656	HOLDER:ELECTRIC POTENTIAL SENSOR	U067	12
D0143657	SHIELDING PLATE	U067	13
D0144247	HOUSING - TEMPERATURE SENSOR	U040	29
		U041	28
D0145952	SUPPORTER:UPPER	U069	5
D0145953	SUPPORTER:LOWER	U069	6
D0145973	COVER:SD-CARD	U069	7
D0145977	COVER:CONTROL BOARD:USB	U069	8
D0146272	BUSHING:BRUSH:REAR	U034_S001	16
D0146458	SPRING:BLADE:NO.1	U001_S001	6
D0146626	BRACKET:ON OFF DETECTOR:FRONT	U008_S001	55
D0146627	BRACKET:ON OFF DETECTOR:REAR	U008_S001	56
D0146780	TRAY BOTTOM PLATE:ASS'Y	U010_S001	29
D0146783	ARM:END FENCE:LOCK	U010_S001	30
D0146784	SPRING PLATE:END FENCE	U010_S001	31

Number	Part Name	Group	ID
D0146785	SPRING PLATE:ARM:END FENCE:LOCK	U010_S001	32
D0396137	ENCODER:ASS'Y	U024	31
		U032	32
		U054	11
D0396327	SPACER:SENSOR:TM	U031	27
D0590761	SPRING:TANDEM TRAY:LOCK	U072	25
D0592399	FLANGED HEXAGONAL HEAD BOLT:M3*4	U008	57
		U024	32
D0592620	RETAINING RINGS-C	U011_S001	17
		U012	17
		U014_S001	17
		U015	17
D0596121	SPRING:CONNECTOR:TANDEM LCT	U068	30
D0596170	BRACKET:SLIDE RAIL:PAPER TRAY:2:ASS'Y	U072	26
D0596172	PAPER TRAY STOPPER	U068	31
D0596212	LEVER:PRESSURE:REVERSE	U012	18
		U015	18
D0596277	COVER:GEAR:PAPER FEED ROLLER	U011_S001	18
		U014_S001	18
D0596278	COVER:GEAR:REVERSE	U012	19
		U015	19
D0596496	GUIDE:MIDDLE:PAPER TRAY	U010	33
D0596591	SPRING:PAPER TRAY:LOCK	U072	27
D0596620	LEVER:COUPLING:LEFT	U007_S001	34
D0596646	INNER COVER:TANDEM LCT:LEFT	U007_S001	35
D0596659	SUPPORTING PLATE:SIDE FENCE:LEFT	U007_S001	36
D0596664	GUIDE:MIDDLE:PAPER TRAY	U008	58
D0596665	BRACKET:DC MOTOR:LEFT:ASS'Y	U007_S001	37
D0596668	SIDE PLATE:SIDE:TANDEM LCT	U008_S001	59
D0596690	PLATE:PAPER:ASS'Y	U008_S001_S001	60
D0596712	INNER COVER:TANDEM LCT	U008_S001	61
D0596721	STOPPER:PAPER TRAY	U009	7
D0596725	BRACKET:STOPPER:PAPER TRAY:RIGHT:PEEN	U009	8

Exclusive Parts

Number	Part Name	Group	ID
D0596728	COMPRESSION SPRING:GRIP:PA PER TRAY	U009	9
D0596731	SHIELD:GUIDE:MISFEED REMOVA L	U072	28
D0596765	DC SOLENOID:LOCK:ASS'Y	U068	32
D0626692	SLIDE RAIL:PAPER TRAY:LEFT:SU B-ASS'Y	U072	29
D0741035	SHEET:UPPER:FRONT:DUCT:C/T BOX	U071	16
D0741036	SHEET:MIDDLE:FRONT:DUCT:C/T BOX	U071	17
D0741037	SHEET:LOWER:DUCT:C/T BOX	U071	18
D0741038	SHEET:SMALL:FRONT:DUCT:C/T B OX	U071	19
D0741039	SHEET:SIDE:UPPER:DUCT:C/T BO X	U071	20
D0741040	SHEET:SIDE:DUCT:C/T BOX	U071	21
D0741041	SHEET:SIDE:LOWER:DUCT:C/T BO X	U071	22
D0741042	SHEET:SIDE:LARGE:DUCT:C/T BO X	U071	23
D0741043	SHEET:UPPER:BRACKET:DUCT:C/ T BOX	U071	24
D0741044	SHEET:MIDDLE:BRACKET:DUCT:C /T BOX	U071	25
D0741045	SHEET:LOWER:BRACKET:DUCT:C /T BOX	U071	26
D0741046	SHEET:UPPER:REAR:DUCT:C/T B OX	U071	27
D0741047	SHEET:LOWER:REAR:DUCT:C/T B OX	U071	28
D0741088	SHEET:BASE:MAIN:FRONT	U072	62
D0741125	PLATE:RADIAL BALL BEARING:TH RUST	U072	30
D0741128	PLAIN SHAFT BEARING:POSITIONI NG PIN:FUSING	U072	31
D0741154	COVER:PAPER EXIT UNIT:EXIT	U072	32
D0741173	BOSS:POSITIONING PIN:TRANSP	U072	33

Number	Part Name	Group	ID
	ORT UNIT:NO.2:10.3MM		
D0741179	LEVER:PULL OUT:REGISTRATION	U021	35
D0741180	LEVER:PULL OUT:PAPER EXIT UN IT	U049	17
D0741194	SHAFT:LOCK:TRANSPORT UNIT	U021	36
D0741195	GUIDE:LOCK:TRANSPORT UNIT	U072	34
D0741212	SUPPORTING PLATE:POSITIONIN G PIN:RIGHT	U049	18
D0741213	HOLDER:COIL SPRING:LOCK:PAP ER EXIT UNIT	U049	19
D0741215	SHAFT:LOCK:PAPER EXIT UNIT	U049	20
D0741219	DUCT:C/T BOX:POWER SUPPLY U NIT	U070	9
D0741251	DUCT:EXHAUST:EXIT:ASS'Y	U071_S001	29
D0741255	SEPARATION PLATE:DUCT	U070	10
D0741258	COVER:C/T BOX:RIGHT LOWER	U002	6
D0741261	COVER:C/T BOX:RIGHT	U002	7
D0741270	COVER:C/T BOX:UPPER	U002	8
D0741271	SEAL:COVER:C/T BOX:UPPER	U002	9
D0741282	SEAL:C/T BOX:EXHAUST	U002	10
D0741284	COVER:C/T BOX:LEFT:CEMENTAT ION	U002	11
D0741286	SEAL:C/T BOX:DUCT:FRONT	U070	11
D0741287	SEAL:C/T BOX:DUCT:UPPER	U070	12
D0741291	DUCT:EXHAUST:CONTROL BOAR D	U070	13
D0741293	COVER:MAIN:LEFT:ASS'Y	U002_S001	12
D0741315	DC MOTOR:DIA65:24V:15.3W	U052	3
D0741316	DRUM SHAFT:ASS'Y	U052	4
D0741327	DC MOTOR:DIA63:24V:21.8W	U053	16
D0741329	DC MOTOR:DIA49:24V:6.3W	U053	17
D0741330	BRACKET:DRIVE:ASS'Y	U053	18
D0741338	TENSION SPRING:TIGHTENER:DR IVE	U053	19
D0741341	BRACKET:AUXILIARY:DRIVE:ARO UND THE PHOTOCONDUCTOR	U053	20
D0741343	SHAFT:DRIVE:DEVELOPMENT SL EEVE:ASS'Y	U053	21

Exclusive Parts

Number	Part Name	Group	ID
D0741348	TIGHTENER:DRIVE:AROUND THE PHOTOCONDUCTOR:ASS'Y	U053	22
D0741352	SHAFT:DRIVE:TRANSPORT SCREW:ASS'Y	U053	23
D0741356	SHAFT:DRIVE:BRUSH ROLLER:ASS'Y	U053	24
D0741363	DRUM STAY:DC MOTOR:DRIVE	U032	33
D0741365	DC MOTOR:DIA56:13W	U032	34
D0741369	COVER:ENCODER	U024	33
		U032	35
		U054	12
D0741371	DC MOTOR:DIA48:24V:17W	U054	13
D0741372	SHAFT:DRIVE:TRANSFER:ASS'Y	U054	14
D0741375	BRACKET:DC BRUSHLESS MOTOR:ASS'Y	U054	15
D0741379	BRACKET:PLATE	U054	16
D0741380	SHAFT:DRIVE:BELT CLEANING:ASS'Y	U054	17
D0741390	SHAFT:OUTPUT:DRIVE:VACUUM:ASS'Y	U055	18
D0741394	PULLEY:DRIVE:TRANSPORT UNIT	U038	15
D0741401	BRACKET:DRIVE:FUSING:ASS'Y	U055	19
D0741404	COVER:GEAR	U055	20
D0741405	SHAFT:OUTPUT:DRIVE:FUSING:ASS'Y	U055	21
D0741409	DC MOTOR:DIA55:33W	U055	22
D0741411	BRACKET:DRIVE:VACUUM:LOWER	U055	23
D0741412	BRACKET:DRIVE:VACUUM:UPPER:ASS'Y	U055	24
D0741418	RUBBER BUSHING:DIA7	U055	25
D0741424	BRACKET:TIGHTENER:ASS'Y	U055	26
D0741426	PULLEY:IDLER	U055	27
D0741430	DRIVE UNIT:ON-OFF:FUSING:ASS'Y	U055_S001	28
D0741439	JOINT:ON-OFF:FUSING	U055_S001	29
D0741445	COVER:HOUSING:UPPER:PRESS FIT	U055_S001	30

Number	Part Name	Group	ID
D0741449	COVER:HOUSING:SIDE:PRESS FIT	U055_S001	31
D0741451	BRACKET:DRIVE:EXIT:ASS'Y	U056	6
D0741452	SHAFT:DRIVE:EXIT:ASS'Y	U056	7
D0741454	DC MOTOR:DIA49:9.8W:BLS	U036	16
		U056	8
		U057	19
D0741460	BRACKET:AUXILIARY:DRIVE:EXIT	U056	9
D0741461	SHAFT:WORM GEAR:ON-OFF:PRESS FIT	U055_S001	32
D0741464	SHAFT:RIGHT:DRIVE:USED TONER:ASS'Y	U057	20
D0741465	BRACKET:TENSION:DRIVE:USED TONER:ASS'Y	U057	21
D0741466	BRACKET:TIGHTENER:DRIVE:USED TONER:ASS'Y	U057	22
D0741468	BRACKET:MIDDLE:DRIVE:USED TONER:ASS'Y	U057	23
D0741470	SHAFT:LEFT:DRIVE:USED TONER:ASS'Y	U057	24
D0741473	BRACKET:TENSIONER:DRIVE UNIT:USED TONER:ASS'Y	U057	25
D0741474	RING	U055_S001	33
D0741476	HOLDER:RIGHT:DRIVE:USED TONER	U057	26
D0741484	HOLDER:LEFT:DRIVE:USED TONER	U057	27
D0741486	BRACKET:MOTOR:DRIVE:USED TONER	U057	28
D0741487	BRACKET:DRIVE UNIT:USED TONER	U057	29
D0741496	JOINT:DRIVE:USED TONER	U057	30
D0741498	BRACKET:SENSOR	U057	31
D0741500	WORM WHEEL:ON-OFF:FUSING	U055_S001	34
D0741501	SHAFT:OUTPUT:ON-OFF:FUSING:PRESS FIT	U055_S001	35
D0741504	SHEET:ON-OFF:FUSING DRIVE SUB-UNIT	U055_S001	36
D0741801	OPTICAL WRITING UNIT:ASS'Y	U005	2

Exclusive Parts

Number	Part Name	Group	ID
D0742172	BRACKET:SOLENOID:ON-OFF	U067	14
D0742175	DC SOLENOID:ON-OFF:ASS'Y	U067	15
D0742178	TENSION SPRING:SOLENOID:ON-OFF	U067	16
D0742181	CONNECTOR:1POLE	U067	23
D0742191	DISCHARGE LAMP:LED ARRAY	U029_S003	8
		U029_S006	8
		U029_S009	8
		U029_S012	8
D0742192	SHEET:DISCHARGE LAMP	U029_S003	9
		U029_S006	9
		U029_S009	9
		U029_S012	9
D0742195	CHARGE UNIT	U029_S001	10
		U029_S004	10
		U029_S007	10
		U029_S010	10
D0742252	FRAME:PHOTOCONDUCTOR	U029	11
D0742272	BRACKET:TEMPERATURE & HUMIDITY SENSOR	U067	17
D0742274	BRACKET:ELECTRIC POTENTIAL SENSOR	U067	18
D0742301	PCU:TAURUS:ASS'Y	U029_S003	12
		U029_S006	12
		U029_S009	12
		U029_S012	12
D0742330	CLEANING UNIT:ASS'Y	U029_S002	13
		U029_S005	13
		U029_S008	13
		U029_S011	13
D0742366	LEVER:LOCK:CHARGE UNIT	U029_S003	14
		U029_S006	14
		U029_S009	14
		U029_S012	14
D0742367	HOLDER:LOCK:CHARGE UNIT	U029_S003	15
		U029_S006	15
		U029_S009	15
		U029_S012	15

Number	Part Name	Group	ID
D0742368	COMPRESSION SPRING:LOCK:CHARGE UNIT	U029_S003	16
		U029_S006	16
		U029_S009	16
		U029_S012	16
D0742376	LEVER:LOCK:PCU	U029_S003	17
		U029_S006	17
		U029_S009	17
		U029_S012	17
D0742377	TENSION SPRING:LOCK:PCU	U029_S003	18
		U029_S006	18
		U029_S009	18
		U029_S012	18
D0742381	COMPRESSION SPRING:LOCK:CLEANING UNIT	U029_S003	19
		U029_S006	19
		U029_S009	19
		U029_S012	19
D0742382	HOLDER:LOCK:CLEANING UNIT:FRONT	U029_S003	20
		U029_S006	20
		U029_S009	20
		U029_S012	20
D0742383	LEVER:LOCK:CLEANING UNIT:FRONT	U029_S003	21
		U029_S006	21
		U029_S009	21
		U029_S012	21
D0742386	HOLDER:LOCK:CLEANING UNIT:REAR	U029_S003	22
		U029_S006	22
		U029_S009	22
		U029_S012	22
D0742392	COVER:PCU:FRONT:ASS'Y	U029_S003_S001	23
		U029_S006_S001	23
		U029_S009_S001	23
		U029_S012_S001	23
D0742393	COVER:PCU:FRONT	U029_S003_S001	24
		U029_S006_S001	24
		U029_S009_S001	24
		U029_S012_S001	24
D0742395	GROUND PLATE:PCU:ASS'Y	U029_S003_S001	25
		U029_S006_S001	25

Exclusive Parts

Number	Part Name	Group	ID
		U029_S009_S001	25
		U029_S012_S001	25
D0742401	FRAME:BASE:ASS'Y	U029_S002	26
		U029_S005	26
		U029_S008	26
		U029_S011	26
D0742414	TRANSPORT SCREW:BASE:ASS'Y	U029_S002	27
		U029_S005	27
		U029_S008	27
		U029_S011	27
D0742419	PLAIN SHAFT BEARING:TRANSPORT SCREW	U029_S002	28
		U029_S005	28
		U029_S008	28
		U029_S011	28
D0742422	BLADE:CLEANING:ASS'Y	U029_S002	29
		U029_S005	29
		U029_S008	29
		U029_S011	29
D0742424	SEAL:BLADE:CLEANING:FRONT	U029_S002	30
		U029_S005	30
		U029_S008	30
		U029_S011	30
D0742425	SEAL:BLADE:CLEANING:REAR	U029_S002	31
		U029_S005	31
		U029_S008	31
		U029_S011	31
D0742448	TRANSPORT SCREW:APPLY:ASS'Y	U029_S002	32
		U029_S005	32
		U029_S008	32
		U029_S011	32
D0742454	BRUSH ROLLER:APPLY:ASS'Y	U029_S002	33
		U029_S005	33
		U029_S008	33
		U029_S011	33
D0742456	PLAIN SHAFT BEARING:BRUSH ROLLER:APPLY:FRONT	U029_S002	34
		U029_S005	34
		U029_S008	34
		U029_S011	34

Number	Part Name	Group	ID
D0742457	PLAIN SHAFT BEARING:BRUSH ROLLER:APPLY:REAR	U029_S002	35
		U029_S005	35
		U029_S008	35
		U029_S011	35
D0742458	GEAR:19Z:RIGHT	U029_S002_S002	36
		U029_S005_S002	36
		U029_S008_S002	36
		U029_S011_S002	36
D0742459	JOINT:CLEANING UNIT	U029_S002	37
		U029_S005	37
		U029_S008	37
D0742466	COATING BAR:ASS'Y	U029_S002	38
		U029_S005	38
		U029_S008	38
D0742471	ARM:COATING BAR	U029_S002	39
		U029_S005	39
		U029_S008	39
D0742473	TENSION SPRING:COATING BAR:9.0N	U029_S002	40
		U029_S005	40
		U029_S008	40
D0742475	STAY:APPLY:ASS'Y	U029_S002	41
		U029_S005	41
		U029_S008	41
D0742481	BLADE:APPLY:ASS'Y	U029_S002_S001	42
		U029_S005_S001	42
		U029_S008_S001	42
		U029_S011_S001	42
D0742485	SEAL:BLADE:APPLY:FRONT	U029_S002	43
		U029_S005	43
		U029_S008	43
D0742486	SEAL:BLADE:APPLY:REAR	U029_S002	44
		U029_S005	44

Exclusive Parts

Number	Part Name	Group	ID
		U029_S008	44
		U029_S011	44
D0742487	SEAL:BLADE	U029_S002_S001	75
		U029_S005_S001	75
		U029_S008_S001	75
		U029_S011_S001	75
D0742491	COVER:TONER OUTLET SUB-UNIT :CLEANING UNIT:ASS'Y	U029_S002	45
		U029_S005	45
		U029_S008	45
		U029_S011	45
D0742497	VIBRATING PLATE:TONER OUTLET SUB-UNIT	U029_S002	46
		U029_S005	46
		U029_S008	46
		U029_S011	46
D0742501	GEAR:21Z:RIGHT	U029_S002_S002	47
		U029_S005_S002	47
		U029_S008_S002	47
		U029_S011_S002	47
D0742502	GEAR:IDLER:20Z:LEFT	U029_S002_S002	48
		U029_S005_S002	48
		U029_S008_S002	48
		U029_S011_S002	48
D0742503	GEAR:IDLER:31Z:LEFT	U029_S002_S002	49
		U029_S005_S002	49
		U029_S008_S002	49
		U029_S011_S002	49
D0742504	DRUM STAY:CLEANING UNIT	U029_S002	50
		U029_S005	50
		U029_S008	50
		U029_S011	50
D0742540	DECAL:LOCK:CLEANING UNIT	Decals and Documents	5
		U029_S003_S001	51
		U029_S006_S001	51
		U029_S009_S001	51
		U029_S012_S001	51
D0742541	DECAL:ARROW LABEL	Decals and Documents	6

Number	Part Name	Group	ID
		U029	52
		U029_S003	52
		U029_S006	52
		U029_S009	52
		U029_S012	52
D0742542	DECAL:GRIP	Decals and Documents	7
		U029	53
		U029_S002	53
		U029_S005	53
		U029_S008	53
		U029_S011	53
D0742543	DECAL:GRIP	U029_S001	54
		U029_S004	54
		U029_S007	54
		U029_S010	54
D0742544	DECAL:POSITIONING DISPLAY	Decals and Documents	8
		U029_S003	55
		U029_S006	55
		U029_S009	55
		U029_S012	55
D0742552	GUIDE PLATE:SLIDE RAIL:PCU	U072	35
D0742553	SLIDE RAIL:PCU:RIGHT	U072	36
D0742558	SLIDE RAIL:PCU:LEFT	U072	37
D0742561	LOCK:SLIDE RAIL:PCU:RIGHT	U072	38
D0742572	STAY:SET SENSOR:PCU	U067	19
D0742575	ARM:SET SENSOR:PCU	U067	20
D0742576	HOLDER:SET SENSOR:PCU	U067	21
D0742577	CONNECTOR:DRAWER:4POLE:RE C	U067	22
D0742601	PLATE:ADJUSTING PIN	U024	34
D0742621	PLATE:DC MOTOR:TIMING ROLLER: TRANSFER	U024	35
D0742622	BRACKET:DC MOTOR:TIMING ROLLER: TRANSFER	U024	36
D0742626	TIMING PULLEY:S2M:31T/31T	U024	37
D0742629	BRACKET:DC STEPPER MOTOR:T	U024	38

Exclusive Parts

Number	Part Name	Group	ID
	RANSPORT ROLLER:SHIFT		
D0742632	BRACKET:DC STEPPER MOTOR:M M56:CAM	U024	39
D0742634	BRACKET:DC STEPPER MOTOR:M M42:REGISTRATION:ENTRANCE	U024	40
D0742636	HOLDER:SENSOR:TRANSFER:TIM ING	U022	19
D0742642	GEAR:TIMING ROLLER:TRANSFER :Z59	U024	41
D0742643	TIMING ROLLER:TRANSFER:DRIV EN	U024	42
D0742652	LEVER:LINK:TRANSPORT ROLLER	U021 U022	37 20
D0742654	CASE:REMOVE PAPER DUST:ASS' Y	U024	43
D0742663	HOLDER:SENSOR:REGISTRATION :TIMING	U022	21
D0742665	REGISTRATION ROLLER:TIMING:D RIVE	U024	44
D0742679	HOLDER:DC STEPPER MOTOR:SH IFT	U021	38
D0742681	SHAFT:CAM:SHIFT	U021_S001	39
D0742684	HOLDER:CAM:SHIFT	U021	40
D0742685	SYNCHRONOUS BELT:B80S2M190	U021	41
D0742686	DUCT:FAN:CONTACT IMAGE SEN SOR	U021	42
D0742687	HOLDER:HOME POSITION SENSO R:GATE	U021	43
D0742691	SHAFT:CAM	U024	45
D0742693	CAM:GATE	U024	46
D0742694	CAM:TRANSPORT ROLLER:SHIFT	U024	47
D0742696	SHAFT:GATE PAWL	U024	48
D0742697	GATE PAWL:PEEN	U024	49
D0742702	SWING UNIT:ASS'Y	U023_S001	12
D0742711	TRANSPORT ROLLER:CONNECTI NG:LARGE CAPACITY TRAY	U024	50
D0742715	BRACKET:SOLENOID:PEEN	U024	51
D0742718	SHAFT:SHIFT	U023	13

Number	Part Name	Group	ID
D0742721	ARM:TRANSPORT ROLLER:SHIFT: TAKE SHEJTER	U023	14
D0742722	PROTECTION:ARM:TRANSPORT R OLLER:SHIFT:TAKE SHEJTER	U023	15
D0742732	GUIDE PLATE:SHIFT:UPPER:PEEN	U023_S001	16
D0742737	SHAFT:SHIFT:TAKE SHEJTER	U023_S001	17
D0742739	PRESSURE ROLLER:TRANSPORT ROLLER:SHIFT:DRIVEN	U023_S001	18
D0742740	SHAFT:SHIFT:DRIVEN:ROLLER	U023_S001	19
D0742741	BRACKET:SHIFT:DRIVEN:TAKE SH EJTER	U023_S001	20
D0742743	BRACKET:VENTILATION	U023_S001	21
D0742744	HOLDER:SHIFT:BEARING:FRONT	U023_S001	22
D0742745	HOLDER:SHIFT:BEARING:REAR	U023_S001	23
D0742748	SHAFT:ARM:REGISTRATION ROLL ER:TIMING	U024	52
D0742749	ARM:REGISTRATION ROLLER:TIMI NG	U024	53
D0742750	STAY:SOLENOID	U024	54
D0742753	GUIDE PLATE:CONNECTING:LAR GE CAPACITY TRAY:UPPER	U022	22
D0742756	HOLDER:SENSOR:CONNECTING:L CT:NO.1	U022	23
D0742757	HOLDER:SENSOR:CONNECTING:L CT:NO.2	U022	24
D0742760	TRANSPORT ROLLER:SHIFT:DRIV E	U023_S001	24
D0742769	BRACKET:DC STEPPER MOTOR:R EGISTRATION ROLLER:TIMING	U024	55
D0742771	SHAFT:REGISTRATION ROLLER:TI MING:DRIVEN	U024	56
D0742772	COVER:BEARING	U024	57
D0742773	FIX STAND:GUIDE PLATE:TIMING: TRANSFER:EXIT	U022	25
D0742774	COVER:TIMING:TRANSFER	U024	58
D0742777	CAM:REGISTRATION ROLLER:TIMI NG	U024	59
D0742783	REGISTRATION GUIDE:OPEN AND	U022	26

Exclusive Parts

Number	Part Name	Group	ID
	CLOSE		
D0742786	GUIDE PLATE:CONNECTING:LARGE CAPACITY TRAY:LOWER	U022	27
D0742789	HOLDER:DOUBLE FEED SENSOR:RADIATE	U022	28
D0742794	HOLDER:DOUBLE FEED SENSOR:PHOTO	U022	29
D0742795	GUIDE PLATE:REGISTRATION:ENTRANCE:LOWER	U022	30
D0742797	STAY:CONNECTION:LARGE CAPACITY TRAY	U072	39
D0742799	GUIDE PLATE:CONNECTION:LCT:LOWER	U072	40
D0742809	COVER:HARNESS:PAPER FEED UNIT:FRONT	U026	27
D0742813	HOOK:COIL SPRING:GATE	U021	44
D0742815	BRACKET:CONTACT POINT:GUIDE PLATE:REAR	U022	31
D0742818	FIX STAND:GUIDE PLATE:REAR	U022	32
D0742850	GUIDE PLATE:VERTICAL TRANSPORT:RIGHT	U021	45
D0742864	GUIDE PLATE:DUPLEX:RIGHT:UPPER	U021	46
D0742873	GUIDE PLATE:PULL OUT:RIGHT:VERTICAL TRANSPORT	U026	28
D0742876	SHAFT:LOCK:GUIDE PLATE	U026	29
D0742880	TRANSPORT ROLLER:VERTICAL TRANSPORT:RIGHT:PRESS FIT	U026	30
D0742881	TRANSPORT ROLLER:REGISTRATION:ENTRANCE:DRIVE:PRESS FIT	U024	60
D0742882	TRANSPORT ROLLER:DUPLEX:RIGHT:NO.1:PRESS FIT	U026	31
D0742883	TRANSPORT ROLLER:DUPLEX:RIGHT:NO.2:PRESS FIT	U026	32
D0742894	DC SOLENOID:VERTICAL TRANSPORT:UPPER	U026	33
D0742896	HOLDER:DC SOLENOID:VERTICAL TRANSPORT:UPPER	U026	34

Number	Part Name	Group	ID
D0742899	HOLDER:DC SOLENOID:VERTICAL TRANSPORT:LOWER:PEEN	U026	35
D0742908	BRACKET:DC STEPPER MOTOR:DUPLEX:RIGHT	U026	36
D0742912	BRACKET:SENSOR:DUPLEX:SHORT	U026	37
D0742924	COVER:HARNESS	U026	38
D0742926	BRACKET:SENSOR:VERTICAL TRANSPORT:NO.2	U026	39
D0742929	BRACKET:SENSOR:VERTICAL TRANSPORT:NO.3	U026	40
D0742930	SHAFT:LINK:ON-OFF:VERTICAL TRANSPORT:LOWER	U021	47
D0742931	SHAFT:LINK:ON-OFF:VERTICAL TRANSPORT:UPPER	U021	48
D0742934	SHAFT:ON-OFF:LARGE CAPACITY TRAY:CONNECTING	U022	33
D0742935	GUIDE:DUPLEX:OPEN AND CLOSE:RIGHT:LOWER	U021	49
D0742938	GUIDE PLATE:CONNECTION:LARGE CAPACITY TRAY:UPPER	U072	41
D0742941	TIMING PULLEY:S2M:30T	U026	41
		U050	37
D0742942	PIN:GUIDE PLATE:CONNECTION:LARGE CAPACITY TRAY:UPPER	U072	42
D0742945	GUIDE PLATE:REGISTRATION:EXIT	U022	34
D0742952	BRACKET:CONTACT IMAGE SENSOR	U022	35
D0742955	GUIDE PLATE:TIMING:TRANSFER	U022	36
D0742960	GUIDE PLATE:REGISTRATION:ENTRANCE:UPPER	U022	37
D0742962	BRACKET:MISFEED REMOVAL:TIMING ROLLER:TRANSFER	U025	18
D0742964	STAY:REGISTRATION:RIGHT UPPER	U024	61
D0742965	HOLDER:PRESSURE:DRIVEN ROLLER:DUPLEX:EXIT	U021	50

Exclusive Parts

Number	Part Name	Group	ID
D0742969	SHAFT:MISFEED REMOVAL:TIMING ROLLER:TRANSFER	U025	19
D0742970	CAM:GUIDE PLATE:OPEN AND CLOSE	U026	42
D0742971	PLATE:LINK:OPEN AND CLOSE:REAR	U026	43
D0742972	LEVER:GUIDE PLATE:OPEN AND CLOSE:FRONT	U026	44
D0742974	STOPPER:LEVER:TRANSPORT UNIT:LEFT	U021	51
D0742975	STOPPER:GUIDE PLATE:CONNECTING:LARGE CAPACITY TRAY	U022	38
D0742977	COVER:HARNESS:FRONT UPPER	U026	45
D0742979	LEVER:GUIDE PLATE	U021_S002	52
D0742984	DECAL:PULL OUT:RIGHT:B1	Decals and Documents	9
		U021	53
D0742985	DECAL:PULL OUT:RIGHT:B3	Decals and Documents	10
		U021	54
D0742986	DECAL:PULL OUT:RIGHT:B4	Decals and Documents	11
		U021	55
D0742987	DECAL:PULL OUT:RIGHT:B6	Decals and Documents	12
		U021	56
D0742988	DECAL:PULL OUT:RIGHT:B7	Decals and Documents	13
		U022	39
D0742989	DECAL:PULL OUT:RIGHT:Z2	Decals and Documents	14
		U021	57
D0742990	DECAL:PULL OUT:RIGHT:Z4	Decals and Documents	15
		U021_S002	58
D0743032	SHAFT:JOINT:PAPER FEED UNIT	U018	15
D0743033	GUIDE PLATE:CONNECTING	U072	43
D0743038	BRACKET:DUPLEX:EXIT	U072	44

Number	Part Name	Group	ID
D0743039	GUIDE PLATE:DUPLEX:EXIT	U072	45
D0743047	BRACKET:HOLDER:DUPLEX:ASSY	U072	46
D0743105	DC MOTOR:DIA35.8:24V:4.1W	U024	62
D0743108	DC STEPPER MOTOR:4.94W:ASSY	U018	16
		U024	63
		U026	46
		U048	13
		U051	12
D0743168	CONTACT IMAGE SENSOR:REGISTRATION:MAIN SCANNING:214MM	U022	40
D0743171	TIMING ROLLER:TRANSFER:DRIVE:PRESS FIT	U024	64
D0743173	TIMING PULLEY:S2M:25T	U018	17
		U024	65
		U026	47
		U047	14
		U051	13
D0743322	FILTER:DEVELOPMENT	U029_S003	56
		U029_S006	56
		U029_S009	56
		U029_S012	56
D0743340	JOINT:DRIVE:TRANSPORT SCREW	U029_S003	57
		U029_S006	57
		U029_S009	57
		U029_S012	57
D0743362	ELECTRODE PLATE:DEVELOPMENT BIAS:FRONT	U029_S003	58
		U029_S006	58
		U029_S009	58
		U029_S012	58
D0743367	ELECTRODE PLATE:DEVELOPMENT BIAS:REAR UPPER	U029_S003	59
		U029_S006	59
		U029_S009	59
		U029_S012	59
D0743368	ELECTRODE PLATE:DEVELOPMENT BIAS:REAR LOWER	U029_S003	60
		U029_S006	60
		U029_S009	60
		U029_S012	60
D0743416	JOINT:DRIVE:DEVELOPMENT UNIT	U029_S003	61

Exclusive Parts

Number	Part Name	Group	ID
	T	U029_S006	61
		U029_S009	61
		U029_S012	61
D0743420	GEAR:TRANSPORT SCREW	U029_S003	62
		U029_S006	62
		U029_S009	62
		U029_S012	62
D0743421	GEAR:TRANSPORT SCREW:UPPER	U029_S003	63
		U029_S006	63
		U029_S009	63
		U029_S012	63
D0743422	GEAR:IDLER:DEVELOPMENT:UPPER:ASS'Y	U029_S003	64
		U029_S006	64
		U029_S009	64
		U029_S012	64
D0743425	GEAR:IDLER:DEVELOPMENT:LOWER:ASS'Y	U029_S003	65
		U029_S006	65
		U029_S009	65
		U029_S012	65
D0743427	RADIAL BALL BEARING:DIA8XDIA16X5	U025	20
D0743440	COVER:INSERT:DEVELOPER	U029_S003	66
		U029_S006	66
		U029_S009	66
		U029_S012	66
D0743446	RECEPTACLE:DEVELOPMENT BIAS:ASS'Y	U072_S001	47
		U072_S002	47
		U072_S003	47
		U072_S004	47
D0743490	FUNNEL:DEVELOPER	U017	19
D0743513	SHAFT:DRIVE:TONER SUPPLY	U028	15
D0743514	GEAR:DRIVE:ELECTROMAGNETIC CLUTCH:TONER SUPPLY	U028	16
D0743516	GEAR:DRIVE:TONER SUPPLY	U028	17
D0743517	GEAR:IDLER:TONER SUPPLY	U028	18
D0743518	GEAR:TIMING PULLEY:DRIVEN:TONER SUPPLY	U028	19
D0743521	BRACKET:TIGHTENER:TONER SUPPLY	U028	20

Number	Part Name	Group	ID
	PPLY		
D0743522	SHAFT:TIGHTENER:TONER SUPPLY	U028	21
D0743525	TENSION SPRING:TIGHTENER:TONER SUPPLY	U028	22
D0743526	SUPPORTING PLATE:GEAR:TONER SUPPLY	U028	23
D0743531	DRIVE SUB-UNIT:TONER SUPPLY:ASS'Y	U028	24
D0743551	PUMP:TONER SUPPLY:SUB-ASS'Y	U028	25
D0743580	CASE:TONER SUPPLY:SUB-ASS'Y	U028	26
D0743621	TUBE:TONER SUPPLY:BK	U028	27
D0743622	TUBE:TONER SUPPLY:C	U028	28
D0743623	TUBE:TONER SUPPLY:M	U028	29
D0743624	TUBE:TONER SUPPLY:Y	U028	30
D0743631	DC BRUSHLESS MOTOR:TONER SUPPLY:47.5W	U028	31
D0743636	SHEET:MAIN SWITCH	U066	8
D0743702	SHAFT:DRIVE SUB-UNIT:TONER SUPPLY UNIT:2	U027	13
D0743703	GEAR:TONER BOTTLE:DIA92	U027	14
D0743707	SHAFT:DRIVE SUB-UNIT:TONER SUPPLY UNIT:1	U027	15
D0743708	SPRING LOCK WASHER:DRIVE SUB-UNIT:TONER BOTTLE	U027	16
D0743714	BRACKET:DRIVE:TONER BOTTLE	U027	17
D0743721	JOINT:DRIVE:TONER SUPPLY UNIT	U027	18
D0743722	COIL SPRING:DRIVE SUB-UNIT:TONER SUPPLY UNIT	U027	19
D0743736	SEAL:NOZZLE:NOZZLE COVER	U027	20
D0743741	STOPPER:SHUTTER:TONER CART RIDGE:TYPE A	U027	21
D0743742	HOLDER:STOPPER:SHUTTER:TYPE A	U027	22
D0743743	SPRING PLATE:STOPPER:SHUTTER:TYPE B	U027	23
D0743744	TONER CATCHPAN:HOLDER:STOPPER	U027	24

Exclusive Parts

Number	Part Name	Group	ID
	PPER		
D0743745	SEAL:HOLDER:STOPPER:RIGHT	U027	25
D0743746	SEAL:HOLDER:STOPPER:LEFT	U027	26
D0743747	SEAL:HOLDER	U027	27
D0743756	SEAL:BLOCK LIGHT:LEVER	U027	28
D0743762	NOZZLE:TONER SUPPLY:TAURUS	U027	29
D0743763	NOZZLE COVER:TONER SUPPLY SUB-UNIT	U027	30
D0743764	LEVER:TONER BOTTLE	U027	31
D0743765	CASE:LOWER FRONT:TONER SUPPLY UNIT	U027	32
D0743766	PLATE:COIL SPRING	U027	33
D0743767	COIL SPRING:LEVER:TONER SUPPLY UNIT	U027	34
D0743768	TENSION SPRING:SHUTTER:TONER SUPPLY UNIT	U027	35
D0743770	DECAL:OPERATE:TONER BOTTLE :K	Decals and Documents U027	16 36
D0743771	DECAL:OPERATE:TONER BOTTLE :C	Decals and Documents U027	17 37
D0743772	DECAL:OPERATE:TONER BOTTLE :M	Decals and Documents U027	18 38
D0743773	DECAL:OPERATE:TONER BOTTLE :Y	Decals and Documents U027	19 39
D0743801	DRIVE ROLLER:INTERMEDIATE TRANSFER:ASS'Y	U032	36
D0743805	HOUSING:DRIVE:INTERMEDIATE TRANSFER:PRESS FIT	U032	37
D0743820	GUIDE:TRANSPORT:INTERMEDIATE TRANSFER:ASS'Y	U031	43
D0743821	TENSION SPRING:PRESSURE:INTERMEDIATE TRANSFER:COLLAR	U031	28
D0743822	ROLLER:OPPOSED:BELT CLEANING:PRESS FIT	U032	38

Number	Part Name	Group	ID
D0743829	DECAL:POSITIONING DISPLAY:TC RU	Decals and Documents U029_S003_S001 U029_S006_S001 U029_S009_S001 U029_S012_S001 U030	20 67 67 67 67 4
D0743830	DECAL:OPERATE:LEVER:INTERMEDIATE TRANSFER	Decals and Documents U031	21 29
D0743836	SEAL:MIDDLE:INTERMEDIATE TRANSFER	U031	30
D0743841	SEAL:RIGHT:INTERMEDIATE TRANSFER	U031	31
D0743842	COVER:HARNESS:SECOND:INTERMEDIATE TRANSFER	U031	32
D0743845	FLAT NUT:INNER COVER:INTERMEDIATE TRANSFER	U030	5
D0743846	INNER COVER:BELT CLEANING	U030	6
D0743847	INNER COVER:INTERMEDIATE TRANSFER:PCU	U030	7
D0743848	INNER COVER:INTERMEDIATE TRANSFER:RIGHT	U030	8
D0743850	TRANSPORT BELT UNIT:ASS'Y	U038_S001	16
D0743851	TRANSPORT ROLLER:DRIVE	U038_S001	17
D0743853	PLATE:FRAME:INTERMEDIATE TRANSFER	U031	33
D0743854	COVER:OPPOSED:TRANSFER ROLLER	U032	39
D0743855	BRACKET:SENSOR:VACUUM	U038_S001	18
D0743858	PULLEY:DRIVE:VACUUM	U038	19
D0743859	INNER COVER:INTERMEDIATE TRANSFER:LEFT	U030	9
D0743860	INNER COVER:INTERMEDIATE TRANSFER:LEVER	U030	10
D0743863	SHAFT:DRIVEN:FLAT CONVEYER BELT	U038_S001	20
D0743871	STOPPER:WIRE:PULLEY	U032	40

Exclusive Parts

Number	Part Name	Group	ID
D0743872	PULLEY:DRIVE WERE:ASS'Y	U032	41
D0743873	FEELER:DRIVE WERE	U032	42
D0743881	BRACKET:DC STEPPER MOTOR:POSITIONING CONTROL	U032	43
D0743882	HOLDER:DRIVEN ROLLER:FRONT	U032	44
D0743884	SCALE:BRACKET:DRIVEN ROLLER:FRONT	U032	45
D0743887	BRACKET:ON-OFF:TRANSFER ROLLER	U032	46
D0743889	BRACKET:POSITIONING SENSOR:FLAT BELT-TRANSFER	U032	47
D0743892	LEVER:POSITIONING SENSOR:FLAT BELT-TRANSFER	U032	48
D0743896	COVER:POSITIONING SENSOR:FLAT BELT-TRANSFER	U032	49
D0743898	BRACKET:POSITIONING SENSOR:SLACK PREVENTION	U032	50
D0743899	LEVER:POSITIONING SENSOR:SLACK PREVENTION	U032	51
D0743921	SHAFT:COOLING:ENTRANCE	U044	33
D0743923	DRIVE ROLLER:BELT:COOLING SUB-UNIT:EXIT	U044	34
D0743926	TRANSPORT ROLLER:DRIVE:FUSING EXIT:PRESS FIT	U044	35
D0743927	GUIDE PLATE:BELT:LOWER:PEEN	U044	36
D0743931	GUIDE:EXIT:ENTRANCE	U044	37
D0743932	LEVER:STOPPER	U044	38
D0743941	GUIDE:EXIT:ENTRANCE:UPPER	U044	39
D0743943	ROLLER:FUSING EXIT:DRIVEN:ASS'Y	U044	40
D0743947	SPRING PLATE:ROLLER:BELT:BELT:ENTRANCE	U044	41
D0743951	SHAFT:GRIP:GUIDE PLATE	U044	42
D0743957	BRACKET:SENSOR:EXIT:ENTRANCE	U044	43
D0743960	ROLLER:HEAT PIPE:COOLING:DIA 30.4	U044	44
D0743961	SHEET:TRANSPORT:COOLING:FRONT	U044	45

Number	Part Name	Group	ID
	ONT		
D0743962	SHEET:TRANSPORT:COOLING:MIDDLE	U044	46
D0743963	SHEET:TRANSPORT:COOLING:INNER BACK	U044	47
D0743982	BRACKET:CAP:HEAT PIPE:UPPER	U044	48
D0743986	BRACKET:CAP:HEAT PIPE:LOWER	U044	49
D0743991	PLATE:EXIT:ENTRANCE	U044	50
D0744000	SUPPORTING PLATE:LEVER:PRESSURE	U041	29
D0744001	LEVER:PRESSURE:FRONT:INNER	U041	30
D0744004	LEVER:PRESSURE:REAR:INNER	U041	31
D0744009	HOLDER:M5	U041	32
D0744010	LEVER:PRESSURE:FRONT:OUTER	U041	33
D0744011	LEVER:PRESSURE:REAR:OUTER	U041	34
D0744014	HOLDER:HEATER:PRESSURE:FRONT	U041	35
D0744015	HOLDER:HEATER:PRESSURE:REAR	U041	36
D0744016	LEVER:WEB:ASS'Y	U041	37
D0744026	ELECTRODE PLATE:HEATER:PRESSURE:FRONT	U041	38
D0744028	HOLDER:STRIPPER PLATE:UNIT	U041_S002	39
D0744049	LEVER:STRIPPER PLATE:RELEASE:PEEN	U041_S002	40
D0744053	LEVER:RELEASE:STRIPPER PLATE:PRESSURE	U041_S002	41
D0744054	BRACKET:PAPER FEED SENSOR:FUSING EXIT	U041_S002	42
D0744056	FUSING ENTRANCE GUIDE PLATE:LOWER	U041	43
D0744059	SIDE PLATE:PRESSURE:FRONT	U041	44
D0744060	SIDE PLATE:PRESSURE:REAR	U041	45
D0744061	CLAMP:HARNESS:PRESSURE	U041	46
D0744062	BRACKET:THERMISTOR:PRESSURE	U041	47
D0744063	HOUSING:THERMOSTAT:ASS'Y	U041	48
D0744064	COVER:THERMOSTAT:PRESSURE	U041	49

Exclusive Parts

Number	Part Name	Group	ID
D0744065	COVER:TEMPERATURE SENSOR:PRESSURE	U041	50
D0744066	LIQUID STREAM PLATE:PRESSURE:ENTRANCE	U041	51
D0744067	LEVER:CONTROL PLATE:PRESSURE	U041	52
D0744068	SHAFT:RADIAL BALL BEARING:LEVER:PRESSURE	U041	53
D0744070	SUPPORTING PLATE:LEVER:PRESSURE	U041	54
D0744072	STEPPED SCREW:M5	U041	55
D0744089	DUCT:PRESSURE:LOWER	U041	56
D0744090	DUCT:PRESSURE:EXIT:CONNECTING:A	U041	57
D0744091	DUCT:PRESSURE:EXIT:CONNECTING:B	U041	58
D0744092	DUCT:PRESSURE:EXIT	U041	59
D0744093	DUCT:PRESSURE:UPPER	U041	60
D0744094	FIX STAND:TERMINAL:HEATER:ASSY	U041	61
D0744095	JOINT UNIT:PAPER FEED SENSOR:PRESSURE:FRONT	U041	62
D0744096	TERMINAL:CONNECTING	U041	63
D0744097	TAB:TERMINAL:CONNECTING	U041	64
D0744098	COVER:TERMINAL:CONNECTING	U041	65
D0744099	COVER:HARNESS:FIRST:LOWER	U041	66
D0744100	COVER:BASE:ID	U041	67
D0744101	SHAFT:CAM:PRESSURE	U041	68
D0744102	COLLAR:DIA10X:DIA14X:12	U041	69
D0744103	CAM:PRESSURE:A	U041	70
D0744104	FEELER:CAM:PRESSURE:FRONT	U041	71
D0744105	FEELER:CAM:PRESSURE:REAR	U041	72
D0744106	JOINT:CAM:PRESSURE:A	U041	73
D0744107	COLLAR:DIA10XDIA14X9.4	U041	74
D0744123	LEVER:STRIPPER PLATE:PLATE	U040_S001	30
D0744124	BRACKET:STRIPPER PLATE:PLATE:PEEN	U040_S001	31
D0744127	SUPPORTING PLATE:FRAME:STRIPPER	U040_S001	32

Number	Part Name	Group	ID
	PPER PLATE		
D0744128	COVER:STRIPPER PLATE:UNI:FUSING:ASSY	U040_S001	33
D0744143	SHAFT:STRIPPER PLATE	U040_S001	34
D0744144	LEVER:PAPER EXIT UNIT:FRONT	U040_S001	35
D0744145	LEVER:PAPER EXIT UNIT:REAR	U040_S001	36
D0744172	COVER:HARNESS:FIRST	U040	37
D0744173	HOLDER:HEATER:HEAT ROLLER:FRONT	U040	38
D0744174	HOLDER:HEATER:HEAT ROLLER:REAR	U040	39
D0744176	HOLDER:THERMISTOR:HOT ROLLER	U040	40
D0744179	HOLDER:THERMISTOR:HEAT ROLLER:REAR	U040	41
D0744180	HOUSING:THERMOSTAT:HEAT ROLLER:ASSY	U040	42
D0744181	ELECTRODE PLATE:THERMOSTAT:HEAT ROLLER:MIDDLE	U040	43
D0744182	ELECTRODE PLATE:THERMOSTAT:HEAT ROLLER	U040	44
D0744183	TAB:TERMINAL:187:2P:UPPER	U040	45
D0744184	TAB:TERMINAL:187:2P:LOWER	U040	46
D0744185	RING:GUIDE:HEAT ROLLER:DIA40	U040	47
D0744188	DUCT:HEAT ROLLER:UPPER	U039_S001	9
D0744190	COVER:FUSING UNIT:UPPER:FIBER	U039_S001_S001	10
D0744196	DISCHARGE BRUSH:HEAT ROLLER:PEEN	U040	48
D0744197	FLAT BELT-FUSING:DIA80:SEAL	U040	49
D0744200	GUIDE PLATE:FUSING EXIT:CONNECTING:UPPER:SHEET	U040_S001	50
D0744207	COVER:GREASE:GEAR:JOINT:PRESSURE	U041	75
D0744208	COVER:GUARD:SIDE PLATE:REAR	U041	76
D0744224	JOINT:KNOB:FUSING	U040	51
D0744225	KNOB:FUSING	Accessories	1
D0744227	BOLT:M5:ROUND POINT	U041	77

Exclusive Parts

Number	Part Name	Group	ID
D0744230	GUIDE PLATE:FUSING EXIT:LOWER:NO.2:ASS'Y	U041	78
D0744232	GUIDE PLATE:FUSING EXIT:LOWER:CONNECTING:ASS'Y	U041_S001	79
D0744235	SUPPORTING PLATE:GUIDE PLATE:FUSING EXIT:LOWER	U041_S001	80
D0744236	GUIDE PLATE:FUSING EXIT:LOWER:ASS'Y	U041_S002	86
D0744255	COVER:FUSING UNIT:FRONT	U039_S001	11
D0744264	BRACKET:DRAWER	U039_S001	12
D0744265	BRACKET:DRAWER:LOWER	U039_S001	13
D0744266	CLAMP:HARNESS:PRESSURE:HEATER:REAR	U039_S001	14
D0744267	BRACKET:GRIP:REAR	U039_S001	15
D0744269	PIN:HANDLE:COVER	U039_S001	16
D0744277	GUIDE PLATE:EXIT:CONNECTING:UPPER:SHEET	U039_S001	17
D0744280	COVER:GUIDE PLATE:EXIT:UPPER	U039_S001	18
D0744281	BRACKET:TORSION SPRING:PEEN	U040	52
D0744283	COVER:DRAWER:UPPER	U039_S001	19
D0744284	GRIP:FUSING UNIT:REAR:FIBER	U039_S001	20
D0744285	POSITIONING PLATE:FRONT	U039_S001	21
D0744287	POSITIONING PLATE:REAR	U039_S001	22
D0744289	COVER:FUSING UNIT:FRONT:WINDOW	U039_S001	23
D0744293	PLATE:LEVER:PRESSURE	U039_S001	24
D0744297	PLATE:RADIAL BALL BEARING:HEAT ROLLER	U040	53
D0744300	SPRING PLATE:CLEANING UNIT:FUSING	U042_S001	21
D0744302	PLAIN SHAFT BEARING:ROLLER:REAR	U042_S001	22
D0744303	FEELER:CLEANING	U042_S001	23
D0744304	SHAFT:WORM GEAR:SUB-ASS'Y	U042_S001	24
D0744308	BRACKET:FRONT:WEB	U042_S001	25
D0744309	BRACKET:FRONT:AUXILIARY	U042_S001	26

Number	Part Name	Group	ID
D0744310	BRACKET:REAR	U042_S001	27
D0744311	BRACKET:REAR:WEB	U042_S001	28
D0744314	BRACKET:REAR:PIN	U042_S001	29
D0744325	COVER:WEB:CLEANING FELT	U042_S001_S001	30
D0744329	WEB:GEAR:ASS'Y	U042_S001_S002	31
D0744333	ROLLER:PLATE	U042_S001	32
D0744336	DECAL:WARNING (REMOVAL AND INSTALLATION):FUSING	Decals and Documents	22
		U039_S001_S001	25
D0744342	COVER:FUSING UNIT:REAR:PRINTING	U039_S001	26
D0744345	FUSING ENTRANCE GUIDE PLATE:UPPER:FIBER	U040	54
D0744350	BRACKET:DRAWER:FUSING SECTION:24	U043	19
D0744351	STEPPED SCREW:DIA5.4DIA:DIA3.5:M3	U043	20
		U072	48
D0744352	JOINT:GEAR:WEB:DRIVE	U043	21
D0744353	COVER:GEAR:JOINT	U043	22
D0744354	GEAR:SLOW DOWN:WORM GEAR	U043	23
D0744356	BRACKET:LEVER:WEB:DRIVE SUB-UNIT	U043	24
D0744364	BRACKET:WEB:CLEANING	U043	25
D0744371	GRIP:SLIDER:FUSING	U043	26
D0744372	BRACKET:WEB:PHOTOINTERRUPTOR:MAIN	U043	27
D0744380	DECAL:H-TEMP WARNING:FUSING:WEB	Decals and Documents	23
		U042_S001_S001	33
D0744381	DECAL:FUSING UNIT:POSITIONING	Decals and Documents	24
		U039_S001	27
D0744390	ACCESSORY:KNOB:FUSING:ASS'Y	Accessories	10
D0744391	HOLDER:KNOB:FUSING:DUAL FACES TEPE	Accessories	2
D0744398	DUCT:PRESSURE:CONNECTING:A	U043	28
D0744399	DUCT:PRESSURE:CONNECTING:B	U043	29
D0744429	STRIPPER PLATE:UNI:FUSING:AS	U040_S001	55

Exclusive Parts

Number	Part Name	Group	ID
	S'Y		
D0744450	WEB:CLEANING UNIT:ASS'Y	U042_S001	34
D0744467	PRESSURE SUB-UNIT:STRIPPER PLATE:UNI:ASS'Y	U041_S002	81
D0744478	GUIDE PLATE:FUSING EXIT:LOWER:CONNECTING:ASS'Y	U041_S001	82
D0744487	FUSING UNIT:TAURUS:230V:ASS'Y	U039_S001	28
D0744514	GATE:DUPLEX:EXIT:ASS'Y	U047	15
D0744519	COVER:HARNESS:SWITCHBACK:LEFT LOWER	U046	14
D0744528	BRACKET:SENSOR:EXIT:EXIT	U045	14
D0744540	DAMPING INSULATION:DUPLEX:ENTRANCE:ADHESION	U046_S001	15
D0744541	DAMPING INSULATION:REVERSE:ADHESION	U046_S002	16
D0744544	DAMPING INSULATION:REVERSE:ENTRANCE:ADHESION	U046_S003	17
D0744550	GATE:REVERSE:EXIT:ASS'Y	U047	16
D0744551	DECAL:PULL OUT:LEFT:Z1	Decals and Documents U049	25 21
D0744552	DECAL:PULL OUT:LEFT:Z3	Decals and Documents U050_S001	26 38
D0744553	DECAL:PULL OUT:LEFT:D1	Decals and Documents U049	27 22
D0744554	DECAL:PULL OUT:LEFT:D3	Decals and Documents U044	28 51
D0744555	DECAL:PULL OUT:LEFT:D4	Decals and Documents U045	29 15
D0744556	DECAL:PULL OUT:LEFT:D5	Decals and Documents U046	30 18
D0744557	DECAL:H-TEMP WARNING:EXIT	Decals and Documents	31

Number	Part Name	Group	ID
		U049	23
D0744558	BRACKET:EXIT:SENSOR	U045	16
D0744559	DECAL:RECEIVING SUB-UNIT:ENTRANCE	Decals and Documents U002	32 13
D0744567	SHAFT:LOCK:REVERSE	U046	19
D0744577	GATE PAWL:SWITCHBACK	U046	20
D0744580	DC SOLENOID:REVERSE ROLLER:ASS'Y	U046	21
D0744589	GATE PAWL:REVERSE EXIT	U047	17
D0744594	GUIDE:EXIT:UPPER	U047	18
D0744602	GUIDE:REVERSE	U047	19
D0744608	DC SOLENOID:GATE PAWL:EXIT:ASS'Y	U047	20
D0744609	SHEET:TRANSPORT:EXIT:ADHESION	U045	17
D0744611	DC SOLENOID:GATE PAWL:SWITCHBACK:ASS'Y	U046	22
D0744612	TRANSPORT ROLLER:DRIVE:REVERSE:PRESS FIT	U047 U051	21 14
D0744613	EXIT ROLLER:DRIVE:REVERSE:EXIT:PRESS FIT	U047	22
D0744614	TRANSPORT ROLLER:CONNECTING:DRIVE:EXIT:PRESS FIT	U047	23
D0744615	GUIDE PLATE:REVERSE EXIT:ASS'Y	U047	24
D0744625	COVER:REVERSE UNIT:LEFT LOWER	U046	23
D0744626	DAMPING INSULATION:REVERSE:ENTRANCE:UPPER	U046_S003	24
D0744627	DAMPING INSULATION:REVERSE:ENTRANCE:LOWER	U046 U046_S003	25 25
D0744628	DAMPING INSULATION:REVERSE:UPPER	U046_S002	26
D0744629	DAMPING INSULATION:DUPLEX:ENTRANCE	U046_S001	27
D0744630	DAMPING INSULATION:COVER:REVERSE UNIT	U046	28

Exclusive Parts

Number	Part Name	Group	ID
D0744631	DAMPING INSULATION:REVERSE:LOWER	U046_S002	29
		U046_S003	29
D0744650	LINK:REVERSE ROLLER:ASS'Y	U046	30
D0744654	HANDLE:LOCK:FIBER	U044	52
		U045	18
D0744656	LEVER:GATE PAWL:REVERSE	U047	25
D0744657	BRACKET:COUPLING:DC BRUSHLESS MOTOR	U048	14
D0744665	SHAFT:DRIVE:COUPLING:EXIT	U048	15
D0744667	GUIDE:DUPLEX:ENTRANCE	U047	26
D0744670	BRACKET:DUPLEX:REVERSE:SENSOR	U047	27
D0744680	SHAFT:GRIP:GUIDE PLATE	U045	19
D0744682	PAPER EXIT SUB-UNIT:EXIT:MAIN	U072	49
D0744683	JOINT:EXIT:DRIVE	U026	48
		U048	16
D0744690	PIN:PLATE	U045	20
D0744701	GUIDE:DUPLEX:OPEN AND CLOSE:UPPER	U050	39
D0744710	KNOB:TRANSPORT ROLLER:AUXILIARY:PRESS FIT	U050	40
D0744718	TRANSPORT ROLLER:DUPLEX:NO.1:PRESS FIT	U050	41
D0744719	TRANSPORT ROLLER:DRIVE:DUPLEX:KNOB:PRESS FIT	U050	42
D0744802	HOLDER:PRESSURE ROLLER:DUPLEX:NO.2	U050	43
D0744806	PLATE:OPEN AND CLOSE:DUPLEX:RIGHT LOWER	U050	44
D0744810	PLATE:OPEN AND CLOSE:DUPLEX:LEFT LOWER	U050	45
D0744813	GUIDE:DUPLEX:OPEN AND CLOSE:LOWER	U050	46
D0744816	BRACKET:DRAWER:DUPLEX	U050	47
D0744817	PLATE:GUARD:DRAWER:DUPLEX	U050	48
D0744821	BRACKET:DRAWER:DUPLEX:MAIN	U050	49
D0744826	GRIP:DUPLEX:GUIDE PLATE:LEFT	U050_S001	50
D0744853	INNER COVER:RECEIVING SUB-U	U002	14

Number	Part Name	Group	ID
	NIT:LEFT LOWER		
D0744854	INNER COVER:RECEIVING SUB-UNIT:LEFT LOWER:LED	U068	33
D0744857	GUIDE PLATE:RECEIVING SUB-UNIT:LEFT LOWER:LEFT	U051	15
D0744860	GUIDE PLATE:RECEIVING SUB-UNIT:LEFT LOWER:LOWER	U051	16
D0744865	BRACKET:SENSOR:RECEIVING SUB-UNIT:LEFT LOWER	U051	17
D0744871	GUIDE PLATE:TRANSPORT ROLLER:DUPLEX:REVERSE	U051	18
D0744872	BRACKET:TRANSPORT ROLLER:DUPLEX:REVERSE:RIGHT	U051	19
D0744881	GUIDE PLATE:PRESSURE ROLLER:DUPLEX:REVERSE	U051	20
D0744885	GUIDE PLATE:PRESSURE ROLLER:DUPLEX:REVERSE:LEFT	U051	21
D0745194	GASKET:10X10X250	U070	14
D0745363	TEMPERATURE SENSOR:FUSING UNIT:UPPER:13PIN:ASS'Y	U040	56
D0745364	TEMPERATURE SENSOR:FUSING UNIT:UPPER:11PIN:ASS'Y	U040	57
D0745374	TEMPERATURE SENSOR:FUSING UNIT:DRAWER:17PIN:ASS'Y	U041	83
D0745414	PCB:TCRU-IDB	U041	84
D0745424	PCB:RYB	U065	11
D0745430	AC CONTROL BOARD	U065	12
D0745440	PCB:RELAY:AC	U065	13
D0745506	PCB:IOB	U065	14
D0745520	PCB:TDCU:ASS'Y	U065	15
D0745532	PCB:DRB	U026	49
D0745542	PCB:TDRB	U031	34
D0745701	PCB:IPU	U069	9
D0745832	HDD UNIT:ASS'Y	U069	10
D0745838	DRUM STAY:CONTROL BOARD	U069	11
D0745858	COVER:BRACKET:CONTROL BOARD	U069	12
D0745860	BRACKET:CONTROL BOARD	U069	13

Exclusive Parts

Number	Part Name	Group	ID
D0745870	DUCT:AUXILIARY:POWER SUPPLY UNIT	U070	15
D0745874	DECAL:CAPTION:INTERFACE	Decals and Documents	33
		U069	14
D0745911	BRACKET:NOISE FILTER	U065	16
D0745914	BRACKET:SAFETY SWITCH	U066	9
D0745916	SPRING PLATE:SAFETY SWITCH	U066	10
D0745917	ARM:SAFETY SWITCH	U066	11
D0745920	BRACKET:MAIN SWITCH	U066	12
D0746008	POSITIONING SENSOR:SCALE:INTERMEDIATE TRANSFER:ASS'Y	U032	52
D0746055	FLAT BELT-TRANSFER:SERVICE PARTS:ASS'Y	U030	11
D0746066	ROLLER:DRIVEN:INTERMEDIATE TRANSFER:NO.2:ASS'Y	U032	53
D0746068	ROLLER:TRANSFER:FRONT:ASS'Y	U032	54
D0746071	ROLLER:DRIVEN:INTERMEDIATE TRANSFER:ASS'Y	U032	55
D0746074	TENSION SPRING:SLEEVE:WIRE:INTERMEDIATE TRANSFER	U031	35
D0746075	GRIP:INTERMEDIATE TRANSFER:LEFT	U031	36
D0746076	DUCT:TM SENSOR:INTERMEDIATE TRANSFER	U031	37
D0746078	COMPRESSION SPRING:DRAWER:INTERMEDIATE TRANSFER	U072	50
D0746088	COVER:INTERMEDIATE TRANSFER:ASS'Y	U031	38
D0746092	BRACKET:HEATER:INTERMEDIATE TRANSFER	U031	39
D0746093	COVER:INTERMEDIATE TRANSFER:NO.2	U031	40
D0746097	THERMOSTAT:INTERMEDIATE TRANSFER	U031	41
D0746100	DENSITY SENSOR	U031	42
D0746103	COVER:INTERMEDIATE TRANSFER:NO.1	U032	56

Number	Part Name	Group	ID
D0746110	ROLLER:OPPOSED:PAPER:ASS'Y	U032	57
D0746112	CORE:OPPOSED:TRANSFER ROLLER	U032	58
D0746113	CAM:ON-OFF:TRANSFER ROLLER:FRONT	U032	59
D0746114	CAM:ON-OFF:TRANSFER ROLLER:REAR	U032	60
D0746115	CASE:OPPOSED:TRANSFER ROLLER:FRONT	U032	61
D0746117	CASE:BEARING:OPPOSED	U032	62
D0746119	CASE:OPPOSED:TRANSFER ROLLER:REAR	U032	63
D0746120	PULLEY:ON-OFF:TRANSFER ROLLER	U032	64
D0746121	BRACKET:SENSOR:ON-OFF:TRANSFER ROLLER	U032	65
D0746125	FEELER:ON-OFF:INTERMEDIATE TRANSFER:BLACK	U032	66
D0746130	SPRING PLATE:EARTH:INTERMEDIATE TRANSFER:ASS'Y	U031	44
D0746131	CAM:INTERMEDIATE TRANSFER:BLACK:2	U032	67
D0746134	PLAIN SHAFT BEARING:INSULATE	U031	45
D0746136	BRACKET:ROLLER:TRANSFER:LEFT FRONT:ASS'Y	U031	46
D0746138	BRACKET:ROLLER:TRANSFER:LEFT REAR:ASS'Y	U031	47
D0746139	GEAR:CONNECTING:ON-OFF:BLACK	U032	68
D0746140	SHAFT:CAM:INTERMEDIATE TRANSFER:BLACK:2	U032	69
D0746141	SHAFT:CAM:INTERMEDIATE TRANSFER:BLACK	U032	70
D0746142	CAM:INTERMEDIATE TRANSFER:BLACK	U032	71
D0746143	GRIP:ON-OFF:INTERMEDIATE TRANSFER	U032	72
D0746147	TERMINAL:INTERMEDIATE TRANSFER	U031	48

Exclusive Parts

Number	Part Name	Group	ID
	FER		
D0746148	SHAFT:CAM:INTERMEDIATE TRANSFER:COLLAR	U032	73
D0746149	CAM:INTERMEDIATE TRANSFER:COLLAR	U032	74
D0746153	SLIDE RAIL:ON-OFF:INTERMEDIATE TRANSFER:FRONT:ASS'Y	U031	49
D0746155	SLIDE RAIL:ON-OFF:INTERMEDIATE TRANSFER:REAR:ASS'Y	U031	50
D0746156	TENSION SPRING:ON-OFF:SLIDE RAIL	U031	51
D0746158	ROLLER:INTERMEDIATE TRANSFER:ASS'Y	U031	52
D0746160	ROLLER:FRONT:INTERMEDIATE TRANSFER:RIGHT:ASS'Y	U031	53
D0746161	COVER:BIAS:INTERMEDIATE TRANSFER	U031	54
D0746162	TIMING PULLEY:CAM:ON-OFF:INTERMEDIATE TRANSFER	U032	75
D0746163	GEAR:TIMING PULLEY:IDLER:INTERMEDIATE TRANSFER	U032	76
D0746164	SYNCHRONOUS BELT:ON-OFF:INTERMEDIATE TRANSFER	U032	77
D0746165	PULLEY:ON-OFF:BELT TENSIONER	U032	78
D0746168	TIGHTENER:INTERMEDIATE TRANSFER:ASS'Y	U032	79
D0746169	ROLLER:FRONT:INTERMEDIATE TRANSFER:LEFT	U031	55
D0746170	COIL SPRING:PRESSURE:TIGHTENER	U032	80
D0746171	GUIDE PLATE:COIL SPRING:PRESSURE:TIGHTENER	U031	56
D0746172	COLLAR:ON-OFF:INTERMEDIATE TRANSFER	U032	81
D0746173	TENSION SPRING:PRESSURE:INTERMEDIATE TRANSFER	U031	57
D0746175	PLAIN SHAFT BEARING:SLIDE RAIL	U031	58

Number	Part Name	Group	ID
	L:ON-OFF		
D0746177	DC STEPPER MOTOR:24V:14.8W	U032	82
D0746179	GEAR:IDLER:INTERMEDIATE TRANSFER:Z17:Z53	U032	83
D0746180	COMPRESSION SPRING:BIAS:INTERMEDIATE TRANSFER	U031	59
D0746184	BRACKET:ON-OFF:BLACK:FRONT:ASS'Y	U032	84
D0746187	BRACKET:ON-OFF:BLACK:REAR:ASS'Y	U032	85
D0746195	GEAR:COUPLING:ON-OFF:BLACK	U032	86
D0746196	DC MOTOR:ON-OFF:5.28W:BRS	U032	87
D0746197	TERMINAL:CONNECTING:BIAS:INTERMEDIATE TRANSFER	U031	60
D0746198	GEAR:ON-OFF:BLACK	U032	88
D0746199	COVER:GEAR:ON-OFF:BLACK	U032	89
D0746201	TRANSFER/SEPARATION UNIT:ASS'Y	U034_S001	17
D0746216	SHUTTER:TONER OUTLET SUB-UNIT:SUB-ASS'Y	U034_S001	18
D0746219	COIL SPRING:SHUTTER:DISCHARGE USED TONER	U034_S001	19
D0746228	ELECTRODE PLATE:FRAME	U034_S001	20
D0746230	CASE:TERMINAL:SEPARATION:ASS'Y	U025	21
D0746238	JOINT:TRANSFER:DRIVE	U025	22
D0746240	SHAFT:CONTACT POINT:T/S UNIT	U025	23
D0746241	DECAL:GRIP:TRANSFER/SEPARATION UNIT	Decals and Documents U034_S001	34 21
D0746242	DECAL:LEVER:TRANSFER/SEPARATION UNIT:FRONT	Decals and Documents U025	35 24
D0746243	DECAL:LEVER:TRANSFER/SEPARATION UNIT:REAR	Decals and Documents U025	36 25
D0746250	TRANSFER ROLLER	U034_S001	22
D0746255	BRUSH ROLLER:TRANSFER ROLL	U034_S001	23

Exclusive Parts

Number	Part Name	Group	ID
	ER:ASS'Y		
D0746257	BRUSH ROLLER:APPLY:ASS'Y	U034_S001	24
D0746265	BLADE:TRANSFER ROLLER:ASS'Y	U034_S001	25
D0746270	HOLDER:BLADE:ASS'Y	U034_S001	26
D0746273	SEAL:HOLDER	U034_S001	27
D0746274	SEAL:HOLDER:UPPER	U034_S001	28
D0746276	PIN:POSITIONING PLATE:BLADE:TRANSFER ROLLER:ASS'Y	U034_S001	29
D0746279	COIL SPRING:BLADE:TRANSFER ROLLER	U034_S001	30
D0746280	GUIDE PLATE:ENTRANCE:TRANSFER ROLLER:ASS'Y	U034_S001	31
D0746291	COIL SPRING:COATING BAR	U034_S001	32
D0746294	TRANSPORT SCREW:TRANSFER ROLLER:ASS'Y	U034_S001	33
D0746300	SEPARATION CORONA:ASS'Y	U034_S001	34
D0746311	GEAR:TRANSFER ROLLER	U034_S001	35
D0746312	GEAR:IDLER:TRANSFER ROLLER	U034_S001	36
D0746313	GEAR:IDLER:COLLECTION COIL	U034_S001	37
D0746314	GEAR:COLLECTION COIL	U034_S001	38
D0746315	GEAR:BRUSH:APPLY	U034_S001	39
D0746324	GEAR:DRIVE:TRANSFER/SEPARATION UNIT	U025	26
D0746330	LEVER:PRESSURE:T/S UNIT:FRONT	U025	27
D0746333	SHAFT:LEVER:PRESSURE:TRANSFER ROLLER	U025	28
D0746334	COIL SPRING:PRESSURE:TRANSFER ROLLER	U025	29
D0746335	SHAFT:CAM:TRANSFER/SEPARATION UNIT	U025	30
D0746336	CAM:TRANSFER/SEPARATION UNIT	U025	31
D0746337	LEVER:PRESSURE:T/S UNIT:REAR	U025	32
D0746338	PIN:LEVER:PRESSURE:TRANSFER ROLLER	U025	33
D0746340	LINK:HANDLE	U025	34
D0746343	LINK:HANDLE:MIDDLE	U025	35

Number	Part Name	Group	ID
D0746349	BRACKET:SHAFT:CONTACT POINT:TRANSFER ROLLER	U025	36
D0746381	CASE:TENSION:ROLLER:ASS'Y	U030_S001	12
D0746397	COIL SPRING:TENSION:ROLLER	U030_S001	13
D0746398	COVER:COIL SPRING:INTERMEDIATE TRANSFER	U031	61
D0746400	BELT CLEANING:ASS'Y	U033_S001	12
D0746410	GROUND PLATE:BELT CLEANING	U033_S001	13
D0746411	COIL SPRING:EARTH:BELT CLEANING	U033_S001	14
D0746414	SCRAPER:BRUSH:REMOVE PAPER DUST	U033_S001	15
D0746415	DUAL FACES TEPE:ENTRANCE SEAL:BELT CLEANING	U033_S001	16
D0746416	SEAL:ENTRANCE SEAL:BELT CLEANING	U033_S001	17
D0746417	SEAL:SCRAPER	U033_S001	18
D0746420	BRUSH:REMOVE PAPER DUST:BELT CLEANING	U033_S001	19
D0746424	BLADE:CLEANING:BELT CLEANING:ASS'Y	U033_S001	20
D0746428	HOLDER:CLEANING:BELT CLEANING:ASS'Y	U033_S001	21
D0746431	COIL SPRING:BLADE:CLEANING:BELT CLEANING	U033_S001	22
D0746434	TONER COLLECTION COIL:BELT CLEANING:ASS'Y	U033_S001	23
D0746439	PLAIN SHAFT BEARING:REMOVE PAPER DUST:TRANSPORT SCREW	U033_S001	24
D0746440	GUIDE:DISCHARGE USED TONER:BELT CLEANING	U033_S001	25
D0746441	SHUTTER:TRANSPORT SCREW:BELT CLEANING	U033_S001	26
D0746442	COIL SPRING:DISCHARGE USED TONER	U033_S001	27
D0746443	SEAL:DISCHARGE USED TONER	U033_S001	28
D0746446	BRUSH:APPLY:BELT CLEANING	U033_S001	29

Exclusive Parts

Number	Part Name	Group	ID
D0746450	COATING BAR:ASS'Y	U033_S001_S001	30
D0746454	ARM:COATING BAR:BELT CLEANING	U033_S001_S001	31
D0746455	COIL SPRING:COATING BAR	U033_S001_S001	32
D0746457	BLADE:APPLY:ASS'Y	U033_S001	33
D0746461	HOLDER:APPLY:BELT CLEANING:ASS'Y	U033_S001	34
D0746464	COIL SPRING:BLADE:APPLY:BELT CLEANING	U033_S001	35
D0746467	COIL SPRING:STOPPER:CASE:BELT CLEANING	U033_S001	36
D0746468	STOPPER:CASE:BELT CLEANING	U033_S001	37
D0746469	SLIDE RAIL:UPPER:BELT CLEANING	U033_S001	38
D0746470	RELEASE PLATE:BLADE:CLEANING	U033_S001	39
D0746471	RELEASE PLATE:BLADE:APPLY	U033_S001	40
D0746477	GEAR:BRUSH:REMOVE PAPER DUST:Z17	U033_S001	41
D0746478	GEAR:PULLEY:IDLER:BELT CLEANING	U033_S001	42
D0746479	GEAR:COLLECT:COIL:Z19	U033_S001	43
D0746480	PULLEY:BRUSH:APPLY:Z30	U033_S001	44
D0746481	JOINT:BRUSH:REMOVE PAPER DUST:BELT CLEANING	U033_S001	45
D0746482	SEAL:HOLDER:CLEANING BLADE:UPPER	U033_S001	46
D0746483	SEAL:HOLDER:CLEANING BLADE:FRONT LOWER	U033_S001	47
D0746484	SEAL:HOLDER:CLEANING BLADE:REAR LOWER	U033_S001	48
D0746485	SEAL:CASE:BRUSH:FRONT	U033_S001	49
D0746486	SEAL:CASE:BRUSH:REAR	U033_S001	50
D0746487	SEAL:HOLDER:CLEANING BLADE:LOWER	U033_S001	51
D0746488	SEAL:HOLDER:BEHIND:BELT CLEANING	U033_S001	52
D0746489	VIBRATING PLATE:TRANSPORT S	U033_S001	53

Number	Part Name	Group	ID
	CREW:BELT CLEANING		
D0746490	SEAL:BASE:CASE:BELT CLEANING	U033_S001	54
D0746491	SEAL:CASE:CLEANING BLADE:FRONT	U033_S001	55
D0746492	SEAL:CASE:CLEANING BLADE:REAR	U033_S001	56
D0746495	LEVER:RELEASE:BLADE	U033_S001	57
D0746496	GRIP:BELT CLEANING	U033_S001	58
D0746497	DECAL:POSITIONING DISPLAY:TCRU	Decals and Documents	37
		U008_S001	62
		U021	59
		U033_S001	59
D0746501	TONER OUTLET SUB-UNIT:PCU:MAIN:ASS'Y	U035_S001	6
D0746504	TRANSPORT SCREW:PCU:MAIN:ASS'Y	U035_S001	7
D0746511	PLAIN SHAFT BEARING:TONER RECYCLING SUB-UNIT	U035_S001	8
		U035_S002	8
		U035_S004	8
D0746512	GEAR:Z35:TRANSPORT SCREW:PCU:MAIN	U035_S001	9
D0746514	SEAL:TONER OUTLET SUB-UNIT:PCU	U035_S001	10
D0746515	SEAL:COVER:5ST.:PCU	U035_S001	11
D0746516	SEAL:COVER:5ST.:DEVELOPMENT	U035_S001	12
D0746517	STEEL BALL:TONER OUTLET SUB-UNIT	U035_S001	13
		U035_S002	13
D0746520	COVER:DISCHARGE USED TONER:DEVELOPMENT	U035	14
D0746531	TONER OUTLET SUB-UNIT:BELT CLEANING:MAIN:ASS'Y	U035_S002	15
D0746534	TRANSPORT SCREW:BELT CLEANING:MAIN:ASS'Y	U035_S002	16
D0746539	GEAR:Z29:TRANSPORT SCREW:BELT CLEANING	U035_S002	17

Exclusive Parts

Number	Part Name	Group	ID
D0746540	SEAL:BELT CLEANING:MAIN	U035_S002	18
D0746541	SEAL:RING:TONER OUTLET SUB-UNIT:BELT CLEANING	U035_S002	19
D0746551	TONER OUTLET SUB-UNIT:VERTICAL TRANSPORT:ASS'Y	U035_S003	20
D0746564	TONER OUTLET SUB-UNIT:T/S UNIT:SHUTTER:OUTER	U035_S003	21
D0746565	TONER OUTLET SUB-UNIT:T/S UNIT:SHUTTER:INNER	U035_S003	22
D0746566	SEAL:VERTICAL TRANSPORT:LOWER	U035_S003	23
D0746567	SEAL:VERTICAL TRANSPORT:UPPER	U035_S003	24
D0746572	BRACKET:VERTICAL TRANSPORT:ASS'Y	U035	25
D0746574	COVER:CAM:VERTICAL TRANSPORT	U035	26
D0746575	SHAFT:CAM:VERTICAL TRANSPORT	U035	27
D0746577	CAM:VERTICAL TRANSPORT:DIA15	U035	28
D0746578	GEAR:Z37:CAM:VERTICAL TRANSPORT	U035	29
D0746579	SEAL:COVER:CAM:VERTICAL TRANSPORT	U035	30
D0746585	GEAR:Z38/Z24:VERTICAL TRANSPORT	U035	31
D0746586	GEAR:Z35:IDLER:VERTICAL TRANSPORT	U035	32
D0746590	COLLECTION BOTTLE:ASS'Y	U037_S001	2
D0746601	TONER OUTLET SUB-UNIT:LOWER:ASS'Y	U035_S004	33
D0746604	TRANSPORT SCREW:TONER OUTLET SUB-UNIT:LOWER:ASS'Y	U035_S004	34
D0746609	GEAR:Z23:TRANSPORT SCREW:LOWER	U035_S004	35
D0746610	SEAL:RING:TONER OUTLET SUB-UNIT:LOWER	U035_S004	36

Number	Part Name	Group	ID
D0746626	INNER COVER:TONER RECYCLING SUB-UNIT	U036	17
D0746627	COLLECTION BOTTLE:SMALL:ASS'Y	U036_S001	18
D0746629	COVER:COLLECTION BOTTLE:SMALL	U036_S001	19
D0746630	PIPE:COLLECTION BOTTLE:SMALL	U036_S001	20
D0746631	SHUTTER:TONER RECYCLING SUB-UNIT:SMALL	U036_S001	21
D0746632	COMPRESSION SPRING:SHUTTER:SMALL	U036_S001	22
D0746633	COVER:BEARING:SMALL	U036_S001	23
D0746634	AGITATOR:SMALL	U036_S001	24
D0746635	TRANSPORT SCREW:SMALL:ASS'Y	U036_S001	25
D0746640	PLAIN SHAFT BEARING:TRANSPORT SCREW:SMALL	U036_S001	26
D0746641	PLAIN SHAFT BEARING:SMALL:GEAR	U036_S001	27
D0746642	PLAIN SHAFT BEARING:SMALL	U036_S001	28
D0746643	GEAR:TRANSPORT SCREW:COLLECTION BOTTLE:SMALL:Z31	U036_S001	29
D0746644	GEAR:AGITATOR:COLLECTION BOTTLE:SMALL:Z49/Z41	U036_S001	30
D0746645	GEAR:AGITATOR:COLLECTION BOTTLE:SMALL:Z41	U036_S001	31
D0746646	SEAL:TONER RECYCLING SUB-UNIT:SMALL	U036_S001	32
D0746647	BRACKET:PUSH SWITCH	U036	33
D0746648	LINK:PUSH SWITCH:TONER RECYCLING SUB-UNIT	U036	34
D0746656	COVER:GEAR:SIDE PLATE:PEEN	U036	35
D0746659	SHAFT:JOINT:COLLECTION BOTTLE:ASS'Y	U036	36
D0746663	TORQUE LIMITER MECHANICAL CLUTCH:GEAR:Z63	U036	37
D0746664	GEAR:IDLER:Z49/Z27	U036	38

Exclusive Parts

Number	Part Name	Group	ID
D0746665	GEAR:JOINT:COLLECTION BOTTLE:Z65	U036	39
D0746666	GEAR:IDLER:Z37/Z28	U036	40
D0746667	HOLDER:RADIAL BALL BEARING:JOINT	U036	41
D0746668	SEAL:PIPE:TONER RECYCLING SUB-UNIT:SMALL	U036_S001	42
D0746669	SPRING PLATE:PUSH SWITCH	U036	43
D0746684	SEAL:TANK:USED TONER:COLLECT	U037_S001	3
D0746708	BASE:ARM:OPERATION SUB-UNIT:ASS'Y	U004	4
D0746711	FRAME:ARM:OPERATION SUB-UNIT:INNER	U004	5
D0746712	GUIDE PLATE:ARM:OPERATION SUB-UNIT	U004	6
D0746713	FRAME:ARM:OPERATION SUB-UNIT:OUTER	U004	7
D0746714	GUIDE PLATE:HINGE:OPERATION SUB-UNIT:LOWER	U004	8
D0746715	SUPPORTING PLATE:GUIDE PLATE:HINGE	U004	9
D0746716	HOLDER:HINGE:OPERATION SUB-UNIT:LOWER	U004	10
D0746717	BRACKET:COVER:ARM:RIGHT	U004	11
D0746718	HINGE:ARM:OPERATION SUB-UNIT:LOWER	U004	12
D0746719	FRAME:ARM:OPERATION SUB-UNIT:FRONT	U004	13
D0746721	GUIDE PLATE:HINGE:OPERATION SUB-UNIT:UPPER	U004	14
D0746722	HINGE:ARM:OPERATION SUB-UNIT:UPPER	U004	15
D0746723	GUIDE PLATE:OPERATION PANEL	U004	16
D0746724	BRACKET:COVER:ARM:FRONT	U004	17
D0746725	BRACKET:COVER:ARM:FRONT LOWER	U004	18
D0746726	SUPPORTING PLATE:COVER:ARM	U004	19

Number	Part Name	Group	ID
	:INNER		
D0746727	COVER:HARNESS:OPERATION PANEL	Accessories	3
D0746728	COVER:ARM:OPERATION SUB-UNIT:RIGHT	U004	20
D0746729	COVER:ARM:OPERATION SUB-UNIT:INNER	U004	21
D0746730	COVER:ARM:OPERATION SUB-UNIT:RIGHT LOWER	U004	22
D0746731	COVER:ARM:OPERATION SUB-UNIT:LEFT	U004	23
D0746732	COVER:ARM:OPERATION SUB-UNIT:LEFT LOWER	U004	24
D0746733	COVER:ARM:OPERATION SUB-UNIT:FRONT	U004	25
D0746734	COVER:OPERATION PANEL:REAR	U003	1
D0746735	COVER:OPERATION PANEL:REAR UPPER	U003	2
D0746736	COVER:ARM:OPERATION SUB-UNIT:FRONT LOWER	U004	26
D0746737	CAP:COVER:ARM:FRONT	U004	27
D0746738	CAP:COVER:ARM:RIGHT	U004	28
D0746739	HOLDER:HINGE:OPERATION SUB-UNIT:UPPER	U004	29
D0746831	PCB:OPU:P:NA:SERVICE	U003_S001	3
D0746851	OPERATION SUB-UNIT:TAP:NA:ASS'Y	U003_S001	4
D0746922	HEAT PIPE:ASS'Y	U060	5
D0746932	DUCT:HEAT PIPE:FUSING:UPPER	U060	6
D0746933	SEAL:DUCT:HEAT PIPE:FUSING:UPPER	U060	7
D0746934	DUCT:HEAT PIPE:FUSING:LOWER	U060	8
D0746935	SEAL:DUCT:HEAT PIPE:FUSING	U060	9
D0746936	DUCT:HEAT PIPE:FUSING:SIDE	U060	10
D0746937	HEAT INSULATION:HEAT PIPE:PANEL	U060	11
D0746938	DUCT:CONNECTING:COOLING:FUSING EXIT	U063	7

Exclusive Parts

Number	Part Name	Group	ID
D0746939	SEAL:DUCT:CONNECTING:COOLING:FUSING EXIT	U063	8
D0746940	DUCT:UPPER:HEAT SINKER	U060	12
D0746941	DUCT:LOWER:HEAT SINKER	U060	13
D0746942	SEAL:SHORT:DUCT:HEAT SINKER	U060	14
D0746943	SEAL:LONG:DUCT:HEAT SINKER	U060	15
D0746944	SHEET:C/T BOX:LIQUID COOLING:UPPER	U071	64
D0746945	SHEET:C/T BOX:LIQUID COOLING:LOWER	U071	30
D0746947	FILTER:VACUUM:RIGHT UPPER	U064	12
D0746948	SEAL:DUCT:VACUUM:RIGHT LOWER	U064	13
D0746957	DUCT:UPPER:VACUUM:CONNECTING:HEAT SINKER	U060	16
D0746958	DUCT:LOWER:VACUUM:CONNECTING:HEAT SINKER	U060	17
D0746960	SEAL:DUCT:VACUUM:CONNECTING:HEAT SINKER	U060	18
D0746962	DUCT:UPPER:EXHAUST:HEAT SINKER	U060	19
D0746963	DUCT:LOWER:EXHAUST:HEAT SINKER	U060	20
D0746964	BRACKET:FAN:DUCT:EXHAUST:HEAT SINKER	U060	21
D0746965	BRACKET:DUCT:EXHAUST:HEAT SINKER	U060	22
D0746967	DUCT:UPPER:FUSING:EXIT	U061	5
D0746968	DUCT:LOWER:FUSING:EXIT	U061	6
D0746969	SEAL:LONG:DUCT:FUSING:EXIT	U061	7
D0746970	SEAL:SHORT:DUCT:FUSING:EXIT	U061	8
D0746972	SEAL:DUCT:EXHAUST:HEAT SINKER	U060	23
D0746973	SEAL:DUCT:EXHAUST:EXIT:OPTICAL WRITING UNIT	U061	9
D0746974	CAP:LOUVER:MM90	U002	15
D0746975	FILTER:POWER SUPPLY UNIT:MM90	U002	16

Number	Part Name	Group	ID
D0746977	DUCT:RIGHT:EXIT:EXHAUST	U061	10
D0746978	DUCT:LEFT:EXIT:EXHAUST	U061	11
D0746979	SEAL:DUCT:EXIT:CONNECTING	U061	12
D0746982	DUCT:RIGHT:CONNECTING:EXHAUST	U061	13
D0746983	DUCT:LEFT:CONNECTING:EXHAUST	U061	14
D0746984	DUCT:COOLING:BELT CLEANING:RIGHT	U062	11
D0746987	DUCT:UPPER:FUSING:EXIT:EXHAUST	U061	15
D0746988	DUCT:LOWER:FUSING:EXIT:EXHAUST	U061	16
D0746992	DUCT:HEAT PIPE:ROLLER:FRONT	U063	9
D0746993	DUCT:HEAT PIPE:ROLLER:INNER BACK	U063	10
D0746995	SEAL:DUCT:HEAT PIPE:ROLLER:VACUUM	U063	11
D0746996	SEAL:DUCT:HEAT PIPE:ROLLER:FRONT	U063	12
D0746997	SEAL:DUCT:HEAT PIPE:ROLLER:EXHAUST	U063	13
D0746998	DUCT:VACUUM:HEAT PIPE:ROLLER	U063	14
D0747000	DUCT:EXHAUST:HEAT PIPE:ROLLER:RIGHT	U063	15
D0747001	DUCT:EXHAUST:HEAT PIPE:ROLLER:LEFT	U063	16
D0747010	SEAL:LOWER:PANEL:HEAT PIPE	U060	24
D0747012	DUCT:UPPER:EXHAUST:DEVELOPMENT UNIT	U059	7
D0747013	DUCT:LOWER:EXHAUST:DEVELOPMENT UNIT	U059	8
D0747014	SEAL:VACUUM:DUCT:EXHAUST:DEVELOPMENT UNIT	U059	9
D0747015	SEAL:EXIT:DUCT:EXHAUST:DEVELOPMENT UNIT	U059	10
D0747017	DUCT:CONNECTING:EXHAUST:DEVELOPMENT UNIT	U059	11

Exclusive Parts

Number	Part Name	Group	ID
	VELOPMENT UNIT		
D0747022	DUCT:RIGHT:EXHAUST:ABSORB DUST SUB-UNIT	U059	12
D0747026	DUCT:UPPER:CONNECTING:EXHAUST	U059	13
D0747027	DUCT:LOWER:CONNECTING:EXHAUST	U059	14
D0747028	SEAL:CONNECTING:ENTRANCE	U059	15
D0747030	DUCT:LEFT:EXHAUST	U059	16
D0747033	SEAL:RIGHT:EXHAUST	U059	17
D0747034	BRACKET:DUCT:EXHAUST:LEFT	U059	18
D0747035	BRACKET:DUCT:EXHAUST:RIGHT	U059	19
D0747037	DUCT:FRONT:COOLING:FUSING	U063	17
D0747038	DUCT:REAR:COOLING:FUSING	U063	18
D0747039	SEAL:DUCT:COOLING:FUSING	U063	19
D0747042	DUCT:FRONT:EXIT:COOLING:FUSING	U063	20
D0747043	DUCT:REAR:EXIT:COOLING:FUSING	U063	21
D0747045	SEAL:EXIT:SIROCCO	U063	22
D0747047	DUCT:CONNECTING:COOLING:FUSING	U063	23
D0747048	SEAL:VACUUM:DUCT:CONNECTING:FUSING	U063	24
D0747049	SEAL:EXHAUST:DUCT:CONNECTING:FUSING	U063	25
D0747051	DUCT:LEFT:COOLING:USED TONER	U062	12
D0747052	DUCT:RIGHT:COOLING:USED TONER	U062	13
D0747054	SEAL:DUCT:LEFT AND RIGHT:COOLING:USED TONER	U062	14
D0747067	DUCT:FRONT:EXHAUST:OPTICAL WRITING UNIT	U061	17
D0747068	DUCT:REAR:EXHAUST:OPTICAL WRITING UNIT	U061	18
D0747070	SEAL:FAN:DUCT:EXHAUST:OPTICAL WRITING UNIT	U061 U062	19 15

Number	Part Name	Group	ID
D0747071	SEAL:DUCT:EXHAUST:OPTICAL WRITING UNIT	U061	20
D0747073	DUCT:RIGHT:EXHAUST:EXIT:OPTICAL WRITING UNIT	U061	21
D0747074	DUCT:LEFT:EXHAUST:EXIT:OPTICAL WRITING UNIT	U061	22
D0747077	DUCT:FRONT:COOLING:PRESSURE ROLLER:PULL OUT	U049	24
D0747078	DUCT:INNER BACK:COOLING:PRESSURE ROLLER:PULL OUT	U049	25
D0747080	SEAL:DUCT:COOLING:PRESSURE ROLLER:PULL OUT	U049	26
D0747082	DUCT:RIGHT:COOLING:INTERMEDIATE TRANSFER:PULL OUT	U049	27
D0747083	DUCT:LEFT:COOLING:INTERMEDIATE TRANSFER:PULL OUT	U049	28
D0747084	SEAL:DUCT:EXHAUST:ABSORB DUST SUB-UNIT:LOWER	U059	20
D0747086	SEAL:VACUUM:COOLING:INTERMEDIATE TRANSFER:PULL OUT	U049	29
D0747087	SEAL:DC FAN MOTOR:SIROCCO	U032 U049	90 30
D0747088	SEAL:CONNECTING:ABSORB DUST SUB-UNIT:ENTRANCE:SHORT	U059	21
D0747089	SEAL:JOINT:DUCT:COOLING:PRESSURE ROLLER	U049	31
D0747090	SEAL:VACUUM:POSITIONING SENSOR	U032	91
D0747091	SEAL:DUCT:USED TONER:RIGHT:LONG	U062	16
D0747092	SEAL:DUCT:USED TONER:RIGHT:SHORT	U062	17
D0747094	SEAL:DUCT:FRONT:COOLING:BELT CLEANING	U062	18
D0747095	SEAL:CONNECTING:ABSORB DUST SUB-UNIT:FAN:ENTRANCE	U059	22
D0747099	SEAL:CONNECTING:ABSORB DUST SUB-UNIT:UPPER LOWER	U059	23

Exclusive Parts

Number	Part Name	Group	ID
D0747102	SEAL:LOWER:DUCT:CONNECTING:DEVELOPMENT UNIT	U059	24
D0747103	SEAL:UPPER:DUCT:CONNECTING:DEVELOPMENT UNIT	U059	25
D0747104	BRACKET:FAN:DUCT:EXHAUST:C/T BOX	U071	31
D0747105	SEAL:UPPER:DUCT:COOLING:FUSING	U063	26
D0747106	SEAL:LOWER:DUCT:COOLING:FUSING	U063	27
D0747107	SEAL:LOWER:DUCT:EXHAUST:C/T BOX	U071	32
D0747109	SEAL:EXIT:EXHAUST:DUCT:C/T BOX	U071	33
D0747110	OZONE FILTER	U071	34
D0747111	FILTER:PREVENTFENCE	U071	35
D0747114	BRACKET:FAN:DUCT:EXHAUST:C/T BOX	U071	36
D0747115	COVER:DUCT:EXHAUST:C/T BOX	U071	37
D0747116	SEAL:COVER:DUCT:EXHAUST:C/T BOX	U071	38
D0747118	DUCT:INNER BACK:COOLING:POSITIONING SENSOR	U032	92
D0747119	DUCT:FRONT:COOLING:POSITIONING SENSOR	U032	93
D0747122	DUCT:FRONT:OZONE UNIT:C/T BOX	U071	39
D0747123	DUCT:REAR:OZONE UNIT:C/T BOX	U071	40
D0747124	BRACKET:FAN:DUCT:OZONE FILTER:C/T BOX	U071	41
D0747125	COVER:DUCT:OZONE UNIT:C/T BOX	U071	42
D0747126	SEAL:COVER:DUCT:OZONE UNIT:C/T BOX	U071	43
D0747128	SEAL:LOWER:DUCT:OZONE FILTER:C/T BOX	U071	44
D0747129	SEAL:UPPER:DUCT:OZONE FILTER:C/T BOX	U071	45

Number	Part Name	Group	ID
D0747130	SEAL:EXIT:DUCT:OZONE FILTER:C/T BOX	U071	46
D0747134	BRACKET:FIN:RADIATOR	U071	47
D0747135	SEAL:FIN	U071	48
D0747137	DUCT:RIGHT:VACUUM:HEAT SINKER:C/T BOX	U070	16
D0747138	DUCT:LEFT:VACUUM:HEAT SINKER:C/T BOX	U070	17
D0747139	BRACKET:FAN:C/T BOX:RIGHT UPPER	U070	18
D0747140	DUCT:FRONT:EXHAUST:C/T BOX	U070	19
D0747141	DUCT:REAR:COOLING:USED TONER	U062	19
D0747142	DUCT:FRONT:COOLING:USED TONER	U062	20
D0747144	SEAL:DUCT:REAR:COOLING:USED TONER	U062	21
D0747145	SEAL:DUCT:FRONT:COOLING:USED TONER	U062	22
D0747147	DUCT:FRONT:COOLING:BELT CLEANING	U062	23
D0747148	DUCT:REAR:COOLING:BELT CLEANING	U062	24
D0747150	FILTER:BRACKET:VACUUM:RIGHT LOWER	U064	14
D0747152	SEAL:DUCT:EXHAUST:LEFT REAR	U002_S001	17
D0747165	SEAL:DUCT:EXHAUST:OPTICAL WRITING UNIT	U061	23
D0747170	SEAL:EXIT:MIDDLE:DUCT:C/T BOX	U071	49
D0747172	SEAL:OPTICAL WRITING UNIT:LOWER	U072	51
D0747174	SEAL:DUCT:EXIT	U071_S001	50
D0747176	DUCT:VACUUM:RIGHT UPPER:FRONT	U064	15
D0747177	DUCT:VACUUM:RIGHT UPPER:REAR	U064	16
D0747187	SEAL:DC FAN MOTOR:VACUUM:RIGHT UPPER	U064	17

Exclusive Parts

Number	Part Name	Group	ID
D0747188	SEAL:DUCT:VACUUM:RIGHT UPPER	U064	18
D0747189	DUCT:FRONT:EXHAUST:C/T BOX	U071	51
D0747190	DUCT:REAR:EXHAUST:C/T BOX	U071	52
D0747191	BRACKET:UPPER:DUCT:EXHAUST:C/T BOX	U071	53
D0747192	BRACKET:MIDDLE:DUCT:EXHAUST:C/T BOX	U071	54
D0747193	BRACKET:LOWER:DUCT:EXHAUST:C/T BOX	U071	55
D0747194	BRACKET:DUCT:EXHAUST:C/T BOX	U071	56
D0747195	SEAL:DUCT:C/T BOX:MIDDLE UPPER	U071	57
D0747196	BRACKET:UPPER:FAN:DUCT:C/T BOX	U071	58
D0747197	SEAL:DUCT:C/T BOX:MIDDLE SIDEWAYS	U071	59
D0747198	SEAL:DUCT:C/T BOX:MIDDLE LOWER	U071	60
D0747199	COVER:LIQUID COOLING:BASE:C/T BOX	U071	61
D0747207	SHEET:C/T BOX:LIQUID COOLING:WINDOW	U071	65
D0747250	LIQUID COOLING:FAN:ASS'Y	U071_S002	62
D0747261	LIQUID COOLING:PT:ASS'Y	U071	63
D0747326	SLIDE RAIL:RIGHT:NO.2:ASS'Y	U072	52
D0747330	SLIDE RAIL:LEFT:NO.1	U072	53
D0747331	STAY:SLIDE RAIL:LEFT INNER REAR:NO.1:PEEN	U072	54
D0747333	STAY:SLIDE RAIL:LEFT FRONT:NO.1	U072	55
D0747335	STAY:SLIDE RAIL:LEFT:NO.2	U072	56
D0747339	STAY:SLIDE RAIL:LEFT FRONT	U068	34
D0747349	COMPRESSION SPRING:BRACKET:SENSOR:PAPER SIZE SENSOR	U068	35
D0747367	BRACKET:STOPPER:TANDEM LCT	U072	57
D0747377	DECAL:SWITCH:HEATER:PAPER T	Decals and Docu	38

Number	Part Name	Group	ID
	RAY:EXP	ments U002	18
D0747380	DECAL:SWITCH:HEATER:INTERMEDIATE TRANSFER:EXP	Decals and Documents U002	39 19
D0747381	DECAL:VERTICAL TRANSPORT:A1	Decals and Documents U017	40 20
D0747382	DECAL:VERTICAL TRANSPORT:A2	Decals and Documents U017	41 21
D0747383	DECAL:VERTICAL TRANSPORT:A3	Decals and Documents U017	42 22
D0747384	DECAL:VERTICAL TRANSPORT:B2	U017	23
D0747385	DECAL:CAUTION CHART:TANDEM LCT	Decals and Documents U008_S001	43 63
D0747387	DECAL:BASE:TANDEM LCT:LEFT	Decals and Documents U007_S001_S001	44 38
D0747388	DECAL:PAPER SET DIRECTION:TANDEM LCT:RIGHT	Decals and Documents U008_S001	45 64
D0747389	DECAL:PAPER SET DIRECTION:TANDEM LCT:LEFT	U007_S001	39
D0747390	DECAL:PAPER SET DIRECTION:PAPER TRAY	Decals and Documents U010_S001	46 34
D0747391	DECAL:PAPER SET DIRECTION	Accessories Decals and Documents	4 47
D0747392	DECAL:PAPER TRAY:NO.1	Decals and Documents U006	48 13
D0747393	DECAL:PAPER TRAY:NO.2	Decals and Documents U009	49 10

Exclusive Parts

Number	Part Name	Group	ID
D0747431	STAY:HANDLE:ASS'Y	U020	13
D0747433	STUD:HANDLE:RELEASE:ASS'Y	U020	14
D0747450	GUIDE PLATE:VERTICAL TRANSP ORT:DRIVE	U019	13
D0747455	GUIDE PLATE:GRIP:UPPER	U019	14
D0747461	GUIDE PLATE:GRIP:LOWER	U019	15
D0747465	GUIDE PLATE:FEED PAPER AGAI N	U019	16
D0747470	GUIDE PLATE:CONNECTING:UPP ER	U019	17
D0747474	GUIDE PLATE:CONNECTING:RIGH T	U019	18
D0747476	GUIDE PLATE:OPEN AND CLOSE: ASS'Y	U019	19
D0747481	GUIDE PLATE:OPEN AND CLOSE: CONNECTING:ASS'Y	U019	20
D0747500	PAPER FEED UNIT:PAPER BANK:A SS'Y	U011_S001	19
		U014_S001	19
D0747521	GUIDE PLATE:UPPER:PAPER FEE D UNIT	U013	14
		U016	14
D0747522	GUIDE PLATE:LOWER:PAPER FEE D UNIT	U013	15
		U016	15
D0747527	SHAFT:FEED:ASS'Y	U011_S001	20
		U014_S001	20
D0747541	TANDEM LCT:RIGHT:NA:ASS'Y	U008_S001	65
D0747546	TANDEM LCT:LEFT:NA:ASS'Y	U007_S001	40
D0747551	COVER:PAPER TRAY:NO.1	U006	14
D0747558	COVER:GRIP:INNER BACK	U006	15
D0747561	GRIP:UPPER	U006	16
D0747562	GRIP:LOWER	U006	17
D0747565	STAY:COVER:PAPER TRAY	U006	18
D0747566	BRACKET:ARM:LINK	U006	19
D0747567	BRACKET:ARM:LINK:LEFT	U006	20
D0747568	BRACKET:FIX:AUXILIARY:COVER	U006	21
D0747570	BASE:LINK:PAPER TRAY:ASS'Y	U006	22
D0747573	BRACKET:ARM:PLATE	U006	23
D0747575	LINK:UPPER LOWER:LEFT:ASS'Y	U006	24
D0747577	LINK:UPPER LOWER:ASS'Y	U006	25

Number	Part Name	Group	ID
D0747579	STOPPER:TANDEM LCT	U006	26
D0747595	BASE:TANDEM LCT:RIGHT:ADHES ION	U008_S001	66
D0747596	TRAY BOTTOM PLATE:LEFT MIDD LE:ASS'Y	U007_S001_S001	41
D0747601	COVER:PAPER TRAY:NO.2	U009	11
D0747603	PLATE:GRIP:PAPER TRAY:NO.2	U009	12
D0747606	GRIP:PAPER TRAY:NO.2	U009	13
D0747607	ARM:PAPER TRAY:GRIP	U009	14
D0747609	PROTECTION:COVER:LED	U006	27
		U009	15
D0747631	PAPER TRAY:UNIVERSAL:DOM:SU B-ASS'Y	U010_S001	35
D0747654	INNER COVER:VERTICAL TRANSP ORT:LEFT	U017	24
D0747656	INNER COVER:VERTICAL TRANSP ORT:RIGHT	U017	25
D0747659	COVER:FUNNEL:DEVELOPER	U017	26
D0747680	HEAT SINK:HEATER:LOWER:ASS' Y	U068	36
D0747681	HEAT SINK:HEATER:UPPER:ASS'Y	U068	37
D0747752	CAP:COVER:TONER SUPPLY	U002	20
D0747753	COVER:TONER SUPPLY:UPPER:A SS'Y	U002	21
D0747761	DOOR:TONER SUPPLY	U002	22
D0747762	BRACKET:HINGE:TONER SUPPLY	U002	23
D0747768	COVER:FRONT LEFT:ASS'Y	U002_S003	24
D0747773	DECAL:OPERATION INSTRUCTIO NS:TONER SUPPLY	Decals and Docu ments	50
		U002_S003	25
D0747774	DECAL:MAIN SWITCH	Decals and Docu ments	51
		U002_S003	26
D0747775	PLATE:LOGO:RICOH	U001	7
D0747780	DOOR:FRONT LEFT:UPPER:ASS'Y	U001	8
D0747785	DOOR:FRONT LEFT:LOWER	U001	9
D0747787	HINGE:DOOR:COLLECTION BOTT LE:ASS'Y	U001	10

Exclusive Parts

Number	Part Name	Group	ID
D0747791	DOOR:COLLECTION BOTTLE:ASS'Y	U001_S001	11
D0747793	GRIP:DOOR:COLLECTION BOTTLE	U001_S001	12
D0747794	LEVER:RELEASE:DOOR:COLLECTION BOTTLE	U001_S001	13
D0747795	SHAFT:CONTACT POINT:GRIP	U001_S001	14
D0747797	SPRING PLATE:DOOR:LEFT LOWER	U001	15
D0747800	SUPPORTING PLATE:DOOR:FRONT LEFT:ASS'Y	U001_S002	16
D0747810	DOOR:FRONT RIGHT:UPPER:ASS'Y	U001	17
D0747814	DOOR:FRONT RIGHT:LOWER	U001	18
D0747822	COVER:MAIN:LEFT:WELDING	U002_S001	27
D0747826	COVER:MAIN:RIGHT:ASS'Y	U002_S002	28
D0747828	CAP:CONNECTOR	U002_S002	29
D0747829	CAP:JOINT:LARGE CAPACITY TRAY	U002_S002	30
D0747830	COVER:LARGE CAPACITY TRAY	U002_S002	31
D0747831	COVER:CONNECTOR:LARGE CAPACITY TRAY	U002_S002	32
D0747836	DECAL:MISFEED REMOVAL:AB	Decals and Documents	52
		U001_S003	19
D0747837	DECAL:MISFEED REMOVAL:CDE	Decals and Documents	53
		U001_S002	20
D0747838	DECAL:MISFEED REMOVAL:Z-1	Decals and Documents	54
		U001_S002	21
D0747839	DECAL:MISFEED REMOVAL:Z-2	Decals and Documents	55
		U001_S002	22
D0747843	INNER COVER:PULL OUT:LEFT	U049	32
D0747844	INNER COVER:PULL OUT:RIGHT	U021	60
D0747845	INNER COVER:5ST	U002	33
D0747847	DECAL:CAUTION CHART:INKJET:APPER:NA	Accessories	5
		Decals and Documents	56

Number	Part Name	Group	ID
		ments	
D0747848	DECAL:PULL OUT:LEFT:FUSING UNIT:SET	Decals and Documents	57
		U049	33
D0747849	DECAL:PULL OUT:LEFT:FUSING UNIT:TCRU	Decals and Documents	58
		U049	34
D0747850	HINGE:LEFT UPPER:ASS'Y	U001	23
D0747854	HINGE:LEFT LOWER:ASS'Y	U001	24
D0747858	HINGE:RIGHT UPPER:ASS'Y	U001	25
D0747861	HINGE:RIGHT LOWER:ASS'Y	U001	26
D0747905	SEAL:MAIN:FRONT LEFT:LOWER	Accessories	6
D0747906	SEAL:MAIN:FRONT LEFT:UPPER	Accessories	7
D0749510	OPC DRUM DIA60	U029	68
D0749640	DEVELOPER BLACK	U029	69
D0749660	DEVELOPER CYAN	U029	70
D0749670	DEVELOPER MAGENTA	U029	71
D0749680	DEVELOPER YELLOW	U029	72
D0751184	SEAL:OPTICAL WRITING UNIT:UPPER	U072	58
D0751188	GROUND PLATE:ELECTRICAL COMPONENTS SECTION:C/T BOX	U070	20
D0757185	CUSHION:DC FAN MOTOR:LEFT LOWER	U064	19
D0757187	COVER:DC FAN MOTOR:MM120	U064	20
D0757188	COVER:MOTOR:TONER SUPPLY	U028	32
D0757877	SEAL:EXHAUST:LEFT MIDDLE	U002_S001	34
D0757884	SEAL:EXHAUST:LEFT UPPER	U002_S001	35
D0758701	GEAR:CLEANING:DRUM:SERVICE	U029_S002_S002	73
		U029_S005_S002	73
		U029_S008_S002	73
		U029_S011_S002	73
D0936007	SD-CARD:Z-V4:EXP	U069	16
D3553810	BRACKET:DETENT:RIGHT:ASS'Y	U019	21
D3553828	HOLDER:STAY:GUIDE PLATE	U019	22
D3553844	SHOE:HANDLE:RELEASE	U020	15
D3553858	TORSION SPRING:GUIDE PLATE:16N	U019	24

Exclusive Parts

Number	Part Name	Group	ID
D3553875	TIMING BELT:60S2M224	U048	17
D4341911	TIMING BELT:60S3M402	U044	53
D5161261	COVER:LED	U006	28
		U009	16
D5161453	DIFFUSION PLATE:LED	U006	29
		U009	17
D5165200	PCB:LED:ASS'Y	U068	38
G0049668	GREASE:KS660:SHIN-ETSU	Special Tools	6
G0143291	SNAP RING - PICK UP	U031	62
G0291982	LD DECAL	Decals and Documents	59
		U029_S003_S001	74
		U029_S006_S001	74
		U029_S009_S001	74
		U029_S012_S001	74
G0294176	TURN ROLLER - EXIT SUB-UNIT	U040_S001	58
G0602296	BALL BEARING:8X16X5MM	U024	66
G1781141	HOLDER:STAND:M20	Accessories	8
G1783543	ROLLER:PLATE:TONER BOTTLE	U027	40
G1783593	TENSION SPRING:STOPPER	U047	28
G1784018	CASE:COATING BAR:TRANSFER ROLLER	U034_S001	40
G1784636	TIMING BELT:S2M134_67	U024	68
G1784651	SUPPORTING PLATE:GUIDE PLATE	U050	51
G1784669	BRACKET:MAGNET CATCH:DUPLICATE	U050	52
G1784759	BRACKET:LOCK:EXIT	U021	61
		U049	35
G1784793	SPRING:REVERSE:GATE	U047	29
G1784794	SPRING:TENSIONER:EXIT	U048	18
G1784798	SPRING:SWITCHBACK:GATE	U046	32
G1784808	BRACKET:PRESSURE:ROLLER	U021	62
		U050	53
G1784813	STOPPER:LEFT LOWER:FRAME	U046	33
G1784815	LEVER:LOCK:LEFT LOWER:FRAME	U044	54
		U045	21
		U046	34

Number	Part Name	Group	ID
G1784817	SPRING:PRESSURE:ROLLER:DUPLEX	U021	63
		U050	54
G1784818	SPRING:PULL OUT:LOCK:EXIT	U021	64
		U049	36
G1784822	SPRING:PRESSURE:0.8N:DIA0.65	U046	35
		U047	30
G1784828	STAY:LOCK:LEVER:LEFT LOWER	U044	55
		U045	22
		U046	36
G1784852	RUBBER FOOT:7086082	U047	31
G1784866	COMPRESSION SPRING:EXIT:CONNECTOR	U026	50
G1784890	SPRING PLATE:DUPLEX:GUIDE:LOWER	U050	55
G1784895	SHEET:DUPLEX:SPRING PLATE	U050	56
G1784900	COVER:DC STEPPER MOTOR:MM56	U024	69
		U050	57
G1784907	HOLDER:PRESSURE ROLLER:DUPLICATE	U050	58
G1784908	COIL SPRING:LEFT LOWER:LOCK	U045	23
		U046	37
G1784909	SCREW:TRANSPORT	U049	37
G1784912	PULLEY:S2M:30T	U024	70
G1784916	SCREW:ROUND POINT	U050	59
G1785023	TIMING BELT:S2M190	U032	95
G1785029	GEAR:DECURA:Z20/M1	U017	27
G1786036	PCB:GIGAETHERNET:PCIE:ASS'Y	U069	17
G1786062	PCB:PC4200:RAWCARD-C:512MB	U069	18
G1786072	PCB:PC4200:RAWCARD-A:1GB:ASS'Y	U069	19
G1786392	HOUSING:LOWER:COVER	U031	63
G1786393	SLEEVE:WIRE:LOWER:COVER	U031	64
G1786394	WIRE:STOPPER:LOWER:COVER	U031	65
G1786621	COVER:RELEASE PLATE:BLADE	U033_S001	60
G1786767	COATING BAR:TRANSFER ROLLER	U034_S001	41
G1787392	DISC:SENSOR:CAM	U024	71
G1787421	BRACKET:BEARING:GUIDE:REAR	U022	41

Exclusive Parts

Number	Part Name	Group	ID
G1787453	ARM:ON-OFF:TRANSPORT ROLLER	U021	65
		U022	42
G1787515	CONNECTOR GUIDE PIN:CONNECTOR	U026	51
G1787618	PLATE:FIX:BAND	U021	66
		U050	60
G1787633	HOOK:GUIDE PLATE:DUPLEX:ASS'Y	U021	67
G1787647	TENSION SPRING:SOLENOID	U024	72
		U026	52
G1787651	TENSION SPRING:REGISTRATION	U024	73
G1787652	TENSION SPRING:TRANSPORT ROLLER	U024	74
G1787656	TENSION SPRING:TENSIONER	U050	61
G1787660	PRESSURE ROLLER:TRANSPORT ROLLER	U024	75
G1787664	SPACER	U023_S001	25
		U024	76
G1787694	COVER:DC STEPPER MOTOR:MM42	U024	77
G1787717	GEAR:SHIFT:ROLLER	U023_S001	26
G1787743	BOSS:POSITIONING PIN:TRANSPORT UNIT:NO.1	U021	68
		U049	38
		U072	59
G1787744	BOSS:POSITIONING PIN:TRANSPORT UNIT:NO.2	U021	69
		U049	39
		U072	60
G1787751	DC SOLENOID	U024	78
		U026	53
G1787781	GEAR:PULLEY	U024	79
G1787793	SCREW:REGISTRATION:FIX	U021	70
G1788350	WRENCH:HEXAGONAL BOLT	Accessories	9
GA082010	BUSHING:DIA6:DIA10:9	U035	37
GA143003	SCREW:MM5:2.5MM	U038_S001	21
GW020020	PHOTOINTERRUPTOR:LG248NL1	U041	85
H0722216	COMPRESSION SPRING	U044	56
H0722220	SPACER - M6X10	U024	80
M0262872	TENSION SPRING:GRIP	U044	57

Number	Part Name	Group	ID
M0265108	PCB:RFID-CPU	U027	41
M0265152	PCB:RFID-AFE:K	U027	42
M0265158	PCB:RFID-AFE:M	U027	43
M0265166	PCB:RFID-AFE:C	U027	44
M0265168	PCB:RFID-AFE:Y	U027	45
M0445401	PCB:BCU:ASS'Y	U065	17
M0445791	PCB:CTL:EX1	U069	20
M0447741	COVER:UPPER FRONT	U002	36
M0447743	COVER:UPPER MIDDLE	U002	37
M0447744	BRACKET:COVER:UPPER MIDDLE:REAR	U002	38
M0447745	BRACKET:COVER:UPPER MIDDLE:FRONT	U002	39
M0447746	COVER:UPPER REAR	U002	40
M0447747	CAP:COVER:REAR	U002	41
M0447816	SUPPORTING PLATE:DOOR:FRONT RIGHT:ASS'Y	U001_S003	27
M0447835	DECAL:MISFEED REMOVAL:LOCATION	Decals and Documents	60
		U001_S003	28
M0447880	MODEL NAME PLATE:PRO_C751	U002	42
M0447898	DECAL:POWER SOURCE:OFF:ENGLISH	Decals and Documents	61
		U002	43
M0449590	NV-RAM	U069	15
M0771765	COVER:REAR	U003_S001	5
M0771766	KNOB:VARIABLE RESISTOR	U003_S001	6
M0771767	KEYTOP:START	U003_S001	7
M0771768	KEYTOP:10KEY	U003_S001	8
M0771770	KEYTOP:POWER SOURCE	U003_S001	9
M0771771	KEYTOP:OPTION:P	U003_S001	10
M0771772	SPACER:APPLICATION:P	U003_S001	11
M0771773	SPACER:START:P	U003_S001	12
M0771774	KEYTOP:PRINTER	U003_S001	13
M0771778	KEYTOP:BLANK	U003_S001	14
M0771781	LENS:INPUT	U003_S001	15
M0771782	BRACKET:LCD	U003_S001	16
M0771783	SHADEING PLATE:TOUCH PANEL	U003_S001	17

Exclusive Parts

Number	Part Name	Group	ID
M0771785	BRACKET:STAY:ARM	U003_S001	18
M0771786	COVER:FRONT:P:NA:ASS'Y	U003_S001	19
M0771789	KEYTOP:RESET SWITCH:EXP	U003_S001	20
M0771790	PLATE:APPLICATION:P:NA	U003_S001	21
M0771800	TOUCH PANEL:10.4INCH	U003_S001	22
M0771810	LCD:10.4SVGA-LED	U003_S001	23
M0771812	PCB:P:KEY:MAIN:ASS'Y	U003_S001	24
M0771813	PCB:P:KEY:SUB:ASS'Y	U003_S001	25
M0771814	PCB:P:KEY:APPLI:ASS'Y	U003_S001	26
M0771861	TUBE TYPE LAMP:TAC:ASS'Y	U002	44
M0774200	MECHANICAL ROLLER CLUTCH:R OLLER	U042_S001	35
M0774642	TRANSPORT ROLLER:COOLING:E NTRANCE	U044	58
M0774821	TRANSPORT BELT:COOLING	U044	59
M0774862	TRANSPORT ROLLER:DRIVEN:DU PLEX:DIA18X2	U019	25
		U021	71
		U050	62
		U051	22
M3791627	TRANSPORT ROLLER:DRIVEN	U045	24
		U046	38
		U047	32
VSSG9002	FLUOTRIBO MG GREASE : 100G	Special Tools	5

Standard Parts



03125050N
SCREW - M2.5X5



03130040N
SCREW:M3X4



03130080N
PAN HEAD SCREW:M3X8



03130120N
PAN HEAD SCREW:M3X12



03140060N
SCREW - M4X6

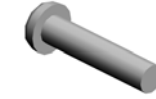

03140180N
PAN HEAD SCREW:M4X18



03530030N
SCREW:M3X3



03530040N
SCREW - M3X4



03530050N
SCREW-M3X5



03530060N
BIND SCREW - M3X6



03530080N
SCREW:M3X8



03540040N
SCREW-M4X4

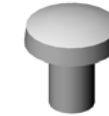

03540060N
SCREW-M4X6



03540080N
SCREW:M4X8

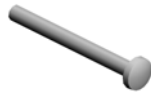

03540400N
SCREW:M4X40



03603005N
SCREW - M3X5



03603006N
SCREW - M3X6



03603008N
SCREW:M3X8



03603014N
SCREW - M3X14



03603020N
SCREW:M3X20



03603030N
SCREW:M3X30

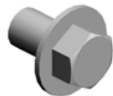

03604006N
SCREW - M4X6



03604008N
SCREW - M4X8



03604010N
SCREW:M4X10



03604014N
SCREW - M4X14



03604020N
SCREW:M4X20



03604030N
SCREW:M4X30



04503008N
TAPPING SCREW - M3X8

Standard Parts



04503010N
TAPPING SCREW - M3X10



04504008N
TAPPING SCREW - M4X8



04504010N
TAPPING SCREW:M4X10



04513006N
TAPPING SCREW - 3X6



04513008N
TAPPING SCREW - M3X8



04514006N
TAPPING SCREW - 4X6



04514008N
TAPPING SCREW:4X8



04514010N
TAPPING SCREW:4X10



04523008N
TAPPING SCREW - M3X8



04534006N
BINDING SELF TAPPING SCREW:4X6



04534008N
BINDING SELF TAPPING SCREW:4X8



04543006Q
TAPPING SCREW - M3X6



04543008Q
TAPPING SCREW:3X8



04543010Q
TAPPING SCREW:3X10



04544006Q
TAPPING SCREW:4X6



04544008Q
TAPPING SCREW - M4X8



05730030E
HEXAGON HEADLESS SET SCREW - M3X3

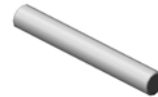

06320140G
PARALLEL PIN



06330140G
PARALLEL PIN - 3X14

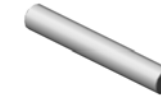

06330200G
PIN - M3X20



07010060N
WASHER DIA6



07073050N
BUSHING:DIA3X5



07080060N
WASHER:DIA6



07080080N
WASHER-DIA8



07200030E
RETAINING RING - M3



07200040E
RETAINING RING - M4



07200060E
RETAINING RING - M6



07200080E
RETAINING RING - M8

Standard Parts



07250100E
RETAINING RING C - M10



07250200E
RETAINING RING C - M20



07250300E
RETAINING RING C - M30



07270060E
RETAINING RING - M6



07403008
BALL BEARING - 8X22X7

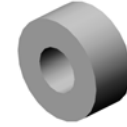

07403804
BALL BEARING: DIA4XDIA9X4



07403806
BALL BEARING - 6X13X5



07403906
BALL BEARING - 6X15X5



07413006
BALL BEARING - 6X17X6MM



07413506
BALL BEARING - 6X12X4 MM



07413706
BALL BEARING - 6X10X3



07413708
BALL BEARING - 8X12X3.5M
M

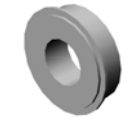

07423808
BALL BEARING - 8X16X5



07423910
BALL BEARING: 10X22X6



08010237
HEXAGONAL BOLT: DOUBLE
SCREW: M4X12



08025220
TAPPING SCREW - M4X8



08025324
HEXAGON HEAD TAPPING S
CREW: PF: 4X10



08030058
STEPPED SCREW



08046123
HEXAGONAL BOLT: W/WASH
ER: M3X8



08050088
RETAINING RING - M6



08050089
RETAINING RING - M4



08050092
RETAINING RING - 3M



08053384
BUSHING - 5MM



08053566
RADIAL BALL BEARING: DIA6
XDIA12X4



09300404A
PARALLEL KEY: 4X4X25



09513006N
SCREW - M3X6



09514006N
SCREW: POLISHED ROUND:
M4X6



09543008N
SCREW - M3X8

Standard Parts



09543010N
SCREW:POLISHED ROUND/
SPRING:M3X10



09544008N
SCREW - M4X8



09573030P
SCREW:SMALL ROUND WIT
H SPRING WASHER:M3X30



11028502
CONNECTOR - 54679-1615



11029387
CONNECTOR:DRAWER:5140
5-2611



11029781
CONNECTOR:51405-3919



11029782
CONNECTOR:51405-1819



11029783
CONNECTOR:55949-3919



11029784
CONNECTOR:55949-2619



11029785
CONNECTOR:55949-1819



11050487
HARNESS CLAMP



11050488
HARNESS CLAMP



11050508
HARNESS CLAMP - LWS-071
1



11050511
HARNESS CLAMP - LWS-030
6ZC



11050516
CLAMP

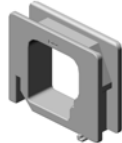

11050518
EDGE SADDLE - LES-1010



11050534
CLAMP



11050551
CLAMP:LES-0505



11050600
CLAMP:LWSM-0306-2M

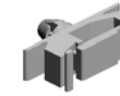

11050601
CLAMP:LWSM-0511-2M



11050692
CLAMP:LES-0503



11050723
CLAMPS:WES-0507



11071281
FUSE:BJS2012F2



12042521
MICRO SWITCH

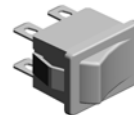

12042570
ROCKER SWITCH:SDDJE132
00



12042614
SWITCH AC250V/16A

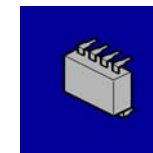

14077036
EEPROM:AT24C128B-PU



16071799
FILTER - SUP-ET20-ER-0

PM Part List

Number	Part Name	Num	Group	ID
AE010104	HOT ROLLER:DIA54:ASS'Y	1	U040	19
AE020200	PRESSURE ROLLER:DIA65	1	U041	15
AE030058	BALL BEARING:DIA25:DIA37	2	U041	18
AF030072	PAPER FEED ROLLER:PICK UP	2	U011_S001	9
			U014_S001	9
AF031080	PAPER FEED ROLLER:FEED	2	U011_S001	10
			U014_S001	10
AF032080	PAPER FEED ROLLER:SEPA RATE	2	U012	11
			U015	11
D0742195	CHARGE UNIT	4	U029_S001	10
			U029_S004	10
			U029_S007	10
			U029_S010	10
D0742422	BLADE:CLEANING:ASS'Y	4	U029_S002	29
			U029_S005	29
			U029_S008	29
			U029_S011	29
D0742424	SEAL:BLADE:CLEANING:FRONT	4	U029_S002	30
			U029_S005	30
			U029_S008	30
			U029_S011	30
D0742425	SEAL:BLADE:CLEANING:REAR	4	U029_S002	31
			U029_S005	31
			U029_S008	31
			U029_S011	31
D0742454	BRUSH ROLLER:APPLY:ASS'Y	4	U029_S002	33
			U029_S005	33
			U029_S008	33
			U029_S011	33
D0742459	JOINT:CLEANING UNIT	4	U029_S002	37
			U029_S005	37
			U029_S008	37
			U029_S011	37
D0742466	COATING BAR:ASS'Y	4	U029_S002	38
			U029_S005	38
			U029_S008	38
			U029_S011	38
D0742481	BLADE:APPLY:ASS'Y	4	U029_S002_S001	42

Number	Part Name	Num	Group	ID
			U029_S005_S001	42
			U029_S008_S001	42
			U029_S011_S001	42
D0742485	SEAL:BLADE:APPLY:FRONT	4	U029_S002	43
			U029_S005	43
			U029_S008	43
			U029_S011	43
D0742486	SEAL:BLADE:APPLY:REAR	4	U029_S002	44
			U029_S005	44
			U029_S008	44
			U029_S011	44
D0743322	FILTER:DEVELOPMENT	4	U029_S003	56
			U029_S006	56
			U029_S009	56
			U029_S012	56
D0744197	FLAT BELT-FUSING:DIA80:SEAL	1	U040	49
D0744300	SPRING PLATE:CLEANING UNIT:FUSING	1	U042_S001	21
D0744329	WEB:GEAR:ASS'Y	1	U042_S001_S002	31
D0744333	ROLLER:PLATE	1	U042_S001	32
D0746055	FLAT BELT-TRANSFER:SERVICE PARTS:ASS'Y	1	U030	11
D0746158	ROLLER:INTERMEDIATE TRANSFER:ASS'Y	4	U031	52
D0746250	TRANSFER ROLLER	1	U034_S001	22
D0746265	BLADE:TRANSFER ROLLER:ASS'Y	1	U034_S001	25
D0746300	SEPARATION CORONA:ASS'Y	1	U034_S001	34
D0746424	BLADE:CLEANING:BELT CLEANING:ASS'Y	1	U033_S001	20
D0746446	BRUSH:APPLY:BELT CLEANING	1	U033_S001	29
D0746450	COATING BAR:ASS'Y	1	U033_S001_S001	30
D0746457	BLADE:APPLY:ASS'Y	1	U033_S001	33
D0747110	OZONE FILTER	1	U071	34
D0747111	FILTER:PREVENTFENCE	5	U071	35

PM Part List

Number	Part Name	Num	Group	ID
D0749510	OPC DRUM DIA60	4	U029	68
D0749640	DEVELOPER BLACK	1	U029	69
D0749660	DEVELOPER CYAN	1	U029	70
D0749670	DEVELOPER MAGENTA	1	U029	71
D0749680	DEVELOPER YELLOW	1	U029	72
D0758701	GEAR:CLEANING:DRUM:SERVICE	4	U029_S002_S002	73
			U029_S005_S002	73
			U029_S008_S002	73
			U029_S011_S002	73
G1786767	COATING BAR:TRANSFER ROLLER	1	U034_S001	41

Design Change List

Number	Title	Set	Old Part		New Part		Index No.		Q'ty	Interchg		Reason	Cut-in S/N
			P/N	Name	P/N	Name	Group	ID		Indiv.	Set		
201109-01	1109 Modification	-	AB017817	GEAR:PULLEY:D EVELOPMENT D RIVE UNIT:46Z/3 7T	AB017836	GEAR:PULLEY:D EVELOPMENT D RIVE UNIT:46Z/3 7T	U053	10	1	X/O			M04417:
			AB017817	GEAR:PULLEY:D EVELOPMENT D RIVE UNIT:46Z/3 7T	AB017836	GEAR:PULLEY:D EVELOPMENT D RIVE UNIT:46Z/3 7T	U053	10	1	X/O			
			AB017817	GEAR:PULLEY:D EVELOPMENT D RIVE UNIT:46Z/3 7T	AB017836	GEAR:PULLEY:D EVELOPMENT D RIVE UNIT:46Z/3 7T	U053	10	1				
			AB017817	GEAR:PULLEY:D EVELOPMENT D RIVE UNIT:46Z/3 7T	AB017836	GEAR:PULLEY:D EVELOPMENT D RIVE UNIT:46Z/3 7T	U053	10	1	X/O			
201109-02	1109 Modification	-	AW000011	OPTICS SENSOR :PHOTO	AW000012	OPTICS SENSOR :PHOTO	U022	14	1	O/O			M04417:
201109-04	1109 Modification	-	D0742701	SWING UNIT:AS S'Y	D0742702	SWING UNIT:AS S'Y	U023_S001	12	1	X/O			M04417:
201109-06	1109 Modification	-	D0742733	GUIDE PLATE:S HIFT:UPPER:PEE N	D0742732	GUIDE PLATE:S HIFT:UPPER:PEE N	U023_S001	16	1	X/O			M04417:
201109-07	1109 Modification	-	D0742901	HOLDER:DC SOL ENOID:VERTICA L TRANSPORT:L OWER	D0742899	HOLDER:DC SOL ENOID:VERTICA L TRANSPORT:L OWER:PEEN	U026	35	1	X/O			M04417:
201109-09	1109 Modification	-	D0746122	GUIDE:TRANSP ORT:INTERMEDI ATE TRANSFER:	D0743820	GUIDE:TRANSP ORT:INTERMEDI ATE TRANSFER:	U031	43	1	X/O			M04417:

Design Change List

Number	Title	Set	Old Part		New Part		Index No.		Q'ty	Interchg		Reason	Cut-in S/N
			P/N	Name	P/N	Name	Group	ID		Indiv.	Set		
		-		ASS'Y		ASS'Y							
201109-10	1109 Modification	-	D0746670	COLLECTION BO TTLE:ASS'Y	D0746590	COLLECTION BO TTLE:ASS'Y	U037_S001	2	1	X/O			M04417:
201109-11	1109 Modification	-			G0049668	GREASE:KS660: SHIN-ETSU	Special Too ls	6	1				M04417:
201109-12	1109 Modification	-			AA063371	SPRING	U072_S001	61	1				M04417:
							U072_S002	61	1				
							U072_S003	61	1				
							U072_S004	61	1				
201109-14	1109 Modification	-			AA143544	SCREW - M3	U061	24	2				M04417:
201109-16	1109 Modification	-			D0741088	SHEET:BASE:MA IN:FRONT	U072	62	1				M04417:
201109-20	1109 Modification	-			D0742487	SEAL:BLADE	U029_S002 _S001	75	2				M04417:
							U029_S005 _S001	75	2				
							U029_S008 _S001	75	2				
							U029_S011 _S001	75	2				
201109-21	1109 Modification	-			D0744236	GUIDE PLATE:FU SING EXIT:LOWE R:ASS'Y	U041_S002	86	1				M04417:
201109-22	1109 Modification	-			D0744390	ACCESSORY:KN OB:FUSING:ASS' Y	Accessories	10	1				M04417:
201109-24	1109 Modification	-			D0746684	SEAL:TANK:USE D TONER:COLLE CT	U037_S001	3	1				M04417:
201109-25	1109 Modification	-			D0746944	SHEET:C/T BOX:	U071	64	1				M04417:

Design Change List

Number	Title	Set	Old Part		New Part		Index No.		Q'ty	Interchg		Reason	Cut-in S/N
			P/N	Name	P/N	Name	Group	ID		Indiv.	Set		
		-				LIQUID COOLING :UPPER							
201109-26	1109 Modification	-			D0747207	SHEET:C/T BOX: LIQUID COOLING :WINDOW	U071	65	1				M04417:
201109-28	1109 Modification	-			D0742181	CONNECTOR:1P OLE	U067	23	4				M04417:
201109-29	1109 Modification	-	D0742939	GUIDE PLATE:C ONNECTION:LAR GE CAPACITY T RAY:UPPER	D0742938	GUIDE PLATE:C ONNECTION:LAR GE CAPACITY T RAY:UPPER	U072	41	1	X/O			M04417:
201109-30	1109 Modification	-	D0749590	NV-RAM	M0449590	NV-RAM	U069	15	1	X/O			M04417:

