

Pro C5200S/C5210S
(D260/D261)
Parts Catalog

Model	Product Code	PC Style
Pro C5200S/C5210S	D260/D261	3D
Multi Bypass Banner Sheet Tray Type S6	D3D1	3D
Banner Sheet Guide Tray for A3/11"x17" LCIT Type S6	D710	3D
Cooling Fan Unit Type M26	D3CK	3D
SR4000 series Output Tray for Banner Sheet Type S6	D3CF	3D
Finisher SR5070	D3CB	3D
Booklet Finisher SR5080	D3CA	3D
SR5000 series Output Tray for Banner Sheet Type S6	D3CC	3D
LCIT RT4050	D710	3D
A3/11"x17" Tray Unit Type M26	D3D2	3D
Buffer Pass Unit Type S6	D3D0	3D
Media Identification Unit Type S3	D3AK	3D
Copy Tray Type M26	D3D2	Traditional
PostScript3 Unit Type M26	D3D8	Traditional
IPDS Unit Type M26	D3D8	Traditional
OCR Unit Type M13	D3AC	Traditional
XPS Direct Print Option Type M26	D3D8	Traditional
IEEE 1248 Interface Board Type M19	D3C0	Traditional
File Format Converter Type M19	D3BR	Traditional
IEEE 802.11a/g/n Interface Unit M19	D3BR	Traditional
Copy Connector Type M25	D3D3	Traditional
USB Device Server Option Type M19	D3BC	Traditional
Extended USB Board Type M19	D3BS	Traditional
Optional Counter Interface Unit Type M12	B870	Traditional
Smart Card Reader Built-in Unit Type S6	D3DH	Traditional
NFC Card Reader Type S6	D3DH	Traditional
Tab Sheet Holder Type M2	D750	Traditional
Smart Operation Panel Type S6	D3C9	Traditional

Unit All



U001
EXTERIOR

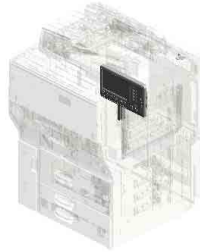

U002
OPERATION

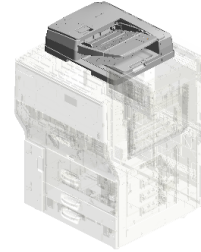

U003
ADF

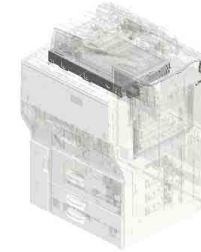

U004
SCANNER

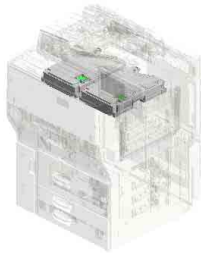

U005
LASER UNIT

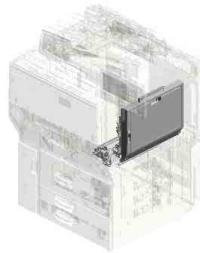

U006
BY-PASS FEED

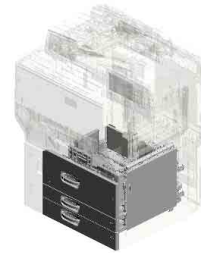

U007
PAPER FEED

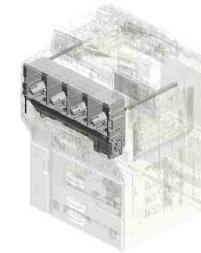

U008
TONNER SUPPLY

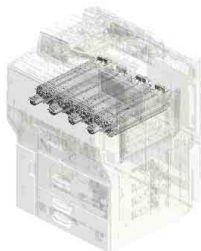

U009
PCDU

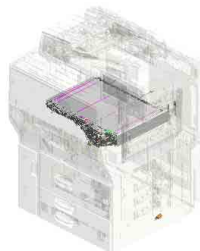

U010
ITB UNIT

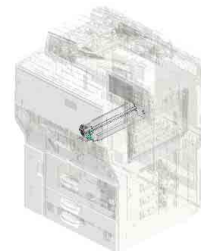

U011
ITB CLEANING

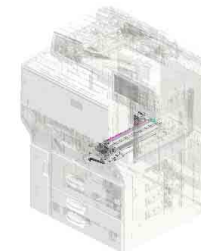

U012
TRANSFER/SEPARATION

Unit All

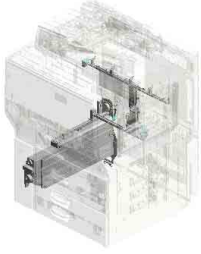

U013
USED TONER

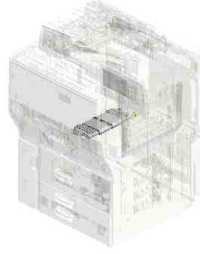

U014
PAPER TRANSPORT

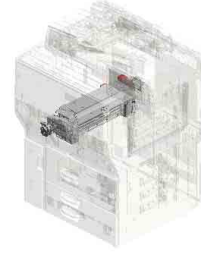

U015
FUSING

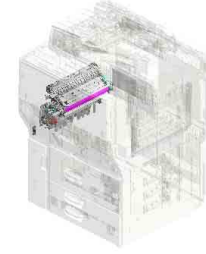

U016
PAPER EXIT

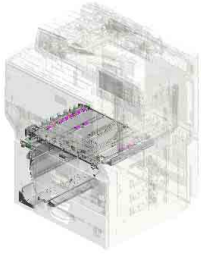

U017
DUPLEX

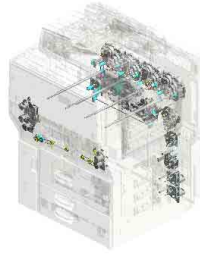

U018
MAIN DRIVE

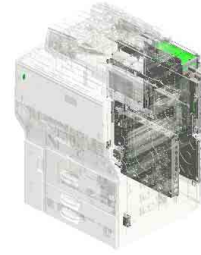

U019
ELECTRICAL

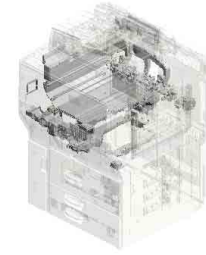

U020
AIR COOLING

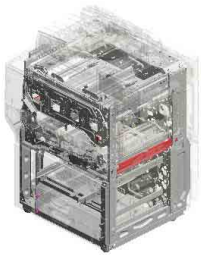

U021
MAIN FRAME

U001.EXTERIOR

U001_S004
D2581460
COVER:LEFT MIDDLE:ASS'Y

U001_S005
D1381461
COVER:UPPER FRONT:ASS'
Y

U001_S003
D2581480
INNER COVER:EXIT:UPPER:
ASS'Y

U001_S001
D2581468
COVER:REAR MIDDLE:ASS'Y

U001_S002
D2581464
INNER COVER:TH:TRANSPO
RT:ASS'Y

U001_S006
D2581492
INNER COVER:FRONT MIDD
LE:UPPER

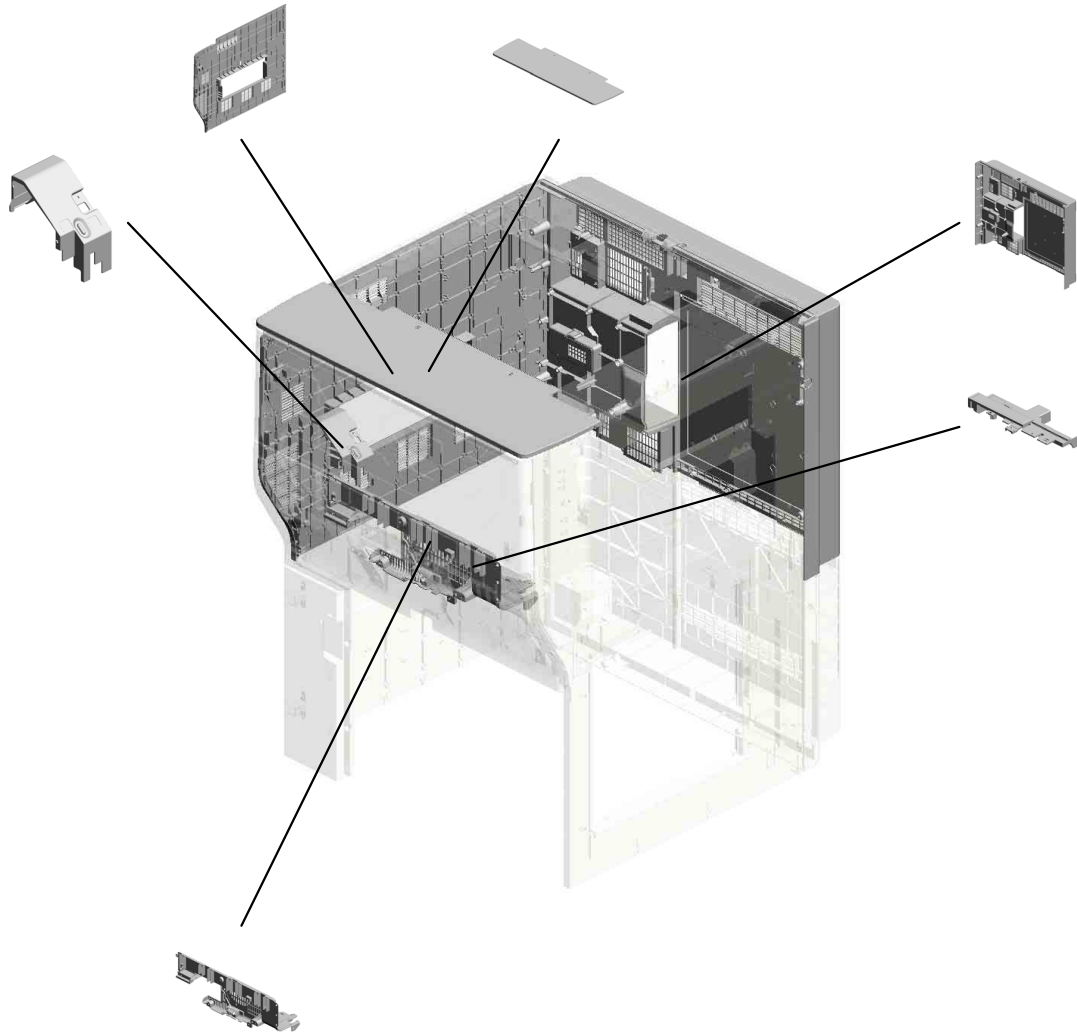

U001 EXTERIOR

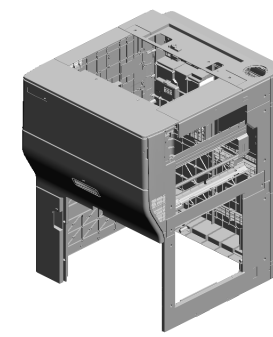

- 2.04543006N (x38)
TAPPING SCREW:
ROUND POINT:3X6
- 10.11050758 (x7)
CLAMP:LWSM-030
6A
- 12.AA000290 (x10)
DECAL:POSITIONI
NG DISPLAY:SCRE
W:PET
- 17.AA063965
COMPRESSION SP
RING:GRIP:LEFT
- 18.AA143537 (x2)
SCREW:M3:BLACK

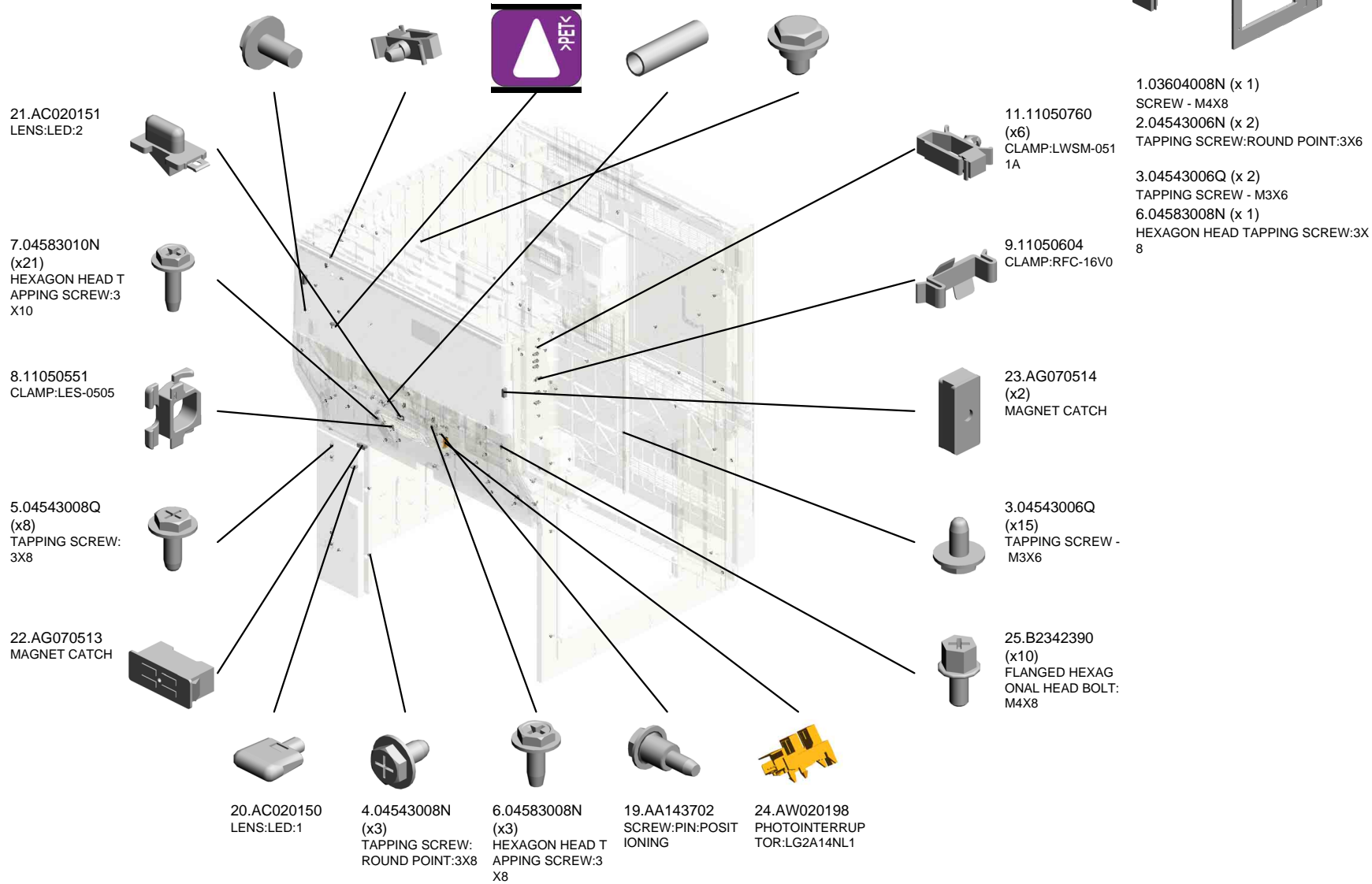

U001 EXTERIOR

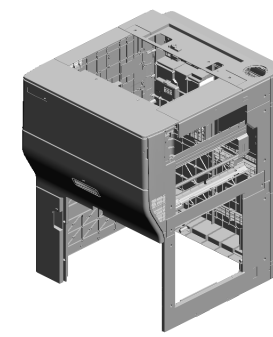

- 55.D1381479 COVER:LEFT MIDDLE:SMALL
- 33.D1351490 STAY:COVER:TONER SUPPLY SUB-UNIT
- 44.D1363395 DECAL:OPERATE:TONER CARTRIDGE
- 39.D1361474 COVER:UPPER REAR:SMALL
- 53.D1381468 CAP:LOUVER:OZONE FILTER:LARGE

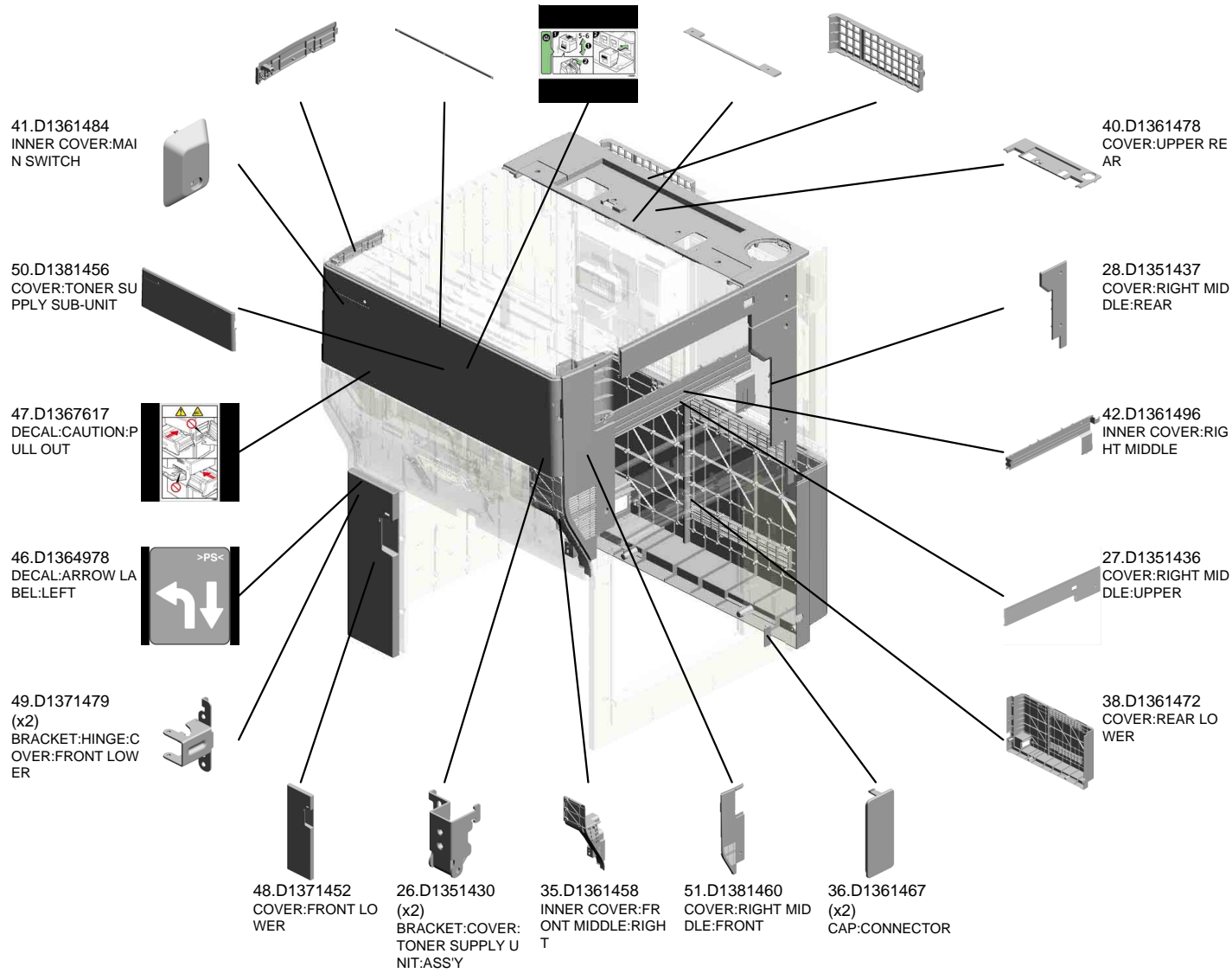

U001 EXTERIOR

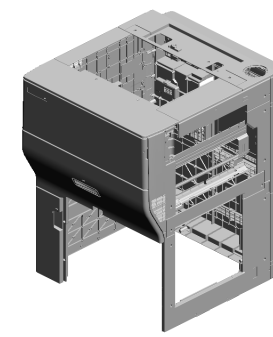

- 73.D2571452 BRACKET:COVER:LEFT MIDDLE:PROTECT
- 75.D2571455 SEAL:FRONT MIDDLE:UPPER LEFT:UPPER
- 58.D1381571 COMPRESSION SPRING:PULL OUT:GRIP:3N
- 77.D2571457 SEAL:INNER COVER:FRONT MIDDLE:UPPER LEFT:MIDDLE
- 56.D1381485 CAP:LOUVER:PREVENT FENCE:OZONE FILTER:ASSY

59.D1381573
BRACKET:GRIP:PULL OUT

71.D2416290
LED:RED

62.D1381579
LEVER:PULL OUT

74.D2571453
PLATE:FRONT:CASE:2

68.D1491306
MAGNET CATCH:COVER:FRONT

57.D1381570
TORSION SPRING:CAP:GRIP:PULL OUT:0.5N

64.D1381584
CAP:GRIP:PULL OUT

63.D1381581
LINK:LEVER:PULL OUT

60.D1381577
BRACKET:CONTACT POINT:LINK

61.D1381578
LINK:GRIP:LENGTHWISE

67.D1491305
CAP:TOTAL COUNTER

72.D2571451
BRACKET:COVER:RIGHT MIDDLE:PROTECT:PEEN

76.D2571456
SEAL:FRONT MIDDLE:LEFT UPPER:LOWER

65.D1441085
(x4)
STEPPED SCREW:M3

66.D1491291
CAP:HARNESS

U001 EXTERIOR

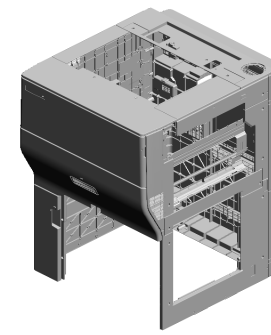

92.D2581454 INNER COVER:FRONT MIDDLE:UPPER LEFT
 93.D2581455 COVER:FRONT MIDDLE
 88.D2571476 COVER:UPPER LEFT
 100.D2581469 CAP:LOUVER:DEODORIZE FILTER:SMALL
 83.D2571463 COVER:UPPER RIGHT

84.D2571464 INNER COVER:FRONT MIDDLE:LEFT

109.D2581487 PLATE:FRONT:CASE:1

113.D2581538 BRACKET:DRAWER:LED:2

98.D2581466 COVER:LEFT LOWER

102.D2581471 INNER COVER:FRONT LOWER

110.D2581489 PLATE:FRONT:CASE:3
 90.D2576971 SEAL:CAP:REGISTRATION:LOWER
 111.D2581490 PLATE:FRONT:CASE:4
 94.D2581458 CAP:REGISTRATION:ADJUSTING PIN
 89.D2576970 SEAL:CAP:REGISTRATION:RIGHT

96.D2581462 CAP:LOUVER:DEODORIZE FILTER:LARGE

106.D2581482 INNER COVER:MANUAL FEED:LOWER

107.D2581485 INNER COVER:MANUAL FEED:LOWER:SMALL

108.D2581486 COVER:LCT

91.D2581438 COVER:RIGHT LOWER

U001
EXTERIOR

118.D2611474
BRACKET:UPPER
FRONT:LEFT

117.D2611473
BRACKET:UPPER
FRONT:RIGHT

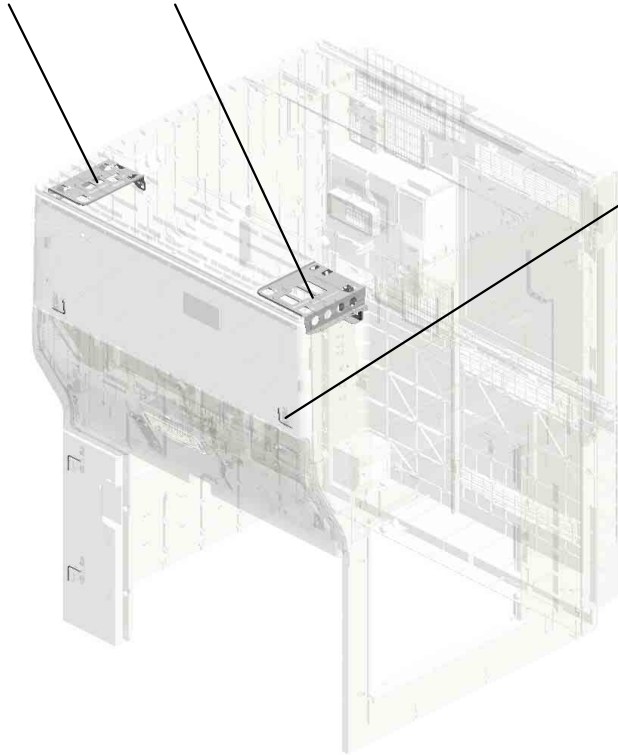

120.G0201332
(x4)
HINGE - FRONT C
OVER

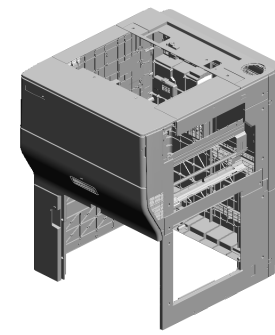

U001_S001
COVER:REAR MIDDLE:ASS'Y

32.D1351484 SEAL:AROUND THE PHOTOCONDUCTOR:EXHAUST:EXIT:REAR MIDDLE
 101.D2581470 PLATE:FAN:GUARD:REAR MIDDLE:UPPER
 30.D1351467 (x2) SEAL:DEVELOPMENT:EXHAUST:EXIT

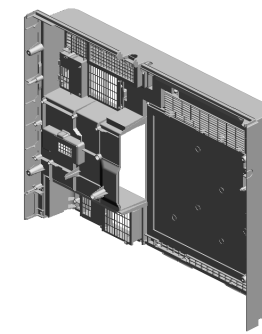

99.D2581468 COVER:REAR MIDDLE:ASS'Y

31.D1351468 SEAL:AROUND THE PHOTOCONDUCTOR:EXHAUST:EXIT:REAR

34.D1351493 SEAL:AROUND THE PHOTOCONDUCTOR:EXHAUST:EXIT

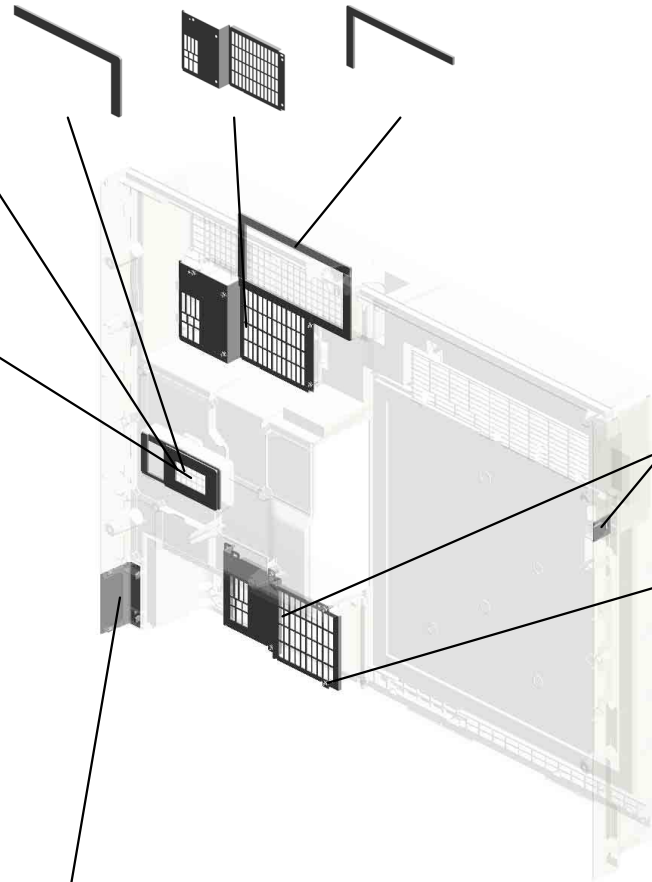

66.D1491291 CAP:HARNESS

103.D2581472 PLATE:FAN:GUARD:REAR MIDDLE:LOWER

6.04583008N (x11) HEXAGON HEAD TAPPING SCREW:3X8

37.D1361469 CAP:CONNECTOR:DECURA

U001_S002
 INNER COVER:TH:TRANSPORT:ASS'Y

45.D1363891
 DECAL:LED:GRIP:
 VACUUM

10.11050758
 (x3)
 CLAMP:LWSM-030
 6A

21.AC020151
 LENS:LED:2

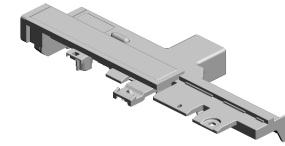

97.D2581464
 INNER COVER:TH:
 TRANSPORT:ASS'
 Y

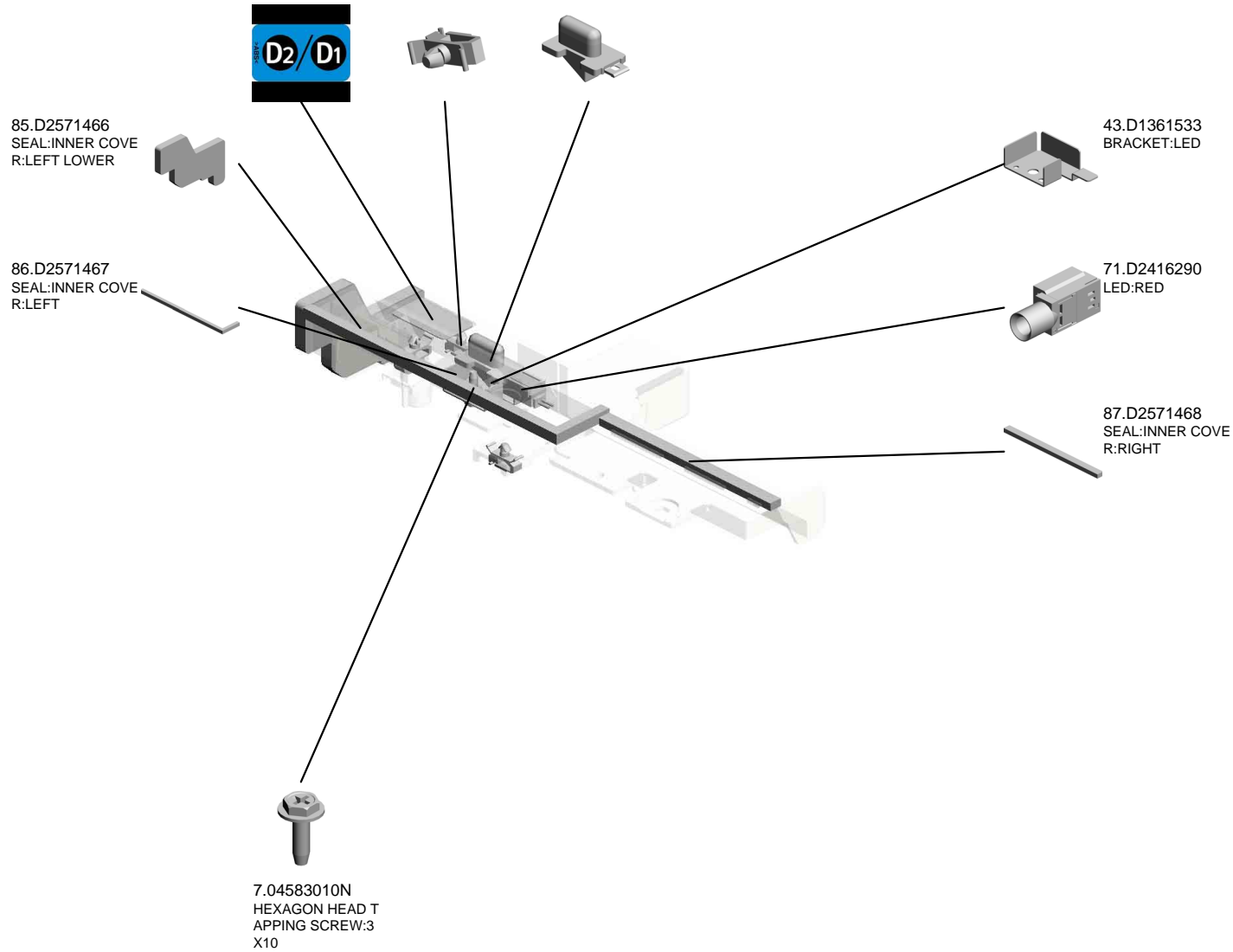

U001_S003
INNER COVER:EXIT:UPPER:ASS'Y

71.D2416290
LED:RED

43.D1361533
BRACKET:LED

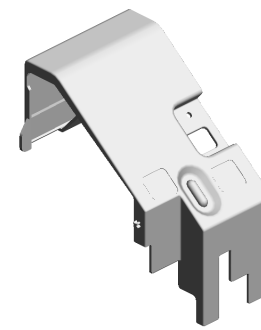

105.D2581480
INNER COVER:EXI
T:UPPER:ASS'Y

15.AA003070
DECAL:LED:REVE
RSE:ENTRANCE

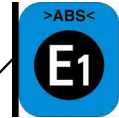
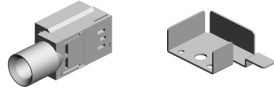

13.AA003060
DECAL:LED:EXIT:U
PPER



7.04583010N
HEXAGON HEAD T
APPING SCREW:3
X10

21.AC020151
LENS:LED:2

U001	U002	U003	U004	U005	U006	U007	U008	U009	U010	U011	U012	U013	U014	U015	U016	U017	U018	U019	U020	U021
------	------	------	------	------	------	------	------	------	------	------	------	------	------	------	------	------	------	------	------	------

U001_S004
COVER:LEFT MIDDLE:ASS'Y

70.D1495884
COMPRESSION SP
RING:KEYTOP

69.D1495883
KEYTOP:MAIN SWI
TCH

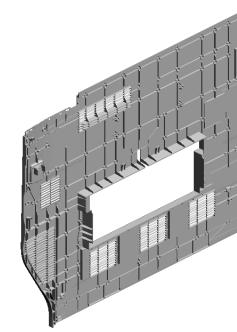

95.D2581460
COVER:LEFT MIDD
LE:ASS'Y

54.D1381475
COVER:MAIN SWIT
CH

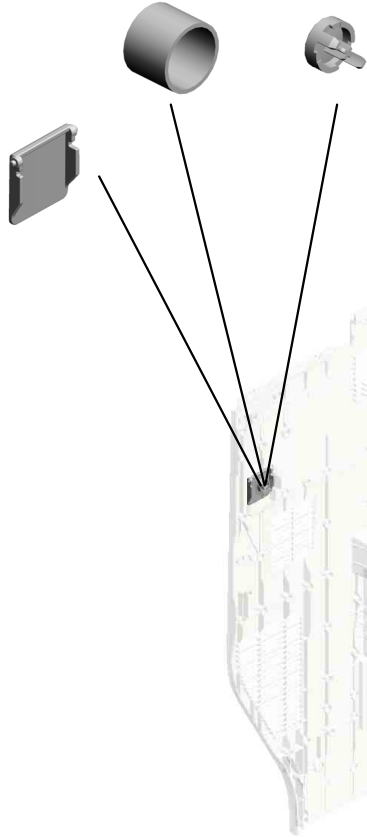

36.D1361467
CAP:CONNECTOR



U001_S005
COVER:UPPER FRONT:ASS'Y

119.D4573963
(x2)
CUSHION:COVER:
GUIDE PLATE

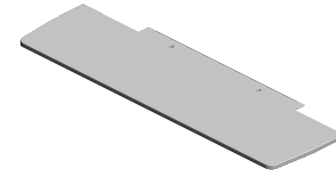
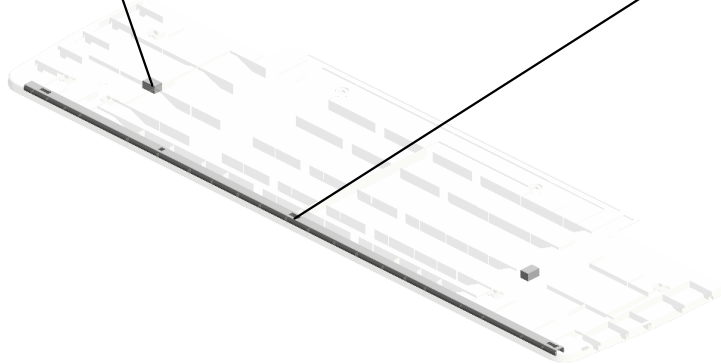
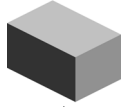

52.D1381461
COVER:UPPER FR
ONT:ASS'Y

33.D1351490
STAY:COVER:TON
ER SUPPLY SUB-U
NIT

U001	U002	U003	U004	U005	U006	U007	U008	U009	U010	U011	U012	U013	U014	U015	U016	U017	U018	U019	U020	U021
------	------	------	------	------	------	------	------	------	------	------	------	------	------	------	------	------	------	------	------	------

U001_S006

INNER COVER:FRONT MIDDLE:UPPER

104.D2581474
COVER:LED:HORIZ
ONTAL:TRANSPOR
T

14.AA003061
DECAL:PICK-UP P
APER JAM:DUPL
X

7.04583010N
(x5)
HEXAGON HEAD T
APPING SCREW:3
X10

114.D2586987
SEAL:COVER:FRO
NT MIDDLE:LEFT U
PPER

115.D2586988
SEAL:COVER:FRO
NT MIDDLE:RIGHT
LOWER

112.D2581492
INNER COVER:FR
ONT MIDDLE:UPPE
R

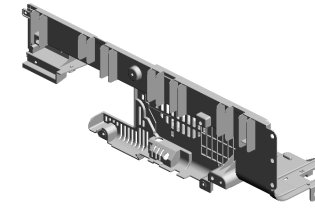

82.D2571462
SEAL:INNER COVE
R:FRONT MIDDLE:
5

16.AA003071
DECAL:PAPER JA
M:EXIT:LEFT LOW
ER

116.D2586989
SEAL:COVER:FRO
NT MIDDLE:LEFT L
OWER

29.D1351442
SEAL:COVER:FRO
NT MIDDLE:MIDDL
E LOWER

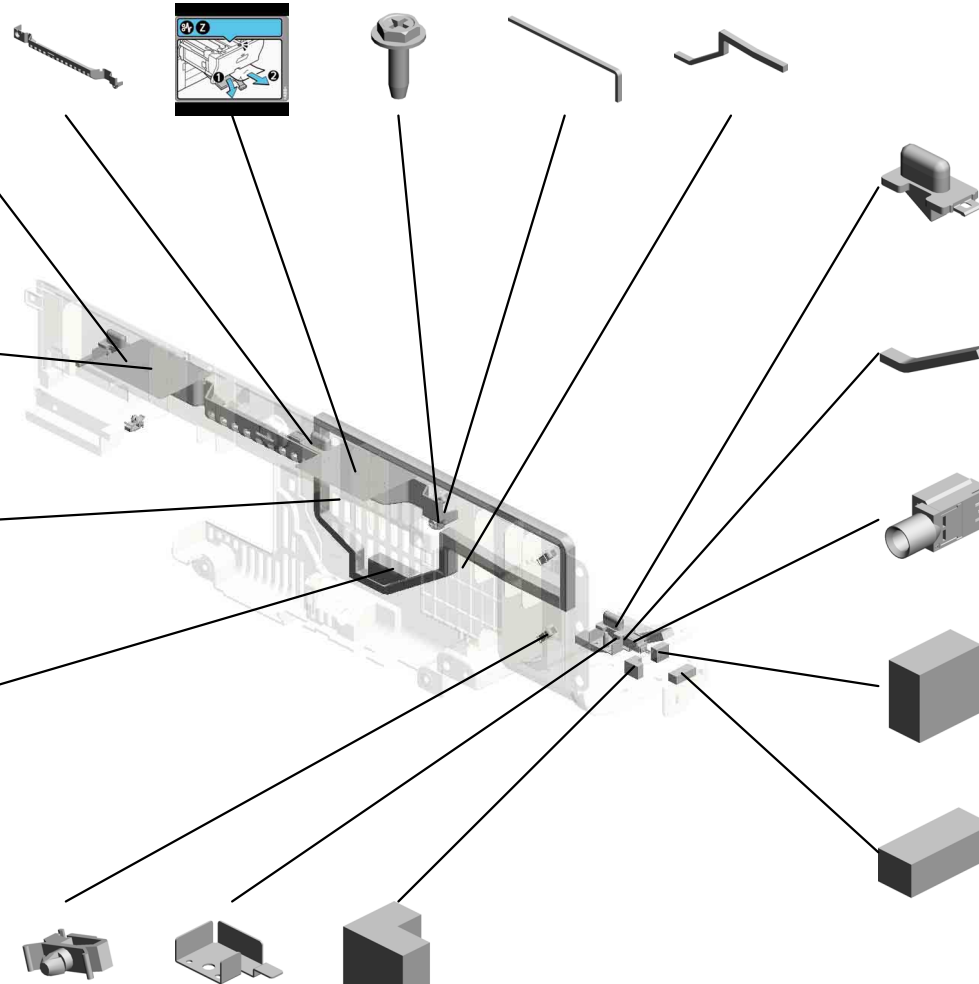

21.AC020151
(x3)
LENS:LED:2

78.D2571458
SEAL:INNER COVE
R:FRONT MIDDLE

71.D2416290
(x3)
LED:RED

80.D2571460
SEAL:INNER COVE
R:FRONT MIDDLE:
3

81.D2571461
SEAL:INNER COVE
R:FRONT MIDDLE:
4

10.11050758
(x5)
CLAMP:LWSM-030
6A

43.D1361533
(x3)
BRACKET:LED

79.D2571459
SEAL:INNER COVE
R:FRONT MIDDLE:
2

U002.OPERATION

U002_S002
D2617228
(NA/AA/KOR/TWN):OPERATI
ON PANEL UNIT:ASS'Y

U002_S003
D2617228
(NA/AA/KOR/TWN):OPERATI
ON PANEL UNIT:ASS'Y

U002_S004
D2617227
(EU):OPERATION PANEL UNI
T:ASS'Y

U002_S005
D2617230
(CHN):OPERATION PANEL:A
SS'Y

U002_S001
D2617300
ARM:OPERATION PANEL:AS
S'Y

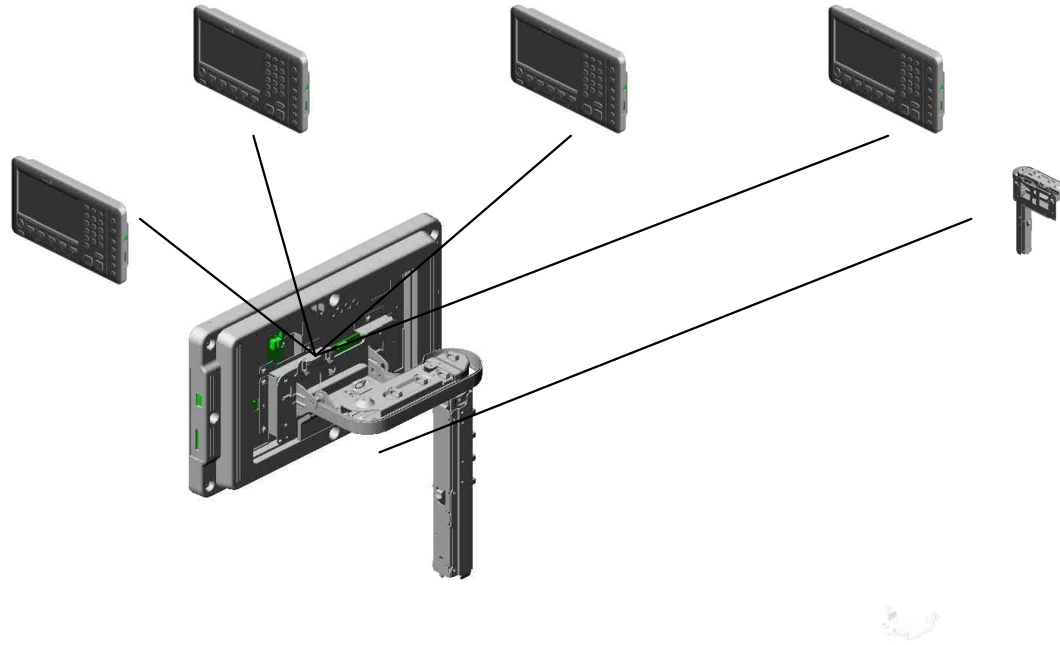

U002_S001.ARM:OPERATION PANEL:ASS'Y

U002_S001_S001
D1387251
HINGE:OPERATION PANEL:A
SS'Y

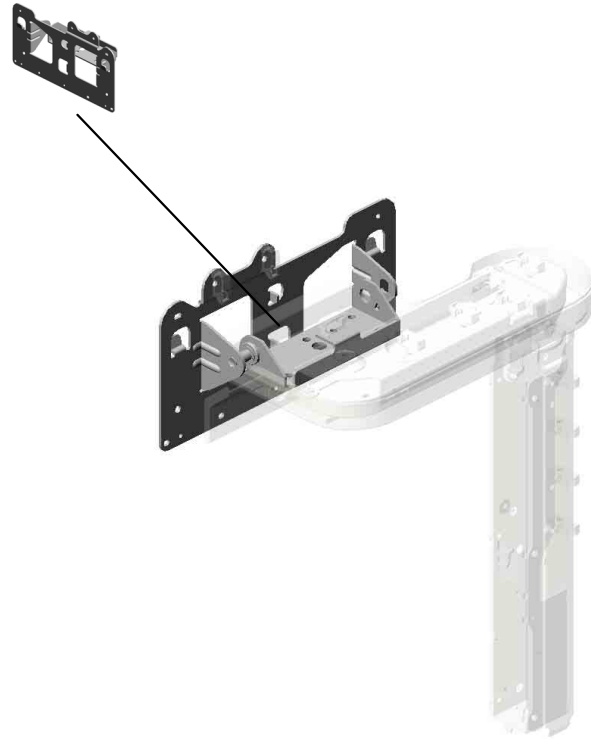

U001	U002	U003	U004	U005	U006	U007	U008	U009	U010	U011	U012	U013	U014	U015	U016	U017	U018	U019	U020	U021
------	------	------	------	------	------	------	------	------	------	------	------	------	------	------	------	------	------	------	------	------

U002 OPERATION

6.11050516
CLAMP

15.D1387281
BRACKET:PILOT L
AMP

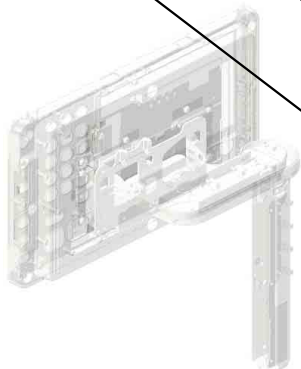

2.04543006N
(x2)
TAPPING SCREW:
ROUND POINT:3X6

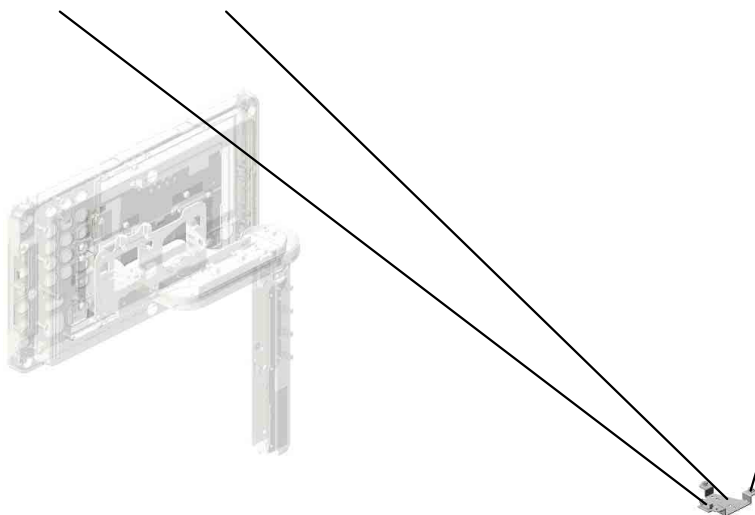

U002_S001
 ARM:OPERATION PANEL:ASS'Y

12.D1387260
 SUPPORTING PLATE:ARM:OPERATION SUB-UNIT

13.D1387265
 GUARD:HARNESS:ARM

9.AA143803
 FLANGED HEXAGONAL HEAD BOLT:CASTER

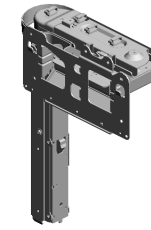

37.D2617300
 ARM:OPERATION PANEL:ASS'Y

36.D2617274
 COVER:ARM:OPERATION PANEL:LOWER

14.D1387276
 COVER:OPERATION PANEL:REAR LOWER

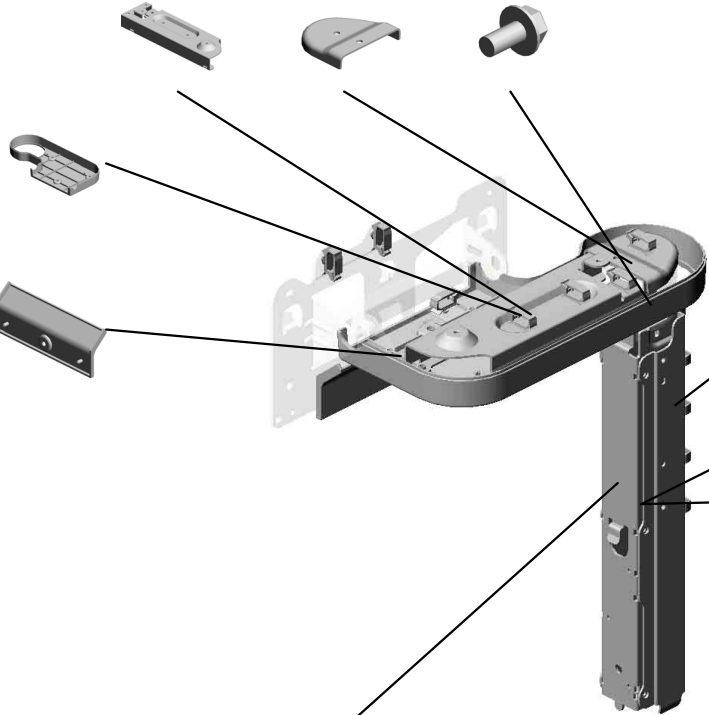

2.04543006N
 TAPPING SCREW:ROUND POINT:3X6

6.11050516
 (x12)
 CLAMP

3.04543008Q (x 3)
 TAPPING SCREW:3X8

35.D2617253
 POST:ARM:OPERATION PANEL:LEFT

11.D1387252
 POST:ARM:OPERATION SUB-UNIT:RIGHT

U002_S001_S001
HINGE:OPERATION PANEL:ASS'Y

5.07200040E
RETAINING RING -
M4

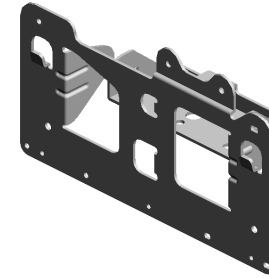
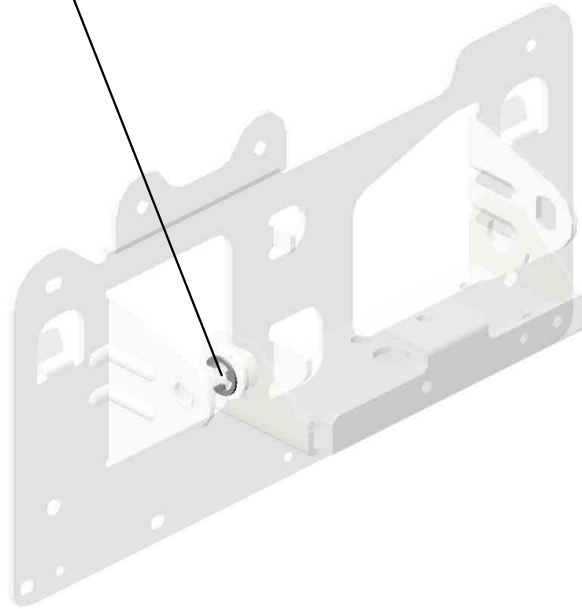

10.D1387251
HINGE:OPERATIO
N PANEL:ASS'Y

U002_S002

(NA/AA/KOR/TWN):OPERATION PANEL UNIT:ASS'Y

16.D1387301
(NA/AA/KOR/TWN):
COVER:FRONT

17.D1387305
COVER:REAR

29.D1491427
TOUCH PANEL:WV
GA-9:MV

30.D1491530
(x2)
SPACER:LCD:A

28.D1491424
LCD:TFT:WVGA-9:
LED:SH

33.D2617228
(NA/AA/KOR/TWN):
OPERATION PANE
L UNIT:ASS'Y

21.D1387312
KEYTOP:RESET S
WITCH

18.D1387308
(NA/AA/KOR/TWN)
FKEYTOP:10KEY

40.D2617387
PCB:OP-R:ASS'Y

26.D1387362
KEYTOP:RIGHT:BA

19.D1387310
KEYTOP:START

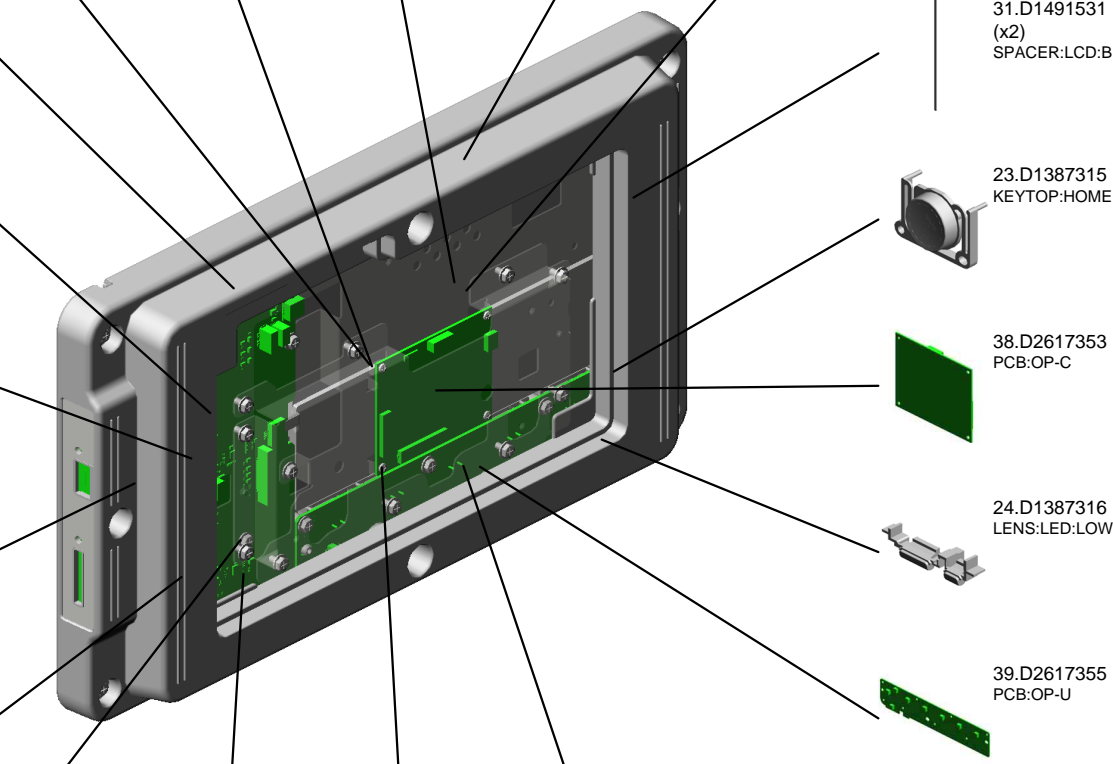

4.04583010N
(x34)
HEXAGON HEAD T
APPING SCREW:3
X10

20.D1387311
KEYTOP:STOP

1.03603005N
(x14)
SCREW - M3X5

22.D1387314
KEYTOP:LOWER

31.D1491531
(x2)
SPACER:LCD:B

23.D1387315
KEYTOP:HOME

38.D2617353
PCB:OP-C

24.D1387316
LENS:LED:LOWER

39.D2617355
PCB:OP-U

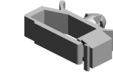
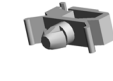

7.11050758
(x2)
CLAMP:LWSM-030
6A

8.11050760
CLAMP:LWSM-051
1A

1.03603005N (x 1)
SCREW - M3X5

U002_S003

(NA/AA/KOR/TWN):OPERATION PANEL UNIT:ASS'Y

16.D1387301
(NA/AA/KOR/TWN):
COVER:FRONT

17.D1387305
COVER:REAR

1.03603005N
(x14)
SCREW - M3X5

29.D1491427
TOUCH PANEL:WV
GA:9:MV

28.D1491424
LCD:TFT:WVGA-9:
LED:SH

33.D2617228
(NA/AA/KOR/TWN):
OPERATION PANE
L UNIT:ASS'Y

21.D1387312
KEYTOP:RESET S
WITCH

18.D1387308
(NA/AA/KOR/TWN)
FKEYTOP:10KEY

40.D2617387
PCB:OP-R:ASS'Y

26.D1387362
KEYTOP:RIGHT:BA

19.D1387310
KEYTOP:START

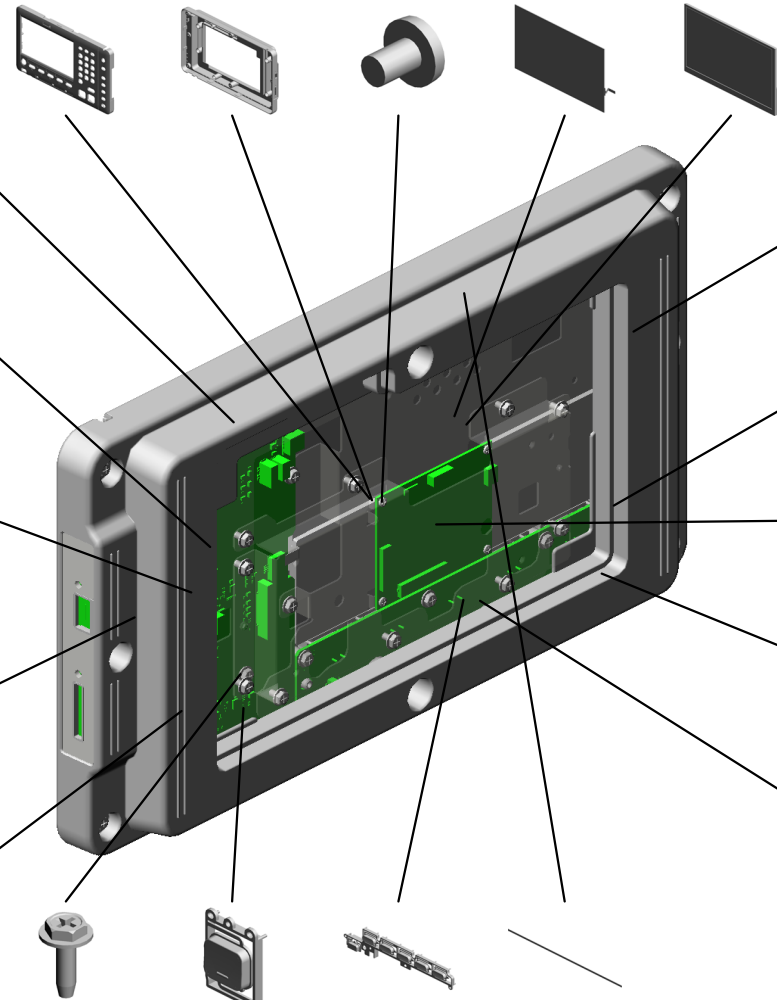

4.04583010N
(x34)
HEXAGON HEAD T
APPING SCREW:3
X10

20.D1387311
KEYTOP:STOP

22.D1387314
KEYTOP:LOWER

30.D1491530
(x2)
SPACER:LCD:A

31.D1491531
(x2)
SPACER:LCD:B

7.11050758
(x2)
CLAMP:LWSM-030
6A

8.11050760
CLAMP:LWSM-051
1A

1.03603005N (x 1)
SCREW - M3X5

23.D1387315
KEYTOP:HOME

38.D2617353
PCB:OP-C

24.D1387316
LENS:LED:LOWER

39.D2617355
PCB:OP-U



U002_S004

(EU):OPERATION PANEL UNIT:ASS'Y

- 21.D1387312 KEYTOP:RESET SWITCH
- 27.D1387363 (EU):COVER:FRONT
- 17.D1387305 COVER:REAR
- 29.D1491427 TOUCH PANEL:WVGA-9:MV
- 28.D1491424 LCD:TFT:WVGA-9:LED:SH



32.D2617227
(EU):OPERATION PANEL UNIT:ASS'Y

31.D1491531
(x2)
SPACER:LCD:B

25.D1387331
(EU/CHN)FKEYTOP:
:10KEY

40.D2617387
PCB:OP-R:ASS'Y

26.D1387362
KEYTOP:RIGHT:BA

19.D1387310
KEYTOP:START



23.D1387315
KEYTOP:HOME



7.11050758
(x2)
CLAMP:LWSM-030
6A

8.11050760
CLAMP:LWSM-051
1A

38.D2617353
PCB:OP-C



1.03603005N (x 1)
SCREW - M3X5

24.D1387316
LENS:LED:LOWER



39.D2617355
PCB:OP-U



22.D1387314
KEYTOP:LOWER



20.D1387311
KEYTOP:STOP



1.03603005N
(x14)
SCREW - M3X5



30.D1491530
(x2)
SPACER:LCD:A

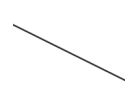

4.04583010N
(x34)
HEXAGON HEAD TAPPING
SCREW:3 X10



U002_S005
(CHN):OPERATION PANEL:ASS'Y

- 25.D1387331 (EU/CHN)FKEYTOP :10KEY
- 21.D1387312 KEYTOP:RESET SWITCH
- 17.D1387305 COVER:REAR
- 29.D1491427 TOUCH PANEL:WV GA-9:MV
- 28.D1491424 LCD:TFT:WVGA-9: LED:SH



34.D2617230 (CHN):OPERATION PANEL:ASS'Y

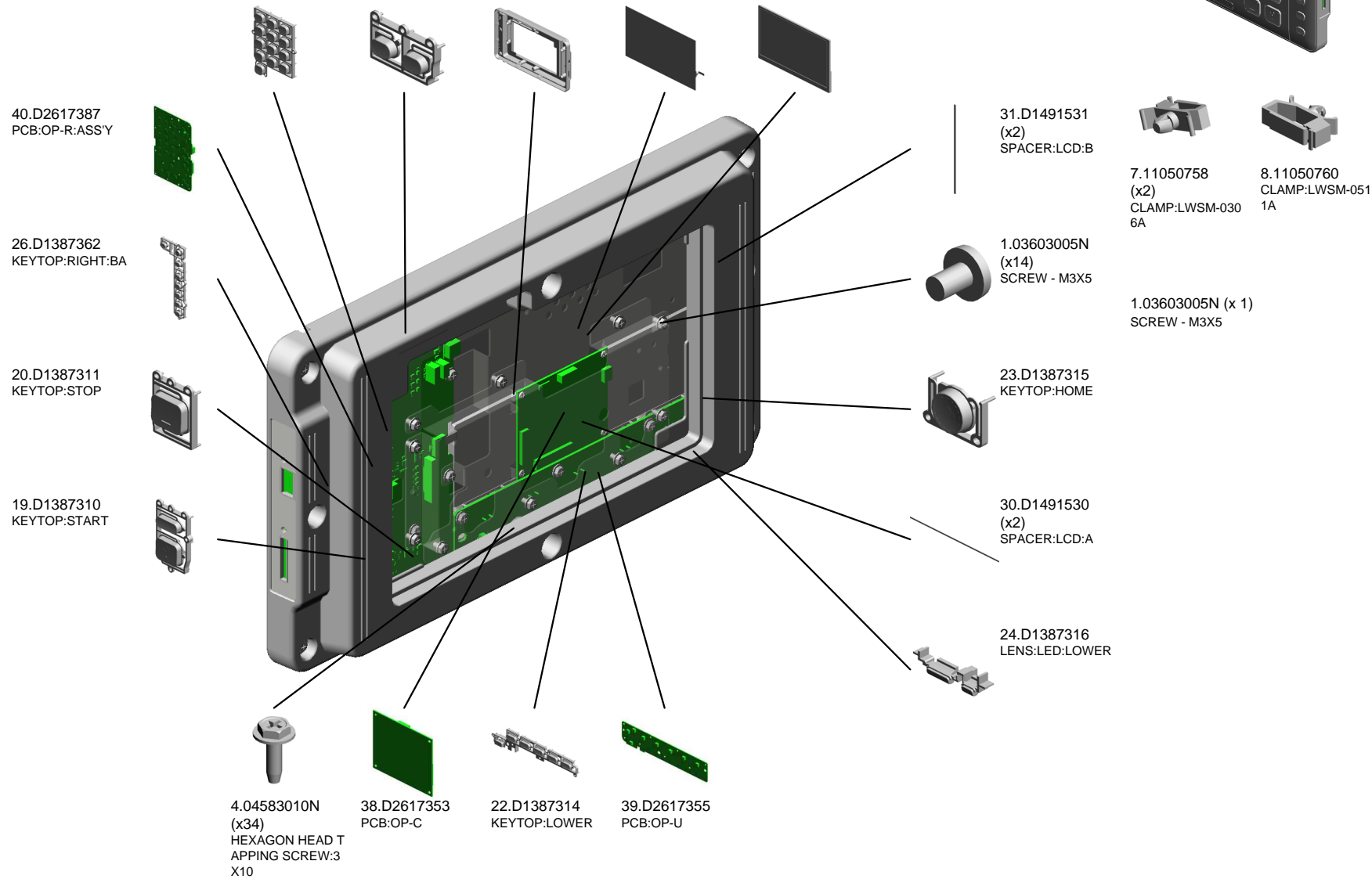

U003.ADF

U003_S001
D3AY7000
ADF UNIT:ASS'Y

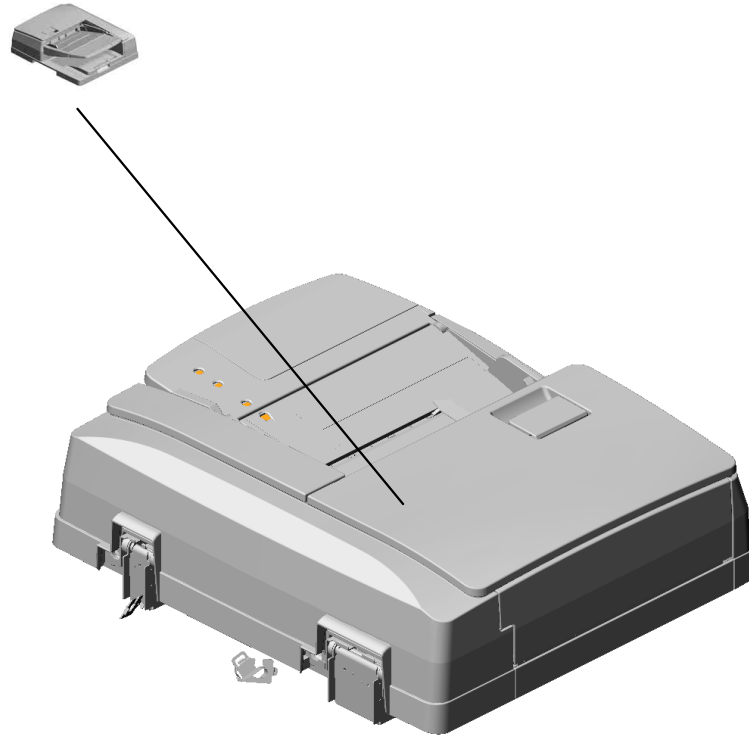

U001	U002	U003	U004	U005	U006	U007	U008	U009	U010	U011	U012	U013	U014	U015	U016	U017	U018	U019	U020	U021
------	------	------	------	------	------	------	------	------	------	------	------	------	------	------	------	------	------	------	------	------

U003_S001.ADF UNIT:ASS'Y

U003_S001_S010
D6834510
COVER:LOWER RIGHT:ASS'
Y

U003_S001_S011
D6831632
SHAFT:REVERSE ROLLER:S
UB-ASS'Y

U003_S001_S006
D3B02200
SHAFT:SEPARATION:ASS'Y

U003_S001_S007
AX040199
DC MOTOR:RISING TRAY:AS
S'Y

U003_S001_S009
D3B00430
COVER:PAPER FEED:ASS'Y

U003_S001_S008
D3B04210
COVER:REAR:ASS'Y

U003_S001_S004
D6833150
ROLLER:SCANNING:EXIT:DR
IVE:ASS'Y

U003_S001_S012
D6831640
SHAFT:INPUT:PAPER FEED:
SUB-ASS'Y

U003_S001_S005
D6833411
GUIDE:SCANNING:ENTRANC
E:LOWER:SUB-ASS'Y

U003_S001_S003
D3B03810
GUIDE PLATE:EXIT:UPPER:A
SS'Y

U003_S001_S002
D6833641
GUIDE:CONTACT IMAGE SE
NSOR:EXIT:LOWER:ASS'Y

U003_S001_S001
D5433631
ROLLER:SCANNING:BEHIND
:ASS'Y

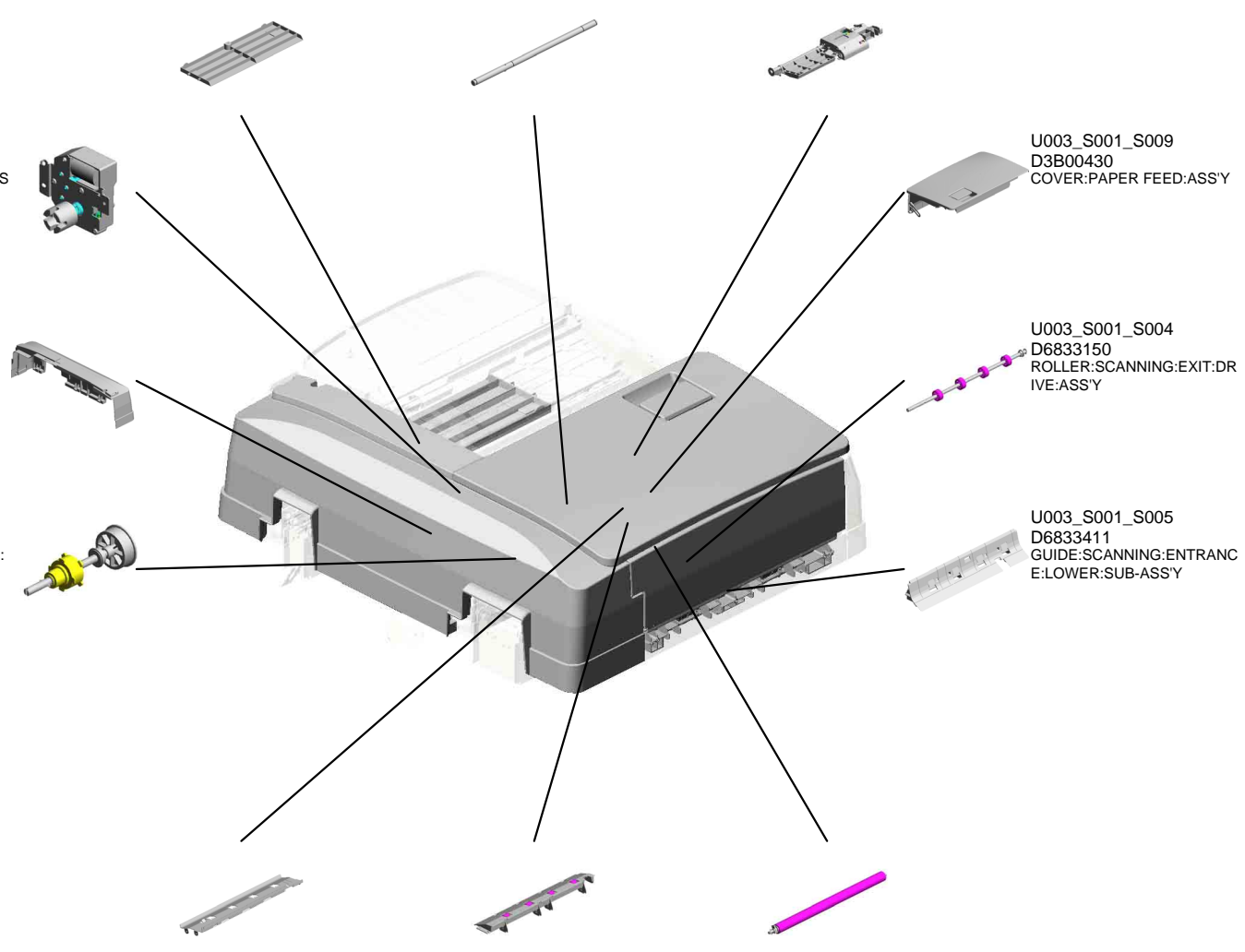

U003_S001_S006.SHAFT:SEPARATION:ASS'Y

U003_S001_S006_S001
D6832240
GUIDE:PAPER FEED:ENTRA
NCE:INNER BACK:ASS'Y

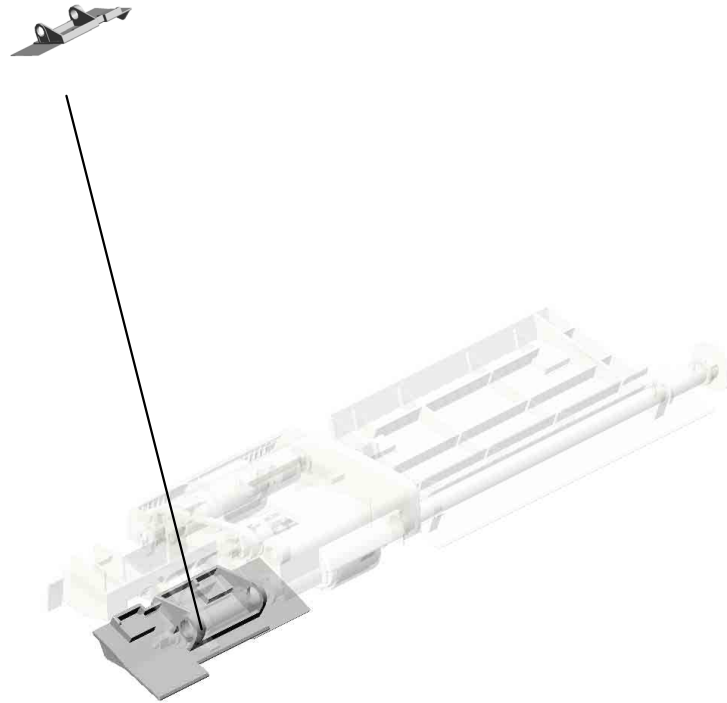

U001	U002	U003	U004	U005	U006	U007	U008	U009	U010	U011	U012	U013	U014	U015	U016	U017	U018	U019	U020	U021
------	------	------	------	------	------	------	------	------	------	------	------	------	------	------	------	------	------	------	------	------

U003_S001_S009.COVER:PAPER FEED:ASS'Y

U003_S001_S009_S001
D3B04750
COVER:PAPER FEED:UPPER
:ASS'Y

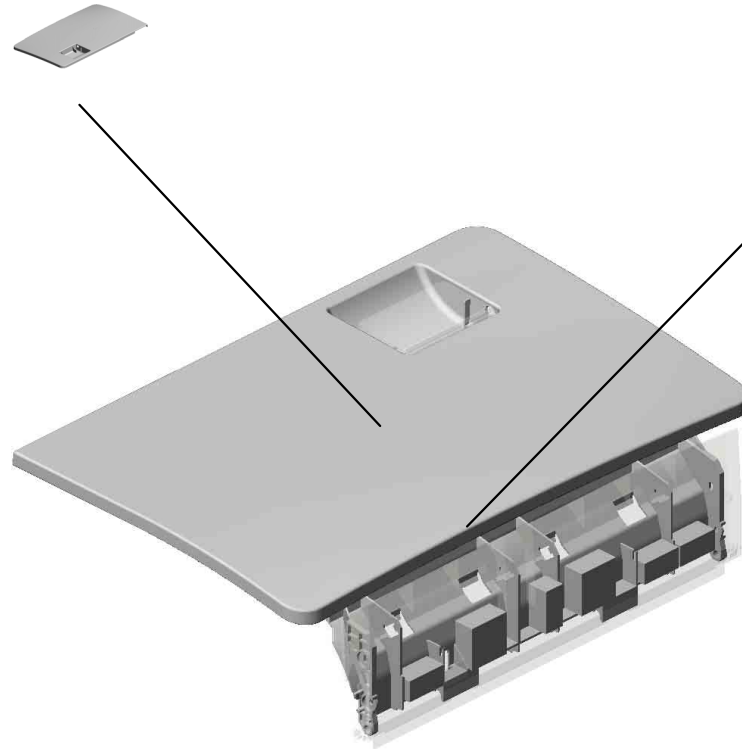

U003_S001_S009_S002
D3B04310
GUIDE:PAPER FEED:UPPER:
SUB-ASS'Y

U001	U002	U003	U004	U005	U006	U007	U008	U009	U010	U011	U012	U013	U014	U015	U016	U017	U018	U019	U020	U021
------	------	------	------	------	------	------	------	------	------	------	------	------	------	------	------	------	------	------	------	------

U003
ADF

127.D5406121
(x2)
FULL DUG POINT
SCREW:FIX:HINGE

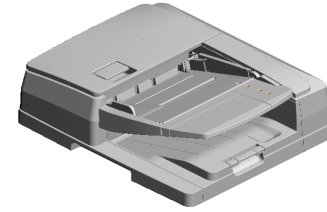
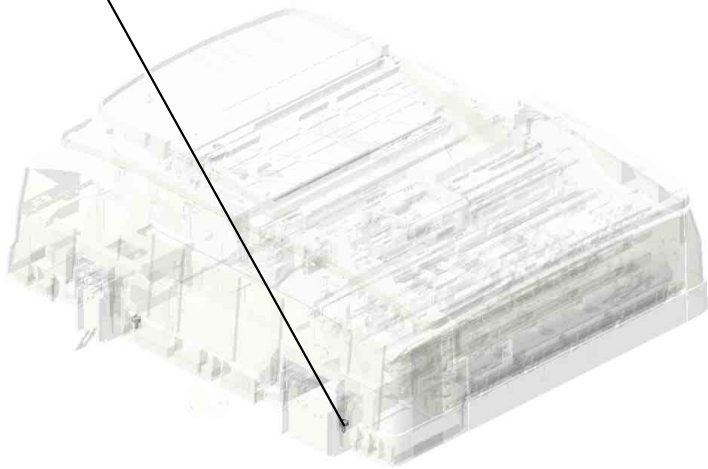

37.A8597211
(x2)
STEPPED SCREW

6.04543006Q (x 4)
TAPPING SCREW - M3X6

U003_S001
ADF UNIT:ASS'Y

7.04543014Q
(x4)
TAPPING SCREW:
3X14

18.11050487
(x5)
HARNESS CLAMP

12.07433806
RADIAL BALL BEA
RING:DIA6XDIA13X
5

6.04543006Q
(x112)
TAPPING SCREW -
M3X6

5.04543006N
(x6)
TAPPING SCREW:
ROUND POINT:3X6

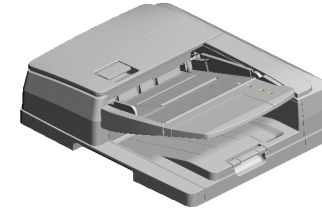

88.D3AY7000
ADF UNIT:ASS'Y

22.11050723
(x2)
CLAMPS:WES-050
7

9.07200030E
RETAINING RING -
M3

21.11050692
(x4)
CLAMP:LES-0503

4.04543005N
(x2)
HEXAGON HEAD T
APPING SCREW:R
OUND POINT:3X5

2.03530060N
(x2)
BIND SCREW - M3
X6

14.08025299
TAPPING SCREW -
M3X8

17.08050106
(x6)
RETAINING RINGS
-E:SILENCER:DIA6

19.11050508
(x6)
HARNESS CLAMP -
LWS-0711

24.11050758
(x14)
CLAMP:LWSM-030
6A

8.04583008N
(x20)
HEXAGON HEAD T
APPING SCREW:3
X8

20.11050551
CLAMP:LES-0505

16.08050104
RETAINING RINGS
-E:SILENCER:DIA4

18.11050487
HARNESS CLAMP

16.08050104
(x9)
RETAINING RINGS
-E:SILENCER:DIA4

3.03603006N
(x4)
SCREW - M3X6

19.11050508
HARNESS CLAMP -
LWS-0711

23.11050724
CLAMPS:WES-121
0

13.07433808
(x3)
RADIAL BALL BEA
RING:DIA8XDIA16X
5

15.08050103
(x2)
RETAINING RINGS
-E:SILENCER:DIA3

24.11050758
(x3)
CLAMP:LWSM-030
6A

126.D5224906
STEPPED SCREW:
M3:DIA6:1.7MM:RO
UND POINT

6.04543006Q (x 4)
TAPPING SCREW - M3X6

8.04583008N (x 1)
HEXAGON HEAD TAPPING SCREW:3X
8

U003_S001
ADF UNIT:ASS'Y

47.AA043698
SYNCHRONOUS B
ELT:40S1.5M300

52.AA080347
BUSHING - 8MM

27.52062686
(x2)
SNAP RING

26.12042612
(x2)
MICRO SWITCH:D3
V-16506-3C25

51.AA080346
BUSHING:FLANGE
TYPE:DIA6

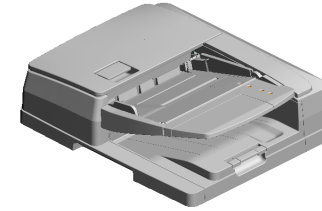

88.D3AY7000
ADF UNIT:ASS'Y

25.11050760
CLAMP:LWSM-051
1A

28.52152621
SNAP RING - M6

40.AA043632
TIMING BELT - 40S
2M126

49.AA060842
(x3)
TENSION SPRING

45.AA043685
SYNCHRONOUS B
ELT:40S2M258

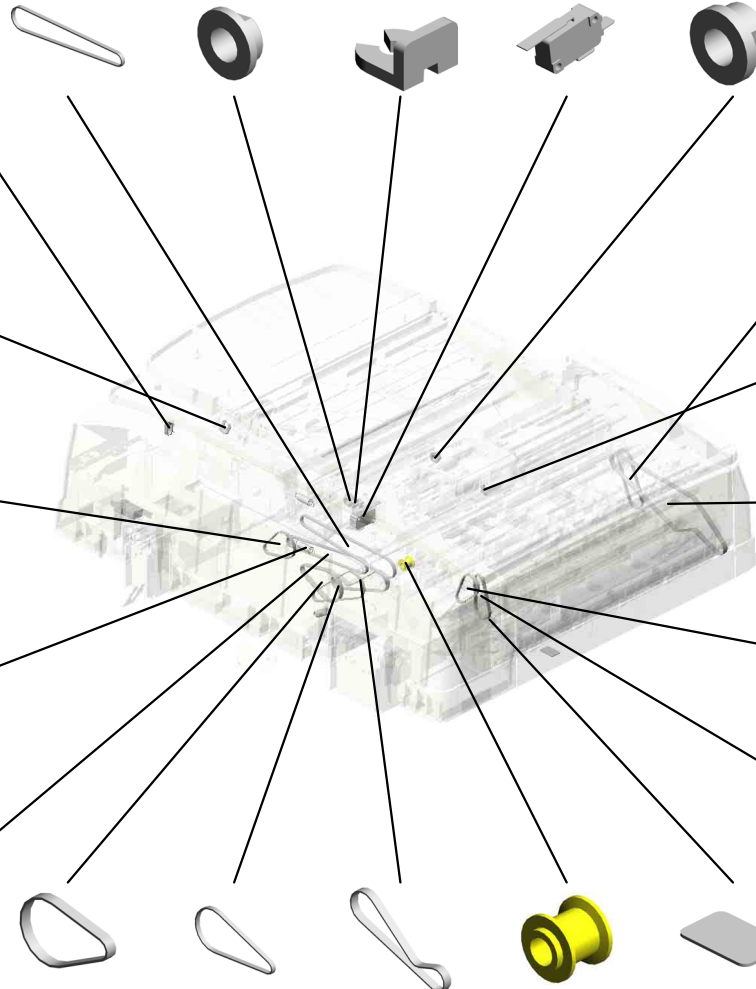

10.07200040E (x 3)
RETAINING RING - M4

48.AA043710
SYNCHRONOUS B
ELT:40S2M158

29.54472681
SNAP RING

44.AA043684
SYNCHRONOUS B
ELT:60S1.5M390

41.AA043681
SYNCHRONOUS B
ELT:40S2M108

39.AA043339
TIMING BELT:PAP
ER EXIT:40S2M122

42.AA043682
SYNCHRONOUS B
ELT:60S1.5M150

46.AA043694
SYNCHRONOUS B
ELT:B40S2M202

43.AA043683
SYNCHRONOUS B
ELT:60S1.5M204

32.A5482139
PULLEY

31.A4221063
(x2)
SEAL - 0.7X13X20

U003_S001
ADF UNIT:ASS'Y

61.AW010150
(x4)
PHOTO REFLECTIO
N SENSOR:ORIGIN
AL TRAY

63.AW020190
PHOTOINTERRUP
TOR

77.B7003305
TIMING BELT:B40S
2M152

80.B8022532
SPRING PLATE:SI
DE FENCE

81.B8022536
SLIDER:SIDE FEN
CE

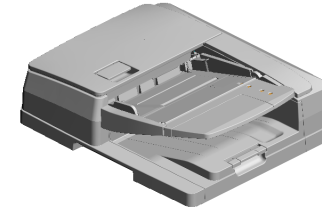

88.D3AY7000
ADF UNIT:ASS'Y

86.B8722524
SPACER:DIA9



85.B8301135
SCREW



78.B7061859
SCREW:SLIDER:L
OCK



76.B6523174
TENSION SPRING



68.B3871951
SPRING - PAPER S
IZE SENSOR



59.AA143842
SCREW:DIA6:14.5:
M4



74.B4774131
(x4)
SPRING



55.AA082144
(x2)
BUSHING - 8X12X7



62.AW010151
(x3)
PHOTO REFLECTIO
N SENSOR:PS122T
L1-A



84.B8041180
(x8)
DISCHARGE BRUS
H:PUNCH UNIT



58.AA143789
SHAFT:CLEANER



53.AA082101
(x6)
BUSHING - 6X10X6

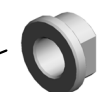

64.AW020224
(x9)
PHOTOINTERRUP
TOR:GP1A173LCS
VF



57.AA143788
(x2)
PIN:GUIDE PLATE:
PAPER FEED



73.B4774129
(x2)
SPRING - 12N



U003_S001
ADF UNIT:ASS'Y

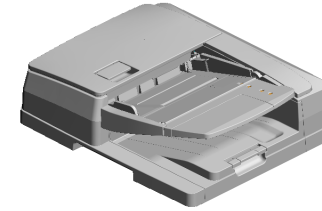

88.D3AY7000
ADF UNIT:ASS'Y

130.D5431625
GEAR:Z24:SEPARATION

91.D3AZ4720
PRESSURE PLATE:ASS'Y

89.D3AZ1762
BRACKET:MOTOR:MIDDLE

128.D5412241
REVERSE ROLLER
:PAPER FEED

97.D3B02510
GUIDE PLATE:PAPER FEED:LOWER:ASS'Y

92.D3AZ5100
PCB:MAIN CONTROL

95.D3B01766
DC MOTOR:10W:NIDEC:ASS'Y

131.D5431717
SHAFT:PULLEY:SCANNING:EXIT

123.D4122653
BUSHING:DIA6

129.D5431313
COMPRESSION SPRING:HINGE:LEFT

125.D4123145
TENSION SPRING:LEVER:MISFEED REMOVAL

93.D3AZ5860
CONTACT IMAGE SENSOR:ASS'Y

124.D4122669
(x2)
TENSION SPRING:GUIDE PLATE:PRESSURE:2N

132.D5431821
TIMING PULLEY:T3/3/Z24

136.D5433635
GEAR:ROLLER:SCANNING:BEHIND

90.D3AZ2914
(x6)
COIL SPRING:FEELEVER:P SIZE SENSOR

121.D3B05869
SHIELD PLATE:CONTACT IMAGE SENSOR:FRONT

133.D5431822
FLANGE:DIA24

122.D3B06321
DECAL:CAUTION:CONTACT IMAGE SENSOR

126.D5224906
(x9)
STEPPED SCREW:M3:DIA6:1.7MM:ROUND POINT

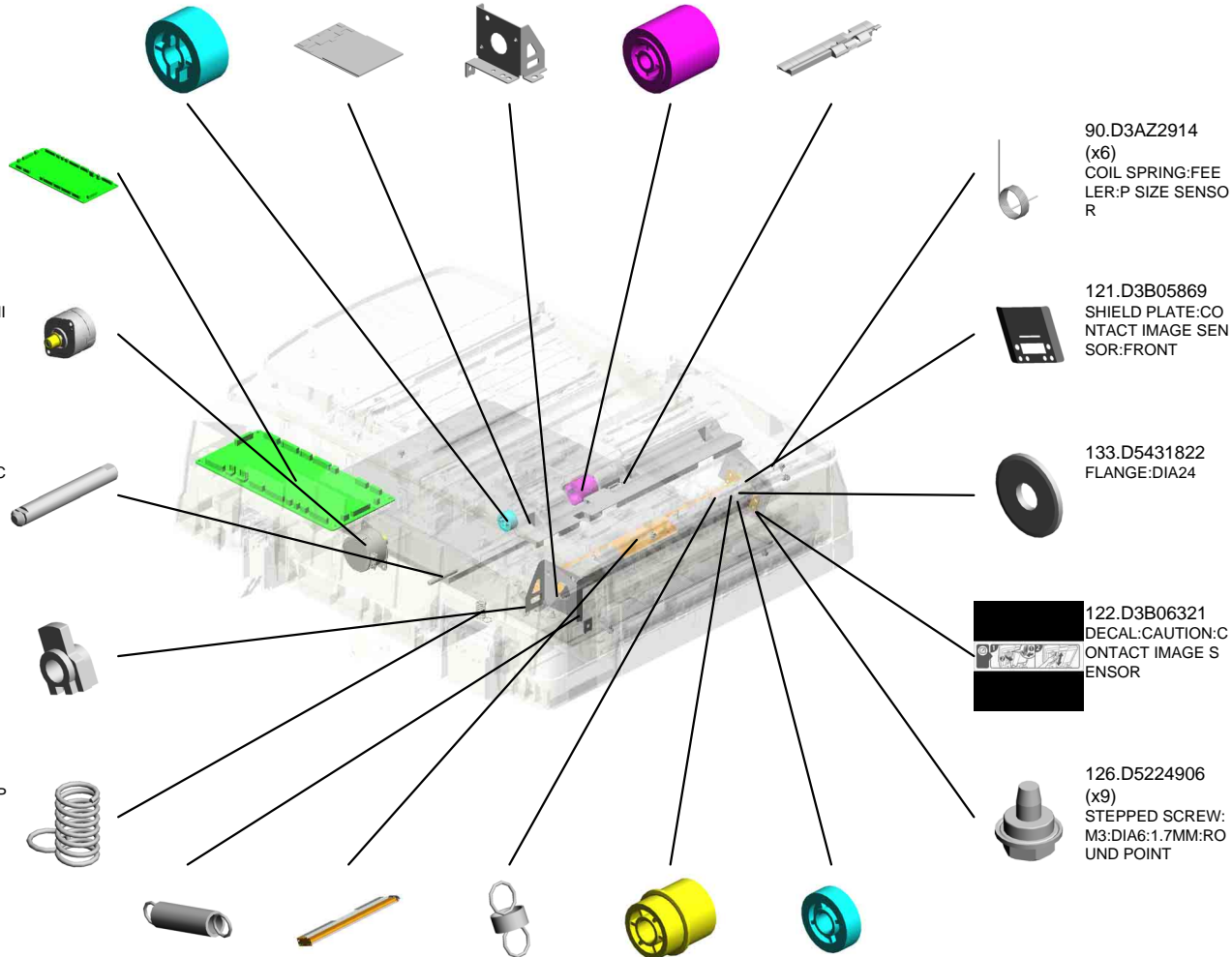

U003_S001
ADF UNIT:ASS'Y

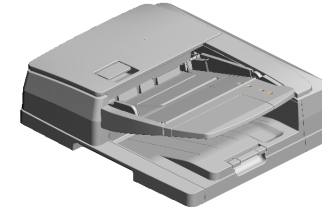

88.D3AY7000
ADF UNIT:ASS'Y

- 152.D6831615 STAY:MOTOR:PAPER FEED
- 145.D6831386 SHAFT:CONTACT POINT:ON OFF DETECTOR:PAPER FEED
- 144.D6831385 BRACKET:SAFETY SWITCH:PAPER FEED
- 146.D6831387 TENSION SPRING:ON OFF DETECTOR:PAPER FEED
- 154.D6831620 SHAFT:SEPARATION:DRIVE:INPUT:SUB-ASSY

143.D6831362 COMPRESSION SPRING:HINGE:RIGHT



148.D6831414 SPRING PLATE:SAFETY SWITCH



147.D6831413 BRACKET:SAFETY SWITCH



142.D6831350 HINGE:RIGHT:ASSY



149.D6831415 FEELER:SENSOR:ON OFF DETECTOR



150.D6831451 HOLDER:FEELER:APS



140.D6421454 FEELER:APS



151.D6831614 BRACKET:MOTOR:PAPER FEED



153.D6831617 DC MOTOR:ASSY:20W:BRUSHLESS



141.D6831320 HINGE:LEFT:ASSY



138.D5434393 (x6) CUSHION:GUIDE PLATE:ENTRANCE:PAPER FEED:INNER BACK

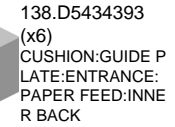

156.D6831635 GEAR:REVERSE ROLLER:DRIVE

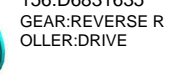

159.D6831643 GEAR:INPUT:PAPER FEED

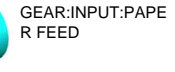

139.D5435125 SPRING PLATE:CONTACT IMAGE SENSOR



158.D6831642 TIMING PULLEY:IDLER:PULL OUT

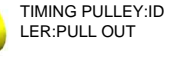

U003_S001
ADF UNIT:ASS'Y

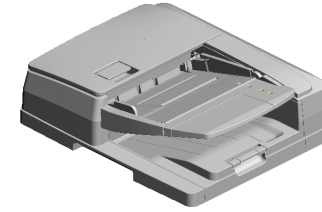

88.D3AY7000
ADF UNIT:ASS'Y

167.D6831711 BRACKET:MOTOR:
PULL OUT
171.D6831813 TIMING PULLEY:C
OUPLING:SCANNI
NG:INNER BACK
174.D6831841 BRACKET:TENSIO
NER:SCANNING:IN
NER BACK
175.D6831845 (x2)
PULLEY:IDLER:DI
A 14
165.D6831682 TIMING PULLEY:PI
CKUP:DRIVE

172.D6831814
TIMING PULLEY:C
OUPLING:EXIT

179.D6831912
BRACKET:HINGE:R
IGHT

168.D6831718
(x2)
STAY:MOTOR:PUL
L OUT

173.D6831822
(x2)
DC MOTOR:20W:S
CANNING:20W:BR
USHLESS

170.D6831811
BRACKET:MOTOR:
SCANNING:EXIT

160.D6831644
SPACER:SHAFT:IN
PUT:PAPER FEED

162.D6831671
BRACKET:MOTOR:
PICK UP

163.D6831675
DC STEPPER MOT
OR:DIA42:T15:S2M:
ASS'Y

166.D6831691
GEAR:PAPER FEE
D:COUPLING

169.D6831766
DC MOTOR:10W:B
RUSHLESS

178.D6831856
TENSION SPRING:
TENSION:SCANNI
NG:FRONT

176.D6831851
BRACKET:TENSIO
NER:SCANNING:F
RONT

177.D6831855
TIMING PULLEY:TE
NSIONER:SCANNI
NG:FRONT

180.D6832110
ROLLER:PULL OUT
:DRIVE

164.D6831680
CAM:PICKUP

U003_S001
ADF UNIT:ASS'Y

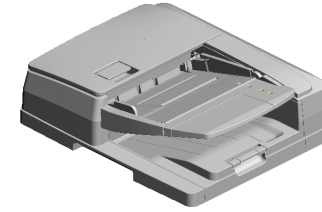

88.D3AY7000
ADF UNIT:ASS'Y

- 214.D6832771 ORIGINAL TABLE
- 213.D6832756 RAIL:SIDE FENCE
- 210.D6832748 (x2) PAD:SIDE FENCE:LARGE
- 209.D6832747 (x3) PAD:SIDE FENCE:SMALL
- 208.D6832746 SIDE FENCE:ORIGINAL TABLE

199.D6832393 HOLDER:ORIGINAL TABLE

212.D6832755 SHAFT:RISE:BASE:SUB-ASS'Y

204.D6832729 JOINT:RISING TRAY:AUXILIARY

203.D6832728 STOPPER:RELEASE:SHAFT:BASE

205.D6832733 FEELER:SENSOR:ORIGINAL SENSOR

206.D6832742 (x4) CUSHION:STOPPER PAWL

181.D6832112 (x2) TIMING PULLEY:ROLLER:PULL OUT:DRIVE

207.D6832743 (x2) SHEET:CUSHION:STOPPER PAWL

211.D6832752 LEVER:RISE:BASE

198.D6832311 TORQUE LIMITER MECHANICAL CLUTCH:SEPARATOR

202.D6832724 COVER:LOWER:BASE

184.D6832222 STOPPER:SHAFT:SEPARATION:DRIVE

201.D6832417 SHEET:ENTRANCE:SEPARATION PAD

200.D6832415 SHEET:SEPARATION:ENTRANCE

182.D6832210 ROLLER:MIDDLE:DRIVE

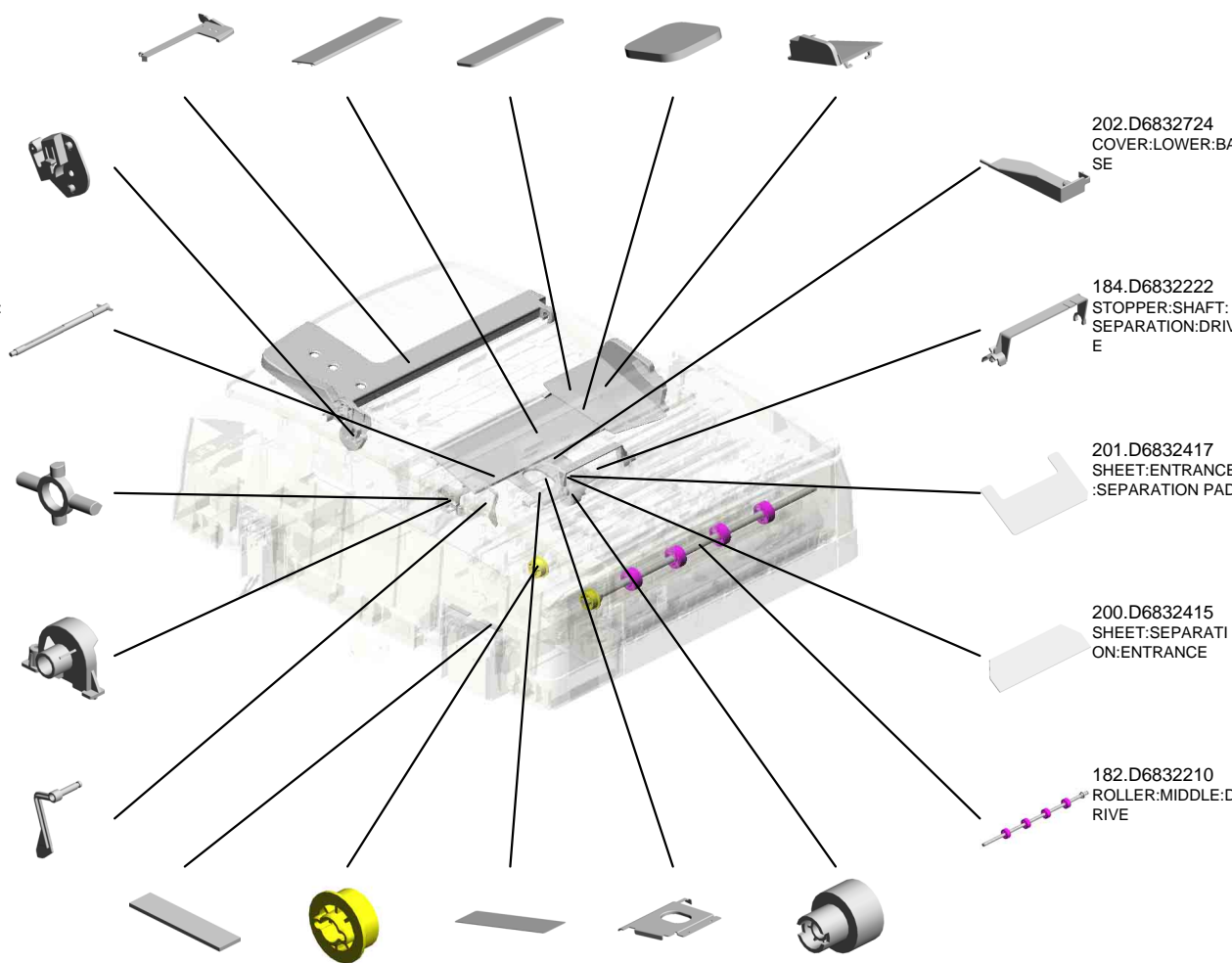

U003_S001
ADF UNIT:ASS'Y

- 218.D6832913 (x2) SHEET:SENSOR:SEPARATION
- 224.D6833260 SHEET:SCANNING:EXIT:UPPER:ASS'Y
- 233.D6833616 (x2) BRACKET:DISCHARGE BRUSH
- 231.D6833510 SHAFT:LEVER:MISFEED REMOVAL:ASSY
- 216.D6832911 GUIDE PLATE:PULL OUT:LOWER

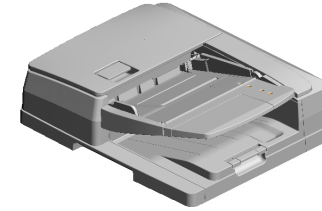

88.D3AY7000
ADF UNIT:ASS'Y

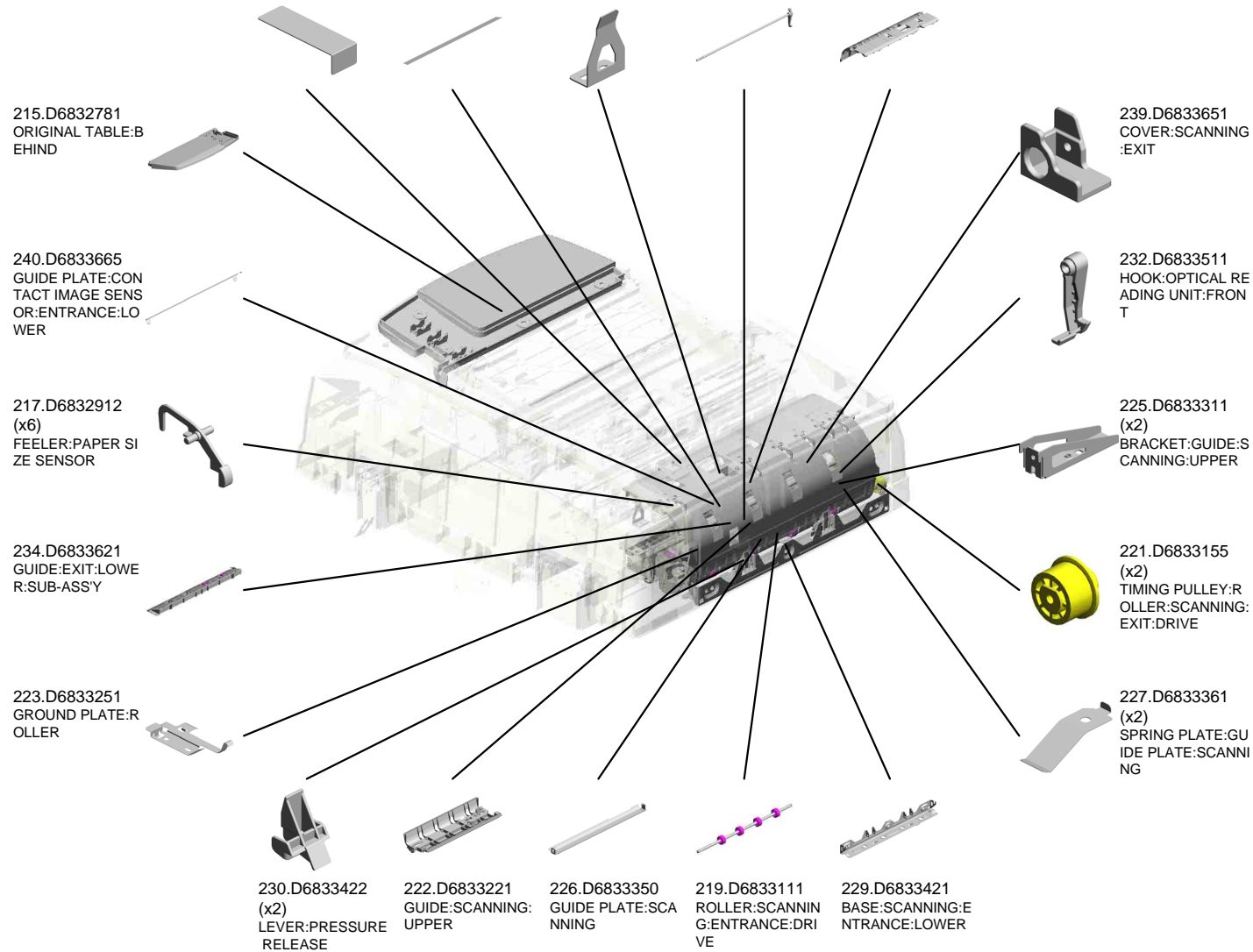

U003_S001
ADF UNIT:ASS'Y

274.D6834412
TRAY:EXIT:AUXILIARY:LARGE

277.D6834418
TRAY:EXIT

278.D6834421
(x2)
SHAFT:EXIT:DRIVE

249.D6833911
ROLLER:EXIT:DRIVE

252.D6834112
COVER:FRONT RIGHT

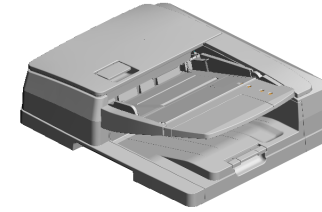

88.D3AY7000
ADF UNIT:ASS'Y

275.D6834413
TRAY:EXIT:AUXILIARY:SMALL

253.D6834212
COVER:UPPER REAR

279.D6834430
(x4)
ROLLER:EXIT:DRIVE

250.D6833915
TIMING PULLEY:ROLLER:EXIT:DRIVE

245.D6833714
TIMING PULLEY:ROLLER:CIS:EXIT:DRIVE

242.D6833667
LEVER:GUIDE PLATE:CONTACT IMAGE SENSOR:REAR

244.D6833710
ROLLER:CONTACT IMAGE SENSOR:EXIT:DRIVE:PRESS FIT

276.D6834414
(x4)
SPACER:EXIT ROLLER

248.D6833812
DISCHARGE BRUSH:EXIT

281.D6834442
(x8)
TAPE:PRESSURE PLATE

246.D6833715
TIMING PULLEY:ROLLER:CIS:EXIT:FRONT

251.D6834111
COVER:FRONT

280.D6834441
(x2)
HOLDER:CUSHION:PRESSURE PLATE

241.D6833666
LEVER:GUIDE PLATE:CONTACT IMAGE SENSOR:FRONT

243.D6833668
(x2)
SPACER:GUIDE PLATE:CONTACT IMAGE SENSOR:ENTRANCE

U003_S001
ADF UNIT:ASS'Y

290.D6836051 DECAL:BASE:ORIGINAL
 288.D6836011 DECAL:SIZE:ORIGINAL
 298.M3644131 TIMING BELT:B40S2M160
 295.D7316241 DECAL:STOPPER:SEPARATION UNIT

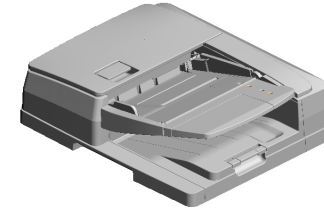

88.D3AY7000
ADF UNIT:ASS'Y

287.D6835121
GUIDE:HARNES
SUB

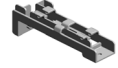

286.D6835111
GUIDE:HARNES
MAIN

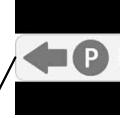

289.D6836041
DECAL:DESIGN SK
ETCH:MISFEED RE
MOVAL:P2

283.D6834611
COVER:LEFT LOW
ER



284.D6834616
SHEET:BASE:SEAL
:LEFT LOWER



292.D6842412
(x2)
PAD:STOPPER:ORI
GINAL

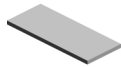

285.D6834617
SEAL:LEFT LOWE
R



U003_S001_S001
ROLLER:SCANNING:BEHIND:ASS'Y

123.D4122653
BUSHING:DIA6

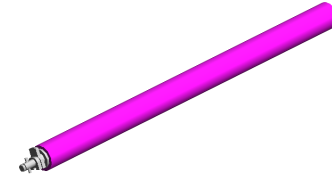

135.D5433631
ROLLER:SCANNIN
G:BEHIND:ASS'Y

U001	U002	U003	U004	U005	U006	U007	U008	U009	U010	U011	U012	U013	U014	U015	U016	U017	U018	U019	U020	U021
------	------	------	------	------	------	------	------	------	------	------	------	------	------	------	------	------	------	------	------	------

U003_S001_S002
 GUIDE:CONTACT IMAGE SENSOR:EXIT:LOWER:ASS'Y

238.D6833645
 (x2)
 ROLLER:MIDDLE:D
 RIVEN

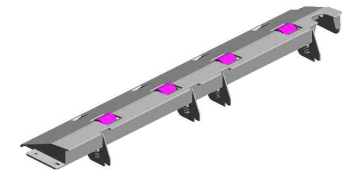

235.D6833641
 GUIDE:CONTACT I
 MAGE SENSOR:EX
 IT:LOWER:ASS'Y

296.G0602652
 (x4)
 BUSHING - M4

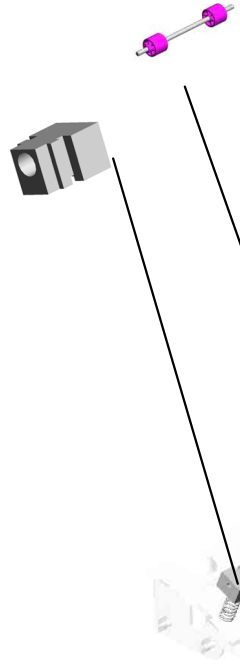

236.D6833643
 (x4)
 COMPRESSION SP
 RING:CONTACT IM
 AGE SENSOR:EXIT



237.D6833644
 (x4)
 SHEET:GUIDE:CO
 NTACTION IMAGE SEN
 SOR:EXIT:LOWER

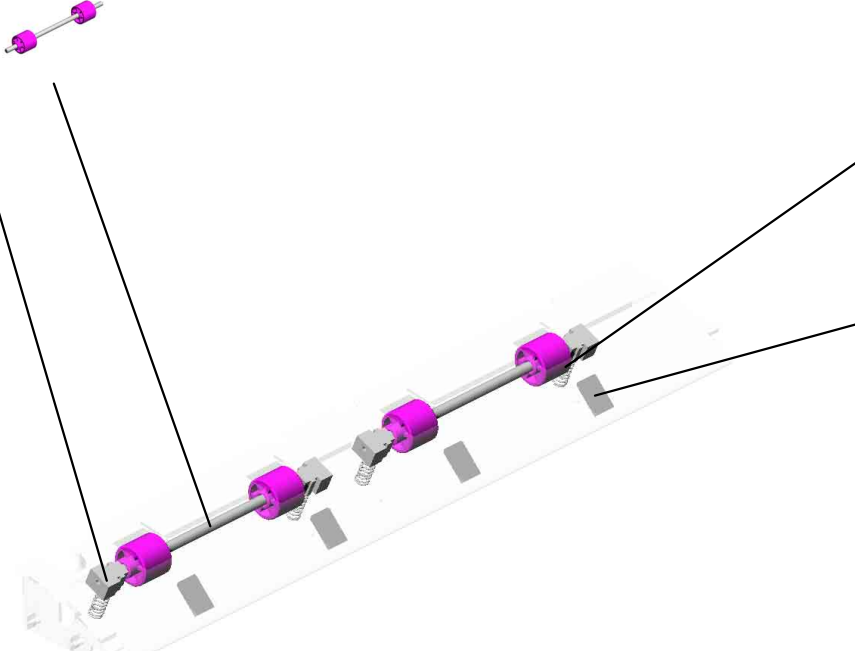

U001	U002	U003	U004	U005	U006	U007	U008	U009	U010	U011	U012	U013	U014	U015	U016	U017	U018	U019	U020	U021
------	------	------	------	------	------	------	------	------	------	------	------	------	------	------	------	------	------	------	------	------

U003_S001_S003
GUIDE PLATE:EXIT:UPPER:ASS'Y

248.D6833812
DISCHARGE BRUS
H:EXIT

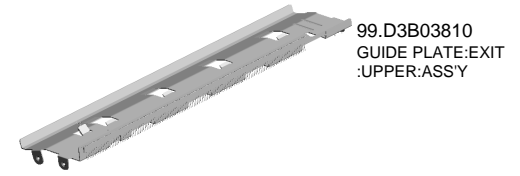

294.D6902425
DISCHARGE BRUS
H:SHORT:FRONT

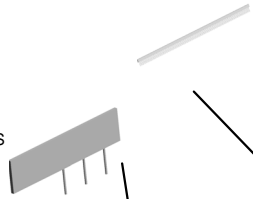

84.B8041180
(x2)
DISCHARGE BRUS
H:PUNCH UNIT

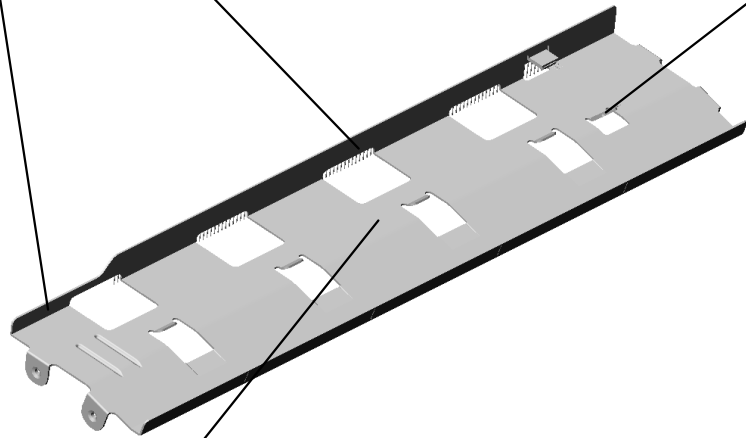

247.D6833811
GUIDE PLATE:EXIT
:UPPER



U001	U002	U003	U004	U005	U006	U007	U008	U009	U010	U011	U012	U013	U014	U015	U016	U017	U018	U019	U020	U021
------	------	------	------	------	------	------	------	------	------	------	------	------	------	------	------	------	------	------	------	------

U003_S001_S004

ROLLER:SCANNING:EXIT:DRIVE:ASS'Y

11.07200060E
RETAINING RING -
M6

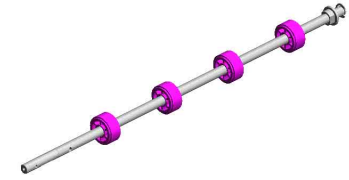

220.D6833150
ROLLER:SCANNIN
G:EXIT:DRIVE:ASS'
Y



54.AA082104
BUSHING - 8X12X7

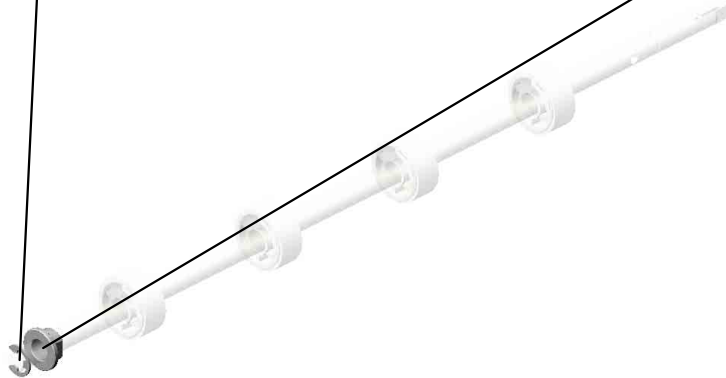

U001	U002	U003	U004	U005	U006	U007	U008	U009	U010	U011	U012	U013	U014	U015	U016	U017	U018	U019	U020	U021
------	------	------	------	------	------	------	------	------	------	------	------	------	------	------	------	------	------	------	------	------

U003_S001_S005
GUIDE:SCANNING:ENTRANCE:LOWER:SUB-ASS'Y

134.D5433314
(x4)
SHEET:SCANNING:
ENTRANCE:MIDDLE

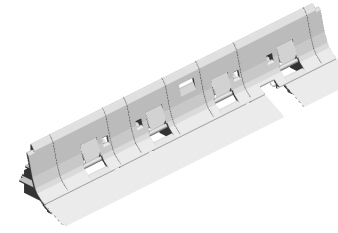

228.D6833411
GUIDE:SCANNING:
ENTRANCE:LOWER:
SUB-ASS'Y

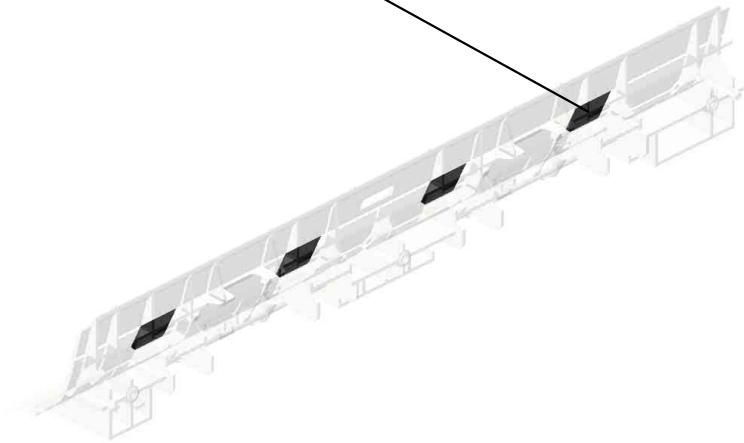
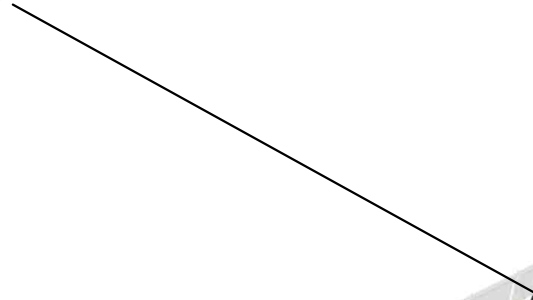

U001	U002	U003	U004	U005	U006	U007	U008	U009	U010	U011	U012	U013	U014	U015	U016	U017	U018	U019	U020	U021
------	------	------	------	------	------	------	------	------	------	------	------	------	------	------	------	------	------	------	------	------

U003_S001_S006
SHAFT:SEPARATION:ASS'Y

70.B4772227
PICKUP ROLLER:COUPLING

183.D6832221
GEAR:IDLER:Z18

69.B3872113
ROLLER - PAPER FEED BELT

35.A8592112
DRIVE SHAFT - PAPER FEED BELT

119.D3B04781
CUSHION:BRACKET:PICKUP:FRONT

96.D3B02200
SHAFT:SEPARATION:ASS'Y

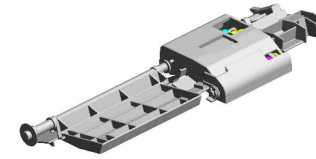

38.AA043328
TIMING BELT:40S2 M130

29.54472681
(x2)
SNAP RING

67.B3863320
(x2)
SPRING:BELT:PAPER FEED:8N

36.A8592319
BASE CUSHION

17.08050106
(x2)
RETAINING RINGS -E:SILENCER:DIA6

79.B7892114
PAPER FEED BELT ROLLER

75.B6522215
GUIDE:PAPER FEED BELT:FRONT

33.A6281225
(x4)
BUSHING - 8MM

185.D6832224
GUIDE:PAPER FEED:ENTRANCE:FRONT

34.A8061163
(x2)
GUIDE PLATE CUSHION

53.AA082101
BUSHING - 6X10X6

30.A4181158
SPACER - M6.5X1

50.AA063435
COMPRESSION SPRING:PAPER FEED JOINT

56.AA132013
SPACER

11.07200060E
RETAINING RING - M6

U003_S001_S006
SHAFT:SEPARATION:ASS'Y

186.D6832228
PICKUP ROLLER

191.D6832235
SHAFT:PICKUP:SU
B-ASS'Y

193.D6832239
COVER:PICKUP R
OLLER

297.H0602126
(x2)
BUSHING - M6X7



96.D3B02200
SHAFT:SEPARATI
ON:ASS'Y

189.D6832232
TIMING PULLEY:PI
CKUP:T21



192.D6832236
SHEET:BRACKET:
PICKUP:INNER BA
CK



190.D6832233
BRACKET:PAPER
FEED BELT



187.D6832229
TIMING PULLEY:G
EAR:T19/Z23

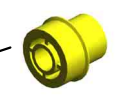

291.D6842171
PAPER FEED BELT

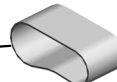

197.D6832272
LEVER:PICKUP RO
LLER:RISE



188.D6832231
BRACKET:PICKUP



U003_S001_S006_S001
GUIDE:PAPER FEED:ENTRANCE:INNER BACK:ASS'Y

34.A8061163 (x2)
GUIDE PLATE CUSHION

195.D6832241
GUIDE:PAPER FEED:ENTRANCE:INNER BACK

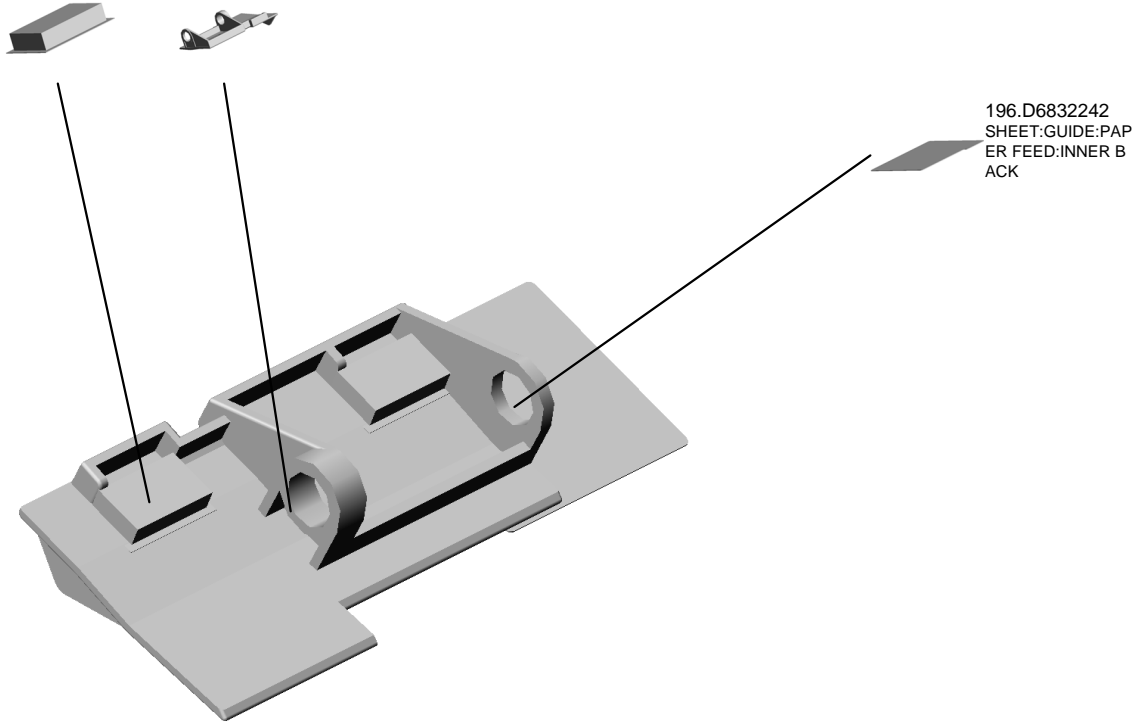

U003_S001_S007
DC MOTOR:RISING TRAY:ASS'Y

87.D0812966
DC MOTOR:ASS'Y:
1.007W:BRUSH

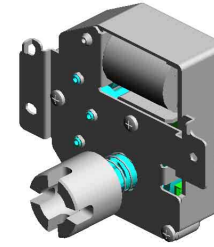

65.AX040199
DC MOTOR:RISING
TRAY:ASS'Y



1.03530030N
(x2)
SCREW:M3X3

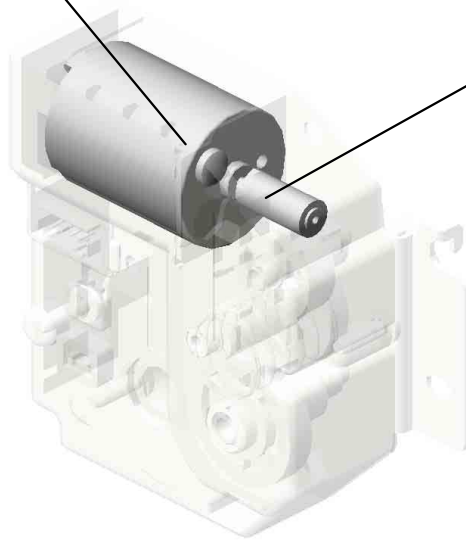

U003_S001_S008
COVER:REAR:ASS'Y

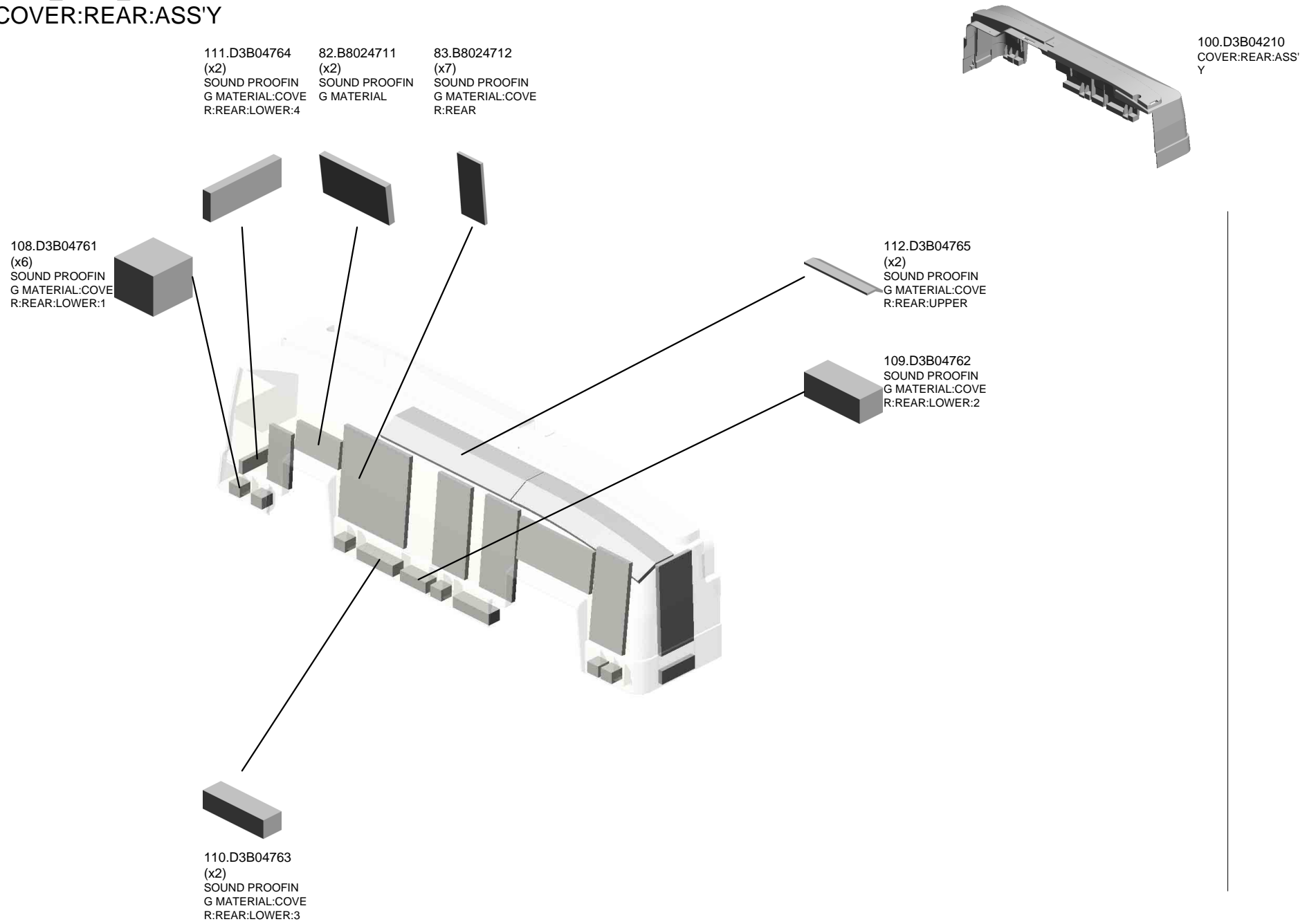

U003_S001_S009 COVER:PAPER FEED:ASS'Y

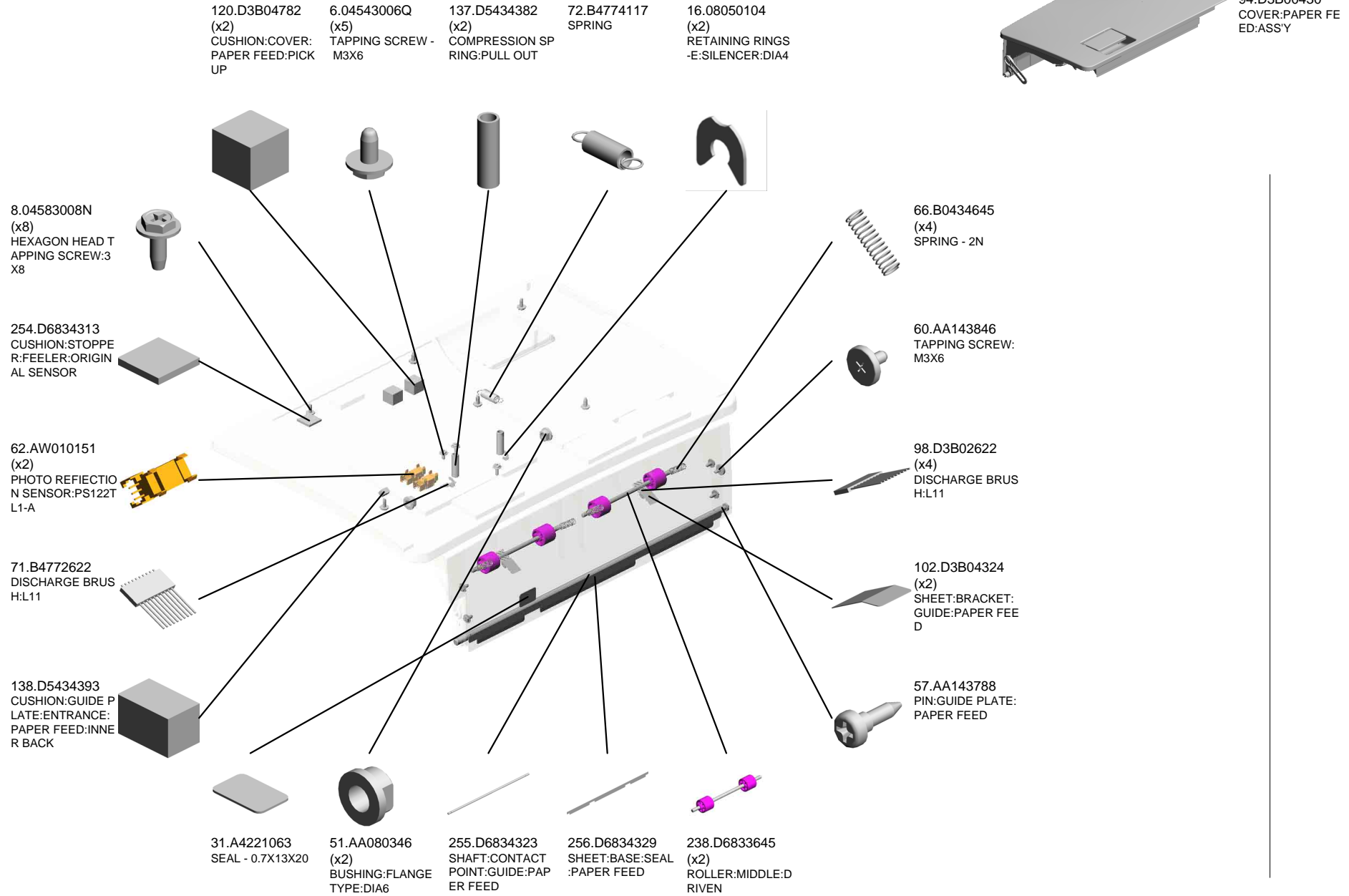

U003_S001_S009
COVER:PAPER FEED:ASS'Y

- 263.D6834347 SEAL:ENTRANCE: PAPER FEED
- 262.D6834346 SHIELD PLATE:EN TRANCE:PAPER FEED
- 271.D6834394 GUIDE PLATE:ENT RANCE:PAPER FE ED:UPPER
- 266.D6834361 SHAFT:CONTACT POINT:GRIP
- 268.D6834371 GRIP:COVER:PAP ER FEED

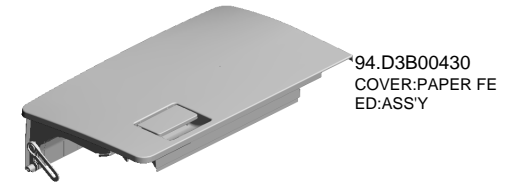

258.D6834342
BRACKET:PRESSU RE:PICKUP



259.D6834343
PRESSURE PLATE :PICKUP



260.D6834344
COMPRESSION SP RING:PICKUP:2.1N



270.D6834374
HOOK:CONTACT P OINT:INNER BACK: GRIP



267.D6834367
GROUND PLATE:H OOK:INNER BACK



261.D6834345
DISCHARGE BRUS H:EXIT:L37



296.G0602652 (x4)
BUSHING - M4



257.D6834341
BRACKET:PULL O UT:DRIVEN



264.D6834350
DRIVEN ROLLER:P ULL OUT

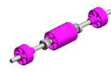

285.D6834617
SEAL:LEFT LOWE R



269.D6834372
HOOK:CONTACT P OINT:FRONT:GRIP



293.D6866128
SPONGE:COVER:F RONT:SMALL



273.D6834396
CUSHION:GUIDE P LATE:ENTRANCE: PAPER FEED:STO PPER



272.D6834395
CUSHION:GUIDE P LATE:ENTRANCE: PAPER FEED:FRO NT



265.D6834351
LINK:STOPPER:CO VER:PAPER FEED



U003_S001_S009_S001
COVER:PAPER FEED:UPPER:ASS'Y

105.D3B04752 CUSHION:COVER:
PAPER FEED:UPP
ER:2

104.D3B04751 CUSHION:COVER:
PAPER FEED:UPP
ER:1

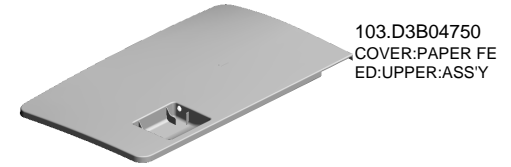

103.D3B04750
COVER:PAPER FE
ED:UPPER:ASS'Y

107.D3B04754
SOUND PROOFIN
G MATERIAL:COVE
R:PAPER FEED:UP
PER:INNER BACK

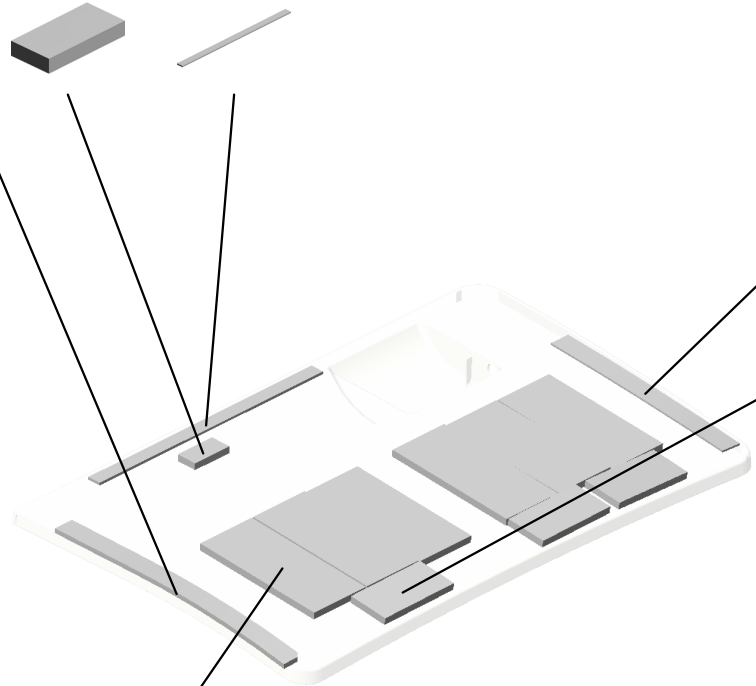

106.D3B04753
SOUND PROOFIN
G MATERIAL:COVE
R:PAPER FEED:UP
PER:FRONT

82.B8024711
(x3)
SOUND PROOFIN
G MATERIAL

83.B8024712
(x6)
SOUND PROOFIN
G MATERIAL:COVE
R:REAR

U003_S001_S009_S002
 GUIDE:PAPER FEED:UPPER:SUB-ASS'Y

113.D3B04771
 SOUND PROOFIN
 G MATERIAL:GUID
 E:PAPER FEED:UP
 PER:1

114.D3B04772
 SOUND PROOFIN
 G MATERIAL:GUID
 E:PAPER FEED:UP
 PER:2

118.D3B04776
 SOUND PROOFIN
 G MATERIAL:GUID
 E:PAPER FEED:UP
 PER:6

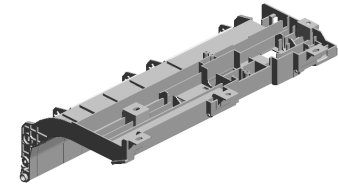

101.D3B04310
 GUIDE:PAPER FEE
 D:UPPER:SUB-ASS
 Y

115.D3B04773
 (x2)
 SOUND PROOFIN
 G MATERIAL:GUID
 E:PAPER FEED:UP
 PER:3

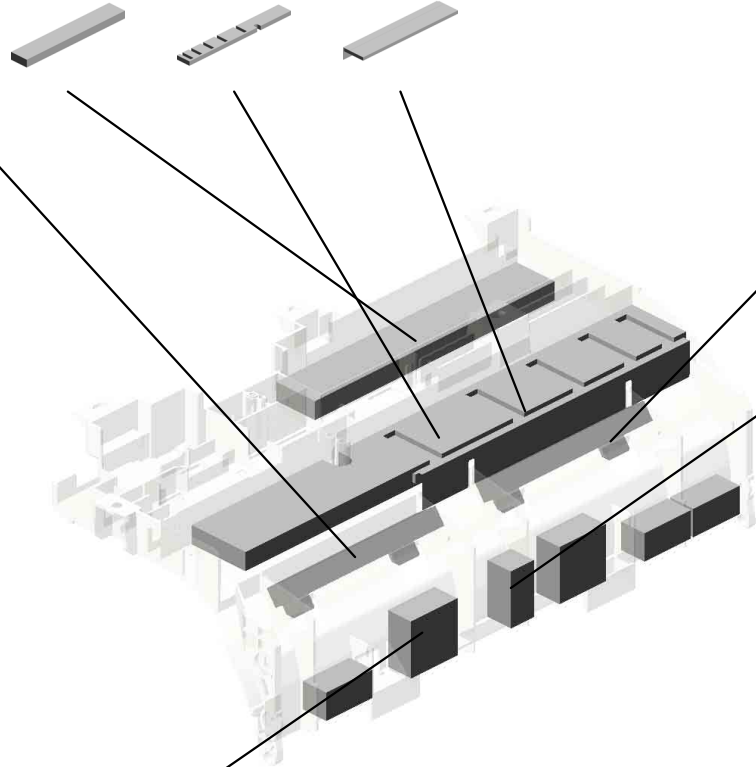

134.D5433314
 (x4)
 SHEET:SCANNING:
 ENTRANCE:MIDDL
 E

116.D3B04774
 (x4)
 SOUND PROOFIN
 G MATERIAL:GUID
 E:PAPER FEED:UP
 PER:4

117.D3B04775
 (x2)
 SOUND PROOFIN
 G MATERIAL:GUID
 E:PAPER FEED:UP
 PER:5

U003_S001_S010
COVER:LOWER RIGHT:ASS'Y

281.D6834442
(x2)
TAPE:PRESSURE
PLATE

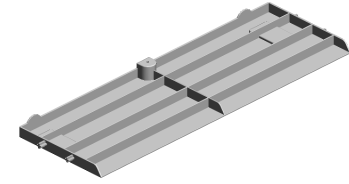
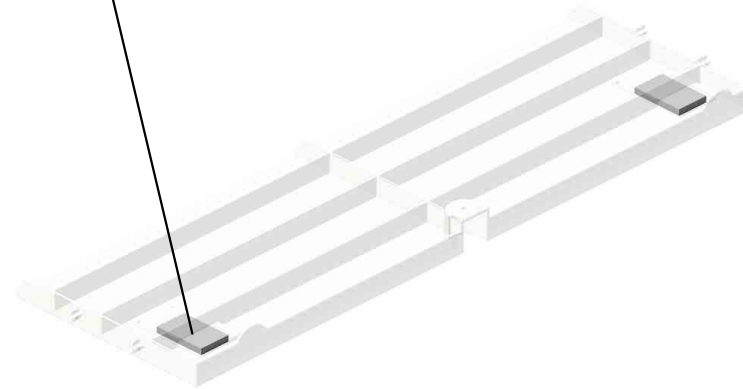
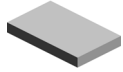

282.D6834510
COVER:LOWER RI
GHT:ASS'Y

U001	U002	U003	U004	U005	U006	U007	U008	U009	U010	U011	U012	U013	U014	U015	U016	U017	U018	U019	U020	U021
------	------	------	------	------	------	------	------	------	------	------	------	------	------	------	------	------	------	------	------	------

U003_S001_S011
SHAFT:REVERSE ROLLER:SUB-ASS'Y

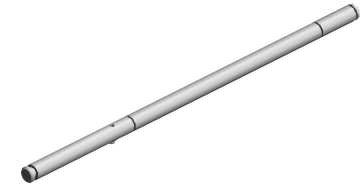

155.D6831632
SHAFT:REVERSE
ROLLER:SUB-ASS'
Y

10.07200040E (x 1)
RETAINING RING - M4

U001	U002	U003	U004	U005	U006	U007	U008	U009	U010	U011	U012	U013	U014	U015	U016	U017	U018	U019	U020	U021
------	------	------	------	------	------	------	------	------	------	------	------	------	------	------	------	------	------	------	------	------

U003_S001_S012

SHAFT:INPUT:PAPER FEED:SUB-ASS'Y

12.07433806
RADIAL BALL BEA
RING: DIA6X DIA13X
5

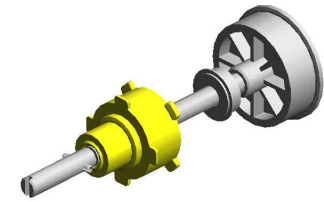
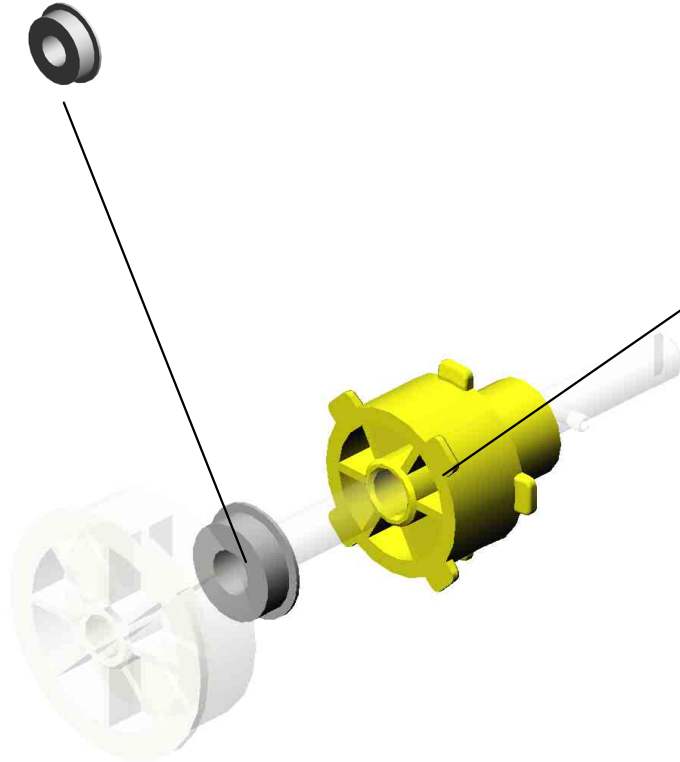

157.D6831640
SHAFT:INPUT:PAP
ER FEED:SUB-ASS'
Y

10.07200040E (x 1)
RETAINING RING - M4

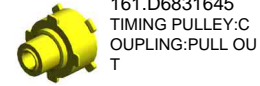

161.D6831645
TIMING PULLEY:C
OUPLING:PULL OU
T

U001	U002	U003	U004	U005	U006	U007	U008	U009	U010	U011	U012	U013	U014	U015	U016	U017	U018	U019	U020	U021
------	------	------	------	------	------	------	------	------	------	------	------	------	------	------	------	------	------	------	------	------

U004.SCANNER

U004_S004
D2581769
ILLUMINATION UNIT:LED-B:A
SS'Y

U004_S003
D2581769
ILLUMINATION UNIT:LED-B:A
SS'Y

U004_S001
D2581739
LENSBLOCK SMD:ASS'Y

U004_S002
D2581751
CARRIAGE:NO.1:ASS'Y

U004_S005
D2581776
CARRIAGE:NO.2:ASS'Y

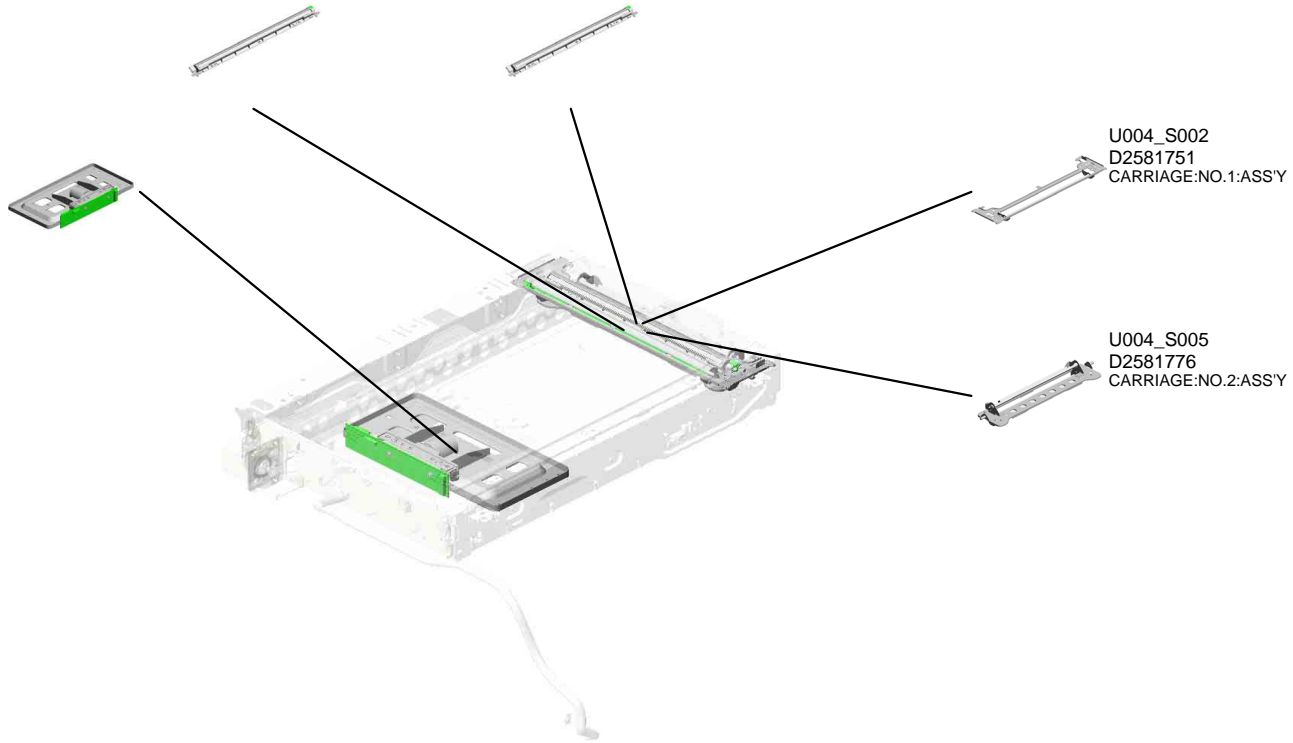

U001	U002	U003	U004	U005	U006	U007	U008	U009	U010	U011	U012	U013	U014	U015	U016	U017	U018	U019	U020	U021
------	------	------	-------------	------	------	------	------	------	------	------	------	------	------	------	------	------	------	------	------	------

U004 SCANNER

- 17.A2501752 EXPOSURE GLASS
- 11.08046123 (x7) HEXAGONAL BOLT :W/WASHER:M3X8
- 8.07200040E (x2) RETAINING RING - M4
- 3.03530060N (x18) BIND SCREW - M3 X6
- 18.AA143537 (x5) SCREW:M3:BLACK



- 1.03130060N (x4) SCREW - M3X6

- 16.A2324666 CUSHION - STEPPER MOTOR

- 21.AW010160 (x2) ORIGINAL SENSOR:48MM:5V

- 6.04543006Q (x13) TAPPING SCREW - M3X6

- 14.11050762 CLAMP:LWS-0711A

- 12.11050723 (x2) CLAMPS:WES-0507

- 9.07433808 (x2) RADIAL BALL BEARING: DIA8X DIA16X5

- 10.08025312 (x3) TAPPING SCREW: WASHER:3X10

- 4.03603006N (x37) SCREW - M3X6

- 13.11050758 (x17) CLAMP:LWSM-0306A

- 7.07074050N (x2) BUSHING - 4X5

- 5.03604010N (x4) SCREW:M4X10

- 19.AA161104 (x2) CUSHION - MOTOR

- 22.AW020207 PHOTOINTERRUPTOR:FLAT:PICH2MM:M4

- 2.03140120N SCREW - M4X12



- 13.11050758 (x2) CLAMP:LWSM-0306A

- 15.16072258 FERRITE CORE:K3 NFR-10BK0

U004 SCANNER

42.D1491715 PULLEY:DRIVE WERE:FRONT
 24.D0291749 PULLEYTECTION
 37.D1361810 (x2) TENSION SPRING: TENSION:11N
 36.D1361809 (x2) BRACKET:TENSIO
 35.D1361806 (x2) DRIVE WERE:DIA1

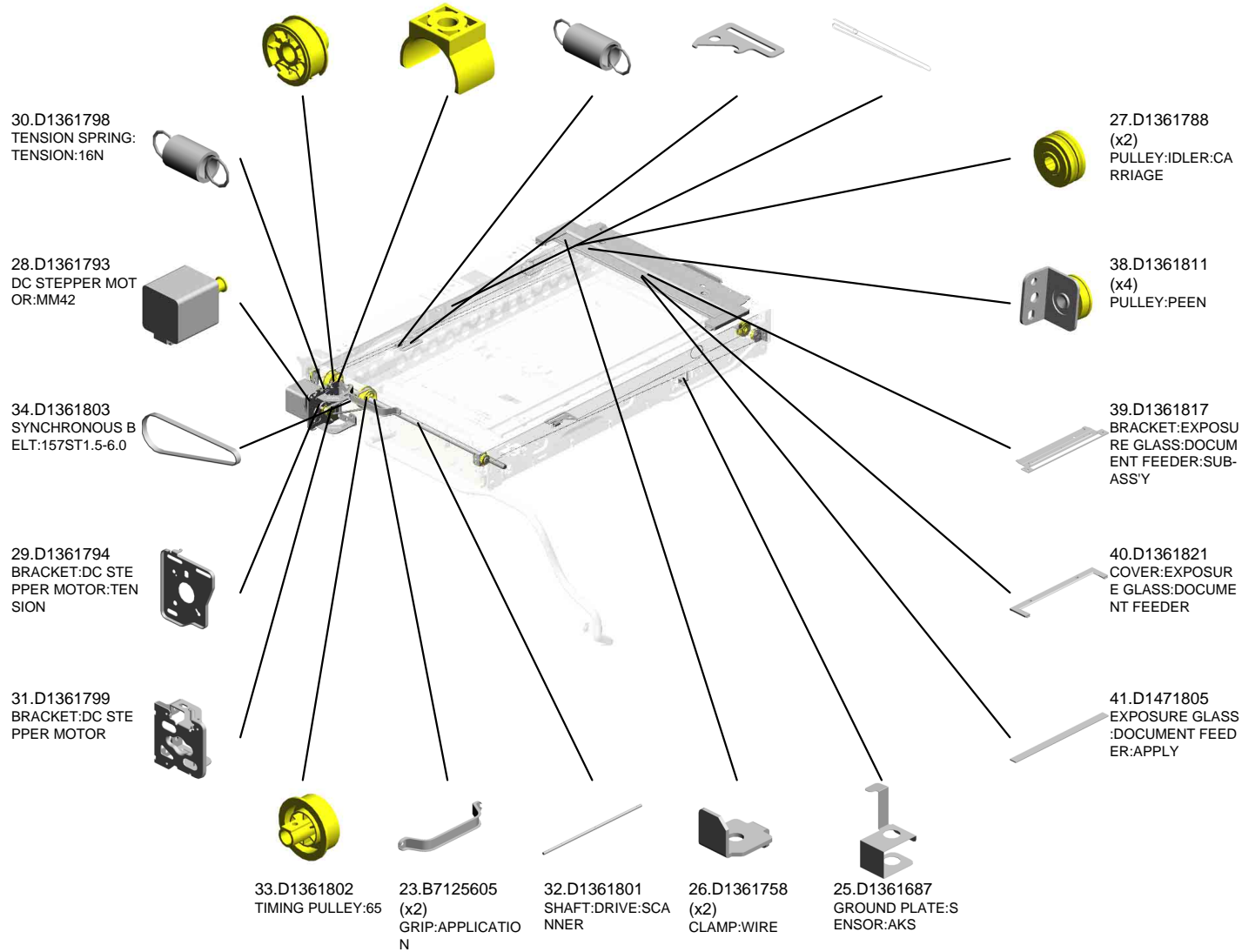

U004 SCANNER

44.D1491804
(x2)
HOLDER:EXPOSURE
GLASS:SCANNER

57.D2581759
GUIDE:FFC:CARRIAGE
NO.1:FRONT

66.D2581822
(x3)
(EU/AA/KOR/TWN/
CHN):SCALE:LEFT:
ASS'Y

67.D2581828
(NA):SCALE:LEFT:
ASS'Y

58.D2581760
GUIDE:FFC:CARRIAGE
NO.1:MIDDLE

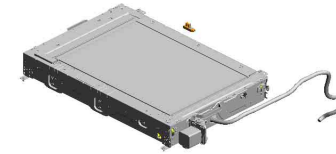

50.D2581715
GUIDE:FFC:BASE

52.D2581718
SHEET:FFC:BASE

54.D2581727
INNER COVER:SCANNER

51.D2581717
COVER:SHAFT:SCANNER

47.D2231805
(x4)
HOLDER:EXPOSURE
GLASS

53.D2581719
COVER:PULLEY

68.D2585832
INTERFACE CABLE:
SBU:BICU:ASS'Y

43.D1491717
PULLEY:DRIVE WHEEL:
REAR

48.D2411738
(x3)
(EU/AA/KOR/TWN/
CHN):SCALE:REAR:
PRINTING:MM

49.D2411739
(NA):SCALE:REAR:
PRINTING:INCH

64.D2581786
GUIDE:FFC:CARRIAGE
NO.2

65.D2581787
SIDE PLATE:GUIDE:
FFC:CARRIAGE:
NO.2

46.D2231763
(x2)
INSULATING SHEET:
LED:CONNECTOR

45.D2231762
(x2)
INSULATING SHEET:
LED

59.D2581761
GUIDE:FFC:CARRIAGE
NO.1:REAR

U004 SCANNER

70.G5701225
SENSOR SHIELDIN
G PLATE

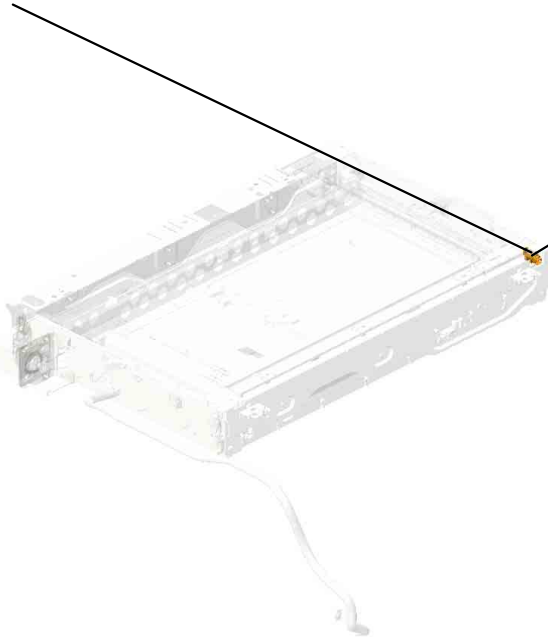

71.GW020022
PHOTOINTERRUP
TOR:LG2A24BL1

U001	U002	U003	U004	U005	U006	U007	U008	U009	U010	U011	U012	U013	U014	U015	U016	U017	U018	U019	U020	U021
------	------	------	-------------	------	------	------	------	------	------	------	------	------	------	------	------	------	------	------	------	------

U004_S001
LENSBLOCK SMD:ASS'Y

4.03603006N
(x5)
SCREW - M3X6

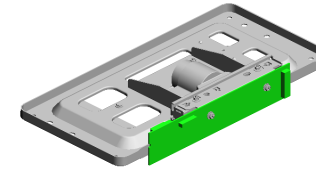

55.D2581739
LENSBLOCK SMD:
ASS'Y

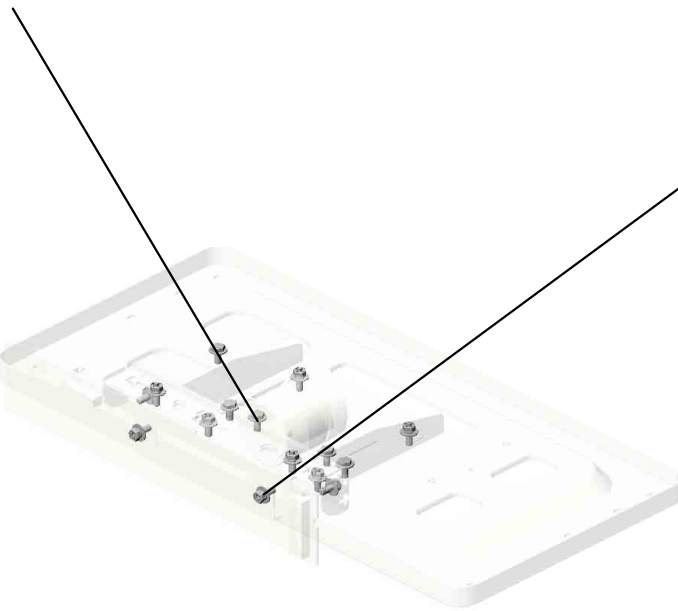

11.08046123
(x10)
HEXAGONAL BOLT
:W/WASHER:M3X8

U001	U002	U003	U004	U005	U006	U007	U008	U009	U010	U011	U012	U013	U014	U015	U016	U017	U018	U019	U020	U021
------	------	------	------	------	------	------	------	------	------	------	------	------	------	------	------	------	------	------	------	------

U004_S002
CARRIAGE:NO.1:ASS'Y

72.M0261815
(x2)
CLAMP:MIRROR:N
O.1



20.AC030211
MIRROR:NO.1

U001	U002	U003	U004	U005	U006	U007	U008	U009	U010	U011	U012	U013	U014	U015	U016	U017	U018	U019	U020	U021
------	------	------	------	------	------	------	------	------	------	------	------	------	------	------	------	------	------	------	------	------

U004_S003
ILLUMINATION UNIT:LED-B:ASS'Y

3.03530060N
(x3)
BIND SCREW - M3
X6



60.D2581769
ILLUMINATION UNI
T:LED-B:ASS'Y

U001	U002	U003	U004	U005	U006	U007	U008	U009	U010	U011	U012	U013	U014	U015	U016	U017	U018	U019	U020	U021
------	------	------	-------------	------	------	------	------	------	------	------	------	------	------	------	------	------	------	------	------	------

U004_S004
ILLUMINATION UNIT:LED-B:ASS'Y

3.03530060N
(x3)
BIND SCREW - M3
X6



60.D2581769
ILLUMINATION UNI
T:LED-B:ASS'Y

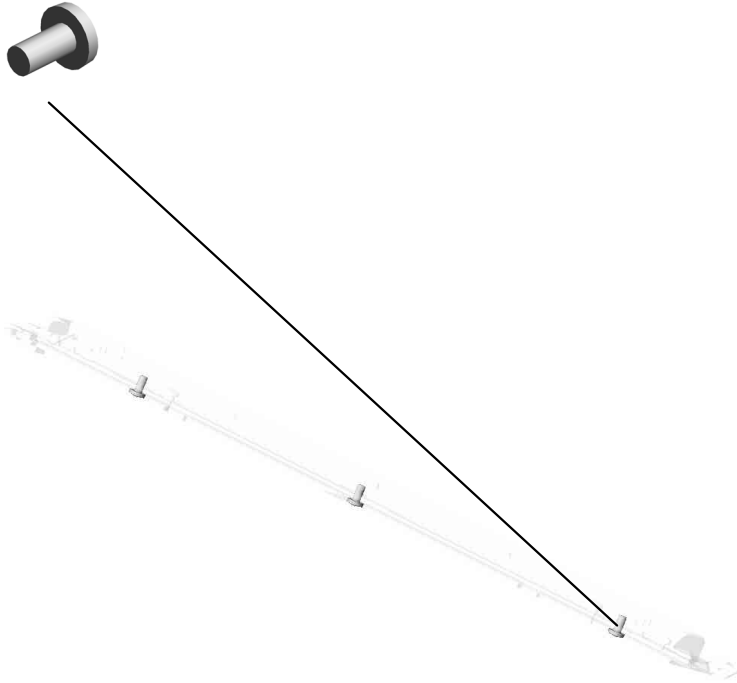

U001	U002	U003	U004	U005	U006	U007	U008	U009	U010	U011	U012	U013	U014	U015	U016	U017	U018	U019	U020	U021
------	------	------	-------------	------	------	------	------	------	------	------	------	------	------	------	------	------	------	------	------	------

U004_S005
CARRIAGE:NO.2:ASS'Y

62.D2581784
MIRROR:NO.2:CON
CAVE:ASS'Y

63.D2581785
MIRROR:NO.3:CON
VEX:ASS'Y



61.D2581776
CARRIAGE:NO.2:A
SS'Y



69.G4042810
(x4)
SPRING PLATE - 2
ND MIRROR

U001	U002	U003	U004	U005	U006	U007	U008	U009	U010	U011	U012	U013	U014	U015	U016	U017	U018	U019	U020	U021
------	------	------	------	------	------	------	------	------	------	------	------	------	------	------	------	------	------	------	------	------

U005
LASER UNIT

1.D2581940
(x2)
OPTICAL WRITING
UNIT:SERVICE PA
RTS

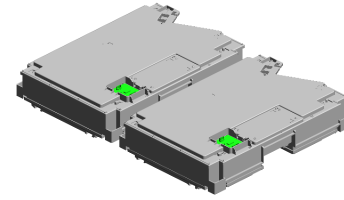
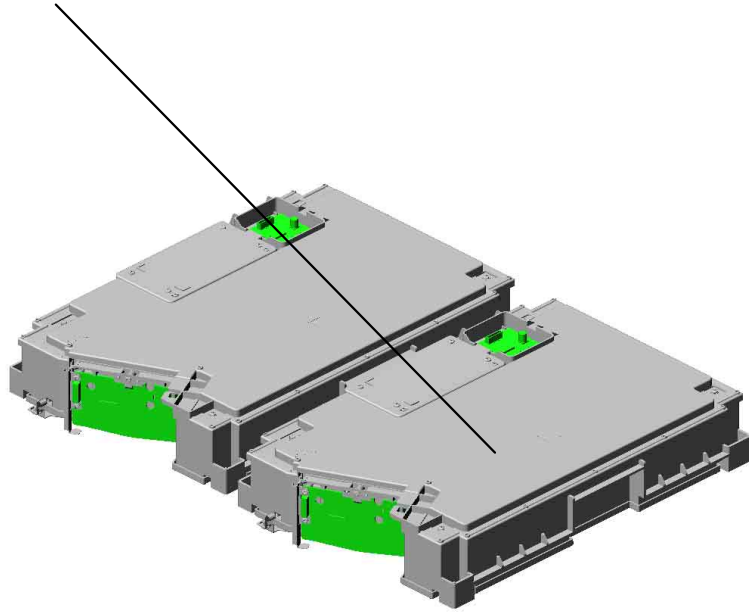

U001	U002	U003	U004	U005	U006	U007	U008	U009	U010	U011	U012	U013	U014	U015	U016	U017	U018	U019	U020	U021
------	------	------	------	-------------	------	------	------	------	------	------	------	------	------	------	------	------	------	------	------	------

U006.BY-PASS FEED

U006_S003
D2612802
MANUAL FEED UNIT:ASS'Y

U006_S001
D2582652
GUIDE PLATE:REGISTRATIO
N:ASS'Y

U006_S002
D2612635
COVER:REGISTRATION:UPP
ER:ASS'Y

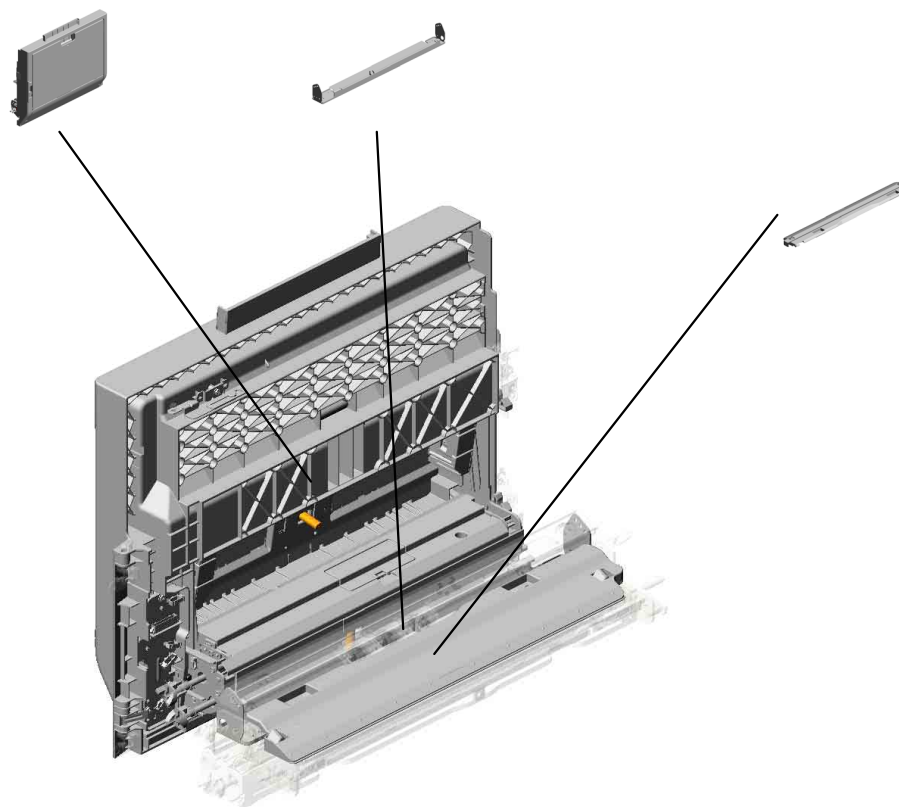

U001	U002	U003	U004	U005	U006	U007	U008	U009	U010	U011	U012	U013	U014	U015	U016	U017	U018	U019	U020	U021
------	------	------	------	------	-------------	------	------	------	------	------	------	------	------	------	------	------	------	------	------	------

U006_S003.MANUAL FEED UNIT:ASS'Y

U006_S003_S002
D2612805
MANUAL FEED TABLE:ASS'Y

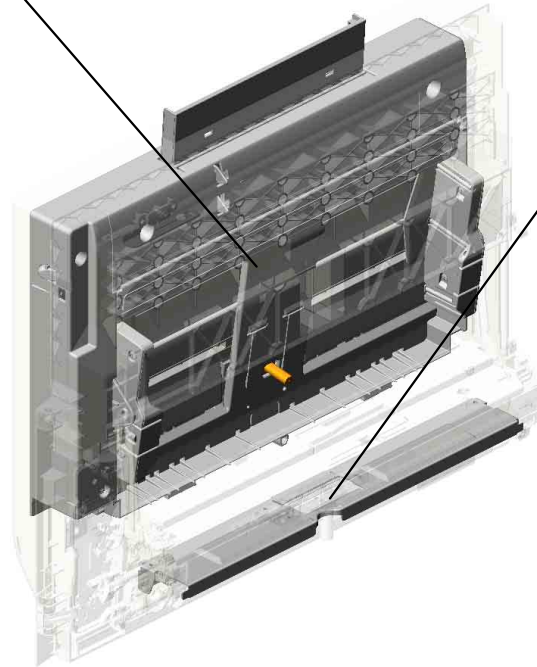

U006_S003_S001
D2612765
GUIDE PLATE:SEPARATOR:
ASS'Y



U001	U002	U003	U004	U005	U006	U007	U008	U009	U010	U011	U012	U013	U014	U015	U016	U017	U018	U019	U020	U021
------	------	------	------	------	-------------	------	------	------	------	------	------	------	------	------	------	------	------	------	------	------

U006_S003_S002.MANUAL FEED TABLE:ASS'Y

U006_S003_S002_S001
D2612784
SIDE FENCE:REAR:ASS'Y

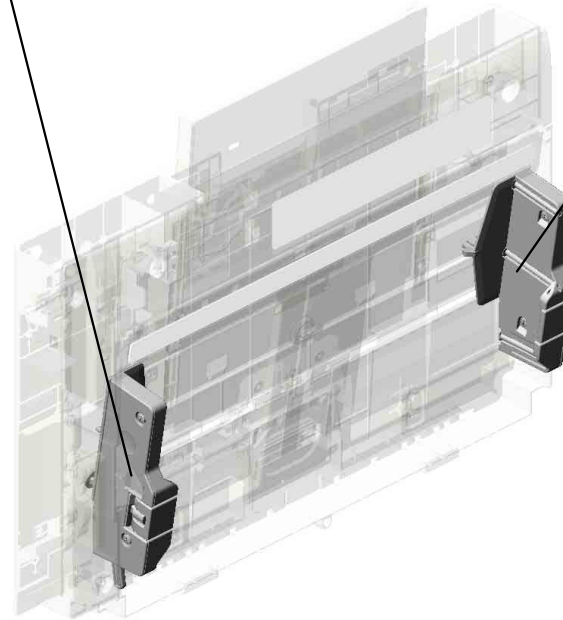

U006_S003_S002_S002
D2612866
SIDE FENCE:FRONT:ASS'Y



U001	U002	U003	U004	U005	U006	U007	U008	U009	U010	U011	U012	U013	U014	U015	U016	U017	U018	U019	U020	U021
------	------	------	------	------	-------------	------	------	------	------	------	------	------	------	------	------	------	------	------	------	------

U006 BY-PASS FEED

40.AA100014
RETAINING RING
C - SEPARATE

41.AA143599
STEPPED SCREW:
M3:ROUND POINT

6.04543006N
(x2)
TAPPING SCREW:
ROUND POINT:3X6

31.AA061234
TENSION SPRING:
REGISTRATION:D
RIVEN

9.04543008Q
(x4)
TAPPING SCREW:
3X8

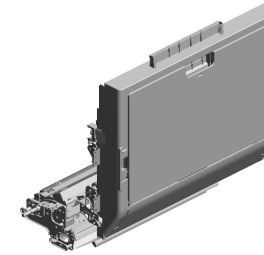

11.04583010N
(x3)
HEXAGON HEAD T
APPING SCREW:3
X10

36.AA063746
TORSION SPRING:
COVER:REGISTRA
TION

35.AA063745
COMPRESSION SP
RING:LEVER:OPEN
/CLOSE

16.07200060E
(x8)
RETAINING RING -
M6

12.06320140G
(x2)
PARALLEL PIN

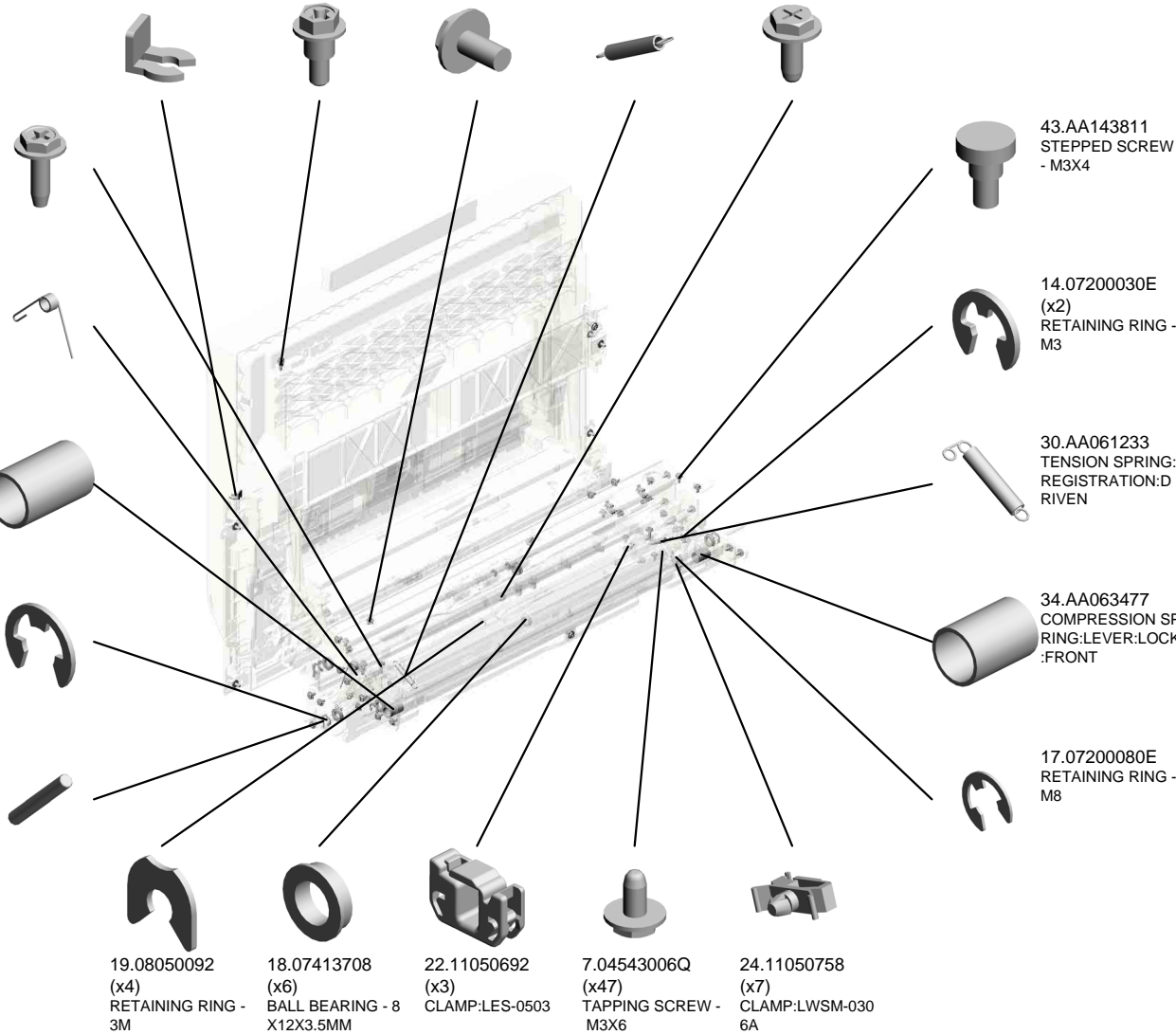

19.08050092
(x4)
RETAINING RING -
3M

18.07413708
(x6)
BALL BEARING - 8
X12X3.5MM

22.11050692
(x3)
CLAMP:LES-0503

7.04543006Q
(x47)
TAPPING SCREW -
M3X6

24.11050758
(x7)
CLAMP:LWSM-030
6A

43.AA143811
STEPPED SCREW
- M3X4

14.07200030E
(x2)
RETAINING RING -
M3

30.AA061233
TENSION SPRING:
REGISTRATION:D
RIVEN

34.AA063477
COMPRESSION SP
RING:LEVER:LOCK
:FRONT

17.07200080E
RETAINING RING -
M8

U006 BY-PASS FEED

- 68.D1362665 GUIDE PLATE:CONNECTING:MANUAL FEED:UPPER:ASSY
- 69.D1362670 (x3) ROLLER:DIA18:CONNECTING:MANUAL FEED
- 66.D1362660 GUIDE PLATE:CONNECTING:MANUAL FEED:LOWER:ASSY
- 72.D1362678 COVER:MANUAL FEED:ENTRANCE:UPPER
- 57.AW020209 (x2) ENCODER:PAPER THICK

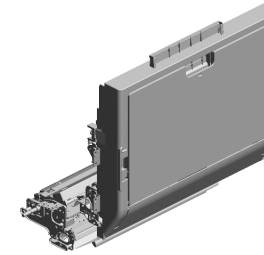

67.D1362663
GUIDE:CONNECTING:MANUAL FEED:LOWER

61.B2342399
(x2)
BOLT - M3X6

71.D1362673
(x8)
PLAIN SHAFT BEARING:CONNECTING

75.D1362715
(x12)
TENSION SPRING:DRIVEN:CONNECTING

63.D1362573
(x3)
COLLAR:REGISTRATION:DRIVE

64.D1362581
PLAIN SHAFT BEARING:LEVER:OPEN AND CLOSE:INNER BACK

76.D1362718
GUIDE PLATE:CONNECTING:FRONT LEFT

77.D1362719
GUIDE:CONNECTING:FRONT LEFT

73.D1362712
GUIDE:CONNECTING:DRIVEN

70.D1362671
(x2)
SHAFT:DRIVEN ROLLER:ENCODER

59.AW500040
(x2)
PUSH SWITCH:SW 1AG-550:10MA

48.AB011570
GEAR:Z20:DRIVEN:REGISTRATION ROLLER

47.AB011569
GEAR:Z25:DRIVE:REGISTRATION ROLLER

74.D1362714
(x3)
ROLLER:CONNECTING:DIA20

51.AF020798
REGISTRATION ROLLER:DRIVE

U006 BY-PASS FEED

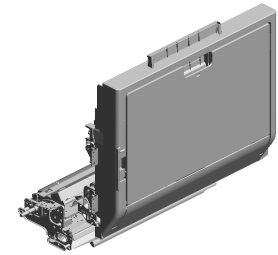
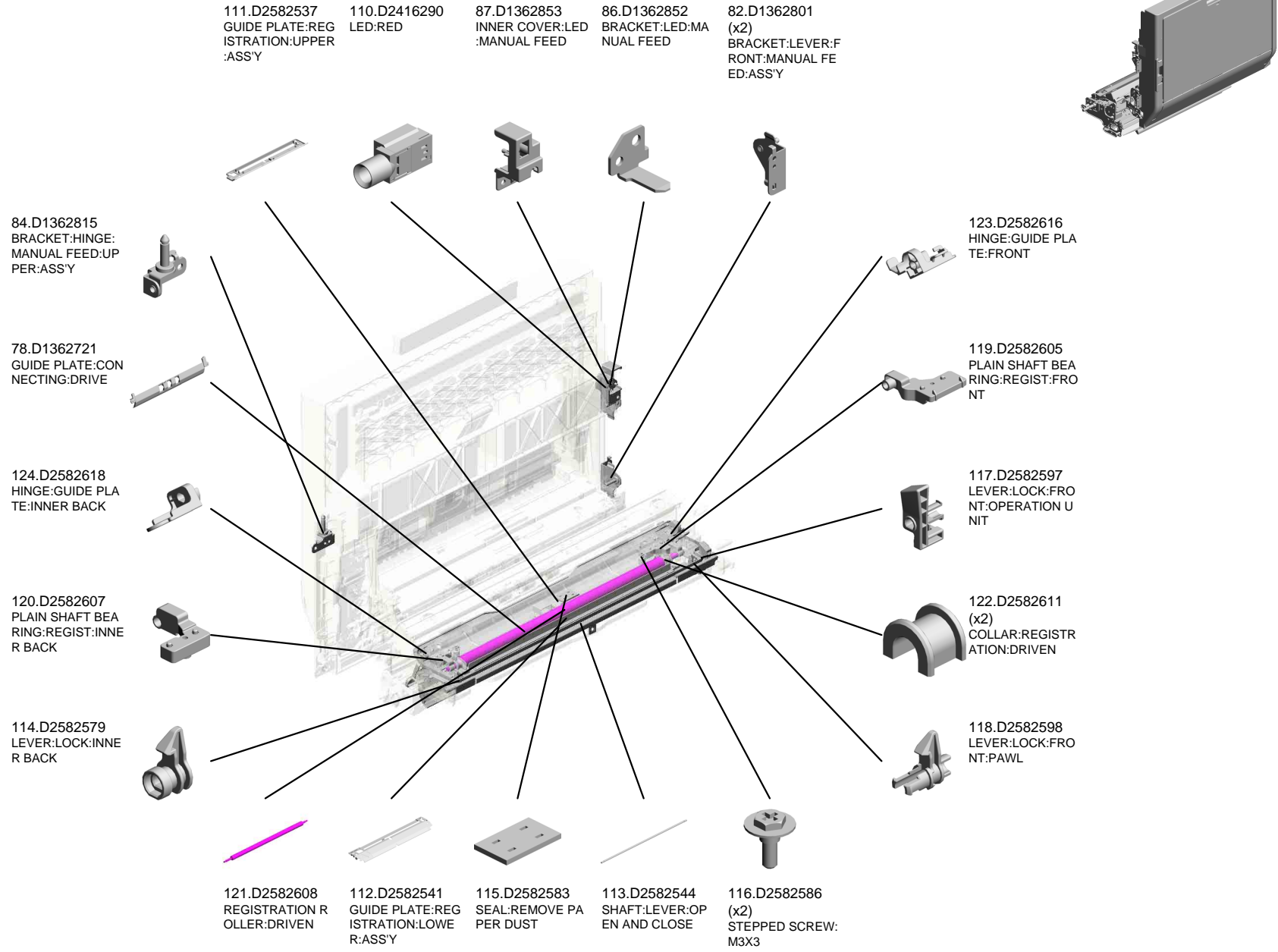

U006 BY-PASS FEED

131.D2582656 TRANSPORT ROLLER:CONNECTING:MANUAL FEED:DRIVER
 133.D2582672 (x2) SHAFT:DRIVEN ROLLER
 174.D2612870 GUIDE:COVER:MANUAL FEED
 139.D2582848 GUIDE:POSITIONING:FRONT:MANUAL FEED UNIT

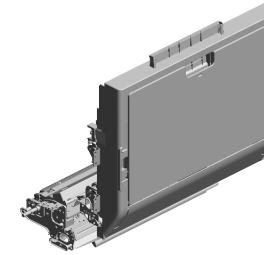

135.D2582729 TRANSPORT ROLLER:CONNECTING:DRIVE

137.D2582816 BRACKET:HINGE:MANUAL FEED:LOWER:ASSY

127.D2582630 BRACKET:STUD:REGISTRATION:INNER BACK:ASSY

132.D2582657 (x2) JOINT:CONNECTING:DRIVE

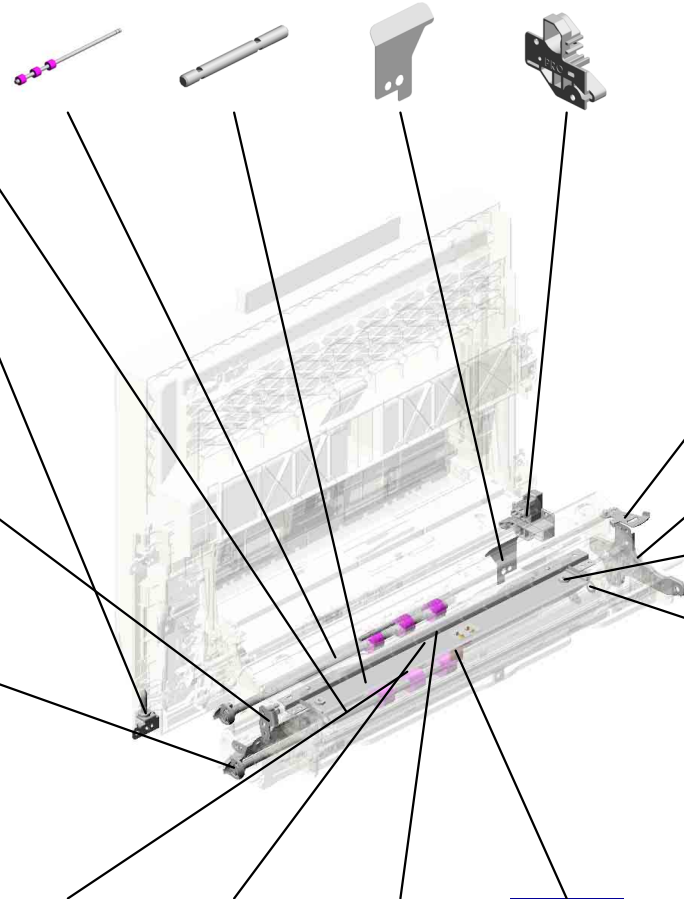

129.D2582648 ADJUSTING PIN:REGISTRATION:ASSY

128.D2582647 BRACKET:MIDDLE:REGISTRATION

126.D2582626 (x2) SEAL:REMOVE PAPER DUST:STEPPED SCREW

196.H5192415 (x2) WASHER:MM7.2

134.D2582708 GUIDE PLATE:DRIVEN:CONNECTING

195.GW010007 (x2) PHOTO REFLECTION SENSOR:EXIT

125.D2582622 BRACKET:REMOVE PAPER DUST:ASSY

197.M0262657 SHEET:VERTICAL TRANSPORT:SENSOR

U006_S001
GUIDE PLATE:REGISTRATION:ASS'Y

42.AA143702
SCREW:PIN:POSIT
IONING

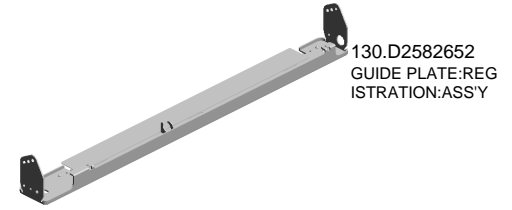

130.D2582652
GUIDE PLATE:REG
ISTRATION:ASS'Y

U001	U002	U003	U004	U005	U006	U007	U008	U009	U010	U011	U012	U013	U014	U015	U016	U017	U018	U019	U020	U021
------	------	------	------	------	-------------	------	------	------	------	------	------	------	------	------	------	------	------	------	------	------

U006_S002
COVER:REGISTRATION:UPPER:ASS'Y

29.AA003067
DECAL:PUSH



27.AA000290
(x2)
DECAL:POSITIONI
NG DISPLAY:SCRE
W:PET



28.AA003055
DECAL:COVER:PU
SH

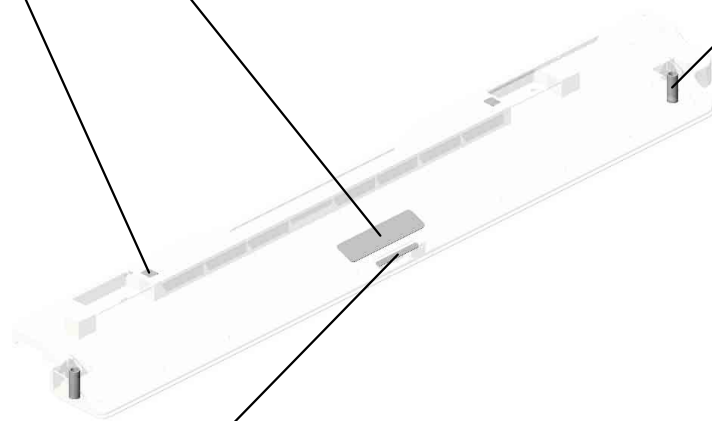

143.D2612635
COVER:REGISTRA
TION:UPPER:ASS'
Y



65.D1362639
(x2)
COMPRESSION SP
RING:COVER:REGI
STRATION

U006_S003
MANUAL FEED UNIT:ASS'Y

10.04583008N
HEXAGON HEAD TAPPING SCREW:3 X8

3.03530040N (x2)
SCREW - M3X4

11.04583010N (x23)
HEXAGON HEAD TAPPING SCREW:3 X10

21.08050104 (x11)
RETAINING RINGS -E:SILENCER:DIA4

14.07200030E (x2)
RETAINING RING - M3

159.D2612802
MANUAL FEED UNIT:ASS'Y

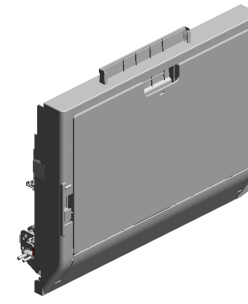

24.11050758 (x5)
CLAMP:LWSM-030 6A



25.11050760 (x3)
CLAMP:LWSM-051 1A

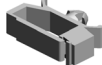

39.AA083018
ROLLER CLUTCH - 6X14X10



15.07200040E (x3)
RETAINING RING - M4



12.06320140G (x2)
PARALLEL PIN



38.AA083014
ONE-WAY CLUTCH



22.11050692
CLAMP:LES-0503



32.AA062174
COIL SPRING:PRE SSURE:SEPARATOR:2.9N



45.AB011387
GEAR - 23Z



37.AA082173 (x5)
PLAIN SHAFT BEARING RING:6X10X6



33.AA062175
COIL SPRING:LEVELER:COVER:MANUAL FEED

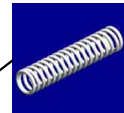

4.03603006N
SCREW - M3X6



24.11050758
CLAMP:LWSM-030 6A

7.04543006Q (x 1)
TAPPING SCREW - M3X6
8.04543008N (x 1)
TAPPING SCREW:ROUND POINT:3X8

8.04543008N (x6)
TAPPING SCREW:ROUND POINT:3X8



23.11050723
CLAMPS:WES-050 7

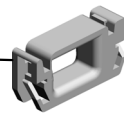

40.AA100014 (x2)
RETAINING RING C - SEPARATE



U006_S003
MANUAL FEED UNIT:ASS'Y

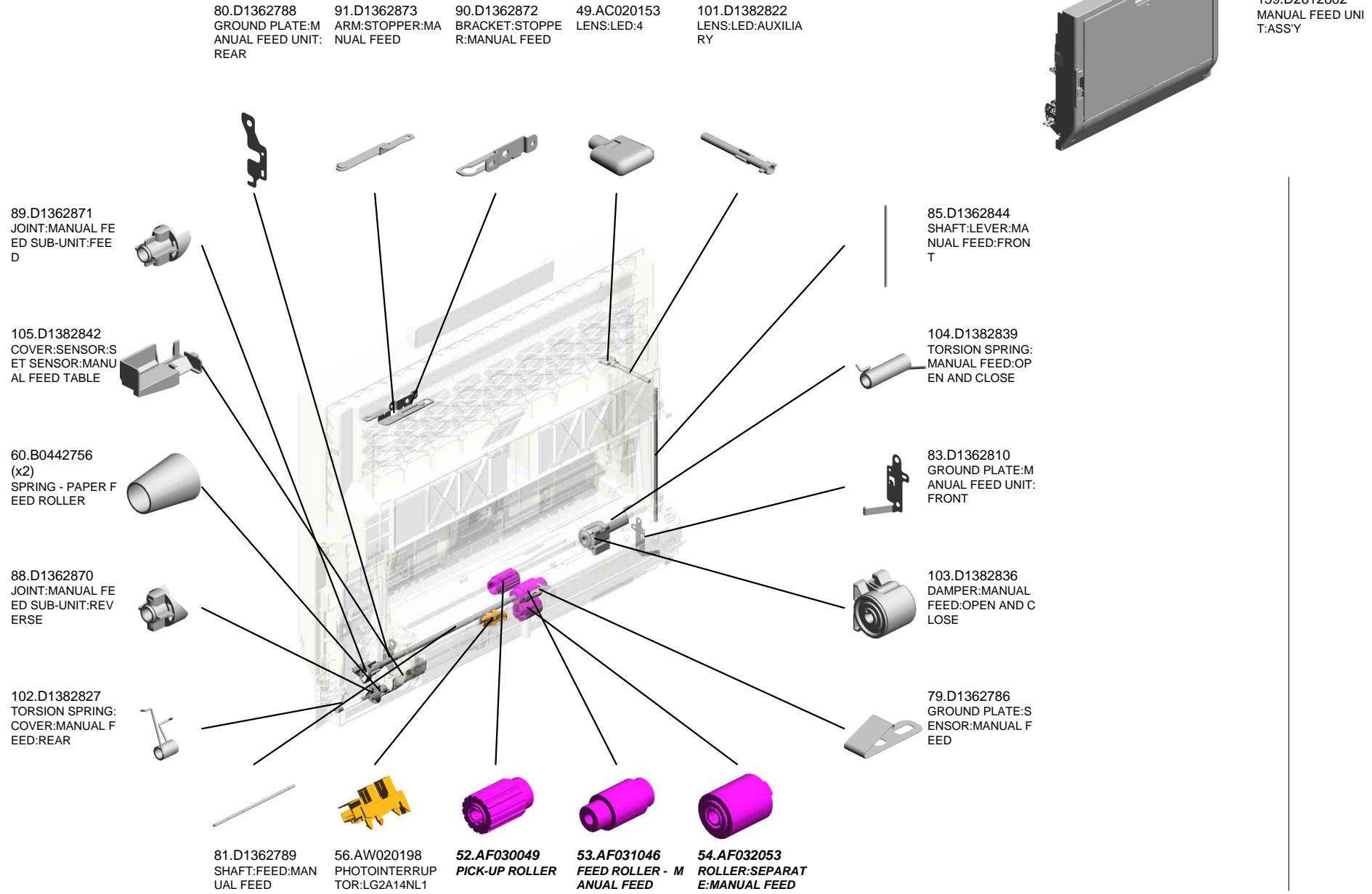

U001	U002	U003	U004	U005	U006	U007	U008	U009	U010	U011	U012	U013	U014	U015	U016	U017	U018	U019	U020	U021
------	------	------	------	------	------	------	------	------	------	------	------	------	------	------	------	------	------	------	------	------

U006_S003 MANUAL FEED UNIT:ASS'Y

150.D2612770 ARM:MANUAL FEE
D:REAR:250:PEEN
157.D2612795 DC SOLENOID:PIC
KUP:MANUAL FEE
D:ASSY
165.D2612834 COVER:MANUAL F
EED:LOWER
171.D2612862 COVER:MANUAL F
EED
146.D2612714 SHEET:LEVER

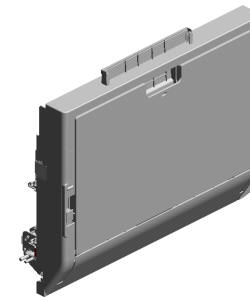

159.D2612802
MANUAL FEED UNI
T:ASSY

151.D2612775
ARM:MANUAL FEE
D:SHORT:REAR

148.D2612762
BRACKET:ARM:MA
NUAL FEED:REAR:
ASSY

170.D2612850
BRACKET:GROUN
D PLATE:MANUAL
FEED:ASSY

140.D2582854
GROUND PLATE:M
ANUAL FEED:REA
R

138.D2582829
GROUND PLATE:M
ANUAL FEED:COV
ER:REAR

145.D2612712
SHAFT:SEPARATO
R:DRIVE

144.D2612703
SHAFT:SEPARATO
R:DRIVEN:ASSY

154.D2612783
TORQUE LIMITER:
80MN/M:DA18

136.D2582778
COVER:MANUAL F
EED UNIT

141.D2582890
COVER:COVER:MA
NUAL FEED UNIT

162.D2612824
BRACKET:COVER:
MANUAL FEED:FR
ONT:ASSY

167.D2612840
ARM:MANUAL FEE
D:FRONT:250

142.D2582953
TAPE:GUIDE

152.D2612778
SHAFT:MANUAL F
EED:OPEN/CLOSE

109.D1382862
TORSION SPRING:
COVER:MANUAL F
EED:FRONT

U006_S003
 MANUAL FEED UNIT:ASS'Y

181.D2612934 COIL SPRING:REL
 EASE:PICKUP:MAN
 UAL FEED

187.D2612948 BALANCER:FRICTI
 ON:MANUAL FEED:
 ASSY

182.D2612935 COIL SPRING:PRE
 SSURE:PICKUP

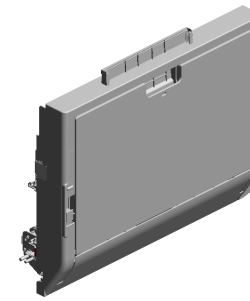

159.D2612802
 MANUAL FEED UNI
 T:ASSY

183.D2612936
 CAP:CONNECTOR



190.D2612970
 SHEET:GUARD:HA
 RNESS

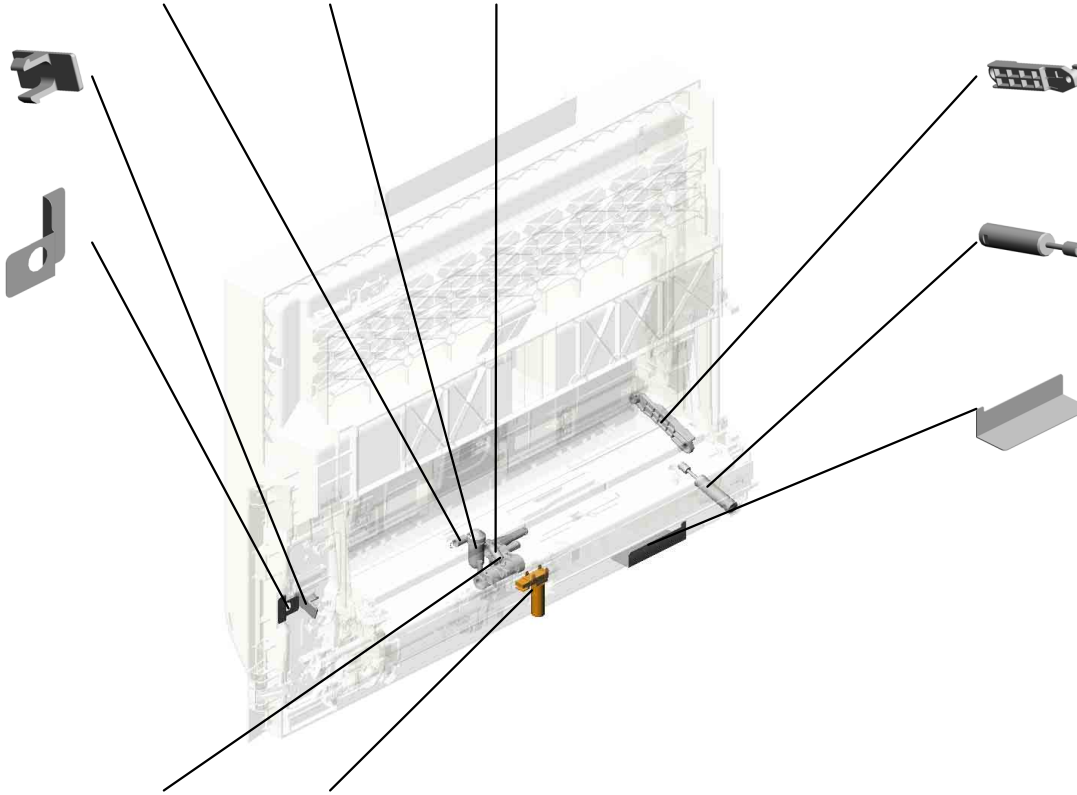

192.D2612973
 ARM:MANUAL FEE
 D:SHORT:FRONT

191.D2612971
 OIL DAMPER:STRA
 IGH:50N

173.D2612868
 SHEET:GUIDE:CO
 VER

178.D2612925
 ARM:PICKUP:MAN
 UAL FEED

195.GW010007
 PHOTO REFLECTI
 ON SENSOR:EXIT

U001	U002	U003	U004	U005	U006	U007	U008	U009	U010	U011	U012	U013	U014	U015	U016	U017	U018	U019	U020	U021
------	------	------	------	------	-------------	------	------	------	------	------	------	------	------	------	------	------	------	------	------	------

U006_S003_S001
GUIDE PLATE:SEPARATOR:ASS'Y

59.AW500040
PUSH SWITCH:SW
1AG-550:10MA



149.D2612765
GUIDE PLATE:SEP
ARATOR:ASS'Y

U001	U002	U003	U004	U005	U006	U007	U008	U009	U010	U011	U012	U013	U014	U015	U016	U017	U018	U019	U020	U021
------	------	------	------	------	-------------	------	------	------	------	------	------	------	------	------	------	------	------	------	------	------

U006_S003_S002
MANUAL FEED TABLE:ASS'Y

1.03130030N (x2) PAN HEAD SCREW :M3X3
 62.D0812966 DC MOTOR:ASS'Y: 1.007W:BRUSH
 26.52152621 SNAP RING - M6
 24.11050758 (x2) CLAMP:LWSM-030 6A
 58.AW500039 ROTARY SWITCH: PAPER SIZE SENS OR: CW

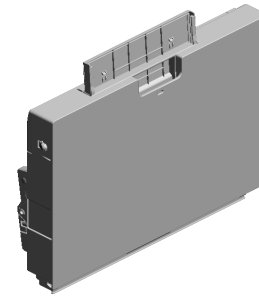

160.D2612805
MANUAL FEED TABLE:ASS'Y

7.04543006Q (x3) TAPPING SCREW - M3X6



93.D1382802 GEAR:LIFT MOTOR :1



94.D1382803 GEAR:LIFT MOTOR :2



95.D1382804 GEAR:LIFT MOTOR :3



37.AA082173 PLAIN SHAFT BEARING RING:6X10X6



21.08050104 (x2) RETAINING RINGS -E:SILENCER:DIA4



56.AW020198 (x2) PHOTOINTERRUPTOR:LG2A14NL1



4.03603006N (x3) SCREW - M3X6



50.AF013016 BOTTOM PLATE PAD



55.AW010150 PHOTO REFLECTIVE SENSOR:ORIGINAL TRAY



5.04522006N (x2) BINDING SELF-TAPPING SCREW - M2X6



10.04583008N (x22) HEXAGON HEAD TAPPING SCREW:3X8



46.AB011561 GEAR:MANUAL FEED



20.08050100 (x2) RETAINING RING - M2.5



2.03130060N SCREW - M3X6



22.11050692 CLAMP:LES-0503

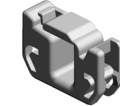

25.11050760 (x4) CLAMP:LWSM-051 1A

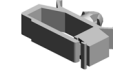

7.04543006Q (x 4) TAPPING SCREW - M3X6

U006_S003_S002
 MANUAL FEED TABLE:ASS'Y

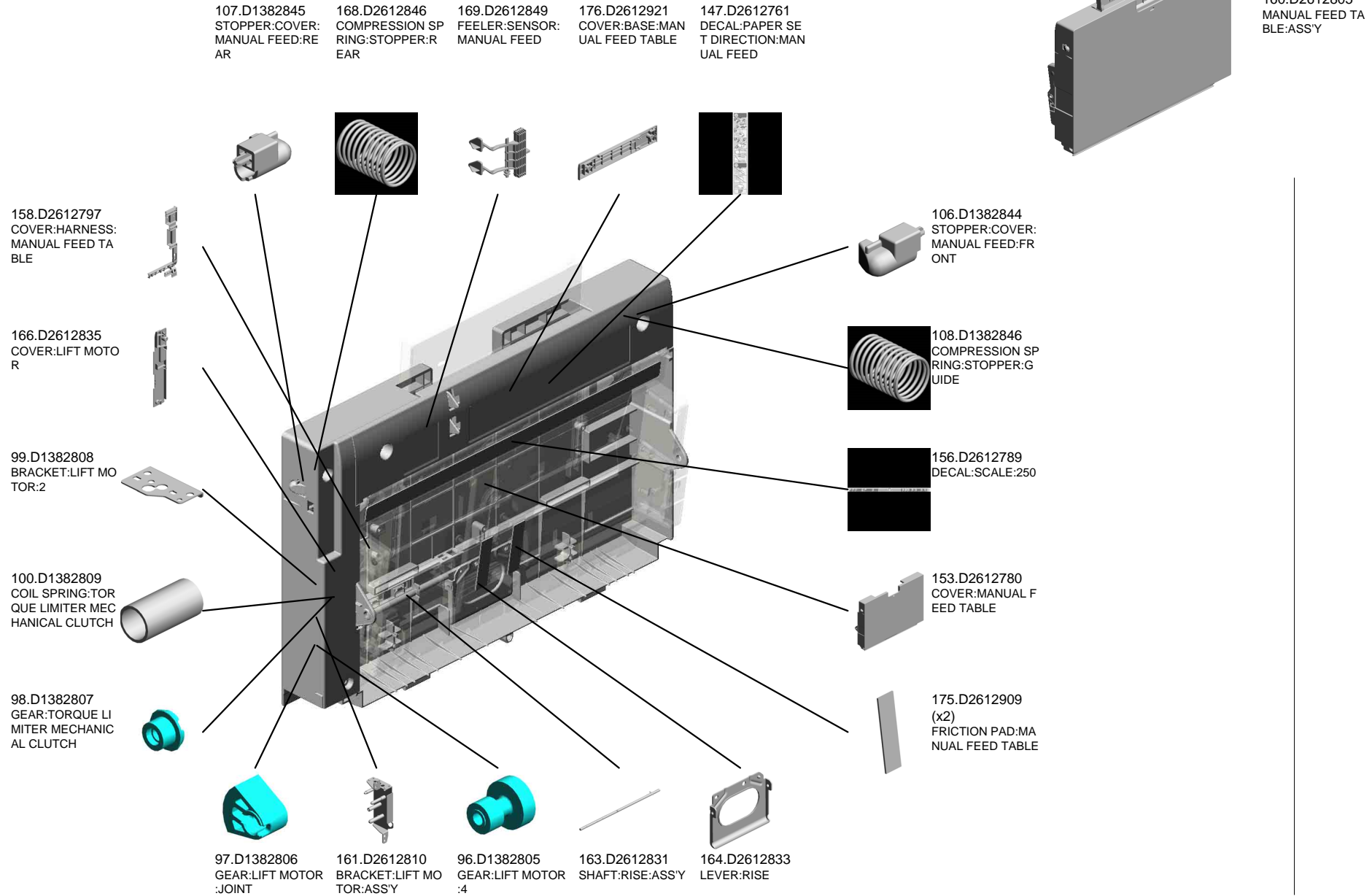

U001	U002	U003	U004	U005	U006	U007	U008	U009	U010	U011	U012	U013	U014	U015	U016	U017	U018	U019	U020	U021
------	------	------	------	------	------	------	------	------	------	------	------	------	------	------	------	------	------	------	------	------

U006_S003_S002
 MANUAL FEED TABLE:ASS'Y

179.D2612931 EXTENSION TRAY: MANUAL FEED
 180.D2612932 EXTENSION TRAY: MANUAL FEED
 193.D2612974 HOLDER:EXTENSION TRAY:FRONT

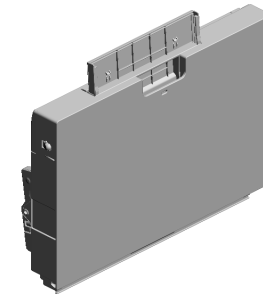

160.D2612805
 MANUAL FEED TABLE:ASS'Y

194.D2612975
 HOLDER:EXTENSION TRAY:REAR

184.D2612937
 BRACKET:LIFT MOTOR:3

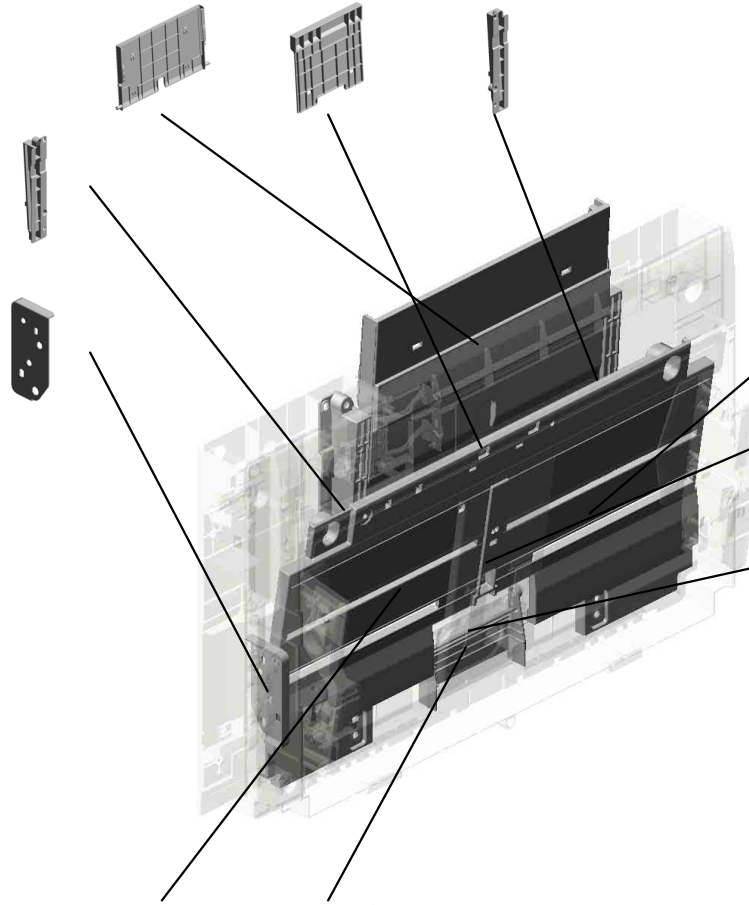

185.D2612938
 (x2)
 RAIL:LOCK:SIDE FENCE:MANUAL FEED

177.D2612922
 SEPARATION PLATE:MANUAL FEED TABLE

189.D2612953
 SHAFT:LEVER:RISE

186.D2612941
 (x2)
 RACK:MANUAL FEED:250

188.D2612952
 COVER:LEVER:RISE

U006_S003_S002_S001
SIDE FENCE:REAR:ASS'Y

13.07010020N
WASHER:DIA2

92.D1382786
DECAL:SIDE FENC
E:MANUAL FEED:2
50

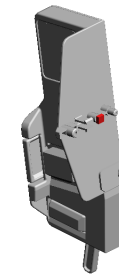

155.D2612784
SIDE FENCE:REAR
:ASS'Y

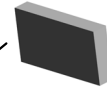
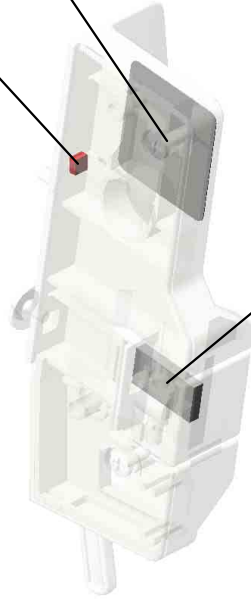

44.AA162082
CUSHION:PLATE:P
APER

U001	U002	U003	U004	U005	U006	U007	U008	U009	U010	U011	U012	U013	U014	U015	U016	U017	U018	U019	U020	U021
------	------	------	------	------	-------------	------	------	------	------	------	------	------	------	------	------	------	------	------	------	------

U006_S003_S002_S002
SIDE FENCE:FRONT:ASS'Y

13.07010020N
WASHER:DIA2

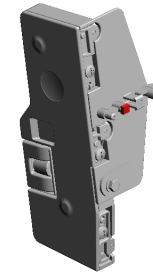
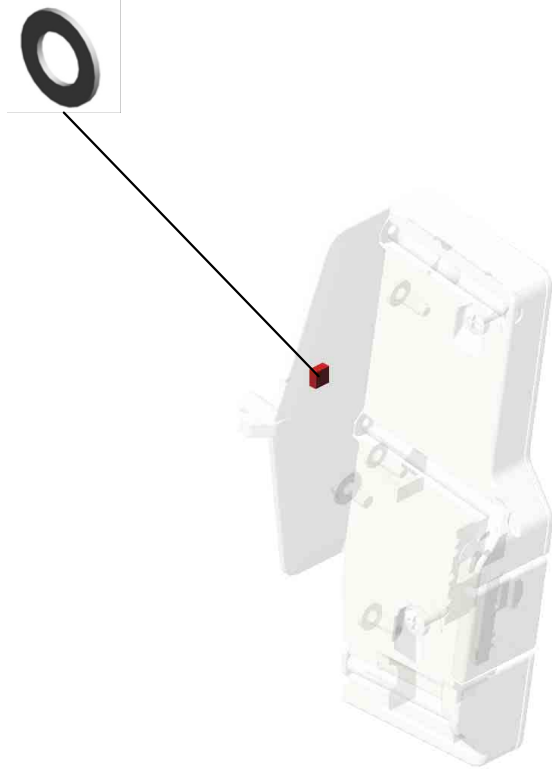

172.D2612866
SIDE FENCE:FRON
T:ASS'Y

U001	U002	U003	U004	U005	U006	U007	U008	U009	U010	U011	U012	U013	U014	U015	U016	U017	U018	U019	U020	U021
------	------	------	------	------	-------------	------	------	------	------	------	------	------	------	------	------	------	------	------	------	------

U007.PAPER FEED

U007_S005
D1386683
HEAT SINK:HEATER:UPPER:
ASS'Y

U007_S008
D2616651
PAPER FEED UNIT:NO.1:ASS
'Y

U007_S007
D2616737
DOOR:VERTICAL TRANSP
RT:ASS'Y

U007_S011
D2616712
PAPER TRAY:ASS'Y

U007_S006
D1386685
HEAT SINK:HEATER:LOWER
:ASS'Y

U007_S012
D2616713
PAPER TRAY:NO.4:ASS'Y

U007_S002
AX040281
DC MOTOR:RISING TRAY:1.0
07W:BRUSH

U007_S003
D1366751
LEVER:STRETCH:PAPER TR
AY:ASS'Y

U007_S004
D1366751
LEVER:STRETCH:PAPER TR
AY:ASS'Y

U007_S009
D2616652
PAPER FEED UNIT:NO.2:ASS
'Y

U007_S010
D2616652
PAPER FEED UNIT:NO.2:ASS
'Y

U007_S001
AX040281
DC MOTOR:RISING TRAY:1.0
07W:BRUSH

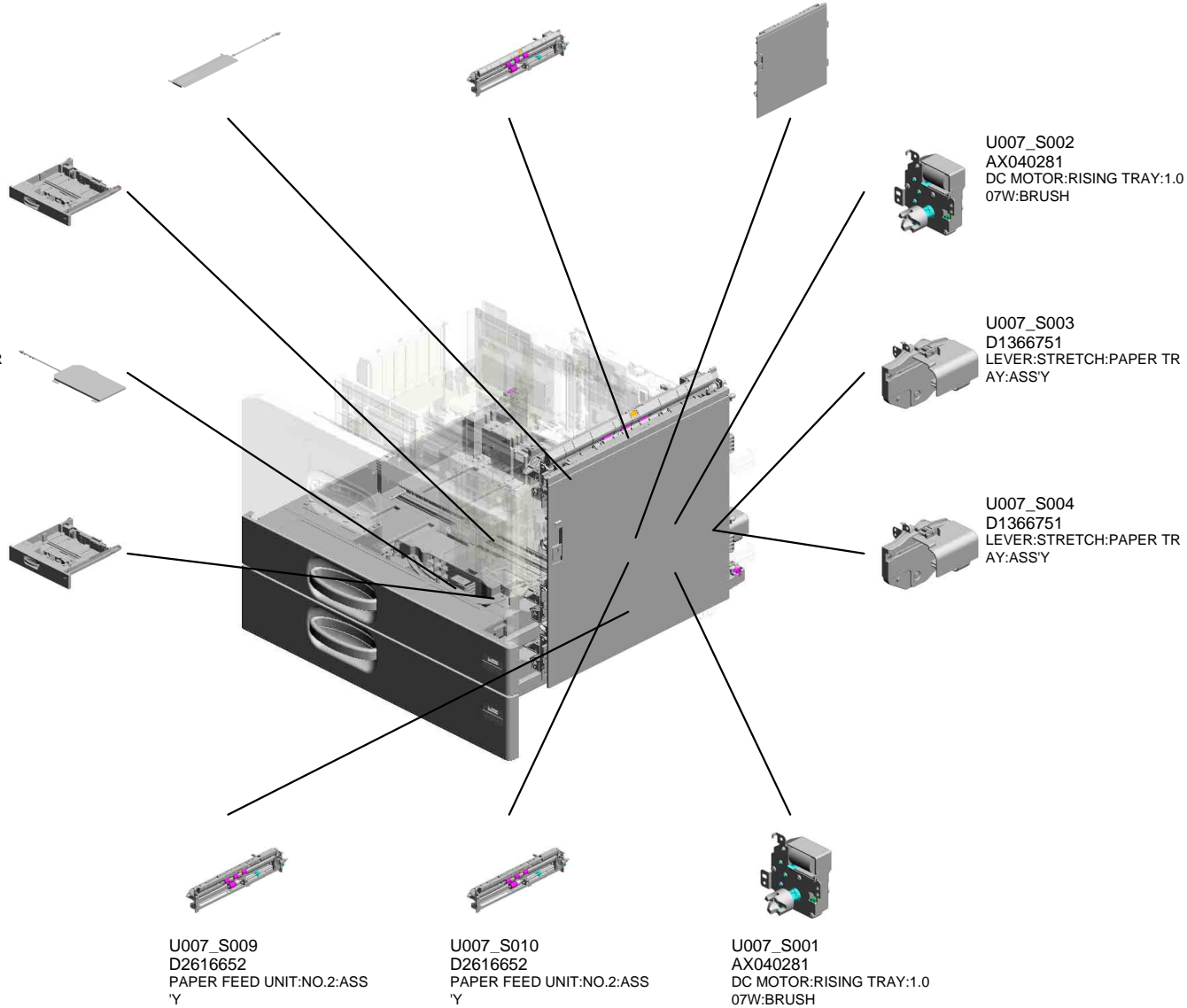

U007.PAPER FEED

U007_S014
D2587507
(NA):TANDEM LCT:LEFT:ASS
Y

U007_S016
D2587506
(EU/AA/KOR/TWN/CHN):TAN
DEM LCT:LEFT:ASS'Y

U007_S018
D2587506
(EU/AA/KOR/TWN/CHN):TAN
DEM LCT:LEFT:ASS'Y

U007_S013
D2617599
(NA):TANDEM LCT:RIGHT:AS
S'Y

U007_S020
D2587506
(EU/AA/KOR/TWN/CHN):TAN
DEM LCT:LEFT:ASS'Y

U007_S015
D2617598
(EU/AA/KOR/TWN/CHN):TAN
DEM LCT:RIGHT:ASS'Y

U007_S017
D2617598
(EU/AA/KOR/TWN/CHN):TAN
DEM LCT:RIGHT:ASS'Y

U007_S019
D2617598
(EU/AA/KOR/TWN/CHN):TAN
DEM LCT:RIGHT:ASS'Y

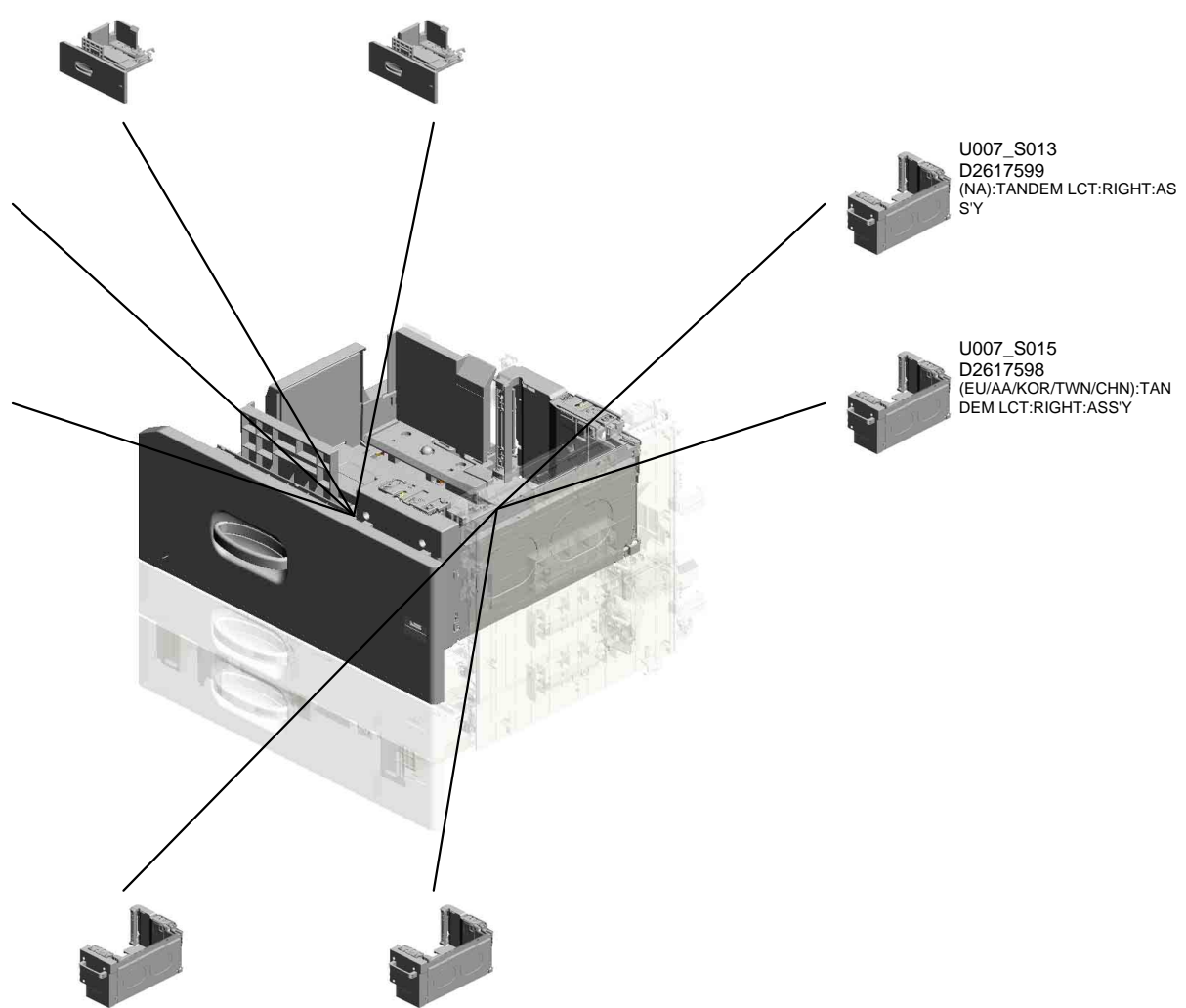

U007_S008.PAPER FEED UNIT:NO.1:ASS'Y

U007_S008_S001
D1356667
SHAFT:SEPARATE:DRIVEN:A
SS'Y

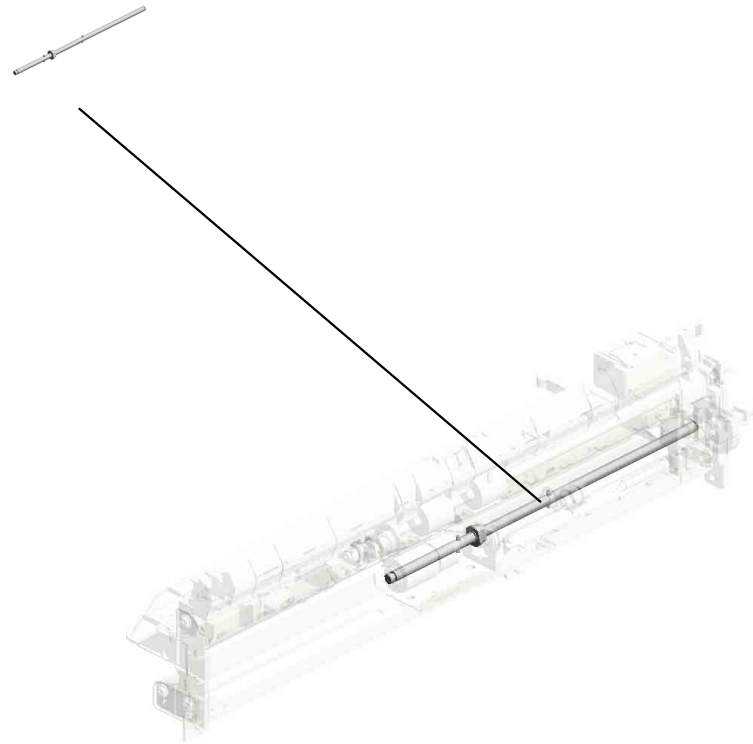

U001	U002	U003	U004	U005	U006	U007	U008	U009	U010	U011	U012	U013	U014	U015	U016	U017	U018	U019	U020	U021
------	------	------	------	------	------	------	------	------	------	------	------	------	------	------	------	------	------	------	------	------

U007_S009.PAPER FEED UNIT:NO.2:ASS'Y

U007_S009_S001
D1356667
SHAFT:SEPARATE:DRIVEN:A
SS'Y

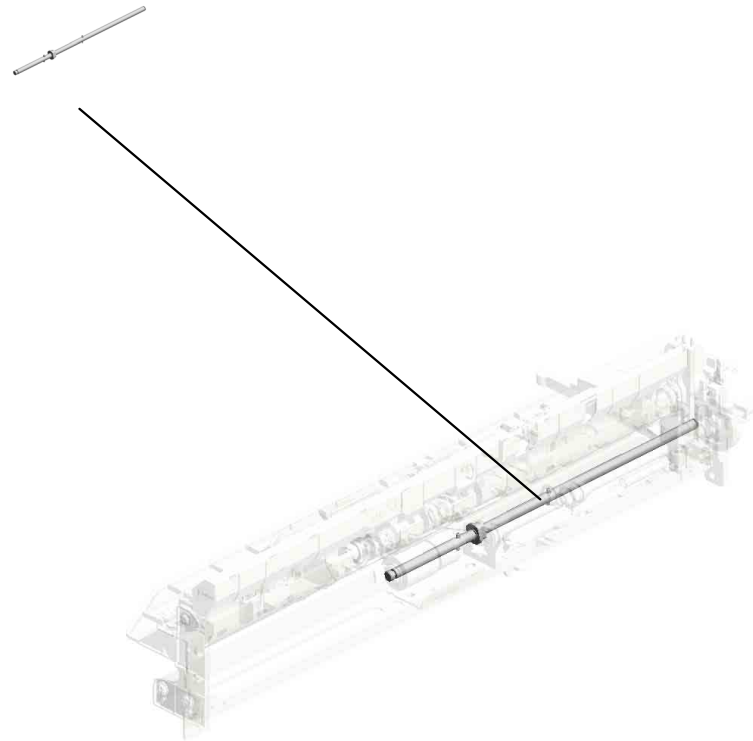

U001	U002	U003	U004	U005	U006	U007	U008	U009	U010	U011	U012	U013	U014	U015	U016	U017	U018	U019	U020	U021
------	------	------	------	------	------	------	------	------	------	------	------	------	------	------	------	------	------	------	------	------

U007_S010.PAPER FEED UNIT:NO.2:ASS'Y

U007_S010_S001
D1356667
SHAFT:SEPARATE:DRIVEN:A
SS'Y

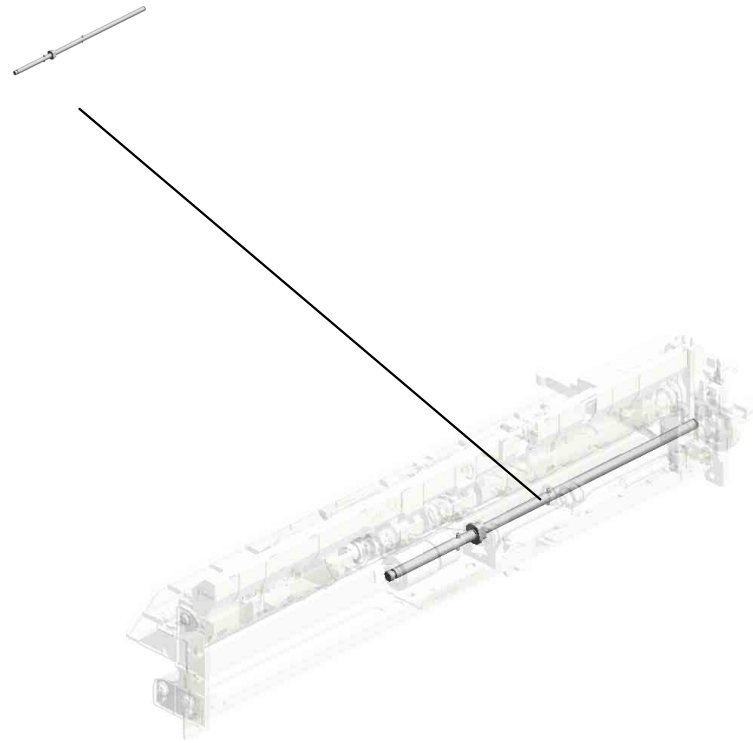

U001	U002	U003	U004	U005	U006	U007	U008	U009	U010	U011	U012	U013	U014	U015	U016	U017	U018	U019	U020	U021
------	------	------	------	------	------	------	------	------	------	------	------	------	------	------	------	------	------	------	------	------

U007_S011.PAPER TRAY:ASS'Y

U007_S011_S001
D1492840
END FENCE:PAPER TRAY:A
SS'Y

U007_S011_S002
D2616783
COVER:PAPER TRAY:NO.3:A
SS'Y

U007_S011_S003
D2616786
SIDE FENCE:REAR:ASS'Y

U007_S011_S004
D2616798
SIDE FENCE:FRONT:ASS'Y

U001	U002	U003	U004	U005	U006	U007	U008	U009	U010	U011	U012	U013	U014	U015	U016	U017	U018	U019	U020	U021
------	------	------	------	------	------	------	------	------	------	------	------	------	------	------	------	------	------	------	------	------

U007_S012.PAPER TRAY:NO.4:ASS'Y

U007_S012_S001
D1492840
END FENCE:PAPER TRAY:A
SS'Y

U007_S012_S004
D2616793
COVER:PAPER TRAY:NO.4:A
SS'Y

U007_S012_S002
D2616786
SIDE FENCE:REAR:ASS'Y

U007_S012_S003
D2616798
SIDE FENCE:FRONT:ASS'Y

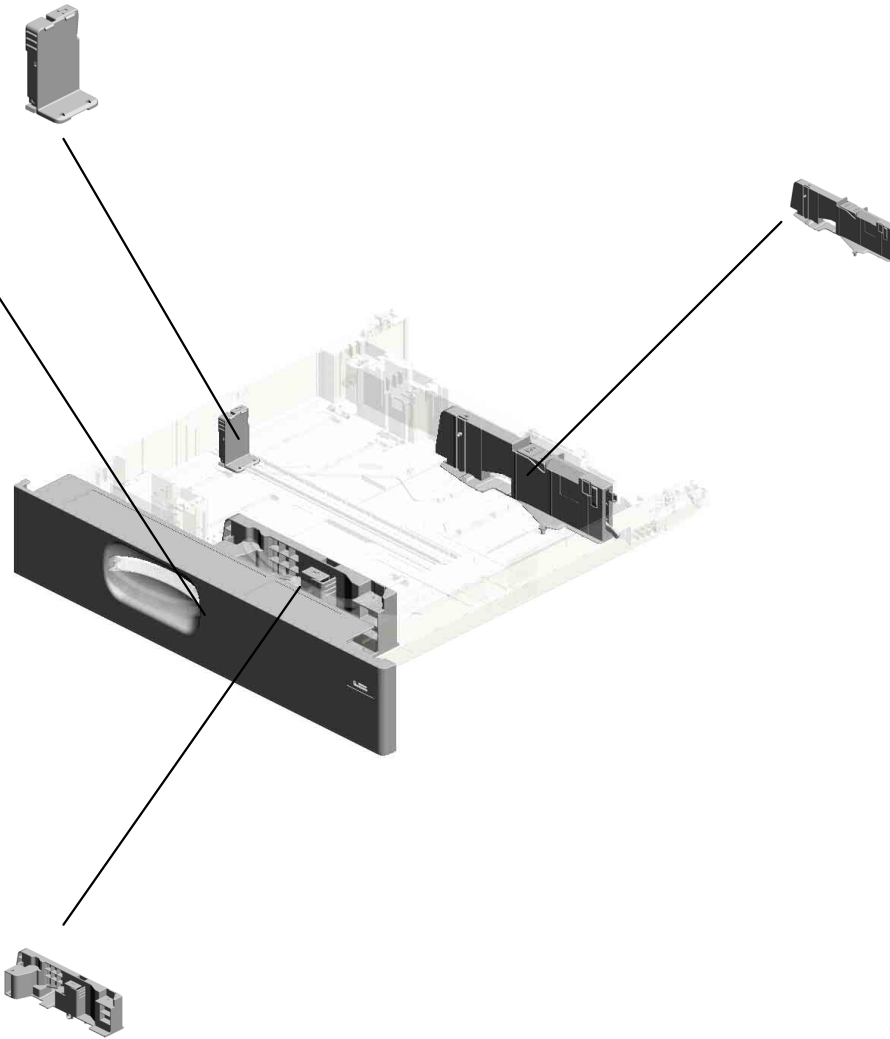

U001	U002	U003	U004	U005	U006	U007	U008	U009	U010	U011	U012	U013	U014	U015	U016	U017	U018	U019	U020	U021
------	------	------	------	------	------	------	------	------	------	------	------	------	------	------	------	------	------	------	------	------

U007_S013.(NA):TANDEM LCT:RIGHT:ASS'Y

U007_S013_S003
D1357531
GRIP:INNER COVER:ASS'Y

U007_S013_S004
D2617526
INNER COVER:RIGHT:TAND
EM LCT:ASS'Y

U007_S013_S001
D2617563
SIDE FENCE:RIGHT REAR:T
ANDEM LCT:ASS'Y

U007_S013_S002
D2617562
SIDE FENCE:RIGHT FRONT:
TANDEM LCT:ASS'Y

U001	U002	U003	U004	U005	U006	U007	U008	U009	U010	U011	U012	U013	U014	U015	U016	U017	U018	U019	U020	U021
------	------	------	------	------	------	------	------	------	------	------	------	------	------	------	------	------	------	------	------	------

U007_S013_S001.SIDE FENCE:RIGHT REAR:TANDEM LCT:ASS'Y

U007_S013_S001_S001
D0596690
PLATE:PAPER:ASS'Y

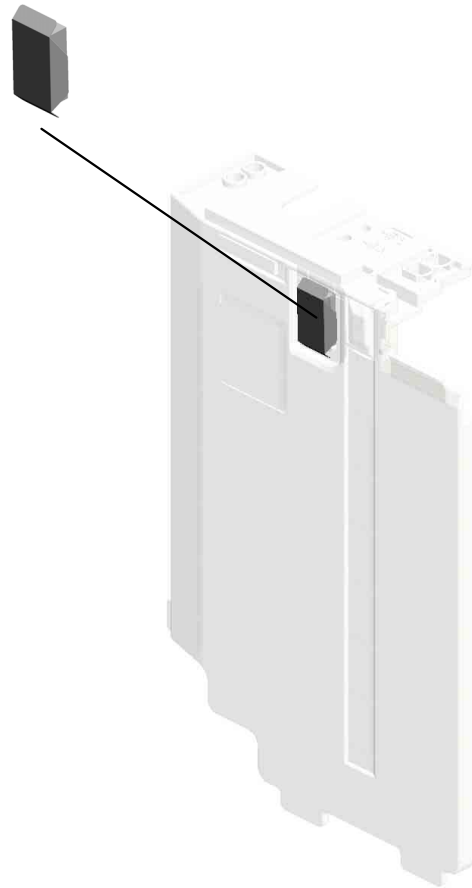

U001	U002	U003	U004	U005	U006	U007	U008	U009	U010	U011	U012	U013	U014	U015	U016	U017	U018	U019	U020	U021
------	------	------	------	------	------	------	------	------	------	------	------	------	------	------	------	------	------	------	------	------

U007_S014.(NA):TANDEM LCT:LEFT:ASS'Y

U007_S014_S001
D2617529
SIDE FENCE:LEFT REAR:TA
NDEM:ASS'Y

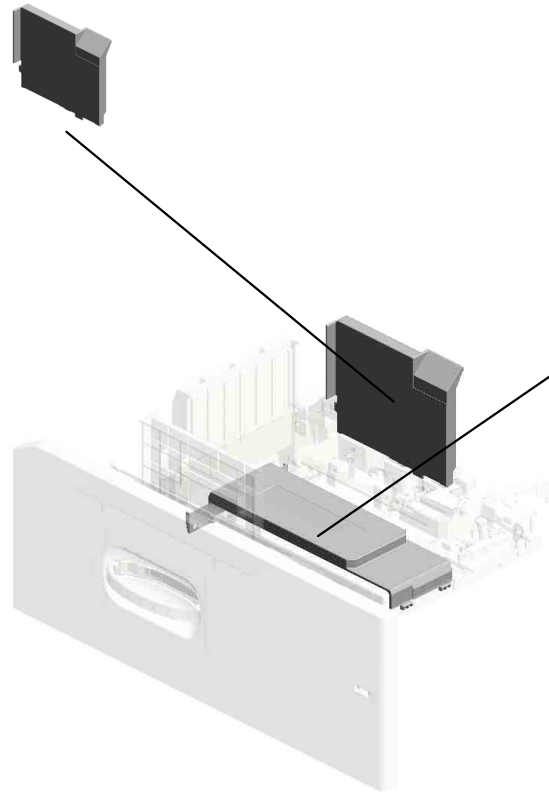

U007_S014_S002
D2617586
COVER:SYNCHRONOUS BE
LT:TANDEM TRAY

U001	U002	U003	U004	U005	U006	U007	U008	U009	U010	U011	U012	U013	U014	U015	U016	U017	U018	U019	U020	U021
------	------	------	------	------	------	-------------	------	------	------	------	------	------	------	------	------	------	------	------	------	------

U007_S015.(EU/AA/KOR/TWN/CHN):TANDEM LCT:RIGHT:ASS'Y

U007_S015_S003
D1357531
GRIP:INNER COVER:ASS'Y

U007_S015_S004
D2617526
INNER COVER:RIGHT:TAND
EM LCT:ASS'Y

U007_S015_S001
D2617563
SIDE FENCE:RIGHT REAR:T
ANDEM LCT:ASS'Y

U007_S015_S002
D2617562
SIDE FENCE:RIGHT FRONT:
TANDEM LCT:ASS'Y

U001	U002	U003	U004	U005	U006	U007	U008	U009	U010	U011	U012	U013	U014	U015	U016	U017	U018	U019	U020	U021
------	------	------	------	------	------	------	------	------	------	------	------	------	------	------	------	------	------	------	------	------

U007_S015_S001.SIDE FENCE:RIGHT REAR:TANDEM LCT:ASS'Y

U007_S015_S001_S001
D0596690
PLATE:PAPER:ASS'Y

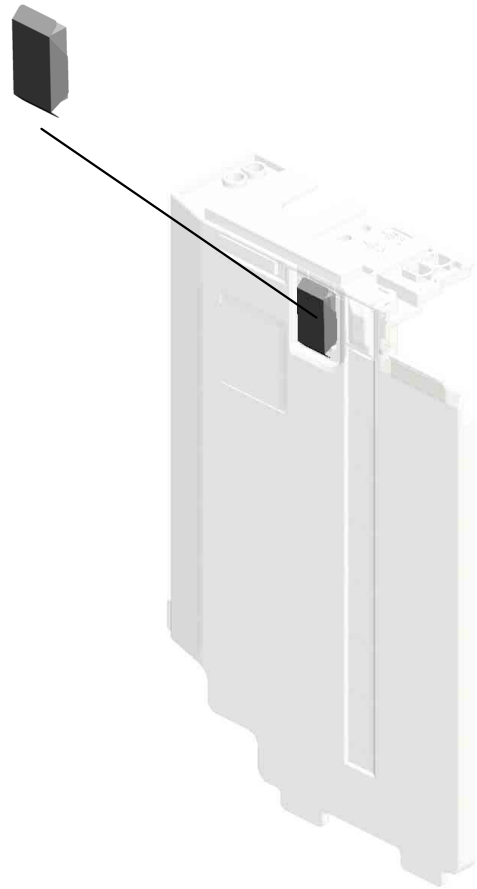

U001	U002	U003	U004	U005	U006	U007	U008	U009	U010	U011	U012	U013	U014	U015	U016	U017	U018	U019	U020	U021
------	------	------	------	------	------	------	------	------	------	------	------	------	------	------	------	------	------	------	------	------

U007_S016.(EU/AA/KOR/TWN/CHN):TANDEM LCT:LEFT:ASS'Y

U007_S016_S001
D2617529
SIDE FENCE:LEFT REAR:TA
NDEM:ASS'Y

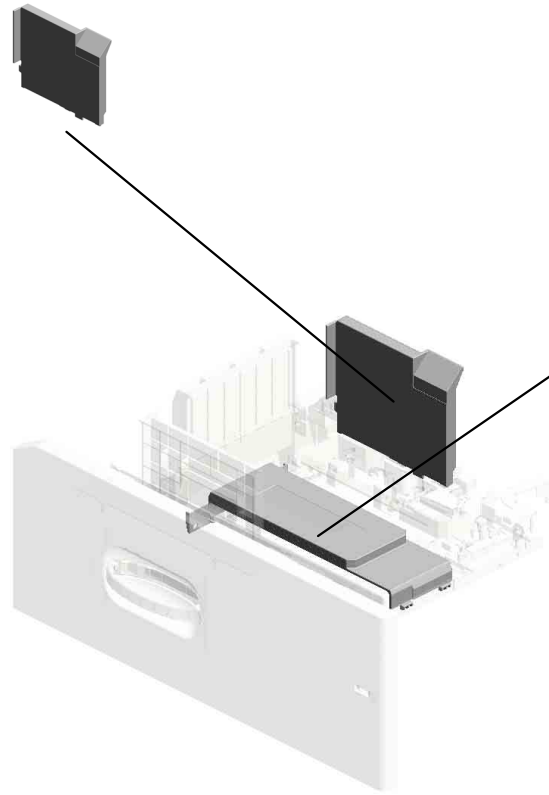

U007_S016_S002
D2617586
COVER:SYNCHRONOUS BE
LT:TANDEM TRAY

U001	U002	U003	U004	U005	U006	U007	U008	U009	U010	U011	U012	U013	U014	U015	U016	U017	U018	U019	U020	U021
------	------	------	------	------	------	------	------	------	------	------	------	------	------	------	------	------	------	------	------	------

U007_S017.(EU/AA/KOR/TWN/CHN):TANDEM LCT:RIGHT:ASS'Y

U007_S017_S003
D1357531
GRIP:INNER COVER:ASS'Y

U007_S017_S004
D2617526
INNER COVER:RIGHT:TAND
EM LCT:ASS'Y

U007_S017_S001
D2617563
SIDE FENCE:RIGHT REAR:T
ANDEM LCT:ASS'Y

U007_S017_S002
D2617562
SIDE FENCE:RIGHT FRONT:
TANDEM LCT:ASS'Y

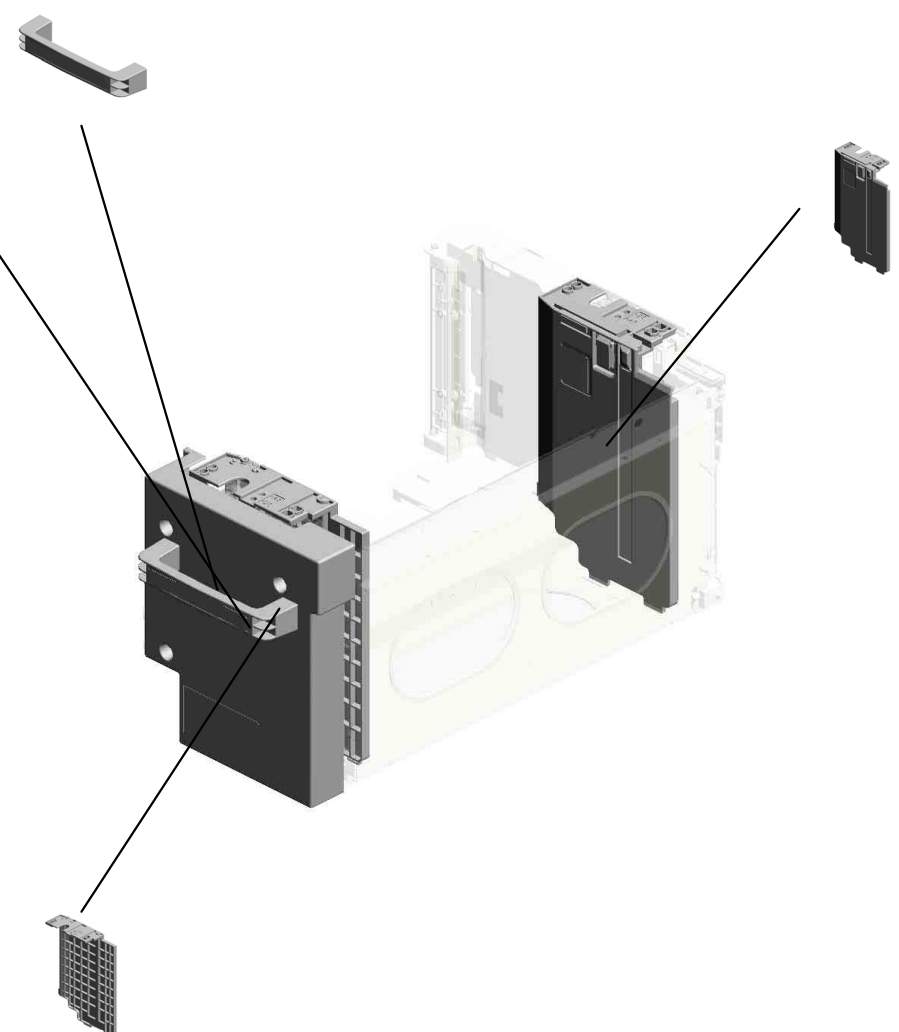

U001	U002	U003	U004	U005	U006	U007	U008	U009	U010	U011	U012	U013	U014	U015	U016	U017	U018	U019	U020	U021
------	------	------	------	------	------	------	------	------	------	------	------	------	------	------	------	------	------	------	------	------

U007_S017_S001.SIDE FENCE:RIGHT REAR:TANDEM LCT:ASS'Y

U007_S017_S001_S001
D0596690
PLATE:PAPER:ASS'Y

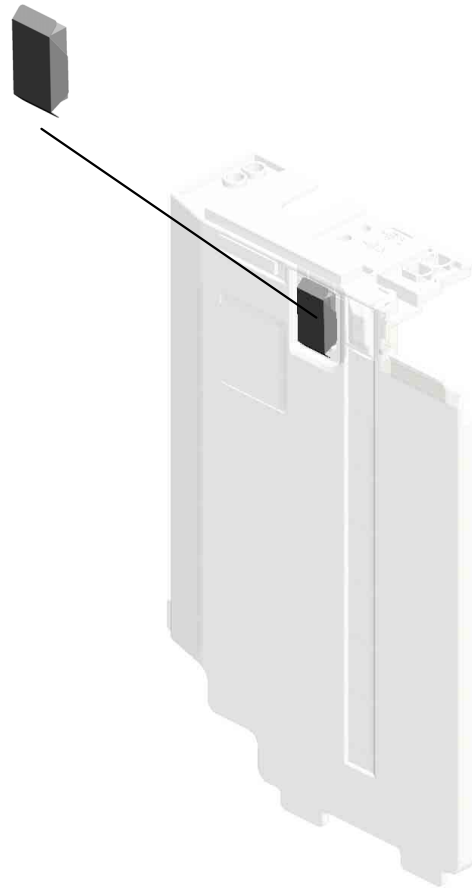

U001	U002	U003	U004	U005	U006	U007	U008	U009	U010	U011	U012	U013	U014	U015	U016	U017	U018	U019	U020	U021
------	------	------	------	------	------	------	------	------	------	------	------	------	------	------	------	------	------	------	------	------

U007_S018.(EU/AA/KOR/TWN/CHN):TANDEM LCT:LEFT:ASS'Y

U007_S018_S001
D2617529
SIDE FENCE:LEFT REAR:TA
NDEM:ASS'Y

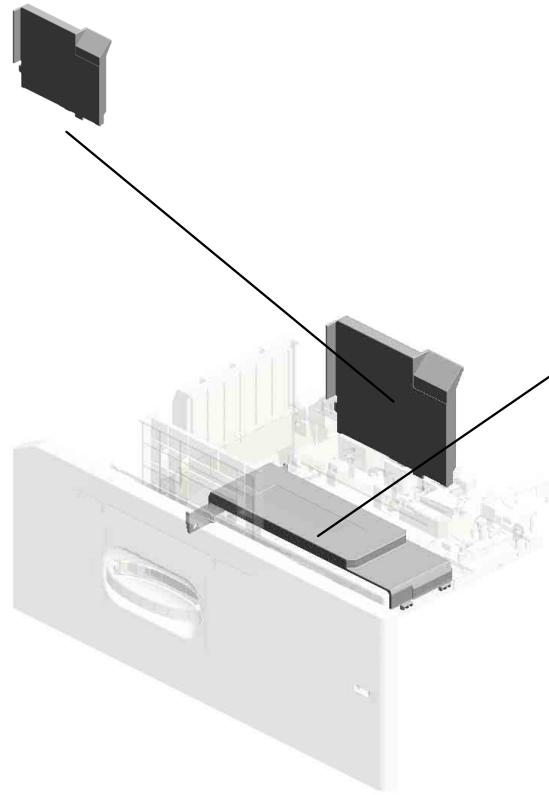

U007_S018_S002
D2617586
COVER:SYNCHRONOUS BE
LT:TANDEM TRAY

U001	U002	U003	U004	U005	U006	U007	U008	U009	U010	U011	U012	U013	U014	U015	U016	U017	U018	U019	U020	U021
------	------	------	------	------	------	------	------	------	------	------	------	------	------	------	------	------	------	------	------	------

U007_S019.(EU/AA/KOR/TWN/CHN):TANDEM LCT:RIGHT:ASS'Y

U007_S019_S003
D1357531
GRIP:INNER COVER:ASS'Y

U007_S019_S004
D2617526
INNER COVER:RIGHT:TAND
EM LCT:ASS'Y

U007_S019_S001
D2617563
SIDE FENCE:RIGHT REAR:T
ANDEM LCT:ASS'Y

U007_S019_S002
D2617562
SIDE FENCE:RIGHT FRONT:
TANDEM LCT:ASS'Y

U001	U002	U003	U004	U005	U006	U007	U008	U009	U010	U011	U012	U013	U014	U015	U016	U017	U018	U019	U020	U021
------	------	------	------	------	------	------	------	------	------	------	------	------	------	------	------	------	------	------	------	------

U007_S019_S001.SIDE FENCE:RIGHT REAR:TANDEM LCT:ASS'Y

U007_S019_S001_S001
D0596690
PLATE:PAPER:ASS'Y

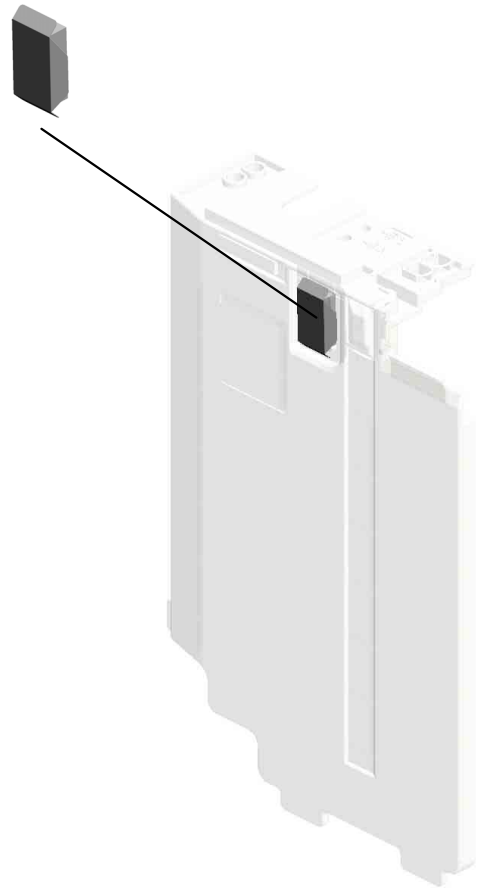

U001	U002	U003	U004	U005	U006	U007	U008	U009	U010	U011	U012	U013	U014	U015	U016	U017	U018	U019	U020	U021
------	------	------	------	------	------	------	------	------	------	------	------	------	------	------	------	------	------	------	------	------

U007_S020.(EU/AA/KOR/TWN/CHN):TANDEM LCT:LEFT:ASS'Y

U007_S020_S001
D2617529
SIDE FENCE:LEFT REAR:TA
NDEM:ASS'Y

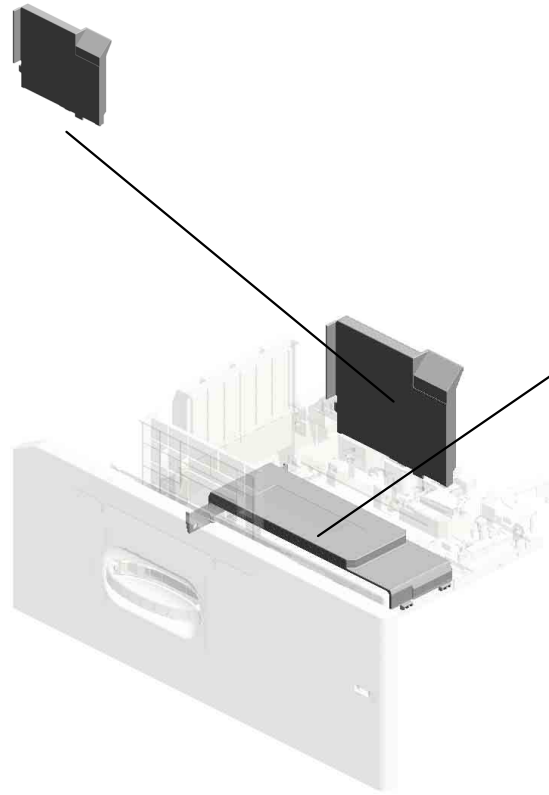

U007_S020_S002
D2617586
COVER:SYNCHRONOUS BE
LT:TANDEM TRAY

U001	U002	U003	U004	U005	U006	U007	U008	U009	U010	U011	U012	U013	U014	U015	U016	U017	U018	U019	U020	U021
------	------	------	------	------	------	------	------	------	------	------	------	------	------	------	------	------	------	------	------	------

U007 PAPER FEED

19.07200040E
RETAINING RING -
M4

27.11050692
CLAMP:LES-0503

1.03130040N
(x4)
SCREW:M3X4

28.11050758
(x9)
CLAMP:LWSM-030
6A

21.08050089
(x5)
RETAINING RING -
M4

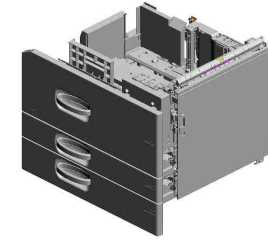

12.04544008Q
TAPPING SCREW -
M4X8



29.11050760
(x12)
CLAMP:LWSM-051
1A



35.AA000290
(x2)
DECAL:POSITIONI
NG DISPLAY:SCRE
W:PET



10.04543008N
(x11)
TAPPING SCREW:
ROUND POINT:3X8



11.04543008Q
(x9)
TAPPING SCREW:
3X8



32.AA000285
DECAL:PAPER TR
AY:DESIGN SKETC
H1



33.AA000286
DECAL:PAPER TR
AY:DESIGN SKETC
H2



34.AA000287
DECAL:PAPER TR
AY:DESIGN SKETC
H3



13.04583008N
(x4)
HEXAGON HEAD T
APPING SCREW:3
X8



9.04543006Q
(x36)
TAPPING SCREW -
M3X6

30.52062686
(x5)
SNAP RING



20.07200060E
RETAINING RING -
M6



7.04504010N
(x3)
TAPPING SCREW:
M4X10



26.11050551
(x2)
CLAMP:LES-0505

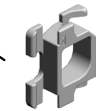

14.04583010N
(x7)
HEXAGON HEAD T
APPING SCREW:3
X10



U007 PAPER FEED

116.D1366703
COVER:PAPER TR
AY:REAR LEFT

115.D1366699
BRACKET:DC SOL
ENOID:LOCK:ASS'
Y

43.AA060986
TENSION SPRING:
DC SOLENOID:LO
CK

74.AW020230
ON OFF DETECTO
R:END FENCE

83.D0592399
(x8)
FLANGED HEXAG
ONAL HEAD BOLT:
M3*4

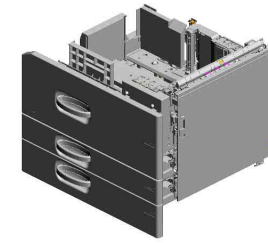

102.D1356755
(x8)
HEXAGON HEAD B
OLT:DOUBLE SCR
EW:M3X8:ROUND
POINT



113.D1366667
HOLDER:POSITIO
NING:VERTICAL T
RANSPORT



59.AA143598
(x12)
STEPPED SCREW:
TANDEM TRAY:MI
DDLE



112.D1366665
BRACKET:LED:VE
RTICAL TRANSPOR
T



68.AC020152
(x3)
LENS:LED:3



44.AA061227
COMPRESSION SP
RING:FRONT RIGH
T



114.D1366676
CUSHION:SEPARA
TE

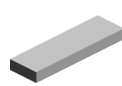

117.D1366707
BRACKET:DC MOT
OR:LEFT



64.AB019475
GEAR - 48T



119.D1366729
BRACKET:STOPPE
R:VERTICAL TRAN
SPORT:RIGHT LO
WER:ASSY



54.AA082173
(x2)
PLAIN SHAFT BEA
RING:6X10X6



63.AB014135
GEAR - 18Z



118.D1366708
SHAFT:JOINT



56.AA082175
PLAIN SHAFT BEA
RING:8X12X7



97.D1356728
(x2)
BRACKET:DOOR:V
ERTICAL TRANSP
ORT:ASSY



U007 PAPER FEED

150.D1386669 COVER:SIDE PLATE:REAR:TANDEM LEFT
 199.D2586719 DC SOLENOID:TANDEM TRAY:END FENCE
 197.D2586716 LEVER:RELEASE:REAR
 122.D1366744 TENSION SPRING:END FENCE:SOLENOID
 196.D2586714 BRACKET:DC SOLENOID:REAR:ASSY

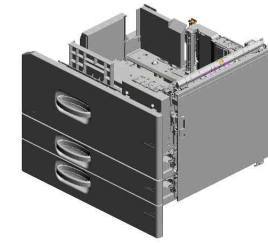

194.D2586697 DC SOLENOID:TANDEM TRAY:LOCK:ASSY



120.D1366741 COVER:CONNECTOR:HEATER:UPPER



123.D1366746 JOINT:TANDEM LEFT



200.D2586734 INNER COVER:LED:VERTICAL TRANSPORT



121.D1366743 PLATE:CONNECTOR:HEATER:LOWER



153.D1386714 GROUND PLATE:GUIDE PLATE:VERTICAL TRANSPORT:CONNECTING



187.D2416290 LED:RED

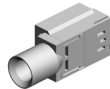

233.D2616667 (x3) GUIDE PLATE:SWIVEL:ASSY



184.D2412719 GROUND PLATE:SENSOR:TRANSPORT

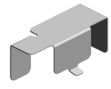

185.D2412759 TRANSPORT ROLLER:VERTICAL TRANSPORT:ASSY



198.D2586718 DC MOTOR:TANDEM LCT:19.2W:BRUSH



195.D2586711 BRACKET:LIFT MOTOR:TANDEM TRAY



181.D2236747 DC MOTOR:TANDEM LCT:19.2W:BRUSH



155.D1482702 SPACER:TRANSPORT ROLLER



149.D1386665 COVER:LIFT MOTOR

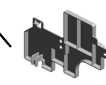

U007 PAPER FEED

286.G5692901
SPRING - LIFT MO
TOR

288.GW010007
PHOTO REFLECTI
ON SENSOR:EXIT

284.G1782971
LEVER:LOCK:TAN
DEM LCT

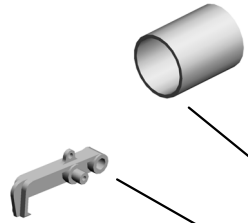

237.D2616679
GUIDE PLATE:V TR
ANSPORT:THREE
WAY



238.D2616680
(x3)
DECAL:PAPER TR
AY:LED

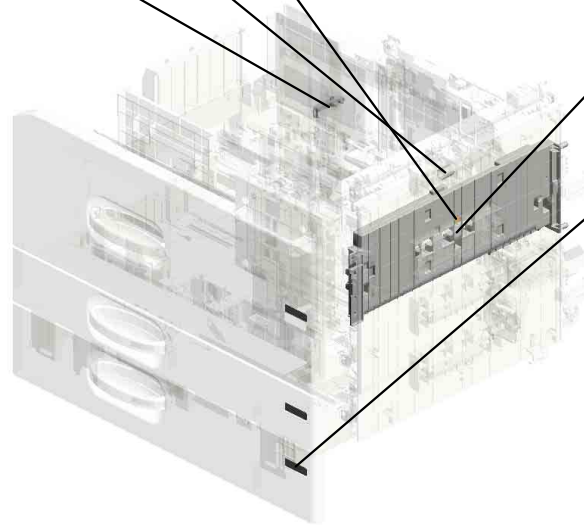
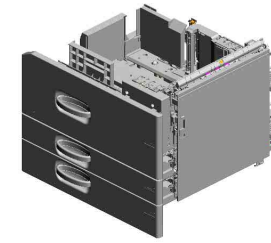

U007_S001
DC MOTOR:RISING TRAY:1.007W:BRUSH

3.03530030N
(x2)
SCREW:M3X3

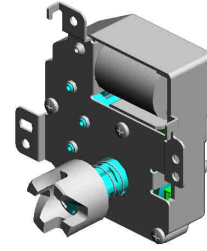

75.AX040281
DC MOTOR:RISING
TRAY:1.007W:BRU
SH



85.D0812966
DC MOTOR:ASSY:
1.007W:BRUSH

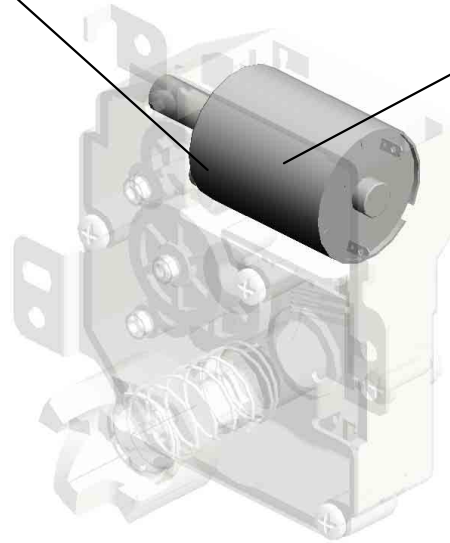

U001	U002	U003	U004	U005	U006	U007	U008	U009	U010	U011	U012	U013	U014	U015	U016	U017	U018	U019	U020	U021
------	------	------	------	------	------	------	------	------	------	------	------	------	------	------	------	------	------	------	------	------

U007_S002
DC MOTOR:RISING TRAY:1.007W:BRUSH

3.03530030N
(x2)
SCREW:M3X3

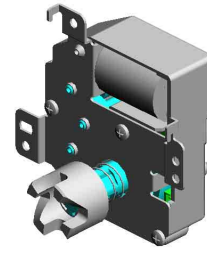

75.AX040281
DC MOTOR:RISING
TRAY:1.007W:BRU
SH



85.D0812966
DC MOTOR:ASSY:
1.007W:BRUSH

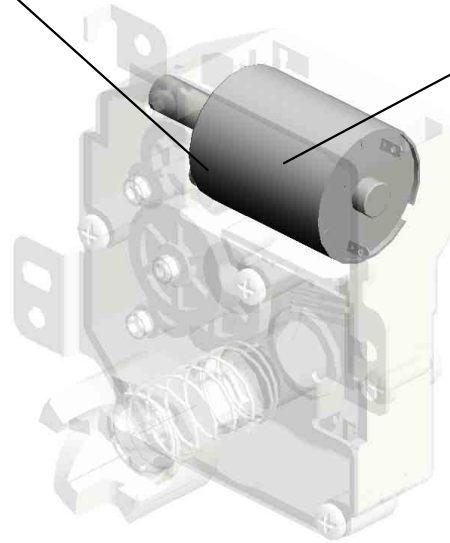

U001	U002	U003	U004	U005	U006	U007	U008	U009	U010	U011	U012	U013	U014	U015	U016	U017	U018	U019	U020	U021
------	------	------	------	------	------	------	------	------	------	------	------	------	------	------	------	------	------	------	------	------

U007_S003
LEVER:STRETCH:PAPER TRAY:ASS'Y

135.D1366775 COVER:GEAR
133.D1366773 COLLAR:GEAR
137.D1366778 OIL DAMPER:23MN /M
131.D1366770 HOLDER:OIL DAM PER
132.D1366772 GEAR:PAWL:Z18

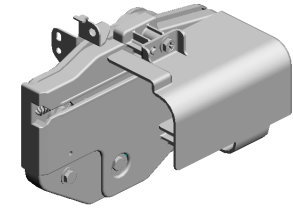

126.D1366751 LEVER:STRETCH: PAPER TRAY:ASS' Y

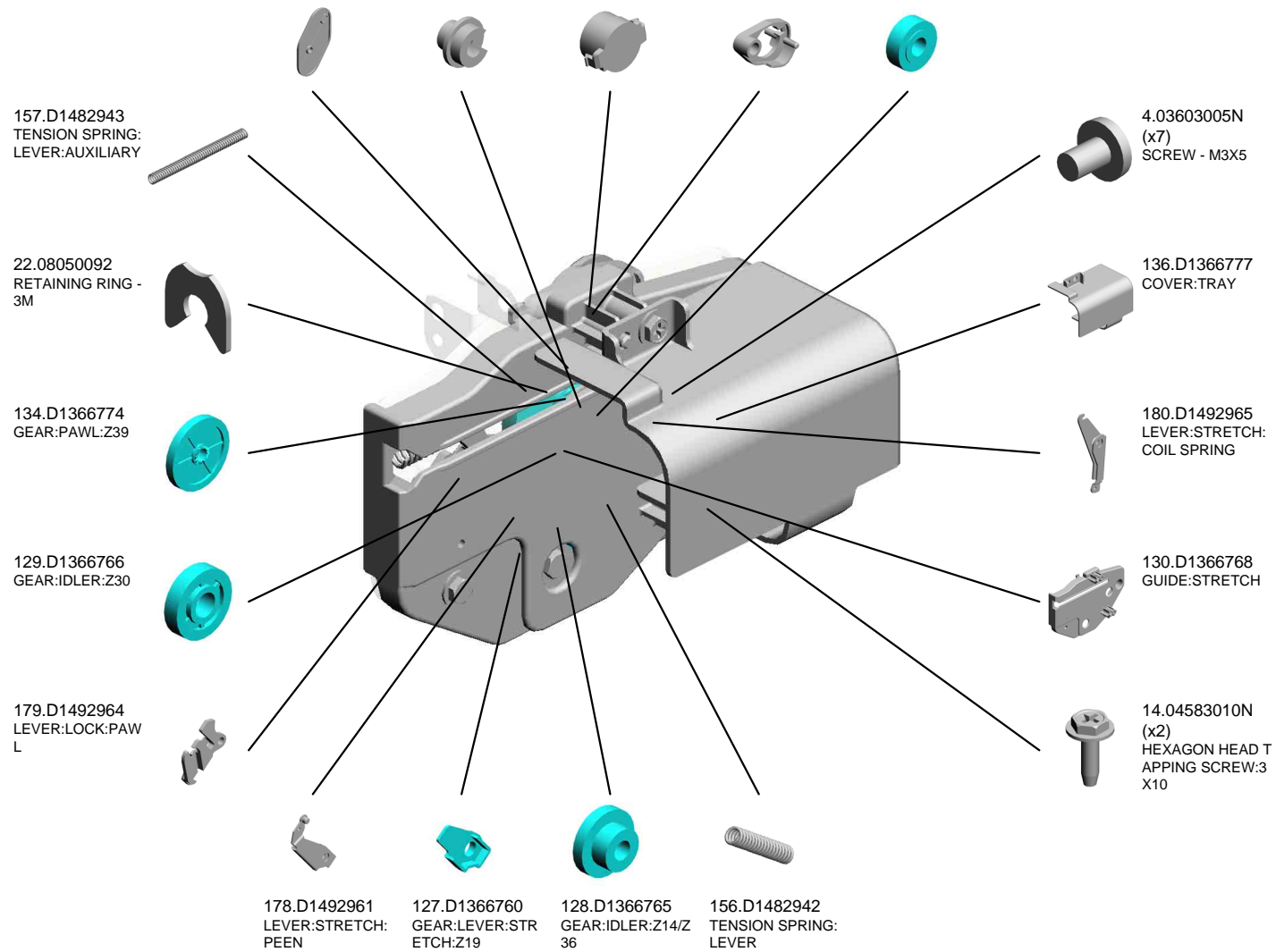

U007_S004
LEVER:STRETCH:PAPER TRAY:ASS'Y

135.D1366775 COVER:GEAR
133.D1366773 COLLAR:GEAR
137.D1366778 OIL DAMPER:23MN /M
131.D1366770 HOLDER:OIL DAM PER
132.D1366772 GEAR:PAWL:Z18

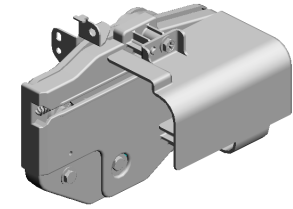

126.D1366751 LEVER:STRETCH: PAPER TRAY:ASS' Y

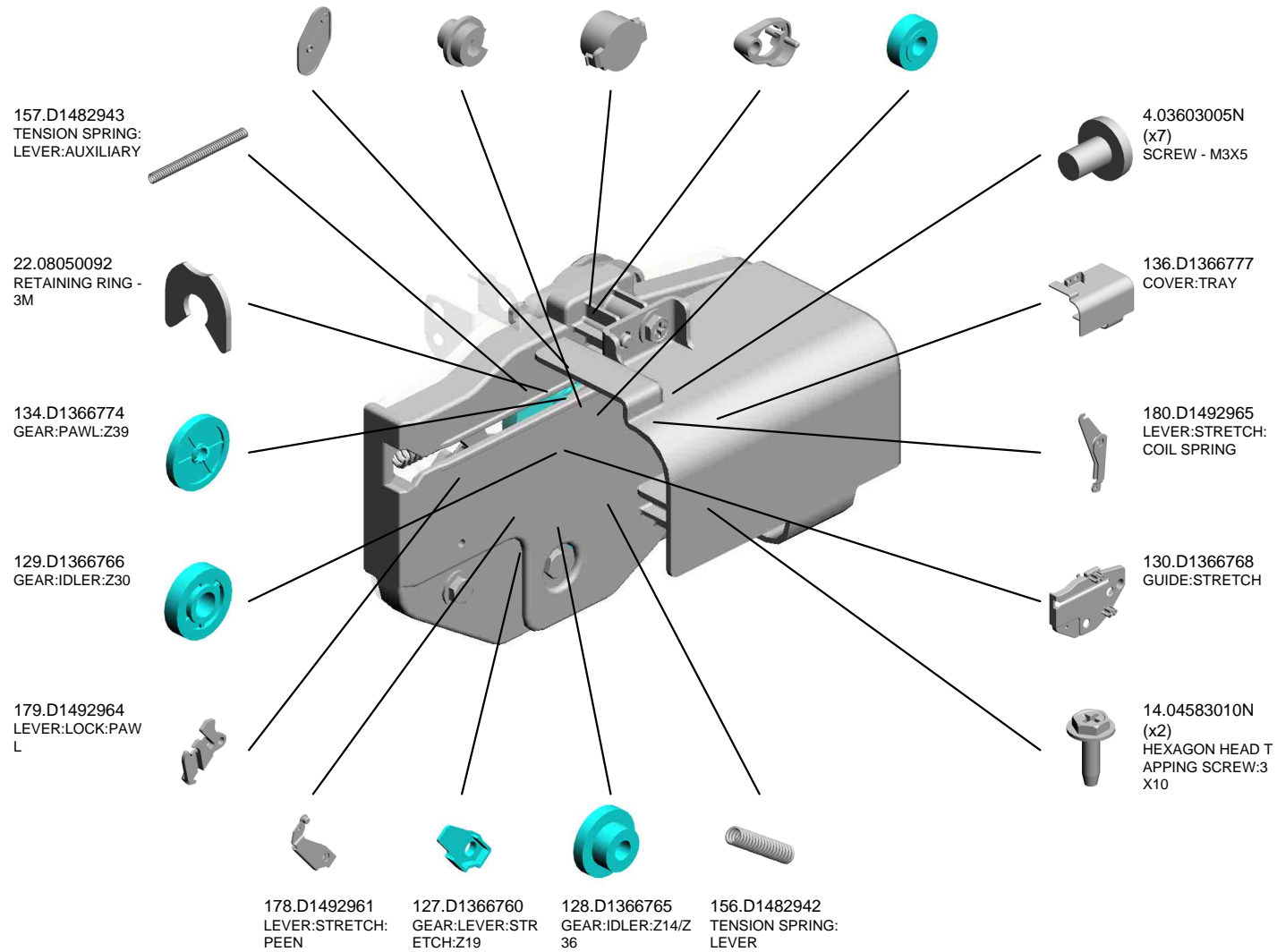

U001	U002	U003	U004	U005	U006	U007	U008	U009	U010	U011	U012	U013	U014	U015	U016	U017	U018	U019	U020	U021
------	------	------	------	------	------	------	------	------	------	------	------	------	------	------	------	------	------	------	------	------

U007_S005
HEAT SINK:HEATER:UPPER:ASS'Y

138.D1366788
DECAL:H-TEMP W
ARNING:HEATER

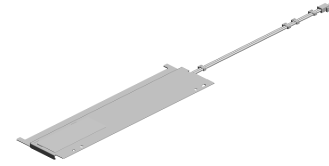
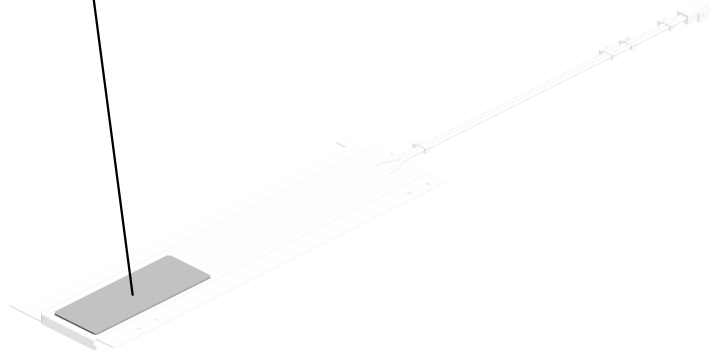

151.D1386683
HEAT SINK:HEATE
R:UPPER:ASSY

U001	U002	U003	U004	U005	U006	U007	U008	U009	U010	U011	U012	U013	U014	U015	U016	U017	U018	U019	U020	U021
------	------	------	------	------	------	------	------	------	------	------	------	------	------	------	------	------	------	------	------	------

U007_S006
HEAT SINK:HEATER:LOWER:ASS'Y

29.11050760
CLAMP:LWSM-051
1A

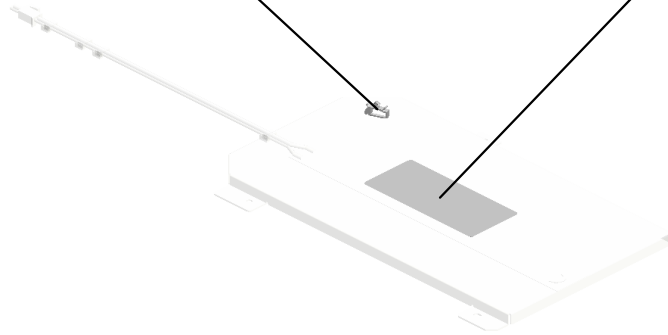
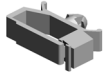

289.M0262734
DECAL:H-TEMP W
ARNING:HEATER

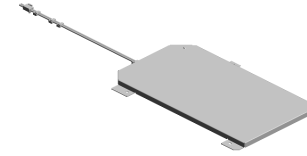

152.D1386685
HEAT SINK:HEATE
R:LOWER:ASS'Y

U001	U002	U003	U004	U005	U006	U007	U008	U009	U010	U011	U012	U013	U014	U015	U016	U017	U018	U019	U020	U021
------	------	------	------	------	------	------	------	------	------	------	------	------	------	------	------	------	------	------	------	------

U007_S007
DOOR:VERTICAL TRANSPORT:ASS'Y

82.D0392993 (x4) SHAFT:TRANSPORT BELT:PULLEY
 183.D2412678 (x4) SHAFT:FLAT CONVEYER BELT:DRIVE N
 182.D2412676 (x4) HOLDER:DRIVEN:BELT
 91.D1356631 (x4) GUIDE PLATE:FLAT CONVEYER BELT:NO.1
 204.D2586744 COVER:VERTICAL TRANSPORT:UPPER

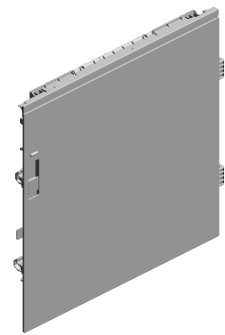

244.D2616737 DOOR:VERTICAL TRANSPORT:ASS'Y

158.D1492676 (x8) COMPRESSION SPRING:FLAT CONVEYER BELT:DRIVEN



78.D0092573 (x12) PULLEY - VERTICAL TRANSPORT



80.D0292677 (x12) TRANSPORT BELT:DRIVEN:VERTICAL TRANSPORT



14.04583010N (x25) HEXAGON HEAD TAPPING SCREW:3 X10



68.AC020152 LENS:LED:3



45.AA061228 COIL SPRING:LEVER:COVER:VERTICAL TRANSPORT



202.D2586740 SHAFT:LEVER:DOOR:VERTICAL TRANSPORT



201.D2586739 LEVER:VERTICAL TRANSPORT



203.D2586741 STAY:DOOR:VERTICAL TRANSPORT



96.D1356708 (x3) GUIDE PLATE:FLAT CONVEYER BELT:NO.2

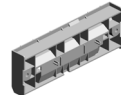

154.D1444489 (x8) STOPPER:DRIVEN ROLLER



24.08050104 (x2) RETAINING RINGS: SILENCER:DIA4



79.D0092574 (x12) PULLEY - IDLER



245.D2616742 GUIDE PLATE:VERTICAL TRANSPORT

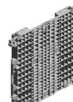

88.D1175916 STEPPED SCREW: M3X8:SECOND KIND



95.D1356703 STOPPER:DOOR:VERTICAL TRANSPORT



U001	U002	U003	U004	U005	U006	U007	U008	U009	U010	U011	U012	U013	U014	U015	U016	U017	U018	U019	U020	U021
------	------	------	------	------	------	------	------	------	------	------	------	------	------	------	------	------	------	------	------	------

U007_S007
DOOR:VERTICAL TRANSPORT:ASS'Y

246.D2616743
COVER:VERTICAL
TRANSPORT

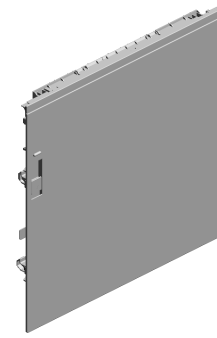
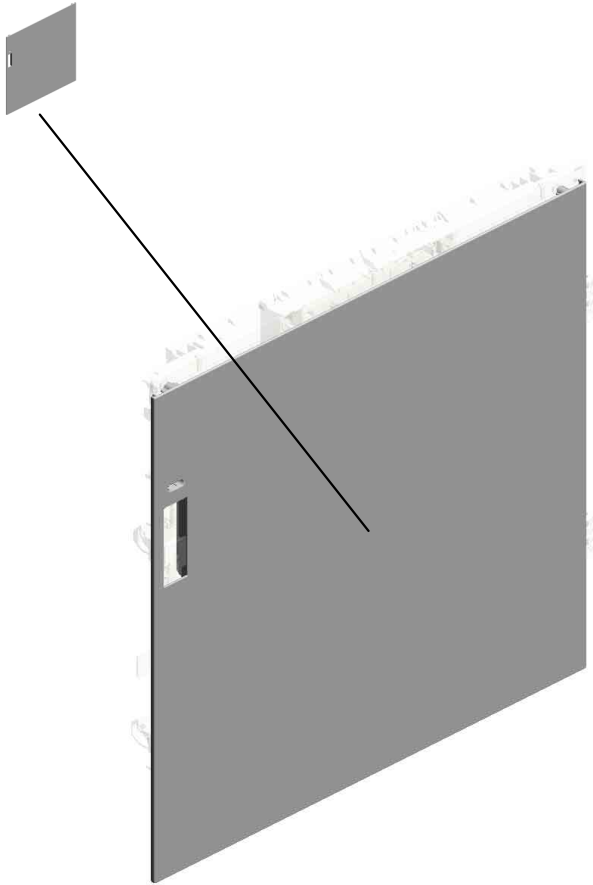

244.D2616737
DOOR:VERTICAL T
RANSPORT:ASS'Y

U001	U002	U003	U004	U005	U006	U007	U008	U009	U010	U011	U012	U013	U014	U015	U016	U017	U018	U019	U020	U021
------	------	------	------	------	------	------	------	------	------	------	------	------	------	------	------	------	------	------	------	------

U007_S008
PAPER FEED UNIT:NO.1:ASS'Y

- 9.04543006Q (x7) TAPPING SCREW - M3X6
- 55.AA082174 PLAIN SHAFT BEARING:6X10X9
- 13.04583008N (x8) HEXAGON HEAD TAPPING SCREW:3X8
- 73.AW020203 (x2) PHOTOINTERRUPTOR:GP1A173LCS2F
- 27.11050692 CLAMP:LES-0503

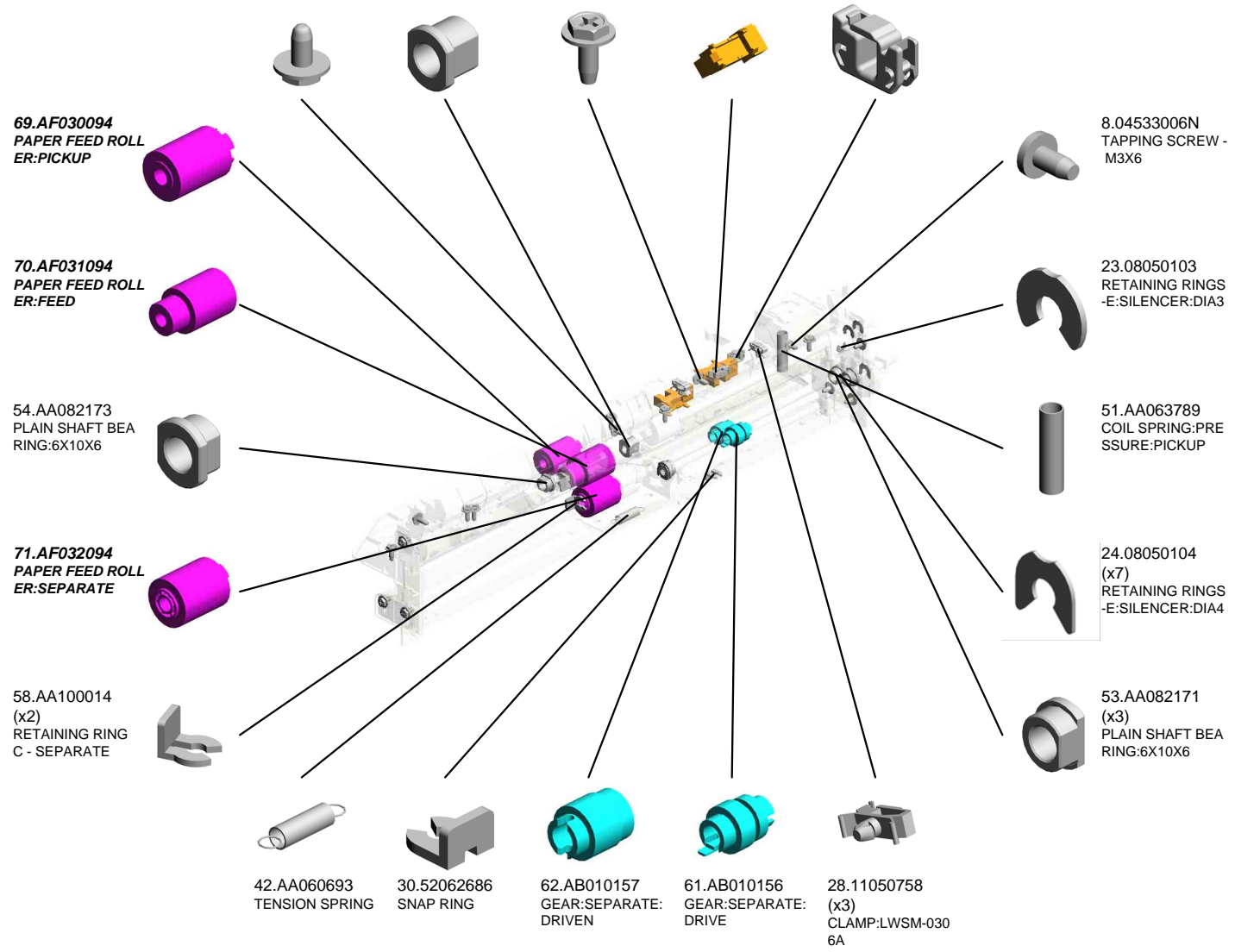
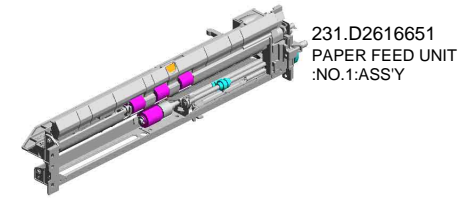

U001	U002	U003	U004	U005	U006	U007	U008	U009	U010	U011	U012	U013	U014	U015	U016	U017	U018	U019	U020	U021
------	------	------	------	------	------	------	------	------	------	------	------	------	------	------	------	------	------	------	------	------

U007_S008
 PAPER FEED UNIT:NO.1:ASS'Y

234.D2616675
 BALANCER:FRICTI
 ON:ASS'Y

189.D2586672
 GUIDE PLATE:V TR
 ANSPORT:NO.1

188.D2586669
 ARM:PICKUP

185.D2412759
 TRANSPORT ROLL
 ER:VERTICAL TRA
 NSPORT:ASS'Y

191.D2586674
 DC SOLENOID:PIC
 KUP:NO.1:ASS'Y

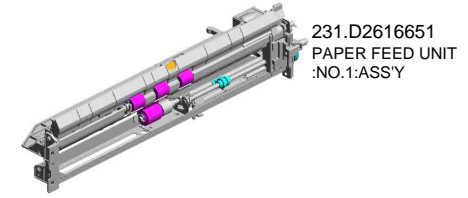

231.D2616651
 PAPER FEED UNIT
 :NO.1:ASS'Y

162.D1492774
 PULLEY:IDLER:PIC
 KUP



77.B8303504
 TIMING BELT - 40S
 2M100



186.D2412782
 PLATE:HARNESS:
 PAPER FEED UNIT



89.D1292783
 TORQUE LIMITER
 MECHANICAL CLU
 TCH:40MNM:DIA18



163.D1492781
 GROUND PLATE:P
 APER FEED UNIT



161.D1492773
 PULLEY:PICKUP:M
 ECHANICAL ROLL
 ER CLUTCH



193.D2586678
 LINK:RELEASE



93.D1356669
 SHAFT:SEPARATE:
 DRIVE:ASS'Y



159.D1492739
 LEVER:PRESSURE
 RELEASE



100.D1356746
 COIL SPRING:REL
 EASE



192.D2586677
 LEVER:PRESSURE
 :PICKUP:NO.1



155.D1482702
 SPACER:TRANSP
 ORT ROLLER



86.D0892764
 GEAR:FEED



94.D1356675
 COVER:HARNESS:
 PAPER FEED UNIT



87.D0892819
 GEAR:SEPARATO
 R:INPUT



U007_S008
 PAPER FEED UNIT:NO.1:ASS'Y

235.D2616677
 COVER:FRICTION

288.GW010007
 (x2)
 PHOTO REFLECTI
 ON SENSOR:EXIT

236.D2616678
 GROUND PLATE:B
 ALANCER:PAPER
 FEED U

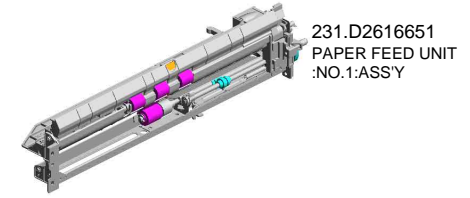

231.D2616651
 PAPER FEED UNIT
 :NO.1:ASS'Y

240.D2616687
 FEELER:PAPER E
 ND:NO.1

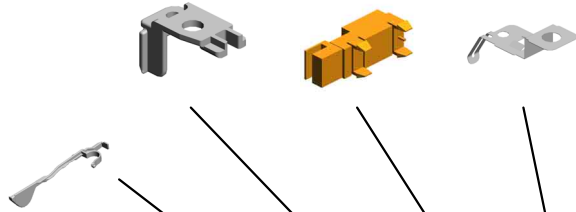

282.G0652767
 LEVER - FEED



241.D2616693
 SHAFT:FEED:ASS'
 Y



283.G0652774
 PRESSURE LEVER

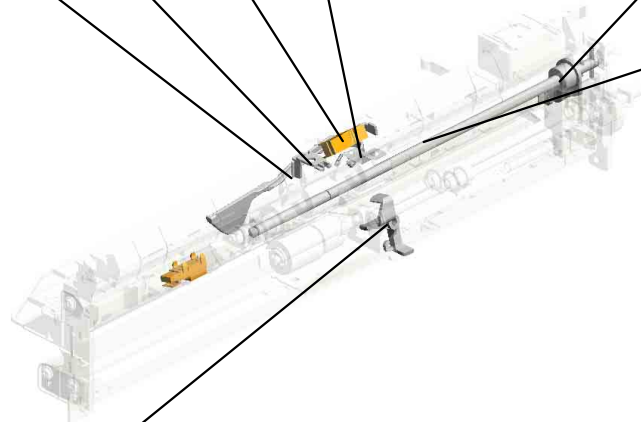

U001	U002	U003	U004	U005	U006	U007	U008	U009	U010	U011	U012	U013	U014	U015	U016	U017	U018	U019	U020	U021
------	------	------	------	------	------	------	------	------	------	------	------	------	------	------	------	------	------	------	------	------

U007_S008_S001
SHAFT:SEPARATE:DRIVEN:ASS'Y

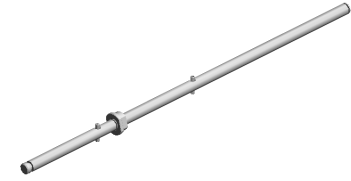

92.D1356667
SHAFT:SEPARATE:
DRIVEN:ASS'Y

19.07200040E (x 1)
RETAINING RING - M4

U001	U002	U003	U004	U005	U006	U007	U008	U009	U010	U011	U012	U013	U014	U015	U016	U017	U018	U019	U020	U021
------	------	------	------	------	------	------	------	------	------	------	------	------	------	------	------	------	------	------	------	------

U007_S009
PAPER FEED UNIT:NO.2:ASS'Y

- 77.B8303504 TIMING BELT - 40S 2M100
- 55.AA082174 PLAIN SHAFT BEA RING:6X10X9
- 73.AW020203 (x2) PHOTOINTERRUP TOR:GP1A173LCS 2F
- 28.11050758 CLAMP:LWSM-030 6A
- 27.11050692 CLAMP:LES-0503

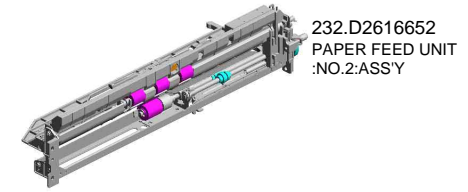

232.D2616652
PAPER FEED UNIT
:NO.2:ASS'Y

69.AF030094
PAPER FEED ROLL
ER:PICKUP



54.AA082173
PLAIN SHAFT BEA
RING:6X10X6



71.AF032094
PAPER FEED ROLL
ER:SEPARATE



58.AA100014
(x2)
RETAINING RING
C - SEPARATE



13.04583008N
(x8)
HEXAGON HEAD T
APPING SCREW:3
X8



70.AF031094
PAPER FEED ROLL
ER:FEED



42.AA060693
TENSION SPRING



30.52062686
SNAP RING



62.AB010157
GEAR:SEPARATE:
DRIVEN

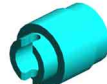

61.AB010156
GEAR:SEPARATE:
DRIVE

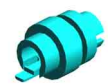

86.D0892764
GEAR:FEED



23.08050103
RETAINING RINGS
-E:SILENCER:DIA3



24.08050104
(x2)
RETAINING RINGS
-E:SILENCER:DIA4



9.04543006Q
(x8)
TAPPING SCREW -
M3X6



51.AA063789
COIL SPRING:PRE
SSURE:PICKUP



24.08050104
(x5)
RETAINING RINGS
-E:SILENCER:DIA4



53.AA082171
(x3)
PLAIN SHAFT BEA
RING:6X10X6



U007_S009
PAPER FEED UNIT:NO.2:ASS'Y

234.D2616675 BALANCER:FRICTI
ON:ASS'Y
190.D2586673 GUIDE PLATE:V TR
ANSPORT:NO.2
184.D2412719 GROUND PLATE:S
ENSOR:TRANSP
ORT
236.D2616678 GROUND PLATE:B
ALANCER:PAPER
FEED U
188.D2586669 ARM:PICKUP

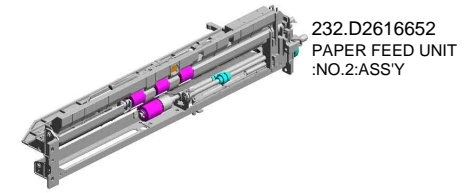

235.D2616677
COVER:FRICION



162.D1492774
PULLEY:IDLER:PIC
KUP



161.D1492773
PULLEY:PICKUP:M
ECHANICAL ROLL
ER CLUTCH

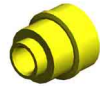

186.D2412782
PLATE:HARNES:
PAPER FEED UNIT



163.D1492781
GROUND PLATE:P
APER FEED UNIT



89.D1292783
TORQUE LIMITER
MECHANICAL CLU
TCH:40MM:DIA18



185.D2412759
TRANSPORT ROLL
ER:VERTICAL TRA
NSPORT:ASS'Y



193.D2586678
LINK:RELEASE



93.D1356669
SHAFT:SEPARATE:
DRIVE:ASS'Y



100.D1356746
COIL SPRING:REL
EASE



160.D1492767
LEVER:PRESSURE
:PICKUP



155.D1482702
SPACER:TRANSP
ORT ROLLER



159.D1492739
LEVER:PRESSURE
RELEASE



87.D0892819
GEAR:SEPARATO
R:INPUT



94.D1356675
COVER:HARNES:
PAPER FEED UNIT



U007_S009
 PAPER FEED UNIT:NO.2:ASS'Y

288.GW010007 (x2)
 PHOTO REFLECTI
 ON SENSOR:EXIT

241.D2616693
 SHAFT:FEED:ASS'
 Y

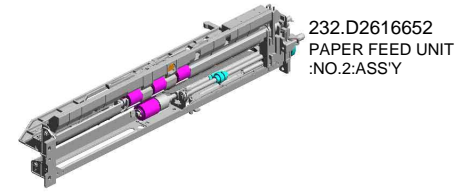

276.D2617574
 FEELER:PAPER E
 ND

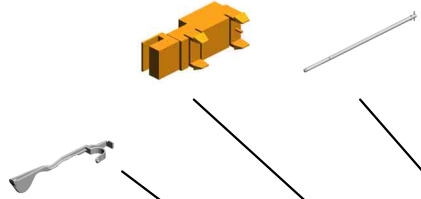

239.D2616686
 DC SOLENOID:PIC
 KUP:NO.2:ASSY

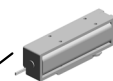

282.G0652767
 LEVER - FEED



283.G0652774
 PRESSURE LEVER



U001	U002	U003	U004	U005	U006	U007	U008	U009	U010	U011	U012	U013	U014	U015	U016	U017	U018	U019	U020	U021
------	------	------	------	------	------	------	------	------	------	------	------	------	------	------	------	------	------	------	------	------

U007_S009_S001
SHAFT:SEPARATE:DRIVEN:ASS'Y

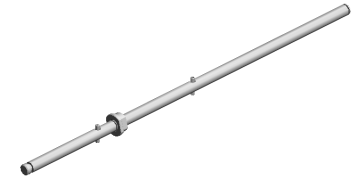

92.D1356667
SHAFT:SEPARATE:
DRIVEN:ASS'Y

19.07200040E (x 1)
RETAINING RING - M4

U001	U002	U003	U004	U005	U006	U007	U008	U009	U010	U011	U012	U013	U014	U015	U016	U017	U018	U019	U020	U021
------	------	------	------	------	------	------	------	------	------	------	------	------	------	------	------	------	------	------	------	------

U007_S010
PAPER FEED UNIT:NO.2:ASS'Y

77.B8303504 TIMING BELT - 40S 2M100
55.AA082174 PLAIN SHAFT BEA RING:6X10X9
73.AW020203 (x2) PHOTOINTERRUP TOR:GP1A173LCS 2F
28.11050758 CLAMP:LWSM-030 6A
27.11050692 CLAMP:LES-0503

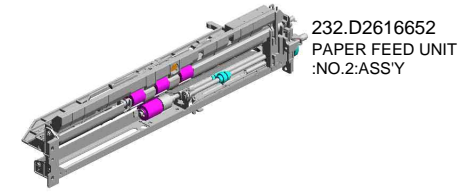

69.AF030094
PAPER FEED ROLL
ER:PICKUP



54.AA082173
PLAIN SHAFT BEA
RING:6X10X6



71.AF032094
PAPER FEED ROLL
ER:SEPARATE



58.AA100014
(x2)
RETAINING RING
C - SEPARATE



13.04583008N
(x8)
HEXAGON HEAD T
APPING SCREW:3
X8



70.AF031094
PAPER FEED ROLL
ER:FEED



42.AA060693
TENSION SPRING



30.52062686
SNAP RING



62.AB010157
GEAR:SEPARATE:
DRIVEN

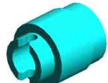

61.AB010156
GEAR:SEPARATE:
DRIVE

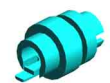

86.D0892764
GEAR:FEED



23.08050103
RETAINING RINGS
-E:SILENCER:DIA3



24.08050104
(x2)
RETAINING RINGS
-E:SILENCER:DIA4

9.04543006Q
(x8)
TAPPING SCREW -
M3X6



51.AA063789
COIL SPRING:PRE
SSURE:PICKUP



24.08050104
(x5)
RETAINING RINGS
-E:SILENCER:DIA4



53.AA082171
(x3)
PLAIN SHAFT BEA
RING:6X10X6



U001	U002	U003	U004	U005	U006	U007	U008	U009	U010	U011	U012	U013	U014	U015	U016	U017	U018	U019	U020	U021
------	------	------	------	------	------	------	------	------	------	------	------	------	------	------	------	------	------	------	------	------

U007_S010 PAPER FEED UNIT:NO.2:ASS'Y

234.D2616675 BALANCER:FRICTI
ON:ASS'Y
190.D2586673 GUIDE PLATE:V TR
ANSPORT:NO.2
184.D2412719 GROUND PLATE:S
ENSOR:TRANSP
ORT
236.D2616678 GROUND PLATE:B
ALANCER:PAPER
FEED U
188.D2586669 ARM:PICKUP

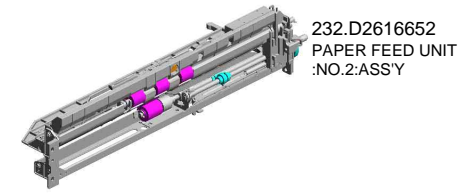

235.D2616677
COVER:FRICION



162.D1492774
PULLEY:IDLER:PIC
KUP



161.D1492773
PULLEY:PICKUP:M
ECHANICAL ROLL
ER CLUTCH

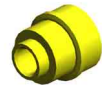

186.D2412782
PLATE:HARNESS:
PAPER FEED UNIT



163.D1492781
GROUND PLATE:P
APER FEED UNIT



89.D1292783
TORQUE LIMITER
MECHANICAL CLU
TCH:40MM:DIA18



185.D2412759
TRANSPORT ROLL
ER:VERTICAL TRA
NSPORT:ASS'Y



193.D2586678
LINK:RELEASE



93.D1356669
SHAFT:SEPARATE:
DRIVE:ASS'Y



100.D1356746
COIL SPRING:REL
EASE



160.D1492767
LEVER:PRESSURE
:PICKUP



155.D1482702
SPACER:TRANSP
ORT ROLLER



159.D1492739
LEVER:PRESSURE
RELEASE



87.D0892819
GEAR:SEPARATO
R:INPUT



94.D1356675
COVER:HARNESS:
PAPER FEED UNIT



U007_S010
 PAPER FEED UNIT:NO.2:ASS'Y

288.GW010007 (x2)
 PHOTO REFLECTI
 ON SENSOR:EXIT

241.D2616693
 SHAFT:FEED:ASS'
 Y

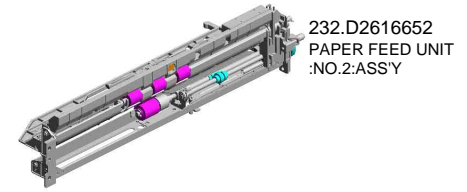

276.D2617574
 FEELER:PAPER E
 ND

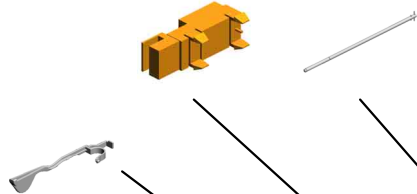

239.D2616686
 DC SOLENOID:PIC
 KUP:NO.2:ASS'Y



282.G0652767
 LEVER - FEED



283.G0652774
 PRESSURE LEVER

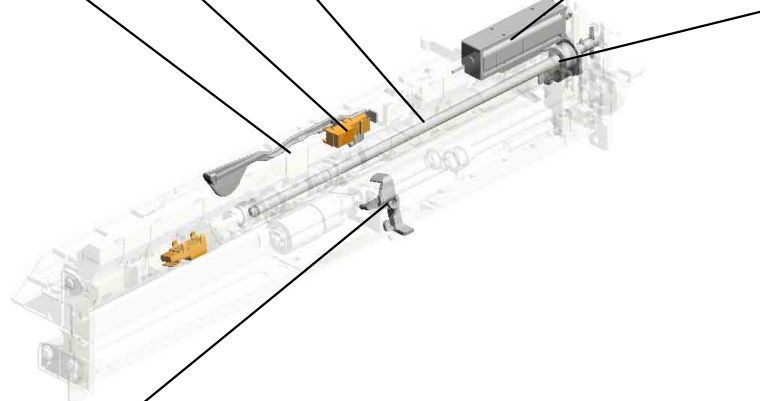

U001	U002	U003	U004	U005	U006	U007	U008	U009	U010	U011	U012	U013	U014	U015	U016	U017	U018	U019	U020	U021
------	------	------	------	------	------	------	------	------	------	------	------	------	------	------	------	------	------	------	------	------

U007_S010_S001
SHAFT:SEPARATE:DRIVEN:ASS'Y

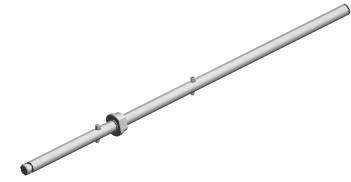

92.D1356667
SHAFT:SEPARATE:
DRIVEN:ASS'Y

19.07200040E (x 1)
RETAINING RING - M4

U001	U002	U003	U004	U005	U006	U007	U008	U009	U010	U011	U012	U013	U014	U015	U016	U017	U018	U019	U020	U021
------	------	------	------	------	------	------	------	------	------	------	------	------	------	------	------	------	------	------	------	------

U007_S011 PAPER TRAY:ASS'Y

124.D1366748
DECAL:SIZE INDIC
ATION:END FENCE
:FRONT

125.D1366749
DECAL:SIZE INDIC
ATION:END FENCE
:REAR

99.D1356740
LINK:END FENCE:
PAPER SIZE SENS
OR

14.04583010N
(x7)
HEXAGON HEAD T
APPING SCREW:3
X10

166.D1492814
COIL SPRING:EAR
TH

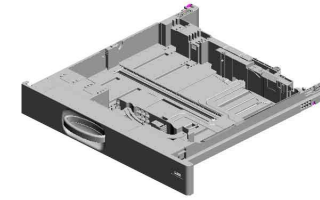

242.D2616712
PAPER TRAY:ASS'
Y

205.D2586757
DECAL:SIZE INDIC
ATION:SIDE FENC
E



98.D1356739
GRIP:PAPER TRAY



17.07200020G
(x2)
RETAINING RING -
M2



31.A1096533
SPACER:TRANSP
ORT SCREW:COLL
ECT



210.D2586775
(x2)
SPACER:PAPER T
RAY:UNIVERSAL



209.D2586772
SHAFT:SIDE FENC
E:FRONT

206.D2586761
TRAY BOTTOM PL
ATE

171.D1492836
GEAR:Z20

5.03603006N
(x4)
SCREW - M3X6

168.D1492818
LEVER:RISE

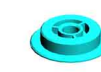

24.08050104
RETAINING RINGS
-E:SILENCER:DIA4



287.GA143003
SCREW:MM5:2.5M
M



165.D1492813
PIN:STRETCH:TRA
Y



164.D1492812
(x4)
ROLLER:PAPER T
RAY:DIA19



170.D1492835
(x2)
RACK:SIDE FENCE



167.D1492816
SHAFT:RISE:ASS'Y



U007_S011
PAPER TRAY:ASS'Y

258.D2616779
COVER:PAPER TR
AY:UNIVERSAL:LE
FT

257.D2616778
COVER:PAPER TR
AY:UNIVERSAL:RI
GHT

253.D2616758
KNOB SCREW:SID
E FENCE

250.D2616754
KNOB SCREW:SU
PPORTING PLATE

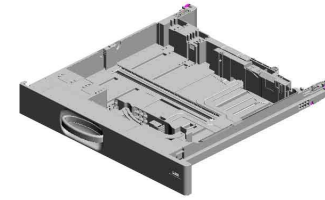

242.D2616712
PAPER TRAY:ASS'
Y

251.D2616756
HOLDER:FLAT NU
T

252.D2616757
FLAT NUT:SIDE FE
NCE

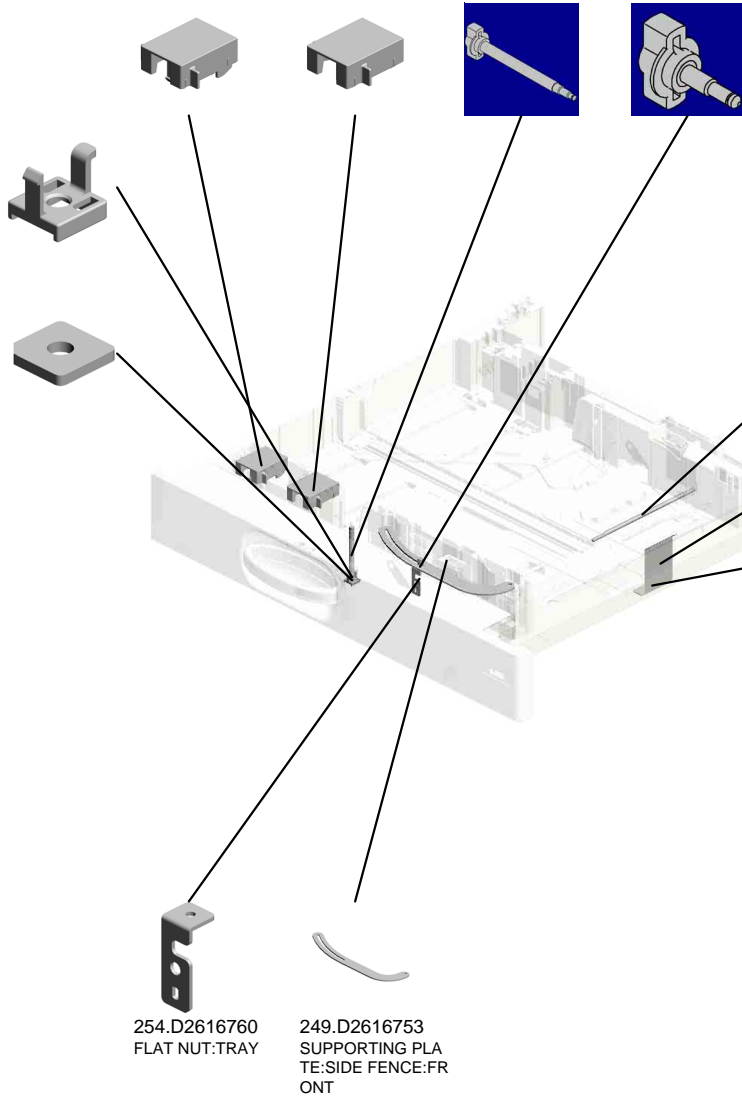

256.D2616762
SHAFT:SIDE FENC
E:REAR

211.D2586799
GUIDE:MIDDLE:PA
PER TRAY:UNIVER
SAL

281.D7942612
PAD:TRAY BOTTO
M PLATE

254.D2616760
FLAT NUT:TRAY

249.D2616753
SUPPORTING PLA
TE:SIDE FENCE:FR
ONT

U007_S011_S001
END FENCE:PAPER TRAY:ASS'Y

173.D1492842 174.D1492843
LEVER:END FENC CLICK:END FENCE
E

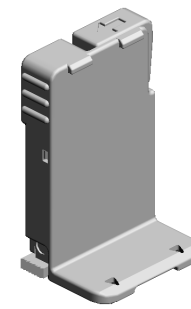

172.D1492840
END FENCE:PAPE
R TRAY:ASS'Y

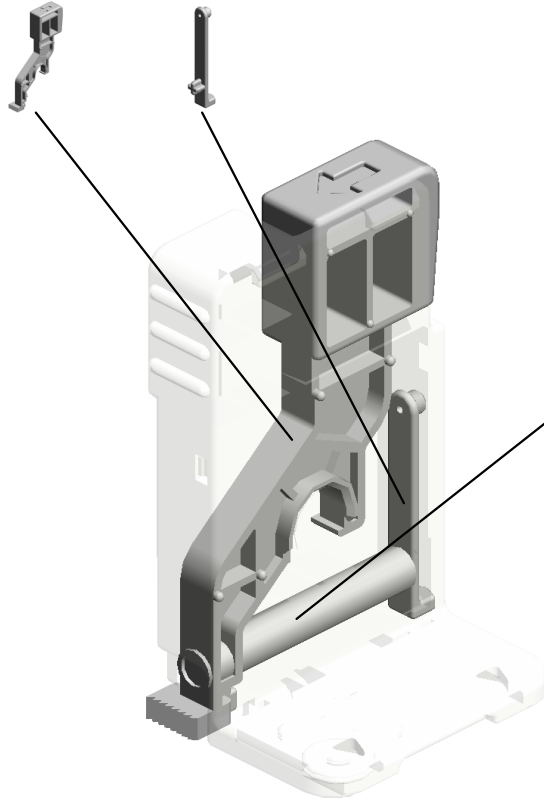

175.D1492845
COMPRESSION SP
RING:END FENCE:
LEVER:5N

U001	U002	U003	U004	U005	U006	U007	U008	U009	U010	U011	U012	U013	U014	U015	U016	U017	U018	U019	U020	U021
------	------	------	------	------	------	------	------	------	------	------	------	------	------	------	------	------	------	------	------	------

U007_S011_S002
COVER:PAPER TRAY:NO.3:ASS'Y

255.D2616761
DECAL:PAPER SE
T DIRECTION:TRA
Y

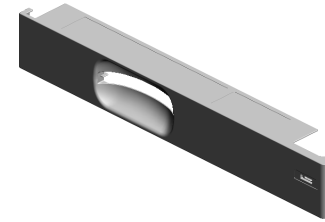
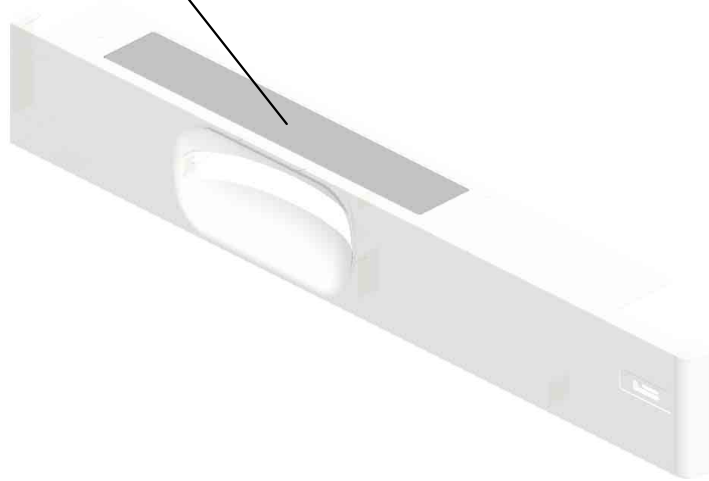

259.D2616783
COVER:PAPER TR
AY:NO.3:ASS'Y

U001	U002	U003	U004	U005	U006	U007	U008	U009	U010	U011	U012	U013	U014	U015	U016	U017	U018	U019	U020	U021
------	------	------	------	------	------	------	------	------	------	------	------	------	------	------	------	------	------	------	------	------

U007_S011_S003
SIDE FENCE:REAR:ASS'Y

248.D2616752
LEVER:STOPPER:
REAR

176.D1492952
DECAL:SIDE FENC
E:PAPER VOLUME

177.D1492954
DECAL:SIDE FENC
E:PAPER VOLUME:
ENVELOPE

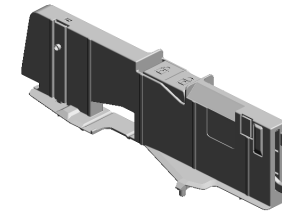

260.D2616786
SIDE FENCE:REAR
:ASS'Y

169.D1492826
COMPRESSION SP
RING:SIDE FENCE:
PLATE:FRONT

46.AA061229
COMPRESSION SP
RING:SIDE FENCE:
FIX

14.04583010N
(x2)
HEXAGON HEAD T
APPING SCREW:3
X10

48.AA061232
COMPRESSION SP
RING:SIDE FENCE:
REAR

207.D2586764
COVER:SIDE FENC
E:REAR

247.D2616750
LINK:SIDE FENCE:
REAR:UNIVERSAL

U007_S011_S004
SIDE FENCE:FRONT:ASS'Y

208.D2586770
LEVER:STOPPER:
FRONT

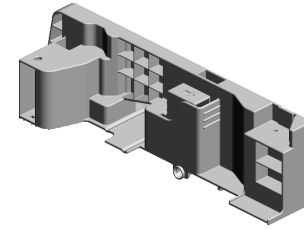

262.D2616798
SIDE FENCE:FRON
T:ASS'Y

14.04583010N
(x5)
HEXAGON HEAD T
APPING SCREW:3
X10

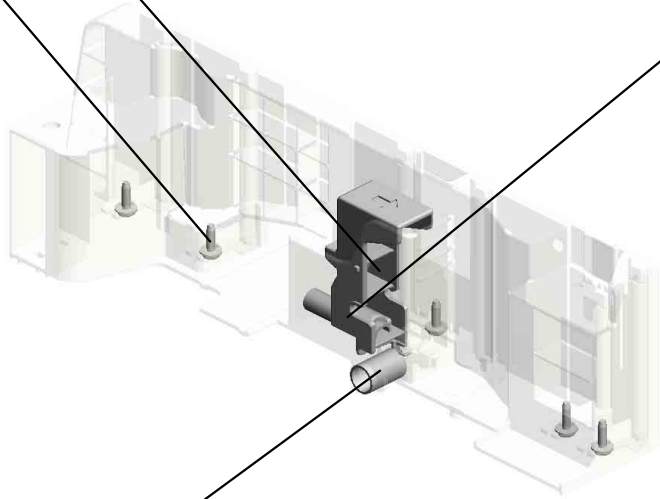

47.AA061230
COMPRESSION SP
RING:SIDE FENCE

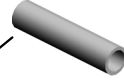

46.AA061229
COMPRESSION SP
RING:SIDE FENCE:
FIX

U001	U002	U003	U004	U005	U006	U007	U008	U009	U010	U011	U012	U013	U014	U015	U016	U017	U018	U019	U020	U021
------	------	------	------	------	------	-------------	------	------	------	------	------	------	------	------	------	------	------	------	------	------

U007_S012
PAPER TRAY:NO.4:ASS'Y

124.D1366748
DECAL:SIZE INDIC
ATION:END FENCE
:FRONT

125.D1366749
DECAL:SIZE INDIC
ATION:END FENCE
:REAR

99.D1356740
LINK:END FENCE:
PAPER SIZE SENS
OR

14.04583010N
(x7)
HEXAGON HEAD T
APPING SCREW:3
X10

166.D1492814
COIL SPRING:EAR
TH

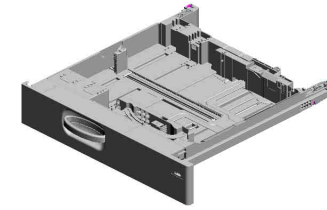

243.D2616713
PAPER TRAY:NO.4
:ASS'Y

205.D2586757
DECAL:SIZE INDIC
ATION:SIDE FENC
E



24.08050104
RETAINING RINGS
-E:SILENCER:DIA4



287.GA143003
SCREW:MM5:2.5M
M

98.D1356739
GRIP:PAPER TRAY



165.D1492813
PIN:STRETCH:TRA
Y



17.07200020G
(x2)
RETAINING RING -
M2



164.D1492812
(x4)
ROLLER:PAPER T
RAY:DIA19



31.A1096533
SPACER:TRANSP
ORT SCREW:COLL
ECT



170.D1492835
(x2)
RACK:SIDE FENCE



210.D2586775
(x2)
SPACER:PAPER T
RAY:UNIVERSAL



167.D1492816
SHAFT:RISE:ASS'Y



209.D2586772
SHAFT:SIDE FENC
E:FRONT



206.D2586761
TRAY BOTTOM PL
ATE



171.D1492836
GEAR:Z20



5.03603006N
(x4)
SCREW - M3X6



168.D1492818
LEVER:RISE



U007_S012
 PAPER TRAY:NO.4:ASS'Y

258.D2616779
 COVER:PAPER TRAY:UNIVERSAL:LEFT

257.D2616778
 COVER:PAPER TRAY:UNIVERSAL:RIGHT

253.D2616758
 KNOB SCREW:SIDE FENCE

250.D2616754
 KNOB SCREW:SUPPORTING PLATE

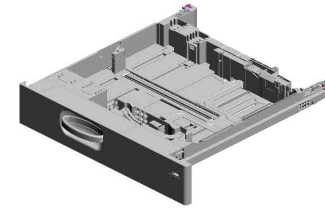

243.D2616713
 PAPER TRAY:NO.4:ASS'Y

251.D2616756
 HOLDER:FLAT NUT

252.D2616757
 FLAT NUT:SIDE FENCE

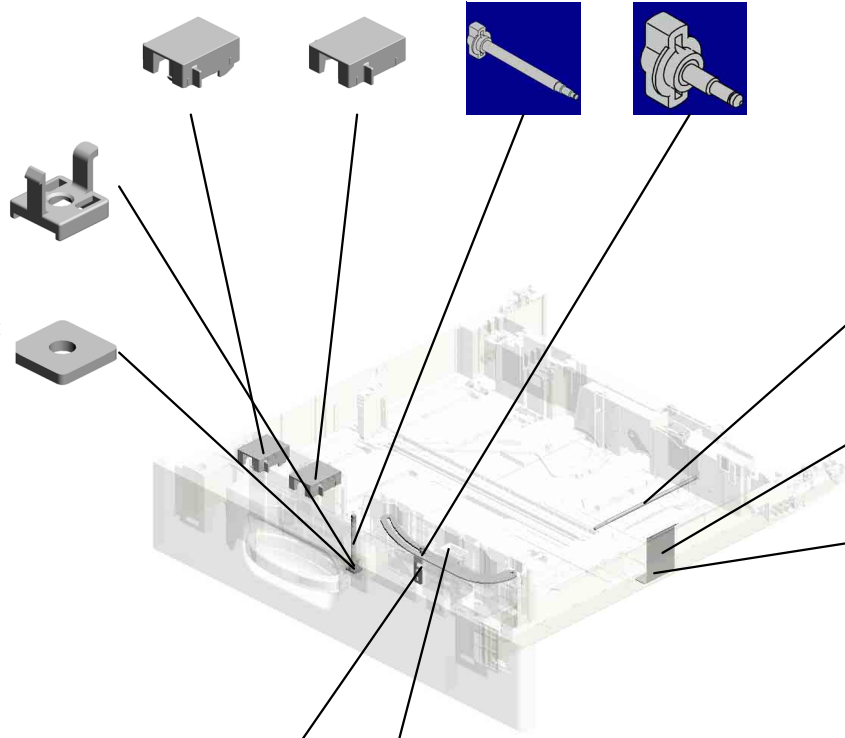

256.D2616762
 SHAFT:SIDE FENCE:REAR

211.D2586799
 GUIDE:MIDDLE:PAPER TRAY:UNIVERSAL

281.D7942612
 PAD:TRAY BOTTOM PLATE

254.D2616760
 FLAT NUT:TRAY

249.D2616753
 SUPPORTING PLATE:SIDE FENCE:FRONT

U007_S012_S001
END FENCE:PAPER TRAY:ASS'Y

173.D1492842 174.D1492843
LEVER:END FENC CLICK:END FENCE
E

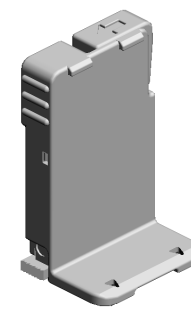

172.D1492840
END FENCE:PAPE
R TRAY:ASS'Y

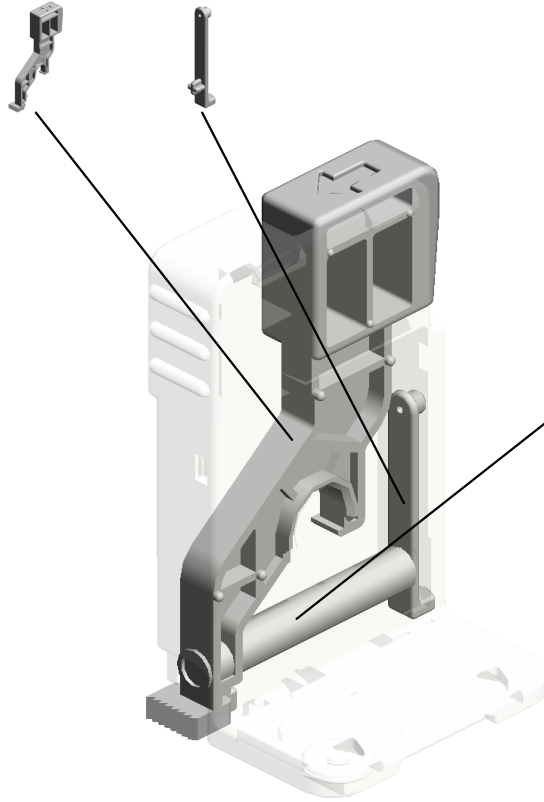

175.D1492845
COMPRESSION SP
RING:END FENCE:
LEVER:5N

U001	U002	U003	U004	U005	U006	U007	U008	U009	U010	U011	U012	U013	U014	U015	U016	U017	U018	U019	U020	U021
------	------	------	------	------	------	------	------	------	------	------	------	------	------	------	------	------	------	------	------	------

U007_S012_S002
SIDE FENCE:REAR:ASS'Y

248.D2616752
LEVER:STOPPER:
REAR

176.D1492952
DECAL:SIDE FENC
E:PAPER VOLUME

177.D1492954
DECAL:SIDE FENC
E:PAPER VOLUME:
ENVELOPE

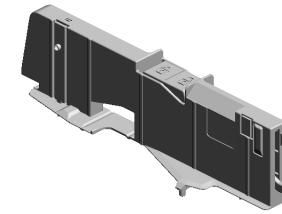

260.D2616786
SIDE FENCE:REAR
:ASS'Y

169.D1492826
COMPRESSION SP
RING:SIDE FENCE:
PLATE:FRONT

46.AA061229
COMPRESSION SP
RING:SIDE FENCE:
FIX

14.04583010N
(x2)
HEXAGON HEAD T
APPING SCREW:3
X10

48.AA061232
COMPRESSION SP
RING:SIDE FENCE:
REAR

207.D2586764
COVER:SIDE FENC
E:REAR

247.D2616750
LINK:SIDE FENCE:
REAR:UNIVERSAL

U001	U002	U003	U004	U005	U006	U007	U008	U009	U010	U011	U012	U013	U014	U015	U016	U017	U018	U019	U020	U021
------	------	------	------	------	------	------	------	------	------	------	------	------	------	------	------	------	------	------	------	------

U007_S012_S003
SIDE FENCE:FRONT:ASS'Y

208.D2586770
LEVER:STOPPER:
FRONT

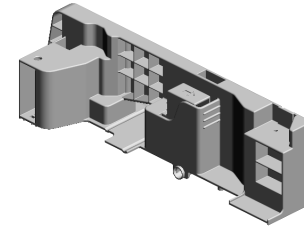

262.D2616798
SIDE FENCE:FRON
T:ASS'Y

14.04583010N
(x5)
HEXAGON HEAD T
APPING SCREW:3
X10

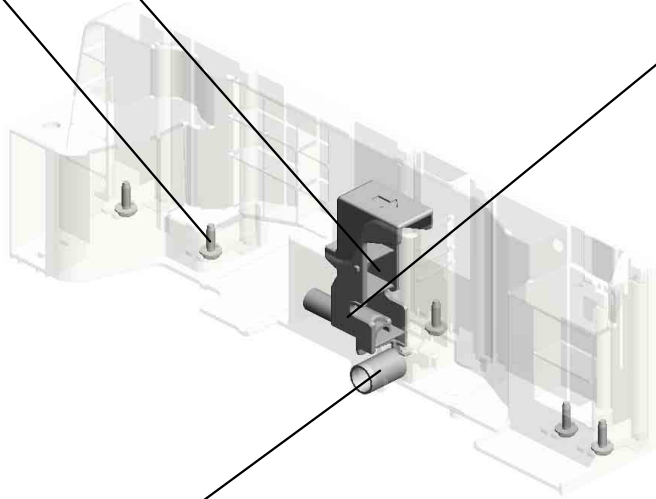

47.AA061230
COMPRESSION SP
RING:SIDE FENCE

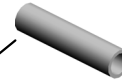

46.AA061229
COMPRESSION SP
RING:SIDE FENCE:
FIX

U001	U002	U003	U004	U005	U006	U007	U008	U009	U010	U011	U012	U013	U014	U015	U016	U017	U018	U019	U020	U021
------	------	------	------	------	------	-------------	------	------	------	------	------	------	------	------	------	------	------	------	------	------

U007_S012_S004
COVER:PAPER TRAY:NO.4:ASS'Y

255.D2616761
DECAL:PAPER SE
T DIRECTION:TRA
Y

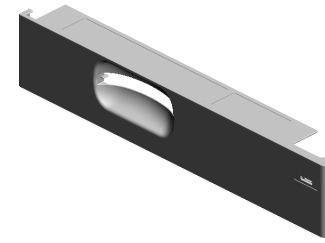
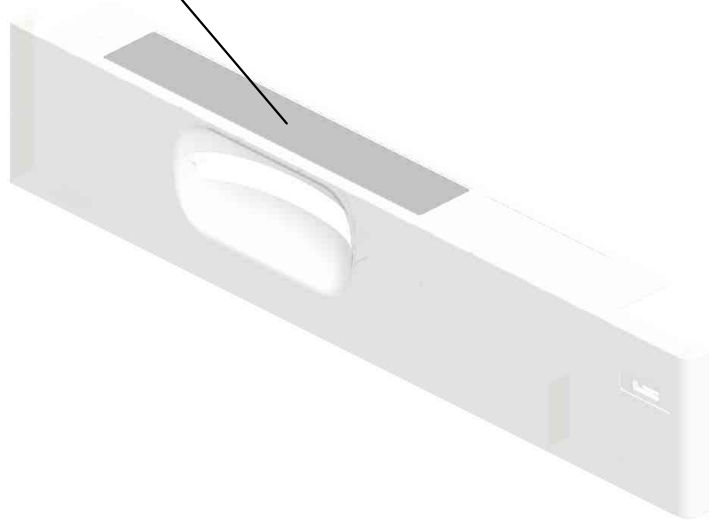

261.D2616793
COVER:PAPER TR
AY:NO.4:ASS'Y

U001	U002	U003	U004	U005	U006	U007	U008	U009	U010	U011	U012	U013	U014	U015	U016	U017	U018	U019	U020	U021
------	------	------	------	------	------	------	------	------	------	------	------	------	------	------	------	------	------	------	------	------

U007_S013
(NA):TANDEM LCT:RIGHT:ASS'Y

- 81.D0294486 TENSION SPRING: GATE PAWL:1.5N
- 219.D2587552 (x2) TIMING PULLEY:TRAY BOTTOM PLATE
- 220.D2587553 (x2) CAP:TRAY BOTTOM PLATE:TANDEM TRAY
- 14.04583010N (x27) HEXAGON HEAD TAPPING SCREW:3 X10
- 218.D2587549 (x2) BRACKET:SHAFT:LEFT MOTOR:ASS'Y

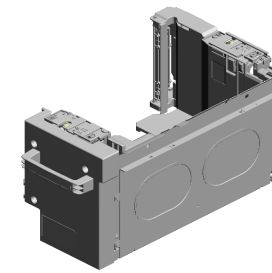

280.D2617599
(NA):TANDEM LCT:RIGHT:ASS'Y

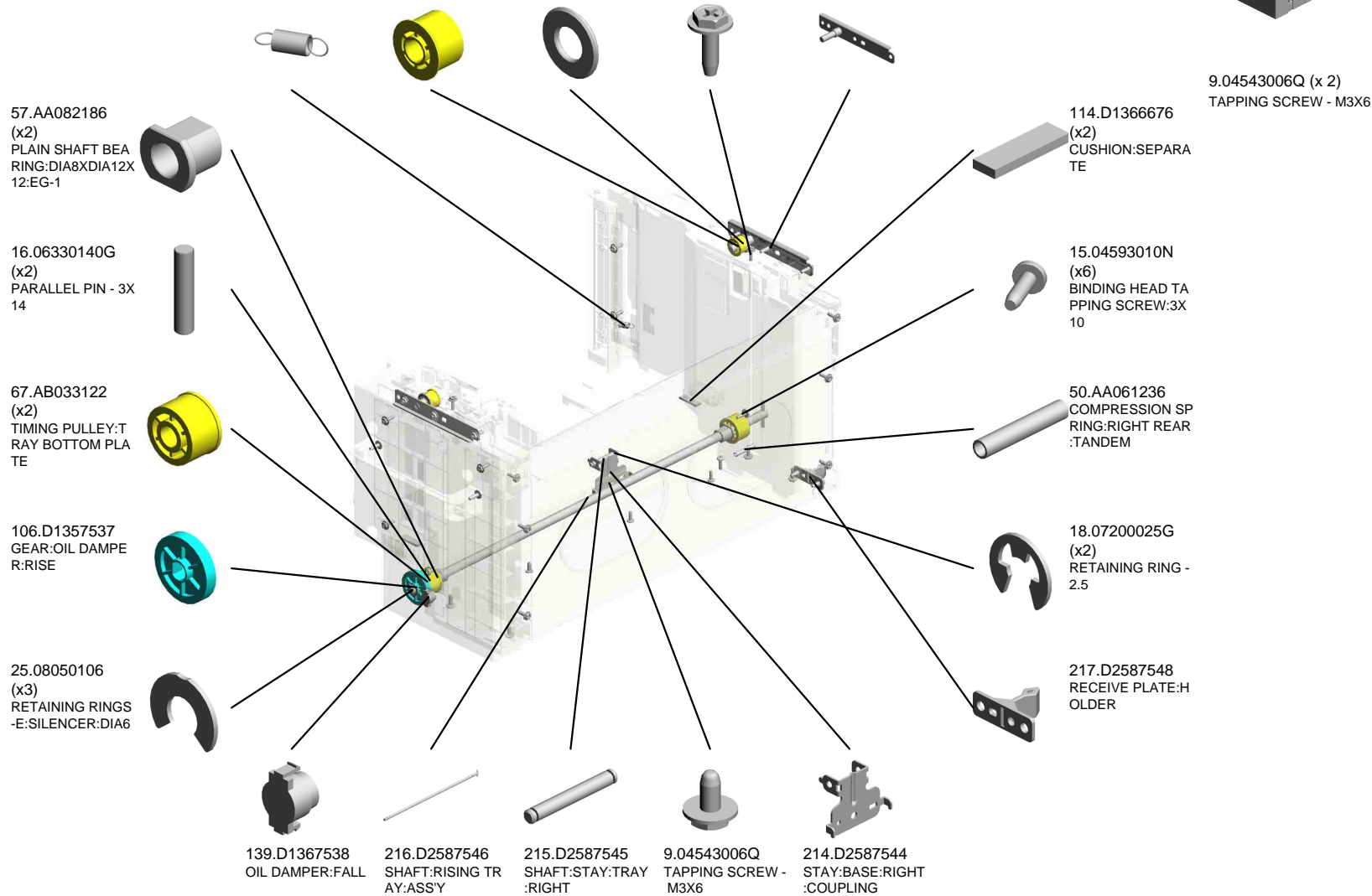

U001	U002	U003	U004	U005	U006	U007	U008	U009	U010	U011	U012	U013	U014	U015	U016	U017	U018	U019	U020	U021
------	------	------	------	------	------	------	------	------	------	------	------	------	------	------	------	------	------	------	------	------

U007_S013
(NA):TANDEM LCT:RIGHT:ASS'Y

287.GA143003
SCREW:MM5:2.5M
M

265.D2617538
END FENCE:TAND
EM LCT

230.D2587597
(x2)
COLLAR:RISE:TAN
DEM TRAY

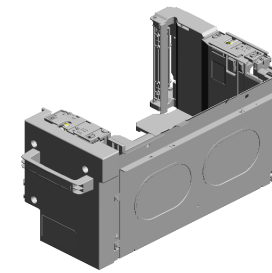

280.D2617599
(NA):TANDEM LCT:
RIGHT:ASS'Y

222.D2587555
(x2)
GROUND PLATE:T
ANDEM TRAY:RIG
HT

266.D2617550
BRACKET:COUPLI
NG:RIGHT:ASS'Y

227.D2587579
ROLLER:TRAY BO
TTOM PLATE:TAN
DEM TRAY

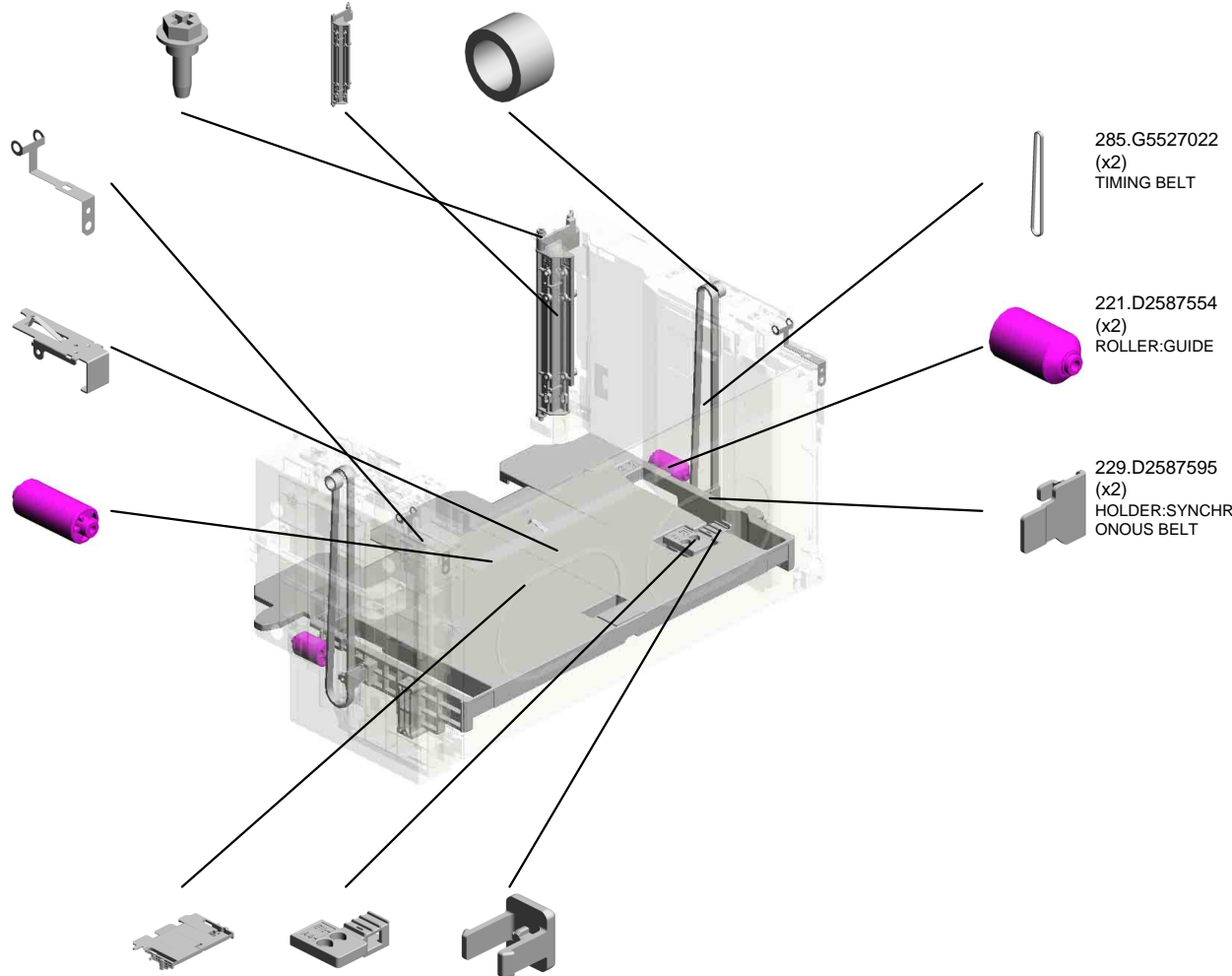

285.G5527022
(x2)
TIMING BELT

221.D2587554
(x2)
ROLLER:GUIDE

229.D2587595
(x2)
HOLDER:SYNCHR
ONOUS BELT

226.D2587578
TRAY BOTTOM PL
ATE:TANDEM TRA
Y:ASS'Y

269.D2617558
PRESSURE PLATE
:TANDEM TRAY:AU
XILIARY:BRACKET

268.D2617557
PRESSURE PLATE
:TANDEM TRAY:AU
XILIARY

U007_S013_S001
SIDE FENCE:RIGHT REAR:TANDEM LCT:ASS'Y

76.B2342864
PAD:CLEANER

40.AA000316
DECAL:SIDE FENC
E:REAR



273.D2617563
SIDE FENCE:RIGH
T REAR:TANDEM L
CT:ASS'Y

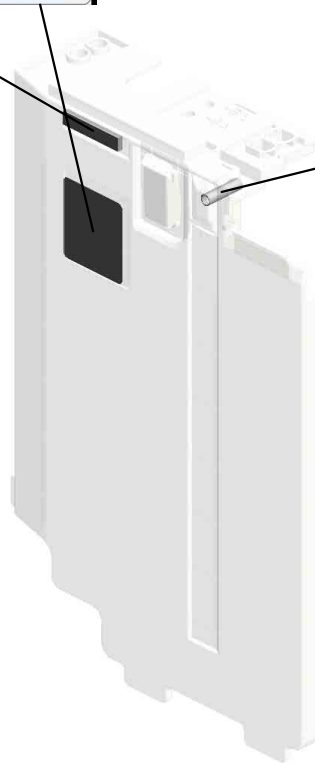
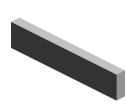

275.D2617569
COMPRESSION SP
RING:RIGHT REAR

U001	U002	U003	U004	U005	U006	U007	U008	U009	U010	U011	U012	U013	U014	U015	U016	U017	U018	U019	U020	U021
------	------	------	------	------	------	------	------	------	------	------	------	------	------	------	------	------	------	------	------	------

U007_S013_S001_S001
PLATE:PAPER:ASS'Y

60.AA162082
CUSHION:PLATE:P
APER

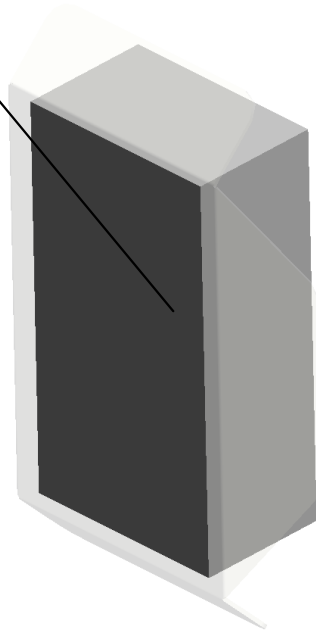
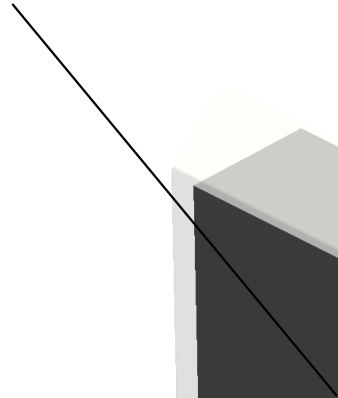
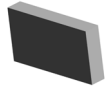

84.D0596690
PLATE:PAPER:ASS
Y

U001	U002	U003	U004	U005	U006	U007	U008	U009	U010	U011	U012	U013	U014	U015	U016	U017	U018	U019	U020	U021
------	------	------	------	------	------	------	------	------	------	------	------	------	------	------	------	------	------	------	------	------

U007_S013_S002
SIDE FENCE:RIGHT FRONT:TANDEM LCT:ASS'Y

14.04583010N
(x2)
HEXAGON HEAD TAPPING SCREW:3
X10

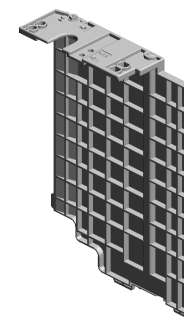
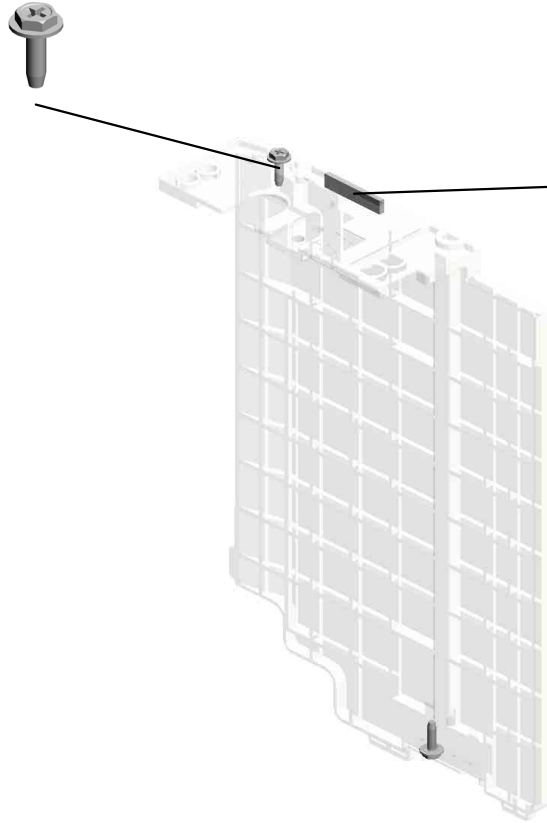

272.D2617562
SIDE FENCE:RIGHT FRONT:TANDEM LCT:ASS'Y

2.03520040N (x 1)
SCREW M2X4

76.B2342864
PAD:CLEANER

U001	U002	U003	U004	U005	U006	U007	U008	U009	U010	U011	U012	U013	U014	U015	U016	U017	U018	U019	U020	U021
------	------	------	------	------	------	------	------	------	------	------	------	------	------	------	------	------	------	------	------	------

U007_S013_S003
GRIP:INNER COVER:ASS'Y

37.AA000295
DECAL:GRIP:INNE
R COVER:RIGHT

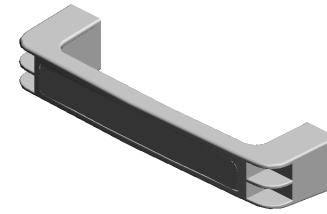

105.D1357531
GRIP:INNER COVE
R:ASS'Y

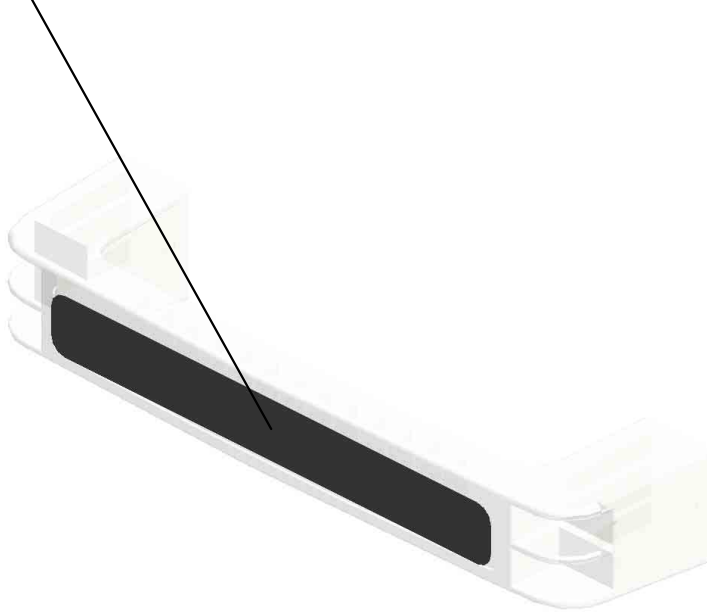

U001	U002	U003	U004	U005	U006	U007	U008	U009	U010	U011	U012	U013	U014	U015	U016	U017	U018	U019	U020	U021
------	------	------	------	------	------	------	------	------	------	------	------	------	------	------	------	------	------	------	------	------

U007_S013_S004
INNER COVER:RIGHT:TANDEM LCT:ASS'Y

36.AA000292
DECAL:CAUTION C
HART:TANDEM LC
T

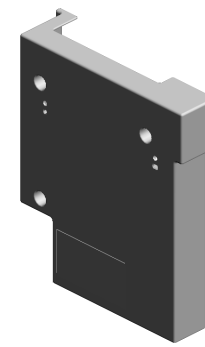
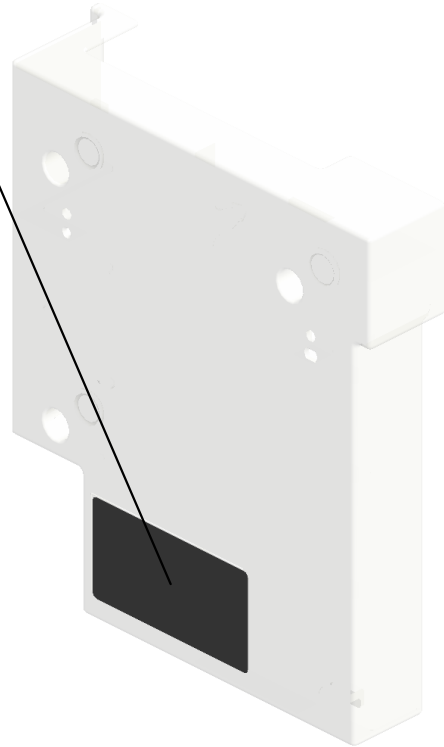
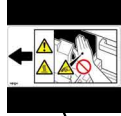

263.D2617526
INNER COVER:RIG
HT:TANDEM LCT:A
SS'Y

U001	U002	U003	U004	U005	U006	U007	U008	U009	U010	U011	U012	U013	U014	U015	U016	U017	U018	U019	U020	U021
------	------	------	------	------	------	------	------	------	------	------	------	------	------	------	------	------	------	------	------	------

U007_S014
(NA):TANDEM LCT:LEFT:ASS'Y

38.AA000314
SHEET:PAPER SE
T DIRECTION

14.04583010N
(x29)
HEXAGON HEAD T
APPING SCREW:3
X10

66.AB033085
TIMING PULLEY - 1
5T

41.AA043714
TIMING BELT:60S3
M588

27.11050692
CLAMP:LES-0503

213.D2587507
(NA):TANDEM LCT:
LEFT:ASS'Y

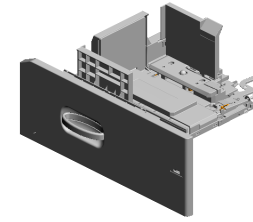

90.D1351499
HOLDER:SD-CARD

101.D1356748
TORSION SPRING:
STOPPER:TANDE
M TRAY

104.D1357523
ARM:GRIP:TANDE
M LCT

103.D1357522
COVER:TANDEM L
CT

6.03603008N
(x3)
SCREW:M3X8

107.D1357542
BRACKET:TRAY:PL
ATE:LOWER

108.D1357543
BRACKET:TRAY:PL
ATE:UPPER

102.D1356755
(x2)
HEXAGON HEAD B
OLT:DOUBLE SCR
EW:M3X8:ROUND
POINT

24.08050104
(x3)
RETAINING RINGS
-E:SILENCER:DIA4

65.AB030831
TIMING PULLEY:15
T:DRIVE

28.11050758
(x9)
CLAMP:LWSM-030
6A

28.11050758
CLAMP:LWSM-030
6A

72.AW020198
(x3)
PHOTOINTERRUP
TOR:LG2A14NL1

23.08050103
RETAINING RINGS
-E:SILENCER:DIA3

49.AA061235
COMPRESSION SP
RING:LEVER:TANDE
M TRAY

52.AA080184
(x2)
BUSHING - FUSIN
G EXIT

U007_S014
(NA):TANDEM LCT:LEFT:ASS'Y

270.D2617560 SIDE FENCE:LEFT FRONT:TANDEM LCT
 278.D2617594 COVER:BACK FENCE:TANDEM LCT
 267.D2617555 BACK FENCE:TANDEM LCT
 110.D1357568 STOPPER:SYNCHRONOUS BELT:SLIDER
 148.D1367579 SLIDER:BACK FENCE

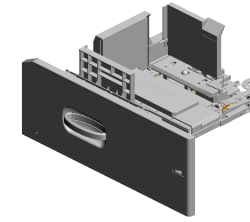

213.D2587507 (NA):TANDEM LCT:LEFT:ASS'Y

271.D2617561 HOLDER:TANDEM LCT:LEFT

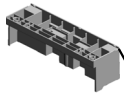

217.D2587548 RECEIVE PLATE:HOLDER



143.D1367566 STOPPER:TANDEM TRAY



147.D1367575 (x2) CAP:LEVER



146.D1367571 GRIP:PAPER TRAY:TANDEM TRAY



274.D2617564 LEVER:COUPLING:TANDEM LCT



111.D1357582 BRACKET:STOPPER:TANDEM TRAY:LEFT



223.D2587556 GROUND PLATE:SLIDER:DRIVE



142.D1367565 SHAFT:GRIP:TANDEM TRAY



109.D1357548 SHAFT:SLIDER:DRIVE:PRESS FIT



145.D1367570 GRIP:TANDEM TRAY:REAR



144.D1367567 BRACKET:STOPPER:TANDEM TRAY:RIGHT:ASSY



228.D2587592 BRACKET:SYNCHRONOUS BELT:DRIVEN



224.D2587557 COVER:PAPER:SET SENSOR:TANDEM TRAY



225.D2587558 FEELER:PAPER:SET SENSOR:TANDEM TRAY



U007_S014_S001
SIDE FENCE:LEFT REAR:TANDEM:ASS'Y

140.D1367546
DECAL:PAPER VO
LUME:SIDE FENCE
:LEFT REAR:1

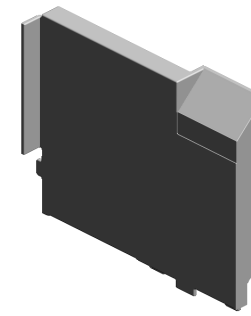
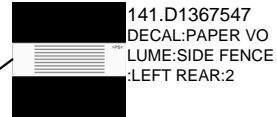

264.D2617529
SIDE FENCE:LEFT
REAR:TANDEM:AS
SY

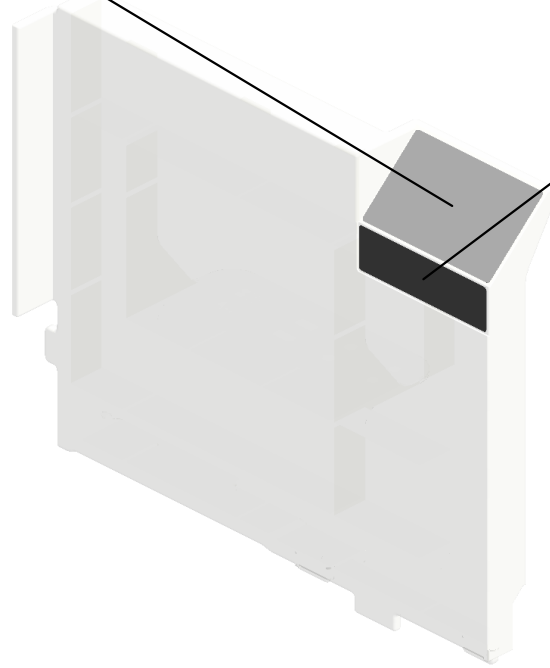

U001	U002	U003	U004	U005	U006	U007	U008	U009	U010	U011	U012	U013	U014	U015	U016	U017	U018	U019	U020	U021
------	------	------	------	------	------	------	------	------	------	------	------	------	------	------	------	------	------	------	------	------

U007_S014_S002

COVER:SYNCHRONOUS BELT:TANDEM TRAY

14.04583010N
(x2)
HEXAGON HEAD TAPPING SCREW:3
X10

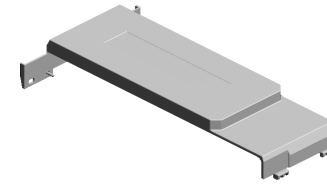

277.D2617586
COVER:SYNCHRO
NOUS BELT:TAND
EM TRAY

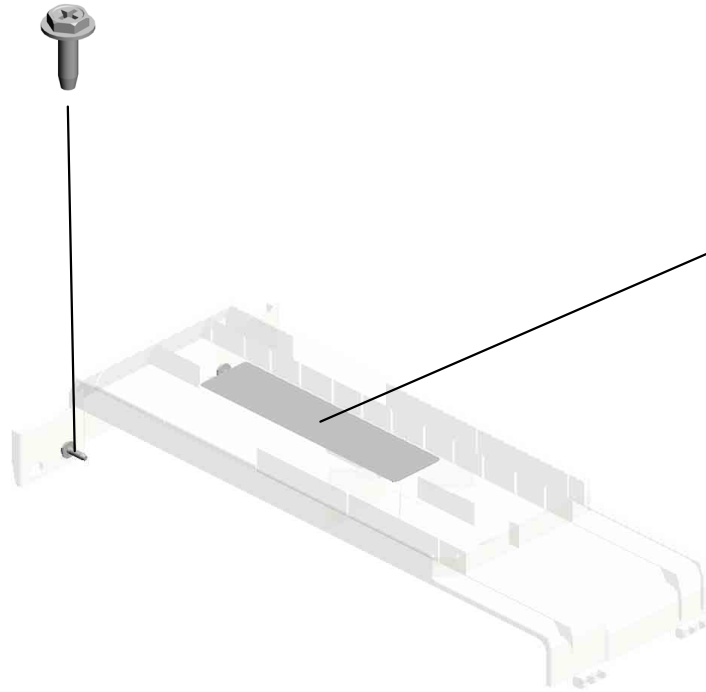

39.AA000315
DECAL:CAUTION C
HART:LEFT

U001	U002	U003	U004	U005	U006	U007	U008	U009	U010	U011	U012	U013	U014	U015	U016	U017	U018	U019	U020	U021
------	------	------	------	------	------	------	------	------	------	------	------	------	------	------	------	------	------	------	------	------

U007_S015
(EU/AA/KOR/TWN/CHN):TANDEM LCT:RIGHT:ASS'Y

- 15.04593010N (x6) BINDING HEAD TAPPING SCREW:3X10
- 81.D0294486 TENSION SPRING: GATE PAWL:1.5N
- 219.D2587552 (x2) TIMING PULLEY:TRAY BOTTOM PLATE
- 220.D2587553 (x2) CAP:TRAY BOTTOM PLATE:TANDEM TRAY
- 14.04583010N (x27) HEXAGON HEAD TAPPING SCREW:3X10

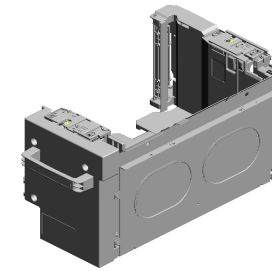

279.D2617598
(EU/AA/KOR/TWN/CHN):TANDEM LCT:RIGHT:ASS'Y

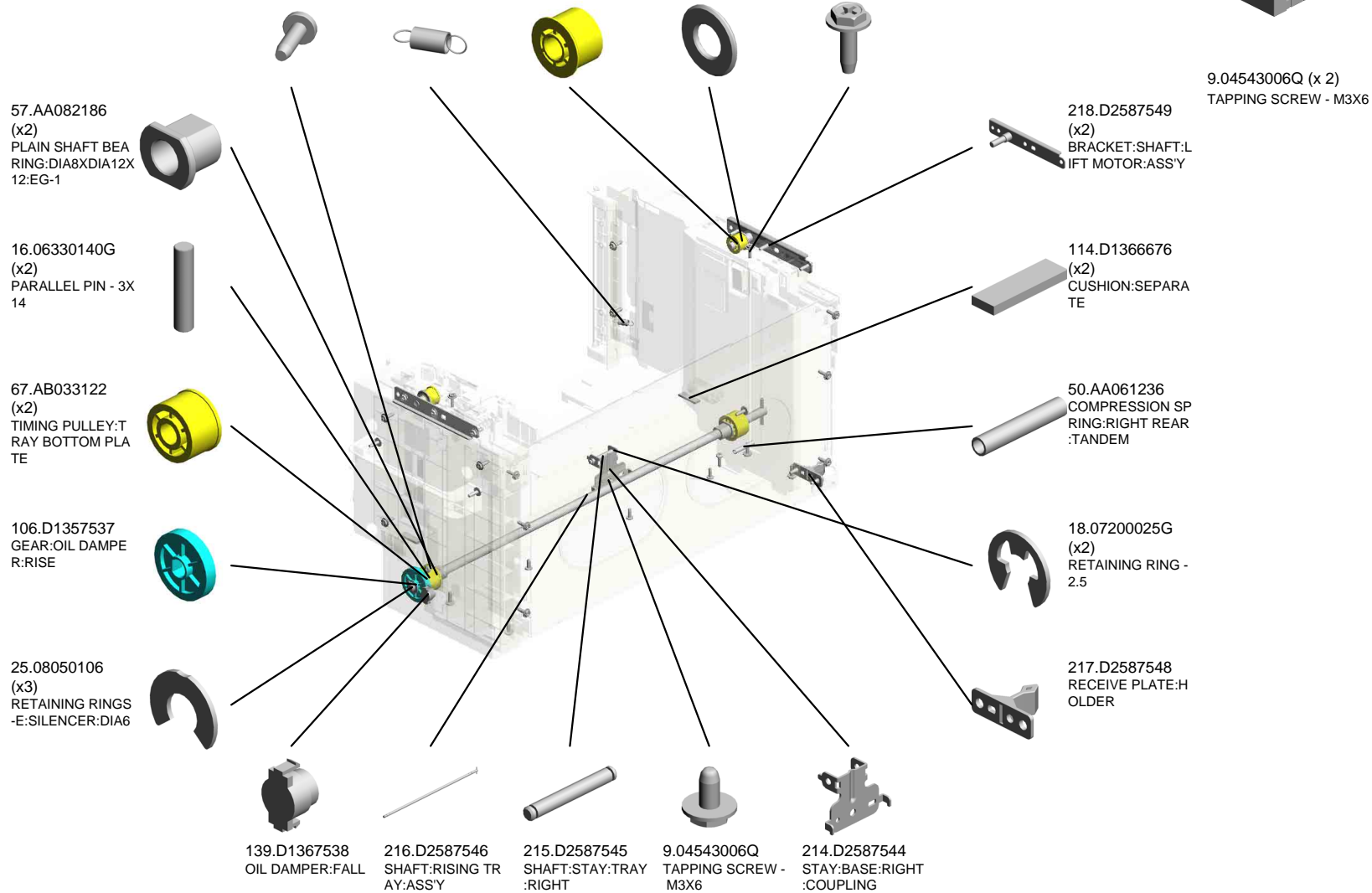

U007_S015
 (EU/AA/KOR/TWN/CHN):TANDEM LCT:RIGHT:ASS'Y

287.GA143003 SCREW:MM5:2.5M
 265.D2617538 END FENCE:TANDEM LCT
 230.D2587597 (x2) COLLAR:RISE:TANDEM TRAY

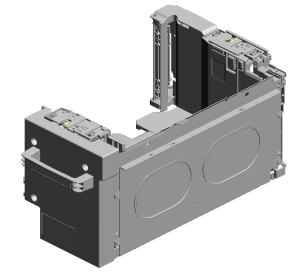

279.D2617598
 (EU/AA/KOR/TWN/CHN):TANDEM LCT:RIGHT:ASS'Y

222.D2587555 (x2) GROUND PLATE:TANDEM TRAY:RIGHT

221.D2587554 (x2) ROLLER:GUIDE

229.D2587595 (x2) HOLDER:SYNCHRONOUS BELT

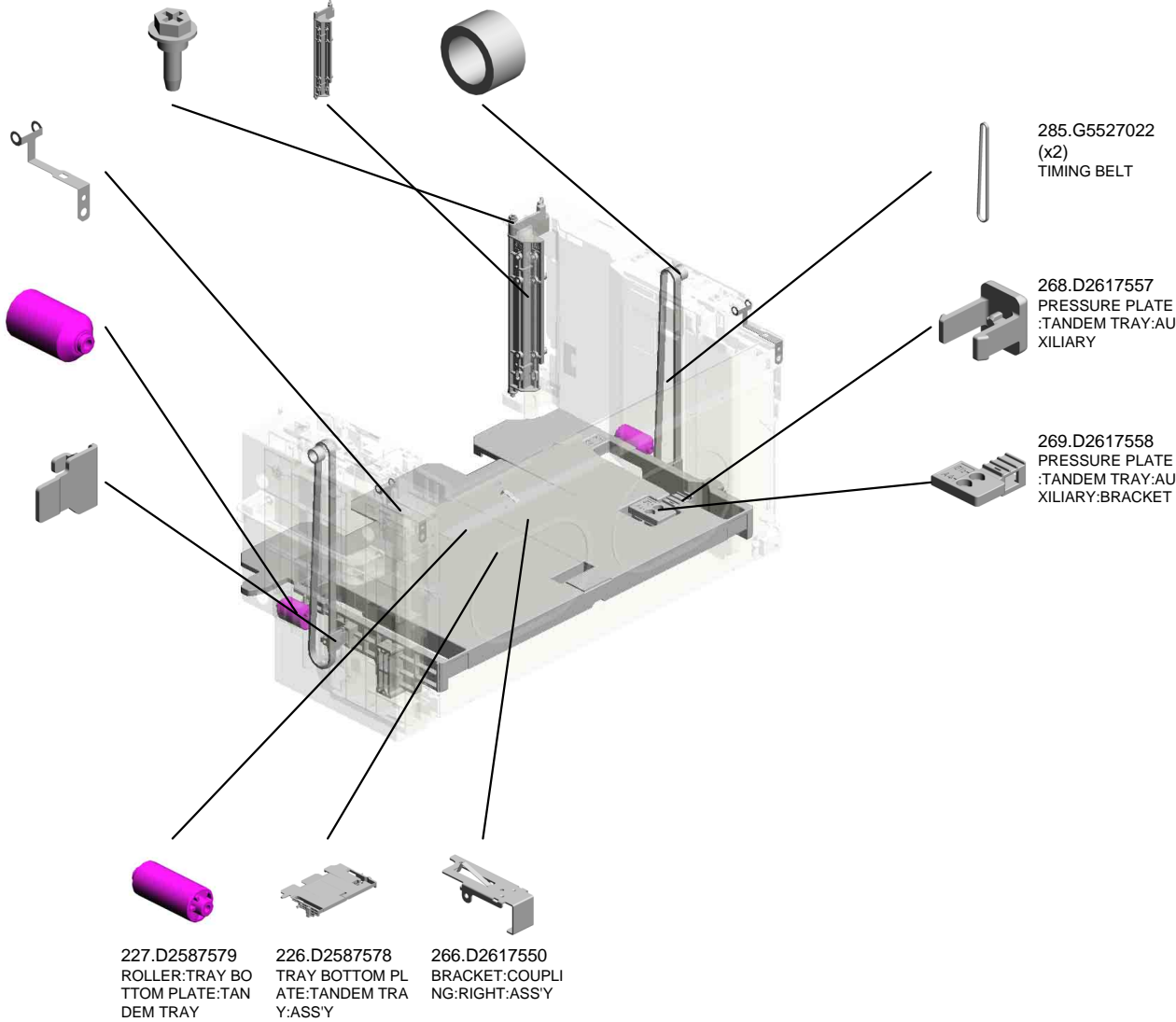

U007_S015_S001
SIDE FENCE:RIGHT REAR:TANDEM LCT:ASS'Y

76.B2342864
PAD:CLEANER

40.AA000316
DECAL:SIDE FENC
E:REAR



273.D2617563
SIDE FENCE:RIGH
T REAR:TANDEM L
CT:ASS'Y

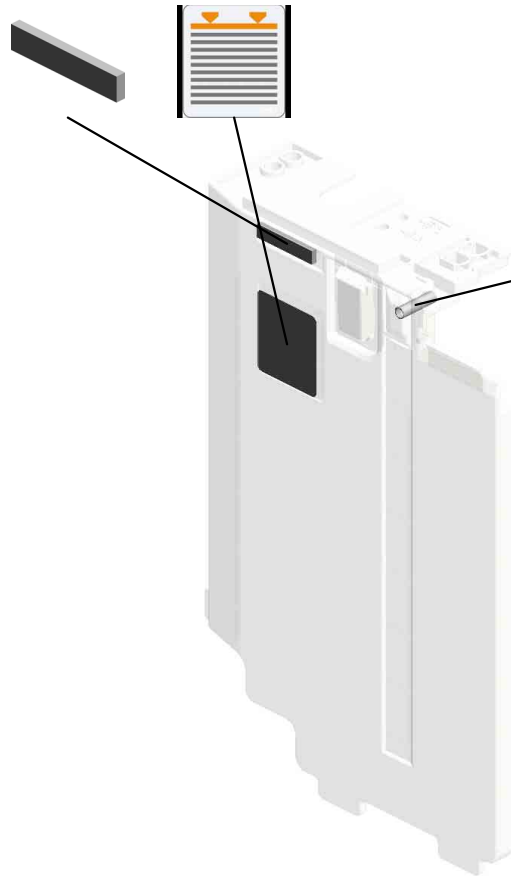

275.D2617569
COMPRESSION SP
RING:RIGHT REAR

U001	U002	U003	U004	U005	U006	U007	U008	U009	U010	U011	U012	U013	U014	U015	U016	U017	U018	U019	U020	U021
------	------	------	------	------	------	------	------	------	------	------	------	------	------	------	------	------	------	------	------	------

U007_S015_S001_S001
PLATE:PAPER:ASS'Y

60.AA162082
CUSHION:PLATE:P
APER

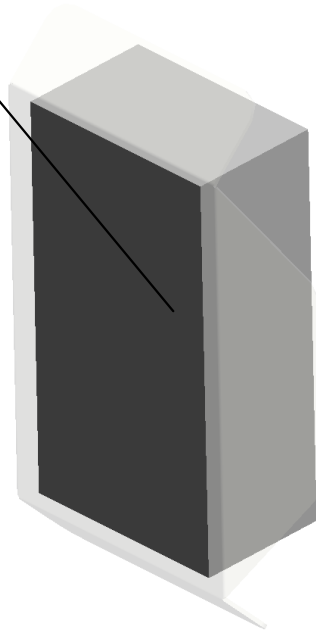
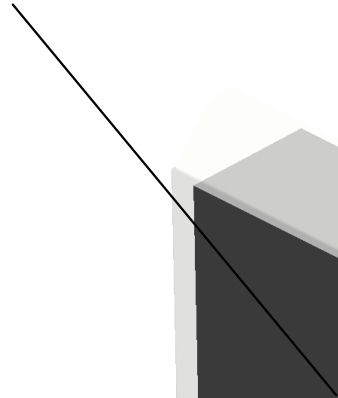
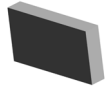

84.D0596690
PLATE:PAPER:ASS
Y

U001	U002	U003	U004	U005	U006	U007	U008	U009	U010	U011	U012	U013	U014	U015	U016	U017	U018	U019	U020	U021
------	------	------	------	------	------	------	------	------	------	------	------	------	------	------	------	------	------	------	------	------

U007_S015_S002
SIDE FENCE:RIGHT FRONT:TANDEM LCT:ASS'Y

14.04583010N
(x2)
HEXAGON HEAD TAPPING SCREW:3
X10

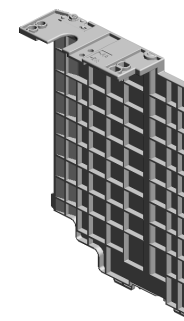
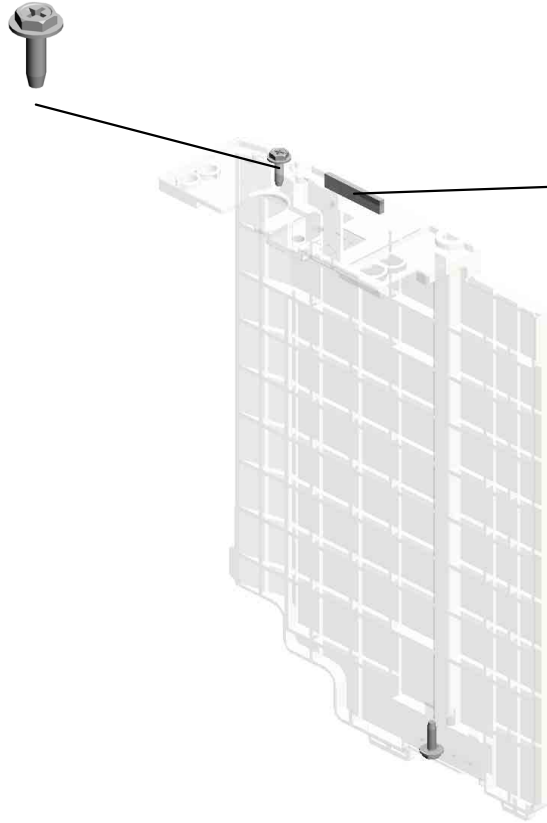

272.D2617562
SIDE FENCE:RIGHT FRONT:TANDEM LCT:ASS'Y

2.03520040N (x 1)
SCREW M2X4

76.B2342864
PAD:CLEANER

U001	U002	U003	U004	U005	U006	U007	U008	U009	U010	U011	U012	U013	U014	U015	U016	U017	U018	U019	U020	U021
------	------	------	------	------	------	------	------	------	------	------	------	------	------	------	------	------	------	------	------	------

U007_S015_S003
GRIP:INNER COVER:ASS'Y

37.AA000295
DECAL:GRIP:INNE
R COVER:RIGHT

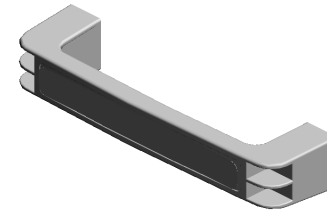

105.D1357531
GRIP:INNER COVE
R:ASS'Y

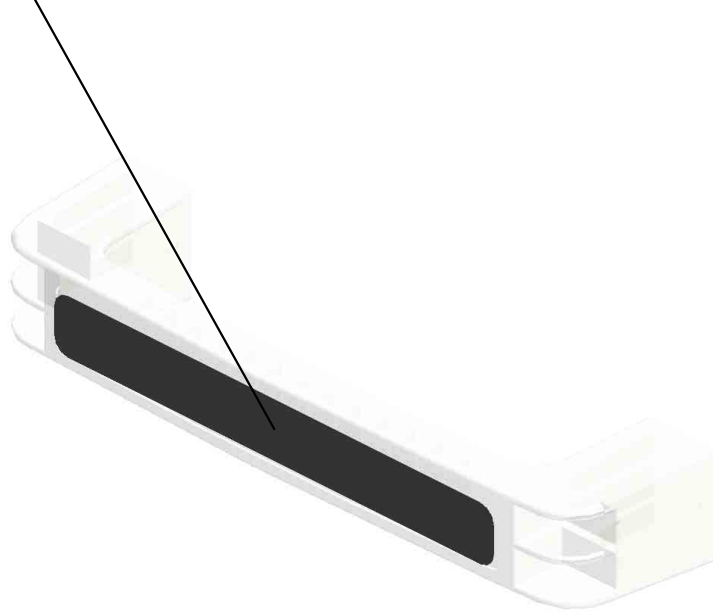

U001	U002	U003	U004	U005	U006	U007	U008	U009	U010	U011	U012	U013	U014	U015	U016	U017	U018	U019	U020	U021
------	------	------	------	------	------	------	------	------	------	------	------	------	------	------	------	------	------	------	------	------

U007_S015_S004
INNER COVER:RIGHT:TANDEM LCT:ASS'Y

36.AA000292
DECAL:CAUTION C
HART:TANDEM LC
T

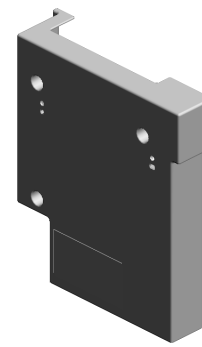
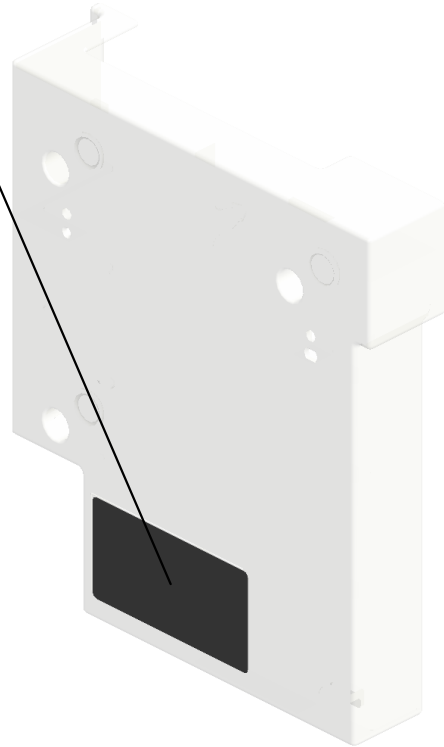
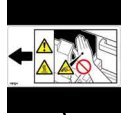

263.D2617526
INNER COVER:RIG
HT:TANDEM LCT:A
SS'Y

U001	U002	U003	U004	U005	U006	U007	U008	U009	U010	U011	U012	U013	U014	U015	U016	U017	U018	U019	U020	U021
------	------	------	------	------	------	------	------	------	------	------	------	------	------	------	------	------	------	------	------	------

U007_S016
(EU/AA/KOR/TWN/CHN):TANDEM LCT:LEFT:ASS'Y

38.AA000314
SHEET:PAPER SE
T DIRECTION

14.04583010N
(x29)
HEXAGON HEAD T
APPING SCREW:3
X10

66.AB033085
TIMING PULLEY - 1
5T

72.AW020198
(x3)
PHOTOINTERRUP
TOR:LG2A14NL1

27.11050692
CLAMP:LES-0503

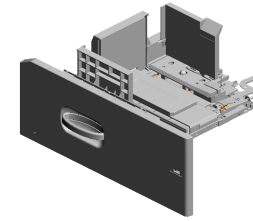

212.D2587506
(EU/AA/KOR/TWN/
CHN):TANDEM LCT
:LEFT:ASS'Y

90.D1351499
HOLDER:SD-CARD

101.D1356748
TORSION SPRING:
STOPPER:TANDE
M TRAY

104.D1357523
ARM:GRIP:TANDE
M LCT

103.D1357522
COVER:TANDEM L
CT

6.03603008N
(x3)
SCREW:M3X8

107.D1357542
BRACKET:TRAY:PL
ATE:LOWER

108.D1357543
BRACKET:TRAY:PL
ATE:UPPER

102.D1356755
(x2)
HEXAGON HEAD B
OLT:DOUBLE SCR
EW:M3X8:ROUND
POINT

41.AA043714
TIMING BELT:60S3
M588

65.AB030831
TIMING PULLEY:15
T:DRIVE

28.11050758
(x9)
CLAMP:LWSM-030
6A

28.11050758
CLAMP:LWSM-030
6A

23.08050103
RETAINING RINGS
-E:SILENCER:DIA3

24.08050104
(x3)
RETAINING RINGS
-E:SILENCER:DIA4

49.AA061235
COMPRESSION SP
RING:LEVER:TAND
EM TRAY

52.AA080184
(x2)
BUSHING - FUSIN
G EXIT

U007_S016
 (EU/AA/KOR/TWN/CHN):TANDEM LCT:LEFT:ASS'Y

270.D2617560 SIDE FENCE:LEFT FRONT:TANDEM LCT
 278.D2617594 COVER:BACK FENCE:TANDEM LCT
 267.D2617555 BACK FENCE:TANDEM LCT
 110.D1357568 STOPPER:SYNCHRONOUS BELT:SLIDER
 148.D1367579 SLIDER:BACK FENCE

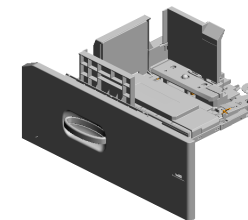

212.D2587506 (EU/AA/KOR/TWN/CHN):TANDEM LCT:LEFT:ASS'Y

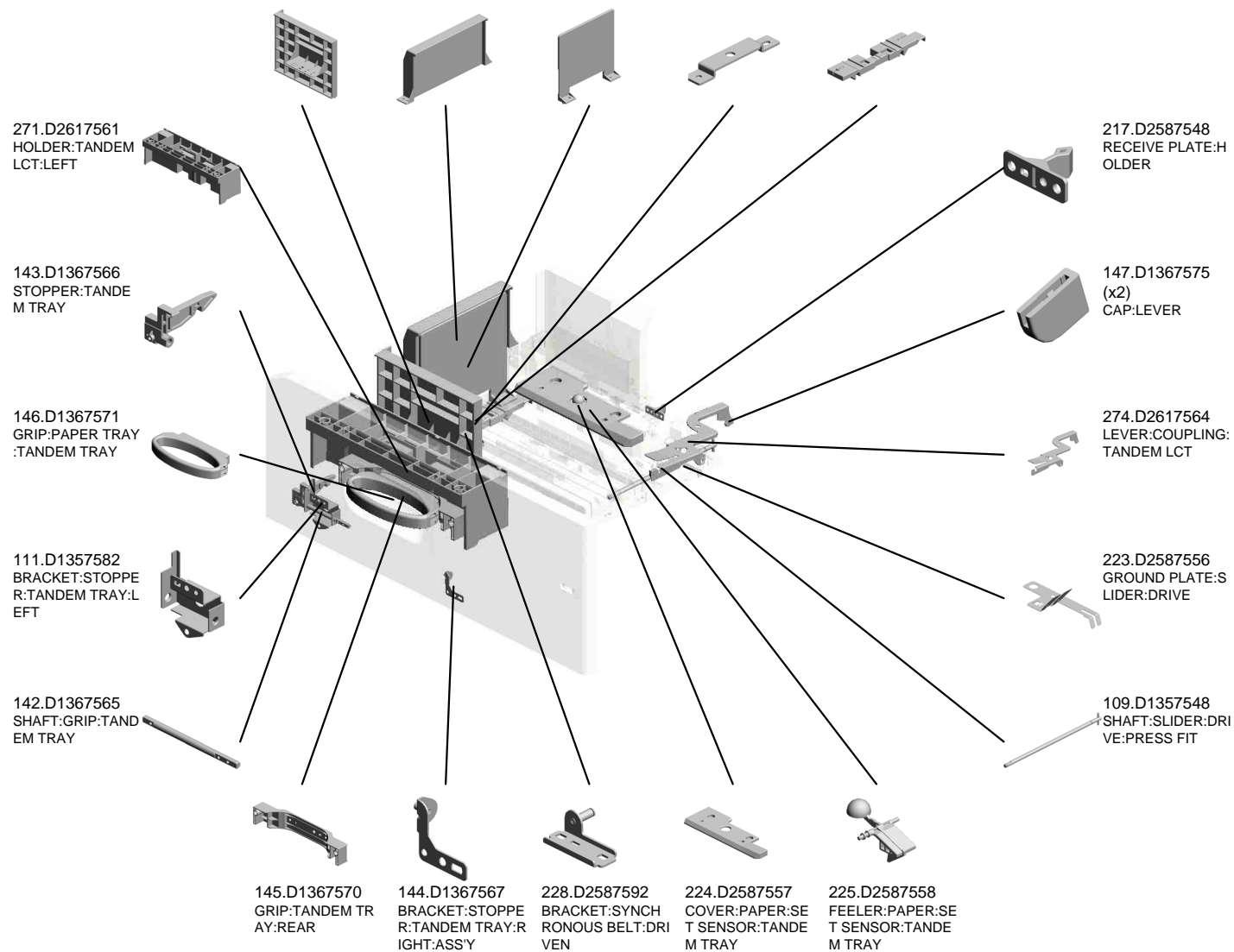

U007_S016_S001
SIDE FENCE:LEFT REAR:TANDEM:ASS'Y

140.D1367546
DECAL:PAPER VO
LUME:SIDE FENCE
:LEFT REAR:1

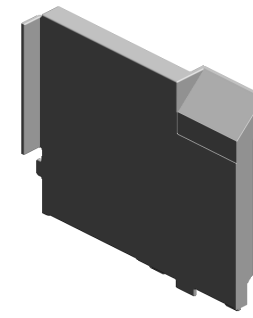
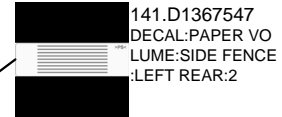
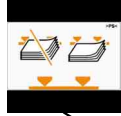

264.D2617529
SIDE FENCE:LEFT
REAR:TANDEM:AS
SY

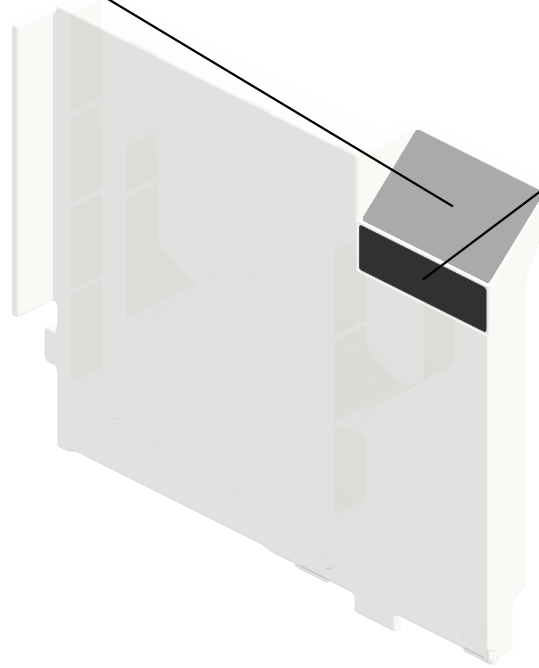

U001	U002	U003	U004	U005	U006	U007	U008	U009	U010	U011	U012	U013	U014	U015	U016	U017	U018	U019	U020	U021
------	------	------	------	------	------	------	------	------	------	------	------	------	------	------	------	------	------	------	------	------

U007_S016_S002

COVER:SYNCHRONOUS BELT:TANDEM TRAY

14.04583010N
(x2)
HEXAGON HEAD TAPPING SCREW:3
X10

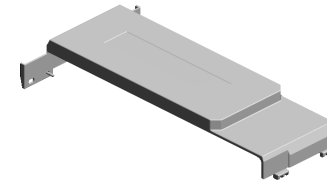

277.D2617586
COVER:SYNCHRO
NOUS BELT:TAND
EM TRAY

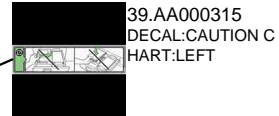
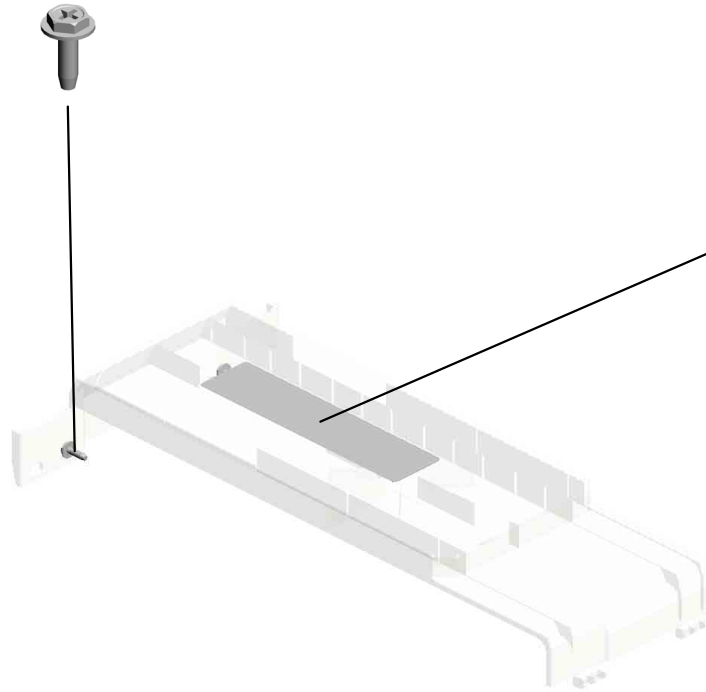

39.AA000315
DECAL:CAUTION C
HART:LEFT

U001	U002	U003	U004	U005	U006	U007	U008	U009	U010	U011	U012	U013	U014	U015	U016	U017	U018	U019	U020	U021
------	------	------	------	------	------	------	------	------	------	------	------	------	------	------	------	------	------	------	------	------

U007_S017
(EU/AA/KOR/TWN/CHN):TANDEM LCT:RIGHT:ASS'Y

- 81.D0294486 TENSION SPRING: GATE PAWL:1.5N
- 219.D2587552 (x2) TIMING PULLEY:TRAY BOTTOM PLATE
- 220.D2587553 (x2) CAP:TRAY BOTTOM PLATE:TANDEM TRAY
- 14.04583010N (x27) HEXAGON HEAD TAPPING SCREW:3 X10
- 218.D2587549 (x2) BRACKET:SHAFT:LEFT MOTOR:ASS'Y

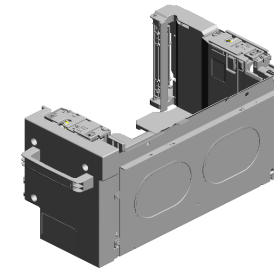

279.D2617598
(EU/AA/KOR/TWN/CHN):TANDEM LCT:RIGHT:ASS'Y

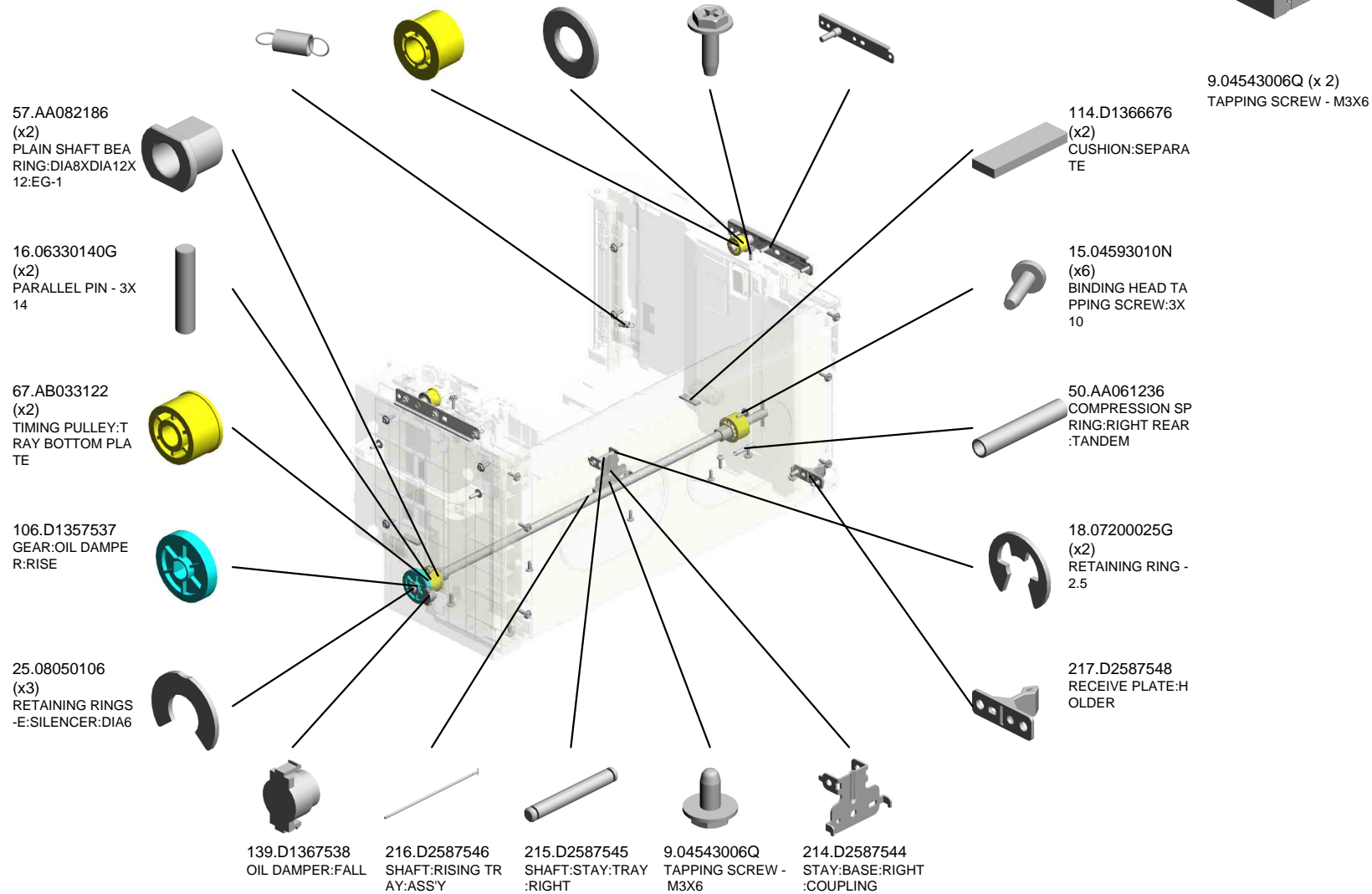

U001	U002	U003	U004	U005	U006	U007	U008	U009	U010	U011	U012	U013	U014	U015	U016	U017	U018	U019	U020	U021
------	------	------	------	------	------	------	------	------	------	------	------	------	------	------	------	------	------	------	------	------

U007_S017
 (EU/AA/KOR/TWN/CHN):TANDEM LCT:RIGHT:ASS'Y

287.GA143003 SCREW:MM5:2.5M
 265.D2617538 END FENCE:TANDEM LCT
 230.D2587597 (x2) COLLAR:RISE:TANDEM TRAY

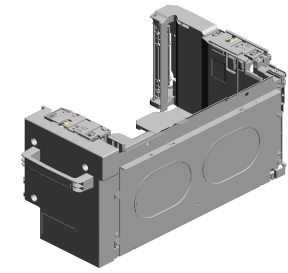

279.D2617598 (EU/AA/KOR/TWN/CHN):TANDEM LCT:RIGHT:ASS'Y

222.D2587555 (x2) GROUND PLATE:TANDEM TRAY:RIGHT

221.D2587554 (x2) ROLLER:GUIDE

229.D2587595 (x2) HOLDER:SYNCHRONOUS BELT

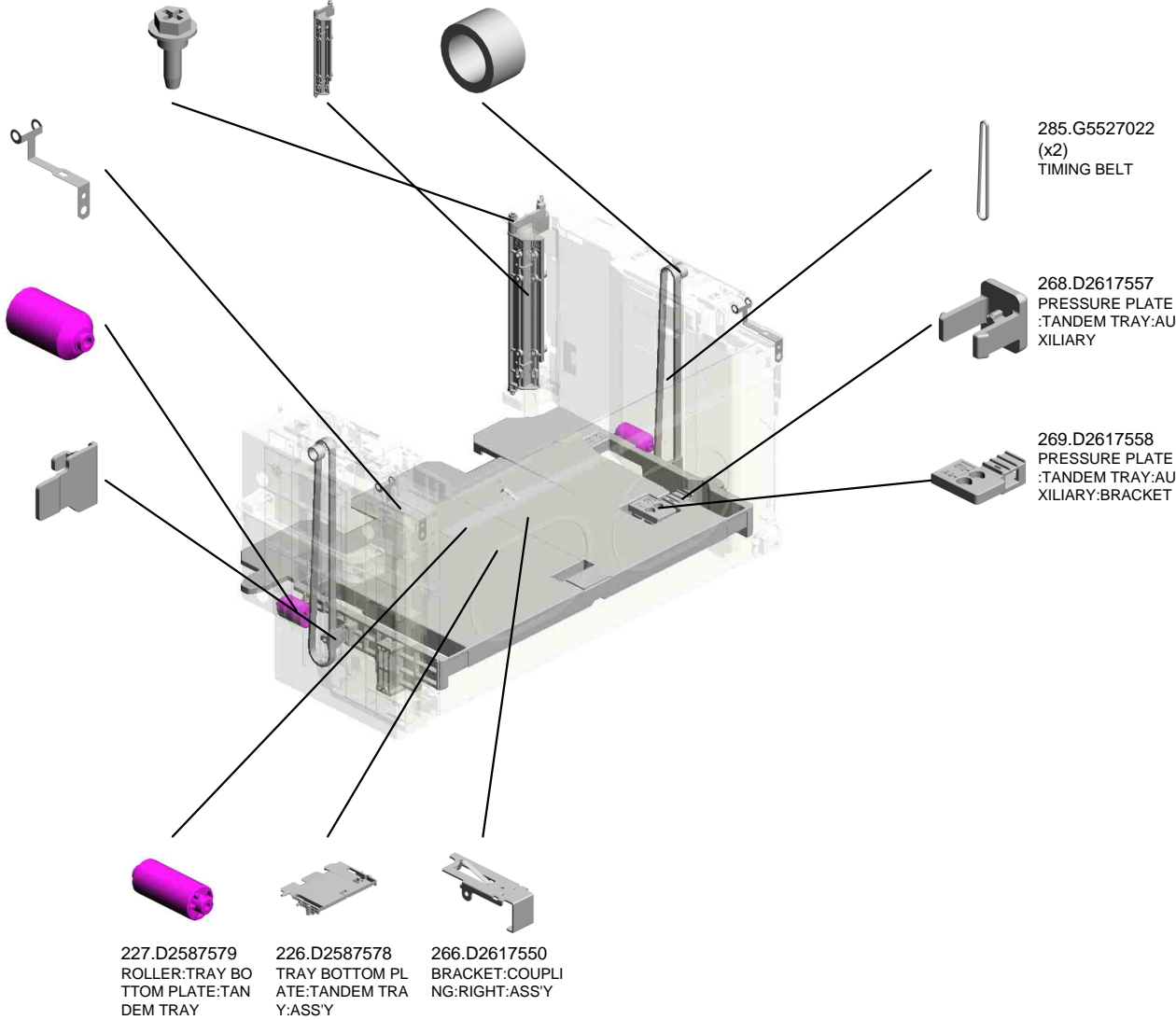

U007_S017_S001
SIDE FENCE:RIGHT REAR:TANDEM LCT:ASS'Y

76.B2342864
PAD:CLEANER

40.AA000316
DECAL:SIDE FENC
E:REAR



273.D2617563
SIDE FENCE:RIGH
T REAR:TANDEM L
CT:ASS'Y

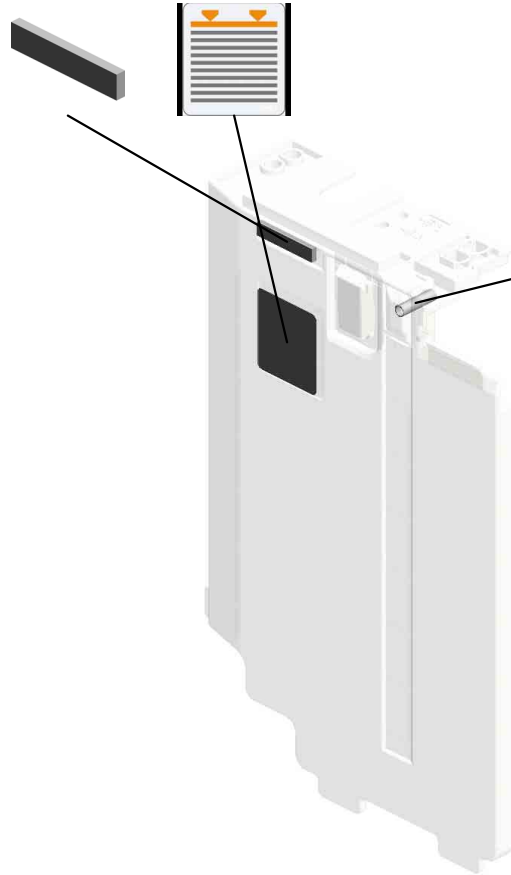

275.D2617569
COMPRESSION SP
RING:RIGHT REAR

U001	U002	U003	U004	U005	U006	U007	U008	U009	U010	U011	U012	U013	U014	U015	U016	U017	U018	U019	U020	U021
------	------	------	------	------	------	------	------	------	------	------	------	------	------	------	------	------	------	------	------	------

U007_S017_S001_S001
PLATE:PAPER:ASS'Y

60.AA162082
CUSHION:PLATE:P
APER

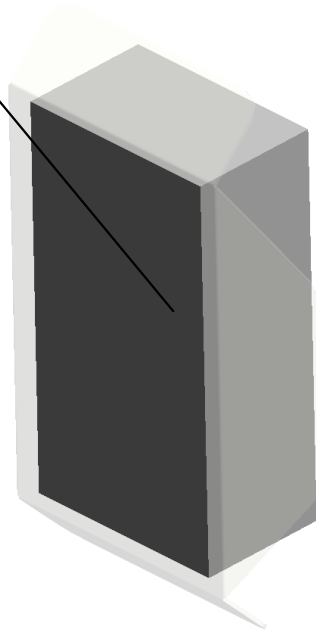
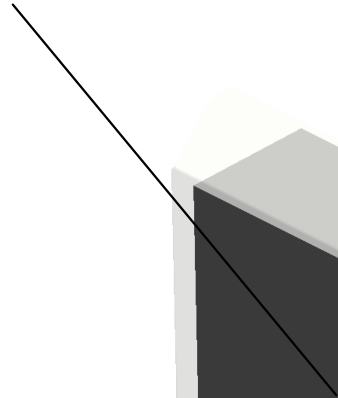
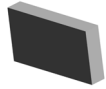

84.D0596690
PLATE:PAPER:ASS
Y

U001	U002	U003	U004	U005	U006	U007	U008	U009	U010	U011	U012	U013	U014	U015	U016	U017	U018	U019	U020	U021
------	------	------	------	------	------	------	------	------	------	------	------	------	------	------	------	------	------	------	------	------

U007_S017_S002
SIDE FENCE:RIGHT FRONT:TANDEM LCT:ASS'Y

14.04583010N
(x2)
HEXAGON HEAD TAPPING SCREW:3
X10

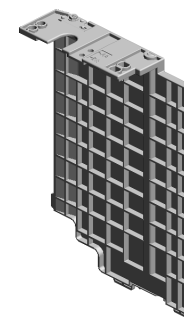
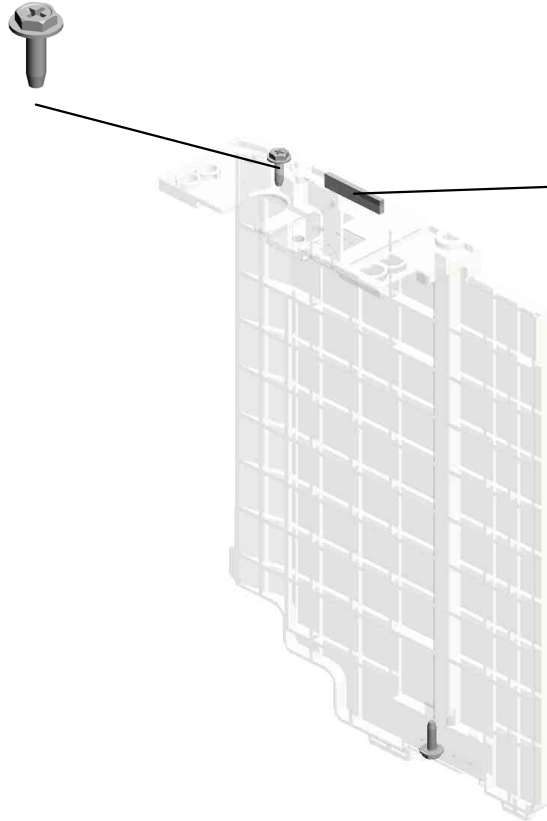

272.D2617562
SIDE FENCE:RIGHT FRONT:TANDEM LCT:ASS'Y

76.B2342864
PAD:CLEANER

2.03520040N (x 1)
SCREW M2X4



U001	U002	U003	U004	U005	U006	U007	U008	U009	U010	U011	U012	U013	U014	U015	U016	U017	U018	U019	U020	U021
------	------	------	------	------	------	------	------	------	------	------	------	------	------	------	------	------	------	------	------	------

U007_S017_S003
GRIP:INNER COVER:ASS'Y

37.AA000295
DECAL:GRIP:INNE
R COVER:RIGHT

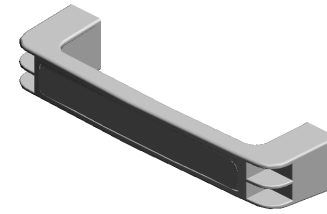

105.D1357531
GRIP:INNER COVE
R:ASS'Y

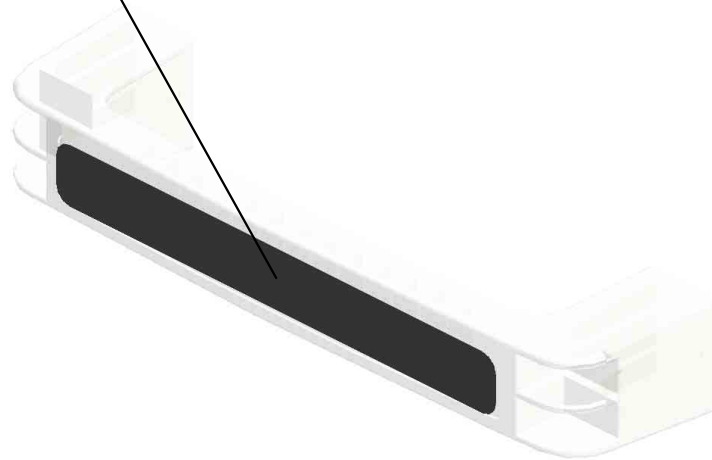

U001	U002	U003	U004	U005	U006	U007	U008	U009	U010	U011	U012	U013	U014	U015	U016	U017	U018	U019	U020	U021
------	------	------	------	------	------	------	------	------	------	------	------	------	------	------	------	------	------	------	------	------

U007_S017_S004
INNER COVER:RIGHT:TANDEM LCT:ASS'Y

36.AA000292
DECAL:CAUTION C
HART:TANDEM LC
T

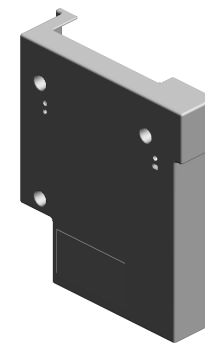
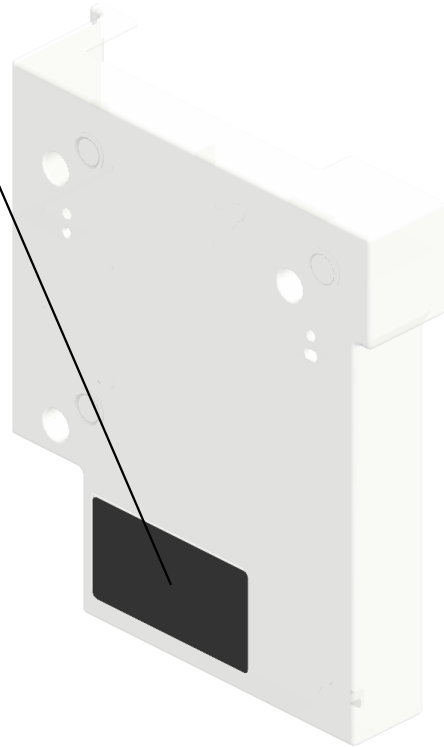
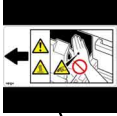

263.D2617526
INNER COVER:RIG
HT:TANDEM LCT:A
SS'Y

U001	U002	U003	U004	U005	U006	U007	U008	U009	U010	U011	U012	U013	U014	U015	U016	U017	U018	U019	U020	U021
------	------	------	------	------	------	------	------	------	------	------	------	------	------	------	------	------	------	------	------	------

U007_S018

(EU/AA/KOR/TWN/CHN):TANDEM LCT:LEFT:ASS'Y

38.AA000314
SHEET:PAPER SE
T DIRECTION

14.04583010N
(x29)
HEXAGON HEAD T
APPING SCREW:3
X10

66.AB033085
TIMING PULLEY - 1
5T

72.AW020198
(x3)
PHOTOINTERRUP
TOR:LG2A14NL1

27.11050692
CLAMP:LES-0503

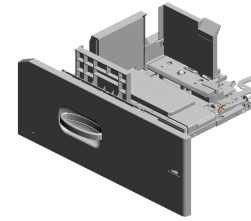

212.D2587506
(EU/AA/KOR/TWN/
CHN):TANDEM LCT
:LEFT:ASS'Y

90.D1351499
HOLDER:SD-CARD

101.D1356748
TORSION SPRING:
STOPPER:TANDE
M TRAY

104.D1357523
ARM:GRIP:TANDE
M LCT

103.D1357522
COVER:TANDEM L
CT

6.03603008N
(x3)
SCREW:M3X8

107.D1357542
BRACKET:TRAY:PL
ATE:LOWER

108.D1357543
BRACKET:TRAY:PL
ATE:UPPER

102.D1356755
(x2)
HEXAGON HEAD B
OLT:DOUBLE SCR
EW:M3X8:ROUND
POINT

41.AA043714
TIMING BELT:60S3
M588

24.08050104
(x3)
RETAINING RINGS
-E:SILENCER:DIA4

28.11050758
(x9)
CLAMP:LWSM-030
6A

28.11050758
CLAMP:LWSM-030
6A

23.08050103
RETAINING RINGS
-E:SILENCER:DIA3

49.AA061235
COMPRESSION SP
RING:LEVER:TAND
EM TRAY

52.AA080184
(x2)
BUSHING - FUSIN
G EXIT

65.AB030831
TIMING PULLEY:15
T:DRIVE

U001	U002	U003	U004	U005	U006	U007	U008	U009	U010	U011	U012	U013	U014	U015	U016	U017	U018	U019	U020	U021
------	------	------	------	------	------	------	------	------	------	------	------	------	------	------	------	------	------	------	------	------

U007_S018

(EU/AA/KOR/TWN/CHN):TANDEM LCT:LEFT:ASS'Y

- 270.D2617560 SIDE FENCE:LEFT FRONT:TANDEM LCT
- 278.D2617594 COVER:BACK FENCE:TANDEM LCT
- 267.D2617555 BACK FENCE:TANDEM LCT
- 110.D1357568 STOPPER:SYNCHRONOUS BELT:SLIDER
- 148.D1367579 SLIDER:BACK FENCE

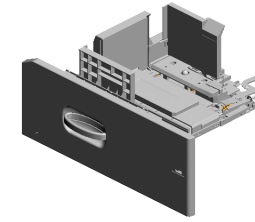

212.D2587506
(EU/AA/KOR/TWN/CHN):TANDEM LCT
:LEFT:ASS'Y

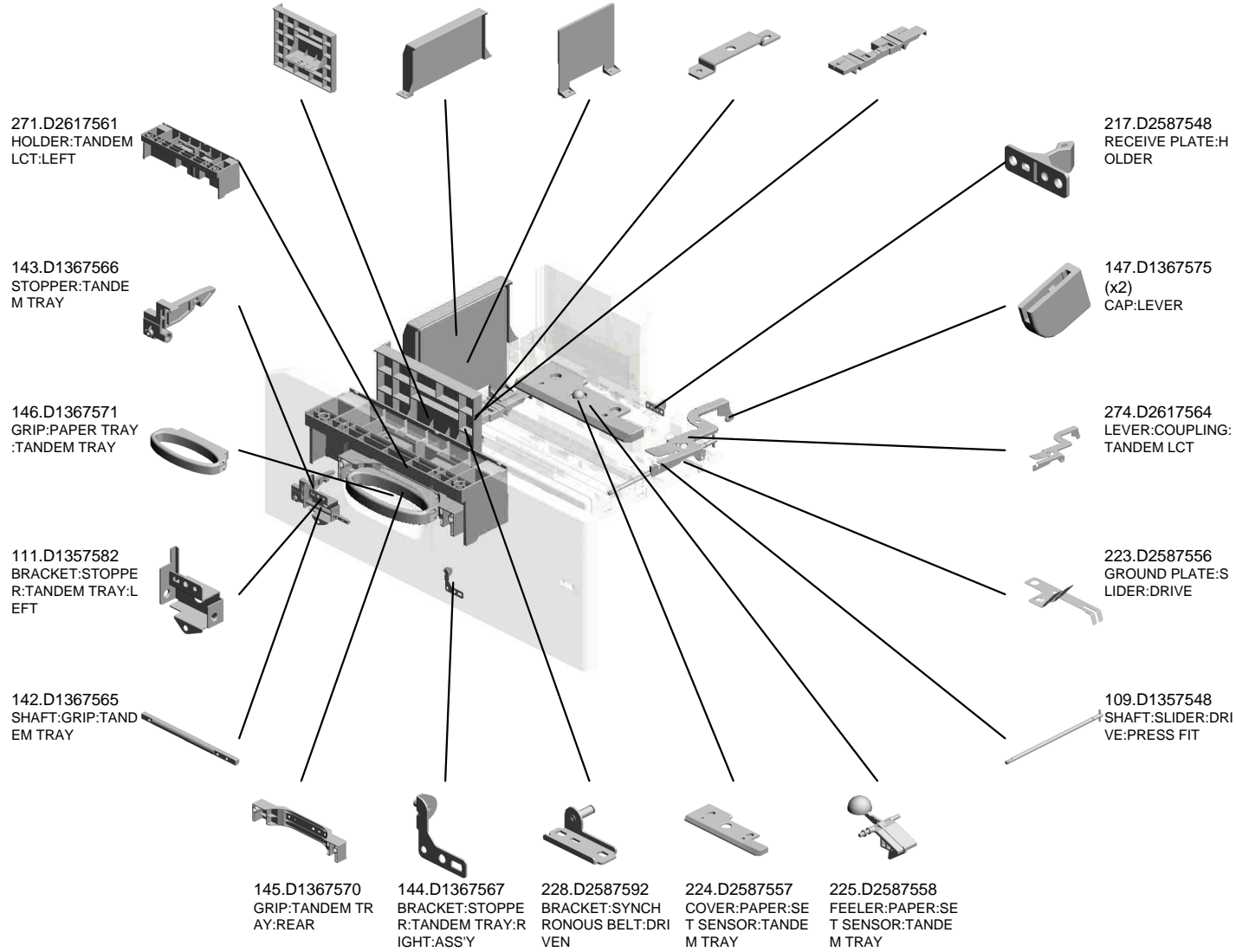

U001	U002	U003	U004	U005	U006	U007	U008	U009	U010	U011	U012	U013	U014	U015	U016	U017	U018	U019	U020	U021
------	------	------	------	------	------	------	------	------	------	------	------	------	------	------	------	------	------	------	------	------

U007_S018_S001
SIDE FENCE:LEFT REAR:TANDEM:ASS'Y

140.D1367546
DECAL:PAPER VO
LUME:SIDE FENCE
:LEFT REAR:1

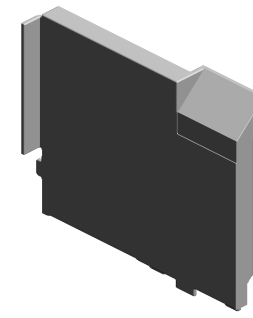
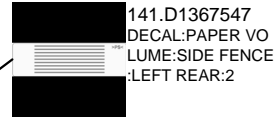
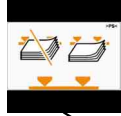

264.D2617529
SIDE FENCE:LEFT
REAR:TANDEM:AS
SY

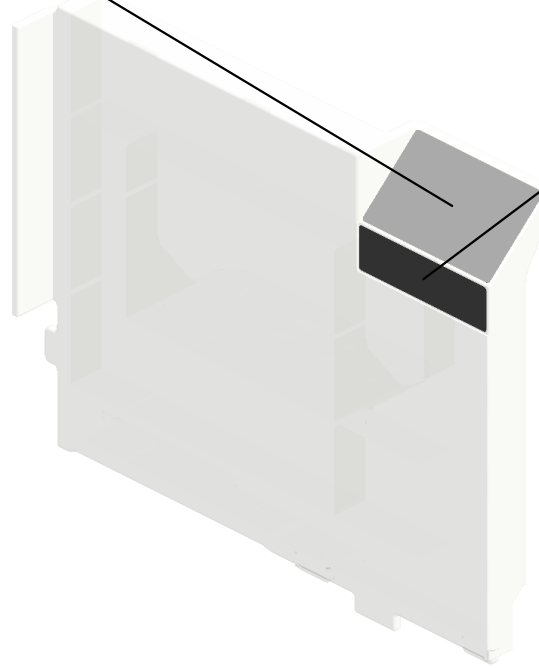

U001	U002	U003	U004	U005	U006	U007	U008	U009	U010	U011	U012	U013	U014	U015	U016	U017	U018	U019	U020	U021
------	------	------	------	------	------	------	------	------	------	------	------	------	------	------	------	------	------	------	------	------

U007_S018_S002

COVER:SYNCHRONOUS BELT:TANDEM TRAY

14.04583010N
(x2)
HEXAGON HEAD TAPPING SCREW:3
X10

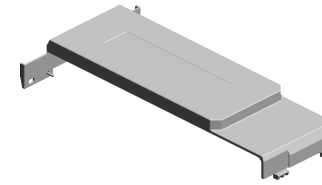

277.D2617586
COVER:SYNCHRO
NOUS BELT:TAND
EM TRAY

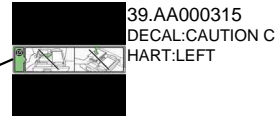
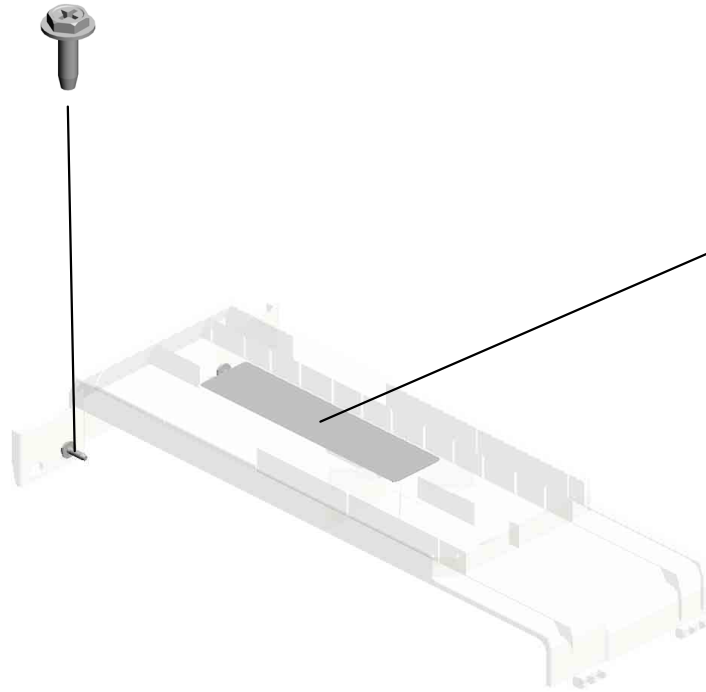

U001	U002	U003	U004	U005	U006	U007	U008	U009	U010	U011	U012	U013	U014	U015	U016	U017	U018	U019	U020	U021
------	------	------	------	------	------	------	------	------	------	------	------	------	------	------	------	------	------	------	------	------

U007_S019
(EU/AA/KOR/TWN/CHN):TANDEM LCT:RIGHT:ASS'Y

- 81.D0294486 TENSION SPRING: GATE PAWL:1.5N
- 219.D2587552 (x2) TIMING PULLEY:TRAY BOTTOM PLATE
- 220.D2587553 (x2) CAP:TRAY BOTTOM PLATE:TANDEM TRAY
- 14.04583010N (x27) HEXAGON HEAD TAPPING SCREW:3 X10
- 218.D2587549 (x2) BRACKET:SHAFT:LEFT MOTOR:ASS'Y

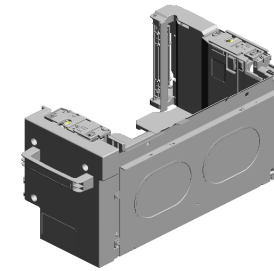

279.D2617598
(EU/AA/KOR/TWN/CHN):TANDEM LCT:RIGHT:ASS'Y

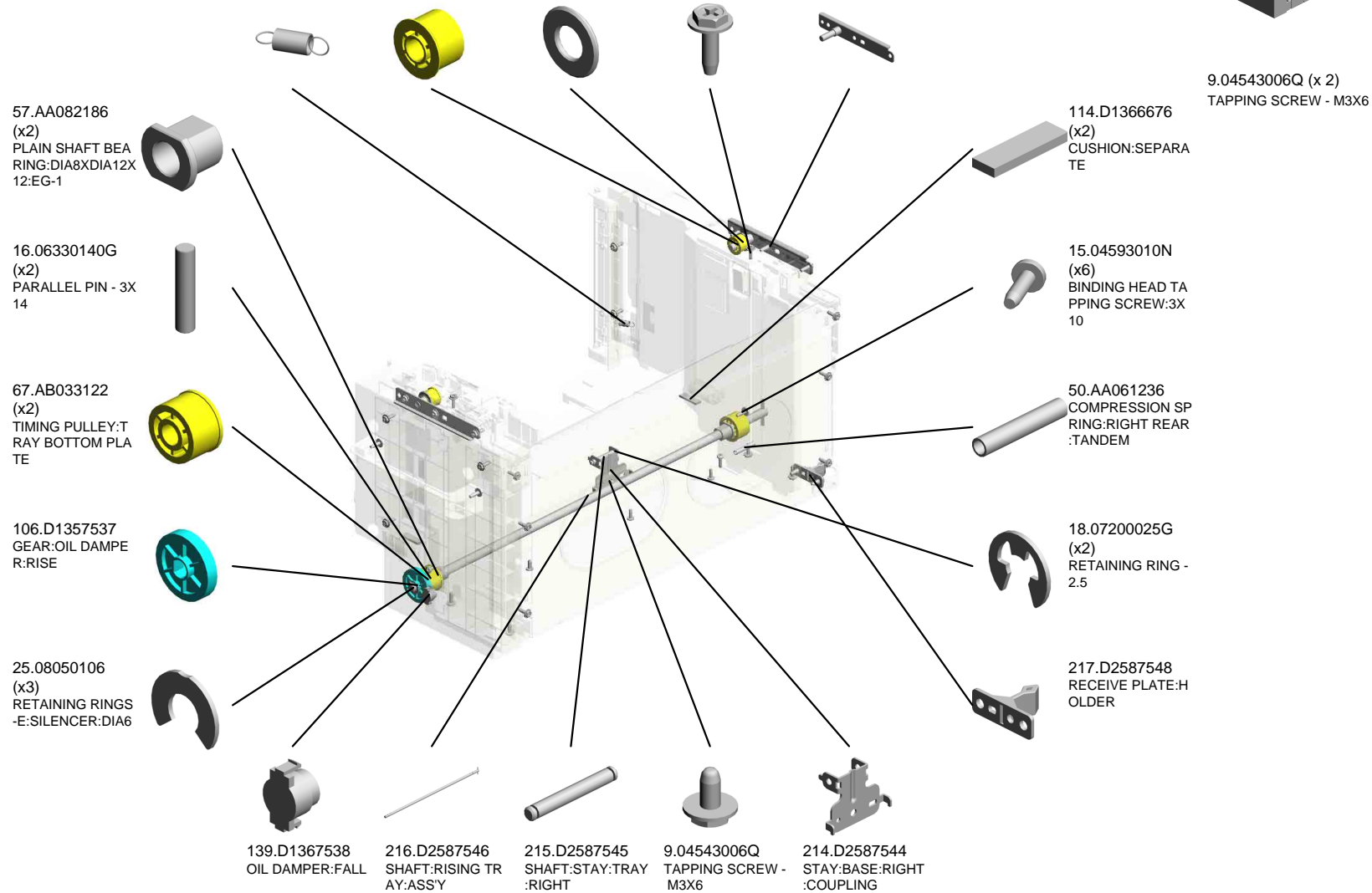

U007_S019
 (EU/AA/KOR/TWN/CHN):TANDEM LCT:RIGHT:ASS'Y

287.GA143003 SCREW:MM5:2.5M
 265.D2617538 END FENCE:TANDEM LCT
 230.D2587597 (x2) COLLAR:RISE:TANDEM TRAY

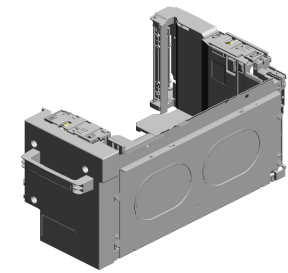

279.D2617598
 (EU/AA/KOR/TWN/CHN):TANDEM LCT:RIGHT:ASS'Y

222.D2587555 (x2) GROUND PLATE:TANDEM TRAY:RIGHT

221.D2587554 (x2) ROLLER:GUIDE

229.D2587595 (x2) HOLDER:SYNCHRONOUS BELT

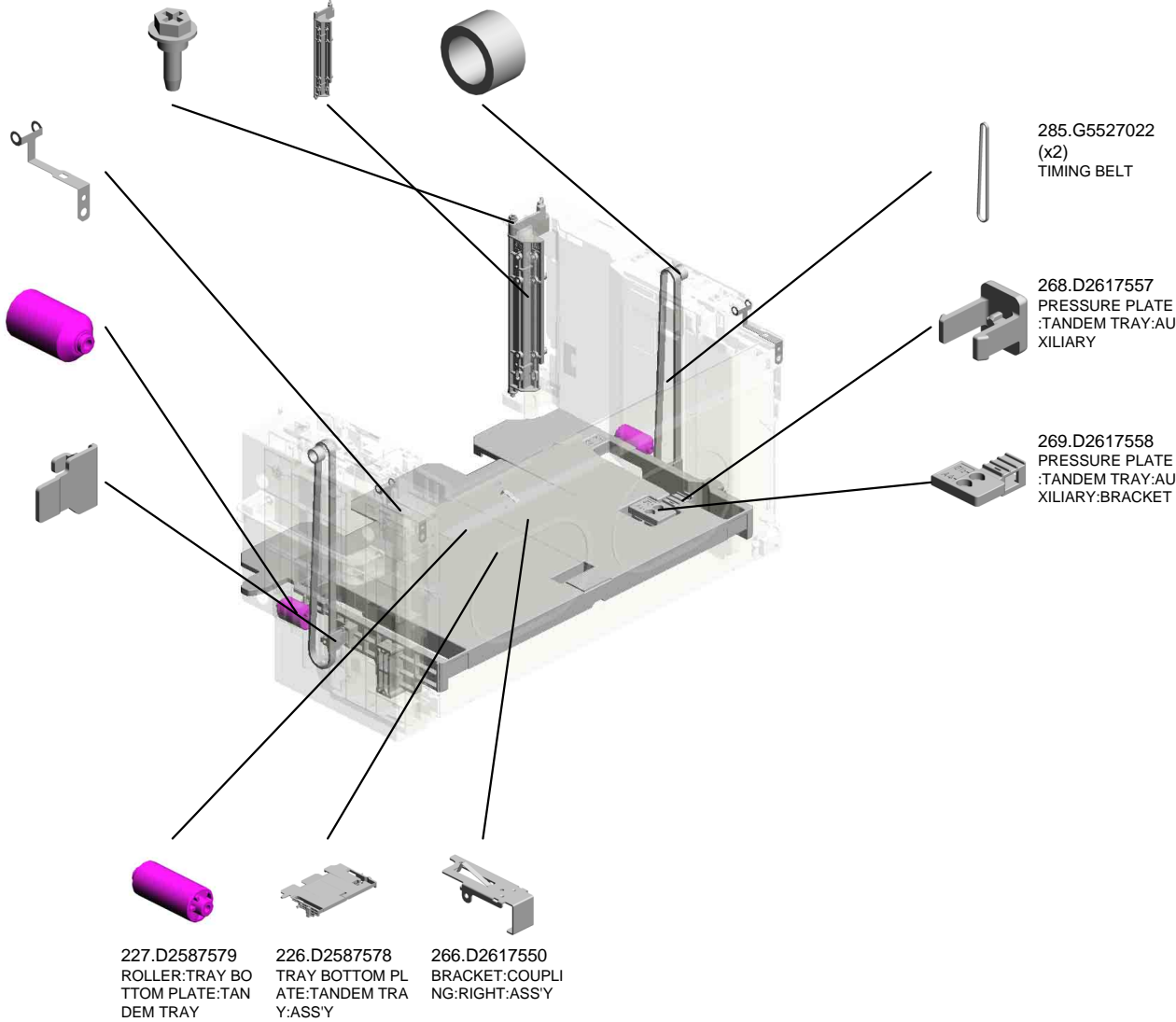

U007_S019_S001
SIDE FENCE:RIGHT REAR:TANDEM LCT:ASS'Y

76.B2342864
PAD:CLEANER

40.AA000316
DECAL:SIDE FENC
E:REAR



273.D2617563
SIDE FENCE:RIGH
T REAR:TANDEM L
CT:ASS'Y

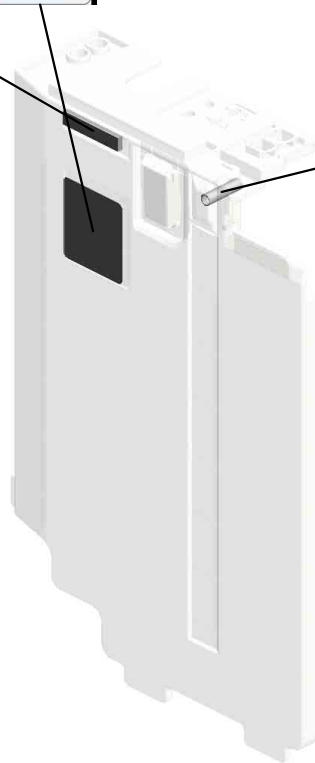
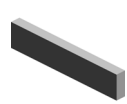

275.D2617569
COMPRESSION SP
RING:RIGHT REAR

U001	U002	U003	U004	U005	U006	U007	U008	U009	U010	U011	U012	U013	U014	U015	U016	U017	U018	U019	U020	U021
------	------	------	------	------	------	------	------	------	------	------	------	------	------	------	------	------	------	------	------	------

U007_S019_S001_S001
PLATE:PAPER:ASS'Y

60.AA162082
CUSHION:PLATE:P
APER

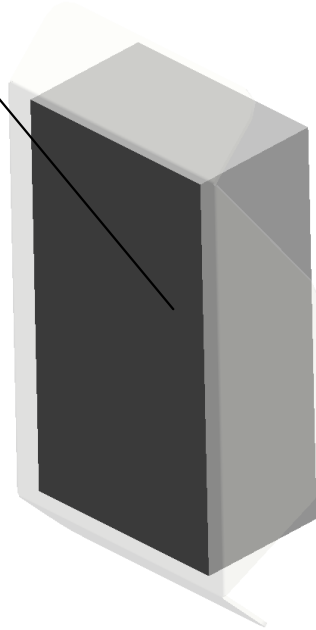
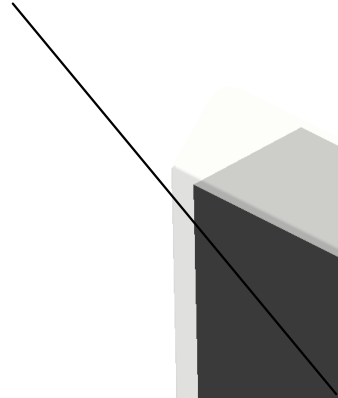
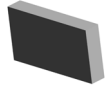

84.D0596690
PLATE:PAPER:ASS
Y

U001	U002	U003	U004	U005	U006	U007	U008	U009	U010	U011	U012	U013	U014	U015	U016	U017	U018	U019	U020	U021
------	------	------	------	------	------	------	------	------	------	------	------	------	------	------	------	------	------	------	------	------

U007_S019_S002
SIDE FENCE:RIGHT FRONT:TANDEM LCT:ASS'Y

14.04583010N
(x2)
HEXAGON HEAD TAPPING SCREW:3
X10

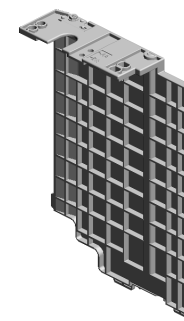
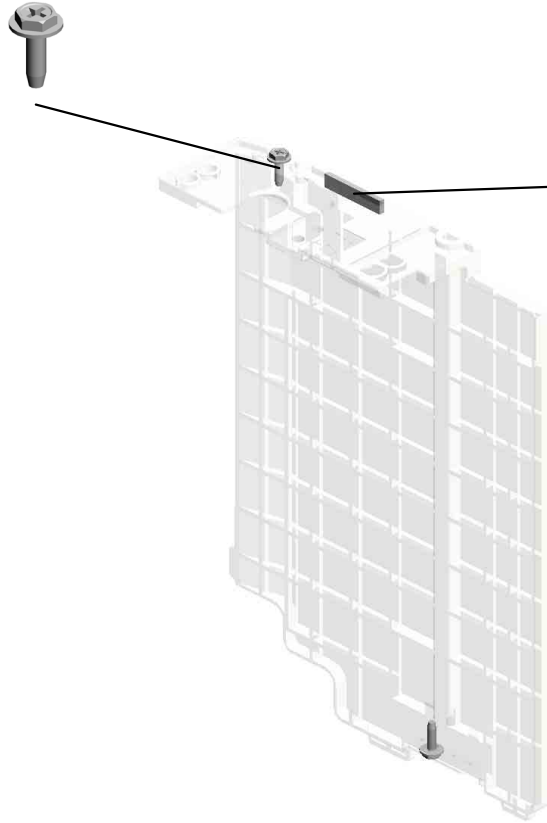

272.D2617562
SIDE FENCE:RIGHT FRONT:TANDEM LCT:ASS'Y

2.03520040N (x 1)
SCREW M2X4

76.B2342864
PAD:CLEANER

U001	U002	U003	U004	U005	U006	U007	U008	U009	U010	U011	U012	U013	U014	U015	U016	U017	U018	U019	U020	U021
------	------	------	------	------	------	------	------	------	------	------	------	------	------	------	------	------	------	------	------	------

U007_S019_S003
GRIP:INNER COVER:ASS'Y

37.AA000295
DECAL:GRIP:INNE
R COVER:RIGHT

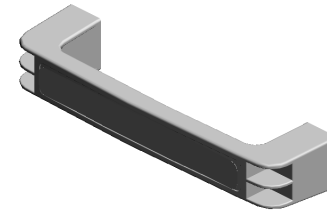

105.D1357531
GRIP:INNER COVE
R:ASS'Y

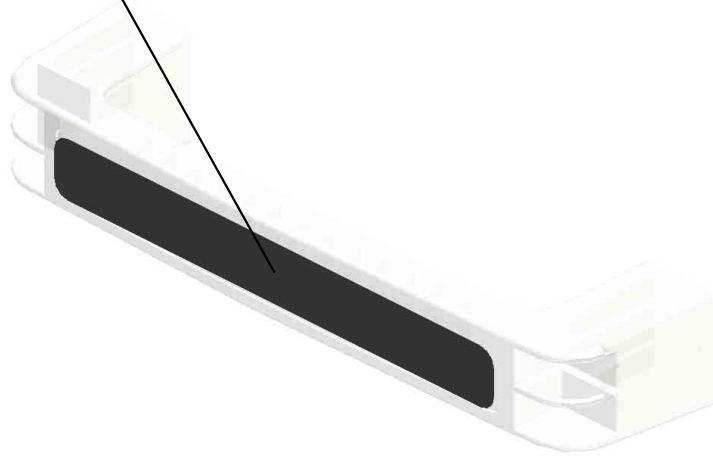

U001	U002	U003	U004	U005	U006	U007	U008	U009	U010	U011	U012	U013	U014	U015	U016	U017	U018	U019	U020	U021
------	------	------	------	------	------	------	------	------	------	------	------	------	------	------	------	------	------	------	------	------

U007_S019_S004
INNER COVER:RIGHT:TANDEM LCT:ASS'Y

36.AA000292
DECAL:CAUTION C
HART:TANDEM LC
T

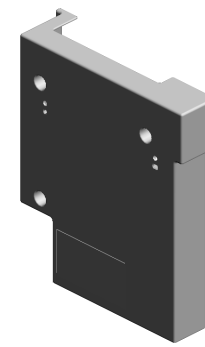
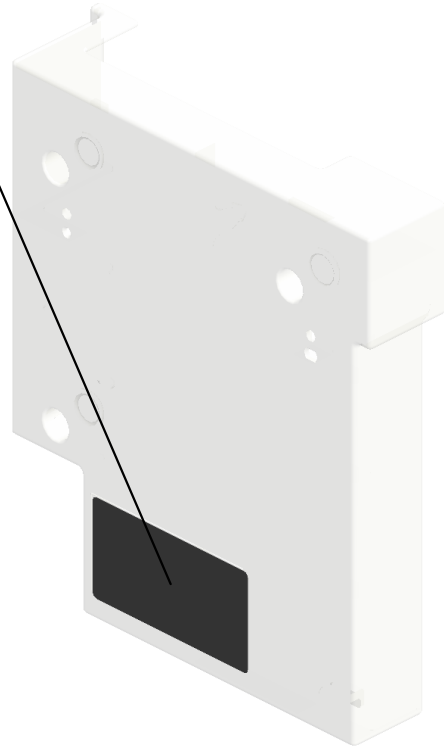
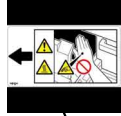

263.D2617526
INNER COVER:RIG
HT:TANDEM LCT:A
SS'Y

U001	U002	U003	U004	U005	U006	U007	U008	U009	U010	U011	U012	U013	U014	U015	U016	U017	U018	U019	U020	U021
------	------	------	------	------	------	------	------	------	------	------	------	------	------	------	------	------	------	------	------	------

U007_S020
 (EU/AA/KOR/TWN/CHN):TANDEM LCT:LEFT:ASS'Y

38.AA000314 SHEET:PAPER SE T DIRECTION
 14.04583010N (x29) HEXAGON HEAD T APPING SCREW:3 X10
 66.AB033085 TIMING PULLEY - 1 5T
 41.AA043714 TIMING BELT:60S3 M588
 27.11050692 CLAMP:LES-0503

212.D2587506 (EU/AA/KOR/TWN/ CHN):TANDEM LCT :LEFT:ASS'Y

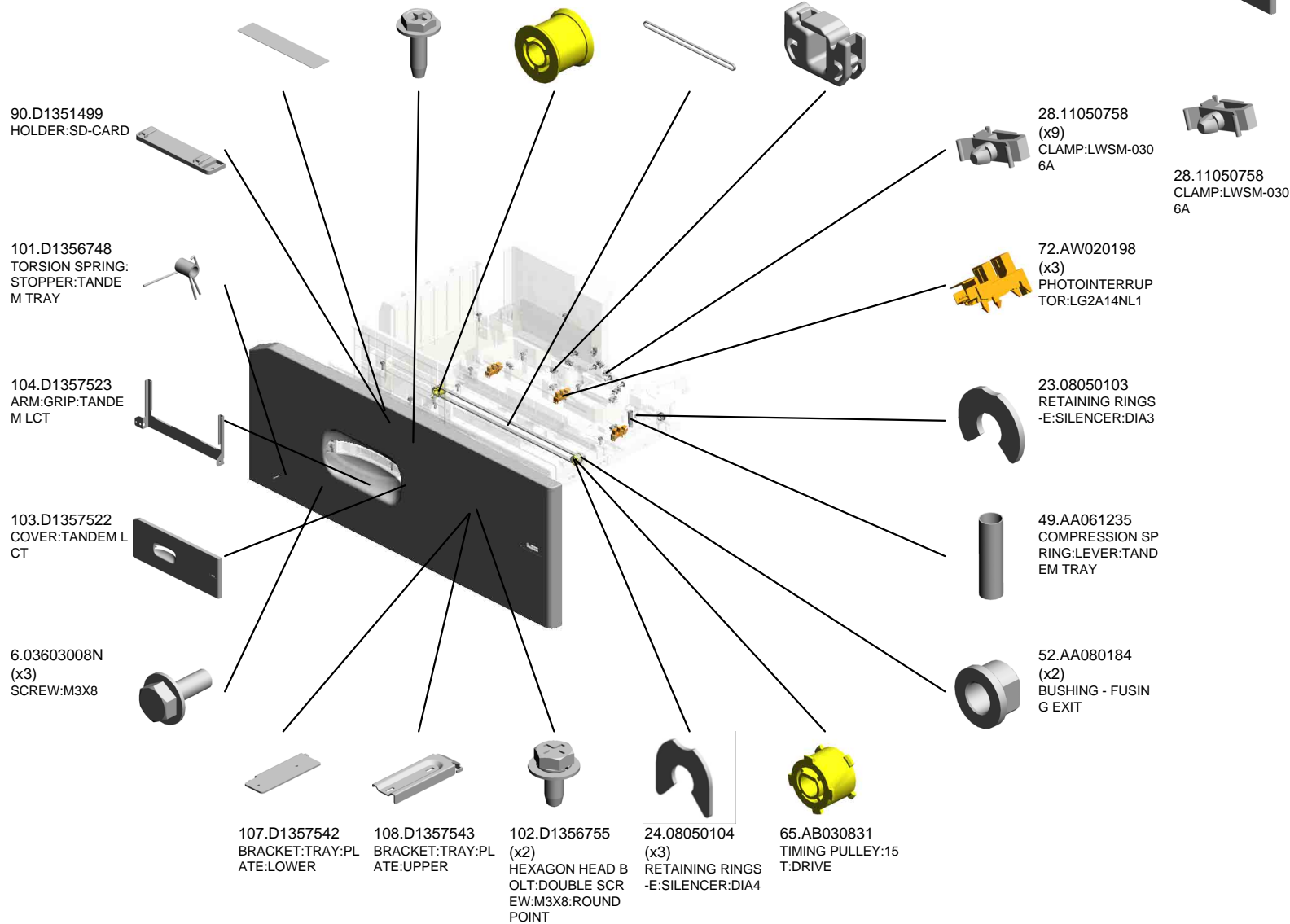
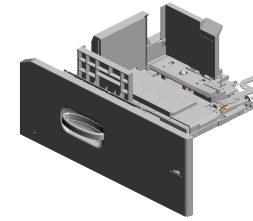

U007_S020

(EU/AA/KOR/TWN/CHN):TANDEM LCT:LEFT:ASS'Y

- 270.D2617560 SIDE FENCE:LEFT FRONT:TANDEM LCT
- 278.D2617594 COVER:BACK FENCE:TANDEM LCT
- 267.D2617555 BACK FENCE:TANDEM LCT
- 110.D1357568 STOPPER:SYNCHRONOUS BELT:SLIDER
- 148.D1367579 SLIDER:BACK FENCE

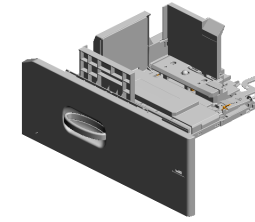

212.D2587506
(EU/AA/KOR/TWN/CHN):TANDEM LCT
:LEFT:ASS'Y

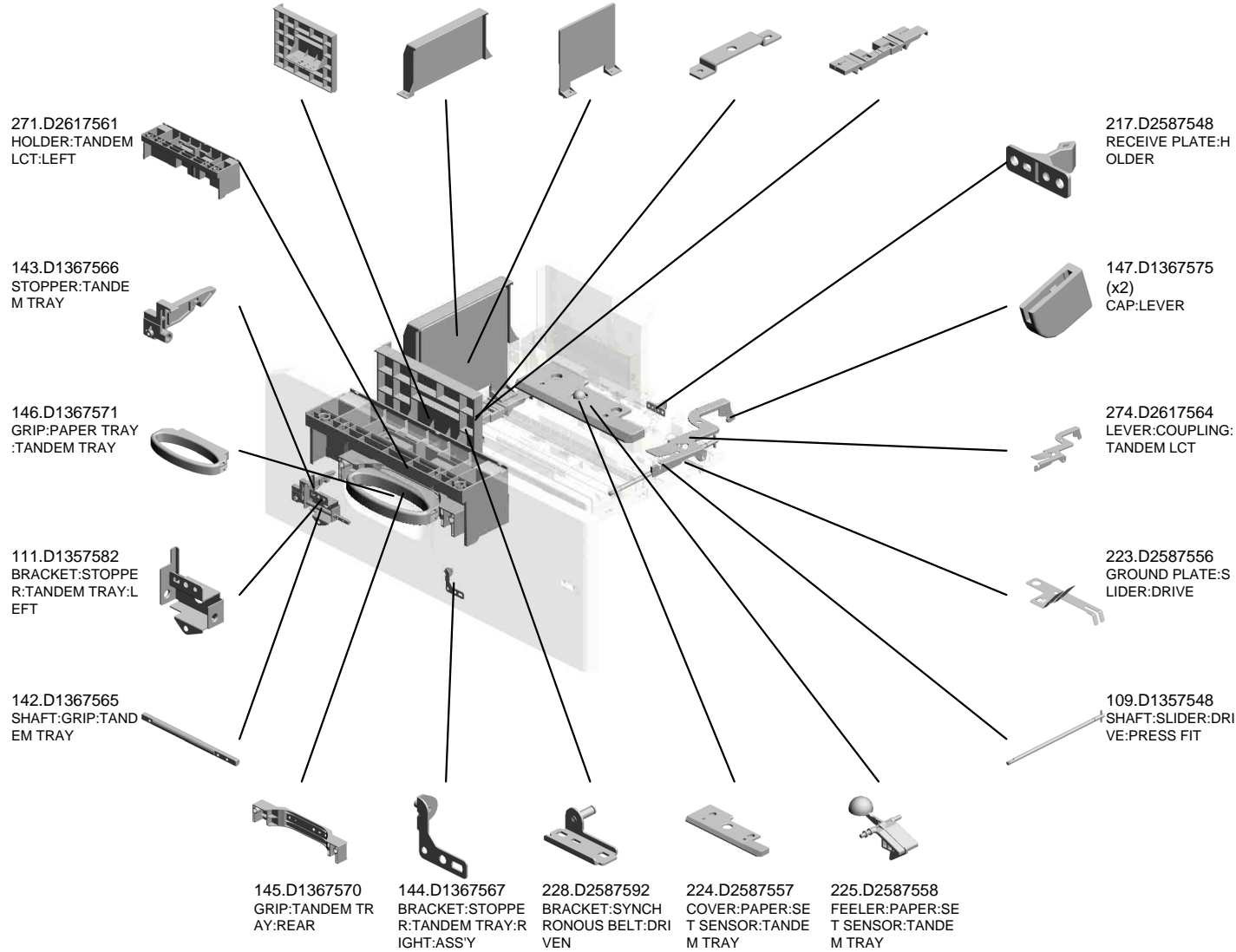

U007_S020_S001
SIDE FENCE:LEFT REAR:TANDEM:ASS'Y

140.D1367546
DECAL:PAPER VO
LUME:SIDE FENCE
:LEFT REAR:1



141.D1367547
DECAL:PAPER VO
LUME:SIDE FENCE
:LEFT REAR:2

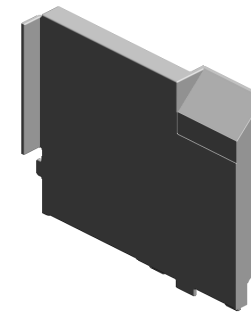

264.D2617529
SIDE FENCE:LEFT
REAR:TANDEM:AS
SY

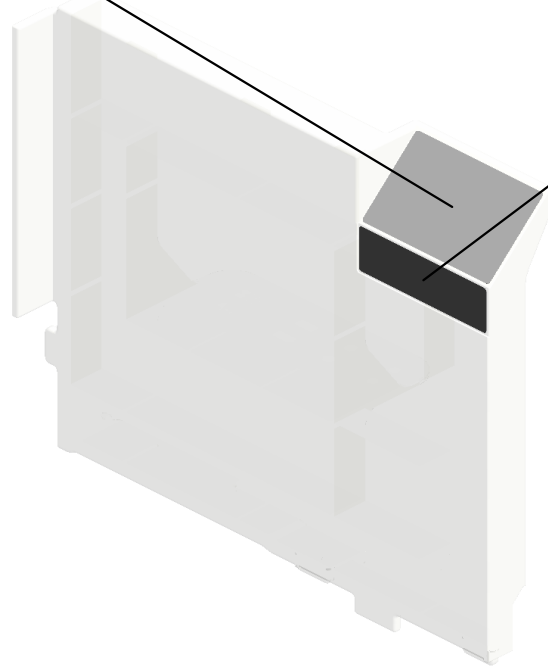

U001	U002	U003	U004	U005	U006	U007	U008	U009	U010	U011	U012	U013	U014	U015	U016	U017	U018	U019	U020	U021
------	------	------	------	------	------	------	------	------	------	------	------	------	------	------	------	------	------	------	------	------

U007_S020_S002

COVER:SYNCHRONOUS BELT:TANDEM TRAY

14.04583010N
(x2)
HEXAGON HEAD TAPPING SCREW:3
X10

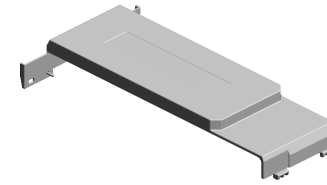

277.D2617586
COVER:SYNCHRO
NOUS BELT:TAND
EM TRAY

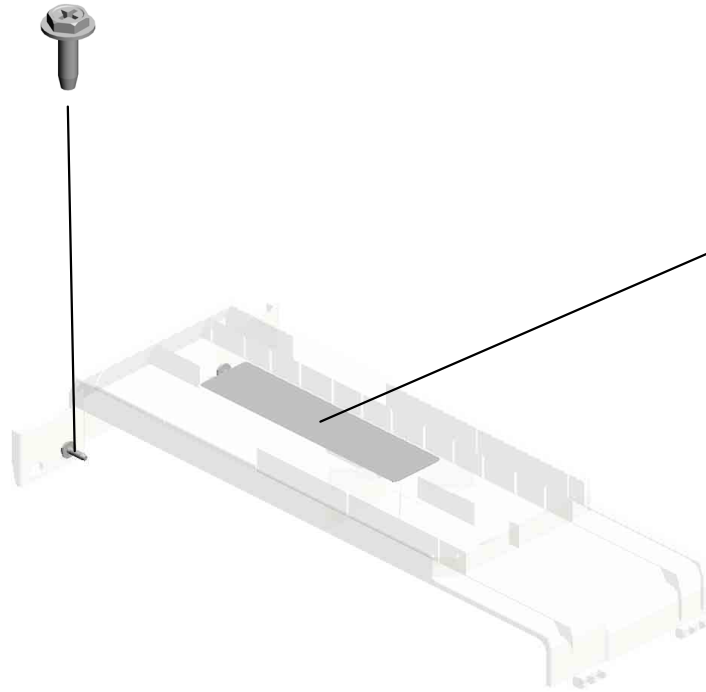

39.AA000315
DECAL:CAUTION C
HART:LEFT

U001	U002	U003	U004	U005	U006	U007	U008	U009	U010	U011	U012	U013	U014	U015	U016	U017	U018	U019	U020	U021
------	------	------	------	------	------	------	------	------	------	------	------	------	------	------	------	------	------	------	------	------

U008.TONNER SUPPLY

U008_S001
D2613200
TONER SUPPLY U:MAIN:ASS
Y

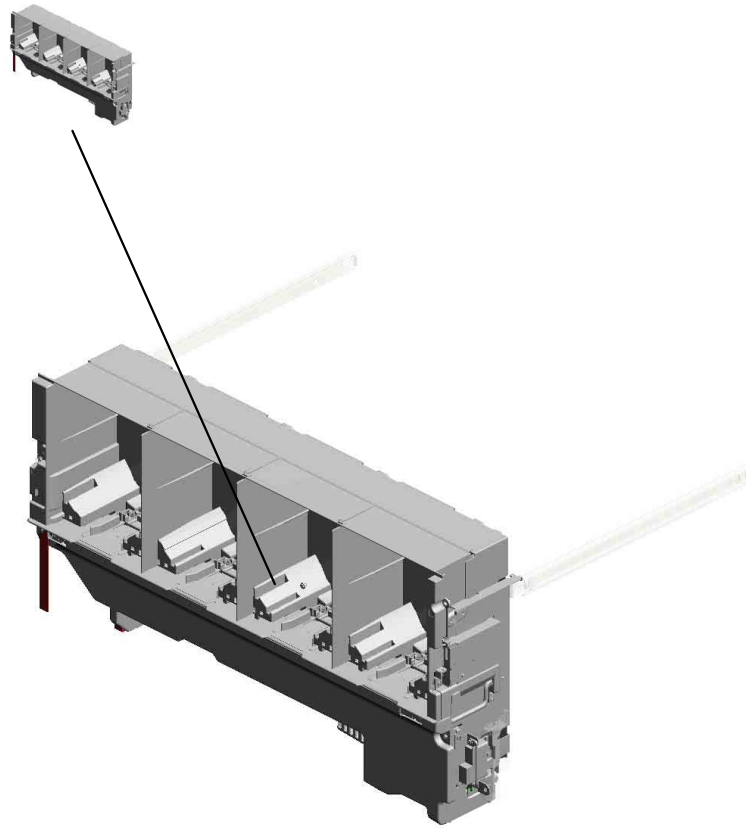

U001	U002	U003	U004	U005	U006	U007	U008	U009	U010	U011	U012	U013	U014	U015	U016	U017	U018	U019	U020	U021
------	------	------	------	------	------	------	-------------	------	------	------	------	------	------	------	------	------	------	------	------	------

U008_S001.TONER SUPPLY U:MAIN:ASS'Y

U008_S001_S005
D1383206
BASE:SHUTTER:OPEN AND
CLOSE:ASS'Y

U008_S001_S002
D1363305
TONER SUPPLY UNIT:ASS'Y

U008_S001_S006
D1383206
BASE:SHUTTER:OPEN AND
CLOSE:ASS'Y

U008_S001_S010
D2586934
DUCT:DEVELOPMENT:Y:UPP
ER:ASS'Y

U008_S001_S011
D2586935
DUCT:DEVELOPMENT:Y:LO
WER:ASS'Y

U008_S001_S003
D1363305
TONER SUPPLY UNIT:ASS'Y

U008_S001_S007
D1383206
BASE:SHUTTER:OPEN AND
CLOSE:ASS'Y

U008_S001_S008
D1383206
BASE:SHUTTER:OPEN AND
CLOSE:ASS'Y

U008_S001_S001
D1363305
TONER SUPPLY UNIT:ASS'Y

U008_S001_S009
D2583291
INNER COVER:TONER SUPP
LY UNIT:FRONT:ASS'Y

U008_S001_S004
D1363305
TONER SUPPLY UNIT:ASS'Y

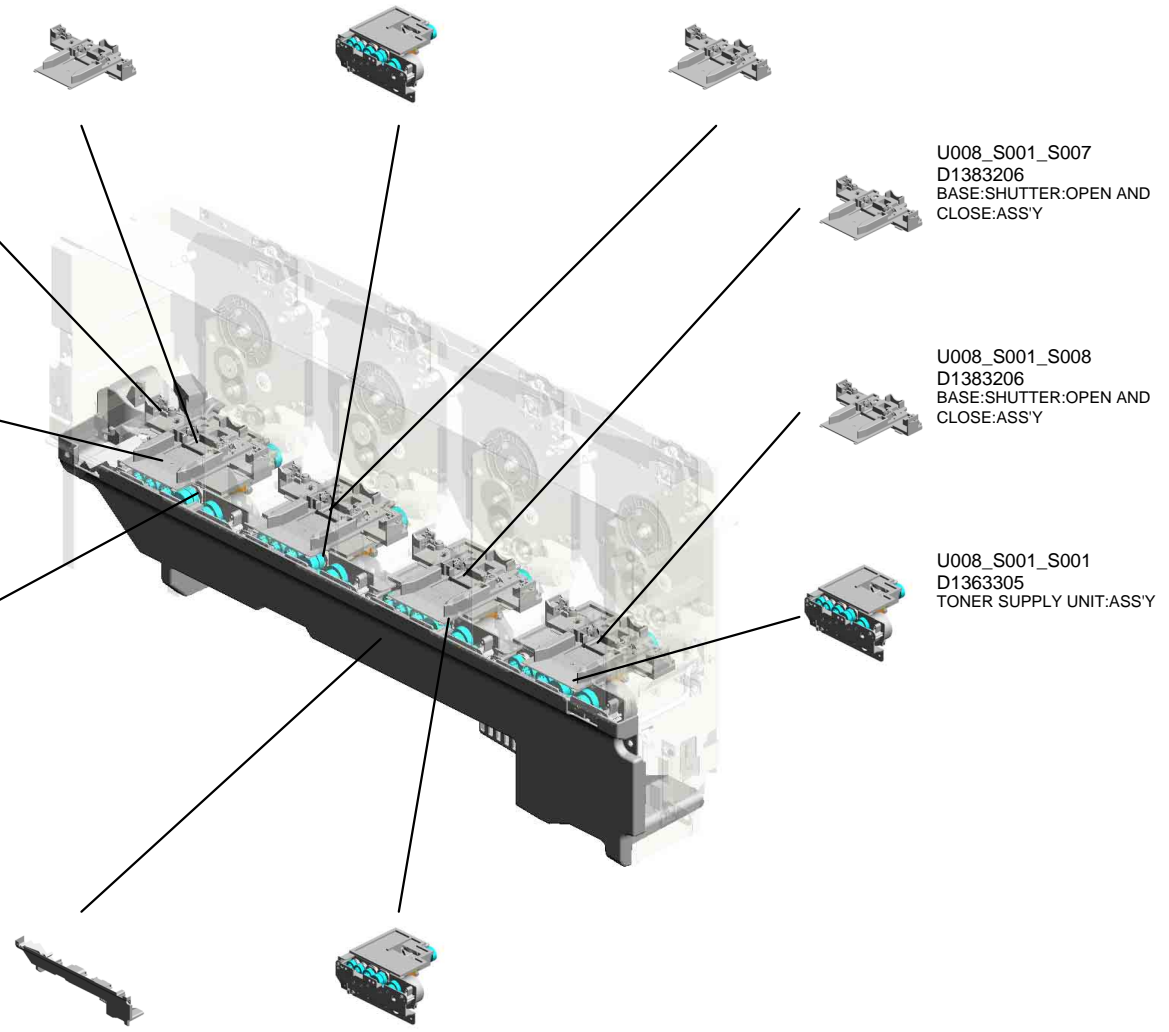

U008 TONNER SUPPLY

26.AA000290 (x2)
DECAL:POSITIONING DISPLAY:SCREEN:PET

90.D2583247
SLIDE RAIL:TONER SUPPLY:LEFT:ASSY

91.D2583249
COVER:SLIDE RAIL:TONER SUPPLY:RIGHT

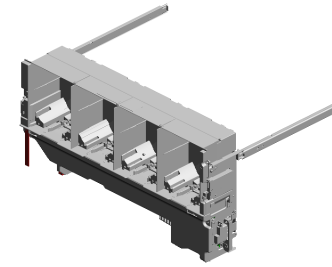

92.D2583250
COVER:SLIDE RAIL:TONER SUPPLY:LEFT



31.B2342390 (x5)
FLANGED HEXAGONAL HEAD BOLT: M4X8



89.D2583245
SLIDE RAIL:TONER SUPPLY:RIGHT:ASSY



13.08025305 (x4)
TAPPING SCREW - M3X6



19.11050723
CLAMPS:WES-0507

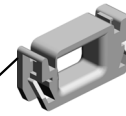

5.04543006Q (x 1)
TAPPING SCREW - M3X6

27.AA143579 (x2)
SCREW - M3



64.D1363374
BRACKET:DRAWER:TONER SUPPLY:MAIN



U008_S001
 TONER SUPPLY U:MAIN:ASS'Y

- 21.11050758 (x16) CLAMP:LWSM-030 6A
- 8.04583008N (x12) HEXAGON HEAD TAPPING SCREW:3 X8
- 17.11050568 (x8) CLAMP:LWSS-0504
- 18.11050692 (x7) CLAMP:LES-0503
- 5.04543006Q (x60) TAPPING SCREW - M3X6

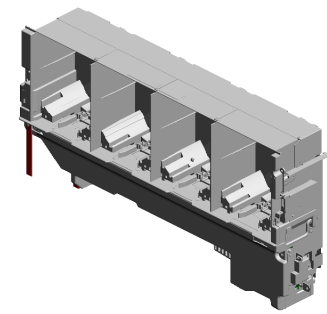

109.D2613200
 TONER SUPPLY U:
 MAIN:ASS'Y

2.03603006N
 (x8)
 SCREW - M3X6



1.03530030N
 (x8)
 SCREW:M3X3



30.AX640223
 (x4)
 FAN:SIROCCO:DC
 24V:60MM



3.04503014N
 (x8)
 TAPPING SCREW:
 M3X14



4.04543006N
 (x12)
 TAPPING SCREW:
 ROUND POINT:3X6



28.AW020198
 PHOTOINTERRUP
 TOR:LG2A14NL1



24.11050761
 (x4)
 CLAMP:LWS-0511A



23.11050760
 (x8)
 CLAMP:LWSM-051
 1A

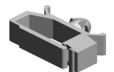

20.11050724
 CLAMPS:WES-121
 0



6.04543008Q
 (x2)
 TAPPING SCREW:
 3X8



26.AA000290
 (x3)
 DECAL:POSITIONI
 NG DISPLAY:SCRE
 W:PET



15.08050092
 RETAINING RING -
 3M



25.12042612
 MICRO SWITCH:D3
 V-16506-3C25



7.04543014Q
 TAPPING SCREW:
 3X14



16.11050410
 CARD SPACER - 9.
 4MM



14.08050089
 (x8)
 RETAINING RING -
 M4



21.11050758
 (x9)
 CLAMP:LWSM-030
 6A



22.11050759
 CLAMP:LWSM-060
 5A

12.07200040E (x 4)
 RETAINING RING - M4

U008_S001
 TONER SUPPLY U:MAIN:ASS'Y

- 66.D1363478 (x4) SPACER:DRIVE:TONER CARTRIDGE
- 46.D1363299 (x4) DC MOTOR:TONE R CARTRIDGE:ASSY
- 39.D1363251 (x4) HOLDER:TONER CARTRIDGE:CONNECTOR
- 67.D1365428 (x4) PCB:TCB
- 40.D1363254 (x4) COVER:CHIP:BASE

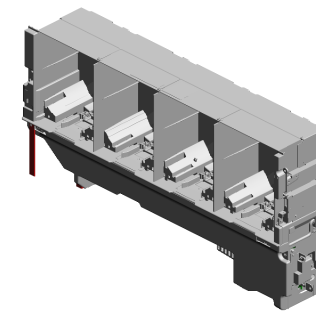

109.D2613200
 TONER SUPPLY U:
 MAIN:ASSY

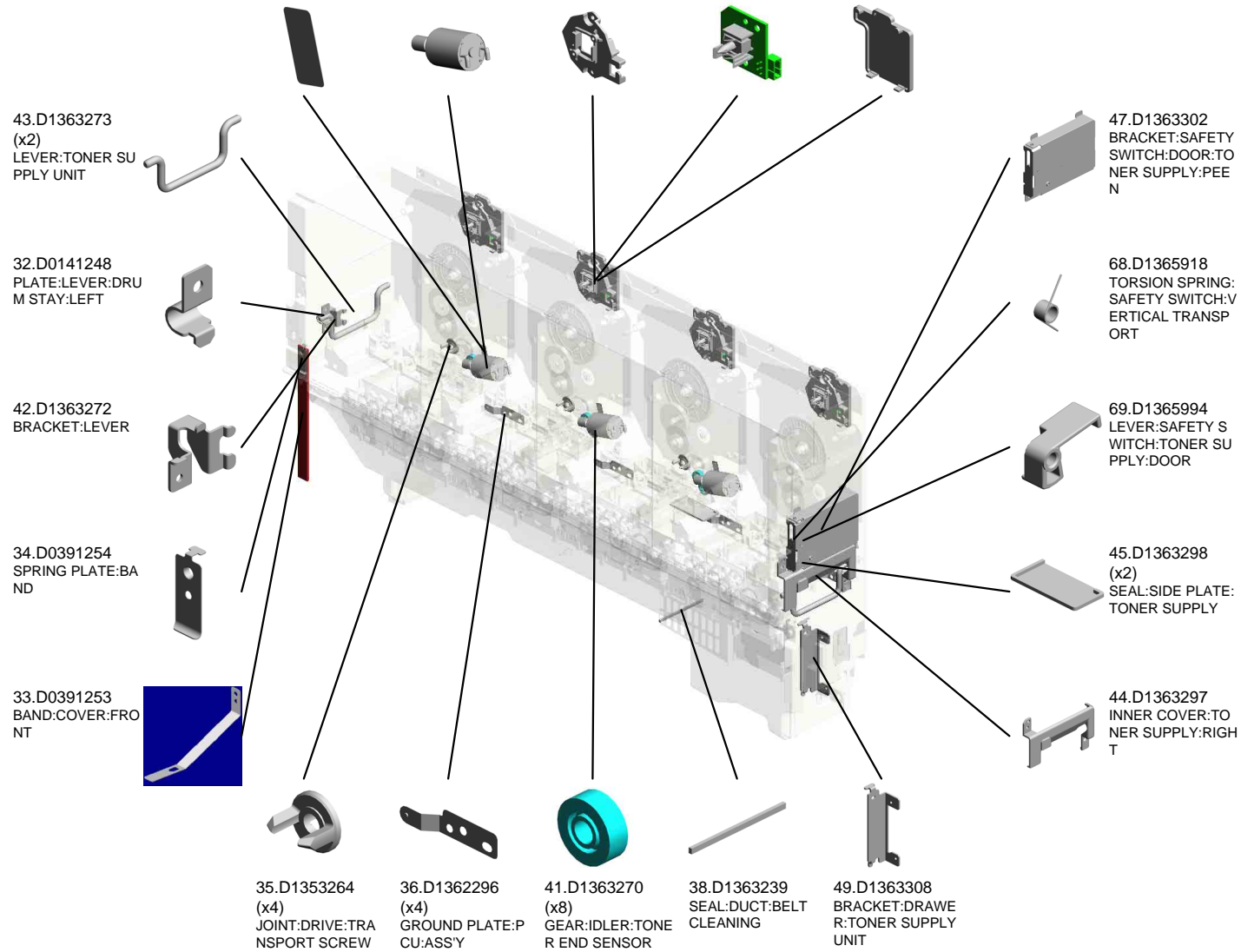

U008_S001 TONER SUPPLY U:MAIN:ASS'Y

- 74.D1383228 (x4) BRACKET:DRIVE:TONER CARTRIDGE:ASS'Y
- 86.D2583237 (x4) JOINT:DRIVE:AGITATOR
- 87.D2583238 (x4) TORSION SPRING:DRIVE:AGITATOR
- 85.D2583236 (x4) GEAR:DRIVE:AGITATOR
- 76.D1383391 DECAL:CAUTION:TONER SUPPLY SUB-UNIT

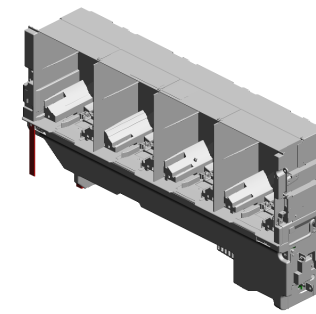

109.D2613200
TONER SUPPLY U:
MAIN:ASS'Y

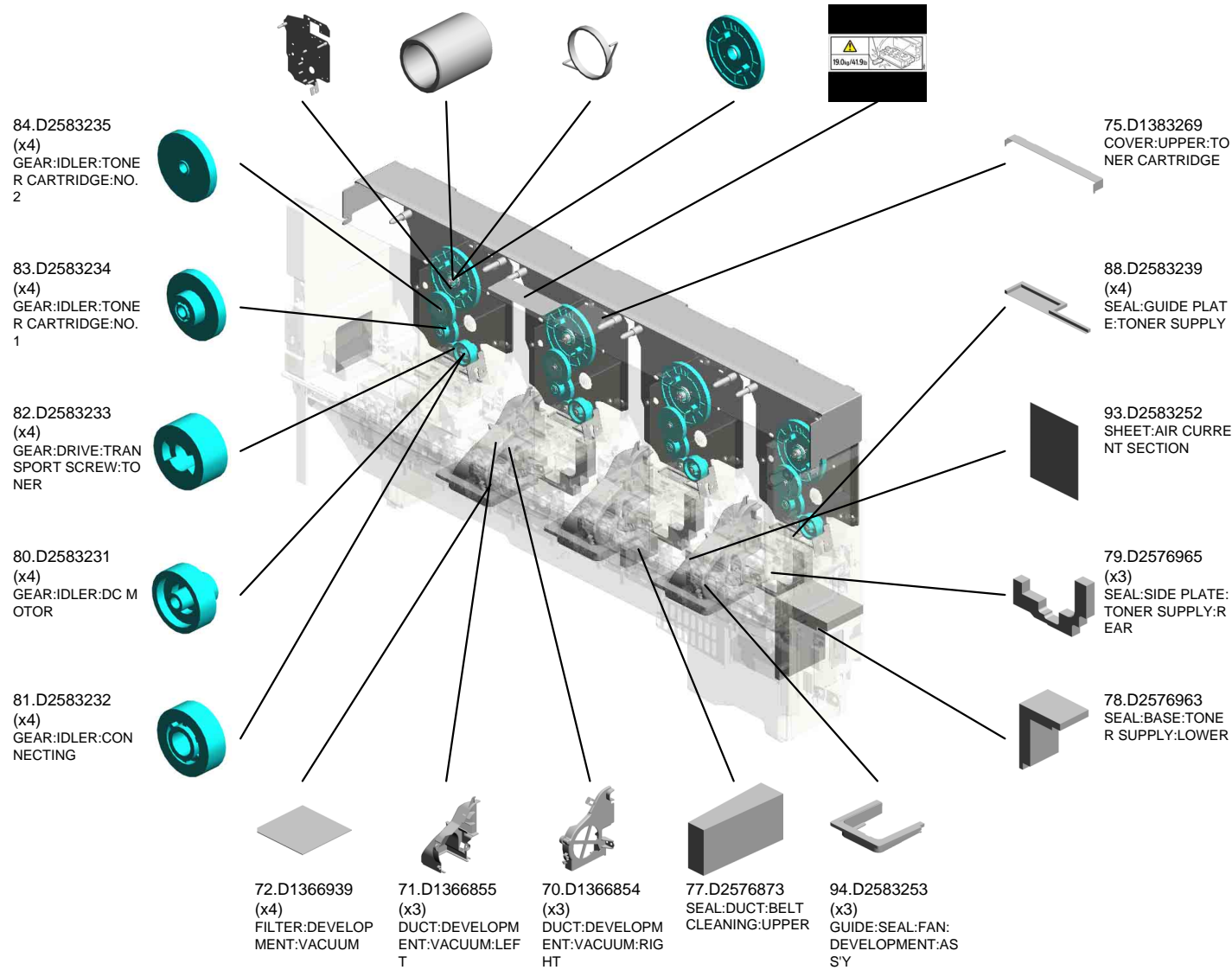

U008_S001
 TONER SUPPLY U:MAIN:ASS'Y

107.D2586960 SEAL:SUPPLY:BASE
 96.D2583257 SEAL:LEFT LOWER:TONER SUPPLY: LARGE
 112.D2613233 DECAL:OPERATE: TONER SUPPLY U: M
 114.D2613235 DECAL:CAUTION: PULL OUT

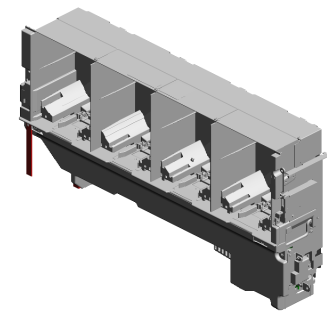

109.D2613200 TONER SUPPLY U: MAIN:ASS'Y

113.D2613234 DECAL:OPERATE: TONER SUPPLY U: Y



98.D2583259 SEAL:LEFT LOWER:FRAME:TONER SUPPLY



97.D2583258 SEAL:LEFT LOWER:TONER SUPPLY: SMALL

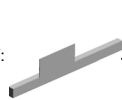

110.D2613231 DECAL:OPERATE: TONER SUPPLY U: BK

95.D2583256 (x3) SEAL:DUCT:FAN DEVELOPMENT:FRONT

100.D2583298 (x3) SEAL:DUCT:INNER COVER:TONER SUPPLY

101.D2585130 PCB:TSB:ASS'Y



111.D2613232 DECAL:OPERATE: TONER SUPPLY U: C



116.J0155505 DRAWER:CONNECTOR:USED DEVELOPER:PLUG

U008_S001_S001
 TONER SUPPLY UNIT:ASS'Y

51.D1363331
 SHUTTER:CASE:T
 ONER SUPPLY

57.D1363338
 GEAR:AGITATOR:T
 ONER SUPPLY:NO.
 1

50.D1363315
 CASE:TONER SUP
 PLY

58.D1363345
 SEAL:CASE:UPPE
 R:TONER SUPPLY

15.08050092
 RETAINING RING -
 3M

48.D1363305
 TONER SUPPLY U
 NIT:ASSY

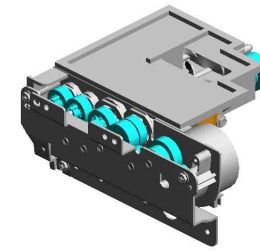

53.D1363334
 (x2)
 GEAR:TRANSPOR
 T SCREW:TONER
 SUPPLY

52.D1363333
 GEAR:AGITATOR:T
 ONER SUPPLY:NO.
 2

62.D1363366
 GEAR:IDLER:TRAN
 SPORT SCREW:TO
 NER SUPPLY:LAR
 GE

54.D1363335
 GEAR:MECHANICA
 L ROLLER CLUTCH
 :TONER SUPPLY:F
 RONT

61.D1363365
 (x2)
 GEAR:IDLER:TRAN
 SPORT SCREW:TO
 NER SUPPLY:SMA
 LL

11.07200030E
 (x3)
 RETAINING RING -
 M3

56.D1363337
 GEAR:IDLER:AGIT
 ATOR:TONER SUP
 PLY

8.04583008N
 (x5)
 HEXAGON HEAD T
 APPING SCREW:3
 X8

10.06320120G
 PARALLEL PIN - 2X
 12

59.D1363361
 GEAR:IDLER:TRAN
 SPORT SCREW:N
 O.1:TONER SUPPL
 Y

55.D1363336
 GEAR:MECHANICA
 L ROLLER CLUTCH
 :TONER SUPPLY:R
 EAR

15.08050092
 (x2)
 RETAINING RING -
 3M

115.GW230008
 TONER END SENS
 OR

11.07200030E (x 4)
 RETAINING RING - M3

9.04593008N
 (x2)
 BINDING HEAD TA
 PPING SCREW:3X
 8

60.D1363364
 GEAR:IDLER:DRIV
 E:TONER SUPPLY

29.AX050345
 DC STEPPER MOT
 OR:DIA42

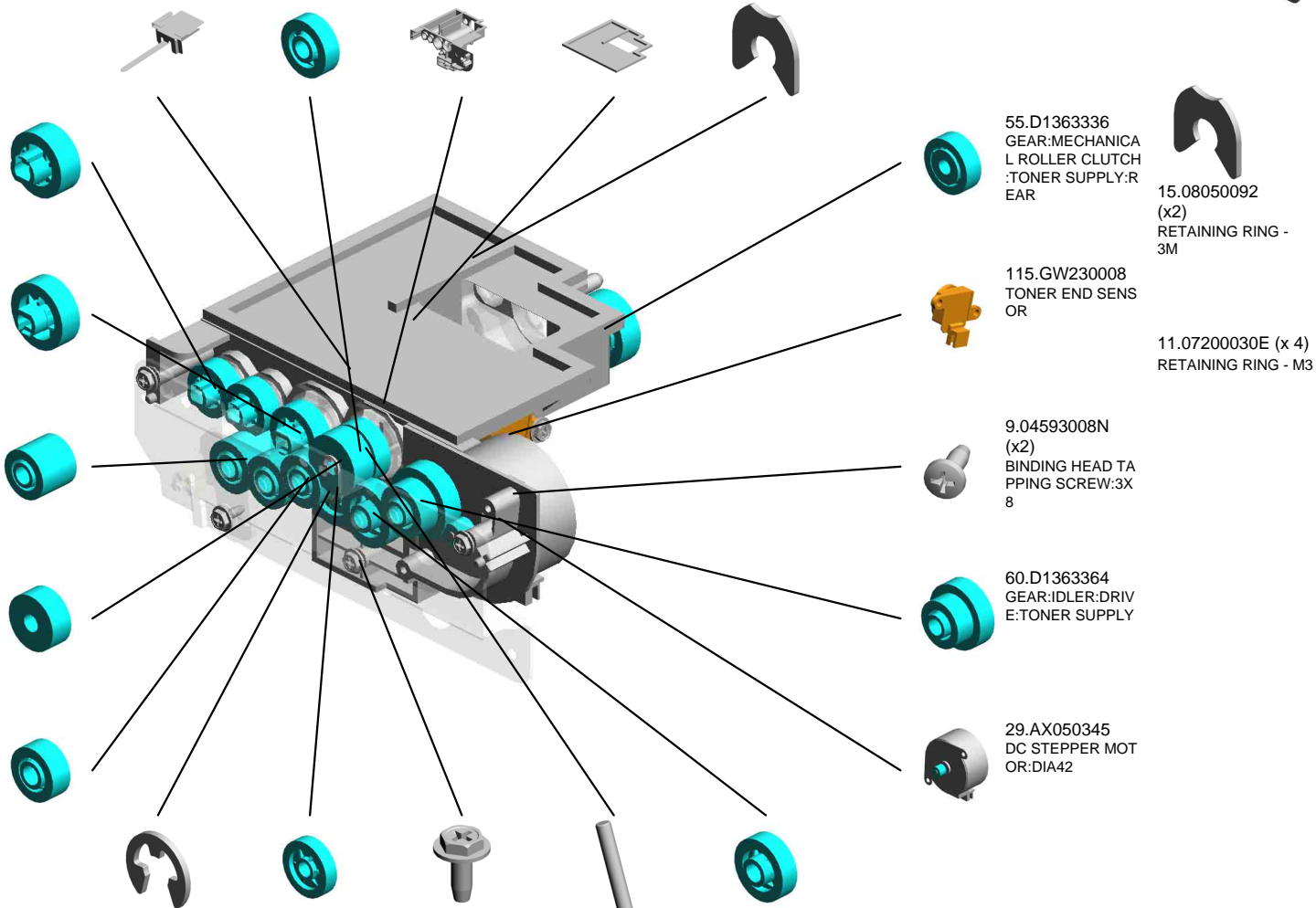

U008_S001_S002
 TONER SUPPLY UNIT:ASS'Y

51.D1363331
 SHUTTER:CASE:T
 ONER SUPPLY

57.D1363338
 GEAR:AGITATOR:T
 ONER SUPPLY:NO.
 1

50.D1363315
 CASE:TONER SUP
 PLY

58.D1363345
 SEAL:CASE:UPPE
 R:TONER SUPPLY

15.08050092
 RETAINING RING -
 3M

48.D1363305
 TONER SUPPLY U
 NIT:ASSY

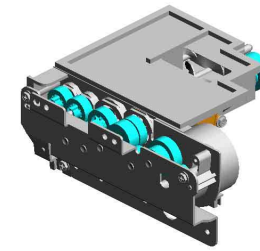

53.D1363334
 (x2)
 GEAR:TRANSPOR
 T SCREW:TONER
 SUPPLY

52.D1363333
 GEAR:AGITATOR:T
 ONER SUPPLY:NO.
 2

62.D1363366
 GEAR:IDLER:TRAN
 SPORT SCREW:TO
 NER SUPPLY:LAR
 GE

54.D1363335
 GEAR:MECHANICA
 L ROLLER CLUTCH
 :TONER SUPPLY:F
 RONT

61.D1363365
 (x2)
 GEAR:IDLER:TRAN
 SPORT SCREW:TO
 NER SUPPLY:SMA
 LL

11.07200030E
 (x3)
 RETAINING RING -
 M3

56.D1363337
 GEAR:IDLER:AGIT
 ATOR:TONER SUP
 PLY

8.04583008N
 (x5)
 HEXAGON HEAD T
 APPING SCREW:3
 X8

10.06320120G
 PARALLEL PIN - 2X
 12

59.D1363361
 GEAR:IDLER:TRAN
 SPORT SCREW:N
 O.1:TONER SUPPL
 Y

55.D1363336
 GEAR:MECHANICA
 L ROLLER CLUTCH
 :TONER SUPPLY:R
 EAR

15.08050092
 (x2)
 RETAINING RING -
 3M

115.GW230008
 TONER END SENS
 OR

11.07200030E (x 4)
 RETAINING RING - M3

9.04593008N
 (x2)
 BINDING HEAD TA
 PPING SCREW:3X
 8

60.D1363364
 GEAR:IDLER:DRIV
 E:TONER SUPPLY

29.AX050345
 DC STEPPER MOT
 OR:DIA42

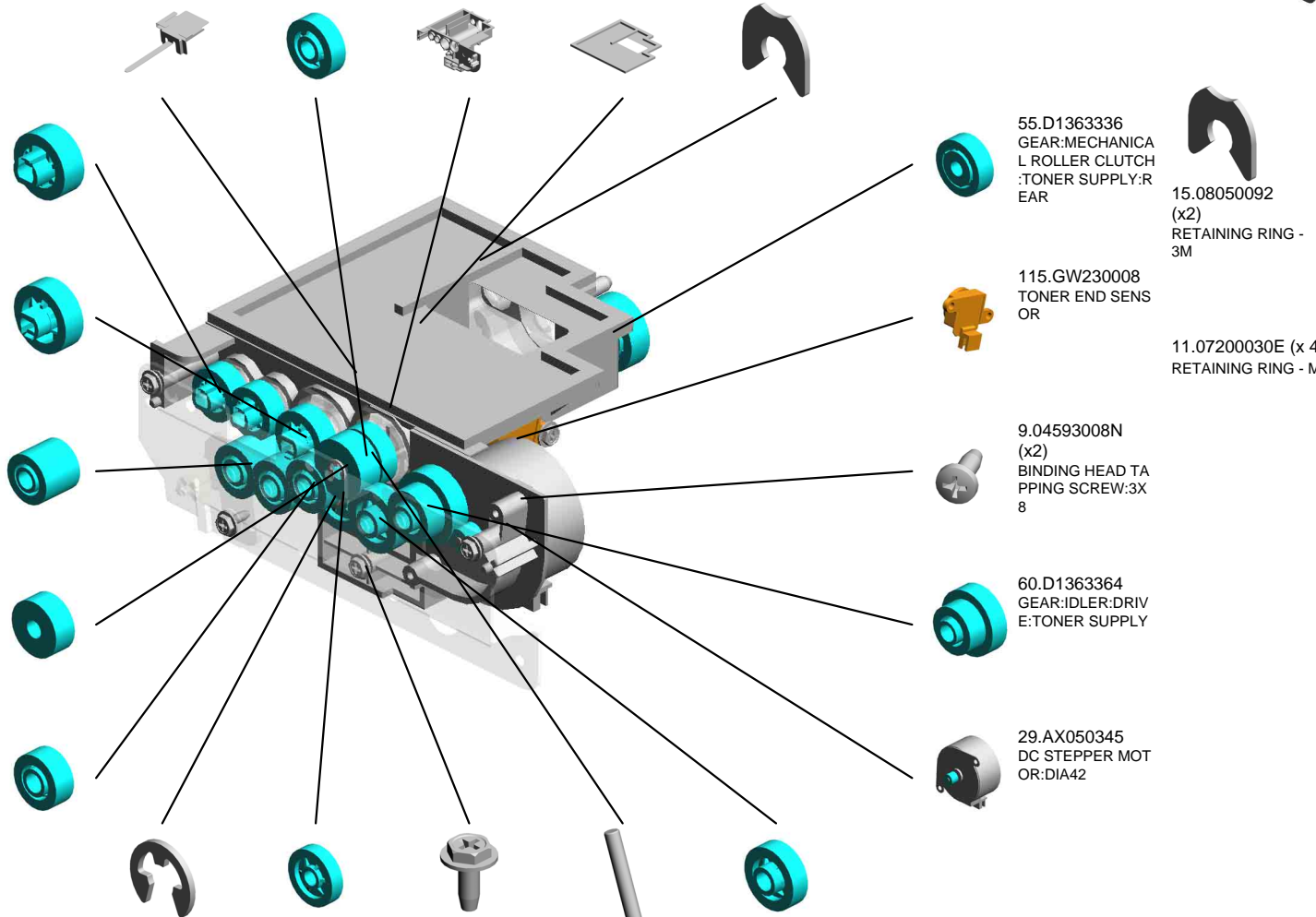

U008_S001_S003
 TONER SUPPLY UNIT:ASS'Y

51.D1363331
 SHUTTER:CASE:T
 ONER SUPPLY

57.D1363338
 GEAR:AGITATOR:T
 ONER SUPPLY:NO.
 1

50.D1363315
 CASE:TONER SUP
 PLY

58.D1363345
 SEAL:CASE:UPPE
 R:TONER SUPPLY

15.08050092
 RETAINING RING -
 3M

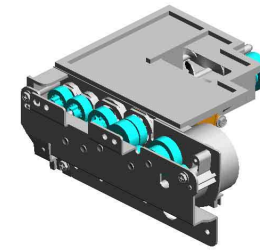

48.D1363305
 TONER SUPPLY U
 NIT:ASSY

53.D1363334
 (x2)
 GEAR:TRANSPOR
 T SCREW:TONER
 SUPPLY

52.D1363333
 GEAR:AGITATOR:T
 ONER SUPPLY:NO.
 2

62.D1363366
 GEAR:IDLER:TRAN
 SPORT SCREW:TO
 NER SUPPLY:LAR
 GE

54.D1363335
 GEAR:MECHANICA
 L ROLLER CLUTCH
 :TONER SUPPLY:F
 RONT

61.D1363365
 (x2)
 GEAR:IDLER:TRAN
 SPORT SCREW:TO
 NER SUPPLY:SMA
 LL

11.07200030E
 (x3)
 RETAINING RING -
 M3

56.D1363337
 GEAR:IDLER:AGIT
 ATOR:TONER SUP
 PLY

8.04583008N
 (x5)
 HEXAGON HEAD T
 APPING SCREW:3
 X8

10.06320120G
 PARALLEL PIN - 2X
 12

59.D1363361
 GEAR:IDLER:TRAN
 SPORT SCREW:N
 O.1:TONER SUPPL
 Y

55.D1363336
 GEAR:MECHANICA
 L ROLLER CLUTCH
 :TONER SUPPLY:R
 EAR

15.08050092
 (x2)
 RETAINING RING -
 3M

115.GW230008
 TONER END SENS
 OR

11.07200030E (x 4)
 RETAINING RING - M3

9.04593008N
 (x2)
 BINDING HEAD TA
 PPING SCREW:3X
 8

60.D1363364
 GEAR:IDLER:DRIV
 E:TONER SUPPLY

29.AX050345
 DC STEPPER MOT
 OR:DIA42

U008_S001_S004
 TONER SUPPLY UNIT:ASS'Y

51.D1363331
 SHUTTER:CASE:T
 ONER SUPPLY

57.D1363338
 GEAR:AGITATOR:T
 ONER SUPPLY:NO.
 1

50.D1363315
 CASE:TONER SUP
 PLY

58.D1363345
 SEAL:CASE:UPPE
 R:TONER SUPPLY

15.08050092
 RETAINING RING -
 3M

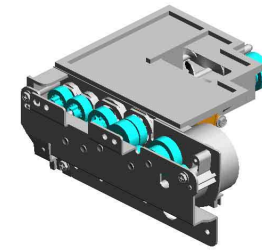

48.D1363305
 TONER SUPPLY U
 NIT:ASSY

53.D1363334
 (x2)
 GEAR:TRANSPOR
 T SCREW:TONER
 SUPPLY

52.D1363333
 GEAR:AGITATOR:T
 ONER SUPPLY:NO.
 2

62.D1363366
 GEAR:IDLER:TRAN
 SPORT SCREW:TO
 NER SUPPLY:LAR
 GE

54.D1363335
 GEAR:MECHANICA
 L ROLLER CLUTCH
 :TONER SUPPLY:F
 RONT

61.D1363365
 (x2)
 GEAR:IDLER:TRAN
 SPORT SCREW:TO
 NER SUPPLY:SMA
 LL

11.07200030E
 (x3)
 RETAINING RING -
 M3

56.D1363337
 GEAR:IDLER:AGIT
 ATOR:TONER SUP
 PLY

8.04583008N
 (x5)
 HEXAGON HEAD T
 APPING SCREW:3
 X8

10.06320120G
 PARALLEL PIN - 2X
 12

59.D1363361
 GEAR:IDLER:TRAN
 SPORT SCREW:N
 O.1:TONER SUPPL
 Y

55.D1363336
 GEAR:MECHANICA
 L ROLLER CLUTCH
 :TONER SUPPLY:R
 EAR

15.08050092
 (x2)
 RETAINING RING -
 3M

115.GW230008
 TONER END SENS
 OR

11.07200030E (x 4)
 RETAINING RING - M3

9.04593008N
 (x2)
 BINDING HEAD TA
 PPING SCREW:3X
 8

60.D1363364
 GEAR:IDLER:DRIV
 E:TONER SUPPLY

29.AX050345
 DC STEPPER MOT
 OR:DIA42

U008_S001_S005

BASE:SHUTTER:OPEN AND CLOSE:ASS'Y

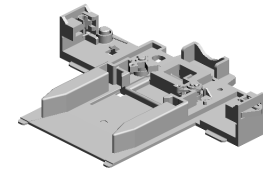

73.D1383206
BASE:SHUTTER:O
PEN AND CLOSE:A
SS'Y

37.D1363211
TORSION SPRING:
STOPPER:TONER
CARTRIDGE:RIGH
T

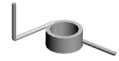

117.M0263344
TORSION SPRING:
STOPPER:LEFT



63.D1363371
TORSION SPRING:
STOPPER:TONER
CARTRIDGE:LEFT

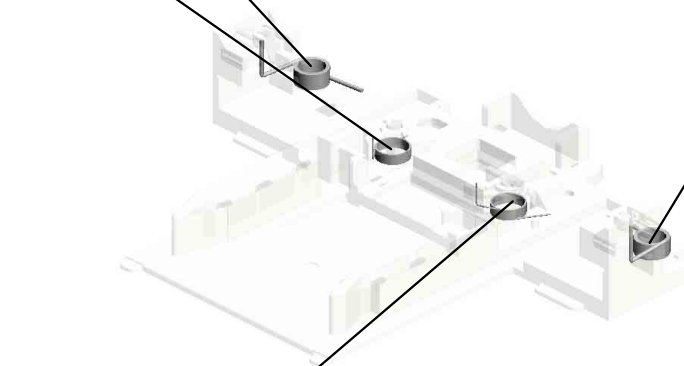

65.D1363381
TORSION SPRING:
STOPPER:RIGHT



U001	U002	U003	U004	U005	U006	U007	U008	U009	U010	U011	U012	U013	U014	U015	U016	U017	U018	U019	U020	U021
------	------	------	------	------	------	------	------	------	------	------	------	------	------	------	------	------	------	------	------	------

U008_S001_S006

BASE:SHUTTER:OPEN AND CLOSE:ASS'Y

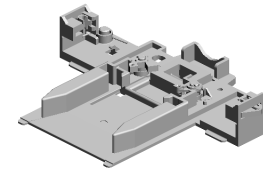

73.D1383206
BASE:SHUTTER:O
PEN AND CLOSE:A
SS'Y

37.D1363211
TORSION SPRING:
STOPPER:TONER
CARTRIDGE:RIGH
T

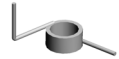

117.M0263344
TORSION SPRING:
STOPPER:LEFT



63.D1363371
TORSION SPRING:
STOPPER:TONER
CARTRIDGE:LEFT



65.D1363381
TORSION SPRING:
STOPPER:RIGHT

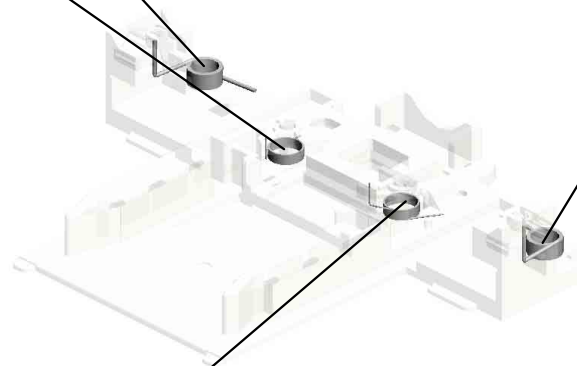

U001	U002	U003	U004	U005	U006	U007	U008	U009	U010	U011	U012	U013	U014	U015	U016	U017	U018	U019	U020	U021
------	------	------	------	------	------	------	-------------	------	------	------	------	------	------	------	------	------	------	------	------	------

U008_S001_S007

BASE:SHUTTER:OPEN AND CLOSE:ASS'Y

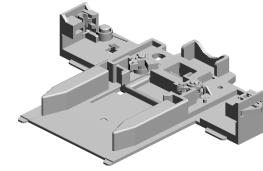

73.D1383206
BASE:SHUTTER:O
PEN AND CLOSE:A
SS'Y

37.D1363211
TORSION SPRING:
STOPPER:TONER
CARTRIDGE:RIGH
T

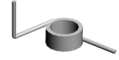

117.M0263344
TORSION SPRING:
STOPPER:LEFT



63.D1363371
TORSION SPRING:
STOPPER:TONER
CARTRIDGE:LEFT

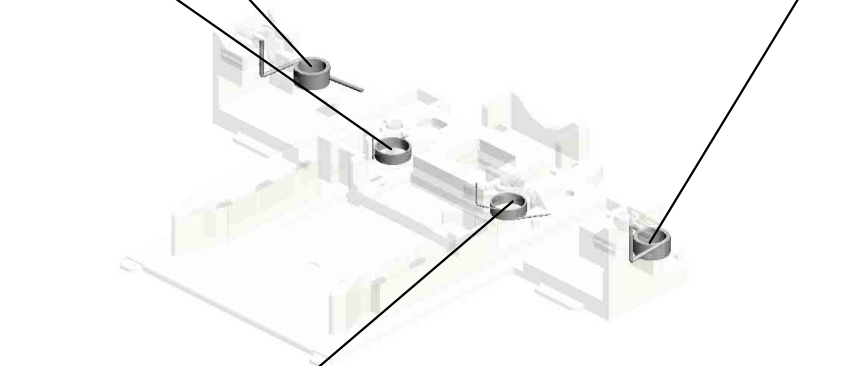

65.D1363381
TORSION SPRING:
STOPPER:RIGHT



U001	U002	U003	U004	U005	U006	U007	U008	U009	U010	U011	U012	U013	U014	U015	U016	U017	U018	U019	U020	U021
------	------	------	------	------	------	------	-------------	------	------	------	------	------	------	------	------	------	------	------	------	------

U008_S001_S008

BASE:SHUTTER:OPEN AND CLOSE:ASS'Y

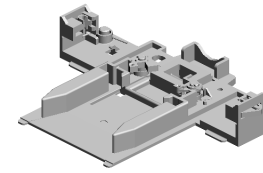

73.D1383206
BASE:SHUTTER:O
PEN AND CLOSE:A
SS'Y

37.D1363211
TORSION SPRING:
STOPPER:TONER
CARTRIDGE:RIGH
T

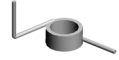

117.M0263344
TORSION SPRING:
STOPPER:LEFT



63.D1363371
TORSION SPRING:
STOPPER:TONER
CARTRIDGE:LEFT

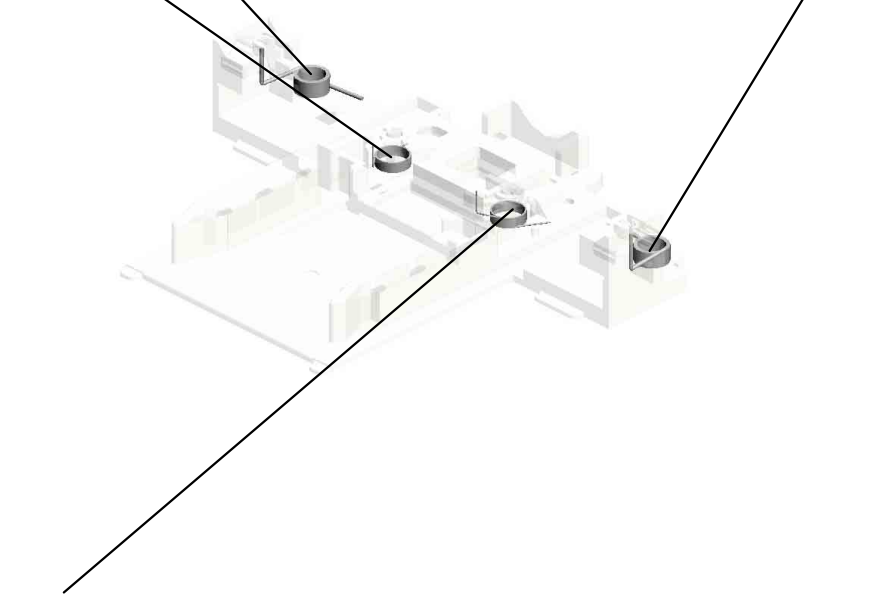

65.D1363381
TORSION SPRING:
STOPPER:RIGHT



U001	U002	U003	U004	U005	U006	U007	U008	U009	U010	U011	U012	U013	U014	U015	U016	U017	U018	U019	U020	U021
------	------	------	------	------	------	------	-------------	------	------	------	------	------	------	------	------	------	------	------	------	------

U008_S001_S009
INNER COVER:TONER SUPPLY UNIT:FRONT:ASS'Y

108.D2586961
SEAL:SUPPLY:INN
ER COVER

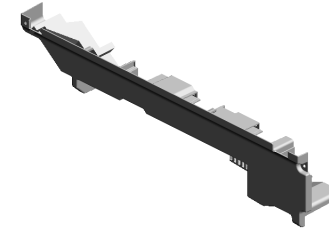

99.D2583291
INNER COVER:TO
NER SUPPLY UNIT
:FRONT:ASS'Y

U001	U002	U003	U004	U005	U006	U007	U008	U009	U010	U011	U012	U013	U014	U015	U016	U017	U018	U019	U020	U021
------	------	------	------	------	------	------	-------------	------	------	------	------	------	------	------	------	------	------	------	------	------

U008_S001_S010
DUCT:DEVELOPMENT:Y:UPPER:ASS'Y

104.D2586957
SEAL:DUCT:TONE
R SUPPLY UNIT:Y:
LARGE

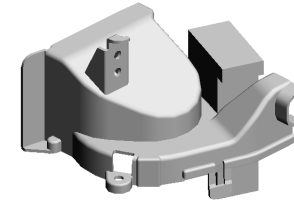

102.D2586934
DUCT:DEVELOPM
ENT:Y:UPPER:ASS'
Y

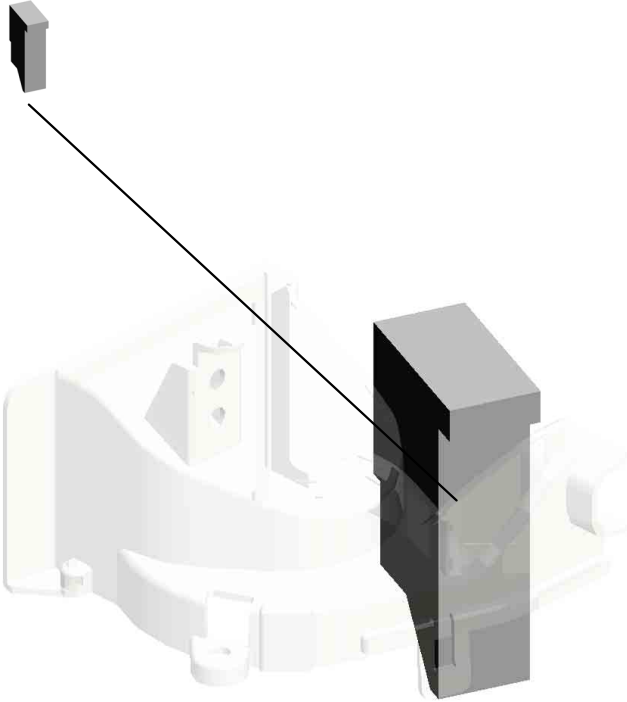

U001	U002	U003	U004	U005	U006	U007	U008	U009	U010	U011	U012	U013	U014	U015	U016	U017	U018	U019	U020	U021
------	------	------	------	------	------	------	-------------	------	------	------	------	------	------	------	------	------	------	------	------	------

U008_S001_S011
DUCT:DEVELOPMENT:Y:LOWER:ASS'Y

106.D2586959
SEAL:DUCT:TONE
R OUTLET UNIT:Y:
FRONT

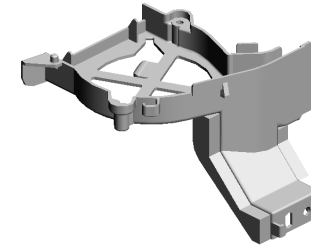
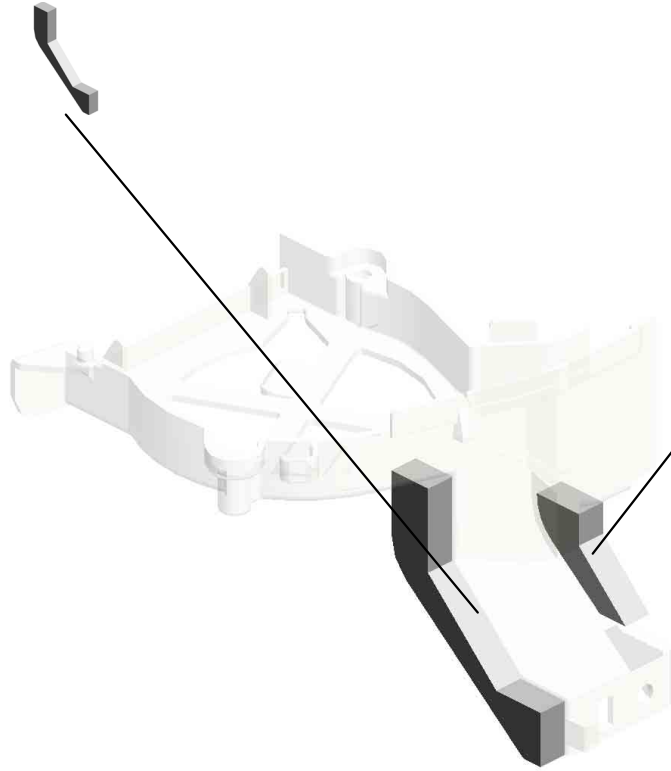

103.D2586935
DUCT:DEVELOPM
ENT:Y:LOWER:AS
SY

105.D2586958
SEAL:DUCT:TONE
R SUPPLY UNIT:Y:
REAR

U001	U002	U003	U004	U005	U006	U007	U008	U009	U010	U011	U012	U013	U014	U015	U016	U017	U018	U019	U020	U021
------	------	------	------	------	------	------	-------------	------	------	------	------	------	------	------	------	------	------	------	------	------

U009.PCDU

U009_S002
D2610155
DEVELOPMENT UNIT:ASS'Y

U009_S003
D2613530
CHARGE UNIT:ASS'Y

U009_S001
D2612203
CLEANING UNIT:ASS'Y

U009_S012
D2613530
CHARGE UNIT:ASS'Y

U009_S009
D2613530
CHARGE UNIT:ASS'Y

U009_S011
D2612203
CLEANING UNIT:ASS'Y

U009_S007
D2612203
CLEANING UNIT:ASS'Y

U009_S010
D2610150
DEVELOPMENT UNIT:BK:AS
S'Y

U009_S008
D2610155
DEVELOPMENT UNIT:ASS'Y

U009_S005
D2610155
DEVELOPMENT UNIT:ASS'Y

U009_S006
D2613530
CHARGE UNIT:ASS'Y

U009_S004
D2612203
CLEANING UNIT:ASS'Y

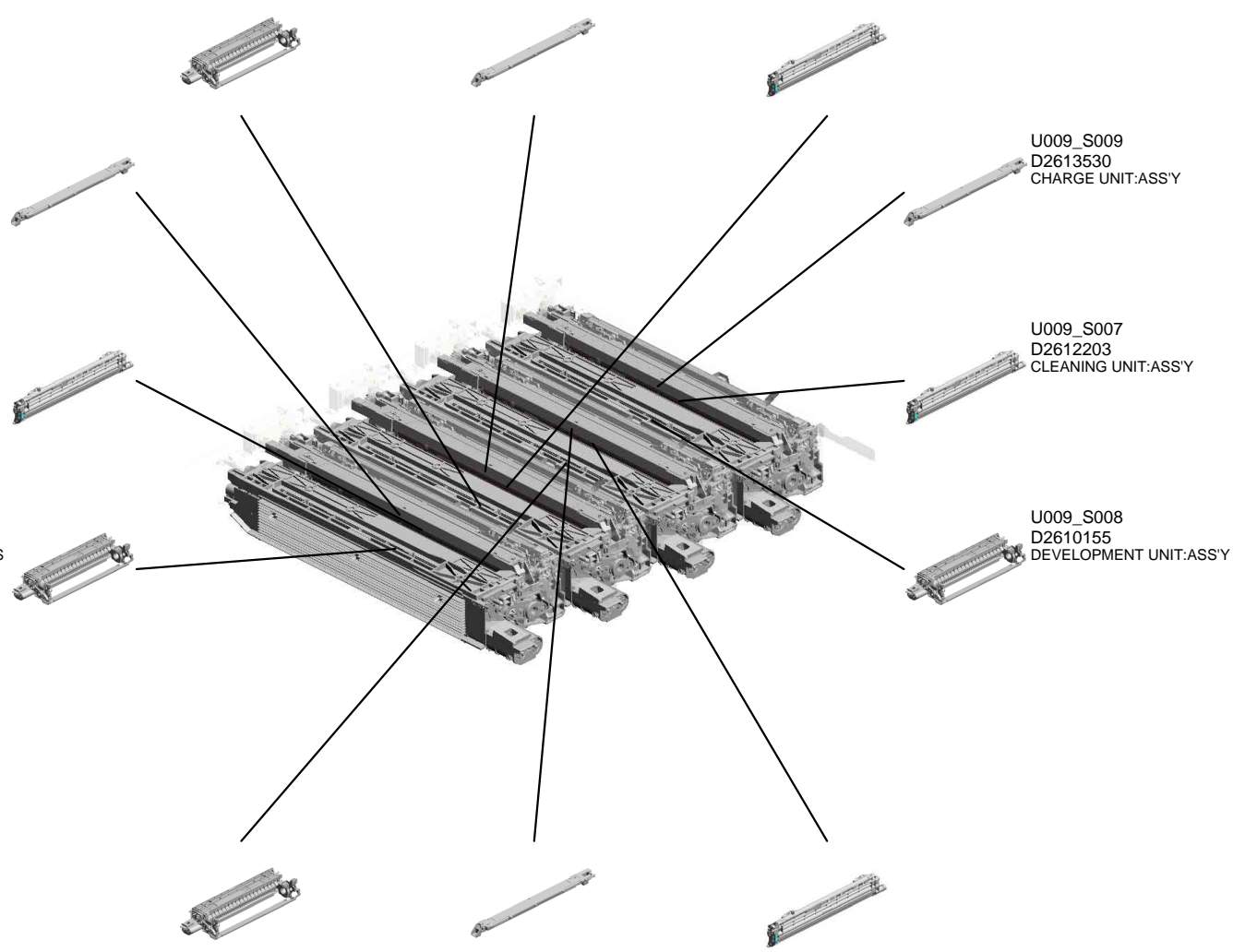

U001	U002	U003	U004	U005	U006	U007	U008	U009	U010	U011	U012	U013	U014	U015	U016	U017	U018	U019	U020	U021
------	------	------	------	------	------	------	------	------	------	------	------	------	------	------	------	------	------	------	------	------

U009_S001.CLEANING UNIT:ASS'Y

U009_S001_S001
D1362451
COVER:TONER OUTLET SU
B-UNIT:CLEANING UNIT:ASS'
Y



U001	U002	U003	U004	U005	U006	U007	U008	U009	U010	U011	U012	U013	U014	U015	U016	U017	U018	U019	U020	U021
------	------	------	------	------	------	------	------	------	------	------	------	------	------	------	------	------	------	------	------	------

U009_S004.CLEANING UNIT:ASS'Y

U009_S004_S001
D1362451
COVER:TONER OUTLET SU
B-UNIT:CLEANING UNIT:ASS'
Y



U001	U002	U003	U004	U005	U006	U007	U008	U009	U010	U011	U012	U013	U014	U015	U016	U017	U018	U019	U020	U021
------	------	------	------	------	------	------	------	------	------	------	------	------	------	------	------	------	------	------	------	------

U009_S007.CLEANING UNIT:ASS'Y

U009_S007_S001
D1362451
COVER:TONER OUTLET SU
B-UNIT:CLEANING UNIT:ASS'
Y



U001	U002	U003	U004	U005	U006	U007	U008	U009	U010	U011	U012	U013	U014	U015	U016	U017	U018	U019	U020	U021
------	------	------	------	------	------	------	------	------	------	------	------	------	------	------	------	------	------	------	------	------

U009_S011.CLEANING UNIT:ASS'Y

U009_S011_S001
D1362451
COVER:TONER OUTLET SU
B-UNIT:CLEANING UNIT:ASS'
Y



U001	U002	U003	U004	U005	U006	U007	U008	U009	U010	U011	U012	U013	U014	U015	U016	U017	U018	U019	U020	U021
------	------	------	------	------	------	------	------	------	------	------	------	------	------	------	------	------	------	------	------	------

U009
PCDU

- 8.07200030E (x4) RETAINING RING - M3
- 13.11050758 (x4) CLAMP:LWSM-030 6A
- 23.D0742178 (x4) TENSION SPRING: SOLENOID:ON-OFF
- 28.D1362276 (x4) CONNECTOR:1POLE
- 25.D1362258 (x4) CONNECTOR:DRAWER:8POLE:REC

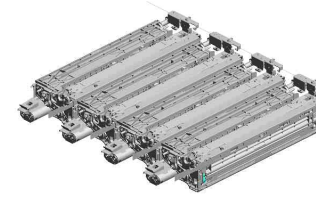

1.03530030N
(x8)
SCREW:M3X3



12.11050723
(x4)
CLAMPS:WES-0507

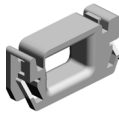

15.AA000290
(x16)
DECAL:POSITIONING DISPLAY:SCREW:PET



6.04543008Q
(x4)
TAPPING SCREW: 3X8



20.B2591131
(x8)
SCREW:PCU



14.11050760
(x4)
CLAMP:LWSM-051 1A

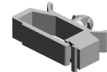

19.B2342399
(x24)
BOLT - M3X6



29.D1362302
(x4)
HOLDER:LOCK:CLEANING UNIT:FRONT



30.D1362304
(x4)
TORSION SPRING: LOCK:PCU



31.D1362305
(x4)
GROUND PLATE:HOLDER:CLEANING UNIT



5.04543006Q
(x16)
TAPPING SCREW - M3X6



27.D1362268
(x4)
SHIELDING PLATE: ELECTRIC POTENTIAL SENSOR

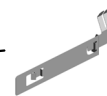

26.D1362266
(x4)
HOLDER:ELECTRIC POTENTIAL SENSOR

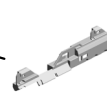

22.D0143655
(x4)
ELECTRIC POTENTIAL SENSOR



16.AA003056
(x8)
DECAL:GRIP:SHORT:PP

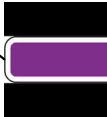

U009
PCDU

- 76.D2583784 (x4) DC SOLENOID:ON-OFF:ASSY
- 75.D2583781 (x4) BRACKET:SOLENOID:ON-OFF:CHARGE
- 34.D1362308 (x4) STAY:PCU
- 64.D2582256 (x3) SUPPORTER:PCU
- 63.D2582252 SUPPORTER:PCU:RIGHT

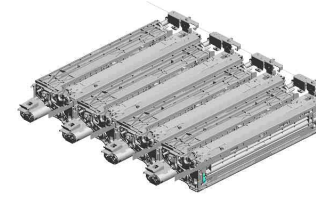

- 66.D2582317 (x4) HOLDER:LOCK:CLEANING UNIT:REAR

- 74.D2583490 (x4) RECEPTACLE:DEVELOPMENT VIAS:ASSY

- 77.D2589510 (x4) OPC DRUM DIA60

- 62.D1363445 DECAL:COLORED DISPLAY:MAIN:Y

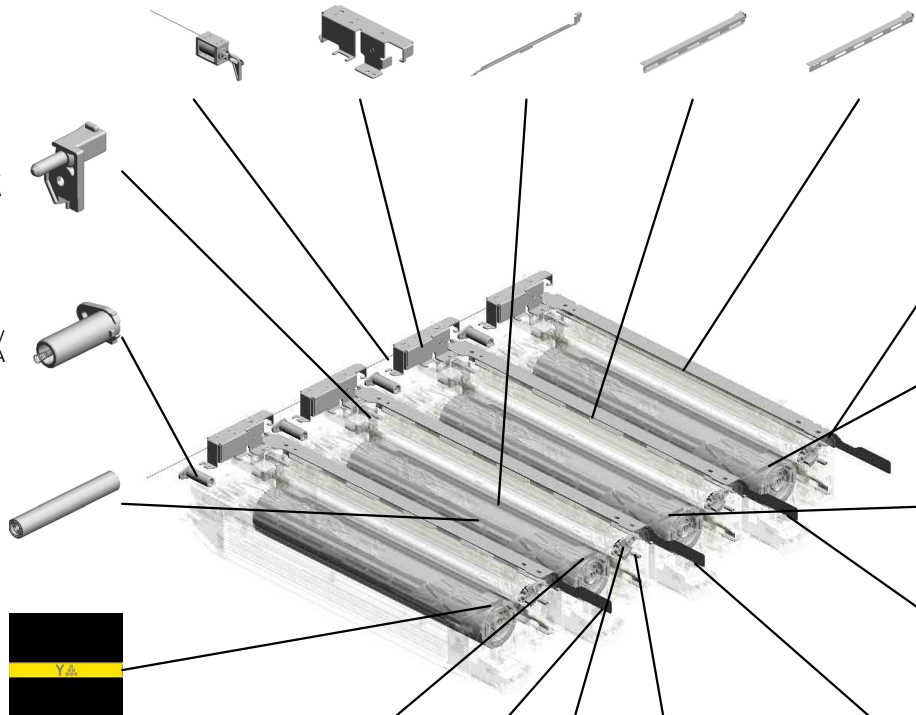

- 65.D2582257 (x4) SHEET:SUPPORTER:PCU

- 59.D1363442 DECAL:COLORED DISPLAY:MAIN:BK

- 60.D1363443 DECAL:COLORED DISPLAY:MAIN:C

- 87.D2613494 DECAL:COLORED DISPLAY:DEV UNIT:Y

- 86.D2613493 DECAL:COLORED DISPLAY:DEV UNIT:M

- 61.D1363444 DECAL:COLORED DISPLAY:MAIN:M

- 85.D2613492 DECAL:COLORED DISPLAY:DEV UNIT:C

- 33.D1362307 (x4) LEVER:LOCK:PCU

- 32.D1362306 (x8) COMPRESSION SPRING:GROUND PLATE:HOLDER:CLEANING UNIT

U009_S001
CLEANING UNIT:ASS'Y

48.D1362441 BLADE:APPLY:ASS'Y
 46.D1362423 SEAL:STAY:APPLY
 47.D1362424 SEAL:STAY:APPLY:UPPER
 17.AA003057 DECAL:GRIP:LONG:PP
 45.D1362418 TENSION SPRING:COATING BAR:18N

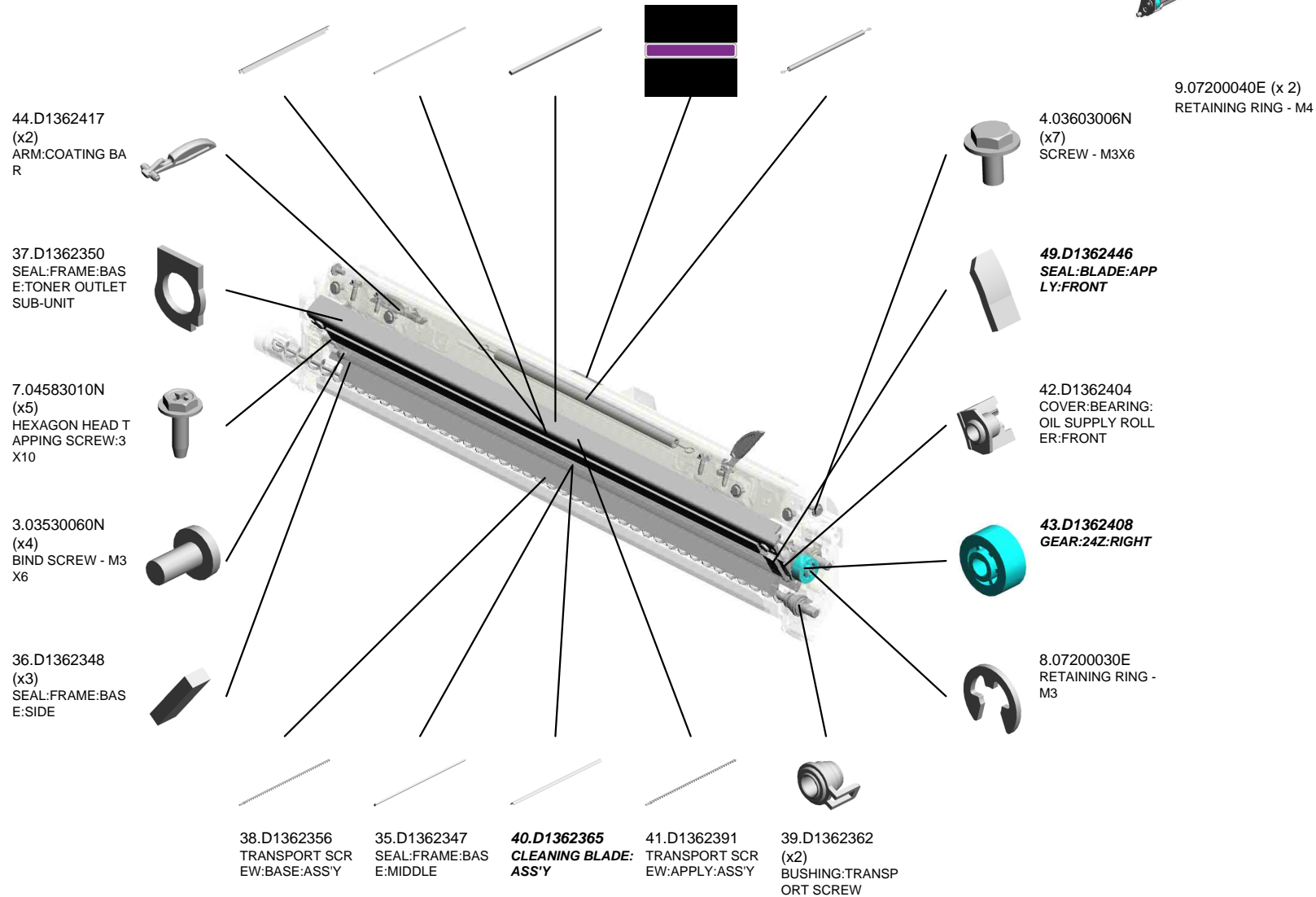
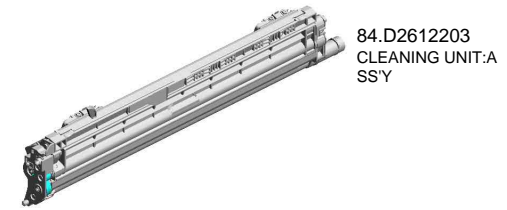

CLEANING UNIT:ASS'Y

53.D1362458
VIBRATING PLATE:
TONER OUTLET S
UB-UNIT

68.D2582407
COVER:BEARING:
OIL SUPPLY ROLL
ER:REAR:0.2POM

67.D2582402
OIL SUPPLY ROLL
ER:ASS'Y

69.D2582411
COATING BAR:AS
S'Y

84.D2612203
CLEANING UNIT:A
SS'Y

72.D2582459
JOINT:CLEANING
UNIT

71.D2582447
SEAL:BLADE:APP
LY:REAR

51.D1362449
SEAL:CLEANING B
LADE:REAR

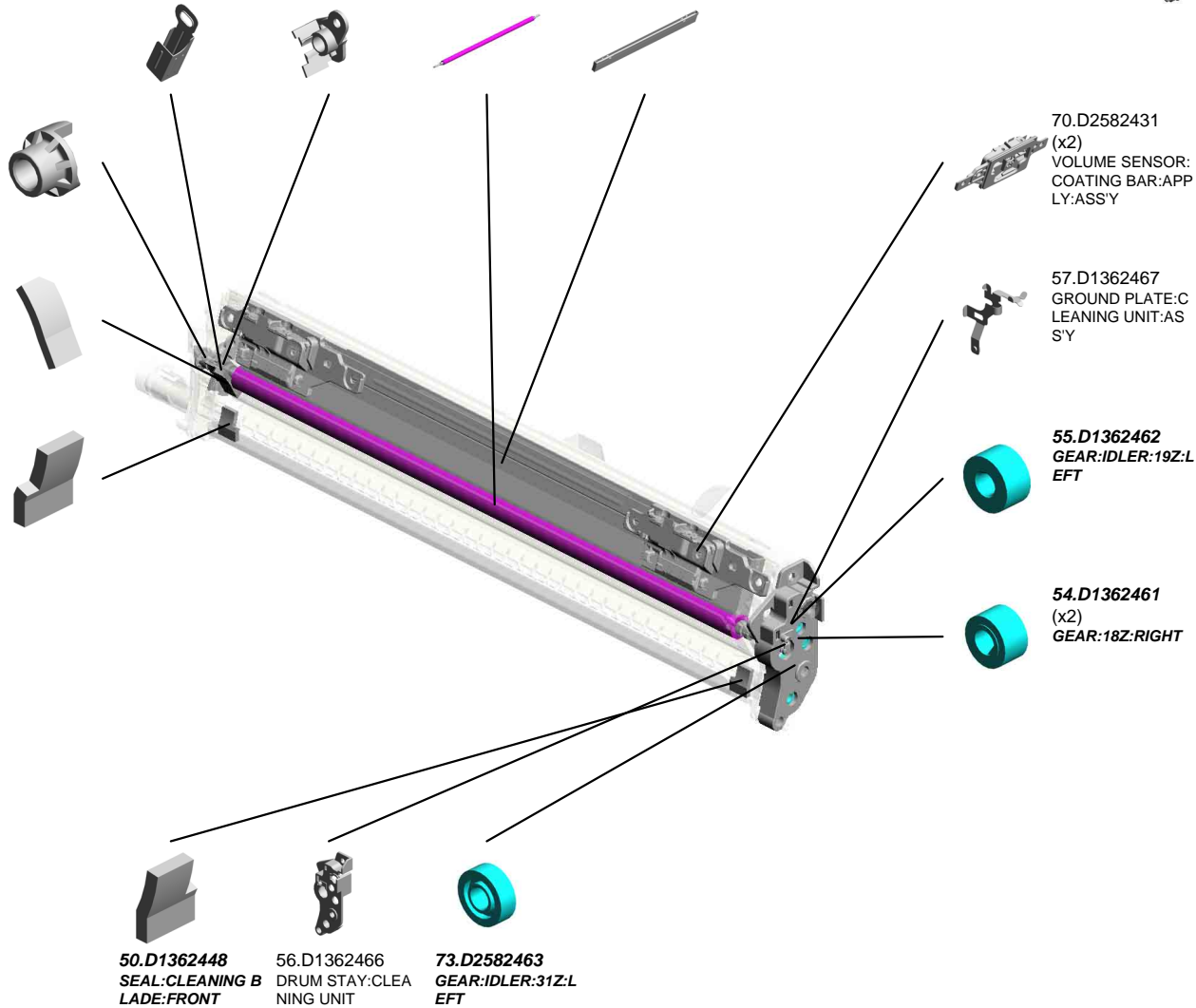

U009_S001_S001
COVER:TONER OUTLET SUB-UNIT:CLEANING UNIT:ASS'Y

24.D0742495
SHUTTER:TONER
OUTLET SUB-UNIT

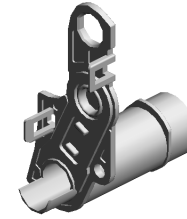

52.D1362451
COVER:TONER OU
TLET SUB-UNIT:CL
EANING UNIT:ASS'
Y

U001	U002	U003	U004	U005	U006	U007	U008	U009	U010	U011	U012	U013	U014	U015	U016	U017	U018	U019	U020	U021
------	------	------	------	------	------	------	------	------	------	------	------	------	------	------	------	------	------	------	------	------

U009_S002
DEVELOPMENT UNIT:ASS'Y

58.D1363431
FILTER:DEVELOPMENT
3.03530060N
(x4)
BIND SCREW - M3
X6

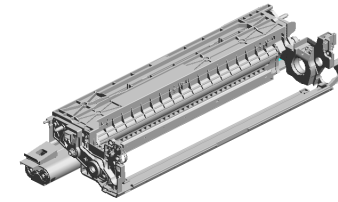

83.D2610155
DEVELOPMENT U
NIT:ASSY

4.03603006N
(x7)
SCREW - M3X6



2.03530050N
(x2)
SCREW-M3X5

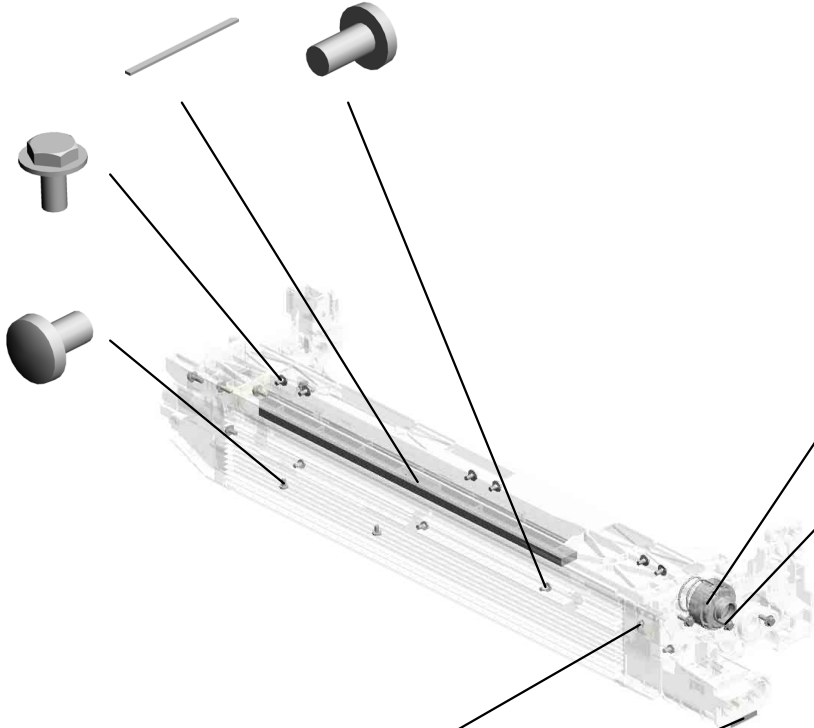

21.D0142380
COMPRESSION SP
RING - DRUM



10.08046128
(x7)
HEXAGONAL BOLT
:DOUBLE SCREW:
M3X10



9.07200040E (x 6)
RETAINING RING - M4

8.07200030E
RETAINING RING -
M3



17.AA003057
(x2)
DECAL:GRIP:LONG
:PP



U009_S003
CHARGE UNIT:ASS'Y

18.B1322264
(x2)
BUSHING:TERMIN
AL



88.D2613530
CHARGE UNIT:ASS
'Y

U001	U002	U003	U004	U005	U006	U007	U008	U009	U010	U011	U012	U013	U014	U015	U016	U017	U018	U019	U020	U021
------	------	------	------	------	------	------	------	------	------	------	------	------	------	------	------	------	------	------	------	------

U009_S004
CLEANING UNIT:ASS'Y

48.D1362441 BLADE:APPLY:ASS'Y
 46.D1362423 SEAL:STAY:APPLY
 47.D1362424 SEAL:STAY:APPLY:UPPER
 17.AA003057 DECAL:GRIP:LONG:PP
 45.D1362418 TENSION SPRING:COATING BAR:18N

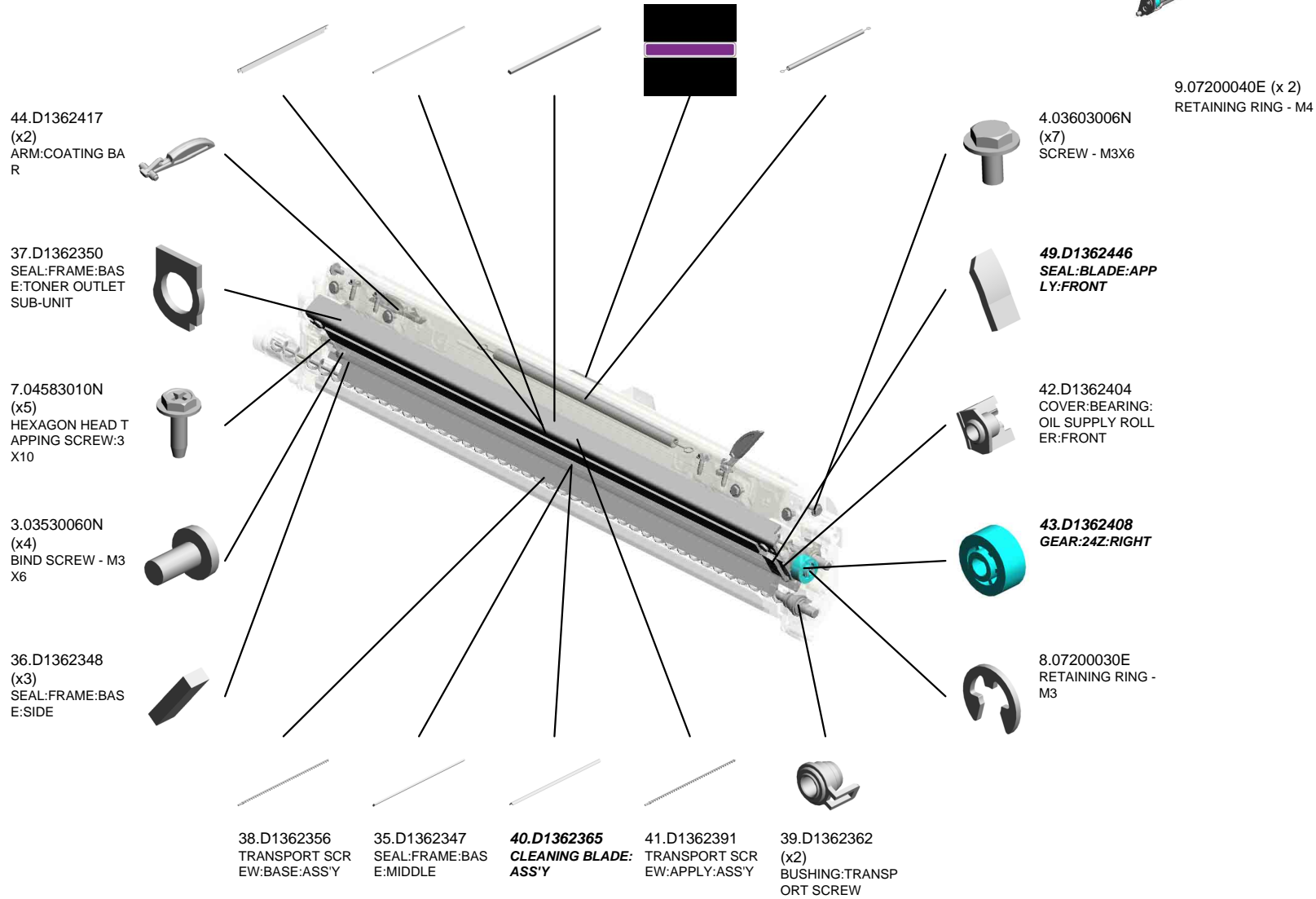
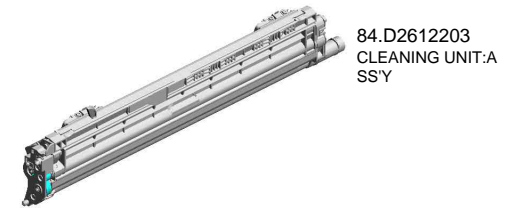

CLEANING UNIT:ASS'Y

53.D1362458
VIBRATING PLATE:
TONER OUTLET S
UB-UNIT

68.D2582407
COVER:BEARING:
OIL SUPPLY ROLL
ER:REAR:0.2POM

67.D2582402
OIL SUPPLY ROLL
ER:ASS'Y

69.D2582411
COATING BAR:AS
S'Y

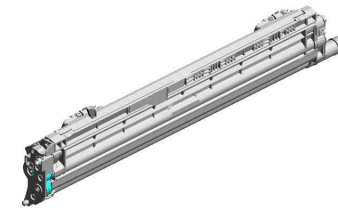

84.D2612203
CLEANING UNIT:A
SS'Y

72.D2582459
JOINT:CLEANING
UNIT

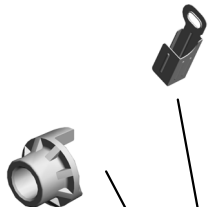

71.D2582447
SEAL:BLADE:APP
LY:REAR



51.D1362449
SEAL:CLEANING B
LADE:REAR

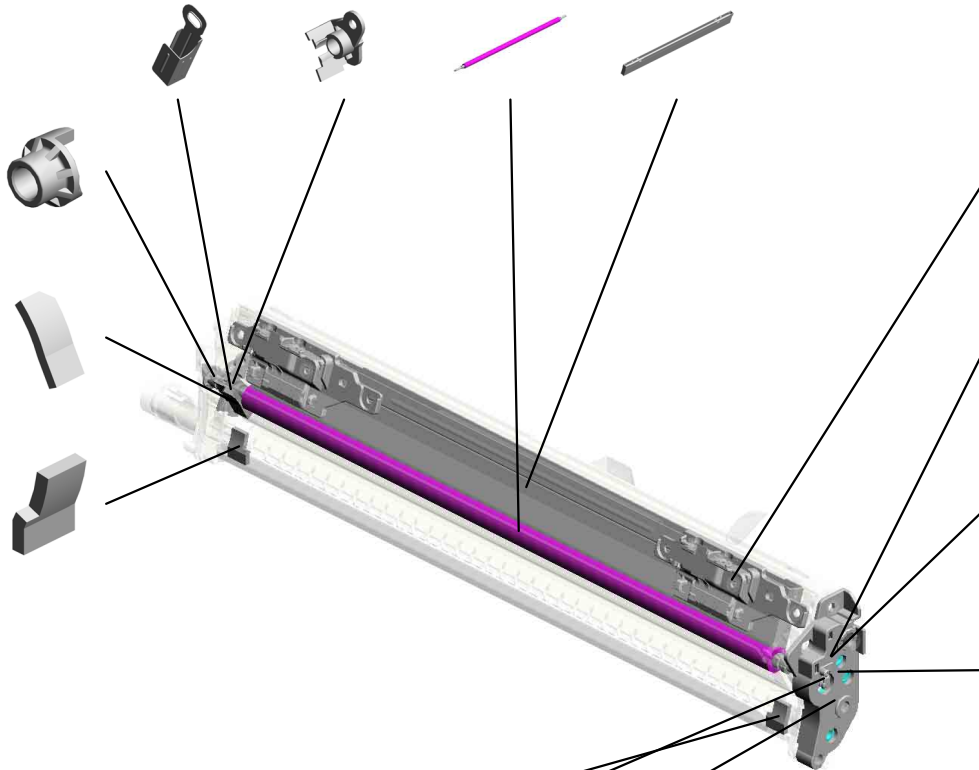

70.D2582431
(x2)
VOLUME SENSOR:
COATING BAR:APP
LY:ASS'Y



57.D1362467
GROUND PLATE:C
LEANING UNIT:AS
S'Y



55.D1362462
GEAR:IDLER:19Z:L
EFT



54.D1362461
(x2)
GEAR:18Z:RIGHT



50.D1362448
SEAL:CLEANING B
LADE:FRONT



56.D1362466
DRUM STAY:Clea
NING UNIT



73.D2582463
GEAR:IDLER:31Z:L
EFT



U009_S004_S001
COVER:TONER OUTLET SUB-UNIT:CLEANING UNIT:ASS'Y

24.D0742495
SHUTTER:TONER
OUTLET SUB-UNIT

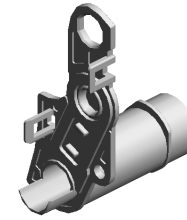

52.D1362451
COVER:TONER OU
TLET SUB-UNIT:CL
EANING UNIT:ASS'
Y

U001	U002	U003	U004	U005	U006	U007	U008	U009	U010	U011	U012	U013	U014	U015	U016	U017	U018	U019	U020	U021
------	------	------	------	------	------	------	------	------	------	------	------	------	------	------	------	------	------	------	------	------

U009_S005
DEVELOPMENT UNIT:ASS'Y

4.03603006N
(x7)
SCREW - M3X6

58.D1363431
FILTER:DEVELOP
MENT

3.03530060N
(x4)
BIND SCREW - M3
X6

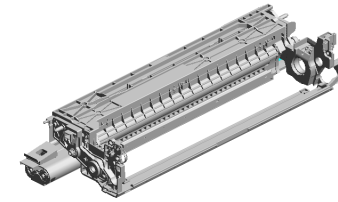

83.D2610155
DEVELOPMENT U
NIT:ASSY

11.08053573
RADIAL BALL BEA
RING:DIA8XDIA16X
5

2.03530050N
(x2)
SCREW-M3X5

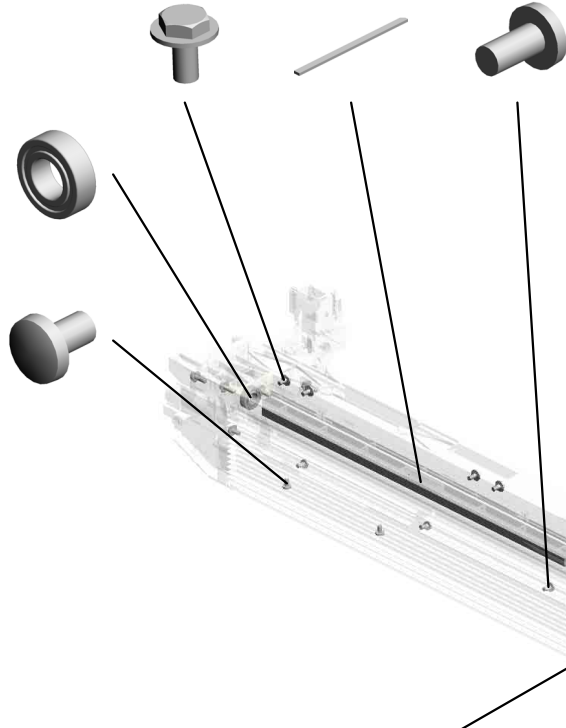

9.07200040E (x 6)
RETAINING RING - M4

21.D0142380
COMPRESSION SP
RING - DRUM

10.08046128
(x7)
HEXAGONAL BOLT
:DOUBLE SCREW:
M3X10

17.AA003057
(x2)
DECAL:GRIP:LONG
:PP

8.07200030E
RETAINING RING -
M3

U009_S006
CHARGE UNIT:ASS'Y

18.B1322264
(x2)
BUSHING:TERMIN
AL

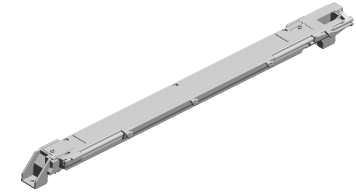

88.D2613530
CHARGE UNIT:ASS
'Y

U001	U002	U003	U004	U005	U006	U007	U008	U009	U010	U011	U012	U013	U014	U015	U016	U017	U018	U019	U020	U021
------	------	------	------	------	------	------	------	------	------	------	------	------	------	------	------	------	------	------	------	------

U009_S007
CLEANING UNIT:ASS'Y

48.D1362441
BLADE:APPLY:AS
S'Y

46.D1362423
SEAL:STAY:APPLY

47.D1362424
SEAL:STAY:APPLY:
UPPER

17.AA003057
DECAL:GRIP:LONG
:PP

45.D1362418
TENSION SPRING:
COATING BAR:18N

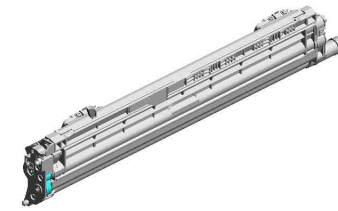

84.D2612203
CLEANING UNIT:A
SS'Y

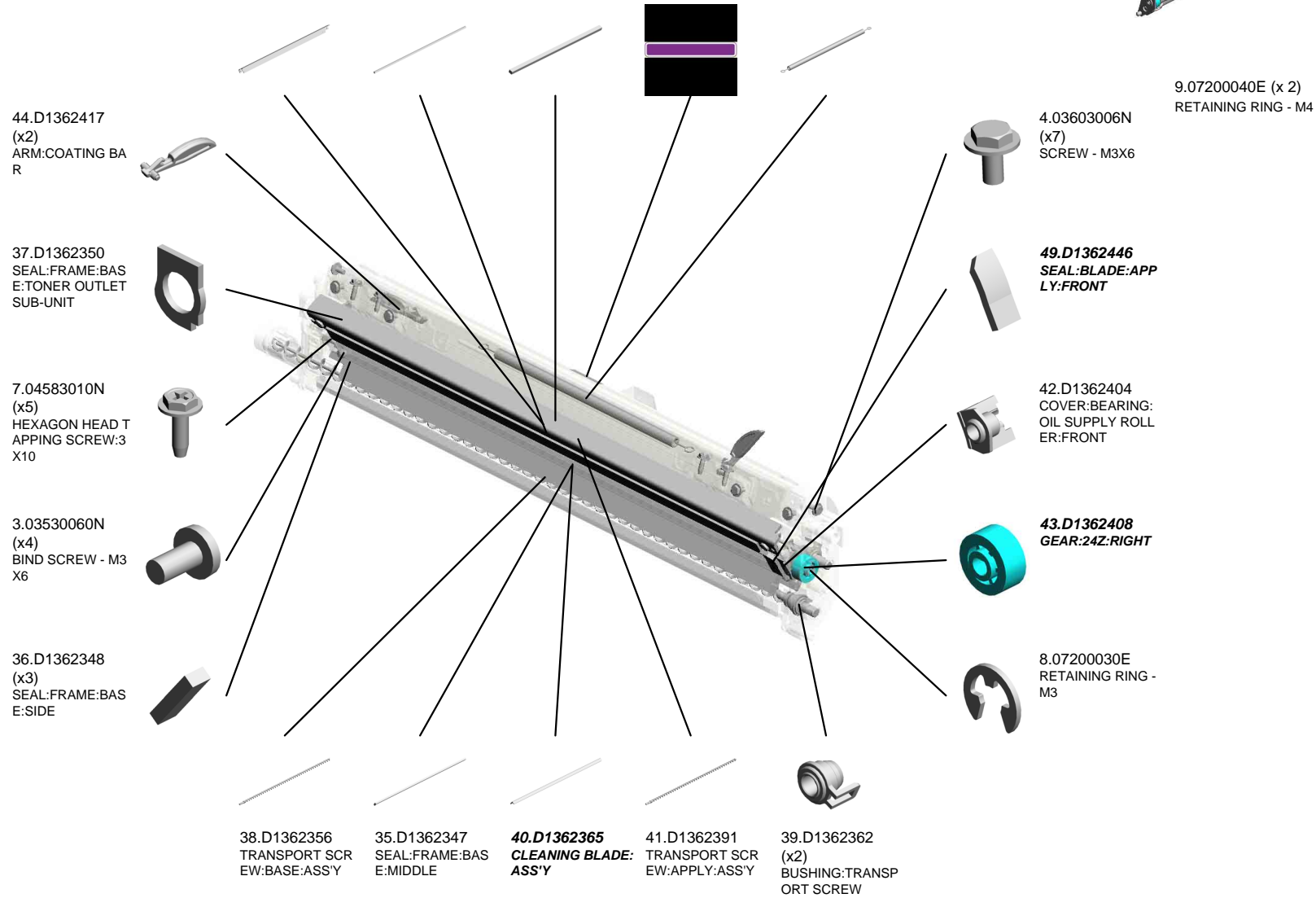

CLEANING UNIT:ASS'Y

53.D1362458
VIBRATING PLATE:
TONER OUTLET S
UB-UNIT

68.D2582407
COVER:BEARING:
OIL SUPPLY ROLL
ER:REAR:0.2POM

67.D2582402
OIL SUPPLY ROLL
ER:ASS'Y

69.D2582411
COATING BAR:AS
S'Y

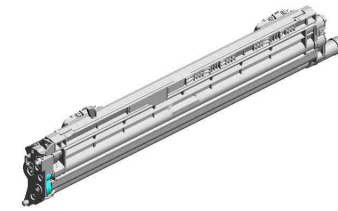

84.D2612203
CLEANING UNIT:A
SS'Y

72.D2582459
JOINT:CLEANING
UNIT

71.D2582447
SEAL:BLADE:APP
LY:REAR

51.D1362449
SEAL:CLEANING B
LADE:REAR

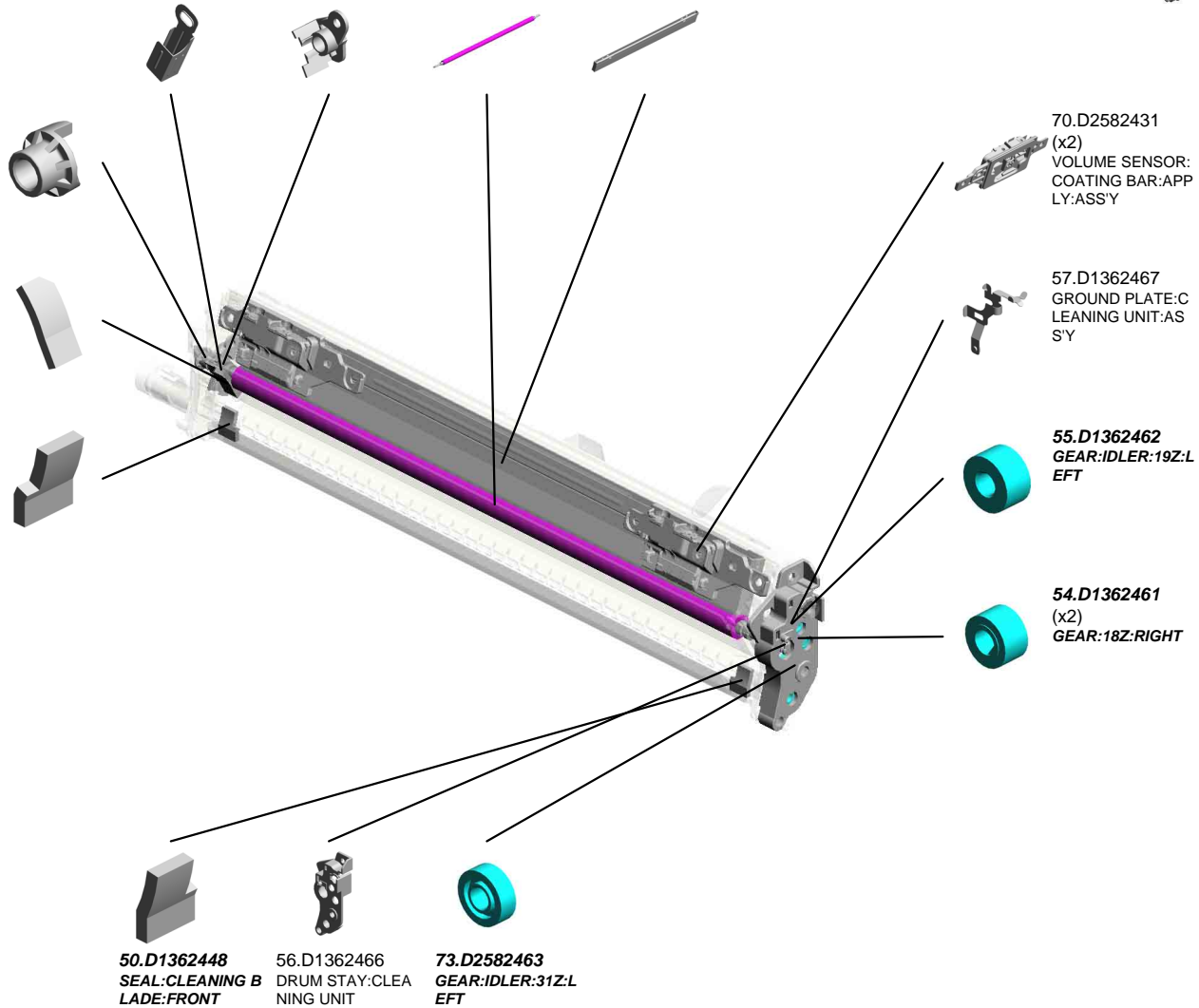

U009_S007_S001
COVER:TONER OUTLET SUB-UNIT:CLEANING UNIT:ASS'Y

24.D0742495
SHUTTER:TONER
OUTLET SUB-UNIT

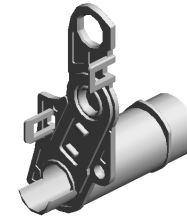

52.D1362451
COVER:TONER OU
TLET SUB-UNIT:CL
EANING UNIT:ASS'
Y

U001	U002	U003	U004	U005	U006	U007	U008	U009	U010	U011	U012	U013	U014	U015	U016	U017	U018	U019	U020	U021
------	------	------	------	------	------	------	------	------	------	------	------	------	------	------	------	------	------	------	------	------

U009_S008
DEVELOPMENT UNIT:ASS'Y

4.03603006N
(x7)
SCREW - M3X6

58.D1363431
FILTER:DEVELOP
MENT

3.03530060N
(x4)
BIND SCREW - M3
X6

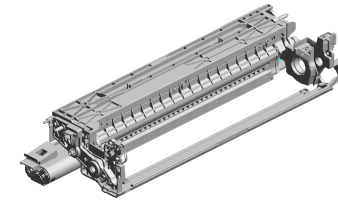

83.D2610155
DEVELOPMENT U
NIT:ASSY

11.08053573
RADIAL BALL BEA
RING:DIA8XDIA16X
5

2.03530050N
(x2)
SCREW-M3X5

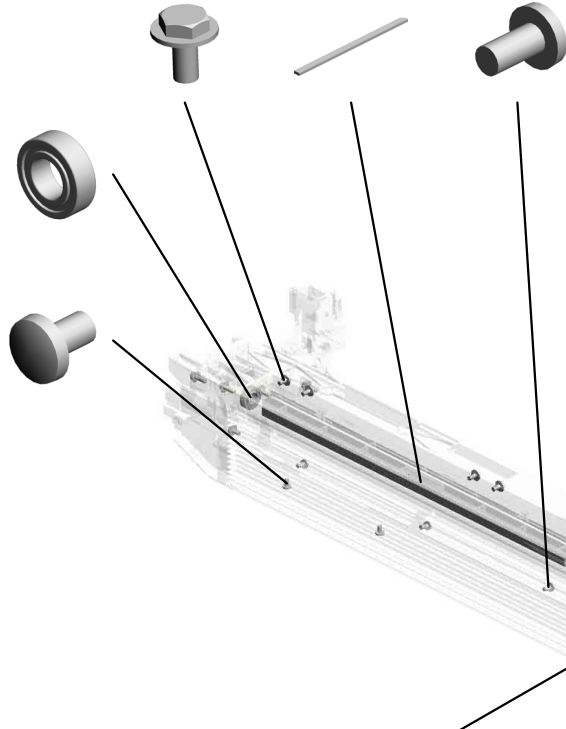

9.07200040E (x 6)
RETAINING RING - M4

21.D0142380
COMPRESSION SP
RING - DRUM

10.08046128
(x7)
HEXAGONAL BOLT
:DOUBLE SCREW:
M3X10

17.AA003057
(x2)
DECAL:GRIP:LONG
:PP

8.07200030E
RETAINING RING -
M3

U009_S009
CHARGE UNIT:ASS'Y

18.B1322264
(x2)
BUSHING:TERMIN
AL

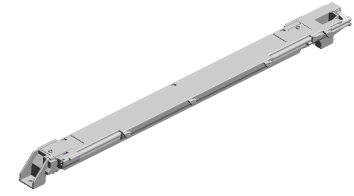

88.D2613530
CHARGE UNIT:ASS
'Y

U001	U002	U003	U004	U005	U006	U007	U008	U009	U010	U011	U012	U013	U014	U015	U016	U017	U018	U019	U020	U021
------	------	------	------	------	------	------	------	------	------	------	------	------	------	------	------	------	------	------	------	------

U009_S010
DEVELOPMENT UNIT: BK: ASS'Y

4.03603006N
(x7)
SCREW - M3X6

58.D1363431
*FILTER: DEVELOP
MENT*

3.03530060N
(x4)
BIND SCREW - M3
X6

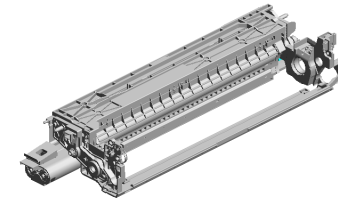

82.D2610150
DEVELOPMENT U
NIT: BK: ASS'Y

11.08053573
RADIAL BALL BEA
RING: DIA8XDIA16X
5

2.03530050N
(x2)
SCREW-M3X5

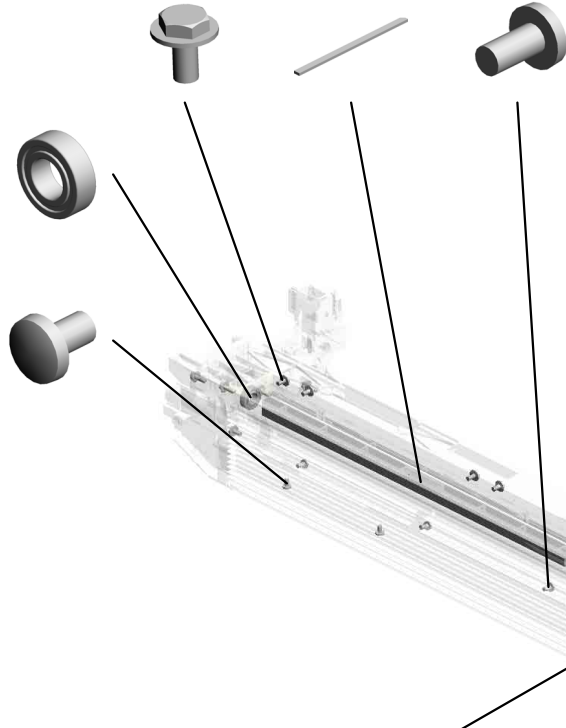

9.07200040E (x 6)
RETAINING RING - M4

21.D0142380
COMPRESSION SP
RING - DRUM

10.08046128
(x7)
HEXAGONAL BOLT
:DOUBLE SCREW:
M3X10

17.AA003057
(x2)
DECAL: GRIP: LONG
:PP

8.07200030E
RETAINING RING -
M3

U009_S011
CLEANING UNIT:ASS'Y

48.D1362441 BLADE:APPLY:ASS'Y
 46.D1362423 SEAL:STAY:APPLY
 47.D1362424 SEAL:STAY:APPLY:UPPER
 17.AA003057 DECAL:GRIP:LONG:PP
 45.D1362418 TENSION SPRING:COATING BAR:18N

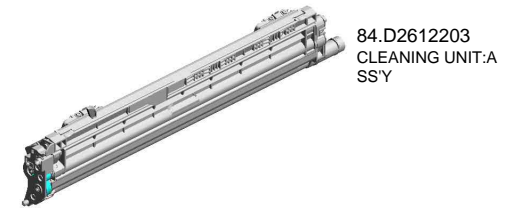

84.D2612203
CLEANING UNIT:ASS'Y

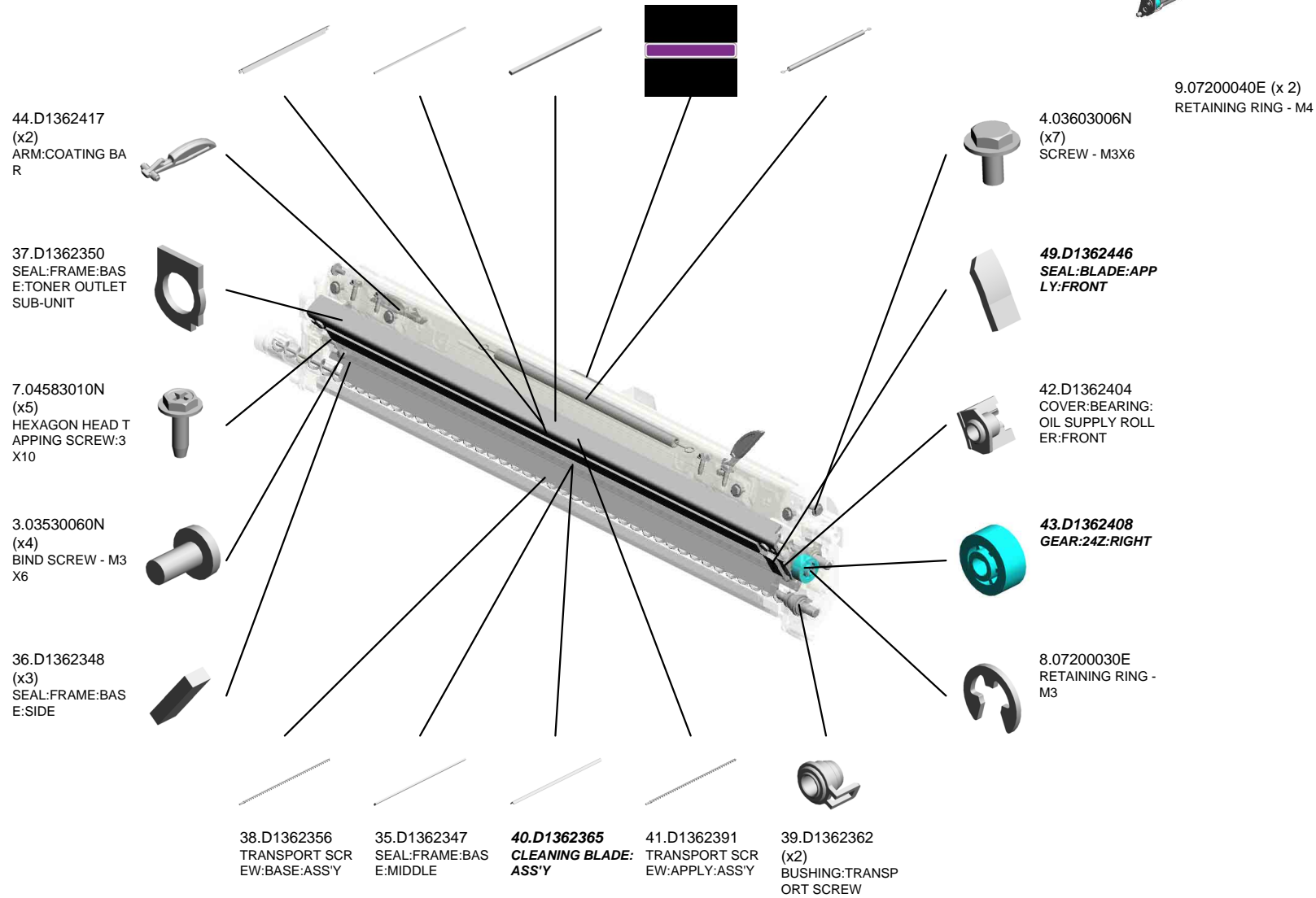

CLEANING UNIT:ASS'Y

53.D1362458
VIBRATING PLATE:
TONER OUTLET S
UB-UNIT

68.D2582407
COVER:BEARING:
OIL SUPPLY ROLL
ER:REAR:0.2POM

67.D2582402
OIL SUPPLY ROLL
ER:ASS'Y

69.D2582411
COATING BAR:AS
S'Y

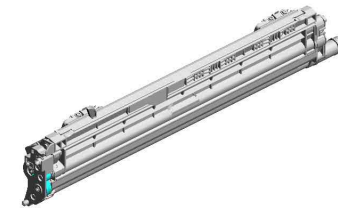

84.D2612203
CLEANING UNIT:A
SS'Y

72.D2582459
JOINT:CLEANING
UNIT

71.D2582447
SEAL:BLADE:APP
LY:REAR

51.D1362449
SEAL:CLEANING B
LADE:REAR

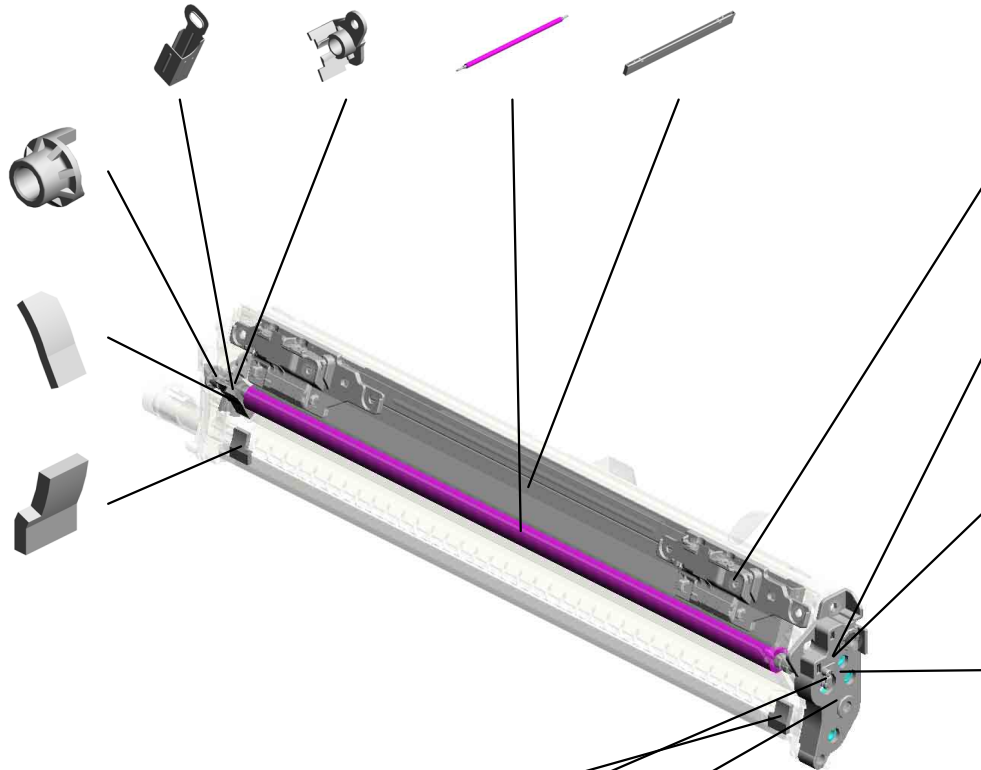

70.D2582431
(x2)
VOLUME SENSOR:
COATING BAR:APP
LY:ASS'Y

57.D1362467
GROUND PLATE:C
LEANING UNIT:AS
S'Y

55.D1362462
GEAR:IDLER:19Z:L
EFT

54.D1362461
(x2)
GEAR:18Z:RIGHT

50.D1362448
SEAL:CLEANING B
LADE:FRONT

56.D1362466
DRUM STAY:Clea
NING UNIT

73.D2582463
GEAR:IDLER:31Z:L
EFT

U009_S011_S001
COVER:TONER OUTLET SUB-UNIT:CLEANING UNIT:ASS'Y

24.D0742495
SHUTTER:TONER
OUTLET SUB-UNIT

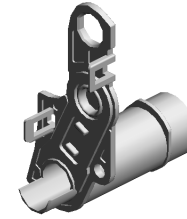

52.D1362451
COVER:TONER OU
TLET SUB-UNIT:CL
EANING UNIT:ASS'
Y

U001	U002	U003	U004	U005	U006	U007	U008	U009	U010	U011	U012	U013	U014	U015	U016	U017	U018	U019	U020	U021
------	------	------	------	------	------	------	------	------	------	------	------	------	------	------	------	------	------	------	------	------

U009_S012
CHARGE UNIT:ASS'Y

18.B1322264
(x2)
BUSHING:TERMIN
AL

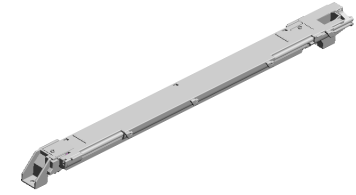

88.D2613530
CHARGE UNIT:ASS
'Y

U001	U002	U003	U004	U005	U006	U007	U008	U009	U010	U011	U012	U013	U014	U015	U016	U017	U018	U019	U020	U021
------	------	------	------	------	------	------	------	------	------	------	------	------	------	------	------	------	------	------	------	------

U010 ITB UNIT

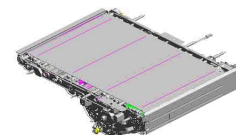

- 9.07200030E RETAINING RING - M3
- 12.07403804 BALL BEARING: DIA 4XDIA9X4
- 20.11050568 CLAMP: LWSS-0504
- 1.03130100N (x2) PAN HEAD SCREW :M3X10
- 11.07200060E (x6) RETAINING RING - M6

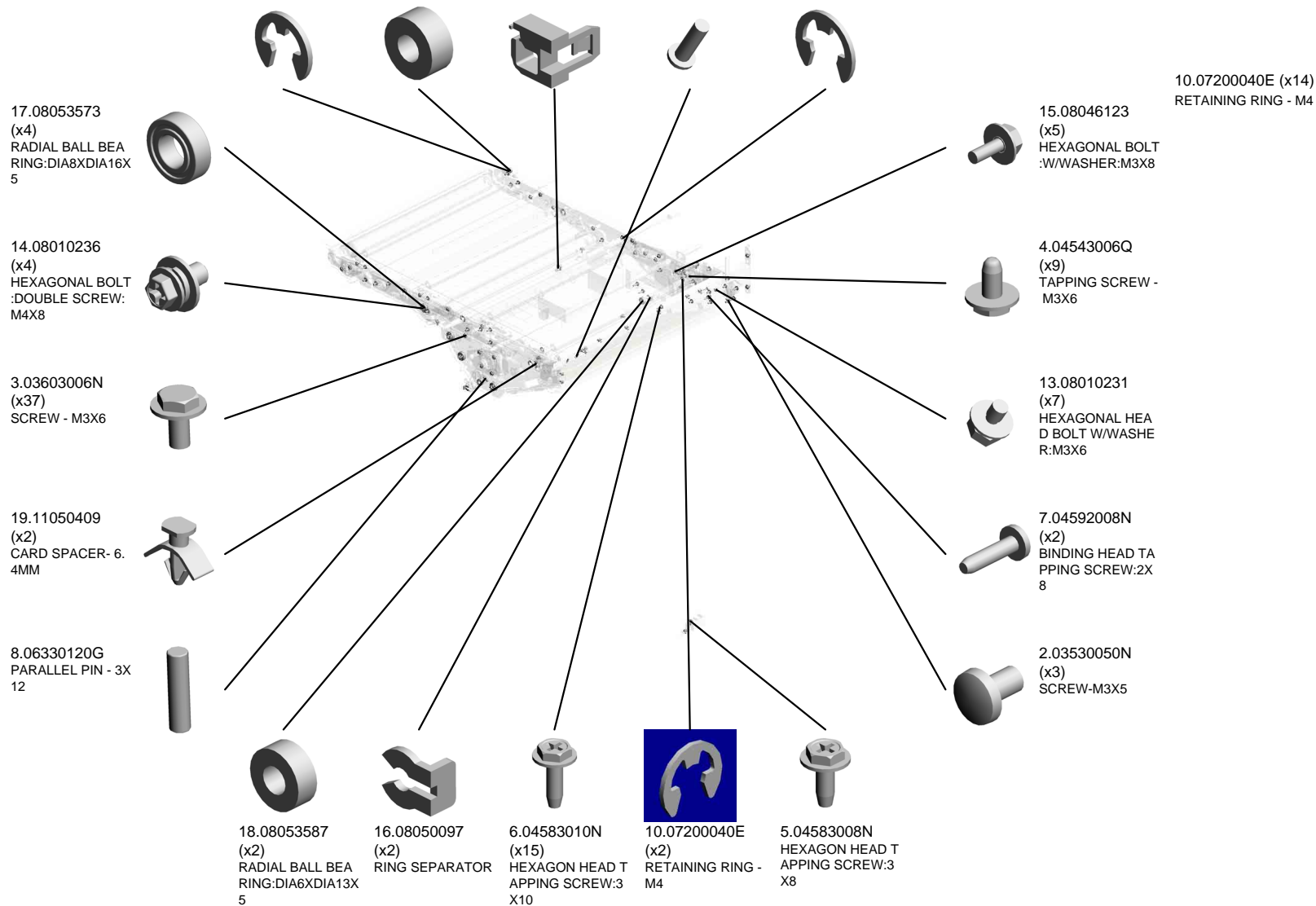

U001	U002	U003	U004	U005	U006	U007	U008	U009	U010	U011	U012	U013	U014	U015	U016	U017	U018	U019	U020	U021
------	------	------	------	------	------	------	------	------	------	------	------	------	------	------	------	------	------	------	------	------

U010 ITB UNIT

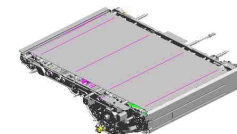

- 39.B2236171 RUBBER BUSHING :ENCODER
- 31.AW020213 OPTICS SENSOR:ENCODER:300LPI
- 22.11050723 (x4) CLAMPS:WES-0507
- 28.AA082104 (x4) BUSHING - 8X12X7
- 23.11050758 (x2) CLAMP:LWSM-0306A

21.11050598
CLAMP:LWSS-1N

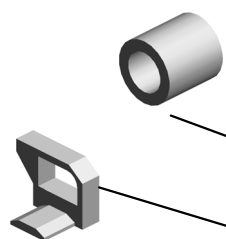

34.AX400246
HEATER:240V:9W



25.11050762
(x7)
CLAMP:LWS-0711A



26.A2324666
CUSHION - STEPPER MOTOR



27.AA043608
TIMING BELT:40S2 M184



24.11050760
(x4)
CLAMP:LWSM-0511A

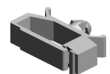

40.B7125605
GRIP:APPLICATION



35.AZ310034
POWER PACK:TRANSFER

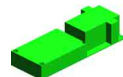

36.AZ320133
POWER PACK:T1/T2



32.AW140026
TEMPERATURE & HUMIDITY SENSOR



33.AX060434
DC MOTOR:10W:B RUSHLESS



30.AW020210
OPTICS SENSOR:ENCODER:300LPI



29.AW020203
(x2)
PHOTOINTERRUPTOR:GP1A173LCS 2F



37.B1326114
CAM:ON-OFF:BLACK



38.B1326124
SPRING PLATE:CAM

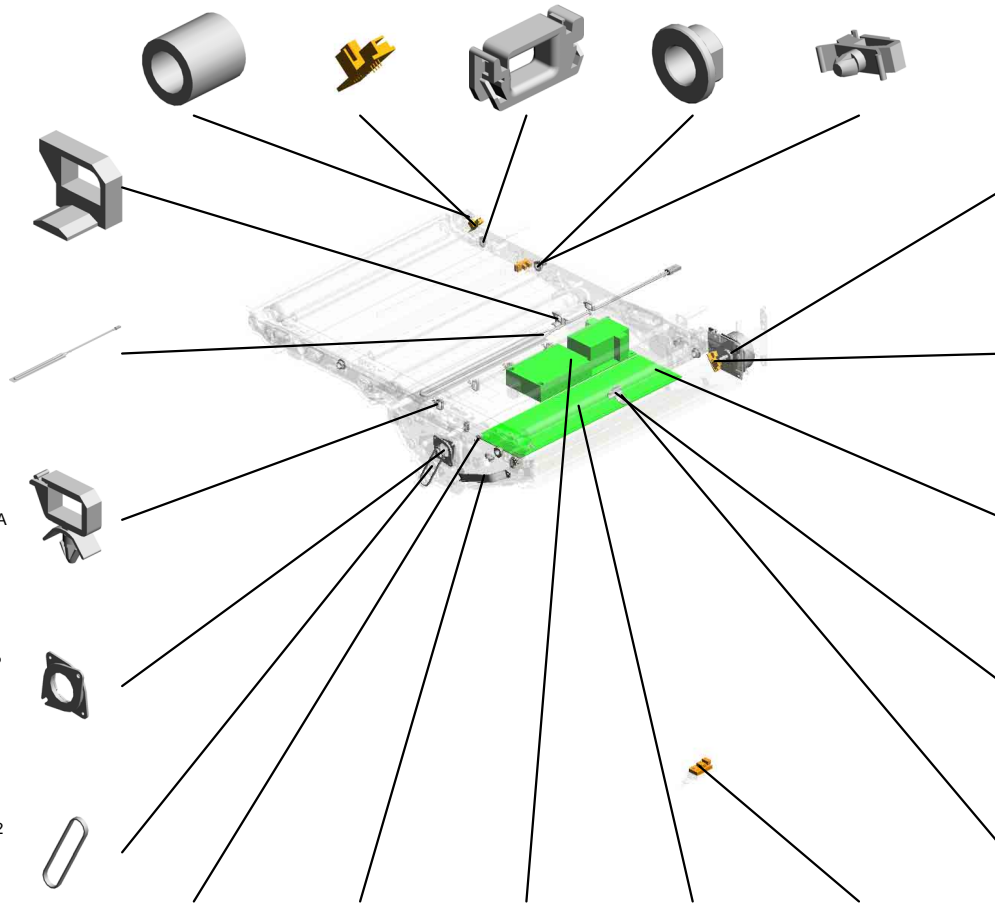

U010 ITB UNIT

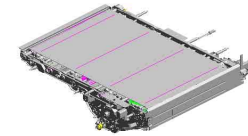

- 52.D1366086 COVER:ENCODER
- 41.D0396137 ENCODER:ASS'Y
- 54.D1366089 (x2) PLAIN SHAFT BEARING:CONTACT POINT:BRACKET:ENCODER
- 59.D1366112 BRACKET:INTERMEDIATE TRANSFER:REAR
- 50.D1366058 STOPPER:BRACKET:ENCODER:REAR

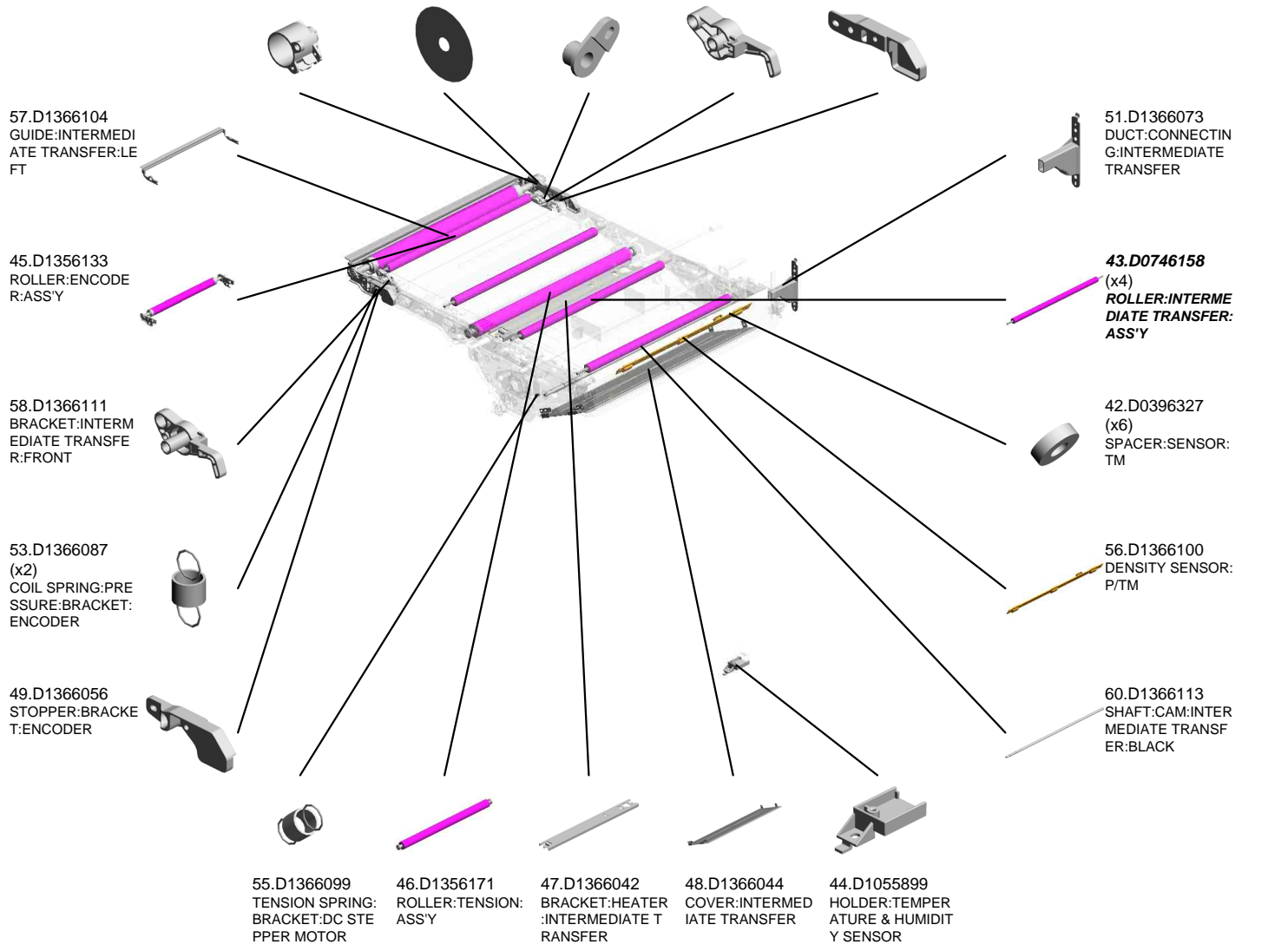

U001	U002	U003	U004	U005	U006	U007	U008	U009	U010	U011	U012	U013	U014	U015	U016	U017	U018	U019	U020	U021
------	------	------	------	------	------	------	------	------	------	------	------	------	------	------	------	------	------	------	------	------

U010 ITB UNIT

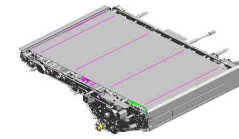

71.D1366146 SHAFT:CAM:INTERMEDIATE TRANSFER:COLOR
 64.D1366119 (x3) TERMINAL:CONNECTING:INTERMEDIATE TRANSFER
 75.D1366175 SLIDE RAIL:CASE:TENSION:ROLLER
 74.D1366174 BRACKET:TENSION:ROLLER
 73.D1366154 FEELER:INTERMEDIATE TRANSFER

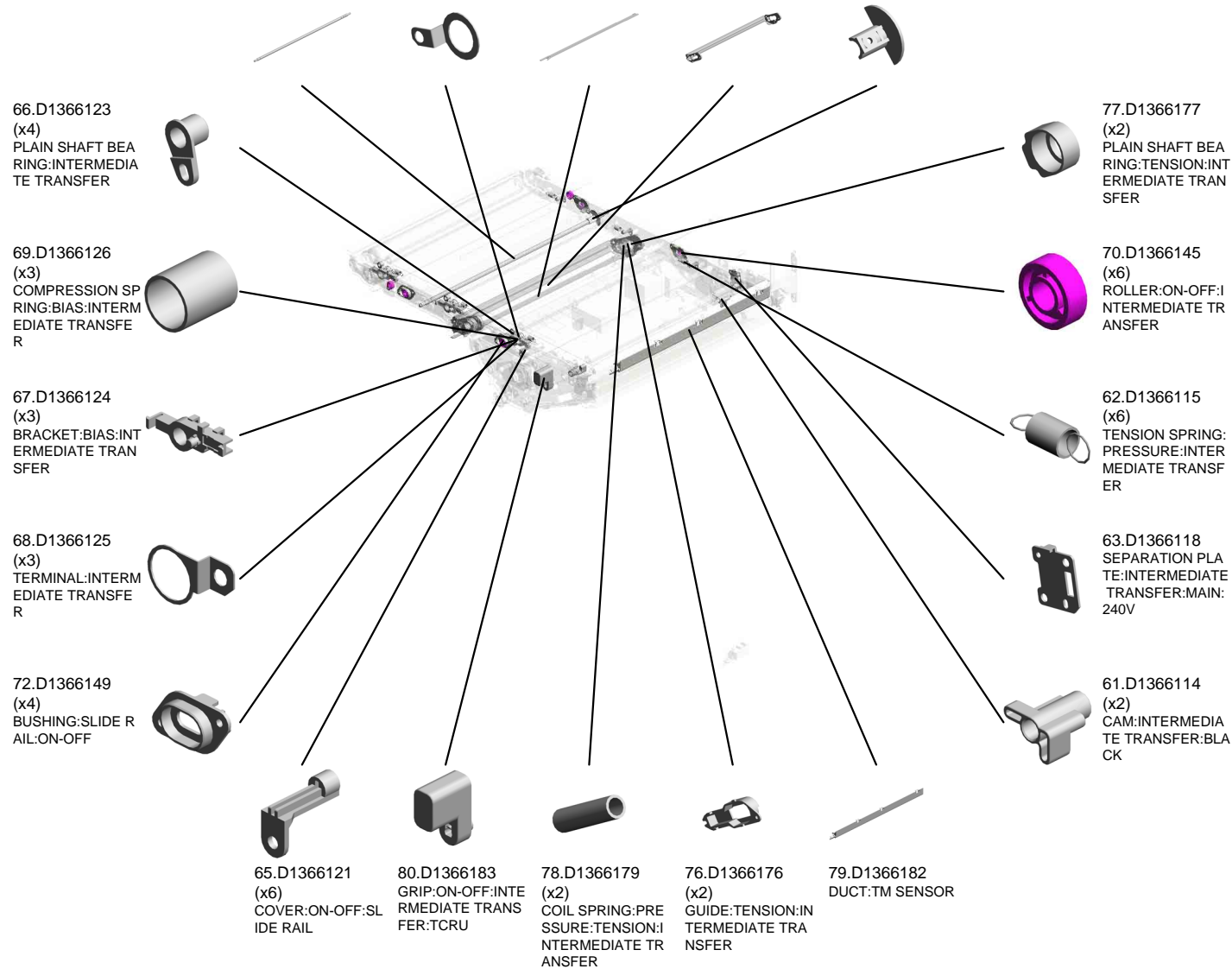

U001	U002	U003	U004	U005	U006	U007	U008	U009	U010	U011	U012	U013	U014	U015	U016	U017	U018	U019	U020	U021
------	------	------	------	------	------	------	------	------	------	------	------	------	------	------	------	------	------	------	------	------

U010 ITB UNIT

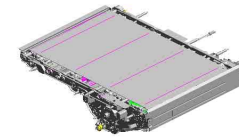

- 86.D2581147 (x2) RIVET:GRIP:DIA2.0
- 93.D2583869 GUIDE:TRANSPORT:INT TRANSFER:ASSY
- 96.D2586075 BRACKET:DRAWER:INT TRANSFER:ASSY
- 98.D2586104 BRACKET:INT TRANSFER:REAR:BACK
- 100.D2586106 BRACKET:BIAS:INT TRANSFER:BACK

94.D2585410 PCB:TDRB



97.D2586102 SPRING PLATE:EA RTH:DC STEPPER MOTOR



99.D2586105 BRACKET:INT TRANSFER:FRONT:BACK



82.D1366196 HOME POSITION SENSOR:FLAT BELT-TRANSFER



92.D2583868 DC STEPPER MOTOR:MM42:1.0A:3.60V

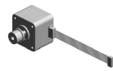

95.D2586070 DRIVE ROLLER:INT TRANSFER:ASSY

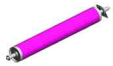

84.D1386052 GUIDE:INTERMEDIATE TRANSFER:RIGHT



89.D2581206 HOUSING:DRIVE:INT TRANSFER



83.D1367600 DECAL:CAUTION:PULL OUT:PAPER FEED

85.D1386053 (x2) SEAL:GUIDE:INTERMEDIATE TRANSFER:RIGHT



81.D1366195 SEAL:DUCT:TM SENSOR



90.D2581207 SHEET:DRIVE:INTERMEDIATE TRANSFER



87.D2581201 DRUM STAY:DRIVE:INT TRANSFER:ASSY



91.D2581245 SPACER:REAR:INT TRANSFER



88.D2581204 GEAR:INTERMEDIATE TRANSFER:ASSY



U010 ITB UNIT

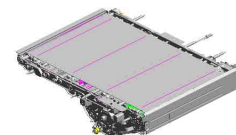

- 110.D2586132 ROLLER:TRANSFER:FRONT:ASS'Y
- 109.D2586130 (x2) ROLLER:OPPOSED:BELT CLEANING:ASS'Y
- 105.D2586112 (x2) BRACKET:INT TRANSFER:REAR:MCK
- 114.D2586143 SLIDE RAIL:INT TRANSFER:REAR:ASS'Y
- 112.D2586139 (x2) TENSION SPRING:ON-OFF:INT TRANSFER

115.D2586147 (x2) CAM:INTERMEDIATE TRANSFER:COLLOR

104.D2586111 (x2) BRACKET:INT TRANSFER:FRONT:MCK

113.D2586141 SLIDE RAIL:INT TRANSFER:FRONT:ASS'Y

117.D2586162 BRACKET:ON-OFF:TRANSFER ROLLER

107.D2586128 CASE:OPPOSED:TRANSFER ROLLER:FRONT

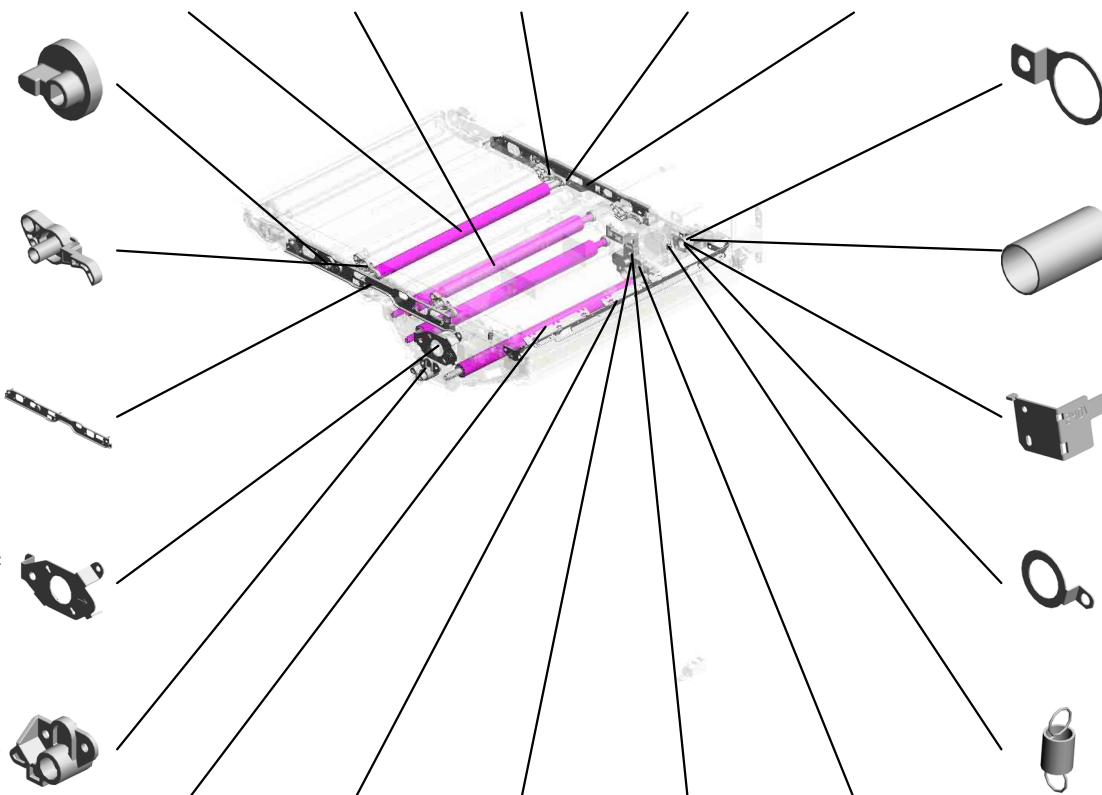

102.D2586109 TERMINAL:INTERMEDIATE TRANSFER:R:BK

103.D2586110 COMPRESSION SPRING:BIAS:BK

116.D2586152 SEPARATION PLATE:INT TRANSFER:240V

101.D2586107 TERMINAL:CONNECTING:INT TRANSFER:BK

106.D2586117 (x2) TENSION SPRING:PRESSURE:BK

- 119.D2586176 ROLLER:TRANSFER:ENTRANCE:ASS'Y
- 120.D2586181 BRACKET:DENSITY SENSOR
- 111.D2586138 SPRING PLATE:TRANSFER:OPPOSED:PAPER
- 108.D2586129 CASE:OPPOSED:TRANSFER ROLLER:REAR
- 118.D2586165 FEELER:ON-OFF:TRANSFER:PAPER



U010 ITB UNIT

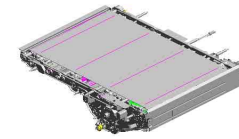

129.G0143291 (x4)
SNAP RING - PICK UP

130.G1786352
GUIDE PLATE:ENC ODER

128.D2616090
FLAT BELT-TRANSFER:ASS'Y

123.D2586190
CAM:ON-OFF:TRANSFER ROLLER:FRONT

127.D2586199
PULLEY:ON-OFF:TRANSFER ROLLER

124.D2586191
CAM:ON-OFF:TRANSFER ROLLER:REAR

126.D2586195
CLAMP:TM SENSOR:REAR

121.D2586186
ROLLER:OPPOSED:PAPER:ASS'Y

122.D2586187
CORE:OPPOSED:TRANSFER ROLLER

125.D2586193 (x4)
CLAMP:TM SENSOR:FRONT

U001	U002	U003	U004	U005	U006	U007	U008	U009	U010	U011	U012	U013	U014	U015	U016	U017	U018	U019	U020	U021
------	------	------	------	------	------	------	------	------	-------------	------	------	------	------	------	------	------	------	------	------	------

U011.ITB CLEANING

U011_S001
D2616402
BELT CLEANING:ASS'Y

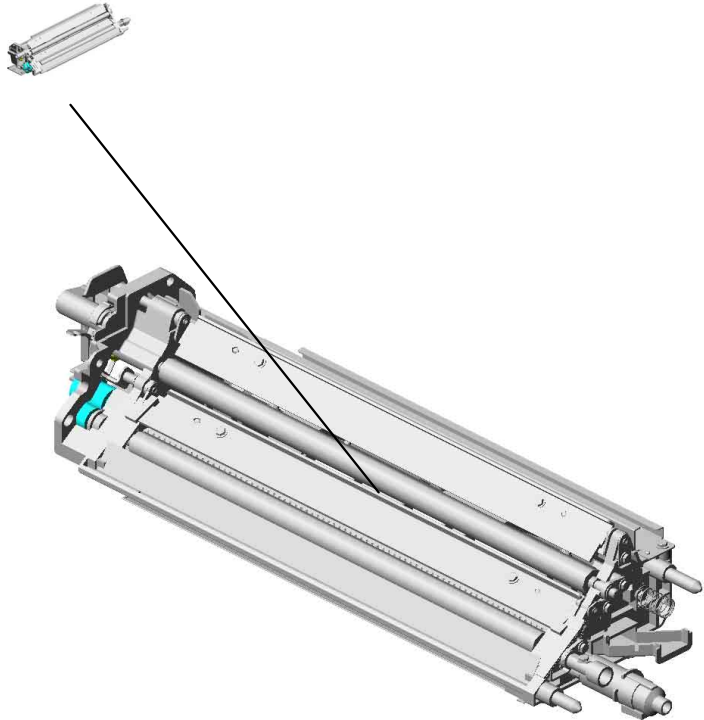

U001	U002	U003	U004	U005	U006	U007	U008	U009	U010	U011	U012	U013	U014	U015	U016	U017	U018	U019	U020	U021
------	------	------	------	------	------	------	------	------	------	------	------	------	------	------	------	------	------	------	------	------

U011
ITB CLEANING



11.B2342390
FLANGED HEXAG
ONAL HEAD BOLT:
M4X8

U001	U002	U003	U004	U005	U006	U007	U008	U009	U010	U011	U012	U013	U014	U015	U016	U017	U018	U019	U020	U021
------	------	------	------	------	------	------	------	------	------	------	------	------	------	------	------	------	------	------	------	------

U011_S001
BELT CLEANING:ASS'Y

- 9.AA143820 STEPPED SCREW
- 21.D0746480 PULLEY:BRUSH:APPLY:Z30
- 8.AA082137 BUSHING:6X10X6
- 5.08050089 (x2) RETAINING RING - M4
- 10.B1322264 (x2) BUSHING:TERMINAL

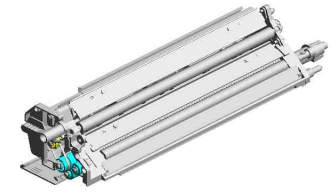

43.D2616402
BELT CLEANING:ASS'Y

7.AA000290
DECAL:POSITIONING DISPLAY:SCREW:PET



6.54472681 (x2)
SNAP RING



19.D0746478
GEAR:PULLEY:IDLER:BELT CLEANING

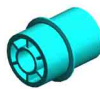

18.D0746477
GEAR:BRUSH:REMOVE PAPER DUST:Z17

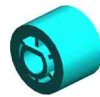

4.07200040E (x3)
RETAINING RING - M4



20.D0746479
GEAR:COLLECTOR OIL:Z19



2.04583008N (x2)
HEXAGON HEAD TAPPING SCREW:3 X8



13.D0746415
DUAL FACES TEPE:ENTRANCE SEAL:BELT CLEANING



14.D0746416
SEAL:ENTRANCE SEAL:BELT CLEANING



15.D0746420
BRUSH:REMOVE PAPER DUST:BELT CLEANING



17.D0746457
BLADE:APPLY:ASS'Y



16.D0746446
BRUSH:APPLY:BELT CLEANING



1.03603006N (x 2)
SCREW - M3X6

1.03603006N (x14)
SCREW - M3X6



12.D0746411
COIL SPRING:EAR TH:BELT CLEANING



3.07080060N (x2)
WASHER:DIA6



U011_S001 BELT CLEANING:ASS'Y

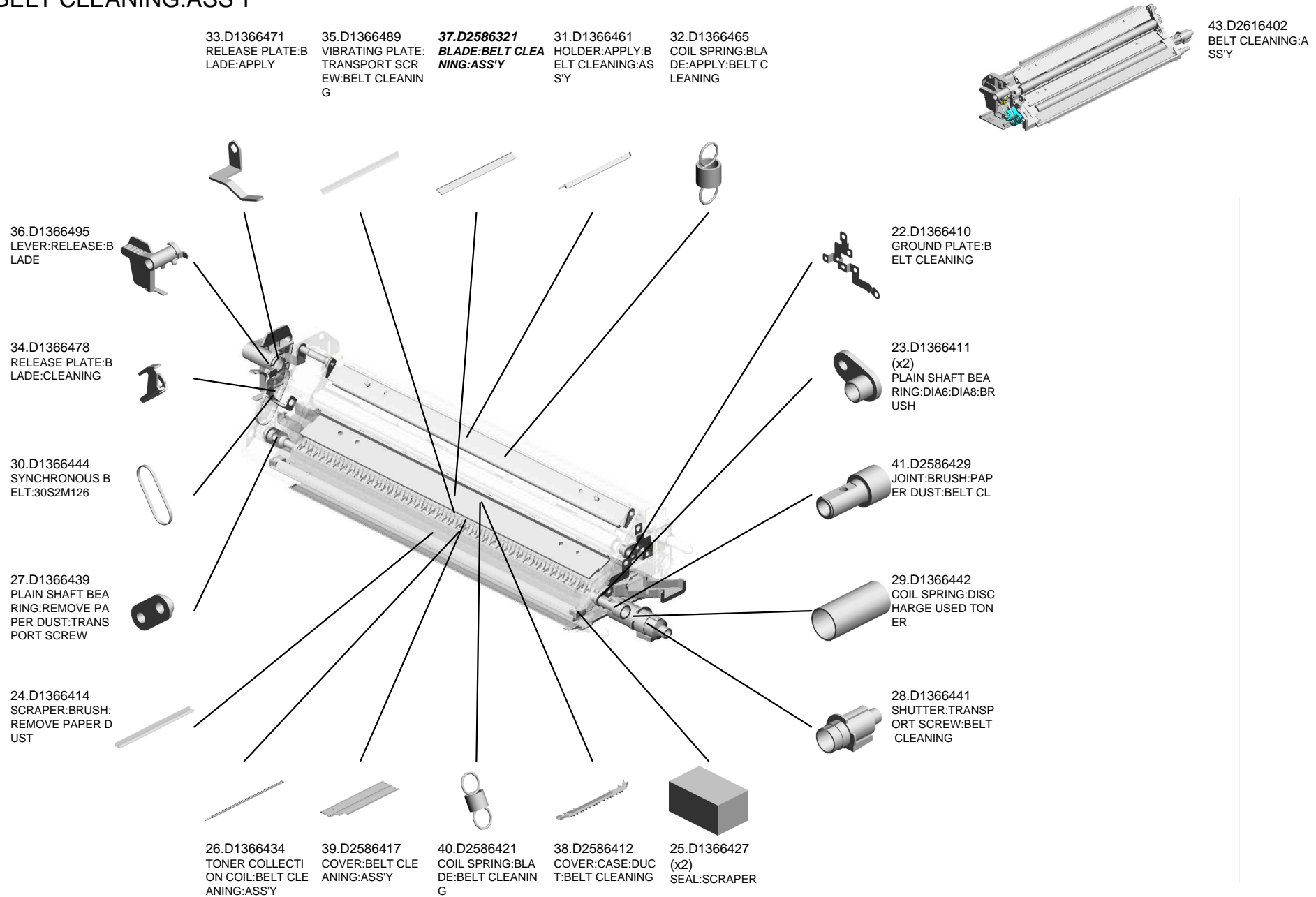

U001	U002	U003	U004	U005	U006	U007	U008	U009	U010	U011	U012	U013	U014	U015	U016	U017	U018	U019	U020	U021
------	------	------	------	------	------	------	------	------	------	-------------	------	------	------	------	------	------	------	------	------	------

U011_S001
BELT CLEANING:ASS'Y

42.D2586450
COATING BAR:AS
S'Y

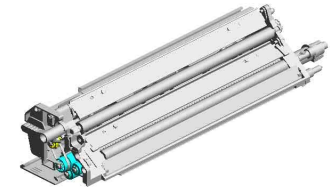
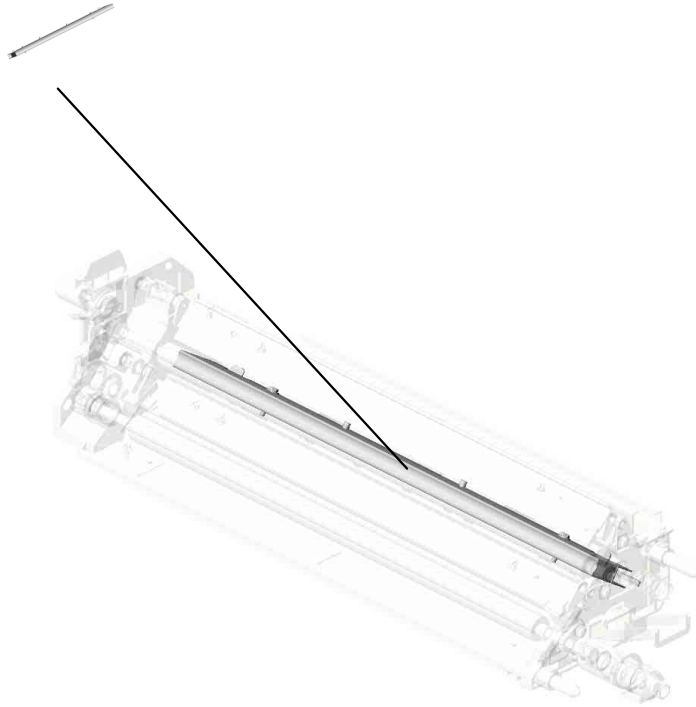

43.D2616402
BELT CLEANING:A
SS'Y

U001	U002	U003	U004	U005	U006	U007	U008	U009	U010	U011	U012	U013	U014	U015	U016	U017	U018	U019	U020	U021
------	------	------	------	------	------	------	------	------	------	------	------	------	------	------	------	------	------	------	------	------

U012.TRANSFER/SEPARATION

U012_S002
D2586502
USED TONER:T/S UNIT:SIDE
:ASS'Y



U012_S001
D2616210
TRANSFER/SEPARATION UN
IT:ASS'Y

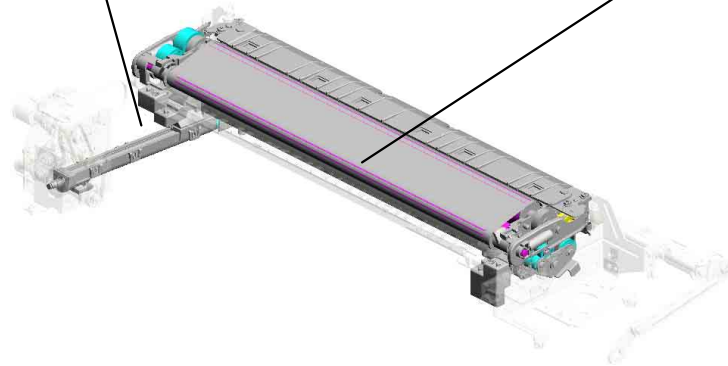

U001	U002	U003	U004	U005	U006	U007	U008	U009	U010	U011	U012	U013	U014	U015	U016	U017	U018	U019	U020	U021
------	------	------	------	------	------	------	------	------	------	------	------	------	------	------	------	------	------	------	------	------

U012_S001.TRANSFER/SEPARATION UNIT:ASS'Y

U012_S001_S001
D2616231
FLAT BELT-TRANSFER:NO.2:
ASS'Y

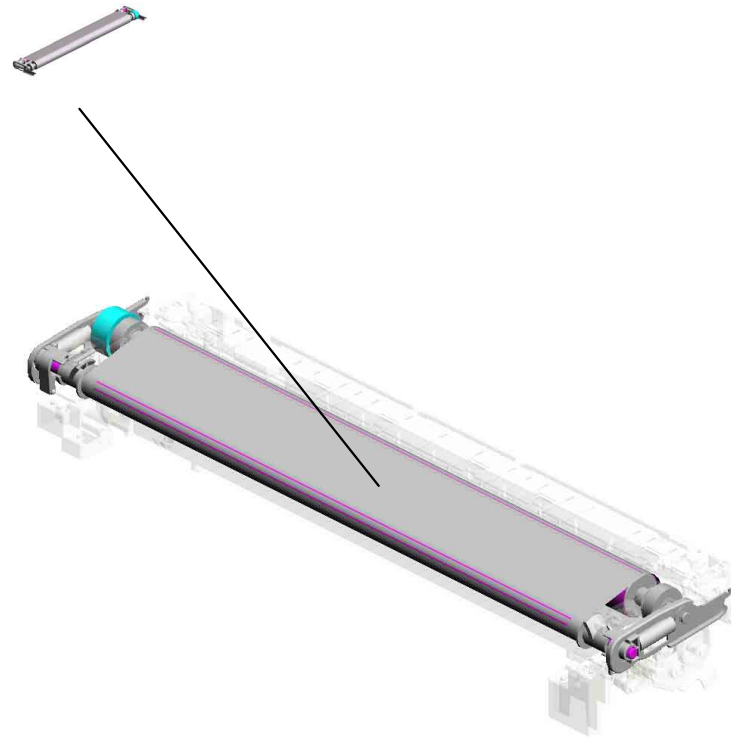

U001	U002	U003	U004	U005	U006	U007	U008	U009	U010	U011	U012	U013	U014	U015	U016	U017	U018	U019	U020	U021
------	------	------	------	------	------	------	------	------	------	------	------	------	------	------	------	------	------	------	------	------

U012 TRANSFER/SEPARATION

1.03240120N
SCREW:M4X12

20.B2342399
(x2)
BOLT - M3X6

15.AA000290
(x2)
DECAL:POSITIONI
NG DISPLAY:SCRE
W:PET

4.04543006Q
(x16)
TAPPING SCREW -
M3X6

19.AA082175
(x2)
PLAIN SHAFT BEA
RING:8X12X7

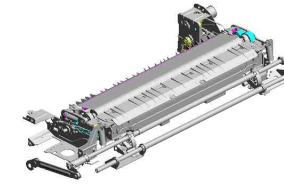

22.D0743416
JOINT:DRIVE:DEV
ELOPMENT UNIT

18.AA043954
(x2)
TIMING BELT - B40
S2M104G

21.D0742495
SHUTTER:TONER
OUTLET SUB-UNIT

3.03603006N
(x4)
SCREW - M3X6

8.07200030E
RETAINING RING -
M3

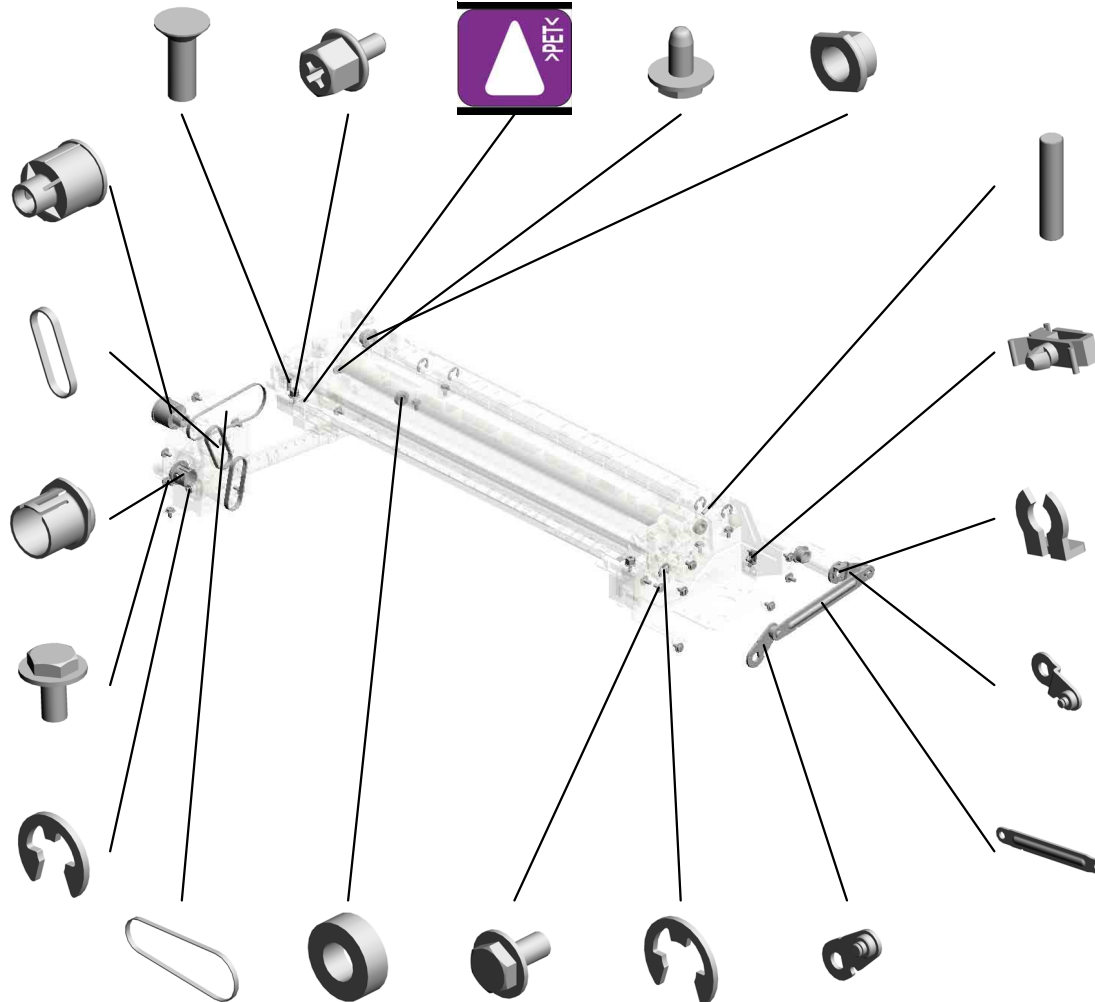

7.06330140G
PARALLEL PIN - 3X
14



12.11050758
CLAMP:LWSM-030
6A

13.11050761
CLAMP:LWS-0511A

12.11050758
CLAMP:LWSM-030
6A

4.04543006Q (x 1)
TAPPING SCREW - M3X6
9.07200040E (x 4)
RETAINING RING - M4

14.52152621
SNAP RING - M6

25.D1366350
LINK:RELEASE:RIG
HT

29.D2586275
LINK:CONNECTIN
G

24.D1363870
SYNCHRONOUS B
ELT:DRIVE:TRANS
PORT BELT UNIT

11.08053581
(x2)
RADIAL BALL BEA
RING:DIA6XDIA12X
4

26.D2051082
(x2)
HEXAGON HEAD S
CREW:ROUND POI
NT:M3X6:BK

10.07200060E
(x7)
RETAINING RING -
M6

28.D2586273
LINK:RELEASE:LO
WER

U012 TRANSFER/SEPARATION

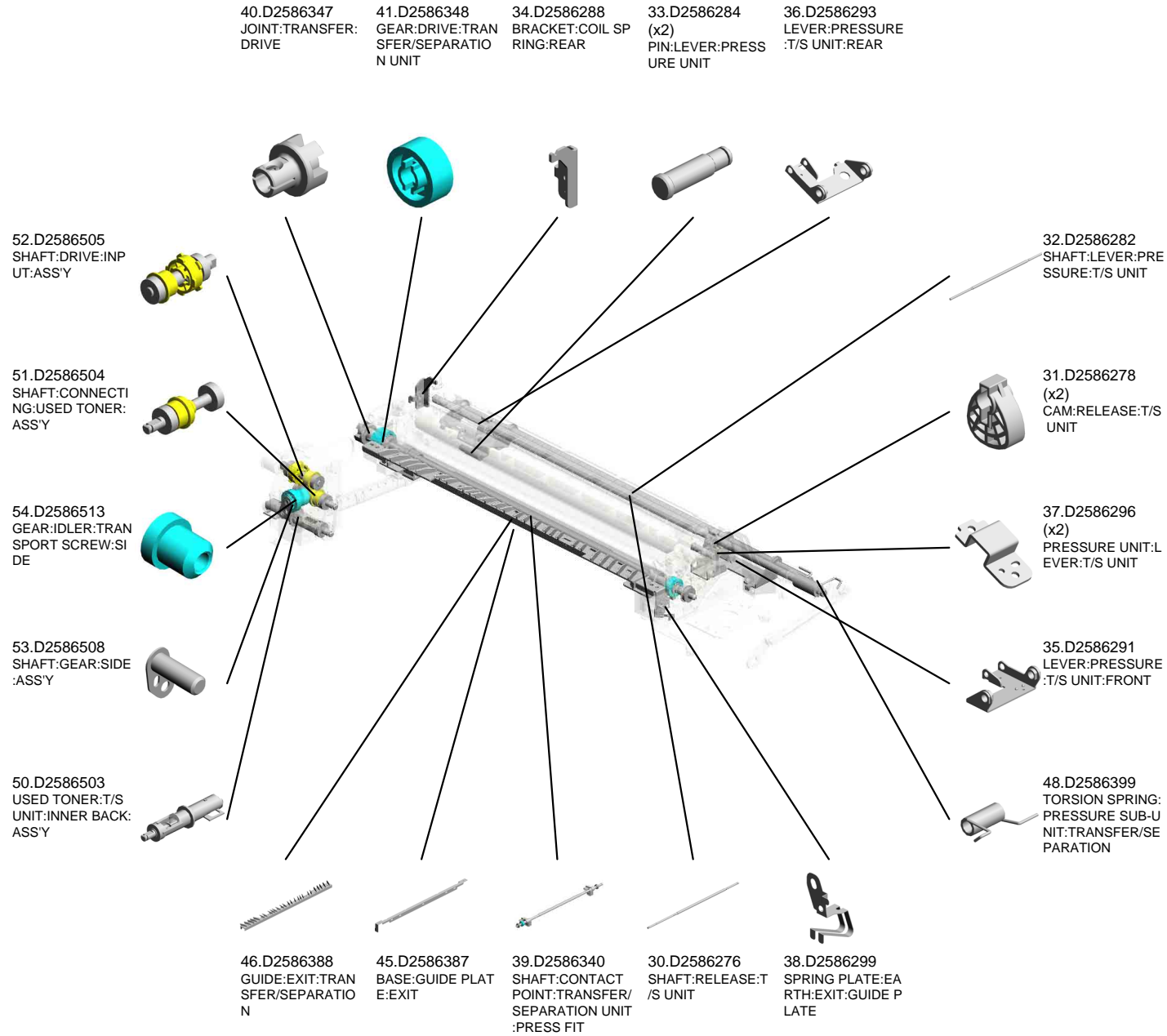
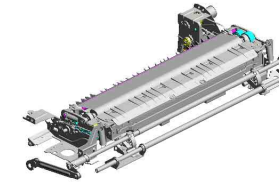

U001	U002	U003	U004	U005	U006	U007	U008	U009	U010	U011	U012	U013	U014	U015	U016	U017	U018	U019	U020	U021
------	------	------	------	------	------	------	------	------	------	------	------	------	------	------	------	------	------	------	------	------

U012 TRANSFER/SEPARATION

63.D2586587
BRACKET:AUXILIARY:USED TONER:TRANSFER/SEPARATION UNIT

62.D2586586
BRACKET:USED TONER:TRANSFER/SEPARATION UNIT

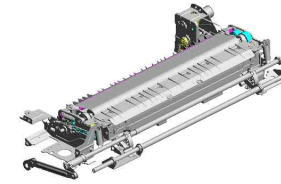

56.D2586515
COMPRESSION SPRING:SHUTTER:PULL OUT



57.D2586525
PLAIN SHAFT BEARING:DIASXDIASX4.5



61.D2586558
(x2)
PULLEY:TRANSPORT SCREW:INNER BACK



84.D2616391
(x2)
COIL SPRING:PRESSURE:TRANSFER/SEPARATION UNIT

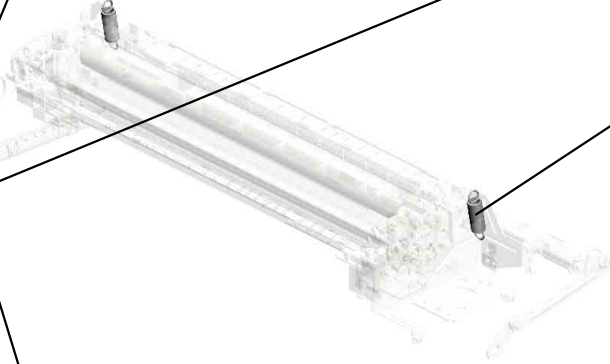

55.D2586514
GEAR:DRIVE:TRANSPORT SCREW:SIDE



60.D2586557
PLATE:BEARING:USED TONER



U012_S001

TRANSFER/SEPARATION UNIT:ASS'Y

- 44.D2586375 PLAIN SHAFT BEARING:BLADE:REAR
- 47.D2586396 SEAL:HOLDER:LOWER
- 68.D2616252 VIBRATING PLATE:TRANSPORT SCREW:FLAT BELT-TRANSFER
- 69.D2616254 BRUSH ROLLER:APPLICATION:ASS'Y**
- 65.D2616228 GUIDE PLATE:ENTRANCE:TRANSFER ROLLER:ASS'Y

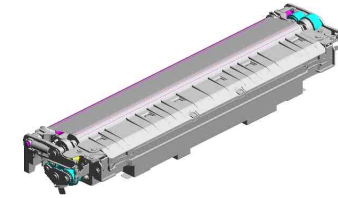

64.D2616210
TRANSFER/SEPARATION UNIT:ASS'Y

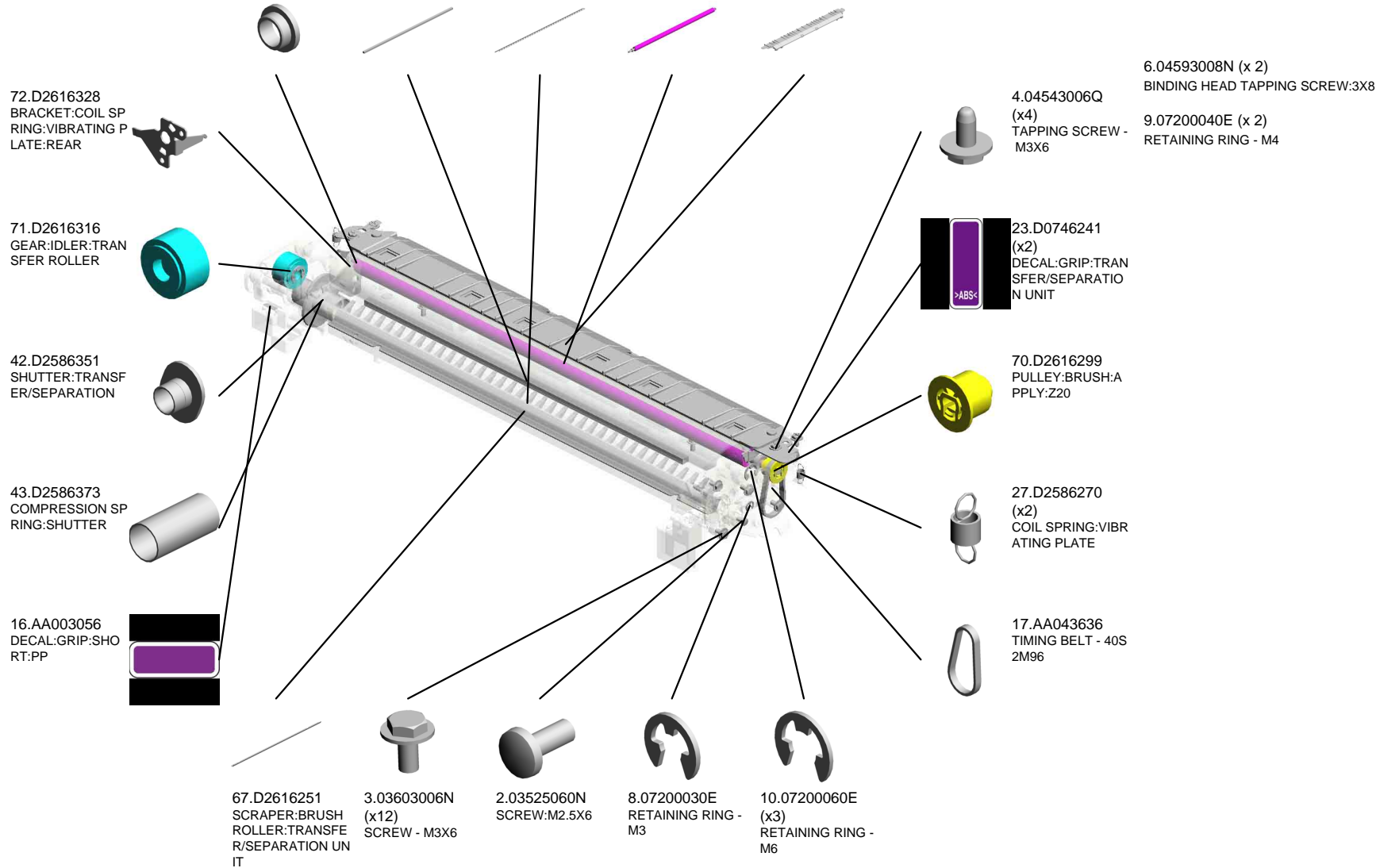

U012_S001
TRANSFER/SEPARATION UNIT:ASS'Y

74.D2616332 BLADE:BELT CLEANING:ASS'Y
 73.D2616330 HOLDER:BLADE:ASS'Y
 82.D2616349 COATING BAR:ASS'Y
 86.D2616399 BASE:COATING BAR:ASS'Y

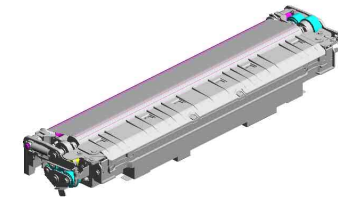

64.D2616210
TRANSFER/SEPARATION UNIT:ASS'Y

75.D2616333 (x2)
SPACER:DIA8XDIA11X0.5

76.D2616336 BRUSH ROLLER:REMOVE PAPER DUST:TRANSFER/SEPARATION:ASS'Y

83.D2616355 TRANSPORT SCREW:TRANSFER ROLLER:ASS'Y

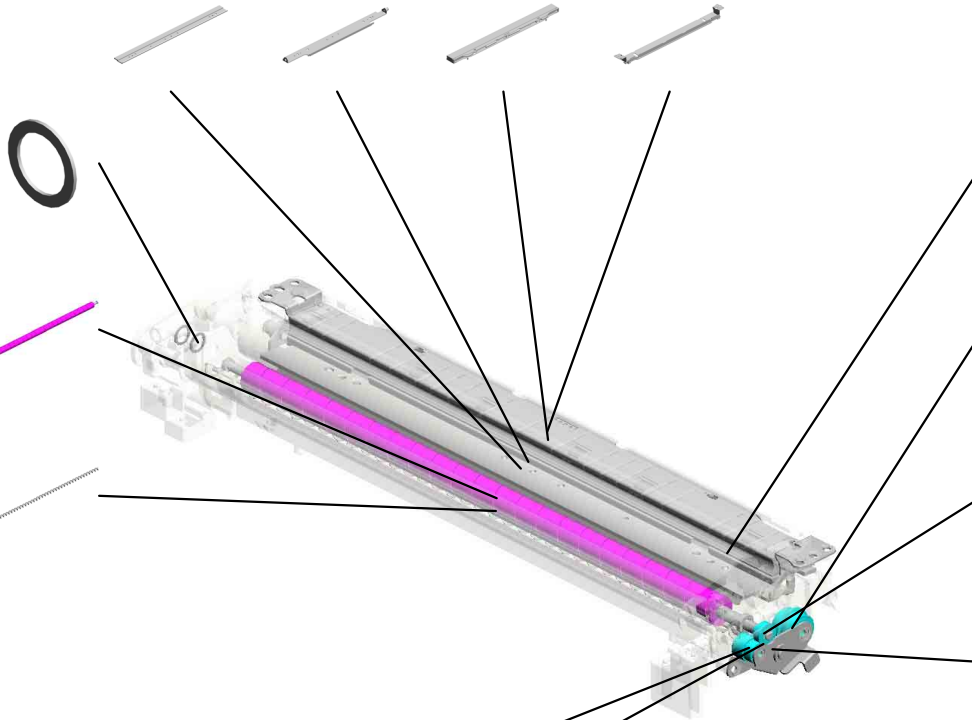

85.D2616394 (x2)
COIL SPRING:BLADE

80.D2616346 GEAR:IDLER:BRUSH ROLLER:APPLY

78.D2616344 GEAR:BRUSH:REMOVE PAPER DUST

77.D2616338 POSITIONING PLATE:IDLER:TRANSFER/SEPARATION:PRESS FIT

79.D2616345 GEAR:IDLER:TRANSPORT SCREW

81.D2616347 GEAR:TRANSPORT SCREW

U012_S001_S001
FLAT BELT-TRANSFER:NO.2:ASS'Y

10.07200060E
RETAINING RING -
M6

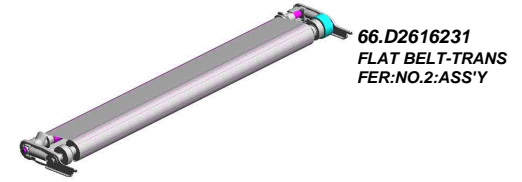

66.D2616231
FLAT BELT-TRANS
FER:NO.2:ASS'Y

9.07200040E (x 4)
RETAINING RING - M4

U001	U002	U003	U004	U005	U006	U007	U008	U009	U010	U011	U012	U013	U014	U015	U016	U017	U018	U019	U020	U021
------	------	------	------	------	------	------	------	------	------	------	------	------	------	------	------	------	------	------	------	------

U012_S002
USED TONER:T/S UNIT:SIDE:ASS'Y

5.04583010N
(x2)
HEXAGON HEAD TAPPING SCREW:3
X10



59.D2586542
TENSION SPRING:
VIBRATING PLATE



8.07200030E
(x2)
RETAINING RING -
M3



58.D2586537
GEAR:INPUT:VIBRATING PLATE

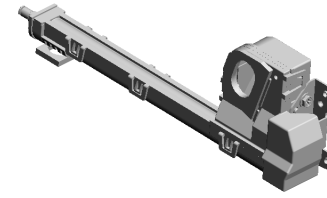

49.D2586502
USED TONER:T/S
UNIT:SIDE:ASS'Y

U001	U002	U003	U004	U005	U006	U007	U008	U009	U010	U011	U012	U013	U014	U015	U016	U017	U018	U019	U020	U021
------	------	------	------	------	------	------	------	------	------	------	------	------	------	------	------	------	------	------	------	------

U013.USED TONER

U013_S001
D2583587
PIPE:MIDDLE:ASSY



U013_S002
D1373521
COLLECTION BOTTLE:ASSY

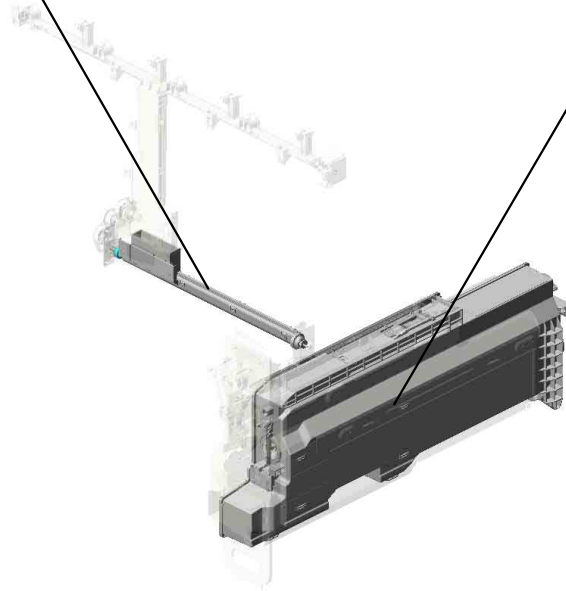

U001	U002	U003	U004	U005	U006	U007	U008	U009	U010	U011	U012	U013	U014	U015	U016	U017	U018	U019	U020	U021
------	------	------	------	------	------	------	------	------	------	------	------	------	------	------	------	------	------	------	------	------

U013 USED TONER

2.04543012Q TAPPING SCREW: 3X12
 11.D0746574 COVER:CAM:VERTICAL TRANSPORT
 15.D0746579 SEAL:COVER:CAM:VERTICAL TRANSPORT
 13.D0746577 CAM:VERTICAL TRANSPORT:DIA15
 19.D1363550 PIPE:UPPER:ASSY

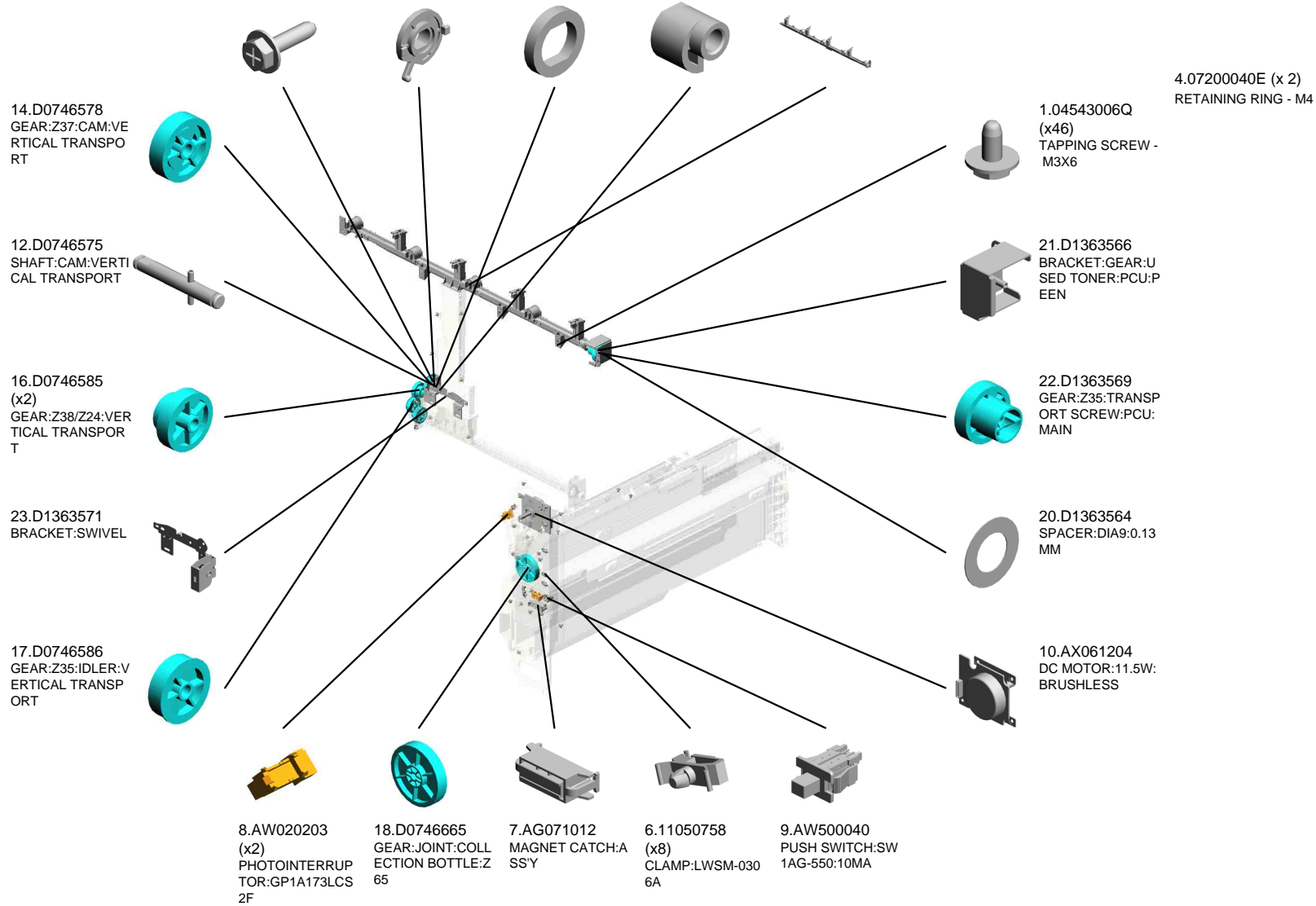
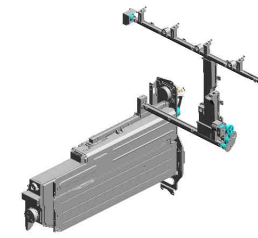

U013 USED TONER

25.D1363608 BRACKET:DRIVE:TRANSPORT SCREW:MIDDLE
 24.D1363603 BRACKET:DRIVE:PIPE:MIDDLE:PEEN
 40.GA082010 BUSHING:DIA6:DIA10:9
 38.D2583575 PIPE:LENGTHWISE:ASSY
 36.D1373622 SEAL:RELAY DUCT

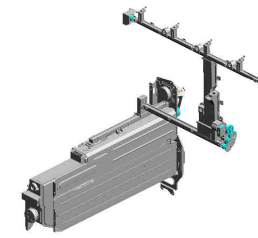

32.D1366089 PLAIN SHAFT BEARING:CONTACT POINT:BRACKET:ENCODER

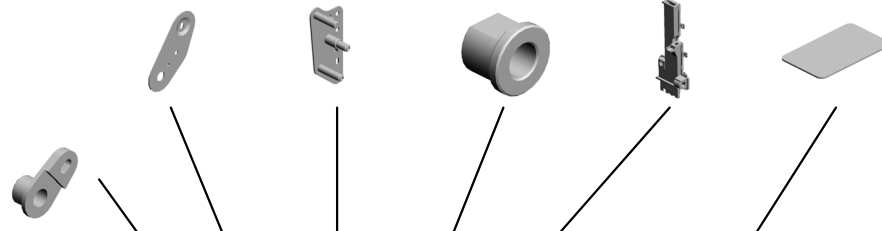

29.D1363646 TORQUE LIMITER MECHANICAL CLUTCH:GEAR:Z65/Z35

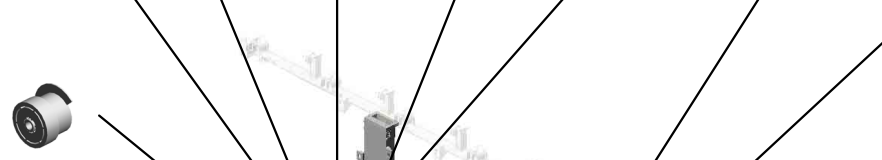

27.D1363641 GEAR:TRANSPORT SCREW:LOWER:Z41

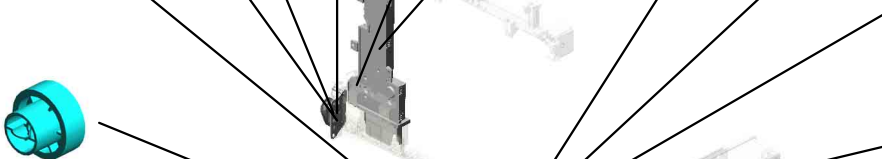

35.D1373621 VIBRATING PLATE:RELAY DUCT

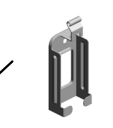

34.D1373620 CASE:RELAY DUCT

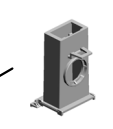

37.D1373652 PIPE:LOWER:ASSY



26.D1363623 SEAL:RELAY DUCT:SPONGE

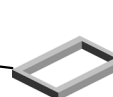

30.D1363647 GEAR:IDLER:Z49/Z27



28.D1363642 HOLDER:RADIAL BALL BEARING:JOINT:PRESS FIT



31.D1363667 SHAFT:JOINT:TONER RECYCLING SUB-UNIT:ASSY



U013_S001
PIPE:MIDDLE:ASS'Y

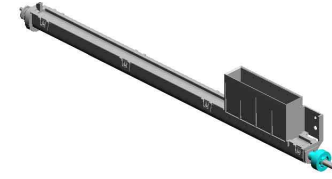

39.D2583587
PIPE:MIDDLE:ASS'
Y

4.07200040E (x 1)
RETAINING RING - M4

U001	U002	U003	U004	U005	U006	U007	U008	U009	U010	U011	U012	U013	U014	U015	U016	U017	U018	U019	U020	U021
------	------	------	------	------	------	------	------	------	------	------	------	------	------	------	------	------	------	------	------	------

U013_S002
COLLECTION BOTTLE:ASS'Y

3.04583008N
(x7)
HEXAGON HEAD TAPPING SCREW:3
X8

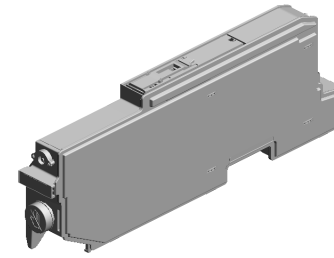

33.D1373521
COLLECTION BOT
TLE:ASS'Y



5.08050089
RETAINING RING -
M4

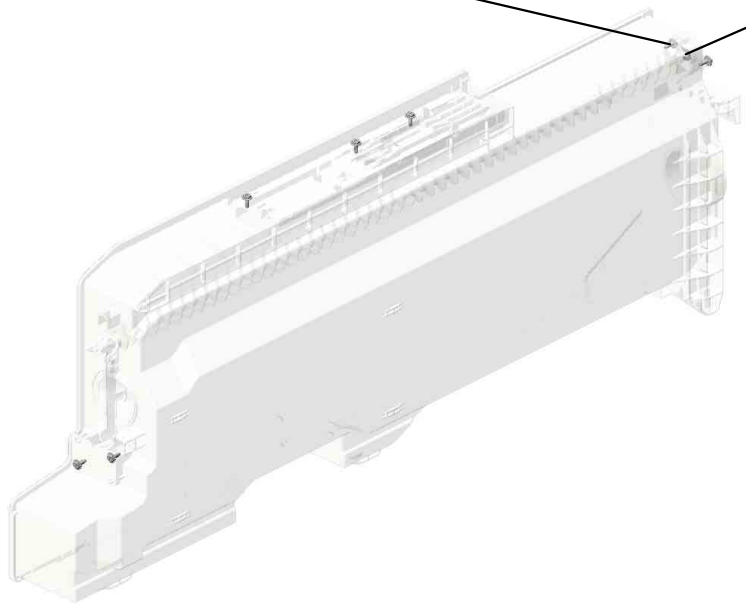

U001	U002	U003	U004	U005	U006	U007	U008	U009	U010	U011	U012	U013	U014	U015	U016	U017	U018	U019	U020	U021
------	------	------	------	------	------	------	------	------	------	------	------	------	------	------	------	------	------	------	------	------

U014.PAPER TRANSPORT

U014_S001
D2583850
TRANSPORT BELT UNIT:ASS
Y

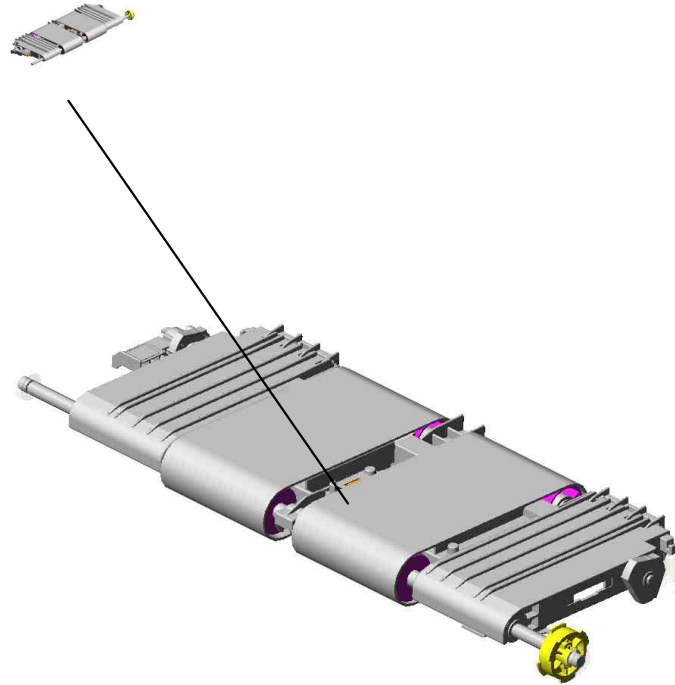

U001	U002	U003	U004	U005	U006	U007	U008	U009	U010	U011	U012	U013	U014	U015	U016	U017	U018	U019	U020	U021
------	------	------	------	------	------	------	------	------	------	------	------	------	------	------	------	------	------	------	------	------

U014 PAPER TRANSPORT

7.08053573
(x2)
RADIAL BALL BEA
RING: DIA8XDIA16X
5

5.07200060E
RETAINING RING -
M6

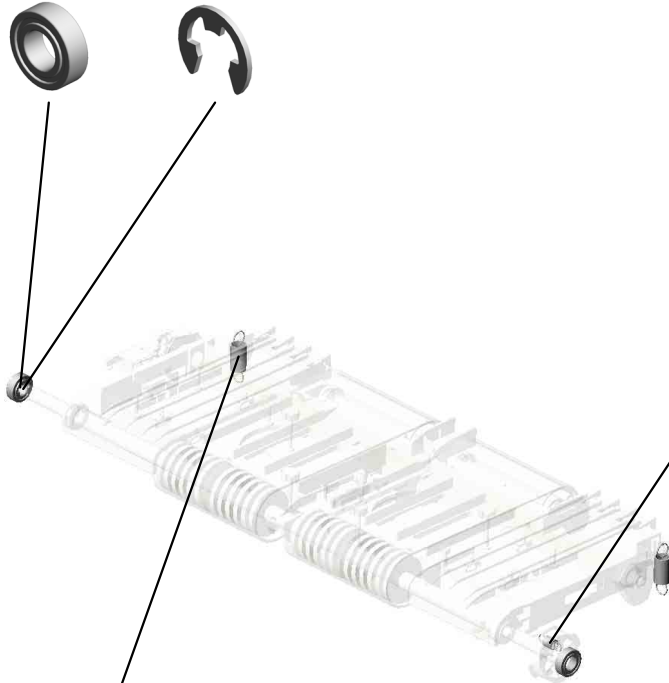
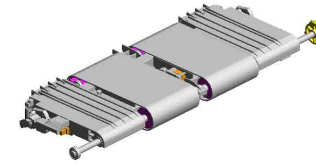

21.D2583889
COIL SPRING: VAC
UUM: EARTH

11.D1353882
(x2)
TENSION SPRING:
PRESSURE: TRANS
PORT BELT UNIT

U001	U002	U003	U004	U005	U006	U007	U008	U009	U010	U011	U012	U013	U014	U015	U016	U017	U018	U019	U020	U021
------	------	------	------	------	------	------	------	------	------	------	------	------	------	------	------	------	------	------	------	------

U014_S001 TRANSPORT BELT UNIT:ASS'Y

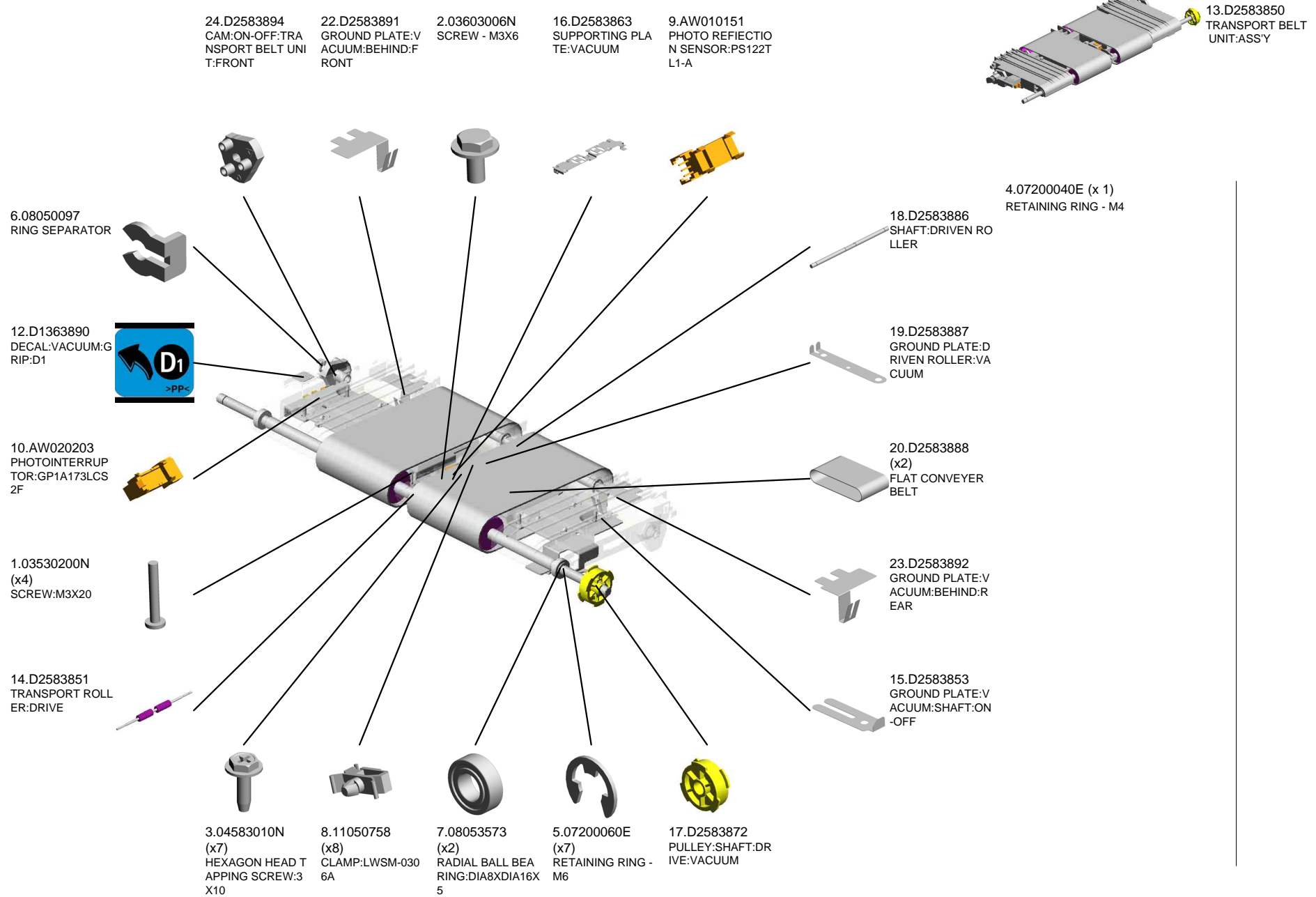

U001	U002	U003	U004	U005	U006	U007	U008	U009	U010	U011	U012	U013	U014	U015	U016	U017	U018	U019	U020	U021
------	------	------	------	------	------	------	------	------	------	------	------	------	-------------	------	------	------	------	------	------	------

U014_S001
 TRANSPORT BELT UNIT:ASS'Y

30.D2583910
 (x2)
 FAN:MM60X15

29.D2583905
 GROUND PLATE:S
 ENSOR:VACUUM

31.M2053893
 (x2)
 DRIVEN ROLLER:P
 RESS FIT

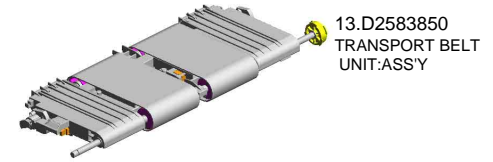

13.D2583850
 TRANSPORT BELT
 UNIT:ASS'Y

26.D2583896
 LEVER:ON-OFF:TR
 ANSPORT BELT U
 NIT



28.D2583900
 (x2)
 GUIDE:TRANSPOR
 T BELT UNIT



25.D2583895
 CAM:ON-OFF:TRA
 NSPORT BELT UNI
 T:REAR



27.D2583897
 SHAFT:LEVER:VAC
 UUM

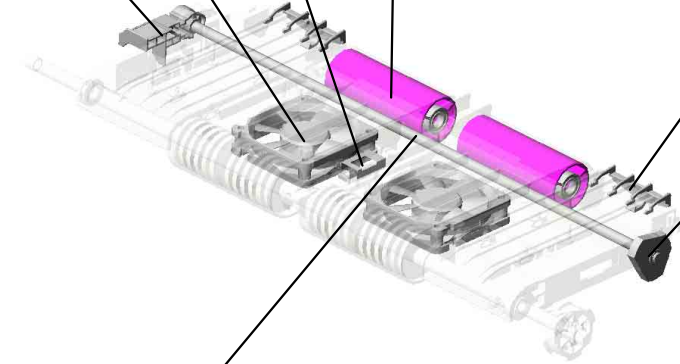

U001	U002	U003	U004	U005	U006	U007	U008	U009	U010	U011	U012	U013	U014	U015	U016	U017	U018	U019	U020	U021
------	------	------	------	------	------	------	------	------	------	------	------	------	------	------	------	------	------	------	------	------

U015.FUSING

U015_S003
D2614036
ROLLER:POLISH:ASS'Y



U015_S004
D2614045
WEB:CLEANING UNIT:ASS'Y



U015_S001
D2584289
COIL:IH:200V:ASS'Y

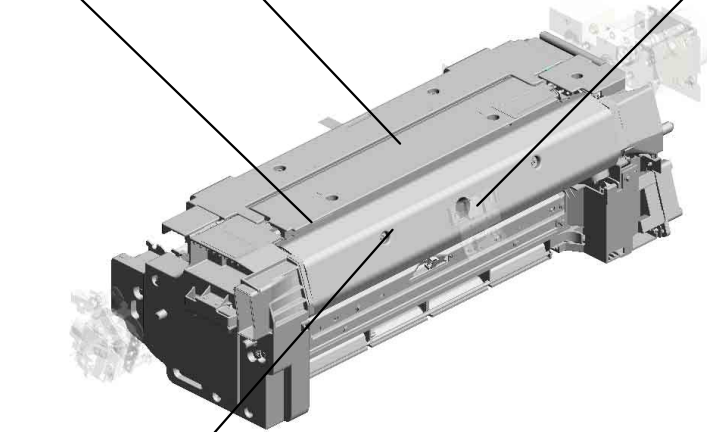

U015_S002
D2614013
FUSING UNIT:ASSY



U001	U002	U003	U004	U005	U006	U007	U008	U009	U010	U011	U012	U013	U014	U015	U016	U017	U018	U019	U020	U021
------	------	------	------	------	------	------	------	------	------	------	------	------	------	------	------	------	------	------	------	------

U015_S002.FUSING UNIT:ASS'Y

U015_S002_S001
D2614383
SHAFT:CAM:ASS'Y

U015_S002_S003
D2614031
STRIPPER PLATE:UNI:FUSIN
G:ASS'Y

U015_S002_S002
D2584356
COVER:SEPARATION:OPEN/
CLOSE:ASS'Y

U015_S002_S007
D2584204
COVER:FUSING UNIT:FRON
T:ASS'Y

U015_S002_S005
D2614352
FUSING COVER:UPPER:ASS'
Y

U015_S002_S004
D2584460
HEAT ROLLER:ASS'Y

U015_S002_S006
D2584228
STRIPPER PLATE:PRESSUR
E ROLLER:ASS'Y

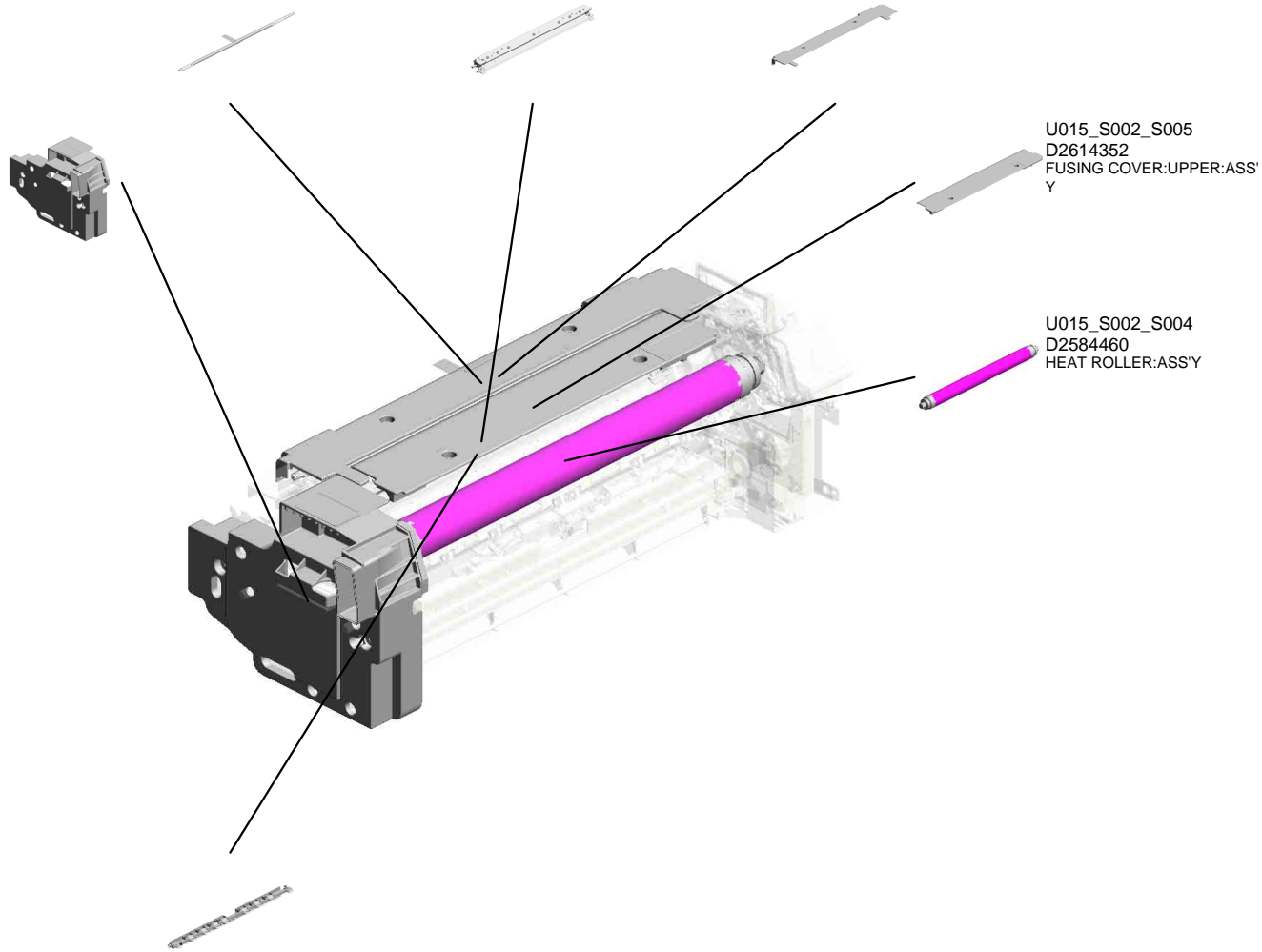

U001	U002	U003	U004	U005	U006	U007	U008	U009	U010	U011	U012	U013	U014	U015	U016	U017	U018	U019	U020	U021
------	------	------	------	------	------	------	------	------	------	------	------	------	------	------	------	------	------	------	------	------

U015_S002_S004.HEAT ROLLER:ASS'Y

U015_S002_S004_S001
D2584468
CORE:HEAT ROLLER:ASS'Y

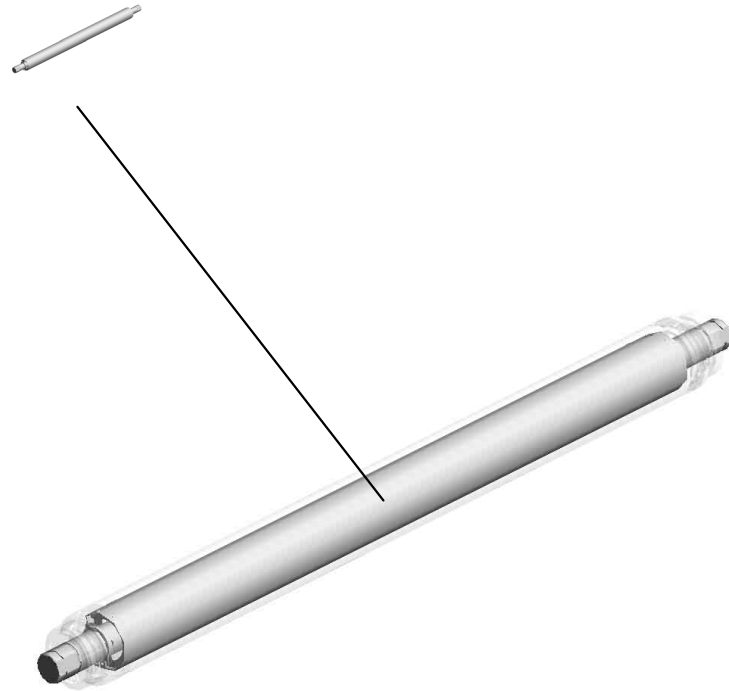

U001	U002	U003	U004	U005	U006	U007	U008	U009	U010	U011	U012	U013	U014	U015	U016	U017	U018	U019	U020	U021
------	------	------	------	------	------	------	------	------	------	------	------	------	------	------	------	------	------	------	------	------

U015_S004.WEB:CLEANING UNIT:ASS'Y

U015_S004_S001
D2614372
COVER:WEB:ASS'Y



U001	U002	U003	U004	U005	U006	U007	U008	U009	U010	U011	U012	U013	U014	U015	U016	U017	U018	U019	U020	U021
------	------	------	------	------	------	------	------	------	------	------	------	------	------	------	------	------	------	------	------	------

U015 FUSING

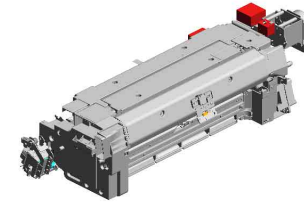
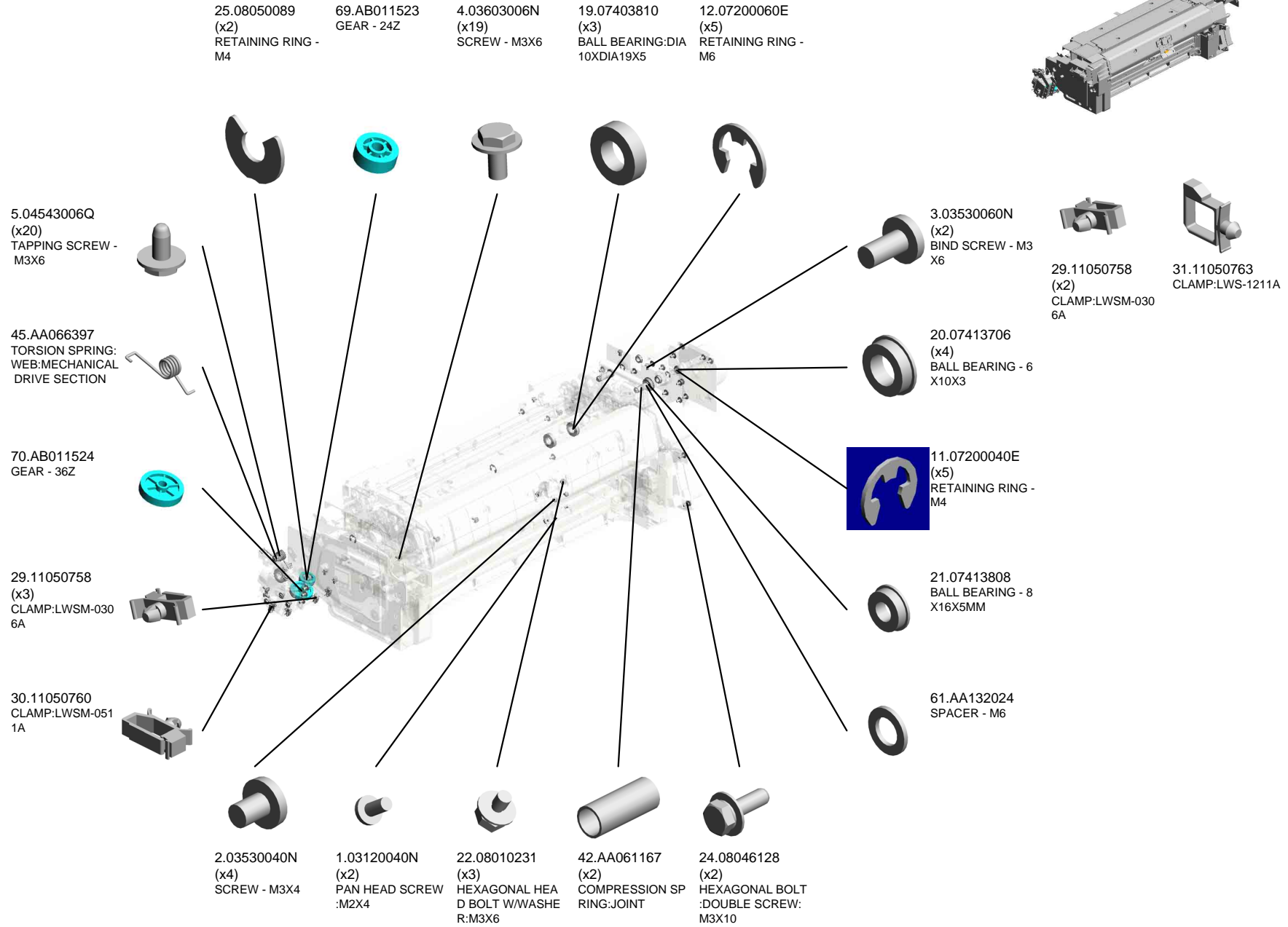

U001	U002	U003	U004	U005	U006	U007	U008	U009	U010	U011	U012	U013	U014	U015	U016	U017	U018	U019	U020	U021
------	------	------	------	------	------	------	------	------	------	------	------	------	------	------	------	------	------	------	------	------

U015 FUSING

89.AW010200
PAPER FEED SEN
SOR:FUSING EXIT

79.AB012217
GEAR:WORM WHE
EL:MOTOR:FUSIN
G:ON-OFF

80.AB012218
GEAR:IDLER:WEB:
ON-OFF:1

96.AX040267
DC STEPPER MOT
OR:DIA42:24V

97.AX040268
DC STEPPER MOT
OR:DIA42:24V:ON-
OFF:ROLLER

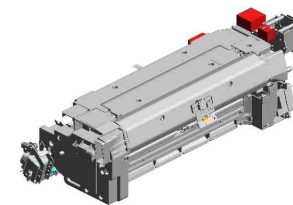

101.B2342390
(x2)
FLANGED HEXAG
ONAL HEAD BOLT:
M4X8



100.B2234317
STEPPER MOTOR:
DC24V 24.3W



91.AW020198
(x2)
PHOTOINTERRUP
TOR:LG2A14NL1



117.D0744354
GEAR:SLOW DOW
N:WORM GEAR



71.AB011526
GEAR - 24Z



92.AW100138
THERMOPILE



119.D0894365
HOLDER:THERMIS
TOR:LENS



120.D0894366
COVER:THERMIST
OR:LENS



136.D1364195
COVER:ENTRANC
E SENSOR:FUSIN
G



90.AW010201
DISTANCE MEASU
RING SENSOR:150
MM

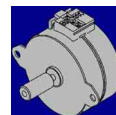
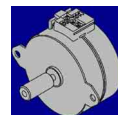

82.AB012227
GEAR:ON-OFF:MO
TOR



72.AB012201
GEAR:IDLER:ROLL
ER:FUSING

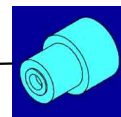

73.AB012202
GEAR:DRIVE:ROLL
ER:POLISH



98.AX060503
DC MOTOR:39.5W:
BRUSHLESS



81.AB012219
GEAR:CAM:SHAFT:
WEB:ON-OFF



U015 FUSING

156.D1384130
COVER:GEAR:JOI
NT

159.D1384136
SHAFT:ON-OFF:W
EB

233.D2614381
(x2)
CAM:WEB:A

162.D1384141
BRACKET:DC STE
PPER MOTOR:WE
B:ON-OFF

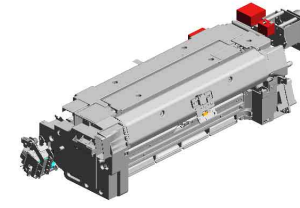

161.D1384139
FEELER:CAM:WEB
:ON-OFF

166.D1384161
JOINT:CLEANING:F
USING DRIVE SUB-
UNIT

158.D1384134
HOLDER:DC STEP
PER MOTOR

157.D1384131
BRACKET:MOTOR

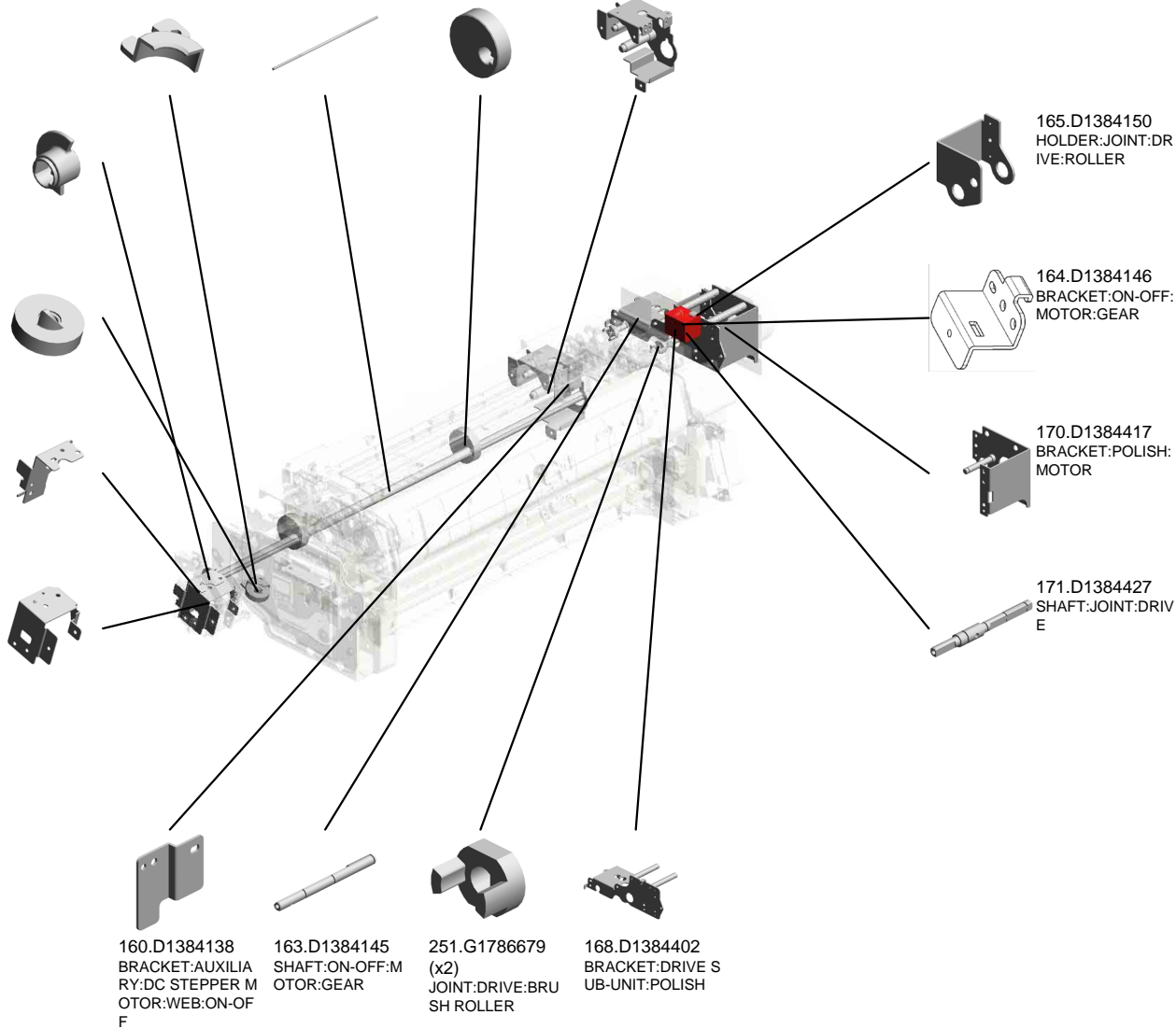

165.D1384150
HOLDER:JOINT:DR
IVE:ROLLER

164.D1384146
BRACKET:ON-OFF:
MOTOR:GEAR

170.D1384417
BRACKET:POLISH:
MOTOR

171.D1384427
SHAFT:JOINT:DRIV
E

160.D1384138
BRACKET:AUXILIA
RY:DC STEPPER M
OTOR:WEB:ON-OF
F

163.D1384145
SHAFT:ON-OFF:M
OTOR:GEAR

251.G1786679
(x2)
JOINT:DRIVE:BRU
SH ROLLER

168.D1384402
BRACKET:DRIVE S
UB-UNIT:POLISH

U015_S001
COIL:IH:200V:ASS'Y

22.08010231
(x4)
HEXAGONAL HEAD BOLT W/WASHER
R:M3X6

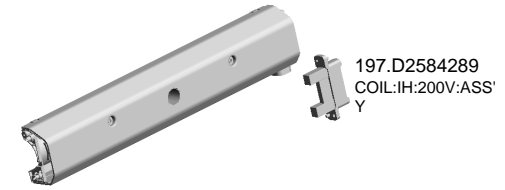

197.D2584289
COIL:IH:200V:ASS'Y

172.D1441085
(x2)
STEPPED SCREW:
M3

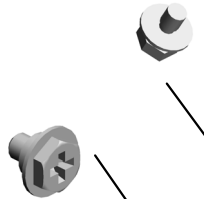

62.AA143812
(x2)
SCREW - SCALE

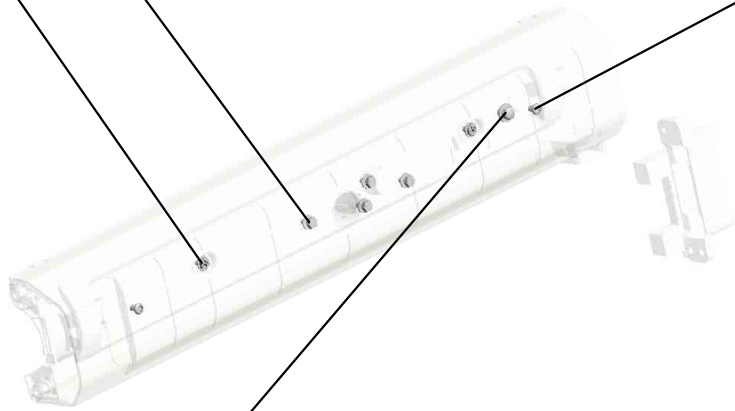

26.09544006N
SCREW:POLISHED
ROUND/SPRING:M
4X6



U001	U002	U003	U004	U005	U006	U007	U008	U009	U010	U011	U012	U013	U014	U015	U016	U017	U018	U019	U020	U021
------	------	------	------	------	------	------	------	------	------	------	------	------	------	------	------	------	------	------	------	------

U015_S002 FUSING UNIT:ASS'Y

- 17.07403505 (x4) BEARING
- 2.03530040N (x9) SCREW - M3X4
- 22.08010231 (x3) HEXAGONAL HEAD BOLT W/WASHER: M3X6
- 20.07413706 (x5) BALL BEARING - 6 X10X3
- 9.07200020G RETAINING RING - M2

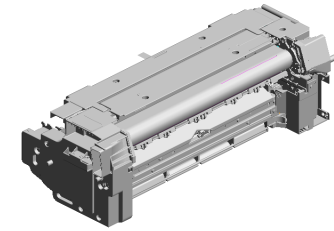

220.D2614013
FUSING UNIT:ASS'Y

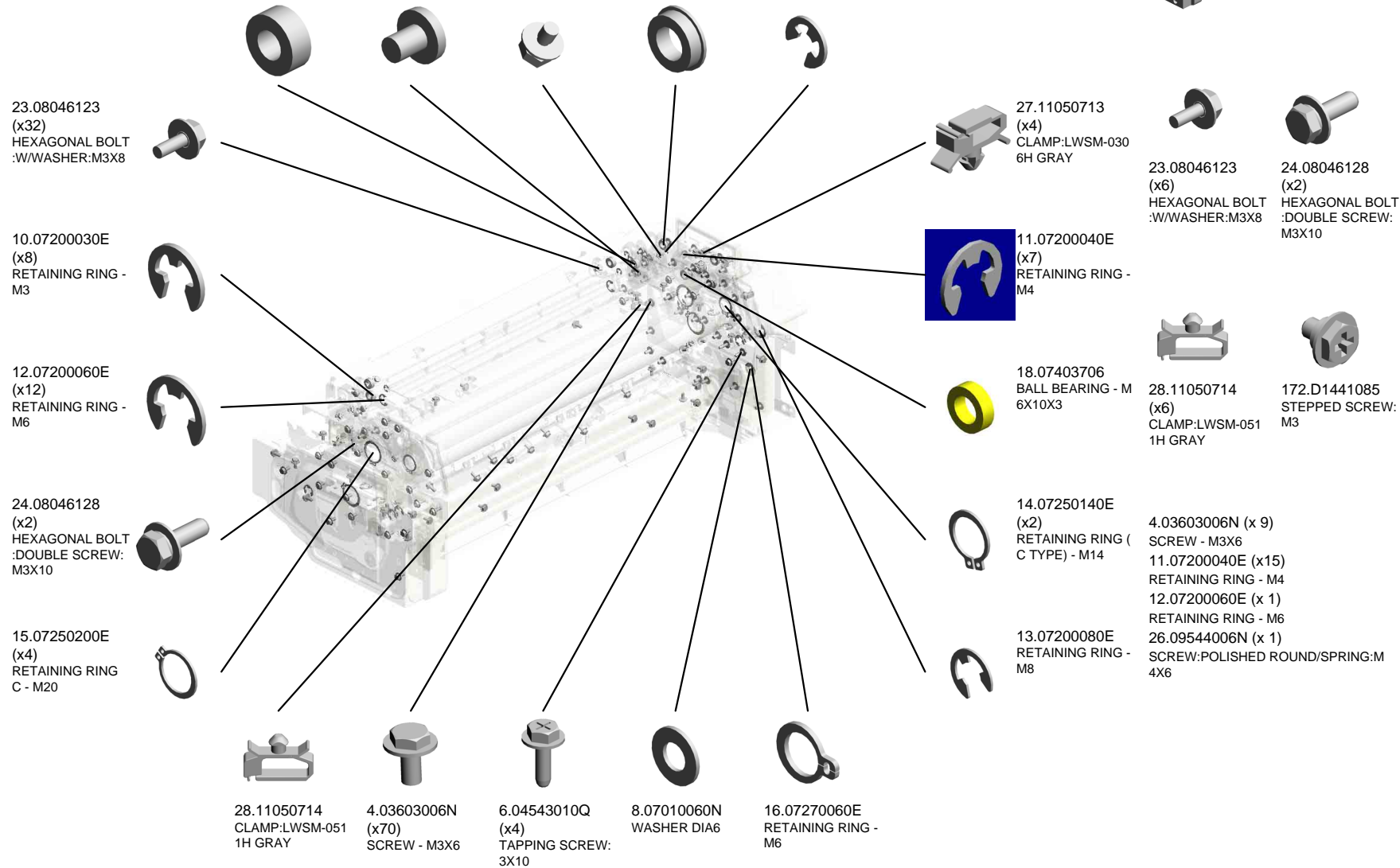

U015_S002
FUSING UNIT:ASS'Y

43.AA061237
(x2)
TENSION SPRING:
LEVER:ON-OFF

44.AA063931
(x2)
COMPRESSION SP
RING:ROLLER:POL
ISH

53.AA066698
TORSION SPRING:
LOCK:STRIPPER P
LATE:FRONT:13N

60.AA082172
BUSHING:DIA6XDI
A10X4:EG-1

35.AA000290
DECAL:POSITIONI
NG DISPLAY:SCRE
W:PET

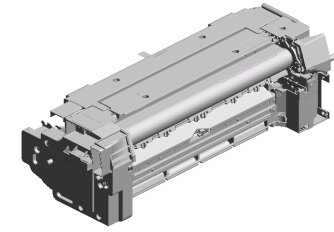

220.D2614013
FUSING UNIT:ASS'
Y



58.AA082101
(x4)
BUSHING - 6X10X6



46.AA066441
TORSION SPRING:
LEVER:OPEN/CLO
SE



49.AA066444
TORSION SPRING:
ON-OFF:POLISH:F
RONT



47.AA066442
TORSION SPRING:
STRIPPER PLATE:
FRONT



37.AA061148
(x2)
COMPRESSION SP
RING:PRESSURE



38.AA061158
(x2)
TENSION SPRING:
HEAT ROLLER



41.AA061164
TENSION SPRING:
GEAR:ON-OFF



48.AA066443
TORSION SPRING:
STRIPPER PLATE:
REAR



32.54472768
(x2)
STEPPED SCREW
- M3



33.A2171340
KNOB SCREW - M4
X10



59.AA082109
PLAIN SHAFT BEA
RING:DIA4



54.AA080247
(x2)
BUSHING - B-F6-3



51.AA066450
TORSION SPRING:
ON-OFF:POLISH:R
EAR



52.AA066697
TORSION SPRING:
LOCK:STRIPPER P
LATE:REAR:13N

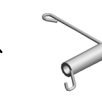

39.AA061159
TENSION SPRING:
HEAT ROLLER:TU
RN

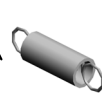

U015_S002 FUSING UNIT:ASS'Y

83.AE010127
HOT ROLLER:DIAS
7

102.B8722614
(x2)
BUSHING:R1

78.AB012214
(x2)
GEAR:POLISH:ROL
LER:A

75.AB012205
GEAR:IDLER:ON-O
FF

91.AW020198
(x4)
PHOTOINTERRUP
TOR:LG2A14NL1

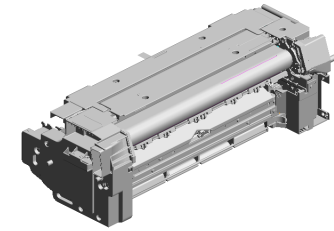

220.D2614013
FUSING UNIT:ASS'
Y

89.AW010200
PAPER FEED SEN
SOR:FUSING EXIT



99.AX430209
HEATER:PRESSUR
E ROLLER:208V:60
0W:INFRARED



93.AW100178
THERMISTOR:FUSI
NG



87.AE030059
(x4)
BALL BEARING:MM
20XMM32X7



85.AE030035
(x4)
BALL BEARING - 6
X16X5



95.AW110044
THERMOSTAT:150
C:250V/17A



84.AE020243
PRESSURE ROLLE
R:DIAS55

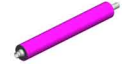

92.AW100138
THERMOPILE



94.AW100179
THERMISTOR:FUSI
NG:70ANG



86.AE030044
(x2)
BALL BEARING - 1
0X22X6



76.AB012207
GEAR:POLISH:ROL
LER:A

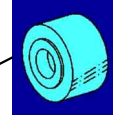

74.AB012203
GEAR:DRIVE:ROLL
ER:FUSING:B

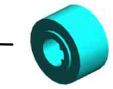

103.BB013041
GEAR:JOINT:PRES
SURE:ASSY

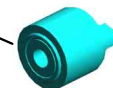

77.AB012211
GEAR:HEAT ROLL
ER:TURN

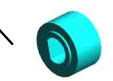

104.BB013042
GEAR:IDLER:PRES
SURE:ASSY

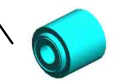

U015_S002
FUSING UNIT:ASS'Y

109.C2442601
FRONT STEPPED
SCREW

112.D0744063
HOUSING:THERM
OSTAT:ASS'Y

129.D1364081
COVER:THERMOS
TAT:PRESSURE

108.BB013046
GEAR:IDLER:28Z:A
SS'Y

107.BB013045
GEAR:IDLER:FUSI
NG

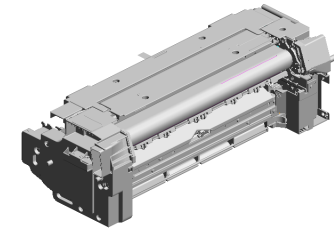

220.D2614013
FUSING UNIT:ASS'
Y

111.D0744009
(x4)
HOLDER:M5



134.D1364131
(x2)
HOLDER:COIL SPR
ING:PRESSURE



133.D1364129
HOLDER:HEATER:
PRESSURE:FRON
T

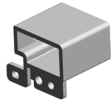

132.D1364127
(x2)
RECEIVE PLATE:P
RESSURE



125.D1364071
COLLAR:DIA10XDI
A14X13.4



126.D1364072
SHAFT:CAM:PRES
SURE



121.D1054365
HOLDER:THERMO
PILE



130.D1364082
CLAMP:HARNES:
PRESSURE



128.D1364075
FEELER:CAM:PRE
SSURE:REAR



131.D1364111
COVER:HARNES:
FIRST:LOWER



106.BB013044
GEAR:HOT ROLLE
R



105.BB013043
GEAR:PRESSURE
ROLLER



127.D1364073
JOINT:CAM:PRESS
URE:B



124.D1364070
(x2)
COLLAR:DIA10X:DI
A14X:15.8



113.D0744097
TAB:TERMINAL:CO
NNECTING



U015_S002
FUSING UNIT:ASS'Y

172.D1441085
(x14)
STEPPED SCREW:
M3

144.D1364412
LEVER:WEB:ASS'Y

146.D1364441
COVER:HARNESS:
LEFT INNER REAR

169.D1384405
HOLDER:GEAR:ON
-OFF

145.D1364428
GRIP:FUSING UNIT
:REAR

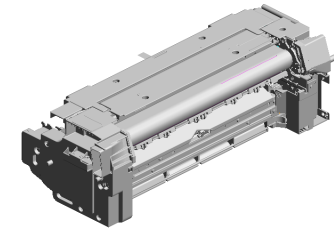

220.D2614013
FUSING UNIT:ASS'
Y

141.D1364254
STAY:FUSING:ENT
RANCE

148.D1384117
DUCT:PRESSURE:
EXIT:CONNECTIN
G:A

138.D1364222
GROUND PLATE:H
EAT ROLLER

152.D1384121
FEELER:CAM:PRE
SSURE:FRONT

155.D1384124
CAM:SHUTTER:DU
CT:PRESSURE RO
LLER:FUSING UNIT

154.D1384123
TORSION SPRING:
SHUTTER:DUCT:F
USING UNIT

150.D1384119
SEAL:DUCT:PRES
SURE:LOWER:A

153.D1384122
SHUTTER:DUCT:P
RESSURE ROLLER
:FUSING UNIT

142.D1364258
HOLDER:GUIDE:E
NTRANCE:MIDDLE

151.D1384120
SEAL:DUCT:PRES
SURE:ENTRANCE

139.D1364232
SHAFT:HEAT ROLL
ER:TURN:FEELER

137.D1364218
SUPPORTING PLA
TE:SIDE PLATE:HO
T ROLLER:REAR

135.D1364135
(x2)
SHAFT:RADIAL BA
LL BEARING:LEVE
R:PRESSURE

143.D1364259
(x4)
HOLDER:GUIDE:E
NTRANCE

149.D1384118
DUCT:PRESSURE:
EXIT

U015_S002
FUSING UNIT:ASS'Y

174.D2584080
STOPPER:STRIPP
ER PLATE:FRONT

180.D2584118
SUPPORTING PLA
TE:PRESSURE:FR
ONT

189.D2584163
(x2)
BOLT:M5:ROUND P
OINT:BLACK

173.D1944242
(x2)
CAM:ON-OFF

175.D2584081
STOPPER:STRIPP
ER PLATE:REAR

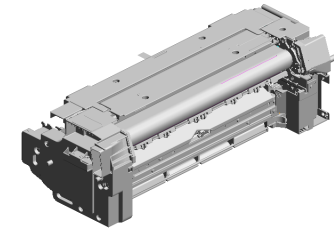

220.D2614013
FUSING UNIT:ASS'
Y

191.D2584178
ELECTRODE PLAT
E:HEATER:FRONT

190.D2584175
FIX STAND:TERMI
NAL:HEATER

176.D2584112
LEVER:PRESSURE
:FRONT:INNER

187.D2584161
(x2)
LEVER:CONTROL
PLATE:PRESSURE

177.D2584114
LEVER:PRESSURE
:FRONT:OUTER

182.D2584128
FUSING ENTRANC
E GUIDE PLATE:LO
WER

181.D2584119
SUPPORTING PLA
TE:PRESSURE:RE
AR

183.D2584131
(x2)
CAM:PRESSURE

184.D2584135
(x2)
BRACKET:CONNE
CTOR:THERMOST
AT

185.D2584136
COVER:HARNES
S:CAM

192.D2584203
COVER:DUCT:FUSI
NG UNIT:REAR:AS
S'Y

179.D2584117
LEVER:PRESSURE
:REAR:OUTER

186.D2584147
HOLDER:HEATER:
PRESSURE:REAR

188.D2584162
(x2)
STEPPED SCREW:
M5

178.D2584115
LEVER:PRESSURE
:REAR:INNER

U001	U002	U003	U004	U005	U006	U007	U008	U009	U010	U011	U012	U013	U014	U015	U016	U017	U018	U019	U020	U021
------	------	------	------	------	------	------	------	------	------	------	------	------	------	------	------	------	------	------	------	------

U015_S002 FUSING UNIT:ASS'Y

195.D2584226
(x13)
GUIDE:FUSING EXIT:PFA

198.D2584294
(x2)
STOPPER PIN:SEPARATION UNIT:OPEN/CLOSE

207.D2584355
COVER:FUSING EXIT:UPPER

213.D2584383
SHAFT:SEPARATION UNIT

214.D2584397
SHAFT:LEVER:PAPER EXIT UNIT:OPEN/CLOSE

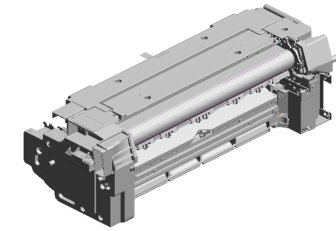

220.D2614013
FUSING UNIT:ASS'Y

210.D2584359
GRIP:SEPARATION UNIT:OPEN AND CLOSE

211.D2584360
LEVER:SEPARATION:OPEN/CLOSE:FRONT

205.D2584338
BRACKET:STRIPPER PLATE:FRONT

199.D2584302
(x2)
STEPPED SCREW:LEVER:HEAT ROLLER

203.D2584326
SUPPORTING PLATE:SIDE PLATE:HEAT ROLLER:FRONT

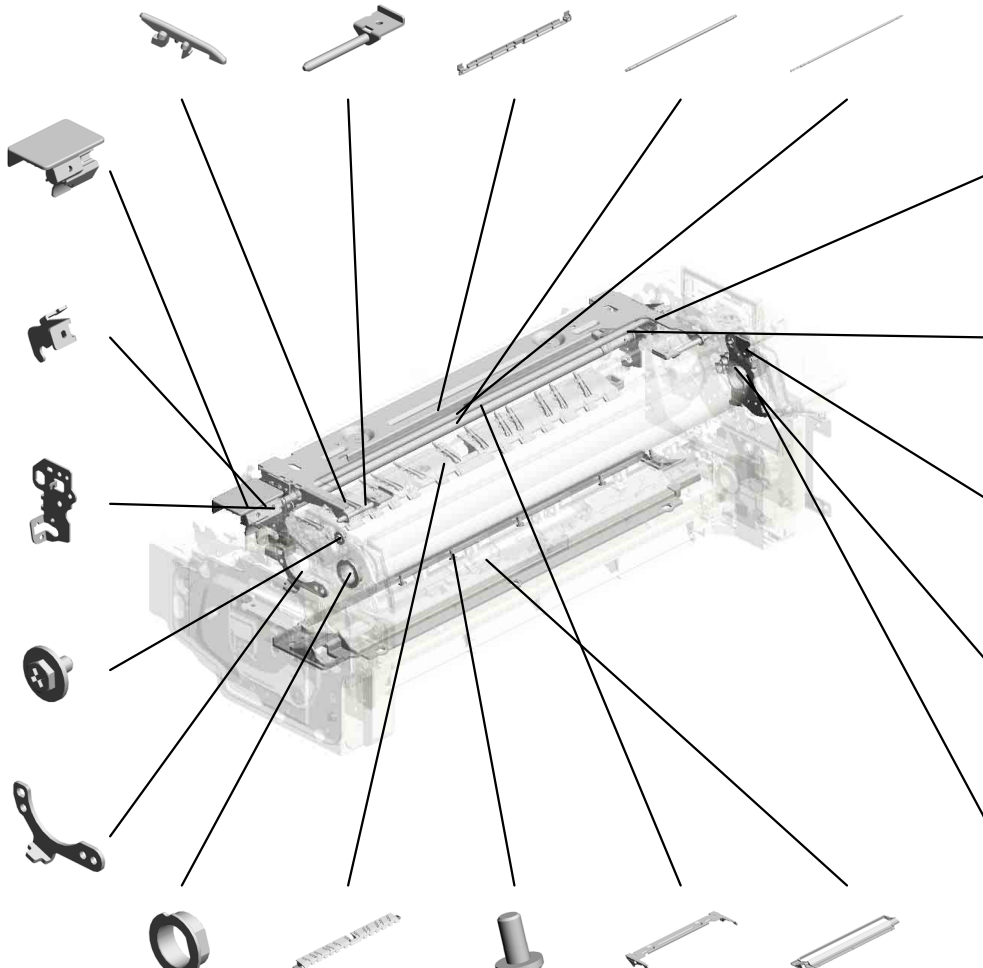

212.D2584364
LEVER:SEPARATION:OPEN/CLOSE:REAR

206.D2584341
BRACKET:STRIPPER PLATE:REAR

202.D2584322
FEELER:HEAT ROLLER:TURN

201.D2584321
BRACKET:SHAFT:TURN:FEELER

200.D2584317
LEVER:TENSION:HEAT ROLLER:REAR

218.D2584467
(x2)
BUSHING:HEAT ROLLER:SHAFT

194.D2584225
GUIDE PLATE:FUSING EXIT:LOWER

204.D2584336
(x5)
STEPPED SCREW:DIA3:M3

209.D2584358
BRACKET:PAPER EXIT UNIT

224.D2614171
DUCT:PRESSURE:UPPER

U015_S002
FUSING UNIT:ASS'Y

243.D2614399
(x2)
PIN:LEVER:ON-OFF:
F:B

239.D2614388
LEVER:ON-OFF:B:
REAR

237.D2614386
(x2)
PIN:LEVER:ON-OFF:
F:A

252.GA082007
(x2)
PLAIN SHAFT BEA
RING:4XDIA6DIA8

240.D2614390
FEELER:SENSOR:
ON-OFF

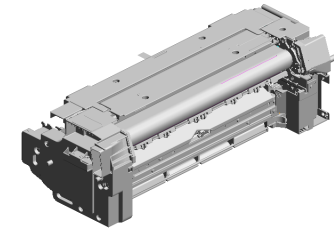

220.D2614013
FUSING UNIT:ASS'
Y

246.D2614430
BRACKET:GEAR:P
OLISH:SWIVEL

238.D2614387
LEVER:ON-OFF:B:
FRONT

235.D2614384
LEVER:ON-OFF:A:
FRONT

253.GA082015
(x2)
PLAIN SHAFT BEA
RING:DIA6:DIA9:7

244.D2614400
BRACKET:SUPPO
RT SHAFT:DRIVE:P
OLISH

248.D2614440
FLAT BELT-FUSIN
G:386XDIA80:SEAL

225.D2614172
DUCT:PRESSURE:
LOWER

236.D2614385
LEVER:ON-OFF:A:
REAR

249.G1021193
(x2)
HEXAGONAL BOLT
:DOUBLE:SCREW:
ROUND POINT:M3
X7

251.G1786679
(x2)
JOINT:DRIVE:BRU
SH ROLLER

241.D2614392
SHAFT:JOINT:POLI
SH:ROLLER:DRIVE

245.D2614410
SHAFT:JOINT:POLI
SH:ROLLER

255.M2054446
(x4)
WASHER:POLISH:
ON-OFF

242.D2614398
HOOK:GEAR:ON-O
FF

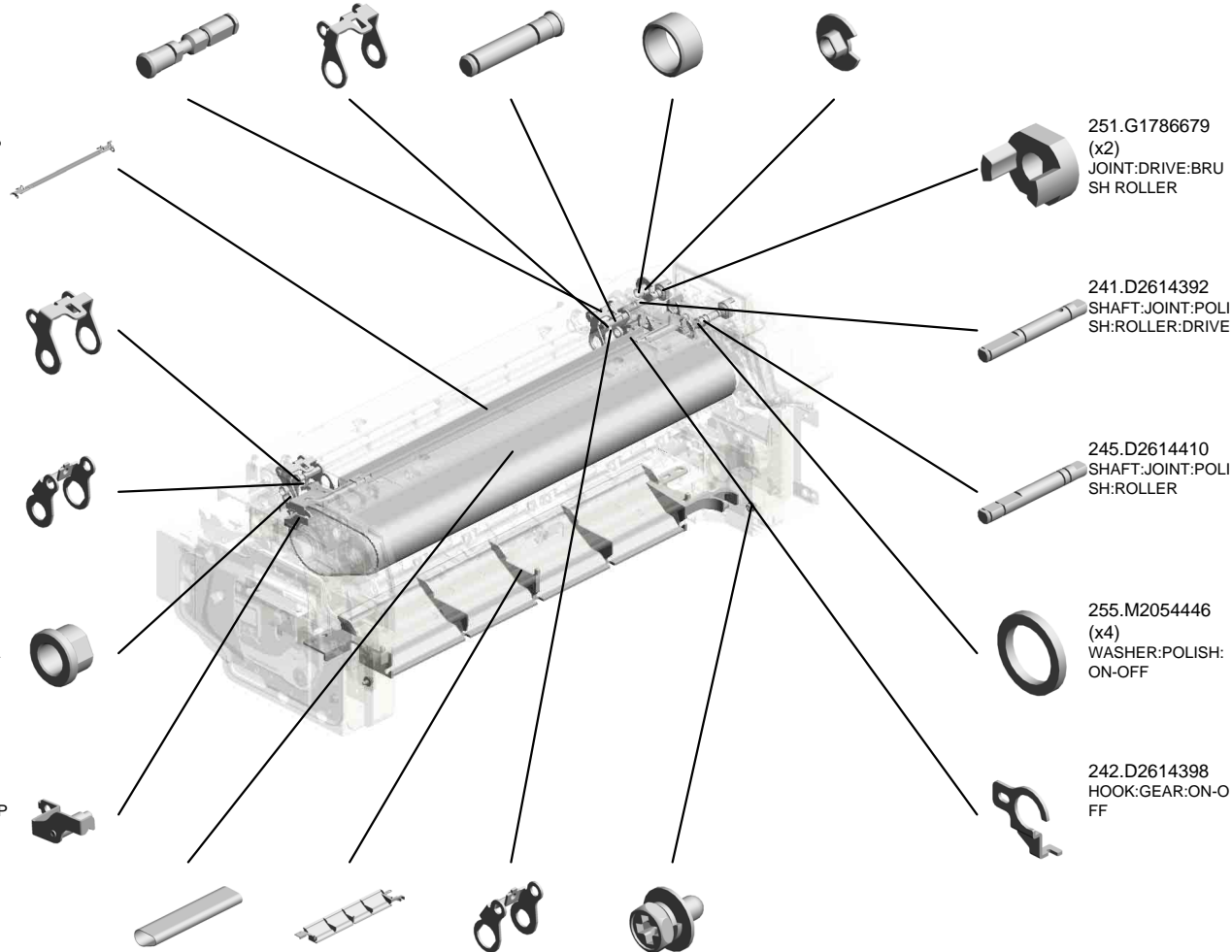

U015_S002_S001
SHAFT:CAM:ASS'Y

250.G1026341
SHEET:SENSOR

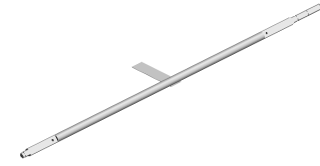
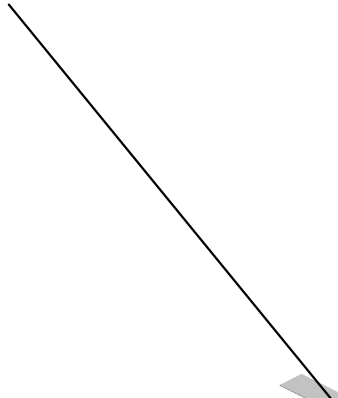

234.D2614383
SHAFT:CAM:ASS'Y

U001	U002	U003	U004	U005	U006	U007	U008	U009	U010	U011	U012	U013	U014	U015	U016	U017	U018	U019	U020	U021
------	------	------	------	------	------	------	------	------	------	------	------	------	------	------	------	------	------	------	------	------

U015_S002_S002

COVER:SEPARATION:OPEN/CLOSE:ASS'Y

36.AA003059
DECAL:EXIT:GUID
E PLATE:UPPER:P
USH

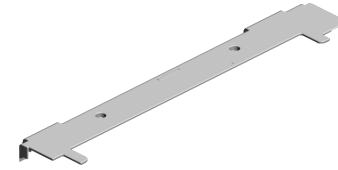
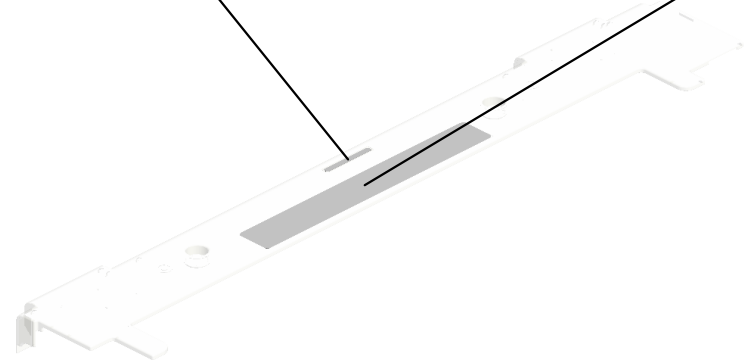

208.D2584356
COVER:SEPARATI
ON:OPEN/CLOSE:
ASSY



122.D1174263
DECAL:H-TEMP W
ARNING:FUSING

U001	U002	U003	U004	U005	U006	U007	U008	U009	U010	U011	U012	U013	U014	U015	U016	U017	U018	U019	U020	U021
------	------	------	------	------	------	------	------	------	------	------	------	------	------	------	------	------	------	------	------	------

U015_S002_S003
STRIPPER PLATE:UNI:FUSING:ASS'Y

172.D1441085
(x2)
STEPPED SCREW:
M3



221.D2614031
STRIPPER PLATE:
UNI:FUSING:ASS'Y

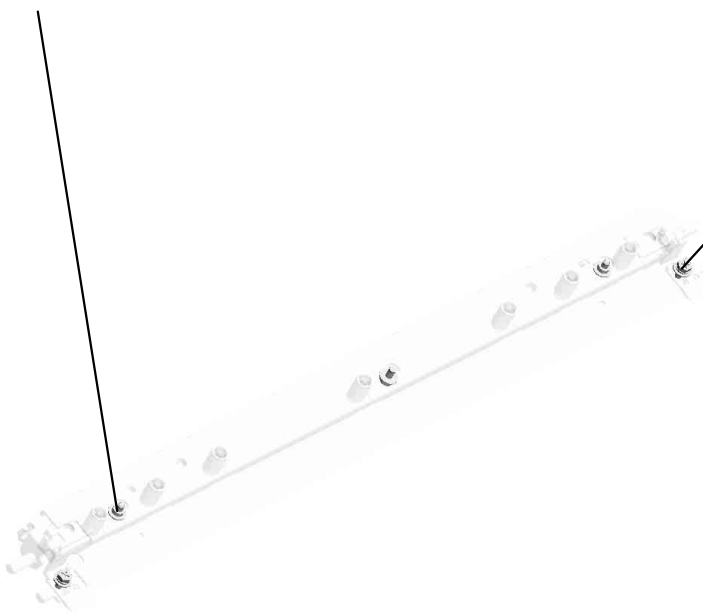

22.08010231
(x3)
HEXAGONAL HEA
D BOLT W/WASHE
R:M3X6

U001	U002	U003	U004	U005	U006	U007	U008	U009	U010	U011	U012	U013	U014	U015	U016	U017	U018	U019	U020	U021
------	------	------	------	------	------	------	------	------	------	------	------	------	------	------	------	------	------	------	------	------

U015_S002_S004
HEAT ROLLER:ASS'Y

14.07250140E
(x2)
RETAINING RING (C TYPE) - M14

217.D2584465
FLANGE:HEAT ROLLER:EARTH:ASS'Y

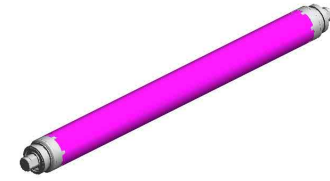

215.D2584460
HEAT ROLLER:ASS'Y

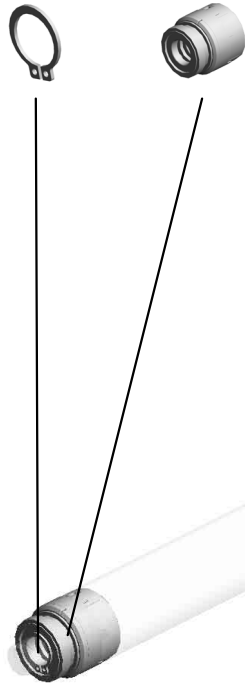

216.D2584464
FLANGE:HEAT ROLLER:ASS'Y

U001	U002	U003	U004	U005	U006	U007	U008	U009	U010	U011	U012	U013	U014	U015	U016	U017	U018	U019	U020	U021
------	------	------	------	------	------	------	------	------	------	------	------	------	------	------	------	------	------	------	------	------

U015_S002_S004_S001
CORE:HEAT ROLLER:ASS'Y

4.03603006N
(x2)
SCREW - M3X6

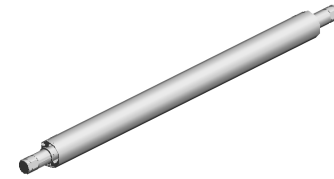

219.D2584468
CORE:HEAT ROLL
ER:ASS'Y

U001	U002	U003	U004	U005	U006	U007	U008	U009	U010	U011	U012	U013	U014	U015	U016	U017	U018	U019	U020	U021
------	------	------	------	------	------	------	------	------	------	------	------	------	------	------	------	------	------	------	------	------

U015_S002_S005
FUSING COVER:UPPER:ASS'Y

35.AA000290
(x2)
DECAL:POSITIONI
NG DISPLAY:SCRE
W:PET

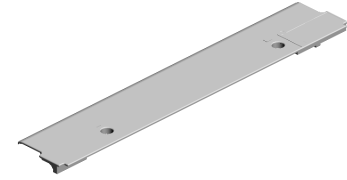
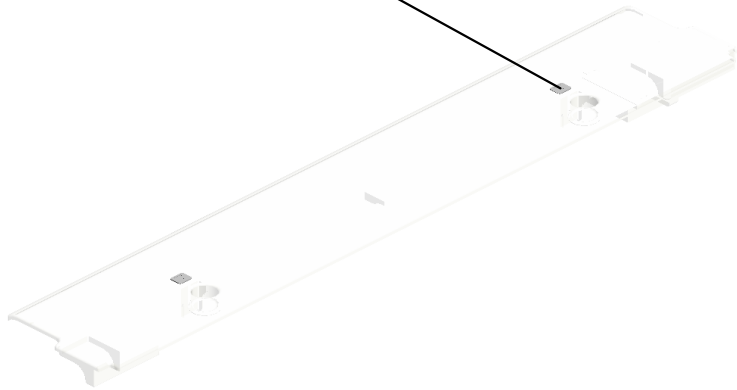

226.D2614352
FUSING COVER:U
PPER:ASS'Y

U001	U002	U003	U004	U005	U006	U007	U008	U009	U010	U011	U012	U013	U014	U015	U016	U017	U018	U019	U020	U021
------	------	------	------	------	------	------	------	------	------	------	------	------	------	------	------	------	------	------	------	------

U015_S002_S006
STRIPPER PLATE:PRESSURE ROLLER:ASS'Y

4.03603006N
(x3)
SCREW - M3X6

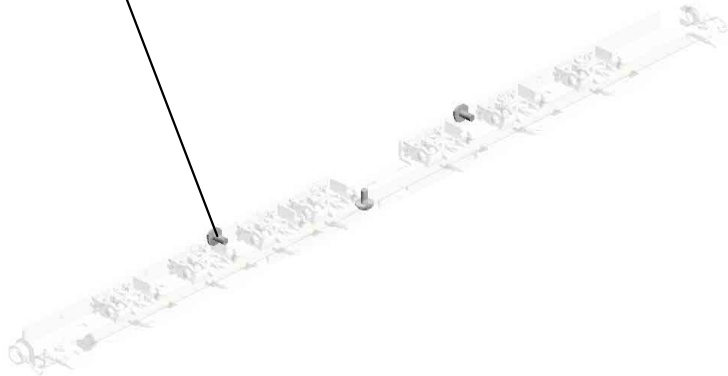

196.D2584228
STRIPPER PLATE:
PRESSURE ROLLER:
ASS'Y



22.08010231
(x9)
HEXAGONAL HEAD
BOLT W/WASHER:
M3X6

4.03603006N (x 1)
SCREW - M3X6

U001	U002	U003	U004	U005	U006	U007	U008	U009	U010	U011	U012	U013	U014	U015	U016	U017	U018	U019	U020	U021
------	------	------	------	------	------	------	------	------	------	------	------	------	------	------	------	------	------	------	------	------

U015_S002_S007
COVER:FUSING UNIT:FRONT:ASS'Y

35.AA000290
(x3)
DECAL:POSITIONI
NG DISPLAY:SCRE
W:PET

34.AA000284
DECAL:GRIP:FUSI
NG:FRONT

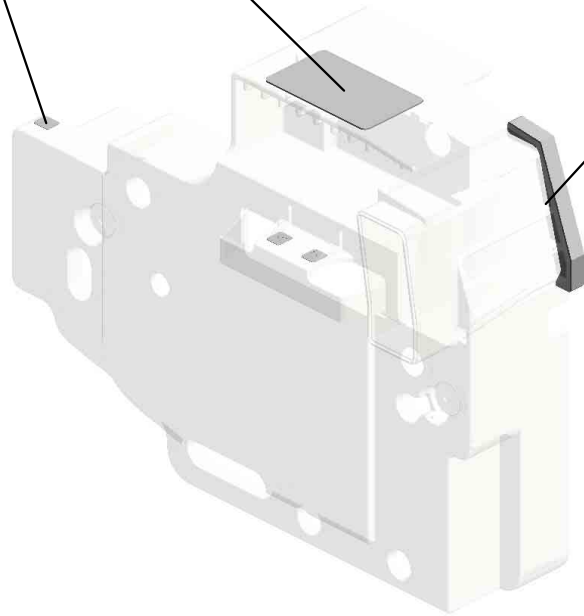

140.D1364236
SPONGE:IH:DUCT:
FRONT

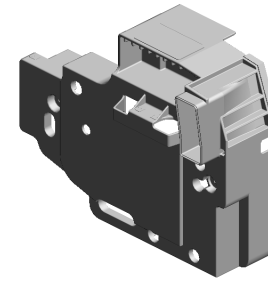

193.D2584204
COVER:FUSING U
NIT:FRONT:ASSY

U015_S003
ROLLER:POLISH:ASS'Y

20.07413706
(x3)
BALL BEARING - 6
X10X3

252.GA082007
PLAIN SHAFT BEA
RING:4XDIA6DIA8

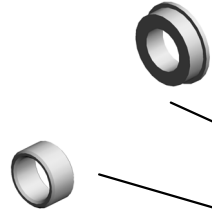

18.07403706
(x2)
BALL BEARING - M
6X10X3



74.AB012203
GEAR:DRIVE:ROLL
ER:FUSING:B



11.07200040E (x 4)
RETAINING RING - M4

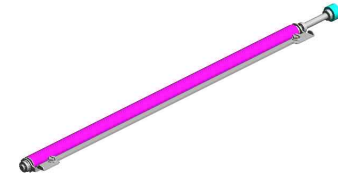

222.D2614036
ROLLER:POLISH:A
SS'Y

U001	U002	U003	U004	U005	U006	U007	U008	U009	U010	U011	U012	U013	U014	U015	U016	U017	U018	U019	U020	U021
------	------	------	------	------	------	------	------	------	------	------	------	------	------	------	------	------	------	------	------	------

U015_S004
WEB:CLEANING UNIT:ASS'Y

- 50.AA066447 TORSION SPRING: FEELER
- 57.AA080356 (x3) BUSHING - 6MM
- 40.AA061160 (x2) COIL SPRING:WEB TENSION:ROLLER
- 18.07403706 (x2) BALL BEARING - M 6X10X3
- 23.08046123 HEXAGONAL BOLT :W/WASHER:M3X8

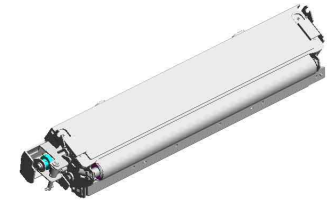

223.D2614045
WEB:CLEANING U
NIT:ASSY

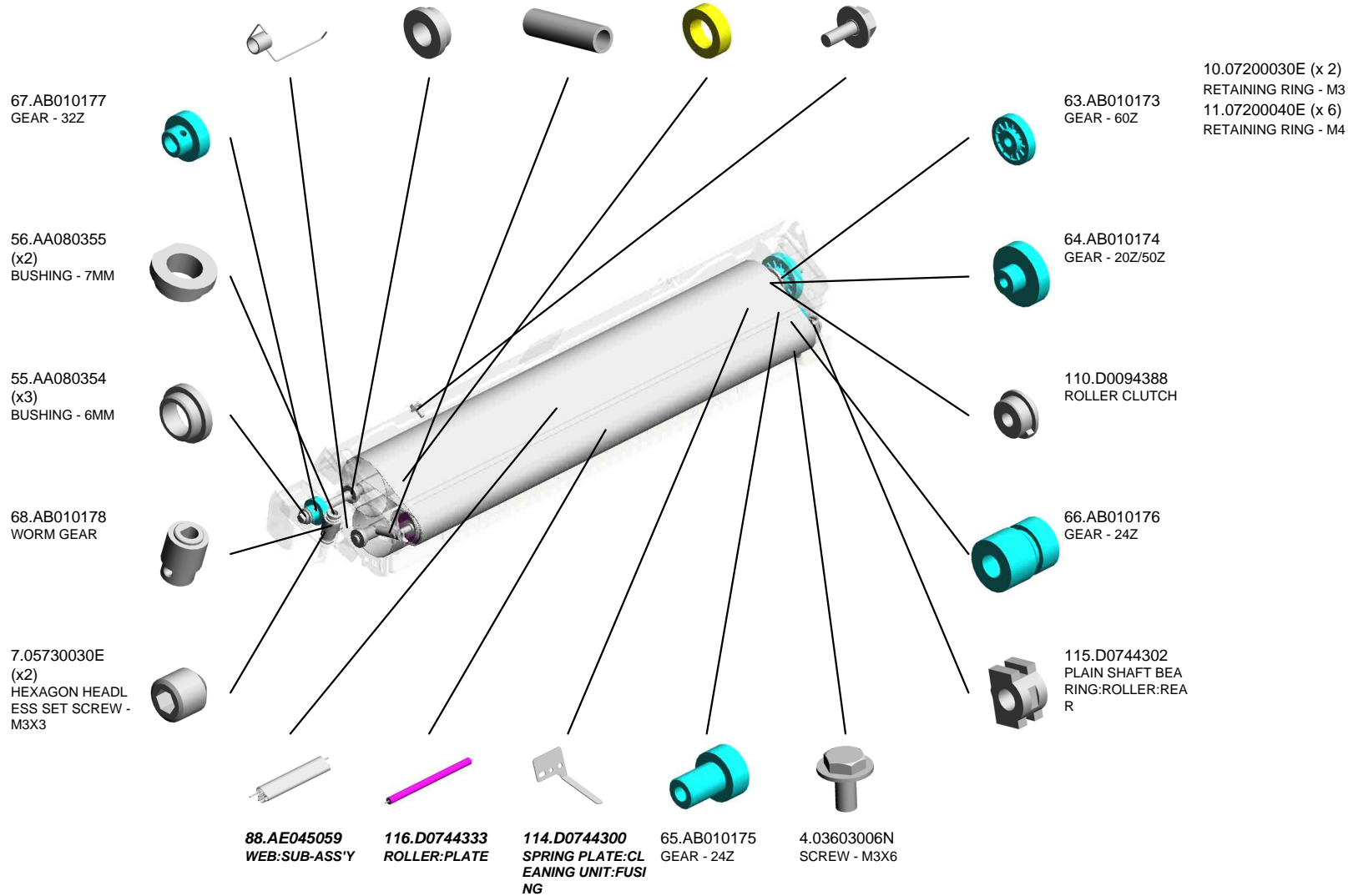

U015_S004
 WEB:CLEANING UNIT:ASS'Y

229.D2614367
 BRACKET:WEB:FRONT

247.D2614434
 RING:WEB:CLEANING

227.D2614364
 FEELER:CLEANING

231.D2614376
 (x2)
 BRACKET:CAM FOLLOWER:WEB:ON-OFF

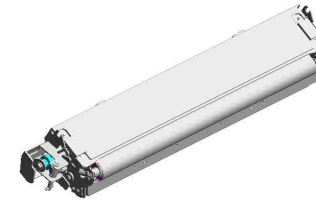

223.D2614045
 WEB:CLEANING UNIT:ASSY

167.D1384401
 BRACKET:WEB:FRONT:AUXILIARY

147.D1384081
 SHAFT:WORM GEAR:WEB:SUB-ASSY

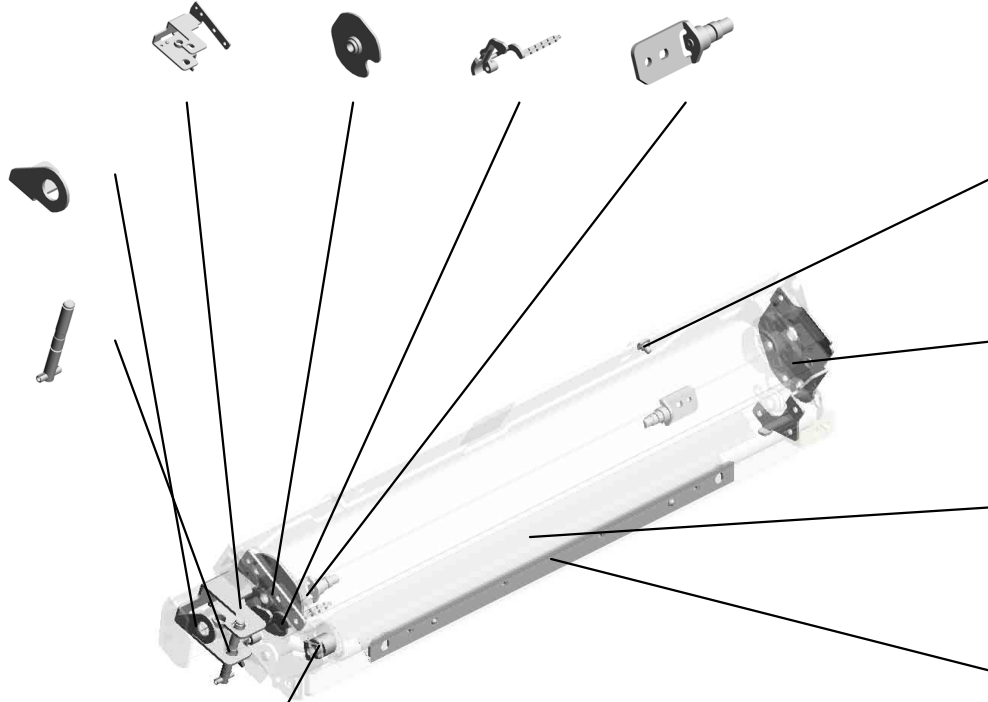

172.D1441085
 STEPPED SCREW: M3

228.D2614365
 BRACKET:REAR:WEB:PEEN

232.D2614378
 BRAKE:WEB

123.D1294331
 FLAT NUT:BRAKE

254.M0774200
 MECHANICAL ROLLER CLUTCH:ROLLER

U015_S004_S001
COVER:WEB:ASS'Y

118.D0744380
DECAL:H-TEMP W
ARNING:FUSING:
WEB

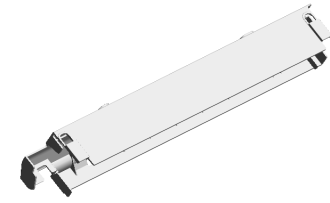
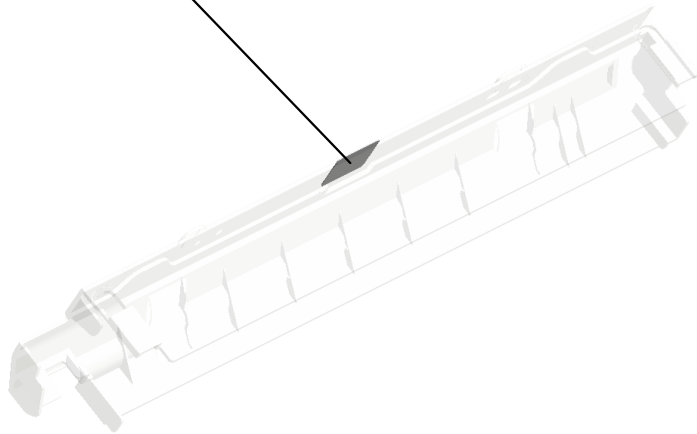

230.D2614372
COVER:WEB:ASS'
Y

U001	U002	U003	U004	U005	U006	U007	U008	U009	U010	U011	U012	U013	U014	U015	U016	U017	U018	U019	U020	U021
------	------	------	------	------	------	------	------	------	------	------	------	------	------	------	------	------	------	------	------	------

U016.PAPER EXIT

U016_S001
D2587011
PAPER EXIT UNIT:ASS'Y

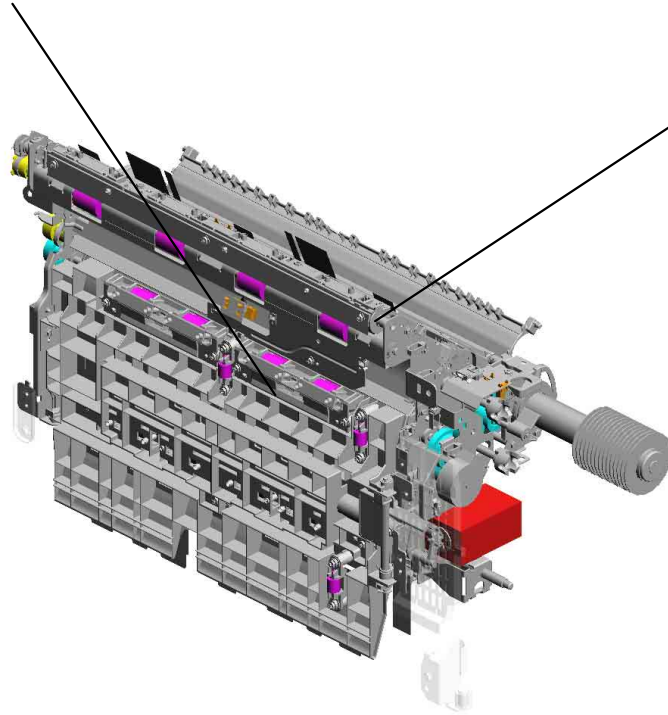
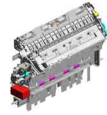

U016_S002
D2587007
HEAT PIPE:PAPER EXIT SUB
-UNIT:ASS'Y



U001	U002	U003	U004	U005	U006	U007	U008	U009	U010	U011	U012	U013	U014	U015	U016	U017	U018	U019	U020	U021
------	------	------	------	------	------	------	------	------	------	------	------	------	------	------	------	------	------	------	------	------

U016_S001.PAPER EXIT UNIT:ASS'Y

U016_S001_S010
D2587167
ROLLER:DRIVEN:EXIT:ASS'Y

U016_S001_S009
D2587167
ROLLER:DRIVEN:EXIT:ASS'Y

U016_S001_S003
D2587167
ROLLER:DRIVEN:EXIT:ASS'Y

U016_S001_S004
D2587167
ROLLER:DRIVEN:EXIT:ASS'Y

U016_S001_S008
D2587167
ROLLER:DRIVEN:EXIT:ASS'Y

U016_S001_S005
D2587167
ROLLER:DRIVEN:EXIT:ASS'Y

U016_S001_S002
D2587167
ROLLER:DRIVEN:EXIT:ASS'Y

U016_S001_S012
D2587167
ROLLER:DRIVEN:EXIT:ASS'Y

U016_S001_S007
D2587167
ROLLER:DRIVEN:EXIT:ASS'Y

U016_S001_S001
D2587023
GUIDE PLATE:EXIT:MIDDLE:
ASS'Y

U016_S001_S006
D2587097
HOLDER:DRIVEN ROLLER:C
ONNECTING

U016_S001_S011
D2587167
ROLLER:DRIVEN:EXIT:ASS'Y

U001	U002	U003	U004	U005	U006	U007	U008	U009	U010	U011	U012	U013	U014	U015	U016	U017	U018	U019	U020	U021
------	------	------	------	------	------	------	------	------	------	------	------	------	------	------	------	------	------	------	------	------

U016_S001.PAPER EXIT UNIT:ASS'Y

U016_S001_S014
D2587167
ROLLER:DRIVEN:EXIT:ASS'Y

U016_S001_S013
D2587167
ROLLER:DRIVEN:EXIT:ASS'Y

U016_S001_S016
D2587123
GRIP:OPEN AND CLOSE:GA
TE PAWL:ASS'Y

U016_S001_S015
D2587144
LEVER:RELEASE:LEFT LOW
ER:ASS'Y

U001	U002	U003	U004	U005	U006	U007	U008	U009	U010	U011	U012	U013	U014	U015	U016	U017	U018	U019	U020	U021
------	------	------	------	------	------	------	------	------	------	------	------	------	------	------	------	------	------	------	------	------

U016_S001_S001.GUIDE PLATE:EXIT:MIDDLE:ASS'Y

U016_S001_S001_S001
D2587075
GUIDE PLATE:EXIT:MIDDLE:
ASS'Y

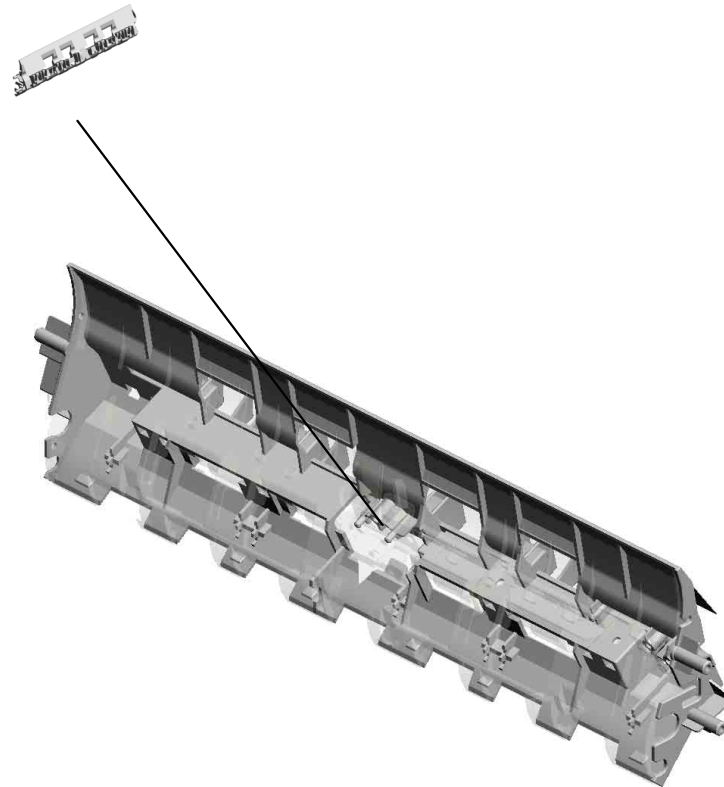

U001	U002	U003	U004	U005	U006	U007	U008	U009	U010	U011	U012	U013	U014	U015	U016	U017	U018	U019	U020	U021
------	------	------	------	------	------	------	------	------	------	------	------	------	------	------	------	------	------	------	------	------

U016 PAPER EXIT

58.B2342390 (x2)
FLANGED HEXAGONAL HEAD BOLT: M4X8

4.04543006N (x4)
TAPPING SCREW: ROUND POINT:3X6

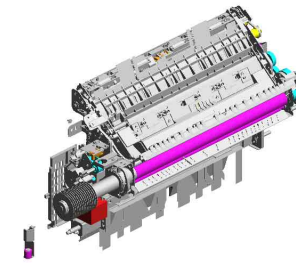

64.D1357110
BRACKET:PROTECT:PAPER EXIT UNIT



63.D1357105
INNER COVER:EXIT:LEFT LOWER



62.D1357100
BRACKET:HOLDER:ASSY

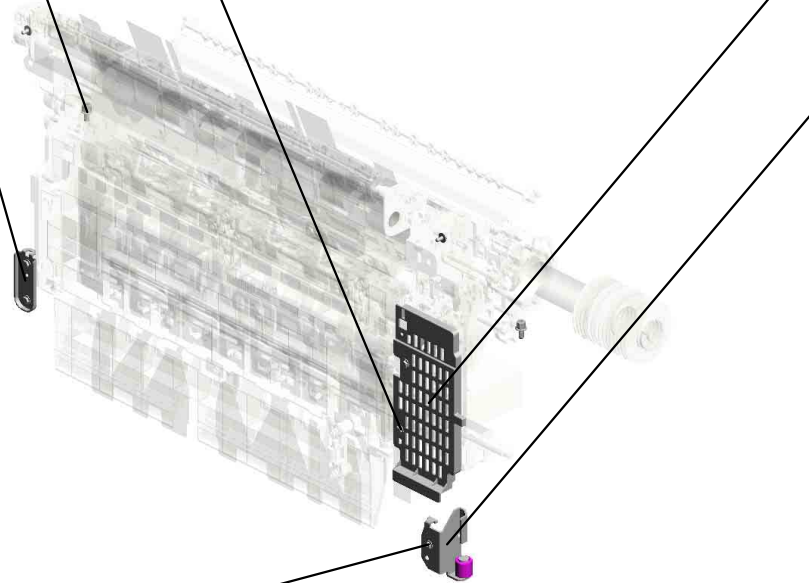

5.04543006Q (x3)
TAPPING SCREW - M3X6



U016_S001 PAPER EXIT UNIT:ASS'Y

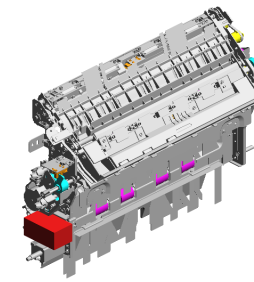

93.D2587011
PAPER EXIT UNIT:
ASS'Y

- 19.54472681 (x2) SNAP RING
- 7.07200020G (x5) RETAINING RING - M2
- 28.AA061146 TENSION SPRING: LINK:GATE PAWL
- 9.07200030G (x2) RETAINING RING - M3
- 29.AA063717 (x32) COMPRESSION SPRING:DRIVEN:EXIT:NO.2

5.04543006Q (x27) TAPPING SCREW - M3X6

26.AA043677 SYNCHRONOUS BELT:40S3M120

21.A4701703 SHIFT CLUTCH

20.59374158 SPRING WASHER - BD10

27.AA043702 SYNCHRONOUS BELT:80S3M204

32.AA063738 (x7) COMPRESSION SPRING:GATE:REVERSE EXIT:0.1N

31.AA063719 (x6) COMPRESSION SPRING:HOLDER:GUIDE PLATE:EXIT

3.03603006N SCREW - M3X6

1.03530040N (x2) SCREW - M3X4

2.03530060N (x2) BIND SCREW - M3X6

6.04583010N (x26) HEXAGON HEAD TAPPING SCREW:3X10

18.11050760 (x4) CLAMP:LWSM-0511A

14.07433806 (x5) RADIAL BALL BEARING:DIA6X DIA13X5

17.11050758 (x10) CLAMP:LWSM-0306A

16.11050692 (x7) CLAMP:LES-0503

5.04543006Q (x3) TAPPING SCREW - M3X6
10.07200040E (x22) RETAINING RING - M4

U001	U002	U003	U004	U005	U006	U007	U008	U009	U010	U011	U012	U013	U014	U015	U016	U017	U018	U019	U020	U021
------	------	------	------	------	------	------	------	------	------	------	------	------	------	------	------	------	------	------	------	------

U016_S001 PAPER EXIT UNIT:ASS'Y

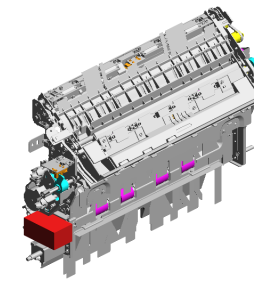

93.D2587011
PAPER EXIT UNIT:
ASS'Y

- 51.AB030881 PULLEY:TORQUE LIMITER:MECHANICAL CLUTCH
- 37.AA066802 TENSION SPRING:TIGHTENER:EXIT
- 43.AB012115 GEAR:SHAFT:HEAT PIPE
- 42.AB012114 GEAR:COUPLING:HEAT PIPE
- 36.AA066801 COIL SPRING:GUIDE PLATE:UPPER:REAR

50.AB017933 PULLEY:GEAR:EXIT

44.AB012970 GEAR:ROLLER:REVERSE:EXIT

47.AB017930 GEAR:REVERSE EXIT:IDLER:NO.1

40.AA160030 (x2) DAMPING INSULATION:STAY:OUTER

52.AB030882 TIMING PULLEY:EXIT

39.AA120145 DISCHARGE BRUSH:REVERSE:17MM

41.AA160031 DAMPING INSULATION:STAY:INNER

38.AA082173 (x6) PLAIN SHAFT BEARING:6X10X6

34.AA066432 COIL SPRING:OPEN AND CLOSE:LEFT LOWER:GUIDE PLATE:LOWER

33.AA066431 COIL SPRING:OPEN AND CLOSE:LEFT LOWER:GUIDE PLATE:UPPER

35.AA066800 COIL SPRING:GUIDE PLATE:UPPER:FRONT

45.AB012973 GEAR:SHAFT:GATE PAWL:EXIT

46.AB012974 GEAR:IDLER:COUPLING:GATE PAWL

49.AB017932 GEAR:IDLER:CONTACT POINT:GATE PAWL

48.AB017931 GEAR:IDLER:DC STEPPER MOTOR:GATE PAWL

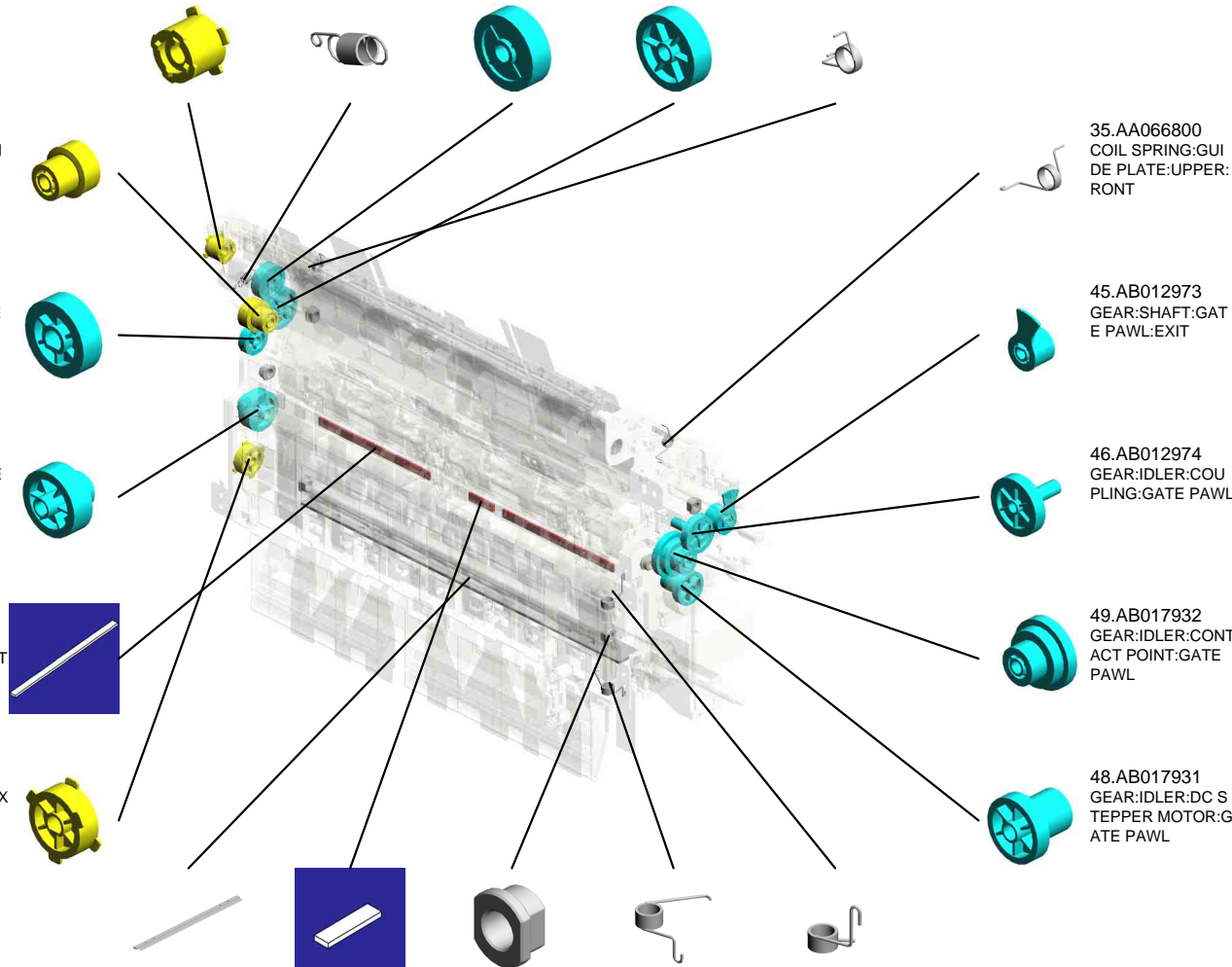

U016_S001 PAPER EXIT UNIT:ASS'Y

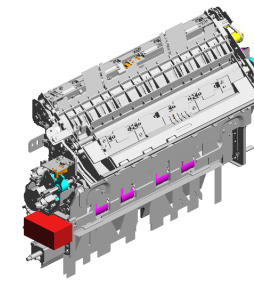

93.D2587011
PAPER EXIT UNIT:
ASSY

- 66.D1357121 COIL SPRING:STOPPER:EXIT:NO.1
- 68.D1357127 STOPPER:GUIDE PLATE:EXIT:UPPER
- 54.AB030884 PULLEY:EXIT:NO.2
- 72.D1367081 LINK:GATE PAWL:RETURN
- 71.D1357169 ROLLER:REVERSE:ENTRANCE:ASS'Y

69.D1357128
BRACKET:CONTACT POINT:STOPPER:ASS'Y

59.B2474456
SPRING - LOWER EXIT ROLLER

53.AB030883
PULLEY:EXIT:NO.1

70.D1357136
BRACKET:PAPER EXIT SUB-UNIT:REVERSE:NO.1

60.B7002649
TIMING BELT:40S2 M144

65.D1357114
ROLLER:REVERSE EXIT:ASS'Y

73.D1367115
LINK:ON-OFF:REVERSE EXIT

76.D1367119
SHAFT:LEVER:GUIDE PLATE:LEFT LOWER

74.D1367117
LEVER:LINK:ON-OFF:REVERSE EXIT

61.D0294439
STOPPER:GATE PAWL:ENTRANCE

56.AW020203
PHOTOINTERRUPTOR:GP1A173LCS 2F

55.AF022067
(x3)
GUIDE STOPPER ROLLER

67.D1357122
BRACKET:DC STOPPER MOTOR:GATE PAWL:ASS'Y

75.D1367118
(x2)
LEVER:FIX:GUIDE PLATE:LEFT LOWER

57.AW500040
(x2)
PUSH SWITCH:SW1AG-550:10MA

U001	U002	U003	U004	U005	U006	U007	U008	U009	U010	U011	U012	U013	U014	U015	U016	U017	U018	U019	U020	U021
------	------	------	------	------	------	------	------	------	------	------	------	------	------	------	------	------	------	------	------	------

U016_S001
PAPER EXIT UNIT:ASS'Y

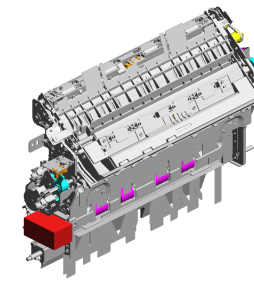

93.D2587011
PAPER EXIT UNIT:
ASS'Y

103.D2587081
GUIDE PLATE:EXIT
:LEFT UPPER:ASS'
Y

86.D1367194
(x24)
PLAIN SHAFT BEA
RING:DIA4:EXIT

105.D2587091
GUIDE PLATE:EXIT
:UPPER

81.D1367133
SHAFT:RELEASE:
GUIDE PLATE:UPP
ER

95.D2587047
GATE PAWL:PAPE
R EXIT SUB-UNIT:
REVERSE:ENTRAN
CE:ASS'Y

84.D1367159
CUSHION:STOPPE
R:GUIDE PLATE:E
XIT:UPPER

104.D2587090
(x2)
LEVER:FIX:GUIDE
PLATE:UPPER

97.D2587066
GUIDE PLATE:EXIT
:RIGHT

91.D2412719
(x2)
GROUND PLATE:S
ENSOR:TRANSPO
RT

85.D1367193
(x8)
HOLDER:PRESSU
RE:RADIAL BALL B
EARING:EXIT

89.D1387055
HOLDER:DRIVEN
ROLLER:REVERSE
EXIT

90.D1444484
(x3)
SHOULDER SCRE
W - M3

96.D2587065
GUIDE PLATE:EXIT
:RIGHT LOWER

79.D1367125
COMPRESSION SP
RING:PLATE:ON O
FF DETECTOR:LEF
T LOWER

80.D1367126
BRACKET:PLATE:
ON OFF DETECTO
R:LEFT LOWER:AS
S'Y

82.D1367135
LINK:GRIP:GUIDE
PLATE:UPPER

83.D1367136
GRIP:GUIDE PLAT
E:EXIT:UPPER:ASS
Y

88.D1381308
(x2)
JOINT:EXIT:DRIVE:
0.5

78.D1367123
(x3)
HOLDER:PRESSU
RE:GUIDE PLATE:
EXIT

77.D1367120
(x2)
BRACKET:LEVER:F
IX:GUIDE PLATE:L
EFT LOWER

U016_S001 PAPER EXIT UNIT:ASS'Y

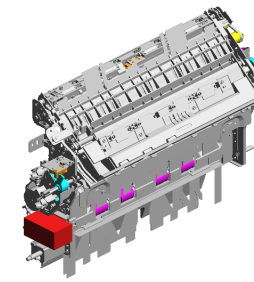

93.D2587011
PAPER EXIT UNIT:
ASS'Y

- 112.D2587106 BRACKET:TIGHTNER:EXIT:ASS'Y
- 115.D2587115 ROLLER:EXIT:EXIT:ASS'Y
- 108.D2587095 DISCHARGE BRUSH:EXIT:SUS
- 106.D2587093 HOLDER:DRIVEN ROLLER:EXIT:EXIT
- 116.D2587116 ROLLER:EXIT:MIDDLE:ASS'Y

113.D2587108 COLLAR:COUPLING:HEAT PIPE



120.D2587127 (x3) GATE:REVERSE EXIT:REAR



123.D2587142 (x2) HOLDER:DRIVEN ROLLER:REVERSE EXIT



119.D2587126 (x4) GATE:REVERSE EXIT:FRONT



107.D2587094 GROUND PLATE:EXIT:GUIDE PLATE:UPPER

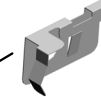

117.D2587117 ROLLER:REVERSE EXIT:ASS'Y

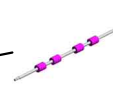

114.D2587113 STEPPER MOTOR:GEAR



111.D2587102 BRACKET:DC SOLENOID:REVERSE EXIT

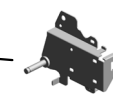

110.D2587100 DC SOLENOID:REVERSE EXIT:ASS'Y

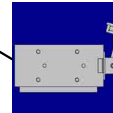

122.D2587134 GUIDE PLATE:EXIT:LEFT LOWER:ASS'Y

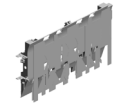

129.GW010007 (x4) PHOTO REFLECTION SENSOR:EXIT



121.D2587128 SHAFT:GATE:REVERSE EXIT



128.D2587168 (x4) ROLLER:DRIVEN:REVERSE EXIT:ASS'Y



U016_S001_S001

GUIDE PLATE:EXIT:MIDDLE:ASS'Y

29.AA063717 (x4)
COMPRESSION SPRING:DRIVEN:EXIT:NO.2

87.D1367199
SHEET:OPPOSED: REFLECTION PHOTO SENSOR

98.D2587071
GUIDE PLATE:MIDDLE:LEFT

90.D1444484
SHOULDER SCREW - M3

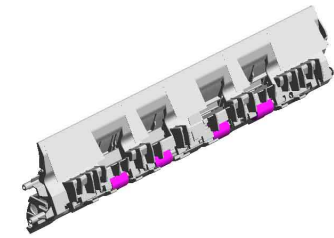

94.D2587023
GUIDE PLATE:EXIT:MIDDLE:ASS'Y

6.04583010N (x4)
HEXAGON HEAD TAPPING SCREW:3X10



85.D1367193 (x6)
HOLDER:PRESSURE:RADIAL BALL BEARING:EXIT



125.D2587163 (x2)
ROLLER:DRIVEN:NO.2:SHORT:ASSY

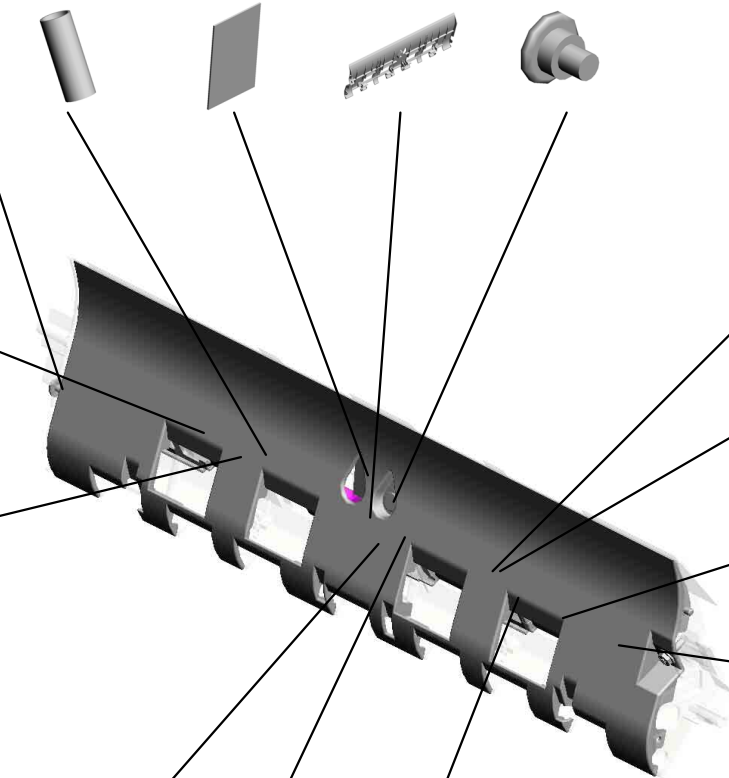

30.AA063718 (x2)
COMPRESSION SPRING:DRIVEN:EXIT:NO.1



17.11050758
CLAMP:LWSM-0306A



126.D2587164
ROLLER:DRIVEN:NO.2:LONG:ASSY



101.D2587074 (x2)
GUIDE PLATE:DRIVEN:MIDDLE:FRONT



129.GW010007
PHOTO REFLECTION SENSOR:EXIT



99.D2587072
GUIDE PLATE:DRIVEN:MIDDLE:MIDDLE



100.D2587073 (x2)
GUIDE PLATE:DRIVEN:MIDDLE:REAR



U016_S001_S001_S001
GUIDE PLATE:EXIT:MIDDLE:ASS'Y

87.D1367199
SHEET:OPPOSED:
REFLECTION PHO
TO SENSOR

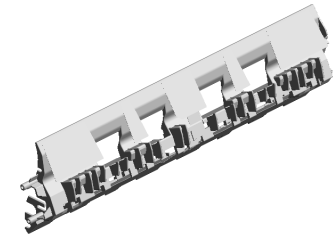

102.D2587075
GUIDE PLATE:EXIT
:MIDDLE:ASS'Y

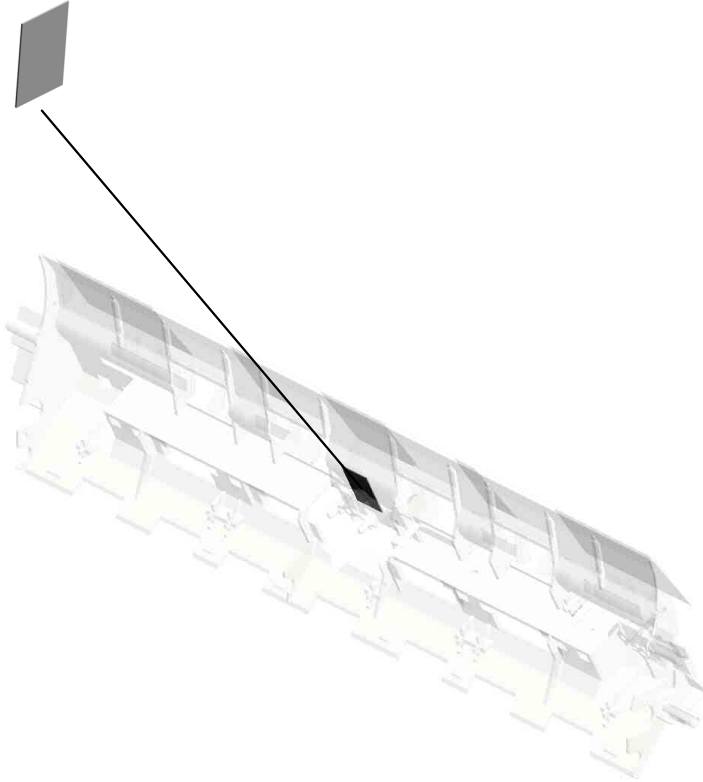

U001	U002	U003	U004	U005	U006	U007	U008	U009	U010	U011	U012	U013	U014	U015	U016	U017	U018	U019	U020	U021
------	------	------	------	------	------	------	------	------	------	------	------	------	------	------	------	------	------	------	------	------

U016_S001_S002
ROLLER:DRIVEN:EXIT:ASS'Y

10.07200040E
(x2)
RETAINING RING -
M4

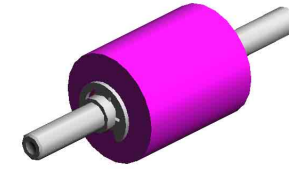

127.D2587167
ROLLER:DRIVEN:EXIT:ASS'Y

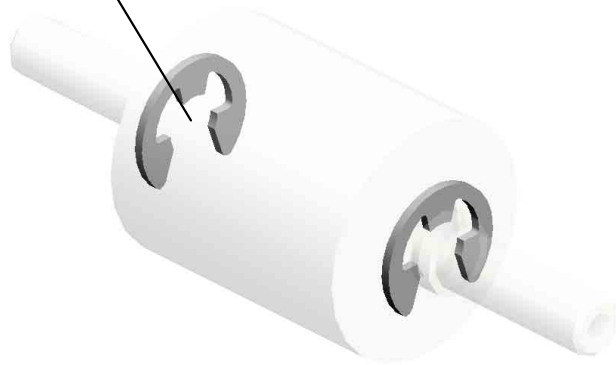

U001	U002	U003	U004	U005	U006	U007	U008	U009	U010	U011	U012	U013	U014	U015	U016	U017	U018	U019	U020	U021
------	------	------	------	------	------	------	------	------	------	------	------	------	------	------	------	------	------	------	------	------

U016_S001_S003
ROLLER:DRIVEN:EXIT:ASS'Y

10.07200040E
(x2)
RETAINING RING -
M4

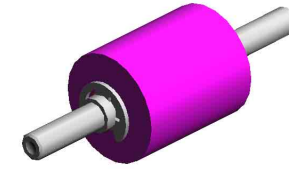

127.D2587167
ROLLER:DRIVEN:EXIT:ASS'Y

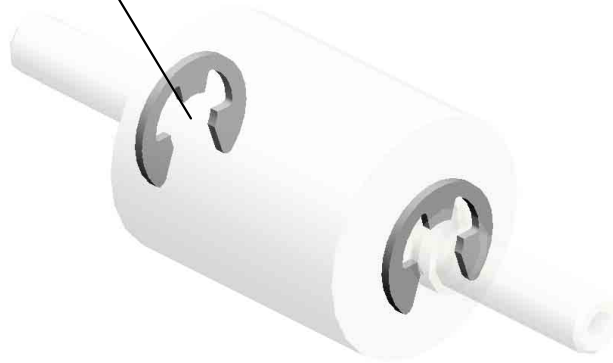

U001	U002	U003	U004	U005	U006	U007	U008	U009	U010	U011	U012	U013	U014	U015	U016	U017	U018	U019	U020	U021
------	------	------	------	------	------	------	------	------	------	------	------	------	------	------	------	------	------	------	------	------

U016_S001_S004
ROLLER:DRIVEN:EXIT:ASS'Y

10.07200040E
(x2)
RETAINING RING -
M4

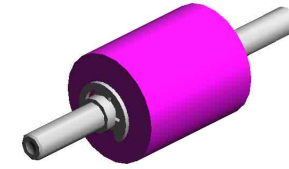

127.D2587167
ROLLER:DRIVEN:EXIT:ASS'Y

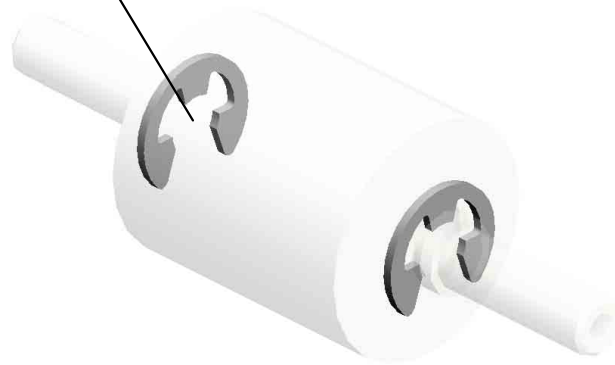

U001	U002	U003	U004	U005	U006	U007	U008	U009	U010	U011	U012	U013	U014	U015	U016	U017	U018	U019	U020	U021
------	------	------	------	------	------	------	------	------	------	------	------	------	------	------	------	------	------	------	------	------

U016_S001_S005
ROLLER:DRIVEN:EXIT:ASS'Y

10.07200040E
(x2)
RETAINING RING -
M4

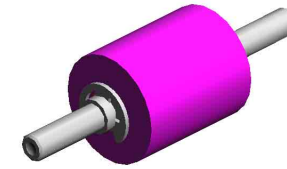

127.D2587167
ROLLER:DRIVEN:EXIT:ASS'Y

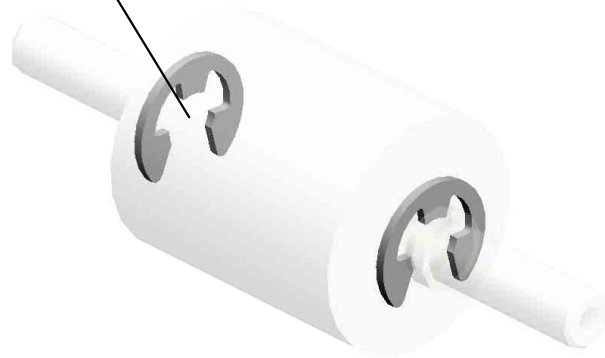

U001	U002	U003	U004	U005	U006	U007	U008	U009	U010	U011	U012	U013	U014	U015	U016	U017	U018	U019	U020	U021
------	------	------	------	------	------	------	------	------	------	------	------	------	------	------	------	------	------	------	------	------

U016_S001_S006
HOLDER:DRIVEN ROLLER:CONNECTING

22.AA003059
DECAL:EXIT:GUID
E PLATE:UPPER:P
USH

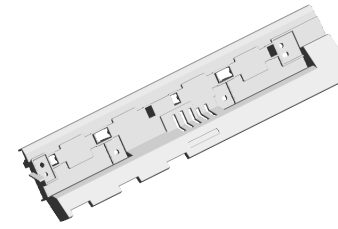

109.D2587097
HOLDER:DRIVEN
ROLLER:CONNEC
TING

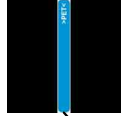

U001	U002	U003	U004	U005	U006	U007	U008	U009	U010	U011	U012	U013	U014	U015	U016	U017	U018	U019	U020	U021
------	------	------	------	------	------	------	------	------	------	------	------	------	------	------	------	------	------	------	------	------

U016_S001_S007
ROLLER:DRIVEN:EXIT:ASS'Y

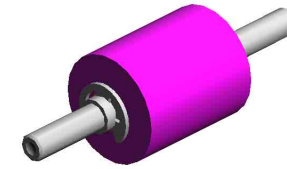

127.D2587167
ROLLER:DRIVEN:EXIT:ASS'Y

10.07200040E (x 2)
RETAINING RING - M4

U001	U002	U003	U004	U005	U006	U007	U008	U009	U010	U011	U012	U013	U014	U015	U016	U017	U018	U019	U020	U021
------	------	------	------	------	------	------	------	------	------	------	------	------	------	------	------	------	------	------	------	------

U016_S001_S008
ROLLER:DRIVEN:EXIT:ASS'Y

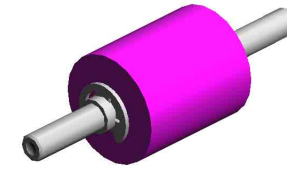

127.D2587167
ROLLER:DRIVEN:EXIT:ASS'Y

10.07200040E (x 2)
RETAINING RING - M4

U001	U002	U003	U004	U005	U006	U007	U008	U009	U010	U011	U012	U013	U014	U015	U016	U017	U018	U019	U020	U021
------	------	------	------	------	------	------	------	------	------	------	------	------	------	------	------	------	------	------	------	------

U016_S001_S009
ROLLER:DRIVEN:EXIT:ASS'Y

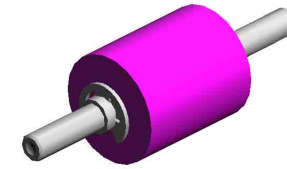

127.D2587167
ROLLER:DRIVEN:EXIT:ASS'Y

10.07200040E (x 2)
RETAINING RING - M4

U001	U002	U003	U004	U005	U006	U007	U008	U009	U010	U011	U012	U013	U014	U015	U016	U017	U018	U019	U020	U021
------	------	------	------	------	------	------	------	------	------	------	------	------	------	------	------	------	------	------	------	------

U016_S001_S010
ROLLER:DRIVEN:EXIT:ASS'Y

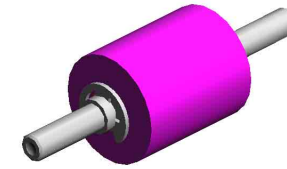

127.D2587167
ROLLER:DRIVEN:EXIT:ASS'Y

10.07200040E (x 2)
RETAINING RING - M4

U001	U002	U003	U004	U005	U006	U007	U008	U009	U010	U011	U012	U013	U014	U015	U016	U017	U018	U019	U020	U021
------	------	------	------	------	------	------	------	------	------	------	------	------	------	------	------	------	------	------	------	------

U016_S001_S011
ROLLER:DRIVEN:EXIT:ASS'Y

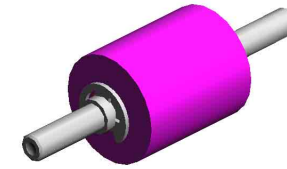

127.D2587167
ROLLER:DRIVEN:EXIT:ASS'Y

10.07200040E (x 2)
RETAINING RING - M4

U001	U002	U003	U004	U005	U006	U007	U008	U009	U010	U011	U012	U013	U014	U015	U016	U017	U018	U019	U020	U021
------	------	------	------	------	------	------	------	------	------	------	------	------	------	------	------	------	------	------	------	------

U016_S001_S012
ROLLER:DRIVEN:EXIT:ASS'Y

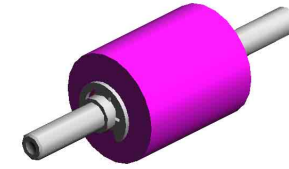

127.D2587167
ROLLER:DRIVEN:EXIT:ASS'Y

10.07200040E (x 2)
RETAINING RING - M4

U001	U002	U003	U004	U005	U006	U007	U008	U009	U010	U011	U012	U013	U014	U015	U016	U017	U018	U019	U020	U021
------	------	------	------	------	------	------	------	------	------	------	------	------	------	------	------	------	------	------	------	------

U016_S001_S013
ROLLER:DRIVEN:EXIT:ASS'Y

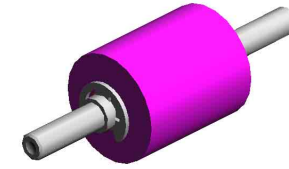

127.D2587167
ROLLER:DRIVEN:EXIT:ASS'Y

10.07200040E (x 2)
RETAINING RING - M4

U001	U002	U003	U004	U005	U006	U007	U008	U009	U010	U011	U012	U013	U014	U015	U016	U017	U018	U019	U020	U021
------	------	------	------	------	------	------	------	------	------	------	------	------	------	------	------	------	------	------	------	------

U016_S001_S014
ROLLER:DRIVEN:EXIT:ASS'Y

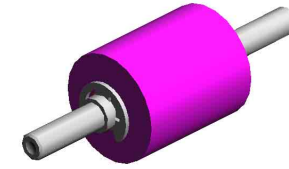

127.D2587167
ROLLER:DRIVEN:EXIT:ASS'Y

10.07200040E (x 2)
RETAINING RING - M4

U001	U002	U003	U004	U005	U006	U007	U008	U009	U010	U011	U012	U013	U014	U015	U016	U017	U018	U019	U020	U021
------	------	------	------	------	------	------	------	------	------	------	------	------	------	------	------	------	------	------	------	------

U016_S001_S015
LEVER:RELEASE:LEFT LOWER:ASS'Y

25.AA003081
DECAL:LEVER::GU
IDE PLATE:LEFT L
OWER

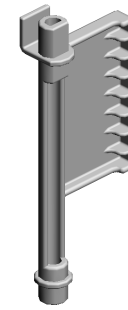

124.D2587144
LEVER:RELEASE:L
EFT LOWER:ASS'Y

U001	U002	U003	U004	U005	U006	U007	U008	U009	U010	U011	U012	U013	U014	U015	U016	U017	U018	U019	U020	U021
------	------	------	------	------	------	------	------	------	------	------	------	------	------	------	------	------	------	------	------	------

U016_S001_S016

GRIP:OPEN AND CLOSE:GATE PAWL:ASS'Y

24.AA003080
DECAL:GRIP:OPEN
AND CLOSE:GATE
PAWL:NO.1

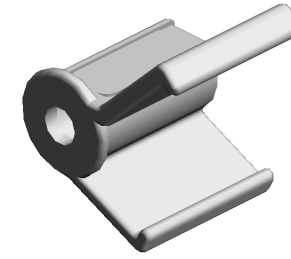

118.D2587123
GRIP:OPEN AND C
LOSE:GATE PAWL:
ASSY

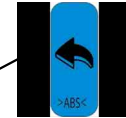

23.AA003064
DECAL:GRIP:OPEN
AND CLOSE:GATE
PAWL:NO.2

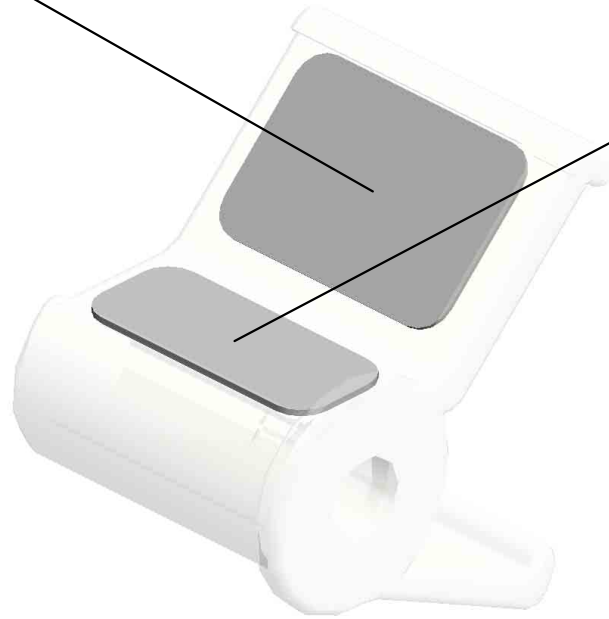

U001	U002	U003	U004	U005	U006	U007	U008	U009	U010	U011	U012	U013	U014	U015	U016	U017	U018	U019	U020	U021
------	------	------	------	------	------	------	------	------	------	------	------	------	------	------	------	------	------	------	------	------

U016_S002
HEAT PIPE:PAPER EXIT SUB-UNIT:ASS'Y

3.03603006N
(x8)
SCREW - M3X6

8.07200030E
(x2)
RETAINING RING -
M3



92.D2587007
HEAT PIPE:PAPER
EXIT SUB-UNIT:AS
SY

15.08050104
RETAINING RINGS
-E:SILENCER:DIA4



10.07200040E
RETAINING RING -
M4

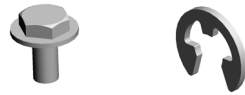

11.07200060E
RETAINING RING -
M6



13.07413708
BALL BEARING - 8
X12X3.5MM



5.04543006Q
(x5)
TAPPING SCREW -
M3X6



12.07413706
BALL BEARING - 6
X10X3



10.07200040E (x 1)
RETAINING RING - M4

U017.DUPLEX

U017_S004
D2584907
GUIDE PLATE:SWIVEL:UPPE
R:ASS'Y

U017_S001
D1364611
TRANSPORT ROLLER:DUPL
EX:DRIVEN:1

U017_S002
D2584550
GUIDE PLATE:DUPLEX:LOW
ER:ASS'Y

U017_S003
D2584921
GRIP:VIBRATING PLATE:RE
CEIVING UNIT:LOWER:ASS'Y

U017_S005
D2584919
INNER COVER:RECEIVING U
NIT:LEFT LOWER:ASS'Y

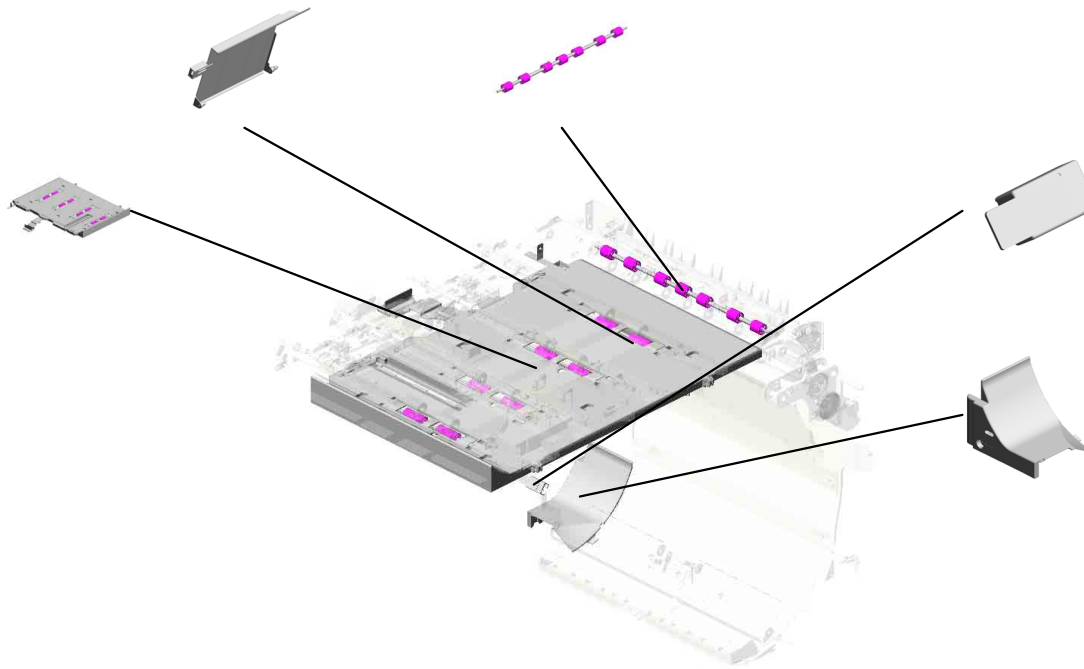

U001	U002	U003	U004	U005	U006	U007	U008	U009	U010	U011	U012	U013	U014	U015	U016	U017	U018	U019	U020	U021
------	------	------	------	------	------	------	------	------	------	------	------	------	------	------	------	------	------	------	------	------

U017 DUPLEX

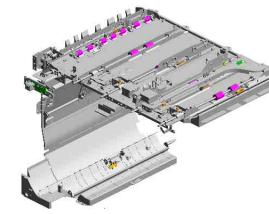

- 15.11050517 (x2) HARNESS CLAMP - LWS-2111Z
- 5.04583008N (x2) HEXAGON HEAD TAPPING SCREW:3 X8
- 12.08025299 TAPPING SCREW - M3X8
- 19.11050758 (x20) CLAMP:LWSM-030 6A
- 20.11050760 CLAMP:LWSM-051 1A

- 14.11050328 (x2) HARNESS CLAMP - ES-0505

- 2.04543006Q (x73) TAPPING SCREW - M3X6

- 1.03530040N (x12) SCREW - M3X4

- 7.07200030E (x6) RETAINING RING - M3

- 13.08050089 (x7) RETAINING RING - M4

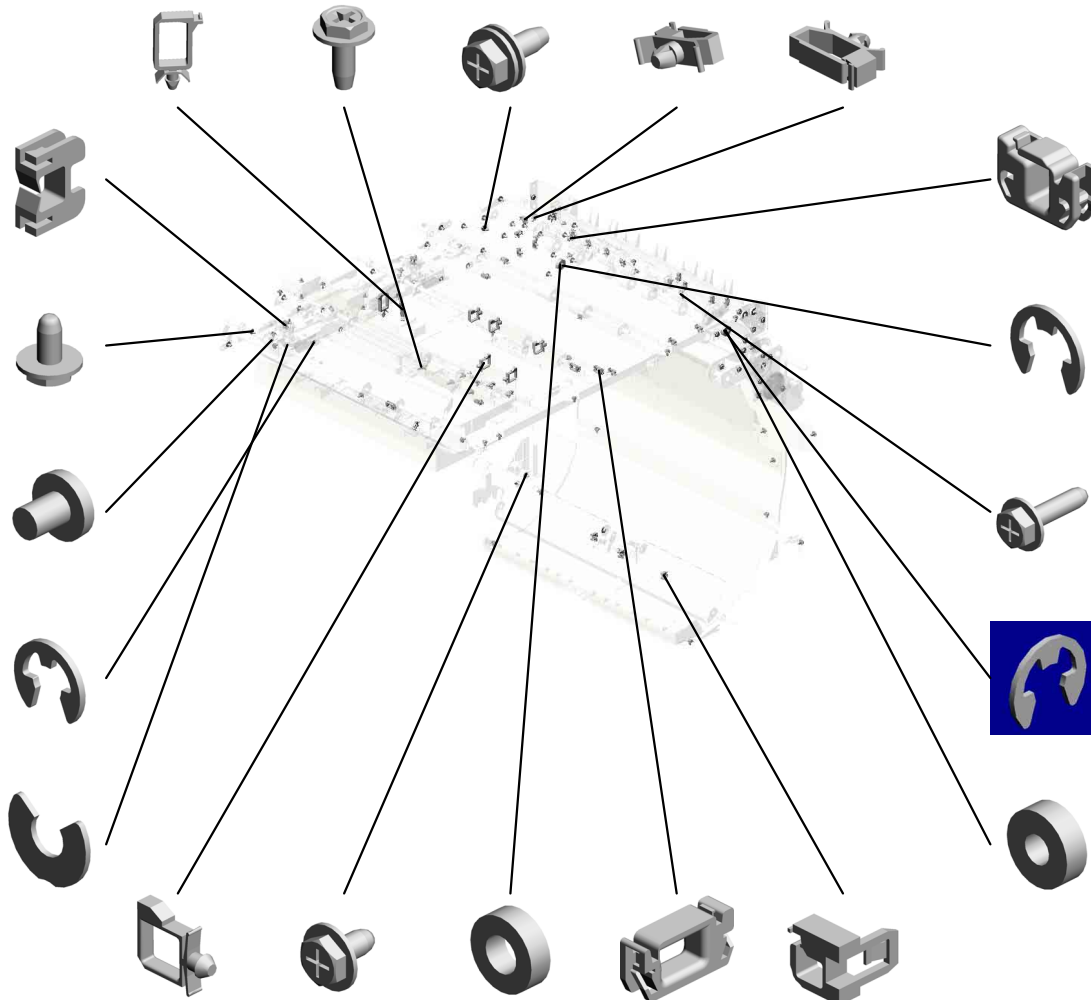

- 17.11050692 (x2) CLAMP:LES-0503



- 17.11050692 CLAMP:LES-0503

- 21.11050762 CLAMP:LWS-0711A

- 9.07200060E RETAINING RING - M6



- 2.04543006Q (x 1) TAPPING SCREW - M3X6
- 8.07200040E (x 1) RETAINING RING - M4

- 4.04543012Q TAPPING SCREW: 3X12



- 8.07200040E (x2) RETAINING RING - M4



- 11.07403906 BALL BEARING - 6 X15X5



- 22.11050763 (x5) CLAMP:LWS-1211A

- 3.04543008N TAPPING SCREW: ROUND POINT:3X8

- 10.07403808 BALL BEARING - 8 X16X5MM

- 18.11050723 (x3) CLAMPS:WES-050 7

- 16.11050568 (x3) CLAMP:LWSS-0504

U017 DUPLEX

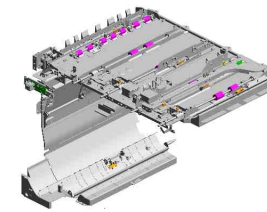

29.AA143183
(x2)
STEPPED SCREW

25.AA021034
MAGNETIC

42.B7004720
TIMING BELT:B40S
2M214

41.B2234552
(x2)
BUSHING:DIA4

40.B2234494
STOPPER- UPPER
GATE PAWL

39.AW500040
(x2)
PUSH SWITCH:SW
1AG-550:10MA

27.AA080346
(x4)
BUSHING:FLANGE
TYPE:DIA6

26.AA043634
TIMING BELT - 40S
2M296

38.AW020203
(x3)
PHOTOINTERRUPTOR:
GP1A173LCS
2F

31.AF020794
(x4)
TRANSPORT ROLLER:
SHIFT:DUPLEX

45.D1364531
BRACKET:BELT TENSIONER:
ASS'Y

23.54472681
(x2)
SNAP RING

35.AG070515
(x2)
MAGNET CATCH:1
3N

30.AC020150
LENS:LED:1

37.AW020198
PHOTOINTERRUPTOR:
TOR:LG2A14NL1

33.AF020842
TRANSPORT ROLLER:
DUPLEX:ENTRANCE

36.AW010091
PHOTO REFLECTION
SENSOR

28.AA082173
(x4)
PLAIN SHAFT BEARING:
6X10X6

32.AF020840
TRANSPORT ROLLER:
DRIVE:REVERSE

43.B8352889
TIMING BELT - B60
S2M144

U017 DUPLEX

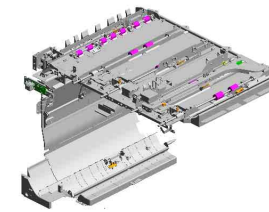

- 60.D1364653 STOPPER:PULLEY: LEFT
- 66.D1364673 GUIDE PLATE:POSITIONING SENSOR :DUPLEX
- 70.D1364751 BRACKET:DUPLEX :ENTRANCE:FRONT
- 72.D1364762 LEVER:GATE PAWL:REVERSE
- 74.D1364768 (x7) COIL SPRING:GATE PAWL:DUPLEX:ENTRANCE:NO.2

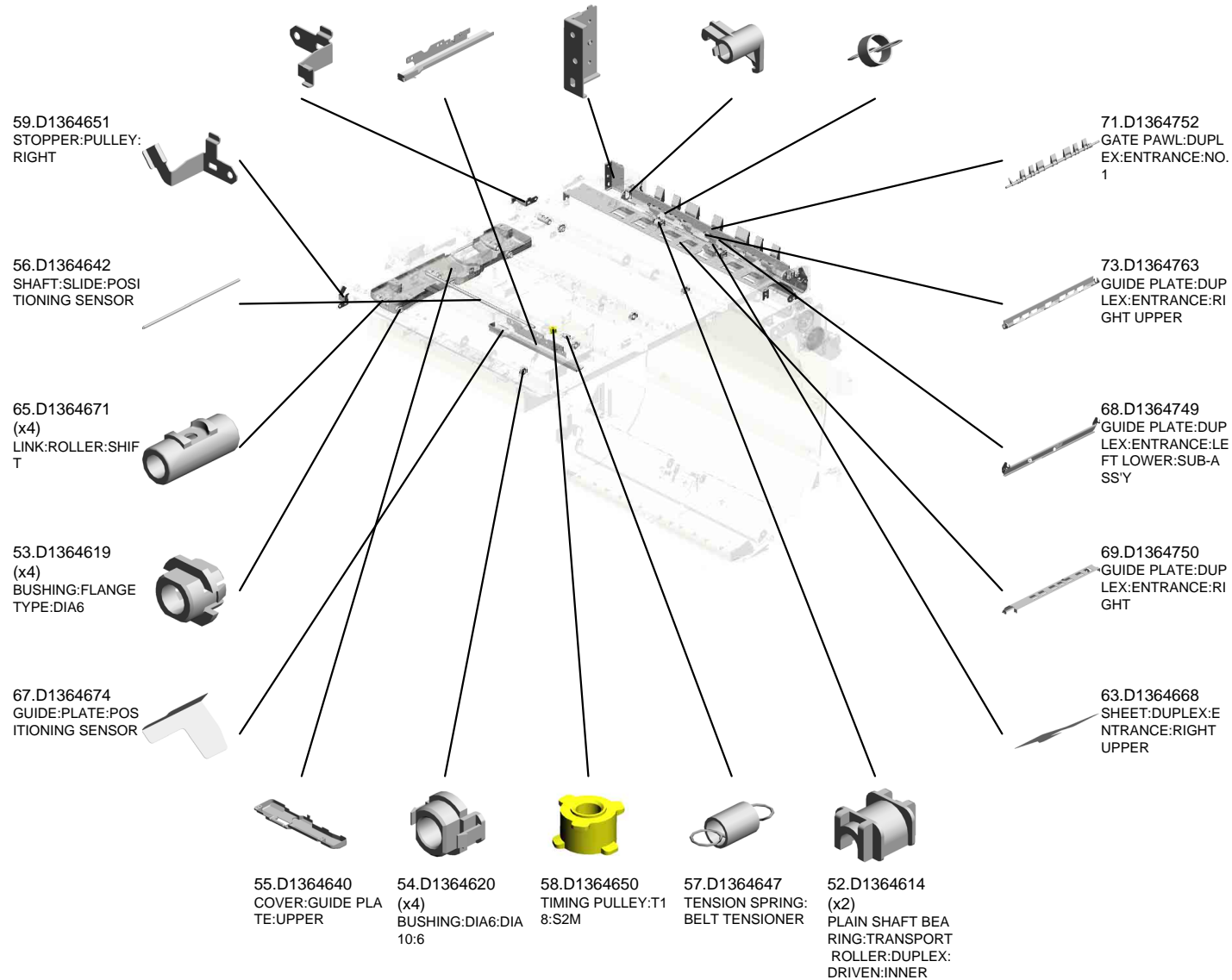

U017 DUPLEX

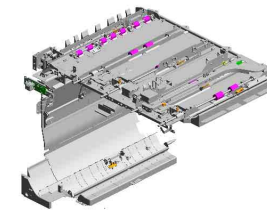

- 82.D1364961 LED:SWITCH:REV
ERSE EXIT:ASS'Y
- 75.D1364770 TENSION SPRING:
GATE PAWL:DUPL
EX
- 76.D1364771 TENSION SPRING:
DC SOLENOID:REL
EASE
- 84.D1367167 (x2)
ROLLER:DRIVEN:N
O.2:SHORT:ASS'Y
- 78.D1364830 GUIDE PLATE:LEF
T:REVERSE:DUPL
EX

91.D2416290
(x2)
LED:RED

93.D2584523
GUIDE PLATE:DUPL
EX:UPPER:ADHE
SION

96.D2584621
(x4)
SHAFT:LINK:SHIFT

95.D2584563
GUIDE PLATE:DUPL
EX:EXIT:ASS'Y

89.D1374965
COVER:GUIDE PLA
TE:SWIVEL:RECEI
VING SUB-UNIT:LO
WER

81.D1364949
COVER:RECEIVIN
G SUB-UNIT:RIGHT
LOWER

86.D1374913
GUIDE PLATE:SWI
VEL:RECEIVING S
UB-UNIT:LOWER:P
EEN

90.D1374966
FEELER:SENSOR:
RECEIVING SUB-U
NIT

87.D1374941
COIL SPRING:GUI
DE PLATE:SWIVEL
:RECEIVING SUB-U
NIT:UPPER

80.D1364936
GUIDE PLATE:REC
EIVING SUB-UNIT:
LOWER

77.D1364829
TIMING PULLEY:D
UPLEX:REVERSE:
S2M54T

85.D1374828
BRACKET:DC MOT
OR:REVERSE

79.D1364928
GUIDE PLATE:REC
EIVING SUB-UNIT:
LEFT LOWER

92.D2581320
DC MOTOR:20W:B
RUSHLESS

88.D1374948
GUIDE PLATE:REC
EIVING SUB-UNIT:
UPPER:PEEN

U017 DUPLEX

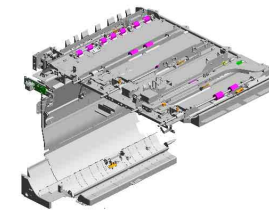

- 105.D2584790 COVER:DUPLEX:DC STEPPER MOTOR
- 101.D2584690 (x2) DC STEPPER MOTOR:MM39:S2M:T20:ASSY
- 116.D4543636 TIMING BELT:40S2 M672
- 115.D2585467 PCB:LSB
- 104.D2584780 DC SOLENOID:DUPLEX:ENTRANCE

100.D2584689 STEPPER MOTOR:MM39:S2M:T15:ASSY

98.D2584669 BRACKET:DC STEPPER MOTOR:DUPLEX

99.D2584681 (x2) LINK:SHIFT:DUPLEX

97.D2584638 (x2) GEAR:PULLEY:ROLLER:SHIFT

117.D6885150 PCB:PUNCH:SENSOR:CONNECTING:ASSY

108.D2584834 GUIDE PLATE:REVERSE ROLLER:LEFT

113.D2584980 LED:WHITE

102.D2584747 GATE PAWL:DUPLEX:ENTRANCE:NO.2:ASSY

118.GW010007 (x6) PHOTO REFLECTION SENSOR:EXIT

103.D2584761 GUIDE PLATE:DUPLEX:ENTRANCE:MIDDLE

106.D2584802 GUIDE PLATE:MIDDLE:REVERSE:DUPLEX:ASSY

107.D2584823 ROLLER:DRIVEN:REVERSE:106MM

U017_S001
TRANSPORT ROLLER:DUPLEX:DRIVEN:1

6.06230100E
(x7)
SPRING PIN - 3X10
MM

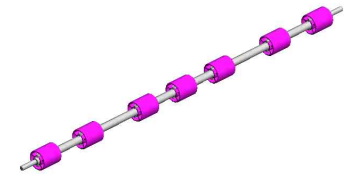

51.D1364611
TRANSPORT ROLL
ER:DUPLEX:DRIVE
N:1

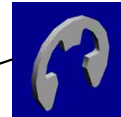
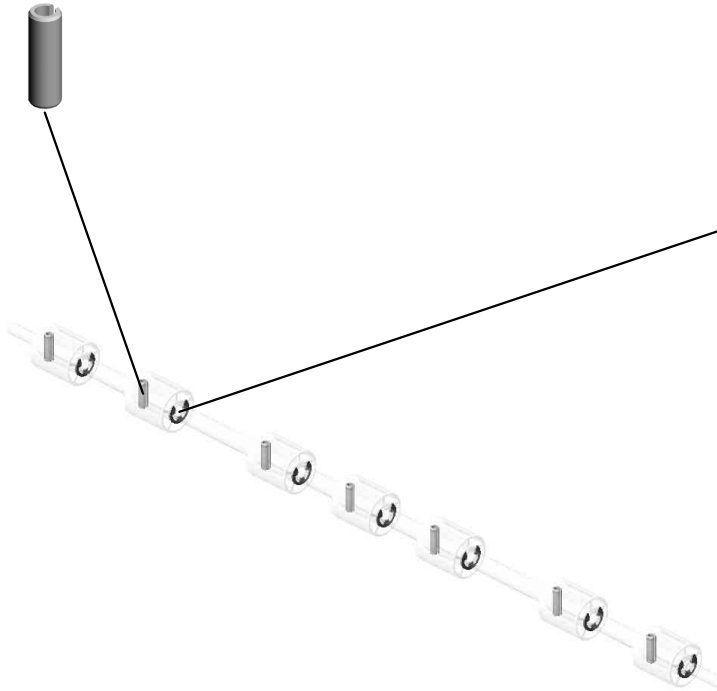

8.07200040E
(x7)
RETAINING RING -
M4

U001	U002	U003	U004	U005	U006	U007	U008	U009	U010	U011	U012	U013	U014	U015	U016	U017	U018	U019	U020	U021
------	------	------	------	------	------	------	------	------	------	------	------	------	------	------	------	------	------	------	------	------

U017_S002 GUIDE PLATE:DUPLEX:LOWER:ASS'Y

5.04583008N (x6)
HEXAGON HEAD TAPPING SCREW:3X8

50.D1364609 TENSION SPRING: GUIDE PLATE:MOV E

44.D1364516 LEVER:GUIDE PLATE:DUPLEX:ASS'Y

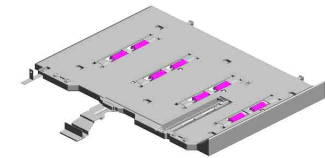

94.D2584550
GUIDE PLATE:DUPLEX:LOWER:ASS'Y

48.D1364607 (x4)
COMPRESSION SPRING:HOLDER:GUIDE PLATE



47.D1364606 (x2)
HOLDER:PRESSURE:GUIDE PLATE



34.AF022067 (x2)
GUIDE STOPPER ROLLER



24.A0964928
GUIDE PLATE BAND



46.D1364602 (x4)
ROLLER:DRIVEN:DUPLEX



62.D1364666 (x6)
TENSION SPRING:DRIVEN ROLLER:DUPLEX



61.D1364665 (x2)
TENSION SPRING:DRIVEN ROLLER:EXIT



49.D1364608
GUIDE PLATE:POSITIONING SENSOR:LOWER



64.D1364670 (x8)
PLAIN SHAFT BEARING:RING:DIA4



U017_S003
GRIP:VIBRATING PLATE:RECEIVING UNIT:LOWER:ASS'Y

114.D2584985
DECAL:GRIP:RECE
IVING UNIT:LOWE
R

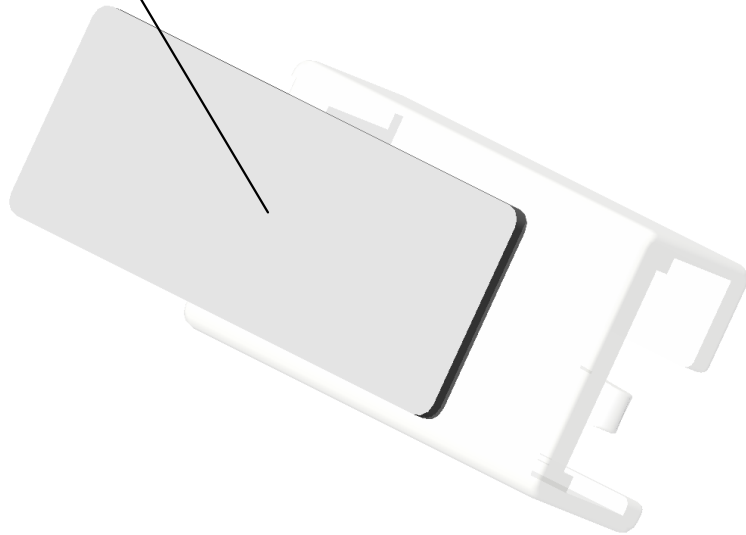

111.D2584921
GRIP:VIBRATING P
LATE:RECEIVING
UNIT:LOWER:ASS'
Y

U001	U002	U003	U004	U005	U006	U007	U008	U009	U010	U011	U012	U013	U014	U015	U016	U017	U018	U019	U020	U021
------	------	------	------	------	------	------	------	------	------	------	------	------	------	------	------	------	------	------	------	------

U017_S004
GUIDE PLATE:SWIVEL:UPPER:ASS'Y

112.D2584922
GRIP:GUIDE PLAT
E:RECEIVING UNIT

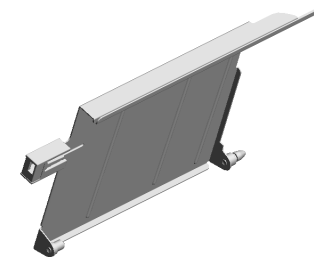
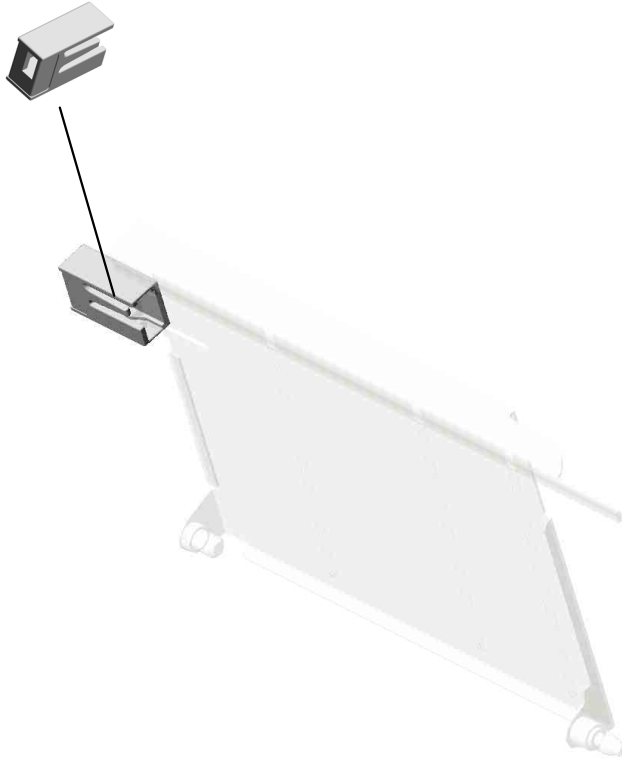

109.D2584907
GUIDE PLATE:SWI
VEL:UPPER:ASS'Y

U001	U002	U003	U004	U005	U006	U007	U008	U009	U010	U011	U012	U013	U014	U015	U016	U017	U018	U019	U020	U021
------	------	------	------	------	------	------	------	------	------	------	------	------	------	------	------	------	------	------	------	------

U017_S005
INNER COVER:RECEIVING UNIT:LEFT LOWER:ASS'Y

83.D1364976
DECAL:INNER COV
ER:RECEIVING SU
B-UNIT:UPPER

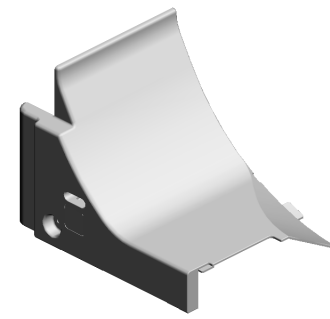
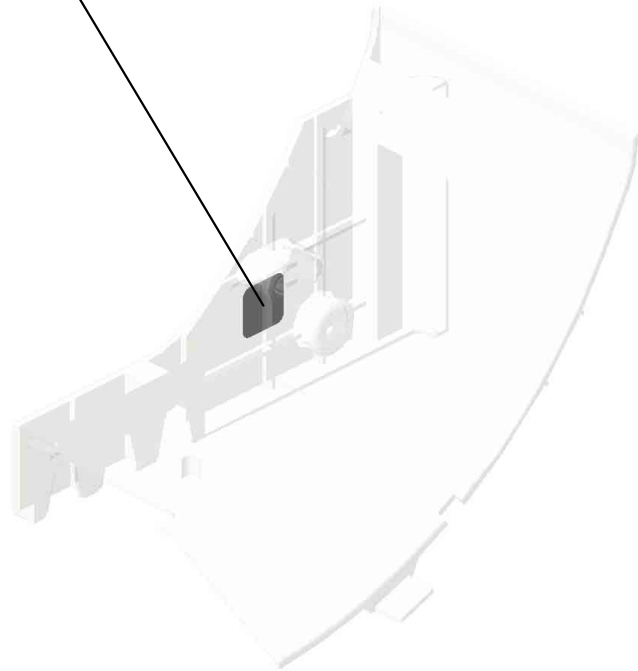

110.D2584919
INNER COVER:RE
CEIVING UNIT:LEF
T LOWER:ASSY

U001	U002	U003	U004	U005	U006	U007	U008	U009	U010	U011	U012	U013	U014	U015	U016	U017	U018	U019	U020	U021
------	------	------	------	------	------	------	------	------	------	------	------	------	------	------	------	------	------	------	------	------

U018.MAIN DRIVE

U018_S006
D2611014
DRIVE UNIT:PHOTOCONDU
CTOR:ASSY

U018_S007
D2611014
DRIVE UNIT:PHOTOCONDU
CTOR:ASSY

U018_S008
D2611014
DRIVE UNIT:PHOTOCONDU
CTOR:ASSY

U018_S005
D2611014
DRIVE UNIT:PHOTOCONDU
CTOR:ASSY

U018_S003
D2581062
DRIVE UNIT:TRANSPORT UN
IT:CONNECTING:ASSY

U018_S009
D2581028
FUSING DRIVE UNIT:GEAR:S
LOW DOWN:ASSY

U018_S010
D2581351
DRIVE UNIT:PAPER FEED U
NIT:NO.1:ASSY

U018_S002
D2581286
BRACKET:TENSIONER:USE
D TONER

U018_S012
D2611341
DRIVE UNIT:PF UNIT:NO.2:A
SSY

U018_S001
D2581210
DRIVE UNIT:TRANSFER:SEC
OND:ASSY

U018_S004
D2581354
DRIVE UNIT:PAPER EXIT UNI
T:ASSY

U018_S011
D2611330
DRIVE UNIT:PAPER FEED NI
T:NO.3:ASSY

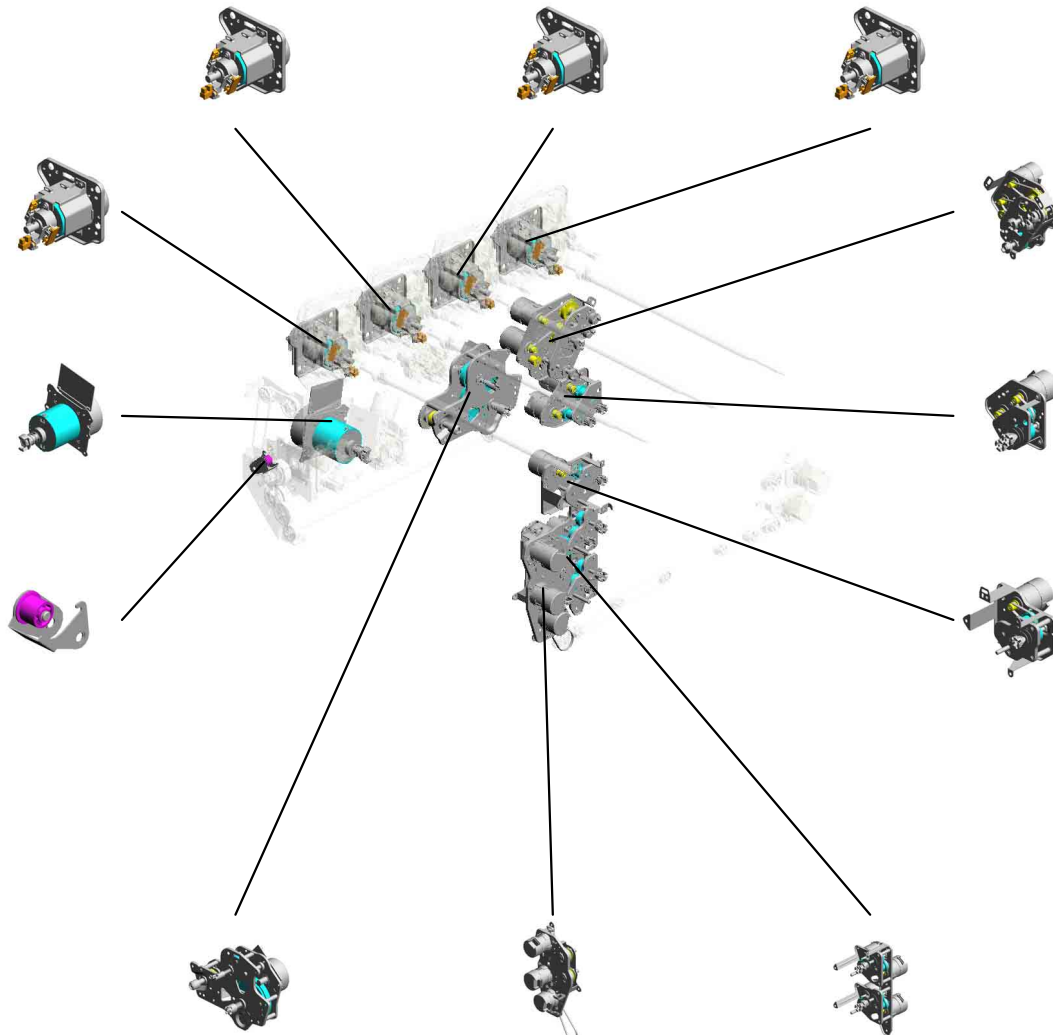

U001	U002	U003	U004	U005	U006	U007	U008	U009	U010	U011	U012	U013	U014	U015	U016	U017	U018	U019	U020	U021
------	------	------	------	------	------	------	------	------	------	------	------	------	------	------	------	------	-------------	------	------	------

U018.MAIN DRIVE

U018_S014
D2581020
DRIVE UNIT:IMAGING:CMY

U018_S013
D2581020
DRIVE UNIT:IMAGING:CMY

U018_S016
D2581019
DRIVE UNIT:IMAGING:K

U018_S015
D2581020
DRIVE UNIT:IMAGING:CMY

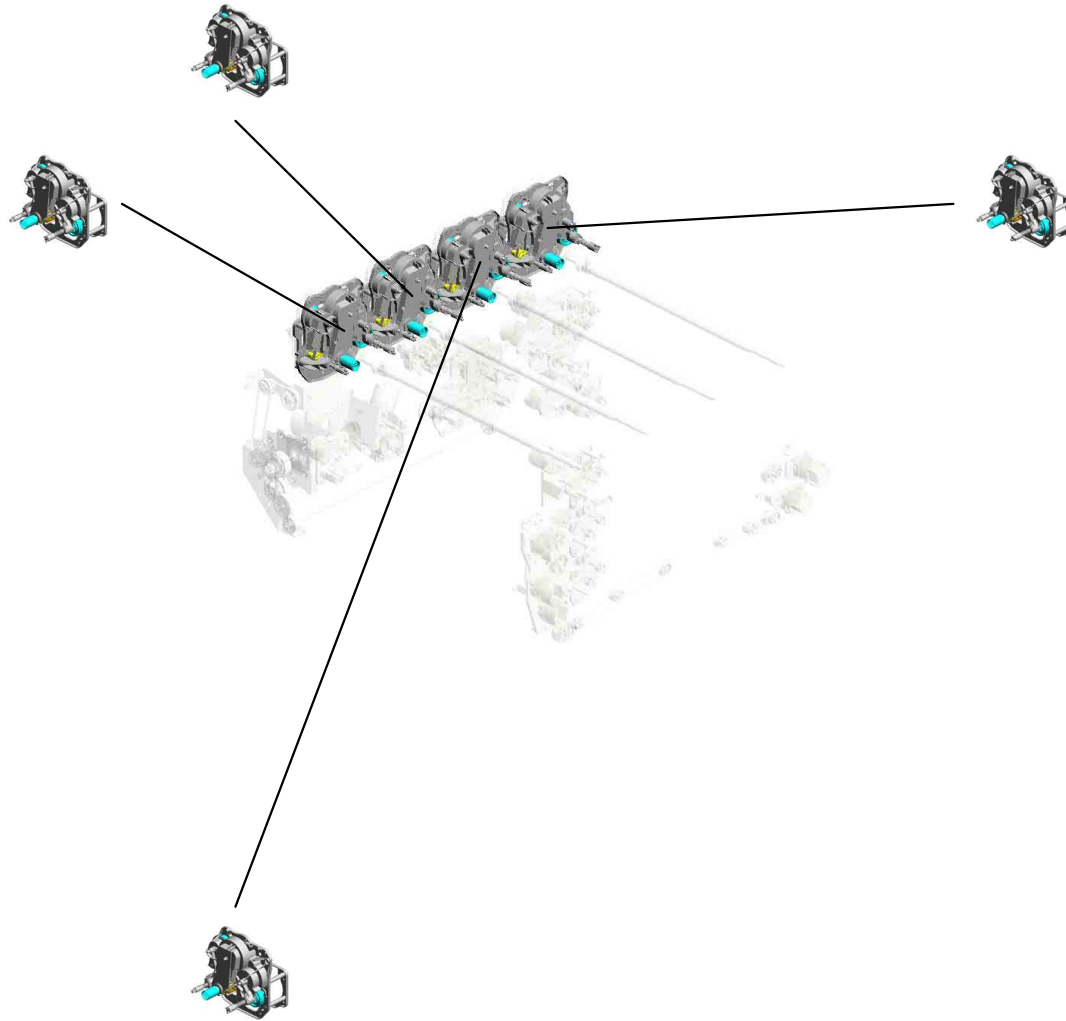

U001	U002	U003	U004	U005	U006	U007	U008	U009	U010	U011	U012	U013	U014	U015	U016	U017	U018	U019	U020	U021
------	------	------	------	------	------	------	------	------	------	------	------	------	------	------	------	------	-------------	------	------	------

U018_S005.DRIVE UNIT:PHOTOCONDUCTOR:ASS'Y

U018_S005_S001
D2581100
DRUM:GEAR:SLOW DOWN:A
SS'Y

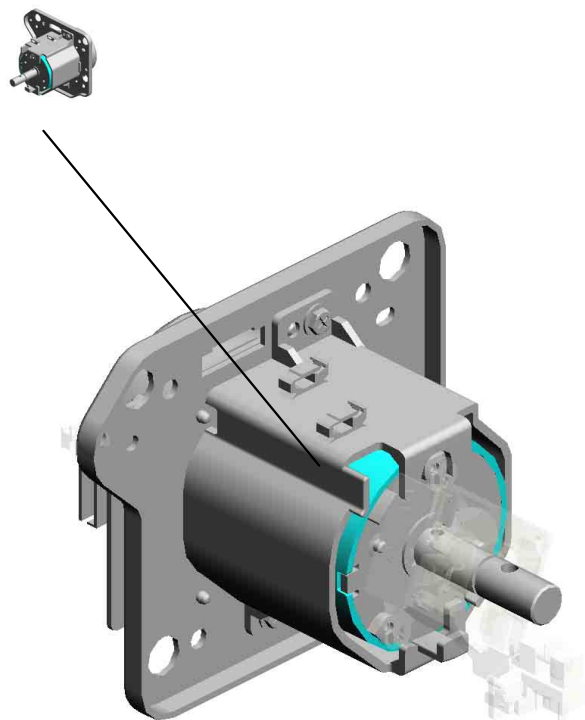

U001	U002	U003	U004	U005	U006	U007	U008	U009	U010	U011	U012	U013	U014	U015	U016	U017	U018	U019	U020	U021
------	------	------	------	------	------	------	------	------	------	------	------	------	------	------	------	------	------	------	------	------

U018_S006.DRIVE UNIT:PHOTOCONDUCTOR:ASS'Y

U018_S006_S001
D2581100
DRUM:GEAR:SLOW DOWN:A
SS'Y

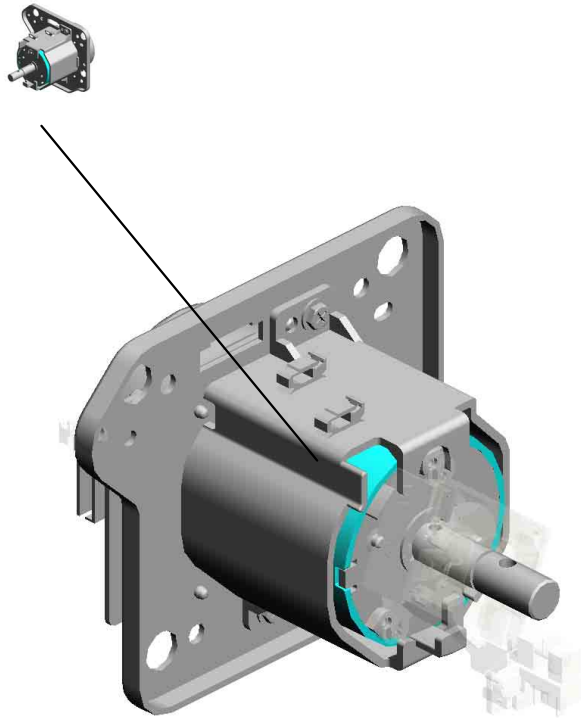

U001	U002	U003	U004	U005	U006	U007	U008	U009	U010	U011	U012	U013	U014	U015	U016	U017	U018	U019	U020	U021
------	------	------	------	------	------	------	------	------	------	------	------	------	------	------	------	------	------	------	------	------

U018_S007.DRIVE UNIT:PHOTOCONDUCTOR:ASS'Y

U018_S007_S001
D2581100
DRUM:GEAR:SLOW DOWN:A
SS'Y

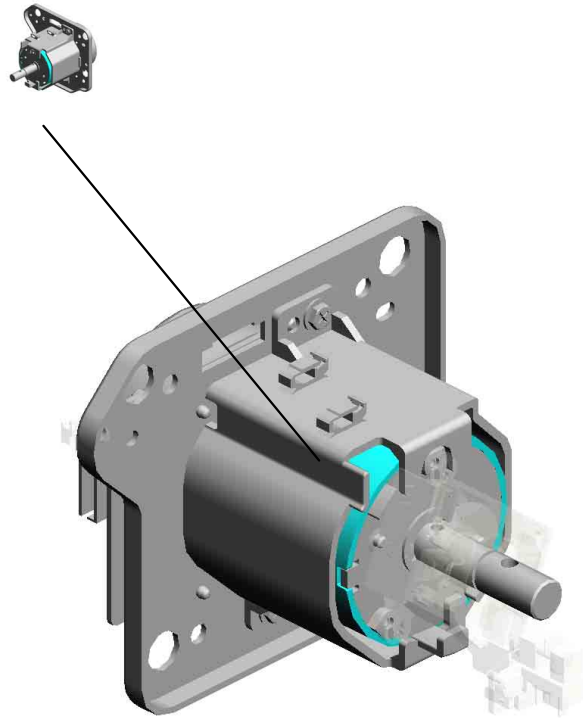

U001	U002	U003	U004	U005	U006	U007	U008	U009	U010	U011	U012	U013	U014	U015	U016	U017	U018	U019	U020	U021
------	------	------	------	------	------	------	------	------	------	------	------	------	------	------	------	------	------	------	------	------

U018_S008.DRIVE UNIT:PHOTOCONDUCTOR:ASS'Y

U018_S008_S001
D2581100
DRUM:GEAR:SLOW DOWN:A
SS'Y

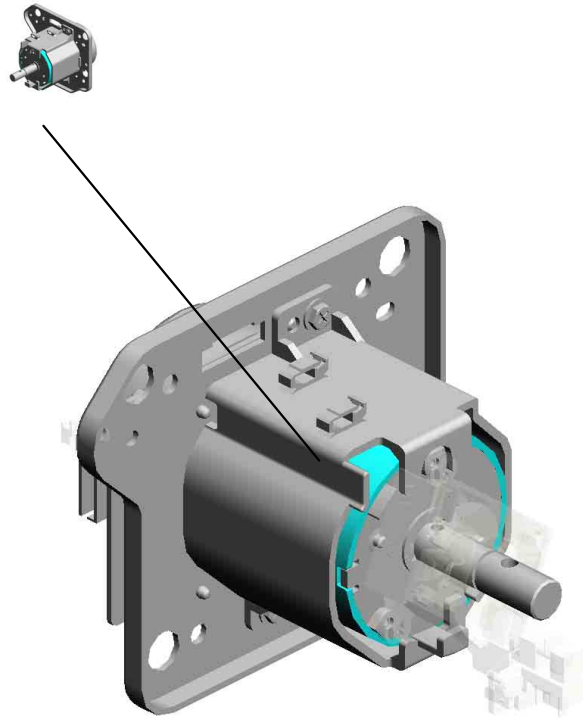

U001	U002	U003	U004	U005	U006	U007	U008	U009	U010	U011	U012	U013	U014	U015	U016	U017	U018	U019	U020	U021
------	------	------	------	------	------	------	------	------	------	------	------	------	------	------	------	------	------	------	------	------

U018 MAIN DRIVE

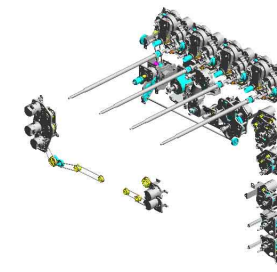

- 1.03130040N (x12) SCREW:M3X4
- 5.03603014N (x4) SCREW - M3X14
- 30.AA082173 PLAIN SHAFT BEARING:6X10X6
- 32.AB011607 GEAR:ON-OFF:TRANSFER
- 7.04583010N (x3) HEXAGON HEAD TAPPING SCREW:3X10

27.AA043721
SYNCHRONOUS BELT:40S2M176

4.03603006N (x55) SCREW - M3X6

28.AA043929
TIMING BELT - B40S2M114

11.07200060E
RETAINING RING - M6

15.11050758 (x3) CLAMP:LWSM-0306A

31.AB011577 (x2) GEAR:STOPPER PIN:35Z

2.03530030N (x2) SCREW:M3X3

6.04543006Q (x47) TAPPING SCREW - M3X6

19.11050762 (x3) CLAMP:LWS-0711A

21.AA043311
TIMING BELT:40S2M302G

10.07200040E (x13)
RETAINING RING - M4

18.11050761
CLAMP:LWS-0511A

17.11050760 (x5) CLAMP:LWSM-0511A

26.AA043694 (x2) SYNCHRONOUS BELT:B40S2M202

25.AA043663
TIMING BELT:40S2M162

24.AA043660
TIMING BELT:40S2M172

U018 MAIN DRIVE

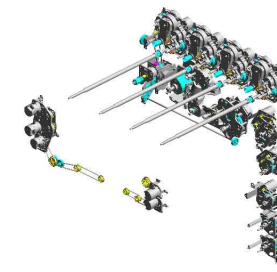

- 56.AB033121 TIMING PULLEY:S2 M41T:S2M31T
- 40.AB017915 GEAR:PULLEY:USED TONER:UPPER:Z37/S2M31T
- 62.AX061203 (x4) DC BRUSHLESS MOTOR:26Z:25W
- 36.AB017837 GEAR:ON-OFF:TRANSFER:IDLER:NO.1
- 37.AB017838 GEAR:ON-OFF:TRANSFER:IDLER:NO.2

48.AB017956
GEAR:PULLEY:LOWER:Z32/S2M45T

39.AB017912
GEAR:USED TONER:IDLER:NO.1

57.AW020198
PHOTOINTERERRUPTOR:LG2A14NL1

47.AB017955
GEAR:IDLER:59Z/31Z

33.AB011610
GEAR:USED TONER:IDLER:NO.3

42.AB017918
GEAR:REVERSE EXIT:IDLER:NO.2

61.AX060510
DRIVE SUB-UNIT:ON-OFF:PRESSURE ROLLER

35.AB016002
GEAR:Z36

50.AB030866
PULLEY:DUPLICATION:REGISTRATION:S2M54T

43.AB017919
GEAR:Z26/26T

52.AB030887
PULLEY:T60

55.AB033116
PULLEY:DUPLICATION:SUB-UNIT:54T/36T

54.AB033115
PULLEY:DUPLICATION:SUB-UNIT:IDLER:S2M:36T

51.AB030876
(x2)
PULLEY:S2M:36T

53.AB033114
PULLEY:DUPLICATION:SUB-UNIT:S2M:36T:COUPLING

U018 MAIN DRIVE

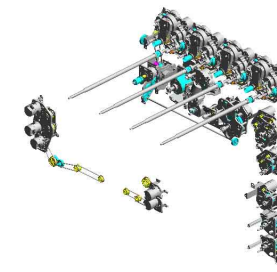

- 75.D1361159 (x4) DC MOTOR:24V:8.8W:BRUSHLESS
- 70.D0141265 (x4) BRACKET:DC MOTOR
- 105.D2581219 SHAFT:ON-OFF:TRANSFER:ASS'Y
- 113.D2581246 COMPRESSION SPRING:DRIVE:ON-OFF:TRANSFER
- 80.D1361247 HOUSING:ON-OFF:TRANSFER

95.D1381137 (x4) FEELER:POSITIONING SENSOR:PHOTOCONDUCTOR

82.D1361275 BRACKET:DRIVE:FEELING

116.D2581288 TENSION SPRING:USED TONER

118.D2581310 (x2) DC MOTOR:10W:BRUSHLESS

63.AX061204 DC MOTOR:11.5W:BRUSHLESS

128.D2581391 BRACKET:PAPER EXIT UNIT:REVERSE:NO.2

117.D2581295 SHAFT:DRIVE:USED TONER

104.D2581217 JOINT:ON-OFF:INTERMEDIATE TRANSFER

101.D2581132 (x4) DRUM SHAFT:GEAR:ASS'Y

136.D4345209 TIMING BELT:B40S 2M246

81.D1361249 BRACKET:ON-OFF:TRANSFER:ASS'Y

76.D1361212 DC MOTOR:ON-OFF:TRANSFER:ASS'Y

120.D2581349 BRACKET:MOTOR:REGISTRATION

119.D2581320 DC MOTOR:20W:BRUSHLESS

129.D2581398 BRACKET:MOTOR:DUPLIX UNIT

U018 MAIN DRIVE

137.D4345279
TIMING BELT:B40S
2M380

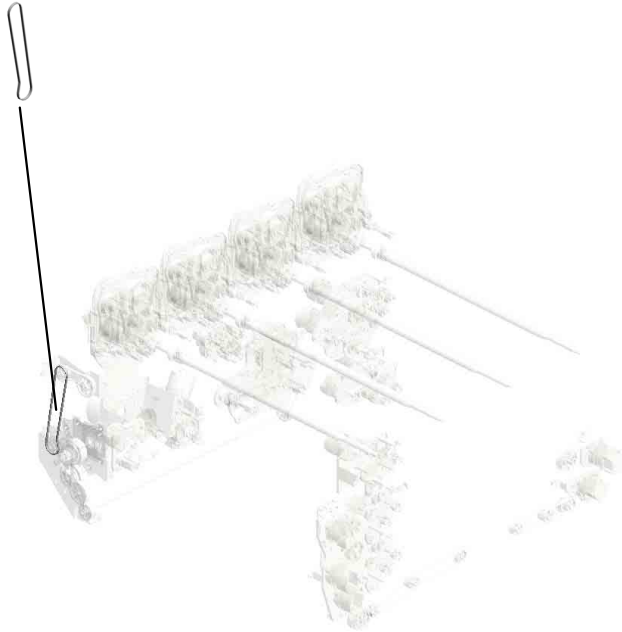
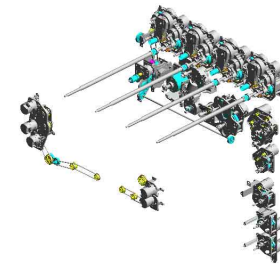

U001	U002	U003	U004	U005	U006	U007	U008	U009	U010	U011	U012	U013	U014	U015	U016	U017	U018	U019	U020	U021
------	------	------	------	------	------	------	------	------	------	------	------	------	------	------	------	------	-------------	------	------	------

U018_S001
 DRIVE UNIT:TRANSFER:SECOND:ASS'Y

- 114.D2581248 ENCODER:ASS'Y
- 64.AX061205 DC MOTOR:28W:B RUSHLESS
- 108.D2581235 SHAFT:DRIVE:BELT CLEANING:ASS'Y
- 38.AB017839 GEAR:IDLER:BELT CLEANING
- 11.07200060E RETAINING RING - M6

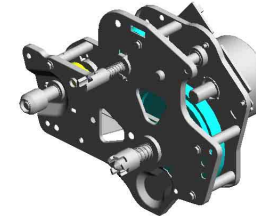

103.D2581210
 DRIVE UNIT:TRANSFER:SECOND:ASS'Y

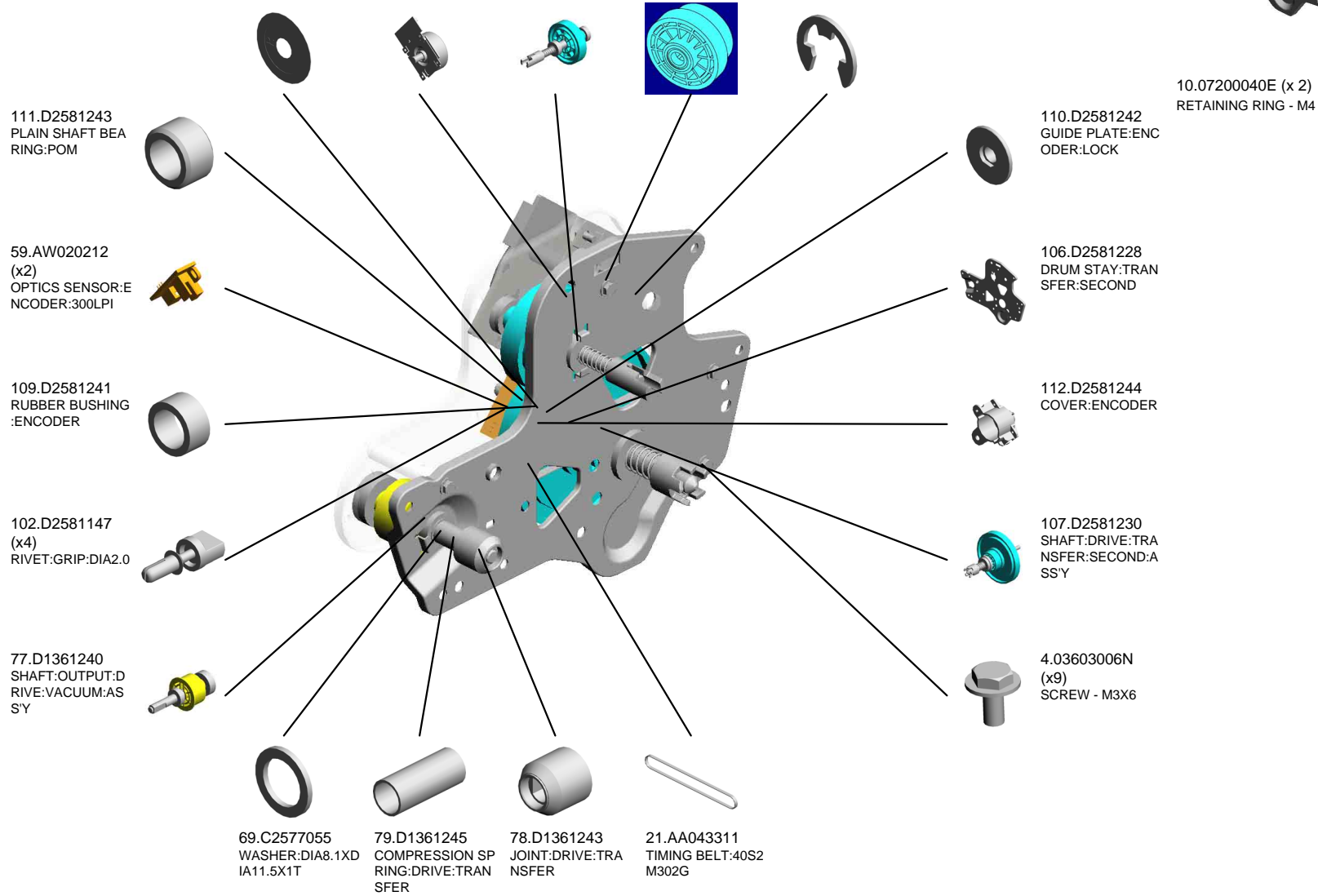

U018_S002
BRACKET:TENSIONER:USED TONER

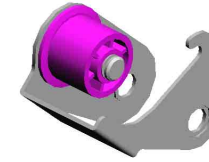

115.D2581286
BRACKET:TENSIO
NER:USED TONER

10.07200040E (x 1)
RETAINING RING - M4

U001	U002	U003	U004	U005	U006	U007	U008	U009	U010	U011	U012	U013	U014	U015	U016	U017	U018	U019	U020	U021
------	------	------	------	------	------	------	------	------	------	------	------	------	------	------	------	------	------	------	------	------

U018_S003

DRIVE UNIT:TRANSPORT UNIT:CONNECTING:ASS'Y

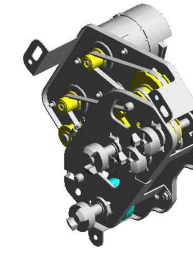

99.D2581062
DRIVE UNIT:TRANSPORT UNIT:CONNECTING:ASSY

68.B8301456
TIMING BELT - 40S
2M190

87.D1361370
SHAFT:MANUAL FEED UNIT:CONNECTING

49.AB030865
PULLEY:S2M:54T/27T

67.B7003535
(x2)
TIMING BELT:B40S
2M116

89.D1361374
(x2)
SHAFT:MANUAL FEED UNIT

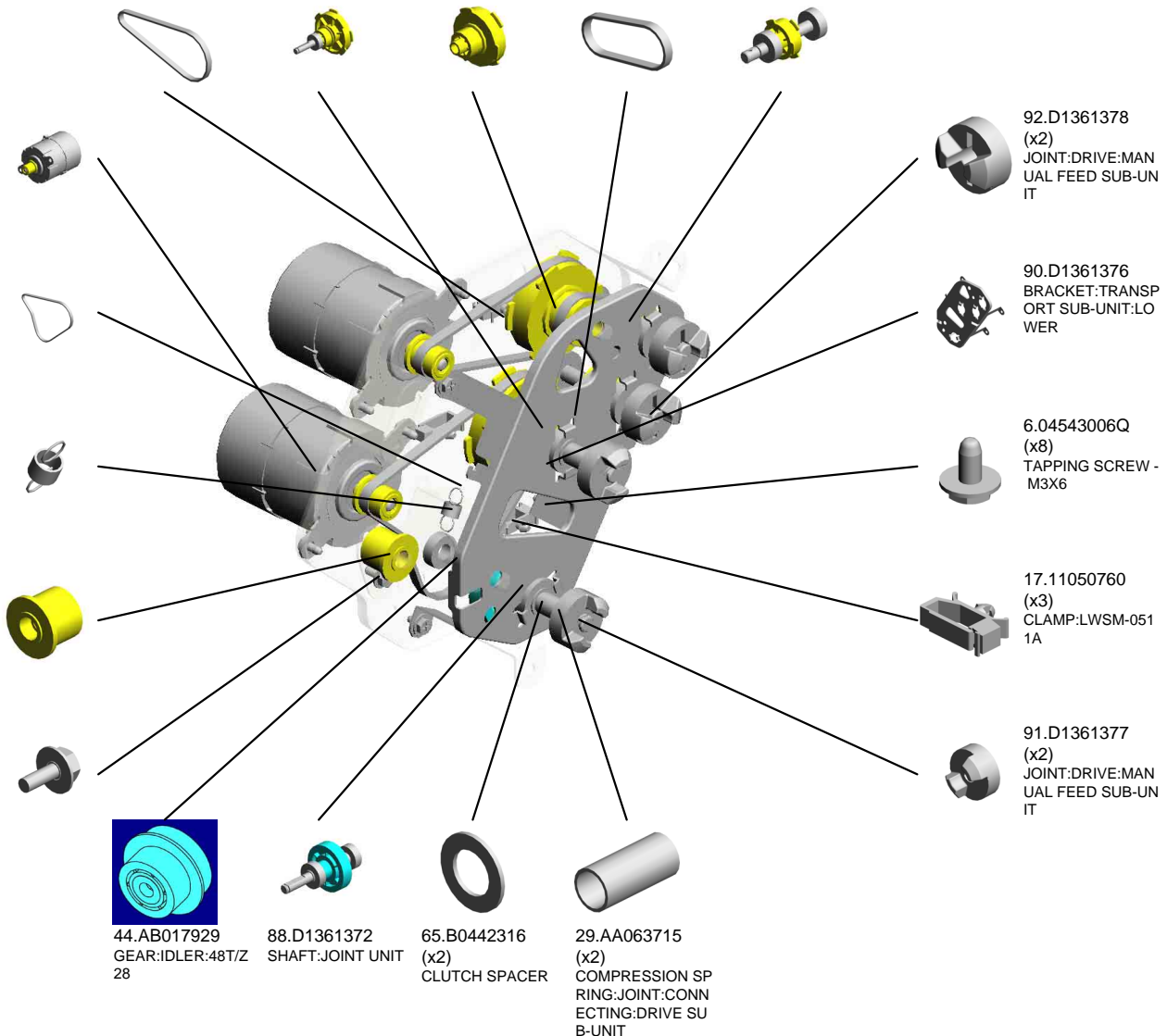

119.D2581320
(x2)
DC MOTOR:20W:BRUSHLESS

22.AA043325
TIMING BELT - B40
S2M250

123.D2581366
TENSION SPRING:
TIGHTENER:TRANSPORT

138.D6831845
PULLEY:IDLER:DIA
14

13.08046123
HEXAGONAL BOLT:
W/WASHER:M3X8

44.AB017929
GEAR:IDLER:48T/
28

88.D1361372
SHAFT:JOINT UNIT

65.B0442316
(x2)
CLUTCH SPACER

29.AA063715
(x2)
COMPRESSION SPRING:
JOINT:CONNECTING:DRIVE
SUB-UNIT

10.07200040E (x 5)
RETAINING RING - M4

92.D1361378
(x2)
JOINT:DRIVE:MANUAL FEED
SUB-UNIT

90.D1361376
BRACKET:TRANSPORT
SUB-UNIT:LOWER

6.04543006Q
(x8)
TAPPING SCREW - M3X6

17.11050760
(x3)
CLAMP:LWSM-051
1A

91.D1361377
(x2)
JOINT:DRIVE:MANUAL FEED
SUB-UNIT

U001	U002	U003	U004	U005	U006	U007	U008	U009	U010	U011	U012	U013	U014	U015	U016	U017	U018	U019	U020	U021
------	------	------	------	------	------	------	------	------	------	------	------	------	------	------	------	------	------	------	------	------

U018_S004
 DRIVE UNIT:PAPER EXIT UNIT:ASS'Y

- 18.11050761 CLAMP:LWS-0511A
- 125.D2581386 PAPER EXIT UNIT:TIGHTENER:ASS'Y
- 124.D2581384 SYNCHRONOUS BELT:B60S2M182
- 93.D1361394 (x2) SHAFT:DRIVE:PAPER EXIT SUB-UNIT:ENTRANCE:ASS'Y

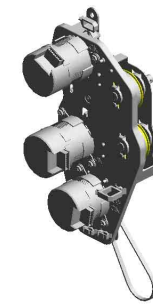

122.D2581354
 DRIVE UNIT:PAPER EXIT UNIT:ASS'Y

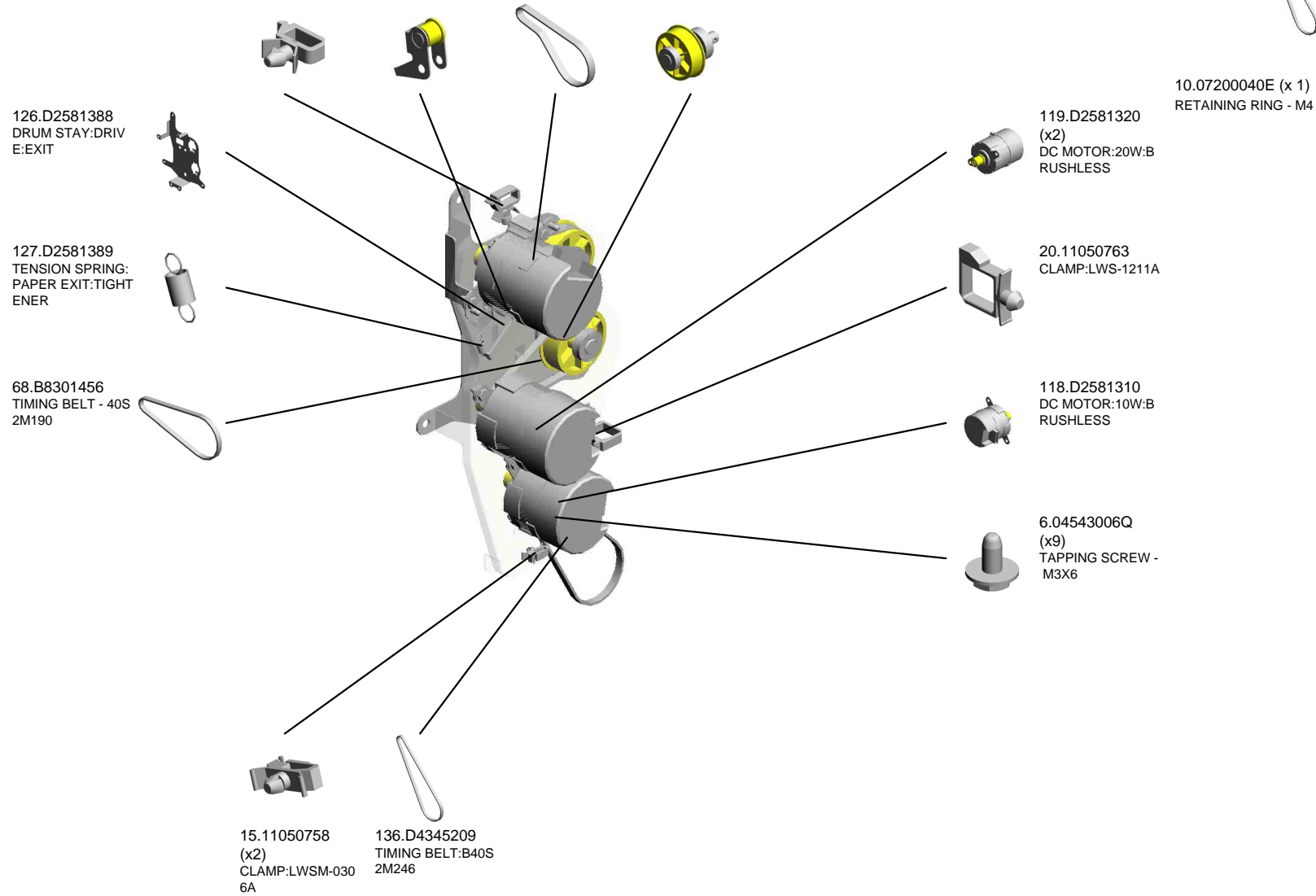

U018_S005
 DRIVE UNIT:PHOTOCONDUCTOR:ASS'Y

7.04583010N (x2)
 HEXAGON HEAD TAPPING SCREW:3X10

102.D2581147 (x4)
 RIVET:GRIP:DIA2.0

72.D1361125
 GUIDE PLATE:ENCODER

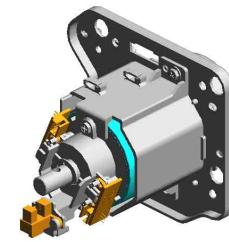

130.D2611014
 DRIVE UNIT:PHOTOCONDUCTOR:ASSY

15.11050758
 CLAMP:LWSM-0306A



59.AW020212 (x2)
 OPTICS SENSOR:ENCODER:300LPI



8.06330140G
 PARALLEL PIN - 3X14

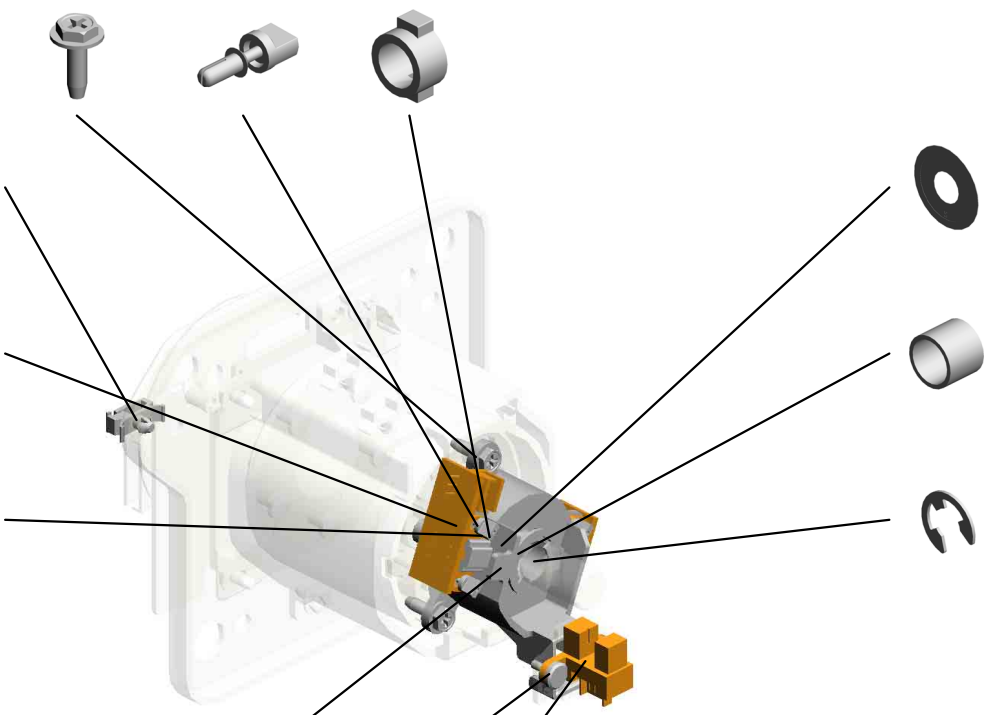

73.D1361126
 ENCODER:300LPI:900CT



74.D1361127
 RUBBER BUSHING:ENCODER



12.07200080E
 RETAINING RING - M8



94.D1381128
 COVER:ENCODER



14.10050734 (x2)
 NYLON RIVET - NR P355



58.AW020211
 PHOTOINTERRUPTOR:PHOTOCONDUCTOR:HOME POSITION SENSOR



U018_S005_S001
DRUM:GEAR:SLOW DOWN:ASS'Y

6.04543006Q (x6)
TAPPING SCREW - M3X6

3.03530050N (x9)
SCREW-M3X5

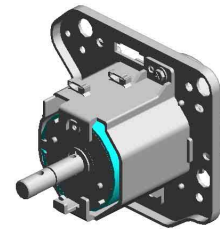

100.D2581100
DRUM:GEAR:SLO
W DOWN:ASS'Y

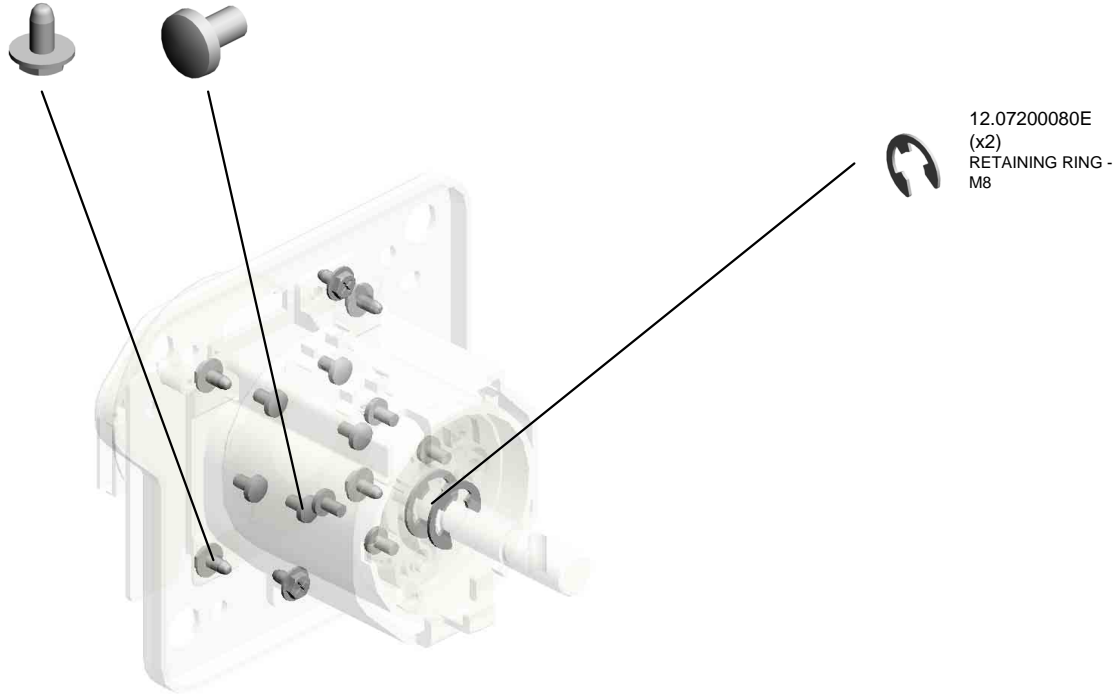

12.07200080E
(x2)
RETAINING RING - M8

U018_S006
 DRIVE UNIT:PHOTOCONDUCTOR:ASS'Y

7.04583010N (x2)
 HEXAGON HEAD TAPPING SCREW:3X10

102.D2581147 (x4)
 RIVET:GRIP:DIA2.0

72.D1361125
 GUIDE PLATE:ENCODER

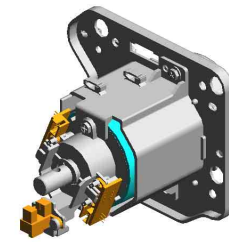

130.D2611014
 DRIVE UNIT:PHOTOCONDUCTOR:ASSY

15.11050758
 CLAMP:LWSM-0306A



59.AW020212 (x2)
 OPTICS SENSOR:ENCODER:300LPI



8.06330140G
 PARALLEL PIN - 3X14

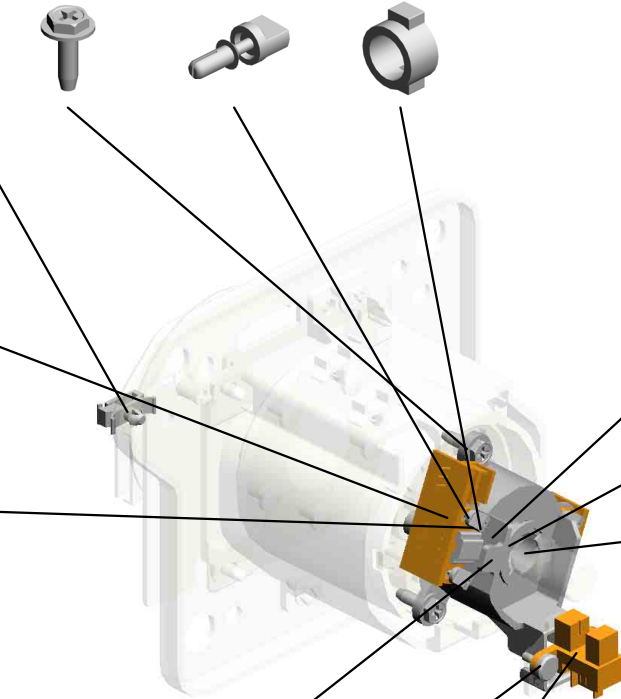

73.D1361126
 ENCODER:300LPI:900CT



74.D1361127
 RUBBER BUSHING:ENCODER



12.07200080E
 RETAINING RING - M8

94.D1381128
 COVER:ENCODER



14.10050734 (x2)
 NYLON RIVET - NR P355



58.AW020211
 PHOTOINTERRUPTOR:PHOTOCONDUCTOR:HOME POSITION SENSOR



U018_S006_S001
DRUM:GEAR:SLOW DOWN:ASS'Y

6.04543006Q (x6)
TAPPING SCREW - M3X6

3.03530050N (x9)
SCREW-M3X5

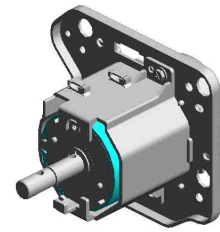

100.D2581100
DRUM:GEAR:SLO
W DOWN:ASS'Y

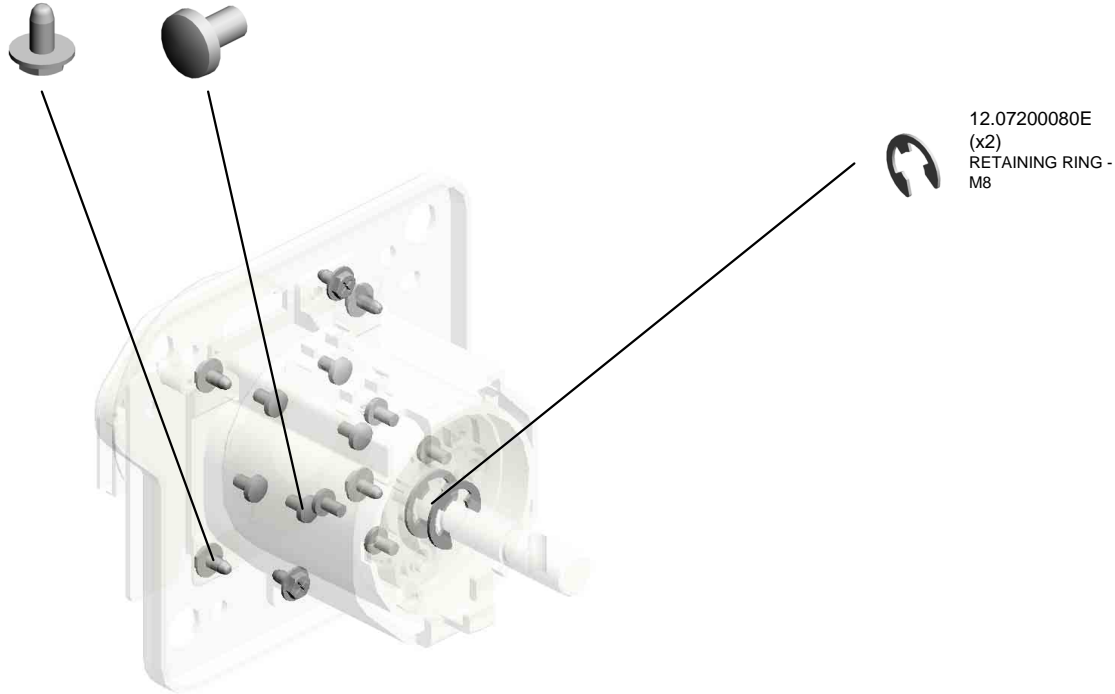

U018_S007
 DRIVE UNIT:PHOTOCONDUCTOR:ASS'Y

7.04583010N (x2)
 HEXAGON HEAD TAPPING SCREW:3X10

102.D2581147 (x4)
 RIVET:GRIP:DIA2.0

72.D1361125
 GUIDE PLATE:ENCODER

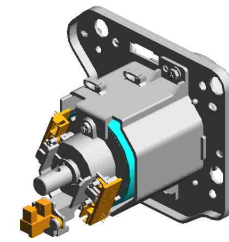

130.D2611014
 DRIVE UNIT:PHOTOCONDUCTOR:ASSY

15.11050758
 CLAMP:LWSM-0306A



59.AW020212 (x2)
 OPTICS SENSOR:ENCODER:300LPI



8.06330140G
 PARALLEL PIN - 3X14

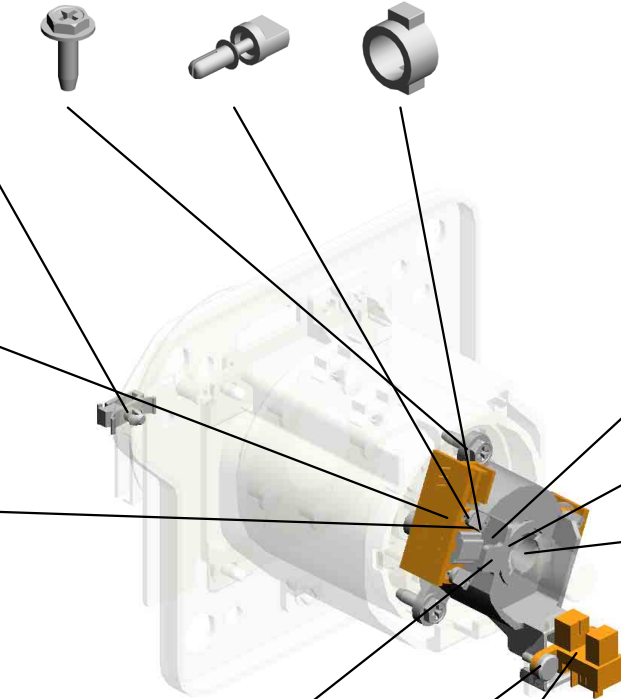

73.D1361126
 ENCODER:300LPI:900CT



74.D1361127
 RUBBER BUSHING:ENCODER



12.07200080E
 RETAINING RING - M8

94.D1381128
 COVER:ENCODER



14.10050734 (x2)
 NYLON RIVET - NR P355



58.AW020211
 PHOTOINTERRUPTOR:PHOTOCONDUCTOR:HOME POSITION SENSOR



U018_S007_S001
DRUM:GEAR:SLOW DOWN:ASS'Y

6.04543006Q (x6)
TAPPING SCREW - M3X6

3.03530050N (x9)
SCREW-M3X5

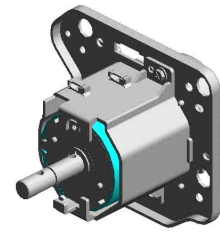

100.D2581100
DRUM:GEAR:SLO
W DOWN:ASS'Y

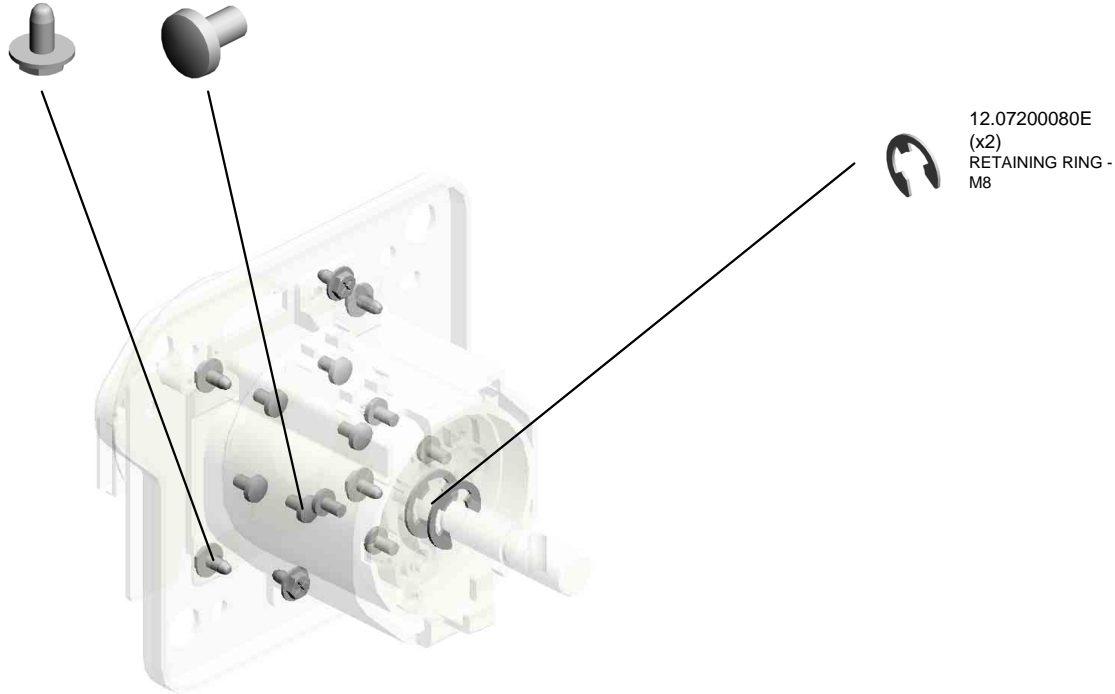

U018_S008
 DRIVE UNIT:PHOTOCONDUCTOR:ASS'Y

7.04583010N (x2)
 HEXAGON HEAD TAPPING SCREW:3X10

102.D2581147 (x4)
 RIVET:GRIP:DIA2.0

72.D1361125
 GUIDE PLATE:ENCODER

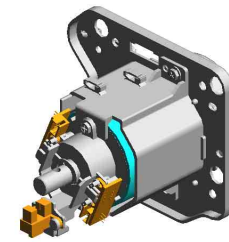

130.D2611014
 DRIVE UNIT:PHOTOCONDUCTOR:ASS'Y

15.11050758
 CLAMP:LWSM-0306A



59.AW020212 (x2)
 OPTICS SENSOR:ENCODER:300LPI



8.06330140G
 PARALLEL PIN - 3X14

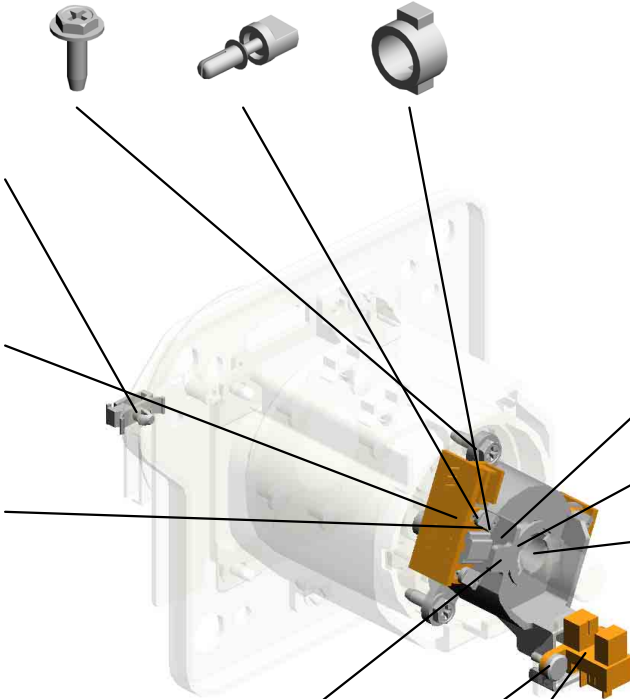

73.D1361126
 ENCODER:300LPI:900CT



74.D1361127
 RUBBER BUSHING:ENCODER



12.07200080E
 RETAINING RING - M8

94.D1381128
 COVER:ENCODER



14.10050734 (x2)
 NYLON RIVET - NR P355



58.AW020211
 PHOTOINTERRUPTOR:PHOTOCONDUCTOR:HOME POSITION SENSOR



U018_S008_S001
DRUM:GEAR:SLOW DOWN:ASS'Y

6.04543006Q (x6)
TAPPING SCREW - M3X6

3.03530050N (x9)
SCREW-M3X5

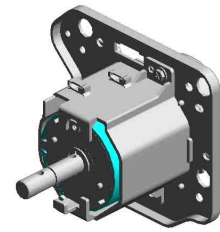

100.D2581100
DRUM:GEAR:SLO
W DOWN:ASS'Y

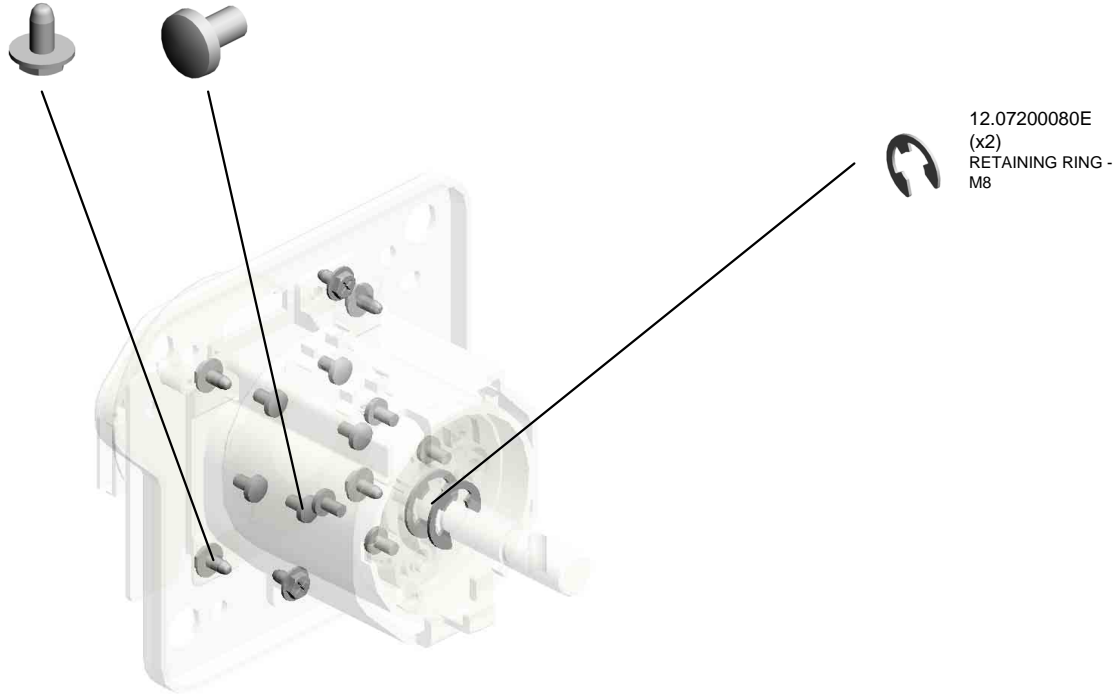

12.07200080E
(x2)
RETAINING RING - M8

U018_S009
FUSING DRIVE UNIT:GEAR:SLOW DOWN:ASS'Y

6.04543006Q
(x4)
TAPPING SCREW -
M3X6

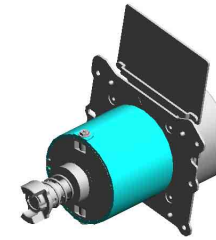

98.D2581028
FUSING DRIVE UNI
T:GEAR:SLOW DO
WN:ASS'Y

3.03530050N
(x11)
SCREW-M3X5

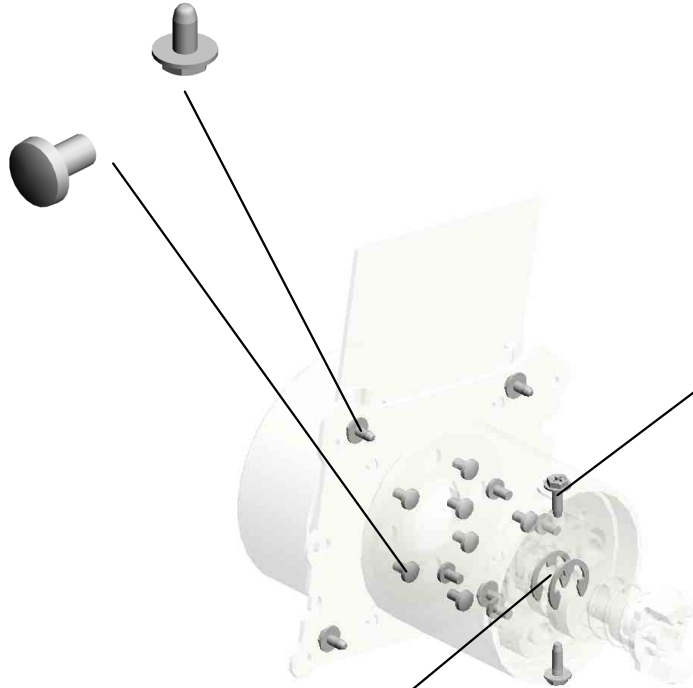

7.04583010N
(x2)
HEXAGON HEAD T
APPING SCREW:3
X10

12.07200080E
(x2)
RETAINING RING -
M8

U001	U002	U003	U004	U005	U006	U007	U008	U009	U010	U011	U012	U013	U014	U015	U016	U017	U018	U019	U020	U021
------	------	------	------	------	------	------	------	------	------	------	------	------	------	------	------	------	------	------	------	------

U018_S010

DRIVE UNIT:PAPER FEED UNIT:NO.1:ASS'Y

30.AA082173 (x4) PLAIN SHAFT BEARING RING:6X10X6
 71.D0894466 (x2) SYNCHRONOUS BELT ELT:S2M:104
 83.D1361318 DRUM STAY:PAPE R FEED SUB-UNIT: NO.1

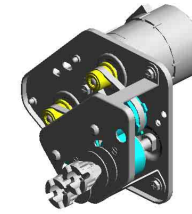

121.D2581351 DRIVE UNIT:PAPE R FEED UNIT:NO.1: ASS'Y

119.D2581320 (x2) DC MOTOR:20W:B RUSHLESS

41.AB017916 (x2) GEAR:PAPER FEED SUB-UNIT:IDLER

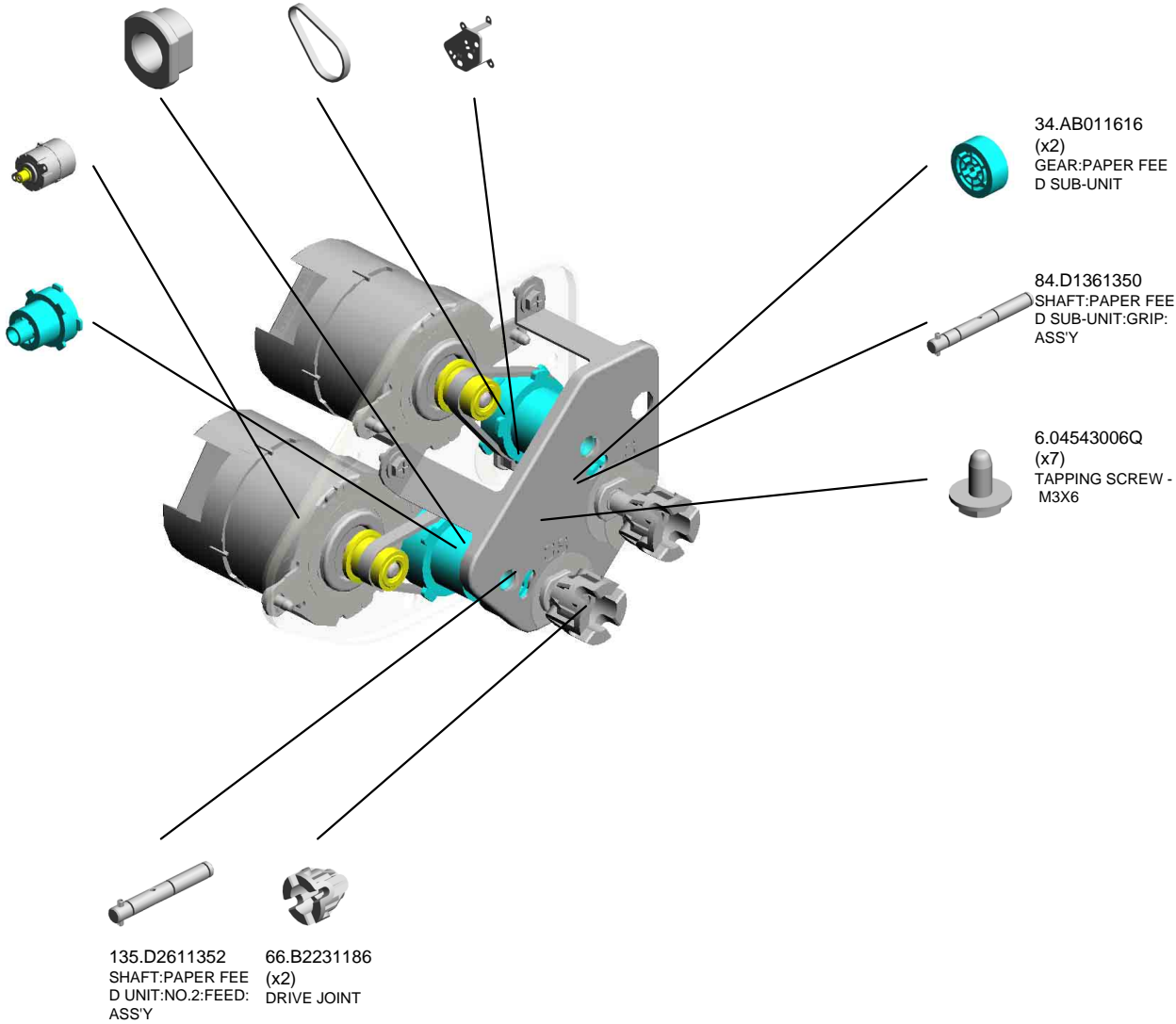

U018_S011
 DRIVE UNIT:PAPER FEED NIT:NO.3:ASS'Y

119.D2581320 (x2) DC MOTOR:20W:BRUSHLESS
 4.03603006N (x14) SCREW - M3X6
 41.AB017916 (x2) GEAR:PAPER FEED SUB-UNIT:IDLER
 85.D1361355 (x2) SHAFT:PAPER FEED SUB-UNIT:GRIP: NO.3:ASS'Y

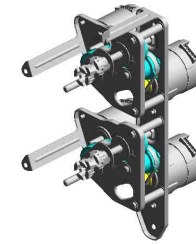

132.D2611330
 DRIVE UNIT:PAPER FEED NIT:NO.3:ASS'Y

60.AX060439 (x2) DC MOTOR:GEAR:20W:BRUSHLESS

30.AA082173 (x8) PLAIN SHAFT BEARING:6X10X6

34.AB011616 (x2) GEAR:PAPER FEED SUB-UNIT

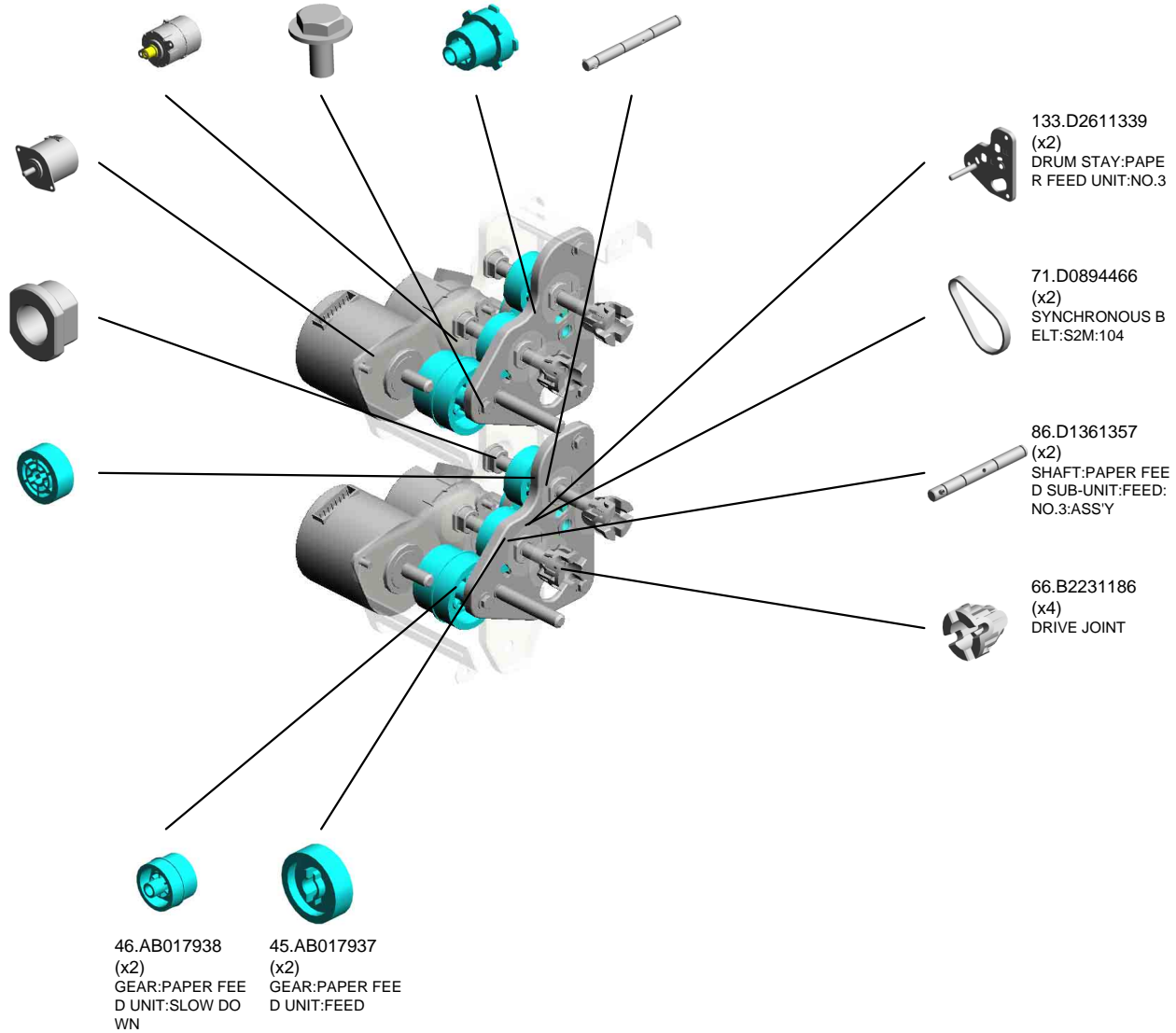

U018_S012
 DRIVE UNIT:PF UNIT:NO.2:ASS'Y

41.AB017916 GEAR:PAPER FEE
 D SUB-UNIT:IDLER
 30.AA082173 (x2)
 PLAIN SHAFT BEA
 RING:6X10X6
 34.AB011616 GEAR:PAPER FEE
 D SUB-UNIT

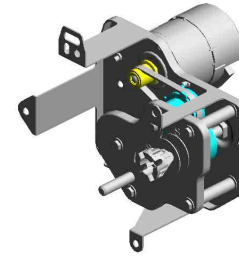

134.D2611341
 DRIVE UNIT:PF UN
 IT:NO.2:ASSY

119.D2581320
 DC MOTOR:20W:B
 RUSHLESS

23.AA043637
 TIMING BELT - 40S
 2M124

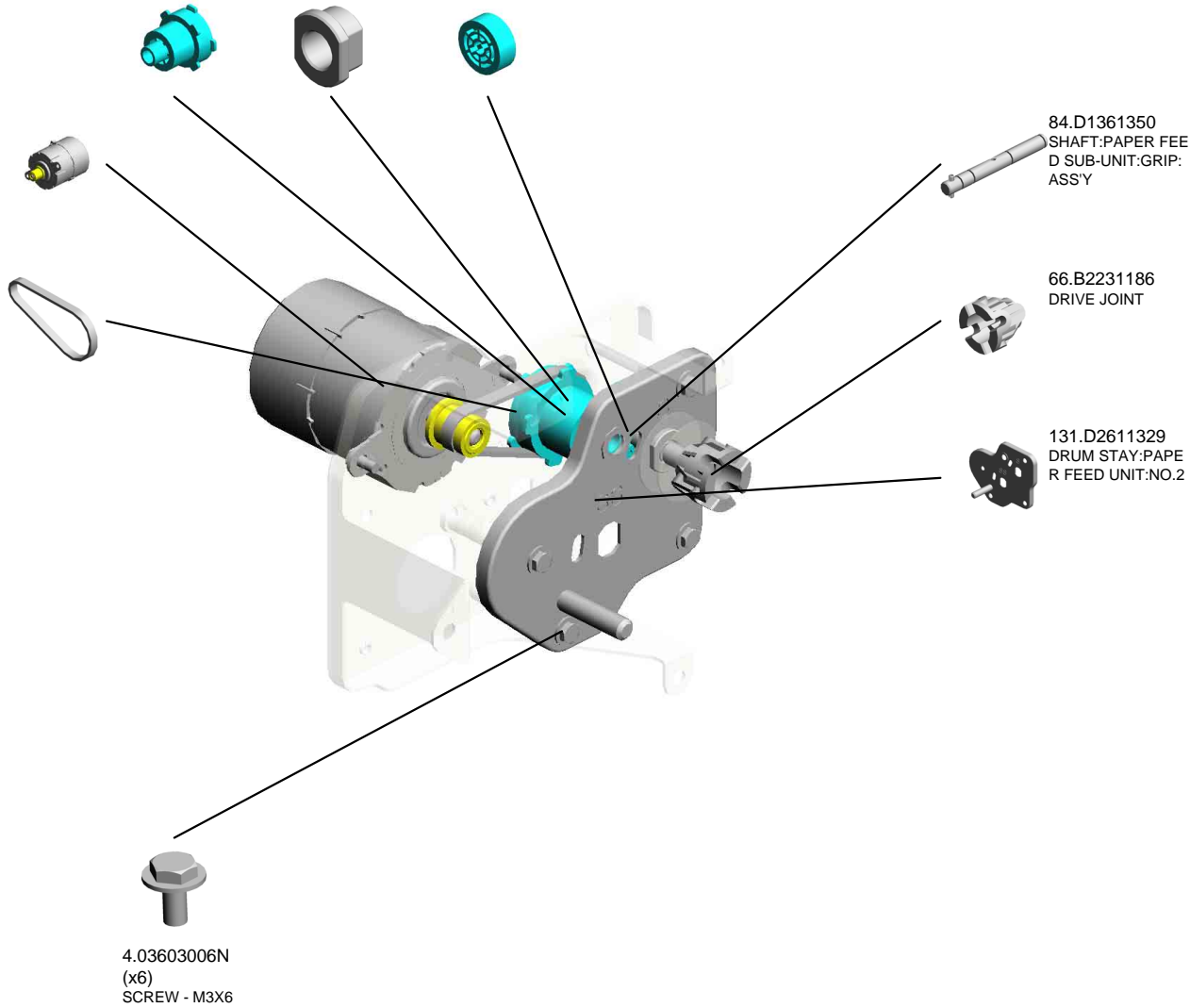

84.D1361350
 SHAFT:PAPER FEE
 D SUB-UNIT:GRIP:
 ASSY

66.B2231186
 DRIVE JOINT

131.D2611329
 DRUM STAY:PAPE
 R FEED UNIT:NO.2

4.03603006N
 (x6)
 SCREW - M3X6

U001	U002	U003	U004	U005	U006	U007	U008	U009	U010	U011	U012	U013	U014	U015	U016	U017	U018	U019	U020	U021
------	------	------	------	------	------	------	------	------	------	------	------	------	------	------	------	------	-------------	------	------	------

U018_S013
DRIVE UNIT:IMAGING:CMY

16.11050759 (x3)
CLAMP:LWSM-060
5A

13.08046123 (x2)
HEXAGONAL BOLT
:W/WASHER:M3X8

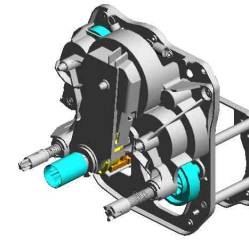

97.D2581020
DRIVE UNIT:IMAGI
NG:CMY

65.B0442316
CLUTCH SPACER



9.07200030E
RETAINING RING -
M3



6.04543006Q
(x3)
TAPPING SCREW -
M3X6



4.03603006N
(x8)
SCREW - M3X6



11.07200060E
RETAINING RING -
M6



57.AW020198
PHOTOINTERRUP
TOR:LG2A14NL1



U001	U002	U003	U004	U005	U006	U007	U008	U009	U010	U011	U012	U013	U014	U015	U016	U017	U018	U019	U020	U021
------	------	------	------	------	------	------	------	------	------	------	------	------	------	------	------	------	------	------	------	------

U018_S014
 DRIVE UNIT:IMAGING:CMY

16.11050759 (x3)
 CLAMP:LWSM-060
 5A

13.08046123 (x2)
 HEXAGONAL BOLT
 :W/WASHER:M3X8

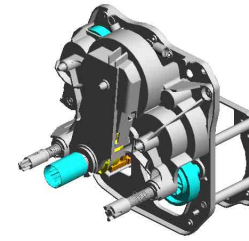

97.D2581020
 DRIVE UNIT:IMAGI
 NG:CMY

57.AW020198
 PHOTOINTERRUP
 TOR:LG2A14NL1

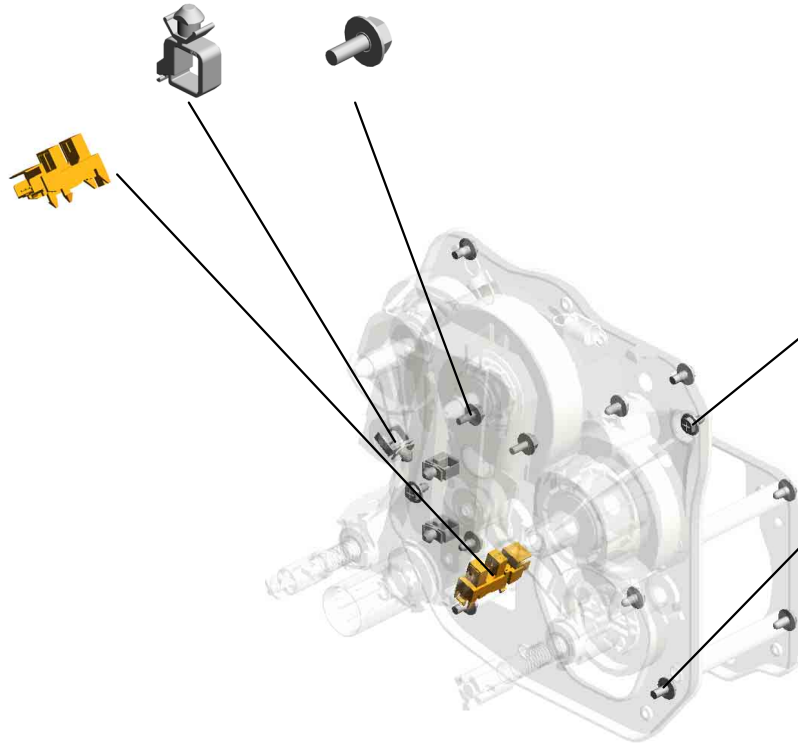

6.04543006Q
 (x3)
 TAPPING SCREW -
 M3X6

4.03603006N
 (x8)
 SCREW - M3X6

U001	U002	U003	U004	U005	U006	U007	U008	U009	U010	U011	U012	U013	U014	U015	U016	U017	U018	U019	U020	U021
------	------	------	------	------	------	------	------	------	------	------	------	------	------	------	------	------	-------------	------	------	------

U018_S015
 DRIVE UNIT:IMAGING:CMY

16.11050759 (x3)
 CLAMP:LWSM-060
 5A

13.08046123 (x2)
 HEXAGONAL BOLT
 :W/WASHER:M3X8

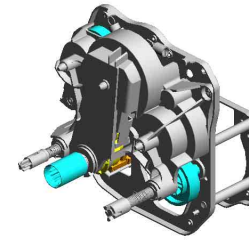

97.D2581020
 DRIVE UNIT:IMAGI
 NG:CMY

65.B0442316
 CLUTCH SPACER



9.07200030E
 RETAINING RING -
 M3



6.04543006Q
 (x3)
 TAPPING SCREW -
 M3X6



4.03603006N
 (x8)
 SCREW - M3X6



11.07200060E
 RETAINING RING -
 M6



57.AW020198
 PHOTOINTERUP
 TOR:LG2A14NL1

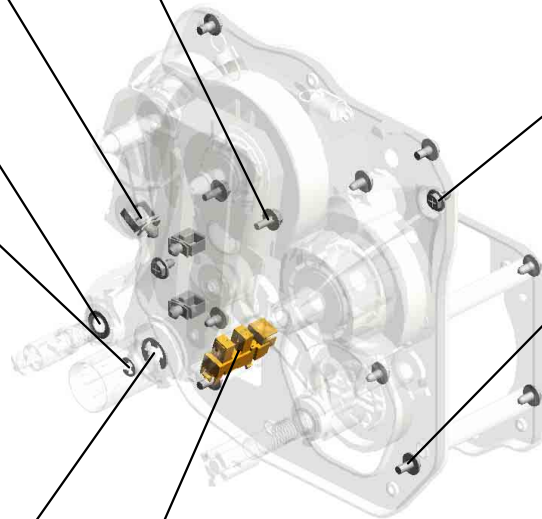

U018_S016
DRIVE UNIT:IMAGING:K

57.AW020198
PHOTOINTERRUP
TOR:LG2A14NL1

13.08046123
(x2)
HEXAGONAL BOLT
:W/WASHER:M3X8

6.04543006Q
(x3)
TAPPING SCREW -
M3X6

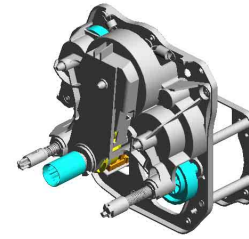

96.D2581019
DRIVE UNIT:IMAGI
NG:K

16.11050759
(x3)
CLAMP:LWSM-060
5A



4.03603006N
(x8)
SCREW - M3X6



9.07200030E
RETAINING RING -
M3



11.07200060E
RETAINING RING -
M6

U001	U002	U003	U004	U005	U006	U007	U008	U009	U010	U011	U012	U013	U014	U015	U016	U017	U018	U019	U020	U021
------	------	------	------	------	------	------	------	------	------	------	------	------	------	------	------	------	------	------	------	------

U019.ELECTRICAL

U019_S001
D2615918
(EU/AA/KOR/TWN):POWER SUPPLY CORD:200V:AC CONTROL BOARD

U019_S003
D2585465
AC CONTROL BOARD:200V

U019_S002
D2615918
(EU/AA/KOR/TWN):POWER SUPPLY CORD:200V:AC CONTROL BOARD

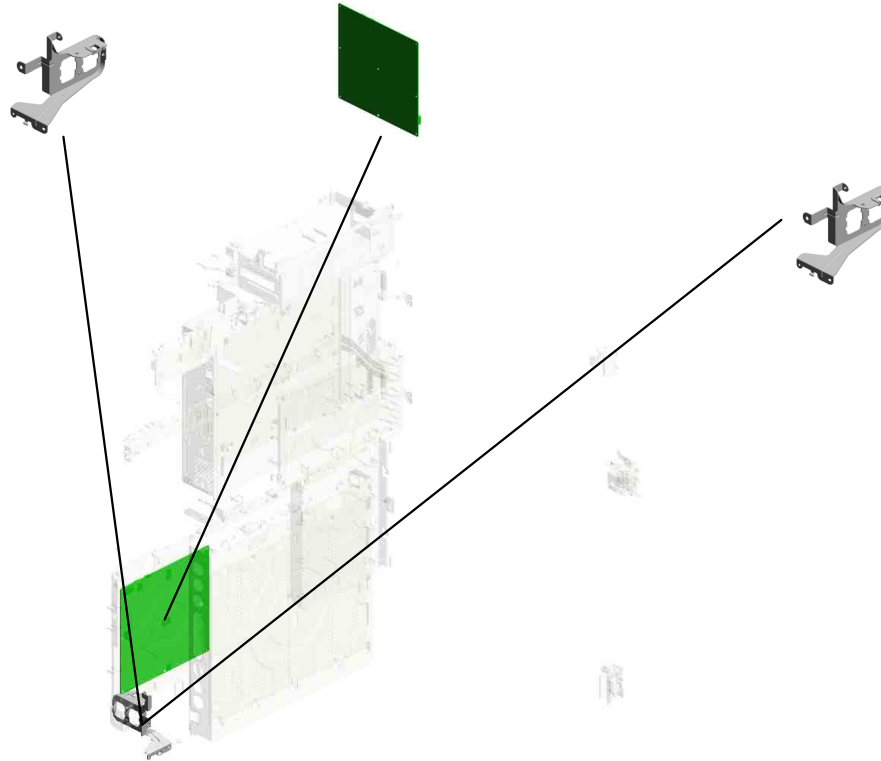

U001	U002	U003	U004	U005	U006	U007	U008	U009	U010	U011	U012	U013	U014	U015	U016	U017	U018	U019	U020	U021
------	------	------	------	------	------	------	------	------	------	------	------	------	------	------	------	------	------	------	------	------

U019 ELECTRICAL

- 13.11050517 (x2) HARNESS CLAMP - LWS-2111Z
- 7.04543030Q (x2) TAPPING SCREW: ROUND POINT:3X30
- 8.04583010N (x8) HEXAGON HEAD TAPPING SCREW:3X10
- 15.11050532 (x8) EDGE SADDLE - L ES-25L
- 17.11050723 (x8) CLAMPS:WES-0507

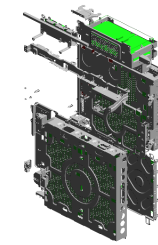

- 16.11050692 (x3) CLAMP:LES-0503



- 14.11050528 (x2) NYLON CLAMP - E MT-2N



- 2.04543006N (x10) TAPPING SCREW: ROUND POINT:3X6

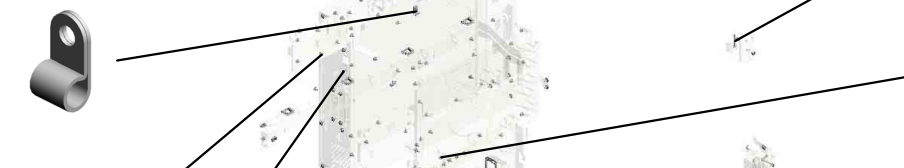

- 1.03530060N BIND SCREW - M3 X6



- 4.04543008Q (x2) TAPPING SCREW: 3X8

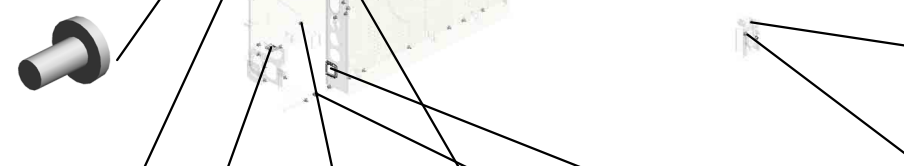

- 18.11050724 (x6) CLAMPS:WES-1210
- 9.08010231 (x2) HEXAGONAL HEAD BOLT W/WASHER:M3X6
- 20.11050758 (x5) CLAMP:LWSM-0306A
- 10.08010234 SCREW WITH WASHER:SMALL ROUND WITH SPRING WASHER:M5X8
- 19.11050726 (x2) CLAMPS:WES-2217

- 6.04543025Q (x2) TAPPING SCREW: ROUND POINT:3X25



- 14.11050528 (x2) NYLON CLAMP - E MT-2N

- 16.11050692 CLAMP:LES-0503

- 3.04543006Q (x166) TAPPING SCREW - M3X6



- 11.08046123 (x3) HEXAGONAL BOLT :W/WASHER:M3X8

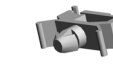

- 20.11050758 (x7) CLAMP:LWSM-0306A

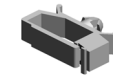

- 22.11050760 CLAMP:LWSM-0511A

- 12.08050092 (x6) RETAINING RING - 3M



- 25.11050763 (x5) CLAMP:LWS-1211A

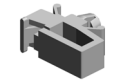

- 26.11050764 CLAMP:LWS-1316A

- 5.04543014Q TAPPING SCREW: 3X14



- 2.04543006N (x 1) TAPPING SCREW:ROUND POINT:3X6

- 3.04543006Q (x 5) TAPPING SCREW - M3X6

U019 ELECTRICAL

22.11050760
(x11)
CLAMP:LWSM-051
1A

38.AZ320230
(x2)
POWER PACK:C/B

21.11050759
(x7)
CLAMP:LWSM-060
5A

26.11050764
(x14)
CLAMP:LWS-1316A

39.D0744351
(x12)
STEPPED SCREW:
DIA5.4DIA:DIA3.5:M
3

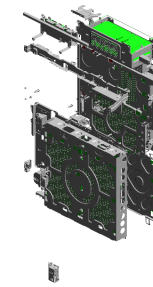

24.11050762
(x5)
CLAMP:LWS-0711A

40.D0895887
(x2)
PANEL:INTERFAC
E

30.AA143848
(x8)
STEPPED SCREW
- M3

32.AA161167
(x8)
BUSHING:HDD

31.AA143884
(x2)
STEPPED SCREW:
DIA5.4:DIA3.5:M3:L
ONG

28.12042570
ROCKER SWITCH:
SDDJE13200

23.11050761
CLAMP:LWS-0511A

34.AX640219
DC FAN MOTOR:D
C24V:MM60:25MM

37.AZ240288
POWER SUPPLY U
NIT:FW:200V

35.AX640231
(x3)
DC FAN MOTOR:A
XIAL:MM80:25MM

4.04543008Q (x 3)
TAPPING SCREW:3X8

25.11050763
(x27)
CLAMP:LWS-1211A

27.11050765
(x7)
CLAMP:LWS-2218A

36.AZ240284
POWER SUPPLY U
NIT:ECO:200V

29.12042612
(x5)
MICRO SWITCH:D3
V-16506-3C25

33.AW500040
PUSH SWITCH:SW
1AG-550:10MA

U019 ELECTRICAL

- 41.D1355926 BRACKET:ELECTR IC POTENTIAL SENSOR:PEEN
- 55.D1365964 COVER:C/T BOX:REAR
- 42.D1361499 (x2) BRACKET:HOLDER :COVER:REAR
- 56.D1365974 (x2) ARM:HINGE:C/T BOX
- 60.D1385989 BRACKET:SAFETY SWITCH:TONER SUPPLY UNIT

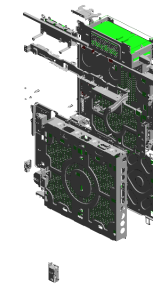

43.D1365455
INVERTOR:IH:200V

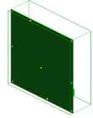

44.D1365903
(x2)
DUCT:POWER SUPPLY UNIT



57.D1375905
BRACKET:INDUCTION HEATING UNIT: AC CONTROL BOARD



45.D1365904
BRACKET:DC FAN MOTOR:INDUCTION HEATING UNIT



58.D1375992
(x2)
BRACKET:INLET:1 POINT



47.D1365913
COVER:SAFETY SWITCH:VERTICAL TRANSPORT



48.D1365914
BRACKET:SAFETY SWITCH:VERTICAL TRANSPORT



49.D1365918
(x2)
TORSION SPRING: SAFETY SWITCH:VERTICAL TRANSPORT



46.D1365912
LEVER:SAFETY SWITCH:VERTICAL TRANSPORT



54.D1365934
LEVER:SAFETY SWITCH:2



50.D1365923
LEVER:SAFETY SWITCH:3

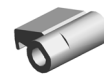

52.D1365932
SHAFT:SAFETY SWITCH:LEVER:1



53.D1365933
LEVER:SAFETY SWITCH:1



51.D1365931
TORSION SPRING: SAFETY SWITCH



59.D1385987
COVER:SAFETY SWITCH:TONER SUPPLY UNIT

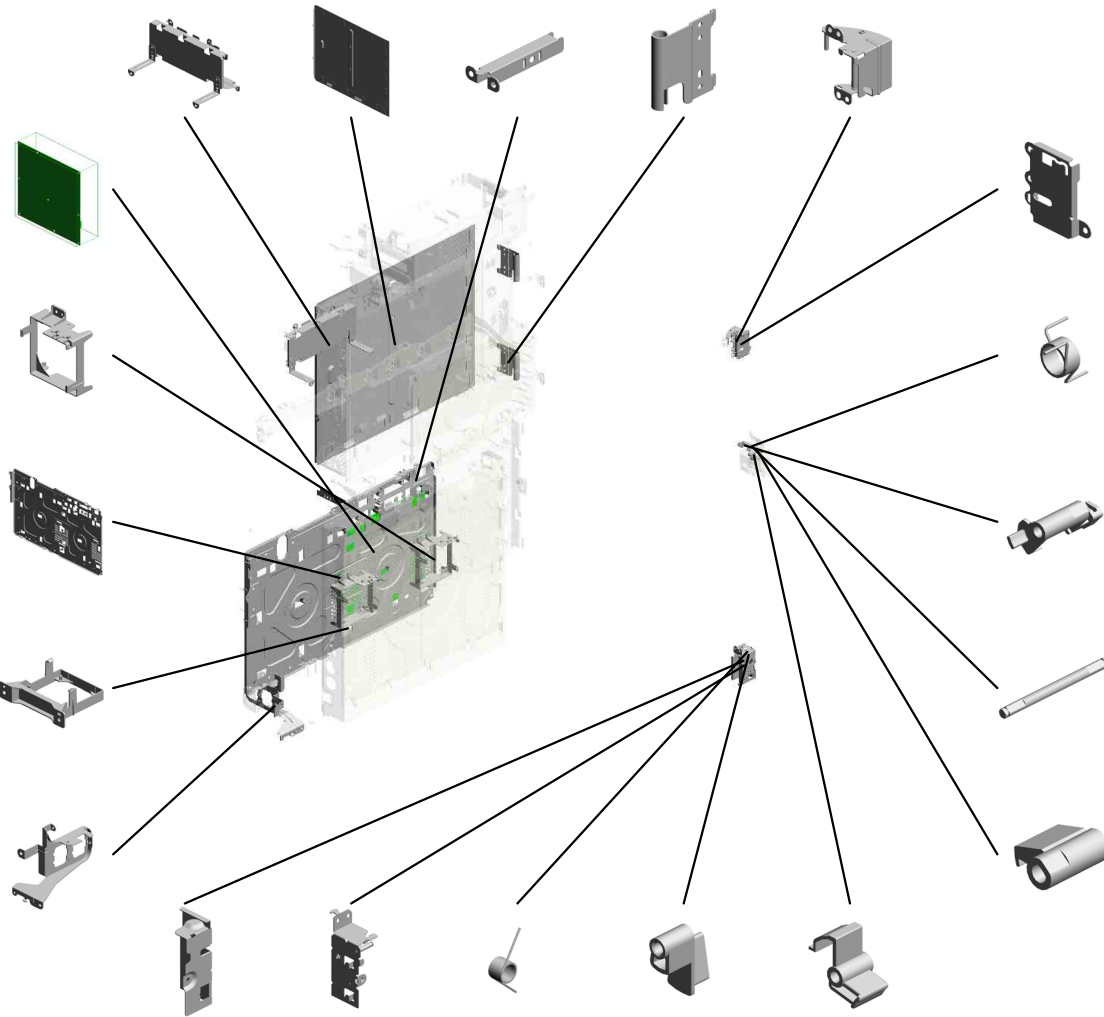

U019 ELECTRICAL

66.D2395629 PCB:DDR3-DIMM:R
C-A:4GB:ASS'Y

79.D2615704 (D260):PCB:CTL:SE
RVICE PARTS:ASS'
Y

80.D2615705 (D261):PCB:CTL:SE
RVICE PARTS:ASS'
Y

70.D2585967 GASKET:13X10X37
0

67.D2585101 PCB:BICU:SUB-AS
S'Y

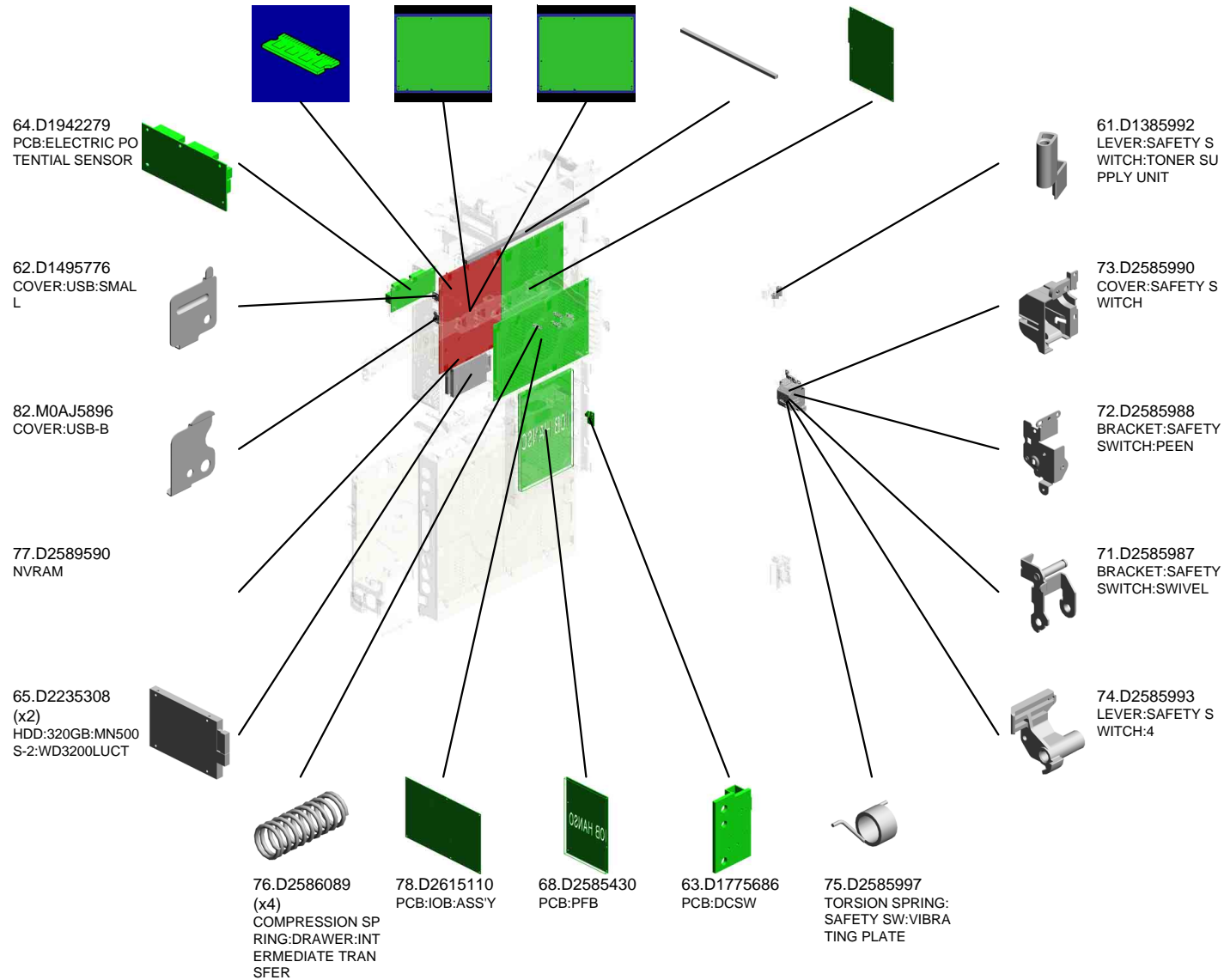
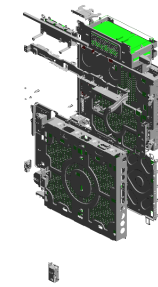

U019
ELECTRICAL

83.M2056436
(x10)
COMPRESSION SP
RING:DRAWER:INT
ERMEDIATE TRAN
SFER:NO.2

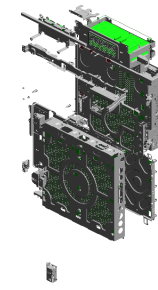
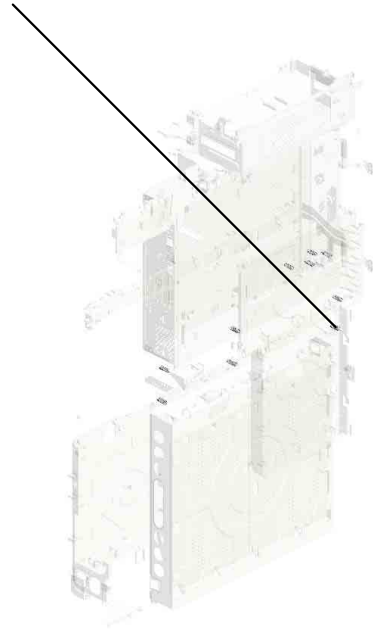

U019_S001
(EU/AA/KOR/TWN):POWER SUPPLY CORD:200V:AC CONTROL BOARD

18.11050724
CLAMPS:WES-121
0

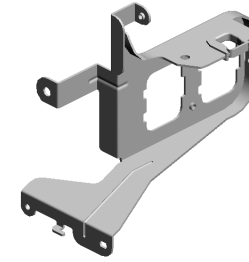

81.D2615918
(EU/AA/KOR/TWN):
POWER SUPPLY C
ORD:200V:AC CON
TROL BOARD



58.D1375992
BRACKET:INLET:1
POINT

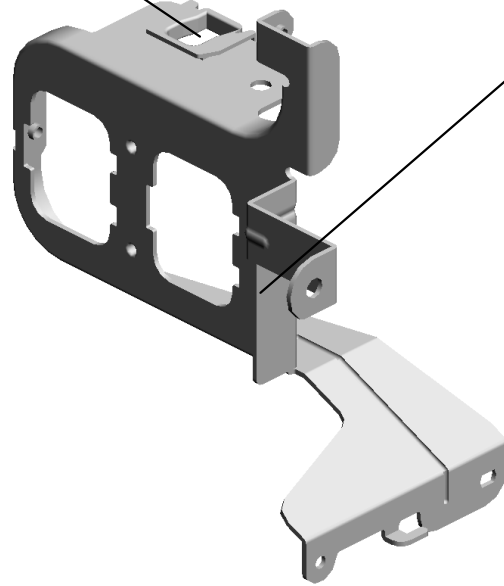

U001	U002	U003	U004	U005	U006	U007	U008	U009	U010	U011	U012	U013	U014	U015	U016	U017	U018	U019	U020	U021
------	------	------	------	------	------	------	------	------	------	------	------	------	------	------	------	------	------	------	------	------

U019_S002
(EU/AA/KOR/TWN):POWER SUPPLY CORD:200V:AC CONTROL BOARD

18.11050724
CLAMPS:WES-121
0

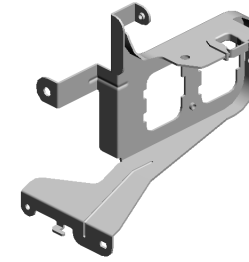

81.D2615918
(EU/AA/KOR/TWN):
POWER SUPPLY C
ORD:200V:AC CON
TROL BOARD



58.D1375992
BRACKET:INLET:1
POINT

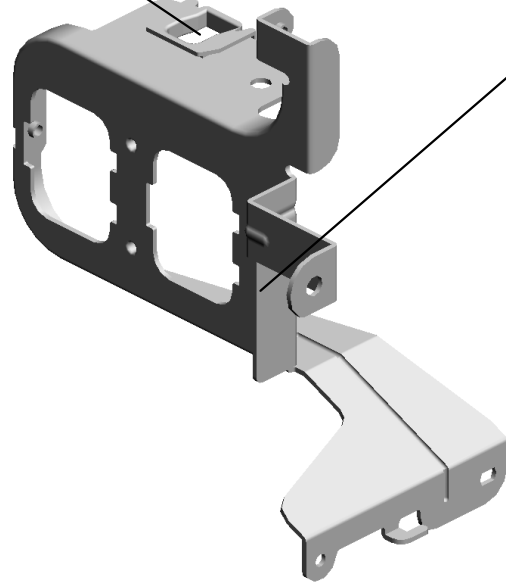

U001	U002	U003	U004	U005	U006	U007	U008	U009	U010	U011	U012	U013	U014	U015	U016	U017	U018	U019	U020	U021
------	------	------	------	------	------	------	------	------	------	------	------	------	------	------	------	------	------	------	------	------

U019_S003
AC CONTROL BOARD:200V

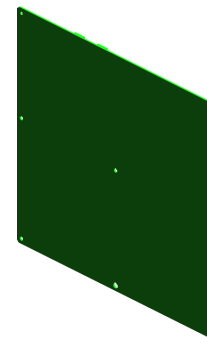

69.D2585465
AC CONTROL BOA
RD:200V

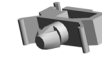

20.11050758
CLAMP:LWSM-030
6A

U001	U002	U003	U004	U005	U006	U007	U008	U009	U010	U011	U012	U013	U014	U015	U016	U017	U018	U019	U020	U021
------	------	------	------	------	------	------	------	------	------	------	------	------	------	------	------	------	------	------	------	------

U020.AIR COOLING

U020_S001
D1366957
DC FAN MOTOR:INTERMEDI
ATE TRANSFER:ASS'Y

U020_S002
D1366966
DUCT:HEAT SINKER:REAR:A
SS'Y

U020_S003
D1351435
DC FAN MOTOR:SIROCCO:A
SS'Y

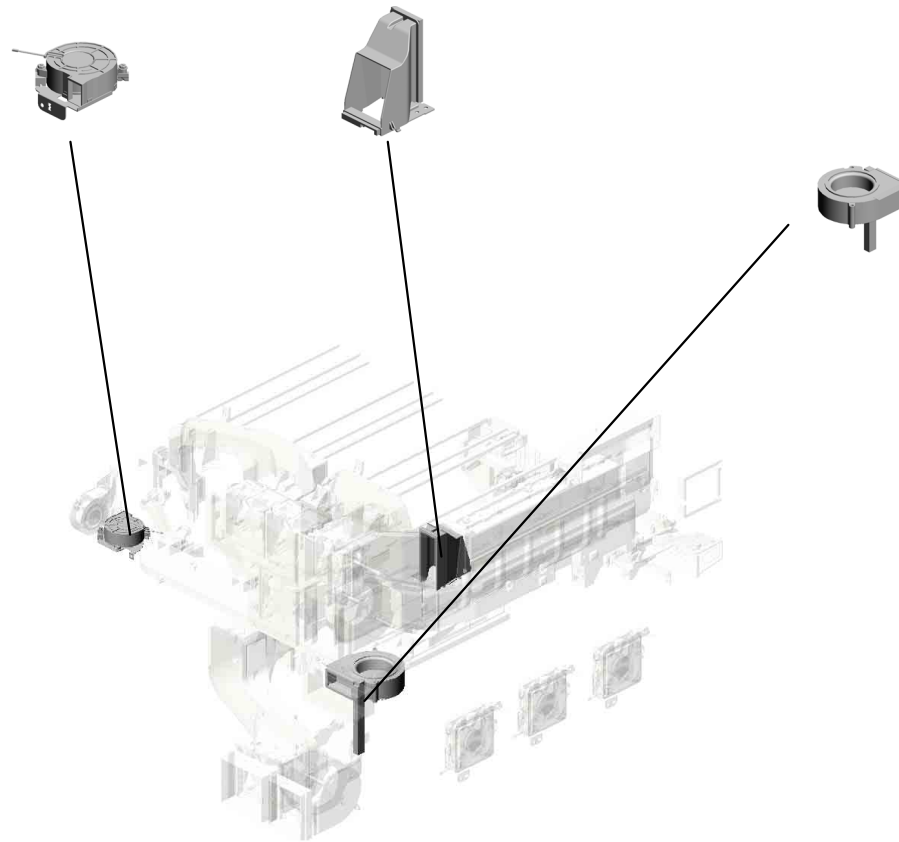

U001	U002	U003	U004	U005	U006	U007	U008	U009	U010	U011	U012	U013	U014	U015	U016	U017	U018	U019	U020	U021
------	------	------	------	------	------	------	------	------	------	------	------	------	------	------	------	------	------	------	------	------

U020 AIR COOLING

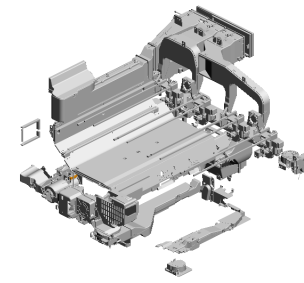

18.11050760
CLAMP:LWSM-051
1A

13.04583008N
(x17)
HEXAGON HEAD T
APPING SCREW:3
X8

1.03530040N
(x4)
SCREW - M3X4

7.04503025N
(x2)
TAPPING SCREW:
3X25

3.03530100N
(x2)
SCREW-M3X10

9.04543006Q
(x66)
TAPPING SCREW -
M3X6

5.04503014N
(x2)
TAPPING SCREW:
M3X14

22.11050764
(x2)
CLAMP:LWS-1316A

10.04543008Q
(x31)
TAPPING SCREW:
3X8

8.04503035N
(x4)
TAPPING SCREW:
3X35

14.04583010N
(x2)
HEXAGON HEAD T
APPING SCREW:3
X10

15.08025328
(x6)
HEXAGON HEAD T
APPING SCREW:3
X40

17.11050758
(x29)
CLAMP:LWSM-030
6A

2.03530060N
BIND SCREW - M3
X6

4.03540400N
(x2)
SCREW:M4X40

16.11050692
(x4)
CLAMP:LES-0503

16.11050692
(x2)
CLAMP:LES-0503

17.11050758
(x3)
CLAMP:LWSM-030
6A

12.04543030Q
(x2)
TAPPING SCREW:
ROUND POINT:3X3
0

6.04503020N
(x2)
TAPPING SCREW:
M3X20

20.11050762
CLAMP:LWS-0711A

21.11050763
(x5)
CLAMP:LWS-1211A

9.04543006Q (x 4)
TAPPING SCREW - M3X6

19.11050761
CLAMP:LWS-0511A

U020 AIR COOLING

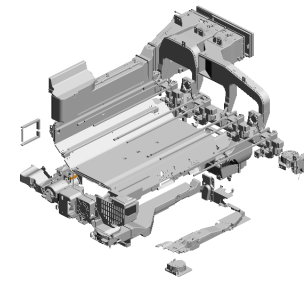

- 32.AX640224 (x2) DC FAN MOTOR:A XIAL:MM80
- 30.AX640221 (x3) FAN:SIROCCO:DC 24V:50MM
- 34.AX640231 (x3) DC FAN MOTOR:A XIAL:MM80:25MM
- 28.AW100165 THERMISTOR:ASS' Y
- 39.D0742577 CONNECTOR:DRA WER:4POLE:REC

31.AX640223
FAN:SIROCCO:DC
24V:60MM

36.AX650056
DC FAN MOTOR:A
XIAL:MM92

37.AX660015
DC FAN MOTOR:SI
ROCCO:DC24V:PW
M

24.AA012137
FILTER:CORPUSC
LE:FUSING:EXIT

43.D1351491
(x2)
SEAL:AROUND TH
E PHOTOCONDU
TOR:EXHAUST:SI
ROCCO

25.AA012138
FILTER:CORPUSC
LE:TRANSFER:FUS
ING

26.AA012139
FILTER:CORPUSC
LE:PRESSURE RO
LLER

35.AX650054
(x2)
DC FAN MOTOR:SI
ROCCO:DC24V:PW
M

47.D1366052
SUPPORTER:INTE
RMEDIATE TRANS
FER:LEFT

33.AX640226
(x3)
DC FAN MOTOR:A
XIAL:MM80:20MM

29.AX640219
(x2)
DC FAN MOTOR:D
C24V:MM60:25MM

41.D1351448
SEAL:DUCT:BELT
CLEANING:INNER

27.AW010147
PHOTO REFLECTI
ON SENSOR

23.AA000290
(x2)
DECAL:POSITIONI
NG DISPLAY:SCRE
W:PET

38.B2342390
(x2)
FLANGED HEXAG
ONAL HEAD BOLT:
M4X8

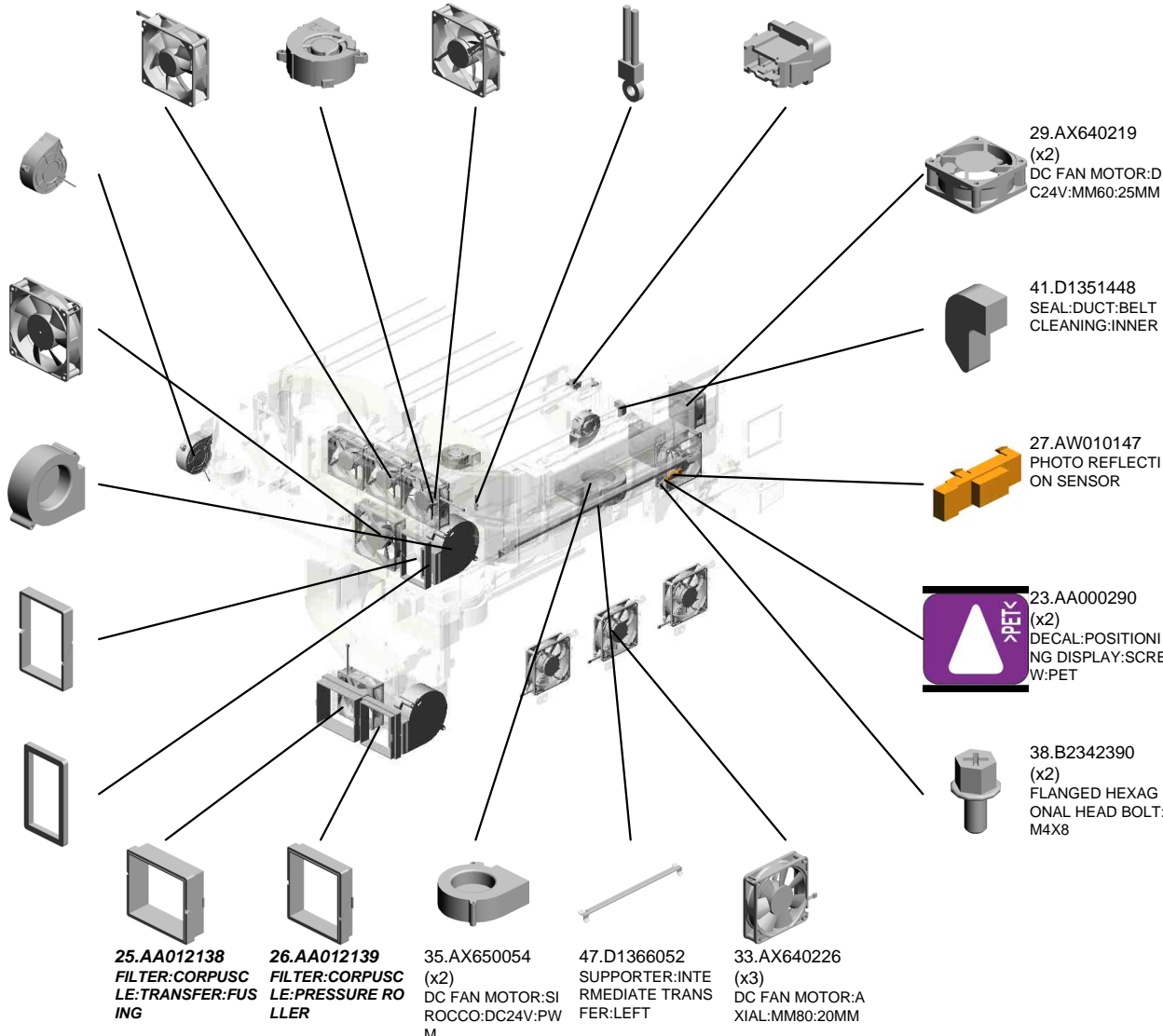

U020 AIR COOLING

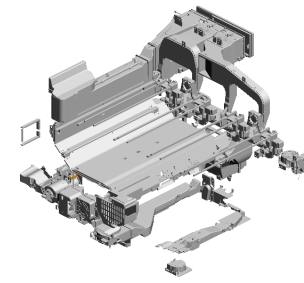

- 56.D1366890 DUCT:DEVELOPM ENT:EXHAUST:RIG HT:FRONT
- 65.D1366920 (x2) DUCT:DEVELOPM ENT:EXHAUST:EXI T:LEFT
- 59.D1366895 DUCT:DEVELOPM ENT:EXHAUST:LEF T:REAR
- 58.D1366894 DUCT:DEVELOPM ENT:EXHAUST:LEF T:FRONT
- 49.D1366466 BRACKET:GUARD: BELT CLEANING

57.D1366891
DUCT:DEVELOPM ENT:EXHAUST:RIG HT:REAR

66.D1366921
(x2)
DUCT:DEVELOPM ENT:EXHAUST:EXI T:RIGHT

68.D1366923
(x2)
SEAL:DEVELOPME NT:EXHAUST:LEFT

61.D1366900
(x3)
RELAY DUCT:ARO UND THE PHOTOC ONDUCTOR:ASS'Y

48.D1366409
GUIDE:BELT CLEA NING

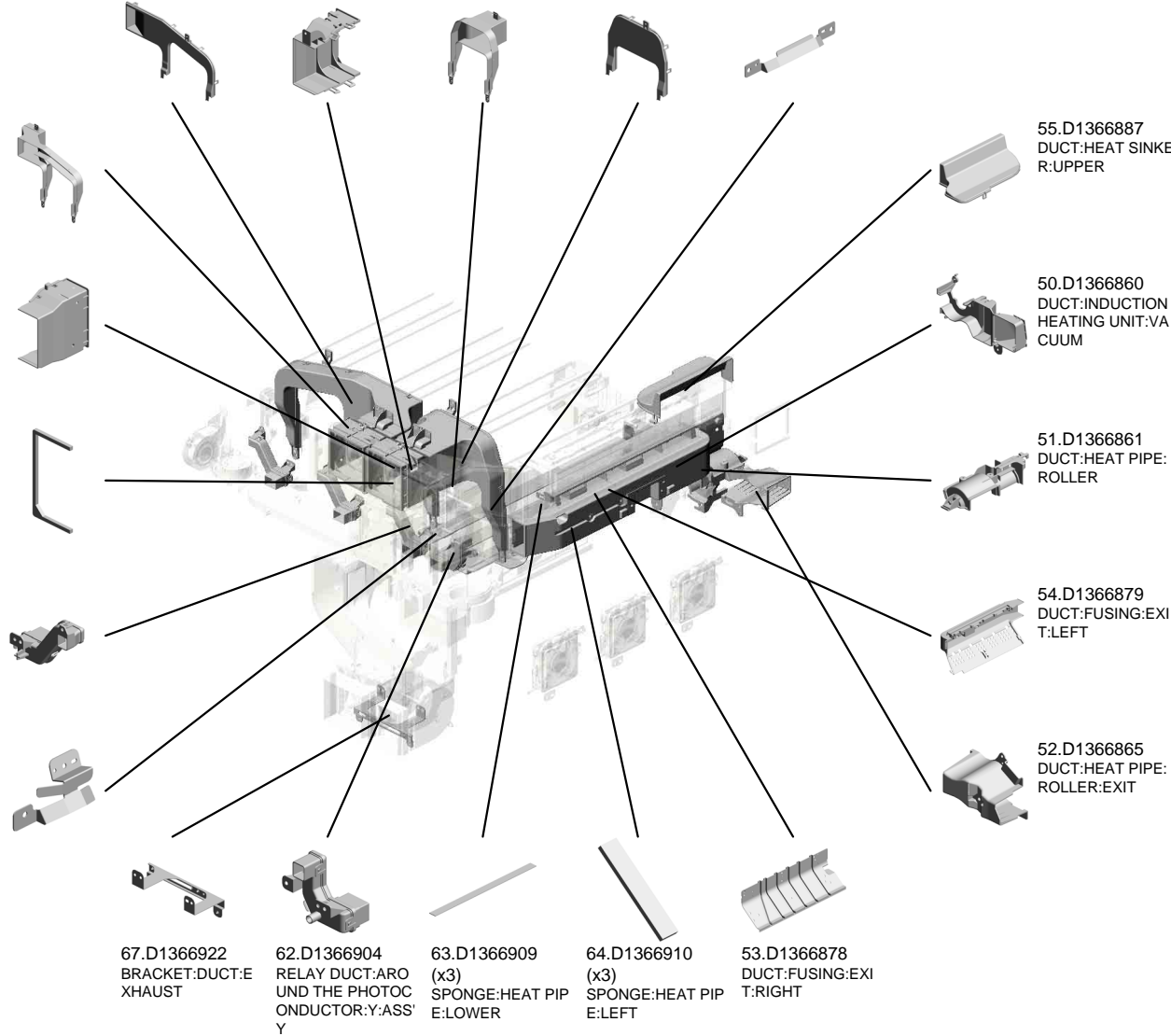

U020 AIR COOLING

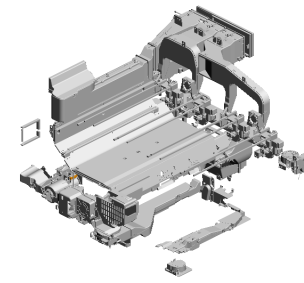

73.D1366935
 FILTER:DEVELOPMENT:EXHAUST: LARGE

69.D1366924 (x2)
 SEAL:DEVELOPMENT:EXHAUST:RIGHT

71.D1366928 (x2)
 DUCT:DC FAN MOTOR:OPTICAL WRITING UNIT

79.D1366948
 BRACKET:THERMOSTOR

75.D1366941
 HEAT INSULATING PLATE:HEAT PIPE:RIGHT

70.D1366927 (x4)
 SEAL:DUCT:AROUND THE PHOTOCOINDUCTOR:ENTRANCE

89.D1366974
 DUCT:DENSITY SENSOR:LEFT

88.D1366972
 DUCT:DENSITY SENSOR:RIGHT

85.D1366963
 SEAL:RELAY DUCT:BELT CLEANING

76.D1366943
 SEAL:DUCT:EXHAUST:INDUCTION HEATING UNIT

82.D1366959
 SEAL:DEVELOPMENT:VACUUM:Y:UPPER

84.D1366961
 SEAL:DEVELOPMENT:VACUUM:Y:FRONT

91.D1366980
 SEAL:INDUCTION HEATING UNIT:VACUUM

83.D1366960
 SEAL:DEVELOPMENT:VACUUM:Y:LOWER

87.D1366971
 BRACKET:HINGEDUCT:HEAT PIPE:ROLLER

92.D1366982 (x2)
 SEAL:HEAT SINKER:LEFT AND RIGHT

72.D1366932
 FILTER:PRESSURE ROLLER:VACUUM

74.D1366940
 HEAT INSULATING PLATE:HEAT PIPE:UPPER

77.D1366946 (x3)
 BRACKET:SETTING LEVER JUMPER:DC FAN MOTOR:DUPLX:EXIT

78.D1366947 (x3)
 OZONE FILTER:EXIT

U020 AIR COOLING

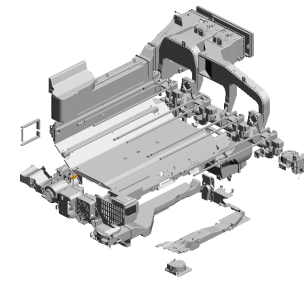

- 98.D1386863 DUCT:PRESSURE ROLLER:VACUUM: UPPER
- 112.D2576887 (x2) SEAL:DUCT:HEAT SINKER:EXHAUST: FRONT UPPER
- 109.D2576870 SEAL:DUCT:BELT CLEANING:REAR:R IGH T
- 110.D2576871 SEAL:DUCT:BELT CLEANING:REAR:L EFT
- 111.D2576872 SEAL:DUCT:BELT CLEANING:LEFT

106.D2576864 (x4) SEAL:DUCT:ENTR ANCE:RIGHT

104.D2576862 (x4) SEAL:DUCT:ENTR ANCE:LARGE

97.D1366995 BRACKET:DEVELO PMENT:EXHAUST

95.D1366990 DUCT:MECHANICA L DRIVE SECTION: LEFT UPPER

96.D1366992 RELAY DUCT:BELT CLEANING

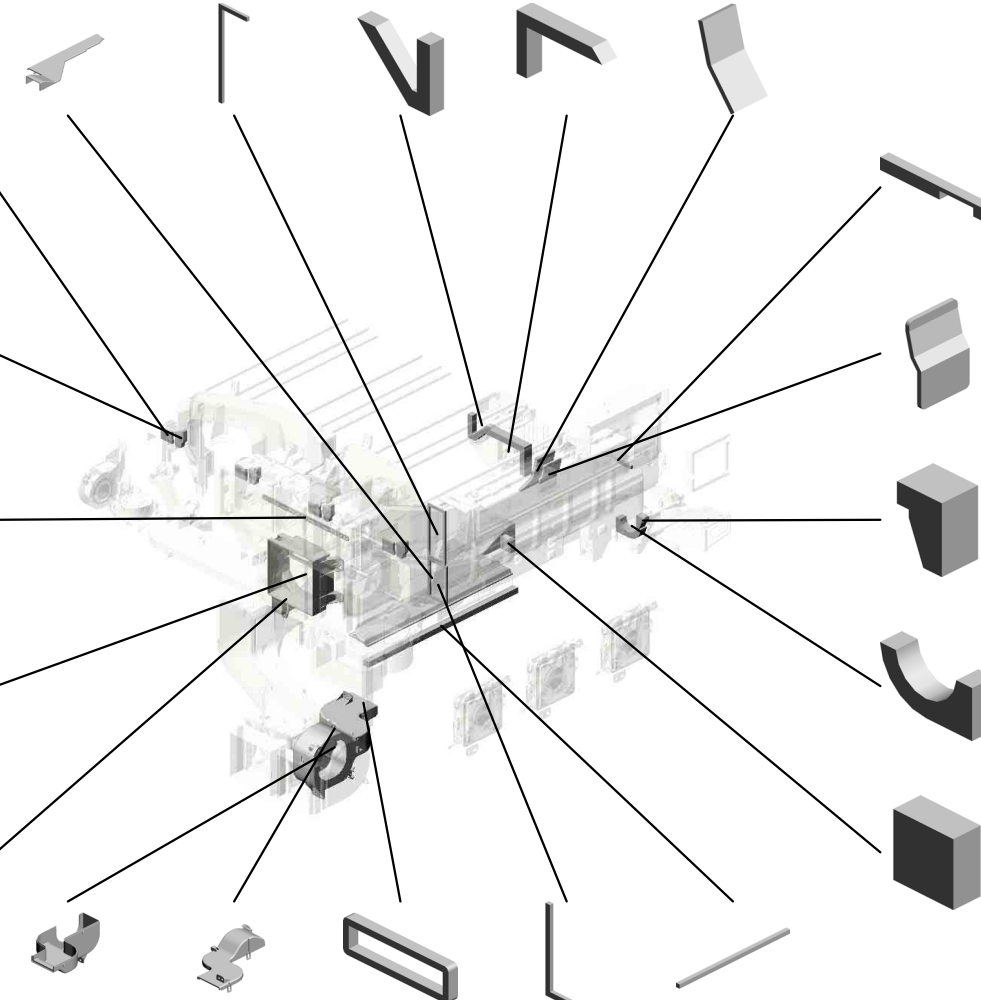

93.D1366983 SEAL:HEAT SINKE R:FRONT

103.D2576852 SEAL:DUCT:VACU UM

105.D2576863 SEAL:DUCT:HEAT PIPE:ROLLER

107.D2576865 SEAL:INDUCTION HEATING UNIT:VA CUUM:LEFT

108.D2576866 SEAL:DUCT:VACU UM:FRONT LEFT

99.D1386923 DUCT:PRESSURE ROLLER:EXHAUST :LOWER

100.D1386924 DUCT:PRESSURE ROLLER:EXHAUST :UPPER

101.D1386946 SEAL:DUCT:PRES SURE ROLLER:EX HAUST

113.D2576888 (x2) SEAL:DUCT:HEAT SINKER:EXHAUST: FRONT LOWER

102.D1386972 SEAL:DUCT:PRES SURE ROLLER:VA CUUM:LOWER

U020 AIR COOLING

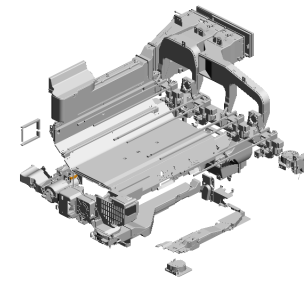

- 114.D2576889 SEAL:DUCT:HEAT SINKER:EXHAUST:MIDDLE UPPER
- 117.D2576966 SEAL:HEAT PIPE:ANEL:UPPER
- 120.D2576969 SEAL:DUCT:BELT CLEANING:VACUUM
- 126.D2586869 DUCT:BELT CLEANING:VACUUM:REAR
- 125.D2586868 DUCT:BELT CLEANING:VACUUM:FRONT

133.D2586899 (x4)
DUCT:PCU:ENTRANCE



129.D2586885 DUCT:HEAT SINKER:EXHAUST:RIGHT

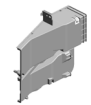

130.D2586886 DUCT:HEAT SINKER:EXHAUST:LEFT

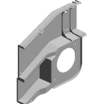

132.D2586893 DUCT:PCU:EXHAUST:UPPER



115.D2576890 SEAL:DUCT:HEAT SINKER:EXHAUST:MIDDLE LOWER



116.D2576921 (x2)
SEAL:DUCT:TRANSFER:FUSING:EXIT



127.D2586875 DUCT:PRESSURE ROLLER:VACUUM:LOWER



131.D2586892 HEAT PIPE:ASS'Y

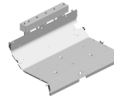

118.D2576967 SEAL:HEAT PIPE:ANEL:LOWER

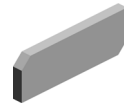

122.D2576997 SEAL:DUCT:FUSING:EXIT:LARGE



123.D2576998 SEAL:DUCT:FUSING:EXIT:SMALL



128.D2586882 DUCT:HEAT SINKER:MIDDLE



119.D2576968 SEAL:DUCT:BELT CLEANING:MIDDLE LOWER

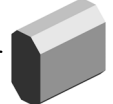

121.D2576973 SEAL:HEAT PIPE:GUIDE:LEFT



124.D2586851 DUCT:VACUUM

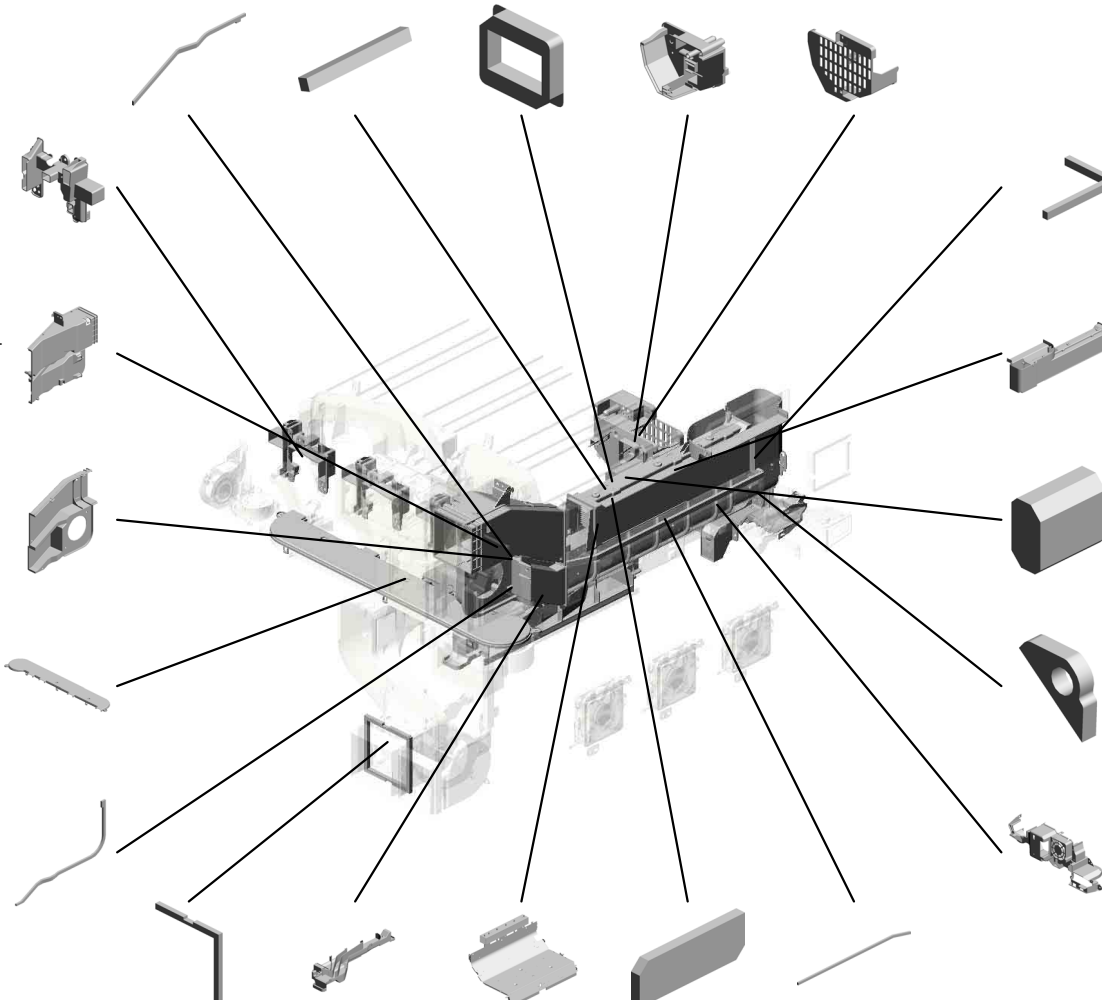

U020 AIR COOLING

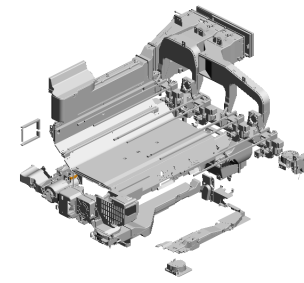

145.D2586955
OZONE FILTER:LA
RGE

147.D2586972
DUCT:T/S UNIT:LO
WER

148.D2586973
DUCT:T/S UNIT:UP
PER

150.D2586978
BRACKET:DC FAN
MOTOR:T/S UNIT

151.D2586979
(x2)
FILTER:DC FAN M
OTOR:T/S UNIT

146.D2586956
DEODORIZE FILTE
R:SMALL

134.D2586907
DUCT:PCU:EXHAU
ST:LOWER

140.D2586946
SEAL:AUXILIARY:D
UCT:TRANSFER/S
EPARATION UNIT:
UPPER

153.D2586991
SEAL:AUXILIARY:D
UCT:TRANSFER/S
EPARATION UNIT

141.D2586947
GUIDE PLATE:HAR
NESS:PULL OUT

137.D2586919
DUCT:TRANSFER:
FUSING:EXHAUST:
REAR

136.D2586918
DUCT:TRANSFER:
FUSING:EXHAUST:
FRONT

142.D2586948
DUCT:USED TONE
R:BRACKET:FRON
T

138.D2586938
OZONE FILTER:SM
ALL

135.D2586917
FILTER:DEVELOP
MENT:EXHAUST:S
MALL:ASS'Y

152.D2586986
BRACKET:DC FAN
MOTOR:VACUUM

143.D2586949
SEAL:SHIELD PLA
TE:HEAT PIPE

149.D2586974
COVER:DUCT:T/S
UNIT

144.D2586950
SHIELD PLATE:US
ED TONER:TRANS
FER/SEPARATION
UNIT

139.D2586944
(x3)
BRACKET:DC FAN
MOTOR:DUPLX:E
XIT

U020 AIR COOLING

155.GX640028
(x2)
FAN MOTOR DC24
V 1.92W

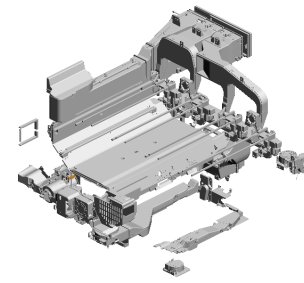

154.D2616920
CAP:DUCT:TRANS
FER:FUSING

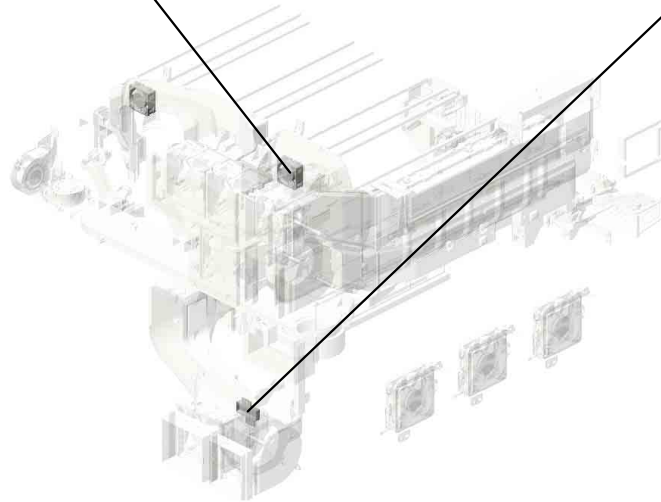

U001	U002	U003	U004	U005	U006	U007	U008	U009	U010	U011	U012	U013	U014	U015	U016	U017	U018	U019	U020	U021
------	------	------	------	------	------	------	------	------	------	------	------	------	------	------	------	------	------	------	-------------	------

U020_S001
DC FAN MOTOR:INTERMEDIATE TRANSFER:ASS'Y

31.AX640223
FAN:SIROCCO:DC
24V:60MM

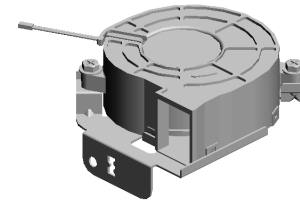

80.D1366957
DC FAN MOTOR:IN
TERMEDIATE TRA
NSFER:ASSY

11.04543010Q
(x2)
TAPPING SCREW:
3X10

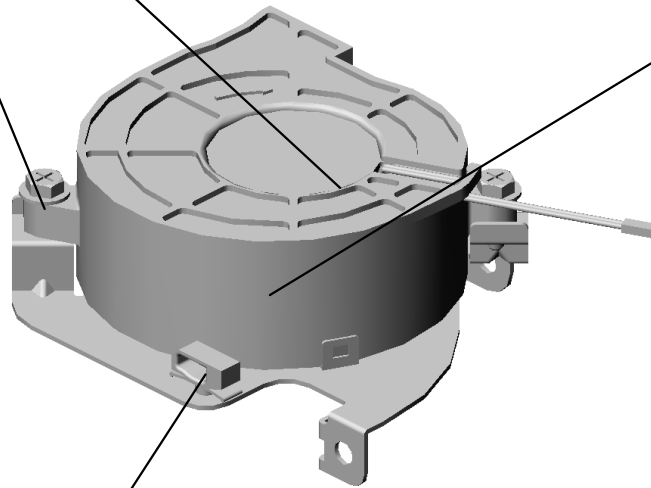

81.D1366958
BRACKET:DC FAN
MOTOR:INTERME
DIATE TRANSFER



17.11050758
CLAMP:LWSM-030
6A



U001	U002	U003	U004	U005	U006	U007	U008	U009	U010	U011	U012	U013	U014	U015	U016	U017	U018	U019	U020	U021
------	------	------	------	------	------	------	------	------	------	------	------	------	------	------	------	------	------	------	------	------

U020_S002
DUCT:HEAT SINKER:REAR:ASS'Y

90.D1366979
SEAL:HEAT SINKE
R:EXIT

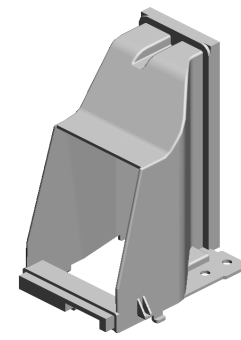
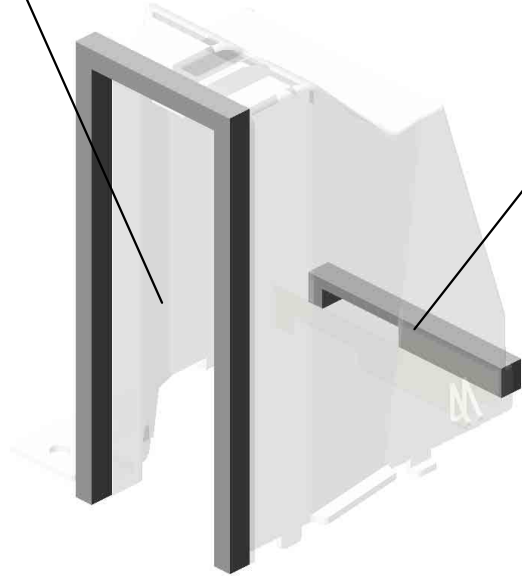

86.D1366966
DUCT:HEAT SINKE
R:REAR:ASS'Y

94.D1366984
SEAL:HEAT SINKE
R:REAR



U020_S003
DC FAN MOTOR:SIROCCO:ASS'Y

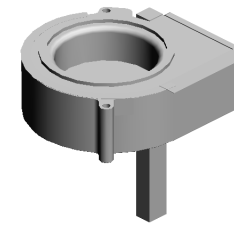

40.D1351435
DC FAN MOTOR:SI
ROCCO:ASS'Y

45.D1351497
SEAL:SIROCCO

35.AX650054
DC FAN MOTOR:SI
ROCCO:DC24V:PW
M

44.D1351496
SEAL:AROUND TH
E PHOTOCONDUCT
OR:EXHAUST:SI
ROCCO:UPPER

43.D1351491
SEAL:AROUND TH
E PHOTOCONDUCT
OR:EXHAUST:SI
ROCCO

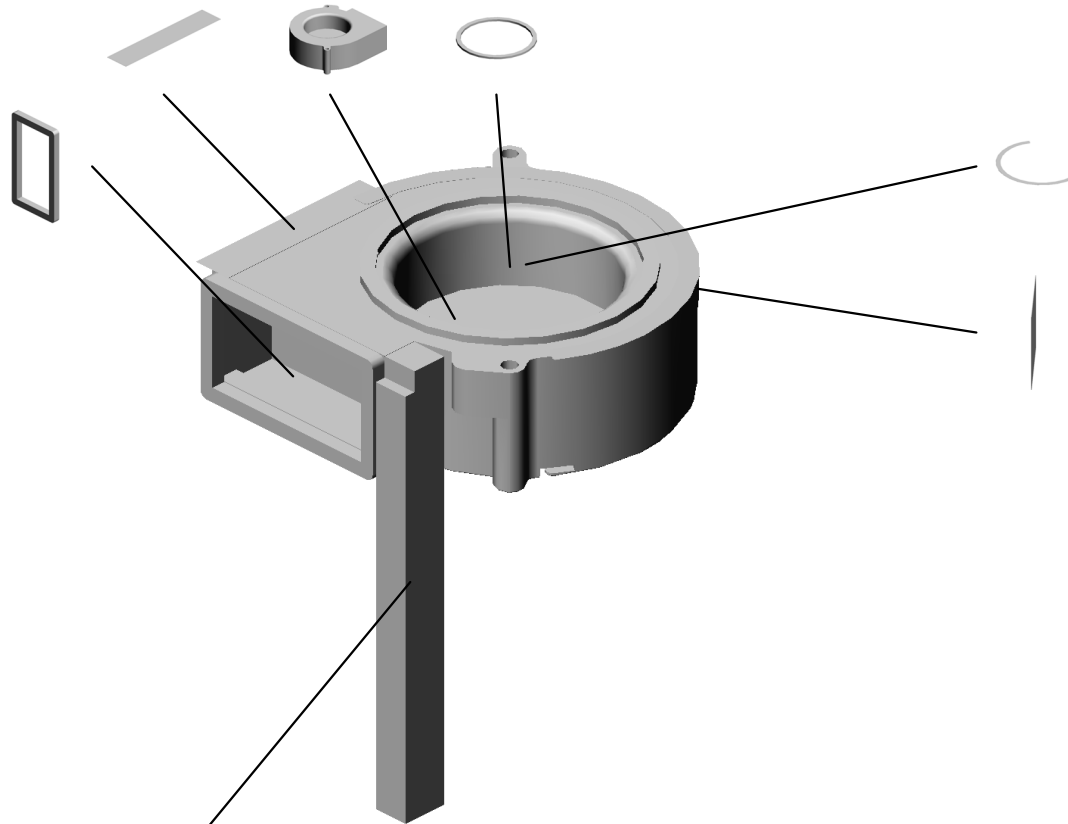

42.D1351478
SEAL:SIROCCO:4

46.D1351498
(x2)
SEAL:SIROCCO:2

60.D1366896
SEAL:AROUND TH
E PHOTOCONDUCT
OR:EXHAUST

U001	U002	U003	U004	U005	U006	U007	U008	U009	U010	U011	U012	U013	U014	U015	U016	U017	U018	U019	U020	U021
------	------	------	------	------	------	------	------	------	------	------	------	------	------	------	------	------	------	------	------	------

U021.MAIN FRAME

U021_S002
D2610032
SLIDE RAIL:ASSY

U021_S003
D2611416
DRUM STAY:PCU:ASS'Y

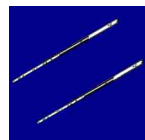

U021_S001
AA071017
SLIDE RAIL:RIGHT:ASS'Y

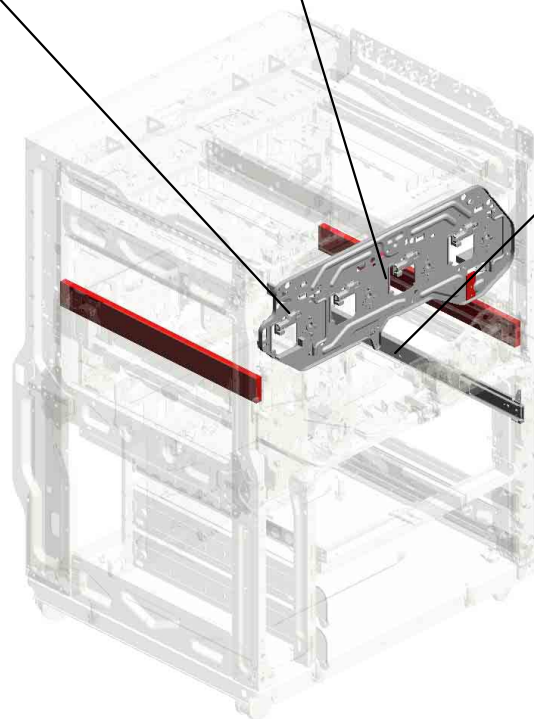

U021_S003.DRUM STAY:PCU:ASS'Y

U021_S003_S001
D1363434
DECAL:COLORED DISPLAY:
DRUM STAY:ASS'Y

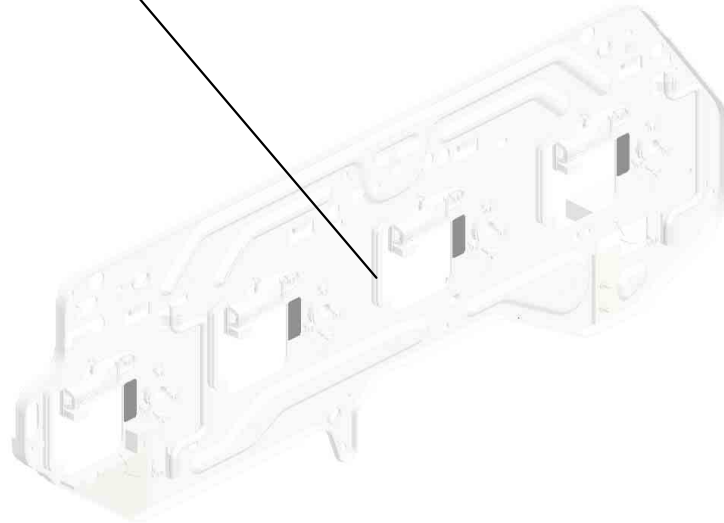

U021 MAIN FRAME

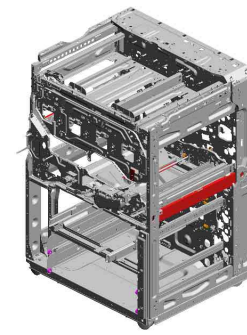

- 16.08046123 (x6) HEXAGONAL BOLT :W/WASHER:M3X8
- 5.04543006Q (x151) TAPPING SCREW - M3X6
- 8.04544008Q (x13) TAPPING SCREW - M4X8
- 3.04533006N (x3) TAPPING SCREW - M3X6
- 6.04543008N (x10) TAPPING SCREW: ROUND POINT:3X8

22.11050723
(x4)
CLAMPS:WES-050
7



1.03140180N
PAN HEAD SCREW
:M4X18



20.11050551
(x3)
CLAMP:LES-0505



24.11050758
(x62)
CLAMP:LWSM-030
6A



15.08030058
(x2)
STEPPED SCREW



21.11050692
CLAMP:LES-0503

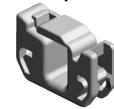

7.04543008Q
(x117)
TAPPING SCREW:
3X8



17.08050092
(x2)
RETAINING RING -
3M



23.11050724
(x2)
CLAMPS:WES-121
0



18.08050103
(x2)
RETAINING RINGS
-E:SILENCER:DIA3



11.07200040E
(x2)
RETAINING RING -
M4

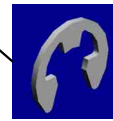

4.04543006N
(x4)
TAPPING SCREW:
ROUND POINT:3X6



14.08010240
(x2)
BINDING HEAD SC
REW:M2.6X4



12.07200060E
(x5)
RETAINING RING -
M6



9.04583008N
(x4)
HEXAGON HEAD T
APPING SCREW:3
X8



26.11050760
CLAMP:LWSM-051
1A

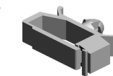

27.11050761
(x5)
CLAMP:LWS-0511A



28.11050762
CLAMP:LWS-0711A



29.11050763
(x8)
CLAMP:LWS-1211A



13.08010231
(x2)
HEXAGONAL HEA
D BOLT W/WASHE
R:M3X6



19.11050328
HARNESS CLAMP -
ES-0505



24.11050758
(x19)
CLAMP:LWSM-030
6A



25.11050759
(x2)
CLAMP:LWSM-060
5A



U021 MAIN FRAME

25.11050759 CLAMP:LWSM-0605A
 29.11050763 (x44) CLAMP:LWS-1211A
 27.11050761 (x8) CLAMP:LWS-0511A
 31.11050765 (x4) CLAMP:LWS-2218A
 30.11050764 (x9) CLAMP:LWS-1316A

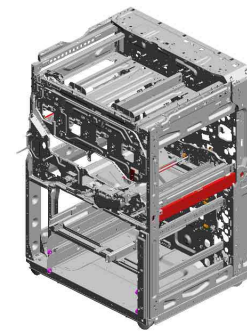

40.AA132300
 ROLLER:LOCK:PU
 LL OUT



28.11050762
 (x13)
 CLAMP:LWS-0711A



33.AA063902
 (x2)
 SPRING:CONNECT
 OR:TANDEM LCT



26.11050760
 (x16)
 CLAMP:LWSM-051
 1A

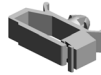

36.AA071018
 SLIDE RAIL:LEFT:A
 SS'Y



38.AA082175
 (x2)
 PLAIN SHAFT BEA
 RING:8X12X7



48.AH012031
 (x4)
 CASTER:1470N



37.AA071029
 SLIDE RAIL:MIDDL
 E:THREE WAY:AS
 S'Y



43.AA145909
 SHAFT:STOPPER:
 PULL OUT



39.AA132030
 (x2)
 SPACER:DIA14



42.AA143870
 (x4)
 STEPPED SCREW



46.AB017921
 GEAR:PULL OUT:L
 OCK:NO.2



45.AB017920
 GEAR:PULL OUT:L
 OCK:NO.1



47.AB017922
 GEAR:PULL OUT:L
 OCK:NO.3

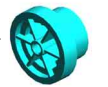

44.AB012078
 GEAR:PULL OUT:L
 OCK:DRIVE



30.11050764
 CLAMP:LWS-1316A



54.B2342390
 (x2)
 FLANGED HEXAG
 ONAL HEAD BOLT:
 M4X8

2.03604008N (x 3)
 SCREW - M4X8
 5.04543006Q (x26)
 TAPPING SCREW - M3X6
 7.04543008Q (x17)
 TAPPING SCREW:3X8

U021 MAIN FRAME

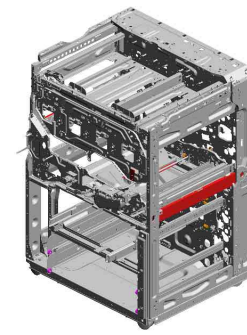

- 60.D1361547 HANDLE:DRUM STAY
- 49.AW020198 (x7) PHOTOINTERRUPTOR:LG2A14NL1
- 54.B2342390 (x6) FLANGED HEXAGONAL HEAD BOLT:M4X8
- 69.D1361590 GUIDE:CURL CORND
- 70.D1361591 EXTENSION TRAY:CURL CORD

67.D1361584 SUPPORTING PLATE:BRACKET:LOCK

68.D1361585 BRACKET:LOCK

59.D1351583 FEELER:PULL OUT:LOCK

55.C2592267 (x2) LOCK HOLDER

53.B1881125 (x12) FLANGED HEXAGONAL HEAD BOLT:M5X14

51.AW500046 (x2) PUSH SWITCH:PAUPER SIZE SENSOR

57.D1351451 SUPPORTER:COVER:FRONT MIDDLE:LEFT

50.AW500040 (x3) PUSH SWITCH:SW1AG-550:10MA

63.D1361553 GRIP:PULL OUT:CURU

62.D1361552 STAY:COVER:FRONT MIDDLE

61.D1361549 STAY:DRUM STAY:FRONT RIGHT

56.D1351450 SUPPORTER:COVER:FRONT MIDDLE:RIGHT

64.D1361577 BRACKET:DRIVE SUB-UNIT:PULL OUT:LOCK

65.D1361579 DC MOTOR:PULL OUT:LOCK:6.78W:BRUSH

66.D1361580 HOLDER:DRIVE SUB-UNIT:PULL OUT:LOCK

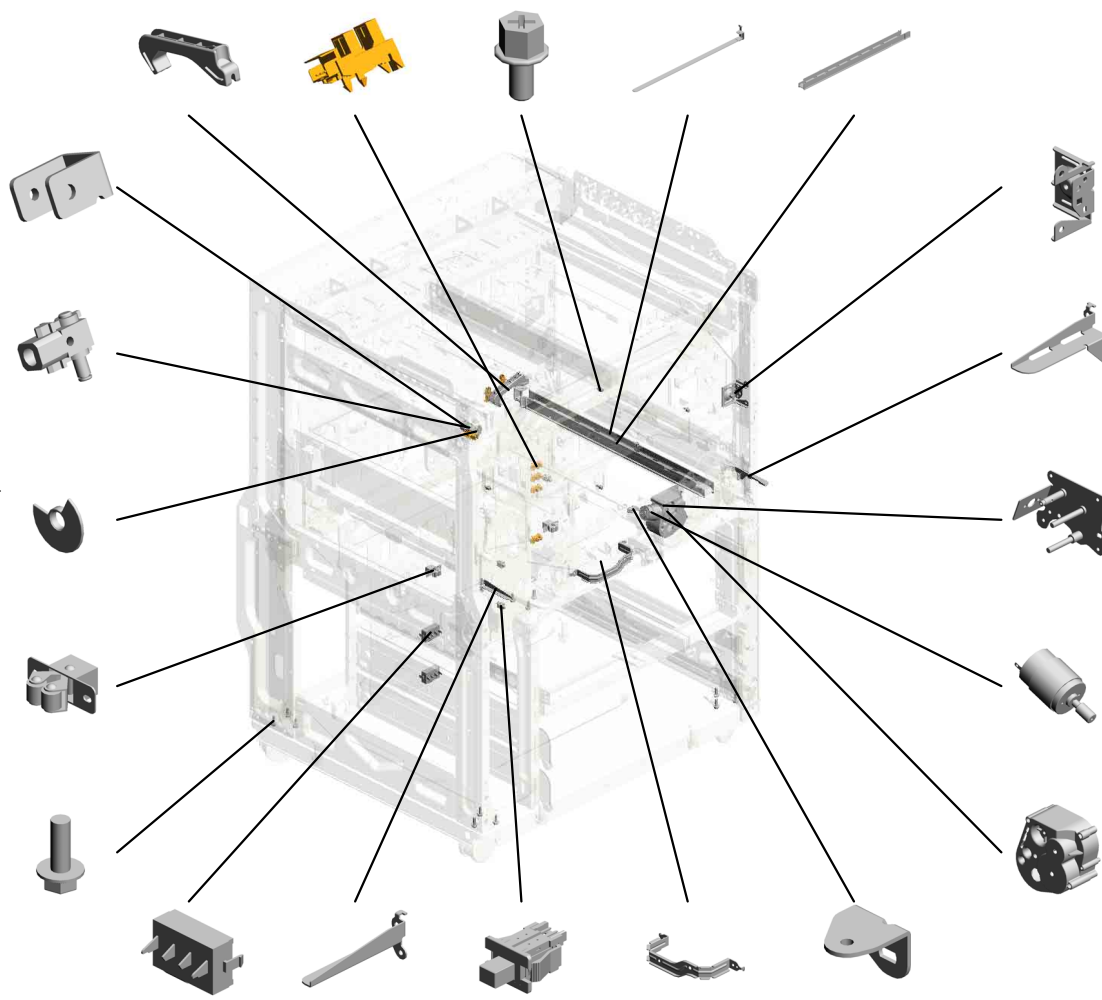

U021 MAIN FRAME

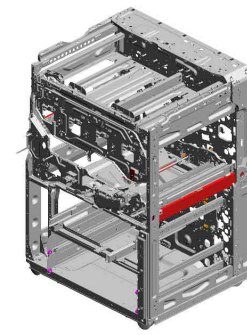

- 96.D2571450 72.D1361594 71.D1361593 73.D1362150 92.D1381562
- FIX STAND:HANDL GUIDE:CURL COR STOPPER:GUIDE: CLEANER:SHIELD BRACKET:STOPPE
- E:DRUM STAY D:REAR UPPER CURL CORD:0.3T GLASS:ASS'Y R:PULL OUT

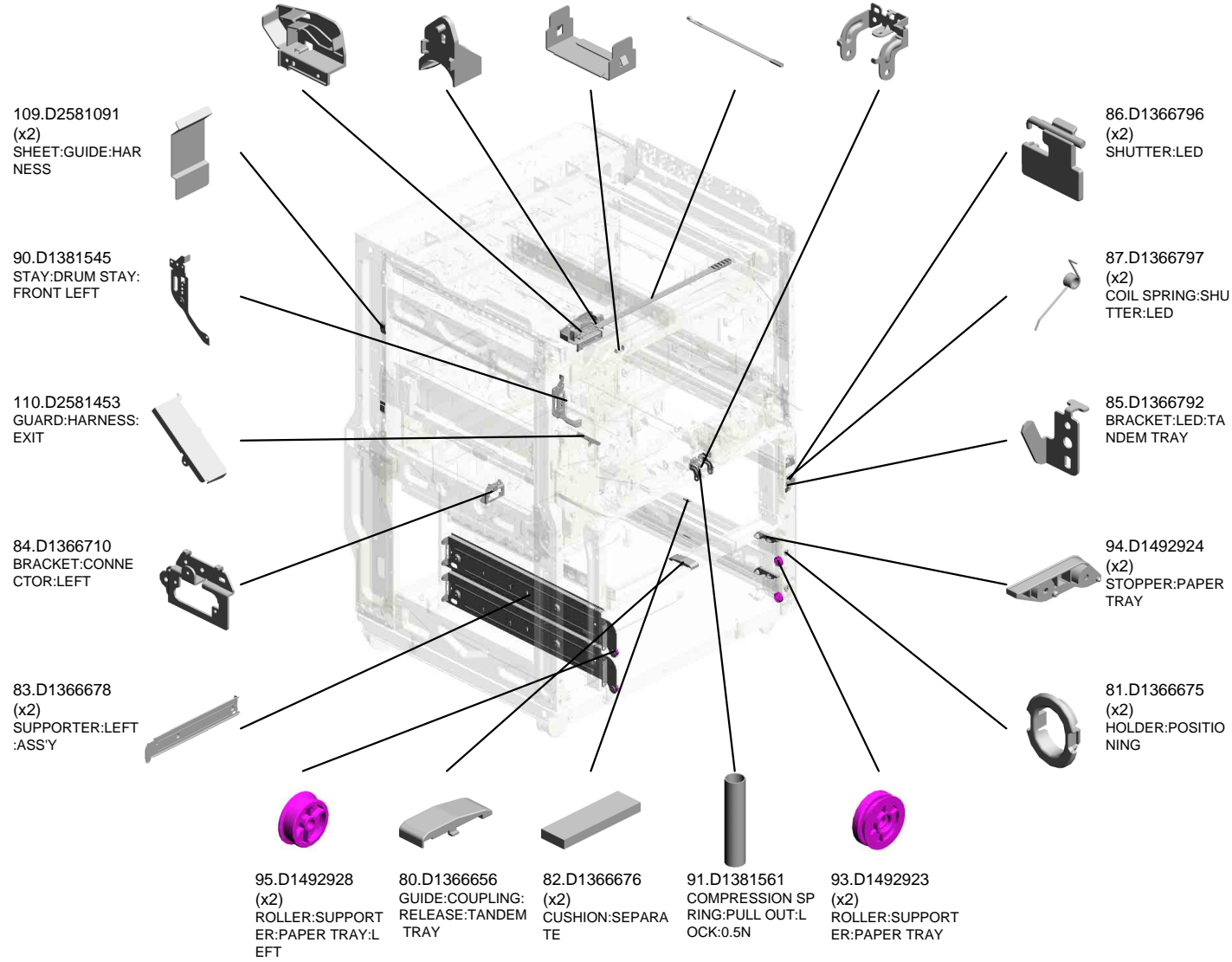

U021 MAIN FRAME

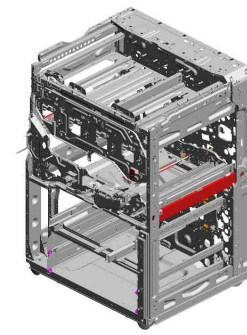

- 117.D2581594 FEELER:PULL OUT :SET:SENSOR
- 111.D2581498 FIX STAND:CLEAN ER:SHIELD GLASS: 1
- 116.D2581586 SHAFT:LOCK:PULL OUT
- 112.D2581499 FIX STAND:CLEAN ER:SHIELD GLASS: 2

118.D2581595 BRACKET:DRAWER:PULL OUT

119.D2581599 COVER:DUB

126.D2615120 PCB:DUB:ASSY

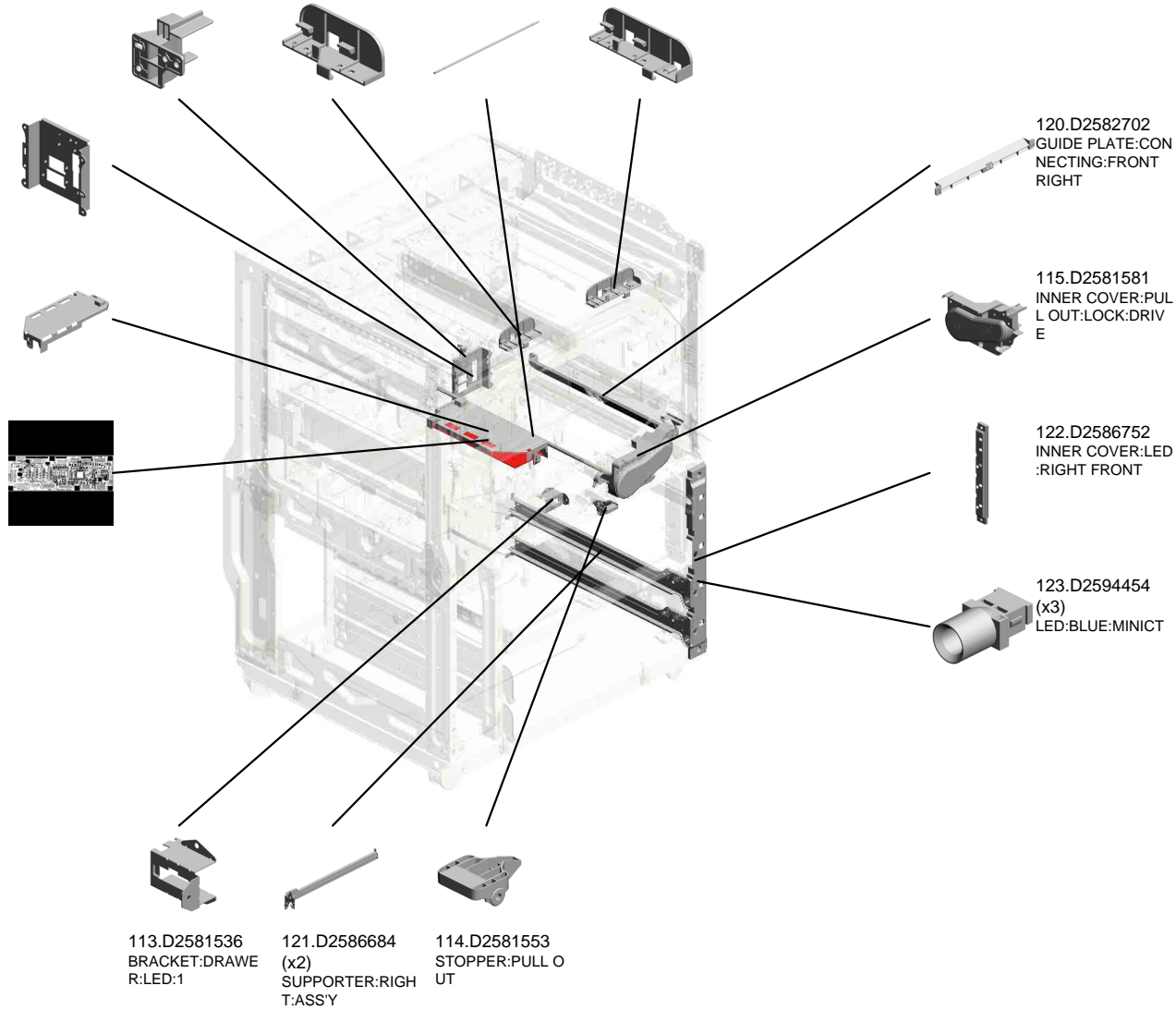

U021_S001
SLIDE RAIL:RIGHT:ASS'Y

10.04593008N
BINDING HEAD TA
PPING SCREW:3X
8

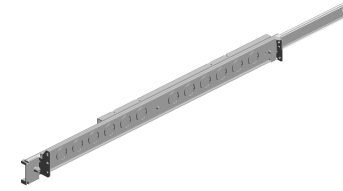
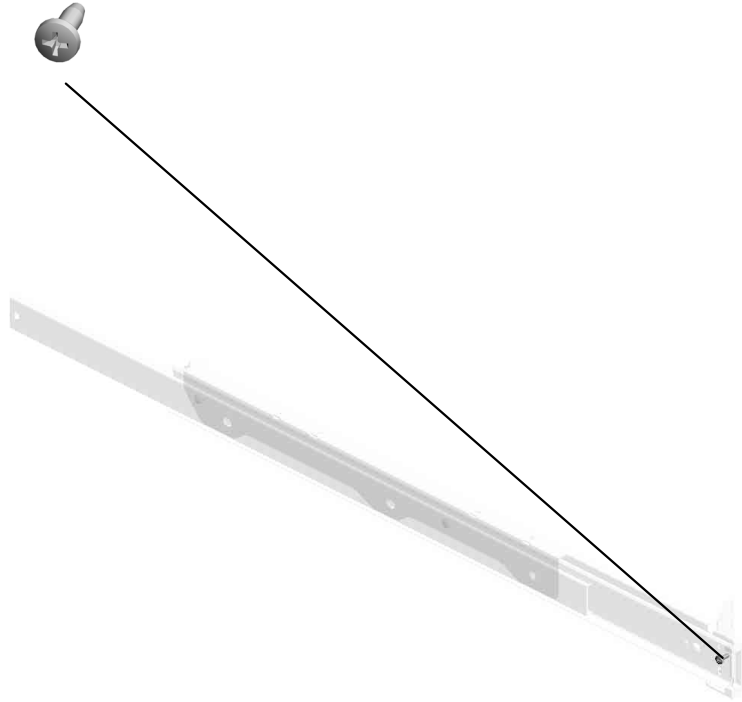

35.AA071017
SLIDE RAIL:RIGHT:
ASS'Y

U001	U002	U003	U004	U005	U006	U007	U008	U009	U010	U011	U012	U013	U014	U015	U016	U017	U018	U019	U020	U021
------	------	------	------	------	------	------	------	------	------	------	------	------	------	------	------	------	------	------	------	------

U021_S002
SLIDE RAIL:ASS'Y

32.AA000290
(x2)
DECAL:POSITIONI
NG DISPLAY:SCRE
W:PET

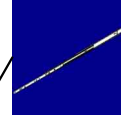
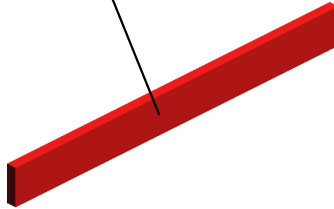

34.AA070094
(x2)
SLIDE RAIL:PULL
OUT

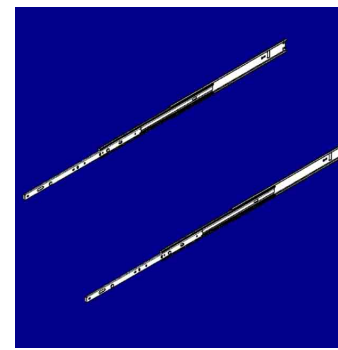
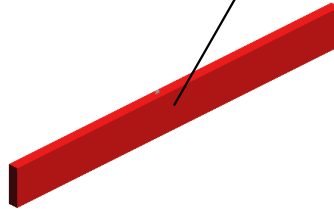

124.D2610032
SLIDE RAIL:ASS'Y

U001	U002	U003	U004	U005	U006	U007	U008	U009	U010	U011	U012	U013	U014	U015	U016	U017	U018	U019	U020	U021
------	------	------	------	------	------	------	------	------	------	------	------	------	------	------	------	------	------	------	------	------

U021_S003
 DRUM STAY:PCU:ASS'Y

89.D1366985
 (x4)
 SEAL:DRUM STAY:
 FRONT:RIGHT

88.D1366897
 (x4)
 DUCT:DRUM STAY
 :SMALL

100.D2576954
 (x4)
 SEAL:DUCT:DRUM
 STAY:DEVELOPME
 NT

41.AA143579
 (x4)
 SCREW - M3

52.B1322366
 (x2)
 LEVER:DRUM STA
 Y:LEFT

125.D2611416
 DRUM STAY:PCU:
 ASS'Y

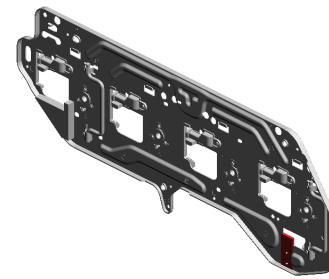

98.D2576952
 (x4)
 SEAL:DRUM STAY:
 DUCT:FRONT

101.D2576955
 (x4)
 SEAL:DRUM STAY:
 REAR

99.D2576953
 (x4)
 SEAL:DRUM STAY:
 FRONT

97.D2576951
 SEAL:DRUM STAY:
 Y

108.D2576962
 SEAL:DRUM STAY:
 LEFT:Y

107.D2576961
 SEAL:DRUM STAY:
 Y

106.D2576960
 SEAL:DRUM STAY:
 M

105.D2576959
 SEAL:DRUM STAY:
 REAR LOWER:M

104.D2576958
 SEAL:DRUM STAY:
 C

102.D2576956
 (x3)
 SEAL:DRUM STAY:
 DUCT:REAR

58.D1351489
 SEAL:SIROCCO:3

32.AA000290
 (x8)
 DECAL:POSITIONI
 NG DISPLAY:SCRE
 W:PET

103.D2576957
 SEAL:DRUM STAY:
 K

74.D1362642
 SLOPE:COVER:RE
 GISTRATION

5.04543006Q
 (x20)
 TAPPING SCREW -
 M3X6

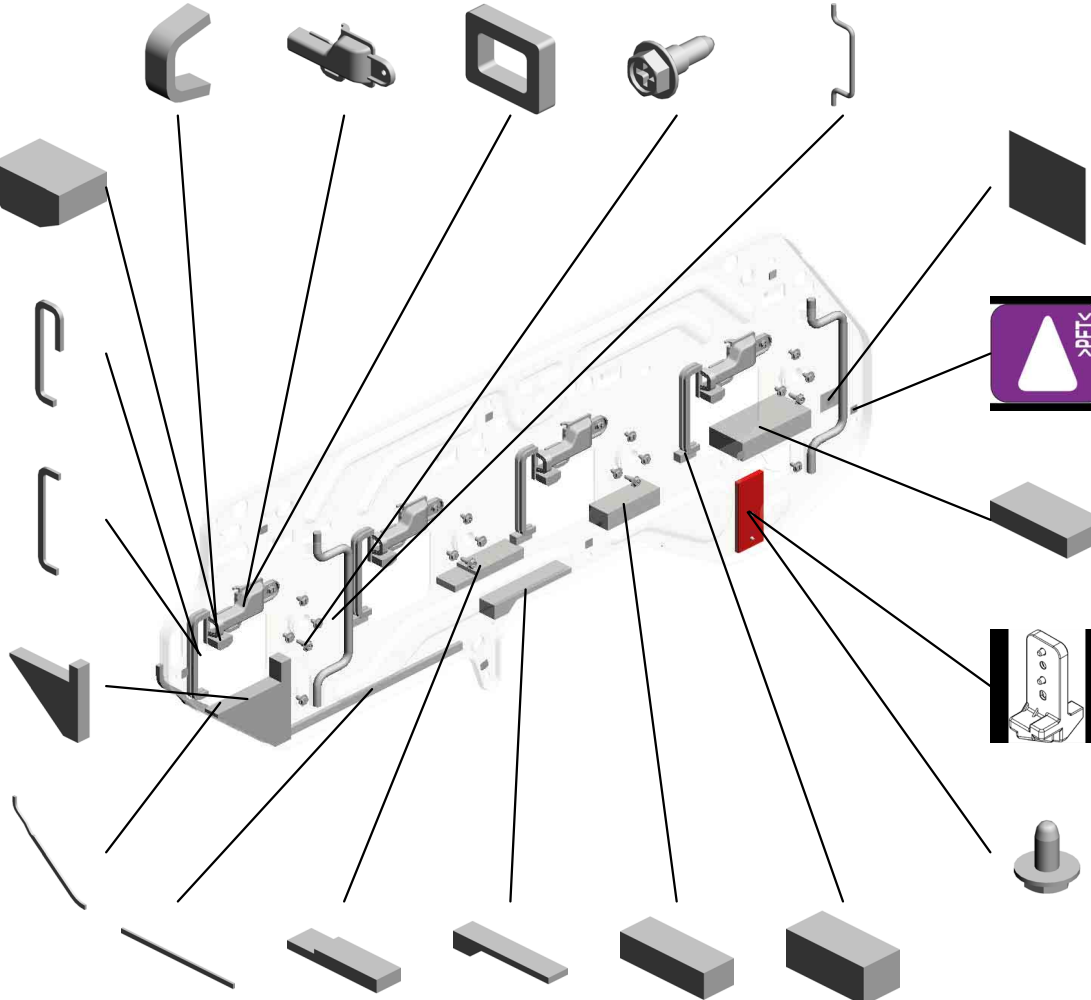

U021_S003_S001

DECAL:COLORED DISPLAY:DRUM STAY:ASS'Y

78.D1363448
DECAL:COLORED
DISPLAY:DRUM ST
AY:M

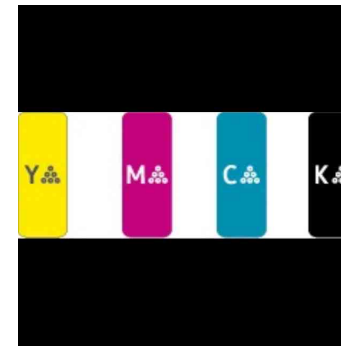

75.D1363434
DECAL:COLORED
DISPLAY:DRUM ST
AY:ASS'Y

79.D1363449
DECAL:COLORED
DISPLAY:DRUM ST
AY:Y

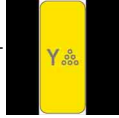

76.D1363446
DECAL:COLORED
DISPLAY:DRUM ST
AY:BK

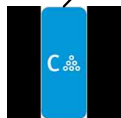
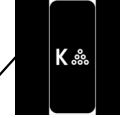

77.D1363447
DECAL:COLORED
DISPLAY:DRUM ST
AY:C

U001	U002	U003	U004	U005	U006	U007	U008	U009	U010	U011	U012	U013	U014	U015	U016	U017	U018	U019	U020	U021
------	------	------	------	------	------	------	------	------	------	------	------	------	------	------	------	------	------	------	------	------

ACCESSORIES



1.03603006N
SCREW - M3X6

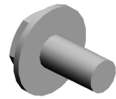

2.04543006N
TAPPING SCREW:ROUND POINT:3X
6

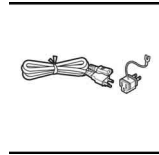

3.11500446
(x2)
(EU/AA/KOR/TWN):POWER SUPPLY
CODE:250V:16A

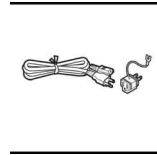

4.11500466
(CHN):POWER SUPPLY CODE:250V:
16A

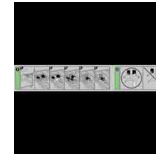

5.AA000318
(NA/EU/AA(D261)/KOR(D261)/TWN(D
261)/CHN):DECAL:PAPER FEED ROL
LER



6.AA001611
(x2)
(NA/CHN):PLATE:LOGOTYPE:RIC
HER

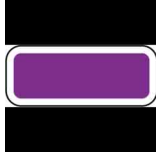

7.AA003056
(x4)
DECAL:GRIP:SHORT:PP

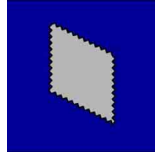

8.B0651374
CLOTH - DF EXPOSURE GLASS



9.B1321226
(x4)
HOLDER:STAND

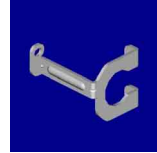

10.D1355930
STOPPER:POWER SUPPLY CORD



11.D1362490
HOLDER:DRUM:FRONT



12.D1362493
HOLDER:DRUM:REAR

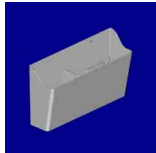

13.D1362495
HOLDER:PCU



14.D1363437
(x4)
CAP:DEVELOPMENT:SUB-ASSY

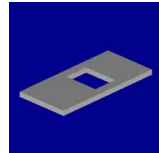

15.D1363497
SEAL:SHUTTER:FUNNEL

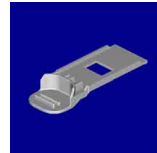

16.D1363498
SHUTTER:FUNNEL

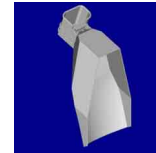

17.D1363499
FUNNEL:DEVELOPER

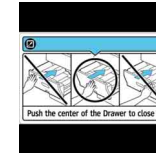

18.D1367446
DECAL:CAUTION:PULL OUT:SLIDE R
AIL



19.D1367448
(x3)
(EU/AA/KOR/TWN/CHN):DECAL:PULL
OUT:SET:CAUTION:MANY LANGUA
GES

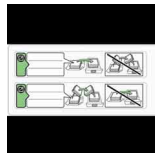

20.D1367541
(x3)
DECAL:CAUTION CHART:PAPER SE
T DIRECTION



21.D1367600
DECAL:CAUTION:PULL OUT:PAPER
FEED



22.D1367601
DECAL:CAUTION:PULL OUT:EXIT

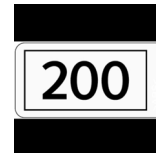

23.D1367607
DECAL:POWER SUPPLY CORD:200V
:MAIN

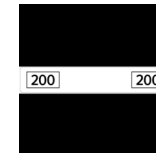

24.D1367608
DECAL:POWER SUPPLY CORD:200V

ACCESSORIES

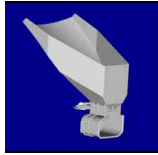

25.D1367985
DEVELOPER:EXCHANGEABLE:ASSY



26.D1387270
COVER:POST:OPERATION SUB-UNIT:LOWER



27.D1387275
COVER:OPERATION PANEL:REAR UPPER

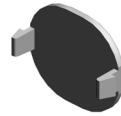

28.D1387277
(x5)
CAP:COVER:POST:OPERATION SUB-UNIT

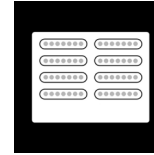

29.D1387333
(x2)
(NA/AA/KOR/TWN):DECAL:APPLICATION:MULTI-LANGUAGE

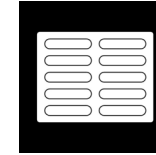

30.D1387353
DECAL:FUNCTION:BLANK:MULTI-LANGUAGE

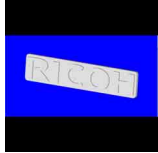

31.D1491553
(x2)
(NA/CHN):SHEET:LOGO

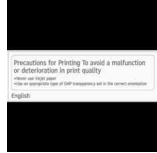

32.D1494390
(x2)
(NA/AA/KOR/TWN):DECAL:CAUTION:INKJET



33.D1496667
(CHN):DECAL:CAUTION:INKJET



34.D1496766
(x3)
(NA/EU/AA/KOR/TWN):DECAL:CAUTION:ORIGINAL:ENGLISH



35.D1496767
(CHN):DECAL:CAUTION:ORIGINAL:CHINESE

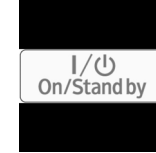

36.D1496851
(x2)
(NA/AA/KOR/TWN):DECAL:MAIN SWITCH:ON-STANDBY:ENGLISH

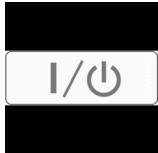

37.D1496852
(x2)
(EU/CHN):DECAL:MAIN SWITCH:ON-STANDBY



38.D2231381
DECAL:EXPOSURE GLASS:CLEANING

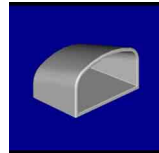

39.D2581317
HOLDER:GLASS:CLEANER:ASSY



40.D2581569
JIG:TRANSFER

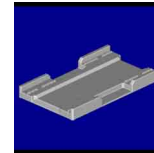

41.D2582492
HOLDER:PCU

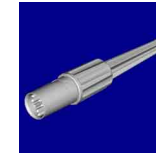

42.D2583485
JIG:DEVELOPMENT UNIT



43.D2587602
(x2)
(NA/AA/KOR/TWN):DECAL:SWITCH:DEHUMIDIFIER



44.D2587605
(x2)
(EU/CHN):DECAL:SWITCH:DEHUMIDIFIER



45.D2607603
(D260):DECAL:MODEL NAME PLATE:RIC



46.D2617252
GUIDE PLATE:POST:ARM:OPERATION PANEL



47.D2617271
COVER:POST:OPERATION PANEL:REAR



48.D2617272
COVER:POST:OPERATION PANEL:FRONT

ACCESSORIES



49.D2617273
COVER:ARM:OPERATION PANEL:UP
PER



50.D2617603
(D261):DECAL:MODEL NAME PLATE:
RIC



51.D3B06303
(EU):DECAL:CAUTION:ORIGINAL:MA
NY LANGUAGES



52.D3B06304
(CHN):DECAL:CAUTION:ORIGINAL



53.D3B06322
(x2)
(NA/AA/KOR/TWN):DECAL:CAUTION:
ORIGINAL

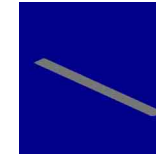

54.D3CH7101
GUIDE:ENTRANCE:UPPER



55.D6836031
DECAL:SET:ORIGINAL TABLE

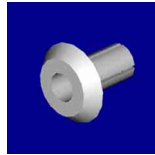

56.G0381299
(x2)
RIVET - 5



57.M0771861
TUBE TYPE LAMP:TAC:ASSY

SPECIAL TOOLS



1.A0929503
C4 COLOR TEST CHART (3 PCS/SET)



2.A1849501
OPTICS ADJUSTMENT TOOL

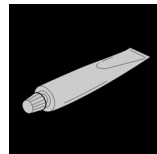

3.A2579100
SILICONE OIL TYPE SS

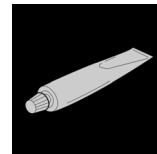

4.A2579300
GREASE - BARRIERTA S552R

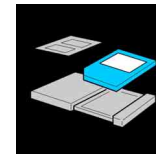

5.B6455020
SD-CARD:SERVICE:1GB:ASS'Y

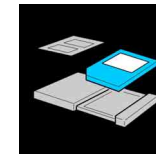

6.B6455030
SD-CARD:SERVICE PARTS:2GB:ASS'
Y

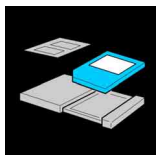

7.B6455040
SD-CARD:SERVICE PARTS:8GB:ASS'
Y



8.C4019503
20X MAGNIFICATION SCOPE

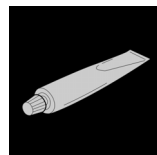

9.D0149800
GREASE-KS660B



10.D0159500
G104 YELLOW TONER



11.D0159501
ZINC STEARATE

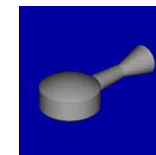

12.D0747690
BRUSH:BLOWER

SPECIAL TOOLS



13.D0749548
DG CLEANER 5PCS/SET



14.VSSG9002
FLUOTRIBO MG GREASE : 100G



15.VSSG9006
MOLYKOTE(R) G-1077 GREASE 50G

Exclusive Parts

Number	Part Name	Group	ID
52062686	SNAP RING	U003_S001	27
		U007	30
		U007_S008	30
		U007_S009	30
		U007_S010	30
52152621	SNAP RING - M6	U003_S001	28
		U006_S003_S002	26
		U012	14
54472681	SNAP RING	U003_S001	29
		U003_S001_S006	29
		U011_S001	6
		U016_S001	19
		U017	23
54472768	STEPPED SCREW - M3	U015_S002	32
59374158	SPRING WASHER - BD10	U016_S001	20
A0929503	C4 COLOR TEST CHART (3 PCS/SET)	SPECIAL TOOLS	1
A0964928	GUIDE PLATE BAND	U017_S002	24
A1096533	SPACER:TRANSPORT SCREW:COLLECT	U007_S011	31
		U007_S012	31
A1849501	OPTICS ADJUSTMENT TOOL	SPECIAL TOOLS	2
A2171340	KNOB SCREW - M4X10	U015_S002	33
A2324666	CUSHION - STEPPER MOTOR	U004	16
		U010	26
A2501752	EXPOSURE GLASS	U004	17
A2579100	SILICONE OIL TYPE SS	SPECIAL TOOLS	3
A2579300	GREASE - BARRIERTA S552R	SPECIAL TOOLS	4
A4181158	SPACER - M6.5X1	U003_S001_S006	30
A4221063	SEAL - 0.7X13X20	U003_S001	31
		U003_S001_S009	31
A4701703	SHIFT CLUTCH	U016_S001	21
A5482139	PULLEY	U003_S001	32
A6281225	BUSHING - 8MM	U003_S001_S006	33
A8061163	GUIDE PLATE CUSHION	U003_S001_S006	34
		U003_S001_S006_S001	34
A8592112	DRIVE SHAFT - PAPER FEED BELT	U003_S001_S006	35

Number	Part Name	Group	ID
A8592319	BASE CUSHION	U003_S001_S006	36
A8597211	STEPPED SCREW	U003	37
AA000284	DECAL:GRIP:FUSING:FRONT	U015_S002_S007	34
AA000285	DECAL:PAPER TRAY:DESIGN SKETCH1	U007	32
AA000286	DECAL:PAPER TRAY:DESIGN SKETCH2	U007	33
AA000287	DECAL:PAPER TRAY:DESIGN SKETCH3	U007	34
AA000290	DECAL:POSITIONING DISPLAY:SCREW:PET	U001	12
		U006_S002	27
		U007	35
		U008	26
		U008_S001	26
		U009	15
		U011_S001	7
		U012	15
		U015_S002	35
		U015_S002_S005	35
		U015_S002_S007	35
		U020	23
		U021_S002	32
		U021_S003	32
AA000292	DECAL:CAUTION CHART:TANDEM LCT	U007_S013_S004	36
		U007_S015_S004	36
		U007_S017_S004	36
		U007_S019_S004	36
AA000295	DECAL:GRIP:INNER COVER:RIGHT	U007_S013_S003	37
		U007_S015_S003	37
		U007_S017_S003	37
		U007_S019_S003	37
AA000314	SHEET:PAPER SET DIRECTION	U007_S014	38
		U007_S016	38
		U007_S018	38
		U007_S020	38
AA000315	DECAL:CAUTION CHART:LEFT	U007_S014_S002	39
		U007_S016_S002	39
		U007_S018_S002	39

Exclusive Parts

Number	Part Name	Group	ID
		U007_S020_S002	39
AA000316	DECAL:SIDE FENCE:REAR	U007_S013_S001	40
		U007_S015_S001	40
		U007_S017_S001	40
		U007_S019_S001	40
AA000318	(NA/EU/AA(D261)/KOR(D261)/TWN(D261)/CHN):DECAL:PAPER FEED ROLLER	ACCESSORIES	5
AA001611	(NA/CHN):PLATE:LOGOTYPE:RIC	ACCESSORIES	6
AA003055	DECAL:COVER:PUSH	U006_S002	28
AA003056	DECAL:GRIP:SHORT:PP	ACCESSORIES	7
		U009	16
		U012_S001	16
AA003057	DECAL:GRIP:LONG:PP	U009_S001	17
		U009_S002	17
		U009_S004	17
		U009_S005	17
		U009_S007	17
		U009_S008	17
		U009_S010	17
		U009_S011	17
AA003059	DECAL:EXIT:GUIDE PLATE:UPPER:PUSH	U015_S002_S002	36
		U016_S001_S006	22
AA003060	DECAL:LED:EXIT:UPPER	U001_S003	13
AA003061	DECAL:PICK-UP PAPER JAM:DUPL EX	U001_S006	14
AA003064	DECAL:GRIP:OPEN AND CLOSE:GATE PAWL:NO.2	U016_S001_S016	23
AA003067	DECAL:PUSH	U006_S002	29
AA003070	DECAL:LED:REVERSE:ENTRANCE	U001_S003	15
AA003071	DECAL:PAPER JAM:EXIT:LEFT LOWER	U001_S006	16
AA003080	DECAL:GRIP:OPEN AND CLOSE:GATE PAWL:NO.1	U016_S001_S016	24
AA003081	DECAL:LEVER::GUIDE PLATE:LEFT LOWER	U016_S001_S015	25
AA012137	FILTER:CORPUSCLE:FUSING:EXIT	U020	24
AA012138	FILTER:CORPUSCLE:TRANSFER:F	U020	25

Number	Part Name	Group	ID
	USING		
AA012139	FILTER:CORPUSCLE:PRESSURE ROLLER	U020	26
AA021034	MAGNETIC	U017	25
AA043311	TIMING BELT:40S2M302G	U018	21
		U018_S001	21
AA043325	TIMING BELT - B40S2M250	U018_S003	22
AA043328	TIMING BELT:40S2M130	U003_S001_S006	38
AA043339	TIMING BELT:PAPER EXIT:40S2M122	U003_S001	39
AA043608	TIMING BELT:40S2M184	U010	27
AA043632	TIMING BELT - 40S2M126	U003_S001	40
AA043634	TIMING BELT - 40S2M296	U017	26
AA043636	TIMING BELT - 40S2M96	U012_S001	17
AA043637	TIMING BELT - 40S2M124	U018_S012	23
AA043660	TIMING BELT:40S2M172	U018	24
AA043663	TIMING BELT:40S2M162	U018	25
AA043677	SYNCHRONOUS BELT:40S3M120	U016_S001	26
AA043681	SYNCHRONOUS BELT:40S2M108	U003_S001	41
AA043682	SYNCHRONOUS BELT:60S1.5M150	U003_S001	42
AA043683	SYNCHRONOUS BELT:60S1.5M204	U003_S001	43
AA043684	SYNCHRONOUS BELT:60S1.5M390	U003_S001	44
AA043685	SYNCHRONOUS BELT:40S2M258	U003_S001	45
AA043694	SYNCHRONOUS BELT:B40S2M202	U003_S001	46
		U018	26
AA043698	SYNCHRONOUS BELT:40S1.5M300	U003_S001	47
AA043702	SYNCHRONOUS BELT:80S3M204	U016_S001	27
AA043710	SYNCHRONOUS BELT:40S2M158	U003_S001	48
AA043714	TIMING BELT:60S3M588	U007_S014	41
		U007_S016	41
		U007_S018	41
		U007_S020	41
AA043721	SYNCHRONOUS BELT:40S2M176	U018	27
AA043929	TIMING BELT - B40S2M114	U018	28

Exclusive Parts

Number	Part Name	Group	ID
AA043954	TIMING BELT - B40S2M104G	U012	18
AA060693	TENSION SPRING	U007_S008	42
		U007_S009	42
		U007_S010	42
		U003_S001	49
AA060842	TENSION SPRING	U003_S001	49
AA060986	TENSION SPRING:DC SOLENOID:LOCK	U007	43
AA061146	TENSION SPRING:LINK:GATE PAWL	U016_S001	28
AA061148	COMPRESSION SPRING:PRESSURE	U015_S002	37
AA061158	TENSION SPRING:HEAT ROLLER	U015_S002	38
AA061159	TENSION SPRING:HEAT ROLLER:TURN	U015_S002	39
AA061160	COIL SPRING:WEB:TENSION:ROLLER	U015_S004	40
AA061164	TENSION SPRING:GEAR:ON-OFF	U015_S002	41
AA061167	COMPRESSION SPRING:JOINT	U015	42
AA061227	COMPRESSION SPRING:FRONT RIGHT	U007	44
AA061228	COIL SPRING:LEVER:COVER:V TRANSPORT	U007_S007	45
AA061229	COMPRESSION SPRING:SIDE FENCE:FIX	U007_S011_S003	46
		U007_S011_S004	46
		U007_S012_S002	46
		U007_S012_S003	46
AA061230	COMPRESSION SPRING:SIDE FENCE	U007_S011_S004	47
		U007_S012_S003	47
AA061232	COMPRESSION SPRING:SIDE FENCE:REAR	U007_S011_S003	48
		U007_S012_S002	48
AA061233	TENSION SPRING:REGISTRATION:DRIVEN	U006	30
AA061234	TENSION SPRING:REGISTRATION:DRIVEN	U006	31
AA061235	COMPRESSION SPRING:LEVER:TANDEM TRAY	U007_S014	49
		U007_S016	49
		U007_S018	49
		U007_S020	49

Number	Part Name	Group	ID
AA061236	COMPRESSION SPRING:RIGHT REAR:TANDEM	U007_S013	50
		U007_S015	50
		U007_S017	50
		U007_S019	50
AA061237	TENSION SPRING:LEVER:ON-OFF	U015_S002	43
AA062174	COIL SPRING:PRESSURE:SEPARATOR:2.9N	U006_S003	32
AA062175	COIL SPRING:LEVER:COVER:MANUAL FEED	U006_S003	33
AA063435	COMPRESSION SPRING:PAPER FEED:JOINT	U003_S001_S006	50
AA063477	COMPRESSION SPRING:LEVER:LOCK:FRONT	U006	34
AA063715	COMPRESSION SPRING:JOINT:CONNECTING:DRIVE SUB-UNIT	U018_S003	29
AA063717	COMPRESSION SPRING:DRIVEN:EXIT:NO.2	U016_S001	29
		U016_S001_S001	29
AA063718	COMPRESSION SPRING:DRIVEN:EXIT:NO.1	U016_S001_S001	30
AA063719	COMPRESSION SPRING:HOLDER:GUIDE PLATE:EXIT	U016_S001	31
AA063738	COMPRESSION SPRING:GATE:REVERSE EXIT:0.1N	U016_S001	32
AA063745	COMPRESSION SPRING:LEVER:OPEN/CLOSE	U006	35
AA063746	TORSION SPRING:COVER:REGISTRATION	U006	36
AA063789	COIL SPRING:PRESSURE:PICKUP	U007_S008	51
		U007_S009	51
		U007_S010	51
AA063902	SPRING:CONNECTOR:TANDEM LEFT	U021	33
AA063931	COMPRESSION SPRING:ROLLER:POLISH	U015_S002	44
AA063965	COMPRESSION SPRING:GRIP:LEFT	U001	17
AA066397	TORSION SPRING:WEB:MECHANICAL DRIVE SECTION	U015	45

Exclusive Parts

Number	Part Name	Group	ID
AA066431	COIL SPRING:OPEN AND CLOSE:LEFT LOWER:GUIDE PLATE:UPPER	U016_S001	33
AA066432	COIL SPRING:OPEN AND CLOSE:LEFT LOWER:GUIDE PLATE:LOWER	U016_S001	34
AA066441	TORSION SPRING:LEVER:OPEN/CLOSE	U015_S002	46
AA066442	TORSION SPRING:STRIPPER PLATE:FRONT	U015_S002	47
AA066443	TORSION SPRING:STRIPPER PLATE:REAR	U015_S002	48
AA066444	TORSION SPRING:ON-OFF:POLISH:FRONT	U015_S002	49
AA066447	TORSION SPRING:FEELER	U015_S004	50
AA066450	TORSION SPRING:ON-OFF:POLISH:REAR	U015_S002	51
AA066697	TORSION SPRING:LOCK:STRIPPER PLATE:REAR:13N	U015_S002	52
AA066698	TORSION SPRING:LOCK:STRIPPER PLATE:FRONT:13N	U015_S002	53
AA066800	COIL SPRING:GUIDE PLATE:UPPER:FRONT	U016_S001	35
AA066801	COIL SPRING:GUIDE PLATE:UPPER:REAR	U016_S001	36
AA066802	TENSION SPRING:TIGHTENER:EXIT	U016_S001	37
AA070094	SLIDE RAIL:PULL OUT	U021_S002	34
AA071017	SLIDE RAIL:RIGHT:ASS'Y	U021_S001	35
AA071018	SLIDE RAIL:LEFT:ASS'Y	U021	36
AA071029	SLIDE RAIL:MIDDLE:THREE WAY:ASS'Y	U021	37
AA080184	BUSHING - FUSING EXIT	U007_S014	52
		U007_S016	52
		U007_S018	52
		U007_S020	52
AA080247	BUSHING - B-F6-3	U015_S002	54
AA080346	BUSHING:FLANGE TYPE:DIA6	U003_S001	51
		U003_S001_S009	51

Number	Part Name	Group	ID
		U017	27
AA080347	BUSHING - 8MM	U003_S001	52
AA080354	BUSHING - 6MM	U015_S004	55
AA080355	BUSHING - 7MM	U015_S004	56
AA080356	BUSHING - 6MM	U015_S004	57
AA082101	BUSHING - 6X10X6	U003_S001	53
		U003_S001_S006	53
		U015_S002	58
AA082104	BUSHING - 8X12X7	U003_S001_S004	54
		U010	28
AA082109	PLAIN SHAFT BEARING:DIA4	U015_S002	59
AA082137	BUSHING:6X10X6	U011_S001	8
AA082144	BUSHING - 8X12X7	U003_S001	55
AA082171	PLAIN SHAFT BEARING:6X10X6	U007_S008	53
		U007_S009	53
		U007_S010	53
AA082172	BUSHING:DIA6XDIA10X4:EG-1	U015_S002	60
AA082173	PLAIN SHAFT BEARING:6X10X6	U006_S003	37
		U006_S003_S002	37
		U007	54
		U007_S008	54
		U007_S009	54
		U007_S010	54
		U016_S001	38
		U017	28
		U018	30
		U018_S010	30
AA082174	PLAIN SHAFT BEARING:6X10X9	U007_S008	55
		U007_S009	55
		U007_S010	55
		U018_S012	30
AA082175	PLAIN SHAFT BEARING:8X12X7	U007	56
		U012	19
		U021	38
AA082186	PLAIN SHAFT BEARING:DIA8XDIA12X12:EG-1	U007_S013	57
		U007_S015	57
		U007_S017	57

Exclusive Parts

Number	Part Name	Group	ID
		U007_S019	57
AA083014	ONE-WAY CLUTCH	U006_S003	38
AA083018	ROLLER CLUTCH - 6X14X10	U006_S003	39
AA100014	RETAINING RING C - SEPARATE	U006	40
		U006_S003	40
		U007_S008	58
		U007_S009	58
		U007_S010	58
AA120145	DISCHARGE BRUSH:REVERSE:17MM	U016_S001	39
AA132013	SPACER	U003_S001_S006	56
AA132024	SPACER - M6	U015	61
AA132030	SPACER:DIA14	U021	39
AA132300	ROLLER:LOCK:PULL OUT	U021	40
AA143183	STEPPED SCREW	U017	29
AA143537	SCREW:M3:BLACK	U001	18
		U004	18
AA143579	SCREW - M3	U008	27
		U021_S003	41
AA143598	STEPPED SCREW:TANDEM TRAY:MIDDLE	U007	59
AA143599	STEPPED SCREW:M3:ROUND POINT	U006	41
AA143702	SCREW:PIN:POSITIONING	U001	19
		U006_S001	42
AA143788	PIN:GUIDE PLATE:PAPER FEED	U003_S001	57
		U003_S001_S009	57
AA143789	SHAFT:CLEANER	U003_S001	58
AA143803	FLANGED HEXAGONAL HEAD BOLT:CASTER	U002_S001	9
AA143811	STEPPED SCREW - M3X4	U006	43
AA143812	SCREW - SCALE	U015_S001	62
AA143820	STEPPED SCREW	U011_S001	9
AA143842	SCREW:DIA6:14.5:M4	U003_S001	59
AA143846	TAPPING SCREW:M3X6	U003_S001_S009	60
AA143848	STEPPED SCREW - M3	U019	30
AA143870	STEPPED SCREW	U021	42
AA143884	STEPPED SCREW:DIA5.4:DIA3.5:M	U019	31

Number	Part Name	Group	ID
	3:LONG		
AA145909	SHAFT:STOPPER:PULL OUT	U021	43
AA160030	DAMPING INSULATION:STAY:OUTER	U016_S001	40
AA160031	DAMPING INSULATION:STAY:INNER	U016_S001	41
AA161104	CUSHION - MOTOR	U004	19
AA161167	BUSHING:HDD	U019	32
AA162082	CUSHION:PLATE:PAPER	U006_S003_S002_S001	44
		U007_S013_S001_S001	60
		U007_S015_S001_S001	60
		U007_S017_S001_S001	60
		U007_S019_S001_S001	60
AB010156	GEAR:SEPARATE:DRIVE	U007_S008	61
		U007_S009	61
		U007_S010	61
AB010157	GEAR:SEPARATE:DRIVEN	U007_S008	62
		U007_S009	62
		U007_S010	62
AB010173	GEAR - 60Z	U015_S004	63
AB010174	GEAR - 20Z/50Z	U015_S004	64
AB010175	GEAR - 24Z	U015_S004	65
AB010176	GEAR - 24Z	U015_S004	66
AB010177	GEAR - 32Z	U015_S004	67
AB010178	WORM GEAR	U015_S004	68
AB011387	GEAR - 23Z	U006_S003	45
AB011523	GEAR - 24Z	U015	69
AB011524	GEAR - 36Z	U015	70
AB011526	GEAR - 24Z	U015	71
AB011561	GEAR:MANUAL FEED	U006_S003_S002	46
AB011569	GEAR:Z25:DRIVE:REGISTRATION ROLLER	U006	47
AB011570	GEAR:Z20:DRIVEN:REGISTRATION ROLLER	U006	48

Exclusive Parts

Number	Part Name	Group	ID
	N ROLLER		
AB011577	GEAR:STOPPER PIN:35Z	U018	31
AB011607	GEAR:ON-OFF:TRANSFER	U018	32
AB011610	GEAR:USED TONER:IDLER:NO.3	U018	33
AB011616	GEAR:PAPER FEED SUB-UNIT	U018_S010	34
		U018_S011	34
		U018_S012	34
AB012078	GEAR:PULL OUT:LOCK:DRIVE	U021	44
AB012114	GEAR:COUPLING:HEAT PIPE	U016_S001	42
AB012115	GEAR:SHAFT:HEAT PIPE	U016_S001	43
AB012201	GEAR:IDLER:ROLLER:FUSING	U015	72
AB012202	GEAR:DRIVE:ROLLER:POLISH	U015	73
AB012203	GEAR:DRIVE:ROLLER:FUSING:B	U015_S002	74
		U015_S003	74
AB012205	GEAR:IDLER:ON-OFF	U015_S002	75
AB012207	GEAR:POLISH:ROLLER:A	U015_S002	76
AB012211	GEAR:HEAT ROLLER:TURN	U015_S002	77
AB012214	GEAR:POLISH:ROLLER:A	U015_S002	78
AB012217	GEAR:WORM WHEEL:MOTOR:FUSING:ON-OFF	U015	79
AB012218	GEAR:IDLER:WEB:ON-OFF:1	U015	80
AB012219	GEAR:CAM:SHAFT:WEB:ON-OFF	U015	81
AB012227	GEAR:ON-OFF:MOTOR	U015	82
AB012970	GEAR:ROLLER:REVERSE:EXIT	U016_S001	44
AB012973	GEAR:SHAFT:GATE PAWL:EXIT	U016_S001	45
AB012974	GEAR:IDLER:COUPLING:GATE PAWL	U016_S001	46
AB014135	GEAR - 18Z	U007	63
AB016002	GEAR:Z36	U018	35
AB017837	GEAR:ON-OFF:TRANSFER:IDLER:NO.1	U018	36
AB017838	GEAR:ON-OFF:TRANSFER:IDLER:NO.2	U018	37
AB017839	GEAR:IDLER:BELT CLEANING	U018_S001	38
AB017912	GEAR:USED TONER:IDLER:NO.1	U018	39
AB017915	GEAR:PULLEY:USED TONER:UPPER:Z37/S2M31T	U018	40
AB017916	GEAR:PAPER FEED SUB-UNIT:IDL	U018_S010	41

Number	Part Name	Group	ID
	ER	U018_S011	41
		U018_S012	41
AB017918	GEAR:REVERSE EXIT:IDLER:NO.2	U018	42
AB017919	GEAR:Z26/26T	U018	43
AB017920	GEAR:PULL OUT:LOCK:NO.1	U021	45
AB017921	GEAR:PULL OUT:LOCK:NO.2	U021	46
AB017922	GEAR:PULL OUT:LOCK:NO.3	U021	47
AB017929	GEAR:IDLER:48T/Z28	U018_S003	44
AB017930	GEAR:REVERSE EXIT:IDLER:NO.1	U016_S001	47
AB017931	GEAR:IDLER:DC STEPPER MOTOR:GATE PAWL	U016_S001	48
AB017932	GEAR:IDLER:CONTACT POINT:GATE PAWL	U016_S001	49
AB017933	PULLEY:GEAR:EXIT	U016_S001	50
AB017937	GEAR:PAPER FEED UNIT:FEED	U018_S011	45
AB017938	GEAR:PAPER FEED UNIT:SLOW DOWN	U018_S011	46
AB017955	GEAR:IDLER:59Z/31Z	U018	47
AB017956	GEAR:PULLEY:LOWER:Z32/S2M45T	U018	48
AB019475	GEAR - 48T	U007	64
AB030831	TIMING PULLEY:15T:DRIVE	U007_S014	65
		U007_S016	65
		U007_S018	65
		U007_S020	65
AB030865	PULLEY:S2M:54T/27T	U018_S003	49
AB030866	PULLEY:DUPLEX SUB-UNIT:REGISTRATION:S2M54T	U018	50
AB030876	PULLEY:S2M:36T	U018	51
AB030881	PULLEY:TORQUE LIMITER MECHANICAL CLUTCH	U016_S001	51
AB030882	TIMING PULLEY:EXIT	U016_S001	52
AB030883	PULLEY:EXIT:NO.1	U016_S001	53
AB030884	PULLEY:EXIT:NO.2	U016_S001	54
AB030887	PULLEY:T60	U018	52
AB033085	TIMING PULLEY - 15T	U007_S014	66
		U007_S016	66
		U007_S018	66

Exclusive Parts

Number	Part Name	Group	ID
		U007_S020	66
AB033114	PULLEY:DUPLEX SUB-UNIT:S2M:36T:COUPLING	U018	53
AB033115	PULLEY:DUPLEX SUB-UNIT:IDLER:S2M:36T	U018	54
AB033116	PULLEY:DUPLEX SUB-UNIT:54T/36T	U018	55
AB033121	TIMING PULLEY:S2M41T:S2M31T	U018	56
AB033122	TIMING PULLEY:TRAY BOTTOM PLATE	U007_S013	67
		U007_S015	67
		U007_S017	67
		U007_S019	67
AC020150	LENS:LED:1	U001	20
		U017	30
AC020151	LENS:LED:2	U001	21
		U001_S002	21
		U001_S003	21
		U001_S006	21
AC020152	LENS:LED:3	U007	68
		U007_S007	68
AC020153	LENS:LED:4	U006_S003	49
AC030211	MIRROR:NO.1	U004_S002	20
AE010127	HOT ROLLER:DIA57	U015_S002	83
AE020243	PRESSURE ROLLER:DIA55	U015_S002	84
AE030035	BALL BEARING - 6X16X5	U015_S002	85
AE030044	BALL BEARING - 10X22X6	U015_S002	86
AE030059	BALL BEARING:MM20XMM32X7	U015_S002	87
AE045059	WEB:SUB-ASS'Y	U015_S004	88
AF013016	BOTTOM PLATE PAD	U006_S003_S002	50
AF020794	TRANSPORT ROLLER:SHIFT:DUPL EX	U017	31
AF020798	REGISTRATION ROLLER:DRIVE	U006	51
AF020840	TRANSPORT ROLLER:DRIVE:REVERSE	U017	32
AF020842	TRANSPORT ROLLER:DUPLEX:ENTRANCE	U017	33
AF022067	GUIDE STOPPER ROLLER	U016_S001	55
		U017_S002	34

Number	Part Name	Group	ID
AF030049	PICK-UP ROLLER	U006_S003	52
AF030094	PAPER FEED ROLLER:PICKUP	U007_S008	69
		U007_S009	69
		U007_S010	69
AF031046	FEED ROLLER - MANUAL FEED	U006_S003	53
AF031094	PAPER FEED ROLLER:FEED	U007_S008	70
		U007_S009	70
		U007_S010	70
AF032053	ROLLER:SEPARATE:MANUAL FEED	U006_S003	54
AF032094	PAPER FEED ROLLER:SEPARATE	U007_S008	71
		U007_S009	71
		U007_S010	71
AG070513	MAGNET CATCH	U001	22
AG070514	MAGNET CATCH	U001	23
AG070515	MAGNET CATCH:13N	U017	35
AG071012	MAGNET CATCH:ASS'Y	U013	7
AH012031	CASTER:1470N	U021	48
AW010091	PHOTO REFLECTION SENSOR	U017	36
AW010147	PHOTO REFLECTION SENSOR	U020	27
AW010150	PHOTO REFLECTION SENSOR:ORIGINAL TRAY	U003_S001	61
		U006_S003_S002	55
AW010151	PHOTO REFLECTION SENSOR:PS122TL1-A	U003_S001	62
		U003_S001_S009	62
		U014_S001	9
AW010160	ORIGINAL SENSOR:48MM:5V	U004	21
AW010200	PAPER FEED SENSOR:FUSING EXCIT	U015	89
		U015_S002	89
AW010201	DISTANCE MEASURING SENSOR:150MM	U015	90
AW020190	PHOTOINTERRUPTOR	U003_S001	63
AW020198	PHOTOINTERRUPTOR:LG2A14NL1	U001	24
		U006_S003	56
		U006_S003_S002	56
		U007_S014	72
		U007_S016	72
		U007_S018	72
		U007_S020	72

Exclusive Parts

Number	Part Name	Group	ID
		U008_S001	28
		U015	91
		U015_S002	91
		U017	37
		U018	57
		U018_S013	57
		U018_S014	57
		U018_S015	57
		U018_S016	57
		U021	49
AW020203	PHOTOINTERRUPTOR:GP1A173L CS2F	U007_S008	73
		U007_S009	73
		U007_S010	73
		U010	29
		U013	8
		U014_S001	10
		U016_S001	56
		U017	38
AW020207	PHOTOINTERRUPTOR:FLAT:PICH 2MM:M4	U004	22
AW020209	ENCODER:PAPER THICK	U006	57
AW020210	OPTICS SENSOR:ENCODER:300L PI	U010	30
AW020211	PHOTOINTERRUPTOR:PHOTOCO NDUCTOR:HOME POSITION SENS OR	U018_S005	58
		U018_S006	58
		U018_S007	58
		U018_S008	58
AW020212	OPTICS SENSOR:ENCODER:300L PI	U018_S001	59
		U018_S005	59
		U018_S006	59
		U018_S007	59
		U018_S008	59
AW020213	OPTICS SENSOR:ENCODER:300L PI	U010	31
AW020224	PHOTOINTERRUPTOR:GP1A173L CSVF	U003_S001	64
AW020230	ON OFF DETECTOR:END FENCE	U007	74
AW100138	THERMOPILE	U015	92

Number	Part Name	Group	ID
		U015_S002	92
AW100165	THERMISTOR:ASS'Y	U020	28
AW100178	THERMISTOR:FUSING	U015_S002	93
AW100179	THERMISTOR:FUSING:70ANG	U015_S002	94
AW110044	THERMOSTAT:150C:250V/17A	U015_S002	95
AW140026	TEMPERATURE & HUMIDITY SEN SOR	U010	32
AW500039	ROTARY SWITCH:PAPER SIZE SE NSOR:CW	U006_S003_S002	58
AW500040	PUSH SWITCH:SW1AG-550:10MA	U006	59
		U006_S003_S001	59
		U013	9
		U016_S001	57
		U017	39
		U019	33
		U021	50
AW500046	PUSH SWITCH:PAPER SIZE SENS OR	U021	51
AX040199	DC MOTOR:RISING TRAY:ASS'Y	U003_S001_S007	65
AX040267	DC STEPPER MOTOR:DIA42:24V	U015	96
AX040268	DC STEPPER MOTOR:DIA42:24V:O N-OFF:ROLLER	U015	97
AX040281	DC MOTOR:RISING TRAY:1.007W: BRUSH	U007_S001	75
		U007_S002	75
AX050345	DC STEPPER MOTOR:DIA42	U008_S001_S001	29
		U008_S001_S002	29
		U008_S001_S003	29
		U008_S001_S004	29
AX060434	DC MOTOR:10W:BRUSHLESS	U010	33
AX060439	DC MOTOR:GEAR:20W:BRUSHLES S	U018_S011	60
AX060503	DC MOTOR:39.5W:BRUSHLESS	U015	98
AX060510	DRIVE SUB-UNIT:ON-OFF:PRESSU RE ROLLER	U018	61
AX061203	DC BRUSHLESS MOTOR:26Z:25W	U018	62
AX061204	DC MOTOR:11.5W:BRUSHLESS	U013	10
		U018	63
AX061205	DC MOTOR:28W:BRUSHLESS	U018_S001	64

Exclusive Parts

Number	Part Name	Group	ID
AX400246	HEATER:240V:9W	U010	34
AX430209	HEATER:PRESSURE ROLLER:208V:600W:INFRARED	U015_S002	99
AX640219	DC FAN MOTOR:DC24V:MM60:25MM	U019	34
		U020	29
AX640221	FAN:SIROCCO:DC24V:50MM	U020	30
AX640223	FAN:SIROCCO:DC24V:60MM	U008_S001	30
		U020	31
		U020_S001	31
AX640224	DC FAN MOTOR:AXIAL:MM80	U020	32
AX640226	DC FAN MOTOR:AXIAL:MM80:20MM	U020	33
AX640231	DC FAN MOTOR:AXIAL:MM80:25MM	U019	35
		U020	34
AX650054	DC FAN MOTOR:SIROCCO:DC24V:PWM	U020	35
		U020_S003	35
AX650056	DC FAN MOTOR:AXIAL:MM92	U020	36
AX660015	DC FAN MOTOR:SIROCCO:DC24V:PWM	U020	37
AZ240284	POWER SUPPLY UNIT:ECO:200V	U019	36
AZ240288	POWER SUPPLY UNIT:FW:200V	U019	37
AZ310034	POWER PACK:TRANSFER	U010	35
AZ320133	POWER PACK:T1/T2	U010	36
AZ320230	POWER PACK:C/B	U019	38
B0434645	SPRING - 2N	U003_S001_S009	66
B0442316	CLUTCH SPACER	U018_S003	65
		U018_S013	65
		U018_S015	65
B0442756	SPRING - PAPER FEED ROLLER	U006_S003	60
B0651374	CLOTH - DF EXPOSURE GLASS	ACCESSORIES	8
B1321226	HOLDER:STAND	ACCESSORIES	9
B1322264	BUSHING:TERMINAL	U009_S003	18
		U009_S006	18
		U009_S009	18
		U009_S012	18
		U011_S001	10
B1322366	LEVER:DRUM STAY:LEFT	U021_S003	52
B1326114	CAM:ON-OFF:BLACK	U010	37

Number	Part Name	Group	ID
B1326124	SPRING PLATE:CAM	U010	38
B1881125	FLANGED HEXAGONAL HEAD BOLT:M5X14	U021	53
		U018_S010	66
		U018_S011	66
B2231186	DRIVE JOINT	U018_S012	66
		U015	100
B2234317	STEPPER MOTOR:DC24V 24.3W	U015	100
B2234494	STOPPER- UPPERGATE PAWL	U017	40
B2234552	BUSHING:DIA4	U017	41
B2236171	RUBBER BUSHING:ENCODER	U010	39
B2342390	FLANGED HEXAGONAL HEAD BOLT:M4X8	U001	25
		U008	31
		U011	11
		U015	101
		U016	58
		U020	38
B2342399	BOLT - M3X6	U021	54
		U006	61
		U009	19
B2342864	PAD:CLEANER	U012	20
		U007_S013_S001	76
		U007_S013_S002	76
		U007_S015_S001	76
		U007_S015_S002	76
		U007_S017_S001	76
		U007_S017_S002	76
U007_S019_S001	76		
B2474456	SPRING - LOWER EXIT ROLLER	U016_S001	59
B2591131	SCREW:PCU	U009	20
B3863320	SPRING:BELT:PAPER FEED:8N	U003_S001_S006	67
B3871951	SPRING - PAPER SIZE SENSOR	U003_S001	68
B3872113	ROLLER - PAPER FEED BELT	U003_S001_S006	69
B4772227	PICKUP ROLLER:COUPLING	U003_S001_S006	70
B4772622	DISCHARGE BRUSH:L11	U003_S001_S009	71
B4774117	SPRING	U003_S001_S009	72
B4774129	SPRING - 12N	U003_S001	73
B4774131	SPRING	U003_S001	74

Exclusive Parts

Number	Part Name	Group	ID
B6455020	SD-CARD:SERVICE:1GB:ASS'Y	SPECIAL TOOLS	5
B6455030	SD-CARD:SERVICE PARTS:2GB:ASS'Y	SPECIAL TOOLS	6
B6455040	SD-CARD:SERVICE PARTS:8GB:ASS'Y	SPECIAL TOOLS	7
B6522215	GUIDE:PAPER FEED BELT:FRONT	U003_S001_S006	75
B6523174	TENSION SPRING	U003_S001	76
B7002649	TIMING BELT:40S2M144	U016_S001	60
B7003305	TIMING BELT:B40S2M152	U003_S001	77
B7003535	TIMING BELT:B40S2M116	U018_S003	67
B7004720	TIMING BELT:B40S2M214	U017	42
B7061859	SCREW:SLIDER:LOCK	U003_S001	78
B7125605	GRIP:APPLICATION	U004	23
		U010	40
B7892114	PAPER FEED BELT ROLLER	U003_S001_S006	79
B8022532	SPRING PLATE:SIDE FENCE	U003_S001	80
B8022536	SLIDER:SIDE FENCE	U003_S001	81
B8024711	SOUND PROOFING MATERIAL	U003_S001_S008	82
		U003_S001_S009_S001	82
B8024712	SOUND PROOFING MATERIAL:COVER:REAR	U003_S001_S008	83
		U003_S001_S009_S001	83
B8041180	DISCHARGE BRUSH:PUNCH UNIT	U003_S001	84
		U003_S001_S003	84
B8301135	SCREW	U003_S001	85
B8301456	TIMING BELT - 40S2M190	U018_S003	68
		U018_S004	68
B8303504	TIMING BELT - 40S2M100	U007_S008	77
		U007_S009	77
		U007_S010	77
B8352889	TIMING BELT - B60S2M144	U017	43
B8722524	SPACER:DIA9	U003_S001	86
B8722614	BUSHING:R1	U015_S002	102
BB013041	GEAR:JOINT:PRESSURE:ASS'Y	U015_S002	103
BB013042	GEAR:IDLER:PRESSURE:ASS'Y	U015_S002	104
BB013043	GEAR:PRESSURE ROLLER	U015_S002	105
BB013044	GEAR:HOT ROLLER	U015_S002	106

Number	Part Name	Group	ID
BB013045	GEAR:IDLER:FUSING	U015_S002	107
BB013046	GEAR:IDLER:28Z:ASS'Y	U015_S002	108
C2442601	FRONT STEPPED SCREW	U015_S002	109
C2577055	WASHER:DIA8.1XDIA11.5X1T	U018_S001	69
C2592267	LOCK HOLDER	U021	55
C4019503	20X MAGNIFICATION SCOPE	SPECIAL TOOLS	8
D0092573	PULLEY - VERTICAL TRANSPORT	U007_S007	78
D0092574	PULLEY - IDLER	U007_S007	79
D0094388	ROLLER CLUTCH	U015_S004	110
D0141248	PLATE:LEVER:DRUM STAY:LEFT	U008_S001	32
D0141265	BRACKET:DC MOTOR	U018	70
D0142380	COMPRESSION SPRING - DRUM	U009_S002	21
		U009_S005	21
		U009_S008	21
		U009_S010	21
D0143655	ELECTRIC POTENTIAL SENSOR	U009	22
D0149800	GREASE-KS660B	SPECIAL TOOLS	9
D0159500	G104 YELLOW TONER	SPECIAL TOOLS	10
D0159501	ZINC STEARATE	SPECIAL TOOLS	11
D0291749	PULLEYTECTION	U004	24
D0292677	TRANSPORT BELT:DRIVEN:VERTICAL TRANSPORT	U007_S007	80
D0294439	STOPPER:GATE PAWL:ENTRANCE	U016_S001	61
D0294486	TENSION SPRING:GATE PAWL:1.5N	U007_S013	81
		U007_S015	81
		U007_S017	81
		U007_S019	81
D0391253	BAND:COVER:FRONT	U008_S001	33
D0391254	SPRING PLATE:BAND	U008_S001	34
D0392993	SHAFT:TRANSPORT BELT:PULLEY	U007_S007	82
D0396137	ENCODER:ASS'Y	U010	41
D0396327	SPACER:SENSOR:TM	U010	42
D0592399	FLANGED HEXAGONAL HEAD BOLT:M3*4	U007	83
D0596690	PLATE:PAPER:ASS'Y	U007_S013_S001_S001	84

Exclusive Parts

Number	Part Name	Group	ID
		U007_S015_S001	84
		U007_S017_S001	84
		U007_S019_S001	84
D0742178	TENSION SPRING:SOLENOID:ON-OFF	U009	23
D0742495	SHUTTER:TONER OUTLET SUB-UNIT	U009_S001_S001	24
		U009_S004_S001	24
		U009_S007_S001	24
		U009_S011_S001	24
		U012	21
D0742577	CONNECTOR:DRAWER:4POLE:REC	U020	39
D0743416	JOINT:DRIVE:DEVELOPMENT UNIT	U012	22
D0744009	HOLDER:M5	U015_S002	111
D0744063	HOUSING:THERMOSTAT:ASS'Y	U015_S002	112
D0744097	TAB:TERMINAL:CONNECTING	U015_S002	113
D0744300	SPRING PLATE:CLEANING UNIT:FUSING	U015_S004	114
D0744302	PLAIN SHAFT BEARING:ROLLER:REAR	U015_S004	115
D0744333	ROLLER:PLATE	U015_S004	116
D0744351	STEPPED SCREW:DIA5.4DIA:DIA3.5:M3	U019	39
D0744354	GEAR:SLOW DOWN:WORM GEAR	U015	117
D0744380	DECAL:H-TEMP WARNING:FUSING:WEB	U015_S004_S001	118
D0746158	ROLLER:INTERMEDIATE TRANSFER:ASS'Y	U010	43
D0746241	DECAL:GRIP:TRANSFER/SEPARATION UNIT	U012_S001	23
D0746411	COIL SPRING:EARTH:BELT CLEANING	U011_S001	12
D0746415	DUAL FACES TEPE:ENTRANCE SEAL:BELT CLEANING	U011_S001	13

Number	Part Name	Group	ID
D0746416	SEAL:ENTRANCE SEAL:BELT CLEANING	U011_S001	14
D0746420	BRUSH:REMOVE PAPER DUST:BELT CLEANING	U011_S001	15
D0746446	BRUSH:APPLY:BELT CLEANING	U011_S001	16
D0746457	BLADE:APPLY:ASS'Y	U011_S001	17
D0746477	GEAR:BRUSH:REMOVE PAPER DUST:Z17	U011_S001	18
D0746478	GEAR:PULLEY:IDLER:BELT CLEANING	U011_S001	19
D0746479	GEAR:COLLECT:COIL:Z19	U011_S001	20
D0746480	PULLEY:BRUSH:APPLY:Z30	U011_S001	21
D0746574	COVER:CAM:VERTICAL TRANSPORT	U013	11
D0746575	SHAFT:CAM:VERTICAL TRANSPORT	U013	12
D0746577	CAM:VERTICAL TRANSPORT:DIA15	U013	13
D0746578	GEAR:Z37:CAM:VERTICAL TRANSPORT	U013	14
D0746579	SEAL:COVER:CAM:VERTICAL TRANSPORT	U013	15
D0746585	GEAR:Z38/Z24:VERTICAL TRANSPORT	U013	16
D0746586	GEAR:Z35:IDLER:VERTICAL TRANSPORT	U013	17
D0746665	GEAR:JOINT:COLLECTION BOTTLE:Z65	U013	18
D0747690	BRUSH:BLOWER	SPECIAL TOOLS	12
D0749548	DG CLEANER 5PCS/SET	SPECIAL TOOLS	13
D0812966	DC MOTOR:ASS'Y:1.007W:BRUSH	U003_S001_S007	87
		U006_S003_S002	62
		U007_S001	85
		U007_S002	85
D0892764	GEAR:FEED	U007_S008	86
		U007_S009	86
		U007_S010	86
D0892819	GEAR:SEPARATOR:INPUT	U007_S008	87

Exclusive Parts

Number	Part Name	Group	ID
		U007_S009	87
		U007_S010	87
D0894365	HOLDER:THERMISTOR:LENS	U015	119
D0894366	COVER:THERMISTOR:LENS	U015	120
D0894466	SYNCHRONOUS BELT:S2M:104	U018_S010	71
		U018_S011	71
D0895887	PANEL:INTERFACE	U019	40
D1054365	HOLDER:THERMOPILE	U015_S002	121
D1055899	HOLDER:TEMPERATURE & HUMIDITY SENSOR	U010	44
D1174263	DECAL:H-TEMP WARNING:FUSING	U015_S002_S002	122
D1175916	STEPPED SCREW:M3X8:SECOND KIND	U007_S007	88
D1292783	TORQUE LIMITER MECHANICAL CLUTCH:40MM:DIA18	U007_S008	89
		U007_S009	89
		U007_S010	89
D1294331	FLAT NUT:BRAKE	U015_S004	123
D1351430	BRACKET:COVER:TONER SUPPLY UNIT:ASS'Y	U001	26
D1351435	DC FAN MOTOR:SIROCCO:ASS'Y	U020_S003	40
D1351436	COVER:RIGHT MIDDLE:UPPER	U001	27
D1351437	COVER:RIGHT MIDDLE:REAR	U001	28
D1351442	SEAL:COVER:FRONT MIDDLE:MIDDLE LOWER	U001_S006	29
D1351448	SEAL:DUCT:BELT CLEANING:INNER	U020	41
D1351450	SUPPORTER:COVER:FRONT MIDDLE:RIGHT	U021	56
D1351451	SUPPORTER:COVER:FRONT MIDDLE:LEFT	U021	57
D1351467	SEAL:DEVELOPMENT:EXHAUST:EXIT	U001_S001	30
D1351468	SEAL:AROUND THE PHOTOCONDUCTOR:EXHAUST:EXIT:REAR	U001_S001	31
D1351478	SEAL:SIROCCO:4	U020_S003	42
D1351484	SEAL:AROUND THE PHOTOCONDUCTOR:EXHAUST:EXIT:REAR MID	U001_S001	32

Number	Part Name	Group	ID
	DLE		
D1351489	SEAL:SIROCCO:3	U021_S003	58
D1351490	STAY:COVER:TONER SUPPLY SUB-UNIT	U001	33
		U001_S005	33
D1351491	SEAL:AROUND THE PHOTOCONDUCTOR:EXHAUST:SIROCCO	U020	43
		U020_S003	43
D1351493	SEAL:AROUND THE PHOTOCONDUCTOR:EXHAUST:EXIT	U001_S001	34
D1351496	SEAL:AROUND THE PHOTOCONDUCTOR:EXHAUST:SIROCCO:UPPER	U020_S003	44
D1351497	SEAL:SIROCCO	U020_S003	45
D1351498	SEAL:SIROCCO:2	U020_S003	46
D1351499	HOLDER:SD-CARD	U007_S014	90
		U007_S016	90
		U007_S018	90
		U007_S020	90
D1351583	FEELER:PULL OUT:LOCK	U021	59
D1353264	JOINT:DRIVE:TRANSPORT SCREW	U008_S001	35
D1353882	TENSION SPRING:PRESSURE:TRANSPORT BELT UNIT	U014	11
D1355926	BRACKET:ELECTRIC POTENTIAL SENSOR:PEEN	U019	41
D1355930	STOPPER:POWER SUPPLY CORD	ACCESSORIES	10
D1356133	ROLLER:ENCODER:ASS'Y	U010	45
D1356171	ROLLER:TENSION:ASS'Y	U010	46
D1356631	GUIDE PLATE:FLAT CONVEYER BELT:NO.1	U007_S007	91
D1356667	SHAFT:SEPARATE:DRIVEN:ASS'Y	U007_S008_S001	92
		U007_S009_S001	92
		U007_S010_S001	92
D1356669	SHAFT:SEPARATE:DRIVE:ASS'Y	U007_S008	93
		U007_S009	93
		U007_S010	93
D1356675	COVER:HARNESS:PAPER FEED UNIT	U007_S008	94
		U007_S009	94
		U007_S010	94

Exclusive Parts

Number	Part Name	Group	ID
D1356703	STOPPER:DOOR:VERTICAL TRANSPORT	U007_S007	95
D1356708	GUIDE PLATE:FLAT CONVEYER BELT:NO.2	U007_S007	96
D1356728	BRACKET:DOOR:VERTICAL TRANSPORT:ASS'Y	U007	97
D1356739	GRIP:PAPER TRAY	U007_S011	98
		U007_S012	98
D1356740	LINK:END FENCE:PAPER SIZE SENSOR	U007_S011	99
		U007_S012	99
D1356746	COIL SPRING:RELEASE	U007_S008	100
		U007_S009	100
		U007_S010	100
D1356748	TORSION SPRING:STOPPER:TANDEM TRAY	U007_S014	101
		U007_S016	101
		U007_S018	101
		U007_S020	101
D1356755	HEXAGON HEAD BOLT:DOUBLE SCREW:M3X8:ROUND POINT	U007	102
		U007_S014	102
		U007_S016	102
		U007_S018	102
		U007_S020	102
D1357100	BRACKET:HOLDER:ASS'Y	U016	62
D1357105	INNER COVER:EXIT:LEFT LOWER	U016	63
D1357110	BRACKET:PROTECT:PAPER EXIT UNIT	U016	64
D1357114	ROLLER:REVERSE EXIT:ASS'Y	U016_S001	65
D1357121	COIL SPRING:STOPPER:EXIT:NO.1	U016_S001	66
D1357122	BRACKET:DC STEPPER MOTOR:GUIDE PLATE PAWL:ASS'Y	U016_S001	67
D1357127	STOPPER:GUIDE PLATE:EXIT:UPPER	U016_S001	68
D1357128	BRACKET:CONTACT POINT:STOPPER:ASS'Y	U016_S001	69
D1357136	BRACKET:PAPER EXIT SUB-UNIT:REVERSE:NO.1	U016_S001	70
D1357169	ROLLER:REVERSE:ENTRANCE:AS	U016_S001	71

Number	Part Name	Group	ID
	S'Y		
D1357522	COVER:TANDEM LCT	U007_S014	103
		U007_S016	103
		U007_S018	103
		U007_S020	103
D1357523	ARM:GRIP:TANDEM LCT	U007_S014	104
		U007_S016	104
		U007_S018	104
		U007_S020	104
D1357531	GRIP:INNER COVER:ASS'Y	U007_S013_S003	105
		U007_S015_S003	105
		U007_S017_S003	105
		U007_S019_S003	105
D1357537	GEAR:OIL DAMPER:RISE	U007_S013	106
		U007_S015	106
		U007_S017	106
		U007_S019	106
D1357542	BRACKET:TRAY:PLATE:LOWER	U007_S014	107
		U007_S016	107
		U007_S018	107
		U007_S020	107
D1357543	BRACKET:TRAY:PLATE:UPPER	U007_S014	108
		U007_S016	108
		U007_S018	108
		U007_S020	108
D1357548	SHAFT:SLIDER:DRIVE:PRESS FIT	U007_S014	109
		U007_S016	109
		U007_S018	109
		U007_S020	109
D1357568	STOPPER:SYNCHRONOUS BELT:SLIDER	U007_S014	110
		U007_S016	110
		U007_S018	110
		U007_S020	110
D1357582	BRACKET:STOPPER:TANDEM TRAY:LEFT	U007_S014	111
		U007_S016	111
		U007_S018	111
		U007_S020	111
D1361125	GUIDE PLATE:ENCODER	U018_S005	72

Exclusive Parts

Number	Part Name	Group	ID
		U018_S006	72
		U018_S007	72
		U018_S008	72
D1361126	ENCODER:300LPI:900CT	U018_S005	73
		U018_S006	73
		U018_S007	73
		U018_S008	73
D1361127	RUBBER BUSHING:ENCODER	U018_S005	74
		U018_S006	74
		U018_S007	74
		U018_S008	74
D1361159	DC MOTOR:24V:8.8W:BRUSHLESS	U018	75
D1361212	DC MOTOR:ON-OFF:TRANSFER:ASS'Y	U018	76
D1361240	SHAFT:OUTPUT:DRIVE:VACUUM:ASS'Y	U018_S001	77
D1361243	JOINT:DRIVE:TRANSFER	U018_S001	78
D1361245	COMPRESSION SPRING:DRIVE:TRANSFER	U018_S001	79
D1361247	HOUSING:ON-OFF:TRANSFER	U018	80
D1361249	BRACKET:ON-OFF:TRANSFER:ASS'Y	U018	81
D1361275	BRACKET:DRIVE:FUSING	U018	82
D1361318	DRUM STAY:PAPER FEED SUB-UNIT:NO.1	U018_S010	83
D1361350	SHAFT:PAPER FEED SUB-UNIT:GRIP:ASS'Y	U018_S010	84
		U018_S012	84
D1361355	SHAFT:PAPER FEED SUB-UNIT:GRIP:NO.3:ASS'Y	U018_S011	85
D1361357	SHAFT:PAPER FEED SUB-UNIT:FEED:NO.3:ASS'Y	U018_S011	86
D1361370	SHAFT:MANUAL FEED UNIT:CONNECTING	U018_S003	87
D1361372	SHAFT:JOINT UNIT	U018_S003	88
D1361374	SHAFT:MANUAL FEED UNIT	U018_S003	89
D1361376	BRACKET:TRANSPORT SUB-UNIT:LOWER	U018_S003	90
D1361377	JOINT:DRIVE:MANUAL FEED SUB-	U018_S003	91

Number	Part Name	Group	ID
	UNIT		
D1361378	JOINT:DRIVE:MANUAL FEED SUB-UNIT	U018_S003	92
D1361394	SHAFT:DRIVE:PAPER EXIT SUB-UNIT:ENTRANCE:ASS'Y	U018_S004	93
D1361458	INNER COVER:FRONT MIDDLE:RIGHT	U001	35
D1361467	CAP:CONNECTOR	U001	36
		U001_S004	36
D1361469	CAP:CONNECTOR:DECURA	U001_S001	37
D1361472	COVER:REAR LOWER	U001	38
D1361474	COVER:UPPER REAR:SMALL	U001	39
D1361478	COVER:UPPER REAR	U001	40
D1361484	INNER COVER:MAIN SWITCH	U001	41
D1361496	INNER COVER:RIGHT MIDDLE	U001	42
D1361499	BRACKET:HOLDER:COVER:REAR	U019	42
D1361533	BRACKET:LED	U001_S002	43
		U001_S003	43
		U001_S006	43
D1361547	HANDLE:DRUM STAY	U021	60
D1361549	STAY:DRUM STAY:FRONT RIGHT	U021	61
D1361552	STAY:COVER:FRONT MIDDLE	U021	62
D1361553	GRIP:PULL OUT:TCRU	U021	63
D1361577	BRACKET:DRIVE SUB-UNIT:PULL OUT:LOCK	U021	64
D1361579	DC MOTOR:PULL OUT:LOCK:6.78W:BRUSH	U021	65
D1361580	HOLDER:DRIVE SUB-UNIT:PULL OUT:LOCK	U021	66
D1361584	SUPPORTING PLATE:BRACKET:LOCK	U021	67
D1361585	BRACKET:LOCK	U021	68
D1361590	GUIDE:CURL CORD	U021	69
D1361591	EXTENSION TRAY:CURL CORD	U021	70
D1361593	STOPPER:GUIDE:CURL CORD:0.3T	U021	71
D1361594	GUIDE:CURL CORD:REAR UPPER	U021	72
D1361687	GROUND PLATE:SENSOR:AKS	U004	25

Exclusive Parts

Number	Part Name	Group	ID
D1361758	CLAMP:WIRE	U004	26
D1361788	PULLEY:IDLER:CARRIAGE	U004	27
D1361793	DC STEPPER MOTOR:MM42	U004	28
D1361794	BRACKET:DC STEPPER MOTOR:TENSION	U004	29
D1361798	TENSION SPRING:TENSION:16N	U004	30
D1361799	BRACKET:DC STEPPER MOTOR	U004	31
D1361801	SHAFT:DRIVE:SCANNER	U004	32
D1361802	TIMING PULLEY:65	U004	33
D1361803	SYNCHRONOUS BELT:157ST1.5-6.0	U004	34
D1361806	DRIVE WERE:DIA1	U004	35
D1361809	BRACKET:TENSION	U004	36
D1361810	TENSION SPRING:TENSION:11N	U004	37
D1361811	PULLEY:PEEN	U004	38
D1361817	BRACKET:EXPOSURE GLASS:DOCUMENT FEEDER:SUB-ASS'Y	U004	39
D1361821	COVER:EXPOSURE GLASS:DOCUMENT FEEDER	U004	40
D1362150	CLEANER:SHIELD GLASS:ASS'Y	U021	73
D1362258	CONNECTOR:DRAWER:8POLE:REC	U009	25
D1362266	HOLDER:ELECTRIC POTENTIAL SENSOR	U009	26
D1362268	SHIELDING PLATE:ELECTRIC POTENTIAL SENSOR	U009	27
D1362276	CONNECTOR:1POLE	U009	28
D1362296	GROUND PLATE:PCU:ASS'Y	U008_S001	36
D1362302	HOLDER:LOCK:CLEANING UNIT:FRONT	U009	29
D1362304	TORSION SPRING:LOCK:PCU	U009	30
D1362305	GROUND PLATE:HOLDER:CLEANING UNIT	U009	31
D1362306	COMPRESSION SPRING:GROUND PLATE:HOLDER:CLEANING UNIT	U009	32
D1362307	LEVER:LOCK:PCU	U009	33
D1362308	STAY:PCU	U009	34
D1362347	SEAL:FRAME:BASE:MIDDLE	U009_S001	35

Number	Part Name	Group	ID
		U009_S004	35
		U009_S007	35
		U009_S011	35
D1362348	SEAL:FRAME:BASE:SIDE	U009_S001	36
		U009_S004	36
		U009_S007	36
		U009_S011	36
D1362350	SEAL:FRAME:BASE:TONER OUTLET SUB-UNIT	U009_S001	37
		U009_S004	37
		U009_S007	37
		U009_S011	37
D1362356	TRANSPORT SCREW:BASE:ASS'Y	U009_S001	38
		U009_S004	38
		U009_S007	38
		U009_S011	38
D1362362	BUSHING:TRANSPORT SCREW	U009_S001	39
		U009_S004	39
		U009_S007	39
		U009_S011	39
D1362365	CLEANING BLADE:ASS'Y	U009_S001	40
		U009_S004	40
		U009_S007	40
		U009_S011	40
D1362391	TRANSPORT SCREW:APPLY:ASS'Y	U009_S001	41
		U009_S004	41
		U009_S007	41
		U009_S011	41
D1362404	COVER:BEARING:OIL SUPPLY ROLLER:FRONT	U009_S001	42
		U009_S004	42
		U009_S007	42
		U009_S011	42
D1362408	GEAR:24Z:RIGHT	U009_S001	43
		U009_S004	43
		U009_S007	43
		U009_S011	43
D1362417	ARM:COATING BAR	U009_S001	44
		U009_S004	44
		U009_S007	44

Exclusive Parts

Number	Part Name	Group	ID
		U009_S011	44
D1362418	TENSION SPRING:COATING BAR:18N	U009_S001	45
		U009_S004	45
		U009_S007	45
		U009_S011	45
D1362423	SEAL:STAY:APPLY	U009_S001	46
		U009_S004	46
		U009_S007	46
		U009_S011	46
D1362424	SEAL:STAY:APPLY:UPPER	U009_S001	47
		U009_S004	47
		U009_S007	47
		U009_S011	47
D1362441	BLADE:APPLY:ASS'Y	U009_S001	48
		U009_S004	48
		U009_S007	48
		U009_S011	48
D1362446	SEAL:BLADE:APPLY:FRONT	U009_S001	49
		U009_S004	49
		U009_S007	49
		U009_S011	49
D1362448	SEAL:CLEANING BLADE:FRONT	U009_S001	50
		U009_S004	50
		U009_S007	50
		U009_S011	50
D1362449	SEAL:CLEANING BLADE:REAR	U009_S001	51
		U009_S004	51
		U009_S007	51
		U009_S011	51
D1362451	COVER:TONER OUTLET SUB-UNIT:CLEANING UNIT:ASS'Y	U009_S001_S001	52
		U009_S004_S001	52
		U009_S007_S001	52
		U009_S011_S001	52
D1362458	VIBRATING PLATE:TONER OUTLET SUB-UNIT	U009_S001	53
		U009_S004	53
		U009_S007	53
		U009_S011	53
D1362461	GEAR:18Z:RIGHT	U009_S001	54

Number	Part Name	Group	ID
		U009_S004	54
		U009_S007	54
		U009_S011	54
D1362462	GEAR:IDLER:19Z:LEFT	U009_S001	55
		U009_S004	55
		U009_S007	55
		U009_S011	55
D1362466	DRUM STAY:CLEANING UNIT	U009_S001	56
		U009_S004	56
		U009_S007	56
		U009_S011	56
D1362467	GROUND PLATE:CLEANING UNIT:ASS'Y	U009_S001	57
		U009_S004	57
		U009_S007	57
		U009_S011	57
D1362490	HOLDER:DRUM:FRONT	ACCESSORIES	11
D1362493	HOLDER:DRUM:REAR	ACCESSORIES	12
D1362495	HOLDER:PCU	ACCESSORIES	13
D1362573	COLLAR:REGISTRATION:DRIVE	U006	63
D1362581	PLAIN SHAFT BEARING:LEVER:OPEN AND CLOSE:INNER BACK	U006	64
D1362639	COMPRESSION SPRING:COVER:REGISTRATION	U006_S002	65
D1362642	SLOPE:COVER:REGISTRATION	U021_S003	74
D1362660	GUIDE PLATE:CONNECTING:MANUAL FEED:LOWER:ASS'Y	U006	66
D1362663	GUIDE:CONNECTING:MANUAL FEED:LOWER	U006	67
D1362665	GUIDE PLATE:CONNECTING:MANUAL FEED:UPPER:ASS'Y	U006	68
D1362670	ROLLER:DIA18:CONNECTING:MANUAL FEED	U006	69
D1362671	SHAFT:DRIVEN ROLLER:ENCODER	U006	70
D1362673	PLAIN SHAFT BEARING:CONNECTING	U006	71
D1362678	COVER:MANUAL FEED:ENTRANCE:UPPER	U006	72

Exclusive Parts

Number	Part Name	Group	ID
D1362712	GUIDE:CONNECTING:DRIVEN	U006	73
D1362714	ROLLER:CONNECTING:DIA20	U006	74
D1362715	TENSION SPRING:DRIVEN:CONNECTING	U006	75
D1362718	GUIDE PLATE:CONNECTING:FRONT LEFT	U006	76
D1362719	GUIDE:CONNECTING:FRONT LEFT	U006	77
D1362721	GUIDE PLATE:CONNECTING:DRIVE	U006	78
D1362786	GROUND PLATE:SENSOR:MANUAL FEED	U006_S003	79
D1362788	GROUND PLATE:MANUAL FEED UNIT:REAR	U006_S003	80
D1362789	SHAFT:FEED:MANUAL FEED	U006_S003	81
D1362801	BRACKET:LEVER:FRONT:MANUAL FEED:ASS'Y	U006	82
D1362810	GROUND PLATE:MANUAL FEED UNIT:FRONT	U006_S003	83
D1362815	BRACKET:HINGE:MANUAL FEED:UPPER:ASS'Y	U006	84
D1362844	SHAFT:LEVER:MANUAL FEED:FRONT	U006_S003	85
D1362852	BRACKET:LED:MANUAL FEED	U006	86
D1362853	INNER COVER:LED:MANUAL FEED	U006	87
D1362870	JOINT:MANUAL FEED SUB-UNIT:REVERSE	U006_S003	88
D1362871	JOINT:MANUAL FEED SUB-UNIT:FEED	U006_S003	89
D1362872	BRACKET:STOPPER:MANUAL FEED	U006_S003	90
D1362873	ARM:STOPPER:MANUAL FEED	U006_S003	91
D1363211	TORSION SPRING:STOPPER:TONER CARTRIDGE:RIGHT	U008_S001_S005	37
		U008_S001_S006	37
		U008_S001_S007	37
		U008_S001_S008	37
D1363239	SEAL:DUCT:BELT CLEANING	U008_S001	38
D1363251	HOLDER:TONER CARTRIDGE:CO	U008_S001	39

Number	Part Name	Group	ID
	CONNECTOR		
D1363254	COVER:CHIP:BASE	U008_S001	40
D1363270	GEAR:IDLER:TONER END SENSOR	U008_S001	41
D1363272	BRACKET:LEVER	U008_S001	42
D1363273	LEVER:TONER SUPPLY UNIT	U008_S001	43
D1363297	INNER COVER:TONER SUPPLY:RIGHT	U008_S001	44
D1363298	SEAL:SIDE PLATE:TONER SUPPLY	U008_S001	45
D1363299	DC MOTOR:TONER CARTRIDGE:ASS'Y	U008_S001	46
D1363302	BRACKET:SAFETY SWITCH:DOOR:TONER SUPPLY:PEEN	U008_S001	47
D1363305	TONER SUPPLY UNIT:ASS'Y	U008_S001_S001	48
		U008_S001_S002	48
		U008_S001_S003	48
		U008_S001_S004	48
D1363308	BRACKET:DRAWER:TONER SUPPLY UNIT	U008_S001	49
D1363315	CASE:TONER SUPPLY	U008_S001_S001	50
		U008_S001_S002	50
		U008_S001_S003	50
		U008_S001_S004	50
D1363331	SHUTTER:CASE:TONER SUPPLY	U008_S001_S001	51
		U008_S001_S002	51
		U008_S001_S003	51
		U008_S001_S004	51
D1363333	GEAR:AGITATOR:TONER SUPPLY:NO.2	U008_S001_S001	52
		U008_S001_S002	52
		U008_S001_S003	52
		U008_S001_S004	52
D1363334	GEAR:TRANSPORT SCREW:TONER SUPPLY	U008_S001_S001	53
		U008_S001_S002	53
		U008_S001_S003	53
		U008_S001_S004	53
D1363335	GEAR:MECHANICAL ROLLER CLUTCH:TONER SUPPLY:FRONT	U008_S001_S001	54
		U008_S001_S002	54

Exclusive Parts

Number	Part Name	Group	ID
		U008_S001_S003	54
		U008_S001_S004	54
D1363336	GEAR:MECHANICAL ROLLER CLUTCH:TONER SUPPLY:REAR	U008_S001_S001	55
		U008_S001_S002	55
		U008_S001_S003	55
		U008_S001_S004	55
D1363337	GEAR:IDLER:AGITATOR:TONER SUPPLY	U008_S001_S001	56
		U008_S001_S002	56
		U008_S001_S003	56
		U008_S001_S004	56
D1363338	GEAR:AGITATOR:TONER SUPPLY:NO.1	U008_S001_S001	57
		U008_S001_S002	57
		U008_S001_S003	57
		U008_S001_S004	57
D1363345	SEAL:CASE:UPPER:TONER SUPPLY	U008_S001_S001	58
		U008_S001_S002	58
		U008_S001_S003	58
		U008_S001_S004	58
D1363361	GEAR:IDLER:TRANSPORT SCREW:NO.1:TONER SUPPLY	U008_S001_S001	59
		U008_S001_S002	59
		U008_S001_S003	59
		U008_S001_S004	59
D1363364	GEAR:IDLER:DRIVE:TONER SUPPLY	U008_S001_S001	60
		U008_S001_S002	60
		U008_S001_S003	60
		U008_S001_S004	60
D1363365	GEAR:IDLER:TRANSPORT SCREW:TONER SUPPLY:SMALL	U008_S001_S001	61
		U008_S001_S002	61
		U008_S001_S003	61
		U008_S001_S004	61
D1363366	GEAR:IDLER:TRANSPORT SCREW:TONER SUPPLY:LARGE	U008_S001_S001	62
		U008_S001_S002	62
		U008_S001_S003	62
		U008_S001_S004	62
D1363371	TORSION SPRING:STOPPER:TONER CARTRIDGE:LEFT	U008_S001_S005	63
		U008_S001_S006	63
		U008_S001_S007	63
		U008_S001_S008	63

Number	Part Name	Group	ID
D1363374	BRACKET:DRAWER:TONER SUPPLY:MAIN	U008	64
D1363381	TORSION SPRING:STOPPER:RIGHT	U008_S001_S005	65
		U008_S001_S006	65
		U008_S001_S007	65
		U008_S001_S008	65
D1363395	DECAL:OPERATE:TONER CARTRIDGE	U001	44
D1363431	FILTER:DEVELOPMENT	U009_S002	58
		U009_S005	58
		U009_S008	58
		U009_S010	58
D1363434	DECAL:COLORED DISPLAY:DRUM STAY:ASS'Y	U021_S003_S001	75
D1363437	CAP:DEVELOPMENT:SUB-ASS'Y	ACCESSORIES	14
D1363442	DECAL:COLORED DISPLAY:MAIN: BK	U009	59
D1363443	DECAL:COLORED DISPLAY:MAIN: C	U009	60
D1363444	DECAL:COLORED DISPLAY:MAIN: M	U009	61
D1363445	DECAL:COLORED DISPLAY:MAIN: Y	U009	62
D1363446	DECAL:COLORED DISPLAY:DRUM STAY:BK	U021_S003_S001	76
D1363447	DECAL:COLORED DISPLAY:DRUM STAY:C	U021_S003_S001	77
D1363448	DECAL:COLORED DISPLAY:DRUM STAY:M	U021_S003_S001	78
D1363449	DECAL:COLORED DISPLAY:DRUM STAY:Y	U021_S003_S001	79
D1363478	SPACER:DRIVE:TONER CARTRIDGE	U008_S001	66
D1363497	SEAL:SHUTTER:FUNNEL	ACCESSORIES	15
D1363498	SHUTTER:FUNNEL	ACCESSORIES	16
D1363499	FUNNEL:DEVELOPER	ACCESSORIES	17
D1363550	PIPE:UPPER:ASS'Y	U013	19
D1363564	SPACER:DIA9:0.13MM	U013	20

Exclusive Parts

Number	Part Name	Group	ID
D1363566	BRACKET:GEAR:USED TONER:PC U:PEEN	U013	21
D1363569	GEAR:Z35:TRANSPORT SCREW:P CU:MAIN	U013	22
D1363571	BRACKET:SWIVEL	U013	23
D1363603	BRACKET:DRIVE:PIPE:MIDDLE:PE EN	U013	24
D1363608	BRACKET:DRIVE:TRANSPORT SC REW:MIDDLE	U013	25
D1363623	SEAL:RELAY DUCT:SPONGE	U013	26
D1363641	GEAR:TRANSPORT SCREW:LOWE R:Z41	U013	27
D1363642	HOLDER:RADIAL BALL BEARING:J OINT:PRESS FIT	U013	28
D1363646	TORQUE LIMITER MECHANICAL C LUTCH:GEAR:Z65/Z35	U013	29
D1363647	GEAR:IDLER:Z49/Z27	U013	30
D1363667	SHAFT:JOINT:TONER RECYCLING SUB-UNIT:ASS'Y	U013	31
D1363870	SYNCHRONOUS BELT:DRIVE:TRA NSPORT BELT UNIT	U012	24
D1363890	DECAL:VACUUM:GRIP:D1	U014_S001	12
D1363891	DECAL:LED:GRIP:VACUUM	U001_S002	45
D1364070	COLLAR:DIA10X:DIA14X:15.8	U015_S002	124
D1364071	COLLAR:DIA10XDIA14X13.4	U015_S002	125
D1364072	SHAFT:CAM:PRESSURE	U015_S002	126
D1364073	JOINT:CAM:PRESSURE:B	U015_S002	127
D1364075	FEELER:CAM:PRESSURE:REAR	U015_S002	128
D1364081	COVER:THERMOSTAT:PRESSURE	U015_S002	129
D1364082	CLAMP:HARNESS:PRESSURE	U015_S002	130
D1364111	COVER:HARNESS:FIRST:LOWER	U015_S002	131
D1364127	RECEIVE PLATE:PRESSURE	U015_S002	132
D1364129	HOLDER:HEATER:PRESSURE:FR ONT	U015_S002	133
D1364131	HOLDER:COIL SPRING:PRESSUR E	U015_S002	134
D1364135	SHAFT:RADIAL BALL BEARING:LE VER:PRESSURE	U015_S002	135

Number	Part Name	Group	ID
D1364195	COVER:ENTRANCE SENSOR:FUSI NG	U015	136
D1364218	SUPPORTING PLATE:SIDE PLATE: HOT ROLLER:REAR	U015_S002	137
D1364222	GROUND PLATE:HEAT ROLLER	U015_S002	138
D1364232	SHAFT:HEAT ROLLER:TURN:FEEL ER	U015_S002	139
D1364236	SPONGE:IH:DUCT:FRONT	U015_S002_S007	140
D1364254	STAY:FUSING:ENTRANCE	U015_S002	141
D1364258	HOLDER:GUIDE:ENTRANCE:MIDD LE	U015_S002	142
D1364259	HOLDER:GUIDE:ENTRANCE	U015_S002	143
D1364412	LEVER:WEB:ASS'Y	U015_S002	144
D1364428	GRIP:FUSING UNIT:REAR	U015_S002	145
D1364441	COVER:HARNESS:LEFT INNER RE AR	U015_S002	146
D1364516	LEVER:GUIDE PLATE:DUPLIX:AS S'Y	U017_S002	44
D1364531	BRACKET:BELT TENSIONER:ASS' Y	U017	45
D1364602	ROLLER:DRIVEN:DUPLIX	U017_S002	46
D1364606	HOLDER:PRESSURE:GUIDE PLAT E	U017_S002	47
D1364607	COMPRESSION SPRING:HOLDER: GUIDE PLATE	U017_S002	48
D1364608	GUIDE PLATE:POSITIONING SENS OR:LOWER	U017_S002	49
D1364609	TENSION SPRING:GUIDE PLATE:M OVE	U017_S002	50
D1364611	TRANSPORT ROLLER:DUPLIX:DR IVEN:1	U017_S001	51
D1364614	PLAIN SHAFT BEARING:TRANSP ORT ROLLER:DUPLIX:DRIVEN:INN ER	U017	52
D1364619	BUSHING:FLANGE TYPE:DIA6	U017	53
D1364620	BUSHING:DIA6:DIA10:6	U017	54
D1364640	COVER:GUIDE PLATE:UPPER	U017	55
D1364642	SHAFT:SLIDE:POSITIONING SENS	U017	56

Exclusive Parts

Number	Part Name	Group	ID
	OR		
D1364647	TENSION SPRING:BELT TENSION ER	U017	57
D1364650	TIMING PULLEY:T18:S2M	U017	58
D1364651	STOPPER:PULLEY:RIGHT	U017	59
D1364653	STOPPER:PULLEY:LEFT	U017	60
D1364665	TENSION SPRING:DRIVEN ROLLER:EXIT	U017_S002	61
D1364666	TENSION SPRING:DRIVEN ROLLER:DUPLEX	U017_S002	62
D1364668	SHEET:DUPLEX:ENTRANCE:RIGHT UPPER	U017	63
D1364670	PLAIN SHAFT BEARING:DIA4	U017_S002	64
D1364671	LINK:ROLLER:SHIFT	U017	65
D1364673	GUIDE PLATE:POSITIONING SENSOR:DUPLEX	U017	66
D1364674	GUIDE:PLATE:POSITIONING SENSOR	U017	67
D1364749	GUIDE PLATE:DUPLEX:ENTRANCE:LEFT LOWER:SUB-ASS'Y	U017	68
D1364750	GUIDE PLATE:DUPLEX:ENTRANCE:RIGHT	U017	69
D1364751	BRACKET:DUPLEX:ENTRANCE:FRONT	U017	70
D1364752	GATE PAWL:DUPLEX:ENTRANCE:NO.1	U017	71
D1364762	LEVER:GATE PAWL:REVERSE	U017	72
D1364763	GUIDE PLATE:DUPLEX:ENTRANCE:RIGHT UPPER	U017	73
D1364768	COIL SPRING:GATE PAWL:DUPLEX:ENTRANCE:NO.2	U017	74
D1364770	TENSION SPRING:GATE PAWL:DUPLEX	U017	75
D1364771	TENSION SPRING:DC SOLENOID:RELEASE	U017	76
D1364829	TIMING PULLEY:DUPLEX:REVERSE:S2M54T	U017	77
D1364830	GUIDE PLATE:LEFT:REVERSE:DU	U017	78

Number	Part Name	Group	ID
	PLEX		
D1364928	GUIDE PLATE:RECEIVING SUB-UNIT:LEFT LOWER	U017	79
D1364936	GUIDE PLATE:RECEIVING SUB-UNIT:LOWER	U017	80
D1364949	COVER:RECEIVING SUB-UNIT:RIGHT LOWER	U017	81
D1364961	LED:SWITCH:REVERSE EXIT:ASS'Y	U017	82
D1364976	DECAL:INNER COVER:RECEIVING SUB-UNIT:UPPER	U017_S005	83
D1364978	DECAL:ARROW LABEL:LEFT	U001	46
D1365428	PCB:TCB	U008_S001	67
D1365455	INVERTOR:IH:200V	U019	43
D1365903	DUCT:POWER SUPPLY UNIT	U019	44
D1365904	BRACKET:DC FAN MOTOR:INDUCTION HEATING UNIT	U019	45
D1365912	LEVER:SAFETY SWITCH:VERTICAL TRANSPORT	U019	46
D1365913	COVER:SAFETY SWITCH:VERTICAL TRANSPORT	U019	47
D1365914	BRACKET:SAFETY SWITCH:VERTICAL TRANSPORT	U019	48
D1365918	TORSION SPRING:SAFETY SWITCH:VERTICAL TRANSPORT	U008_S001 U019	68 49
D1365923	LEVER:SAFETY SWITCH:3	U019	50
D1365931	TORSION SPRING:SAFETY SWITCH	U019	51
D1365932	SHAFT:SAFETY SWITCH:LEVER:1	U019	52
D1365933	LEVER:SAFETY SWITCH:1	U019	53
D1365934	LEVER:SAFETY SWITCH:2	U019	54
D1365964	COVER:C/T BOX:REAR	U019	55
D1365974	ARM:HINGE:C/T BOX	U019	56
D1365994	LEVER:SAFETY SWITCH:TONER SUPPLY:DOOR	U008_S001	69
D1366042	BRACKET:HEATER:INTERMEDIATE TRANSFER	U010	47
D1366044	COVER:INTERMEDIATE TRANSFER	U010	48

Exclusive Parts

Number	Part Name	Group	ID
	R		
D1366052	SUPPORTER:INTERMEDIATE TRANSFER:LEFT	U020	47
D1366056	STOPPER:BRACKET:ENCODER	U010	49
D1366058	STOPPER:BRACKET:ENCODER:REAR	U010	50
D1366073	DUCT:CONNECTING:INTERMEDIATE TRANSFER	U010	51
D1366086	COVER:ENCODER	U010	52
D1366087	COIL SPRING:PRESSURE:BRACKET:ENCODER	U010	53
D1366089	PLAIN SHAFT BEARING:CONTACT POINT:BRACKET:ENCODER	U010 U013	54 32
D1366099	TENSION SPRING:BRACKET:DC STOPPER MOTOR	U010	55
D1366100	DENSITY SENSOR:P/TM	U010	56
D1366104	GUIDE:INTERMEDIATE TRANSFER:LEFT	U010	57
D1366111	BRACKET:INTERMEDIATE TRANSFER:FRONT	U010	58
D1366112	BRACKET:INTERMEDIATE TRANSFER:REAR	U010	59
D1366113	SHAFT:CAM:INTERMEDIATE TRANSFER:BLACK	U010	60
D1366114	CAM:INTERMEDIATE TRANSFER:BLACK	U010	61
D1366115	TENSION SPRING:PRESSURE:INTERMEDIATE TRANSFER	U010	62
D1366118	SEPARATION PLATE:INTERMEDIATE TRANSFER:MAIN:240V	U010	63
D1366119	TERMINAL:CONNECTING:INTERMEDIATE TRANSFER	U010	64
D1366121	COVER:ON-OFF:SLIDE RAIL	U010	65
D1366123	PLAIN SHAFT BEARING:INTERMEDIATE TRANSFER	U010	66
D1366124	BRACKET:BIAS:INTERMEDIATE TRANSFER	U010	67
D1366125	TERMINAL:INTERMEDIATE TRANSFER	U010	68

Number	Part Name	Group	ID
	FER		
D1366126	COMPRESSION SPRING:BIAS:INTERMEDIATE TRANSFER	U010	69
D1366145	ROLLER:ON-OFF:INTERMEDIATE TRANSFER	U010	70
D1366146	SHAFT:CAM:INTERMEDIATE TRANSFER:COLOR	U010	71
D1366149	BUSHING:SLIDE RAIL:ON-OFF	U010	72
D1366154	FEELER:INTERMEDIATE TRANSFER	U010	73
D1366174	BRACKET:TENSION:ROLLER	U010	74
D1366175	SLIDE RAIL:CASE:TENSION:ROLLER	U010	75
D1366176	GUIDE:TENSION:INTERMEDIATE TRANSFER	U010	76
D1366177	PLAIN SHAFT BEARING:TENSION:INTERMEDIATE TRANSFER	U010	77
D1366179	COIL SPRING:PRESSURE:TENSION:INTERMEDIATE TRANSFER	U010	78
D1366182	DUCT:TM SENSOR	U010	79
D1366183	GRIP:ON-OFF:INTERMEDIATE TRANSFER:TCRU	U010	80
D1366195	SEAL:DUCT:TM SENSOR	U010	81
D1366196	HOME POSITION SENSOR:FLAT BELT-TRANSFER	U010	82
D1366350	LINK:RELEASE:RIGHT	U012	25
D1366409	GUIDE:BELT CLEANING	U020	48
D1366410	GROUND PLATE:BELT CLEANING	U011_S001	22
D1366411	PLAIN SHAFT BEARING:DIA6:DIA8:BRUSH	U011_S001	23
D1366414	SCRAPER:BRUSH:REMOVE PAPER DUST	U011_S001	24
D1366427	SEAL:SCRAPER	U011_S001	25
D1366434	TONER COLLECTION COIL:BELT CLEANING:ASS'Y	U011_S001	26
D1366439	PLAIN SHAFT BEARING:REMOVE PAPER DUST:TRANSPORT SCREW	U011_S001	27

Exclusive Parts

Number	Part Name	Group	ID
D1366441	SHUTTER:TRANSPORT SCREW:BELT CLEANING	U011_S001	28
D1366442	COIL SPRING:DISCHARGE USED TONER	U011_S001	29
D1366444	SYNCHRONOUS BELT:30S2M126	U011_S001	30
D1366461	HOLDER:APPLY:BELT CLEANING:ASS'Y	U011_S001	31
D1366465	COIL SPRING:BLADE:APPLY:BELT CLEANING	U011_S001	32
D1366466	BRACKET:GUARD:BELT CLEANING	U020	49
D1366471	RELEASE PLATE:BLADE:APPLY	U011_S001	33
D1366478	RELEASE PLATE:BLADE:CLEANING	U011_S001	34
D1366489	VIBRATING PLATE:TRANSPORT SCREW:BELT CLEANING	U011_S001	35
D1366495	LEVER:RELEASE:BLADE	U011_S001	36
D1366656	GUIDE:COUPLING:RELEASE:TANDEM TRAY	U021	80
D1366665	BRACKET:LED:VERTICAL TRANSPORT	U007	112
D1366667	HOLDER:POSITIONING:VERTICAL TRANSPORT	U007	113
D1366675	HOLDER:POSITIONING	U021	81
D1366676	CUSHION:SEPARATE	U007	114
		U007_S013	114
		U007_S015	114
		U007_S017	114
		U007_S019	114
		U021	82
D1366678	SUPPORTER:LEFT:ASS'Y	U021	83
D1366699	BRACKET:DC SOLENOID:LOCK:ASS'Y	U007	115
D1366703	COVER:PAPER TRAY:REAR LEFT	U007	116
D1366707	BRACKET:DC MOTOR:LEFT	U007	117
D1366708	SHAFT:JOINT	U007	118
D1366710	BRACKET:CONNECTOR:LEFT	U021	84
D1366729	BRACKET:STOPPER:VERTICAL TR	U007	119

Number	Part Name	Group	ID
	TRANSPORT:RIGHT LOWER:ASS'Y		
D1366741	COVER:CONNECTOR:HEATER:UPPER	U007	120
D1366743	PLATE:CONNECTOR:HEATER:LOWER	U007	121
D1366744	TENSION SPRING:END FENCE:SOLENOID	U007	122
D1366746	JOINT:TANDEM LCT	U007	123
D1366748	DECAL:SIZE INDICATION:END FENCE:FRONT	U007_S011	124
		U007_S012	124
D1366749	DECAL:SIZE INDICATION:END FENCE:REAR	U007_S011	125
		U007_S012	125
D1366751	LEVER:STRETCH:PAPER TRAY:ASS'Y	U007_S003	126
		U007_S004	126
D1366760	GEAR:LEVER:STRETCH:Z19	U007_S003	127
		U007_S004	127
D1366765	GEAR:IDLER:Z14/Z36	U007_S003	128
		U007_S004	128
D1366766	GEAR:IDLER:Z30	U007_S003	129
		U007_S004	129
D1366768	GUIDE:STRETCH	U007_S003	130
		U007_S004	130
D1366770	HOLDER:OIL DAMPER	U007_S003	131
		U007_S004	131
D1366772	GEAR:PAWL:Z18	U007_S003	132
		U007_S004	132
D1366773	COLLAR:GEAR	U007_S003	133
		U007_S004	133
D1366774	GEAR:PAWL:Z39	U007_S003	134
		U007_S004	134
D1366775	COVER:GEAR	U007_S003	135
		U007_S004	135
D1366777	COVER:TRAY	U007_S003	136
		U007_S004	136
D1366778	OIL DAMPER:23MN/M	U007_S003	137
		U007_S004	137
D1366788	DECAL:H-TEMP WARNING:HEATER	U007_S005	138

Exclusive Parts

Number	Part Name	Group	ID
D1366792	BRACKET:LED:TANDEM TRAY	U021	85
D1366796	SHUTTER:LED	U021	86
D1366797	COIL SPRING:SHUTTER:LED	U021	87
D1366854	DUCT:DEVELOPMENT:VACUUM:RIGHT	U008_S001	70
D1366855	DUCT:DEVELOPMENT:VACUUM:LEFT	U008_S001	71
D1366860	DUCT:INDUCTION HEATING UNIT:VACUUM	U020	50
D1366861	DUCT:HEAT PIPE:ROLLER	U020	51
D1366865	DUCT:HEAT PIPE:ROLLER:EXIT	U020	52
D1366878	DUCT:FUSING:EXIT:RIGHT	U020	53
D1366879	DUCT:FUSING:EXIT:LEFT	U020	54
D1366887	DUCT:HEAT SINKER:UPPER	U020	55
D1366890	DUCT:DEVELOPMENT:EXHAUST:RIGHT:FRONT	U020	56
D1366891	DUCT:DEVELOPMENT:EXHAUST:RIGHT:REAR	U020	57
D1366894	DUCT:DEVELOPMENT:EXHAUST:LEFT:FRONT	U020	58
D1366895	DUCT:DEVELOPMENT:EXHAUST:LEFT:REAR	U020	59
D1366896	SEAL:AROUND THE PHOTOCONDUCTOR:EXHAUST	U020_S003	60
D1366897	DUCT:DRUM STAY:SMALL	U021_S003	88
D1366900	RELAY DUCT:AROUND THE PHOTOCONDUCTOR:ASS'Y	U020	61
D1366904	RELAY DUCT:AROUND THE PHOTOCONDUCTOR:Y:ASS'Y	U020	62
D1366909	SPONGE:HEAT PIPE:LOWER	U020	63
D1366910	SPONGE:HEAT PIPE:LEFT	U020	64
D1366920	DUCT:DEVELOPMENT:EXHAUST:EXIT:LEFT	U020	65
D1366921	DUCT:DEVELOPMENT:EXHAUST:EXIT:RIGHT	U020	66
D1366922	BRACKET:DUCT:EXHAUST	U020	67
D1366923	SEAL:DEVELOPMENT:EXHAUST:LEFT	U020	68

Number	Part Name	Group	ID
D1366924	SEAL:DEVELOPMENT:EXHAUST:RIGHT	U020	69
D1366927	SEAL:DUCT:AROUND THE PHOTOCONDUCTOR:ENTRANCE	U020	70
D1366928	DUCT:DC FAN MOTOR:OPTICAL WRITING UNIT	U020	71
D1366932	FILTER:PRESSURE ROLLER:VACUUM	U020	72
D1366935	FILTER:DEVELOPMENT:EXHAUST:LARGE	U020	73
D1366939	FILTER:DEVELOPMENT:VACUUM	U008_S001	72
D1366940	HEAT INSULATING PLATE:HEAT PIPE:UPPER	U020	74
D1366941	HEAT INSULATING PLATE:HEAT PIPE:RIGHT	U020	75
D1366943	SEAL:DUCT:EXHAUST:INDUCTION HEATING UNIT	U020	76
D1366946	BRACKET:SETTING LEVER JUMPPER:DC FAN MOTOR:DUPLEX:EXIT	U020	77
D1366947	OZONE FILTER:EXIT	U020	78
D1366948	BRACKET:THERMISTOR	U020	79
D1366957	DC FAN MOTOR:INTERMEDIATE TRANSFER:ASS'Y	U020_S001	80
D1366958	BRACKET:DC FAN MOTOR:INTERMEDIATE TRANSFER	U020_S001	81
D1366959	SEAL:DEVELOPMENT:VACUUM:Y:UPPER	U020	82
D1366960	SEAL:DEVELOPMENT:VACUUM:Y:LOWER	U020	83
D1366961	SEAL:DEVELOPMENT:VACUUM:Y:FRONT	U020	84
D1366963	SEAL:RELAY DUCT:BELT CLEANING	U020	85
D1366966	DUCT:HEAT SINKER:REAR:ASS'Y	U020_S002	86
D1366971	BRACKET:HINGE:DUCT:HEAT PIPE:ROLLER	U020	87
D1366972	DUCT:DENSITY SENSOR:RIGHT	U020	88

Exclusive Parts

Number	Part Name	Group	ID
D1366974	DUCT:DENSITY SENSOR:LEFT	U020	89
D1366979	SEAL:HEAT SINKER:EXIT	U020_S002	90
D1366980	SEAL:INDUCTION HEATING UNIT: VACUUM	U020	91
D1366982	SEAL:HEAT SINKER:LEFT AND RI GHT	U020	92
D1366983	SEAL:HEAT SINKER:FRONT	U020	93
D1366984	SEAL:HEAT SINKER:REAR	U020_S002	94
D1366985	SEAL:DRUM STAY:FRONT:RIGHT	U021_S003	89
D1366990	DUCT:MECHANICAL DRIVE SECTI ON:LEFT UPPER	U020	95
D1366992	RELAY DUCT:BELT CLEANING	U020	96
D1366995	BRACKET:DEVELOPMENT:EXHAU ST	U020	97
D1367081	LINK:GATE PAWL:RETURN	U016_S001	72
D1367115	LINK:ON-OFF:REVERSE EXIT	U016_S001	73
D1367117	LEVER:LINK:ON-OFF:REVERSE EX IT	U016_S001	74
D1367118	LEVER:FIX:GUIDE PLATE:LEFT LO WER	U016_S001	75
D1367119	SHAFT:LEVER:GUIDE PLATE:LEFT LOWER	U016_S001	76
D1367120	BRACKET:LEVER:FIX:GUIDE PLAT E:LEFT LOWER	U016_S001	77
D1367123	HOLDER:PRESSURE:GUIDE PLAT E:EXIT	U016_S001	78
D1367125	COMPRESSION SPRING:PLATE:O N OFF DETECTOR:LEFT LOWER	U016_S001	79
D1367126	BRACKET:PLATE:ON OFF DETECT OR:LEFT LOWER:ASS'Y	U016_S001	80
D1367133	SHAFT:RELEASE:GUIDE PLATE:U PPER	U016_S001	81
D1367135	LINK:GRIP:GUIDE PLATE:UPPER	U016_S001	82
D1367136	GRIP:GUIDE PLATE:EXIT:UPPER:A SS'Y	U016_S001	83
D1367159	CUSHION:STOPPER:GUIDE PLATE :EXIT:UPPER	U016_S001	84
D1367167	ROLLER:DRIVEN:NO.2:SHORT:AS	U017	84

Number	Part Name	Group	ID
	S'Y		
D1367193	HOLDER:PRESSURE:RADIAL BALL BEARING:EXIT	U016_S001 U016_S001_S001	85 85
D1367194	PLAIN SHAFT BEARING:DIA4:EXIT	U016_S001	86
D1367199	SHEET:OPPOSED:REFLECTION P HOTO SENSOR	U016_S001_S001 U016_S001_S001	87 87
D1367446	DECAL:CAUTION:PULL OUT:SLIDE RAIL	ACCESSORIES	18
D1367448	(EU/AA/KOR/TWN/CHN):DECAL:PU LL OUT:SET:CAUTION:MANY LAN GUAGES	ACCESSORIES	19
D1367538	OIL DAMPER:FALL	U007_S013 U007_S015 U007_S017 U007_S019	139 139 139 139
D1367541	DECAL:CAUTION CHART:PAPER S ET DIRECTION	ACCESSORIES	20
D1367546	DECAL:PAPER VOLUME:SIDE FEN CE:LEFT REAR:1	U007_S014_S001 U007_S016_S001 U007_S018_S001 U007_S020_S001	140 140 140 140
D1367547	DECAL:PAPER VOLUME:SIDE FEN CE:LEFT REAR:2	U007_S014_S001 U007_S016_S001 U007_S018_S001 U007_S020_S001	141 141 141 141
D1367565	SHAFT:GRIP:TANDEM TRAY	U007_S014 U007_S016 U007_S018 U007_S020	142 142 142 142
D1367566	STOPPER:TANDEM TRAY	U007_S014 U007_S016 U007_S018 U007_S020	143 143 143 143
D1367567	BRACKET:STOPPER:TANDEM TRA Y:RIGHT:ASS'Y	U007_S014 U007_S016 U007_S018 U007_S020	144 144 144 144

Exclusive Parts

Number	Part Name	Group	ID
D1367570	GRIP:TANDEM TRAY:REAR	U007_S014	145
		U007_S016	145
		U007_S018	145
		U007_S020	145
D1367571	GRIP:PAPER TRAY:TANDEM TRAY	U007_S014	146
		U007_S016	146
		U007_S018	146
		U007_S020	146
D1367575	CAP:LEVER	U007_S014	147
		U007_S016	147
		U007_S018	147
		U007_S020	147
D1367579	SLIDER:BACK FENCE	U007_S014	148
		U007_S016	148
		U007_S018	148
		U007_S020	148
D1367600	DECAL:CAUTION:PULL OUT:PAPE R FEED	ACCESSORIES	21
		U010	83
D1367601	DECAL:CAUTION:PULL OUT:EXIT	ACCESSORIES	22
D1367607	DECAL:POWER SUPPLY CORD:20 0V:MAIN	ACCESSORIES	23
D1367608	DECAL:POWER SUPPLY CORD:20 0V	ACCESSORIES	24
D1367617	DECAL:CAUTION:PULL OUT	U001	47
D1367985	DEVELOPER:EXCHANGEABLE:AS S'Y	ACCESSORIES	25
D1371452	COVER:FRONT LOWER	U001	48
D1371479	BRACKET:HINGE:COVER:FRONT L OWER	U001	49
D1373521	COLLECTION BOTTLE:ASS'Y	U013_S002	33
D1373620	CASE:RELAY DUCT	U013	34
D1373621	VIBRATING PLATE:RELAY DUCT	U013	35
D1373622	SEAL:RELAY DUCT	U013	36
D1373652	PIPE:LOWER:ASS'Y	U013	37
D1374828	BRACKET:DC MOTOR:REVERSE	U017	85
D1374913	GUIDE PLATE:SWIVEL:RECEIVING SUB-UNIT:LOWER:PEEN	U017	86
D1374941	COIL SPRING:GUIDE PLATE:SWIV	U017	87

Number	Part Name	Group	ID
	EL:RECEIVING SUB-UNIT:UPPER		
D1374948	GUIDE PLATE:RECEIVING SUB-UN IT:UPPER:PEEN	U017	88
D1374965	COVER:GUIDE PLATE:SWIVEL:RE CEIVING SUB-UNIT:LOWER	U017	89
D1374966	FEELER:SENSOR:RECEIVING SUB -UNIT	U017	90
D1375905	BRACKET:INDUCTION HEATING U NIT:AC CONTROL BOARD	U019	57
D1375992	BRACKET:INLET:1POINT	U019	58
		U019_S001	58
		U019_S002	58
D1381128	COVER:ENCODER	U018_S005	94
		U018_S006	94
		U018_S007	94
		U018_S008	94
D1381137	FEELER:POSITIONING SENSOR:P HOTOCONDUCTOR	U018	95
D1381308	JOINT:EXIT:DRIVE:0.5	U016_S001	88
D1381456	COVER:TONER SUPPLY SUB-UNIT	U001	50
D1381460	COVER:RIGHT MIDDLE:FRONT	U001	51
D1381461	COVER:UPPER FRONT:ASS'Y	U001_S005	52
D1381468	CAP:LOUVER:OZONE FILTER:LAR GE	U001	53
D1381475	COVER:MAIN SWITCH	U001_S004	54
D1381479	COVER:LEFT MIDDLE:SMALL	U001	55
D1381485	CAP:LOUVER:PREVENTFENCE:OZ ONE FILTER:ASS'Y	U001	56
D1381545	STAY:DRUM STAY:FRONT LEFT	U021	90
D1381561	COMPRESSION SPRING:PULL OU T:LOCK:0.5N	U021	91
D1381562	BRACKET:STOPPER:PULL OUT	U021	92
D1381570	TORSION SPRING:CAP:GRIP:PULL OUT:0.5N	U001	57
D1381571	COMPRESSION SPRING:PULL OU T:GRIP:3N	U001	58
D1381573	BRACKET:GRIP:PULL OUT	U001	59
D1381577	BRACKET:CONTACT POINT:LINK	U001	60

Exclusive Parts

Number	Part Name	Group	ID
D1381578	LINK:GRIP:LENGTHWISE	U001	61
D1381579	LEVER:PULL OUT	U001	62
D1381581	LINK:LEVER:PULL OUT	U001	63
D1381584	CAP:GRIP:PULL OUT	U001	64
D1382786	DECAL:SIDE FENCE:MANUAL FEED:250	U006_S003_S002_S001	92
D1382802	GEAR:LIFT MOTOR:1	U006_S003_S002	93
D1382803	GEAR:LIFT MOTOR:2	U006_S003_S002	94
D1382804	GEAR:LIFT MOTOR:3	U006_S003_S002	95
D1382805	GEAR:LIFT MOTOR:4	U006_S003_S002	96
D1382806	GEAR:LIFT MOTOR:JOINT	U006_S003_S002	97
D1382807	GEAR:TORQUE LIMITER MECHANICAL CLUTCH	U006_S003_S002	98
D1382808	BRACKET:LIFT MOTOR:2	U006_S003_S002	99
D1382809	COIL SPRING:TORQUE LIMITER MECHANICAL CLUTCH	U006_S003_S002	100
D1382822	LENS:LED:AUXILIARY	U006_S003	101
D1382827	TORSION SPRING:COVER:MANUAL FEED:REAR	U006_S003	102
D1382836	DAMPER:MANUAL FEED:OPEN AND CLOSE	U006_S003	103
D1382839	TORSION SPRING:MANUAL FEED:OPEN AND CLOSE	U006_S003	104
D1382842	COVER:SENSOR:SET SENSOR:MANUAL FEED TABLE	U006_S003	105
D1382844	STOPPER:COVER:MANUAL FEED:FRONT	U006_S003_S002	106
D1382845	STOPPER:COVER:MANUAL FEED:REAR	U006_S003_S002	107
D1382846	COMPRESSION SPRING:STOPPER:GUIDE	U006_S003_S002	108
D1382862	TORSION SPRING:COVER:MANUAL FEED:FRONT	U006_S003	109
D1383206	BASE:SHUTTER:OPEN AND CLOSE:ASS'Y	U008_S001_S005	73
		U008_S001_S006	73
		U008_S001_S007	73
		U008_S001_S008	73
D1383228	BRACKET:DRIVE:TONER CARTRIDGE	U008_S001	74

Number	Part Name	Group	ID
	GE:ASS'Y		
D1383269	COVER:UPPER:TONER CARTRIDGE	U008_S001	75
D1383391	DECAL:CAUTION:TONER SUPPLY SUB-UNIT	U008_S001	76
D1384081	SHAFT:WORM GEAR:WEB:SUB-ASS'Y	U015_S004	147
D1384117	DUCT:PRESSURE:EXIT:CONNECTING:A	U015_S002	148
D1384118	DUCT:PRESSURE:EXIT	U015_S002	149
D1384119	SEAL:DUCT:PRESSURE:LOWER:A	U015_S002	150
D1384120	SEAL:DUCT:PRESSURE:ENTRANCE	U015_S002	151
D1384121	FEELER:CAM:PRESSURE:FRONT	U015_S002	152
D1384122	SHUTTER:DUCT:PRESSURE ROLLER:FUSING UNIT	U015_S002	153
D1384123	TORSION SPRING:SHUTTER:DUCT:FUSING UNIT	U015_S002	154
D1384124	CAM:SHUTTER:DUCT:PRESSURE ROLLER:FUSING UNIT	U015_S002	155
D1384130	COVER:GEAR:JOINT	U015	156
D1384131	BRACKET:MOTOR	U015	157
D1384134	HOLDER:DC STEPPER MOTOR	U015	158
D1384136	SHAFT:ON-OFF:WEB	U015	159
D1384138	BRACKET:AUXILIARY:DC STEPPER MOTOR:WEB:ON-OFF	U015	160
D1384139	FEELER:CAM:WEB:ON-OFF	U015	161
D1384141	BRACKET:DC STEPPER MOTOR:WEB:ON-OFF	U015	162
D1384145	SHAFT:ON-OFF:MOTOR:GEAR	U015	163
D1384146	BRACKET:ON-OFF:MOTOR:GEAR	U015	164
D1384150	HOLDER:JOINT:DRIVE:ROLLER	U015	165
D1384161	JOINT:CLEANING:FUSING DRIVE SUB-UNIT	U015	166
D1384401	BRACKET:WEB:FRONT:AUXILIARY	U015_S004	167
D1384402	BRACKET:DRIVE SUB-UNIT:POLISH	U015	168
D1384405	HOLDER:GEAR:ON-OFF	U015_S002	169

Exclusive Parts

Number	Part Name	Group	ID
D1384417	BRACKET:POLISH:MOTOR	U015	170
D1384427	SHAFT:JOINT:DRIVE	U015	171
D1385987	COVER:SAFETY SWITCH:TONER SUPPLY UNIT	U019	59
D1385989	BRACKET:SAFETY SWITCH:TONE R SUPPLY UNIT	U019	60
D1385992	LEVER:SAFETY SWITCH:TONER SUPPLY UNIT	U019	61
D1386052	GUIDE:INTERMEDIATE TRANSFER:RIGHT	U010	84
D1386053	SEAL:GUIDE:INTERMEDIATE TRANSFER:RIGHT	U010	85
D1386665	COVER:LIFT MOTOR	U007	149
D1386669	COVER:SIDE PLATE:REAR:TANDEM LCT	U007	150
D1386683	HEAT SINK:HEATER:UPPER:ASS'Y	U007_S005	151
D1386685	HEAT SINK:HEATER:LOWER:ASS'Y	U007_S006	152
D1386714	GROUND PLATE:GUIDE PLATE:VERTICAL TRANSPORT:CONNECTING	U007	153
D1386863	DUCT:PRESSURE ROLLER:VACUUM:UPPER	U020	98
D1386923	DUCT:PRESSURE ROLLER:EXHAUST:LOWER	U020	99
D1386924	DUCT:PRESSURE ROLLER:EXHAUST:UPPER	U020	100
D1386946	SEAL:DUCT:PRESSURE ROLLER:EXHAUST	U020	101
D1386972	SEAL:DUCT:PRESSURE ROLLER:VACUUM:LOWER	U020	102
D1387055	HOLDER:DRIVEN ROLLER:REVERSE EXIT	U016_S001	89
D1387251	HINGE:OPERATION PANEL:ASS'Y	U002_S001_S001	10
D1387252	POST:ARM:OPERATION SUB-UNIT:RIGHT	U002_S001	11
D1387260	SUPPORTING PLATE:ARM:OPERATION SUB-UNIT	U002_S001	12

Number	Part Name	Group	ID
D1387265	GUARD:HARNESS:ARM	U002_S001	13
D1387270	COVER:POST:OPERATION SUB-UNIT:LOWER	ACCESSORIES	26
D1387275	COVER:OPERATION PANEL:REAR UPPER	ACCESSORIES	27
D1387276	COVER:OPERATION PANEL:REAR LOWER	U002_S001	14
D1387277	CAP:COVER:POST:OPERATION SUB-UNIT	ACCESSORIES	28
D1387281	BRACKET:PILOT LAMP	U002	15
D1387301	(NA/AA/KOR/TWN):COVER:FRONT	U002_S002	16
		U002_S003	16
D1387305	COVER:REAR	U002_S002	17
		U002_S003	17
		U002_S004	17
		U002_S005	17
D1387308	(NA/AA/KOR/TWN)FKEYTOP:10KEY	U002_S002	18
		U002_S003	18
D1387310	KEYTOP:START	U002_S002	19
		U002_S003	19
		U002_S004	19
		U002_S005	19
D1387311	KEYTOP:STOP	U002_S002	20
		U002_S003	20
		U002_S004	20
		U002_S005	20
D1387312	KEYTOP:RESET SWITCH	U002_S002	21
		U002_S003	21
		U002_S004	21
		U002_S005	21
D1387314	KEYTOP:LOWER	U002_S002	22
		U002_S003	22
		U002_S004	22
		U002_S005	22
D1387315	KEYTOP:HOME	U002_S002	23
		U002_S003	23
		U002_S004	23
		U002_S005	23

Exclusive Parts

Number	Part Name	Group	ID
D1387316	LENS:LED:LOWER	U002_S002	24
		U002_S003	24
		U002_S004	24
		U002_S005	24
D1387331	(EU/CHN)FKEYTOP:10KEY	U002_S004	25
		U002_S005	25
D1387333	(NA/AA/KOR/TWN):DECAL:APPLICATION:MULTI-LANGUAGE	ACCESSORIES	29
D1387353	DECAL:FUNCTION:BLANK:MULTI-LANGUAGE	ACCESSORIES	30
D1387362	KEYTOP:RIGHT:BA	U002_S002	26
		U002_S003	26
		U002_S004	26
		U002_S005	26
D1387363	(EU):COVER:FRONT	U002_S004	27
D1441085	STEPPED SCREW:M3	U001	65
		U015_S001	172
		U015_S002	172
		U015_S002_S003	172
		U015_S004	172
D1444484	SHOULDER SCREW - M3	U016_S001	90
		U016_S001_S001	90
D1444489	STOPPER:DRIVEN ROLLER	U007_S007	154
D1471805	EXPOSURE GLASS:DOCUMENT FEEDER:APPLY	U004	41
D1482702	SPACER:TRANSPORT ROLLER	U007	155
		U007_S008	155
		U007_S009	155
		U007_S010	155
D1482942	TENSION SPRING:LEVER	U007_S003	156
		U007_S004	156
D1482943	TENSION SPRING:LEVER:AUXILIARY	U007_S003	157
		U007_S004	157
D1491291	CAP:HARNESS	U001	66
		U001_S001	66
D1491305	CAP:TOTAL COUNTER	U001	67
D1491306	MAGNET CATCH:COVER:FRONT	U001	68
D1491424	LCD:TFT:WVGA-9:LED:SH	U002_S002	28

Number	Part Name	Group	ID
		U002_S003	28
		U002_S004	28
		U002_S005	28
D1491427	TOUCH PANEL:WVGA-9:MV	U002_S002	29
		U002_S003	29
		U002_S004	29
		U002_S005	29
D1491530	SPACER:LCD:A	U002_S002	30
		U002_S003	30
		U002_S004	30
		U002_S005	30
D1491531	SPACER:LCD:B	U002_S002	31
		U002_S003	31
		U002_S004	31
		U002_S005	31
D1491553	(NA/CHN):SHEET:LOGO	ACCESSORIES	31
D1491715	PULLEY:DRIVE WERE:FRONT	U004	42
D1491717	PULLEY:DRIVE WERE:REAR	U004	43
D1491804	HOLDER:EXPOSURE GLASS:SCANNER	U004	44
D1492676	COMPRESSION SPRING:FLAT CONVEYER BELT:DRIVEN	U007_S007	158
D1492739	LEVER:PRESSURE RELEASE	U007_S008	159
		U007_S009	159
		U007_S010	159
D1492767	LEVER:PRESSURE:PICKUP	U007_S009	160
		U007_S010	160
D1492773	PULLEY:PICKUP:MECHANICAL ROLLER CLUTCH	U007_S008	161
		U007_S009	161
		U007_S010	161
D1492774	PULLEY:IDLER:PICKUP	U007_S008	162
		U007_S009	162
		U007_S010	162
D1492781	GROUND PLATE:PAPER FEED UNIT	U007_S008	163
		U007_S009	163
		U007_S010	163
D1492812	ROLLER:PAPER TRAY:DIA19	U007_S011	164
		U007_S012	164

Exclusive Parts

Number	Part Name	Group	ID
D1492813	PIN:STRETCH:TRAY	U007_S011	165
		U007_S012	165
D1492814	COIL SPRING:EARTH	U007_S011	166
		U007_S012	166
D1492816	SHAFT:RISE:ASS'Y	U007_S011	167
		U007_S012	167
D1492818	LEVER:RISE	U007_S011	168
		U007_S012	168
D1492826	COMPRESSION SPRING:SIDE FENCE:PLATE:FRONT	U007_S011_S003	169
		U007_S012_S002	169
D1492835	RACK:SIDE FENCE	U007_S011	170
		U007_S012	170
D1492836	GEAR:Z20	U007_S011	171
		U007_S012	171
D1492840	END FENCE:PAPER TRAY:ASS'Y	U007_S011_S001	172
		U007_S012_S001	172
D1492842	LEVER:END FENCE	U007_S011_S001	173
		U007_S012_S001	173
D1492843	CLICK:END FENCE	U007_S011_S001	174
		U007_S012_S001	174
D1492845	COMPRESSION SPRING:END FENCE:LEVER:5N	U007_S011_S001	175
		U007_S012_S001	175
D1492923	ROLLER:SUPPORTER:PAPER TRAY	U021	93
D1492924	STOPPER:PAPER TRAY	U021	94
D1492928	ROLLER:SUPPORTER:PAPER TRAY:LEFT	U021	95
D1492952	DECAL:SIDE FENCE:PAPER VOLUME	U007_S011_S003	176
		U007_S012_S002	176
D1492954	DECAL:SIDE FENCE:PAPER VOLUME:ENVELOPE	U007_S011_S003	177
		U007_S012_S002	177
D1492961	LEVER:STRETCH:PEEN	U007_S003	178
		U007_S004	178
D1492964	LEVER:LOCK:PAWL	U007_S003	179
		U007_S004	179
D1492965	LEVER:STRETCH:COIL SPRING	U007_S003	180
		U007_S004	180
D1494390	(NA/AA/KOR/TWN):DECAL:CAUTION:ORIGINAL:ENGLISH	ACCESSORIES	32

Number	Part Name	Group	ID
	N:INKJET		
D1495776	COVER:USB:SMALL	U019	62
D1495883	KEYTOP:MAIN SWITCH	U001_S004	69
D1495884	COMPRESSION SPRING:KEYTOP	U001_S004	70
D1496667	(CHN):DECAL:CAUTION:INKJET	ACCESSORIES	33
D1496766	(NA/EU/AA/KOR/TWN):DECAL:CAUTION:ORIGINAL:ENGLISH	ACCESSORIES	34
D1496767	(CHN):DECAL:CAUTION:ORIGINAL:CHINESE	ACCESSORIES	35
D1496851	(NA/AA/KOR/TWN):DECAL:MAIN SWITCH:ON-STANDBY:ENGLISH	ACCESSORIES	36
D1496852	(EU/CHN):DECAL:MAIN SWITCH:ON-STANDBY	ACCESSORIES	37
D1775686	PCB:DCSW	U019	63
D1942279	PCB:ELECTRIC POTENTIAL SENSOR	U019	64
D1944242	CAM:ON-OFF	U015_S002	173
D2051082	HEXAGON HEAD SCREW:ROUND POINT:M3X6:BK	U012	26
D2231381	DECAL:EXPOSURE GLASS:CLEANING	ACCESSORIES	38
D2231762	INSULATING SHEET:LED	U004	45
D2231763	INSULATING SHEET:LED:CONNECTOR	U004	46
D2231805	HOLDER:EXPOSURE GLASS	U004	47
D2235308	HDD:320GB:MN500S-2:WD3200LUCT	U019	65
D2236747	DC MOTOR:TANDEM LCT:19.2W:BRUSH	U007	181
D2395629	PCB:DDR3-DIMM:RC-A:4GB:ASS'Y	U019	66
D2411738	(EU/AA/KOR/TWN/CHN):SCALE:REAR:PRINTING:MM	U004	48
D2411739	(NA):SCALE:REAR:PRINTING:INCH	U004	49
D2412676	HOLDER:DRIVEN:BELT	U007_S007	182
D2412678	SHAFT:FLAT CONVEYER BELT:DRIVEN	U007_S007	183
D2412719	GROUND PLATE:SENSOR:TRANSPORT	U007	184
		U007_S009	184

Exclusive Parts

Number	Part Name	Group	ID
		U007_S010	184
		U016_S001	91
D2412759	TRANSPORT ROLLER:VERTICAL TRANSPORT:ASS'Y	U007	185
		U007_S008	185
		U007_S009	185
		U007_S010	185
D2412782	PLATE:HARNESS:PAPER FEED UNIT	U007_S008	186
		U007_S009	186
		U007_S010	186
D2416290	LED:RED	U001	71
		U001_S002	71
		U001_S003	71
		U001_S006	71
		U006	110
		U007	187
		U017	91
D2571450	FIX STAND:HANDLE:DRUM STAY	U021	96
D2571451	BRACKET:COVER:RIGHT MIDDLE:PROTECT:PEEN	U001	72
D2571452	BRACKET:COVER:LEFT MIDDLE:PROTECT	U001	73
D2571453	PLATE:FRONT:CASE:2	U001	74
D2571455	SEAL:FRONT MIDDLE:UPPER LEFT:UPPER	U001	75
D2571456	SEAL:FRONT MIDDLE:LEFT UPPER:LOWER	U001	76
D2571457	SEAL:INNER COVER:FRONT MIDDLE:UPPER LEFT:MIDDLE	U001	77
D2571458	SEAL:INNER COVER:FRONT MIDDLE	U001_S006	78
D2571459	SEAL:INNER COVER:FRONT MIDDLE:2	U001_S006	79
D2571460	SEAL:INNER COVER:FRONT MIDDLE:3	U001_S006	80
D2571461	SEAL:INNER COVER:FRONT MIDDLE:4	U001_S006	81
D2571462	SEAL:INNER COVER:FRONT MIDDLE:5	U001_S006	82

Number	Part Name	Group	ID
D2571463	COVER:UPPER RIGHT	U001	83
D2571464	INNER COVER:FRONT MIDDLE:LEFT	U001	84
D2571466	SEAL:INNER COVER:LEFT LOWER	U001_S002	85
D2571467	SEAL:INNER COVER:LEFT	U001_S002	86
D2571468	SEAL:INNER COVER:RIGHT	U001_S002	87
D2571476	COVER:UPPER LEFT	U001	88
D2576852	SEAL:DUCT:VACUUM	U020	103
D2576862	SEAL:DUCT:ENTRANCE:LARGE	U020	104
D2576863	SEAL:DUCT:HEAT PIPE:ROLLER	U020	105
D2576864	SEAL:DUCT:ENTRANCE:RIGHT	U020	106
D2576865	SEAL:INDUCTION HEATING UNIT:VACUUM:LEFT	U020	107
D2576866	SEAL:DUCT:VACUUM:FRONT LEFT	U020	108
D2576870	SEAL:DUCT:BELT CLEANING:REAR:RIGHT	U020	109
D2576871	SEAL:DUCT:BELT CLEANING:REAR:LEFT	U020	110
D2576872	SEAL:DUCT:BELT CLEANING:LEFT	U020	111
D2576873	SEAL:DUCT:BELT CLEANING:UPPER	U008_S001	77
D2576887	SEAL:DUCT:HEAT SINKER:EXHAUST:FRONT UPPER	U020	112
D2576888	SEAL:DUCT:HEAT SINKER:EXHAUST:FRONT LOWER	U020	113
D2576889	SEAL:DUCT:HEAT SINKER:EXHAUST:MIDDLE UPPER	U020	114
D2576890	SEAL:DUCT:HEAT SINKER:EXHAUST:MIDDLE LOWER	U020	115
D2576921	SEAL:DUCT:TRANSFER:FUSING:EXIT	U020	116
D2576951	SEAL:DRUM STAY:Y	U021_S003	97
D2576952	SEAL:DRUM STAY:DUCT:FRONT	U021_S003	98
D2576953	SEAL:DRUM STAY:FRONT	U021_S003	99
D2576954	SEAL:DUCT:DRUM STAY:DEVELOPMENT	U021_S003	100
D2576955	SEAL:DRUM STAY:REAR	U021_S003	101

Exclusive Parts

Number	Part Name	Group	ID
D2576956	SEAL:DRUM STAY:DUCT:REAR	U021_S003	102
D2576957	SEAL:DRUM STAY:K	U021_S003	103
D2576958	SEAL:DRUM STAY:C	U021_S003	104
D2576959	SEAL:DRUM STAY:REAR LOWER: M	U021_S003	105
D2576960	SEAL:DRUM STAY:M	U021_S003	106
D2576961	SEAL:DRUM STAY:Y	U021_S003	107
D2576962	SEAL:DRUM STAY:LEFT:Y	U021_S003	108
D2576963	SEAL:BASE:TONER SUPPLY:LOW ER	U008_S001	78
D2576965	SEAL:SIDE PLATE:TONER SUPPL Y:REAR	U008_S001	79
D2576966	SEAL:HEAT PIPE:PANEL:UPPER	U020	117
D2576967	SEAL:HEAT PIPE:PANEL:LOWER	U020	118
D2576968	SEAL:DUCT:BELT CLEANING:MID DLE LOWER	U020	119
D2576969	SEAL:DUCT:BELT CLEANING:VAC UUM	U020	120
D2576970	SEAL:CAP:REGISTRATION:RIGHT	U001	89
D2576971	SEAL:CAP:REGISTRATION:LOWE R	U001	90
D2576973	SEAL:HEAT PIPE:GUIDE:LEFT	U020	121
D2576997	SEAL:DUCT:FUSING:EXIT:LARGE	U020	122
D2576998	SEAL:DUCT:FUSING:EXIT:SMALL	U020	123
D2581019	DRIVE UNIT:IMAGING:K	U018_S016	96
D2581020	DRIVE UNIT:IMAGING:CMY	U018_S013	97
		U018_S014	97
		U018_S015	97
D2581028	FUSING DRIVE UNIT:GEAR:SLOW DOWN:ASS'Y	U018_S009	98
D2581062	DRIVE UNIT:TRANSPORT UNIT:CO NNECTING:ASS'Y	U018_S003	99
D2581091	SHEET:GUIDE:HARNESS	U021	109
D2581100	DRUM:GEAR:SLOW DOWN:ASS'Y	U018_S005_S001	100
		U018_S006_S001	100
		U018_S007_S001	100
		U018_S008_S001	100
D2581132	DRUM SHAFT:GEAR:ASS'Y	U018	101

Number	Part Name	Group	ID
D2581147	RIVET:GRIP:DIA2.0	U010	86
		U018_S001	102
		U018_S005	102
		U018_S006	102
		U018_S007	102
		U018_S008	102
D2581201	DRUM STAY:DRIVE:INT TRANSFE R:ASS'Y	U010	87
D2581204	GEAR:INTERMEDIATE TRANSFER: ASS'Y	U010	88
D2581206	HOUSING:DRIVE:INT TRANSFER	U010	89
D2581207	SHEET:DRIVE:INTERMEDIATE TR ANSFER	U010	90
D2581210	DRIVE UNIT:TRANSFER:SECOND: ASS'Y	U018_S001	103
D2581217	JOINT:ON-OFF:INTERMEDIATE TR ANSFER	U018	104
D2581219	SHAFT:ON-OFF:TRANSFER:ASS'Y	U018	105
D2581228	DRUM STAY:TRANSFER:SECOND	U018_S001	106
D2581230	SHAFT:DRIVE:TRANSFER:SECON D:ASS'Y	U018_S001	107
D2581235	SHAFT:DRIVE:BELT CLEANING:AS S'Y	U018_S001	108
D2581241	RUBBER BUSHING:ENCODER	U018_S001	109
D2581242	GUIDE PLATE:ENCODER:LOCK	U018_S001	110
D2581243	PLAIN SHAFT BEARING:POM	U018_S001	111
D2581244	COVER:ENCODER	U018_S001	112
D2581245	SPACER:REAR:INT TRANSFER	U010	91
D2581246	COMPRESSION SPRING:DRIVE:O N-OFF:TRANSFER	U018	113
D2581248	ENCODER:ASS'Y	U018_S001	114
D2581286	BRACKET:TENSIONER:USED TON ER	U018_S002	115
D2581288	TENSION SPRING:USED TONER	U018	116
D2581295	SHAFT:DRIVE:USED TONER	U018	117
D2581310	DC MOTOR:10W:BRUSHLESS	U018	118
		U018_S004	118
D2581317	HOLDER:GLASS:CLEANER:ASS'Y	ACCESSORIES	39

Exclusive Parts

Number	Part Name	Group	ID
D2581320	DC MOTOR:20W:BRUSHLESS	U017	92
		U018	119
		U018_S003	119
		U018_S004	119
		U018_S010	119
		U018_S011	119
		U018_S012	119
D2581349	BRACKET:MOTOR:REGISTRATION	U018	120
D2581351	DRIVE UNIT:PAPER FEED UNIT:NO.1:ASS'Y	U018_S010	121
D2581354	DRIVE UNIT:PAPER EXIT UNIT:ASS'Y	U018_S004	122
D2581366	TENSION SPRING:TIGHTENER:TRANSPORT	U018_S003	123
D2581384	SYNCHRONOUS BELT:B60S2M182	U018_S004	124
D2581386	PAPER EXIT UNIT:TIGHTENER:ASS'Y	U018_S004	125
D2581388	DRUM STAY:DRIVE:EXIT	U018_S004	126
D2581389	TENSION SPRING:PAPER EXIT:TIGHTENER	U018_S004	127
D2581391	BRACKET:PAPER EXIT UNIT:REVERSE:NO.2	U018	128
D2581398	BRACKET:MOTOR:DUPLEX UNIT	U018	129
D2581438	COVER:RIGHT LOWER	U001	91
D2581453	GUARD:HARNES:EXIT	U021	110
D2581454	INNER COVER:FRONT MIDDLE:UPPER LEFT	U001	92
D2581455	COVER:FRONT MIDDLE	U001	93
D2581458	CAP:REGISTRATION:ADJUSTING PIN	U001	94
D2581460	COVER:LEFT MIDDLE:ASS'Y	U001_S004	95
D2581462	CAP:LOUVER:DEODORIZE FILTER:LARGE	U001	96
D2581464	INNER COVER:TH:TRANSPORT:ASS'Y	U001_S002	97
D2581466	COVER:LEFT LOWER	U001	98
D2581468	COVER:REAR MIDDLE:ASS'Y	U001_S001	99
D2581469	CAP:LOUVER:DEODORIZE FILTER	U001	100

Number	Part Name	Group	ID
	:SMALL		
D2581470	PLATE:FAN:GUARD:REAR MIDDLE:UPPER	U001_S001	101
D2581471	INNER COVER:FRONT LOWER	U001	102
D2581472	PLATE:FAN:GUARD:REAR MIDDLE:LOWER	U001_S001	103
D2581474	COVER:LED:HORIZONTAL:TRANSPORT	U001_S006	104
D2581480	INNER COVER:EXIT:UPPER:ASS'Y	U001_S003	105
D2581482	INNER COVER:MANUAL FEED:LOWER	U001	106
D2581485	INNER COVER:MANUAL FEED:LOWER:SMALL	U001	107
D2581486	COVER:LCT	U001	108
D2581487	PLATE:FRONT:CASE:1	U001	109
D2581489	PLATE:FRONT:CASE:3	U001	110
D2581490	PLATE:FRONT:CASE:4	U001	111
D2581492	INNER COVER:FRONT MIDDLE:UPPER	U001_S006	112
D2581498	FIX STAND:CLEANER:SHIELD GLASS:1	U021	111
D2581499	FIX STAND:CLEANER:SHIELD GLASS:2	U021	112
D2581536	BRACKET:DRAWER:LED:1	U021	113
D2581538	BRACKET:DRAWER:LED:2	U001	113
D2581553	STOPPER:PULL OUT	U021	114
D2581569	JIG:TRANSFER	ACCESSORIES	40
D2581581	INNER COVER:PULL OUT:LOCK:DRIVE	U021	115
D2581586	SHAFT:LOCK:PULL OUT	U021	116
D2581594	FEELER:PULL OUT:SET:SENSOR	U021	117
D2581595	BRACKET:DRAWER:PULL OUT	U021	118
D2581599	COVER:DUB	U021	119
D2581715	GUIDE:FFC:BASE	U004	50
D2581717	COVER:SHAFT:SCANNER	U004	51
D2581718	SHEET:FFC:BASE	U004	52
D2581719	COVER:PULLEY	U004	53
D2581727	INNER COVER:SCANNER	U004	54

Exclusive Parts

Number	Part Name	Group	ID
D2581739	LENSBLOCK SMD:ASS'Y	U004_S001	55
D2581751	CARRIAGE:NO.1:ASS'Y	U004_S002	56
D2581759	GUIDE:FFC:CARRIAGE:NO.1:FRO NT	U004	57
D2581760	GUIDE:FFC:CARRIAGE:NO.1:MIDD LE	U004	58
D2581761	GUIDE:FFC:CARRIAGE:NO.1:REAR	U004	59
D2581769	ILLUMINATION UNIT:LED-B:ASS'Y	U004_S003	60
		U004_S004	60
D2581776	CARRIAGE:NO.2:ASS'Y	U004_S005	61
D2581784	MIRROR:NO.2:CONCAVE:ASS'Y	U004_S005	62
D2581785	MIRROR:NO.3:CONVEX:ASS'Y	U004_S005	63
D2581786	GUIDE:FFC:CARRIAGE:NO.2	U004	64
D2581787	SIDE PLATE:GUIDE:FFC:CARRIAG E:NO.2	U004	65
D2581822	(EU/AA/KOR/TWN/CHN):SCALE:LE FT:ASS'Y	U004	66
D2581828	(NA):SCALE:LEFT:ASS'Y	U004	67
D2581940	OPTICAL WRITING UNIT:SERVICE PARTS	U005	1
D2582252	SUPPORTER:PCU:RIGHT	U009	63
D2582256	SUPPORTER:PCU	U009	64
D2582257	SHEET:SUPPORTER:PCU	U009	65
D2582317	HOLDER:LOCK:CLEANING UNIT:R EAR	U009	66
D2582402	OIL SUPPLY ROLLER:ASS'Y	U009_S001	67
		U009_S004	67
		U009_S007	67
		U009_S011	67
D2582407	COVER:BEARING:OIL SUPPLY RO LLER:REAR:0.2POM	U009_S001	68
		U009_S004	68
		U009_S007	68
		U009_S011	68
D2582411	COATING BAR:ASS'Y	U009_S001	69
		U009_S004	69
		U009_S007	69
		U009_S011	69
D2582431	VOLUME SENSOR:COATING BAR:	U009_S001	70

Number	Part Name	Group	ID
	APPLY:ASS'Y	U009_S004	70
		U009_S007	70
		U009_S011	70
D2582447	SEAL:BLADE:APPLY:REAR	U009_S001	71
		U009_S004	71
		U009_S007	71
		U009_S011	71
D2582459	JOINT:CLEANING UNIT	U009_S001	72
		U009_S004	72
		U009_S007	72
		U009_S011	72
D2582463	GEAR:IDLER:31Z:LEFT	U009_S001	73
		U009_S004	73
		U009_S007	73
		U009_S011	73
D2582492	HOLDER:PCU	ACCESSORIES	41
D2582537	GUIDE PLATE:REGISTRATION:UP PER:ASS'Y	U006	111
D2582541	GUIDE PLATE:REGISTRATION:LO WER:ASS'Y	U006	112
D2582544	SHAFT:LEVER:OPEN AND CLOSE	U006	113
D2582579	LEVER:LOCK:INNER BACK	U006	114
D2582583	SEAL:REMOVE PAPER DUST	U006	115
D2582586	STEPPED SCREW:M3X3	U006	116
D2582597	LEVER:LOCK:FRONT:OPERATION UNIT	U006	117
D2582598	LEVER:LOCK:FRONT:PAWL	U006	118
D2582605	PLAIN SHAFT BEARING:REGIST:F RONT	U006	119
D2582607	PLAIN SHAFT BEARING:REGIST:IN NER BACK	U006	120
D2582608	REGISTRATION ROLLER:DRIVEN	U006	121
D2582611	COLLAR:REGISTRATION:DRIVEN	U006	122
D2582616	HINGE:GUIDE PLATE:FRONT	U006	123
D2582618	HINGE:GUIDE PLATE:INNER BACK	U006	124
D2582622	BRACKET:REMOVE PAPER DUST: ASS'Y	U006	125
D2582626	SEAL:REMOVE PAPER DUST:STE	U006	126

Exclusive Parts

Number	Part Name	Group	ID
	PPED SCREW		
D2582630	BRACKET:STUD:REGIST:INNER B ACK:ASS'Y	U006	127
D2582647	BRACKET:MIDDLE:REGISTRATION	U006	128
D2582648	ADJUSTING PIN:REGISTRATION:A SS'Y	U006	129
D2582652	GUIDE PLATE:REGISTRATION:AS S'Y	U006_S001	130
D2582656	TRANSPORT ROLLER:CONNECTI NG:MANUAL FEED:DRIVE	U006	131
D2582657	JOINT:CONNECTING:DRIVE	U006	132
D2582672	SHAFT:DRIVEN ROLLER	U006	133
D2582702	GUIDE PLATE:CONNECTING:FRO NT RIGHT	U021	120
D2582708	GUIDE PLATE:DRIVEN:CONNECTI NG	U006	134
D2582729	TRANSPORT ROLLER:CONNECTI NG:DRIVE	U006	135
D2582778	COVER:MANUAL FEED UNIT	U006_S003	136
D2582816	BRACKET:HINGE:MANUAL FEED:L OWER:ASS'Y	U006	137
D2582829	GROUND PLATE:MANUAL FEED:C OVER:REAR	U006_S003	138
D2582848	GUIDE:POSITIONING:FRONT:MAN UAL FEED UNIT	U006	139
D2582854	GROUND PLATE:MANUAL FEED:R EAR	U006_S003	140
D2582890	COVER:COVER:MANUAL FEED UN IT	U006_S003	141
D2582953	TAPE:GUIDE	U006_S003	142
D2583231	GEAR:IDLER:DC MOTOR	U008_S001	80
D2583232	GEAR:IDLER:CONNECTING	U008_S001	81
D2583233	GEAR:DRIVE:TRANSPORT SCRE W:TONER	U008_S001	82
D2583234	GEAR:IDLER:TONER CARTRIDGE: NO.1	U008_S001	83
D2583235	GEAR:IDLER:TONER CARTRIDGE: NO.2	U008_S001	84

Number	Part Name	Group	ID
D2583236	GEAR:DRIVE:AGITATOR	U008_S001	85
D2583237	JOINT:DRIVE:AGITATOR	U008_S001	86
D2583238	TORSION SPRING:DRIVE:AGITAT OR	U008_S001	87
D2583239	SEAL:GUIDE PLATE:TONER SUPP LY	U008_S001	88
D2583245	SLIDE RAIL:TONER SUPPLY:RIGH T:ASS'Y	U008	89
D2583247	SLIDE RAIL:TONER SUPPLY:LEFT: ASS'Y	U008	90
D2583249	COVER:SLIDE RAIL:TONER SUPPL Y:RIGHT	U008	91
D2583250	COVER:SLIDE RAIL:TONER SUPPL Y:LEFT	U008	92
D2583252	SHEET:AIR CURRENT SECTION	U008_S001	93
D2583253	GUIDE:SEAL:FAN:DEVELOPMENT: ASS'Y	U008_S001	94
D2583256	SEAL:DUCT:FAN:DEVELOPMENT: FRONT	U008_S001	95
D2583257	SEAL:LEFT LOWER:TONER SUPPL Y:LARGE	U008_S001	96
D2583258	SEAL:LEFT LOWER:TONER SUPPL Y:SMALL	U008_S001	97
D2583259	SEAL:LEFT LOWER:FRAME:TONE R SUPPLY	U008_S001	98
D2583291	INNER COVER:TONER SUPPLY U NIT:FRONT:ASS'Y	U008_S001_S009	99
D2583298	SEAL:DUCT:INNER COVER:TONE R SUPPLY	U008_S001	100
D2583485	JIG:DEVELOPMENT UNIT	ACCESSORIES	42
D2583490	RECEPTACLE:DEVELOPMENT VIA S:ASS'Y	U009	74
D2583575	PIPE:LENGTHWISE:ASS'Y	U013	38
D2583587	PIPE:MIDDLE:ASS'Y	U013_S001	39
D2583781	BRACKET:SOLENOID:ON-OFF:CH ARGE	U009	75
D2583784	DC SOLENOID:ON-OFF:ASS'Y	U009	76
D2583850	TRANSPORT BELT UNIT:ASS'Y	U014_S001	13

Exclusive Parts

Number	Part Name	Group	ID
D2583851	TRANSPORT ROLLER:DRIVE	U014_S001	14
D2583853	GROUND PLATE:VACUUM:SHAFT:ON-OFF	U014_S001	15
D2583863	SUPPORTING PLATE:VACUUM	U014_S001	16
D2583868	DC STEPPER MOTOR:MM42:1.0A:3.60V	U010	92
D2583869	GUIDE:TRANSPORT:INT TRANSFER:ASS'Y	U010	93
D2583872	PULLEY:SHAFT:DRIVE:VACUUM	U014_S001	17
D2583886	SHAFT:DRIVEN ROLLER	U014_S001	18
D2583887	GROUND PLATE:DRIVEN ROLLER:VACUUM	U014_S001	19
D2583888	FLAT CONVEYER BELT	U014_S001	20
D2583889	COIL SPRING:VACUUM:EARTH	U014	21
D2583891	GROUND PLATE:VACUUM:BEHIND:FRONT	U014_S001	22
D2583892	GROUND PLATE:VACUUM:BEHIND:REAR	U014_S001	23
D2583894	CAM:ON-OFF:TRANSPORT BELT UNIT:FRONT	U014_S001	24
D2583895	CAM:ON-OFF:TRANSPORT BELT UNIT:REAR	U014_S001	25
D2583896	LEVER:ON-OFF:TRANSPORT BELT UNIT	U014_S001	26
D2583897	SHAFT:LEVER:VACUUM	U014_S001	27
D2583900	GUIDE:TRANSPORT BELT UNIT	U014_S001	28
D2583905	GROUND PLATE:SENSOR:VACUUM	U014_S001	29
D2583910	FAN:MM60X15	U014_S001	30
D2584080	STOPPER:STRIPPER PLATE:FRONT	U015_S002	174
D2584081	STOPPER:STRIPPER PLATE:REAR	U015_S002	175
D2584112	LEVER:PRESSURE:FRONT:INNER	U015_S002	176
D2584114	LEVER:PRESSURE:FRONT:OUTER	U015_S002	177
D2584115	LEVER:PRESSURE:REAR:INNER	U015_S002	178
D2584117	LEVER:PRESSURE:REAR:OUTER	U015_S002	179
D2584118	SUPPORTING PLATE:PRESSURE:FRONT	U015_S002	180

Number	Part Name	Group	ID
D2584119	SUPPORTING PLATE:PRESSURE:REAR	U015_S002	181
D2584128	FUSING ENTRANCE GUIDE PLATE:LOWER	U015_S002	182
D2584131	CAM:PRESSURE	U015_S002	183
D2584135	BRACKET:CONNECTOR:THERMOSTAT	U015_S002	184
D2584136	COVER:HARNESS:CAM	U015_S002	185
D2584147	HOLDER:HEATER:PRESSURE:REAR	U015_S002	186
D2584161	LEVER:CONTROL PLATE:PRESSURE	U015_S002	187
D2584162	STEPPED SCREW:M5	U015_S002	188
D2584163	BOLT:M5:ROUND POINT:BLACK	U015_S002	189
D2584175	FIX STAND:TERMINAL:HEATER	U015_S002	190
D2584178	ELECTRODE PLATE:HEATER:FRONT	U015_S002	191
D2584203	COVER:DUCT:FUSING UNIT:REAR:ASS'Y	U015_S002	192
D2584204	COVER:FUSING UNIT:FRONT:ASS'Y	U015_S002_S007	193
D2584225	GUIDE PLATE:FUSING EXIT:LOWER	U015_S002	194
D2584226	GUIDE:FUSING EXIT:PFA	U015_S002	195
D2584228	STRIPPER PLATE:PRESSURE ROLLER:ASS'Y	U015_S002_S006	196
D2584289	COIL:IH:200V:ASS'Y	U015_S001	197
D2584294	STOPPER PIN:SEPARATION UNIT:OPEN/CLOSE	U015_S002	198
D2584302	STEPPED SCREW:LEVER:HEAT ROLLER	U015_S002	199
D2584317	LEVER:TENSION:HEAT ROLLER:REAR	U015_S002	200
D2584321	BRACKET:SHAFT:TURN:FEELER	U015_S002	201
D2584322	FEELER:HEAT ROLLER:TURN	U015_S002	202
D2584326	SUPPORTING PLATE:SIDE PLATE:HOT ROLLER:FRONT	U015_S002	203
D2584336	STEPPED SCREW:DIA3:M3	U015_S002	204

Exclusive Parts

Number	Part Name	Group	ID
D2584338	BRACKET:STRIPPER PLATE:FRONT	U015_S002	205
D2584341	BRACKET:STRIPPER PLATE:REAR	U015_S002	206
D2584355	COVER:FUSING EXIT:UPPER	U015_S002	207
D2584356	COVER:SEPARATION:OPEN/CLOSE:ASS'Y	U015_S002_S002	208
D2584358	BRACKET:PAPER EXIT UNIT	U015_S002	209
D2584359	GRIP:SEPARATION:OPEN AND CLOSE	U015_S002	210
D2584360	LEVER:SEPARATION:OPEN/CLOSE:FRONT	U015_S002	211
D2584364	LEVER:SEPARATION:OPEN/CLOSE:REAR	U015_S002	212
D2584383	SHAFT:SEPARATION UNIT	U015_S002	213
D2584397	SHAFT:LEVER:PAPER EXIT UNIT:OPEN/CLOSE	U015_S002	214
D2584460	HEAT ROLLER:ASS'Y	U015_S002_S004	215
D2584464	FLANGE:HEAT ROLLER:ASS'Y	U015_S002_S004	216
D2584465	FLANGE:HEAT ROLLER:EARTH:ASS'Y	U015_S002_S004	217
D2584467	BUSHING:HEAT ROLLER:SHAFT	U015_S002	218
D2584468	CORE:HEAT ROLLER:ASS'Y	U015_S002_S004_S001	219
D2584523	GUIDE PLATE:DUPLEX:UPPER:ADHESION	U017	93
D2584550	GUIDE PLATE:DUPLEX:LOWER:ASS'Y	U017_S002	94
D2584563	GUIDE PLATE:DUPLEX:EXIT:ASS'Y	U017	95
D2584621	SHAFT:LINK:SHIFT	U017	96
D2584638	GEAR:PULLEY:ROLLER:SHIFT	U017	97
D2584669	BRACKET:DC STEPPER MOTOR:DUPLEX	U017	98
D2584681	LINK:SHIFT:DUPLEX	U017	99
D2584689	STEPPER MOTOR:MM39:S2M:T15:ASS'Y	U017	100
D2584690	DC STEPPER MOTOR:MM39:S2M:T20:ASS'Y	U017	101
D2584747	GATE PAWL:DUPLEX:ENTRANCE:	U017	102

Number	Part Name	Group	ID
	NO.2:ASS'Y		
D2584761	GUIDE PLATE:DUPLEX:ENTRANCE:MIDDLE	U017	103
D2584780	DC SOLENOID:DUPLEX:ENTRANCE	U017	104
D2584790	COVER:DUPLEX:DC STEPPER MOTOR	U017	105
D2584802	GUIDE PLATE:MIDDLE:REVERSE:DUPLEX:ASS'Y	U017	106
D2584823	ROLLER:DRIVEN:REVERSE:106MM	U017	107
D2584834	GUIDE PLATE:REVERSE ROLLER:LEFT	U017	108
D2584907	GUIDE PLATE:SWIVEL:UPPER:ASS'Y	U017_S004	109
D2584919	INNER COVER:RECEIVING UNIT:LEFT LOWER:ASS'Y	U017_S005	110
D2584921	GRIP:VIBRATING PLATE:RECEIVING UNIT:LOWER:ASS'Y	U017_S003	111
D2584922	GRIP:GUIDE PLATE:RECEIVING UNIT	U017_S004	112
D2584980	LED:WHITE	U017	113
D2584985	DECAL:GRIP:RECEIVING UNIT:LOWER	U017_S003	114
D2585101	PCB:BICU:SUB-ASS'Y	U019	67
D2585130	PCB:TSB:ASS'Y	U008_S001	101
D2585410	PCB:TDRB	U010	94
D2585430	PCB:PFB	U019	68
D2585465	AC CONTROL BOARD:200V	U019_S003	69
D2585467	PCB:LSB	U017	115
D2585832	INTERFACE CABLE:SBU:BICU:ASS'Y	U004	68
D2585967	GASKET:13X10X370	U019	70
D2585987	BRACKET:SAFETY SWITCH:SWIVEL	U019	71
D2585988	BRACKET:SAFETY SWITCH:PEEN	U019	72
D2585990	COVER:SAFETY SWITCH	U019	73
D2585993	LEVER:SAFETY SWITCH:4	U019	74

Exclusive Parts

Number	Part Name	Group	ID
D2585997	TORSION SPRING:SAFETY SW:VI BRATING PLATE	U019	75
D2586070	DRIVE ROLLER:INTE TRANSFER:A SS'Y	U010	95
D2586075	BRACKET:DRAWER:INT TRANSFE R:ASS'Y	U010	96
D2586089	COMPRESSION SPRING:DRAWER :INTERMEDIATE TRANSFER	U019	76
D2586102	SPRING PLATE:EARTH:DC STEPP ER MOTOR	U010	97
D2586104	BRACKET:INT TRANSFER:REAR:B K	U010	98
D2586105	BRACKET:INT TRANSFER:FRONT: BK	U010	99
D2586106	BRACKET:BIAS:INT TRANSFER:BK	U010	100
D2586107	TERMINAL:CONNECTING:INT TRA NSFER:BK	U010	101
D2586109	TERMINAL:INTERMEDIATE TRANS FER:BK	U010	102
D2586110	COMPRESSION SPRING:BIAS:BK	U010	103
D2586111	BRACKET:INT TRANSFER:FRONT: MCK	U010	104
D2586112	BRACKET:INT TRANSFER:REAR:M CK	U010	105
D2586117	TENSION SPRING:PRESSURE:BK	U010	106
D2586128	CASE:OPPOSED:TRANSFER ROLL ER:FRONT	U010	107
D2586129	CASE:OPPOSED:TRANSFER ROLL ER:REAR	U010	108
D2586130	ROLLER:OPPOSED:BELT CLEANI NG:ASS'Y	U010	109
D2586132	ROLLER:TRANSFER:FRONT:ASS'Y	U010	110
D2586138	SPRING PLATE:TRANSFER:OPPO SED:PAPER	U010	111
D2586139	TENSION SPRING:ON-OFF:INT TR ANSFER	U010	112
D2586141	SLIDE RAIL:INT TRANSFER:FRON T:ASS'Y	U010	113

Number	Part Name	Group	ID
D2586143	SLIDE RAIL:INT TRANSFER:REAR: ASS'Y	U010	114
D2586147	CAM:INTERMEDIATE TRANSFER: COLOR	U010	115
D2586152	SEPARATION PLATE:INT TRANSF ER:240V	U010	116
D2586162	BRACKET:ON-OFF:TRANSFER RO LLER	U010	117
D2586165	FEELER:ON-OFF:TRANSFER:PAP ER	U010	118
D2586176	ROLLER:TRANSFER:ENTRANCE:A SS'Y	U010	119
D2586181	BRACKET:DENSITY SENSOR	U010	120
D2586186	ROLLER:OPPOSED:PAPER:ASS'Y	U010	121
D2586187	CORE:OPPOSED:TRANSFER ROL LER	U010	122
D2586190	CAM:ON-OFF:TRANSFER ROLLER: FRONT	U010	123
D2586191	CAM:ON-OFF:TRANSFER ROLLER: REAR	U010	124
D2586193	CLAMP:TM SENSOR:FRONT	U010	125
D2586195	CLAMP:TM SENSOR:REAR	U010	126
D2586199	PULLEY:ON-OFF:TRANSFER ROLL ER	U010	127
D2586270	COIL SPRING:VIBRATING PLATE	U012_S001	27
D2586273	LINK:RELEASE:LOWER	U012	28
D2586275	LINK:CONNECTING	U012	29
D2586276	SHAFT:RELEASE:T/S UNIT	U012	30
D2586278	CAM:RELEASE:T/S UNIT	U012	31
D2586282	SHAFT:LEVER:PRESSURE:T/S UNI T	U012	32
D2586284	PIN:LEVER:PRESSURE UNIT	U012	33
D2586288	BRACKET:COIL SPRING:REAR	U012	34
D2586291	LEVER:PRESSURE:T/S UNIT:FRO NT	U012	35
D2586293	LEVER:PRESSURE:T/S UNIT:REAR	U012	36
D2586296	PRESSURE UNIT:LEVER:T/S UNIT	U012	37
D2586299	SPRING PLATE:EARTH:EXIT:GUID	U012	38

Exclusive Parts

Number	Part Name	Group	ID
	E PLATE		
D2586321	BLADE:BELT CLEANING:ASS'Y	U011_S001	37
D2586340	SHAFT:CONTACT POINT:TRANSF ER/SEPARATION UNIT:PRESS FIT	U012	39
D2586347	JOINT:TRANSFER:DRIVE	U012	40
D2586348	GEAR:DRIVE:TRANSFER/SEPARA TION UNIT	U012	41
D2586351	SHUTTER:TRANSFER/SEPARATIO N	U012_S001	42
D2586373	COMPRESSION SPRING:SHUTTE R	U012_S001	43
D2586375	PLAIN SHAFT BEARING:BLADE:RE AR	U012_S001	44
D2586387	BASE:GUIDE PLATE:EXIT	U012	45
D2586388	GUIDE:EXIT:TRANSFER/SEPARATI ON	U012	46
D2586396	SEAL:HOLDER:LOWER	U012_S001	47
D2586399	TORSION SPRING:PRESSURE SU B-UNIT:TRANSFER/SEPARATION	U012	48
D2586412	COVER:CASE:DUCT:BELT CLEANI NG	U011_S001	38
D2586417	COVER:BELT CLEANING:ASS'Y	U011_S001	39
D2586421	COIL SPRING:BLADE:BELT CLEAN ING	U011_S001	40
D2586429	JOINT:BRUSH:PAPER DUST:BELT CL	U011_S001	41
D2586450	COATING BAR:ASS'Y	U011_S001	42
D2586502	USED TONER:T/S UNIT:SIDE:ASS' Y	U012_S002	49
D2586503	USED TONER:T/S UNIT:INNER BA CK:ASS'Y	U012	50
D2586504	SHAFT:CONNECTING:USED TONE R:ASS'Y	U012	51
D2586505	SHAFT:DRIVE:INPUT:ASS'Y	U012	52
D2586508	SHAFT:GEAR:SIDE:ASS'Y	U012	53
D2586513	GEAR:IDLER:TRANSPORT SCREW :SIDE	U012	54
D2586514	GEAR:DRIVE:TRANSPORT SCRE	U012	55

Number	Part Name	Group	ID
	W:SIDE		
D2586515	COMPRESSION SPRING:SHUTTE R:PULL OUT	U012	56
D2586525	PLAIN SHAFT BEARING:DIA5XDIA 8X4.5	U012	57
D2586537	GEAR:INPUT:VIBRATING PLATE	U012_S002	58
D2586542	TENSION SPRING:VIBRATING PLA TE	U012_S002	59
D2586557	PLATE:BEARING:USED TONER	U012	60
D2586558	PULLEY:TRANSPORT SCREW:INN ER BACK	U012	61
D2586586	BRACKET:USED TONER:TRANSFE R/SEPARATION UNIT	U012	62
D2586587	BRACKET:AUXILIARY:USED TONE R:TRANSFER/SEPARATION UNIT	U012	63
D2586669	ARM:PICKUP	U007_S008	188
		U007_S009	188
		U007_S010	188
D2586672	GUIDE PLATE:V TRANSPORT:NO. 1	U007_S008	189
D2586673	GUIDE PLATE:V TRANSPORT:NO. 2	U007_S009	190
		U007_S010	190
D2586674	DC SOLENOID:PICKUP:NO.1:ASS' Y	U007_S008	191
D2586677	LEVER:PRESSURE:PICKUP:NO.1	U007_S008	192
D2586678	LINK:RELEASE	U007_S008	193
		U007_S009	193
		U007_S010	193
D2586684	SUPPORTER:RIGHT:ASS'Y	U021	121
D2586697	DC SOLENOID:TANDEM TRAY:LO CK:ASS'Y	U007	194
D2586711	BRACKET:LIFT MOTOR:TANDEM T RAY	U007	195
D2586714	BRACKET:DC SOLENOID:REAR:AS S'Y	U007	196
D2586716	LEVER:RELEASE:REAR	U007	197
D2586718	DC MOTOR:TANDEM LCT:19.2W:B RUSH	U007	198

Exclusive Parts

Number	Part Name	Group	ID
D2586719	DC SOLENOID:TANDEM TRAY:EN D FENCE	U007	199
D2586734	INNER COVER:LED:VERTICAL TR ANSPO RT	U007	200
D2586739	LEVER:VERTICAL TRANSPORT	U007_S007	201
D2586740	SHAFT:LEVER:DOOR:VERTICAL T RANSPORT	U007_S007	202
D2586741	STAY:DOOR:VERTICAL TRANSPO RT	U007_S007	203
D2586744	COVER:VERTICAL TRANSPORT:U PPER	U007_S007	204
D2586752	INNER COVER:LED:RIGHT FRONT	U021	122
D2586757	DECAL:SIZE INDICATION:SIDE FE NCE	U007_S011	205
		U007_S012	205
D2586761	TRAY BOTTOM PLATE	U007_S011	206
		U007_S012	206
D2586764	COVER:SIDE FENCE:REAR	U007_S011_S003	207
		U007_S012_S002	207
D2586770	LEVER:STOPPER:FRONT	U007_S011_S004	208
		U007_S012_S003	208
D2586772	SHAFT:SIDE FENCE:FRONT	U007_S011	209
		U007_S012	209
D2586775	SPACER:PAPER TRAY:UNIVERSA L	U007_S011	210
		U007_S012	210
D2586799	GUIDE:MIDDLE:PAPER TRAY:UNIV ERSAL	U007_S011	211
		U007_S012	211
D2586851	DUCT:VACUUM	U020	124
D2586868	DUCT:BELT CLEANING:VACUUM:F RONT	U020	125
D2586869	DUCT:BELT CLEANING:VACUUM:R EAR	U020	126
D2586875	DUCT:PRESSURE ROLLER:VACU UM:LOWER	U020	127
D2586882	DUCT:HEAT SINKER:MIDDLE	U020	128
D2586885	DUCT:HEAT SINKER:EXHAUST:RI GHT	U020	129
D2586886	DUCT:HEAT SINKER:EXHAUST:LE FT	U020	130

Number	Part Name	Group	ID
D2586892	HEAT PIPE:ASS'Y	U020	131
D2586893	DUCT:PCU:EXHAUST:UPPER	U020	132
D2586899	DUCT:PCU:ENTRANCE	U020	133
D2586907	DUCT:PCU:EXHAUST:LOWER	U020	134
D2586917	FILTER:DEVELOPMENT:EXHAUST: SMALL:ASS'Y	U020	135
D2586918	DUCT:TRANSFER:FUSING:EXHAU ST:FRONT	U020	136
D2586919	DUCT:TRANSFER:FUSING:EXHAU ST:REAR	U020	137
D2586934	DUCT:DEVELOPMENT:Y:UPPER:A SS'Y	U008_S001_S010	102
D2586935	DUCT:DEVELOPMENT:Y:LOWER:A SS'Y	U008_S001_S011	103
D2586938	OZONE FILTER:SMALL	U020	138
D2586944	BRACKET:DC FAN MOTOR:DUPL E X:EXIT	U020	139
D2586946	SEAL:AUXILIARY:DUCT:TRANSFE R/SEPARATION UNIT:UPPER	U020	140
D2586947	GUIDE PLATE:HARNESS:PULL OU T	U020	141
D2586948	DUCT:USED TONER:BRACKET:FR ONT	U020	142
D2586949	SEAL:SHIELD PLATE:HEAT PIPE	U020	143
D2586950	SHIELD PLATE:USED TONER:TRA NSFER/SEPARATION UNIT	U020	144
D2586955	OZONE FILTER:LARGE	U020	145
D2586956	DEODORIZE FILTER:SMALL	U020	146
D2586957	SEAL:DUCT:TONER SUPPLY UNIT: Y:LARGE	U008_S001_S010	104
D2586958	SEAL:DUCT:TONER SUPPLY UNIT: Y:REAR	U008_S001_S011	105
D2586959	SEAL:DUCT:TONER OUTLET UNIT: Y:FRONT	U008_S001_S011	106
D2586960	SEAL:SUPPLY:BASE	U008_S001	107
D2586961	SEAL:SUPPLY:INNER COVER	U008_S001_S009	108
D2586972	DUCT:T/S UNIT:LOWER	U020	147
D2586973	DUCT:T/S UNIT:UPPER	U020	148

Exclusive Parts

Number	Part Name	Group	ID
D2586974	COVER:DUCT:T/S UNIT	U020	149
D2586978	BRACKET:DC FAN MOTOR:T/S UNIT	U020	150
D2586979	FILTER:DC FAN MOTOR:T/S UNIT	U020	151
D2586986	BRACKET:DC FAN MOTOR:VACUUM	U020	152
D2586987	SEAL:COVER:FRONT MIDDLE:LEFT UPPER	U001_S006	114
D2586988	SEAL:COVER:FRONT MIDDLE:RIGHT LOWER	U001_S006	115
D2586989	SEAL:COVER:FRONT MIDDLE:LEFT LOWER	U001_S006	116
D2586991	SEAL:AUXILIARY:DUCT:TRANSFER/SEPARATION UNIT	U020	153
D2587007	HEAT PIPE:PAPER EXIT SUB-UNIT:ASS'Y	U016_S002	92
D2587011	PAPER EXIT UNIT:ASS'Y	U016_S001	93
D2587023	GUIDE PLATE:EXIT:MIDDLE:ASS'Y	U016_S001_S001	94
D2587047	GATE PAWL:PAPER EXIT SUB-UNIT:REVERSE:ENTRANCE:ASS'Y	U016_S001	95
D2587065	GUIDE PLATE:EXIT:RIGHT LOWER	U016_S001	96
D2587066	GUIDE PLATE:EXIT:RIGHT	U016_S001	97
D2587071	GUIDE PLATE:MIDDLE:LEFT	U016_S001_S001	98
D2587072	GUIDE PLATE:DRIVEN:MIDDLE:MIDDLE	U016_S001_S001	99
D2587073	GUIDE PLATE:DRIVEN:MIDDLE:REAR	U016_S001_S001	100
D2587074	GUIDE PLATE:DRIVEN:MIDDLE:FRONT	U016_S001_S001	101
D2587075	GUIDE PLATE:EXIT:MIDDLE:ASS'Y	U016_S001_S001_S001	102
D2587081	GUIDE PLATE:EXIT:LEFT UPPER:ASS'Y	U016_S001	103
D2587090	LEVER:FIX:GUIDE PLATE:UPPER	U016_S001	104
D2587091	GUIDE PLATE:EXIT:UPPER	U016_S001	105
D2587093	HOLDER:DRIVEN ROLLER:EXIT:EXIT	U016_S001	106
D2587094	GROUND PLATE:EXIT:GUIDE PLATE	U016_S001	107

Number	Part Name	Group	ID
	TE:UPPER		
D2587095	DISCHARGE BRUSH:EXIT:SUS	U016_S001	108
D2587097	HOLDER:DRIVEN ROLLER:CONNECTING	U016_S001_S006	109
D2587100	DC SOLENOID:REVERSE EXIT:ASS'Y	U016_S001	110
D2587102	BRACKET:DC SOLENOID:REVERSE EXIT	U016_S001	111
D2587106	BRACKET:TIGHTENER:EXIT:ASS'Y	U016_S001	112
D2587108	COLLAR:COUPLING:HEAT PIPE	U016_S001	113
D2587113	STEPPER MOTOR:GEAR	U016_S001	114
D2587115	ROLLER:EXIT:EXIT:ASS'Y	U016_S001	115
D2587116	ROLLER:EXIT:MIDDLE:ASS'Y	U016_S001	116
D2587117	ROLLER:REVERSE:EXIT:ASS'Y	U016_S001	117
D2587123	GRIP:OPEN AND CLOSE:GATE PAWL:ASS'Y	U016_S001_S016	118
D2587126	GATE:REVERSE EXIT:FRONT	U016_S001	119
D2587127	GATE:REVERSE EXIT:REAR	U016_S001	120
D2587128	SHAFT:GATE:REVERSE EXIT	U016_S001	121
D2587134	GUIDE PLATE:EXIT:LEFT LOWER:ASS'Y	U016_S001	122
D2587142	HOLDER:DRIVEN ROLLER:REVERSE:EXIT	U016_S001	123
D2587144	LEVER:RELEASE:LEFT LOWER:ASS'Y	U016_S001_S015	124
D2587163	ROLLER:DRIVEN:NO.2:SHORT:ASS'Y	U016_S001_S001	125
D2587164	ROLLER:DRIVEN:NO.2:LONG:ASS'Y	U016_S001_S001	126
D2587167	ROLLER:DRIVEN:EXIT:ASS'Y	U016_S001_S002	127
		U016_S001_S003	127
		U016_S001_S004	127
		U016_S001_S005	127
		U016_S001_S007	127
		U016_S001_S008	127
		U016_S001_S009	127
		U016_S001_S010	127
		U016_S001_S011	127

Exclusive Parts

Number	Part Name	Group	ID
		U016_S001_S012	127
		U016_S001_S013	127
		U016_S001_S014	127
D2587168	ROLLER:DRIVEN:REVERSE EXIT:ASS'Y	U016_S001	128
D2587506	(EU/AA/KOR/TWN/CHN):TANDEM LCT:LEFT:ASS'Y	U007_S016	212
		U007_S018	212
		U007_S020	212
D2587507	(NA):TANDEM LCT:LEFT:ASS'Y	U007_S014	213
D2587544	STAY:BASE:RIGHT:COUPLING	U007_S013	214
		U007_S015	214
		U007_S017	214
		U007_S019	214
D2587545	SHAFT:STAY:TRAY:RIGHT	U007_S013	215
		U007_S015	215
		U007_S017	215
		U007_S019	215
D2587546	SHAFT:RISING TRAY:ASS'Y	U007_S013	216
		U007_S015	216
		U007_S017	216
		U007_S019	216
D2587548	RECEIVE PLATE:HOLDER	U007_S013	217
		U007_S014	217
		U007_S015	217
		U007_S016	217
		U007_S017	217
		U007_S018	217
		U007_S019	217
		U007_S020	217
D2587549	BRACKET:SHAFT:LIFT MOTOR:ASS'Y	U007_S013	218
		U007_S015	218
		U007_S017	218
		U007_S019	218
D2587552	TIMING PULLEY:TRAY BOTTOM PLATE	U007_S013	219
		U007_S015	219
		U007_S017	219
		U007_S019	219
D2587553	CAP:TRAY BOTTOM PLATE:TANDEM	U007_S013	220

Number	Part Name	Group	ID
	EM TRAY	U007_S015	220
		U007_S017	220
		U007_S019	220
D2587554	ROLLER:GUIDE	U007_S013	221
		U007_S015	221
		U007_S017	221
		U007_S019	221
D2587555	GROUND PLATE:TANDEM TRAY:RIGHT	U007_S013	222
		U007_S015	222
		U007_S017	222
		U007_S019	222
D2587556	GROUND PLATE:SLIDER:DRIVE	U007_S014	223
		U007_S016	223
		U007_S018	223
		U007_S020	223
D2587557	COVER:PAPER:SET SENSOR:TANDEM TRAY	U007_S014	224
		U007_S016	224
		U007_S018	224
		U007_S020	224
D2587558	FEELER:PAPER:SET SENSOR:TANDEM TRAY	U007_S014	225
		U007_S016	225
		U007_S018	225
		U007_S020	225
D2587578	TRAY BOTTOM PLATE:TANDEM TRAY:ASS'Y	U007_S013	226
		U007_S015	226
		U007_S017	226
		U007_S019	226
D2587579	ROLLER:TRAY BOTTOM PLATE:TANDEM TRAY	U007_S013	227
		U007_S015	227
		U007_S017	227
		U007_S019	227
D2587592	BRACKET:SYNCHRONOUS BELT:DRIVEN	U007_S014	228
		U007_S016	228
		U007_S018	228
		U007_S020	228
D2587595	HOLDER:SYNCHRONOUS BELT	U007_S013	229
		U007_S015	229
		U007_S017	229

Exclusive Parts

Number	Part Name	Group	ID
		U007_S019	229
D2587597	COLLAR:RISE:TANDEM TRAY	U007_S013	230
		U007_S015	230
		U007_S017	230
		U007_S019	230
D2587602	(NA/AA/KOR/TWN):DECAL:SWITCH:DEHUMIDIFIER	ACCESSORIES	43
D2587605	(EU/CHN):DECAL:SWITCH:DEHUMIDIFIER	ACCESSORIES	44
D2589510	OPC DRUM DIA60	U009	77
D2589590	NVRAM	U019	77
D2589640	DEVELOPER BLACK	U009	78
D2589660	DEVELOPER CYAN	U009	79
D2589670	DEVELOPER MAGENTA	U009	80
D2589680	DEVELOPER YELLOW	U009	81
D2594454	LED:BLUE:MINICT	U021	123
D2607603	(D260):DECAL:MODEL NAME PLATE:RIC	ACCESSORIES	45
D2610032	SLIDE RAIL:ASS'Y	U021_S002	124
D2610150	DEVELOPMENT UNIT:BK:ASS'Y	U009_S010	82
D2610155	DEVELOPMENT UNIT:ASS'Y	U009_S002	83
		U009_S005	83
		U009_S008	83
D2611014	DRIVE UNIT:PHOTOCONDUCTOR:ASS'Y	U018_S005	130
		U018_S006	130
		U018_S007	130
		U018_S008	130
D2611329	DRUM STAY:PAPER FEED UNIT:NO.2	U018_S012	131
D2611330	DRIVE UNIT:PAPER FEED NIT:NO.3:ASS'Y	U018_S011	132
D2611339	DRUM STAY:PAPER FEED UNIT:NO.3	U018_S011	133
D2611341	DRIVE UNIT:PF UNIT:NO.2:ASS'Y	U018_S012	134
D2611352	SHAFT:PAPER FEED UNIT:NO.2:FEED:ASS'Y	U018_S010	135
D2611416	DRUM STAY:PCU:ASS'Y	U021_S003	125
D2611473	BRACKET:UPPER FRONT:RIGHT	U001	117

Number	Part Name	Group	ID
D2611474	BRACKET:UPPER FRONT:LEFT	U001	118
D2612203	CLEANING UNIT:ASS'Y	U009_S001	84
		U009_S004	84
		U009_S007	84
		U009_S011	84
D2612635	COVER:REGISTRATION:UPPER:ASS'Y	U006_S002	143
D2612703	SHAFT:SEPARATOR:DRIVEN:ASS'Y	U006_S003	144
D2612712	SHAFT:SEPARATOR:DRIVE	U006_S003	145
D2612714	SHEET:LEVER	U006_S003	146
D2612761	DECAL:PAPER SET DIRECTION:MANUAL FEED	U006_S003_S002	147
D2612762	BRACKET:ARM:MANUAL FEED:REAR:ASS'Y	U006_S003	148
D2612765	GUIDE PLATE:SEPARATOR:ASS'Y	U006_S003_S001	149
D2612770	ARM:MANUAL FEED:REAR:250:PEEN	U006_S003	150
D2612775	ARM:MANUAL FEED:SHORT:REAR	U006_S003	151
D2612778	SHAFT:MANUAL FEED:OPEN/CLOSE	U006_S003	152
D2612780	COVER:MANUAL FEED TABLE	U006_S003_S002	153
D2612783	TORQUE LIMITER:80MN/M:DIA18	U006_S003	154
D2612784	SIDE FENCE:REAR:ASS'Y	U006_S003_S002_S001	155
D2612789	DECAL:SCALE:250	U006_S003_S002	156
D2612795	DC SOLENOID:PICKUP:MANUAL FEED:ASS'Y	U006_S003	157
D2612797	COVER:HARNES:MANUAL FEED TABLE	U006_S003_S002	158
D2612802	MANUAL FEED UNIT:ASS'Y	U006_S003	159
D2612805	MANUAL FEED TABLE:ASS'Y	U006_S003_S002	160
D2612810	BRACKET:LIFT MOTOR:ASS'Y	U006_S003_S002	161
D2612824	BRACKET:COVER:MANUAL FEED:FRONT:ASS'Y	U006_S003	162
D2612831	SHAFT:RISE:ASS'Y	U006_S003_S002	163
D2612833	LEVER:RISE	U006_S003_S002	164
D2612834	COVER:MANUAL FEED:LOWER	U006_S003	165

Exclusive Parts

Number	Part Name	Group	ID
D2612835	COVER:LIFT MOTOR	U006_S003_S002	166
D2612840	ARM:MANUAL FEED:FRONT:250	U006_S003	167
D2612846	COMPRESSION SPRING:STOPPER:REAR	U006_S003_S002	168
D2612849	FEELER:SENSOR:MANUAL FEED	U006_S003_S002	169
D2612850	BRACKET:GROUND PLATE:MANUAL FEED:ASS'Y	U006_S003	170
D2612862	COVER:MANUAL FEED	U006_S003	171
D2612866	SIDE FENCE:FRONT:ASS'Y	U006_S003_S002_S002	172
D2612868	SHEET:GUIDE:COVER	U006_S003	173
D2612870	GUIDE:COVER:MANUAL FEED	U006	174
D2612909	FRICITION PAD:MANUAL FEED TABLE	U006_S003_S002	175
D2612921	COVER:BASE:MANUAL FEED TABLE	U006_S003_S002	176
D2612922	SEPARATION PLATE:MANUAL FEED TABLE	U006_S003_S002	177
D2612925	ARM:PICKUP:MANUAL FEED	U006_S003	178
D2612931	EXTENSION TRAY:MANUAL FEED	U006_S003_S002	179
D2612932	EXTENSION TRAY:MANUAL FEED	U006_S003_S002	180
D2612934	COIL SPRING:RELEASE:PICKUP:MANUAL FEED	U006_S003	181
D2612935	COIL SPRING:PRESSURE:PICKUP	U006_S003	182
D2612936	CAP:CONNECTOR	U006_S003	183
D2612937	BRACKET:LIFT MOTOR:3	U006_S003_S002	184
D2612938	RAIL:LOCK:SIDE FENCE:MANUAL FEED	U006_S003_S002	185
D2612941	RACK:MANUAL FEED:250	U006_S003_S002	186
D2612948	BALANCER:FRICITION:MANUAL FEED:ASS'Y	U006_S003	187
D2612952	COVER:LEVER:RISE	U006_S003_S002	188
D2612953	SHAFT:LEVER:RISE	U006_S003_S002	189
D2612970	SHEET:GUARD:HARNESS	U006_S003	190
D2612971	OIL DAMPER:STRAIGHT:50N	U006_S003	191
D2612973	ARM:MANUAL FEED:SHORT:FRONT	U006_S003	192
D2612974	HOLDER:EXTENSION TRAY:FRONT	U006_S003_S002	193

Number	Part Name	Group	ID
	T		
D2612975	HOLDER:EXTENSION TRAY:REAR	U006_S003_S002	194
D2613200	TONER SUPPLY U:MAIN:ASS'Y	U008_S001	109
D2613231	DECAL:OPERATE:TONER SUPPLY U:BK	U008_S001	110
D2613232	DECAL:OPERATE:TONER SUPPLY U:C	U008_S001	111
D2613233	DECAL:OPERATE:TONER SUPPLY U:M	U008_S001	112
D2613234	DECAL:OPERATE:TONER SUPPLY U:Y	U008_S001	113
D2613235	DECAL:CAUTION:PULL OUT	U008_S001	114
D2613492	DECAL:COLORED DISPLAY:DEV UNIT:C	U009	85
D2613493	DECAL:COLORED DISPLAY:DEV UNIT:M	U009	86
D2613494	DECAL:COLORED DISPLAY:DEV UNIT:Y	U009	87
D2613530	CHARGE UNIT:ASS'Y	U009_S003	88
		U009_S006	88
		U009_S009	88
		U009_S012	88
D2614013	FUSING UNIT:ASS'Y	U015_S002	220
D2614031	STRIPPER PLATE:UNI:FUSING:ASS'Y	U015_S002_S003	221
D2614036	ROLLER:POLISH:ASS'Y	U015_S003	222
D2614045	WEB:CLEANING UNIT:ASS'Y	U015_S004	223
D2614171	DUCT:PRESSURE:UPPER	U015_S002	224
D2614172	DUCT:PRESSURE:LOWER	U015_S002	225
D2614352	FUSING COVER:UPPER:ASS'Y	U015_S002_S005	226
D2614364	FEELER:CLEANING	U015_S004	227
D2614365	BRACKET:REAR:WEB:PEEN	U015_S004	228
D2614367	BRACKET:WEB:FRONT	U015_S004	229
D2614372	COVER:WEB:ASS'Y	U015_S004_S001	230
D2614376	BRACKET:CAM FOLLOWER:WEB:ON-OFF	U015_S004	231
D2614378	BRAKE:WEB	U015_S004	232
D2614381	CAM:WEB:A	U015	233

Exclusive Parts

Number	Part Name	Group	ID
D2614383	SHAFT:CAM:ASS'Y	U015_S002_S001	234
D2614384	LEVER:ON-OFF:A:FRONT	U015_S002	235
D2614385	LEVER:ON-OFF:A:REAR	U015_S002	236
D2614386	PIN:LEVER:ON-OFF:A	U015_S002	237
D2614387	LEVER:ON-OFF:B:FRONT	U015_S002	238
D2614388	LEVER:ON-OFF:B:REAR	U015_S002	239
D2614390	FEELER:SENSOR:ON-OFF	U015_S002	240
D2614392	SHAFT:JOINT:POLISH:ROLLER:DRIVE	U015_S002	241
D2614398	HOOK:GEAR:ON-OFF	U015_S002	242
D2614399	PIN:LEVER:ON-OFF:B	U015_S002	243
D2614400	BRACKET:SUPPORT SHAFT:DRIVE:POLISH	U015_S002	244
D2614410	SHAFT:JOINT:POLISH:ROLLER	U015_S002	245
D2614430	BRACKET:GEAR:POLISH:SWIVEL	U015_S002	246
D2614434	RING:WEB:CLEANING	U015_S004	247
D2614440	FLAT BELT-FUSING:386XDIA80:SEAL	U015_S002	248
D2615110	PCB:I0B:ASS'Y	U019	78
D2615120	PCB:DUB:ASS'Y	U021	126
D2615704	(D260):PCB:CTL:SERVICE PARTS:ASS'Y	U019	79
D2615705	(D261):PCB:CTL:SERVICE PARTS:ASS'Y	U019	80
D2615918	(EU/AA/KOR/TWN):POWER SUPPLY CORD:200V:AC CONTROL BOARD	U019_S001 U019_S002	81 81
D2616090	FLAT BELT-TRANSFER:ASS'Y	U010	128
D2616210	TRANSFER/SEPARATION UNIT:ASS'Y	U012_S001	64
D2616228	GUIDE PLATE:ENTRANCE:TRANSFER ROLLER:ASS'Y	U012_S001	65
D2616231	FLAT BELT-TRANSFER:NO.2:ASS'Y	U012_S001_S001	66
D2616251	SCRAPER:BRUSH ROLLER:TRANSFER/SEPARATION UNIT	U012_S001	67
D2616252	VIBRATING PLATE:TRANSPORT SCREW:FLAT BELT-TRANSFER	U012_S001	68

Number	Part Name	Group	ID
D2616254	BRUSH ROLLER:APPLY:TRANSFER/SEPARATION:ASS'Y	U012_S001	69
D2616299	PULLEY:BRUSH:APPLY:Z20	U012_S001	70
D2616316	GEAR:IDLER:TRANSFER ROLLER	U012_S001	71
D2616328	BRACKET:COIL SPRING:VIBRATING PLATE:REAR	U012_S001	72
D2616330	HOLDER:BLADE:ASS'Y	U012_S001	73
D2616332	BLADE:BELT CLEANING:ASS'Y	U012_S001	74
D2616333	SPACER:DIA8XDIA11X0.5	U012_S001	75
D2616336	BRUSH ROLLER:REMOVE PAPER DUST:TRANSFER/SEPARATION:ASS'Y	U012_S001	76
D2616338	POSITIONING PLATE:IDLER:TRANSFER/SEPARATION:PRESS FIT	U012_S001	77
D2616344	GEAR:BRUSH:REMOVE PAPER DUST	U012_S001	78
D2616345	GEAR:IDLER:TRANSPORT SCREW	U012_S001	79
D2616346	GEAR:IDLER:BRUSH ROLLER:APPLY	U012_S001	80
D2616347	GEAR:TRANSPORT SCREW	U012_S001	81
D2616349	COATING BAR:ASS'Y	U012_S001	82
D2616355	TRANSPORT SCREW:TRANSFER ROLLER:ASS'Y	U012_S001	83
D2616391	COIL SPRING:PRESSURE:TRANSFER/SEPARATION UNIT	U012	84
D2616394	COIL SPRING:BLADE	U012_S001	85
D2616399	BASE:COATING BAR:ASS'Y	U012_S001	86
D2616402	BELT CLEANING:ASS'Y	U011_S001	43
D2616651	PAPER FEED UNIT:NO.1:ASS'Y	U007_S008	231
D2616652	PAPER FEED UNIT:NO.2:ASS'Y	U007_S009 U007_S010	232 232
D2616667	GUIDE PLATE:SWIVEL:ASS'Y	U007	233
D2616675	BALANCER:FRICTION:ASS'Y	U007_S008 U007_S009 U007_S010	234 234 234
D2616677	COVER:FRICTION	U007_S008 U007_S009 U007_S010	235 235 235

Exclusive Parts

Number	Part Name	Group	ID
D2616678	GROUND PLATE:BALANCER:PAPER FEED U	U007_S008	236
		U007_S009	236
		U007_S010	236
D2616679	GUIDE PLATE:V TRANSPORT:THREE WAY	U007	237
D2616680	DECAL:PAPER TRAY:LED	U007	238
D2616686	DC SOLENOID:PICKUP:NO.2:ASS'Y	U007_S009	239
		U007_S010	239
D2616687	FEELER:PAPER END:NO.1	U007_S008	240
D2616693	SHAFT:FEED:ASS'Y	U007_S008	241
		U007_S009	241
		U007_S010	241
D2616712	PAPER TRAY:ASS'Y	U007_S011	242
D2616713	PAPER TRAY:NO.4:ASS'Y	U007_S012	243
D2616737	DOOR:VERTICAL TRANSPORT:ASS'Y	U007_S007	244
D2616742	GUIDE PLATE:VERTICAL TRANSPORT	U007_S007	245
D2616743	COVER:VERTICAL TRANSPORT	U007_S007	246
D2616750	LINK:SIDE FENCE:REAR:UNIVERSAL	U007_S011_S003	247
		U007_S012_S002	247
D2616752	LEVER:STOPPER:REAR	U007_S011_S003	248
		U007_S012_S002	248
D2616753	SUPPORTING PLATE:SIDE FENCE:FRONT	U007_S011	249
		U007_S012	249
D2616754	KNOB SCREW:SUPPORTING PLATE	U007_S011	250
		U007_S012	250
D2616756	HOLDER:FLAT NUT	U007_S011	251
		U007_S012	251
D2616757	FLAT NUT:SIDE FENCE	U007_S011	252
		U007_S012	252
D2616758	KNOB SCREW:SIDE FENCE	U007_S011	253
		U007_S012	253
D2616760	FLAT NUT:TRAY	U007_S011	254
		U007_S012	254
D2616761	DECAL:PAPER SET DIRECTION:TRAY	U007_S011_S002	255
		U007_S012_S004	255
D2616762	SHAFT:SIDE FENCE:REAR	U007_S011	256

Number	Part Name	Group	ID
		U007_S012	256
D2616778	COVER:PAPER TRAY:UNIVERSAL:RIGHT	U007_S011	257
		U007_S012	257
D2616779	COVER:PAPER TRAY:UNIVERSAL:LEFT	U007_S011	258
		U007_S012	258
D2616783	COVER:PAPER TRAY:NO.3:ASS'Y	U007_S011_S002	259
D2616786	SIDE FENCE:REAR:ASS'Y	U007_S011_S003	260
		U007_S012_S002	260
D2616793	COVER:PAPER TRAY:NO.4:ASS'Y	U007_S012_S004	261
D2616798	SIDE FENCE:FRONT:ASS'Y	U007_S011_S004	262
		U007_S012_S003	262
D2616920	CAP:DUCT:TRANSFER:FUSING	U020	154
D2617227	(EU):OPERATION PANEL UNIT:ASS'Y	U002_S004	32
D2617228	(NA/AA/KOR/TWN):OPERATION PANEL UNIT:ASS'Y	U002_S002	33
		U002_S003	33
D2617230	(CHN):OPERATION PANEL:ASS'Y	U002_S005	34
D2617252	GUIDE PLATE:POST:ARM:OPERATION PANEL	ACCESSORIES	46
D2617253	POST:ARM:OPERATION PANEL:LEFT	U002_S001	35
D2617271	COVER:POST:OPERATION PANEL:REAR	ACCESSORIES	47
D2617272	COVER:POST:OPERATION PANEL:FRONT	ACCESSORIES	48
D2617273	COVER:ARM:OPERATION PANEL:UPPER	ACCESSORIES	49
D2617274	COVER:ARM:OPERATION PANEL:LOWER	U002_S001	36
D2617300	ARM:OPERATION PANEL:ASS'Y	U002_S001	37
D2617353	PCB:OP-C	U002_S002	38
		U002_S003	38
		U002_S004	38
		U002_S005	38
D2617355	PCB:OP-U	U002_S002	39
		U002_S003	39
		U002_S004	39
		U002_S005	39

Exclusive Parts

Number	Part Name	Group	ID
D2617387	PCB:OP-R:ASS'Y	U002_S002	40
		U002_S003	40
		U002_S004	40
		U002_S005	40
D2617526	INNER COVER:RIGHT:TANDEM LCT:ASS'Y	U007_S013_S004	263
		U007_S015_S004	263
		U007_S017_S004	263
		U007_S019_S004	263
D2617529	SIDE FENCE:LEFT REAR:TANDEM:ASS'Y	U007_S014_S001	264
		U007_S016_S001	264
		U007_S018_S001	264
		U007_S020_S001	264
D2617538	END FENCE:TANDEM LCT	U007_S013	265
		U007_S015	265
		U007_S017	265
		U007_S019	265
D2617550	BRACKET:COUPLING:RIGHT:ASS'Y	U007_S013	266
		U007_S015	266
		U007_S017	266
		U007_S019	266
D2617555	BACK FENCE:TANDEM LCT	U007_S014	267
		U007_S016	267
		U007_S018	267
		U007_S020	267
D2617557	PRESSURE PLATE:TANDEM TRAY:AUXILIARY	U007_S013	268
		U007_S015	268
		U007_S017	268
		U007_S019	268
D2617558	PRESSURE PLATE:TANDEM TRAY:AUXILIARY:BRACKET	U007_S013	269
		U007_S015	269
		U007_S017	269
		U007_S019	269
D2617560	SIDE FENCE:LEFT FRONT:TANDEM LCT	U007_S014	270
		U007_S016	270
		U007_S018	270
		U007_S020	270
D2617561	HOLDER:TANDEM LCT:LEFT	U007_S014	271
		U007_S016	271

Number	Part Name	Group	ID
		U007_S018	271
		U007_S020	271
D2617562	SIDE FENCE:RIGHT FRONT:TANDEM LCT:ASS'Y	U007_S013_S002	272
		U007_S015_S002	272
		U007_S017_S002	272
		U007_S019_S002	272
D2617563	SIDE FENCE:RIGHT REAR:TANDEM LCT:ASS'Y	U007_S013_S001	273
		U007_S015_S001	273
		U007_S017_S001	273
D2617564	LEVER:COUPLING:TANDEM LCT	U007_S014	274
		U007_S016	274
		U007_S018	274
D2617569	COMPRESSION SPRING:RIGHT REAR	U007_S013_S001	275
		U007_S015_S001	275
		U007_S017_S001	275
D2617574	FEELER:PAPER END	U007_S009	276
		U007_S010	276
D2617586	COVER:SYNCHRONOUS BELT:TANDEM TRAY	U007_S014_S002	277
		U007_S016_S002	277
		U007_S018_S002	277
		U007_S020_S002	277
D2617594	COVER:BACK FENCE:TANDEM LCT	U007_S014	278
		U007_S016	278
		U007_S018	278
		U007_S020	278
D2617598	(EU/AA/KOR/TWN/CHN):TANDEM LCT:RIGHT:ASS'Y	U007_S015	279
		U007_S017	279
		U007_S019	279
D2617599	(NA):TANDEM LCT:RIGHT:ASS'Y	U007_S013	280
D2617603	(D261):DECAL:MODEL NAME PLATE:RIC	ACCESSORIES	50
D3AY7000	ADF UNIT:ASS'Y	U003_S001	88
D3AZ1762	BRACKET:MOTOR:MIDDLE	U003_S001	89
D3AZ2914	COIL SPRING:FEELER:P SIZE SENSOR	U003_S001	90

Exclusive Parts

Number	Part Name	Group	ID
D3AZ4720	PRESSURE PLATE:ASS'Y	U003_S001	91
D3AZ5100	PCB:MAIN CONTROL	U003_S001	92
D3AZ5860	CONTACT IMAGE SENSOR:ASS'Y	U003_S001	93
D3B00430	COVER:PAPER FEED:ASS'Y	U003_S001_S009	94
D3B01766	DC MOTOR:10W:NIDEC:ASS'Y	U003_S001	95
D3B02200	SHAFT:SEPARATION:ASS'Y	U003_S001_S006	96
D3B02510	GUIDE PLATE:PAPER FEED:LOWER:ASS'Y	U003_S001	97
D3B02622	DISCHARGE BRUSH:L11	U003_S001_S009	98
D3B03810	GUIDE PLATE:EXIT:UPPER:ASS'Y	U003_S001_S003	99
D3B04210	COVER:REAR:ASS'Y	U003_S001_S008	100
D3B04310	GUIDE:PAPER FEED:UPPER:SUB-ASS'Y	U003_S001_S009_S002	101
D3B04324	SHEET:BRACKET:GUIDE:PAPER FEED	U003_S001_S009	102
D3B04750	COVER:PAPER FEED:UPPER:ASS'Y	U003_S001_S009_S001	103
D3B04751	CUSHION:COVER:PAPER FEED:UPPER:1	U003_S001_S009_S001	104
D3B04752	CUSHION:COVER:PAPER FEED:UPPER:2	U003_S001_S009_S001	105
D3B04753	SOUND PROOFING MATERIAL:COVER:PAPER FEED:UPPER:FRONT	U003_S001_S009_S001	106
D3B04754	SOUND PROOFING MATERIAL:COVER:PAPER FEED:UPPER:INNER BACK	U003_S001_S009_S001	107
D3B04761	SOUND PROOFING MATERIAL:COVER:REAR:LOWER:1	U003_S001_S008	108
D3B04762	SOUND PROOFING MATERIAL:COVER:REAR:LOWER:2	U003_S001_S008	109
D3B04763	SOUND PROOFING MATERIAL:COVER:REAR:LOWER:3	U003_S001_S008	110
D3B04764	SOUND PROOFING MATERIAL:COVER:REAR:LOWER:4	U003_S001_S008	111
D3B04765	SOUND PROOFING MATERIAL:COVER:REAR:UPPER	U003_S001_S008	112
D3B04771	SOUND PROOFING MATERIAL:GUIDE:PAPER FEED:UPPER:1	U003_S001_S009_S002	113

Number	Part Name	Group	ID
D3B04772	SOUND PROOFING MATERIAL:GUIDE:PAPER FEED:UPPER:2	U003_S001_S009_S002	114
D3B04773	SOUND PROOFING MATERIAL:GUIDE:PAPER FEED:UPPER:3	U003_S001_S009_S002	115
D3B04774	SOUND PROOFING MATERIAL:GUIDE:PAPER FEED:UPPER:4	U003_S001_S009_S002	116
D3B04775	SOUND PROOFING MATERIAL:GUIDE:PAPER FEED:UPPER:5	U003_S001_S009_S002	117
D3B04776	SOUND PROOFING MATERIAL:GUIDE:PAPER FEED:UPPER:6	U003_S001_S009_S002	118
D3B04781	CUSHION:BRACKET:PICKUP:FRONT	U003_S001_S006	119
D3B04782	CUSHION:COVER:PAPER FEED:PICKUP	U003_S001_S009	120
D3B05869	SHIELD PLATE:CONTACT IMAGE SENSOR:FRONT	U003_S001	121
D3B06303	(EU):DECAL:CAUTION:ORIGINAL:MANY LANGUAGES	ACCESSORIES	51
D3B06304	(CHN):DECAL:CAUTION:ORIGINAL	ACCESSORIES	52
D3B06321	DECAL:CAUTION:CONTACT IMAGE SENSOR	U003_S001	122
D3B06322	(NA/AA/KOR/TWN):DECAL:CAUTION:ORIGINAL	ACCESSORIES	53
D3CH7101	GUIDE:ENTRANCE:UPPER	ACCESSORIES	54
D4122653	BUSHING:DIA6	U003_S001	123
		U003_S001_S001	123
D4122669	TENSION SPRING:GUIDE PLATE:PRESSURE:2N	U003_S001	124
D4123145	TENSION SPRING:LEVER:MISFEED REMOVAL	U003_S001	125
D4345209	TIMING BELT:B40S2M246	U018	136
		U018_S004	136
D4345279	TIMING BELT:B40S2M380	U018	137
D4543636	TIMING BELT:40S2M672	U017	116
D4573963	CUSHION:COVER:GUIDE PLATE	U001_S005	119
D5224906	STEPPED SCREW:M3:DIA6:1.7MM:ROUND POINT	U003_S001	126
D5406121	FULL DUG POINT SCREW:FIX:HIN	U003	127

Exclusive Parts

Number	Part Name	Group	ID
	GE		
D5412241	REVERSE ROLLER:PAPER FEED	U003_S001	128
D5431313	COMPRESSION SPRING:HINGE:LEFT	U003_S001	129
D5431625	GEAR:Z24:SEPARATION	U003_S001	130
D5431717	SHAFT:PULLEY:SCANNING:EXIT	U003_S001	131
D5431821	TIMING PULLEY:T33/Z24	U003_S001	132
D5431822	FLANGE:DIA24	U003_S001	133
D5433314	SHEET:SCANNING:ENTRANCE:MIDDLE	U003_S001_S005	134
		U003_S001_S009_S002	134
D5433631	ROLLER:SCANNING:BEHIND:ASS'Y	U003_S001_S001	135
D5433635	GEAR:ROLLER:SCANNING:BEHIND	U003_S001	136
D5434382	COMPRESSION SPRING:PULL OUT	U003_S001_S009	137
D5434393	CUSHION:GUIDE PLATE:ENTRANCE:PAPER FEED:INNER BACK	U003_S001	138
		U003_S001_S009	138
D5435125	SPRING PLATE:CABLE:CONTACT IMAGE SENSOR	U003_S001	139
D6421454	FEELER:APS	U003_S001	140
D6831320	HINGE:LEFT:ASS'Y	U003_S001	141
D6831350	HINGE:RIGHT:ASS'Y	U003_S001	142
D6831362	COMPRESSION SPRING:HINGE:RIGHT	U003_S001	143
D6831385	BRACKET:SAFETY SWITCH:PAPER FEED	U003_S001	144
D6831386	SHAFT:CONTACT POINT:ON OFF DETECTOR:PAPER FEED	U003_S001	145
D6831387	TENSION SPRING:ON OFF DETECTOR:PAPER FEED	U003_S001	146
D6831413	BRACKET:SAFETY SWITCH	U003_S001	147
D6831414	SPRING PLATE:SAFETY SWITCH	U003_S001	148
D6831415	FEELER:SENSOR:ON OFF DETECTOR	U003_S001	149
D6831451	HOLDER:FEELER:APS	U003_S001	150
D6831614	BRACKET:MOTOR:PAPER FEED	U003_S001	151

Number	Part Name	Group	ID
D6831615	STAY:MOTOR:PAPER FEED	U003_S001	152
D6831617	DC MOTOR:ASS'Y:20W:BRUSHLESS	U003_S001	153
D6831620	SHAFT:SEPARATION:DRIVE:INPUT:SUB-ASS'Y	U003_S001	154
D6831632	SHAFT:REVERSE ROLLER:SUB-ASS'Y	U003_S001_S011	155
D6831635	GEAR:REVERSE ROLLER:DRIVE	U003_S001	156
D6831640	SHAFT:INPUT:PAPER FEED:SUB-ASS'Y	U003_S001_S012	157
D6831642	TIMING PULLEY:IDLER:PULL OUT	U003_S001	158
D6831643	GEAR:INPUT:PAPER FEED	U003_S001	159
D6831644	SPACER:SHAFT:INPUT:PAPER FEED	U003_S001	160
D6831645	TIMING PULLEY:COUPLING:PULL OUT	U003_S001_S012	161
D6831671	BRACKET:MOTOR:PICK UP	U003_S001	162
D6831675	DC STEPPER MOTOR:DIA42:T15:52M:ASS'Y	U003_S001	163
D6831680	CAM:PICKUP	U003_S001	164
D6831682	TIMING PULLEY:PICKUP:DRIVE	U003_S001	165
D6831691	GEAR:PAPER FEED:COUPLING	U003_S001	166
D6831711	BRACKET:MOTOR:PULL OUT	U003_S001	167
D6831718	STAY:MOTOR:PULL OUT	U003_S001	168
D6831766	DC MOTOR:10W:BRUSHLESS	U003_S001	169
D6831811	BRACKET:MOTOR:SCANNING:EXIT	U003_S001	170
D6831813	TIMING PULLEY:COUPLING:SCANNING:INNER BACK	U003_S001	171
D6831814	TIMING PULLEY:COUPLING:EXIT	U003_S001	172
D6831822	DC MOTOR:20W:SCANNING:20W:BRUSHLESS	U003_S001	173
D6831841	BRACKET:TENSIONER:SCANNING:INNER BACK	U003_S001	174
D6831845	PULLEY:IDLER:DIA14	U003_S001	175
		U018_S003	138
D6831851	BRACKET:TENSIONER:SCANNING:FRONT	U003_S001	176

Exclusive Parts

Number	Part Name	Group	ID
D6831855	TIMING PULLEY:TENSIONER:SCANNING:FRONT	U003_S001	177
D6831856	TENSION SPRING:TENSION:SCANNING:FRONT	U003_S001	178
D6831912	BRACKET:HINGE:RIGHT	U003_S001	179
D6832110	ROLLER:PULL OUT:DRIVE	U003_S001	180
D6832112	TIMING PULLEY:ROLLER:PULL OUT:DRIVE	U003_S001	181
D6832210	ROLLER:MIDDLE:DRIVE	U003_S001	182
D6832221	GEAR:IDLER:Z18	U003_S001_S006	183
D6832222	STOPPER:SHAFT:SEPARATION:DRIVE	U003_S001	184
D6832224	GUIDE:PAPER FEED:ENTRANCE:FRONT	U003_S001_S006	185
D6832228	PICKUP ROLLER	U003_S001_S006	186
D6832229	TIMING PULLEY:GEAR:T19/Z23	U003_S001_S006	187
D6832231	BRACKET:PICKUP	U003_S001_S006	188
D6832232	TIMING PULLEY:PICKUP:T21	U003_S001_S006	189
D6832233	BRACKET:PAPER FEED BELT	U003_S001_S006	190
D6832235	SHAFT:PICKUP:SUB-ASS'Y	U003_S001_S006	191
D6832236	SHEET:BRACKET:PICKUP:INNER BACK	U003_S001_S006	192
D6832239	COVER:PICKUP ROLLER	U003_S001_S006	193
D6832240	GUIDE:PAPER FEED:ENTRANCE:INNER BACK:ASS'Y	U003_S001_S006_S001	194
D6832241	GUIDE:PAPER FEED:ENTRANCE:INNER BACK	U003_S001_S006_S001	195
D6832242	SHEET:GUIDE:PAPER FEED:INNER BACK	U003_S001_S006_S001	196
D6832272	LEVER:PICKUP ROLLER:RISE	U003_S001_S006	197
D6832311	TORQUE LIMITER MECHANICAL CLUTCH:SEPARATOR	U003_S001	198
D6832393	HOLDER:ORIGINAL TABLE	U003_S001	199
D6832415	SHEET:SEPARATION:ENTRANCE	U003_S001	200
D6832417	SHEET:ENTRANCE:SEPARATION PAD	U003_S001	201
D6832724	COVER:LOWER:BASE	U003_S001	202
D6832728	STOPPER:RELEASE:SHAFT:BASE	U003_S001	203

Number	Part Name	Group	ID
D6832729	JOINT:RISING TRAY:AUXILIARY	U003_S001	204
D6832733	FEELER:SENSOR:ORIGINAL SENSOR	U003_S001	205
D6832742	CUSHION:STOPPER PAWL	U003_S001	206
D6832743	SHEET:CUSHION:STOPPER PAWL	U003_S001	207
D6832746	SIDE FENCE:ORIGINAL TABLE	U003_S001	208
D6832747	PAD:SIDE FENCE:SMALL	U003_S001	209
D6832748	PAD:SIDE FENCE:LARGE	U003_S001	210
D6832752	LEVER:RISE:BASE	U003_S001	211
D6832755	SHAFT:RISE:BASE:SUB-ASS'Y	U003_S001	212
D6832756	RAIL:SIDE FENCE	U003_S001	213
D6832771	ORIGINAL TABLE	U003_S001	214
D6832781	ORIGINAL TABLE:BEHIND	U003_S001	215
D6832911	GUIDE PLATE:PULL OUT:LOWER	U003_S001	216
D6832912	FEELER:PAPER SIZE SENSOR	U003_S001	217
D6832913	SHEET:SENSOR:SEPARATION	U003_S001	218
D6833111	ROLLER:SCANNING:ENTRANCE:DRIVE	U003_S001	219
D6833150	ROLLER:SCANNING:EXIT:DRIVE:ASS'Y	U003_S001_S004	220
D6833155	TIMING PULLEY:ROLLER:SCANNING:EXIT:DRIVE	U003_S001	221
D6833221	GUIDE:SCANNING:UPPER	U003_S001	222
D6833251	GROUND PLATE:ROLLER	U003_S001	223
D6833260	SHEET:SCANNING:EXIT:UPPER:ASS'Y	U003_S001	224
D6833311	BRACKET:GUIDE:SCANNING:UPPER	U003_S001	225
D6833350	GUIDE PLATE:SCANNING	U003_S001	226
D6833361	SPRING PLATE:GUIDE PLATE:SCANNING	U003_S001	227
D6833411	GUIDE:SCANNING:ENTRANCE:LOWER:SUB-ASS'Y	U003_S001_S005	228
D6833421	BASE:SCANNING:ENTRANCE:LOWER	U003_S001	229
D6833422	LEVER:PRESSURE RELEASE	U003_S001	230
D6833510	SHAFT:LEVER:MISFEED REMOVAL:ASS'Y	U003_S001	231

Exclusive Parts

Number	Part Name	Group	ID
D6833511	HOOK:OPTICAL READING UNIT:FRONT	U003_S001	232
D6833616	BRACKET:DISCHARGE BRUSH	U003_S001	233
D6833621	GUIDE:EXIT:LOWER:SUB-ASS'Y	U003_S001	234
D6833641	GUIDE:CONTACT IMAGE SENSOR:EXIT:LOWER:ASS'Y	U003_S001_S002	235
D6833643	COMPRESSION SPRING:CONTACT IMAGE SENSOR:EXIT	U003_S001_S002	236
D6833644	SHEET:GUIDE:CONTACT IMAGE SENSOR:EXIT:LOWER	U003_S001_S002	237
D6833645	ROLLER:MIDDLE:DRIVEN	U003_S001_S002	238
		U003_S001_S009	238
D6833651	COVER:SCANNING:EXIT	U003_S001	239
D6833665	GUIDE PLATE:CONTACT IMAGE SENSOR:ENTRANCE:LOWER	U003_S001	240
D6833666	LEVER:GUIDE PLATE:CONTACT IMAGE SENSOR:FRONT	U003_S001	241
D6833667	LEVER:GUIDE PLATE:CONTACT IMAGE SENSOR:REAR	U003_S001	242
D6833668	SPACER:GUIDE PLATE:CONTACT IMAGE SENSOR:ENTRANCE	U003_S001	243
D6833710	ROLLER:CONTACT IMAGE SENSOR:EXIT:DRIVE:PRESS FIT	U003_S001	244
D6833714	TIMING PULLEY:ROLLER:CIS:EXIT:DRIVE	U003_S001	245
D6833715	TIMING PULLEY:ROLLER:CIS:EXIT:FRONT	U003_S001	246
D6833811	GUIDE PLATE:EXIT:UPPER	U003_S001_S003	247
D6833812	DISCHARGE BRUSH:EXIT	U003_S001	248
		U003_S001_S003	248
D6833911	ROLLER:EXIT:DRIVE	U003_S001	249
D6833915	TIMING PULLEY:ROLLER:EXIT:DRIVE	U003_S001	250
D6834111	COVER:FRONT	U003_S001	251
D6834112	COVER:FRONT RIGHT	U003_S001	252
D6834212	COVER:UPPER REAR	U003_S001	253
D6834313	CUSHION:STOPPER:FEELER:ORIGINAL SENSOR	U003_S001_S009	254

Number	Part Name	Group	ID
D6834323	SHAFT:CONTACT POINT:GUIDE:APER FEED	U003_S001_S009	255
D6834329	SHEET:BASE:SEAL:PAPER FEED	U003_S001_S009	256
D6834341	BRACKET:PULL OUT:DRIVEN	U003_S001_S009	257
D6834342	BRACKET:PRESSURE:PICKUP	U003_S001_S009	258
D6834343	PRESSURE PLATE:PICKUP	U003_S001_S009	259
D6834344	COMPRESSION SPRING:PICKUP:2.1N	U003_S001_S009	260
D6834345	DISCHARGE BRUSH:EXIT:L37	U003_S001_S009	261
D6834346	SHIELD PLATE:ENTRANCE:PAPER FEED	U003_S001_S009	262
D6834347	SEAL:ENTRANCE:PAPER FEED	U003_S001_S009	263
D6834350	DRIVEN ROLLER:PULL OUT	U003_S001_S009	264
D6834351	LINK:STOPPER:COVER:PAPER FEED	U003_S001_S009	265
D6834361	SHAFT:CONTACT POINT:GRIP	U003_S001_S009	266
D6834367	GROUND PLATE:HOOK:INNER BACK	U003_S001_S009	267
D6834371	GRIP:COVER:PAPER FEED	U003_S001_S009	268
D6834372	HOOK:CONTACT POINT:FRONT:GRIP	U003_S001_S009	269
D6834374	HOOK:CONTACT POINT:INNER BACK:GRIP	U003_S001_S009	270
D6834394	GUIDE PLATE:ENTRANCE:PAPER FEED:UPPER	U003_S001_S009	271
D6834395	CUSHION:GUIDE PLATE:ENTRANCE:PAPER FEED:FRONT	U003_S001_S009	272
D6834396	CUSHION:GUIDE PLATE:ENTRANCE:PAPER FEED:STOPPER	U003_S001_S009	273
D6834412	TRAY:EXIT:AUXILIARY:LARGE	U003_S001	274
D6834413	TRAY:EXIT:AUXILIARY:SMALL	U003_S001	275
D6834414	SPACER:EXIT ROLLER	U003_S001	276
D6834418	TRAY:EXIT	U003_S001	277
D6834421	SHAFT:EXIT:DRIVEN	U003_S001	278
D6834430	ROLLER:EXIT:DRIVEN	U003_S001	279
D6834441	HOLDER:CUSHION:PRESSURE PLATE	U003_S001	280
D6834442	TAPE:PRESSURE PLATE	U003_S001	281

Exclusive Parts

Number	Part Name	Group	ID
		U003_S001_S010	281
D6834510	COVER:LOWER RIGHT:ASS'Y	U003_S001_S010	282
D6834611	COVER:LEFT LOWER	U003_S001	283
D6834616	SHEET:BASE:SEAL:LEFT LOWER	U003_S001	284
D6834617	SEAL:LEFT LOWER	U003_S001	285
		U003_S001_S009	285
D6835111	GUIDE:HARNESS:MAIN	U003_S001	286
D6835121	GUIDE:HARNESS:SUB	U003_S001	287
D6836011	DECAL:SIZE:ORIGINAL	U003_S001	288
D6836031	DECAL:SET:ORIGINAL TABLE	ACCESSORIES	55
D6836041	DECAL:DESIGN SKETCH:MISFEED REMOVAL:P2	U003_S001	289
D6836051	DECAL:BASE:ORIGINAL	U003_S001	290
D6842171	PAPER FEED BELT	U003_S001_S006	291
D6842412	PAD:STOPPER:ORIGINAL	U003_S001	292
D6866128	SPONGE:COVER:FRONT:SMALL	U003_S001_S009	293
D6885150	PCB:PUNCH:SENSOR:CONNECTI NG:ASS'Y	U017	117
D6902425	DISCHARGE BRUSH:SHORT:FRO NT	U003_S001_S003	294
D7316241	DECAL:STOPPER:SEPARATION U NIT	U003_S001	295
D7942612	PAD:TRAY BOTTOM PLATE	U007_S011	281
		U007_S012	281
G0143291	SNAP RING - PICK UP	U010	129
G0201332	HINGE - FRONT COVER	U001	120
G0381299	RIVET - 5	ACCESSORIES	56
G0602652	BUSHING - M4	U003_S001_S002	296
		U003_S001_S009	296
G0652767	LEVER - FEED	U007_S008	282
		U007_S009	282
		U007_S010	282
G0652774	PRESSURE LEVER	U007_S008	283
		U007_S009	283
		U007_S010	283
G1021193	HEXAGONAL BOLT:DOUBLE:SCRE W:ROUND POINT:M3X7	U015_S002	249
G1026341	SHEET:SENSOR	U015_S002_S001	250

Number	Part Name	Group	ID
G1782971	LEVER:LOCK:TANDEM LCT	U007	284
G1786352	GUIDE PLATE:ENCODER	U010	130
G1786679	JOINT:DRIVE:BRUSH ROLLER	U015	251
		U015_S002	251
G4042810	SPRING PLATE - 2ND MIRROR	U004_S005	69
G5527022	TIMING BELT	U007_S013	285
		U007_S015	285
		U007_S017	285
		U007_S019	285
G5692901	SPRING - LIFT MOTOR	U007	286
G5701225	SENSOR SHIELDING PLATE	U004	70
GA082007	PLAIN SHAFT BEARING:4XDIA6DI A8	U015_S002	252
		U015_S003	252
GA082010	BUSHING:DIA6:DIA10:9	U013	40
GA082015	PLAIN SHAFT BEARING:DIA6:DIA9: 7	U015_S002	253
GA143003	SCREW:MM5:2.5MM	U007_S011	287
		U007_S012	287
		U007_S013	287
		U007_S015	287
		U007_S017	287
		U007_S019	287
GW010007	PHOTO REFLECTION SENSOR:EXI T	U006	195
		U006_S003	195
		U007	288
		U007_S008	288
		U007_S009	288
		U007_S010	288
		U016_S001	129
		U016_S001_S001	129
		U017	118
GW020022	PHOTOINTERRUPTOR:LG2A24BL1	U004	71
GW230008	TONER END SENSOR	U008_S001_S001	115
		U008_S001_S002	115
		U008_S001_S003	115
		U008_S001_S004	115
GX640028	FAN MOTOR DC24V 1.92W	U020	155
H0602126	BUSHING - M6X7	U003_S001_S006	297

Exclusive Parts

Number	Part Name	Group	ID
H5192415	WASHER:MM7.2	U006	196
J0155505	DRAWER:CONNECTOR:USED DEV ELPER:PLUG	U008_S001	116
M0261815	CLAMP:MIRROR:NO.1	U004_S002	72
M0262657	SHEET:VERTICAL TRANSPORT:SE NSOR	U006	197
M0262734	DECAL:H-TEMP WARNING:HEATE R	U007_S006	289
M0263344	TORSION SPRING:STOPPER:LEFT	U008_S001_S005	117
		U008_S001_S006	117
		U008_S001_S007	117
		U008_S001_S008	117
M0771861	TUBE TYPE LAMP:TAC:ASS'Y	ACCESSORIES	57
M0774200	MECHANICAL ROLLER CLUTCH:R OLLER	U015_S004	254
M0AJ5896	COVER:USB-B	U019	82
M2053893	DRIVEN ROLLER:PRESS FIT	U014_S001	31
M2054446	WASHER:POLISH:ON-OFF	U015_S002	255
M2056436	COMPRESSION SPRING:DRAWER :INTERMEDIATE TRANSFER:NO.2	U019	83
M3644131	TIMING BELT:B40S2M160	U003_S001	298
VSSG9002	FLUOTRIBO MG GREASE : 100G	SPECIAL TOOLS	14
VSSG9006	MOLYKOTE(R) G-1077 GREASE 50 G	SPECIAL TOOLS	15

Standard Parts



03120040N
PAN HEAD SCREW:M2X4



03130030N
PAN HEAD SCREW:M3X3



03130040N
SCREW:M3X4



03130060N
SCREW - M3X6



03130100N
PAN HEAD SCREW:M3X10



03140120N
SCREW - M4X12



03140180N
PAN HEAD SCREW:M4X18



03240120N
SCREW:M4X12



03520040N
SCREW M2X4

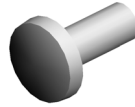

03525060N
SCREW:M2.5X6



03530030N
SCREW:M3X3



03530040N
SCREW - M3X4

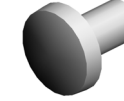

03530050N
SCREW-M3X5



03530060N
BIND SCREW - M3X6



03530100N
SCREW-M3X10



03530200N
SCREW:M3X20



03540400N
SCREW:M4X40



03603005N
SCREW - M3X5

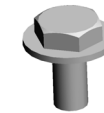

03603006N
SCREW - M3X6

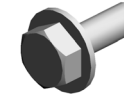

03603008N
SCREW:M3X8



03603014N
SCREW - M3X14



03604008N
SCREW - M4X8



03604010N
SCREW:M4X10

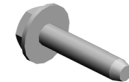

04503014N
TAPPING SCREW:M3X14



04503020N
TAPPING SCREW:M3X20



04503025N
TAPPING SCREW:3X25



04503035N
TAPPING SCREW:3X35



04504010N
TAPPING SCREW:M4X10

Standard Parts



04522006N
BINDING SELF-TAPPING SCREW - M2X6



04533006N
TAPPING SCREW - M3X6



04543005N
HEXAGON HEAD TAPPING SCREW:ROUND POINT:3X5

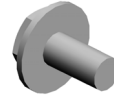

04543006N
TAPPING SCREW:ROUND POINT:3X6



04543006Q
TAPPING SCREW - M3X6



04543008N
TAPPING SCREW:ROUND POINT:3X8



04543008Q
TAPPING SCREW:3X8



04543010Q
TAPPING SCREW:3X10



04543012Q
TAPPING SCREW:3X12

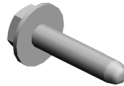

04543014Q
TAPPING SCREW:3X14



04543025Q
TAPPING SCREW:ROUND POINT:3X25



04543030Q
TAPPING SCREW:ROUND POINT:3X30



04544008Q
TAPPING SCREW - M4X8



04583008N
HEXAGON HEAD TAPPING SCREW:3X8



04583010N
HEXAGON HEAD TAPPING SCREW:3X10



04592008N
BINDING HEAD TAPPING SCREW:2X8



04593008N
BINDING HEAD TAPPING SCREW:3X8



04593010N
BINDING HEAD TAPPING SCREW:3X10



05730030E
HEXAGON HEADLESS SET SCREW - M3X3



06230100E
SPRING PIN - 3X10MM



06320120G
PARALLEL PIN - 2X12



06320140G
PARALLEL PIN



06330120G
PARALLEL PIN - 3X12



06330140G
PARALLEL PIN - 3X14



07010020N
WASHER:DIA2



07010060N
WASHER DIA6

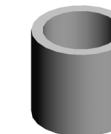

07074050N
BUSHING - 4X5



07080060N
WASHER:DIA6

Standard Parts



07200020G
RETAINING RING - M2



07200025G
RETAINING RING - 2.5



07200030E
RETAINING RING - M3



07200030G
RETAINING RING - M3



07200040E
RETAINING RING - M4



07200060E
RETAINING RING - M6



07200080E
RETAINING RING - M8



07250140E
RETAINING RING (C TYPE) -
M14



07250200E
RETAINING RING C - M20



07270060E
RETAINING RING - M6



07403505
BEARING



07403706
BALL BEARING - M6X10X3



07403804
BALL BEARING: DIA4XDIA9X4



07403808
BALL BEARING - 8X16X5MM



07403810
BALL BEARING: DIA10XDIA19
X5



07403906
BALL BEARING - 6X15X5



07413706
BALL BEARING - 6X10X3



07413708
BALL BEARING - 8X12X3.5M
M



07413808
BALL BEARING - 8X16X5MM



07433806
RADIAL BALL BEARING: DIA6
XDIA13X5

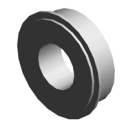

07433808
RADIAL BALL BEARING: DIA8
XDIA16X5



08010231
HEXAGONAL HEAD BOLT W/
WASHER: M3X6



08010234
SCREW WITH WASHER: SMA
LL ROUND WITH SPRING WA
SHER: M5X8



08010236
HEXAGONAL BOLT: DOUBLE
SCREW: M4X8



08010240
BINDING HEAD SCREW: M2.6
X4



08025299
TAPPING SCREW - M3X8



08025305
TAPPING SCREW - M3X6



08025312
TAPPING SCREW: WASHER: 3
X10

Standard Parts



08025328
HEXAGON HEAD TAPPING S
CREW:3X40



08030058
STEPPED SCREW



08046123
HEXAGONAL BOLT:W/WASH
ER:M3X8



08046128
HEXAGONAL BOLT:DOUBLE
SCREW:M3X10



08050089
RETAINING RING - M4



08050092
RETAINING RING - 3M



08050097
RING SEPARATOR



08050100
RETAINING RING - M2.5



08050103
RETAINING RINGS-E:SILENC
ER:DIA3



08050104
RETAINING RINGS-E:SILENC
ER:DIA4



08050106
RETAINING RINGS-E:SILENC
ER:DIA6

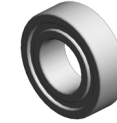

08053573
RADIAL BALL BEARING:DIA8
XDIA16X5

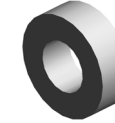

08053581
RADIAL BALL BEARING:DIA6
XDIA12X4



08053587
RADIAL BALL BEARING:DIA6
XDIA13X5



09544006N
SCREW:POLISHED ROUND/
SPRING:M4X6

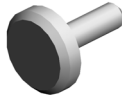

10050734
NYLON RIVET - NRP355



11050328
HARNESS CLAMP - ES-0505



11050409
CARD SPACER- 6.4MM

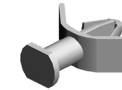

11050410
CARD SPACER - 9.4MM



11050487
HARNESS CLAMP

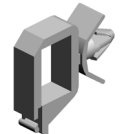

11050508
HARNESS CLAMP - LWS-071
1



11050516
CLAMP



11050517
HARNESS CLAMP - LWS-211
1Z



11050528
NYLON CLAMP - EMT-2N

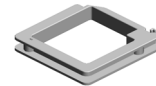

11050532
EDGE SADDLE - LES-25L



11050551
CLAMP:LES-0505



11050568
CLAMP:LWSS-0504



11050598
CLAMP:LWSS-1N

Standard Parts



11050604
CLAMP:RFC-16V0

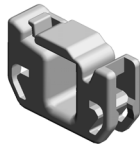

11050692
CLAMP:LES-0503

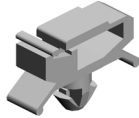

11050713
CLAMP:LWSM-0306H GRAY

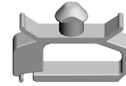

11050714
CLAMP:LWSM-0511H GRAY

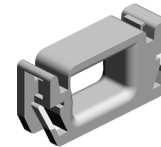

11050723
CLAMPS:WES-0507



11050724
CLAMPS:WES-1210

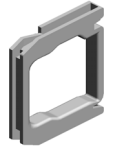

11050726
CLAMPS:WES-2217



11050758
CLAMP:LWSM-0306A



11050759
CLAMP:LWSM-0605A

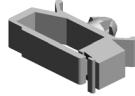

11050760
CLAMP:LWSM-0511A

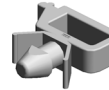

11050761
CLAMP:LWS-0511A



11050762
CLAMP:LWS-0711A

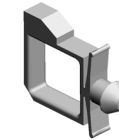

11050763
CLAMP:LWS-1211A

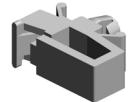

11050764
CLAMP:LWS-1316A

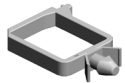

11050765
CLAMP:LWS-2218A

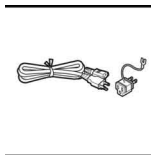

11500446
(EU/AA/KOR/TWN):POWER S
UPPLY CODE:250V:16A

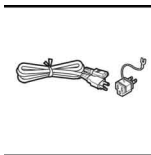

11500466
(CHN):POWER SUPPLY COD
E:250V:16A

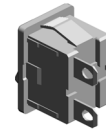

12042570
ROCKER SWITCH:SDDJE132
00

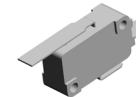

12042612
MICRO SWITCH:D3V-16506-3
C25

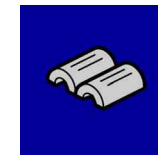

16072258
FERRITE CORE:K3 NFR-10B
K0

PM Part List

Number	Part Name	Num	Group	ID
AA012137	FILTER:CORPUSCLE:FUSING:EXIT	1	U020	24
AA012138	FILTER:CORPUSCLE:TRANSFER:FUSING	1	U020	25
AA012139	FILTER:CORPUSCLE:PRESSURE ROLLER	1	U020	26
AE010127	HOT ROLLER:DIA57	1	U015_S002	83
AE020243	PRESSURE ROLLER:DIA55	1	U015_S002	84
AE045059	WEB:SUB-ASS'Y	1	U015_S004	88
AF030049	PICK-UP ROLLER	1	U006_S003	52
AF030094	PAPER FEED ROLLER:PICK UP	3	U007_S008	69
			U007_S009	69
			U007_S010	69
AF031046	FEED ROLLER - MANUAL FEED	1	U006_S003	53
AF031094	PAPER FEED ROLLER:FEED	3	U007_S008	70
			U007_S009	70
			U007_S010	70
AF032053	ROLLER:SEPARATE:MANUAL FEED	1	U006_S003	54
AF032094	PAPER FEED ROLLER:SEPARATE	3	U007_S008	71
			U007_S009	71
			U007_S010	71
D0744300	SPRING PLATE:CLEANING UNIT:FUSING	1	U015_S004	114
D0744333	ROLLER:PLATE	1	U015_S004	116
D0746158	ROLLER:INTERMEDIATE TRANSFER:ASS'Y	4	U010	43
D0746446	BRUSH:APPLY:BELT CLEANING	1	U011_S001	16
D0746457	BLADE:APPLY:ASS'Y	1	U011_S001	17
D1362365	CLEANING BLADE:ASS'Y	4	U009_S001	40
			U009_S004	40
			U009_S007	40
			U009_S011	40
D1362408	GEAR:24Z:RIGHT	4	U009_S001	43
			U009_S004	43
			U009_S007	43

Number	Part Name	Num	Group	ID
			U009_S011	43
D1362441	BLADE:APPLY:ASS'Y	4	U009_S001	48
			U009_S004	48
			U009_S007	48
			U009_S011	48
D1362446	SEAL:BLADE:APPLY:FRONT	4	U009_S001	49
			U009_S004	49
			U009_S007	49
			U009_S011	49
D1362448	SEAL:CLEANING BLADE:FRONT	4	U009_S001	50
			U009_S004	50
			U009_S007	50
			U009_S011	50
D1362449	SEAL:CLEANING BLADE:REAR	4	U009_S001	51
			U009_S004	51
			U009_S007	51
			U009_S011	51
D1362461	GEAR:18Z:RIGHT	8	U009_S001	54
			U009_S004	54
			U009_S007	54
			U009_S011	54
D1362462	GEAR:IDLER:19Z:LEFT	4	U009_S001	55
			U009_S004	55
			U009_S007	55
			U009_S011	55
D1363431	FILTER:DEVELOPMENT	4	U009_S002	58
			U009_S005	58
			U009_S008	58
			U009_S010	58
D1366935	FILTER:DEVELOPMENT:EXHAUST:LARGE	1	U020	73
D2582402	OIL SUPPLY ROLLER:ASS'Y	4	U009_S001	67
			U009_S004	67
			U009_S007	67
			U009_S011	67
D2582411	COATING BAR:ASS'Y	4	U009_S001	69
			U009_S004	69
			U009_S007	69

PM Part List

Number	Part Name	Num	Group	ID
			U009_S011	69
D2582447	SEAL:BLADE:APPLY:REAR	4	U009_S001	71
			U009_S004	71
			U009_S007	71
			U009_S011	71
D2582459	JOINT:CLEANING UNIT	4	U009_S001	72
			U009_S004	72
			U009_S007	72
			U009_S011	72
D2582463	GEAR:IDLER:31Z:LEFT	4	U009_S001	73
			U009_S004	73
			U009_S007	73
			U009_S011	73
D2584464	FLANGE:HEAT ROLLER:ASS'Y	1	U015_S002_S004	216
D2584465	FLANGE:HEAT ROLLER:EAR TH:ASS'Y	1	U015_S002_S004	217
D2584468	CORE:HEAT ROLLER:ASS'Y	1	U015_S002_S004_S001	219
D2586186	ROLLER:OPPOSED:PAPER:ASS'Y	1	U010	121
D2586321	BLADE:BELT CLEANING:ASS'Y	1	U011_S001	37
D2586450	COATING BAR:ASS'Y	1	U011_S001	42
D2586917	FILTER:DEVELOPMENT:EXHAUST:SMALL:ASS'Y	1	U020	135
D2586938	OZONE FILTER:SMALL	1	U020	138
D2586955	OZONE FILTER:LARGE	1	U020	145
D2586956	DEODORIZE FILTER:SMALL	1	U020	146
D2589510	OPC DRUM DIA60	4	U009	77
D2589640	DEVELOPER BLACK	1	U009	78
D2589660	DEVELOPER CYAN	1	U009	79
D2589670	DEVELOPER MAGENTA	1	U009	80
D2589680	DEVELOPER YELLOW	1	U009	81
D2613530	CHARGE UNIT:ASS'Y	4	U009_S003	88
			U009_S006	88
			U009_S009	88
			U009_S012	88

Number	Part Name	Num	Group	ID
D2614036	ROLLER:POLISH:ASS'Y	1	U015_S003	222
D2614440	FLAT BELT-FUSING:386XDIA80:SEAL	1	U015_S002	248
D2616090	FLAT BELT-TRANSFER:ASS'Y	1	U010	128
D2616231	FLAT BELT-TRANSFER:NO.2:ASS'Y	1	U012_S001_S001	66
D2616254	BRUSH ROLLER:APPLY:TRANSFER/SEPARATION:ASS'Y	1	U012_S001	69
D2616332	BLADE:BELT CLEANING:ASS'Y	1	U012_S001	74
D2616349	COATING BAR:ASS'Y	1	U012_S001	82
D5412241	REVERSE ROLLER:PAPER FEED	1	U003_S001	128
D6832228	PICKUP ROLLER	1	U003_S001_S006	186
D6842171	PAPER FEED BELT	1	U003_S001_S006	291

