

Pro 8310/8320
(M0CL/M0CM-NA)
Parts Catalog

Parts change information sample

 **Add**

 **Update**

 **Delete**

Model	Product Code	PC Style
RICOH Pro 8300S	D0BX	3D
RICOH Pro 8310S	D0BY	
RICOH Pro 8320S	D0BZ	
RICOH Pro 8310Y/8310HT	M0CL	3D
RICOH Pro 8320Y/8320HT	M0CM	
Decurl Unit DU5070	D3DR	3D
Finisher SR5110	D3G9	3D
Booklet Finisher SR5120	D3G8	3D
Punch Unit PU5030	D3GJ	3D
Booklet Finisher SR5100	D3GD	3D
Finisher SR5090	D3GC	3D
Shift Sort Tray SH5000	D3GE	3D
Buffer Pass Unit Type S11	D3FC	3D
LCIT RT5130	D3GB	3D
Cover Interposer Tray CI5040	D3GA	3D
Cover Interposer Tray Double-Feed Detection Kit Type S11		
A3/11" x17" Tray Unit TK5020	B331	3D
Bridge Unit BU5020	D3GN	3D
Ring Binder RB5030	D3GH	Traditional
Trimmer Unit TR5050	D3GG	Traditional
RPIP Interface Box Type S3	M462	Traditional
PostScript3 Unit Type S11	D0C3	Traditional
PostScript3 Unit Type S12	D0C3	Traditional
IPDS Unit Type S11	D0C3	Traditional
XPS Direct Print Option Type S11	D0C3	Traditional
OCR Unit Type M2	D166	Traditional
VM Card Type P18	D0C3/D3EN	Traditional
SD Card for Fonts Type D	D641	Traditional
IEEE 802.11a/g/n Interface Unit Type M19	D3BR	Traditional
File Format Converter Type M19	D3BR	Traditional
NFC Card Reader Type S6	D3DH	Traditional

Unit All



U001
EXTERIOR



U002
OPERATION



U003
LASER UNIT



U004
PAPER FEED



U005
TONNER SUPPLY



U006
PCDU



U007
ITB UNIT



U008
ITB CLEANING



U009
TRANSFER/SEPARATION



U010
USED TONER



U011
PAPER TRANSPORT



U012
FUSING

Unit All



U013
PAPER EXIT



U014
DUPLEX



U015
MAIN DRIVE



U016
ELECTRICAL



U017
CONTROLLER



U018
AIR COOLING



U019
MAIN FRAME



U020
ACCESSORIES

U001.EXTERIOR

U001_S003
D0BX1549
INNER COVER:PULL OUT:LE
FT:ASS'Y

U001_S001
D0BX1484
SUPPORTING PLATE:DOOR:
FRONT LEFT:ASS'Y

U001_S005
D0BX1555
INNER COVER:REVERSE SU
B-UNIT:UPPER:ASS'Y

U001_S006
D1791454
DOOR:TONER SUPPLY:ASS'
Y

U001_S004
D0BX1550
INNER COVER:INTERMEDIA
TE TRANSFER:ASS'Y

U001_S002
D0BX1547
INNER COVER:PULL OUT:RI
GHT:ASS'Y

U001	U002	U003	U004	U005	U006	U007	U008	U009	U010	U011	U012	U013	U014	U015	U016	U017	U018	U019	U020
------	------	------	------	------	------	------	------	------	------	------	------	------	------	------	------	------	------	------	------

U001 EXTERIOR

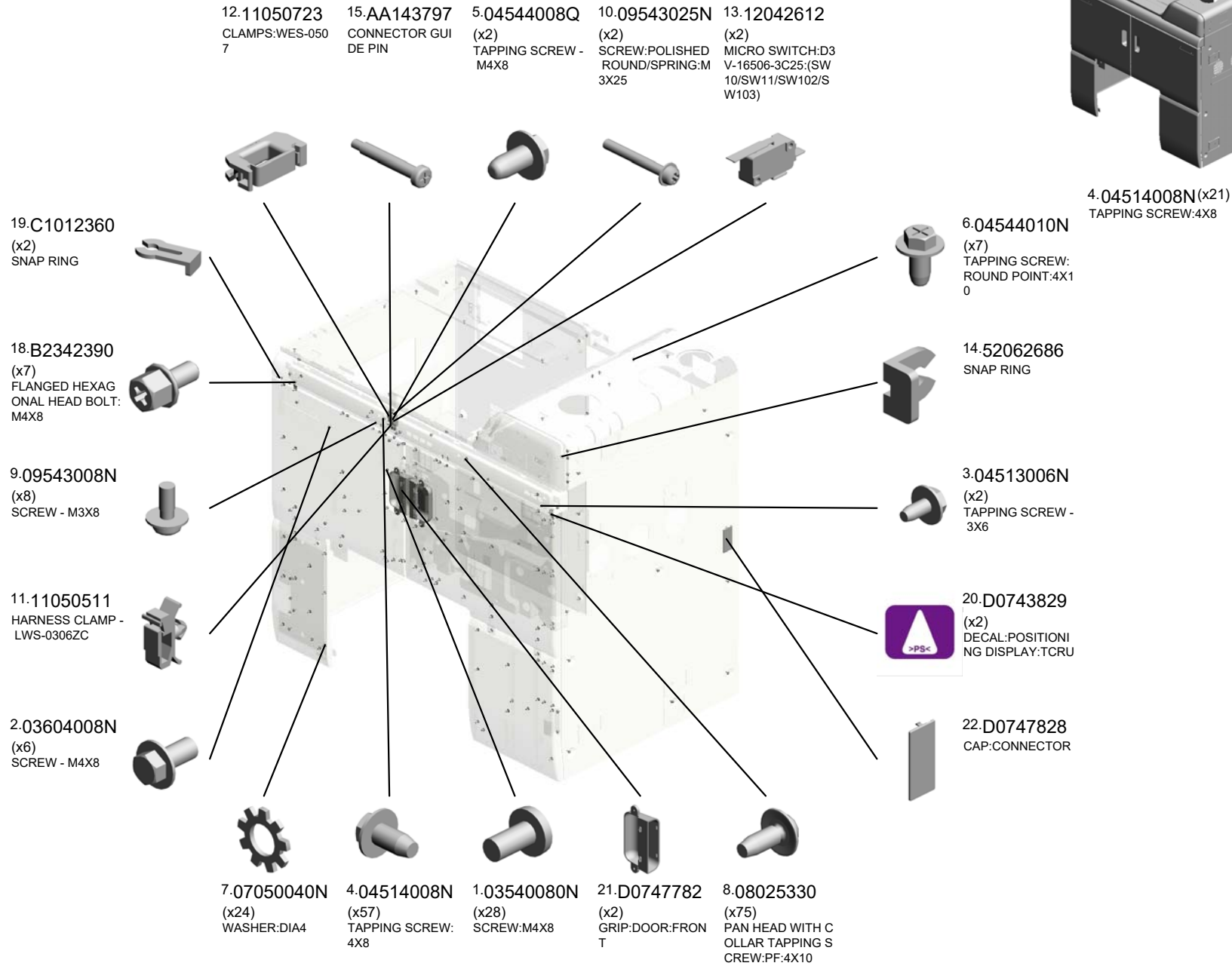

U001	U002	U003	U004	U005	U006	U007	U008	U009	U010	U011	U012	U013	U014	U015	U016	U017	U018	U019	U020
------	------	------	------	------	------	------	------	------	------	------	------	------	------	------	------	------	------	------	------

U001 EXTERIOR

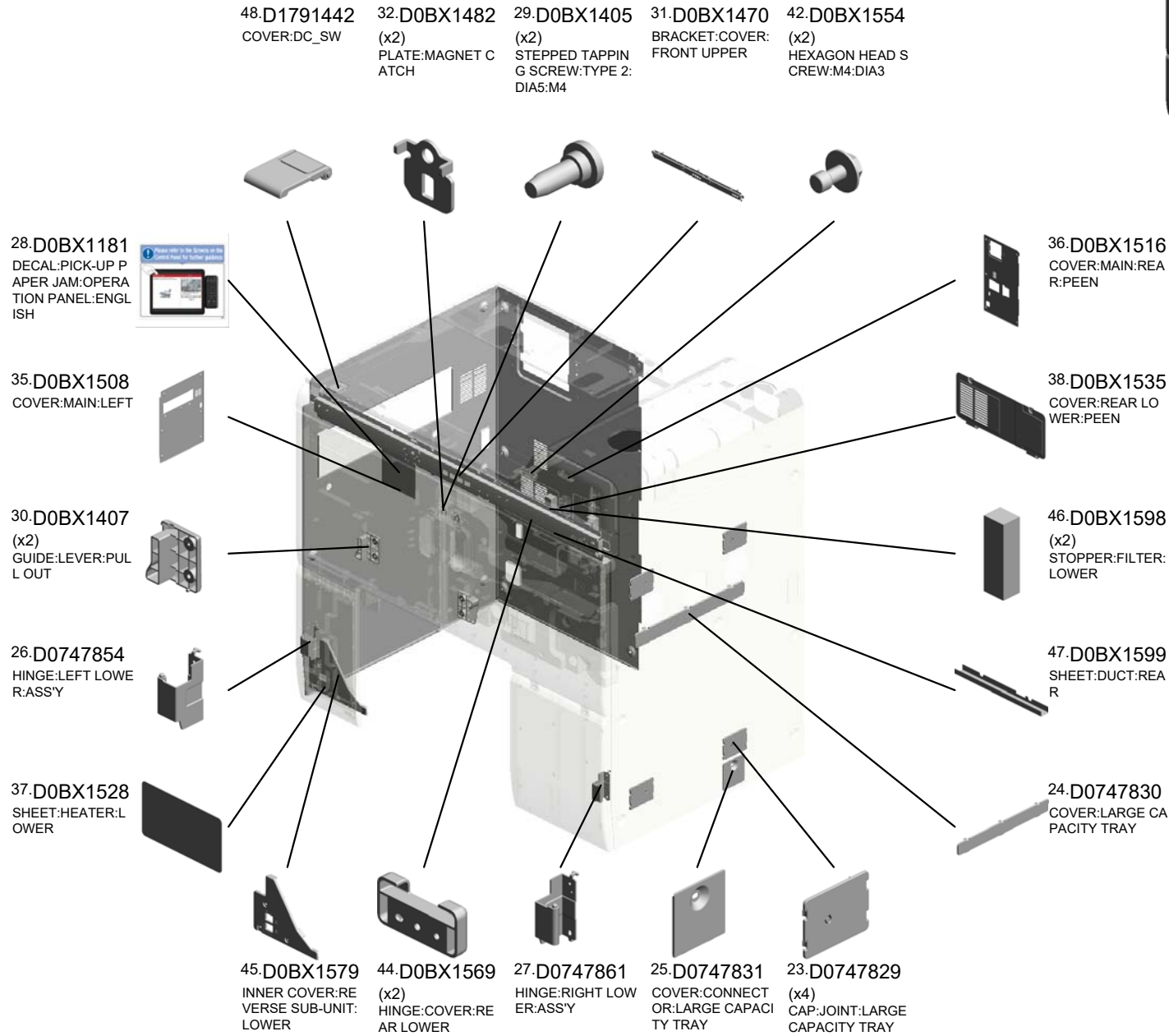

U001 EXTERIOR

55.D1791471 LEVER:SAFETY SWITCH
 56.D1791476 BRACKET:SAFETY SWITCH
 57.D1791477 SHIELD PLATE:SAFETY SWITCH
 67.D1791526 STAY:SAFETY SWITCH
 54.D1791469 COVER:FRONT UPPER



68.D1791531 HINGE:LEFT UPPER

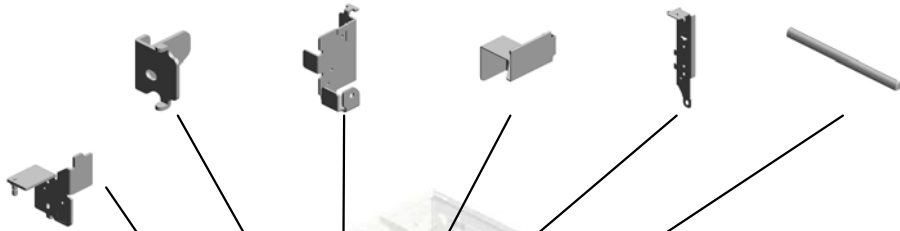

49.D1791451 CAP:KEY COUNTER



58.D1791483 (x2) LEVER:SAFETY SWITCH



63.D1791499 CAP:MM22



60.D1791487 DUCT:DOOR:FRONT LEFT:ASSY



53.D1791460 (x2) HINGE:DOOR:TONER SUPPLY



70.D1791571 (x2) BRACKET:EARTH:DOOR:MIDDLE



69.D1791533 HINGE:RIGHT UPPER



59.D1791485 DOOR:FRONT LEFT:LOWER



66.D1791514 COVER:MAIN:RIGHT



71.D1791572 (x2) BRACKET:EARTH:DOOR:LOWER
 62.D1791497 DOOR:FRONT RIGHT:UPPER
 64.D1791500 DOOR:FRONT RIGHT:LOWER
 65.D1791505 STOPPER:GUIDE PLATE:VERTICAL TRANSPORT
 72.D1796913 SEAL:INNER COVER:OPTICAL WRITING MD:COOLING



U001 EXTERIOR

- 94.M2631445 COVER:UPPER LEFT
- 93.M2631444 COVER:UPPER FRONT
- 90.G1781602 ARM:SAFETY SWITCH:UPPER:ASS'Y
- 97.M2631566 (x4) STAY:COVER:UPPER MIDDLE
- 95.M2631446 COVER:UPPER REAR

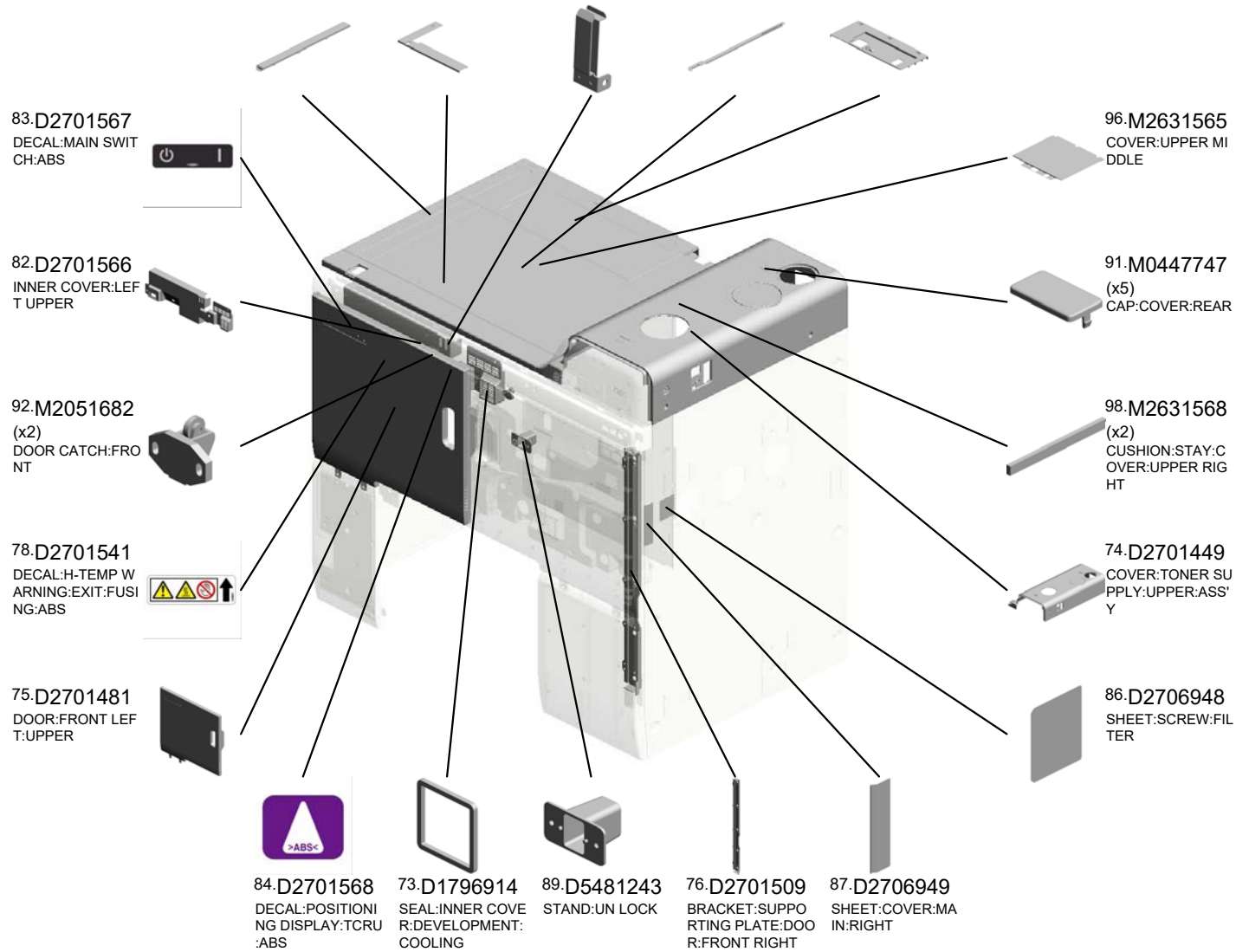

U001_S001
SUPPORTING PLATE:DOOR:FRONT LEFT:ASS'Y

61.D1791490 1.03540080N
BRACKET:SUPPO (x10)
RTING PLATE:DOO SCREW:M4X8
R:FRONT LEFT

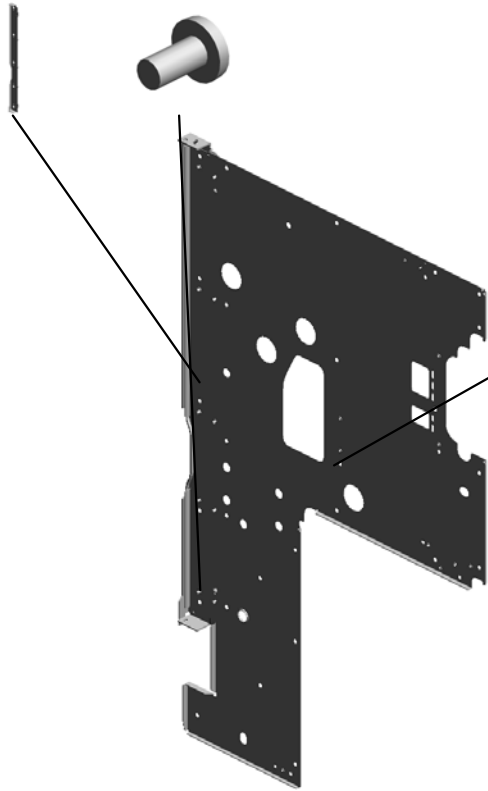

34.D0BX1489
SUPPORTING PLA
TE:DOOR:FRONT L
EFT



33.D0BX1484
SUPPORTING PLA
TE:DOOR:FRONT L
EFT:ASS'Y

U001	U002	U003	U004	U005	U006	U007	U008	U009	U010	U011	U012	U013	U014	U015	U016	U017	U018	U019	U020
------	------	------	------	------	------	------	------	------	------	------	------	------	------	------	------	------	------	------	------

U001_S002

INNER COVER:PULL OUT:RIGHT:ASS'Y

16.AC020152
LENS:LED:3

79.D2701542
DECAL:H-TEMP W
ARNING:PAPER FE
ED:ABS

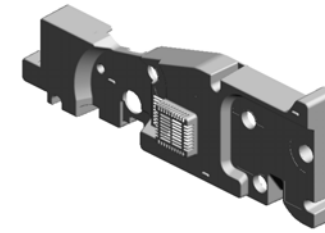

39.D0BX1547
INNER COVER:PUL
L OUT:RIGHT:ASS'
Y

A callout box containing two small images: a lens (16) and a decal (79). To the right of the images are two warning symbols: a high-temperature warning (triangle with exclamation mark and 'H') and a no fire warning (circle with slash and flame), with a downward arrow pointing to the decal.

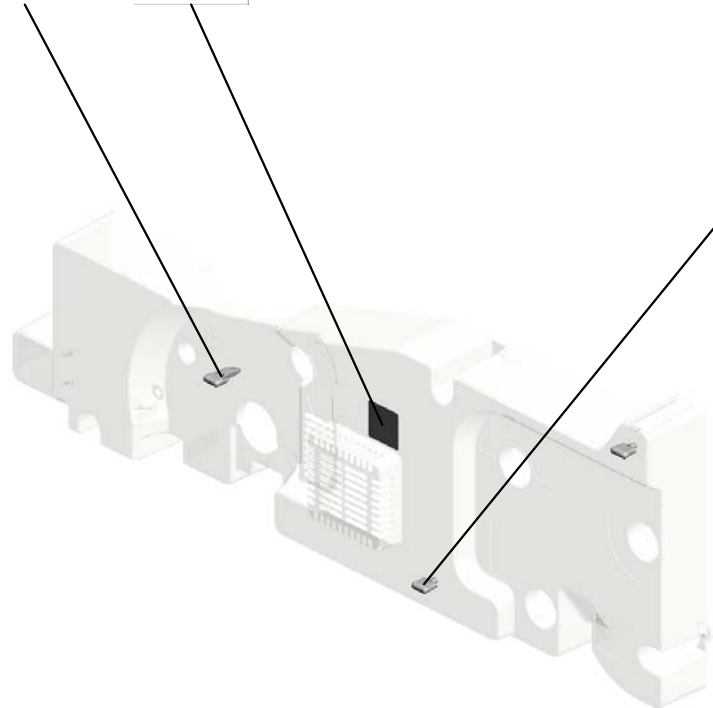

17.AC020153
(x2)
LENS:LED:4

U001	U002	U003	U004	U005	U006	U007	U008	U009	U010	U011	U012	U013	U014	U015	U016	U017	U018	U019	U020
------	------	------	------	------	------	------	------	------	------	------	------	------	------	------	------	------	------	------	------

U001_S003
INNER COVER:PULL OUT:LEFT:ASS'Y

16.AC020152
LENS:LED:3

40.D0BX1549
INNER COVER:PUL
L OUT:LEFT:ASS'Y

79.D2701542
(x2)
DECAL:H-TEMP W
ARNING:PAPER FE
ED:ABS



77.D2701540
INNER COVER:PUL
L OUT:LEFT



17.AC020153
(x2)
LENS:LED:4

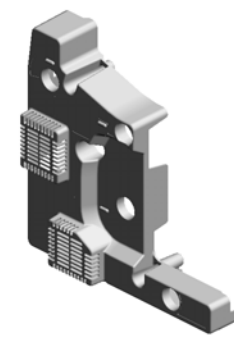

U001	U002	U003	U004	U005	U006	U007	U008	U009	U010	U011	U012	U013	U014	U015	U016	U017	U018	U019	U020
------	------	------	------	------	------	------	------	------	------	------	------	------	------	------	------	------	------	------	------

U001_S004

INNER COVER:INTERMEDIATE TRANSFER:ASS'Y

80.D2701546
DECAL:PULL OUT:
MIDDLE:ABS

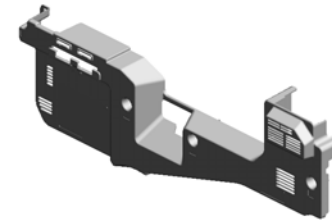
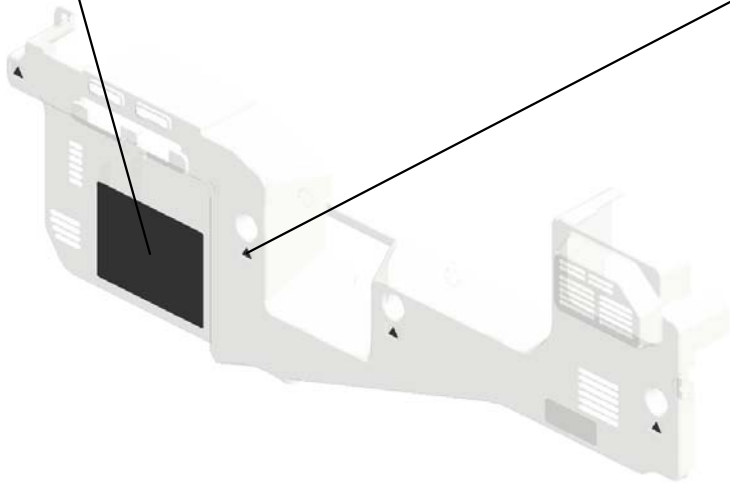

41.D0BX1550
INNER COVER:INT
ERMEDIATE TRAN
SFER:ASS'Y



84.D2701568
(x4)
DECAL:POSITIONI
NG DISPLAY:TCRU
:ABS

U001	U002	U003	U004	U005	U006	U007	U008	U009	U010	U011	U012	U013	U014	U015	U016	U017	U018	U019	U020
------	------	------	------	------	------	------	------	------	------	------	------	------	------	------	------	------	------	------	------

U001_S005
INNER COVER:REVERSE SUB-UNIT:UPPER:ASS'Y

81.D2701562
INNER COVER:RE
VERSE SUB-UNIT:
UPPER

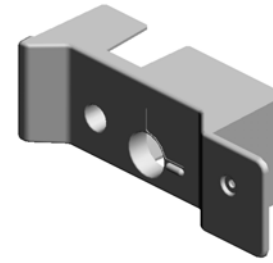

43.D0BX1555
INNER COVER:RE
VERSE SUB-UNIT:
UPPER:ASS'Y

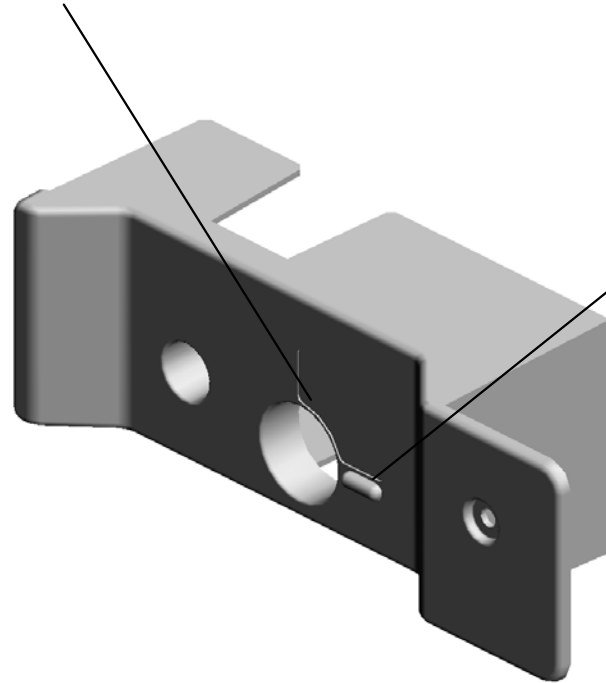

17.AC020153
LENS:LED:4



U001	U002	U003	U004	U005	U006	U007	U008	U009	U010	U011	U012	U013	U014	U015	U016	U017	U018	U019	U020
------	------	------	------	------	------	------	------	------	------	------	------	------	------	------	------	------	------	------	------

U001_S006
DOOR:TONER SUPPLY:ASS'Y

88.D3551333 SHIELDING PLATE:
SAFETY SWITCH:DOOR

85.D2703366 DECAL:REPLACEMENT INDICATION:TONER BOTTLE



50.D1791454
DOOR:TONER SUPPLY:ASS'Y

52.D1791457
(x2)
MAGNET CATCH PLATE:DOOR:TONER SUPPLY

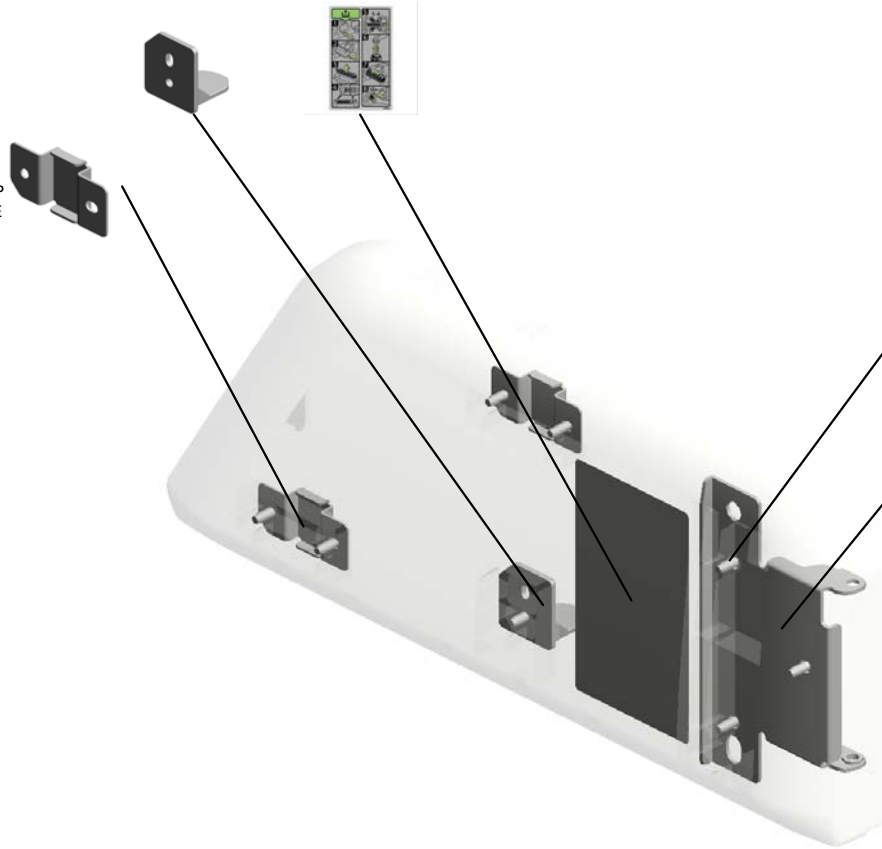

8.08025330
(x8)
PAN HEAD WITH COLLAR TAPPING SCREW:PF:4X10

51.D1791456
SUPPORTING PLATE:HINGE:DOOR:TONER SUPPLY

U002 OPERATION

14.M0BJ5780 DISPLSY:TM170-RI X01
 9.D0A56840 SPRING PLATE:OP U-DISPLAY
 2.03604008N (x7) SCREW - M4X8
 16.D0BX5726 (NA):OPERATION S UB-UNIT:KEY_BOX :ASS'Y

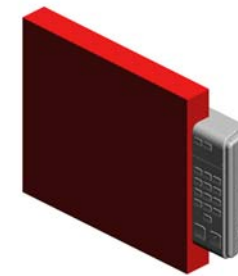

3.03604016N
SCREW:M4X16

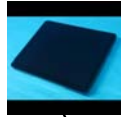

8.D0A56731
COVER:DISPLSY:R EAR LOWER

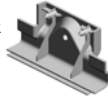

12.D0BX1594
HOLDER:HINGE:O PERATION SUB-U NIT:LOWER



5.11050042
WIRE BAND



7.11050534
(x3)
CLAMP

6.11050508
HARNESS CLAMP - LWS-0711



1.03530040N(x 6)
SCREW - M3X4
3.03604016N(x 7)
SCREW:M4X16

11.D0BX1589
COVER:HINGE:LO WER



10.D0BX1586
HOLDER:FIX:OPER ATION SUB-UNIT
4.04544008Q (x7)
TAPPING SCREW - M4X8



U003
LASER UNIT

1-03604012N
(x4)
SCREW:M4X12

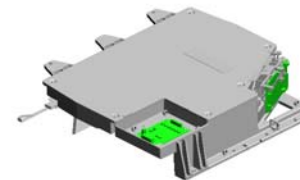

2-D0BX1901
OPTICAL WRITING
UNIT:ASSY

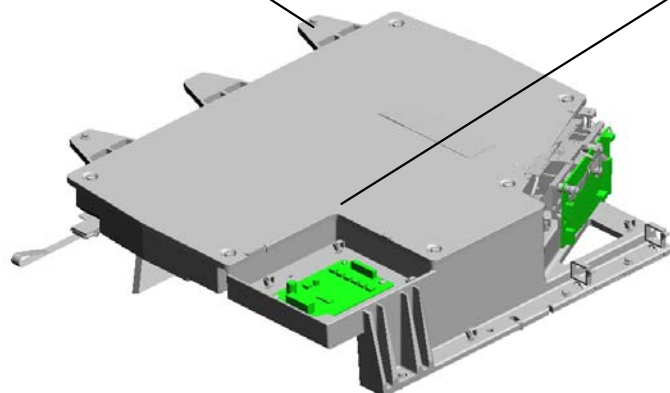

U001	U002	U003	U004	U005	U006	U007	U008	U009	U010	U011	U012	U013	U014	U015	U016	U017	U018	U019	U020
------	------	------	------	------	------	------	------	------	------	------	------	------	------	------	------	------	------	------	------

U004.PAPER FEED

U004 S003
D2236231
DC SOLENOID:LOCK:ASSY:(
SOL5)

U004 S002
M2057305
REGISTRATION ROLLER:GA
TE:ASSY

U004 S001
D2702771
ARM:REGISTRATION:TIMING
:ASSY

U004 S012
D0BX6685
(NA):TANDEM LCT:RIGHT:AS
S'Y

U004 S004
D2236233
DC SOLENOID:COUPLING:A
SSY:(SOL6)

U004 S010
D0BX7631
PAPER TRAY:UNIVERSAL:S
UB-ASSY

U004 S007
D0BX6628
PAPER FEED UNIT:PAPER B
ANK:ASSY

U004 S005
D1797525
STOPPER:REGISTRATION:T
ANDEM LCT:ASSY

U004 S009
D0BX6771
GUIDE PLATE:OPEN AND CL
OSE:VERTICAL TRANSPORT
:LOWER:ASSY

U004 S011
D0BX7631
PAPER TRAY:UNIVERSAL:S
UB-ASSY

U004 S006
D0BX6628
PAPER FEED UNIT:PAPER B
ANK:ASSY

U004 S008
D0BX6628
PAPER FEED UNIT:PAPER B
ANK:ASSY

U001	U002	U003	U004	U005	U006	U007	U008	U009	U010	U011	U012	U013	U014	U015	U016	U017	U018	U019	U020
------	------	------	------	------	------	------	------	------	------	------	------	------	------	------	------	------	------	------	------

U004.PAPER FEED

U004_S014
D2707544
SIDE FENCE:TANDEM LCT:L
EFT REAR:ASSY

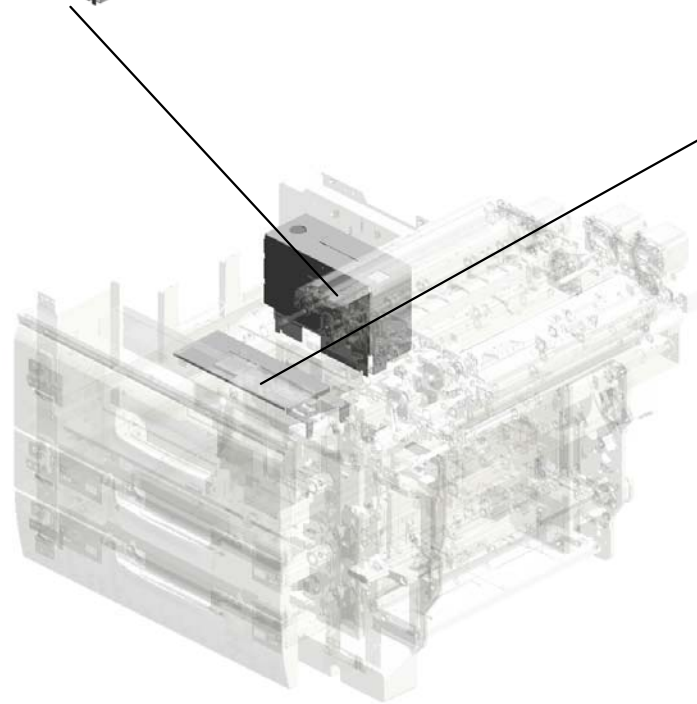
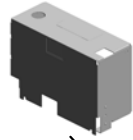

U004_S013
D0747596
(CHN[Pro 8310/8320]/NA/EU/
AA/TWN/KOR):TRAY BOTTO
M PLATE:LEFT MIDDLE:ASS'
Y

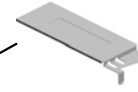

U001	U002	U003	U004	U005	U006	U007	U008	U009	U010	U011	U012	U013	U014	U015	U016	U017	U018	U019	U020
------	------	------	-------------	------	------	------	------	------	------	------	------	------	------	------	------	------	------	------	------

U004_S009.GUIDE PLATE:OPEN AND CLOSE:VERTICAL TRANSPORT:LOWER:ASS'Y

U004 S009 S002
D3553840
BRACKET:DETENT:ASS'Y



U004 S009 S001
D3553810
BRACKET:DETENT:RIGHT:ASS'Y

U001	U002	U003	U004	U005	U006	U007	U008	U009	U010	U011	U012	U013	U014	U015	U016	U017	U018	U019	U020
------	------	------	------	------	------	------	------	------	------	------	------	------	------	------	------	------	------	------	------

U004_S010.PAPER TRAY:UNIVERSAL:SUB-ASS'Y

U004_S010_S003
D1316777
SIDE FENCE:FRONT:ASS'Y

U004_S010_S001
D0BX6780
TRAY BOTTOM PLATE:ASS'Y

U004_S010_S002
D1316775
SIDE FENCE:REAR:ASS'Y

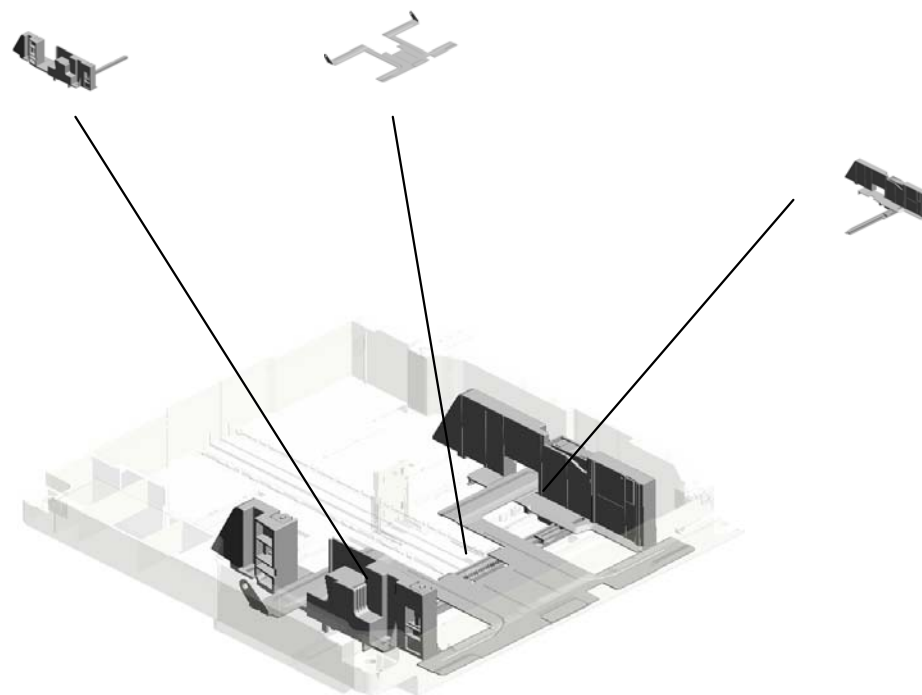

U001	U002	U003	U004	U005	U006	U007	U008	U009	U010	U011	U012	U013	U014	U015	U016	U017	U018	U019	U020
------	------	------	-------------	------	------	------	------	------	------	------	------	------	------	------	------	------	------	------	------

U004_S011.PAPER TRAY:UNIVERSAL:SUB-ASS'Y

U004_S011_S003
D1316777
SIDE FENCE:FRONT:ASS'Y

U004_S011_S001
D0BX6780
TRAY BOTTOM PLATE:ASS'Y

U004_S011_S002
D1316775
SIDE FENCE:REAR:ASS'Y

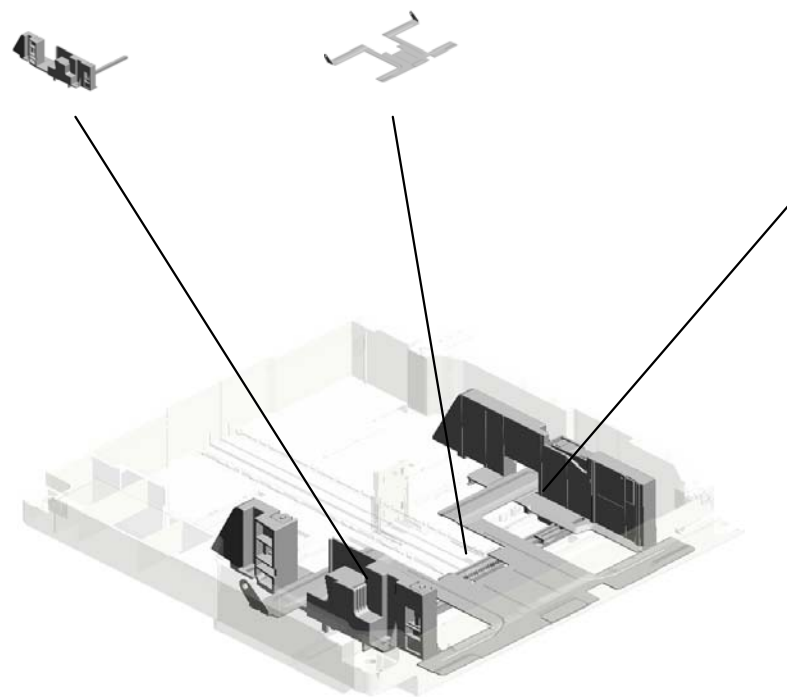

U001	U002	U003	U004	U005	U006	U007	U008	U009	U010	U011	U012	U013	U014	U015	U016	U017	U018	U019	U020
------	------	------	------	------	------	------	------	------	------	------	------	------	------	------	------	------	------	------	------

U004_S012.(NA):TANDEM LCT:RIGHT:ASS'Y

U004 S012 S001
B2346691
SIDE FENCE:TANDEM LCT:R
IGHT:ASS'Y

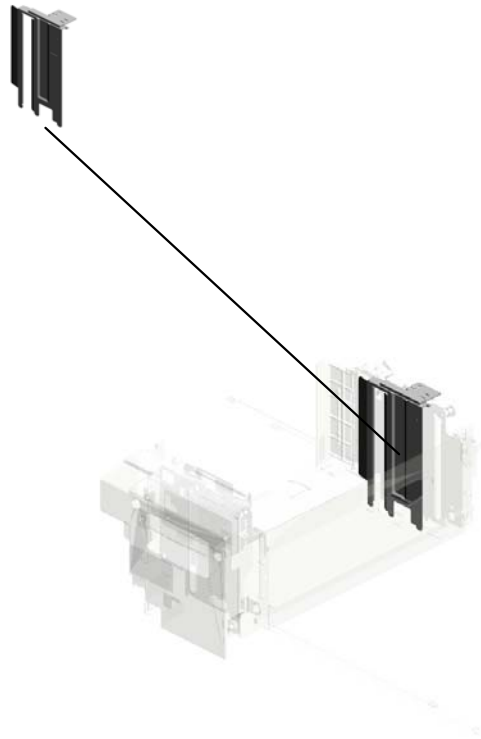

U001	U002	U003	U004	U005	U006	U007	U008	U009	U010	U011	U012	U013	U014	U015	U016	U017	U018	U019	U020
------	------	------	------	------	------	------	------	------	------	------	------	------	------	------	------	------	------	------	------

U004 PAPER FEED

6.03540040N (x2) SCREW-M4X4
 11.03604008N (x31) SCREW - M4X8
 7.03540060N (x17) SCREW-M4X6
 2.03130080N (x2) PAN HEAD SCREW :M3X8
 17.04513006P (x5) TAPPING SCREW: M3X6

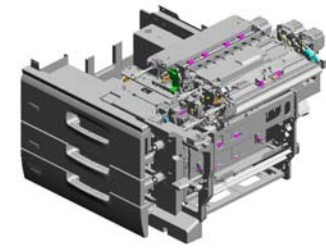

15.04504010N (x2) TAPPING SCREW: M4X10

13.04503008N (x9) TAPPING SCREW - M3X8

23.04524010N (x6) BINDING SELF-TAPPING SCREW:4X10

9.03603008N (x2) SCREW:M3X8

18.04513010N (x4) TAPPING SCREW: 3X10

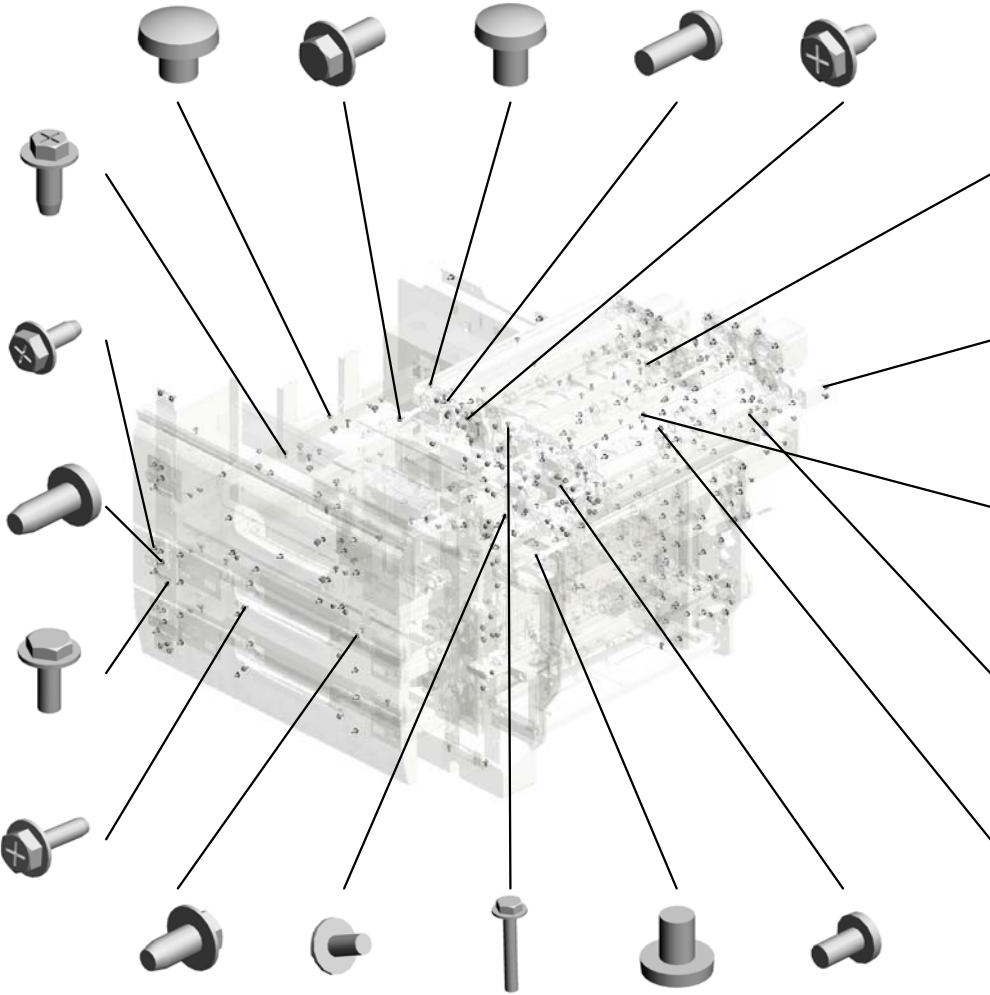

14.04504008N (x20) TAPPING SCREW - M4X8
 8.03603006N SCREW - M3X6 201904-05 X/O
 10.03603020N (x2) SCREW:M3X20
 4.03530040N SCREW - M3X4
 5.03530060N (x9) BIND SCREW - M3 X6

16.04513006N (x144) TAPPING SCREW - 3X6

20.04514008N (x69) TAPPING SCREW: 4X8

21.04514010N (x16) TAPPING SCREW: 4X10

8.03603006N (x15) SCREW - M3X6

19.04514006N (x29) TAPPING SCREW - 4X6

47.08050088 (x4) RETAINING RING - M6
 48.08050089 RETAINING RING - M4

56.11050046 (x85) HARNESS BAND
 59.11050488 HARNESS CLAMP

61.11050511 (x9) HARNESS CLAMP - LWS-0306ZC
 62.11050516 (x3) CLAMP

66.11050723 CLAMPS:WES-0507

U004 PAPER FEED

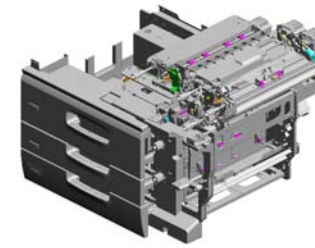

- 36.07200030E (x4) RETAINING RING - M3
- 40.07403808 (x4) BALL BEARING - 8 X16X5MM
- 48.08050089 (x9) RETAINING RING - M4
- 32.06320140G PARALLEL PIN
- 38.07200060E (x54) RETAINING RING - M6

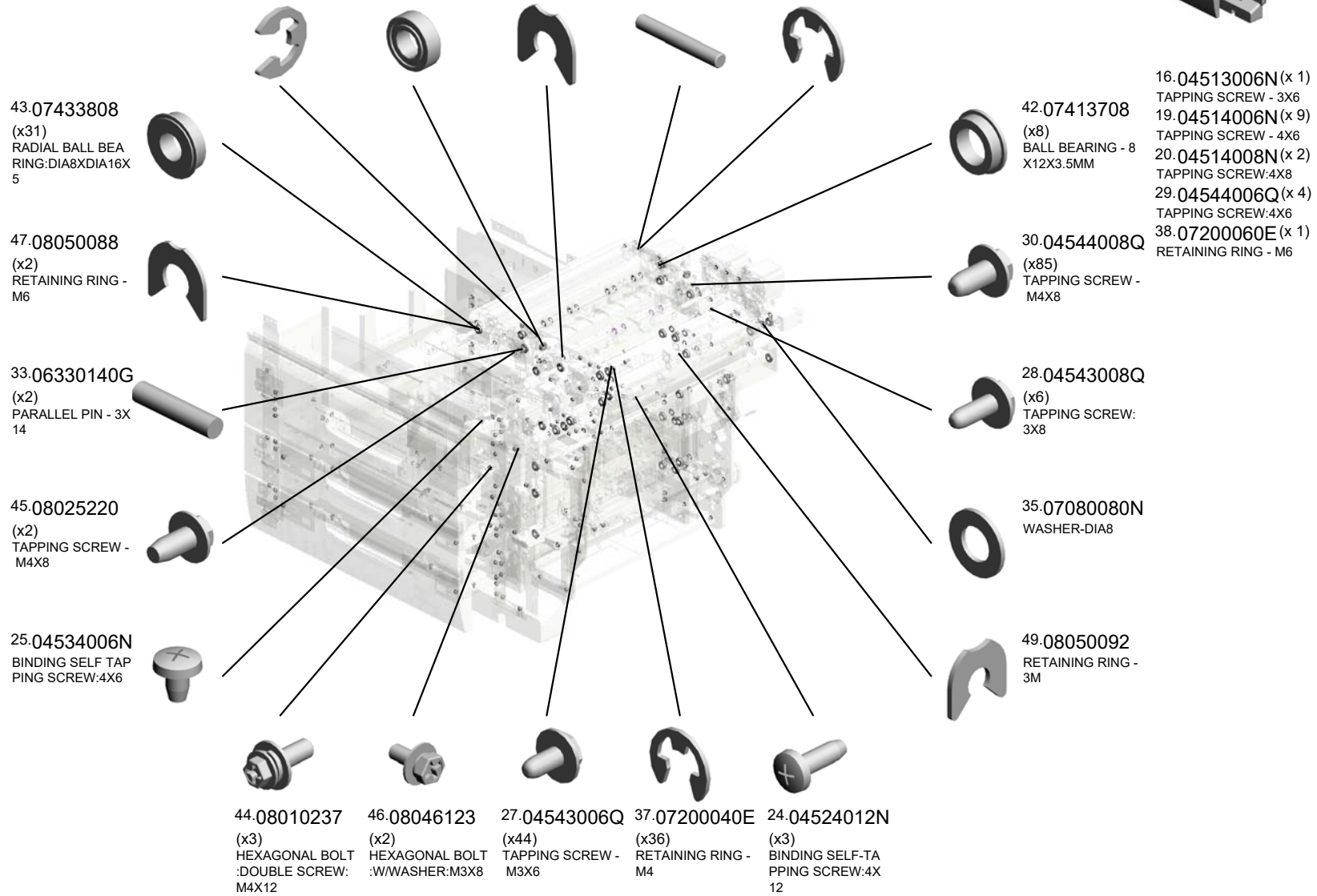

U001	U002	U003	U004	U005	U006	U007	U008	U009	U010	U011	U012	U013	U014	U015	U016	U017	U018	U019	U020
------	------	------	------	------	------	------	------	------	------	------	------	------	------	------	------	------	------	------	------

U004 PAPER FEED

- 62.11050516 (x36) CLAMP
- 60.11050490 (x3) HARNESS CLAMP - IWS-2218
- 67.11050724 (x2) CLAMPS:WES-1210
- 50.08053263 (x2) BEARING - 6X10X6 MM
- 55.09543008N (x4) SCREW - M3X8

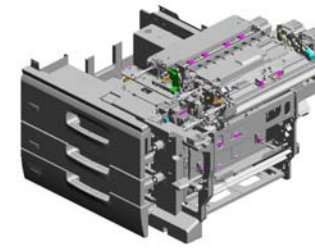

- 57.11050328 (x4) HARNESS CLAMP - ES-0505

- 58.11050487 (x20) HARNESS CLAMP

- 59.11050488 (x5) HARNESS CLAMP

- 71.50530447 (x2) BUSHING - 6MM

- 51.08053386 (x2) BUSHING - 8MM

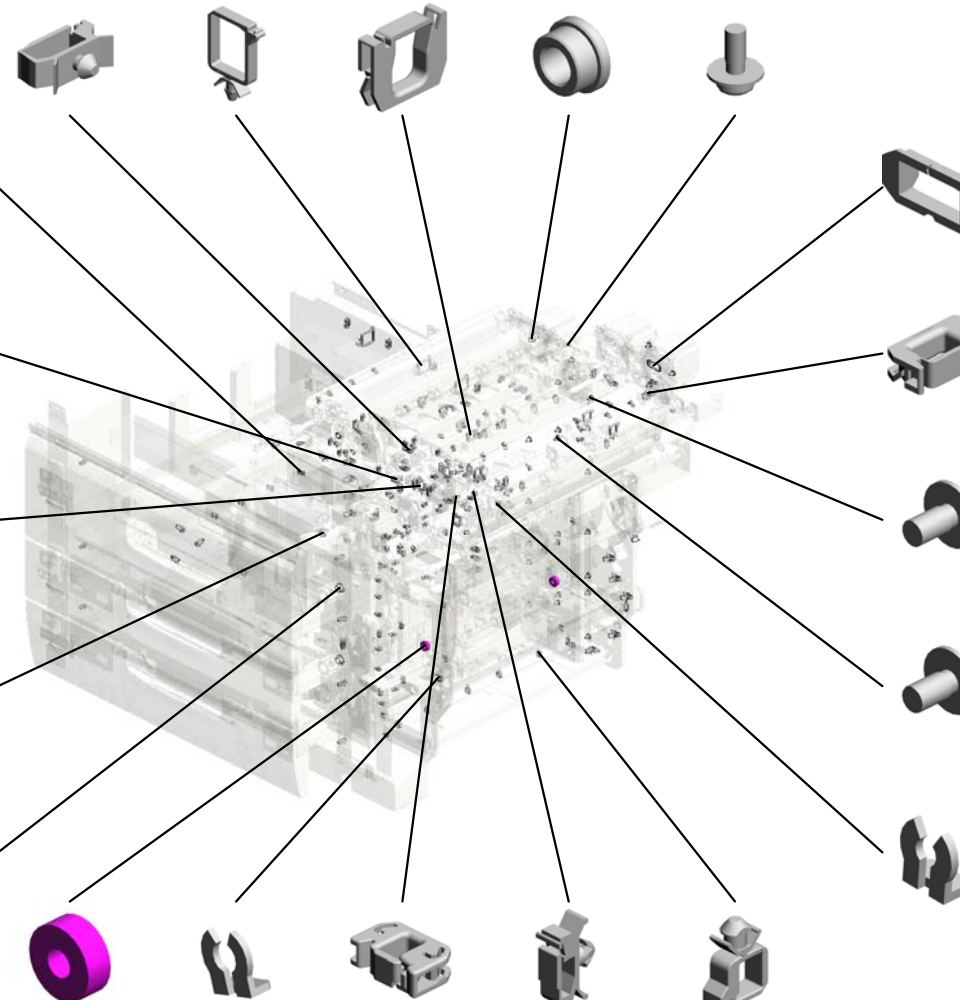

- 69.11060911 BUSHING:SB-1909

- 66.11050723 (x9) CLAMPS:WES-0507

- 54.09514008N (x6) SCREW:POLISHED ROUND:M4X8

- 53.09514006N (x18) SCREW:POLISHED ROUND:M4X6

- 73.54472681 (x6) SNAP RING

- 75.67542866 (x2) ROLLER - POSITIONING GUIDE

- 72.52152621 SNAP RING - M6

- 65.11050692 (x18) CLAMP:LES-0503

- 61.11050511 (x77) HARNESS CLAMP - LWS-0306ZC

- 63.11050534 (x6) CLAMP

U004 PAPER FEED

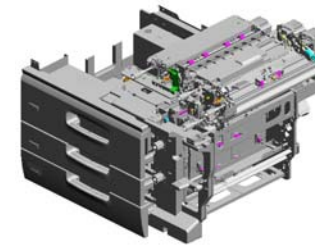

- 93.AA043324 TIMING BELT - B40 S2M152
- 106.AA063268 (x2) CONNECTOR SPRING
- 105.AA061192 (x2) TENSION SPRING: TIMING ROLLER
- 95.AA043443 TIMING BELT - S2 M 140
- 104.AA061191 (x2) TENSION SPRING: REGISTRATION

103.AA060987
TENSION SPRING:
TIMING BELT:10N

85.A2946643
LEFT FRONT FENCE

92.AA043271
TIMING BELT S3M
196T

114.AA066667
SPRING:STRIPPER
PLATE:FRONT

110.AA063695
(x8)
COMPRESSION SP
RING:GRIP

94.AA043325
TIMING BELT - B40
S2M250

96.AA043627
(x2)
TIMING BELT - B40
S2M148

108.AA063693
(x2)
COMPRESSION SP
RING:PRESSURE:
DRIVEN ROLLER

113.AA066419
TORSION SPRING:
GRIP

109.AA063694
(x2)
COMPRESSION SP
RING:HANDLE

111.AA066402
TORSION SPRING:
GUIDE PLATE:REA
R

107.AA063678
(x6)
SPRING - 3.5N

112.AA066403
TORSION SPRING:
GUIDE PLATE:FRO
NT

97.AA043647
TIMING BELT:60S2
M188

77.A2324666
CUSHION - STEPP
ER MOTOR

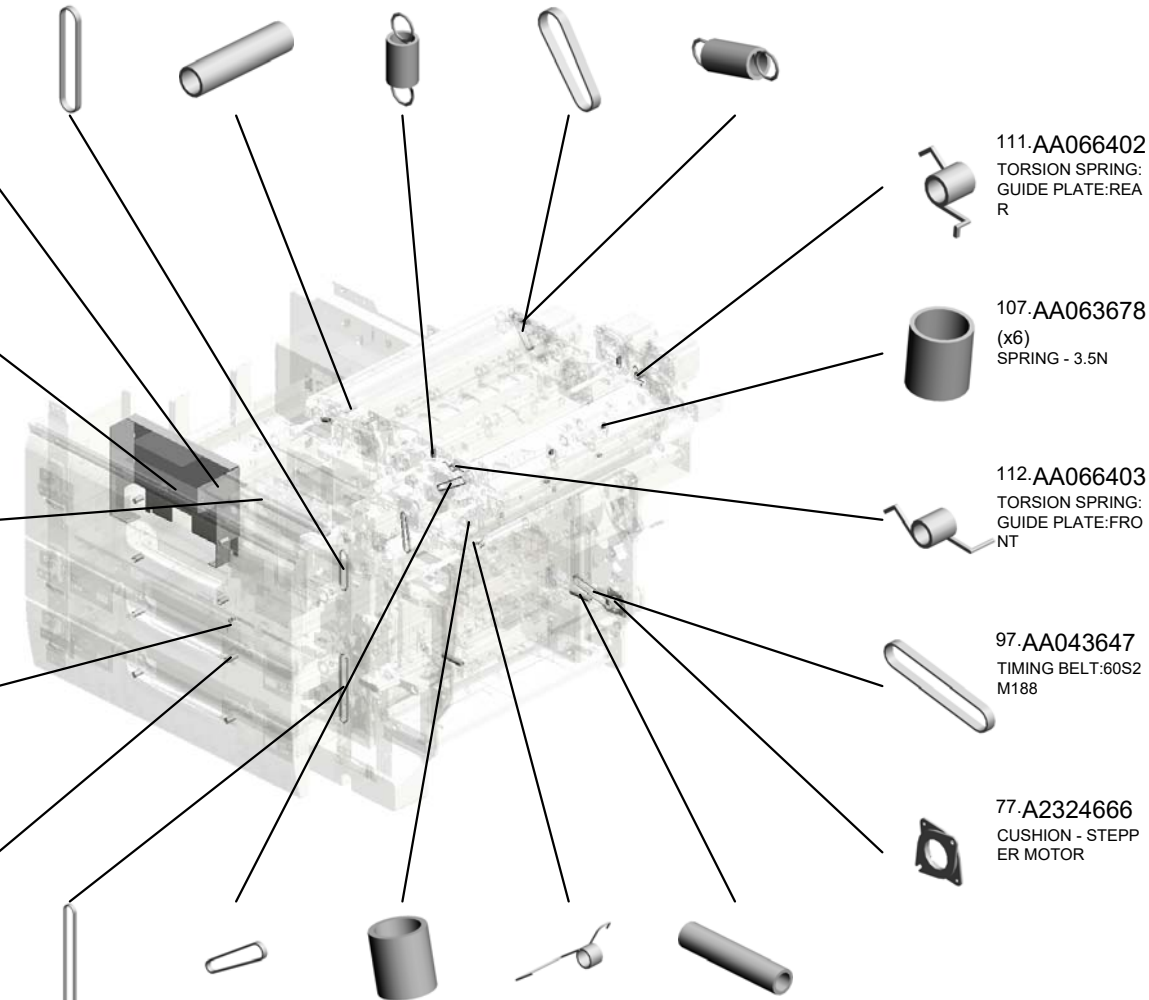

U004 PAPER FEED

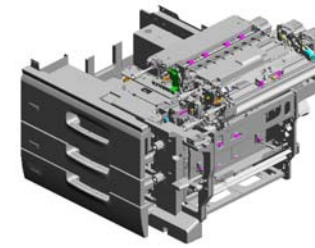

- 121.AA120127 (x2) DISCHARGE BRUSH: FUSING
- 130.AA143812 SCREW - SCALE
- 128.AA143797 (x2) CONNECTOR GUI DE PIN
- 123.AA132203 SPACER - 6MM
- 117.AA082104 (x2) BUSHING - 8X12X7

- 141.AB017725 (x2) GEAR/TIMING PULLEY - 20Z/20T

- 124.AA140686 SHAFT - TIMING PULLEY

- 139.AB013798 GEAR - Z18

- 131.AA148778 (x2) SHAFT: ARM: PLATE

- 129.AA143810 (x2) DEVELOPMENT COVER SCREW

- 115.AA080265 (x2) BUSHING: 6X8X5
- 125.AA140912 (x2) SCREW - 8X14X2.8
- 127.AA143569 (x4) SCREW
- 116.AA080346 (x4) BUSHING: FLANGE TYPE: DIA6
- 126.AA143550 (x2) SCREW: DIA4: M3

- 140.AB014243 (x2) GEAR: IDLER: Z30

- 134.AA161180 (x11) CUSHION: DC STEPPER MOTOR

- 122.AA120150 DISCHARGE BRUSH: REVERSE: 17MM

- 118.AA082144 (x6) BUSHING - 8X12X7

- 120.AA084059 (x8) BALL BEARING HOLDER

U001	U002	U003	U004	U005	U006	U007	U008	U009	U010	U011	U012	U013	U014	U015	U016	U017	U018	U019	U020
------	------	------	------	------	------	------	------	------	------	------	------	------	------	------	------	------	------	------	------

U004 PAPER FEED

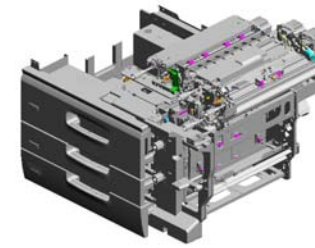

- 165.AG050100 (x4) KNOB - TRANSPOR
RT ROLLER
- 148.AB033084 TIMING PULLEY - 1
5T
- 172.AW500010 (x2) PUSH SWITCH:(S
W1/SW4)
- 173.AW500045 (x2) PUSH SWITCH:(S
W2/SW3/SW13/SW
14)
- 156.AF020852 TRANSPORT ROLL
ER:VERTICAL TRA
NSPORT:DRIVE:EX
IT

- 149.AB033085 TIMING PULLEY - 1
5T

- 171.AW020163 PAPER FEED SEN
SOR:SEN56

- 144.AB019475 GEAR - 48T

- 142.AB017726 (x2) GEAR/TIMING PUL
LEY - 20Z/20T

- 166.AG050101 (x2) KNOB - MISFEED R
EMOVAL

- 150.AC020153 (x3) LENS:LED:4
- 167.AG051141 RELEASE LEVER
- 168.AG070513 MAGNET CATCH
- 157.AF020853 (x2) TRANSPORT ROLL
ER:VERTICAL TRA
NSPORT:DRIVE
- 174.AX040199 (x2) DC MOTOR:RISING
TRAY:ASSY:(M7/B
M2/BM3)

- 145.AB030842 TIMING PULLEY:S2
M:30T

- 170.AW010151 (x2) PHOTO REFLECTI
ON SENSOR:PS12
2TL1-A:(S6/S7/S10/
S11/S12/SEN7/SEN
8/SEN10/SEN32/SE

- 161.AF022167 (x3) TRANSPORT ROLL
ER - DRIVEN

- 160.AF022165 TRANSPORT ROLL
ER - DRIVEN

- 158.AF020854 TRANSPORT ROLL
ER:VERTICAL TRA
NSPORT:DRIVE:C
ONNECTING

U004 PAPER FEED

- 207.B1327541 TRAY BOTTOM PLATE:LEFT REAR
- 181.B0656136 (x3) TRAY LOCK ARM
- 192.B0656831 SENSOR BRACKET
- 178.AX040297 (x2) STEPPER MOTOR: MM56:TRANSPORT:(STM14/STM17)
- 175.AX040276 (x10) STEPPER MOTOR: MM56:TRANSPORT:(STM5/STM6/STM7/STM8/STM9/STM10/STM12/STM13/)

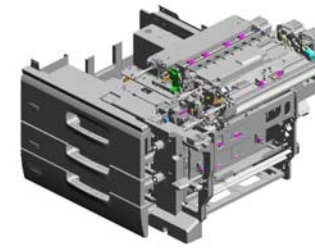

208.B1327561
BACK FENCE:LEFT

209.B1327564
SLIDER:BACK FENCE:LEFT

190.B0656823
TIMING BELT COVER

187.B0656591
(x2)
PAPER TRAY HOLDER BASE

186.B0656589
(x2)
LEFT SUPPORT PLATE

191.B0656830
PULLEY BRACKET

180.B0042995
(x3)
CAP - POSITIONING

211.B1327591
RAIL:PAPER TRAY: ASS'Y

177.AX040280
(x2)
STEPPER MOTOR: DRIVE:(STM24/STM25/STM26/STM27)

201.B1326726
BRACKET:ARM:ASS'Y

179.AX060517
DC STEPPER MOTOR:MM56XL76:(STM16)

189.B0656769
LOCK ARM

203.B1326764
BRACKET:CONNECTOR:RIGHT

202.B1326738
BRACKET:LIFT MOTOR:TANDEM LCT

176.AX040279
STEPPER MOTOR: PAPER TRANSPORT MD:MM42:(STM11)

U004 PAPER FEED

- 238.B2346531 (x3) TIGHTENER BRACKET
- 234.B2346506 (x6) TIMING PULLEY - 30T
- 235.B2346508 (x9) TENSION SPRING
- 241.B2346542 (x3) GRIP DRIVE SHAFT
- 240.B2346533 (x6) TIMING BELT - S2 M152

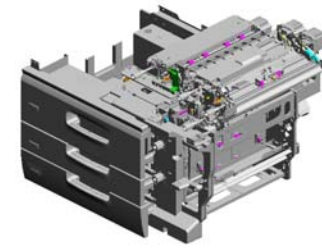

218.B2346141
POSITIONING SLIDE
VE - INNER BACK



237.B2346530
(x3)
BRACKET



228.B2346424
RELEASE GRIP

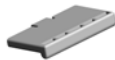

221.B2346198
COVER - SAFETY -
PAPER SIZE SENSOR



229.B2346455
BRACKET - UPPER



220.B2346188
(x2)
SLIDE SLEEVE POSITIONING



217.B2346125
(x2)
HARNES GUIDE BRACKET



230.B2346475
BRACKET - LOWER



231.B2346495
(x2)
GUIDE:FRONT:PAPER TRAY



219.B2346181
(x2)
SLIDE RAIL - RIGHT



236.B2346514
(x3)
TIMING BELT - S2 M126



239.B2346532
(x3)
TIGHTENER BRACKET



242.B2346565
HARNES CLAMP BRACKET



232.B2346497
(x2)
GUIDE:REAR:PAPER TRAY



216.B2346120
(x2)
BRACKET:POSITIONING:PAPER TRAY



U004 PAPER FEED

- 256.B2476950 SHAFT:SLIDER:BACK FENCE
- 281.D0596591 (x2) SPRING:PAPER TRAY:LOCK
- 276.D0596172 (x2) PAPER TRAY STOPPER
- 271.D0592399 (x6) FLANGED HEXAGONAL HEAD BOLT:M3*4
- 264.BB013040 (x2) GEAR:SHIFT:ROLLER:Z30

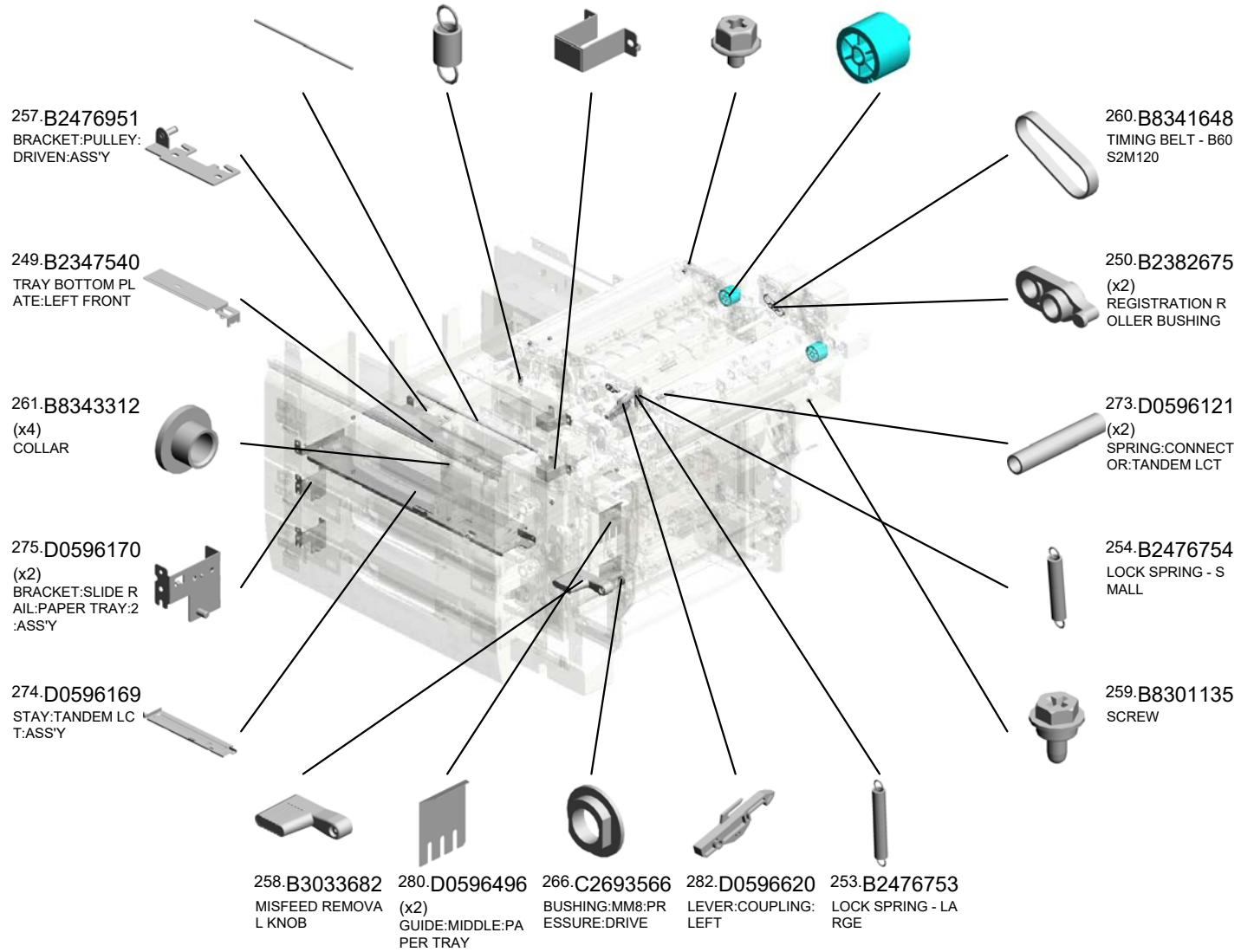
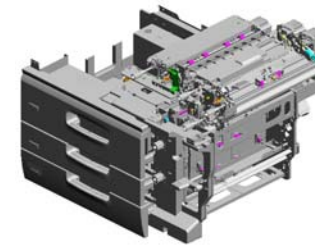

U004 PAPER FEED

- 297.D0742744 (x3) HOLDER:SHIFT:BEARING:FRONT
- 304.D0746497 (x4) DECAL:POSITIONING DISPLAY:TCRU
- 295.D0742685 SYNCHRONOUS BELT:B80S2M190
- 294.D0742681 SHAFT:CAM:SHIFT
- 296.D0742739 (x4) PRESSURE ROLLER:TRANSPORT ROLLER:SHIFT:DRIVEN

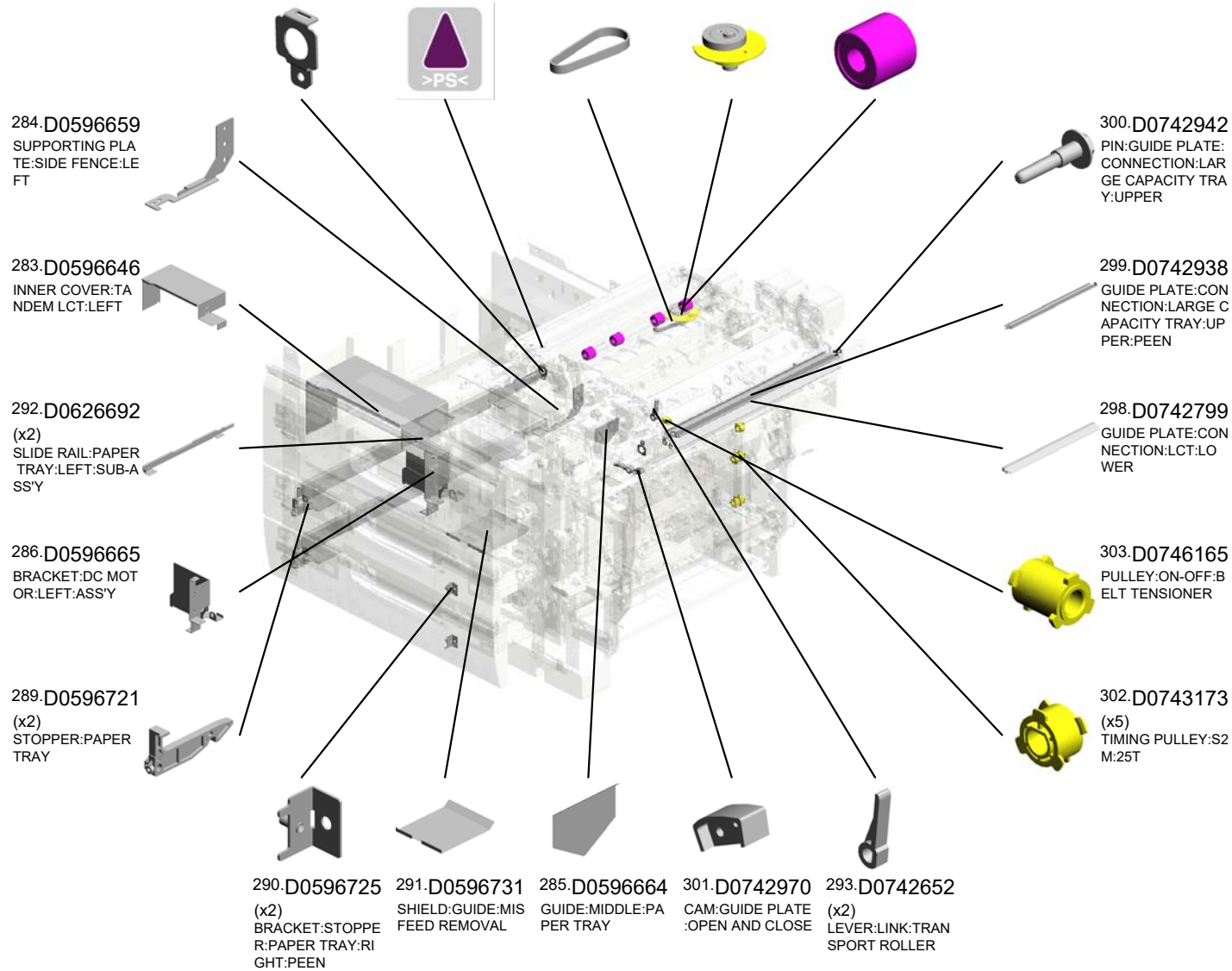
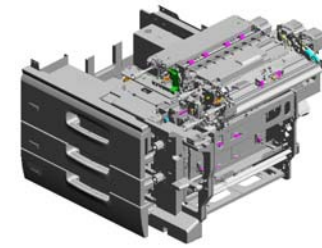

U004 PAPER FEED

305.D0747330 SLIDE RAIL:LEFT:NO.1
 324.D0747561 GRIP:UPPER
 325.D0747562 GRIP:LOWER
 306.D0747331 STAY:SLIDE RAIL:LEFT INNER REAR:NO.1:PEEN
 308.D0747335 (x2) STAY:SLIDE RAIL:LEFT:NO.2

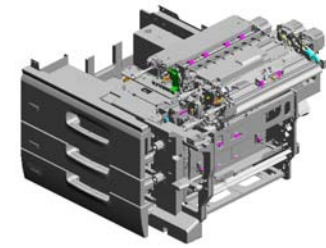

316.D0747392
 DECAL:PAPER TRAY:NO.1



307.D0747333
 STAY:SLIDE RAIL:LEFT FRONT:NO.1



327.D0747567
 BRACKET:ARM:LINK:LEFT



317.D0747393
 DECAL:PAPER TRAY:NO.2



326.D0747563
 BRACKET:SLIDER:GRIP



333.D0931266
 DECAL:WARNING (HIGH TEMPERATURE):LENGTHWISE

309.D0747349 (x4)
 COMPRESSION SPRING:BRACKET:SENSOR:PAPER SIZE SENSOR

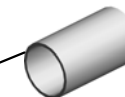

319.D0747433 (x2)
 STUD:HANDLE:RELEASE:ASSY



320.D0747446
 BRACKET:DC STEPPER MOTOR:TRANSPORT UNIT

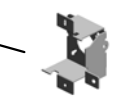

318.D0747431
 STAY:HANDLE:ASSY



332.D0747607 (x2) ARM:PAPER TRAY:GRIP
 331.D0747606 (x2) GRIP:PAPER TRAY:NO.2
 330.D0747603 (x2) PLATE:GRIP:PAPER TRAY:NO.2
 328.D0747573 (x2) BRACKET:ARM:PLATE
 310.D0747381 DECAL:VERTICAL TRANSPORT:A1



U001	U002	U003	U004	U005	U006	U007	U008	U009	U010	U011	U012	U013	U014	U015	U016	U017	U018	U019	U020
------	------	------	------	------	------	------	------	------	------	------	------	------	------	------	------	------	------	------	------

U004 PAPER FEED

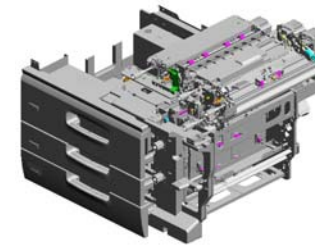

- 341.D0BX2766 TIMING ROLLER:TRANSFER:DRIVE:PRESS FIT
- 347.D0BX2990 CONTACT IMAGE SENSOR:HINGE:(PCB24)
- 335.D0BX2576 SHEET:CONTACT IMAGE SENSOR:DUCT:2
- 336.D0BX2679 HOLDER:DC STEP PER MOTOR:SHIFT
- 337.D0BX2702 TIMING ROLLER:REGISTRATION:DRIVE:PRESS FIT

352.D0BX6648
COIL SPRING:TANDEM TRAY:LOCK

349.D0BX5430
PCB:CRB:(PCB22)

334.D0BX2575
SHEET:CONTACT IMAGE SENSOR:DUCT:1

360.D0BX7531
COVER:PAPER TRAY:NO.1

359.D0BX7512
COVER:PAPER TRAY:NO.2

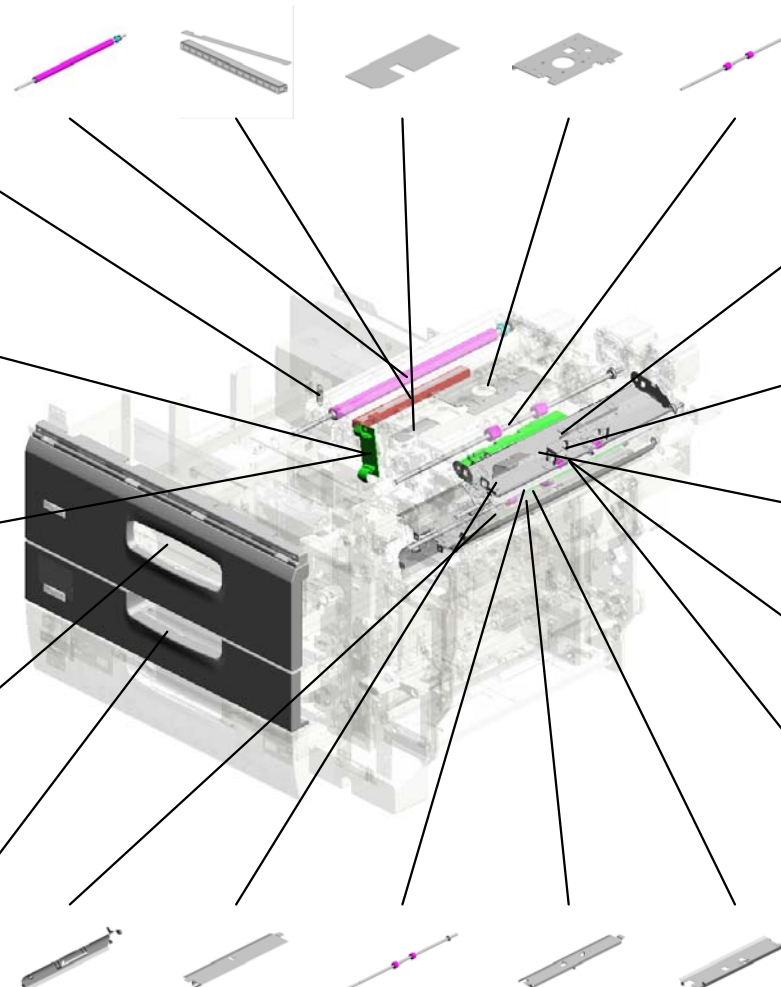

342.D0BX2851
GUIDE PLATE:CONNECTING:OPEN AND CLOSE:PEEN

343.D0BX2856
GUIDE PLATE:CONNECTING:LARGE CAPACITY TRAY:PEEN

348.D0BX5422
PCB:DRB:(PCB20)

338.D0BX2703
TRANSPORT ROLLER:CONNECTING:LARGE CAPACITY TRAY:PRESS FIT

340.D0BX2705
TRANSPORT ROLLER:SHIFT:TRAILING EDGE:PRESS FIT

- 356.D0BX6775 GUIDE PLATE:OPEN AND CLOSE:VERTICAL TRANSPORT:UPPER:PEEN
- 344.D0BX2900 GUIDE PLATE:CONNECTING:DUPLIX:EXIT:PEEN
- 339.D0BX2704 TRANSPORT ROLLER:CONNECTING:MAIN:PRESS FIT
- 346.D0BX2906 GUIDE PLATE:CONNECTING:LOWER:PEEN
- 345.D0BX2902 GUIDE PLATE:CONNECTING:UPPER:PEEN

U004 PAPER FEED

373.D1792651 GUIDE PLATE:REGISTRATION:EXIT
 384.D1792711 TIMING ROLLER:TRANSFER-DRIVEN:PRESS FIT
 380.D1792685 CASE:REMOVE PAPER DUST:ASSY
 381.D1792689 COVER:REGISTRATION:EXIT
 368.D1792621 SHAFT:DRIVEN ROLLER:SHIFT

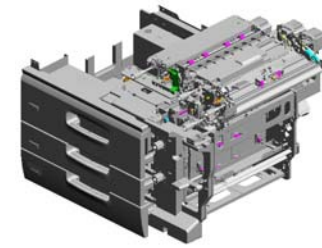

382.D1792691 (x2) TENSION SPRING:PRESSURE ROLLER



365.D1316511 BRACKET:CONNECTOR:LEFT



374.D1792660 BRACKET:GUIDE PLATE:FRONT:CIS



372.D1792648 PLATE:ADJUSTING PIN



371.D1792643 (x2) CAM:REGISTRATION:GATE:RELEASE



369.D1792631 GUIDE PLATE:SHIFT:REGISTRATION:UPPER
 379.D1792684 REGISTRATION GUIDE:OPEN AND CLOSE
 378.D1792675 COVER:REGISTRATION:DOUBLE FEE D SENSOR
 377.D1792670 GUIDE PLATE:REGISTRATION:TIMING:LOWER
 385.D1792727 SHAFT:TIMING ROLLER:REGISTRATION:DRIVEN

375.D1792661 BRACKET:GUIDE PLATE:INNER BACK:CIS



383.D1792698 COMPRESSION SPRING:SHIFT

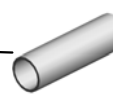

370.D1792642 HOLDER:SHIFT:BEARING:REAR



386.D1792751 (x2) BRACKET:DC STEPPER MOTOR:PAPER FEED:TIMING



376.D1792666 GUIDE PLATE:REGISTRATION:TIMING:UPPER



U004 PAPER FEED

394.D1792783 COVER:BASE:MAIN PAPER SMD
 392.D1792764 SHAFT:CAM:REGISTRATION:TIMING
 393.D1792768 TIMING PULLEY:S2 M:30T
 387.D1792754 (x2) BRACKET:DC STEPPER MOTOR:PAPER FEED
 389.D1792758 (x2) GEAR:Z41:TIMING PULLEY:T41

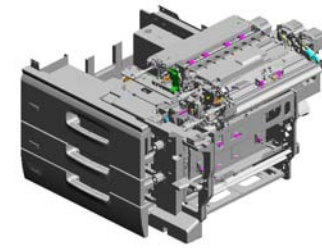

398.D1792861 BRACKET:OPEN AND CLOSE:LARGE CAPACITY TRAY

391.D1792763 (x2) CAM:REGISTRATION:TIMING

406.D1792944 (x2) DISC:ON-OFF:SENSOR

399.D1792872 BRACKET:DC STEPPER MOTOR:TRAILING EDGE

405.D1792943 BRACKET:CAM:ON-OFF

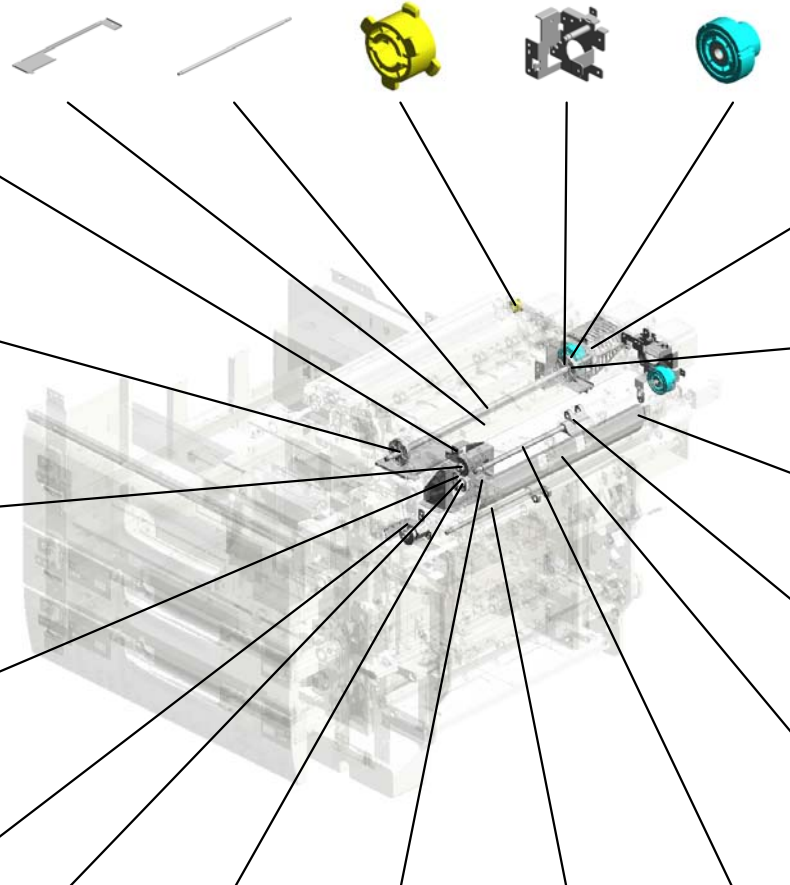

390.D1792760 COVER:MOTOR

388.D1792757 (x2) TIGHTENER:BRACKET:DC STEPPER MOTOR

401.D1792909 JOINT:CONNECTING:DRIVEN

402.D1792932 (x2) ARM:ON-OFF:TRANSPORT ROLLER

395.D1792809 GUIDE PLATE:SHIFT:LEFT LOWER

400.D1792891 GUIDE PIN:SHIFT:TRAILING EDGE

396.D1792814 (x2) GUIDE:SHIFT:TRAILING EDGE

397.D1792817 BRACKET:SHIFT:SYNCHRONOUS BELT

404.D1792934 SHAFT:LINK:ON-OFF:CONNECTING

403.D1792933 SHAFT:LINK:ON-OFF:CONNECTING:LARGE CAPACITY TRAY

U001	U002	U003	U004	U005	U006	U007	U008	U009	U010	U011	U012	U013	U014	U015	U016	U017	U018	U019	U020
------	------	------	------	------	------	------	------	------	------	------	------	------	------	------	------	------	------	------	------

U004 PAPER FEED

- 411.D1792963 BRACKET:GRIP:OPEN AND CLOSE:GUIDE PLATE
- 409.D1792952 BRACKET:DC STEPPER MOTOR:DRIVEN:ON-OFF
- 407.D1792946 SHAFT:CAM:ON-OFF:LARGE CAPACITY TRAY
- 408.D1792948 (x2) CAM:TRANSPORT ROLLER:ON-OFF
- 413.D1795435 PCB:URRB:(PCB19)

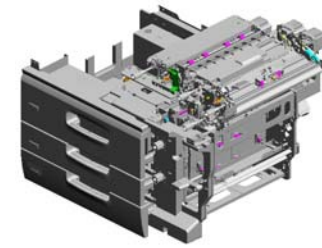

416.D1796643
RAIL:TANDEM LCT:MIDDLE:ASS'Y

417.D1796726
(x3)
COVER:LED:MAIN

412.D1792964
GUIDE:MAIN:CONNECTING:OPEN AND CLOSE

414.D1796619
(x2)
STAY:HOLDER:PAPER TRAY:ASS'Y

415.D1796626
(x2)
SUPPORTING PLATE:RIGHT:HOLDER:PAPER TRAY

410.D1792960
GUIDE PLATE:OPEN AND CLOSE:MAIN:CONNECTING

428.D1796761
SYNCHRONOUS BELT:60S2M226

429.D1796762
SYNCHRONOUS BELT:60S2M166

430.D1796763
SYNCHRONOUS BELT:80S2M300

423.D1796751
BRACKET:STM:MM56:TRANSPORT:LENGTHWISE

427.D1796758
SYNCHRONOUS BELT:80S2M216

424.D1796753
BRACKET:JOINT:PROTECT

425.D1796756
BRACKET:CONNECTING:JOINT

431.D1796764
SYNCHRONOUS BELT:80S2M242

426.D1796757
SHAFT:DRIVE

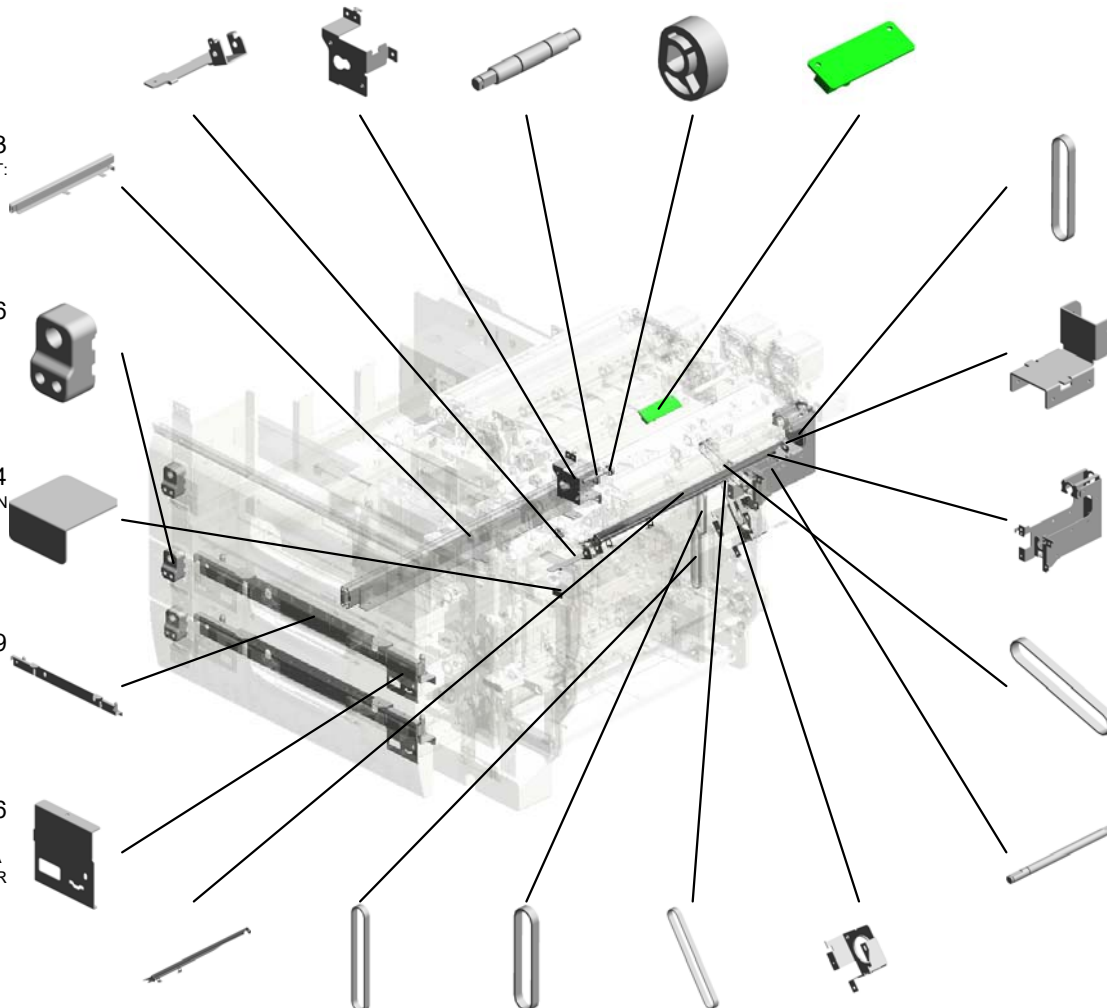

U004 PAPER FEED

444.D1797550 COVER:PAPER TRAY:NO.1:UPPER
 447.D1797564 BRACKET:SLIDER:GRIP:UPPER
 452.D1797581 STAY:COVER:TANDEM LCT
 446.D1797562 ARM:LINK:RIGHT
 448.D1797566 BRACKET:ARM:LINK:RIGHT

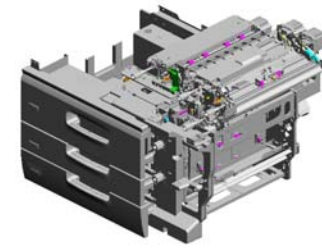

443.D1797540 (x8) SCREW:DIA6:M4X3:ADHESIVE

445.D1797561 ARM:LINK:LEFT

451.D1797579 COVER:GRIP:INNER BACK

440.D1797519 (x2) BRACKET:STOPPER:PAPER TRAY

449.D1797573 BRACKET:ARM:UNLOCK

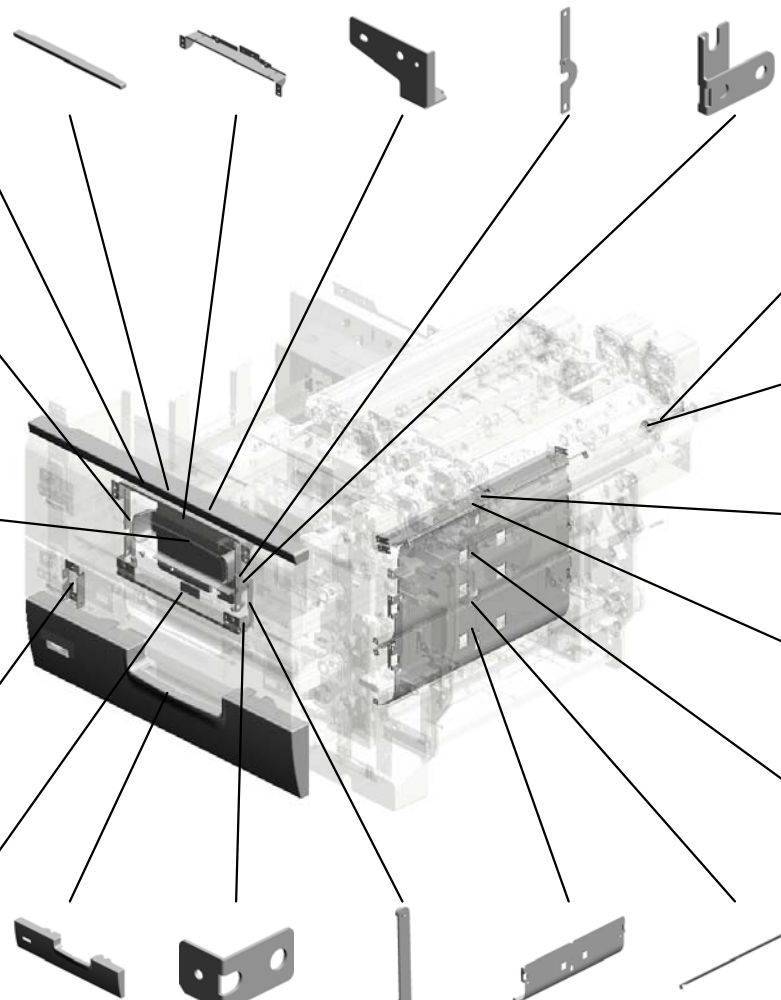

432.D1796768 SHAFT:JOINT:CONNECTING:ASSY

438.D1796797 COMPRESSION SPRING:JOINT:TRANSPORT

433.D1796781 GUIDE PLATE:VERTICAL TRANSPORT:F1

434.D1796783 GUIDE PLATE:VERTICAL TRANSPORT:F1:LOWER

436.D1796786 GUIDE PLATE:VERTICAL TRANSPORT:F2

439.D1797513 COVER:PAPER TRAY:NO.3

450.D1797576 (x2) ARM:LINK:UNLOCK

442.D1797533 (x2) JOINT:LINK:UNLOCK:PEEN

435.D1796784 GUIDE PLATE:VERTICAL TRANSPORT:F3

437.D1796790 GUIDE PLATE:VERTICAL TRANSPORT:F2:LOWER

U004 PAPER FEED

468.D2702624 SIDE PLATE:SHIFT :REGISTRATION:F RONT:PEEN
 477.D2702786 DUCT:FAN:CONTA CT IMAGE SENSO R
 473.D2702637 (x4) COLOR:4M
 475.D2702656 GUIDE PLATE:REG ISTRATION:CIS
 474.D2702647 SHAFT:SHIFT

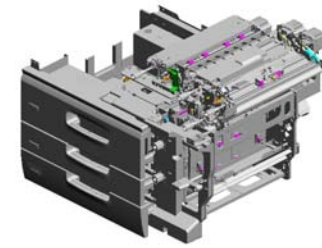

459.D1947552 SIDE PLATE:TANDE M LCT:LEFT SIDE WAYS

465.D2236747 DC MOTOR:TANDE M LCT:19.2W:BRU SH:(BM4)

454.D1797591 (x3) PLATE:TRANSPAR ENT:LED

456.D1797597 (x3) COVER:LED

455.D1797596 (x3) DIFFUSION PLATE: LED

453.D1797586 STOPPER:TANDE M LCT

466.D2416290 (x2) LED:RED

471.D2702634 BRACKET:HOOK:C OIL SPRING:FRON T:PEEN

472.D2702636 GUIDE PLATE:SHIF T:REGISTRATION: LOWER

458.D1947346 DC MOTOR:RISE:T ANDEM LCT:ASS'Y: 19.2W:BRUSH:(BM 1)

467.D2702622 (x2) TENSION SPRING: 48N

469.D2702627 SIDE PLATE:SHIFT :REGISTRATION:R EAR:PEEN

470.D2702632 BRACKET:HOOK:C OIL SPRING:REAR: PEEN

457.D1942945 HOLDER:CAM:SHI FT

478.D2702802 STAY:SHIFT:TRAILI NG EDGE

U004 PAPER FEED

491.D2706721 COVER:GUARD:HA
RNESS
484.D2706453 (x2)
SHAFT:MISFEED R
EMOVAL
509.G0703088 (x2)
SPACER:DEVELOP
MENT ROLLER
507.D7315310 PCB:URTB:DOCUM
ENT FEEDER:ASS'
Y:(PCB18)
508.G0602296 (x4)
BALL BEARING:8X
16X5MM

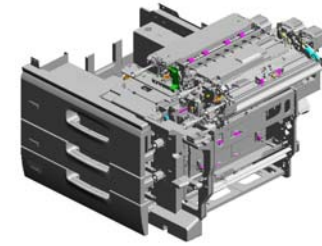

492.D2706725 COVER:GUARD:HA
RNESS

506.D5165200 (x6)
PCB:LED:ASS'Y:(P
CB35/PCB36/PCB3
7/PCB38/PCB39/PC
B40)

497.D2707574 SHAFT:ARM:UN LO
CK

494.D2707518 (x2)
SHAFT:STOPPER:
PAPER TRAY

504.D5161326 DECAL:PAPER TR
AY:DESIGN SKETC
H:3



481.D2702947 SHAFT:CAM:ON-O
FF:MAIN

482.D2702965 SHAFT:GUIDE PLA
TE:OPEN AND CLO
SE

480.D2702816 SHAFT:TRAILING E
DGE:SHIFT

501.D3553844 (x4)
SHOE:HANDLE:RE
LEASE

505.D5163809 (x2)
CUSHION:STAY

511.G1784900 (x3)
COVER:DC STEPP
ER MOTOR:MM56

485.D2706541 (x3)
SHAFT:DRIVE:FEE
D:ASSY

503.D4342535 TORSION SPRING:
PROOF TRAY

483.D2702986 BRACKET:GUIDE P
LATE:CONNECTIO
N:LARGE CAPACIT
Y TRAY

479.D2702810 GUIDE PLATE:SHIF
T:RIGHT UPPER:P
EEN

U001	U002	U003	U004	U005	U006	U007	U008	U009	U010	U011	U012	U013	U014	U015	U016	U017	U018	U019	U020
------	------	------	------	------	------	------	------	------	------	------	------	------	------	------	------	------	------	------	------

U004 PAPER FEED

523.M2057311 518.GX640028 524.M2057466
 DISC:GATE:REGIS FAN MOTOR DC24 DUCT:SHIFT:CIS
 TRATION:HOME P V 1.92W:(FAN3/FA
 OSITION SENSOR N28/FAN29)

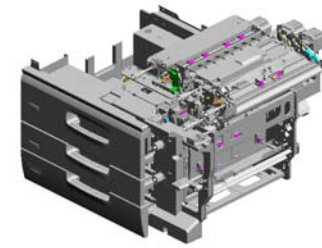

519.H5194238
 (x2)
 SPACER:ROLLER:
 CONNECTING

520.M0777428
 BALL BEARING:RE
 GISTRATION:DRIV
 EN:FRONT

528.D2707389
 DECAL:PAPER SE
 T DIRECTION:TAN
 DEM LCT:LEFT
 201909-02 O/O

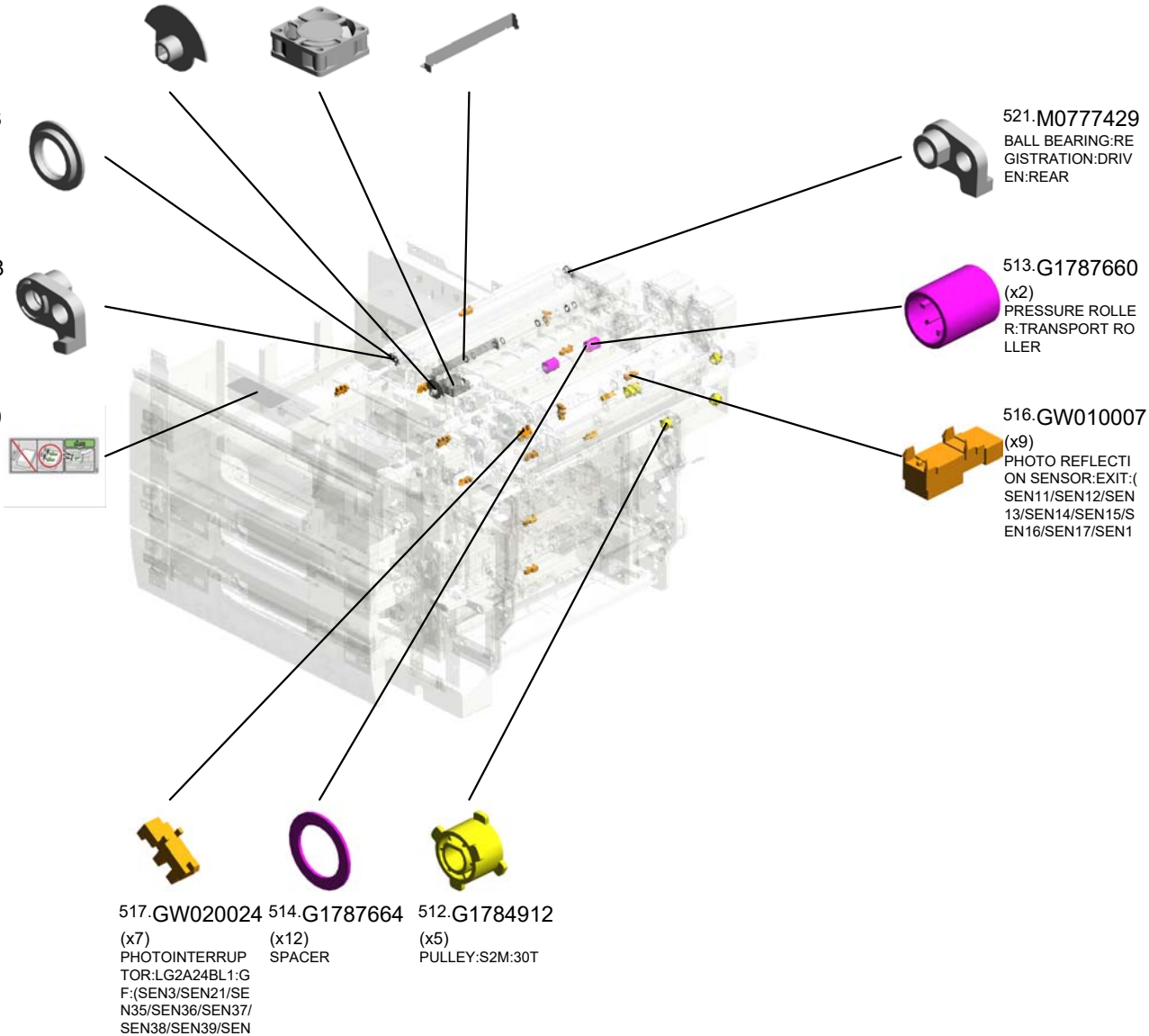

U001	U002	U003	U004	U005	U006	U007	U008	U009	U010	U011	U012	U013	U014	U015	U016	U017	U018	U019	U020
------	------	------	------	------	------	------	------	------	------	------	------	------	------	------	------	------	------	------	------

U004_S001
ARM:REGISTRATION:TIMING:ASS'Y

40.07403808
(x2)
BALL BEARING - 8
X16X5MM



476.D2702771
ARM:REGISTRATI
ON:TIMING:ASSY



38.07200060E
(x6)
RETAINING RING -
M6

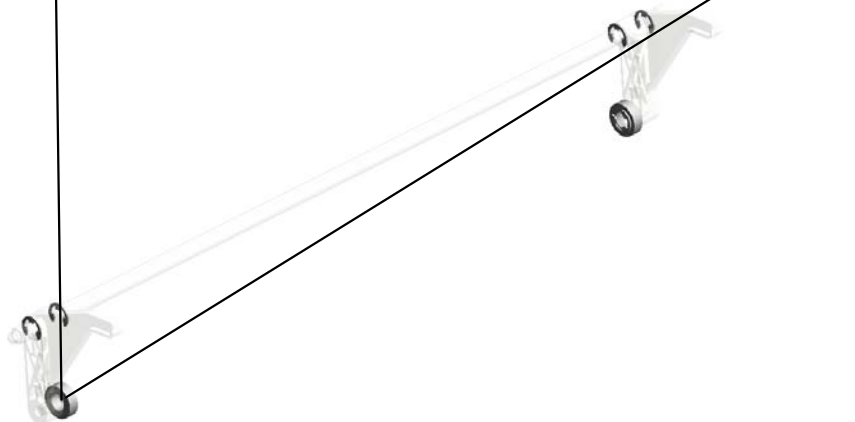

U001	U002	U003	U004	U005	U006	U007	U008	U009	U010	U011	U012	U013	U014	U015	U016	U017	U018	U019	U020
------	------	------	------	------	------	------	------	------	------	------	------	------	------	------	------	------	------	------	------

U004_S002
REGISTRATION ROLLER:GATE:ASS'Y

39.07200080E
(x4)
RETAINING RING -
M8



522.M2057305
REGISTRATION R
OLLER:GATE:ASS'
Y

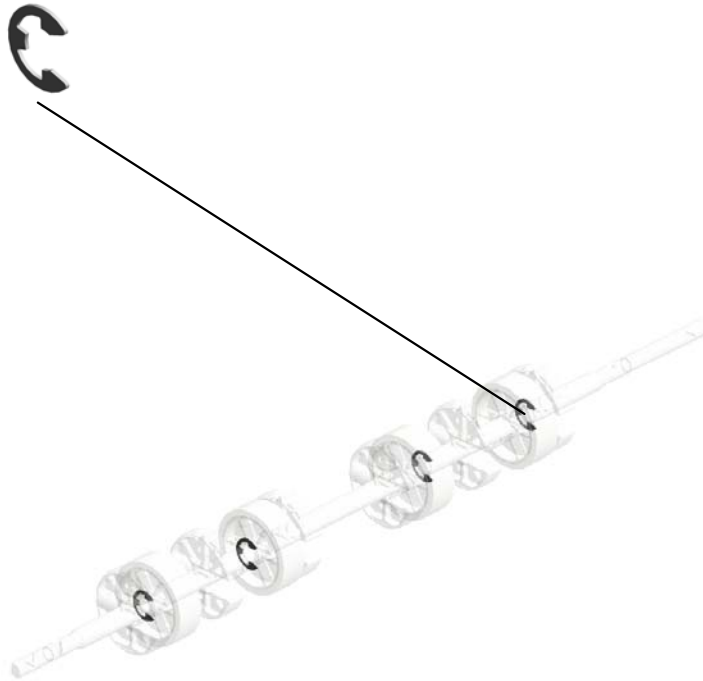

U001	U002	U003	U004	U005	U006	U007	U008	U009	U010	U011	U012	U013	U014	U015	U016	U017	U018	U019	U020
------	------	------	------	------	------	------	------	------	------	------	------	------	------	------	------	------	------	------	------

U004_S003
DC SOLENOID:LOCK:ASS'Y:(SOL5)

510.G1782971 13.04503008N
LEVER:LOCK:TAN TAPPING SCREW -
DEM LCT M3X8



461.D2236231
DC SOLENOID:LO
CK:ASS'Y:(SOL5)

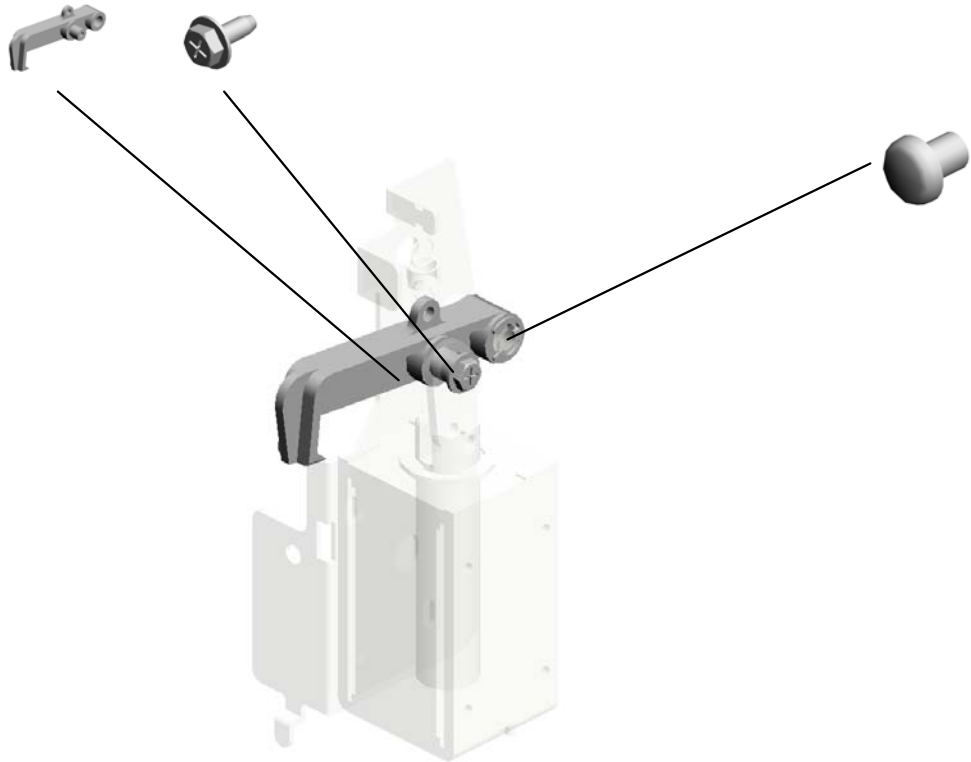

1.03130040N
SCREW:M3X4

1.03130040N(x 1)
SCREW:M3X4
37.07200040E(x 1)
RETAINING RING - M4

U001	U002	U003	U004	U005	U006	U007	U008	U009	U010	U011	U012	U013	U014	U015	U016	U017	U018	U019	U020
------	------	------	------	------	------	------	------	------	------	------	------	------	------	------	------	------	------	------	------

U004_S004
DC SOLENOID:COUPLING:ASS'Y:(SOL6)

37.07200040E
RETAINING RING -
M4

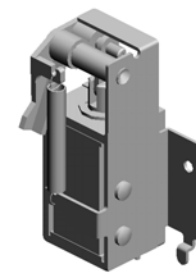

462.D2236233
DC SOLENOID:CO
UPLING:ASS'Y:(SO
L6)

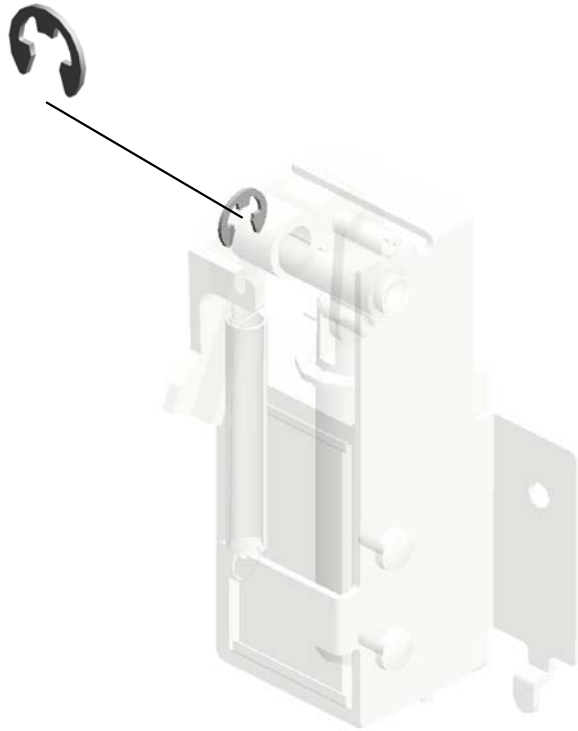

U001	U002	U003	U004	U005	U006	U007	U008	U009	U010	U011	U012	U013	U014	U015	U016	U017	U018	U019	U020
------	------	------	------	------	------	------	------	------	------	------	------	------	------	------	------	------	------	------	------

U004_S005
STOPPER:REGISTRATION:TANDEM LCT:ASS'Y

20.04514008N
TAPPING SCREW:
4X8



441.D1797525
STOPPER:REGIST
RATION:TANDEM L
CT:ASSY



U001	U002	U003	U004	U005	U006	U007	U008	U009	U010	U011	U012	U013	U014	U015	U016	U017	U018	U019	U020
------	------	------	------	------	------	------	------	------	------	------	------	------	------	------	------	------	------	------	------

U004_S006
PAPER FEED UNIT:PAPER BANK:ASS'Y

61.11050511 (x13) HARNESS CLAMP - LWS-0306ZC
 64.11050551 (x2) CLAMP:LES-0505
 74.54472706 GEAR - 15T
 12.04340060N (x3) PAN SELF-TAPPING SCREW:M4X6
 47.08050088 (x2) RETAINING RING - M6



351.D0BX6628
PAPER FEED UNIT
:PAPER BANK:ASS'
Y

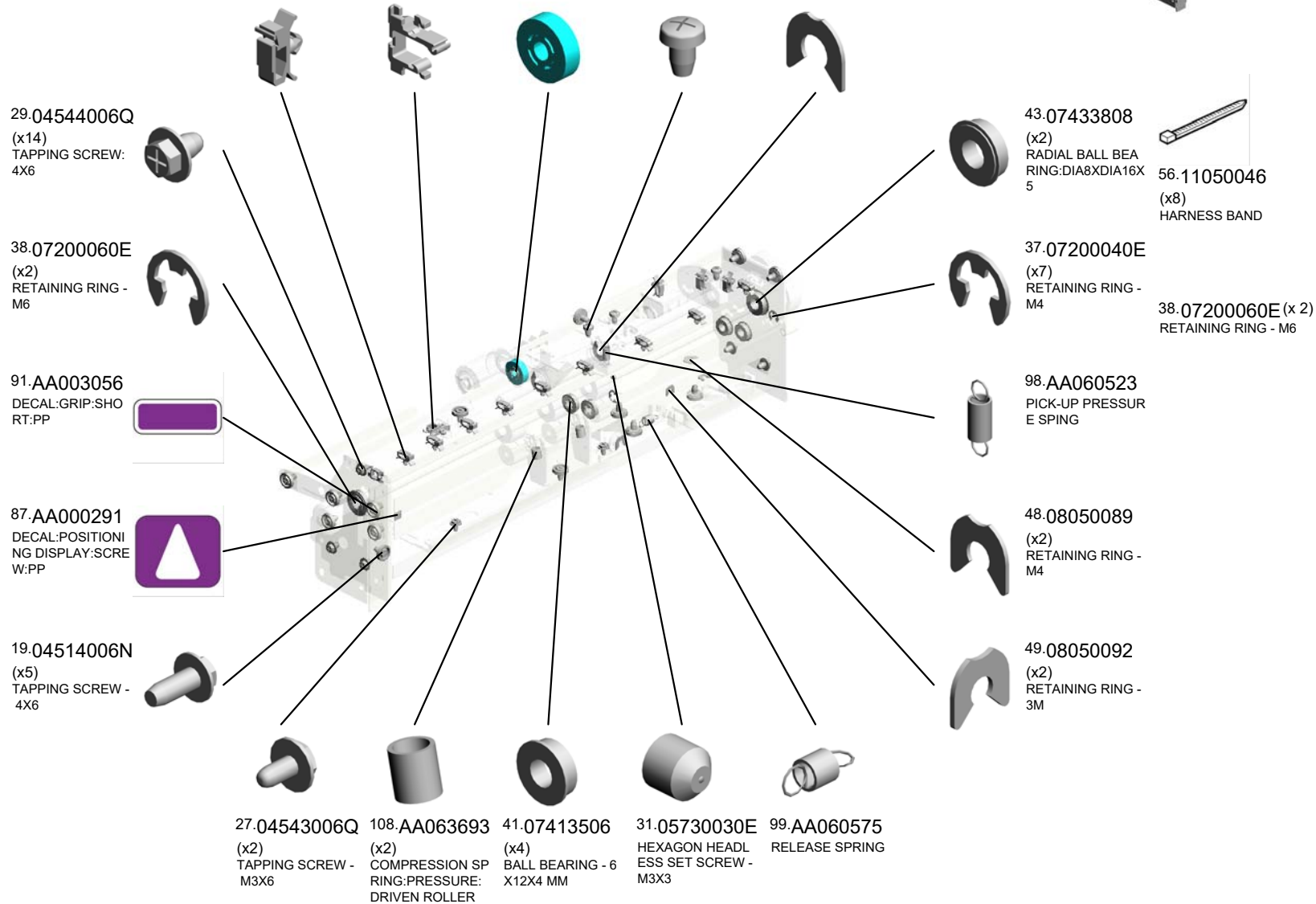

U001	U002	U003	U004	U005	U006	U007	U008	U009	U010	U011	U012	U013	U014	U015	U016	U017	U018	U019	U020
------	------	------	------	------	------	------	------	------	------	------	------	------	------	------	------	------	------	------	------

U004_S006
 PAPER FEED UNIT:PAPER BANK:ASS'Y

- 214.B2342624 BALL BEARING - 8 X12X5
- 225.B2346275 PICKUP ARM
- 154.AF020850 TRANSPORT ROLLER:DRIVE:PAPER FEED UNIT
- 182.B0656345 PAPER END SENSOR:DRIVE:PAPER FEED UNIT
- 226.B2346288 SENSOR BRACKET - SENSOR

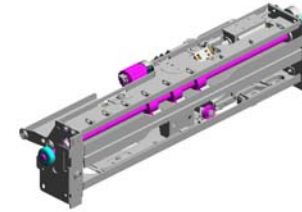

351.D0BX6628
 PAPER FEED UNIT
 :PAPER BANK:ASS'
 Y

162.AF030072
 PAPER FEED ROLLER:PICKUP



163.AF031098
 PAPER FEED ROLLER:FEED



164.AF032098
 PAPER FEED ROLLER:SEPARATE

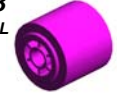

170.AW010151
 (x2)
 PHOTO REFLECTIVE SENSOR:PS12 2TL1-A:(S6/S7/S10/S11/S12/SEN7/SEN8/SEN10/SEN32/SEN



262.BB013007
 GEAR - 20Z

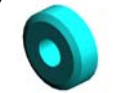

227.B2346301
 TORQUE LIMITER: 75MN M



155.AF020851
 TRANSPORT ROLLER:DRIVEN:PAPER FEED UNIT



224.B2346242
 GUIDE - ROLLER:DRIVEN PRESSURE



120.AA084059
 (x2)
 BALL BEARING HOLDER



136.AB011591
 GEAR:REVERSE



119.AA083009
 CLUTCH ROLLER - 8X18X11



143.AB017771
 GEAR:TRANSPORT ROLLER:INPUT:Z 23/Z28

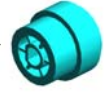

222.B2346222
 REVERSE DRIVE SHAFT



223.B2346223
 DRIVEN REVERSE SHAFT



135.AB011392
 DRIVE REVERSE GEAR - 24Z

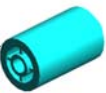

U001	U002	U003	U004	U005	U006	U007	U008	U009	U010	U011	U012	U013	U014	U015	U016	U017	U018	U019	U020
------	------	------	------	------	------	------	------	------	------	------	------	------	------	------	------	------	------	------	------

U004_S006
PAPER FEED UNIT:PAPER BANK:ASS'Y

- 278.D0596277 COVER:GEAR:PAPER FEED ROLLER
- 321.D0747521 GUIDE PLATE:UPPER:PAPER FEED UNIT
- 279.D0596278 COVER:GEAR:REVERSE
- 323.D0747527 SHAFT:FEED:ASS'Y
- 350.D0BX6282 SWING UNIT:PICK UP ROLLER:ASS'Y:(SOL1/SOL2/SOL3)

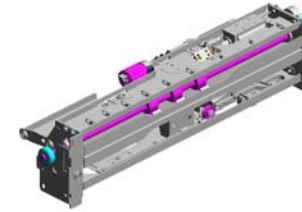

- 351.D0BX6628 PAPER FEED UNIT:PAPER BANK:ASS'Y

- 322.D0747522 GUIDE PLATE:LOWER:PAPER FEED UNIT

- 272.D0592620 (x3) RETAINING RINGS-C

- 486.D2706658 FLANGED HEXAGONAL HEAD BOLT:M3X6

- 488.D2706664 HOOK:COIL SPRING:SLIDER

- 265.C2443522 STEPPED SCREW



- 263.BB013008 GEAR - 31Z

- 418.D1796731 LEVER:PRESSURE:SLIDER

- 422.D1796739 LEVER:REVERSE:PRESSURE RELEASE:JOINT

- 421.D1796738 SLIDER:CAM:REVERSE

- 419.D1796734 BRACKET:SLIDER:CAM

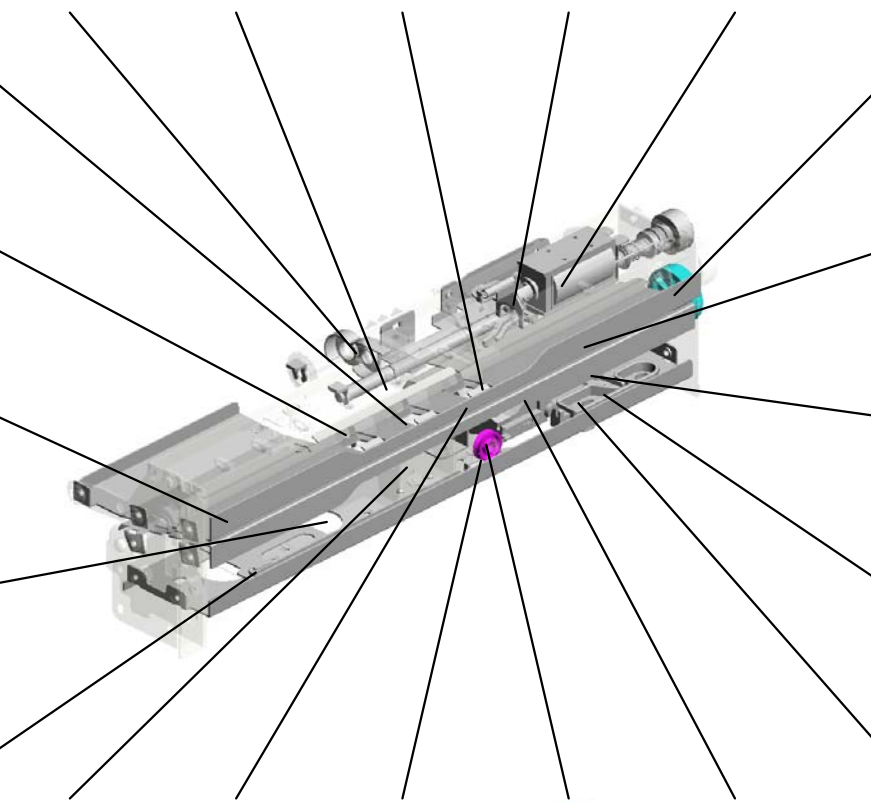

- 493.D2706740 STAY:REVERSE:ASS'Y

- 277.D0596212 LEVER:PRESSURE:REVERSE

- 489.D2706668 TENSION SPRING:REVERSE ROLLER

- 487.D2706659 ROLLER:GUIDE

- 420.D1796737 LEVER:PRESSURE RELEASE:REVERSE



U004_S006
PAPER FEED UNIT:PAPER BANK:ASS'Y

517.GW020024
PHOTOINTERRUP
TOR:LG2A24BL1:G
F:(SEN3/SEN21/SE
N35/SEN36/SEN37/
SEN38/SEN39/SEN
40/SEN41/SEN42/S

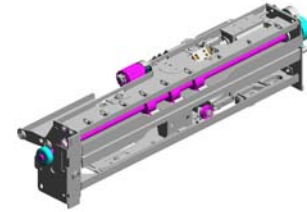
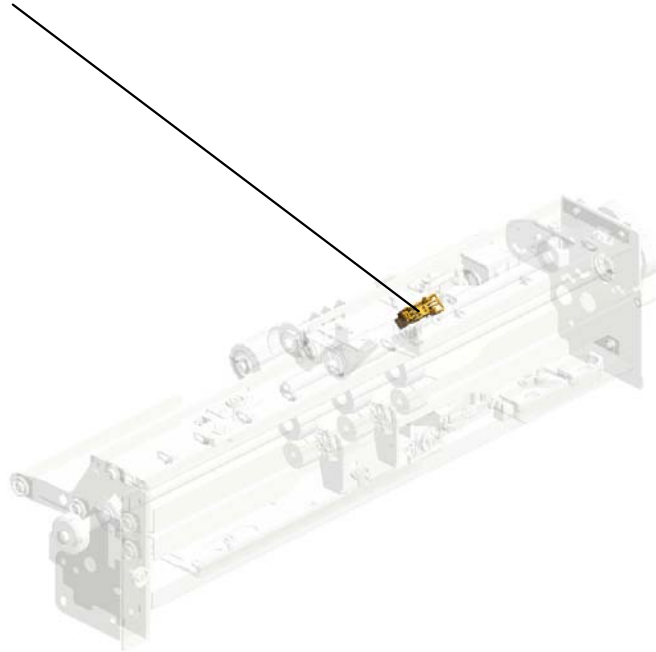

351.D0BX6628
PAPER FEED UNIT
:PAPER BANK:ASS'
Y

U001	U002	U003	U004	U005	U006	U007	U008	U009	U010	U011	U012	U013	U014	U015	U016	U017	U018	U019	U020
------	------	------	------	------	------	------	------	------	------	------	------	------	------	------	------	------	------	------	------

U004_S007
 PAPER FEED UNIT:PAPER BANK:ASS'Y

- 61.11050511 (x13) HARNESS CLAMP - LWS-0306ZC
- 64.11050551 (x2) CLAMP:LES-0505
- 74.54472706 GEAR - 15T
- 12.04340060N (x3) PAN SELF-TAPPING SCREW:M4X6
- 47.08050088 (x2) RETAINING RING - M6

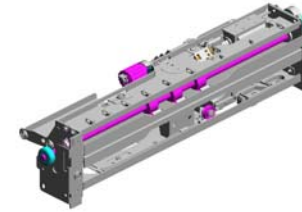

351.D0BX6628
 PAPER FEED UNIT
 :PAPER BANK:ASS'
 Y

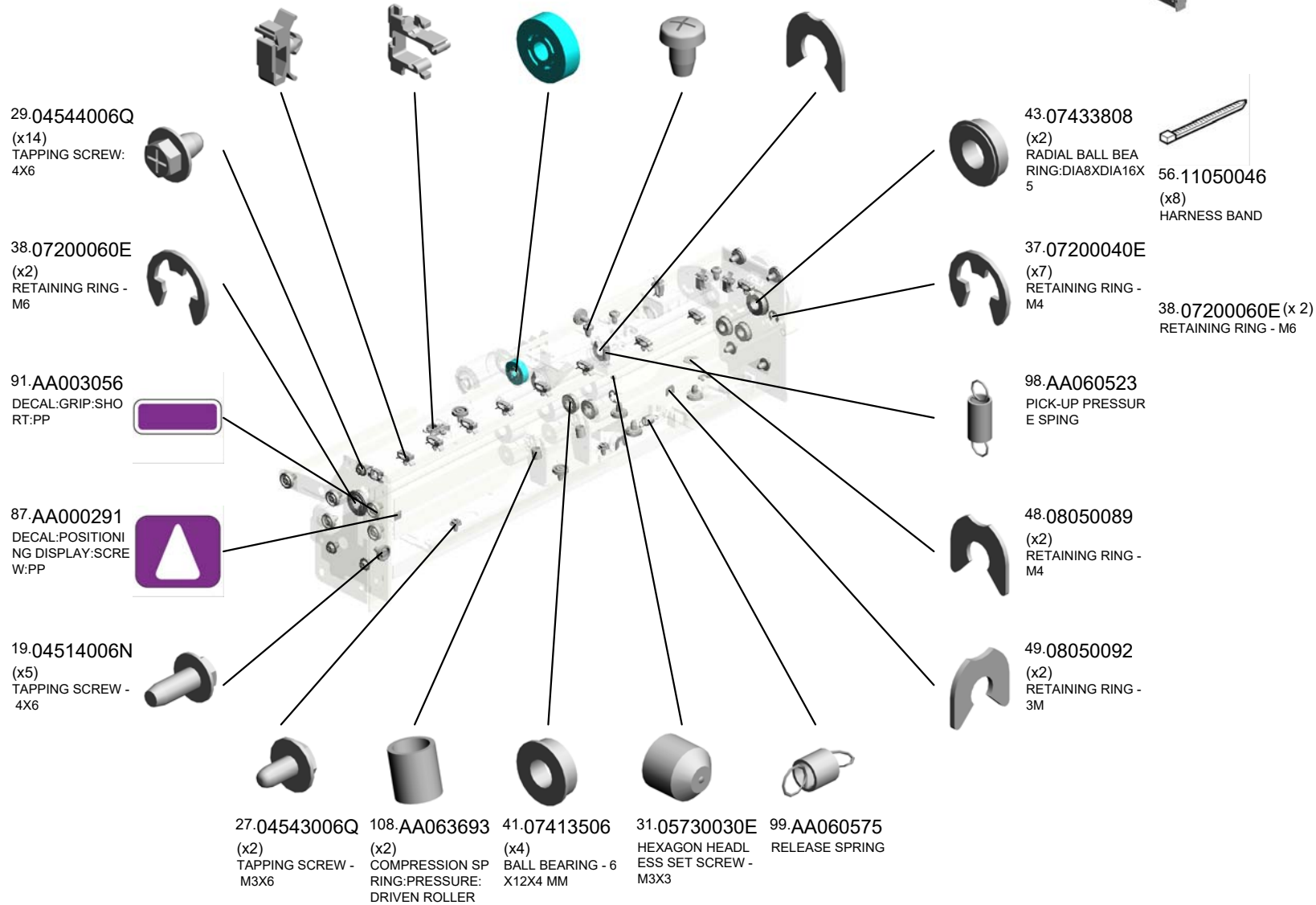

U004_S007
 PAPER FEED UNIT:PAPER BANK:ASS'Y

- 214.B2342624 BALL BEARING - 8 X12X5
- 225.B2346275 PICKUP ARM
- 154.AF020850 TRANSPORT ROLLER:DRIVE:PAPER FEED UNIT
- 182.B0656345 PAPER END SENSOR:DRIVE:PAPER FEED UNIT
- 226.B2346288 SENSOR BRACKET - SENSOR

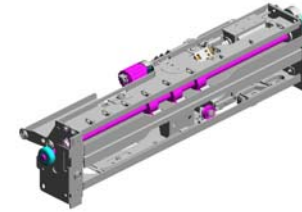

351.D0BX6628
 PAPER FEED UNIT
 :PAPER BANK:ASS'
 Y

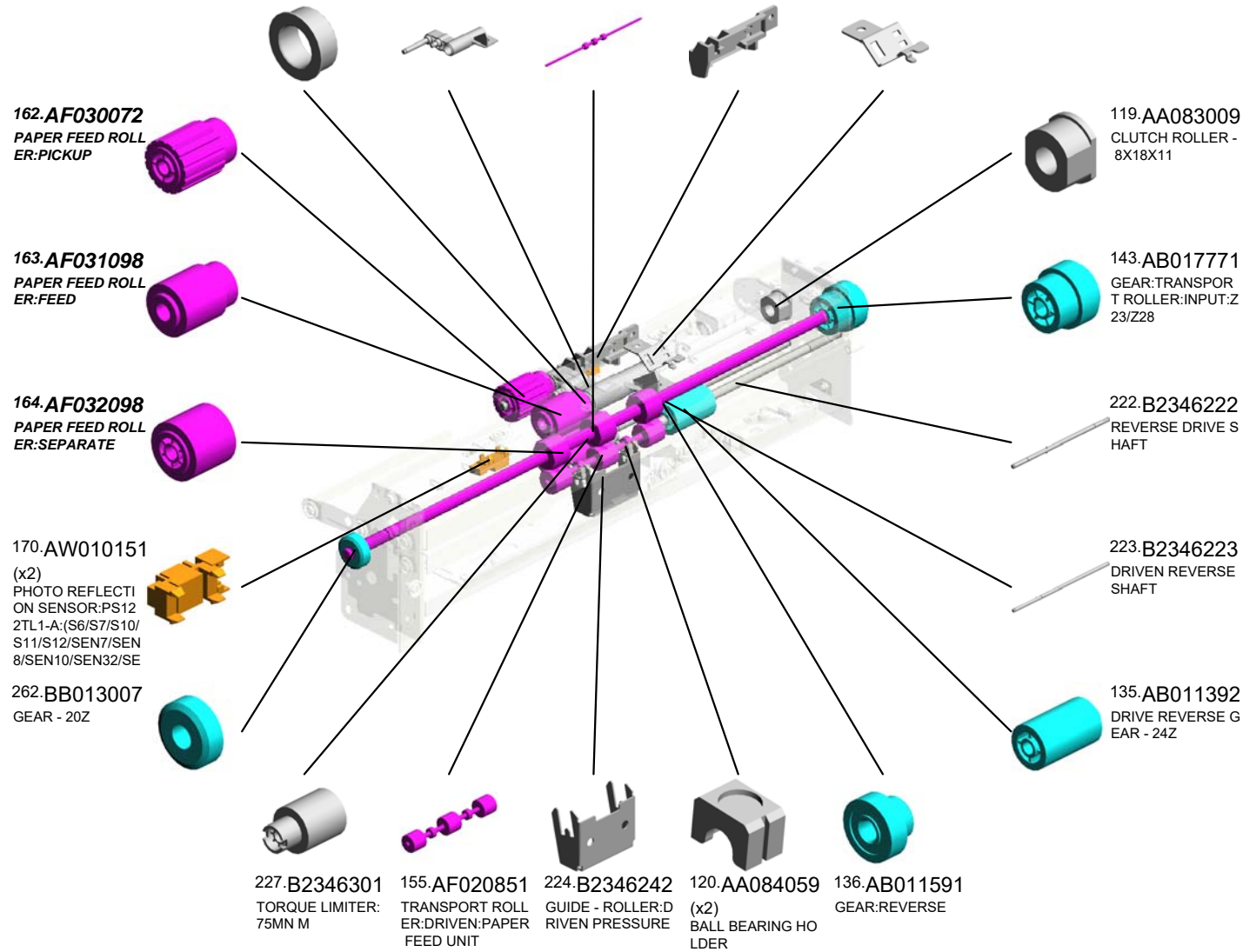

U001	U002	U003	U004	U005	U006	U007	U008	U009	U010	U011	U012	U013	U014	U015	U016	U017	U018	U019	U020
------	------	------	------	------	------	------	------	------	------	------	------	------	------	------	------	------	------	------	------

U004_S007
 PAPER FEED UNIT:PAPER BANK:ASS'Y

- 278.D0596277 COVER:GEAR:PAPER FEED ROLLER
- 321.D0747521 GUIDE PLATE:UPPER:PAPER FEED UNIT
- 279.D0596278 COVER:GEAR:REVERSE
- 323.D0747527 SHAFT:FEED:ASS'Y
- 350.D0BX6282 SWING UNIT:PICK UP ROLLER:ASS'Y:(SOL1/SOL2/SOL3)

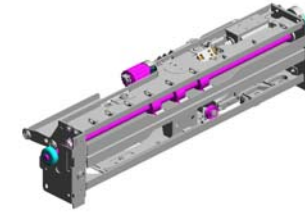

351.D0BX6628
 PAPER FEED UNIT
 :PAPER BANK:ASS'Y

322.D0747522
 GUIDE PLATE:LOWER:PAPER FEED UNIT

272.D0592620
 (x3)
 RETAINING RINGS -C

486.D2706658
 FLANGED HEXAGONAL HEAD BOLT: M3X6

488.D2706664
 HOOK:COIL SPRING:SLIDER

265.C2443522
 STEPPED SCREW



263.BB013008
 GEAR - 31Z

418.D1796731
 LEVER:PRESSURE SLIDER

422.D1796739
 LEVER:REVERSE:PRESSURE RELEASE:JOINT

421.D1796738
 SLIDER:CAM:REVERSE

419.D1796734
 BRACKET:SLIDER:CAM

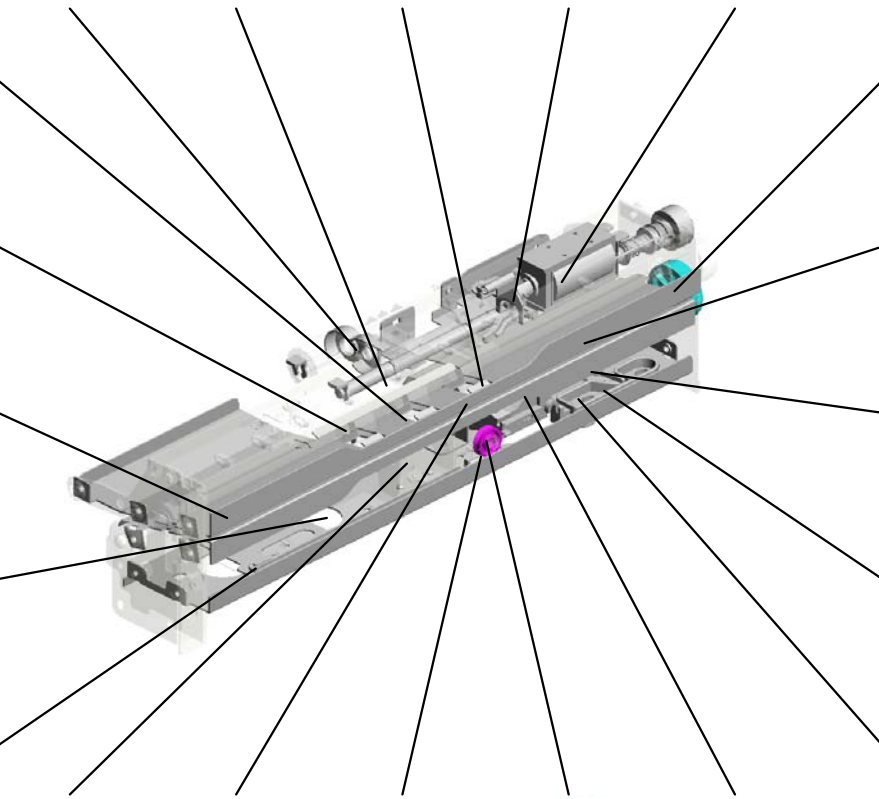

493.D2706740
 STAY:REVERSE:ASSY

277.D0596212
 LEVER:PRESSURE:REVERSE

489.D2706668
 TENSION SPRING:REVERSE ROLLER

487.D2706659
 ROLLER:GUIDE

420.D1796737
 LEVER:PRESSURE RELEASE:REVERSE



U001	U002	U003	U004	U005	U006	U007	U008	U009	U010	U011	U012	U013	U014	U015	U016	U017	U018	U019	U020
------	------	------	------	------	------	------	------	------	------	------	------	------	------	------	------	------	------	------	------

U004_S007
PAPER FEED UNIT:PAPER BANK:ASS'Y

517.GW020024
PHOTOINTERRUP
TOR:LG2A24BL1:G
F:(SEN3/SEN21/SE
N35/SEN36/SEN37/
SEN38/SEN39/SEN
40/SEN41/SEN42/S

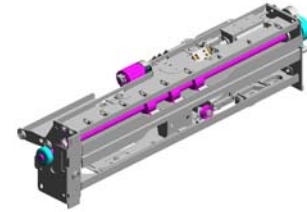
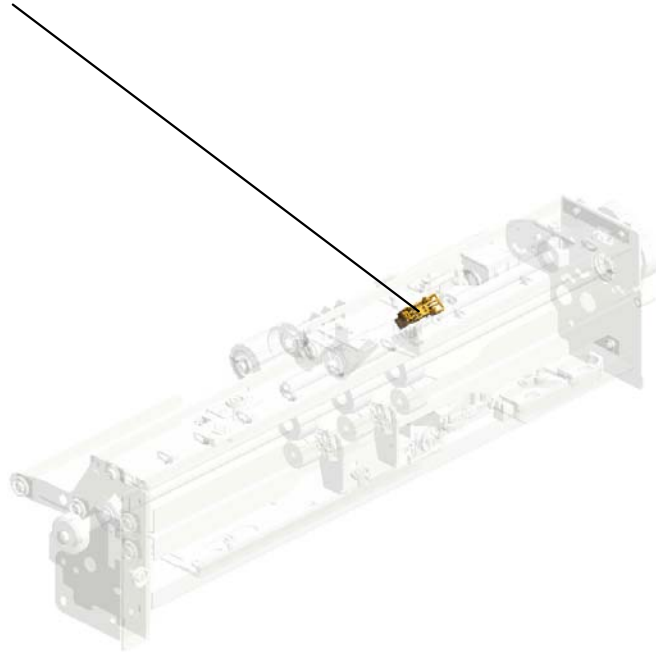

351.D0BX6628
PAPER FEED UNIT
:PAPER BANK:ASS'
Y

U001	U002	U003	U004	U005	U006	U007	U008	U009	U010	U011	U012	U013	U014	U015	U016	U017	U018	U019	U020
------	------	------	------	------	------	------	------	------	------	------	------	------	------	------	------	------	------	------	------

U004_S008
PAPER FEED UNIT:PAPER BANK:ASS'Y

29.04544006Q (x14) TAPPING SCREW: 4X6
 61.11050511 (x13) HARNESS CLAMP - LWS-0306ZC
 64.11050551 (x2) CLAMP:LES-0505
 74.54472706 GEAR - 15T
 12.04340060N (x3) PAN SELF-TAPPING SCREW:M4X6



351.D0BX6628
PAPER FEED UNIT
:PAPER BANK:ASS'
Y

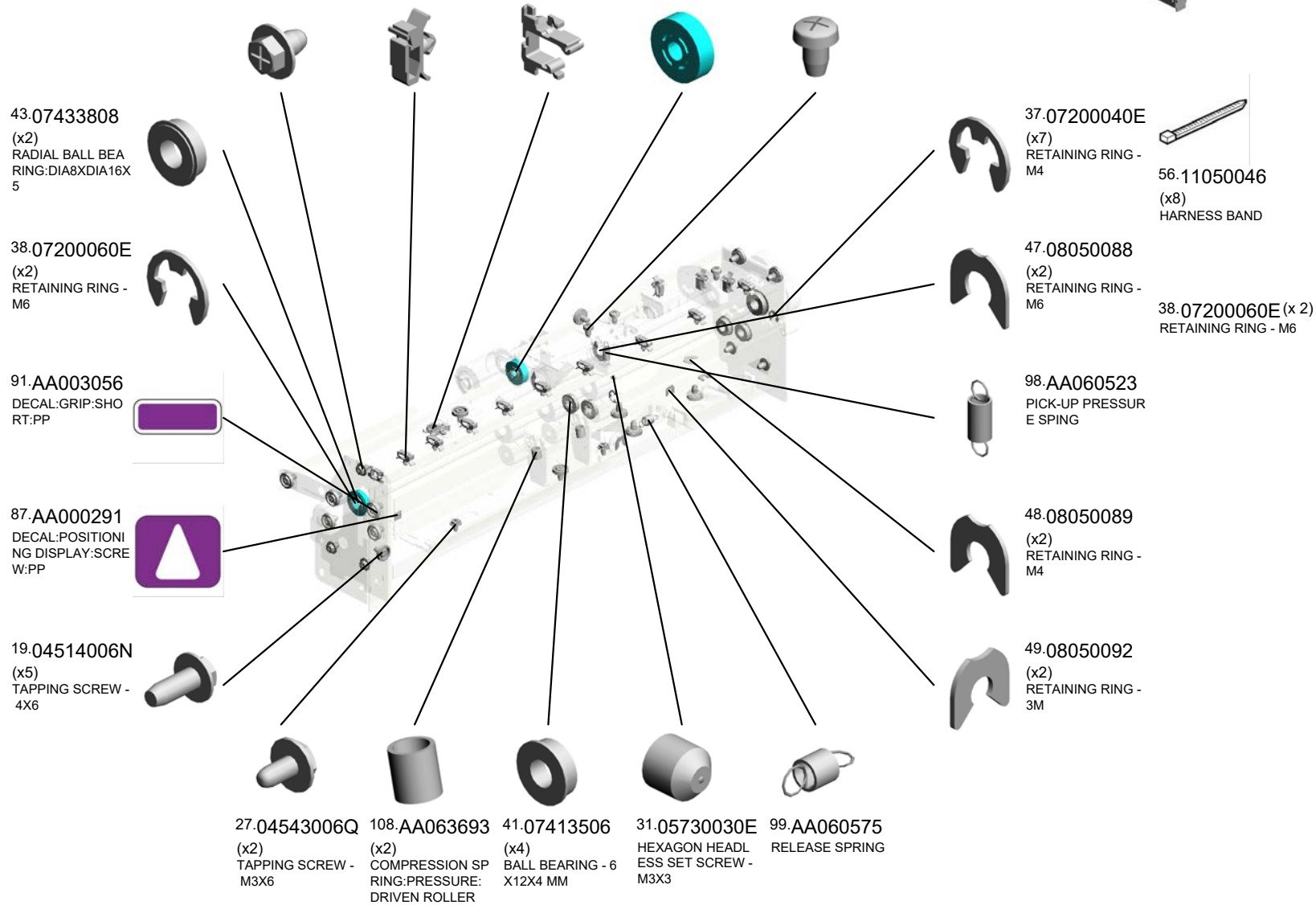

U001	U002	U003	U004	U005	U006	U007	U008	U009	U010	U011	U012	U013	U014	U015	U016	U017	U018	U019	U020
------	------	------	------	------	------	------	------	------	------	------	------	------	------	------	------	------	------	------	------

U004_S008
PAPER FEED UNIT:PAPER BANK:ASS'Y

- 214.B2342624 BALL BEARING - 8 X12X5
- 225.B2346275 PICKUP ARM
- 154.AF020850 TRANSPORT ROLLER:DRIVE:PAPER FEED UNIT
- 182.B0656345 PAPER END SENSOR:DRIVE:PAPER FEED UNIT
- 226.B2346288 SENSOR BRACKET - SENSOR

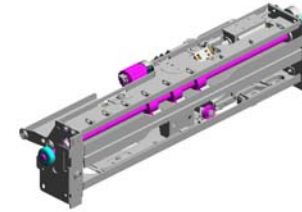

351.D0BX6628
PAPER FEED UNIT
:PAPER BANK:ASS'
Y

162.AF030072
PAPER FEED ROLLER:PICKUP



163.AF031098
PAPER FEED ROLLER:FEED



164.AF032098
PAPER FEED ROLLER:SEPARATE



170.AW010151
(x2)
PHOTO REFLECTOR SENSOR:PS12 2TL1-A:(S6/S7/S10/S11/S12/SEN7/SEN8/SEN10/SEN32/SEN



262.BB013007
GEAR - 20Z

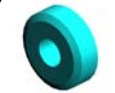

227.B2346301
TORQUE LIMITER: 75MN M



155.AF020851
TRANSPORT ROLLER:DRIVEN:PAPER FEED UNIT



224.B2346242
GUIDE - ROLLER:DRIVEN PRESSURE



120.AA084059
(x2)
BALL BEARING HOLDER



136.AB011591
GEAR:REVERSE



119.AA083009
CLUTCH ROLLER - 8X18X11



143.AB017771
GEAR:TRANSPORT ROLLER:INPUT:Z 23/Z28

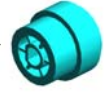

222.B2346222
REVERSE DRIVE SHAFT



223.B2346223
DRIVEN REVERSE SHAFT



135.AB011392
DRIVE REVERSE GEAR - 24Z

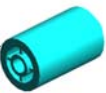

U004_S008
 PAPER FEED UNIT:PAPER BANK:ASS'Y

- 278.D0596277 COVER:GEAR:PAPER FEED ROLLER
- 321.D0747521 GUIDE PLATE:UPPER:PAPER FEED UNIT
- 279.D0596278 COVER:GEAR:REVERSE
- 323.D0747527 SHAFT:FEED:ASS'Y
- 350.D0BX6282 SWING UNIT:PICK UP ROLLER:ASS'Y:(SOL1/SOL2/SOL3)

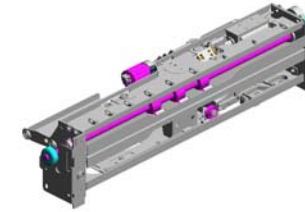

351.D0BX6628
 PAPER FEED UNIT
 :PAPER BANK:ASS'Y

322.D0747522
 GUIDE PLATE:LOWER:PAPER FEED UNIT

272.D0592620
 (x3)
 RETAINING RINGS -C

486.D2706658
 FLANGED HEXAGONAL HEAD BOLT: M3X6

488.D2706664
 HOOK:COIL SPRING:SLIDER

265.C2443522
 STEPPED SCREW



263.BB013008
 GEAR - 31Z

418.D1796731
 LEVER:PRESSURE SLIDER

422.D1796739
 LEVER:REVERSE:PRESSURE RELEASE:JOINT

421.D1796738
 SLIDER:CAM:REVERSE

419.D1796734
 BRACKET:SLIDER:CAM

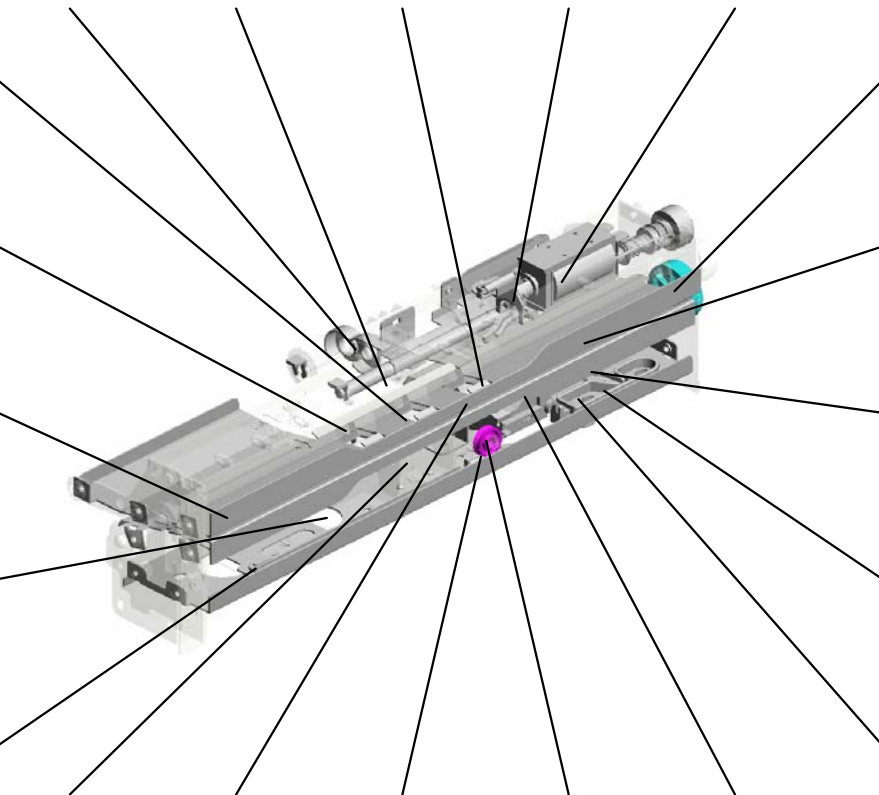

493.D2706740
 STAY:REVERSE:ASS'Y

277.D0596212
 LEVER:PRESSURE:REVERSE

489.D2706668
 TENSION SPRING:REVERSE ROLLER

487.D2706659
 ROLLER:GUIDE

420.D1796737
 LEVER:PRESSURE RELEASE:REVERSE



U001	U002	U003	U004	U005	U006	U007	U008	U009	U010	U011	U012	U013	U014	U015	U016	U017	U018	U019	U020
------	------	------	------	------	------	------	------	------	------	------	------	------	------	------	------	------	------	------	------

U004_S008
PAPER FEED UNIT:PAPER BANK:ASS'Y

517.GW020024
PHOTOINTERRUP
TOR:LG2A24BL1:G
F:(SEN3/SEN21/SE
N35/SEN36/SEN37/
SEN38/SEN39/SEN
40/SEN41/SEN42/S

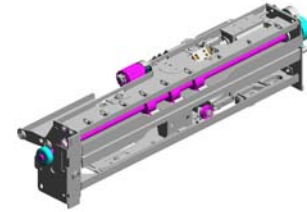
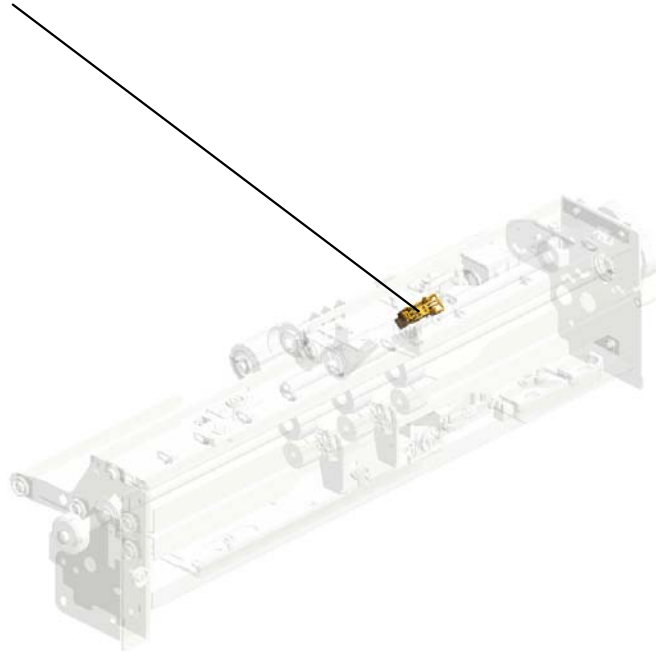

351.D0BX6628
PAPER FEED UNIT
:PAPER BANK:ASS'
Y

U001	U002	U003	U004	U005	U006	U007	U008	U009	U010	U011	U012	U013	U014	U015	U016	U017	U018	U019	U020
------	------	------	------	------	------	------	------	------	------	------	------	------	------	------	------	------	------	------	------

U004_S009

GUIDE PLATE:OPEN AND CLOSE:VERTICAL TRANSPORT:LOWER:ASS'Y

- 160.AF022165 (x3) TRANSPORT ROLLER - DRIVEN
- 120.AA084059 (x6) BALL BEARING HOLDER
- 108.AA063693 (x6) COMPRESSION SPRING:PRESSURE-DRIVEN ROLLER

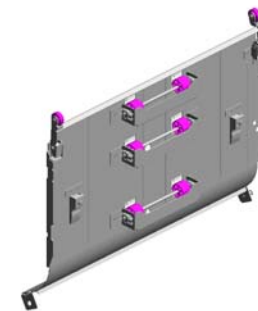

355.D0BX6771
GUIDE PLATE:OPEN AND CLOSE:VERTICAL TRANSPORT:LOWER:ASS'Y

36.07200030E (x2) RETAINING RING - M3

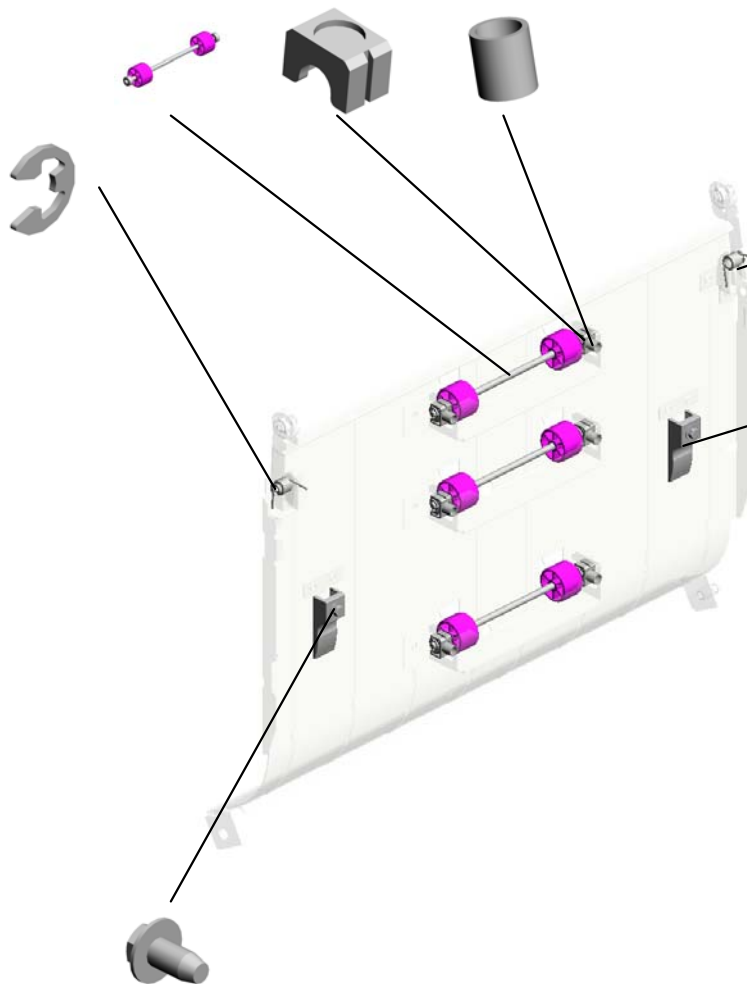

502.D3553858 (x2) TORSION SPRING: GUIDE PLATE:16N

358.D0BX6795 (x2) HOLDER:STAY:GUIDE PLATE

20.04514008N (x2) TAPPING SCREW: 4X8

U001	U002	U003	U004	U005	U006	U007	U008	U009	U010	U011	U012	U013	U014	U015	U016	U017	U018	U019	U020
------	------	------	-------------	------	------	------	------	------	------	------	------	------	------	------	------	------	------	------	------

U004_S009_S001
BRACKET:DETENT:RIGHT:ASS'Y

498.D3551196 515.G3631105
ROLLER:DETENT DETENT ROLLER
SHAFT

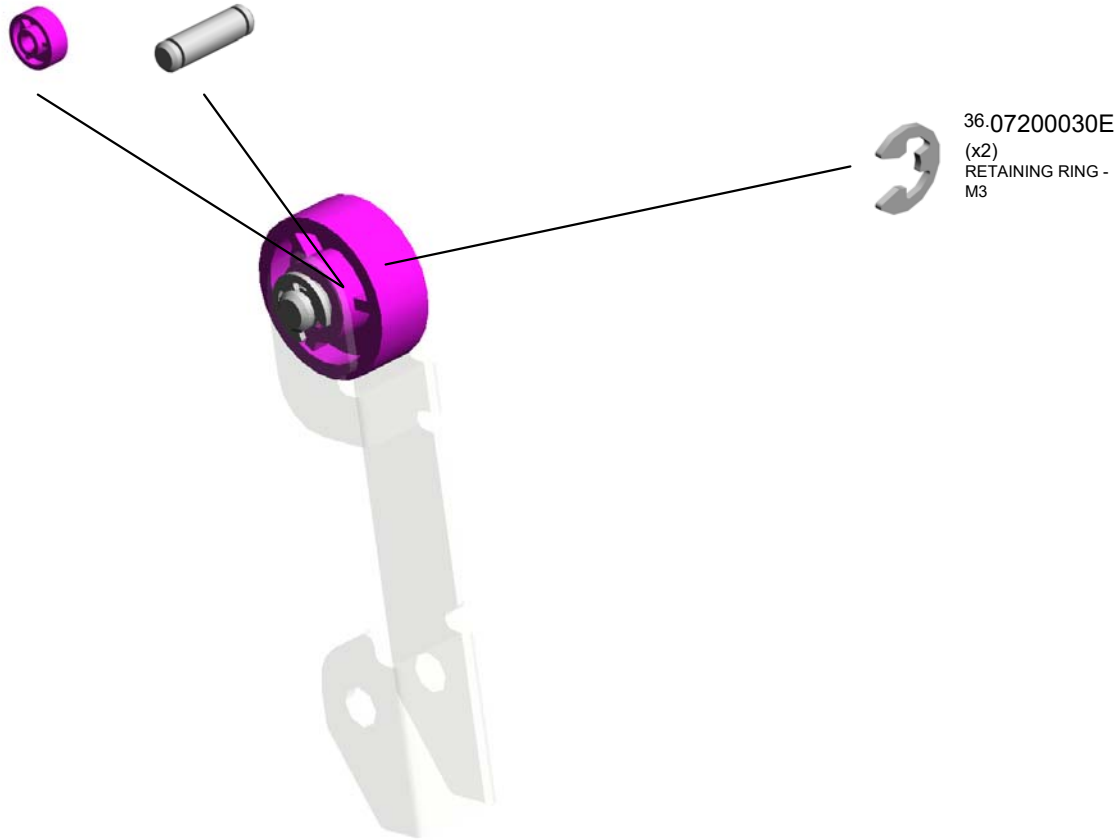

499.D3553810
BRACKET:DETENT
:RIGHT:ASS'Y

U001	U002	U003	U004	U005	U006	U007	U008	U009	U010	U011	U012	U013	U014	U015	U016	U017	U018	U019	U020
------	------	------	------	------	------	------	------	------	------	------	------	------	------	------	------	------	------	------	------

U004_S009_S002
BRACKET:DETENT:ASS'Y

498.D3551196 515.G3631105
ROLLER:DETENT DETENT ROLLER
SHAFT



500.D3553840
BRACKET:DETENT
:ASS'Y

36.07200030E
(x2)
RETAINING RING -
M3

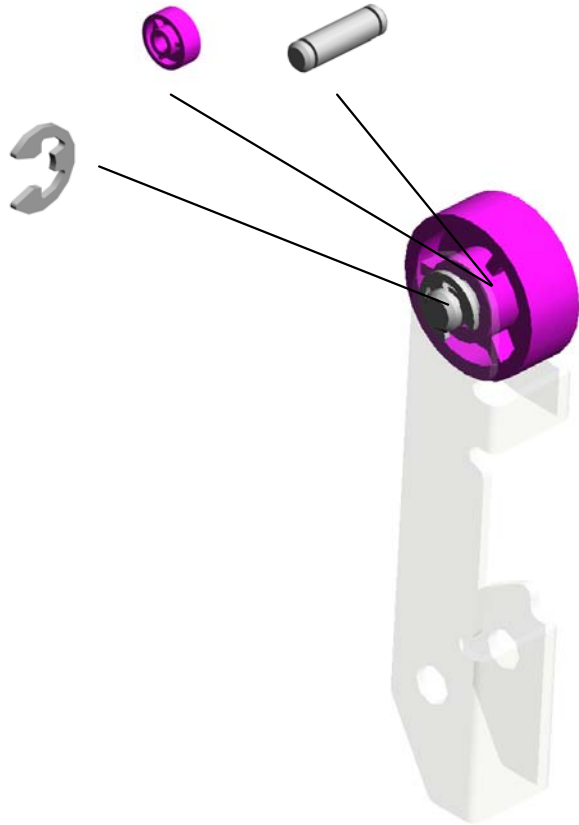

U001	U002	U003	U004	U005	U006	U007	U008	U009	U010	U011	U012	U013	U014	U015	U016	U017	U018	U019	U020
------	------	------	------	------	------	------	------	------	------	------	------	------	------	------	------	------	------	------	------

U004_S010
PAPER TRAY:UNIVERSAL:SUB-ASS'Y

270.D0146785 SPRING PLATE:AR
M:END FENCE:LO
CK
153.AF017033 END FENCE
212.B1816780 LINK:END FENCE:
PAPER SIZE SENS
OR:ASS'Y
213.B1816789 LINK:SIDE FENCE:
PAPER SIZE SENS
OR
205.B1326797 SIDE FENCE:REAR
:AUXILIARY

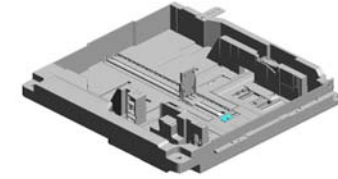

364.D0BX7631
PAPER TRAY:UNIV
ERSAL:SUB-ASS'Y

185.B0656545
(x2)
DECAL - POSITION
ING

460.D1947635
ARM:END FENCE:LOCK

151.AF010097
PAPER TRAY:UNIV
ERSAL:REMOVER/
INSTALL

315.D0747390
DECAL:PAPER SE
T DIRECTION:PAP
ER TRAY

206.B1326798
SPRING PLATE:PA
PER TRAY:EARTH

102.AA060961
TENSION SPRING:
SIDE FENCE:REAR

269.D0146784
SPRING PLATE:EN
D FENCE

38.07200060E
RETAINING RING -
M6

14.04504008N
(x3)
TAPPING SCREW -
M4X8

137.AB012327
GEAR:16Z

252.B2476695
GUIDE:MISFEED R
EMOVAL:PAPER T
RAY

233.B2346498
(x2)
SHEET:TRAY BOT
TOM PLATE

183.B0656524
BOTTOM PLATE LI
FT SHAFT

11.03604008N
(x2)
SCREW - M4X8

184.B0656526
LIFT LEVER

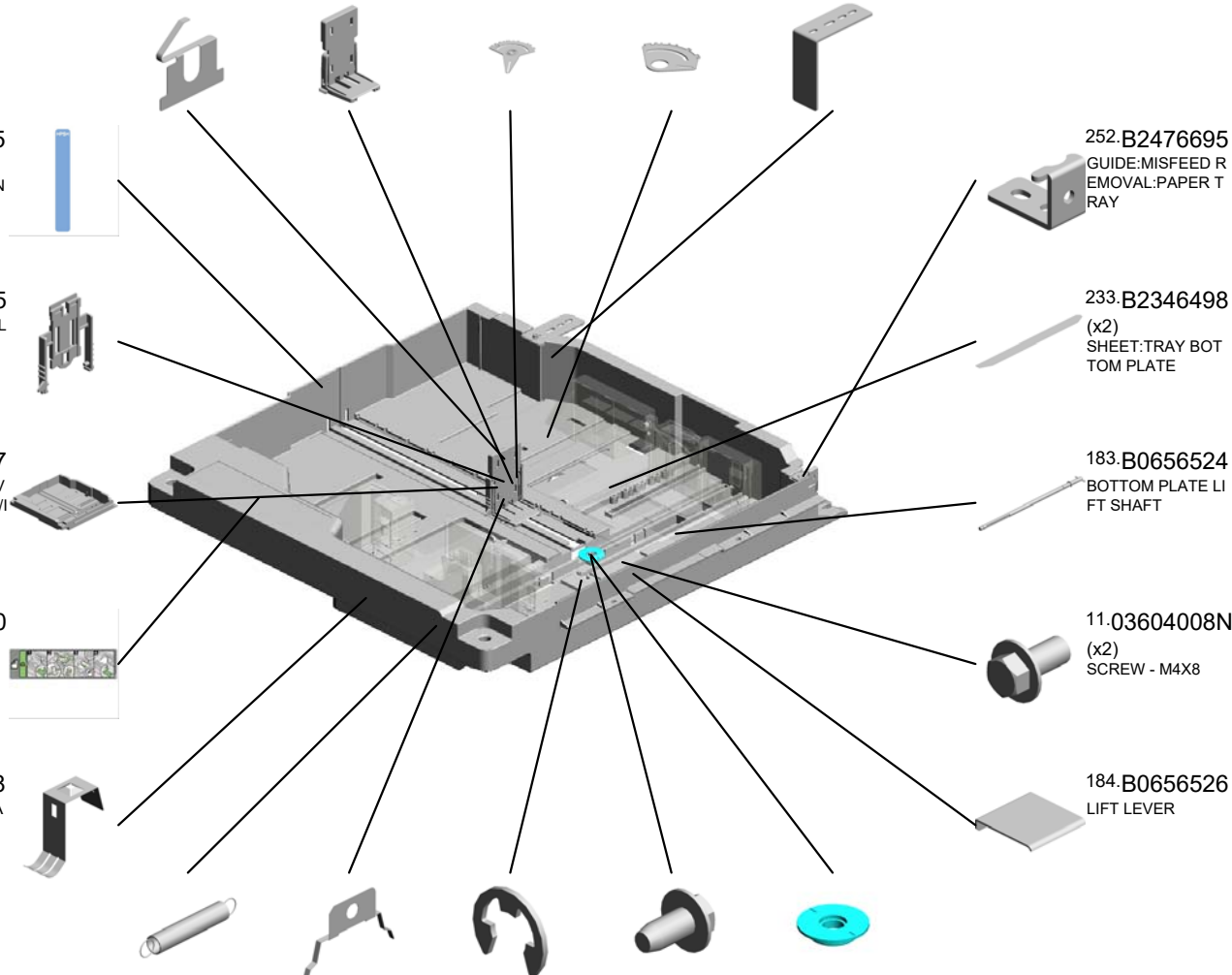

U004_S010_S001
TRAY BOTTOM PLATE:ASS'Y

152.AF013029
PAD:BASE



357.D0BX6780
TRAY BOTTOM PL
ATE:ASS'Y

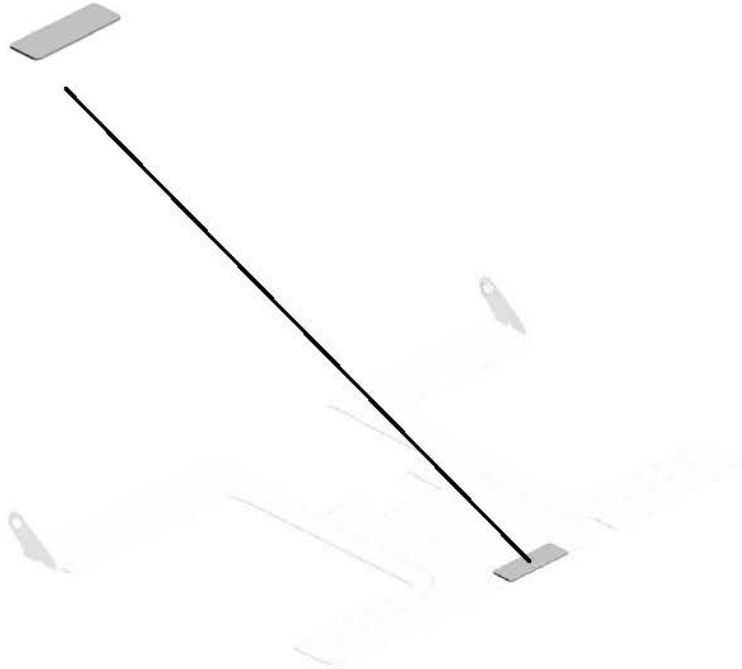

U001	U002	U003	U004	U005	U006	U007	U008	U009	U010	U011	U012	U013	U014	U015	U016	U017	U018	U019	U020
------	------	------	------	------	------	------	------	------	------	------	------	------	------	------	------	------	------	------	------

U004_S010_S002
SIDE FENCE:REAR:ASS'Y

83.A2672857 90.AA001597
SPRING PLATE - SI DE FENCE DECAL:SIDE FENCE:REAR

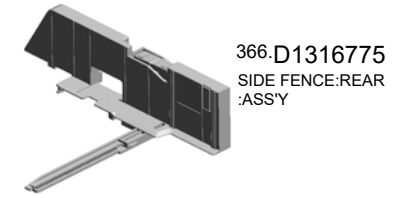

84.A2672859
SIDE FENCE STOP PER

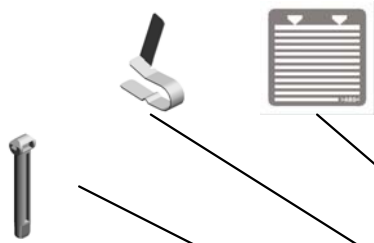

215.B2342864
PAD:CLEANER

13.04503008N
(x2)
TAPPING SCREW - M3X8

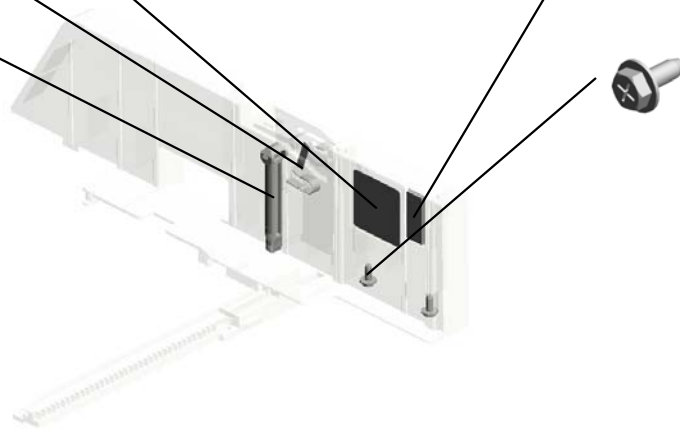

U001	U002	U003	U004	U005	U006	U007	U008	U009	U010	U011	U012	U013	U014	U015	U016	U017	U018	U019	U020
------	------	------	------	------	------	------	------	------	------	------	------	------	------	------	------	------	------	------	------

U004_S010_S003
SIDE FENCE:FRONT:ASS'Y

204.B1326791 76.A1342978
(x2) SPRING PLATE
PLATE:SIDE FENCE

367.D1316777
SIDE FENCE:FRONT:ASS'Y

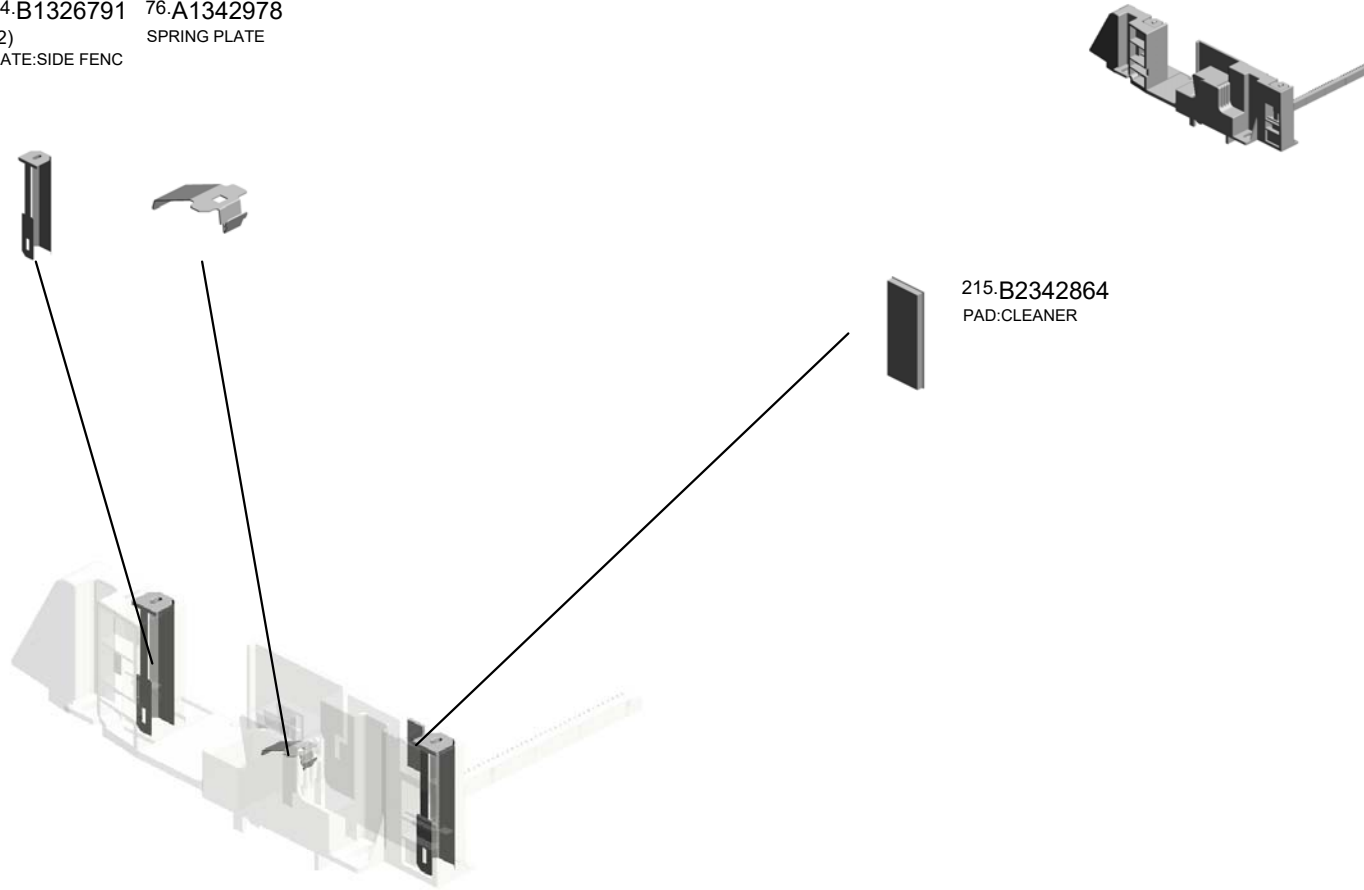

U001	U002	U003	U004	U005	U006	U007	U008	U009	U010	U011	U012	U013	U014	U015	U016	U017	U018	U019	U020
------	------	------	-------------	------	------	------	------	------	------	------	------	------	------	------	------	------	------	------	------

U004_S011 PAPER TRAY:UNIVERSAL:SUB-ASS'Y

270.D0146785 SPRING PLATE:AR
M:END FENCE:LO
CK

153.AF017033 END FENCE

212.B1816780 LINK:END FENCE:
PAPER SIZE SENS
OR:ASS'Y

213.B1816789 LINK:SIDE FENCE:
PAPER SIZE SENS
OR

205.B1326797 SIDE FENCE:REAR
:AUXILIARY

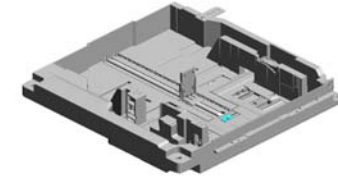

364.D0BX7631
PAPER TRAY:UNIV
ERSAL:SUB-ASS'Y

185.B0656545
(x2)
DECAL - POSITION
ING

460.D1947635
ARM:END FENCE:L
OCK

151.AF010097
PAPER TRAY:UNIV
ERSAL:REMOVER/I
NSTALL

315.D0747390
DECAL:PAPER SE
T DIRECTION:PAP
ER TRAY

206.B1326798
SPRING PLATE:PA
PER TRAY:EARTH

102.AA060961
TENSION SPRING:
SIDE FENCE:REAR

269.D0146784
SPRING PLATE:EN
D FENCE

38.07200060E
RETAINING RING -
M6

14.04504008N
(x3)
TAPPING SCREW -
M4X8

137.AB012327
GEAR:16Z

252.B2476695
GUIDE:MISFEED R
EMOVAL:PAPER T
RAY

233.B2346498
(x2)
SHEET:TRAY BOT
TOM PLATE

183.B0656524
BOTTOM PLATE LI
FT SHAFT

11.03604008N
(x2)
SCREW - M4X8

184.B0656526
LIFT LEVER

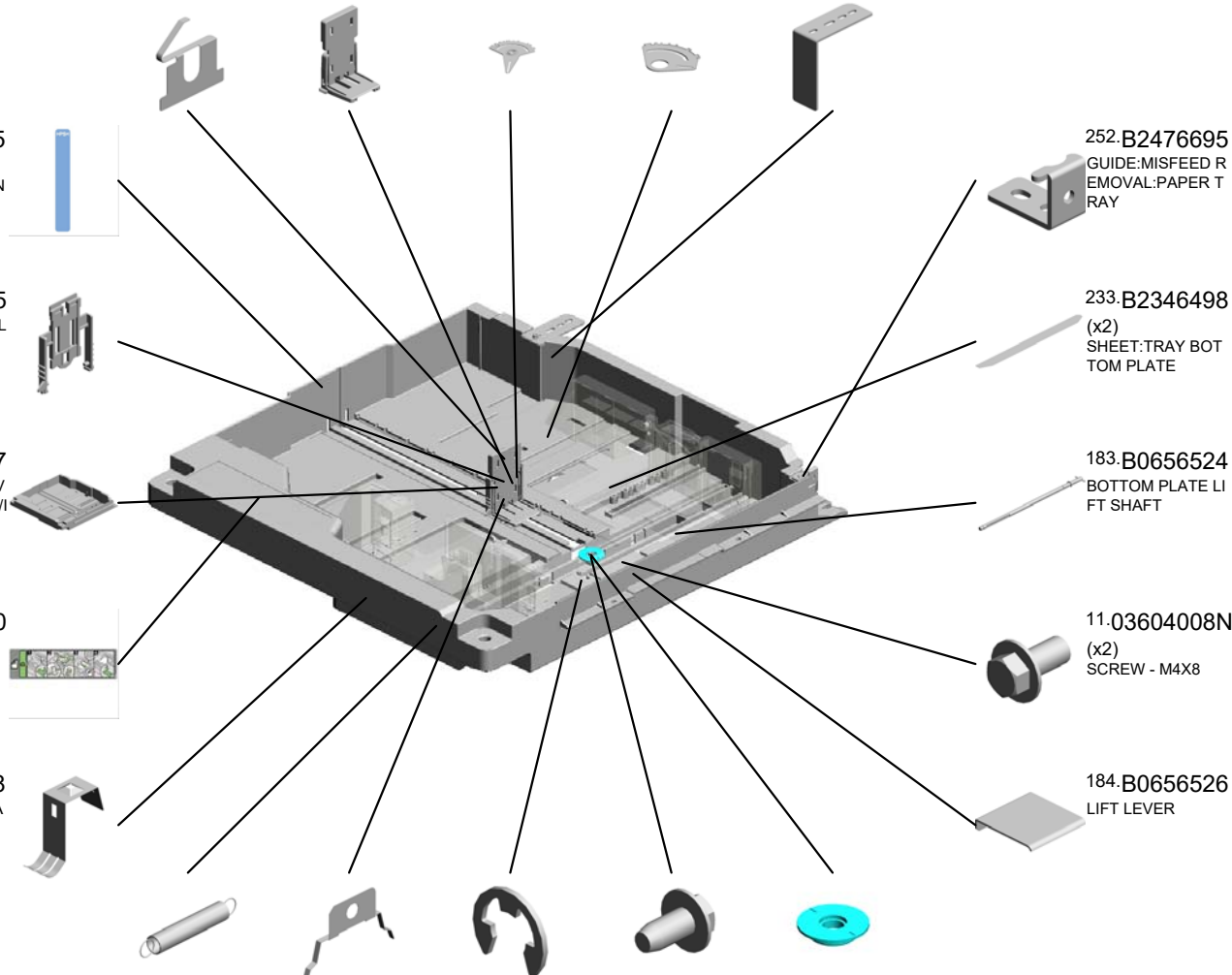

U004_S011_S001
TRAY BOTTOM PLATE:ASS'Y

152.AF013029
PAD:BASE



357.D0BX6780
TRAY BOTTOM PL
ATE:ASS'Y

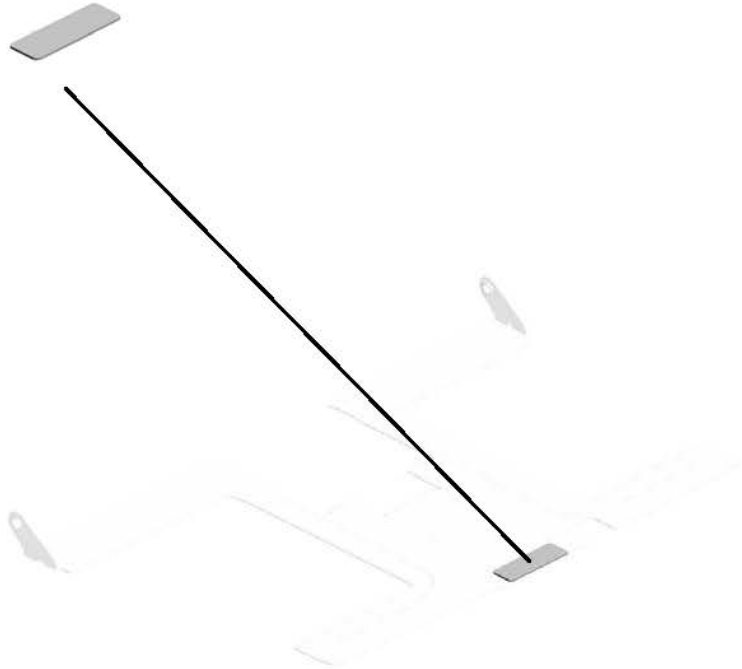

U001	U002	U003	U004	U005	U006	U007	U008	U009	U010	U011	U012	U013	U014	U015	U016	U017	U018	U019	U020
------	------	------	------	------	------	------	------	------	------	------	------	------	------	------	------	------	------	------	------

U004_S011_S002
SIDE FENCE:REAR:ASS'Y

83.A2672857 90.AA001597
SPRING PLATE - SI DE FENCE DECAL:SIDE FENCE:REAR

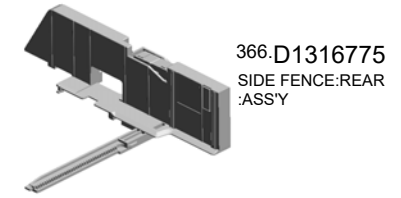

84.A2672859
SIDE FENCE STOP PER

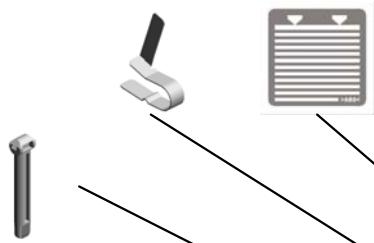

215.B2342864
PAD:CLEANER



13.04503008N
(x2)
TAPPING SCREW - M3X8

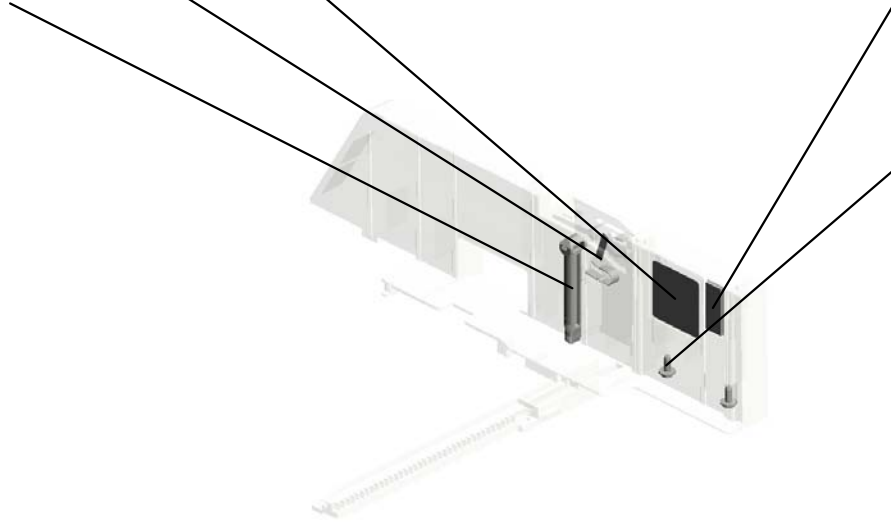

U001	U002	U003	U004	U005	U006	U007	U008	U009	U010	U011	U012	U013	U014	U015	U016	U017	U018	U019	U020
------	------	------	------	------	------	------	------	------	------	------	------	------	------	------	------	------	------	------	------

U004_S011_S003
SIDE FENCE:FRONT:ASS'Y

204.B1326791 76.A1342978
(x2) SPRING PLATE
PLATE:SIDE FENCE

367.D1316777
SIDE FENCE:FRONT:ASS'Y

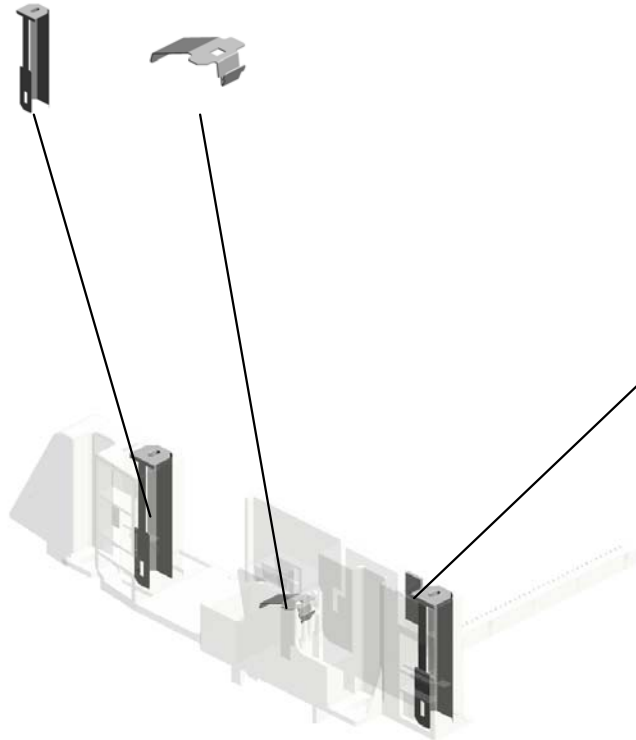
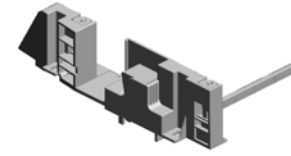

215.B2342864
PAD:CLEANER

U001	U002	U003	U004	U005	U006	U007	U008	U009	U010	U011	U012	U013	U014	U015	U016	U017	U018	U019	U020
------	------	------	------	------	------	------	------	------	------	------	------	------	------	------	------	------	------	------	------

U004_S012
(NA):TANDEM LCT:RIGHT:ASS'Y

- 82.A2486713 (x2) HOOK - TENSION SPRING
- 37.07200040E (x8) RETAINING RING - M4
- 63.11050534 (x8) CLAMP
- 80.A2486695 (x4) GUIDE - PULLEY
- 52.09513006N SCREW - M3X6

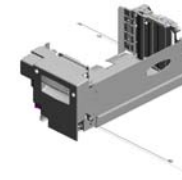

527.D0BX6685
(NA):TANDEM LCT:
RIGHT:ASS'Y

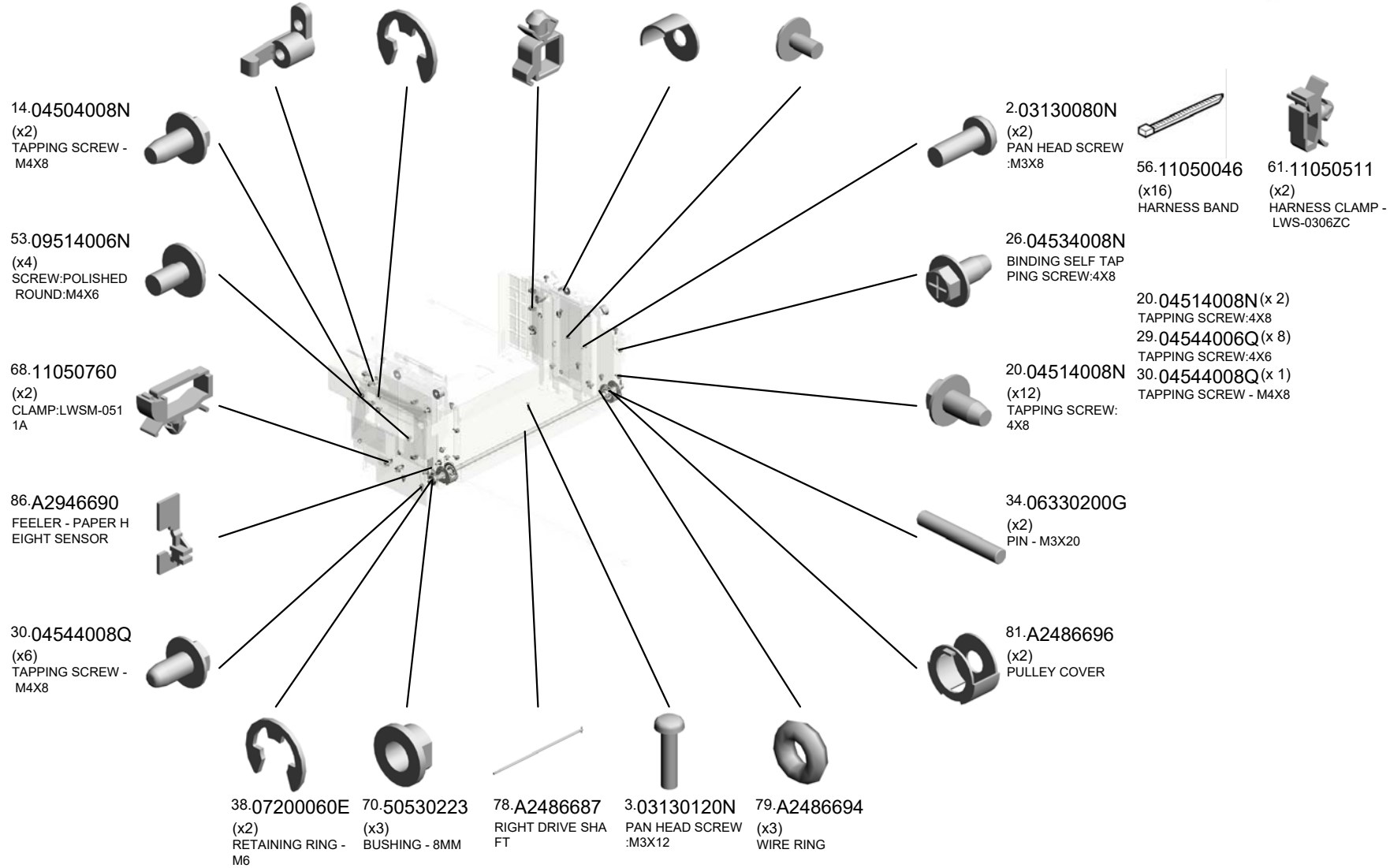

U004_S012
(NA):TANDEM LCT:RIGHT:ASS'Y

- 100.AA060757 (x2) TENSION SPRING - LONG
- 146.AB032058 (x2) WIRE PULLEY - M10
- 147.AB032719 (x2) PULLEY - M10
- 195.B0656870 (x2) STAY - RIGHTBASE
- 200.B0706684 LEVER:RELEASE:REAR

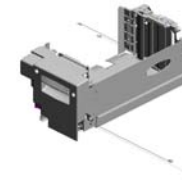

527.D0BX6685
(NA):TANDEM LCT:
RIGHT:ASS'Y

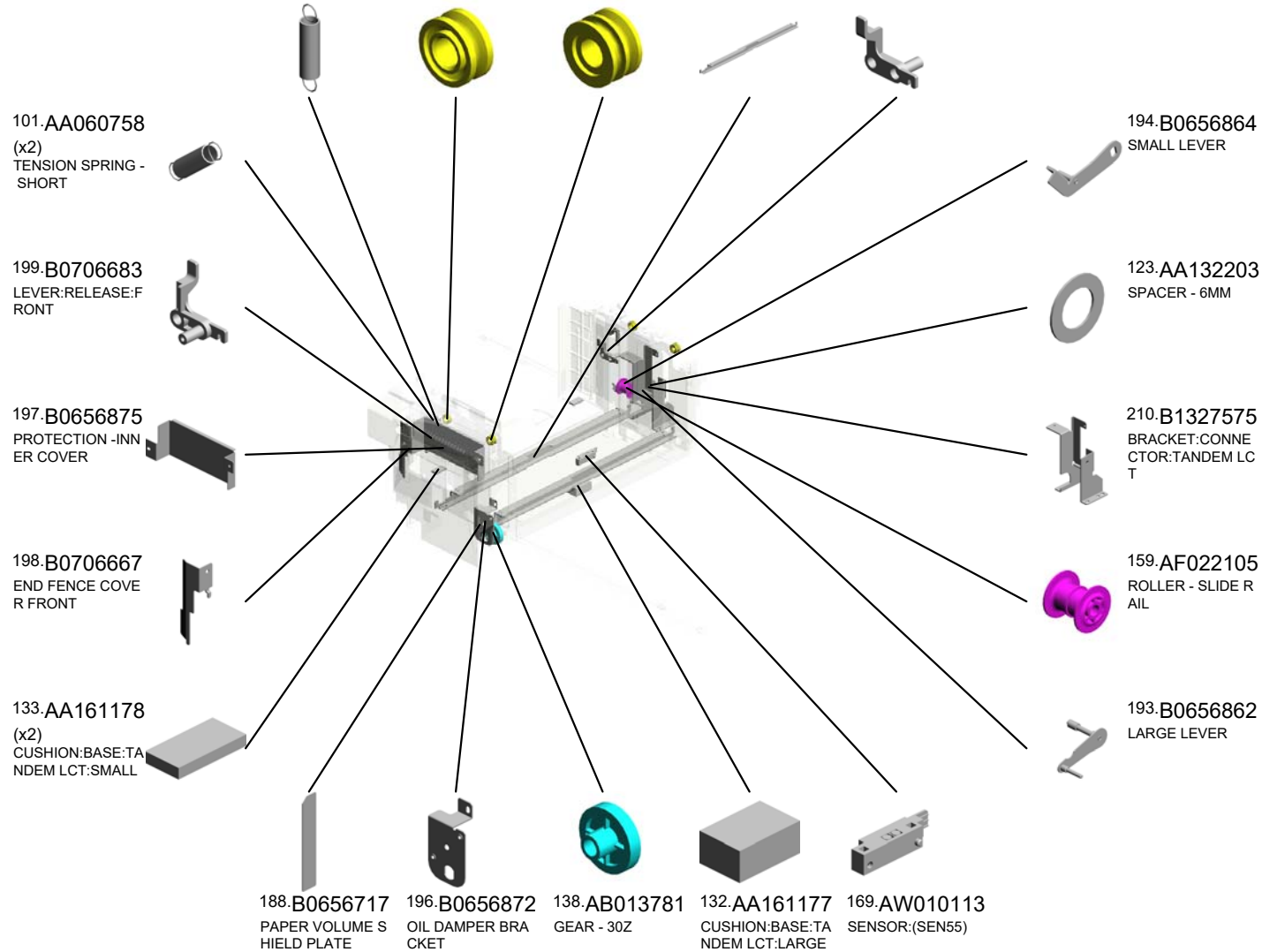

U004_S012
(NA):TANDEM LCT:RIGHT:ASS'Y

- 267.D0146626 BRACKET:ON OFF DETECTOR:FRONT
- 313.D0747388 DECAL:PAPER SE T DIRECTION:TANDEM LCT:RIGHT
- 247.B2346686 SIDE FENCE - RIGHT FRONT
- 245.B2346625 END FENCE - REAR
- 268.D0146627 BRACKET:ON OFF DETECTOR:REAR

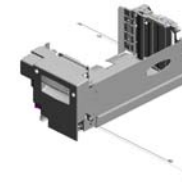

527.D0BX6685
(NA):TANDEM LCT:RIGHT:ASS'Y

244.B2346612
END FENCE - FRONT

288.D0596712
INNER COVER:TANDEM LCT

463.D2236722
DC SOLENOID:END FENCE:FRONT:ASS'Y:(SOL8)

311.D0747385
DECAL:CAUTION CHART:TANDEM LCT

353.D0BX6677
ROLLER:SLIDE RAIL:FRONT

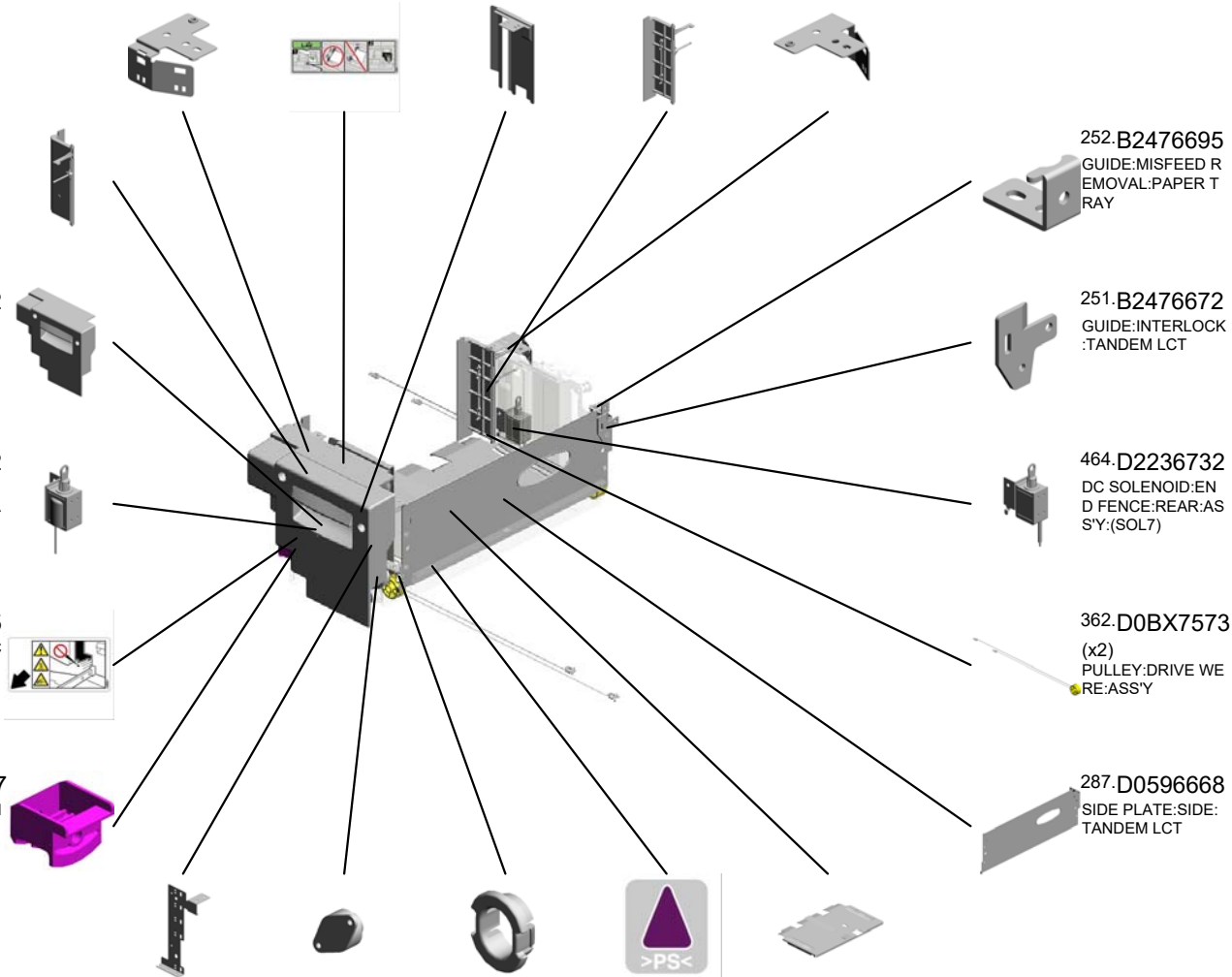

252.B2476695
GUIDE:MISFEED REMOVAL:PAPER TRAY

251.B2476672
GUIDE:INTERLOCK:TANDEM LCT

464.D2236732
DC SOLENOID:END FENCE:REAR:ASS'Y:(SOL7)

362.D0BX7573
(x2)
PULLEY:DRIVE WHEEL:ASS'Y

287.D0596668
SIDE PLATE:SIDE:TANDEM LCT

- 243.B2346606 SENSOR BRACKET
- 255.B2476901 OIL DAMPER:FALL
- 218.B2346141 POSITIONING SLEEVE - INNER BACK
- 304.D0746497 (x2)
DECAL:POSITIONING DISPLAY:TCRU
- 363.D0BX7595 (CHN|Pro 8310/8320|NA/EU/AA/TWN/KOR):BASE:TANDEM LCT:RIGHT:ADHESION

U001	U002	U003	U004	U005	U006	U007	U008	U009	U010	U011	U012	U013	U014	U015	U016	U017	U018	U019	U020
------	------	------	------	------	------	------	------	------	------	------	------	------	------	------	------	------	------	------	------

U004_S012
(NA):TANDEM LCT:RIGHT:ASS'Y

490.D2706678
(x2)
COVER:CUSHION

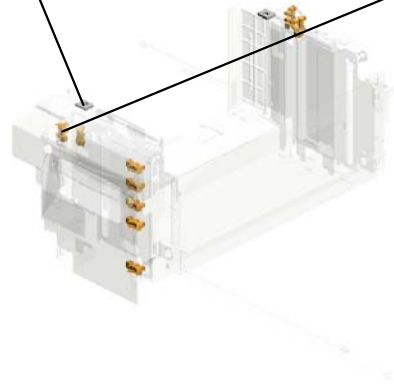
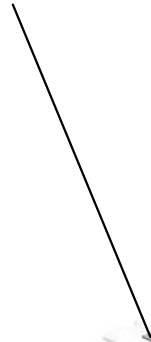
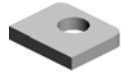

517.GW020024
(x9)
PHOTOINTERRUP
TOR:LG2A24BL1:G
F:(SEN3/SEN21/SE
N35/SEN36/SEN37/
SEN38/SEN39/SEN

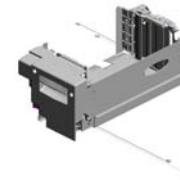

527.D0BX6685
(NA):TANDEM LCT:
RIGHT:ASS'Y

U001	U002	U003	U004	U005	U006	U007	U008	U009	U010	U011	U012	U013	U014	U015	U016	U017	U018	U019	U020
------	------	------	------	------	------	------	------	------	------	------	------	------	------	------	------	------	------	------	------

U004_S012_S001
SIDE FENCE:TANDEM LCT:RIGHT:ASS'Y

89-AA001509
DECAL:SIDE FENC
E:16X30

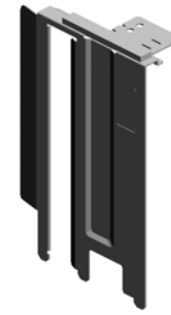
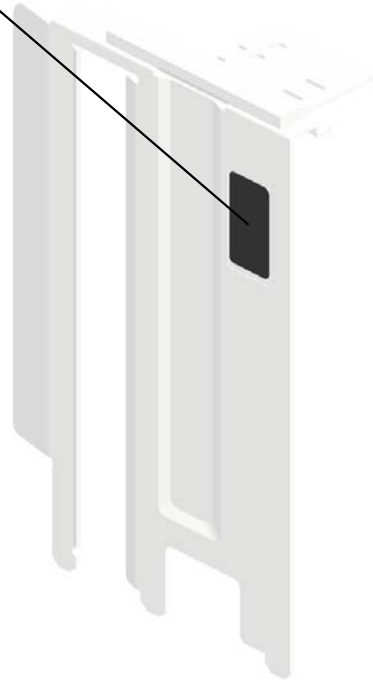

248-B2346691
SIDE FENCE:TAND
EM LCT:RIGHT:AS
SY

U001	U002	U003	U004	U005	U006	U007	U008	U009	U010	U011	U012	U013	U014	U015	U016	U017	U018	U019	U020
------	------	------	------	------	------	------	------	------	------	------	------	------	------	------	------	------	------	------	------

U004_S013

(CHN[Pro 8310/8320]/NA/EU/AA/TWN/KOR):TRAY BOTTOM PLATE:LEFT MIDDLE:ASS'Y

312.D0747387
(CHN[Pro 8310/8320]/NA/EU/AA/TWN/KOR):DECAL:BASE
:TANDEM LCT:LEFT
T

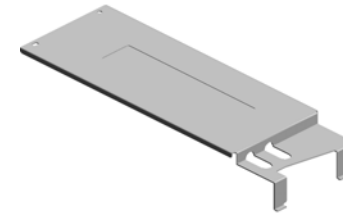
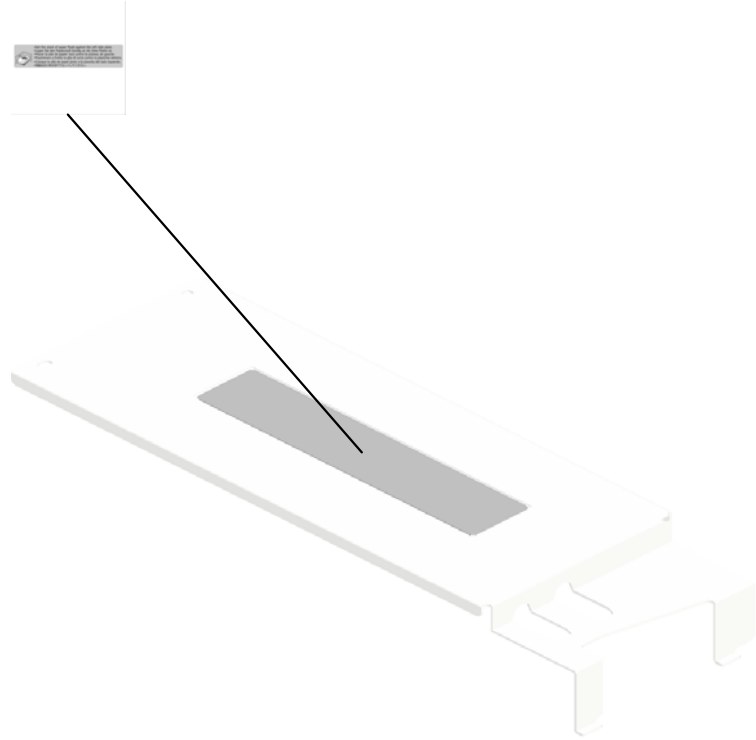

329.D0747596
(CHN[Pro 8310/8320]/NA/EU/AA/TWN/KOR):TRAY BOTTO
M PLATE:LEFT MID
DLE:ASS'Y

U001	U002	U003	U004	U005	U006	U007	U008	U009	U010	U011	U012	U013	U014	U015	U016	U017	U018	U019	U020
------	------	------	------	------	------	------	------	------	------	------	------	------	------	------	------	------	------	------	------

U004_S014
SIDE FENCE:TANDEM LCT:LEFT REAR:ASS'Y

88-AA001508
DECAL:SIDE FENC
E:40X30

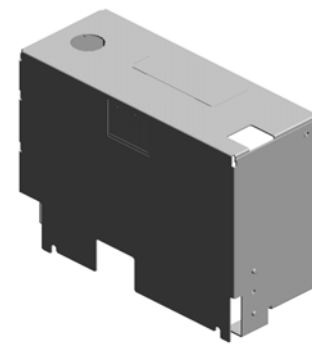
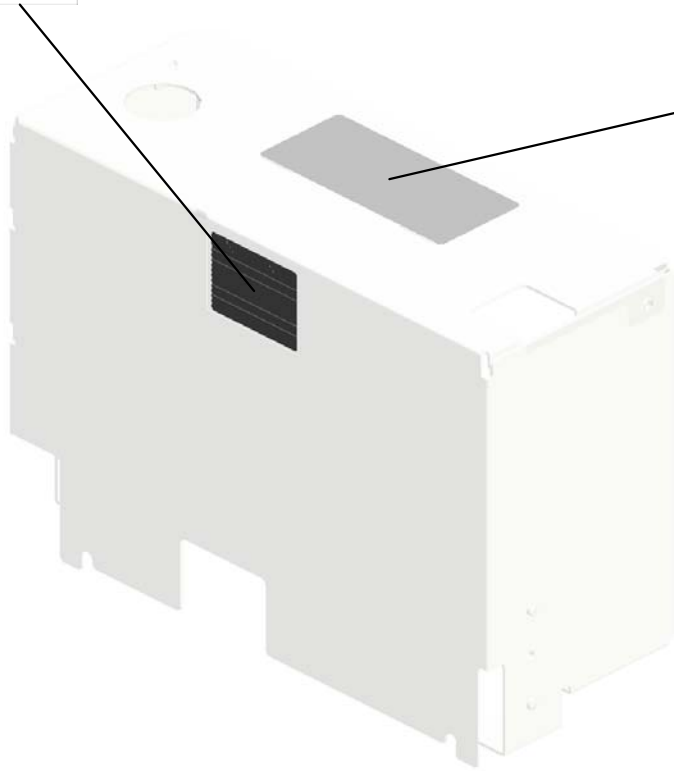

495-D2707544
SIDE FENCE:TAND
EM LCT:LEFT REA
R:ASS'Y



496-D2707548
DECAL:CAUTION:1
NSERT:PAPER FE
ED SUB-UNIT

U001	U002	U003	U004	U005	U006	U007	U008	U009	U010	U011	U012	U013	U014	U015	U016	U017	U018	U019	U020
------	------	------	-------------	------	------	------	------	------	------	------	------	------	------	------	------	------	------	------	------

U005.TONNER SUPPLY

U005_S001
D1793334
CASE:TONER BANK:ASS'Y

U005_S003
D1793370
INNER COVER:TONER BANK
:ASS'Y

U005_S002
D1793334
CASE:TONER BANK:ASS'Y

U005_S004
D1793201
TONER SUPPLY UNIT:TONE
R HOPPER:ASS'Y

U001	U002	U003	U004	U005	U006	U007	U008	U009	U010	U011	U012	U013	U014	U015	U016	U017	U018	U019	U020
------	------	------	------	-------------	------	------	------	------	------	------	------	------	------	------	------	------	------	------	------

U005 TONNER SUPPLY

- 19.11050489 HARNESS CLAMP - LWS 1316
- 11.04514008N (x18) TAPPING SCREW: 4X8
- 20.11050511 (x2) HARNESS CLAMP - LWS-0306ZC
- 7.04504012N (x6) TAPPING SCREW: 4X12
- 1.03125060N (x8) SCREW - M2.5X6

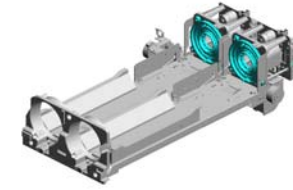

- 21.11050516 (x14) CLAMP

- 9.04513014N TAPPING SCREW: 3X14

- 12.04524008N (x2) TAPPING SCREW: M4X8

- 24.12042612 MICRO SWITCH:D3 V-16506-3C25:(SW 10/SW11/SW102/S W103)

- 16.08050092 RETAINING RING - 3M

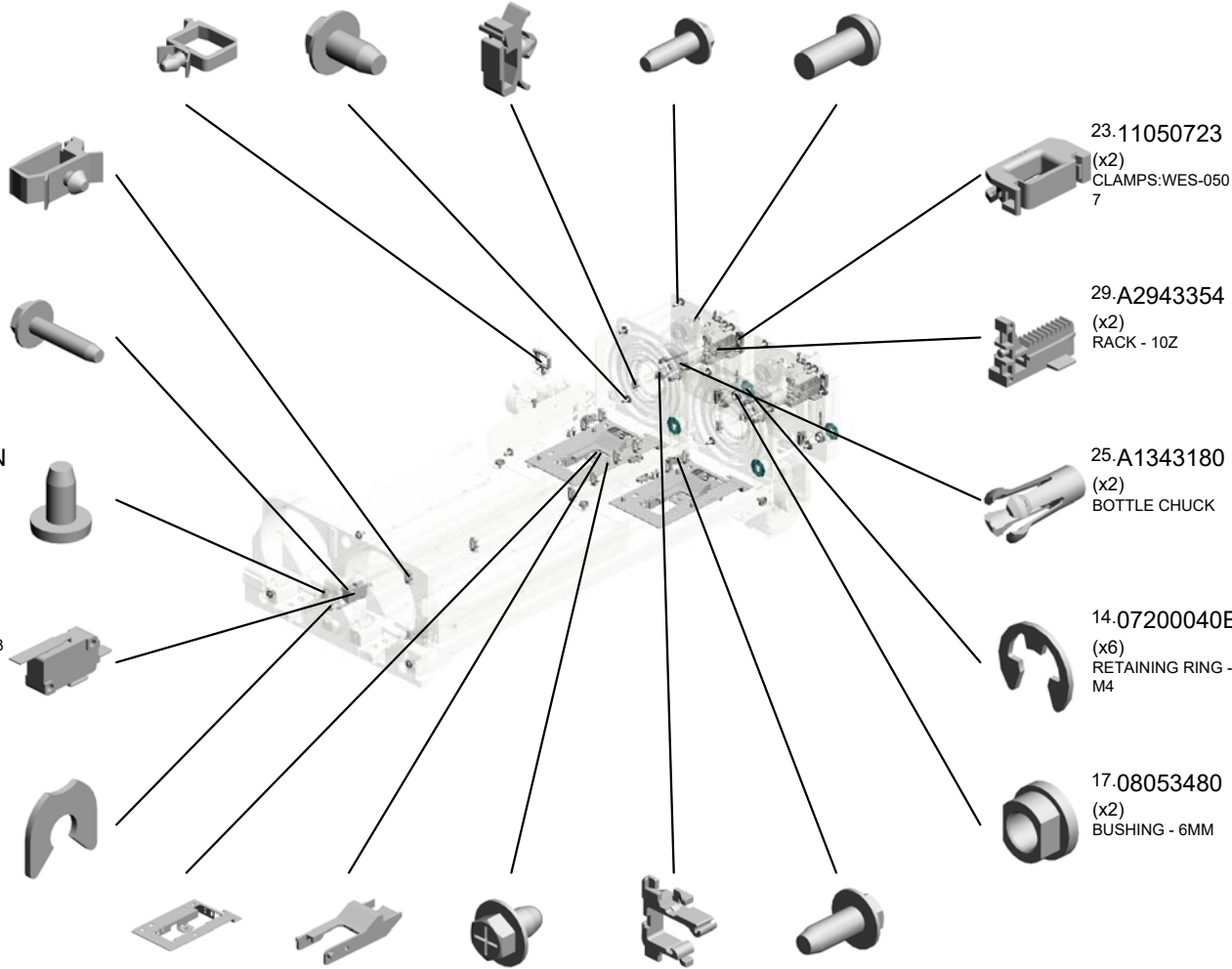

- 30.A2943445 (x2) STOPPER SUPPO RT PLATE
- 31.A2943446 (x2) TONER BOTTLE S TOPPER
- 13.04544006Q (x6) TAPPING SCREW: 4X6
- 22.11050551 (x6) CLAMP:LES-0505
- 10.04514006N (x12) TAPPING SCREW - 4X6

- 23.11050723 (x2) CLAMPS:WES-050 7

- 29.A2943354 (x2) RACK - 10Z

- 25.A1343180 (x2) BOTTLE CHUCK

- 14.07200040E (x6) RETAINING RING - M4

- 17.08053480 (x2) BUSHING - 6MM

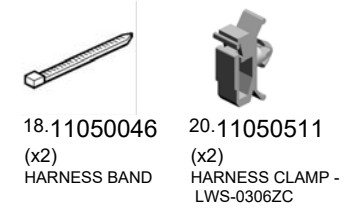

- 18.11050046 (x2) HARNESS BAND

- 20.11050511 (x2) HARNESS CLAMP - LWS-0306ZC

- 11.04514008N (x 8) TAPPING SCREW:4X8
- 14.07200040E (x 4) RETAINING RING - M4

U005 TONNER SUPPLY

- 34.A2943461 (x2) LEVER RACK JOINT
- 45.AB012005 (x4) GEAR - 13Z
- 44.AA152299 (x2) BOTTLE HOLD SE
- 43.AA143816 (x2) FLAT SCREW:CHU
- 49.AB017515 (x2) DOUBLE GEAR - 1

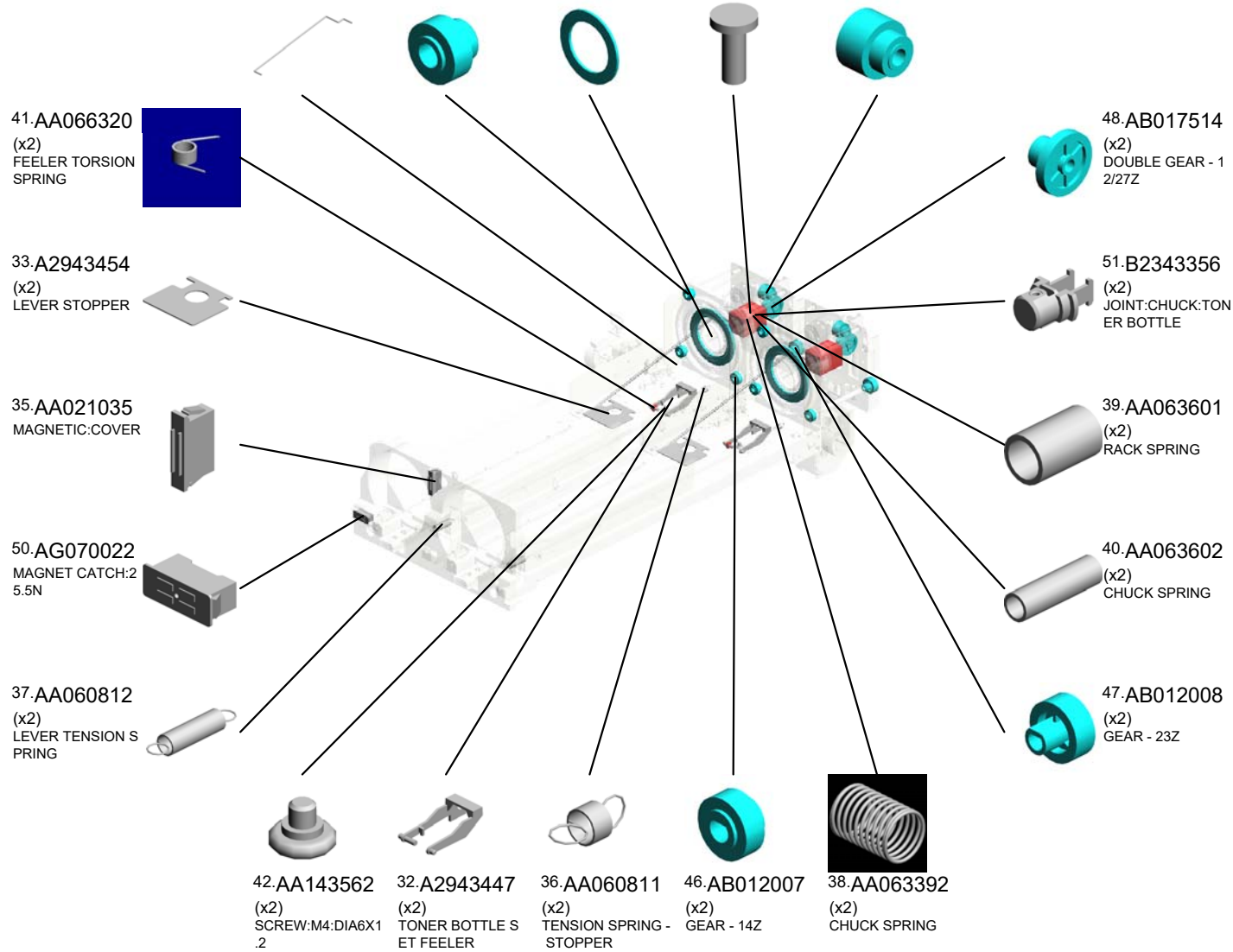
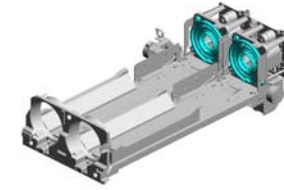

U005 TONNER SUPPLY

- 54.D0BX3451 (x2) LEVER:TONER BOTTLE:PEEN
- 66.D1793272 SHUTTER:TONER SUPPLY:ASS'Y
- 67.D1793275 (x2) COIL SPRING:SHUTTER:TONER SUPPLY
- 65.D1793271 CASE:SHUTTER:TONER SUPPLY
- 75.D1793361 (x2) BRACKET:JOINT:REAR:LEVER

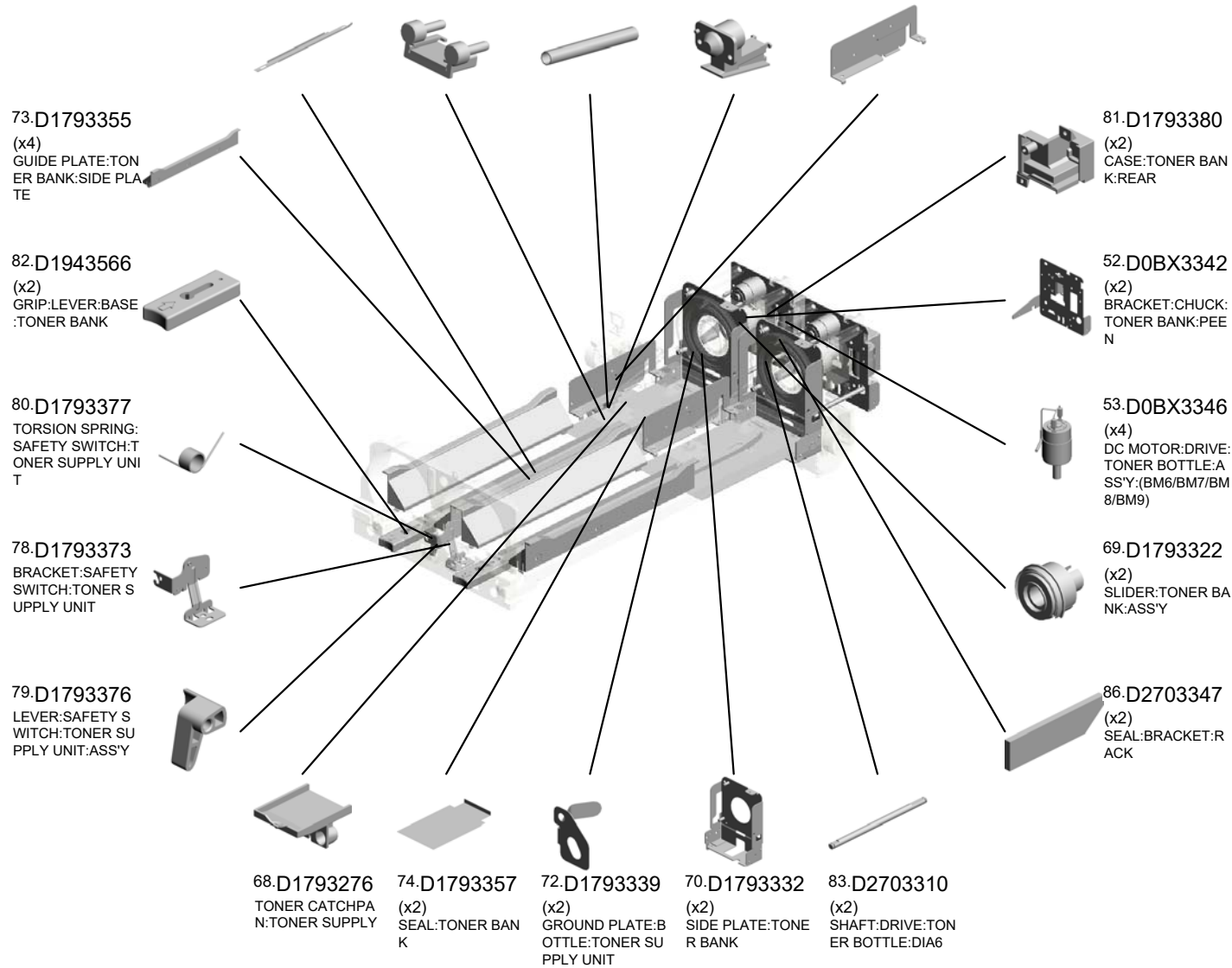
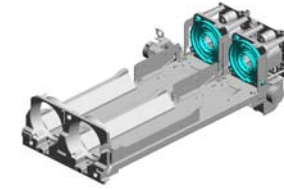

U001	U002	U003	U004	U005	U006	U007	U008	U009	U010	U011	U012	U013	U014	U015	U016	U017	U018	U019	U020
------	------	------	------	------	------	------	------	------	------	------	------	------	------	------	------	------	------	------	------

U005 TONNER SUPPLY

87.D2703383
(x2)
SEAL:CASE:TONE
R BANK:REAR

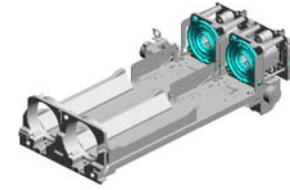

92.A2943293
(x2)
(Pro 8310/8320):GE
AR:108Z
201908-01 O/O



88.D2703384
(x2)
SEAL:CASE:TONE
R BANK:LEFT



89.GW020024
(x2)
PHOTOINTERRUP
TOR:LG2A24BL1.G
F:(SEN3/SEN21/SE
N35/SEN36/SEN37/
SEN38/SEN39/SEN

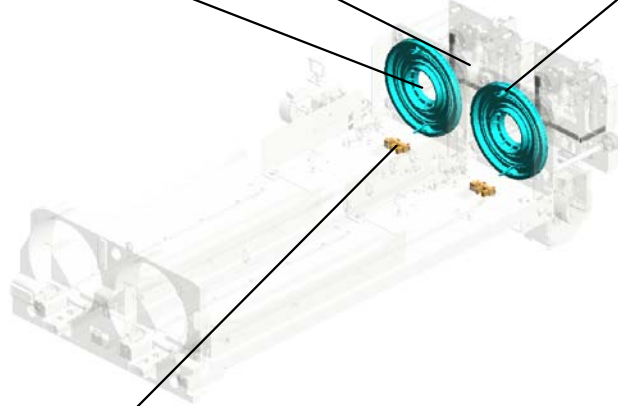

U001	U002	U003	U004	U005	U006	U007	U008	U009	U010	U011	U012	U013	U014	U015	U016	U017	U018	U019	U020
------	------	------	------	-------------	------	------	------	------	------	------	------	------	------	------	------	------	------	------	------

U005_S001
CASE:TONER BANK:ASS'Y

85.D2703336 28.A2943319
SEAL:CASE:TONE CASE CUSHION
R BANK:FRONT

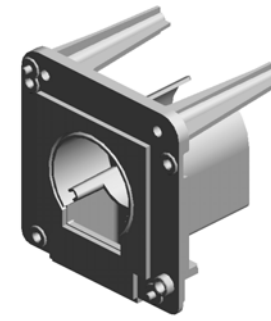

71.D1793334
CASE:TONER BAN
K:ASS'Y

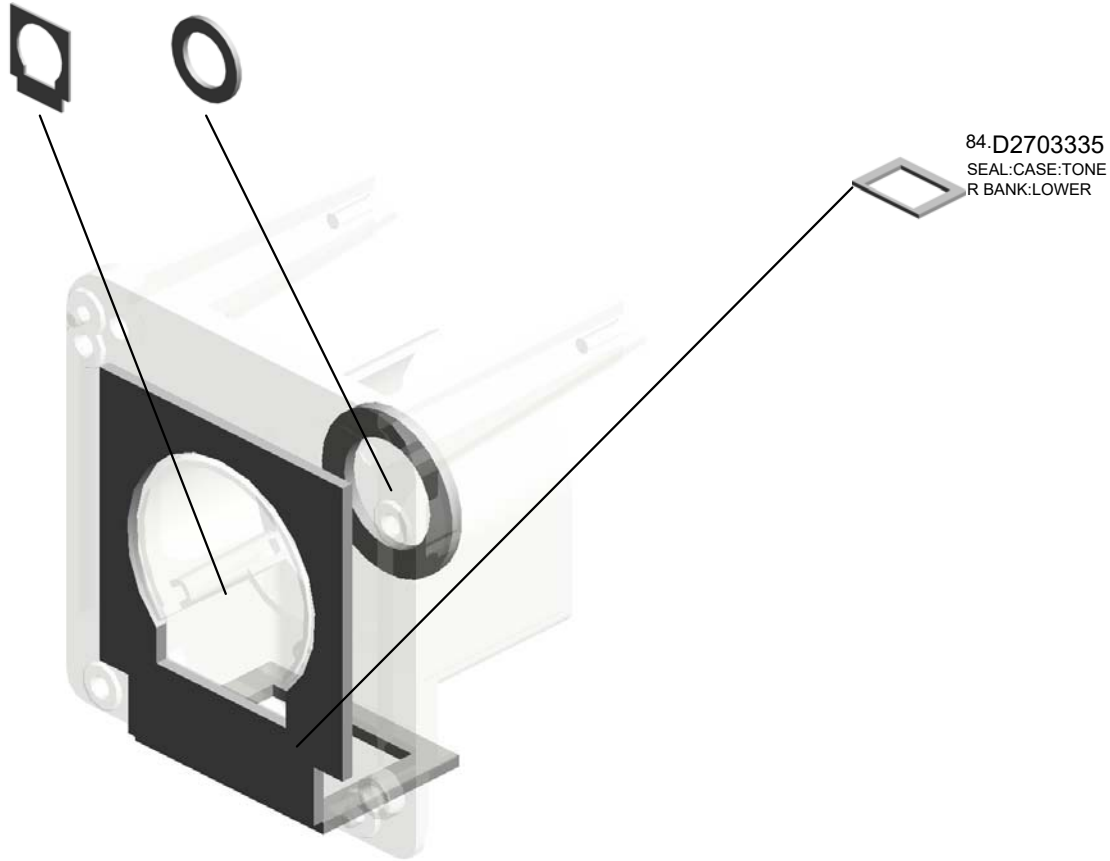

84.D2703335
SEAL:CASE:TONE
R BANK:LOWER

U001	U002	U003	U004	U005	U006	U007	U008	U009	U010	U011	U012	U013	U014	U015	U016	U017	U018	U019	U020
------	------	------	------	------	------	------	------	------	------	------	------	------	------	------	------	------	------	------	------

U005_S002
CASE:TONER BANK:ASS'Y

85.D2703336 28.A2943319
SEAL:CASE:TONE CASE CUSHION
R BANK:FRONT

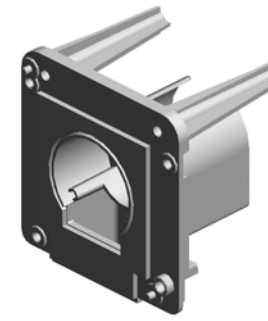

71.D1793334
CASE:TONER BAN
K:ASS'Y

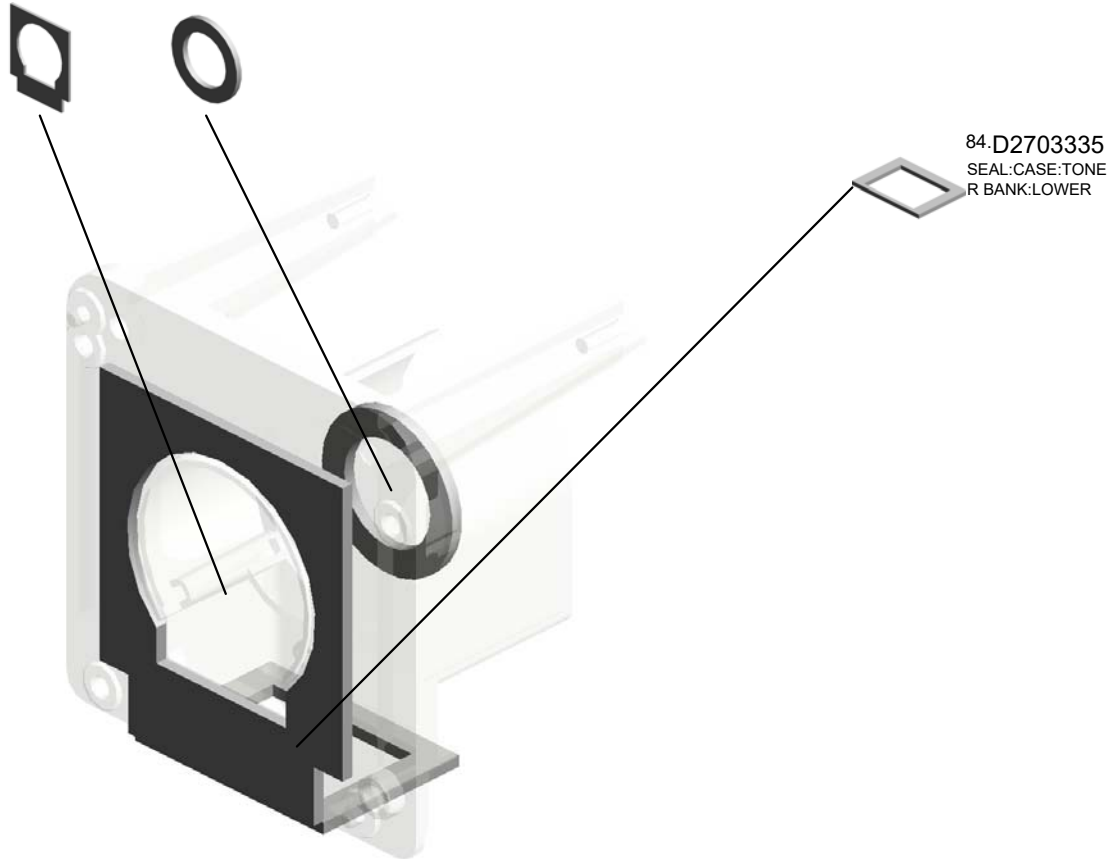

U001	U002	U003	U004	U005	U006	U007	U008	U009	U010	U011	U012	U013	U014	U015	U016	U017	U018	U019	U020
------	------	------	------	-------------	------	------	------	------	------	------	------	------	------	------	------	------	------	------	------

U005_S003
INNER COVER:TONER BANK:ASS'Y

76:D1793367
DECAL:DESIGN SK
ETCH:TONER BOT
TLE

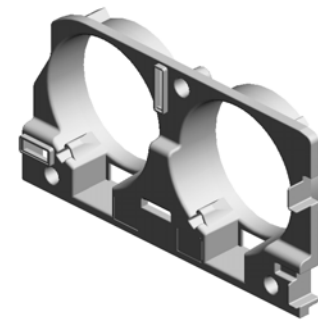

77:D1793370
INNER COVER:TO
NER BANK:ASS'Y

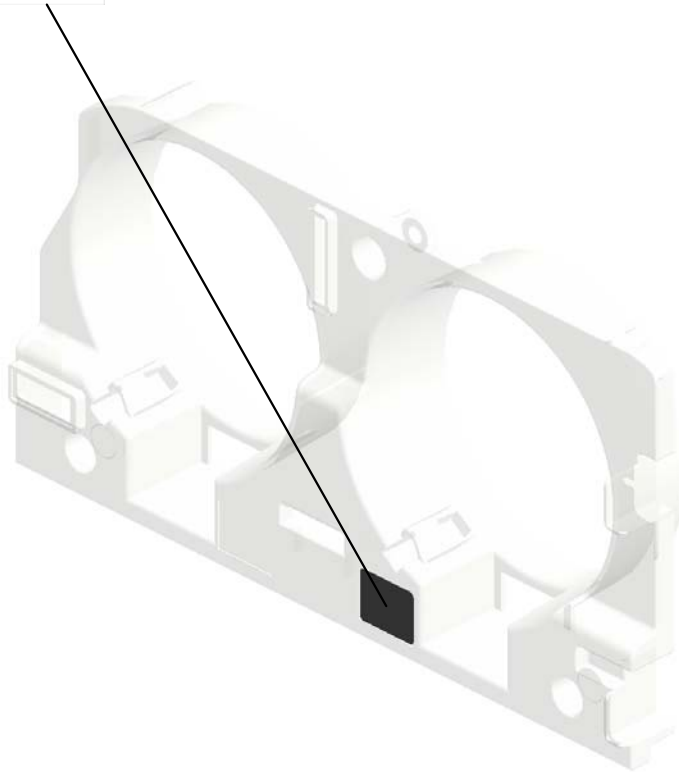

U001	U002	U003	U004	U005	U006	U007	U008	U009	U010	U011	U012	U013	U014	U015	U016	U017	U018	U019	U020
------	------	------	------	-------------	------	------	------	------	------	------	------	------	------	------	------	------	------	------	------

U005_S004

TONER SUPPLY UNIT:TONER HOPPER:ASS'Y

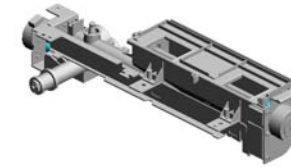

55.D1793201
TONER SUPPLY U
NIT:TONER HOPPE
R:ASS'Y

2.03530060N (x4) BIND SCREW - M3 X6
56.D1793234 GEAR:TRANSPORT SCREW:LONG:TONER SUPPLY
61.D1793254 (x2) GEAR:IDLER:FEED:TONER SUPPLY:2
59.D1793252 COVER:GEAR:TONER SUPPLY
26.A2941163 (x2) GEAR - 30Z

91.GX060019 (x2) STEPPER MOTOR:PM42L048RBG8:(STM32/STM33)

60.D1793253 GEAR:IDLER:FEED:TONER SUPPLY:1

64.D1793263 BRACKET:DC STEPPER MOTOR:TONER SUPPLY

8.04513006N (x2) TAPPING SCREW - 3X6

15.08050089 RETAINING RING - M4

57.D1793237 GEAR:TRANSPORT SCREW:SHORT:TONER SUPPLY
6.04503012N (x3) TAPPING SCREW: 3X12
5.04503010N (x9) TAPPING SCREW - M3X10
3.03530100N (x2) SCREW-M3X10
14.07200040E (x5) RETAINING RING - M4

90.GW230008 TONER END SENSOR:(SEN73)

4.04503008N (x2) TAPPING SCREW - M3X8

58.D1793244 GEAR:AGITATOR:TONER SUPPLY

62.D1793256 BRACKET:DC STEPPER MOTOR:AGITATOR:ASS'Y

63.D1793259 GEAR:IDLER:AGITATOR:TONER SUPPLY

U001	U002	U003	U004	U005	U006	U007	U008	U009	U010	U011	U012	U013	U014	U015	U016	U017	U018	U019	U020
------	------	------	------	------	------	------	------	------	------	------	------	------	------	------	------	------	------	------	------

U006.PCDU

U006_S001
D1792255
CHARGE CORONA

U006_S005
D2702214
DUCT:CHARGE UNIT:ASS'Y

U006_S003
D0BX2432
SERVICE PARTS:DEVELOPM
ENT UNIT:ASS'Y

U006_S004
D1792239
SHAFT:CLEANER:CHARGE:D
RIVE:ASS'Y

U006_S002
D1793504
CLEANING UNIT:ASS'Y

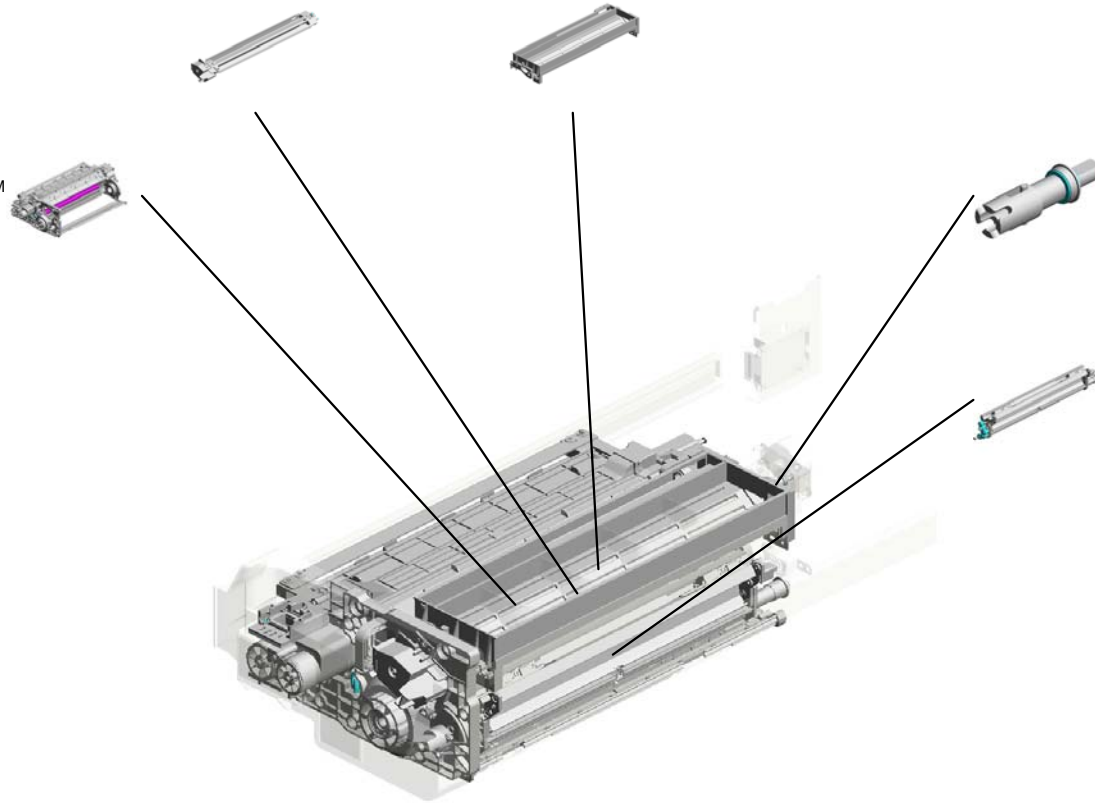

U001	U002	U003	U004	U005	U006	U007	U008	U009	U010	U011	U012	U013	U014	U015	U016	U017	U018	U019	U020
------	------	------	------	------	-------------	------	------	------	------	------	------	------	------	------	------	------	------	------	------

U006_S001.CHARGE CORONA

U006 S001 S001
D1792256
COVER:CHARGE CORONA:A
SSY



U001	U002	U003	U004	U005	U006	U007	U008	U009	U010	U011	U012	U013	U014	U015	U016	U017	U018	U019	U020
------	------	------	------	------	-------------	------	------	------	------	------	------	------	------	------	------	------	------	------	------

U006_S002.CLEANING UNIT:ASS'Y

U006 S002 S002
D1793535
GEAR SET:CLEANING UNIT:
SERVICE PARTS

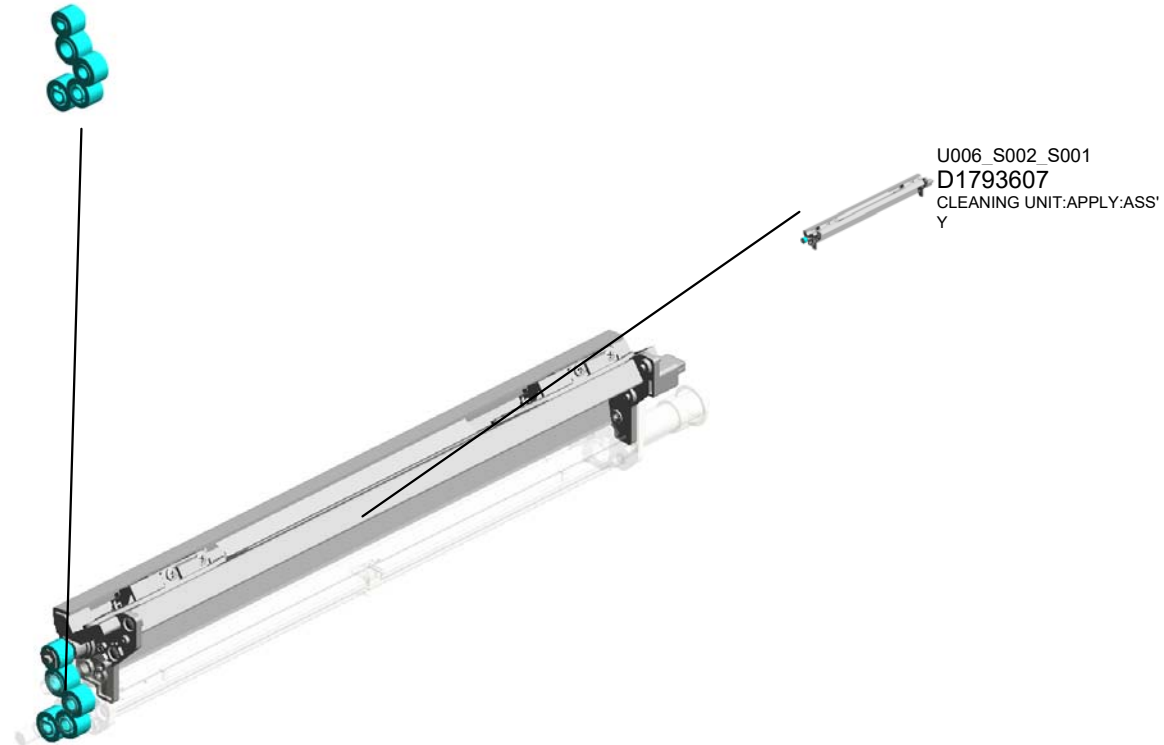

U001	U002	U003	U004	U005	U006	U007	U008	U009	U010	U011	U012	U013	U014	U015	U016	U017	U018	U019	U020
------	------	------	------	------	-------------	------	------	------	------	------	------	------	------	------	------	------	------	------	------

U006_S002_S001.CLEANING UNIT:APPLY:ASS'Y

U006 S002 S001 S001
D1793681
HOLDER:COVER:COATING B
AR:ASS'Y:(OT14)



U006_S002_S001_S002
D1793681
HOLDER:COVER:COATING B
AR:ASS'Y:(OT14)

U001	U002	U003	U004	U005	U006	U007	U008	U009	U010	U011	U012	U013	U014	U015	U016	U017	U018	U019	U020
------	------	------	------	------	-------------	------	------	------	------	------	------	------	------	------	------	------	------	------	------

U006
PCDU

- 5.03540120N (x2) SCREW M4X12
- 17.04533006N (x2) TAPPING SCREW - M3X6
- 1.03530060N (x3) BIND SCREW - M3X6
- 52.D1792237 HOLDER:MOTOR:CHARGE
- 36.B7005804 STEPPER MOTOR: DIA42:Z17:ASS'Y:(S TM1)

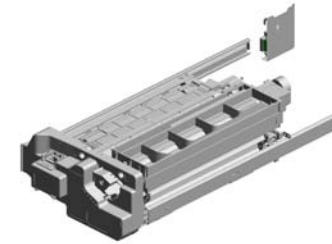

42.D0743829
DECAL:POSITIONING
DISPLAY:TCRU



59.D1792370
GRIP:DRUM:ASS'Y



33.AW140027
TEMPERATURE &
HUMIDITY SENSOR:
(SEN2)



11.04503008N
(x10)
TAPPING SCREW -
M3X8



60.D1792376
HOLDER:DRUM:TA
KE OFF:FRONT



18.04543006Q
TAPPING SCREW -
M3X6

63.D1792412
HOLDER:SLIDE RA
IL:PCU:RIGHT

37.D0592469
(x4)
SCREW:ROUND P
OINT:M4X6

62.D1792411
(x2)
SLIDE RAIL:PCU

61.D1792377
HOLDER:DRUM:TA
KE OFF:REAR

26.07413706
BALL BEARING - 6
X10X3



53.D1792238
SOCKET:CHARGE



55.D1792246
SEAL:DUCT:SIDE P
LATE:REAR



15.04514008N
(x5)
TAPPING SCREW:
4X8



41.D0742577
CONNECTOR:DR
WER:4POLE:REC



35.B2342390
(x3)
FLANGED HEXAG
ONAL HEAD BOLT:
M4X8



37.D0592469
(x2)
SCREW:ROUND P
OINT:M4X6

1.03530060N(x 1)
BIND SCREW - M3X6

2.03530080N(x 1)
SCREW:M3X8

11.04503008N(x 1)
TAPPING SCREW - M3X8

15.04514008N(x 2)
TAPPING SCREW:4X8

U006
PCDU

- 117.D3724561 SPACER:DIA4
- 143.GW020024 PHOTOINTERRUPTOR:LG2A24BL1:GF:(SEN3/SEN21/SEN35/SEN36/SEN37/SEN38/SEN39/SEN40/SEN41/SEN42/S
- 64.D1792416 STAY:ELECTRIC POTENTIAL SENSOR
- 65.D1792417 HOLDER:ELECTRIC POTENTIAL SENSOR
- 67.D1792421 ELECTRIC POTENTIAL SENSOR:(SEN5)

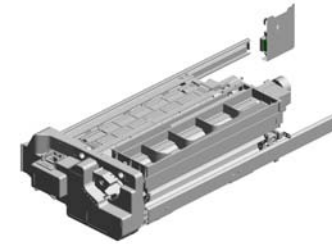

- 116.D2703136 DECAL:DEVELOPMENT UNIT:CAUTION



- 110.D2701568 (x3) DECAL:POSITIONING DISPLAY:TCRU:ABS



- 115.D2703134 DECAL:WARNING: AROUND THE PHOTOCONDUCTOR:ABS



- 71.D1792469 KNOB SCREW:DRUM

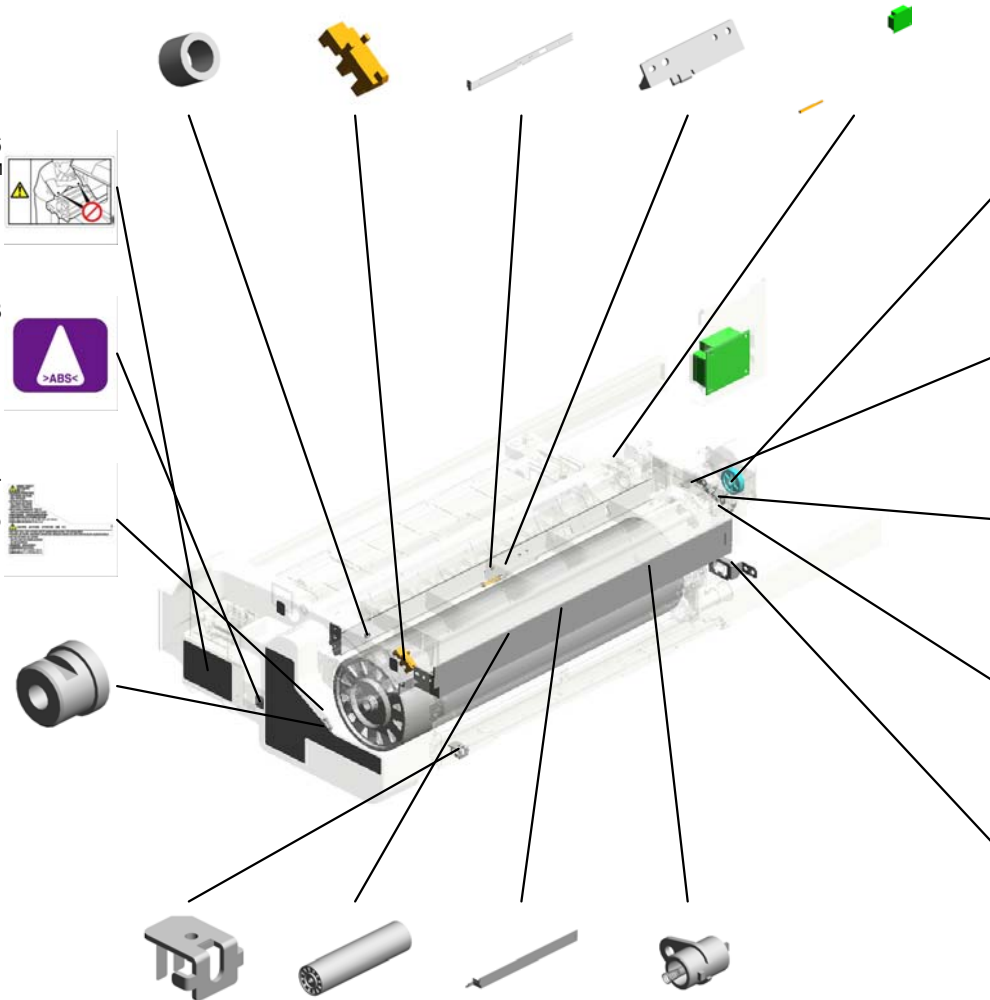

- 118.G1781282 GEAR:CHARGE:CLANER:Z51



- 120.G1781313 SPRING:PLATE:RIGHT:CHARGE



- 119.G1781311 (x3) TERMINAL:CHARGE



- 121.G1781316 SPRING:PLATE:LEFT:CHARGE



- 68.D1792427 BRACKET:DRAWER:CLEANING UNIT



- 66.D1792419 STOPPER:SLIDE RAIL:PCU:PEEN
- 109.D1799510 OPC DRUM
- 112.D2702247 DUCT:SIDE PLATE
- 83.D1793131 RECEPTACLE:DEVELOPMENT VIAS:ASSY



U006_S001
CHARGE CORONA

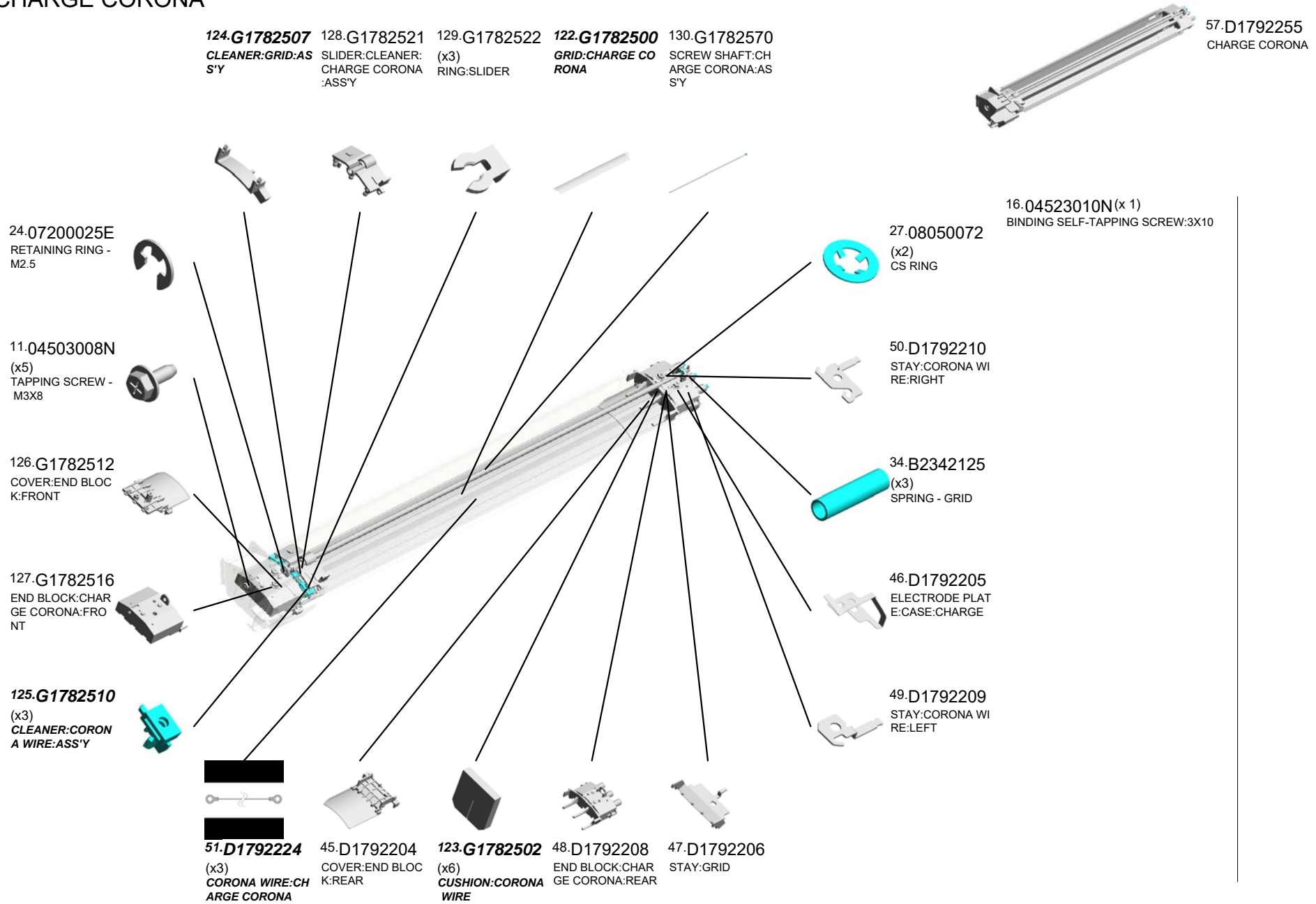

U001	U002	U003	U004	U005	U006	U007	U008	U009	U010	U011	U012	U013	U014	U015	U016	U017	U018	U019	U020
------	------	------	------	------	------	------	------	------	------	------	------	------	------	------	------	------	------	------	------

U006_S001
CHARGE CORONA

131.G1782605
(x3)
TENSION SPRING:
CORONA WIRE



57.D1792255
CHARGE CORONA

U001	U002	U003	U004	U005	U006	U007	U008	U009	U010	U011	U012	U013	U014	U015	U016	U017	U018	U019	U020
------	------	------	------	------	-------------	------	------	------	------	------	------	------	------	------	------	------	------	------	------

U006_S001_S001
COVER:CHARGE CORONA:ASS'Y

56.D1792254
DECAL:CHARGE:G
RIP

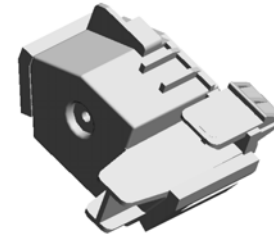

58.D1792256
COVER:CHARGE C
ORONA:ASS'Y

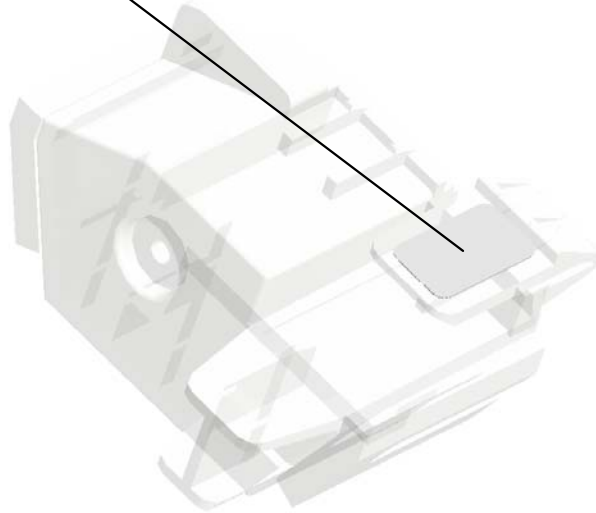

U001	U002	U003	U004	U005	U006	U007	U008	U009	U010	U011	U012	U013	U014	U015	U016	U017	U018	U019	U020
------	------	------	------	------	-------------	------	------	------	------	------	------	------	------	------	------	------	------	------	------

U006_S002
CLEANING UNIT:ASS'Y

92.D1793561
SHAFT:CLEANING
BLADE:FRONT

96.D1793581
BLADE:CLEANING:
ASS'Y

94.D1793571
BRACKET:CLEANING
BLADE:ASS'Y

85.D1793525
TONER COLLECTION
COIL:CLEANING
ASS'Y



84.D1793504
CLEANING UNIT:ASS'Y

97.D1793589
RETAINING RINGS -E:GUIDE

25.07200040E
RETAINING RING -M4

28.08050089
(x2)
RETAINING RING -M4

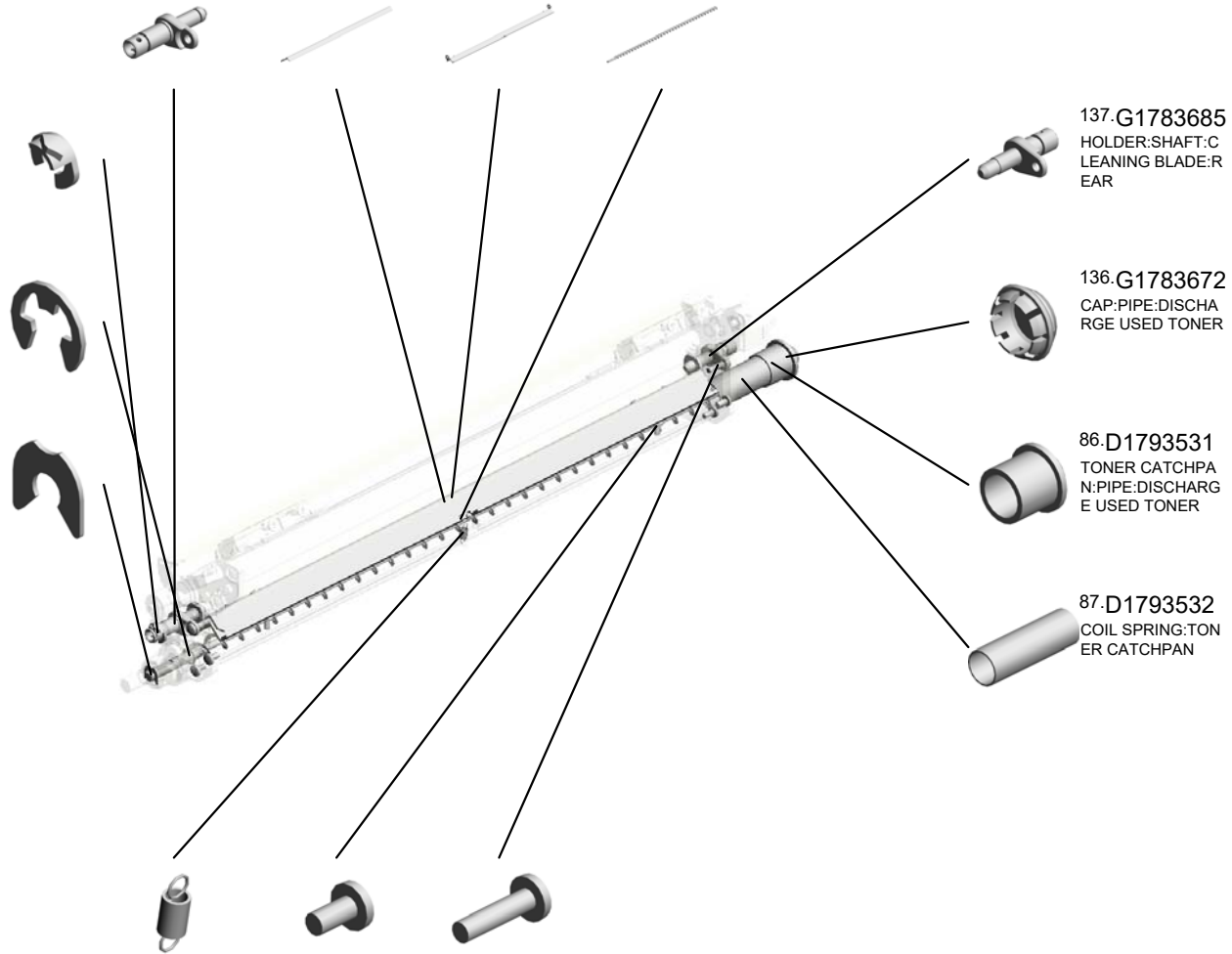

137.G1783685
HOLDER:SHAFT:CLEANING
BLADE:REAR

136.G1783672
CAP:PIPE:DISCHARGE
USED TONER

86.D1793531
TONER CATCHPAN:PIPE:DISCHARGE
USED TONER

87.D1793532
COIL SPRING:TONER
CATCHPAN

95.D1793576
TENSION SPRING:CLEANING
BLADE:6N

1.03530060N
(x8)
BIND SCREW - M3
X6

4.03530120N
(x2)
SCREW M3X12

U001	U002	U003	U004	U005	U006	U007	U008	U009	U010	U011	U012	U013	U014	U015	U016	U017	U018	U019	U020
------	------	------	------	------	-------------	------	------	------	------	------	------	------	------	------	------	------	------	------	------

U006_S002_S001
CLEANING UNIT:APPLY:ASS'Y

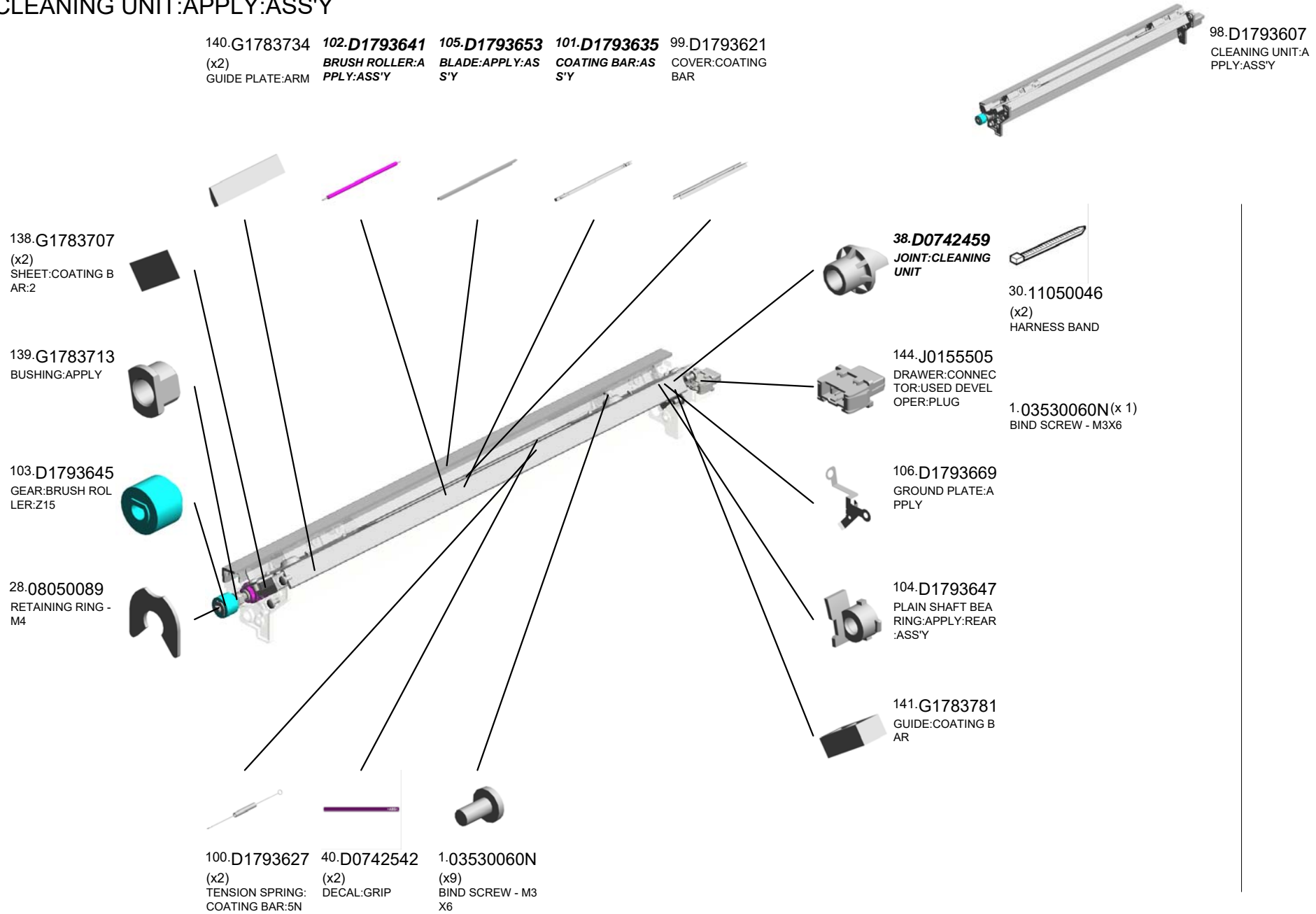

U001	U002	U003	U004	U005	U006	U007	U008	U009	U010	U011	U012	U013	U014	U015	U016	U017	U018	U019	U020
------	------	------	------	------	------	------	------	------	------	------	------	------	------	------	------	------	------	------	------

U006_S002_S001_S001
HOLDER:COVER:COATING BAR:ASS'Y:(OT14)

108.D1793689
GROUND PLATE:C
OVER:APPLY

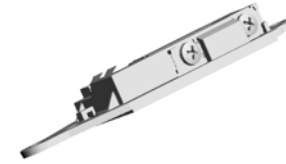

107.D1793681
HOLDER:COVER:C
OATING BAR:ASS'
Y:(OT14)

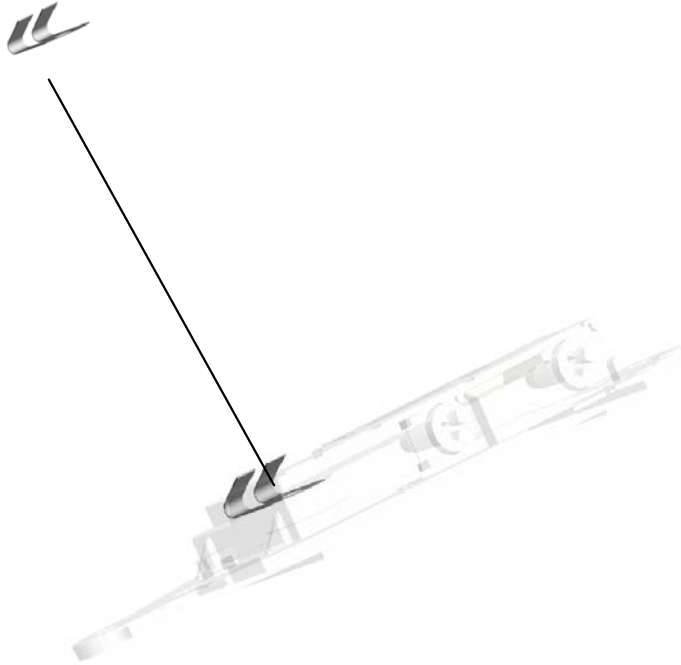

U001	U002	U003	U004	U005	U006	U007	U008	U009	U010	U011	U012	U013	U014	U015	U016	U017	U018	U019	U020
------	------	------	------	------	-------------	------	------	------	------	------	------	------	------	------	------	------	------	------	------

U006_S002_S001_S002
HOLDER:COVER:COATING BAR:ASS'Y:(OT14)

108.D1793689
GROUND PLATE:C
OVER:APPLY

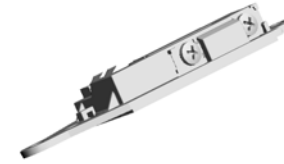

107.D1793681
HOLDER:COVER:C
OATING BAR:ASS'
Y:(OT14)

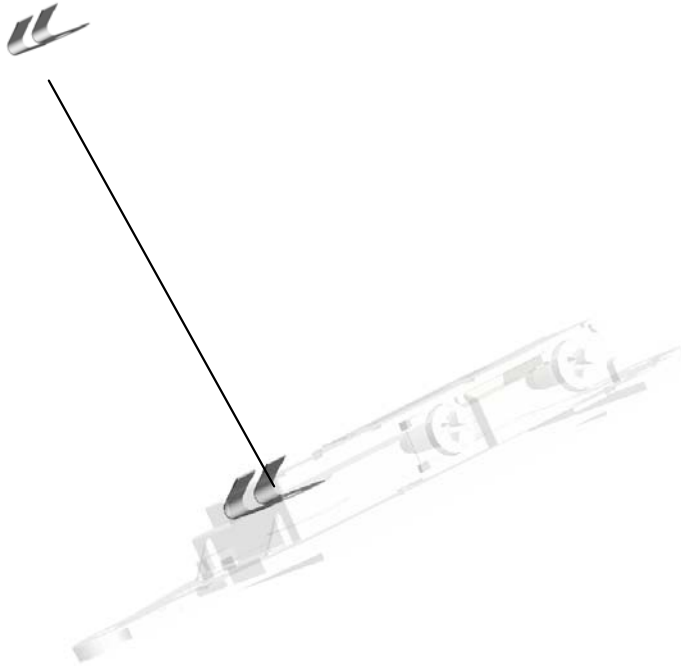

U001	U002	U003	U004	U005	U006	U007	U008	U009	U010	U011	U012	U013	U014	U015	U016	U017	U018	U019	U020
------	------	------	------	------	-------------	------	------	------	------	------	------	------	------	------	------	------	------	------	------

U006_S002_S002

GEAR SET:CLEANING UNIT:SERVICE PARTS

103.D1793645 93.D1793564
GEAR:BRUSH ROLLER:Z15 GEAR:IDLER:Z17:UPPER



88.D1793535
GEAR SET:CLEANING UNIT:SERVICE PARTS

89.D1793536
GEAR:IDLER:Z16

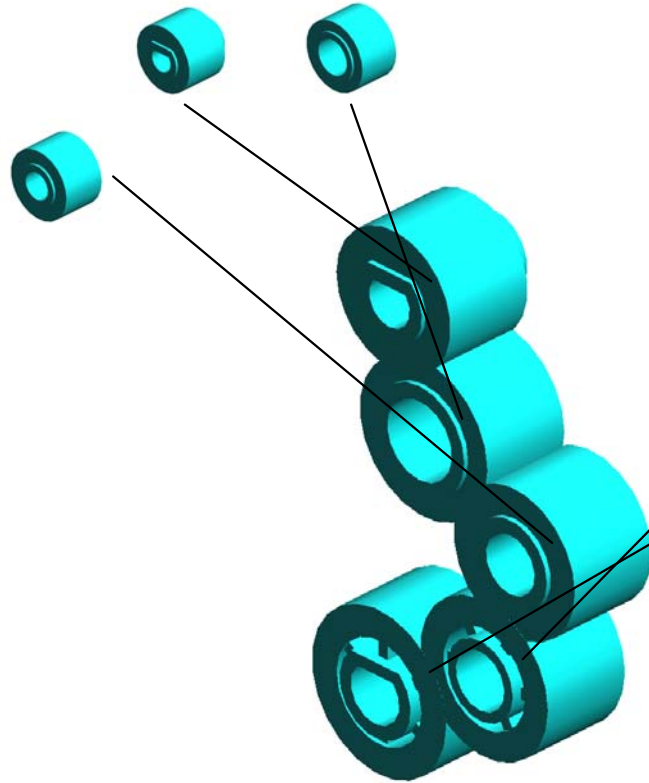

90.D1793537
GEAR:IDLER:Z17:LOWER

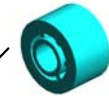

91.D1793538
GEAR:TONER COLLECTION COIL:Z18

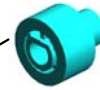

U001	U002	U003	U004	U005	U006	U007	U008	U009	U010	U011	U012	U013	U014	U015	U016	U017	U018	U019	U020
------	------	------	------	------	-------------	------	------	------	------	------	------	------	------	------	------	------	------	------	------

- 14.04504025N (x8) TAPPING SCREW: 4X25
- 13.04504012N (x12) TAPPING SCREW: 4X12
- 8.03603010N (x4) SCREW:M3X10
- 32.11050534 (x4) CLAMP
- 4.03530120N (x2) SCREW M3X12

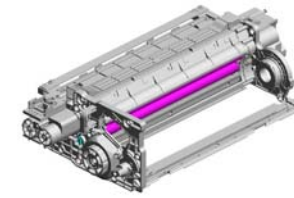

43.D0BX2432
SERVICE PARTS:DEVELOPMENT UNIT:ASS'Y

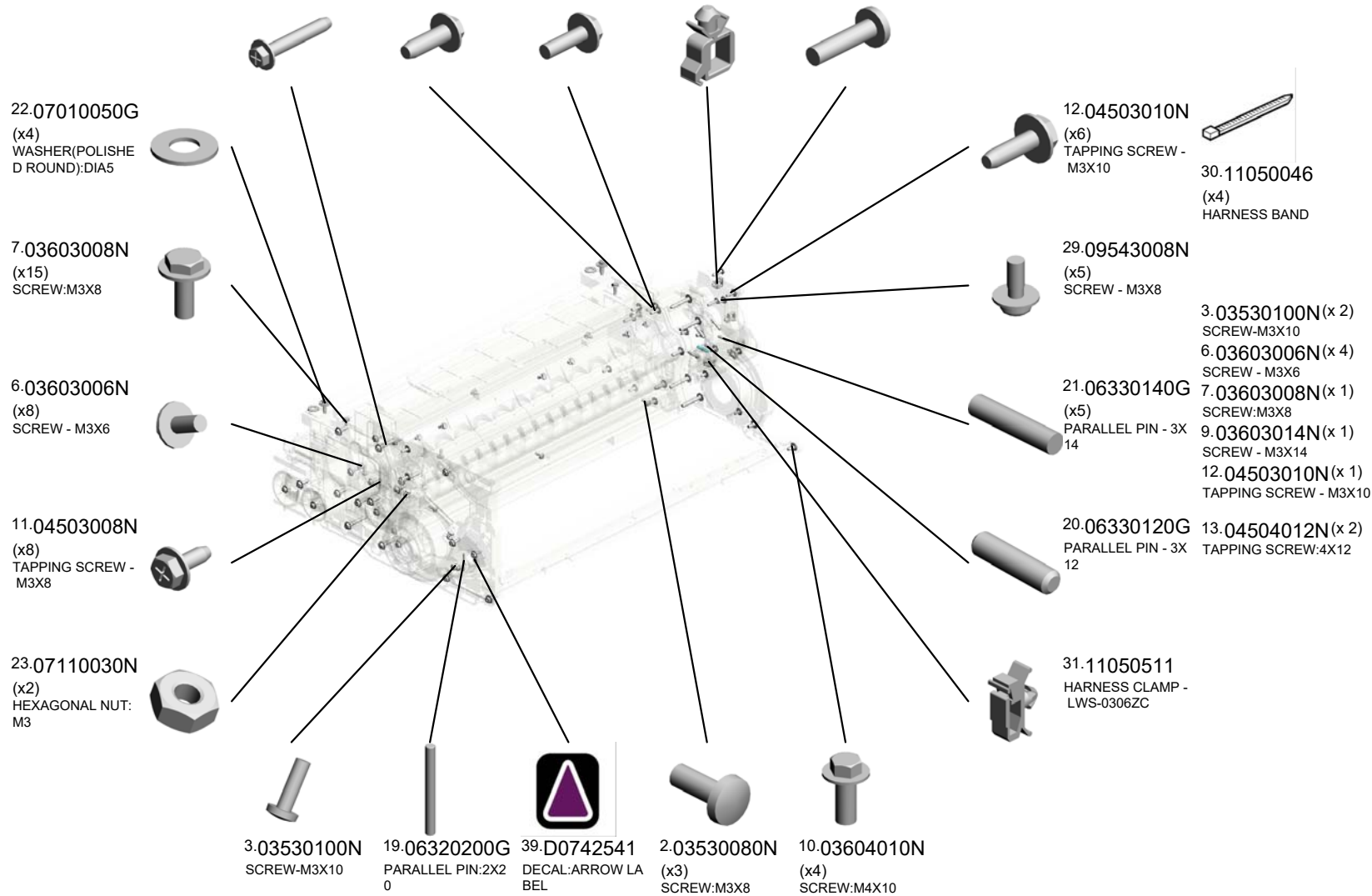

U001	U002	U003	U004	U005	U006	U007	U008	U009	U010	U011	U012	U013	U014	U015	U016	U017	U018	U019	U020
------	------	------	------	------	------	------	------	------	------	------	------	------	------	------	------	------	------	------	------

- 80.D1793075 FILTER:DEVELOPMENT
- 77.D1793072 GEAR:TRANSPORT SCREW:NO.3
- 82.D1793090 PLATE:GEAR:IDLER:ASS'Y
- 114.D2703097 COVER:GEAR:DEVELOPMENT
- 78.D1793073 GEAR:IDLER:TRANSPORT SCREW:UPPER:ASS'Y

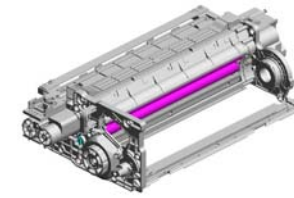

43.D0BX2432
SERVICE PARTS:DEVELOPMENT UNIT:ASS'Y

74.D1793043
DUCT:FILTER:DEVELOPMENT:ASS'Y

81.D1793084
ENTRANCE SEAL:DEVELOPMENT:ASS'Y

113.D2703079
SERVICE PARTS:DENSITY SENSOR:DEVELOPMENT:(SEN1)

70.D1792468
GRIP:DRUM STAY:PCU

69.D1792467
LEVER:POSITIONING:CLEANING

72.D1792474
DECAL:DIAL

73.D1792494
GROUND PLATE:STAY:PCU

42.D0743829
DECAL:POSITIONING DISPLAY:TCRU

44.D0BX2485
LED ARRAY:ASS'Y:(OT1)

133.G1783332
(x2)
GEAR:DEVELOPMENT ROLLER

75.D1793070
GEAR:TRANSPORT SCREW:NO.1

79.D1793074
GEAR:IDLER:TRANSPORT SCREW:LOWER:ASS'Y

134.G1783356
(x2)
GEAR:JOINT:DEVELOPMENT UNIT

76.D1793071
GEAR:TRANSPORT SCREW:NO.2

132.G1783330
GEAR:IDLER:DEVELOPMENT ROLLER:ASS'Y

U001	U002	U003	U004	U005	U006	U007	U008	U009	U010	U011	U012	U013	U014	U015	U016	U017	U018	U019	U020
------	------	------	------	------	------	------	------	------	------	------	------	------	------	------	------	------	------	------	------

U006_S003
SERVICE PARTS:DEVELOPMENT UNIT:ASS'Y

135.G1783475
SPONGE:COUPLIN
G:TONER SUPPLY:
DEVELOPMENT U
NIT

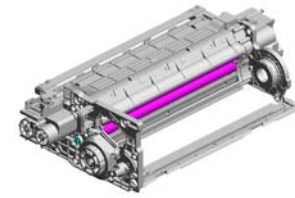

43.D0BX2432
SERVICE PARTS:D
EVELOPMENT UNI
T:ASS'Y

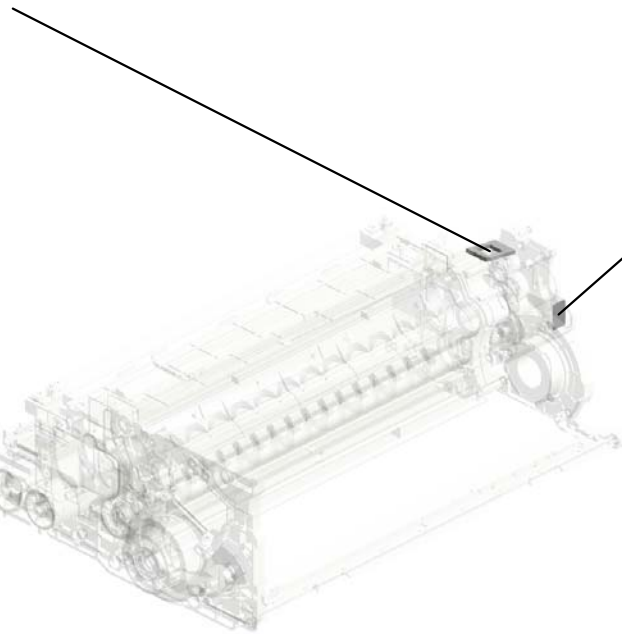

142.GA000063
DECAL:DEVELOPM
ENT UNIT:DISPLAY

U001	U002	U003	U004	U005	U006	U007	U008	U009	U010	U011	U012	U013	U014	U015	U016	U017	U018	U019	U020
------	------	------	------	------	-------------	------	------	------	------	------	------	------	------	------	------	------	------	------	------

U006_S004
SHAFT:CLEANER:CHARGE:DRIVE:ASS'Y

26.07413706
BALL BEARING - 6
X10X3



54.D1792239
SHAFT:CLEANER:
CHARGE:DRIVE:A
SS'Y



25.07200040E
RETAINING RING -
M4



U001	U002	U003	U004	U005	U006	U007	U008	U009	U010	U011	U012	U013	U014	U015	U016	U017	U018	U019	U020
------	------	------	------	------	-------------	------	------	------	------	------	------	------	------	------	------	------	------	------	------

U006_S005
DUCT:CHARGE UNIT:ASS'Y

31.11050511
HARNESS CLAMP -
LWS-03062C



111.D2702214
DUCT:CHARGE UN
IT:ASS'Y

U001	U002	U003	U004	U005	U006	U007	U008	U009	U010	U011	U012	U013	U014	U015	U016	U017	U018	U019	U020
------	------	------	------	------	-------------	------	------	------	------	------	------	------	------	------	------	------	------	------	------

U007.ITB UNIT

U007 S001
D0BX6000
TRANSFER UNIT:INTERMEDI
ATE TRANSFER:ASSY

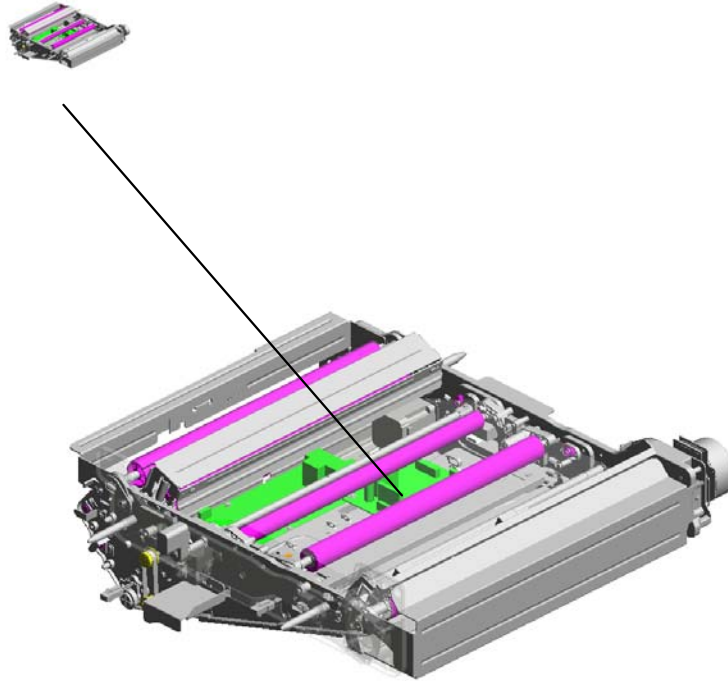

U001	U002	U003	U004	U005	U006	U007	U008	U009	U010	U011	U012	U013	U014	U015	U016	U017	U018	U019	U020
------	------	------	------	------	------	------	------	------	------	------	------	------	------	------	------	------	------	------	------

U007
ITB UNIT

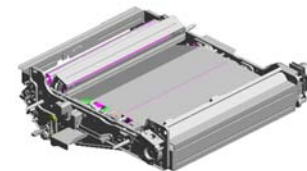

2.03603006N (x6) SCREW - M3X6
 61.D0747118 DUCT:INNER BACK :COOLING:POSITIONING SENSOR
 85.D1796050 FLAT BELT-TRANSFER
 49.D0744351 (x4) STEPPED SCREW: DIA5.4DIA:DIA3.5:MM3

6.03604008N (x7) SCREW - M4X8

126.D2706176 INNER COVER:INTERMEDIATE TRANSFER:LEVER

125.D2706166 DRUM STAY:INTERMEDIATE TRANSFER:ASSY

41.B7125605 GRIP:APPLICATION

4.03603020N (x2) SCREW:M3X20

62.D0747119 DUCT:FRONT:COOLING:POSITIONING SENSOR

39.AX640330 FAN:SIROCCO:DIA51:(FAN26/FAN27)

21.11050511 (x3) HARNESS CLAMP - LWS-0306ZC

30.AA063463 (x4) COMPRESSION SPRING:DRAWER

113.D1796173 SEAL:DUCT:DENSITY SENSOR

60.D0747087 SEAL:DC FAN MOTOR:SIROCCO

63.D0747120 BRACKET:DUCT:COOLING:POSITIONING SENSOR

U001	U002	U003	U004	U005	U006	U007	U008	U009	U010	U011	U012	U013	U014	U015	U016	U017	U018	U019	U020
------	------	------	------	------	------	------	------	------	------	------	------	------	------	------	------	------	------	------	------

U007_S001
TRANSFER UNIT:INTERMEDIATE TRANSFER:ASS'Y

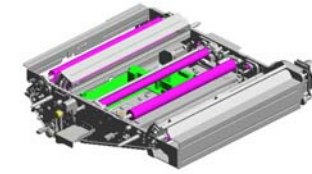

65.D0BX6000
TRANSFER UNIT:INTERMEDIATE TRANSFER:ASS'Y

17.09544008N (x7) SCREW - M4X8
7.04503008N (x4) TAPPING SCREW - M3X8
13.07200080E (x4) RETAINING RING - M8
9.04543006Q (x6) TAPPING SCREW - M3X6
10.07200030E RETAINING RING - M3

16.08053573 (x4) RADIAL BALL BEARING: DIA8X DIA16X5

21.11050511 (x59) HARNESS CLAMP - LWS-0306ZC

11.07200040E (x11) RETAINING RING - M4

25.A2324666 CUSHION - STEPPER MOTOR

1.03603005N (x8) SCREW - M3X5

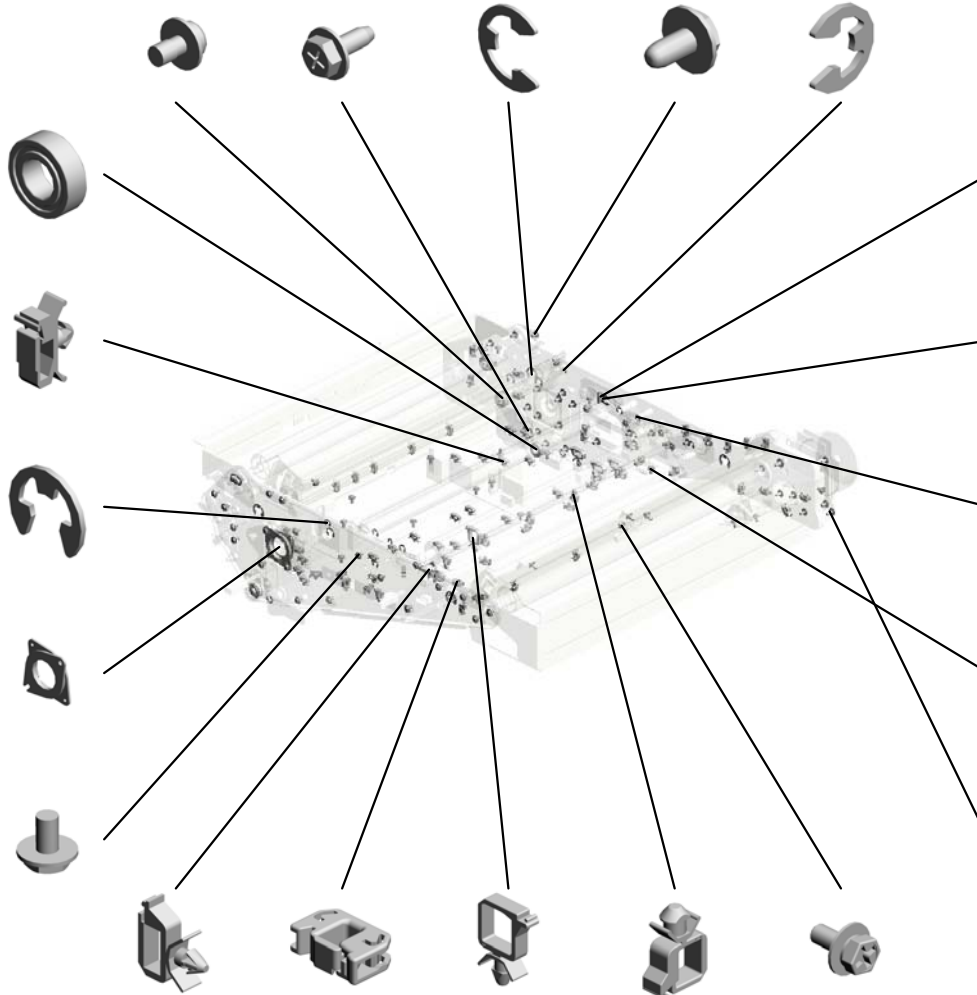

12.07200060E (x4) RETAINING RING - M6



24.52152621 SNAP RING - M6

3.03603008N (x 2) SCREW:M3X8
5.03604006N (x 4) SCREW - M4X6
8.04503012N (x 2) TAPPING SCREW:3X12
9.04543006Q (x 2) TAPPING SCREW - M3X6
10.07200030E (x 1) RETAINING RING - M3

15.08050100 (x2) RETAINING RING - M2.5

2.03603006N (x63) SCREW - M3X6

3.03603008N (x2) SCREW:M3X8

19.11050487 (x4) HARNESS CLAMP
23.11050692 (x2) CLAMP:LES-0503
20.11050488 HARNESS CLAMP
22.11050534 (x7) CLAMP
14.08046123 (x2) HEXAGONAL BOLT :W/WASHER:M3X8

U001	U002	U003	U004	U005	U006	U007	U008	U009	U010	U011	U012	U013	U014	U015	U016	U017	U018	U019	U020
------	------	------	------	------	------	------	------	------	------	------	------	------	------	------	------	------	------	------	------

U007_S001 TRANSFER UNIT:INTERMEDIATE TRANSFER:ASS'Y

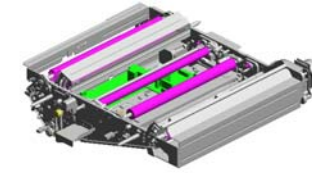

65.D0BX6000
TRANSFER UNIT:INTERMEDIATE TRANSFER:ASS'Y

- 36.AW500045 PUSH SWITCH:(SW2/SW3/SW13/SW14)
- 28.AA061068 TENSION SPRING:BRACKET:DRIVEN ROLLER:INNER BACK
- 47.D0743878 HOLDER:RADIAL BALL BEARING:DRIVEN ROLLER:INNER BACK
- 34.AB032072 (x2) PULLEY:DRIVEN:WIRE
- 46.D0743872 PULLEY:DRIVE WIRE:ASS'Y

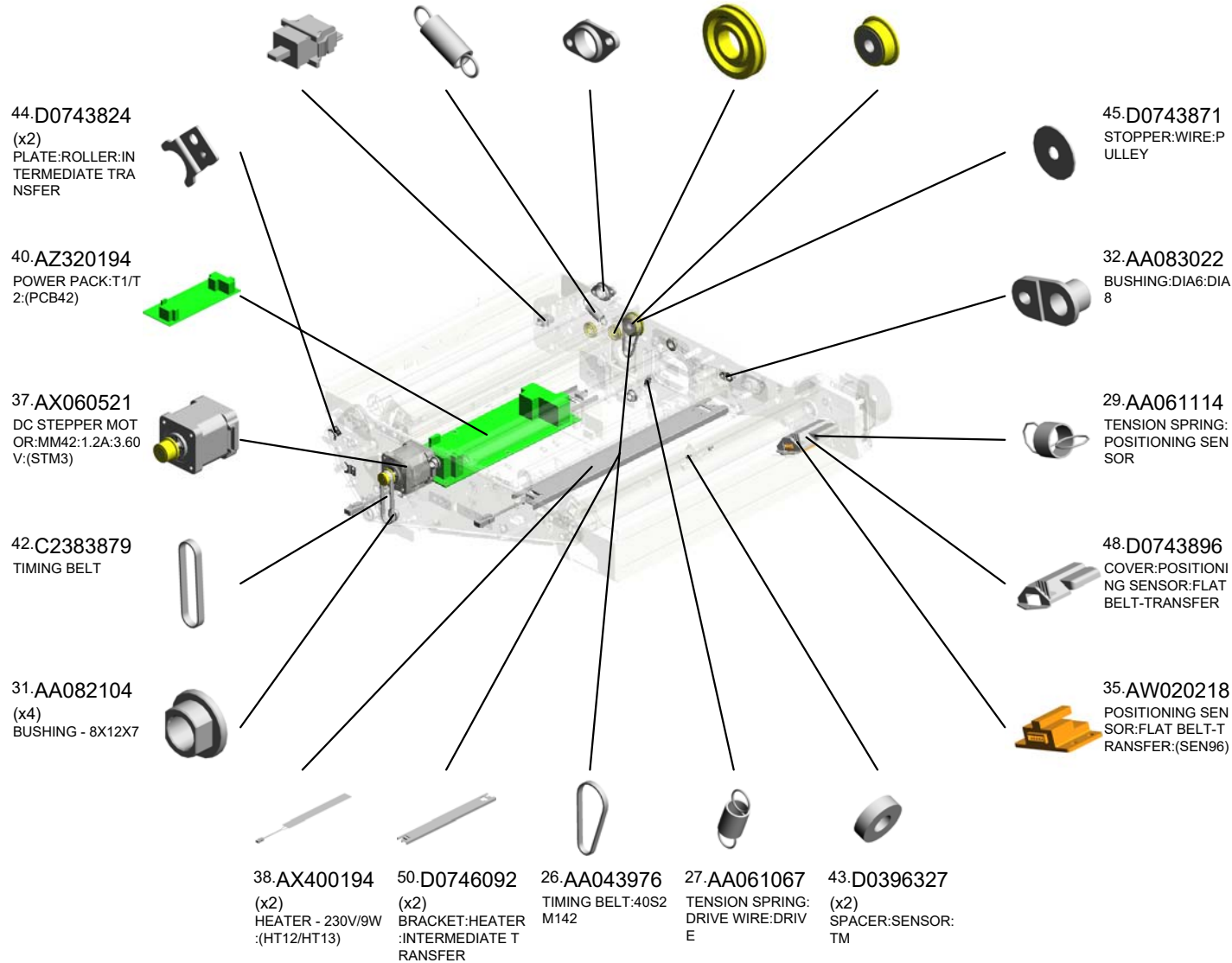

U001	U002	U003	U004	U005	U006	U007	U008	U009	U010	U011	U012	U013	U014	U015	U016	U017	U018	U019	U020
------	------	------	------	------	------	------	------	------	------	------	------	------	------	------	------	------	------	------	------

U007_S001
TRANSFER UNIT:INTERMEDIATE TRANSFER:ASS'Y

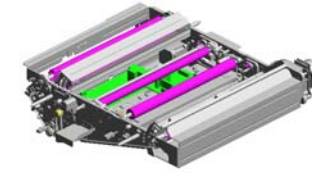

65.D0BX6000
TRANSFER UNIT:INTERMEDIATE TRANSFER:ASS'Y

- 68.D0BX6078 ROLLER:OPPOSED:PAPER:ASS'Y
- 75.D0BX6189 DC STEPPER MOTOR:MM42:1.3A:4.42V:PULLEY:(STM2)
- 71.D0BX6155 CASE:OPPOSED:TRANSFER ROLLER:REAR
- 73.D0BX6163 SPRING PLATE:TRANSFER:OPPOSED:PAPER
- 74.D0BX6185 BRACKET:MOTOR:POSITIONING CONTROL:DRIVEN ROLLER

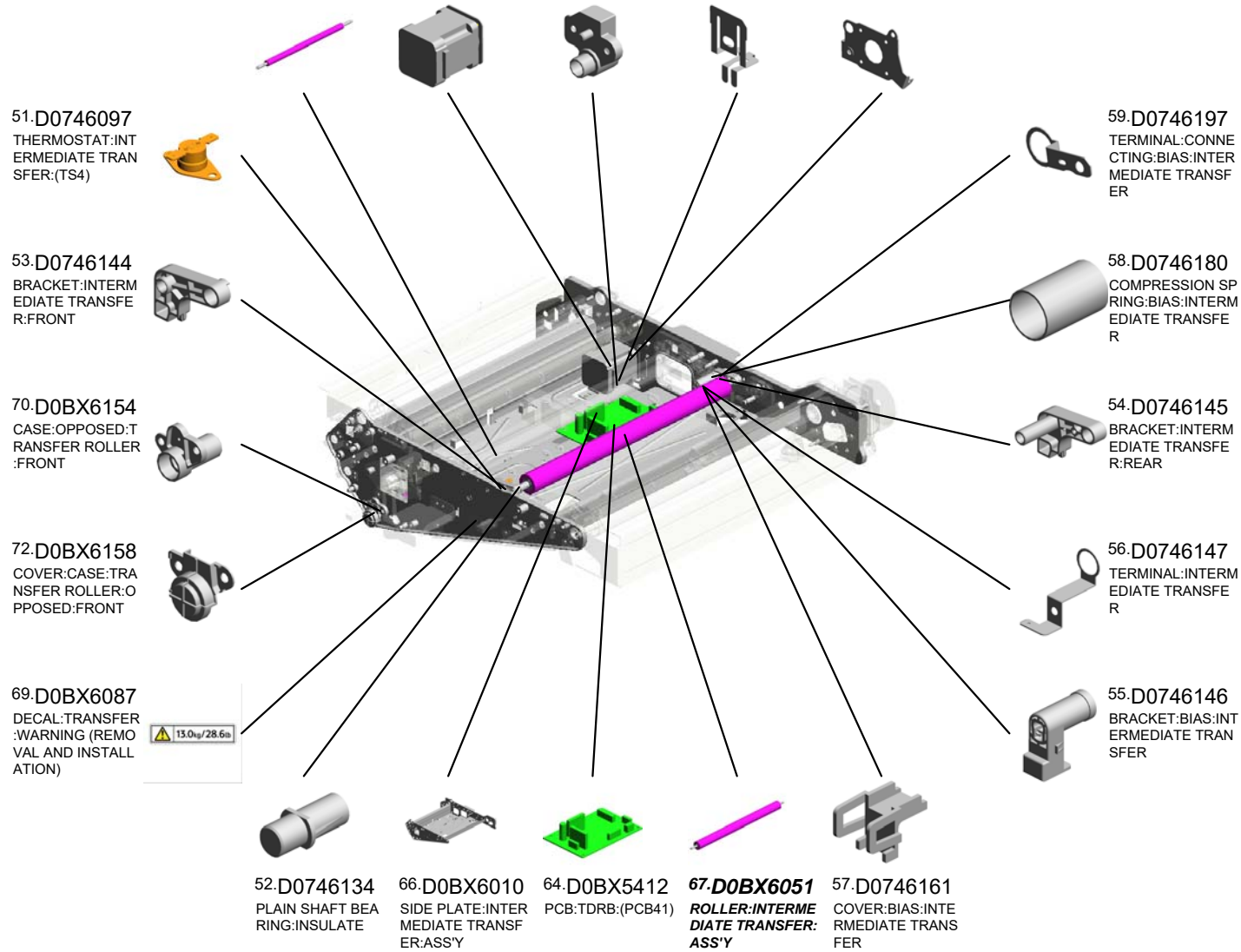

U007_S001
TRANSFER UNIT:INTERMEDIATE TRANSFER:ASS'Y

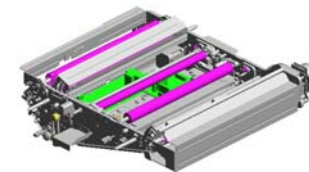

65.D0BX6000
TRANSFER UNIT:INTERMEDIATE TRANSFER:ASS'Y

- 89.D1796080 (x2) ROLLER:OPPOSITE:BELT CLEANING:ASS'Y
- 90.D1796085 ROLLER:DRIVEN:INTERMEDIATE TRANSFER:ASS'Y
- 91.D1796091 ROLLER:TENSION:ASS'Y
- 92.D1796094 CASE:TENSION:ROLLER
- 93.D1796095 SUPPORTING PLATE:CASE:TENSION:ROLLER

95.D1796098 (x2) COIL SPRING:PRESSURE:TENSION:INTERMEDIATE TRANSFER

94.D1796097 (x2) PLAIN SHAFT BEARING:TENSION:ROLLER:INTERMEDIATE TRANSFER

79.D1366183 GRIP:ON-OFF:INTERMEDIATE TRANSFER:TCRU

76.D1366099 TENSION SPRING:BRACKET:DC STEPPER MOTOR

77.D1366145 (x6) ROLLER:ON-OFF:INTERMEDIATE TRANSFER

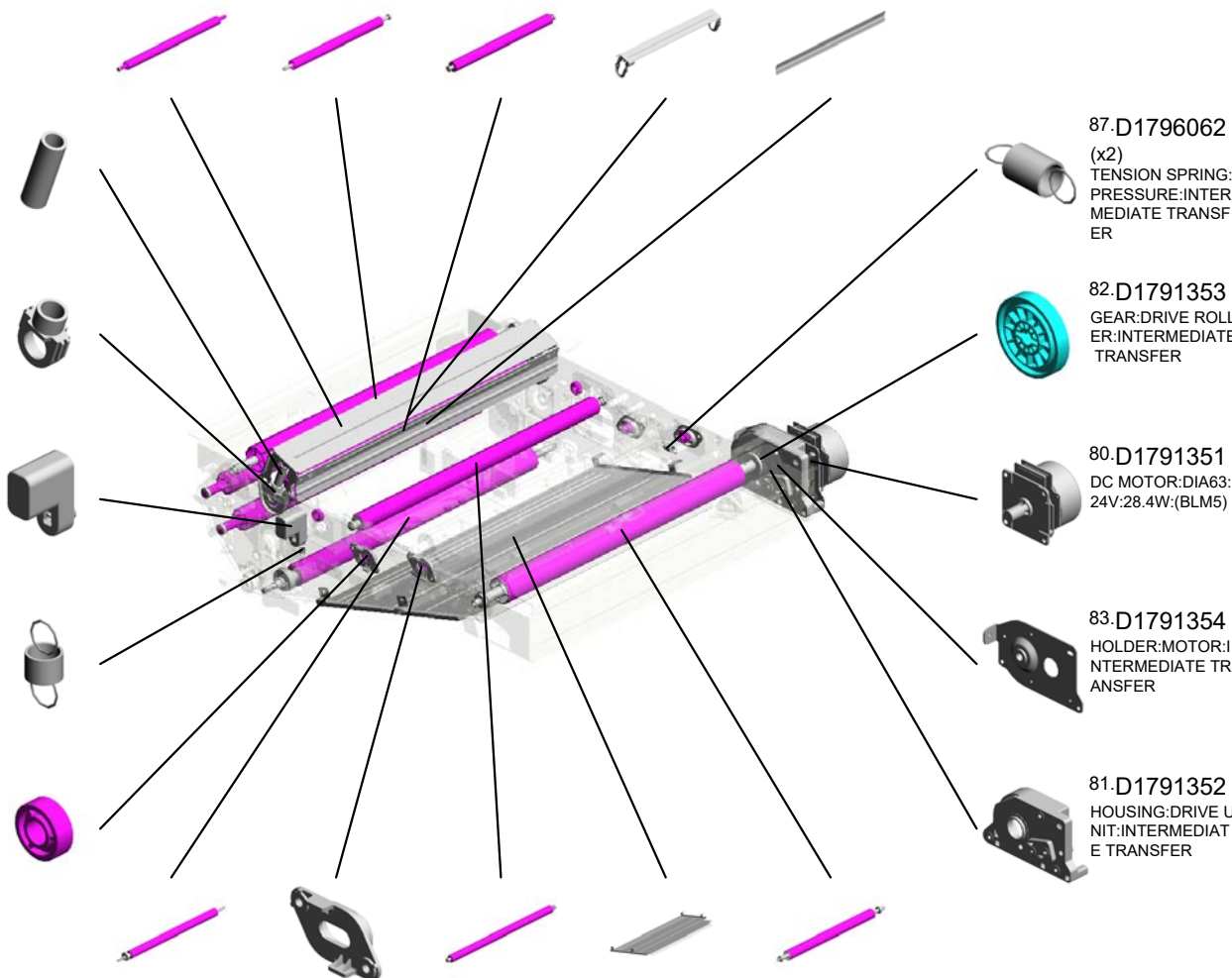

87.D1796062 (x2) TENSION SPRING:PRESSURE:INTERMEDIATE TRANSFER

82.D1791353 GEAR:DRIVE ROLLER:INTERMEDIATE TRANSFER

80.D1791351 DC MOTOR:DIA63:24V:28.4W:(BLM5)

83.D1791354 HOLDER:MOTOR:INTERMEDIATE TRANSFER

81.D1791352 HOUSING:DRIVE UNIT:INTERMEDIATE TRANSFER

- 96.D1796108 ROLLER:TRANSFER:PAPER:FRONT:ASS'Y
- 78.D1366149 (x4) BUSHING:SLIDE RAIL:ON-OFF
- 86.D1796057 ROLLER:TRANSFER:FRONT:ASS'Y
- 84.D1793144 COVER:INTERMEDIATE TRANSFER:LOWER
- 88.D1796065 DRIVE ROLLER:INTERMEDIATE TRANSFER:ASS'Y

U007_S001
TRANSFER UNIT:INTERMEDIATE TRANSFER:ASS'Y

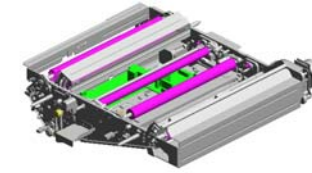

65.D0BX6000
TRANSFER UNIT:INTERMEDIATE TRANSFER:ASS'Y

- 107.D1796146 SHAFT:ON-OFF:INTERMEDIATE TRANSFER
- 117.D1796188 BRACKET:COIL SPRING:MOTOR:POSITIONING CONTROL
- 116.D1796187 FEELER:POSITIONING CONTROL:DRIVE WIRE
- 114.D1796182 BRACKET:POSITIONING CONTROL:DRIVEN ROLLER:REAR:ASS'Y
- 115.D1796186 DRIVE WIRE:DRIVEN ROLLER

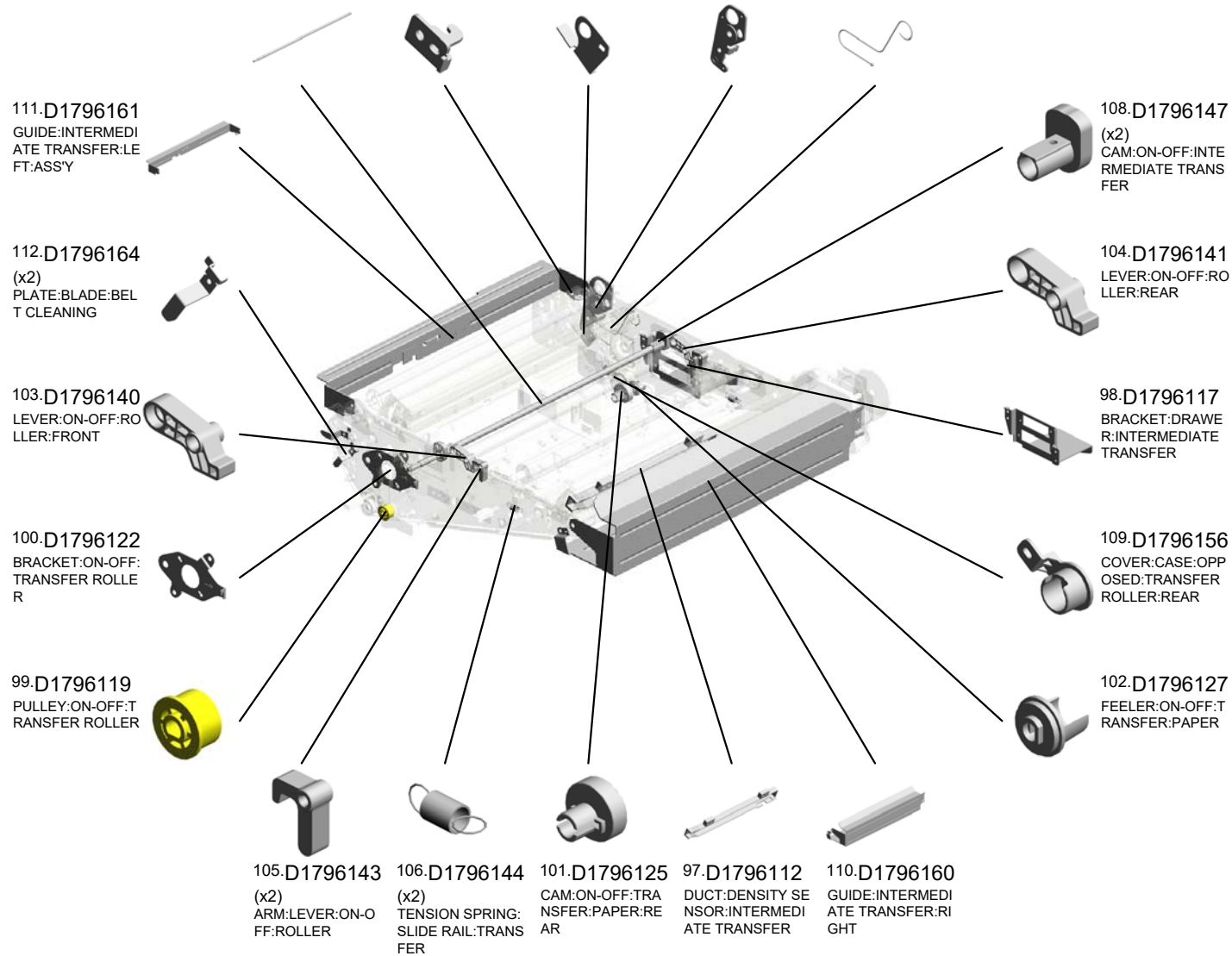

U001	U002	U003	U004	U005	U006	U007	U008	U009	U010	U011	U012	U013	U014	U015	U016	U017	U018	U019	U020
------	------	------	------	------	------	------	------	------	------	------	------	------	------	------	------	------	------	------	------

U007_S001
TRANSFER UNIT:INTERMEDIATE TRANSFER:ASS'Y

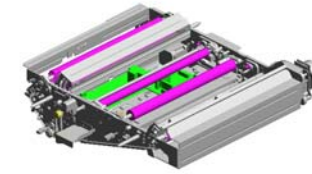

65.D0BX6000
TRANSFER UNIT:INTERMEDIATE TRANSFER:ASS'Y

- 122.D2706124 GUIDE PLATE:INTERMEDIATE TRANSFER:ASS'Y
- 123.D2706128 GUIDE:TRANSPORT:INTERMEDIATE TRANSFER:10MM:ASS'Y
- 129.GW020024 (x2) PHOTO INTERRUPTOR:LG2A24BL1:GF:(SEN3/SEN21/SEN35/SEN36/SEN37/SEN38/SEN39/SEN

119.D1796196 SCALE:BRACKET:DRIVEN ROLLER:FRONT

120.D1796197 HOLDER:DRIVEN ROLLER:FRONT

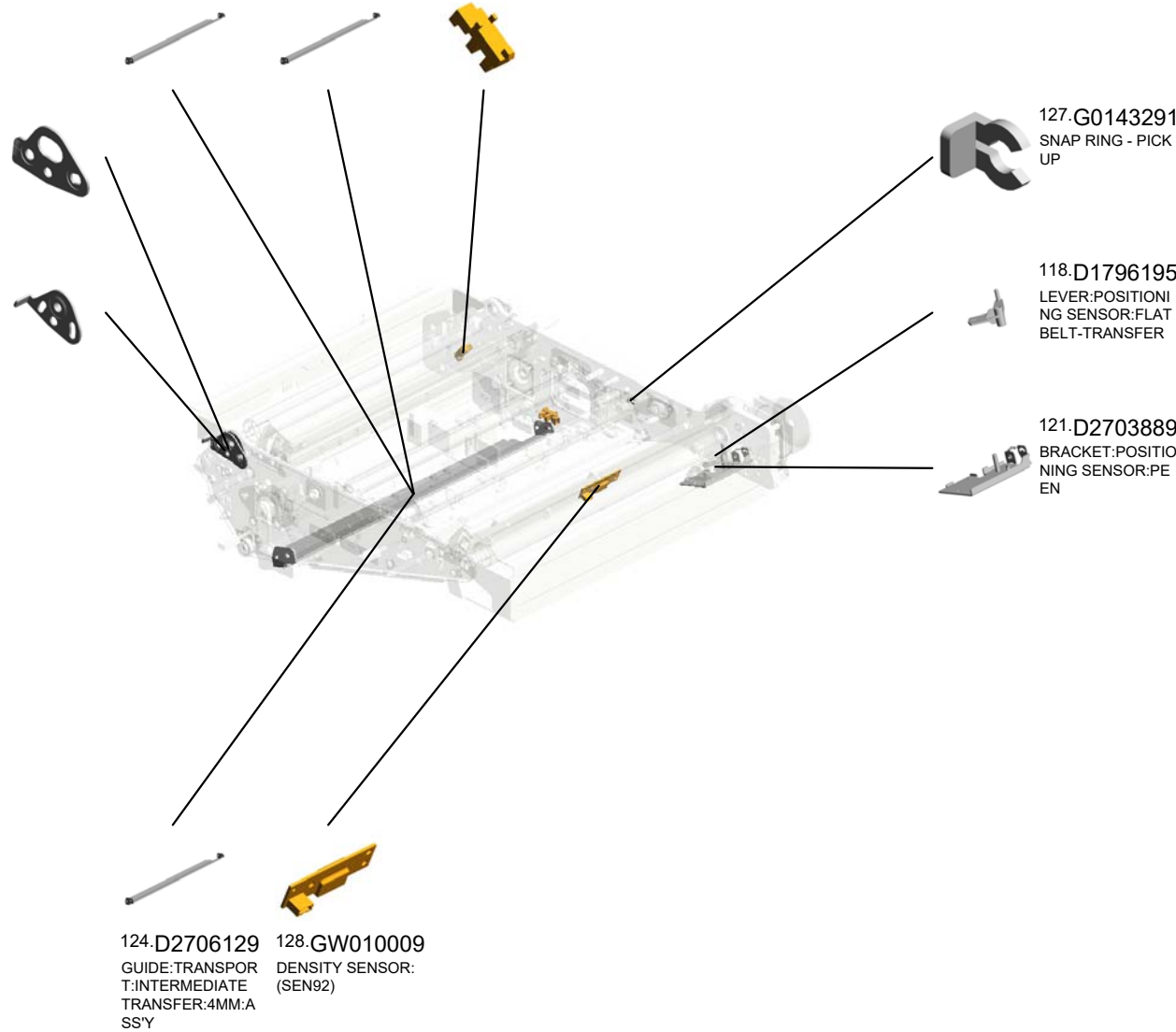

127.G0143291 SNAP RING - PICK UP

118.D1796195 LEVER:POSITIONING SENSOR:FLAT BELT-TRANSFER

121.D2703889 BRACKET:POSITIONING SENSOR:PEEN

- 124.D2706129 GUIDE:TRANSPORT:INTERMEDIATE TRANSFER:4MM:ASS'Y
- 128.GW010009 DENSITY SENSOR:(SEN92)

U001	U002	U003	U004	U005	U006	U007	U008	U009	U010	U011	U012	U013	U014	U015	U016	U017	U018	U019	U020
------	------	------	------	------	------	------	------	------	------	------	------	------	------	------	------	------	------	------	------

U008.ITB CLEANING

U008_S001
D0BX6400
BELT CLEANING:ASS'Y

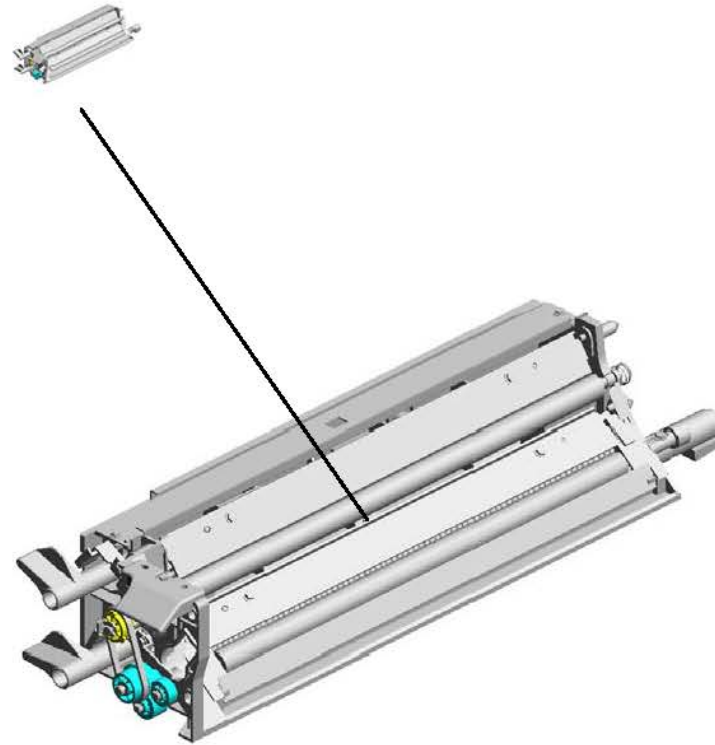

U001	U002	U003	U004	U005	U006	U007	U008	U009	U010	U011	U012	U013	U014	U015	U016	U017	U018	U019	U020
------	------	------	------	------	------	------	------	------	------	------	------	------	------	------	------	------	------	------	------

U008_S001.BELT CLEANING:ASS'Y

U008_S001_S001
D0746450
COATING BAR:ASS'Y

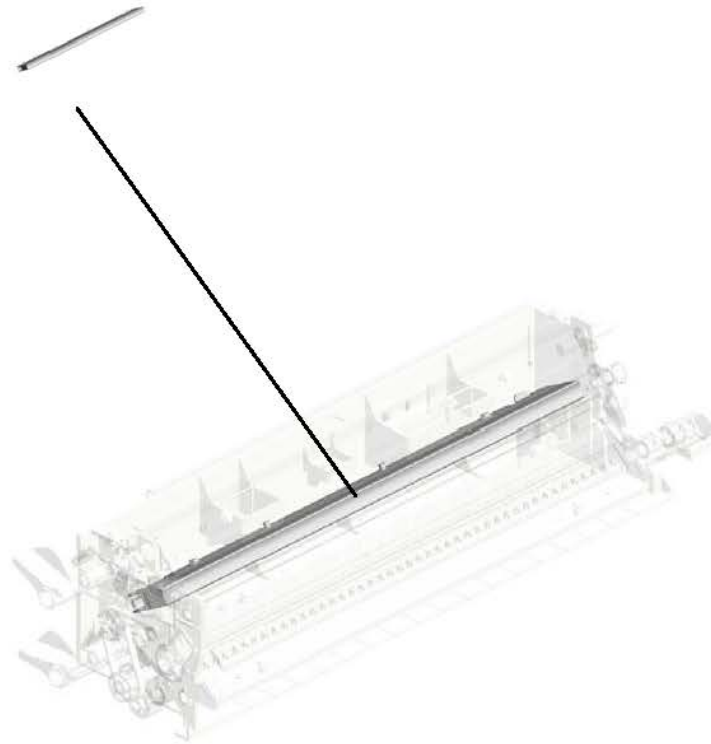

U001	U002	U003	U004	U005	U006	U007	U008	U009	U010	U011	U012	U013	U014	U015	U016	U017	U018	U019	U020
------	------	------	------	------	------	------	-------------	------	------	------	------	------	------	------	------	------	------	------	------

U008
ITB CLEANING

9-B2342390
FLANGED HEXAG
ONAL HEAD BOLT:
M4X8

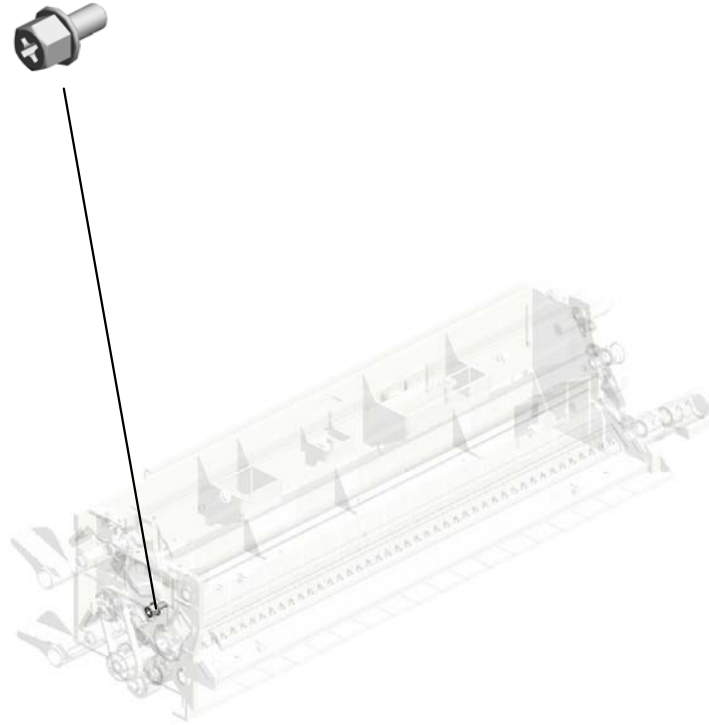
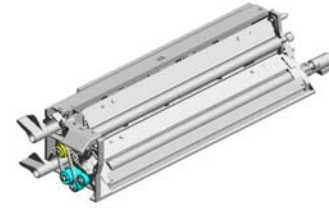

U001	U002	U003	U004	U005	U006	U007	U008	U009	U010	U011	U012	U013	U014	U015	U016	U017	U018	U019	U020
------	------	------	------	------	------	------	-------------	------	------	------	------	------	------	------	------	------	------	------	------

U008_S001
BELT CLEANING:ASS'Y

- 8.B1322264 (x2) BUSHING:TERMINAL
- 4.08050104 RETAINING RINGS -E:SILENCER:DIA4
- 17.D0746431 COIL SPRING:BLADE:CLEANING:BELT CLEANING
- 16.D0746428 HOLDER:CLEANING:BELT CLEANING:ASS'Y
- 10.B5457506 SCREW:BUSHING

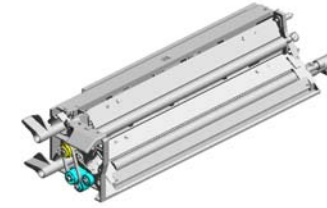

51.D0BX6400
BELT CLEANING:ASS'Y

6.AA082137
BUSHING:6X10X6

5.54472681
(x2)
SNAP RING

1.03603006N
(x19)
SCREW - M3X6

11.B7001802
TIMING BELT:B40S
2M134

19.D0746439
PLAIN SHAFT BEARING:REMOVE PAPER DUST:TRANSPORT SCREW

15.D0746424
BLADE:CLEANING:BELT CLEANING:ASS'Y

18.D0746434
TONER COLLECTION COIL:BELT CLEANING:ASS'Y

14.D0746413
SCRAPER:BRUSH:REMOVE PAPER DUST:ASS'Y

12.D0746410
GROUND PLATE:BELT CLEANING

7.AA083022
(x2)
BUSHING:DIA6:DIA8

2.07080060N
(x2)
WASHER:DIA6

3.07200040E
(x4)
RETAINING RING - M4

13.D0746411
COIL SPRING:EAR TH:BELT CLEANING

21.D0746441
SHUTTER:TRANSPORT SCREW:BELT CLEANING

20.D0746440
GUIDE:DISCHARGE USED TONER:BELT CLEANING

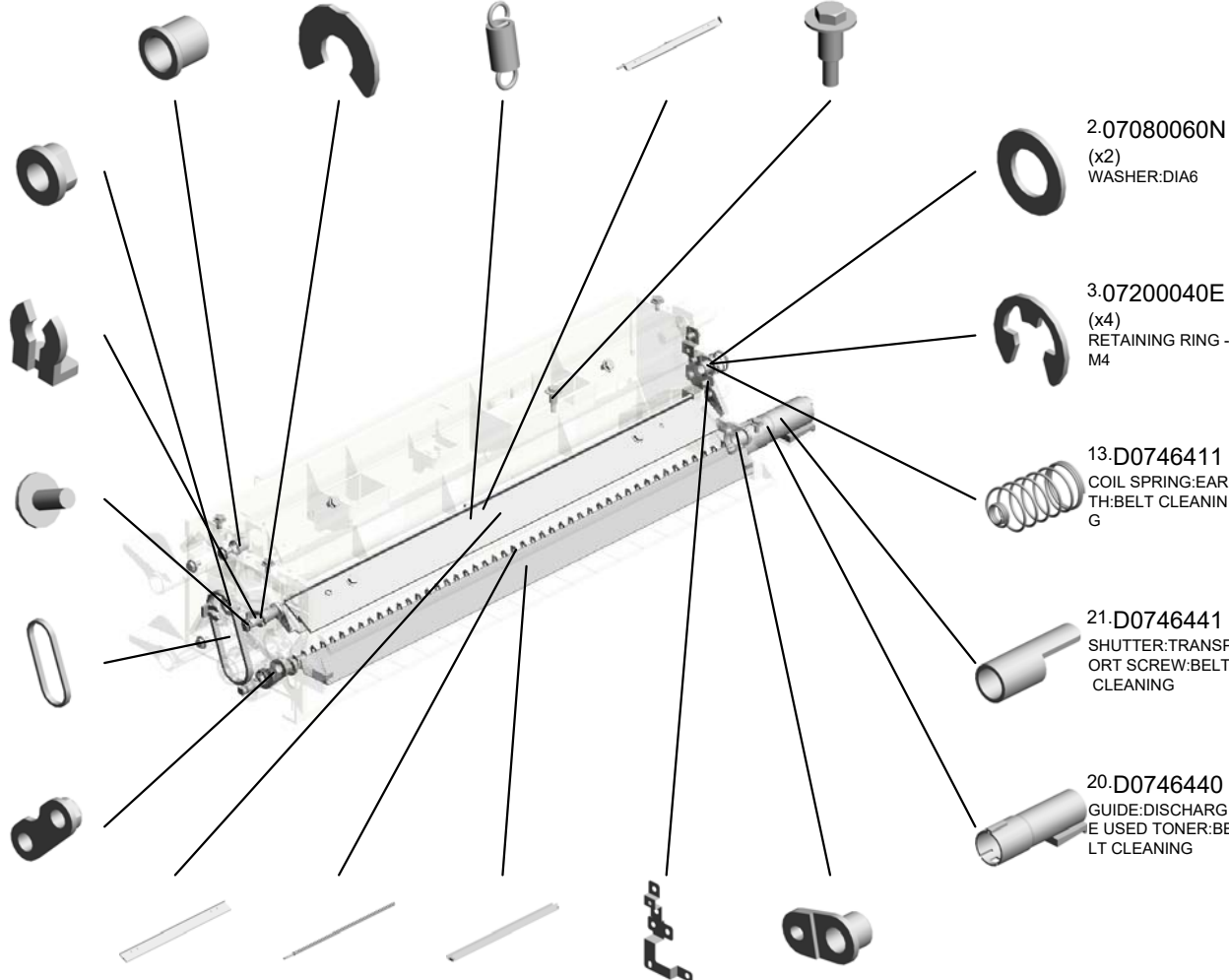

U008_S001
BELT CLEANING:ASS'Y

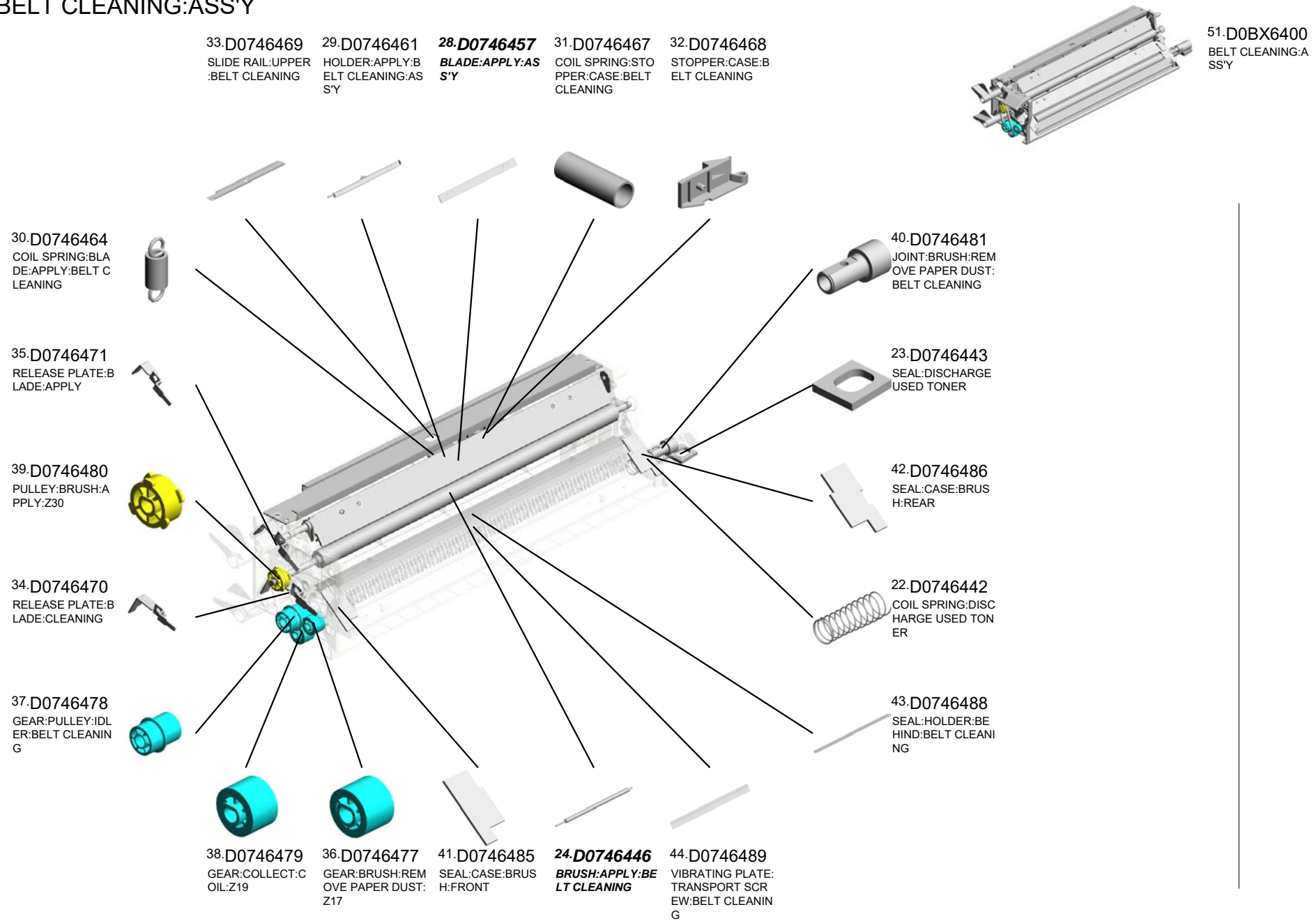

U001	U002	U003	U004	U005	U006	U007	U008	U009	U010	U011	U012	U013	U014	U015	U016	U017	U018	U019	U020
------	------	------	------	------	------	------	------	------	------	------	------	------	------	------	------	------	------	------	------

U008_S001
BELT CLEANING:ASS'Y

- 49.D0746496 GRIP:BELT CLEANING
- 46.D0746491 SEAL:CASE:CLEANING BLADE:FRONT
- 45.D0746490 SEAL:BASE:CASE:BELT CLEANING
- 50.D0746497 (x2) DECAL:POSITIONING DISPLAY:TCRU

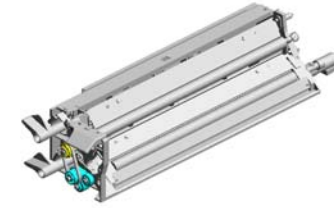

- 51.D0BX6400 BELT CLEANING:ASS'Y

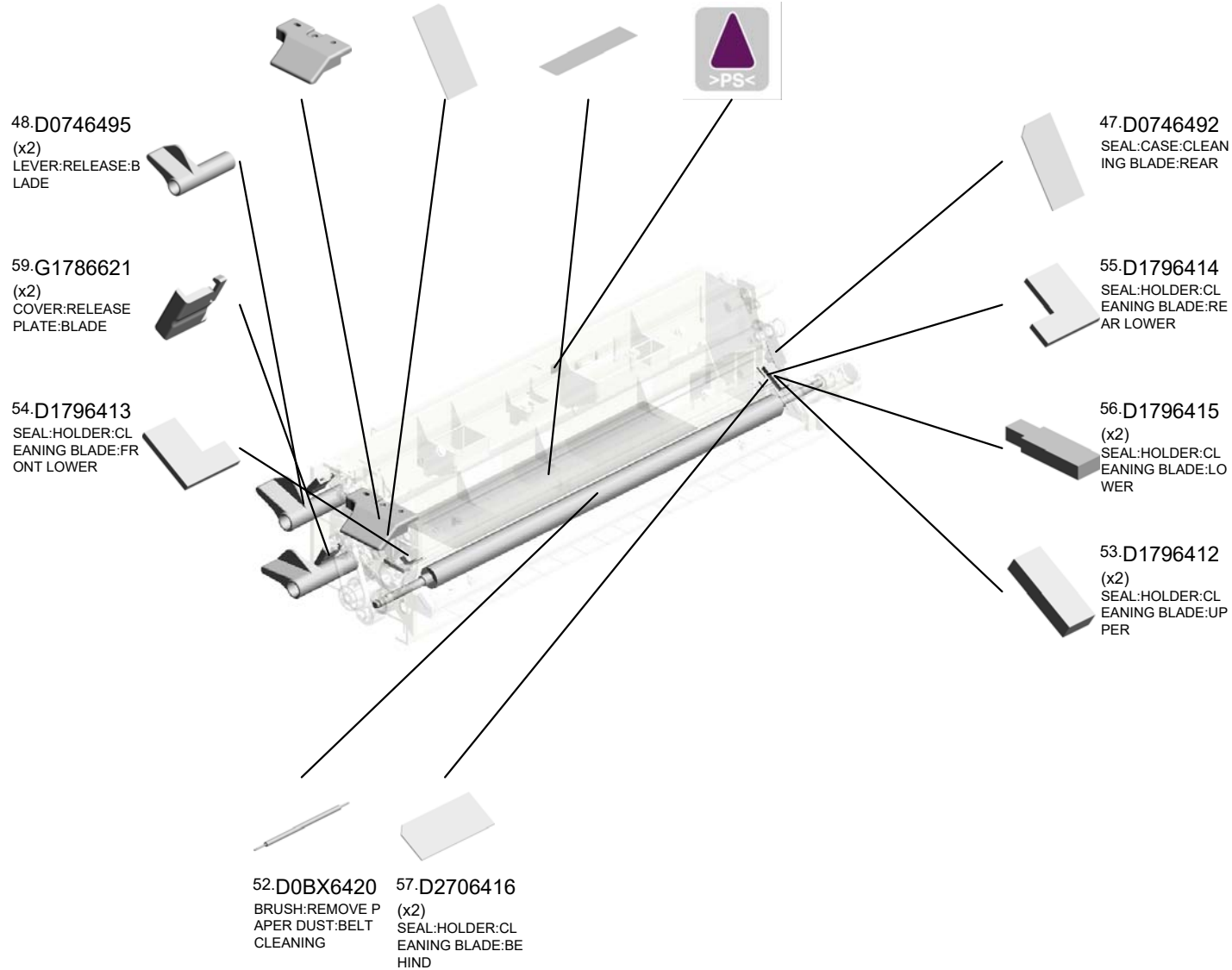

U001	U002	U003	U004	U005	U006	U007	U008	U009	U010	U011	U012	U013	U014	U015	U016	U017	U018	U019	U020
------	------	------	------	------	------	------	------	------	------	------	------	------	------	------	------	------	------	------	------

U008_S001_S001
COATING BAR:ASS'Y

58.G0801169
(x2)
SCREW:M3

27.D0746455
COIL SPRING:COA
TING BAR



25.D0746450
COATING BAR:AS
S'Y



26.D0746454
(x2)
ARM:COATING BA
R:BELT CLEANING



U001	U002	U003	U004	U005	U006	U007	U008	U009	U010	U011	U012	U013	U014	U015	U016	U017	U018	U019	U020
------	------	------	------	------	------	------	-------------	------	------	------	------	------	------	------	------	------	------	------	------

U009.TRANSFER/SEPARATION

U009_S002
D1796230
CASE:TERMINAL:SEPARATI
ON:ASSY

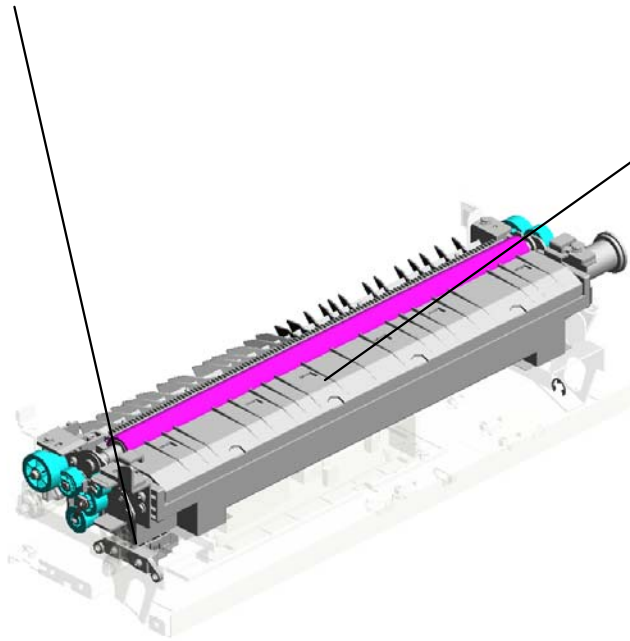

U009_S001
D0BX6210
TRANSFER UNIT:ASSY



U001	U002	U003	U004	U005	U006	U007	U008	U009	U010	U011	U012	U013	U014	U015	U016	U017	U018	U019	U020
------	------	------	------	------	------	------	------	------	------	------	------	------	------	------	------	------	------	------	------

U009_S001.TRANSFER UNIT:ASS'Y

U009 S001 S001
D1796310
SEPARATION CORONA:ASS'
Y

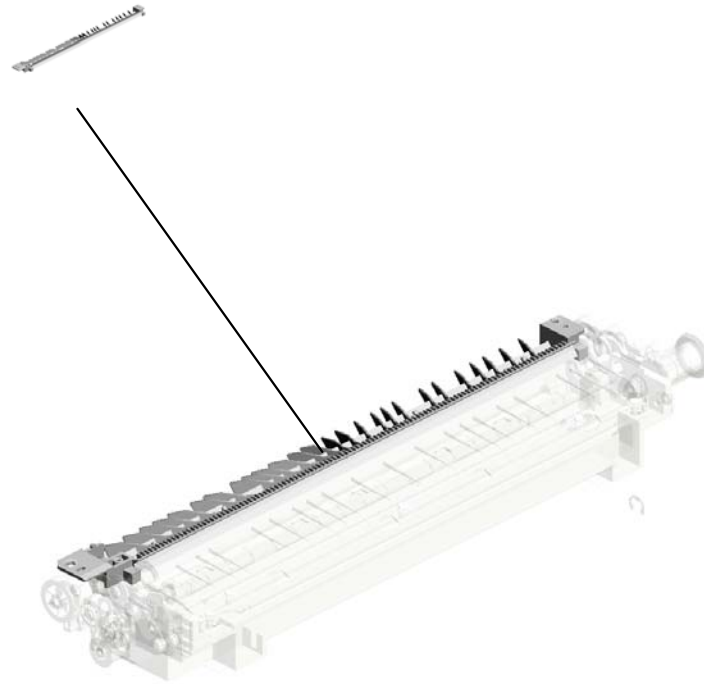

U001	U002	U003	U004	U005	U006	U007	U008	U009	U010	U011	U012	U013	U014	U015	U016	U017	U018	U019	U020
------	------	------	------	------	------	------	------	------	------	------	------	------	------	------	------	------	------	------	------

U009 TRANSFER/SEPARATION

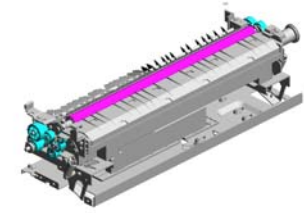
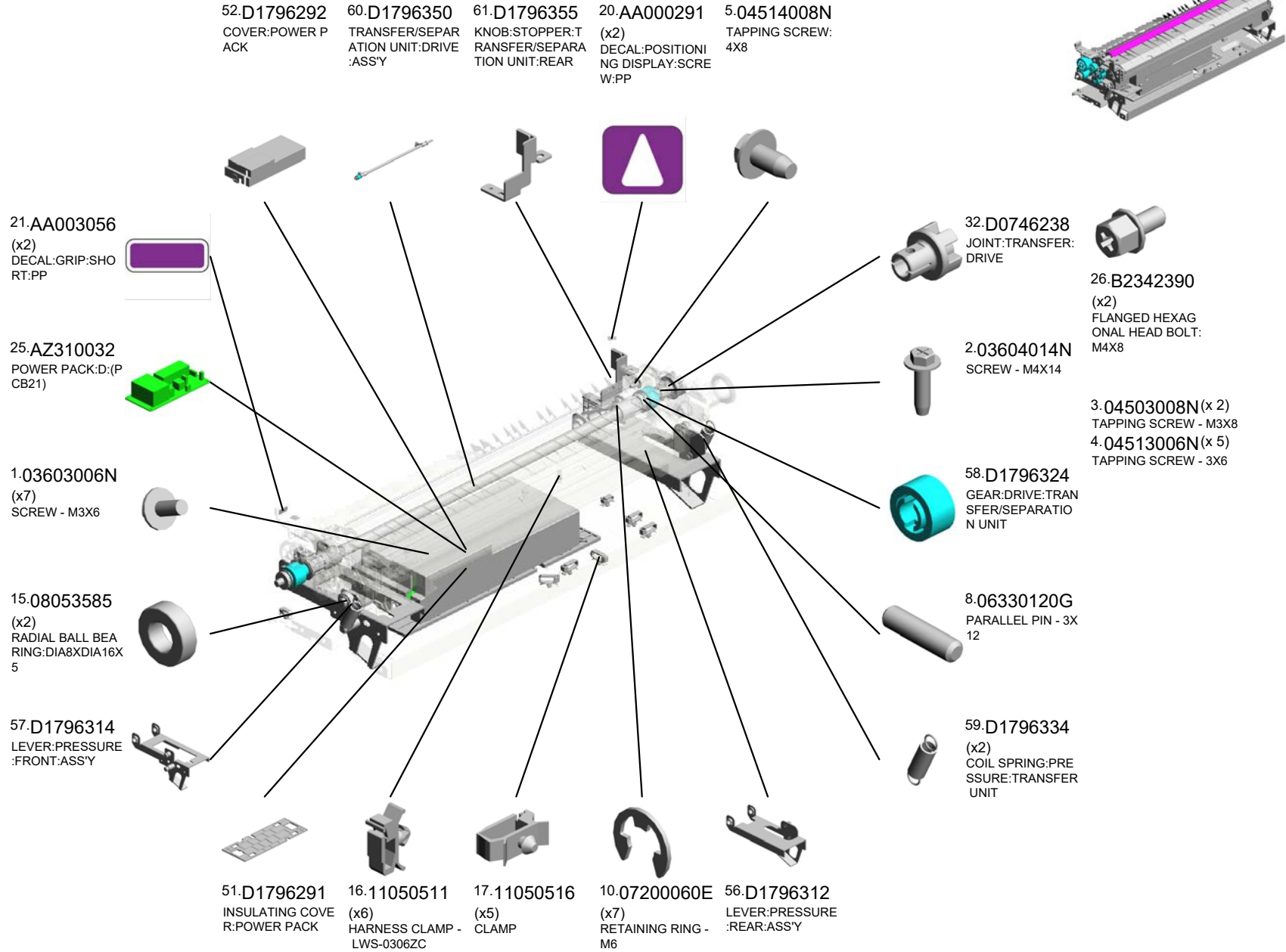

U001	U002	U003	U004	U005	U006	U007	U008	U009	U010	U011	U012	U013	U014	U015	U016	U017	U018	U019	U020
------	------	------	------	------	------	------	------	------	------	------	------	------	------	------	------	------	------	------	------

U009
TRANSFER/SEPARATION

62.D1796356 64.D2706333
KNOB:STOPPER:T SHAFT:LEVER:PRE
RANSFER/SEPARA SSURE:TRANSFER
TION UNIT:FRONT ROLLER

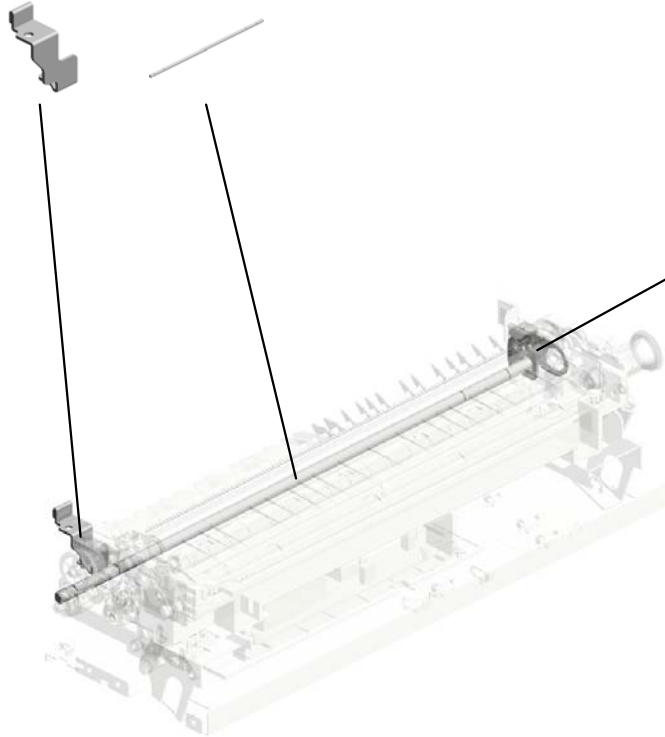
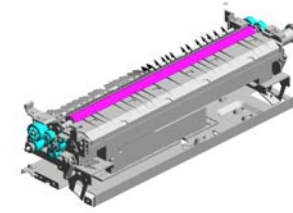

65.D2706350
BRACKET:SHAFT:
CONTACT POINT:T
RANSFER ROLLER

U001	U002	U003	U004	U005	U006	U007	U008	U009	U010	U011	U012	U013	U014	U015	U016	U017	U018	U019	U020
------	------	------	------	------	------	------	------	------	------	------	------	------	------	------	------	------	------	------	------

U009_S001
TRANSFER UNIT:ASS'Y

- 14.08053568 RADIAL BALL BEARING:DIA8XDIA14X4
- 27.D0146272 BUSHING:BRUSH:REAR
- 30.D0746228 ELECTRODE PLATE:FRAME
- 7.04543008Q (x2) TAPPING SCREW: 3X8
- 1.03603006N (x16) SCREW - M3X6

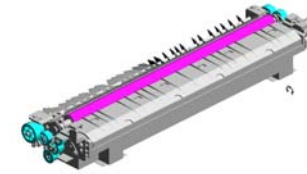

45.D0BX6210
TRANSFER UNIT:ASS'Y

23.AB011125
GEAR:20/29Z

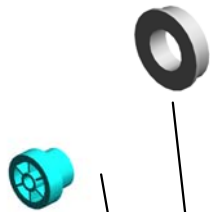

13.08053445
(x2)
BEARING - M6X10X3



33.D0746241
(x2)
DECAL:GRIP:TRANSFER/SEPARATION UNIT



24.AB011126
GEAR:20Z



18.52062686
SNAP RING



3.04503008N
TAPPING SCREW - M3X8



34.D0746257
BRUSH ROLLER:APPLY:ASS'Y



6.04523008N (x2)
TAPPING SCREW - M3X8



10.07200060E (x2)
RETAINING RING - M6



22.AA080154
REAR BUSHING



19.52152621
SNAP RING - M6



11.08050103
RETAINING RINGS (x2)
-E:SILENCER:DIA3



12.08050104
RETAINING RINGS (x2)
-E:SILENCER:DIA4



9.07200040E
RETAINING RING - M4



9.07200040E (x 2)
RETAINING RING - M4

28.D0746216
SHUTTER:TONER OUTLET SUB-UNIT:SUB-ASS'Y



29.D0746219
COIL SPRING:SHUTTER:DISCHARGE USED TONER



31.D0746235
CASE:TONER RECYCLING SUB-UNIT:SUB-ASS'Y



U009_S001
TRANSFER UNIT:ASS'Y

- 48.D0BX6255 BRUSH ROLLER:TRANSFER ROLLER:ASS'Y
- 47.D0BX6250 TRANSFER ROLLER
- 37.D0746273 SEAL:HOLDER
- 35.D0746265 BLADE:TRANSFER ROLLER:ASS'Y
- 50.D1796280 GUIDE PLATE:ENTRANCE:LOWER:ASS'Y

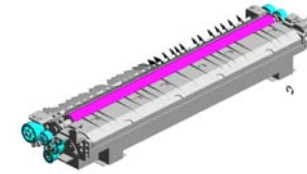

45.D0BX6210
TRANSFER UNIT:ASS'Y

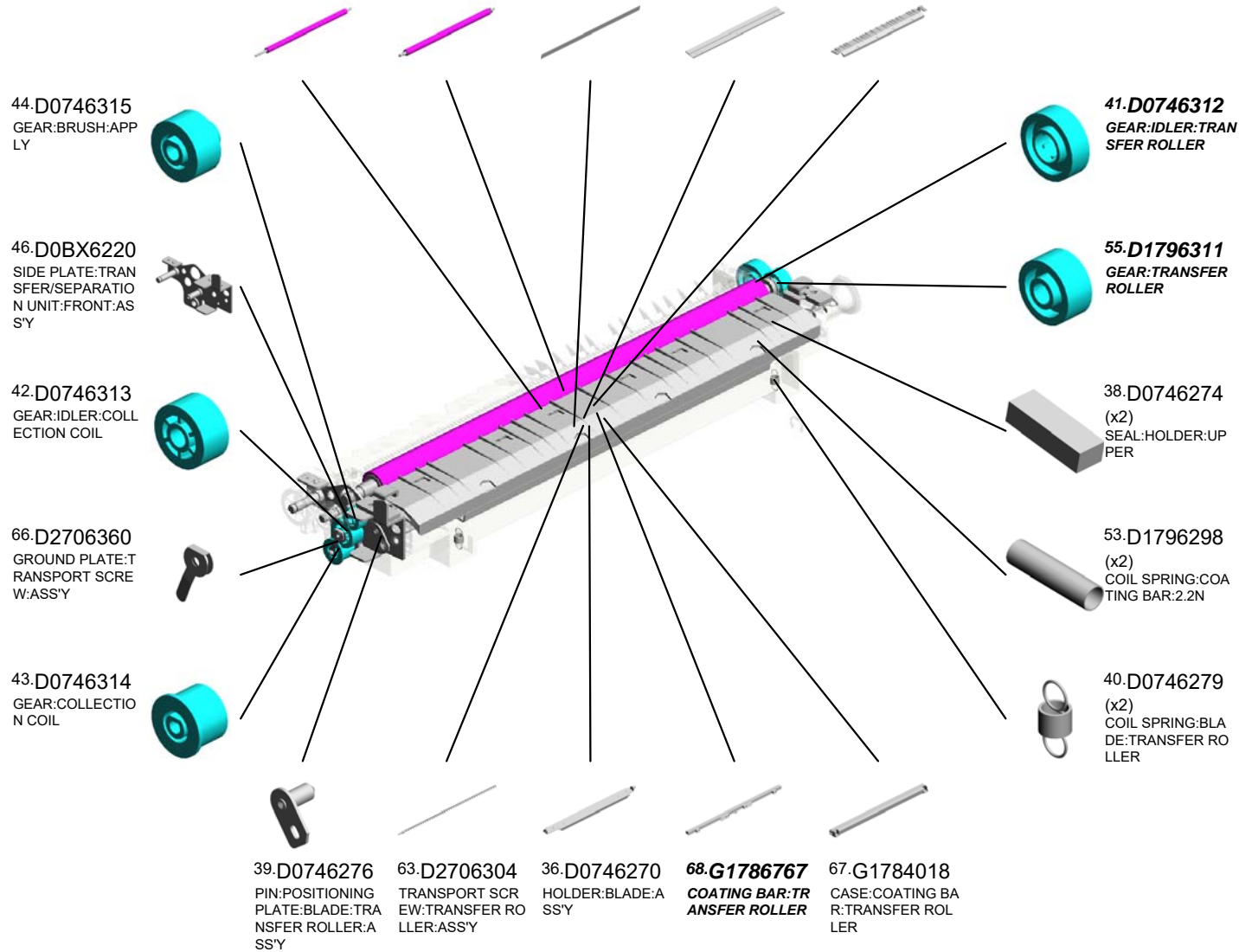

U001	U002	U003	U004	U005	U006	U007	U008	U009	U010	U011	U012	U013	U014	U015	U016	U017	U018	U019	U020
------	------	------	------	------	------	------	------	------	------	------	------	------	------	------	------	------	------	------	------

U009_S001_S001
SEPARATION CORONA:ASS'Y

6.04523008N
TAPPING SCREW -
M3X8



54.D1796310
SEPARATION COR
ONA:ASS'Y



U001	U002	U003	U004	U005	U006	U007	U008	U009	U010	U011	U012	U013	U014	U015	U016	U017	U018	U019	U020
------	------	------	------	------	------	------	------	------	------	------	------	------	------	------	------	------	------	------	------

U009_S002
CASE:TERMINAL:SEPARATION:ASS'Y

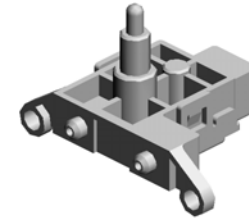

49.D1796230
CASE:TERMINAL:SEPARATION:ASS'Y

- 1.03603006N(x 2)
SCREW - M3X6
- 3.04503008N(x 1)
TAPPING SCREW - M3X8

U001	U002	U003	U004	U005	U006	U007	U008	U009	U010	U011	U012	U013	U014	U015	U016	U017	U018	U019	U020
------	------	------	------	------	------	------	------	------	------	------	------	------	------	------	------	------	------	------	------

U010.USED TONER

U010_S003
D1796501
TONER OUTLET SUB-UNIT:P
CU:ASSY



U010_S004
D1796528
TONER OUTLET SUB-UNIT:V
ERTICAL TRANSPORT:MAIN:
ASSY



U010_S001
D1796461
TONER OUTLET SUB-UNIT:C
OLLECTION BOTTLE:ASSY



U010_S002
D2706570
COLLECTION BOTTLE:SERVI
CE PARTS:ASSY



U001	U002	U003	U004	U005	U006	U007	U008	U009	U010	U011	U012	U013	U014	U015	U016	U017	U018	U019	U020
------	------	------	------	------	------	------	------	------	------	------	------	------	------	------	------	------	------	------	------

U010 USED TONER

23.AB030877 TIMING PULLEY:Z5
1

31.D0746574 COVER:CAM:VERTICAL TRANSPORT

32.D0746575 SHAFT:CAM:VERTICAL TRANSPORT

33.D0746579 SEAL:COVER:CAM:VERTICAL TRANSPORT

38.D0746663 TORQUE LIMITER MECHANICAL CLUTCH:GEAR:Z63

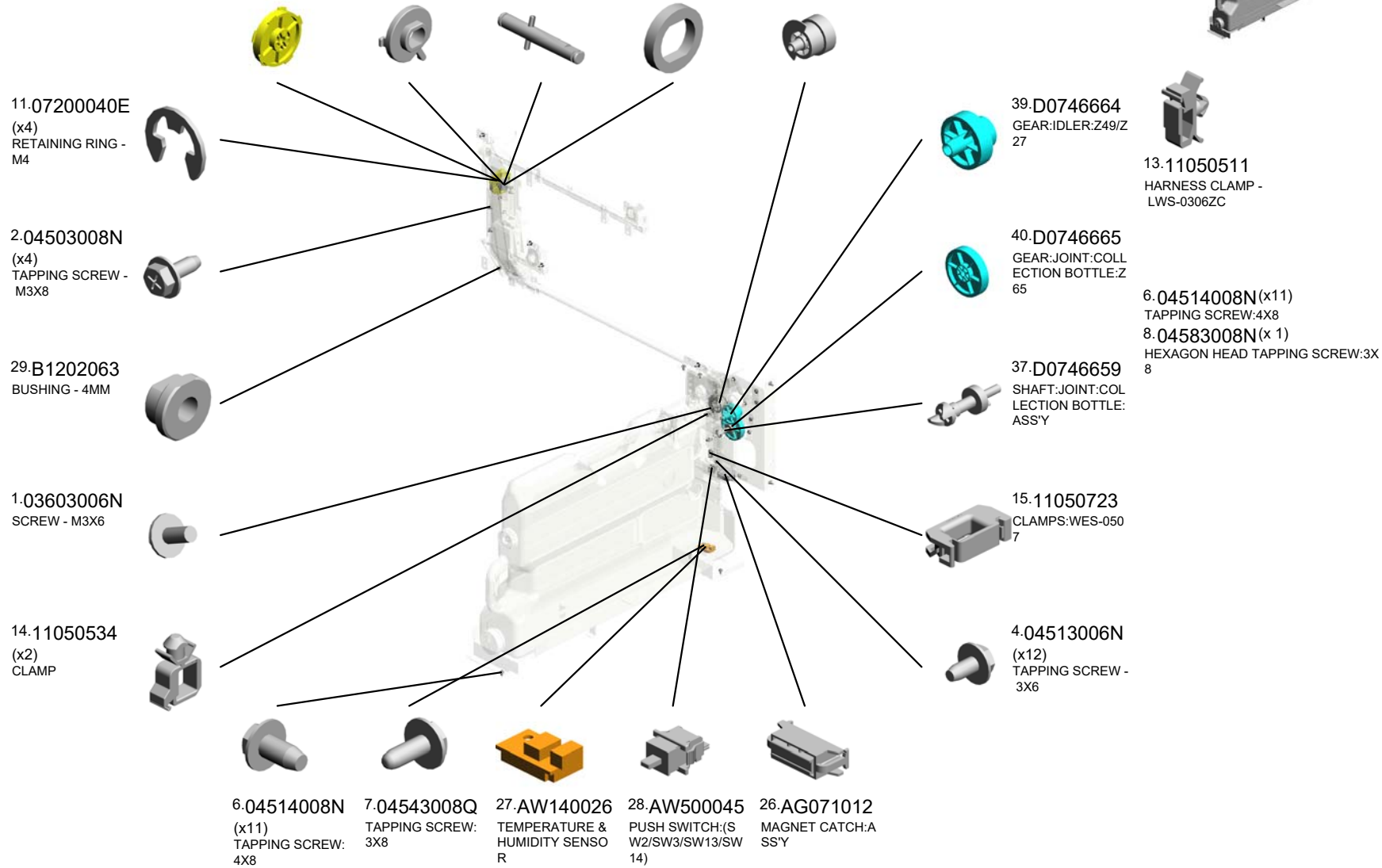

U001	U002	U003	U004	U005	U006	U007	U008	U009	U010	U011	U012	U013	U014	U015	U016	U017	U018	U019	U020
------	------	------	------	------	------	------	------	------	-------------	------	------	------	------	------	------	------	------	------	------

U010 USED TONER

- 62.D6831845 PULLEY:IDLER:DIA 14
- 54.D1796523 BRACKET:VERTICAL TRANSPORT
- 64.GA082010 BUSHING:DIA6:DIA 10:9
- 56.D1796527 CAM:VERTICAL TRANSPORT:DIA15
- 50.D1796472 COVER:TONER OUTLET SUB-UNIT:ASY



55.D1796525
BRACKET:IDLER

46.D1202829
TENSION SPRING:REGISTRATION:DRIVEN

53.D1796521
BRACKET:TONER OUTLET SUB-UNIT:VERTICAL TRANSPORT:LOWER

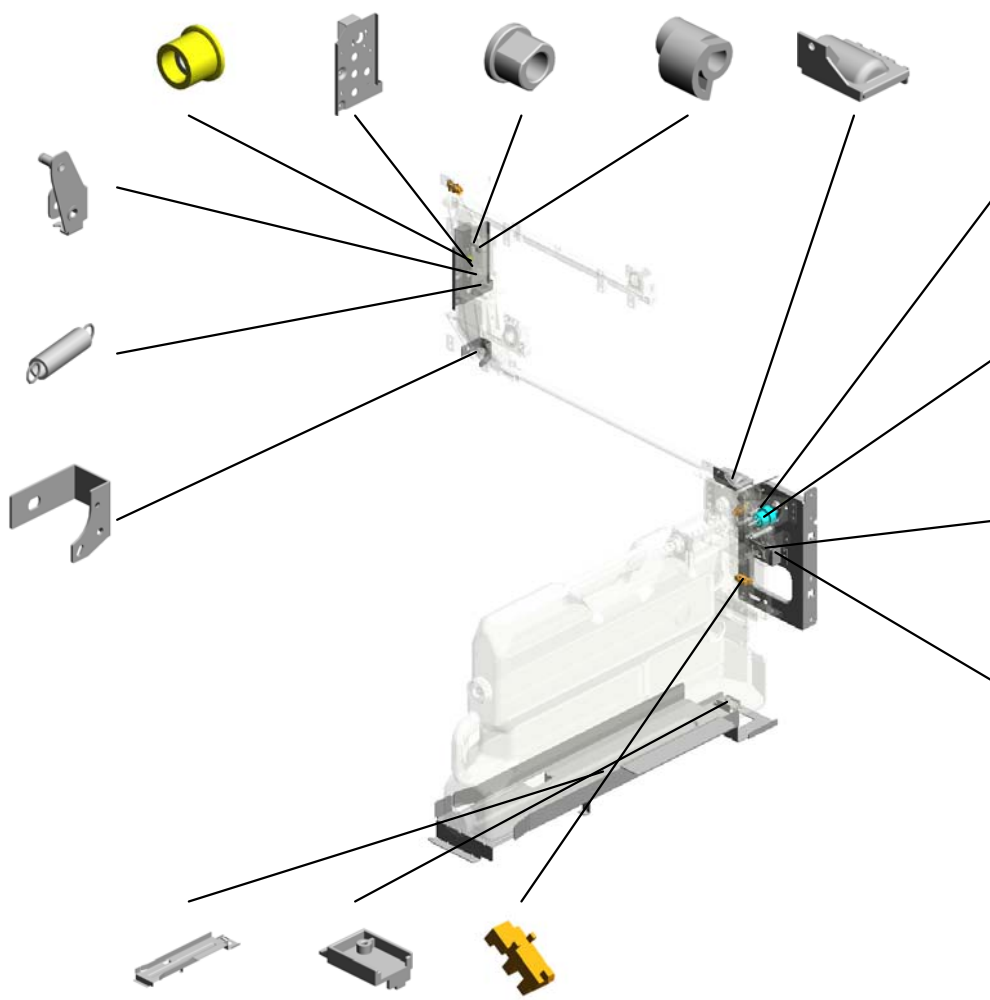

44.D0BX6487
DC MOTOR:COLLECTION BOTTLE:DI A49:9.8W:(BLM3)

41.D0746666
GEAR:IDLER:Z37/Z 28

42.D0746667
HOLDER:RADIAL BALL BEARING:JOINT

51.D1796483
BRACKET:DRIVE SUB-UNIT:COLLECTION BOTTLE

- 59.D2706492 GUIDE PLATE:COLLECTION BOTTLE:LOWER
- 45.D1055898 HOLDER:TEMPERATURE & HUMIDITY SENSOR
- 65.GW020024 (x3) PHOTOINTERRUPTOR:LG2A24BL1:GF:(SEN3/SEN21/SEN35/SEN36/SEN37/SEN38/SEN39/SEN

U001	U002	U003	U004	U005	U006	U007	U008	U009	U010	U011	U012	U013	U014	U015	U016	U017	U018	U019	U020
------	------	------	------	------	------	------	------	------	------	------	------	------	------	------	------	------	------	------	------

U010_S001
 TONER OUTLET SUB-UNIT:COLLECTION BOTTLE:ASS'Y

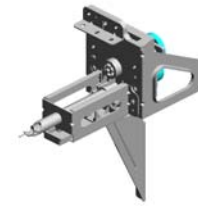

49.D1796461
 TONER OUTLET S
 UB-UNIT:COLLEC
 TION BOTTLE:ASS'Y

4.04513006N (x4) TAPPING SCREW - 3X6
 34.D0746640 PLAIN SHAFT BEARING:TRANSPORT RING:SMALL
 22.AB011540 GEAR:AGITATOR:DRIVE

35.D0746641 (x2) PLAIN SHAFT BEARING:SMALL:GEAR

20.AA061169 TENSION SPRING:TONER CATCHPAN:DISCHARGE USED TONER

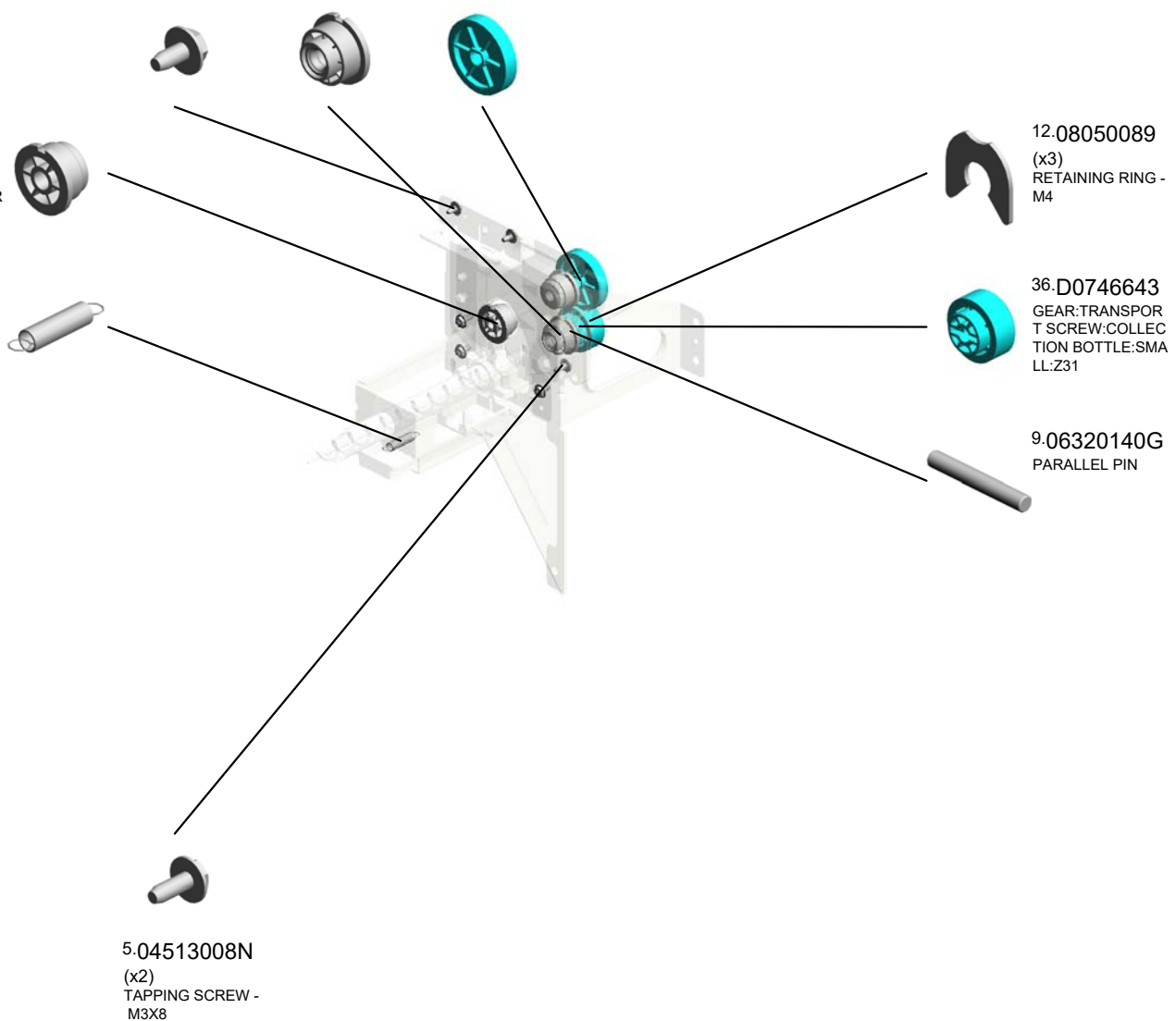

U001	U002	U003	U004	U005	U006	U007	U008	U009	U010	U011	U012	U013	U014	U015	U016	U017	U018	U019	U020
------	------	------	------	------	------	------	------	------	------	------	------	------	------	------	------	------	------	------	------

U010_S002
COLLECTION BOTTLE:SERVICE PARTS:ASS'Y

43.D0746697 60.D2706498
DECAL:COLLECTI ON BOTTLE:GRIP: FRONT DECAL:COLLECTI ON BOTTLE:CAUTI ON

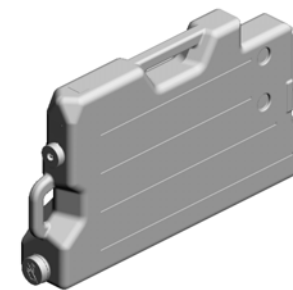

61.D2706570
COLLECTION BOT TLE:SERVICE PAR TS:ASS'Y



47.D1363692
(x2)
DECAL:COLLECTI ON BOTTLE:GRIP: UPPER

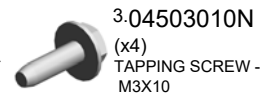

3.04503010N
(x4)
TAPPING SCREW - M3X10



12.08050089
RETAINING RING - M4



17.AA036015
CAP:COLLECTION BOTTLE

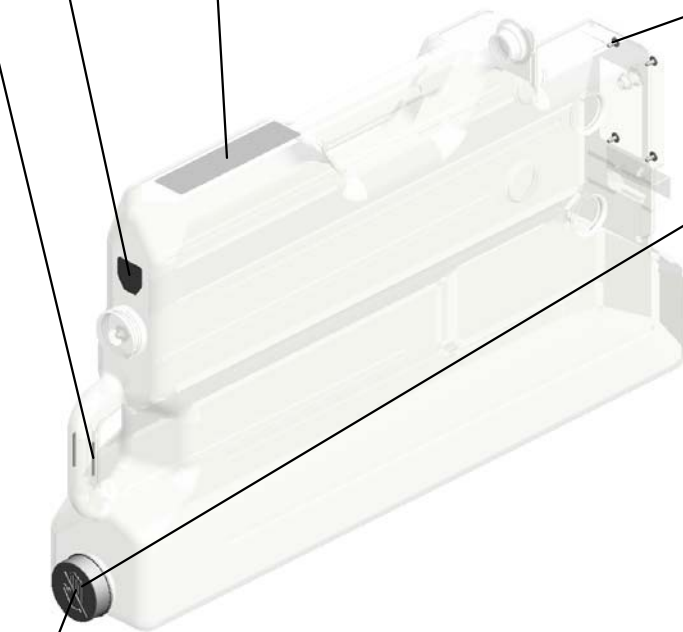

63.G1787819
SEAL:CAP:COLLEC TION BOTTLE

U001	U002	U003	U004	U005	U006	U007	U008	U009	U010	U011	U012	U013	U014	U015	U016	U017	U018	U019	U020
------	------	------	------	------	------	------	------	------	------	------	------	------	------	------	------	------	------	------	------

U010_S003
TONER OUTLET SUB-UNIT:PCU:ASS'Y

24.AB033118
TORQUE LIMITER
MECHANICAL CLU
TCH:TONER RECY
CLING SUB-UNIT



52.D1796501
TONER OUTLET S
UB-UNIT:PCU:ASS'
Y

12.08050089
RETAINING RING -
M4

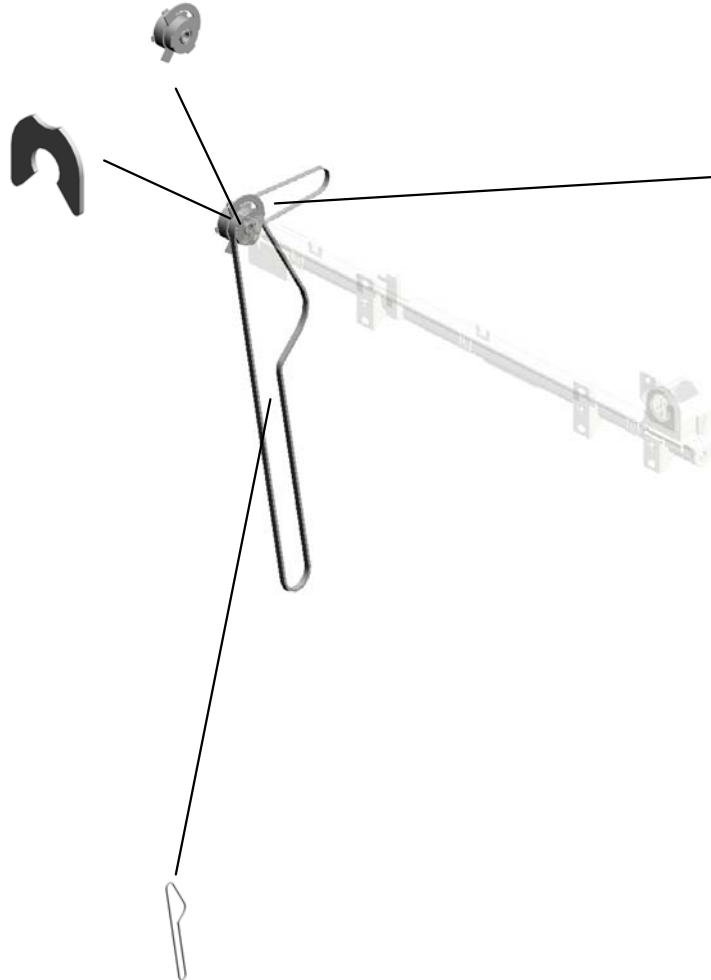

48.D1791324
SYNCHRONOUS B
ELT:40S3M222

18.AA043342
SYNCHRONOUS B
ELT:40S3M666

U001	U002	U003	U004	U005	U006	U007	U008	U009	U010	U011	U012	U013	U014	U015	U016	U017	U018	U019	U020
------	------	------	------	------	------	------	------	------	------	------	------	------	------	------	------	------	------	------	------

U010_S004

TONER OUTLET SUB-UNIT:VERTICAL TRANSPORT:MAIN:ASS'Y

16.A8063281 TIMING PULLEY - T
14 S3M
21.AA061177 TENSION SPRING:
VIBRATING PLATE:
VERTICAL TRANS
PORT
30.D0746540 SEAL:BELT CLEAN
ING:MAIN



57.D1796528
TONER OUTLET S
UB-UNIT:VERTICA
L TRANSPORT:MAI
N:ASS'Y

11.07200040E
RETAINING RING -
M4

19.AA043659
SYNCHRONOUS B
ELT:40S3M231

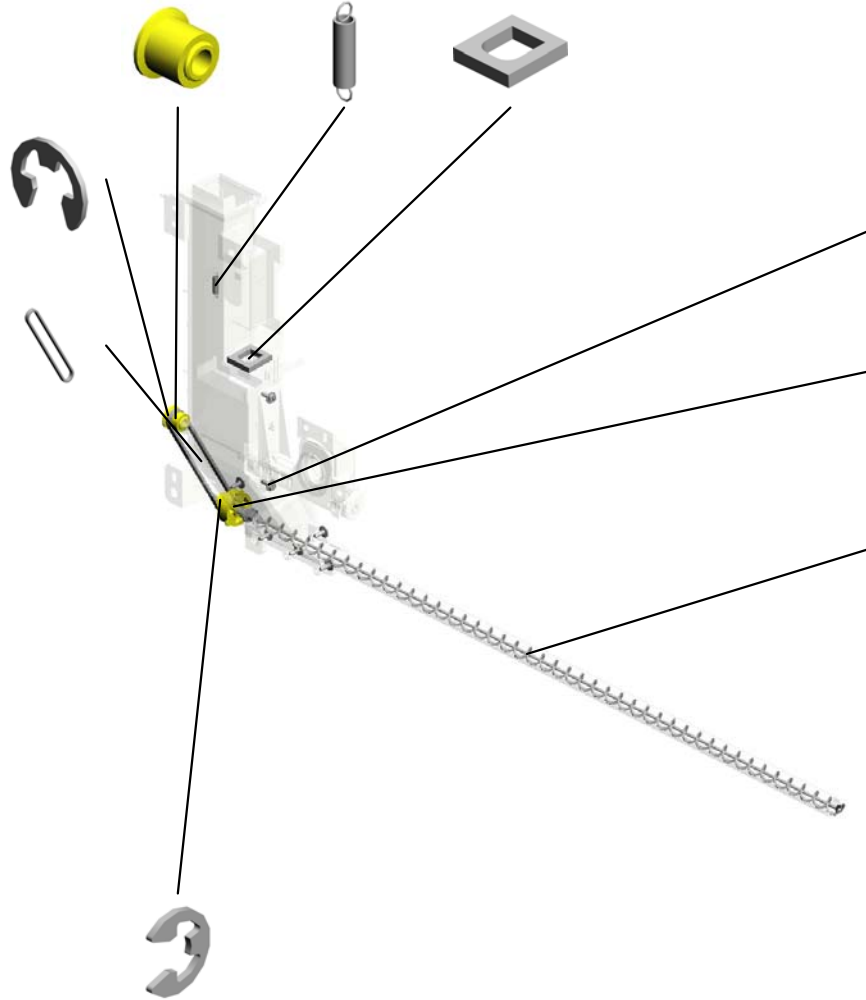

3.04503010N
(x7)
TAPPING SCREW -
M3X10

25.AB033119
TIMING PULLEY:Z2
5:Z14

58.D1796552
TRANSPORT SCR
EW:TONER OUTLE
T SUB-UNIT:LOWE
R:ASSY

10.07200030E
RETAINING RING -
M3

U001	U002	U003	U004	U005	U006	U007	U008	U009	U010	U011	U012	U013	U014	U015	U016	U017	U018	U019	U020
------	------	------	------	------	------	------	------	------	------	------	------	------	------	------	------	------	------	------	------

U011 PAPER TRANSPORT

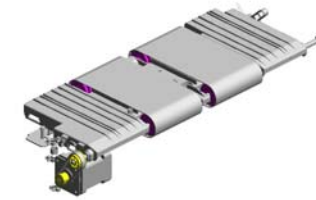
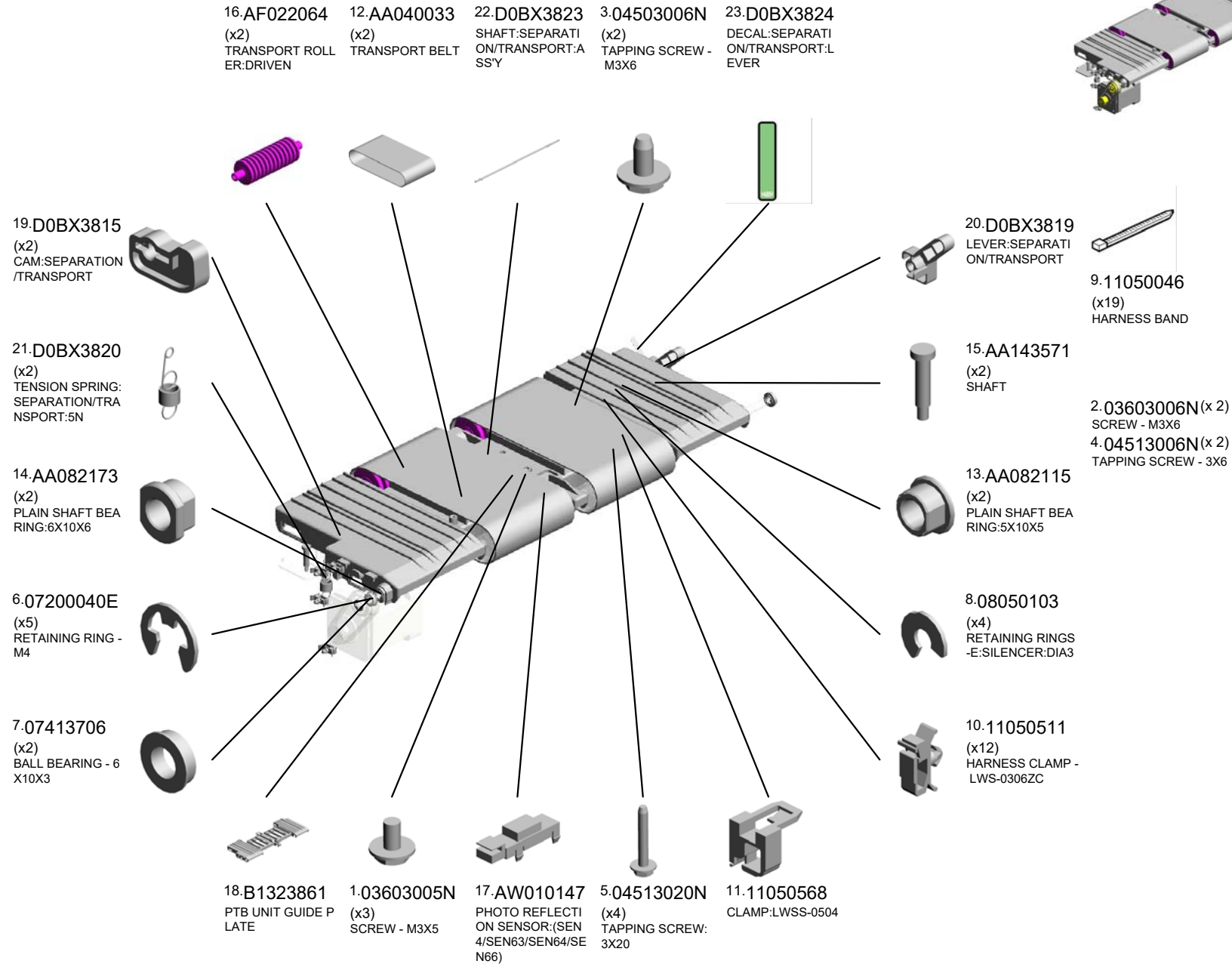

U001	U002	U003	U004	U005	U006	U007	U008	U009	U010	U011	U012	U013	U014	U015	U016	U017	U018	U019	U020
------	------	------	------	------	------	------	------	------	------	------	------	------	------	------	------	------	------	------	------

U011 PAPER TRANSPORT

27.G1783870 24.D0BX3830 29.D0BX3862
 TIMING PULLEY:T3 DC STEPPER MOT SUPPORTING PLA
 0 OR:MM42:ASSY TE:VACUUM

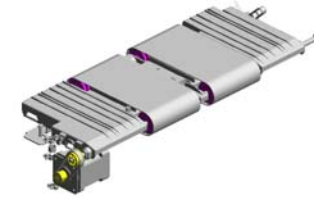

28.G1784636
 TIMING BELT:S2M1
 34_67

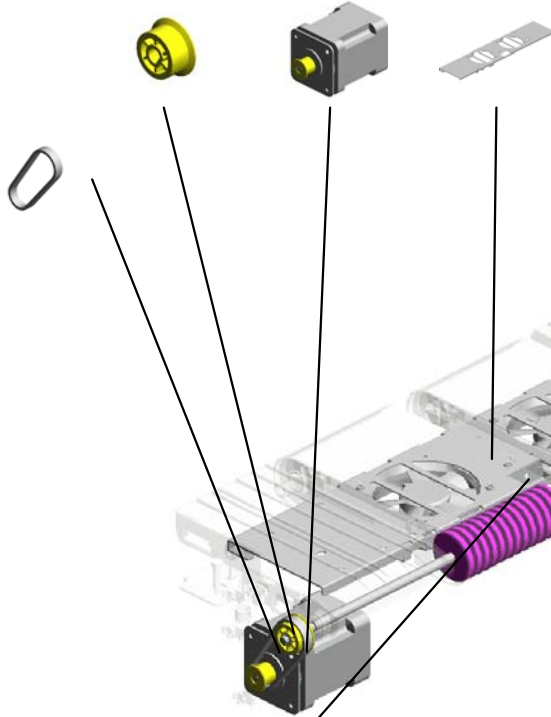

26.D2583910
 (x2)
 FAN:MM60X15:(FA
 N1/FAN2)

25.D1793851
 TRANSPORT ROLL
 ER:DRIVE

30.D1793865
 BRACKET:SENSO
 R:VACUUM

U001	U002	U003	U004	U005	U006	U007	U008	U009	U010	U011	U012	U013	U014	U015	U016	U017	U018	U019	U020
------	------	------	------	------	------	------	------	------	------	------	------	------	------	------	------	------	------	------	------

U012.FUSING

U012_S002
D0BX4311
WEB:CLEANING UNIT:ASS'Y

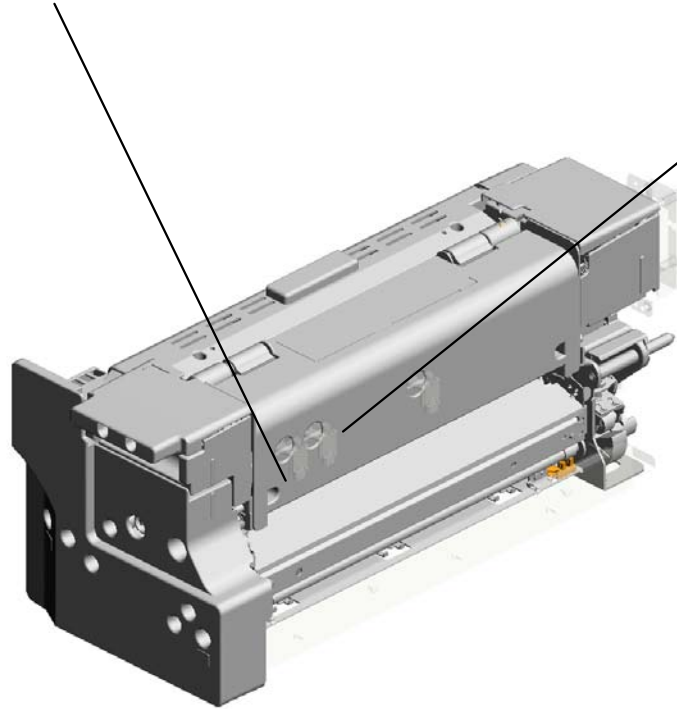

U012_S001
D0BX4017
(NA):FUSING UNIT:208V:ASS'
Y



U001	U002	U003	U004	U005	U006	U007	U008	U009	U010	U011	U012	U013	U014	U015	U016	U017	U018	U019	U020
------	------	------	------	------	------	------	------	------	------	------	------	------	------	------	------	------	------	------	------

U012_S001.(NA):FUSING UNIT:208V:ASS'Y

U012_S001_S005
D0BX4239
STRIPPER PLATE:ASS'Y

U012_S001_S002
D0BX4162
HOT ROLLER:DIA54:ASS'Y

U012_S001_S006
D0BX4275
COVER:FUSING UNIT:UPPER:ASS'Y

U012_S001_S007
D2704290
DRIVE UNIT:WEB:CLEANING:ASS'Y

U012_S001_S003
D1795381
TEMPERATURE SENSOR:FUSING UNIT:UPPER:19PIN:(SEN9/SEN59/SEN87/SEN88)

U012_S001_S004
D1795387
TEMPERATURE SENSOR:FUSING UNIT:LOWER:17PIN:(SEN80)

U012_S001_S001
D0BX4401
(NA):PRESSURE ROLLER:208V:ASS'Y

U001	U002	U003	U004	U005	U006	U007	U008	U009	U010	U011	U012	U013	U014	U015	U016	U017	U018	U019	U020
------	------	------	------	------	------	------	------	------	------	------	------	------	------	------	------	------	------	------	------

U012_S001_S007.DRIVE UNIT:WEB:CLEANING:ASS'Y

U012 S001 S007 S001
AX040300
DC MOTOR:CLEANER:ASS'Y:
(BM5)

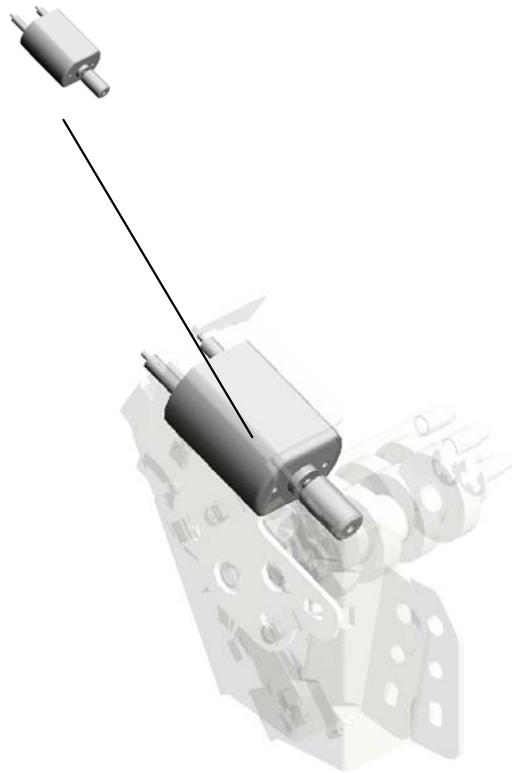

U001	U002	U003	U004	U005	U006	U007	U008	U009	U010	U011	U012	U013	U014	U015	U016	U017	U018	U019	U020
------	------	------	------	------	------	------	------	------	------	------	------	------	------	------	------	------	------	------	------

U012_S002.WEB:CLEANING UNIT:ASS'Y

U012 S002 S001
D0BX4313
COVER:WEB:CLEANING FEL
T



U001	U002	U003	U004	U005	U006	U007	U008	U009	U010	U011	U012	U013	U014	U015	U016	U017	U018	U019	U020
------	------	------	------	------	------	------	------	------	------	------	------	------	------	------	------	------	------	------	------

U012 FUSING

- 116.D1054365 (x3) HOLDER:THERMOPILE
- 95.D0746497 (x2) DECAL:POSITIONING DISPLAY:TCRU
- 19.08046123 (x4) HEXAGONAL BOLT:W/WASHER:M3X8
- 139.D1794352 BRACKET:DRAWER:FUSING:UPPER:MAIN
- 26.11050511 HARNESS CLAMP - LWS-0306ZC

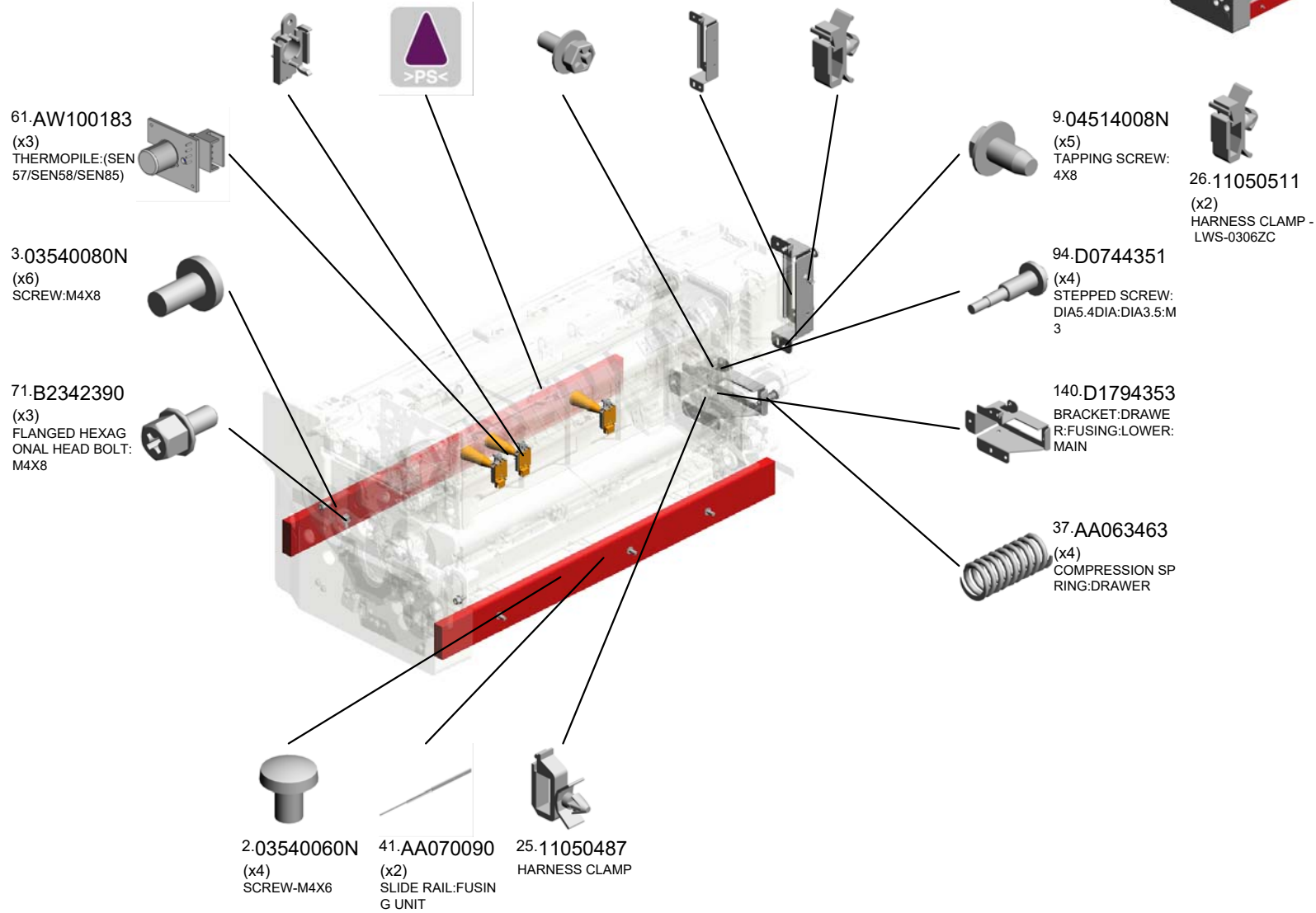

U001	U002	U003	U004	U005	U006	U007	U008	U009	U010	U011	U012	U013	U014	U015	U016	U017	U018	U019	U020
------	------	------	------	------	------	------	------	------	------	------	------	------	------	------	------	------	------	------	------

U012_S001
(NA):FUSING UNIT:208V:ASS'Y

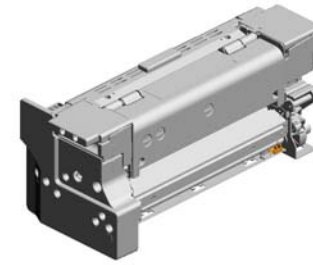

161.D0BX4017
(NA):FUSING UNIT:
208V:ASS'Y

- 12.07200030E RETAINING RING - M3
- 8.04503008N (x2) TAPPING SCREW - M3X8
- 1.03530060N (x3) BIND SCREW - M3 X6
- 6.03603010N (x2) SCREW:M3X10
- 22.09543010N SCREW:POLISHED ROUND/SPRING:M 3X10

- 10.04543006Q (x10) TAPPING SCREW - M3X6

- 7.03604008N (x3) SCREW - M4X8

- 21.09543006N SCREW - M3X6

- 26.11050511 (x12) HARNESS CLAMP - LWS-0306ZC

- 27.11050516 (x5) CLAMP

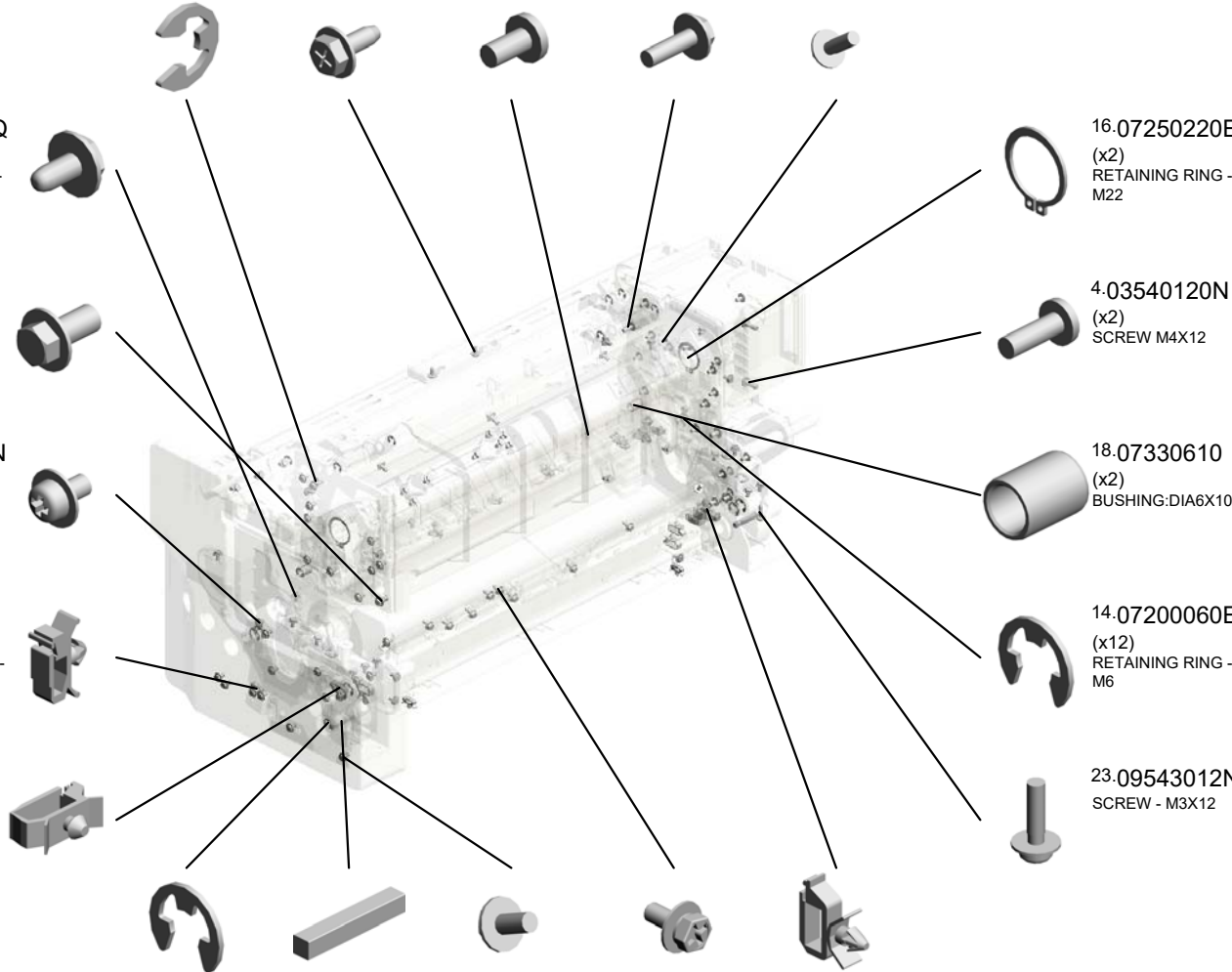

- 16.07250220E (x2) RETAINING RING - M22

- 19.08046123 (x10) HEXAGONAL BOLT :W/WASHER:M3X8
- 24.11050046 (x5) HARNESS BAND

- 4.03540120N (x2) SCREW M4X12

- 1.03530060N (x 3) BIND SCREW - M3X6
- 5.03603006N (x 7) SCREW - M3X6
- 10.04543006Q (x 3) TAPPING SCREW - M3X6
- 14.07200060E (x 1) RETAINING RING - M6

- 18.07330610 (x2) BUSHING:DIA6X10

- 14.07200060E (x12) RETAINING RING - M6

- 23.09543012N SCREW - M3X12

- 13.07200040E (x10) RETAINING RING - M4
- 20.09300404A (x2) PARALLEL KEY:4X 4X25
- 5.03603006N (x64) SCREW - M3X6
- 19.08046123 (x20) HEXAGONAL BOLT :W/WASHER:M3X8
- 25.11050487 (x2) HARNESS CLAMP

U001	U002	U003	U004	U005	U006	U007	U008	U009	U010	U011	U012	U013	U014	U015	U016	U017	U018	U019	U020
------	------	------	------	------	------	------	------	------	------	------	------	------	------	------	------	------	------	------	------

U012_S001
(NA):FUSING UNIT:208V:ASS'Y

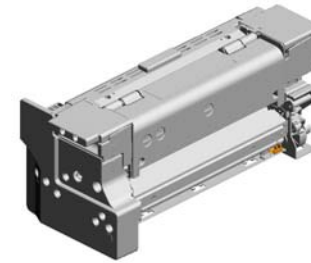

161.D0BX4017
(NA):FUSING UNIT:
208V:ASS'Y

- 60.AW010147 (x3) PHOTO REFLECTI ON SENSOR:(SEN 4/SEN63/SEN64/SE N66)
- 28.11050551 (x2) CLAMP:LES-0505
- 50.AE012048 HEAT ROLLER:DIA 39.2
- 42.AA082101 (x2) BUSHING - 6X10X6
- 46.AA143847 (x2) STEPPED SCREW: DIA5:3.5:M3

31.58942540
ARM SCREW

57.AE032034
(x2)
THERMAL INSULA TING BUSHING:DIA 22

30.11050744
(x5)
CLAMP:F-LWS-071 1

40.AA064000
(x2)
COMPRESSION SP RING:PRESSURE

29.11050723
(x5)
CLAMPS:WES-050 7

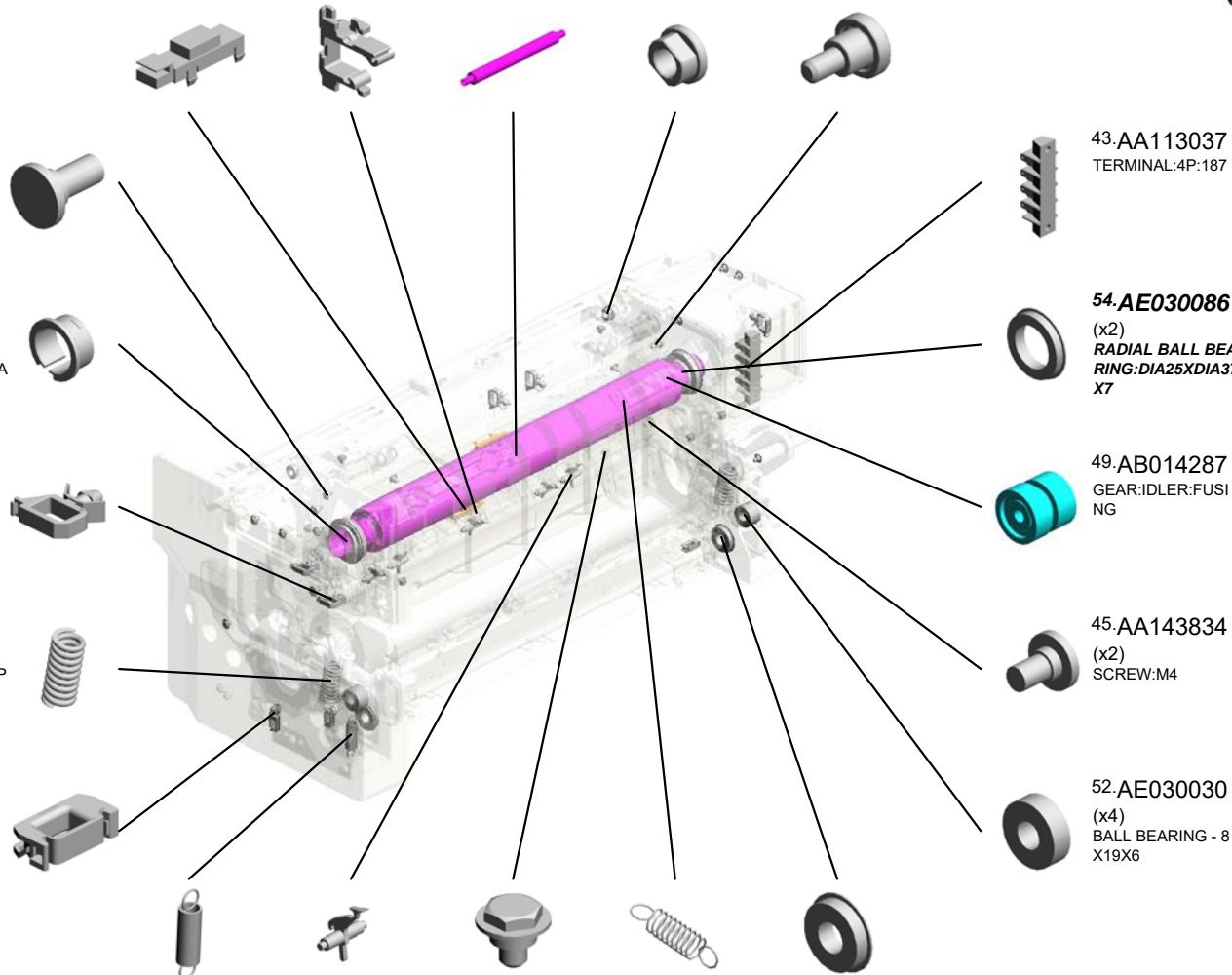

43.AA113037
TERMINAL:4P:187

54.AE030086
(x2)
RADIAL BALL BEA RING:DIA25XDIA37 X7

49.AB014287
GEAR:IDLER:FUSI NG

45.AA143834
(x2)
SCREW:M4

52.AE030030
(x4)
BALL BEARING - 8 X19X6

- 35.AA061134 TENSION SPRING: LEVER:PRESSURE
- 58.AE044075 (x5) STRIPPER PAWLS
- 44.AA143520 (x19) SHOULDER SCRE W - M3
- 34.AA061116 (x2) TENSION SPRING: STRIPPER PLATE: 2N
- 53.AE030044 (x2) BALL BEARING - 1 0X22X6

U001	U002	U003	U004	U005	U006	U007	U008	U009	U010	U011	U012	U013	U014	U015	U016	U017	U018	U019	U020
------	------	------	------	------	------	------	------	------	------	------	------	------	------	------	------	------	------	------	------

U012_S001
(NA):FUSING UNIT:208V:ASS'Y

- 70.B1324268 (x5) HOLDER:ROLLER: PICK-OFF PAWL
- 69.B1324265 (x5) ROLLER:PICK-OFF PAWL
- 68.B1324197 TORSION SPRING: LEVER
- 74.BB013028 GEAR:IDLER:35Z:A SS'Y
- 76.BB013037 GEAR:JOINT:PRES SURE:ASS'Y

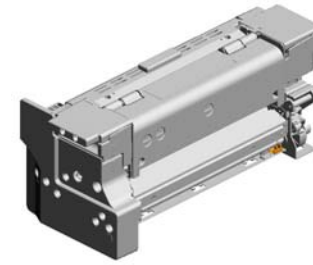

161.D0BX4017
(NA):FUSING UNIT:
208V:ASS'Y

62.AW110052
(x2)
THERMOSTAT:211
C:(TS1/TS2)

66.B1324167
GRIP:OIL APPLICA
TION UNIT:FIBER

80.D0744063
HOUSING:THERM
OSTAT:ASS'Y

63.AW110122
THERMOSTAT:225
C:250V/17A:(TS3)

86.D0744104
FEELER:CAM:PRE
SSURE:FRONT



79.D0743829
(x2)
DECAL:POSITIONI
NG DISPLAY:TCRU

81.D0744064
COVER:THERMOS
TAT:PRESSURE

78.D0144247
(x4)
HOUSING - TEMPE
RATURE SENSOR

67.B1324196
(x5)
SPRING:PICK-OFF
PAWL

84.D0744102
(x2)
COLLAR:DIA10X:DI
A14X:12

77.BB013047
GEAR:HOT ROLLE
R:ASS'Y

75.BB013036
GEAR:IDLER:25Z:A
SS'Y

83.D0744072
(x2)
STEPPED SCREW:
M5

82.D0744070
SUPPORTING PLA
TE:LEVER:PRESS
URE

85.D0744103
(x2)
CAM:PRESSURE:A

U001	U002	U003	U004	U005	U006	U007	U008	U009	U010	U011	U012	U013	U014	U015	U016	U017	U018	U019	U020
------	------	------	------	------	------	------	------	------	------	------	------	------	------	------	------	------	------	------	------

U012_S001
(NA):FUSING UNIT:208V:ASS'Y

- 89.D0744180 HOUSING:THERM
OSTAT:HEAT ROLL
ER:ASS'Y
- 122.D1794107 BRACKET:STRIPP
ER PAWLS:PRESS
URE:PEEN
- 90.D0744181 ELECTRODE PLAT
E:THERMOSTAT:H
EAT ROLLER:MIDD
LE
- 91.D0744182 ELECTRODE PLAT
E:THERMOSTAT:H
EAT ROLLER
- 108.D0BX4264 COVER:FUSING U
NIT:REAR:UPPER:
ASS'Y

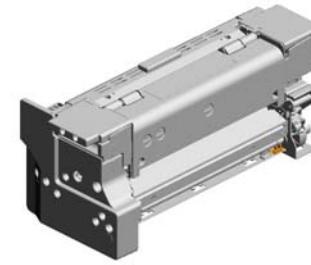

161.D0BX4017
(NA):FUSING UNIT:
208V:ASS'Y

112.D0BX4288
DECAL:H-TEMP W
ARNING:FUSING/P
APER EXIT UNIT:F
USING UNIT

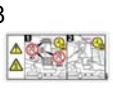

105.D0BX4260
COVER:FUSING U
NIT:FRONT:UPPER
:ASS'Y

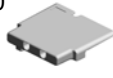

106.D0BX4262
COVER:FUSING U
NIT:FRONT:MIDD
LE



107.D0BX4263
COVER:FUSING U
NIT:FRONT:LOWE
R



92.D0744227
(x2)
BOLT:M5:ROUND P
OINT

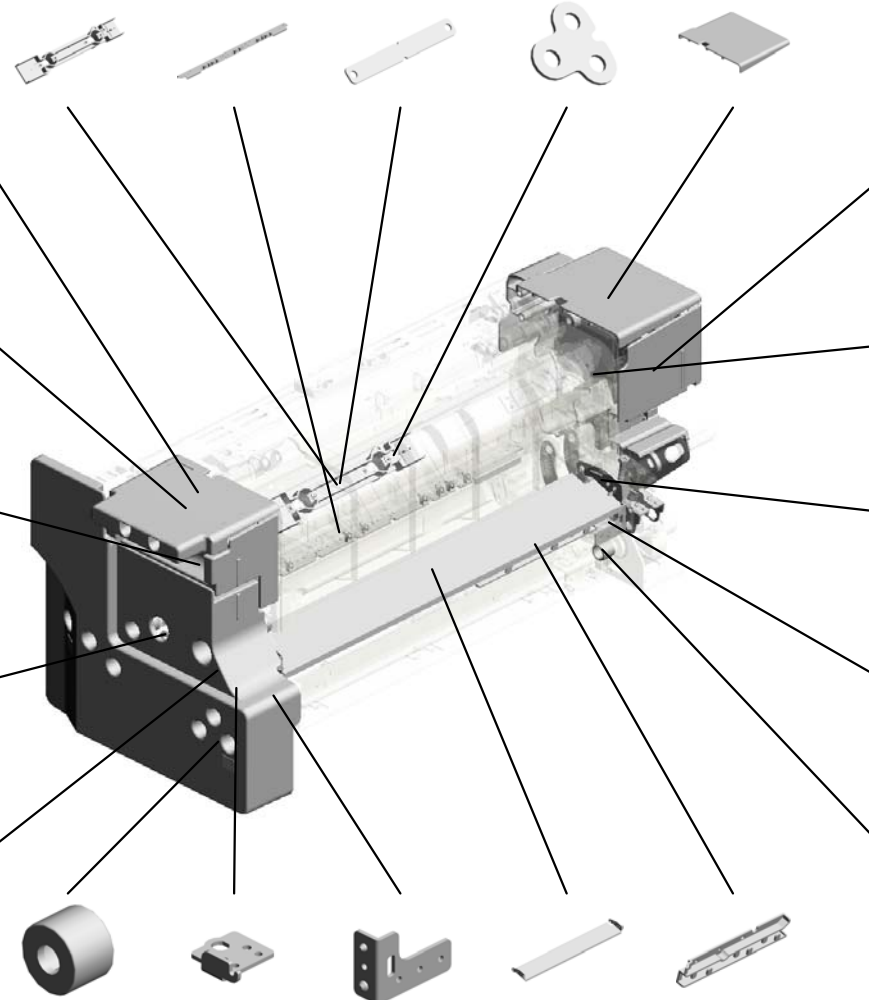

109.D0BX4266
COVER:FUSING U
NIT:REAR:MIDDLE



110.D0BX4267
COVER:FUSING U
NIT:REAR:LOWER



98.D0BX4045
(x2)
LEVER:CONTROL
PLATE:PRESSURE



119.D1794072
BRACKET:FUSING
ENTRANCE GUIDE
PLATE:REAR



87.D0744105
FEELER:CAM:PRE
SSURE:REAR



88.D0744107
COLLAR:DIA10XDI
A14X9.4



117.D1794028
SUPPORTING PLA
TE:LEVER:PRESS
URE:FRONT



118.D1794071
BRACKET:FUSING
ENTRANCE GUIDE
PLATE:FRONT



120.D1794081
FUSING ENTRANC
E GUIDE PLATE:LO
WER



121.D1794095
CLAMP:HARNES
S:PRESSURE



U001	U002	U003	U004	U005	U006	U007	U008	U009	U010	U011	U012	U013	U014	U015	U016	U017	U018	U019	U020
------	------	------	------	------	------	------	------	------	------	------	------	------	------	------	------	------	------	------	------

U012_S001
(NA):FUSING UNIT:208V:ASS'Y

- 133.D1794232 SHAFT:FUSING/PAPER EXIT UNIT
- 136.D1794279 COVER:FUSING/PAPER EXIT UNIT:ASS'Y
- 135.D1794255 GUIDE PLATE:FUSING EXIT:UPPER:ASS'Y
- 137.D1794283 GRIP:COVER:FUSING/PAPER EXIT UNIT:ASS'Y
- 130.D1794224 LEVER:PAPER EXIT UNIT:REAR

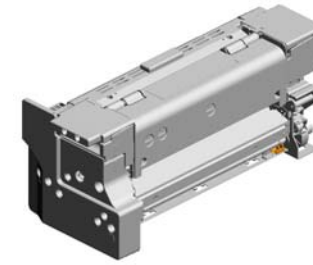

161.D0BX4017
(NA):FUSING UNIT:208V:ASS'Y

129.D1794223
LEVER:PAPER EXIT UNIT:FRONT

132.D1794231
STOPPER:LEVER:FUSING/PAPER EXIT UNIT

126.D1794170
TAB:TERMINAL:187:4P

125.D1794114
GUIDE PLATE:FUSING EXIT:LOWER

124.D1794113
(x2)
DISCHARGE BRUSH:H:21MM

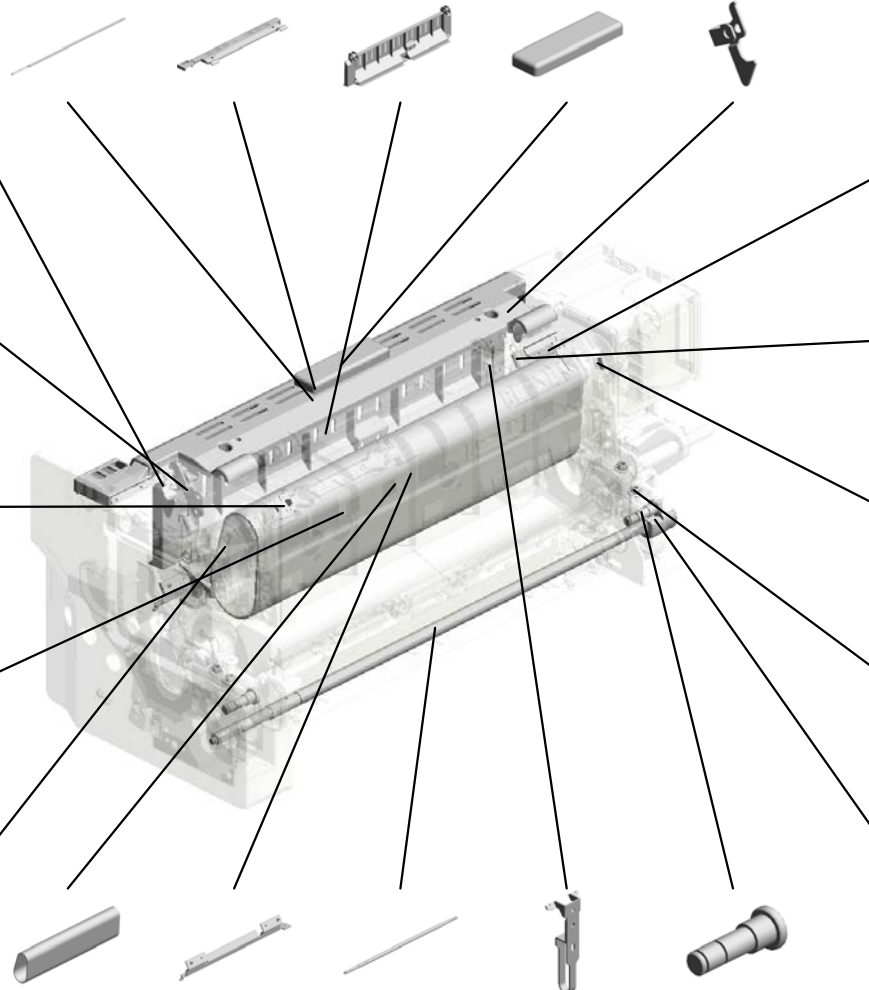

148.D2704156
HOLDER:THERMISTOR:HEAT ROLLER

134.D1794235
(x2)
TENSION SPRING:FUSING/PAPER EXIT UNIT

127.D1794182
DISCHARGE BRUSH:H:HEAT ROLLER

146.D2704009
(x4)
HOLDER:M5

144.D1944106
JOINT:CAM:PRESSURE

128.D1794197
FLAT BELT-FUSING
G:DIA80:SEAL

123.D1794109
(x2)
ADJUSTING PIN:DISCHARGE BRUSH

143.D1944101
SHAFT:CAM:PRESSURE

131.D1794228
(x2)
SUPPORTER:GUIDE PLATE:FUSING EXIT:UPPER

147.D2704068
(x2)
SHAFT:RADIAL BALL BEARING:LEVER:PRESSURE

U001	U002	U003	U004	U005	U006	U007	U008	U009	U010	U011	U012	U013	U014	U015	U016	U017	U018	U019	U020
------	------	------	------	------	------	------	------	------	------	------	------	------	------	------	------	------	------	------	------

U012_S001
 (NA):FUSING UNIT:208V:ASS'Y

149.D2704185 (x2)
 RING:GUIDE:HEAT ROLLER:DIA39.2

150.D2704236
 TORSION SPRING:
 FUSING/PAPER EX
 IT UNIT:FRONT

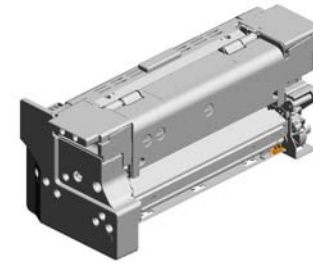

161.D0BX4017
 (NA):FUSING UNIT:
 208V:ASS'Y

158.GW020024
 (x3)
 PHOTOINTERUP
 TOR:LG2A24BL1:G
 F:(SEN3/SEN21/SE
 N35/SEN36/SEN37/
 SEN38/SEN39/SEN

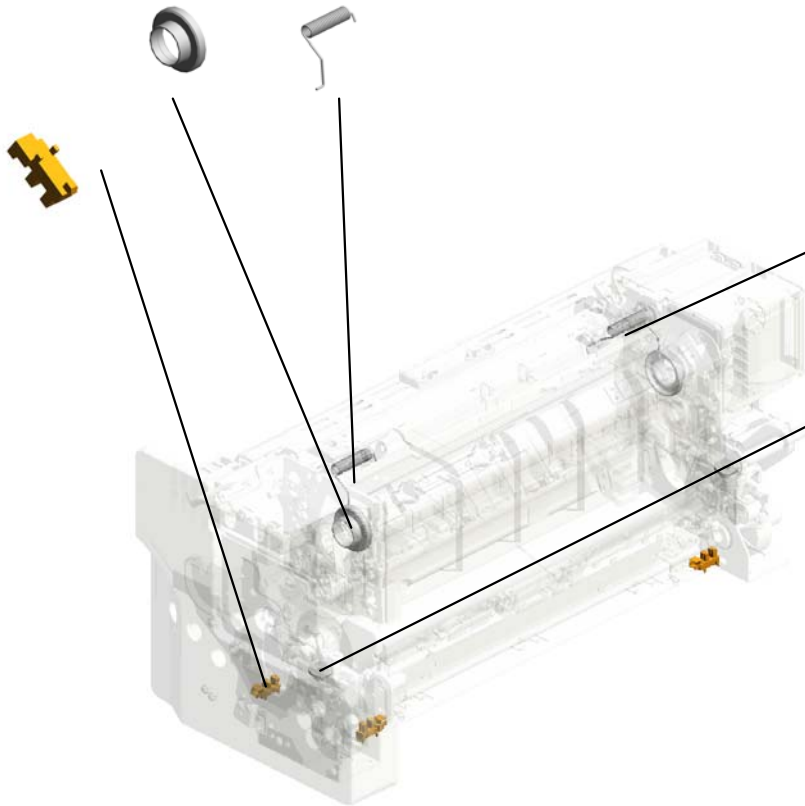

151.D2704237
 TORSION SPRING:
 FUSING/PAPER EX
 IT UNIT:REAR

156.D2704383
 (x2)
 HOLDER:COIL SPR
 ING:PRESSURE

U001	U002	U003	U004	U005	U006	U007	U008	U009	U010	U011	U012	U013	U014	U015	U016	U017	U018	U019	U020
------	------	------	------	------	------	------	------	------	------	------	------	------	------	------	------	------	------	------	------

U012_S001_S001

(NA):PRESSURE ROLLER:208V:ASS'Y

54.AE030086 (x2) RADIAL BALL BEARING:FRONT
RING:DIA25XDIA37X7

100.D0BX4048 HOLDER:HEATER:PRESSURE:FRONT

160.AX440348 (NA):HEATER:PRESSURE ROLLER:208V:800W:(HT5)

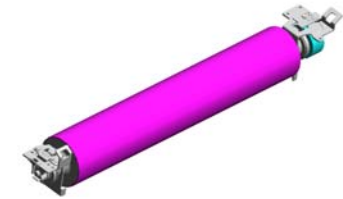

162.D0BX4401 (NA):PRESSURE ROLLER:208V:ASS'Y

29.11050723 CLAMPS:WES-0507



17.07250250E (x2) RETAINING RING C - M25



5.03603006N (x3) SCREW - M3X6



99.D0BX4047 HOLDER:HEATER:PRESSURE:REAR



73.BB013025 GEAR:PRESSURE ROLLER



51.AE020220 PRESSURE ROLLER:FRONT
R:DIA65



U001	U002	U003	U004	U005	U006	U007	U008	U009	U010	U011	U012	U013	U014	U015	U016	U017	U018	U019	U020
------	------	------	------	------	------	------	------	------	------	------	------	------	------	------	------	------	------	------	------

U012_S001_S002
HOT ROLLER:DIA54:ASS'Y

19.08046123
HEXAGONAL BOLT
:W/WASHER:M3X8



101.D0BX4162
HOT ROLLER:DIA54:ASS'Y

96.D0A53995
JOINT:KNOB:FUSION

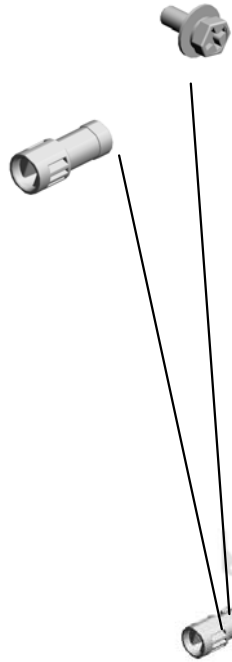

15.07250200E
RETAINING RING
C - M20

145.D2584302
(x2)
STEPPED SCREW:
LEVER:HEAT ROLLER

U001	U002	U003	U004	U005	U006	U007	U008	U009	U010	U011	U012	U013	U014	U015	U016	U017	U018	U019	U020
------	------	------	------	------	------	------	------	------	------	------	------	------	------	------	------	------	------	------	------

U012_S001_S003

TEMPERATURE SENSOR:FUSING UNIT:UPPER:19PIN:(SEN9/SEN59/SEN87/SEN88)



141.D1795381
TEMPERATURE SE
NSOR:FUSING UNI
T:UPPER:19PIN:(S
EN9/SEN59/SEN87/
SEN88)



24.11050046
HARNESS BAND

U001	U002	U003	U004	U005	U006	U007	U008	U009	U010	U011	U012	U013	U014	U015	U016	U017	U018	U019	U020
------	------	------	------	------	------	------	------	------	------	------	------	------	------	------	------	------	------	------	------

U012_S001_S004
TEMPERATURE SENSOR:FUSING UNIT:LOWER:17PIN:(SEN80)

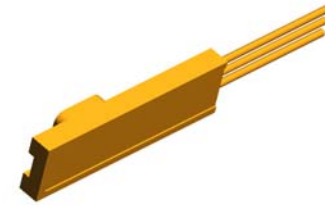

142.D1795387
TEMPERATURE SE
NSOR:FUSING UNI
T:LOWER:17PIN:(S
EN80)



24.11050046
HARNESS BAND

U001	U002	U003	U004	U005	U006	U007	U008	U009	U010	U011	U012	U013	U014	U015	U016	U017	U018	U019	U020
------	------	------	------	------	------	------	------	------	------	------	------	------	------	------	------	------	------	------	------

U012_S001_S005
STRIPPER PLATE:ASS'Y

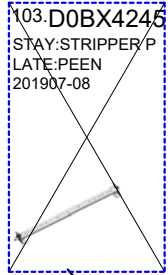

36.AA061154
(x7)
COMPRESSION SP
RING:11N

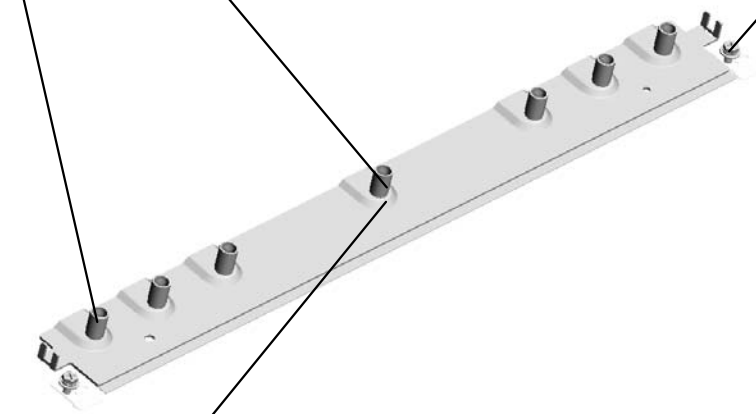

157.G1021193
(x2)
HEXAGONAL BOLT
:DOUBLE:SCREW:
ROUND POINT:M3
X7



104.D0BX4251
STRIPPER PLATE:
ADHESION



102.D0BX4239
STRIPPER PLATE:
ASS'Y

U001	U002	U003	U004	U005	U006	U007	U008	U009	U010	U011	U012	U013	U014	U015	U016	U017	U018	U019	U020
------	------	------	------	------	------	------	------	------	------	------	------	------	------	------	------	------	------	------	------

U012_S001_S006
COVER:FUSING UNIT:UPPER:ASS'Y

152-D2704277
DECAL:H-TEMP W
ARNING:FUSING

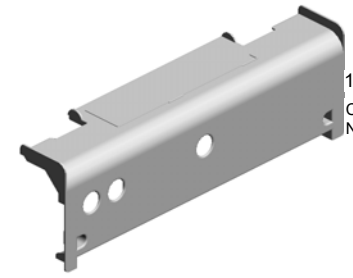
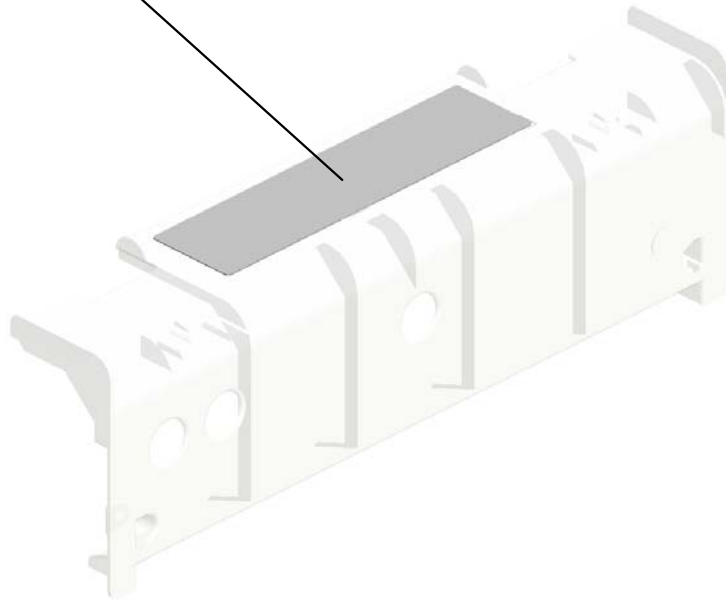

111-D0BX4275
COVER:FUSING U
NIT:UPPER:ASSY

U001	U002	U003	U004	U005	U006	U007	U008	U009	U010	U011	U012	U013	U014	U015	U016	U017	U018	U019	U020
------	------	------	------	------	------	------	------	------	------	------	------	------	------	------	------	------	------	------	------

U012_S001_S007
 DRIVE UNIT:WEB:CLEANING:ASS'Y

33.A2944171 48.AB014229
 (x4) (x4)
 COUPLED GEAR - 17Z/32Z COUPLEDGEAR - 17Z/32Z

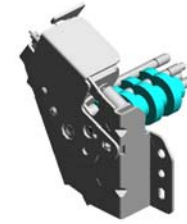

153.D2704290
 DRIVE UNIT:WEB:
 CLEANING:ASS'Y

26.11050511
 (x2)
 HARNESS CLAMP - LWS-0306ZC



12.07200030E
 (x2)
 RETAINING RING - M3



56.AE031037
 (x4)
 BUSHING - M4



28.11050551
 (x2)
 CLAMP:LES-0505

U001	U002	U003	U004	U005	U006	U007	U008	U009	U010	U011	U012	U013	U014	U015	U016	U017	U018	U019	U020
------	------	------	------	------	------	------	------	------	------	------	------	------	------	------	------	------	------	------	------

U012_S001_S007_S001
DC MOTOR:CLEANER:ASS'Y:(BM5)

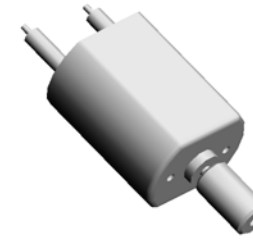

64.AX040300
DC MOTOR:CLEAN
ER:ASS'Y:(BM5)



24.11050046
HARNESS BAND

U001	U002	U003	U004	U005	U006	U007	U008	U009	U010	U011	U012	U013	U014	U015	U016	U017	U018	U019	U020
------	------	------	------	------	------	------	------	------	------	------	------	------	------	------	------	------	------	------	------

U012_S002
WEB:CLEANING UNIT:ASS'Y

- 21.09543006N SCREW - M3X6
- 32.A2944156 GEAR - 23Z
- 11.07200020E RETAINING RING - M2
- 154.D2704338 FEELER:CLEANING
- 159.M0774200 MECHANICAL ROLLER CLUTCH:ROLLER

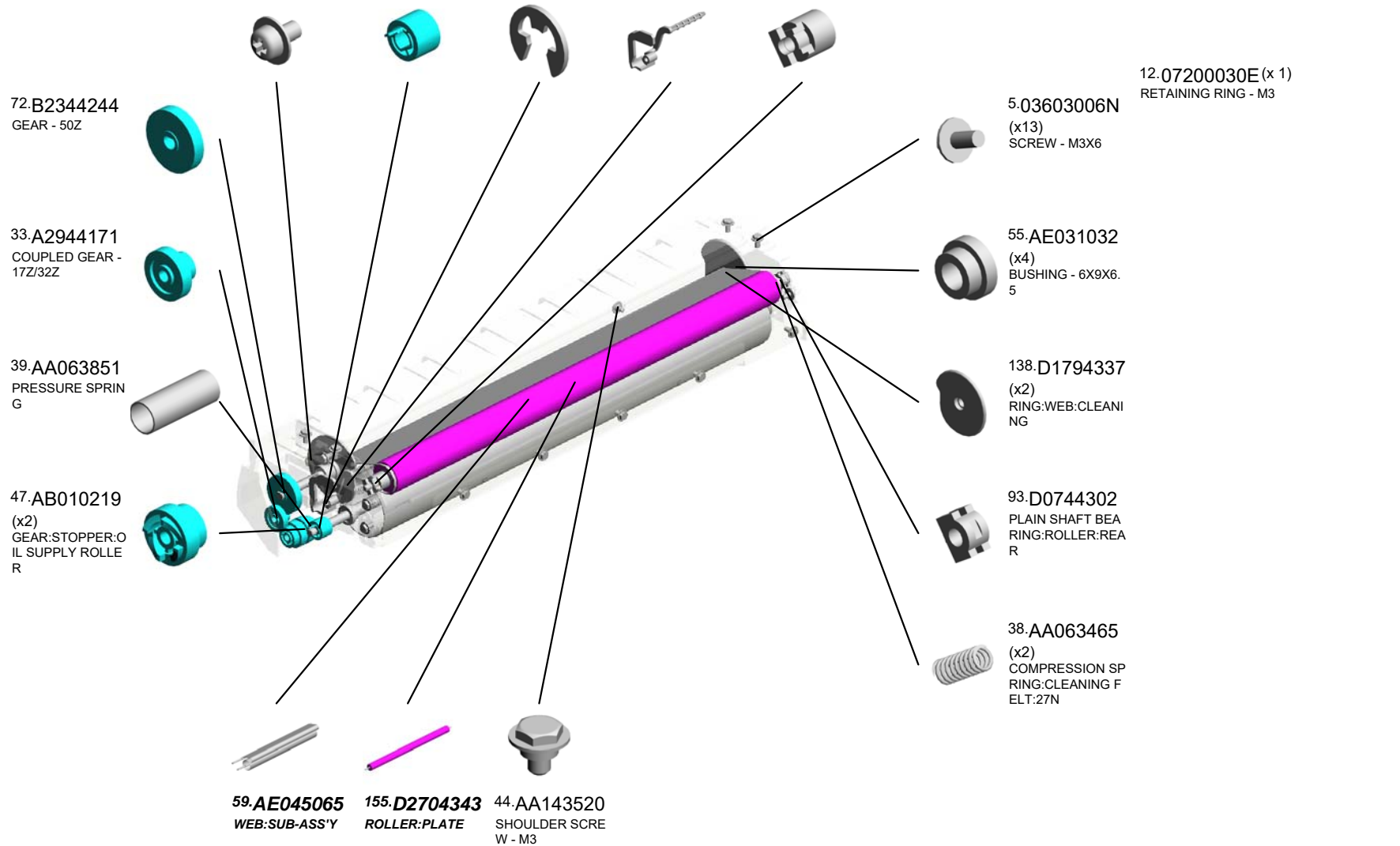
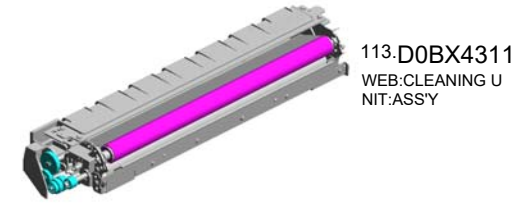

U001	U002	U003	U004	U005	U006	U007	U008	U009	U010	U011	U012	U013	U014	U015	U016	U017	U018	U019	U020
------	------	------	------	------	------	------	------	------	------	------	------	------	------	------	------	------	------	------	------

U012_S002_S001
COVER:WEB:CLEANING FELT

95.D0746497
DECAL:POSITIONI
NG DISPLAY:TCRU

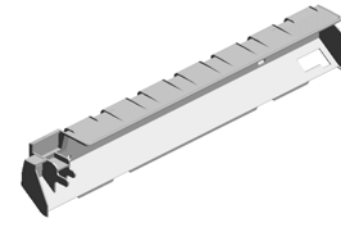
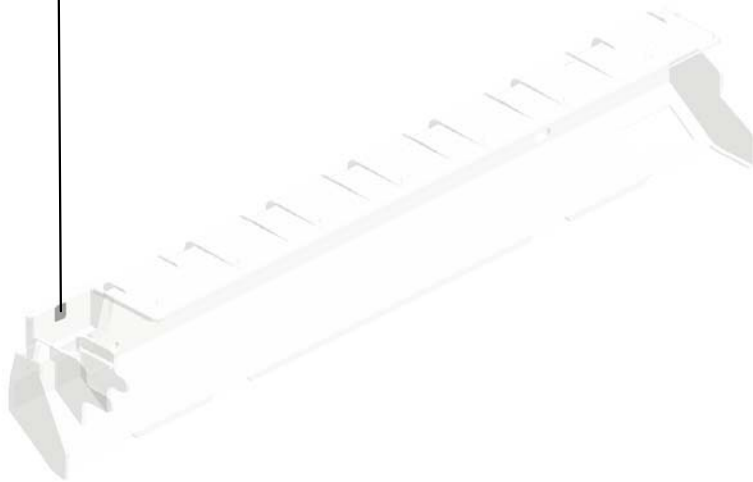

114.D0BX4313
COVER:WEB:CLEA
NING FELT

U001	U002	U003	U004	U005	U006	U007	U008	U009	U010	U011	U012	U013	U014	U015	U016	U017	U018	U019	U020
------	------	------	------	------	------	------	------	------	------	------	------	------	------	------	------	------	------	------	------

U013.PAPER EXIT

U013 S001
D0BX4783
GUIDE PLATE:REVERSE:LO
WER:ASSY

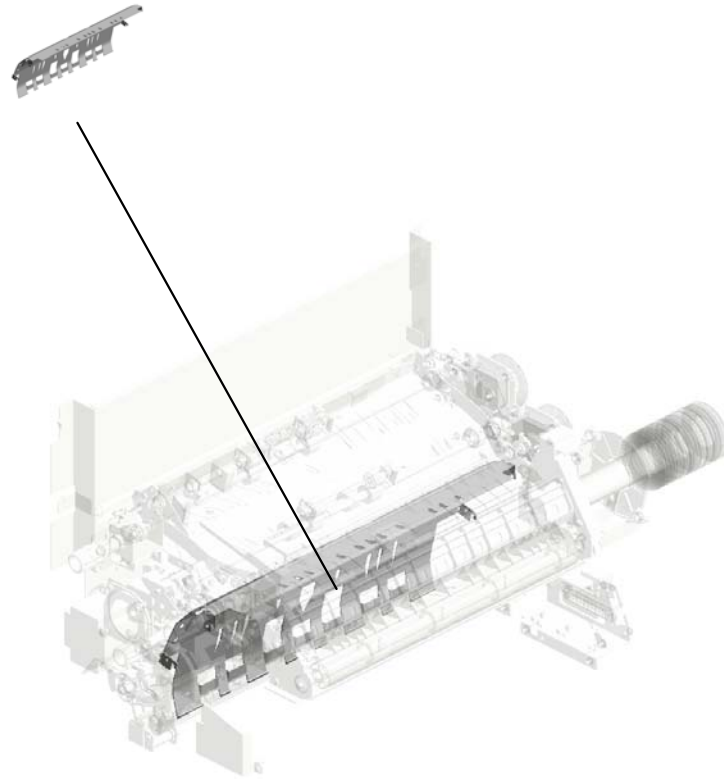

U001	U002	U003	U004	U005	U006	U007	U008	U009	U010	U011	U012	U013	U014	U015	U016	U017	U018	U019	U020
------	------	------	------	------	------	------	------	------	------	------	------	------	------	------	------	------	------	------	------

U013 PAPER EXIT

- 3.03530060N (x4) BIND SCREW - M3 X6
- 19.07200060E (x19) RETAINING RING - M6
- 21.07433808 (x10) RADIAL BALL BEA RING: DIA8XDIA16X 5
- 16.07200020E (x2) RETAINING RING - M2
- 22.08046123 (x2) HEXAGONAL BOLT :W/WASHER:M3X8

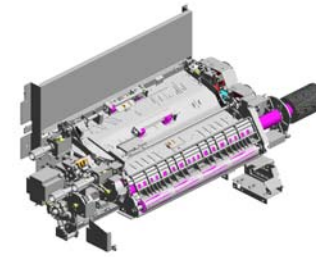

- 5.03603008N (x2) SCREW:M3X8

- 8.03604010N (x4) SCREW:M4X10

- 18.07200040E (x23) RETAINING RING - M4

- 7.03604008N (x3) SCREW - M4X8

- 6.03604006N (x4) SCREW - M4X6

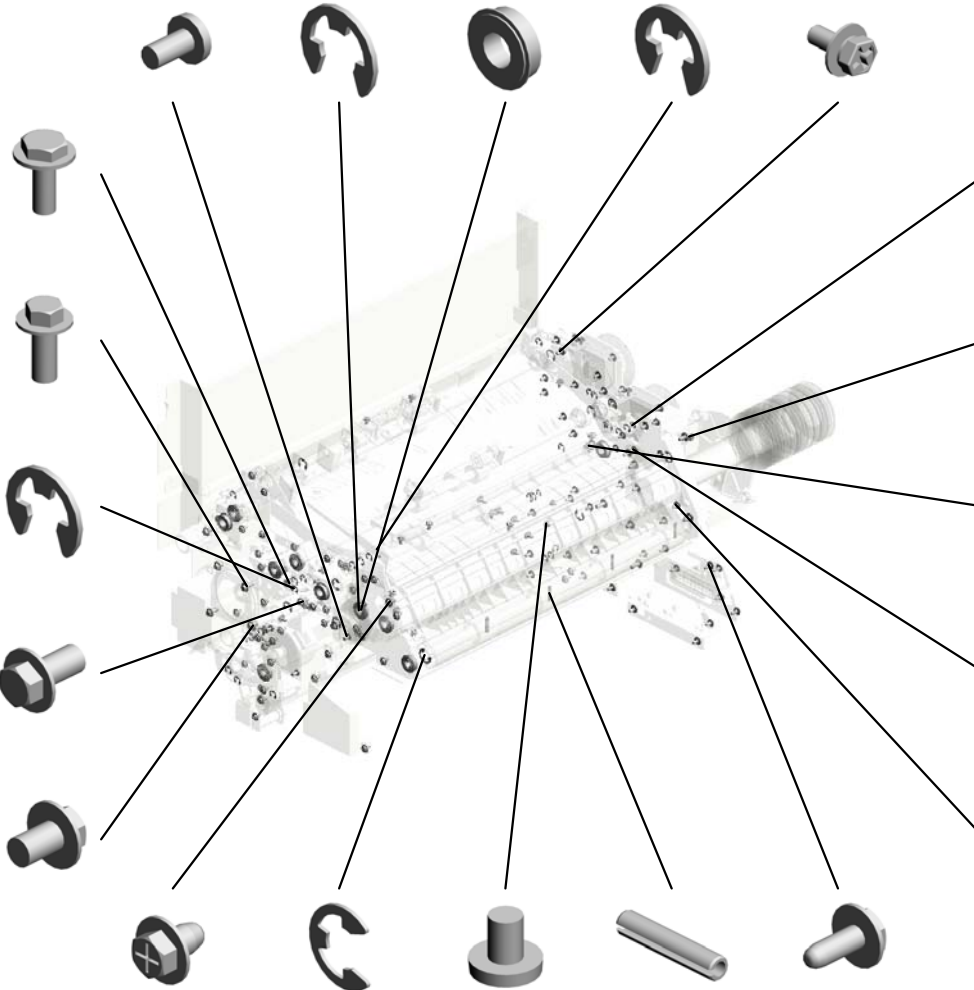

- 14.04544006Q (x5) TAPPING SCREW: 4X6
- 20.07200080E RETAINING RING - M8
- 2.03530040N (x2) SCREW - M3X4
- 15.06230160E (x4) SPRING PIN - 3X16 MM
- 13.04543008Q (x6) TAPPING SCREW: 3X8

- 17.07200030E (x5) RETAINING RING - M3

- 4.03603006N (x10) SCREW - M3X6

- 9.04503008N (x3) TAPPING SCREW - M3X8

- 10.04513006N (x49) TAPPING SCREW - 3X6

- 12.04543006Q (x44) TAPPING SCREW - M3X6



- 25.11050046 (x78) HARNESS BAND



- 26.11050511 (x10) HARNESS CLAMP - LWS-0306ZC



- 27.11050516 (x4) CLAMP

- 1.03130060N (x 1) SCREW - M3X6

- 10.04513006N (x 3) TAPPING SCREW - 3X6

- 11.04514008N (x10) TAPPING SCREW:4X8

- 19.07200060E (x 2) RETAINING RING - M6

U013 PAPER EXIT

- 24.08050089 (x2) RETAINING RING - M4
- 23.08050088 RETAINING RING - M6
- 42.AA084059 (x12) BALL BEARING HOLDER
- 43.AA120084 DISCHARGE BRUSH
- 29.11050723 (x3) CLAMPS:WES-0507

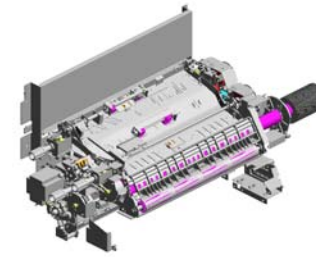

30.AA043323
TIMING BELT:40S2
M120



40.AA082101
(x8)
BUSHING - 6X10X6

26.11050511
(x27)
HARNESS CLAMP -
LWS-0306ZC

39.AA080346
(x2)
BUSHING:FLANGE
TYPE:DIA6

34.AA061170
COIL SPRING:GAT
E PAWL:EXIT:ENT
RANCE

38.AA063675
(x2)
SPRING - 5N

41.AA082104
(x2)
BUSHING - 8X12X7

27.11050516
(x8)
CLAMP

35.AA061171
(x2)
COIL SPRING:LAT
CH:REVERSE EXIT
:LEFT LOWER

32.AA043652
TIMING BELT - B60
S2M130

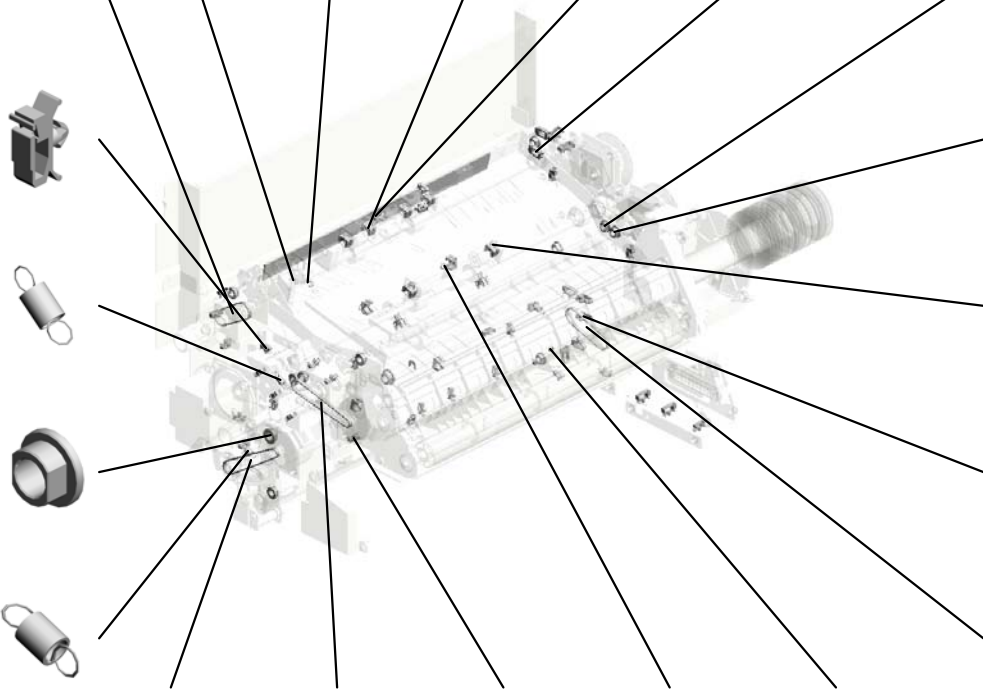

31.AA043608
TIMING BELT:40S2
M184

33.AA043660
TIMING BELT:40S2
M172

28.11050692
(x3)
CLAMP:LES-0503

37.AA063674
(x4)
SPRING - 8N

36.AA061172
COIL SPRING:GAT
E PAWL:EXIT:DUP
LEX

U013 PAPER EXIT

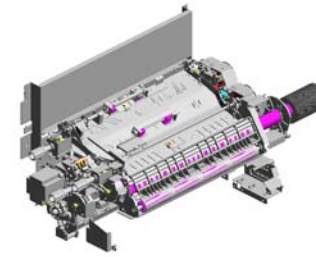

- 56.AW010151 PHOTO REFLECTI
ON SENSOR:PS12
2TL1-A:(S6/S7/S10/
S11/S12/SEN7/SEN
8/SEN10/SEN32/SE
N33/SEN34/SEN10
- 55.AW010150 PHOTO REFLECTIO
N SENSOR:ORIGIN
AL TRAY:(S14/S15/
S16/S19/SEN21)
- 57.AW010200 PAPER FEED SEN
SOR:FUSING EXIT:
(SEN20)
- 53.AF022182 (x4)
TRANSPORT ROLL
ER:DRIVEN:DIA17.
5X2
- 50.AB017961 (x2)
GEAR:EXIT:70Z/T2
4

62.B1322264
BUSHING:TERMIN
AL

47.AA161180
(x2)
CUSHION:DC STE
PPER MOTOR

54.AG050100
(x3)
KNOB - TRANSPO
RT ROLLER

58.AX040276
(x2)
STEPPER MOTOR:
MM56:TRANSPOR
T:(STM5/STM6/ST
M7/STM8/STM9/ST
M10/STM12/STM13/

52.AB030880
(x3)
PULLEY:S2M:22T

59.AX040280
(x2)
STEPPER MOTOR:
DRIVE:(STM24/ST
M25/STM26/STM27
)

45.AA120150
DISCHARGE BRUS
H:REVERSE:17MM

51.AB017962
GEAR:IDLER:EXIT

48.AB011626
GEAR:IDLER:EXIT:
CONNECTING

61.B1253659
(x2)
CUSHION:SWIVEL:
STOPPER

49.AB011627
(x2)
GEAR:EXIT:25Z

46.AA143444
(x2)
STEPPED SCREW

60.AX061102
(x2)
DC BRUSHLESS M
OTOR:25W:NMB:E
XIT:(BLM7/BLM12)

44.AA120097
ANTISTATIC BRUS
H

63.B2344258
(x2)
CAP:HEAT PIPE

U013 PAPER EXIT

- 74.D0BX4742 (x2) TRANSPORT ROLLER:DRIVEN:DIA17.5
- 75.D0BX4743 (x4) COMPRESSION SPRING:EXIT:2.5N
- 84.D0BX4841 TRANSPORT ROLLER:EXIT:PRESS FIT
- 80.D0BX4792 GUIDE PLATE:REVERSE EXIT:UPPER
- 72.D0BX4731 GUIDE PLATE:EXIT:UPPER:SUB-ASS'Y

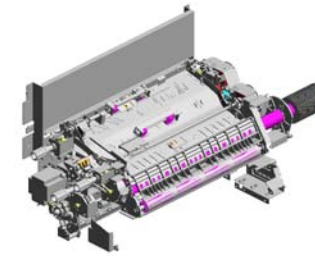

- 71.D0931266 (x2) DECAL:WARNING (HIGH TEMPERATURE):LENGTHWISE



- 79.D0BX4789 GUIDE PLATE:REVERSE EXIT:LOWER:PEEN

- 69.D0743173 (x3) TIMING PULLEY:S2M:25T

- 68.D0742632 (x2) BRACKET:DC STEPPER MOTOR:MM56:CAM

- 67.D0464655 TIMING BELT:S2M180

- 66.B8304263 TIMING BELT - 60S2M140

- 83.D0BX4840 (x2) TRANSPORT ROLLER:EXIT:ENTRANCE:PRESS FIT

- 73.D0BX4740 GUIDE PLATE:EXIT:UPPER:ENTRANCE

- 76.D0BX4782 GUIDE PLATE:EXIT:ENTRANCE

- 64.B2344460 DISCHARGE BRUSH:PH-L=341 SUS

- 70.D0744698 (x2) LEVER:LOCK:GUIDE PLATE
- 82.D0BX4802 (x6) GATE PAWL:REVERSE EXIT
- 65.B2346424 (x2) RELEASE GRIP
- 85.D0BX4842 TRANSPORT ROLLER:REVERSE:PRESS FIT
- 81.D0BX4801 GATE PAWL:REVERSE EXIT:MIDDLE

U013 PAPER EXIT

88.D0BX4889 DISCHARGE BRUSH:EXIT:INNER
 102.D1794785 GUIDE PLATE:EXIT:MIDDLE
 105.D1794811 SHAFT:GATE PAWL:EXIT:REVERSE
 87.D0BX4888 (x2) DISCHARGE BRUSH:EXIT:OUTER
 104.D1794810 PLATE:GATE PAWL:EXIT:REVERSE

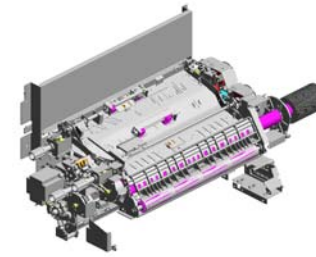

97.D1794757 SHAFT:LOCK:REVERSE EXIT:LEFT LOWER

99.D1794759 SHAFT:ON-OFF:DRIVEN ROLLER:REVERSE EXIT

96.D1794755 (x2) LEVER:LOCK:REVERSE EXIT:LEFT LOWER

98.D1794758 LINK:ON-OFF:DRIVEN ROLLER:REVERSE EXIT

95.D1794754 STOPPER:GUIDE PLATE:REVERSE EXIT:LEFT LOWER

93.D1794538 BRACKET:CAP:HEAT PIPE:UPPER

94.D1794539 BRACKET:CAP:HEAT PIPE:LOWER

89.D1793960 TRANSPORT ROLLER:HEAT PIPE:DIA 30.4:ASSY

100.D1794761 BRACKET:SOLENOID:GATE PAWL:SWITCHBACK

101.D1794766 LINK:GATE PAWL:SWITCHBACK

86.D0BX4843 TRANSPORT ROLLER:REVERSE:ENTRANCE:PRESS FIT
 103.D1794796 GUIDE PLATE:REVERSE:UPPER
 91.D1794533 (x4) DRIVE ROLLER:COOLING UNIT:ENTRANCE
 92.D1794537 GUIDE PLATE:COOLING UNIT:ENTRANCE
 90.D1794531 SHAFT:COOLING UNIT:ENTRANCE

U013 PAPER EXIT

122.D1797084 BRACKET:MISFEED
REMOVAL:DUPL
EX
124.D2452528 (x2)
BUSHING:MM8
116.D1794847 BRACKET:CONNE
CTION:MAIN:EXIT
118.D1794866 COVER:EXIT
117.D1794860 GUIDE PLATE:MAI
N:EXIT

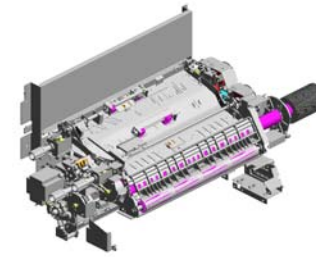

123.D2416290
(x2)
LED:RED

121.D1797083
SHAFT:MISFEED R
EMOVAL:DUPL

109.D1794821
LINK:GATE PAWL:
EXIT:ENTRANCE

107.D1794816
BRACKET:CAM:GA
TE PAWL

108.D1794820
(x2)
CAM:ON-OFF

110.D1794822
LINK:ON-OFF:REV
ERSE EXIT:CAM

113.D1794830
BRACKET:CONTA
CT POINT:REVER
SE EXIT:FRONT

106.D1794813
BRACKET:DC STE
PPER MOTOR:ON-
OFF

120.D1794887
(x2)
SHEET:TRANSPOR
T:REVERSE EXIT

112.D1794827
GUIDE PLATE:REV
ERSE EXIT:LEFT L
OWER:MIDDLE

125.D2704535
DRIVE ROLLER:CO
ROLLING UNIT:EXIT:P
RESS FIT

114.D1794835
BRACKET:CONTA
CT POINT:REVER
SE EXIT:REAR

119.D1794882
COVER:HARNES
S:LEFT LOWER

115.D1794838
BRACKET:DRAWE
R:LEFT

111.D1794824
GUIDE PLATE:REV
ERSE EXIT:LEFT L
OWER:PEEN

U013 PAPER EXIT

137.D2704748 COMPRESSION SPRING:STOPPER:20N
 133.D2704740 BRACKET:ARM:STOPPER:RELEASE
 135.D2704745 PIN:ARM:GRIP
 144.D6884895 (x8) BINDING HEAD SCREW:ROUND POINT:M3X8
 140.D2704757 STOPPER:GUIDE PLATE:EXIT:INNER BACK

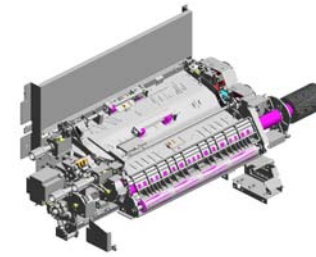

138.D2704750 STOPPER:GUIDE PLATE:EXIT:UPPER:SUB-ASS'Y

132.D2704737 BRACKET:LINK:LEVER

126.D2704543 SHAFT:MISFEED REMOVAL:EXIT

139.D2704753 PLATE:HANDLE:GUIDE:OPEN AND CLOSE

136.D2704746 BRACKET:CAM:ON-OFF:PEEN

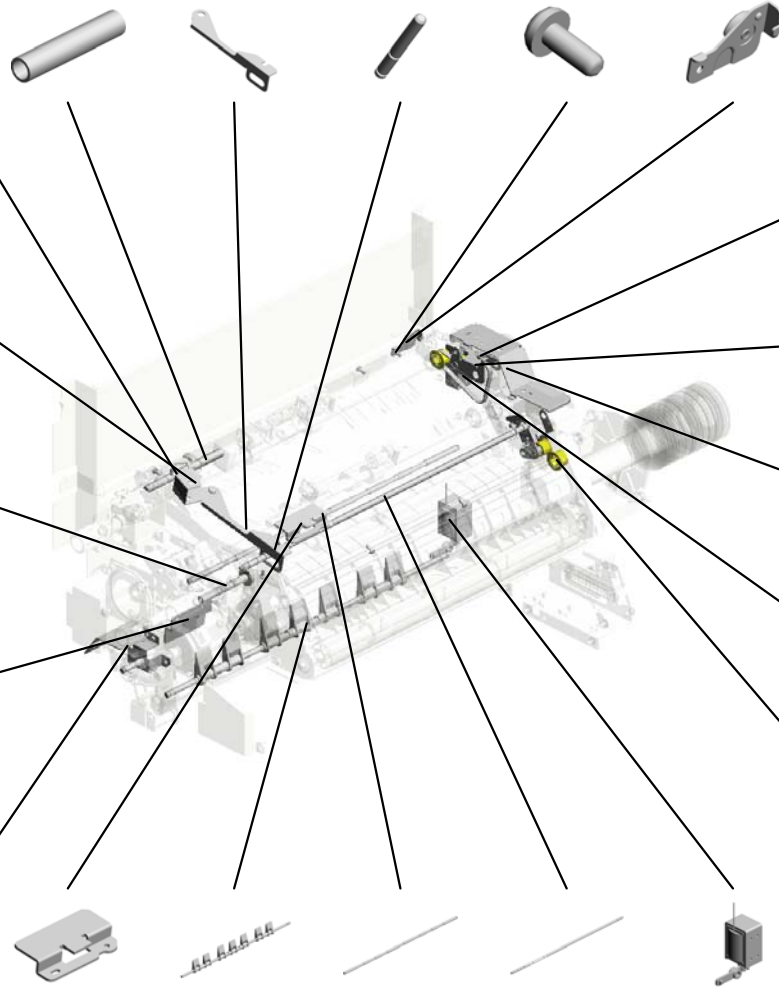

128.D2704551 (x2) COIL SPRING:TENSIONER:EXIT

127.D2704547 (x2) BRACKET:TIGHTENER:EXIT:ASS'Y

130.D2704557 COVER:EXIT:MOTOR

129.D2704555 SYNCHRONOUS BELT:B50S2M200

145.D7773126 (x2) TIMING PULLEY:DRIVE:T25S2M

131.D2704658 SHEET:HANDLE:LOCK:ASS'Y

142.D2704768 GATE PAWL:SWITCH:BACK

143.D2704800 SHAFT:GATE PAWL:REVERSE

134.D2704742 SHAFT:GUIDE PLATE:EXIT:UPPER:OPEN/CLOSE

141.D2704764 DC SOLENOID:GATE PAWL:SWITCH:BACK:(SOL4)

U013 PAPER EXIT

151.G1784908 (x2) COIL SPRING:LEFT LOWER:LOCK
 152.G1787453 ARM:ON-OFF:TRANSPORT ROLLER
 158.M0B14675 GATE PAWL:EXIT:REVERSE
 147.G1783593 (x7) TENSION SPRING:STOPPER

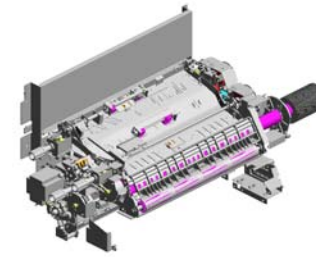

154.GW020024 (x2) PHOTO INTERRUPTOR:LG2A24BL1:G F:(SEN3/SEN21/SEN35/SEN36/SEN37/SEN38/SEN39/SEN

149.G1784828 (x4) STAY:LOCK:LEVER:LEFT LOWER

156.J5033116 TIMING BELT:40S2 M128

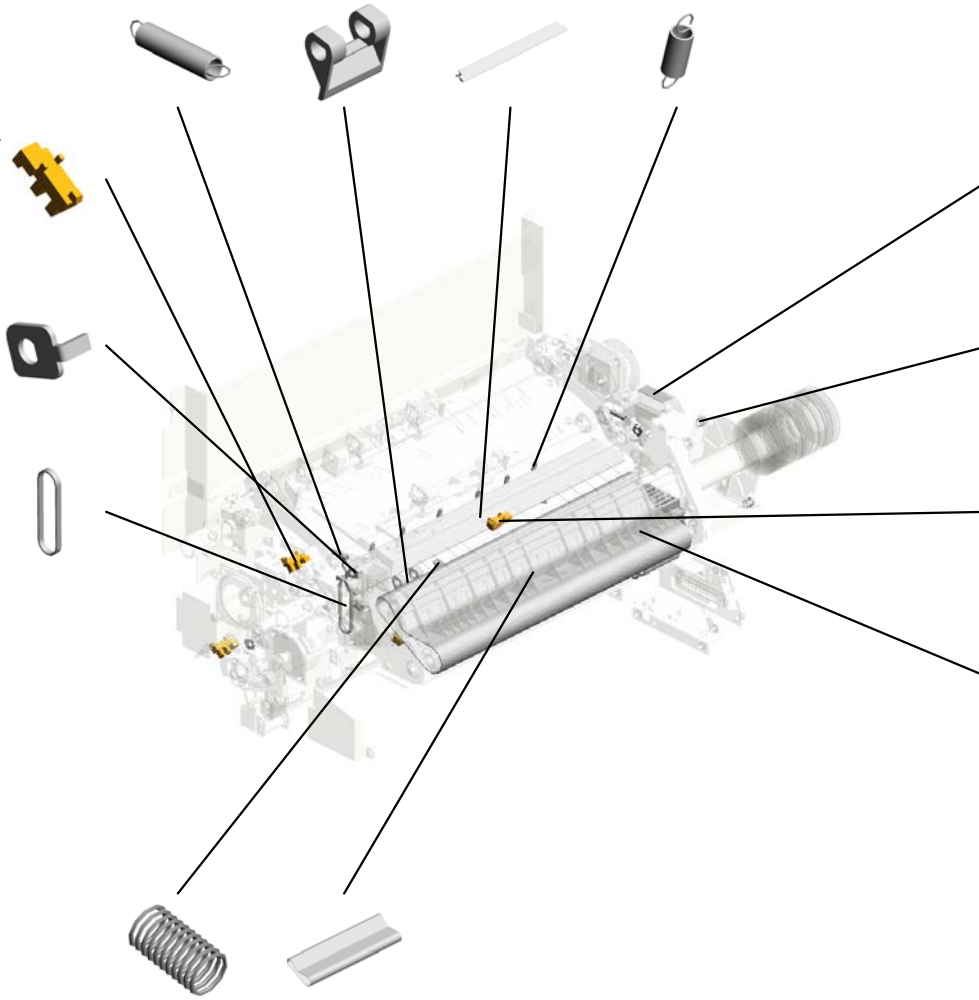

146.G1664310 DECAL:WARNING (HIGH TEMPERATURE):1:CUD

155.H0722216 (x2) COMPRESSION SPRING

153.GW010007 (x2) PHOTO REFLECTION SENSOR:EXIT:(SEN11/SEN12/SEN13/SEN14/SEN15/SEN16/SEN17/SEN1

150.G1784900 COVER:DC STEPPER MOTOR:MM56

148.G1784822 (x2) SPRING:PRESSURE:0.8N:DIA0.65
 157.M0774821 TRANSPORT BELT:COOLING

U013_S001
GUIDE PLATE:REVERSE:LOWER:ASS'Y

78:D0BX4786
CUSHION:GUIDE P
LATE:REVERSE:LO
WER

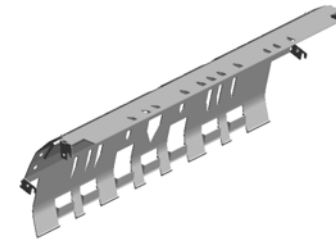
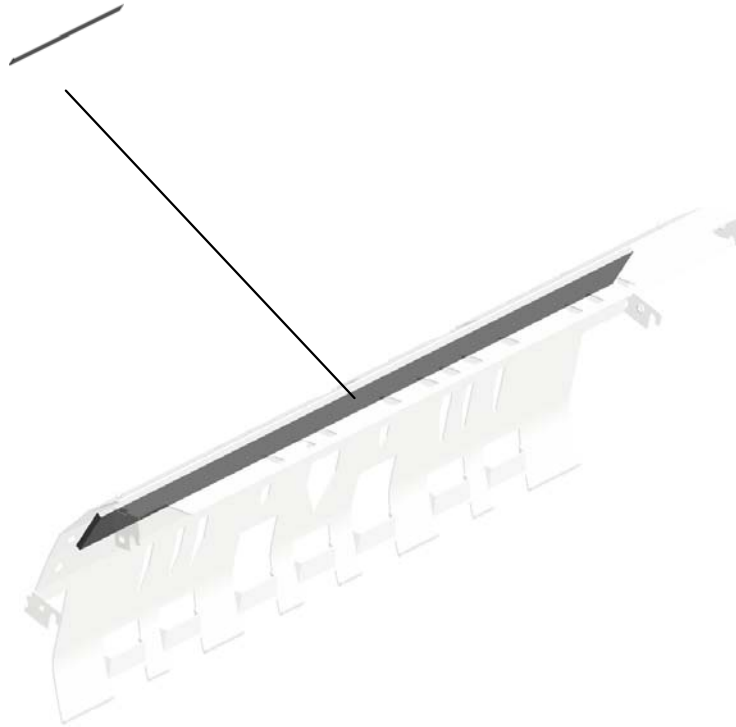

77:D0BX4783
GUIDE PLATE:REV
ERSE:LOWER:ASS'
Y

U001	U002	U003	U004	U005	U006	U007	U008	U009	U010	U011	U012	U013	U014	U015	U016	U017	U018	U019	U020
------	------	------	------	------	------	------	------	------	------	------	------	------	------	------	------	------	------	------	------

U014 DUPLEX

8.04513006N (x54) TAPPING SCREW - 3X6
 22.11050724 (x0) CLAMPS:WES-1210
 19.11050516 (x2) CLAMP
 11.07200040E (x2) RETAINING RING - M4
 13.07433808 (x10) RADIAL BALL BEARING: DIA8X DIA16X5

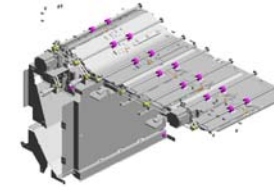

5.03604010N (x6) SCREW:M4X10

3.03604006N (x6) SCREW - M4X6

18.11050511 (x63) HARNESS CLAMP - LWS-0306ZC

9.04514008N (x17) TAPPING SCREW: 4X8

14.08010237 HEXAGONAL BOLT :DOUBLE SCREW: M4X12

10.04543008Q (x24) TAPPING SCREW: 3X8

4.03604008N SCREW - M4X8

1.03530100N SCREW-M3X10

6.04503008N (x10) TAPPING SCREW - M3X8

21.11050723 CLAMPS:WES-0507

20.11050692 (x6) CLAMP:LWS-0503

2.03603006N (x2) SCREW - M3X6

7.04504008N (x18) TAPPING SCREW - M4X8

16.11050487 (x3) HARNESS CLAMP

12.07200060E (x25) RETAINING RING - M6

15.11050046 (x28) HARNESS BAND

17.11050508 (x5) HARNESS CLAMP - LWS-0711

19.11050516 (x5) CLAMP

22.11050724 CLAMPS:WES-1210

U014 DUPLEX

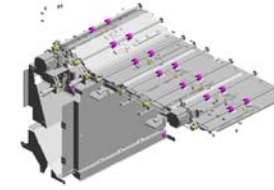

- 29.AA061173 (x7) COIL SPRING:GATE PAWL:DUPLEX:ENTRANCE
- 38.AF022182 (x8) TRANSPORT ROLLER:DRIVEN:DIA17.5X2
- 33.AA084059 (x16) BALL BEARING HOLDER
- 31.AA063675 (x8) SPRING - 5N
- 32.AA080346 (x2) BUSHING:FLANGE TYPE:DIA6

- 36.AB030842 (x2) TIMING PULLEY:S2M:30T

- 41.AW010151 PHOTO REFLECTION SENSOR:PS12 2TL1-A:(S6/S7/S10/S11/S12/SEN7/SEN8/SEN10/SEN32/SEN33/SEN34/SEN10)

- 26.AA043293 TIMING BELT - 40S 2M268G

- 35.AA161180 (x3) CUSHION:DC STEPPER MOTOR

- 42.AX040276 (x3) STEPPER MOTOR:MM56:TRANSPORT:(STM5/STM6/STM7/STM8/STM9/STM10/STM12/STM13/)

- 39.AG050100 (x2) KNOB - TRANSPORT ROLLER
- 37.AF022067 (x5) GUIDE STOPPER ROLLER
- 40.AW010143 PHOTO REFLECTION SENSOR:PSR11 TL1R-C:(SEN23)
- 34.AA143811 (x4) STEPPED SCREW - M3X4
- 25.AA021034 (x2) MAGNETIC

- 23.54472681 (x2) SNAP RING

- 30.AA063674 (x8) SPRING - 8N

- 24.A2574493 (x2) BAND

- 28.AA043650 (x3) TIMING BELT - B60 S2M290

- 27.AA043333 TIMING BELT:60S2 M168

U001	U002	U003	U004	U005	U006	U007	U008	U009	U010	U011	U012	U013	U014	U015	U016	U017	U018	U019	U020
------	------	------	------	------	------	------	------	------	------	------	------	------	------	------	------	------	------	------	------

U014 DUPLEX

- 49.D0BX7085 (x7) TRANSPORT ROLLER:DUPL
EX:PRESS FIT
- 60.D1797062 GUIDE PLATE:DUP
LEX:ENTRANCE:U
PPER
- 61.D1797066 GUIDE PLATE:DUP
LEX:ENTRANCE:L
OWER
- 50.D0BX7114 GUIDE PLATE:REV
ERSE:DUPL
EX:DRI
VE
- 59.D1797060 (x7) GATE PAWL:DUPL
EX:ENTRANCE

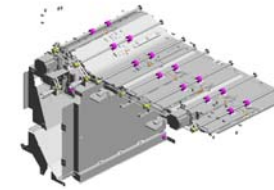

54.D0BX7128
DISCHARGE BRUSH:RECEIVING SUB-UNIT:REVERSE:ENTRANCE

52.D0BX7118
GUIDE PLATE:REVERSE:DUPL
EX:LEFT

51.D0BX7116
GUIDE PLATE:REVERSE:DUPL
EX:DRI
VEN:PEEN

53.D0BX7120
TRANSPORT ROLLER:REVERSE:DUPL
EX:PRESS FIT

47.D0743173 (x15)
TIMING PULLEY:S2
M:25T

46.D0743047 (x2)
BRACKET:HOLDER:DUPL
EX:ASSY

44.D0592620
RETAINING RINGS -C

43.B0654935 (x2)
LEVER:GUIDE PLATE:ASSY

55.D0BX7142
GUIDE PLATE:RECEIVING SUB-UNIT:RIGHT:PEEN

56.D1797050
GUIDE PLATE:DUPLEX:UPPER:LEFT

45.D0742632
BRACKET:DC STEPPER MOTOR:MM56:CAM

62.D1797070
GUIDE PLATE:DUPLEX:OPEN AND CLOSE:LEFT

57.D1797053
GUIDE PLATE:DUPLEX:UPPER:MIDDLE

48.D0BX7076
GUIDE PLATE:DUPLEX:LOWER

58.D1797056
GUIDE PLATE:DUPLEX:UPPER:RIGHT

U014 DUPLEX

- 77.D6844142 (x4) TIMING BELT:60S2 M174
- 79.G1784817 (x10) SPRING:PRESSURE:ROLLER:DUPLEX
- 78.G1784808 (x5) BRACKET:PRESSURE:ROLLER
- 71.D1797131 BRACKET:ROLLER:PEEN
- 74.D2707061 SHAFT:GATE PAWL:DUPLEX:ENTRANCE

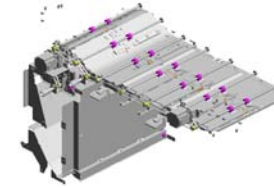

76.D5163823
TIMING BELT:60S2
M146

65.D1797081
BRACKET:DC STEPPER MOTOR:DUPLEX:LEFT

67.D1797083
(x2)
SHAFT:MISFEED REMOVAL:DUPLEX

68.D1797084
(x2)
BRACKET:MISFEED REMOVAL:DUPLEX

72.D2416290
LED:RED

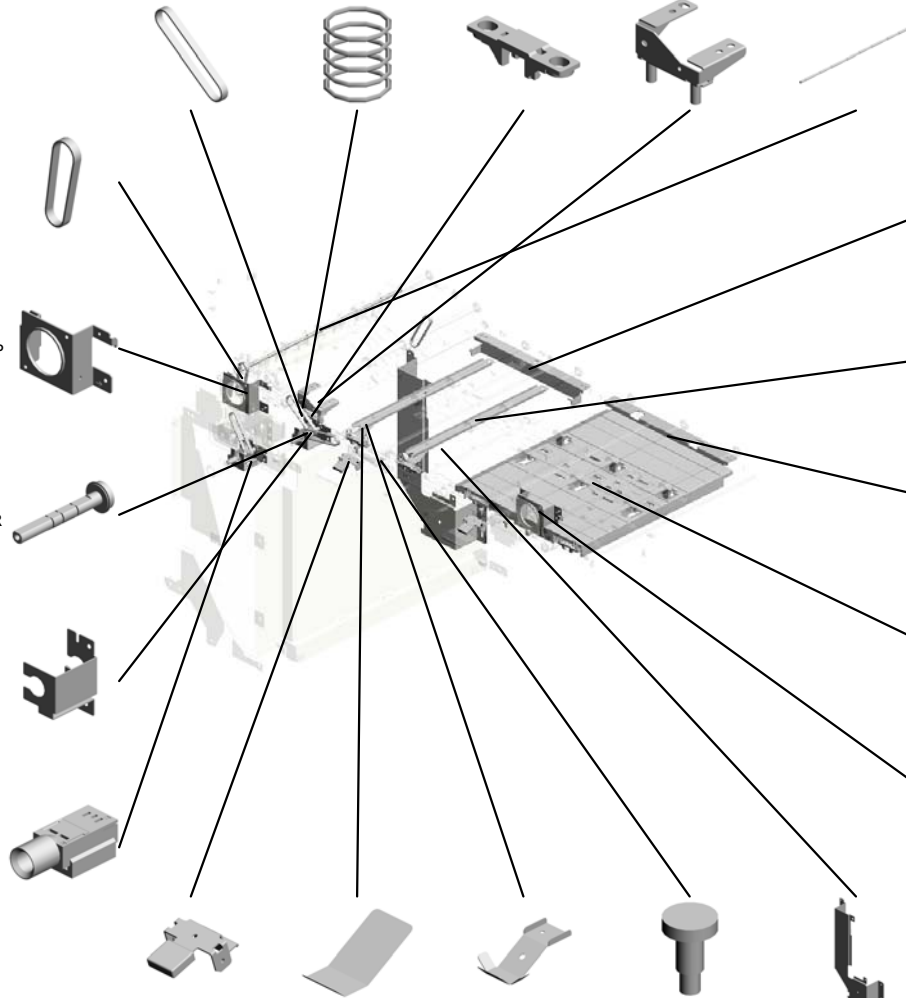

69.D1797096
BRACKET:DUPLEX:OPEN AND CLOSE:LEFT:PEEN

63.D1797071
(x4)
SUPPORTING PLATE:GUIDE PLATE:DUPLEX:OPEN AND CLOSE

70.D1797098
BRACKET:DUPLEX:OPEN AND CLOSE:RIGHT:PEEN

64.D1797075
GUIDE PLATE:DUPLEX:OPEN AND CLOSE:RIGHT

66.D1797082
BRACKET:DC STEPPER MOTOR:DUPLEX:RIGHT

- 73.D2704933 (x2) HOOK:LEVER:GUIDE PLATE:ASSY
- 81.G1784895 (x4) SHEET:DUPLEX:SPRING PLATE
- 80.G1784890 (x4) SPRING PLATE:DUPLEX:GUIDE:LOW
- 82.G1784916 (x4) SCREW:ROUND POINT
- 75.D2707103 DRUM STAY:RECEIVING SUB-UNIT:REVERSE

U014
DUPLEX

84.GW010007
(x8)
PHOTO REFLECTI
ON SENSOR:EXIT:(
SEN11/SEN12/SEN
13/SEN14/SEN15/S
EN16/SEN17/SEN1

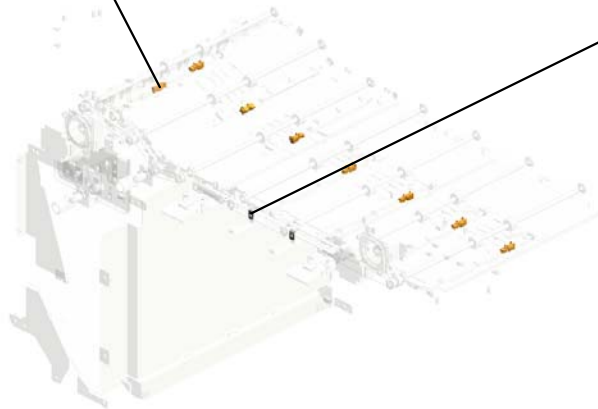

83.G1787618
(x2)
PLATE:FIX:BAND

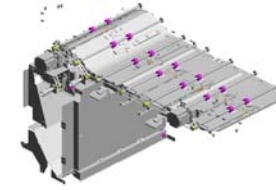

U001	U002	U003	U004	U005	U006	U007	U008	U009	U010	U011	U012	U013	U014	U015	U016	U017	U018	U019	U020
------	------	------	------	------	------	------	------	------	------	------	------	------	------	------	------	------	------	------	------

U015.MAIN DRIVE

U015 S002
D1791300
DRIVE UNIT:FUSING:ASS'Y

U015 S003
D2701317
DRIVE SUB-UNIT:ON-OFF:PR
ESSURE ROLLER:(BLM11)

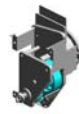

U015_S001
D1791391
MECHANICAL DRIVE SECTIO
N:TRANSFER:SECOND:ASS'
Y

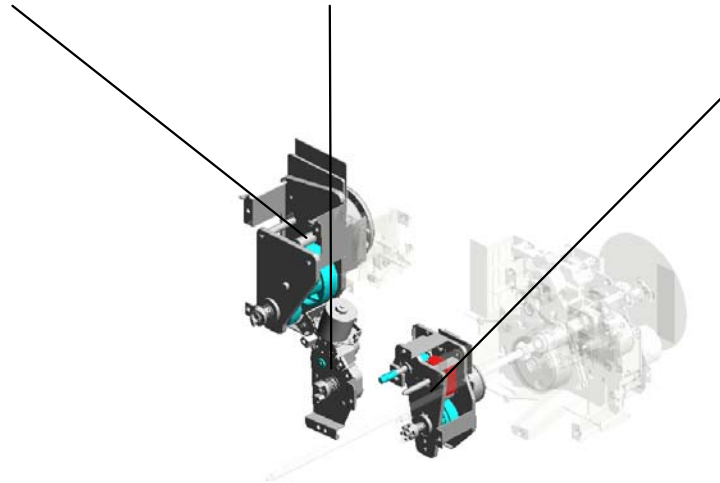

U001	U002	U003	U004	U005	U006	U007	U008	U009	U010	U011	U012	U013	U014	U015	U016	U017	U018	U019	U020
------	------	------	------	------	------	------	------	------	------	------	------	------	------	------	------	------	------	------	------

U015 MAIN DRIVE

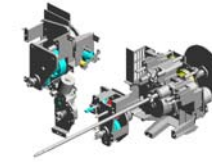

- 21.A0793626 (x2) STEPPED SCREW - SWING CLEANING
- 20.11050724 CLAMPS:WES-1210
- 15.11050410 (x2) CARD SPACER - 9.4MM
- 9.07403012 BALL BEARING - 1 2X28X8
- 12.09544008N (x9) SCREW - M4X8

17.11050511
HARNES CLAMP - LWS-0306ZC



22.AX061204
DC MOTOR:11.5W: BRUSHLESS:(BLM4)



7.07200040E
RETAINING RING - M4



18.11050601 (x3) CLAMP:LWSM-0511-2M



5.04514008N (x17) TAPPING SCREW: 4X8

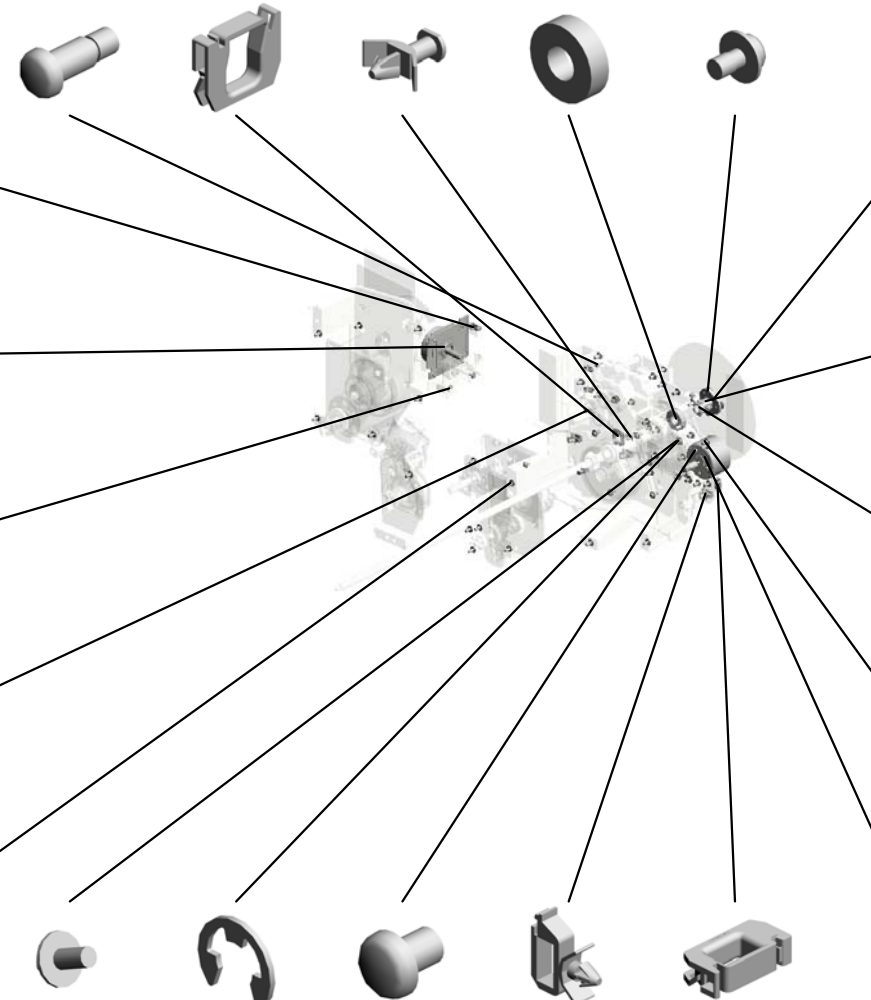

2.03603006N (x10) SCREW - M3X6

8.07200060E RETAINING RING - M6

1.03130040N (x3) SCREW:M3X4

16.11050487 (x3) HARNES CLAMP

19.11050723 CLAMPS:WES-0507

13.09545010N SCREW:POLISHED ROUND/SPRING:M 5X10

23.B2341118 FLY WHEEL FLANGE

11.09514020N SCREW - M4X20

4.03604008N (x22) SCREW - M4X8

24.D0741329 DC MOTOR: DIA49: 24V:6.3W:(BLM2)

U001	U002	U003	U004	U005	U006	U007	U008	U009	U010	U011	U012	U013	U014	U015	U016	U017	U018	U019	U020
------	------	------	------	------	------	------	------	------	------	------	------	------	------	------	------	------	------	------	------

U015 MAIN DRIVE

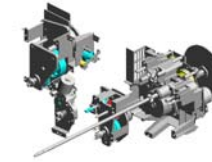

- 40.D1791275 TENSION SPRING: 3.8N
- 29.D1791254 SHAFT:DRIVE:DEV ELOPMENT ROLLER:ASSY
- 35.D1791266 PULLEY:DRIVE:DEVELOPMENT ROLLER:59T
- 43.D1791278 HOLDER:BEARING :DRUM SHAFT
- 31.D1791258 PLATE:HOLDER:ANTISTATIC BRUSH :DRUM

39.D1791273
GEAR:DRIVE:TRANSPORT SCREW:54Z



30.D1791256
SHAFT:DRIVE:TRANSPORT SCREW:ASSY



37.D1791268
SYNCHRONOUS BELT:80S2M300



28.D1791252
DC MOTOR:DIA82.2:63.7W:BRUSHLESS:(BLM8)



26.D1791220
DRUM SHAFT:DRIVE:ASSY



32.D1791262
SHAFT:DRIVE:CLEANER:ASSY



36.D1791267
SYNCHRONOUS BELT:120S2M316



27.D1791251
DC MOTOR:DIA63.29.7W:BRUSHLESS:(BLM1)



45.D1791288
GEAR:IDLER:CLEANER:49Z/33Z



41.D1791276
TENSION SPRING: 3.6N



33.D1791264
PLATE:HOLDER:RADIAL BALL BEARING



34.D1791265
PULLEY:DRIVE:DRUM:107T



42.D1791277
GEAR:DRIVE:CLEANER:39Z



44.D1791286
BRACKET:DRIVE:CLEANER:ASSY



38.D1791269
BRACKET:DC MOTOR:CLEANING DRIVE SUB-UNIT



U015 MAIN DRIVE

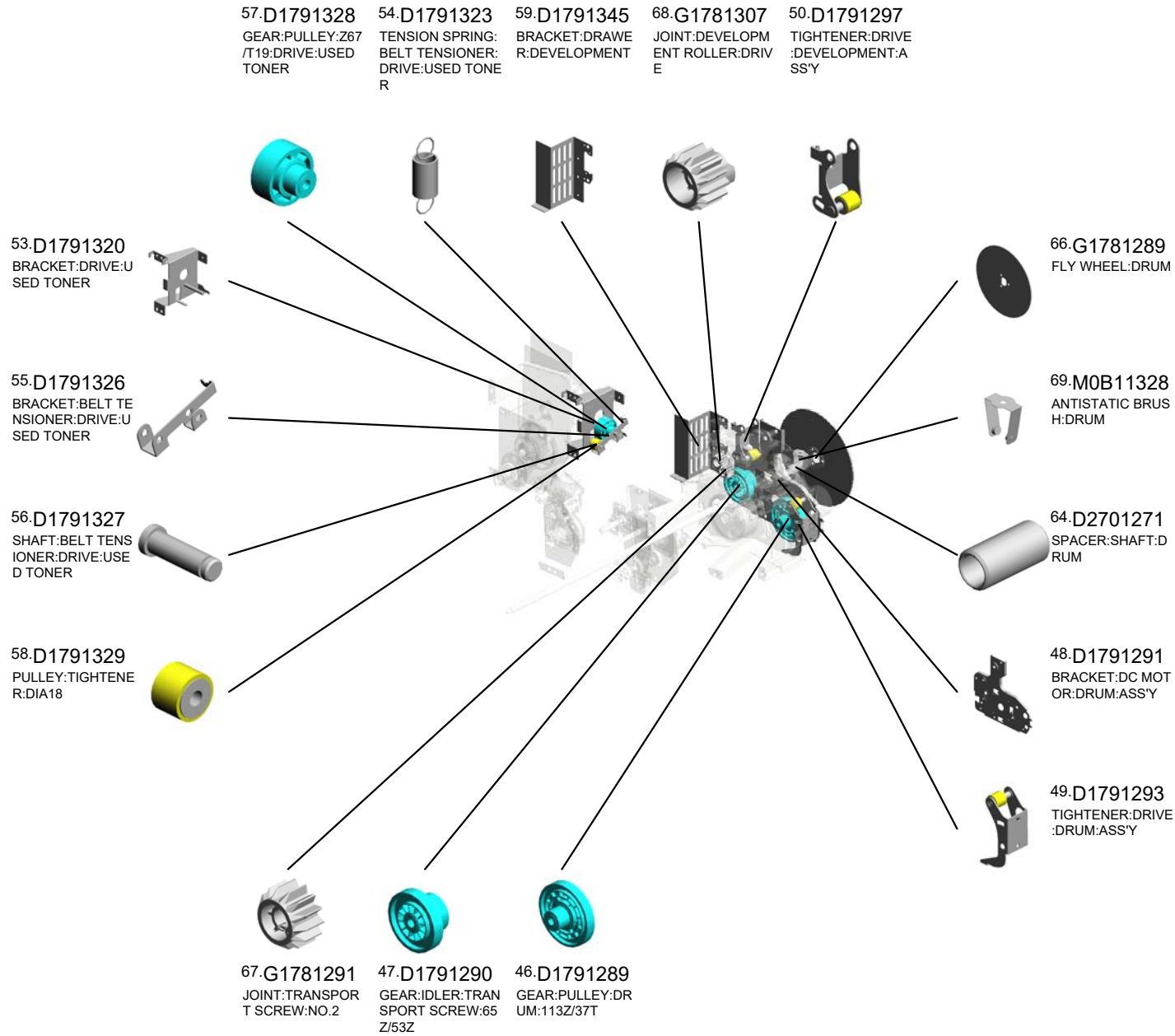
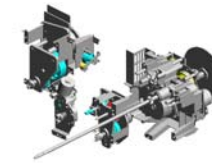

U001	U002	U003	U004	U005	U006	U007	U008	U009	U010	U011	U012	U013	U014	U015	U016	U017	U018	U019	U020
------	------	------	------	------	------	------	------	------	------	------	------	------	------	------	------	------	------	------	------

U015_S001
 MECHANICAL DRIVE SECTION:TRANSFER:SECOND:ASS'Y

61.D1791375 14.11050367
 GEAR:IDLER:BELT SPACER
 CLEANING

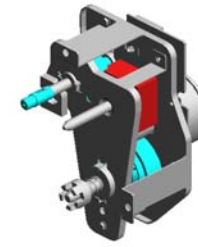

62.D1791391
 MECHANICAL DRIVE SECTION:TRANSFER:SECOND:ASS'Y

63.D1796411
 SEAL:TONER OUT
 LET SUB-UNIT

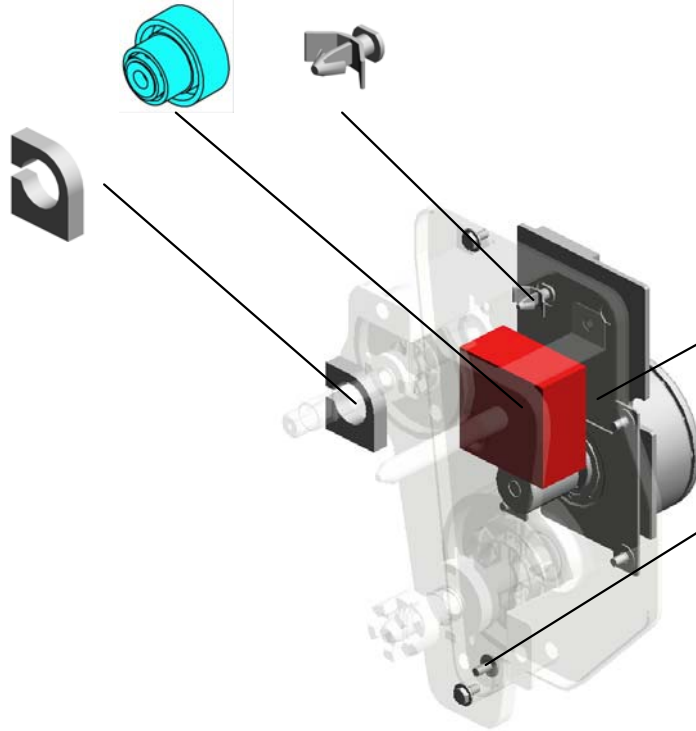

60.D1791370
 DC MOTOR:40W:B
 RUSHLESS:(BLM6)

2-03603006N
 (x7)
 SCREW - M3X6

U001	U002	U003	U004	U005	U006	U007	U008	U009	U010	U011	U012	U013	U014	U015	U016	U017	U018	U019	U020
------	------	------	------	------	------	------	------	------	------	------	------	------	------	------	------	------	------	------	------

U015_S002
DRIVE UNIT:FUSING:ASS'Y

52.D1791309
DC BRUSHLESS M
OTOR:58W:DRIVE:
FUSING UNIT:(BLM
9)

3.03604006N
(x7)
SCREW - M4X6

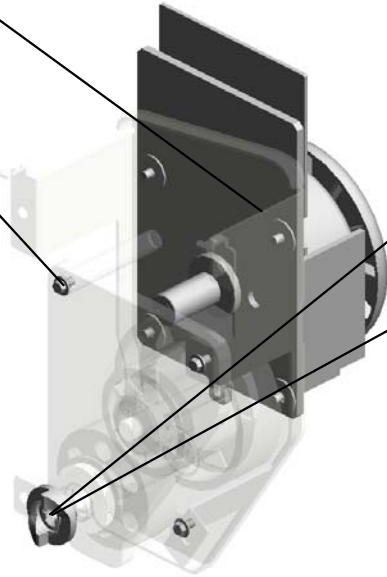
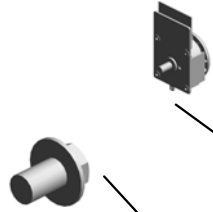

8.07200060E
RETAINING RING -
M6



70.D1791316
JOINT:DRIVE:FUSI
NG

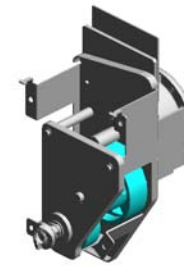

51.D1791300
DRIVE UNIT:FUSIN
G:ASS'Y

U001	U002	U003	U004	U005	U006	U007	U008	U009	U010	U011	U012	U013	U014	U015	U016	U017	U018	U019	U020
------	------	------	------	------	------	------	------	------	------	------	------	------	------	------	------	------	------	------	------

U015_S003
DRIVE SUB-UNIT:ON-OFF:PRESSURE ROLLER:(BLM11)

6.04523010N 10.07433806
(x4) (x2)
BINDING SELF-TAPPING SCREW:3X10
RADIAL BALL BEARING RING:DIA6XDIA13X5



65.D2701317
DRIVE SUB-UNIT:ON-OFF:PRESSURE ROLLER:(BLM11)

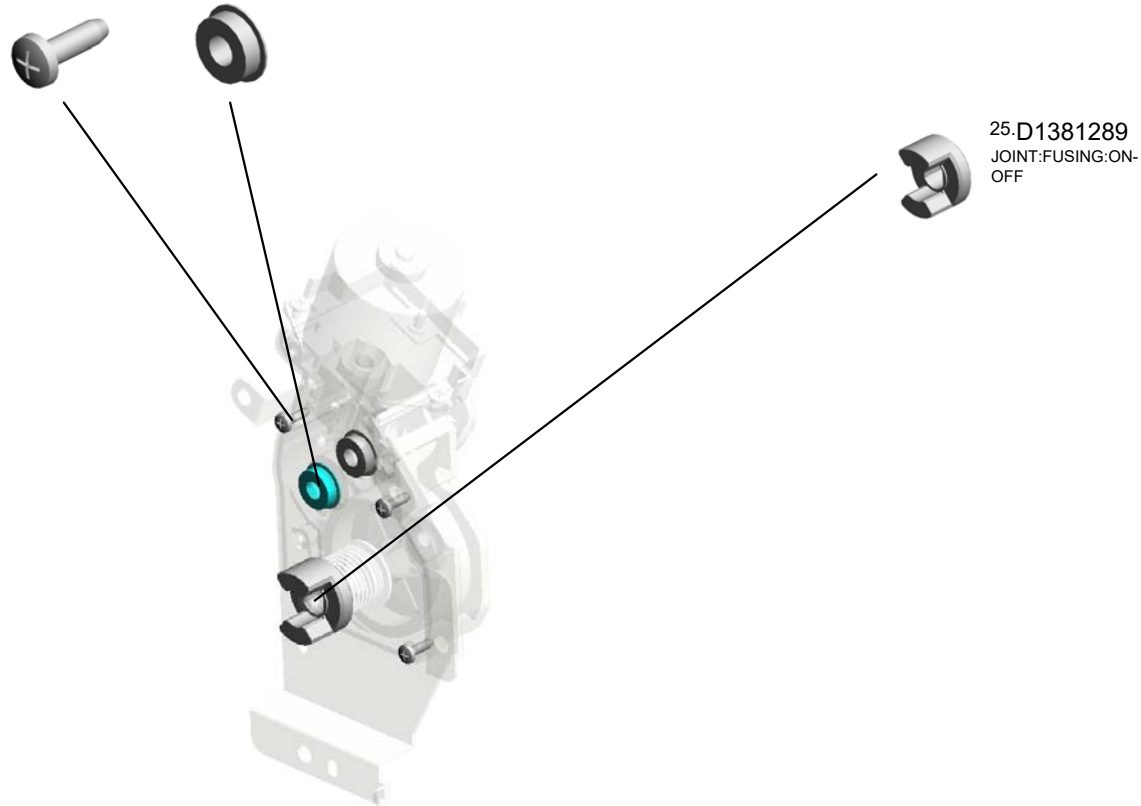

U001	U002	U003	U004	U005	U006	U007	U008	U009	U010	U011	U012	U013	U014	U015	U016	U017	U018	U019	U020
------	------	------	------	------	------	------	------	------	------	------	------	------	------	------	------	------	------	------	------

U016 ELECTRICAL

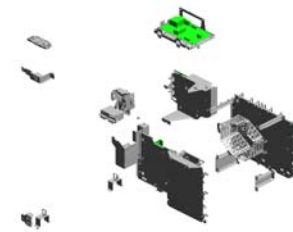

- 11.09543025N (x8) SCREW:POLISHED ROUND/SPRING:M 3X25
- 9.07040050N (x2) WASHER:DIA5
- 10.08010234 (x2) SCREW WITH WASHER:SMALL ROUND WITH SPRING WASHER:M5X8
- 21.11050516 (x8) CLAMP
- 16.11050487 (x20) HARNESS CLAMP

- 5.04503008N (x6) TAPPING SCREW - M3X8

- 1.03140120N (x8) SCREW - M4X12

- 4.04340200N (x4) PAN SELF-TAPPING SCREW:4X20

- 17.11050488 (x6) HARNESS CLAMP

- 7.04543006Q (x6) TAPPING SCREW - M3X6

- 15.11050410 (x16) CARD SPACER - 9.4MM
- 3.03604008N (x6) SCREW - M4X8
- 6.04514008N (x84) TAPPING SCREW: 4X8
- 19.11050490 (x42) HARNESS CLAMP - IWS-2218
- 2.03603006N (x60) SCREW - M3X6

- 18.11050489 (x40) HARNESS CLAMP - LWS 1316

- 12.11050042 (x284) WIRE BAND

- 13.11050046 (x598) HARNESS BAND

- 20.11050511 (x6) HARNESS CLAMP - LWS-0306ZC

- 14.11050367 (x4) SPACER

- 16.11050487 (x2) HARNESS CLAMP

- 21.11050516 (x4) CLAMP

- 22.11050529 (x2) NYLON CLAMP-EM T-3N

- 31.16072256 (x2) FERRITE CORE:K3 NFR-08-ABK0

- 8.04544008Q (x8) TAPPING SCREW - M4X8

U001	U002	U003	U004	U005	U006	U007	U008	U009	U010	U011	U012	U013	U014	U015	U016	U017	U018	U019	U020
------	------	------	------	------	------	------	------	------	------	------	------	------	------	------	------	------	------	------	------

U016 ELECTRICAL

- 35.C2182185 (x8) STEPPER SCREW
- 43.D1795913 (x4) ARM:SAFETY SWI TCH
- 32.AA143797 (x4) CONNECTOR GUI DE PIN
- 28.12042612 (x8) MICRO SWITCH:D3 V-16506-3C25:(SW 10/SW11/SW102/S W103)
- 34.AZ320193 (x2) POWER PACK:CG B:(PCB25)

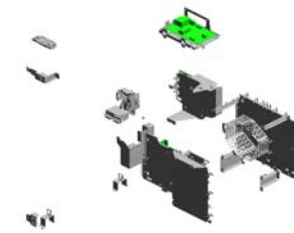

- 39.D1495883 (x2) KEYTOP:MAIN SWI TCH

- 40.D1495884 (x2) COMPRESSION SP RING:KEYTOP

- 41.D1791553 (x2) COVER:DC_SW

- 42.D1791557 (x2) BRACKET:DC_SW

- 29.12042614 (x2) SWITCH AC250V/1 6A:(SW12)

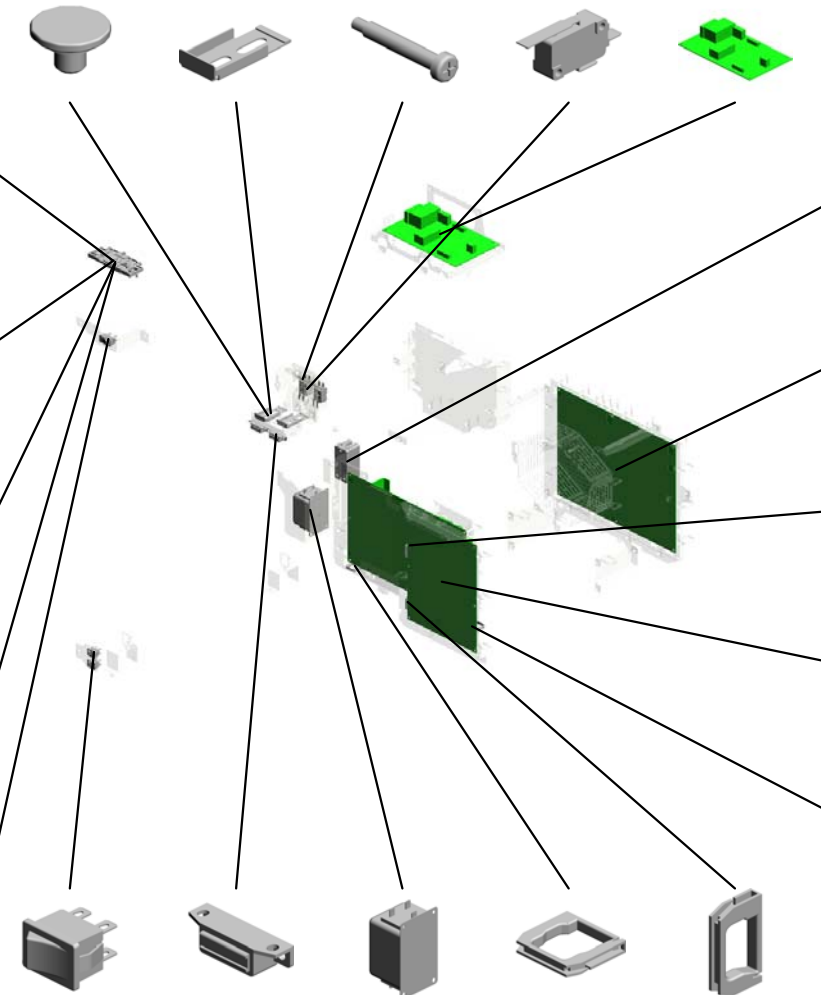

- 26.11071280 (Pro 8300S/8310S/8 310):FUSE:BJS151 2F2:(BL1)

- 36.D0BX5405 (x2) PCB:IOB:(PCB26)

- 38.D0BX5445 (x2) AC CONTROL BOA RD:200V:3800W:(P CB1)

- 37.D0BX5427 (x2) PCB:RYB:(PCB32)

- 23.11050532 (x2) EDGE SADDLE - L ES-25L

- 27.12042570 (x4) ROCKER SWITCH: SDDJE13200:(SW1 00/SW101)
- 33.AG070504 (x4) MAGNET CATCH:4 4.1N
- 30.16071799 (x2) FILTER - SUP-ET20 -ER-0:(NF1)
- 25.11050726 (x2) CLAMPS:WES-221 7
- 24.11050725 (x4) CLAMPS:WES-111 7

U001	U002	U003	U004	U005	U006	U007	U008	U009	U010	U011	U012	U013	U014	U015	U016	U017	U018	U019	U020
------	------	------	------	------	------	------	------	------	------	------	------	------	------	------	------	------	------	------	------

U016 ELECTRICAL

45.D1795915 (x4) LEVER:SAFETY SWITCH:WELDING
 50.D1795928 (x2) BRACKET:SAFETY SWITCH:REAR
 46.D1795917 (x4) BRACKET:SAFETY SWITCH

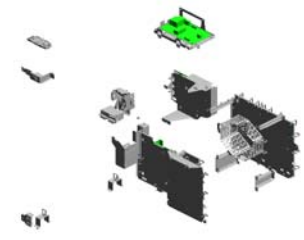

51.D2445730 (x2) PCB:DCSW:(PCB12)

47.D1795920 (x2) BRACKET:MAIN SWITCH

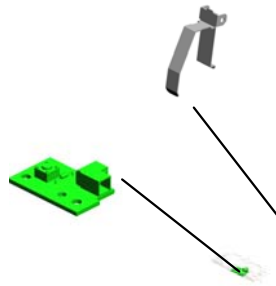

52.D2705415 (x2) PCB:EDRB:(PCB24)

49.D1795924 (x2) COVER:SAFETY SWITCH:UPPER FRONT

44.D1795914 (x2) BRACKET:SAFETY SWITCH:FRONT

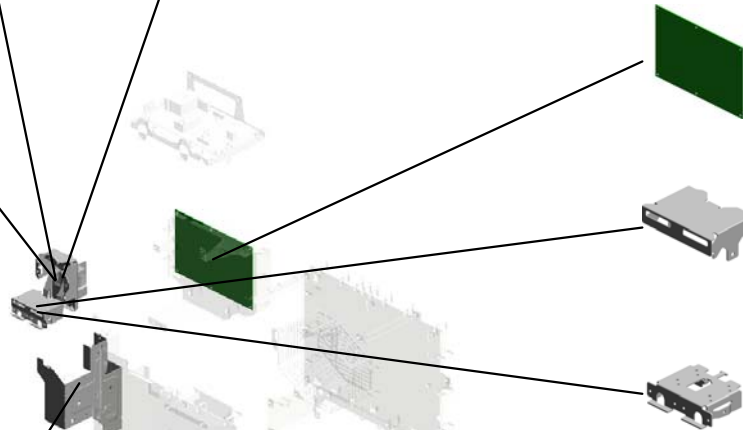

48.D1795922 (x2) BRACKET:POWER SUPPLY CORD:INLET:NOISE FILTER



U001	U002	U003	U004	U005	U006	U007	U008	U009	U010	U011	U012	U013	U014	U015	U016	U017	U018	U019	U020
------	------	------	------	------	------	------	------	------	------	------	------	------	------	------	------	------	------	------	------

U017.CONTROLLER

U017_S002
D0BX5927
PCB:SDCU:ASS'Y



U017_S001
D1795089
COVER:C/T BOX:UPPER:ASS
'Y

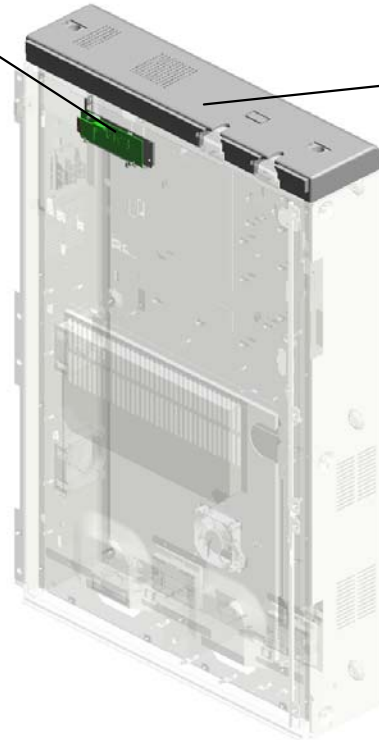

U001	U002	U003	U004	U005	U006	U007	U008	U009	U010	U011	U012	U013	U014	U015	U016	U017	U018	U019	U020
------	------	------	------	------	------	------	------	------	------	------	------	------	------	------	------	------	------	------	------

U017 CONTROLLER

- 18.11050723 CLAMPS:WES-050 7
- 4.03604008N SCREW - M4X8
- 12.11050489 (x42) HARNESS CLAMP - LWS 1316
- 13.11050490 (x2) HARNESS CLAMP - IWS-2218
- 6.04543006Q (x53) TAPPING SCREW - M3X6



- 5.04514008N (x17) TAPPING SCREW: 4X8

- 1.03530060N BIND SCREW - M3 X6

- 20.14078389 EEPROM:BR24T12 8-W

- 16.11050529 NYLON CLAMP-EM T-3N

- 2.03603006N (x42) SCREW - M3X6

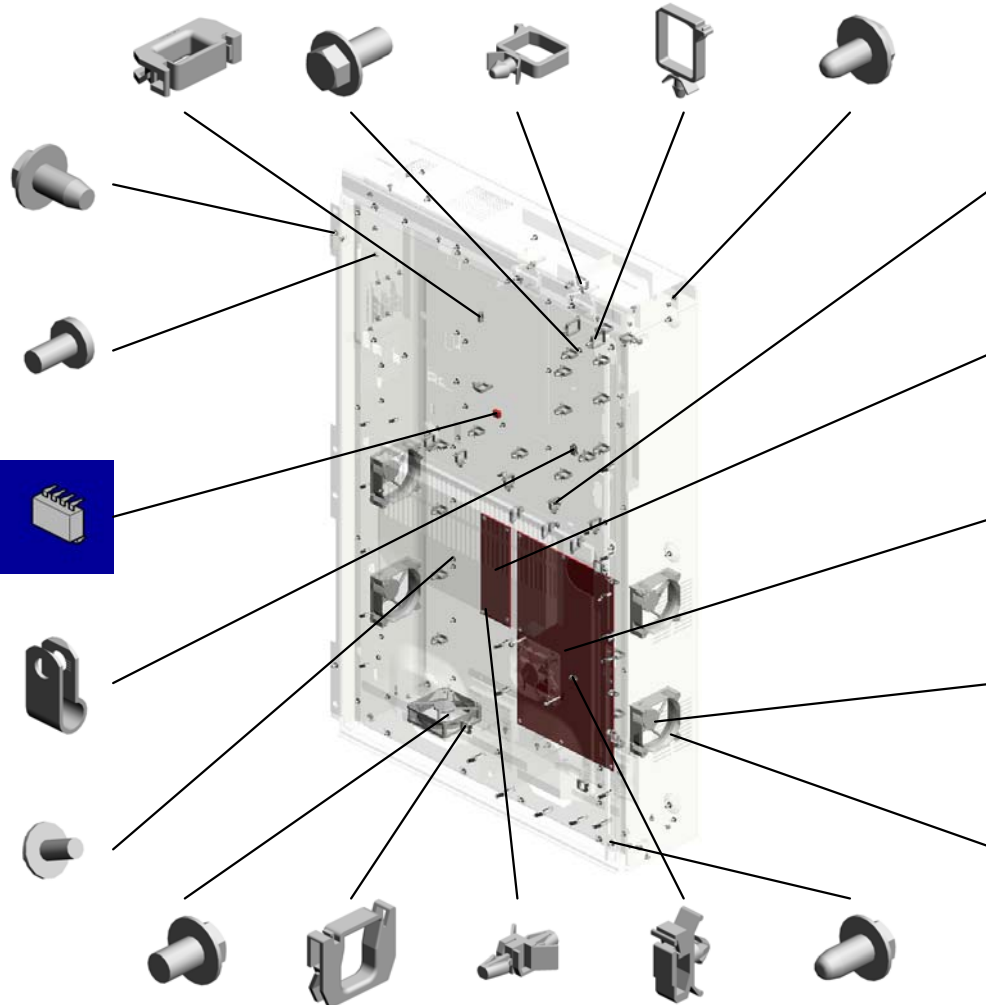

- 3.03604006N (x4) SCREW - M4X6
- 19.11050724 (x2) CLAMPS:WES-1210
- 11.11050193 NYLON STUD
- 14.11050511 HARNESS CLAMP - LWS-0306ZC
- 8.04544008Q (x11) TAPPING SCREW - M4X8

- 15.11050516 (x18) CLAMP

- 9.11050042 (x29) WIRE BAND

- 10.11050046 (x3) HARNESS BAND

- 23.AZ210003 DC POWER SUPPL Y:12V:25W;(PCB31)

- 26.AZ250066 POWER SUPPLY U NIT:864W;(PCB30)



- 61.D2585715 CABLE:HDD:SATA: 2CON_POWER_3P

- 22.AX640247 (x5) DC FAN MOTOR:A XIAL:MM80:25MM:(FAN4/FAN5/FAN8/F AN14/FAN17/FAN2 0/FAN22/FAN23//FA

- 7.04543030Q (x12) TAPPING SCREW: ROUND POINT:3X3 0

- 5.04514008N(x 1) TAPPING SCREW:4X8

U017 CONTROLLER

- 38.D1495776 COVER:USB:SMALL
- 45.D2235824 (x2) COVER:SD-CARD
- 46.D2425605 PCB:DDR3-DIMM:R C-C:2GB:ASSY:(PCB27)
- 50.M0CL5401 PCB:BICU:ASSY:(PCB11)
- 33.D0747752 (x2) CAP:COVER:TONE R SUPPLY

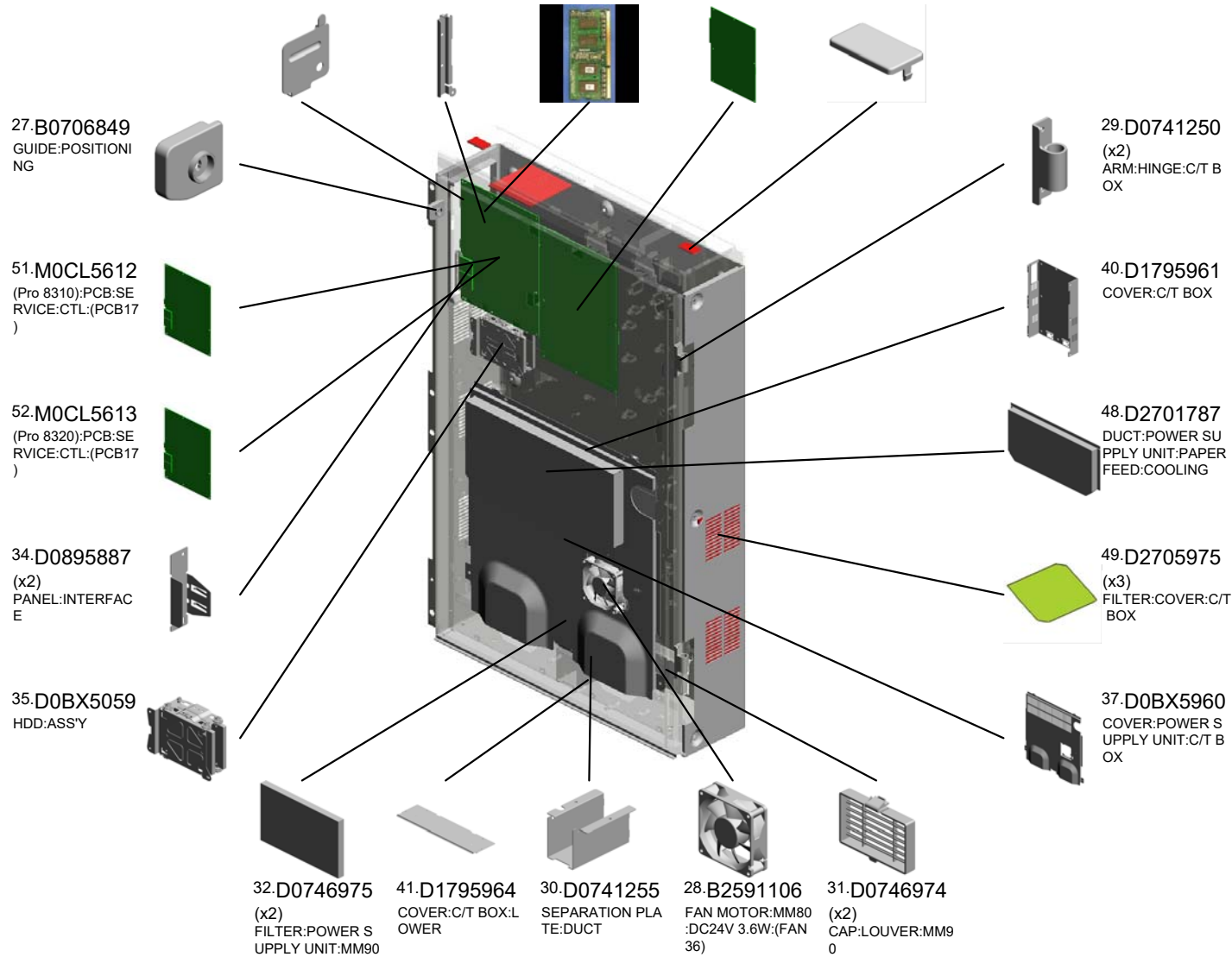

U001	U002	U003	U004	U005	U006	U007	U008	U009	U010	U011	U012	U013	U014	U015	U016	U017	U018	U019	U020
------	------	------	------	------	------	------	------	------	------	------	------	------	------	------	------	------	------	------	------

U017 CONTROLLER

53.MOCL9590
NVRAM

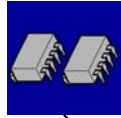

64.AZ240356
[B]
POWER SUPPLY U
NIT:FW:(PCB29)
201910-02 X/O

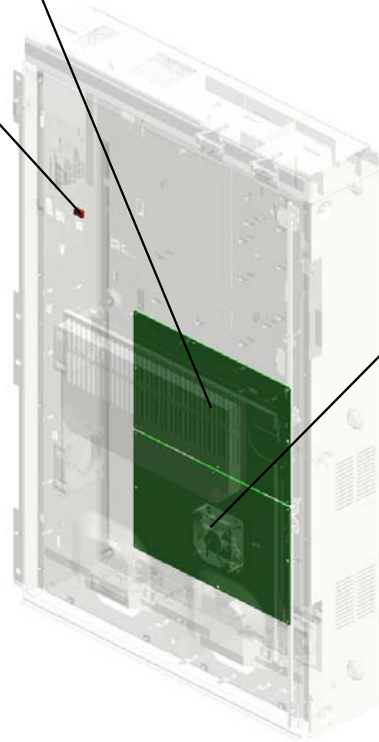

63.AZ240355
[A]
POWER SUPPLY U
NIT:ECO:(PCB28)
201910-01 X/O

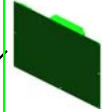

AZ240309
[A]
POWER SUPPLY U
NIT:ECO:456.4W:(P
CB28)
201910-01 X/O

AZ240311
[B]
POWER SUPPLY U
NIT:FW:446.4W:(P
CB29)
201910-02 X/O

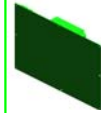

U001	U002	U003	U004	U005	U006	U007	U008	U009	U010	U011	U012	U013	U014	U015	U016	U017	U018	U019	U020
------	------	------	------	------	------	------	------	------	------	------	------	------	------	------	------	------	------	------	------

U017_S001
COVER:C/T BOX:UPPER:ASS'Y

42.D1795966
SEAL:COVER:C/T
BOX:UPPER:A

43.D1795967
SEAL:COVER:C/T
BOX:UPPER:B

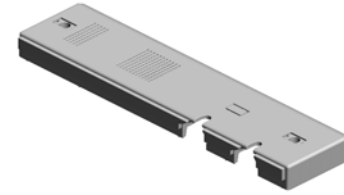

39.D1795089
COVER:C/T BOX:U
PPER:ASS'Y

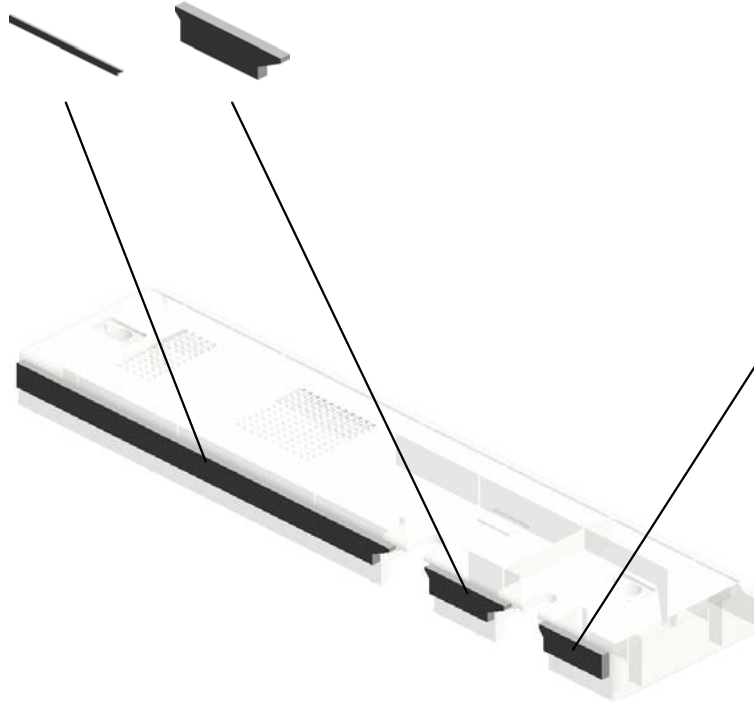

44.D1795973
SEAL:COVER:C/T
BOX:UPPER:C

U001	U002	U003	U004	U005	U006	U007	U008	U009	U010	U011	U012	U013	U014	U015	U016	U017	U018	U019	U020
------	------	------	------	------	------	------	------	------	------	------	------	------	------	------	------	------	------	------	------

U017_S002
PCB:SDCU:ASS'Y

6.04543006Q 2.03603006N
(x2) SCREW - M3X6
TAPPING SCREW -
M3X6

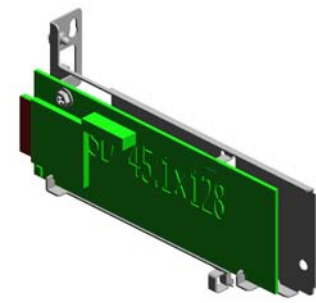

36.D0BX5927
PCB:SDCU:ASS'Y

21.14078476
ROM STORAGE:SD
XC8GB

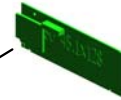
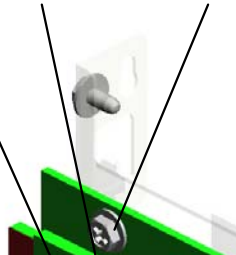

47.D2615140
PCB:SDCU:ASS'Y:(
PCB15)



9.11050042
(x6)
WIRE BAND



17.11050534
CLAMP

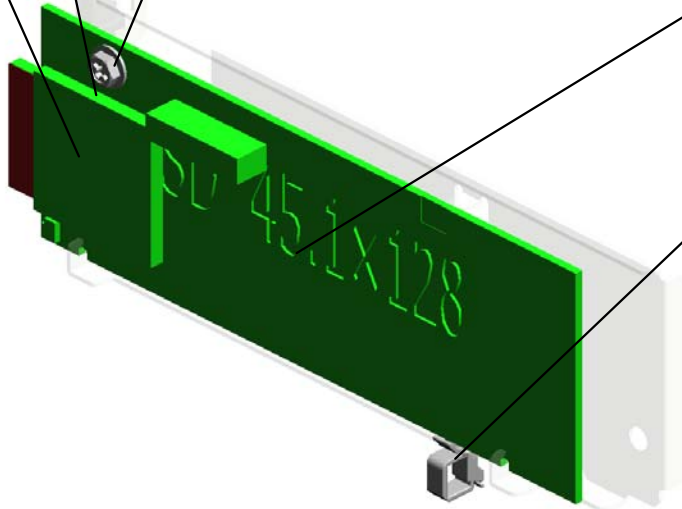

U001	U002	U003	U004	U005	U006	U007	U008	U009	U010	U011	U012	U013	U014	U015	U016	U017	U018	U019	U020
------	------	------	------	------	------	------	------	------	------	------	------	------	------	------	------	------	------	------	------

U018.AIR COOLING

U018_S001
D1796987
DUCT:HEAT PIPE:ENTRANC
E:ASSY

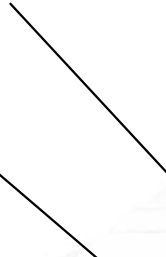

U018_S002
D1796836
DUCT:CHARGE CORONA:CO
NNECTING:LOWER:ASSY



U018_S004
D1796963
BRACKET:HEAT SHIELD:BEL
T CLEANING:ASSY

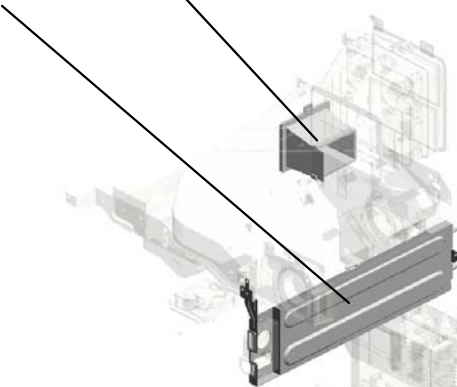

U018_S003
D1806811
DUCT:FLAT CONVEYER BEL
T:EXHAUST:CONNECTING:A
SSY

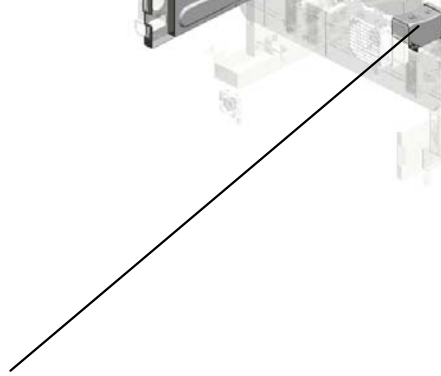

U001	U002	U003	U004	U005	U006	U007	U008	U009	U010	U011	U012	U013	U014	U015	U016	U017	U018	U019	U020
------	------	------	------	------	------	------	------	------	------	------	------	------	------	------	------	------	------	------	------

U018 AIR COOLING

12.04514008N (x59)
TAPPING SCREW: 4X8

9.04513006N (x15)
TAPPING SCREW - 3X6

7.04503008N (x16)
TAPPING SCREW - M3X8

1.03530060N
BIND SCREW - M3 X6

15.11050328
HARNESS CLAMP - ES-0505

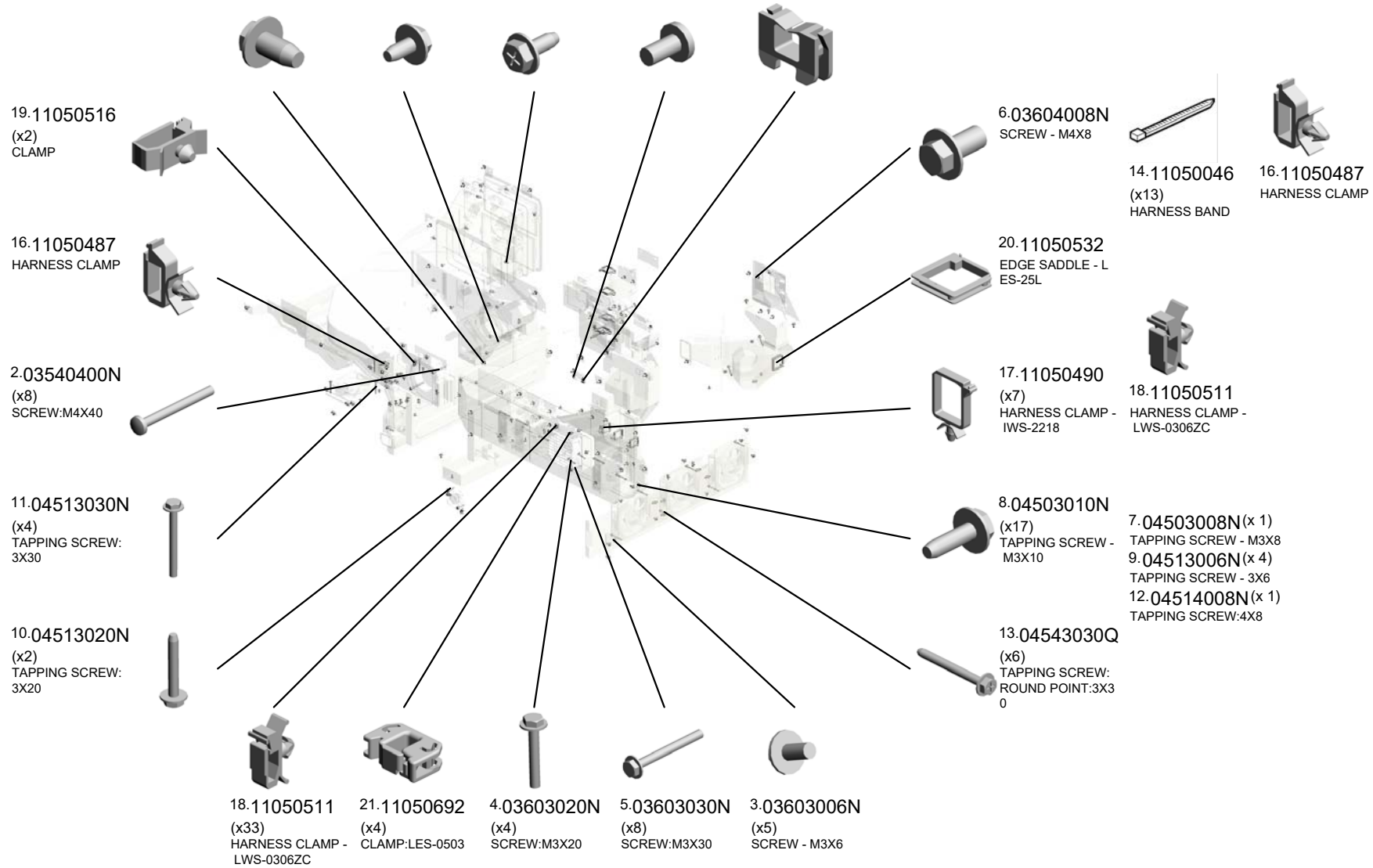
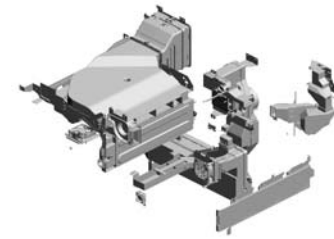

U018 AIR COOLING

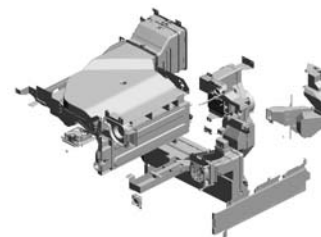

- 35.D1796821 DUCT:DEVELOPMENT:VACUUM:FRONT
- 28.AX660015 (x4) DC FAN MOTOR:SIROCCO:DC24V:PWM:(FAN9/FAN10/FAN11/FAN12)
- 31.D0BX6893 BRACKET:DUCT:MAIN:EXHAUST:LOWER
- 30.D0BX6889 (x2) FILTER:MAIN:EXHAUST:RIGHT
- 32.D0BX6909 (x2) FILTER:DUCT:MAIN:REAR

- 33.D1364233 (x16) STEPPED SCREW: DIA5:M3X3.8

- 34.D1791786 (x2) BRACKET:INNER COVER

- 22.11050723 CLAMPS:WES-0507

- 36.D1796822 BRACKET:FAN:DEVELOPMENT:COOLING:FRONT

- 26.AX640330 FAN:SIROCCO:DIA51:(FAN26/FAN27)

- 24.AX640224 (x7) DC FAN MOTOR:AXIAL:MM80:(FAN6/FAN7/FAN13/FAN16/FAN18/FAN19)

- 25.AX640247 (x5) DC FAN MOTOR:AXIAL:MM80:25MM:(FAN4/FAN5/FAN8/FAN14/FAN17/FAN20/FAN22/FAN23//FAN2)

- 23.AW100169 THERMISTOR:ASSY:(SEN94)

- 37.D1796831 DUCT:DEVELOPMENT:EXHAUST:FRONT

- 27.AX650056 (x3) DC FAN MOTOR:AXIAL:MM92:(FAN30/FAN31/FAN33)

- 40.D1796835 EXTERIOR:LOUVER:CHARGE CORONA

- 42.D1796840 BRACKET:DUCT:CHARGE CORONA:VACUUM:UPPER

- 38.D1796832 DUCT:DEVELOPMENT:EXHAUST:REAR

- 39.D1796834 SEAL:DUCT:DEVELOPMENT:EXHAUST:REAR RIGHT

- 29.D0BX6844 BRACKET:DUCT:CHARGE CORONA:VACUUM

U018 AIR COOLING

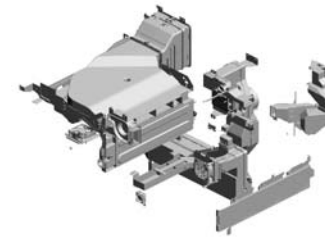

- 60.D1796932 DUCT:HEAT SHIELD:FUSING:UPPER
- 59.D1796927 DUCT:HEAT PIPE:EXHAUST
- 58.D1796918 SEAL:EXTERIOR:REAR:UPPER
- 51.D1796860 DUCT:DEVELOPMENT:TONER:UPPER:ASSY
- 50.D1796858 BRACKET:DUCT:CHARGE:EXHAUST:UPPER

61.D1796934
DUCT:HEAT SHIELD:FUSING:LOWER

62.D1796940
(x2)
BRACKET:FAN:EXHAUST:MIDDLE

55.D1796875
(x2)
BRACKET:DUCT:FLAT CONVEYER BELT:EXHAUST

53.D1796873
DUCT:FLAT CONVEYER BELT:EXHAUST:UPPER

54.D1796874
DUCT:FLAT CONVEYER BELT:EXHAUST:LOWER

56.D1796897
BRACKET:FAN:OPTICAL WRITING UNIT:COOLING

57.D1796898
SEAL:DUCT:OPTICAL WRITING UNIT:VACUUM

52.D1796864
DUCT:DEVELOPMENT:TONER:ASSY

49.D1796849
SEAL:DUCT:CHARGE CORONA:VACUUM:MAIN

48.D1796848
DUCT:CHARGE CORONA:VACUUM:MAIN:LEFT

44.D1796842
FILTER:CHARGE CORONA:VACUUM

43.D1796841
DUCT:CHARGE CORONA:VACUUM:CONNECTING:UPPER

47.D1796847
DUCT:CHARGE CORONA:VACUUM:MAIN:RIGHT

45.D1796845
DUCT:CHARGE CORONA:VACUUM:LOWER RIGHT

46.D1796846
DUCT:CHARGE CORONA:VACUUM:LOWER LEFT

U018 AIR COOLING

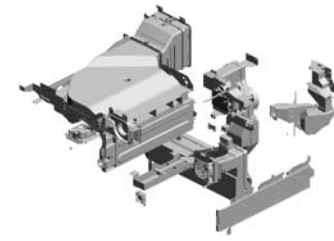

- 67.D1796954 BRACKET:DUCT:EXHAUST:PAPER EXIT SUB-UNIT:RIGHT
- 75.D1796978 SEAL:EXTERIOR:REAR:SMALL
- 68.D1796955 PLATE:DUCT:EXHAUST:BACK:ASSY
- 63.D1796946 DUCT:EXHAUST:PAPEXIT SUB-UNIT:A
- 64.D1796947 BRACKET:DUCT:EXHAUST:PAPER EXIT SUB-UNIT:LEFT

66.D1796953
DUCT:EXHAUST:PAPEXIT SUB-UNIT:B

65.D1796948
PLATE:DUCT:EXHAUST:A:ASSY

77.D1796984
DUCT:HEAT PIPE:EXIT

83.D1806821
BASE:HEAT SHIELD:FUSING SUB-UNIT:SUB-ASSY

76.D1796981
BRACKET:DUCT:HEAT PIPE:EXIT:ASSY

72.D1796971
SEAL:DUCT:THERMOPILE:ENTRANCE:LOWER

73.D1796972
DUCT:THERMOPILE:ENTRANCE:ASSY

71.D1796970
DUCT:THERMOPILE

82.D1806818
OZONE FILTER:MAIN:EXHAUST:RIGHT

80.D1796995
BRACKET:FAN:TRANSFER/SEPARATION UNIT:COOLING:REAR

85.D2706806
SEAL:DUCT:LARGE

84.D1806831
GASKET:DUCT:CHARGE CORONA:VACUUM

78.D1796985
DUCT:HEAT PIPE:EXIT:MIDDLE

86.D2706818
SEAL:DUCT:FAN:M97

74.D1796977
GUARD:FAN:OPTICAL WRITING UNIT

U018 AIR COOLING

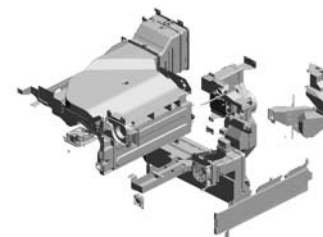

- 88.D2706823 OZONE FILTER:DU CT:MAIN:REAR
- 92.D2706854 DUCT:CHARGE CO RONA:EXHAUST:M IDDLE:FRONT
- 91.D2706853 DUCT:CHARGE CO RONA:EXHAUST:M IDDLE:REAR
- 93.D2706856 DUCT:CHARGE CO RONA:EXHAUST:C ONNECTING:FRON T
- 94.D2706857 DUCT:CHARGE CO RONA:EXHAUST:C ONNECTING:REAR

87.D2706822
SEAL:DUCT:HEAT SHIELD:FUSING:A



102.D2706910
SEAL:DUCT:CHARGE CORONA:EXHAUST:MIDDLE



89.D2706833
BRACKET:FAN:DEVELOPMENT:EXHAUST



101.D2706909
(x2)
SEAL:DUCT:LARGE



99.D2706892
(x2)
COVER:FILTER:EXHAUST



98.D2706891
DUCT:MAIN:EXHAUST:REAR

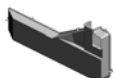

97.D2706890
DUCT:MAIN:EXHAUST:FRONT



104.D2706917
SEAL:DUCT:MAIN:EXHAUST



100.D2706896
DUCT:OPTICAL WRITING UNIT:VACUUM:FRONT

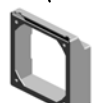

103.D2706911
(x3)
SEAL:DUCT:MAIN:EXHAUST:FRONT



90.D2706851
DUCT:CHARGE CORONA:EXHAUST:MIDDLE:RIGHT

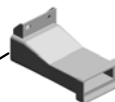

95.D2706869
DUCT:CHARGE CORONA:EXHAUST:MULTI-LANGUAGE:REAR



96.D2706870
DUCT:CHARGE CORONA:EXHAUST:MULTI-LANGUAGE:FRONT



106.D2706921
SEAL:DUCT:MAIN:EXHAUST:B



105.D2706920
SEAL:DUCT:MAIN:EXHAUST:A



U018 AIR COOLING

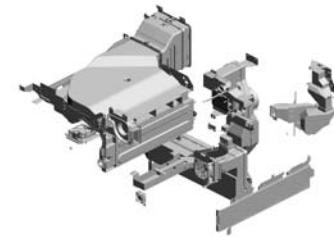

113.D2706989 (x2) SEAL:DUCT:HEAT PIPE:ENTRANCE
 107.D2706929 (x3) COVER:FAN:MAIN: EXHAUST

114.GX640028 (x2) FAN MOTOR DC24 V 1.92W:(FAN3/FAN28/FAN29)

112.D2706948 SHEET:SCREW:FILTER

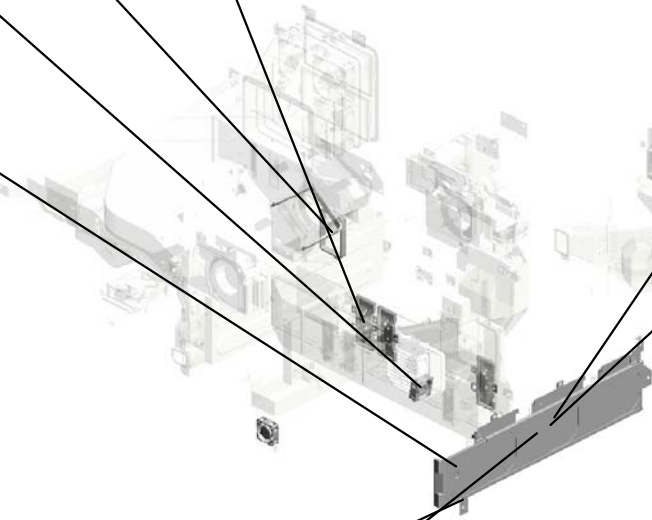
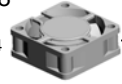

108.D2706942 BRACKET:FAN:SIDE:RIGHT:SUB-ASS'Y

109.D2706944 BRACKET:GUIDE:BASE



111.D2706947 BRACKET:AUXILIARY:BASE

110.D2706945 FILTER:VACUUM:MAIN:RIGHT



U018_S001
DUCT:HEAT PIPE:ENTRANCE:ASS'Y

113.D2706989
SEAL:DUCT:HEAT
PIPE:ENTRANCE

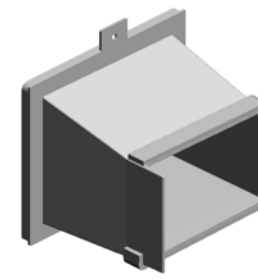
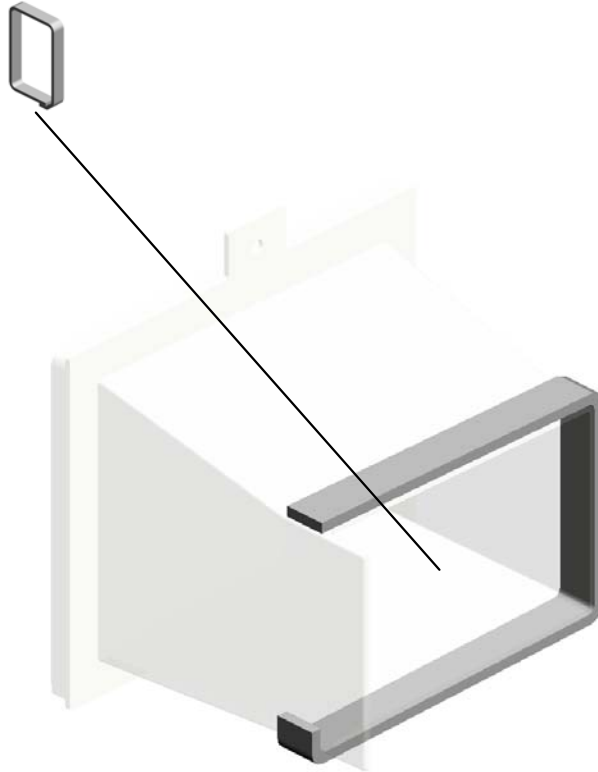

79.D1796987
DUCT:HEAT PIPE:
ENTRANCE:ASS'Y

U001	U002	U003	U004	U005	U006	U007	U008	U009	U010	U011	U012	U013	U014	U015	U016	U017	U018	U019	U020
------	------	------	------	------	------	------	------	------	------	------	------	------	------	------	------	------	------	------	------

U018_S002
DUCT:CHARGE CORONA:CONNECTING:LOWER:ASS'Y

101.D2706909
SEAL:DUCT:LARG
E

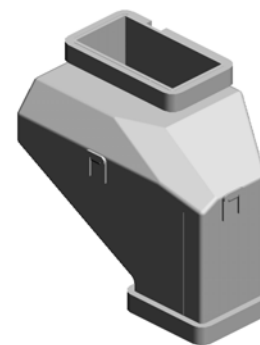
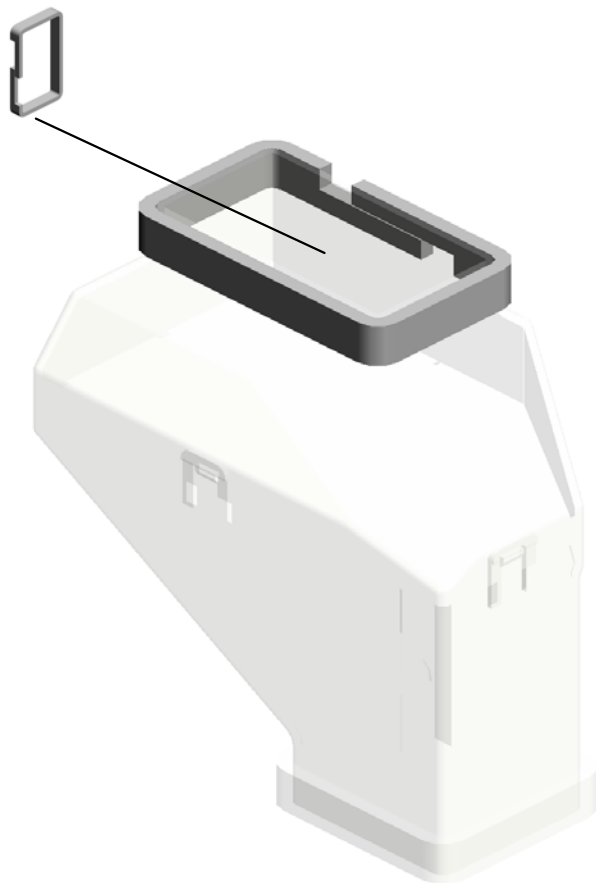

41.D1796836
DUCT:CHARGE CO
RONA:CONNECTIN
G:LOWER:ASS'Y

U001	U002	U003	U004	U005	U006	U007	U008	U009	U010	U011	U012	U013	U014	U015	U016	U017	U018	U019	U020
------	------	------	------	------	------	------	------	------	------	------	------	------	------	------	------	------	------	------	------

U018_S003
DUCT:FLAT CONVEYER BELT:EXHAUST:CONNECTING:ASS'Y

7.04503008N
TAPPING SCREW -
M3X8



81.D1806811
DUCT:FLAT CONV
EYER BELT:EXHAU
ST:CONNECTING:
ASS'Y



86.D2706818
SEAL:DUCT:FAN:M
M97

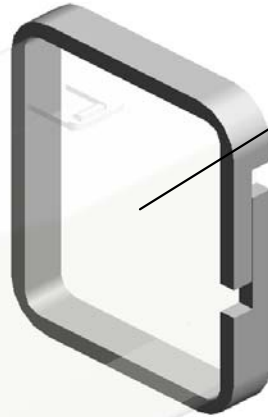

U001	U002	U003	U004	U005	U006	U007	U008	U009	U010	U011	U012	U013	U014	U015	U016	U017	U018	U019	U020
------	------	------	------	------	------	------	------	------	------	------	------	------	------	------	------	------	------	------	------

U018_S004

BRACKET:HEAT SHIELD:BELT CLEANING:ASS'Y

70.D1796966
SEAL:DUCT:THER
MOPILE:ENTRANC
E:UPPER

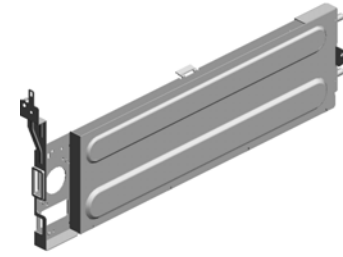

69.D1796963
BRACKET:HEAT S
HIELD:BELT CLEA
NING:ASS'Y

U001	U002	U003	U004	U005	U006	U007	U008	U009	U010	U011	U012	U013	U014	U015	U016	U017	U018	U019	U020
------	------	------	------	------	------	------	------	------	------	------	------	------	------	------	------	------	------	------	------

U019 MAIN FRAME

- 19.11050488 (x9) HARNESS CLAMP
- 7.04514008N (x168) TAPPING SCREW: 4X8
- 1.03140180N (x2) PAN HEAD SCREW :M4X18
- 13.07200040E (x4) RETAINING RING - M4
- 23.11050511 (x17) HARNESS CLAMP - LWS-0306ZC

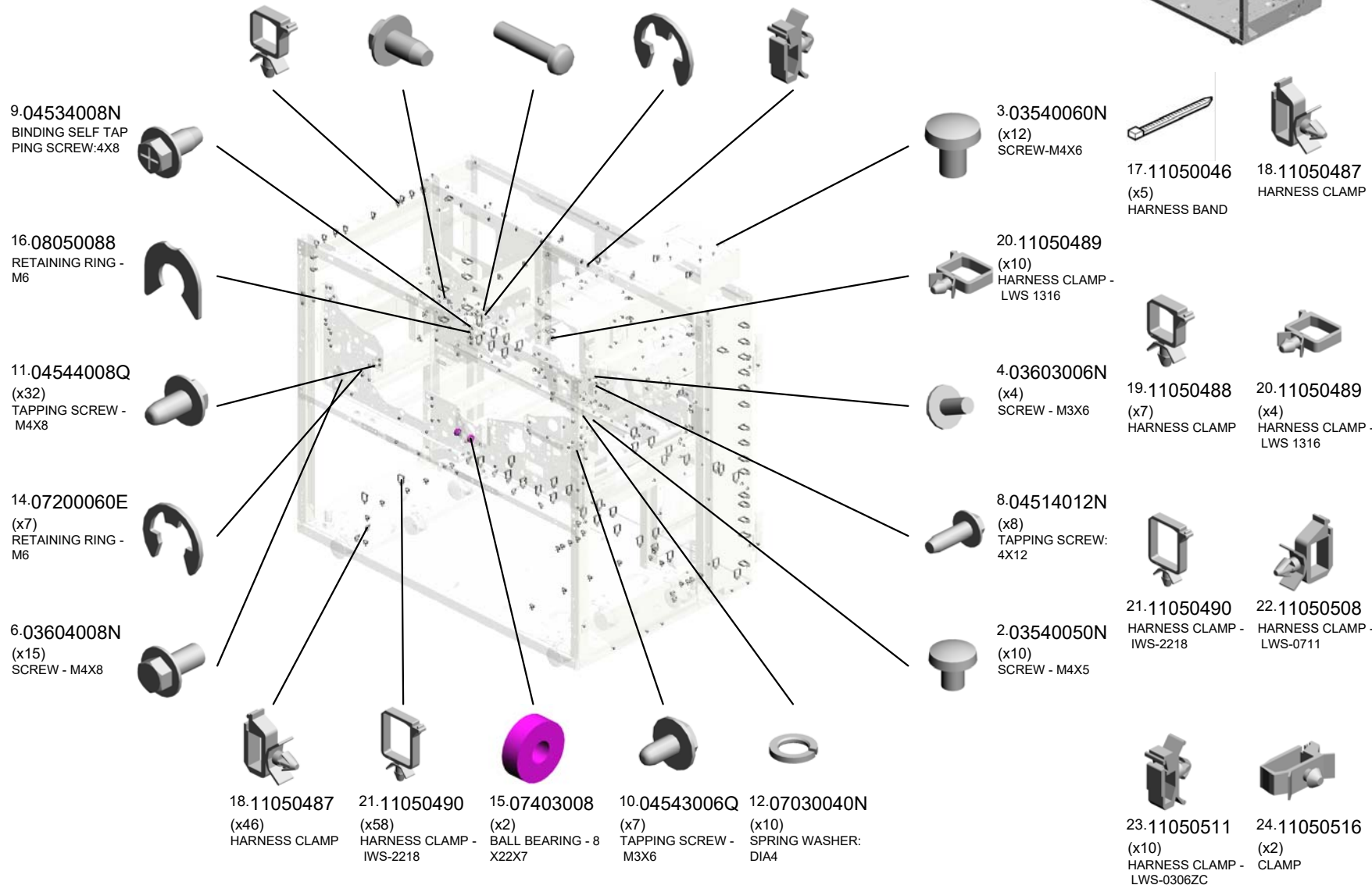
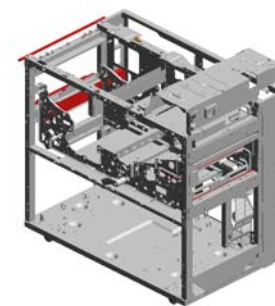

U019 MAIN FRAME

- 30.11050724 (x2) CLAMPS:WES-1210
- 40.B1321221 (x2) HOLDER:SPRING:PULL OUT
- 39.B1321183 (x2) BRACKET:LOCK
- 36.AA132300 (x4) ROLLER:LOCK:PU LL OUT
- 26.11050534 (x2) CLAMP

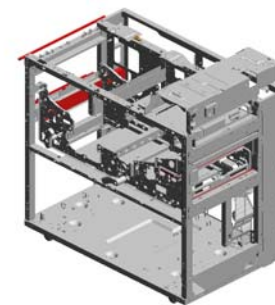

- 28.11050711 (x6) CLAMP:JDL-1S

- 31.11050726 CLAMPS:WES-2217

- 24.11050516 (x3) CLAMP

- 35.AA082104 (x6) BUSHING - 8X12X7

- 41.B5457507 (x2) SCREW:PUNCH

- 42.D0741180 LEVER:PULL OUT:PAPER EXIT UNIT
- 27.11050692 (x2) CLAMP:LES-0503
- 32.11050751 (x2) CLAMP:LWSM-060 6-3.2M
- 38.AH012042 (x6) CASTER:1470N:BB
- 29.11050723 CLAMPS:WES-0507

- 25.11050528 NYLON CLAMP - E MT-2N



- 32.11050751 CLAMP:LWSM-060 6-3.2M



- 37.AA143594 (x2) STEPPED SCREW: M3X5

- 43.D0741225 (x2) HINGE:C/T BOX:RIGHT UPPER:PEEN



- 44.D0741228 (x2) COVER:HINGE



- 83.G1784909 (x4) SCREW:TRANSPORT

- 34.AA063472 (x10) COMPRESSION SPRING:CONNECTOR:UPPER

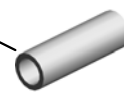

- 33.AA062797 (x2) COMPRESSION SPRING:DRAWER:22.2N



- 5.03604006N (x 1) SCREW - M4X6
- 6.03604008N (x 4) SCREW - M4X8
- 7.04514008N (x31) TAPPING SCREW:4X8
- 10.04543006Q (x 1) TAPPING SCREW - M3X6
- 11.04544008Q (x 3) TAPPING SCREW - M4X8
- 14.07200060E (x 3) RETAINING RING - M6

U019 MAIN FRAME

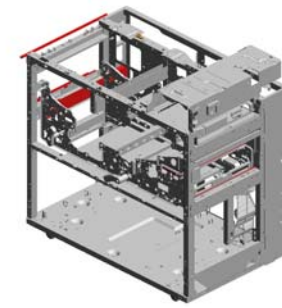

- 58.D1791221 (x2) HOLDER:COIL SPRING:LOCK:PULL OUT
- 57.D1791185 GUIDE:INTERMEDIATE TRANSFER:LEFT
- 62.D1796410 SLIDE RAIL:CASE TENSION:ROLLER
- 52.D1791115 RAIL:INTERMEDIATE TRANSFER:LEFT
- 63.D1796823 DUCT:DEVELOPMENT:EXHAUST:MULTI-LANGUAGE:ASSY

47.D0BX1219
SHAFT:LOCK:PULL OUT:LEFT

48.D0BX1220
TORSION SPRING: KNOB:LEFT

60.D1791734
LEVER:PULL OUT: LEFT

50.D0BX1233
TORSION SPRING: KNOB:RIGHT

56.D1791130
GUIDE:PULL OUT: MIDDLE:LOWER

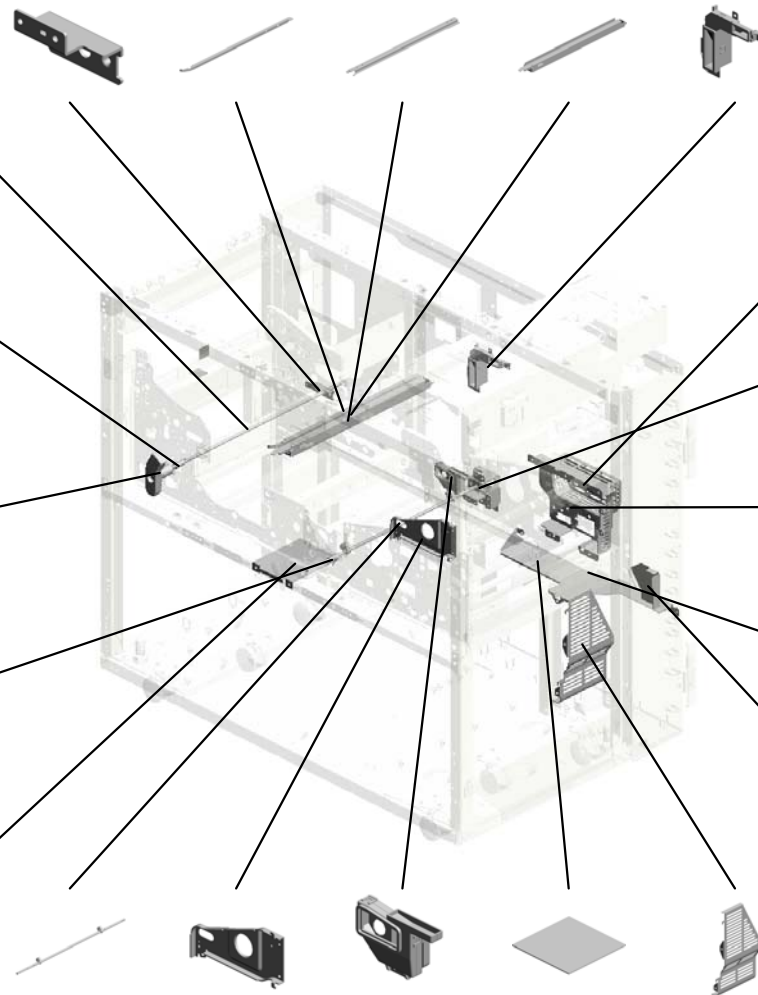

59.D1791731
COVER:REGISTRATION:MOTOR

55.D1791129
GUIDE:PULL OUT:LOCK

54.D1791128
HOLDER:REGISTRATION:DRAWER

53.D1791118
SEPARATION PLATE:MAIN:REAR MIDDLE

45.D0BX1069
COVER:MOTOR:USED TONER

- 49.D0BX1232 SHAFT:LOCK:PULL OUT:RIGHT:ASSY
- 46.D0BX1165 SUPPORTING PLATE:RAIL:INTERMEDIATE TRANSFER
- 64.D1806801 DUCT:FLAT CONVEYER BELT:EXHAUST:SMALL:ASSY
- 61.D1794884 (x3) SHEET:OPPOSED: PAPER FEED SENSOR
- 51.D1791043 GUARD:MAIN:VERTICAL TRANSPORT

U001	U002	U003	U004	U005	U006	U007	U008	U009	U010	U011	U012	U013	U014	U015	U016	U017	U018	U019	U020
------	------	------	------	------	------	------	------	------	------	------	------	------	------	------	------	------	------	------	------

U019 MAIN FRAME

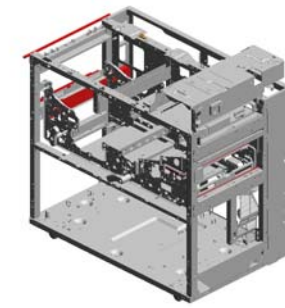

- 66.D1944759 (x2) BRACKET:LOCK:EXIT
- 82.G1784818 (x4) SPRING:PULL OUT:LOCK:EXIT
- 65.D1941234 (x2) SUPPORTING PLATE:BRACKET:LOCK
- 70.D2701155 BRACKET:RADIAL BALL BEARING
- 69.D2701151 SLIDE RAIL:PULL OUT:RIGHT UPPER

83.G1784909 (x4) SCREW:TRANSPORT

76.D2701174 GUIDE:PICK-UP PAPER JAM

72.D2701166 SUPPORTING PLATE:AUXILIARY:RAIL:INTERMEDIATE TRANSFER

73.D2701167 STOPPER:SLIDE RAIL:RIGHT UPPER

81.G1781138 (x18) SCREW WITH WASHER:M6X14

67.D2416290 (x3) LED:RED

80.G0342986 FLANGED HEXAGONAL HEAD BOLT - M4X8

75.D2701173 STOPPER:SUPPORTER

79.D2706815 SHEET:GUIDE MILLER:PAPER FEED:COOLING:INNER BACK

68.D2701132 (x2) SLIDE RAIL:PULL OUT:PROTECT

71.D2701160 RAIL:INTERMEDIATE TRANSFER

84.G1787515 (x12) CONNECTOR GUIDE PIN:CONNECTOR

74.D2701171 SUPPORTER:PULL OUT:RIGHT UPPER

78.D2706814 SHEET:GUIDE MILLER:PAPER FEED:COOLING:UPPER

77.D2706813 SHEET:GUIDE MILLER:PAPER FEED:COOLING:LOWER

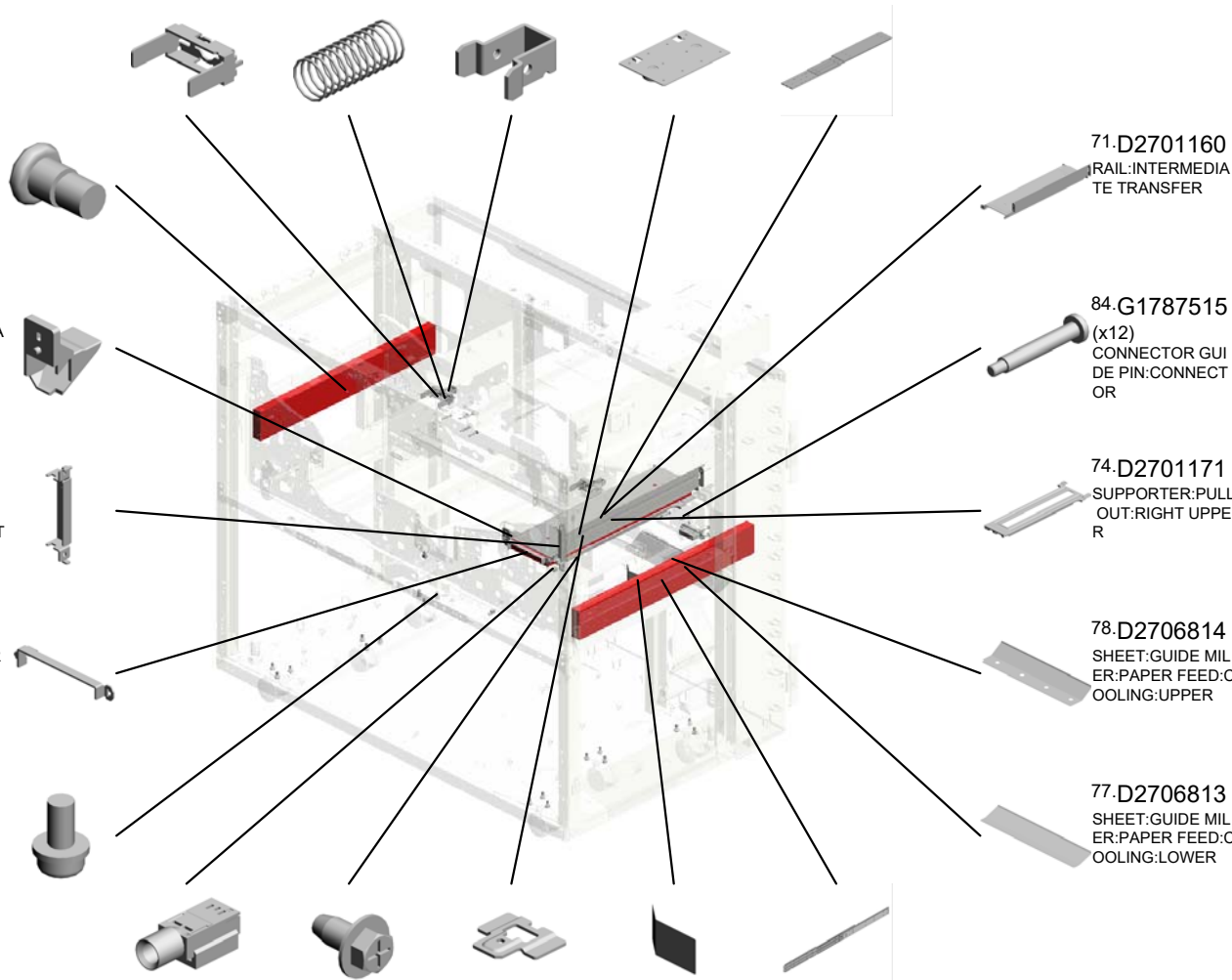

U019
MAIN FRAME

95.D0BX1465
BRACKET:KEY CO
UNTER

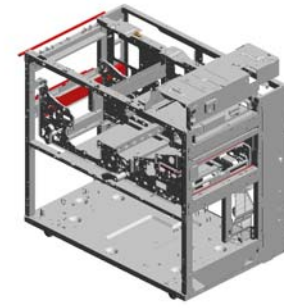
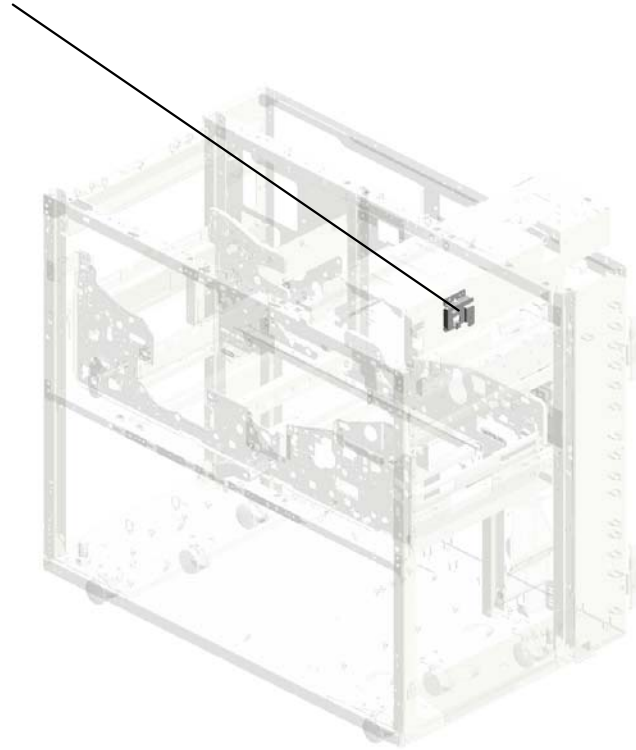

U001	U002	U003	U004	U005	U006	U007	U008	U009	U010	U011	U012	U013	U014	U015	U016	U017	U018	U019	U020
------	------	------	------	------	------	------	------	------	------	------	------	------	------	------	------	------	------	------	------

U020.ACCESSORIES

U020_S001
D0BX1580
HINGE:STAND:OPERATION
SUB-UNIT:ASS'Y

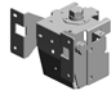

U020_S003
D0BX1580
HINGE:STAND:OPERATION
SUB-UNIT:ASS'Y

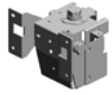

U020_S002
M5001861
TUBE TYPE LAMP:ASS'Y:(PC
B14)



U020_S004
M5001861
TUBE TYPE LAMP:ASS'Y:(PC
B14)

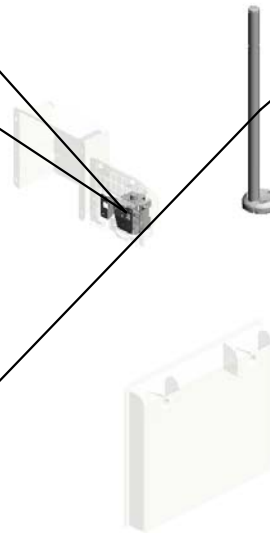

U001	U002	U003	U004	U005	U006	U007	U008	U009	U010	U011	U012	U013	U014	U015	U016	U017	U018	U019	U020
------	------	------	------	------	------	------	------	------	------	------	------	------	------	------	------	------	------	------	------

U020 ACCESSORIES

10.11050724 2.03604008N
(x6) (x20)
CLAMPS:WES-121 SCREW - M4X8
0

15.D0BX1518
(x2)
COVER:EXHAUST:
PAPER EXIT SUB-
UNIT

12.D0744225
(x2)
KNOB:FUSING

53.D0BX7662
(x2)
ACCESSORY:COV
ER:SIDE:RIGHT:AS
S'Y

17.D0BX1588
(x2)
COVER:HINGE:MID
DLE

18.D0BX1590
(x2)
COVER:HINGE:FR
ONT

1.03150100N
(x2)
PAN HEAD SCREW
:M5X10

9.11050508
(x8)
HARNESS CLAMP -
LWS-0711

14.D0747391
(x6)
DECAL:PAPER SE
T DIRECTION

20.D0BX4385
(x4)
TAPE:HOLDER:FU
SING UNIT:HEATE
R:ASS'Y

25.D1793402
(x2)
BOTTLE:DEVELOP
ER:ASS'Y

13.D0744391
(x2)
HOLDER:KNOB:FU
SING:DUAL FACES
TEPE

19.D0BX1593
(x2)
OZONE FILTER:EX
HAUST:PAPER EXI
T SUB-UNIT

21.D0BX7648
(x2)
DECAL:MULTI-LAN
GUAGE:MAIN:13:A
BS

26.D1795923
(x2)
PLATE:POWER SU
PPLY CORD:INLET

U020
ACCESSORIES

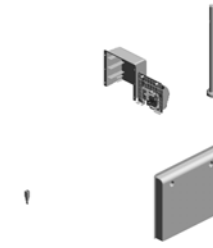

27.D1796193
(x2)
HOLDER:FLAT BEL
T-TRANSFER:DRIV
E ROLLER:ASS'Y



28.D1796194
(x2)
HOLDER:FLAT BEL
T-TRANSFER:CLE
ANING:ASS'Y



29.D1799640
(x2)
**DEVELOPER BLAC
K**



31.D2707649
(x2)
DECAL:MULTI-LAN
GUAGE:MAIN:5



33.G1781141
(x8)
HOLDER:STAND:M
20



34.G1788350
(x2)
WRENCH:HEXAGO
NAL BOLT



35.M0CL7682
(Pro 8310):MODEL
NAME PLATE:PRO
_8310



36.M0CM7682
(Pro 8320):MODEL
NAME PLATE:PRO
_8320

U020
ACCESSORIES

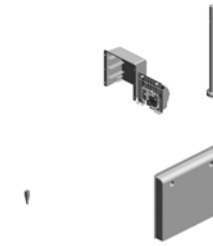

37.M2631596
(x2)
DECAL:USER CAUTIONS:COVER:UPPER



41.D0747775
(x2)
(CHN|Pro 8300S/8310S/8320S|NA);PLATE:LOGO:RICOH

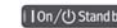

48.D1791595
(x2)
(NA):DECAL:DC:MAIN SWITCH



49.D2701588
(x4)
(NA):DECAL:CAUTION:PULL OUT:ENGLISH



50.D2701761
(x2)
(NA):DECAL:CAUTION CHART:INKJET:PAPER



51.D2707669
(x2)
(NA):DECAL:POWER SOURCE:OFF:ABS

4.04514006N(x 2)
TAPPING SCREW - 4X6
5.04514008N(x 2)
TAPPING SCREW:4X8

U020
ACCESSORIES

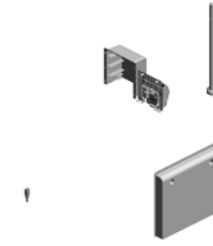

6.04544010N(x 4)
TAPPING SCREW:ROUND POINT:4X10

7.09545010N(x 8)
SCREW:POLISHED ROUND/SPRING:M
5X10

47.11500455(x 2)
(NA):POWER SUPPLY CODE250V:20A

U001	U002	U003	U004	U005	U006	U007	U008	U009	U010	U011	U012	U013	U014	U015	U016	U017	U018	U019	U020
------	------	------	------	------	------	------	------	------	------	------	------	------	------	------	------	------	------	------	------

U020_S001
HINGE:STAND:OPERATION SUB-UNIT:ASS'Y

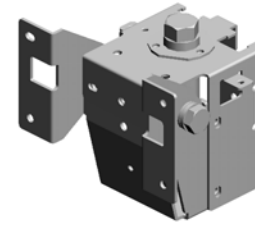

16.D0BX1580
HINGE:STAND:OP
ERATION SUB-UNI
T:ASS'Y

2.03604008N(x12)
SCREW - M4X8

U001	U002	U003	U004	U005	U006	U007	U008	U009	U010	U011	U012	U013	U014	U015	U016	U017	U018	U019	U020
------	------	------	------	------	------	------	------	------	------	------	------	------	------	------	------	------	------	------	------

U020_S002
TUBE TYPE LAMP:ASS'Y:(PCB14)

3.04503012N
(x3)
TAPPING SCREW:
3X12



38.M5001861
TUBE TYPE LAMP:
ASS'Y:(PCB14)



8.11050046
HARNESS BAND

U001	U002	U003	U004	U005	U006	U007	U008	U009	U010	U011	U012	U013	U014	U015	U016	U017	U018	U019	U020
------	------	------	------	------	------	------	------	------	------	------	------	------	------	------	------	------	------	------	------

U020_S003
HINGE:STAND:OPERATION SUB-UNIT:ASS'Y

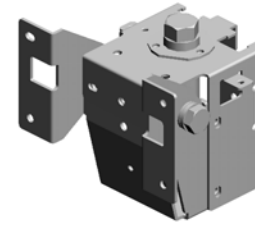

16.D0BX1580
HINGE:STAND:OP
ERATION SUB-UNI
T:ASS'Y

2.03604008N(x12)
SCREW - M4X8

U001	U002	U003	U004	U005	U006	U007	U008	U009	U010	U011	U012	U013	U014	U015	U016	U017	U018	U019	U020
------	------	------	------	------	------	------	------	------	------	------	------	------	------	------	------	------	------	------	------

U020_S004
TUBE TYPE LAMP:ASS'Y:(PCB14)

3.04503012N
(x3)
TAPPING SCREW:
3X12

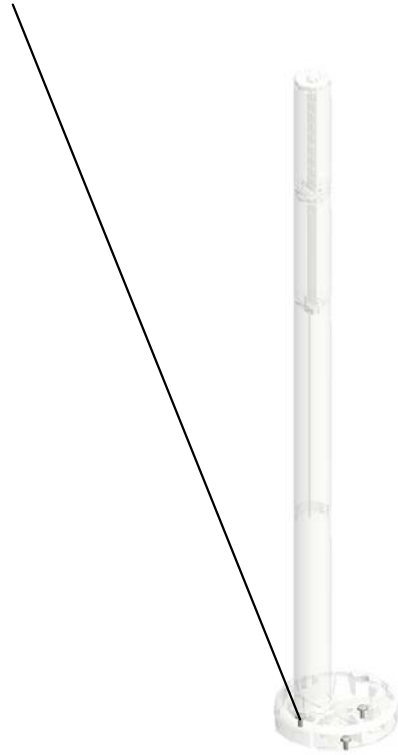

38.M5001861
TUBE TYPE LAMP:
ASS'Y:(PCB14)



8.11050046
HARNESS BAND

U001	U002	U003	U004	U005	U006	U007	U008	U009	U010	U011	U012	U013	U014	U015	U016	U017	U018	U019	U020
------	------	------	------	------	------	------	------	------	------	------	------	------	------	------	------	------	------	------	------

SPECIAL TOOLS

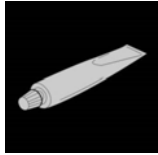

1.52039502
GREASE 501



3.A0069104
ADJUSTING SCANNER PIN (4PCS/SET)

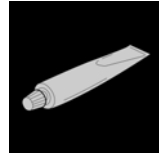

4.A2579300
GREASE - BARRIERTA S552R



5.B1329700
LUBRICANT POWDER

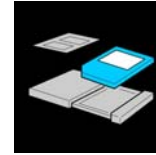

6.B6455010
SD-CARD:ASSY



7.C4019503
20X MAGNIFICATION SCOPE



8.D0159500
G104 YELLOW TONER



9.D0159501
ZINC STEARATE

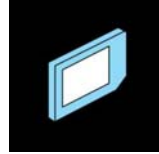

10.D0745100
SD-CARD:NICE:REGI:ASSY



11.D1793402
BOTTLE:DEVELOPER:ASSY

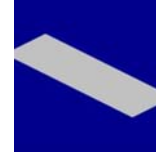

12.D1793414
SEAL:DEVELOPMENT ROLLER:SER
VICE PARTS:ASSY



13.D1793420
JIG:SHEET:DOCTOR BLADE



14.D1793421
KNOB:DRIVE:DEVELOPMENT UNIT:ASSY



15.D1796193
HOLDER:FLAT BELT-TRANSFER:DRIVE ROLLER:ASSY



16.D1796194
HOLDER:FLAT BELT-TRANSFER:CLEANING:ASSY



17.VSSG9002
FLUOTRIBO MG GREASE : 100G



18.VSSM9000
DIGITAL MULTIMETER-FLUKE189/FVF

Exclusive Parts

Number	Part Name	Group	ID
50530223	BUSHING - 8MM	U004_S012	70
50530447	BUSHING - 6MM	U004	71
52039502	GREASE 501	SPECIAL TOOLS	1
52062686	SNAP RING	U001	14
		U009_S001	18
52152621	SNAP RING - M6	U004	72
		U007_S001	24
		U009_S001	19
54472681	SNAP RING	U004	73
		U008_S001	5
		U014	23
54472706	GEAR - 15T	U004_S006	74
		U004_S007	74
		U004_S008	74
58942540	ARM SCREW	U012_S001	31
67542866	ROLLER - POSITIONING GUIDE	U004	75
A0069104	ADJUSTING SCANNER PIN (4PCS/SET)	SPECIAL TOOLS	3
A0793626	STEPPED SCREW - SWING CLEANING	U015	21
A1342978	SPRING PLATE	U004_S010_S003	76
		U004_S011_S003	76
A1343180	BOTTLE CHUCK	U005	25
A2324666	CUSHION - STEPPER MOTOR	U004	77
		U007_S001	25
A2486687	RIGHT DRIVE SHAFT	U004_S012	78
A2486694	WIRE RING	U004_S012	79
A2486695	GUIDE - PULLEY	U004_S012	80
A2486696	PULLEY COVER	U004_S012	81
A2486713	HOOK - TENSION SPRING	U004_S012	82
A2574493	BAND	U014	24
A2579300	GREASE - BARRIERTA S552R	SPECIAL TOOLS	4
A2672857	SPRING PLATE - SIDE FENCE	U004_S010_S002	83
		U004_S011_S002	83
A2672859	SIDE FENCE STOPPER	U004_S010_S002	84
		U004_S011_S002	84
A2941163	GEAR - 30Z	U005_S004	26
A2943293	(Pro 8310/8320):GEAR:108Z	U005	92

Number	Part Name	Group	ID
A2943319	CASE CUSHION	U005_S001	28
		U005_S002	28
A2943354	RACK - 10Z	U005	29
A2943445	STOPPER SUPPORT PLATE	U005	30
A2943446	TONER BOTTLE STOPPER	U005	31
A2943447	TONER BOTTLE SET FEELER	U005	32
A2943454	LEVER STOPPER	U005	33
A2943461	LEVER RACK JOINT	U005	34
A2944156	GEAR - 23Z	U012_S002	32
A2944171	COUPLED GEAR - 17Z/32Z	U012_S001_S007	33
		U012_S002	33
A2946643	LEFT FRONT FENCE	U004	85
A2946690	FEELER - PAPER HEIGHT SENSOR	U004_S012	86
A8063281	TIMING PULLEY - T14 S3M	U010_S004	16
AA000291	DECAL:POSITIONING DISPLAY:SCREW:PP	U004_S006	87
		U004_S007	87
		U004_S008	87
		U009	20
AA001508	DECAL:SIDE FENCE:40X30	U004_S014	88
AA001509	DECAL:SIDE FENCE:16X30	U004_S012_S001	89
AA001597	DECAL:SIDE FENCE:REAR	U004_S010_S002	90
		U004_S011_S002	90
AA003056	DECAL:GRIP:SHORT:PP	U004_S006	91
		U004_S007	91
		U004_S008	91
		U009	21
AA021034	MAGNETIC	U014	25
AA021035	MAGNETIC:COVER	U005	35
AA036015	CAP:COLLECTION BOTTLE	U010_S002	17
AA040033	TRANSPORT BELT	U011	12
AA043271	TIMING BELT S3M 196T	U004	92
AA043293	TIMING BELT - 40S2M268G	U014	26
AA043323	TIMING BELT:40S2M120	U013	30
AA043324	TIMING BELT - B40S2M152	U004	93
AA043325	TIMING BELT - B40S2M250	U004	94
AA043333	TIMING BELT:60S2M168	U014	27
AA043342	SYNCHRONOUS BELT:40S3M666	U010_S003	18

Exclusive Parts

Number	Part Name	Group	ID
AA043443	TIMING BELT - S2M 140	U004	95
AA043608	TIMING BELT:40S2M184	U013	31
AA043627	TIMING BELT - B40S2M148	U004	96
AA043647	TIMING BELT:60S2M188	U004	97
AA043650	TIMING BELT - B60S2M290	U014	28
AA043652	TIMING BELT - B60S2M130	U013	32
AA043659	SYNCHRONOUS BELT:40S3M231	U010_S004	19
AA043660	TIMING BELT:40S2M172	U013	33
AA043976	TIMING BELT:40S2M142	U007_S001	26
AA060523	PICK-UP PRESSURE SPING	U004_S006	98
		U004_S007	98
		U004_S008	98
AA060575	RELEASE SPRING	U004_S006	99
		U004_S007	99
		U004_S008	99
AA060757	TENSION SPRING - LONG	U004_S012	100
AA060758	TENSION SPRING - SHORT	U004_S012	101
AA060811	TENSION SPRING - STOPPER	U005	36
AA060812	LEVER TENSION SPRING	U005	37
AA060961	TENSION SPRING:SIDE FENCE:REAR	U004_S010	102
		U004_S011	102
AA060987	TENSION SPRING:TIMING BELT:10N	U004	103
AA061067	TENSION SPRING:DRIVE WIRE:DRIVE	U007_S001	27
AA061068	TENSION SPRING:BRACKET:DRIVEN ROLLER:INNER BACK	U007_S001	28
AA061114	TENSION SPRING:POSITIONING SENSOR	U007_S001	29
AA061116	TENSION SPRING:STRIPPER PLATE:2N	U012_S001	34
AA061134	TENSION SPRING:LEVER:PRESSURE	U012_S001	35
AA061154	COMPRESSION SPRING:11N	U012_S001_S005	36
AA061169	TENSION SPRING:TONER CATCH PAN:DISCHARGE USED TONER	U010_S001	20
AA061170	COIL SPRING:GATE PAWL:EXIT:ENTRANCE	U013	34

Number	Part Name	Group	ID
AA061171	COIL SPRING:LATCH:REVERSE EXIT:LEFT LOWER	U013	35
AA061172	COIL SPRING:GATE PAWL:EXIT:DUPLICATION	U013	36
AA061173	COIL SPRING:GATE PAWL:DUPLICATION:ENTRANCE	U014	29
AA061177	TENSION SPRING:VIBRATING PLATE:VERTICAL TRANSPORT	U010_S004	21
AA061191	TENSION SPRING:REGISTRATION	U004	104
AA061192	TENSION SPRING:TIMING ROLLER	U004	105
AA062797	COMPRESSION SPRING:DRAWER:22.2N	U019	33
AA063268	CONNECTOR SPRING	U004	106
AA063392	CHUCK SPRING	U005	38
AA063463	COMPRESSION SPRING:DRAWER	U007	30
		U012	37
AA063465	COMPRESSION SPRING:CLEANING FELT:27N	U012_S002	38
AA063472	COMPRESSION SPRING:CONNECTOR:UPPER	U019	34
AA063601	RACK SPRING	U005	39
AA063602	CHUCK SPRING	U005	40
AA063674	SPRING - 8N	U013	37
		U014	30
AA063675	SPRING - 5N	U013	38
		U014	31
AA063678	SPRING - 3.5N	U004	107
AA063693	COMPRESSION SPRING:PRESSURE:DRIVEN ROLLER	U004	108
		U004_S006	108
		U004_S007	108
		U004_S008	108
AA063694	COMPRESSION SPRING:HANDLE	U004	109
		U004	110
AA063695	COMPRESSION SPRING:GRIP	U004	110
AA063851	PRESSURE SPRING	U012_S002	39
AA064000	COMPRESSION SPRING:PRESSURE	U012_S001	40

Exclusive Parts

Number	Part Name	Group	ID
AA066320	FEELER TORSION SPRING	U005	41
AA066402	TORSION SPRING:GUIDE PLATE:R EAR	U004	111
AA066403	TORSION SPRING:GUIDE PLATE:F RONT	U004	112
AA066419	TORSION SPRING:GRIP	U004	113
AA066667	SPRING:STRIPPER PLATE:FRONT	U004	114
AA070090	SLIDE RAIL:FUSING UNIT	U012	41
AA080154	REAR BUSHING	U009_S001	22
AA080265	BUSHING:6X8X5	U004	115
AA080346	BUSHING:FLANGE TYPE:DIA6	U004	116
		U013	39
		U014	32
AA082101	BUSHING - 6X10X6	U012_S001	42
		U013	40
AA082104	BUSHING - 8X12X7	U004	117
		U007_S001	31
		U013	41
		U019	35
AA082115	PLAIN SHAFT BEARING:5X10X5	U011	13
AA082137	BUSHING:6X10X6	U008_S001	6
AA082144	BUSHING - 8X12X7	U004	118
AA082173	PLAIN SHAFT BEARING:6X10X6	U011	14
AA083009	CLUTCH ROLLER - 8X18X11	U004_S006	119
		U004_S007	119
		U004_S008	119
AA083022	BUSHING:DIA6:DIA8	U007_S001	32
		U008_S001	7
AA084059	BALL BEARING HOLDER	U004	120
		U004_S006	120
		U004_S007	120
		U004_S008	120
		U004_S009	120
		U013	42
U014	33		
AA113037	TERMINAL:4P:187	U012_S001	43
AA120084	DISCHARGE BRUSH	U013	43
AA120097	ANTISTATIC BRUSH	U013	44

Number	Part Name	Group	ID
AA120127	DISCHARGE BRUSH:FUSING	U004	121
AA120150	DISCHARGE BRUSH:REVERSE:17 MM	U004	122
		U013	45
AA132203	SPACER - 6MM	U004	123
		U004_S012	123
AA132300	ROLLER:LOCK:PULL OUT	U019	36
AA140686	SHAFT - TIMING PULLEY	U004	124
AA140912	SCREW - 8X14X2.8	U004	125
AA143444	STEPPED SCREW	U007_S001	33
		U013	46
AA143520	SHOULDER SCREW - M3	U012_S001	44
		U012_S002	44
AA143550	SCREW:DIA4:M3	U004	126
AA143562	SCREW:M4:DIA6X1.2	U005	42
AA143569	SCREW	U004	127
AA143571	SHAFT	U011	15
AA143594	STEPPED SCREW:M3X5	U019	37
AA143797	CONNECTOR GUIDE PIN	U001	15
		U004	128
		U016	32
AA143810	DEVELOPMENT COVER SCREW	U004	129
AA143811	STEPPED SCREW - M3X4	U014	34
AA143812	SCREW - SCALE	U004	130
AA143816	FLAT SCREW:CHUCK:BOTTLE	U005	43
AA143834	SCREW:M4	U012_S001	45
AA143847	STEPPED SCREW:DIA5:3.5:M3	U012_S001	46
AA148778	SHAFT:ARM:PLATE	U004	131
AA152299	BOTTLE HOLD SEAL	U005	44
AA161177	CUSHION:BASE:TANDEM LCT:LAR GE	U004_S012	132
AA161178	CUSHION:BASE:TANDEM LCT:SM ALL	U004_S012	133
AA161180	CUSHION:DC STEPPER MOTOR	U004	134
		U013	47
		U014	35
AB010219	GEAR:STOPPER:OIL SUPPLY ROL LER	U012_S002	47
AB011125	GEAR:20/29Z	U009_S001	23

Exclusive Parts

Number	Part Name	Group	ID
AB011126	GEAR:20Z	U009_S001	24
AB011392	DRIVE REVERSE GEAR - 24Z	U004_S006	135
		U004_S007	135
		U004_S008	135
AB011540	GEAR:AGITATOR:DRIVE	U010_S001	22
AB011591	GEAR:REVERSE	U004_S006	136
		U004_S007	136
		U004_S008	136
AB011626	GEAR:IDLER:EXIT:CONNECTING	U013	48
AB011627	GEAR:EXIT:25Z	U013	49
AB012005	GEAR - 13Z	U005	45
AB012007	GEAR - 14Z	U005	46
AB012008	GEAR - 23Z	U005	47
AB012327	GEAR:16Z	U004_S010	137
		U004_S011	137
AB013781	GEAR - 30Z	U004_S012	138
AB013798	GEAR - Z18	U004	139
AB014229	COUPLEDGEAR - 17Z/32Z	U012_S001_S007	48
AB014243	GEAR:IDLER:Z30	U004	140
AB014287	GEAR:IDLER:FUSING	U012_S001	49
AB017514	DOUBLE GEAR - 12/27Z	U005	48
AB017515	DOUBLE GEAR - 12/23Z	U005	49
AB017725	GEAR/TIMING PULLEY - 20Z/20T	U004	141
AB017726	GEAR/TIMING PULLEY - 20Z/20T	U004	142
AB017771	GEAR:TRANSPORT ROLLER:INPUT:Z23/Z28	U004_S006	143
		U004_S007	143
		U004_S008	143
AB017961	GEAR:EXIT:70Z/T24	U013	50
AB017962	GEAR:IDLER:EXIT	U013	51
AB019475	GEAR - 48T	U004	144
AB030842	TIMING PULLEY:S2M:30T	U004	145
		U014	36
AB030877	TIMING PULLEY:Z51	U010	23
AB030880	PULLEY:S2M:22T	U013	52
AB032058	WIRE PULLEY - M10	U004_S012	146
AB032072	PULLEY:DRIVEN:WIRE	U007_S001	34
AB032719	PULLEY - M10	U004_S012	147
AB033084	TIMING PULLEY - 15T	U004	148

Number	Part Name	Group	ID
AB033085	TIMING PULLEY - 15T	U004	149
AB033118	TORQUE LIMITER MECHANICAL CLUTCH:TONER RECYCLING SUB-UNIT	U010_S003	24
AB033119	TIMING PULLEY:Z25:Z14	U010_S004	25
AC020152	LENS:LED:3	U001_S002	16
		U001_S003	16
AC020153	LENS:LED:4	U001_S002	17
		U001_S003	17
		U001_S005	17
		U004	150
AE012048	HEAT ROLLER:DIA39.2	U012_S001	50
AE020220	PRESSURE ROLLER:DIA65	U012_S001_S001	51
AE030030	BALL BEARING - 8X19X6	U012_S001	52
AE030044	BALL BEARING - 10X22X6	U012_S001	53
AE030086	RADIAL BALL BEARING:DIA25XDIA37X7	U012_S001	54
		U012_S001_S001	54
AE031032	BUSHING - 6X9X6.5	U012_S002	55
AE031037	BUSHING - M4	U012_S001_S007	56
AE032034	THERMAL INSULATING BUSHING:DIA22	U012_S001	57
AE044075	STRIPPER PAWLS	U012_S001	58
AE045065	WEB:SUB-ASS'Y	U012_S002	59
AF010097	PAPER TRAY:UNIVERSAL:REMOVER/INSTALL	U004_S010	151
		U004_S011	151
AF013029	PAD:BASE	U004_S010_S001	152
		U004_S011_S001	152
AF017033	END FENCE	U004_S010	153
		U004_S011	153
AF020850	TRANSPORT ROLLER:DRIVE:PAPER FEED UNIT	U004_S006	154
		U004_S007	154
		U004_S008	154
AF020851	TRANSPORT ROLLER:DRIVEN:PAPER FEED UNIT	U004_S006	155
		U004_S007	155
		U004_S008	155
AF020852	TRANSPORT ROLLER:VERTICAL TRANSPORT:DRIVE:EXIT	U004	156
AF020853	TRANSPORT ROLLER:VERTICAL T	U004	157

Exclusive Parts

Number	Part Name	Group	ID
	RANSPORT:DRIVE		
AF020854	TRANSPORT ROLLER:VERTICAL T RANSPORT:DRIVE:CONNECTING	U004	158
AF022064	TRANSPORT ROLLER:DRIVEN	U011	16
AF022067	GUIDE STOPPER ROLLER	U014	37
AF022105	ROLLER - SLIDE RAIL	U004_S012	159
AF022165	TRANSPORT ROLLER - DRIVEN	U004 U004_S009	160 160
AF022167	TRANSPORT ROLLER - DRIVEN	U004	161
AF022182	TRANSPORT ROLLER:DRIVEN:DIA 17.5X2	U013 U014	53 38
AF030072	PAPER FEED ROLLER:PICKUP	U004_S006 U004_S007 U004_S008	162 162 162
AF031098	PAPER FEED ROLLER:FEED	U004_S006 U004_S007 U004_S008	163 163 163
AF032098	PAPER FEED ROLLER:SEPARATE	U004_S006 U004_S007 U004_S008	164 164 164
AG050100	KNOB - TRANSPORT ROLLER	U004 U013 U014	165 54 39
AG050101	KNOB - MISFEED REMOVAL	U004	166
AG051141	RELEASE LEVER	U004	167
AG070022	MAGNET CATCH:25.5N	U005	50
AG070504	MAGNET CATCH:44.1N	U016	33
AG070513	MAGNET CATCH	U004	168
AG071012	MAGNET CATCH:ASS'Y	U010	26
AH012042	CASTER:1470N:BB	U019	38
AW010113	SENSOR:(SEN55)	U004_S012	169
AW010143	PHOTO REFIECTION SENSOR:PS R11TL1R-C:(SEN23)	U014	40
AW010147	PHOTO REFLECTION SENSOR:(S EN4/SEN63/SEN64/SEN66)	U011 U012_S001	17 60
AW010150	PHOTO REFIECTION SENSOR:ORI GINAL TRAY:(S14/S15/S16/S19/SE N21)	U013	55

Number	Part Name	Group	ID
AW010151	PHOTO REFLECTION SENSOR:PS 122TL1-A:(S6/S7/S10/S11/S12/SEN 7/SEN8/SEN10/SEN32/SEN33/SEN 34/SEN108/SEN110/SEN112)	U004 U004_S006 U004_S007 U004_S008 U013 U014	170 170 170 170 56 41
AW010200	PAPER FEED SENSOR:FUSING EX IT:(SEN20)	U013	57
AW020163	PAPER FEED SENSOR:SEN56	U004	171
AW020218	POSITIONING SENSOR:FLAT BELT -TRANSFER:(SEN96)	U007_S001	35
AW100169	THERMISTOR:ASS'Y:(SEN94)	U018	23
AW100183	THERMOPILE:(SEN57/SEN58/SEN 85)	U012	61
AW110052	THERMOSTAT:211C:(TS1/TS2)	U012_S001	62
AW110122	THERMOSTAT:225C:250V/17A:(TS 3)	U012_S001	63
AW140026	TEMPERATURE & HUMIDITY SEN SOR	U010	27
AW140027	TEMPERATURE & HUMIDITY SEN SOR:(SEN2)	U006	33
AW500010	PUSH SWITCH:(SW1/SW4)	U004	172
AW500045	PUSH SWITCH:(SW2/SW3/SW13/S W14)	U004 U007_S001 U010	173 36 28
AX040199	DC MOTOR:RISING TRAY:ASS'Y:(M7/BM2/BM3)	U004	174
AX040276	STEPPER MOTOR:MM56:TRANSP ORT:(STM5/STM6/STM7/STM8/ST M9/STM10/STM12/STM13/STM15/S TM18/STM19/STM20/STM21/STM2 2/STM23)	U004 U013 U014	175 58 42
AX040279	STEPPER MOTOR:PAPER TRANS PORT MD:MM42:(STM11)	U004	176
AX040280	STEPPER MOTOR:DRIVE:(STM24/ STM25/STM26/STM27)	U004 U013	177 59
AX040297	STEPPER MOTOR:MM56:TRANSP ORT:(STM14/STM17)	U004	178

Exclusive Parts

Number	Part Name	Group	ID
AX040300	DC MOTOR:CLEANER:ASS'Y:(BM5)	U012_S001_S007	64
AX060517	DC STEPPER MOTOR:MM56XL76:(STM16)	U004	179
AX060521	DC STEPPER MOTOR:MM42:1.2A:3.60V:(STM3)	U007_S001	37
AX061102	DC BRUSHLESS MOTOR:25W:NMB:EXIT:(BLM7/BLM12)	U013	60
AX061204	DC MOTOR:11.5W:BRUSHLESS:(BLM4)	U015	22
AX400194	HEATER - 230V/9W:(HT12/HT13)	U007_S001	38
AX440348	(NA):HEATER:PRESSURE ROLLER:208V:800W:(HT5)	U012_S001_S001	160
AX640224	DC FAN MOTOR:AXIAL:MM80:(FAN6/FAN7/FAN13/FAN16/FAN18/FAN19)	U018	24
AX640247	DC FAN MOTOR:AXIAL:MM80:25MM:(FAN4/FAN5/FAN8/FAN14/FAN17/FAN20/FAN22/FAN23//FAN24//FAN25)	U017 U018	22 25
AX640330	FAN:SIROCCO:DIA51:(FAN26/FAN27)	U007 U018	39 26
AX650056	DC FAN MOTOR:AXIAL:MM92:(FAN30/FAN31/FAN33)	U018	27
AX660015	DC FAN MOTOR:SIROCCO:DC24V:PWM:(FAN9/FAN10/FAN11/FAN12)	U018	28
AZ210003	DC POWER SUPPLY:12V:25W:(PCB31)	U017	23
AZ240355	POWER SUPPLY UNIT:ECO:(PCB28)	U017	63
AZ240356	POWER SUPPLY UNIT:FW:(PCB29)	U017	64
AZ250066	POWER SUPPLY UNIT:864W:(PCB30)	U017	26
AZ310032	POWER PACK:D:(PCB21)	U009	25
AZ320193	POWER PACK:CGB:(PCB25)	U016	34
AZ320194	POWER PACK:T1/T2:(PCB42)	U007_S001	40
B0042995	CAP - POSITIONING	U004	180
B0654935	LEVER:GUIDE PLATE:ASS'Y	U014	43

Number	Part Name	Group	ID
B0656136	TRAY LOCK ARM	U004	181
B0656345	PAPER END SENSOR BRACKET	U004_S006 U004_S007 U004_S008	182 182 182
B0656524	BOTTOM PLATE LIFT SHAFT	U004_S010 U004_S011	183 183
B0656526	LIFT LEVER	U004_S010 U004_S011	184 184
B0656545	DECAL - POSITIONING	U004_S010 U004_S011	185 185
B0656589	LEFT SUPPORT PLATE	U004	186
B0656591	PAPER TRAY HOLDER BASE	U004	187
B0656717	PAPER VOLUME SHIELD PLATE	U004_S012	188
B0656769	LOCK ARM	U004	189
B0656823	TIMING BELT COVER	U004	190
B0656830	PULLEY BRACKET	U004	191
B0656831	SENSOR BRACKET	U004	192
B0656862	LARGE LEVER	U004_S012	193
B0656864	SMALL LEVER	U004_S012	194
B0656870	STAY -RIGHTBASE	U004_S012	195
B0656872	OIL DAMPER BRACKET	U004_S012	196
B0656875	PROTECTION -INNER COVER	U004_S012	197
B0706667	END FENCE COVER FRONT	U004_S012	198
B0706683	LEVER:RELEASE:FRONT	U004_S012	199
B0706684	LEVER:RELEASE:REAR	U004_S012	200
B0706849	GUIDE:POSITIONING	U017	27
B1202063	BUSHING - 4MM	U010	29
B1253659	CUSHION:SWIVEL:STOPPER	U013	61
B1321183	BRACKET:LOCK	U019	39
B1321221	HOLDER:SPRING:PULL OUT	U019	40
B1322264	BUSHING:TERMINAL	U008_S001 U013	8 62
B1323861	PTB UNIT GUIDE PLATE	U011	18
B1324167	GRIP:OIL APPLICATION UNIT:FIBER	U012_S001	66
B1324196	SPRING:PICK-OFF PAWL	U012_S001	67
B1324197	TORSION SPRING:LEVER	U012_S001	68
B1324265	ROLLER:PICK-OFF PAWL	U012_S001	69

Exclusive Parts

Number	Part Name	Group	ID
B1324268	HOLDER:ROLLER:PICK-OFF PAWL	U012_S001	70
B1326726	BRACKET:ARM:ASS'Y	U004	201
B1326738	BRACKET:LIFT MOTOR:TANDEM LCT	U004	202
B1326764	BRACKET:CONNECTOR:RIGHT	U004	203
B1326791	PLATE:SIDE FENCE	U004_S010_S003	204
		U004_S011_S003	204
B1326797	SIDE FENCE:REAR:AUXILIARY	U004_S010	205
		U004_S011	205
B1326798	SPRING PLATE:PAPER TRAY:EAR TH	U004_S010	206
		U004_S011	206
B1327541	TRAY BOTTOM PLATE:LEFT REAR	U004	207
B1327561	BACK FENCE:LEFT	U004	208
B1327564	SLIDER:BACK FENCE:LEFT	U004	209
B1327575	BRACKET:CONNECTOR:TANDEM LCT	U004_S012	210
B1327591	RAIL:PAPER TRAY:ASS'Y	U004	211
B1329700	LUBRICANT POWDER	SPECIAL TOOLS	5
B1816780	LINK:END FENCE:PAPER SIZE SENSOR:ASS'Y	U004_S010	212
		U004_S011	212
B1816789	LINK:SIDE FENCE:PAPER SIZE SENSOR	U004_S010	213
		U004_S011	213
B2341118	FLY WHEEL FLANGE	U015	23
B2342125	SPRING - GRID	U006_S001	34
B2342390	FLANGED HEXAGONAL HEAD BOLT:M4X8	U001	18
		U006	35
		U008	9
		U009	26
		U012	71
B2342624	BALL BEARING - 8X12X5	U004_S006	214
		U004_S007	214
		U004_S008	214
B2342864	PAD:CLEANER	U004_S010_S002	215
		U004_S010_S003	215
		U004_S011_S002	215
		U004_S011_S003	215
B2343356	JOINT:CHUCK:TONER BOTTLE	U005	51
B2344244	GEAR - 50Z	U012_S002	72

Number	Part Name	Group	ID
B2344258	CAP:HEAT PIPE	U013	63
B2344460	DISCHARGE BRUSH - L=341 SUS	U013	64
B2346120	BRACKET:POSITIONING:PAPER TRAY	U004	216
B2346125	HARNESS GUIDE BRACKET	U004	217
B2346141	POSITIONING SLEEVE - INNER BACK	U004	218
		U004_S012	218
B2346181	SLIDE RAIL - RIGHT	U004	219
B2346188	SLIDE SLEEVE POSITIONING	U004	220
B2346198	COVER - SAFETY - PAPER SIZE SENSOR	U004	221
B2346222	REVERSE DRIVE SHAFT	U004_S006	222
		U004_S007	222
		U004_S008	222
B2346223	DRIVEN REVERSE SHAFT	U004_S006	223
		U004_S007	223
		U004_S008	223
B2346242	GUIDE - ROLLER:DRIVEN PRESSURE	U004_S006	224
		U004_S007	224
		U004_S008	224
B2346275	PICKUP ARM	U004_S006	225
		U004_S007	225
		U004_S008	225
B2346288	SENSOR BRACKET - SENSOR	U004_S006	226
		U004_S007	226
		U004_S008	226
B2346301	TORQUE LIMITER:75MN M	U004_S006	227
		U004_S007	227
		U004_S008	227
B2346424	RELEASE GRIP	U004	228
		U013	65
B2346455	BRACKET - UPPER	U004	229
B2346475	BRACKET - LOWER	U004	230
B2346495	GUIDE:FRONT:PAPER TRAY	U004	231
B2346497	GUIDE:REAR:PAPER TRAY	U004	232
B2346498	SHEET:TRAY BOTTOM PLATE	U004_S010	233
		U004_S011	233
B2346506	TIMING PULLEY - 30T	U004	234

Exclusive Parts

Number	Part Name	Group	ID
B2346508	TENSION SPRING	U004	235
B2346514	TIMING BELT - S2M126	U004	236
B2346530	BRACKET	U004	237
B2346531	TIGHTENER BRACKET	U004	238
B2346532	TIGHTENER BRACKET	U004	239
B2346533	TIMING BELT - S2M152	U004	240
B2346542	GRIP DRIVE SHAFT	U004	241
B2346565	HARNESS CLAMP BRACKET	U004	242
B2346606	SENSOR BRACKET	U004_S012	243
B2346612	END FENCE - FRONT	U004_S012	244
B2346625	END FENCE - REAR	U004_S012	245
B2346686	SIDE FENCE - RIGHT FRONT	U004_S012	247
B2346691	SIDE FENCE:TANDEM LCT:RIGHT: ASS'Y	U004_S012_S001	248
B2347540	TRAY BOTTOM PLATE:LEFT FRONT	U004	249
B2382675	REGISTRATION ROLLER BUSHING	U004	250
B2476672	GUIDE:INTERLOCK:TANDEM LCT	U004_S012	251
B2476695	GUIDE:MISFEED REMOVAL:PAPER TRAY	U004_S010 U004_S011 U004_S012	252 252 252
B2476753	LOCK SPRING - LARGE	U004	253
B2476754	LOCK SPRING - SMALL	U004	254
B2476901	OIL DAMPER:FALL	U004_S012	255
B2476950	SHAFT:SLIDER:BACK FENCE	U004	256
B2476951	BRACKET:PULLEY:DRIVEN:ASS'Y	U004	257
B2591106	FAN MOTOR:MM80:DC24V 3.6W:(FAN36)	U017	28
B3033682	MISFEED REMOVAL KNOB	U004	258
B5457506	SCREW:BUSHING	U008_S001	10
B5457507	SCREW:PUNCH	U019	41
B6455010	SD-CARD:ASS'Y	SPECIAL TOOLS	6
B7001802	TIMING BELT:B40S2M134	U008_S001	11
B7005804	STEPPER MOTOR:DIA42:Z17:ASS'Y:(STM1)	U006	36
B7125605	GRIP:APPLICATION	U007	41
B8301135	SCREW	U004	259

Number	Part Name	Group	ID
B8304263	TIMING BELT - 60S2M140	U013	66
B8341648	TIMING BELT - B60S2M120	U004	260
B8343312	COLLAR	U004	261
BB013007	GEAR - 20Z	U004_S006 U004_S007 U004_S008	262 262 262
BB013008	GEAR - 31Z	U004_S006 U004_S007 U004_S008	263 263 263
BB013025	GEAR:PRESSURE ROLLER	U012_S001_S001	73
BB013028	GEAR:IDLER:35Z:ASS'Y	U012_S001	74
BB013036	GEAR:IDLER:25Z:ASS'Y	U012_S001	75
BB013037	GEAR:JOINT:PRESSURE:ASS'Y	U012_S001	76
BB013040	GEAR:SHIFT:ROLLER:Z30	U004	264
BB013047	GEAR:HOT ROLLER:ASS'Y	U012_S001	77
C1012360	SNAP RING	U001	19
C2182185	STEPPER SCREW	U016	35
C2383879	TIMING BELT	U007_S001	42
C2443522	STEPPED SCREW	U004_S006 U004_S007 U004_S008	265 265 265
C2693566	BUSHING:MM8:PRESSURE:DRIVE	U004	266
C4019503	20X MAGNIFICATION SCOPE	SPECIAL TOOLS	7
D0144247	HOUSING - TEMPERATURE SENSOR	U012_S001	78
D0146272	BUSHING:BRUSH:REAR	U009_S001	27
D0146626	BRACKET:ON OFF DETECTOR:FRONT	U004_S012	267
D0146627	BRACKET:ON OFF DETECTOR:REAR	U004_S012	268
D0146784	SPRING PLATE:END FENCE	U004_S010 U004_S011	269 269
D0146785	SPRING PLATE:ARM:END FENCE:LOCK	U004_S010 U004_S011	270 270
D0159500	G104 YELLOW TONER	SPECIAL TOOLS	8
D0159501	ZINC STEARATE	SPECIAL TOOLS	9
D0396327	SPACER:SENSOR:TM	U007_S001	43
D0464655	TIMING BELT:S2M180	U013	67

Exclusive Parts

Number	Part Name	Group	ID
D0592399	FLANGED HEXAGONAL HEAD BOLT:M3*4	U004	271
D0592469	SCREW:ROUND POINT:M4X6	U006	37
D0592620	RETAINING RINGS-C	U004_S006	272
		U004_S007	272
		U004_S008	272
		U014	44
D0596121	SPRING:CONNECTOR:TANDEM LCT	U004	273
D0596169	STAY:TANDEM LCT:ASS'Y	U004	274
D0596170	BRACKET:SLIDE RAIL:PAPER TRAY:2:ASS'Y	U004	275
D0596172	PAPER TRAY STOPPER	U004	276
D0596212	LEVER:PRESSURE:REVERSE	U004_S006	277
		U004_S007	277
		U004_S008	277
D0596277	COVER:GEAR:PAPER FEED ROLLER	U004_S006	278
		U004_S007	278
		U004_S008	278
D0596278	COVER:GEAR:REVERSE	U004_S006	279
		U004_S007	279
		U004_S008	279
D0596496	GUIDE:MIDDLE:PAPER TRAY	U004	280
D0596591	SPRING:PAPER TRAY:LOCK	U004	281
D0596620	LEVER:COUPLING:LEFT	U004	282
D0596646	INNER COVER:TANDEM LCT:LEFT	U004	283
D0596659	SUPPORTING PLATE:SIDE FENCE:LEFT	U004	284
D0596664	GUIDE:MIDDLE:PAPER TRAY	U004	285
D0596665	BRACKET:DC MOTOR:LEFT:ASS'Y	U004	286
D0596668	SIDE PLATE:SIDE:TANDEM LCT	U004_S012	287
D0596712	INNER COVER:TANDEM LCT	U004_S012	288
D0596721	STOPPER:PAPER TRAY	U004	289
D0596725	BRACKET:STOPPER:PAPER TRAY:RIGHT:PEEN	U004	290
D0596731	SHIELD:GUIDE:MISFEED REMOVAL	U004	291
D0626692	SLIDE RAIL:PAPER TRAY:LEFT:SU	U004	292

Number	Part Name	Group	ID
	B-ASS'Y		
D0741180	LEVER:PULL OUT:PAPER EXIT UNIT	U019	42
D0741225	HINGE:C/T BOX:RIGHT UPPER:PEEN	U019	43
D0741228	COVER:HINGE	U019	44
D0741250	ARM:HINGE:C/T BOX	U017	29
D0741255	SEPARATION PLATE:DUCT	U017	30
D0741329	DC MOTOR:DIA49:24V:6.3W:(BLM2)	U015	24
D0742459	JOINT:CLEANING UNIT	U006_S002_S001	38
D0742541	DECAL:ARROW LABEL	U006_S003	39
D0742542	DECAL:GRIP	U006_S002_S001	40
D0742577	CONNECTOR:DRAWER:4POLE:REVERSE	U006	41
D0742632	BRACKET:DC STEPPER MOTOR:M56:CAM	U013	68
		U014	45
D0742652	LEVER:LINK:TRANSPORT ROLLER	U004	293
D0742681	SHAFT:CAM:SHIFT	U004	294
D0742685	SYNCHRONOUS BELT:B80S2M190	U004	295
D0742739	PRESSURE ROLLER:TRANSPORT ROLLER:SHIFT:DRIVEN	U004	296
D0742744	HOLDER:SHIFT:BEARING:FRONT	U004	297
D0742799	GUIDE PLATE:CONNECTION:LCT:LOWER	U004	298
D0742938	GUIDE PLATE:CONNECTION:LARGE CAPACITY TRAY:UPPER:PEEN	U004	299
D0742942	PIN:GUIDE PLATE:CONNECTION:LARGE CAPACITY TRAY:UPPER	U004	300
D0742970	CAM:GUIDE PLATE:OPEN AND CLOSE	U004	301
D0743047	BRACKET:HOLDER:DUPLEX:ASS'Y	U014	46
D0743173	TIMING PULLEY:S2M:25T	U004	302
		U013	69
		U014	47
D0743824	PLATE:ROLLER:INTERMEDIATE TRANSFER	U007_S001	44
D0743829	DECAL:POSITIONING DISPLAY:TC	U001	20

Exclusive Parts

Number	Part Name	Group	ID
	RU	U006	42
		U006_S003	42
		U012_S001	79
D0743871	STOPPER:WIRE:PULLEY	U007_S001	45
D0743872	PULLEY:DRIVE WIRE:ASS'Y	U007_S001	46
D0743878	HOLDER:RADIAL BALL BEARING:DRIVEN ROLLER:INNER BACK	U007_S001	47
D0743896	COVER:POSITIONING SENSOR:FLAT BELT-TRANSFER	U007_S001	48
D0744063	HOUSING:THERMOSTAT:ASS'Y	U012_S001	80
D0744064	COVER:THERMOSTAT:PRESSURE	U012_S001	81
D0744070	SUPPORTING PLATE:LEVER:PRESSURE	U012_S001	82
D0744072	STEPPED SCREW:M5	U012_S001	83
D0744102	COLLAR:DIA10X:DIA14X:12	U012_S001	84
D0744103	CAM:PRESSURE:A	U012_S001	85
D0744104	FEELER:CAM:PRESSURE:FRONT	U012_S001	86
D0744105	FEELER:CAM:PRESSURE:REAR	U012_S001	87
D0744107	COLLAR:DIA10XDIA14X9.4	U012_S001	88
D0744180	HOUSING:THERMOSTAT:HEAT ROLLER:ASS'Y	U012_S001	89
D0744181	ELECTRODE PLATE:THERMOSTAT:HEAT ROLLER:MIDDLE	U012_S001	90
D0744182	ELECTRODE PLATE:THERMOSTAT:HEAT ROLLER	U012_S001	91
D0744225	KNOB:FUSING	U020	12
D0744227	BOLT:M5:ROUND POINT	U012_S001	92
D0744302	PLAIN SHAFT BEARING:ROLLER:REAR	U012_S002	93
D0744351	STEPPED SCREW:DIA5.4DIA:DIA3.5:M3	U007	49
		U012	94
D0744391	HOLDER:KNOB:FUSING:DUAL FACES TEPE	U020	13
D0744698	LEVER:LOCK:GUIDE PLATE	U013	70
D0745100	SD-CARD:NICE:REGI:ASS'Y	SPECIAL TOOLS	10
D0746092	BRACKET:HEATER:INTERMEDIATE TRANSFER	U007_S001	50
D0746097	THERMOSTAT:INTERMEDIATE TR	U007_S001	51

Number	Part Name	Group	ID
	ANSFER:(TS4)		
D0746134	PLAIN SHAFT BEARING:INSULATE	U007_S001	52
D0746144	BRACKET:INTERMEDIATE TRANSFER:FRONT	U007_S001	53
D0746145	BRACKET:INTERMEDIATE TRANSFER:REAR	U007_S001	54
D0746146	BRACKET:BIAS:INTERMEDIATE TRANSFER	U007_S001	55
D0746147	TERMINAL:INTERMEDIATE TRANSFER	U007_S001	56
D0746161	COVER:BIAS:INTERMEDIATE TRANSFER	U007_S001	57
D0746165	PULLEY:ON-OFF:BELT TENSIONER	U004	303
D0746180	COMPRESSION SPRING:BIAS:INTERMEDIATE TRANSFER	U007_S001	58
D0746197	TERMINAL:CONNECTING:BIAS:INTERMEDIATE TRANSFER	U007_S001	59
D0746216	SHUTTER:TONER OUTLET SUB-UNIT:SUB-ASS'Y	U009_S001	28
D0746219	COIL SPRING:SHUTTER:DISCHARGE USED TONER	U009_S001	29
D0746228	ELECTRODE PLATE:FRAME	U009_S001	30
D0746235	CASE:TONER RECYCLING SUB-UNIT:SUB-ASS'Y	U009_S001	31
D0746238	JOINT:TRANSFER:DRIVE	U009	32
D0746241	DECAL:GRIP:TRANSFER/SEPARATION UNIT	U009_S001	33
D0746257	BRUSH ROLLER:APPLY:ASS'Y	U009_S001	34
D0746265	BLADE:TRANSFER ROLLER:ASS'Y	U009_S001	35
D0746270	HOLDER:BLADE:ASS'Y	U009_S001	36
D0746273	SEAL:HOLDER	U009_S001	37
D0746274	SEAL:HOLDER:UPPER	U009_S001	38
D0746276	PIN:POSITIONING PLATE:BLADE:TRANSFER ROLLER:ASS'Y	U009_S001	39
D0746279	COIL SPRING:BLADE:TRANSFER ROLLER	U009_S001	40
D0746312	GEAR:IDLER:TRANSFER ROLLER	U009_S001	41

Exclusive Parts

Number	Part Name	Group	ID
D0746313	GEAR:IDLER:COLLECTION COIL	U009_S001	42
D0746314	GEAR:COLLECTION COIL	U009_S001	43
D0746315	GEAR:BRUSH:APPLY	U009_S001	44
D0746410	GROUND PLATE:BELT CLEANING	U008_S001	12
D0746411	COIL SPRING:EARTH:BELT CLEANING	U008_S001	13
D0746413	SCRAPER:BRUSH:REMOVE PAPER DUST:ASS'Y	U008_S001	14
D0746424	BLADE:CLEANING:BELT CLEANING:ASS'Y	U008_S001	15
D0746428	HOLDER:CLEANING:BELT CLEANING:ASS'Y	U008_S001	16
D0746431	COIL SPRING:BLADE:CLEANING:BELT CLEANING	U008_S001	17
D0746434	TONER COLLECTION COIL:BELT CLEANING:ASS'Y	U008_S001	18
D0746439	PLAIN SHAFT BEARING:REMOVE PAPER DUST:TRANSPORT SCREW	U008_S001	19
D0746440	GUIDE:DISCHARGE USED TONER:BELT CLEANING	U008_S001	20
D0746441	SHUTTER:TRANSPORT SCREW:BELT CLEANING	U008_S001	21
D0746442	COIL SPRING:DISCHARGE USED TONER	U008_S001	22
D0746443	SEAL:DISCHARGE USED TONER	U008_S001	23
D0746446	BRUSH:APPLY:BELT CLEANING	U008_S001	24
D0746450	COATING BAR:ASS'Y	U008_S001_S001	25
D0746454	ARM:COATING BAR:BELT CLEANING	U008_S001_S001	26
D0746455	COIL SPRING:COATING BAR	U008_S001_S001	27
D0746457	BLADE:APPLY:ASS'Y	U008_S001	28
D0746461	HOLDER:APPLY:BELT CLEANING:ASS'Y	U008_S001	29
D0746464	COIL SPRING:BLADE:APPLY:BELT CLEANING	U008_S001	30
D0746467	COIL SPRING:STOPPER:CASE:BELT CLEANING	U008_S001	31

Number	Part Name	Group	ID
D0746468	STOPPER:CASE:BELT CLEANING	U008_S001	32
D0746469	SLIDE RAIL:UPPER:BELT CLEANING	U008_S001	33
D0746470	RELEASE PLATE:BLADE:CLEANING	U008_S001	34
D0746471	RELEASE PLATE:BLADE:APPLY	U008_S001	35
D0746477	GEAR:BRUSH:REMOVE PAPER DUST:Z17	U008_S001	36
D0746478	GEAR:PULLEY:IDLER:BELT CLEANING	U008_S001	37
D0746479	GEAR:COLLECT:COIL:Z19	U008_S001	38
D0746480	PULLEY:BRUSH:APPLY:Z30	U008_S001	39
D0746481	JOINT:BRUSH:REMOVE PAPER DUST:BELT CLEANING	U008_S001	40
D0746485	SEAL:CASE:BRUSH:FRONT	U008_S001	41
D0746486	SEAL:CASE:BRUSH:REAR	U008_S001	42
D0746488	SEAL:HOLDER:BEHIND:BELT CLEANING	U008_S001	43
D0746489	VIBRATING PLATE:TRANSPORT SCREW:BELT CLEANING	U008_S001	44
D0746490	SEAL:BASE:CASE:BELT CLEANING	U008_S001	45
D0746491	SEAL:CASE:CLEANING BLADE:FRONT	U008_S001	46
D0746492	SEAL:CASE:CLEANING BLADE:REAR	U008_S001	47
D0746495	LEVER:RELEASE:BLADE	U008_S001	48
D0746496	GRIP:BELT CLEANING	U008_S001	49
D0746497	DECAL:POSITIONING DISPLAY:TCRU	U004	304
		U004_S012	304
		U008_S001	50
		U012	95
		U012_S002_S001	95
D0746540	SEAL:BELT CLEANING:MAIN	U010_S004	30
D0746574	COVER:CAM:VERTICAL TRANSPORT	U010	31
D0746575	SHAFT:CAM:VERTICAL TRANSPORT	U010	32

Exclusive Parts

Number	Part Name	Group	ID
D0746579	SEAL:COVER:CAM:VERTICAL TRANSPORT	U010	33
D0746640	PLAIN SHAFT BEARING:TRANSPORT SCREW:SMALL	U010_S001	34
D0746641	PLAIN SHAFT BEARING:SMALL:GEAR	U010_S001	35
D0746643	GEAR:TRANSPORT SCREW:COLLECTION BOTTLE:SMALL:Z31	U010_S001	36
D0746659	SHAFT:JOINT:COLLECTION BOTTLE:ASS'Y	U010	37
D0746663	TORQUE LIMITER MECHANICAL CLUTCH:GEAR:Z63	U010	38
D0746664	GEAR:IDLER:Z49/Z27	U010	39
D0746665	GEAR:JOINT:COLLECTION BOTTLE:Z65	U010	40
D0746666	GEAR:IDLER:Z37/Z28	U010	41
D0746667	HOLDER:RADIAL BALL BEARING:JOINT	U010	42
D0746697	DECAL:COLLECTION BOTTLE:GRIP:FRONT	U010_S002	43
D0746974	CAP:LOUVER:MM90	U017	31
D0746975	FILTER:POWER SUPPLY UNIT:MM90	U017	32
D0747087	SEAL:DC FAN MOTOR:SIROCCO	U007	60
D0747118	DUCT:INNER BACK:COOLING:POSITIONING SENSOR	U007	61
D0747119	DUCT:FRONT:COOLING:POSITIONING SENSOR	U007	62
D0747120	BRACKET:DUCT:COOLING:POSITIONING SENSOR	U007	63
D0747330	SLIDE RAIL:LEFT:NO.1	U004	305
D0747331	STAY:SLIDE RAIL:LEFT INNER REAR:NO.1:PEEN	U004	306
D0747333	STAY:SLIDE RAIL:LEFT FRONT:NO.1	U004	307
D0747335	STAY:SLIDE RAIL:LEFT:NO.2	U004	308
D0747349	COMPRESSION SPRING:BRACKET:SENSOR:PAPER SIZE SENSOR	U004	309

Number	Part Name	Group	ID
D0747381	DECAL:VERTICAL TRANSPORT:A1	U004	310
D0747385	DECAL:CAUTION CHART:TANDEM LCT	U004_S012	311
D0747387	(CHN[Pro 8310/8320]/NA/EU/AA/TWN/KOR):DECAL:BASE:TANDEM LCT:LEFT	U004_S013	312
D0747388	DECAL:PAPER SET DIRECTION:TANDEM LCT:RIGHT	U004_S012	313
D0747390	DECAL:PAPER SET DIRECTION:PAPER TRAY	U004_S010 U004_S011	315 315
D0747391	DECAL:PAPER SET DIRECTION	U020	14
D0747392	DECAL:PAPER TRAY:NO.1	U004	316
D0747393	DECAL:PAPER TRAY:NO.2	U004	317
D0747431	STAY:HANDLE:ASS'Y	U004	318
D0747433	STUD:HANDLE:RELEASE:ASS'Y	U004	319
D0747446	BRACKET:DC STEPPER MOTOR:TRANSPORT UNIT	U004	320
D0747521	GUIDE PLATE:UPPER:PAPER FEED UNIT	U004_S006 U004_S007 U004_S008	321 321 321
D0747522	GUIDE PLATE:LOWER:PAPER FEED UNIT	U004_S006 U004_S007 U004_S008	322 322 322
D0747527	SHAFT:FEED:ASS'Y	U004_S006 U004_S007 U004_S008	323 323 323
D0747561	GRIP:UPPER	U004	324
D0747562	GRIP:LOWER	U004	325
D0747563	BRACKET:SLIDER:GRIP	U004	326
D0747567	BRACKET:ARM:LINK:LEFT	U004	327
D0747573	BRACKET:ARM:PLATE	U004	328
D0747596	(CHN[Pro 8310/8320]/NA/EU/AA/TWN/KOR):TRAY BOTTOM PLATE:LEFT MIDDLE:ASS'Y	U004_S013	329
D0747603	PLATE:GRIP:PAPER TRAY:NO.2	U004	330
D0747606	GRIP:PAPER TRAY:NO.2	U004	331
D0747607	ARM:PAPER TRAY:GRIP	U004	332
D0747752	CAP:COVER:TONER SUPPLY	U017	33

Exclusive Parts

Number	Part Name	Group	ID
D0747775	(CHN[Pro 8300S/8310S/8320S]/NA): PLATE:LOGO:RICOH	U020	41
D0747782	GRIP:DOOR:FRONT	U001	21
D0747828	CAP:CONNECTOR	U001	22
D0747829	CAP:JOINT:LARGE CAPACITY TRAY	U001	23
D0747830	COVER:LARGE CAPACITY TRAY	U001	24
D0747831	COVER:CONNECTOR:LARGE CAPACITY TRAY	U001	25
D0747854	HINGE:LEFT LOWER:ASS'Y	U001	26
D0747861	HINGE:RIGHT LOWER:ASS'Y	U001	27
D0895887	PANEL:INTERFACE	U017	34
D0931266	DECAL:WARNING (HIGH TEMPERATURE):LENGTHWISE	U004	333
		U013	71
D0A53995	JOINT:KNOB:FUSING	U012_S001_S002	96
D0A56731	COVER:DISPLSY:REAR LOWER	U002	8
D0A56840	SPRING PLATE:OPU-DISPLAY	U002	9
D0BX1069	COVER:MOTOR:USED TONER	U019	45
D0BX1165	SUPPORTING PLATE:RAIL:INTERMEDIATE TRANSFER	U019	46
D0BX1181	DECAL:PICK-UP PAPER JAM:OPERATION PANEL:ENGLISH	U001	28
D0BX1219	SHAFT:LOCK:PULL OUT:LEFT	U019	47
D0BX1220	TORSION SPRING:KNOB:LEFT	U019	48
D0BX1232	SHAFT:LOCK:PULL OUT:RIGHT:ASS'Y	U019	49
D0BX1233	TORSION SPRING:KNOB:RIGHT	U019	50
D0BX1405	STEPPED TAPPING SCREW:TYPE 2:DIA5:M4	U001	29
D0BX1407	GUIDE:LEVER:PULL OUT	U001	30
D0BX1465	BRACKET:KEY COUNTER	U019	95
D0BX1470	BRACKET:COVER:FRONT UPPER	U001	31
D0BX1482	PLATE:MAGNET CATCH	U001	32
D0BX1484	SUPPORTING PLATE:DOOR:FRONT LEFT:ASS'Y	U001_S001	33
D0BX1489	SUPPORTING PLATE:DOOR:FRONT LEFT	U001_S001	34
D0BX1508	COVER:MAIN:LEFT	U001	35

Number	Part Name	Group	ID
D0BX1516	COVER:MAIN:REAR:PEEN	U001	36
D0BX1518	COVER:EXHAUST:PAPER EXIT SUB-UNIT	U020	15
D0BX1528	SHEET:HEATER:LOWER	U001	37
D0BX1535	COVER:REAR LOWER:PEEN	U001	38
D0BX1547	INNER COVER:PULL OUT:RIGHT:ASS'Y	U001_S002	39
D0BX1549	INNER COVER:PULL OUT:LEFT:ASS'Y	U001_S003	40
D0BX1550	INNER COVER:INTERMEDIATE TRANSFER:ASS'Y	U001_S004	41
D0BX1554	HEXAGON HEAD SCREW:M4:DIA3	U001	42
D0BX1555	INNER COVER:REVERSE SUB-UNIT:UPPER:ASS'Y	U001_S005	43
D0BX1569	HINGE:COVER:REAR LOWER	U001	44
D0BX1579	INNER COVER:REVERSE SUB-UNIT:LOWER	U001	45
D0BX1580	HINGE:STAND:OPERATION SUB-UNIT:ASS'Y	U020_S001	16
		U020_S003	16
D0BX1586	HOLDER:FIX:OPERATION SUB-UNIT	U002	10
D0BX1588	COVER:HINGE:MIDDLE	U020	17
D0BX1589	COVER:HINGE:LOWER	U002	11
D0BX1590	COVER:HINGE:FRONT	U020	18
D0BX1593	OZONE FILTER:EXHAUST:PAPER EXIT SUB-UNIT	U020	19
D0BX1594	HOLDER:HINGE:OPERATION SUB-UNIT:LOWER	U002	12
D0BX1598	STOPPER:FILTER:LOWER	U001	46
D0BX1599	SHEET:DUCT:REAR	U001	47
D0BX1901	OPTICAL WRITING UNIT:ASS'Y	U003	2
D0BX2432	SERVICE PARTS:DEVELOPMENT UNIT:ASS'Y	U006_S003	43
D0BX2485	LED ARRAY:ASS'Y:(OT1)	U006_S003	44
D0BX2575	SHEET:CONTACT IMAGE SENSOR:DUCT:1	U004	334
D0BX2576	SHEET:CONTACT IMAGE SENSOR:DUCT:2	U004	335

Exclusive Parts

Number	Part Name	Group	ID
D0BX2679	HOLDER:DC STEPPER MOTOR:SHIFT	U004	336
D0BX2702	TIMING ROLLER:REGISTRATION:DRIVE:PRESS FIT	U004	337
D0BX2703	TRANSPORT ROLLER:CONNECTING:LARGE CAPACITY TRAY:PRESS FIT	U004	338
D0BX2704	TRANSPORT ROLLER:CONNECTING:MAIN:PRESS FIT	U004	339
D0BX2705	TRANSPORT ROLLER:SHIFT:TRAILING EDGE:PRESS FIT	U004	340
D0BX2766	TIMING ROLLER:TRANSFER:DRIVE:PRESS FIT	U004	341
D0BX2851	GUIDE PLATE:CONNECTING:OPEN AND CLOSE:PEEN	U004	342
D0BX2856	GUIDE PLATE:CONNECTING:LARGE CAPACITY TRAY:PEEN	U004	343
D0BX2900	GUIDE PLATE:CONNECTING:DUPLICATE:EXIT:PEEN	U004	344
D0BX2902	GUIDE PLATE:CONNECTING:UPPER:PEEN	U004	345
D0BX2906	GUIDE PLATE:CONNECTING:LOWER:PEEN	U004	346
D0BX2990	CONTACT IMAGE SENSOR:CING:(PCB24)	U004	347
D0BX3342	BRACKET:CHUCK:TONER BANK:PEEN	U005	52
D0BX3346	DC MOTOR:DRIVE:TONER BOTTLE:ASS'Y:(BM6/BM7/BM8/BM9)	U005	53
D0BX3451	LEVER:TONER BOTTLE:PEEN	U005	54
D0BX3815	CAM:SEPARATION/TRANSPORT	U011	19
D0BX3819	LEVER:SEPARATION/TRANSPORT	U011	20
D0BX3820	TENSION SPRING:SEPARATION/TRANSPORT:5N	U011	21
D0BX3823	SHAFT:SEPARATION/TRANSPORT:ASS'Y	U011	22
D0BX3824	DECAL:SEPARATION/TRANSPORT:LEVER	U011	23

Number	Part Name	Group	ID
D0BX3830	DC STEPPER MOTOR:MM42:ASS'Y	U011	24
D0BX3862	SUPPORTING PLATE:VACUUM	U011	29
D0BX4017	(NA):FUSING UNIT:208V:ASS'Y	U012_S001	161
D0BX4045	LEVER:CONTROL PLATE:PRESSURE	U012_S001	98
D0BX4047	HOLDER:HEATER:PRESSURE:REAR	U012_S001_S001	99
D0BX4048	HOLDER:HEATER:PRESSURE:FRONT	U012_S001_S001	100
D0BX4162	HOT ROLLER:DIA54:ASS'Y	U012_S001_S002	101
D0BX4239	STRIPPER PLATE:ASS'Y	U012_S001_S005	102
D0BX4251	STRIPPER PLATE:ADHESION	U012_S001_S005	104
D0BX4260	COVER:FUSING UNIT:FRONT:UPPER:ASS'Y	U012_S001	105
D0BX4262	COVER:FUSING UNIT:FRONT:MIDDLE	U012_S001	106
D0BX4263	COVER:FUSING UNIT:FRONT:LOWER	U012_S001	107
D0BX4264	COVER:FUSING UNIT:REAR:UPPER:ASS'Y	U012_S001	108
D0BX4266	COVER:FUSING UNIT:REAR:MIDDLE	U012_S001	109
D0BX4267	COVER:FUSING UNIT:REAR:LOWER	U012_S001	110
D0BX4275	COVER:FUSING UNIT:UPPER:ASS'Y	U012_S001_S006	111
D0BX4288	DECAL:H-TEMP WARNING:FUSING UNIT/PAPER EXIT UNIT:FUSING UNIT	U012_S001	112
D0BX4311	WEB:CLEANING UNIT:ASS'Y	U012_S002	113
D0BX4313	COVER:WEB:CLEANING FELT	U012_S002_S001	114
D0BX4385	TAPE:HOLDER:FUSING UNIT:HEATER:ASS'Y	U020	20
D0BX4401	(NA):PRESSURE ROLLER:208V:ASS'Y	U012_S001_S001	162
D0BX4731	GUIDE PLATE:EXIT:UPPER:SUB-A:ASS'Y	U013	72
D0BX4740	GUIDE PLATE:EXIT:UPPER:ENTRANCE	U013	73

Exclusive Parts

Number	Part Name	Group	ID
	NCE		
D0BX4742	TRANSPORT ROLLER:DRIVEN:DIA 17.5	U013	74
D0BX4743	COMPRESSION SPRING:EXIT:2.5N	U013	75
D0BX4782	GUIDE PLATE:EXIT:ENTRANCE	U013	76
D0BX4783	GUIDE PLATE:REVERSE:LOWER:ASS'Y	U013_S001	77
D0BX4786	CUSHION:GUIDE PLATE:REVERSE:LOWER	U013_S001	78
D0BX4789	GUIDE PLATE:REVERSE EXIT:LOWER:PEEN	U013	79
D0BX4792	GUIDE PLATE:REVERSE EXIT:UPPER	U013	80
D0BX4801	GATE PAWL:REVERSE EXIT:MIDDLE	U013	81
D0BX4802	GATE PAWL:REVERSE EXIT	U013	82
D0BX4840	TRANSPORT ROLLER:EXIT:ENTRANCE:PRESS FIT	U013	83
D0BX4841	TRANSPORT ROLLER:EXIT:EXIT:PRESS FIT	U013	84
D0BX4842	TRANSPORT ROLLER:REVERSE:PRESS FIT	U013	85
D0BX4843	TRANSPORT ROLLER:REVERSE:ENTRANCE:PRESS FIT	U013	86
D0BX4888	DISCHARGE BRUSH:EXIT:OUTER	U013	87
D0BX4889	DISCHARGE BRUSH:EXIT:INNER	U013	88
D0BX5059	HDD:ASS'Y	U017	35
D0BX5405	PCB:IOB:(PCB26)	U016	36
D0BX5412	PCB:TDRB:(PCB41)	U007_S001	64
D0BX5422	PCB:DRB:(PCB20)	U004	348
D0BX5427	PCB:RYB:(PCB32)	U016	37
D0BX5430	PCB:CRB:(PCB22)	U004	349
D0BX5445	AC CONTROL BOARD:200V:3800W:(PCB1)	U016	38
D0BX5726	(NA):OPERATION SUB-UNIT:KEY_BOX:ASS'Y	U002	16
D0BX5927	PCB:SDCU:ASS'Y	U017_S002	36
D0BX5960	COVER:POWER SUPPLY UNIT:C/T	U017	37

Number	Part Name	Group	ID
	BOX		
D0BX6000	TRANSFER UNIT:INTERMEDIATE TRANSFER:ASS'Y	U007_S001	65
D0BX6010	SIDE PLATE:INTERMEDIATE TRANSFER:ASS'Y	U007_S001	66
D0BX6051	ROLLER:INTERMEDIATE TRANSFER:ASS'Y	U007_S001	67
D0BX6078	ROLLER:OPPOSED:PAPER:ASS'Y	U007_S001	68
D0BX6087	DECAL:TRANSFER:WARNING (REMOVAL AND INSTALLATION)	U007_S001	69
D0BX6154	CASE:OPPOSED:TRANSFER ROLLER:FRONT	U007_S001	70
D0BX6155	CASE:OPPOSED:TRANSFER ROLLER:REAR	U007_S001	71
D0BX6158	COVER:CASE:TRANSFER ROLLER:OPPOSED:FRONT	U007_S001	72
D0BX6163	SPRING PLATE:TRANSFER:OPPOSED:PAPER	U007_S001	73
D0BX6185	BRACKET:MOTOR:POSITIONING CONTROL:DRIVEN ROLLER	U007_S001	74
D0BX6189	DC STEPPER MOTOR:MM42:1.3A:4.42V:PULLEY:(STM2)	U007_S001	75
D0BX6210	TRANSFER UNIT:ASS'Y	U009_S001	45
D0BX6220	SIDE PLATE:TRANSFER/SEPARATION UNIT:FRONT:ASS'Y	U009_S001	46
D0BX6250	TRANSFER ROLLER	U009_S001	47
D0BX6255	BRUSH ROLLER:TRANSFER ROLLER:ASS'Y	U009_S001	48
D0BX6282	SWING UNIT:PICKUP ROLLER:ASS'Y:(SOL1/SOL2/SOL3)	U004_S006 U004_S007 U004_S008	350 350 350
D0BX6400	BELT CLEANING:ASS'Y	U008_S001	51
D0BX6420	BRUSH:REMOVE PAPER DUST:BELT CLEANING	U008_S001	52
D0BX6487	DC MOTOR:COLLECTION BOTTLE:DIA49:9.8W:(BLM3)	U010	44
D0BX6628	PAPER FEED UNIT:PAPER BANK:ASS'Y	U004_S006 U004_S007	351 351

Exclusive Parts

Number	Part Name	Group	ID
		U004_S008	351
D0BX6648	COIL SPRING:TANDEM TRAY:LOK	U004	352
D0BX6677	ROLLER:SLIDE RAIL:FRONT	U004_S012	353
D0BX6685	(NA):TANDEM LCT:RIGHT:ASS'Y	U004_S012	527
D0BX6771	GUIDE PLATE:OPEN AND CLOSE:VERTICAL TRANSPORT:LOWER:ASS'Y	U004_S009	355
D0BX6775	GUIDE PLATE:OPEN AND CLOSE:VERTICAL TRANSPORT:UPPER:PEEN	U004	356
D0BX6780	TRAY BOTTOM PLATE:ASS'Y	U004_S010_S001	357
		U004_S011_S001	357
D0BX6795	HOLDER:STAY:GUIDE PLATE	U004_S009	358
D0BX6844	BRACKET:DUCT:CHARGE CORONA:VACUUM	U018	29
D0BX6889	FILTER:MAIN:EXHAUST:RIGHT	U018	30
D0BX6893	BRACKET:DUCT:MAIN:EXHAUST:LOWER	U018	31
D0BX6909	FILTER:DUCT:MAIN:REAR	U018	32
D0BX7076	GUIDE PLATE:DUPLX:LOWER	U014	48
D0BX7085	TRANSPORT ROLLER:DUPLX:PRESS FIT	U014	49
D0BX7114	GUIDE PLATE:REVERSE:DUPLX:DRIVE	U014	50
D0BX7116	GUIDE PLATE:REVERSE:DUPLX:DRIVEN:PEEN	U014	51
D0BX7118	GUIDE PLATE:REVERSE:DUPLX:LEFT	U014	52
D0BX7120	TRANSPORT ROLLER:REVERSE:DUPLX:PRESS FIT	U014	53
D0BX7128	DISCHARGE BRUSH:RECEIVING SUB-UNIT:REVERSE:ENTRANCE	U014	54
D0BX7142	GUIDE PLATE:RECEIVING SUB-UNIT:RIGHT:PEEN	U014	55
D0BX7512	COVER:PAPER TRAY:NO.2	U004	359
D0BX7531	COVER:PAPER TRAY:NO.1	U004	360
D0BX7573	PULLEY:DRIVE WERE:ASS'Y	U004_S012	362

Number	Part Name	Group	ID
D0BX7595	(CHN[Pro 8310/8320]/NA/EU/AA/TWN/KOR):BASE:TANDEM LCT:RIGHT:ADHESION	U004_S012	363
D0BX7631	PAPER TRAY:UNIVERSAL:SUB-ASS'Y	U004_S010	364
		U004_S011	364
D0BX7648	DECAL:MULTI-LANGUAGE:MAIN:13:ABS	U020	21
D0BX7662	ACCESSORY:COVER:SIDE:RIGHT:ASS'Y	U020	53
D1054365	HOLDER:THERMOPILE	U012	116
D1055898	HOLDER:TEMPERATURE & HUMIDITY SENSOR	U010	45
D1202829	TENSION SPRING:REGISTRATION:DRIVEN	U010	46
D1316511	BRACKET:CONNECTOR:LEFT	U004	365
D1316775	SIDE FENCE:REAR:ASS'Y	U004_S010_S002	366
		U004_S011_S002	366
D1316777	SIDE FENCE:FRONT:ASS'Y	U004_S010_S003	367
		U004_S011_S003	367
D1363692	DECAL:COLLECTION BOTTLE:GRIP:UPPER	U010_S002	47
D1364233	STEPPED SCREW:DIA5:M3X3.8	U018	33
D1366099	TENSION SPRING:BRACKET:DC STEPPER MOTOR	U007_S001	76
D1366145	ROLLER:ON-OFF:INTERMEDIATE TRANSFER	U007_S001	77
D1366149	BUSHING:SLIDE RAIL:ON-OFF	U007_S001	78
D1366183	GRIP:ON-OFF:INTERMEDIATE TRANSFER:TCRU	U007_S001	79
D1381289	JOINT:FUSING:ON-OFF	U015_S003	25
D1495776	COVER:USB:SMALL	U017	38
D1495883	KEYTOP:MAIN SWITCH	U016	39
D1495884	COMPRESSION SPRING:KEYTOP	U016	40
D1791043	GUARD:MAIN:VERTICAL TRANSPORT	U019	51
D1791115	RAIL:INTERMEDIATE TRANSFER:LEFT	U019	52
D1791118	SEPARATION PLATE:MAIN:REAR	U019	53

Exclusive Parts

Number	Part Name	Group	ID
	MIDDLE		
D1791128	HOLDER:REGISTRATION:DRAWE R	U019	54
D1791129	GUIDE:PULL OUT:LOCK	U019	55
D1791130	GUIDE:PULL OUT:MIDDLE:LOWER	U019	56
D1791185	GUIDE:INTERMEDIATE TRANSFER :LEFT	U019	57
D1791220	DRUM SHAFT:DRIVE:ASS'Y	U015	26
D1791221	HOLDER:COIL SPRING:LOCK:PUL L OUT	U019	58
D1791251	DC MOTOR:DIA63:29.7W:BRUSHL ESS:(BLM1)	U015	27
D1791252	DC MOTOR:DIA82.2:63.7W:BRUSH LESS:(BLM8)	U015	28
D1791254	SHAFT:DRIVE:DEVELOPMENT RO LLER:ASS'Y	U015	29
D1791256	SHAFT:DRIVE:TRANSPORT SCRE W:ASS'Y	U015	30
D1791258	PLATE:HOLDER:ANTISTATIC BRU SH:DRUM	U015	31
D1791262	SHAFT:DRIVE:CLEANER:ASS'Y	U015	32
D1791264	PLATE:HOLDER:RADIAL BALL BEA RING	U015	33
D1791265	PULLEY:DRIVE:DRUM:107T	U015	34
D1791266	PULLEY:DRIVE:DEVELOPMENT R OLLER:59T	U015	35
D1791267	SYNCHRONOUS BELT:120S2M316	U015	36
D1791268	SYNCHRONOUS BELT:80S2M300	U015	37
D1791269	BRACKET:DC MOTOR:CLEANING DRIVE SUB-UNIT	U015	38
D1791273	GEAR:DRIVE:TRANSPORT SCRE W:54Z	U015	39
D1791275	TENSION SPRING:3.8N	U015	40
D1791276	TENSION SPRING:3.6N	U015	41
D1791277	GEAR:DRIVE:CLEANER:39Z	U015	42
D1791278	HOLDER:BEARING:DRUM SHAFT	U015	43
D1791286	BRACKET:DRIVE:CLEANER:ASS'Y	U015	44
D1791288	GEAR:IDLER:CLEANER:49Z/33Z	U015	45

Number	Part Name	Group	ID
D1791289	GEAR:PULLEY:DRUM:113Z/37T	U015	46
D1791290	GEAR:IDLER:TRANSPORT SCREW :65Z/53Z	U015	47
D1791291	BRACKET:DC MOTOR:DRUM:ASS' Y	U015	48
D1791293	TIGHTENER:DRIVE:DRUM:ASS'Y	U015	49
D1791297	TIGHTENER:DRIVE:DEVELOPMEN T:ASS'Y	U015	50
D1791300	DRIVE UNIT:FUSING:ASS'Y	U015_S002	51
D1791309	DC BRUSHLESS MOTOR:58W:DRI VE:FUSING UNIT:(BLM9)	U015_S002	52
D1791316	JOINT:DRIVE:FUSING	U015_S002	70
D1791320	BRACKET:DRIVE:USED TONER	U015	53
D1791323	TENSION SPRING:BELT TENSION ER:DRIVE:USED TONER	U015	54
D1791324	SYNCHRONOUS BELT:40S3M222	U010_S003	48
D1791326	BRACKET:BELT TENSIONER:DRIV E:USED TONER	U015	55
D1791327	SHAFT:BELT TENSIONER:DRIVE:U SED TONER	U015	56
D1791328	GEAR:PULLEY:Z67/T19:DRIVE:US ED TONER	U015	57
D1791329	PULLEY:TIGHTENER:DIA18	U015	58
D1791345	BRACKET:DRAWER:DEVELOPME NT	U015	59
D1791351	DC MOTOR:DIA63:24V:28.4W:(BLM 5)	U007_S001	80
D1791352	HOUSING:DRIVE UNIT:INTERMEDI ATE TRANSFER	U007_S001	81
D1791353	GEAR:DRIVE ROLLER:INTERMEDI ATE TRANSFER	U007_S001	82
D1791354	HOLDER:MOTOR:INTERMEDIATE TRANSFER	U007_S001	83
D1791370	DC MOTOR:40W:BRUSHLESS:(BL M6)	U015_S001	60
D1791375	GEAR:IDLER:BELT CLEANING	U015_S001	61
D1791391	MECHANICAL DRIVE SECTION:TR ANSFER:SECOND:ASS'Y	U015_S001	62

Exclusive Parts

Number	Part Name	Group	ID
D1791442	COVER:DC_SW	U001	48
D1791451	CAP:KEY COUNTER	U001	49
D1791454	DOOR:TONER SUPPLY:ASS'Y	U001_S006	50
D1791456	SUPPORTING PLATE:HINGE:DOOR:TONER SUPPLY	U001_S006	51
D1791457	MAGNET CATCH PLATE:DOOR:TONER SUPPLY	U001_S006	52
D1791460	HINGE:DOOR:TONER SUPPLY	U001	53
D1791469	COVER:FRONT UPPER	U001	54
D1791471	LEVER:SAFETY SWITCH	U001	55
D1791476	BRACKET:SAFETY SWITCH	U001	56
D1791477	SHIELD PLATE:SAFETY SWITCH	U001	57
D1791483	LEVER:SAFETY SWITCH	U001	58
D1791485	DOOR:FRONT LEFT:LOWER	U001	59
D1791487	DUCT:DOOR:FRONT LEFT:ASS'Y	U001	60
D1791490	BRACKET:SUPPORTING PLATE:DOOR:FRONT LEFT	U001_S001	61
D1791497	DOOR:FRONT RIGHT:UPPER	U001	62
D1791499	CAP:MM22	U001	63
D1791500	DOOR:FRONT RIGHT:LOWER	U001	64
D1791505	STOPPER:GUIDE PLATE:VERTICAL TRANSPORT	U001	65
D1791514	COVER:MAIN:RIGHT	U001	66
D1791526	STAY:SAFETY SWITCH	U001	67
D1791531	HINGE:LEFT UPPER	U001	68
D1791533	HINGE:RIGHT UPPER	U001	69
D1791553	COVER:DC_SW	U016	41
D1791557	BRACKET:DC_SW	U016	42
D1791571	BRACKET:EARTH:DOOR:MIDDLE	U001	70
D1791572	BRACKET:EARTH:DOOR:LOWER	U001	71
D1791595	(NA):DECAL:DC:MAIN SWITCH	U020	48
D1791731	COVER:REGISTRATION:MOTOR	U019	59
D1791734	LEVER:PULL OUT:LEFT	U019	60
D1791786	BRACKET:INNER COVER	U018	34
D1792204	COVER:END BLOCK:REAR	U006_S001	45
D1792205	ELECTRODE PLATE:CASE:CHARGE	U006_S001	46
D1792206	STAY:GRID	U006_S001	47

Number	Part Name	Group	ID
D1792208	END BLOCK:CHARGE CORONA:REAR	U006_S001	48
D1792209	STAY:CORONA WIRE:LEFT	U006_S001	49
D1792210	STAY:CORONA WIRE:RIGHT	U006_S001	50
D1792224	CORONA WIRE:CHARGE CORONA	U006_S001	51
D1792237	HOLDER:MOTOR:CHARGE	U006	52
D1792238	SOCKET:CHARGE	U006	53
D1792239	SHAFT:CLEANER:CHARGE:DRIVE:ASS'Y	U006_S004	54
D1792246	SEAL:DUCT:SIDE PLATE:REAR	U006	55
D1792254	DECAL:CHARGE:GRIP	U006_S001_S001	56
D1792255	CHARGE CORONA	U006_S001	57
D1792256	COVER:CHARGE CORONA:ASS'Y	U006_S001_S001	58
D1792370	GRIP:DRUM:ASS'Y	U006	59
D1792376	HOLDER:DRUM:TAKE OFF:FRONT	U006	60
D1792377	HOLDER:DRUM:TAKE OFF:REAR	U006	61
D1792411	SLIDE RAIL:PCU	U006	62
D1792412	HOLDER:SLIDE RAIL:PCU:RIGHT	U006	63
D1792416	STAY:ELECTRIC POTENTIAL SENSOR	U006	64
D1792417	HOLDER:ELECTRIC POTENTIAL SENSOR	U006	65
D1792419	STOPPER:SLIDE RAIL:PCU:PEEN	U006	66
D1792421	ELECTRIC POTENTIAL SENSOR:(SEN5)	U006	67
D1792427	BRACKET:DRAWER:CLEANING UNIT	U006	68
D1792467	LEVER:POSITIONING:CLEANING	U006_S003	69
D1792468	GRIP:DRUM STAY:PCU	U006_S003	70
D1792469	KNOB SCREW:DRUM	U006	71
D1792474	DECAL:DIAL	U006_S003	72
D1792494	GROUND PLATE:STAY:PCU	U006_S003	73
D1792621	SHAFT:DRIVEN ROLLER:SHIFT	U004	368
D1792631	GUIDE PLATE:SHIFT:REGISTRATION:UPPER	U004	369
D1792642	HOLDER:SHIFT:BEARING:REAR	U004	370
D1792643	CAM:REGISTRATION:GATE:RELEASE	U004	371

Exclusive Parts

Number	Part Name	Group	ID
D1792648	PLATE:ADJUSTING PIN	U004	372
D1792651	GUIDE PLATE:REGISTRATION:EXIT	U004	373
D1792660	BRACKET:GUIDE PLATE:FRONT:CLIP	U004	374
D1792661	BRACKET:GUIDE PLATE:INNER BACK:CLIP	U004	375
D1792666	GUIDE PLATE:REGISTRATION:TIMING:UPPER	U004	376
D1792670	GUIDE PLATE:REGISTRATION:TIMING:LOWER	U004	377
D1792675	COVER:REGISTRATION:DOUBLE FEED SENSOR	U004	378
D1792684	REGISTRATION GUIDE:OPEN AND CLOSE	U004	379
D1792685	CASE:REMOVE PAPER DUST:ASS'Y	U004	380
D1792689	COVER:REGISTRATION:EXIT	U004	381
D1792691	TENSION SPRING:PRESSURE ROLLER	U004	382
D1792698	COMPRESSION SPRING:SHIFT	U004	383
D1792711	TIMING ROLLER:TRANSFER:DRIVEN:PRESS FIT	U004	384
D1792727	SHAFT:TIMING ROLLER:REGISTRATION:DRIVEN	U004	385
D1792751	BRACKET:DC STEPPER MOTOR:PAAPER FEED:TIMING	U004	386
D1792754	BRACKET:DC STEPPER MOTOR:PAAPER FEED	U004	387
D1792757	TIGHTENER:BRACKET:DC STEPPER MOTOR	U004	388
D1792758	GEAR:Z41:TIMING PULLEY:T41	U004	389
D1792760	COVER:MOTOR	U004	390
D1792763	CAM:REGISTRATION:TIMING	U004	391
D1792764	SHAFT:CAM:REGISTRATION:TIMING	U004	392
D1792768	TIMING PULLEY:S2M:30T	U004	393
D1792783	COVER:BASE:MAIN PAPER SMD	U004	394

Number	Part Name	Group	ID
D1792809	GUIDE PLATE:SHIFT:LEFT LOWER	U004	395
D1792814	GUIDE:SHIFT:TRAILING EDGE	U004	396
D1792817	BRACKET:SHIFT:SYNCHRONOUS BELT	U004	397
D1792861	BRACKET:OPEN AND CLOSE:LARGE CAPACITY TRAY	U004	398
D1792872	BRACKET:DC STEPPER MOTOR:TRAILING EDGE	U004	399
D1792891	GUIDE PIN:SHIFT:TRAILING EDGE	U004	400
D1792909	JOINT:CONNECTING:DRIVEN	U004	401
D1792932	ARM:ON-OFF:TRANSPORT ROLLER	U004	402
D1792933	SHAFT:LINK:ON-OFF:CONNECTING:LARGE CAPACITY TRAY	U004	403
D1792934	SHAFT:LINK:ON-OFF:CONNECTING	U004	404
D1792943	BRACKET:CAM:ON-OFF	U004	405
D1792944	DISC:ON-OFF:SENSOR	U004	406
D1792946	SHAFT:CAM:ON-OFF:LARGE CAPACITY TRAY	U004	407
D1792948	CAM:TRANSPORT ROLLER:ON-OFF	U004	408
D1792952	BRACKET:DC STEPPER MOTOR:DRIVEN:ON-OFF	U004	409
D1792960	GUIDE PLATE:OPEN AND CLOSE:MAIN:CONNECTING	U004	410
D1792963	BRACKET:GRIP:OPEN AND CLOSE:GUIDE PLATE	U004	411
D1792964	GUIDE:MAIN:CONNECTING:OPEN AND CLOSE	U004	412
D1793043	DUCT:FILTER:DEVELOPMENT:ASS'Y	U006_S003	74
D1793070	GEAR:TRANSPORT SCREW:NO.1	U006_S003	75
D1793071	GEAR:TRANSPORT SCREW:NO.2	U006_S003	76
D1793072	GEAR:TRANSPORT SCREW:NO.3	U006_S003	77
D1793073	GEAR:IDLER:TRANSPORT SCREW:UPPER:ASS'Y	U006_S003	78
D1793074	GEAR:IDLER:TRANSPORT SCREW	U006_S003	79

Exclusive Parts

Number	Part Name	Group	ID
	:LOWER:ASS'Y		
D1793075	FILTER:DEVELOPMENT	U006_S003	80
D1793084	ENTRANCE SEAL:DEVELOPMENT:ASS'Y	U006_S003	81
D1793090	PLATE:GEAR:IDLER:ASS'Y	U006_S003	82
D1793131	RECEPTACLE:DEVELOPMENT VIAS:ASS'Y	U006	83
D1793144	COVER:INTERMEDIATE TRANSFER:LOWER	U007_S001	84
D1793201	TONER SUPPLY UNIT:TONER HOPPER:ASS'Y	U005_S004	55
D1793234	GEAR:TRANSPORT SCREW:LONG:TONER SUPPLY	U005_S004	56
D1793237	GEAR:TRANSPORT SCREW:SHORT:TONER SUPPLY	U005_S004	57
D1793244	GEAR:AGITATOR:TONER SUPPLY	U005_S004	58
D1793252	COVER:GEAR:TONER SUPPLY	U005_S004	59
D1793253	GEAR:IDLER:FEED:TONER SUPPLY:1	U005_S004	60
D1793254	GEAR:IDLER:FEED:TONER SUPPLY:2	U005_S004	61
D1793256	BRACKET:DC STEPPER MOTOR:AGITATOR:ASS'Y	U005_S004	62
D1793259	GEAR:IDLER:AGITATOR:TONER SUPPLY	U005_S004	63
D1793263	BRACKET:DC STEPPER MOTOR:TONER SUPPLY	U005_S004	64
D1793271	CASE:SHUTTER:TONER SUPPLY	U005	65
D1793272	SHUTTER:TONER SUPPLY:ASS'Y	U005	66
D1793275	COIL SPRING:SHUTTER:TONER SUPPLY	U005	67
D1793276	TONER CATCHPAN:TONER SUPPLY	U005	68
D1793322	SLIDER:TONER BANK:ASS'Y	U005	69
D1793332	SIDE PLATE:TONER BANK	U005	70
D1793334	CASE:TONER BANK:ASS'Y	U005_S001	71
		U005_S002	71
D1793339	GROUND PLATE:BOTTLE:TONER	U005	72

Number	Part Name	Group	ID
	SUPPLY UNIT		
D1793355	GUIDE PLATE:TONER BANK:SIDE PLATE	U005	73
D1793357	SEAL:TONER BANK	U005	74
D1793361	BRACKET:JOINT:RACK:LEVER	U005	75
D1793367	DECAL:DESIGN SKETCH:TONER BOTTLE	U005_S003	76
D1793370	INNER COVER:TONER BANK:ASS'Y	U005_S003	77
D1793373	BRACKET:SAFETY SWITCH:TONER SUPPLY UNIT	U005	78
D1793376	LEVER:SAFETY SWITCH:TONER SUPPLY UNIT:ASS'Y	U005	79
D1793377	TORSION SPRING:SAFETY SWITCH:TONER SUPPLY UNIT	U005	80
D1793380	CASE:TONER BANK:REAR	U005	81
D1793402	BOTTLE:DEVELOPER:ASS'Y	SPECIAL TOOLS	11
		U020	25
D1793414	SEAL:DEVELOPMENT ROLLER:SERVICE PARTS:ASS'Y	SPECIAL TOOLS	12
D1793420	JIG:SHEET:DOCTOR BLADE	SPECIAL TOOLS	13
D1793421	KNOB:DRIVE:DEVELOPMENT UNIT:ASS'Y	SPECIAL TOOLS	14
D1793504	CLEANING UNIT:ASS'Y	U006_S002	84
D1793525	TONER COLLECTION COIL:CLEANING:ASS'Y	U006_S002	85
D1793531	TONER CATCHPAN:PIPE:DISCHARGE USED TONER	U006_S002	86
D1793532	COIL SPRING:TONER CATCHPAN	U006_S002	87
D1793535	GEAR SET:CLEANING UNIT:SERVICE PARTS	U006_S002_S002	88
D1793536	GEAR:IDLER:Z16	U006_S002_S002	89
D1793537	GEAR:IDLER:Z17:LOWER	U006_S002_S002	90
D1793538	GEAR:TONER COLLECTION COIL:Z18	U006_S002_S002	91
D1793561	SHAFT:CLEANING BLADE:FRONT	U006_S002	92
D1793564	GEAR:IDLER:Z17:UPPER	U006_S002_S002	93
D1793571	BRACKET:CLEANING BLADE:ASS'Y	U006_S002	94

Exclusive Parts

Number	Part Name	Group	ID
	Y		
D1793576	TENSION SPRING:CLEANING BLADE:6N	U006_S002	95
D1793581	BLADE:CLEANING:ASS'Y	U006_S002	96
D1793589	RETAINING RINGS-E:GUIDE	U006_S002	97
D1793607	CLEANING UNIT:APPLY:ASS'Y	U006_S002_S001	98
D1793621	COVER:COATING BAR	U006_S002_S001	99
D1793627	TENSION SPRING:COATING BAR:5N	U006_S002_S001	100
D1793635	COATING BAR:ASS'Y	U006_S002_S001	101
D1793641	BRUSH ROLLER:APPLY:ASS'Y	U006_S002_S001	102
D1793645	GEAR:BRUSH ROLLER:Z15	U006_S002_S001 U006_S002_S002	103 103
D1793647	PLAIN SHAFT BEARING:APPLY:REAR:ASS'Y	U006_S002_S001	104
D1793653	BLADE:APPLY:ASS'Y	U006_S002_S001	105
D1793669	GROUND PLATE:APPLY	U006_S002_S001	106
D1793681	HOLDER:COVER:COATING BAR:ASS'Y:(OT14)	U006_S002_S001 U006_S002_S001 U006_S002_S002	107 107 107
D1793689	GROUND PLATE:COVER:APPLY	U006_S002_S001 U006_S002_S001	108 108
D1793851	TRANSPORT ROLLER:DRIVE	U011	25
D1793865	BRACKET:SENSOR:VACUUM	U011	30
D1793960	TRANSPORT ROLLER:HEAT PIPE:DIA30.4:ASS'Y	U013	89
D1794028	SUPPORTING PLATE:LEVER:PRESSURE:FRONT	U012_S001	117
D1794071	BRACKET:FUSING ENTRANCE GUIDE PLATE:FRONT	U012_S001	118
D1794072	BRACKET:FUSING ENTRANCE GUIDE PLATE:REAR	U012_S001	119
D1794081	FUSING ENTRANCE GUIDE PLATE:LOWER	U012_S001	120
D1794095	CLAMP:HARNESS:PRESSURE	U012_S001	121

Number	Part Name	Group	ID
D1794107	BRACKET:STRIPPER PAWLS:PRESSURE:PEEN	U012_S001	122
D1794109	ADJUSTING PIN:DISCHARGE BRUSH	U012_S001	123
D1794113	DISCHARGE BRUSH:21MM	U012_S001	124
D1794114	GUIDE PLATE:FUSING EXIT:LOWER	U012_S001	125
D1794170	TAB:TERMINAL:187:4P	U012_S001	126
D1794182	DISCHARGE BRUSH:HEAT ROLLER	U012_S001	127
D1794197	FLAT BELT-FUSING:DIA80:SEAL	U012_S001	128
D1794223	LEVER:PAPER EXIT UNIT:FRONT	U012_S001	129
D1794224	LEVER:PAPER EXIT UNIT:REAR	U012_S001	130
D1794228	SUPPORTER:GUIDE PLATE:FUSING EXIT:UPPER	U012_S001	131
D1794231	STOPPER:LEVER:FUSING/PAPER EXIT UNIT	U012_S001	132
D1794232	SHAFT:FUSING/PAPER EXIT UNIT	U012_S001	133
D1794235	TENSION SPRING:FUSING/PAPER EXIT UNIT	U012_S001	134
D1794255	GUIDE PLATE:FUSING EXIT:UPPER:ASS'Y	U012_S001	135
D1794279	COVER:FUSING/PAPER EXIT UNIT:ASS'Y	U012_S001	136
D1794283	GRIP:COVER:FUSING/PAPER EXIT UNIT:ASS'Y	U012_S001	137
D1794337	RING:WEB:CLEANING	U012_S002	138
D1794352	BRACKET:DRAWER:FUSING:UPPER:MAIN	U012	139
D1794353	BRACKET:DRAWER:FUSING:LOWER:MAIN	U012	140
D1794531	SHAFT:COOLING UNIT:ENTRANCE	U013	90
D1794533	DRIVE ROLLER:COOLING UNIT:ENTRANCE	U013	91
D1794537	GUIDE PLATE:COOLING UNIT:ENTRANCE	U013	92
D1794538	BRACKET:CAP:HEAT PIPE:UPPER	U013	93
D1794539	BRACKET:CAP:HEAT PIPE:LOWER	U013	94

Exclusive Parts

Number	Part Name	Group	ID
D1794754	STOPPER:GUIDE PLATE:REVERSE EXIT:LEFT LOWER	U013	95
D1794755	LEVER:LOCK:REVERSE EXIT:LEFT LOWER	U013	96
D1794757	SHAFT:LOCK:REVERSE EXIT:LEFT LOWER	U013	97
D1794758	LINK:ON-OFF:DRIVEN ROLLER:REVERSE EXIT	U013	98
D1794759	SHAFT:ON-OFF:DRIVEN ROLLER:REVERSE EXIT	U013	99
D1794761	BRACKET:SOLENOID:GATE PAWL:SWITCHBACK	U013	100
D1794766	LINK:GATE PAWL:SWITCHBACK	U013	101
D1794785	GUIDE PLATE:EXIT:MIDDLE	U013	102
D1794796	GUIDE PLATE:REVERSE:UPPER	U013	103
D1794810	PLATE:GATE PAWL:EXIT:REVERSE	U013	104
D1794811	SHAFT:GATE PAWL:EXIT:REVERSE	U013	105
D1794813	BRACKET:DC STEPPER MOTOR:ON-OFF	U013	106
D1794816	BRACKET:CAM:GATE PAWL	U013	107
D1794820	CAM:ON-OFF	U013	108
D1794821	LINK:GATE PAWL:EXIT:ENTRANCE	U013	109
D1794822	LINK:ON-OFF:REVERSE EXIT:CAM	U013	110
D1794824	GUIDE PLATE:REVERSE EXIT:LEFT LOWER:PEEN	U013	111
D1794827	GUIDE PLATE:REVERSE EXIT:LEFT LOWER:MIDDLE	U013	112
D1794830	BRACKET:CONTACT POINT:REVERSE EXIT:FRONT	U013	113
D1794835	BRACKET:CONTACT POINT:REVERSE EXIT:REAR	U013	114
D1794838	BRACKET:DRAWER:LEFT	U013	115
D1794847	BRACKET:CONNECTION:MAIN:EXIT	U013	116
D1794860	GUIDE PLATE:MAIN:EXIT	U013	117

Number	Part Name	Group	ID
D1794866	COVER:EXIT	U013	118
D1794882	COVER:HARNESS:LEFT LOWER	U013	119
D1794884	SHEET:OPPOSED:PAPER FEED SENSOR	U019	61
D1794887	SHEET:TRANSPORT:REVERSE EXIT	U013	120
D1795089	COVER:C/T BOX:UPPER:ASS'Y	U017_S001	39
D1795381	TEMPERATURE SENSOR:FUSING UNIT:UPPER:19PIN:(SEN9/SEN59/SEN87/SEN88)	U012_S001_S003	141
D1795387	TEMPERATURE SENSOR:FUSING UNIT:LOWER:17PIN:(SEN80)	U012_S001_S004	142
D1795435	PCB:URRB:(PCB19)	U004	413
D1795913	ARM:SAFETY SWITCH	U016	43
D1795914	BRACKET:SAFETY SWITCH:FRONT	U016	44
D1795915	LEVER:SAFETY SWITCH:WELDING	U016	45
D1795917	BRACKET:SAFETY SWITCH	U016	46
D1795920	BRACKET:MAIN SWITCH	U016	47
D1795922	BRACKET:POWER SUPPLY CORD:INLET:NOISE FILTER	U016	48
D1795923	PLATE:POWER SUPPLY CORD:INLET	U020	26
D1795924	COVER:SAFETY SWITCH:UPPER FRONT	U016	49
D1795928	BRACKET:SAFETY SWITCH:REAR	U016	50
D1795961	COVER:C/T BOX	U017	40
D1795964	COVER:C/T BOX:LOWER	U017	41
D1795966	SEAL:COVER:C/T BOX:UPPER:A	U017_S001	42
D1795967	SEAL:COVER:C/T BOX:UPPER:B	U017_S001	43
D1795973	SEAL:COVER:C/T BOX:UPPER:C	U017_S001	44
D1796050	FLAT BELT-TRANSFER	U007	85
D1796057	ROLLER:TRANSFER:FRONT:ASS'Y	U007_S001	86
D1796062	TENSION SPRING:PRESSURE:INTERMEDIATE TRANSFER	U007_S001	87
D1796065	DRIVE ROLLER:INTERMEDIATE TRANSFER:ASS'Y	U007_S001	88

Exclusive Parts

Number	Part Name	Group	ID
D1796080	ROLLER:OPPOSED:BELT CLEANING:ASS'Y	U007_S001	89
D1796085	ROLLER:DRIVEN:INTERMEDIATE TRANSFER:ASS'Y	U007_S001	90
D1796091	ROLLER:TENSION:ASS'Y	U007_S001	91
D1796094	CASE:TENSION:ROLLER	U007_S001	92
D1796095	SUPPORTING PLATE:CASE:TENSION:ROLLER	U007_S001	93
D1796097	PLAIN SHAFT BEARING:TENSION:ROLLER:INTERMEDIATE TRANSFER	U007_S001	94
D1796098	COIL SPRING:PRESSURE:TENSION:INTERMEDIATE TRANSFER	U007_S001	95
D1796108	ROLLER:TRANSFER:PAPER:FRONT:ASS'Y	U007_S001	96
D1796112	DUCT:DENSITY SENSOR:INTERMEDIATE TRANSFER	U007_S001	97
D1796117	BRACKET:DRAWER:INTERMEDIATE TRANSFER	U007_S001	98
D1796119	PULLEY:ON-OFF:TRANSFER ROLLER	U007_S001	99
D1796122	BRACKET:ON-OFF:TRANSFER ROLLER	U007_S001	100
D1796125	CAM:ON-OFF:TRANSFER:PAPER:REAR	U007_S001	101
D1796127	FEELER:ON-OFF:TRANSFER:PAPER	U007_S001	102
D1796140	LEVER:ON-OFF:ROLLER:FRONT	U007_S001	103
D1796141	LEVER:ON-OFF:ROLLER:REAR	U007_S001	104
D1796143	ARM:LEVER:ON-OFF:ROLLER	U007_S001	105
D1796144	TENSION SPRING:SLIDE RAIL:TRANSFER	U007_S001	106
D1796146	SHAFT:ON-OFF:INTERMEDIATE TRANSFER	U007_S001	107
D1796147	CAM:ON-OFF:INTERMEDIATE TRANSFER	U007_S001	108
D1796156	COVER:CASE:OPPOSED:TRANSFER ROLLER:REAR	U007_S001	109

Number	Part Name	Group	ID
D1796160	GUIDE:INTERMEDIATE TRANSFER:RIGHT	U007_S001	110
D1796161	GUIDE:INTERMEDIATE TRANSFER:LEFT:ASS'Y	U007_S001	111
D1796164	PLATE:BLADE:BELT CLEANING	U007_S001	112
D1796173	SEAL:DUCT:DENSITY SENSOR	U007	113
D1796182	BRACKET:POSITIONING CONTROL:DRIVEN ROLLER:REAR:ASS'Y	U007_S001	114
D1796186	DRIVE WIRE:DRIVEN ROLLER	U007_S001	115
D1796187	FEELER:POSITIONING CONTROL:DRIVE WIRE	U007_S001	116
D1796188	BRACKET:COIL SPRING:MOTOR:POSITIONING CONTROL	U007_S001	117
D1796193	HOLDER:FLAT BELT-TRANSFER:DRIVE ROLLER:ASS'Y	SPECIAL TOOLS U020	15 27
D1796194	HOLDER:FLAT BELT-TRANSFER:CLEANING:ASS'Y	SPECIAL TOOLS U020	16 28
D1796195	LEVER:POSITIONING SENSOR:FLAT BELT-TRANSFER	U007_S001	118
D1796196	SCALE:BRACKET:DRIVEN ROLLER:FRONT	U007_S001	119
D1796197	HOLDER:DRIVEN ROLLER:FRONT	U007_S001	120
D1796230	CASE:TERMINAL:SEPARATION:ASS'Y	U009_S002	49
D1796280	GUIDE PLATE:ENTRANCE:LOWER:ASS'Y	U009_S001	50
D1796291	INSULATING COVER:POWER PACK	U009	51
D1796292	COVER:POWER PACK	U009	52
D1796298	COIL SPRING:COATING BAR:2.2N	U009_S001	53
D1796310	SEPARATION CORONA:ASS'Y	U009_S001_S001	54
D1796311	GEAR:TRANSFER ROLLER	U009_S001	55
D1796312	LEVER:PRESSURE:REAR:ASS'Y	U009	56
D1796314	LEVER:PRESSURE:FRONT:ASS'Y	U009	57
D1796324	GEAR:DRIVE:TRANSFER/SEPARATION UNIT	U009	58
D1796334	COIL SPRING:PRESSURE:TRANSFER UNIT	U009	59

Exclusive Parts

Number	Part Name	Group	ID
D1796350	TRANSFER/SEPARATION UNIT:DRIVE:ASS'Y	U009	60
D1796355	KNOB:STOPPER:TRANSFER/SEPARATION UNIT:REAR	U009	61
D1796356	KNOB:STOPPER:TRANSFER/SEPARATION UNIT:FRONT	U009	62
D1796410	SLIDE RAIL:CASE:TENSION:ROLLER	U019	62
D1796411	SEAL:TONER OUTLET SUB-UNIT	U015_S001	63
D1796412	SEAL:HOLDER:CLEANING BLADE:UPPER	U008_S001	53
D1796413	SEAL:HOLDER:CLEANING BLADE:FRONT LOWER	U008_S001	54
D1796414	SEAL:HOLDER:CLEANING BLADE:REAR LOWER	U008_S001	55
D1796415	SEAL:HOLDER:CLEANING BLADE:LOWER	U008_S001	56
D1796461	TONER OUTLET SUB-UNIT:COLLECTION BOTTLE:ASS'Y	U010_S001	49
D1796472	COVER:TONER OUTLET SUB-UNIT:ASS'Y	U010	50
D1796483	BRACKET:DRIVE SUB-UNIT:COLLECTION BOTTLE	U010	51
D1796501	TONER OUTLET SUB-UNIT:PCU:ASS'Y	U010_S003	52
D1796521	BRACKET:TONER OUTLET SUB-UNIT:VERTICAL TRANSPORT:LOWER	U010	53
D1796523	BRACKET:VERTICAL TRANSPORT	U010	54
D1796525	BRACKET:IDLER	U010	55
D1796527	CAM:VERTICAL TRANSPORT:DIA15	U010	56
D1796528	TONER OUTLET SUB-UNIT:VERTICAL TRANSPORT:MAIN:ASS'Y	U010_S004	57
D1796552	TRANSPORT SCREW:TONER OUTLET SUB-UNIT:LOWER:ASS'Y	U010_S004	58
D1796619	STAY:HOLDER:PAPER TRAY:ASS'Y	U004	414

Number	Part Name	Group	ID
D1796626	SUPPORTING PLATE:RIGHT:HOLDER:PAPER TRAY	U004	415
D1796643	RAIL:TANDEM LCT:MIDDLE:ASS'Y	U004	416
D1796726	COVER:LED:MAIN	U004	417
D1796731	LEVER:PRESSURE:SLIDER	U004_S006	418
		U004_S007	418
		U004_S008	418
D1796734	BRACKET:SLIDER:CAM	U004_S006	419
		U004_S007	419
		U004_S008	419
D1796737	LEVER:PRESSURE RELEASE:REVERSE	U004_S006	420
		U004_S007	420
		U004_S008	420
D1796738	SLIDER:CAM:REVERSE	U004_S006	421
		U004_S007	421
		U004_S008	421
D1796739	LEVER:REVERSE:PRESSURE RELEASE:JOINT	U004_S006	422
		U004_S007	422
		U004_S008	422
D1796751	BRACKET:STM:MM56:TRANSPORT:LENGTHWISE	U004	423
D1796753	BRACKET:JOINT:PROTECT	U004	424
D1796756	BRACKET:CONNECTING:JOINT	U004	425
D1796757	SHAFT:DRIVE	U004	426
D1796758	SYNCHRONOUS BELT:80S2M216	U004	427
D1796761	SYNCHRONOUS BELT:60S2M226	U004	428
D1796762	SYNCHRONOUS BELT:60S2M166	U004	429
D1796763	SYNCHRONOUS BELT:80S2M300	U004	430
D1796764	SYNCHRONOUS BELT:80S2M242	U004	431
D1796768	SHAFT:JOINT:CONNECTING:ASS'Y	U004	432
D1796781	GUIDE PLATE:VERTICAL TRANSPORT:F1	U004	433
D1796783	GUIDE PLATE:VERTICAL TRANSPORT:F1:LOWER	U004	434
D1796784	GUIDE PLATE:VERTICAL TRANSPORT:F3	U004	435
D1796786	GUIDE PLATE:VERTICAL TRANSPORT:F2	U004	436

Exclusive Parts

Number	Part Name	Group	ID
D1796790	GUIDE PLATE:VERTICAL TRANSP ORT:F2:LOWER	U004	437
D1796797	COMPRESSION SPRING:JOINT:TR ANSPORT	U004	438
D1796821	DUCT:DEVELOPMENT:VACUUM:F RONT	U018	35
D1796822	BRACKET:FAN:DEVELOPMENT:C OOLING:FRONT	U018	36
D1796823	DUCT:DEVELOPMENT:EXHAUST: MULTI-LANGUAGE:ASS'Y	U019	63
D1796831	DUCT:DEVELOPMENT:EXHAUST:F RONT	U018	37
D1796832	DUCT:DEVELOPMENT:EXHAUST: REAR	U018	38
D1796834	SEAL:DUCT:DEVELOPMENT:EXHA UST:REAR RIGHT	U018	39
D1796835	EXTERIOR:LOUVER:CHARGE COR ONA	U018	40
D1796836	DUCT:CHARGE CORONA:CONNE CTING:LOWER:ASS'Y	U018_S002	41
D1796840	BRACKET:DUCT:CHARGE CORON A:VACUUM:UPPER	U018	42
D1796841	DUCT:CHARGE CORONA:VACUU M:CONNECTING:UPPER	U018	43
D1796842	FILTER:CHARGE CORONA:VACUU M	U018	44
D1796845	DUCT:CHARGE CORONA:VACUU M:LOWER RIGHT	U018	45
D1796846	DUCT:CHARGE CORONA:VACUU M:LOWER LEFT	U018	46
D1796847	DUCT:CHARGE CORONA:VACUU M:MAIN:RIGHT	U018	47
D1796848	DUCT:CHARGE CORONA:VACUU M:MAIN:LEFT	U018	48
D1796849	SEAL:DUCT:CHARGE CORONA:VA CUUM:MAIN	U018	49
D1796858	BRACKET:DUCT:CHARGE:EXHAU ST:UPPER	U018	50

Number	Part Name	Group	ID
D1796860	DUCT:DEVELOPMENT:TONER:UP PER:ASS'Y	U018	51
D1796864	DUCT:DEVELOPMENT:TONER:AS S'Y	U018	52
D1796873	DUCT:FLAT CONVEYER BELT:EXH AUST:UPPER	U018	53
D1796874	DUCT:FLAT CONVEYER BELT:EXH AUST:LOWER	U018	54
D1796875	BRACKET:DUCT:FLAT CONVEYER BELT:EXHAUST	U018	55
D1796897	BRACKET:FAN:OPTICAL WRITING UNIT:COOLING	U018	56
D1796898	SEAL:DUCT:OPTICAL WRITING UN IT:VACUUM	U018	57
D1796913	SEAL:INNER COVER:OPTICAL WRI TING MD:COOLING	U001	72
D1796914	SEAL:INNER COVER:DEVELOPME NT:COOLING	U001	73
D1796918	SEAL:EXTERIOR:REAR:UPPER	U018	58
D1796927	DUCT:HEAT PIPE:EXHAUST	U018	59
D1796932	DUCT:HEAT SHIELD:FUSING:UPP ER	U018	60
D1796934	DUCT:HEAT SHIELD:FUSING:LOW ER	U018	61
D1796940	BRACKET:FAN:EXIT:MIDDLE	U018	62
D1796946	DUCT:EXHAUST:PAPER EXIT SUB -UNIT:A	U018	63
D1796947	BRACKET:DUCT:EXHAUST:PAPER EXIT SUB-UNIT:LEFT	U018	64
D1796948	PLATE:DUCT:EXHAUST:A:ASS'Y	U018	65
D1796953	DUCT:EXHAUST:PAPER EXIT SUB -UNIT:B	U018	66
D1796954	BRACKET:DUCT:EXHAUST:PAPER EXIT SUB-UNIT:RIGHT	U018	67
D1796955	PLATE:DUCT:EXHAUST:B:ASS'Y	U018	68
D1796963	BRACKET:HEAT SHIELD:BELT CLE ANING:ASS'Y	U018_S004	69
D1796966	SEAL:DUCT:THERMOPILE:ENTRA	U018_S004	70

Exclusive Parts

Number	Part Name	Group	ID
	NCE:UPPER		
D1796970	DUCT:THERMOPILE	U018	71
D1796971	SEAL:DUCT:THERMOPILE:ENTRANCE:LOWER	U018	72
D1796972	DUCT:THERMOPILE:ENTRANCE:ASS'Y	U018	73
D1796977	GUARD:FAN:OPTICAL WRITING UNIT	U018	74
D1796978	SEAL:EXTERIOR:REAR:SMALL	U018	75
D1796981	BRACKET:DUCT:HEAT PIPE:EXIT:ASS'Y	U018	76
D1796984	DUCT:HEAT PIPE:EXIT	U018	77
D1796985	DUCT:HEAT PIPE:EXIT:MIDDLE	U018	78
D1796987	DUCT:HEAT PIPE:ENTRANCE:ASS'Y	U018_S001	79
D1796995	BRACKET:FAN:TRANSFER/SEPARATION UNIT:COOLING:REAR	U018	80
D1797050	GUIDE PLATE:DUPLEX:UPPER:LEFT	U014	56
D1797053	GUIDE PLATE:DUPLEX:UPPER:MIDDLE	U014	57
D1797056	GUIDE PLATE:DUPLEX:UPPER:RIGHT	U014	58
D1797060	GATE PAWL:DUPLEX:ENTRANCE	U014	59
D1797062	GUIDE PLATE:DUPLEX:ENTRANCE:UPPER	U014	60
D1797066	GUIDE PLATE:DUPLEX:ENTRANCE:LOWER	U014	61
D1797070	GUIDE PLATE:DUPLEX:OPEN AND CLOSE:LEFT	U014	62
D1797071	SUPPORTING PLATE:GUIDE PLATE:DUPLEX:OPEN AND CLOSE	U014	63
D1797075	GUIDE PLATE:DUPLEX:OPEN AND CLOSE:RIGHT	U014	64
D1797081	BRACKET:DC STEPPER MOTOR:DUPLEX:LEFT	U014	65
D1797082	BRACKET:DC STEPPER MOTOR:DUPLEX:RIGHT	U014	66

Number	Part Name	Group	ID
D1797083	SHAFT:MISFEED REMOVAL:DUPLEX	U013 U014	121 67
D1797084	BRACKET:MISFEED REMOVAL:DUPLEX	U013 U014	122 68
D1797096	BRACKET:DUPLEX:OPEN AND CLOSE:LEFT:PEEN	U014	69
D1797098	BRACKET:DUPLEX:OPEN AND CLOSE:RIGHT:PEEN	U014	70
D1797131	BRACKET:ROLLER:PEEN	U014	71
D1797513	COVER:PAPER TRAY:NO.3	U004	439
D1797519	BRACKET:STOPPER:PAPER TRAY	U004	440
D1797525	STOPPER:REGISTRATION:TANDEM LCT:ASS'Y	U004_S005	441
D1797533	JOINT:LINK:UN LOCK:PEEN	U004	442
D1797540	SCREW:DIA6:M4X3:ADHESIVE	U004	443
D1797550	COVER:PAPER TRAY:NO.1:UPPER	U004	444
D1797561	ARM:LINK:LEFT	U004	445
D1797562	ARM:LINK:RIGHT	U004	446
D1797564	BRACKET:SLIDER:GRIP:UPPER	U004	447
D1797566	BRACKET:ARM:LINK:RIGHT	U004	448
D1797573	BRACKET:ARM:UN LOCK	U004	449
D1797576	ARM:LINK:UN LOCK	U004	450
D1797579	COVER:GRIP:INNER BACK	U004	451
D1797581	STAY:COVER:TANDEM LCT	U004	452
D1797586	STOPPER:TANDEM LCT	U004	453
D1797591	PLATE:TRANSPARENT:LED	U004	454
D1797596	DIFFUSION PLATE:LED	U004	455
D1797597	COVER:LED	U004	456
D1799510	OPC DRUM	U006	109
D1799640	DEVELOPER BLACK	U020	29
D1806801	DUCT:FLAT CONVEYER BELT:EXHAUST:SMALL:ASS'Y	U019	64
D1806811	DUCT:FLAT CONVEYER BELT:EXHAUST:CONNECTING:ASS'Y	U018_S003	81
D1806818	OZONE FILTER:MAIN:EXHAUST:RIGHT	U018	82
D1806821	BASE:HEAT SHIELD:FUSING SUB-UNIT:SUB-ASS'Y	U018	83

Exclusive Parts

Number	Part Name	Group	ID
D1806831	GASKET:DUCT:CHARGE CORONA :VACUUM	U018	84
D1941234	SUPPORTING PLATE:BRACKET:L OCK	U019	65
D1942945	HOLDER:CAM:SHIFT	U004	457
D1943566	GRIP:LEVER:BASE:TONER BANK	U005	82
D1944101	SHAFT:CAM:PRESSURE	U012_S001	143
D1944106	JOINT:CAM:PRESSURE	U012_S001	144
D1944759	BRACKET:LOCK:EXIT	U019	66
D1947346	DC MOTOR:RISE:TANDEM LCT:AS S'Y:19.2W:BRUSH:(BM1)	U004	458
D1947552	SIDE PLATE:TANDEM LCT:LEFT SI DEWAYS	U004	459
D1947635	ARM:END FENCE:LOCK	U004_S010	460
		U004_S011	460
D2235824	COVER:SD-CARD	U017	45
D2236231	DC SOLENOID:LOCK:ASS'Y:(SOL5)	U004_S003	461
D2236233	DC SOLENOID:COUPLING:ASS'Y:(SOL6)	U004_S004	462
D2236722	DC SOLENOID:END FENCE:FRON T:ASS'Y:(SOL8)	U004_S012	463
D2236732	DC SOLENOID:END FENCE:REAR: ASS'Y:(SOL7)	U004_S012	464
D2236747	DC MOTOR:TANDEM LCT:19.2W:B RUSH:(BM4)	U004	465
D2416290	LED:RED	U004	466
		U013	123
		U014	72
		U019	67
D2425605	PCB:DDR3-DIMM:RC-C:2GB:ASS'Y: (PCB27)	U017	46
D2445730	PCB:DCSW:(PCB12)	U016	51
D2452528	BUSHING:MM8	U013	124
D2583910	FAN:MM60X15:(FAN1/FAN2)	U011	26
D2584302	STEPPED SCREW:LEVER:HEAT R OLLER	U012_S001_S002	145
D2585715	CABLE:HDD:SATA:2CON_POWER_ 3P	U017	61

Number	Part Name	Group	ID
D2615140	PCB:SDCU:ASS'Y:(PCB15)	U017_S002	47
D2701132	SLIDE RAIL:PULL OUT:PROTECT	U019	68
D2701151	SLIDE RAIL:PULL OUT:RIGHT UPP ER	U019	69
D2701155	BRACKET:RADIAL BALL BEARING	U019	70
D2701160	RAIL:INTERMEDIATE TRANSFER	U019	71
D2701166	SUPPORTING PLATE:AUXILIARY:R AIL:INTERMEDIATE TRANSFER	U019	72
D2701167	STOPPER:SLIDE RAIL:RIGHT UPP ER	U019	73
D2701171	SUPPORTER:PULL OUT:RIGHT UP PER	U019	74
D2701173	STOPPER:SUPPORTER	U019	75
D2701174	GUIDE:PICK-UP PAPER JAM	U019	76
D2701271	SPACER:SHAFT:DRUM	U015	64
D2701317	DRIVE SUB-UNIT:ON-OFF:PRESSU RE ROLLER:(BLM11)	U015_S003	65
D2701449	COVER:TONER SUPPLY:UPPER:A SS'Y	U001	74
D2701481	DOOR:FRONT LEFT:UPPER	U001	75
D2701509	BRACKET:SUPPORTING PLATE:D OOR:FRONT RIGHT	U001	76
D2701540	INNER COVER:PULL OUT:LEFT	U001_S003	77
D2701541	DECAL:H-TEMP WARNING:EXIT:F USING:ABS	U001	78
D2701542	DECAL:H-TEMP WARNING:PAPER FEED:ABS	U001_S002	79
		U001_S003	79
D2701546	DECAL:PULL OUT:MIDDLE:ABS	U001_S004	80
D2701562	INNER COVER:REVERSE SUB-UNI T:UPPER	U001_S005	81
D2701566	INNER COVER:LEFT UPPER	U001	82
D2701567	DECAL:MAIN SWITCH:ABS	U001	83
D2701568	DECAL:POSITIONING DISPLAY:TC RU:ABS	U001	84
		U001_S004	84
		U006	110
D2701588	(NA):DECAL:CAUTION:PULL OUT:E NGLISH	U020	49
D2701761	(NA):DECAL:CAUTION CHART:INK	U020	50

Exclusive Parts

Number	Part Name	Group	ID
	JET:PAPER		
D2701787	DUCT:POWER SUPPLY UNIT:PAPER FEED:COOLING	U017	48
D2702214	DUCT:CHARGE UNIT:ASS'Y	U006_S005	111
D2702247	DUCT:SIDE PLATE	U006	112
D2702622	TENSION SPRING:48N	U004	467
D2702624	SIDE PLATE:SHIFT:REGISTRATION:FRONT:PEEN	U004	468
D2702627	SIDE PLATE:SHIFT:REGISTRATION:REAR:PEEN	U004	469
D2702632	BRACKET:HOOK:COIL SPRING:REAR:PEEN	U004	470
D2702634	BRACKET:HOOK:COIL SPRING:FRONT:PEEN	U004	471
D2702636	GUIDE PLATE:SHIFT:REGISTRATION:LOWER	U004	472
D2702637	COLOR:4M	U004	473
D2702647	SHAFT:SHIFT	U004	474
D2702656	GUIDE PLATE:REGISTRATION:CIS	U004	475
D2702771	ARM:REGISTRATION:TIMING:ASS'Y	U004_S001	476
D2702786	DUCT:FAN:CONTACT IMAGE SENSOR	U004	477
D2702802	STAY:SHIFT:TRAILING EDGE	U004	478
D2702810	GUIDE PLATE:SHIFT:RIGHT UPPER:PEEN	U004	479
D2702816	SHAFT:TRAILING EDGE:SHIFT	U004	480
D2702947	SHAFT:CAM:ON-OFF:MAIN	U004	481
D2702965	SHAFT:GUIDE PLATE:OPEN AND CLOSE	U004	482
D2702986	BRACKET:GUIDE PLATE:CONNECTION:LARGE CAPACITY TRAY	U004	483
D2703079	SERVICE PARTS:DENSITY SENSOR:DEVELOPMENT:(SEN1)	U006_S003	113
D2703097	COVER:GEAR:DEVELOPMENT	U006_S003	114
D2703134	DECAL:WARNING:AROUND THE PHOTOCONDUCTOR:ABS	U006	115
D2703136	DECAL:DEVELOPMENT UNIT:CAUTION	U006	116

Number	Part Name	Group	ID
	TION		
D2703310	SHAFT:DRIVE:TONER BOTTLE:DIA6	U005	83
D2703335	SEAL:CASE:TONER BANK:LOWER	U005_S001	84
		U005_S002	84
D2703336	SEAL:CASE:TONER BANK:FRONT	U005_S001	85
		U005_S002	85
D2703347	SEAL:BRACKET:RACK	U005	86
D2703366	DECAL:REPLACEMENT INDICATION:TONER BOTTLE	U001_S006	85
D2703383	SEAL:CASE:TONER BANK:REAR	U005	87
D2703384	SEAL:CASE:TONER BANK:LEFT	U005	88
D2703889	BRACKET:POSITIONING SENSOR:PEEN	U007_S001	121
D2704009	HOLDER:M5	U012_S001	146
D2704068	SHAFT:RADIAL BALL BEARING:LEVER:PRESSURE	U012_S001	147
D2704156	HOLDER:THERMISTOR:HEAT ROLLER	U012_S001	148
D2704185	RING:GUIDE:HEAT ROLLER:DIA39.2	U012_S001	149
D2704236	TORSION SPRING:FUSING/PAPER EXIT UNIT:FRONT	U012_S001	150
D2704237	TORSION SPRING:FUSING/PAPER EXIT UNIT:REAR	U012_S001	151
D2704277	DECAL:H-TEMP WARNING:FUSING	U012_S001_S006	152
D2704290	DRIVE UNIT:WEB:CLEANING:ASS'Y	U012_S001_S007	153
D2704338	FEELER:CLEANING	U012_S002	154
D2704343	ROLLER:PLATE	U012_S002	155
D2704383	HOLDER:COIL SPRING:PRESSURE	U012_S001	156
D2704535	DRIVE ROLLER:COOLING UNIT:EXIT:PRESS FIT	U013	125
D2704543	SHAFT:MISFEED REMOVAL:EXIT	U013	126
D2704547	BRACKET:TIGHTENER:EXIT:ASS'Y	U013	127
D2704551	COIL SPRING:TENSIONER:EXIT	U013	128

Exclusive Parts

Number	Part Name	Group	ID
D2704555	SYNCHRONOUS BELT:B50S2M200	U013	129
D2704557	COVER:EXIT:MOTOR	U013	130
D2704658	SHEET:HANDLE:LOCK:ASS'Y	U013	131
D2704737	BRACKET:LINK:LEVER	U013	132
D2704740	BRACKET:ARM:STOPPER:RELEASE	U013	133
D2704742	SHAFT:GUIDE PLATE:EXIT:UPPER:OPEN/CLOSE	U013	134
D2704745	PIN:ARM:GRIP	U013	135
D2704746	BRACKET:CAM:ON-OFF:PEEN	U013	136
D2704748	COMPRESSION SPRING:STOPPER:20N	U013	137
D2704750	STOPPER:GUIDE PLATE:EXIT:UPPER:SUB-ASS'Y	U013	138
D2704753	PLATE:HANDLE:GUIDE:OPEN AND CLOSE	U013	139
D2704757	STOPPER:GUIDE PLATE:EXIT:INNER BACK	U013	140
D2704764	DC SOLENOID:GATE PAWL:SWITCHBACK:(SOL4)	U013	141
D2704768	GATE PAWL:SWITCHBACK	U013	142
D2704800	SHAFT:GATE PAWL:REVERSE	U013	143
D2704933	HOOK:LEVER:GUIDE PLATE:ASS'Y	U014	73
D2705415	PCB:EDRB:(PCB24)	U016	52
D2705975	FILTER:COVER:C/T BOX	U017	49
D2706124	GUIDE PLATE:INTERMEDIATE TRANSFER:ASS'Y	U007_S001	122
D2706128	GUIDE:TRANSPORT:INTERMEDIATE TRANSFER:10MM:ASS'Y	U007_S001	123
D2706129	GUIDE:TRANSPORT:INTERMEDIATE TRANSFER:4MM:ASS'Y	U007_S001	124
D2706166	DRUM STAY:INTERMEDIATE TRANSFER:ASS'Y	U007	125
D2706176	INNER COVER:INTERMEDIATE TRANSFER:LEVER	U007	126
D2706304	TRANSPORT SCREW:TRANSFER ROLLER:ASS'Y	U009_S001	63
D2706333	SHAFT:LEVER:PRESSURE:TRANSFER	U009	64

Number	Part Name	Group	ID
	FER ROLLER		
D2706350	BRACKET:SHAFT:CONTACT POINT:TRANSFER ROLLER	U009	65
D2706360	GROUND PLATE:TRANSPORT SCREW:ASS'Y	U009_S001	66
D2706416	SEAL:HOLDER:CLEANING BLADE:BEHIND	U008_S001	57
D2706453	SHAFT:MISFEED REMOVAL	U004	484
D2706492	GUIDE PLATE:COLLECTION BOTTLE:LOWER	U010	59
D2706498	DECAL:COLLECTION BOTTLE:CAUTION	U010_S002	60
D2706541	SHAFT:DRIVE:FEED:ASS'Y	U004	485
D2706570	COLLECTION BOTTLE:SERVICE PARTS:ASS'Y	U010_S002	61
D2706658	FLANGED HEXAGONAL HEAD BOLT:M3X6	U004_S006 U004_S007 U004_S008	486 486 486
D2706659	ROLLER:GUIDE	U004_S006 U004_S007 U004_S008	487 487 487
D2706664	HOOK:COIL SPRING:SLIDER	U004_S006 U004_S007 U004_S008	488 488 488
D2706668	TENSION SPRING:REVERSE ROLLER	U004_S006 U004_S007 U004_S008	489 489 489
D2706678	COVER:CUSHION	U004_S012	490
D2706721	COVER:GUARD:HARNESS	U004	491
D2706725	COVER:GUARD:HARNESS	U004	492
D2706740	STAY:REVERSE:ASS'Y	U004_S006 U004_S007 U004_S008	493 493 493
D2706806	SEAL:DUCT:LARGE	U018	85
D2706813	SHEET:GUIDE MILER:PAPER FEED:COOLING:LOWER	U019	77
D2706814	SHEET:GUIDE MILER:PAPER FEED:COOLING:UPPER	U019	78

Exclusive Parts

Number	Part Name	Group	ID
D2706815	SHEET:GUIDE MILER:PAPER FEE D:COOLING:INNER BACK	U019	79
D2706818	SEAL:DUCT:FAN:MM97	U018	86
		U018_S003	86
D2706822	SEAL:DUCT:HEAT SHIELD:FUSING :A	U018	87
D2706823	OZONE FILTER:DUCT:MAIN:REAR	U018	88
D2706833	BRACKET:FAN:DEVELOPMENT:EX HAUST	U018	89
D2706851	DUCT:CHARGE CORONA:EXHAUS T:MIDDLE:RIGHT	U018	90
D2706853	DUCT:CHARGE CORONA:EXHAUS T:MIDDLE:REAR	U018	91
D2706854	DUCT:CHARGE CORONA:EXHAUS T:MIDDLE:FRONT	U018	92
D2706856	DUCT:CHARGE CORONA:EXHAUS T:CONNECTING:FRONT	U018	93
D2706857	DUCT:CHARGE CORONA:EXHAUS T:CONNECTING:REAR	U018	94
D2706869	DUCT:CHARGE CORONA:EXHAUS T:MULTI-LANGUAGE:REAR	U018	95
D2706870	DUCT:CHARGE CORONA:EXHAUS T:MULTI-LANGUAGE:FRONT	U018	96
D2706890	DUCT:MAIN:EXHAUST:FRONT	U018	97
D2706891	DUCT:MAIN:EXHAUST:REAR	U018	98
D2706892	COVER:FILTER:EXHAUST	U018	99
D2706896	DUCT:OPTICAL WRITING UNIT:VA CUUM:FRONT	U018	100
D2706909	SEAL:DUCT:LARGE	U018	101
		U018_S002	101
D2706910	SEAL:DUCT:CHARGE CORONA:EX HAUST:MIDDLE	U018	102
D2706911	SEAL:DUCT:MAIN:EXHAUST:FRON T	U018	103
D2706917	SEAL:DUCT:MAIN:EXHAUST	U018	104
D2706920	SEAL:DUCT:MAIN:EXHAUST:A	U018	105
D2706921	SEAL:DUCT:MAIN:EXHAUST:B	U018	106
D2706929	COVER:FAN:MAIN:EXHAUST	U018	107

Number	Part Name	Group	ID
D2706942	BRACKET:FAN:SIDE:RIGHT:SUB-A SS'Y	U018	108
D2706944	BRACKET:GUIDE:BASE	U018	109
D2706945	FILTER:VACUUM:MAIN:RIGHT	U018	110
D2706947	BRACKET:AUXILIARY:BASE	U018	111
D2706948	SHEET:SCREW:FILTER	U001	86
		U018	112
D2706949	SHEET:COVER:MAIN:RIGHT	U001	87
D2706989	SEAL:DUCT:HEAT PIPE:ENTRANC E	U018	113
		U018_S001	113
D2707061	SHAFT:GATE PAWL:DUPLIX:ENT RANCE	U014	74
D2707103	DRUM STAY:RECEIVING SUB-UNI T:REVERSE	U014	75
D2707389	DECAL:PAPER SET DIRECTION:TA NDEM LCT:LEFT	U004	528
D2707518	SHAFT:STOPPER:PAPER TRAY	U004	494
D2707544	SIDE FENCE:TANDEM LCT:LEFT R EAR:ASS'Y	U004_S014	495
D2707548	DECAL:CAUTION:INSERT:PAPER FEED SUB-UNIT	U004_S014	496
D2707574	SHAFT:ARM:UN LOCK	U004	497
D2707649	DECAL:MULTI-LANGUAGE:MAIN:5	U020	31
D2707669	(NA):DECAL:POWER SOURCE:OFF :ABS	U020	51
D3551196	ROLLER:DETENT	U004_S009_S001	498
		U004_S009_S002	498
D3551333	SHIELDING PLATE:SAFETY SWITC H:DOOR	U001_S006	88
D3553810	BRACKET:DETENT:RIGHT:ASS'Y	U004_S009_S001	499
D3553840	BRACKET:DETENT:ASS'Y	U004_S009_S002	500
D3553844	SHOE:HANDLE:RELEASE	U004	501
D3553858	TORSION SPRING:GUIDE PLATE:1 6N	U004_S009	502
D3724561	SPACER:DIA4	U006	117
D4342535	TORSION SPRING:PROOF TRAY	U004	503
D5161326	DECAL:PAPER TRAY:DESIGN SKE TCH:3	U004	504

Exclusive Parts

Number	Part Name	Group	ID
D5163809	CUSHION:STAY	U004	505
D5163823	TIMING BELT:60S2M146	U014	76
D5165200	PCB:LED:ASS'Y:(PCB35/PCB36/PCB37/PCB38/PCB39/PCB40)	U004	506
D5481243	STAND:UN LOCK	U001	89
D6831845	PULLEY:IDLER:DIA14	U010	62
D6844142	TIMING BELT:60S2M174	U014	77
D6884895	BINDING HEAD SCREW:ROUND POINT:M3X8	U013	144
D7315310	PCB:URTB:DOCUMENT FEEDER:ASS'Y:(PCB18)	U004	507
D7773126	TIMING PULLEY:DRIVE:T25S2M	U013	145
G0143291	SNAP RING - PICK UP	U007_S001	127
G0342986	FLANGED HEXAGONAL HEAD BOLT - M4X8	U019	80
G0602296	BALL BEARING:8X16X5MM	U004	508
G0703088	SPACER:DEVELOPMENT ROLLER	U004	509
G0801169	SCREW:M3	U008_S001_S001	58
G1021193	HEXAGONAL BOLT:DOUBLE:SCREW:ROUND POINT:M3X7	U012_S001_S005	157
G1664310	DECAL:WARNING (HIGH TEMPERATURE):1:CUD	U013	146
G1781138	SCREW WITH WASHER:M6X14	U019	81
G1781141	HOLDER:STAND:M20	U020	33
G1781282	GEAR:CHARGE:CLEANER:Z51	U006	118
G1781289	FLY WHEEL:DRUM	U015	66
G1781291	JOINT:TRANSPORT SCREW:NO.2	U015	67
G1781307	JOINT:DEVELOPMENT ROLLER:DRIVE	U015	68
G1781311	TERMINAL:CHARGE	U006	119
G1781313	SPRING:PLATE:RIGHT:CHARGE	U006	120
G1781316	SPRING:PLATE:LEFT:CHARGE	U006	121
G1781602	ARM:SAFETY SWITCH:UPPER:ASS'Y	U001	90
G1782500	GRID:CHARGE CORONA	U006_S001	122
G1782502	CUSHION:CORONA WIRE	U006_S001	123
G1782507	CLEANER:GRID:ASS'Y	U006_S001	124
G1782510	CLEANER:CORONA WIRE:ASS'Y	U006_S001	125

Number	Part Name	Group	ID
G1782512	COVER:END BLOCK:FRONT	U006_S001	126
G1782516	END BLOCK:CHARGE CORONA:FRONT	U006_S001	127
G1782521	SLIDER:CLEANER:CHARGE CORONA:ASS'Y	U006_S001	128
G1782522	RING:SLIDER	U006_S001	129
G1782570	SCREW SHAFT:CHARGE CORONA:ASS'Y	U006_S001	130
G1782605	TENSION SPRING:CORONA WIRE	U006_S001	131
G1782971	LEVER:LOCK:TANDEM LCT	U004_S003	510
G1783330	GEAR:IDLER:DEVELOPMENT ROLLER:ASS'Y	U006_S003	132
G1783332	GEAR:DEVELOPMENT ROLLER	U006_S003	133
G1783356	GEAR:JOINT:DEVELOPMENT UNIT	U006_S003	134
G1783475	SPONGE:COUPLING:TONER SUPPLY:DEVELOPMENT UNIT	U006_S003	135
G1783593	TENSION SPRING:STOPPER	U013	147
G1783672	CAP:PIPE:DISCHARGE USED TONER	U006_S002	136
G1783685	HOLDER:SHAFT:CLEANING BLADE:REAR	U006_S002	137
G1783707	SHEET:COATING BAR:2	U006_S002_S001	138
G1783713	BUSHING:APPLY	U006_S002_S001	139
G1783734	GUIDE PLATE:ARM	U006_S002_S001	140
G1783781	GUIDE:COATING BAR	U006_S002_S001	141
G1783870	TIMING PULLEY:T30	U011	27
G1784018	CASE:COATING BAR:TRANSFER ROLLER	U009_S001	67
G1784636	TIMING BELT:S2M134_67	U011	28
G1784808	BRACKET:PRESSURE:ROLLER	U014	78
G1784817	SPRING:PRESSURE:ROLLER:DUPLEX	U014	79
G1784818	SPRING:PULL OUT:LOCK:EXIT	U019	82
G1784822	SPRING:PRESSURE:0.8N:DIA0.65	U013	148
G1784828	STAY:LOCK:LEVER:LEFT LOWER	U013	149
G1784890	SPRING PLATE:DUPLEX:GUIDE:LOWER	U014	80
G1784895	SHEET:DUPLEX:SPRING PLATE	U014	81

Exclusive Parts

Number	Part Name	Group	ID
G1784900	COVER:DC STEPPER MOTOR:MM56	U004	511
		U013	150
G1784908	COIL SPRING:LEFT LOWER:LOCK	U013	151
G1784909	SCREW:TRANSPORT	U019	83
G1784912	PULLEY:S2M:30T	U004	512
G1784916	SCREW:ROUND POINT	U014	82
G1786621	COVER:RELEASE PLATE:BLADE	U008_S001	59
G1786767	COATING BAR:TRANSFER ROLLER	U009_S001	68
G1787453	ARM:ON-OFF:TRANSPORT ROLLER	U013	152
G1787515	CONNECTOR GUIDE PIN:CONNECTOR	U019	84
G1787618	PLATE:FIX:BAND	U014	83
G1787660	PRESSURE ROLLER:TRANSPORT ROLLER	U004	513
G1787664	SPACER	U004	514
G1787819	SEAL:CAP:COLLECTION BOTTLE	U010_S002	63
G1788350	WRENCH:HEXAGONAL BOLT	U020	34
G3631105	DETENT ROLLER SHAFT	U004_S009_S001	515
		U004_S009_S002	515
GA000063	DECAL:DEVELOPMENT UNIT:DISPLAY	U006_S003	142
GA082010	BUSHING:DIA6:DIA10:9	U010	64
GW010007	PHOTO REFLECTION SENSOR:EXIT:(SEN11/SEN12/SEN13/SEN14/SEN15/SEN16/SEN17/SEN18/SEN19/SEN22/SEN24/SEN25/SEN26/SEN27/SEN28/SEN29/SEN30/SEN31/SEN49/SEN109)	U004	516
		U013	153
		U014	84
GW010009	DENSITY SENSOR:(SEN92)	U007_S001	128
GW020024	PHOTO INTERRUPTOR:LG2A24BL1:GF:(SEN3/SEN21/SEN35/SEN36/SEN37/SEN38/SEN39/SEN40/SEN41/SEN42/SEN43/SEN44/SEN45/SEN46/SEN47/SEN48/SEN51/SEN53/SEN54/SEN60/SEN61/SEN62/SEN71/SEN72/SEN81/SEN82/SEN89/SEN9	U004	517
		U004_S006	517
		U004_S007	517
		U004_S008	517
		U004_S012	517
		U005	89
U006	143		

Number	Part Name	Group	ID
	0/SEN91/SEN104)	U007_S001	129
		U010	65
		U012_S001	158
		U013	154
GW230008	TONER END SENSOR:(SEN73)	U005_S004	90
GX060019	STEPPER MOTOR:PM42L048RBG8:(STM32/STM33)	U005_S004	91
GX640028	FAN MOTOR DC24V 1.92W:(FAN3/FAN28/FAN29)	U004	518
		U018	114
H0722216	COMPRESSION SPRING	U013	155
H5194238	SPACER:ROLLER:CONNECTING	U004	519
J0155505	DRAWER:CONNECTOR:USED DEVELOPER:PLUG	U006_S002_S001	144
J5033116	TIMING BELT:40S2M128	U013	156
M0447747	CAP:COVER:REAR	U001	91
M0774200	MECHANICAL ROLLER CLUTCH:ROLLER	U012_S002	159
M0774821	TRANSPORT BELT:COOLING	U013	157
M0777428	BALL BEARING:REGISTRATION:DRIVEN:FRONT	U004	520
		U004	521
M0777429	BALL BEARING:REGISTRATION:DRIVEN:REAR	U004	521
M0B11328	ANTISTATIC BRUSH:DRUM	U015	69
M0B14675	GATE PAWL:EXIT:REVERSE	U013	158
M0BJ5780	DISPLSY:TM170-RIX01	U002	14
M0CL5401	PCB:BICU:ASS'Y:(PCB11)	U017	50
M0CL5612	(Pro 8310):PCB:SERVICE:CTL:(PCB17)	U017	51
M0CL5613	(Pro 8320):PCB:SERVICE:CTL:(PCB17)	U017	52
M0CL7682	(Pro 8310):MODEL NAME PLATE:PRO_8310	U020	35
M0CL9590	NVRAM	U017	53
M0CM7682	(Pro 8320):MODEL NAME PLATE:PRO_8320	U020	36
M2051682	DOOR CATCH:FRONT	U001	92
M2057305	REGISTRATION ROLLER:GATE:ASS'Y	U004_S002	522

Exclusive Parts

Number	Part Name	Group	ID
M2057311	DISC:GATE:REGISTRATION:HOME POSITION SENSOR	U004	523
M2057466	DUCT:SHIFT:CIS	U004	524
M2631444	COVER:UPPER FRONT	U001	93
M2631445	COVER:UPPER LEFT	U001	94
M2631446	COVER:UPPER REAR	U001	95
M2631565	COVER:UPPER MIDDLE	U001	96
M2631566	STAY:COVER:UPPER MIDDLE	U001	97
M2631568	CUSHION:STAY:COVER:UPPER RIGHT	U001	98
M2631596	DECAL:USER CAUTIONS:COVER:UPPER	U020	37
M5001861	TUBE TYPE LAMP:ASS'Y:(PCB14)	U020_S002	38
		U020_S004	38
VSSG9002	FLUOTRIBO MG GREASE : 100G	SPECIAL TOOLS	17
VSSM9000	DIGITAL MULTIMETER-FLUKE189/FVF	SPECIAL TOOLS	18

Standard Parts



03125060N
SCREW - M2.5X6



03130040N
SCREW:M3X4



03130060N
SCREW - M3X6



03130080N
PAN HEAD SCREW:M3X8



03130120N
PAN HEAD SCREW:M3X12



03140120N
SCREW - M4X12



03140180N
PAN HEAD SCREW:M4X18



03150100N
PAN HEAD SCREW:M5X10



03530040N
SCREW - M3X4



03530060N
BIND SCREW - M3X6



03530080N
SCREW:M3X8



03530100N
SCREW-M3X10



03530120N
SCREW M3X12

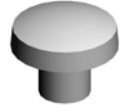

03540040N
SCREW-M4X4



03540050N
SCREW - M4X5



03540060N
SCREW-M4X6



03540080N
SCREW:M4X8



03540120N
SCREW M4X12



03540400N
SCREW:M4X40



03603005N
SCREW - M3X5



03603006N
SCREW - M3X6



03603008N
SCREW:M3X8



03603010N
SCREW:M3X10



03603014N
SCREW - M3X14



03603020N
SCREW:M3X20



03603030N
SCREW:M3X30



03604006N
SCREW - M4X6



03604008N
SCREW - M4X8

Standard Parts



03604010N
SCREW:M4X10



03604012N
SCREW:M4X12



03604014N
SCREW - M4X14



03604016N
SCREW:M4X16



04340060N
PAN SELF-TAPPING SCREW:
M4X6



04340200N
PAN SELF-TAPPING SCREW:
4X20

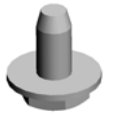

04503006N
TAPPING SCREW - M3X6



04503008N
TAPPING SCREW - M3X8



04503010N
TAPPING SCREW - M3X10



04503012N
TAPPING SCREW:3X12



04504008N
TAPPING SCREW - M4X8



04504010N
TAPPING SCREW:M4X10



04504012N
TAPPING SCREW:4X12



04504025N
TAPPING SCREW:4X25



04513006N
TAPPING SCREW - 3X6



04513006P
TAPPING SCREW:M3X6



04513008N
TAPPING SCREW - M3X8



04513010N
TAPPING SCREW:3X10



04513014N
TAPPING SCREW:3X14



04513020N
TAPPING SCREW:3X20



04513030N
TAPPING SCREW:3X30



04514006N
TAPPING SCREW - 4X6



04514008N
TAPPING SCREW:4X8



04514010N
TAPPING SCREW:4X10



04514012N
TAPPING SCREW:4X12



04523008N
TAPPING SCREW - M3X8



04523010N
BINDING SELF-TAPPING SC
REW:3X10



04524008N
TAPPING SCREW:M4X8

Standard Parts



04524010N
BINDING SELF-TAPPING SC
REW:4X10



04524012N
BINDING SELF-TAPPING SC
REW:4X12



04533006N
TAPPING SCREW - M3X6



04534006N
BINDING SELF TAPPING SC
REW:4X6



04534008N
BINDING SELF TAPPING SC
REW:4X8



04543006Q
TAPPING SCREW - M3X6



04543008Q
TAPPING SCREW:3X8



04543030Q
TAPPING SCREW:ROUND P
OINT:3X30



04544006Q
TAPPING SCREW:4X6



04544008Q
TAPPING SCREW - M4X8



04544010N
TAPPING SCREW:ROUND P
OINT:4X10



04583008N
HEXAGON HEAD TAPPING S
CREW:3X8

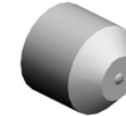

05730030E
HEXAGON HEADLESS SET S
CREW - M3X3

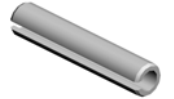

06230160E
SPRING PIN - 3X16MM

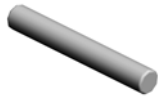

06320140G
PARALLEL PIN



06320200G
PARALLEL PIN:2X20

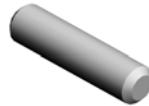

06330120G
PARALLEL PIN - 3X12

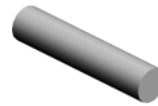

06330140G
PARALLEL PIN - 3X14

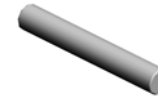

06330200G
PIN - M3X20



07010050G
WASHER(POLISHED ROUND



07030040N
SPRING WASHER:DIA4



07040050N
WASHER:DIA5



07050040N
WASHER:DIA4



07080060N
WASHER:DIA6



07080080N
WASHER-DIA8



07110030N
HEXAGONAL NUT:M3



07200020E
RETAINING RING - M2



07200025E
RETAINING RING - M2.5

Standard Parts



07200030E
RETAINING RING - M3



07200040E
RETAINING RING - M4



07200060E
RETAINING RING - M6



07200080E
RETAINING RING - M8



07250200E
RETAINING RING C - M20



07250220E
RETAINING RING - M22



07250250E
RETAINING RING C - M25



07330610
BUSHING: DIA6X10



07403008
BALL BEARING - 8X22X7



07403012
BALL BEARING - 12X28X8



07403808
BALL BEARING - 8X16X5MM



07413506
BALL BEARING - 6X12X4 MM



07413706
BALL BEARING - 6X10X3



07413708
BALL BEARING - 8X12X3.5MM



07433806
RADIAL BALL BEARING: DIA6 X DIA13X5



07433808
RADIAL BALL BEARING: DIA8 X DIA16X5



08010234
SCREW WITH WASHER: SMA LL ROUND WITH SPRING WASHER: M5X8



08010237
HEXAGONAL BOLT: DOUBLE SCREW: M4X12



08025220
TAPPING SCREW - M4X8



08025330
PAN HEAD WITH COLLAR TAPPING SCREW: PF: 4X10



08046123
HEXAGONAL BOLT: W/WASHER: M3X8



08050072
CS RING



08050088
RETAINING RING - M6



08050089
RETAINING RING - M4



08050092
RETAINING RING - 3M



08050100
RETAINING RING - M2.5



08050103
RETAINING RINGS-E: SILENCER: DIA3



08050104
RETAINING RINGS-E: SILENCER: DIA4

Standard Parts



08053263
BEARING - 6X10X6MM



08053386
BUSHING - 8MM



08053445
BEARING - M6X10X3



08053480
BUSHING - 6MM



08053568
RADIAL BALL BEARING: DIA8
XDIA14X4

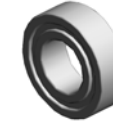

08053573
RADIAL BALL BEARING: DIA8
XDIA16X5



08053585
RADIAL BALL BEARING: DIA8
XDIA16X5

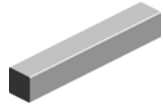

09300404A
PARALLEL KEY: 4X4X25



09513006N
SCREW - M3X6



09514006N
SCREW: POLISHED ROUND:
M4X6



09514008N
SCREW: POLISHED ROUND:
M4X8



09514020N
SCREW - M4X20



09543006N
SCREW - M3X6



09543008N
SCREW - M3X8



09543010N
SCREW: POLISHED ROUND/
SPRING: M3X10



09543012N
SCREW - M3X12



09543025N
SCREW: POLISHED ROUND/
SPRING: M3X25



09544008N
SCREW - M4X8

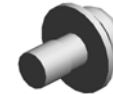

09545010N
SCREW: POLISHED ROUND/
SPRING: M5X10



11050042
WIRE BAND



11050046
HARNESS BAND

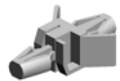

11050193
NYLON STUD



11050328
HARNESS CLAMP - ES-0505



11050367
SPACER



11050410
CARD SPACER - 9.4MM



11050487
HARNESS CLAMP



11050488
HARNESS CLAMP



11050489
HARNESS CLAMP - LWS 131
6

Standard Parts



11050490
HARNESS CLAMP - IWS-2218



11050508
HARNESS CLAMP - LWS-071
1



11050511
HARNESS CLAMP - LWS-030
6ZC

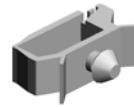

11050516
CLAMP



11050528
NYLON CLAMP - EMT-2N



11050529
NYLON CLAMP-EMT-3N

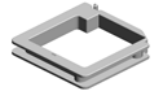

11050532
EDGE SADDLE - LES-25L



11050534
CLAMP



11050551
CLAMP:LES-0505



11050568
CLAMP:LWSS-0504



11050601
CLAMP:LWSM-0511-2M



11050692
CLAMP:LES-0503



11050711
CLAMP:JDL-1S



11050723
CLAMPS:WES-0507



11050724
CLAMPS:WES-1210



11050725
CLAMPS:WES-1117

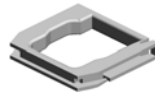

11050726
CLAMPS:WES-2217



11050744
CLAMP:F-LWS-0711



11050751
CLAMP:LWSM-0606-3.2M

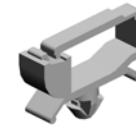

11050760
CLAMP:LWSM-0511A



11060911
BUSHING:SB-1909



11071280
(Pro 8300S/8310S/8310):FUS
E:BJS1512F2:(BL1)

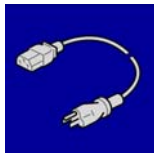

11500455
(NA):POWER SUPPLY CODE
250V:20A



12042570
ROCKER SWITCH:SDDJE132
00:(SW100/SW101)

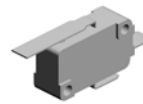

12042612
MICRO SWITCH:D3V-16506-3
C25:(SW10/SW11/SW102/SW
103)

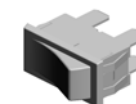

12042614
SWITCH AC250V/16A:(SW12)

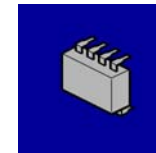

14078389
EEPROM:BR24T128-W



14078476
ROM STORAGE:SDXC8GB

Standard Parts



16071799

FILTER - SUP-ET20-ER-0:(NF
1)



16072256

FERRITE CORE:K3 NFR-08-A
BK0

PM Part List

Number	Part Name	Num	Group	ID
AB011125	GEAR:20/29Z	1	U009_S001	23
AB011126	GEAR:20Z	1	U009_S001	24
AE020220	PRESSURE ROLLER:DIA65	1	U012_S001_S001	51
AE030086	RADIAL BALL BEARING:DIA25XDIA37X7	4	U012_S001	54
			U012_S001_S001	54
AE045065	WEB:SUB-ASS'Y	1	U012_S002	59
AF030072	PAPER FEED ROLLER:PICK UP	3	U004_S006	162
			U004_S007	162
			U004_S008	162
AF031098	PAPER FEED ROLLER:FEED	3	U004_S006	163
			U004_S007	163
			U004_S008	163
AF032098	PAPER FEED ROLLER:SEPARATE	3	U004_S006	164
			U004_S007	164
			U004_S008	164
D0742459	JOINT:CLEANING UNIT	1	U006_S002_S001	38
D0746257	BRUSH ROLLER:APPLY:ASS'Y	1	U009_S001	34
D0746265	BLADE:TRANSFER ROLLER:ASS'Y	1	U009_S001	35
D0746312	GEAR:IDLER:TRANSFER ROLLER	1	U009_S001	41
D0746424	BLADE:CLEANING:BELT CLEANING:ASS'Y	1	U008_S001	15
D0746446	BRUSH:APPLY:BELT CLEANING	1	U008_S001	24
D0746450	COATING BAR:ASS'Y	1	U008_S001_S001	25
D0746457	BLADE:APPLY:ASS'Y	1	U008_S001	28
D0BX4162	HOT ROLLER:DIA54:ASS'Y	1	U012_S001_S002	101
D0BX6051	ROLLER:INTERMEDIATE TRANSFER:ASS'Y	1	U007_S001	67
D0BX6078	ROLLER:OPPOSED:PAPER:ASS'Y	1	U007_S001	68
D0BX6250	TRANSFER ROLLER	1	U009_S001	47
D0BX6889	FILTER:MAIN:EXHAUST:RIGHT	2	U018	30
D0BX6909	FILTER:DUCT:MAIN:REAR	2	U018	32
D1792224	CORONA WIRE:CHARGE CO	3	U006_S001	51

Number	Part Name	Num	Group	ID
	RONA			
D1793535	GEAR SET:CLEANING UNIT:SERVICE PARTS	1	U006_S002_S002	88
D1793581	BLADE:CLEANING:ASS'Y	1	U006_S002	96
D1793635	COATING BAR:ASS'Y	1	U006_S002_S001	101
D1793641	BRUSH ROLLER:APPLY:ASS'Y	1	U006_S002_S001	102
D1793653	BLADE:APPLY:ASS'Y	1	U006_S002_S001	105
D1794197	FLAT BELT-FUSING:DIA80:SEAL	1	U012_S001	128
D1796050	FLAT BELT-TRANSFER	1	U007	85
D1796310	SEPARATION CORONA:ASS'Y	1	U009_S001_S001	54
D1796311	GEAR:TRANSFER ROLLER	1	U009_S001	55
D1799510	OPC DRUM	1	U006	109
D1799640	DEVELOPER BLACK	2	U020	29
D2704343	ROLLER:PLATE	1	U012_S002	155
G1782500	GRID:CHARGE CORONA	1	U006_S001	122
G1782502	CUSHION:CORONA WIRE	6	U006_S001	123
G1782507	CLEANER:GRID:ASS'Y	1	U006_S001	124
G1782510	CLEANER:CORONA WIRE:ASS'Y	3	U006_S001	125
G1786767	COATING BAR:TRANSFER ROLLER	1	U009_S001	68

Design Change List

Number	Title	Set	Old Part		New Part		Index No.		Q'ty	Interchg		Reason	Cut-in S/N
			P/N	Name	P/N	Name	Group	ID		Indiv.	Set		
201910-01	1910 Modification	-	AZ240309	POWER SUPPLY UNIT:ECO:456.4W:(PCB28)	AZ240355	POWER SUPPLY UNIT:ECO:(PCB28)	U017	63	1	X/O			
201910-02	1910 Modification	-	AZ240311	POWER SUPPLY UNIT:FW:446.4W:(PCB29)	AZ240356	POWER SUPPLY UNIT:FW:(PCB29)	U017	64	1	X/O			
201909-02	1909 Modification	-	D0747389	DECAL:PAPER SET DIRECTION:TANDEM LCT:LEFT	D2707389	DECAL:PAPER SET DIRECTION:TANDEM LCT:LEFT	U004	528	1	O/O			
201908-01	1908 Modification	-	A2943294	GEAR - 108Z USA (RIC)	A2943293	(Pro 8310/8320): GEAR:108Z	U005	92	1	O/O			
			A2943294	GEAR - 108Z USA (RIC)	A2943293	(Pro 8310/8320): GEAR:108Z	U005	92	1	O/O			
201907-01	1907 Modification	-			D0BX1465	BRACKET:KEY COUNTER	U019	95	1				
201907-02	1907 Modification	-			D1791316	JOINT:DRIVE:FUSING	U015_S002	70	1				
201907-08	1907 Modification	-	D0BX4245	STAY:STRIPPER PLATE:PEEN			U012_S001_S005	103	1				
201907-09	1907 Modification	-			D0BX7662	ACCESSORY:COVER:SIDE:RIGHT:ASS'Y	U020	53	2				
201907-10	1907 Modification	-			D2585715	CABLE:HDD:SATA:2CON_POWER_3P	U017	61	1				
201904-03	1904 Modification	-			D0BX3862	SUPPORTING PLATE:VACUUM	U011	29	1				
201904-04	1904 Modification	-			D1793865	BRACKET:SENSOR:VACUUM	U011	30	1				

Design Change List

Number	Title	Set	Old Part		New Part		Index No.		Q'ty	Interchg		Reason	Cut-in S/N
			P/N	Name	P/N	Name	Group	ID		Indiv.	Set		
201904-05	1904 Modification	-	04513006N	TAPPING SCREW - 3X6	03603006N	SCREW - M3X6	U004	8	1	X/O			

