

**Pro 8300S/8310S/8320S**  
**(D0BX/D0BY/D0BZ-NA)**  
**Parts Catalog**

**Parts change information sample**

 **Add**

 **Update**

 **Delete**

Model	Product Code	PC Style
RICOH Pro 8300S	D0BX	3D
RICOH Pro 8310S	D0BY	
RICOH Pro 8320S	D0BZ	
RICOH Pro 8310Y/8310HT	M0CL	3D
RICOH Pro 8320Y/8320HT	M0CM	
Decurl Unit DU5070	D3DR	3D
Finisher SR5110	D3G9	3D
Booklet Finisher SR5120	D3G8	3D
Punch Unit PU5030	D3GJ	3D
Booklet Finisher SR5100	D3GD	3D
Finisher SR5090	D3GC	3D
Shift Sort Tray SH5000	D3GE	3D
Buffer Pass Unit Type S11	D3FC	3D
LCIT RT5130	D3GB	3D
Cover Interposer Tray CI5040	D3GA	3D
Cover Interposer Tray Double-Feed Detection Kit Type S11		
A3/11" x17" Tray Unit TK5020	B331	3D
Bridge Unit BU5020	D3GN	3D
Ring Binder RB5030	D3GH	Traditional
Trimmer Unit TR5050	D3GG	Traditional
RPIP Interface Box Type S3	M462	Traditional
PostScript3 Unit Type S11	D0C3	Traditional
PostScript3 Unit Type S12	D0C3	Traditional
IPDS Unit Type S11	D0C3	Traditional
XPS Direct Print Option Type S11	D0C3	Traditional
OCR Unit Type M2	D166	Traditional
VM Card Type P18	D0C3/D3EN	Traditional
SD Card for Fonts Type D	D641	Traditional
IEEE 802.11a/g/n Interface Unit Type M19	D3BR	Traditional
File Format Converter Type M19	D3BR	Traditional
NFC Card Reader Type S6	D3DH	Traditional

# Unit All



U001  
EXTERIOR



U002  
OPERATION



U003  
ADF



U004  
SCANNER



U005  
LASER UNIT



U006  
PAPER FEED



U007  
TONNER SUPPLY



U008  
PCDU



U009  
ITB UNIT



U010  
ITB CLEANING

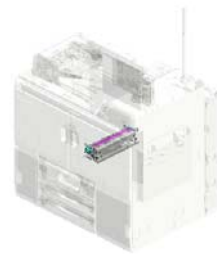

U011  
TRANSFER/SEPARATION



U012  
USED TONER

# Unit All



**U013**  
PAPER TRANSPORT



**U014**  
FUSING

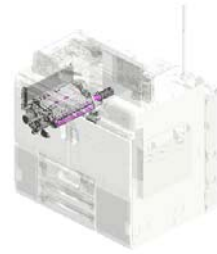

**U015**  
PAPER EXIT



**U016**  
DUPLEX



**U017**  
MAIN DRIVE



**U018**  
ELECTRICAL



**U019**  
CONTROLLER



**U020**  
AIR COOLING

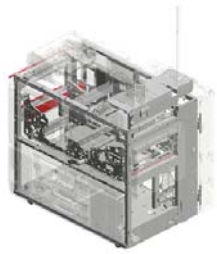

**U021**  
MAIN FRAME



**U022**  
ACCESSORIES



**U023**  
(For Pro 8300S):Attention Light AL3000

# U001.EXTERIOR

U001\_S004  
D0BX1549  
INNER COVER:PULL OUT:LE  
FT:ASS'Y

U001\_S011  
D0BX1549  
INNER COVER:PULL OUT:LE  
FT:ASS'Y

U001\_S007  
D1791454  
DOOR:TONER SUPPLY:ASS'  
Y

U001\_S001  
D0BX1484  
SUPPORTING PLATE:DOOR:  
FRONT LEFT:ASS'Y

U001\_S005  
D0BX1550  
INNER COVER:INTERMEDIA  
TE TRANSFER:ASS'Y

U001\_S008  
D0BX1484  
SUPPORTING PLATE:DOOR:  
FRONT LEFT:ASS'Y

U001\_S012  
D0BX1550  
INNER COVER:INTERMEDIA  
TE TRANSFER:ASS'Y

U001\_S006  
D0BX1555  
INNER COVER:REVERSE SU  
B-UNIT:UPPER:ASS'Y

U001\_S003  
D0BX1547  
INNER COVER:PULL OUT:RI  
GHT:ASS'Y

U001\_S010  
D0BX1547  
INNER COVER:PULL OUT:RI  
GHT:ASS'Y

U001\_S002  
D0BX1498  
SUPPORTING PLATE:DOOR:  
FRONT RIGHT:ASS'Y

U001\_S009  
D0BX1498  
SUPPORTING PLATE:DOOR:  
FRONT RIGHT:ASS'Y

U001	U002	U003	U004	U005	U006	U007	U008	U009	U010	U011	U012	U013	U014	U015	U016	U017	U018	U019	U020	U021
------	------	------	------	------	------	------	------	------	------	------	------	------	------	------	------	------	------	------	------	------

# U001.EXTERIOR

U001\_S013  
D0BX1555  
INNER COVER:REVERSE SU  
B-UNIT:UPPER:ASS'Y



U001\_S014  
D1791454  
DOOR:TONER SUPPLY:ASS'  
Y

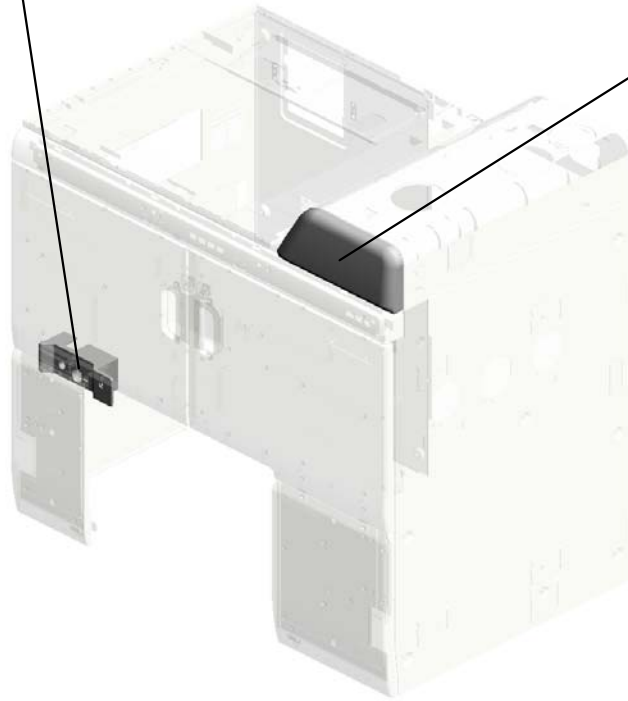

U001	U002	U003	U004	U005	U006	U007	U008	U009	U010	U011	U012	U013	U014	U015	U016	U017	U018	U019	U020	U021
------	------	------	------	------	------	------	------	------	------	------	------	------	------	------	------	------	------	------	------	------

# U001 EXTERIOR



- 12.11050723 (x2) CLAMPS:WES-0507
- 15.AA143797 (x2) CONNECTOR GUI DE PIN
- 5.04544008Q (x4) TAPPING SCREW - M4X8
- 10.09543025N (x4) SCREW:POLISHED ROUND/SPRING:M 3X25
- 13.12042612 (x4) MICRO SWITCH:D3 V-16506-3C25:(SW 10/SW11/SW102/S W103)

- 19.C1012360 (x4) SNAP RING

- 18.B2342390 (x14) FLANGED HEXAGONAL HEAD BOLT: M4X8

- 9.09543008N (x16) SCREW - M3X8

- 11.11050511 (x2) HARNESS CLAMP - LWS-0306ZC

- 2.03604008N (x12) SCREW - M4X8

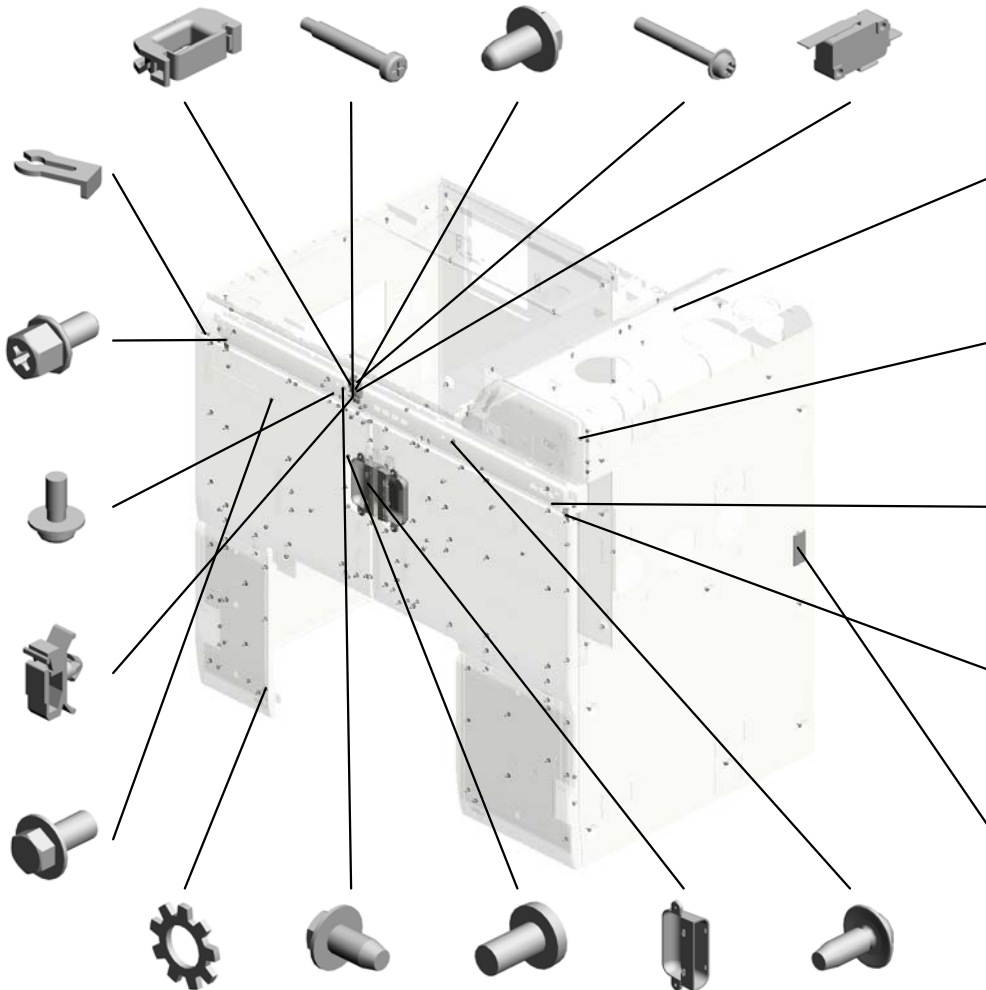

- 6.04544010N (x14) TAPPING SCREW: ROUND POINT:4X10

- 14.52062686 (x2) SNAP RING

- 3.04513006N (x4) TAPPING SCREW - 3X6

- 20.D0743829 (x4) DECAL:POSITIONING DISPLAY:TCRU

- 22.D0747828 (x2) CAP:CONNECTOR

- 7.07050040N (x48) WASHER:DIA4
- 4.04514008N (x124) TAPPING SCREW: 4X8
- 1.03540080N (x32) SCREW:M4X8
- 21.D0747782 (x4) GRIP:DOOR:FRONT
- 8.08025330 (x150) PAN HEAD WITH COLLAR TAPPING SCREW:PF:4X10



# U001 EXTERIOR



- 48.D1791442 (x2) COVER.DC\_SW
- 32.D0BX1482 (x4) PLATE.MAGNET CATCH
- 29.D0BX1405 (x4) STEPPED TAPPING SCREW:TYPE 2: DIA5:M4
- 31.D0BX1470 (x2) BRACKET:COVER:FRONT UPPER
- 42.D0BX1554 (x4) HEXAGON HEAD SCREW:M4:DIA3

- 28.D0BX1181 (x2) DECAL:PICK-UP PAPER JAM:OPERATION PANEL:ENGLISH

- 35.D0BX1508 (x2) COVER.MAIN:LEFT

- 30.D0BX1407 (x4) GUIDE:LEVER:PULL OUT

- 26.D0747854 (x2) HINGE:LEFT LOWER:ASSY

- 37.D0BX1528 (x2) SHEET:HEATER:LOWER

- 45.D0BX1579 (x2) INNER COVER:REVERSE SUB-UNIT:LOWER
- 44.D0BX1569 (x4) HINGE:COVER:REAR LOWER
- 27.D0747861 (x2) HINGE:RIGHT LOWER:ASSY
- 25.D0747831 (x2) COVER:CONNECTOR:LARGE CAPACITY TRAY
- 23.D0747829 (x8) CAP:JOINT:LARGE CAPACITY TRAY

- 36.D0BX1516 (x2) COVER.MAIN:REAR:PEEN

- 38.D0BX1535 (x2) COVER:REAR LOWER:PEEN

- 46.D0BX1598 (x4) STOPPER:FILTER:LOWER

- 47.D0BX1599 (x2) SHEET:DUCT:REAR

- 24.D0747830 (x2) COVER:LARGE CAPACITY TRAY

# U001 EXTERIOR

- 55.D1791471 (x2) LEVER:SAFETY SWITCH
- 56.D1791476 (x2) BRACKET:SAFETY SWITCH
- 57.D1791477 (x2) SHIELD PLATE:SAFETY SWITCH
- 67.D1791526 (x2) STAY:SAFETY SWITCH
- 54.D1791469 (x2) COVER:FRONT UPPER

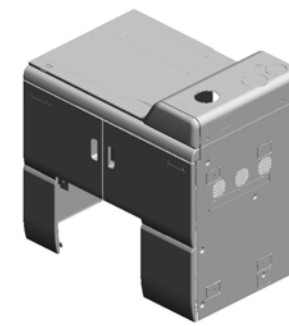

- 68.D1791531 (x2) HINGE:LEFT UPPER

- 58.D1791483 (x4) LEVER:SAFETY SWITCH

- 75.D2701481 (x2) DOOR:FRONT LEFT:UPPER

- 60.D1791487 (x2) DUCT:DOOR:FRONT LEFT:ASSY

- 59.D1791485 (x2) DOOR:FRONT LEFT:LOWER

- 71.D1791572 (x4) BRACKET:EARTH:DOOR:LOWER
- 70.D1791571 (x4) BRACKET:EARTH:DOOR:MIDDLE
- 62.D1791497 (x2) DOOR:FRONT RIGHT:UPPER
- 64.D1791500 (x2) DOOR:FRONT RIGHT:LOWER
- 69.D1791533 (x2) HINGE:RIGHT UPPER

- 74.D2701449 (x2) COVER:TONER SUPPLY:UPPER:ASSY

- 49.D1791451 (x2) CAP:KEY COUNTER

- 63.D1791499 (x2) CAP:MM22

- 53.D1791460 (x4) HINGE:DOOR:TONER SUPPLY

- 66.D1791514 (x2) COVER:MAIN:RIGHT

# U001 EXTERIOR

- 82.D2701566 (x2) INNER COVER:LEFT UPPER
- 103.D1791444 (x2) COVER:UPPER FRONT
- 90.G1781602 (x2) ARM:SAFETY SWITCH:UPPER:ASS'Y
- 99.C2672944 (x4) SCREW:ACTUATOR:SURFACE OF PA
- 104.D1791446 (x2) COVER:UPPER REAR



- 83.D2701567 (x2) DECAL:MAIN SWITCH:ABS



- 92.M2051682 (x4) DOOR CATCH:FRONT

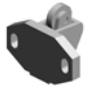

- 78.D2701541 (x2) DECAL:H-TEMP WARNING:EXIT:FUSING:ABS



- 91.M0447747 (x14) CAP:COVER:REAR

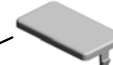

- 101.D0BX1592 COVER:PILOT LAMP



- 102.D1791443 (x2) COVER:UPPER RIGHT



- 86.D2706948 (x2) SHEET:SCREW:FILTER



- 84.D2701568 (x2) DECAL:POSITIONING DISPLAY:TCRU:ABS



- 89.D5481243 (x2) STAND:UN LOCK



- 87.D2706949 (x2) SHEET:COVER:MAIN:RIGHT

U001\_S001  
SUPPORTING PLATE:DOOR:FRONT LEFT:ASS'Y

61.D1791490 1.03540080N  
BRACKET:SUPPO (x10)  
RTING PLATE:DOO SCREW:M4X8  
R:FRONT LEFT

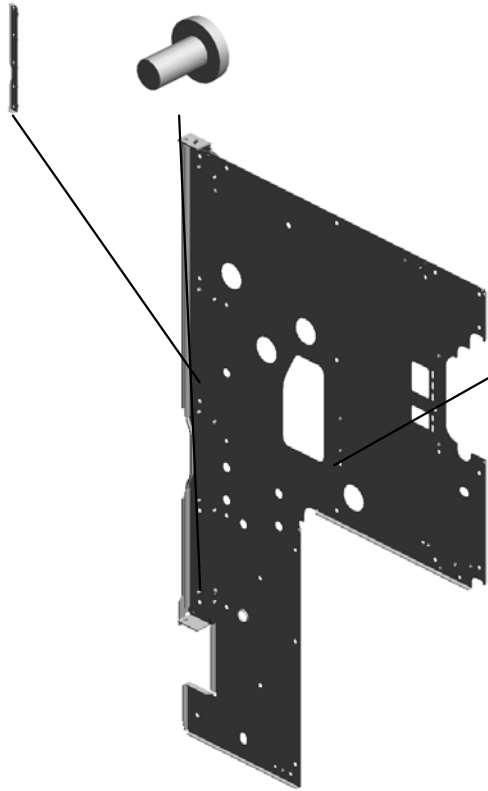

34.D0BX1489  
SUPPORTING PLA  
TE:DOOR:FRONT L  
EFT



33.D0BX1484  
SUPPORTING PLA  
TE:DOOR:FRONT L  
EFT:ASS'Y

U001\_S002

SUPPORTING PLATE:DOOR:FRONT RIGHT:ASS'Y

73.D1796914 72.D1796913  
SEAL:INNER COVE SEAL:INNER COVE  
R:DEVELOPMENT: R:OPTICAL WRITIN  
COOLING G MD:COOLING



100.D0BX1498  
SUPPORTING PLA  
TE:DOOR:FRONT  
RIGHT:ASS'Y

76.D2701509  
BRACKET:SUPPO  
RTING PLATE:DOO  
R:FRONT RIGHT

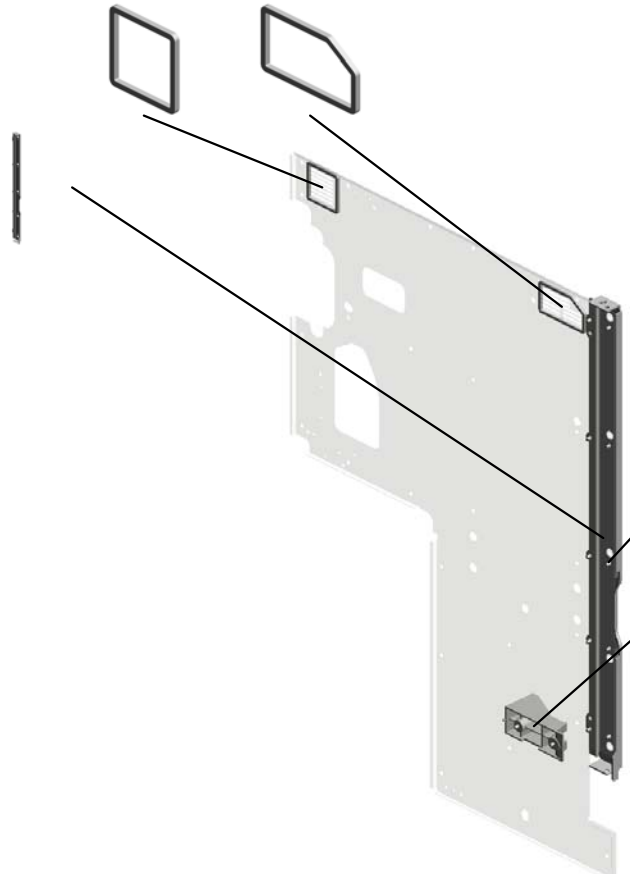

1.03540080N  
(x12)  
SCREW:M4X8

65.D1791505  
STOPPER:GUIDE P  
LATE:VERTICAL T  
RANSPORT

U001	U002	U003	U004	U005	U006	U007	U008	U009	U010	U011	U012	U013	U014	U015	U016	U017	U018	U019	U020	U021
------	------	------	------	------	------	------	------	------	------	------	------	------	------	------	------	------	------	------	------	------

U001\_S003

INNER COVER:PULL OUT:RIGHT:ASS'Y

16.AC020152  
LENS:LED:3

79.D2701542  
DECAL:H-TEMP W  
ARNING:PAPER FE  
ED:ABS

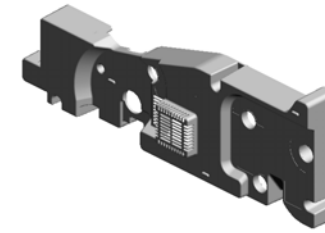

39.D0BX1547  
INNER COVER:PUL  
L OUT:RIGHT:ASS'  
Y

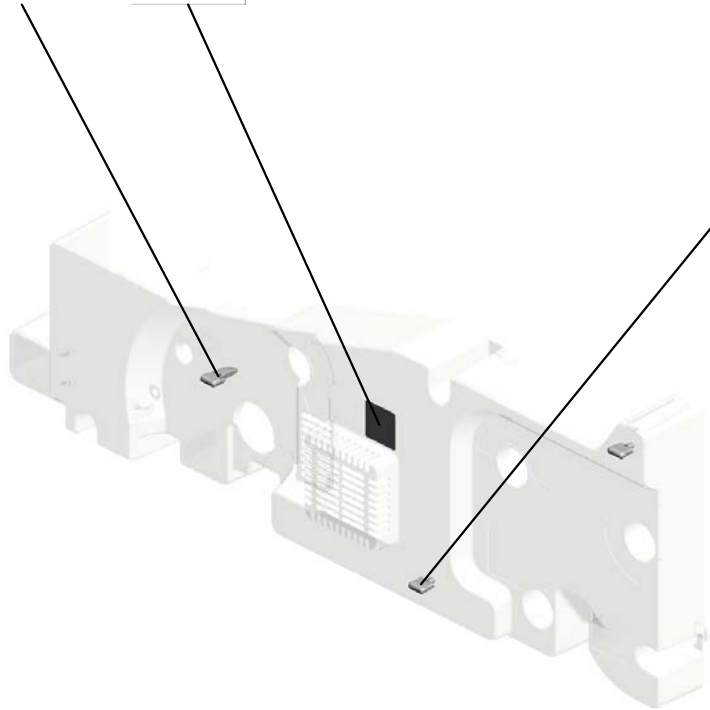

17.AC020153  
(x2)  
LENS:LED:4

U001\_S004  
INNER COVER:PULL OUT:LEFT:ASS'Y

16.AC020152  
LENS:LED:3

40.D0BX1549  
INNER COVER:PUL  
L OUT:LEFT:ASS'Y

79.D2701542  
(x2)  
DECAL:H-TEMP W  
ARNING:PAPER FE  
ED:ABS

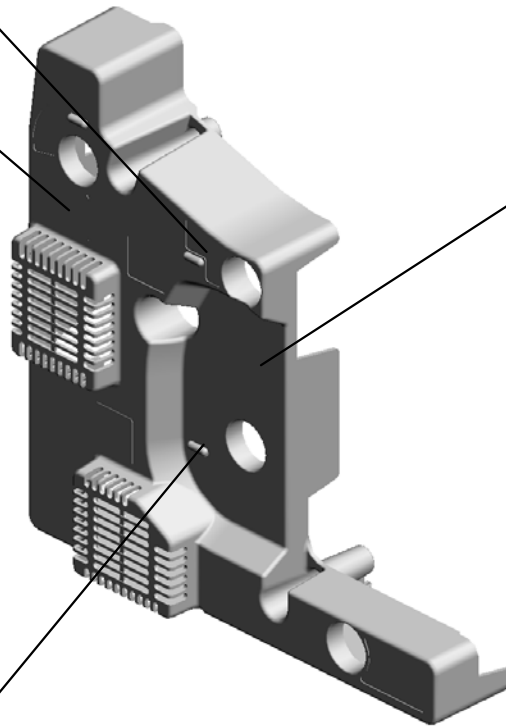

77.D2701540  
INNER COVER:PUL  
L OUT:LEFT



17.AC020153  
(x2)  
LENS:LED:4

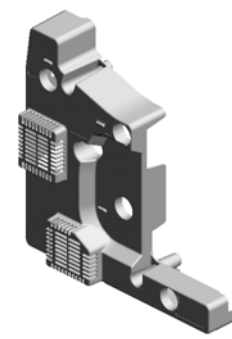

U001\_S005

INNER COVER:INTERMEDIATE TRANSFER:ASS'Y

80.D2701546  
DECAL:PULL OUT:  
MIDDLE:ABS

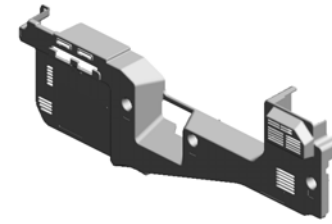
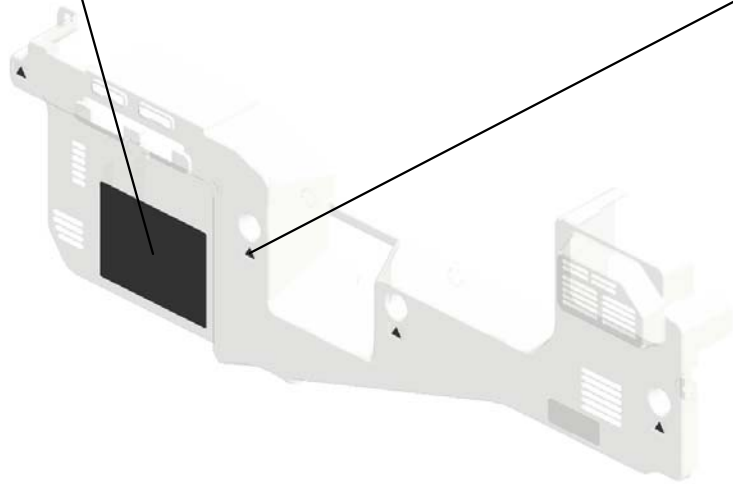

41.D0BX1550  
INNER COVER:INT  
ERMEDIATE TRAN  
SFER:ASS'Y



84.D2701568  
(x4)  
DECAL:POSITIONI  
NG DISPLAY:TCRU  
:ABS



U001\_S006  
INNER COVER:REVERSE SUB-UNIT:UPPER:ASS'Y

81.D2701562  
INNER COVER:RE  
VERSE SUB-UNIT:  
UPPER

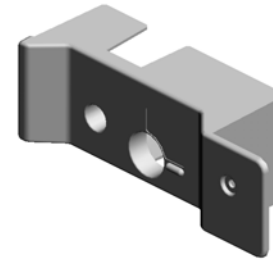

43.D0BX1555  
INNER COVER:RE  
VERSE SUB-UNIT:  
UPPER:ASS'Y

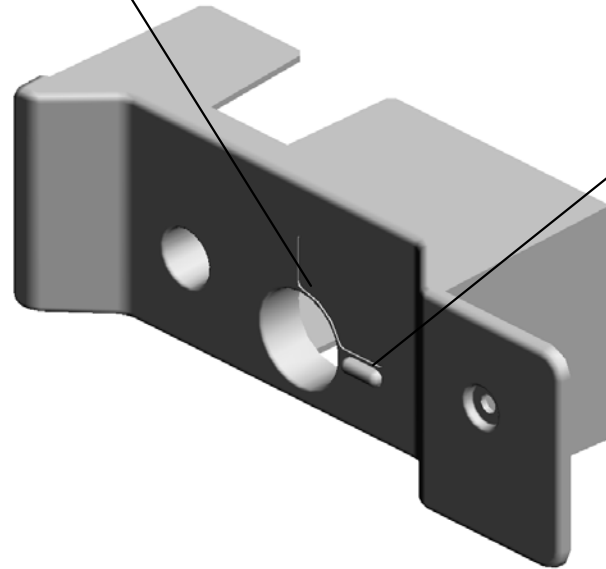

17.AC020153  
LENS:LED:4



U001\_S007  
DOOR:TONER SUPPLY:ASS'Y

88.D3551333 SHIELDING PLATE:  
SAFETY SWITCH:DOOR  
85.D2703366 DECAL:REPLACEM  
ENT INDICATION:TONER BOTTLE



50.D1791454  
DOOR:TONER SUPPLY:ASS'Y

52.D1791457  
(x2)  
MAGNET CATCH PLATE:DOOR:TONER SUPPLY

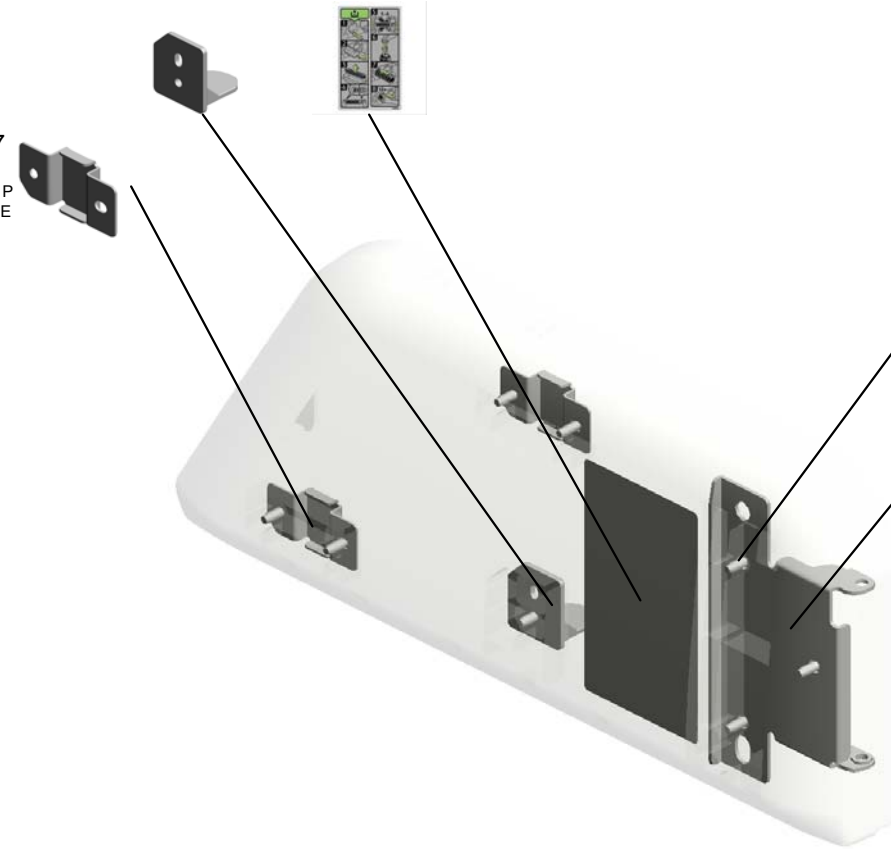

8.08025330  
(x8)  
PAN HEAD WITH COLLAR TAPPING SCREW:PF:4X10

51.D1791456  
SUPPORTING PLATE:HINGE:DOOR:TONER SUPPLY

U001\_S008

SUPPORTING PLATE:DOOR:FRONT LEFT:ASS'Y

61.D1791490 1.03540080N  
BRACKET:SUPPO (x10)  
RTING PLATE:DOO SCREW:M4X8  
R:FRONT LEFT

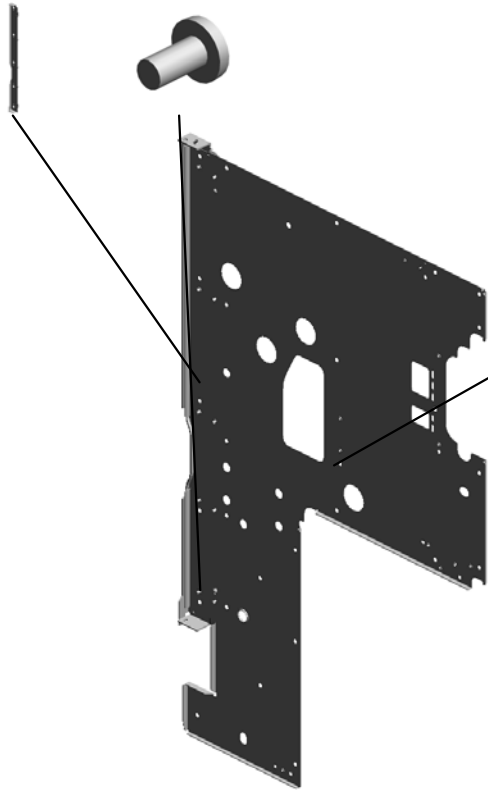

34.D0BX1489  
SUPPORTING PLA  
TE:DOOR:FRONT L  
EFT



33.D0BX1484  
SUPPORTING PLA  
TE:DOOR:FRONT L  
EFT:ASS'Y

U001\_S009

SUPPORTING PLATE:DOOR:FRONT RIGHT:ASS'Y

73.D1796914 72.D1796913  
SEAL:INNER COVE SEAL:INNER COVE  
R:DEVELOPMENT: R:OPTICAL WRITIN  
COOLING G MD:COOLING



100.D0BX1498  
SUPPORTING PLA  
TE:DOOR:FRONT  
RIGHT:ASS'Y

76.D2701509  
BRACKET:SUPPO  
RTING PLATE:DOO  
R:FRONT RIGHT

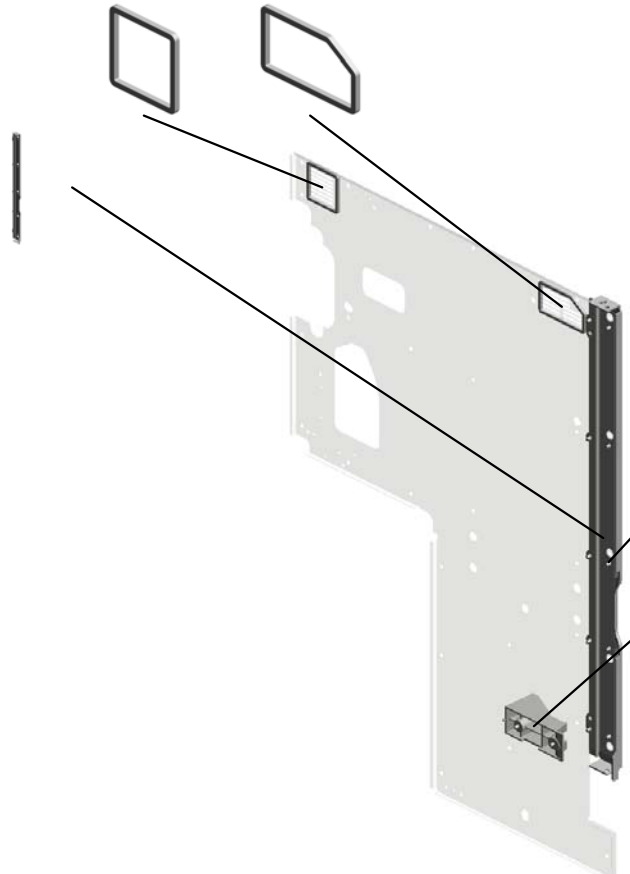

1.03540080N  
(x12)  
SCREW:M4X8

65.D1791505  
STOPPER:GUIDE P  
LATE:VERTICAL T  
RANSPORT

U001	U002	U003	U004	U005	U006	U007	U008	U009	U010	U011	U012	U013	U014	U015	U016	U017	U018	U019	U020	U021
------	------	------	------	------	------	------	------	------	------	------	------	------	------	------	------	------	------	------	------	------

U001\_S010  
INNER COVER:PULL OUT:RIGHT:ASS'Y

16.AC020152  
LENS:LED:3

79.D2701542  
DECAL:H-TEMP W  
ARNING:PAPER FE  
ED:ABS

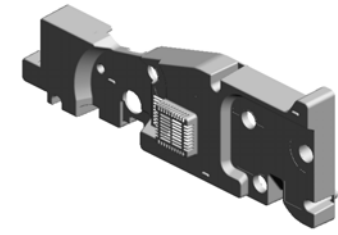

39.D0BX1547  
INNER COVER:PUL  
L OUT:RIGHT:ASS'  
Y

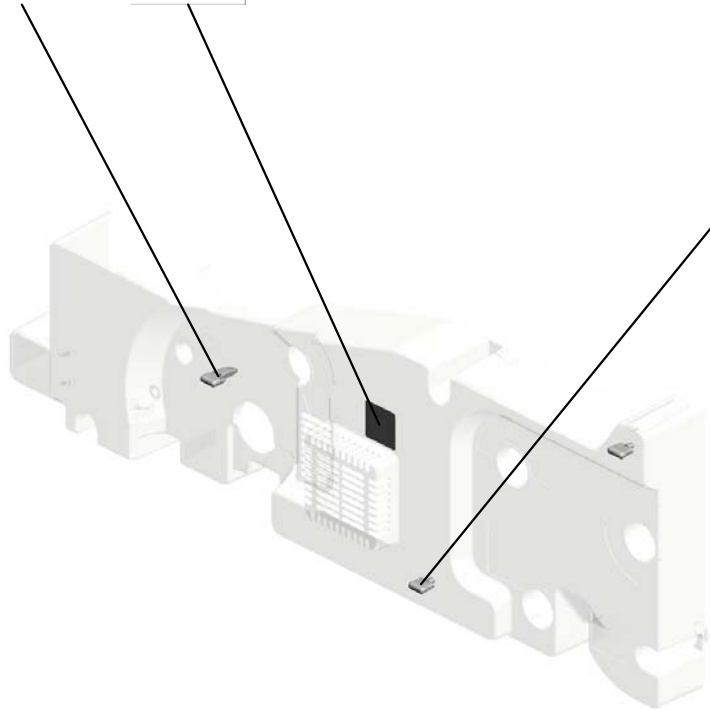

17.AC020153  
(x2)  
LENS:LED:4

U001\_S011  
INNER COVER:PULL OUT:LEFT:ASS'Y

16.AC020152  
LENS:LED:3

40.D0BX1549  
INNER COVER:PUL  
L OUT:LEFT:ASS'Y

79.D2701542  
(x2)  
DECAL:H-TEMP W  
ARNING:PAPER FE  
ED:ABS

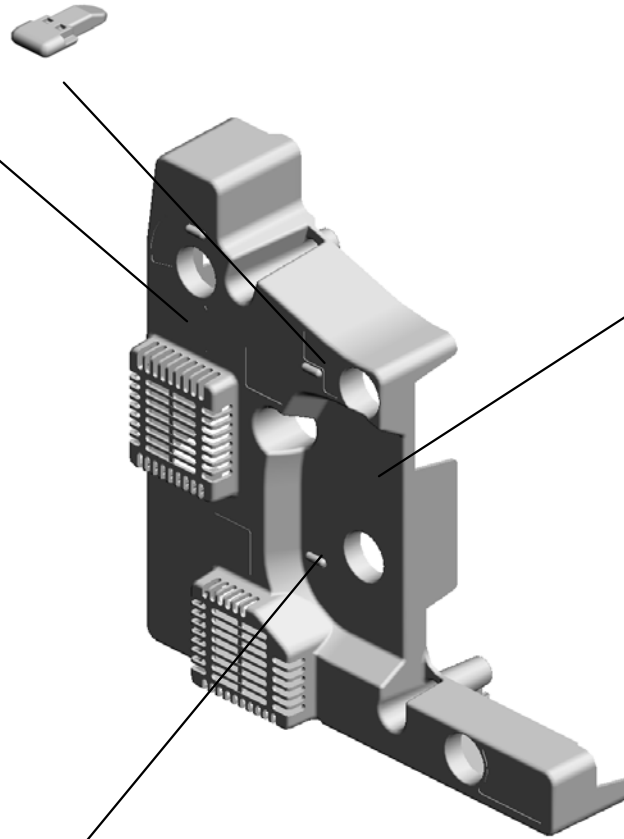

77.D2701540  
INNER COVER:PUL  
L OUT:LEFT

17.AC020153  
(x2)  
LENS:LED:4

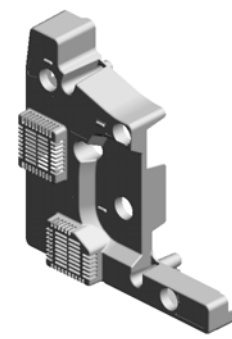

U001\_S012

INNER COVER:INTERMEDIATE TRANSFER:ASS'Y

80.D2701546  
DECAL:PULL OUT:  
MIDDLE:ABS

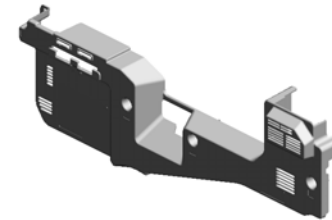
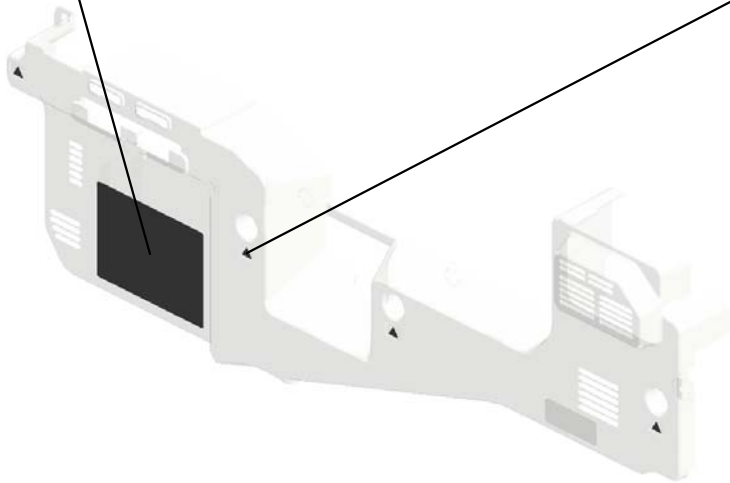

41.D0BX1550  
INNER COVER:INT  
ERMEDIATE TRAN  
SFER:ASS'Y



84.D2701568  
(x4)  
DECAL:POSITIONI  
NG DISPLAY:TCRU  
:ABS

U001\_S013  
INNER COVER:REVERSE SUB-UNIT:UPPER:ASS'Y

81.D2701562  
INNER COVER:RE  
VERSE SUB-UNIT:  
UPPER

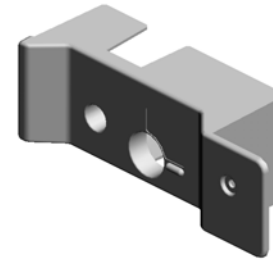

43.D0BX1555  
INNER COVER:RE  
VERSE SUB-UNIT:  
UPPER:ASS'Y

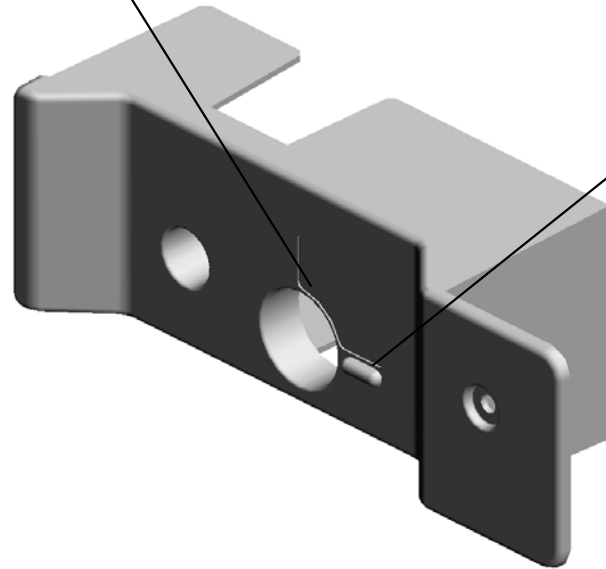

17.AC020153  
LENS:LED:4





U001\_S014  
DOOR:TONER SUPPLY:ASS'Y

88.D3551333 SHIELDING PLATE:  
SAFETY SWITCH:DOOR  
85.D2703366 DECAL:REPLACEM  
ENT INDICATION:TONER BOTTLE

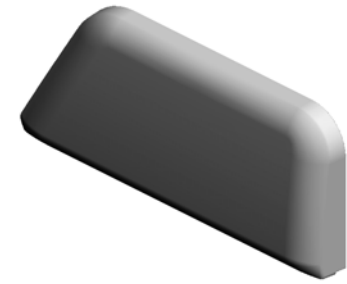

50.D1791454  
DOOR:TONER SUPPLY:ASS'Y

52.D1791457  
(x2)  
MAGNET CATCH PLATE:DOOR:TONER SUPPLY

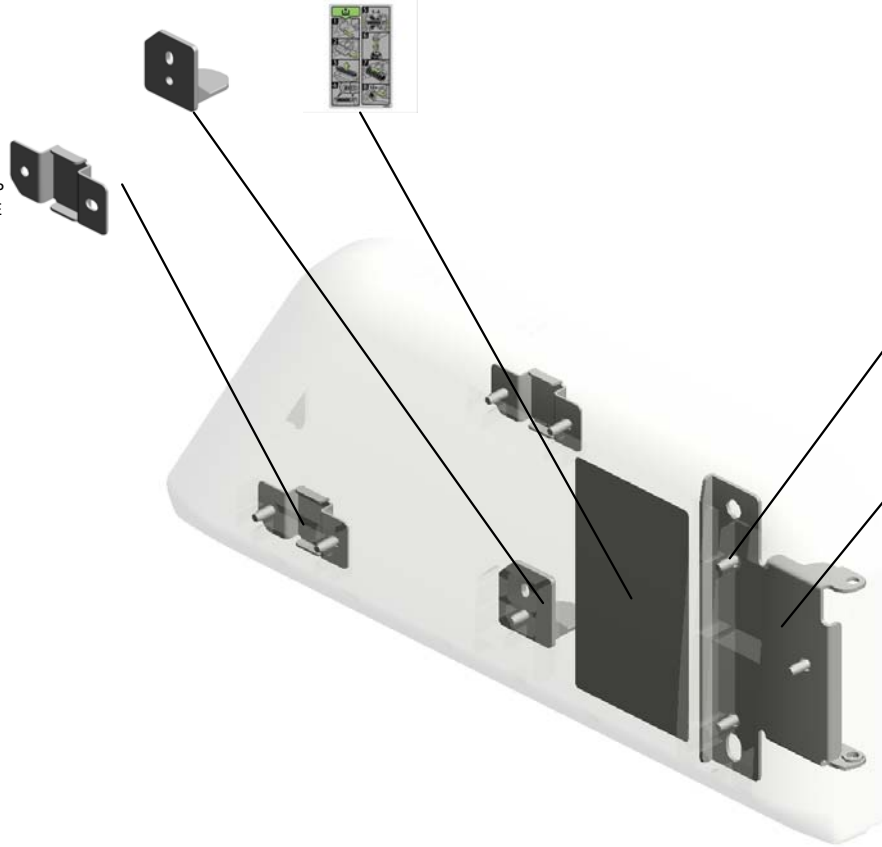

8.08025330  
(x8)  
PAN HEAD WITH COLLAR TAPPING SCREW:PF:4X10

51.D1791456  
SUPPORTING PLATE:HINGE:DOOR:TONER SUPPLY

# U002 OPERATION

14.M0BJ5780 DISPLSY:TM170-RI X01  
 9.D0A56840 SPRING PLATE:OP U-DISPLAY  
 2.03604008N (x7) SCREW - M4X8  
 16.D0BX5726 (NA):OPERATION S UB-UNIT:KEY\_BOX :ASS'Y

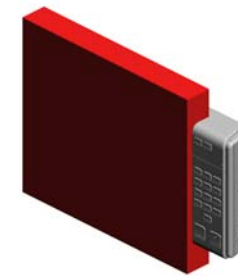

3.03604016N  
SCREW:M4X16

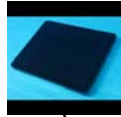

8.D0A56731  
COVER:DISPLSY:R EAR LOWER



12.D0BX1594  
HOLDER:HINGE:O PERATION SUB-U NIT:LOWER



5.11050042  
WIRE BAND



7.11050534  
(x3)  
CLAMP



6.11050508  
HARNESS CLAMP - LWS-0711

1.03530040N(x 6)  
SCREW - M3X4  
3.03604016N(x 7)  
SCREW:M4X16



11.D0BX1589  
COVER:HINGE:LO WER



10.D0BX1586  
HOLDER:FIX:OPER ATION SUB-UNIT



4.04544008Q  
(x7)  
TAPPING SCREW - M4X8

# U003.ADF

U003\_S001  
D0A51200  
ADF:ASS'Y

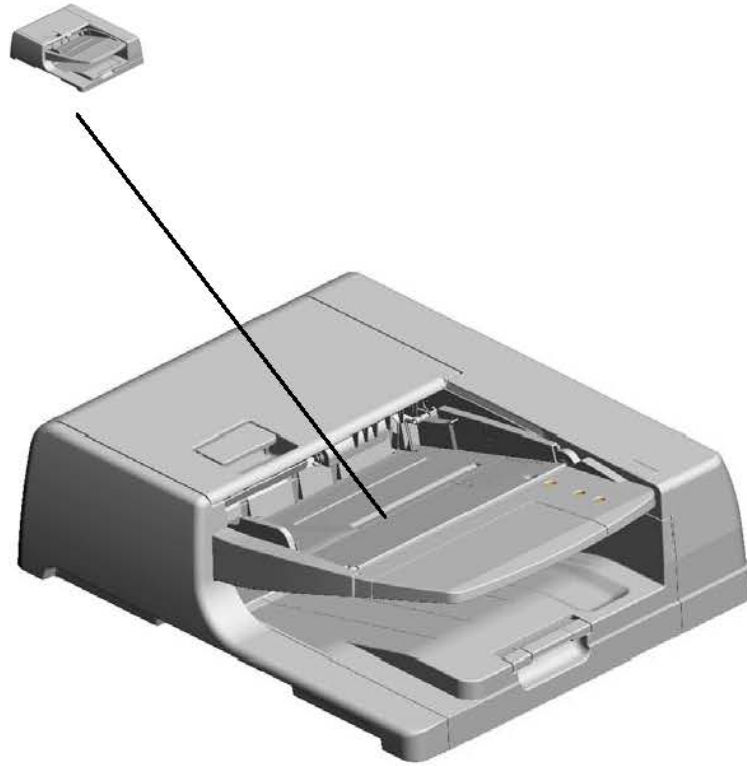

U001	U002	U003	U004	U005	U006	U007	U008	U009	U010	U011	U012	U013	U014	U015	U016	U017	U018	U019	U020	U021
------	------	------	------	------	------	------	------	------	------	------	------	------	------	------	------	------	------	------	------	------

# U003\_S001.ADF:ASS'Y

U003 S001 S003  
D7314311  
GUIDE:PAPER FEED:UPPER:  
SUB-ASS'Y

U003 S001 S004  
D7314370  
COVER:PAPER FEED:ASS'Y

U003 S001 S001  
D3B02200  
SHAFT:SEPARATION:ASS'Y

U003 S001 S009  
D6833411  
GUIDE:SCANNING:ENTRANC  
E:LOWER:SUB-ASS'Y

U003 S001 S006  
D3B03810  
GUIDE PLATE:EXIT:UPPER:A  
SS'Y

U003 S001 S007  
D6833150  
ROLLER:SCANNING:EXIT:DR  
IVE:ASS'Y

U003 S001 S002  
D3AZ4720  
PRESSURE PLATE:ASS'Y

U003 S001 S005  
D7314510  
COVER:LOWER:ASS'Y

U003 S001 S008  
D6830360  
GUIDE:EXIT:LOWER:ASS'Y

# U003\_S001\_S001.SHAFT:SEPARATION:ASS'Y

U003 S001 S001 S001  
D6832240  
GUIDE:PAPER FEED:ENTRA  
NCE:INNER BACK:ASS'Y

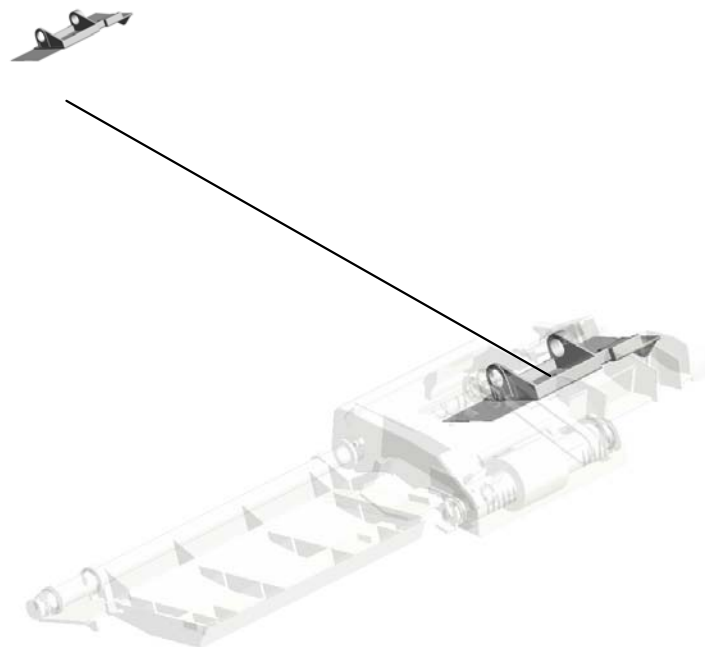

U001	U002	U003	U004	U005	U006	U007	U008	U009	U010	U011	U012	U013	U014	U015	U016	U017	U018	U019	U020	U021
------	------	------	------	------	------	------	------	------	------	------	------	------	------	------	------	------	------	------	------	------

# U003\_S001\_S008.GUIDE:EXIT:LOWER:ASS'Y

U003 S001 S008 S002  
D6833662  
GUIDE PLATE:CONTACT IMAGE  
GE SENSOR:ENTRANCE:AS  
SY

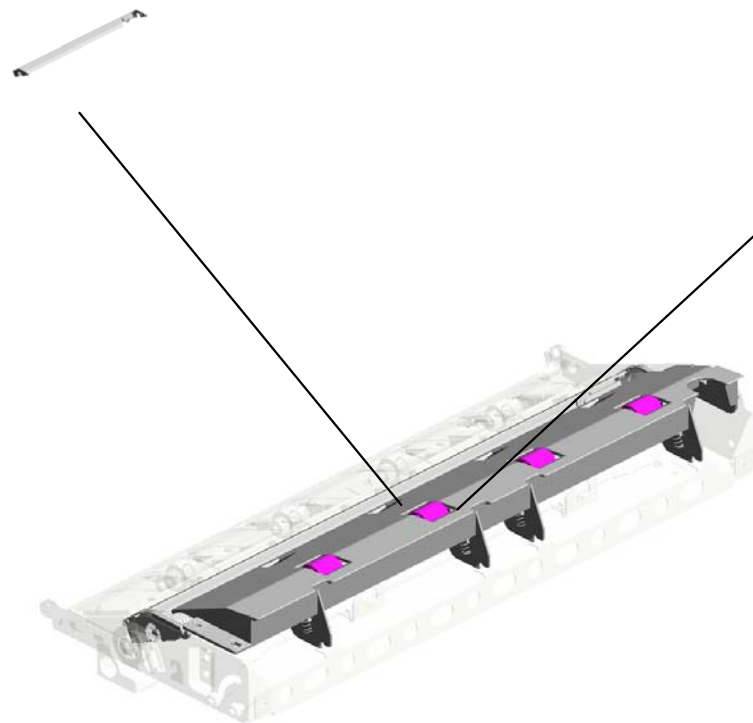

U003\_S001\_S008\_S001  
D6833641  
GUIDE:CONTACT IMAGE SE  
NSOR:EXIT:LOWER:ASS'Y

U001	U002	U003	U004	U005	U006	U007	U008	U009	U010	U011	U012	U013	U014	U015	U016	U017	U018	U019	U020	U021
------	------	------	------	------	------	------	------	------	------	------	------	------	------	------	------	------	------	------	------	------

U003  
ADF

19.09514010N  
(x2)  
SCREW:POLISHED  
ROUND:M4X10

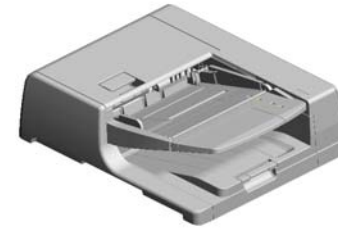
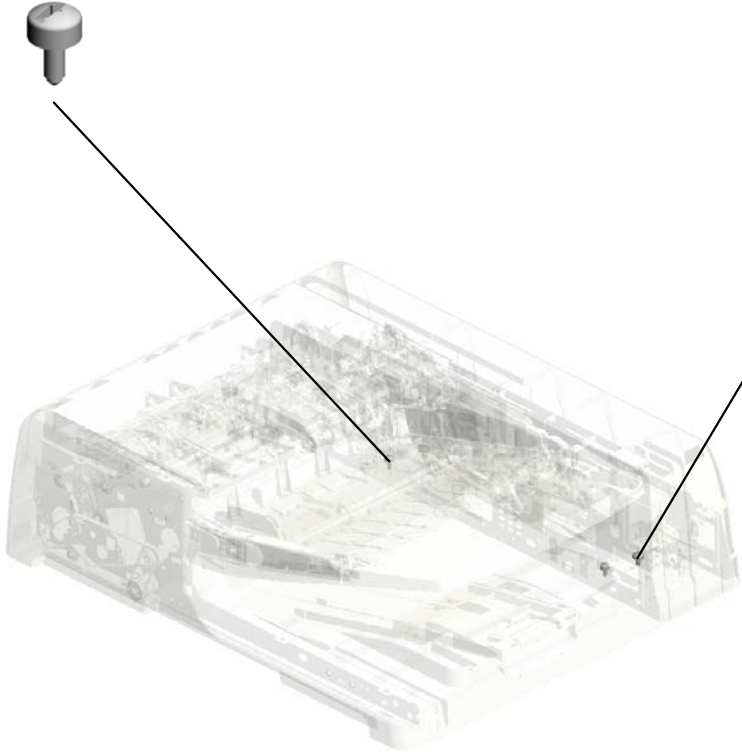

3.04514008N (x 2)  
TAPPING SCREW:4X8

41.A8597211  
(x2)  
STEPPED SCREW



U003\_S001  
ADF:ASS'Y

- 21.11050487 (x4) HARNESS CLAMP
- 15.08025299 (x110) TAPPING SCREW - M3X8
- 7.04543006Q (x110) TAPPING SCREW - M3X6
- 1.03530060N (x2) BIND SCREW - M3X6
- 11.07200040E (x3) RETAINING RING - M4

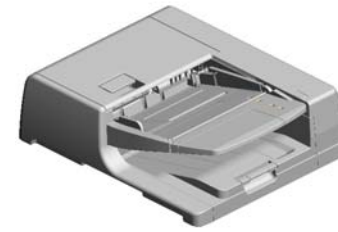

91.D0A51200  
ADF:ASS'Y

23.11050551  
CLAMP:LES-0505



16.08050103  
(x2)  
RETAINING RINGS  
-E:SILENCER:DIA3



14.07433808  
(x3)  
RADIAL BALL BEARING  
RING:DIA8XDIA16X5



6.04543006N  
(x8)  
TAPPING SCREW:  
ROUND POINT:3X6



18.08050106  
(x6)  
RETAINING RINGS  
-E:SILENCER:DIA6



9.04583008N  
(x24)  
HEXAGON HEAD TAPPING SCREW:3X8



13.07433806  
RADIAL BALL BEARING  
RING:DIA6XDIA13X5



5.04543005N  
(x2)  
HEXAGON HEAD TAPPING SCREW:ROUND POINT:3X5



8.04543014Q  
(x4)  
TAPPING SCREW:3X14



17.08050104  
(x11)  
RETAINING RINGS  
-E:SILENCER:DIA4



24.11050692  
(x4)  
CLAMP:LES-0503



27.11050758  
(x16)  
CLAMP:LWSM-0306A



25.11050723  
(x2)  
CLAMPS:WES-0507



22.11050508  
(x7)  
HARNESS CLAMP - LWS-0711



10.07200030E  
RETAINING RING - M3



20.11050046  
(x43)  
HARNESS BAND



21.11050487  
(x2)  
HARNESS CLAMP



26.11050724  
CLAMPS:WES-1210



27.11050758  
(x3)  
CLAMP:LWSM-0306A



28.11050760  
CLAMP:LWSM-0511A



30.16072256  
FERRITE CORE:K3 NFR-08-ABK0



115.D5224906  
(x4)  
STEPPED SCREW: M3:DIA6:1.7MM:ROUND POINT



U003\_S001  
ADF:ASS'Y

- 45.AA043681 SYNCHRONOUS B  
ELT:40S2M108
- 36.A5482139 PULLEY
- 57.AA082101 (x6)  
BUSHING - 6X10X6
- 29.12042612 (x2)  
MICRO SWITCH:D3  
V-16506-3C25:(SW  
10/SW11/SW102/S  
W103)
- 31.52062686 (x2)  
SNAP RING

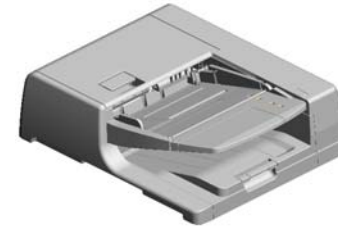

91.D0A51200  
ADF:ASS'Y

43.AA043339  
TIMING BELT:PAP  
ER EXIT:40S2M122

33.54472681  
SNAP RING

35.A4221063  
SEAL - 0.7X13X20

48.AA043684  
SYNCHRONOUS B  
ELT:60S1.5M390

52.AA043710  
SYNCHRONOUS B  
ELT:40S2M158

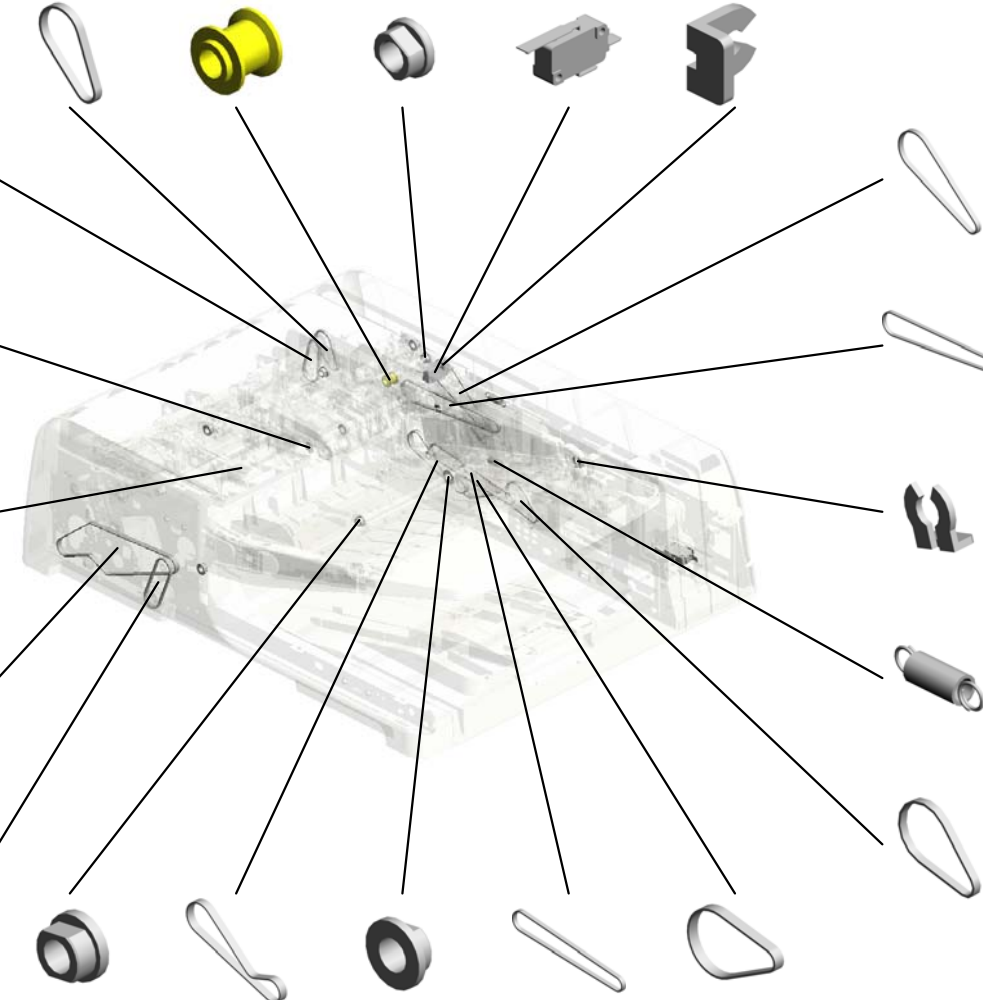

7.04543006Q (x 2)

TAPPING SCREW - M3X6

9.04583008N (x 1)  
HEXAGON HEAD TAPPING SCREW:3X  
8

50.AA043694  
SYNCHRONOUS B  
ELT:B40S2M202

51.AA043698  
SYNCHRONOUS B  
ELT:40S1.5M300

32.52152621  
SNAP RING - M6

53.AA060842  
(x3)  
TENSION SPRING

44.AA043632  
TIMING BELT - 40S  
2M126

- 55.AA080346 (x3)  
BUSHING:FLANGE  
TYPE:DIA6
- 47.AA043683 SYNCHRONOUS B  
ELT:60S1.5M204
- 56.AA080347 BUSHING - 8MM
- 49.AA043685 SYNCHRONOUS B  
ELT:40S2M258
- 46.AA043682 SYNCHRONOUS B  
ELT:60S1.5M150

U003\_S001  
ADF:ASS'Y

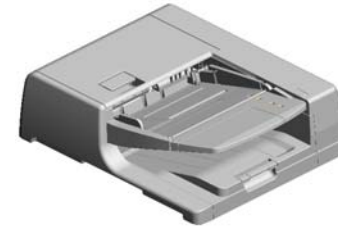

91.D0A51200  
ADF:ASS'Y

- 67.AW010151 (x5) PHOTO REFLECTI ON SENSOR:PS12 2TL1-A:(S6/S7/S10/ S11/S12/SEN7/SEN 8/SEN10/SEN32/SE
- 71.B0434645 (x4) SPRING - 2N
- 76.B4772622 DISCHARGE BRUS H:L11
- 69.AW020234 (x9) PHOTOINTERRUP TOR:GP1A173LCS 5F:(S1/S2/S3/S4/S5 /S8/S9/S13/S17)
- 81.B7003305 TIMING BELT:B40S 2M152

86.B8041180 (x4) DISCHARGE BRUS H:PUNCH UNIT

63.AA143791 SCREW:SAFETY

59.AA082144 (x2) BUSHING - 8X12X7

62.AA143789 SHAFT:CLEANER

61.AA143788 PIN:GUIDE PLATE: PAPER FEED

64.AA143842 SCREW:DIA6:14.5: M4

70.AX040199 DC MOTOR:RISING TRAY:ASS'Y:(M7/B M2/BM3)

73.B3871951 SPRING - PAPER S IZE SENSOR

66.AW010150 (x4) PHOTO REFLECTIO N SENSOR:ORIGIN AL TRAY:(S14/S15/ S16/S19/SEN21)

82.B7061859 SCREW:SLIDER:L OCK

- 85.B8022536 SLIDER:SIDE FEN CE
- 84.B8022532 SPRING PLATE:SI DE FENCE
- 68.AW020190 PHOTOINTERRUP TOR:(S18)
- 79.B4774131 (x4) SPRING
- 80.B6523174 TENSION SPRING

U003\_S001  
ADF:ASS'Y

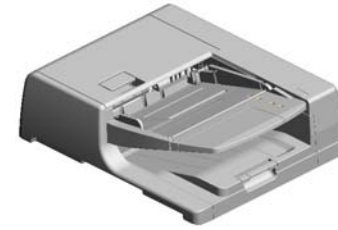

91.D0A51200  
ADF:ASS'Y

- 98.D3B02510 GUIDE PLATE:PAPER FEED:LOWER:ASS'Y
- 93.D3AZ2914 (x6) COIL SPRING:FEELEVER:P SIZE SENSOR
- 116.D5412241 REVERSE ROLLER:PAPER FEED
- 114.D4123145 TENSION SPRING:LEVER:MISFEED REMOVAL
- 92.D3AZ1762 BRACKET:MOTOR:MIDDLE

99.D3B02622 (x4) DISCHARGE BRUSH:L11

101.D3B04324 (x2) SHEET:BRACKET:GUIDE:PAPER FEED

115.D5224906 (x6) STEPPED SCREW:M3:DIA6:1.7MM:ROUND POINT

95.D3AZ5860 CONTACT IMAGE SENSOR:ASS'Y:(PCB3)

109.D3B05869 SHIELD PLATE:CONTACT IMAGE SENSOR:FRONT

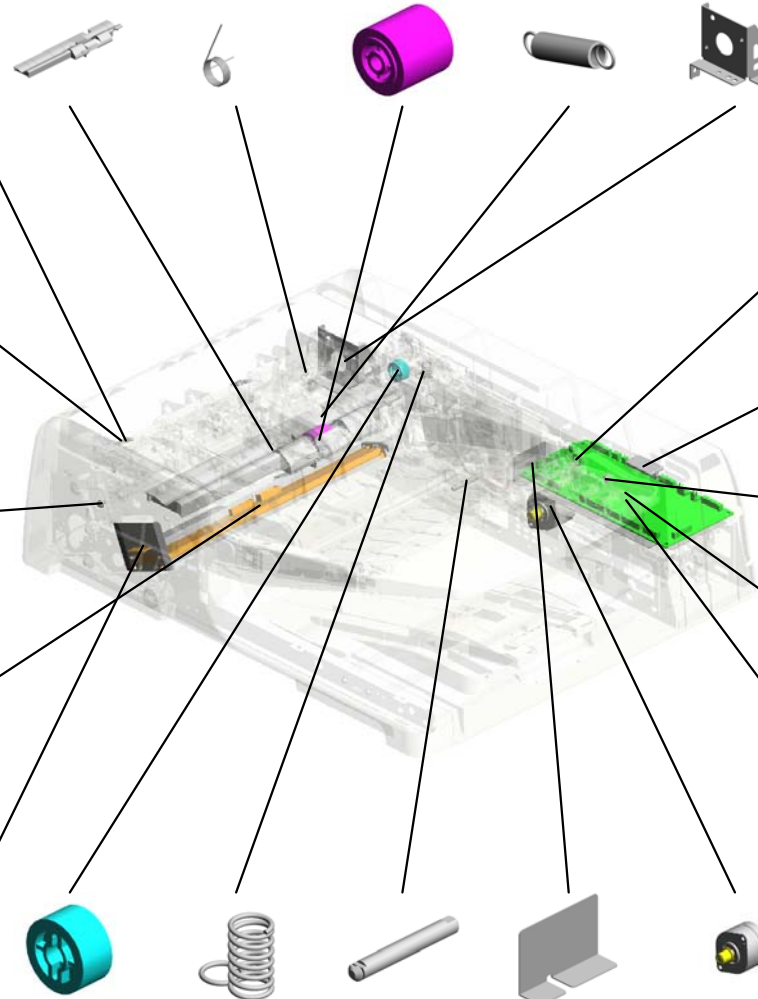

88.B8722524 SPACER:DIA9

89.D0951260 CAP:COVER:SCA

87.B8301135 SCREW

110.D3EK5100 PCB:MAIN CONTROL:DF:ASS'Y:(PCB2)

107.D3B05111 SHIELD PLATE:PCB:LOWER

- 118.D5431625 GEAR:Z24:SEPARATION
- 117.D5431313 COMPRESSION SPRING:HINGE:LEFT
- 119.D5431717 SHAFT:PULLEY:SCANNING:EXIT
- 108.D3B05112 SHIELD PLATE:PCB:RIGHT
- 96.D3B01766 DC MOTOR:10W:NIDE:ASS'Y:(M5)

U003\_S001  
ADF:ASS'Y

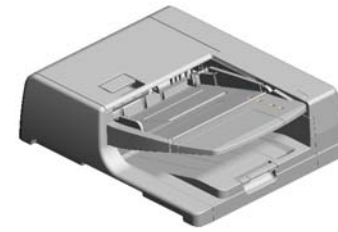

91.D0A51200  
ADF:ASS'Y

- 142.D6831632 SHAFT:REVERSE ROLLER:SUB-ASS'Y
- 141.D6831620 SHAFT:SEPARATI ON:DRIVE:INPUT:SUB-ASS'Y
- 133.D6831387 TENSION SPRING: ON OFF DETECTOR:PAPER FEED
- 131.D6831385 BRACKET:SAFETY SWITCH:PAPER FEED
- 132.D6831386 SHAFT:CONTACT POINT:ON OFF DETECTOR:PAPER FEED

125.D5434382  
(x2)  
COMPRESSION SPRING:PULL OUT

126.D5434393  
(x6)  
CUSHION:GUIDE PLATE:ENTRANCE:PAPER FEED:INNER BACK

127.D5435125  
SPRING PLATE:CABLE:CONTACT IMAGE SENSOR

120.D5431821  
TIMING PULLEY:T3 3/24

121.D5431822  
FLANGE:DIA24



139.D6831615  
STAY:MOTOR:PAPER FEED

130.D6831362  
COMPRESSION SPRING:HINGE:RIGHT

135.D6831414  
SPRING PLATE:SAFETY SWITCH

134.D6831413  
BRACKET:SAFETY SWITCH

136.D6831415  
FEELER:SENSOR:ON OFF DETECTOR

- 143.D6831635 GEAR:REVERSE ROLLER:DRIVE
- 140.D6831617 DC MOTOR:ASS'Y:20W:BRUSHLESS:(M2)
- 138.D6831614 BRACKET:MOTOR:PAPER FEED
- 128.D6421454 FEELER:APS
- 137.D6831451 HOLDER:FEELER:APS

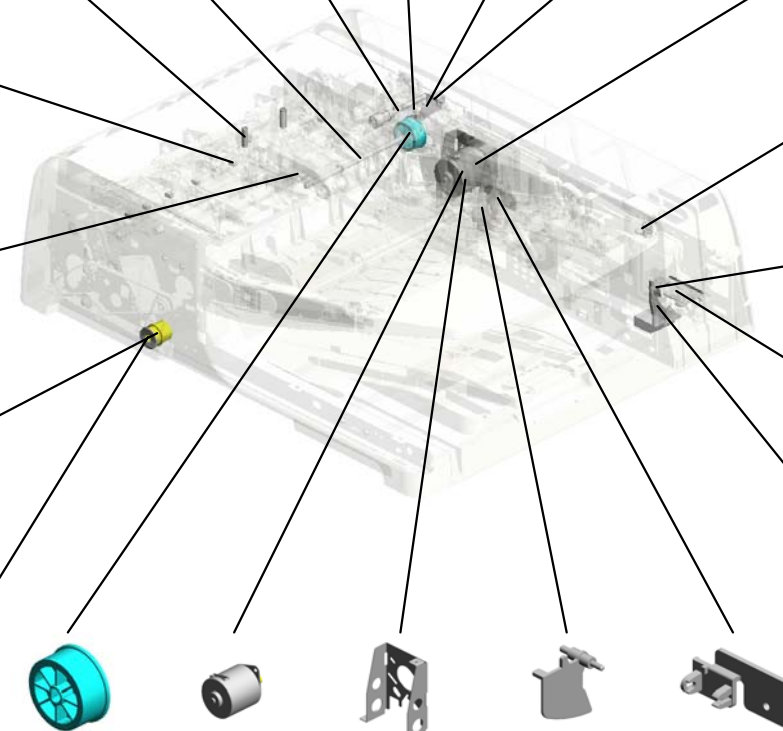

U003\_S001  
ADF:ASS'Y

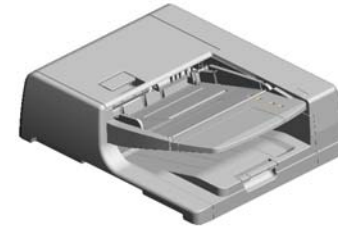

91.D0A51200  
ADF:ASS'Y

150.D6831680 CAM:PICKUP  
152.D6831691 GEAR:PAPER FEE  
D:COUPLING  
149.D6831675 DC STEPPER MOT  
OR:DIA42:T15:S2M:  
ASS'Y:(M4)  
151.D6831682 TIMING PULLEY:PI  
CKUP:DRIVE  
148.D6831671 BRACKET:MOTOR:  
PICK UP

145.D6831642  
TIMING PULLEY:ID  
LER:PULL OUT



144.D6831640  
SHAFT:INPUT:PAP  
ER FEED:SUB-ASS'  
Y

155.D6831766  
DC MOTOR:10W:B  
RUSHLESS:(M1)



147.D6831644  
SPACER:SHAFT:IN  
PUT:PAPER FEED

146.D6831643  
GEAR:INPUT:PAPE  
R FEED



153.D6831711  
BRACKET:MOTOR:  
PULL OUT

162.D6831851  
BRACKET:TENSIO  
NER:SCANNING:F  
RONT



159.D6831822  
(x2)  
DC MOTOR:20W:S  
CANNING:20W:BR  
USHLESS:(M3/M6)

163.D6831855  
TIMING PULLEY:TE  
NSIONER:SCANNI  
NG:FRONT



156.D6831811  
BRACKET:MOTOR:  
SCANNING:EXIT

161.D6831845 (x2)  
PULLEY:IDLER: DIA  
14  
160.D6831841 BRACKET:TENSIO  
NER:SCANNING:IN  
NER BACK  
157.D6831813 TIMING PULLEY:C  
OUPLING:SCANNI  
NG:INNER BACK  
154.D6831718 (x2)  
STAY:MOTOR:PUL  
L OUT  
158.D6831814 TIMING PULLEY:C  
OUPLING:EXIT



U003\_S001  
ADF:ASS'Y

- 171.D6832222 STOPPER:SHAFT:SEPARATION:DRIVE
- 184.D6832311 TORQUE LIMITER MECHANICAL CLUTCH:SEPARATOR
- 187.D6832417 SHEET:ENTRANCE:SEPARATION PAD
- 186.D6832415 SHEET:SEPARATION:ENTRANCE
- 167.D6832112 (x2) TIMING PULLEY:ROLLER:PULL OUT:DRIVE

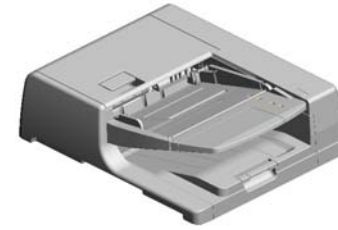

91.D0A51200  
ADF:ASS'Y

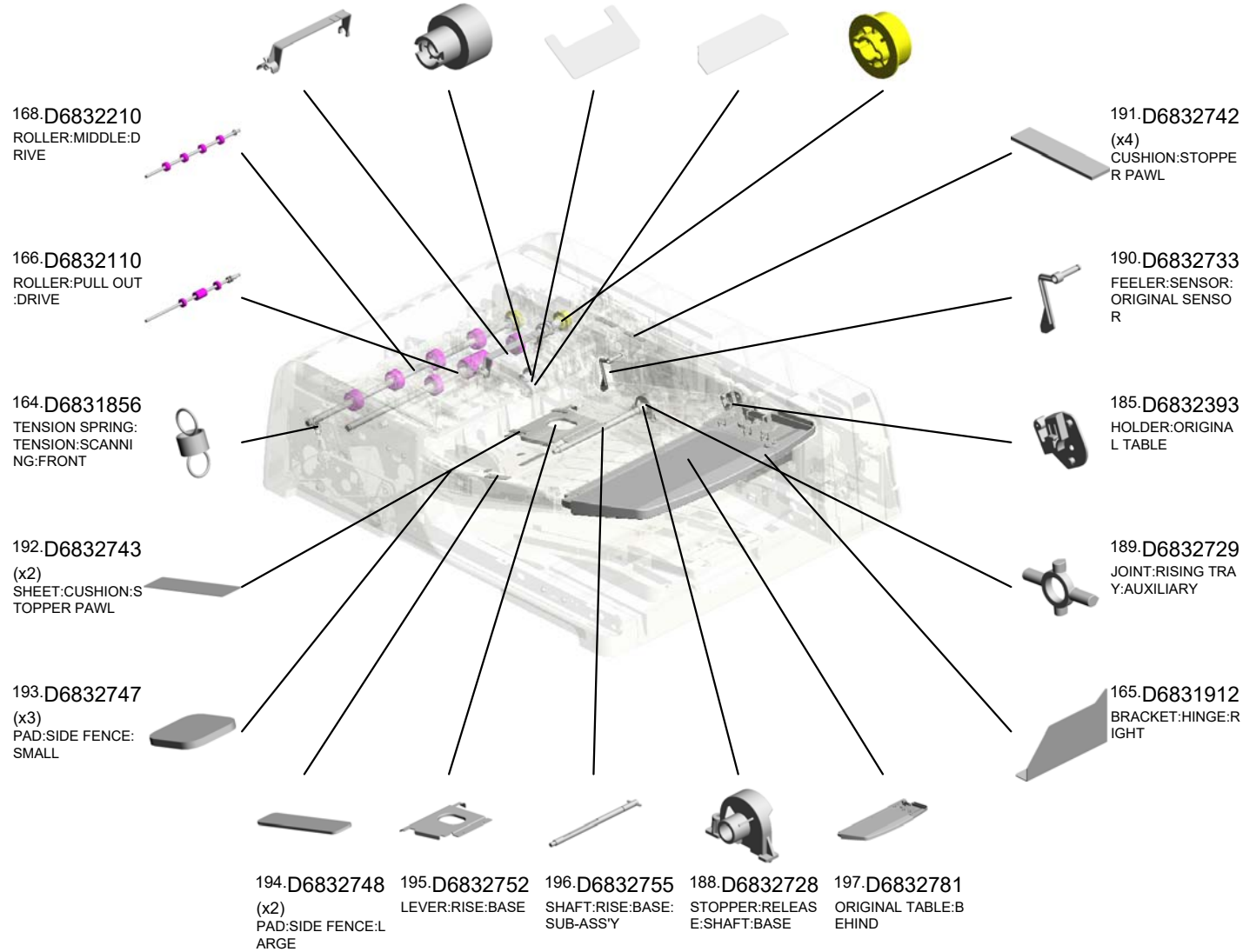

U003\_S001  
ADF:ASS'Y

- 231.D6834323 SHAFT:CONTACT POINT:GUIDE:PAPER FEED
- 203.D6833221 GUIDE:SCANNING:UPPER
- 198.D6832912 (x6) FEELER:PAPER SIZE SENSOR
- 212.D6833510 SHAFT:LEVER:MISFEED REMOVAL:ASSY
- 218.D6833645 (x2) ROLLER:MIDDLE:DRIVEN

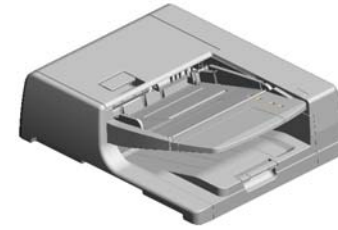

91.D0A51200  
ADF:ASS'Y

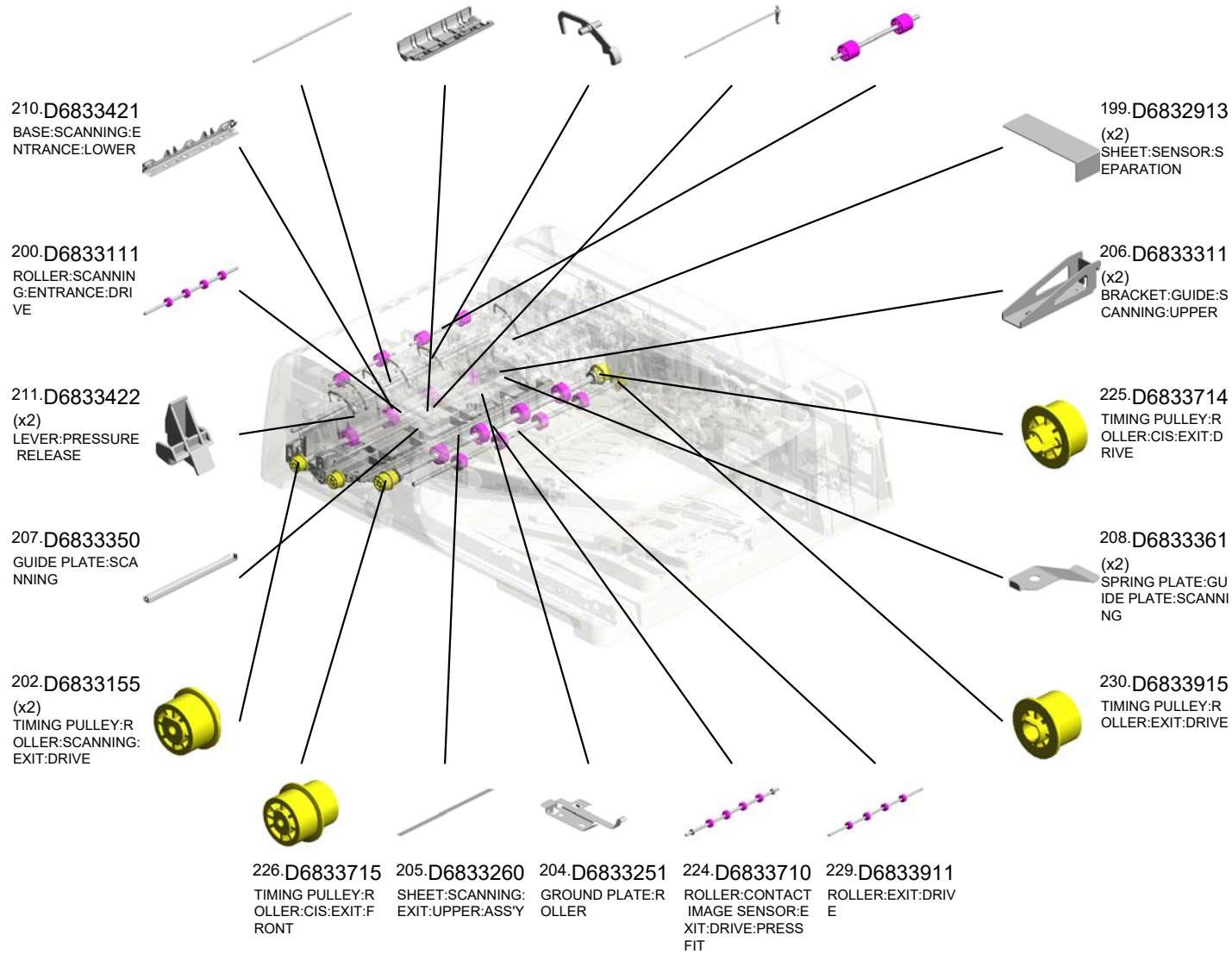

U003\_S001  
ADF:ASS'Y

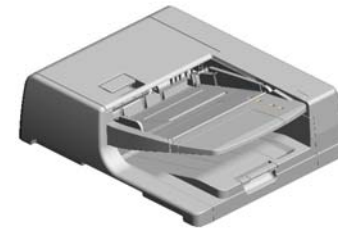

91.D0A51200  
ADF:ASS'Y

- 232.D6834341 BRACKET:PULL OUT:DRIVEN
- 257.D7312914 GUIDE PLATE:PULL OUT:LOWER:DOUBLE FEED SENSOR
- 235.D6834345 DISCHARGE BRUSH:EXIT:L37
- 250.D6842412 (x2) PAD:STOPPER:ORIGINAL
- 247.D6835111 GUIDE:HARNESS:MAIN

236.D6834350 DRIVEN ROLLER:PULL OUT

256.D7312913 GUIDE PLATE:PULL OUT:LOWER

253.D7312746 SIDE FENCE:ORIGINAL TABLE

258.D7313511 HOOK:OPTICAL READING UNIT:FRONT

260.D7314113 COVER:FRONT

- 259.D7314112 COVER:FRONT RIGHT
- 252.D7312734 COVER:LOWER:BASE
- 244.D6834430 (x4) ROLLER:EXIT:DRIVEN
- 254.D7312751 RAIL:SIDE FENCE
- 243.D6834421 (x2) SHAFT:EXIT:DRIVEN

248.D6835121 GUIDE:HARNESS:SUB

242.D6834414 (x4) SPACER:EXIT ROLLER

255.D7312771 ORIGINAL TABLE:FENCE FRONT

245.D6834441 (x2) HOLDER:CUSHION:PRESSURE PLATE

246.D6834442 (x4) TAPE:PRESSURE PLATE



U003\_S001  
ADF:ASS'Y

- 278.G0602652 (x4) BUSHING - M4
- 277.D7316241 DECAL:STOPPER:SEPARATION UNIT
- 280.M3644131 TIMING BELT:B40S 2M160
- 283.D3FF2852 COVER:SENSOR
- 282.D3FF2851 SENSOR COVER:PHOTO INTERRUPTOR

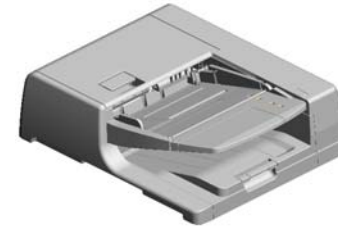

91.D0A51200  
ADF:ASS'Y

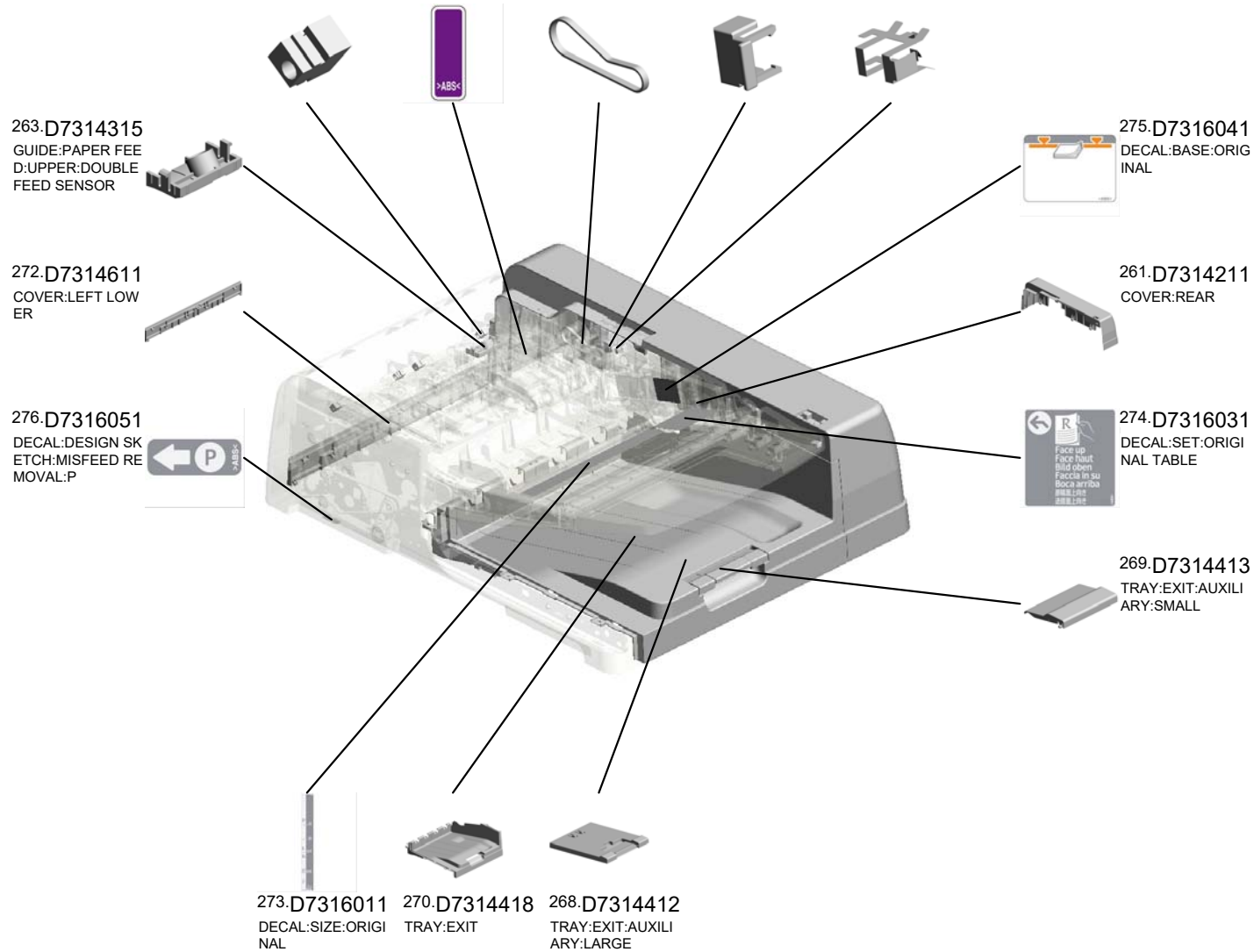

U003\_S001\_S001  
SHAFT:SEPARATION:ASS'Y

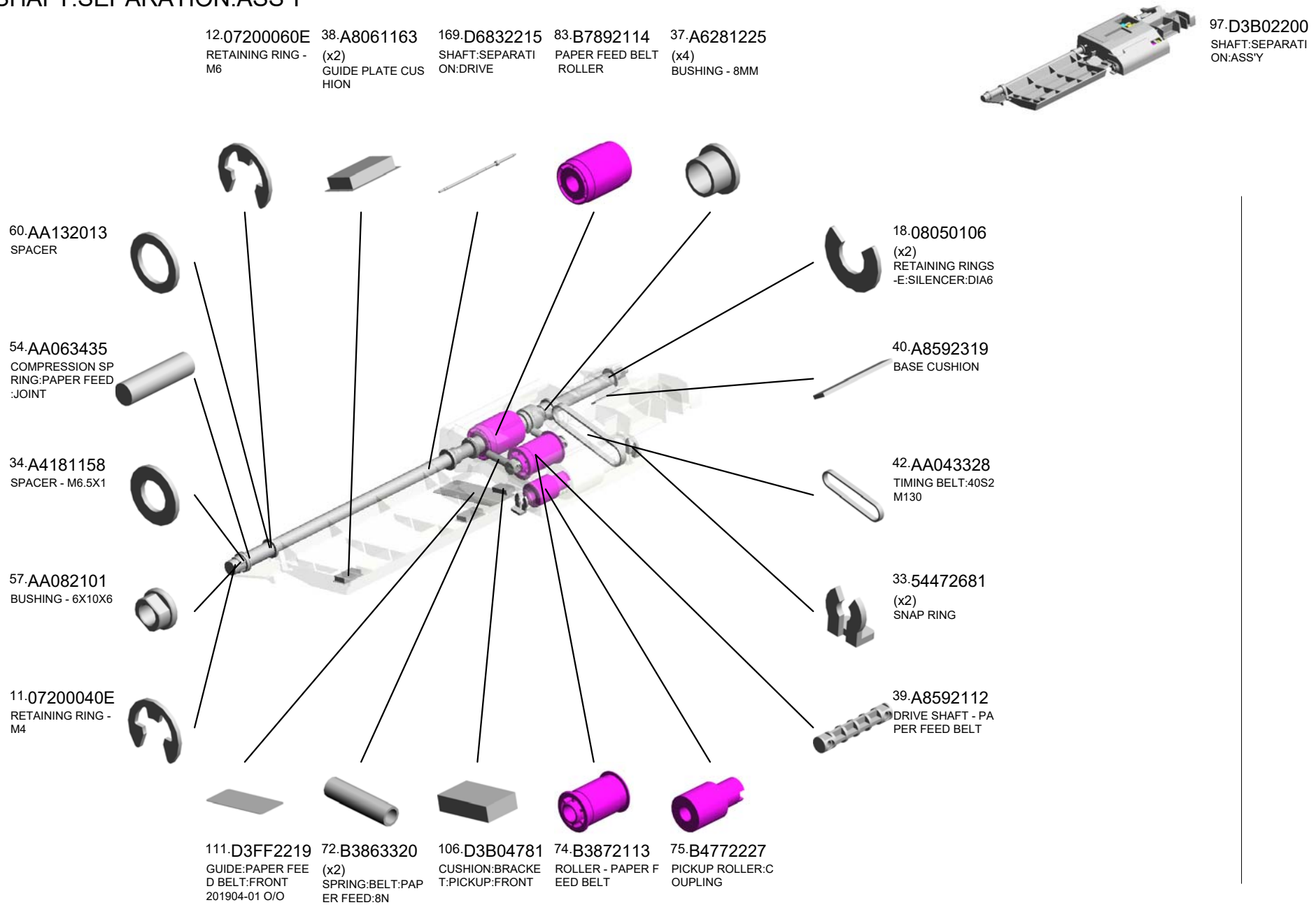

U003\_S001\_S001  
SHAFT:SEPARATION:ASS'Y

- 177.D6832233 BRACKET:PAPER FEED BELT
- 170.D6832221 GEAR:IDLER:Z18
- 174.D6832229 TIMING PULLEY:GEAR:T19/Z23
- 183.D6832272 LEVER:PICKUP ROLLER:RISE



97.D3B02200  
SHAFT:SEPARATION:ASS'Y

284.D3FF6071  
DECAL:CAUTION:ORIGINAL:PICK-UP PAPER JAM  
201911-02

249.D6842171  
PAPER FEED BELT

172.D6832224  
GUIDE:PAPER FEED:ENTRANCE:FRONT

180.D6832239  
COVER:PICKUP ROLLER

178.D6832235  
SHAFT:PICKUP:SUB-ASS'Y

173.D6832228  
PICKUP ROLLER

179.D6832236  
SHEET:BRACKET:PICKUP:INNER BACK

175.D6832231  
BRACKET:PICKUP

279.H0602126  
(x2)  
BUSHING - M6X7

176.D6832232  
TIMING PULLEY:PICKUP:T21

U003\_S001\_S001\_S001  
GUIDE:PAPER FEED:ENTRANCE:INNER BACK:ASS'Y

182.D6832242  
SHEET:GUIDE:PAP  
ER FEED:INNER B  
ACK

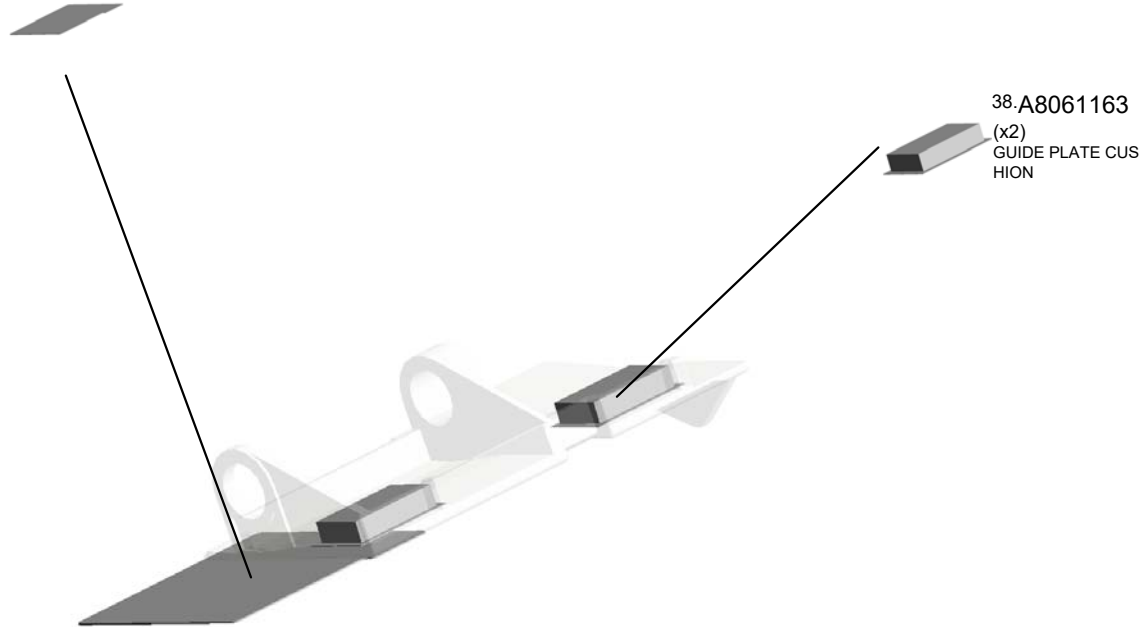

U001	U002	U003	U004	U005	U006	U007	U008	U009	U010	U011	U012	U013	U014	U015	U016	U017	U018	U019	U020	U021
------	------	------	------	------	------	------	------	------	------	------	------	------	------	------	------	------	------	------	------	------

U003\_S001\_S002  
PRESSURE PLATE:ASS'Y

102.D3B04711 105.D3B04725  
GUIDE PLATE:PRE CUSHION:PRESSU  
SSURE PLATE:LEF RE PLATE:SMALL  
T:ASS'Y

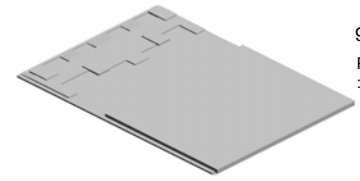

94.D3AZ4720  
PRESSURE PLATE  
:ASS'Y

103.D3B04722  
(x4)  
CUSHION:TAPE:SMALL

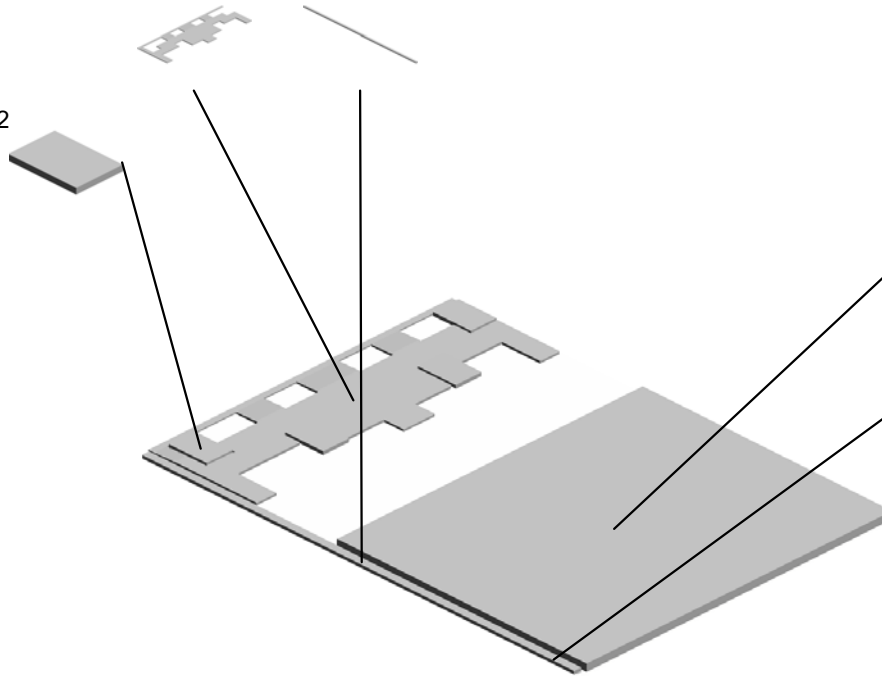

104.D3B04724  
CUSHION:PRESSURE PLATE:LARGE

90.D0A46099  
(x2)  
SHEET:PRESSURE PLATE:SMALL

U003\_S001\_S003  
GUIDE:PAPER FEED:UPPER:SUB-ASS'Y

122.D5433314  
(x4)  
SHEET:SCANNING:  
ENTRANCE:MIDDL  
E

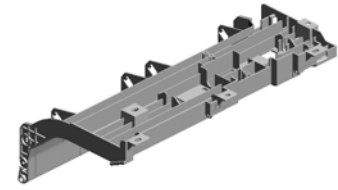

262.D7314311  
GUIDE:PAPER FEE  
D:UPPER:SUB-ASS  
'Y

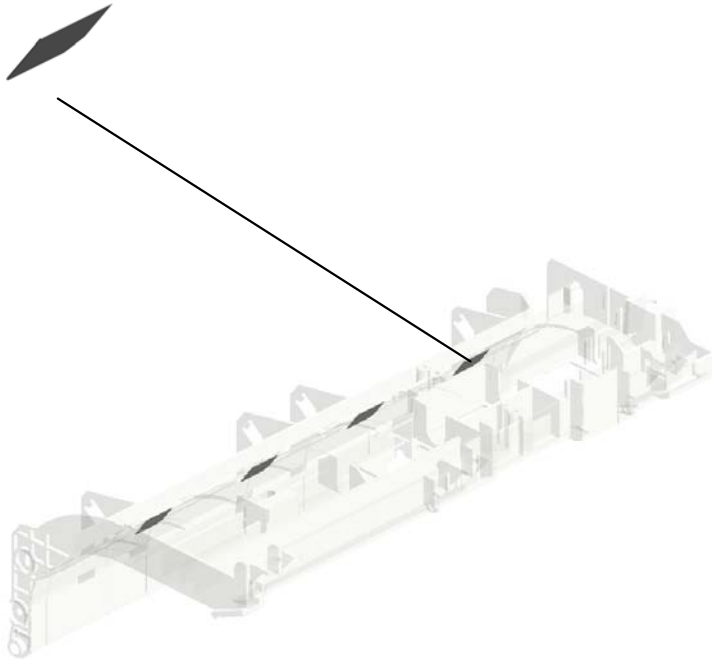

U001	U002	U003	U004	U005	U006	U007	U008	U009	U010	U011	U012	U013	U014	U015	U016	U017	U018	U019	U020	U021
------	------	------	------	------	------	------	------	------	------	------	------	------	------	------	------	------	------	------	------	------

U003\_S001\_S004  
COVER:PAPER FEED:ASS'Y

35.A4221063 SEAL - 0.7X13X20  
267.D7314371 GRIP:COVER:PAPER FEED  
77.B4774117 SPRING  
238.D6834361 SHAFT:CONTACT POINT:GRIP

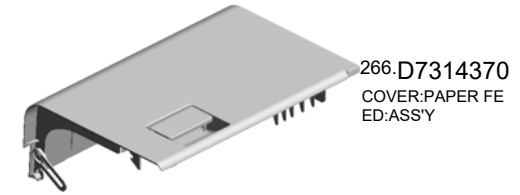

266.D7314370 COVER:PAPER FEED:ASS'Y

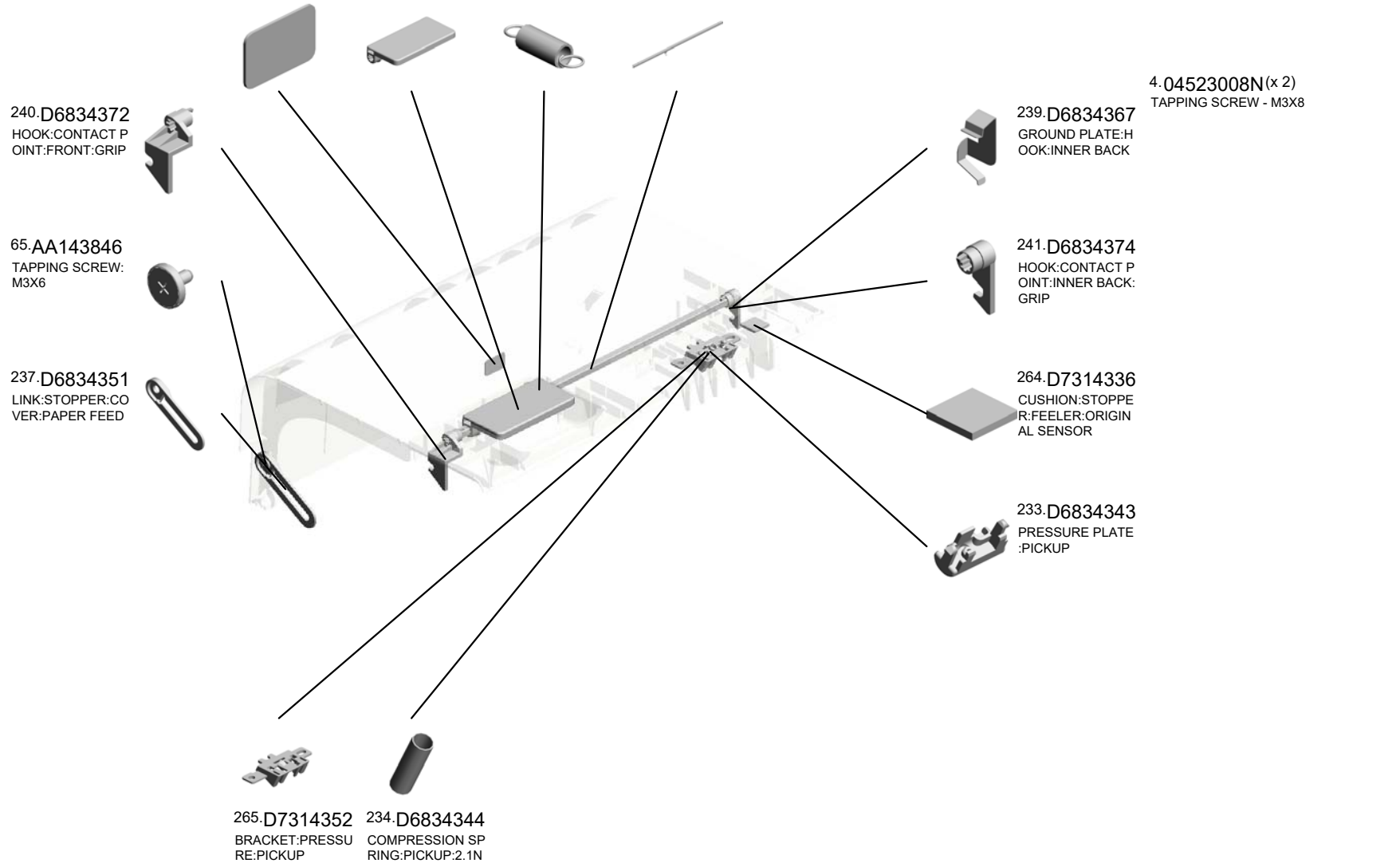

U003\_S001\_S005  
COVER:LOWER:ASS'Y

246.D6834442  
(x2)  
TAPE:PRESSURE  
PLATE

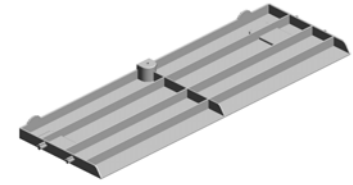

271.D7314510  
COVER:LOWER:AS  
SY

U001	U002	U003	U004	U005	U006	U007	U008	U009	U010	U011	U012	U013	U014	U015	U016	U017	U018	U019	U020	U021
------	------	------	------	------	------	------	------	------	------	------	------	------	------	------	------	------	------	------	------	------



U003\_S001\_S006  
GUIDE PLATE:EXIT:UPPER:ASS'Y

227.D6833811  
GUIDE PLATE:EXIT  
:UPPER



86.B8041180  
(x2)  
DISCHARGE BRUS  
H:PUNCH UNIT

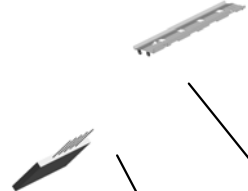

251.D6902425  
DISCHARGE BRUS  
H:SHORT:FRONT

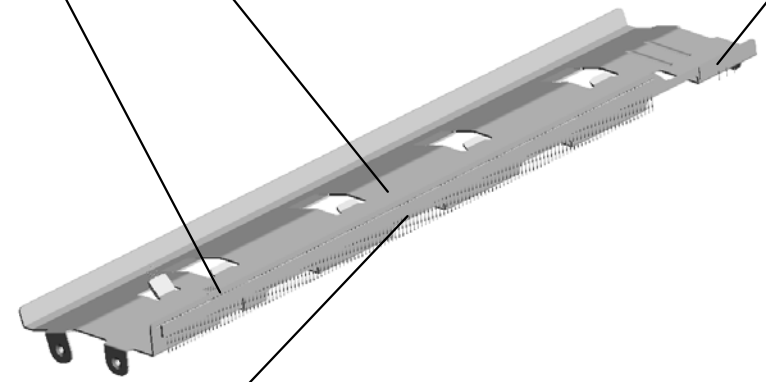

228.D6833812  
DISCHARGE BRUS  
H:EXIT



U001	U002	U003	U004	U005	U006	U007	U008	U009	U010	U011	U012	U013	U014	U015	U016	U017	U018	U019	U020	U021
------	------	------	------	------	------	------	------	------	------	------	------	------	------	------	------	------	------	------	------	------

U003\_S001\_S007  
ROLLER:SCANNING:EXIT:DRIVE:ASS'Y

58-AA082104  
(x2)  
BUSHING - 8X12X7



201-D6833150  
ROLLER:SCANNIN  
G:EXIT:DRIVE:ASS'  
Y



12.07200060E  
RETAINING RING -  
M6

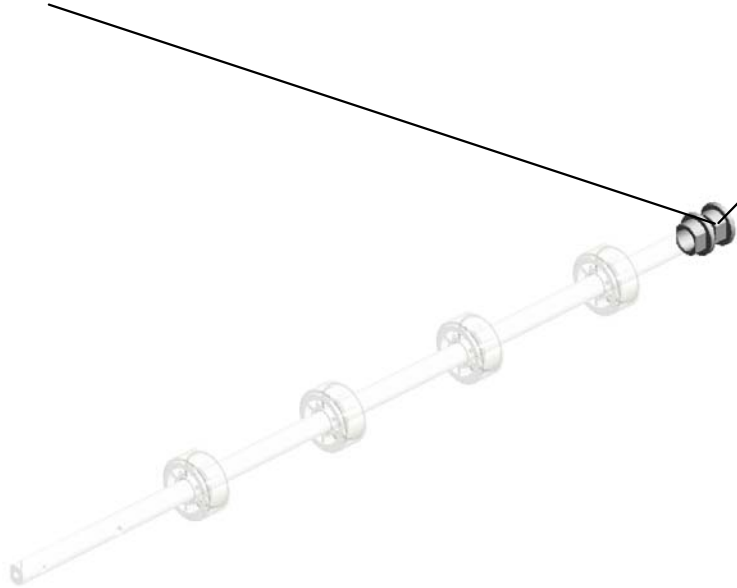

U001	U002	U003	U004	U005	U006	U007	U008	U009	U010	U011	U012	U013	U014	U015	U016	U017	U018	U019	U020	U021
------	------	------	------	------	------	------	------	------	------	------	------	------	------	------	------	------	------	------	------	------

U003\_S001\_S008  
GUIDE:EXIT:LOWER:ASS'Y

214.D6833621 GUIDE:EXIT:LOWE  
R:SUB-ASS'Y  
86.B8041180 (x4)  
DISCHARGE BRUS  
H:PUNCH UNIT  
123.D5433631 ROLLER:SCANNIN  
G:BEHIND:ASS'Y  
35.A4221063 SEAL - 0.7X13X20

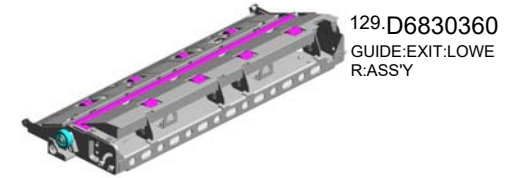

129.D6830360  
GUIDE:EXIT:LOWE  
R:ASS'Y

124.D5433635  
GEAR:ROLLER:SC  
ANNING:BEHIND



17.08050104  
RETAINING RINGS  
-E:SILENCER:DIA4



219.D6833651  
COVER:SCANNING  
:EXIT



112.D4122653  
BUSHING:DIA6



113.D4122669  
(x2)  
TENSION SPRING:  
GUIDE PLATE:PRE  
SSURE:2N



78.B4774129  
(x2)  
SPRING - 12N



246.D6834442  
(x4)  
TAPE:PRESSURE  
PLATE

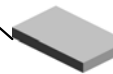

61.AA143788 (x2)  
PIN:GUIDE PLATE:  
PAPER FEED  
7.04543006Q (x7)  
TAPPING SCREW -  
M3X6  
213.D6833616 (x2)  
BRACKET:DISCHA  
RGE BRUSH



U003\_S001\_S008\_S001  
GUIDE:CONTACT IMAGE SENSOR:EXIT:LOWER:ASS'Y

218.D6833645  
(x2)  
ROLLER:MIDDLE:D  
RIVEN



215.D6833641  
GUIDE:CONTACT I  
MAGE SENSOR:EX  
IT:LOWER:ASS'Y

278.G0602652  
(x4)  
BUSHING - M4

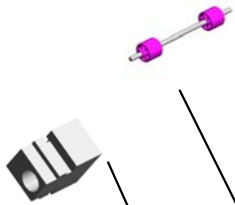

216.D6833643  
(x4)  
COMPRESSION SP  
RING:CONTACT IM  
AGE SENSOR:EXIT

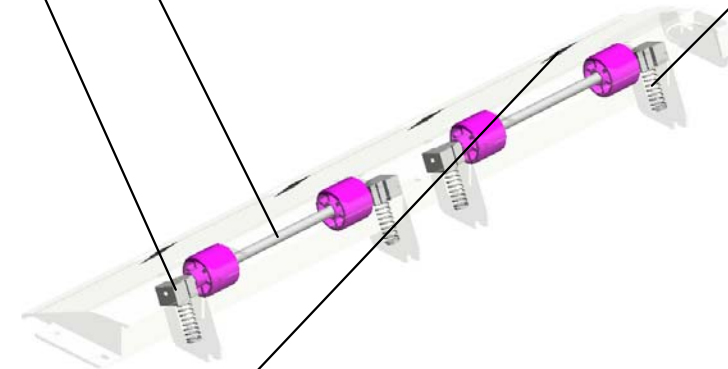

217.D6833644  
(x4)  
SHEET:GUIDE:CO  
NTACT IMAGE SEN  
SOR:EXIT:LOWER



U003\_S001\_S008\_S002

GUIDE PLATE:CONTACT IMAGE SENSOR:ENTRANCE:ASS'Y

228.D6833812 DISCHARGE BRUSH:EXIT  
223.D6833668 (x2) SPACER:GUIDE PLATE:CONTACT IMAGE SENSOR:ENTRANCE



221.D6833666 LEVER:GUIDE PLATE:CONTACT IMAGE SENSOR:FRONT



222.D6833667 LEVER:GUIDE PLATE:CONTACT IMAGE SENSOR:REAR

2-03603006N (x4) SCREW - M3X6

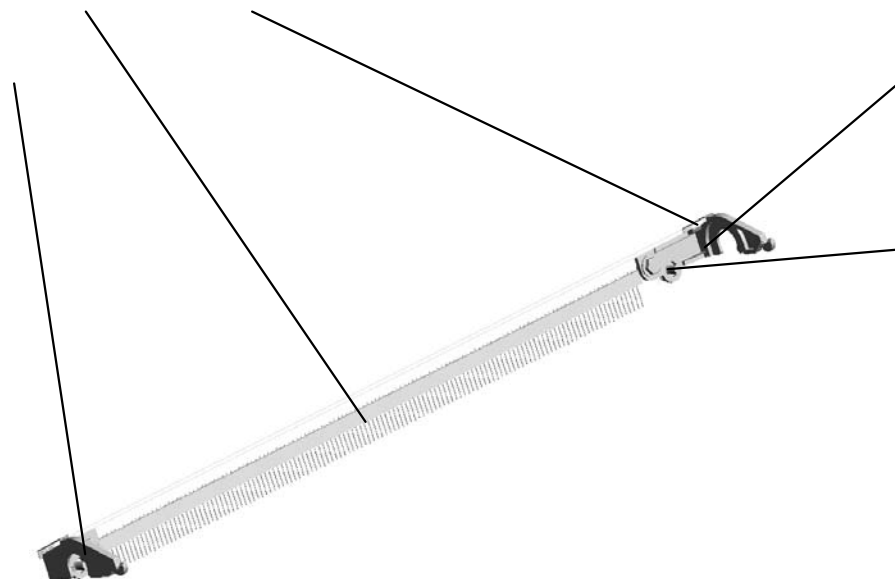

U003\_S001\_S009  
GUIDE:SCANNING:ENTRANCE:LOWER:SUB-ASS'Y

122.D5433314  
(x4)  
SHEET:SCANNING:  
ENTRANCE:MIDDLE

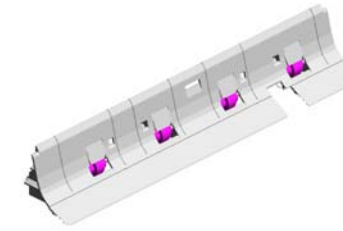

209.D6833411  
GUIDE:SCANNING:  
ENTRANCE:LOWER:  
SUB-ASS'Y



U001	U002	U003	U004	U005	U006	U007	U008	U009	U010	U011	U012	U013	U014	U015	U016	U017	U018	U019	U020	U021
------	------	------	------	------	------	------	------	------	------	------	------	------	------	------	------	------	------	------	------	------

# U004.SCANNER

U004 S002  
D2581751  
CARRIAGE:NO.1:ASS'Y

U004 S003  
D2581769  
ILLUMINATION UNIT:LED-B:A  
SS'Y

U004 S005  
D2581776  
CARRIAGE:NO.2:ASS'Y

U004 S004  
D2581769  
ILLUMINATION UNIT:LED-B:A  
SS'Y

U004 S001  
D2581739  
LENSBLOCK SMD:ASS'Y

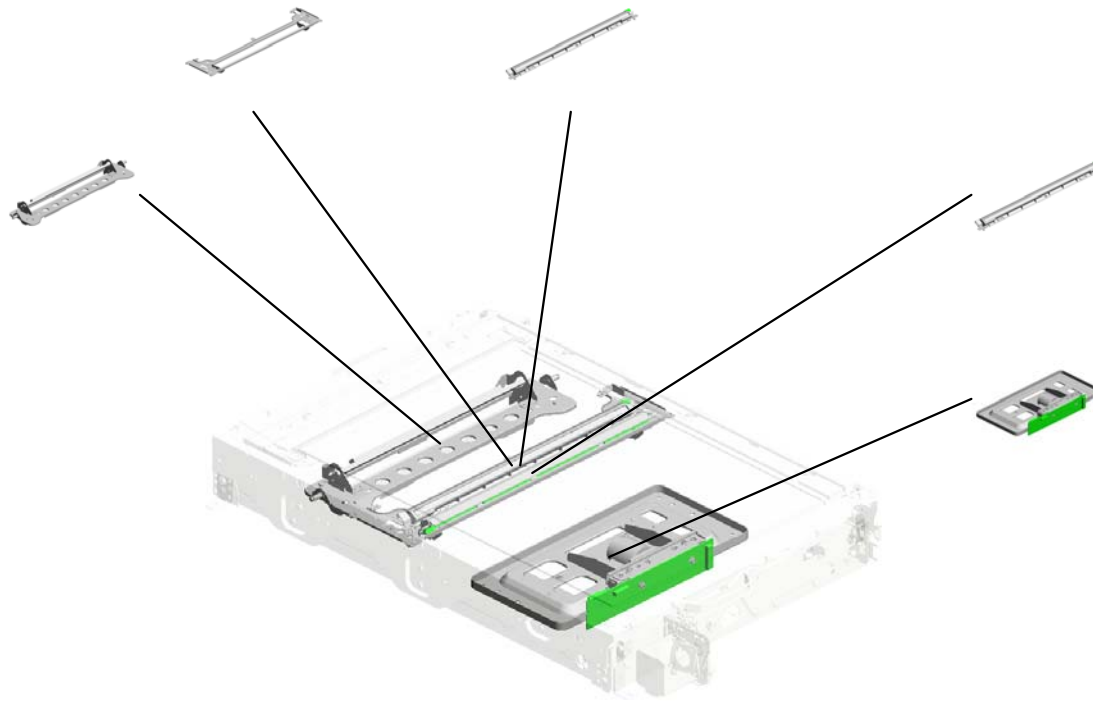

U001	U002	U003	U004	U005	U006	U007	U008	U009	U010	U011	U012	U013	U014	U015	U016	U017	U018	U019	U020	U021
------	------	------	------	------	------	------	------	------	------	------	------	------	------	------	------	------	------	------	------	------

# U004 SCANNER

- 6.07074050N (x2) BUSHING - 4X5
- 17.AA161104 (x2) CUSHION - MOTO R
- 16.A2501752 EXPOSURE GLASS
- 12.11050511 (x17) HARNESS CLAMP - LWS-0306ZC 201904-02 X/O
- 19.AW010160 (x2) ORIGINAL SENSO R:48MM:5V:(SEN10 5/SEN106)

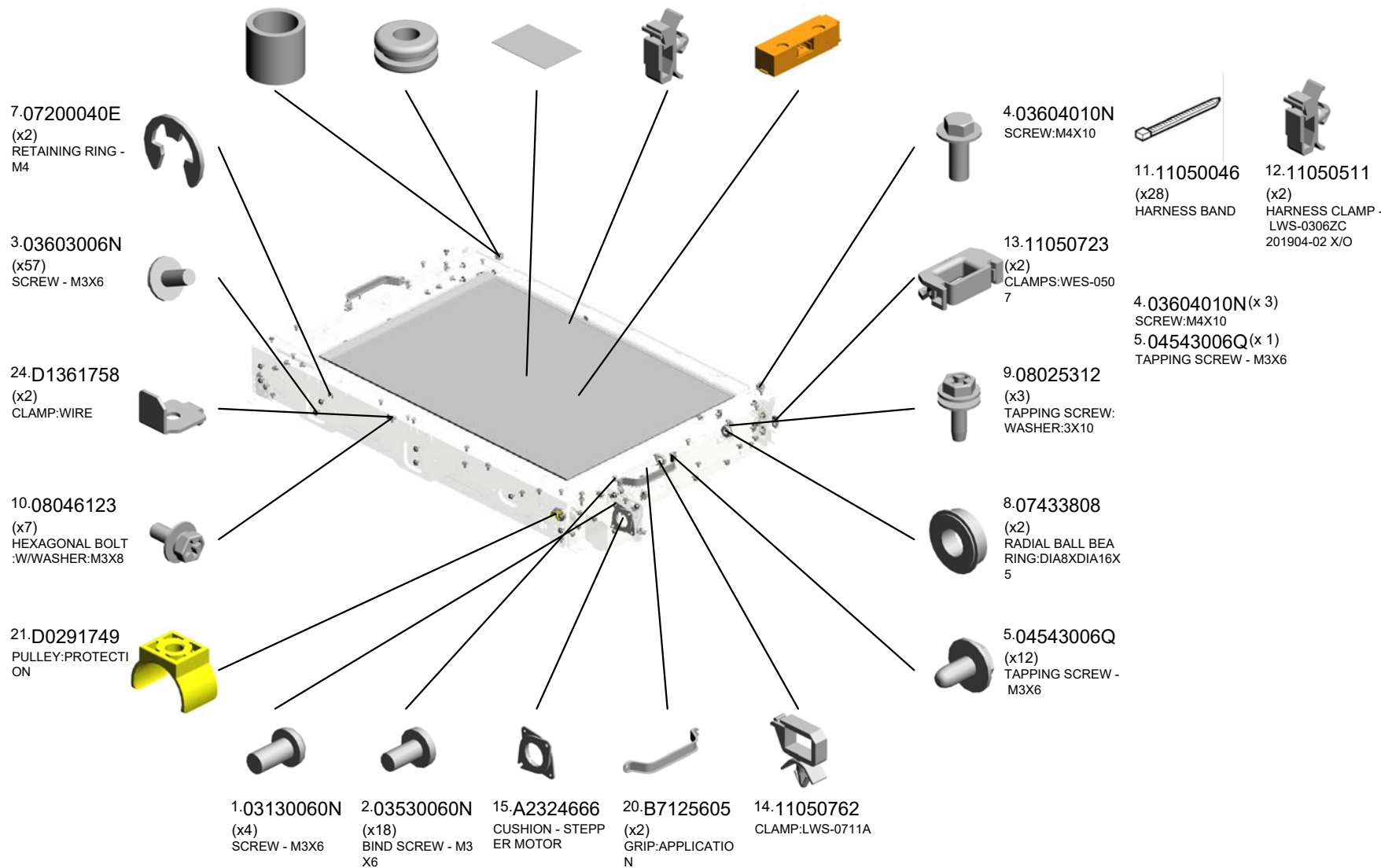



# U004 SCANNER

- 37.D1361817 BRACKET:EXPOSURE GLASS:DOCUMENT FEEDER:SUBASS'Y
- 42.D1791768 EXPOSURE GLASS:DOCUMENT FEEDER
- 43.D1791777 COVER:EXPOSURE GLASS:DOCUMENT FEEDER
- 44.D2231762 (x2) INSULATING SHEET:LED
- 38.D1441085 (x5) STEPPED SCREW:M3

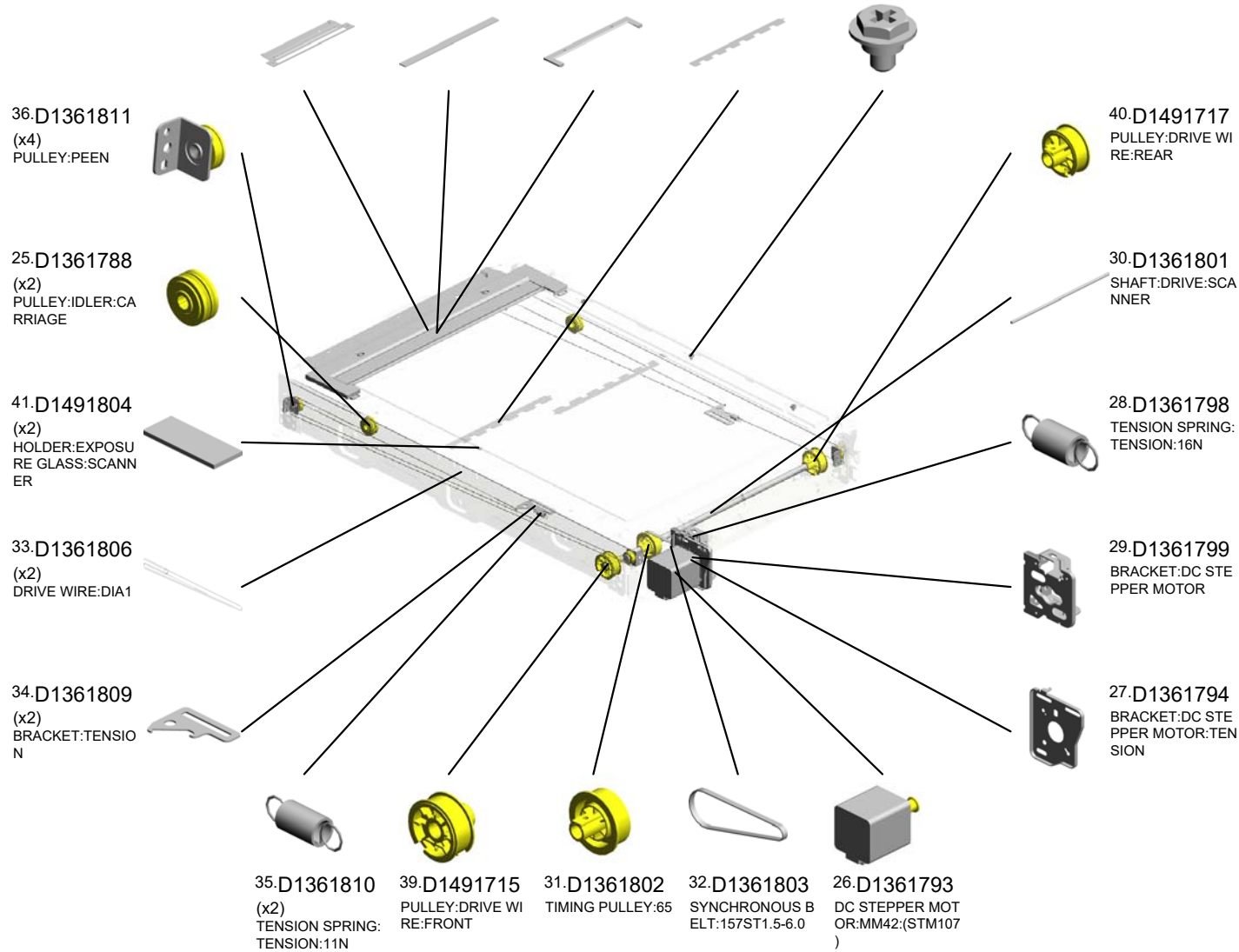

# U004 SCANNER

68.D0A51741 (NA):SCALE:LEFT:ASSY  
 62.D2581787 SIDE PLATE:GUIDE:FFC:CARRIAGE:NO.2  
 64.G5701225 SENSOR SHIELDING PLATE  
 65.GW020024 PHOTOINTERRUPTOR:LG2A24BL1:GF:(SEN3/SEN21/SEN35/SEN36/SEN37/SEN38/SEN39/SEN40/SEN41/SEN42/S



61.D2581786 GUIDE:FFC:CARRIAGE:NO.2

45.D2231763 (x2) INSULATING SHEET:LED:CONNECTOR

54.D2581759 GUIDE:FFC:CARRIAGE:NO.1:FRONT

56.D2581761 GUIDE:FFC:CARRIAGE:NO.1:REAR

50.D2581719 COVER:PULLEY

51.D2581727 INNER COVER:SCANNER

48.D2581717 COVER:SHAFT:SCANNER

47.D2581715 GUIDE:FFC:BASE  
 49.D2581718 SHEET:FFC:BASE  
 46.D2231805 (x4) HOLDER:EXPOSURE GLASS

U004\_S001  
LENSBLOCK SMD:ASS'Y

3-03603006N  
(x4)  
SCREW - M3X6



52-D2581739  
LENSBLOCK SMD:  
ASS'Y



10-08046123  
(x10)  
HEXAGONAL BOLT  
:WASHER:M3X8

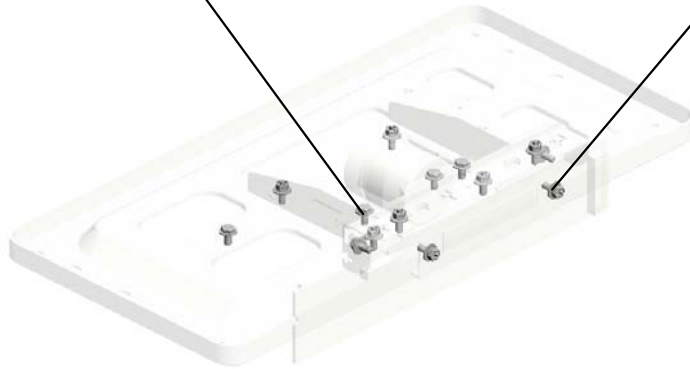

U001	U002	U003	U004	U005	U006	U007	U008	U009	U010	U011	U012	U013	U014	U015	U016	U017	U018	U019	U020	U021
------	------	------	------	------	------	------	------	------	------	------	------	------	------	------	------	------	------	------	------	------

U004\_S002  
CARRIAGE:NO.1:ASS'Y

66.M0261815  
(x2)  
CLAMP:MIRROR:NO.1  
O.1



53.D2581751  
CARRIAGE:NO.1:ASS'Y

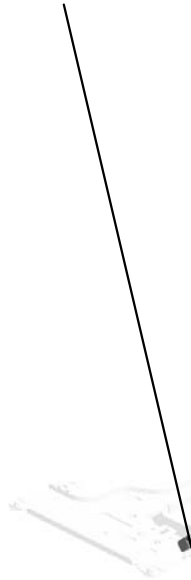

18.AC030211  
MIRROR:NO.1

U001	U002	U003	U004	U005	U006	U007	U008	U009	U010	U011	U012	U013	U014	U015	U016	U017	U018	U019	U020	U021
------	------	------	------	------	------	------	------	------	------	------	------	------	------	------	------	------	------	------	------	------

U004\_S003  
ILLUMINATION UNIT:LED-B:ASS'Y

2-03530060N  
(x3)  
BIND SCREW - M3  
X6

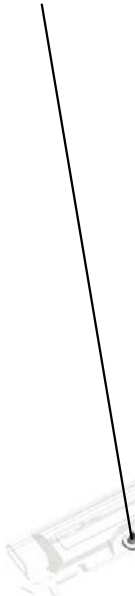

57-D2581769  
ILLUMINATION UNI  
T:LED-B:ASS'Y

U001	U002	U003	U004	U005	U006	U007	U008	U009	U010	U011	U012	U013	U014	U015	U016	U017	U018	U019	U020	U021
------	------	------	------	------	------	------	------	------	------	------	------	------	------	------	------	------	------	------	------	------

U004\_S004  
ILLUMINATION UNIT:LED-B:ASS'Y

2-03530060N  
(x3)  
BIND SCREW - M3  
X6



57-D2581769  
ILLUMINATION UNI  
T:LED-B:ASS'Y



U001	U002	U003	<b>U004</b>	U005	U006	U007	U008	U009	U010	U011	U012	U013	U014	U015	U016	U017	U018	U019	U020	U021
------	------	------	-------------	------	------	------	------	------	------	------	------	------	------	------	------	------	------	------	------	------

U004\_S005  
CARRIAGE:NO.2:ASS'Y

59.D2581784 60.D2581785  
MIRROR:NO.2:CON MIRROR:NO.3:CON  
CAVE:ASS'Y VEX:ASS'Y



58.D2581776  
CARRIAGE:NO.2:A  
SS'Y

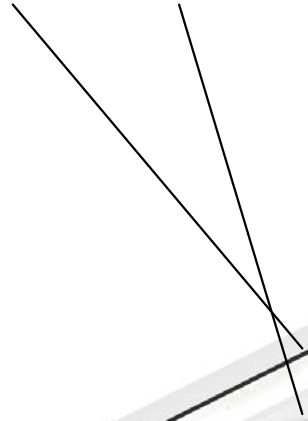

63.G4042810  
(x4)  
SPRING PLATE - 2  
ND MIRROR



U001	U002	U003	U004	U005	U006	U007	U008	U009	U010	U011	U012	U013	U014	U015	U016	U017	U018	U019	U020	U021
------	------	------	------	------	------	------	------	------	------	------	------	------	------	------	------	------	------	------	------	------

U005  
LASER UNIT

1-03604012N  
(x4)  
SCREW:M4X12



2-D0BX1901  
OPTICAL WRITING  
UNIT:ASSY

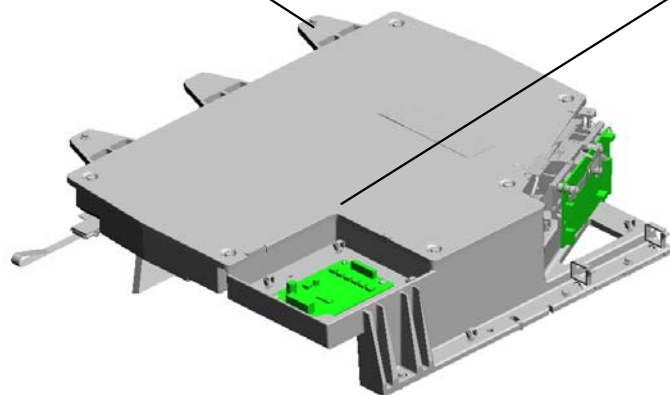

U001	U002	U003	U004	U005	U006	U007	U008	U009	U010	U011	U012	U013	U014	U015	U016	U017	U018	U019	U020	U021
------	------	------	------	------	------	------	------	------	------	------	------	------	------	------	------	------	------	------	------	------



# U006.PAPER FEED

U006\_S003  
D2236231  
DC SOLENOID:LOCK:ASSY:(  
SOL5)

U006\_S002  
M2057305  
REGISTRATION ROLLER:GA  
TE:ASSY

U006\_S001  
D2702771  
ARM:REGISTRATION:TIMING  
:ASSY

U006\_S012  
D0BX6685  
(NA):TANDEM LCT:RIGHT:AS  
S'Y

U006\_S004  
D2236233  
DC SOLENOID:COUPLING:A  
SSY:(SOL6)

U006\_S010  
D0BX7631  
PAPER TRAY:UNIVERSAL:S  
UB-ASSY

U006\_S007  
D0BX6628  
PAPER FEED UNIT:PAPER B  
ANK:ASSY

U006\_S005  
D1797525  
STOPPER:REGISTRATION:T  
ANDEM LCT:ASSY

U006\_S009  
D0BX6771  
GUIDE PLATE:OPEN AND CL  
OSE:VERTICAL TRANSPORT  
:LOWER:ASSY

U006\_S011  
D0BX7631  
PAPER TRAY:UNIVERSAL:S  
UB-ASSY

U006\_S006  
D0BX6628  
PAPER FEED UNIT:PAPER B  
ANK:ASSY

U006\_S008  
D0BX6628  
PAPER FEED UNIT:PAPER B  
ANK:ASSY

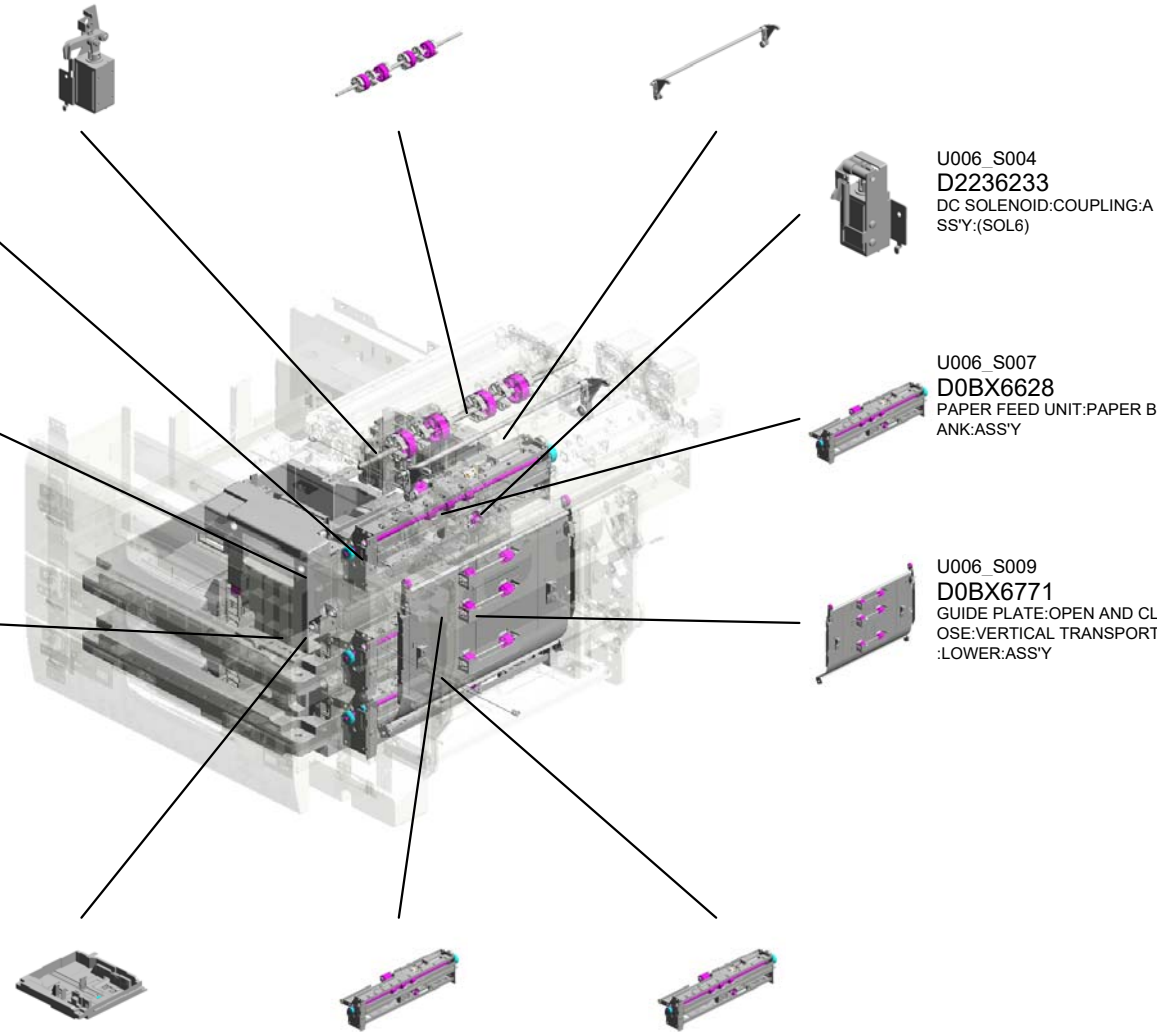

# U006.PAPER FEED

U006\_S014  
D2707544  
SIDE FENCE:TANDEM LCT:L  
EFT REAR:ASSY

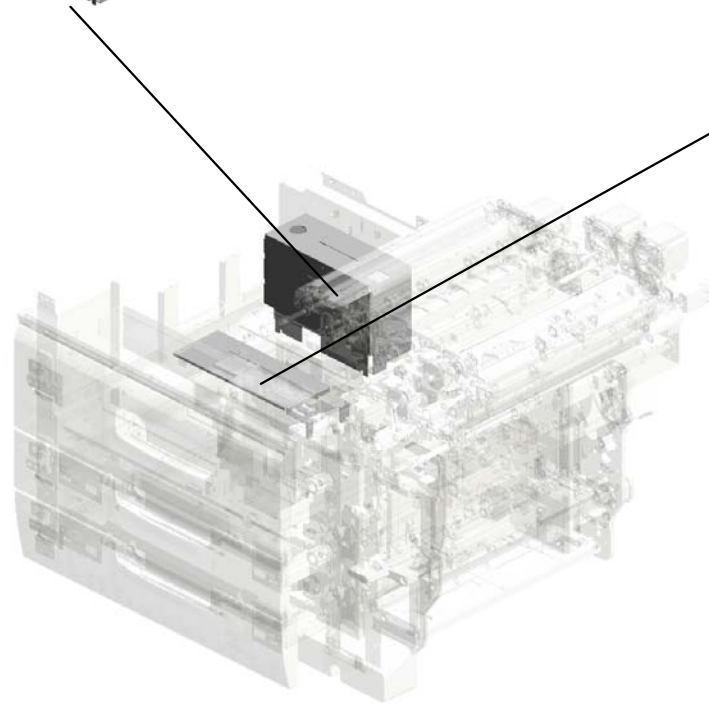
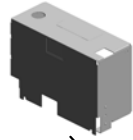

U006\_S013  
D0747596  
(CHN[Pro 8310/8320]/NA/EU/  
AA/TWN/KOR):TRAY BOTTO  
M PLATE:LEFT MIDDLE:ASS'  
Y

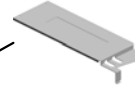

U001	U002	U003	U004	U005	<b>U006</b>	U007	U008	U009	U010	U011	U012	U013	U014	U015	U016	U017	U018	U019	U020	U021
------	------	------	------	------	-------------	------	------	------	------	------	------	------	------	------	------	------	------	------	------	------

# U006\_S009.GUIDE PLATE:OPEN AND CLOSE:VERTICAL TRANSPORT:LOWER:ASS'Y

U006 S009 S002  
D3553840  
BRACKET:DETENT:ASS'Y



U006\_S009\_S001  
D3553810  
BRACKET:DETENT:RIGHT:ASS'Y

U001	U002	U003	U004	U005	<b>U006</b>	U007	U008	U009	U010	U011	U012	U013	U014	U015	U016	U017	U018	U019	U020	U021
------	------	------	------	------	-------------	------	------	------	------	------	------	------	------	------	------	------	------	------	------	------

# U006\_S010.PAPER TRAY:UNIVERSAL:SUB-ASS'Y

U006\_S010\_S003  
D1316777  
SIDE FENCE:FRONT:ASS'Y

U006\_S010\_S001  
D0BX6780  
TRAY BOTTOM PLATE:ASS'Y

U006\_S010\_S002  
D1316775  
SIDE FENCE:REAR:ASS'Y

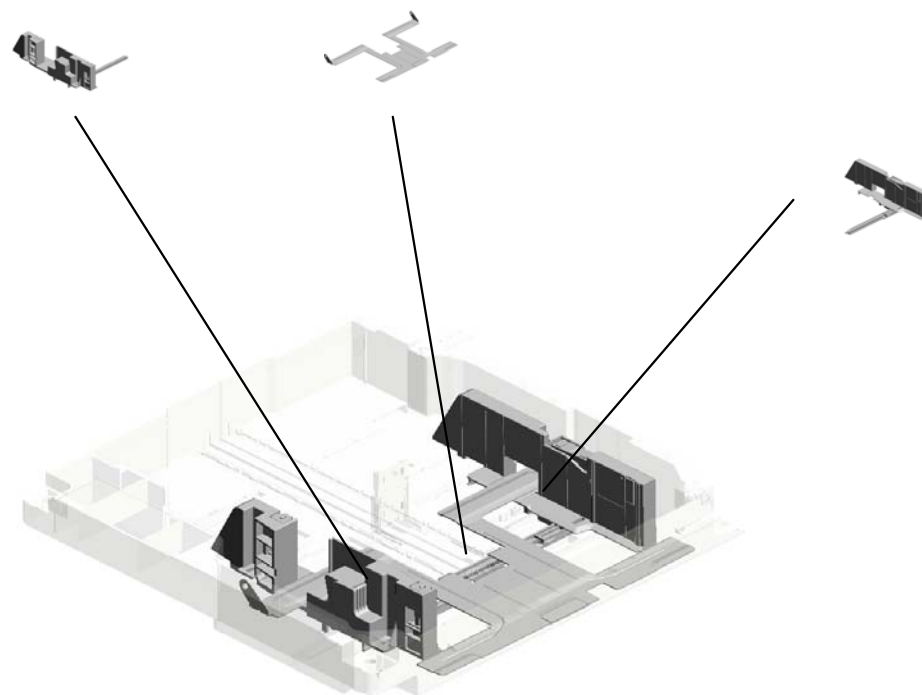

U001	U002	U003	U004	U005	<b>U006</b>	U007	U008	U009	U010	U011	U012	U013	U014	U015	U016	U017	U018	U019	U020	U021
------	------	------	------	------	-------------	------	------	------	------	------	------	------	------	------	------	------	------	------	------	------

# U006\_S011.PAPER TRAY:UNIVERSAL:SUB-ASS'Y

U006\_S011\_S003  
D1316777  
SIDE FENCE:FRONT:ASS'Y

U006\_S011\_S001  
D0BX6780  
TRAY BOTTOM PLATE:ASS'Y

U006\_S011\_S002  
D1316775  
SIDE FENCE:REAR:ASS'Y

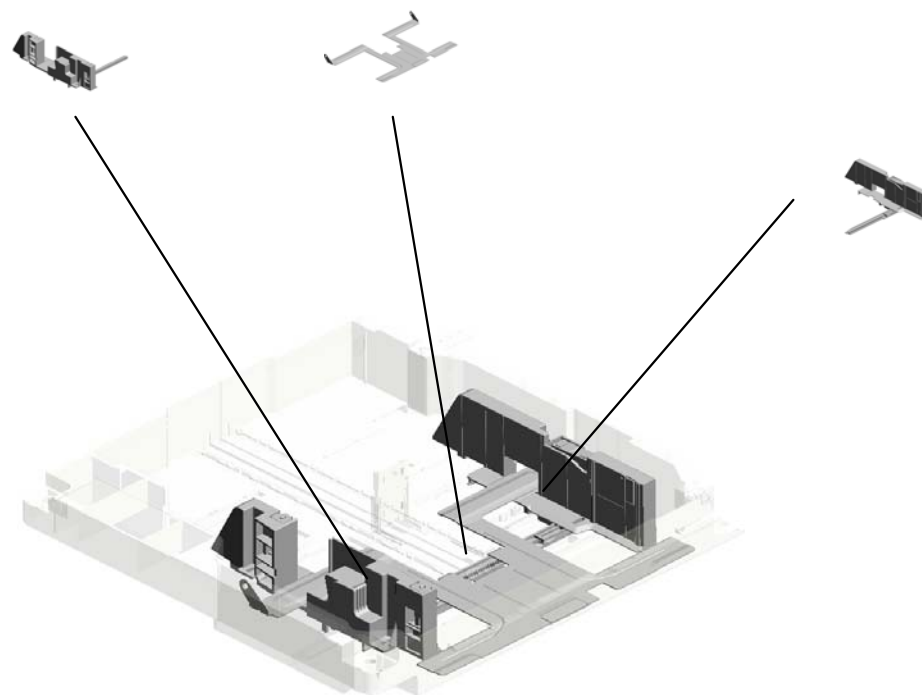

U001	U002	U003	U004	U005	<b>U006</b>	U007	U008	U009	U010	U011	U012	U013	U014	U015	U016	U017	U018	U019	U020	U021
------	------	------	------	------	-------------	------	------	------	------	------	------	------	------	------	------	------	------	------	------	------

# U006\_S012.(NA):TANDEM LCT:RIGHT:ASS'Y

U006 S012 S001  
B2346691  
SIDE FENCE:TANDEM LCT:R  
IGHT:ASS'Y

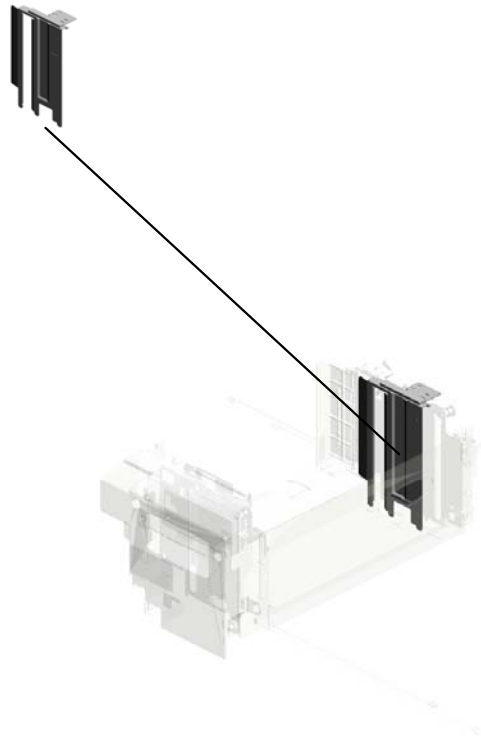

U001	U002	U003	U004	U005	<b>U006</b>	U007	U008	U009	U010	U011	U012	U013	U014	U015	U016	U017	U018	U019	U020	U021
------	------	------	------	------	-------------	------	------	------	------	------	------	------	------	------	------	------	------	------	------	------

# U006 PAPER FEED

6.03540040N (x2) SCREW-M4X4  
 11.03604008N (x31) SCREW - M4X8  
 7.03540060N (x17) SCREW-M4X6  
 2.03130080N (x2) PAN HEAD SCREW :M3X8  
 17.04513006P (x5) TAPPING SCREW: M3X6

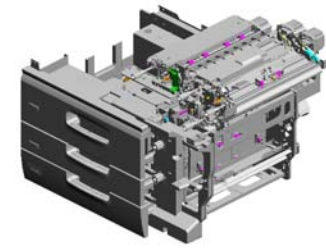

15.04504010N (x2) TAPPING SCREW: M4X10

13.04503008N (x9) TAPPING SCREW - M3X8

23.04524010N (x6) BINDING SELF-TAPPING SCREW:4X10

9.03603008N (x2) SCREW:M3X8

18.04513010N (x4) TAPPING SCREW: 3X10

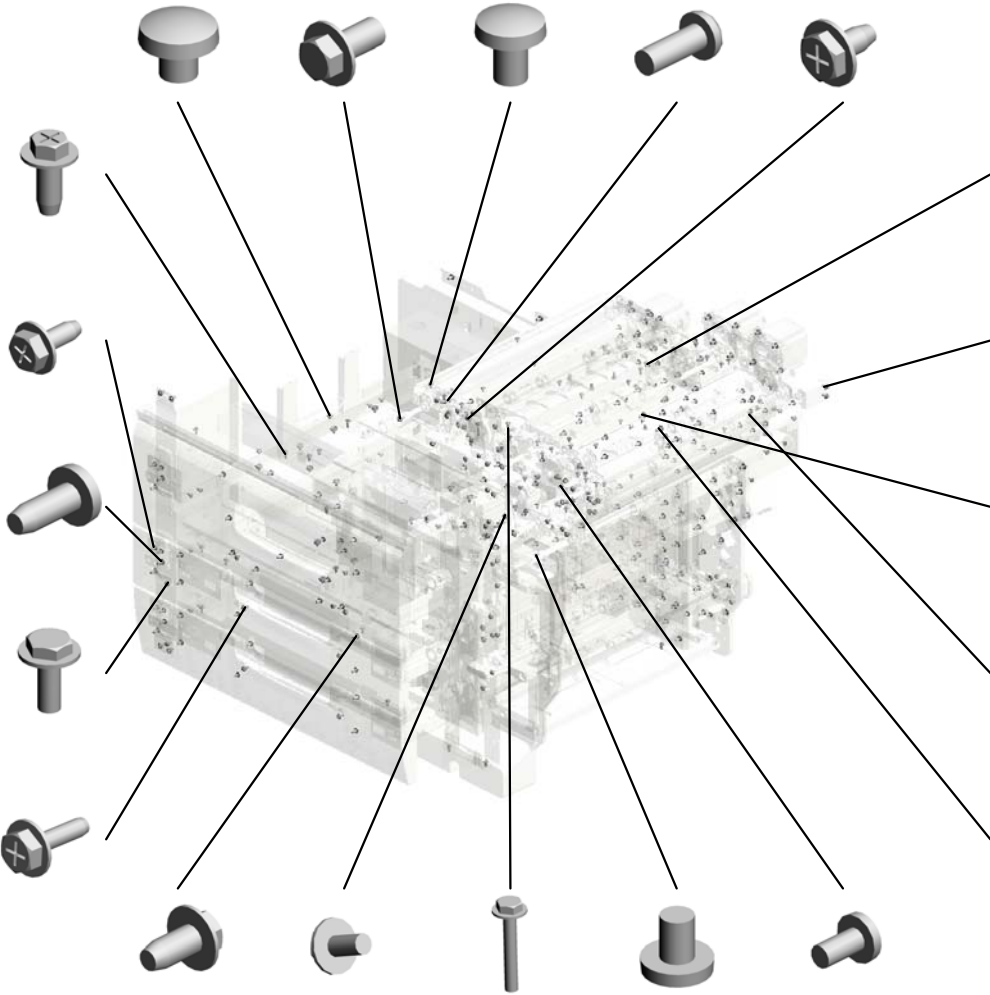

14.04504008N (x20) TAPPING SCREW - M4X8  
 8.03603006N SCREW - M3X6 201904-05 X/O  
 10.03603020N (x2) SCREW:M3X20  
 4.03530040N SCREW - M3X4  
 5.03530060N (x9) BIND SCREW - M3 X6

16.04513006N (x144) TAPPING SCREW - 3X6

20.04514008N (x69) TAPPING SCREW: 4X8

21.04514010N (x16) TAPPING SCREW: 4X10

8.03603006N (x15) SCREW - M3X6

19.04514006N (x29) TAPPING SCREW - 4X6

47.08050088 (x4) RETAINING RING - M6  
 48.08050089 RETAINING RING - M4

56.11050046 (x85) HARNESS BAND  
 59.11050488 HARNESS CLAMP

61.11050511 (x9) HARNESS CLAMP - LWS-0306ZC  
 62.11050516 (x3) CLAMP

66.11050723 CLAMPS:WES-0507

# U006 PAPER FEED

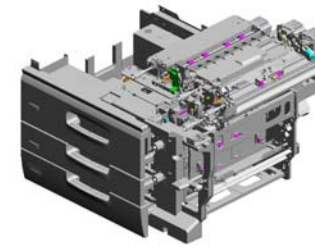

- 36.07200030E (x4) RETAINING RING - M3
- 40.07403808 (x4) BALL BEARING - 8 X16X5MM
- 48.08050089 (x9) RETAINING RING - M4
- 32.06320140G PARALLEL PIN
- 38.07200060E (x54) RETAINING RING - M6

- 43.07433808 (x31) RADIAL BALL BEARING: DIA8X DIA16X 5

- 47.08050088 (x2) RETAINING RING - M6

- 33.06330140G (x2) PARALLEL PIN - 3X 14

- 45.08025220 (x2) TAPPING SCREW - M4X8

- 25.04534006N BINDING SELF TAPPING SCREW: 4X6

- 44.08010237 (x3) HEXAGONAL BOLT :DOUBLE SCREW: M4X12
- 46.08046123 (x2) HEXAGONAL BOLT :W/WASHER: M3X8
- 27.04543006Q (x44) TAPPING SCREW - M3X6
- 37.07200040E (x36) RETAINING RING - M4
- 24.04524012N (x3) BINDING SELF-TAPPING SCREW: 4X 12

- 42.07413708 (x8) BALL BEARING - 8 X12X3.5MM

- 30.04544008Q (x85) TAPPING SCREW - M4X8

- 28.04543008Q (x6) TAPPING SCREW: 3X8

- 35.07080080N WASHER-DIA8

- 49.08050092 RETAINING RING - 3M

- 16.04513006N (x 1) TAPPING SCREW - 3X6
- 19.04514006N (x 9) TAPPING SCREW - 4X6
- 20.04514008N (x 2) TAPPING SCREW: 4X8
- 29.04544006Q (x 4) TAPPING SCREW: 4X6
- 38.07200060E (x 1) RETAINING RING - M6



# U006 PAPER FEED

- 62.11050516 (x36) CLAMP
- 60.11050490 (x3) HARNESS CLAMP - IWS-2218
- 67.11050724 (x2) CLAMPS:WES-1210
- 50.08053263 (x2) BEARING - 6X10X6 MM
- 55.09543008N (x4) SCREW - M3X8

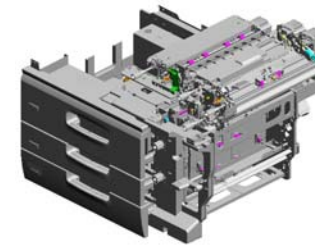

- 57.11050328 (x4) HARNESS CLAMP - ES-0505

- 58.11050487 (x20) HARNESS CLAMP

- 59.11050488 (x5) HARNESS CLAMP

- 71.50530447 (x2) BUSHING - 6MM

- 51.08053386 (x2) BUSHING - 8MM

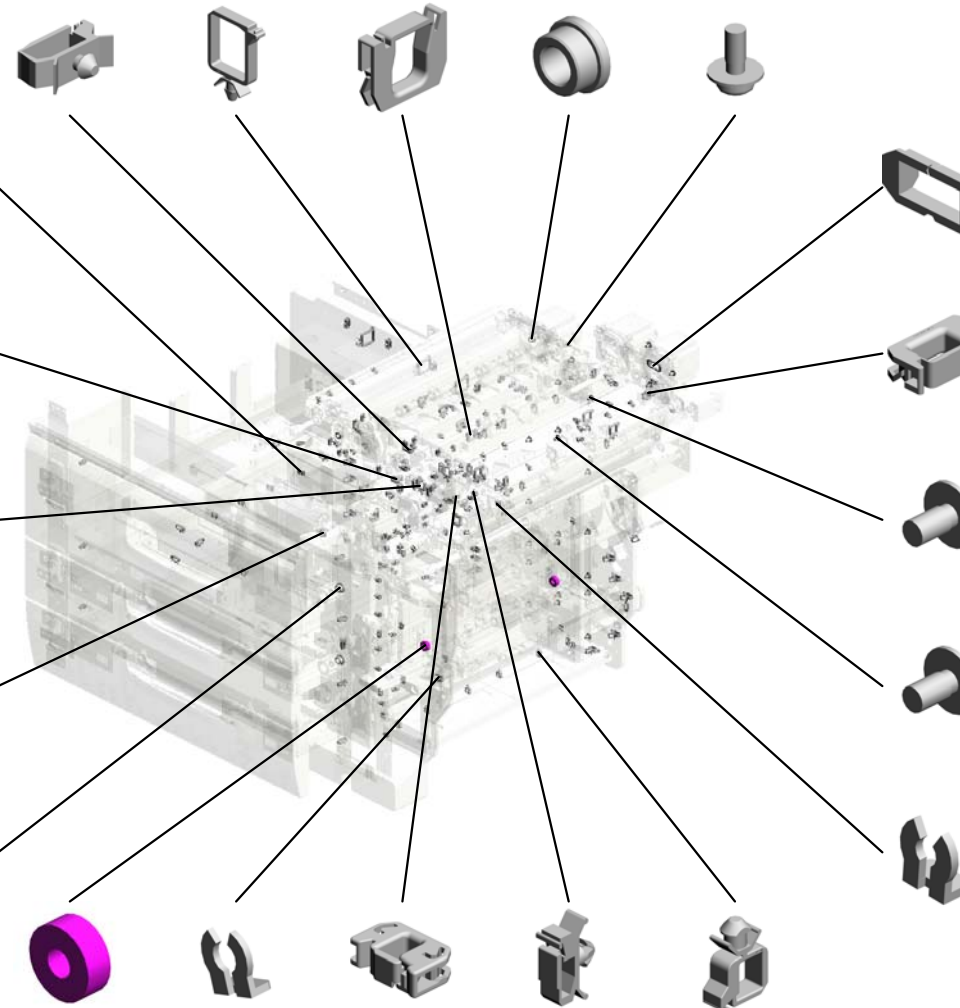

- 69.11060911 BUSHING:SB-1909

- 66.11050723 (x9) CLAMPS:WES-0507

- 54.09514008N (x6) SCREW:POLISHED ROUND:M4X8

- 53.09514006N (x18) SCREW:POLISHED ROUND:M4X6

- 73.54472681 (x6) SNAP RING

- 75.67542866 (x2) ROLLER - POSITIONING GUIDE
- 72.52152621 SNAP RING - M6
- 65.11050692 (x18) CLAMP:LES-0503
- 61.11050511 (x77) HARNESS CLAMP - LWS-0306ZC
- 63.11050534 (x6) CLAMP

# U006 PAPER FEED

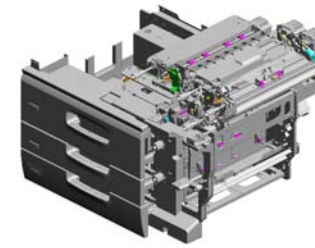

- 93.AA043324 TIMING BELT - B40 S2M152
- 106.AA063268 (x2) CONNECTOR SPRING
- 105.AA061192 (x2) TENSION SPRING: TIMING ROLLER
- 95.AA043443 TIMING BELT - S2 M 140
- 104.AA061191 (x2) TENSION SPRING: REGISTRATION

103.AA060987  
TENSION SPRING:  
TIMING BELT:10N

85.A2946643  
LEFT FRONT FENCE

92.AA043271  
TIMING BELT S3M  
196T

114.AA066667  
SPRING:STRIPPER  
PLATE:FRONT

110.AA063695  
(x8)  
COMPRESSION SPRING:GRIP

94.AA043325  
TIMING BELT - B40  
S2M250

96.AA043627 (x2)  
TIMING BELT - B40  
S2M148

108.AA063693 (x2)  
COMPRESSION SPRING:PRESSURE:  
DRIVEN ROLLER

113.AA066419  
TORSION SPRING:  
GRIP

109.AA063694 (x2)  
COMPRESSION SPRING:HANDLE

111.AA066402  
TORSION SPRING:  
GUIDE PLATE:REAR

107.AA063678  
(x6)  
SPRING - 3.5N

112.AA066403  
TORSION SPRING:  
GUIDE PLATE:FRONT

97.AA043647  
TIMING BELT:60S2  
M188

77.A2324666  
CUSHION - STEPPER MOTOR

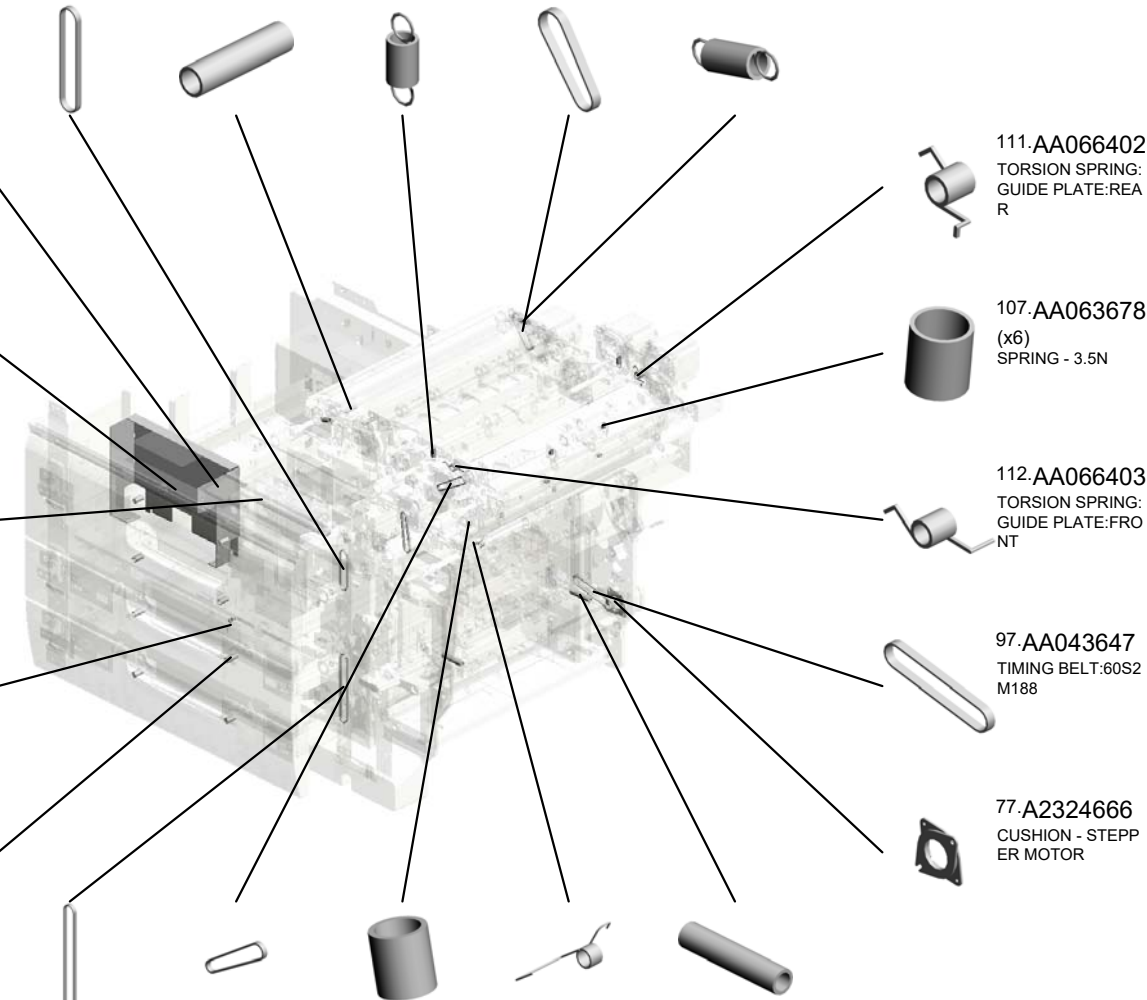

# U006 PAPER FEED

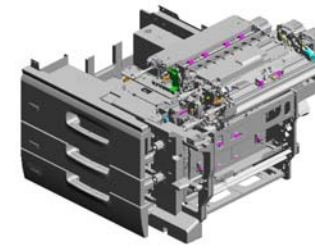

- 121.AA120127 (x2) DISCHARGE BRUSH: FUSING
- 130.AA143812 SCREW - SCALE
- 128.AA143797 (x2) CONNECTOR GUI DE PIN
- 123.AA132203 SPACER - 6MM
- 117.AA082104 (x2) BUSHING - 8X12X7

- 141.AB017725 (x2) GEAR/TIMING PULLEY - 20Z/20T

- 124.AA140686 SHAFT - TIMING PULLEY

- 139.AB013798 GEAR - Z18

- 131.AA148778 (x2) SHAFT: ARM: PLATE

- 129.AA143810 (x2) DEVELOPMENT COVER SCREW

- 115.AA080265 (x2) BUSHING: 6X8X5
- 125.AA140912 (x2) SCREW - 8X14X2.8
- 127.AA143569 (x4) SCREW
- 116.AA080346 (x4) BUSHING: FLANGE TYPE: DIA6
- 126.AA143550 (x2) SCREW: DIA4: M3

- 140.AB014243 (x2) GEAR: IDLER: Z30

- 134.AA161180 (x11) CUSHION: DC STEPPER MOTOR

- 122.AA120150 DISCHARGE BRUSH: REVERSE: 17MM

- 118.AA082144 (x6) BUSHING - 8X12X7

- 120.AA084059 (x8) BALL BEARING HOLDER

# U006 PAPER FEED

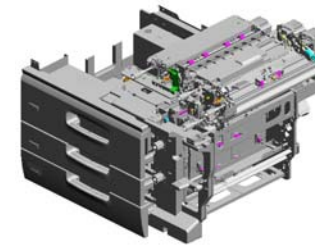

- 165.AG050100 (x4) KNOB - TRANSPORT ROLLER
- 148.AB033084 TIMING PULLEY - 1 5T
- 172.AW500010 (x2) PUSH SWITCH:(S W1/SW4)
- 173.AW500045 (x2) PUSH SWITCH:(S W2/SW3/SW13/SW14)
- 156.AF020852 TRANSPORT ROLLER:VERTICAL TRANSPORT:DRIVE:EXIT

149.AB033085  
TIMING PULLEY - 1  
5T

171.AW020163  
PAPER FEED SENSOR:SEN56

144.AB019475  
GEAR - 48T

142.AB017726  
(x2)  
GEAR/TIMING PULLEY - 20Z/20T

166.AG050101  
(x2)  
KNOB - MISFEED REMOVAL

150.AC020153  
(x3)  
LENS:LED:4

167.AG051141  
RELEASE LEVER

168.AG070513  
MAGNET CATCH

157.AF020853  
(x2)  
TRANSPORT ROLLER:VERTICAL TRANSPORT:DRIVE

174.AX040199  
(x2)  
DC MOTOR:RISING TRAY:ASSY:(M7/B M2/BM3)

145.AB030842  
TIMING PULLEY:S2  
M:30T

170.AW010151  
(x2)  
PHOTO REFLECTION SENSOR:PS12 2TL1-A:(S6/S7/S10/S11/S12/SEN7/SEN8/SEN10/SEN32/SEN

161.AF022167  
(x3)  
TRANSPORT ROLLER - DRIVEN

160.AF022165  
TRANSPORT ROLLER - DRIVEN

158.AF020854  
TRANSPORT ROLLER:VERTICAL TRANSPORT:DRIVE:CONNECTING

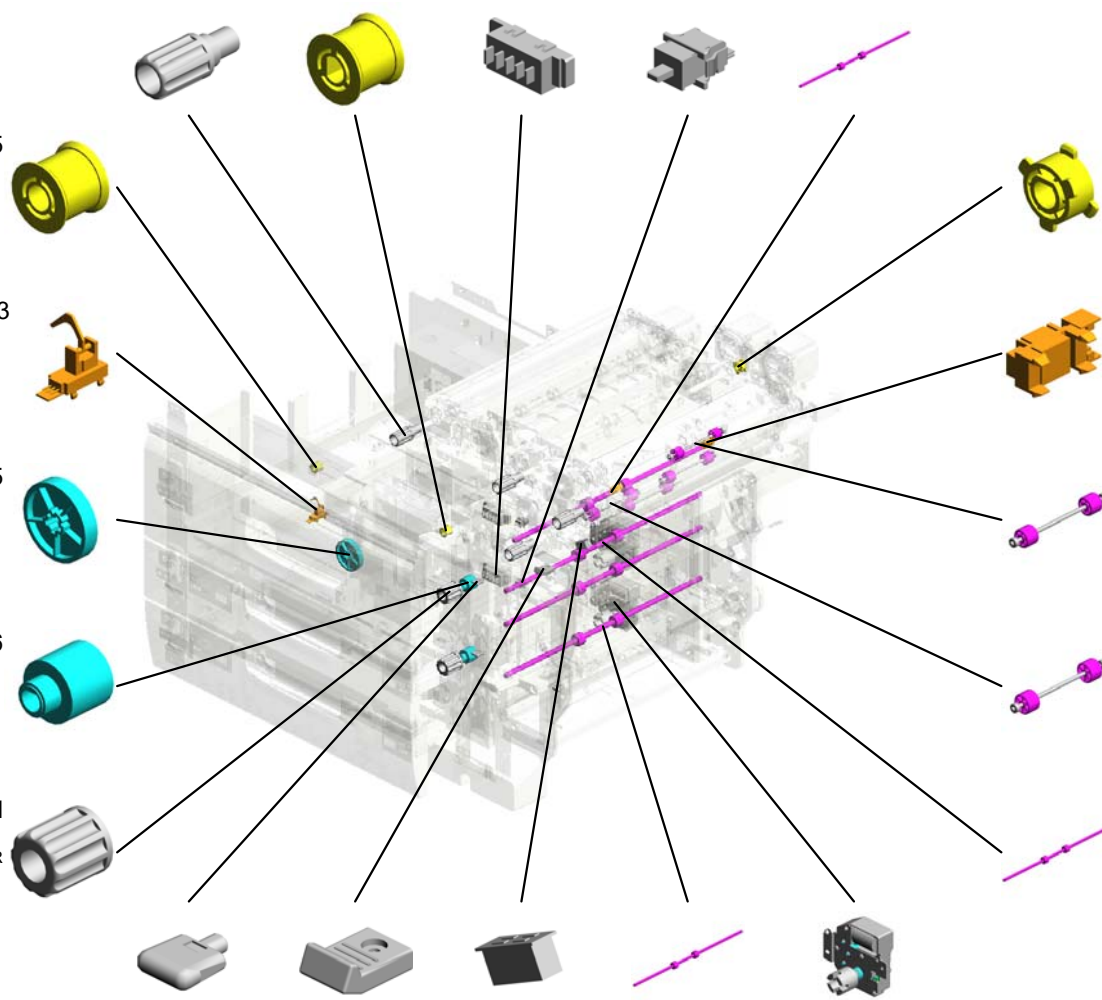

# U006 PAPER FEED

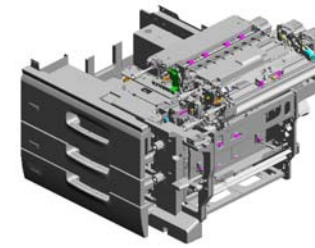

- 207.B1327541 TRAY BOTTOM PLATE:LEFT REAR
- 181.B0656136 (x3) TRAY LOCK ARM
- 192.B0656831 SENSOR BRACKET
- 178.AX040297 (x2) STEPPER MOTOR: MM56:TRANSPORT:(STM14/STM17)
- 175.AX040276 (x10) STEPPER MOTOR: MM56:TRANSPORT:(STM5/STM6/STM7/STM8/STM9/STM10/STM12/STM13/)

208.B1327561  
BACK FENCE:LEFT

209.B1327564  
SLIDER:BACK FENCE:LEFT

190.B0656823  
TIMING BELT COVER

187.B0656591  
(x2)  
PAPER TRAY HOLDER BASE

186.B0656589  
(x2)  
LEFT SUPPORT PLATE

191.B0656830  
PULLEY BRACKET

180.B0042995  
(x3)  
CAP - POSITIONING

211.B1327591  
RAIL:PAPER TRAY: ASS'Y

177.AX040280  
(x2)  
STEPPER MOTOR: DRIVE:(STM24/STM25/STM26/STM27)

201.B1326726  
BRACKET:ARM:ASS'Y

179.AX060517  
DC STEPPER MOTOR:MM56XL76:(STM16)

189.B0656769  
LOCK ARM

203.B1326764  
BRACKET:CONNECTOR:RIGHT

202.B1326738  
BRACKET:LIFT MOTOR:TANDEM LCT

176.AX040279  
STEPPER MOTOR: PAPER TRANSPORT MD:MM42:(STM11)

# U006 PAPER FEED

- 238.B2346531 (x3) TIGHTENER BRACKET
- 234.B2346506 (x6) TIMING PULLEY - 30T
- 235.B2346508 (x9) TENSION SPRING
- 241.B2346542 (x3) GRIP DRIVE SHAFT
- 240.B2346533 (x6) TIMING BELT - S2 M152

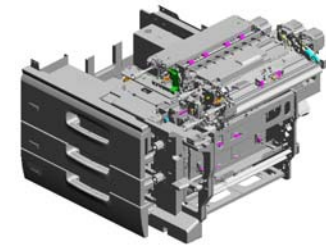

218.B2346141  
POSITIONING SLIDE  
VEE - INNER BACK



237.B2346530  
(x3)  
BRACKET



228.B2346424  
RELEASE GRIP

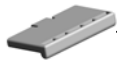

221.B2346198  
COVER - SAFETY -  
PAPER SIZE SENSOR



229.B2346455  
BRACKET - UPPER



220.B2346188  
(x2)  
SLIDE SLEEVE POSITIONING



217.B2346125  
(x2)  
HARNES GUIDE BRACKET



230.B2346475  
BRACKET - LOWER



231.B2346495  
(x2)  
GUIDE:FRONT:PAPER TRAY



219.B2346181  
(x2)  
SLIDE RAIL - RIGHT



236.B2346514  
(x3)  
TIMING BELT - S2 M126



239.B2346532  
(x3)  
TIGHTENER BRACKET



242.B2346565  
HARNES CLAMP BRACKET



232.B2346497  
(x2)  
GUIDE:REAR:PAPER TRAY



216.B2346120  
(x2)  
BRACKET:POSITIONING:PAPER TRAY



# U006 PAPER FEED

- 256.B2476950 SHAFT:SLIDER:BACK FENCE
- 281.D0596591 (x2) SPRING:PAPER TRAY:LOCK
- 276.D0596172 (x2) PAPER TRAY STOPPER
- 271.D0592399 (x6) FLANGED HEXAGONAL HEAD BOLT:M3\*4
- 264.BB013040 (x2) GEAR:SHIFT:ROLLER:Z30

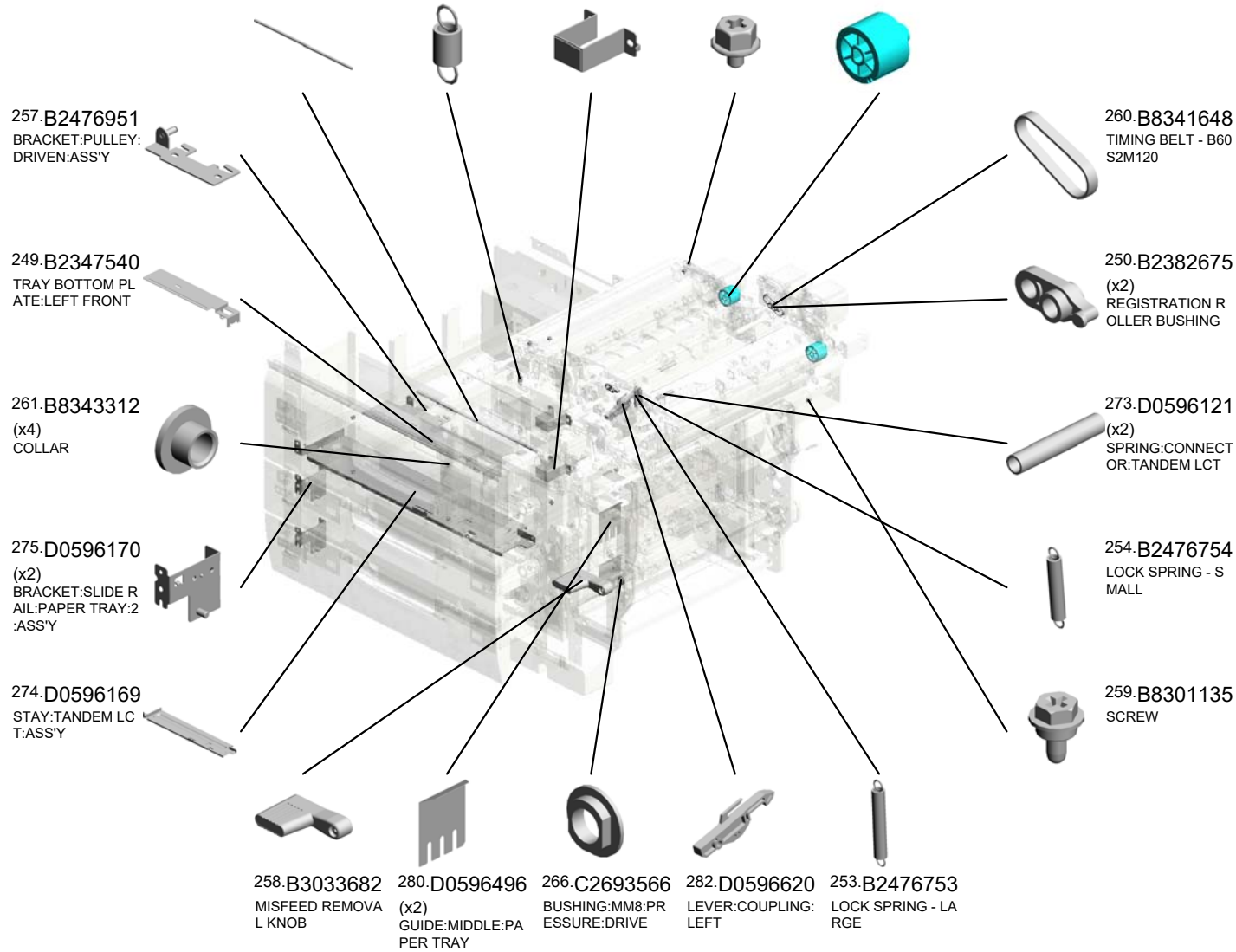
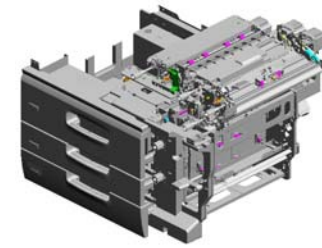

# U006 PAPER FEED

- 297.D0742744 (x3) HOLDER:SHIFT:BEARING:FRONT
- 304.D0746497 (x4) DECAL:POSITIONING DISPLAY:TCRU
- 295.D0742685 SYNCHRONOUS BELT:B80S2M190
- 294.D0742681 SHAFT:CAM:SHIFT
- 296.D0742739 (x4) PRESSURE ROLLER:TRANSPORT ROLLER:SHIFT:DRIVEN

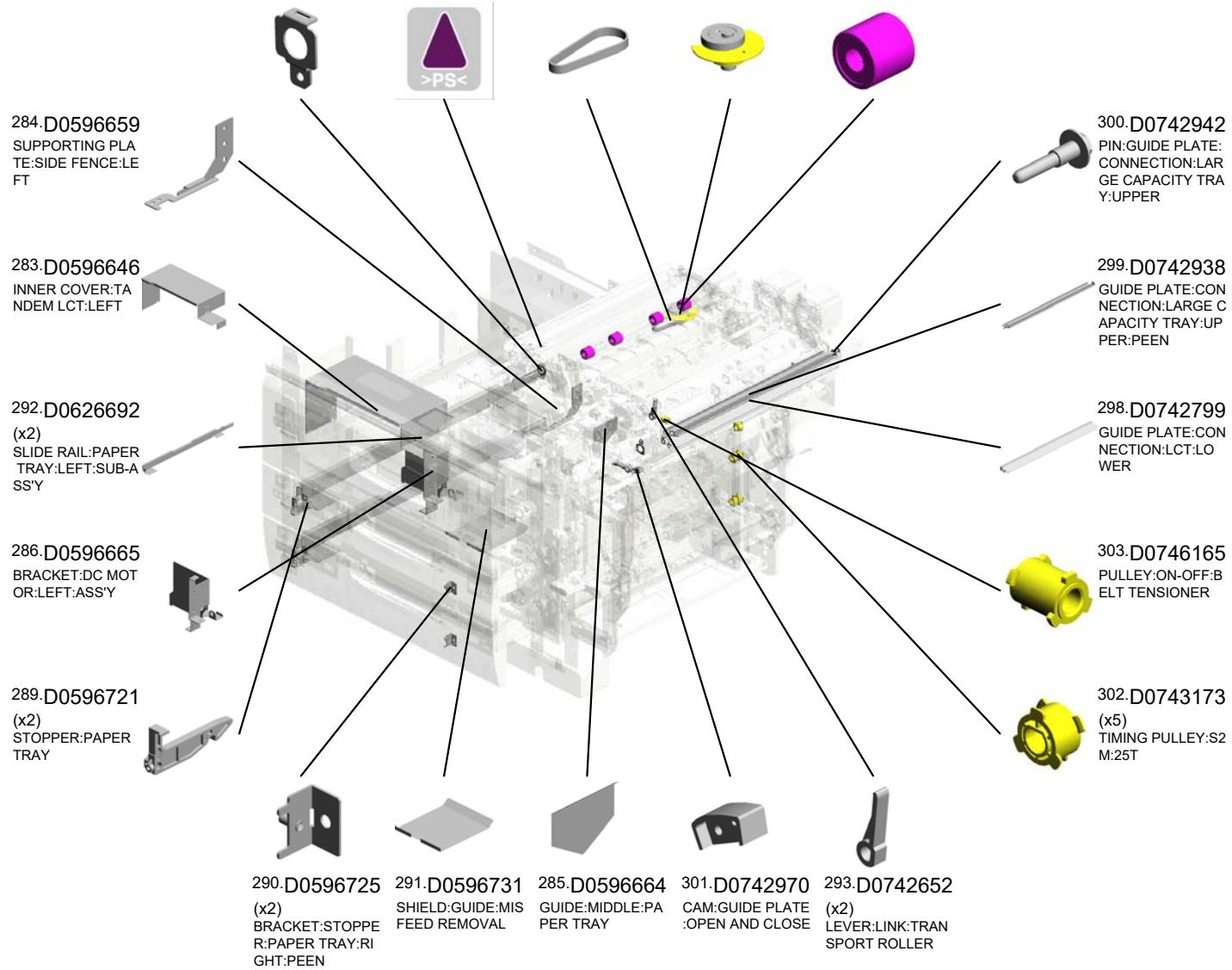
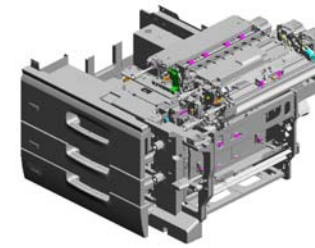



# U006 PAPER FEED

305.D0747330 SLIDE RAIL:LEFT:NO.1  
 324.D0747561 GRIP:UPPER  
 325.D0747562 GRIP:LOWER  
 306.D0747331 STAY:SLIDE RAIL:LEFT INNER REAR:NO.1:PEEN  
 308.D0747335 (x2) STAY:SLIDE RAIL:LEFT:NO.2

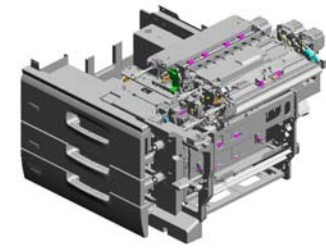

316.D0747392  
 DECAL:PAPER TRAY:NO.1



307.D0747333  
 STAY:SLIDE RAIL:LEFT FRONT:NO.1



327.D0747567  
 BRACKET:ARM:LINK:LEFT



317.D0747393  
 DECAL:PAPER TRAY:NO.2



326.D0747563  
 BRACKET:SLIDER:GRIP



333.D0931266  
 DECAL:WARNING (HIGH TEMPERATURE):LENGTHWISE

309.D0747349 (x4)  
 COMPRESSION SPRING:BRACKET:SENSOR:PAPER SIZE SENSOR

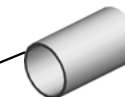

319.D0747433 (x2)  
 STUD:HANDLE:RELEASE:ASSY

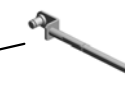

320.D0747446  
 BRACKET:DC STEPPER MOTOR:TRANSPORT UNIT



318.D0747431  
 STAY:HANDLE:ASSY



332.D0747607 (x2) ARM:PAPER TRAY:GRIP  
 331.D0747606 (x2) GRIP:PAPER TRAY:NO.2  
 330.D0747603 (x2) PLATE:GRIP:PAPER TRAY:NO.2  
 328.D0747573 (x2) BRACKET:ARM:PLATE  
 310.D0747381 DECAL:VERTICAL TRANSPORT:A1



# U006 PAPER FEED

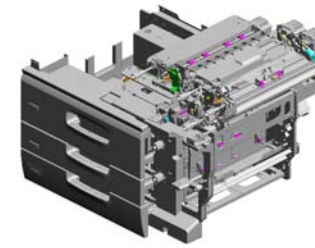

- 341.D0BX2766 TIMING ROLLER:T  
RANSFER:DRIVE:P  
RESS FIT
- 347.D0BX2990 CONTACT IMAGE  
SENSOR:CING:(PC  
B24)
- 335.D0BX2576 SHEET:CONTACT I  
MAGE SENSOR:DU  
CT:2
- 336.D0BX2679 HOLDER:DC STEP  
PER MOTOR:SHIF  
T
- 337.D0BX2702 TIMING ROLLER:R  
EGISTRATION:DRI  
VE:PRESS FIT

352.D0BX6648  
COIL SPRING:TAN  
DEM TRAY:LOCK

349.D0BX5430  
PCB:CRB:(PCB22)

334.D0BX2575  
SHEET:CONTACT I  
MAGE SENSOR:DU  
CT:1

360.D0BX7531  
COVER:PAPER TR  
AY:NO.1

359.D0BX7512  
COVER:PAPER TR  
AY:NO.2

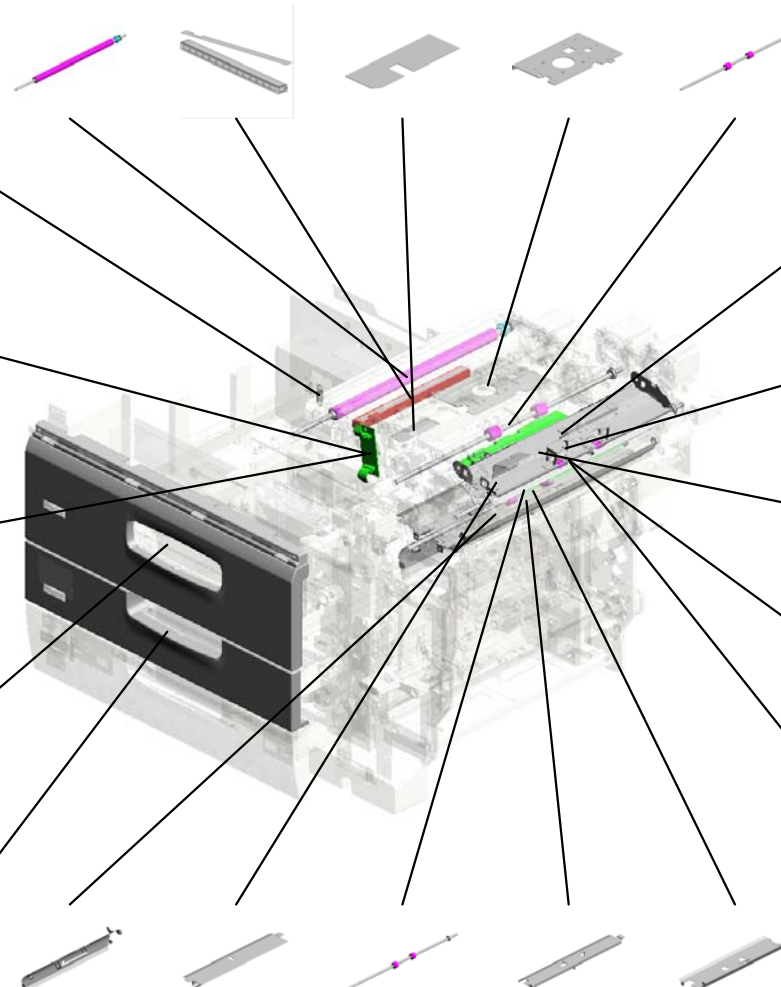

342.D0BX2851  
GUIDE PLATE:CON  
NECTING:OPEN A  
ND CLOSE:PEEN

343.D0BX2856  
GUIDE PLATE:CON  
NECTING:LARGE C  
APACITY TRAY:PE  
EN

348.D0BX5422  
PCB:DRB:(PCB20)

338.D0BX2703  
TRANSPORT ROLL  
ER:CONNECTING:  
LARGE CAPACITY  
TRAY:PRESS FIT

340.D0BX2705  
TRANSPORT ROLL  
ER:SHIFT:TRAILIN  
G EDGE:PRESS FI  
T

- 356.D0BX6775 GUIDE PLATE:OPE  
N AND CLOSE:VER  
TICAL TRANSPOR  
T:UPPER:PEEN
- 344.D0BX2900 GUIDE PLATE:CON  
NECTING:DUPLIX:  
EXIT:PEEN
- 339.D0BX2704 TRANSPORT ROLL  
ER:CONNECTING:  
MAIN:PRESS FIT
- 346.D0BX2906 GUIDE PLATE:CON  
NECTING:LOWER:  
PEEN
- 345.D0BX2902 GUIDE PLATE:CON  
NECTING:UPPER:P  
EEN

# U006 PAPER FEED

373.D1792651 GUIDE PLATE:REGISTRATION:EXIT  
 384.D1792711 TIMING ROLLER:TRANSFER:DRIVEN:PRESS FIT  
 380.D1792685 CASE:REMOVE PAPER DUST:ASSY  
 381.D1792689 COVER:REGISTRATION:EXIT  
 368.D1792621 SHAFT:DRIVEN ROLLER:SHIFT

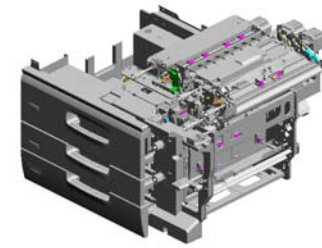

382.D1792691 (x2) TENSION SPRING:PRESSURE ROLLER



365.D1316511 BRACKET:CONNECTOR:LEFT



374.D1792660 BRACKET:GUIDE PLATE:FRONT:CIS



372.D1792648 PLATE:ADJUSTING PIN



371.D1792643 (x2) CAM:REGISTRATION:GATE:RELEASE



375.D1792661 BRACKET:GUIDE PLATE:INNER BACK:CIS



383.D1792698 COMPRESSION SPRING:SHIFT

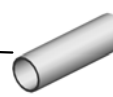

370.D1792642 HOLDER:SHIFT:BEARING:REAR



386.D1792751 (x2) BRACKET:DC STEPPER MOTOR:PAPER FEED:TIMING



376.D1792666 GUIDE PLATE:REGISTRATION:TIMING:UPPER



369.D1792631 GUIDE PLATE:SHIFT:REGISTRATION:UPPER  
 379.D1792684 REGISTRATION GUIDE:OPEN AND CLOSE  
 378.D1792675 COVER:REGISTRATION:DOUBLE FEE D SENSOR  
 377.D1792670 GUIDE PLATE:REGISTRATION:TIMING:LOWER  
 385.D1792727 SHAFT:TIMING ROLLER:REGISTRATION:DRIVEN



# U006 PAPER FEED

394.D1792783 COVER:BASE:MAIN PAPER SMD  
 392.D1792764 SHAFT:CAM:REGISTRATION:TIMING  
 393.D1792768 TIMING PULLEY:S2 M:30T  
 387.D1792754 (x2) BRACKET:DC STEPPER MOTOR:PAPER FEED  
 389.D1792758 (x2) GEAR:Z41:TIMING PULLEY:T41

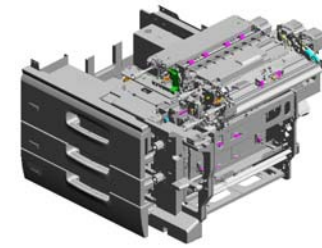

398.D1792861 BRACKET:OPEN AND CLOSE:LARGE CAPACITY TRAY

391.D1792763 (x2) CAM:REGISTRATION:TIMING

406.D1792944 (x2) DISC:ON-OFF:SENSOR

399.D1792872 BRACKET:DC STEPPER MOTOR:TRAILING EDGE

405.D1792943 BRACKET:CAM:ON-OFF

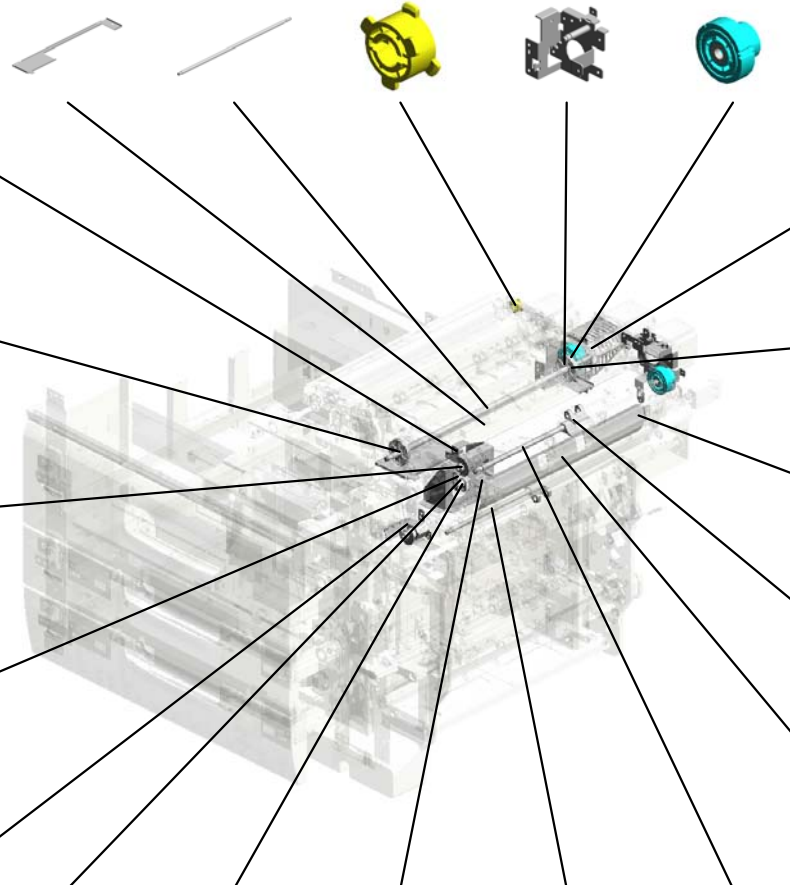

390.D1792760 COVER:MOTOR

388.D1792757 (x2) TIGHTENER:BRACKET:DC STEPPER MOTOR

401.D1792909 JOINT:CONNECTING:DRIVEN

402.D1792932 (x2) ARM:ON-OFF:TRANSPORT ROLLER

395.D1792809 GUIDE PLATE:SHIFT:LEFT LOWER

400.D1792891 GUIDE PIN:SHIFT:TRAILING EDGE

396.D1792814 (x2) GUIDE:SHIFT:TRAILING EDGE

397.D1792817 BRACKET:SHIFT:SYNCHRONOUS BELT

404.D1792934 SHAFT:LINK:ON-OFF:CONNECTING

403.D1792933 SHAFT:LINK:ON-OFF:CONNECTING:LARGE CAPACITY TRAY

# U006 PAPER FEED

- 411.D1792963 BRACKET:GRIP:OPEN AND CLOSE:GUIDE PLATE
- 409.D1792952 BRACKET:DC STEPPER MOTOR:DRIVEN:ON-OFF
- 407.D1792946 SHAFT:CAM:ON-OFF:LARGE CAPACITY TRAY
- 408.D1792948 (x2) CAM:TRANSPORT ROLLER:ON-OFF
- 413.D1795435 PCB:URRB:(PCB19)

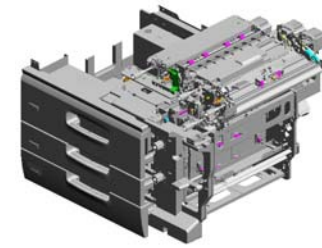

416.D1796643  
RAIL:TANDEM LCT:MIDDLE:ASS'Y

417.D1796726  
(x3)  
COVER:LED:MAIN

412.D1792964  
GUIDE:MAIN:CONNECTING:OPEN AND CLOSE

414.D1796619  
(x2)  
STAY:HOLDER:PAPER TRAY:ASS'Y

415.D1796626  
(x2)  
SUPPORTING PLATE:RIGHT:HOLDER:PAPER TRAY

410.D1792960  
GUIDE PLATE:OPEN AND CLOSE:MAIN:CONNECTING

428.D1796761  
SYNCHRONOUS BELT:60S2M226

429.D1796762  
SYNCHRONOUS BELT:60S2M166

430.D1796763  
SYNCHRONOUS BELT:80S2M300

423.D1796751  
BRACKET:STM:MM56:TRANSPORT:LENGTHWISE

427.D1796758  
SYNCHRONOUS BELT:80S2M216

424.D1796753  
BRACKET:JOINT:PROTECT

425.D1796756  
BRACKET:CONNECTING:JOINT

431.D1796764  
SYNCHRONOUS BELT:80S2M242

426.D1796757  
SHAFT:DRIVE

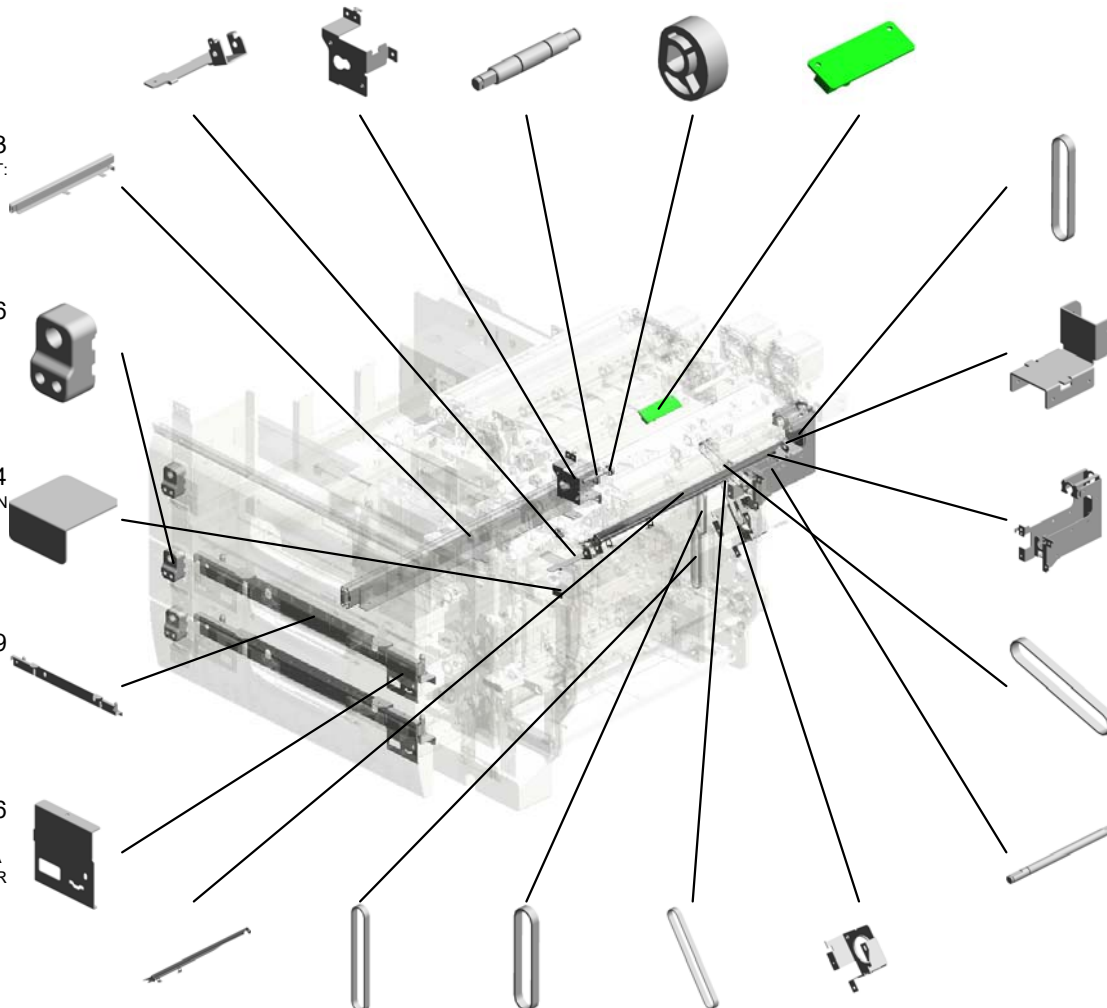

# U006 PAPER FEED

444.D1797550 COVER:PAPER TRAY:NO.1:UPPER  
 447.D1797564 BRACKET:SLIDER:GRIP:UPPER  
 452.D1797581 STAY:COVER:TANDEM LCT  
 446.D1797562 ARM:LINK:RIGHT  
 448.D1797566 BRACKET:ARM:LINK:RIGHT

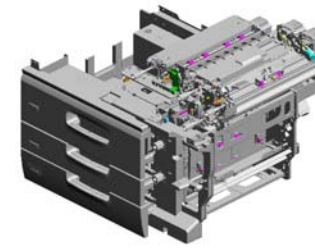

443.D1797540 (x8) SCREW:DIA6:M4X3:ADHESIVE

445.D1797561 ARM:LINK:LEFT

451.D1797579 COVER:GRIP:INNER BACK

440.D1797519 (x2) BRACKET:STOPPER:PAPER TRAY

449.D1797573 BRACKET:ARM:UNLOCK

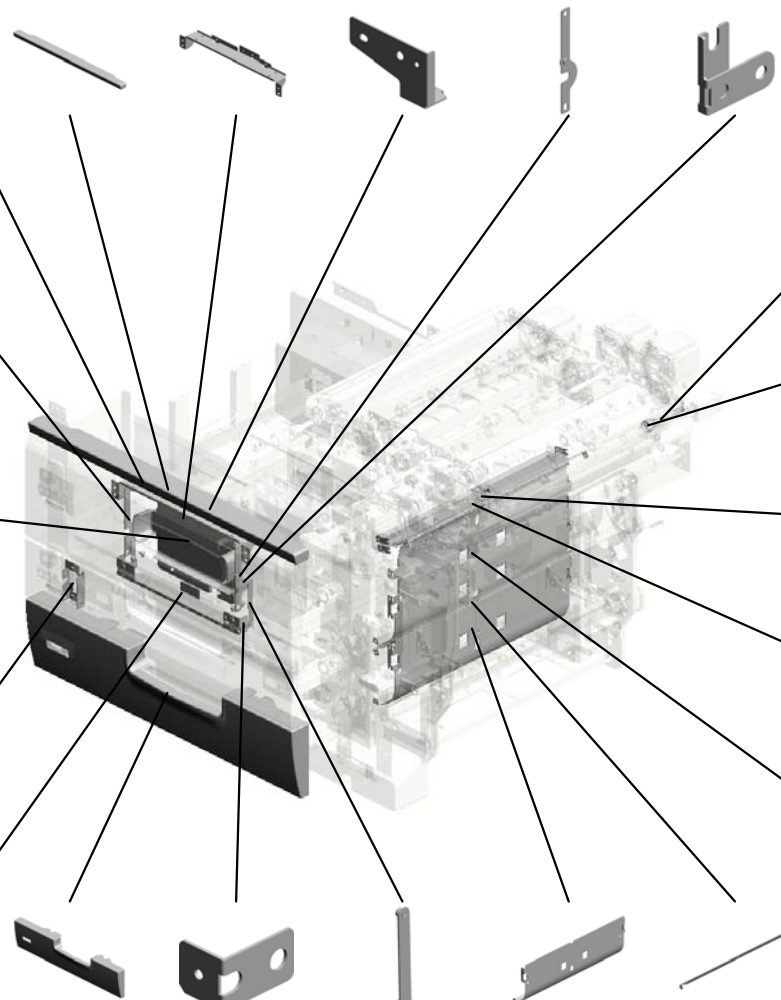

432.D1796768 SHAFT:JOINT:CONNECTING:ASSY

438.D1796797 COMPRESSION SPRING:JOINT:TRANSPORT

433.D1796781 GUIDE PLATE:VERTICAL TRANSPORT:F1

434.D1796783 GUIDE PLATE:VERTICAL TRANSPORT:F1:LOWER

436.D1796786 GUIDE PLATE:VERTICAL TRANSPORT:F2

439.D1797513 COVER:PAPER TRAY:NO.3

450.D1797576 (x2) ARM:LINK:UNLOCK

442.D1797533 (x2) JOINT:LINK:UNLOCK:PEEN

435.D1796784 GUIDE PLATE:VERTICAL TRANSPORT:F3

437.D1796790 GUIDE PLATE:VERTICAL TRANSPORT:F2:LOWER

# U006 PAPER FEED

468.D2702624 SIDE PLATE:SHIFT :REGISTRATION:F RONT:PEEN  
 477.D2702786 DUCT:FAN:CONTA CT IMAGE SENSO R  
 473.D2702637 (x4) COLOR:4M  
 475.D2702656 GUIDE PLATE:REG ISTRATION:CIS  
 474.D2702647 SHAFT:SHIFT

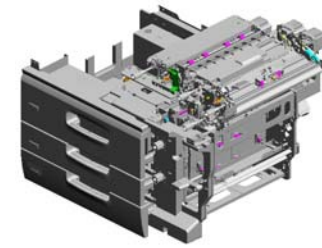

459.D1947552 SIDE PLATE:TANDE M LCT:LEFT SIDE WAYS

465.D2236747 DC MOTOR:TANDE M LCT:19.2W:BRU SH:(BM4)

454.D1797591 (x3) PLATE:TRANSPAR ENT:LED

456.D1797597 (x3) COVER:LED

455.D1797596 (x3) DIFFUSION PLATE: LED

453.D1797586 STOPPER:TANDE M LCT

466.D2416290 (x2) LED:RED

471.D2702634 BRACKET:HOOK:C OIL SPRING:FRON T:PEEN

472.D2702636 GUIDE PLATE:SHIF T:REGISTRATION: LOWER

458.D1947346 DC MOTOR:RISE:T ANDEM LCT:ASS'Y: 19.2W:BRUSH:(BM 1)

467.D2702622 (x2) TENSION SPRING: 48N

469.D2702627 SIDE PLATE:SHIFT :REGISTRATION:R EAR:PEEN

470.D2702632 BRACKET:HOOK:C OIL SPRING:REAR: PEEN

457.D1942945 HOLDER:CAM:SHI FT

478.D2702802 STAY:SHIFT:TRAILI NG EDGE

# U006 PAPER FEED

491.D2706721 COVER:GUARD:HA  
RNESS  
484.D2706453 (x2)  
SHAFT:MISFEED R  
EMOVAL  
509.G0703088 (x2)  
SPACER:DEVELOP  
MENT ROLLER  
507.D7315310 PCB:URTB:DOCUM  
ENT FEEDER:ASS'  
Y:(PCB18)  
508.G0602296 (x4)  
BALL BEARING:8X  
16X5MM

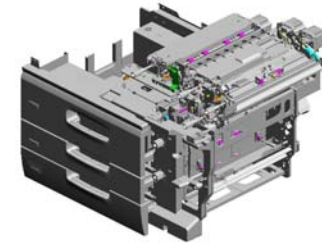

492.D2706725 COVER:GUARD:HA  
RNESS

506.D5165200 (x6)  
PCB:LED:ASS'Y:(P  
CB35/PCB36/PCB3  
7/PCB38/PCB39/PC  
B40)

497.D2707574 SHAFT:ARM:UN LO  
CK

494.D2707518 (x2)  
SHAFT:STOPPER:  
PAPER TRAY

504.D5161326 DECAL:PAPER TR  
AY:DESIGN SKETC  
H:3



481.D2702947 SHAFT:CAM:ON-O  
FF:MAIN

482.D2702965 SHAFT:GUIDE PLA  
TE:OPEN AND CLO  
SE

480.D2702816 SHAFT:TRAILING E  
DGE:SHIFT

501.D3553844 (x4)  
SHOE:HANDLE:RE  
LEASE

505.D5163809 (x2)  
CUSHION:STAY

511.G1784900 (x3)  
COVER:DC STEPP  
ER MOTOR:MM56

485.D2706541 (x3)  
SHAFT:DRIVE:FEE  
D:ASSY

503.D4342535 TORSION SPRING:  
PROOF TRAY

483.D2702986 BRACKET:GUIDE P  
LATE:CONNECTIO  
N:LARGE CAPACIT  
Y TRAY

479.D2702810 GUIDE PLATE:SHIF  
T:RIGHT UPPER:P  
EEN



# U006 PAPER FEED

523.M2057311 518.GX640028 524.M2057466  
 DISC:GATE:REGIS FAN MOTOR DC24 DUCT:SHIFT:CIS  
 TRATION:HOME P V 1.92W:(FAN3/FA  
 OSITION SENSOR N28/FAN29)

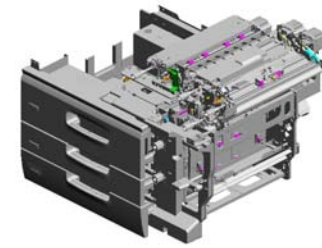

519.H5194238  
 (x2)  
 SPACER:ROLLER:  
 CONNECTING



520.M0777428  
 BALL BEARING:RE  
 GISTRATION:DRIV  
 EN:FRONT



528.D2707389  
 DECAL:PAPER SE  
 T DIRECTION:TAN  
 DEM LCT:LEFT  
 201909-02 O/O



521.M0777429  
 BALL BEARING:RE  
 GISTRATION:DRIV  
 EN:REAR



513.G1787660  
 (x2)  
 PRESSURE ROLLE  
 R:TRANSPORT RO  
 LLER

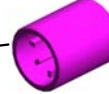

516.GW010007  
 (x9)  
 PHOTO REFLECTI  
 ON SENSOR:EXIT:(  
 SEN11/SEN12/SEN  
 13/SEN14/SEN15/S  
 EN16/SEN17/SEN1



517.GW020024 514.G1787664 512.G1784912  
 (x7) (x12) (x5)  
 PHOTOINTERRUP SPACER PULLEY:S2M:30T  
 TOR:LG2A24BL1.G  
 F:(SEN3/SEN21/SE  
 N35/SEN36/SEN37/  
 SEN38/SEN39/SEN



U006\_S001  
ARM:REGISTRATION:TIMING:ASS'Y

40.07403808  
(x2)  
BALL BEARING - 8  
X16X5MM



476.D2702771  
ARM:REGISTRATI  
ON:TIMING:ASSY



38.07200060E  
(x6)  
RETAINING RING -  
M6

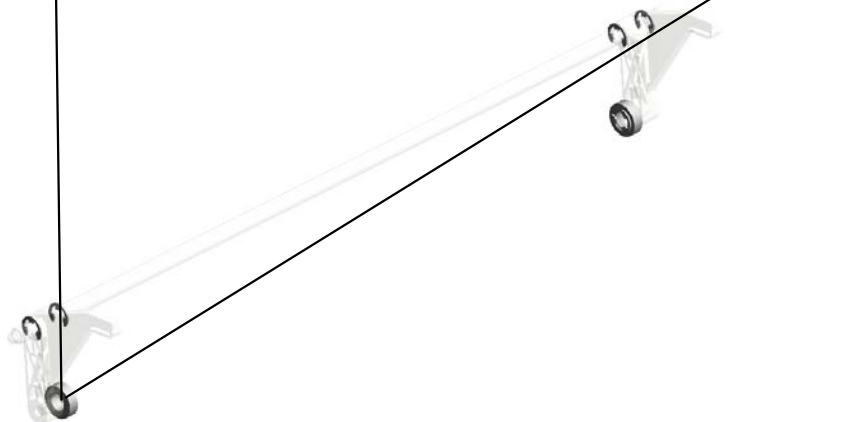

U001	U002	U003	U004	U005	<b>U006</b>	U007	U008	U009	U010	U011	U012	U013	U014	U015	U016	U017	U018	U019	U020	U021
------	------	------	------	------	-------------	------	------	------	------	------	------	------	------	------	------	------	------	------	------	------

U006\_S002  
REGISTRATION ROLLER:GATE:ASS'Y

39.07200080E  
(x4)  
RETAINING RING -  
M8

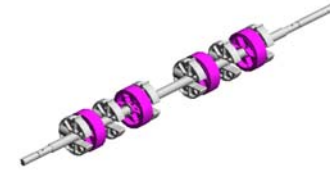

522.M2057305  
REGISTRATION R  
OLLER:GATE:ASS'  
Y

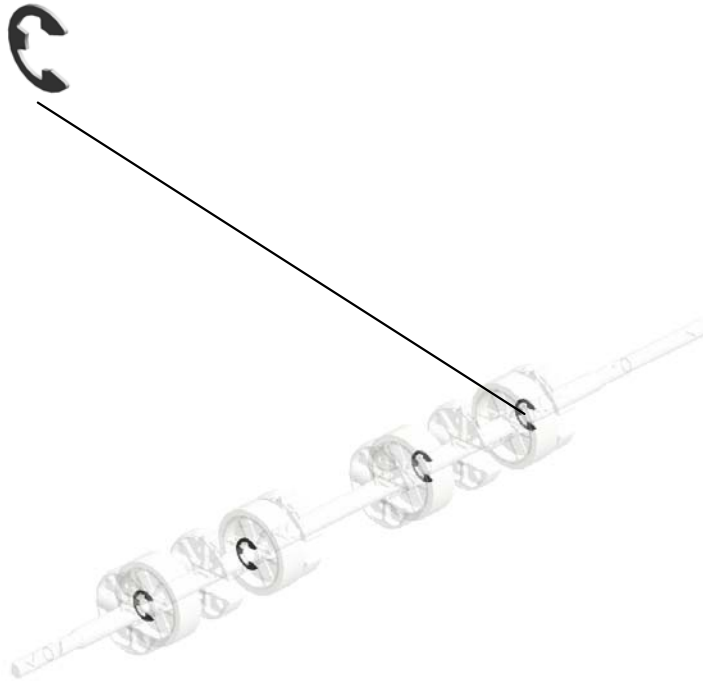

U001	U002	U003	U004	U005	<b>U006</b>	U007	U008	U009	U010	U011	U012	U013	U014	U015	U016	U017	U018	U019	U020	U021
------	------	------	------	------	-------------	------	------	------	------	------	------	------	------	------	------	------	------	------	------	------

U006\_S003  
DC SOLENOID:LOCK:ASS'Y:(SOL5)

510.G1782971 13.04503008N  
LEVER:LOCK:TAN TAPPING SCREW -  
DEM LCT M3X8



461.D2236231  
DC SOLENOID:LO  
CK:ASS'Y:(SOL5)

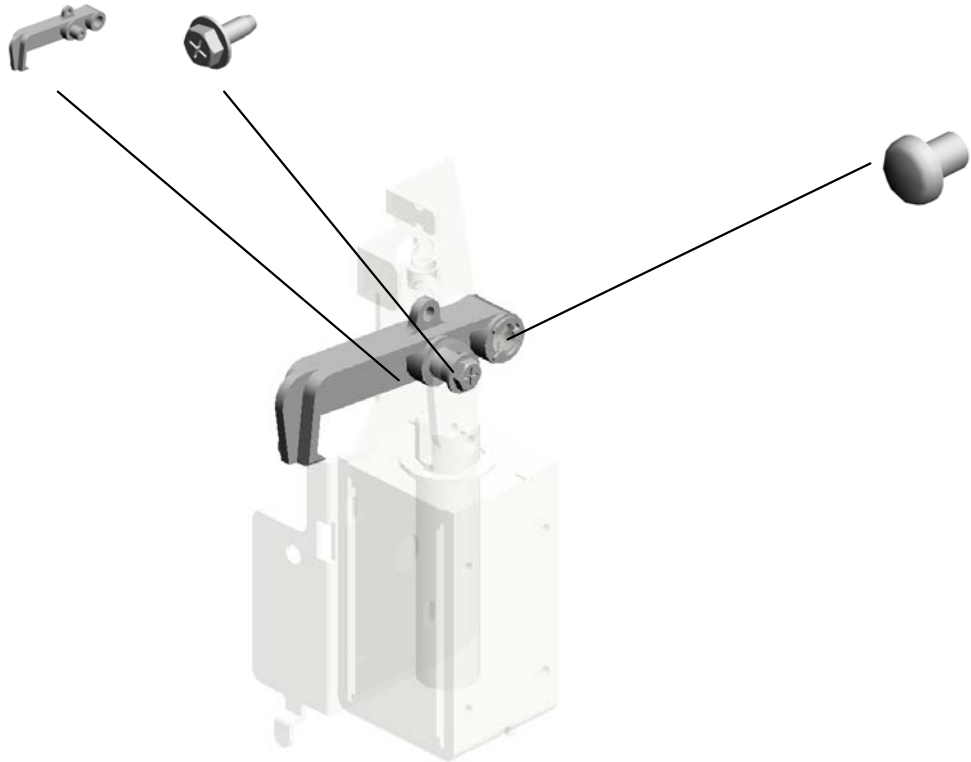

1.03130040N (x 1)  
SCREW:M3X4  
37.07200040E (x 1)  
RETAINING RING - M4

U001	U002	U003	U004	U005	<b>U006</b>	U007	U008	U009	U010	U011	U012	U013	U014	U015	U016	U017	U018	U019	U020	U021
------	------	------	------	------	-------------	------	------	------	------	------	------	------	------	------	------	------	------	------	------	------

U006\_S004  
DC SOLENOID:COUPLING:ASS'Y:(SOL6)

37.07200040E  
RETAINING RING -  
M4

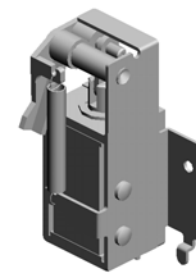

462.D2236233  
DC SOLENOID:CO  
UPLING:ASS'Y:(SO  
L6)

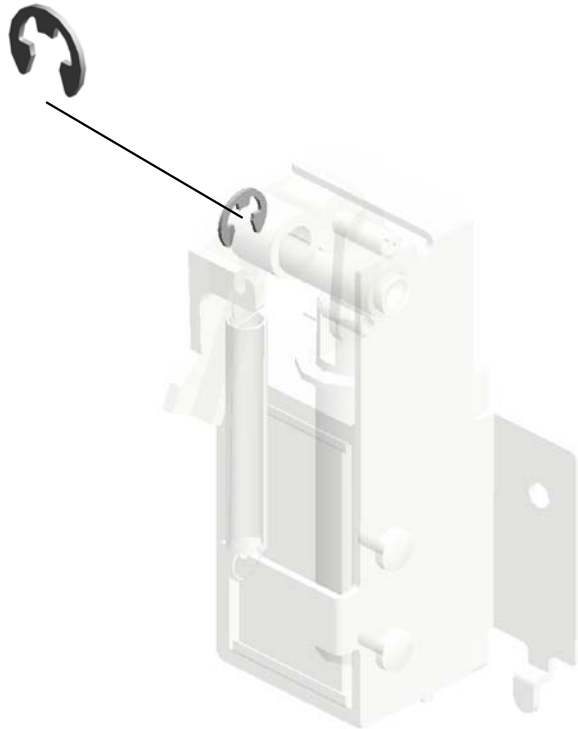

U001	U002	U003	U004	U005	<b>U006</b>	U007	U008	U009	U010	U011	U012	U013	U014	U015	U016	U017	U018	U019	U020	U021
------	------	------	------	------	-------------	------	------	------	------	------	------	------	------	------	------	------	------	------	------	------

U006\_S005  
STOPPER:REGISTRATION:TANDEM LCT:ASS'Y

20.04514008N  
TAPPING SCREW:  
4X8



441.D1797525  
STOPPER:REGIST  
RATION:TANDEM L  
CT:ASSY



U001	U002	U003	U004	U005	<b>U006</b>	U007	U008	U009	U010	U011	U012	U013	U014	U015	U016	U017	U018	U019	U020	U021
------	------	------	------	------	-------------	------	------	------	------	------	------	------	------	------	------	------	------	------	------	------

U006\_S006  
PAPER FEED UNIT:PAPER BANK:ASS'Y

61.11050511 (x13) HARNESS CLAMP - LWS-0306ZC  
 64.11050551 (x2) CLAMP:LES-0505  
 74.54472706 GEAR - 15T  
 12.04340060N (x3) PAN SELF-TAPPING SCREW:M4X6  
 47.08050088 (x2) RETAINING RING - M6

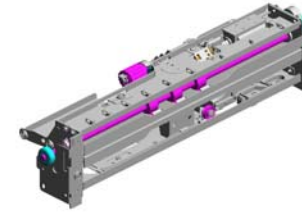

351.D0BX6628  
PAPER FEED UNIT  
:PAPER BANK:ASS'  
Y

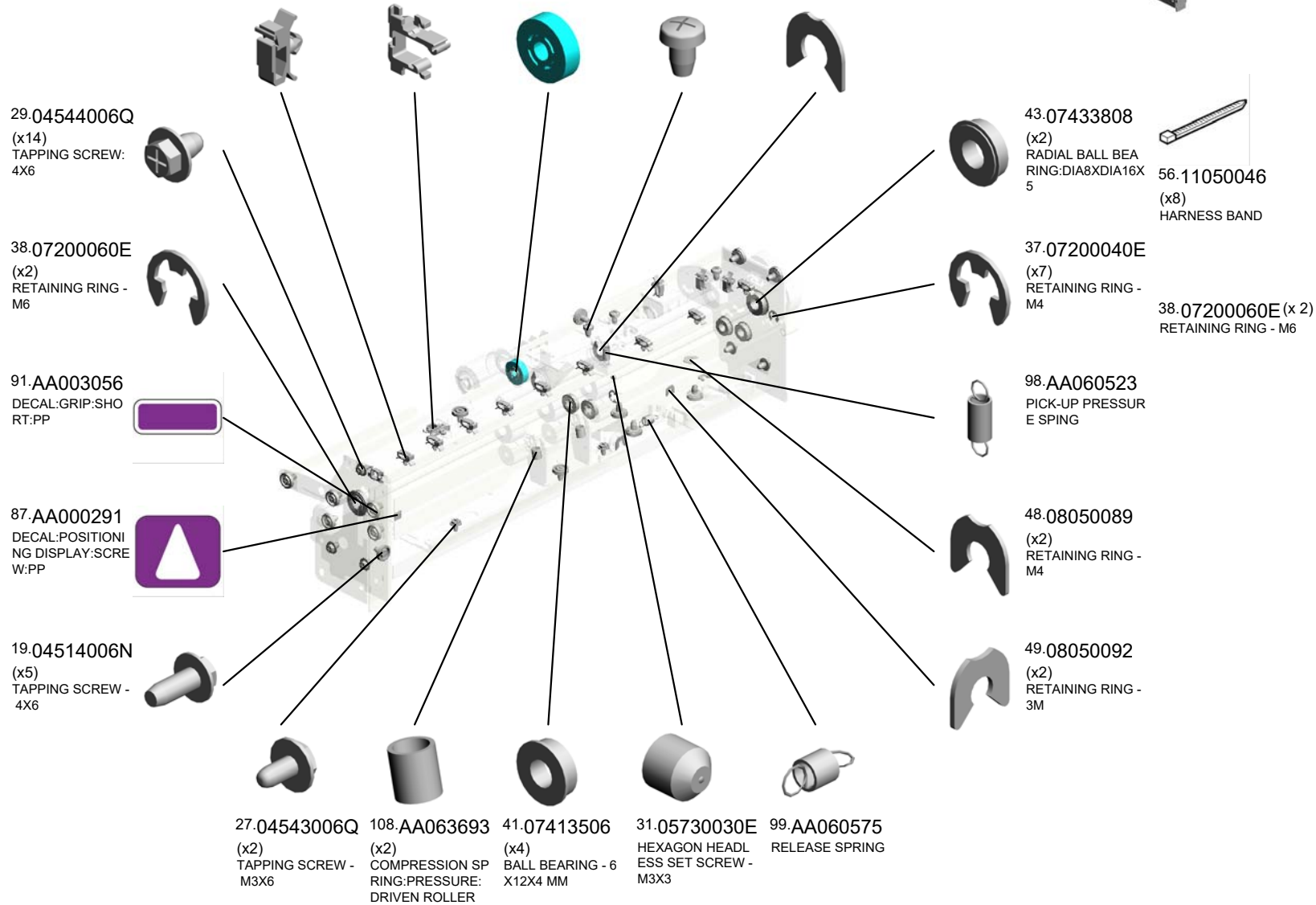

U006\_S006  
 PAPER FEED UNIT:PAPER BANK:ASS'Y

- 214.B2342624 BALL BEARING - 8 X12X5
- 225.B2346275 PICKUP ARM
- 154.AF020850 TRANSPORT ROLLER:DRIVE:PAPER FEED UNIT
- 182.B0656345 PAPER END SENSOR:DRIVE:PAPER FEED UNIT
- 226.B2346288 SENSOR BRACKET - SENSOR

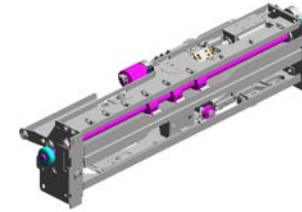

351.D0BX6628  
 PAPER FEED UNIT  
 :PAPER BANK:ASS'  
 Y

162.AF030072  
 PAPER FEED ROLLER:PICKUP



163.AF031098  
 PAPER FEED ROLLER:FEED



164.AF032098  
 PAPER FEED ROLLER:SEPARATE



170.AW010151  
 (x2)  
 PHOTO REFLECTIVE SENSOR:PS12 2TL1-A:(S6/S7/S10/S11/S12/SEN7/SEN8/SEN10/SEN32/SEN



262.BB013007  
 GEAR - 20Z

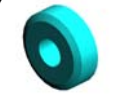

227.B2346301  
 TORQUE LIMITER: 75MN M



155.AF020851  
 TRANSPORT ROLLER:DRIVEN:PAPER FEED UNIT



224.B2346242  
 GUIDE - ROLLER:DRIVEN PRESSURE



120.AA084059  
 (x2)  
 BALL BEARING HOLDER



136.AB011591  
 GEAR:REVERSE



119.AA083009  
 CLUTCH ROLLER - 8X18X11



143.AB017771  
 GEAR:TRANSPORT ROLLER:INPUT:Z 23/Z28

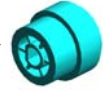

222.B2346222  
 REVERSE DRIVE SHAFT



223.B2346223  
 DRIVEN REVERSE SHAFT



135.AB011392  
 DRIVE REVERSE GEAR - 24Z

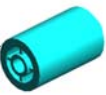



U006\_S006  
PAPER FEED UNIT:PAPER BANK:ASS'Y

278.D0596277 COVER:GEAR:PAPER FEED ROLLER  
 321.D0747521 GUIDE PLATE:UPPER:PAPER FEED UNIT  
 279.D0596278 COVER:GEAR:REVERSE  
 323.D0747527 SHAFT:FEED:ASS'Y  
 350.D0BX6282 SWING UNIT:PICK UP ROLLER:ASS'Y:(SOL1/SOL2/SOL3)

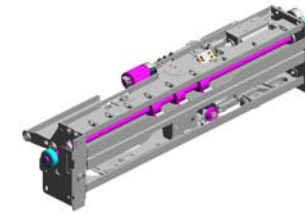

351.D0BX6628 PAPER FEED UNIT:PAPER BANK:ASS'Y

322.D0747522 GUIDE PLATE:LOWER:PAPER FEED UNIT

272.D0592620 (x3) RETAINING RINGS-C

486.D2706658 FLANGED HEXAGONAL HEAD BOLT:M3X6

488.D2706664 HOOK:COIL SPRING:SLIDER

265.C2443522 STEPPED SCREW

493.D2706740 STAY:REVERSE:ASS'Y

277.D0596212 LEVER:PRESSURE:REVERSE

489.D2706668 TENSION SPRING:REVERSE ROLLER

487.D2706659 ROLLER:GUIDE

420.D1796737 LEVER:PRESSURE RELEASE:REVERSE

263.BB013008 GEAR - 31Z

418.D1796731 LEVER:PRESSURE:SLIDER

422.D1796739 LEVER:REVERSE:PRESSURE RELEASE:JOINT

421.D1796738 SLIDER:CAM:REVERSE

419.D1796734 BRACKET:SLIDER:CAM

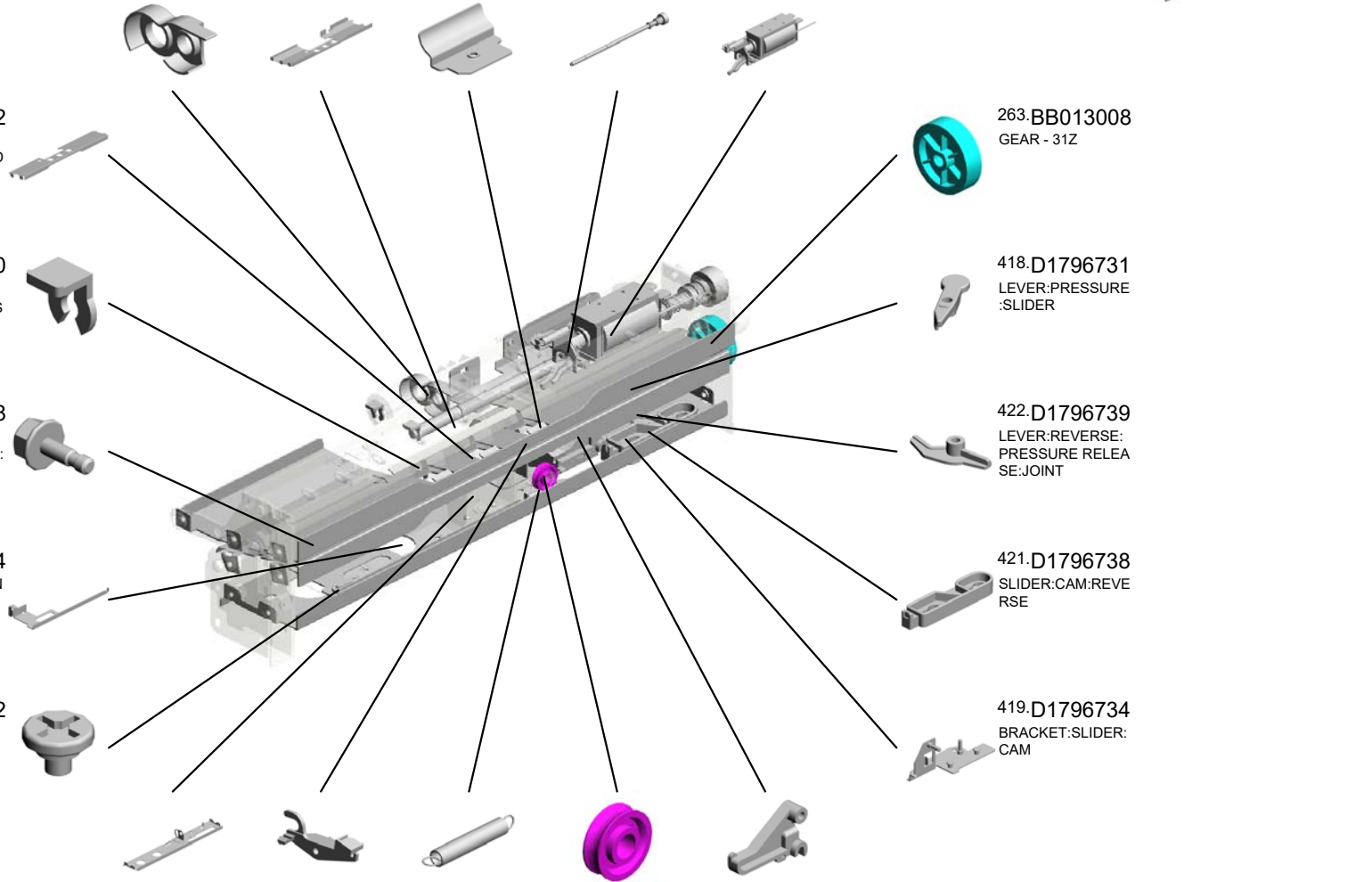

U006\_S006  
PAPER FEED UNIT:PAPER BANK:ASS'Y

517.GW020024  
PHOTOINTERRUP  
TOR:LG2A24BL1:G  
F:(SEN3/SEN21/SE  
N35/SEN36/SEN37/  
SEN38/SEN39/SEN  
40/SEN41/SEN42/S

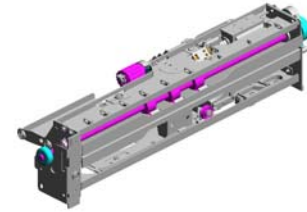
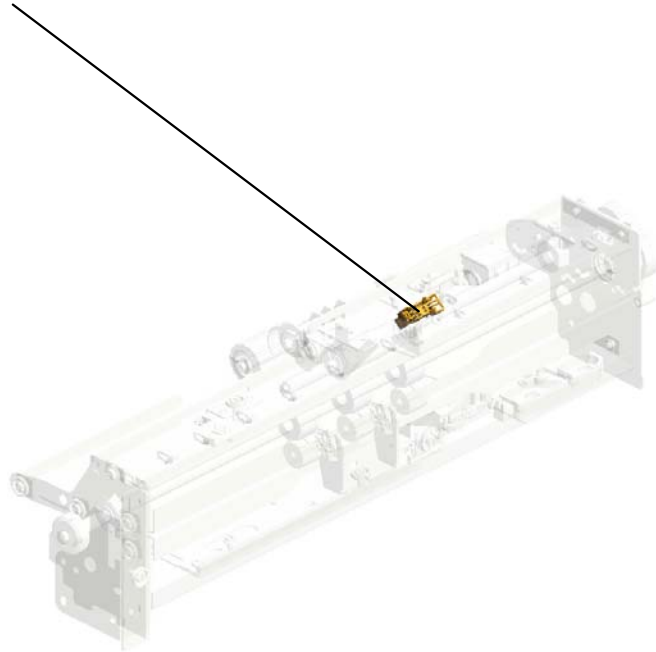

351.D0BX6628  
PAPER FEED UNIT  
:PAPER BANK:ASS'  
Y

U001	U002	U003	U004	U005	<b>U006</b>	U007	U008	U009	U010	U011	U012	U013	U014	U015	U016	U017	U018	U019	U020	U021
------	------	------	------	------	-------------	------	------	------	------	------	------	------	------	------	------	------	------	------	------	------

U006\_S007  
 PAPER FEED UNIT:PAPER BANK:ASS'Y

- 61.11050511 (x13) HARNESS CLAMP - LWS-0306ZC
- 64.11050551 (x2) CLAMP:LES-0505
- 74.54472706 GEAR - 15T
- 12.04340060N (x3) PAN SELF-TAPPING SCREW:M4X6
- 47.08050088 (x2) RETAINING RING - M6

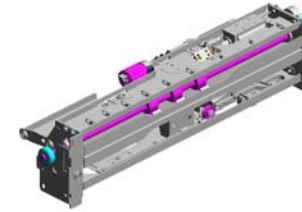

351.D0BX6628  
 PAPER FEED UNIT  
 :PAPER BANK:ASS'  
 Y

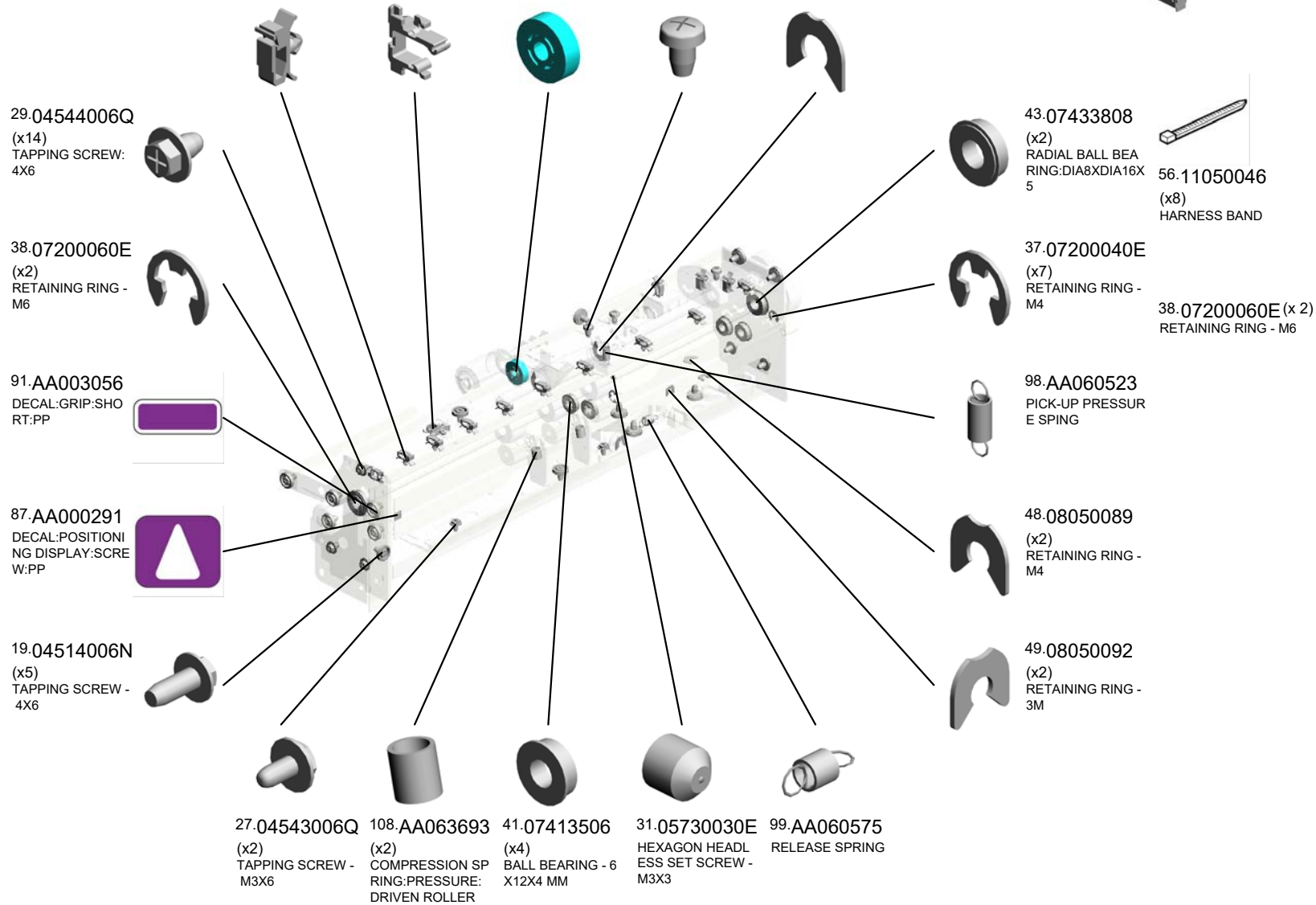

U006\_S007  
 PAPER FEED UNIT:PAPER BANK:ASS'Y

- 214.B2342624 BALL BEARING - 8 X12X5
- 225.B2346275 PICKUP ARM
- 154.AF020850 TRANSPORT ROLLER:DRIVE:PAPER FEED UNIT
- 182.B0656345 PAPER END SENSOR:DRIVE:PAPER FEED UNIT
- 226.B2346288 SENSOR BRACKET - SENSOR

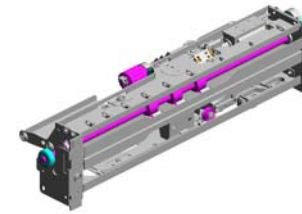

351.D0BX6628  
 PAPER FEED UNIT  
 :PAPER BANK:ASS'  
 Y

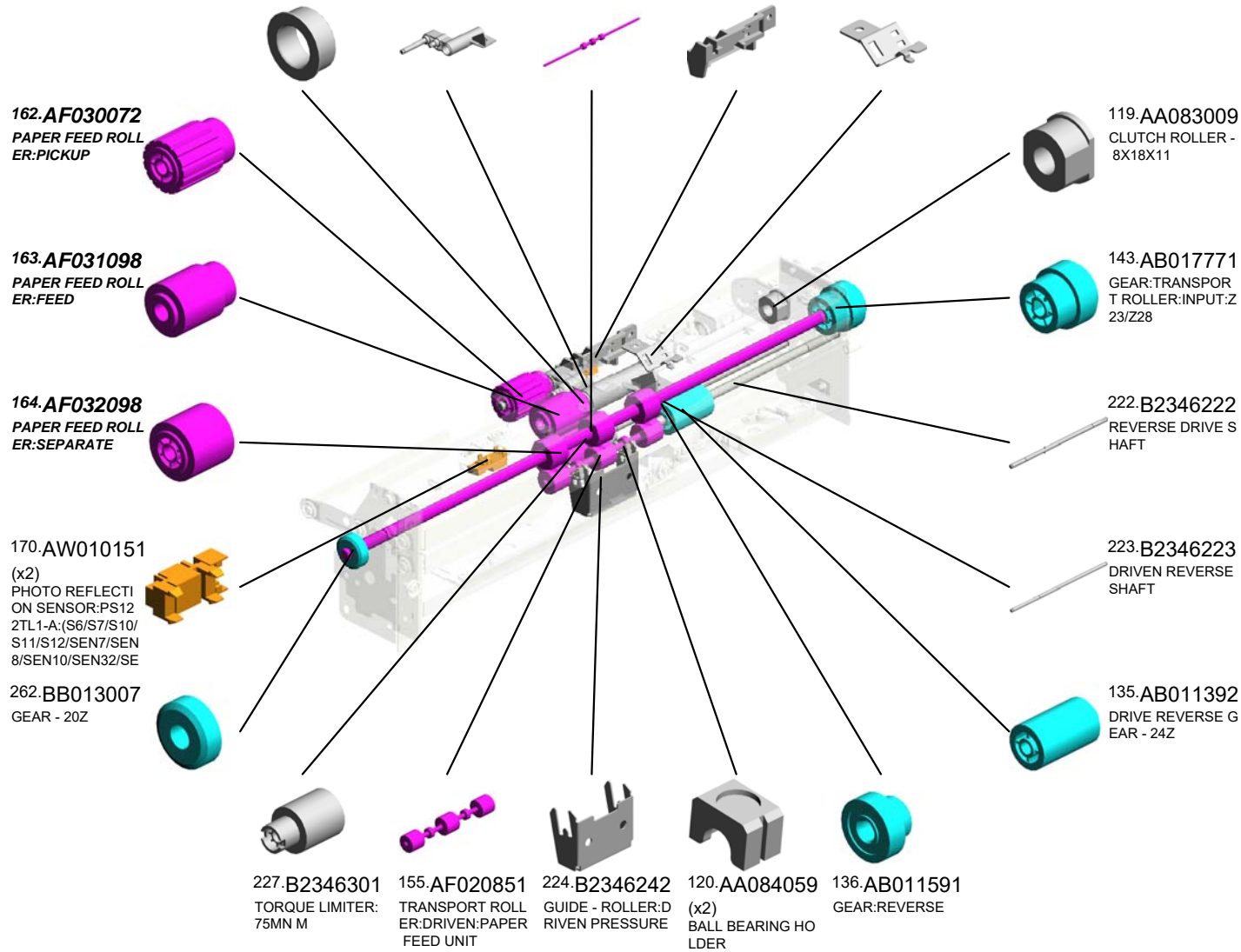

U001	U002	U003	U004	U005	U006	U007	U008	U009	U010	U011	U012	U013	U014	U015	U016	U017	U018	U019	U020	U021
------	------	------	------	------	------	------	------	------	------	------	------	------	------	------	------	------	------	------	------	------

U006\_S007  
 PAPER FEED UNIT:PAPER BANK:ASS'Y

- 278.D0596277 COVER:GEAR:PAPER FEED ROLLER
- 321.D0747521 GUIDE PLATE:UPPER:PAPER FEED UNIT
- 279.D0596278 COVER:GEAR:REVERSE
- 323.D0747527 SHAFT:FEED:ASS'Y
- 350.D0BX6282 SWING UNIT:PICK UP ROLLER:ASS'Y:(SOL1/SOL2/SOL3)

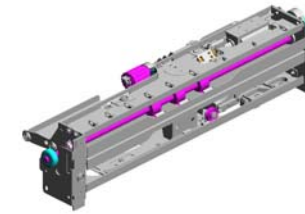

351.D0BX6628  
 PAPER FEED UNIT  
 :PAPER BANK:ASS'Y

322.D0747522  
 GUIDE PLATE:LOWER:PAPER FEED UNIT

272.D0592620  
 (x3)  
 RETAINING RINGS -C

486.D2706658  
 FLANGED HEXAGONAL HEAD BOLT: M3X6

488.D2706664  
 HOOK:COIL SPRING:SLIDER

265.C2443522  
 STEPPED SCREW



263.BB013008  
 GEAR - 31Z

418.D1796731  
 LEVER:PRESSURE SLIDER

422.D1796739  
 LEVER:REVERSE:PRESSURE RELEASE:JOINT

421.D1796738  
 SLIDER:CAM:REVERSE

419.D1796734  
 BRACKET:SLIDER:CAM

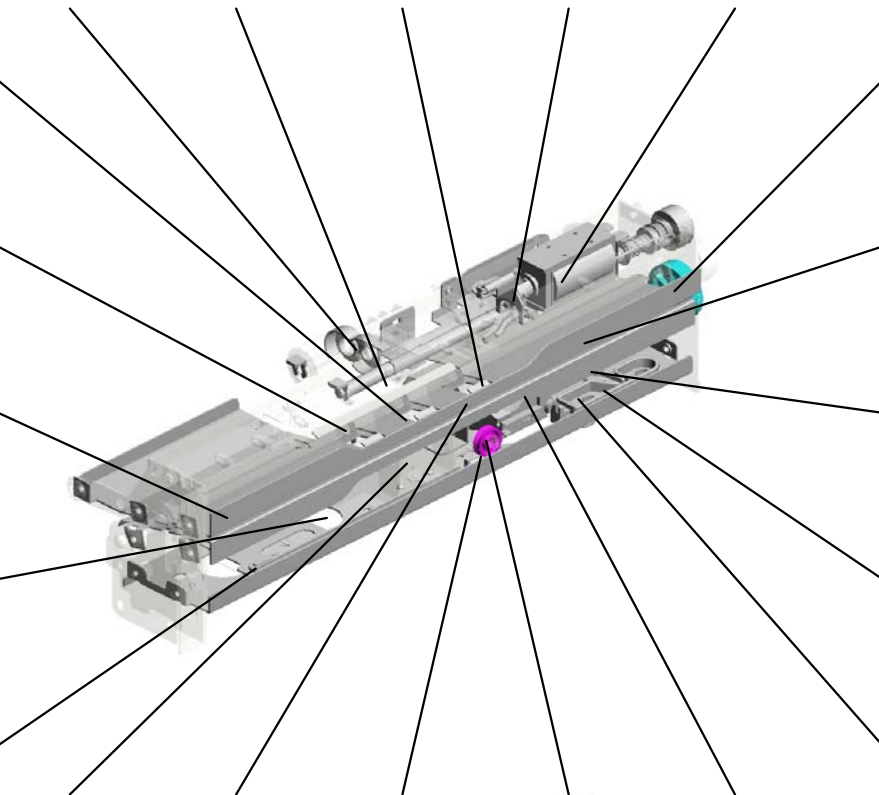

493.D2706740  
 STAY:REVERSE:ASS'Y

277.D0596212  
 LEVER:PRESSURE:REVERSE

489.D2706668  
 TENSION SPRING:REVERSE ROLLER

487.D2706659  
 ROLLER:GUIDE

420.D1796737  
 LEVER:PRESSURE RELEASE:REVERSE



U006\_S007  
PAPER FEED UNIT:PAPER BANK:ASS'Y

517.GW020024  
PHOTOINTERRUP  
TOR:LG2A24BL1:G  
F:(SEN3/SEN21/SE  
N35/SEN36/SEN37/  
SEN38/SEN39/SEN  
40/SEN41/SEN42/S

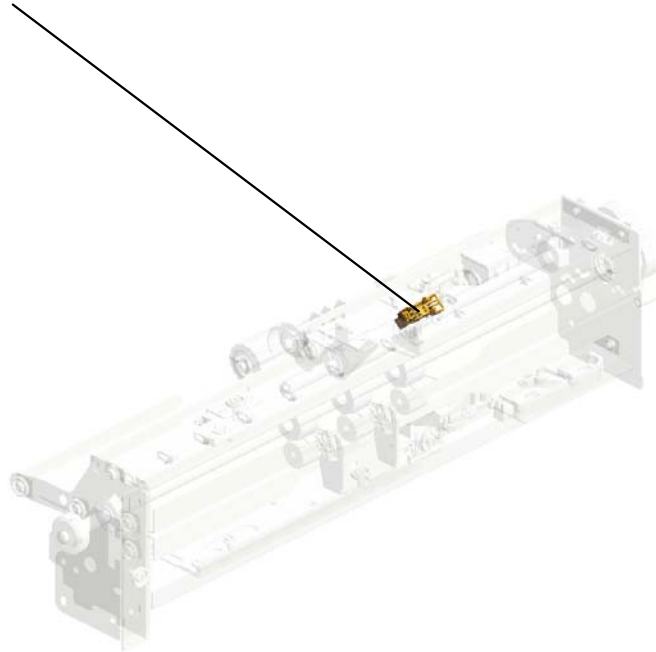

351.D0BX6628  
PAPER FEED UNIT  
:PAPER BANK:ASS'  
Y

U001	U002	U003	U004	U005	<b>U006</b>	U007	U008	U009	U010	U011	U012	U013	U014	U015	U016	U017	U018	U019	U020	U021
------	------	------	------	------	-------------	------	------	------	------	------	------	------	------	------	------	------	------	------	------	------

U006\_S008  
 PAPER FEED UNIT:PAPER BANK:ASS'Y

29.04544006Q (x14) TAPPING SCREW: 4X6  
 61.11050511 (x13) HARNESS CLAMP - LWS-0306ZC  
 64.11050551 (x2) CLAMP:LES-0505  
 74.54472706 GEAR - 15T  
 12.04340060N (x3) PAN SELF-TAPPING SCREW:M4X6

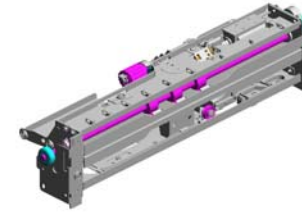

351.D0BX6628  
 PAPER FEED UNIT  
 :PAPER BANK:ASS'  
 Y

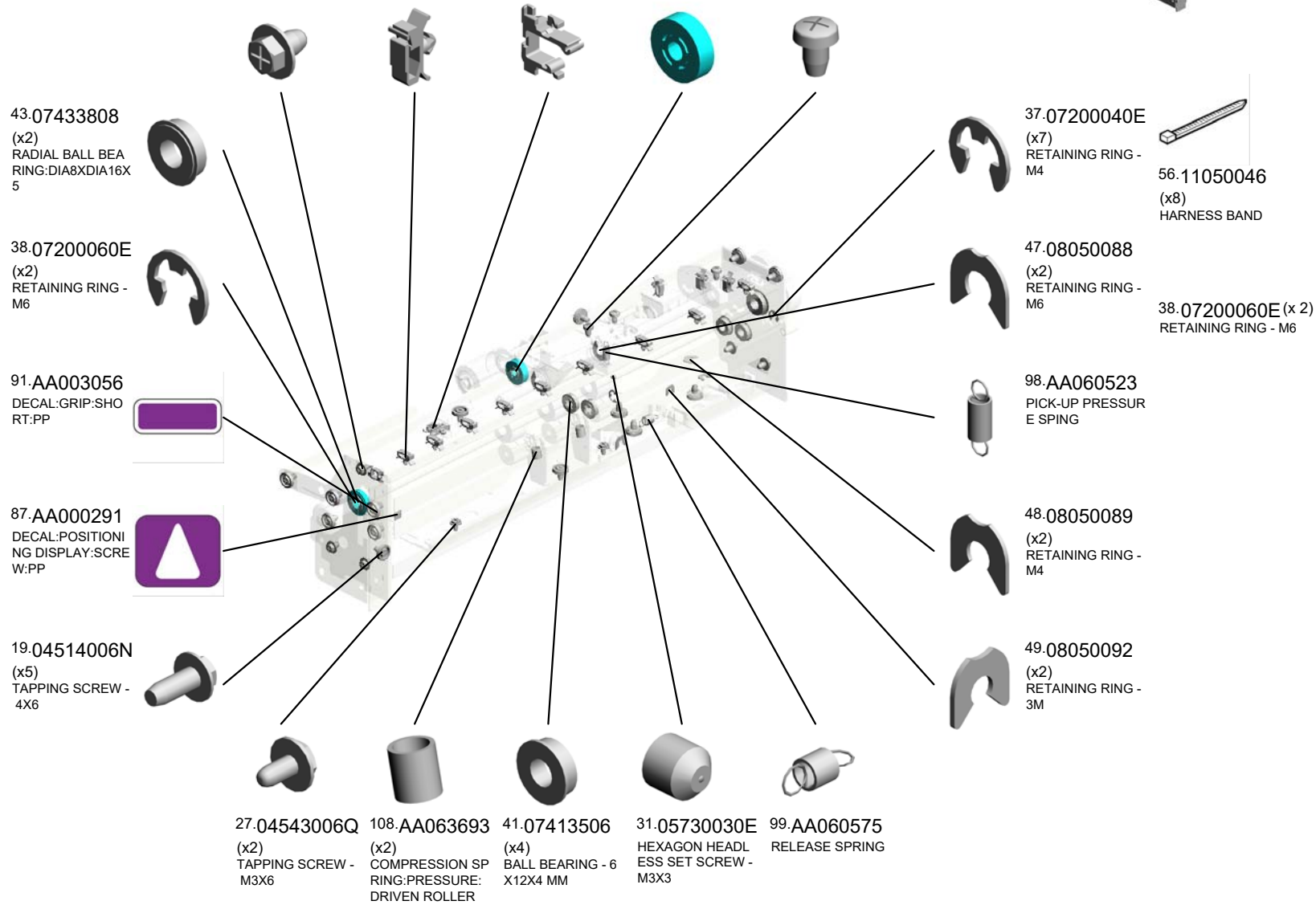

U006\_S008  
 PAPER FEED UNIT:PAPER BANK:ASS'Y

- 214.B2342624 BALL BEARING - 8 X12X5
- 225.B2346275 PICKUP ARM
- 154.AF020850 TRANSPORT ROLLER:DRIVE:PAPER FEED UNIT
- 182.B0656345 PAPER END SENSOR:DRIVE:PAPER FEED UNIT
- 226.B2346288 SENSOR BRACKET - SENSOR

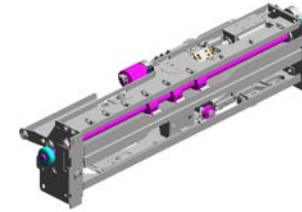

351.D0BX6628  
 PAPER FEED UNIT  
 :PAPER BANK:ASS'  
 Y

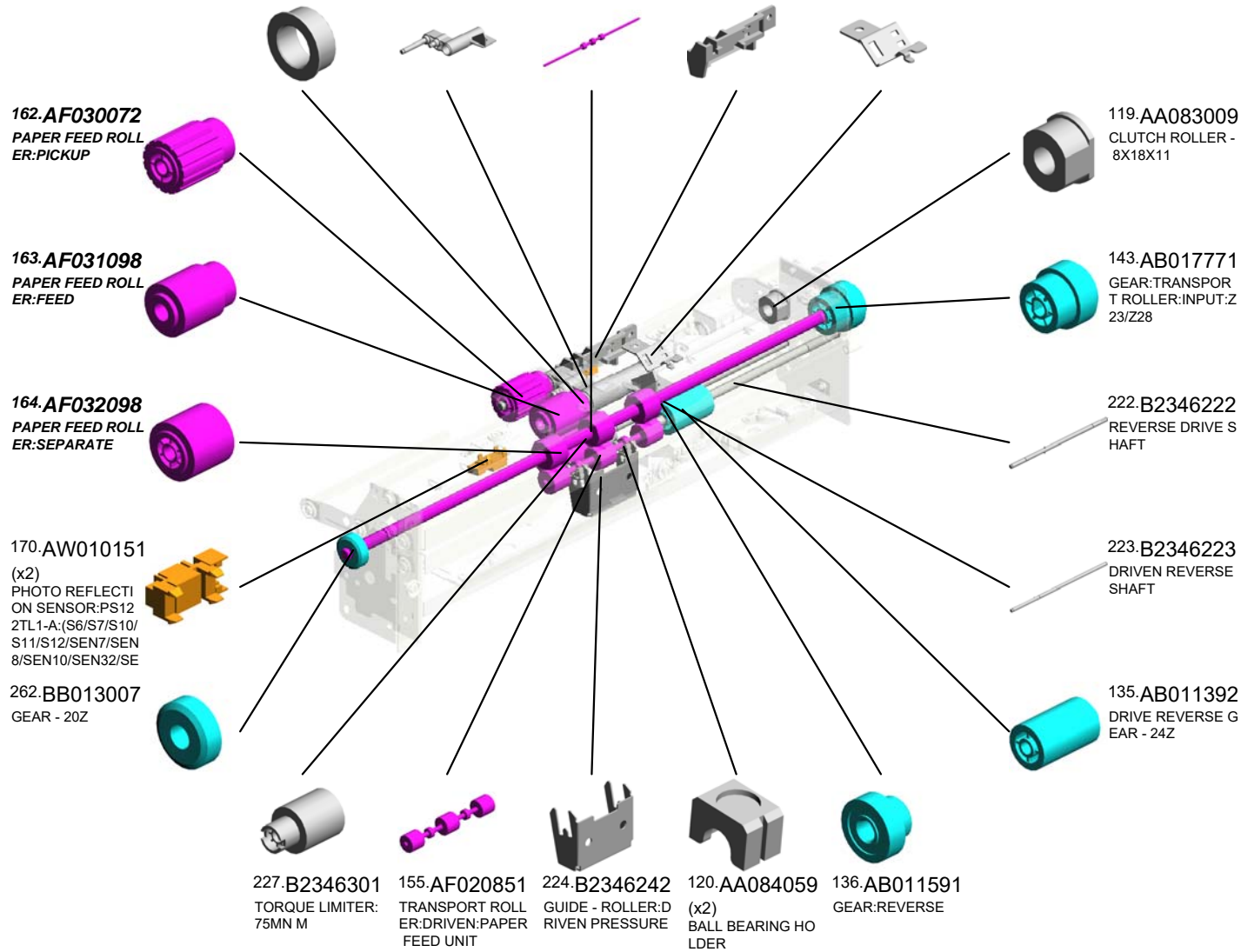



U006\_S008  
 PAPER FEED UNIT:PAPER BANK:ASS'Y

- 278.D0596277 COVER:GEAR:PAPER FEED ROLLER
- 321.D0747521 GUIDE PLATE:UPPER:PAPER FEED UNIT
- 279.D0596278 COVER:GEAR:REVERSE
- 323.D0747527 SHAFT:FEED:ASS'Y
- 350.D0BX6282 SWING UNIT:PICK UP ROLLER:ASS'Y:(SOL1/SOL2/SOL3)



351.D0BX6628  
 PAPER FEED UNIT  
 :PAPER BANK:ASS'Y

322.D0747522  
 GUIDE PLATE:LOWER:PAPER FEED UNIT

272.D0592620  
 (x3)  
 RETAINING RINGS -C

486.D2706658  
 FLANGED HEXAGONAL HEAD BOLT: M3X6

488.D2706664  
 HOOK:COIL SPRING:SLIDER

265.C2443522  
 STEPPED SCREW



263.BB013008  
 GEAR - 31Z

418.D1796731  
 LEVER:PRESSURE SLIDER

422.D1796739  
 LEVER:REVERSE:PRESSURE RELEASE:JOINT

421.D1796738  
 SLIDER:CAM:REVERSE

419.D1796734  
 BRACKET:SLIDER:CAM

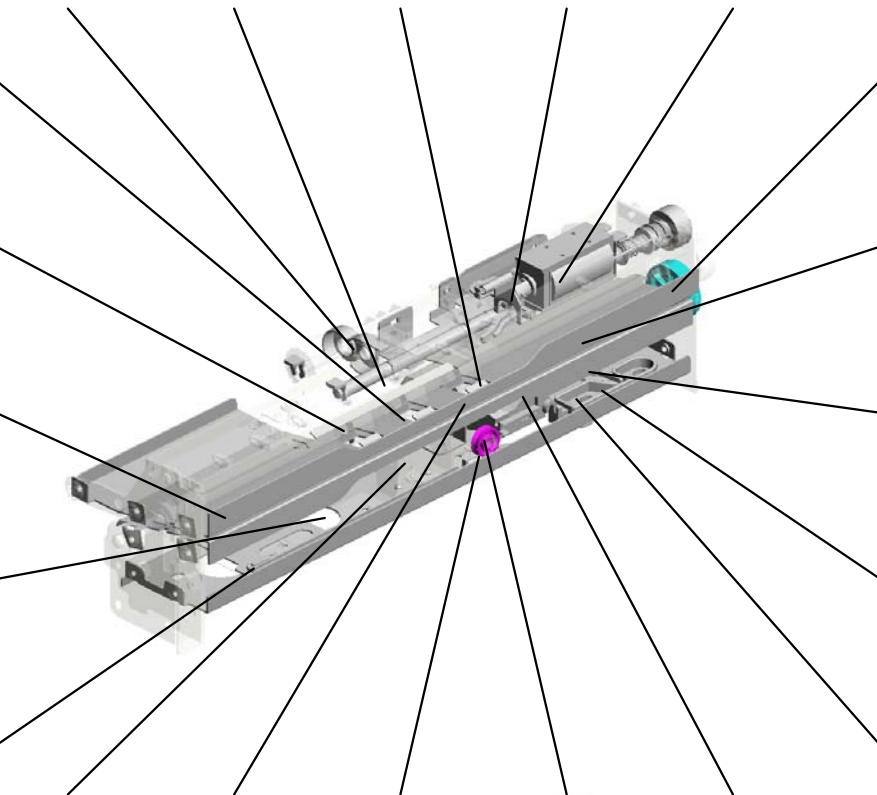

493.D2706740  
 STAY:REVERSE:ASS'Y

277.D0596212  
 LEVER:PRESSURE:REVERSE

489.D2706668  
 TENSION SPRING:REVERSE ROLLER

487.D2706659  
 ROLLER:GUIDE

420.D1796737  
 LEVER:PRESSURE RELEASE:REVERSE



U006\_S008  
PAPER FEED UNIT:PAPER BANK:ASS'Y

517.GW020024  
PHOTOINTERRUP  
TOR:LG2A24BL1:G  
F:(SEN3/SEN21/SE  
N35/SEN36/SEN37/  
SEN38/SEN39/SEN  
40/SEN41/SEN42/S

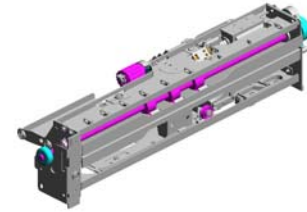
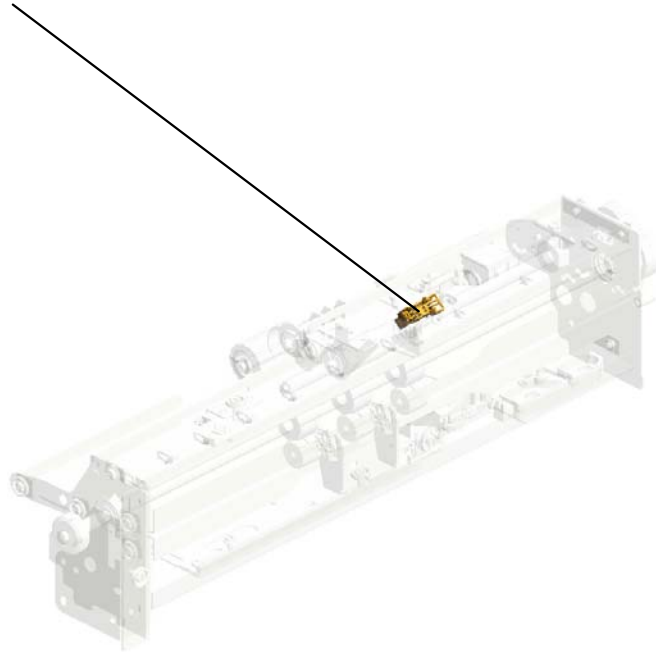

351.D0BX6628  
PAPER FEED UNIT  
:PAPER BANK:ASS'  
Y

U001	U002	U003	U004	U005	<b>U006</b>	U007	U008	U009	U010	U011	U012	U013	U014	U015	U016	U017	U018	U019	U020	U021
------	------	------	------	------	-------------	------	------	------	------	------	------	------	------	------	------	------	------	------	------	------

U006\_S009

GUIDE PLATE:OPEN AND CLOSE:VERTICAL TRANSPORT:LOWER:ASS'Y

160.AF022165 (x3) TRANSPORT ROLLER - DRIVEN  
120.AA084059 (x6) BALL BEARING HOLDER  
108.AA063693 (x6) COMPRESSION SPRING:PRESSURE-DRIVEN ROLLER

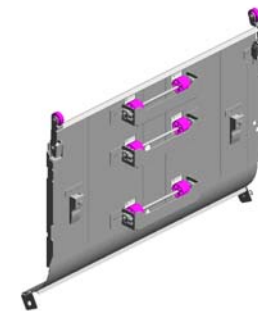

355.D0BX6771  
GUIDE PLATE:OPEN AND CLOSE:VERTICAL TRANSPORT:LOWER:ASS'Y

36.07200030E (x2) RETAINING RING - M3

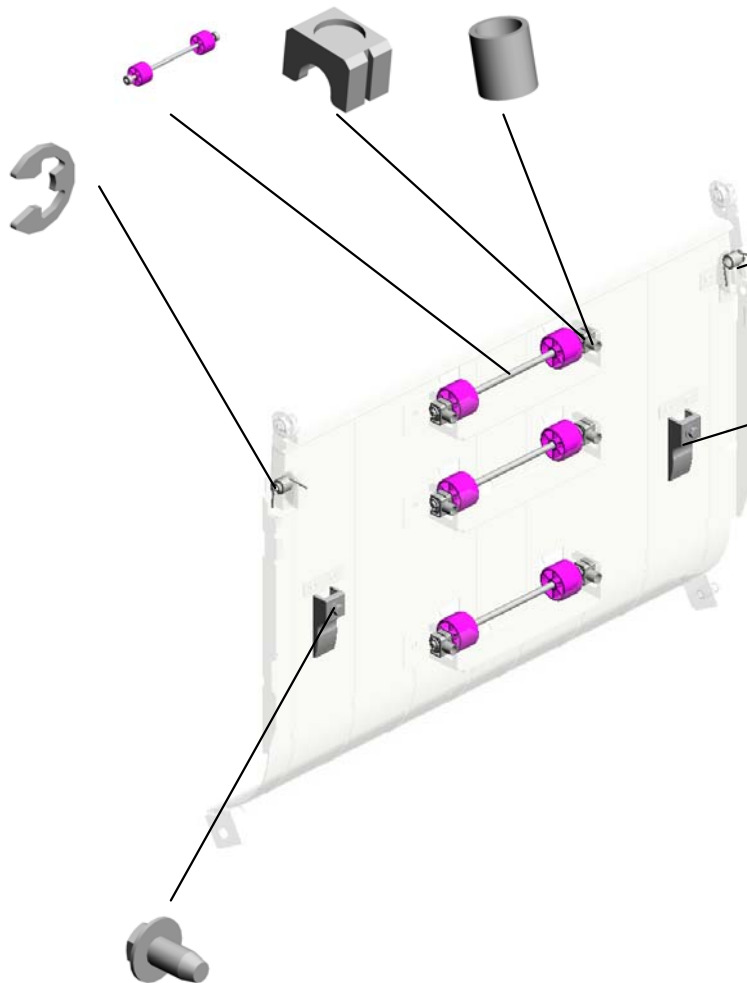

502.D3553858 (x2) TORSION SPRING:GUIDE PLATE:16N

358.D0BX6795 (x2) HOLDER:STAY:GUIDE PLATE

20.04514008N (x2) TAPPING SCREW: 4X8

U001	U002	U003	U004	U005	<b>U006</b>	U007	U008	U009	U010	U011	U012	U013	U014	U015	U016	U017	U018	U019	U020	U021
------	------	------	------	------	-------------	------	------	------	------	------	------	------	------	------	------	------	------	------	------	------

U006\_S009\_S001  
BRACKET:DETENT:RIGHT:ASS'Y

498.D3551196 515.G3631105  
ROLLER:DETENT DETENT ROLLER  
SHAFT

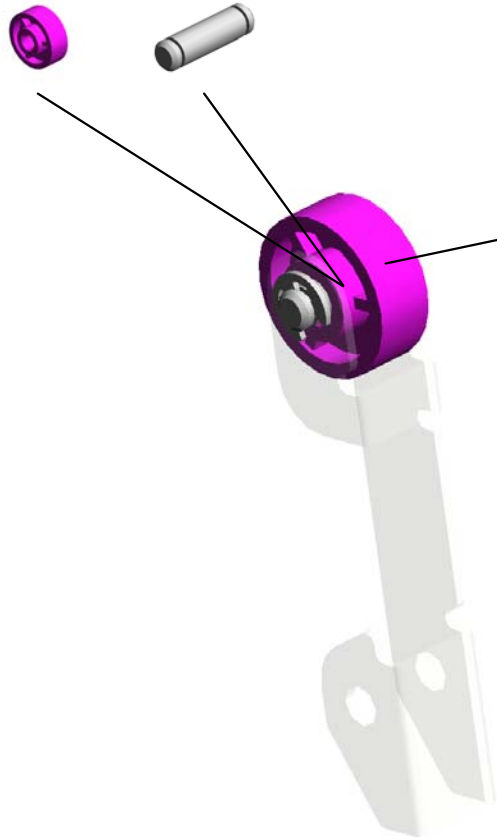

36.07200030E  
(x2)  
RETAINING RING -  
M3



499.D3553810  
BRACKET:DETENT  
:RIGHT:ASS'Y

U001	U002	U003	U004	U005	<b>U006</b>	U007	U008	U009	U010	U011	U012	U013	U014	U015	U016	U017	U018	U019	U020	U021
------	------	------	------	------	-------------	------	------	------	------	------	------	------	------	------	------	------	------	------	------	------

U006\_S009\_S002  
BRACKET:DETENT:ASS'Y

498.D3551196 515.G3631105  
ROLLER:DETENT DETENT ROLLER  
SHAFT



500.D3553840  
BRACKET:DETENT  
:ASS'Y

36.07200030E  
(x2)  
RETAINING RING -  
M3

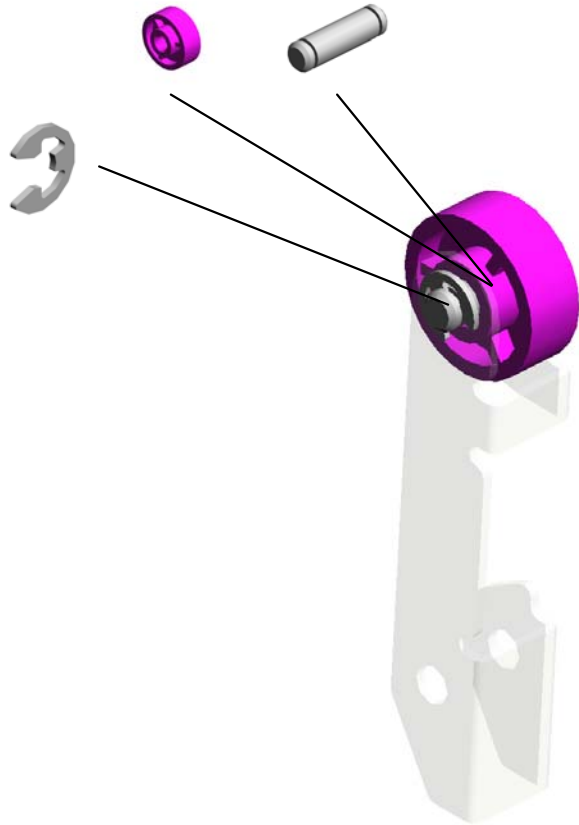

U001	U002	U003	U004	U005	<b>U006</b>	U007	U008	U009	U010	U011	U012	U013	U014	U015	U016	U017	U018	U019	U020	U021
------	------	------	------	------	-------------	------	------	------	------	------	------	------	------	------	------	------	------	------	------	------

U006\_S010  
PAPER TRAY:UNIVERSAL:SUB-ASS'Y

270.D0146785 153.AF017033 212.B1816780 213.B1816789 205.B1326797  
 SPRING PLATE:AR END FENCE LINK:END FENCE: LINK:SIDE FENCE: SIDE FENCE:REAR  
 M:END FENCE:LO PAPER SIZE SENS PAPER SIZE SENS :AUXILIARY  
 CK OR:ASS'Y OR

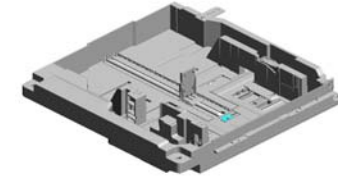

364.D0BX7631  
PAPER TRAY:UNIV  
ERSAL:SUB-ASS'Y

185.B0656545  
(x2)  
DECAL - POSITION  
ING

460.D1947635  
ARM:END FENCE:L  
OCK

151.AF010097  
PAPER TRAY:UNIV  
ERSAL:REMOVER/I  
NSTALL

315.D0747390  
DECAL:PAPER SE  
T DIRECTION:PAP  
ER TRAY

206.B1326798  
SPRING PLATE:PA  
PER TRAY:EARTH

102.AA060961  
TENSION SPRING:  
SIDE FENCE:REAR

269.D0146784  
SPRING PLATE:EN  
D FENCE

38.07200060E  
RETAINING RING -  
M6

14.04504008N  
(x3)  
TAPPING SCREW -  
M4X8

137.AB012327  
GEAR:16Z

252.B2476695  
GUIDE:MISFEED R  
EMOVAL:PAPER T  
RAY

233.B2346498  
(x2)  
SHEET:TRAY BOT  
TOM PLATE

183.B0656524  
BOTTOM PLATE LI  
FT SHAFT

11.03604008N  
(x2)  
SCREW - M4X8

184.B0656526  
LIFT LEVER

U006\_S010\_S001  
TRAY BOTTOM PLATE:ASS'Y

152.AF013029  
PAD:BASE



357.D0BX6780  
TRAY BOTTOM PL  
ATE:ASS'Y

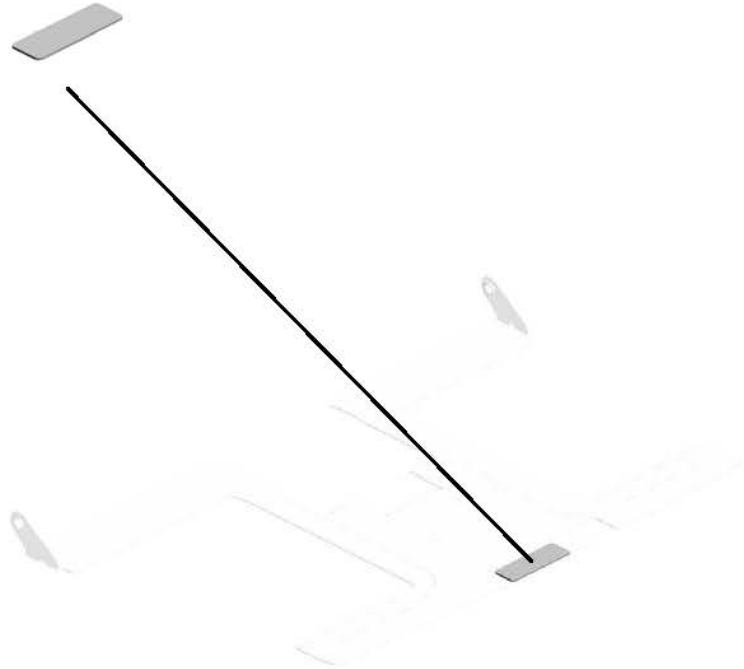

U001	U002	U003	U004	U005	<b>U006</b>	U007	U008	U009	U010	U011	U012	U013	U014	U015	U016	U017	U018	U019	U020	U021
------	------	------	------	------	-------------	------	------	------	------	------	------	------	------	------	------	------	------	------	------	------

U006\_S010\_S002  
SIDE FENCE:REAR:ASS'Y

83.A2672857 90.AA001597  
SPRING PLATE - SI DE FENCE DECAL:SIDE FENCE:REAR

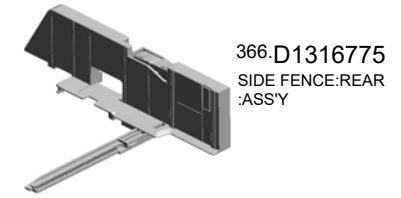

84.A2672859  
SIDE FENCE STOP PER

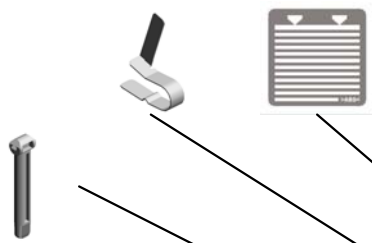

215.B2342864  
PAD:CLEANER

13.04503008N  
(x2)  
TAPPING SCREW - M3X8

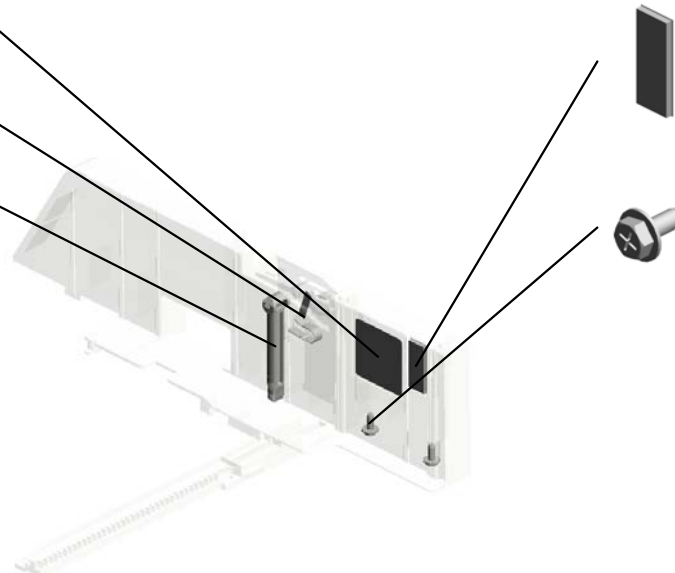

U001	U002	U003	U004	U005	<b>U006</b>	U007	U008	U009	U010	U011	U012	U013	U014	U015	U016	U017	U018	U019	U020	U021
------	------	------	------	------	-------------	------	------	------	------	------	------	------	------	------	------	------	------	------	------	------



U006\_S010\_S003  
SIDE FENCE:FRONT:ASS'Y

204.B1326791 76.A1342978  
(x2) SPRING PLATE  
PLATE:SIDE FENCE

367.D1316777  
SIDE FENCE:FRONT:ASS'Y

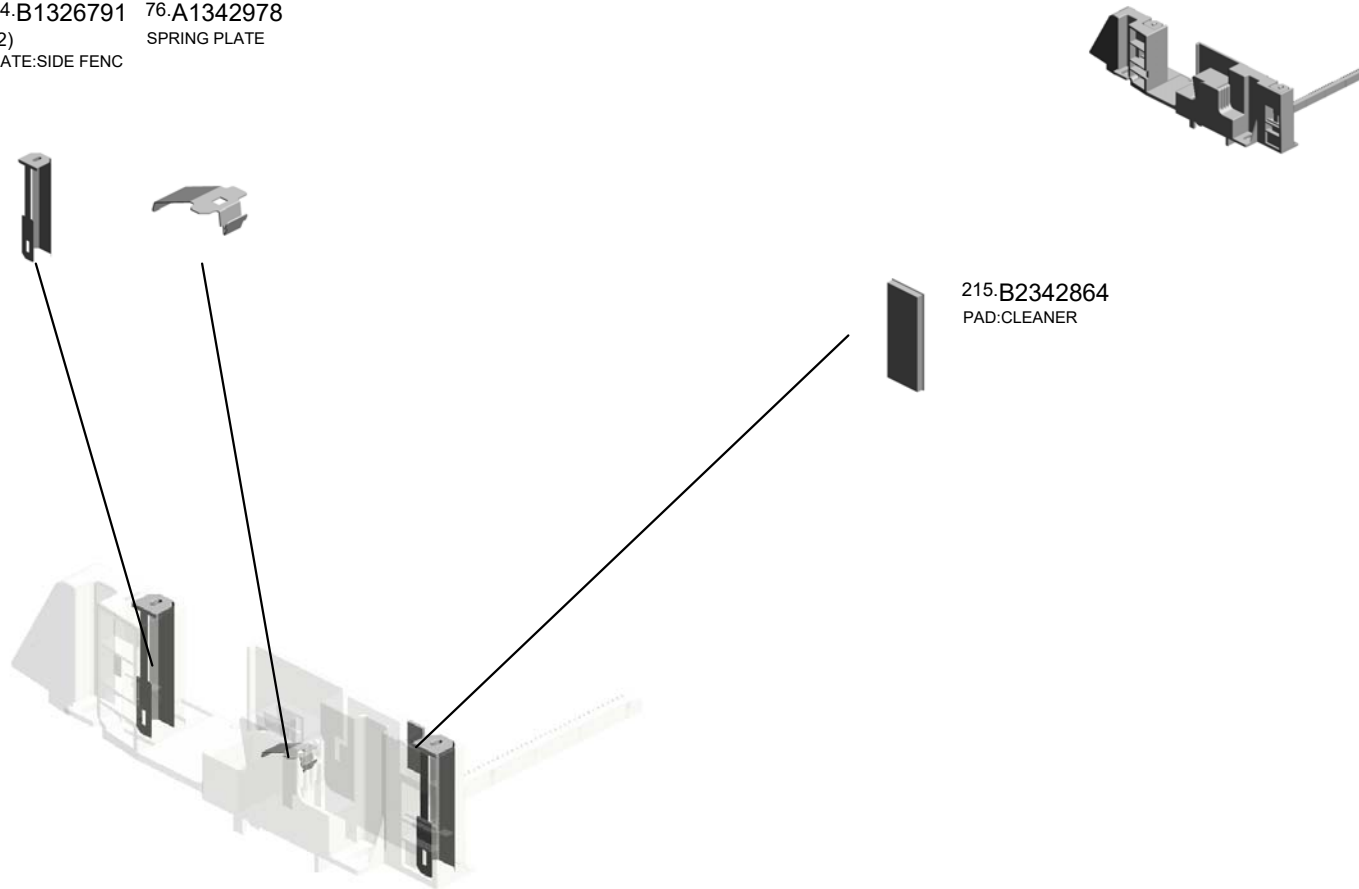

U001	U002	U003	U004	U005	<b>U006</b>	U007	U008	U009	U010	U011	U012	U013	U014	U015	U016	U017	U018	U019	U020	U021
------	------	------	------	------	-------------	------	------	------	------	------	------	------	------	------	------	------	------	------	------	------

U006\_S011  
PAPER TRAY:UNIVERSAL:SUB-ASS'Y

270.D0146785 SPRING PLATE:AR  
M:END FENCE:LO  
CK  
153.AF017033 END FENCE  
212.B1816780 LINK:END FENCE:  
PAPER SIZE SENS  
OR:ASS'Y  
213.B1816789 LINK:SIDE FENCE:  
PAPER SIZE SENS  
OR  
205.B1326797 SIDE FENCE:REAR  
:AUXILIARY

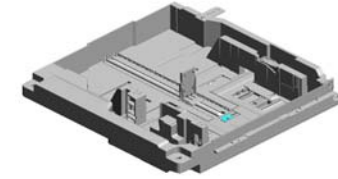

364.D0BX7631  
PAPER TRAY:UNIV  
ERSAL:SUB-ASS'Y

185.B0656545  
(x2)  
DECAL - POSITION  
ING

460.D1947635  
ARM:END FENCE:L  
OCK

151.AF010097  
PAPER TRAY:UNIV  
ERSAL:REMOVER/I  
NSTALL

315.D0747390  
DECAL:PAPER SE  
T DIRECTION:PAP  
ER TRAY

206.B1326798  
SPRING PLATE:PA  
PER TRAY:EARTH

102.AA060961  
TENSION SPRING:  
SIDE FENCE:REAR

269.D0146784  
SPRING PLATE:EN  
D FENCE

38.07200060E  
RETAINING RING -  
M6

14.04504008N  
(x3)  
TAPPING SCREW -  
M4X8

137.AB012327  
GEAR:16Z

252.B2476695  
GUIDE:MISFEED R  
EMOVAL:PAPER T  
RAY

233.B2346498  
(x2)  
SHEET:TRAY BOT  
TOM PLATE

183.B0656524  
BOTTOM PLATE LI  
FT SHAFT

11.03604008N  
(x2)  
SCREW - M4X8

184.B0656526  
LIFT LEVER

U006\_S011\_S001  
TRAY BOTTOM PLATE:ASS'Y

152.AF013029  
PAD:BASE



357.D0BX6780  
TRAY BOTTOM PL  
ATE:ASS'Y

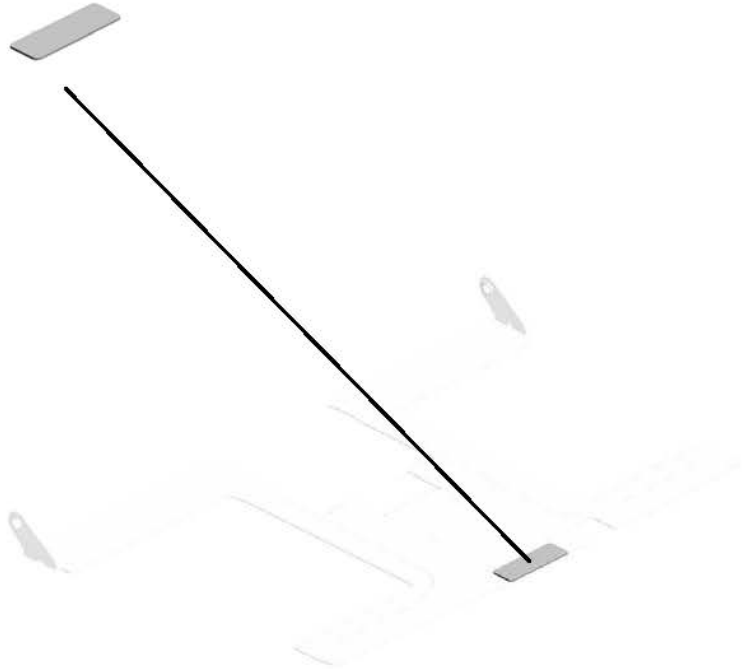

U001	U002	U003	U004	U005	<b>U006</b>	U007	U008	U009	U010	U011	U012	U013	U014	U015	U016	U017	U018	U019	U020	U021
------	------	------	------	------	-------------	------	------	------	------	------	------	------	------	------	------	------	------	------	------	------

U006\_S011\_S002  
SIDE FENCE:REAR:ASS'Y

83.A2672857 90.AA001597  
SPRING PLATE - SI DE FENCE DECAL:SIDE FENCE:REAR

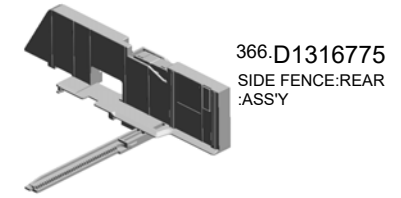

84.A2672859  
SIDE FENCE STOP PER

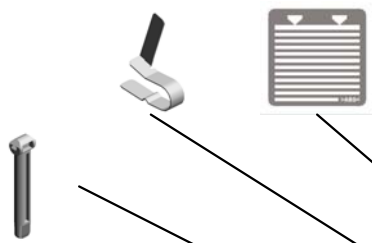

215.B2342864  
PAD:CLEANER

13.04503008N  
(x2)  
TAPPING SCREW - M3X8

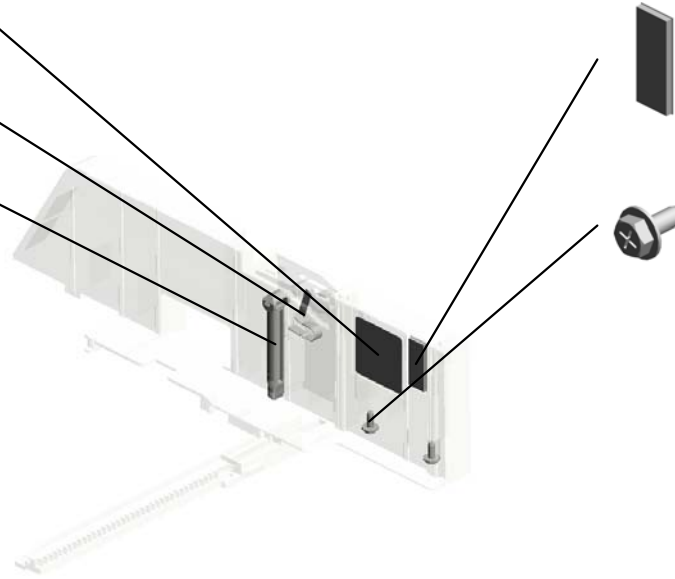

U001	U002	U003	U004	U005	<b>U006</b>	U007	U008	U009	U010	U011	U012	U013	U014	U015	U016	U017	U018	U019	U020	U021
------	------	------	------	------	-------------	------	------	------	------	------	------	------	------	------	------	------	------	------	------	------

U006\_S011\_S003  
SIDE FENCE:FRONT:ASS'Y

204.B1326791 (x2)  
PLATE:SIDE FENCE

76.A1342978  
SPRING PLATE

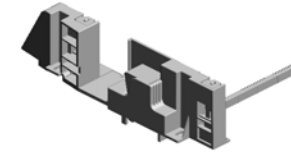

367.D1316777  
SIDE FENCE:FRONT:ASS'Y



215.B2342864  
PAD:CLEANER

U001	U002	U003	U004	U005	<b>U006</b>	U007	U008	U009	U010	U011	U012	U013	U014	U015	U016	U017	U018	U019	U020	U021
------	------	------	------	------	-------------	------	------	------	------	------	------	------	------	------	------	------	------	------	------	------

U006\_S012  
(NA):TANDEM LCT:RIGHT:ASS'Y

- 82.A2486713 (x2) HOOK - TENSION SPRING
- 37.07200040E (x8) RETAINING RING - M4
- 63.11050534 (x8) CLAMP
- 80.A2486695 (x4) GUIDE - PULLEY
- 52.09513006N SCREW - M3X6

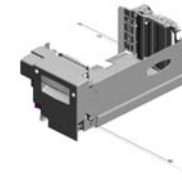

527.D0BX6685  
(NA):TANDEM LCT:  
RIGHT:ASS'Y

14.04504008N  
(x2)  
TAPPING SCREW - M4X8

53.09514006N  
(x4)  
SCREW:POLISHED ROUND:M4X6

68.11050760  
(x2)  
CLAMP:LWSM-051 1A

86.A2946690  
FEELER - PAPER H EIGHT SENSOR

30.04544008Q  
(x6)  
TAPPING SCREW - M4X8

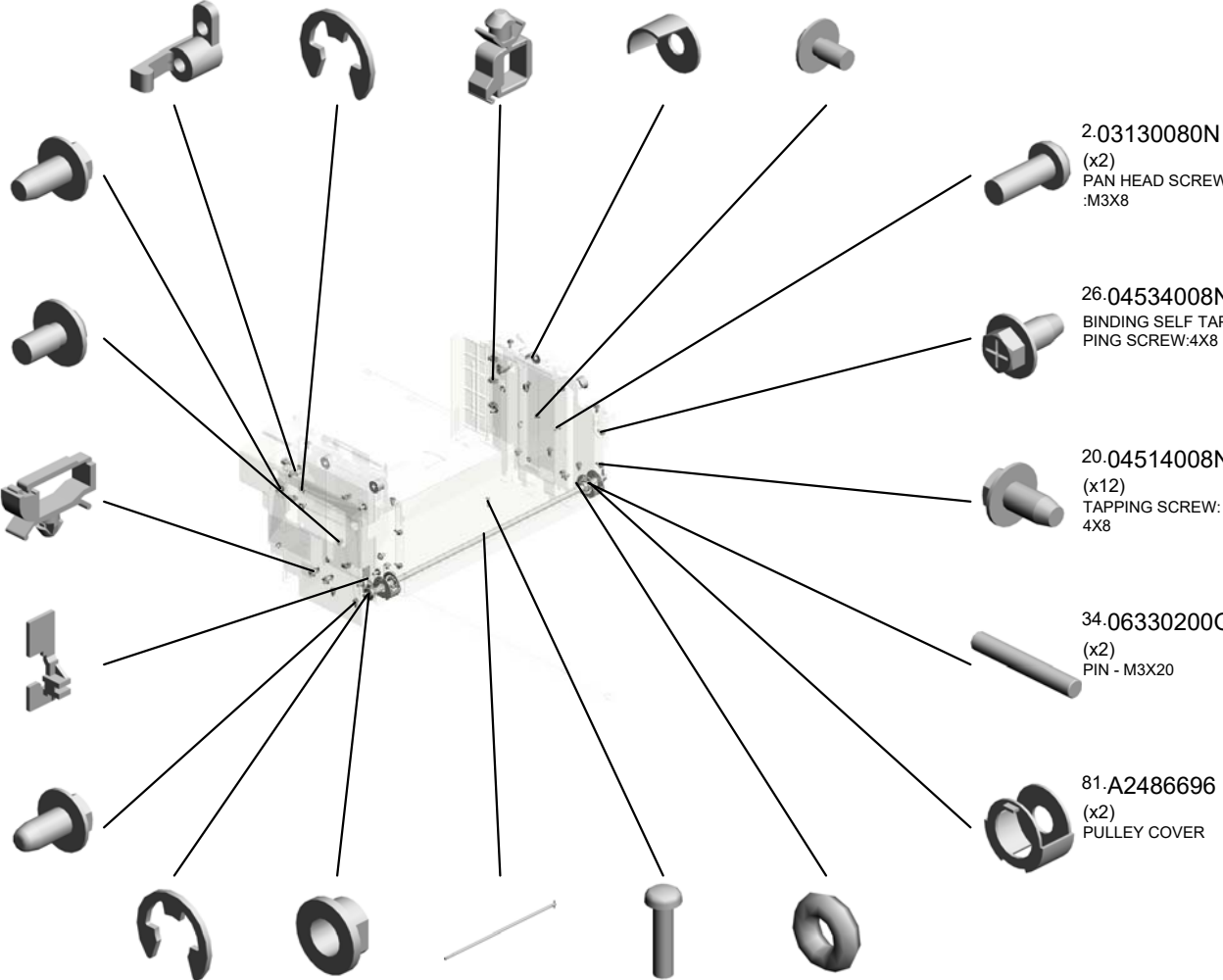

- 38.07200060E (x2) RETAINING RING - M6
- 70.50530223 (x3) BUSHING - 8MM
- 78.A2486687 RIGHT DRIVE SHA FT
- 3.03130120N PAN HEAD SCREW :M3X12
- 79.A2486694 (x3) WIRE RING

2.03130080N  
(x2)  
PAN HEAD SCREW :M3X8

26.04534008N  
BINDING SELF TAP PING SCREW:4X8

20.04514008N  
(x12)  
TAPPING SCREW: 4X8

34.06330200G  
(x2)  
PIN - M3X20

81.A2486696  
(x2)  
PULLEY COVER



56.11050046  
(x16)  
HARNES BAND



61.11050511  
(x2)  
HARNES CLAMP - LWS-0306ZC

20.04514008N (x 2)  
TAPPING SCREW:4X8  
29.04544006Q (x 8)  
TAPPING SCREW:4X6  
30.04544008Q (x 1)  
TAPPING SCREW - M4X8

U006\_S012  
(NA):TANDEM LCT:RIGHT:ASS'Y

- 100.AA060757 (x2) TENSION SPRING - LONG
- 146.AB032058 (x2) WIRE PULLEY - M10
- 147.AB032719 (x2) PULLEY - M10
- 195.B0656870 (x2) STAY - RIGHTBASE
- 200.B0706684 LEVER:RELEASE:REAR

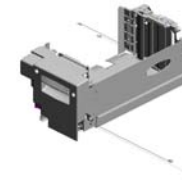

527.D0BX6685  
(NA):TANDEM LCT:RIGHT:ASS'Y

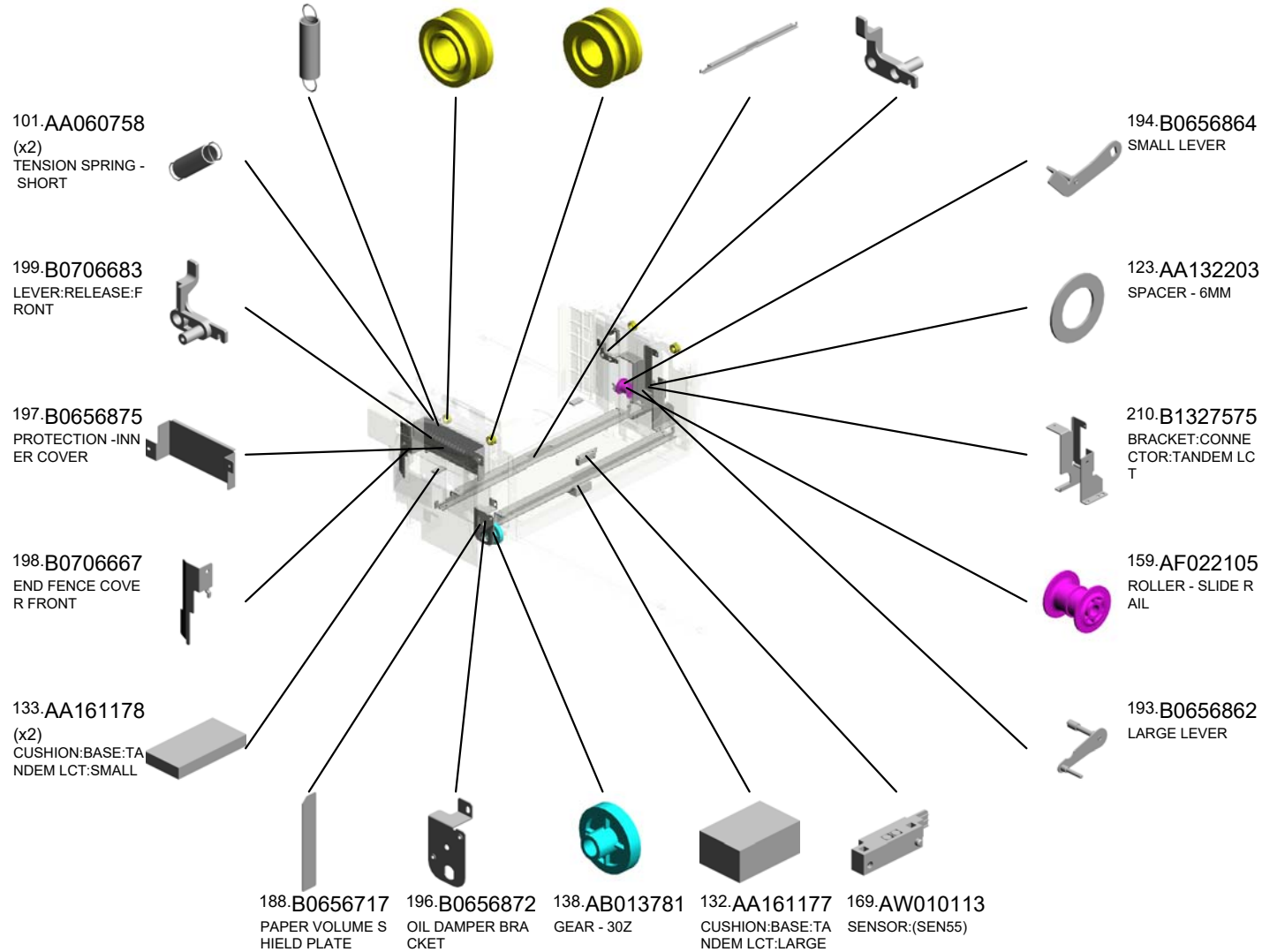

U006\_S012  
(NA):TANDEM LCT:RIGHT:ASS'Y

- 267.D0146626 BRACKET:ON OFF DETECTOR:FRONT
- 313.D0747388 DECAL:PAPER SET DIRECTION:TANDEM LCT:RIGHT
- 247.B2346686 SIDE FENCE - RIGHT FRONT
- 245.B2346625 END FENCE - REAR
- 268.D0146627 BRACKET:ON OFF DETECTOR:REAR

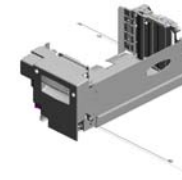

527.D0BX6685  
(NA):TANDEM LCT:RIGHT:ASS'Y

244.B2346612  
END FENCE - FRONT

288.D0596712  
INNER COVER:TANDEM LCT

463.D2236722  
DC SOLENOID:END FENCE:FRONT:ASS'Y:(SOL8)

311.D0747385  
DECAL:CAUTION CHART:TANDEM LCT

353.D0BX6677  
ROLLER:SLIDE RAIL:FRONT

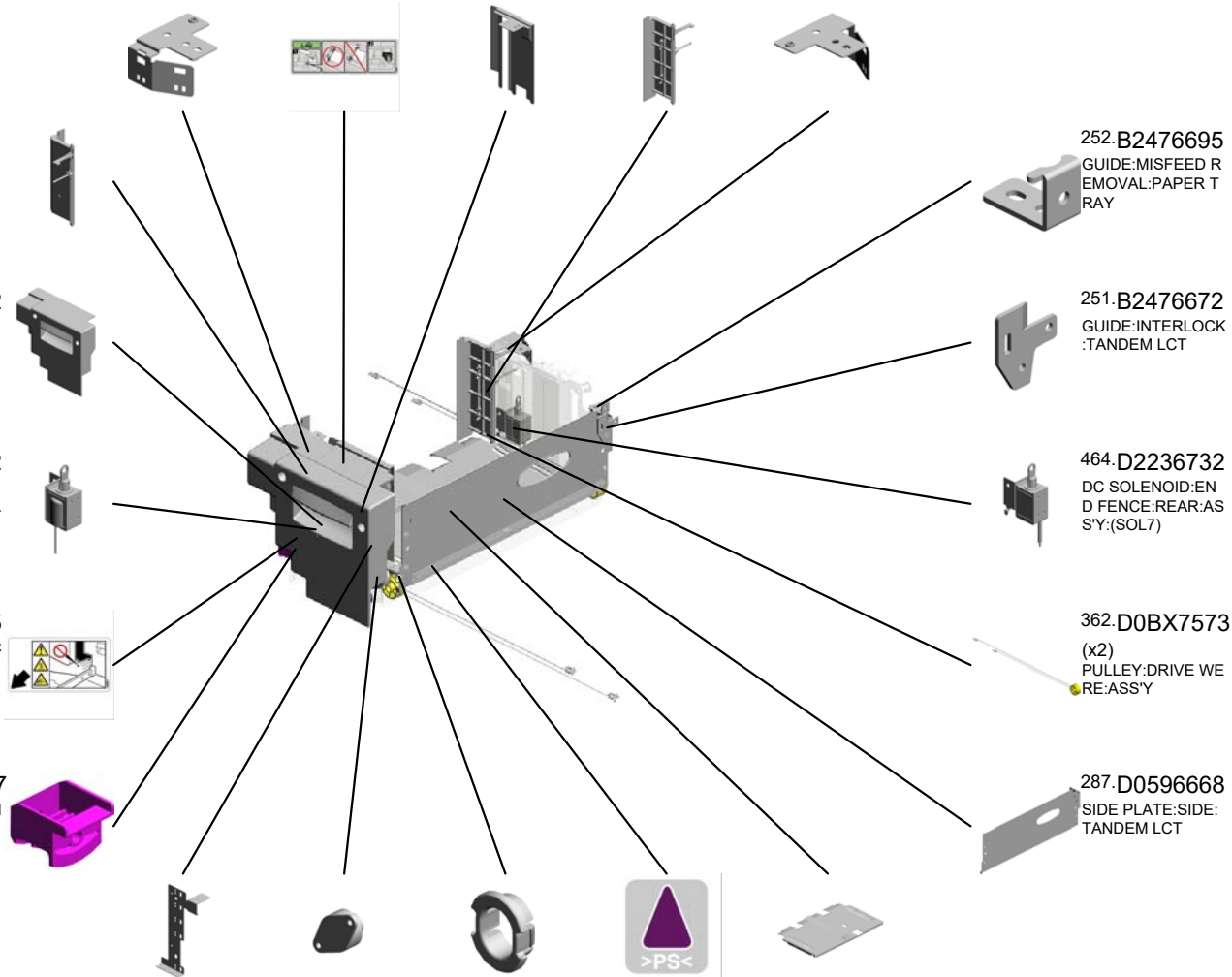

252.B2476695  
GUIDE:MISFEED REMOVAL:PAPER TRAY

251.B2476672  
GUIDE:INTERLOCK:TANDEM LCT

464.D2236732  
DC SOLENOID:END FENCE:REAR:ASS'Y:(SOL7)

362.D0BX7573  
(x2)  
PULLEY:DRIVE WHEEL:ASS'Y

287.D0596668  
SIDE PLATE:SIDE:TANDEM LCT

- 243.B2346606 SENSOR BRACKET
- 255.B2476901 OIL DAMPER:FALL
- 218.B2346141 POSITIONING SLEEVE - INNER BACK
- 304.D0746497 (x2)  
DECAL:POSITIONING DISPLAY:TCRU
- 363.D0BX7595 (CHN|Pro 8310/8320|NA/EU/AA/TWN/KOR):BASE:TANDEM LCT:RIGHT:ADHESION



U006\_S012  
(NA):TANDEM LCT:RIGHT:ASS'Y

490.D2706678  
(x2)  
COVER:CUSHION

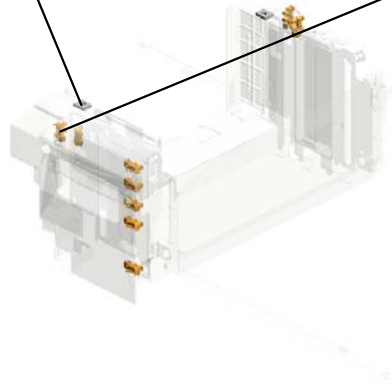
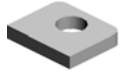

517.GW020024  
(x9)  
PHOTOINTERRUP  
TOR:LG2A24BL1:G  
F:(SEN3/SEN21/SE  
N35/SEN36/SEN37/  
SEN38/SEN39/SEN

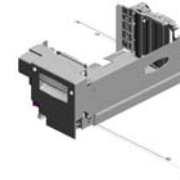

527.D0BX6685  
(NA):TANDEM LCT:  
RIGHT:ASS'Y

U001	U002	U003	U004	U005	<b>U006</b>	U007	U008	U009	U010	U011	U012	U013	U014	U015	U016	U017	U018	U019	U020	U021
------	------	------	------	------	-------------	------	------	------	------	------	------	------	------	------	------	------	------	------	------	------

U006\_S012\_S001  
SIDE FENCE:TANDEM LCT:RIGHT:ASS'Y

89-AA001509  
DECAL:SIDE FENC  
E:16X30

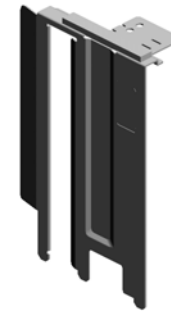
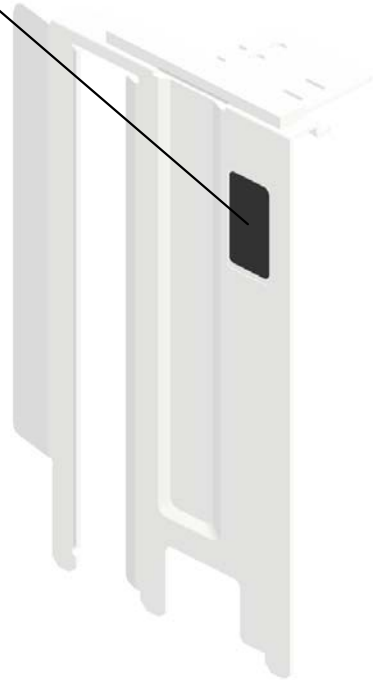

248-B2346691  
SIDE FENCE:TAND  
EM LCT:RIGHT:AS  
SY

U001	U002	U003	U004	U005	<b>U006</b>	U007	U008	U009	U010	U011	U012	U013	U014	U015	U016	U017	U018	U019	U020	U021
------	------	------	------	------	-------------	------	------	------	------	------	------	------	------	------	------	------	------	------	------	------

U006\_S013

(CHN[Pro 8310/8320]/NA/EU/AA/TWN/KOR):TRAY BOTTOM PLATE:LEFT MIDDLE:ASS'Y

312.D0747387  
(CHN[Pro 8310/8320]/NA/EU/AA/TWN/KOR):DECAL:BASE  
:TANDEM LCT:LEFT

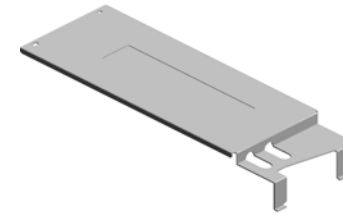
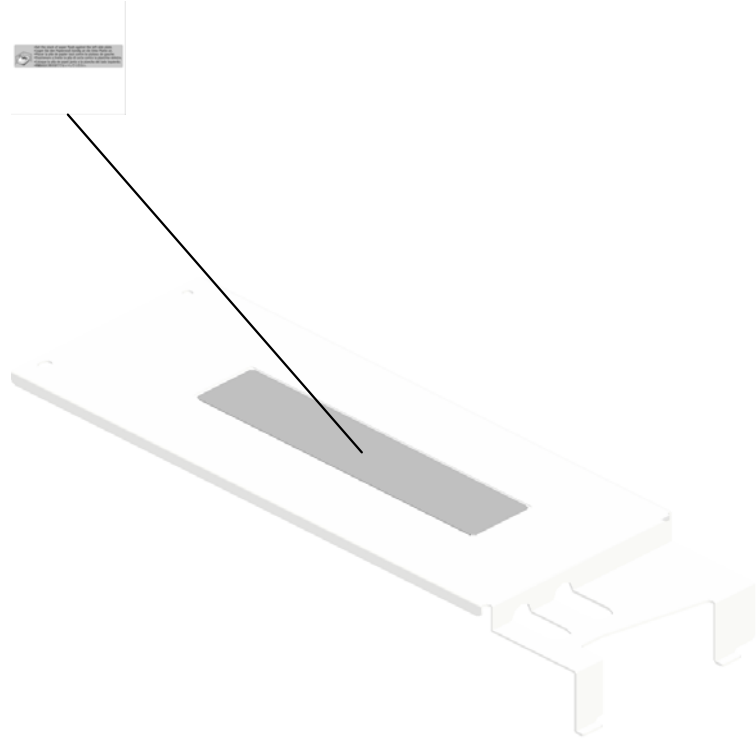

329.D0747596  
(CHN[Pro 8310/8320]/NA/EU/AA/TWN/KOR):TRAY BOTTOM PLATE:LEFT MIDDLE:ASS'Y

U001	U002	U003	U004	U005	<b>U006</b>	U007	U008	U009	U010	U011	U012	U013	U014	U015	U016	U017	U018	U019	U020	U021
------	------	------	------	------	-------------	------	------	------	------	------	------	------	------	------	------	------	------	------	------	------

U006\_S014  
SIDE FENCE:TANDEM LCT:LEFT REAR:ASS'Y

88-AA001508  
DECAL:SIDE FENC  
E:40X30

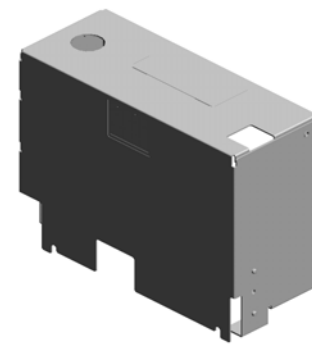
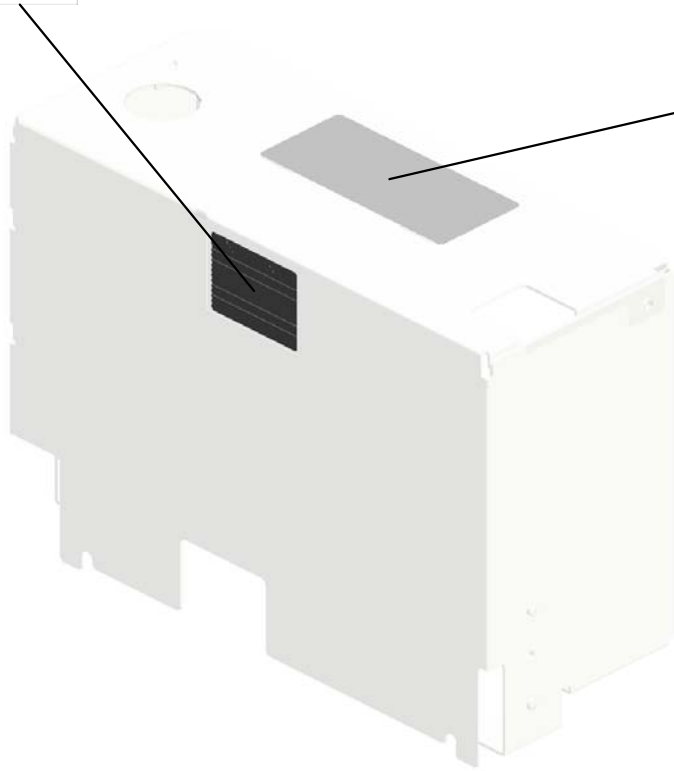

495-D2707544  
SIDE FENCE:TAND  
EM LCT:LEFT REA  
R:ASS'Y



496-D2707548  
DECAL:CAUTION:1  
NSERT:PAPER FE  
ED SUB-UNIT

U001	U002	U003	U004	U005	<b>U006</b>	U007	U008	U009	U010	U011	U012	U013	U014	U015	U016	U017	U018	U019	U020	U021
------	------	------	------	------	-------------	------	------	------	------	------	------	------	------	------	------	------	------	------	------	------

# U007.TONNER SUPPLY

U007\_S001  
D1793334  
CASE:TONER BANK:ASS'Y

U007\_S003  
D1793370  
INNER COVER:TONER BANK  
:ASS'Y

U007\_S002  
D1793334  
CASE:TONER BANK:ASS'Y

U007\_S004  
D1793201  
TONER SUPPLY UNIT:TONE  
R HOPPER:ASS'Y

U001	U002	U003	U004	U005	U006	U007	U008	U009	U010	U011	U012	U013	U014	U015	U016	U017	U018	U019	U020	U021
------	------	------	------	------	------	------	------	------	------	------	------	------	------	------	------	------	------	------	------	------

# U007 TONNER SUPPLY

11.04514008N (x18) TAPPING SCREW: 4X8  
 20.11050511 (x2) HARNESS CLAMP - LWS-0306ZC  
 27.A2943294 (x2) GEAR - 108Z USA (RIC)  
 7.04504012N (x6) TAPPING SCREW: 4X12  
 1.03125060N (x8) SCREW - M2.5X6

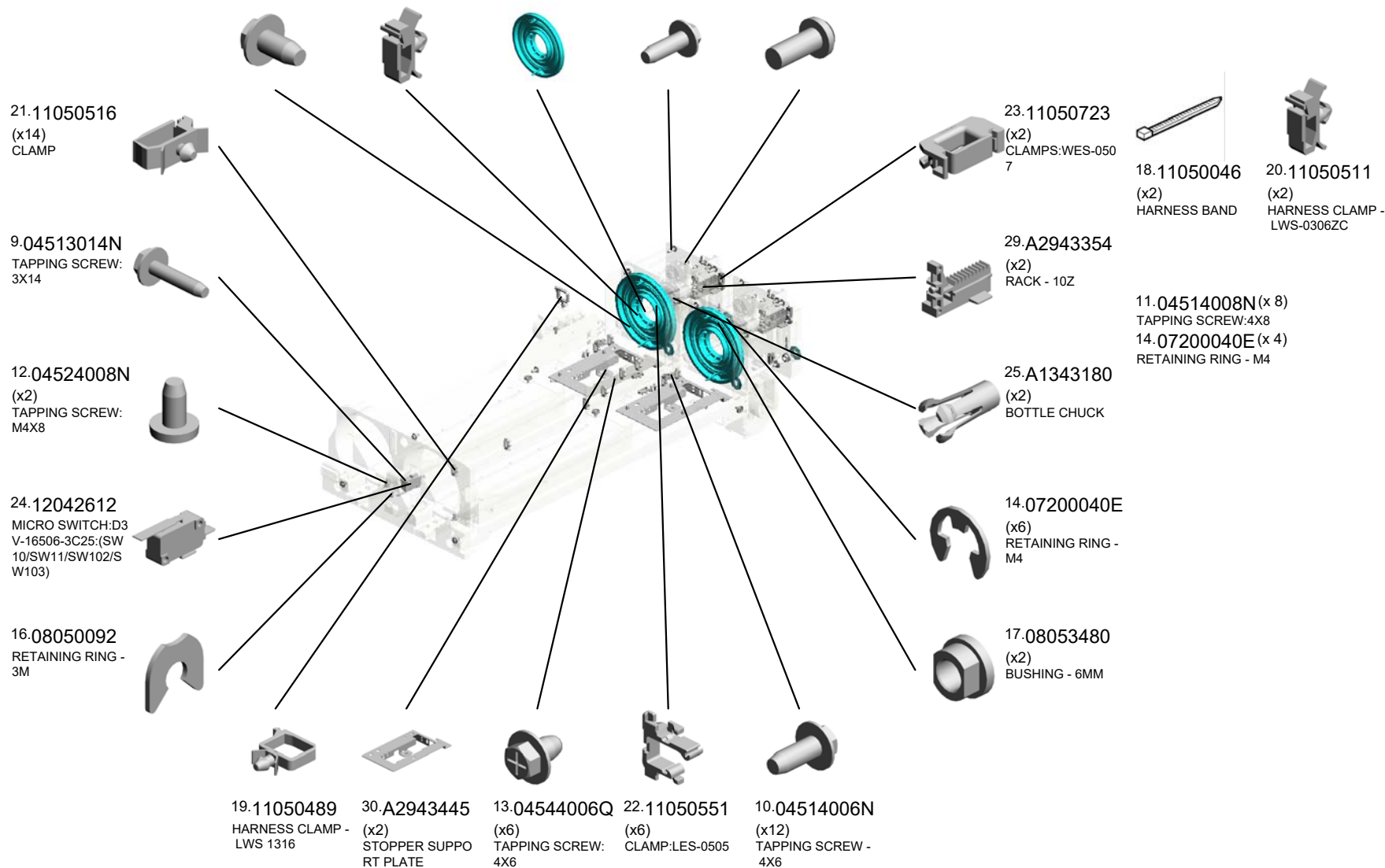
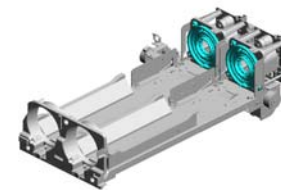

# U007 TONNER SUPPLY

- 34.A2943461 (x2) LEVER RACK JOIN T
- 45.AB012005 (x4) GEAR - 13Z
- 44.AA152299 (x2) BOTTLE HOLD SE AL
- 43.AA143816 (x2) FLAT SCREW:CHU CK:BOTTLE
- 49.AB017515 (x2) DOUBLE GEAR - 1 2/23Z

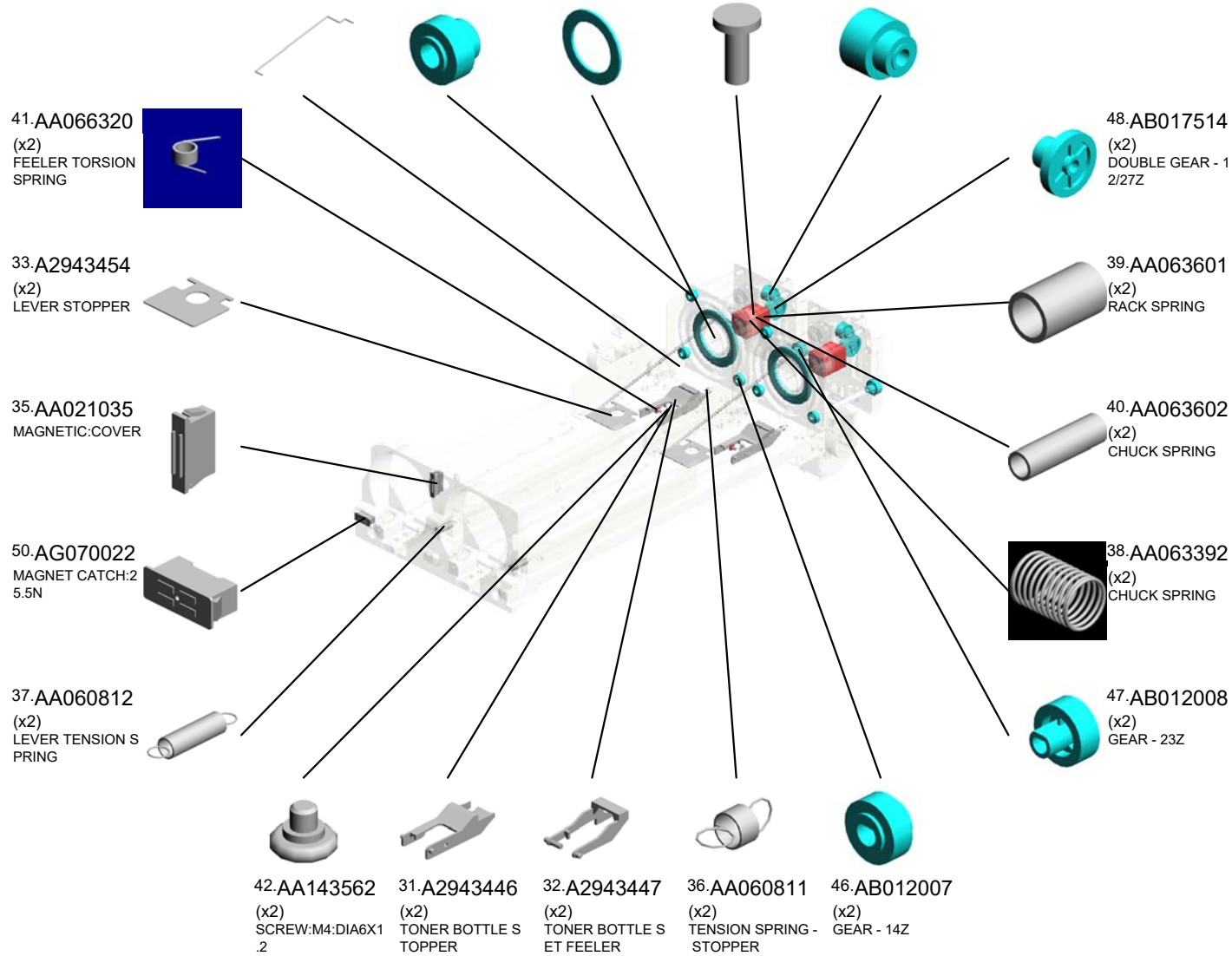
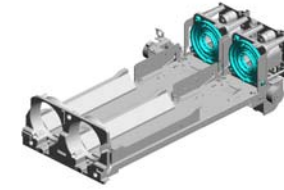

# U007 TONNER SUPPLY

- 54.D0BX3451 (x2) LEVER:TONER BOTTLE:PEEN
- 66.D1793272 SHUTTER:TONER SUPPLY:ASSY
- 67.D1793275 (x2) COIL SPRING:SHUTTER:TONER SUPPLY
- 65.D1793271 CASE:SHUTTER:TONER SUPPLY
- 75.D1793361 (x2) BRACKET:JOINT:REAR:LEVER

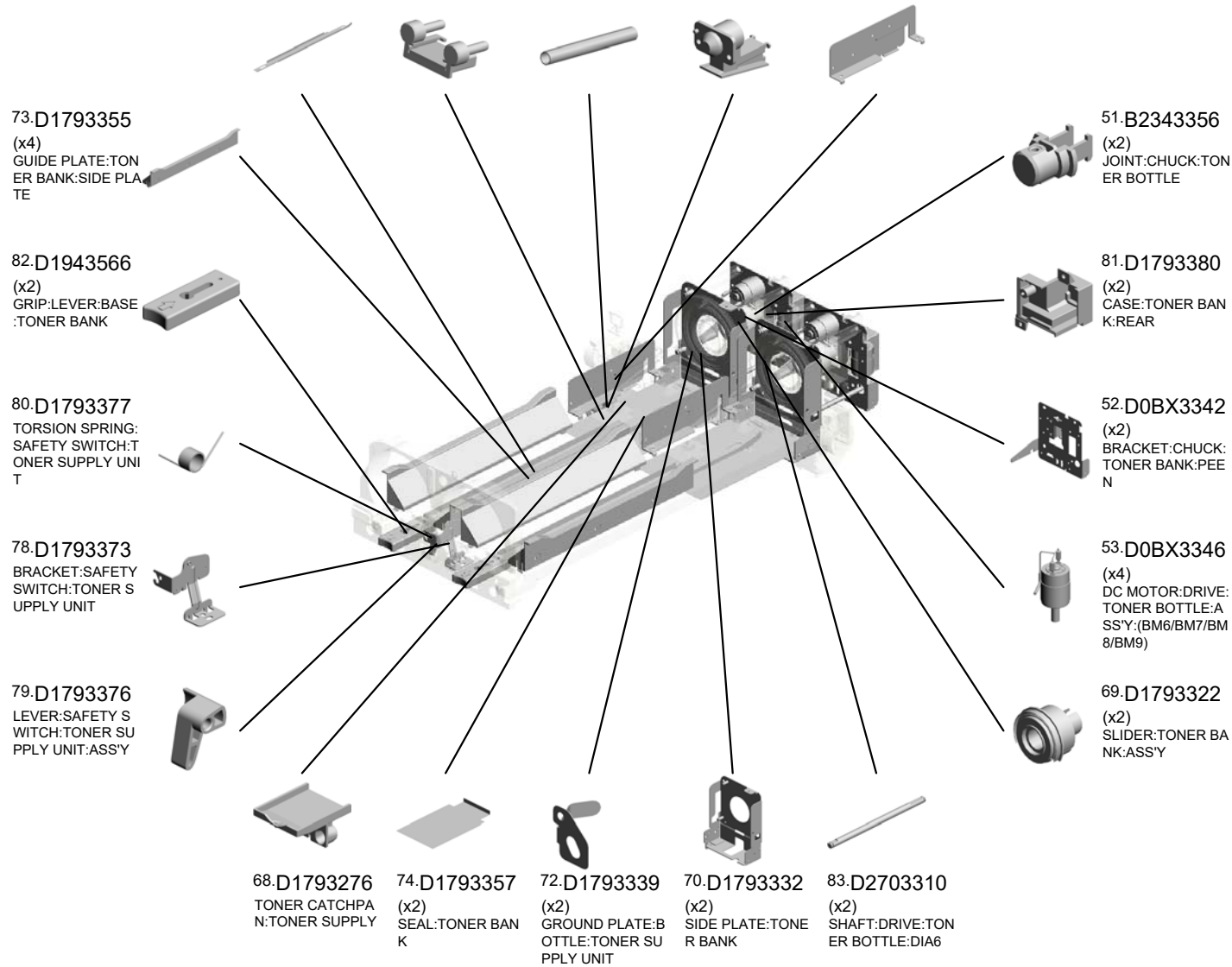
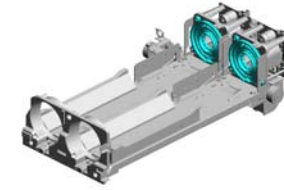



# U007 TONNER SUPPLY

87.D2703383  
(x2)  
SEAL:CASE:TONE  
R BANK:REAR

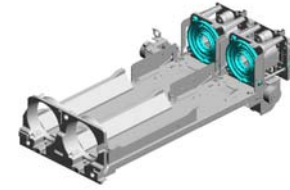

89.GW020024  
(x2)  
PHOTOINTERRUP  
TOR:LG2A24BL1:G  
F:(SEN3/SEN21/SE  
N35/SEN36/SEN37/  
SEN38/SEN39/SEN



86.D2703347  
(x2)  
SEAL:BRACKET:R  
ACK



88.D2703384  
(x2)  
SEAL:CASE:TONE  
R BANK:LEFT

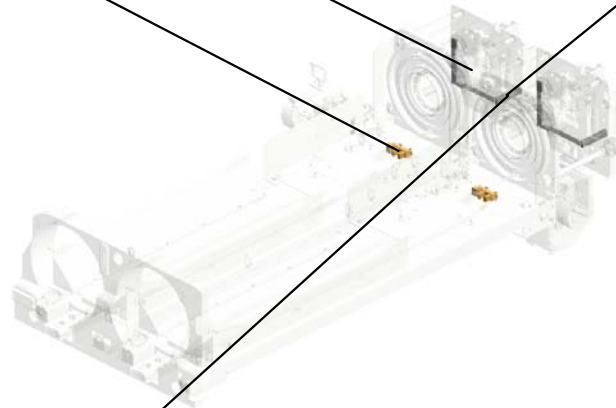

U001	U002	U003	U004	U005	U006	U007	U008	U009	U010	U011	U012	U013	U014	U015	U016	U017	U018	U019	U020	U021
------	------	------	------	------	------	------	------	------	------	------	------	------	------	------	------	------	------	------	------	------

U007\_S001  
CASE:TONER BANK:ASS'Y

85.D2703336 28.A2943319  
SEAL:CASE:TONE CASE CUSHION  
R BANK:FRONT

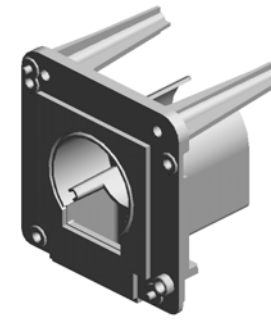

71.D1793334  
CASE:TONER BAN  
K:ASS'Y

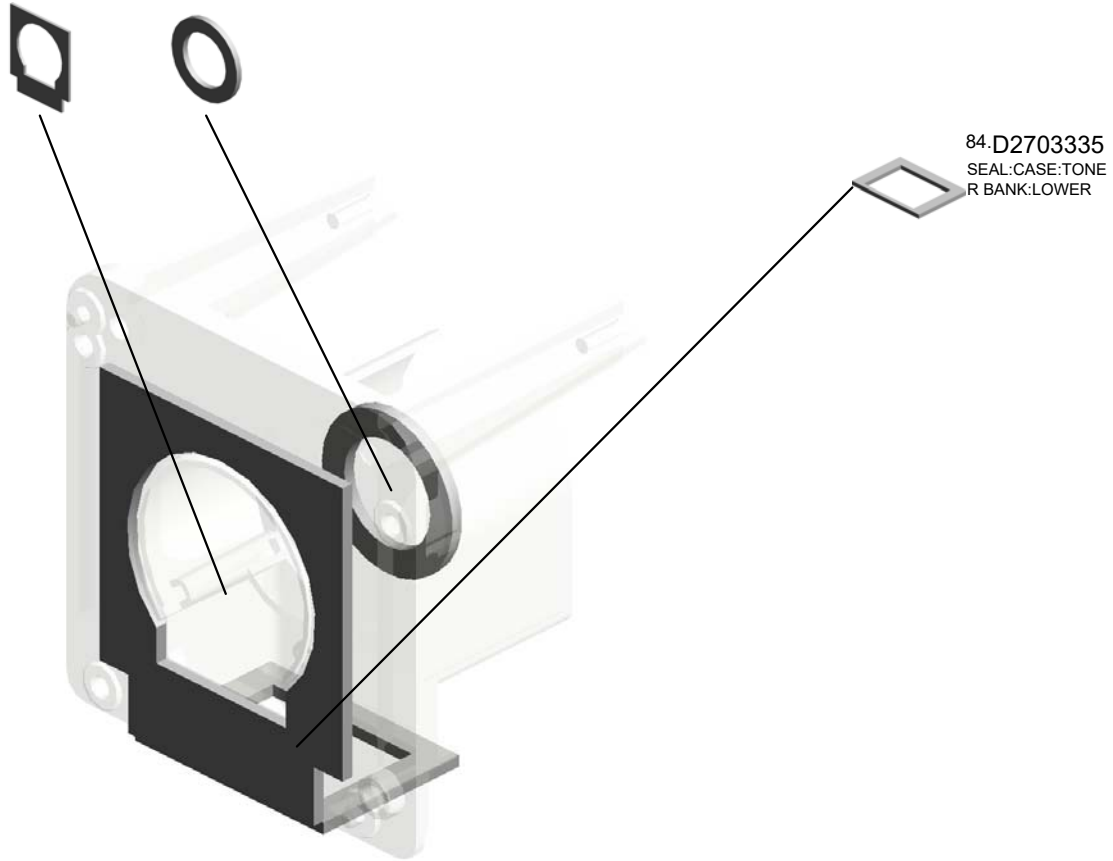

84.D2703335  
SEAL:CASE:TONE  
R BANK:LOWER

U001	U002	U003	U004	U005	U006	U007	U008	U009	U010	U011	U012	U013	U014	U015	U016	U017	U018	U019	U020	U021
------	------	------	------	------	------	------	------	------	------	------	------	------	------	------	------	------	------	------	------	------

U007\_S002  
CASE:TONER BANK:ASS'Y

85.D2703336 28.A2943319  
SEAL:CASE:TONE CASE CUSHION  
R BANK:FRONT

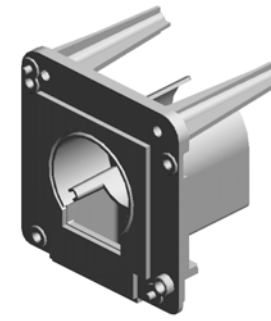

71.D1793334  
CASE:TONER BAN  
K:ASS'Y

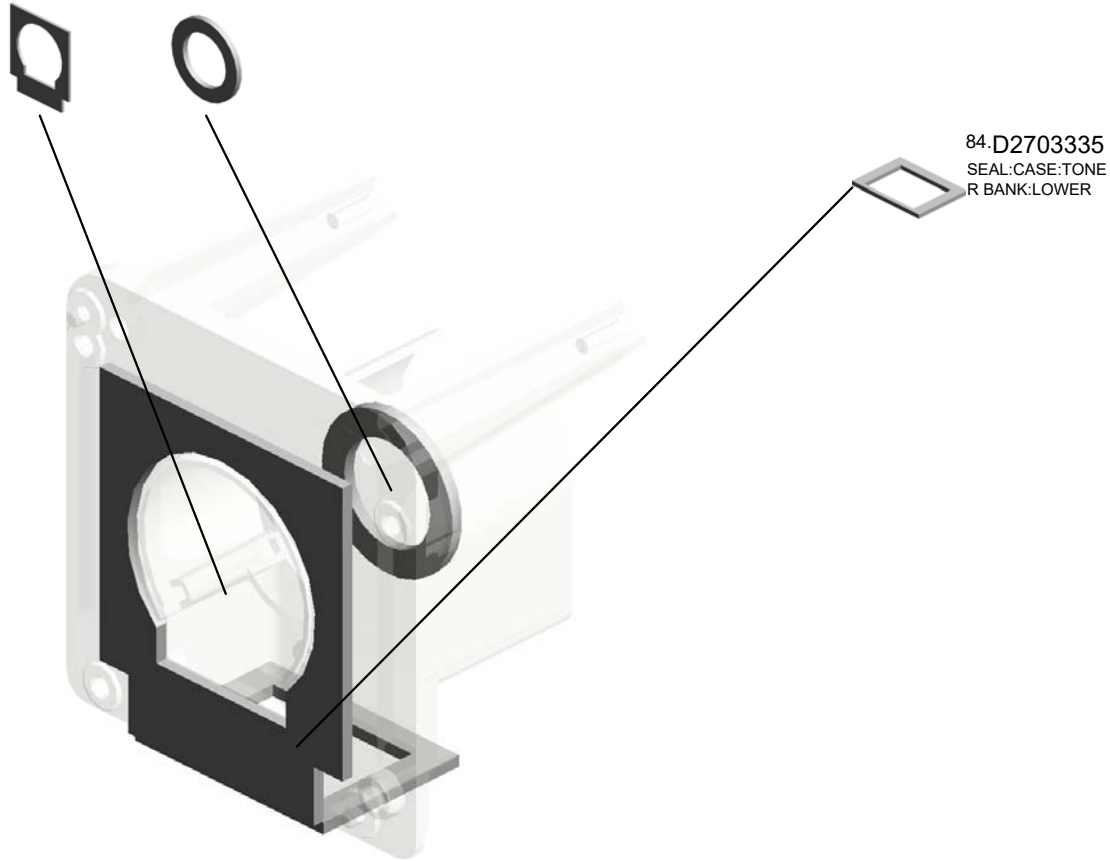

U001	U002	U003	U004	U005	U006	U007	U008	U009	U010	U011	U012	U013	U014	U015	U016	U017	U018	U019	U020	U021
------	------	------	------	------	------	------	------	------	------	------	------	------	------	------	------	------	------	------	------	------

U007\_S003  
INNER COVER:TONER BANK:ASS'Y

76:D1793367  
DECAL:DESIGN SK  
ETCH:TONER BOT  
TLE

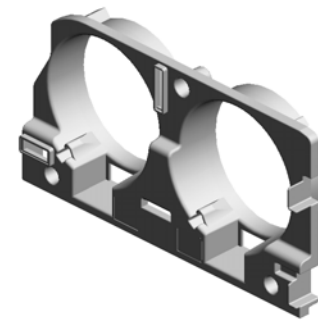
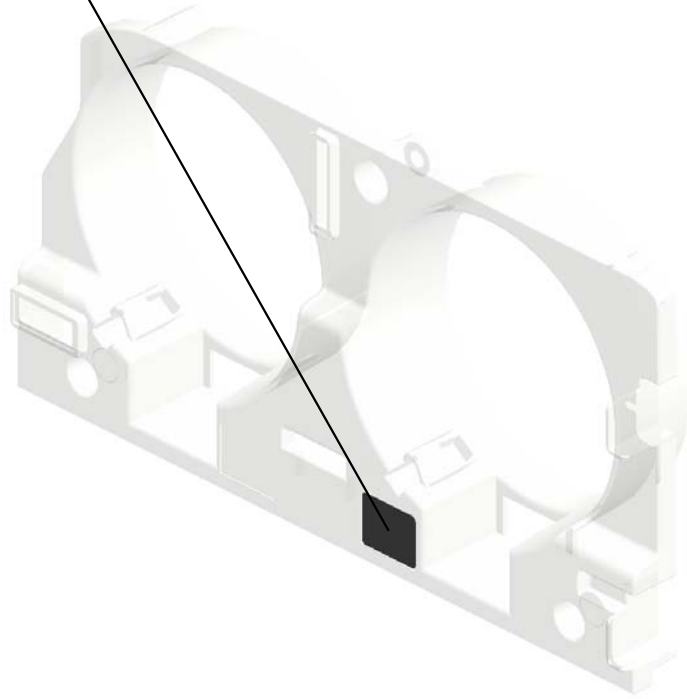

77:D1793370  
INNER COVER:TO  
NER BANK:ASS'Y

U001	U002	U003	U004	U005	U006	U007	U008	U009	U010	U011	U012	U013	U014	U015	U016	U017	U018	U019	U020	U021
------	------	------	------	------	------	------	------	------	------	------	------	------	------	------	------	------	------	------	------	------

U007\_S004

TONER SUPPLY UNIT:TONER HOPPER:ASS'Y

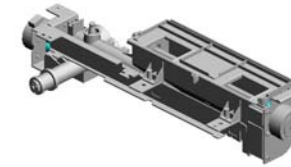

55.D1793201  
TONER SUPPLY UNIT:TONER HOPPER:ASS'Y

2.03530060N (x4) BIND SCREW - M3 X6  
56.D1793234 GEAR:TRANSPORT SCREW:LONG:TONER SUPPLY  
61.D1793254 (x2) GEAR:IDLER:FEED:TONER SUPPLY:2  
59.D1793252 COVER:GEAR:TONER SUPPLY  
26.A2941163 (x2) GEAR - 30Z

91.GX060019 (x2) STEPPER MOTOR:PM42L048RBG8:(STM32/STM33)

60.D1793253 GEAR:IDLER:FEED:TONER SUPPLY:1

64.D1793263 BRACKET:DC STEPPER MOTOR:TONER SUPPLY

8.04513006N (x2) TAPPING SCREW - 3X6

15.08050089 RETAINING RING - M4

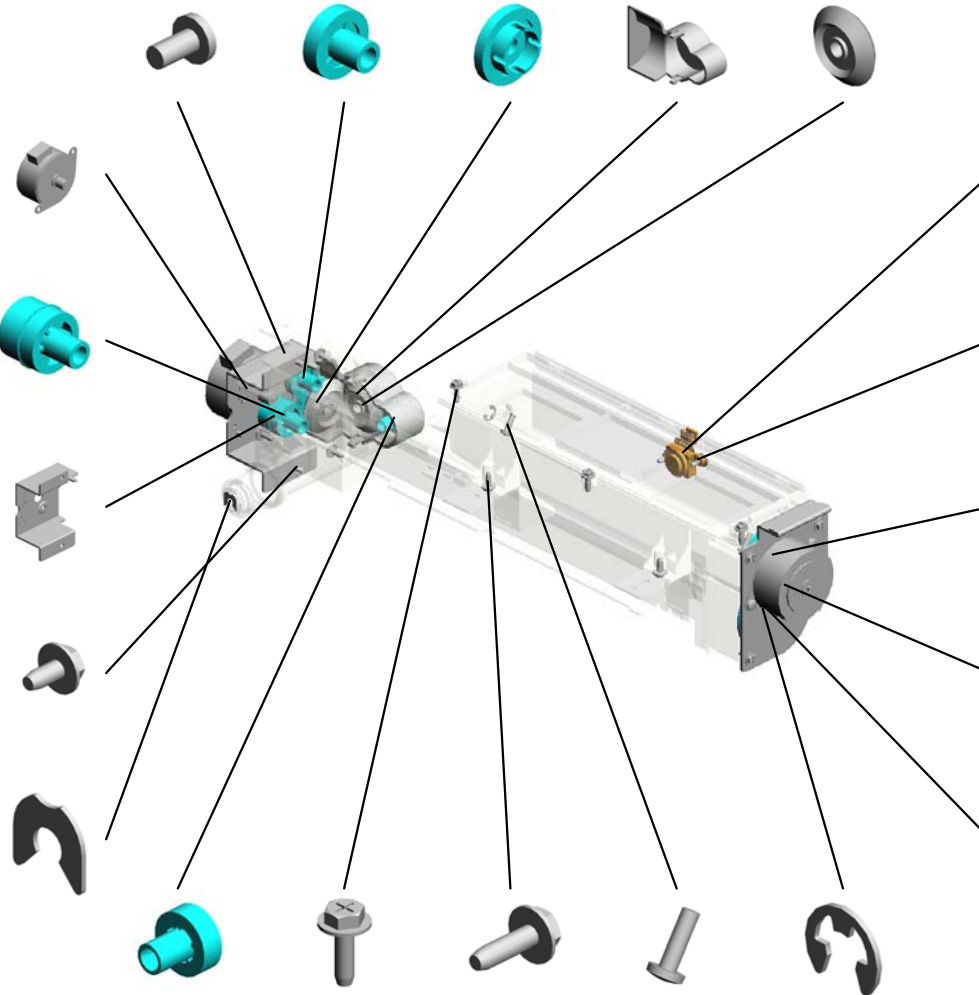

90.GW230008 TONER END SENSOR:(SEN73)

4.04503008N (x2) TAPPING SCREW - M3X8

58.D1793244 GEAR:AGITATOR:TONER SUPPLY

62.D1793256 BRACKET:DC STEPPER MOTOR:AGITATOR:ASS'Y

63.D1793259 GEAR:IDLER:AGITATOR:TONER SUPPLY

57.D1793237 GEAR:TRANSPORT SCREW:SHORT:TONER SUPPLY  
6.04503012N (x3) TAPPING SCREW: 3X12  
5.04503010N (x9) TAPPING SCREW - M3X10  
3.03530100N (x2) SCREW-M3X10  
14.07200040E (x5) RETAINING RING - M4

# U008.PCDU

U008\_S001  
D1792255  
CHARGE CORONA

U008\_S005  
D2702214  
DUCT:CHARGE UNIT:ASS'Y

U008\_S003  
D0BX2432  
SERVICE PARTS:DEVELOPM  
ENT UNIT:ASS'Y

U008\_S004  
D1792239  
SHAFT:CLEANER:CHARGE:D  
RIVE:ASS'Y

U008\_S002  
D1793504  
CLEANING UNIT:ASS'Y

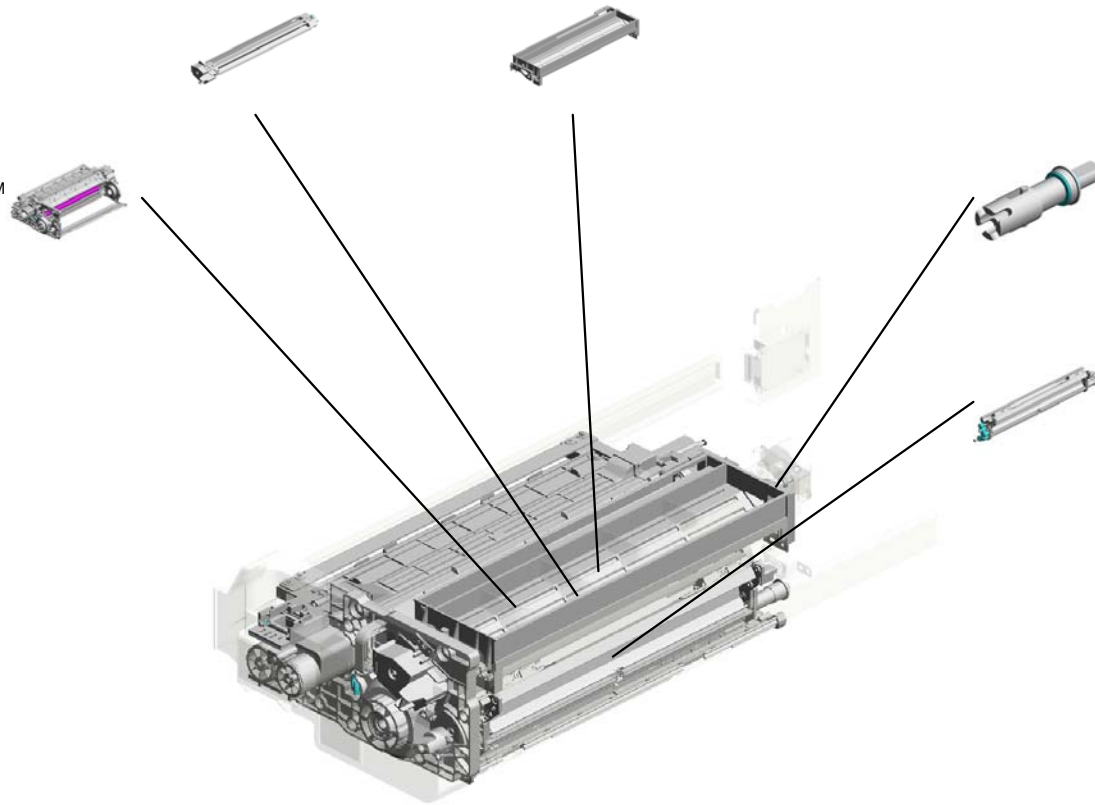

U001	U002	U003	U004	U005	U006	U007	<b>U008</b>	U009	U010	U011	U012	U013	U014	U015	U016	U017	U018	U019	U020	U021
------	------	------	------	------	------	------	-------------	------	------	------	------	------	------	------	------	------	------	------	------	------

# U008\_S001.CHARGE CORONA

U008 S001 S001  
D1792256  
COVER:CHARGE CORONA:A  
SSY



U001	U002	U003	U004	U005	U006	U007	<b>U008</b>	U009	U010	U011	U012	U013	U014	U015	U016	U017	U018	U019	U020	U021
------	------	------	------	------	------	------	-------------	------	------	------	------	------	------	------	------	------	------	------	------	------

# U008\_S002.CLEANING UNIT:ASS'Y

U008 S002 S002  
D1793535  
GEAR SET:CLEANING UNIT:  
SERVICE PARTS

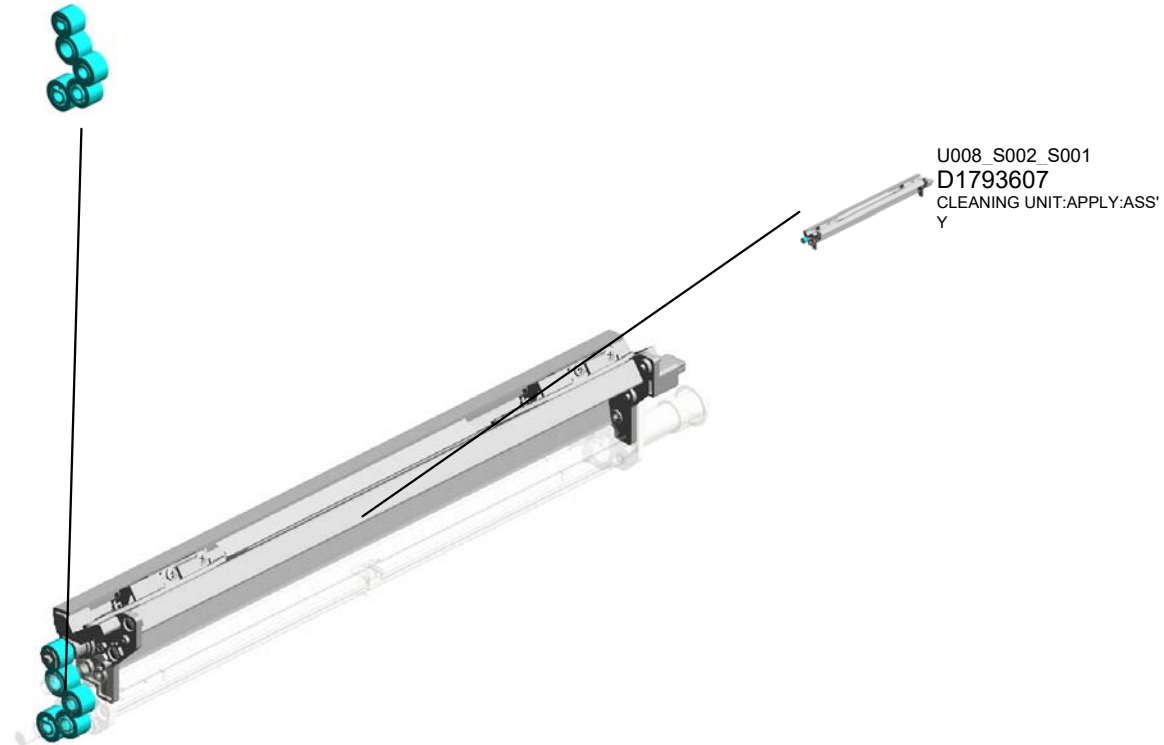

U001	U002	U003	U004	U005	U006	U007	<b>U008</b>	U009	U010	U011	U012	U013	U014	U015	U016	U017	U018	U019	U020	U021
------	------	------	------	------	------	------	-------------	------	------	------	------	------	------	------	------	------	------	------	------	------



# U008\_S002\_S001.CLEANING UNIT:APPLY:ASS'Y

U008 S002 S001 S001  
D1793681  
HOLDER:COVER:COATING B  
AR:ASS'Y:(OT14)



U008\_S002\_S001\_S002  
D1793681  
HOLDER:COVER:COATING B  
AR:ASS'Y:(OT14)

U001	U002	U003	U004	U005	U006	U007	<b>U008</b>	U009	U010	U011	U012	U013	U014	U015	U016	U017	U018	U019	U020	U021
------	------	------	------	------	------	------	-------------	------	------	------	------	------	------	------	------	------	------	------	------	------

U008  
PCDU

- 5.03540120N (x2) SCREW M4X12
- 17.04533006N (x2) TAPPING SCREW - M3X6
- 1.03530060N (x3) BIND SCREW - M3X6
- 52.D1792237 HOLDER:MOTOR:CHARGE
- 36.B7005804 STEPPER MOTOR: DIA42:Z17:ASS'Y:(S TM1)

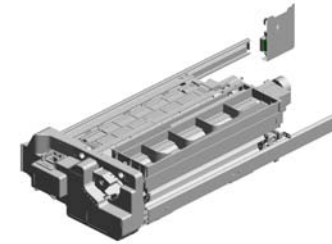

42.D0743829  
DECAL:POSITIONING DISPLAY:TCRU



59.D1792370  
GRIP:DRUM:ASS'Y



33.AW140027  
TEMPERATURE & HUMIDITY SENSOR:(SEN2)



11.04503008N (x10)  
TAPPING SCREW - M3X8



60.D1792376  
HOLDER:DRUM:TAPKE OFF:FRONT



18.04543006Q  
TAPPING SCREW - M3X6

63.D1792412  
HOLDER:SLIDE RAIL:PCU:RIGHT

37.D0592469 (x4)  
SCREW:ROUND POINT:M4X6

62.D1792411 (x2)  
SLIDE RAIL:PCU

61.D1792377  
HOLDER:DRUM:TAPKE OFF:REAR

26.07413706  
BALL BEARING - 6X10X3



53.D1792238  
SOCKET:CHARGE



55.D1792246  
SEAL:DUCT:SIDE PLATE:REAR



15.04514008N (x5)  
TAPPING SCREW: 4X8



41.D0742577  
CONNECTOR:DRUM:DRIVER:4POLE:REC



35.B2342390 (x3)  
FLANGED HEXAGONAL HEAD BOLT: M4X8



37.D0592469 (x2)  
SCREW:ROUND POINT:M4X6

- 1.03530060N(x 1) BIND SCREW - M3X6
- 2.03530080N(x 1) SCREW:M3X8
- 11.04503008N(x 1) TAPPING SCREW - M3X8
- 15.04514008N(x 2) TAPPING SCREW:4X8

U008  
PCDU

- 117.D3724561 SPACER:DIA4
- 143.GW020024 PHOTOINTERRUPTOR:LG2A24BL1:GF:(SEN3/SEN21/SEN35/SEN36/SEN37/SEN38/SEN39/SEN40/SEN41/SEN42/S
- 64.D1792416 STAY:ELECTRIC POTENTIAL SENSOR
- 65.D1792417 HOLDER:ELECTRIC POTENTIAL SENSOR
- 67.D1792421 ELECTRIC POTENTIAL SENSOR:(SEN5)

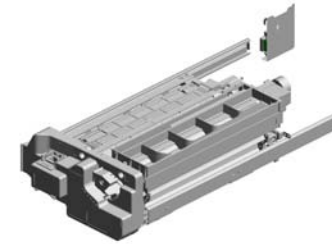

116.D2703136  
DECAL:DEVELOPMENT UNIT:CAUTION



110.D2701568  
(x3)  
DECAL:POSITIONING DISPLAY:TCRU:ABS



115.D2703134  
DECAL:WARNING: AROUND THE PHOTOCONDUCTOR:ABS



71.D1792469  
KNOB SCREW:DRUM

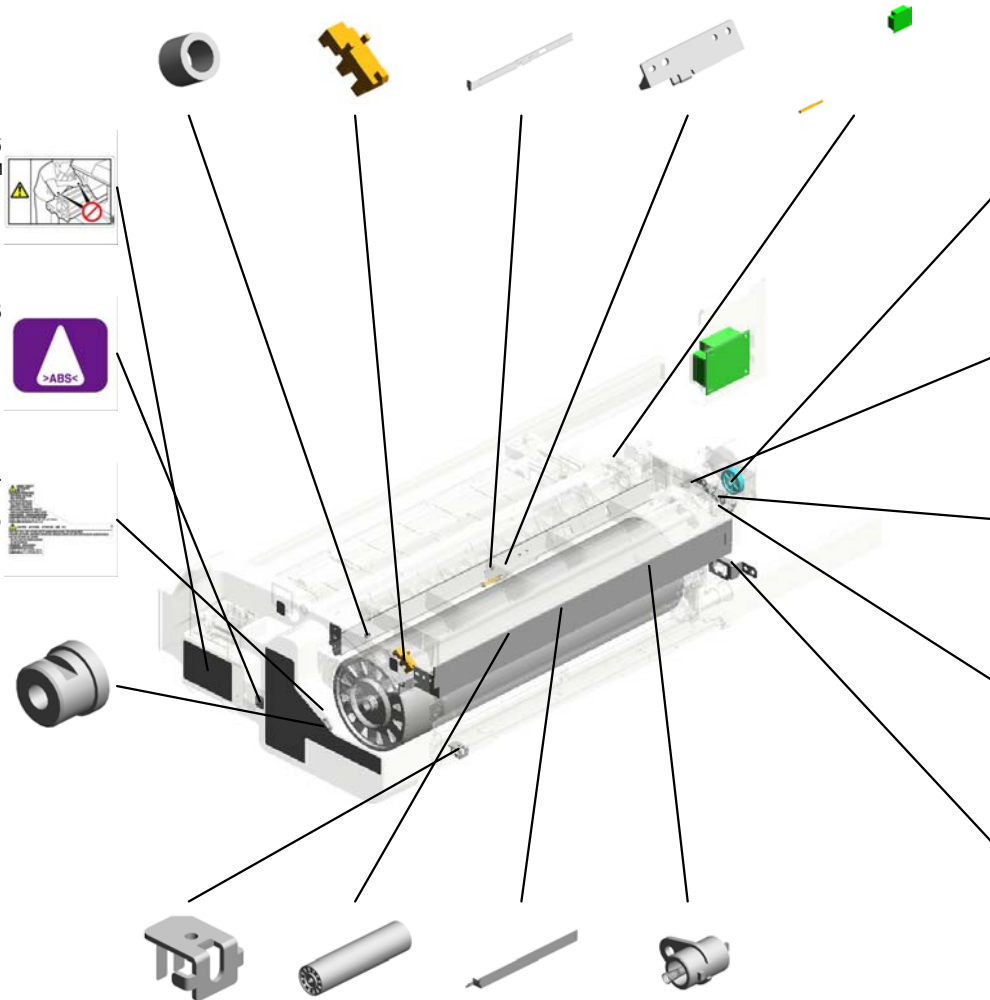

118.G1781282  
GEAR:CHARGE:CL EANER:Z51



120.G1781313  
SPRING:PLATE:RIGHT:CHARGE



119.G1781311  
(x3)  
TERMINAL:CHARGE



121.G1781316  
SPRING:PLATE:LEFT:CHARGE



68.D1792427  
BRACKET:DRAWER:CLEANING UNIT



66.D1792419  
STOPPER:SLIDE RAIL:PCU:PEEN



109.D1799510  
OPC DRUM



112.D2702247  
DUCT:SIDE PLATE



83.D1793131  
RECEPTACLE:DEVELOPMENT VIAS:ASSY



U008\_S001  
CHARGE CORONA

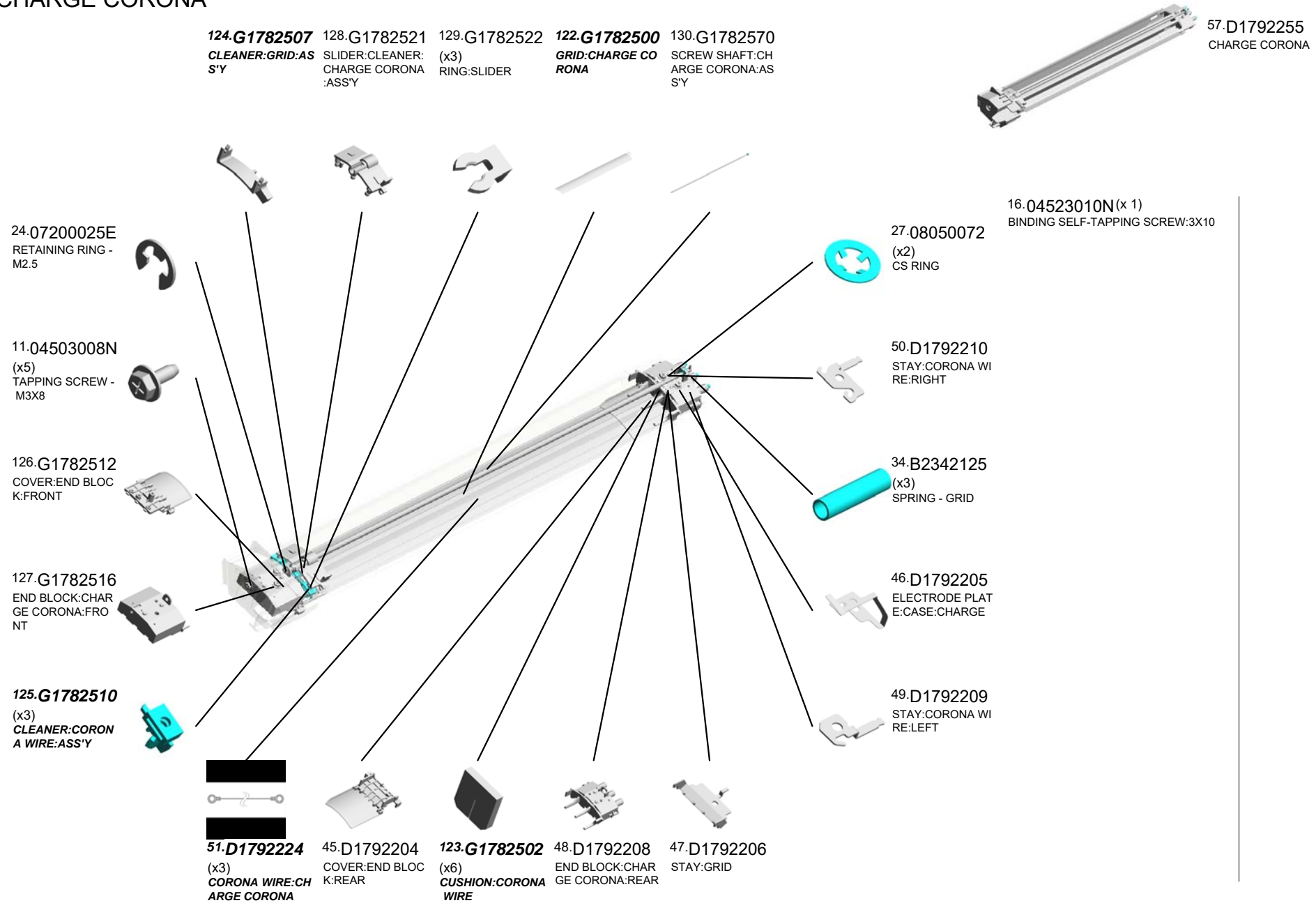

U008\_S001  
CHARGE CORONA

131.G1782605  
(x3)  
TENSION SPRING:  
CORONA WIRE

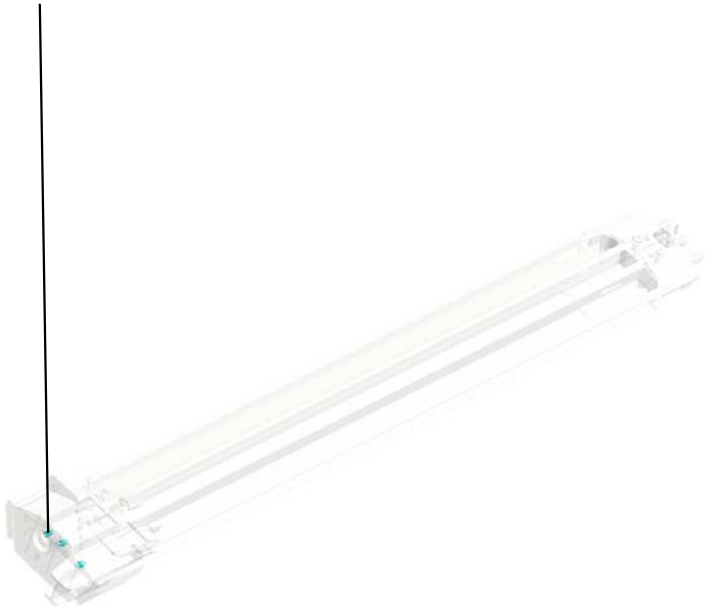

57.D1792255  
CHARGE CORONA

U001	U002	U003	U004	U005	U006	U007	<b>U008</b>	U009	U010	U011	U012	U013	U014	U015	U016	U017	U018	U019	U020	U021
------	------	------	------	------	------	------	-------------	------	------	------	------	------	------	------	------	------	------	------	------	------

U008\_S001\_S001  
COVER:CHARGE CORONA:ASS'Y

56.D1792254  
DECAL:CHARGE:G  
RIP

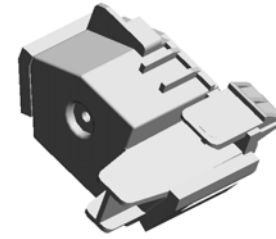
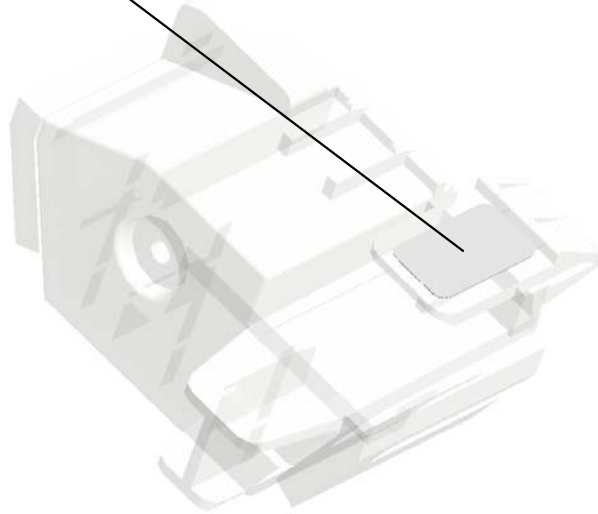

58.D1792256  
COVER:CHARGE C  
ORONA:ASS'Y

U001	U002	U003	U004	U005	U006	U007	<b>U008</b>	U009	U010	U011	U012	U013	U014	U015	U016	U017	U018	U019	U020	U021
------	------	------	------	------	------	------	-------------	------	------	------	------	------	------	------	------	------	------	------	------	------

U008\_S002  
CLEANING UNIT:ASS'Y

92.D1793561  
SHAFT:CLEANING  
BLADE:FRONT

96.D1793581  
BLADE:CLEANING:  
ASS'Y

94.D1793571  
BRACKET:CLEANING  
BLADE:ASS'Y

85.D1793525  
TONER COLLECTI  
ON COIL:CLEANIN  
G:ASSY



84.D1793504  
CLEANING UNIT:ASS'Y

97.D1793589  
RETAINING RINGS  
-E:GUIDE

25.07200040E  
RETAINING RING -  
M4

28.08050089  
(x2)  
RETAINING RING -  
M4

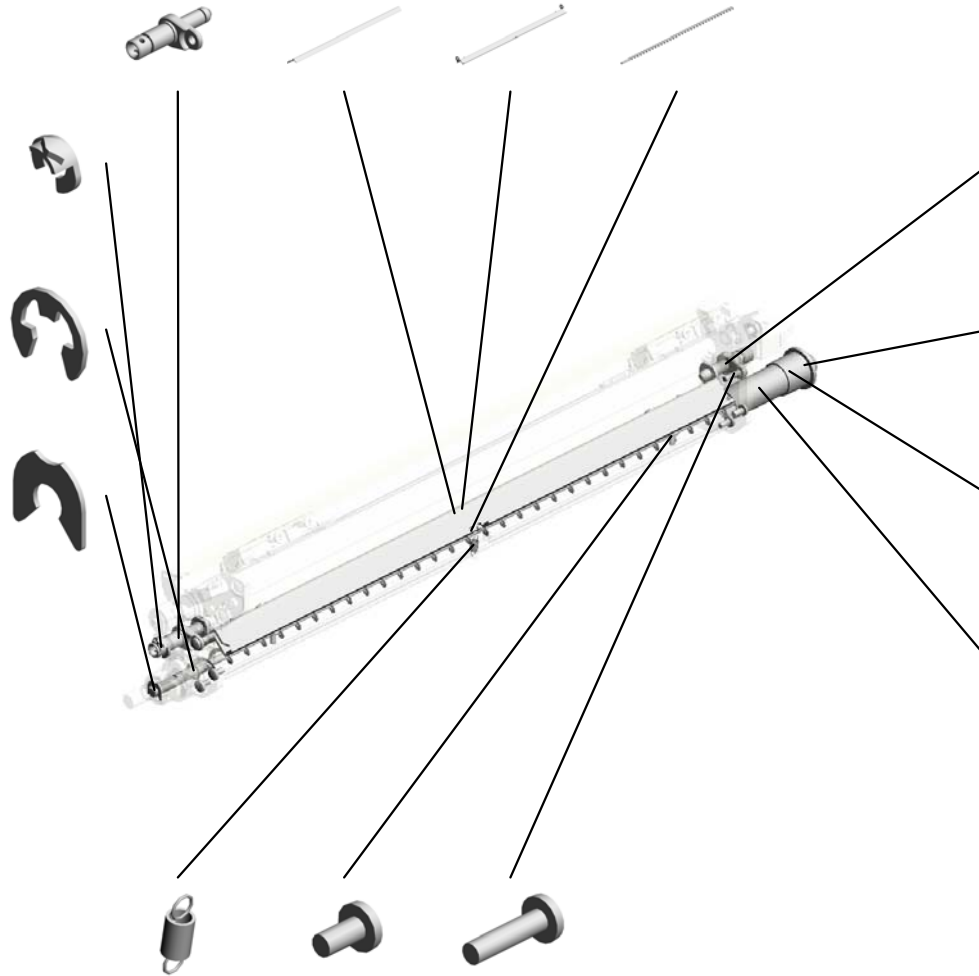

137.G1783685  
HOLDER:SHAFT:CLEANING  
BLADE:REAR

136.G1783672  
CAP:PIPE:DISCHARGE  
USED TONER

86.D1793531  
TONER CATCHPAN:  
PIPE:DISCHARGE  
USED TONER

87.D1793532  
COIL SPRING:TONER  
CATCHPAN

95.D1793576  
TENSION SPRING:  
CLEANING BLADE:  
6N

1.03530060N  
(x8)  
BIND SCREW - M3  
X6

4.03530120N  
(x2)  
SCREW M3X12

U008\_S002\_S001  
CLEANING UNIT:APPLY:ASS'Y

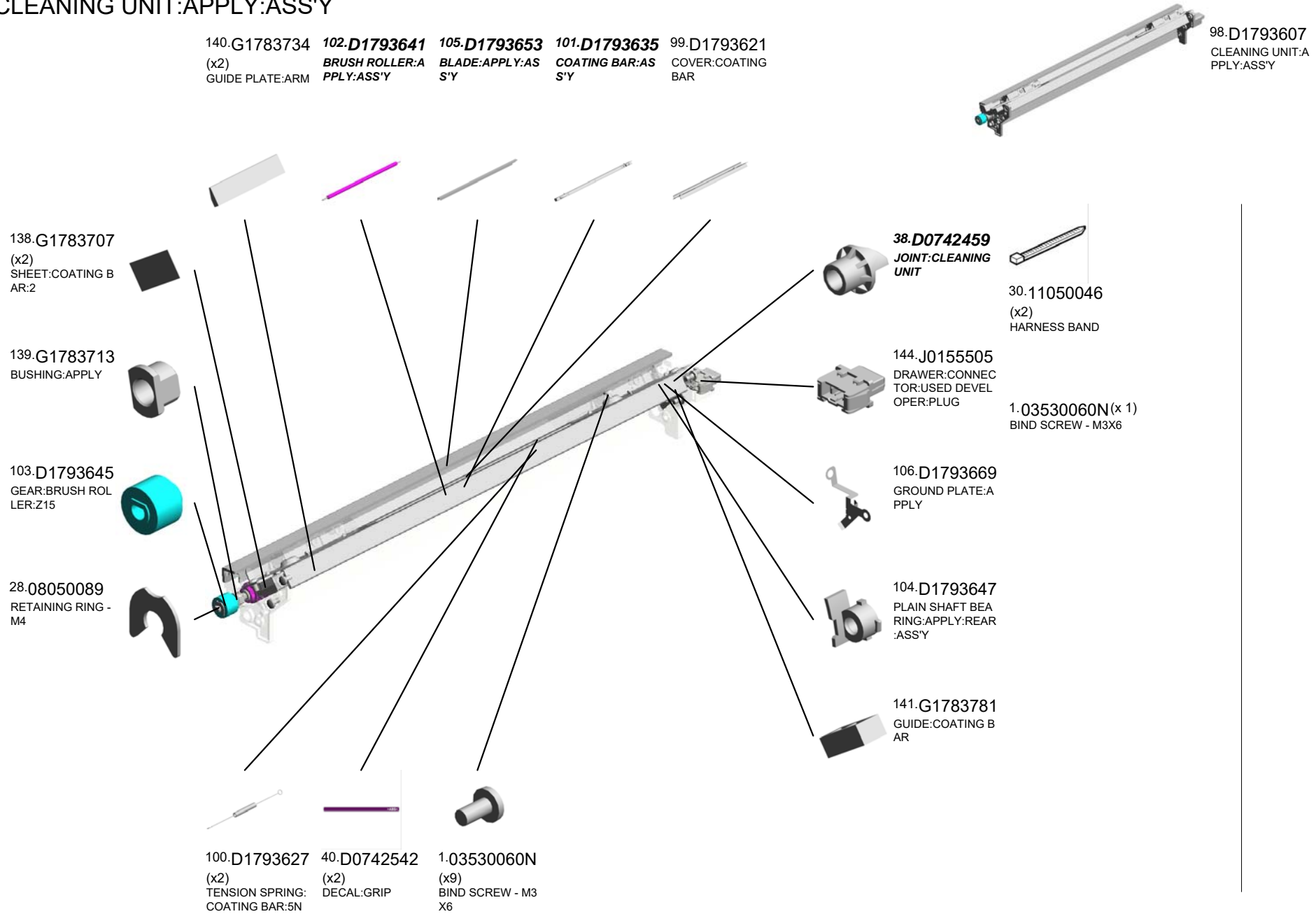

U001	U002	U003	U004	U005	U006	U007	U008	U009	U010	U011	U012	U013	U014	U015	U016	U017	U018	U019	U020	U021
------	------	------	------	------	------	------	------	------	------	------	------	------	------	------	------	------	------	------	------	------



U008\_S002\_S001\_S001  
HOLDER:COVER:COATING BAR:ASS'Y:(OT14)

108.D1793689  
GROUND PLATE:C  
OVER:APPLY

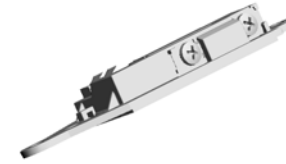

107.D1793681  
HOLDER:COVER:C  
OATING BAR:ASS'  
Y:(OT14)

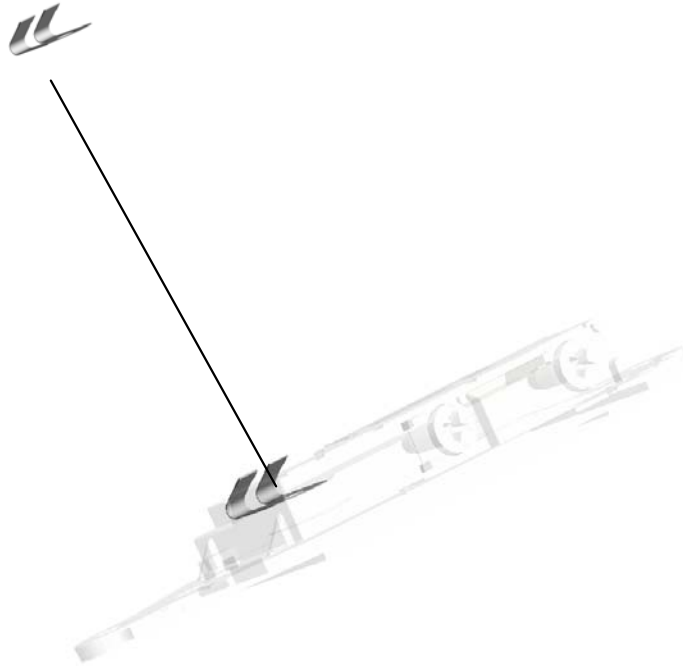

U001	U002	U003	U004	U005	U006	U007	<b>U008</b>	U009	U010	U011	U012	U013	U014	U015	U016	U017	U018	U019	U020	U021
------	------	------	------	------	------	------	-------------	------	------	------	------	------	------	------	------	------	------	------	------	------

U008\_S002\_S001\_S002  
HOLDER:COVER:COATING BAR:ASS'Y:(OT14)

108.D1793689  
GROUND PLATE:C  
OVER:APPLY

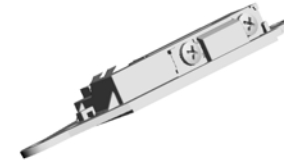

107.D1793681  
HOLDER:COVER:C  
OATING BAR:ASS'  
Y:(OT14)

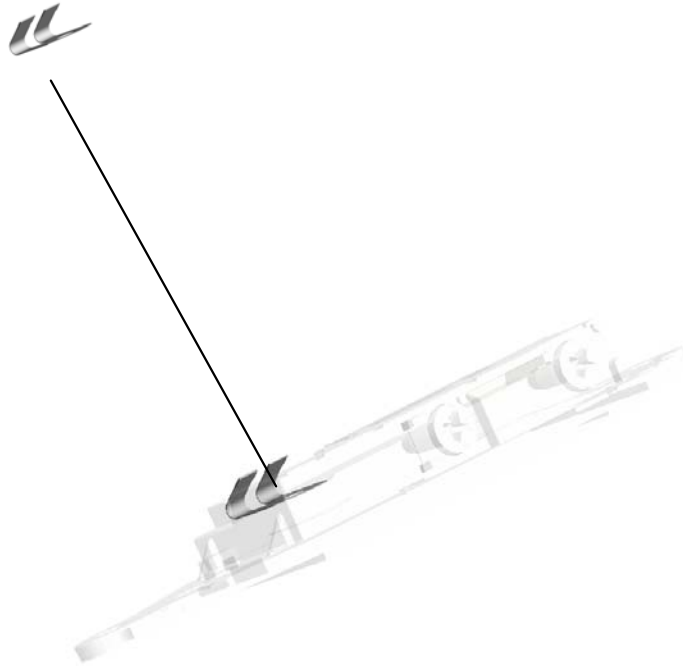

U001	U002	U003	U004	U005	U006	U007	<b>U008</b>	U009	U010	U011	U012	U013	U014	U015	U016	U017	U018	U019	U020	U021
------	------	------	------	------	------	------	-------------	------	------	------	------	------	------	------	------	------	------	------	------	------

GEAR SET:CLEANING UNIT:SERVICE PARTS

103.D1793645 93.D1793564  
GEAR:BRUSH ROLLER:Z15 GEAR:IDLER:Z17:UPPER



**88.D1793535**  
GEAR SET:CLEANING UNIT:SERVICE PARTS

89.D1793536  
GEAR:IDLER:Z16

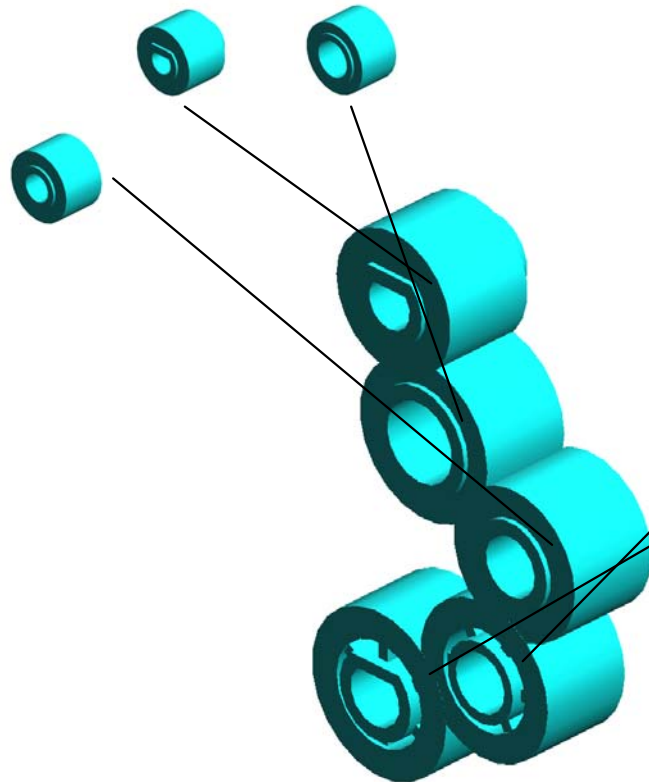

90.D1793537  
GEAR:IDLER:Z17:LOWER

91.D1793538  
GEAR:TONER COLLECTION COIL:Z18

- 14.04504025N (x8) TAPPING SCREW: 4X25
- 13.04504012N (x12) TAPPING SCREW: 4X12
- 8.03603010N (x4) SCREW:M3X10
- 32.11050534 (x4) CLAMP
- 4.03530120N (x2) SCREW M3X12

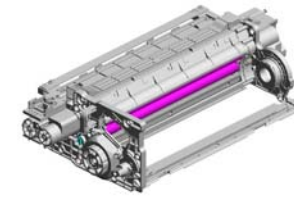

43.D0BX2432  
SERVICE PARTS:DEVELOPMENT UNIT:ASS'Y

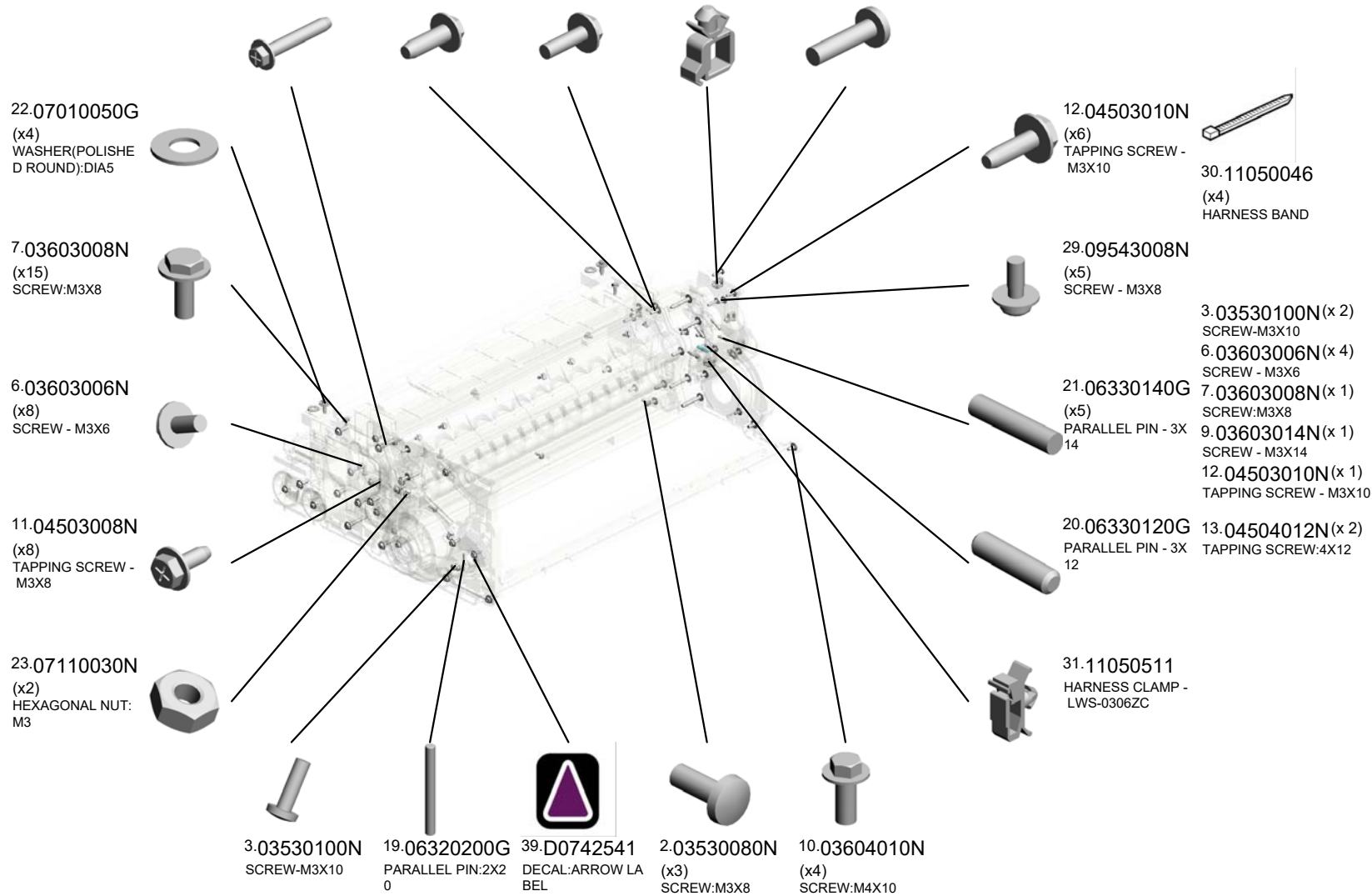

- 80.D1793075 FILTER:DEVELOPMENT
- 77.D1793072 GEAR:TRANSPORT SCREW:NO.3
- 82.D1793090 PLATE:GEAR:IDLER:ASS'Y
- 114.D2703097 COVER:GEAR:DEVELOPMENT
- 78.D1793073 GEAR:IDLER:TRANSPORT SCREW:UPPER:ASS'Y

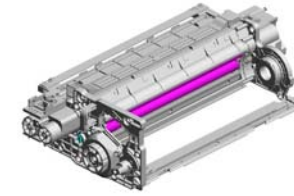

43.D0BX2432  
SERVICE PARTS:DEVELOPMENT UNIT:ASS'Y

74.D1793043  
DUCT:FILTER:DEVELOPMENT:ASS'Y

81.D1793084  
ENTRANCE SEAL:DEVELOPMENT:ASS'Y

113.D2703079  
SERVICE PARTS:DENSITY SENSOR:DEVELOPMENT:(SEN1)

70.D1792468  
GRIP:DRUM STAY:PCU

69.D1792467  
LEVER:POSITIONING:CLEANING

72.D1792474  
DECAL:DIAL

73.D1792494  
GROUND PLATE:STAY:PCU

42.D0743829  
DECAL:POSITIONING DISPLAY:TCRU

44.D0BX2485  
LED ARRAY:ASS'Y:(OT1)

133.G1783332  
(x2)  
GEAR:DEVELOPMENT ROLLER

75.D1793070  
GEAR:TRANSPORT SCREW:NO.1

79.D1793074  
GEAR:IDLER:TRANSPORT SCREW:LOWER:ASS'Y

134.G1783356  
(x2)  
GEAR:JOINT:DEVELOPMENT UNIT

76.D1793071  
GEAR:TRANSPORT SCREW:NO.2

132.G1783330  
GEAR:IDLER:DEVELOPMENT ROLLER:ASS'Y

U008\_S003  
SERVICE PARTS:DEVELOPMENT UNIT:ASS'Y

135.G1783475  
SPONGE:COUPLIN  
G:TONER SUPPLY:  
DEVELOPMENT U  
NIT

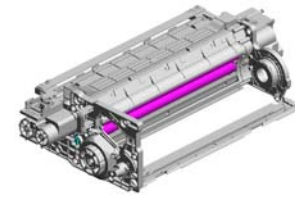

43.D0BX2432  
SERVICE PARTS:D  
EVELOPMENT UNI  
T:ASS'Y

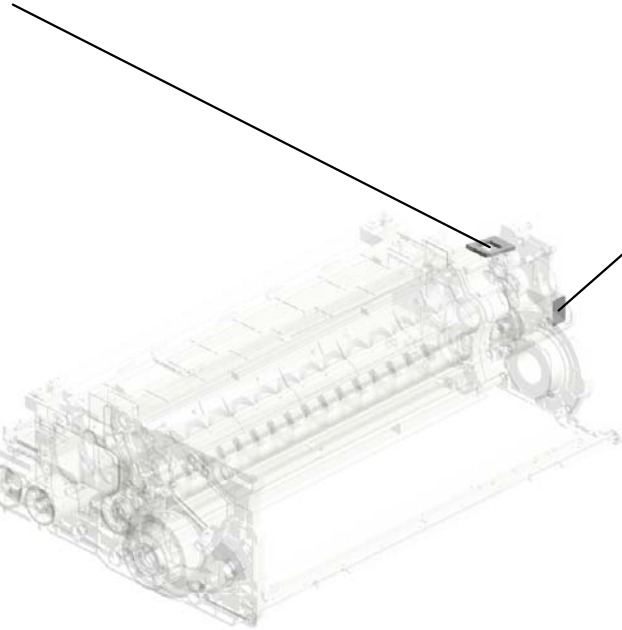

142.GA000063  
DECAL:DEVELOPM  
ENT UNIT:DISPLAY

U001	U002	U003	U004	U005	U006	U007	U008	U009	U010	U011	U012	U013	U014	U015	U016	U017	U018	U019	U020	U021
------	------	------	------	------	------	------	------	------	------	------	------	------	------	------	------	------	------	------	------	------

U008\_S004  
SHAFT:CLEANER:CHARGE:DRIVE:ASS'Y

26.07413706  
BALL BEARING - 6  
X10X3

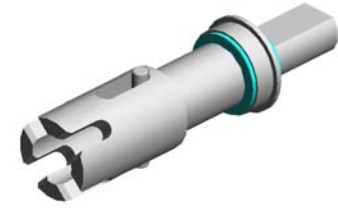

54.D1792239  
SHAFT:CLEANER:  
CHARGE:DRIVE:A  
SS'Y



25.07200040E  
RETAINING RING -  
M4



U001	U002	U003	U004	U005	U006	U007	<b>U008</b>	U009	U010	U011	U012	U013	U014	U015	U016	U017	U018	U019	U020	U021
------	------	------	------	------	------	------	-------------	------	------	------	------	------	------	------	------	------	------	------	------	------

U008\_S005  
DUCT:CHARGE UNIT:ASS'Y

31.11050511  
HARNESS CLAMP -  
LWS-03062C



111.D2702214  
DUCT:CHARGE UN  
IT:ASS'Y

U001	U002	U003	U004	U005	U006	U007	<b>U008</b>	U009	U010	U011	U012	U013	U014	U015	U016	U017	U018	U019	U020	U021
------	------	------	------	------	------	------	-------------	------	------	------	------	------	------	------	------	------	------	------	------	------



# U009.ITB UNIT

U009 S001  
D0BX6000  
TRANSFER UNIT:INTERMEDI  
ATE TRANSFER:ASSY

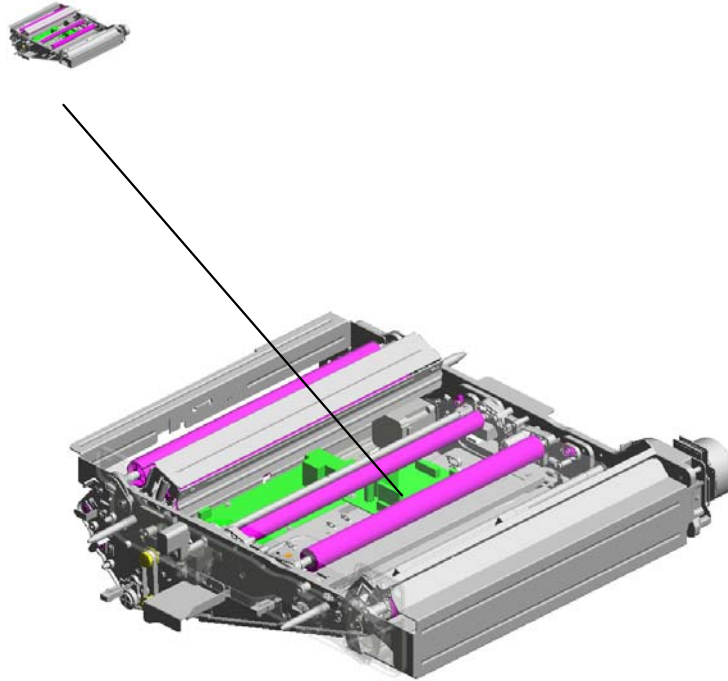

U001	U002	U003	U004	U005	U006	U007	U008	U009	U010	U011	U012	U013	U014	U015	U016	U017	U018	U019	U020	U021
------	------	------	------	------	------	------	------	------	------	------	------	------	------	------	------	------	------	------	------	------

U009  
ITB UNIT

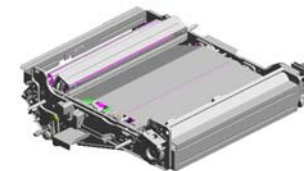

2.03603006N (x6) SCREW - M3X6  
 61.D0747118 DUCT:INNER BACK :COOLING:POSITIONING SENSOR  
 85.D1796050 FLAT BELT-TRANSFER  
 49.D0744351 (x4) STEPPED SCREW: DIA5.4DIA:DIA3.5:MM3

6.03604008N (x7) SCREW - M4X8

126.D2706176 INNER COVER:INTERMEDIATE TRANSFER:LEVER

125.D2706166 DRUM STAY:INTERMEDIATE TRANSFER:ASSY

41.B7125605 GRIP:APPLICATION

4.03603020N (x2) SCREW:M3X20

62.D0747119 DUCT:FRONT:COOLING:POSITIONING SENSOR

39.AX640330 FAN:SIROCCO:DIA51:(FAN26/FAN27)

21.11050511 (x3) HARNESS CLAMP - LWS-0306ZC

30.AA063463 (x4) COMPRESSION SPRING:DRAWER

113.D1796173 SEAL:DUCT:DENSITY SENSOR

60.D0747087 SEAL:DC FAN MOTOR:SIROCCO

63.D0747120 BRACKET:DUCT:COOLING:POSITIONING SENSOR

U009\_S001  
TRANSFER UNIT:INTERMEDIATE TRANSFER:ASS'Y

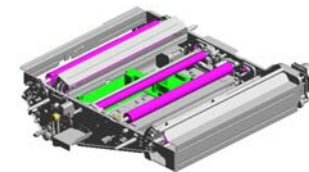

65.D0BX6000  
TRANSFER UNIT:INTERMEDIATE TRANSFER:ASS'Y

- 17.09544008N (x7) SCREW - M4X8
- 7.04503008N (x4) TAPPING SCREW - M3X8
- 13.07200080E (x4) RETAINING RING - M8
- 9.04543006Q (x6) TAPPING SCREW - M3X6
- 10.07200030E RETAINING RING - M3

16.08053573 (x4) RADIAL BALL BEARING: DIA8X DIA16X5

21.11050511 (x59) HARNESS CLAMP - LWS-0306ZC

11.07200040E (x11) RETAINING RING - M4

25.A2324666 CUSHION - STEPPER MOTOR

1.03603005N (x8) SCREW - M3X5

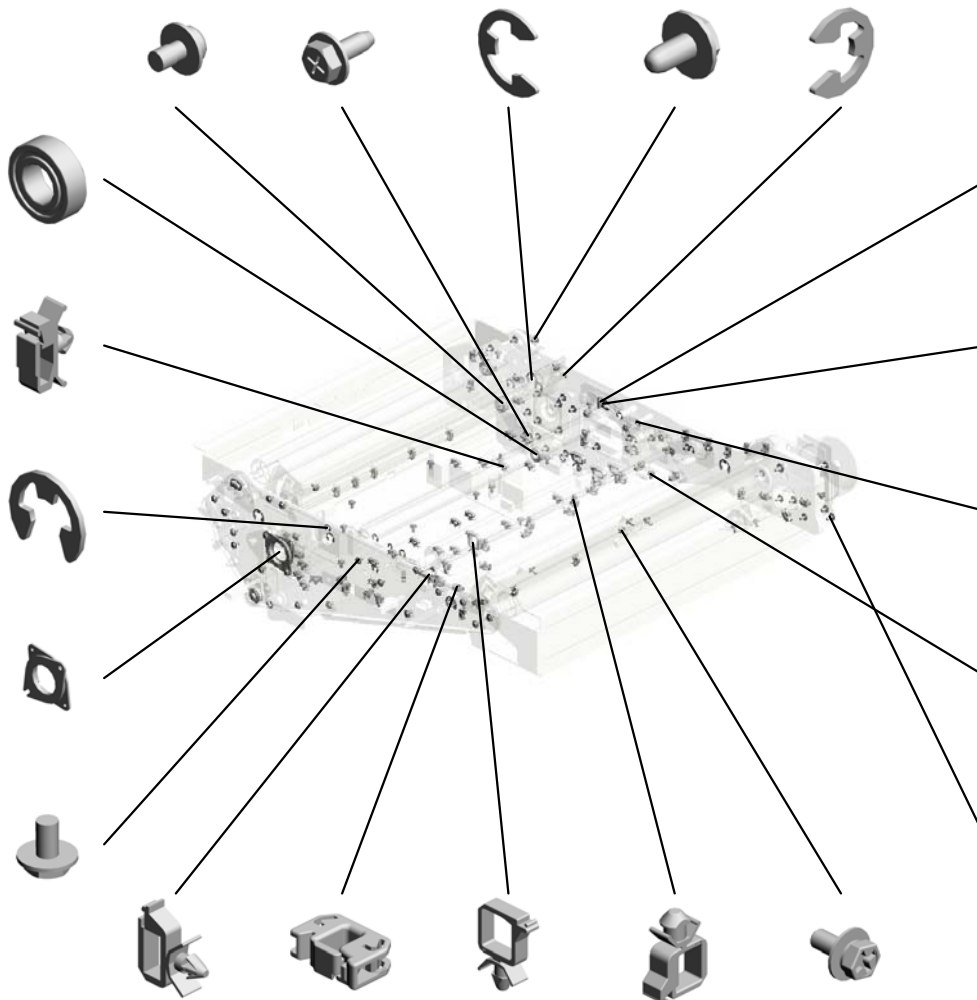

- 19.11050487 (x4) HARNESS CLAMP
- 23.11050692 (x2) CLAMP:LES-0503
- 20.11050488 HARNESS CLAMP
- 22.11050534 (x7) CLAMP
- 14.08046123 (x2) HEXAGONAL BOLT:W/WASHER:M3X8

12.07200060E (x4) RETAINING RING - M6

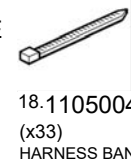

24.52152621 SNAP RING - M6

- 3.03603008N (x 2) SCREW:M3X8
- 5.03604006N (x 4) SCREW - M4X6
- 15.08050100 (x2) RETAINING RING - M2.5
- 8.04503012N (x 2) TAPPING SCREW:3X12
- 9.04543006Q (x 2) TAPPING SCREW - M3X6
- 10.07200030E (x 1) RETAINING RING - M3

2.03603006N (x63) SCREW - M3X6

3.03603008N (x2) SCREW:M3X8

# U009\_S001 TRANSFER UNIT:INTERMEDIATE TRANSFER:ASS'Y

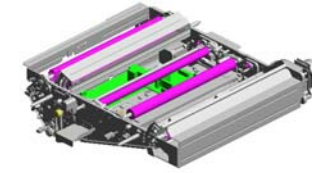

65.D0BX6000  
TRANSFER UNIT:INTERMEDIATE TRANSFER:ASS'Y

- 36.AW500045 PUSH SWITCH:(SW2/SW3/SW13/SW14)
- 28.AA061068 TENSION SPRING:BRACKET:DRIVEN ROLLER:INNER BACK
- 47.D0743878 HOLDER:RADIAL BALL BEARING:DRIVEN ROLLER:INNER BACK
- 34.AB032072 (x2) PULLEY:DRIVEN:WIRE
- 46.D0743872 PULLEY:DRIVE WIRE:ASS'Y

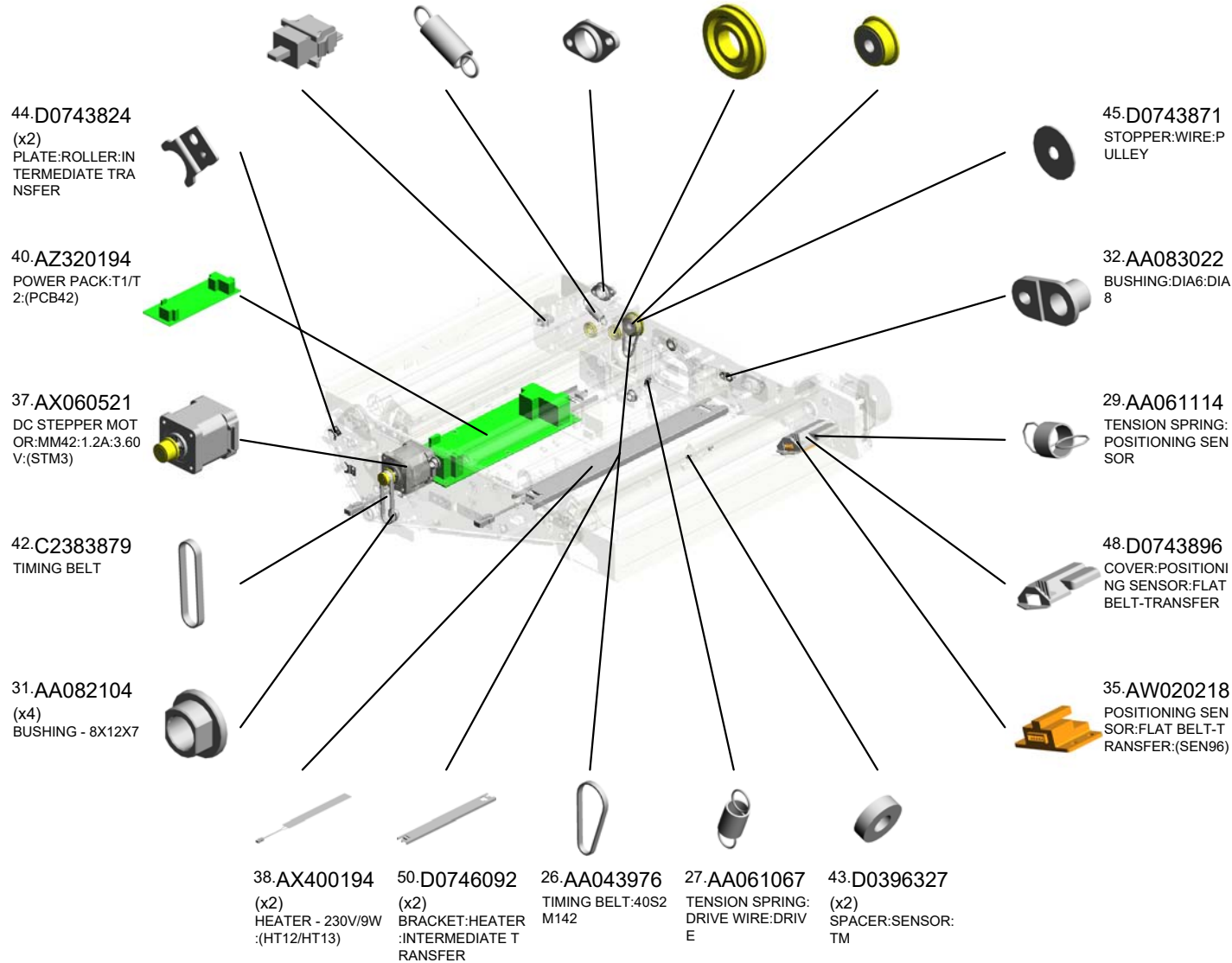

U001	U002	U003	U004	U005	U006	U007	U008	U009	U010	U011	U012	U013	U014	U015	U016	U017	U018	U019	U020	U021
------	------	------	------	------	------	------	------	------	------	------	------	------	------	------	------	------	------	------	------	------

TRANSFER UNIT:INTERMEDIATE TRANSFER:ASS'Y

68.D0BX6078  
ROLLER:OPPOSED  
:PAPER:ASS'Y

75.D0BX6189  
DC STEPPER MOT  
OR:MM42:1.3A:4.42  
V:PULLEY:(STM2)

71.D0BX6155  
CASE:OPPOSED:T  
RANSFER ROLLER  
:REAR

73.D0BX6163  
SPRING PLATE:TR  
ANSFER:OPPOSE  
D:PAPER

74.D0BX6185  
BRACKET:MOTOR:  
POSITIONING CON  
TROL:DRIVEN ROL  
LER

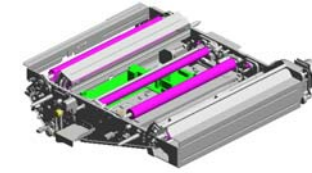

65.D0BX6000  
TRANSFER UNIT:I  
NTERMEDIATE TR  
ANSFER:ASS'Y

51.D0746097  
THERMOSTAT:INT  
ERMEDIATE TRAN  
SFER:(TS4)

53.D0746144  
BRACKET:INTERM  
EDIATE TRANSFE  
R:FRONT

70.D0BX6154  
CASE:OPPOSED:T  
RANSFER ROLLER  
:FRONT

72.D0BX6158  
COVER:CASE:TRA  
NSFER ROLLER:O  
PPOSED:FRONT

69.D0BX6087  
DECAL:TRANSFER  
:WARNING (REMO  
VAL AND INSTALL  
ATION)



52.D0746134  
PLAIN SHAFT BEA  
RING:INSULATE

66.D0BX6010  
SIDE PLATE:INTER  
MEDIATE TRANSF  
ER:ASS'Y

64.D0BX5412  
PCB:TDRB:(PCB41)

67.D0BX6051  
ROLLER:INTERME  
DIATE TRANSFER:  
ASS'Y

57.D0746161  
COVER:BIAS:INTE  
RMEDIATE TRANS  
FER

59.D0746197  
TERMINAL:CONNE  
CTING:BIAS:INTER  
MEDIATE TRANSF  
ER

58.D0746180  
COMPRESSION SP  
RING:BIAS:INTER  
MEDIATE TRANSFE  
R

54.D0746145  
BRACKET:INTERM  
EDIATE TRANSFE  
R:REAR

56.D0746147  
TERMINAL:INTER  
MEDIATE TRANSFE  
R

55.D0746146  
BRACKET:BIAS:INT  
ERMEDIATE TRAN  
SFER

U009\_S001

TRANSFER UNIT:INTERMEDIATE TRANSFER:ASS'Y

- 89.D1796080 (x2) ROLLER:OPPOSE D:BELT CLEANING: ASS'Y
- 90.D1796085 ROLLER:DRIVEN:INTERMEDIATE TRANSFER:ASS'Y
- 91.D1796091 ROLLER:TENSION:ASS'Y
- 92.D1796094 CASE:TENSION:ROLLER
- 93.D1796095 SUPPORTING PLATE:CASE:TENSION:ROLLER

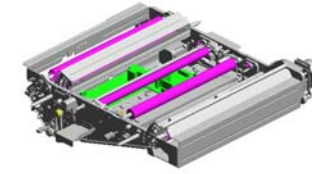

65.D0BX6000  
TRANSFER UNIT:INTERMEDIATE TRANSFER:ASS'Y

95.D1796098 (x2) COIL SPRING:PRESSURE:TENSION:INTERMEDIATE TRANSFER

94.D1796097 (x2) PLAIN SHAFT BEARING:TENSION:ROLLER:INTERMEDIATE TRANSFER

79.D1366183 GRIP:ON-OFF:INTERMEDIATE TRANSFER:TCRU

76.D1366099 TENSION SPRING:BRACKET:DC STEPPER MOTOR

77.D1366145 (x6) ROLLER:ON-OFF:INTERMEDIATE TRANSFER

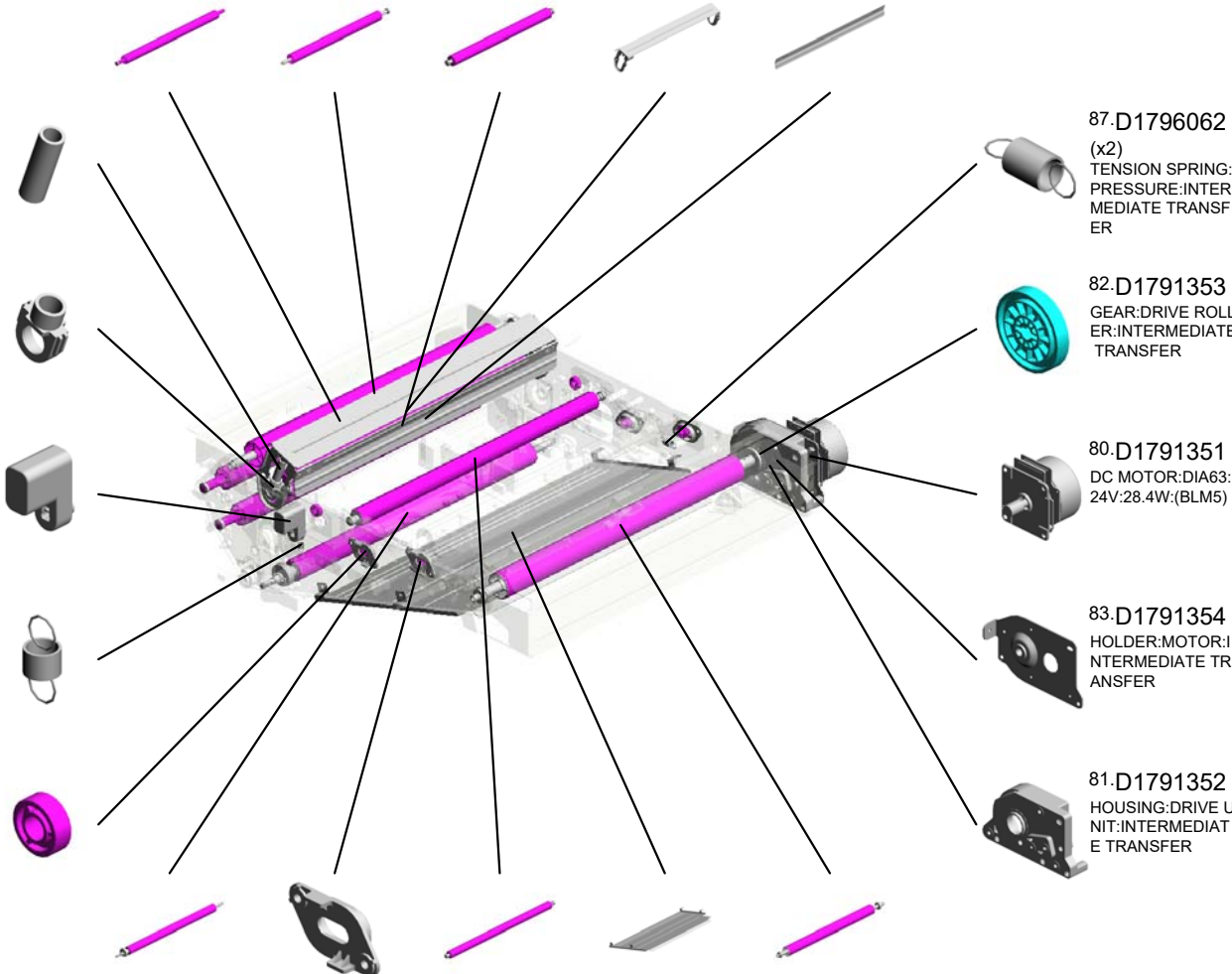

87.D1796062 (x2) TENSION SPRING:PRESSURE:INTERMEDIATE TRANSFER

82.D1791353 GEAR:DRIVE ROLLER:INTERMEDIATE TRANSFER

80.D1791351 DC MOTOR:DIA63:24V:28.4W:(BLM5)

83.D1791354 HOLDER:MOTOR:INTERMEDIATE TRANSFER

81.D1791352 HOUSING:DRIVE UNIT:INTERMEDIATE TRANSFER

- 96.D1796108 ROLLER:TRANSFER:PAPER:FRONT:ASS'Y
- 78.D1366149 (x4) BUSHING:SLIDE RAIL:ON-OFF
- 86.D1796057 ROLLER:TRANSFER:FRONT:ASS'Y
- 84.D1793144 COVER:INTERMEDIATE TRANSFER:LOWER
- 88.D1796065 DRIVE ROLLER:INTERMEDIATE TRANSFER:ASS'Y

U009\_S001  
TRANSFER UNIT:INTERMEDIATE TRANSFER:ASS'Y

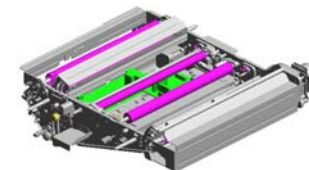

65.D0BX6000  
TRANSFER UNIT:INTERMEDIATE TRANSFER:ASS'Y

- 107.D1796146 SHAFT:ON-OFF:INTERMEDIATE TRANSFER
- 117.D1796188 BRACKET:COIL SPRING:MOTOR:POSITIONING CONTROL
- 116.D1796187 FEELER:POSITIONING CONTROL:DRIVE WIRE
- 114.D1796182 BRACKET:POSITIONING CONTROL:DRIVEN ROLLER:REAR:ASS'Y
- 115.D1796186 DRIVE WIRE:DRIVEN ROLLER

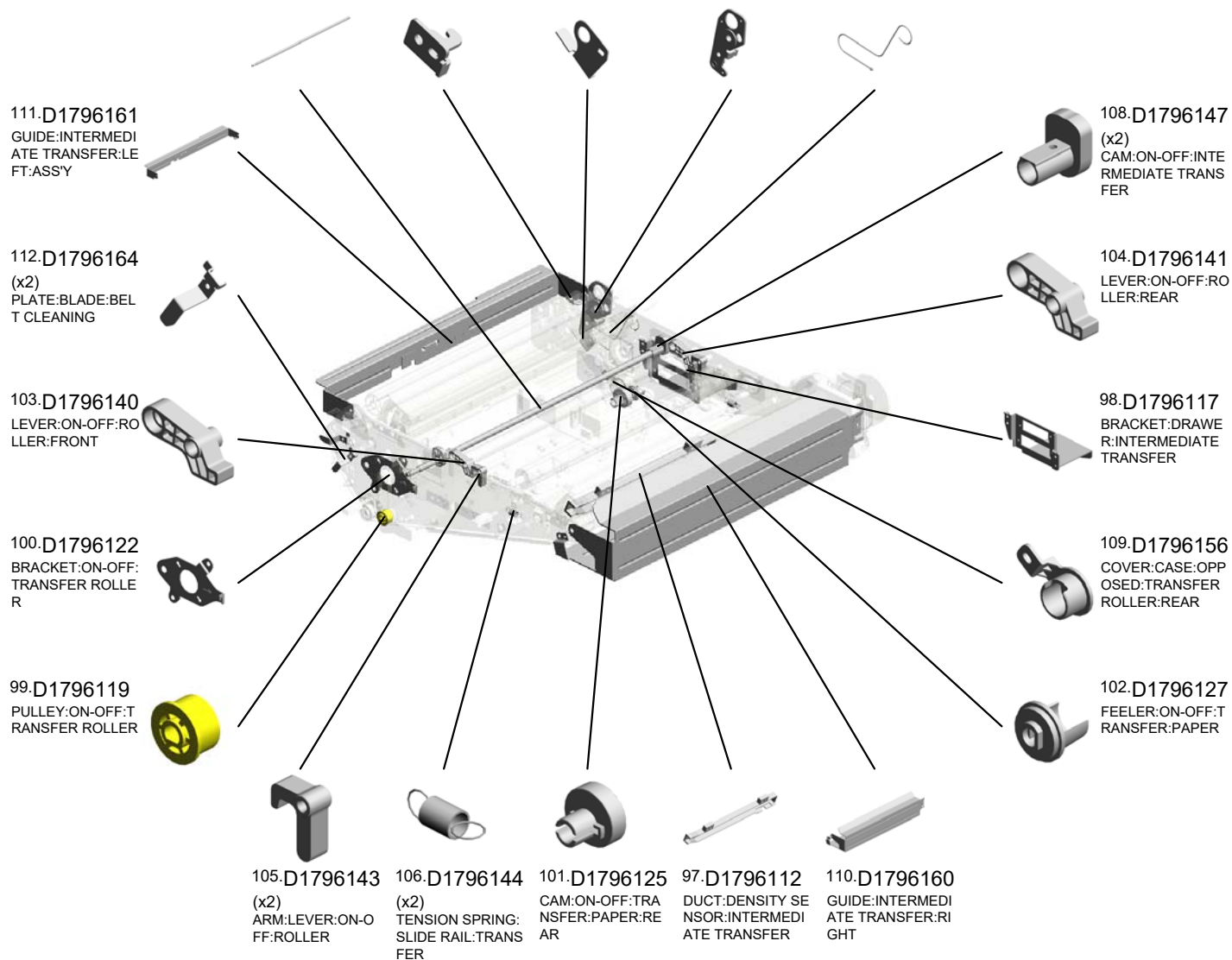

U009\_S001  
TRANSFER UNIT:INTERMEDIATE TRANSFER:ASS'Y

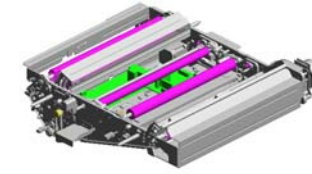

65.D0BX6000  
TRANSFER UNIT:INTERMEDIATE TRANSFER:ASS'Y

- 122.D2706124 GUIDE PLATE:INTERMEDIATE TRANSFER:ASS'Y
- 123.D2706128 GUIDE:TRANSPORT:INTERMEDIATE TRANSFER:10MM:ASS'Y
- 129.GW020024 (x2) PHOTO INTERRUPTOR:LG2A24BL1:GF:(SEN3/SEN21/SEN35/SEN36/SEN37/SEN38/SEN39/SEN

119.D1796196 SCALE:BRACKET:DRIVEN ROLLER:FRONT

120.D1796197 HOLDER:DRIVEN ROLLER:FRONT

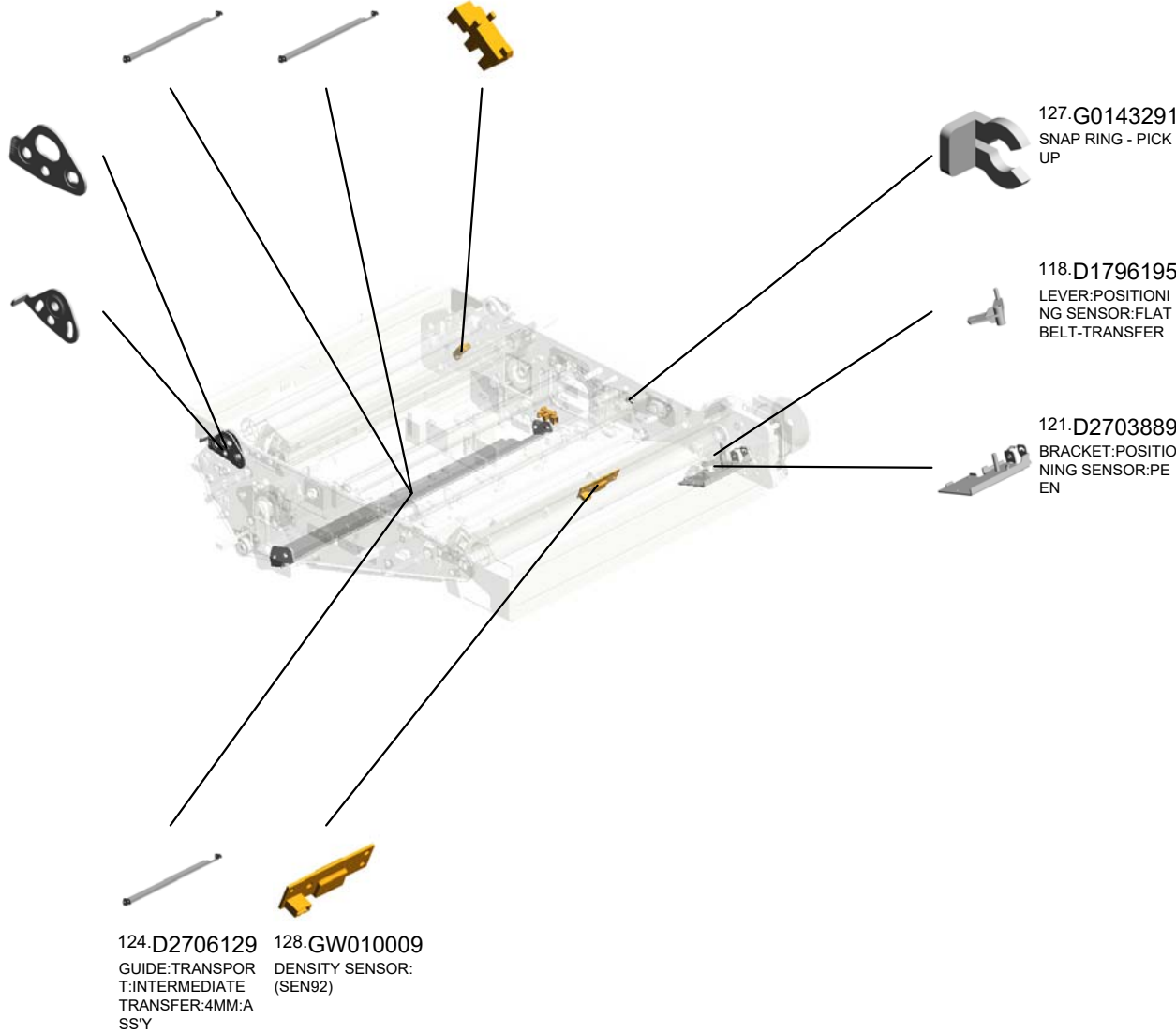

127.G0143291 SNAP RING - PICK UP

118.D1796195 LEVER:POSITIONING SENSOR:FLAT BELT-TRANSFER

121.D2703889 BRACKET:POSITIONING SENSOR:PEEN

- 124.D2706129 GUIDE:TRANSPORT:INTERMEDIATE TRANSFER:4MM:ASS'Y
- 128.GW010009 DENSITY SENSOR:(SEN92)



# U010.ITB CLEANING

U010\_S001  
D0BX6400  
BELT CLEANING:ASS'Y

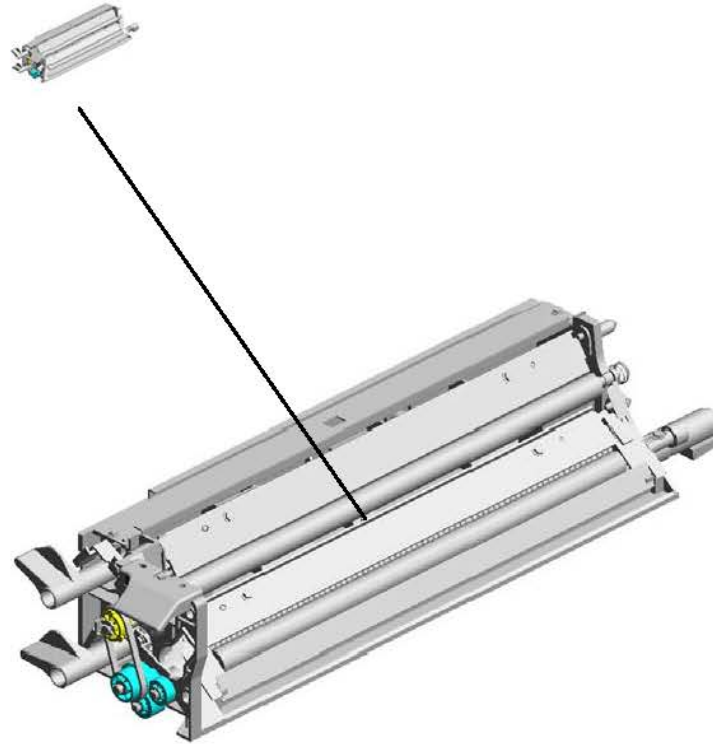

U001	U002	U003	U004	U005	U006	U007	U008	U009	U010	U011	U012	U013	U014	U015	U016	U017	U018	U019	U020	U021
------	------	------	------	------	------	------	------	------	------	------	------	------	------	------	------	------	------	------	------	------

# U010\_S001.BELT CLEANING:ASS'Y

U010\_S001\_S001  
D0746450  
COATING BAR:ASS'Y

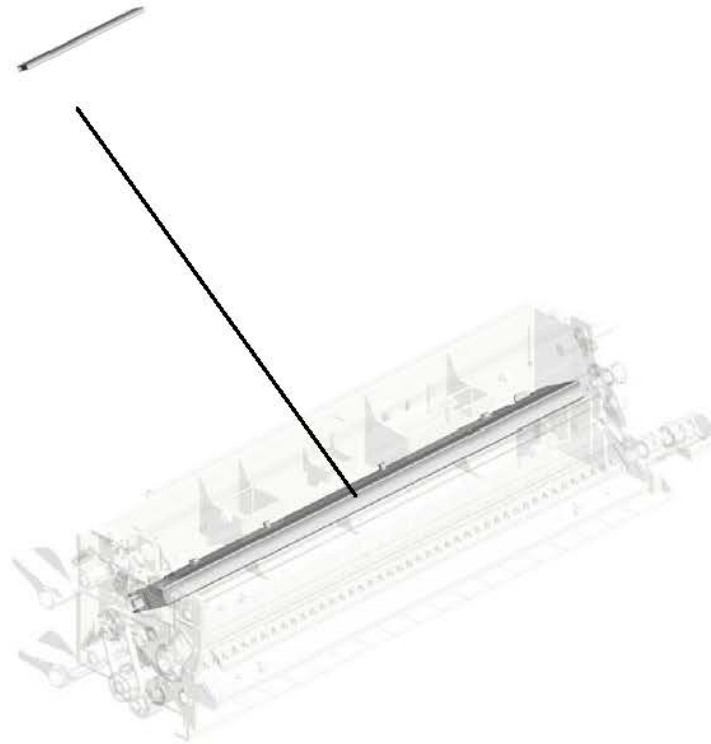

U001	U002	U003	U004	U005	U006	U007	U008	U009	U010	U011	U012	U013	U014	U015	U016	U017	U018	U019	U020	U021
------	------	------	------	------	------	------	------	------	------	------	------	------	------	------	------	------	------	------	------	------

# U010 ITB CLEANING

9-B2342390  
FLANGED HEXAG  
ONAL HEAD BOLT:  
M4X8

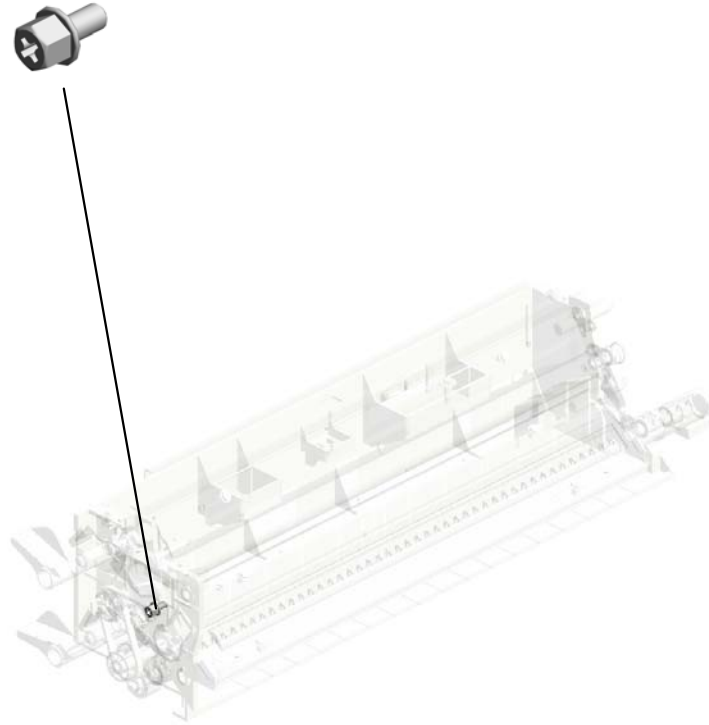

U001	U002	U003	U004	U005	U006	U007	U008	U009	<b>U010</b>	U011	U012	U013	U014	U015	U016	U017	U018	U019	U020	U021
------	------	------	------	------	------	------	------	------	-------------	------	------	------	------	------	------	------	------	------	------	------

# U010\_S001 BELT CLEANING:ASS'Y

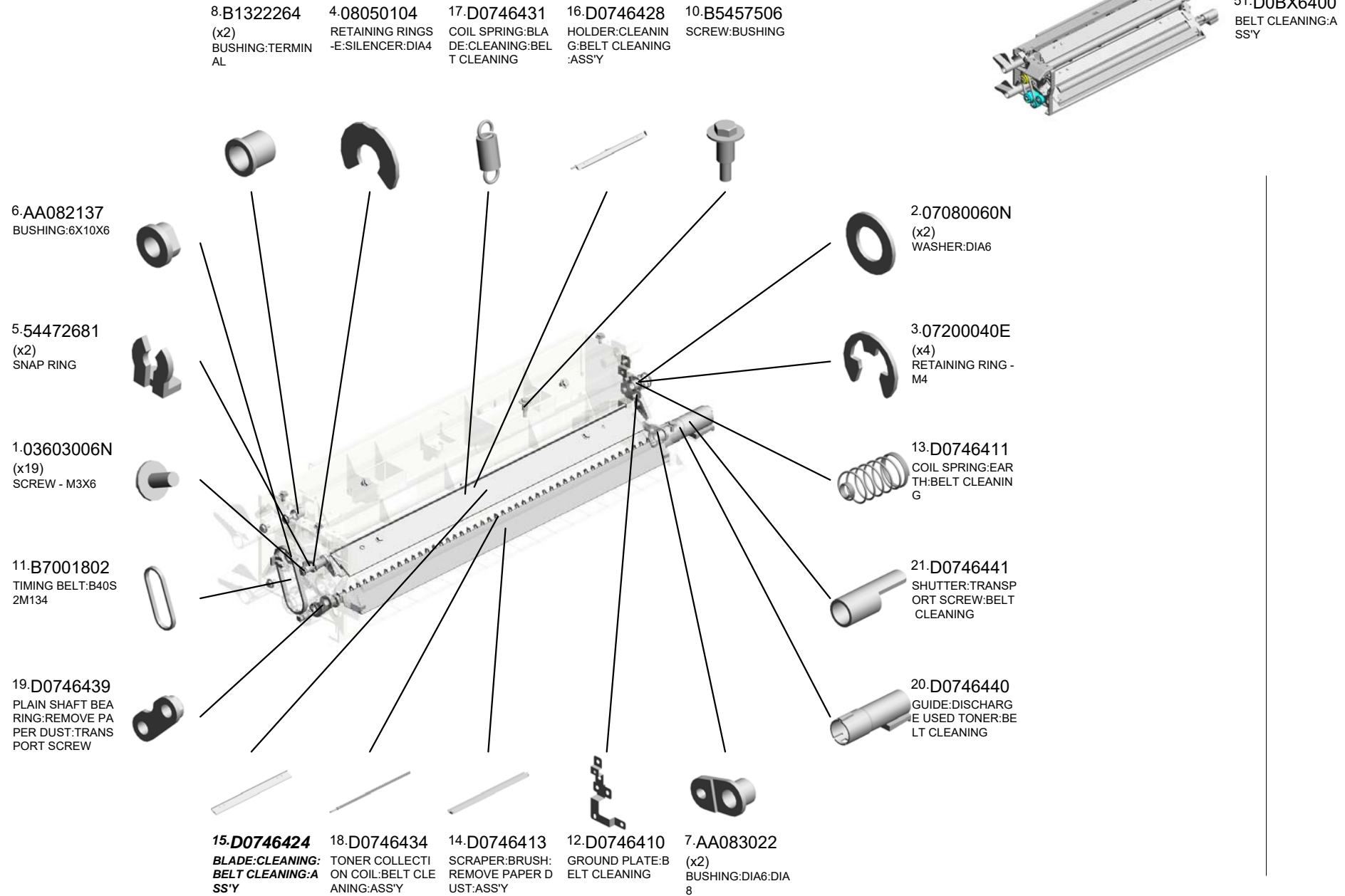

U001	U002	U003	U004	U005	U006	U007	U008	U009	<b>U010</b>	U011	U012	U013	U014	U015	U016	U017	U018	U019	U020	U021
------	------	------	------	------	------	------	------	------	-------------	------	------	------	------	------	------	------	------	------	------	------

U010\_S001  
BELT CLEANING:ASS'Y

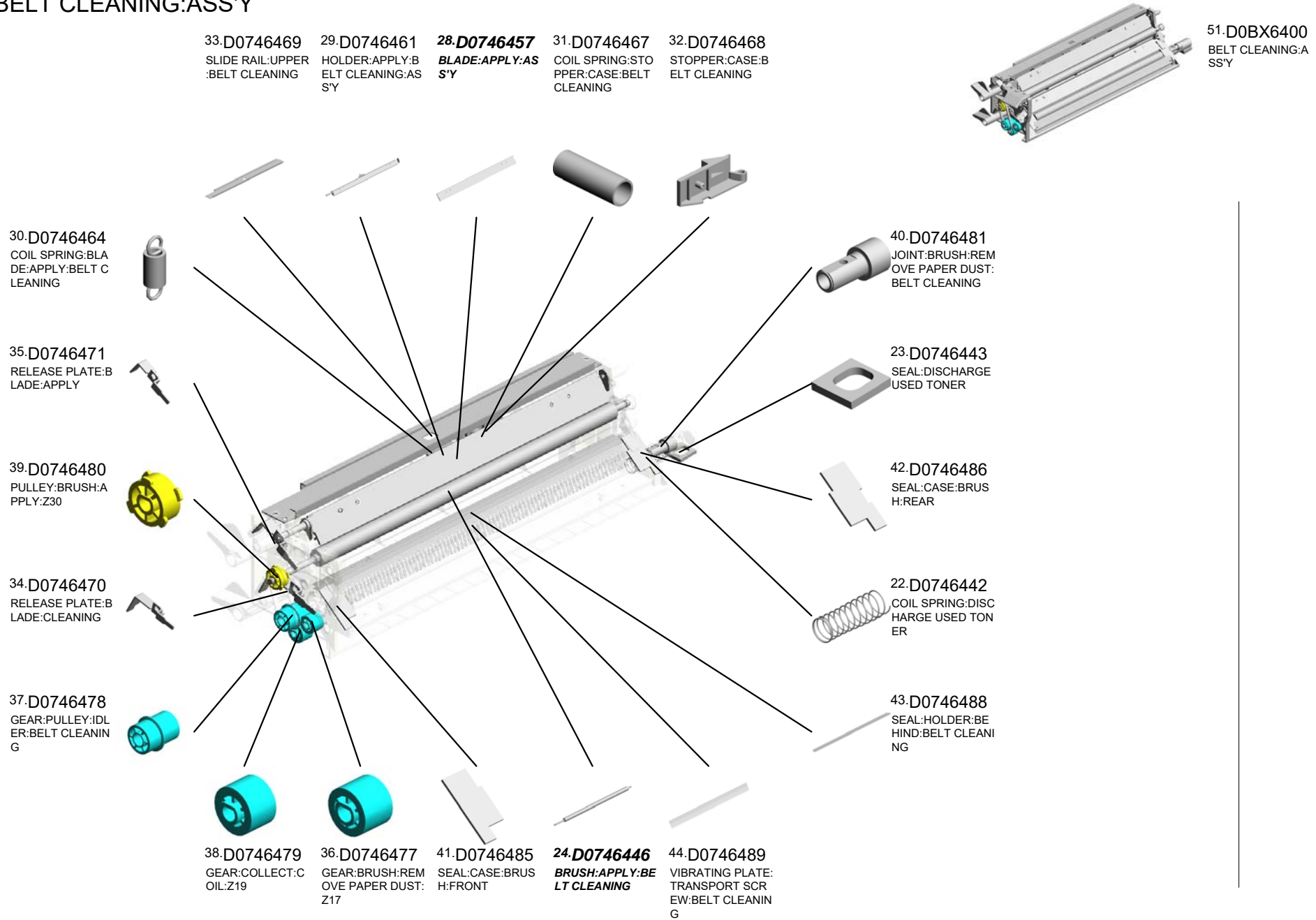

U010\_S001  
BELT CLEANING:ASS'Y

- 49.D0746496 GRIP:BELT CLEANING
- 46.D0746491 SEAL:CASE:CLEANING BLADE:FRONT
- 45.D0746490 SEAL:BASE:CASE:BELT CLEANING
- 50.D0746497 (x2) DECAL:POSITIONING DISPLAY:TCRU



- 51.D0BX6400 BELT CLEANING:ASS'Y

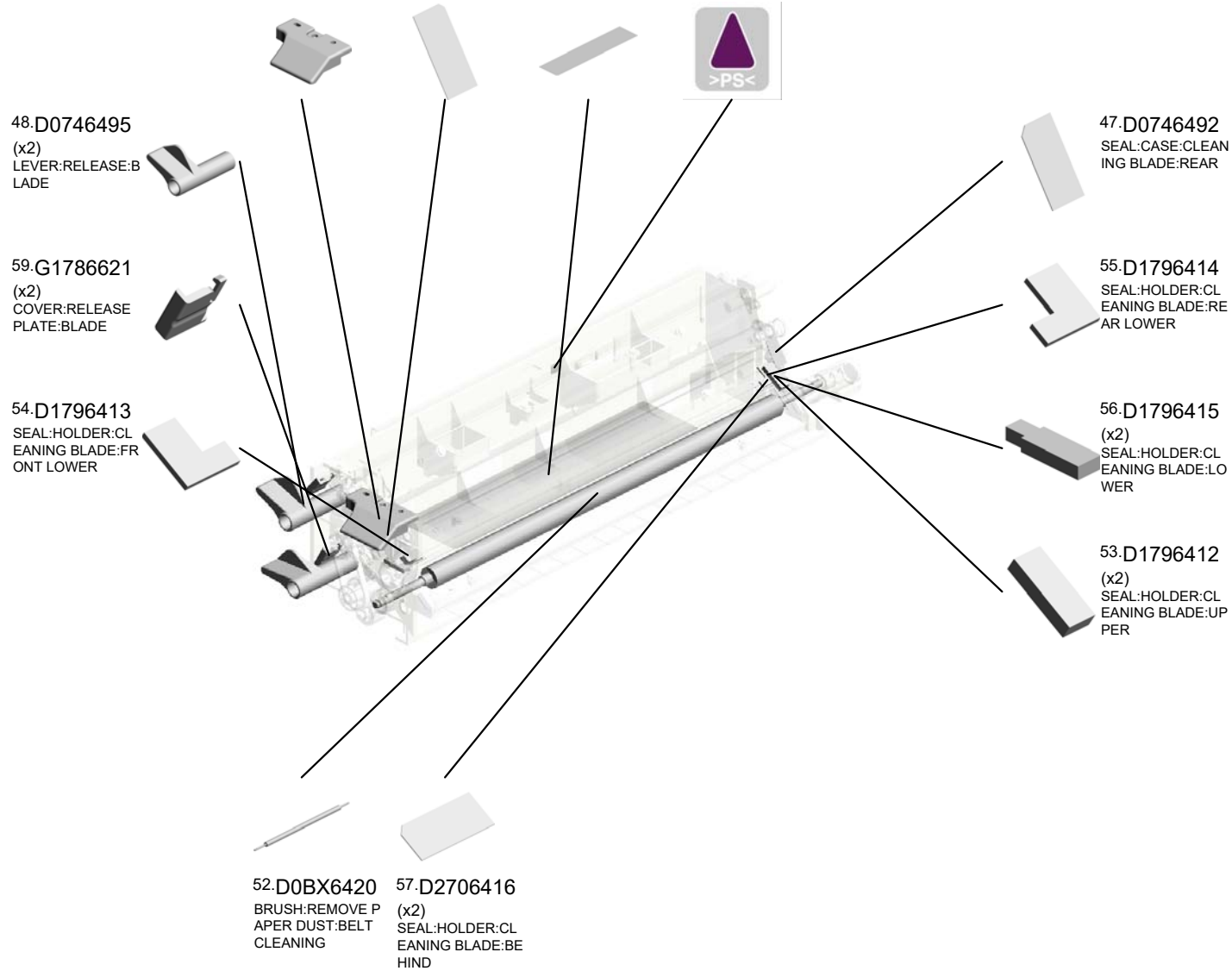

U010\_S001\_S001  
COATING BAR:ASS'Y

58.G0801169  
(x2)  
SCREW:M3

27.D0746455  
COIL SPRING:COA  
TING BAR



25.D0746450  
COATING BAR:AS  
S'Y



26.D0746454  
(x2)  
ARM:COATING BA  
R:BELT CLEANING



U001	U002	U003	U004	U005	U006	U007	U008	U009	U010	U011	U012	U013	U014	U015	U016	U017	U018	U019	U020	U021
------	------	------	------	------	------	------	------	------	------	------	------	------	------	------	------	------	------	------	------	------

# U011.TRANSFER/SEPARATION

U011\_S002  
D1796230  
CASE:TERMINAL:SEPARATI  
ON:ASSY

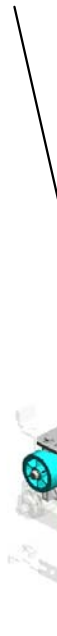

U011\_S001  
D0BX6210  
TRANSFER UNIT:ASSY

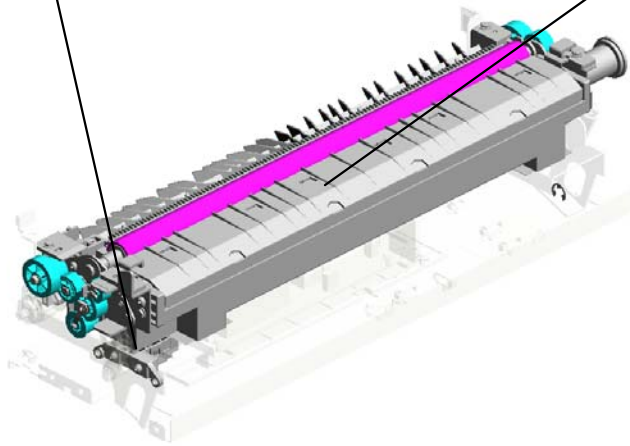

U001	U002	U003	U004	U005	U006	U007	U008	U009	U010	U011	U012	U013	U014	U015	U016	U017	U018	U019	U020	U021
------	------	------	------	------	------	------	------	------	------	------	------	------	------	------	------	------	------	------	------	------



# U011\_S001.TRANSFER UNIT:ASS'Y

U011 S001 S001  
D1796310  
SEPARATION CORONA:ASS'  
Y

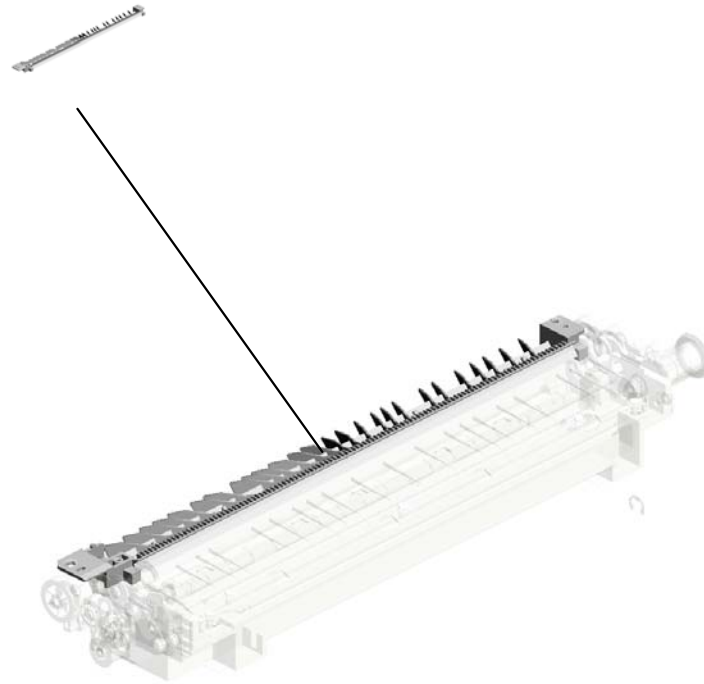

U001	U002	U003	U004	U005	U006	U007	U008	U009	U010	U011	U012	U013	U014	U015	U016	U017	U018	U019	U020	U021
------	------	------	------	------	------	------	------	------	------	------	------	------	------	------	------	------	------	------	------	------

# U011 TRANSFER/SEPARATION

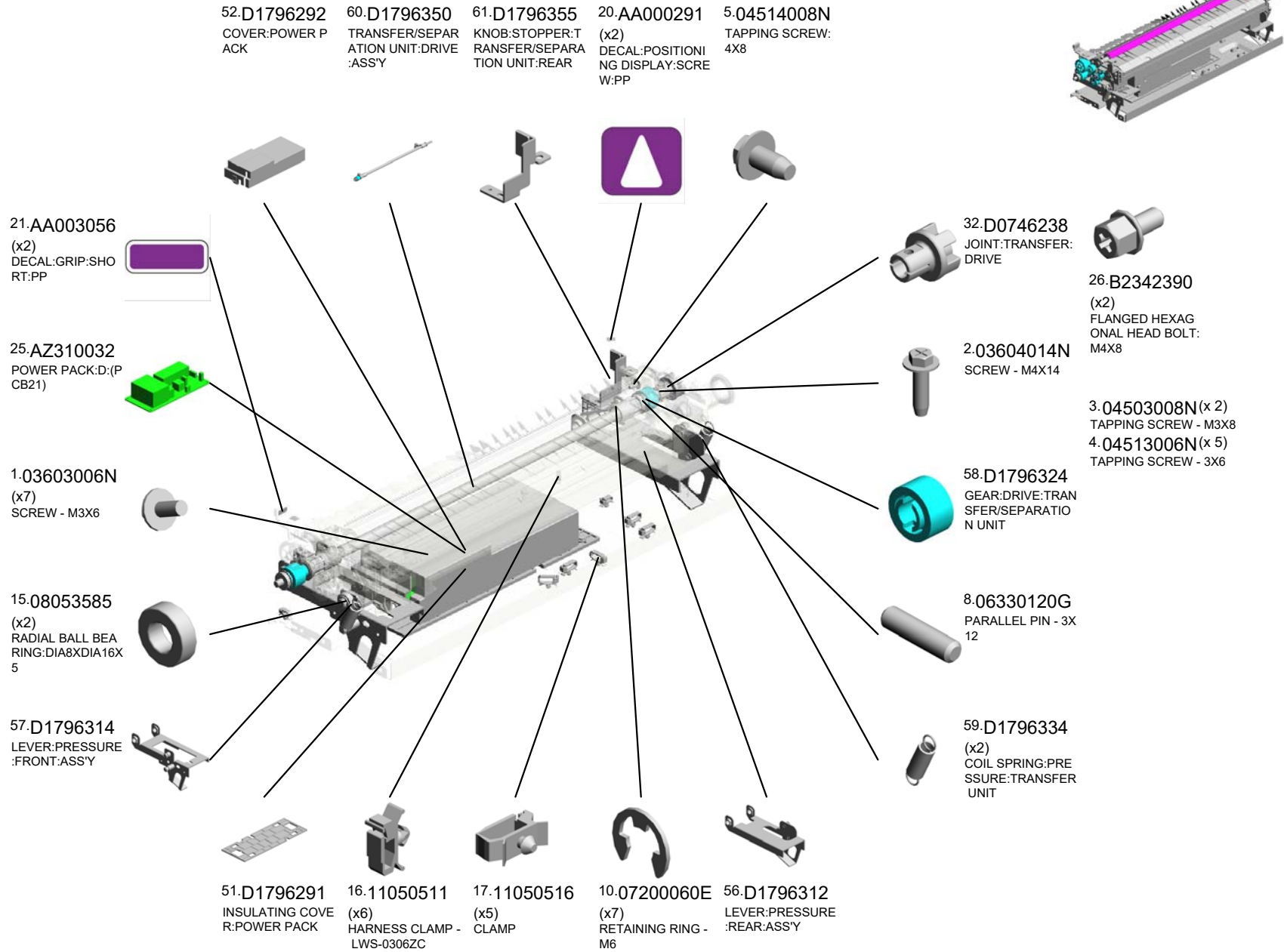

U011  
TRANSFER/SEPARATION

62.D1796356 64.D2706333  
KNOB:STOPPER:T SHAFT:LEVER:PRE  
RANSFER/SEPARA SSURE:TRANSFER  
TION UNIT:FRONT ROLLER

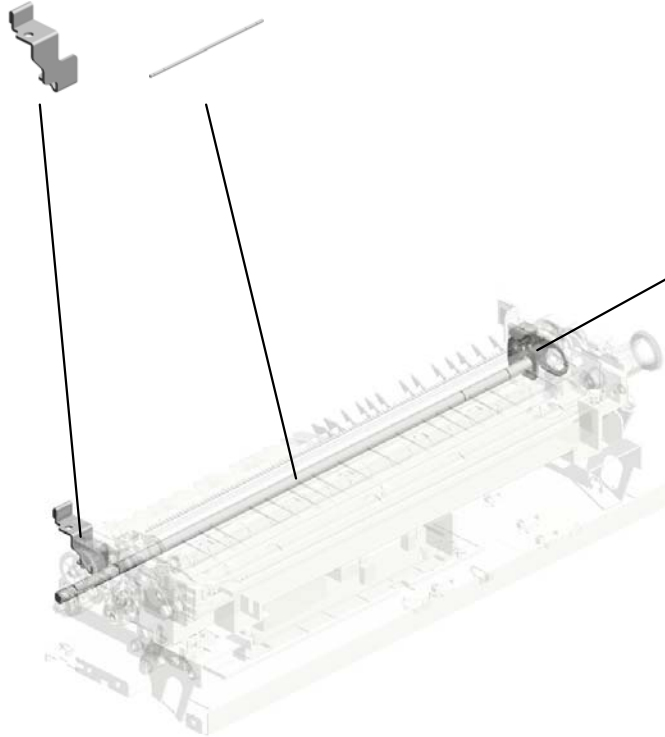
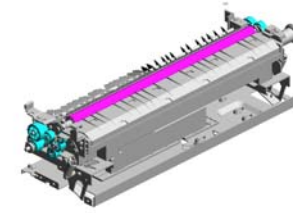

65.D2706350  
BRACKET:SHAFT:  
CONTACT POINT:T  
RANSFER ROLLER



U011\_S001  
TRANSFER UNIT:ASS'Y

- 14.08053568 RADIAL BALL BEARING:DIA8XDIA14X4
- 27.D0146272 BUSHING:BRUSH:REAR
- 30.D0746228 ELECTRODE PLATE:FRAME
- 7.04543008Q (x2) TAPPING SCREW: M3X8
- 1.03603006N (x16) SCREW - M3X6

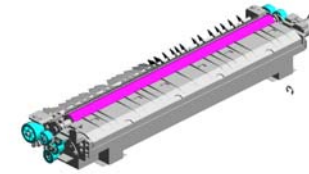

45.D0BX6210  
TRANSFER UNIT:ASS'Y

23.AB011125  
GEAR:20/29Z

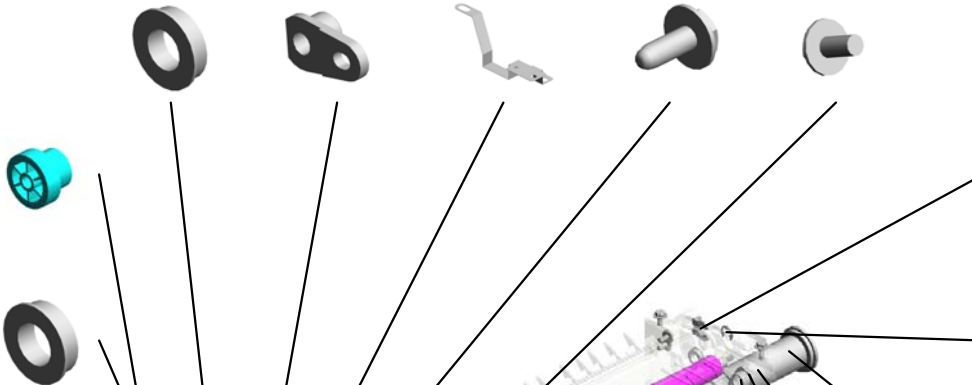

13.08053445  
(x2)  
BEARING - M6X10X3



33.D0746241  
(x2)  
DECAL:GRIP:TRANSFER/SEPARATION UNIT



24.AB011126  
GEAR:20Z



18.52062686  
SNAP RING



3.04503008N  
TAPPING SCREW - M3X8

34.D0746257  
BRUSH ROLLER:APPLY:ASS'Y

6.04523008N (x2)  
TAPPING SCREW - M3X8

10.07200060E (x2)  
RETAINING RING - M6

22.AA080154  
REAR BUSHING

19.52152621  
SNAP RING - M6



11.08050103 RETAINING RINGS -E:SILENCER:DIA3 (x2)  
12.08050104 RETAINING RINGS -E:SILENCER:DIA4

9.07200040E  
RETAINING RING - M4



9.07200040E (x 2)  
RETAINING RING - M4

28.D0746216  
SHUTTER:TONER OUTLET SUB-UNIT:SUB-ASS'Y



29.D0746219  
COIL SPRING:SHUTTER:DISCHARGE USED TONER

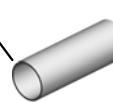

31.D0746235  
CASE:TONER RECYCLING SUB-UNIT:SUB-ASS'Y



U011\_S001  
TRANSFER UNIT:ASS'Y

- 48.D0BX6255 BRUSH ROLLER:TRANSFER ROLLER:ASS'Y  
 47.D0BX6250 TRANSFER ROLLER  
 37.D0746273 SEAL:HOLDER  
 35.D0746265 BLADE:TRANSFER ROLLER:ASS'Y  
 50.D1796280 GUIDE PLATE:ENTRANCE:LOWER:ASS'Y

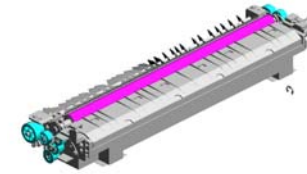

45.D0BX6210  
TRANSFER UNIT:ASS'Y

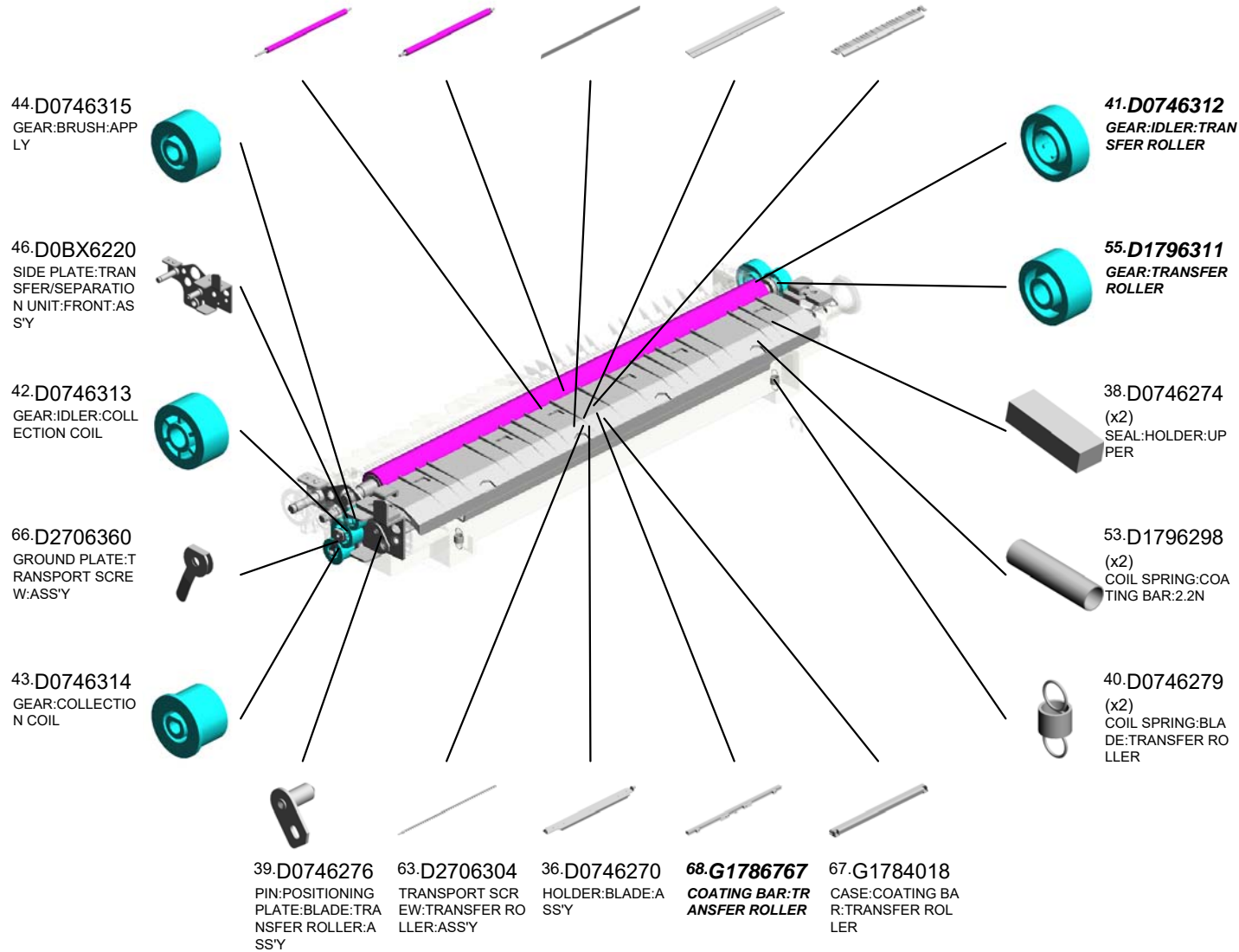

U011\_S001\_S001  
SEPARATION CORONA:ASS'Y

6.04523008N  
TAPPING SCREW -  
M3X8



54.D1796310  
SEPARATION COR  
ONA:ASS'Y



U001	U002	U003	U004	U005	U006	U007	U008	U009	U010	U011	U012	U013	U014	U015	U016	U017	U018	U019	U020	U021
------	------	------	------	------	------	------	------	------	------	------	------	------	------	------	------	------	------	------	------	------

U011\_S002  
CASE:TERMINAL:SEPARATION:ASS'Y

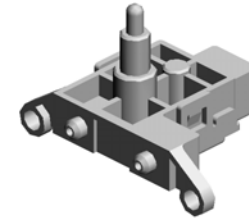

49.D1796230  
CASE:TERMINAL:SEPARATION:ASS'Y

- 1.03603006N(x 2)  
SCREW - M3X6
- 3.04503008N(x 1)  
TAPPING SCREW - M3X8

U001	U002	U003	U004	U005	U006	U007	U008	U009	U010	U011	U012	U013	U014	U015	U016	U017	U018	U019	U020	U021
------	------	------	------	------	------	------	------	------	------	------	------	------	------	------	------	------	------	------	------	------

# U012.USED TONER

U012\_S003  
D1796501  
TONER OUTLET SUB-UNIT:P  
CU:ASSY



U012\_S004  
D1796528  
TONER OUTLET SUB-UNIT:V  
ERTICAL TRANSPORT:MAIN:  
ASSY



U012\_S001  
D1796461  
TONER OUTLET SUB-UNIT:C  
OLLECTION BOTTLE:ASSY



U012\_S002  
D2706570  
COLLECTION BOTTLE:SERVI  
CE PARTS:ASSY

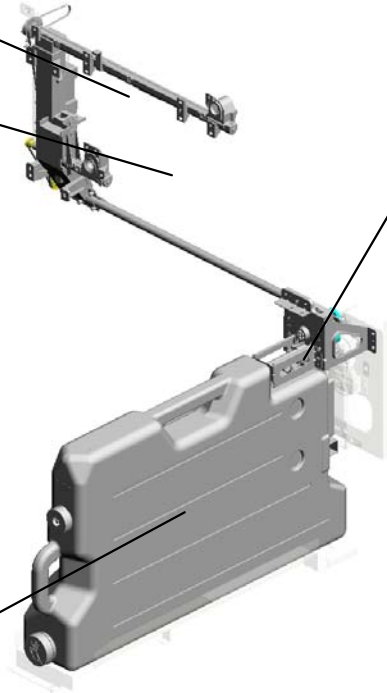



# U012 USED TONER

23.AB030877 TIMING PULLEY:Z5  
1

31.D0746574 COVER:CAM:VERTICAL TRANSPORT

32.D0746575 SHAFT:CAM:VERTICAL TRANSPORT

33.D0746579 SEAL:COVER:CAM:VERTICAL TRANSPORT

38.D0746663 TORQUE LIMITER MECHANICAL CLUTCH:GEAR:Z63

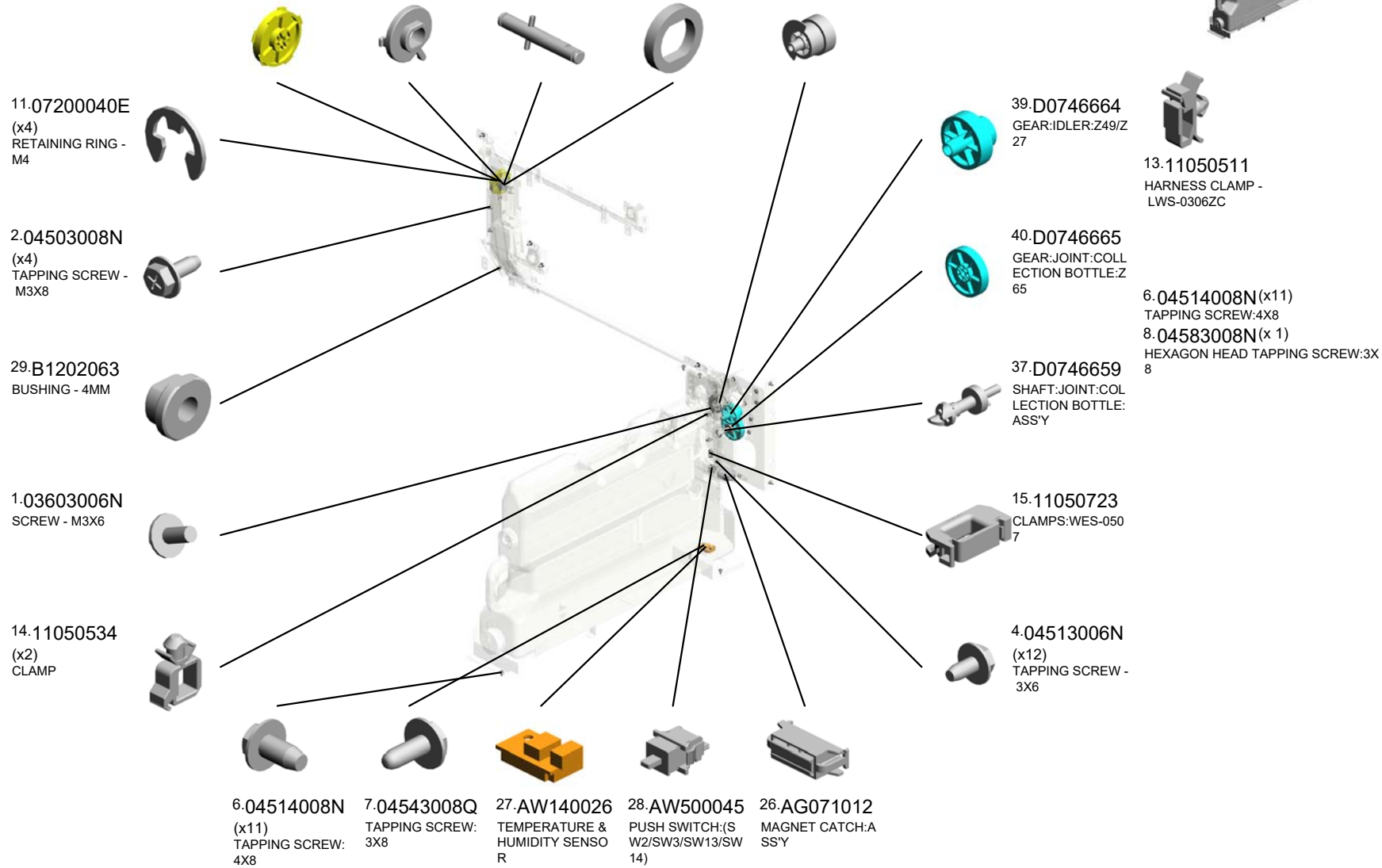

# U012 USED TONER

- 62.D6831845 PULLEY:IDLER:DIA 14
- 54.D1796523 BRACKET:VERTICAL TRANSPORT
- 64.GA082010 BUSHING:DIA6:DIA 10:9
- 56.D1796527 CAM:VERTICAL TRANSPORT:DIA15
- 50.D1796472 COVER:TONER OUTLET SUB-UNIT:ASY



55.D1796525  
BRACKET:IDLER

46.D1202829  
TENSION SPRING:REGISTRATION:DRIVEN

53.D1796521  
BRACKET:TONER OUTLET SUB-UNIT:VERTICAL TRANSPORT:LOWER

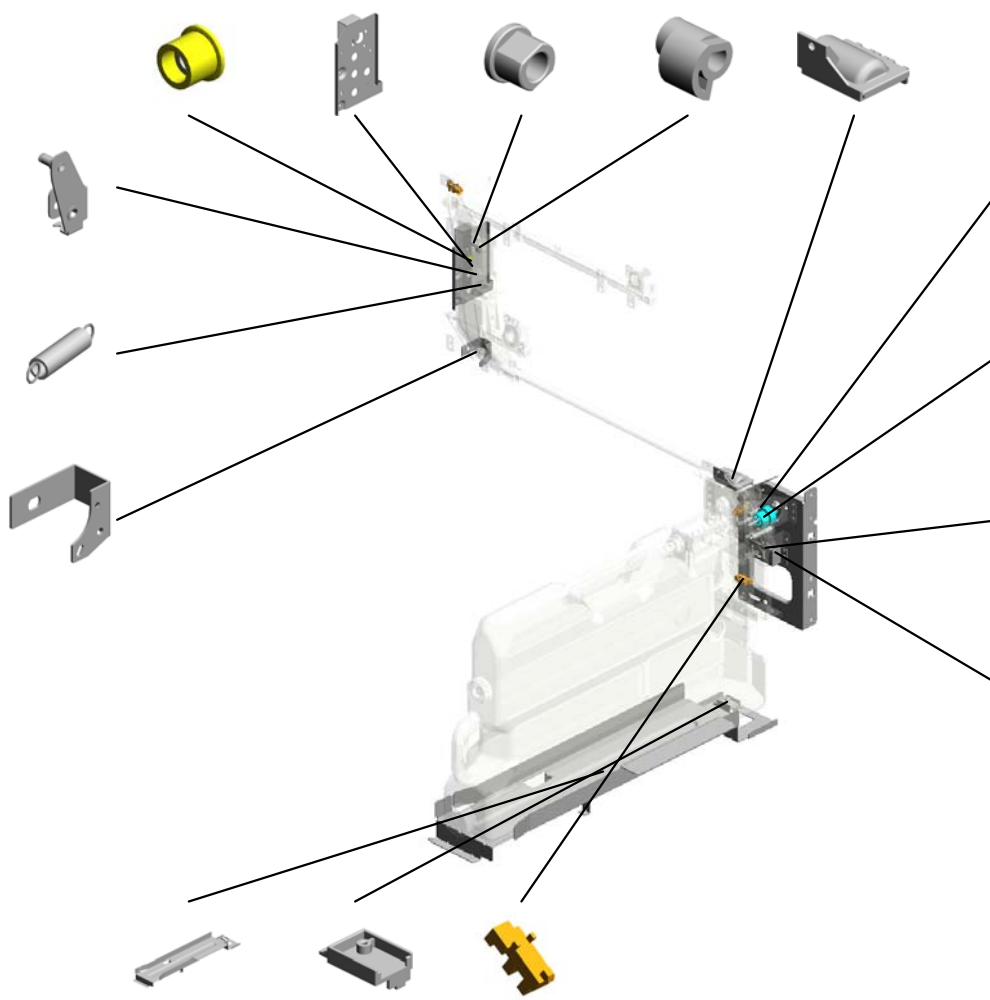

44.D0BX6487  
DC MOTOR:COLLECTION BOTTLE:DI A49:9.8W:(BLM3)

41.D0746666  
GEAR:IDLER:Z37/Z 28

42.D0746667  
HOLDER:RADIAL BALL BEARING:JOINT

51.D1796483  
BRACKET:DRIVE SUB-UNIT:COLLECTION BOTTLE

59.D2706492  
GUIDE PLATE:COLLECTION BOTTLE:LOWER

45.D1055898  
HOLDER:TEMPERATURE & HUMIDITY SENSOR

65.GW020024 (x3)  
PHOTOINTERRUPTOR:LG2A24BL1:GF:(SEN3/SEN21/SEN35/SEN36/SEN37/SEN38/SEN39/SEN

U001	U002	U003	U004	U005	U006	U007	U008	U009	U010	U011	U012	U013	U014	U015	U016	U017	U018	U019	U020	U021
------	------	------	------	------	------	------	------	------	------	------	------	------	------	------	------	------	------	------	------	------

U012\_S001  
 TONER OUTLET SUB-UNIT:COLLECTION BOTTLE:ASS'Y

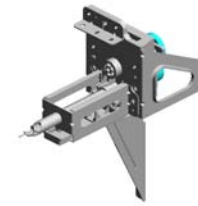

49.D1796461  
 TONER OUTLET SUB-UNIT:COLLECTION BOTTLE:ASS'Y

4.04513006N (x4) TAPPING SCREW - 3X6  
 34.D0746640 PLAIN SHAFT BEARING:TRANSPORT SCREW:SMALL  
 22.AB011540 GEAR:AGITATOR:DRIVE

35.D0746641 (x2) PLAIN SHAFT BEARING:SMALL:GEAR

20.AA061169 TENSION SPRING:TONER CATCHPAN:DISCHARGE USED TONER

5.04513008N (x2) TAPPING SCREW - M3X8

3.04503010N (x 7) TAPPING SCREW - M3X10

12.08050089 (x3) RETAINING RING - M4

36.D0746643 GEAR:TRANSPORT SCREW:COLLECTION BOTTLE:SMALL:Z31

9.06320140G PARALLEL PIN

U001	U002	U003	U004	U005	U006	U007	U008	U009	U010	U011	U012	U013	U014	U015	U016	U017	U018	U019	U020	U021
------	------	------	------	------	------	------	------	------	------	------	------	------	------	------	------	------	------	------	------	------

U012\_S002  
COLLECTION BOTTLE:SERVICE PARTS:ASS'Y

43.D0746697 60.D2706498  
DECAL:COLLECTI ON BOTTLE:GRIP: FRONT DECAL:COLLECTI ON BOTTLE:CAUTI ON

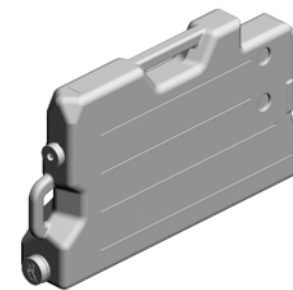

61.D2706570  
COLLECTION BOT TLE:SERVICE PAR TS:ASS'Y

47.D1363692  
(x2)  
DECAL:COLLECTI ON BOTTLE:GRIP: UPPER



3.04503010N  
(x4)  
TAPPING SCREW - M3X10

12.08050089  
RETAINING RING - M4

17.AA036015  
CAP:COLLECTION BOTTLE

63.G1787819  
SEAL:CAP:COLLEC TION BOTTLE

U001	U002	U003	U004	U005	U006	U007	U008	U009	U010	U011	U012	U013	U014	U015	U016	U017	U018	U019	U020	U021
------	------	------	------	------	------	------	------	------	------	------	------	------	------	------	------	------	------	------	------	------

U012\_S003  
TONER OUTLET SUB-UNIT:PCU:ASS'Y

24.AB033118  
TORQUE LIMITER  
MECHANICAL CLU  
TCH:TONER RECY  
CLING SUB-UNIT



52.D1796501  
TONER OUTLET S  
UB-UNIT:PCU:ASS'  
Y

12.08050089  
RETAINING RING -  
M4



48.D1791324  
SYNCHRONOUS B  
ELT:40S3M222

18.AA043342  
SYNCHRONOUS B  
ELT:40S3M666

U001	U002	U003	U004	U005	U006	U007	U008	U009	U010	U011	U012	U013	U014	U015	U016	U017	U018	U019	U020	U021
------	------	------	------	------	------	------	------	------	------	------	------	------	------	------	------	------	------	------	------	------

U012\_S004

TONER OUTLET SUB-UNIT:VERTICAL TRANSPORT:MAIN:ASS'Y

16.A8063281 TIMING PULLEY - T  
14 S3M  
21.AA061177 TENSION SPRING:  
VIBRATING PLATE:  
VERTICAL TRANS  
PORT  
30.D0746540 SEAL:BELT CLEAN  
ING:MAIN



57.D1796528  
TONER OUTLET S  
UB-UNIT:VERTICA  
L TRANSPORT:MAI  
N:ASS'Y

11.07200040E  
RETAINING RING -  
M4

19.AA043659  
SYNCHRONOUS B  
ELT:40S3M231

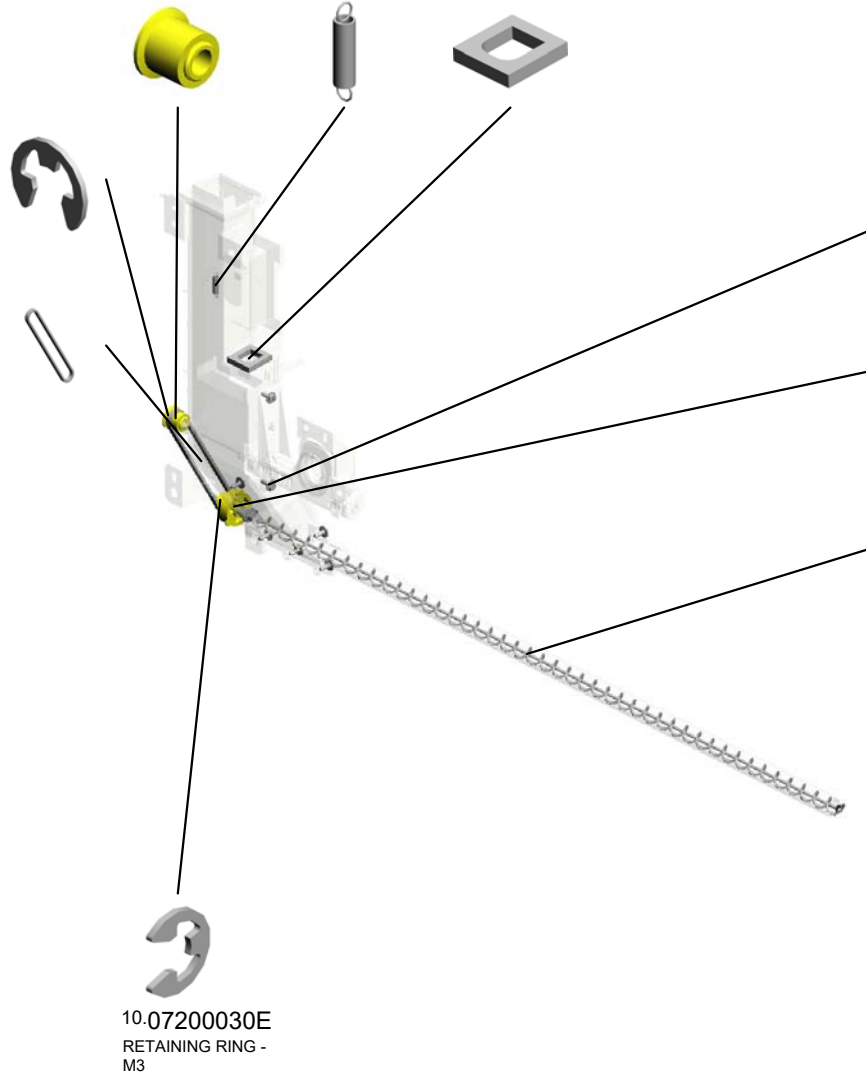

3.04503010N  
(x7)  
TAPPING SCREW -  
M3X10

25.AB033119  
TIMING PULLEY:Z2  
5:Z14

58.D1796552  
TRANSPORT SCR  
EW:TONER OUTLE  
T SUB-UNIT:LOWE  
R:ASS'Y

10.07200030E  
RETAINING RING -  
M3

U001	U002	U003	U004	U005	U006	U007	U008	U009	U010	U011	U012	U013	U014	U015	U016	U017	U018	U019	U020	U021
------	------	------	------	------	------	------	------	------	------	------	------	------	------	------	------	------	------	------	------	------

# U013 PAPER TRANSPORT

- 16.AF022064 (x2) TRANSPORT ROLLER:DRIVEN
- 12.AA040033 (x2) TRANSPORT BELT
- 22.D0BX3823 SHAFT:SEPARATION/TRANSPORT:ASSY
- 3.04503006N (x2) TAPPING SCREW - M3X6
- 23.D0BX3824 DECAL:SEPARATION/TRANSPORT:LEVER

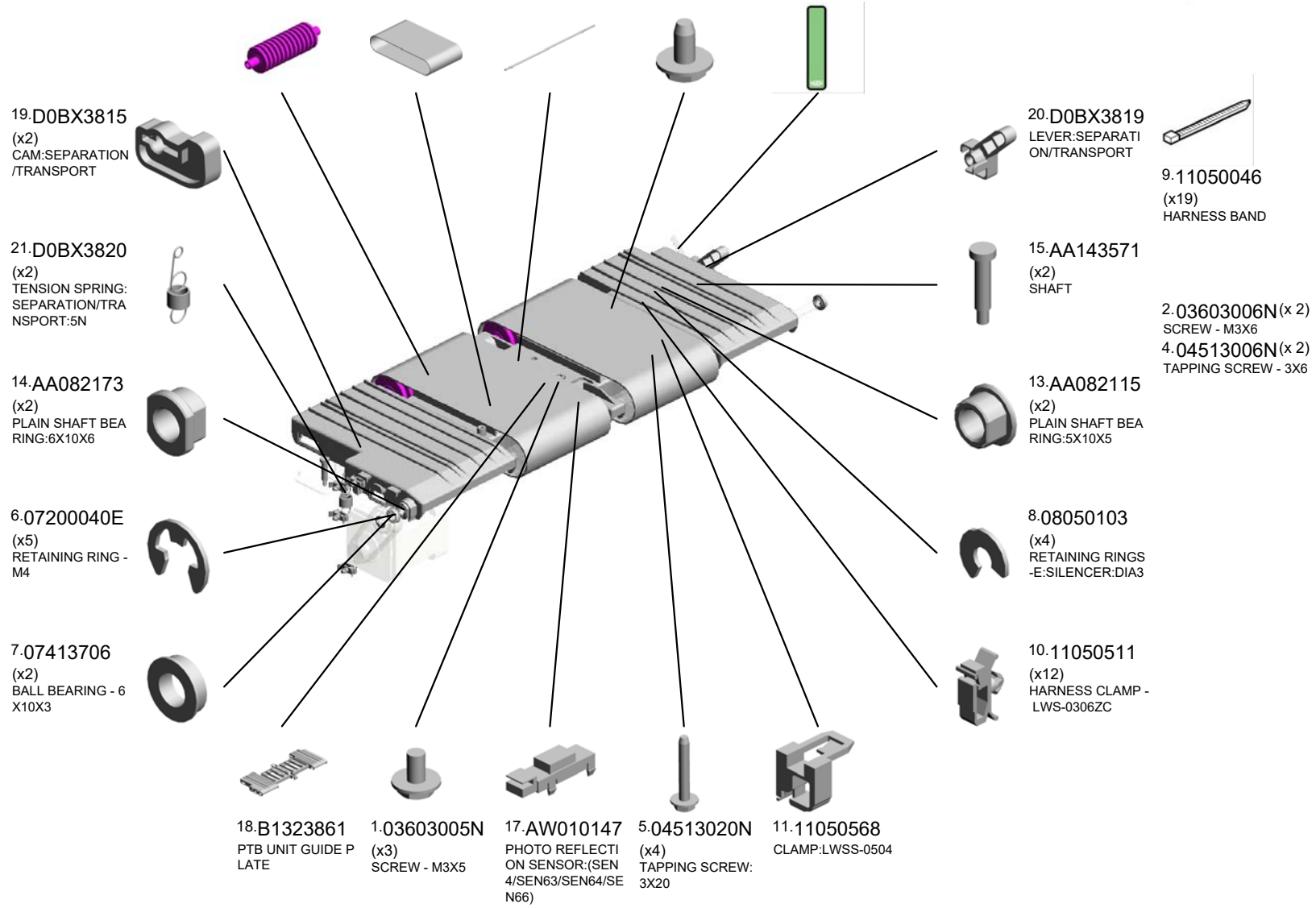
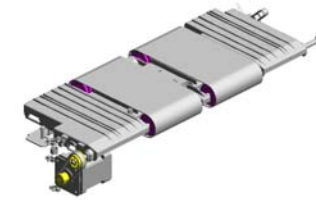

U001	U002	U003	U004	U005	U006	U007	U008	U009	U010	U011	U012	U013	U014	U015	U016	U017	U018	U019	U020	U021
------	------	------	------	------	------	------	------	------	------	------	------	------	------	------	------	------	------	------	------	------

# U013 PAPER TRANSPORT

27.G1783870 24.D0BX3830 29.D0BX3862  
TIMING PULLEY:T3 DC STEPPER MOT SUPPORTING PLA  
0 OR:MM42:ASSY TE:VACUUM

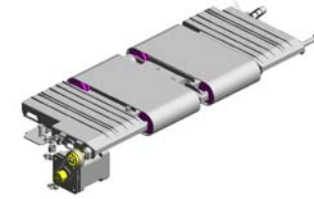

28.G1784636  
TIMING BELT:S2M1  
34\_67

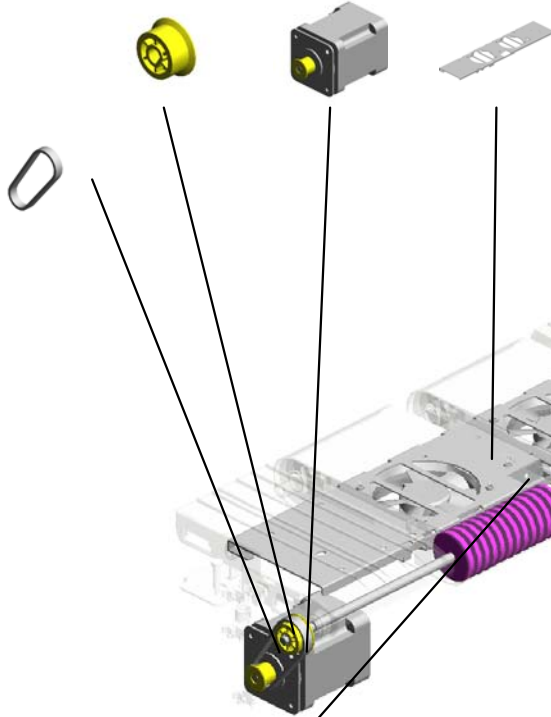

26.D2583910  
(x2)  
FAN:MM60X15:(FA  
N1/FAN2)

25.D1793851  
TRANSPORT ROLL  
ER:DRIVE

30.D1793865  
BRACKET:SENSO  
R:VACUUM

U001	U002	U003	U004	U005	U006	U007	U008	U009	U010	U011	U012	<b>U013</b>	U014	U015	U016	U017	U018	U019	U020	U021
------	------	------	------	------	------	------	------	------	------	------	------	-------------	------	------	------	------	------	------	------	------



# U014.FUSING

U014\_S002  
D0BX4311  
WEB:CLEANING UNIT:ASS'Y

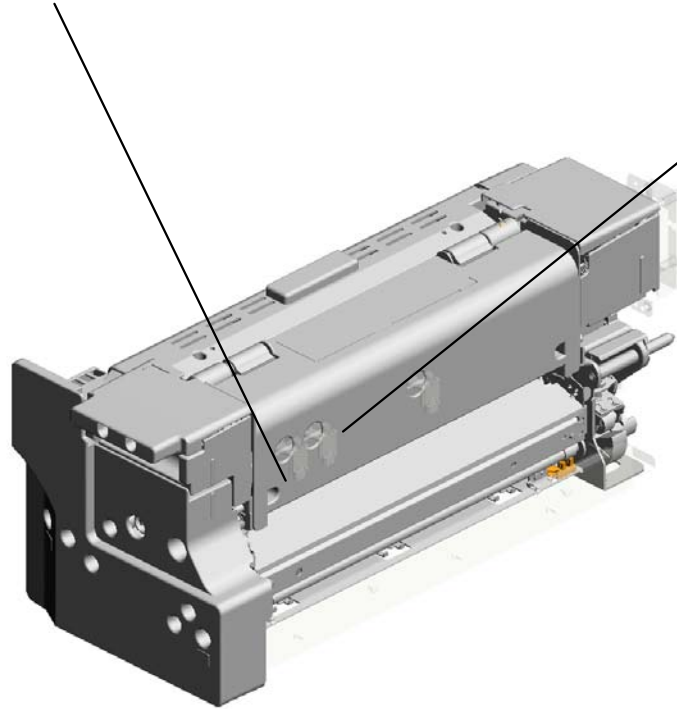

U014\_S001  
D0BX4017  
(NA):FUSING UNIT:208V:ASS'  
Y



U001	U002	U003	U004	U005	U006	U007	U008	U009	U010	U011	U012	U013	U014	U015	U016	U017	U018	U019	U020	U021
------	------	------	------	------	------	------	------	------	------	------	------	------	------	------	------	------	------	------	------	------

# U014\_S001.(NA):FUSING UNIT:208V:ASS'Y

U014\_S001\_S005  
D0BX4239  
STRIPPER PLATE:ASS'Y

U014\_S001\_S002  
D0BX4162  
HOT ROLLER:DIA54:ASS'Y

U014\_S001\_S006  
D0BX4275  
COVER:FUSING UNIT:UPPER:ASS'Y

U014\_S001\_S007  
D2704290  
DRIVE UNIT:WEB:CLEANING:ASS'Y

U014\_S001\_S003  
D1795381  
TEMPERATURE SENSOR:FUSING UNIT:UPPER:19PIN:(SEN9/SEN59/SEN87/SEN88)

U014\_S001\_S004  
D1795387  
TEMPERATURE SENSOR:FUSING UNIT:LOWER:17PIN:(SEN80)

U014\_S001\_S001  
D0BX4401  
(NA):PRESSURE ROLLER:208V:ASS'Y

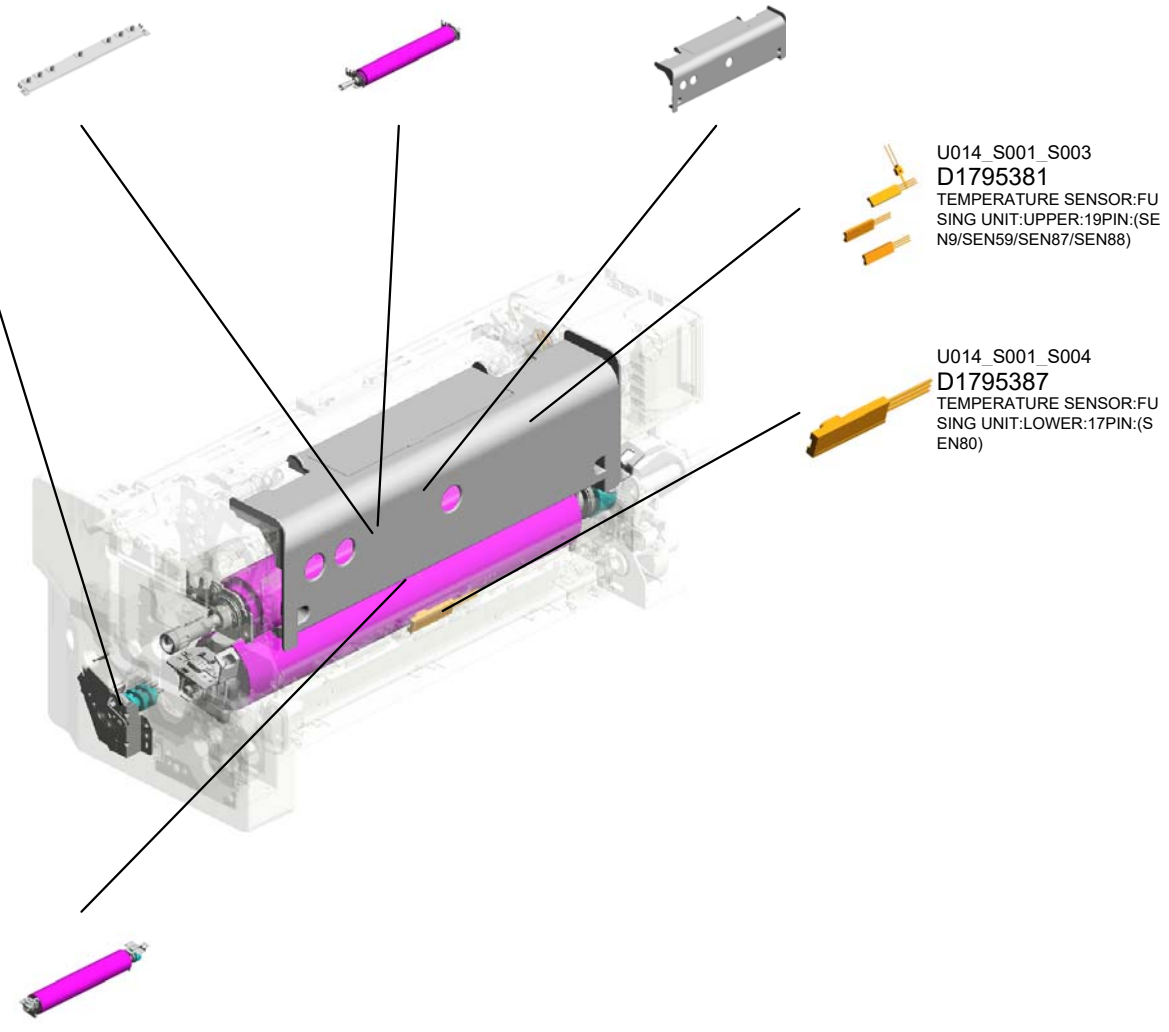

U001	U002	U003	U004	U005	U006	U007	U008	U009	U010	U011	U012	U013	U014	U015	U016	U017	U018	U019	U020	U021
------	------	------	------	------	------	------	------	------	------	------	------	------	------	------	------	------	------	------	------	------

# U014\_S001\_S007.DRIVE UNIT:WEB:CLEANING:ASS'Y

U014 S001 S007 S001  
AX040300  
DC MOTOR:CLEANER:ASS'Y:  
(BM5)

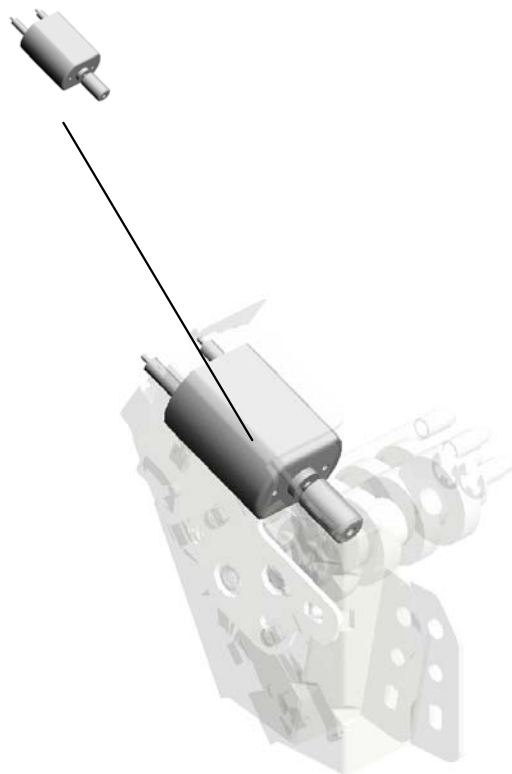

U001	U002	U003	U004	U005	U006	U007	U008	U009	U010	U011	U012	U013	U014	U015	U016	U017	U018	U019	U020	U021
------	------	------	------	------	------	------	------	------	------	------	------	------	------	------	------	------	------	------	------	------

# U014\_S002.WEB:CLEANING UNIT:ASS'Y

U014 S002 S001  
D0BX4313  
COVER:WEB:CLEANING FEL  
T



U001	U002	U003	U004	U005	U006	U007	U008	U009	U010	U011	U012	U013	U014	U015	U016	U017	U018	U019	U020	U021
------	------	------	------	------	------	------	------	------	------	------	------	------	------	------	------	------	------	------	------	------

# U014 FUSING

- 116.D1054365 (x3) HOLDER:THERMOPILE
- 95.D0746497 (x2) DECAL:POSITIONING DISPLAY:TCRU
- 19.08046123 (x4) HEXAGONAL BOLT:W/WASHER:M3X8
- 139.D1794352 BRACKET:DRAWER:FUSING:UPPER:MAIN
- 26.11050511 HARNESS CLAMP - LWS-0306ZC



- 61.AW100183 (x3) THERMOPILE:(SEN57/SEN58/SEN85)

- 3.03540080N (x6) SCREW:M4X8

- 71.B2342390 (x3) FLANGED HEXAGONAL HEAD BOLT:M4X8

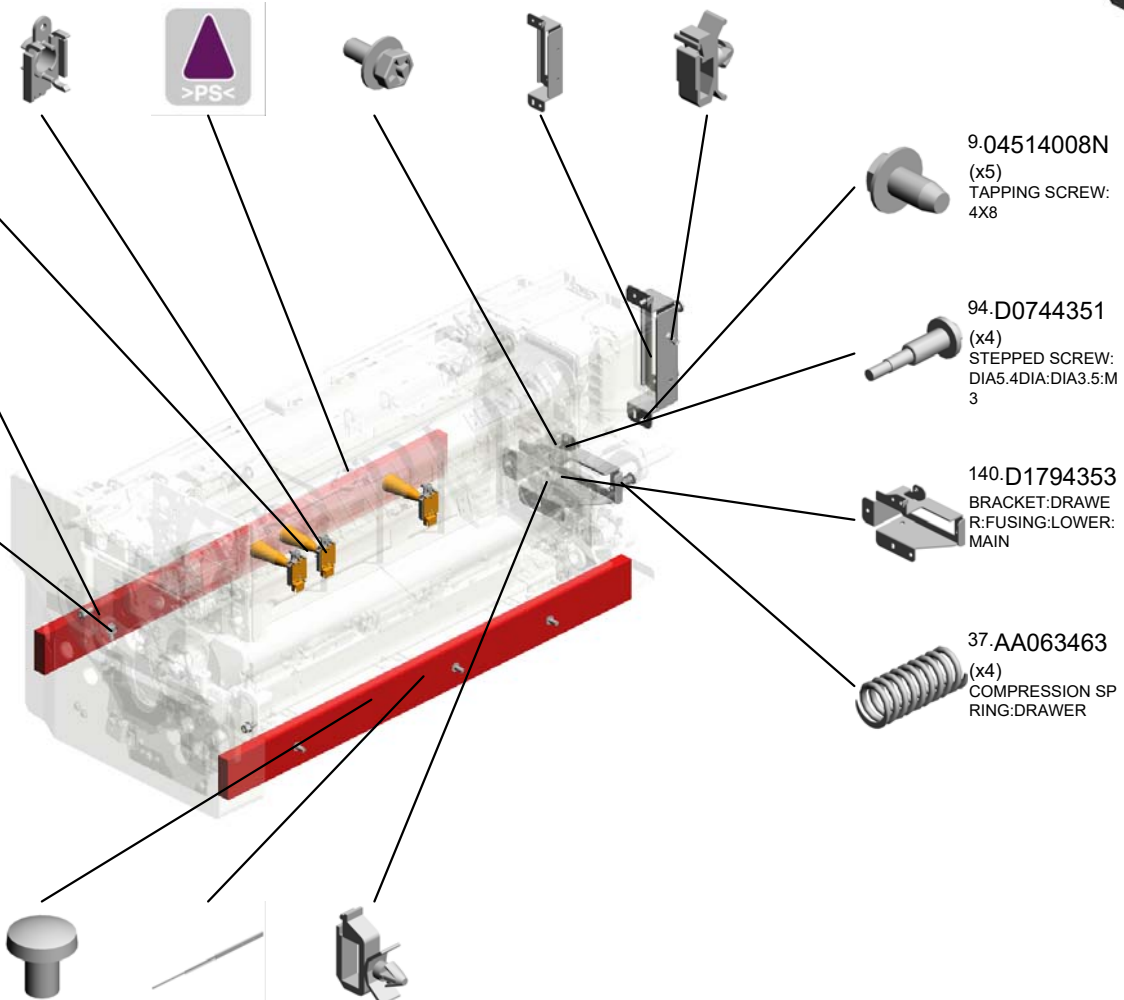

- 2.03540060N (x4) SCREW-M4X6

- 41.AA070090 (x2) SLIDE RAIL:FUSING UNIT

- 25.11050487 HARNESS CLAMP

- 9.04514008N (x5) TAPPING SCREW:4X8

- 94.D0744351 (x4) STEPPED SCREW: DIA5.4DIA:DIA3.5:M3

- 140.D1794353 BRACKET:DRAWER:FUSING:LOWER:MAIN

- 37.AA063463 (x4) COMPRESSION SPRING:DRAWER

- 26.11050511 (x2) HARNESS CLAMP - LWS-0306ZC

U014\_S001  
(NA):FUSING UNIT:208V:ASS'Y

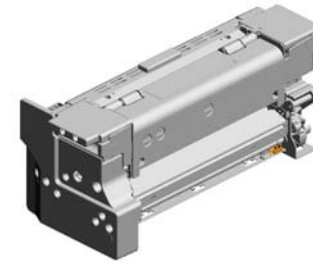

161.D0BX4017  
(NA):FUSING UNIT:  
208V:ASS'Y

- 12.07200030E RETAINING RING - M3
- 8.04503008N (x2) TAPPING SCREW - M3X8
- 1.03530060N (x3) BIND SCREW - M3 X6
- 6.03603010N (x2) SCREW:M3X10
- 22.09543010N SCREW:POLISHED ROUND/SPRING:M 3X10

10.04543006Q (x10) TAPPING SCREW - M3X6

7.03604008N (x3) SCREW - M4X8

21.09543006N SCREW - M3X6

26.11050511 (x12) HARNESS CLAMP - LWS-0306ZC

27.11050516 (x5) CLAMP

13.07200040E (x10) RETAINING RING - M4

20.09300404A (x2) PARALLEL KEY:4X 4X25

5.03603006N (x64) SCREW - M3X6

19.08046123 (x20) HEXAGONAL BOLT :W/WASHER:M3X8

25.11050487 (x2) HARNESS CLAMP

16.07250220E (x2) RETAINING RING - M22

19.08046123 (x10) HEXAGONAL BOLT :W/WASHER:M3X8

24.11050046 (x5) HARNESS BAND

4.03540120N (x2) SCREW M4X12

1.03530060N(x 3) BIND SCREW - M3X6  
5.03603006N(x 7) SCREW - M3X6  
10.04543006Q(x 3) TAPPING SCREW - M3X6  
14.07200060E(x 1) RETAINING RING - M6

18.07330610 (x2) BUSHING:DIA6X10

14.07200060E (x12) RETAINING RING - M6

23.09543012N SCREW - M3X12

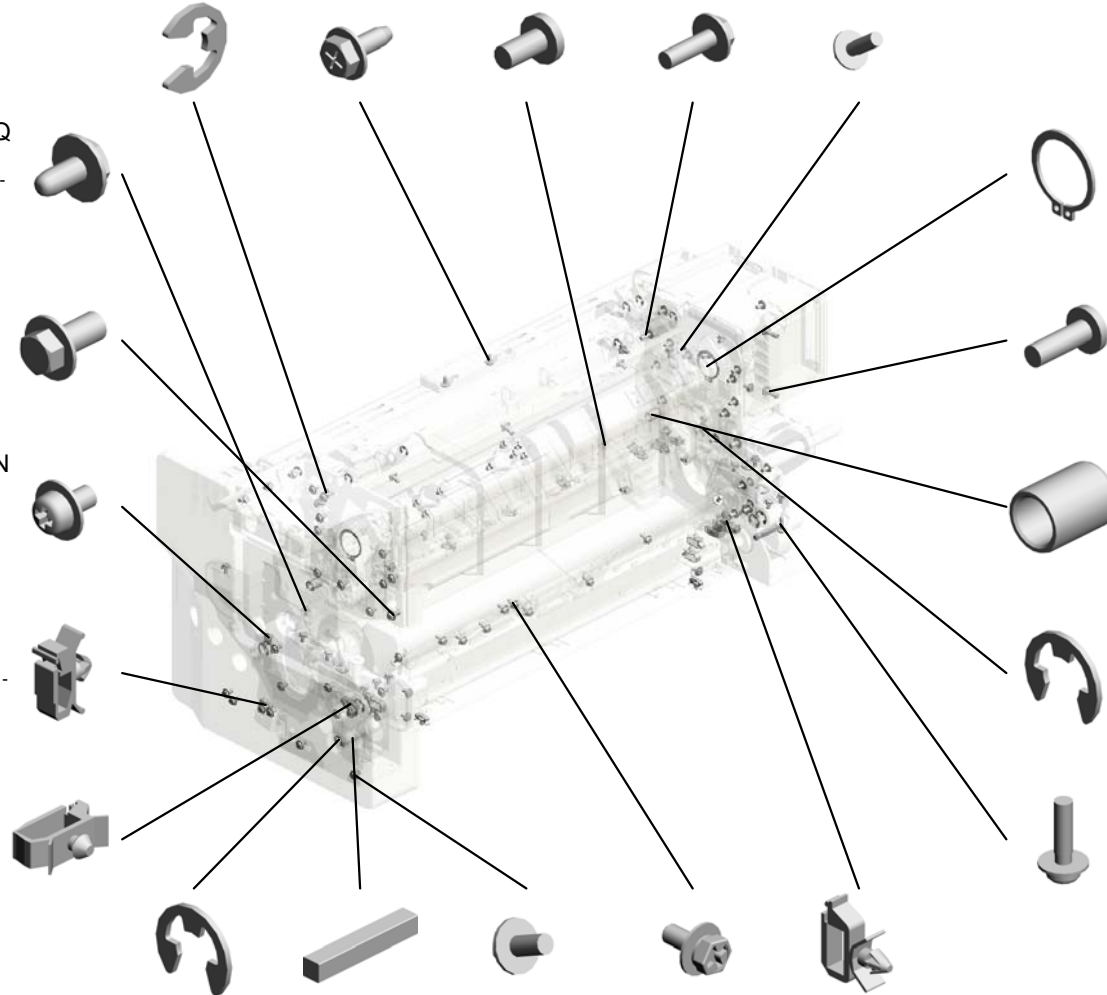

U014\_S001  
(NA):FUSING UNIT:208V:ASS'Y

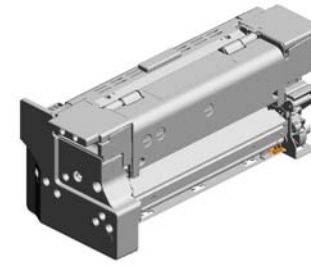

161.D0BX4017  
(NA):FUSING UNIT:  
208V:ASS'Y

- 60.AW010147 (x3) PHOTO REFLECTI ON SENSOR:(SEN 4/SEN63/SEN64/SE N66)
- 28.11050551 (x2) CLAMP:LES-0505
- 50.AE012048 HEAT ROLLER:DIA 39.2
- 42.AA082101 (x2) BUSHING - 6X10X6
- 46.AA143847 (x2) STEPPED SCREW: DIA5:3.5:M3

31.58942540  
ARM SCREW

57.AE032034  
(x2)  
THERMAL INSULA TING BUSHING:DIA 22

30.11050744  
(x5)  
CLAMP:F-LWS-071 1

40.AA064000  
(x2)  
COMPRESSION SP RING:PRESSURE

29.11050723  
(x5)  
CLAMPS:WES-050 7

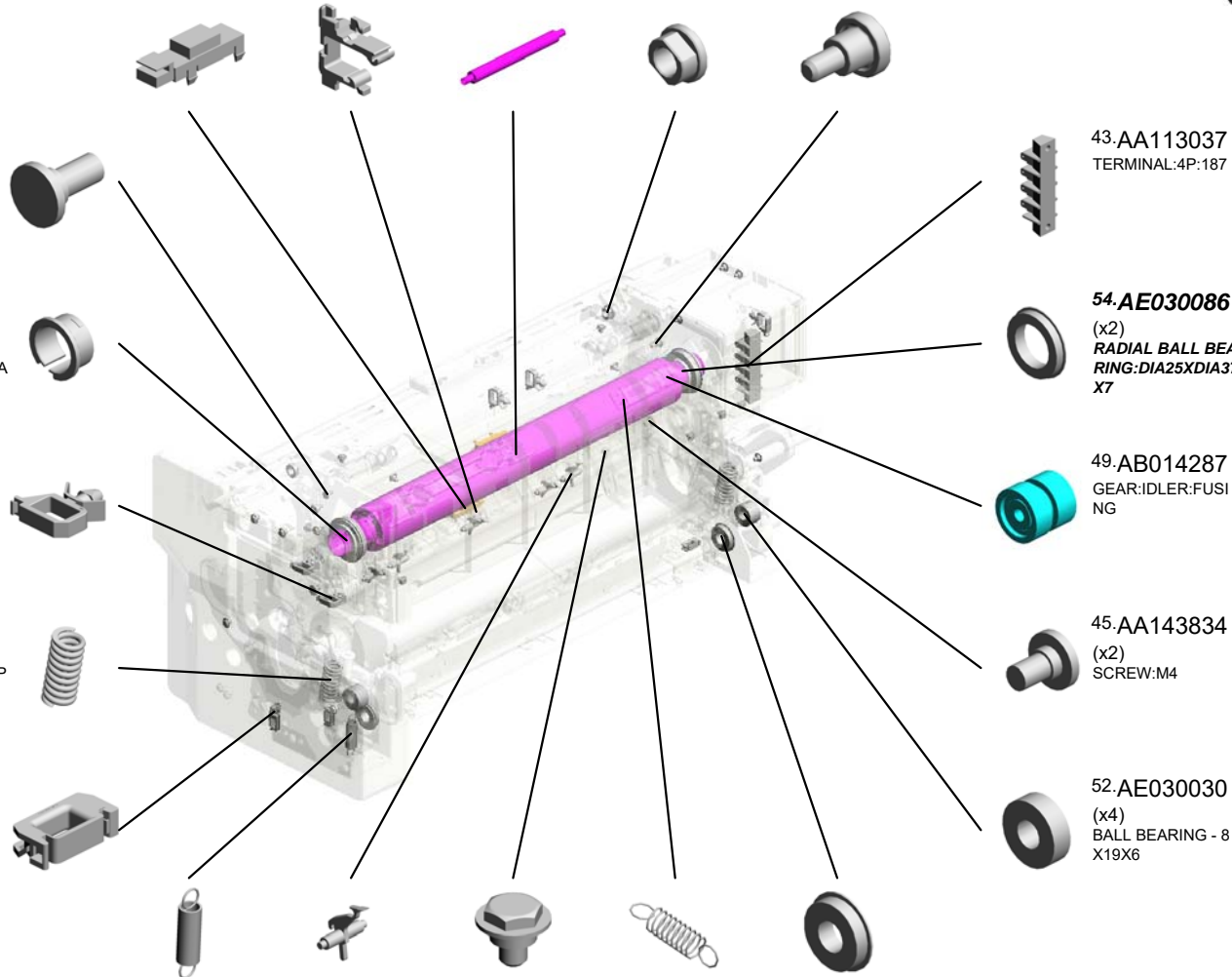

43.AA113037  
TERMINAL:4P:187

54.AE030086  
(x2)  
RADIAL BALL BEA RING:DIA25XDIA37 X7

49.AB014287  
GEAR:IDLER:FUSI NG

45.AA143834  
(x2)  
SCREW:M4

52.AE030030  
(x4)  
BALL BEARING - 8 X19X6

- 35.AA061134 TENSION SPRING: LEVER:PRESSURE
- 58.AE044075 (x5) STRIPPER PAWLS
- 44.AA143520 (x19) SHOULDER SCRE W - M3
- 34.AA061116 (x2) TENSION SPRING: STRIPPER PLATE: 2N
- 53.AE030044 (x2) BALL BEARING - 1 0X22X6

U014\_S001  
(NA):FUSING UNIT:208V:ASS'Y

- 70.B1324268 (x5) HOLDER:ROLLER: PICK-OFF PAWL
- 69.B1324265 (x5) ROLLER:PICK-OFF PAWL
- 68.B1324197 TORSION SPRING: LEVER
- 74.BB013028 GEAR:IDLER:35Z:A SS'Y
- 76.BB013037 GEAR:JOINT:PRES SURE:ASS'Y

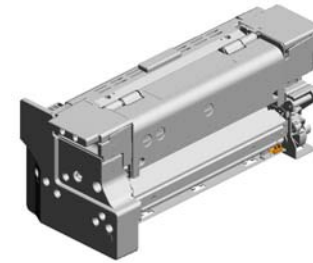

161.D0BX4017  
(NA):FUSING UNIT:  
208V:ASS'Y

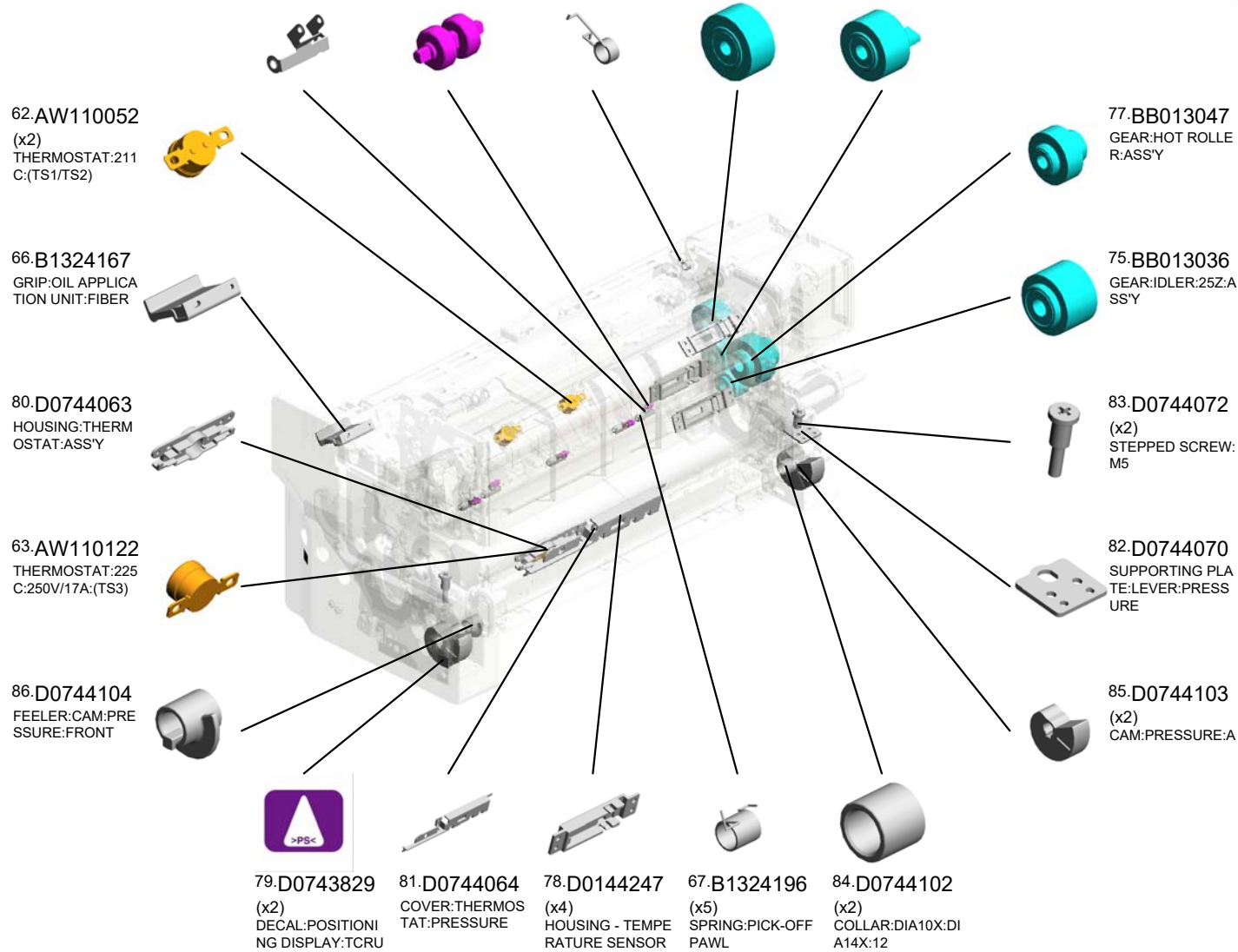



U014\_S001  
(NA):FUSING UNIT:208V:ASS'Y

- 89.D0744180 HOUSING:THERM  
OSTAT:HEAT ROLL  
ER:ASS'Y
- 122.D1794107 BRACKET:STRIPP  
ER PAWLS:PRESS  
URE:PEEN
- 90.D0744181 ELECTRODE PLAT  
E:THERMOSTAT:H  
EAT ROLLER:MIDD  
LE
- 91.D0744182 ELECTRODE PLAT  
E:THERMOSTAT:H  
EAT ROLLER
- 108.D0BX4264 COVER:FUSING U  
NIT:REAR:UPPER:  
ASS'Y

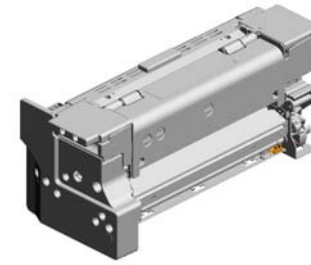

- 161.D0BX4017  
(NA):FUSING UNIT:  
208V:ASS'Y

- 112.D0BX4288  
DECAL:H-TEMP W  
ARNING:FUSING/P  
APER EXIT UNIT:F  
USING UNIT

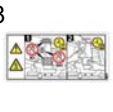

- 105.D0BX4260  
COVER:FUSING U  
NIT:FRONT:UPPER  
:ASS'Y

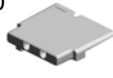

- 106.D0BX4262  
COVER:FUSING U  
NIT:FRONT:MIDD  
LE



- 107.D0BX4263  
COVER:FUSING U  
NIT:FRONT:LOWE  
R

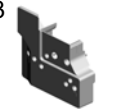

- 92.D0744227  
(x2)  
BOLT:M5:ROUND P  
OINT



- 88.D0744107 COLLAR:DIA10XDI  
A14X9.4
- 117.D1794028 SUPPORTING PLA  
TE:LEVER:PRESS  
URE:FRONT
- 118.D1794071 BRACKET:FUSING  
ENTRANCE GUIDE  
PLATE:FRONT
- 120.D1794081 FUSING ENTRANC  
E GUIDE PLATE:LO  
WER
- 121.D1794095 CLAMP:HARNES  
S:PRESSURE



- 109.D0BX4266  
COVER:FUSING U  
NIT:REAR:MIDDLE



- 110.D0BX4267  
COVER:FUSING U  
NIT:REAR:LOWER



- 98.D0BX4045  
(x2)  
LEVER:CONTROL  
PLATE:PRESSURE



- 119.D1794072  
BRACKET:FUSING  
ENTRANCE GUIDE  
PLATE:REAR



- 87.D0744105  
FEELER:CAM:PRE  
SSURE:REAR



U014\_S001  
(NA):FUSING UNIT:208V:ASS'Y

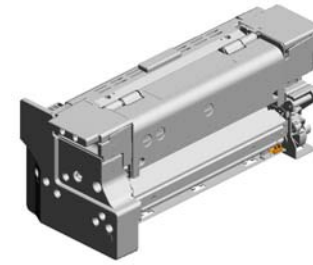

161.D0BX4017  
(NA):FUSING UNIT:  
208V:ASS'Y

- 133.D1794232 SHAFT:FUSING/PAPER EXIT UNIT
- 136.D1794279 COVER:FUSING/PAPER EXIT UNIT:ASS'Y
- 135.D1794255 GUIDE PLATE:FUSING EXIT:UPPER:ASS'Y
- 137.D1794283 GRIP:COVER:FUSING/PAPER EXIT UNIT:ASS'Y
- 130.D1794224 LEVER:PAPER EXIT UNIT:REAR

129.D1794223 LEVER:PAPER EXIT UNIT:FRONT

132.D1794231 STOPPER:LEVER:FUSING/PAPER EXIT UNIT

126.D1794170 TAB:TERMINAL:187:4P

125.D1794114 GUIDE PLATE:FUSING EXIT:LOWER

124.D1794113 (x2) DISCHARGE BRUSH:H:21MM

**128.D1794197**  
**FLAT BELT-FUSING**  
**G:DIA80:SEAL**

123.D1794109 (x2) ADJUSTING PIN:DISCHARGE BRUSH

143.D1944101 SHAFT:CAM:PRESSURE

131.D1794228 (x2) SUPPORTER:GUIDE PLATE:FUSING EXIT:UPPER

147.D2704068 (x2) SHAFT:RADIAL BALL BEARING:LEVER:PRESSURE

148.D2704156 HOLDER:THERMISTOR:HEAT ROLLER

134.D1794235 (x2) TENSION SPRING:FUSING/PAPER EXIT UNIT

127.D1794182 DISCHARGE BRUSH:H:HEAT ROLLER

146.D2704009 (x4) HOLDER:M5

144.D1944106 JOINT:CAM:PRESSURE

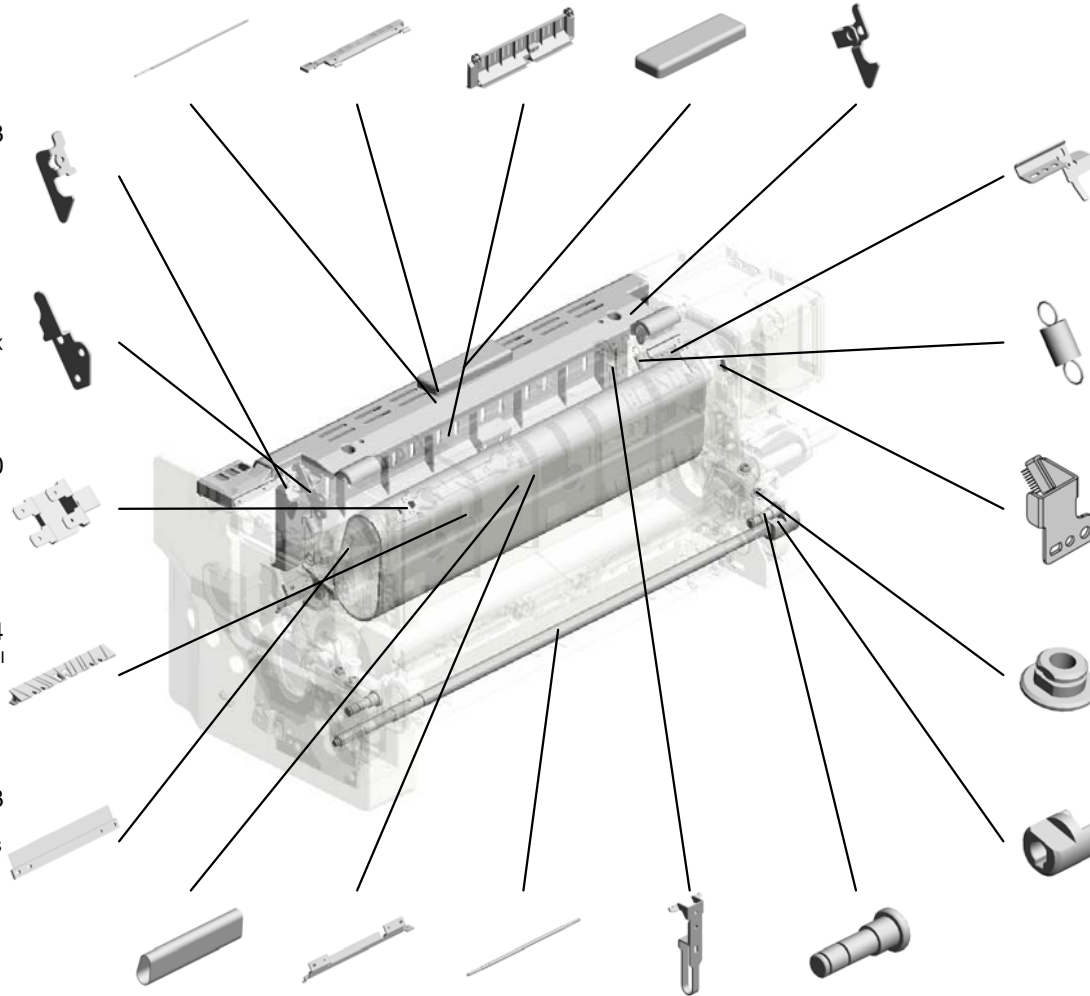

U014\_S001  
 (NA):FUSING UNIT:208V:ASS'Y

149.D2704185 (x2)  
 RING:GUIDE:HEAT ROLLER:DIA39.2

150.D2704236  
 TORSION SPRING:  
 FUSING/PAPER EX  
 IT UNIT:FRONT

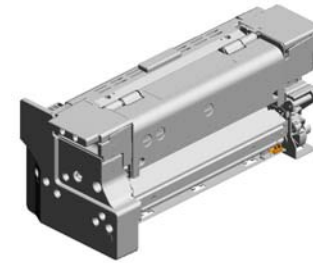

161.D0BX4017  
 (NA):FUSING UNIT:  
 208V:ASS'Y

158.GW020024  
 (x3)  
 PHOTOINTERUP  
 TOR:LG2A24BL1:G  
 F:(SEN3/SEN21/SE  
 N35/SEN36/SEN37/  
 SEN38/SEN39/SEN

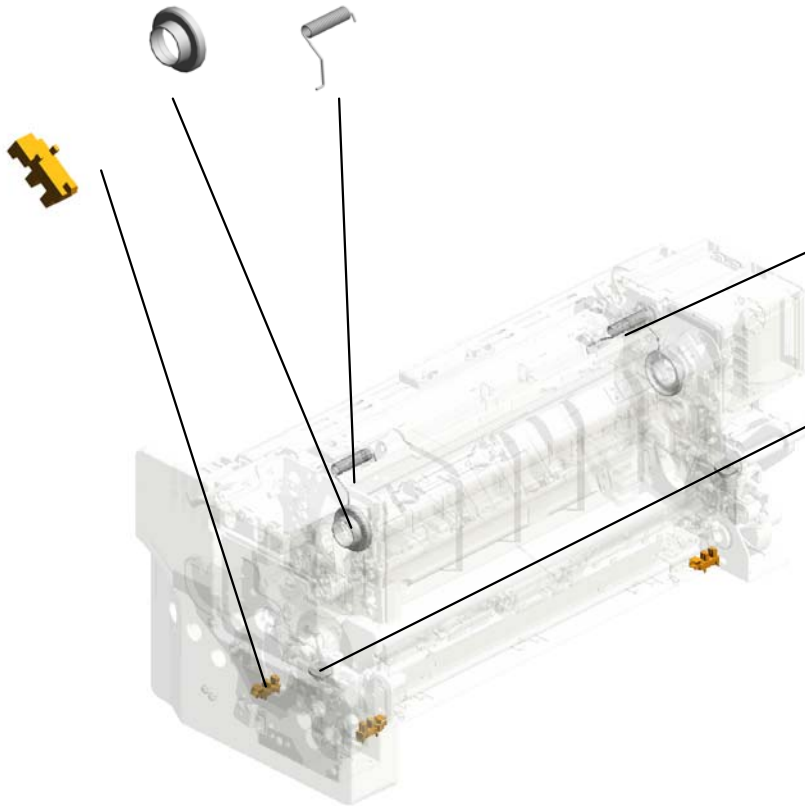

151.D2704237  
 TORSION SPRING:  
 FUSING/PAPER EX  
 IT UNIT:REAR

156.D2704383  
 (x2)  
 HOLDER:COIL SPR  
 ING:PRESSURE

U001	U002	U003	U004	U005	U006	U007	U008	U009	U010	U011	U012	U013	U014	U015	U016	U017	U018	U019	U020	U021
------	------	------	------	------	------	------	------	------	------	------	------	------	------	------	------	------	------	------	------	------

U014\_S001\_S001

(NA):PRESSURE ROLLER:208V:ASS'Y

54.AE030086 (x2) RADIAL BALL BEARING:FRONT  
RING:DIA25XDIA37X7

100.D0BX4048 HOLDER:HEATER:PRESSURE:FRONT

160.AX440348 (NA):HEATER:PRESSURE ROLLER:208V:800W:(HT5)

162.D0BX4401 (NA):PRESSURE ROLLER:208V:ASS'Y

29.11050723 CLAMPS:WES-0507

17.07250250E (x2) RETAINING RING C - M25

5.03603006N (x3) SCREW - M3X6

99.D0BX4047 HOLDER:HEATER:PRESSURE:REAR

73.BB013025 GEAR:PRESSURE ROLLER

51.AE020220 PRESSURE ROLLER:FRONT  
R:DIA65

U001	U002	U003	U004	U005	U006	U007	U008	U009	U010	U011	U012	U013	U014	U015	U016	U017	U018	U019	U020	U021
------	------	------	------	------	------	------	------	------	------	------	------	------	------	------	------	------	------	------	------	------

U014\_S001\_S002  
HOT ROLLER:DIA54:ASS'Y

19.08046123  
HEXAGONAL BOLT  
:W/WASHER:M3X8



101.D0BX4162  
HOT ROLLER:DIA54:ASS'Y

96.D0A53995  
JOINT:KNOB:FUSION

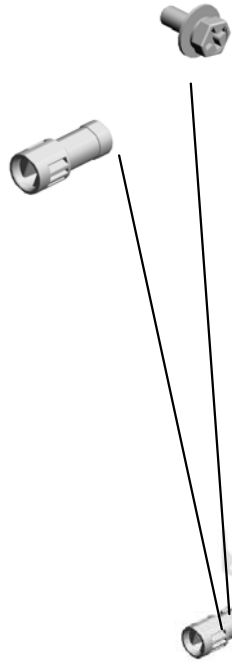

145.D2584302  
(x2)  
STEPPED SCREW:  
LEVER:HEAT ROLLER



15.07250200E  
RETAINING RING  
C - M20

U001	U002	U003	U004	U005	U006	U007	U008	U009	U010	U011	U012	U013	U014	U015	U016	U017	U018	U019	U020	U021
------	------	------	------	------	------	------	------	------	------	------	------	------	------	------	------	------	------	------	------	------

U014\_S001\_S003

TEMPERATURE SENSOR:FUSING UNIT:UPPER:19PIN:(SEN9/SEN59/SEN87/SEN88)



141.D1795381  
TEMPERATURE SE  
NSOR:FUSING UNI  
T:UPPER:19PIN:(S  
EN9/SEN59/SEN87/  
SEN88)



24.11050046  
HARNESS BAND

U001	U002	U003	U004	U005	U006	U007	U008	U009	U010	U011	U012	U013	U014	U015	U016	U017	U018	U019	U020	U021
------	------	------	------	------	------	------	------	------	------	------	------	------	------	------	------	------	------	------	------	------

U014\_S001\_S004  
TEMPERATURE SENSOR:FUSING UNIT:LOWER:17PIN:(SEN80)

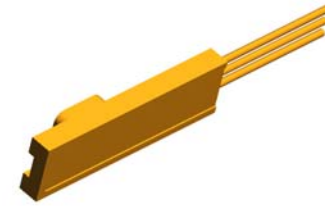

142.D1795387  
TEMPERATURE SE  
NSOR:FUSING UNI  
T:LOWER:17PIN:(S  
EN80)



24.11050046  
HARNESS BAND

U001	U002	U003	U004	U005	U006	U007	U008	U009	U010	U011	U012	U013	U014	U015	U016	U017	U018	U019	U020	U021
------	------	------	------	------	------	------	------	------	------	------	------	------	------	------	------	------	------	------	------	------

U014\_S001\_S005  
STRIPPER PLATE:ASS'Y

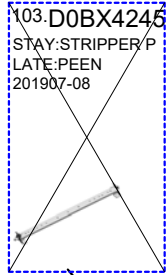

36.AA061154  
(x7)  
COMPRESSION SP  
RING:11N



157.G1021193  
(x2)  
HEXAGONAL BOLT  
:DOUBLE:SCREW:  
ROUND POINT:M3  
X7

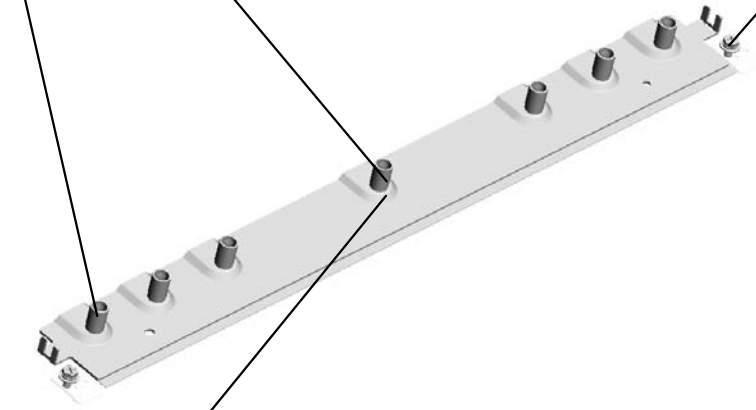

104.D0BX4251  
STRIPPER PLATE:  
ADHESION

U001	U002	U003	U004	U005	U006	U007	U008	U009	U010	U011	U012	U013	U014	U015	U016	U017	U018	U019	U020	U021
------	------	------	------	------	------	------	------	------	------	------	------	------	------	------	------	------	------	------	------	------



U014\_S001\_S006  
COVER:FUSING UNIT:UPPER:ASS'Y

152-D2704277  
DECAL:H-TEMP W  
ARNING:FUSING

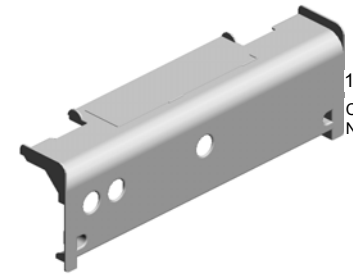
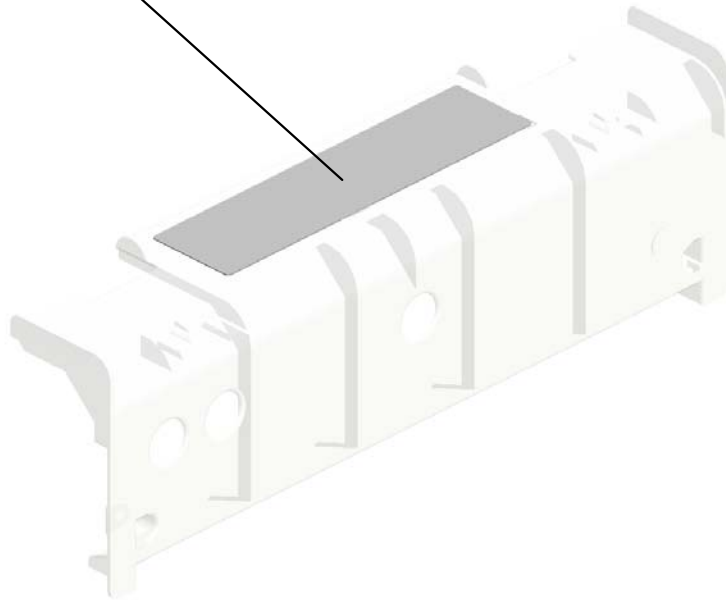

111-D0BX4275  
COVER:FUSING U  
NIT:UPPER:ASSY

U001	U002	U003	U004	U005	U006	U007	U008	U009	U010	U011	U012	U013	U014	U015	U016	U017	U018	U019	U020	U021
------	------	------	------	------	------	------	------	------	------	------	------	------	------	------	------	------	------	------	------	------

U014\_S001\_S007  
 DRIVE UNIT:WEB:CLEANING:ASS'Y

33.A2944171 48.AB014229  
 (x4) (x4)  
 COUPLED GEAR - 17Z/32Z COUPLEDGEAR - 17Z/32Z

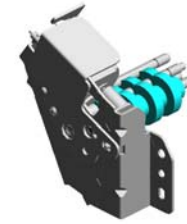

153.D2704290  
 DRIVE UNIT:WEB:  
 CLEANING:ASS'Y

26.11050511  
 (x2)  
 HARNESS CLAMP - LWS-0306ZC



12.07200030E  
 (x2)  
 RETAINING RING - M3



56.AE031037  
 (x4)  
 BUSHING - M4



28.11050551  
 (x2)  
 CLAMP:LES-0505

U001	U002	U003	U004	U005	U006	U007	U008	U009	U010	U011	U012	U013	U014	U015	U016	U017	U018	U019	U020	U021
------	------	------	------	------	------	------	------	------	------	------	------	------	------	------	------	------	------	------	------	------

U014\_S001\_S007\_S001  
DC MOTOR:CLEANER:ASS'Y:(BM5)

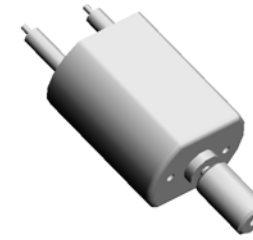

64.AX040300  
DC MOTOR:CLEAN  
ER:ASS'Y:(BM5)



24.11050046  
HARNESS BAND

U001	U002	U003	U004	U005	U006	U007	U008	U009	U010	U011	U012	U013	U014	U015	U016	U017	U018	U019	U020	U021
------	------	------	------	------	------	------	------	------	------	------	------	------	------	------	------	------	------	------	------	------

U014\_S002  
WEB:CLEANING UNIT:ASS'Y

21.09543006N SCREW - M3X6  
32.A2944156 GEAR - 23Z  
11.07200020E RETAINING RING - M2  
154.D2704338 FEELER:CLEANING  
159.M0774200 MECHANICAL ROLLER CLUTCH:ROLLER

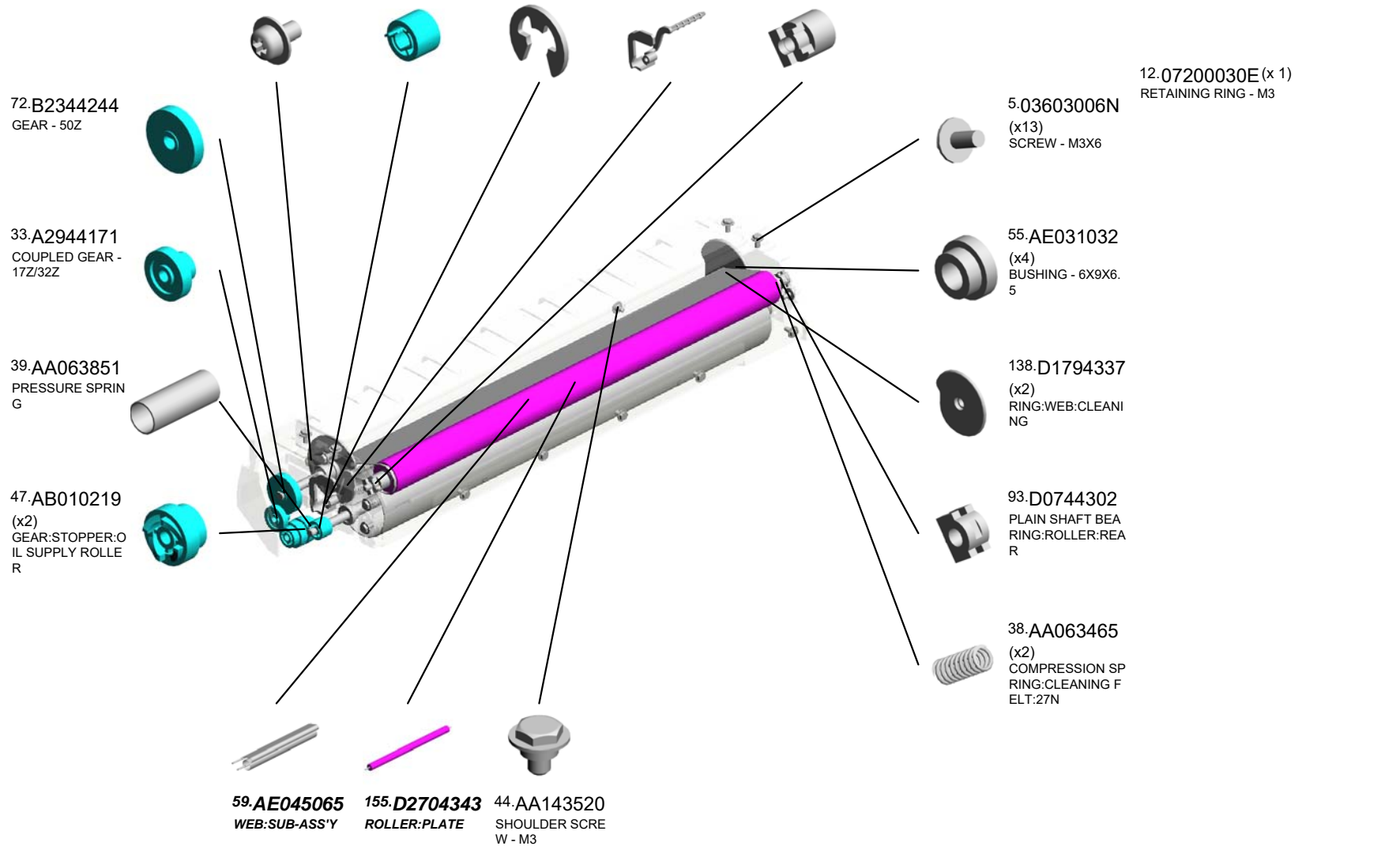
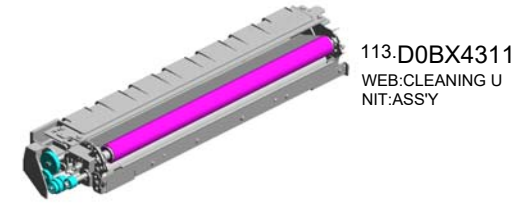

U001	U002	U003	U004	U005	U006	U007	U008	U009	U010	U011	U012	U013	U014	U015	U016	U017	U018	U019	U020	U021
------	------	------	------	------	------	------	------	------	------	------	------	------	------	------	------	------	------	------	------	------

U014\_S002\_S001  
COVER:WEB:CLEANING FELT

95.D0746497  
DECAL:POSITIONI  
NG DISPLAY:TCRU

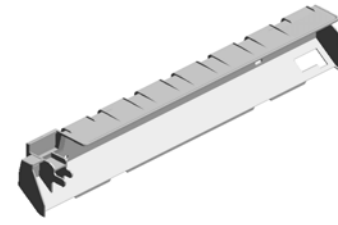

114.D0BX4313  
COVER:WEB:CLEA  
NING FELT

U001	U002	U003	U004	U005	U006	U007	U008	U009	U010	U011	U012	U013	U014	U015	U016	U017	U018	U019	U020	U021
------	------	------	------	------	------	------	------	------	------	------	------	------	------	------	------	------	------	------	------	------

# U015.PAPER EXIT

U015 S001  
D0BX4783  
GUIDE PLATE:REVERSE:LO  
WER:ASSY

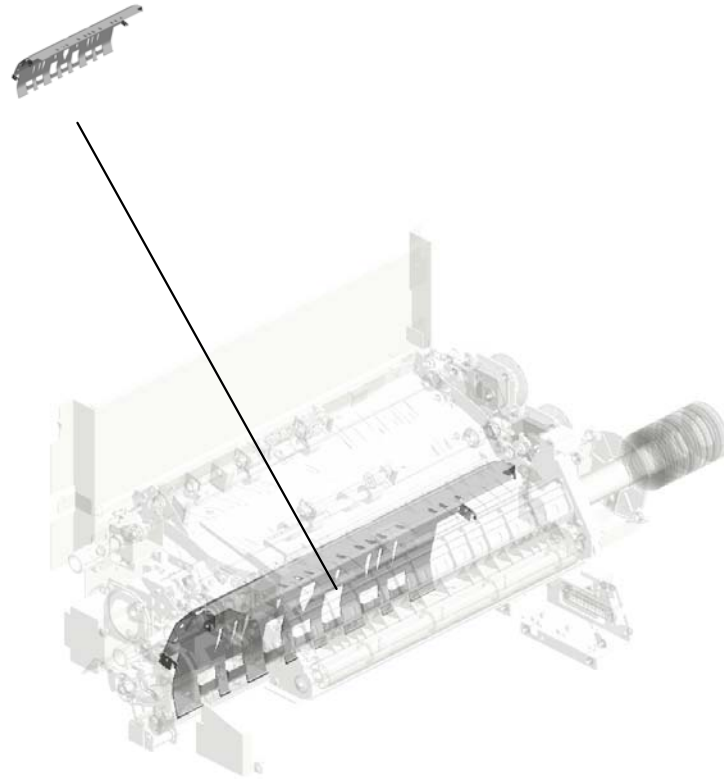

U001	U002	U003	U004	U005	U006	U007	U008	U009	U010	U011	U012	U013	U014	U015	U016	U017	U018	U019	U020	U021
------	------	------	------	------	------	------	------	------	------	------	------	------	------	------	------	------	------	------	------	------

# U015 PAPER EXIT

- 3.03530060N (x4) BIND SCREW - M3 X6
- 19.07200060E (x19) RETAINING RING - M6
- 21.07433808 (x10) RADIAL BALL BEA RING: DIA8XDIA16X 5
- 16.07200020E (x2) RETAINING RING - M2
- 22.08046123 (x2) HEXAGONAL BOLT :W/WASHER:M3X8

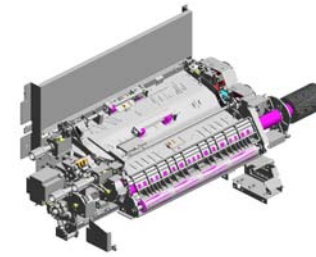

- 5.03603008N (x2) SCREW:M3X8

- 8.03604010N (x4) SCREW:M4X10

- 18.07200040E (x23) RETAINING RING - M4

- 7.03604008N (x3) SCREW - M4X8

- 6.03604006N (x4) SCREW - M4X6

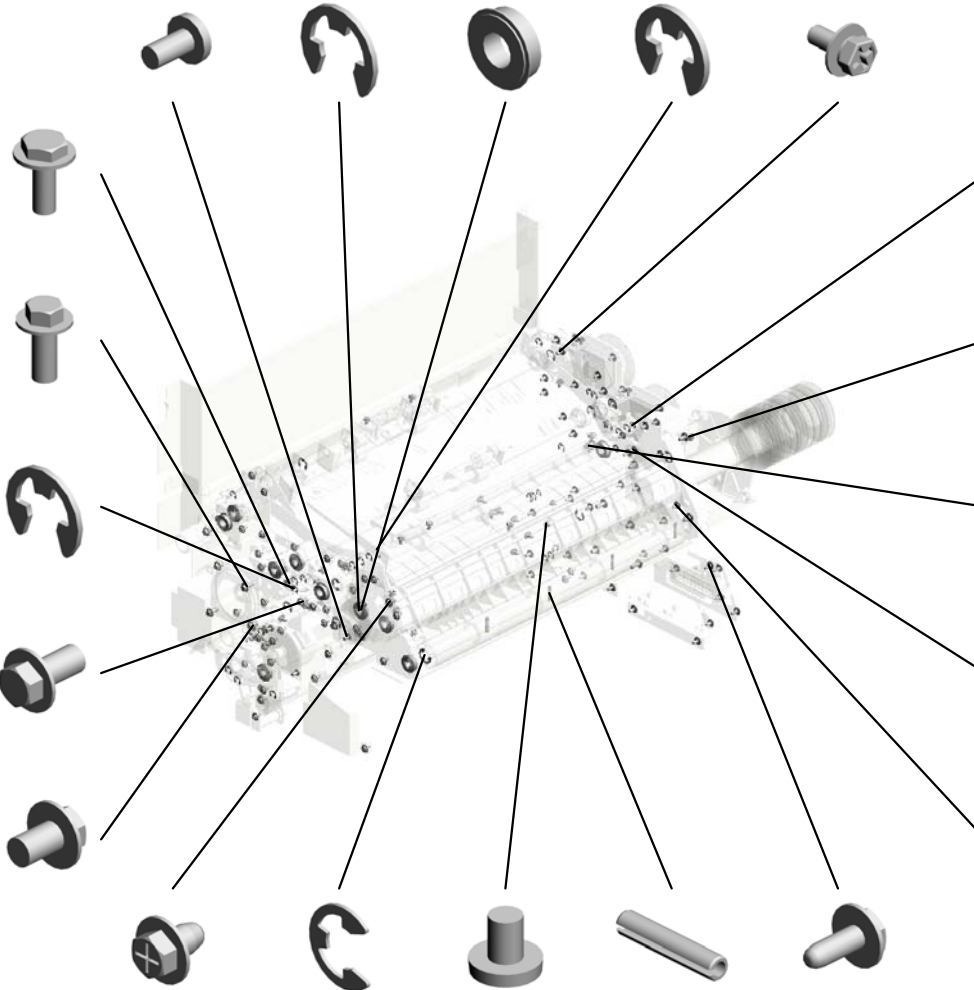

- 14.04544006Q (x5) TAPPING SCREW: 4X6
- 20.07200080E RETAINING RING - M8
- 2.03530040N (x2) SCREW - M3X4
- 15.06230160E (x4) SPRING PIN - 3X16 MM
- 13.04543008Q (x6) TAPPING SCREW: 3X8

- 17.07200030E (x5) RETAINING RING - M3

- 4.03603006N (x10) SCREW - M3X6

- 9.04503008N (x3) TAPPING SCREW - M3X8

- 10.04513006N (x49) TAPPING SCREW - 3X6

- 12.04543006Q (x44) TAPPING SCREW - M3X6



- 25.11050046 (x78) HARNESS BAND



- 26.11050511 (x10) HARNESS CLAMP - LWS-0306ZC



- 27.11050516 (x4) CLAMP

- 1.03130060N (x 1) SCREW - M3X6

- 10.04513006N (x 3) TAPPING SCREW - 3X6

- 11.04514008N (x10) TAPPING SCREW:4X8

- 19.07200060E (x 2) RETAINING RING - M6

# U015 PAPER EXIT

- 24.08050089 (x2) RETAINING RING - M4
- 23.08050088 RETAINING RING - M6
- 42.AA084059 (x12) BALL BEARING HOLDER
- 43.AA120084 DISCHARGE BRUSH
- 29.11050723 (x3) CLAMPS:WES-0507

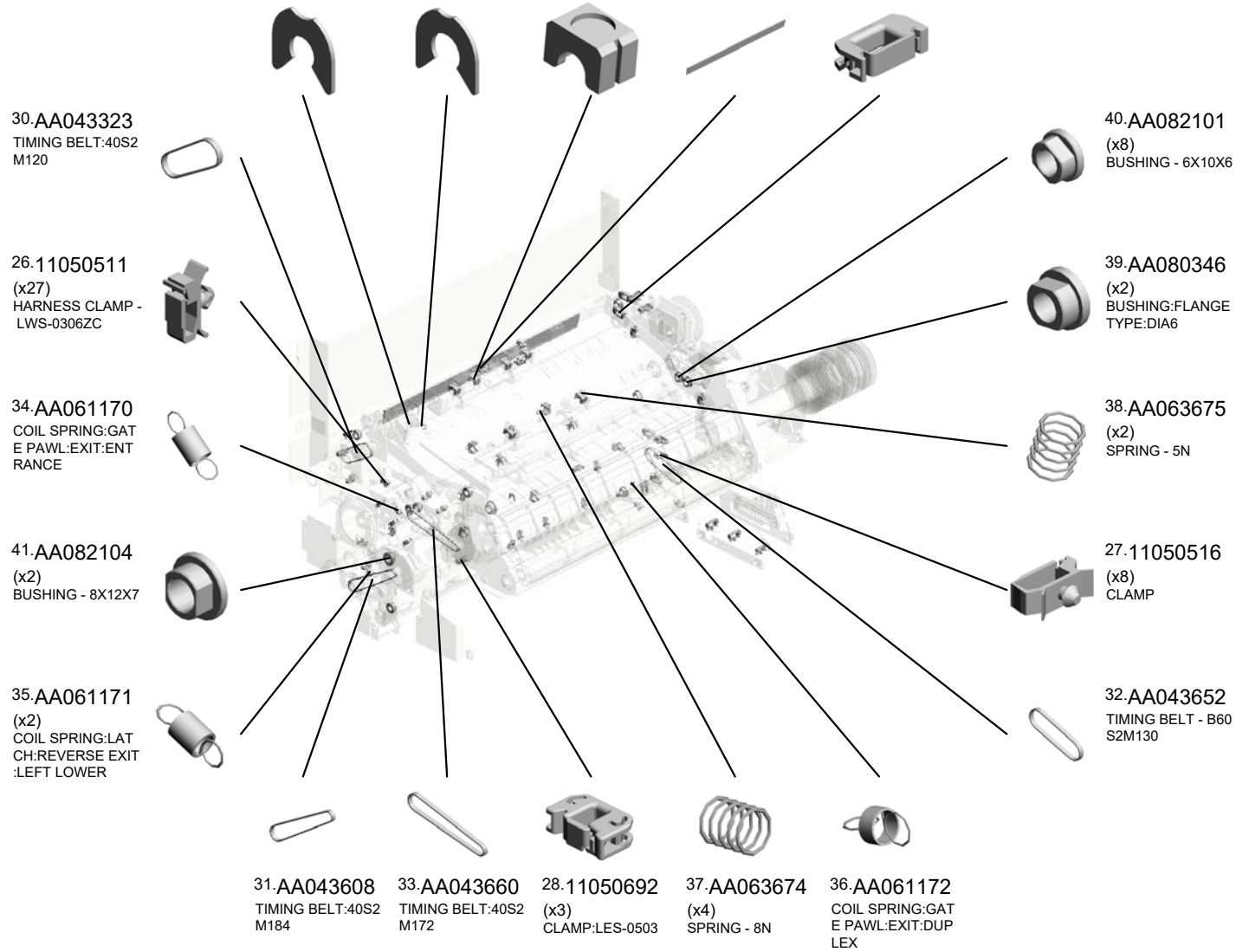
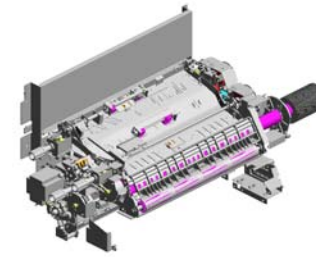



# U015 PAPER EXIT

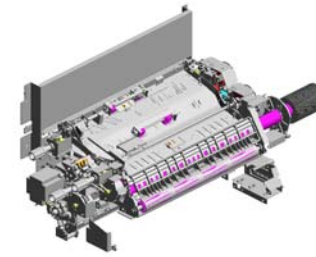

- 56.AW010151 PHOTO REFLECTI  
ON SENSOR:PS12  
2TL1-A:(S6/S7/S10/  
S11/S12/SEN7/SEN  
8/SEN10/SEN32/SE  
N33/SEN34/SEN10
- 55.AW010150 PHOTO REFLECTIO  
N SENSOR:ORIGIN  
AL TRAY:(S14/S15/  
S16/S19/SEN21)
- 57.AW010200 PAPER FEED SEN  
SOR:FUSING EXIT:  
(SEN20)
- 53.AF022182 (x4)  
TRANSPORT ROLL  
ER:DRIVEN:DIA17.  
5X2
- 50.AB017961 (x2)  
GEAR:EXIT:70Z/T2  
4

62.B1322264  
BUSHING:TERMIN  
AL

47.AA161180  
(x2)  
CUSHION:DC STE  
PPER MOTOR

54.AG050100  
(x3)  
KNOB - TRANSPO  
RT ROLLER

58.AX040276  
(x2)  
STEPPER MOTOR:  
MM56:TRANSPOR  
T:(STM5/STM6/ST  
M7/STM8/STM9/ST  
M10/STM12/STM13/

52.AB030880  
(x3)  
PULLEY:S2M:22T

59.AX040280  
(x2)  
STEPPER MOTOR:  
DRIVE:(STM24/ST  
M25/STM26/STM27  
)

45.AA120150  
DISCHARGE BRUS  
H:REVERSE:17MM

51.AB017962  
GEAR:IDLER:EXIT

48.AB011626  
GEAR:IDLER:EXIT:  
CONNECTING

61.B1253659  
(x2)  
CUSHION:SWIVEL:  
STOPPER

49.AB011627  
(x2)  
GEAR:EXIT:25Z

46.AA143444  
(x2)  
STEPPED SCREW

60.AX061102  
(x2)  
DC BRUSHLESS M  
OTOR:25W:NMB:E  
XIT:(BLM7/BLM12)

44.AA120097  
ANTISTATIC BRUS  
H

63.B2344258  
(x2)  
CAP:HEAT PIPE

# U015 PAPER EXIT

- 74.D0BX4742 (x2) TRANSPORT ROLLER:DRIVEN:DIA17.5
- 75.D0BX4743 (x4) COMPRESSION SPRING:EXIT:2.5N
- 84.D0BX4841 TRANSPORT ROLLER:EXIT:PRESS FIT
- 80.D0BX4792 GUIDE PLATE:REVERSE EXIT:UPPER
- 72.D0BX4731 GUIDE PLATE:EXIT:UPPER:SUB-ASS'Y

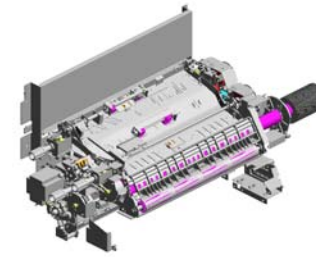

- 71.D0931266 (x2) DECAL:WARNING (HIGH TEMPERATURE):LENGTHWISE



- 79.D0BX4789 GUIDE PLATE:REVERSE EXIT:LOWER:PEEN

- 69.D0743173 (x3) TIMING PULLEY:S2M:25T

- 68.D0742632 (x2) BRACKET:DC STEPPER MOTOR:MM56:CAM

- 67.D0464655 TIMING BELT:S2M180

- 66.B8304263 TIMING BELT - 60S2M140

- 83.D0BX4840 (x2) TRANSPORT ROLLER:EXIT:ENTRANCE:PRESS FIT

- 73.D0BX4740 GUIDE PLATE:EXIT:UPPER:ENTRANCE

- 76.D0BX4782 GUIDE PLATE:EXIT:ENTRANCE

- 64.B2344460 DISCHARGE BRUSH:PH-L=341 SUS

- 70.D0744698 (x2) LEVER:LOCK:GUIDE PLATE
- 82.D0BX4802 (x6) GATE PAWL:REVERSE EXIT
- 65.B2346424 (x2) RELEASE GRIP
- 85.D0BX4842 TRANSPORT ROLLER:REVERSE:PRESS FIT
- 81.D0BX4801 GATE PAWL:REVERSE EXIT:MIDDLE

# U015 PAPER EXIT

88.D0BX4889 DISCHARGE BRUSH:EXIT:INNER  
 102.D1794785 GUIDE PLATE:EXIT:MIDDLE  
 105.D1794811 SHAFT:GATE PAWL:EXIT:REVERSE  
 87.D0BX4888 (x2) DISCHARGE BRUSH:EXIT:OUTER  
 104.D1794810 PLATE:GATE PAWL:EXIT:REVERSE

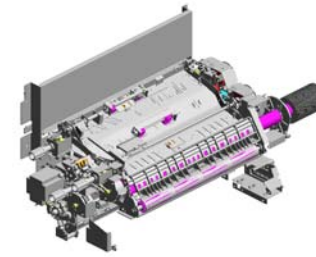

97.D1794757 SHAFT:LOCK:REVERSE EXIT:LEFT LOWER

99.D1794759 SHAFT:ON-OFF:DRIVEN ROLLER:REVERSE EXIT

96.D1794755 (x2) LEVER:LOCK:REVERSE EXIT:LEFT LOWER

98.D1794758 LINK:ON-OFF:DRIVEN ROLLER:REVERSE EXIT

95.D1794754 STOPPER:GUIDE PLATE:REVERSE EXIT:LEFT LOWER

93.D1794538 BRACKET:CAP:HEAT PIPE:UPPER

94.D1794539 BRACKET:CAP:HEAT PIPE:LOWER

89.D1793960 TRANSPORT ROLLER:HEAT PIPE:DIAMETER:30.4:ASSY

100.D1794761 BRACKET:SOLENOID:GATE PAWL:SWITCHBACK

101.D1794766 LINK:GATE PAWL:SWITCHBACK

86.D0BX4843 TRANSPORT ROLLER:REVERSE:ENTRANCE:PRESS FIT  
 103.D1794796 GUIDE PLATE:REVERSE:UPPER  
 91.D1794533 (x4) DRIVE ROLLER:COOLING UNIT:ENTRANCE  
 92.D1794537 GUIDE PLATE:COOLING UNIT:ENTRANCE  
 90.D1794531 SHAFT:COOLING UNIT:ENTRANCE

# U015 PAPER EXIT

122.D1797084 BRACKET:MISFEED  
D REMOVAL:DUPL  
EX  
124.D2452528 (x2)  
BUSHING:MM8  
116.D1794847 BRACKET:CONNE  
CTION:MAIN:EXIT  
118.D1794866 COVER:EXIT  
117.D1794860 GUIDE PLATE:MAI  
N:EXIT

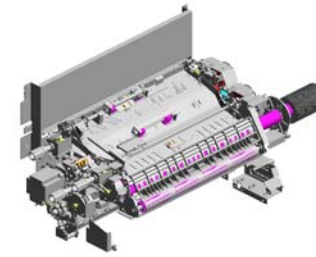

123.D2416290  
(x2)  
LED:RED

121.D1797083  
SHAFT:MISFEED R  
EMOVAL:DUPL

109.D1794821  
LINK:GATE PAWL:  
EXIT:ENTRANCE

107.D1794816  
BRACKET:CAM:GA  
TE PAWL

108.D1794820  
(x2)  
CAM:ON-OFF

110.D1794822  
LINK:ON-OFF:REV  
ERSE EXIT:CAM

113.D1794830  
BRACKET:CONTA  
CT POINT:REVERS  
E EXIT:FRONT

106.D1794813  
BRACKET:DC STE  
PPER MOTOR:ON-  
OFF

120.D1794887  
(x2)  
SHEET:TRANSPOR  
T:REVERSE EXIT

112.D1794827  
GUIDE PLATE:REV  
ERSE EXIT:LEFT L  
OWER:MIDDLE

125.D2704535  
DRIVE ROLLER:CO  
ROLLING UNIT:EXIT:P  
RESS FIT

114.D1794835  
BRACKET:CONTA  
CT POINT:REVERS  
E EXIT:REAR

119.D1794882  
COVER:HARNES  
S:LEFT LOWER

115.D1794838  
BRACKET:DRAWE  
R:LEFT

111.D1794824  
GUIDE PLATE:REV  
ERSE EXIT:LEFT L  
OWER:PEEN

# U015 PAPER EXIT

- 137.D2704748 COMPRESSION SPRING:STOPPER:20N
- 133.D2704740 BRACKET:ARM:STOPPER:RELEASE
- 135.D2704745 PIN:ARM:GRIP
- 144.D6884895 (x8) BINDING HEAD SCREW:ROUND POINT:M3X8
- 140.D2704757 STOPPER:GUIDE PLATE:EXIT:INNER BACK

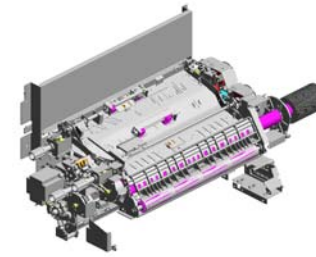

- 138.D2704750 STOPPER:GUIDE PLATE:EXIT:UPPER:SUB-ASS'Y

- 132.D2704737 BRACKET:LINK:LEVER

- 126.D2704543 SHAFT:MISFEED REMOVAL:EXIT

- 139.D2704753 PLATE:HANDLE:GUIDE:OPEN AND CLOSE

- 136.D2704746 BRACKET:CAM:ON-OFF:PEEN

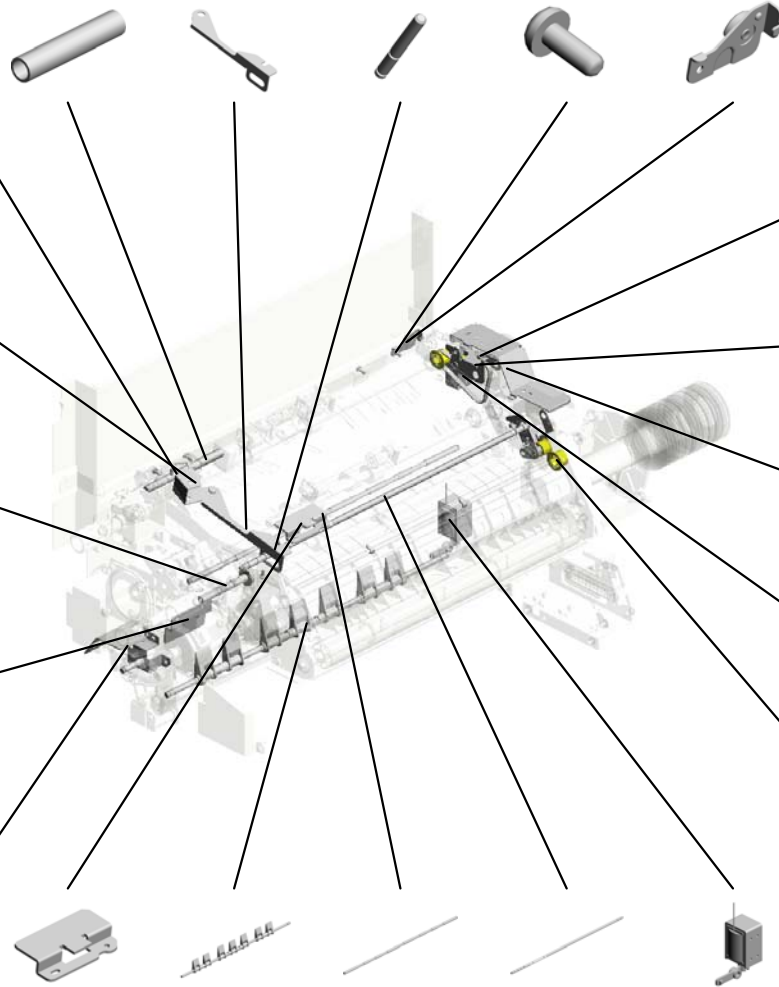

- 128.D2704551 (x2) COIL SPRING:TENSIONER:EXIT

- 127.D2704547 (x2) BRACKET:TIGHTENER:EXIT:ASS'Y

- 130.D2704557 COVER:EXIT:MOTOR

- 129.D2704555 SYNCHRONOUS BELT:B50S2M200

- 145.D7773126 (x2) TIMING PULLEY:DRIVE:T25S2M

- 131.D2704658 SHEET:HANDLE:LOCK:ASS'Y
- 142.D2704768 GATE PAWL:SWITCH:BACK
- 143.D2704800 SHAFT:GATE PAWL:REVERSE
- 134.D2704742 SHAFT:GUIDE PLATE:EXIT:UPPER:OPEN/CLOSE
- 141.D2704764 DC SOLENOID:GATE PAWL:SWITCH:BACK:(SOL4)

# U015 PAPER EXIT

151.G1784908 (x2) COIL SPRING:LEFT LOWER:LOCK  
 152.G1787453 ARM:ON-OFF:TRANSPORT ROLLER  
 158.M0B14675 GATE PAWL:EXIT:REVERSE  
 147.G1783593 (x7) TENSION SPRING:STOPPER

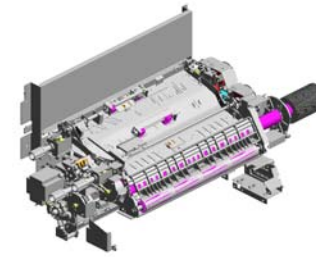

154.GW020024 (x2) PHOTO INTERRUPTOR:LG2A24BL1:G F:(SEN3/SEN21/SEN35/SEN36/SEN37/SEN38/SEN39/SEN

149.G1784828 (x4) STAY:LOCK:LEVER:LEFT LOWER

156.J5033116 TIMING BELT:40S2 M128

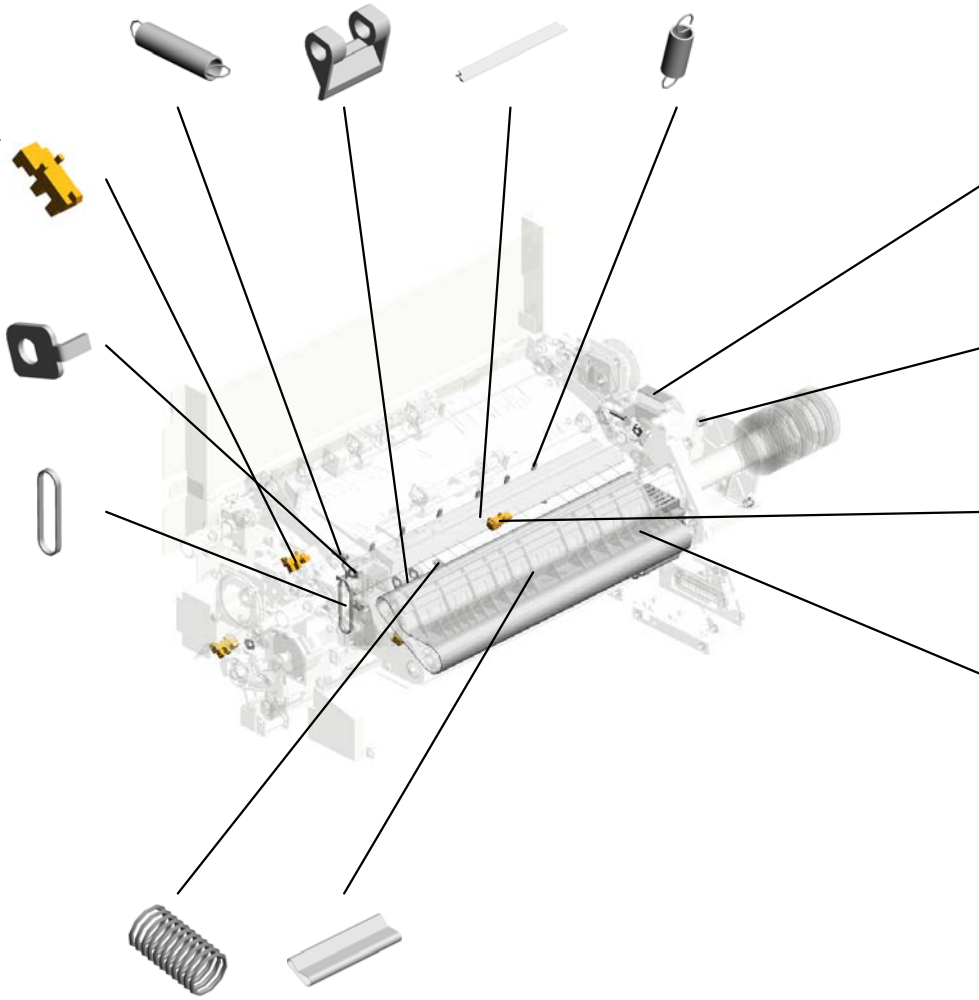

146.G1664310 DECAL:WARNING (HIGH TEMPERATURE):1:CUD



155.H0722216 (x2) COMPRESSION SPRING



153.GW010007 (x2) PHOTO REFLECTOR SENSOR:EXIT:(SEN11/SEN12/SEN13/SEN14/SEN15/SEN16/SEN17/SEN1

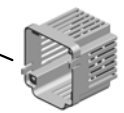

150.G1784900 COVER:DC STEPPER MOTOR:MM56

148.G1784822 (x2) SPRING:PRESSURE:0.8N:DIA0.65  
 157.M0774821 TRANSPORT BELT:COOLING

U015\_S001  
GUIDE PLATE:REVERSE:LOWER:ASS'Y

78:D0BX4786  
CUSHION:GUIDE P  
LATE:REVERSE:LO  
WER

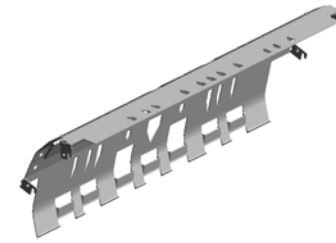
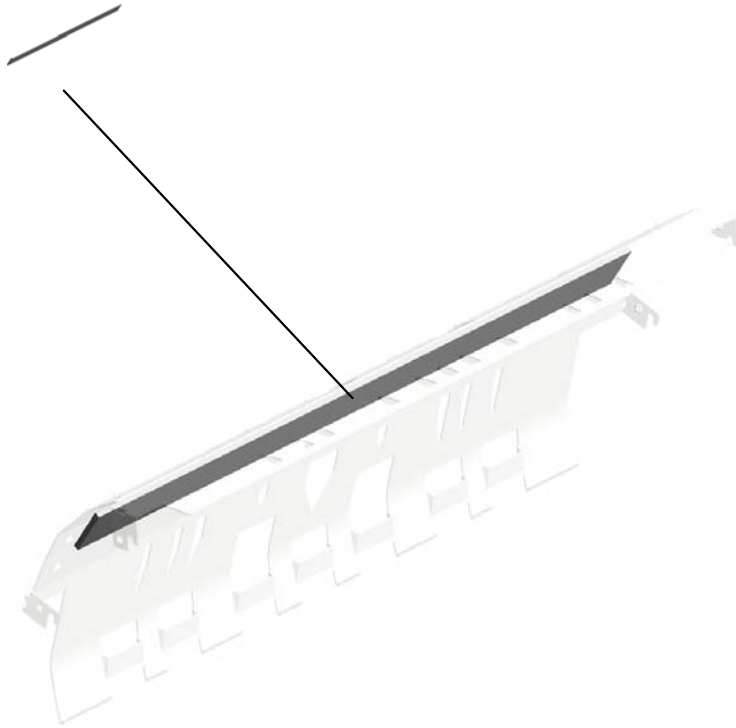

77:D0BX4783  
GUIDE PLATE:REV  
ERSE:LOWER:ASS'  
Y

U001	U002	U003	U004	U005	U006	U007	U008	U009	U010	U011	U012	U013	U014	U015	U016	U017	U018	U019	U020	U021
------	------	------	------	------	------	------	------	------	------	------	------	------	------	------	------	------	------	------	------	------

# U016 DUPLEX

8.04513006N (x54) TAPPING SCREW - 3X6  
 22.11050724 (x0) CLAMPS:WES-1210  
 19.11050516 (x2) CLAMP  
 11.07200040E (x2) RETAINING RING - M4  
 13.07433808 (x10) RADIAL BALL BEARING: DIA8X DIA16X5

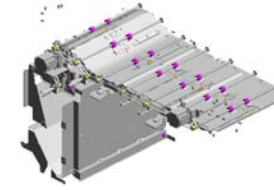

5.03604010N (x6) SCREW:M4X10

3.03604006N (x6) SCREW - M4X6

18.11050511 (x63) HARNESS CLAMP - LWS-0306ZC

9.04514008N (x17) TAPPING SCREW: 4X8

14.08010237 HEXAGONAL BOLT :DOUBLE SCREW: M4X12

10.04543008Q (x24) TAPPING SCREW: 3X8

4.03604008N SCREW - M4X8

1.03530100N SCREW-M3X10

6.04503008N (x10) TAPPING SCREW - M3X8

21.11050723 CLAMPS:WES-0507

20.11050692 (x6) CLAMP:LWS-0503

2.03603006N (x2) SCREW - M3X6

7.04504008N (x18) TAPPING SCREW - M4X8

16.11050487 (x3) HARNESS CLAMP

12.07200060E (x25) RETAINING RING - M6

15.11050046 (x28) HARNESS BAND

17.11050508 (x5) HARNESS CLAMP - LWS-0711

19.11050516 (x5) CLAMP

22.11050724 CLAMPS:WES-1210



# U016 DUPLEX

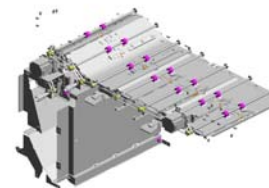

- 29.AA061173 (x7) COIL SPRING:GATE PAWL:DUPLEX:ENTRANCE
- 38.AF022182 (x8) TRANSPORT ROLLER:DRIVEN:DIA17.5X2
- 33.AA084059 (x16) BALL BEARING HOLDER
- 31.AA063675 (x8) SPRING - 5N
- 32.AA080346 (x2) BUSHING:FLANGE TYPE:DIA6

- 36.AB030842 (x2) TIMING PULLEY:S2M:30T

- 41.AW010151 PHOTO REFLECTION SENSOR:PS12 2TL1-A:(S6/S7/S10/S11/S12/SEN7/SEN8/SEN10/SEN32/SEN33/SEN34/SEN10)

- 26.AA043293 TIMING BELT - 40S 2M268G

- 35.AA161180 (x3) CUSHION:DC STEPPER MOTOR

- 42.AX040276 (x3) STEPPER MOTOR:MM56:TRANSPORT:(STM5/STM6/STM7/STM8/STM9/STM10/STM12/STM13/)

- 39.AG050100 (x2) KNOB - TRANSPORT ROLLER
- 37.AF022067 (x5) GUIDE STOPPER ROLLER
- 40.AW010143 PHOTO REFLECTION SENSOR:PSR11 TL1R-C:(SEN23)
- 34.AA143811 (x4) STEPPED SCREW - M3X4
- 25.AA021034 (x2) MAGNETIC

- 23.54472681 (x2) SNAP RING

- 30.AA063674 (x8) SPRING - 8N

- 24.A2574493 (x2) BAND

- 28.AA043650 (x3) TIMING BELT - B60 S2M290

- 27.AA043333 TIMING BELT:60S2 M168

# U016 DUPLEX

- 49.D0BX7085 (x7) TRANSPORT ROLLER:DUPL  
EX:PRESS FIT
- 60.D1797062 GUIDE PLATE:DUP  
LEX:ENTRANCE:U  
PPER
- 61.D1797066 GUIDE PLATE:DUP  
LEX:ENTRANCE:L  
OWER
- 50.D0BX7114 GUIDE PLATE:REV  
ERSE:DUPL  
EX:DRI  
VE
- 59.D1797060 (x7) GATE PAWL:DUPL  
EX:ENTRANCE

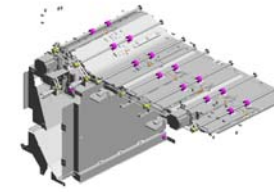

- 54.D0BX7128 DISCHARGE BRUSH:RECEIVING SUB-UNIT:REVERSE:ENTRANCE

- 52.D0BX7118 GUIDE PLATE:REVERSE:DUPL  
EX:LEFT

- 51.D0BX7116 GUIDE PLATE:REVERSE:DUPL  
EX:DRI  
VEN:PEEN

- 53.D0BX7120 TRANSPORT ROLLER:REVERSE:DUPL  
EX:PRESS FIT

- 47.D0743173 (x15) TIMING PULLEY:S2  
M:25T

- 46.D0743047 (x2) BRACKET:HOLDER:DUPL  
EX:ASSY

- 44.D0592620 RETAINING RINGS -C

- 43.B0654935 (x2) LEVER:GUIDE PLATE:ASSY

- 55.D0BX7142 GUIDE PLATE:RECEIVING SUB-UNIT:RIGHT:PEEN

- 56.D1797050 GUIDE PLATE:DUPLEX:UPPER:LEFT

- 45.D0742632 BRACKET:DC STEPPER MOTOR:MM56:CAM

- 62.D1797070 GUIDE PLATE:DUPLEX:OPEN AND CLOSE:LEFT

- 57.D1797053 GUIDE PLATE:DUPLEX:UPPER:MIDDLE

- 48.D0BX7076 GUIDE PLATE:DUPLEX:LOWER

- 58.D1797056 GUIDE PLATE:DUPLEX:UPPER:RIGHT

# U016 DUPLEX

- 77.D6844142 (x4) TIMING BELT:60S2 M174
- 79.G1784817 (x10) SPRING:PRESSURE:ROLLER:DUPL
- 78.G1784808 (x5) BRACKET:PRESSURE:ROLLER
- 71.D1797131 BRACKET:ROLLER:PEEN
- 74.D2707061 SHAFT:GATE PAWL:DUPLX:ENTRANCE

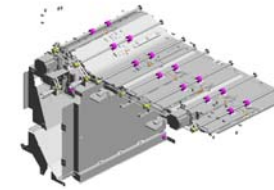

76.D5163823  
TIMING BELT:60S2  
M146

65.D1797081  
BRACKET:DC STEPPER MOTOR:DUPLX:LEFT

67.D1797083  
(x2)  
SHAFT:MISFEED REMOVAL:DUPLX

68.D1797084  
(x2)  
BRACKET:MISFEED REMOVAL:DUPLX

72.D2416290  
LED:RED

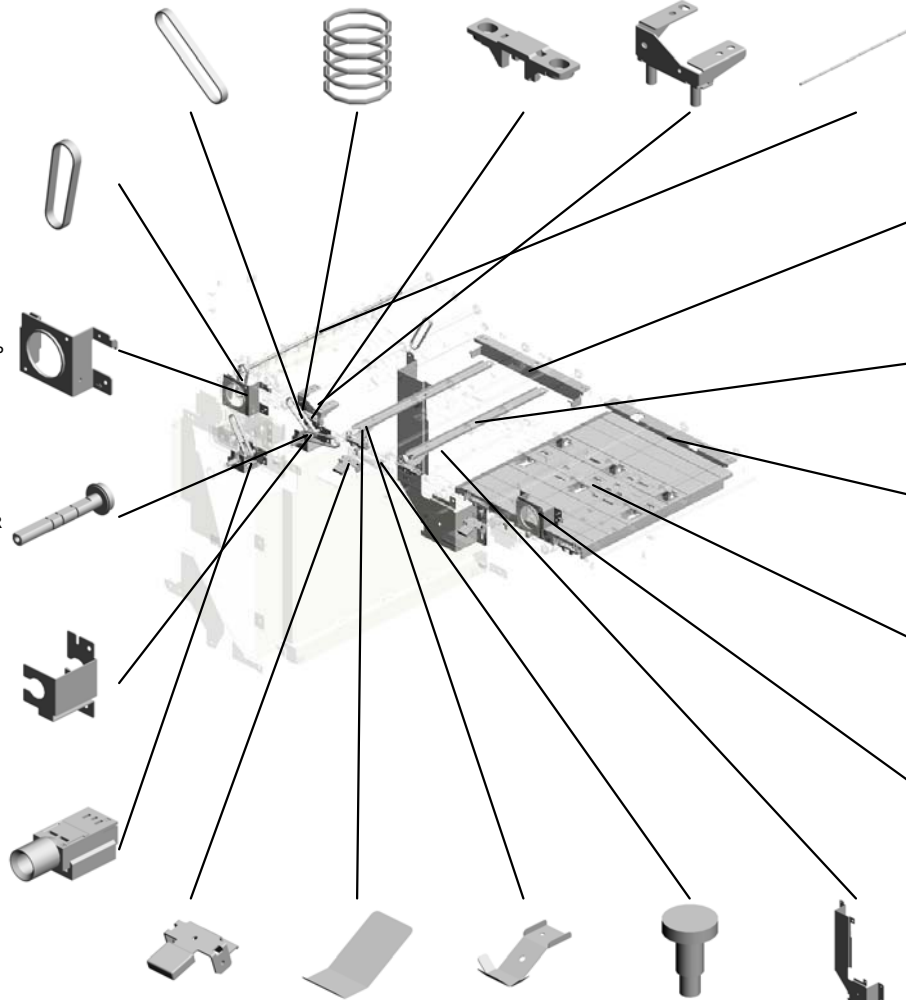

69.D1797096  
BRACKET:DUPLX:OPEN AND CLOSE:LEFT:PEEN

63.D1797071  
(x4)  
SUPPORTING PLATE:GUIDE PLATE:DUPLX:OPEN AND CLOSE

70.D1797098  
BRACKET:DUPLX:OPEN AND CLOSE:RIGHT:PEEN

64.D1797075  
GUIDE PLATE:DUPLX:OPEN AND CLOSE:RIGHT

66.D1797082  
BRACKET:DC STEPPER MOTOR:DUPLX:RIGHT

- 73.D2704933 (x2) HOOK:LEVER:GUIDE PLATE:ASSY
- 81.G1784895 (x4) SHEET:DUPLX:SPRING PLATE
- 80.G1784890 (x4) SPRING PLATE:DUPLX:GUIDE:LOW
- 82.G1784916 (x4) SCREW:ROUND POINT
- 75.D2707103 DRUM STAY:RECEIVING SUB-UNIT:REVERSE

U016  
DUPLEX

84.GW010007  
(x8)  
PHOTO REFLECTI  
ON SENSOR:EXIT:(  
SEN11/SEN12/SEN  
13/SEN14/SEN15/S  
EN16/SEN17/SEN1

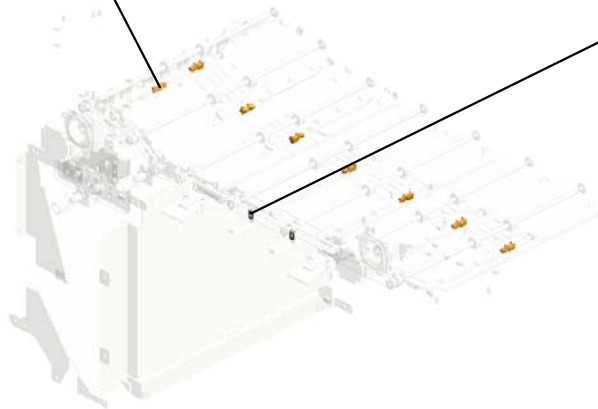

83.G1787618  
(x2)  
PLATE:FIX:BAND

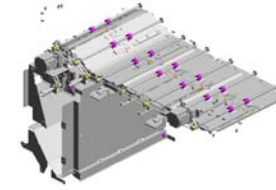

U001	U002	U003	U004	U005	U006	U007	U008	U009	U010	U011	U012	U013	U014	U015	U016	U017	U018	U019	U020	U021
------	------	------	------	------	------	------	------	------	------	------	------	------	------	------	------	------	------	------	------	------

# U017.MAIN DRIVE

U017\_S002  
D1791300  
DRIVE UNIT:FUSING:ASS'Y

U017\_S003  
D2701317  
DRIVE SUB-UNIT:ON-OFF:PR  
ESSURE ROLLER:(BLM11)

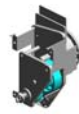

U017\_S001  
D1791391  
MECHANICAL DRIVE SECTIO  
N:TRANSFER:SECOND:ASS'  
Y

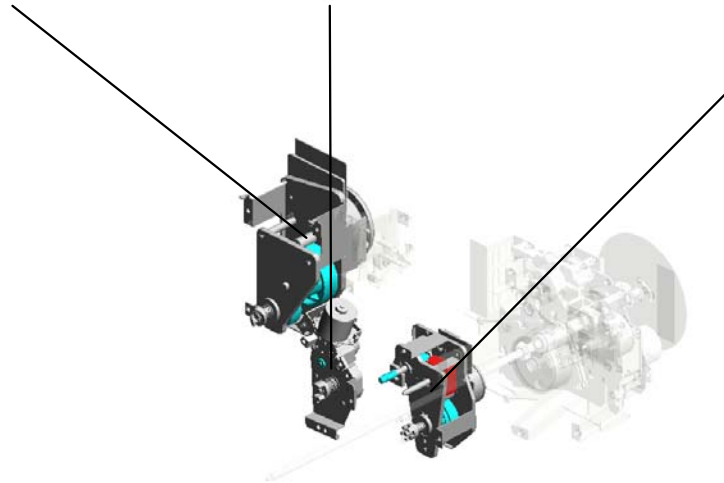

U001	U002	U003	U004	U005	U006	U007	U008	U009	U010	U011	U012	U013	U014	U015	U016	U017	U018	U019	U020	U021
------	------	------	------	------	------	------	------	------	------	------	------	------	------	------	------	------	------	------	------	------

# U017 MAIN DRIVE

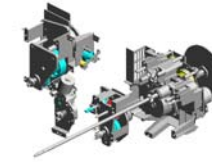

- 21.A0793626 (x2) STEPPED SCREW - SWING CLEANING
- 20.11050724 CLAMPS:WES-1210
- 15.11050410 (x2) CARD SPACER - 9.4MM
- 9.07403012 BALL BEARING - 1 2X28X8
- 12.09544008N (x9) SCREW - M4X8

17.11050511  
HARNES CLAMP - LWS-0306ZC



22.AX061204  
DC MOTOR:11.5W: BRUSHLESS:(BLM4)



7.07200040E  
RETAINING RING - M4



18.11050601 (x3) CLAMP:LWSM-0511-2M



5.04514008N (x17) TAPPING SCREW: 4X8



2.03603006N (x10) SCREW - M3X6



8.07200060E  
RETAINING RING - M6



1.03130040N (x3) SCREW:M3X4



16.11050487 (x3) HARNES CLAMP



19.11050723 CLAMPS:WES-0507



13.09545010N  
SCREW:POLISHED ROUND/SPRING:M 5X10



23.B2341118  
FLY WHEEL FLANGE



11.09514020N  
SCREW - M4X20



4.03604008N (x22) SCREW - M4X8



24.D0741329  
DC MOTOR:DIA49: 24V:6.3W:(BLM2)



# U017 MAIN DRIVE

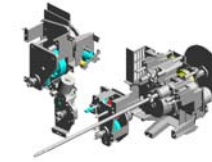

- 40.D1791275 TENSION SPRING: 3.8N
- 29.D1791254 SHAFT:DRIVE:DEV ELOPMENT ROLLER:ASSY
- 35.D1791266 PULLEY:DRIVE:DEVELOPMENT ROLLER:59T
- 43.D1791278 HOLDER:BEARING :DRUM SHAFT
- 31.D1791258 PLATE:HOLDER:ANTISTATIC BRUSH :DRUM

39.D1791273  
GEAR:DRIVE:TRANSPORT SCREW:54Z



30.D1791256  
SHAFT:DRIVE:TRANSPORT SCREW:ASSY



37.D1791268  
SYNCHRONOUS BELT:80S2M300



28.D1791252  
DC MOTOR:DIA82.2:63.7W:BRUSHLESS:(BLM8)



26.D1791220  
DRUM SHAFT:DRIVE:ASSY



32.D1791262  
SHAFT:DRIVE:CLEANER:ASSY



36.D1791267  
SYNCHRONOUS BELT:120S2M316



27.D1791251  
DC MOTOR:DIA63.29.7W:BRUSHLESS:(BLM1)



45.D1791288  
GEAR:IDLER:CLEANER:49Z/33Z



41.D1791276  
TENSION SPRING: 3.6N



33.D1791264  
PLATE:HOLDER:RADIAL BALL BEARING



34.D1791265  
PULLEY:DRIVE:DRUM:107T



42.D1791277  
GEAR:DRIVE:CLEANER:39Z



44.D1791286  
BRACKET:DRIVE:CLEANER:ASSY



38.D1791269  
BRACKET:DC MOTOR:CLEANING DRIVE SUB-UNIT



# U017 MAIN DRIVE

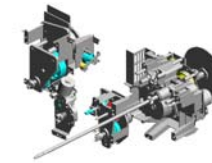

- 57.D1791328 GEAR:PULLEY:Z67 /T19:DRIVE:USED TONER
- 54.D1791323 TENSION SPRING: BELT TENSIONER: DRIVE:USED TONER
- 59.D1791345 BRACKET:DRAWER:DEVELOPMENT
- 68.G1781307 JOINT:DEVELOPMENT ROLLER:DRIVER
- 50.D1791297 TIGHTENER:DRIVE :DEVELOPMENT:ASSY

53.D1791320  
BRACKET:DRIVE:USED TONER



55.D1791326  
BRACKET:BELT TENSIONER:DRIVE:USED TONER



56.D1791327  
SHAFT:BELT TENSIONER:DRIVE:USED TONER



58.D1791329  
PULLEY:TIGHTENER:DIA18

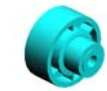

66.G1781289  
FLY WHEEL:DRUM



69.M0B11328  
ANTISTATIC BRUSH:DRUM



64.D2701271  
SPACER:SHAFT:DRUM



48.D1791291  
BRACKET:DC MOTOR:DRUM:ASSY



49.D1791293  
TIGHTENER:DRIVE :DRUM:ASSY



67.G1781291  
JOINT:TRANSPORT SCREW:NO.2



47.D1791290  
GEAR:IDLER:TRANSPORT SCREW:65 Z/53Z



46.D1791289  
GEAR:PULLEY:DRUM:113Z/37T





U017\_S001  
 MECHANICAL DRIVE SECTION:TRANSFER:SECOND:ASS'Y

61.D1791375 14.11050367  
 GEAR:IDLER:BELT SPACER  
 CLEANING

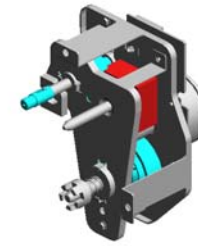

62.D1791391  
 MECHANICAL DRIVE SECTION:TRANSFER:SECOND:ASS'Y

63.D1796411  
 SEAL:TONER OUT  
 LET SUB-UNIT

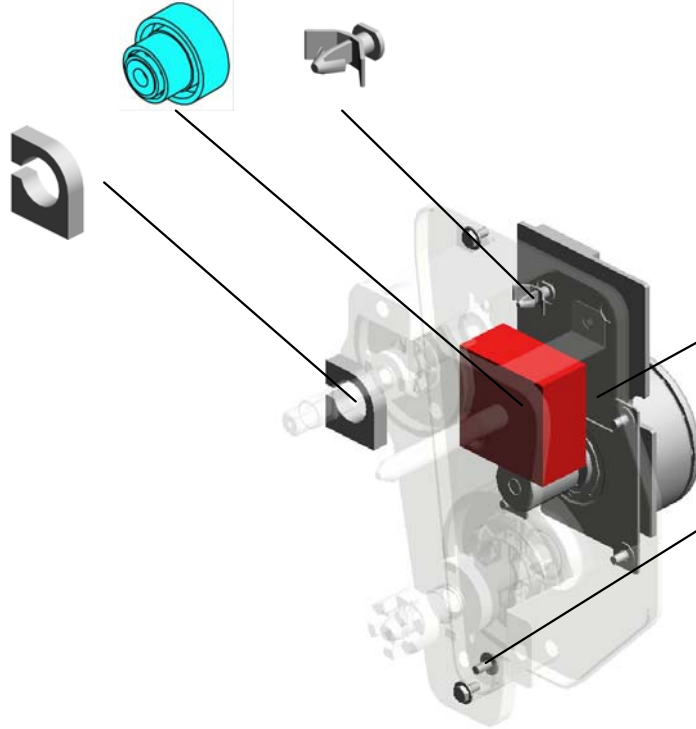

60.D1791370  
 DC MOTOR:40W:B  
 RUSHLESS:(BLM6)

2-03603006N  
 (x7)  
 SCREW - M3X6

U001	U002	U003	U004	U005	U006	U007	U008	U009	U010	U011	U012	U013	U014	U015	U016	U017	U018	U019	U020	U021
------	------	------	------	------	------	------	------	------	------	------	------	------	------	------	------	------	------	------	------	------

U017\_S002  
DRIVE UNIT:FUSING:ASS'Y

52.D1791309  
DC BRUSHLESS M  
OTOR:58W:DRIVE:  
FUSING UNIT:(BLM  
9)

3.03604006N  
(x7)  
SCREW - M4X6

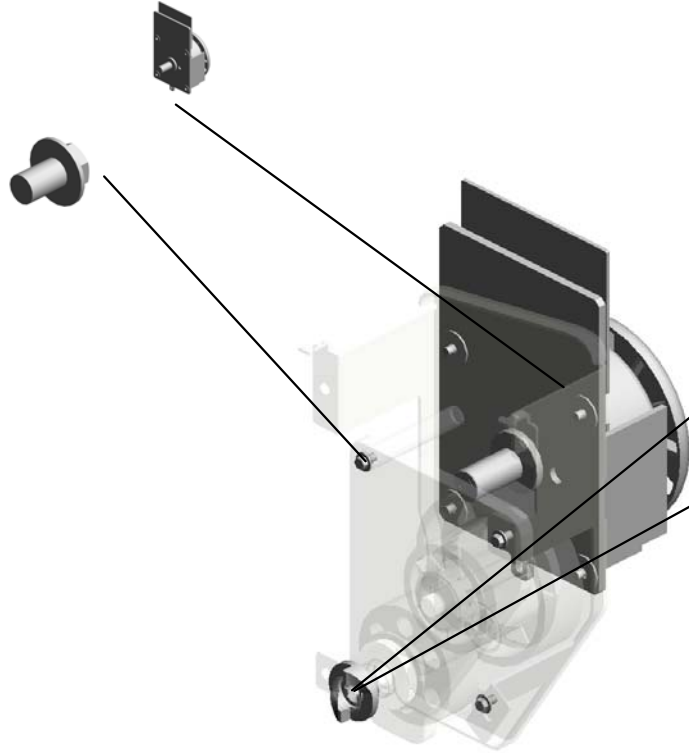

8.07200060E  
RETAINING RING -  
M6

70.D1791316  
JOINT:DRIVE:FUSI  
NG

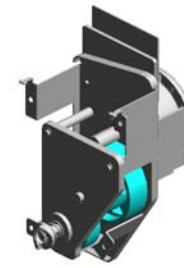

51.D1791300  
DRIVE UNIT:FUSIN  
G:ASS'Y

U001	U002	U003	U004	U005	U006	U007	U008	U009	U010	U011	U012	U013	U014	U015	U016	U017	U018	U019	U020	U021
------	------	------	------	------	------	------	------	------	------	------	------	------	------	------	------	------	------	------	------	------

U017\_S003  
DRIVE SUB-UNIT:ON-OFF:PRESSURE ROLLER:(BLM11)

6.04523010N 10.07433806  
(x4) (x2)  
BINDING SELF-TAPPING SCREW:3X10  
RADIAL BALL BEARING RING:DIA6XDIA13X5



65.D2701317  
DRIVE SUB-UNIT:ON-OFF:PRESSURE ROLLER:(BLM11)

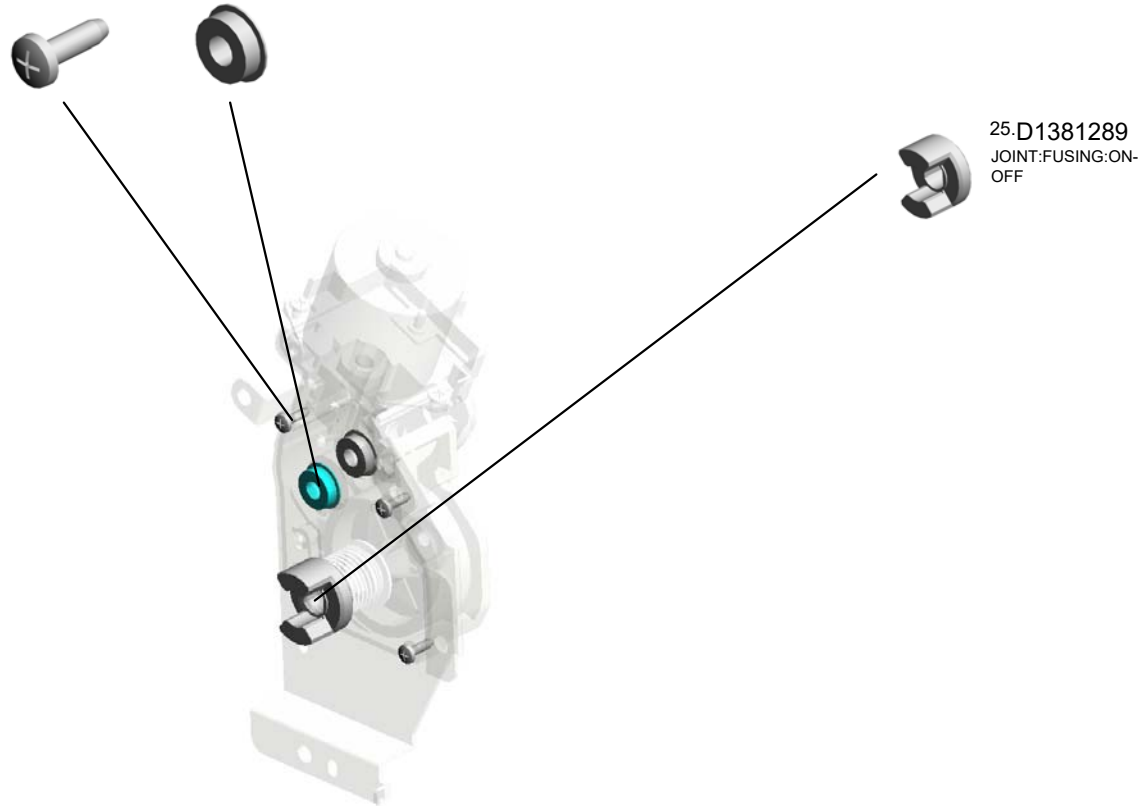

# U018 ELECTRICAL

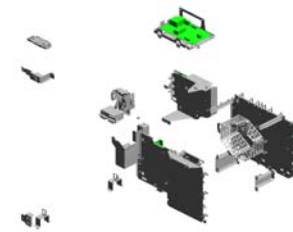

- 11.09543025N (x8) SCREW:POLISHED ROUND/SPRING:M 3X25
- 9.07040050N (x2) WASHER:DIA5
- 10.08010234 (x2) SCREW WITH WASHER:SMALL ROUND WITH SPRING WASHER:M5X8
- 21.11050516 (x8) CLAMP
- 16.11050487 (x20) HARNESS CLAMP

- 5.04503008N (x6) TAPPING SCREW - M3X8

- 1.03140120N (x8) SCREW - M4X12

- 4.04340200N (x4) PAN SELF-TAPPING SCREW:4X20

- 17.11050488 (x6) HARNESS CLAMP

- 7.04543006Q (x6) TAPPING SCREW - M3X6

- 15.11050410 (x16) CARD SPACER - 9.4MM
- 3.03604008N (x6) SCREW - M4X8
- 6.04514008N (x84) TAPPING SCREW: 4X8
- 19.11050490 (x42) HARNESS CLAMP - IWS-2218
- 2.03603006N (x60) SCREW - M3X6

- 18.11050489 (x40) HARNESS CLAMP - LWS 1316

- 12.11050042 (x284) WIRE BAND

- 13.11050046 (x598) HARNESS BAND

- 20.11050511 (x6) HARNESS CLAMP - LWS-0306ZC

- 14.11050367 (x4) SPACER

- 16.11050487 (x2) HARNESS CLAMP

- 21.11050516 (x4) CLAMP

- 22.11050529 (x2) NYLON CLAMP-EM T-3N

- 31.16072256 (x2) FERRITE CORE:K3 NFR-08-ABK0

- 8.04544008Q (x8) TAPPING SCREW - M4X8

# U018 ELECTRICAL

- 35.C2182185 (x8) STEPPER SCREW
- 43.D1795913 (x4) ARM:SAFETY SWIT
- 32.AA143797 (x4) CONNECTOR GUI
- 28.12042612 (x8) MICRO SWITCH:D3
- 34.AZ320193 (x2) POWER PACK:CG

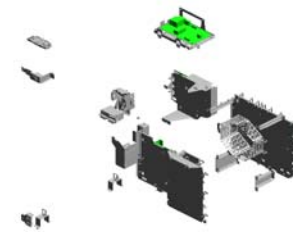

- 39.D1495883 (x2) KEYTOP:MAIN SWIT

- 40.D1495884 (x2) COMPRESSION SPRING:KEYTOP

- 41.D1791553 (x2) COVER:DC\_SW

- 42.D1791557 (x2) BRACKET:DC\_SW

- 29.12042614 (x2) SWITCH AC250V/16A:(SW12)

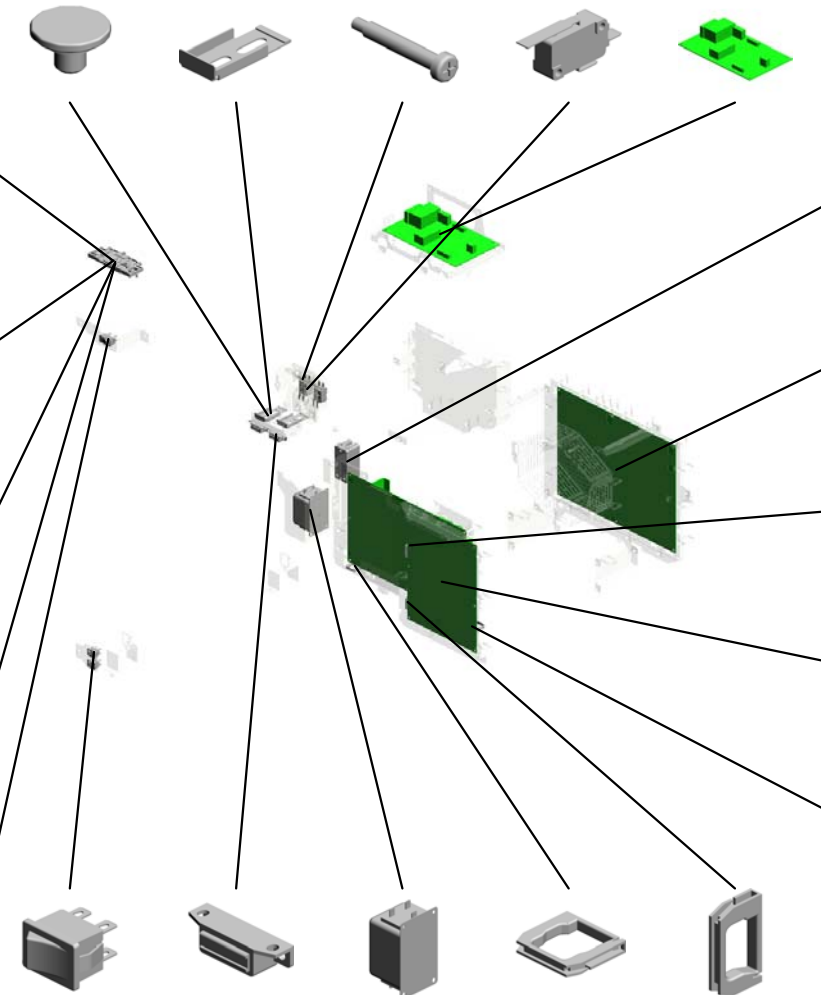

- 26.11071280 (Pro 8300S/8310S/8310):FUSE:BJS151 2F2:(BL1)

- 36.D0BX5405 (x2) PCB:IOB:(PCB26)

- 38.D0BX5445 (x2) AC CONTROL BOARD:200V:3800W:(PCB1)

- 37.D0BX5427 (x2) PCB:RYB:(PCB32)

- 23.11050532 (x2) EDGE SADDLE - L ES-25L

- 27.12042570 (x4) ROCKER SWITCH:SDDJE13200:(SW100/SW101)
- 33.AG070504 (x4) MAGNET CATCH:4.1N
- 30.16071799 (x2) FILTER - SUP-ET20-ER-0:(NF1)
- 25.11050726 (x2) CLAMPS:WES-2217
- 24.11050725 (x4) CLAMPS:WES-1117

# U018 ELECTRICAL

45.D1795915 (x4) LEVER:SAFETY SWITCH:WELDING  
 50.D1795928 (x2) BRACKET:SAFETY SWITCH:REAR  
 46.D1795917 (x4) BRACKET:SAFETY SWITCH

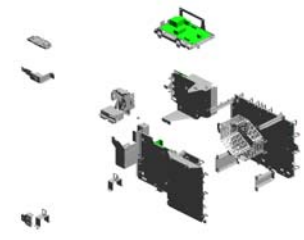

51.D2445730 (x2) PCB:DCSW:(PCB12)

47.D1795920 (x2) BRACKET:MAIN SWITCH

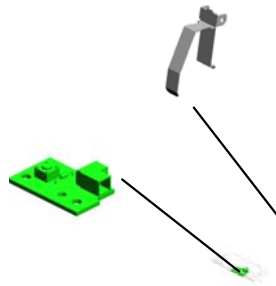

48.D1795922 (x2) BRACKET:POWER SUPPLY CORD:INLET:NOISE FILTER



52.D2705415 (x2) PCB:EDRB:(PCB24)



49.D1795924 (x2) COVER:SAFETY SWITCH:UPPER FRONT

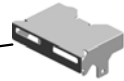

44.D1795914 (x2) BRACKET:SAFETY SWITCH:FRONT

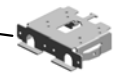

# U019.CONTROLLER

U019\_S001  
D0BX5927  
PCB:SDCU:ASS'Y



U019\_S003  
D0BX5927  
PCB:SDCU:ASS'Y



U019\_S005  
D0BX5927  
PCB:SDCU:ASS'Y



U019\_S002  
D1795089  
COVER:C/T BOX:UPPER:ASS'Y



U019\_S004  
D1795089  
COVER:C/T BOX:UPPER:ASS'Y



U019\_S006  
D1795089  
COVER:C/T BOX:UPPER:ASS'Y

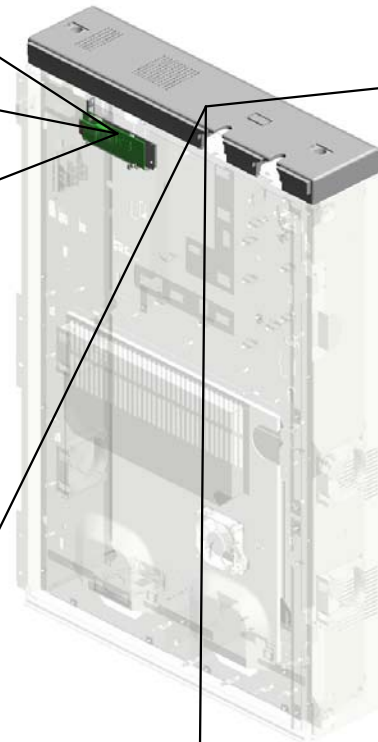

U001	U002	U003	U004	U005	U006	U007	U008	U009	U010	U011	U012	U013	U014	U015	U016	U017	U018	U019	U020	U021
------	------	------	------	------	------	------	------	------	------	------	------	------	------	------	------	------	------	------	------	------

# U019 CONTROLLER

- 5.04514008N (x51) TAPPING SCREW: 4X8
- 4.03604008N (x12) SCREW - M4X8
- 12.11050489 (x126) HARNESS CLAMP - LWS 1316
- 13.11050490 (x6) HARNESS CLAMP - IWS-2218
- 6.04543006Q (x156) TAPPING SCREW - M3X6



- 1.03530060N (x3) BIND SCREW - M3 X6

- 2.03603006N (x126) SCREW - M3X6

- 18.11050723 (x3) CLAMPS:WES-0507

- 20.14078389 (x3) EEPROM:BR24T12 8-W

- 16.11050529 (x3) NYLON CLAMP-EM T-3N

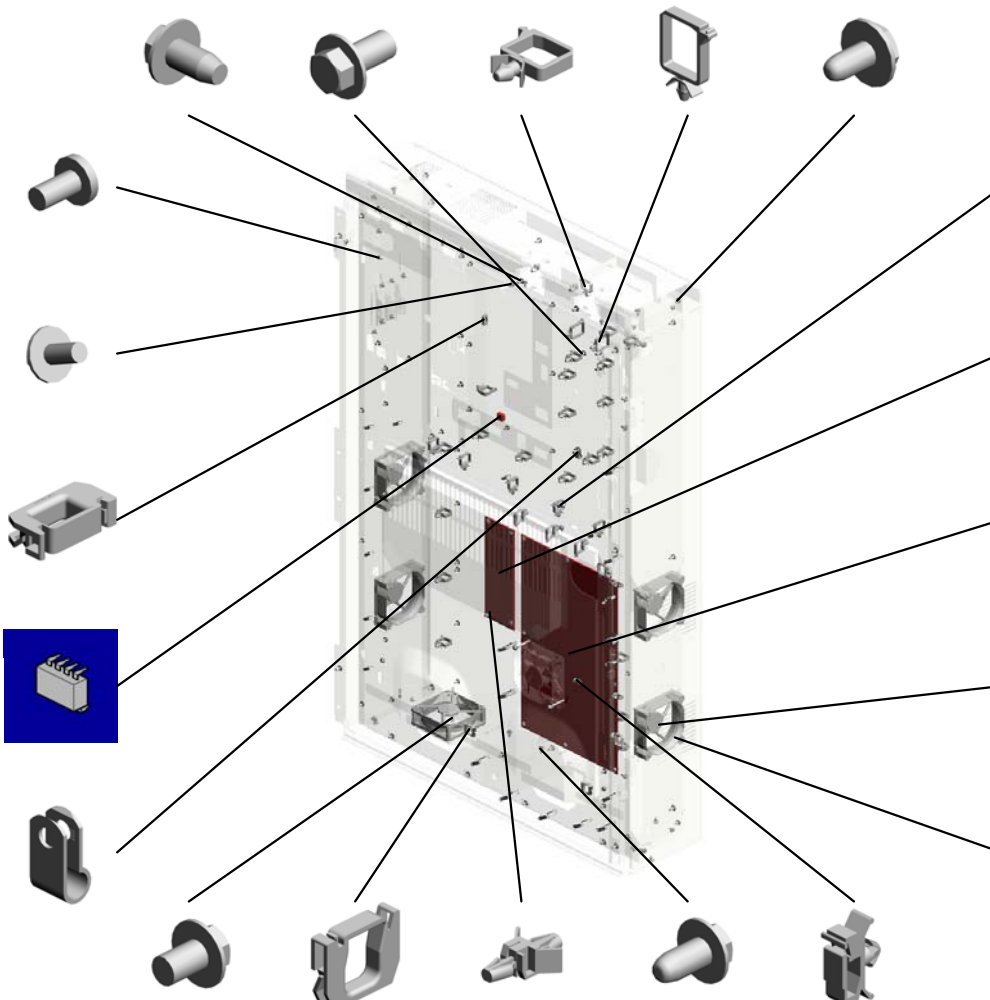

- 3.03604006N (x12) SCREW - M4X6
- 19.11050724 (x6) CLAMPS:WES-1210
- 11.11050193 (x3) NYLON STUD
- 8.04544008Q (x33) TAPPING SCREW - M4X8
- 14.11050511 (x3) HARNESS CLAMP - LWS-0306ZC

- 15.11050516 (x54) CLAMP

- 23.AZ210003 (x3) DC POWER SUPPLY: 12V:25W:(PCB31)

- 26.AZ250066 (x3) POWER SUPPLY UNIT: 864W:(PCB30)

- 22.AX640247 (x15) DC FAN MOTOR: AXIAL:MM80:25MM:(FAN4/FAN5/FAN8/FAN14/FAN17/FAN20/FAN22/FAN23//FA

- 7.04543030Q (x36) TAPPING SCREW: ROUND POINT:3X30

- 9.11050042 (x87) WIRE BAND

- 10.11050046 (x9) HARNESS BAND

- 61.D2585715 (x3) CABLE:HDD:SATA: 2CON\_POWER\_3P

- 5.04514008N (x 3) TAPPING SCREW:4X8



# U019 CONTROLLER

- 46.D2425605 (x3) PCB:DDR3-DIMM:R
- 49.D2705975 (x9) FILTER:COVER:C/T BOX
- 56.D0BX5401 (x3) PCB:BICU:ASS'Y:(P CB11)
- 54.09503006N (x3) SCREW:SPRING W ASHER:M3X6
- 33.D0747752 (x6) CAP:COVER:TONE R SUPPLY

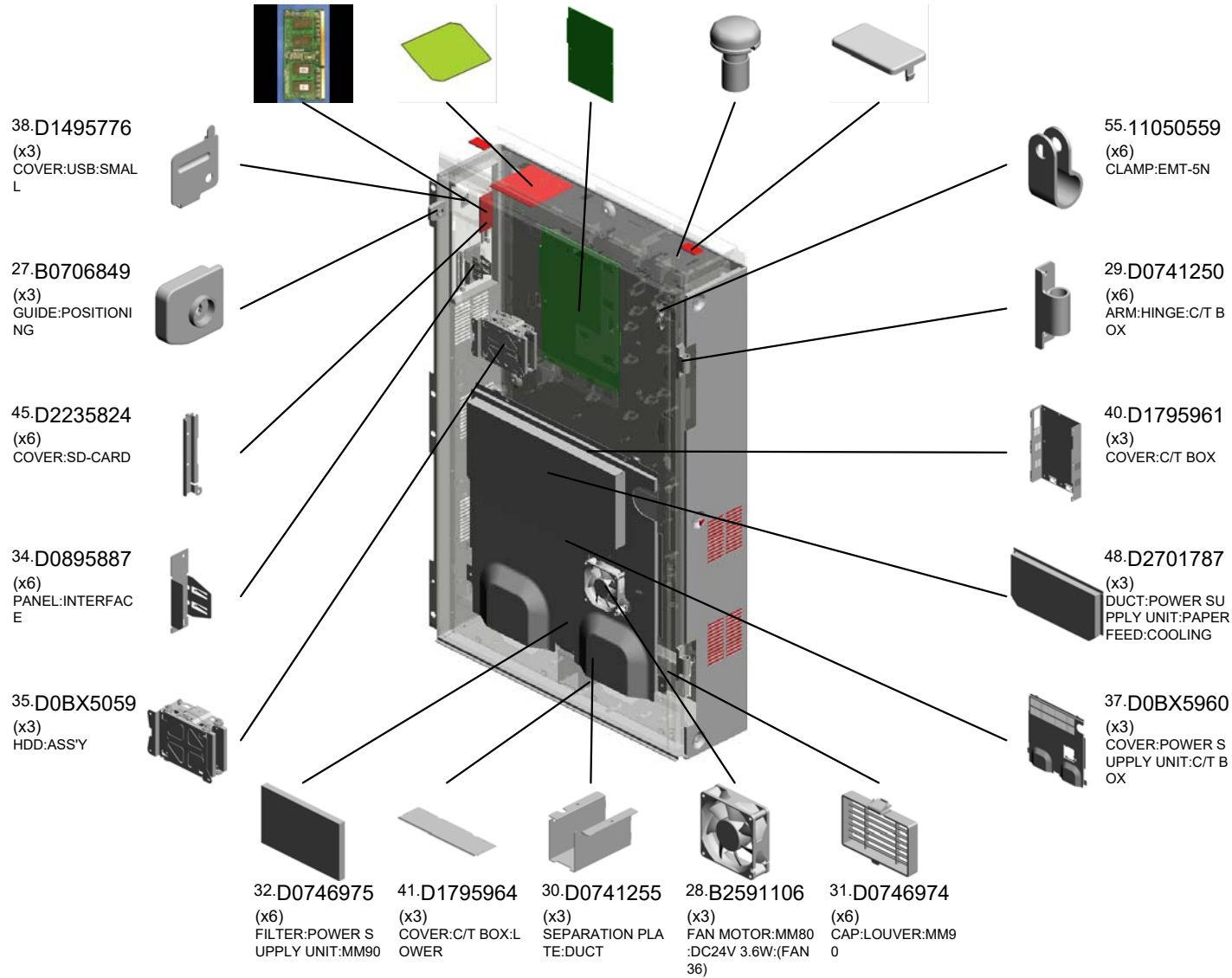

# U019 CONTROLLER



57.D0BX5613  
(Pro 8300S):PCB:S  
ERVICE:CTL:(PCB1  
7)



58.D0BX5614  
(Pro 8310S):PCB:S  
ERVICE:CTL:(PCB1  
7)



62.D0BX5622  
(Pro 8320S):PCB:S  
ERVICE:CTL:(PCB1  
7)  
201909-01 O/O

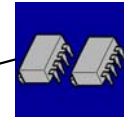
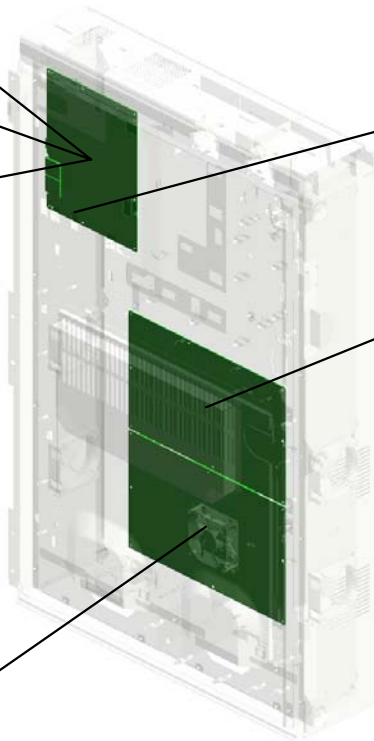

60.D0BX9590  
(x3)  
NVRAM



64.AZ240356  
(x3)  
POWER SUPPLY U  
NIT:FW:(PCB29)  
201910-02 X/O



63.AZ240355  
(x3)  
POWER SUPPLY U  
NIT:ECO:(PCB28)  
201910-01 X/O

U001	U002	U003	U004	U005	U006	U007	U008	U009	U010	U011	U012	U013	U014	U015	U016	U017	U018	U019	U020	U021
------	------	------	------	------	------	------	------	------	------	------	------	------	------	------	------	------	------	------	------	------

U019\_S001  
PCB:SDCU:ASS'Y

6.04543006Q (x2)  
TAPPING SCREW - M3X6  
2.03603006N  
SCREW - M3X6

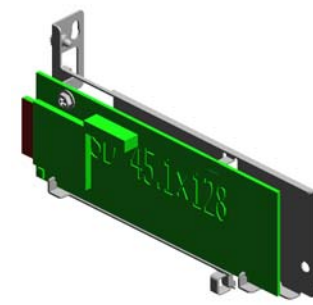

36.D0BX5927  
PCB:SDCU:ASS'Y

21.14078476  
ROM STORAGE:SD  
XC8GB

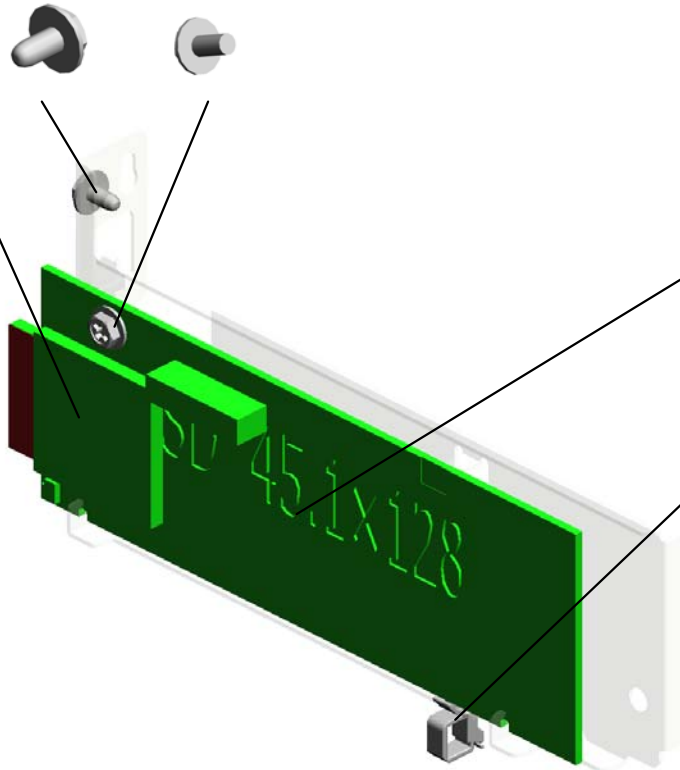

47.D2615140  
PCB:SDCU:ASS'Y:(  
PCB15)



9.11050042  
(x6)  
WIRE BAND

17.11050534  
CLAMP



U001	U002	U003	U004	U005	U006	U007	U008	U009	U010	U011	U012	U013	U014	U015	U016	U017	U018	U019	U020	U021
------	------	------	------	------	------	------	------	------	------	------	------	------	------	------	------	------	------	------	------	------

U019\_S002  
COVER:C/T BOX:UPPER:ASS'Y

42.D1795966  
SEAL:COVER:C/T  
BOX:UPPER:A

43.D1795967  
SEAL:COVER:C/T  
BOX:UPPER:B

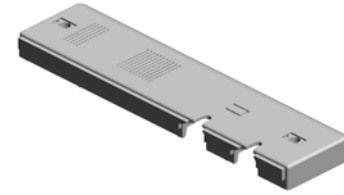

39.D1795089  
COVER:C/T BOX:U  
PPER:ASS'Y

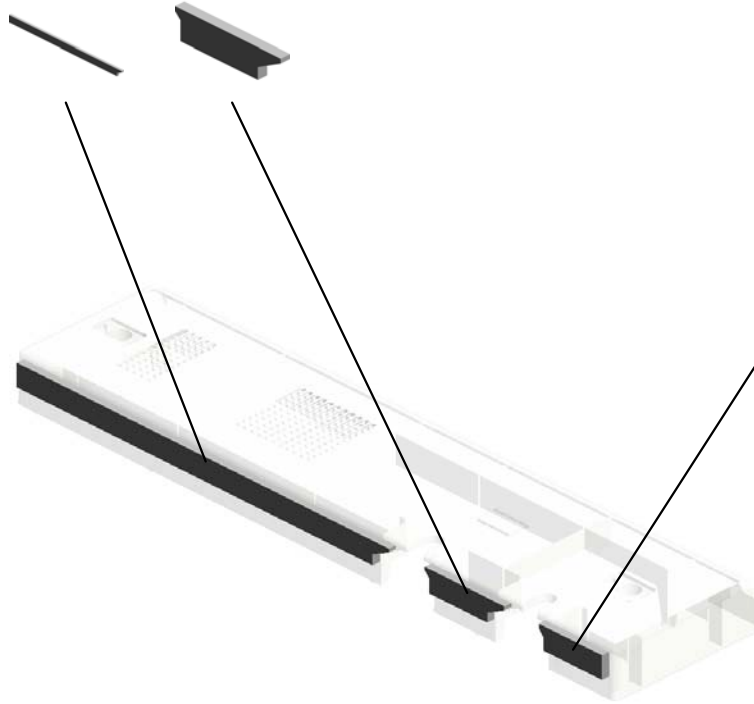

44.D1795973  
SEAL:COVER:C/T  
BOX:UPPER:C

U001	U002	U003	U004	U005	U006	U007	U008	U009	U010	U011	U012	U013	U014	U015	U016	U017	U018	U019	U020	U021
------	------	------	------	------	------	------	------	------	------	------	------	------	------	------	------	------	------	------	------	------

U019\_S003  
PCB:SDCU:ASS'Y

6.04543006Q (x2)  
TAPPING SCREW - M3X6  
2.03603006N  
SCREW - M3X6

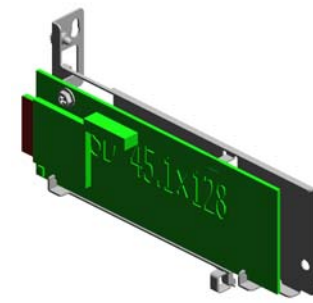

36.D0BX5927  
PCB:SDCU:ASS'Y

21.14078476  
ROM STORAGE:SD  
XC8GB

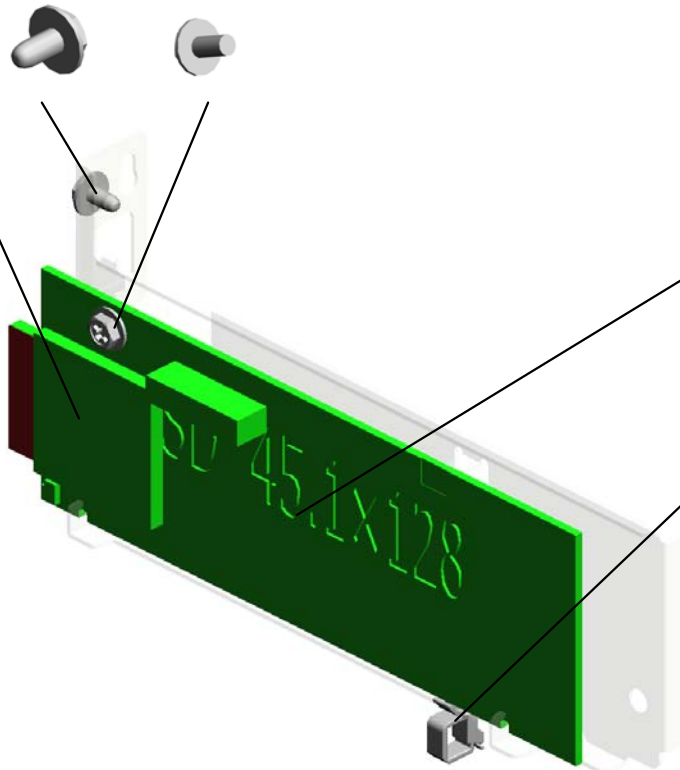

47.D2615140  
PCB:SDCU:ASS'Y:(  
PCB15)



9.11050042  
(x6)  
WIRE BAND

17.11050534  
CLAMP



U001	U002	U003	U004	U005	U006	U007	U008	U009	U010	U011	U012	U013	U014	U015	U016	U017	U018	U019	U020	U021
------	------	------	------	------	------	------	------	------	------	------	------	------	------	------	------	------	------	------	------	------

U019\_S004  
COVER:C/T BOX:UPPER:ASS'Y

42.D1795966  
SEAL:COVER:C/T  
BOX:UPPER:A

43.D1795967  
SEAL:COVER:C/T  
BOX:UPPER:B

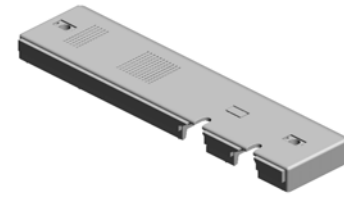

39.D1795089  
COVER:C/T BOX:U  
PPER:ASS'Y

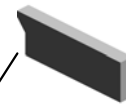
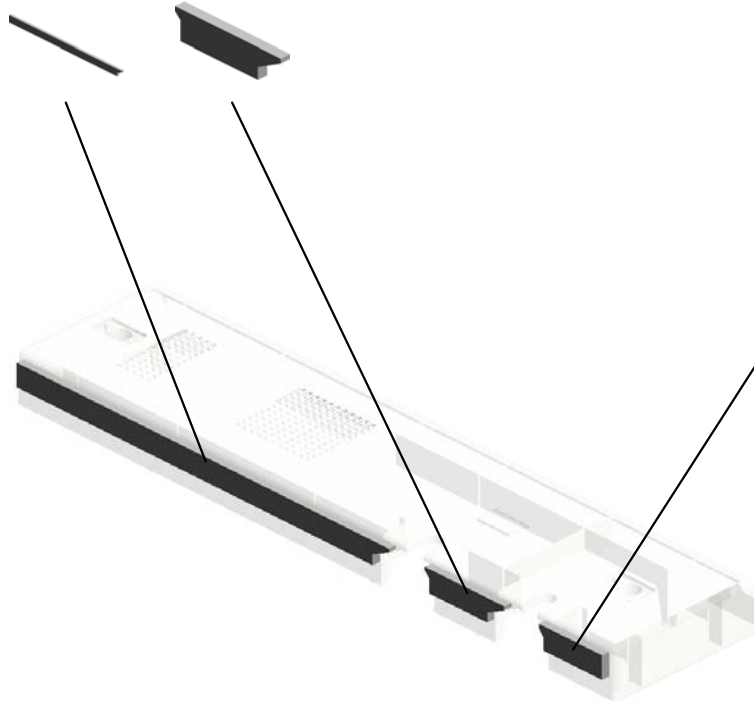

44.D1795973  
SEAL:COVER:C/T  
BOX:UPPER:C

U001	U002	U003	U004	U005	U006	U007	U008	U009	U010	U011	U012	U013	U014	U015	U016	U017	U018	U019	U020	U021
------	------	------	------	------	------	------	------	------	------	------	------	------	------	------	------	------	------	------	------	------

U019\_S005  
PCB:SDCU:ASS'Y

6.04543006Q (x2)  
TAPPING SCREW - M3X6  
2.03603006N  
SCREW - M3X6

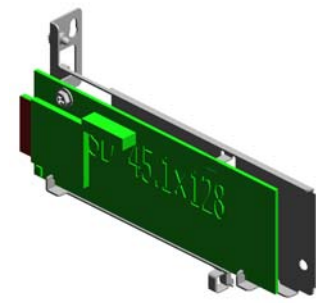

36.D0BX5927  
PCB:SDCU:ASS'Y

21.14078476  
ROM STORAGE:SD  
XC8GB

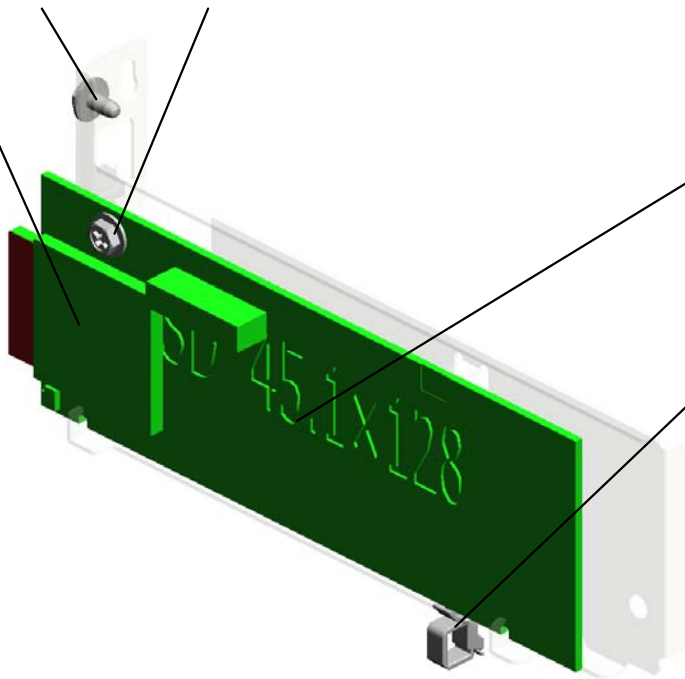

47.D2615140  
PCB:SDCU:ASS'Y:(  
PCB15)

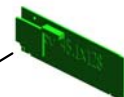

9.11050042  
(x6)  
WIRE BAND

17.11050534  
CLAMP



U001	U002	U003	U004	U005	U006	U007	U008	U009	U010	U011	U012	U013	U014	U015	U016	U017	U018	U019	U020	U021
------	------	------	------	------	------	------	------	------	------	------	------	------	------	------	------	------	------	------	------	------

U019\_S006  
COVER:C/T BOX:UPPER:ASS'Y

42.D1795966  
SEAL:COVER:C/T  
BOX:UPPER:A

43.D1795967  
SEAL:COVER:C/T  
BOX:UPPER:B

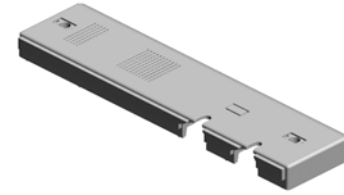

39.D1795089  
COVER:C/T BOX:U  
PPER:ASS'Y

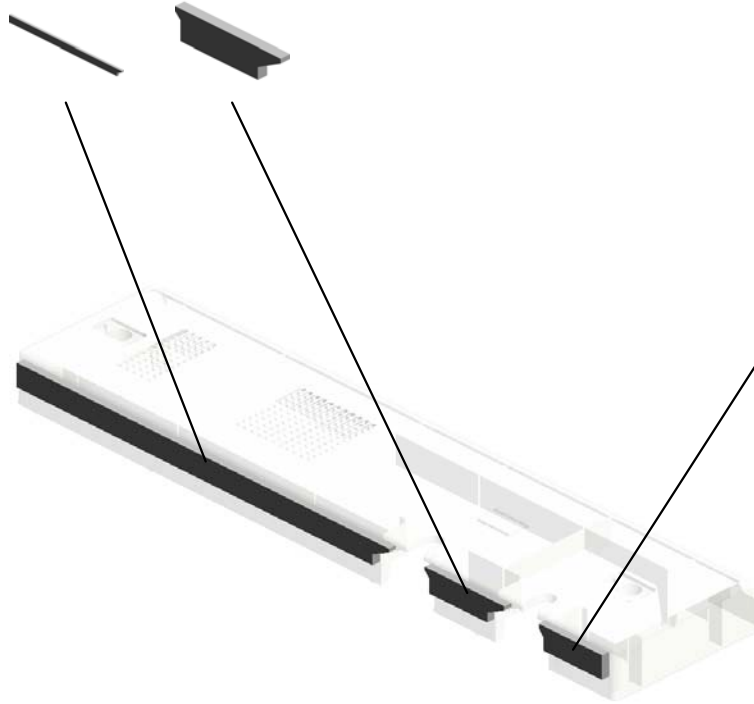

44.D1795973  
SEAL:COVER:C/T  
BOX:UPPER:C

U001	U002	U003	U004	U005	U006	U007	U008	U009	U010	U011	U012	U013	U014	U015	U016	U017	U018	U019	U020	U021
------	------	------	------	------	------	------	------	------	------	------	------	------	------	------	------	------	------	------	------	------



# U020.AIR COOLING

U020\_S001  
D1796987  
DUCT:HEAT PIPE:ENTRANC  
E:ASSY



U020\_S004  
D1796963  
BRACKET:HEAT SHIELD:BEL  
T CLEANING:ASSY



U020\_S002  
D1796836  
DUCT:CHARGE CORONA:CO  
NNECTING:LOWER:ASSY

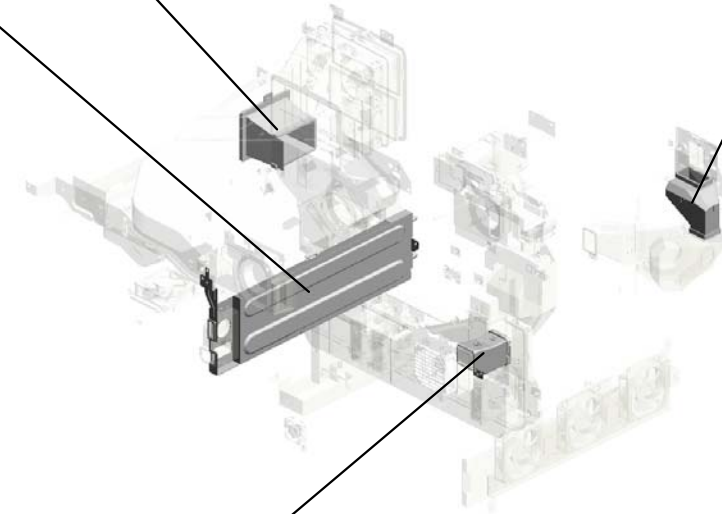

U020\_S003  
D1806811  
DUCT:FLAT CONVEYER BEL  
T:EXHAUST:CONNECTING:A  
SSY



# U020 AIR COOLING

12.04514008N (x59)  
TAPPING SCREW: 4X8

9.04513006N (x15)  
TAPPING SCREW - 3X6

7.04503008N (x16)  
TAPPING SCREW - M3X8

1.03530060N  
BIND SCREW - M3 X6

15.11050328  
HARNESS CLAMP - ES-0505

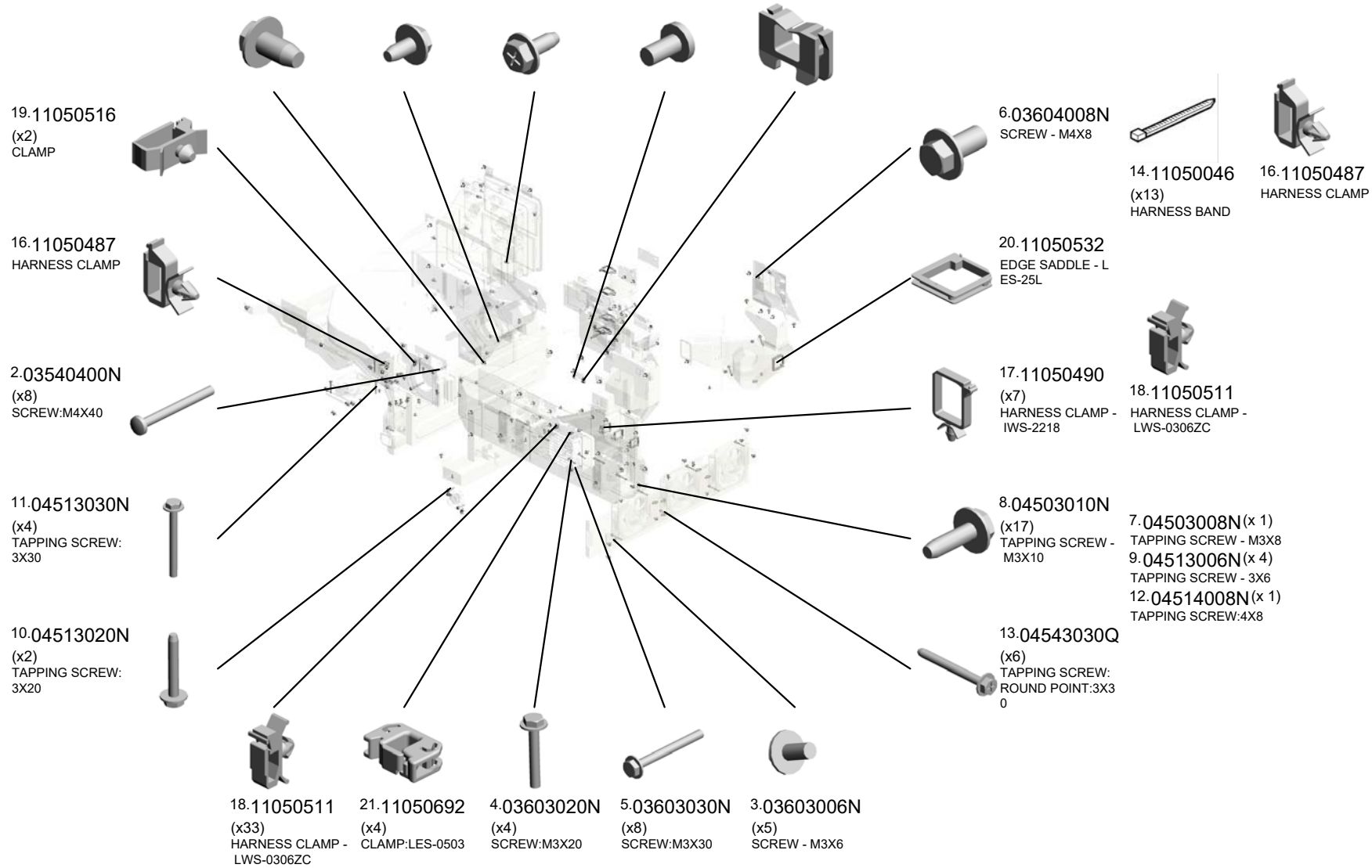
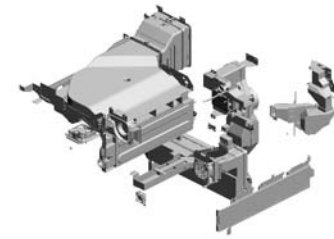

# U020 AIR COOLING

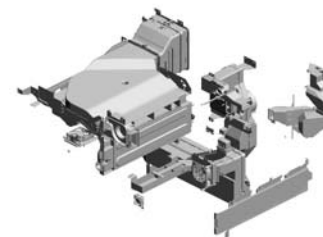

- 35.D1796821 DUCT:DEVELOPMENT:VACUUM:FRONT
- 28.AX660015 (x4) DC FAN MOTOR:SIROCCO:DC24V:PWM:(FAN9/FAN10/FAN11/FAN12)
- 31.D0BX6893 BRACKET:DUCT:MAIN:EXHAUST:LOWER
- 30.D0BX6889 (x2) FILTER:MAIN:EXHAUST:RIGHT
- 32.D0BX6909 (x2) FILTER:DUCT:MAIN:REAR

33.D1364233 (x16) STEPPED SCREW: DIA5:M3X3.8

34.D1791786 (x2) BRACKET:INNER COVER

22.11050723 CLAMPS:WES-0507

36.D1796822 BRACKET:FAN:DEVELOPMENT:COOLING:FRONT

26.AX640330 FAN:SIROCCO:DIA51:(FAN26/FAN27)

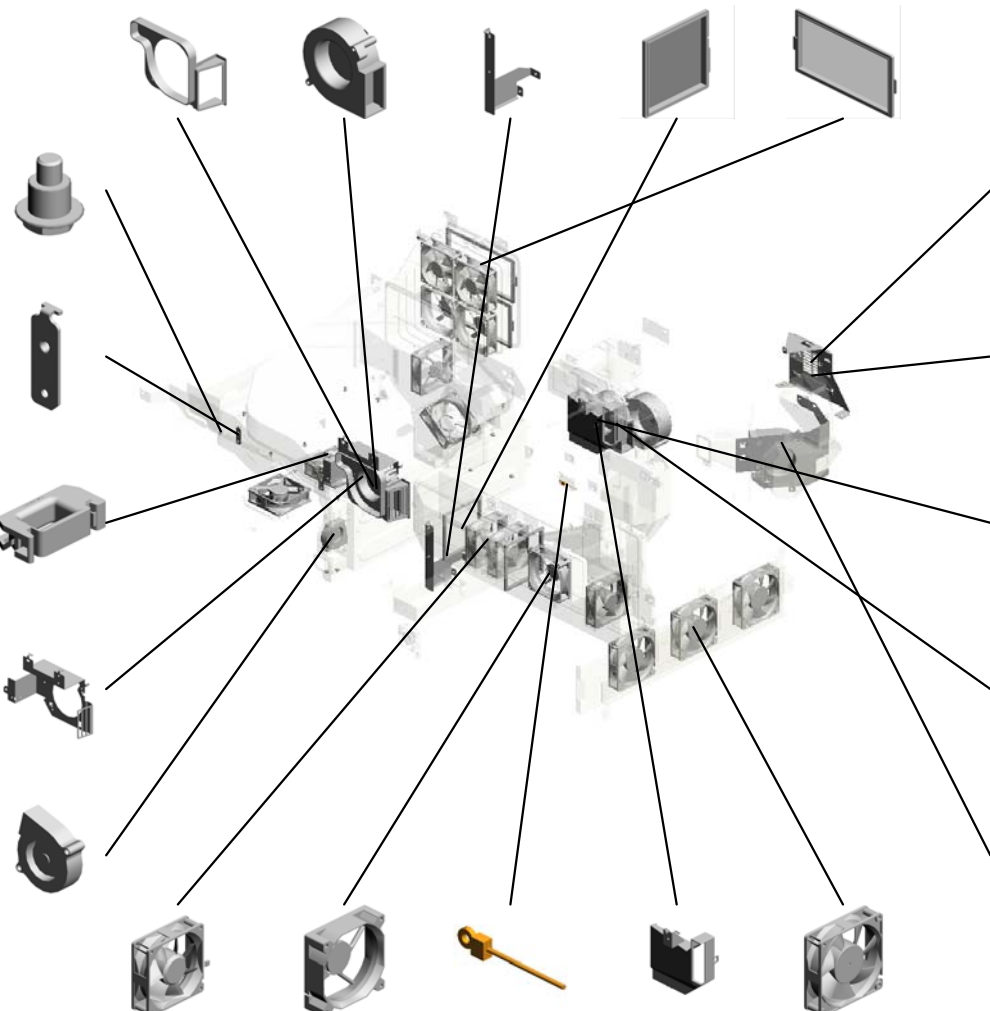

40.D1796835 EXTERIOR:LOUVER:CHARGE CORONA

42.D1796840 BRACKET:DUCT:CHARGE CORONA:VACUUM:UPPER

38.D1796832 DUCT:DEVELOPMENT:EXHAUST:REAR

39.D1796834 SEAL:DUCT:DEVELOPMENT:EXHAUST:REAR RIGHT

29.D0BX6844 BRACKET:DUCT:CHARGE CORONA:VACUUM

24.AX640224 (x7) DC FAN MOTOR:AXIAL:MM80:(FAN6/FAN7/FAN13/FAN16/FAN18/FAN19)

25.AX640247 (x5) DC FAN MOTOR:AXIAL:MM80:25MM:(FAN4/FAN5/FAN8/FAN14/FAN17/FAN20/FAN22/FAN23//FAN2)

23.AW100169 THERMISTOR:ASSY:(SEN94)

37.D1796831 DUCT:DEVELOPMENT:EXHAUST:FRONT

27.AX650056 (x3) DC FAN MOTOR:AXIAL:MM92:(FAN30/FAN31/FAN33)

# U020 AIR COOLING

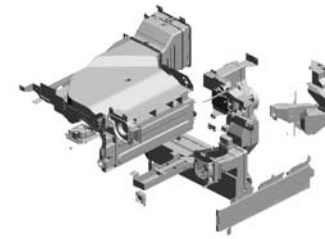

- 60.D1796932 DUCT:HEAT SHIELD:FUSING:UPPER
- 59.D1796927 DUCT:HEAT PIPE:EXHAUST
- 58.D1796918 SEAL:EXTERIOR:REAR:UPPER
- 51.D1796860 DUCT:DEVELOPMENT:TONER:UPPER:ASSY
- 50.D1796858 BRACKET:DUCT:CHARGE:EXHAUST:UPPER

61.D1796934  
DUCT:HEAT SHIELD:FUSING:LOWER

62.D1796940  
(x2)  
BRACKET:FAN:EXHAUST:MIDDLE

55.D1796875  
(x2)  
BRACKET:DUCT:FLAT CONVEYER BELT:EXHAUST

53.D1796873  
DUCT:FLAT CONVEYER BELT:EXHAUST:UPPER

54.D1796874  
DUCT:FLAT CONVEYER BELT:EXHAUST:LOWER

56.D1796897  
BRACKET:FAN:OPTICAL WRITING UNIT:COOLING

57.D1796898  
SEAL:DUCT:OPTICAL WRITING UNIT:VACUUM

52.D1796864  
DUCT:DEVELOPMENT:TONER:ASSY

49.D1796849  
SEAL:DUCT:CHARGE CORONA:VACUUM:MAIN

48.D1796848  
DUCT:CHARGE CORONA:VACUUM:MAIN:LEFT

44.D1796842  
FILTER:CHARGE CORONA:VACUUM

43.D1796841  
DUCT:CHARGE CORONA:VACUUM:CONNECTING:UPPER

47.D1796847  
DUCT:CHARGE CORONA:VACUUM:MAIN:RIGHT

45.D1796845  
DUCT:CHARGE CORONA:VACUUM:LOWER RIGHT

46.D1796846  
DUCT:CHARGE CORONA:VACUUM:LOWER LEFT

# U020 AIR COOLING

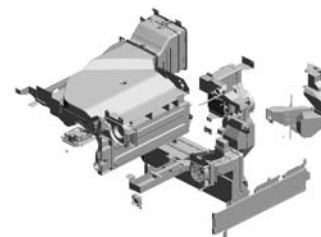

- 67.D1796954 BRACKET:DUCT:EXHAUST:PAPER EXIT SUB-UNIT:RIGHT
- 75.D1796978 SEAL:EXTERIOR:REAR:SMALL
- 68.D1796955 PLATE:DUCT:EXHAUST:B:ASSY
- 63.D1796946 DUCT:EXHAUST:PAPEXIT SUB-UNIT:A
- 64.D1796947 BRACKET:DUCT:EXHAUST:PAPER EXIT SUB-UNIT:LEFT

66.D1796953  
DUCT:EXHAUST:PAPEXIT SUB-UNIT:B

65.D1796948  
PLATE:DUCT:EXHAUST:A:ASSY

77.D1796984  
DUCT:HEAT PIPE:EXIT

83.D1806821  
BASE:HEAT SHIELD:FUSING SUB-UNIT:SUB-ASSY

76.D1796981  
BRACKET:DUCT:HEAT PIPE:EXIT:ASSY

72.D1796971  
SEAL:DUCT:THERMOPILE:ENTRANCE:LOWER

73.D1796972  
DUCT:THERMOPILE:ENTRANCE:ASSY

71.D1796970  
DUCT:THERMOPILE

82.D1806818  
OZONE FILTER:MAIN:EXHAUST:RIGHT

80.D1796995  
BRACKET:FAN:TRANSFER/SEPARATION UNIT:COOLING:REAR

85.D2706806  
SEAL:DUCT:LARGE

84.D1806831  
GASKET:DUCT:CHARGE CORONA:VACUUM

78.D1796985  
DUCT:HEAT PIPE:EXIT:MIDDLE

86.D2706818  
SEAL:DUCT:FAN:M97

74.D1796977  
GUARD:FAN:OPTICAL WRITING UNIT

# U020 AIR COOLING

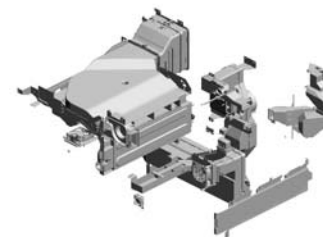

- 88.D2706823 OZONE FILTER:DU  
CT:MAIN:REAR
- 92.D2706854 DUCT:CHARGE CO  
RONA:EXHAUST:M  
IDDLE:FRONT
- 91.D2706853 DUCT:CHARGE CO  
RONA:EXHAUST:M  
IDDLE:REAR
- 93.D2706856 DUCT:CHARGE CO  
RONA:EXHAUST:C  
ONNECTING:FRON  
T
- 94.D2706857 DUCT:CHARGE CO  
RONA:EXHAUST:C  
ONNECTING:REAR

87.D2706822  
SEAL:DUCT:HEAT  
SHIELD:FUSING:A



102.D2706910  
SEAL:DUCT:CHAR  
GE CORONA:EXHA  
UST:MIDDLE



89.D2706833  
BRACKET:FAN:DE  
VELOPMENT:EXHA  
UST



101.D2706909  
(x2)  
SEAL:DUCT:LARG  
E



99.D2706892  
(x2)  
COVER:FILTER:EX  
HAUST



98.D2706891  
DUCT:MAIN:EXHA  
UST:REAR

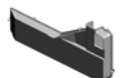

97.D2706890  
DUCT:MAIN:EXHA  
UST:FRONT



104.D2706917  
SEAL:DUCT:MAIN:  
EXHAUST



100.D2706896  
DUCT:OPTICAL W  
RITING UNIT:VACU  
UM:FRONT

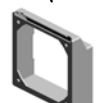

103.D2706911  
(x3)  
SEAL:DUCT:MAIN:  
EXHAUST:FRONT



90.D2706851  
DUCT:CHARGE CO  
RONA:EXHAUST:M  
IDDLE:RIGHT

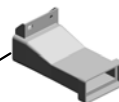

95.D2706869  
DUCT:CHARGE CO  
RONA:EXHAUST:M  
ULTI-LANGUAGE:R  
EAR



96.D2706870  
DUCT:CHARGE CO  
RONA:EXHAUST:M  
ULTI-LANGUAGE:F  
RONT



106.D2706921  
SEAL:DUCT:MAIN:  
EXHAUST:B



105.D2706920  
SEAL:DUCT:MAIN:  
EXHAUST:A



# U020 AIR COOLING

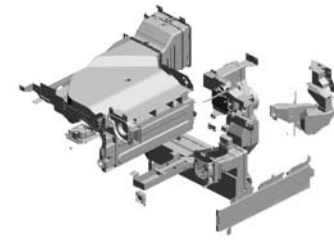

113.D2706989 (x2) SEAL:DUCT:HEAT PIPE:ENTRANCE  
 107.D2706929 (x3) COVER:FAN:MAIN: EXHAUST

114.GX640028 (x2) FAN MOTOR DC24 V 1.92W:(FAN3/FAN28/FAN29)

112.D2706948 SHEET:SCREW:FILTER

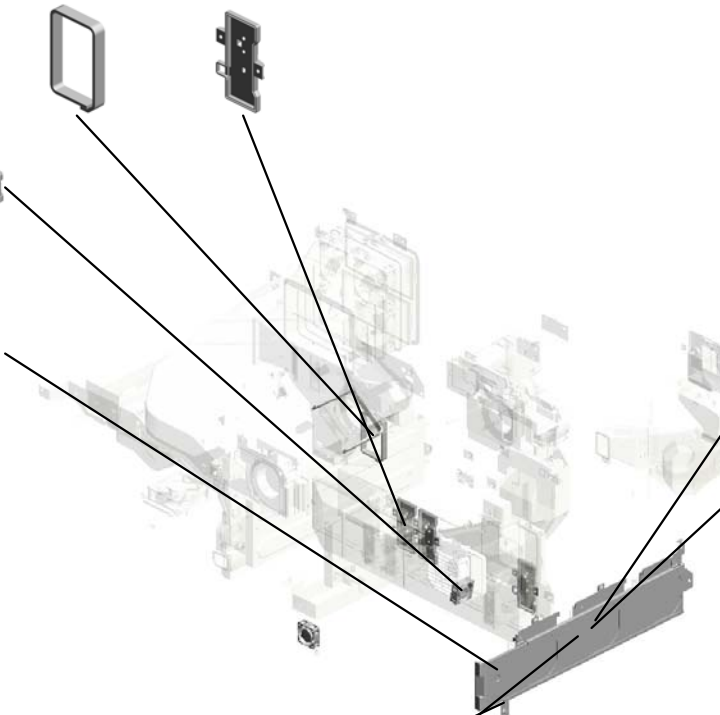

108.D2706942 BRACKET:FAN:SIDE:RIGHT:SUB-ASS'Y

109.D2706944 BRACKET:GUIDE:BASE

111.D2706947 BRACKET:AUXILIARY:BASE

110.D2706945 FILTER:VACUUM:MAIN:RIGHT

U020\_S001  
DUCT:HEAT PIPE:ENTRANCE:ASS'Y

113.D2706989  
SEAL:DUCT:HEAT  
PIPE:ENTRANCE

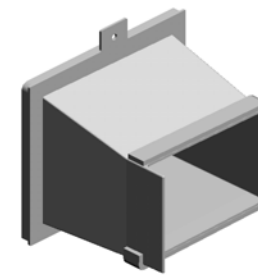
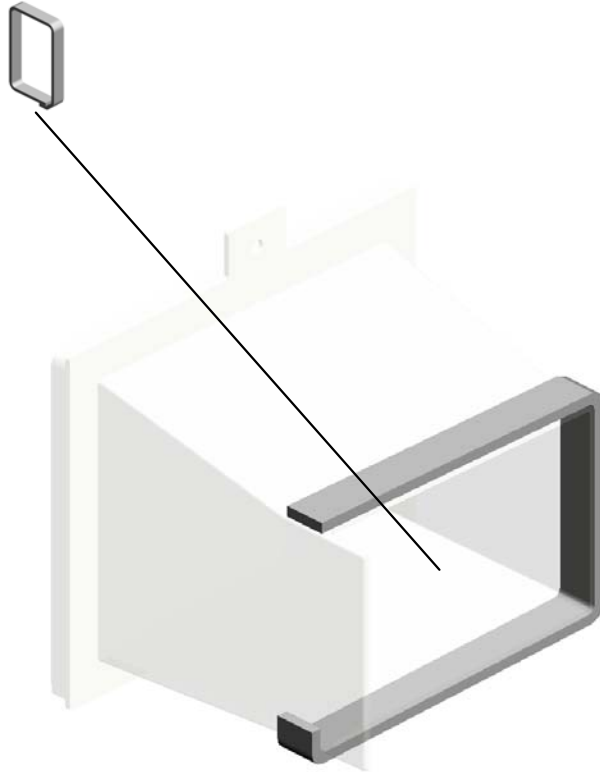

79.D1796987  
DUCT:HEAT PIPE:  
ENTRANCE:ASS'Y

U001	U002	U003	U004	U005	U006	U007	U008	U009	U010	U011	U012	U013	U014	U015	U016	U017	U018	U019	U020	U021
------	------	------	------	------	------	------	------	------	------	------	------	------	------	------	------	------	------	------	------	------



U020\_S002  
DUCT:CHARGE CORONA:CONNECTING:LOWER:ASS'Y

101.D2706909  
SEAL:DUCT:LARG  
E

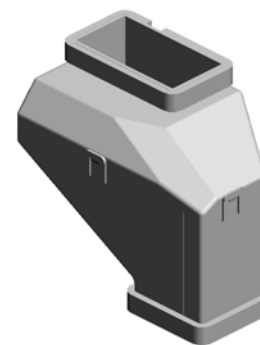
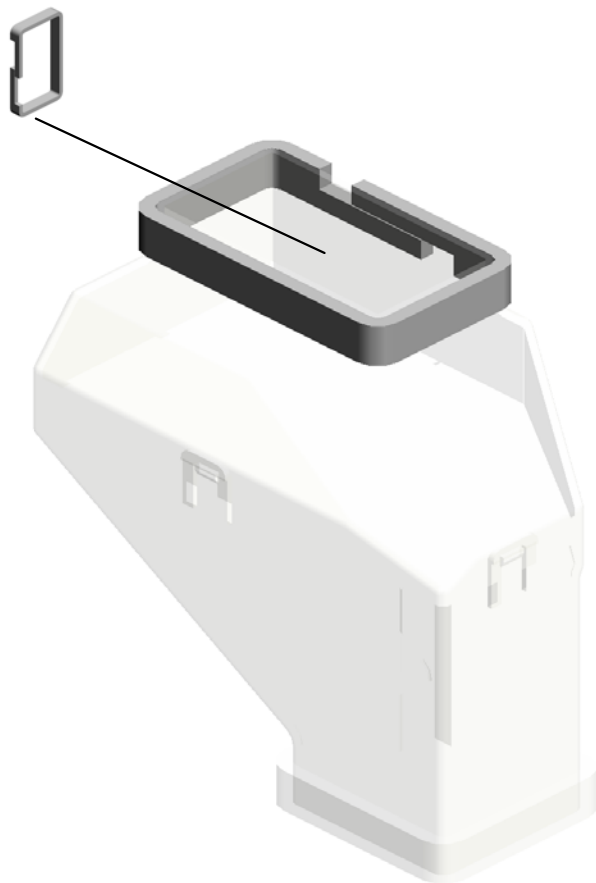

41.D1796836  
DUCT:CHARGE CO  
RONA:CONNECTIN  
G:LOWER:ASS'Y

U001	U002	U003	U004	U005	U006	U007	U008	U009	U010	U011	U012	U013	U014	U015	U016	U017	U018	U019	U020	U021
------	------	------	------	------	------	------	------	------	------	------	------	------	------	------	------	------	------	------	------	------

U020\_S003  
DUCT:FLAT CONVEYER BELT:EXHAUST:CONNECTING:ASS'Y

7.04503008N  
TAPPING SCREW -  
M3X8



81.D1806811  
DUCT:FLAT CONV  
EYER BELT:EXHAU  
ST:CONNECTING:  
ASS'Y

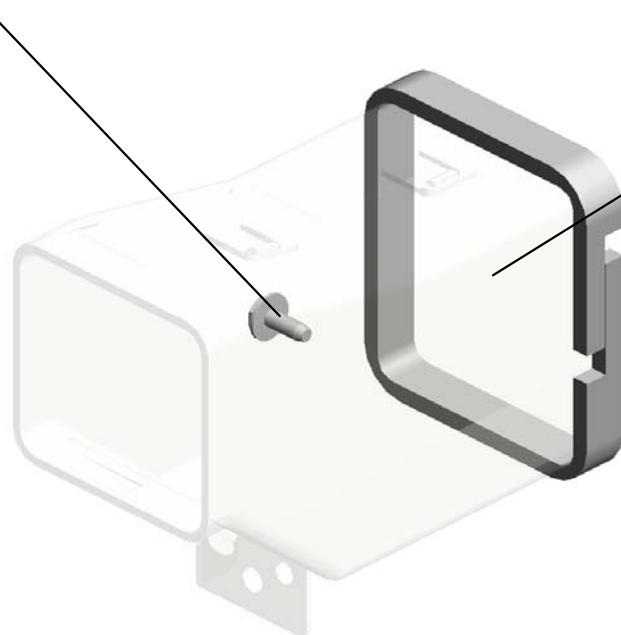

86.D2706818  
SEAL:DUCT:FAN:M  
M97

U020\_S004  
BRACKET:HEAT SHIELD:BELT CLEANING:ASS'Y

70.D1796966  
SEAL:DUCT:THER  
MOPILE:ENTRANC  
E:UPPER

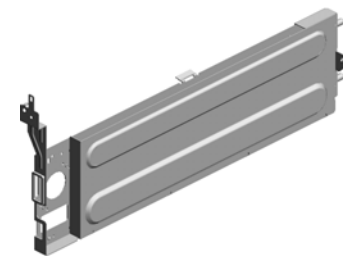

69.D1796963  
BRACKET:HEAT S  
HIELD:BELT CLEA  
NING:ASS'Y

U001	U002	U003	U004	U005	U006	U007	U008	U009	U010	U011	U012	U013	U014	U015	U016	U017	U018	U019	U020	U021
------	------	------	------	------	------	------	------	------	------	------	------	------	------	------	------	------	------	------	------	------

# U021 MAIN FRAME

- 19.11050488 (x9) HARNESS CLAMP
- 1.03140180N (x2) PAN HEAD SCREW :M4X18
- 13.07200040E (x4) RETAINING RING - M4
- 20.11050489 (x10) HARNESS CLAMP - LWS 1316
- 23.11050511 (x17) HARNESS CLAMP - LWS-0306ZC

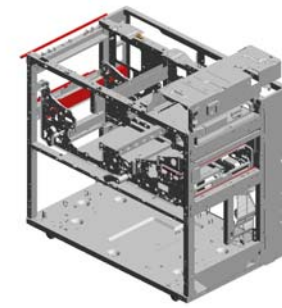

9.04534008N  
BINDING SELF TAP  
PING SCREW:4X8



16.08050088  
RETAINING RING -  
M6



14.07200060E  
(x7)  
RETAINING RING -  
M6



7.04514008N  
(x183)  
TAPPING SCREW:  
4X8



21.11050490  
(x58)  
HARNESS CLAMP -  
IWS-2218

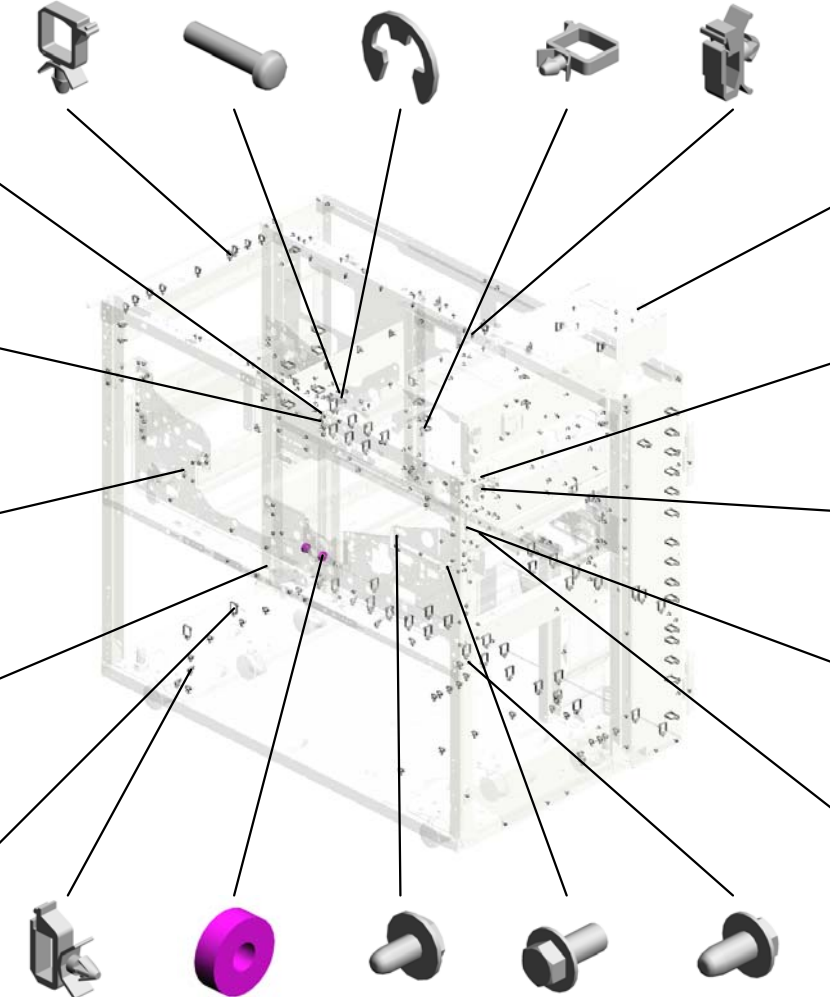

18.11050487  
(x46)  
HARNESS CLAMP



15.07403008  
(x2)  
BALL BEARING - 8  
X22X7



10.04543006Q  
(x7)  
TAPPING SCREW -  
M3X6



6.03604008N  
(x15)  
SCREW - M4X8



11.04544008Q  
(x32)  
TAPPING SCREW -  
M4X8



3.03540060N  
(x12)  
SCREW-M4X6



4.03603006N  
(x4)  
SCREW - M3X6



8.04514012N  
(x8)  
TAPPING SCREW:  
4X12



12.07030040N  
(x10)  
SPRING WASHER:  
DIA4



2.03540050N  
(x10)  
SCREW - M4X5



17.11050046  
(x5)  
HARNESS BAND



18.11050487  
HARNESS CLAMP



19.11050488  
(x7)  
HARNESS CLAMP



20.11050489  
(x4)  
HARNESS CLAMP -  
LWS 1316



21.11050490  
HARNESS CLAMP -  
IWS-2218



22.11050508  
HARNESS CLAMP -  
LWS-0711



23.11050511  
(x10)  
HARNESS CLAMP -  
LWS-0306ZC

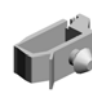

24.11050516  
(x2)  
CLAMP

# U021 MAIN FRAME

- 30.11050724 (x2) CLAMPS:WES-1210
- 40.B1321221 (x2) HOLDER:SPRING:PULL OUT
- 39.B1321183 (x2) BRACKET:LOCK
- 36.AA132300 (x4) ROLLER:LOCK:PU LL OUT
- 26.11050534 (x2) CLAMP

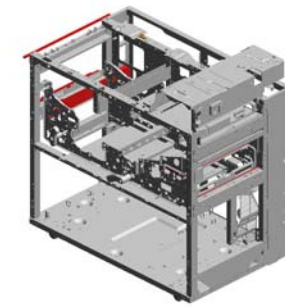

- 28.11050711 (x6) CLAMP:JDL-1S

- 31.11050726 CLAMPS:WES-2217

- 24.11050516 (x3) CLAMP

- 41.B5457507 (x2) SCREW:PUNCH

- 35.AA082104 (x6) BUSHING - 8X12X7

- 42.D0741180 LEVER:PULL OUT:PAPER EXIT UNIT
- 27.11050692 (x2) CLAMP:LES-0503
- 32.11050751 (x2) CLAMP:LWSM-0606-3.2M
- 38.AH012042 (x6) CASTER:1470N:BB
- 29.11050723 CLAMPS:WES-0507

- 25.11050528 NYLON CLAMP - E MT-2N



- 32.11050751 CLAMP:LWSM-0606-3.2M



- 37.AA143594 (x2) STEPPED SCREW: M3X5

- 43.D0741225 (x2) HINGE:C/T BOX:RIGHT UPPER:PEEN



- 44.D0741228 (x2) COVER:HINGE



- 83.G1784909 (x4) SCREW:TRANSPORT

- 34.AA063472 (x10) COMPRESSION SPRING:CONNECTOR:UPPER

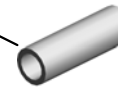

- 33.AA062797 (x2) COMPRESSION SPRING:DRAWER:22.2N

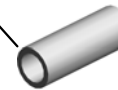

- 5.03604006N (x 1) SCREW - M4X6
- 6.03604008N (x 4) SCREW - M4X8
- 7.04514008N (x35) TAPPING SCREW:4X8
- 10.04543006Q (x 1) TAPPING SCREW - M3X6
- 11.04544008Q (x 3) TAPPING SCREW - M4X8
- 14.07200060E (x 3) RETAINING RING - M6

# U021 MAIN FRAME

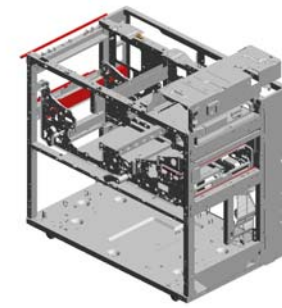

- 58.D1791221 (x2) HOLDER:COIL SPRING:LOCK:PULL OUT
- 57.D1791185 GUIDE:INTERMEDIATE TRANSFER:LEFT
- 62.D1796410 SLIDE RAIL:CASE TENSION:ROLLER
- 52.D1791115 RAIL:INTERMEDIATE TRANSFER:LEFT
- 63.D1796823 DUCT:DEVELOPMENT:EXHAUST:MULTI-LANGUAGE:ASSY

47.D0BX1219  
SHAFT:LOCK:PULL OUT:LEFT

48.D0BX1220  
TORSION SPRING: KNOB:LEFT

60.D1791734  
LEVER:PULL OUT: LEFT

50.D0BX1233  
TORSION SPRING: KNOB:RIGHT

56.D1791130  
GUIDE:PULL OUT: MIDDLE:LOWER

59.D1791731  
COVER:REGISTRATION:MOTOR

55.D1791129  
GUIDE:PULL OUT:LOCK

54.D1791128  
HOLDER:REGISTRATION:DRAWER

53.D1791118  
SEPARATION PLATE:MAIN:REAR MIDDLE

45.D0BX1069  
COVER:MOTOR:USED TONER

- 49.D0BX1232 SHAFT:LOCK:PULL OUT:RIGHT:ASSY
- 46.D0BX1165 SUPPORTING PLATE:RAIL:INTERMEDIATE TRANSFER
- 64.D1806801 DUCT:FLAT CONVEYER BELT:EXHAUST:SMALL:ASSY
- 61.D1794884 (x3) SHEET:OPPOSED: PAPER FEED SENSOR
- 51.D1791043 GUARD:MAIN:VERTICAL TRANSPORT

# U021 MAIN FRAME

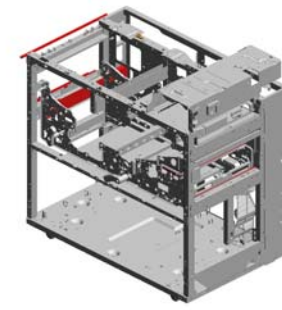

- 82.G1784818 (x4) SPRING:PULL OUT :LOCK:EXIT
- 65.D1941234 (x2) SUPPORTING PLATE:BRACKET:LOCK
- 70.D2701155 BRACKET:RADIAL BALL BEARING
- 69.D2701151 SLIDE RAIL:PULL OUT:RIGHT UPPER
- 71.D2701160 RAIL:INTERMEDIATE TRANSFER

- 83.G1784909 (x4) SCREW:TRANSFER

- 76.D2701174 GUIDE:PICK-UP PAPER JAM

- 72.D2701166 SUPPORTING PLATE:AUXILIARY:RAIL:INTERMEDIATE TRANSFER

- 73.D2701167 STOPPER:SLIDE RAIL:RIGHT UPPER

- 81.G1781138 (x18) SCREW WITH WASHER:M6X14

- 66.D1944759 (x2) BRACKET:LOCK:EXIT
- 67.D2416290 (x3) LED:RED
- 80.G0342986 FLANGED HEXAGONAL HEAD BOLT - M4X8
- 75.D2701173 STOPPER:SUPPORTER
- 79.D2706815 SHEET:GUIDE MILLER:PAPER FEED:COOLING:INNER BACK

- 84.G1787515 (x12) CONNECTOR GUIDE PIN:CONNECTOR

- 74.D2701171 SUPPORTER:PULL OUT:RIGHT UPPER

- 78.D2706814 SHEET:GUIDE MILLER:PAPER FEED:COOLING:UPPER

- 77.D2706813 SHEET:GUIDE MILLER:PAPER FEED:COOLING:LOWER

- 68.D2701132 (x2) SLIDE RAIL:PULL OUT:PROTECT

# U021 MAIN FRAME

92.G1785145 SHEET:GBC:UPPER  
 87.B8321371 SPACER CUSHION  
 91.D1791784 BRACKET:ADF:LEFT  
 86.AW020207 PHOTOINTERRUPTOR:FLAT:PICH2MM:M4:(SEN107)

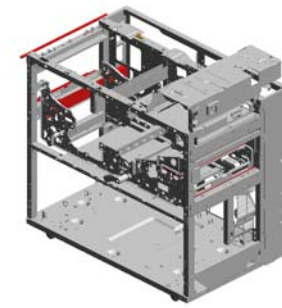

94.M0774707  
GUIDE PLATE:GBC:ASSY



93.M0774703  
BRACKET:ADAPTER SECTION:GBC:PEEN

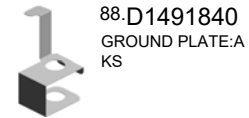
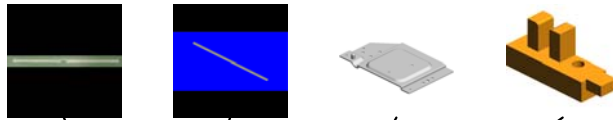

88.D1491840  
GROUND PLATE:AKS



90.D1791782  
BRACKET:ADF:RIGHT



95.D0BX1465  
BRACKET:KEY COUNTER



89.D1791769  
(x2)  
SPRING PLATE:EA  
RTH:FRAME:SCANNER



85.03140120N  
SCREW - M4X12



# U022.ACCESSORIES

U022\_S001  
D0BX1580  
HINGE:STAND:OPERATION  
SUB-UNIT:ASS'Y

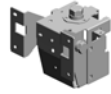

U022\_S002  
D0BX1580  
HINGE:STAND:OPERATION  
SUB-UNIT:ASS'Y

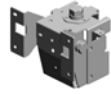

U022\_S004  
D0BX1580  
HINGE:STAND:OPERATION  
SUB-UNIT:ASS'Y

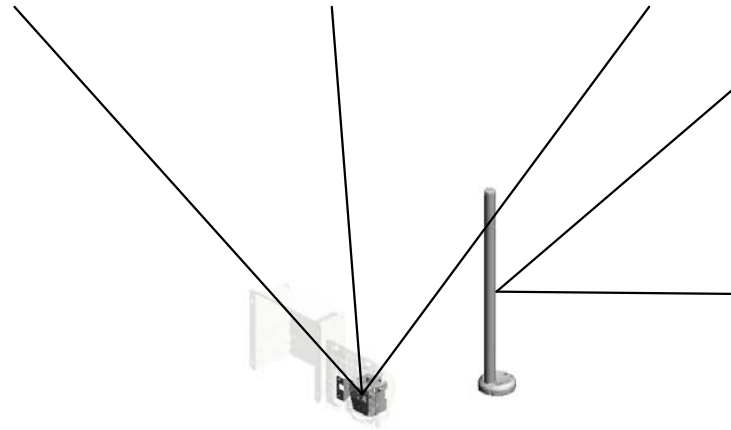
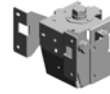

U022\_S003  
M5001861  
TUBE TYPE LAMP:ASS'Y:(PC  
B14)



U022\_S005  
M5001861  
TUBE TYPE LAMP:ASS'Y:(PC  
B14)



U001	U002	U003	U004	U005	U006	U007	U008	U009	U010	U011	U012	U013	U014	U015	U016	U017	U018	U019	U020	U021
------	------	------	------	------	------	------	------	------	------	------	------	------	------	------	------	------	------	------	------	------

# U022 ACCESSORIES

10.11050724 (x9)  
CLAMPS:WES-1210

2.03604008N (x30)  
SCREW - M4X8

15.D0BX1518 (x3)  
COVER:EXHAUST:  
PAPER EXIT SUB-UNIT

12.D0744225 (x3)  
KNOB:FUSING

53.D0BX7662 (x3)  
ACCESSORY:COVER:SIDE:RIGHT:ASSY

17.D0BX1588 (x3)  
COVER:HINGE:MIDDLE

18.D0BX1590 (x3)  
COVER:HINGE:FRONT

1.03150100N (x3)  
PAN HEAD SCREW :M5X10

14.D0747391 (x9)  
DECAL:PAPER SE  
T DIRECTION

20.D0BX4385 (x6)  
TAPE:HOLDER:FUSING UNIT:HEATER:ASSY

25.D1793402 (x3)  
BOTTLE:DEVELOPER:ASSY

9.11050508 (x12)  
HARNESS CLAMP - LWS-0711

19.D0BX1593 (x3)  
OZONE FILTER:EXHAUST:PAPER EXIT SUB-UNIT

21.D0BX7648 (x3)  
DECAL:MULTI-LANGUAGE:MAIN:13:ABS

26.D1795923 (x3)  
PLATE:POWER SUPPLY CORD:INLET

13.D0744391 (x3)  
HOLDER:KNOB:FUSING:DUAL FACES TEPE

U022  
ACCESSORIES

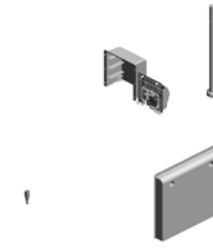

27.D1796193  
(x3)  
HOLDER:FLAT BEL  
T-TRANSFER:DRIV  
E ROLLER:ASS'Y



28.D1796194  
(x3)  
HOLDER:FLAT BEL  
T-TRANSFER:CLE  
ANING:ASS'Y



29.D1799640  
(x3)  
**DEVELOPER BLAC  
K**



31.D2707649  
(x3)  
DECAL:MULTI-LAN  
GUAGE:MAIN:5



33.G1781141  
(x12)  
HOLDER:STAND:M  
20



34.G1788350  
(x3)  
WRENCH:HEXAGO  
NAL BOLT



40.B0651374  
(x3)  
CLOTH - DF EXPO  
SURE GLASS



41.D0747775  
(x3)  
(CHN[Pro 8300S/83  
10S/8320S]/NA):PL  
ATE:LOGO:RICOH

U001	U002	U003	U004	U005	U006	U007	U008	U009	U010	U011	U012	U013	U014	U015	U016	U017	U018	U019	U020	U021
------	------	------	------	------	------	------	------	------	------	------	------	------	------	------	------	------	------	------	------	------

U022  
ACCESSORIES

	
<p>Pro 8300S</p> <p>42.D0BX7681 (Pro 8300S):MODE L NAME PLATE:PR O_8300S</p>	<p>Pro 8310S</p> <p>43.D0BY7681 (Pro 8310S):MODE L NAME PLATE:PR O_8310S</p>
<p>Pro 8320S</p> <p>44.D0BZ7681 (Pro 8320S):MODE L NAME PLATE:PR O_8320S</p>	 <p>45.D1791748 (x3) HOLDER:EXPOSU RE GLASS:ASSY</p>
 <p>46.D2706022 (x3) DECAL:CAUTION:O RIGINAL:MANY LA NGUAGES</p>	 <p>48.D1791595 (x3) (NA):DECAL:DC:MA IN SWITCH</p>
 <p>49.D2701588 (x6) (NA):DECAL:CAUTI ON:PULL OUT:ENG LISH</p>	 <p>50.D2701761 (x3) (NA):DECAL:CAUTI ON CHART:INKJET :PAPER</p>

U022  
ACCESSORIES

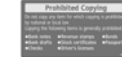
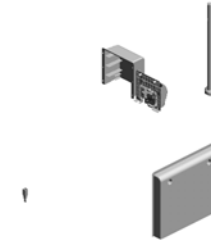

51. D2707669 (x3)  
(NA);DECAL:POWER SOURCE:OFF:ABS

52. D2707671 (x3)  
(NA);DECAL:CAUTION CHART:COPY: ORIGINAL

4. 04514006N(x 3)  
TAPPING SCREW - 4X6

5. 04514008N(x 3)  
TAPPING SCREW:4X8

6. 04544010N(x 6)  
TAPPING SCREW:ROUND POINT:4X10

47. 11500455(x 3)  
(NA);POWER SUPPLY CODE250V:20A

U001	U002	U003	U004	U005	U006	U007	U008	U009	U010	U011	U012	U013	U014	U015	U016	U017	U018	U019	U020	U021
------	------	------	------	------	------	------	------	------	------	------	------	------	------	------	------	------	------	------	------	------

U022\_S001  
HINGE:STAND:OPERATION SUB-UNIT:ASS'Y

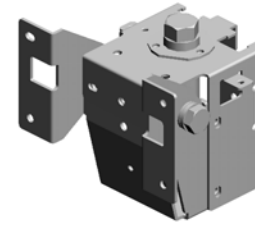

16.D0BX1580  
HINGE:STAND:OP  
ERATION SUB-UNI  
T:ASS'Y

2.03604008N(x12)  
SCREW - M4X8

U001	U002	U003	U004	U005	U006	U007	U008	U009	U010	U011	U012	U013	U014	U015	U016	U017	U018	U019	U020	U021
------	------	------	------	------	------	------	------	------	------	------	------	------	------	------	------	------	------	------	------	------

U022\_S002  
HINGE:STAND:OPERATION SUB-UNIT:ASS'Y

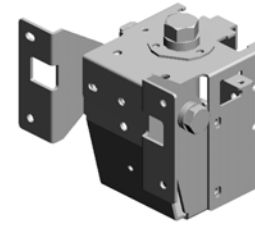

16.D0BX1580  
HINGE:STAND:OP  
ERATION SUB-UNI  
T:ASS'Y

2.03604008N(x12)  
SCREW - M4X8

U001	U002	U003	U004	U005	U006	U007	U008	U009	U010	U011	U012	U013	U014	U015	U016	U017	U018	U019	U020	U021
------	------	------	------	------	------	------	------	------	------	------	------	------	------	------	------	------	------	------	------	------

U022\_S003  
TUBE TYPE LAMP:ASS'Y:(PCB14)

3.04503012N  
(x3)  
TAPPING SCREW:  
3X12

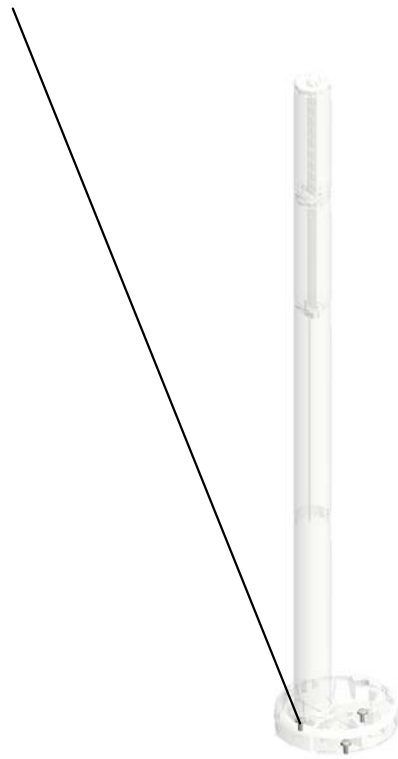

38.M5001861  
TUBE TYPE LAMP:  
ASS'Y:(PCB14)



8.11050046  
HARNESS BAND

U001	U002	U003	U004	U005	U006	U007	U008	U009	U010	U011	U012	U013	U014	U015	U016	U017	U018	U019	U020	U021
------	------	------	------	------	------	------	------	------	------	------	------	------	------	------	------	------	------	------	------	------



U022\_S004  
HINGE:STAND:OPERATION SUB-UNIT:ASS'Y

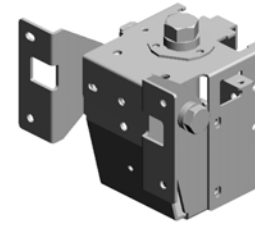

16.D0BX1580  
HINGE:STAND:OP  
ERATION SUB-UNI  
T:ASS'Y

2.03604008N(x12)  
SCREW - M4X8

U001	U002	U003	U004	U005	U006	U007	U008	U009	U010	U011	U012	U013	U014	U015	U016	U017	U018	U019	U020	U021
------	------	------	------	------	------	------	------	------	------	------	------	------	------	------	------	------	------	------	------	------

U022\_S005  
TUBE TYPE LAMP:ASS'Y:(PCB14)

3.04503012N  
(x3)  
TAPPING SCREW:  
3X12

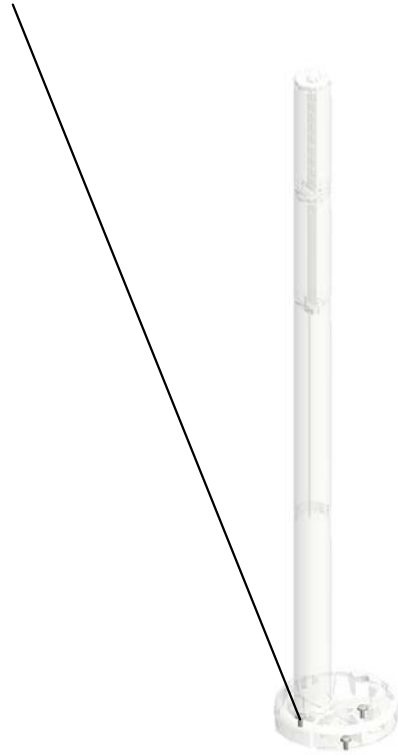

38.M5001861  
TUBE TYPE LAMP:  
ASS'Y:(PCB14)



8.11050046  
HARNESS BAND

U001	U002	U003	U004	U005	U006	U007	U008	U009	U010	U011	U012	U013	U014	U015	U016	U017	U018	U019	U020	U021
------	------	------	------	------	------	------	------	------	------	------	------	------	------	------	------	------	------	------	------	------

U023  
(For Pro 8300S):Attention Light AL3000

1.M5001861  
TUBE TYPE LAMP:  
ASS'Y:(PCB14)

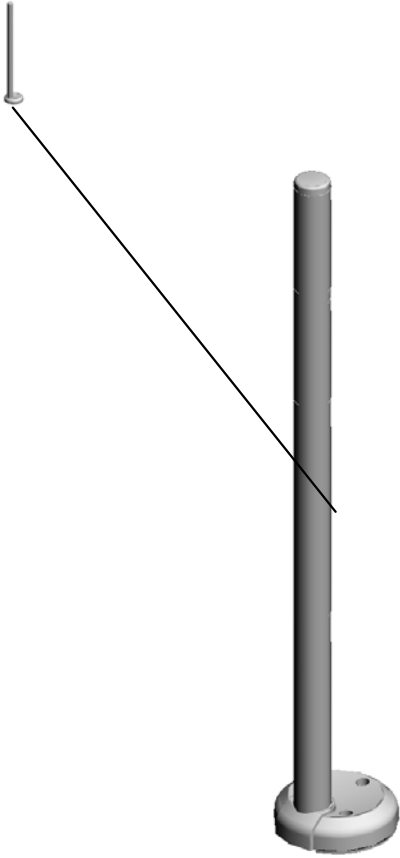

U001	U002	U003	U004	U005	U006	U007	U008	U009	U010	U011	U012	U013	U014	U015	U016	U017	U018	U019	U020	U021
------	------	------	------	------	------	------	------	------	------	------	------	------	------	------	------	------	------	------	------	------

## SPECIAL TOOLS

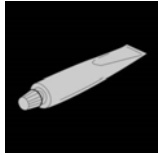

1.52039502  
GREASE 501



3.A0069104  
ADJUSTING SCANNER PIN (4PCS/SET)

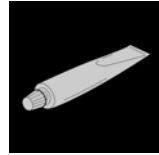

4.A2579300  
GREASE - BARRIERTA S552R



5.B1329700  
LUBRICANT POWDER

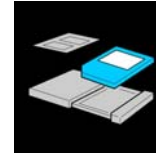

6.B6455010  
SD-CARD:ASS'Y



7.C4019503  
20X MAGNIFICATION SCOPE



8.D0159500  
G104 YELLOW TONER



9.D0159501  
ZINC STEARATE

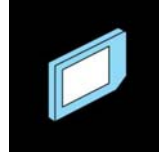

10.D0745100  
SD-CARD:NICE:REGI:ASS'Y



11.D1793402  
BOTTLE:DEVELOPER:ASS'Y

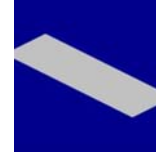

12.D1793414  
SEAL:DEVELOPMENT ROLLER:SER  
VICE PARTS:ASS'Y



13.D1793420  
JIG:SHEET:DOCTOR BLADE



14.D1793421  
KNOB:DRIVE:DEVELOPMENT UNIT:ASS'Y



15.D1796193  
HOLDER:FLAT BELT-TRANSFER:DRIVE ROLLER:ASS'Y



16.D1796194  
HOLDER:FLAT BELT-TRANSFER:CLEANING:ASS'Y



17.VSSG9002  
FLUOTRIBO MG GREASE : 100G



18.VSSM9000  
DIGITAL MULTIMETER-FLUKE189/FVF

## Exclusive Parts

Number	Part Name	Group	ID
50530223	BUSHING - 8MM	U006_S012	70
50530447	BUSHING - 6MM	U006	71
52039502	GREASE 501	SPECIAL TOOLS	1
52062686	SNAP RING	U001	14
		U003_S001	31
		U011_S001	18
52152621	SNAP RING - M6	U003_S001	32
		U006	72
		U009_S001	24
		U011_S001	19
54472681	SNAP RING	U003_S001	33
		U003_S001_S001	33
		U006	73
		U010_S001	5
54472706	GEAR - 15T	U016	23
		U006_S006	74
		U006_S007	74
58942540	ARM SCREW	U006_S008	74
		U014_S001	31
		U006	75
67542866	ROLLER - POSITIONING GUIDE	U006	75
A0069104	ADJUSTING SCANNER PIN (4PCS/SET)	SPECIAL TOOLS	3
A0793626	STEPPED SCREW - SWING CLEANING	U017	21
A1342978	SPRING PLATE	U006_S010_S003	76
		U006_S011_S003	76
A1343180	BOTTLE CHUCK	U007	25
A2324666	CUSHION - STEPPER MOTOR	U004	15
		U006	77
		U009_S001	25
A2486687	RIGHT DRIVE SHAFT	U006_S012	78
A2486694	WIRE RING	U006_S012	79
A2486695	GUIDE - PULLEY	U006_S012	80
A2486696	PULLEY COVER	U006_S012	81
A2486713	HOOK - TENSION SPRING	U006_S012	82
A2501752	EXPOSURE GLASS	U004	16
A2574493	BAND	U016	24
A2579300	GREASE - BARRIERTA S552R	SPECIAL TOOLS	4

Number	Part Name	Group	ID
A2672857	SPRING PLATE - SIDE FENCE	U006_S010_S002	83
		U006_S011_S002	83
A2672859	SIDE FENCE STOPPER	U006_S010_S002	84
		U006_S011_S002	84
A2941163	GEAR - 30Z	U007_S004	26
A2943294	GEAR - 108Z USA (RIC)	U007	27
A2943319	CASE CUSHION	U007_S001	28
		U007_S002	28
A2943354	RACK - 10Z	U007	29
A2943445	STOPPER SUPPORT PLATE	U007	30
A2943446	TONER BOTTLE STOPPER	U007	31
A2943447	TONER BOTTLE SET FEELER	U007	32
A2943454	LEVER STOPPER	U007	33
A2943461	LEVER RACK JOINT	U007	34
A2944156	GEAR - 23Z	U014_S002	32
A2944171	COUPLED GEAR - 17Z/32Z	U014_S001_S007	33
		U014_S002	33
A2946643	LEFT FRONT FENCE	U006	85
A2946690	FEELER - PAPER HEIGHT SENSOR	U006_S012	86
A4181158	SPACER - M6.5X1	U003_S001_S001	34
A4221063	SEAL - 0.7X13X20	U003_S001	35
		U003_S001_S004	35
		U003_S001_S008	35
A5482139	PULLEY	U003_S001	36
A6281225	BUSHING - 8MM	U003_S001_S001	37
A8061163	GUIDE PLATE CUSHION	U003_S001_S001	38
		U003_S001_S001_S001	38
A8063281	TIMING PULLEY - T14 S3M	U012_S004	16
A8592112	DRIVE SHAFT - PAPER FEED BELT	U003_S001_S001	39
A8592319	BASE CUSHION	U003_S001_S001	40
A8597211	STEPPED SCREW	U003	41
AA000291	DECAL:POSITIONING DISPLAY:SCREW:PP	U006_S006	87
		U006_S007	87
		U006_S008	87
		U011	20

## Exclusive Parts

Number	Part Name	Group	ID
AA001508	DECAL:SIDE FENCE:40X30	U006_S014	88
AA001509	DECAL:SIDE FENCE:16X30	U006_S012_S001	89
AA001597	DECAL:SIDE FENCE:REAR	U006_S010_S002	90
		U006_S011_S002	90
AA003056	DECAL:GRIP:SHORT:PP	U006_S006	91
		U006_S007	91
		U006_S008	91
		U011	21
AA021034	MAGNETIC	U016	25
AA021035	MAGNETIC:COVER	U007	35
AA036015	CAP:COLLECTION BOTTLE	U012_S002	17
AA040033	TRANSPORT BELT	U013	12
AA043271	TIMING BELT S3M 196T	U006	92
AA043293	TIMING BELT - 40S2M268G	U016	26
AA043323	TIMING BELT:40S2M120	U015	30
AA043324	TIMING BELT - B40S2M152	U006	93
AA043325	TIMING BELT - B40S2M250	U006	94
AA043328	TIMING BELT:40S2M130	U003_S001_S001	42
AA043333	TIMING BELT:60S2M168	U016	27
AA043339	TIMING BELT:PAPER EXIT:40S2M122	U003_S001	43
AA043342	SYNCHRONOUS BELT:40S3M666	U012_S003	18
AA043443	TIMING BELT - S2M 140	U006	95
AA043608	TIMING BELT:40S2M184	U015	31
AA043627	TIMING BELT - B40S2M148	U006	96
AA043632	TIMING BELT - 40S2M126	U003_S001	44
AA043647	TIMING BELT:60S2M188	U006	97
AA043650	TIMING BELT - B60S2M290	U016	28
AA043652	TIMING BELT - B60S2M130	U015	32
AA043659	SYNCHRONOUS BELT:40S3M231	U012_S004	19
AA043660	TIMING BELT:40S2M172	U015	33
AA043681	SYNCHRONOUS BELT:40S2M108	U003_S001	45
AA043682	SYNCHRONOUS BELT:60S1.5M150	U003_S001	46
AA043683	SYNCHRONOUS BELT:60S1.5M204	U003_S001	47
AA043684	SYNCHRONOUS BELT:60S1.5M390	U003_S001	48

Number	Part Name	Group	ID
AA043685	SYNCHRONOUS BELT:40S2M258	U003_S001	49
AA043694	SYNCHRONOUS BELT:B40S2M202	U003_S001	50
AA043698	SYNCHRONOUS BELT:40S1.5M300	U003_S001	51
AA043710	SYNCHRONOUS BELT:40S2M158	U003_S001	52
AA043976	TIMING BELT:40S2M142	U009_S001	26
AA060523	PICK-UP PRESSURE SPING	U006_S006	98
		U006_S007	98
		U006_S008	98
AA060575	RELEASE SPRING	U006_S006	99
		U006_S007	99
		U006_S008	99
AA060757	TENSION SPRING - LONG	U006_S012	100
AA060758	TENSION SPRING - SHORT	U006_S012	101
AA060811	TENSION SPRING - STOPPER	U007	36
AA060812	LEVER TENSION SPRING	U007	37
AA060842	TENSION SPRING	U003_S001	53
AA060961	TENSION SPRING:SIDE FENCE:REAR	U006_S010	102
		U006_S011	102
AA060987	TENSION SPRING:TIMING BELT:10N	U006	103
AA061067	TENSION SPRING:DRIVE WIRE:DRIVE	U009_S001	27
AA061068	TENSION SPRING:BRACKET:DRIVEN ROLLER:INNER BACK	U009_S001	28
AA061114	TENSION SPRING:POSITIONING SENSOR	U009_S001	29
AA061116	TENSION SPRING:STRIPPER PLATE:2N	U014_S001	34
AA061134	TENSION SPRING:LEVER:PRESSURE	U014_S001	35
AA061154	COMPRESSION SPRING:11N	U014_S001_S005	36
AA061169	TENSION SPRING:TONER CATCH PAN:DISCHARGE USED TONER	U012_S001	20
AA061170	COIL SPRING:GATE PAWL:EXIT:ENTRANCE	U015	34
AA061171	COIL SPRING:LATCH:REVERSE EXIT:LEFT LOWER	U015	35

## Exclusive Parts

Number	Part Name	Group	ID
AA061172	COIL SPRING:GATE PAWL:EXIT:DUPLICATE	U015	36
AA061173	COIL SPRING:GATE PAWL:DUPLICATE:ENTRANCE	U016	29
AA061177	TENSION SPRING:VIBRATING PLATE:VERTICAL TRANSPORT	U012_S004	21
AA061191	TENSION SPRING:REGISTRATION	U006	104
AA061192	TENSION SPRING:TIMING ROLLER	U006	105
AA062797	COMPRESSION SPRING:DRAWER:22.2N	U021	33
AA063268	CONNECTOR SPRING	U006	106
AA063392	CHUCK SPRING	U007	38
AA063435	COMPRESSION SPRING:PAPER FEED:JOINT	U003_S001_S001	54
AA063463	COMPRESSION SPRING:DRAWER	U009 U014	30 37
AA063465	COMPRESSION SPRING:CLEANING FELT:27N	U014_S002	38
AA063472	COMPRESSION SPRING:CONNECTOR:UPPER	U021	34
AA063601	RACK SPRING	U007	39
AA063602	CHUCK SPRING	U007	40
AA063674	SPRING - 8N	U015 U016	37 30
AA063675	SPRING - 5N	U015 U016	38 31
AA063678	SPRING - 3.5N	U006	107
AA063693	COMPRESSION SPRING:PRESSURE:DRIVEN ROLLER	U006 U006_S006 U006_S007 U006_S008 U006_S009	108 108 108 108 108
AA063694	COMPRESSION SPRING:HANDLE	U006	109
AA063695	COMPRESSION SPRING:GRIP	U006	110
AA063851	PRESSURE SPRING	U014_S002	39
AA064000	COMPRESSION SPRING:PRESSURE	U014_S001	40

Number	Part Name	Group	ID
AA066320	FEELER TORSION SPRING	U007	41
AA066402	TORSION SPRING:GUIDE PLATE:REAR	U006	111
AA066403	TORSION SPRING:GUIDE PLATE:FRONT	U006	112
AA066419	TORSION SPRING:GRIP	U006	113
AA066667	SPRING:STRIPPER PLATE:FRONT	U006	114
AA070090	SLIDE RAIL:FUSING UNIT	U014	41
AA080154	REAR BUSHING	U011_S001	22
AA080265	BUSHING:6X8X5	U006	115
AA080346	BUSHING:FLANGE TYPE:DIA6	U003_S001 U006 U015 U016	55 116 39 32
AA080347	BUSHING - 8MM	U003_S001	56
AA082101	BUSHING - 6X10X6	U003_S001 U003_S001_S001 U014_S001 U015	57 57 42 40
AA082104	BUSHING - 8X12X7	U003_S001_S007 U006 U009_S001 U015 U021	58 117 31 41 35
AA082115	PLAIN SHAFT BEARING:5X10X5	U013	13
AA082137	BUSHING:6X10X6	U010_S001	6
AA082144	BUSHING - 8X12X7	U003_S001 U006	59 118
AA082173	PLAIN SHAFT BEARING:6X10X6	U013	14
AA083009	CLUTCH ROLLER - 8X18X11	U006_S006 U006_S007 U006_S008	119 119 119
AA083022	BUSHING:DIA6:DIA8	U009_S001 U010_S001	32 7
AA084059	BALL BEARING HOLDER	U006 U006_S006 U006_S007 U006_S008	120 120 120 120

## Exclusive Parts

Number	Part Name	Group	ID
		U006_S009	120
		U015	42
		U016	33
AA113037	TERMINAL:4P:187	U014_S001	43
AA120084	DISCHARGE BRUSH	U015	43
AA120097	ANTISTATIC BRUSH	U015	44
AA120127	DISCHARGE BRUSH:FUSING	U006	121
AA120150	DISCHARGE BRUSH:REVERSE:17MM	U006	122
		U015	45
AA132013	SPACER	U003_S001_S001	60
AA132203	SPACER - 6MM	U006	123
		U006_S012	123
AA132300	ROLLER:LOCK:PULL OUT	U021	36
AA140686	SHAFT - TIMING PULLEY	U006	124
AA140912	SCREW - 8X14X2.8	U006	125
AA143444	STEPPED SCREW	U009_S001	33
		U015	46
AA143520	SHOULDER SCREW - M3	U014_S001	44
		U014_S002	44
AA143550	SCREW:DIA4:M3	U006	126
AA143562	SCREW:M4:DIA6X1.2	U007	42
AA143569	SCREW	U006	127
AA143571	SHAFT	U013	15
AA143594	STEPPED SCREW:M3X5	U021	37
AA143788	PIN:GUIDE PLATE:PAPER FEED	U003_S001	61
		U003_S001_S008	61
AA143789	SHAFT:CLEANER	U003_S001	62
AA143791	SCREW:SAFETY	U003_S001	63
AA143797	CONNECTOR GUIDE PIN	U001	15
		U006	128
		U018	32
AA143810	DEVELOPMENT COVER SCREW	U006	129
AA143811	STEPPED SCREW - M3X4	U016	34
AA143812	SCREW - SCALE	U006	130
AA143816	FLAT SCREW:CHUCK:BOTTLE	U007	43
AA143834	SCREW:M4	U014_S001	45
AA143842	SCREW:DIA6:14.5:M4	U003_S001	64
AA143846	TAPPING SCREW:M3X6	U003_S001_S004	65

Number	Part Name	Group	ID
AA143847	STEPPED SCREW:DIA5:3.5:M3	U014_S001	46
AA148778	SHAFT:ARM:PLATE	U006	131
AA152299	BOTTLE HOLD SEAL	U007	44
AA161104	CUSHION - MOTOR	U004	17
AA161177	CUSHION:BASE:TANDEM LCT:LARGE	U006_S012	132
AA161178	CUSHION:BASE:TANDEM LCT:SMALL	U006_S012	133
AA161180	CUSHION:DC STEPPER MOTOR	U006	134
		U015	47
		U016	35
AB010219	GEAR:STOPPER:OIL SUPPLY ROLLER	U014_S002	47
AB011125	GEAR:20/29Z	U011_S001	23
AB011126	GEAR:20Z	U011_S001	24
AB011392	DRIVE REVERSE GEAR - 24Z	U006_S006	135
		U006_S007	135
		U006_S008	135
AB011540	GEAR:AGITATOR:DRIVE	U012_S001	22
AB011591	GEAR:REVERSE	U006_S006	136
		U006_S007	136
		U006_S008	136
AB011626	GEAR:IDLER:EXIT:CONNECTING	U015	48
AB011627	GEAR:EXIT:25Z	U015	49
AB012005	GEAR - 13Z	U007	45
AB012007	GEAR - 14Z	U007	46
AB012008	GEAR - 23Z	U007	47
AB012327	GEAR:16Z	U006_S010	137
		U006_S011	137
AB013781	GEAR - 30Z	U006_S012	138
AB013798	GEAR - Z18	U006	139
AB014229	COUPLEDGEAR - 17Z/32Z	U014_S001_S007	48
AB014243	GEAR:IDLER:Z30	U006	140
AB014287	GEAR:IDLER:FUSING	U014_S001	49
AB017514	DOUBLE GEAR - 12/27Z	U007	48
AB017515	DOUBLE GEAR - 12/23Z	U007	49
AB017725	GEAR/TIMING PULLEY - 20Z/20T	U006	141
AB017726	GEAR/TIMING PULLEY - 20Z/20T	U006	142



## Exclusive Parts

Number	Part Name	Group	ID
AB017771	GEAR:TRANSPORT ROLLER:INPUT:Z23/Z28	U006_S006	143
		U006_S007	143
		U006_S008	143
AB017961	GEAR:EXIT:70Z/T24	U015	50
AB017962	GEAR:IDLER:EXIT	U015	51
AB019475	GEAR - 48T	U006	144
AB030842	TIMING PULLEY:S2M:30T	U006	145
		U016	36
AB030877	TIMING PULLEY:Z51	U012	23
AB030880	PULLEY:S2M:22T	U015	52
AB032058	WIRE PULLEY - M10	U006_S012	146
AB032072	PULLEY:DRIVEN:WIRE	U009_S001	34
AB032719	PULLEY - M10	U006_S012	147
AB033084	TIMING PULLEY - 15T	U006	148
AB033085	TIMING PULLEY - 15T	U006	149
AB033118	TORQUE LIMITER MECHANICAL CLUTCH:TONER RECYCLING SUB-UNIT	U012_S003	24
AB033119	TIMING PULLEY:Z25:Z14	U012_S004	25
AC020152	LENS:LED:3	U001_S003	16
		U001_S004	16
		U001_S010	16
		U001_S011	16
AC020153	LENS:LED:4	U001_S003	17
		U001_S004	17
		U001_S006	17
		U001_S010	17
		U001_S011	17
		U001_S013	17
		U006	150
AC030211	MIRROR:NO.1	U004_S002	18
AE012048	HEAT ROLLER:DIA39.2	U014_S001	50
AE020220	PRESSURE ROLLER:DIA65	U014_S001_S001	51
AE030030	BALL BEARING - 8X19X6	U014_S001	52
AE030044	BALL BEARING - 10X22X6	U014_S001	53
AE030086	RADIAL BALL BEARING:DIA25XDIA37X7	U014_S001	54
		U014_S001_S001	54
AE031032	BUSHING - 6X9X6.5	U014_S002	55

Number	Part Name	Group	ID
AE031037	BUSHING - M4	U014_S001_S007	56
AE032034	THERMAL INSULATING BUSHING:DIA22	U014_S001	57
AE044075	STRIPPER PAWLS	U014_S001	58
AE045065	WEB:SUB-ASS'Y	U014_S002	59
AF010097	PAPER TRAY:UNIVERSAL:REMOVER/INSTALL	U006_S010	151
		U006_S011	151
AF013029	PAD:BASE	U006_S010_S001	152
		U006_S011_S001	152
AF017033	END FENCE	U006_S010	153
		U006_S011	153
AF020850	TRANSPORT ROLLER:DRIVE:PAPER FEED UNIT	U006_S006	154
		U006_S007	154
		U006_S008	154
AF020851	TRANSPORT ROLLER:DRIVEN:PAPER FEED UNIT	U006_S006	155
		U006_S007	155
		U006_S008	155
AF020852	TRANSPORT ROLLER:VERTICAL TRANSPORT:DRIVE:EXIT	U006	156
AF020853	TRANSPORT ROLLER:VERTICAL TRANSPORT:DRIVE	U006	157
AF020854	TRANSPORT ROLLER:VERTICAL TRANSPORT:DRIVE:CONNECTING	U006	158
AF022064	TRANSPORT ROLLER:DRIVEN	U013	16
AF022067	GUIDE STOPPER ROLLER	U016	37
AF022105	ROLLER - SLIDE RAIL	U006_S012	159
AF022165	TRANSPORT ROLLER - DRIVEN	U006	160
		U006_S009	160
AF022167	TRANSPORT ROLLER - DRIVEN	U006	161
AF022182	TRANSPORT ROLLER:DRIVEN:DIA17.5X2	U015	53
		U016	38
AF030072	PAPER FEED ROLLER:PICKUP	U006_S006	162
		U006_S007	162
		U006_S008	162
AF031098	PAPER FEED ROLLER:FEED	U006_S006	163
		U006_S007	163
		U006_S008	163
AF032098	PAPER FEED ROLLER:SEPARATE	U006_S006	164

## Exclusive Parts

Number	Part Name	Group	ID
		U006_S007	164
		U006_S008	164
AG050100	KNOB - TRANSPORT ROLLER	U006	165
		U015	54
		U016	39
AG050101	KNOB - MISFEED REMOVAL	U006	166
AG051141	RELEASE LEVER	U006	167
AG070022	MAGNET CATCH:25.5N	U007	50
AG070504	MAGNET CATCH:44.1N	U018	33
AG070513	MAGNET CATCH	U006	168
AG071012	MAGNET CATCH:ASS'Y	U012	26
AH012042	CASTER:1470N:BB	U021	38
AW010113	SENSOR:(SEN55)	U006_S012	169
AW010143	PHOTO REFLECTION SENSOR:PS R11TL1R-C:(SEN23)	U016	40
AW010147	PHOTO REFLECTION SENSOR:(SEN4/SEN63/SEN64/SEN66)	U013	17
		U014_S001	60
AW010150	PHOTO REFLECTION SENSOR:ORIGINAL TRAY:(S14/S15/S16/S19/SEN21)	U003_S001	66
		U015	55
AW010151	PHOTO REFLECTION SENSOR:PS122TL1-A:(S6/S7/S10/S11/S12/SEN7/SEN8/SEN10/SEN32/SEN33/SEN34/SEN108/SEN110/SEN112)	U003_S001	67
		U006	170
		U006_S006	170
		U006_S007	170
		U006_S008	170
		U015	56
		U016	41
AW010160	ORIGINAL SENSOR:48MM:5V:(SEN105/SEN106)	U004	19
AW010200	PAPER FEED SENSOR:FUSING EXIT:(SEN20)	U015	57
AW020163	PAPER FEED SENSOR:SEN56	U006	171
AW020190	PHOTOINTERRUPTOR:(S18)	U003_S001	68
AW020207	PHOTOINTERRUPTOR:FLAT:PICH2MM:M4:(SEN107)	U021	86
AW020218	POSITIONING SENSOR:FLAT BELT-TRANSFER:(SEN96)	U009_S001	35
AW020234	PHOTOINTERRUPTOR:GP1A173L	U003_S001	69

Number	Part Name	Group	ID
	CS5F:(S1/S2/S3/S4/S5/S8/S9/S13/S17)		
AW100169	THERMISTOR:ASS'Y:(SEN94)	U020	23
AW100183	THERMOPILE:(SEN57/SEN58/SEN85)	U014	61
AW110052	THERMOSTAT:211C:(TS1/TS2)	U014_S001	62
AW110122	THERMOSTAT:225C:250V/17A:(TS3)	U014_S001	63
AW140026	TEMPERATURE & HUMIDITY SENSOR	U012	27
AW140027	TEMPERATURE & HUMIDITY SENSOR:(SEN2)	U008	33
AW500010	PUSH SWITCH:(SW1/SW4)	U006	172
AW500045	PUSH SWITCH:(SW2/SW3/SW13/SW14)	U006	173
		U009_S001	36
		U012	28
AX040199	DC MOTOR:RISING TRAY:ASS'Y:(M7/BM2/BM3)	U003_S001	70
		U006	174
AX040276	STEPPER MOTOR:MM56:TRANSPORT:(STM5/STM6/STM7/STM8/STM9/STM10/STM12/STM13/STM15/STM18/STM19/STM20/STM21/STM22/STM23)	U006	175
		U015	58
		U016	42
AX040279	STEPPER MOTOR:PAPER TRANSPORT MD:MM42:(STM11)	U006	176
AX040280	STEPPER MOTOR:DRIVE:(STM24/STM25/STM26/STM27)	U006	177
		U015	59
AX040297	STEPPER MOTOR:MM56:TRANSPORT:(STM14/STM17)	U006	178
AX040300	DC MOTOR:CLEANER:ASS'Y:(BM5)	U014_S001_S007_S001	64
AX060517	DC STEPPER MOTOR:MM56XL76:(STM16)	U006	179
AX060521	DC STEPPER MOTOR:MM42:1.2A:3.60V:(STM3)	U009_S001	37
AX061102	DC BRUSHLESS MOTOR:25W:NMB:EXIT:(BLM7/BLM12)	U015	60
AX061204	DC MOTOR:11.5W:BRUSHLESS:(B	U017	22

## Exclusive Parts

Number	Part Name	Group	ID
	LM4)		
AX400194	HEATER - 230V/9W:(HT12/HT13)	U009_S001	38
AX440348	(NA):HEATER:PRESSURE ROLLER :208V:800W:(HT5)	U014_S001_S001	160
AX640224	DC FAN MOTOR:AXIAL:MM80:(FAN 6/FAN7/FAN13/FAN16/FAN18/FAN1 9)	U020	24
AX640247	DC FAN MOTOR:AXIAL:MM80:25M M:(FAN4/FAN5/FAN8/FAN14/FAN17 /FAN20/FAN22/FAN23//FAN24//FAN 25)	U019 U020	22 25
AX640330	FAN:SIROCCO:DIA51:(FAN26/FAN2 7)	U009 U020	39 26
AX650056	DC FAN MOTOR:AXIAL:MM92:(FAN 30/FAN31/FAN33)	U020	27
AX660015	DC FAN MOTOR:SIROCCO:DC24V: PWM:(FAN9/FAN10/FAN11/FAN12)	U020	28
AZ210003	DC POWER SUPPLY:12V:25W:(PC B31)	U019	23
AZ240355	POWER SUPPLY UNIT:ECO:(PCB2 8)	U019	63
AZ240356	POWER SUPPLY UNIT:FW:(PCB29)	U019	64
AZ250066	POWER SUPPLY UNIT:864W:(PCB 30)	U019	26
AZ310032	POWER PACK:D:(PCB21)	U011	25
AZ320193	POWER PACK:CGB:(PCB25)	U018	34
AZ320194	POWER PACK:T1/T2:(PCB42)	U009_S001	40
B0042995	CAP - POSITIONING	U006	180
B0434645	SPRING - 2N	U003_S001	71
B0651374	CLOTH - DF EXPOSURE GLASS	U022	40
B0654935	LEVER:GUIDE PLATE:ASS'Y	U016	43
B0656136	TRAY LOCK ARM	U006	181
B0656345	PAPER END SENSOR BRACKET	U006_S006 U006_S007 U006_S008	182 182 182
B0656524	BOTTOM PLATE LIFT SHAFT	U006_S010 U006_S011	183 183
B0656526	LIFT LEVER	U006_S010	184

Number	Part Name	Group	ID
		U006_S011	184
B0656545	DECAL - POSITIONING	U006_S010 U006_S011	185 185
B0656589	LEFT SUPPORT PLATE	U006	186
B0656591	PAPER TRAY HOLDER BASE	U006	187
B0656717	PAPER VOLUME SHIELD PLATE	U006_S012	188
B0656769	LOCK ARM	U006	189
B0656823	TIMING BELT COVER	U006	190
B0656830	PULLEY BRACKET	U006	191
B0656831	SENSOR BRACKET	U006	192
B0656862	LARGE LEVER	U006_S012	193
B0656864	SMALL LEVER	U006_S012	194
B0656870	STAY -RIGHTBASE	U006_S012	195
B0656872	OIL DAMPER BRACKET	U006_S012	196
B0656875	PROTECTION -INNER COVER	U006_S012	197
B0706667	END FENCE COVER FRONT	U006_S012	198
B0706683	LEVER:RELEASE:FRONT	U006_S012	199
B0706684	LEVER:RELEASE:REAR	U006_S012	200
B0706849	GUIDE:POSITIONING	U019	27
B1202063	BUSHING - 4MM	U012	29
B1253659	CUSHION:SWIVEL:STOPPER	U015	61
B1321183	BRACKET:LOCK	U021	39
B1321221	HOLDER:SPRING:PULL OUT	U021	40
B1322264	BUSHING:TERMINAL	U010_S001 U015	8 62
B1323861	PTB UNIT GUIDE PLATE	U013	18
B1324167	GRIP:OIL APPLICATION UNIT:FIBE R	U014_S001	66
B1324196	SPRING:PICK-OFF PAWL	U014_S001	67
B1324197	TORSION SPRING:LEVER	U014_S001	68
B1324265	ROLLER:PICK-OFF PAWL	U014_S001	69
B1324268	HOLDER:ROLLER:PICK-OFF PAWL	U014_S001	70
B1326726	BRACKET:ARM:ASS'Y	U006	201
B1326738	BRACKET:LIFT MOTOR:TANDEM L CT	U006	202
B1326764	BRACKET:CONNECTOR:RIGHT	U006	203
B1326791	PLATE:SIDE FENCE	U006_S010_S003 U006_S011_S003	204 204

## Exclusive Parts

Number	Part Name	Group	ID
B1326797	SIDE FENCE:REAR:AUXILIARY	U006_S010	205
		U006_S011	205
B1326798	SPRING PLATE:PAPER TRAY:EAR TH	U006_S010	206
		U006_S011	206
B1327541	TRAY BOTTOM PLATE:LEFT REAR	U006	207
B1327561	BACK FENCE:LEFT	U006	208
B1327564	SLIDER:BACK FENCE:LEFT	U006	209
B1327575	BRACKET:CONNECTOR:TANDEM LCT	U006_S012	210
B1327591	RAIL:PAPER TRAY:ASS'Y	U006	211
B1329700	LUBRICANT POWDER	SPECIAL TOOLS	5
B1816780	LINK:END FENCE:PAPER SIZE SENSOR:ASS'Y	U006_S010	212
		U006_S011	212
B1816789	LINK:SIDE FENCE:PAPER SIZE SENSOR	U006_S010	213
		U006_S011	213
B2341118	FLY WHEEL FLANGE	U017	23
B2342125	SPRING - GRID	U008_S001	34
B2342390	FLANGED HEXAGONAL HEAD BOLT:M4X8	U001	18
		U008	35
		U010	9
		U011	26
		U014	71
B2342624	BALL BEARING - 8X12X5	U006_S006	214
		U006_S007	214
		U006_S008	214
B2342864	PAD:CLEANER	U006_S010_S002	215
		U006_S010_S003	215
		U006_S011_S002	215
		U006_S011_S003	215
B2343356	JOINT:CHUCK:TONER BOTTLE	U007	51
B2344244	GEAR - 50Z	U014_S002	72
B2344258	CAP:HEAT PIPE	U015	63
B2344460	DISCHARGE BRUSH - L=341 SUS	U015	64
B2346120	BRACKET:POSITIONING:PAPER TRAY	U006	216
B2346125	HARNES GUIDE BRACKET	U006	217
B2346141	POSITIONING SLEEVE - INNER BACK	U006	218
		U006_S012	218

Number	Part Name	Group	ID
B2346181	SLIDE RAIL - RIGHT	U006	219
B2346188	SLIDE SLEEVE POSITIONING	U006	220
B2346198	COVER - SAFETY - PAPER SIZE SENSOR	U006	221
B2346222	REVERSE DRIVE SHAFT	U006_S006	222
		U006_S007	222
		U006_S008	222
B2346223	DRIVEN REVERSE SHAFT	U006_S006	223
		U006_S007	223
		U006_S008	223
B2346242	GUIDE - ROLLER:DRIVEN PRESSURE	U006_S006	224
		U006_S007	224
		U006_S008	224
B2346275	PICKUP ARM	U006_S006	225
		U006_S007	225
		U006_S008	225
B2346288	SENSOR BRACKET - SENSOR	U006_S006	226
		U006_S007	226
		U006_S008	226
B2346301	TORQUE LIMITER:75MN M	U006_S006	227
		U006_S007	227
		U006_S008	227
B2346424	RELEASE GRIP	U006	228
		U015	65
B2346455	BRACKET - UPPER	U006	229
B2346475	BRACKET - LOWER	U006	230
B2346495	GUIDE:FRONT:PAPER TRAY	U006	231
B2346497	GUIDE:REAR:PAPER TRAY	U006	232
B2346498	SHEET:TRAY BOTTOM PLATE	U006_S010	233
		U006_S011	233
B2346506	TIMING PULLEY - 30T	U006	234
B2346508	TENSION SPRING	U006	235
B2346514	TIMING BELT - S2M126	U006	236
B2346530	BRACKET	U006	237
B2346531	TIGHTENER BRACKET	U006	238
B2346532	TIGHTENER BRACKET	U006	239
B2346533	TIMING BELT - S2M152	U006	240
B2346542	GRIP DRIVE SHAFT	U006	241

## Exclusive Parts

Number	Part Name	Group	ID
B2346565	HARNESS CLAMP BRACKET	U006	242
B2346606	SENSOR BRACKET	U006_S012	243
B2346612	END FENCE - FRONT	U006_S012	244
B2346625	END FENCE - REAR	U006_S012	245
B2346686	SIDE FENCE - RIGHT FRONT	U006_S012	247
B2346691	SIDE FENCE:TANDEM LCT:RIGHT: ASS'Y	U006_S012_S001	248
B2347540	TRAY BOTTOM PLATE:LEFT FRONT	U006	249
B2382675	REGISTRATION ROLLER BUSHING	U006	250
B2476672	GUIDE:INTERLOCK:TANDEM LCT	U006_S012	251
B2476695	GUIDE:MISFEED REMOVAL:PAPER TRAY	U006_S010	252
		U006_S011	252
		U006_S012	252
B2476753	LOCK SPRING - LARGE	U006	253
B2476754	LOCK SPRING - SMALL	U006	254
B2476901	OIL DAMPER:FALL	U006_S012	255
B2476950	SHAFT:SLIDER:BACK FENCE	U006	256
B2476951	BRACKET:PULLEY:DRIVEN:ASS'Y	U006	257
B2591106	FAN MOTOR:MM80:DC24V 3.6W:(FAN36)	U019	28
B3033682	MISFEED REMOVAL KNOB	U006	258
B3863320	SPRING:BELT:PAPER FEED:8N	U003_S001_S001	72
B3871951	SPRING - PAPER SIZE SENSOR	U003_S001	73
B3872113	ROLLER - PAPER FEED BELT	U003_S001_S001	74
B4772227	PICKUP ROLLER:COUPLING	U003_S001_S001	75
B4772622	DISCHARGE BRUSH:L11	U003_S001	76
B4774117	SPRING	U003_S001_S004	77
B4774129	SPRING - 12N	U003_S001_S008	78
B4774131	SPRING	U003_S001	79
B5457506	SCREW:BUSHING	U010_S001	10
B5457507	SCREW:PUNCH	U021	41
B6455010	SD-CARD:ASS'Y	SPECIAL TOOLS	6
B6523174	TENSION SPRING	U003_S001	80
B7001802	TIMING BELT:B40S2M134	U010_S001	11
B7003305	TIMING BELT:B40S2M152	U003_S001	81
B7005804	STEPPER MOTOR:DIA42:Z17:ASS'Y	U008	36

Number	Part Name	Group	ID
	Y:(STM1)		
B7061859	SCREW:SLIDER:LOCK	U003_S001	82
B7125605	GRIP:APPLICATION	U004	20
		U009	41
B7892114	PAPER FEED BELT ROLLER	U003_S001_S001	83
B8022532	SPRING PLATE:SIDE FENCE	U003_S001	84
B8022536	SLIDER:SIDE FENCE	U003_S001	85
B8041180	DISCHARGE BRUSH:PUNCH UNIT	U003_S001	86
		U003_S001_S006	86
		U003_S001_S008	86
B8301135	SCREW	U003_S001	87
		U006	259
B8304263	TIMING BELT - 60S2M140	U015	66
B8321371	SPACER CUSHION	U021	87
B8341648	TIMING BELT - B60S2M120	U006	260
B8343312	COLLAR	U006	261
B8722524	SPACER:DIA9	U003_S001	88
BB013007	GEAR - 20Z	U006_S006	262
		U006_S007	262
		U006_S008	262
BB013008	GEAR - 31Z	U006_S006	263
		U006_S007	263
		U006_S008	263
BB013025	GEAR:PRESSURE ROLLER	U014_S001_S001	73
BB013028	GEAR:IDLER:35Z:ASS'Y	U014_S001	74
BB013036	GEAR:IDLER:25Z:ASS'Y	U014_S001	75
BB013037	GEAR:JOINT:PRESSURE:ASS'Y	U014_S001	76
BB013040	GEAR:SHIFT:ROLLER:Z30	U006	264
BB013047	GEAR:HOT ROLLER:ASS'Y	U014_S001	77
C1012360	SNAP RING	U001	19
C2182185	STEPPER SCREW	U018	35
C2383879	TIMING BELT	U009_S001	42
C2443522	STEPPED SCREW	U006_S006	265
		U006_S007	265
		U006_S008	265
C2672944	SCREW:ACTUATOR:SURFACE OF PAPER SENSOR	U001	99
C2693566	BUSHING:MM8:PRESSURE:DRIVE	U006	266

## Exclusive Parts

Number	Part Name	Group	ID
C4019503	20X MAGNIFICATION SCOPE	SPECIAL TOOLS	7
D0144247	HOUSING - TEMPERATURE SENSOR	U014_S001	78
D0146272	BUSHING:BRUSH:REAR	U011_S001	27
D0146626	BRACKET:ON OFF DETECTOR:FRONT	U006_S012	267
D0146627	BRACKET:ON OFF DETECTOR:REAR	U006_S012	268
D0146784	SPRING PLATE:END FENCE	U006_S010	269
		U006_S011	269
D0146785	SPRING PLATE:ARM:END FENCE:LOCK	U006_S010	270
		U006_S011	270
D0159500	G104 YELLOW TONER	SPECIAL TOOLS	8
D0159501	ZINC STEARATE	SPECIAL TOOLS	9
D0291749	PULLEY:PROTECTION	U004	21
D0396327	SPACER:SENSOR:TM	U009_S001	43
D0464655	TIMING BELT:S2M180	U015	67
D0592399	FLANGED HEXAGONAL HEAD BOLT:M3*4	U006	271
D0592469	SCREW:ROUND POINT:M4X6	U008	37
D0592620	RETAINING RINGS-C	U006_S006	272
		U006_S007	272
		U006_S008	272
		U016	44
D0596121	SPRING:CONNECTOR:TANDEM LCT	U006	273
D0596169	STAY:TANDEM LCT:ASS'Y	U006	274
D0596170	BRACKET:SLIDE RAIL:PAPER TRAY:2:ASS'Y	U006	275
D0596172	PAPER TRAY STOPPER	U006	276
D0596212	LEVER:PRESSURE:REVERSE	U006_S006	277
		U006_S007	277
		U006_S008	277
D0596277	COVER:GEAR:PAPER FEED ROLLER	U006_S006	278
		U006_S007	278
		U006_S008	278
D0596278	COVER:GEAR:REVERSE	U006_S006	279
		U006_S007	279

Number	Part Name	Group	ID
		U006_S008	279
D0596496	GUIDE:MIDDLE:PAPER TRAY	U006	280
D0596591	SPRING:PAPER TRAY:LOCK	U006	281
D0596620	LEVER:COUPLING:LEFT	U006	282
D0596646	INNER COVER:TANDEM LCT:LEFT	U006	283
D0596659	SUPPORTING PLATE:SIDE FENCE:LEFT	U006	284
D0596664	GUIDE:MIDDLE:PAPER TRAY	U006	285
D0596665	BRACKET:DC MOTOR:LEFT:ASS'Y	U006	286
D0596668	SIDE PLATE:SIDE:TANDEM LCT	U006_S012	287
D0596712	INNER COVER:TANDEM LCT	U006_S012	288
D0596721	STOPPER:PAPER TRAY	U006	289
D0596725	BRACKET:STOPPER:PAPER TRAY:RIGHT:PEEN	U006	290
D0596731	SHIELD:GUIDE:MISFEED REMOVAL	U006	291
D0626692	SLIDE RAIL:PAPER TRAY:LEFT:SUB-ASS'Y	U006	292
D0741180	LEVER:PULL OUT:PAPER EXIT UNIT	U021	42
D0741225	HINGE:C/T BOX:RIGHT UPPER:PEEN	U021	43
D0741228	COVER:HINGE	U021	44
D0741250	ARM:HINGE:C/T BOX	U019	29
D0741255	SEPARATION PLATE:DUCT	U019	30
D0741329	DC MOTOR:DIA49:24V:6.3W:(BLM2)	U017	24
D0742459	JOINT:CLEANING UNIT	U008_S002_S001	38
D0742541	DECAL:ARROW LABEL	U008_S003	39
D0742542	DECAL:GRIP	U008_S002_S001	40
D0742577	CONNECTOR:DRAWER:4POLE:REVERSE	U008	41
D0742632	BRACKET:DC STEPPER MOTOR:M56:CAM	U015	68
		U016	45
D0742652	LEVER:LINK:TRANSPORT ROLLER	U006	293
D0742681	SHAFT:CAM:SHIFT	U006	294
D0742685	SYNCHRONOUS BELT:B80S2M190	U006	295
D0742739	PRESSURE ROLLER:TRANSPORT	U006	296

## Exclusive Parts

Number	Part Name	Group	ID
	ROLLER:SHIFT:DRIVEN		
D0742744	HOLDER:SHIFT:BEARING:FRONT	U006	297
D0742799	GUIDE PLATE:CONNECTION:LCT:LOWER	U006	298
D0742938	GUIDE PLATE:CONNECTION:LARGE CAPACITY TRAY:UPPER:PEEN	U006	299
D0742942	PIN:GUIDE PLATE:CONNECTION:LARGE CAPACITY TRAY:UPPER	U006	300
D0742970	CAM:GUIDE PLATE:OPEN AND CLOSE	U006	301
D0743047	BRACKET:HOLDER:DUPLEX:ASS'Y	U016	46
D0743173	TIMING PULLEY:S2M:25T	U006	302
		U015	69
		U016	47
D0743824	PLATE:ROLLER:INTERMEDIATE TRANSFER	U009_S001	44
D0743829	DECAL:POSITIONING DISPLAY:TCRU	U001	20
		U008	42
		U008_S003	42
		U014_S001	79
D0743871	STOPPER:WIRE:PULLEY	U009_S001	45
D0743872	PULLEY:DRIVE WIRE:ASS'Y	U009_S001	46
D0743878	HOLDER:RADIAL BALL BEARING:DRIVEN ROLLER:INNER BACK	U009_S001	47
D0743896	COVER:POSITIONING SENSOR:FLAT BELT-TRANSFER	U009_S001	48
D0744063	HOUSING:THERMOSTAT:ASS'Y	U014_S001	80
D0744064	COVER:THERMOSTAT:PRESSURE	U014_S001	81
D0744070	SUPPORTING PLATE:LEVER:PRESSURE	U014_S001	82
D0744072	STEPPED SCREW:M5	U014_S001	83
D0744102	COLLAR:DIA10X:DIA14X:12	U014_S001	84
D0744103	CAM:PRESSURE:A	U014_S001	85
D0744104	FEELER:CAM:PRESSURE:FRONT	U014_S001	86
D0744105	FEELER:CAM:PRESSURE:REAR	U014_S001	87
D0744107	COLLAR:DIA10XDIA14X9.4	U014_S001	88
D0744180	HOUSING:THERMOSTAT:HEAT ROLLER:ASS'Y	U014_S001	89

Number	Part Name	Group	ID
D0744181	ELECTRODE PLATE:THERMOSTAT:HEAT ROLLER:MIDDLE	U014_S001	90
D0744182	ELECTRODE PLATE:THERMOSTAT:HEAT ROLLER	U014_S001	91
D0744225	KNOB:FUSING	U022	12
D0744227	BOLT:M5:ROUND POINT	U014_S001	92
D0744302	PLAIN SHAFT BEARING:ROLLER:REAR	U014_S002	93
D0744351	STEPPED SCREW:DIA5.4DIA:DIA3.5:M3	U009	49
		U014	94
D0744391	HOLDER:KNOB:FUSING:DUAL FACES TEPE	U022	13
D0744698	LEVER:LOCK:GUIDE PLATE	U015	70
D0745100	SD-CARD:NICE:REGI:ASS'Y	SPECIAL TOOLS	10
D0746092	BRACKET:HEATER:INTERMEDIATE TRANSFER	U009_S001	50
D0746097	THERMOSTAT:INTERMEDIATE TRANSFER:(TS4)	U009_S001	51
D0746134	PLAIN SHAFT BEARING:INSULATE	U009_S001	52
D0746144	BRACKET:INTERMEDIATE TRANSFER:FRONT	U009_S001	53
D0746145	BRACKET:INTERMEDIATE TRANSFER:REAR	U009_S001	54
D0746146	BRACKET:BIAS:INTERMEDIATE TRANSFER	U009_S001	55
D0746147	TERMINAL:INTERMEDIATE TRANSFER	U009_S001	56
D0746161	COVER:BIAS:INTERMEDIATE TRANSFER	U009_S001	57
D0746165	PULLEY:ON-OFF:BELT TENSIONER	U006	303
D0746180	COMPRESSION SPRING:BIAS:INTERMEDIATE TRANSFER	U009_S001	58
D0746197	TERMINAL:CONNECTING:BIAS:INTERMEDIATE TRANSFER	U009_S001	59
D0746216	SHUTTER:TONER OUTLET SUB-UNIT:SUB-ASS'Y	U011_S001	28
D0746219	COIL SPRING:SHUTTER:DISCHARGE	U011_S001	29

## Exclusive Parts

Number	Part Name	Group	ID
	GE USED TONER		
D0746228	ELECTRODE PLATE:FRAME	U011_S001	30
D0746235	CASE:TONER RECYCLING SUB-UNIT:SUB-ASS'Y	U011_S001	31
D0746238	JOINT:TRANSFER:DRIVE	U011	32
D0746241	DECAL:GRIP:TRANSFER/SEPARATION UNIT	U011_S001	33
D0746257	BRUSH ROLLER:APPLY:ASS'Y	U011_S001	34
D0746265	BLADE:TRANSFER ROLLER:ASS'Y	U011_S001	35
D0746270	HOLDER:BLADE:ASS'Y	U011_S001	36
D0746273	SEAL:HOLDER	U011_S001	37
D0746274	SEAL:HOLDER:UPPER	U011_S001	38
D0746276	PIN:POSITIONING PLATE:BLADE:TRANSFER ROLLER:ASS'Y	U011_S001	39
D0746279	COIL SPRING:BLADE:TRANSFER ROLLER	U011_S001	40
D0746312	GEAR:IDLER:TRANSFER ROLLER	U011_S001	41
D0746313	GEAR:IDLER:COLLECTION COIL	U011_S001	42
D0746314	GEAR:COLLECTION COIL	U011_S001	43
D0746315	GEAR:BRUSH:APPLY	U011_S001	44
D0746410	GROUND PLATE:BELT CLEANING	U010_S001	12
D0746411	COIL SPRING:EARTH:BELT CLEANING	U010_S001	13
D0746413	SCRAPER:BRUSH:REMOVE PAPER DUST:ASS'Y	U010_S001	14
D0746424	BLADE:CLEANING:BELT CLEANING:ASS'Y	U010_S001	15
D0746428	HOLDER:CLEANING:BELT CLEANING:ASS'Y	U010_S001	16
D0746431	COIL SPRING:BLADE:CLEANING:BELT CLEANING	U010_S001	17
D0746434	TONER COLLECTION COIL:BELT CLEANING:ASS'Y	U010_S001	18
D0746439	PLAIN SHAFT BEARING:REMOVE PAPER DUST:TRANSPORT SCREW	U010_S001	19
D0746440	GUIDE:DISCHARGE USED TONER:BELT CLEANING	U010_S001	20

Number	Part Name	Group	ID
D0746441	SHUTTER:TRANSPORT SCREW:BELT CLEANING	U010_S001	21
D0746442	COIL SPRING:DISCHARGE USED TONER	U010_S001	22
D0746443	SEAL:DISCHARGE USED TONER	U010_S001	23
D0746446	BRUSH:APPLY:BELT CLEANING	U010_S001	24
D0746450	COATING BAR:ASS'Y	U010_S001_S001	25
D0746454	ARM:COATING BAR:BELT CLEANING	U010_S001_S001	26
D0746455	COIL SPRING:COATING BAR	U010_S001_S001	27
D0746457	BLADE:APPLY:ASS'Y	U010_S001	28
D0746461	HOLDER:APPLY:BELT CLEANING:ASS'Y	U010_S001	29
D0746464	COIL SPRING:BLADE:APPLY:BELT CLEANING	U010_S001	30
D0746467	COIL SPRING:STOPPER:CASE:BELT CLEANING	U010_S001	31
D0746468	STOPPER:CASE:BELT CLEANING	U010_S001	32
D0746469	SLIDE RAIL:UPPER:BELT CLEANING	U010_S001	33
D0746470	RELEASE PLATE:BLADE:CLEANING	U010_S001	34
D0746471	RELEASE PLATE:BLADE:APPLY	U010_S001	35
D0746477	GEAR:BRUSH:REMOVE PAPER DUST:Z17	U010_S001	36
D0746478	GEAR:PULLEY:IDLER:BELT CLEANING	U010_S001	37
D0746479	GEAR:COLLECT:COIL:Z19	U010_S001	38
D0746480	PULLEY:BRUSH:APPLY:Z30	U010_S001	39
D0746481	JOINT:BRUSH:REMOVE PAPER DUST:BELT CLEANING	U010_S001	40
D0746485	SEAL:CASE:BRUSH:FRONT	U010_S001	41
D0746486	SEAL:CASE:BRUSH:REAR	U010_S001	42
D0746488	SEAL:HOLDER:BEHIND:BELT CLEANING	U010_S001	43
D0746489	VIBRATING PLATE:TRANSPORT SCREW:BELT CLEANING	U010_S001	44
D0746490	SEAL:BASE:CASE:BELT CLEANING	U010_S001	45



## Exclusive Parts

Number	Part Name	Group	ID
	G		
D0746491	SEAL:CASE:CLEANING BLADE:FRONT	U010_S001	46
D0746492	SEAL:CASE:CLEANING BLADE:REAR	U010_S001	47
D0746495	LEVER:RELEASE:BLADE	U010_S001	48
D0746496	GRIP:BELT CLEANING	U010_S001	49
D0746497	DECAL:POSITIONING DISPLAY:TCRU	U006	304
		U006_S012	304
		U010_S001	50
		U014	95
		U014_S002_S001	95
D0746540	SEAL:BELT CLEANING:MAIN	U012_S004	30
D0746574	COVER:CAM:VERTICAL TRANSPORT	U012	31
D0746575	SHAFT:CAM:VERTICAL TRANSPORT	U012	32
D0746579	SEAL:COVER:CAM:VERTICAL TRANSPORT	U012	33
D0746640	PLAIN SHAFT BEARING:TRANSPORT SCREW:SMALL	U012_S001	34
D0746641	PLAIN SHAFT BEARING:SMALL:GEAR	U012_S001	35
D0746643	GEAR:TRANSPORT SCREW:COLLECTION BOTTLE:SMALL:Z31	U012_S001	36
D0746659	SHAFT:JOINT:COLLECTION BOTTLE:ASS'Y	U012	37
D0746663	TORQUE LIMITER MECHANICAL CLUTCH:GEAR:Z63	U012	38
D0746664	GEAR:IDLER:Z49/Z27	U012	39
D0746665	GEAR:JOINT:COLLECTION BOTTLE:Z65	U012	40
D0746666	GEAR:IDLER:Z37/Z28	U012	41
D0746667	HOLDER:RADIAL BALL BEARING:JOINT	U012	42
D0746697	DECAL:COLLECTION BOTTLE:GRIP:FRONT	U012_S002	43
D0746974	CAP:LOUVER:MM90	U019	31

Number	Part Name	Group	ID
D0746975	FILTER:POWER SUPPLY UNIT:MM90	U019	32
D0747087	SEAL:DC FAN MOTOR:SIROCCO	U009	60
D0747118	DUCT:INNER BACK:COOLING:POSITIONING SENSOR	U009	61
D0747119	DUCT:FRONT:COOLING:POSITIONING SENSOR	U009	62
D0747120	BRACKET:DUCT:COOLING:POSITIONING SENSOR	U009	63
D0747330	SLIDE RAIL:LEFT:NO.1	U006	305
D0747331	STAY:SLIDE RAIL:LEFT INNER REAR:NO.1:PEEN	U006	306
D0747333	STAY:SLIDE RAIL:LEFT FRONT:NO.1	U006	307
D0747335	STAY:SLIDE RAIL:LEFT:NO.2	U006	308
D0747349	COMPRESSION SPRING:BRACKET:SENSOR:PAPER SIZE SENSOR	U006	309
D0747381	DECAL:VERTICAL TRANSPORT:A1	U006	310
D0747385	DECAL:CAUTION CHART:TANDEM LCT	U006_S012	311
D0747387	(CHN[Pro 8310/8320]/NA/EU/AA/TWN/KOR):DECAL:BASE:TANDEM LCT:LEFT	U006_S013	312
D0747388	DECAL:PAPER SET DIRECTION:TANDEM LCT:RIGHT	U006_S012	313
D0747390	DECAL:PAPER SET DIRECTION:PAPER TRAY	U006_S010	315
		U006_S011	315
D0747391	DECAL:PAPER SET DIRECTION	U022	14
D0747392	DECAL:PAPER TRAY:NO.1	U006	316
D0747393	DECAL:PAPER TRAY:NO.2	U006	317
D0747431	STAY:HANDLE:ASS'Y	U006	318
D0747433	STUD:HANDLE:RELEASE:ASS'Y	U006	319
D0747446	BRACKET:DC STEPPER MOTOR:TRANSPORT UNIT	U006	320
D0747521	GUIDE PLATE:UPPER:PAPER FEE D UNIT	U006_S006	321
		U006_S007	321
		U006_S008	321
D0747522	GUIDE PLATE:LOWER:PAPER FEE	U006_S006	322

## Exclusive Parts

Number	Part Name	Group	ID
	D UNIT	U006_S007	322
		U006_S008	322
D0747527	SHAFT:FEED:ASS'Y	U006_S006	323
		U006_S007	323
		U006_S008	323
D0747561	GRIP:UPPER	U006	324
D0747562	GRIP:LOWER	U006	325
D0747563	BRACKET:SLIDER:GRIP	U006	326
D0747567	BRACKET:ARM:LINK:LEFT	U006	327
D0747573	BRACKET:ARM:PLATE	U006	328
D0747596	(CHN[Pro 8310/8320]/NA/EU/AA/TW N/KOR):TRAY BOTTOM PLATE:LEFT MIDDLE:ASS'Y	U006_S013	329
D0747603	PLATE:GRIP:PAPER TRAY:NO.2	U006	330
D0747606	GRIP:PAPER TRAY:NO.2	U006	331
D0747607	ARM:PAPER TRAY:GRIP	U006	332
D0747752	CAP:COVER:TONER SUPPLY	U019	33
D0747775	(CHN[Pro 8300S/8310S/8320S]/NA): PLATE:LOGO:RICOH	U022	41
D0747782	GRIP:DOOR:FRONT	U001	21
D0747828	CAP:CONNECTOR	U001	22
D0747829	CAP:JOINT:LARGE CAPACITY TRAY	U001	23
D0747830	COVER:LARGE CAPACITY TRAY	U001	24
D0747831	COVER:CONNECTOR:LARGE CAPACITY TRAY	U001	25
D0747854	HINGE:LEFT LOWER:ASS'Y	U001	26
D0747861	HINGE:RIGHT LOWER:ASS'Y	U001	27
D0895887	PANEL:INTERFACE	U019	34
D0931266	DECAL:WARNING (HIGH TEMPERATURE):LENGTHWISE	U006	333
		U015	71
D0951260	CAP:COVER:SCA	U003_S001	89
D0A46099	SHEET:PRESSURE PLATE:SMALL	U003_S001_S002	90
D0A51200	ADF:ASS'Y	U003_S001	91
D0A51741	(NA):SCALE:LEFT:ASS'Y	U004	68
D0A53995	JOINT:KNOB:FUSING	U014_S001_S002	96
D0A56731	COVER:DISPLSY:REAR LOWER	U002	8
D0A56840	SPRING PLATE:OPU-DISPLAY	U002	9

Number	Part Name	Group	ID
D0BX1069	COVER:MOTOR:USED TONER	U021	45
D0BX1165	SUPPORTING PLATE:RAIL:INTERMEDIATE TRANSFER	U021	46
D0BX1181	DECAL:PICK-UP PAPER JAM:OPERATION PANEL:ENGLISH	U001	28
D0BX1219	SHAFT:LOCK:PULL OUT:LEFT	U021	47
D0BX1220	TORSION SPRING:KNOB:LEFT	U021	48
D0BX1232	SHAFT:LOCK:PULL OUT:RIGHT:ASS'Y	U021	49
D0BX1233	TORSION SPRING:KNOB:RIGHT	U021	50
D0BX1405	STEPPED TAPPING SCREW:TYPE 2:DIA5:M4	U001	29
D0BX1407	GUIDE:LEVER:PULL OUT	U001	30
D0BX1465	BRACKET:KEY COUNTER	U021	95
D0BX1470	BRACKET:COVER:FRONT UPPER	U001	31
D0BX1482	PLATE:MAGNET CATCH	U001	32
D0BX1484	SUPPORTING PLATE:DOOR:FRONT LEFT:ASS'Y	U001_S001	33
		U001_S008	33
D0BX1489	SUPPORTING PLATE:DOOR:FRONT LEFT	U001_S001	34
		U001_S008	34
D0BX1498	SUPPORTING PLATE:DOOR:FRONT RIGHT:ASS'Y	U001_S002	100
		U001_S009	100
D0BX1508	COVER:MAIN:LEFT	U001	35
D0BX1516	COVER:MAIN:REAR:PEEN	U001	36
D0BX1518	COVER:EXHAUST:PAPER EXIT SUB-UNIT	U022	15
D0BX1528	SHEET:HEATER:LOWER	U001	37
D0BX1535	COVER:REAR LOWER:PEEN	U001	38
D0BX1547	INNER COVER:PULL OUT:RIGHT:ASS'Y	U001_S003	39
		U001_S010	39
D0BX1549	INNER COVER:PULL OUT:LEFT:ASS'Y	U001_S004	40
		U001_S011	40
D0BX1550	INNER COVER:INTERMEDIATE TRANSFER:ASS'Y	U001_S005	41
		U001_S012	41
D0BX1554	HEXAGON HEAD SCREW:M4:DIA3	U001	42
D0BX1555	INNER COVER:REVERSE SUB-UNIT:UPPER:ASS'Y	U001_S006	43
		U001_S013	43
D0BX1569	HINGE:COVER:REAR LOWER	U001	44

## Exclusive Parts

Number	Part Name	Group	ID
D0BX1579	INNER COVER:REVERSE SUB-UNIT:LOWER	U001	45
D0BX1580	HINGE:STAND:OPERATION SUB-UNIT:ASS'Y	U022_S001	16
		U022_S002	16
		U022_S004	16
D0BX1586	HOLDER:FIX:OPERATION SUB-UNIT	U002	10
D0BX1588	COVER:HINGE:MIDDLE	U022	17
D0BX1589	COVER:HINGE:LOWER	U002	11
D0BX1590	COVER:HINGE:FRONT	U022	18
D0BX1592	COVER:PILOT LAMP	U001	101
D0BX1593	OZONE FILTER:EXHAUST:PAPER EXIT SUB-UNIT	U022	19
D0BX1594	HOLDER:HINGE:OPERATION SUB-UNIT:LOWER	U002	12
D0BX1598	STOPPER:FILTER:LOWER	U001	46
D0BX1599	SHEET:DUCT:REAR	U001	47
D0BX1901	OPTICAL WRITING UNIT:ASS'Y	U005	2
D0BX2432	SERVICE PARTS:DEVELOPMENT UNIT:ASS'Y	U008_S003	43
D0BX2485	LED ARRAY:ASS'Y:(OT1)	U008_S003	44
D0BX2575	SHEET:CONTACT IMAGE SENSOR:DUCT:1	U006	334
D0BX2576	SHEET:CONTACT IMAGE SENSOR:DUCT:2	U006	335
D0BX2679	HOLDER:DC STEPPER MOTOR:SHIFT	U006	336
D0BX2702	TIMING ROLLER:REGISTRATION:DRIVE:PRESS FIT	U006	337
D0BX2703	TRANSPORT ROLLER:CONNECTING:LARGE CAPACITY TRAY:PRESS FIT	U006	338
D0BX2704	TRANSPORT ROLLER:CONNECTING:MAIN:PRESS FIT	U006	339
D0BX2705	TRANSPORT ROLLER:SHIFT:TRAILING EDGE:PRESS FIT	U006	340
D0BX2766	TIMING ROLLER:TRANSFER:DRIVE:PRESS FIT	U006	341

Number	Part Name	Group	ID
D0BX2851	GUIDE PLATE:CONNECTING:OPEN AND CLOSE:PEEN	U006	342
D0BX2856	GUIDE PLATE:CONNECTING:LARGE CAPACITY TRAY:PEEN	U006	343
D0BX2900	GUIDE PLATE:CONNECTING:DUPLICATE:EXIT:PEEN	U006	344
D0BX2902	GUIDE PLATE:CONNECTING:UPPER:PEEN	U006	345
D0BX2906	GUIDE PLATE:CONNECTING:LOWER:PEEN	U006	346
D0BX2990	CONTACT IMAGE SENSOR:CING:(PCB24)	U006	347
D0BX3342	BRACKET:CHUCK:TONER BANK:PEEN	U007	52
D0BX3346	DC MOTOR:DRIVE:TONER BOTTLE:ASS'Y:(BM6/BM7/BM8/BM9)	U007	53
D0BX3451	LEVER:TONER BOTTLE:PEEN	U007	54
D0BX3815	CAM:SEPARATION/TRANSPORT	U013	19
D0BX3819	LEVER:SEPARATION/TRANSPORT	U013	20
D0BX3820	TENSION SPRING:SEPARATION/TRANSPORT:5N	U013	21
D0BX3823	SHAFT:SEPARATION/TRANSPORT:ASS'Y	U013	22
D0BX3824	DECAL:SEPARATION/TRANSPORT:LEVER	U013	23
D0BX3830	DC STEPPER MOTOR:MM42:ASS'Y	U013	24
D0BX3862	SUPPORTING PLATE:VACUUM	U013	29
D0BX4017	(NA):FUSING UNIT:208V:ASS'Y	U014_S001	161
D0BX4045	LEVER:CONTROL PLATE:PRESSURE	U014_S001	98
D0BX4047	HOLDER:HEATER:PRESSURE:REAR	U014_S001_S001	99
D0BX4048	HOLDER:HEATER:PRESSURE:FRONT	U014_S001_S001	100
D0BX4162	HOT ROLLER:DIA54:ASS'Y	U014_S001_S002	101
D0BX4239	STRIPPER PLATE:ASS'Y	U014_S001_S005	102
D0BX4251	STRIPPER PLATE:ADHESION	U014_S001_S005	104

## Exclusive Parts

Number	Part Name	Group	ID
D0BX4260	COVER:FUSING UNIT:FRONT:UPPER:ASS'Y	U014_S001	105
D0BX4262	COVER:FUSING UNIT:FRONT:MIDDLE	U014_S001	106
D0BX4263	COVER:FUSING UNIT:FRONT:LOWER	U014_S001	107
D0BX4264	COVER:FUSING UNIT:REAR:UPPER:ASS'Y	U014_S001	108
D0BX4266	COVER:FUSING UNIT:REAR:MIDDLE	U014_S001	109
D0BX4267	COVER:FUSING UNIT:REAR:LOWER	U014_S001	110
D0BX4275	COVER:FUSING UNIT:UPPER:ASS'Y	U014_S001_S006	111
D0BX4288	DECAL:H-TEMP WARNING:FUSING UNIT:PAPER EXIT UNIT:FUSING UNIT	U014_S001	112
D0BX4311	WEB:CLEANING UNIT:ASS'Y	U014_S002	113
D0BX4313	COVER:WEB:CLEANING FELT	U014_S002_S001	114
D0BX4385	TAPE:HOLDER:FUSING UNIT:HEATER:ASS'Y	U022	20
D0BX4401	(NA):PRESSURE ROLLER:208V:ASS'Y	U014_S001_S001	162
D0BX4731	GUIDE PLATE:EXIT:UPPER:SUB-A:ASS'Y	U015	72
D0BX4740	GUIDE PLATE:EXIT:UPPER:ENTRANCE	U015	73
D0BX4742	TRANSPORT ROLLER:DRIVEN:DIA 17.5	U015	74
D0BX4743	COMPRESSION SPRING:EXIT:2.5N	U015	75
D0BX4782	GUIDE PLATE:EXIT:ENTRANCE	U015	76
D0BX4783	GUIDE PLATE:REVERSE:LOWER:ASS'Y	U015_S001	77
D0BX4786	CUSHION:GUIDE PLATE:REVERSE:LOWER	U015_S001	78
D0BX4789	GUIDE PLATE:REVERSE EXIT:LOWER:PEEN	U015	79
D0BX4792	GUIDE PLATE:REVERSE EXIT:UPPER	U015	80

Number	Part Name	Group	ID
D0BX4801	GATE PAWL:REVERSE EXIT:MIDDLE	U015	81
D0BX4802	GATE PAWL:REVERSE EXIT	U015	82
D0BX4840	TRANSPORT ROLLER:EXIT:ENTRANCE:PRESS FIT	U015	83
D0BX4841	TRANSPORT ROLLER:EXIT:EXIT:PRESS FIT	U015	84
D0BX4842	TRANSPORT ROLLER:REVERSE:PRESS FIT	U015	85
D0BX4843	TRANSPORT ROLLER:REVERSE:ENTRANCE:PRESS FIT	U015	86
D0BX4888	DISCHARGE BRUSH:EXIT:OUTER	U015	87
D0BX4889	DISCHARGE BRUSH:EXIT:INNER	U015	88
D0BX5059	HDD:ASS'Y	U019	35
D0BX5401	PCB:BICU:ASS'Y:(PCB11)	U019	56
D0BX5405	PCB:IOB:(PCB26)	U018	36
D0BX5412	PCB:TDRB:(PCB41)	U009_S001	64
D0BX5422	PCB:DRB:(PCB20)	U006	348
D0BX5427	PCB:RYB:(PCB32)	U018	37
D0BX5430	PCB:CRB:(PCB22)	U006	349
D0BX5445	AC CONTROL BOARD:200V:3800W:(PCB1)	U018	38
D0BX5613	(Pro 8300S):PCB:SERVICE:CTL:(PCB17)	U019	57
D0BX5614	(Pro 8310S):PCB:SERVICE:CTL:(PCB17)	U019	58
D0BX5622	(Pro 8320S):PCB:SERVICE:CTL:(PCB17)	U019	62
D0BX5726	(NA):OPERATION SUB-UNIT:KEY_BOX:ASS'Y	U002	16
D0BX5927	PCB:SDCU:ASS'Y	U019_S001	36
		U019_S003	36
		U019_S005	36
D0BX5960	COVER:POWER SUPPLY UNIT:C/T BOX	U019	37
D0BX6000	TRANSFER UNIT:INTERMEDIATE TRANSFER:ASS'Y	U009_S001	65
D0BX6010	SIDE PLATE:INTERMEDIATE TRAN	U009_S001	66

## Exclusive Parts

Number	Part Name	Group	ID
	SFER:ASS'Y		
D0BX6051	ROLLER:INTERMEDIATE TRANSFER:ASS'Y	U009_S001	67
D0BX6078	ROLLER:OPPOSED:PAPER:ASS'Y	U009_S001	68
D0BX6087	DECAL:TRANSFER:WARNING (REMOVAL AND INSTALLATION)	U009_S001	69
D0BX6154	CASE:OPPOSED:TRANSFER ROLLER:FRONT	U009_S001	70
D0BX6155	CASE:OPPOSED:TRANSFER ROLLER:REAR	U009_S001	71
D0BX6158	COVER:CASE:TRANSFER ROLLER:OPPOSED:FRONT	U009_S001	72
D0BX6163	SPRING PLATE:TRANSFER:OPPOSED:PAPER	U009_S001	73
D0BX6185	BRACKET:MOTOR:POSITIONING CONTROL:DRIVEN ROLLER	U009_S001	74
D0BX6189	DC STEPPER MOTOR:MM42:1.3A:4.42V:PULLEY:(STM2)	U009_S001	75
D0BX6210	TRANSFER UNIT:ASS'Y	U011_S001	45
D0BX6220	SIDE PLATE:TRANSFER/SEPARATION UNIT:FRONT:ASS'Y	U011_S001	46
D0BX6250	TRANSFER ROLLER	U011_S001	47
D0BX6255	BRUSH ROLLER:TRANSFER ROLLER:ASS'Y	U011_S001	48
D0BX6282	SWING UNIT:PICKUP ROLLER:ASS'Y:(SOL1/SOL2/SOL3)	U006_S006	350
		U006_S007	350
		U006_S008	350
D0BX6400	BELT CLEANING:ASS'Y	U010_S001	51
D0BX6420	BRUSH:REMOVE PAPER DUST:BELT CLEANING	U010_S001	52
D0BX6487	DC MOTOR:COLLECTION BOTTLE:DIA49:9.8W:(BLM3)	U012	44
D0BX6628	PAPER FEED UNIT:PAPER BANK:ASS'Y	U006_S006	351
		U006_S007	351
		U006_S008	351
D0BX6648	COIL SPRING:TANDEM TRAY:LOCK	U006	352
D0BX6677	ROLLER:SLIDE RAIL:FRONT	U006_S012	353

Number	Part Name	Group	ID
D0BX6685	(NA):TANDEM LCT:RIGHT:ASS'Y	U006_S012	527
D0BX6771	GUIDE PLATE:OPEN AND CLOSE:VERTICAL TRANSPORT:LOWER:ASS'Y	U006_S009	355
D0BX6775	GUIDE PLATE:OPEN AND CLOSE:VERTICAL TRANSPORT:UPPER:PEEN	U006	356
D0BX6780	TRAY BOTTOM PLATE:ASS'Y	U006_S010_S001	357
		U006_S011_S001	357
D0BX6795	HOLDER:STAY:GUIDE PLATE	U006_S009	358
D0BX6844	BRACKET:DUCT:CHARGE CORONA:VACUUM	U020	29
D0BX6889	FILTER:MAIN:EXHAUST:RIGHT	U020	30
D0BX6893	BRACKET:DUCT:MAIN:EXHAUST:LOWER	U020	31
D0BX6909	FILTER:DUCT:MAIN:REAR	U020	32
D0BX7076	GUIDE PLATE:DUPLX:LOWER	U016	48
D0BX7085	TRANSPORT ROLLER:DUPLX:PRESS FIT	U016	49
D0BX7114	GUIDE PLATE:REVERSE:DUPLX:DRIVE	U016	50
D0BX7116	GUIDE PLATE:REVERSE:DUPLX:DRIVEN:PEEN	U016	51
D0BX7118	GUIDE PLATE:REVERSE:DUPLX:LEFT	U016	52
D0BX7120	TRANSPORT ROLLER:REVERSE:DUPLX:PRESS FIT	U016	53
D0BX7128	DISCHARGE BRUSH:RECEIVING SUB-UNIT:REVERSE:ENTRANCE	U016	54
D0BX7142	GUIDE PLATE:RECEIVING SUB-UNIT:RIGHT:PEEN	U016	55
D0BX7512	COVER:PAPER TRAY:NO.2	U006	359
D0BX7531	COVER:PAPER TRAY:NO.1	U006	360
D0BX7573	PULLEY:DRIVE WERE:ASS'Y	U006_S012	362
D0BX7595	(CHN[Pro 8310/8320]/NA/EU/AA/TWN/KOR):BASE:TANDEM LCT:RIGHT:ADHESION	U006_S012	363
D0BX7631	PAPER TRAY:UNIVERSAL:SUB-AS	U006_S010	364

## Exclusive Parts

Number	Part Name	Group	ID
	S'Y	U006_S011	364
D0BX7648	DECAL:MULTI-LANGUAGE:MAIN:13:ABS	U022	21
D0BX7662	ACCESSORY:COVER:SIDE:RIGHT:ASS'Y	U022	53
D0BX7681	(Pro 8300S):MODEL NAME PLATE:PRO_8300S	U022	42
D0BX9590	NVRAM	U019	60
D0BY7681	(Pro 8310S):MODEL NAME PLATE:PRO_8310S	U022	43
D0BZ7681	(Pro 8320S):MODEL NAME PLATE:PRO_8320S	U022	44
D1054365	HOLDER:THERMOPILE	U014	116
D1055898	HOLDER:TEMPERATURE & HUMIDITY SENSOR	U012	45
D1202829	TENSION SPRING:REGISTRATION:DRIVEN	U012	46
D1316511	BRACKET:CONNECTOR:LEFT	U006	365
D1316775	SIDE FENCE:REAR:ASS'Y	U006_S010_S002	366
		U006_S011_S002	366
D1316777	SIDE FENCE:FRONT:ASS'Y	U006_S010_S003	367
		U006_S011_S003	367
D1361758	CLAMP:WIRE	U004	24
D1361788	PULLEY:IDLER:CARRIAGE	U004	25
D1361793	DC STEPPER MOTOR:MM42:(STM107)	U004	26
D1361794	BRACKET:DC STEPPER MOTOR:TENSION	U004	27
D1361798	TENSION SPRING:TENSION:16N	U004	28
D1361799	BRACKET:DC STEPPER MOTOR	U004	29
D1361801	SHAFT:DRIVE:SCANNER	U004	30
D1361802	TIMING PULLEY:65	U004	31
D1361803	SYNCHRONOUS BELT:157ST1.5-6.0	U004	32
D1361806	DRIVE WIRE:DIA1	U004	33
D1361809	BRACKET:TENSION	U004	34
D1361810	TENSION SPRING:TENSION:11N	U004	35
D1361811	PULLEY:PEEN	U004	36

Number	Part Name	Group	ID
D1361817	BRACKET:EXPOSURE GLASS:DOCUMENT FEEDER:SUB-ASS'Y	U004	37
D1363692	DECAL:COLLECTION BOTTLE:GRIP:UPPER	U012_S002	47
D1364233	STEPPED SCREW:DIA5:M3X3.8	U020	33
D1366099	TENSION SPRING:BRACKET:DC STEPPER MOTOR	U009_S001	76
D1366145	ROLLER:ON-OFF:INTERMEDIATE TRANSFER	U009_S001	77
D1366149	BUSHING:SLIDE RAIL:ON-OFF	U009_S001	78
D1366183	GRIP:ON-OFF:INTERMEDIATE TRANSFER:TCRU	U009_S001	79
D1381289	JOINT:FUSING:ON-OFF	U017_S003	25
D1441085	STEPPED SCREW:M3	U004	38
D1491715	PULLEY:DRIVE WIRE:FRONT	U004	39
D1491717	PULLEY:DRIVE WIRE:REAR	U004	40
D1491804	HOLDER:EXPOSURE GLASS:SCANNER	U004	41
D1491840	GROUND PLATE:AKS	U021	88
D1495776	COVER:USB:SMALL	U019	38
D1495883	KEYTOP:MAIN SWITCH	U018	39
D1495884	COMPRESSION SPRING:KEYTOP	U018	40
D1791043	GUARD:MAIN:VERTICAL TRANSPORT	U021	51
D1791115	RAIL:INTERMEDIATE TRANSFER:LEFT	U021	52
D1791118	SEPARATION PLATE:MAIN:REAR MIDDLE	U021	53
D1791128	HOLDER:REGISTRATION:DRAWER	U021	54
D1791129	GUIDE:PULL OUT:LOCK	U021	55
D1791130	GUIDE:PULL OUT:MIDDLE:LOWER	U021	56
D1791185	GUIDE:INTERMEDIATE TRANSFER:LEFT	U021	57
D1791220	DRUM SHAFT:DRIVE:ASS'Y	U017	26
D1791221	HOLDER:COIL SPRING:LOCK:PULL OUT	U021	58
D1791251	DC MOTOR:DIA63:29.7W:BRUSHLESS	U017	27

## Exclusive Parts

Number	Part Name	Group	ID
	ESS:(BLM1)		
D1791252	DC MOTOR:DIA82.2:63.7W:BRUSH LESS:(BLM8)	U017	28
D1791254	SHAFT:DRIVE:DEVELOPMENT ROLLER:ASS'Y	U017	29
D1791256	SHAFT:DRIVE:TRANSPORT SCREW:ASS'Y	U017	30
D1791258	PLATE:HOLDER:ANTISTATIC BRUSH:DRUM	U017	31
D1791262	SHAFT:DRIVE:CLEANER:ASS'Y	U017	32
D1791264	PLATE:HOLDER:RADIAL BALL BEARING	U017	33
D1791265	PULLEY:DRIVE:DRUM:107T	U017	34
D1791266	PULLEY:DRIVE:DEVELOPMENT ROLLER:59T	U017	35
D1791267	SYNCHRONOUS BELT:120S2M316	U017	36
D1791268	SYNCHRONOUS BELT:80S2M300	U017	37
D1791269	BRACKET:DC MOTOR:CLEANING DRIVE SUB-UNIT	U017	38
D1791273	GEAR:DRIVE:TRANSPORT SCREW:54Z	U017	39
D1791275	TENSION SPRING:3.8N	U017	40
D1791276	TENSION SPRING:3.6N	U017	41
D1791277	GEAR:DRIVE:CLEANER:39Z	U017	42
D1791278	HOLDER:BEARING:DRUM SHAFT	U017	43
D1791286	BRACKET:DRIVE:CLEANER:ASS'Y	U017	44
D1791288	GEAR:IDLER:CLEANER:49Z/33Z	U017	45
D1791289	GEAR:PULLEY:DRUM:113Z/37T	U017	46
D1791290	GEAR:IDLER:TRANSPORT SCREW:65Z/53Z	U017	47
D1791291	BRACKET:DC MOTOR:DRUM:ASS'Y	U017	48
D1791293	TIGHTENER:DRIVE:DRUM:ASS'Y	U017	49
D1791297	TIGHTENER:DRIVE:DEVELOPMENT:ASS'Y	U017	50
D1791300	DRIVE UNIT:FUSING:ASS'Y	U017_S002	51
D1791309	DC BRUSHLESS MOTOR:58W:DRIVE:FUSING UNIT:(BLM9)	U017_S002	52

Number	Part Name	Group	ID
D1791316	JOINT:DRIVE:FUSING	U017_S002	70
D1791320	BRACKET:DRIVE:USED TONER	U017	53
D1791323	TENSION SPRING:BELT TENSIONER:DRIVE:USED TONER	U017	54
D1791324	SYNCHRONOUS BELT:40S3M222	U012_S003	48
D1791326	BRACKET:BELT TENSIONER:DRIVE:USED TONER	U017	55
D1791327	SHAFT:BELT TENSIONER:DRIVE:USED TONER	U017	56
D1791328	GEAR:PULLEY:Z67/T19:DRIVE:USED TONER	U017	57
D1791329	PULLEY:TIGHTENER:DIA18	U017	58
D1791345	BRACKET:DRAWER:DEVELOPMENT	U017	59
D1791351	DC MOTOR:DIA63:24V:28.4W:(BLM5)	U009_S001	80
D1791352	HOUSING:DRIVE UNIT:INTERMEDIATE TRANSFER	U009_S001	81
D1791353	GEAR:DRIVE ROLLER:INTERMEDIATE TRANSFER	U009_S001	82
D1791354	HOLDER:MOTOR:INTERMEDIATE TRANSFER	U009_S001	83
D1791370	DC MOTOR:40W:BRUSHLESS:(BLM6)	U017_S001	60
D1791375	GEAR:IDLER:BELT CLEANING	U017_S001	61
D1791391	MECHANICAL DRIVE SECTION:TRANSFER:SECOND:ASS'Y	U017_S001	62
D1791442	COVER:DC_SW	U001	48
D1791443	COVER:UPPER RIGHT	U001	102
D1791444	COVER:UPPER FRONT	U001	103
D1791446	COVER:UPPER REAR	U001	104
D1791451	CAP:KEY COUNTER	U001	49
D1791454	DOOR:TONER SUPPLY:ASS'Y	U001_S007	50
		U001_S014	50
D1791456	SUPPORTING PLATE:HINGE:DOOR:TONER SUPPLY	U001_S007	51
		U001_S014	51
D1791457	MAGNET CATCH PLATE:DOOR:TONER SUPPLY	U001_S007	52
		U001_S014	52

## Exclusive Parts

Number	Part Name	Group	ID
D1791460	HINGE:DOOR:TONER SUPPLY	U001	53
D1791469	COVER:FRONT UPPER	U001	54
D1791471	LEVER:SAFETY SWITCH	U001	55
D1791476	BRACKET:SAFETY SWITCH	U001	56
D1791477	SHIELD PLATE:SAFETY SWITCH	U001	57
D1791483	LEVER:SAFETY SWITCH	U001	58
D1791485	DOOR:FRONT LEFT:LOWER	U001	59
D1791487	DUCT:DOOR:FRONT LEFT:ASS'Y	U001	60
D1791490	BRACKET:SUPPORTING PLATE:DOOR:FRONT LEFT	U001_S001	61
		U001_S008	61
D1791497	DOOR:FRONT RIGHT:UPPER	U001	62
D1791499	CAP:MM22	U001	63
D1791500	DOOR:FRONT RIGHT:LOWER	U001	64
D1791505	STOPPER:GUIDE PLATE:VERTICAL TRANSPORT	U001_S002	65
		U001_S009	65
D1791514	COVER:MAIN:RIGHT	U001	66
D1791526	STAY:SAFETY SWITCH	U001	67
D1791531	HINGE:LEFT UPPER	U001	68
D1791533	HINGE:RIGHT UPPER	U001	69
D1791553	COVER:DC_SW	U018	41
D1791557	BRACKET:DC_SW	U018	42
D1791571	BRACKET:EARTH:DOOR:MIDDLE	U001	70
D1791572	BRACKET:EARTH:DOOR:LOWER	U001	71
D1791595	(NA):DECAL:DC:MAIN SWITCH	U022	48
D1791731	COVER:REGISTRATION:MOTOR	U021	59
D1791734	LEVER:PULL OUT:LEFT	U021	60
D1791748	HOLDER:EXPOSURE GLASS:ASS'Y	U022	45
D1791768	EXPOSURE GLASS:DOCUMENT FEEDER	U004	42
D1791769	SPRING PLATE:EARTH:FRAME:SCANNER	U021	89
D1791777	COVER:EXPOSURE GLASS:DOCUMENT FEEDER	U004	43
D1791782	BRACKET:ADF:RIGHT	U021	90
D1791784	BRACKET:ADF:LEFT	U021	91
D1791786	BRACKET:INNER COVER	U020	34
D1792204	COVER:END BLOCK:REAR	U008_S001	45

Number	Part Name	Group	ID
D1792205	ELECTRODE PLATE:CASE:CHARGE	U008_S001	46
	E		
D1792206	STAY:GRID	U008_S001	47
D1792208	END BLOCK:CHARGE CORONA:REAR	U008_S001	48
D1792209	STAY:CORONA WIRE:LEFT	U008_S001	49
D1792210	STAY:CORONA WIRE:RIGHT	U008_S001	50
D1792224	CORONA WIRE:CHARGE CORONA	U008_S001	51
D1792237	HOLDER:MOTOR:CHARGE	U008	52
D1792238	SOCKET:CHARGE	U008	53
D1792239	SHAFT:CLEANER:CHARGE:DRIVE:ASS'Y	U008_S004	54
D1792246	SEAL:DUCT:SIDE PLATE:REAR	U008	55
D1792254	DECAL:CHARGE:GRIP	U008_S001_S001	56
D1792255	CHARGE CORONA	U008_S001	57
D1792256	COVER:CHARGE CORONA:ASS'Y	U008_S001_S001	58
D1792370	GRIP:DRUM:ASS'Y	U008	59
D1792376	HOLDER:DRUM:TAKE OFF:FRONT	U008	60
D1792377	HOLDER:DRUM:TAKE OFF:REAR	U008	61
D1792411	SLIDE RAIL:PCU	U008	62
D1792412	HOLDER:SLIDE RAIL:PCU:RIGHT	U008	63
D1792416	STAY:ELECTRIC POTENTIAL SENSOR	U008	64
D1792417	HOLDER:ELECTRIC POTENTIAL SENSOR	U008	65
D1792419	STOPPER:SLIDE RAIL:PCU:PEEN	U008	66
D1792421	ELECTRIC POTENTIAL SENSOR:(SEN5)	U008	67
D1792427	BRACKET:DRAWER:CLEANING UNIT	U008	68
D1792467	LEVER:POSITIONING:CLEANING	U008_S003	69
D1792468	GRIP:DRUM STAY:PCU	U008_S003	70
D1792469	KNOB SCREW:DRUM	U008	71
D1792474	DECAL:DIAL	U008_S003	72
D1792494	GROUND PLATE:STAY:PCU	U008_S003	73
D1792621	SHAFT:DRIVEN ROLLER:SHIFT	U006	368
D1792631	GUIDE PLATE:SHIFT:REGISTRATION:UPPER	U006	369



## Exclusive Parts

Number	Part Name	Group	ID
D1792642	HOLDER:SHIFT:BEARING:REAR	U006	370
D1792643	CAM:REGISTRATION:GATE:RELEASE	U006	371
D1792648	PLATE:ADJUSTING PIN	U006	372
D1792651	GUIDE PLATE:REGISTRATION:EXIT	U006	373
D1792660	BRACKET:GUIDE PLATE:FRONT:CLIP	U006	374
D1792661	BRACKET:GUIDE PLATE:INNER BACK:CLIP	U006	375
D1792666	GUIDE PLATE:REGISTRATION:TIMING:UPPER	U006	376
D1792670	GUIDE PLATE:REGISTRATION:TIMING:LOWER	U006	377
D1792675	COVER:REGISTRATION:DOUBLE FEED SENSOR	U006	378
D1792684	REGISTRATION GUIDE:OPEN AND CLOSE	U006	379
D1792685	CASE:REMOVE PAPER DUST:ASSY	U006	380
D1792689	COVER:REGISTRATION:EXIT	U006	381
D1792691	TENSION SPRING:PRESSURE ROLLER	U006	382
D1792698	COMPRESSION SPRING:SHIFT	U006	383
D1792711	TIMING ROLLER:TRANSFER:DRIVEN:PRESS FIT	U006	384
D1792727	SHAFT:TIMING ROLLER:REGISTRATION:DRIVEN	U006	385
D1792751	BRACKET:DC STEPPER MOTOR:PAPER FEED:TIMING	U006	386
D1792754	BRACKET:DC STEPPER MOTOR:PAPER FEED	U006	387
D1792757	TIGHTENER:BRACKET:DC STEPPER MOTOR	U006	388
D1792758	GEAR:Z41:TIMING PULLEY:T41	U006	389
D1792760	COVER:MOTOR	U006	390
D1792763	CAM:REGISTRATION:TIMING	U006	391
D1792764	SHAFT:CAM:REGISTRATION:TIMING	U006	392

Number	Part Name	Group	ID
	G		
D1792768	TIMING PULLEY:S2M:30T	U006	393
D1792783	COVER:BASE:MAIN PAPER SMD	U006	394
D1792809	GUIDE PLATE:SHIFT:LEFT LOWER	U006	395
D1792814	GUIDE:SHIFT:TRAILING EDGE	U006	396
D1792817	BRACKET:SHIFT:SYNCHRONOUS BELT	U006	397
D1792861	BRACKET:OPEN AND CLOSE:LARGE CAPACITY TRAY	U006	398
D1792872	BRACKET:DC STEPPER MOTOR:TRAILING EDGE	U006	399
D1792891	GUIDE PIN:SHIFT:TRAILING EDGE	U006	400
D1792909	JOINT:CONNECTING:DRIVEN	U006	401
D1792932	ARM:ON-OFF:TRANSPORT ROLLER	U006	402
D1792933	SHAFT:LINK:ON-OFF:CONNECTING:LARGE CAPACITY TRAY	U006	403
D1792934	SHAFT:LINK:ON-OFF:CONNECTING	U006	404
D1792943	BRACKET:CAM:ON-OFF	U006	405
D1792944	DISC:ON-OFF:SENSOR	U006	406
D1792946	SHAFT:CAM:ON-OFF:LARGE CAPACITY TRAY	U006	407
D1792948	CAM:TRANSPORT ROLLER:ON-OFF	U006	408
D1792952	BRACKET:DC STEPPER MOTOR:DRIVEN:ON-OFF	U006	409
D1792960	GUIDE PLATE:OPEN AND CLOSE:MAIN:CONNECTING	U006	410
D1792963	BRACKET:GRIP:OPEN AND CLOSE:GUIDE PLATE	U006	411
D1792964	GUIDE:MAIN:CONNECTING:OPEN AND CLOSE	U006	412
D1793043	DUCT:FILTER:DEVELOPMENT:ASSY	U008_S003	74
D1793070	GEAR:TRANSPORT SCREW:NO.1	U008_S003	75
D1793071	GEAR:TRANSPORT SCREW:NO.2	U008_S003	76
D1793072	GEAR:TRANSPORT SCREW:NO.3	U008_S003	77

## Exclusive Parts

Number	Part Name	Group	ID
D1793073	GEAR:IDLER:TRANSPORT SCREW:UPPER:ASS'Y	U008_S003	78
D1793074	GEAR:IDLER:TRANSPORT SCREW:LOWER:ASS'Y	U008_S003	79
D1793075	FILTER:DEVELOPMENT	U008_S003	80
D1793084	ENTRANCE SEAL:DEVELOPMENT:ASS'Y	U008_S003	81
D1793090	PLATE:GEAR:IDLER:ASS'Y	U008_S003	82
D1793131	RECEPTACLE:DEVELOPMENT VIAS:ASS'Y	U008	83
D1793144	COVER:INTERMEDIATE TRANSFER:LOWER	U009_S001	84
D1793201	TONER SUPPLY UNIT:TONER HOPPER:ASS'Y	U007_S004	55
D1793234	GEAR:TRANSPORT SCREW:LONG:TONER SUPPLY	U007_S004	56
D1793237	GEAR:TRANSPORT SCREW:SHORT:TONER SUPPLY	U007_S004	57
D1793244	GEAR:AGITATOR:TONER SUPPLY	U007_S004	58
D1793252	COVER:GEAR:TONER SUPPLY	U007_S004	59
D1793253	GEAR:IDLER:FEED:TONER SUPPLY:1	U007_S004	60
D1793254	GEAR:IDLER:FEED:TONER SUPPLY:2	U007_S004	61
D1793256	BRACKET:DC STEPPER MOTOR:AGITATOR:ASS'Y	U007_S004	62
D1793259	GEAR:IDLER:AGITATOR:TONER SUPPLY	U007_S004	63
D1793263	BRACKET:DC STEPPER MOTOR:TONER SUPPLY	U007_S004	64
D1793271	CASE:SHUTTER:TONER SUPPLY	U007	65
D1793272	SHUTTER:TONER SUPPLY:ASS'Y	U007	66
D1793275	COIL SPRING:SHUTTER:TONER SUPPLY	U007	67
D1793276	TONER CATCHPAN:TONER SUPPLY	U007	68
D1793322	SLIDER:TONER BANK:ASS'Y	U007	69
D1793332	SIDE PLATE:TONER BANK	U007	70

Number	Part Name	Group	ID
D1793334	CASE:TONER BANK:ASS'Y	U007_S001	71
		U007_S002	71
D1793339	GROUND PLATE:BOTTLE:TONER SUPPLY UNIT	U007	72
D1793355	GUIDE PLATE:TONER BANK:SIDE PLATE	U007	73
D1793357	SEAL:TONER BANK	U007	74
D1793361	BRACKET:JOINT:RACK:LEVER	U007	75
D1793367	DECAL:DESIGN SKETCH:TONER BOTTLE	U007_S003	76
D1793370	INNER COVER:TONER BANK:ASS'Y	U007_S003	77
D1793373	BRACKET:SAFETY SWITCH:TONER SUPPLY UNIT	U007	78
D1793376	LEVER:SAFETY SWITCH:TONER SUPPLY UNIT:ASS'Y	U007	79
D1793377	TORSION SPRING:SAFETY SWITCH:TONER SUPPLY UNIT	U007	80
D1793380	CASE:TONER BANK:REAR	U007	81
D1793402	BOTTLE:DEVELOPER:ASS'Y	SPECIAL TOOLS	11
		U022	25
D1793414	SEAL:DEVELOPMENT ROLLER:SERVICE PARTS:ASS'Y	SPECIAL TOOLS	12
D1793420	JIG:SHEET:DOCTOR BLADE	SPECIAL TOOLS	13
D1793421	KNOB:DRIVE:DEVELOPMENT UNIT:ASS'Y	SPECIAL TOOLS	14
D1793504	CLEANING UNIT:ASS'Y	U008_S002	84
D1793525	TONER COLLECTION COIL:CLEANING:ASS'Y	U008_S002	85
D1793531	TONER CATCHPAN:PIPE:DISCHARGE USED TONER	U008_S002	86
D1793532	COIL SPRING:TONER CATCHPAN	U008_S002	87
D1793535	GEAR SET:CLEANING UNIT:SERVICE PARTS	U008_S002_S002	88
D1793536	GEAR:IDLER:Z16	U008_S002_S002	89
D1793537	GEAR:IDLER:Z17:LOWER	U008_S002_S002	90
D1793538	GEAR:TONER COLLECTION COIL:Z18	U008_S002_S002	91

## Exclusive Parts

Number	Part Name	Group	ID
D1793561	SHAFT:CLEANING BLADE:FRONT	U008_S002	92
D1793564	GEAR:IDLER:Z17:UPPER	U008_S002_S002	93
D1793571	BRACKET:CLEANING BLADE:ASS'Y	U008_S002	94
D1793576	TENSION SPRING:CLEANING BLADE:6N	U008_S002	95
D1793581	BLADE:CLEANING:ASS'Y	U008_S002	96
D1793589	RETAINING RINGS-E:GUIDE	U008_S002	97
D1793607	CLEANING UNIT:APPLY:ASS'Y	U008_S002_S001	98
D1793621	COVER:COATING BAR	U008_S002_S001	99
D1793627	TENSION SPRING:COATING BAR:5N	U008_S002_S001	100
D1793635	COATING BAR:ASS'Y	U008_S002_S001	101
D1793641	BRUSH ROLLER:APPLY:ASS'Y	U008_S002_S001	102
D1793645	GEAR:BRUSH ROLLER:Z15	U008_S002_S001	103
		U008_S002_S002	103
D1793647	PLAIN SHAFT BEARING:APPLY:REAR:ASS'Y	U008_S002_S001	104
D1793653	BLADE:APPLY:ASS'Y	U008_S002_S001	105
D1793669	GROUND PLATE:APPLY	U008_S002_S001	106
D1793681	HOLDER:COVER:COATING BAR:ASS'Y:(OT14)	U008_S002_S001	107
		U008_S002_S001	107
		U008_S002_S002	107
D1793689	GROUND PLATE:COVER:APPLY	U008_S002_S001	108
		U008_S002_S001	108
		U008_S002_S001	108
D1793851	TRANSPORT ROLLER:DRIVE	U013	25
D1793865	BRACKET:SENSOR:VACUUM	U013	30
D1793960	TRANSPORT ROLLER:HEAT PIPE:DIA30.4:ASS'Y	U015	89
D1794028	SUPPORTING PLATE:LEVER:PRESSURE:FRONT	U014_S001	117
D1794071	BRACKET:FUSING ENTRANCE GUIDE PLATE:FRONT	U014_S001	118
D1794072	BRACKET:FUSING ENTRANCE GUIDE PLATE:REAR	U014_S001	119

Number	Part Name	Group	ID
D1794081	FUSING ENTRANCE GUIDE PLATE:LOWER	U014_S001	120
D1794095	CLAMP:HARNESS:PRESSURE	U014_S001	121
D1794107	BRACKET:STRIPPER PAWLS:PRESSURE:PEEN	U014_S001	122
D1794109	ADJUSTING PIN:DISCHARGE BRUSH	U014_S001	123
D1794113	DISCHARGE BRUSH:21MM	U014_S001	124
D1794114	GUIDE PLATE:FUSING EXIT:LOWER	U014_S001	125
D1794170	TAB:TERMINAL:187:4P	U014_S001	126
D1794182	DISCHARGE BRUSH:HEAT ROLLER	U014_S001	127
D1794197	FLAT BELT-FUSING:DIA80:SEAL	U014_S001	128
D1794223	LEVER:PAPER EXIT UNIT:FRONT	U014_S001	129
D1794224	LEVER:PAPER EXIT UNIT:REAR	U014_S001	130
D1794228	SUPPORTER:GUIDE PLATE:FUSING EXIT:UPPER	U014_S001	131
D1794231	STOPPER:LEVER:FUSING/PAPER EXIT UNIT	U014_S001	132
D1794232	SHAFT:FUSING/PAPER EXIT UNIT	U014_S001	133
D1794235	TENSION SPRING:FUSING/PAPER EXIT UNIT	U014_S001	134
D1794255	GUIDE PLATE:FUSING EXIT:UPPER:ASS'Y	U014_S001	135
D1794279	COVER:FUSING/PAPER EXIT UNIT:ASS'Y	U014_S001	136
D1794283	GRIP:COVER:FUSING/PAPER EXIT UNIT:ASS'Y	U014_S001	137
D1794337	RING:WEB:CLEANING	U014_S002	138
D1794352	BRACKET:DRAWER:FUSING:UPPER:MAIN	U014	139
D1794353	BRACKET:DRAWER:FUSING:LOWER:MAIN	U014	140
D1794531	SHAFT:COOLING UNIT:ENTRANCE	U015	90
D1794533	DRIVE ROLLER:COOLING UNIT:ENTRANCE	U015	91
D1794537	GUIDE PLATE:COOLING UNIT:ENTRANCE	U015	92

## Exclusive Parts

Number	Part Name	Group	ID
	RANCE		
D1794538	BRACKET:CAP:HEAT PIPE:UPPER	U015	93
D1794539	BRACKET:CAP:HEAT PIPE:LOWER	U015	94
D1794754	STOPPER:GUIDE PLATE:REVERSE EXIT:LEFT LOWER	U015	95
D1794755	LEVER:LOCK:REVERSE EXIT:LEFT LOWER	U015	96
D1794757	SHAFT:LOCK:REVERSE EXIT:LEFT LOWER	U015	97
D1794758	LINK:ON-OFF:DRIVEN ROLLER:REVERSE EXIT	U015	98
D1794759	SHAFT:ON-OFF:DRIVEN ROLLER:REVERSE EXIT	U015	99
D1794761	BRACKET:SOLENOID:GATE PAWL:SWITCHBACK	U015	100
D1794766	LINK:GATE PAWL:SWITCHBACK	U015	101
D1794785	GUIDE PLATE:EXIT:MIDDLE	U015	102
D1794796	GUIDE PLATE:REVERSE:UPPER	U015	103
D1794810	PLATE:GATE PAWL:EXIT:REVERSE	U015	104
D1794811	SHAFT:GATE PAWL:EXIT:REVERSE	U015	105
D1794813	BRACKET:DC STEPPER MOTOR:ON-OFF	U015	106
D1794816	BRACKET:CAM:GATE PAWL	U015	107
D1794820	CAM:ON-OFF	U015	108
D1794821	LINK:GATE PAWL:EXIT:ENTRANCE	U015	109
D1794822	LINK:ON-OFF:REVERSE EXIT:CAM	U015	110
D1794824	GUIDE PLATE:REVERSE EXIT:LEFT LOWER:PEEN	U015	111
D1794827	GUIDE PLATE:REVERSE EXIT:LEFT LOWER:MIDDLE	U015	112
D1794830	BRACKET:CONTACT POINT:REVERSE EXIT:FRONT	U015	113
D1794835	BRACKET:CONTACT POINT:REVERSE EXIT:REAR	U015	114
D1794838	BRACKET:DRAWER:LEFT	U015	115

Number	Part Name	Group	ID
D1794847	BRACKET:CONNECTION:MAIN:EXIT	U015	116
D1794860	GUIDE PLATE:MAIN:EXIT	U015	117
D1794866	COVER:EXIT	U015	118
D1794882	COVER:HARNESS:LEFT LOWER	U015	119
D1794884	SHEET:OPPOSED:PAPER FEED SENSOR	U021	61
D1794887	SHEET:TRANSPORT:REVERSE EXIT	U015	120
D1795089	COVER:C/T BOX:UPPER:ASS'Y	U019_S002	39
		U019_S004	39
		U019_S006	39
D1795381	TEMPERATURE SENSOR:FUSING UNIT:UPPER:19PIN:(SEN9/SEN59/SEN87/SEN88)	U014_S001_S003	141
D1795387	TEMPERATURE SENSOR:FUSING UNIT:LOWER:17PIN:(SEN80)	U014_S001_S004	142
D1795435	PCB:URRB:(PCB19)	U006	413
D1795913	ARM:SAFETY SWITCH	U018	43
D1795914	BRACKET:SAFETY SWITCH:FRONT	U018	44
D1795915	LEVER:SAFETY SWITCH:WELDING	U018	45
D1795917	BRACKET:SAFETY SWITCH	U018	46
D1795920	BRACKET:MAIN SWITCH	U018	47
D1795922	BRACKET:POWER SUPPLY CORD:INLET:NOISE FILTER	U018	48
D1795923	PLATE:POWER SUPPLY CORD:INLET	U022	26
D1795924	COVER:SAFETY SWITCH:UPPER FRONT	U018	49
D1795928	BRACKET:SAFETY SWITCH:REAR	U018	50
D1795961	COVER:C/T BOX	U019	40
D1795964	COVER:C/T BOX:LOWER	U019	41
D1795966	SEAL:COVER:C/T BOX:UPPER:A	U019_S002	42
		U019_S004	42
		U019_S006	42
D1795967	SEAL:COVER:C/T BOX:UPPER:B	U019_S002	43

## Exclusive Parts

Number	Part Name	Group	ID
		U019_S004	43
		U019_S006	43
D1795973	SEAL:COVER:C/T BOX:UPPER:C	U019_S002	44
		U019_S004	44
		U019_S006	44
D1796050	FLAT BELT-TRANSFER	U009	85
D1796057	ROLLER:TRANSFER:FRONT:ASS'Y	U009_S001	86
D1796062	TENSION SPRING:PRESSURE:INTERMEDIATE TRANSFER	U009_S001	87
D1796065	DRIVE ROLLER:INTERMEDIATE TRANSFER:ASS'Y	U009_S001	88
D1796080	ROLLER:OPPOSED:BELT CLEANING:ASS'Y	U009_S001	89
D1796085	ROLLER:DRIVEN:INTERMEDIATE TRANSFER:ASS'Y	U009_S001	90
D1796091	ROLLER:TENSION:ASS'Y	U009_S001	91
D1796094	CASE:TENSION:ROLLER	U009_S001	92
D1796095	SUPPORTING PLATE:CASE:TENSION:ROLLER	U009_S001	93
D1796097	PLAIN SHAFT BEARING:TENSION:ROLLER:INTERMEDIATE TRANSFER	U009_S001	94
D1796098	COIL SPRING:PRESSURE:TENSION:INTERMEDIATE TRANSFER	U009_S001	95
D1796108	ROLLER:TRANSFER:PAPER:FRONT:ASS'Y	U009_S001	96
D1796112	DUCT:DENSITY SENSOR:INTERMEDIATE TRANSFER	U009_S001	97
D1796117	BRACKET:DRAWER:INTERMEDIATE TRANSFER	U009_S001	98
D1796119	PULLEY:ON-OFF:TRANSFER ROLLER	U009_S001	99
D1796122	BRACKET:ON-OFF:TRANSFER ROLLER	U009_S001	100
D1796125	CAM:ON-OFF:TRANSFER:PAPER:REAR	U009_S001	101
D1796127	FEELER:ON-OFF:TRANSFER:PAPER	U009_S001	102

Number	Part Name	Group	ID
D1796140	LEVER:ON-OFF:ROLLER:FRONT	U009_S001	103
D1796141	LEVER:ON-OFF:ROLLER:REAR	U009_S001	104
D1796143	ARM:LEVER:ON-OFF:ROLLER	U009_S001	105
D1796144	TENSION SPRING:SLIDE RAIL:TRANSFER	U009_S001	106
D1796146	SHAFT:ON-OFF:INTERMEDIATE TRANSFER	U009_S001	107
D1796147	CAM:ON-OFF:INTERMEDIATE TRANSFER	U009_S001	108
D1796156	COVER:CASE:OPPOSED:TRANSFER ROLLER:REAR	U009_S001	109
D1796160	GUIDE:INTERMEDIATE TRANSFER:RIGHT	U009_S001	110
D1796161	GUIDE:INTERMEDIATE TRANSFER:LEFT:ASS'Y	U009_S001	111
D1796164	PLATE:BLADE:BELT CLEANING	U009_S001	112
D1796173	SEAL:DUCT:DENSITY SENSOR	U009	113
D1796182	BRACKET:POSITIONING CONTROL:DRIVEN ROLLER:REAR:ASS'Y	U009_S001	114
D1796186	DRIVE WIRE:DRIVEN ROLLER	U009_S001	115
D1796187	FEELER:POSITIONING CONTROL:DRIVE WIRE	U009_S001	116
D1796188	BRACKET:COIL SPRING:MOTOR:POSITIONING CONTROL	U009_S001	117
D1796193	HOLDER:FLAT BELT-TRANSFER:DRIVE ROLLER:ASS'Y	SPECIAL TOOLS U022	15 27
D1796194	HOLDER:FLAT BELT-TRANSFER:CLEANING:ASS'Y	SPECIAL TOOLS U022	16 28
D1796195	LEVER:POSITIONING SENSOR:FLAT BELT-TRANSFER	U009_S001	118
D1796196	SCALE:BRACKET:DRIVEN ROLLER:FRONT	U009_S001	119
D1796197	HOLDER:DRIVEN ROLLER:FRONT	U009_S001	120
D1796230	CASE:TERMINAL:SEPARATION:ASS'Y	U011_S002	49
D1796280	GUIDE PLATE:ENTRANCE:LOWER:ASS'Y	U011_S001	50
D1796291	INSULATING COVER:POWER PAC	U011	51

## Exclusive Parts

Number	Part Name	Group	ID
	K		
D1796292	COVER:POWER PACK	U011	52
D1796298	COIL SPRING:COATING BAR:2.2N	U011_S001	53
D1796310	SEPARATION CORONA:ASS'Y	U011_S001_S001	54
D1796311	GEAR:TRANSFER ROLLER	U011_S001	55
D1796312	LEVER:PRESSURE:REAR:ASS'Y	U011	56
D1796314	LEVER:PRESSURE:FRONT:ASS'Y	U011	57
D1796324	GEAR:DRIVE:TRANSFER/SEPARATION UNIT	U011	58
D1796334	COIL SPRING:PRESSURE:TRANSFER UNIT	U011	59
D1796350	TRANSFER/SEPARATION UNIT:DRIVE:ASS'Y	U011	60
D1796355	KNOB:STOPPER:TRANSFER/SEPARATION UNIT:REAR	U011	61
D1796356	KNOB:STOPPER:TRANSFER/SEPARATION UNIT:FRONT	U011	62
D1796410	SLIDE RAIL:CASE:TENSION:ROLLER	U021	62
D1796411	SEAL:TONER OUTLET SUB-UNIT	U017_S001	63
D1796412	SEAL:HOLDER:CLEANING BLADE:UPPER	U010_S001	53
D1796413	SEAL:HOLDER:CLEANING BLADE:FRONT LOWER	U010_S001	54
D1796414	SEAL:HOLDER:CLEANING BLADE:REAR LOWER	U010_S001	55
D1796415	SEAL:HOLDER:CLEANING BLADE:LOWER	U010_S001	56
D1796461	TONER OUTLET SUB-UNIT:COLLECTION BOTTLE:ASS'Y	U012_S001	49
D1796472	COVER:TONER OUTLET SUB-UNIT:ASS'Y	U012	50
D1796483	BRACKET:DRIVE SUB-UNIT:COLLECTION BOTTLE	U012	51
D1796501	TONER OUTLET SUB-UNIT:PCU:ASS'Y	U012_S003	52
D1796521	BRACKET:TONER OUTLET SUB-UNIT:VERTICAL TRANSPORT:LOWE	U012	53

Number	Part Name	Group	ID
	R		
D1796523	BRACKET:VERTICAL TRANSPORT	U012	54
D1796525	BRACKET:IDLER	U012	55
D1796527	CAM:VERTICAL TRANSPORT:DIA15	U012	56
D1796528	TONER OUTLET SUB-UNIT:VERTICAL TRANSPORT:MAIN:ASS'Y	U012_S004	57
D1796552	TRANSPORT SCREW:TONER OUTLET SUB-UNIT:LOWER:ASS'Y	U012_S004	58
D1796619	STAY:HOLDER:PAPER TRAY:ASS'Y	U006	414
D1796626	SUPPORTING PLATE:RIGHT:HOLDER:PAPER TRAY	U006	415
D1796643	RAIL:TANDEM LCT:MIDDLE:ASS'Y	U006	416
D1796726	COVER:LED:MAIN	U006	417
D1796731	LEVER:PRESSURE:SLIDER	U006_S006	418
		U006_S007	418
		U006_S008	418
D1796734	BRACKET:SLIDER:CAM	U006_S006	419
		U006_S007	419
		U006_S008	419
D1796737	LEVER:PRESSURE RELEASE:REVERSE	U006_S006	420
		U006_S007	420
		U006_S008	420
D1796738	SLIDER:CAM:REVERSE	U006_S006	421
		U006_S007	421
		U006_S008	421
D1796739	LEVER:REVERSE:PRESSURE RELEASE:JOINT	U006_S006	422
		U006_S007	422
		U006_S008	422
D1796751	BRACKET:STM:MM56:TRANSPORT:LENGTHWISE	U006	423
D1796753	BRACKET:JOINT:PROTECT	U006	424
D1796756	BRACKET:CONNECTING:JOINT	U006	425
D1796757	SHAFT:DRIVE	U006	426
D1796758	SYNCHRONOUS BELT:80S2M216	U006	427
D1796761	SYNCHRONOUS BELT:60S2M226	U006	428
D1796762	SYNCHRONOUS BELT:60S2M166	U006	429

## Exclusive Parts

Number	Part Name	Group	ID
D1796763	SYNCHRONOUS BELT:80S2M300	U006	430
D1796764	SYNCHRONOUS BELT:80S2M242	U006	431
D1796768	SHAFT:JOINT:CONNECTING:ASS'Y	U006	432
D1796781	GUIDE PLATE:VERTICAL TRANSP ORT:F1	U006	433
D1796783	GUIDE PLATE:VERTICAL TRANSP ORT:F1:LOWER	U006	434
D1796784	GUIDE PLATE:VERTICAL TRANSP ORT:F3	U006	435
D1796786	GUIDE PLATE:VERTICAL TRANSP ORT:F2	U006	436
D1796790	GUIDE PLATE:VERTICAL TRANSP ORT:F2:LOWER	U006	437
D1796797	COMPRESSION SPRING:JOINT:TR ANSPORT	U006	438
D1796821	DUCT:DEVELOPMENT:VACUUM:F RONT	U020	35
D1796822	BRACKET:FAN:DEVELOPMENT:C OOLING:FRONT	U020	36
D1796823	DUCT:DEVELOPMENT:EXHAUST: MULTI-LANGUAGE:ASS'Y	U021	63
D1796831	DUCT:DEVELOPMENT:EXHAUST:F RONT	U020	37
D1796832	DUCT:DEVELOPMENT:EXHAUST: REAR	U020	38
D1796834	SEAL:DUCT:DEVELOPMENT:EXHA UST:REAR RIGHT	U020	39
D1796835	EXTERIOR:LOUVER:CHARGE COR ONA	U020	40
D1796836	DUCT:CHARGE CORONA:CONNE CTING:LOWER:ASS'Y	U020_S002	41
D1796840	BRACKET:DUCT:CHARGE CORON A:VACUUM:UPPER	U020	42
D1796841	DUCT:CHARGE CORONA:VACUU M:CONNECTING:UPPER	U020	43
D1796842	FILTER:CHARGE CORONA:VACUU M	U020	44
D1796845	DUCT:CHARGE CORONA:VACUU	U020	45

Number	Part Name	Group	ID
	M:LOWER RIGHT		
D1796846	DUCT:CHARGE CORONA:VACUU M:LOWER LEFT	U020	46
D1796847	DUCT:CHARGE CORONA:VACUU M:MAIN:RIGHT	U020	47
D1796848	DUCT:CHARGE CORONA:VACUU M:MAIN:LEFT	U020	48
D1796849	SEAL:DUCT:CHARGE CORONA:VA CUUM:MAIN	U020	49
D1796858	BRACKET:DUCT:CHARGE:EXHAU ST:UPPER	U020	50
D1796860	DUCT:DEVELOPMENT:TONER:UP PER:ASS'Y	U020	51
D1796864	DUCT:DEVELOPMENT:TONER:AS S'Y	U020	52
D1796873	DUCT:FLAT CONVEYER BELT:EXH AUST:UPPER	U020	53
D1796874	DUCT:FLAT CONVEYER BELT:EXH AUST:LOWER	U020	54
D1796875	BRACKET:DUCT:FLAT CONVEYER BELT:EXHAUST	U020	55
D1796897	BRACKET:FAN:OPTICAL WRITING UNIT:COOLING	U020	56
D1796898	SEAL:DUCT:OPTICAL WRITING UN IT:VACUUM	U020	57
D1796913	SEAL:INNER COVER:OPTICAL WRI TING MD:COOLING	U001_S002 U001_S009	72 72
D1796914	SEAL:INNER COVER:DEVELOPME NT:COOLING	U001_S002 U001_S009	73 73
D1796918	SEAL:EXTERIOR:REAR:UPPER	U020	58
D1796927	DUCT:HEAT PIPE:EXHAUST	U020	59
D1796932	DUCT:HEAT SHIELD:FUSING:UPP ER	U020	60
D1796934	DUCT:HEAT SHIELD:FUSING:LOW ER	U020	61
D1796940	BRACKET:FAN:EXIT:MIDDLE	U020	62
D1796946	DUCT:EXHAUST:PAPER EXIT SUB -UNIT:A	U020	63

## Exclusive Parts

Number	Part Name	Group	ID
D1796947	BRACKET:DUCT:EXHAUST:PAPER EXIT SUB-UNIT:LEFT	U020	64
D1796948	PLATE:DUCT:EXHAUST:A:ASS'Y	U020	65
D1796953	DUCT:EXHAUST:PAPER EXIT SUB-UNIT:B	U020	66
D1796954	BRACKET:DUCT:EXHAUST:PAPER EXIT SUB-UNIT:RIGHT	U020	67
D1796955	PLATE:DUCT:EXHAUST:B:ASS'Y	U020	68
D1796963	BRACKET:HEAT SHIELD:BELT CLEANING:ASS'Y	U020_S004	69
D1796966	SEAL:DUCT:THERMOPILE:ENTRANCE:UPPER	U020_S004	70
D1796970	DUCT:THERMOPILE	U020	71
D1796971	SEAL:DUCT:THERMOPILE:ENTRANCE:LOWER	U020	72
D1796972	DUCT:THERMOPILE:ENTRANCE:ASS'Y	U020	73
D1796977	GUARD:FAN:OPTICAL WRITING UNIT	U020	74
D1796978	SEAL:EXTERIOR:REAR:SMALL	U020	75
D1796981	BRACKET:DUCT:HEAT PIPE:EXIT:ASS'Y	U020	76
D1796984	DUCT:HEAT PIPE:EXIT	U020	77
D1796985	DUCT:HEAT PIPE:EXIT:MIDDLE	U020	78
D1796987	DUCT:HEAT PIPE:ENTRANCE:ASS'Y	U020_S001	79
D1796995	BRACKET:FAN:TRANSFER/SEPARATION UNIT:COOLING:REAR	U020	80
D1797050	GUIDE PLATE:DUPLEX:UPPER:LEFT	U016	56
D1797053	GUIDE PLATE:DUPLEX:UPPER:MIDDLE	U016	57
D1797056	GUIDE PLATE:DUPLEX:UPPER:RIGHT	U016	58
D1797060	GATE PAWL:DUPLEX:ENTRANCE	U016	59
D1797062	GUIDE PLATE:DUPLEX:ENTRANCE:UPPER	U016	60
D1797066	GUIDE PLATE:DUPLEX:ENTRANCE	U016	61

Number	Part Name	Group	ID
	E:LOWER		
D1797070	GUIDE PLATE:DUPLEX:OPEN AND CLOSE:LEFT	U016	62
D1797071	SUPPORTING PLATE:GUIDE PLATE:DUPLEX:OPEN AND CLOSE	U016	63
D1797075	GUIDE PLATE:DUPLEX:OPEN AND CLOSE:RIGHT	U016	64
D1797081	BRACKET:DC STEPPER MOTOR:DUPLEX:LEFT	U016	65
D1797082	BRACKET:DC STEPPER MOTOR:DUPLEX:RIGHT	U016	66
D1797083	SHAFT:MISFEED REMOVAL:DUPLICATION	U015 U016	121 67
D1797084	BRACKET:MISFEED REMOVAL:DUPLEX	U015 U016	122 68
D1797096	BRACKET:DUPLEX:OPEN AND CLOSE:LEFT:PEEN	U016	69
D1797098	BRACKET:DUPLEX:OPEN AND CLOSE:RIGHT:PEEN	U016	70
D1797131	BRACKET:ROLLER:PEEN	U016	71
D1797513	COVER:PAPER TRAY:NO.3	U006	439
D1797519	BRACKET:STOPPER:PAPER TRAY	U006	440
D1797525	STOPPER:REGISTRATION:TANDEM LCT:ASS'Y	U006_S005	441
D1797533	JOINT:LINK:UN LOCK:PEEN	U006	442
D1797540	SCREW:DIA6:M4X3:ADHESIVE	U006	443
D1797550	COVER:PAPER TRAY:NO.1:UPPER	U006	444
D1797561	ARM:LINK:LEFT	U006	445
D1797562	ARM:LINK:RIGHT	U006	446
D1797564	BRACKET:SLIDER:GRIP:UPPER	U006	447
D1797566	BRACKET:ARM:LINK:RIGHT	U006	448
D1797573	BRACKET:ARM:UN LOCK	U006	449
D1797576	ARM:LINK:UN LOCK	U006	450
D1797579	COVER:GRIP:INNER BACK	U006	451
D1797581	STAY:COVER:TANDEM LCT	U006	452
D1797586	STOPPER:TANDEM LCT	U006	453
D1797591	PLATE:TRANSPARENT:LED	U006	454
D1797596	DIFFUSION PLATE:LED	U006	455



## Exclusive Parts

Number	Part Name	Group	ID
D1797597	COVER:LED	U006	456
D1799510	OPC DRUM	U008	109
D1799640	DEVELOPER BLACK	U022	29
D1806801	DUCT:FLAT CONVEYER BELT:EXH AUST:SMALL:ASS'Y	U021	64
D1806811	DUCT:FLAT CONVEYER BELT:EXH AUST:CONNECTING:ASS'Y	U020_S003	81
D1806818	OZONE FILTER:MAIN:EXHAUST:RI GHT	U020	82
D1806821	BASE:HEAT SHIELD:FUSING SUB- UNIT:SUB-ASS'Y	U020	83
D1806831	GASKET:DUCT:CHARGE CORONA .VACUUM	U020	84
D1941234	SUPPORTING PLATE:BRACKET:L OCK	U021	65
D1942945	HOLDER:CAM:SHIFT	U006	457
D1943566	GRIP:LEVER:BASE:TONER BANK	U007	82
D1944101	SHAFT:CAM:PRESSURE	U014_S001	143
D1944106	JOINT:CAM:PRESSURE	U014_S001	144
D1944759	BRACKET:LOCK:EXIT	U021	66
D1947346	DC MOTOR:RISE:TANDEM LCT:AS S'Y:19.2W:BRUSH:(BM1)	U006	458
D1947552	SIDE PLATE:TANDEM LCT:LEFT SI DEWAYS	U006	459
D1947635	ARM:END FENCE:LOCK	U006_S010 U006_S011	460 460
D2231762	INSULATING SHEET:LED	U004	44
D2231763	INSULATING SHEET:LED:CONNEC TOR	U004	45
D2231805	HOLDER:EXPOSURE GLASS	U004	46
D2235824	COVER:SD-CARD	U019	45
D2236231	DC SOLENOID:LOCK:ASS'Y:(SOL5)	U006_S003	461
D2236233	DC SOLENOID:COUPLING:ASS'Y:( SOL6)	U006_S004	462
D2236722	DC SOLENOID:END FENCE:FRON T:ASS'Y:(SOL8)	U006_S012	463
D2236732	DC SOLENOID:END FENCE:REAR: ASS'Y:(SOL7)	U006_S012	464

Number	Part Name	Group	ID
D2236747	DC MOTOR:TANDEM LCT:19.2W:B RUSH:(BM4)	U006	465
D2416290	LED:RED	U006 U015 U016 U021	466 123 72 67
D2425605	PCB:DDR3-DIMM:RC-C:2GB:ASS'Y: (PCB27)	U019	46
D2445730	PCB:DCSW:(PCB12)	U018	51
D2452528	BUSHING:MM8	U015	124
D2581715	GUIDE:FFC:BASE	U004	47
D2581717	COVER:SHAFT:SCANNER	U004	48
D2581718	SHEET:FFC:BASE	U004	49
D2581719	COVER:PULLEY	U004	50
D2581727	INNER COVER:SCANNER	U004	51
D2581739	LENSBLOCK SMD:ASS'Y	U004_S001	52
D2581751	CARRIAGE:NO.1:ASS'Y	U004_S002	53
D2581759	GUIDE:FFC:CARRIAGE:NO.1:FRO NT	U004	54
D2581760	GUIDE:FFC:CARRIAGE:NO.1:MIDD LE	U004	55
D2581761	GUIDE:FFC:CARRIAGE:NO.1:REAR	U004	56
D2581769	ILLUMINATION UNIT:LED-B:ASS'Y	U004_S003 U004_S004	57 57
D2581776	CARRIAGE:NO.2:ASS'Y	U004_S005	58
D2581784	MIRROR:NO.2:CONCAVE:ASS'Y	U004_S005	59
D2581785	MIRROR:NO.3:CONVEX:ASS'Y	U004_S005	60
D2581786	GUIDE:FFC:CARRIAGE:NO.2	U004	61
D2581787	SIDE PLATE:GUIDE:FFC:CARRIAG E:NO.2	U004	62
D2583910	FAN:MM60X15:(FAN1/FAN2)	U013	26
D2584302	STEPPED SCREW:LEVER:HEAT R OLLER	U014_S001_S002	145
D2585715	CABLE:HDD:SATA:2CON_POWER_ 3P	U019	61
D2615140	PCB:SDCU:ASS'Y:(PCB15)	U019_S001 U019_S003 U019_S005	47 47 47

## Exclusive Parts

Number	Part Name	Group	ID
D2701132	SLIDE RAIL:PULL OUT:PROTECT	U021	68
D2701151	SLIDE RAIL:PULL OUT:RIGHT UPPER	U021	69
D2701155	BRACKET:RADIAL BALL BEARING	U021	70
D2701160	RAIL:INTERMEDIATE TRANSFER	U021	71
D2701166	SUPPORTING PLATE:AUXILIARY:RAIL:INTERMEDIATE TRANSFER	U021	72
D2701167	STOPPER:SLIDE RAIL:RIGHT UPPER	U021	73
D2701171	SUPPORTER:PULL OUT:RIGHT UPPER	U021	74
D2701173	STOPPER:SUPPORTER	U021	75
D2701174	GUIDE:PICK-UP PAPER JAM	U021	76
D2701271	SPACER:SHAFT:DRUM	U017	64
D2701317	DRIVE SUB-UNIT:ON-OFF:PRESSURE ROLLER:(BLM11)	U017_S003	65
D2701449	COVER:TONER SUPPLY:UPPER:ASSY	U001	74
D2701481	DOOR:FRONT LEFT:UPPER	U001	75
D2701509	BRACKET:SUPPORTING PLATE:DOOR:FRONT RIGHT	U001_S002 U001_S009	76 76
D2701540	INNER COVER:PULL OUT:LEFT	U001_S004 U001_S011	77 77
D2701541	DECAL:H-TEMP WARNING:EXIT:FLUORESCENT:ABS	U001	78
D2701542	DECAL:H-TEMP WARNING:PAPER FEED:ABS	U001_S003 U001_S004 U001_S010 U001_S011	79 79 79 79
D2701546	DECAL:PULL OUT:MIDDLE:ABS	U001_S005 U001_S012	80 80
D2701562	INNER COVER:REVERSE SUB-UNIT:UPPER	U001_S006 U001_S013	81 81
D2701566	INNER COVER:LEFT UPPER	U001	82
D2701567	DECAL:MAIN SWITCH:ABS	U001	83
D2701568	DECAL:POSITIONING DISPLAY:TCRU:ABS	U001 U001_S005 U001_S012	84 84 84

Number	Part Name	Group	ID
		U008	110
D2701588	(NA):DECAL:CAUTION:PULL OUT:ENGLISH	U022	49
D2701761	(NA):DECAL:CAUTION CHART:INK JET:PAPER	U022	50
D2701787	DUCT:POWER SUPPLY UNIT:PAPER FEED:COOLING	U019	48
D2702214	DUCT:CHARGE UNIT:ASSY	U008_S005	111
D2702247	DUCT:SIDE PLATE	U008	112
D2702622	TENSION SPRING:48N	U006	467
D2702624	SIDE PLATE:SHIFT:REGISTRATION:FRONT:PEEN	U006	468
D2702627	SIDE PLATE:SHIFT:REGISTRATION:REAR:PEEN	U006	469
D2702632	BRACKET:HOOK:COIL SPRING:REAR:PEEN	U006	470
D2702634	BRACKET:HOOK:COIL SPRING:FRONT:PEEN	U006	471
D2702636	GUIDE PLATE:SHIFT:REGISTRATION:LOWER	U006	472
D2702637	COLOR:4M	U006	473
D2702647	SHAFT:SHIFT	U006	474
D2702656	GUIDE PLATE:REGISTRATION:CIS	U006	475
D2702771	ARM:REGISTRATION:TIMING:ASSY	U006_S001	476
D2702786	DUCT:FAN:CONTACT IMAGE SENSOR	U006	477
D2702802	STAY:SHIFT:TRAILING EDGE	U006	478
D2702810	GUIDE PLATE:SHIFT:RIGHT UPPER:PEEN	U006	479
D2702816	SHAFT:TRAILING EDGE:SHIFT	U006	480
D2702947	SHAFT:CAM:ON-OFF:MAIN	U006	481
D2702965	SHAFT:GUIDE PLATE:OPEN AND CLOSE	U006	482
D2702986	BRACKET:GUIDE PLATE:CONNECTION:LARGE CAPACITY TRAY	U006	483
D2703079	SERVICE PARTS:DENSITY SENSOR:DEVELOPMENT:(SEN1)	U008_S003	113

## Exclusive Parts

Number	Part Name	Group	ID
D2703097	COVER:GEAR:DEVELOPMENT	U008_S003	114
D2703134	DECAL:WARNING:AROUND THE PHOTOCONDUCTOR:ABS	U008	115
D2703136	DECAL:DEVELOPMENT UNIT:CAUTION	U008	116
D2703310	SHAFT:DRIVE:TONER BOTTLE:DIA6	U007	83
D2703335	SEAL:CASE:TONER BANK:LOWER	U007_S001	84
		U007_S002	84
D2703336	SEAL:CASE:TONER BANK:FRONT	U007_S001	85
		U007_S002	85
D2703347	SEAL:BRACKET:RACK	U007	86
D2703366	DECAL:REPLACEMENT INDICATION:TONER BOTTLE	U001_S007	85
		U001_S014	85
D2703383	SEAL:CASE:TONER BANK:REAR	U007	87
D2703384	SEAL:CASE:TONER BANK:LEFT	U007	88
D2703889	BRACKET:POSITIONING SENSOR:PEEN	U009_S001	121
D2704009	HOLDER:M5	U014_S001	146
D2704068	SHAFT:RADIAL BALL BEARING:LEVER:PRESSURE	U014_S001	147
D2704156	HOLDER:THERMISTOR:HEAT ROLLER	U014_S001	148
D2704185	RING:GUIDE:HEAT ROLLER:DIA39.2	U014_S001	149
D2704236	TORSION SPRING:FUSING/PAPER EXIT UNIT:FRONT	U014_S001	150
D2704237	TORSION SPRING:FUSING/PAPER EXIT UNIT:REAR	U014_S001	151
D2704277	DECAL:H-TEMP WARNING:FUSING	U014_S001_S006	152
D2704290	DRIVE UNIT:WEB:CLEANING:ASS'Y	U014_S001_S007	153
D2704338	FEELER:CLEANING	U014_S002	154
D2704343	ROLLER:PLATE	U014_S002	155
D2704383	HOLDER:COIL SPRING:PRESSURE	U014_S001	156
D2704535	DRIVE ROLLER:COOLING UNIT:EX	U015	125

Number	Part Name	Group	ID
	IT:PRESS FIT		
D2704543	SHAFT:MISFEED REMOVAL:EXIT	U015	126
D2704547	BRACKET:TIGHTENER:EXIT:ASS'Y	U015	127
D2704551	COIL SPRING:TENSIONER:EXIT	U015	128
D2704555	SYNCHRONOUS BELT:B50S2M200	U015	129
D2704557	COVER:EXIT:MOTOR	U015	130
D2704658	SHEET:HANDLE:LOCK:ASS'Y	U015	131
D2704737	BRACKET:LINK:LEVER	U015	132
D2704740	BRACKET:ARM:STOPPER:RELEASE	U015	133
D2704742	SHAFT:GUIDE PLATE:EXIT:UPPER:OPEN/CLOSE	U015	134
D2704745	PIN:ARM:GRIP	U015	135
D2704746	BRACKET:CAM:ON-OFF:PEEN	U015	136
D2704748	COMPRESSION SPRING:STOPPER:20N	U015	137
D2704750	STOPPER:GUIDE PLATE:EXIT:UPPER:SUB-ASS'Y	U015	138
D2704753	PLATE:HANDLE:GUIDE:OPEN AND CLOSE	U015	139
D2704757	STOPPER:GUIDE PLATE:EXIT:INNER BACK	U015	140
D2704764	DC SOLENOID:GATE PAWL:SWITCHBACK:(SOL4)	U015	141
D2704768	GATE PAWL:SWITCHBACK	U015	142
D2704800	SHAFT:GATE PAWL:REVERSE	U015	143
D2704933	HOOK:LEVER:GUIDE PLATE:ASS'Y	U016	73
D2705415	PCB:EDRB:(PCB24)	U018	52
D2705975	FILTER:COVER:C/T BOX	U019	49
D2706022	DECAL:CAUTION:ORIGINAL:MANY LANGUAGES	U022	46
D2706124	GUIDE PLATE:INTERMEDIATE TRANSFER:ASS'Y	U009_S001	122
D2706128	GUIDE:TRANSPORT:INTERMEDIATE TRANSFER:10MM:ASS'Y	U009_S001	123
D2706129	GUIDE:TRANSPORT:INTERMEDIATE TRANSFER:4MM:ASS'Y	U009_S001	124
D2706166	DRUM STAY:INTERMEDIATE TRA	U009	125

## Exclusive Parts

Number	Part Name	Group	ID
	NSFER:ASS'Y		
D2706176	INNER COVER:INTERMEDIATE TRANSFER:LEVER	U009	126
D2706304	TRANSPORT SCREW:TRANSFER ROLLER:ASS'Y	U011_S001	63
D2706333	SHAFT:LEVER:PRESSURE:TRANSFER ROLLER	U011	64
D2706350	BRACKET:SHAFT:CONTACT POINT:TRANSFER ROLLER	U011	65
D2706360	GROUND PLATE:TRANSPORT SCREW:ASS'Y	U011_S001	66
D2706416	SEAL:HOLDER:CLEANING BLADE:BEHIND	U010_S001	57
D2706453	SHAFT:MISFEED REMOVAL	U006	484
D2706492	GUIDE PLATE:COLLECTION BOTTLE:LOWER	U012	59
D2706498	DECAL:COLLECTION BOTTLE:CAUTION	U012_S002	60
D2706541	SHAFT:DRIVE:FEED:ASS'Y	U006	485
D2706570	COLLECTION BOTTLE:SERVICE PARTS:ASS'Y	U012_S002	61
D2706658	FLANGED HEXAGONAL HEAD BOLT:M3X6	U006_S006	486
		U006_S007	486
		U006_S008	486
D2706659	ROLLER:GUIDE	U006_S006	487
		U006_S007	487
		U006_S008	487
D2706664	HOOK:COIL SPRING:SLIDER	U006_S006	488
		U006_S007	488
		U006_S008	488
D2706668	TENSION SPRING:REVERSE ROLLER	U006_S006	489
		U006_S007	489
		U006_S008	489
D2706678	COVER:CUSHION	U006_S012	490
D2706721	COVER:GUARD:HARNESS	U006	491
D2706725	COVER:GUARD:HARNESS	U006	492
D2706740	STAY:REVERSE:ASS'Y	U006_S006	493
		U006_S007	493

Number	Part Name	Group	ID
		U006_S008	493
D2706806	SEAL:DUCT:LARGE	U020	85
D2706813	SHEET:GUIDE MILER:PAPER FEED:COOLING:LOWER	U021	77
D2706814	SHEET:GUIDE MILER:PAPER FEED:COOLING:UPPER	U021	78
D2706815	SHEET:GUIDE MILER:PAPER FEED:COOLING:INNER BACK	U021	79
D2706818	SEAL:DUCT:FAN:MM97	U020	86
		U020_S003	86
D2706822	SEAL:DUCT:HEAT SHIELD:FUSING:A	U020	87
D2706823	OZONE FILTER:DUCT:MAIN:REAR	U020	88
D2706833	BRACKET:FAN:DEVELOPMENT:EXHAUST	U020	89
D2706851	DUCT:CHARGE CORONA:EXHAUST:MIDDLE:RIGHT	U020	90
D2706853	DUCT:CHARGE CORONA:EXHAUST:MIDDLE:REAR	U020	91
D2706854	DUCT:CHARGE CORONA:EXHAUST:MIDDLE:FRONT	U020	92
D2706856	DUCT:CHARGE CORONA:EXHAUST:CONNECTING:FRONT	U020	93
D2706857	DUCT:CHARGE CORONA:EXHAUST:CONNECTING:REAR	U020	94
D2706869	DUCT:CHARGE CORONA:EXHAUST:MULTI-LANGUAGE:REAR	U020	95
D2706870	DUCT:CHARGE CORONA:EXHAUST:MULTI-LANGUAGE:FRONT	U020	96
D2706890	DUCT:MAIN:EXHAUST:FRONT	U020	97
D2706891	DUCT:MAIN:EXHAUST:REAR	U020	98
D2706892	COVER:FILTER:EXHAUST	U020	99
D2706896	DUCT:OPTICAL WRITING UNIT:VA CUUM:FRONT	U020	100
D2706909	SEAL:DUCT:LARGE	U020	101
		U020_S002	101
D2706910	SEAL:DUCT:CHARGE CORONA:EXHAUST:MIDDLE	U020	102

## Exclusive Parts

Number	Part Name	Group	ID
D2706911	SEAL:DUCT:MAIN:EXHAUST:FRONT	U020	103
D2706917	SEAL:DUCT:MAIN:EXHAUST	U020	104
D2706920	SEAL:DUCT:MAIN:EXHAUST:A	U020	105
D2706921	SEAL:DUCT:MAIN:EXHAUST:B	U020	106
D2706929	COVER:FAN:MAIN:EXHAUST	U020	107
D2706942	BRACKET:FAN:SIDE:RIGHT:SUB-ASS'Y	U020	108
D2706944	BRACKET:GUIDE:BASE	U020	109
D2706945	FILTER:VACUUM:MAIN:RIGHT	U020	110
D2706947	BRACKET:AUXILIARY:BASE	U020	111
D2706948	SHEET:SCREW:FILTER	U001	86
		U020	112
D2706949	SHEET:COVER:MAIN:RIGHT	U001	87
D2706989	SEAL:DUCT:HEAT PIPE:ENTRANCE	U020	113
		U020_S001	113
D2707061	SHAFT:GATE PAWL:DUPLEX:ENTRANCE	U016	74
D2707103	DRUM STAY:RECEIVING SUB-UNIT:REVERSE	U016	75
D2707389	DECAL:PAPER SET DIRECTION:TANDEM LCT:LEFT	U006	528
D2707518	SHAFT:STOPPER:PAPER TRAY	U006	494
D2707544	SIDE FENCE:TANDEM LCT:LEFT REAR:ASS'Y	U006_S014	495
D2707548	DECAL:CAUTION:INSERT:PAPER FEED SUB-UNIT	U006_S014	496
D2707574	SHAFT:ARM:UN LOCK	U006	497
D2707649	DECAL:MULTI-LANGUAGE:MAIN:5	U022	31
D2707669	(NA):DECAL:POWER SOURCE:OFF:ABS	U022	51
D2707671	(NA):DECAL:CAUTION CHART:COPY:ORIGINAL	U022	52
D3551196	ROLLER:DETENT	U006_S009_S001	498
		U006_S009_S002	498
D3551333	SHIELDING PLATE:SAFETY SWITCH:DOOR	U001_S007	88
		U001_S014	88
D3553810	BRACKET:DETENT:RIGHT:ASS'Y	U006_S009_S001	499

Number	Part Name	Group	ID
D3553840	BRACKET:DETENT:ASS'Y	U006_S009_S002	500
D3553844	SHOE:HANDLE:RELEASE	U006	501
D3553858	TORSION SPRING:GUIDE PLATE:16N	U006_S009	502
D3724561	SPACER:DIA4	U008	117
D3AZ1762	BRACKET:MOTOR:MIDDLE	U003_S001	92
D3AZ2914	COIL SPRING:FEELER:P SIZE SENSOR	U003_S001	93
D3AZ4720	PRESSURE PLATE:ASS'Y	U003_S001_S002	94
D3AZ5860	CONTACT IMAGE SENSOR:ASS'Y:(PCB3)	U003_S001	95
D3B01766	DC MOTOR:10W:NIDEC:ASS'Y:(M5)	U003_S001	96
D3B02200	SHAFT:SEPARATION:ASS'Y	U003_S001_S001	97
D3B02510	GUIDE PLATE:PAPER FEED:LOWER:ASS'Y	U003_S001	98
D3B02622	DISCHARGE BRUSH:L11	U003_S001	99
D3B03810	GUIDE PLATE:EXIT:UPPER:ASS'Y	U003_S001_S006	100
D3B04324	SHEET:BRACKET:GUIDE:PAPER FEED	U003_S001	101
D3B04711	GUIDE PLATE:PRESSURE PLATE:LEFT:ASS'Y	U003_S001_S002	102
D3B04722	CUSHION:TAPE:SMALL	U003_S001_S002	103
D3B04724	CUSHION:PRESSURE PLATE:LARGE	U003_S001_S002	104
D3B04725	CUSHION:PRESSURE PLATE:SMALL	U003_S001_S002	105
D3B04781	CUSHION:BRACKET:PICKUP:FRONT	U003_S001_S001	106
D3B05111	SHIELD PLATE:PCB:LOWER	U003_S001	107
D3B05112	SHIELD PLATE:PCB:RIGHT	U003_S001	108
D3B05869	SHIELD PLATE:CONTACT IMAGE SENSOR:FRONT	U003_S001	109
D3EK5100	PCB:MAIN CONTROL:DF:ASS'Y:(PCB2)	U003_S001	110
D3FF2219	GUIDE:PAPER FEED BELT:FRONT	U003_S001_S001	111
D3FF2851	SENSOR COVER:PHOTOINTERRUPTOR	U003_S001	282

## Exclusive Parts

Number	Part Name	Group	ID
D3FF2852	COVER:SENSOR	U003_S001	283
<b>D3FF6071</b>	<b>DECAL:CAUTION:ORIGINAL:PICK-UP PAPER JAM</b>	<b>U003_S001_S001</b>	<b>284</b>
D4122653	BUSHING:DIA6	U003_S001_S008	112
D4122669	TENSION SPRING:GUIDE PLATE:PRESSURE:2N	U003_S001_S008	113
D4123145	TENSION SPRING:LEVER:MISFEED REMOVAL	U003_S001	114
D4342535	TORSION SPRING:PROOF TRAY	U006	503
D5161326	DECAL:PAPER TRAY:DESIGN SKETCH:3	U006	504
D5163809	CUSHION:STAY	U006	505
D5163823	TIMING BELT:60S2M146	U016	76
D5165200	PCB:LED:ASS'Y:(PCB35/PCB36/PCB37/PCB38/PCB39/PCB40)	U006	506
D5224906	STEPPED SCREW:M3:DIA6:1.7MM:ROUND POINT	U003_S001	115
D5412241	REVERSE ROLLER:PAPER FEED	U003_S001	116
D5431313	COMPRESSION SPRING:HINGE:LEFT	U003_S001	117
D5431625	GEAR:Z24:SEPARATION	U003_S001	118
D5431717	SHAFT:PULLEY:SCANNING:EXIT	U003_S001	119
D5431821	TIMING PULLEY:T33/Z24	U003_S001	120
D5431822	FLANGE:DIA24	U003_S001	121
D5433314	SHEET:SCANNING:ENTRANCE:MIDDLE	U003_S001_S003 U003_S001_S009	122 122
D5433631	ROLLER:SCANNING:BEHIND:ASS'Y	U003_S001_S008	123
D5433635	GEAR:ROLLER:SCANNING:BEHIND	U003_S001_S008	124
D5434382	COMPRESSION SPRING:PULL OUT	U003_S001	125
D5434393	CUSHION:GUIDE PLATE:ENTRANCE:PAPER FEED:INNER BACK	U003_S001	126
D5435125	SPRING PLATE:CABLE:CONTACT IMAGE SENSOR	U003_S001	127
D5481243	STAND:UN LOCK	U001	89
D6421454	FEELER:APS	U003_S001	128

Number	Part Name	Group	ID
D6830360	GUIDE:EXIT:LOWER:ASS'Y	U003_S001_S008	129
D6831362	COMPRESSION SPRING:HINGE:RIGHT	U003_S001	130
D6831385	BRACKET:SAFETY SWITCH:PAPER FEED	U003_S001	131
D6831386	SHAFT:CONTACT POINT:ON OFF DETECTOR:PAPER FEED	U003_S001	132
D6831387	TENSION SPRING:ON OFF DETECTOR:PAPER FEED	U003_S001	133
D6831413	BRACKET:SAFETY SWITCH	U003_S001	134
D6831414	SPRING PLATE:SAFETY SWITCH	U003_S001	135
D6831415	FEELER:SENSOR:ON OFF DETECTOR	U003_S001	136
D6831451	HOLDER:FEELER:APS	U003_S001	137
D6831614	BRACKET:MOTOR:PAPER FEED	U003_S001	138
D6831615	STAY:MOTOR:PAPER FEED	U003_S001	139
D6831617	DC MOTOR:ASS'Y:20W:BRUSHLESS:(M2)	U003_S001	140
D6831620	SHAFT:SEPARATION:DRIVE:INPUT:SUB-ASS'Y	U003_S001	141
D6831632	SHAFT:REVERSE ROLLER:SUB-ASS'Y	U003_S001	142
D6831635	GEAR:REVERSE ROLLER:DRIVE	U003_S001	143
D6831640	SHAFT:INPUT:PAPER FEED:SUB-ASS'Y	U003_S001	144
D6831642	TIMING PULLEY:IDLER:PULL OUT	U003_S001	145
D6831643	GEAR:INPUT:PAPER FEED	U003_S001	146
D6831644	SPACER:SHAFT:INPUT:PAPER FEED	U003_S001	147
D6831671	BRACKET:MOTOR:PICK UP	U003_S001	148
D6831675	DC STEPPER MOTOR:DIA42:T15:52M:ASS'Y:(M4)	U003_S001	149
D6831680	CAM:PICKUP	U003_S001	150
D6831682	TIMING PULLEY:PICKUP:DRIVE	U003_S001	151
D6831691	GEAR:PAPER FEED:COUPLING	U003_S001	152
D6831711	BRACKET:MOTOR:PULL OUT	U003_S001	153
D6831718	STAY:MOTOR:PULL OUT	U003_S001	154
D6831766	DC MOTOR:10W:BRUSHLESS:(M1)	U003_S001	155

## Exclusive Parts

Number	Part Name	Group	ID
D6831811	BRACKET:MOTOR:SCANNING:EXIT	U003_S001	156
D6831813	TIMING PULLEY:COUPLING:SCANNING:INNER BACK	U003_S001	157
D6831814	TIMING PULLEY:COUPLING:EXIT	U003_S001	158
D6831822	DC MOTOR:20W:SCANNING:20W:BRUSHLESS:(M3/M6)	U003_S001	159
D6831841	BRACKET:TENSIONER:SCANNING:INNER BACK	U003_S001	160
D6831845	PULLEY:IDLER:DIA14	U003_S001 U012	161 62
D6831851	BRACKET:TENSIONER:SCANNING:FRONT	U003_S001	162
D6831855	TIMING PULLEY:TENSIONER:SCANNING:FRONT	U003_S001	163
D6831856	TENSION SPRING:TENSION:SCANNING:FRONT	U003_S001	164
D6831912	BRACKET:HINGE:RIGHT	U003_S001	165
D6832110	ROLLER:PULL OUT:DRIVE	U003_S001	166
D6832112	TIMING PULLEY:ROLLER:PULL OUT:DRIVE	U003_S001	167
D6832210	ROLLER:MIDDLE:DRIVE	U003_S001	168
D6832215	SHAFT:SEPARATION:DRIVE	U003_S001_S001	169
D6832221	GEAR:IDLER:Z18	U003_S001_S001	170
D6832222	STOPPER:SHAFT:SEPARATION:DRIVE	U003_S001	171
D6832224	GUIDE:PAPER FEED:ENTRANCE:FRONT	U003_S001_S001	172
D6832228	PICKUP ROLLER	U003_S001_S001	173
D6832229	TIMING PULLEY:GEAR:T19/Z23	U003_S001_S001	174
D6832231	BRACKET:PICKUP	U003_S001_S001	175
D6832232	TIMING PULLEY:PICKUP:T21	U003_S001_S001	176
D6832233	BRACKET:PAPER FEED BELT	U003_S001_S001	177
D6832235	SHAFT:PICKUP:SUB-ASS'Y	U003_S001_S001	178
D6832236	SHEET:BRACKET:PICKUP:INNER BACK	U003_S001_S001	179
D6832239	COVER:PICKUP ROLLER	U003_S001_S001	180
D6832240	GUIDE:PAPER FEED:ENTRANCE:INNER	U003_S001_S001	181

Number	Part Name	Group	ID
	NNER BACK:ASS'Y	S001	
D6832242	SHEET:GUIDE:PAPER FEED:INNER BACK	U003_S001_S001_S001	182
D6832272	LEVER:PICKUP ROLLER:RISE	U003_S001_S001	183
D6832311	TORQUE LIMITER MECHANICAL CLUTCH:SEPARATOR	U003_S001	184
D6832393	HOLDER:ORIGINAL TABLE	U003_S001	185
D6832415	SHEET:SEPARATION:ENTRANCE	U003_S001	186
D6832417	SHEET:ENTRANCE:SEPARATION PAD	U003_S001	187
D6832728	STOPPER:RELEASE:SHAFT:BASE	U003_S001	188
D6832729	JOINT:RISING TRAY:AUXILIARY	U003_S001	189
D6832733	FEELER:SENSOR:ORIGINAL SENSOR	U003_S001	190
D6832742	CUSHION:STOPPER PAWL	U003_S001	191
D6832743	SHEET:CUSHION:STOPPER PAWL	U003_S001	192
D6832747	PAD:SIDE FENCE:SMALL	U003_S001	193
D6832748	PAD:SIDE FENCE:LARGE	U003_S001	194
D6832752	LEVER:RISE:BASE	U003_S001	195
D6832755	SHAFT:RISE:BASE:SUB-ASS'Y	U003_S001	196
D6832781	ORIGINAL TABLE:BEHIND	U003_S001	197
D6832912	FEELER:PAPER SIZE SENSOR	U003_S001	198
D6832913	SHEET:SENSOR:SEPARATION	U003_S001	199
D6833111	ROLLER:SCANNING:ENTRANCE:DRIVE	U003_S001	200
D6833150	ROLLER:SCANNING:EXIT:DRIVE:ASS'Y	U003_S001_S007	201
D6833155	TIMING PULLEY:ROLLER:SCANNING:EXIT:DRIVE	U003_S001	202
D6833221	GUIDE:SCANNING:UPPER	U003_S001	203
D6833251	GROUND PLATE:ROLLER	U003_S001	204
D6833260	SHEET:SCANNING:EXIT:UPPER:ASS'Y	U003_S001	205
D6833311	BRACKET:GUIDE:SCANNING:UPPER	U003_S001	206
D6833350	GUIDE PLATE:SCANNING	U003_S001	207
D6833361	SPRING PLATE:GUIDE PLATE:SCANNING	U003_S001	208

## Exclusive Parts

Number	Part Name	Group	ID
D6833411	GUIDE:SCANNING:ENTRANCE:LOWER:SUB-ASS'Y	U003_S001_S009	209
D6833421	BASE:SCANNING:ENTRANCE:LOWER	U003_S001	210
D6833422	LEVER:PRESSURE RELEASE	U003_S001	211
D6833510	SHAFT:LEVER:MISFEED REMOVAL:ASS'Y	U003_S001	212
D6833616	BRACKET:DISCHARGE BRUSH	U003_S001_S008	213
D6833621	GUIDE:EXIT:LOWER:SUB-ASS'Y	U003_S001_S008	214
D6833641	GUIDE:CONTACT IMAGE SENSOR:EXIT:LOWER:ASS'Y	U003_S001_S008 S001	215
D6833643	COMPRESSION SPRING:CONTACT IMAGE SENSOR:EXIT	U003_S001_S008 S001	216
D6833644	SHEET:GUIDE:CONTACT IMAGE SENSOR:EXIT:LOWER	U003_S001_S008 S001	217
D6833645	ROLLER:MIDDLE:DRIVEN	U003_S001 U003_S001_S008 S001	218 218
D6833651	COVER:SCANNING:EXIT	U003_S001_S008	219
D6833662	GUIDE PLATE:CONTACT IMAGE SENSOR:ENTRANCE:ASS'Y	U003_S001_S008 S002	220
D6833666	LEVER:GUIDE PLATE:CONTACT IMAGE SENSOR:FRONT	U003_S001_S008 S002	221
D6833667	LEVER:GUIDE PLATE:CONTACT IMAGE SENSOR:REAR	U003_S001_S008 S002	222
D6833668	SPACER:GUIDE PLATE:CONTACT IMAGE SENSOR:ENTRANCE	U003_S001_S008 S002	223
D6833710	ROLLER:CONTACT IMAGE SENSOR:EXIT:DRIVE:PRESS FIT	U003_S001	224
D6833714	TIMING PULLEY:ROLLER:CIS:EXIT:DRIVE	U003_S001	225
D6833715	TIMING PULLEY:ROLLER:CIS:EXIT:FRONT	U003_S001	226
D6833811	GUIDE PLATE:EXIT:UPPER	U003_S001_S006	227
D6833812	DISCHARGE BRUSH:EXIT	U003_S001_S006 U003_S001_S008 S002	228 228
D6833911	ROLLER:EXIT:DRIVE	U003_S001	229

Number	Part Name	Group	ID
D6833915	TIMING PULLEY:ROLLER:EXIT:DRIVE	U003_S001	230
D6834323	SHAFT:CONTACT POINT:GUIDE:APER FEED	U003_S001	231
D6834341	BRACKET:PULL OUT:DRIVEN	U003_S001	232
D6834343	PRESSURE PLATE:PICKUP	U003_S001_S004	233
D6834344	COMPRESSION SPRING:PICKUP:2.1N	U003_S001_S004	234
D6834345	DISCHARGE BRUSH:EXIT:L37	U003_S001	235
D6834350	DRIVEN ROLLER:PULL OUT	U003_S001	236
D6834351	LINK:STOPPER:COVER:PAPER FEED	U003_S001_S004	237
D6834361	SHAFT:CONTACT POINT:GRIP	U003_S001_S004	238
D6834367	GROUND PLATE:HOOK:INNER BACK	U003_S001_S004	239
D6834372	HOOK:CONTACT POINT:FRONT:GRIP	U003_S001_S004	240
D6834374	HOOK:CONTACT POINT:INNER BACK:GRIP	U003_S001_S004	241
D6834414	SPACER:EXIT ROLLER	U003_S001	242
D6834421	SHAFT:EXIT:DRIVEN	U003_S001	243
D6834430	ROLLER:EXIT:DRIVEN	U003_S001	244
D6834441	HOLDER:CUSHION:PRESSURE PLATE	U003_S001	245
D6834442	TAPE:PRESSURE PLATE	U003_S001 U003_S001_S005 U003_S001_S008	246 246 246
D6835111	GUIDE:HARNESS:MAIN	U003_S001	247
D6835121	GUIDE:HARNESS:SUB	U003_S001	248
D6842171	PAPER FEED BELT	U003_S001_S001	249
D6842412	PAD:STOPPER:ORIGINAL	U003_S001	250
D6844142	TIMING BELT:60S2M174	U016	77
D6884895	BINDING HEAD SCREW:ROUND POINT:M3X8	U015	144
D6902425	DISCHARGE BRUSH:SHORT:FRONT	U003_S001_S006	251
D7312734	COVER:LOWER:BASE	U003_S001	252
D7312746	SIDE FENCE:ORIGINAL TABLE	U003_S001	253



## Exclusive Parts

Number	Part Name	Group	ID
D7312751	RAIL:SIDE FENCE	U003_S001	254
D7312771	ORIGINAL TABLE:FACE FRONT	U003_S001	255
D7312913	GUIDE PLATE:PULL OUT:LOWER	U003_S001	256
D7312914	GUIDE PLATE:PULL OUT:LOWER: DOUBLE FEED SENSOR	U003_S001	257
D7313511	HOOK:OPTICAL READING UNIT:FR ONT	U003_S001	258
D7314112	COVER:FRONT RIGHT	U003_S001	259
D7314113	COVER:FRONT	U003_S001	260
D7314211	COVER:REAR	U003_S001	261
D7314311	GUIDE:PAPER FEED:UPPER:SUB- ASS'Y	U003_S001_S003	262
D7314315	GUIDE:PAPER FEED:UPPER:DOU BLE FEED SENSOR	U003_S001	263
D7314336	CUSHION:STOPPER:FEELER:ORI GINAL SENSOR	U003_S001_S004	264
D7314352	BRACKET:PRESSURE:PICKUP	U003_S001_S004	265
D7314370	COVER:PAPER FEED:ASS'Y	U003_S001_S004	266
D7314371	GRIP:COVER:PAPER FEED	U003_S001_S004	267
D7314412	TRAY:EXIT:AUXILIARY:LARGE	U003_S001	268
D7314413	TRAY:EXIT:AUXILIARY:SMALL	U003_S001	269
D7314418	TRAY:EXIT	U003_S001	270
D7314510	COVER:LOWER:ASS'Y	U003_S001_S005	271
D7314611	COVER:LEFT LOWER	U003_S001	272
D7315310	PCB:URTB:DOCUMENT FEEDER:A SS'Y:(PCB18)	U006	507
D7316011	DECAL:SIZE:ORIGINAL	U003_S001	273
D7316031	DECAL:SET:ORIGINAL TABLE	U003_S001	274
D7316041	DECAL:BASE:ORIGINAL	U003_S001	275
D7316051	DECAL:DESIGN SKETCH:MISFEED REMOVAL:P	U003_S001	276
D7316241	DECAL:STOPPER:SEPARATION U NIT	U003_S001	277
D7773126	TIMING PULLEY:DRIVE:T25S2M	U015	145
G0143291	SNAP RING - PICK UP	U009_S001	127
G0342986	FLANGED HEXAGONAL HEAD BOL T - M4X8	U021	80
G0602296	BALL BEARING:8X16X5MM	U006	508

Number	Part Name	Group	ID
G0602652	BUSHING - M4	U003_S001	278
		U003_S001_S008 S001	278
G0703088	SPACER:DEVELOPMENT ROLLER	U006	509
G0801169	SCREW:M3	U010_S001_S001	58
G1021193	HEXAGONAL BOLT:DOUBLE:SCRE W:ROUND POINT:M3X7	U014_S001_S005	157
G1664310	DECAL:WARNING (HIGH TEMPER ATURE):1:CUD	U015	146
G1781138	SCREW WITH WASHER:M6X14	U021	81
G1781141	HOLDER:STAND:M20	U022	33
G1781282	GEAR:CHARGE:CLEANER:Z51	U008	118
G1781289	FLY WHEEL:DRUM	U017	66
G1781291	JOINT:TRANSPORT SCREW:NO.2	U017	67
G1781307	JOINT:DEVELOPMENT ROLLER:D RIVE	U017	68
G1781311	TERMINAL:CHARGE	U008	119
G1781313	SPRING:PLATE:RIGHT:CHARGE	U008	120
G1781316	SPRING:PLATE:LEFT:CHARGE	U008	121
G1781602	ARM:SAFETY SWITCH:UPPER:AS S'Y	U001	90
G1782500	GRID:CHARGE CORONA	U008_S001	122
G1782502	CUSHION:CORONA WIRE	U008_S001	123
G1782507	CLEANER:GRID:ASS'Y	U008_S001	124
G1782510	CLEANER:CORONA WIRE:ASS'Y	U008_S001	125
G1782512	COVER:END BLOCK:FRONT	U008_S001	126
G1782516	END BLOCK:CHARGE CORONA:F RONT	U008_S001	127
G1782521	SLIDER:CLEANER:CHARGE CORO NA:ASS'Y	U008_S001	128
G1782522	RING:SLIDER	U008_S001	129
G1782570	SCREW SHAFT:CHARGE CORONA :ASS'Y	U008_S001	130
G1782605	TENSION SPRING:CORONA WIRE	U008_S001	131
G1782971	LEVER:LOCK:TANDEM LCT	U006_S003	510
G1783330	GEAR:IDLER:DEVELOPMENT ROL LER:ASS'Y	U008_S003	132
G1783332	GEAR:DEVELOPMENT ROLLER	U008_S003	133

## Exclusive Parts

Number	Part Name	Group	ID
G1783356	GEAR:JOINT:DEVELOPMENT UNIT	U008_S003	134
G1783475	SPONGE:COUPLING:TONER SUPPLY:DEVELOPMENT UNIT	U008_S003	135
G1783593	TENSION SPRING:STOPPER	U015	147
G1783672	CAP:PIPE:DISCHARGE USED TONER	U008_S002	136
G1783685	HOLDER:SHAFT:CLEANING BLADE:REAR	U008_S002	137
G1783707	SHEET:COATING BAR:2	U008_S002_S001	138
G1783713	BUSHING:APPLY	U008_S002_S001	139
G1783734	GUIDE PLATE:ARM	U008_S002_S001	140
G1783781	GUIDE:COATING BAR	U008_S002_S001	141
G1783870	TIMING PULLEY:T30	U013	27
G1784018	CASE:COATING BAR:TRANSFER ROLLER	U011_S001	67
G1784636	TIMING BELT:S2M134_67	U013	28
G1784808	BRACKET:PRESSURE:ROLLER	U016	78
G1784817	SPRING:PRESSURE:ROLLER:DUPLEX	U016	79
G1784818	SPRING:PULL OUT:LOCK:EXIT	U021	82
G1784822	SPRING:PRESSURE:0.8N:DIA0.65	U015	148
G1784828	STAY:LOCK:LEVER:LEFT LOWER	U015	149
G1784890	SPRING PLATE:DUPLEX:GUIDE:LOWER	U016	80
G1784895	SHEET:DUPLEX:SPRING PLATE	U016	81
G1784900	COVER:DC STEPPER MOTOR:MM56	U006 U015	511 150
G1784908	COIL SPRING:LEFT LOWER:LOCK	U015	151
G1784909	SCREW:TRANSPORT	U021	83
G1784912	PULLEY:S2M:30T	U006	512
G1784916	SCREW:ROUND POINT	U016	82
G1785145	SHEET:GBC:UPPER	U021	92
G1786621	COVER:RELEASE PLATE:BLADE	U010_S001	59
G1786767	COATING BAR:TRANSFER ROLLER	U011_S001	68
G1787453	ARM:ON-OFF:TRANSPORT ROLLER	U015	152
G1787515	CONNECTOR GUIDE PIN:CONNECTOR	U021	84

Number	Part Name	Group	ID
	TOR		
G1787618	PLATE:FIX:BAND	U016	83
G1787660	PRESSURE ROLLER:TRANSPORT ROLLER	U006	513
G1787664	SPACER	U006	514
G1787819	SEAL:CAP:COLLECTION BOTTLE	U012_S002	63
G1788350	WRENCH:HEXAGONAL BOLT	U022	34
G3631105	DETENT ROLLER SHAFT	U006_S009_S001 U006_S009_S002	515 515
G4042810	SPRING PLATE - 2ND MIRROR	U004_S005	63
G5701225	SENSOR SHIELDING PLATE	U004	64
GA000063	DECAL:DEVELOPMENT UNIT:DISPLAY	U008_S003	142
GA082010	BUSHING:DIA6:DIA10:9	U012	64
GW010007	PHOTO REFLECTION SENSOR:EXIT:(SEN11/SEN12/SEN13/SEN14/SEN15/SEN16/SEN17/SEN18/SEN19/SEN22/SEN24/SEN25/SEN26/SEN27/SEN28/SEN29/SEN30/SEN31/SEN49/SEN109)	U006 U015 U016	516 153 84
GW010009	DENSITY SENSOR:(SEN92)	U009_S001	128
GW020024	PHOTO INTERRUPTOR:LG2A24BL1:GF:(SEN3/SEN21/SEN35/SEN36/SEN37/SEN38/SEN39/SEN40/SEN41/SEN42/SEN43/SEN44/SEN45/SEN46/SEN47/SEN48/SEN51/SEN53/SEN54/SEN60/SEN61/SEN62/SEN71/SEN72/SEN81/SEN82/SEN89/SEN90/SEN91/SEN104)	U004 U006 U006_S006 U006_S007 U006_S008 U006_S012 U007 U008 U009_S001 U012 U014_S001 U015	65 517 517 517 517 517 89 143 129 65 158 154
GW230008	TONER END SENSOR:(SEN73)	U007_S004	90
GX060019	STEPPER MOTOR:PM42L048RBG8:(STM32/STM33)	U007_S004	91
GX640028	FAN MOTOR DC24V 1.92W:(FAN3/FAN28/FAN29)	U006 U020	518 114

## Exclusive Parts

Number	Part Name	Group	ID
H0602126	BUSHING - M6X7	U003_S001_S001	279
H0722216	COMPRESSION SPRING	U015	155
H5194238	SPACER:ROLLER:CONNECTING	U006	519
J0155505	DRAWER:CONNECTOR:USED DEV ELOPER:PLUG	U008_S002_S001	144
J5033116	TIMING BELT:40S2M128	U015	156
M0261815	CLAMP:MIRROR:NO.1	U004_S002	66
M0447747	CAP:COVER:REAR	U001	91
M0774200	MECHANICAL ROLLER CLUTCH:R OLLER	U014_S002	159
M0774703	BRACKET:ADAPTER SECTION:GB C:PEEN	U021	93
M0774707	GUIDE PLATE:GBC:ASS'Y	U021	94
M0774821	TRANSPORT BELT:COOLING	U015	157
M0777428	BALL BEARING:REGISTRATION:D RIVEN:FRONT	U006	520
M0777429	BALL BEARING:REGISTRATION:D RIVEN:REAR	U006	521
M0B11328	ANTISTATIC BRUSH:DRUM	U017	69
M0B14675	GATE PAWL:EXIT:REVERSE	U015	158
M0BJ5780	DISPLSY:TM170-RIX01	U002	14
M2051682	DOOR CATCH:FRONT	U001	92
M2057305	REGISTRATION ROLLER:GATE:AS S'Y	U006_S002	522
M2057311	DISC:GATE:REGISTRATION:HOME POSITION SENSOR	U006	523
M2057466	DUCT:SHIFT:CIS	U006	524
M3644131	TIMING BELT:B40S2M160	U003_S001	280
M5001861	TUBE TYPE LAMP:ASS'Y:(PCB14)	U022_S003	38
		U022_S005	38
		U023	1
VSSG9002	FLUOTRIBO MG GREASE : 100G	SPECIAL TOOLS	17
VSSM9000	DIGITAL MULTIMETER-FLUKE189/ FVF	SPECIAL TOOLS	18

# Standard Parts



03125060N  
SCREW - M2.5X6



03130040N  
SCREW:M3X4



03130060N  
SCREW - M3X6



03130080N  
PAN HEAD SCREW:M3X8



03130120N  
PAN HEAD SCREW:M3X12



03140120N  
SCREW - M4X12



03140180N  
PAN HEAD SCREW:M4X18



03150100N  
PAN HEAD SCREW:M5X10



03530040N  
SCREW - M3X4



03530060N  
BIND SCREW - M3X6



03530080N  
SCREW:M3X8



03530100N  
SCREW-M3X10



03530120N  
SCREW M3X12

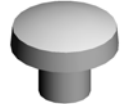

03540040N  
SCREW-M4X4



03540050N  
SCREW - M4X5



03540060N  
SCREW-M4X6



03540080N  
SCREW:M4X8



03540120N  
SCREW M4X12



03540400N  
SCREW:M4X40



03603005N  
SCREW - M3X5



03603006N  
SCREW - M3X6



03603008N  
SCREW:M3X8



03603010N  
SCREW:M3X10



03603014N  
SCREW - M3X14



03603020N  
SCREW:M3X20



03603030N  
SCREW:M3X30



03604006N  
SCREW - M4X6

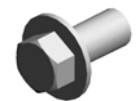

03604008N  
SCREW - M4X8

## Standard Parts



03604010N  
SCREW:M4X10



03604012N  
SCREW:M4X12



03604014N  
SCREW - M4X14



03604016N  
SCREW:M4X16



04340060N  
PAN SELF-TAPPING SCREW:  
M4X6



04340200N  
PAN SELF-TAPPING SCREW:  
4X20

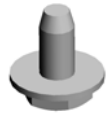

04503006N  
TAPPING SCREW - M3X6



04503008N  
TAPPING SCREW - M3X8



04503010N  
TAPPING SCREW - M3X10



04503012N  
TAPPING SCREW:3X12



04504008N  
TAPPING SCREW - M4X8



04504010N  
TAPPING SCREW:M4X10



04504012N  
TAPPING SCREW:4X12



04504025N  
TAPPING SCREW:4X25



04513006N  
TAPPING SCREW - 3X6



04513006P  
TAPPING SCREW:M3X6



04513008N  
TAPPING SCREW - M3X8



04513010N  
TAPPING SCREW:3X10



04513014N  
TAPPING SCREW:3X14



04513020N  
TAPPING SCREW:3X20



04513030N  
TAPPING SCREW:3X30



04514006N  
TAPPING SCREW - 4X6



04514008N  
TAPPING SCREW:4X8



04514010N  
TAPPING SCREW:4X10



04514012N  
TAPPING SCREW:4X12



04523008N  
TAPPING SCREW - M3X8



04523010N  
BINDING SELF-TAPPING SC  
REW:3X10



04524008N  
TAPPING SCREW:M4X8

## Standard Parts



04524010N  
BINDING SELF-TAPPING SCREW:4X10



04524012N  
BINDING SELF-TAPPING SCREW:4X12



04533006N  
TAPPING SCREW - M3X6



04534006N  
BINDING SELF TAPPING SCREW:4X6



04534008N  
BINDING SELF TAPPING SCREW:4X8



04543005N  
HEXAGON HEAD TAPPING SCREW:ROUND POINT:3X5



04543006N  
TAPPING SCREW:ROUND POINT:3X6



04543006Q  
TAPPING SCREW - M3X6



04543008Q  
TAPPING SCREW:3X8



04543014Q  
TAPPING SCREW:3X14



04543030Q  
TAPPING SCREW:ROUND POINT:3X30



04544006Q  
TAPPING SCREW:4X6



04544008Q  
TAPPING SCREW - M4X8



04544010N  
TAPPING SCREW:ROUND POINT:4X10



04583008N  
HEXAGON HEAD TAPPING SCREW:3X8



05730030E  
HEXAGON HEADLESS SET SCREW - M3X3

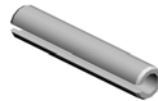

06230160E  
SPRING PIN - 3X16MM

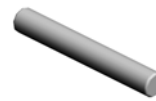

06320140G  
PARALLEL PIN



06320200G  
PARALLEL PIN:2X20

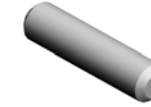

06330120G  
PARALLEL PIN - 3X12

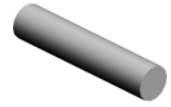

06330140G  
PARALLEL PIN - 3X14

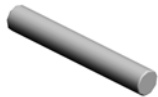

06330200G  
PIN - M3X20



07010050G  
WASHER(POLISHED ROUND):DIA5



07030040N  
SPRING WASHER:DIA4



07040050N  
WASHER:DIA5



07050040N  
WASHER:DIA4

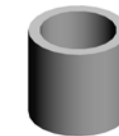

07074050N  
BUSHING - 4X5



07080060N  
WASHER:DIA6

## Standard Parts



07080080N  
WASHER-DIA8



07110030N  
HEXAGONAL NUT:M3



07200020E  
RETAINING RING - M2



07200025E  
RETAINING RING - M2.5



07200030E  
RETAINING RING - M3



07200040E  
RETAINING RING - M4



07200060E  
RETAINING RING - M6



07200080E  
RETAINING RING - M8



07250200E  
RETAINING RING C - M20



07250220E  
RETAINING RING - M22



07250250E  
RETAINING RING C - M25



07330610  
BUSHING: DIA6X10



07403008  
BALL BEARING - 8X22X7



07403012  
BALL BEARING - 12X28X8



07403808  
BALL BEARING - 8X16X5MM



07413506  
BALL BEARING - 6X12X4 MM



07413706  
BALL BEARING - 6X10X3



07413708  
BALL BEARING - 8X12X3.5M



07433806  
RADIAL BALL BEARING: DIA6  
XDIA13X5

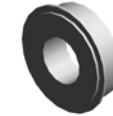

07433808  
RADIAL BALL BEARING: DIA8  
XDIA16X5



08010234  
SCREW WITH WASHER: SMA  
LL ROUND WITH SPRING WA  
SHER: M5X8



08010237  
HEXAGONAL BOLT: DOUBLE  
SCREW: M4X12



08025220  
TAPPING SCREW - M4X8



08025299  
TAPPING SCREW - M3X8



08025312  
TAPPING SCREW: WASHER: 3  
X10



08025330  
PAN HEAD WITH COLLAR TA  
PPING SCREW: PF: 4X10



08046123  
HEXAGONAL BOLT: W/WASH  
ER: M3X8



08050072  
CS RING

## Standard Parts



08050088  
RETAINING RING - M6



08050089  
RETAINING RING - M4



08050092  
RETAINING RING - 3M



08050100  
RETAINING RING - M2.5



08050103  
RETAINING RINGS-E:SILENC  
ER:DIA3



08050104  
RETAINING RINGS-E:SILENC  
ER:DIA4



08050106  
RETAINING RINGS-E:SILENC  
ER:DIA6



08053263  
BEARING - 6X10X6MM



08053386  
BUSHING - 8MM



08053445  
BEARING - M6X10X3



08053480  
BUSHING - 6MM



08053568  
RADIAL BALL BEARING:DIA8  
XDIA14X4

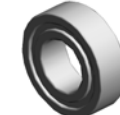

08053573  
RADIAL BALL BEARING:DIA8  
XDIA16X5



08053585  
RADIAL BALL BEARING:DIA8  
XDIA16X5

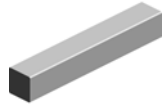

09300404A  
PARALLEL KEY:4X4X25



09503006N  
SCREW:SPRING WASHER:M  
3X6



09513006N  
SCREW - M3X6



09514006N  
SCREW:POLISHED ROUND:  
M4X6



09514008N  
SCREW:POLISHED ROUND:  
M4X8



09514010N  
SCREW:POLISHED ROUND:  
M4X10



09514020N  
SCREW - M4X20



09543006N  
SCREW - M3X6



09543008N  
SCREW - M3X8



09543010N  
SCREW:POLISHED ROUND/  
SPRING:M3X10

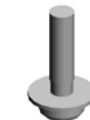

09543012N  
SCREW - M3X12

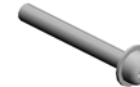

09543025N  
SCREW:POLISHED ROUND/  
SPRING:M3X25



09544008N  
SCREW - M4X8



09545010N  
SCREW:POLISHED ROUND/  
SPRING:M5X10



## Standard Parts



11050042  
WIRE BAND



11050046  
HARNESS BAND

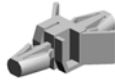

11050193  
NYLON STUD



11050328  
HARNESS CLAMP - ES-0505



11050367  
SPACER



11050410  
CARD SPACER - 9.4MM



11050487  
HARNESS CLAMP



11050488  
HARNESS CLAMP



11050489  
HARNESS CLAMP - LWS 131  
6



11050490  
HARNESS CLAMP - IWS-2218  
6



11050508  
HARNESS CLAMP - LWS-071  
1



11050511  
HARNESS CLAMP - LWS-030  
6ZC



11050516  
CLAMP



11050528  
NYLON CLAMP - EMT-2N



11050529  
NYLON CLAMP-EMT-3N

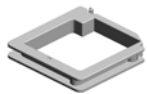

11050532  
EDGE SADDLE - LES-25L



11050534  
CLAMP



11050551  
CLAMP:LES-0505



11050559  
CLAMP:EMT-5N



11050568  
CLAMP:LWSS-0504



11050601  
CLAMP:LWSS-0511-2M



11050692  
CLAMP:LES-0503



11050711  
CLAMP:JDL-1S



11050723  
CLAMPS:WES-0507



11050724  
CLAMPS:WES-1210



11050725  
CLAMPS:WES-1117

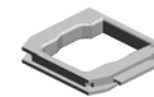

11050726  
CLAMPS:WES-2217



11050744  
CLAMP:F-LWS-0711

## Standard Parts



11050751  
CLAMP:LWSM-0606-3.2M

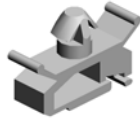

11050758  
CLAMP:LWSM-0306A



11050760  
CLAMP:LWSM-0511A



11050762  
CLAMP:LWS-0711A



11060911  
BUSHING:SB-1909



11071280  
(Pro 8300S/8310S/8310):FUSE:  
E:BJS1512F2:(BL1)

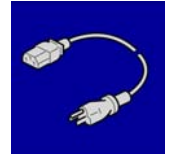

11500455  
(NA):POWER SUPPLY CODE  
250V:20A

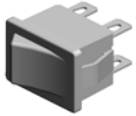

12042570  
ROCKER SWITCH:SDDJE132  
00:(SW100/SW101)

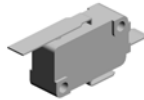

12042612  
MICRO SWITCH:D3V-16506-3  
C25:(SW10/SW11/SW102/SW  
103)

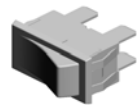

12042614  
SWITCH AC250V/16A:(SW12)

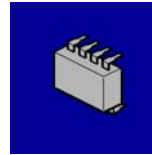

14078389  
EEPROM:BR24T128-W

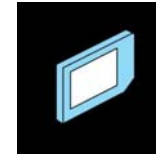

14078476  
ROM STORAGE:SDXC8GB



16071799  
FILTER - SUP-ET20-ER-0:(NF  
1)



16072256  
FERRITE CORE:K3 NFR-08-A  
BK0

## PM Part List

Number	Part Name	Num	Group	ID
AB011125	GEAR:20/29Z	1	U011_S001	23
AB011126	GEAR:20Z	1	U011_S001	24
AE020220	PRESSURE ROLLER:DIA65	1	U014_S001_S001	51
AE030086	RADIAL BALL BEARING:DIA25XDIA37X7	4	U014_S001	54
			U014_S001_S001	54
AE045065	WEB:SUB-ASS'Y	1	U014_S002	59
AF030072	PAPER FEED ROLLER:PICK UP	3	U006_S006	162
			U006_S007	162
			U006_S008	162
AF031098	PAPER FEED ROLLER:FEED	3	U006_S006	163
			U006_S007	163
			U006_S008	163
AF032098	PAPER FEED ROLLER:SEPARATE	3	U006_S006	164
			U006_S007	164
			U006_S008	164
D0742459	JOINT:CLEANING UNIT	1	U008_S002_S001	38
D0746257	BRUSH ROLLER:APPLY:ASS'Y	1	U011_S001	34
D0746265	BLADE:TRANSFER ROLLER:ASS'Y	1	U011_S001	35
D0746312	GEAR:IDLER:TRANSFER ROLLER	1	U011_S001	41
D0746424	BLADE:CLEANING:BELT CLEANING:ASS'Y	1	U010_S001	15
D0746446	BRUSH:APPLY:BELT CLEANING	1	U010_S001	24
D0746450	COATING BAR:ASS'Y	1	U010_S001_S001	25
D0746457	BLADE:APPLY:ASS'Y	1	U010_S001	28
D0BX4162	HOT ROLLER:DIA54:ASS'Y	1	U014_S001_S002	101
D0BX6051	ROLLER:INTERMEDIATE TRANSFER:ASS'Y	1	U009_S001	67
D0BX6078	ROLLER:OPPOSED:PAPER:ASS'Y	1	U009_S001	68
D0BX6250	TRANSFER ROLLER	1	U011_S001	47
D0BX6889	FILTER:MAIN:EXHAUST:RIGHT	2	U020	30
D0BX6909	FILTER:DUCT:MAIN:REAR	2	U020	32
D1792224	CORONA WIRE:CHARGE CO	3	U008_S001	51

Number	Part Name	Num	Group	ID
	RONA			
D1793535	GEAR SET:CLEANING UNIT:SERVICE PARTS	1	U008_S002_S002	88
D1793581	BLADE:CLEANING:ASS'Y	1	U008_S002	96
D1793635	COATING BAR:ASS'Y	1	U008_S002_S001	101
D1793641	BRUSH ROLLER:APPLY:ASS'Y	1	U008_S002_S001	102
D1793653	BLADE:APPLY:ASS'Y	1	U008_S002_S001	105
D1794197	FLAT BELT-FUSING:DIA80:SEAL	1	U014_S001	128
D1796050	FLAT BELT-TRANSFER	1	U009	85
D1796310	SEPARATION CORONA:ASS'Y	1	U011_S001_S001	54
D1796311	GEAR:TRANSFER ROLLER	1	U011_S001	55
D1799510	OPC DRUM	1	U008	109
D1799640	DEVELOPER BLACK	3	U022	29
D2704343	ROLLER:PLATE	1	U014_S002	155
D5412241	REVERSE ROLLER:PAPER FEED	1	U003_S001	116
D6832228	PICKUP ROLLER	1	U003_S001_S001	173
D6842171	PAPER FEED BELT	1	U003_S001_S001	249
G1782500	GRID:CHARGE CORONA	1	U008_S001	122
G1782502	CUSHION:CORONA WIRE	6	U008_S001	123
G1782507	CLEANER:GRID:ASS'Y	1	U008_S001	124
G1782510	CLEANER:CORONA WIRE:ASS'Y	3	U008_S001	125
G1786767	COATING BAR:TRANSFER ROLLER	1	U011_S001	68

## Design Change List

Number	Title	Set	Old Part		New Part		Index No.		Q'ty	Interchg		Reason	Cut-in S/N
			P/N	Name	P/N	Name	Group	ID		Indiv.	Set		
201911-02	1911 Modification	-			D3FF6071	DECAL:CAUTION:ORIGINAL:PICK-UP PAPER JAM	U003_S001_S001	284	1				
201910-01	1910 Modification	-	AZ240309	POWER SUPPLY UNIT:ECO:456.4W:(PCB28)	AZ240355	POWER SUPPLY UNIT:ECO:(PCB28)	U019	63	3	X/O			
201910-02	1910 Modification	-	AZ240311	POWER SUPPLY UNIT:FW:446.4W:(PCB29)	AZ240356	POWER SUPPLY UNIT:FW:(PCB29)	U019	64	3	X/O			
201909-01	1909 Modification	-	D0BX5615	(Pro 8320S):PCB:SERVICE:CTL:(PCB17)	D0BX5622	(Pro 8320S):PCB:SERVICE:CTL:(PCB17)	U019	62	1	O/O			
201909-02	1909 Modification	-	D0747389	DECAL:PAPER SET DIRECTION:TANDEM LCT:LEFT	D2707389	DECAL:PAPER SET DIRECTION:TANDEM LCT:LEFT	U006	528	1	O/O			
201907-01	1907 Modification	-			D0BX1465	BRACKET:KEY COUNTER	U021	95	1				
201907-02	1907 Modification	-			D1791316	JOINT:DRIVE:FUSING	U017_S002	70	1				
201907-03	1907 Modification	-			D3FF2851	SENSOR COVER:PHOTOINTERRUPTOR	U003_S001	282	1				
201907-04	1907 Modification	-			D3FF2852	COVER:SENSOR	U003_S001	283	1				
201907-08	1907 Modification	-	D0BX4245	STAY:STRIPPER PLATE:PEEN			U014_S001_S005	103	1				
201907-09	1907 Modification	-			D0BX7662	ACCESSORY:COVER:SIDE:RIGHT:ASS'Y	U022	53	3				
201907-10	1907 Modification	-			D2585715	CABLE:HDD:SAT	U019	61	3				

## Design Change List

Number	Title	Set	Old Part		New Part		Index No.		Q'ty	Interchg		Reason	Cut-in S/N
			P/N	Name	P/N	Name	Group	ID		Indiv.	Set		
		-				A:2CON_POWER_3P							
201904-01	1904 Modification	-	B6522215	GUIDE:PAPER FEED BELT:FRONT	D3FF2219	GUIDE:PAPER FEED BELT:FRONT	U003_S001_S001	111	1	O/O			
201904-02	1904 Modification	-	11050758	CLAMP:LWSM-0306A	11050511	HARNESS CLAMP - LWS-0306ZC	U004	12	1	X/O			
			11050758	CLAMP:LWSM-0306A	11050511	HARNESS CLAMP - LWS-0306ZC	U004	12	1	X/O			
			11050758	CLAMP:LWSM-0306A	11050511	HARNESS CLAMP - LWS-0306ZC	U004	12	1	X/O			
			11050758	CLAMP:LWSM-0306A	11050511	HARNESS CLAMP - LWS-0306ZC	U004	12	1	X/O			
			11050758	CLAMP:LWSM-0306A	11050511	HARNESS CLAMP - LWS-0306ZC	U004	12	1	X/O			
			11050758	CLAMP:LWSM-0306A	11050511	HARNESS CLAMP - LWS-0306ZC	U004	12	1	X/O			
			11050758	CLAMP:LWSM-0306A	11050511	HARNESS CLAMP - LWS-0306ZC	U004	12	1	X/O			
			11050758	CLAMP:LWSM-0306A	11050511	HARNESS CLAMP - LWS-0306ZC	U004	12	1	X/O			
			11050758	CLAMP:LWSM-0306A	11050511	HARNESS CLAMP - LWS-0306ZC	U004	12	1	X/O			
			11050758	CLAMP:LWSM-0306A	11050511	HARNESS CLAMP - LWS-0306ZC	U004	12	1	X/O			
			11050758	CLAMP:LWSM-0306A	11050511	HARNESS CLAMP - LWS-0306ZC	U004	12	1	X/O			
			11050758	CLAMP:LWSM-0306A	11050511	HARNESS CLAMP - LWS-0306ZC	U004	12	1	X/O			
			11050758	CLAMP:LWSM-0306A	11050511	HARNESS CLAMP - LWS-0306ZC	U004	12	1	X/O			

## Design Change List

Number	Title	Set	Old Part		New Part		Index No.		Q'ty	Interchg		Reason	Cut-in S/N
			P/N	Name	P/N	Name	Group	ID		Indiv.	Set		
		-		06A		P - LWS-0306ZC							
			11050758	CLAMP:LWSM-0306A	11050511	HARNESS CLAMP - LWS-0306ZC	U004	12	1	X/O			
			11050758	CLAMP:LWSM-0306A	11050511	HARNESS CLAMP - LWS-0306ZC	U004	12	1	X/O			
			11050758	CLAMP:LWSM-0306A	11050511	HARNESS CLAMP - LWS-0306ZC	U004	12	1	X/O			
			11050758	CLAMP:LWSM-0306A	11050511	HARNESS CLAMP - LWS-0306ZC	U004	12	1	X/O			
			11050758	CLAMP:LWSM-0306A	11050511	HARNESS CLAMP - LWS-0306ZC	U004	12	1	X/O			
			11050758	CLAMP:LWSM-0306A	11050511	HARNESS CLAMP - LWS-0306ZC	U004	12	1	X/O			
201904-03	1904 Modification	-			D0BX3862	SUPPORTING PLATE:VACUUM	U013	29	1				
201904-04	1904 Modification	-			D1793865	BRACKET:SENSOR:VACUUM	U013	30	1				
201904-05	1904 Modification	-	04513006N	TAPPING SCREW - 3X6	03603006N	SCREW - M3X6	U006	8	1	X/O			

