

MP C501SP
(D0BH-NA)
Parts Catalog

Parts change information sample

 **Add**

 **Update**

 **Delete**

Model	Product Code	PC Style
MP C501SP	D0BH	3D
Paper Feed Unit PB1140	D693	3D
1 Bin Tray BN3130	D3CQ	3D
Fax Option Type M39	D0BH	Traditional
G3 Interface Unit Type M20	D3BT	Traditional
FAX Memory Unit Type M19 64MB	D3BZ	Traditional
Caster Table Type M3	D178	Traditional
IEEE 802.11a/g/n Interface Unit Type M19	D3BR	Traditional
Memory Unit Type M19 4GB	D3BX	Traditional
Extended USB Board Type M19	D3BS	Traditional
IEEE 1284 Interface Board Type M19	D3C0	Traditional
Bluetooth Interface Unit Type D	D566	Traditional
XPS Direct Print Option Type M19	D3BC	Traditional
USB Device Server Option Type M19A	D3BC	Traditional
Postscript3 Unit Type M33	D3BD	Traditional
Camera Direct Print Card Type M19	D3BD	Traditional
File Format Converter Type M19	D3BR	Traditional
DataOverwriteSecurity Unit Type M19	D3BS	Traditional
Enhanced Security HDD Option Type M12	D3A6	Traditional
Fax Connection Unit Type M20	D3BC	Traditional
OCR Unit Type M13	D3AC	Traditional
Optional Counter Interface Unit Type M12	B870	Traditional
Key Counter Bracket Type M3	D739	Traditional
NFC Card Reader Type M19	D3BS	Traditional
Smart Card Reader Built-in Unit Type M19	D3BS	Traditional
SD Card for Fonts Type E	M500	Traditional
Smart Operation Panel	D0AC1415	Traditional

Unit All

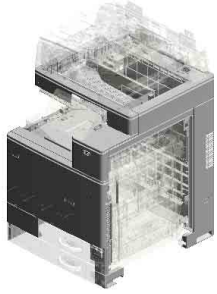

U001
EXTERIOR

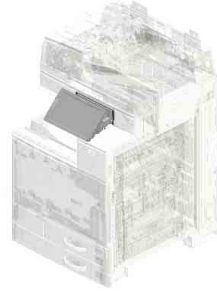

U002
OPERATION

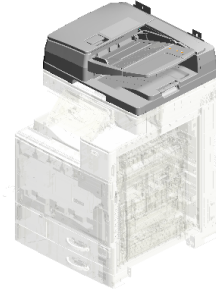

U003
ADF

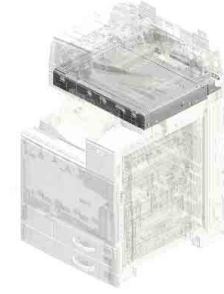

U004
SCANNER

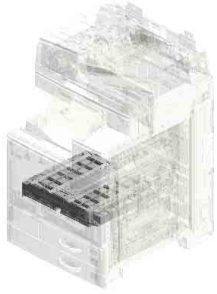

U005
LASER UNIT

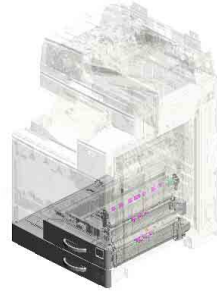

U006
PAPER FEED

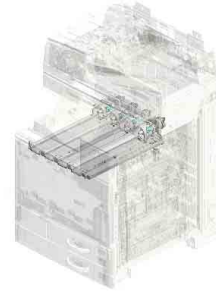

U007
TONER SUPPLY

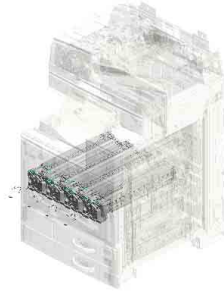

U008
PCDU

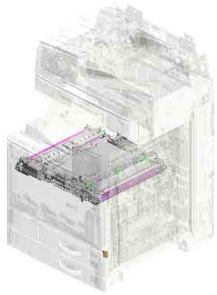

U009
ITB UNIT

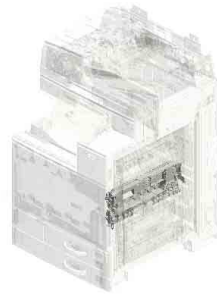

U010
SEPARATION/TRANSPORT

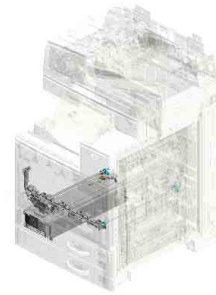

U011
USED TONER

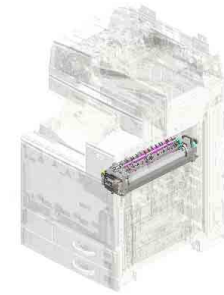

U012
FUSING

Unit All

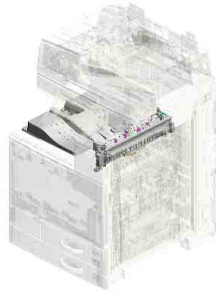

U013
PAPER EXIT

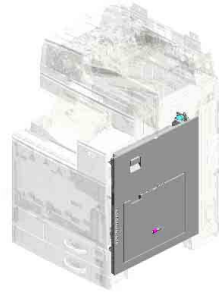

U014
DUPLEX

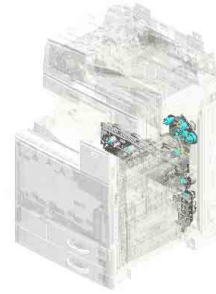

U015
MAIN DRIVE

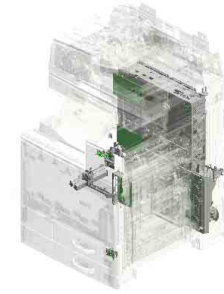

U016
ELECTRICAL

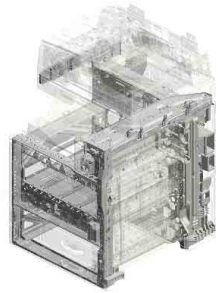

U017
MAIN FRAME

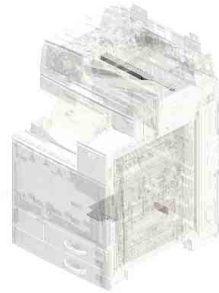

U018
Anti-Condensation Heater (Scanner, PCDU)

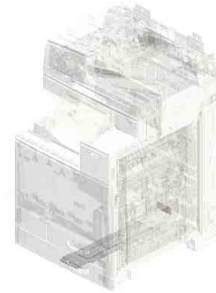

U019
Anti-Condensation Heater for Paper Feed Trays

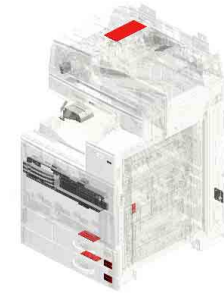

U020
ACCESSORIES

U001 EXTERIOR

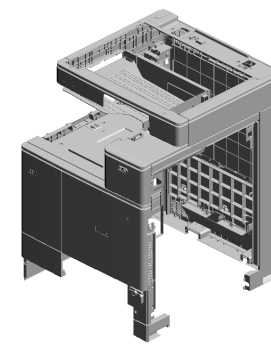

- 19.D0BH1284 COVER:SCANNER:LEFT:IDG
- 8.AA143595 STEPPED SCREW:M3
- 1.04543006Q TAPPING SCREW-M3X6
- 12.D0BH1233 COVER:UPPER:INNER BACK:IDG
- 11.D0AF1290 COVER:SCANNER:UPPER:REAR

- 14.D0BH1235 COVER:UPPER:INNER BACK:BIN:IDG

- 7.AA143537 (x2) SCREW:M3:BLACK

- 15.D0BH1237 COVER:UPPER:INNER BACK:LEFT LOWER:IDG

- 18.D0BH1281 COVER:SCANNER:FRONT:IDG

- 5.52062686 SNAP RING

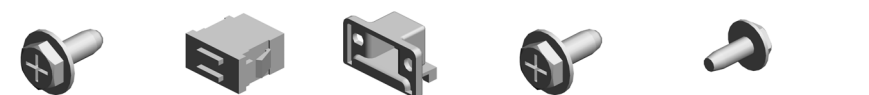
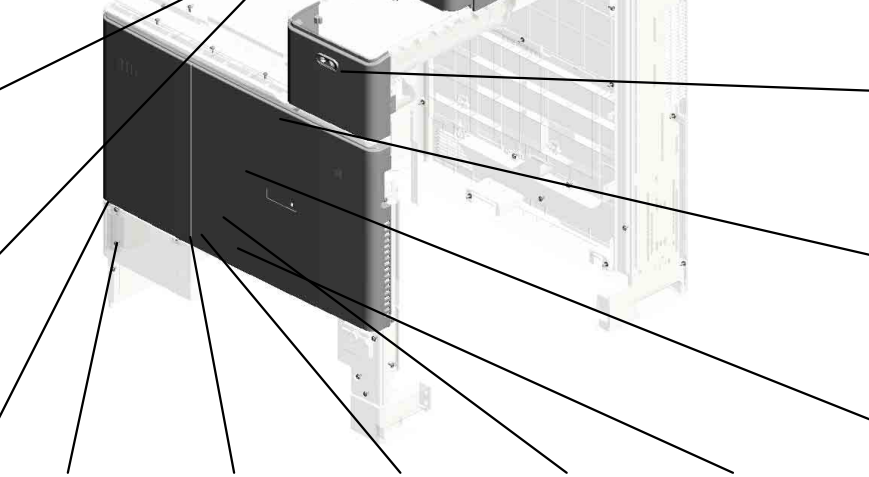
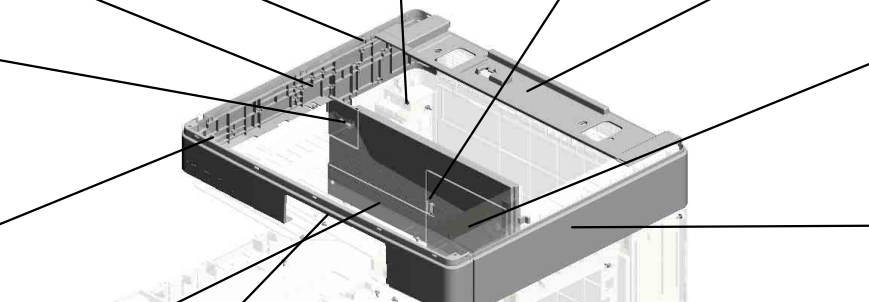

- 3.04543008Q (x2) TAPPING SCREW:3X8
- 6.AA021031 MAGNETIC CATCH
- 17.D0BH1242 PLATE:COVER:FRONT
- 2.04543008N (x55) TAPPING SCREW:ROUND POINT:3X8
- 4.04583008N (x21) HEXAGON HEAD TAPPING SCREW:3X8

- 13.D0BH1234 COVER:UPPER:INNER BACK:MIDDLE:IDG

- 20.D0BH1287 COVER:SCANNER:RIGHT:IDG

- 10.D0AD1244 COVER:FRONT:RIGHT UPPER:MA

- 9.AG070513 MAGNET CATCH

- 16.D0BH1241 COVER:FRONT:A4

U001 EXTERIOR

36.D1494492 TRAY:REVERSE
 30.D1491257 CAP:34X55
 29.D1491252 COVER:LEFT:UPPER:REAR
 24.D0BQ1255 COVER:LEFT:INTERFACE
 26.D1441085 (x7) STEPPED SCREW:M3

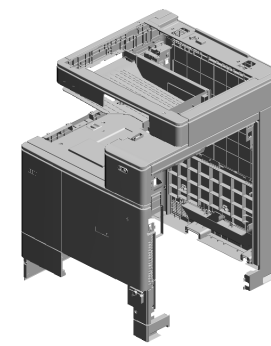

27.D1491243 COVER:FRONT:UPPER:OPERATION SUB-UNIT

22.D0BQ1230 COVER:UPPER

39.D1496859 DECAL:CLEANING:SHIELD GLASS

32.D1491278 TORSION SPRING:COVER:USED TONER

28.D1491248 HINGE:COVER:FRONT:USED TONER

31.D1491274 INNER COVER:FRONT:USED TONER

21.D0BH7911 DUCT:DEVELOPMENT:FRONT

40.D1496893 DECAL:PCU:BLACK

37.D1495883 KEYTOP:MAIN SWITCH

38.D1495884 COMPRESSION SPRING:KEYTOP

25.D0BQ1288 COVER:SCANNER:UPPER:RIGHT

33.D1491291 CAP:HARNESS

23.D0BQ1232 COVER:UPPER:EXTENSION:IDG

34.D1491305 (x2) CAP:TOTAL COUNTER

35.D1491307 SPRING PLATE:BA ND

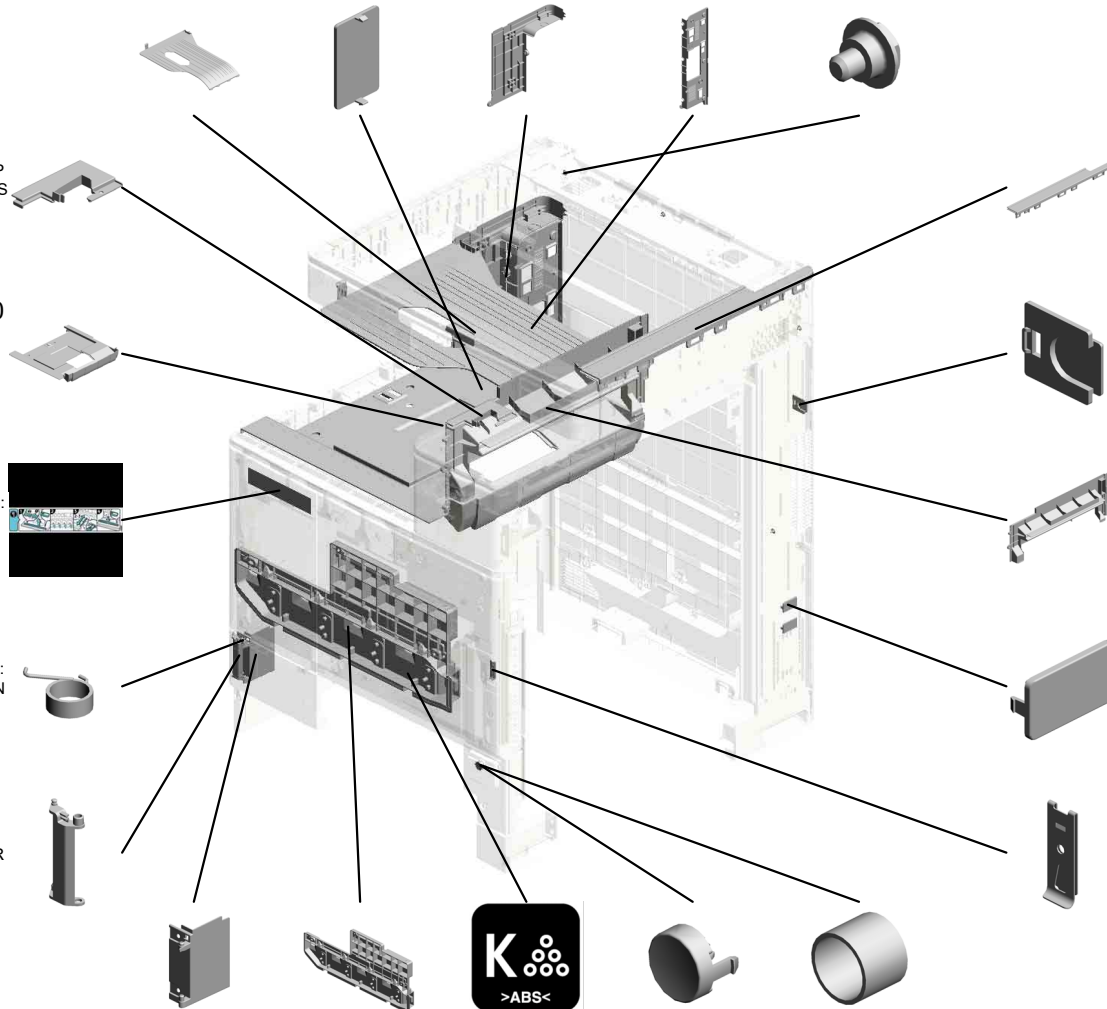

U001 EXTERIOR

58.D2411285 COVER:SCANNER:
UPPER:LEFT
46.D1501282 COVER:SCANNER:
UPPER:FRONT
49.D2411245 COVER:FRONT:UP
PER
59.D2411297 BRACKET:COVER:
LEFT UPPER REA
R
51.D2411256 CAP:COVER:INTER
FACE

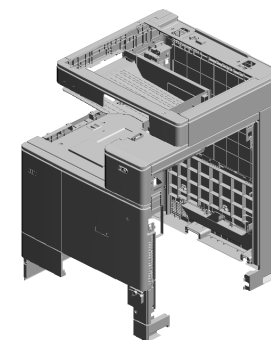

50.D2411251
COVER:LEFT:UPP
ER

45.D1501250
COVER:LEFT

47.D1771302
CLEANER:SHIELD
GLASS:ASSY

43.D1496896
DECAL:PCU:YELL
OW



42.D1496895
DECAL:PCU:MAGE
NTA



41.D1496894
DECAL:PCU:CYAN

56.D2411273
INNER COVER:FR
ONT:LOWER

57.D2411275
INNER COVER:FR
ONT:RIGHT LOWE
R

60.D2411298
INNER COVER:RIG
HT

55.D2411266
COVER:RIGHT:FR
ONT LOWER

53.D2411261
COVER:REAR

54.D2411263
CAP:LOUVER:DEO
DORIZE FILTER

48.D2391265
COVER:RIGHT:RE
AR

52.D2411260
COVER:REAR:LO
WER

44.D1497984
DUCT:REAR:POW
ER SUPPLY UNIT

U001 EXTERIOR

66.D2421231 COVER:UPPER:FRONT
69.M0AJ1276 INNER COVER:TO
NER BOTTLE
62.D2411309 MAGNET CATCH

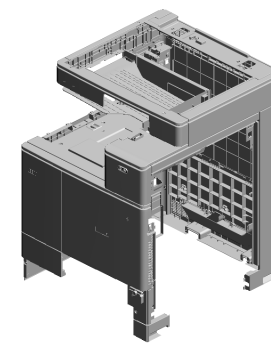

70.D0BQ1309
[A]
MAGNET CATCH:COVER:FRONT
201811-04 O/O

67.D2421247
COVER:FRONT:USED TONER

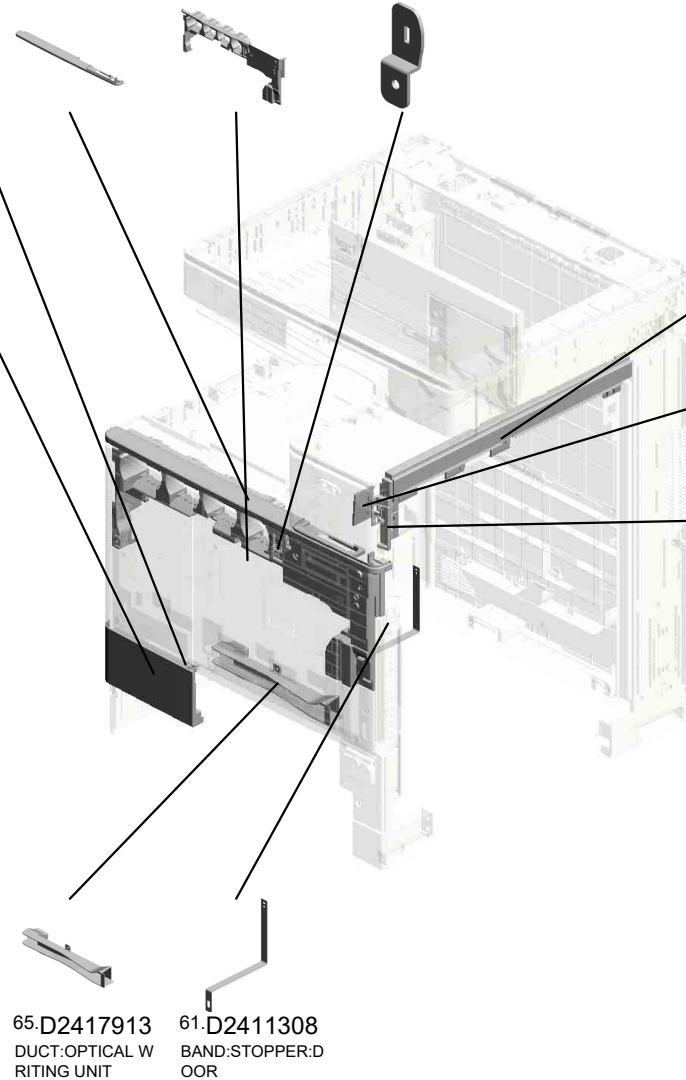

68.D2421267
COVER:RIGHT:UPPER

63.D2414458
(x4)
GUIDE:COVER:UPPER

64.D2415711
COVER:HUMAN DETECTION SENSOR:
CONNECTOR

65.D2417913
DUCT:OPTICAL WRITING UNIT

61.D2411308
BAND:STOPPER:DOOR

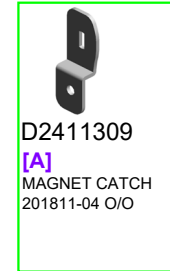

D2411309
[A]
MAGNET CATCH
201811-04 O/O

U001	U002	U003	U004	U005	U006	U007	U008	U009	U010	U011	U012	U013	U014	U015	U016	U017	U018	U019	U020
------	------	------	------	------	------	------	------	------	------	------	------	------	------	------	------	------	------	------	------

U002.OPERATION

U002 S001
D0AC1415
OPERATION SUB-UNIT:ASS'
Y

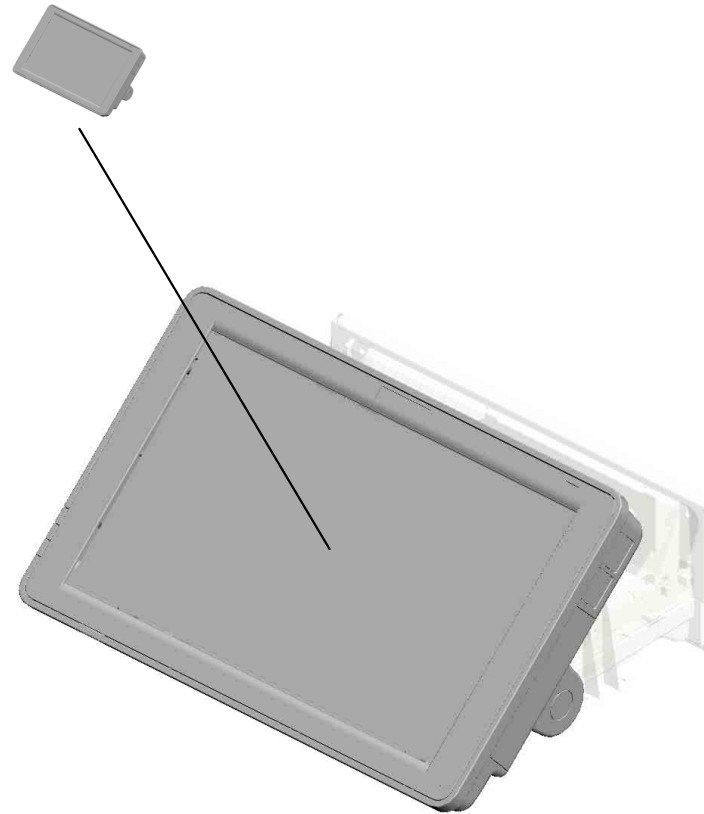

U001	U002	U003	U004	U005	U006	U007	U008	U009	U010	U011	U012	U013	U014	U015	U016	U017	U018	U019	U020
------	-------------	------	------	------	------	------	------	------	------	------	------	------	------	------	------	------	------	------	------

U002_S001
OPERATION SUB-UNIT:ASS'Y



6.D0AC1415
OPERATION SUB-
UNIT:ASS'Y

See 2D parts catalog
for the components of
the Smart Operation
Panel.

11.Note

See 2D parts catalog
for the components of
the Smart Operation
Panel.

U001	U002	U003	U004	U005	U006	U007	U008	U009	U010	U011	U012	U013	U014	U015	U016	U017	U018	U019	U020
------	------	------	------	------	------	------	------	------	------	------	------	------	------	------	------	------	------	------	------

U003.ADF

U003_S001
D3B07010
ADF:ASS'Y

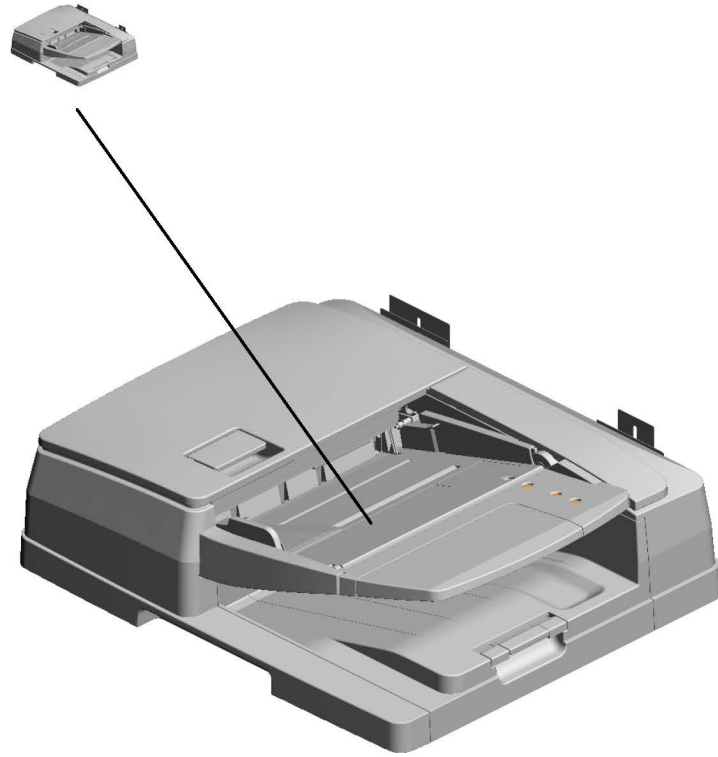

U001	U002	U003	U004	U005	U006	U007	U008	U009	U010	U011	U012	U013	U014	U015	U016	U017	U018	U019	U020
------	------	------	------	------	------	------	------	------	------	------	------	------	------	------	------	------	------	------	------

U003_S001.ADF:ASS'Y

U003 S001 S010
D3B04755
COVER:PAPER FEED:UPPER
:ASS'Y

U003 S001 S004
D3B02200
SHAFT:SEPARATION:ASS'Y

U003 S001 S001
D6831620
SHAFT:SEPARATION:DRIVE:
INPUT:SUB-ASS'Y

U003 S001 S011
D3B04310
GUIDE:PAPER FEED:UPPER:
SUB-ASS'Y

U003 S001 S003
D6831640
SHAFT:INPUT:PAPER FEED:
SUB-ASS'Y

U003 S001 S008
D6833461
GUIDE:SCANNING:ENTRANC
E:NON-CONTACT:SUB-ASS'Y

U003 S001 S002
D6831632
SHAFT:REVERSE ROLLER:S
UB-ASS'Y

U003 S001 S007
D6833150
ROLLER:SCANNING:EXIT:DR
IVE:ASS'Y

U003 S001 S009
D3FF4210
COVER:REAR:ASS'Y

U003 S001 S005
D3B03662
GUIDE PLATE:CONTACT IMA
GE SENSOR:ENTRANCE:AS
SY

U003 S001 S006
D6833641
GUIDE:CONTACT IMAGE SE
NSOR:EXIT:LOWER:ASS'Y

U003 S001 S012
D3B04720
PRESSURE PLATE:ASS'Y

U001	U002	U003	U004	U005	U006	U007	U008	U009	U010	U011	U012	U013	U014	U015	U016	U017	U018	U019	U020
------	------	------	------	------	------	------	------	------	------	------	------	------	------	------	------	------	------	------	------

U003_S001.ADF:ASS'Y

U003 S001 S013
D6834510
COVER:LOWER RIGHT:ASS'
Y

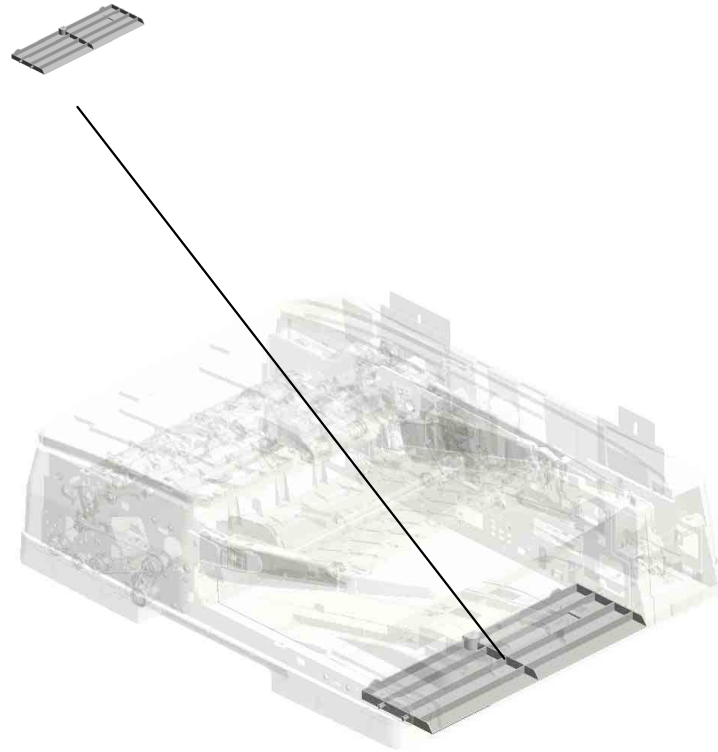

U001	U002	U003	U004	U005	U006	U007	U008	U009	U010	U011	U012	U013	U014	U015	U016	U017	U018	U019	U020
------	------	------	------	------	------	------	------	------	------	------	------	------	------	------	------	------	------	------	------

U003_S001_S004.SHAFT:SEPARATION:ASS'Y

U003 S001 S004 S001
D6832240
GUIDE:PAPER FEED:ENTRA
NCE:INNER BACK:ASS'Y

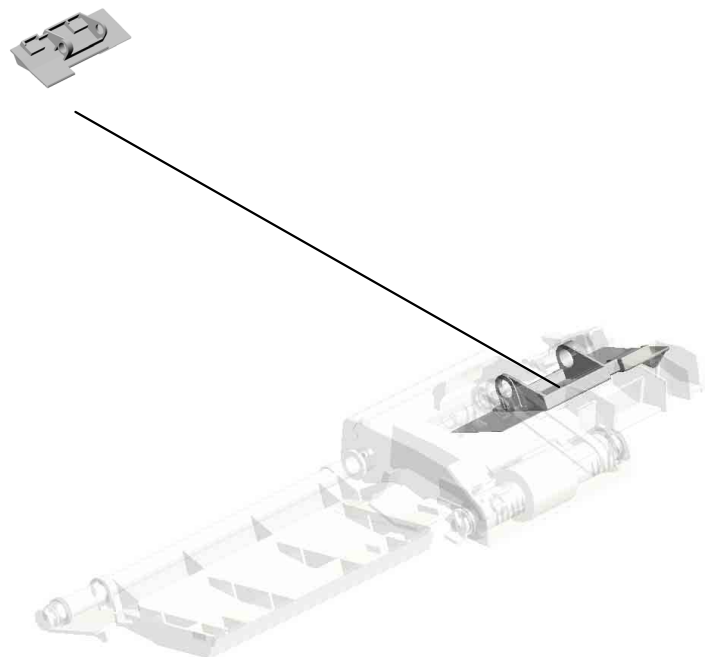

U001	U002	U003	U004	U005	U006	U007	U008	U009	U010	U011	U012	U013	U014	U015	U016	U017	U018	U019	U020
------	------	------	------	------	------	------	------	------	------	------	------	------	------	------	------	------	------	------	------

U003
ADF

38.A8597211
(x2)
STEPPED SCREW

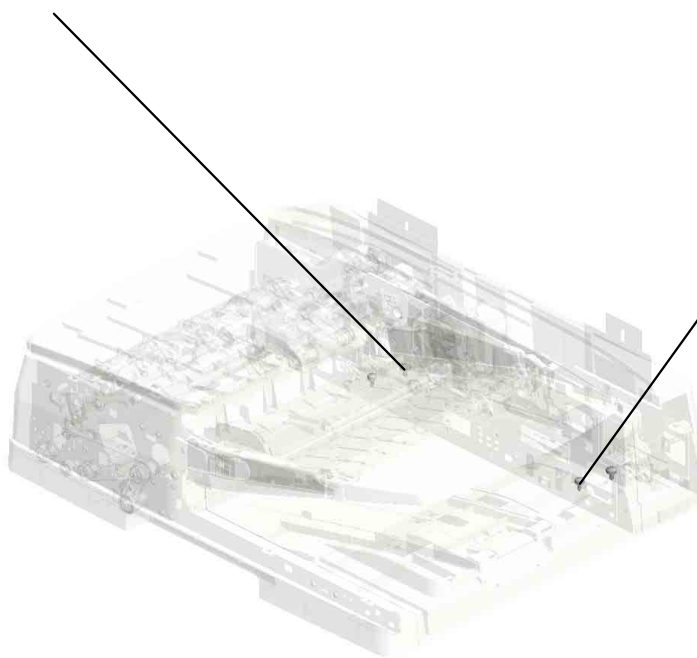
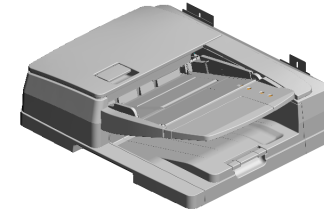

134.D5406121
(x2)
FULL DUG POINT
SCREW:FIX:HINGE

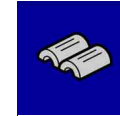

26.16072249
FERRITE CORE:K3
NF-70-A(N)BK0



27.16072251
FERRITE CORE:K3
NF-75(N)BK0

5.04543006Q(x 4)
TAPPING SCREW - M3X6

U003_S001
ADF:ASS'Y

129.D3B07010
ADF:ASS'Y

- 9.07200030E (x2) RETAINING RING - M3
- 5.04543006Q (x117) TAPPING SCREW - M3X6
- 14.08025299 TAPPING SCREW - M3X8
- 1.03530060N (x2) BIND SCREW - M3 X6
- 10.07200040E (x3) RETAINING RING - M4

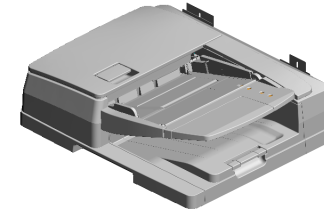

8.07074060N
BUSHING:DIA4X6



4.04543006N
(x8)
TAPPING SCREW:
ROUND POINT:3X6



15.08050103
(x2)
RETAINING RINGS
-E:SILENCER:DIA3



13.07433808
(x3)
RADIAL BALL BEA
RING:DIA8XDIA16X
5



17.08050106
(x6)
RETAINING RINGS
-E:SILENCER:DIA6

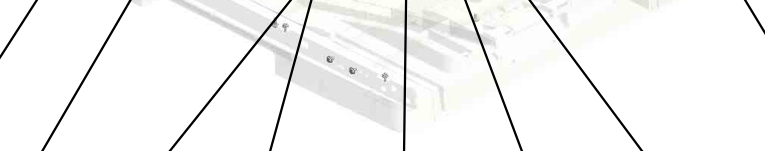

7.04583008N
(x28)
HEXAGON HEAD T
APPING SCREW:3
X8

12.07433806
RADIAL BALL BEA
RING:DIA6XDIA13X
5

20.11050692
(x4)
CLAMP:LES-0503

3.04543005N
(x2)
HEXAGON HEAD T
APPING SCREW:R
OUND POINT:3X5

16.08050104
(x12)
RETAINING RINGS
-E:SILENCER:DIA4

6.04543014Q
(x4)
TAPPING SCREW:
3X14



18.11050487
(x6)
HARNESS CLAMP



19.11050508
(x6)
HARNESS CLAMP -
LWS-0711



23.11050758
(x17)
CLAMP:LWSM-030
6A



21.11050723
(x2)
CLAMPS:WES-050
7



19.11050508
HARNESS CLAMP -
LWS-0711

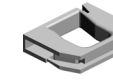

22.11050724
CLAMPS:WES-121
0



23.11050758
(x2)
CLAMP:LWSM-030
6A



24.11050760
CLAMP:LWSM-051
1A



133.D5224906
STEPPED SCREW:
M3:DIA6:1.7MM:RO
UND POINT

5.04543006Q(x 4)
TAPPING SCREW - M3X6
7.04583008N(x 1)
HEXAGON HEAD TAPPING SCREW:3X
8

U003_S001
ADF:ASS'Y

- 42.AA043681 SYNCHRONOUS B
ELT:40S2M108
- 33.A5482139 PULLEY
- 54.AA082101 (x6)
BUSHING - 6X10X6
- 25.12042612 (x2)
MICRO SWITCH:D3
V-16506-3C25
- 28.52062686 (x2)
SNAP RING

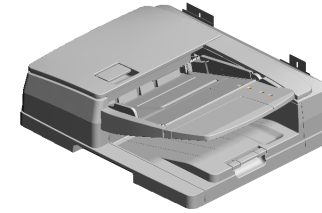

129.D3B07010
ADF:ASS'Y

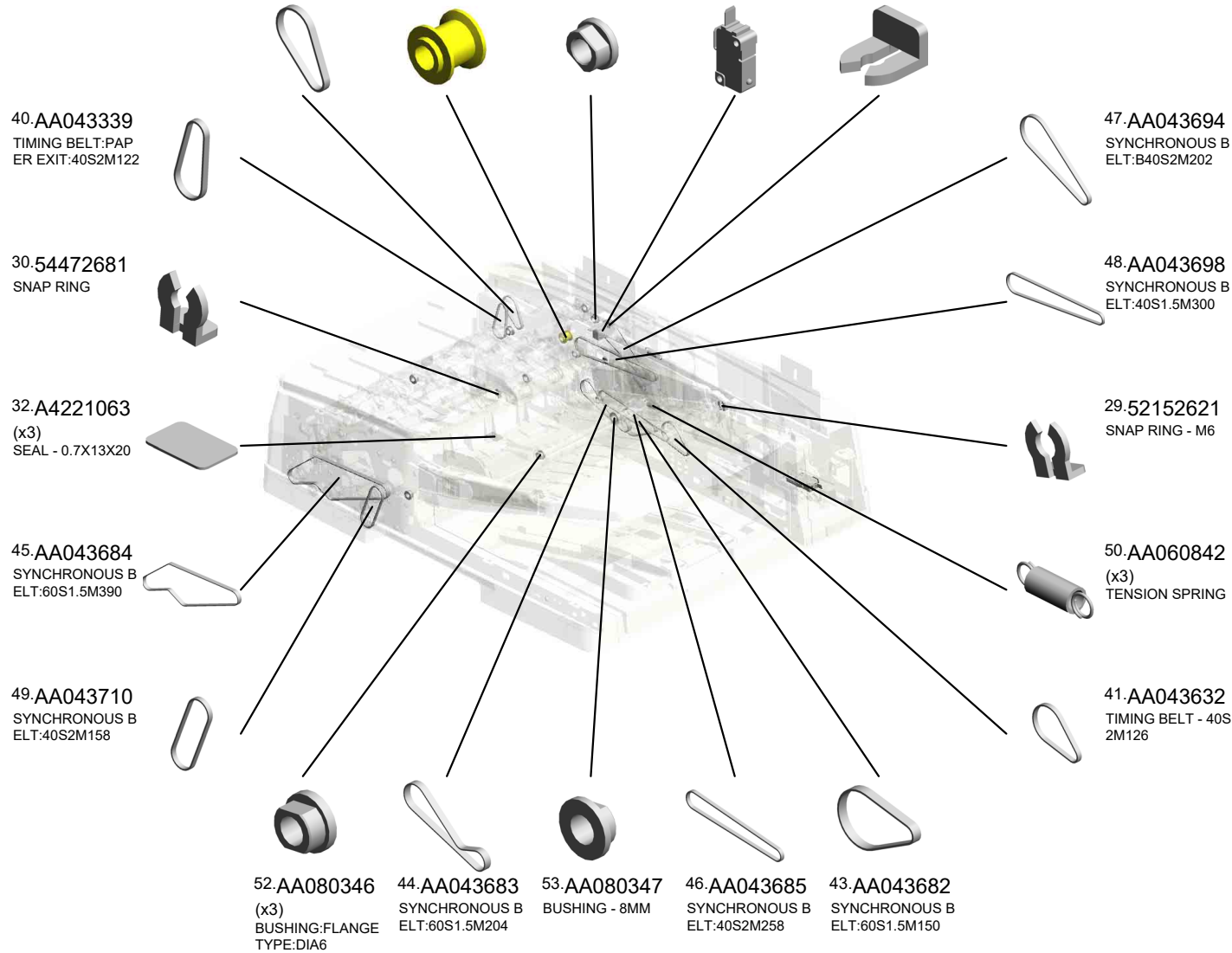

U003_S001
ADF:ASS'Y

- 66.B0434645 (x4) SPRING - 2N
- 71.B4772622 DISCHARGE BRUSH: L11
- 76.B6521134 COMPRESSION SPRING
- 75.B6521133 SHAFT:SLIDER
- 79.B7003305 TIMING BELT:B40S 2M152

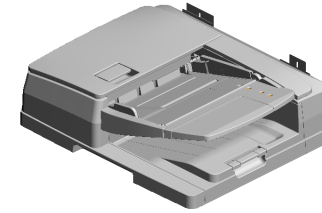

129.D3B07010
ADF:ASS'Y

62.AW010151 (x5) PHOTO REFLECTIVE SENSOR:PS122T L1-A

72.B4774117 SPRING

60.AA143846 TAPPING SCREW: M3X6

55.AA082144 (x2) BUSHING - 8X12X7

58.AA143789 SHAFT:CLEANER

57.AA143788 (x3) PIN:GUIDE PLATE: PAPER FEED

74.B4774131 (x4) SPRING

73.B4774129 (x2) SPRING - 12N

63.AW020190 PHOTOINTERRUPTOR

78.B6523174 TENSION SPRING

59.AA143842 SCREW:DIA6:14.5: M4

65.AX040199 DC MOTOR:RISING TRAY:ASS'Y

68.B3871951 SPRING - PAPER SIZE SENSOR

61.AW010150 (x4) PHOTO REFLECTIVE SENSOR:ORIGINAL TRAY

80.B7061859 SCREW:SLIDER:LOCK

U003_S001
ADF:ASS'Y

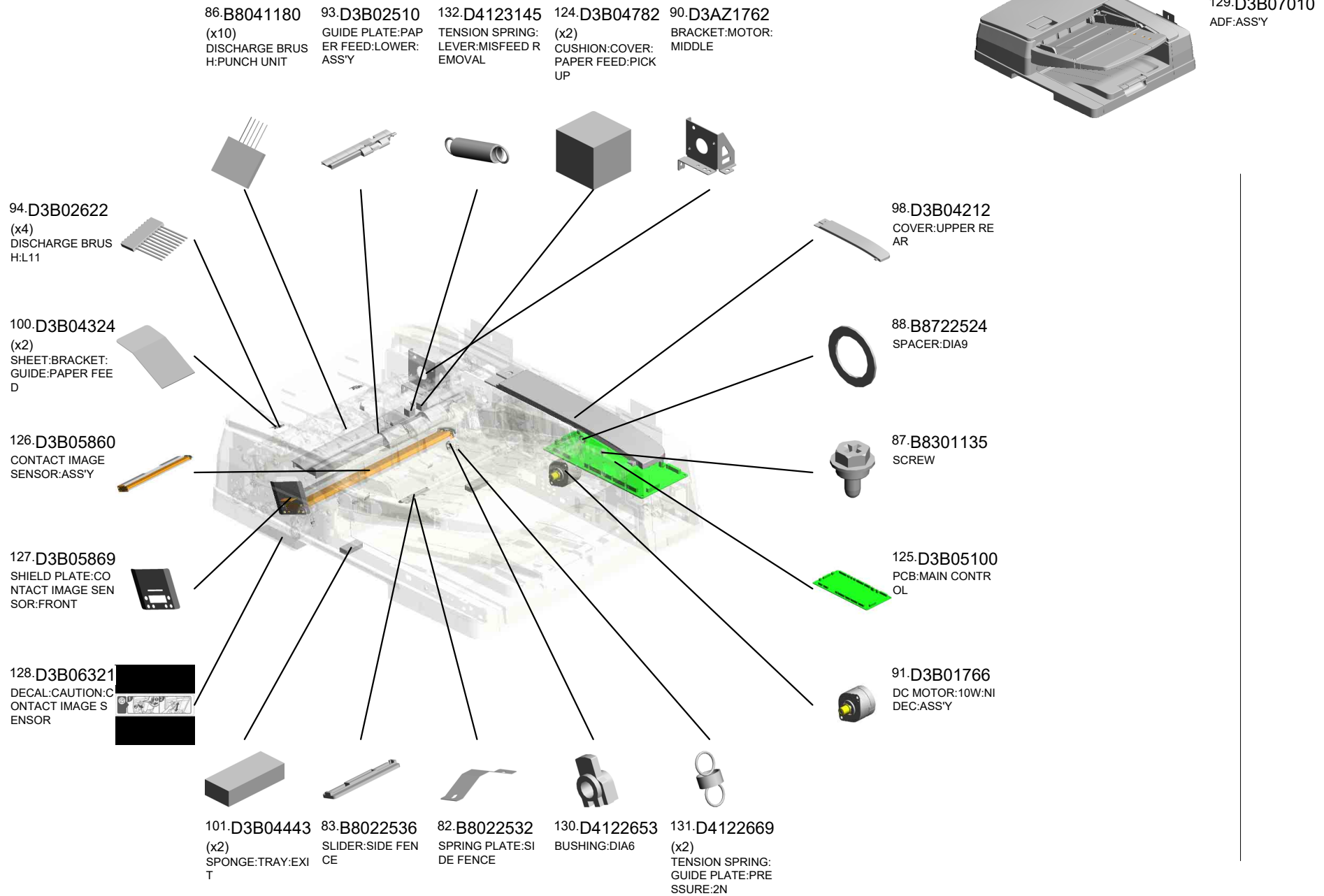

U003_S001
ADF:ASS'Y

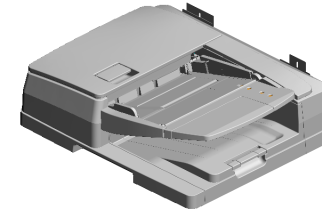

129.D3B07010
ADF:ASS'Y

- 144.D5434382 (x2) COMPRESSION SPRING:PULL OUT
- 146.D5435125 SPRING PLATE:CONTACT IMAGE SENSOR
- 135.D5412241 REVERSE ROLLER:PAPER FEED
- 137.D5431625 GEAR:Z24:SEPARATION
- 153.D6831387 TENSION SPRING:ON OFF DETECTOR:PAPER FEED

145.D5434393 (x7) CUSHION:GUIDE PLATE:ENTRANCE:PAPER FEED:INNER BACK

133.D5224906 (x9) STEPPED SCREW:M3:DIA6:1.7MM:ROUND POINT

143.D5433635 GEAR:ROLLER:SCANNING:BEHIND

139.D5431821 TIMING PULLEY:T33/Z24

140.D5431822 FLANGE:DIA24

142.D5433631 ROLLER:SCANNING:BEHIND:ASSY

136.D5431313 COMPRESSION SPRING:HINGE:LEFT

151.D6831385 BRACKET:SAFETY SWITCH:PAPER FEED

138.D5431717 SHAFT:PULLEY:SCANNING:EXIT

147.D6421454 FEELER:APS

152.D6831386 SHAFT:CONTACT POINT:ON OFF DETECTOR:PAPER FEED

150.D6831362 COMPRESSION SPRING:HINGE:RIGHT

155.D6831414 SPRING PLATE:SAFETY SWITCH

154.D6831413 BRACKET:SAFETY SWITCH

156.D6831415 FEELER:SENSOR:ON OFF DETECTOR

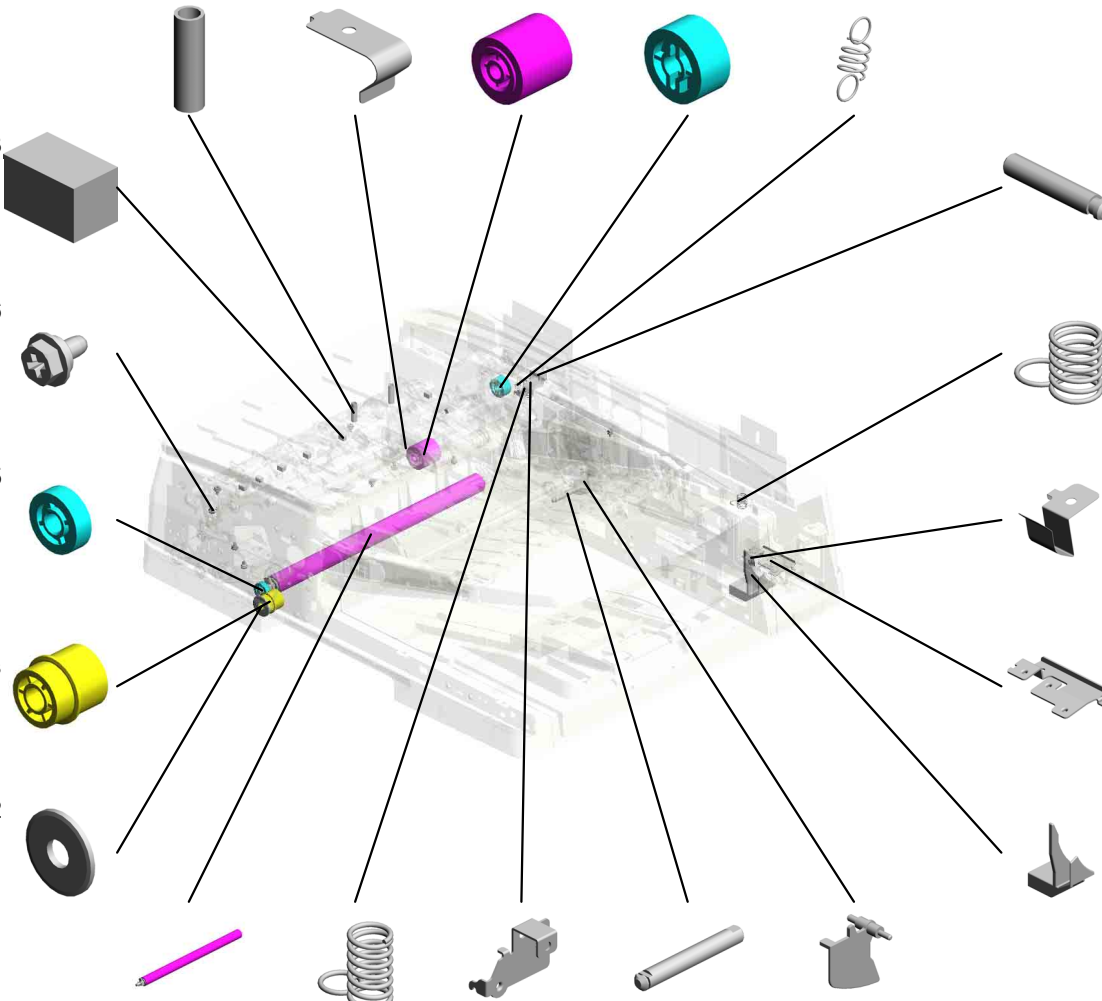

U003_S001
ADF:ASS'Y

170.D6831680 CAM:PICKUP
169.D6831675 DC STEPPER MOTOR:DIA42:T15:S2M:ASS'Y
171.D6831682 TIMING PULLEY:PICKUP:DRIVE
168.D6831671 BRACKET:MOTOR:PICK UP
167.D6831644 SPACER:SHAFT:INPUT:PAPER FEED

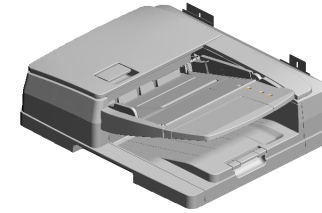

129.D3B07010
ADF:ASS'Y

165.D6831642
TIMING PULLEY:IDLER:PULL OUT



175.D6831766
DC MOTOR:10W:BRUSHLESS



172.D6831691
GEAR:PAPER FEED:COUPLING



163.D6831635
GEAR:REVERSE ROLLER:DRIVE



166.D6831643
GEAR:INPUT:PAPER FEED

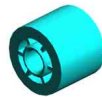

158.D6831614
BRACKET:MOTOR:PAPER FEED



177.D6831813
TIMING PULLEY:COUPLING:SCANNING:INNER BACK



174.D6831718
(x2)
STAY:MOTOR:PULL OUT



176.D6831811
BRACKET:MOTOR:SCANNING:EXIT



178.D6831814
TIMING PULLEY:COUPLING:EXIT



173.D6831711
BRACKET:MOTOR:PULL OUT



159.D6831615
STAY:MOTOR:PAPER FEED



160.D6831617
DC MOTOR:ASS'Y:20W:BRUSHLESS



157.D6831451
HOLDER:FEELER:APS

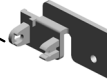

179.D6831822
(x2)
DC MOTOR:20W:SCANNING:20W:BRUSHLESS



U003_S001
ADF:ASS'Y

191.D6832222 STOPPER:SHAFT:SEPARATION:DRIVE
 203.D6832311 TORQUE LIMITER MECHANICAL CLUTCH:SEPARATOR
 206.D6832417 SHEET:ENTRANCE SEPARATION PAD
 205.D6832415 SHEET:SEPARATION:ENTRANCE
 187.D6832112 (x2) TIMING PULLEY:ROLLER:PULL OUT:DRIVE

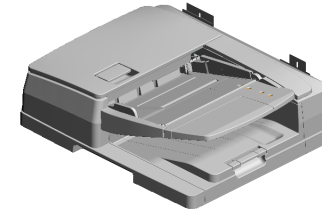

129.D3B07010
ADF:ASS'Y

188.D6832210
ROLLER:MIDDLE:DRIVE

186.D6832110
ROLLER:PULL OUT:DRIVE

184.D6831856
TENSION SPRING: TENSION:SCANNING:FRONT

182.D6831851
BRACKET:TENSIONER:SCANNING:FRONT

183.D6831855
TIMING PULLEY:TENSIONER:SCANNING:FRONT

212.D6832742
(x4)
CUSHION:STOPPER PAWL

210.D6832733
FEELER:SENSOR: ORIGINAL SENSOR

204.D6832393
HOLDER:ORIGINAL TABLE

209.D6832729
JOINT:RISING TRAY:AUXILIARY

185.D6831912
BRACKET:HINGE:RIGHT

207.D6832724
COVER:LOWER:BASE

211.D6832735
BRACKET:SENSOR:ORIGINAL SENSOR

181.D6831845
(x2)
PULLEY:IDLER:DIA 14

180.D6831841
BRACKET:TENSIONER:SCANNING:INNER BACK

208.D6832728
STOPPER:RELEASE:SHAFT:BASE

U001	U002	U003	U004	U005	U006	U007	U008	U009	U010	U011	U012	U013	U014	U015	U016	U017	U018	U019	U020
------	------	------	------	------	------	------	------	------	------	------	------	------	------	------	------	------	------	------	------

U003_S001
ADF:ASS'Y

- 222.D6832912 (x6) FEELER:PAPER SIZE SENSOR
- 229.D6833251 GROUND PLATE:ROLLER
- 231.D6833311 (x2) BRACKET:GUIDE:SCANNING:UPPER
- 232.D6833361 (x2) SPRING PLATE:GUIDE PLATE:SCANNING
- 223.D6832913 (x2) SHEET:SENSOR:SEPARATION

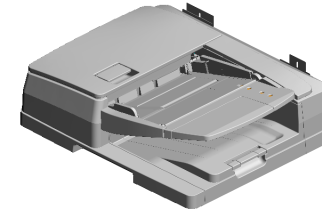

129.D3B07010
ADF:ASS'Y

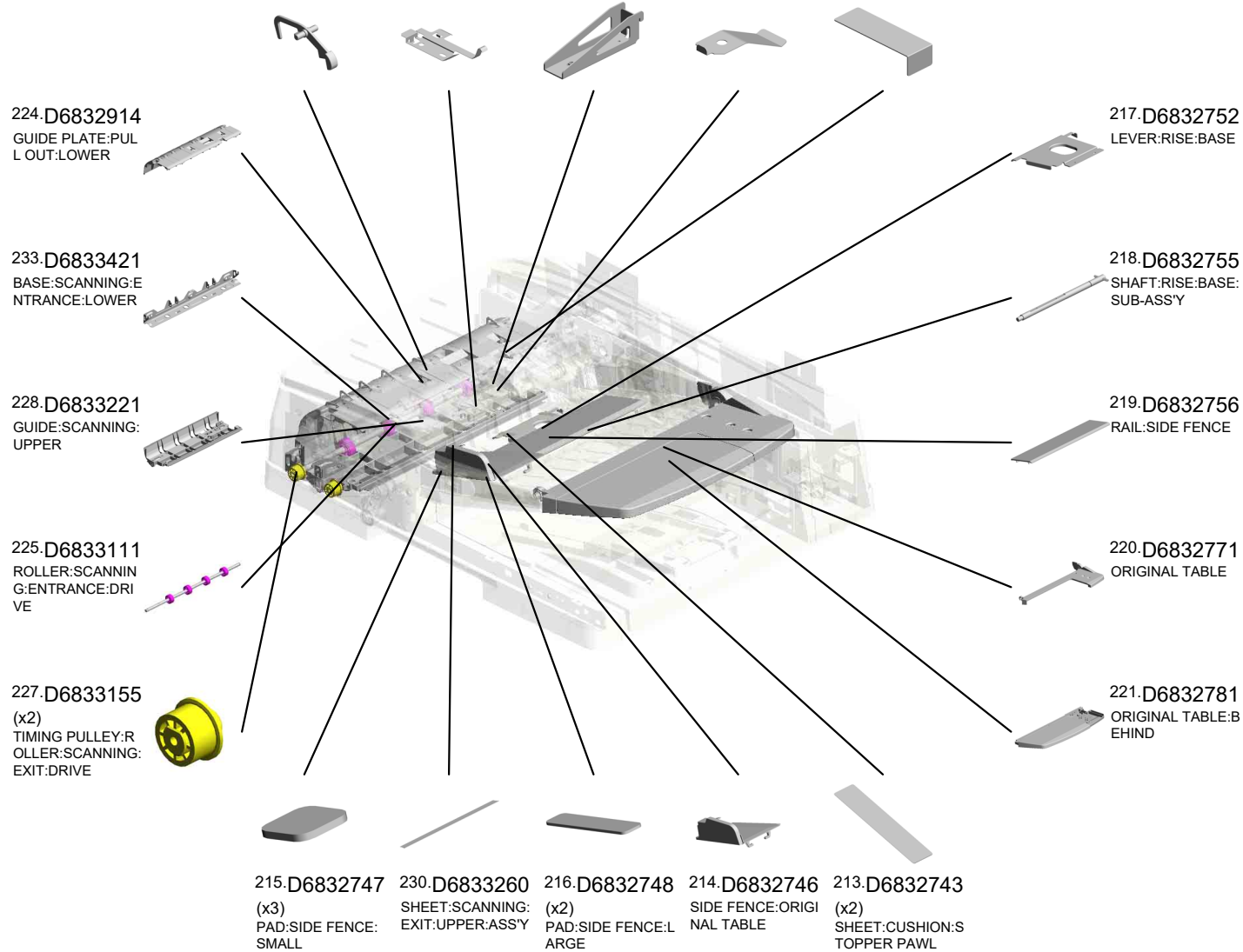

U003_S001
ADF:ASS'Y

- 258.D6834323 SHAFT:CONTACT POINT:GUIDE:PAPER FEED
- 236.D6833510 SHAFT:LEVER:MIS FEED REMOVAL:ASS'Y
- 243.D6833645 (x2) ROLLER:MIDDLE:DRIVEN
- 239.D6833621 GUIDE:EXIT:LOWER:SUB-ASS'Y
- 260.D6834341 BRACKET:PULL OUT:DRIVEN

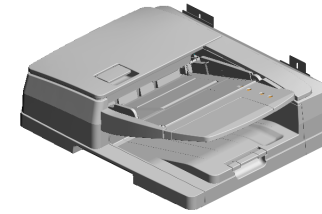

129.D3B07010
ADF:ASS'Y

259.D6834329
SHEET:BASE:SEAL :PAPER FEED

234.D6833422
(x2)
LEVER:PRESSURE RELEASE

237.D6833511
HOOK:OPTICAL READING UNIT:FRONT

250.D6833715
TIMING PULLEY:ROLLER:CIS:EXIT:FRONT

244.D6833651
COVER:SCANNING:EXIT

255.D6834111
COVER:FRONT

256.D6834112
COVER:FRONT RIGHT

248.D6833710
ROLLER:CONTACT IMAGE SENSOR:EXIT:DRIVE:PRESS FIT

251.D6833811
GUIDE PLATE:EXIT:UPPER

252.D6833812
DISCHARGE BRUSH:EXIT

257.D6834313
CUSHION:STOPPER:FEELER:ORIGINAL SENSOR

249.D6833714
TIMING PULLEY:ROLLER:CIS:EXIT:DRIVE

254.D6833915
TIMING PULLEY:ROLLER:EXIT:DRIVE

253.D6833911
ROLLER:EXIT:DRIVE

238.D6833616
(x2)
BRACKET:DISCHARGE BRUSH

U001	U002	U003	U004	U005	U006	U007	U008	U009	U010	U011	U012	U013	U014	U015	U016	U017	U018	U019	U020
------	------	------	------	------	------	------	------	------	------	------	------	------	------	------	------	------	------	------	------

U003_S001
ADF:ASS'Y

- 264.D6834345 DISCHARGE BRUSH:EXIT:L37
- 269.D6834361 SHAFT:CONTACT POINT:GRIP
- 273.D6834394 GUIDE PLATE:ENTRANCE:PAPER FEED:UPPER
- 272.D6834374 HOOK:CONTACT POINT:INNER BACK:GRIP
- 270.D6834367 GROUND PLATE:HOOK:INNER BACK

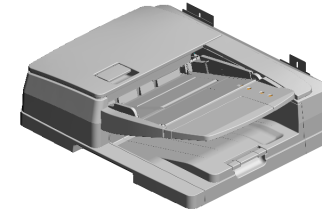

129.D3B07010
ADF:ASS'Y

267.D6834350
DRIVEN ROLLER:FULL OUT



275.D6834396
CUSHION:GUIDE PLATE:ENTRANCE:PAPER FEED:STOPPER

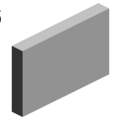

274.D6834395
CUSHION:GUIDE PLATE:ENTRANCE:PAPER FEED:FRONT



271.D6834372
HOOK:CONTACT POINT:FRONT:GRIP



268.D6834351
LINK:STOPPER:COVER:PAPER FEED



265.D6834346
SHIELD PLATE:ENTRANCE:PAPER FEED



266.D6834347
SEAL:ENTRANCE:PAPER FEED



280.D6834430
(x4)
ROLLER:EXIT:DRIVEN



279.D6834421
(x2)
SHAFT:EXIT:DRIVEN



276.D6834412
TRAY:EXIT:AUXILIARY:LARGE

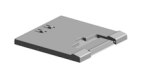

261.D6834342
BRACKET:PRESSURE: PICKUP



263.D6834344
COMPRESSION SPRING: PICKUP:2.1N



262.D6834343
PRESSURE PLATE: PICKUP



278.D6834414
(x4)
SPACER:EXIT ROLLER



277.D6834413
TRAY:EXIT:AUXILIARY:SMALL

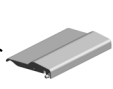

U003_S001
ADF:ASS'Y

- 297.G0602652 (x4) BUSHING - M4
- 293.D6842412 (x2) PAD:STOPPER:ORIGINAL
- 296.D7316241 DECAL:STOPPER:SEPARATION UNIT
- 299.M3644131 TIMING BELT:B40S 2M160
- 302.D3FF1221 SHEET:HINGE:GUI DE:LEFT

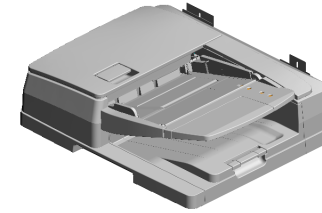

129.D3B07010
ADF:ASS'Y

294.D6866128
SPONGE:COVER:FRONT:SMALL

284.D6834611
COVER:LEFT LOWER

285.D6834616
SHEET:BASE:SEAL:LEFT LOWER

286.D6834617
(x2) SEAL:LEFT LOWER

290.D6836041
DECAL:DESIGN SKETCH:MISFEED REMOVAL

289.D6836011
DECAL:SIZE:ORIGINAL

300.D3B01320
HINGE:LEFT:ASS'Y 201812-01 X/O

295.D6902425
DISCHARGE BRUSH:SHORT:FRONT

281.D6834441
(x2) HOLDER:CUSHION:PRESSURE PLATE

282.D6834442
(x8) TAPE:PRESSURE PLATE

287.D6835111
GUIDE:HARNES:MAIN

288.D6835121
GUIDE:HARNES:SUB

291.D6836051
DECAL:BASE:ORIGINAL

303.D3FF1222
SHEET:HINGE:GUI DE:RIGHT

301.D3B01350
HINGE:RIGHT:ASS'Y 201902-09 X/O

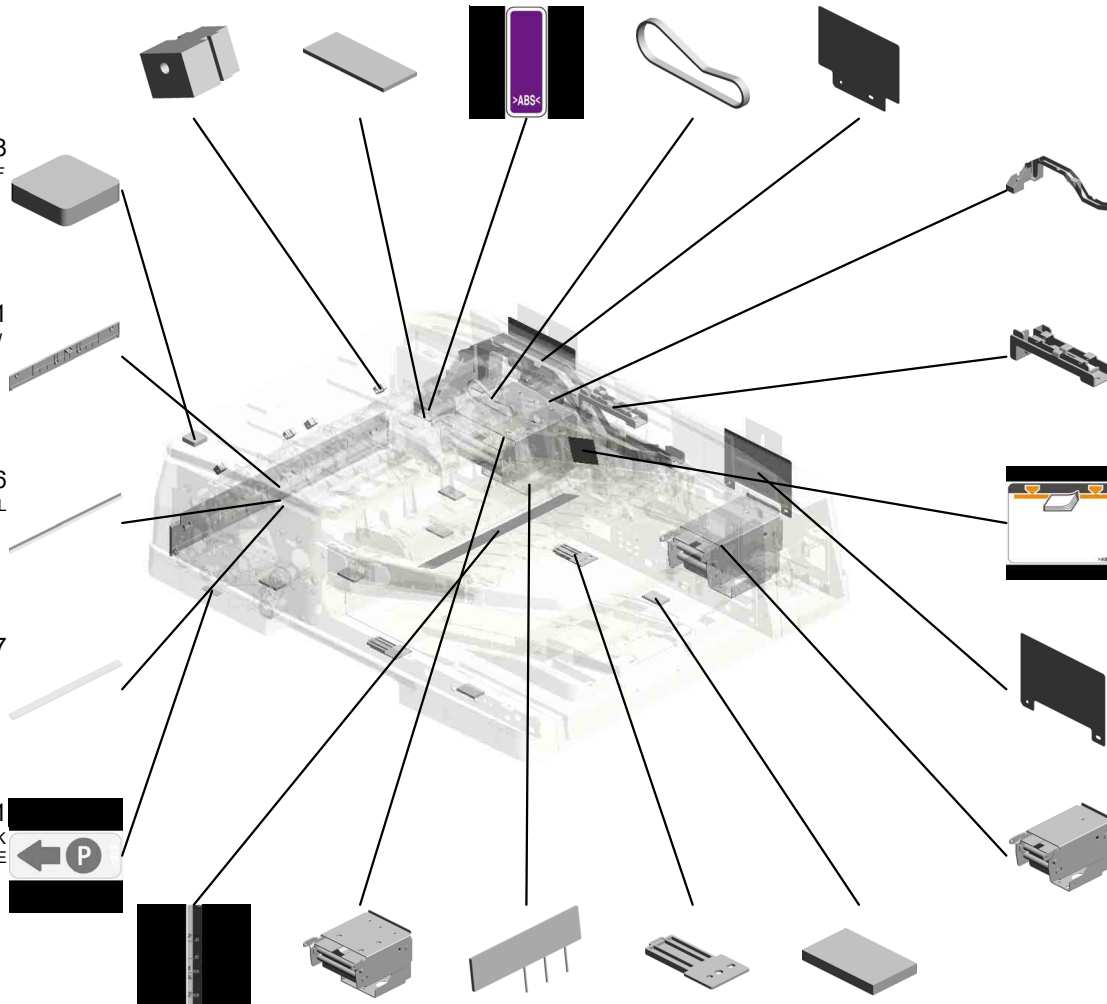

U003_S001
ADF:ASS'Y

307.AW020234
(x9)
PHOTOINTERRUP
TOR:GP1A173LCS
5F
201903-01 O/O



308.D3B03390
GUIDE PLATE:SCA
NNING:NON-CONT
ACT:PEEN
201905-04 X/O

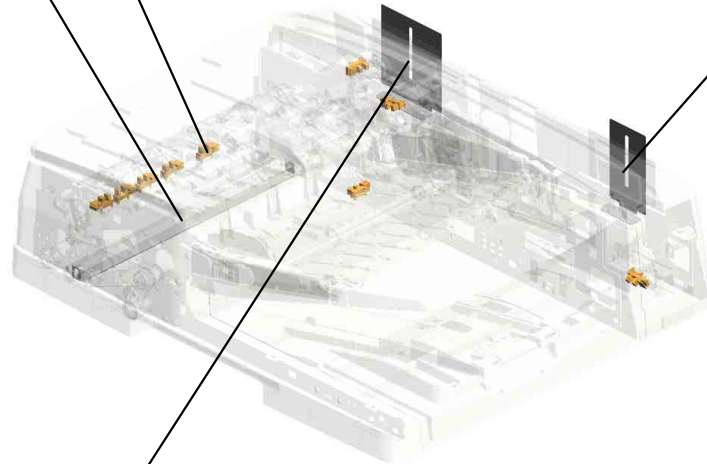

305.D3FF1387
SHEET:HINGE:RIG
HT



304.D3FF1386
SHEET:HINGE:LEF
T

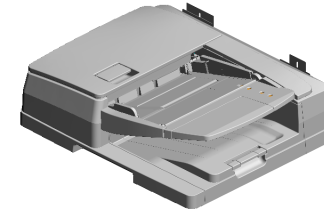

129.D3B07010
ADF:ASS'Y

U001	U002	U003	U004	U005	U006	U007	U008	U009	U010	U011	U012	U013	U014	U015	U016	U017	U018	U019	U020
------	------	------	------	------	------	------	------	------	------	------	------	------	------	------	------	------	------	------	------

U003_S001_S001
SHAFT:SEPARATION:DRIVE:INPUT:SUB-ASS'Y

54-AA082101
BUSHING - 6X10X6

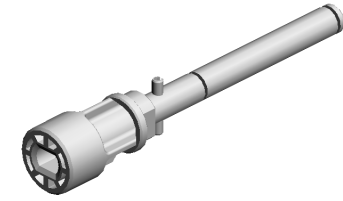
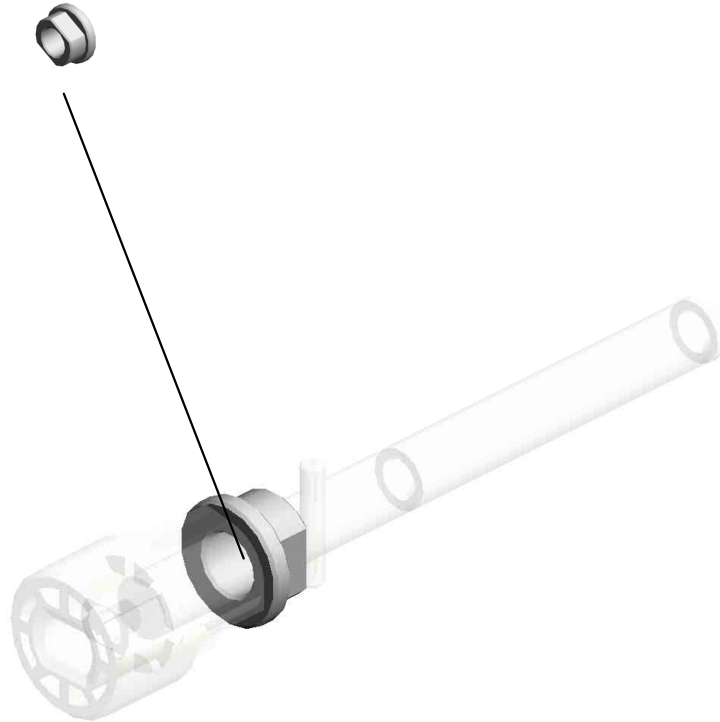

161-D6831620
SHAFT:SEPARATI
ON:DRIVE:INPUT:S
UB-ASS'Y

U001	U002	U003	U004	U005	U006	U007	U008	U009	U010	U011	U012	U013	U014	U015	U016	U017	U018	U019	U020
------	------	------	------	------	------	------	------	------	------	------	------	------	------	------	------	------	------	------	------

U003_S001_S002
SHAFT:REVERSE ROLLER:SUB-ASS'Y

10.07200040E
RETAINING RING -
M4

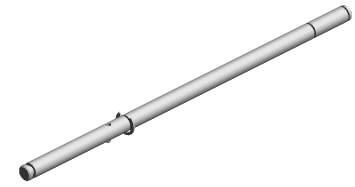

162.D6831632
SHAFT:REVERSE
ROLLER:SUB-ASS'
Y

U001	U002	U003	U004	U005	U006	U007	U008	U009	U010	U011	U012	U013	U014	U015	U016	U017	U018	U019	U020
------	------	------	------	------	------	------	------	------	------	------	------	------	------	------	------	------	------	------	------

U003_S001_S003

SHAFT:INPUT:PAPER FEED:SUB-ASS'Y

10.07200040E
RETAINING RING -
M4

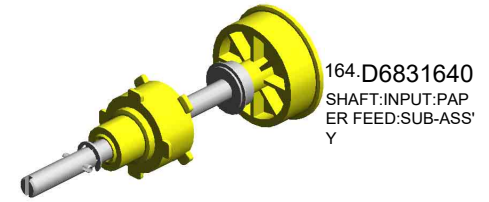

12.07433806
RADIAL BALL BEA
RING:DIA6XDIA13X
5

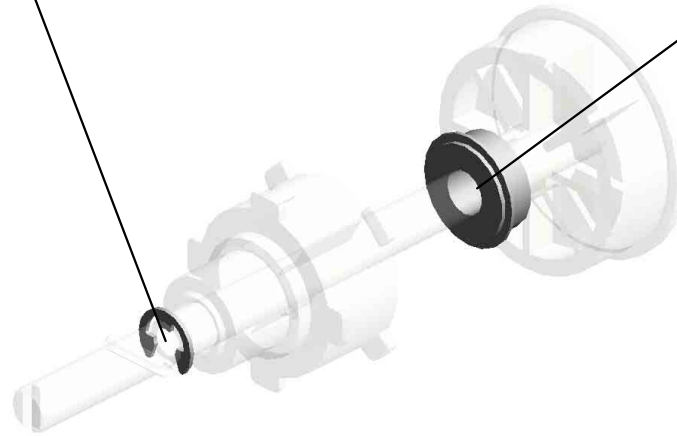

U001	U002	U003	U004	U005	U006	U007	U008	U009	U010	U011	U012	U013	U014	U015	U016	U017	U018	U019	U020
------	------	------	------	------	------	------	------	------	------	------	------	------	------	------	------	------	------	------	------

U003_S001_S004
SHAFT:SEPARATION:ASS'Y

11.07200060E RETAINING RING - M6
 35.A8061163 (x2) GUIDE PLATE CUSHION
 189.D6832215 SHAFT:SEPARATION:DRIVE
 81.B7892114 PAPER FEED BELT ROLLER
 190.D6832221 GEAR:IDLER:Z18



92.D3B02200 SHAFT:SEPARATION:ASS'Y

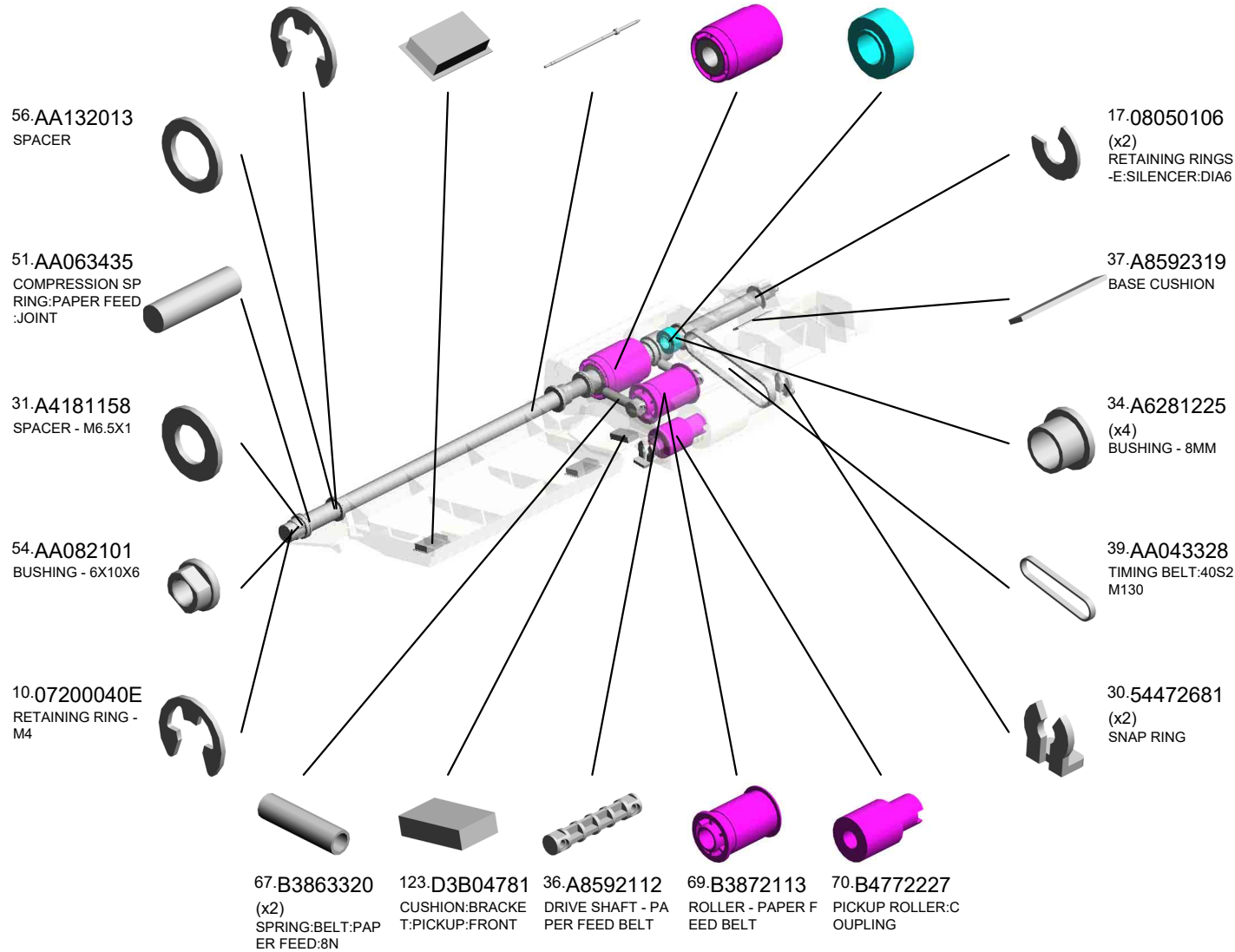

U001	U002	U003	U004	U005	U006	U007	U008	U009	U010	U011	U012	U013	U014	U015	U016	U017	U018	U019	U020
------	------	------	------	------	------	------	------	------	------	------	------	------	------	------	------	------	------	------	------

U003_S001_S004
SHAFT:SEPARATION:ASS'Y

- 197.D6832233 BRACKET:PAPER FEED BELT
- 194.D6832229 TIMING PULLEY:GEAR:T19/Z23
- 195.D6832231 BRACKET:PICKUP
- 202.D6832272 LEVER:PICKUP ROLLER:RISE

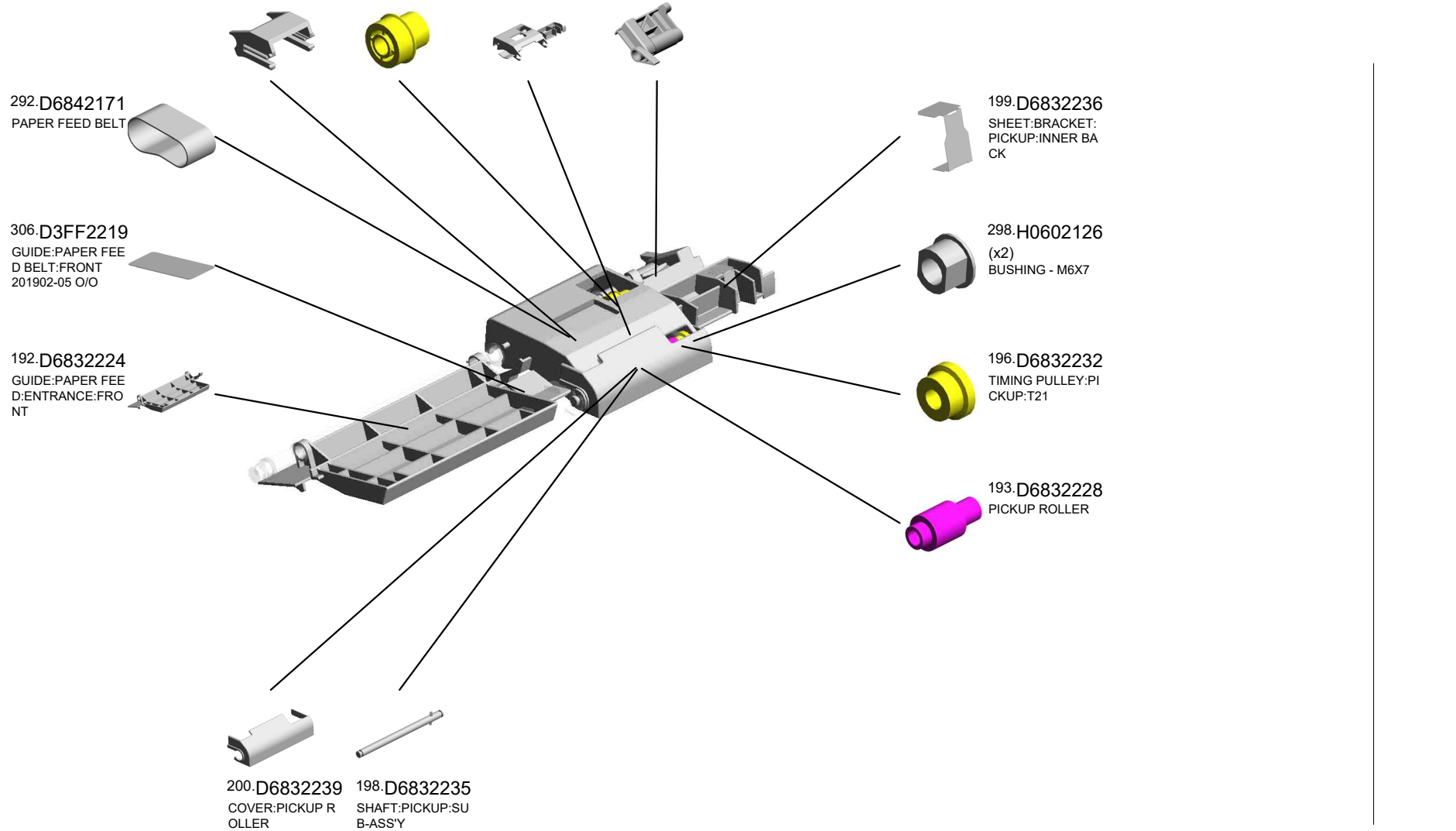
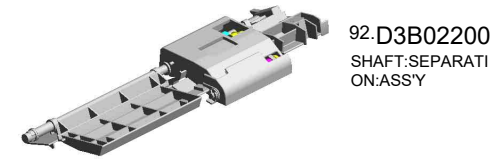

U001	U002	U003	U004	U005	U006	U007	U008	U009	U010	U011	U012	U013	U014	U015	U016	U017	U018	U019	U020
------	------	------	------	------	------	------	------	------	------	------	------	------	------	------	------	------	------	------	------

U003_S001_S004_S001
GUIDE:PAPER FEED:ENTRANCE:INNER BACK:ASS'Y

35.A8061163
(x2)
GUIDE PLATE CUS
HION

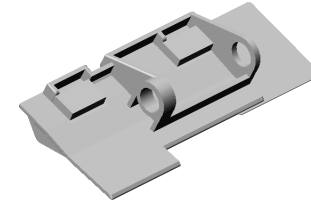

201.D6832240
GUIDE:PAPER FEE
D:ENTRANCE:INNE
R BACK:ASS'Y

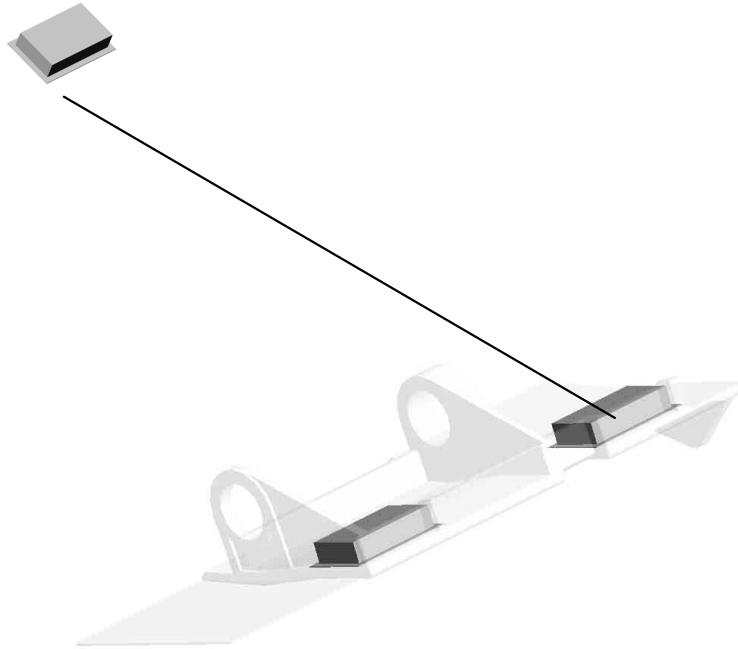

U001	U002	U003	U004	U005	U006	U007	U008	U009	U010	U011	U012	U013	U014	U015	U016	U017	U018	U019	U020
------	------	------	------	------	------	------	------	------	------	------	------	------	------	------	------	------	------	------	------

U003_S001_S005

GUIDE PLATE:CONTACT IMAGE SENSOR:ENTRANCE:ASS'Y

252.D6833812 DISCHARGE BRUSH:EXIT
 247.D6833668 (x2) SPACER:GUIDE PLATE:CONTACT IMAGE SENSOR:ENTRANCE



96.D3B03662 GUIDE PLATE:CONTACT IMAGE SENSOR:ENTRANCE:ASS'Y

245.D6833666 LEVER:GUIDE PLATE:CONTACT IMAGE SENSOR:FRONT



246.D6833667 LEVER:GUIDE PLATE:CONTACT IMAGE SENSOR:REAR



2-03603006N (x4) SCREW - M3X6

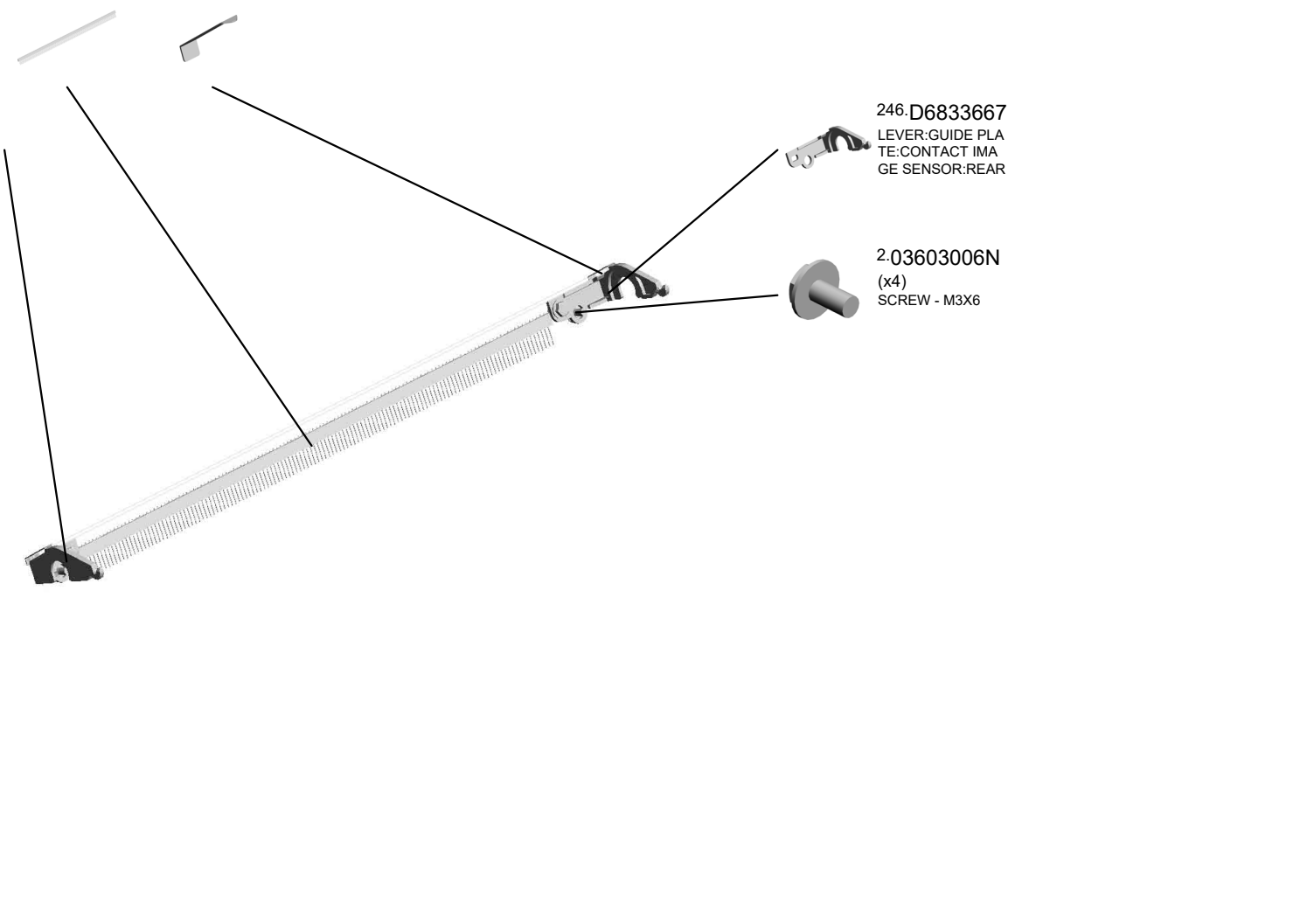

U001	U002	U003	U004	U005	U006	U007	U008	U009	U010	U011	U012	U013	U014	U015	U016	U017	U018	U019	U020
------	------	------	------	------	------	------	------	------	------	------	------	------	------	------	------	------	------	------	------

243.D6833645
(x2)
ROLLER:MIDDLE:DI
RIVEN

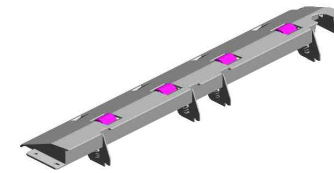

240.D6833641
GUIDE:CONTACT I
MAGE SENSOR:EX
IT:LOWER:ASS'Y

297.G0602652
(x4)
BUSHING - M4

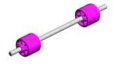

241.D6833643
(x4)
COMPRESSION SP
RING:CONTACT IM
AGE SENSOR:EXIT

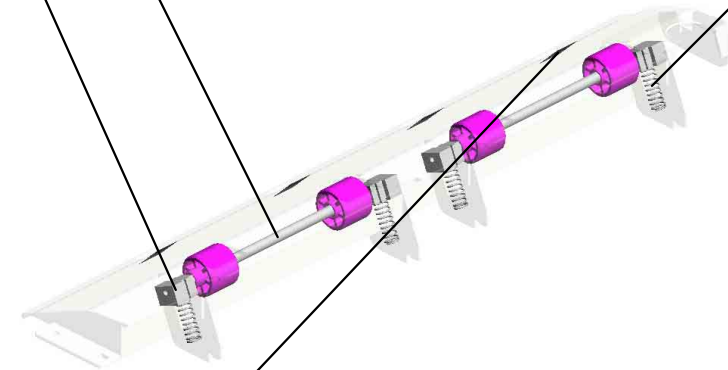

242.D6833644
(x4)
SHEET:GUIDE:CO
NTACT IMAGE SEN
SOR:EXIT:LOWER

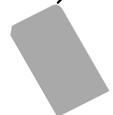

U001	U002	U003	U004	U005	U006	U007	U008	U009	U010	U011	U012	U013	U014	U015	U016	U017	U018	U019	U020
------	------	------	------	------	------	------	------	------	------	------	------	------	------	------	------	------	------	------	------

U003_S001_S007

ROLLER:SCANNING:EXIT:DRIVE:ASS'Y

11.07200060E
RETAINING RING -
M6

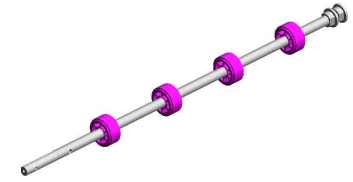

226.D6833150
ROLLER:SCANNIN
G:EXIT:DRIVE:ASS'
Y

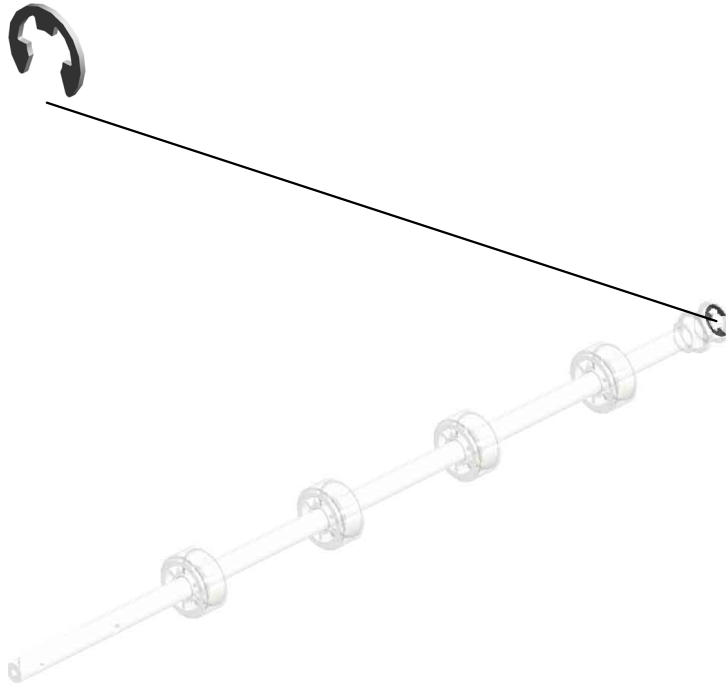

U001	U002	U003	U004	U005	U006	U007	U008	U009	U010	U011	U012	U013	U014	U015	U016	U017	U018	U019	U020
------	------	------	------	------	------	------	------	------	------	------	------	------	------	------	------	------	------	------	------

U003_S001_S008

GUIDE:SCANNING:ENTRANCE:NON-CONTACT:SUB-ASS'Y

141.D5433314

(x4)

SHEET:SCANNING:

ENTRANCE:MIDDLE

E

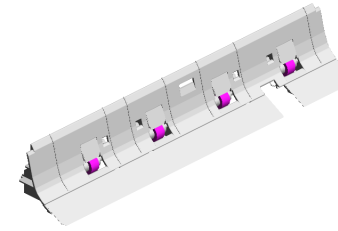

235.D6833461

GUIDE:SCANNING:

ENTRANCE:NON-C

ONTACT:SUB-ASS'

Y

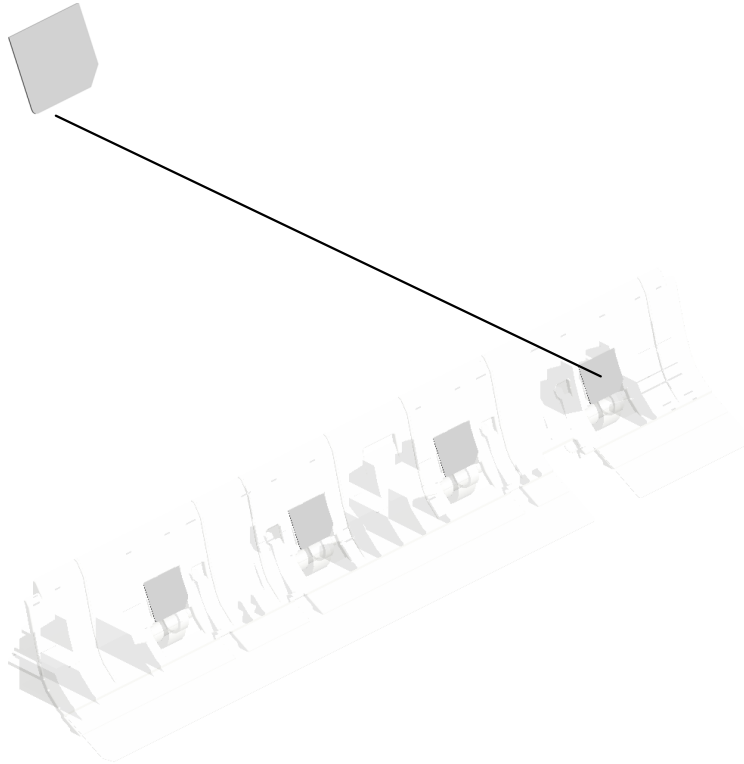

U001	U002	U003	U004	U005	U006	U007	U008	U009	U010	U011	U012	U013	U014	U015	U016	U017	U018	U019	U020
------	------	------	------	------	------	------	------	------	------	------	------	------	------	------	------	------	------	------	------

U003_S001_S009
COVER:REAR:ASS'Y

85.B8024712 (x7) SOUND PROOFIN G MATERIAL:COVE R:REAR
 112.D3B04761 (x6) SOUND PROOFIN G MATERIAL:COVE R:REAR:LOWER:1
 116.D3B04765 (x2) SOUND PROOFIN G MATERIAL:COVE R:REAR:UPPER

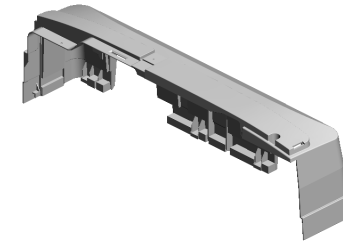

309.D3FF4210
 [A]
 COVER:REAR:ASS'
 Y
 201905-05 X/O

115.D3B04764 (x2) SOUND PROOFIN G MATERIAL:COVE R:REAR:LOWER:4

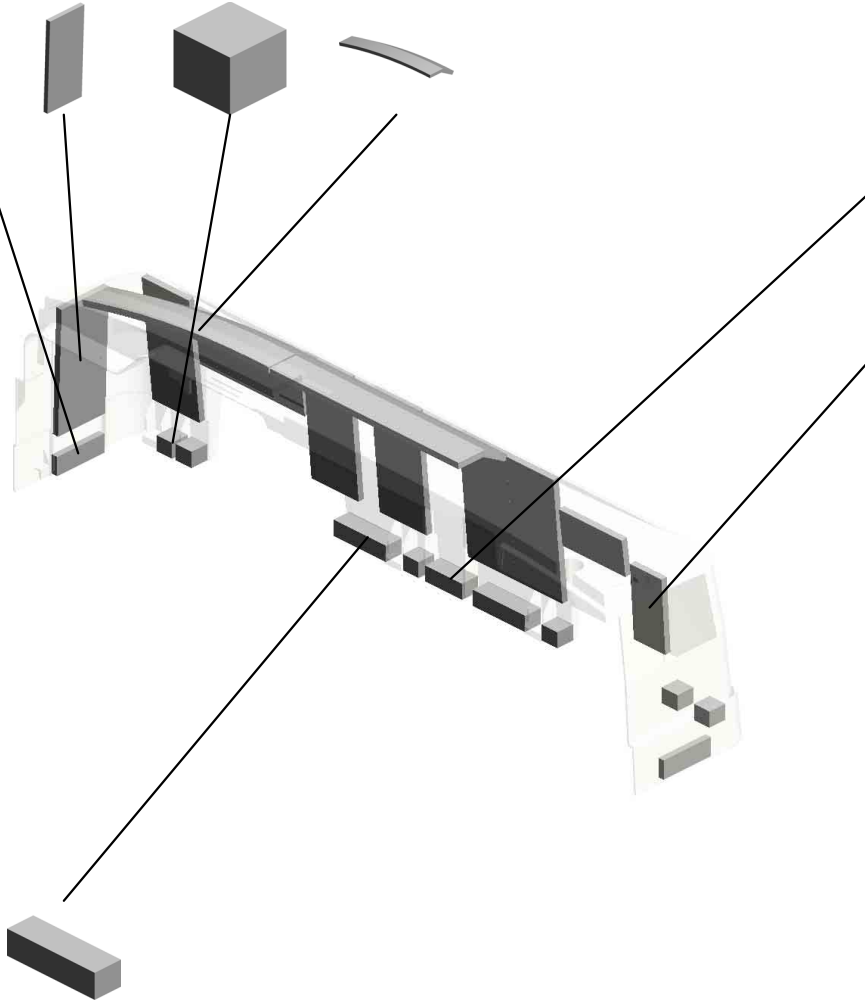

113.D3B04762 SOUND PROOFIN G MATERIAL:COVE R:REAR:LOWER:2

84.B8024711 (x2) SOUND PROOFIN G MATERIAL

114.D3B04763 (x2) SOUND PROOFIN G MATERIAL:COVE R:REAR:LOWER:3



D3B04210
 [A]
 COVER:REAR:ASS'
 Y
 201905-05 X/O

U001	U002	U003	U004	U005	U006	U007	U008	U009	U010	U011	U012	U013	U014	U015	U016	U017	U018	U019	U020
------	------	------	------	------	------	------	------	------	------	------	------	------	------	------	------	------	------	------	------

U003_S001_S010
COVER:PAPER FEED:UPPER:ASS'Y

85.B8024712 (x6)
SOUND PROOFING MATERIAL:COVER:REAR

84.B8024711 (x3)
SOUND PROOFING MATERIAL

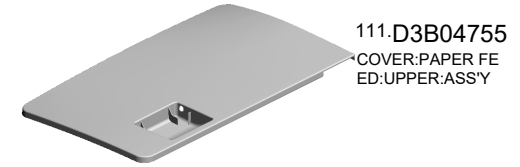

111.D3B04755
COVER:PAPER FEED:UPPER:ASS'Y

109.D3B04753
SOUND PROOFING MATERIAL:COVER:PAPER FEED:UPPER:FRONT

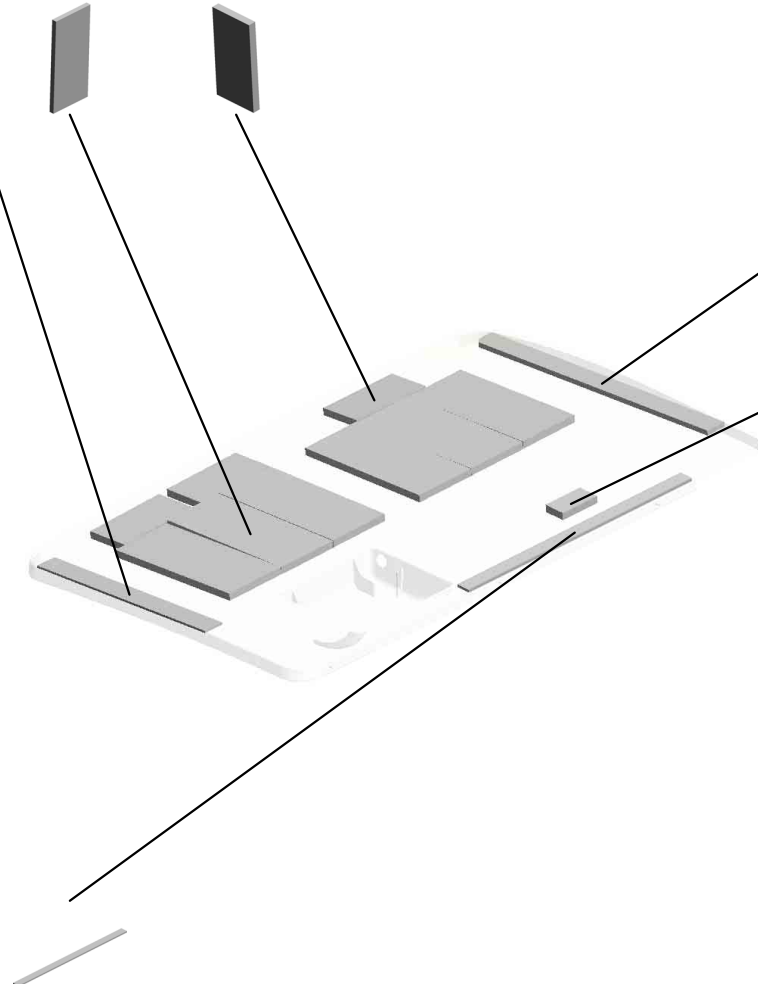

110.D3B04754
SOUND PROOFING MATERIAL:COVER:PAPER FEED:UPPER:INNER BACK

108.D3B04752
CUSHION:COVER:PAPER FEED:UPPER:2

107.D3B04751
CUSHION:COVER:PAPER FEED:UPPER:1

U001	U002	U003	U004	U005	U006	U007	U008	U009	U010	U011	U012	U013	U014	U015	U016	U017	U018	U019	U020
------	------	------	------	------	------	------	------	------	------	------	------	------	------	------	------	------	------	------	------

U003_S001_S011

GUIDE:PAPER FEED:UPPER:SUB-ASS'Y

119.D3B04773 (x2)
SOUND PROOFIN
G MATERIAL:GUID
E:PAPER FEED:UP
PER:3

122.D3B04776
SOUND PROOFIN
G MATERIAL:GUID
E:PAPER FEED:UP
PER:6

118.D3B04772
SOUND PROOFIN
G MATERIAL:GUID
E:PAPER FEED:UP
PER:2

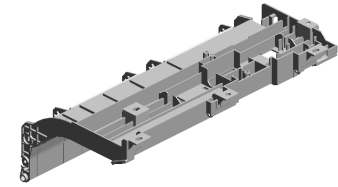

99.D3B04310
GUIDE:PAPER FEE
D:UPPER:SUB-ASS
Y

121.D3B04775
(x2)
SOUND PROOFIN
G MATERIAL:GUID
E:PAPER FEED:UP
PER:5

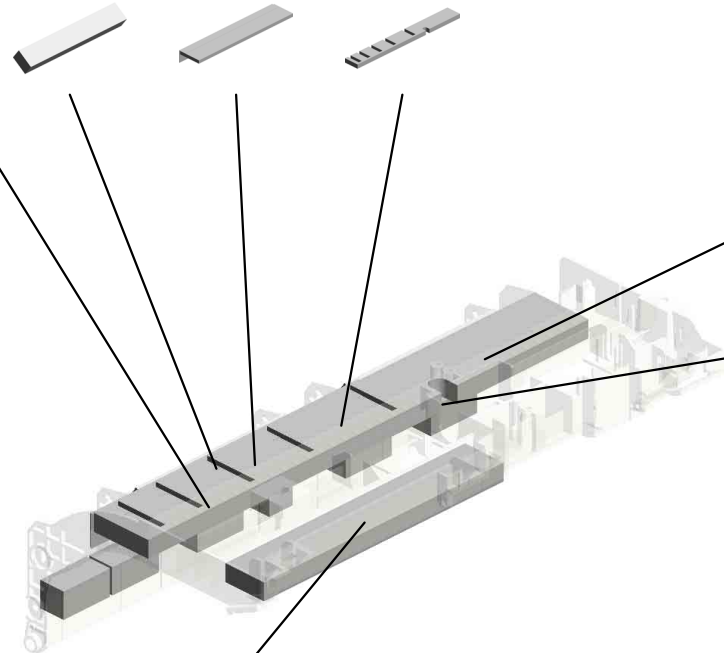

141.D5433314
(x4)
SHEET:SCANNING:
ENTRANCE:MIDDL
E



120.D3B04774
(x4)
SOUND PROOFIN
G MATERIAL:GUID
E:PAPER FEED:UP
PER:4

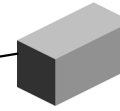

117.D3B04771
SOUND PROOFIN
G MATERIAL:GUID
E:PAPER FEED:UP
PER:1

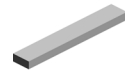

U001	U002	U003	U004	U005	U006	U007	U008	U009	U010	U011	U012	U013	U014	U015	U016	U017	U018	U019	U020
------	------	------	------	------	------	------	------	------	------	------	------	------	------	------	------	------	------	------	------

U003_S001_S012
PRESSURE PLATE:ASS'Y

102.D3B04711 106.D3B04725
GUIDE PLATE:PRE CUSHION:PRESSU
SSURE PLATE:LEF RE PLATE:SMALL
T:ASS'Y

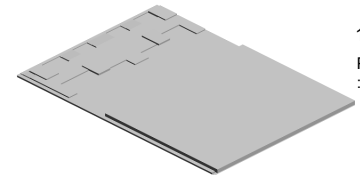

103.D3B04720
PRESSURE PLATE
:ASS'Y

104.D3B04722
(x4)
CUSHION:TAPE:SMALL

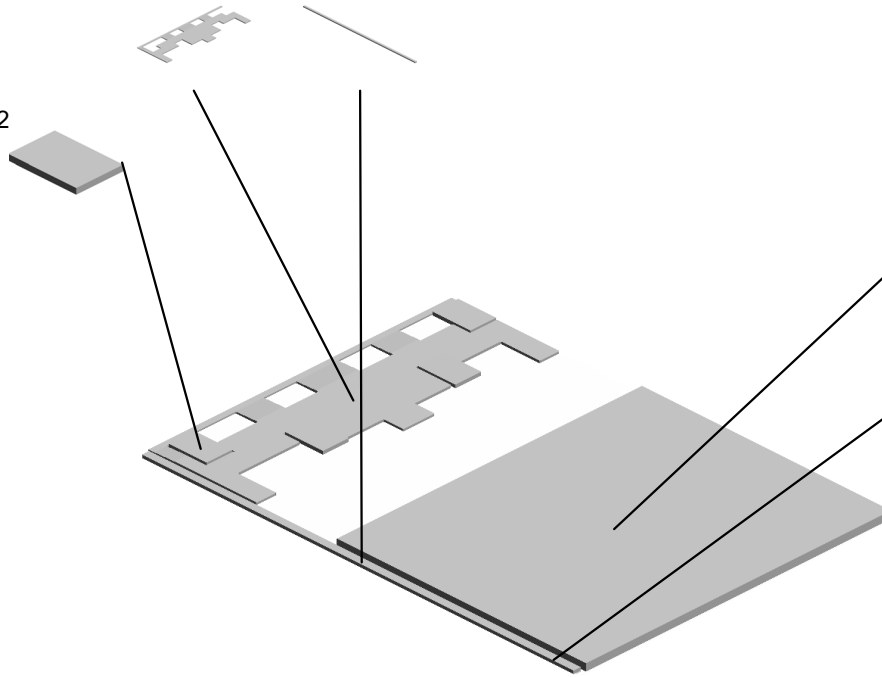

105.D3B04724
CUSHION:PRESSURE PLATE:LARGE

89.D0A46099
SHEET:PRESSURE PLATE:SMALL

U001	U002	U003	U004	U005	U006	U007	U008	U009	U010	U011	U012	U013	U014	U015	U016	U017	U018	U019	U020
------	------	------	------	------	------	------	------	------	------	------	------	------	------	------	------	------	------	------	------

U003_S001_S013
COVER:LOWER RIGHT:ASS'Y

282.D6834442
(x2)
TAPE:PRESSURE
PLATE

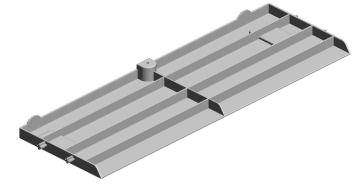
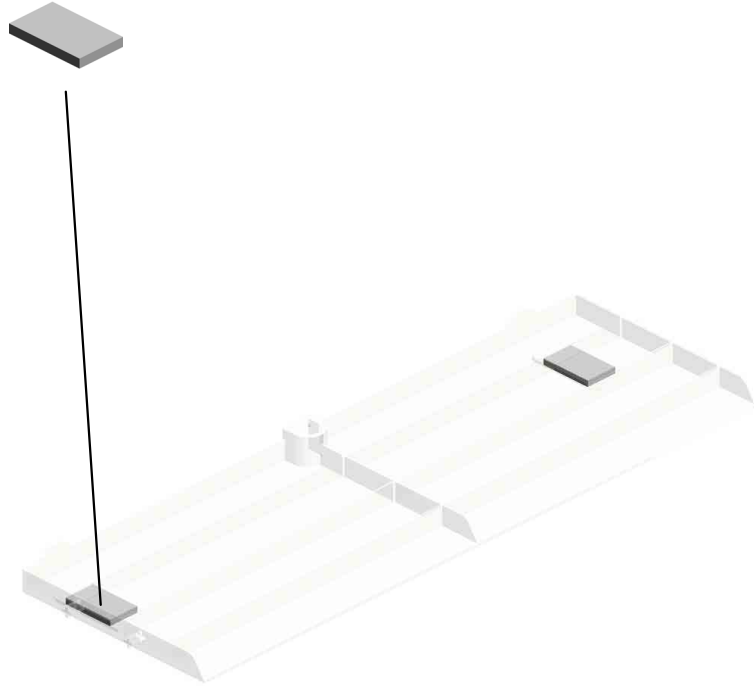

283.D6834510
COVER:LOWER RI
GHT:ASS'Y

U001	U002	U003	U004	U005	U006	U007	U008	U009	U010	U011	U012	U013	U014	U015	U016	U017	U018	U019	U020
------	------	------	------	------	------	------	------	------	------	------	------	------	------	------	------	------	------	------	------

U004.SCANNER

U004 S001
D0AC1640
OPTICAL READING UNIT:CA
RRIAGE:SCANNER

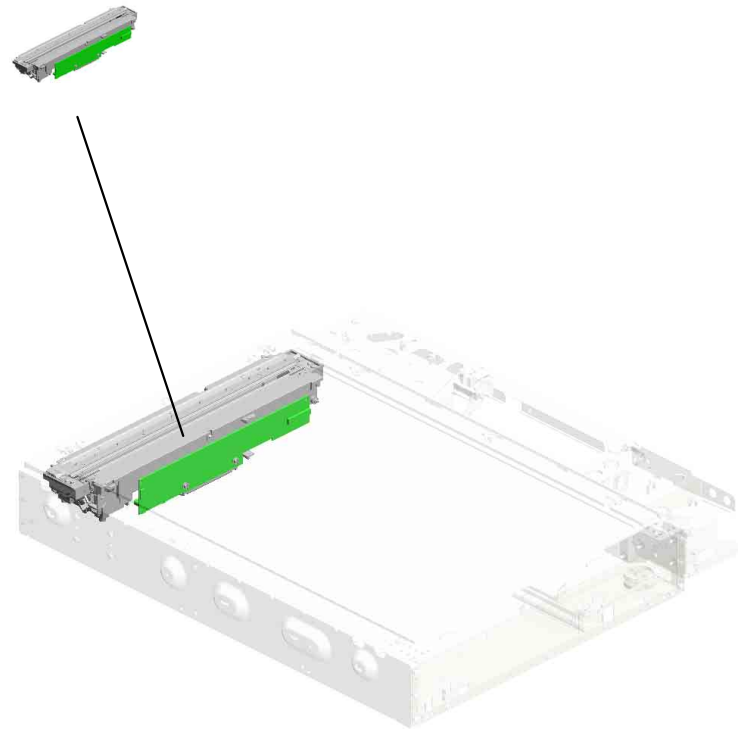

U001	U002	U003	U004	U005	U006	U007	U008	U009	U010	U011	U012	U013	U014	U015	U016	U017	U018	U019	U020
------	------	------	------	------	------	------	------	------	------	------	------	------	------	------	------	------	------	------	------

U004 SCANNER

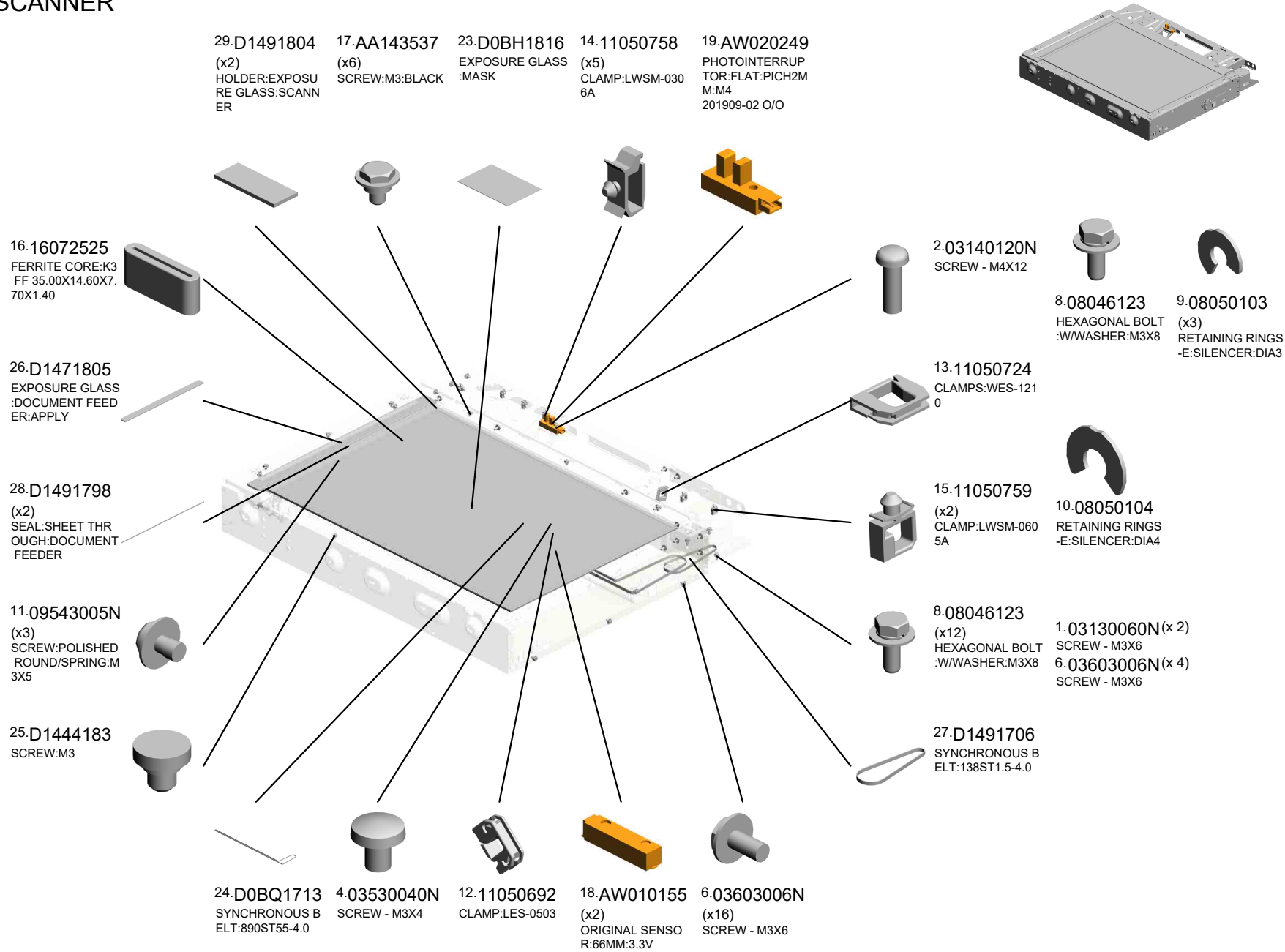

U001	U002	U003	U004	U005	U006	U007	U008	U009	U010	U011	U012	U013	U014	U015	U016	U017	U018	U019	U020
------	------	------	------	------	------	------	------	------	------	------	------	------	------	------	------	------	------	------	------

U004 SCANNER

43.D2411702 (x2) CAP:PULLEY:IDLER:LEADING EDGE
 31.D2411671 (x2) PROTECTION:CARriage:SCANNER
 32.D0BQ1678 SHEET:FFC:LOWE R 201907-02 O/O
 33.D2411680 GUIDE ROD
 30.D1491833 (x5) SHEET:GLASS

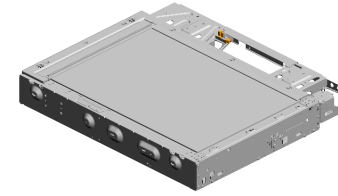

42.D2411701 PULLEY:IDLER:LEADING EDGE



36.D2411685 SPRING PLATE:GUIDE ROD



39.D2411689 (x6) HOLDER:EXPOSURE GLASS



41.D2411698 COVER:BASE:SCANNER



40.D2411697 SLIDE RAIL



35.D2411684 COVER:HARNESS:SCANNER



38.D2411688 SHEET:GLASS: LARGE

44.D2411708 TIGHTENER:DIAPHRAGM

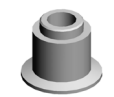

45.D2411710 PULLEY:IDLER:TRAILING EDGE

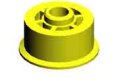

34.D2411681 (x2) STAY:GUIDE ROD

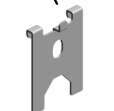

49.D2411716 CAP:PULLEY:DRIVE: UPPER



48.D2411715 PULLEY:DRIVE



47.D2411712 TENSION SPRING: TIGHTENER:TENSION:4N



37.D2411686 (x2) CLAMP:STAY:GUIDE ROD



46.D2411711 CAP:IDLER:TRAILING EDGE



U004 SCANNER

61.D2411734 (NA):SCALE:LEFT:INCH:ASS'Y
 62.GW020024 PHOTOINTERRUPTOR:LG2A24BL1:GF
 201811-03 X/O
 55.D2411741 BRACKET:DOCUMENT FEEDER:LEFT
 60.D0BH1739 (NA):SCALE:REAR:PRINTING:INCH

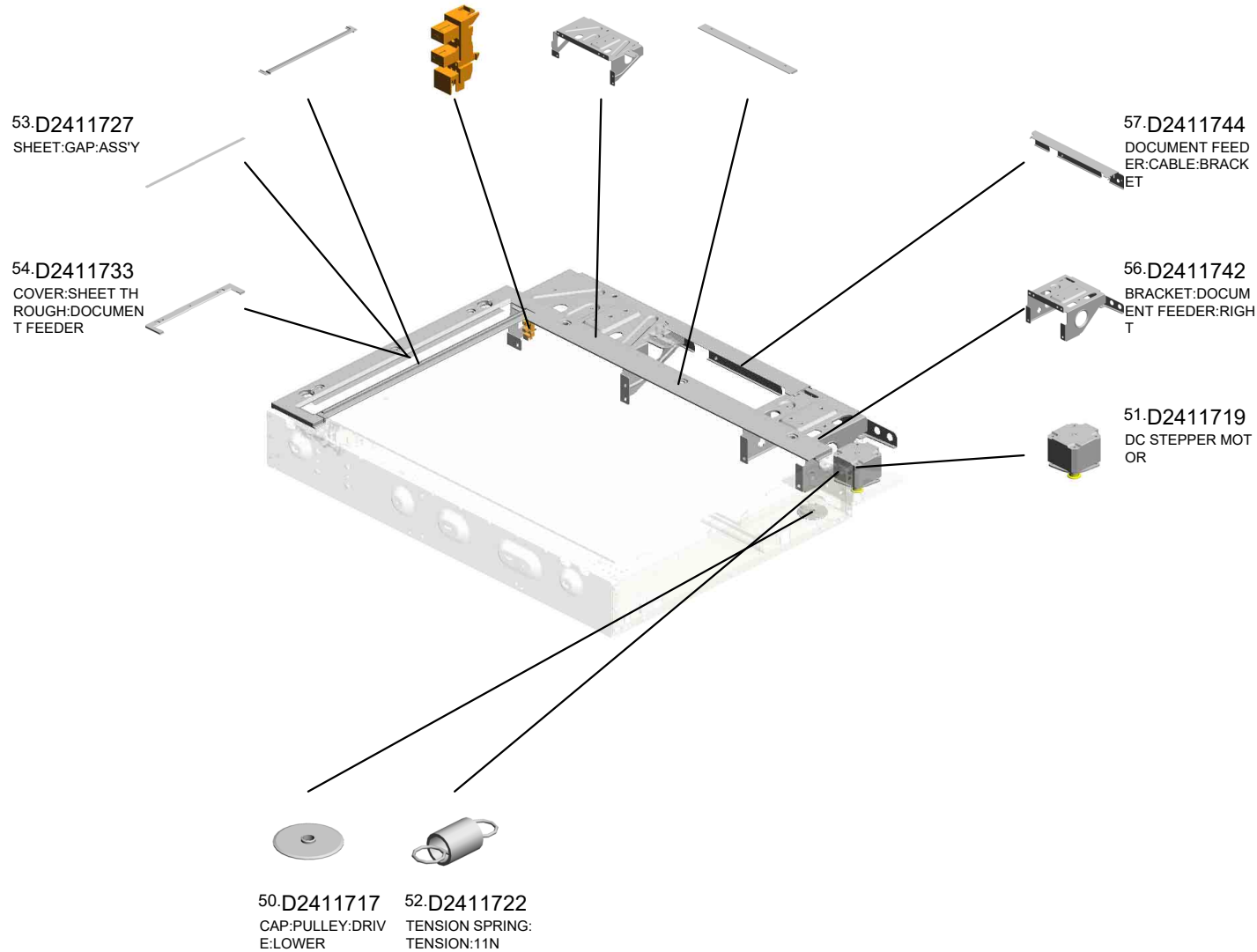

U001	U002	U003	U004	U005	U006	U007	U008	U009	U010	U011	U012	U013	U014	U015	U016	U017	U018	U019	U020
------	------	------	------	------	------	------	------	------	------	------	------	------	------	------	------	------	------	------	------

U004_S001
OPTICAL READING UNIT:CARRIAGE:SCANNER

3.03530030N 7.04583010N
(x2) (x4)
SCREW:M3X3 HEXAGON HEAD T
APPING SCREW:3
X10

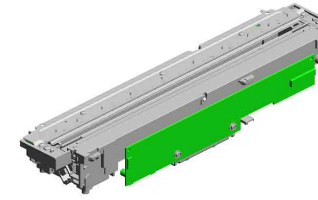

20.D0AC1640
OPTICAL READING
UNIT:CARRIAGE:S
CANNER

5.03530060N
(x3)
BIND SCREW - M3
X6

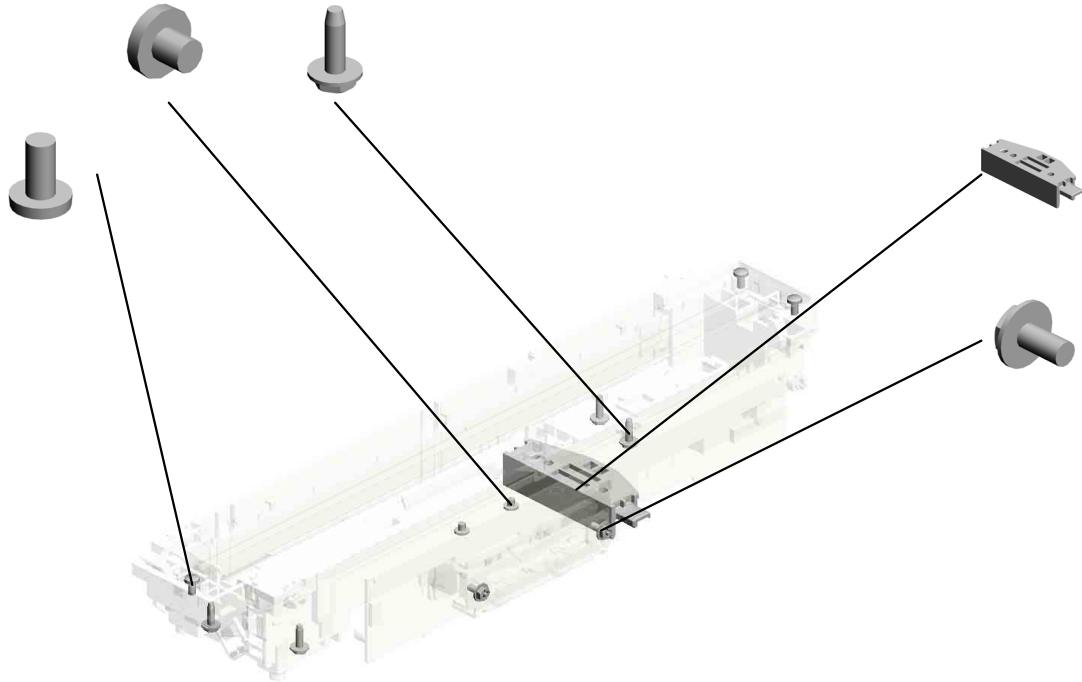

58.D2411767
PLAIN SHAFT BEA
RING:90ANG

6.03603006N
(x2)
SCREW - M3X6

U001	U002	U003	U004	U005	U006	U007	U008	U009	U010	U011	U012	U013	U014	U015	U016	U017	U018	U019	U020
------	------	------	------	------	------	------	------	------	------	------	------	------	------	------	------	------	------	------	------

U005.LASER UNIT

U005_S001
D2411855
OPTICAL WRITING UNIT

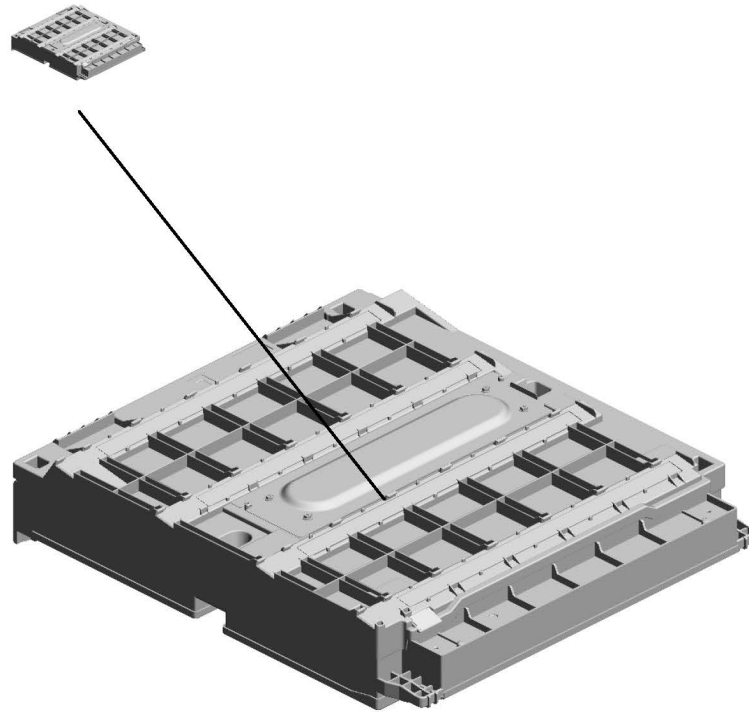

U001	U002	U003	U004	U005	U006	U007	U008	U009	U010	U011	U012	U013	U014	U015	U016	U017	U018	U019	U020
------	------	------	------	-------------	------	------	------	------	------	------	------	------	------	------	------	------	------	------	------

U005
LASER UNIT

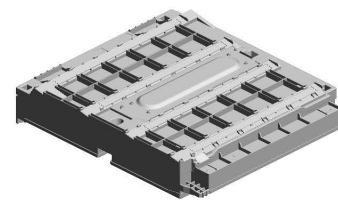

U001	U002	U003	U004	U005	U006	U007	U008	U009	U010	U011	U012	U013	U014	U015	U016	U017	U018	U019	U020
------	------	------	------	------	------	------	------	------	------	------	------	------	------	------	------	------	------	------	------

U005_S001
OPTICAL WRITING UNIT

1.04583010N 2.04593010N
(x4) (x4)
HEXAGON HEAD TAPPING SCREW:3X10 BINDING HEAD TAPPING SCREW:3X10

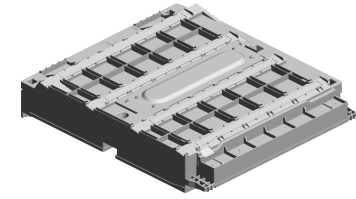

4.D2411855
OPTICAL WRITING UNIT

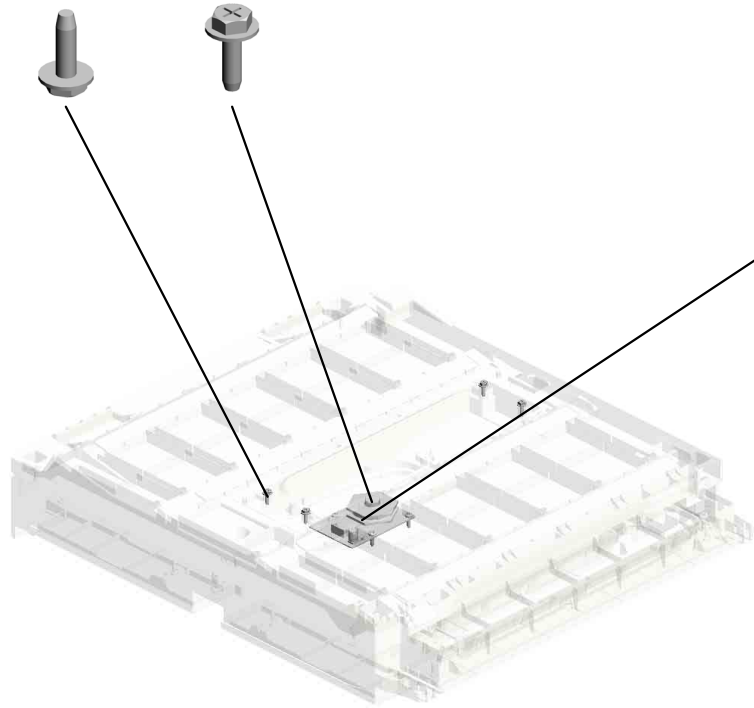

3.AX060519
DC POLYGON MIRROR MOTOR
201908-01 O/O

U001	U002	U003	U004	U005	U006	U007	U008	U009	U010	U011	U012	U013	U014	U015	U016	U017	U018	U019	U020
------	------	------	------	------	------	------	------	------	------	------	------	------	------	------	------	------	------	------	------

U006.PAPER FEED

U006 S001
D0BH2800
PAPER TRAY:NO.1:ASS'Y

U006 S003
D1492905
SUPPORTER:RIGHT:NO.1:AS
SY

U006 S006
D0BQ2711
PAPER FEED UNIT:NO.1:ASS
'Y

U006 S002
D0BH2805
PAPER TRAY:NO.2:ASS'Y

U006 S005
D1492713
GUIDE PLATE:SWIVEL:NO.1

U006 S007
D0BQ2712
PAPER FEED UNIT:NO.2:ASS
'Y

U006 S004
D1492903
SUPPORTER:RIGHT:NO.2:AS
SY

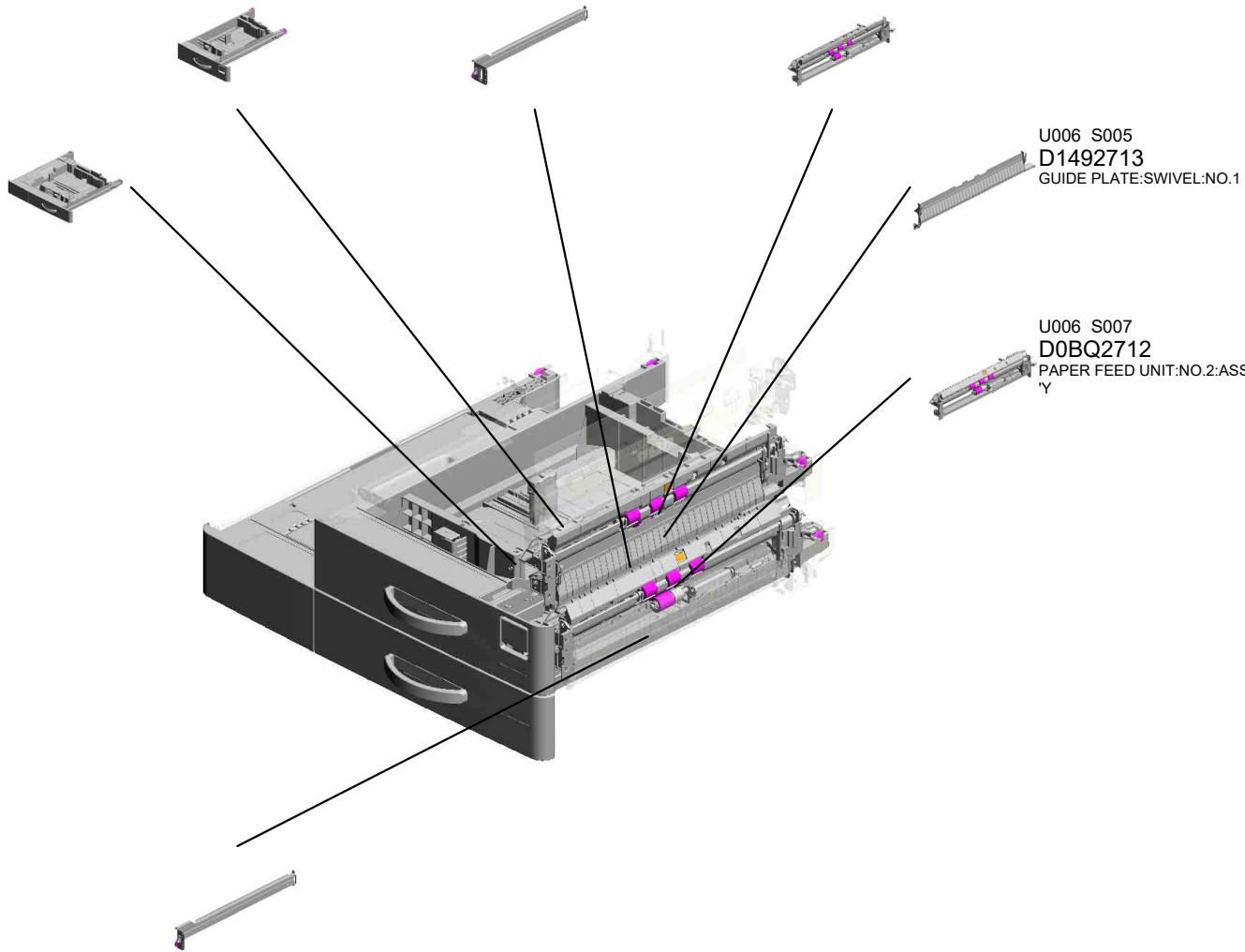

U001	U002	U003	U004	U005	U006	U007	U008	U009	U010	U011	U012	U013	U014	U015	U016	U017	U018	U019	U020
------	------	------	------	------	------	------	------	------	------	------	------	------	------	------	------	------	------	------	------

U006_S001.PAPER TRAY:NO.1:ASS'Y

U006 S001 S004
D0BQ2840
END FENCE:PAPER TRAY:A
SS'Y

U006 S001 S002
D1492828
SIDE FENCE:FRONT:NO.1:A
SS'Y

U006 S001 S003
D1492838
SIDE FENCE:REAR:NO.1:AS
S'Y

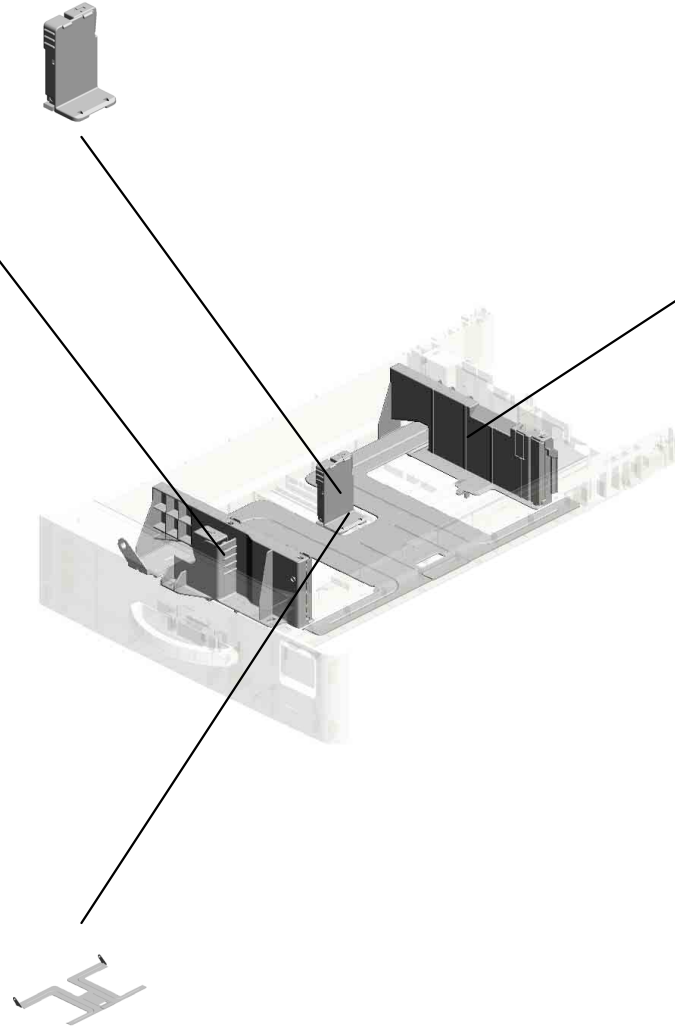

U006 S001 S001
D1492850
TRAY BOTTOM PLATE:ASS'Y

U001	U002	U003	U004	U005	U006	U007	U008	U009	U010	U011	U012	U013	U014	U015	U016	U017	U018	U019	U020
------	------	------	------	------	-------------	------	------	------	------	------	------	------	------	------	------	------	------	------	------

U006_S002.PAPER TRAY:NO.2:ASS'Y

U006 S002 S002
D0BQ2840
END FENCE:PAPER TRAY:A
SS'Y

U006 S002 S003
D2412875
SIDE FENCE:FRONT:ASS'Y

U006 S002 S004
D2412880
SIDE FENCE:REAR:ASS'Y

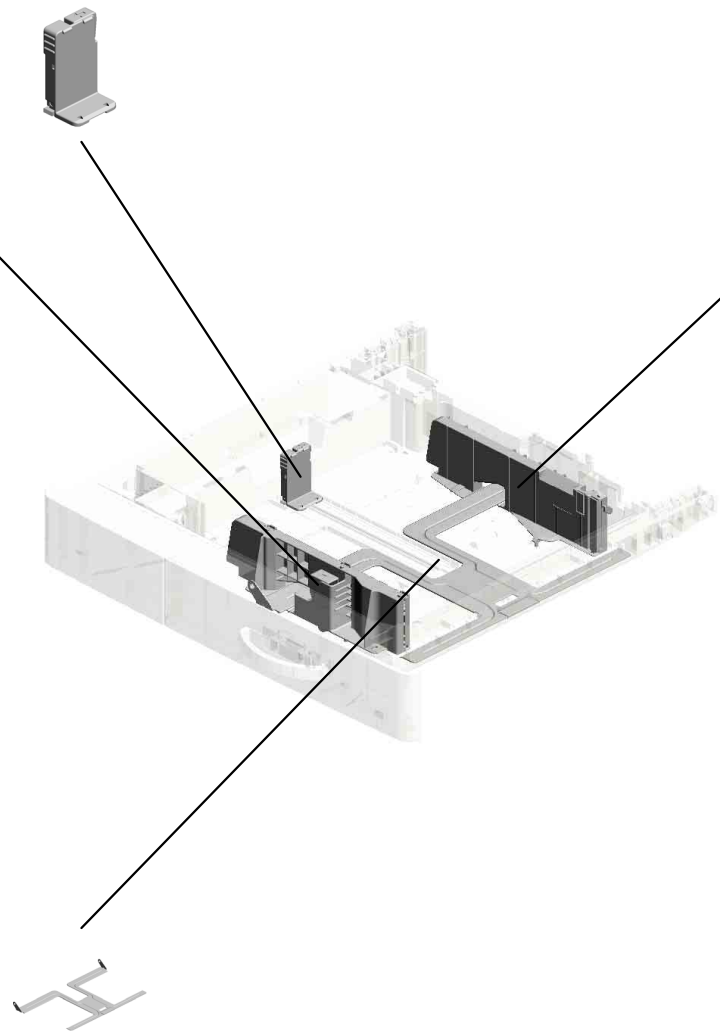

U006 S002 S001
D0BQ2873
TRAY BOTTOM PLATE:NO.2:
ASS'Y

U001	U002	U003	U004	U005	U006	U007	U008	U009	U010	U011	U012	U013	U014	U015	U016	U017	U018	U019	U020
------	------	------	------	------	-------------	------	------	------	------	------	------	------	------	------	------	------	------	------	------

U006 PAPER FEED

- 12.11050765 CLAMP:LWS-2218A
- 11.11050758 (x2) CLAMP:LWSM-030 6A
- 16.AA082175 (x2) PLAIN SHAFT BEARING:8X12X7
- 8.07200060E (x3) RETAINING RING - M6
- 18.AB011572 GEAR:Z19:DRIVEN:REGISTRATION

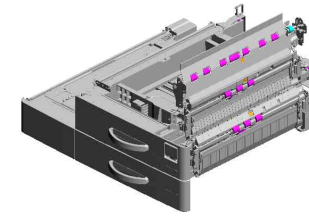

51.D1492566
CASE:REMOVE PA
PER DUST:ASS'Y



50.D1492562
(x2)
COLLAR:REGISTR
ATION ROLLER



26.AW500044
PUSH SWITCH:PA
PER SIZE SENSOR



14.AA082173
(x2)
PLAIN SHAFT BEA
RING:6X10X6



9.08050103
(x2)
RETAINING RINGS
-E:SILENCER-DIA3



54.D1492721
GUIDE PLATE:SWI
VEL:NO.2

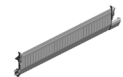

27.AX040273
(x2)
DC MOTOR:RISING
TRAY:ASS'Y:1.007
W:BRUSH



64.D1492788
INNER COVER:HA
RNNESS:PAPER FE
ED UNIT



63.D1492787
BRACKET:SUPPO
RT:COVER



4.04543008Q
(x5)
TAPPING SCREW:
3X8



7.07200040E
(x2)
RETAINING RING -
M4



19.AB011573
GEAR:REGISTRATI
ON:NO.2



5.04583008N
(x4)
HEXAGON HEAD T
APPING SCREW:3
X8



89.D1492886
COVER:TRAY:REA
R RIGHT:NO.1



3.04543006Q
(x43)
TAPPING SCREW -
M3X6



U001	U002	U003	U004	U005	U006	U007	U008	U009	U010	U011	U012	U013	U014	U015	U016	U017	U018	U019	U020
------	------	------	------	------	------	------	------	------	------	------	------	------	------	------	------	------	------	------	------

U006 PAPER FEED

100.D1492930 SUPPORTER:LEFT LOWER:NO.1:PEE N
 95.D1492918 SUPPORTER:LEFT UPPER:NO.1
 92.D1492889 COVER:TRAY:REA R LEFT:NO.2
 119.GA143003 SCREW:MM5:2.5M M
 90.D1492887 COVER:TRAY:REA R LEFT:NO.1

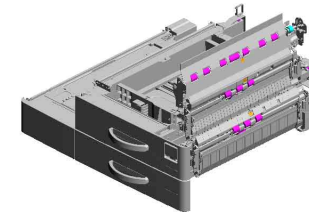

98.D1492925 SUPPORTER:LEFT :NO.2

104.D1492958 ROLLER:SUPPORT ER:PAPER TRAY:L EFT

99.D1492928 ROLLER:SUPPORT ER:PAPER TRAY:L EFT

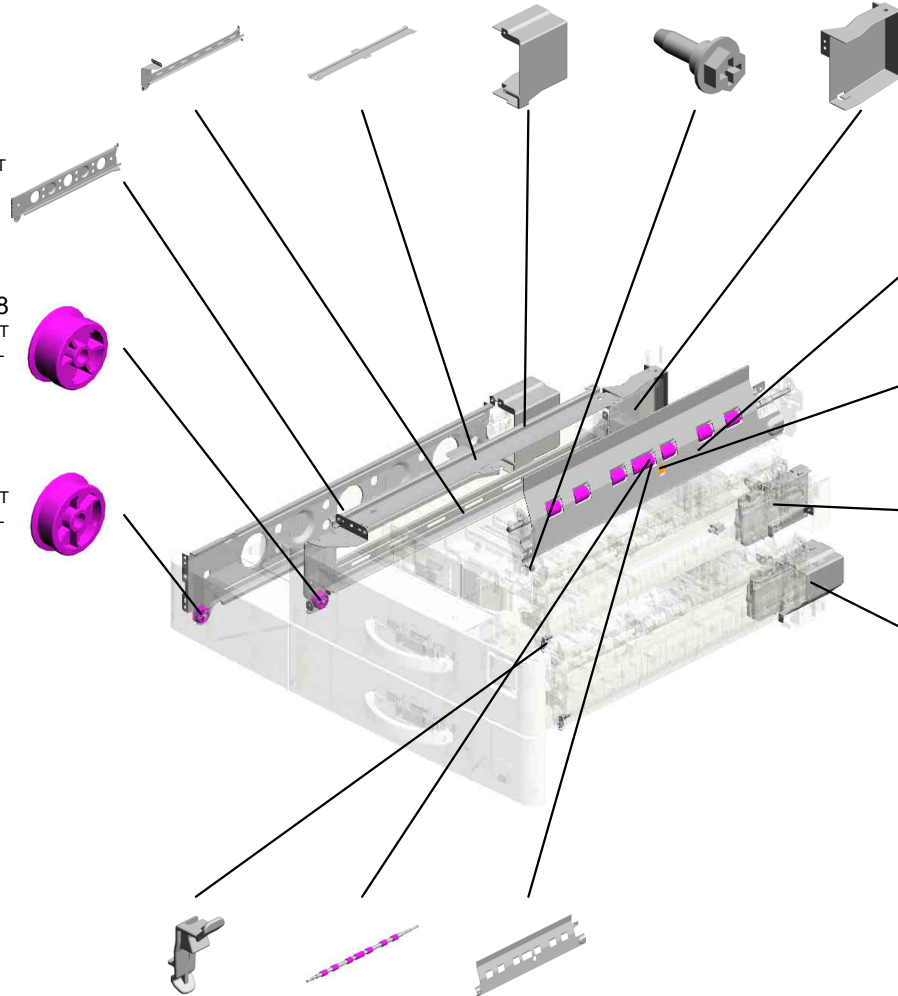

123.AW500049 (x2) PUSH SWITCH:SW 1AG-550 201811-01 O/O

120.GW010007 PHOTO REFLECTI ON SENSOR:EXIT

116.D2412906 (x2) LEVER:STRETCH: PAPER TRAY:ASS Y

91.D1492888 COVER:TRAY:REA R RIGHT:NO.2

111.D2412731 (x2) STOPPER:GUIDE P LATE:SWIVEL

107.D2412559 SHAFT:REGISTRA TION ROLLER:DRI VEN

108.D2412576 GUIDE PLATE:REG ISTRATION:FRONT LEFT

U006_S001
PAPER TRAY:NO.1:ASS'Y

- 85.D1492863 DECAL:PAPER SET DIRECTION:TRAY:NO.1
- 82.D1492846 DECAL:SIZE INDICATION:END FENCE:NO.1:FRONT
- 83.D1492847 DECAL:SIZE INDICATION:END FENCE:NO.1:REAR
- 67.D1492814 COIL SPRING:EAR TH
- 65.D1492812 (x4) ROLLER:PAPER TRAY:DIA19

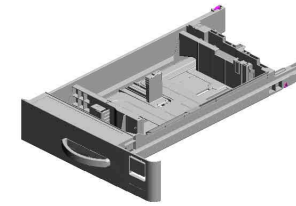

31.D0BH2800
PAPER TRAY:NO.1
:ASS'Y

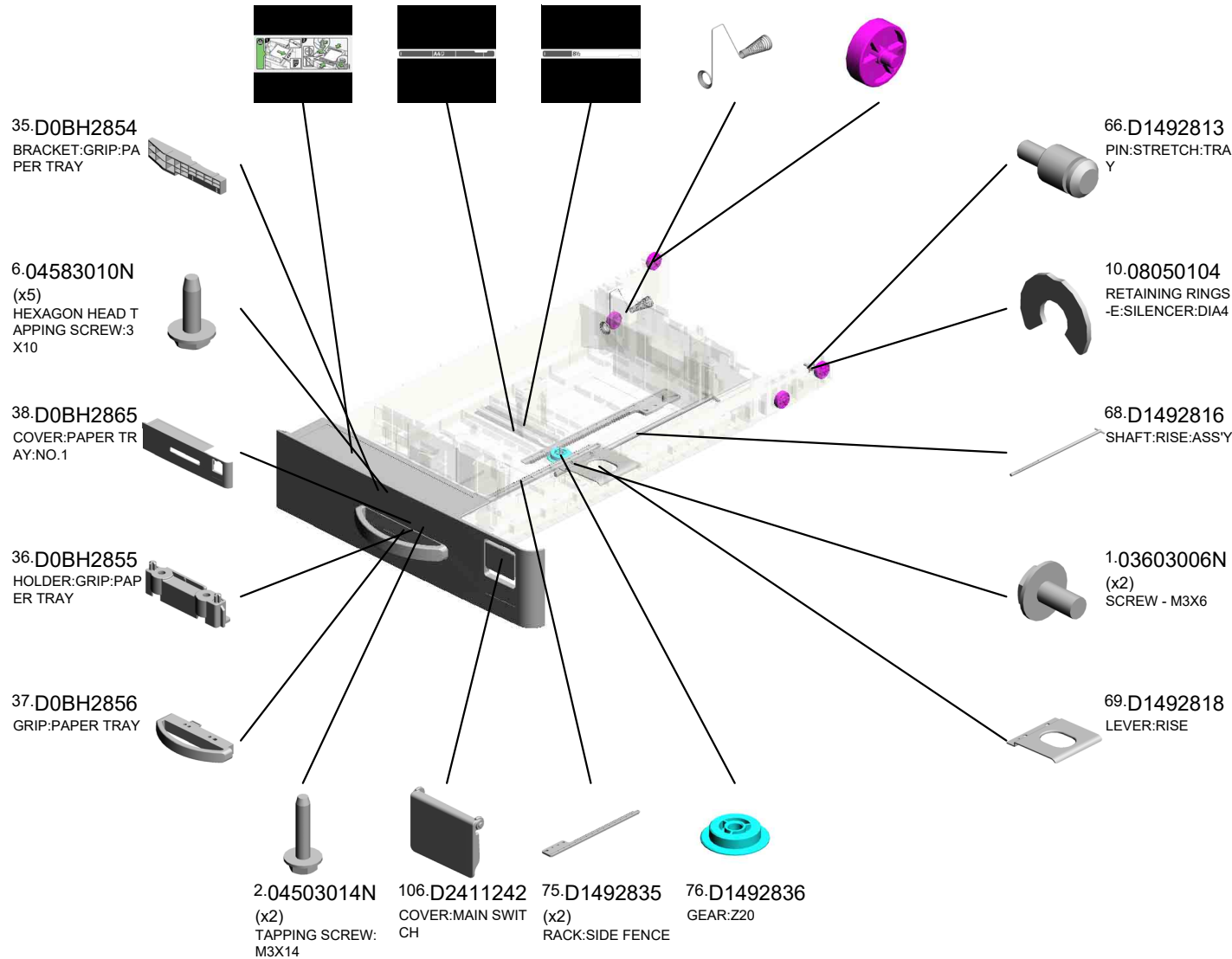

U001	U002	U003	U004	U005	U006	U007	U008	U009	U010	U011	U012	U013	U014	U015	U016	U017	U018	U019	U020
------	------	------	------	------	------	------	------	------	------	------	------	------	------	------	------	------	------	------	------

U006_S001_S001
TRAY BOTTOM PLATE:ASS'Y

122.AF013019
PAD:TRAY BOTTO
M PLATE
201809-01 O/O

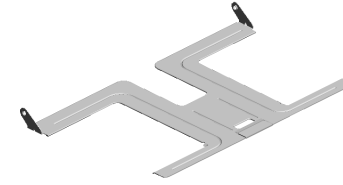

84.D1492850
TRAY BOTTOM PL
ATE:ASS'Y

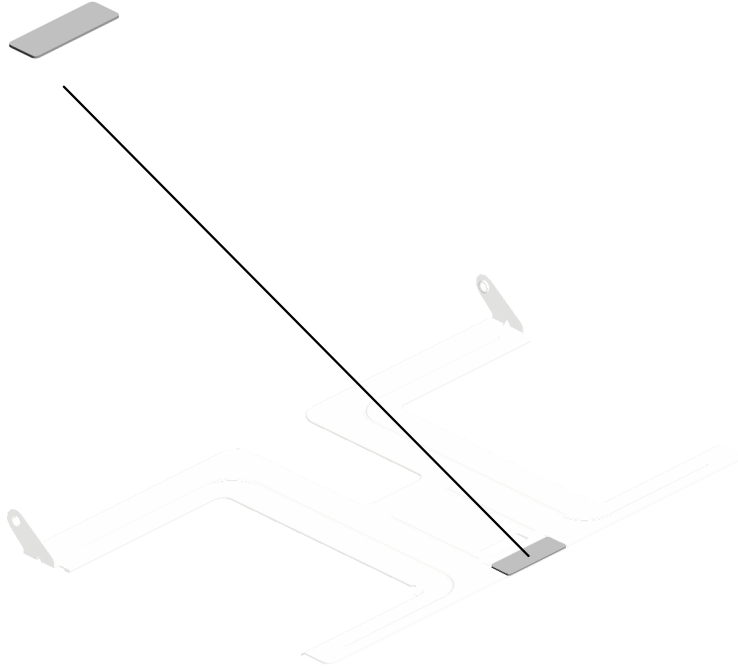

U001	U002	U003	U004	U005	U006	U007	U008	U009	U010	U011	U012	U013	U014	U015	U016	U017	U018	U019	U020
------	------	------	------	------	-------------	------	------	------	------	------	------	------	------	------	------	------	------	------	------

U006_S001_S002
SIDE FENCE:FRONT:NO.1:ASS'Y

70.D1492824
LEVER:STOPPER:
FRONT

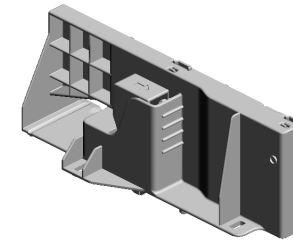

73.D1492828
SIDE FENCE:FRON
T:NO.1:ASS'Y

72.D1492827
COMPRESSION SP
RING:SIDE FENCE:
POSITIONING

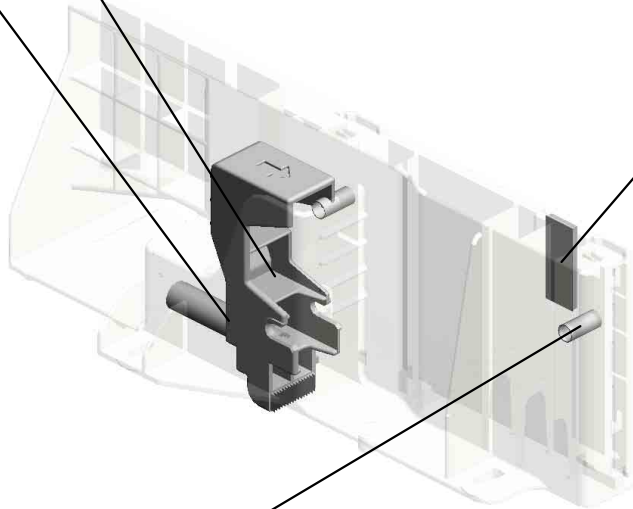
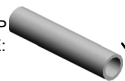

28.B2342864
PAD:CLEANER

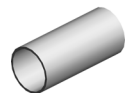

71.D1492826
(x2)
COMPRESSION SP
RING:SIDE FENCE:
PLATE:FRONT

U001	U002	U003	U004	U005	U006	U007	U008	U009	U010	U011	U012	U013	U014	U015	U016	U017	U018	U019	U020
------	------	------	------	------	-------------	------	------	------	------	------	------	------	------	------	------	------	------	------	------

U006_S001_S003
SIDE FENCE:REAR:NO.1:ASS'Y

101.D1492952 28.B2342864
DECAL:SIDE FENC PAD:CLEANER
E:PAPER VOLUME

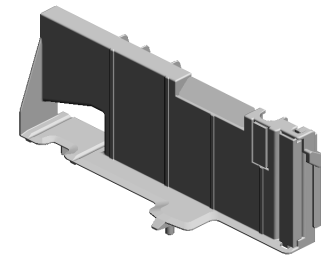

77.D1492838
SIDE FENCE:REAR
:NO.1:ASS'Y

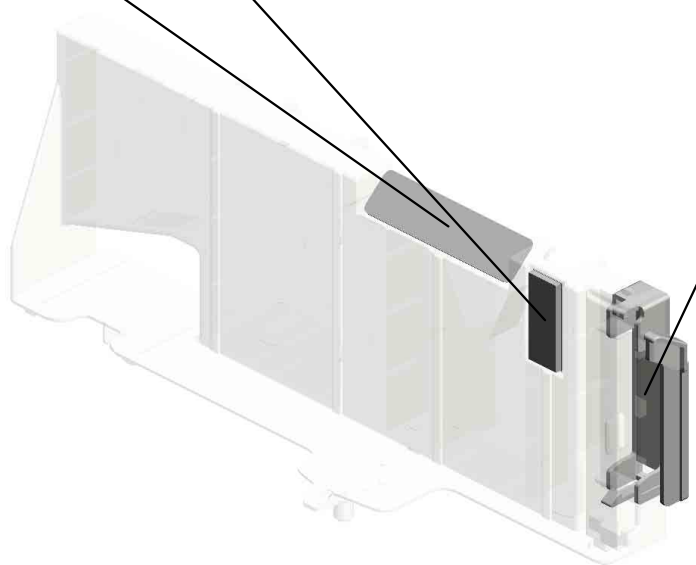
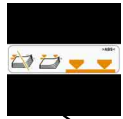

74.D1492834
GUIDE:FEELER:PA
PER END

U001	U002	U003	U004	U005	U006	U007	U008	U009	U010	U011	U012	U013	U014	U015	U016	U017	U018	U019	U020
------	------	------	------	------	-------------	------	------	------	------	------	------	------	------	------	------	------	------	------	------

U006_S001_S004
END FENCE:PAPER TRAY:ASS'Y

79.D1492842 80.D1492843
LEVER:END FENC CLICK:END FENCE
E

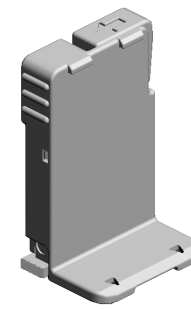

128.D0BQ2840
[A]
END FENCE:PAPE
R TRAY:ASS'Y
201904-02 O/O

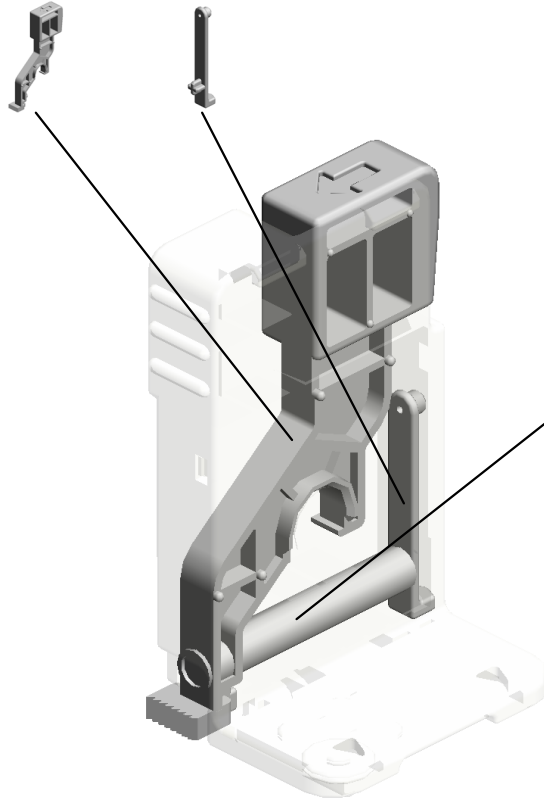

81.D1492845
COMPRESSION SP
RING:END FENCE:
LEVER:5N

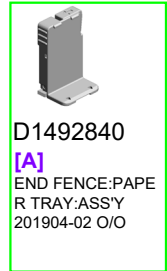

D1492840
[A]
END FENCE:PAPE
R TRAY:ASS'Y
201904-02 O/O

U001	U002	U003	U004	U005	U006	U007	U008	U009	U010	U011	U012	U013	U014	U015	U016	U017	U018	U019	U020
------	------	------	------	------	-------------	------	------	------	------	------	------	------	------	------	------	------	------	------	------

U006_S002
PAPER TRAY:NO.2:ASS'Y

- 41.D0BH2872 INNER COVER:PA
PER TRAY
- 33.D0BH2848 DECAL:SIZE INDIC
ATION:END FENCE
:NO.2:FRONT
- 34.D0BH2849 DECAL:SIZE INDIC
ATION:END FENCE
:NO.2:REAR
- 65.D1492812 (x4)
ROLLER:PAPER T
RAY:DIA19
- 6.04583010N (x6)
HEXAGON HEAD T
APPING SCREW:3
X10

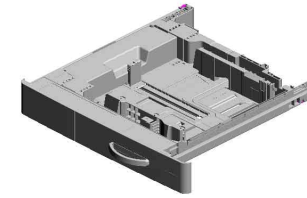

32.D0BH2805
PAPER TRAY:NO.2
:ASS'Y

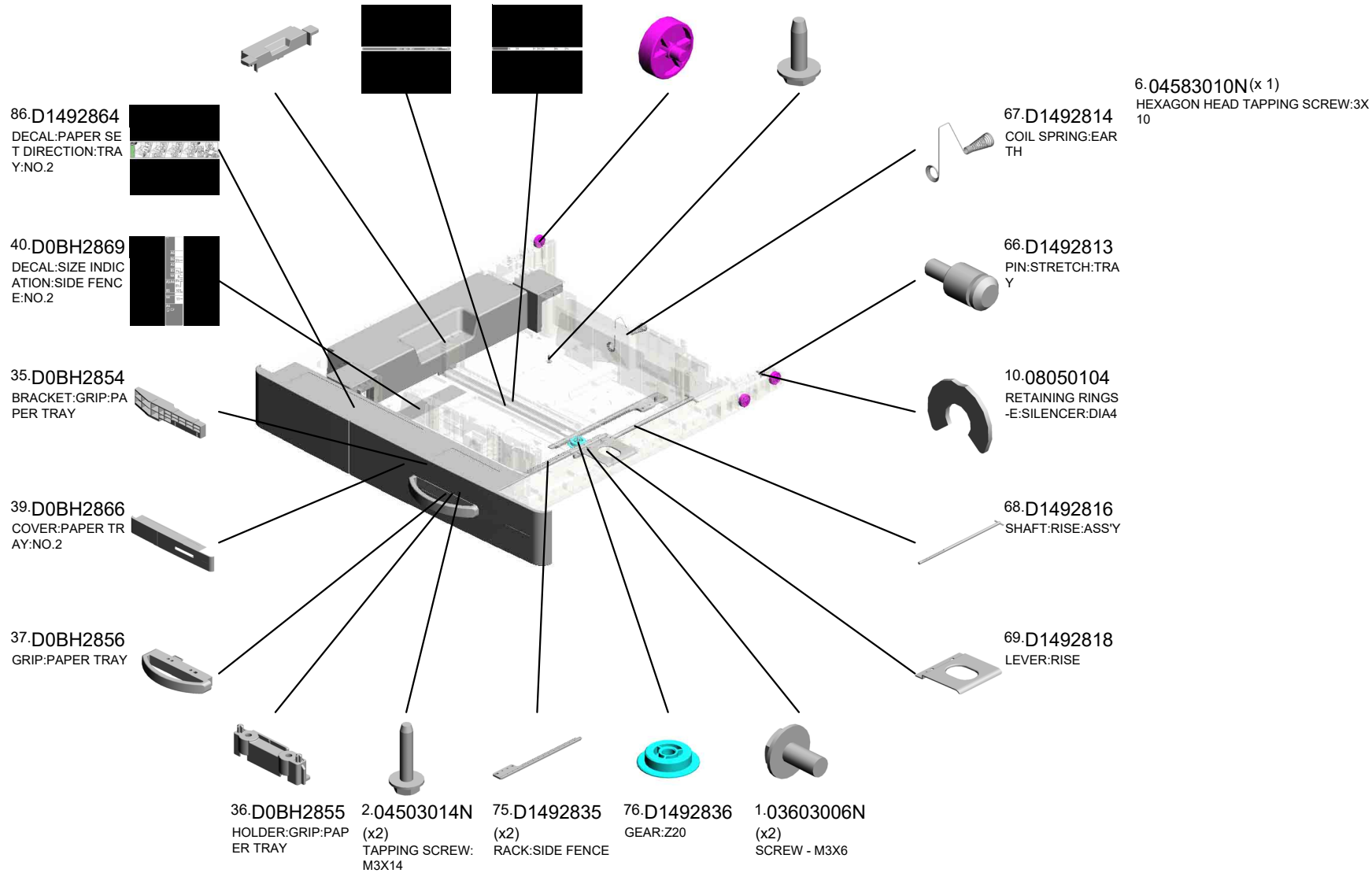

U006_S002
PAPER TRAY:NO.2:ASS'Y

121.M1095857 87.D1492872
(x2) LINK:END FENCE:
HEXAGON HEAD T PAPER SIZE SENS
APPING SCREW:3 OR
X10:DIA10

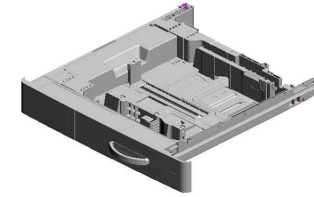

32.D0BH2805
PAPER TRAY:NO.2
:ASS'Y

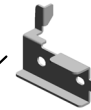
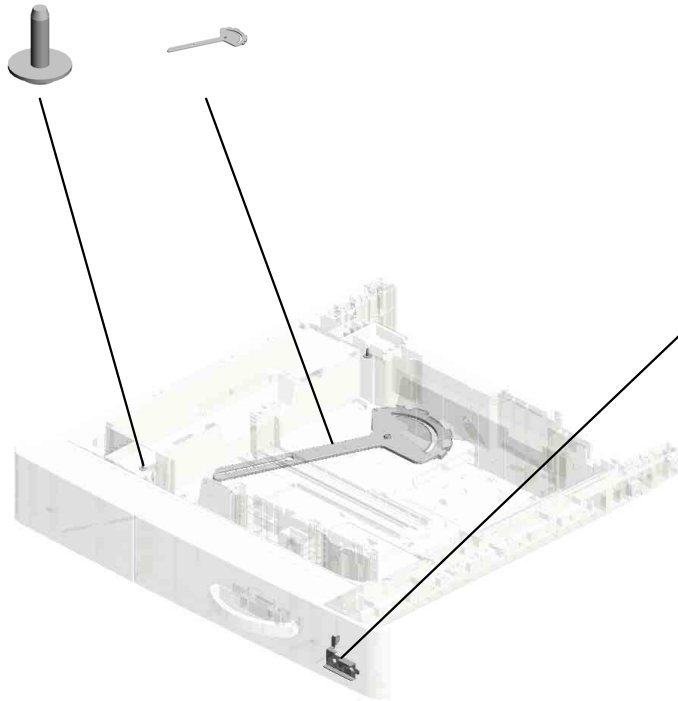

117.D6932867
SUPPORTING PLA
TE:COVER:FRONT:
PAPER TRAY

U001	U002	U003	U004	U005	U006	U007	U008	U009	U010	U011	U012	U013	U014	U015	U016	U017	U018	U019	U020
------	------	------	------	------	-------------	------	------	------	------	------	------	------	------	------	------	------	------	------	------

U006_S002_S001
TRAY BOTTOM PLATE:NO.2:ASS'Y

122-AF013019
PAD:TRAY BOTTO
M PLATE
201809-01 O/O

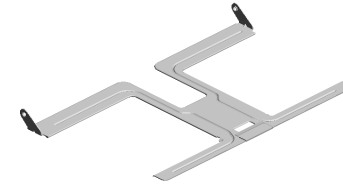

124-D0BQ2873
[A]
TRAY BOTTOM PL
ATE:NO.2:ASS'Y
201901-01 O/O

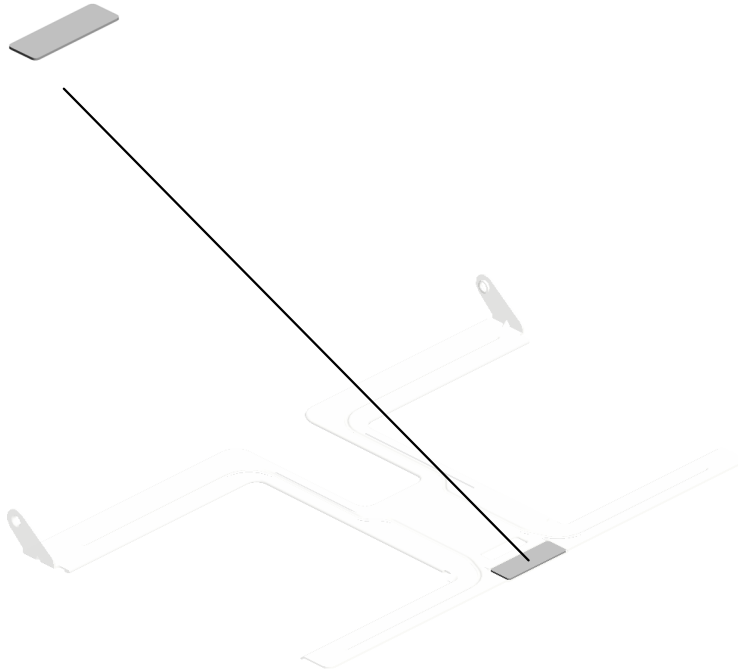

D1492873
[A]
TRAY BOTTOM PL
ATE:NO.2:ASS'Y
201901-01 O/O

U001	U002	U003	U004	U005	U006	U007	U008	U009	U010	U011	U012	U013	U014	U015	U016	U017	U018	U019	U020
------	------	------	------	------	-------------	------	------	------	------	------	------	------	------	------	------	------	------	------	------

U006_S002_S002
END FENCE:PAPER TRAY:ASS'Y

79.D1492842 80.D1492843
LEVER:END FENC CLICK:END FENCE
E

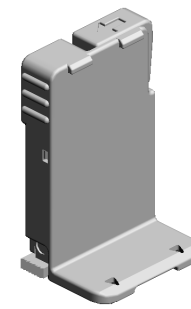

128.D0BQ2840
[A]
END FENCE:PAPE
R TRAY:ASS'Y
201904-02 O/O

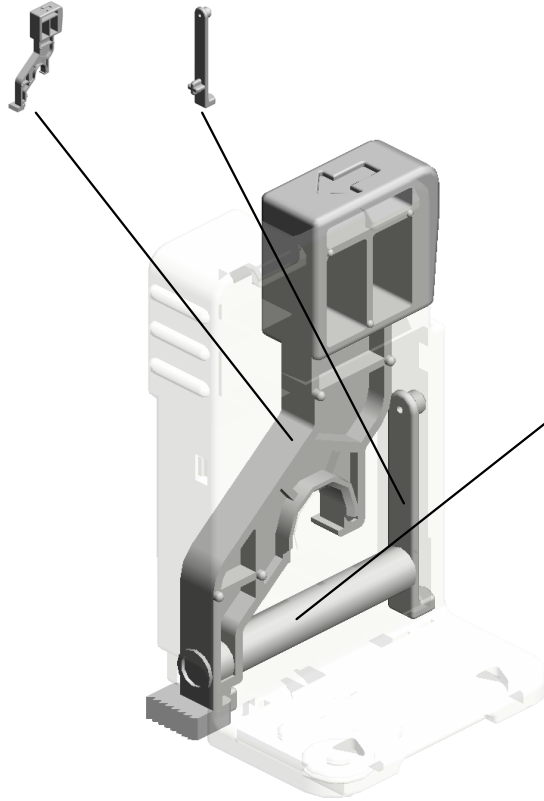

81.D1492845
COMPRESSION SP
RING:END FENCE:
LEVER:5N

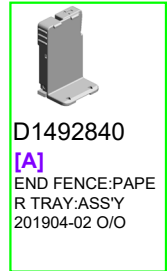

D1492840
[A]
END FENCE:PAPE
R TRAY:ASS'Y
201904-02 O/O

U001	U002	U003	U004	U005	U006	U007	U008	U009	U010	U011	U012	U013	U014	U015	U016	U017	U018	U019	U020
------	------	------	------	------	-------------	------	------	------	------	------	------	------	------	------	------	------	------	------	------

U006_S002_S003
SIDE FENCE:FRONT:ASS'Y

70.D1492824
LEVER:STOPPER:
FRONT

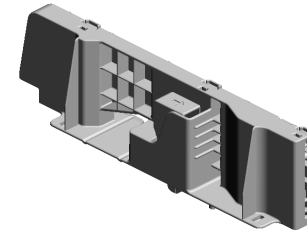

114.D2412875
SIDE FENCE:FRON
T:ASSY

72.D1492827
COMPRESSION SP
RING:SIDE FENCE:
POSITIONING

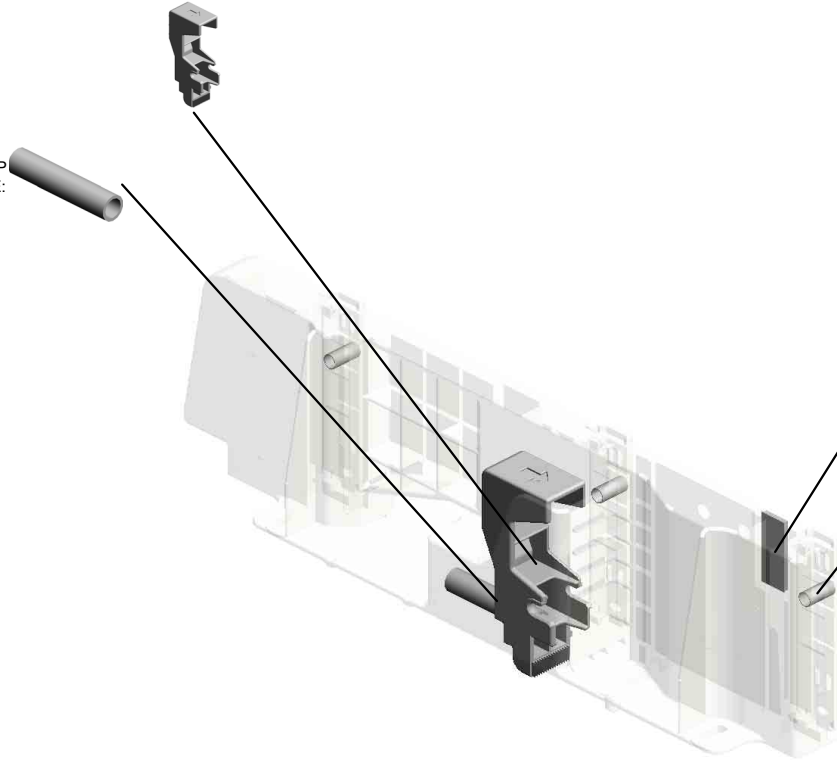

28.B2342864
PAD:CLEANER

71.D1492826
(x3)
COMPRESSION SP
RING:SIDE FENCE:
PLATE:FRONT

U001	U002	U003	U004	U005	U006	U007	U008	U009	U010	U011	U012	U013	U014	U015	U016	U017	U018	U019	U020
------	------	------	------	------	-------------	------	------	------	------	------	------	------	------	------	------	------	------	------	------

U006_S002_S004
SIDE FENCE:REAR:ASS'Y

101.D1492952 102.D1492954
DECAL:SIDE FENC DECAL:SIDE FENC
E:PAPER VOLUME E:PAPER VOLUME:
ENVELOPE

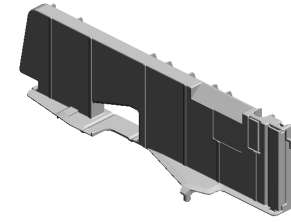

115.D2412880
SIDE FENCE:REAR
:ASS'Y

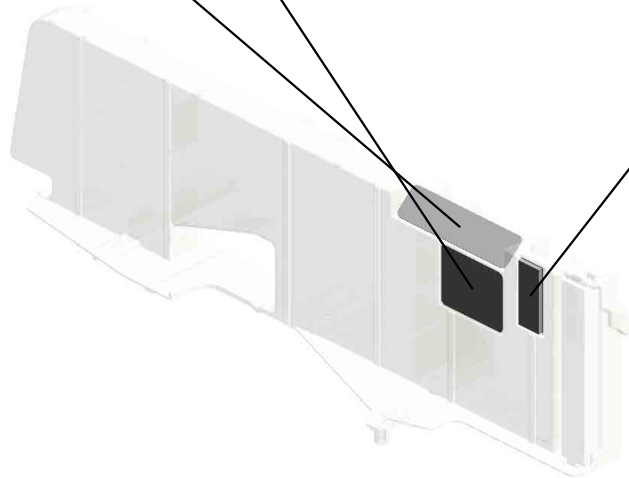

28.B2342864
PAD:CLEANER

U001	U002	U003	U004	U005	U006	U007	U008	U009	U010	U011	U012	U013	U014	U015	U016	U017	U018	U019	U020
------	------	------	------	------	-------------	------	------	------	------	------	------	------	------	------	------	------	------	------	------

U006_S003
SUPPORTER:RIGHT:NO.1:ASS'Y

3.04543006Q
(x3)
TAPPING SCREW -
M3X6



94.D1492905
SUPPORTER:RIGHT:
T:NO.1:ASS'Y

97.D1492924
STOPPER:PAPER
TRAY

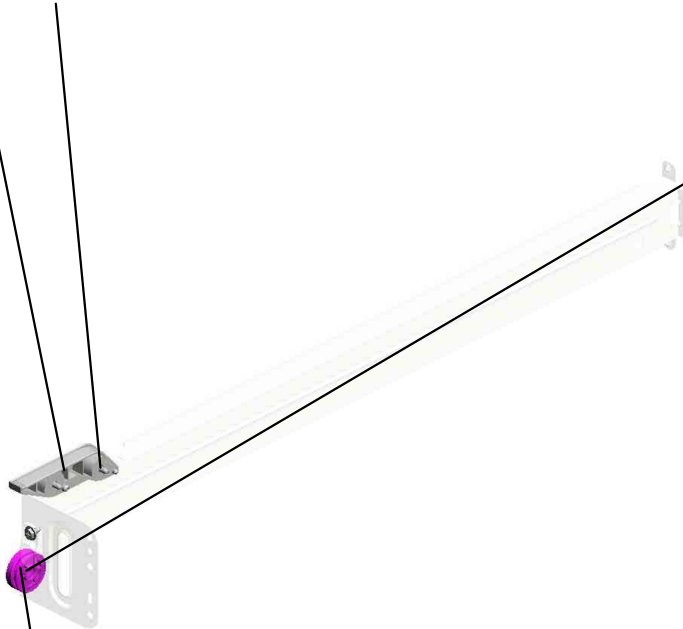

103.D1492956
ROLLER:SUPPORT
ER:PAPER TRAY



9.08050103
RETAINING RINGS
-E:SILENCER:DIA3



U001	U002	U003	U004	U005	U006	U007	U008	U009	U010	U011	U012	U013	U014	U015	U016	U017	U018	U019	U020
------	------	------	------	------	-------------	------	------	------	------	------	------	------	------	------	------	------	------	------	------

U006_S004
SUPPORTER:RIGHT:NO.2:ASS'Y

97.D1492924
STOPPER:PAPER
TRAY

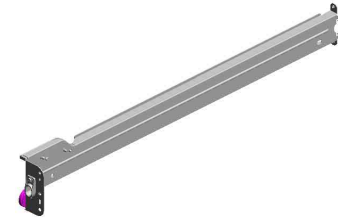

93.D1492903
SUPPORTER:RIGHT:
T:NO.2:ASSY

3.04543006Q
(x3)
TAPPING SCREW -
M3X6

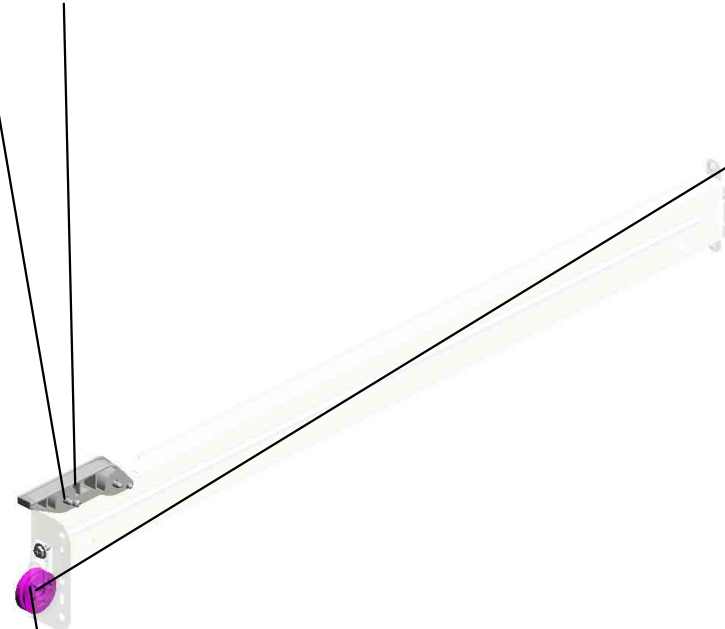

96.D1492923
ROLLER:SUPPORT
ER:PAPER TRAY



9.08050103
RETAINING RINGS
-E:SILENCER:DIA3



U001	U002	U003	U004	U005	U006	U007	U008	U009	U010	U011	U012	U013	U014	U015	U016	U017	U018	U019	U020
------	------	------	------	------	-------------	------	------	------	------	------	------	------	------	------	------	------	------	------	------

U006_S005
GUIDE PLATE:SWIVEL:NO.1

52.D1492712
SHEET:GUIDE PLA
TE:SWIVEL

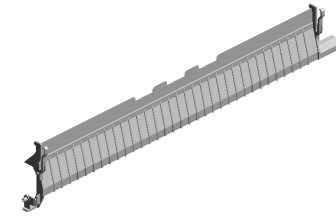

53.D1492713
GUIDE PLATE:SWI
VEL:NO.1

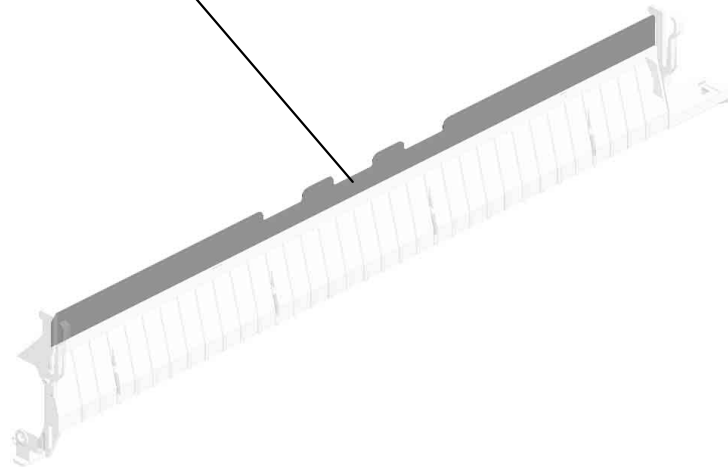
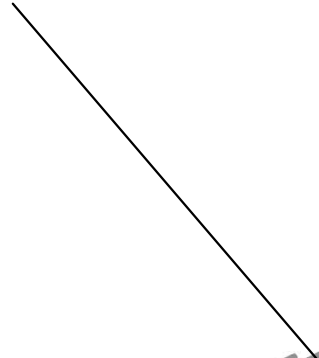

U001	U002	U003	U004	U005	U006	U007	U008	U009	U010	U011	U012	U013	U014	U015	U016	U017	U018	U019	U020
------	------	------	------	------	-------------	------	------	------	------	------	------	------	------	------	------	------	------	------	------

U006_S006
PAPER FEED UNIT:NO.1:ASS'Y

- 22.AF031094 PAPER FEED ROLLER:FEED
- 29.B8303504 TIMING BELT - 40S 2M100
- 42.D1292783 TORQUE LIMITER MECHANICAL CLUTCH:40MNM:DIA18
- 15.AA082174 PLAIN SHAFT BEARING:6X10X9
- 11.11050758 (x2) CLAMP:LWSM-030 6A

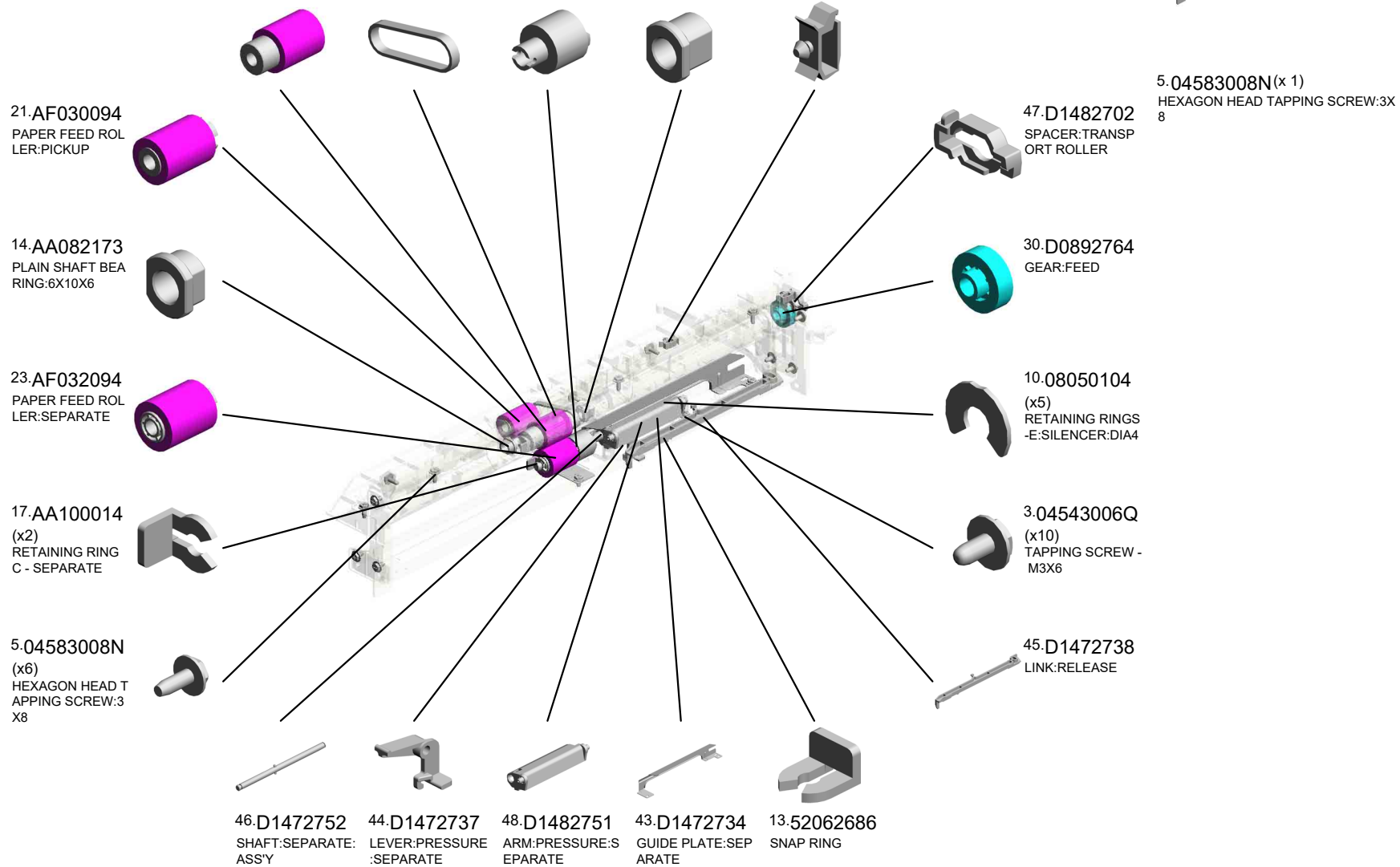
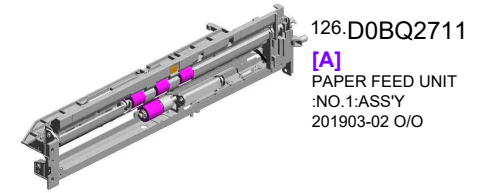

U001	U002	U003	U004	U005	U006	U007	U008	U009	U010	U011	U012	U013	U014	U015	U016	U017	U018	U019	U020
------	------	------	------	------	------	------	------	------	------	------	------	------	------	------	------	------	------	------	------

U006_S006
PAPER FEED UNIT:NO.1:ASS'Y

- 58.D1492774 PULLEY:IDLER:PIKUP
- 105.D2022778 FEELER:PAPER END
- 57.D1492773 PULLEY:PICKUP:MECHANICAL ROLLER CLUTCH
- 125.AW020234 (x2) PHOTOINTERRUPTOR:GP1A173LCS 5F 201903-01 O/O
- 56.D1492772 ARM:PICKUP

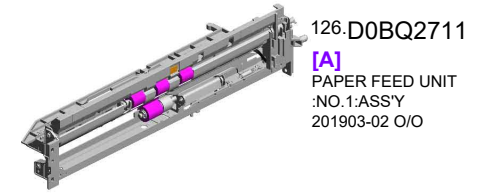

- 120.GW010007 (x2) PHOTO REFLECTOR SENSOR:EXIT

- 61.D1492780 GROUND WIRE:SENSOR:PAPER FEED

- 62.D1492781 GROUND PLATE:PAPER FEED UNIT

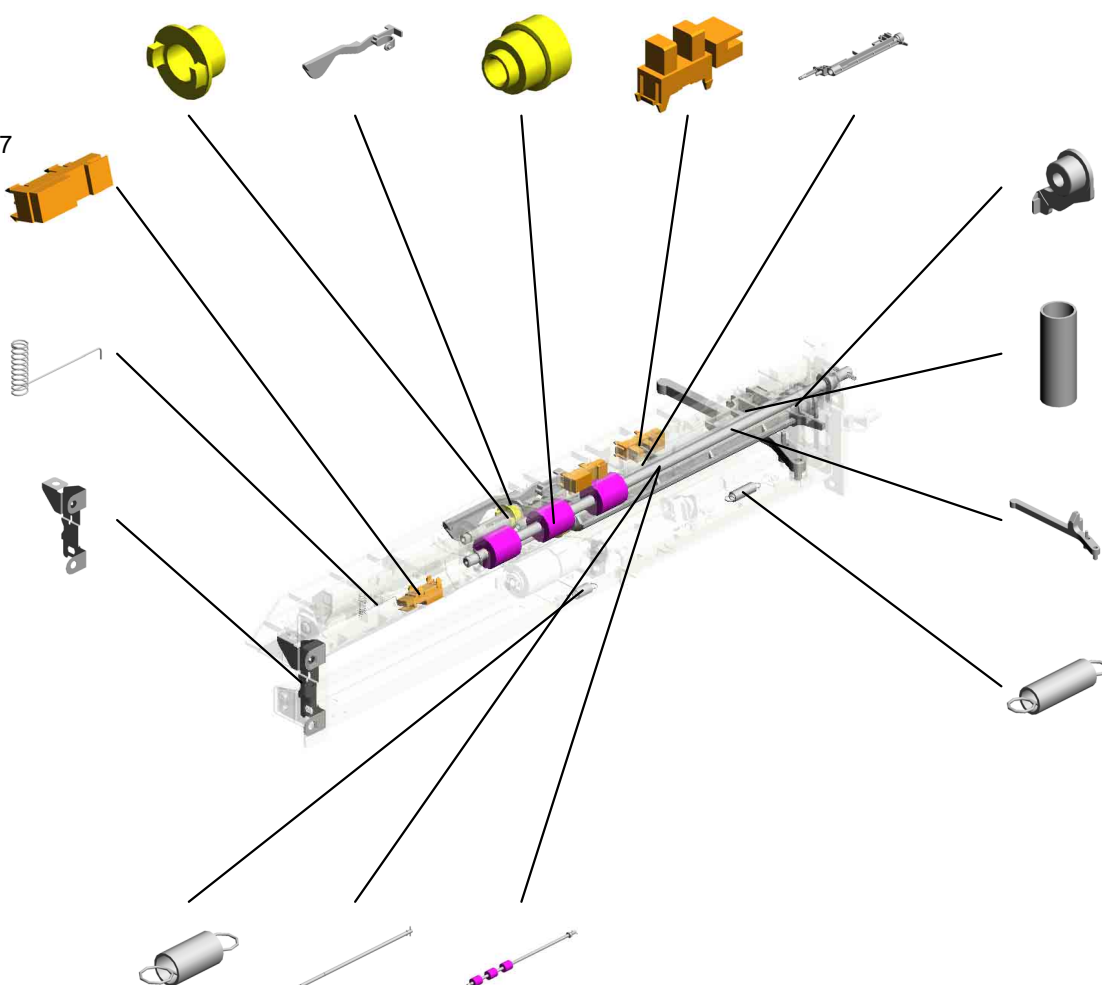

- 118.G0652767 LEVER - FEED

- 60.D1492777 COIL SPRING:PRESSURE:PICKUP

- 55.D1492739 LEVER:PRESSURE RELEASE

- 49.D1482755 COIL SPRING:RELEASE:SEPARATE

- 112.D2412754 COIL SPRING:PRESSURE:SEPARATE
- 59.D1492775 SHAFT:FEED:ASSY
- 113.D2412759 TRANSPORT ROLLER:VERTICAL TRANSPORT:ASSY



U001	U002	U003	U004	U005	U006	U007	U008	U009	U010	U011	U012	U013	U014	U015	U016	U017	U018	U019	U020
------	------	------	------	------	------	------	------	------	------	------	------	------	------	------	------	------	------	------	------

U006_S007
PAPER FEED UNIT:NO.2:ASS'Y

- 22.AF031094 PAPER FEED ROLLER:FEED
- 29.B8303504 TIMING BELT - 40S2M100
- 42.D1292783 TORQUE LIMITER MECHANICAL CLUTCH:40MNM:DIA18
- 15.AA082174 PLAIN SHAFT BEARING:6X10X9
- 11.11050758 CLAMP:LWSM-0306A

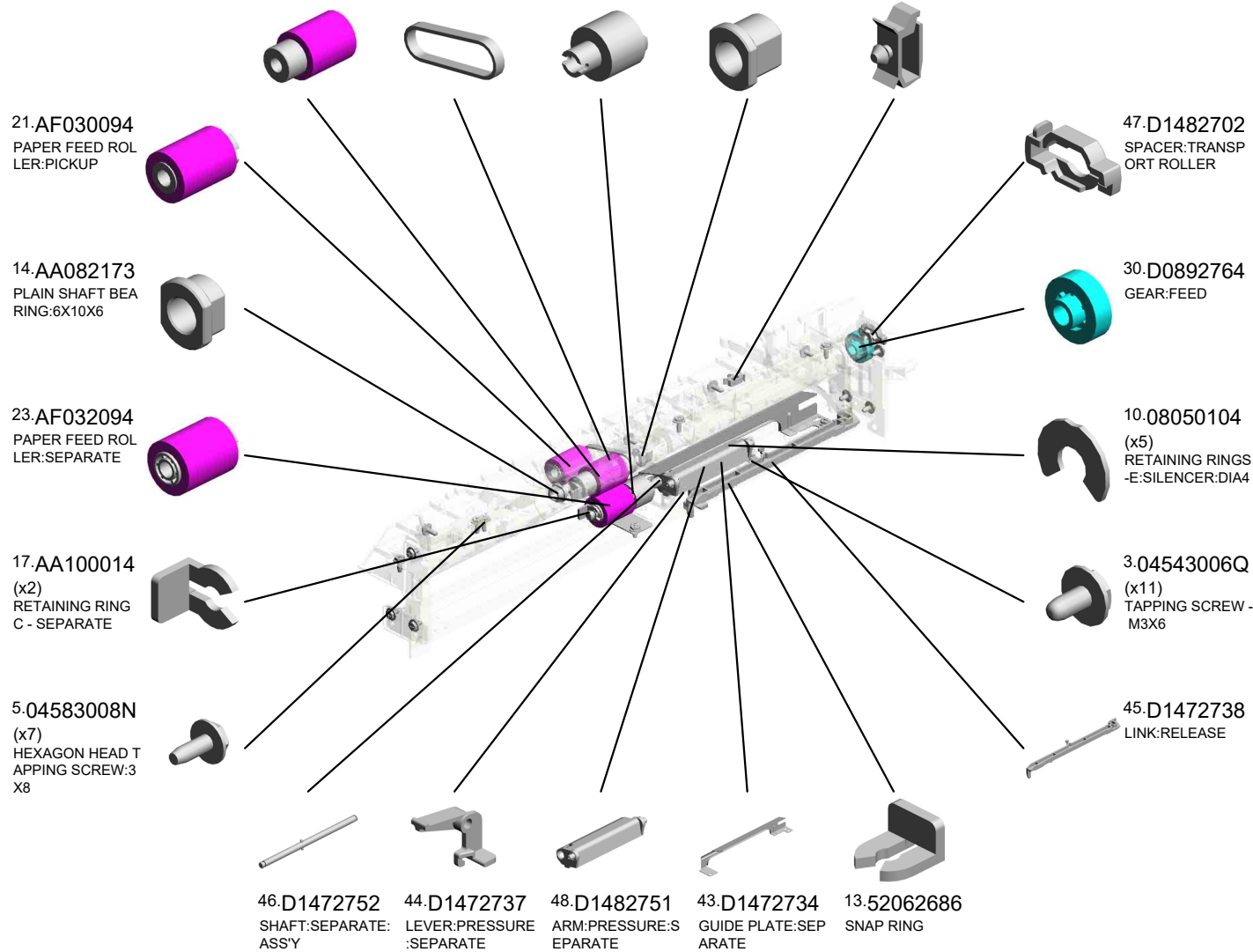
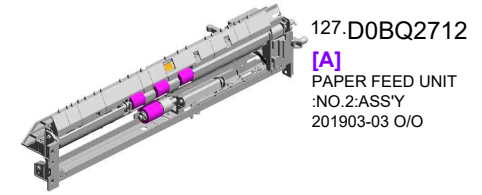

U006_S007
PAPER FEED UNIT:NO.2:ASS'Y

- 58.D1492774 PULLEY:IDLER:PIKUP
- 105.D2022778 FEELER:PAPER END
- 57.D1492773 PULLEY:PICKUP:MECHANICAL ROLLER CLUTCH
- 125.AW020234 (x2) PHOTOINTERRUPTOR:GP1A173LCS 5F 201903-01 O/O
- 56.D1492772 ARM:PICKUP

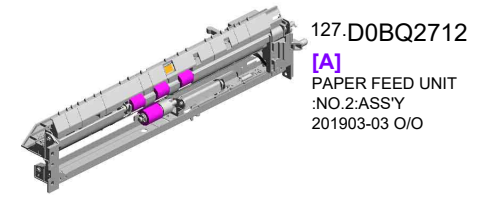

127.D0BQ2712
[A]
PAPER FEED UNIT :NO.2:ASSY
201903-03 O/O

120.GW010007 (x2) PHOTO REFLECTOR SENSOR:EXIT

61.D1492780 GROUND WIRE:SENSOR:PAPER FEED

62.D1492781 GROUND PLATE:PAPER FEED UNIT

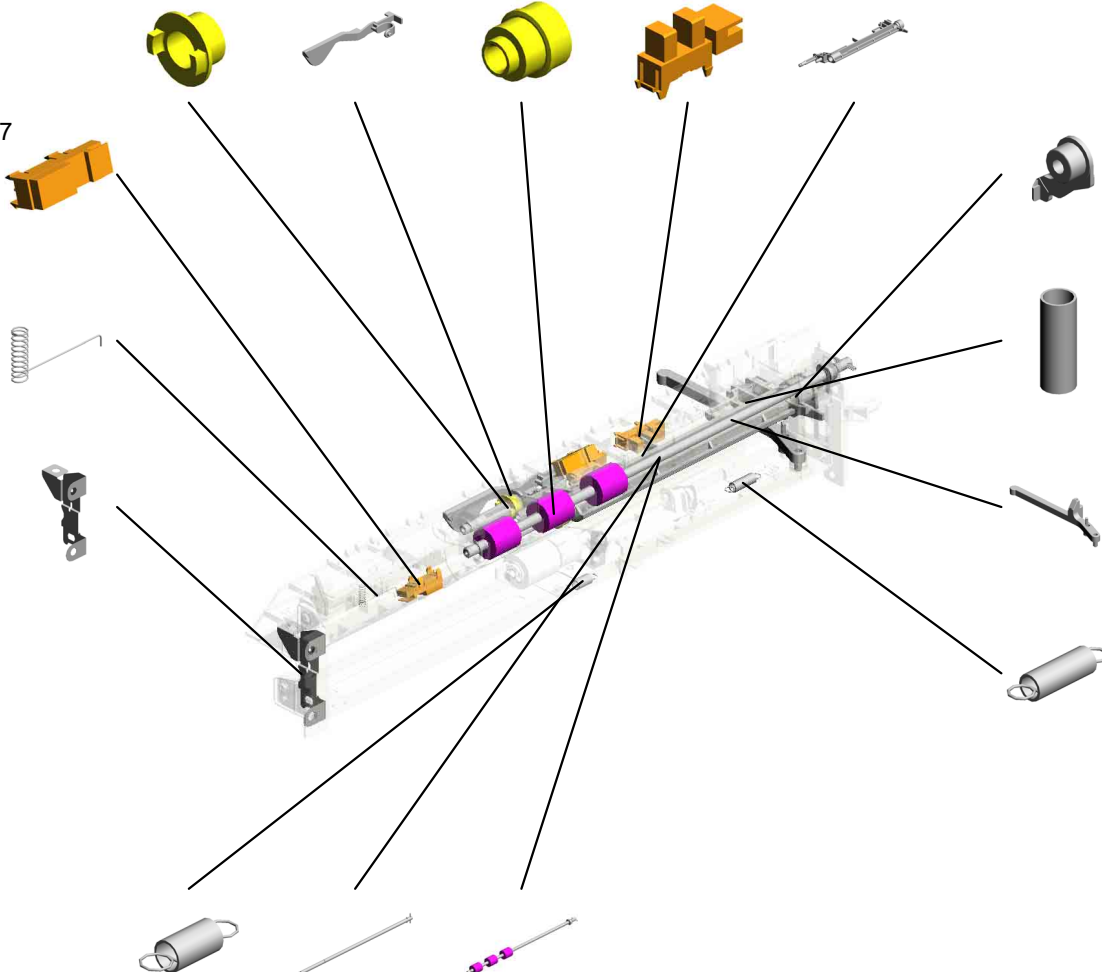

118.G0652767 LEVER - FEED

60.D1492777 COIL SPRING:PRESSURE:PICKUP

55.D1492739 LEVER:PRESSURE RELEASE

49.D1482755 COIL SPRING:RELEASE:SEPARATE

112.D2412754 COIL SPRING:PRESSURE:SEPARATE

59.D1492775 SHAFT:FEED:ASSY

113.D2412759 TRANSPORT ROLLER:VERTICAL TRANSPORT:ASSY



D2412714
[A]
PAPER FEED UNIT :NO.2:ASSY
201903-03 O/O

U001	U002	U003	U004	U005	U006	U007	U008	U009	U010	U011	U012	U013	U014	U015	U016	U017	U018	U019	U020
------	------	------	------	------	------	------	------	------	------	------	------	------	------	------	------	------	------	------	------

U007.TONER SUPPLY

U007 S002
D0BQ3219
DRIVE UNIT:TONER BOTTLE
:ASSY

U007 S011
D0BQ3280
TONER HOPPER:TONER SU
PPLY:M:ASSY

U007 S001
D0BQ3219
DRIVE UNIT:TONER BOTTLE
:ASSY

U007 S008
D1473282
HOUSING:TONER CARTRID
GE:CMY:ASSY

U007 S012
D0BQ3310
TONER HOPPER:TONER SU
PPLY:Y:ASSY

U007 S006
D1473282
HOUSING:TONER CARTRID
GE:CMY:ASSY

U007 S003
D0BQ3219
DRIVE UNIT:TONER BOTTLE
:ASSY

U007 S004
D0BQ3219
DRIVE UNIT:TONER BOTTLE
:ASSY

U007 S009
D0BQ3240
TONER HOPPER:TONER SU
PPLY:BK:ASSY

U007 S007
D1473282
HOUSING:TONER CARTRID
GE:CMY:ASSY

U007 S010
D0BQ3270
TONER HOPPER:TONER SU
PPLY:C:ASSY

U007 S005
D1473281
HOUSING:TONER CARTRID
GE:BK:ASSY

U001	U002	U003	U004	U005	U006	U007	U008	U009	U010	U011	U012	U013	U014	U015	U016	U017	U018	U019	U020
------	------	------	------	------	------	------	------	------	------	------	------	------	------	------	------	------	------	------	------

U007.TONER SUPPLY

U007 S014
 D1473288
 TRANSPORT SCREW:NOZZL
 E:CMY:ASS'Y

U007 S017
 D1493256
 BASE:TONER HOPPER:REA
 R:ASS'Y

U007 S015
 D1473288
 TRANSPORT SCREW:NOZZL
 E:CMY:ASS'Y

U007 S016
 D1473288
 TRANSPORT SCREW:NOZZL
 E:CMY:ASS'Y

U007 S013
 D1473287
 TRANSPORT SCREW:NOZZL
 E:BK:ASS'Y

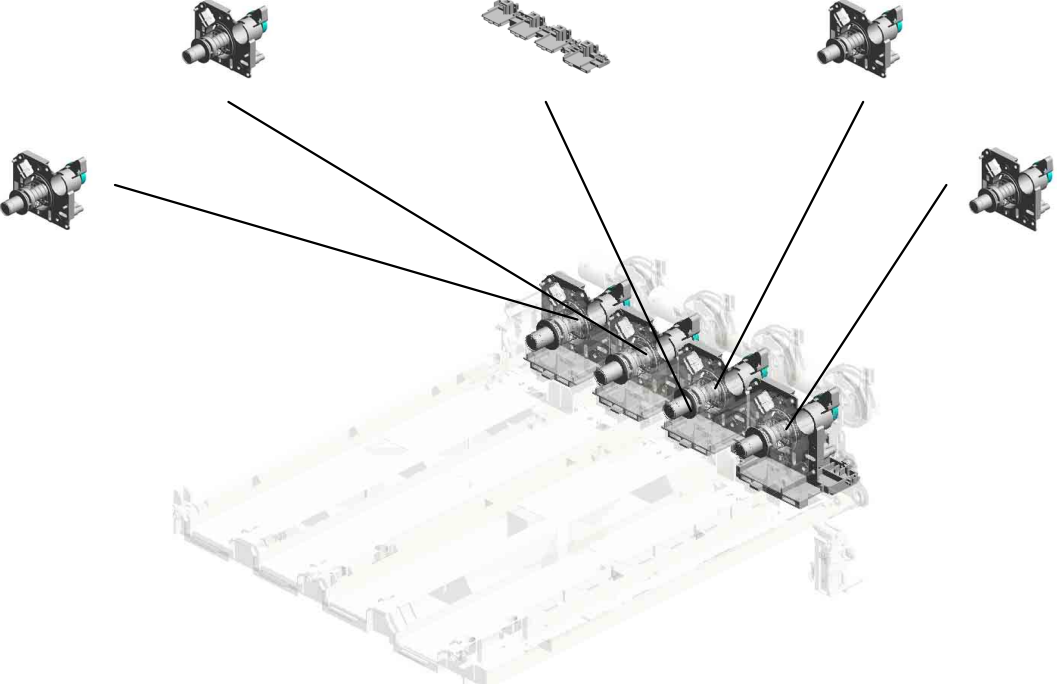

U001	U002	U003	U004	U005	U006	U007	U008	U009	U010	U011	U012	U013	U014	U015	U016	U017	U018	U019	U020
------	------	------	------	------	------	------	------	------	------	------	------	------	------	------	------	------	------	------	------

U007 TONER SUPPLY

13.D0BQ5172 (x4) PCB:TCB
 3.04583008N (x35) HEXAGON HEAD TAPPING SCREW:3 X8
 7.11050488 HARNESS CLAMP

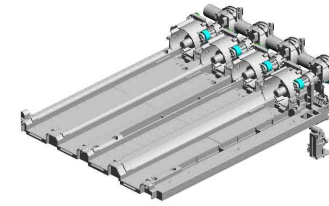

29.D1493331
 COVER:GEAR:TONER SUPPLY SUB-UNIT

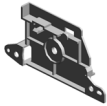

10.11050760 (x3) CLAMP:LWSM-051A



28.D1493330 (x4) SEAL:CONNECTION:CARTRIDGE:TONER SUPPLY



2.04543008Q (x18) TAPPING SCREW:3X8



26.D1493321 (x4) DUCT:VERTICAL TRANSPORT:TONER SUPPLY



12.B2233241 (x4) SPRING:SHUTTER:PUMP UNIT



27.D1493322 (x4) SHUTTER:DUCT:TONER SUPPLY

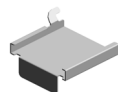

U007_S001
 DRIVE UNIT:TONER BOTTLE:ASS'Y

20.D1493210
 DC MOTOR:TONE
 R BOTTLE:ASS'Y:5.
 28W:BRUSH

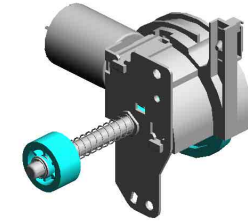

14.D0BQ3219
 [A]
 DRIVE UNIT:TONE
 R BOTTLE:ASS'Y
 201907-05 O/O

5.07200040E
 (x2)
 RETAINING RING -
 M4

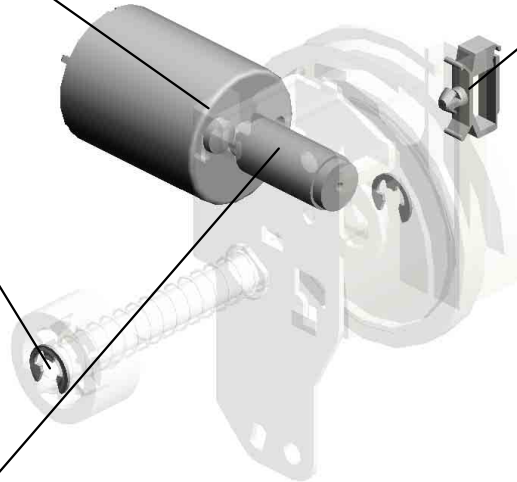
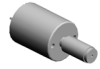

11.11050762
 CLAMP:LWS-0711A



1.03530030N
 (x2)
 SCREW:M3X3



D1473269
 [A]
 DRIVE UNIT:TONE
 R BOTTLE:ASS'Y
 201907-05 O/O

U001	U002	U003	U004	U005	U006	U007	U008	U009	U010	U011	U012	U013	U014	U015	U016	U017	U018	U019	U020
------	------	------	------	------	------	------	------	------	------	------	------	------	------	------	------	------	------	------	------

U007_S002
 DRIVE UNIT:TONER BOTTLE:ASS'Y

20.D1493210
 DC MOTOR:TONE
 R BOTTLE:ASS'Y:5.
 28W:BRUSH

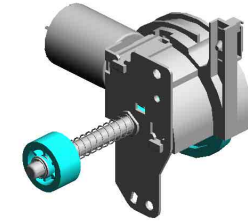

14.D0BQ3219
 [A]
 DRIVE UNIT:TONE
 R BOTTLE:ASS'Y
 201907-05 O/O

5.07200040E
 (x2)
 RETAINING RING -
 M4

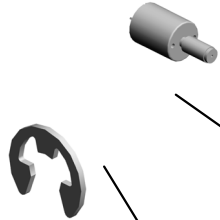

11.11050762
 CLAMP:LWS-0711A

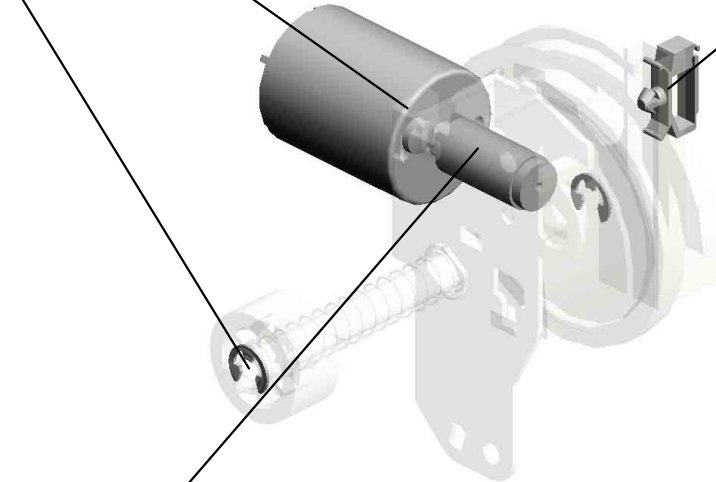

1.03530030N
 (x2)
 SCREW:M3X3



D1473269
 [A]
 DRIVE UNIT:TONE
 R BOTTLE:ASS'Y
 201907-05 O/O

U001	U002	U003	U004	U005	U006	U007	U008	U009	U010	U011	U012	U013	U014	U015	U016	U017	U018	U019	U020
------	------	------	------	------	------	------	------	------	------	------	------	------	------	------	------	------	------	------	------

U007_S003
 DRIVE UNIT:TONER BOTTLE:ASS'Y

20.D1493210
 DC MOTOR:TONE
 R BOTTLE:ASS'Y:5.
 28W:BRUSH

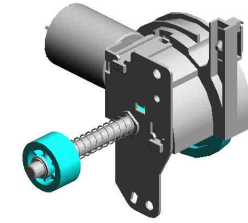

14.D0BQ3219
 [A]
 DRIVE UNIT:TONE
 R BOTTLE:ASS'Y
 201907-05 O/O

5.07200040E
 (x2)
 RETAINING RING -
 M4

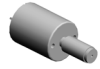

11.11050762
 CLAMP:LWS-0711A

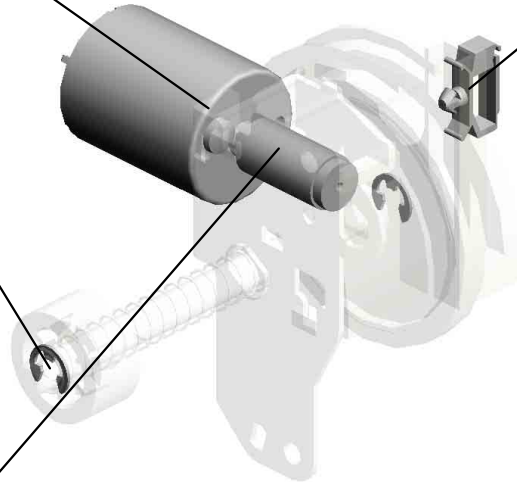

1.03530030N
 (x2)
 SCREW:M3X3



D1473269
 [A]
 DRIVE UNIT:TONE
 R BOTTLE:ASS'Y
 201907-05 O/O

U001	U002	U003	U004	U005	U006	U007	U008	U009	U010	U011	U012	U013	U014	U015	U016	U017	U018	U019	U020
------	------	------	------	------	------	------	------	------	------	------	------	------	------	------	------	------	------	------	------

U007_S004
 DRIVE UNIT:TONER BOTTLE:ASS'Y

20.D1493210
 DC MOTOR:TONE
 R BOTTLE:ASS'Y:5.
 28W:BRUSH

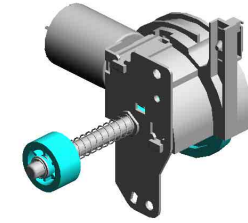

14.D0BQ3219
 [A]
 DRIVE UNIT:TONE
 R BOTTLE:ASS'Y
 201907-05 O/O

5.07200040E
 (x2)
 RETAINING RING -
 M4

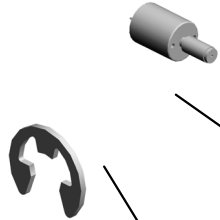

11.11050762
 CLAMP:LWS-0711A

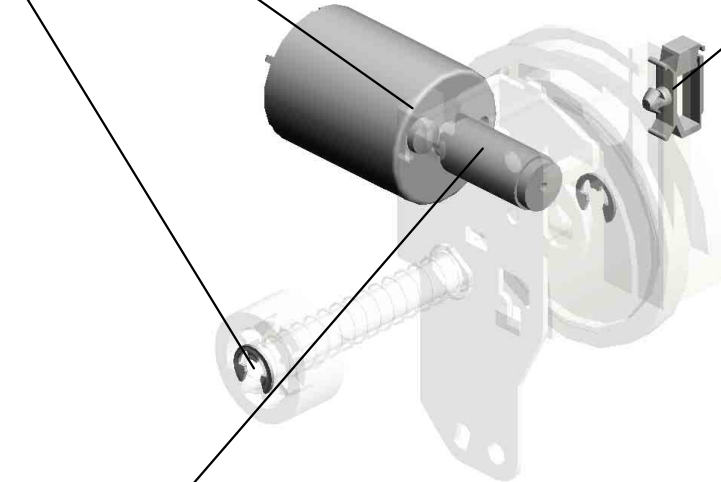

1.03530030N
 (x2)
 SCREW:M3X3



D1473269
 [A]
 DRIVE UNIT:TONE
 R BOTTLE:ASS'Y
 201907-05 O/O

U001	U002	U003	U004	U005	U006	U007	U008	U009	U010	U011	U012	U013	U014	U015	U016	U017	U018	U019	U020
------	------	------	------	------	------	------	------	------	------	------	------	------	------	------	------	------	------	------	------

U007_S005
HOUSING:TONER CARTRIDGE:BK:ASS'Y

19.D1473325

(x2)
TORSION SPRING:
STOPPER:TONER
CARTRIDGE:4.8N

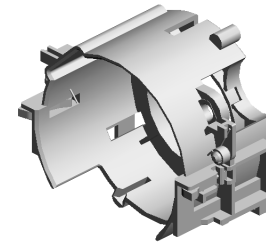

15.D1473281
HOUSING:TONER
CARTRIDGE:BK:AS
SY

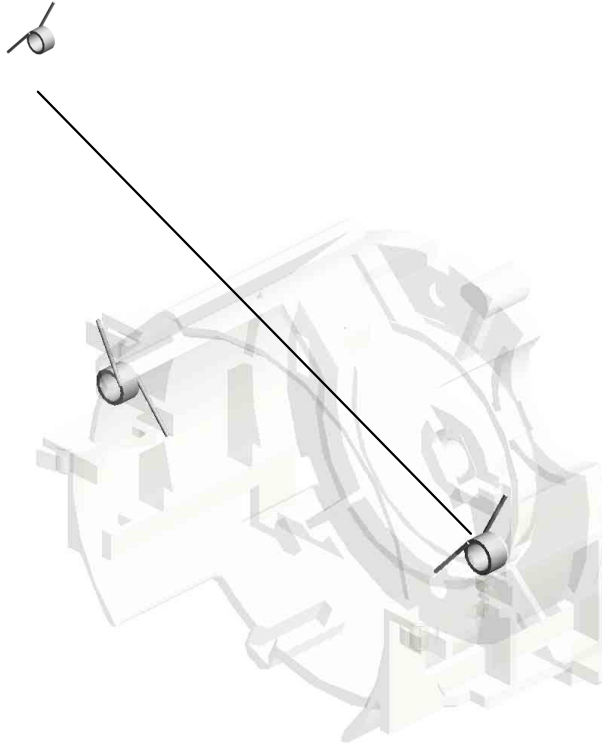

U001	U002	U003	U004	U005	U006	U007	U008	U009	U010	U011	U012	U013	U014	U015	U016	U017	U018	U019	U020
------	------	------	------	------	------	------	------	------	------	------	------	------	------	------	------	------	------	------	------

U007_S006
HOUSING:TONER CARTRIDGE:CMY:ASS'Y

19.D1473325

(x2)
TORSION SPRING:
STOPPER:TONER
CARTRIDGE:4.8N

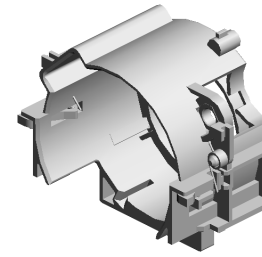
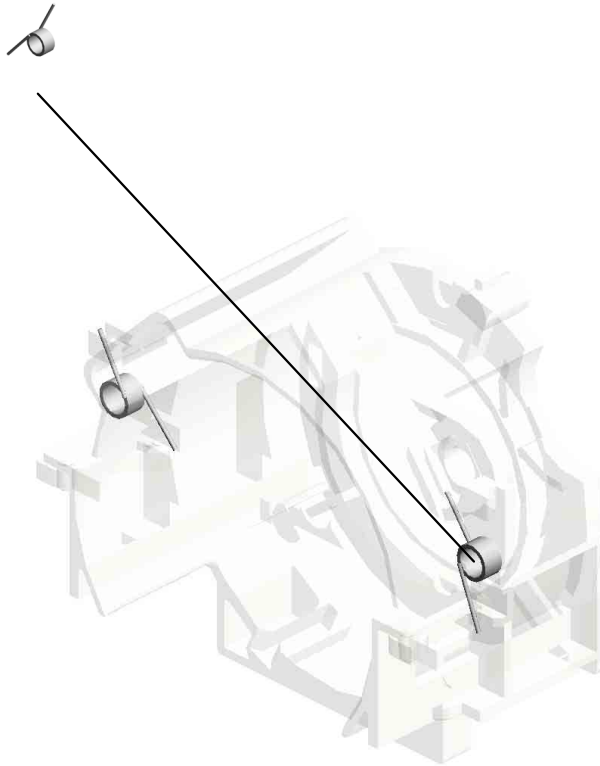

16.D1473282
HOUSING:TONER
CARTRIDGE:CMY:
ASS'Y

U001	U002	U003	U004	U005	U006	U007	U008	U009	U010	U011	U012	U013	U014	U015	U016	U017	U018	U019	U020
------	------	------	------	------	------	------	------	------	------	------	------	------	------	------	------	------	------	------	------

U007_S007
HOUSING:TONER CARTRIDGE:CMY:ASS'Y

19.D1473325

(x2)

TORSION SPRING:
STOPPER:TONER
CARTRIDGE:4.8N

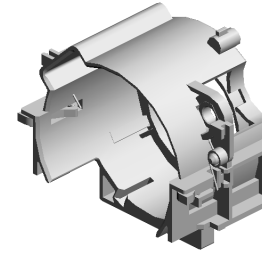

16.D1473282
HOUSING:TONER
CARTRIDGE:CMY:
ASS'Y

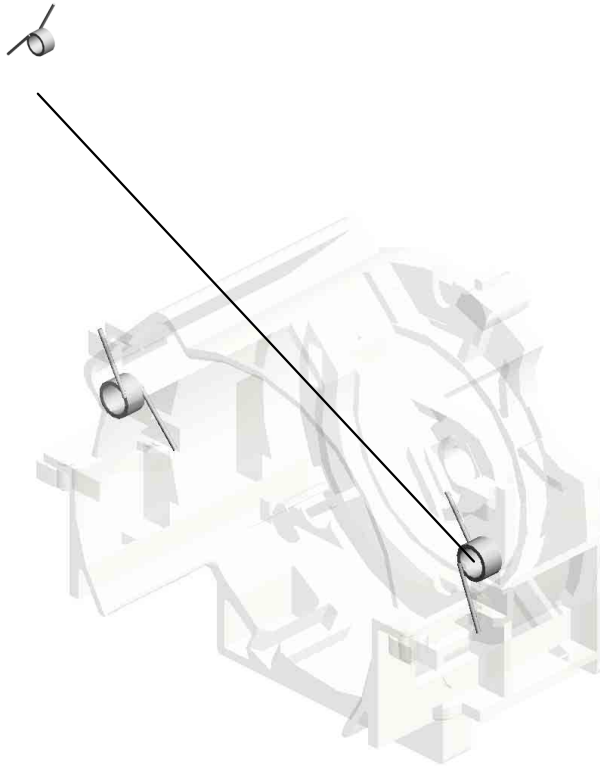

U001	U002	U003	U004	U005	U006	U007	U008	U009	U010	U011	U012	U013	U014	U015	U016	U017	U018	U019	U020
------	------	------	------	------	------	------	------	------	------	------	------	------	------	------	------	------	------	------	------

U007_S008
HOUSING:TONER CARTRIDGE:CMY:ASS'Y

19.D1473325
(x2)
TORSION SPRING:
STOPPER:TONER
CARTRIDGE:4.8N

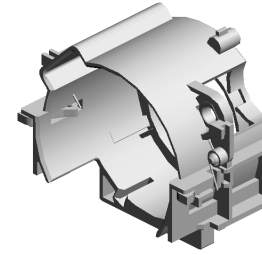

16.D1473282
HOUSING:TONER
CARTRIDGE:CMY:
ASS'Y

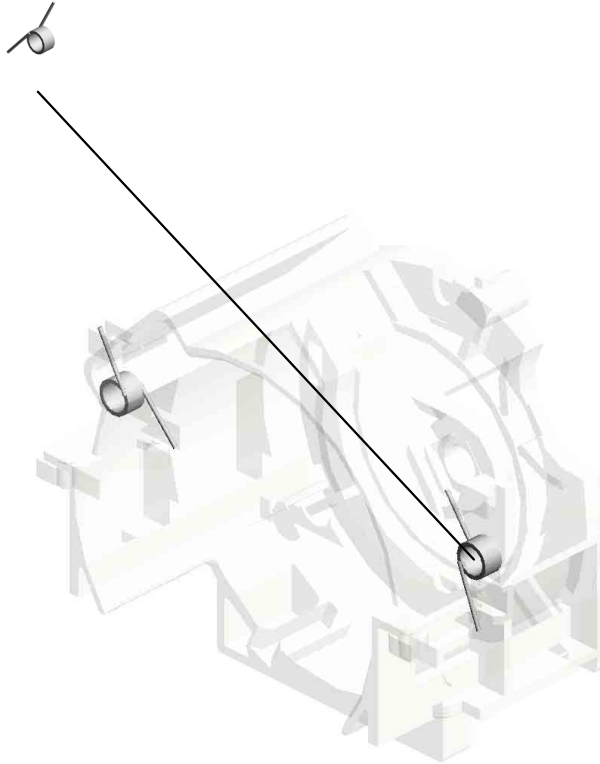

U001	U002	U003	U004	U005	U006	U007	U008	U009	U010	U011	U012	U013	U014	U015	U016	U017	U018	U019	U020
------	------	------	------	------	------	------	------	------	------	------	------	------	------	------	------	------	------	------	------

U007_S009

TONER HOPPER:TONER SUPPLY:BK:ASS'Y

3.04583008N 1.03530030N 30.D1493350
HEXAGON HEAD TAPPING SCREW:3X8 (x2) DC STEPPER MOTOR:TONER SUPPLY

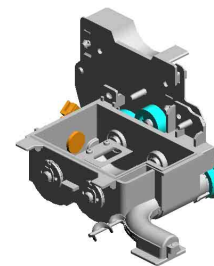

33.D0BQ3240

[A]
TONER HOPPER:TONER SUPPLY:BK:ASS'Y
201904-04 O/O

32.GW230008
TONER END SENSOR

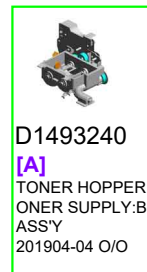
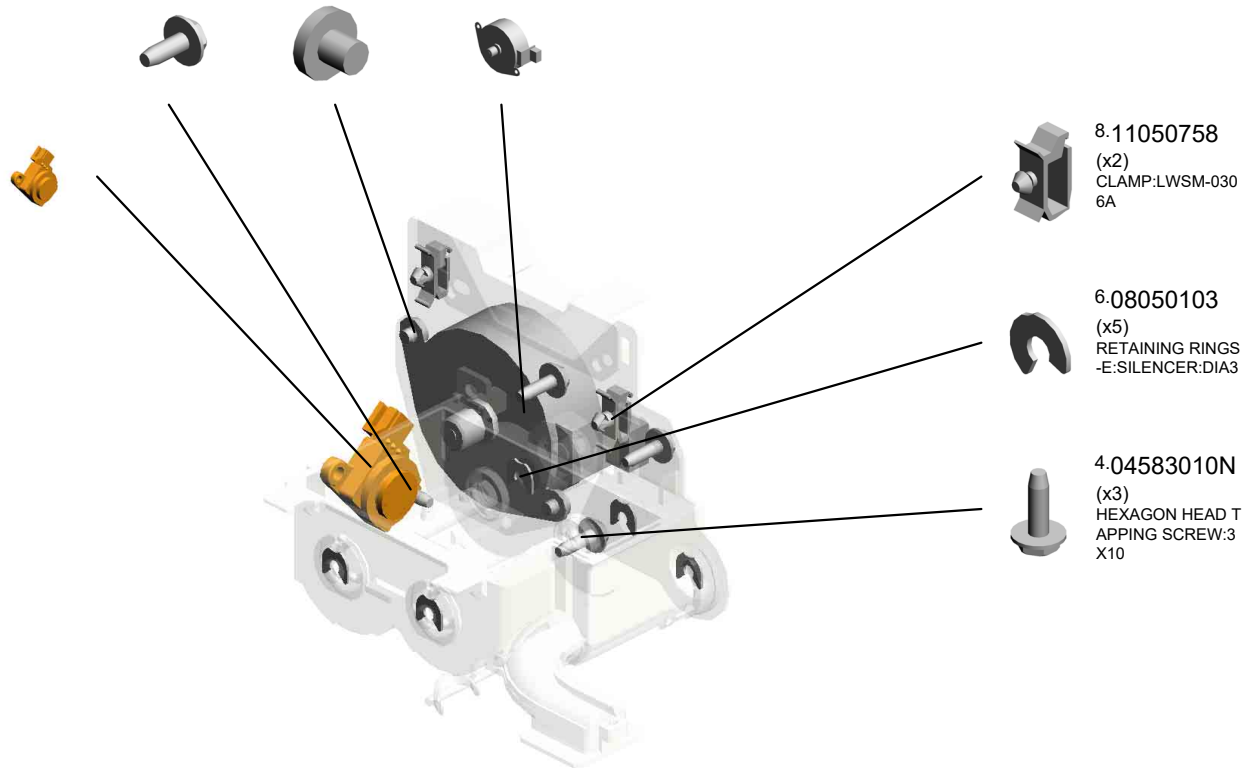

D1493240

[A]
TONER HOPPER:TONER SUPPLY:BK:ASS'Y
201904-04 O/O

U001	U002	U003	U004	U005	U006	U007	U008	U009	U010	U011	U012	U013	U014	U015	U016	U017	U018	U019	U020
------	------	------	------	------	------	------	------	------	------	------	------	------	------	------	------	------	------	------	------

U007_S010
 TONER HOPPER:TONER SUPPLY:C:ASS'Y

6.08050103 (x3) RETAINING RINGS
 -E:SILENCER:DIA3
 1.03530030N (x2) SCREW:M3X3

4.04583010N (x3) HEXAGON HEAD TAPPING SCREW:3X10

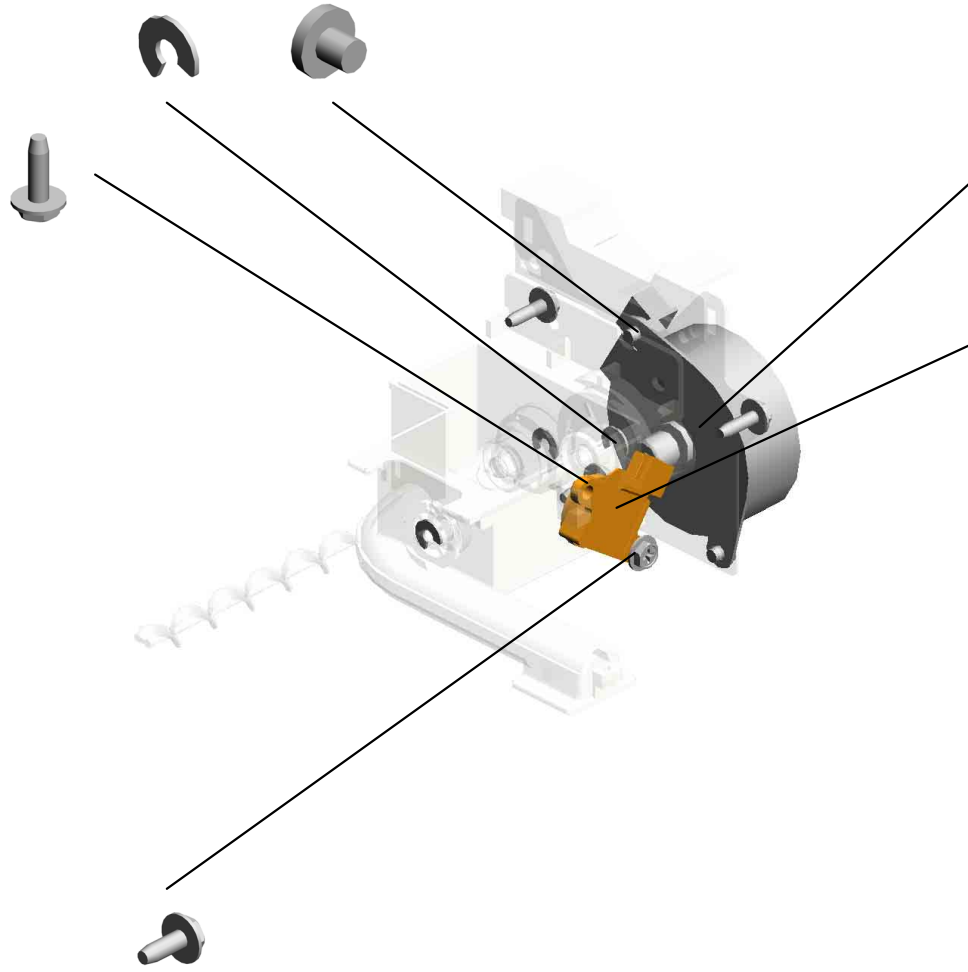

3.04583008N
 HEXAGON HEAD TAPPING SCREW:3X8

30.D1493350
 DC STEPPER MOTOR:TONER SUPPLY

32.GW230008
 TONER END SENSOR

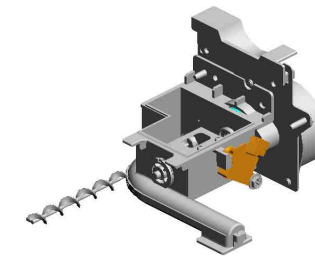

34.D0BQ3270
 [A] TONER HOPPER:TONER SUPPLY:C:ASS'Y
 201905-01 O/O

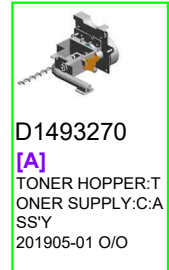

D1493270
 [A] TONER HOPPER:TONER SUPPLY:C:ASS'Y
 201905-01 O/O

U001	U002	U003	U004	U005	U006	U007	U008	U009	U010	U011	U012	U013	U014	U015	U016	U017	U018	U019	U020
------	------	------	------	------	------	------	------	------	------	------	------	------	------	------	------	------	------	------	------

U007_S011
 TONER HOPPER:TONER SUPPLY:M:ASS'Y

4.04583010N (x3) HEXAGON HEAD TAPPING SCREW:3 X10	6.08050103 (x4) RETAINING RINGS -E:SILENCER:DIA3	1.03530030N (x2) SCREW:M3X3
---	--	-----------------------------------

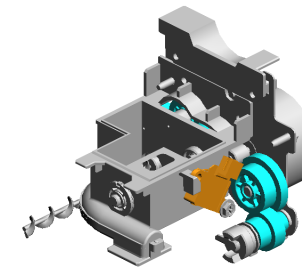

35.D0BQ3280
 [A]
 TONER HOPPER:TONER SUPPLY:M:ASS'Y
 201905-02 O/O

32.GW230008
 TONER END SENSOR

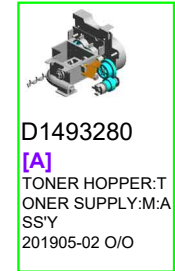
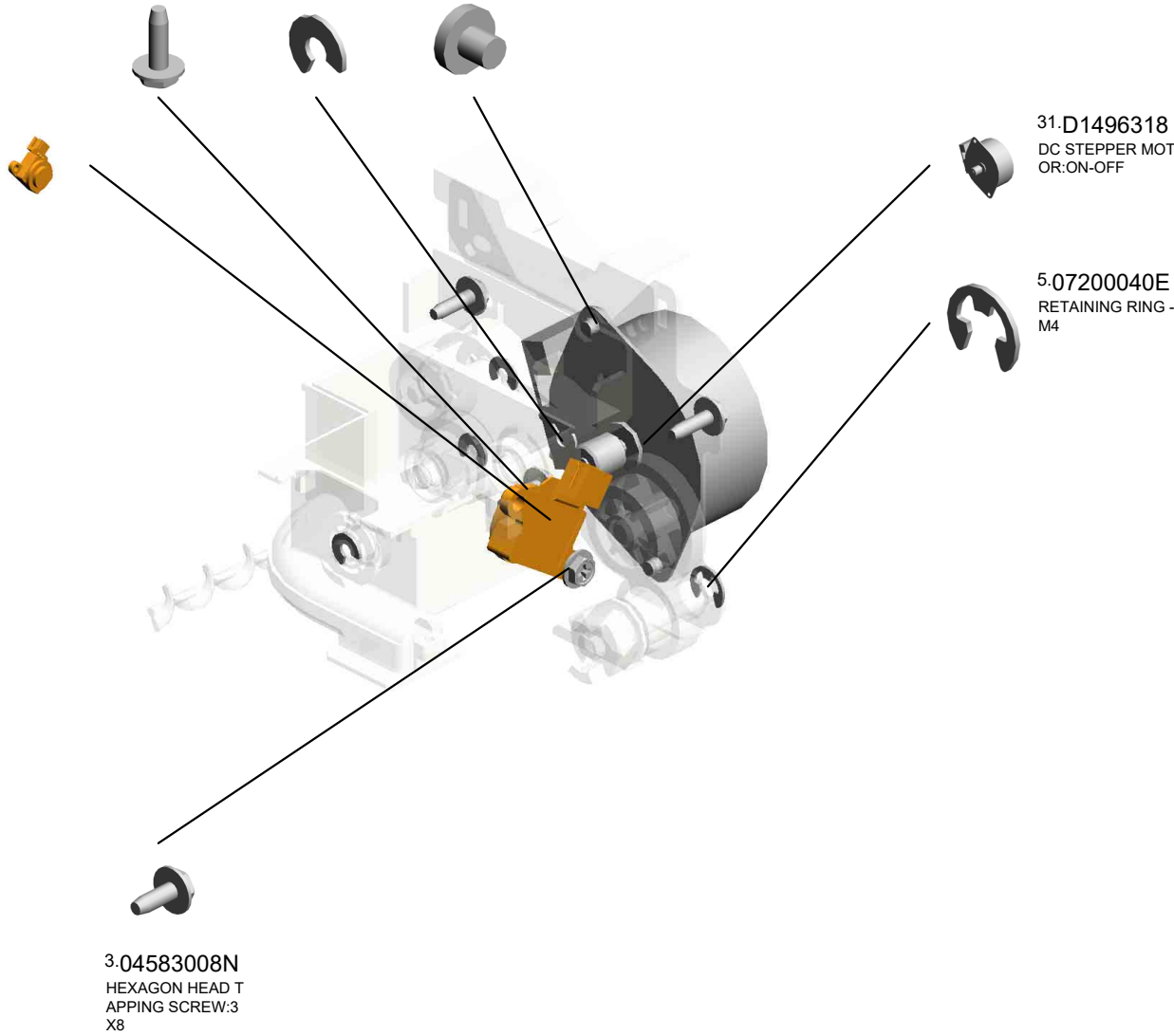

D1493280
 [A]
 TONER HOPPER:TONER SUPPLY:M:ASS'Y
 201905-02 O/O

U001	U002	U003	U004	U005	U006	U007	U008	U009	U010	U011	U012	U013	U014	U015	U016	U017	U018	U019	U020
------	------	------	------	------	------	------	------	------	------	------	------	------	------	------	------	------	------	------	------

U007_S012
 TONER HOPPER:TONER SUPPLY:Y:ASS'Y

32.GW230008 1.03530030N
 TONER END SENS (x2)
 OR SCREW:M3X3

3.04583008N
 HEXAGON HEAD TAPPING SCREW:3 X8

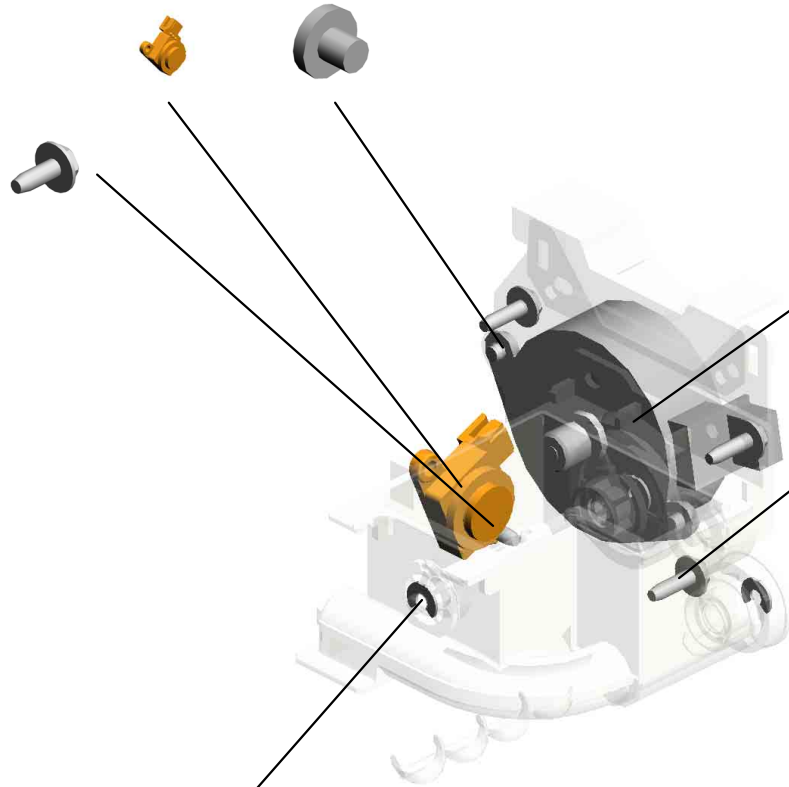

30.D1493350
 DC STEPPER MOTOR:TONER SUPPLY

4.04583010N
 (x3)
 HEXAGON HEAD TAPPING SCREW:3 X10

6.08050103
 (x3)
 RETAINING RINGS
 -E:SILENCER:DIA3

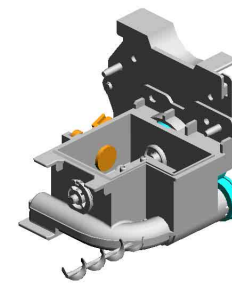

36.D0BQ3310
 [A]
 TONER HOPPER:TONER SUPPLY:Y:ASS'Y
 201905-03 O/O



D1493310
 [A]
 TONER HOPPER:TONER SUPPLY:Y:ASS'Y
 201905-03 O/O

U001	U002	U003	U004	U005	U006	U007	U008	U009	U010	U011	U012	U013	U014	U015	U016	U017	U018	U019	U020
------	------	------	------	------	------	------	------	------	------	------	------	------	------	------	------	------	------	------	------

U007_S013
TRANSPORT SCREW:NOZZLE:BK:ASS'Y

9.11050759
CLAMP:LWSM-060
5A

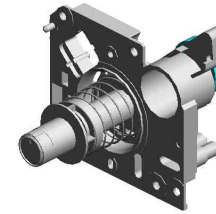

17.D1473287
TRANSPORT SCR
EW:NOZZLE:BK:AS
SY



6.08050103
RETAINING RINGS
-E:SILENCER:DIA3

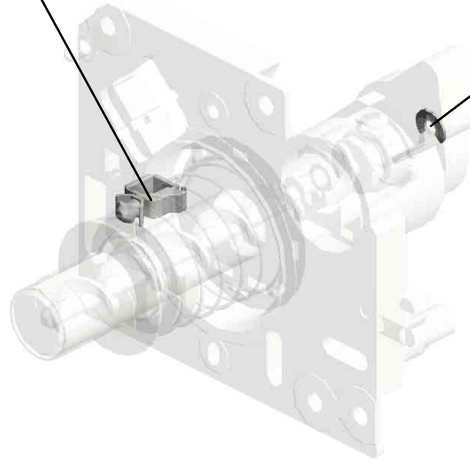

U001	U002	U003	U004	U005	U006	U007	U008	U009	U010	U011	U012	U013	U014	U015	U016	U017	U018	U019	U020
------	------	------	------	------	------	------	------	------	------	------	------	------	------	------	------	------	------	------	------

U007_S014
TRANSPORT SCREW:NOZZLE:CMY:ASS'Y

9.11050759
CLAMP:LWSM-060
5A

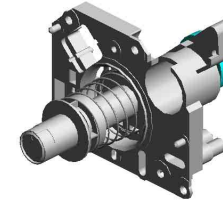

18.D1473288
TRANSPORT SCR
EW:NOZZLE:CMY:
ASS'Y



6.08050103
RETAINING RINGS
-E:SILENCER:DIA3

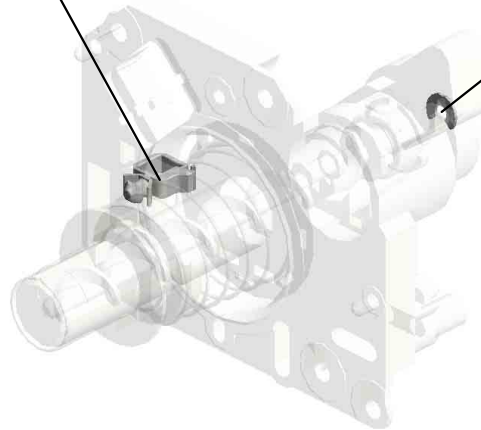

U001	U002	U003	U004	U005	U006	U007	U008	U009	U010	U011	U012	U013	U014	U015	U016	U017	U018	U019	U020
------	------	------	------	------	------	------	------	------	------	------	------	------	------	------	------	------	------	------	------

U007_S015
TRANSPORT SCREW:NOZZLE:CMY:ASS'Y

9.11050759
CLAMP:LWSM-060
5A

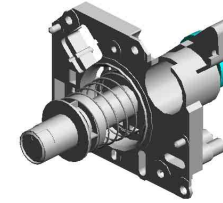

18.D1473288
TRANSPORT SCR
EW:NOZZLE:CMY:
ASS'Y



6.08050103
RETAINING RINGS
-E:SILENCER:DIA3

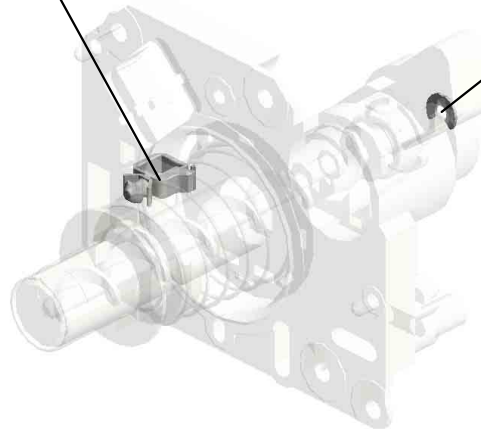

U001	U002	U003	U004	U005	U006	U007	U008	U009	U010	U011	U012	U013	U014	U015	U016	U017	U018	U019	U020
------	------	------	------	------	------	------	------	------	------	------	------	------	------	------	------	------	------	------	------

U007_S016
TRANSPORT SCREW:NOZZLE:CMY:ASS'Y

9.11050759
CLAMP:LWSM-060
5A

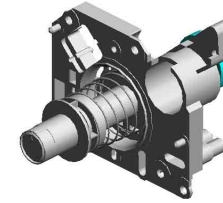

18.D1473288
TRANSPORT SCR
EW:NOZZLE:CMY:
ASS'Y



6.08050103
RETAINING RINGS
-E:SILENCER:DIA3

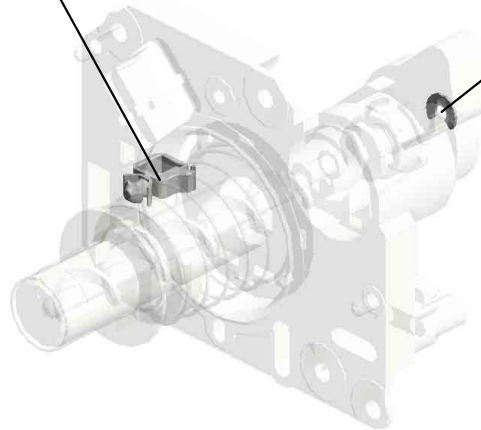

U001	U002	U003	U004	U005	U006	U007	U008	U009	U010	U011	U012	U013	U014	U015	U016	U017	U018	U019	U020
------	------	------	------	------	------	-------------	------	------	------	------	------	------	------	------	------	------	------	------	------

U007_S017
BASE:TONER HOPPER:REAR:ASS'Y

10.11050760
(x4)
CLAMP:LWSM-051
1A

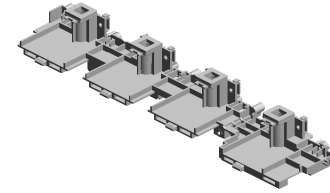

22-D1493256
BASE:TONER HOP
PER:REAR:ASS'Y

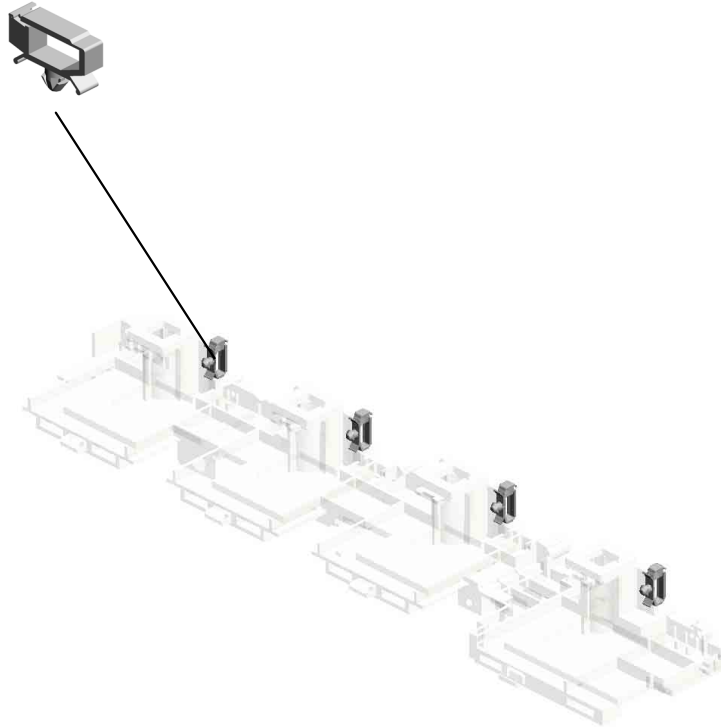

U001	U002	U003	U004	U005	U006	U007	U008	U009	U010	U011	U012	U013	U014	U015	U016	U017	U018	U019	U020
------	------	------	------	------	------	------	------	------	------	------	------	------	------	------	------	------	------	------	------

U008.PCDU

U008 S003
D2422226
PCDU:M

U008 S004
D2422227
PCDU:Y

U008 S001
D2392224
PCDU:K

U008 S002
D2422225
PCDU:C

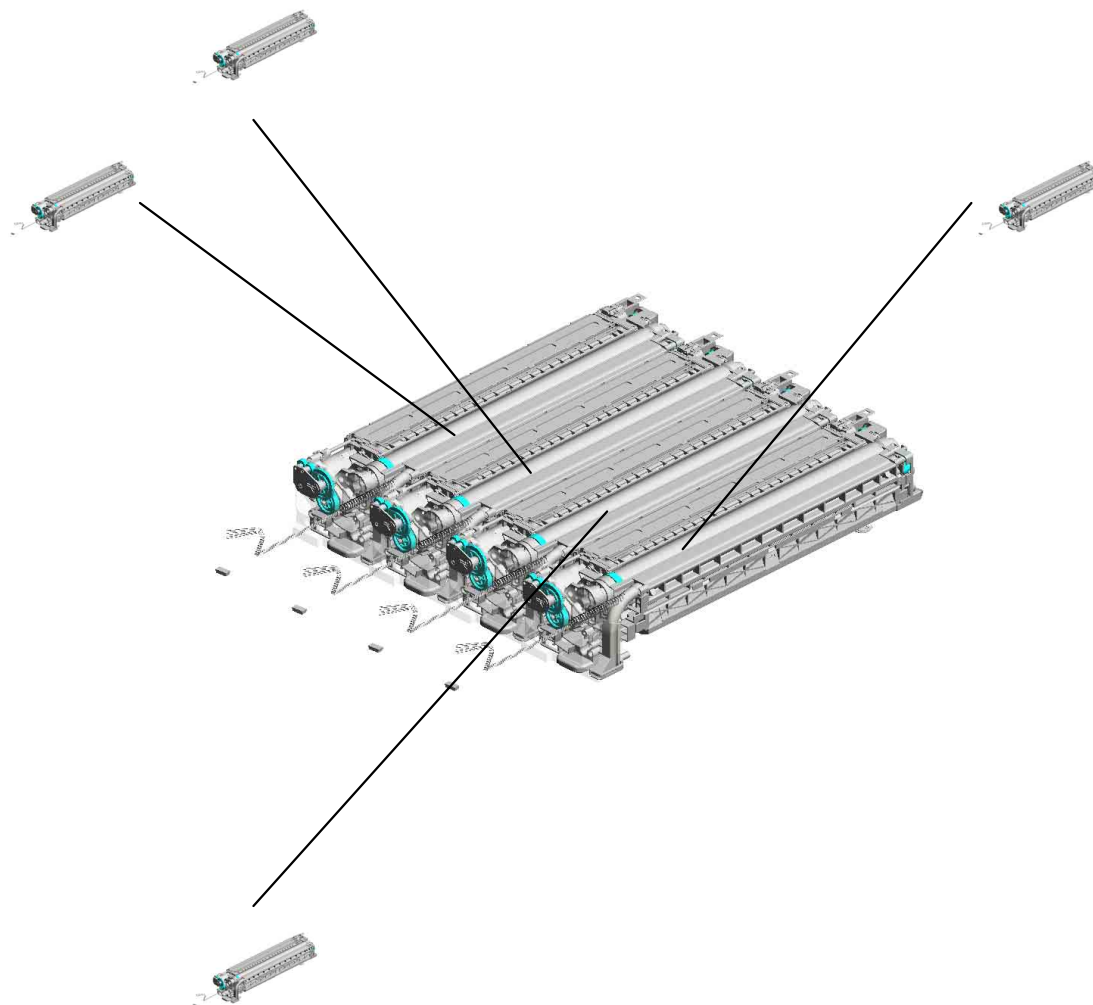

U001	U002	U003	U004	U005	U006	U007	U008	U009	U010	U011	U012	U013	U014	U015	U016	U017	U018	U019	U020
------	------	------	------	------	------	------	-------------	------	------	------	------	------	------	------	------	------	------	------	------

U008_S001.PCDU:K

U008 S001 S002
D2423091
DEVELOPMENT UNIT:K

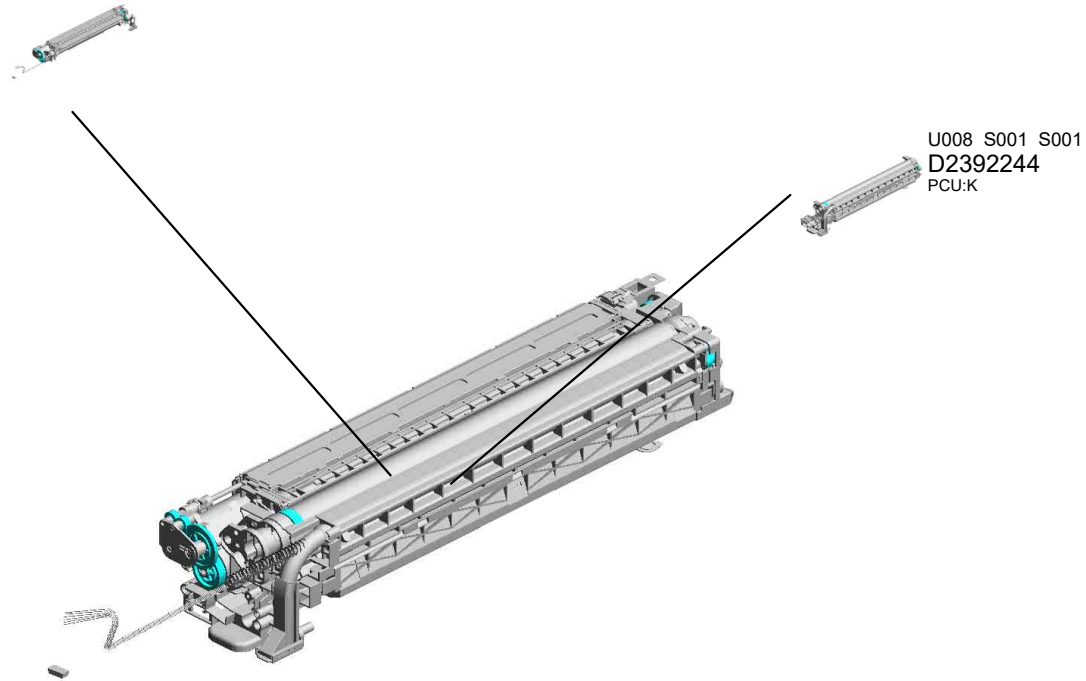

U001	U002	U003	U004	U005	U006	U007	U008	U009	U010	U011	U012	U013	U014	U015	U016	U017	U018	U019	U020
------	------	------	------	------	------	------	-------------	------	------	------	------	------	------	------	------	------	------	------	------

U008_S002.PCDU:C

U008 S002 S002
D2423092
DEVELOPMENT UNIT:C

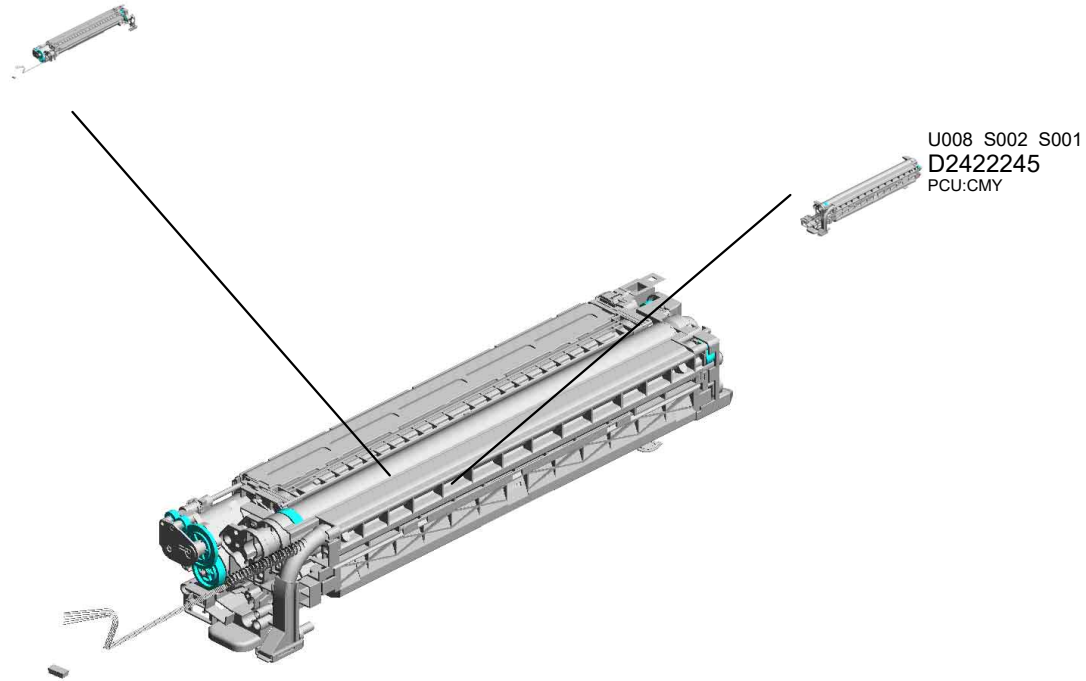

U001	U002	U003	U004	U005	U006	U007	U008	U009	U010	U011	U012	U013	U014	U015	U016	U017	U018	U019	U020
------	------	------	------	------	------	------	-------------	------	------	------	------	------	------	------	------	------	------	------	------

U008_S003.PCDU:M

U008 S003 S002
D2423093
DEVELOPMENT UNIT:M

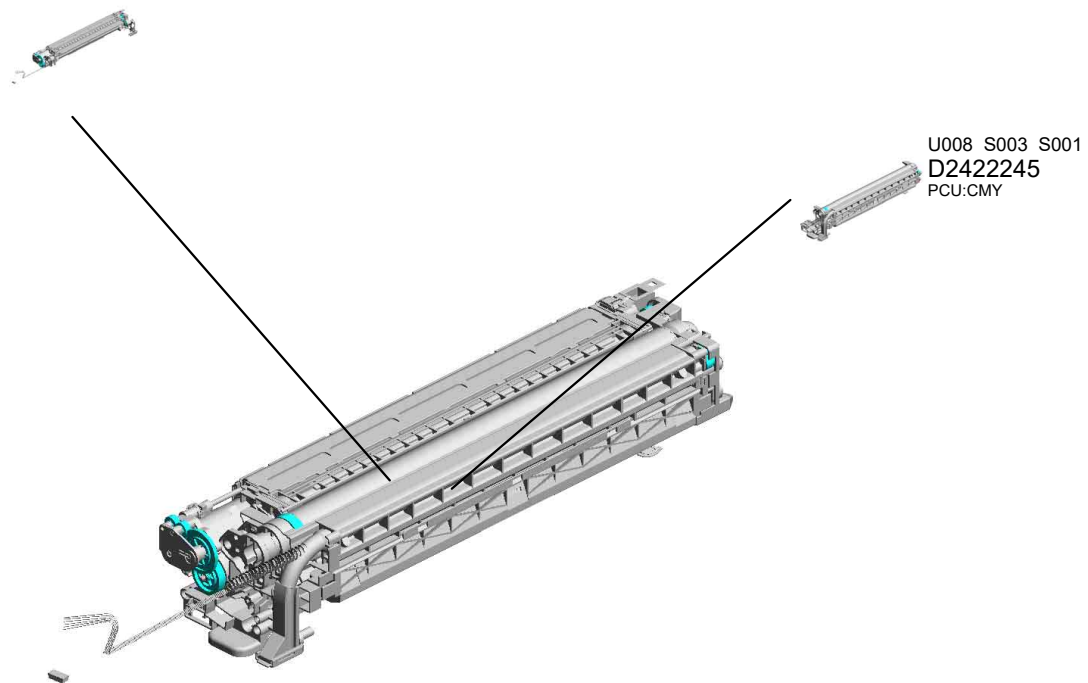

U001	U002	U003	U004	U005	U006	U007	U008	U009	U010	U011	U012	U013	U014	U015	U016	U017	U018	U019	U020
------	------	------	------	------	------	------	-------------	------	------	------	------	------	------	------	------	------	------	------	------

U008_S004.PCDU:Y

U008 S004 S002
D2423094
DEVELOPMENT UNIT:Y

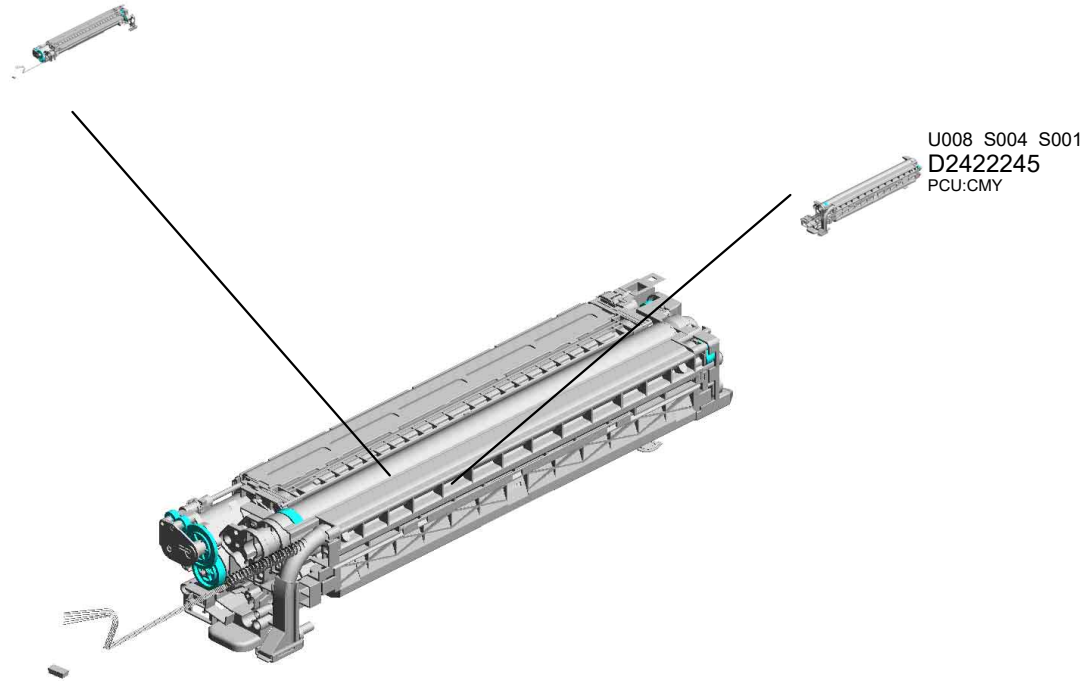

U001	U002	U003	U004	U005	U006	U007	U008	U009	U010	U011	U012	U013	U014	U015	U016	U017	U018	U019	U020
------	------	------	------	------	------	------	-------------	------	------	------	------	------	------	------	------	------	------	------	------

U008
PCDU

1.03603006N 16.D2422389
(x4) (x4)
SCREW - M3X6 COVER:PCU:FRON
T:SUB-ASS'Y

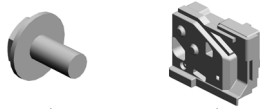
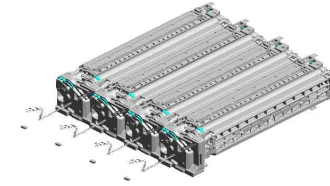

2.04583010N (x 2)
HEXAGON HEAD TAPPING SCREW:3X
10
(x2)
HEXAGON HEAD TAPPING SCREW:3X
10

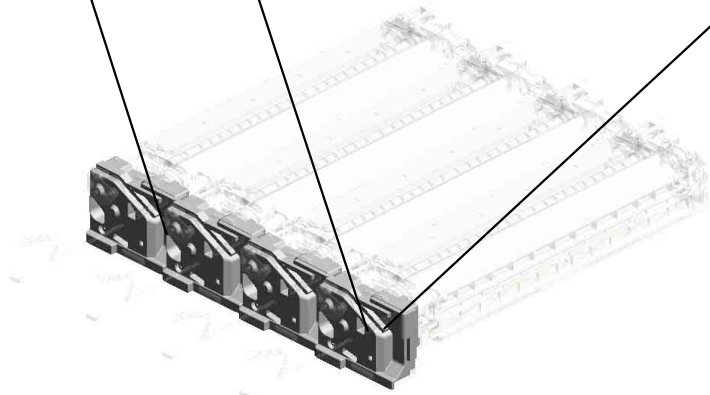

U001	U002	U003	U004	U005	U006	U007	U008	U009	U010	U011	U012	U013	U014	U015	U016	U017	U018	U019	U020
------	------	------	------	------	------	------	-------------	------	------	------	------	------	------	------	------	------	------	------	------

U008_S001
PCDU:K

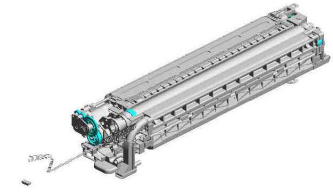

10.D2392224
PCDU:K

U001	U002	U003	U004	U005	U006	U007	U008	U009	U010	U011	U012	U013	U014	U015	U016	U017	U018	U019	U020
------	------	------	------	------	------	------	------	------	------	------	------	------	------	------	------	------	------	------	------

U008_S001_S001
PCU:K

4.04593010N
(x15)
BINDING HEAD TA
PPING SCREW:3X
10

9.11050758
CLAMP:LWSM-030
6A



5.07200030E
RETAINING RING -
M3

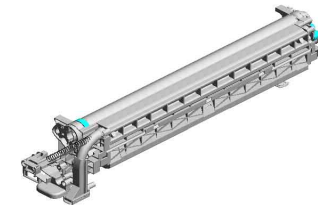

27.D2392244
[A]
PCU:K
201906-01 O/O

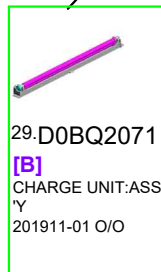

29.D0BQ2071
[B]
CHARGE UNIT:ASS
'Y
201911-01 O/O



D2392243
[A]
PCU:K
201906-01 O/O

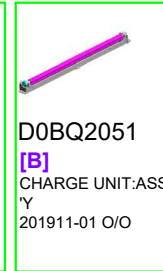

D0BQ2051
[B]
CHARGE UNIT:ASS
'Y
201911-01 O/O

U001	U002	U003	U004	U005	U006	U007	U008	U009	U010	U011	U012	U013	U014	U015	U016	U017	U018	U019	U020
------	------	------	------	------	------	------	------	------	------	------	------	------	------	------	------	------	------	------	------

U008_S001_S002
DEVELOPMENT UNIT:K

5.07200030E (x2)
RETAINING RING - M3
7.08050100
RETAINING RING - M2.5

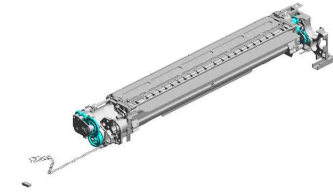

17.D2423091
[A]
DEVELOPMENT UN
IT:K
201907-03 O/O

1.03603006N
(x2)
SCREW - M3X6



6.07200040E
RETAINING RING - M4



8.08050103
RETAINING RINGS
-E:SILENCER:DIA3



4.04593010N
BINDING HEAD TA
PPING SCREW:3X
10



5.07200030E (x 3)
RETAINING RING - M3

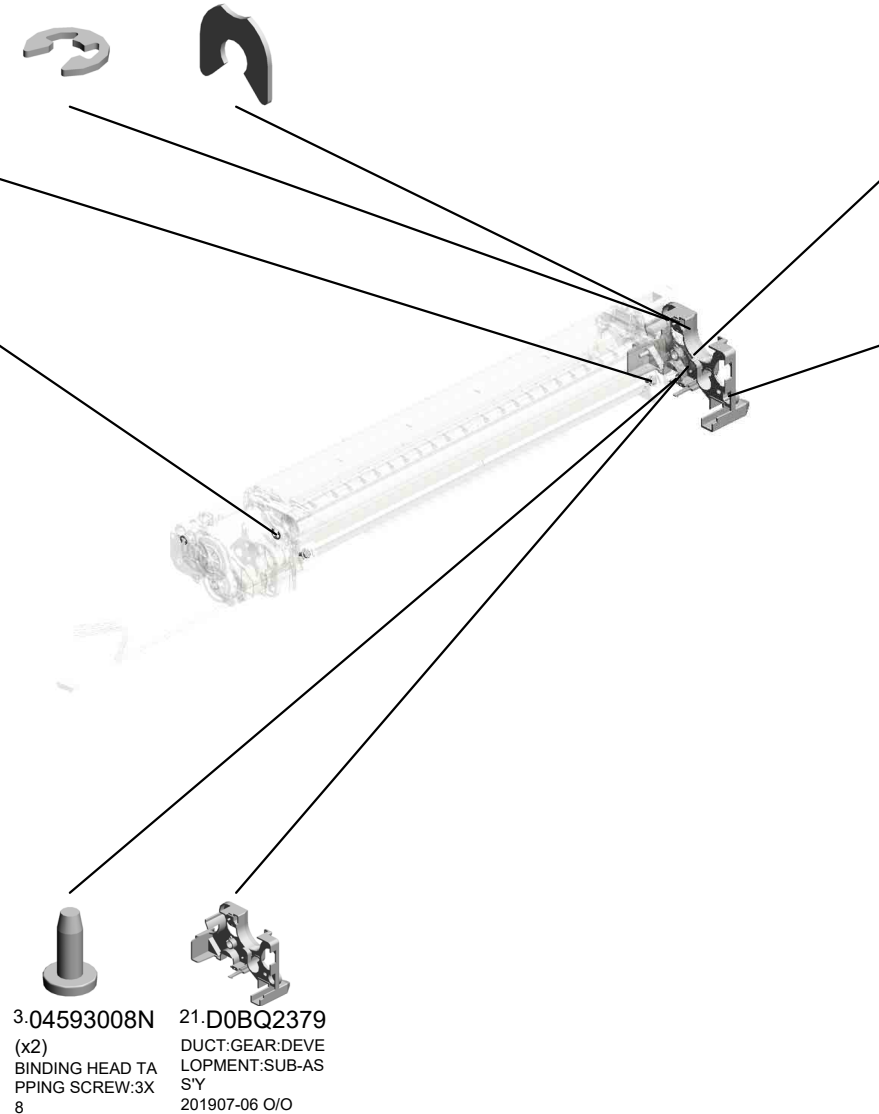

3.04593008N
(x2)
BINDING HEAD TA
PPING SCREW:3X
8



21.D0BQ2379
DUCT:GEAR:DEVE
LOPMENT:SUB-AS
S'Y
201907-06 O/O



D2423064
[A]
DEVELOPMENT UN
IT:K
201907-03 O/O

U001	U002	U003	U004	U005	U006	U007	U008	U009	U010	U011	U012	U013	U014	U015	U016	U017	U018	U019	U020
------	------	------	------	------	------	------	------	------	------	------	------	------	------	------	------	------	------	------	------

U008_S002
PCDU:C

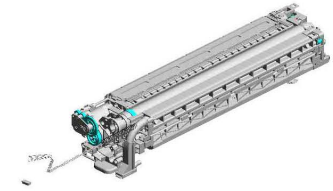

12-D2422225
PCDU:C

U001	U002	U003	U004	U005	U006	U007	U008	U009	U010	U011	U012	U013	U014	U015	U016	U017	U018	U019	U020
------	------	------	------	------	------	------	------	------	------	------	------	------	------	------	------	------	------	------	------

U008_S002_S001
PCU:CMY

4.04593010N
(x15)
BINDING HEAD TA
PPING SCREW:3X
10

9.11050758
CLAMP:LWSM-030
6A



5.07200030E
RETAINING RING -
M3

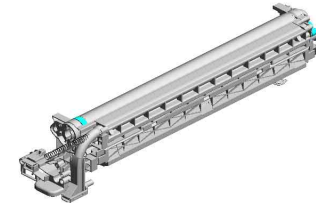

26.D2422245
[A]
PCU:CMY
201907-01 O/O

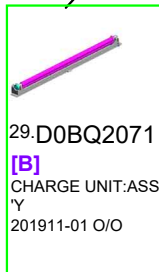

29.D0BQ2071
[B]
CHARGE UNIT:ASS
'Y
201911-01 O/O



D2422244
[A]
PCU:CMY
201907-01 O/O

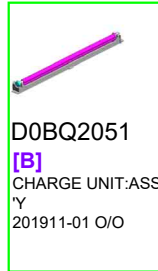

D0BQ2051
[B]
CHARGE UNIT:ASS
'Y
201911-01 O/O

U001	U002	U003	U004	U005	U006	U007	U008	U009	U010	U011	U012	U013	U014	U015	U016	U017	U018	U019	U020
------	------	------	------	------	------	------	------	------	------	------	------	------	------	------	------	------	------	------	------

U008_S002_S002
DEVELOPMENT UNIT:C

5.07200030E (x2)
RETAINING RING - M3
7.08050100
RETAINING RING - M2.5

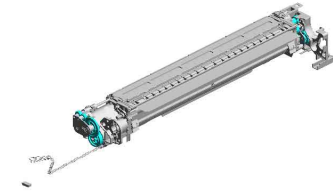

23.D2423092
[A]
DEVELOPMENT UN
IT:C
201908-02 O/O

1.03603006N
(x2)
SCREW - M3X6



6.07200040E
RETAINING RING - M4



8.08050103
RETAINING RINGS
-E:SILENCER:DIA3



4.04593010N
BINDING HEAD TA
PPING SCREW:3X
10



5.07200030E (x 3)
RETAINING RING - M3

3.04593008N (x2)
BINDING HEAD TA
PPING SCREW:3X
8
21.D0BQ2379
DUCT:GEAR:DEVE
LOPMENT:SUB-AS
S'Y
201907-06 O/O



D2423086
[A]
DEVELOPMENT UN
IT:C
201908-02 O/O

U001	U002	U003	U004	U005	U006	U007	U008	U009	U010	U011	U012	U013	U014	U015	U016	U017	U018	U019	U020
------	------	------	------	------	------	------	------	------	------	------	------	------	------	------	------	------	------	------	------

U008_S003
PCDU:M

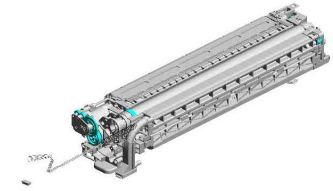

13.D2422226
PCDU:M

U001	U002	U003	U004	U005	U006	U007	U008	U009	U010	U011	U012	U013	U014	U015	U016	U017	U018	U019	U020
------	------	------	------	------	------	------	-------------	------	------	------	------	------	------	------	------	------	------	------	------

U008_S003_S001
PCU:CMY

4.04593010N
(x15)
BINDING HEAD TA
PPING SCREW:3X
10

9.11050758
CLAMP:LWSM-030
6A



5.07200030E
RETAINING RING -
M3

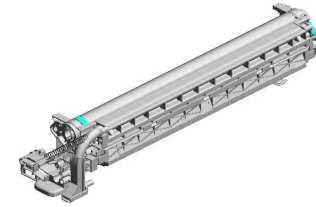

26.D2422245
[A]
PCU:CMY
201907-01 O/O

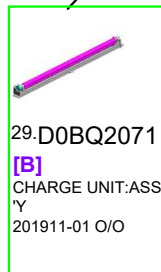

29.D0BQ2071
[B]
CHARGE UNIT:ASS
'Y
201911-01 O/O



D2422244
[A]
PCU:CMY
201907-01 O/O

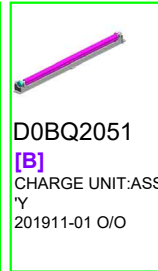

D0BQ2051
[B]
CHARGE UNIT:ASS
'Y
201911-01 O/O

U001	U002	U003	U004	U005	U006	U007	U008	U009	U010	U011	U012	U013	U014	U015	U016	U017	U018	U019	U020
------	------	------	------	------	------	------	------	------	------	------	------	------	------	------	------	------	------	------	------

U008_S003_S002
DEVELOPMENT UNIT:M

5.07200030E (x2)
RETAINING RING - M3
7.08050100
RETAINING RING - M2.5

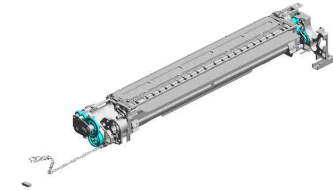

24.D2423093
[A]
DEVELOPMENT UN
IT:M
201908-03 O/O

1.03603006N
(x2)
SCREW - M3X6



6.07200040E
RETAINING RING - M4



8.08050103
RETAINING RINGS
-E:SILENCER:DIA3



4.04593010N
BINDING HEAD TA
PPING SCREW:3X
10



5.07200030E (x 3)
RETAINING RING - M3

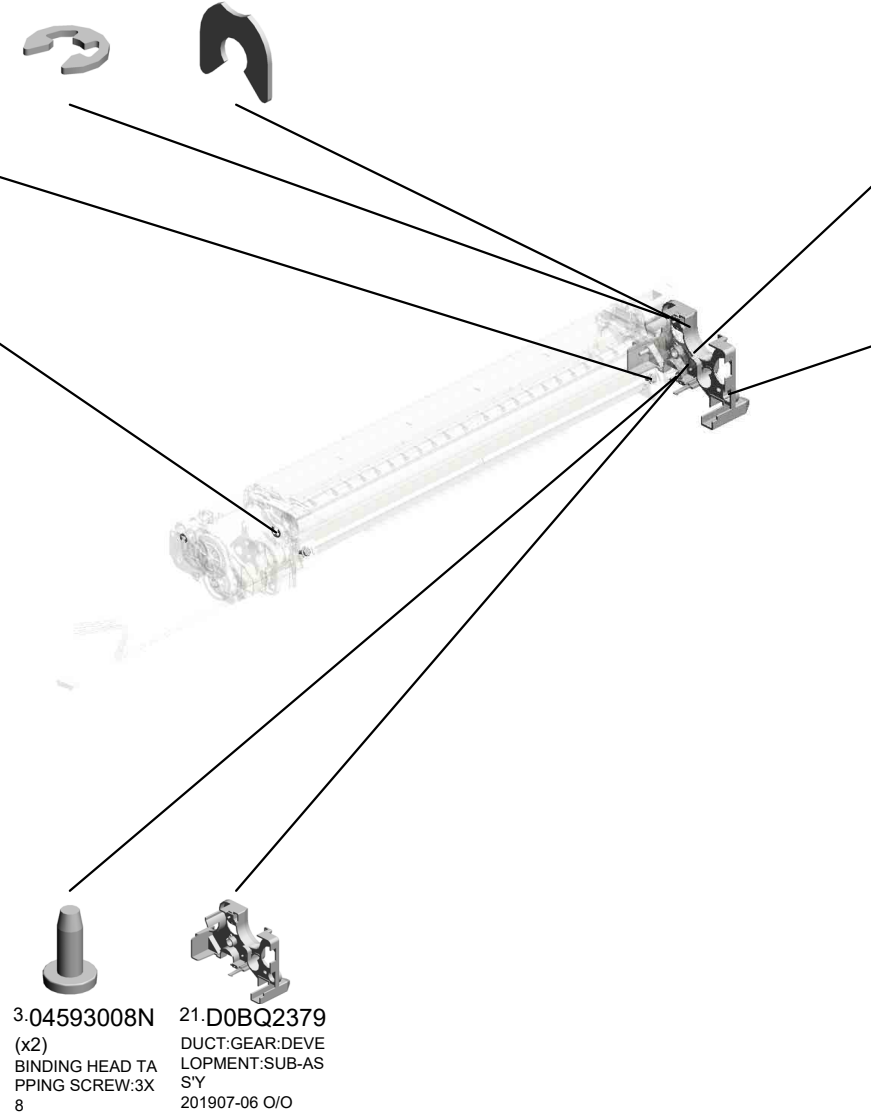

3.04593008N
(x2)
BINDING HEAD TA
PPING SCREW:3X
8



21.D0BQ2379
DUCT:GEAR:DEVE
LOPMENT:SUB-AS
S'Y
201907-06 O/O



D2423087
[A]
DEVELOPMENT UN
IT:M
201908-03 O/O

U001	U002	U003	U004	U005	U006	U007	U008	U009	U010	U011	U012	U013	U014	U015	U016	U017	U018	U019	U020
------	------	------	------	------	------	------	------	------	------	------	------	------	------	------	------	------	------	------	------

U008_S004
PCDU:Y

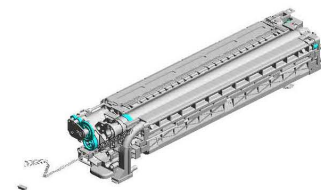

14.D2422227
PCDU:Y

U001	U002	U003	U004	U005	U006	U007	U008	U009	U010	U011	U012	U013	U014	U015	U016	U017	U018	U019	U020
------	------	------	------	------	------	------	------	------	------	------	------	------	------	------	------	------	------	------	------

U008_S004_S001
PCU:CMY

4.04593010N
(x15)
BINDING HEAD TA
PPING SCREW:3X
10

9.11050758
CLAMP:LWSM-030
6A



5.07200030E
RETAINING RING -
M3

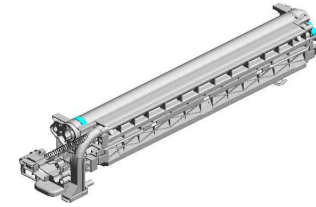

26.D2422245
[A]
PCU:CMY
201907-01 O/O

29.D0BQ2071
[B]
CHARGE UNIT:ASS
'Y
201911-01 O/O

<p>D2422244 [A] PCU:CMY 201907-01 O/O</p>	<p>D0BQ2051 [B] CHARGE UNIT:ASS 'Y 201911-01 O/O</p>
---	--

U001	U002	U003	U004	U005	U006	U007	U008	U009	U010	U011	U012	U013	U014	U015	U016	U017	U018	U019	U020
------	------	------	------	------	------	------	------	------	------	------	------	------	------	------	------	------	------	------	------

U008_S004_S002
DEVELOPMENT UNIT:Y

5.07200030E (x2)
RETAINING RING - M3
7.08050100
RETAINING RING - M2.5

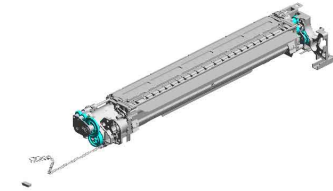

25.D2423094
[A]
DEVELOPMENT UN
IT:Y
201908-04 O/O

1.03603006N
(x2)
SCREW - M3X6



6.07200040E
RETAINING RING - M4



8.08050103
RETAINING RINGS
-E:SILENCER:DIA3



5.07200030E (x 3)
RETAINING RING - M3

4.04593010N
BINDING HEAD TA
PPING SCREW:3X
10



3.04593008N
(x2)
BINDING HEAD TA
PPING SCREW:3X
8



21.D0BQ2379
DUCT:GEAR:DEVE
LOPMENT:SUB-AS
S'Y
201907-06 O/O



D2423088
[A]
DEVELOPMENT UN
IT:Y
201908-04 O/O

U001	U002	U003	U004	U005	U006	U007	U008	U009	U010	U011	U012	U013	U014	U015	U016	U017	U018	U019	U020
------	------	------	------	------	------	------	------	------	------	------	------	------	------	------	------	------	------	------	------

U009.ITB UNIT

U009 S002
D1496370
TONER OUTLET UNIT:BELT
CLEANING:ASS'Y

U009 S003
D0BQ6141
CLEANING UNIT:BELT CLEA
NING:ASS'Y

U009 S001
D2416003
TRANSFER UNIT:INTERMEDI
ATE TRANSFER:ASS'Y

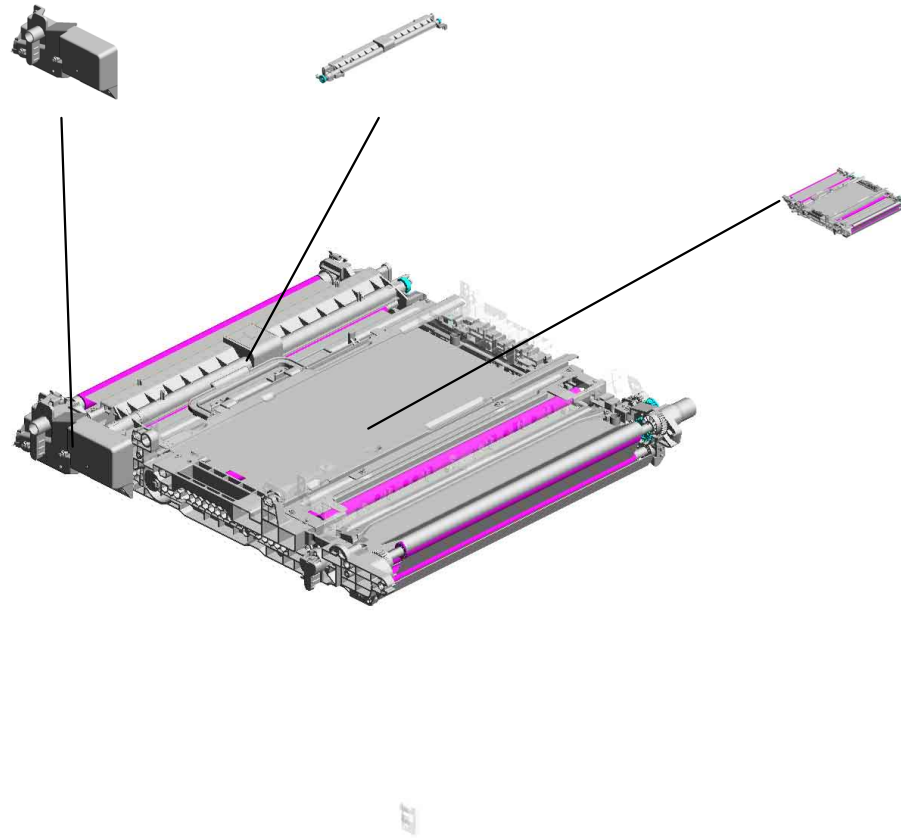

U001	U002	U003	U004	U005	U006	U007	U008	U009	U010	U011	U012	U013	U014	U015	U016	U017	U018	U019	U020
------	------	------	------	------	------	------	------	------	------	------	------	------	------	------	------	------	------	------	------

U009 ITB UNIT

- 24.D1496173 BRACKET:BELT CL EAINING:REAR
- 6.07200040E RETAINING RING - M4
- 32.D1496311 GEAR:ON-OFF:COLLAR:OUTPUT
- 30.D1496309 SHAFT:ON-OFF:COLLAR:MAIN
- 11.AA082101 (x2) BUSHING - 6X10X6

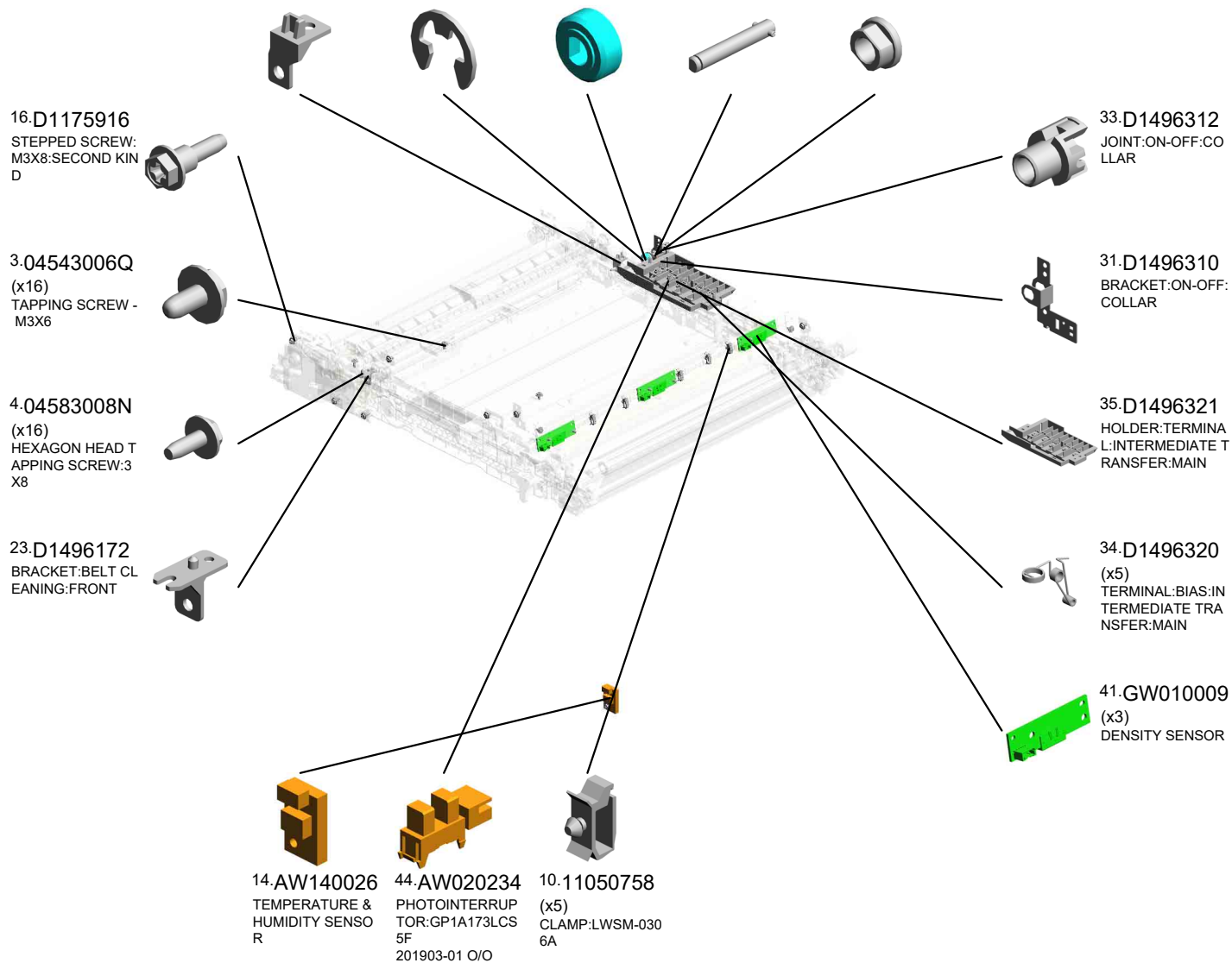
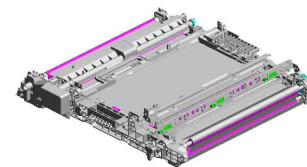

U001	U002	U003	U004	U005	U006	U007	U008	U009	U010	U011	U012	U013	U014	U015	U016	U017	U018	U019	U020
------	------	------	------	------	------	------	------	------	------	------	------	------	------	------	------	------	------	------	------

U009_S001
TRANSFER UNIT:INTERMEDIATE TRANSFER:ASS'Y

- 2.04513006N (x2) TAPPING SCREW - 3X6
- 39.D2416097 FLAT BELT-TRANSFER:INTERMEDIATE TRANSFER:TT
- 17.D1441085 (x2) STEPPED SCREW: M3
- 45.D0BQ6060 (x3) TRANSFER ROLLER:FC:ASS'Y 201904-03 O/O
- 5.07200030E RETAINING RING - M3

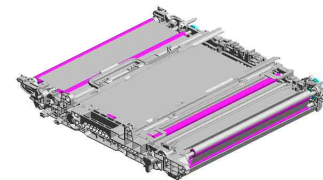

43.D2416003
[A]
TRANSFER UNIT:INTERMEDIATE TRANSFER:ASS'Y
201902-08 O/O

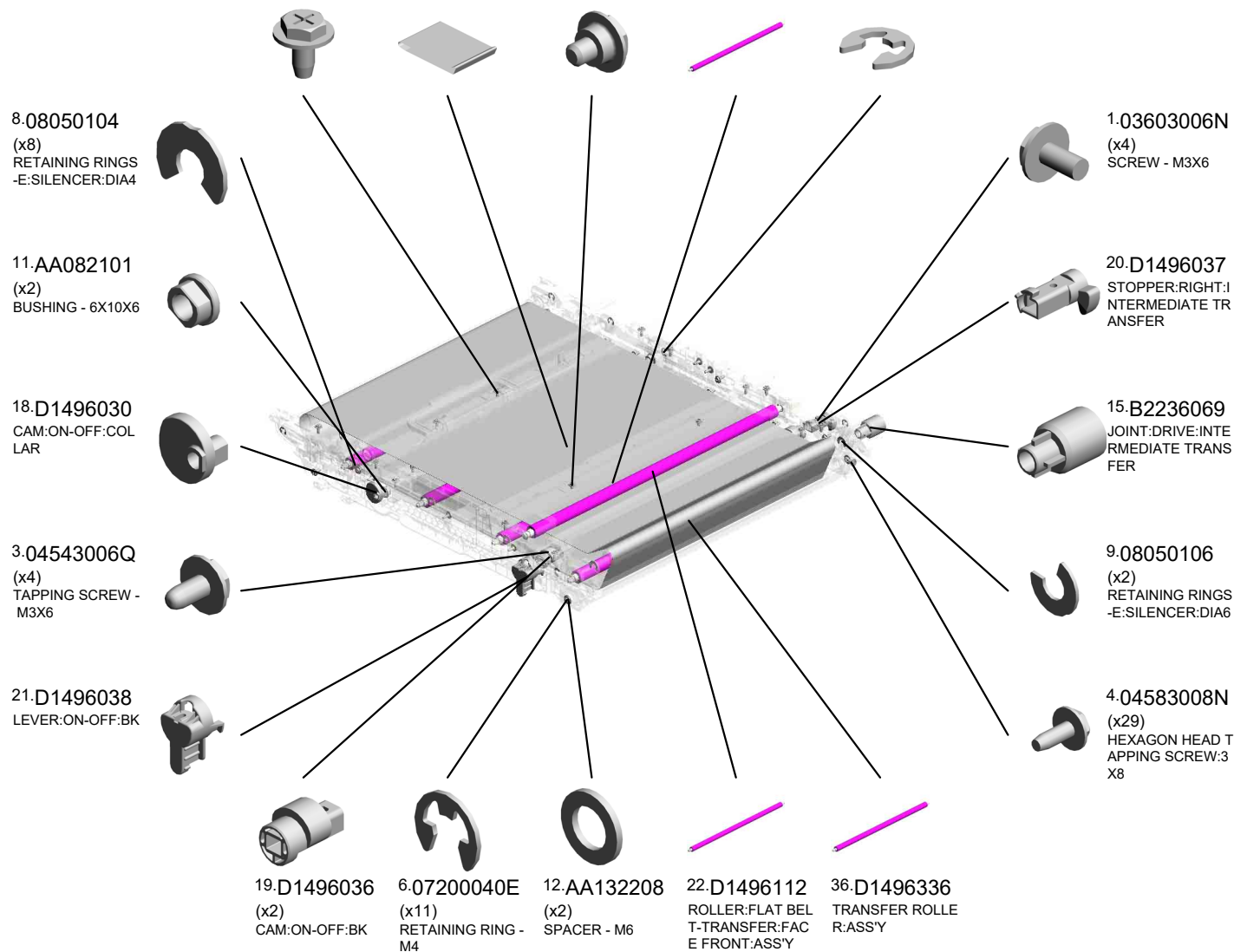

U009_S001
TRANSFER UNIT:INTERMEDIATE TRANSFER:ASS'Y

46.D1496133
VIBRATING PLATE:
FRONT:PEEN
201911-03



47.D1496136
VIBRATING PLATE:
REAR:PEEN
201911-04

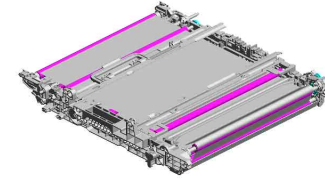
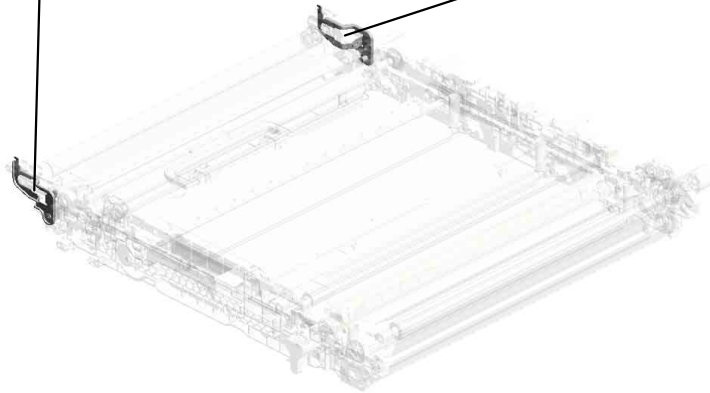

43.D2416003
[A]
TRANSFER UNIT:IN
TERMEDIATE TRA
NSFER:ASS'Y
201902-08 O/O



D2416001
[A]
TRANSFER UNIT:IN
TERMEDIATE TRA
NSFER:ASS'Y
201902-08 O/O

U001	U002	U003	U004	U005	U006	U007	U008	U009	U010	U011	U012	U013	U014	U015	U016	U017	U018	U019	U020
------	------	------	------	------	------	------	------	------	------	------	------	------	------	------	------	------	------	------	------

U009_S002

TONER OUTLET UNIT:BELT CLEANING:ASS'Y

28.D1496194 SHAFT:LEVER:DISCHARGE USED TONER
29.D1496195 CAM:DISCHARGE USED TONER
3.04543006Q (x2) TAPPING SCREW - M3X6

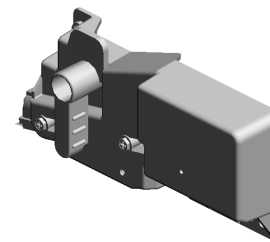

37.D1496370 TONER OUTLET UNIT:BELT CLEANING:ASS'Y

27.D1496192 LEVER:DISCHARGE USED TONER

4.04583008N (x2) HEXAGON HEAD TAPPING SCREW:3 X8

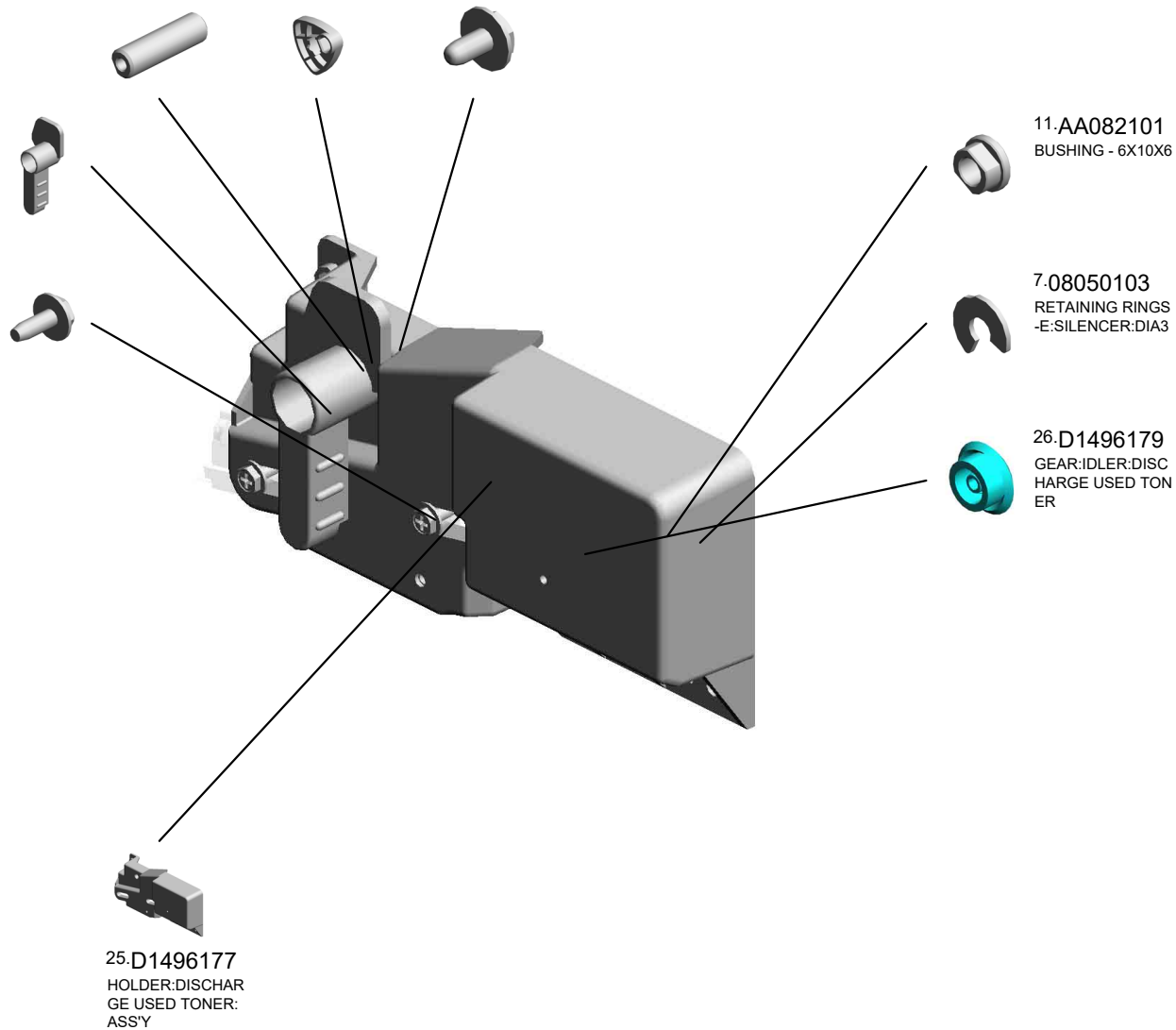

U001	U002	U003	U004	U005	U006	U007	U008	U009	U010	U011	U012	U013	U014	U015	U016	U017	U018	U019	U020
------	------	------	------	------	------	------	------	------	------	------	------	------	------	------	------	------	------	------	------

U009_S003

CLEANING UNIT:BELT CLEANING:ASS'Y

7.08050103 11.AA082101
RETAINING RINGS (x2)
-E:SILENCER:DIA3 BUSHING - 6X10X6

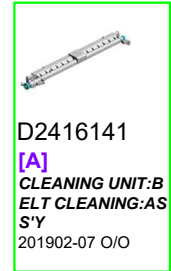
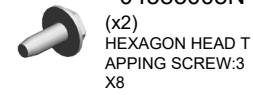
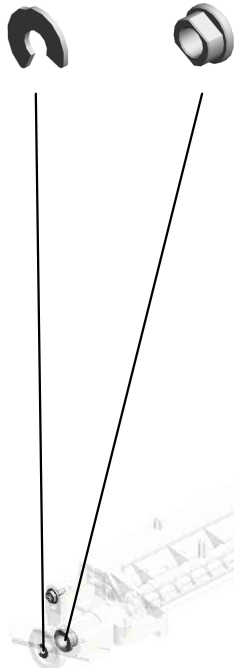
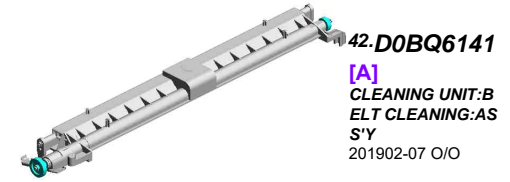

U001	U002	U003	U004	U005	U006	U007	U008	U009	U010	U011	U012	U013	U014	U015	U016	U017	U018	U019	U020
------	------	------	------	------	------	------	------	------	------	------	------	------	------	------	------	------	------	------	------

U010.SEPARATION/TRANSPORT

U010 S001
D2416212
TRANSFER ROLLER:SECON
D:ASSY

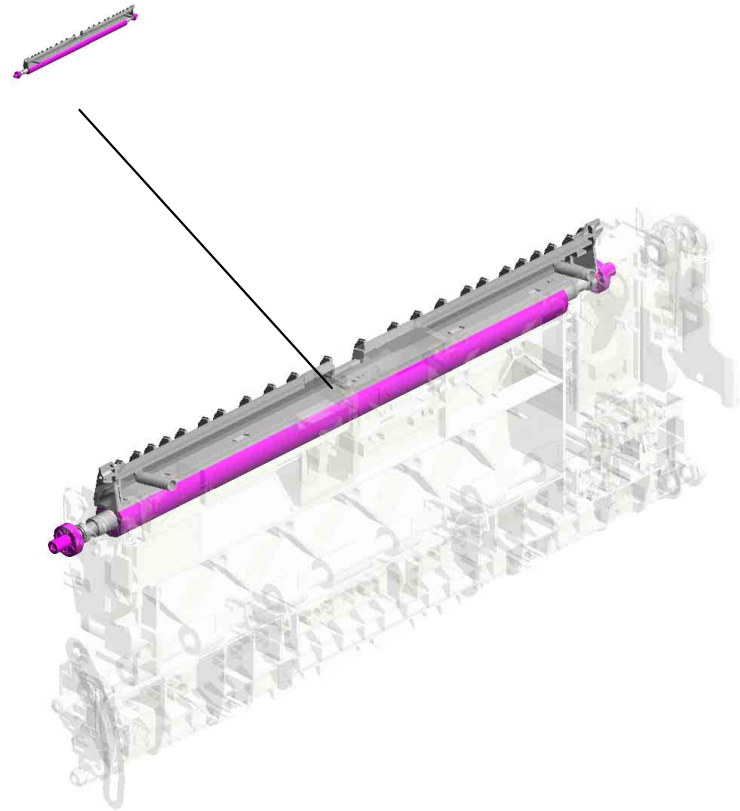

U001	U002	U003	U004	U005	U006	U007	U008	U009	U010	U011	U012	U013	U014	U015	U016	U017	U018	U019	U020
------	------	------	------	------	------	------	------	------	------	------	------	------	------	------	------	------	------	------	------

U010 SEPARATION/TRANSPORT

- 2.04543008Q (x2) TAPPING SCREW: 3X8
- 20.D1492586 GUIDE:REGISTRATION:FRONT RIGHT
- 17.D1492582 GUIDE PLATE:REGISTRATION:FRONT RIGHT
- 14.AW010200 PAPER FEED SENSOR:FUSING EXIT
- 6.07200060E (x2) RETAINING RING - M6

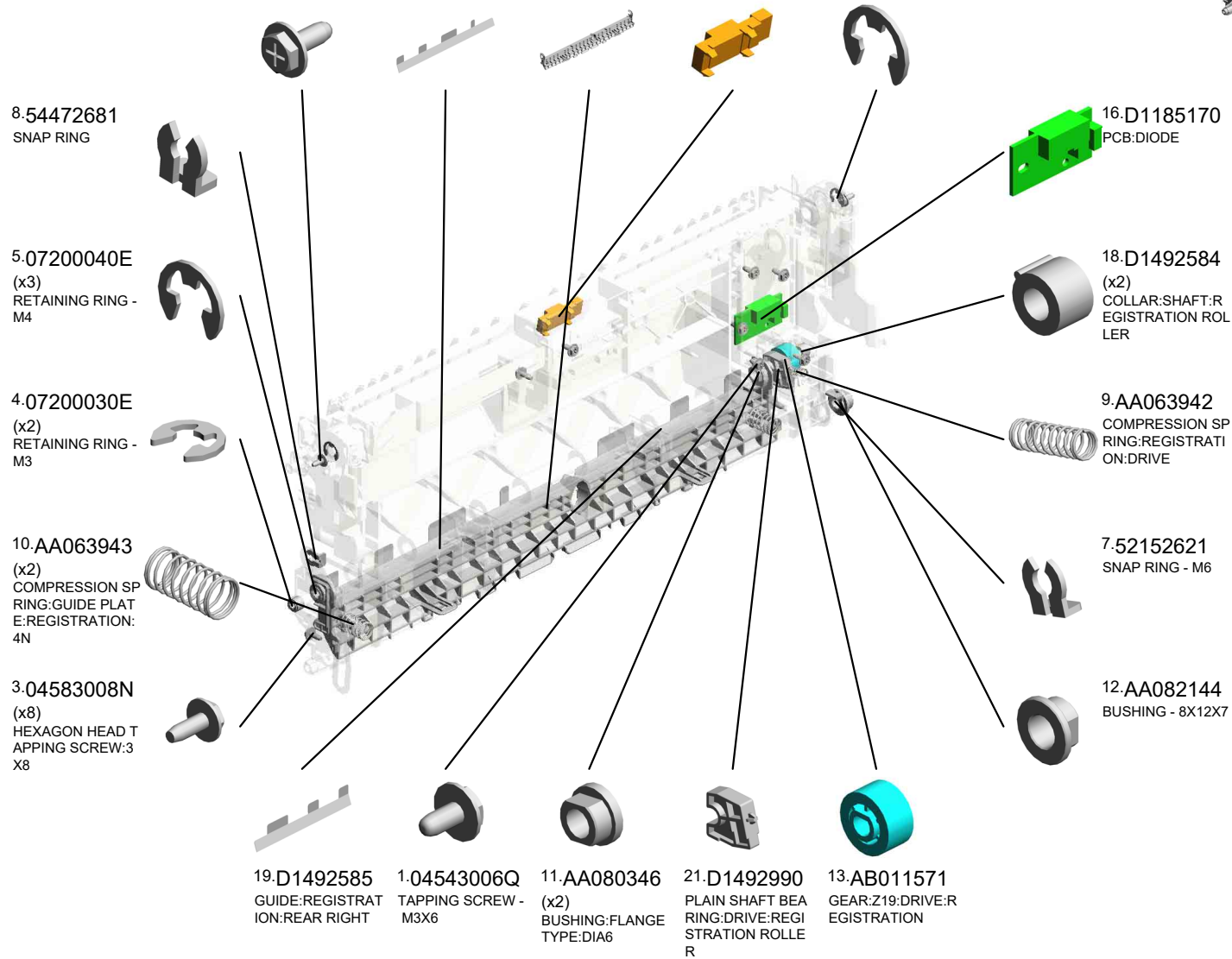
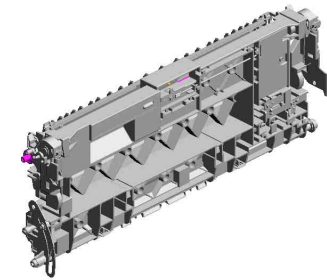

U001	U002	U003	U004	U005	U006	U007	U008	U009	U010	U011	U012	U013	U014	U015	U016	U017	U018	U019	U020
------	------	------	------	------	------	------	------	------	------	------	------	------	------	------	------	------	------	------	------

U010 SEPARATION/TRANSPORT

- 23.D1496226 LEVER:TRANSFER /SEPARATION UNIT:FRONT
- 34.D1496254 DECAL:GRIP:B:LOWER
- 39.D2026255 DECAL:GRIP:B
- 33.D1496248 CAP:LED
- 22.D1494662 DIFFUSION PLATE:LED

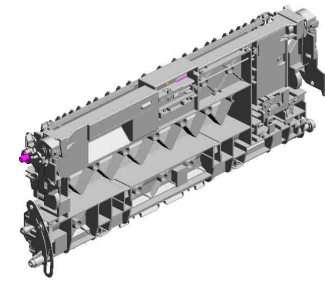

- 36.D1496290 GUIDE:SET:TRANSFER/SEPARATION UNIT:FRONT

- 25.D1496228 TORSION SPRING:LEVER:SET:FRONT

- 26.D1496229 (x2) TENSION SPRING:LEVER:SET

- 24.D1496227 LEVER:SET:FRONT

- 30.D1496242 (x2) COMPRESSION SPRING:PRESSURE:TRANSFER ROLLER

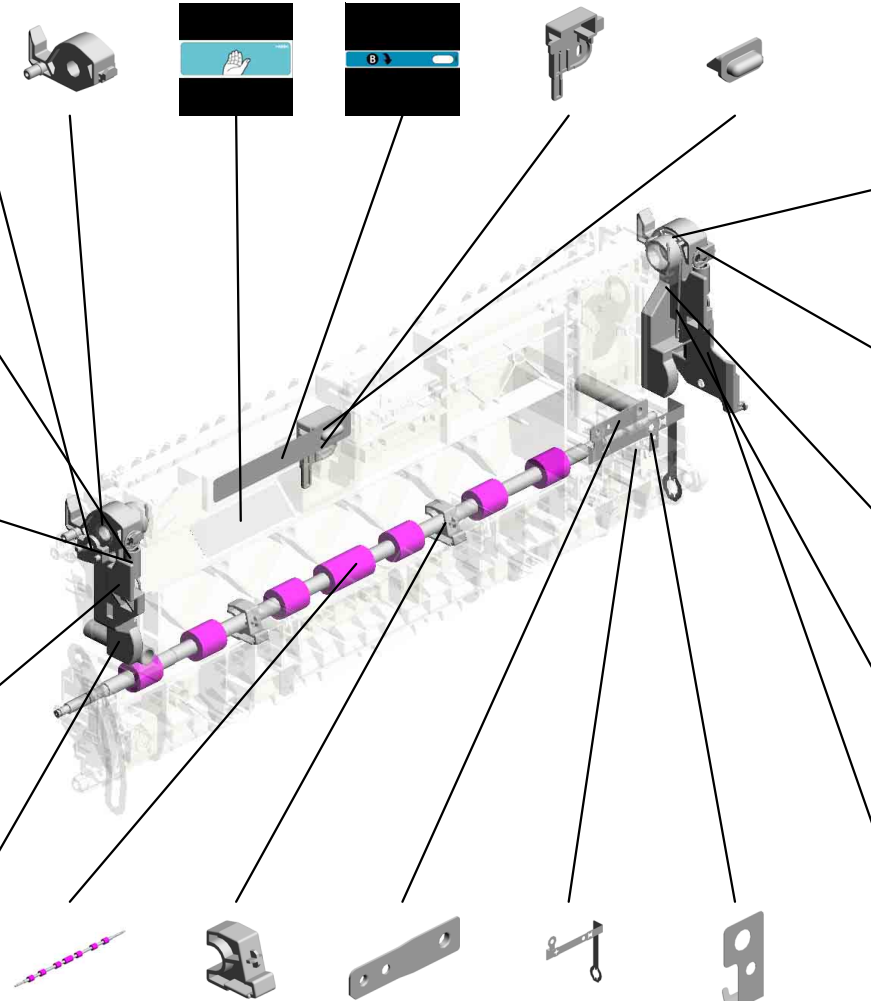

- 27.D1496231 LEVER:TRANSFER /SEPARATION UNIT:REAR

- 37.D1496291 GUIDE:SET:TRANSFER/SEPARATION UNIT:REAR

- 29.D1496233 TORSION SPRING:LEVER:SET:REAR

- 28.D1496232 LEVER:SET:REAR

- 38.D1496295 COVER:HARNESSTransfer/SEPARATION UNIT

- 40.D2412583 REGISTRATION ROLLER:DRIVE
- 41.D2412991 (x2) PLAIN SHAFT BEARING:INNER:DRIVE:REGISTRATION ROLLER
- 31.D1496243 RECEIVE PLATE:COMPRESSION SPRING:TRANSFER ROLLER
- 32.D1496245 GROUND PLATE:TRANSFER/SEPARATION UNIT
- 35.D1496257 GROUND PLATE:REGISTRATION ROLLER

U001	U002	U003	U004	U005	U006	U007	U008	U009	U010	U011	U012	U013	U014	U015	U016	U017	U018	U019	U020
------	------	------	------	------	------	------	------	------	------	------	------	------	------	------	------	------	------	------	------

U010 SEPARATION/TRANSPORT

45.D2416240 LEVER:PRESSURE
:TRANSFER ROLL
ER:FRONT:DIA19.5

52.D2416290 LED:RED

51.D2416275 SHEET:ENTRANCE
:TRANSFER

48.D2416250 GROUND WIRE:BR
ACKET:ENTRANCE
SENSOR

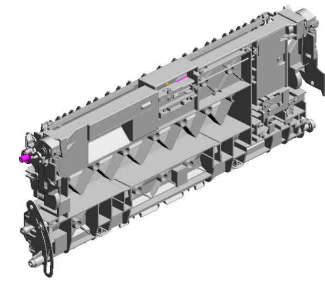

53.GA143003
SCREW:MM5:2.5M



42.D2412993
(x2)
STOPPER:REGISTRATION ROLLER



54.M0BW6246
LINK:TRANSFER/SEPARATION UNIT:
MO

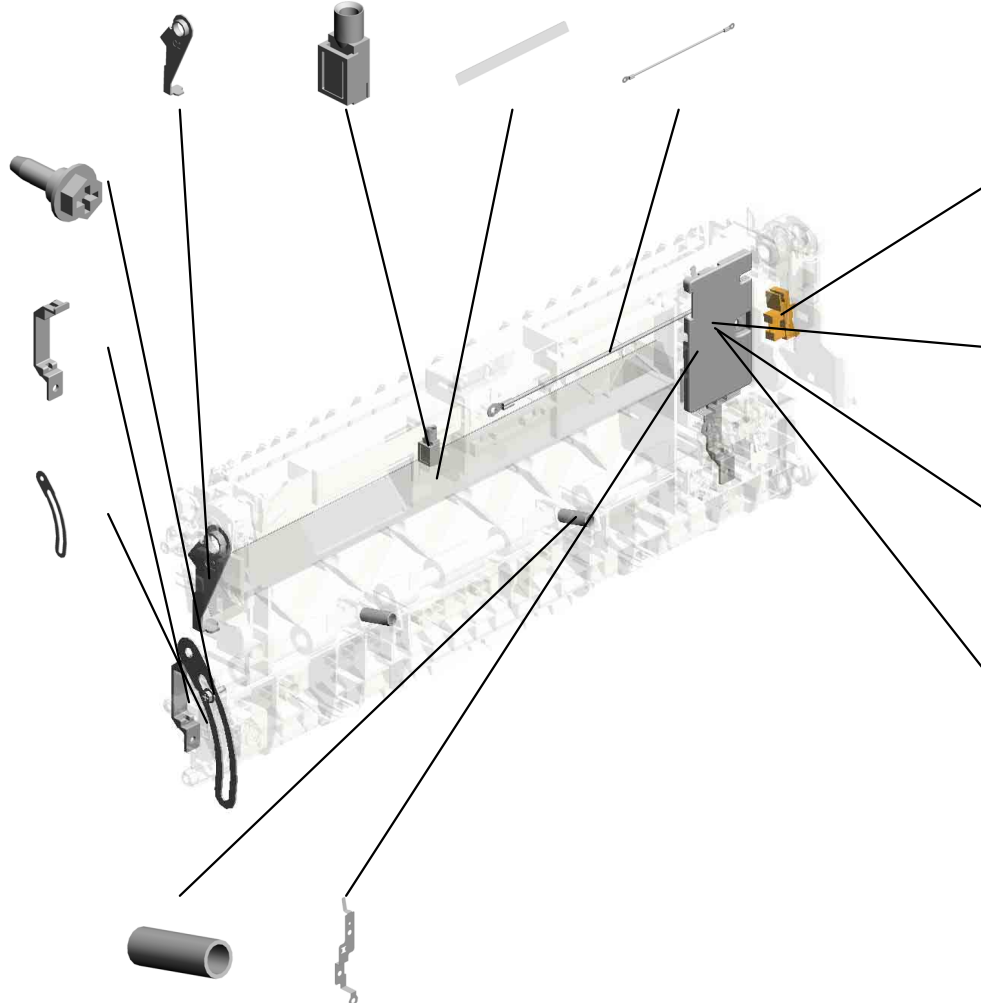

55.AW020234
PHOTOINTERRUPTOR:GP1A173LCS
5F
201903-01 O/O

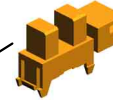

47.D2416244
GROUND PLATE:SEPARATION



46.D2416241
LEVER:PRESSURE
:TRANSFER ROLLER:REAR:DIA19.5



50.D2416258
COVER:TRANSFER/SEPARATION UNIT



43.D2412994
(x2)
COMPRESSION SPRING:REGISTRATION:INNER:DRIVE



49.D2416256
GROUND PLATE:GUIDE:TRANSPORT



U010_S001
TRANSFER ROLLER:SECOND:ASS'Y

5.07200040E
RETAINING RING -
M4

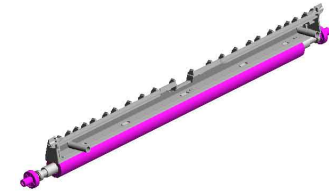

44.D2416212
TRANSFER ROLLE
R:SECOND:ASS'Y



U001	U002	U003	U004	U005	U006	U007	U008	U009	U010	U011	U012	U013	U014	U015	U016	U017	U018	U019	U020
------	------	------	------	------	------	------	------	------	------	------	------	------	------	------	------	------	------	------	------

U011.USED TONER

U011_S001
D2426400
COLLECTION BOTTLE:ASSY

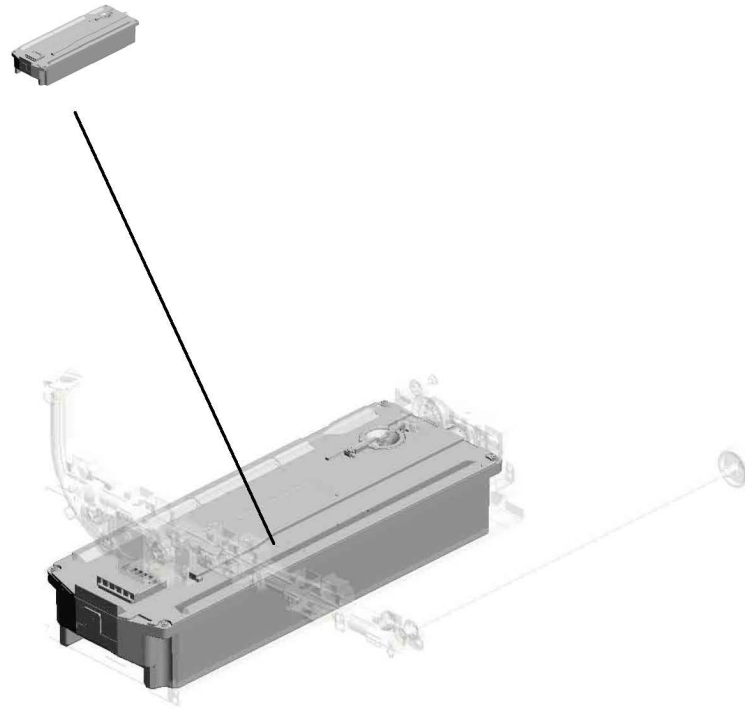

U001	U002	U003	U004	U005	U006	U007	U008	U009	U010	U011	U012	U013	U014	U015	U016	U017	U018	U019	U020
------	------	------	------	------	------	------	------	------	------	------	------	------	------	------	------	------	------	------	------

U011 USED TONER

- 23.D1496561 PULLEY:USED TONER
- 21.D1496556 TENSION SPRING: BELT TENSIONER
- 11.AW020198 PHOTOINTERRUPTOR:LG2A14NL1
- 16.D1491174 GEAR:COLLECTION BOTTLE
- 8.08050103 (x4) RETAINING RINGS -E:SILENCER:DIA3

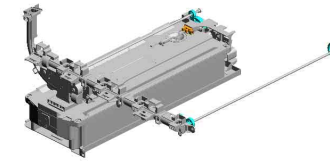

18.D1496553
GEAR:IDLER:Z61



17.D1496552
GEAR:IDLER:Z30



24.D1496562
BRACKET:TIGHTENER:USED TONER



2.04543008Q
(x4)
TAPPING SCREW: 3X8



6.07200040E
(x7)
RETAINING RING - M4



22.D1496557
SYNCHRONOUS BELT:40S3M564



19.D1496554
GEAR:PULLEY:IDLER:Z16



5.07200030E
(x2)
RETAINING RING - M3



20.D1496555
GEAR:IDLER:Z21



1.04543006Q
(x5)
TAPPING SCREW - M3X6



15.D1491173
GEAR:IDLER:TONE R BOTTLE



7.08050089
RETAINING RING - M4



14.D1491168
BRACKET:DRIVE:COLLECTION BOTTLE:ASSY



6.07200040E (x 1)
RETAINING RING - M4

3.04583008N
(x2)
HEXAGON HEAD TAPPING SCREW:3 X8



10.AG070514
MAGNET CATCH

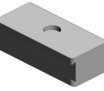

13.B2236476
(x4)
BUSHING - DIA5



U011 USED TONER

25.D1496571 BRACKET:PULLEY:
IDLER:USED TONE
R
27.D1496575 FLANGE:IDLER:US
ED TONER
35.D2426511 PIPE:ASSY
31.D1496586 SHAFT:DRIVE:USE
D TONER:LEFT

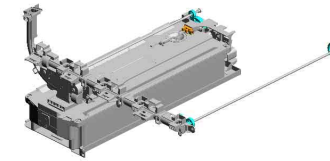

32.D1496587
GEAR:USED TONE
R:LEFT



26.D1496574
GEAR:PULLEY:IDL
ER:Z18



36.AW500049
PUSH SWITCH:SW
1AG-550
201811-01 O/O



30.D1496583
GEAR:USED TONE
R:INPUT

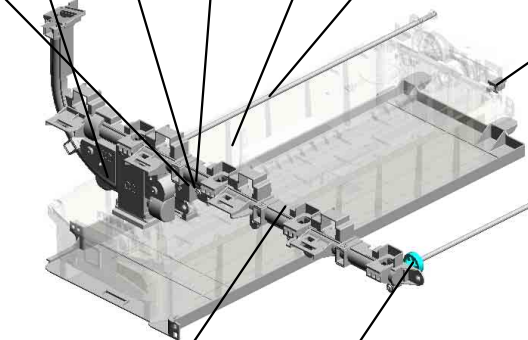

28.D1496581
SHAFT:DRIVE:USE
D TONER:RIGHT



33.D1496592
RAIL:COLLECTION
BOTTLE



29.D1496582
GEAR:USED TONE
R:RIGHT



U001	U002	U003	U004	U005	U006	U007	U008	U009	U010	U011	U012	U013	U014	U015	U016	U017	U018	U019	U020
------	------	------	------	------	------	------	------	------	------	------	------	------	------	------	------	------	------	------	------

U011_S001
COLLECTION BOTTLE:ASS'Y

4.04583010N 9.AA080346
(x5) (x2)
HEXAGON HEAD TAPPING SCREW:3 X10 BUSHING:FLANGE TYPE:DIA6

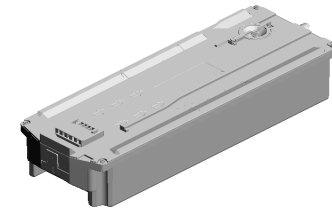

34.D2426400
COLLECTION BOT
TLE:ASS'Y

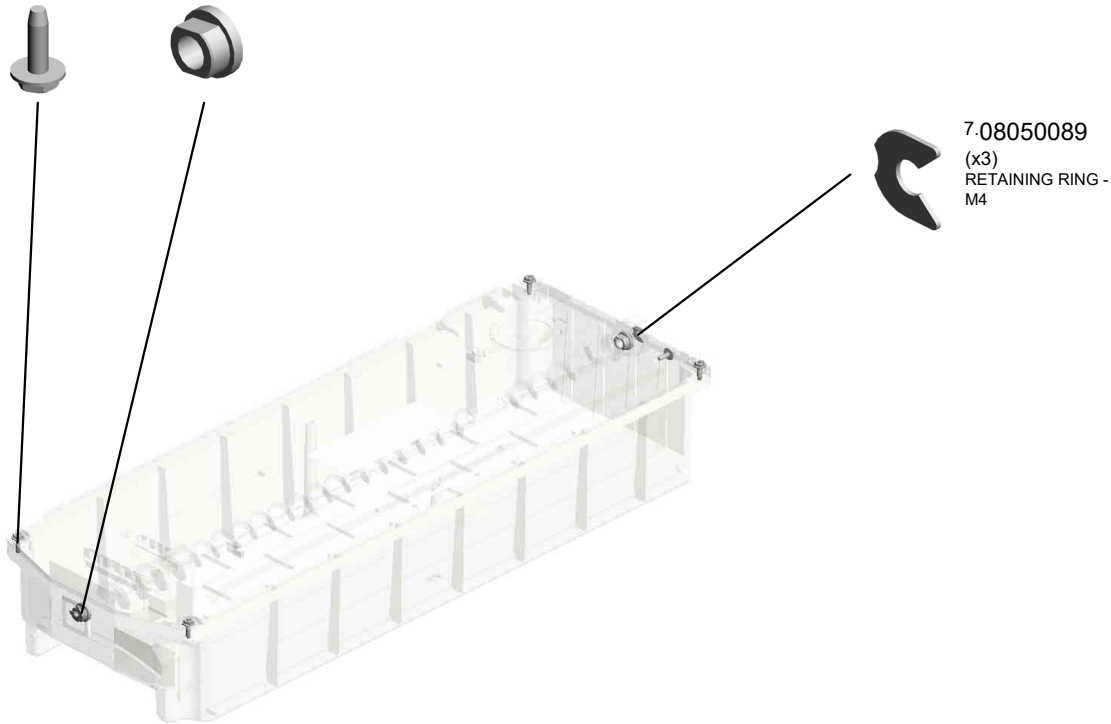

U001	U002	U003	U004	U005	U006	U007	U008	U009	U010	U011	U012	U013	U014	U015	U016	U017	U018	U019	U020
------	------	------	------	------	------	------	------	------	------	------	------	------	------	------	------	------	------	------	------

U012.FUSING

U012_S001
D2424055
(NA):FUSING UNIT:120V

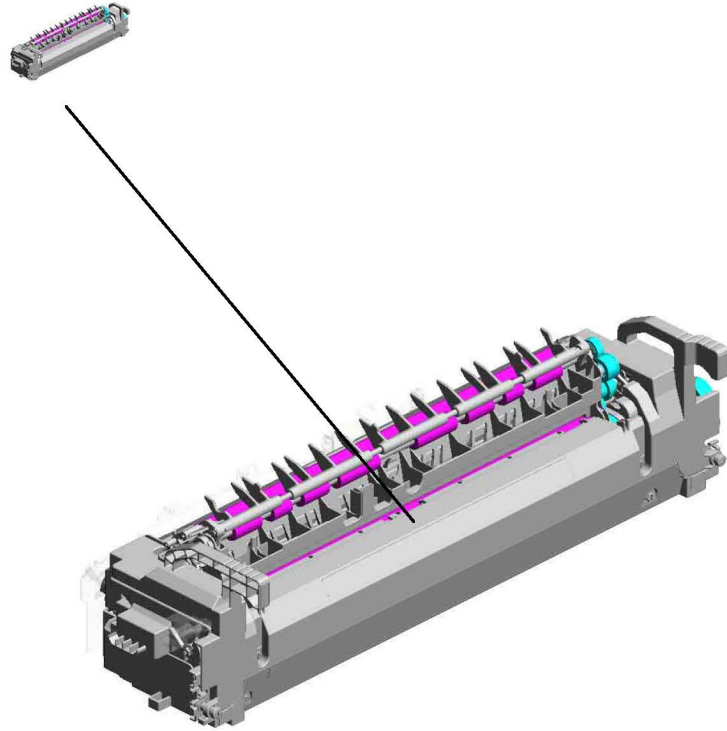

U001	U002	U003	U004	U005	U006	U007	U008	U009	U010	U011	U012	U013	U014	U015	U016	U017	U018	U019	U020
------	------	------	------	------	------	------	------	------	------	------	------	------	------	------	------	------	------	------	------

U012_S001.(NA):FUSING UNIT:120V

U012_S001_S001
D2424041
(NA):SLEEVE:FUSING:120V

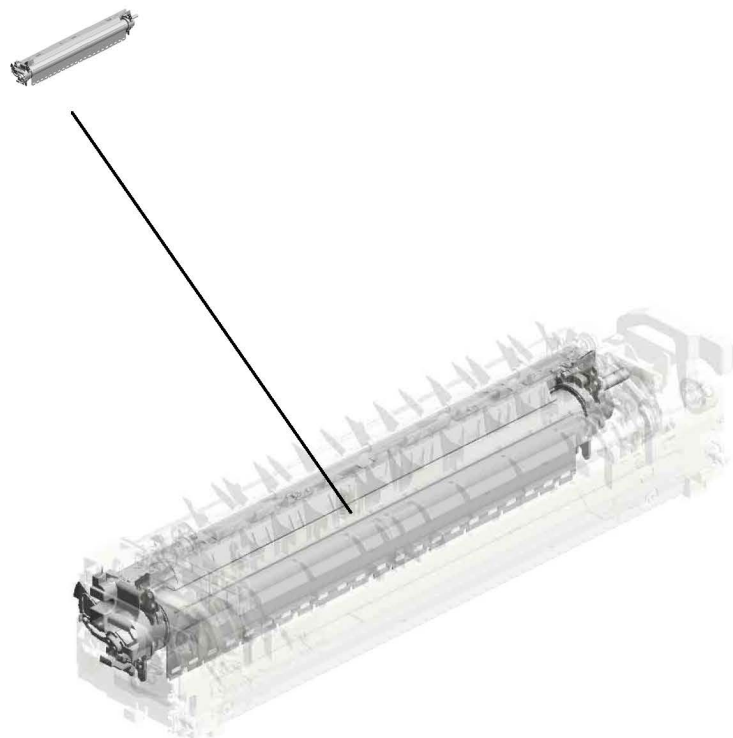

U001	U002	U003	U004	U005	U006	U007	U008	U009	U010	U011	U012	U013	U014	U015	U016	U017	U018	U019	U020
------	------	------	------	------	------	------	------	------	------	------	------	------	------	------	------	------	------	------	------

U012 FUSING

2.03603006N (x4) SCREW - M3X6
 14.11050692 CLAMP:LES-0503
 18.11050759 CLAMP:LWSM-060 5A
 3.04543006Q (x8) TAPPING SCREW - M3X6
 16.11050723 (x2) CLAMPS:WES-050 7

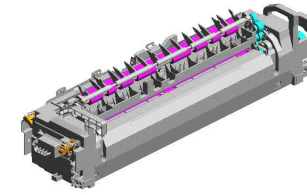

86.D2414367 (x2) STOPPER:THERMOPILE

47.AW100183 (x2) THERMOPILE

85.D2414366 BRACKET:THERMOPILE

84.D2414365 (x2) HOLDER:THERMOPILE

43.AW020190 (x2) PHOTOINTERRUPTOR

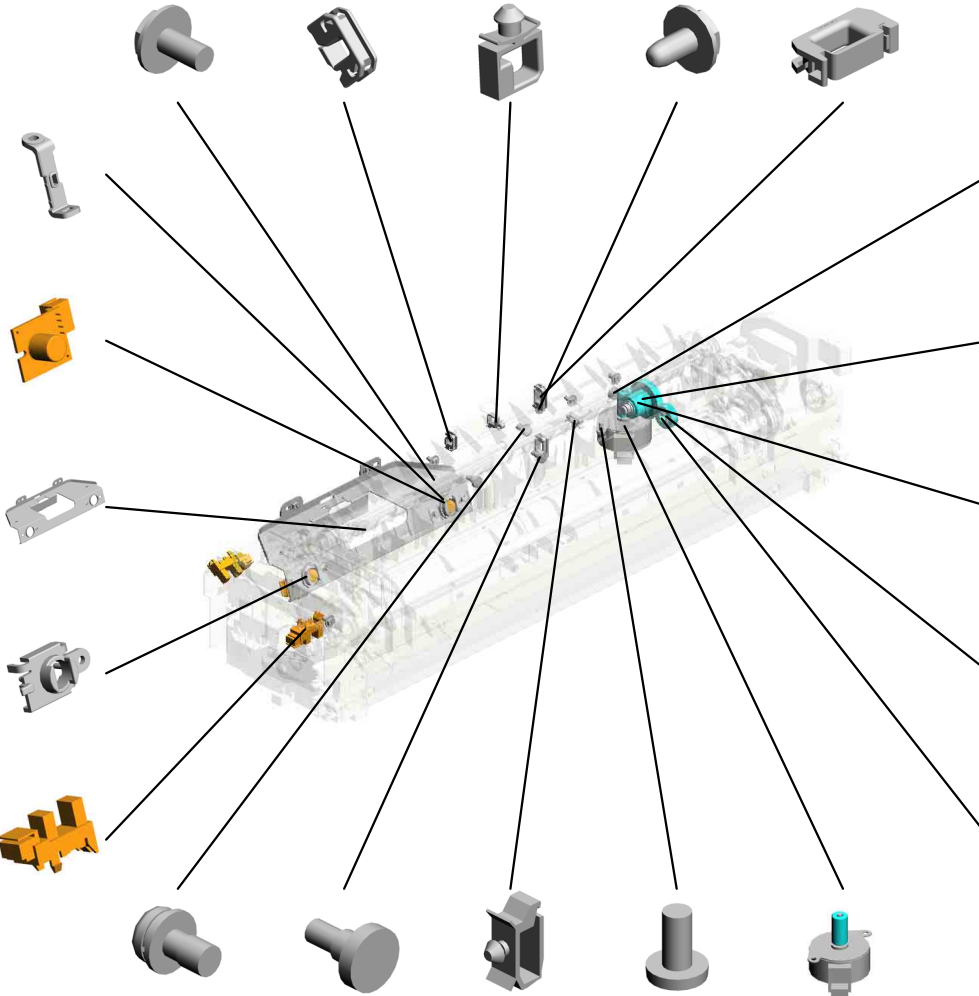

19.AA061207 TENSION SPRING: BRACKET:IDLER

31.AB012102 GEAR:IDLER:WORKING GEAR

29.AA148871 SHAFT:GEAR:IDLER: WORM GEAR

32.AB012104 GEAR:IDLER:LIGHT SHIELDING PLATE

7.07200040E (x2) RETAINING RING - M4

13.09574008N SCREW:SMALL ROUND/SPRING:M4X8
 28.AA143219 (x2) STEPPED SCREW
 17.11050758 CLAMP:LWSM-030 6A
 1.03530060N (x2) BIND SCREW - M3 X6
 90.D2424382 DC STEPPER MOTOR:ASSY

U001	U002	U003	U004	U005	U006	U007	U008	U009	U010	U011	U012	U013	U014	U015	U016	U017	U018	U019	U020
------	------	------	------	------	------	------	------	------	------	------	------	------	------	------	------	------	------	------	------

U012 FUSING

92.D2424386
BRACKET:DC STE
PPER MOTOR

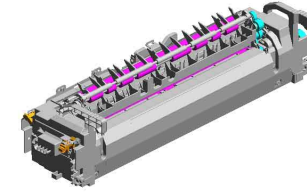

91.D2424383
BRACKET:IDLER:D
C STEPPER MOTO
R

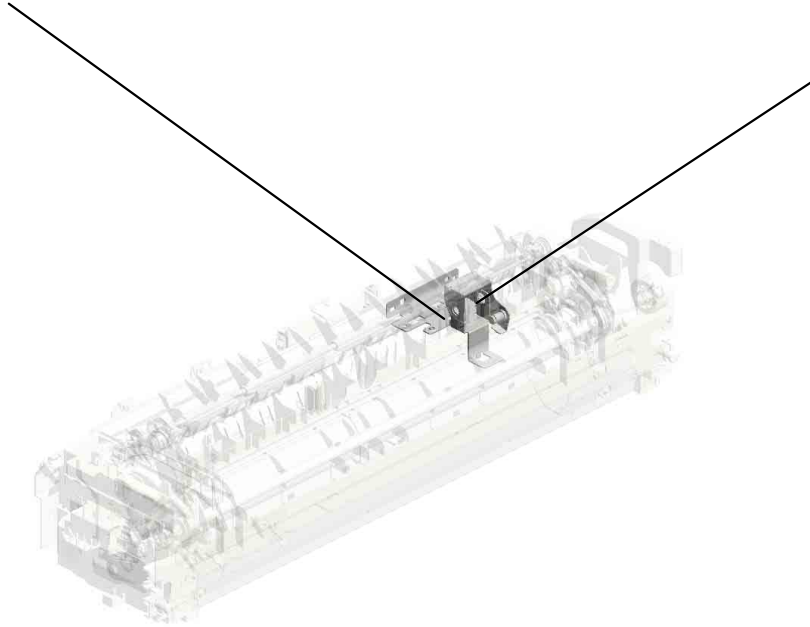

U001	U002	U003	U004	U005	U006	U007	U008	U009	U010	U011	U012	U013	U014	U015	U016	U017	U018	U019	U020
------	------	------	------	------	------	------	------	------	------	------	------	------	------	------	------	------	------	------	------

U012_S001
(NA):FUSING UNIT:120V

- 20.AA061208 (x2) TENSION SPRING: STRIPPER PLATE
- 21.AA061209 TENSION SPRING: GATE PAWL
- 6.07200030E (x3) RETAINING RING - M3
- 24.AA080387 PLAIN SHAFT BEARING:EXIT ROLLER:FUSING EXIT:RIGHT:FRONT
- 15.11050713 (x5) CLAMP:LWSM-030 6H GRAY

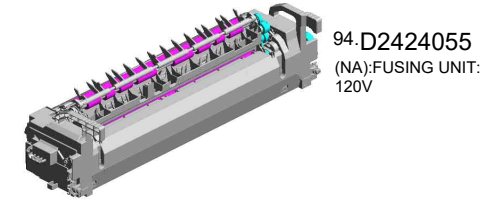

94.D2424055
(NA):FUSING UNIT: 120V

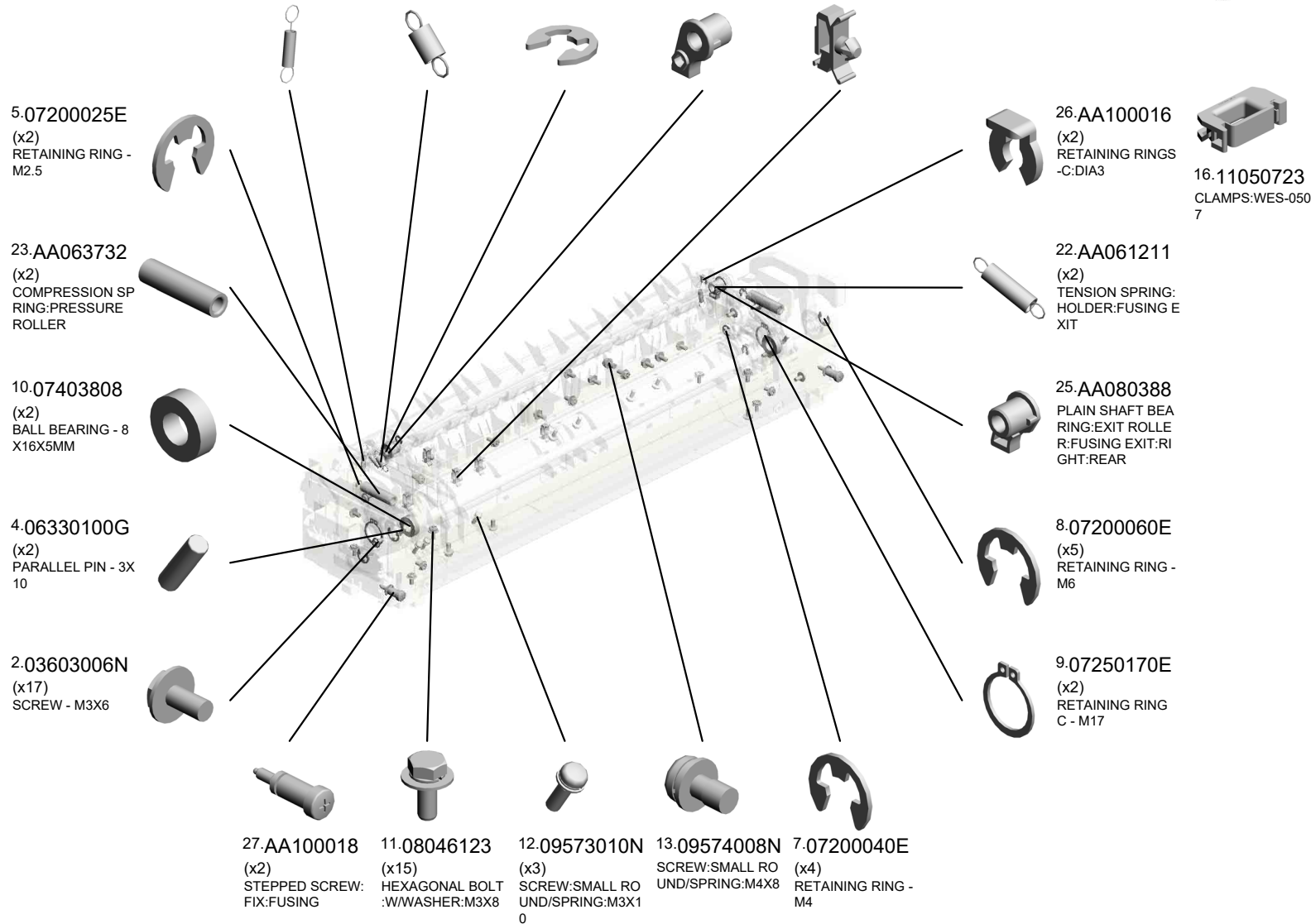

U001	U002	U003	U004	U005	U006	U007	U008	U009	U010	U011	U012	U013	U014	U015	U016	U017	U018	U019	U020
------	------	------	------	------	------	------	------	------	------	------	------	------	------	------	------	------	------	------	------

U012_S001
(NA):FUSING UNIT:120V

44.AW100180
NON-CONTACT TYPE THERMISTOR:FRONT

48.AW110111
THERMOSTAT:MIDDLE

41.AE020261
[A]
PRESSURE ROLLER:DIAMETER 32
201911-08 O/O

49.AW110112
THERMOSTAT:REAR

36.AB012110
GEAR:EXIT ROLLER:FUSING EXIT:RIGHT

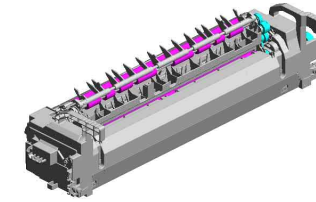

94.D2424055
(NA):FUSING UNIT:120V

46.AW100182
THERMISTOR:PRESSURE:MIDDLE

42.AE030074
(x2)
BALL BEARING:DIAMETER 17X5

53.D1494207
(x2)
PLATE:CAM

51.D1494202
ENCODER:ON-OFF:PRESSURE ROLLER

45.AW100181
THERMISTOR:PRESSURE:FRONT

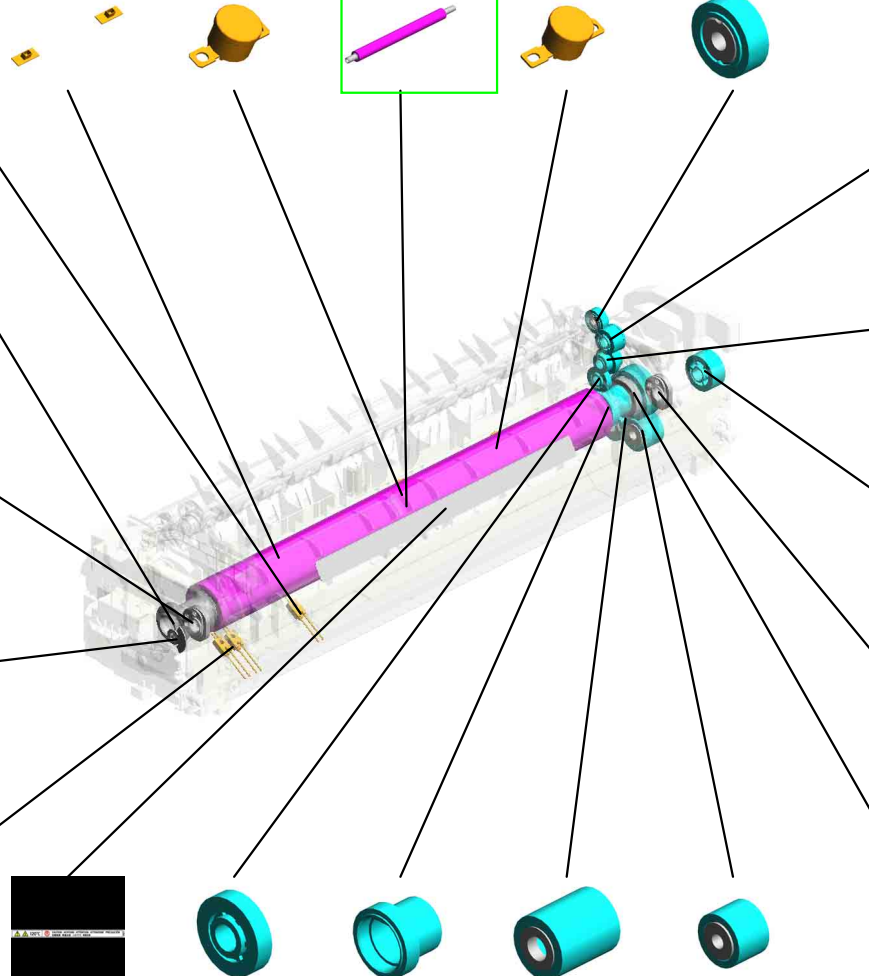

33.AB012107
GEAR:IDLER:EXIT:FUSING EXIT:1

34.AB012108
GEAR:IDLER:EXIT:FUSING EXIT:2

30.AB012099
GEAR:ON-OFF:PRESSURE ROLLER

52.D1494205
(x2)
BRAKE:CAM

39.AB012119
GEAR:PRESSURE ROLLER

50.D1124264
DECAL:WARNING (HIGH TEMPERATURE):FUSING

35.AB012109
GEAR:IDLER:EXIT:FUSING EXIT:3

37.AB012111
GEAR:PRESSURE ROLLER:EXIT

38.AB012116
GEAR:DRIVE:FUSING UNIT

40.AB012120
GEAR:IDLER:PRESSURE ROLLER

U001	U002	U003	U004	U005	U006	U007	U008	U009	U010	U011	U012	U013	U014	U015	U016	U017	U018	U019	U020
------	------	------	------	------	------	------	------	------	------	------	------	------	------	------	------	------	------	------	------

U012_S001
(NA):FUSING UNIT:120V

60.D0BQ4102
[B]
DRIVEN ROLLER:FUSING EXIT:ASS'Y
201911-06 O/O

71.D0BQ4214
[C]
EXIT ROLLER:FUSING EXIT:RIGHT
201911-07 O/O

70.D2414212
GATE PAWL:FUSING EXIT

72.D2414215
GUIDE:FUSING EXIT:RIGHT:ASS'Y

56.D1494235
(x15)
STEPPED SCREW:M3

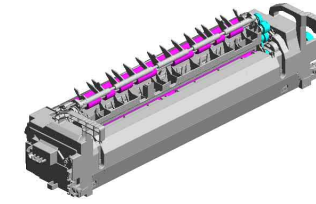

94.D2424055
(NA):FUSING UNIT:120V

61.D2414108
GUIDE:FUSING EXIT:LEFT

73.D2414218
LINK:GATE PAWL:FUSING EXIT

58.D2414023
HOLDER:DRIVEN ROLLER:FUSING EXIT:FRONT

67.D2414140
HOLDER:PRESSURE:FRONT:ASS'Y

66.D2414137
LEVER:PRESSURE:FRONT:PEEN

62.D2414113
BRACKET:THERMOSTOR:PRESSURE ROLLER

64.D2414122
INNER COVER:PRESSURE ROLLER:FRONT

55.D1494209
SHAFT:ON-OFF:PRESSURE ROLLER

57.D1494335
ELECTRODE PLATE:CONNECTING:THERMOSTAT

63.D2414121
INNER COVER:PRESSURE ROLLER:REAR

59.D2414024
HOLDER:DRIVEN ROLLER:FUSING EXIT:REAR

68.D2414155
HOLDER:PRESSURE:REAR:ASS'Y

54.D1494208
(x2)
CAM:ON-OFF:PRESSURE ROLLER

69.D2414160
LEVER:PRESSURE:REAR:PEEN

65.D2414123
DISCHARGE BRUSH:PRESSURE ROLLER

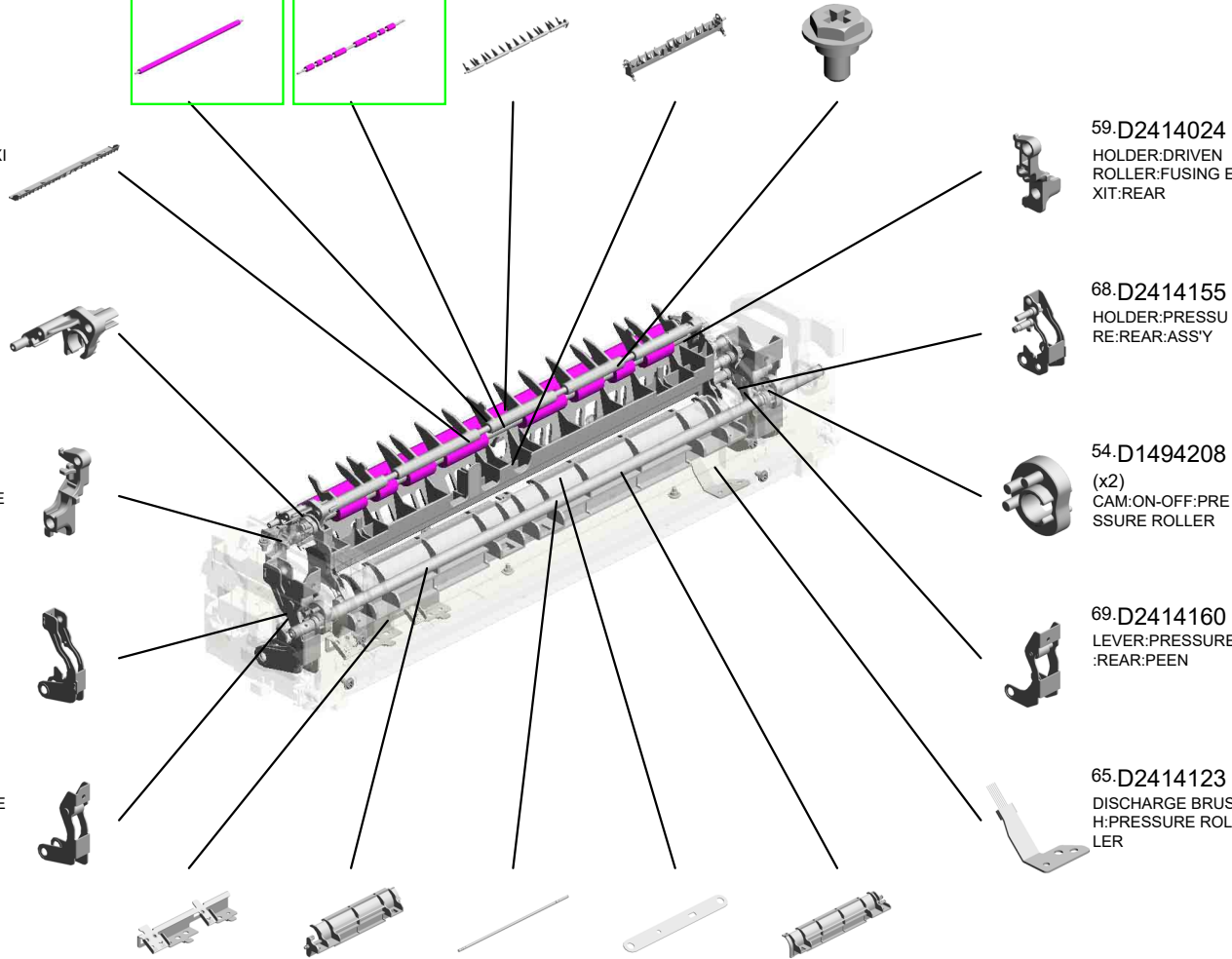

U012_S001
(NA):FUSING UNIT:120V

- 74.D2414219 DECAL:C:GUIDE PLATE:FUSING EXIT
- 75.D2414221 STRIPPER PLATE:FUSING EXIT:ASS'Y
- 82.D2414338 TERMINAL:THERM OSTAT:HEATER
- 77.D2414261 FUSING COVER:UPPER

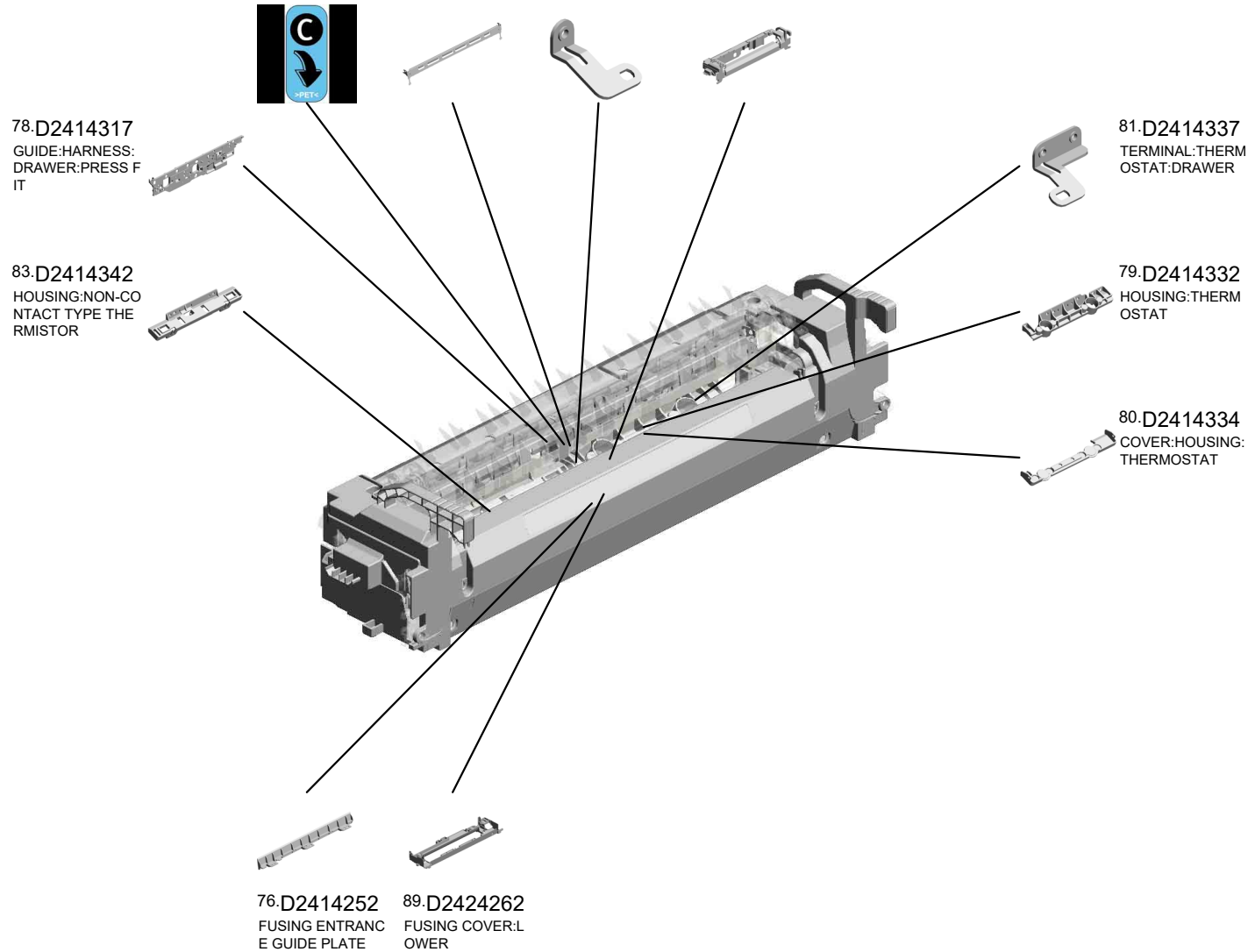
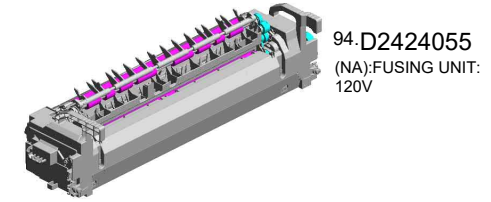

AE020238
[A]
PRESSURE ROLLER: DIA32
201911-08 O/O

D2414102
[B]
DRIVEN ROLLER: FUSING EXIT: ASS'Y
201911-06 O/O

D2414214
[C]
EXIT ROLLER: FUSING EXIT: RIGHT
201911-07 O/O

U012_S001_S001
(NA):SLEEVE:FUSING:120V

2.03603006N
(x7)
SCREW - M3X6

11.08046123
(x3)
HEXAGONAL BOLT
:WASHER:M3X8

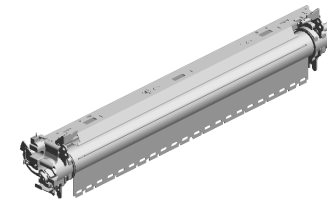

93.D2424041
(NA):SLEEVE:FUSI
NG:120V



5.07200025E
RETAINING RING -
M2.5

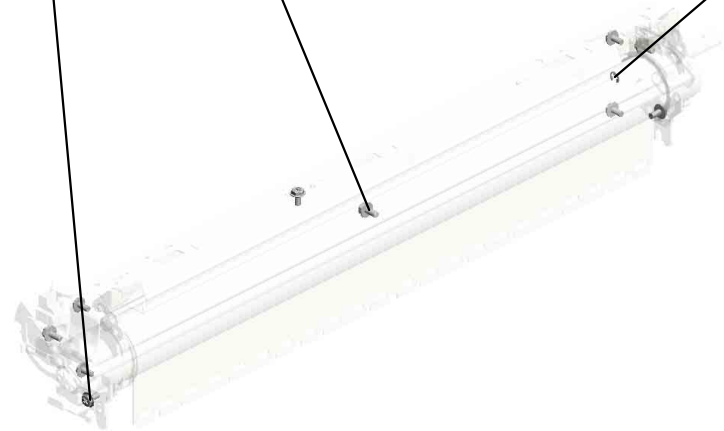

U001	U002	U003	U004	U005	U006	U007	U008	U009	U010	U011	U012	U013	U014	U015	U016	U017	U018	U019	U020
------	------	------	------	------	------	------	------	------	------	------	------	------	------	------	------	------	------	------	------

U013.PAPER EXIT

U013_S001
D2414406
PAPER EXIT UNIT:ASSY

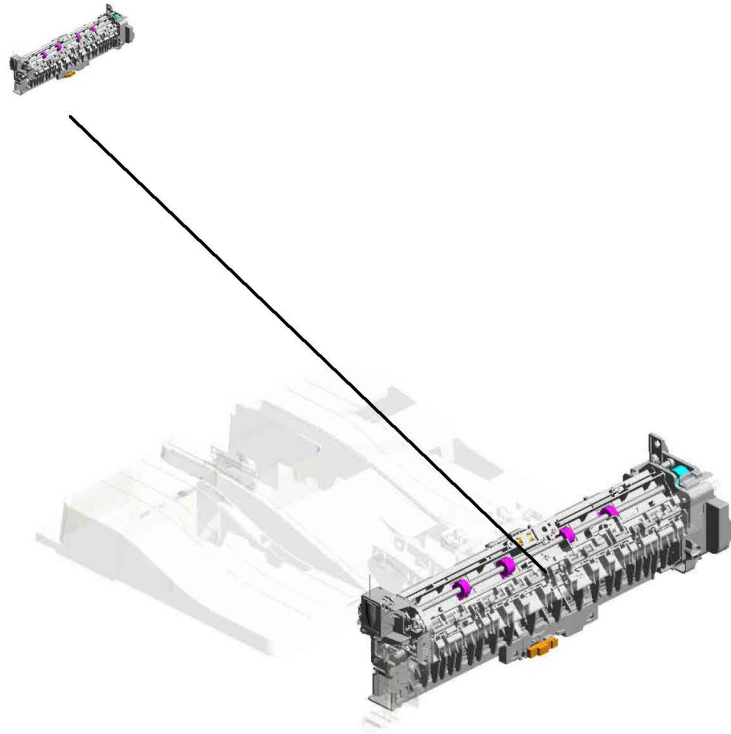

U001	U002	U003	U004	U005	U006	U007	U008	U009	U010	U011	U012	U013	U014	U015	U016	U017	U018	U019	U020
------	------	------	------	------	------	------	------	------	------	------	------	------	------	------	------	------	------	------	------

U013_S001.PAPER EXIT UNIT:ASS'Y

U013 S001 S001
D2414950
ROLLER:EXIT:PRESSURE:2T
YPE:ASS'Y

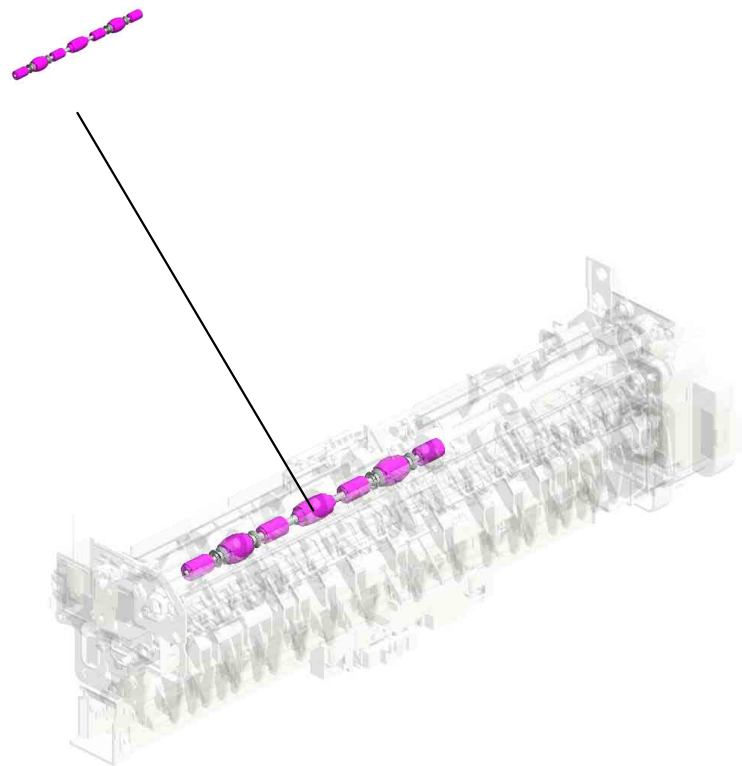

U001	U002	U003	U004	U005	U006	U007	U008	U009	U010	U011	U012	U013	U014	U015	U016	U017	U018	U019	U020
------	------	------	------	------	------	------	------	------	------	------	------	------	------	------	------	------	------	------	------

U013 PAPER EXIT

68.M0AJ4497 TRAY:EXIT
 46.D2414494 TRAY:AUXILIARY:EXIT
 47.D2414499 COMPRESSION SPRING:BASE:TRAY:EXIT
 60.D2414971 (x2) LINK:PLATE:EXIT

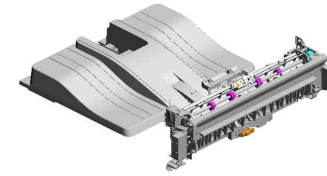

4.04583008N
 (x3) HEXAGON HEAD TAPPING SCREW:3X8

1.03530030N
 (x2) SCREW:M3X3

3.04543006Q
 (x3) TAPPING SCREW - M3X6

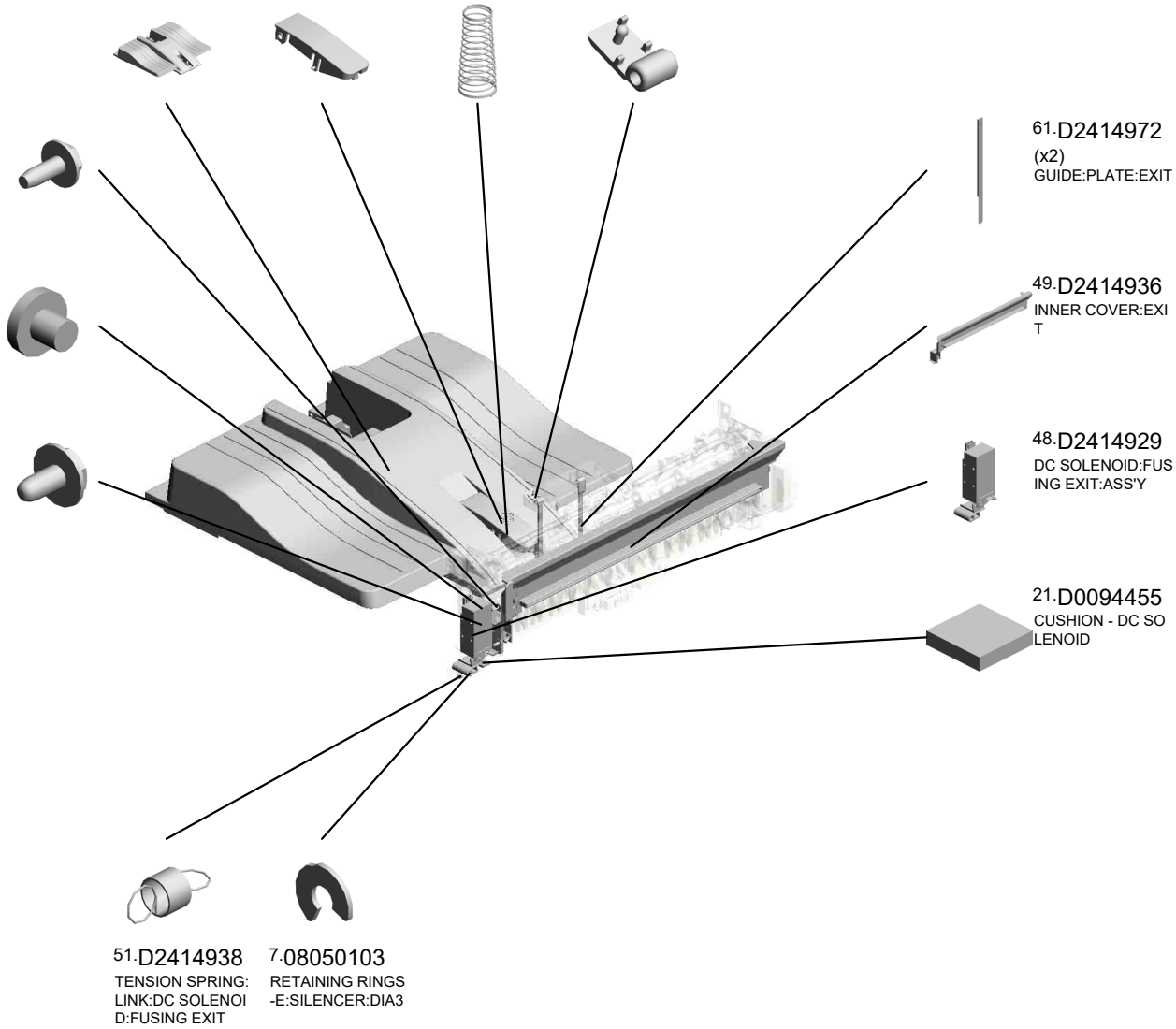

U001	U002	U003	U004	U005	U006	U007	U008	U009	U010	U011	U012	U013	U014	U015	U016	U017	U018	U019	U020
------	------	------	------	------	------	------	------	------	------	------	------	-------------	------	------	------	------	------	------	------

U013_S001 PAPER EXIT UNIT:ASS'Y

7.08050103
(x13)
RETAINING RINGS
-E:SILENCER:DIA3

11.11050759
CLAMP:LWSM-060
5A

14.AA080252
(x2)
BUSHING - M4

20.D0094407
FEELER - OVERFL
OW

23.D0394927
(x2)
COMPRESSION SP
RING:PRESSURE:
REVERSE:DRIVEN

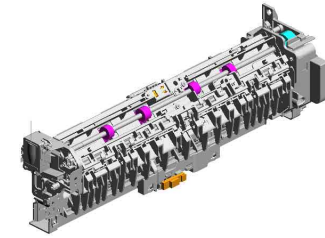

38.D2414406
[A]
PAPER EXIT UNIT:
ASS'Y
201909-03 O/O

9.11050692
(x3)
CLAMP:LES-0503

1.03530030N
(x3)
SCREW:M3X3

8.08050104
RETAINING RINGS
-E:SILENCER:DIA4

21.D0094455
CUSHION - DC SO
LENOID

2.04513006N
(x6)
TAPPING SCREW -
3X6

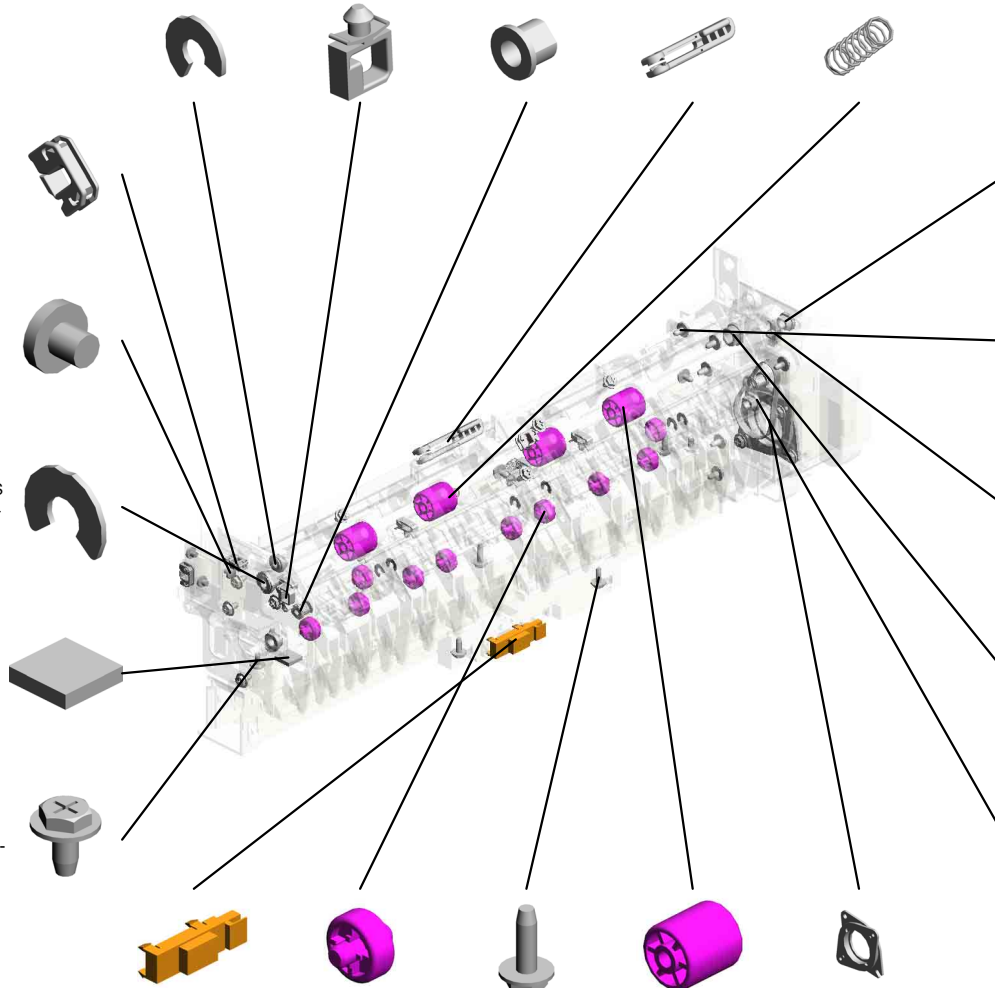

15.AA082170
(x4)
PLAIN SHAFT BEA
RING:DIA4XDIA8X5
:EG-1

3.04543006Q
(x13)
TAPPING SCREW -
M3X6

10.11050758
(x7)
CLAMP:LWSM-030
6A

16.AA082173
(x2)
PLAIN SHAFT BEA
RING:6X10X6

13.AA043339
TIMING BELT:PAP
ER EXIT:40S2M122

18.AW010147
PHOTO REFLECTI
ON SENSOR

17.AF040571
(x11)
GUIDE ROLLER

5.04583010N
(x8)
HEXAGON HEAD T
APPING SCREW:3
X10

22.D0394925
(x4)
ROLLER:REVERSE
:DRIVEN

12.A2324666
CUSHION - STEPP
ER MOTOR

U001	U002	U003	U004	U005	U006	U007	U008	U009	U010	U011	U012	U013	U014	U015	U016	U017	U018	U019	U020
------	------	------	------	------	------	------	------	------	------	------	------	------	------	------	------	------	------	------	------

U013_S001
PAPER EXIT UNIT:ASS'Y

- 41.D2414461 GUIDE PLATE:REV ERSE:UPPER
- 43.D2414476 EXIT ROLLER
- 37.D2024477 REVERSE ROLLER
- 40.D2414448 SHAFT:FEELER:OV ERFLOW
- 32.D1494463 GROUND WIRE:SE NSOR:REVERSE

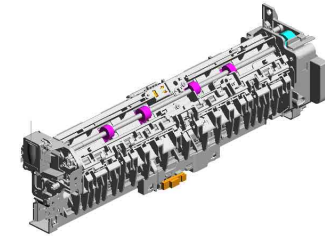

38.D2414406
[A]
PAPER EXIT UNIT:
ASS'Y
201909-03 O/O

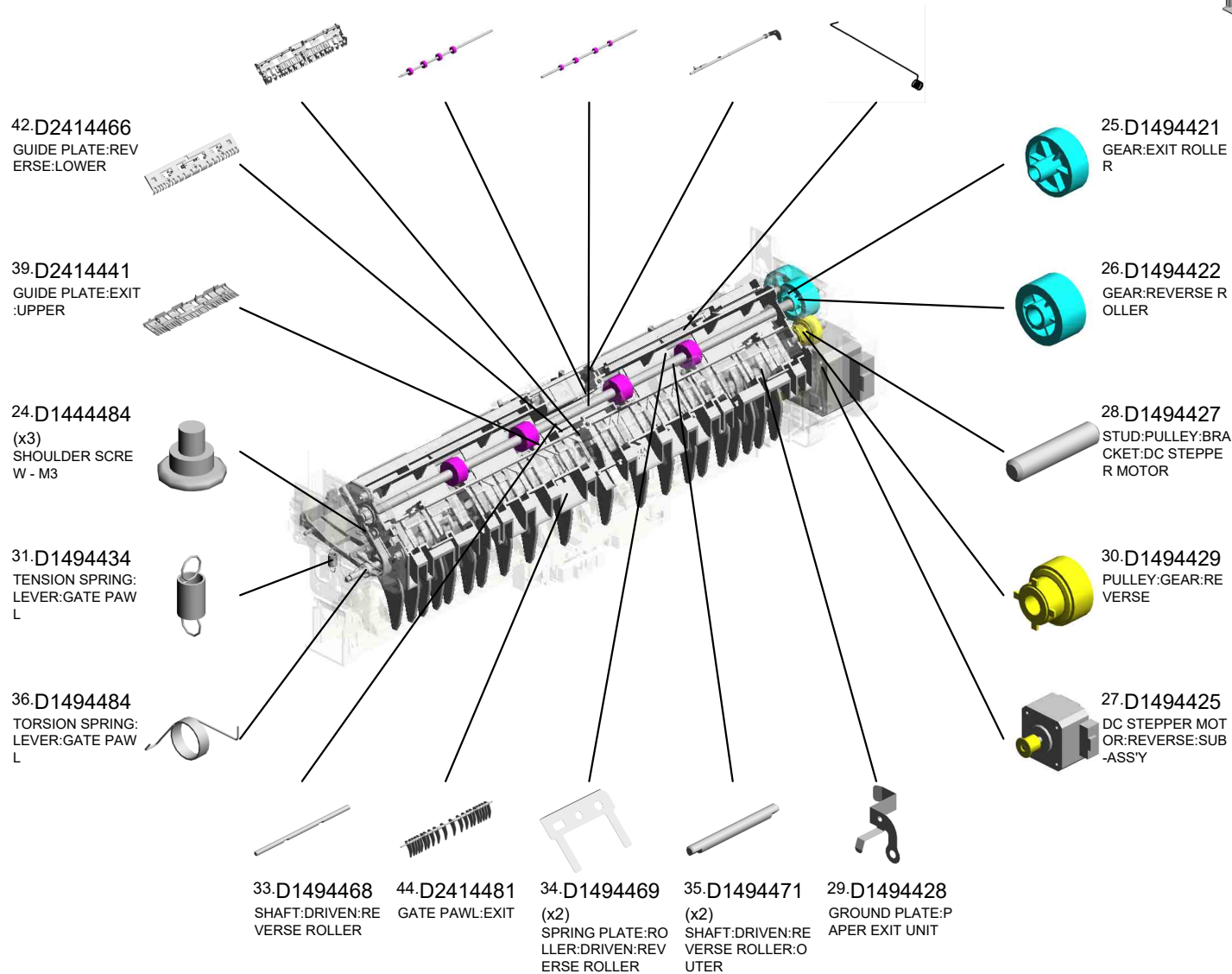

U001	U002	U003	U004	U005	U006	U007	U008	U009	U010	U011	U012	U013	U014	U015	U016	U017	U018	U019	U020
------	------	------	------	------	------	------	------	------	------	------	------	------	------	------	------	------	------	------	------

U013_S001
PAPER EXIT UNIT:ASS'Y

- 62.D2414981 (x2) COIL SPRING:ROLLER:PRESSURE:EXIT
- 63.D2414992 DISCHARGE BRUSH:EXIT
- 59.D2414955 HOLDER:ROLLER:EXIT:PRESSURE:2 TYPE
- 67.GW010007 (x2) PHOTO REFLECTION SENSOR:EXIT

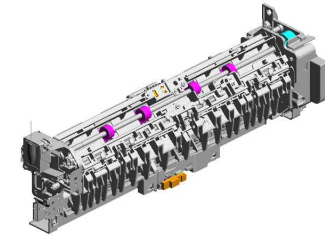

38.D2414406
[A] PAPER EXIT UNIT: ASS'Y
201909-03 O/O

65.D2414996 DC SOLENOID:ASS'Y



56.D2414947 GATE PAWL:REVERSE:FRONT



66.D2414998 CUSHION:DC SOLENOID:4MM

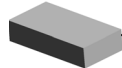

45.D2414483 LEVER:GATE PAWL



50.D2414937 (x4) TENSION SPRING:GATE:REVERSE



52.D2414941 GATE PAWL:REVERSE:FRONT MIDDLE



64.D2414994 GUIDE PLATE:EXIT:LOWER



55.D2414946 SHAFT:GATE PAWL:REVERSE



69.AW020234 PHOTO INTERRUPTOR:GP1A173LCS 5F
201903-01 O/O



54.D2414943 GATE PAWL:REVERSE:REAR



53.D2414942 GATE PAWL:REVERSE:REAR MIDDLE



57.D2414948 GUIDE:HARNES:REVERSE



D2414404
[A] PAPER EXIT UNIT: ASS'Y
201909-03 O/O

U013_S001_S001

ROLLER:EXIT:PRESSURE:2TYPE:ASS'Y

6.07200020G

(x4)

RETAINING RING -
M2

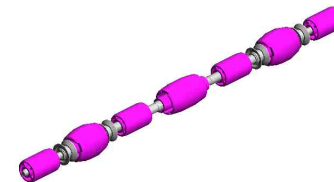
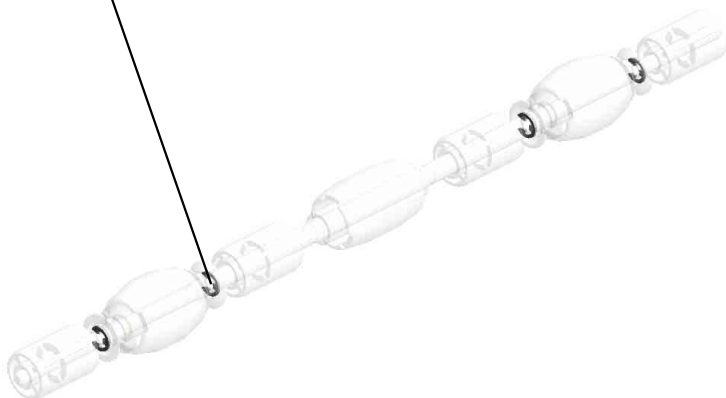

58.D2414950

ROLLER:EXIT:PRE
SSURE:2TYPE:ASS
'Y

U001	U002	U003	U004	U005	U006	U007	U008	U009	U010	U011	U012	U013	U014	U015	U016	U017	U018	U019	U020
------	------	------	------	------	------	------	------	------	------	------	------	------	------	------	------	------	------	------	------

U014.DUPLEX

U014_S001
D0BH4517
DUPLEX UNIT:ASSY

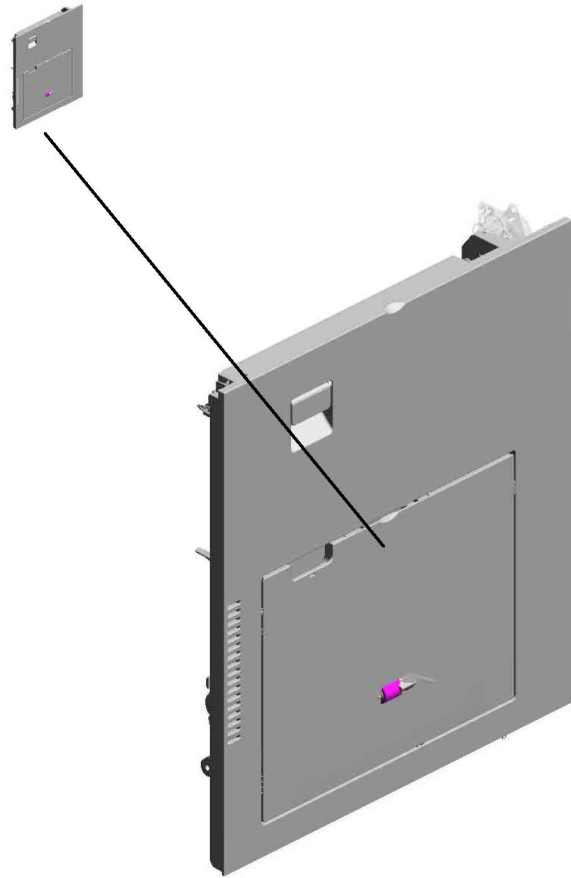

U001	U002	U003	U004	U005	U006	U007	U008	U009	U010	U011	U012	U013	U014	U015	U016	U017	U018	U019	U020
------	------	------	------	------	------	------	------	------	------	------	------	------	------	------	------	------	------	------	------

U014_S001.DUPLEX UNIT:ASS'Y

U014 S001 S001
D2412690
SIDE FENCE:FRONT:ASS'Y

U014 S001 S003
D0BQ2600
MANUAL FEED UNIT:ASS'Y

U014 S001 S002
D2412691
SIDE FENCE:REAR:ASS'Y

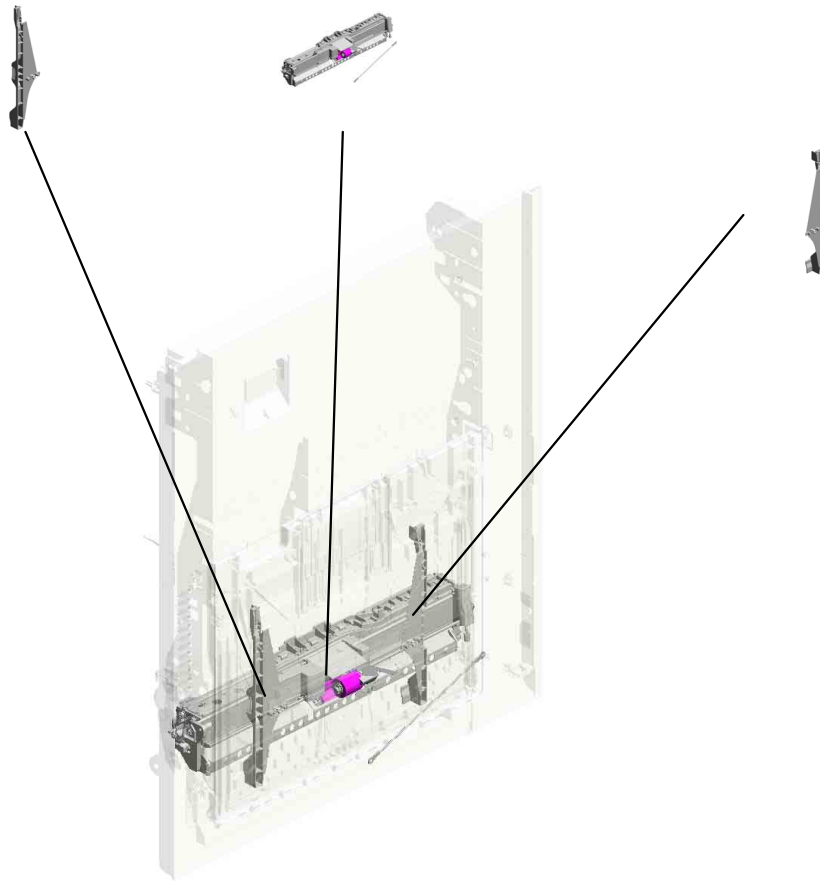

U001	U002	U003	U004	U005	U006	U007	U008	U009	U010	U011	U012	U013	U014	U015	U016	U017	U018	U019	U020
------	------	------	------	------	------	------	------	------	------	------	------	------	------	------	------	------	------	------	------

U014 DUPLEX

4.04543006Q (x3)
TAPPING SCREW - M3X6

173.D2414755
GEAR:OUTPUT:DU
PLEX:ENTRANCE

2.03603006N
SCREW - M3X6

6.04583008N (x3)
HEXAGON HEAD TAPPING SCREW:3 X8

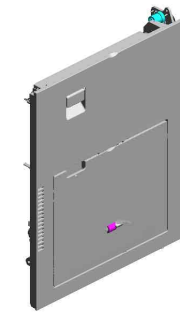

174.D2414757
SPACER:DC MOTO
R:DUPLEX



10.07200040E
RETAINING RING - M4



77.D1494623
GROUND WIRE:BRACKET:ENTRANCE
:DUPLEX



41.AX060464
DC MOTOR:ENCO
DER:NO:10W:GEA
R:BRUSHLESS



172.D2414750
BRACKET:MOTOR:
DUPLEX



189.AW500049
PUSH SWITCH:SW
1AG-550
201811-01 O/O



19.54472681
(x2)
SNAP RING



3.04513006N (x2)
TAPPING SCREW - 3X6

98.D1494755
BRACKET:HINGE:D
UPLEX:FRONT

18.52152621
SNAP RING - M6

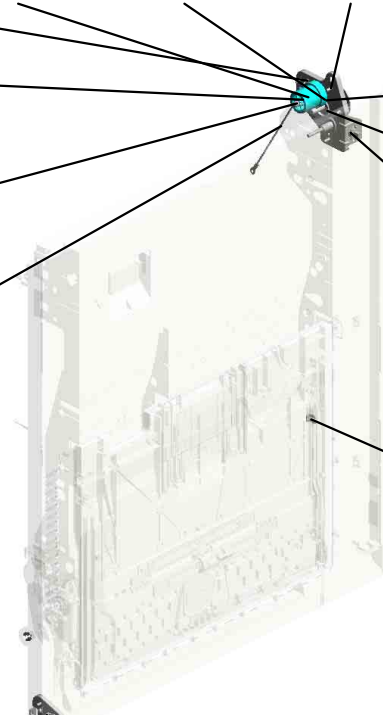

U001	U002	U003	U004	U005	U006	U007	U008	U009	U010	U011	U012	U013	U014	U015	U016	U017	U018	U019	U020
------	------	------	------	------	------	------	------	------	------	------	------	------	------	------	------	------	------	------	------

U014_S001
 DUPLEX UNIT:ASS'Y

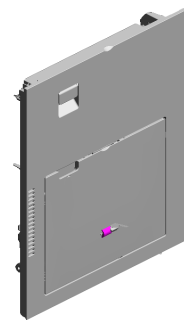

54.D0BH4517
 [A]
 DUPLEX UNIT:ASS'
 Y
 201909-01 O/O

21.AA082170 (x2) PLAIN SHAFT BEARING RING:DIA4XDIA8X5:EG-1
 6.04583008N (x26) HEXAGON HEAD TAPPING SCREW:3X8
 20.AA043980 TIMING BELT:30S2 M300
 11.07200060E RETAINING RING - M6
 14.11050692 (x4) CLAMP:LES-0503

7.04583010N (x8) HEXAGON HEAD TAPPING SCREW:3X10

12.08050103 (x6) RETAINING RINGS -E:SILENCER:DIA3

10.07200040E (x4) RETAINING RING - M4

23.AA082173 (x9) PLAIN SHAFT BEARING RING:6X10X6

9.07200030E (x4) RETAINING RING - M3

1.03530030N SCREW:M3X3

8.04593008N (x6) BINDING HEAD TAPPING SCREW:3X8

5.04543008Q (x4) TAPPING SCREW:3X8

4.04543006Q (x9) TAPPING SCREW - M3X6

15.11050723 CLAMPS:WES-0507

17.11050758 (x9) CLAMP:LWSM-0306A

13.08050104 (x13) RETAINING RINGS -E:SILENCER:DIA4

26.AA083018 ROLLER CLUTCH - 6X14X10

25.AA083014 ONE-WAY CLUTCH

16.11050724 CLAMPS:WES-1210

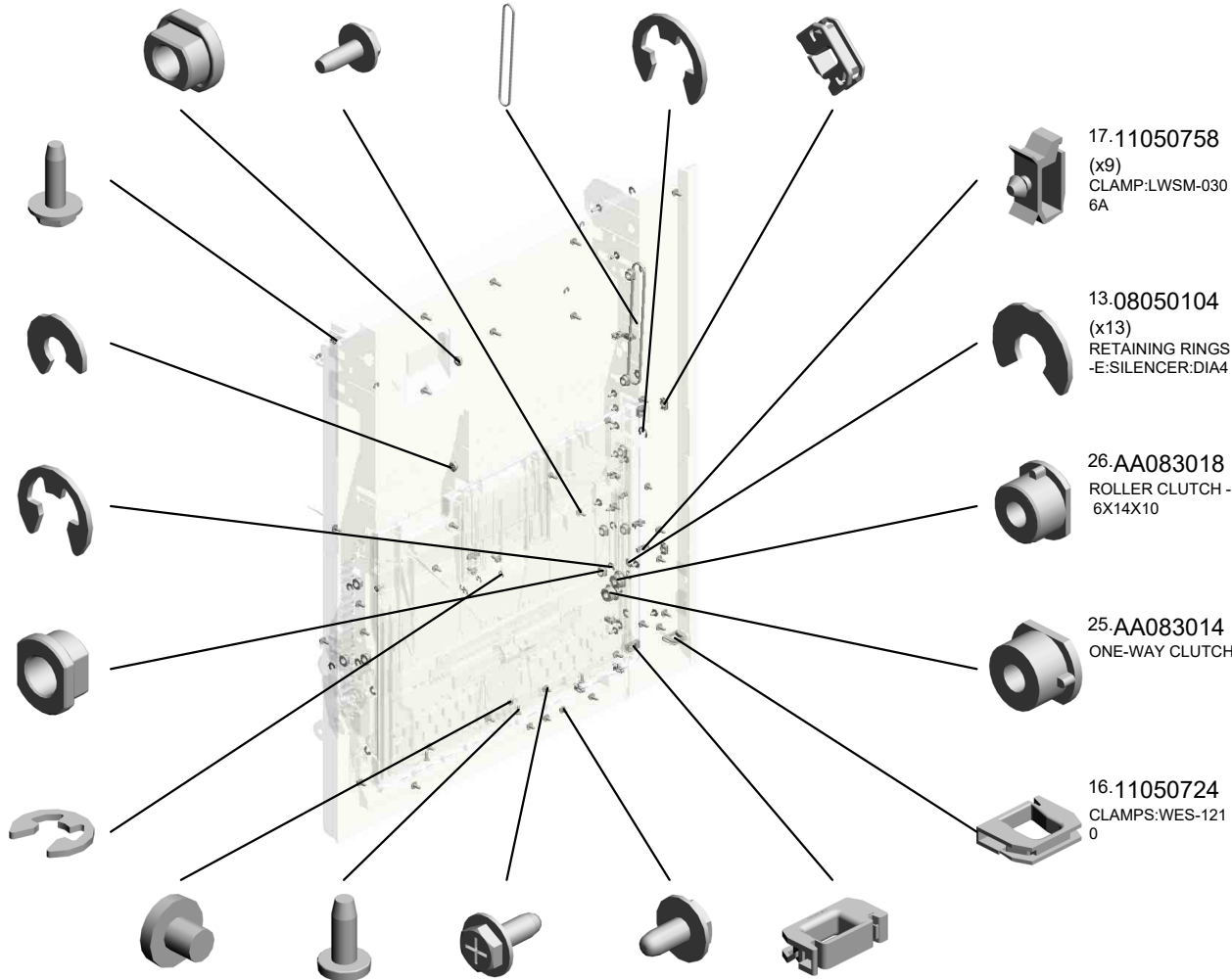

U001	U002	U003	U004	U005	U006	U007	U008	U009	U010	U011	U012	U013	U014	U015	U016	U017	U018	U019	U020
------	------	------	------	------	------	------	------	------	------	------	------	------	------	------	------	------	------	------	------

U014_S001
 DUPLEX UNIT:ASS'Y

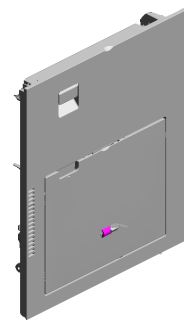

54.D0BH4517
 [A]
 DUPLEX UNIT:ASS'
 Y
 201909-01 O/O

- 48.D0094487 (x2) COMPRESSION SPRING - GATE
- 53.D0394597 (x4) TENSION SPRING: DRIVEN ROLLER
- 47.D0094485 (x2) BUSHING - GATE
- 43.B2234552 (x4) BUSHING:DIA4
- 51.D0394525 (x2) COMPRESSION SPRING:SHAFT:GUIDE PLATE:EXIT

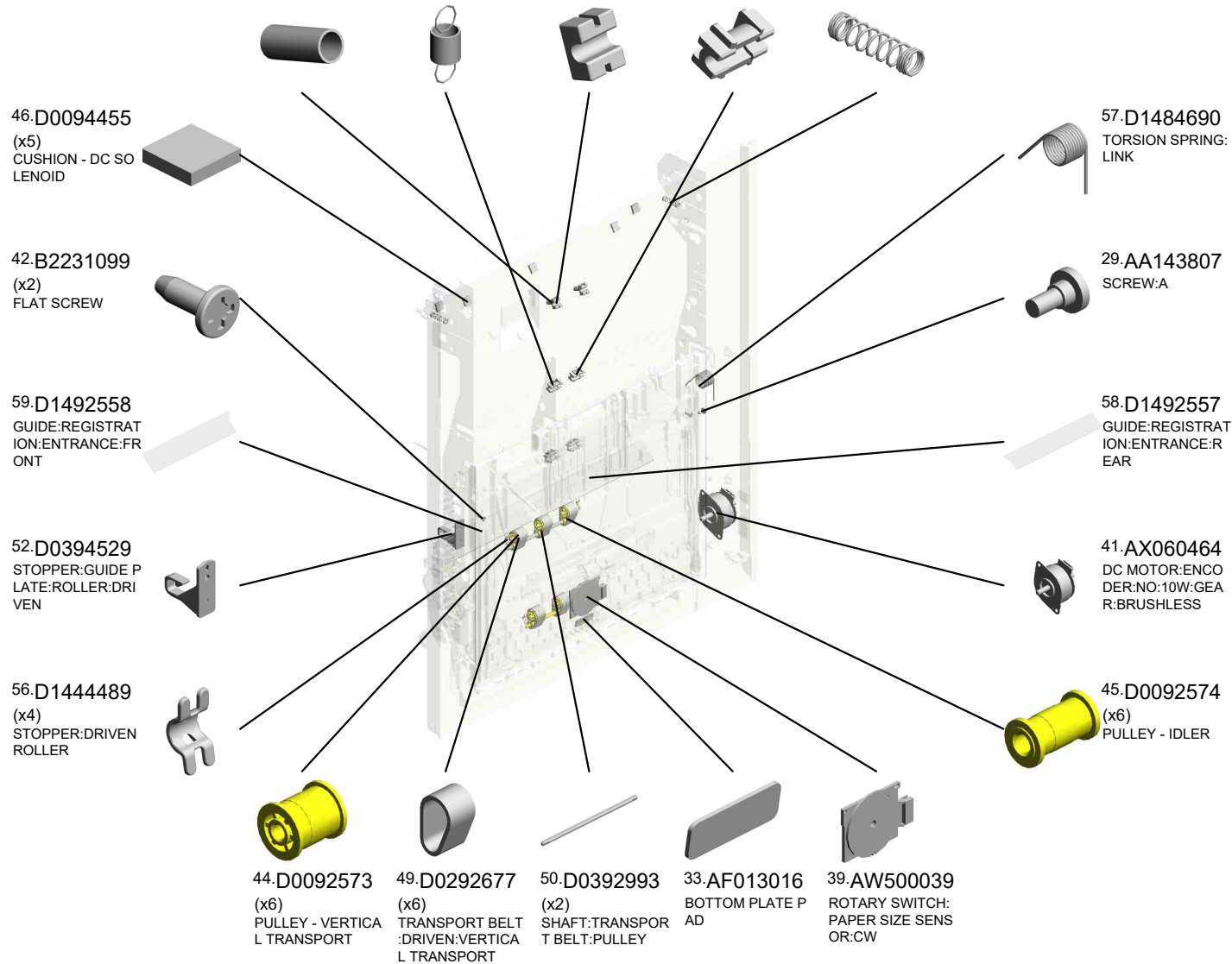

U001	U002	U003	U004	U005	U006	U007	U008	U009	U010	U011	U012	U013	U014	U015	U016	U017	U018	U019	U020
------	------	------	------	------	------	------	------	------	------	------	------	------	------	------	------	------	------	------	------

U014_S001
 DUPLEX UNIT:ASS'Y

- 84.D1494656 HOOK:STOPPER:DUPLEX UNIT:FRONT
- 86.D1494658 COIL SPRING:LEVER:DUPLEX
- 82.D1494653 TENSION SPRING:SWIVEL
- 85.D1494657 HOOK:STOPPER:DUPLEX UNIT:REAR
- 81.D1494647 SYNCHRONOUS BELT:30S2M212

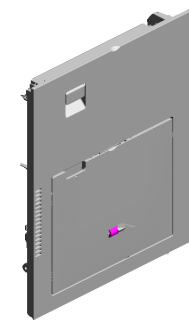

54.D0BH4517
 [A]
 DUPLEX UNIT:ASS'Y
 Y
 201909-01 O/O

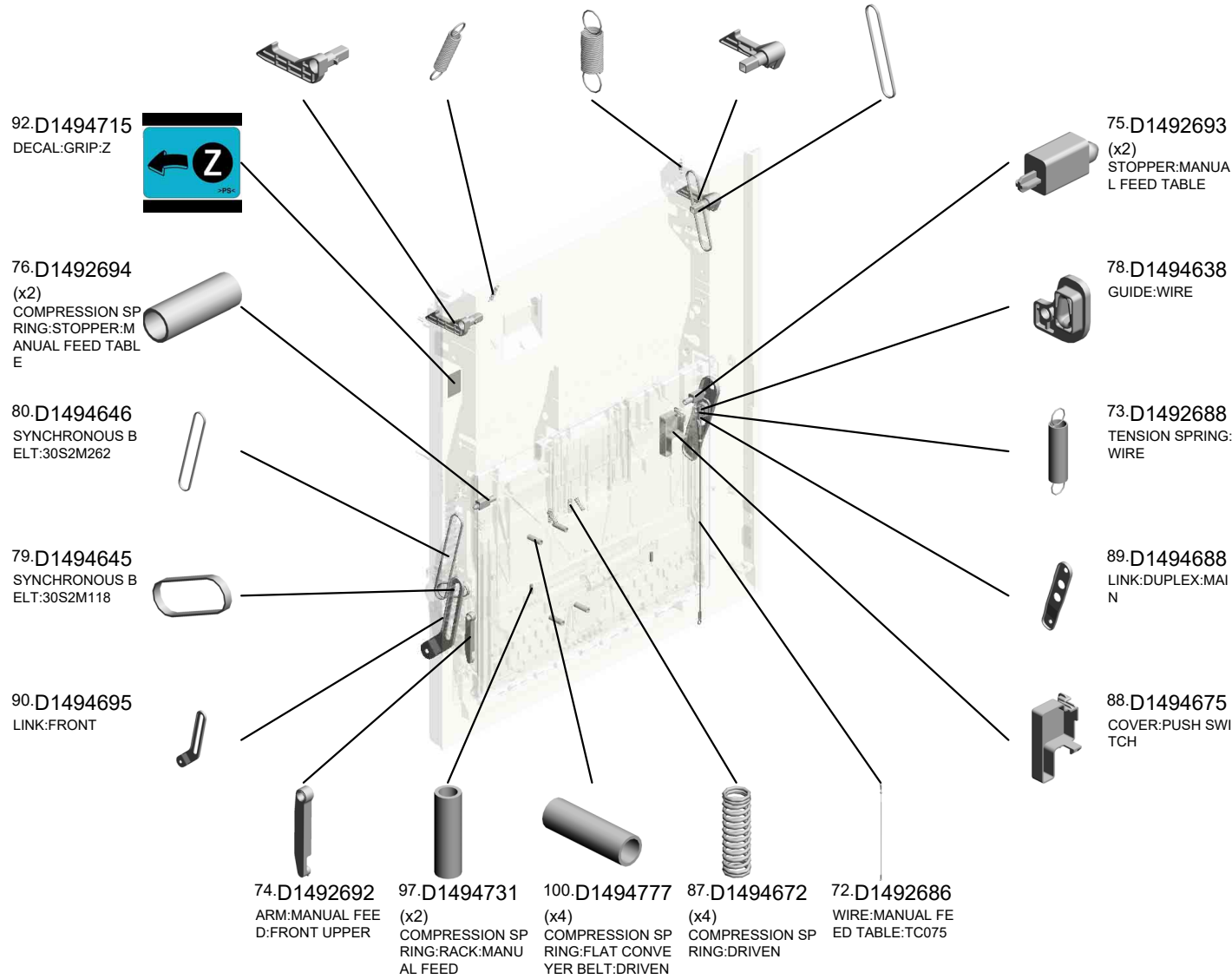

U001	U002	U003	U004	U005	U006	U007	U008	U009	U010	U011	U012	U013	U014	U015	U016	U017	U018	U019	U020
------	------	------	------	------	------	------	------	------	------	------	------	------	------	------	------	------	------	------	------

U014_S001
 DUPLEX UNIT:ASS'Y

- 115.D2022641 EXTENSION TRAY: NO.2
- 121.D2024674 TORSION SPRING: DUPLEX:ENTRANCE SENSOR
- 120.D2024673 FEELER:DUPLEX:ENTRANCE SENSOR
- 113.D2022638 FEELER:PAPER SIZE SENSOR:MANUAL FEED
- 126.D2024692 (x2) SHAFT:PRESSURE GUIDE PLATE:UPPER

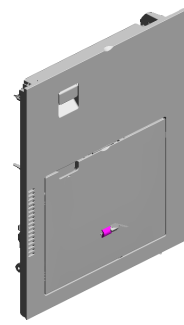

54.D0BH4517
 [A]
 DUPLEX UNIT:ASS'Y
 Y
 201909-01 O/O

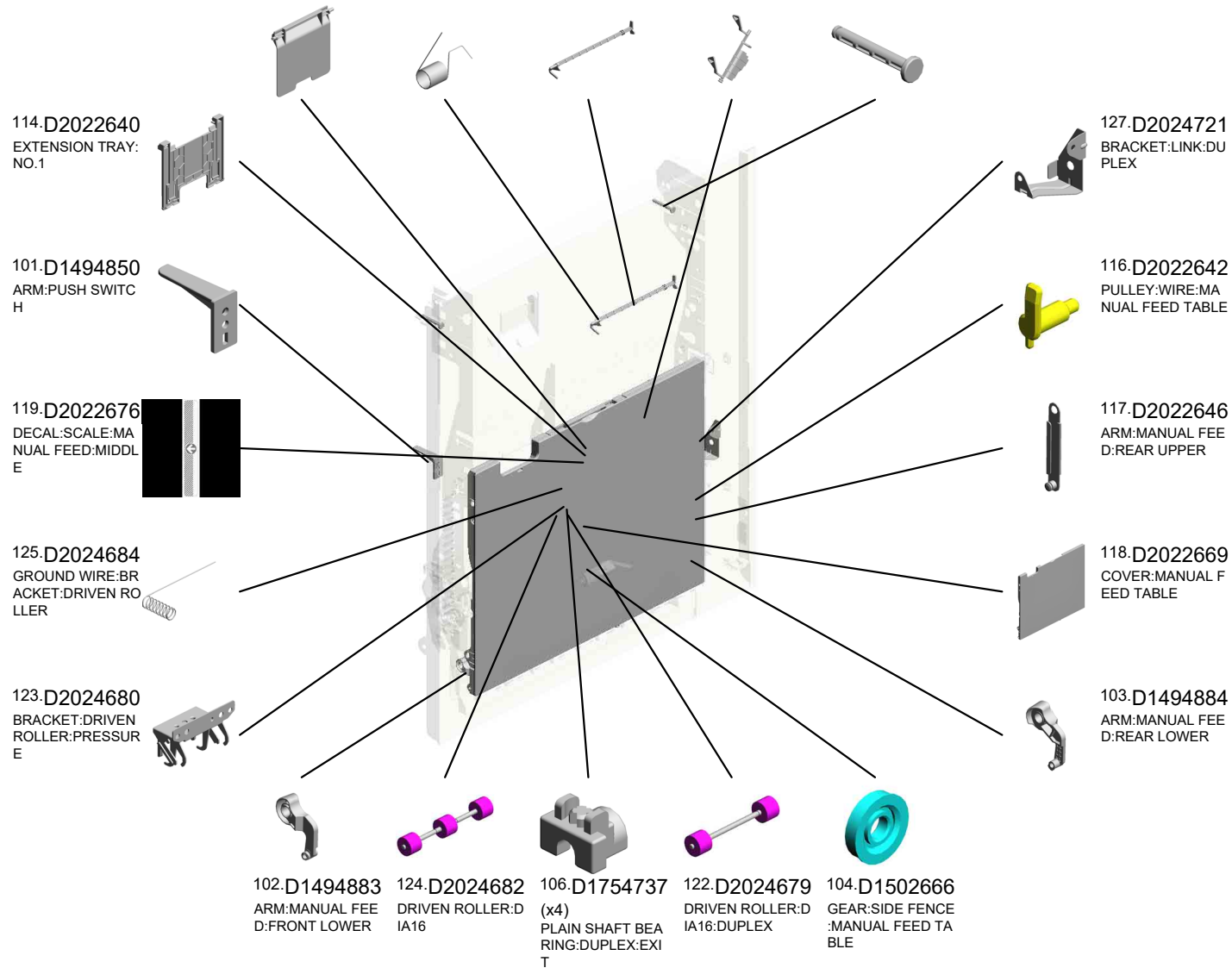

U001	U002	U003	U004	U005	U006	U007	U008	U009	U010	U011	U012	U013	U014	U015	U016	U017	U018	U019	U020
------	------	------	------	------	------	------	------	------	------	------	------	------	------	------	------	------	------	------	------

U014_S001
 DUPLEX UNIT:ASS'Y

- 158.D2414660 GUIDE PLATE:UPPER:RIGHT:DUPLEX
- 152.D2414635 SHEET:CUSHION
- 155.D2414643 (x2) TRANSPORT ROLLER:ENTRANCE
- 160.D2414676 (x2) LEVER:PRESSURE:DUPLEX
- 157.D2414652 GEAR:PULLEY:SWIVEL

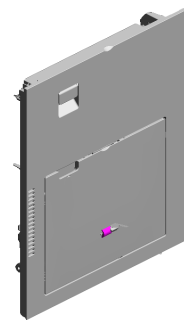

54.D0BH4517
 [A]
 DUPLEX UNIT:ASS'Y
 Y
 201909-01 O/O

145.D2412685
 DECAL:PAPER SE
 T DIRECTION:MAN
 UAL FEED

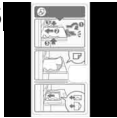

159.D2414673
 GUIDE PLATE:DRIVE
 N



149.D2414627
 COVER:DUPLEX



154.D2414642
 TRANSPORT ROLLER:DUPLEX:1



140.D2412673
 GUIDE PLATE:VERTICAL TRANSPORT:NO.1:DRIVEN



143.D2412678 (x2) SHAFT:FLAT CONVEYER BELT:DRIVEN

142.D2412676 (x2) HOLDER:DRIVEN:BELT

141.D2412674 GUIDE PLATE:VERTICAL TRANSPORT:NO.2:DRIVEN

153.D2414640 TRANSPORT ROLLER:EXIT:DIA8

132.D2412634 (x2) RACK:MANUAL FEED

128.D2024722
 LINK:DUPLEX



129.D2024726
 TORSION SPRING:LINK:CONTACT POINT



144.D2412682
 STAY:REAR:MANUAL FEED TABLE



150.D2414628
 GUIDE PLATE:DUPLEX:EXIT



148.D2414617
 TRANSPORT ROLLER:DUPLEX:2:DIA8



U001	U002	U003	U004	U005	U006	U007	U008	U009	U010	U011	U012	U013	U014	U015	U016	U017	U018	U019	U020
------	------	------	------	------	------	------	------	------	------	------	------	------	------	------	------	------	------	------	------

U014_S001
 DUPLEX UNIT:ASS'Y

- 161.D2414677 (x2) COMPRESSION SPRING:EXIT:UPPER
- 183.D2414995 GUIDE PLATE:UPPER
- 176.D2414762 DRIVEN ROLLER:DIAM18
- 166.D2414694 CAP:BELT:DUPLEX
- 177.D2414763 GUIDE:HARNESS:ENTRANCE SENSOR:DUPLEX

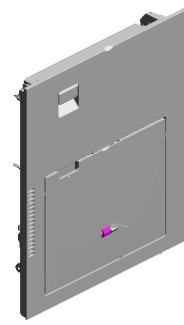

54.D0BH4517
 [A]
 DUPLEX UNIT:ASS'Y
 Y
 201909-01 O/O

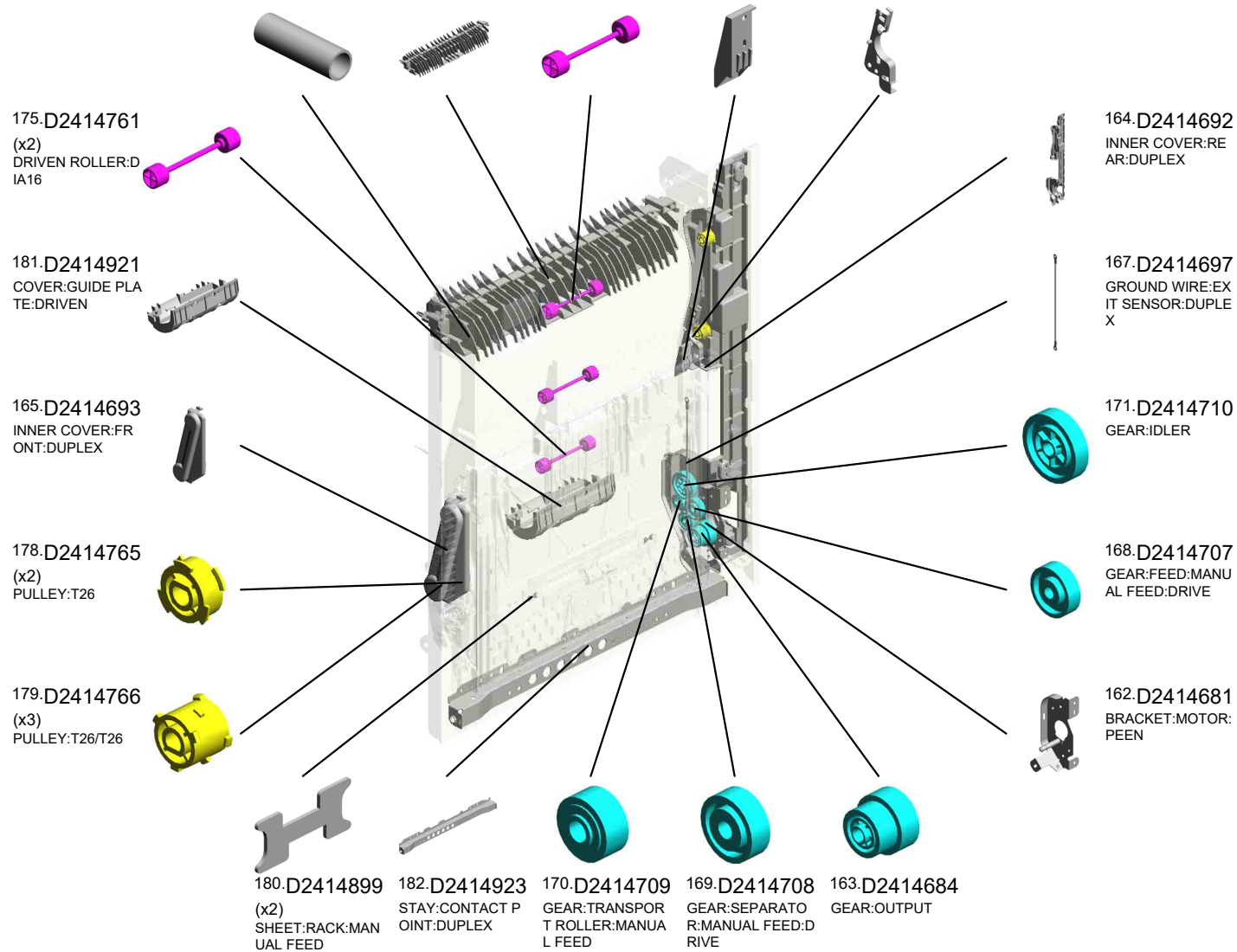

U001	U002	U003	U004	U005	U006	U007	U008	U009	U010	U011	U012	U013	U014	U015	U016	U017	U018	U019	U020
------	------	------	------	------	------	------	------	------	------	------	------	------	------	------	------	------	------	------	------

U014_S001
 DUPLEX UNIT:ASS'Y

200.D0BQ4654 190.GW020024 198.D0BQ4631
 SHAFT:LEVER:LOC PHOTOINTERRUP SIDE PLATE:REAR:
 K TOR:LG2A24BL1:G DUPLEX:PEEN
 201904-06 X/X F 201904-11 X/X
 201811-05 O/O

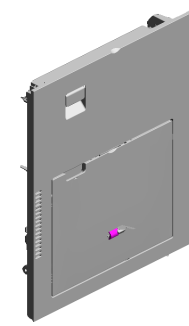

54.D0BH4517
 [A]
 DUPLEX UNIT:ASS'
 Y
 201909-01 O/O

201.D2894655
 GRIP:DUPLEX UNI
 T
 201904-05 X/X



184.GW010007
 PHOTO REFLECTI
 ON SENSOR:EXIT

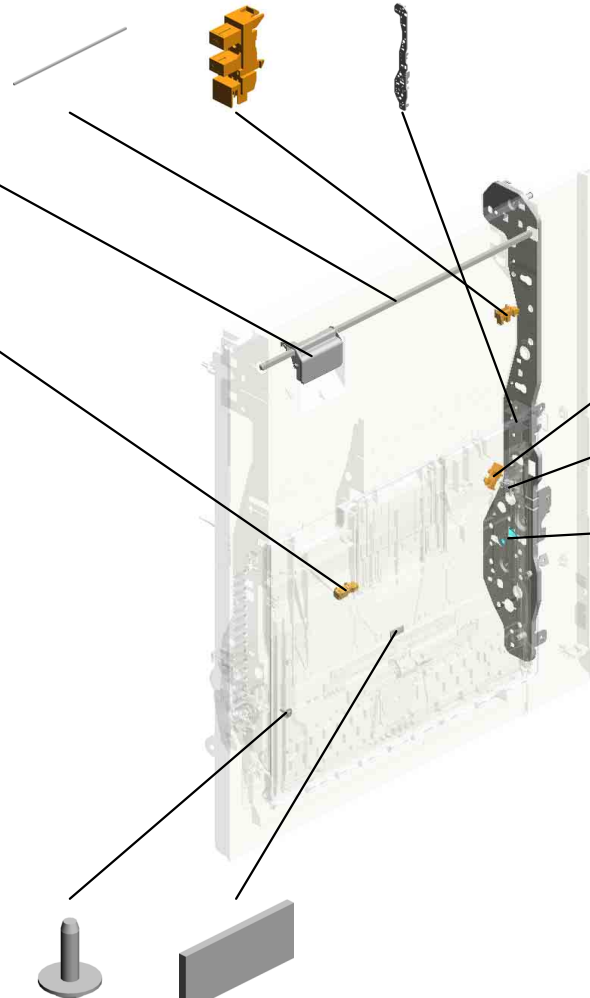

192.AW020234
 PHOTOINTERRUP
 TOR:GP1A173LCS
 5F
 201903-01 O/O



189.AW500049
 PUSH SWITCH:SW
 1AG-550
 201811-01 O/O

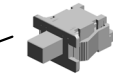

199.D0BQ4644
 GEAR:MECHANICA
 L ROLLER CLUTCH
 201904-12 X/X

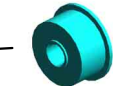

188.M1095857
 HEXAGON HEAD T
 APPING SCREW:3
 X10:DIA10



185.M0662743
 FRICTION PAD:MA
 NUAL FEED TABLE
 :18X7.5

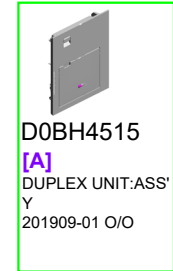
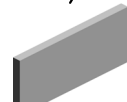

D0BH4515
 [A]
 DUPLEX UNIT:ASS'
 Y
 201909-01 O/O

U001	U002	U003	U004	U005	U006	U007	U008	U009	U010	U011	U012	U013	U014	U015	U016	U017	U018	U019	U020
------	------	------	------	------	------	------	------	------	------	------	------	------	------	------	------	------	------	------	------

U014_S001_S001
SIDE FENCE:FRONT:ASS'Y

93.D1494717
PLATE:SIDE FENC
E:FRONT



94.D1494718
TORSION SPRING:
SIDE FENCE:FRON
T



146.D2412690
SIDE FENCE:FRON
T:ASSY

U001	U002	U003	U004	U005	U006	U007	U008	U009	U010	U011	U012	U013	U014	U015	U016	U017	U018	U019	U020
------	------	------	------	------	------	------	------	------	------	------	------	------	------	------	------	------	------	------	------

U014_S001_S002
SIDE FENCE:REAR:ASS'Y

95.D1494720 96.D1494721
PLATE:SIDE FENC TORSION SPRING:
E:REAR SIDE FENCE:REAR



147.D2412691
SIDE FENCE:REAR
:ASS'Y

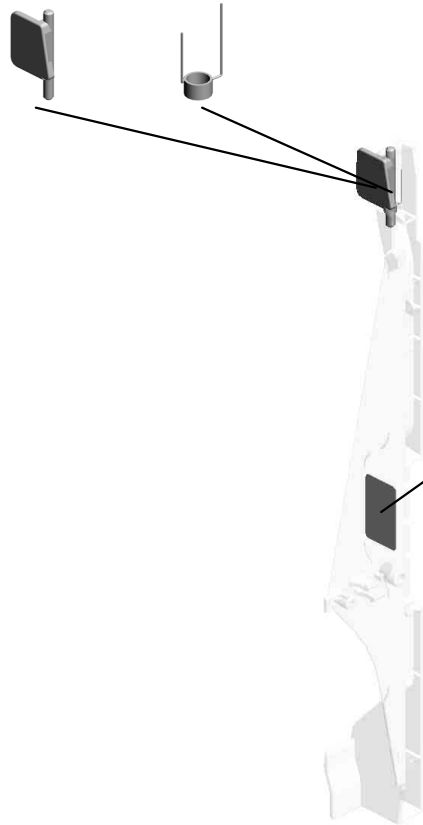

U001	U002	U003	U004	U005	U006	U007	U008	U009	U010	U011	U012	U013	U014	U015	U016	U017	U018	U019	U020
------	------	------	------	------	------	------	------	------	------	------	------	------	------	------	------	------	------	------	------

U014_S001_S003
MANUAL FEED UNIT:ASS'Y

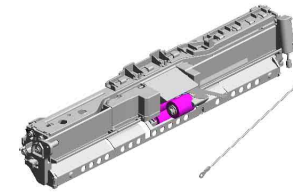

193-DOBQ2600
[A]
MANUAL FEED UNI
T:ASS'Y
201904-01 O/O

- 35.AF031046 FEED ROLLER - MANUAL FEED
- 12.08050103 (x6) RETAINING RINGS -E:SILENCER:DIA3
- 24.AA082187 BUSHING:DIA6XDI A10X9:EG-1
- 32.AB011252 GEAR - 20Z
- 1.03530030N (x2) SCREW:M3X3

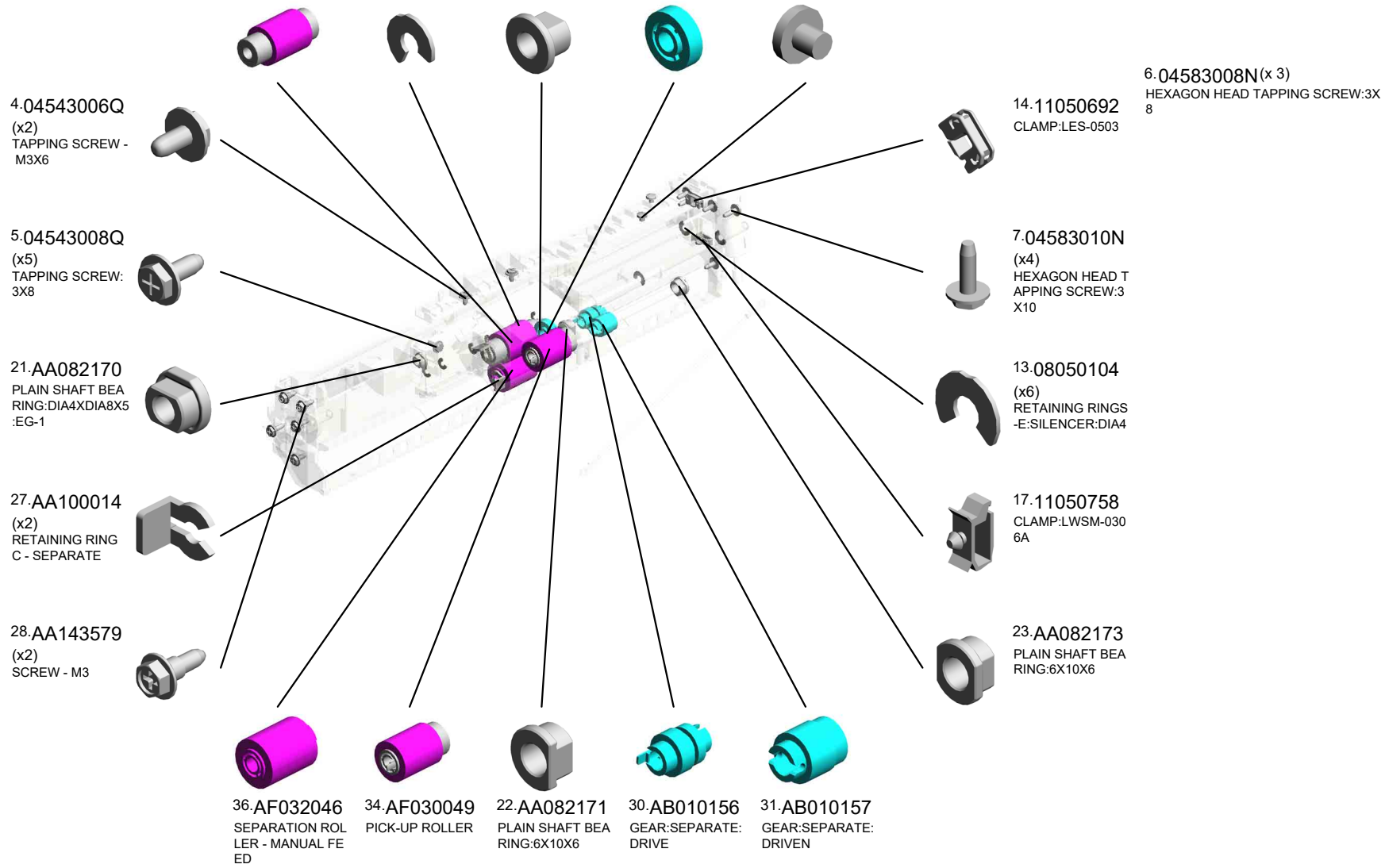

U001	U002	U003	U004	U005	U006	U007	U008	U009	U010	U011	U012	U013	U014	U015	U016	U017	U018	U019	U020
------	------	------	------	------	------	------	------	------	------	------	------	------	------	------	------	------	------	------	------

U014_S001_S003
MANUAL FEED UNIT:ASS'Y

- 71.D1492658 COVER:PAPER FEED ROLLER
- 107.D2022614 COIL SPRING:RELEASE:PICKUP:MANUAL FEED
- 66.D1492638 LINK:PAPER STOPPER:MANUAL FEED
- 68.D1492642 SHAFT:LINK:PAPER STOPPER
- 65.D1492635 TRANSPORT ROLLER:MANUAL FEED

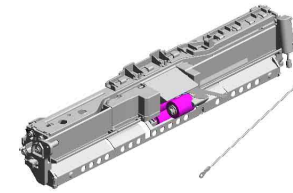

193.D0BQ2600
[A]
MANUAL FEED UNIT:ASS'Y
201904-01 O/O

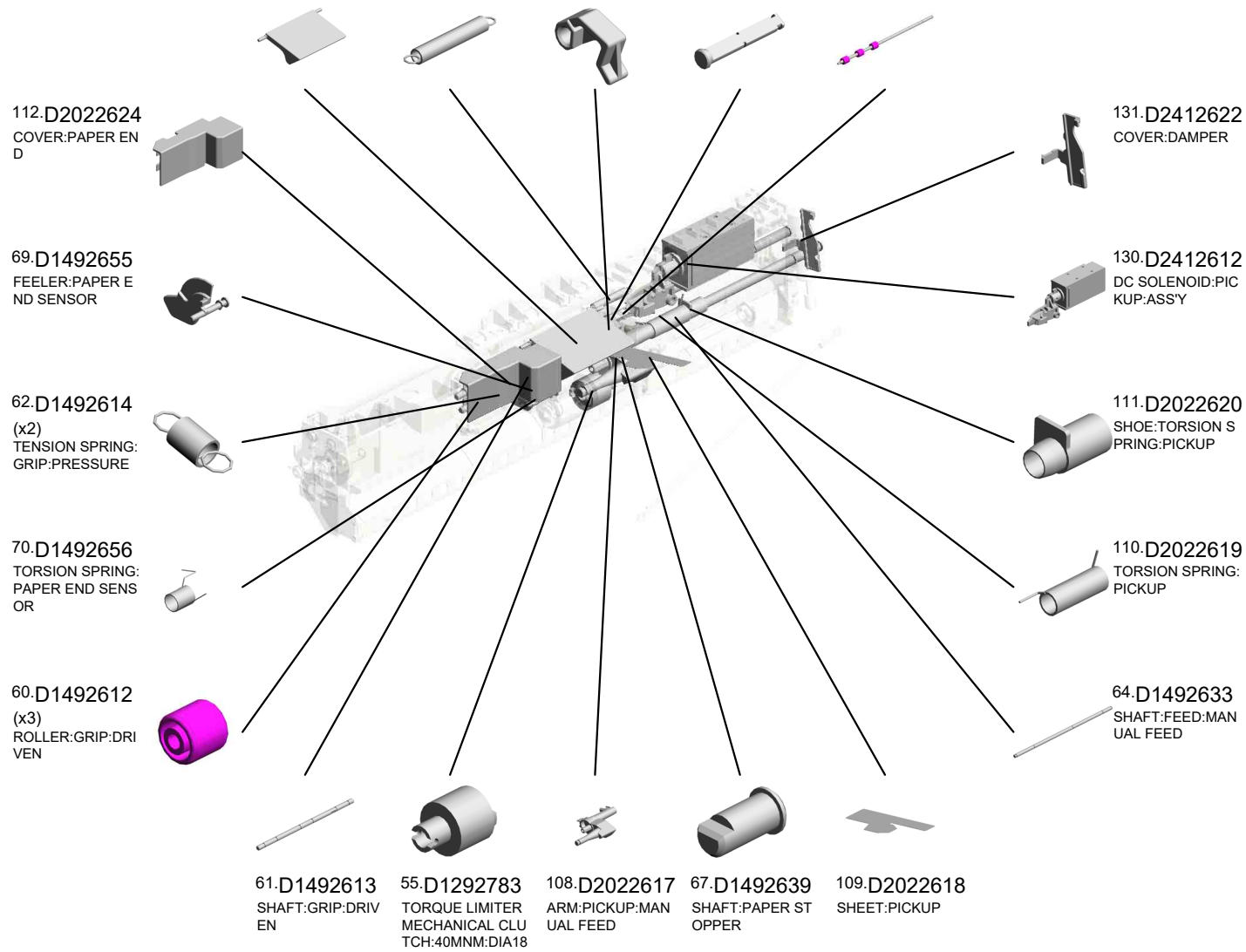

U001	U002	U003	U004	U005	U006	U007	U008	U009	U010	U011	U012	U013	U014	U015	U016	U017	U018	U019	U020
------	------	------	------	------	------	------	------	------	------	------	------	------	------	------	------	------	------	------	------

U014_S001_S003
MANUAL FEED UNIT:ASS'Y

196.D0BQ2637 PAPER STOPPER: MANUAL FEED 201904-07 X/O
 134.D2412641 COVER:PAPER STOPPER:MANUAL FEED
 136.D2412644 TORSION SPRING: LINK:PAPER STOPPER
 135.D2412643 ARM:LINK:PAPER STOPPER

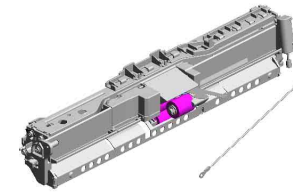

193.D0BQ2600
 [A]
 MANUAL FEED UNIT:ASS'Y
 201904-01 O/O

137.D2412652
 GROUND PLATE:SHAFT:FEED

192.AW020234
 PHOTOINTERRUPTOR:GP1A173LCS5F
 201903-01 O/O

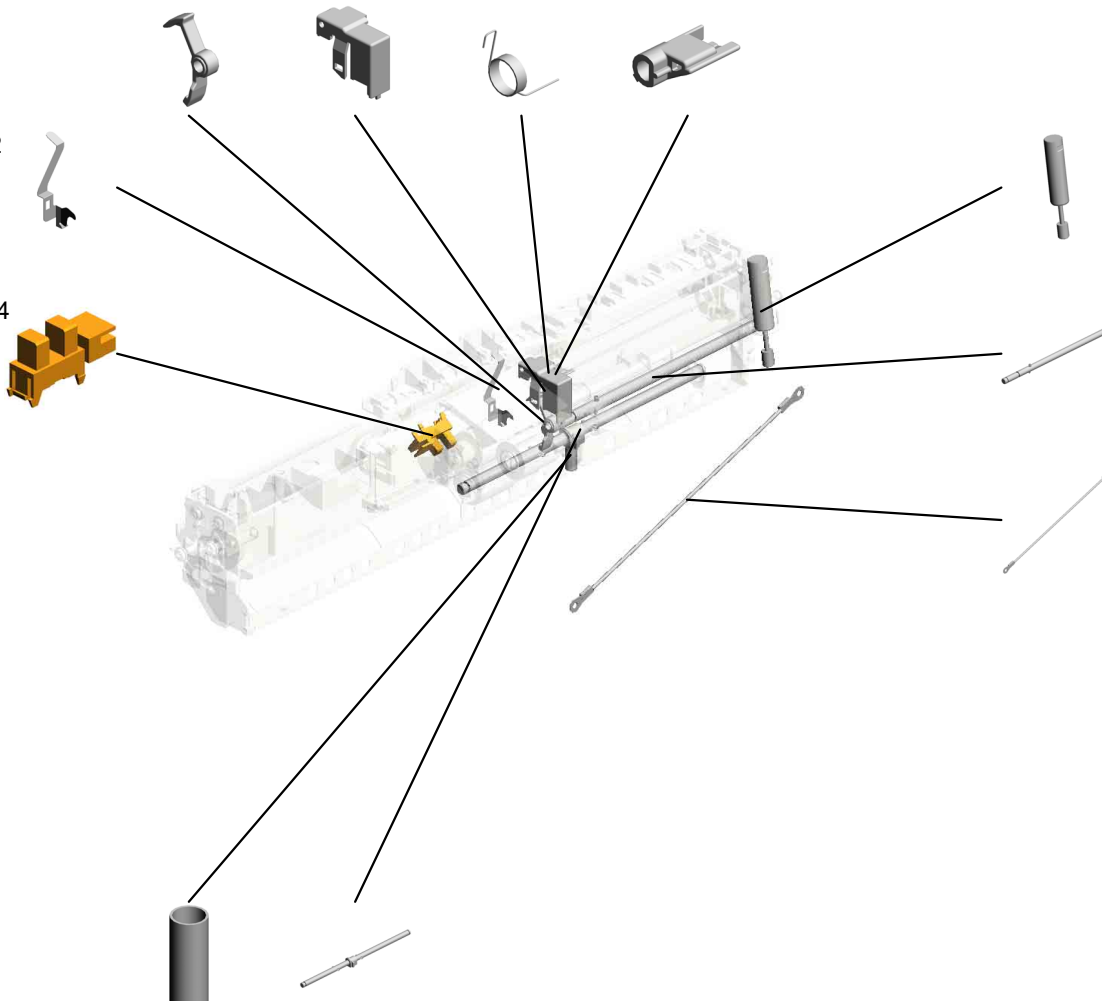

186.M0662749
 OIL DAMPER:STRAIGHT:30N

195.D0BQ2619
 SHAFT:SEPARATOR:DRIVE:ASS'Y
 201904-08 X/X

139.D2412657
 GROUND WIRE:MANUAL FEED UNIT: REAR

197.D0BQ2653 COIL SPRING:PRESSURE:SEPARATOR
 201904-10 X/X
 194.D0BQ2608 SHAFT:SEPARATOR:DRIVEN:ASS'Y
 201904-09 X/X



M0BW2602
 [A]
 MANUAL FEED UNIT:ASS'Y
 201904-01 O/O

U001	U002	U003	U004	U005	U006	U007	U008	U009	U010	U011	U012	U013	U014	U015	U016	U017	U018	U019	U020
------	------	------	------	------	------	------	------	------	------	------	------	------	------	------	------	------	------	------	------

U015.MAIN DRIVE

U015 S002
D2411357
DRIVE UNIT:FUSING/PAPER
EXIT UNIT:ASS'Y



U015 S001
D1491351
DRIVE UNIT:REGISTRATION:
ASS'Y

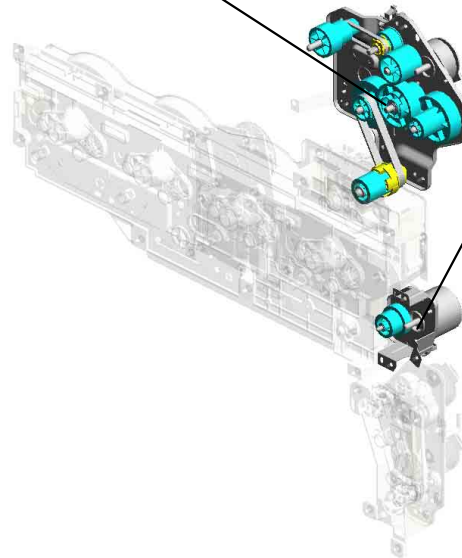

U001	U002	U003	U004	U005	U006	U007	U008	U009	U010	U011	U012	U013	U014	U015	U016	U017	U018	U019	U020
------	------	------	------	------	------	------	------	------	------	------	------	------	------	------	------	------	------	------	------

U015 MAIN DRIVE

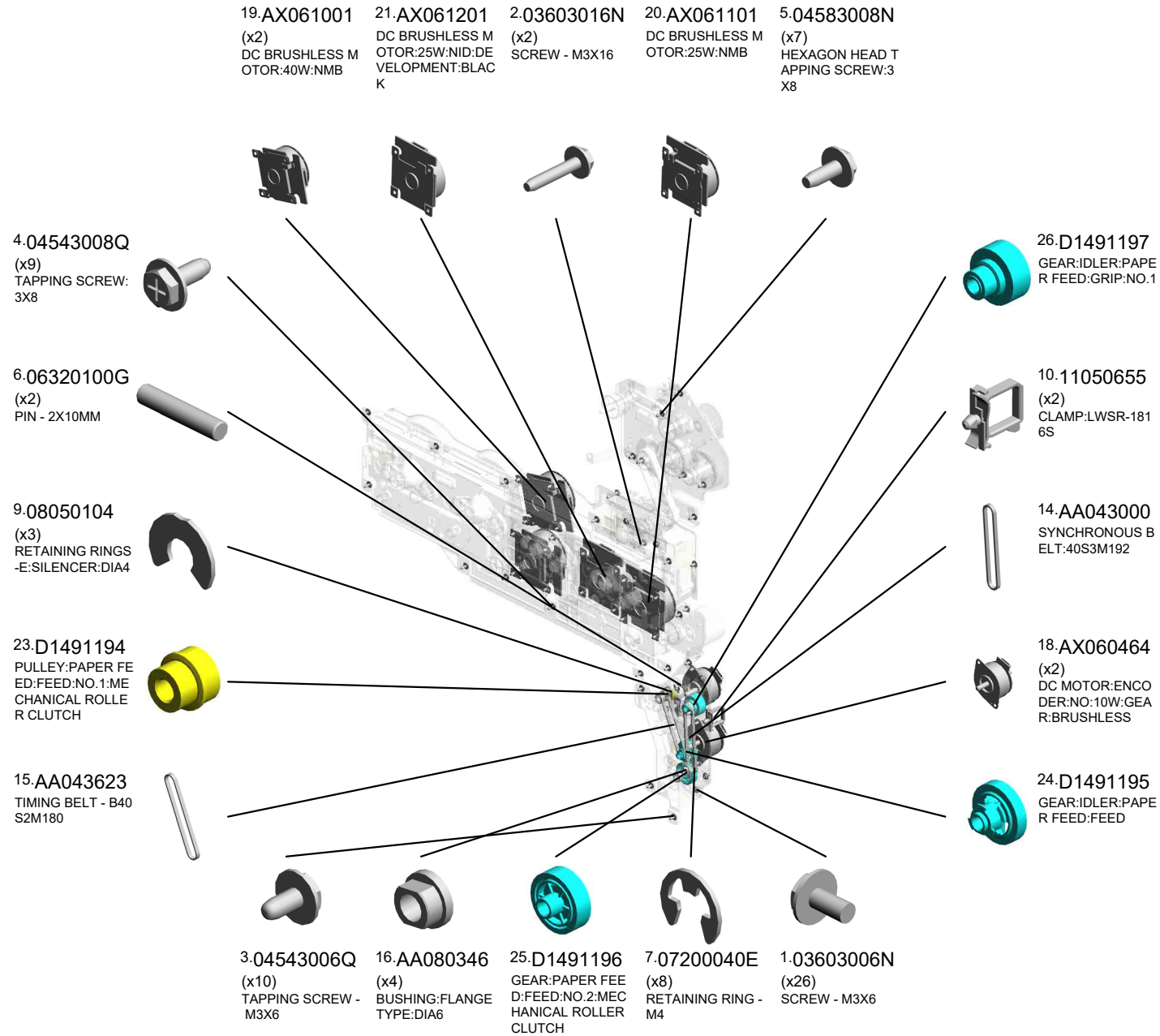
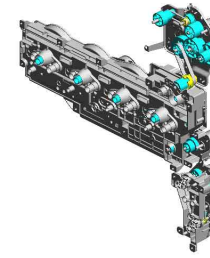

U001	U002	U003	U004	U005	U006	U007	U008	U009	U010	U011	U012	U013	U014	U015	U016	U017	U018	U019	U020
------	------	------	------	------	------	------	------	------	------	------	------	------	------	------	------	------	------	------	------

U015 MAIN DRIVE

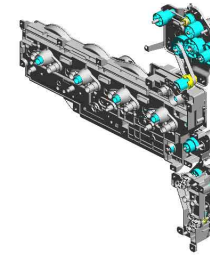

- 43.D2411115 GUIDE:HARNES:L EFT
- 33.D1491394 GROUND PLATE:D RIVE UNIT:FUSING /PAPER EXIT UNIT
- 27.D1491199 DRIVE UNIT:ON-OF F:TRANSFER
- 31.D1491387 GROUND PLATE:D RIVE UNIT:ENGINE

42.D2411113
GUIDE:HARNES:
RIGHT

44.D2411117
DRIVE UNIT:ENGIN
E:ASS'Y

36.D2021143
(x4)
JOINT:DRIVE

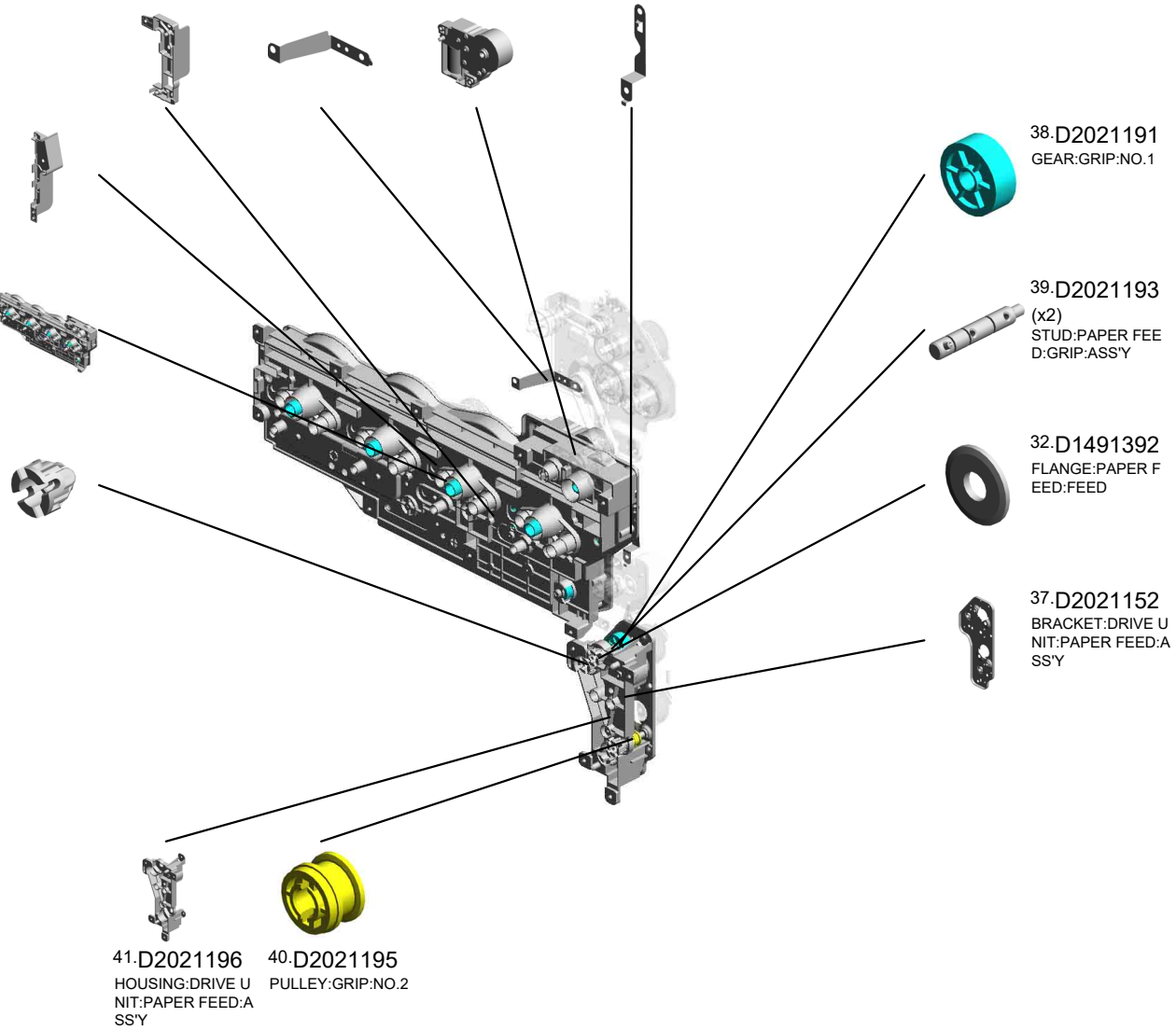

- 41.D2021196 HOUSING:DRIVE U NIT:PAPER FEED:A SS'Y
- 40.D2021195 PULLEY:GRIP:NO.2

38.D2021191
GEAR:GRIP:NO.1

39.D2021193
(x2)
STUD:PAPER FEE
D:GRIP:ASS'Y

32.D1491392
FLANGE:PAPER F
EED:FEED

37.D2021152
BRACKET:DRIVE U
NIT:PAPER FEED:A
SS'Y

U001	U002	U003	U004	U005	U006	U007	U008	U009	U010	U011	U012	U013	U014	U015	U016	U017	U018	U019	U020
------	------	------	------	------	------	------	------	------	------	------	------	------	------	------	------	------	------	------	------

U015_S001
 DRIVE UNIT:REGISTRATION:ASS'Y

29.D1491352 1.03603006N
 BRACKET:DRIVE U (x2)
 NIT:REGISTRATIO SCREW - M3X6
 N:ASS'Y

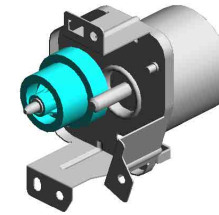

28.D1491351
 DRIVE UNIT:REGIS
 TRATION:ASS'Y

30.D1491355
 GEAR:REGISTRATI
 ON:NO.1

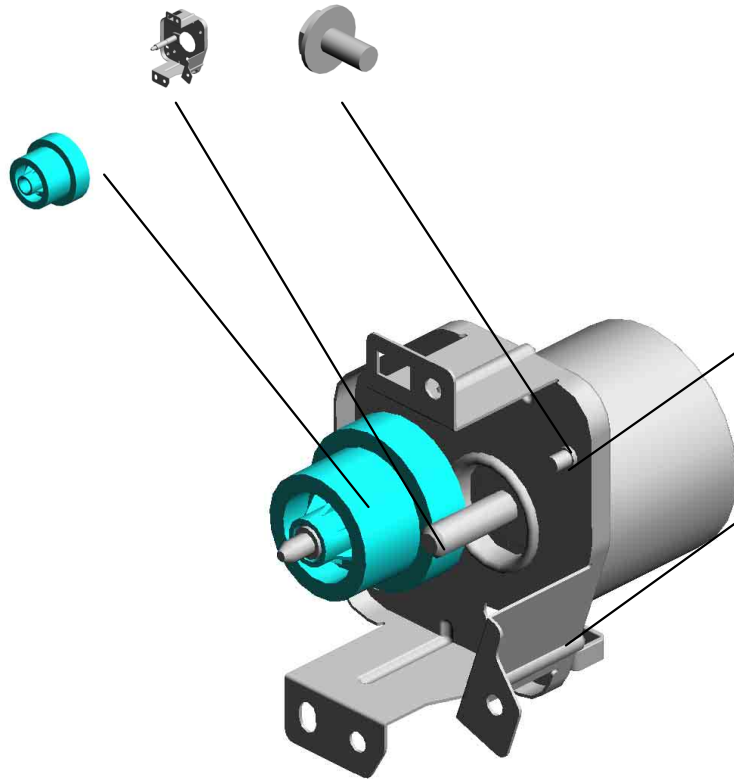

17.AX060435
 DC MOTOR:GEAR:
 10W:BRUSHLESS

11.11050759
 CLAMP:LWSM-060
 5A

U001	U002	U003	U004	U005	U006	U007	U008	U009	U010	U011	U012	U013	U014	U015	U016	U017	U018	U019	U020
------	------	------	------	------	------	------	------	------	------	------	------	------	------	------	------	------	------	------	------

U015_S002

DRIVE UNIT:FUSING/PAPER EXIT UNIT:ASS'Y

- 12.11050760 (x5) CLAMP:LWSM-0511A
- 7.07200040E (x5) RETAINING RING - M4
- 13.11050762 CLAMP:LWS-0711A
- 18.AX060464 DC MOTOR:ENCO DER:NO:10W:GEAR:BRUSHLESS

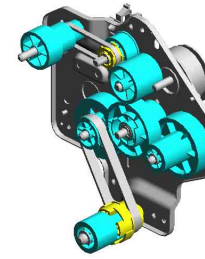

45.D2411357
DRIVE UNIT:FUSING/PAPER EXIT UNIT:ASS'Y

22.AX061202
DC BRUSHLESS MOTOR:25W:NID:FUSING UNIT

47.D2411396
HOLDER:TORQUE LIMITER MECHANICAL CLUTCH:PRESSURE RELEASE

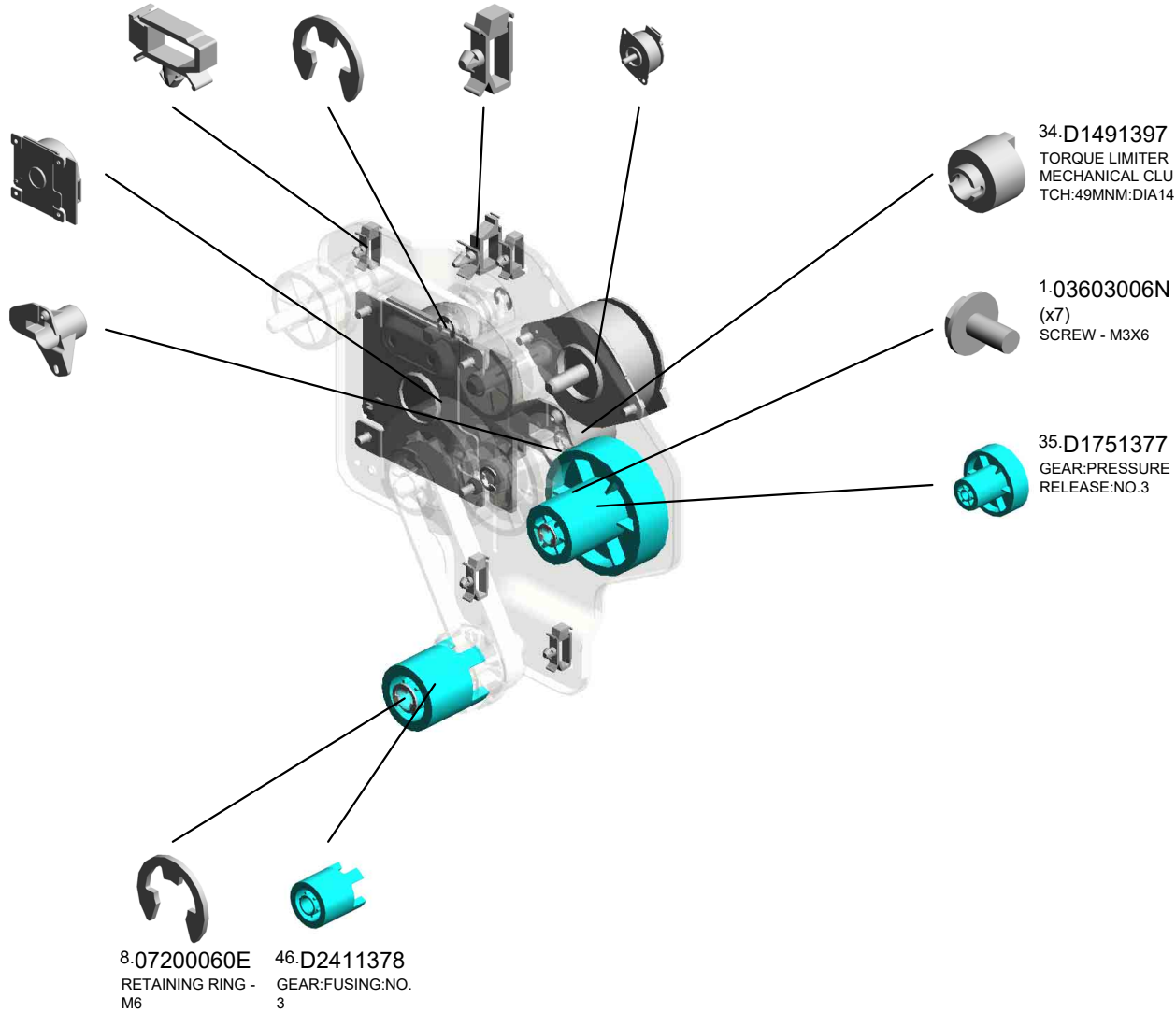

U001	U002	U003	U004	U005	U006	U007	U008	U009	U010	U011	U012	U013	U014	U015	U016	U017	U018	U019	U020
------	------	------	------	------	------	------	------	------	------	------	------	------	------	------	------	------	------	------	------

U016 ELECTRICAL

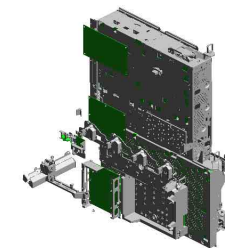

- 6.04543006N (x10) TAPPING SCREW: ROUND POINT:3X6
- 7.04543006Q (x74) TAPPING SCREW - M3X6
- 10.04543020Q (x2) TAPPING SCREW:: 3X20
- 21.11050758 (x3) CLAMP:LWSM-030 6A
- 8.04543008Q (x2) TAPPING SCREW: 3X8

18.11050725
CLAMPS:WES-111
7



22.11050759
(x6)
CLAMP:LWSM-060
5A



27.12042612
(x2)
MICRO SWITCH:D3
V-16506-3C25



5.04513025N
TAPPING SCREW:
M3X25



12.08050103
RETAINING RINGS
-E:SILENCER:DIA3



9.04543010Q (x5)
TAPPING SCREW:
3X10



11.04583008N (x36)
HEXAGON HEAD T
APPING SCREW:3
X8



14.11050488 (x2)
HARNESS CLAMP



2.03603006N (x2)
SCREW - M3X6



16.11050723
CLAMPS:WES-050
7



26.11050765
(x7)
CLAMP:LWS-2218A



3.04513006N
(x15)
TAPPING SCREW -
3X6



19.11050726
(x2)
CLAMPS:WES-221
7



15.11050692
(x2)
CLAMP:LES-0503



17.11050724
CLAMPS:WES-121
0



13.11050409
CARD SPACER- 6.
4MM



14.11050488
(x6)
HARNESS CLAMP



15.11050692
(x2)
CLAMP:LES-0503



16.11050723
(x3)
CLAMPS:WES-050
7

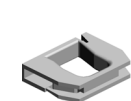

17.11050724
(x2)
CLAMPS:WES-121
0

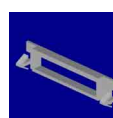

20.11050752
SADDLE:EDS-3005
LS-V0



21.11050758
(x6)
CLAMP:LWSM-030
6A

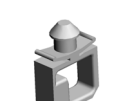

22.11050759
(x46)
CLAMP:LWSM-060
5A

U016 ELECTRICAL

40.D0895824 COVER:SD-CARD: D086/D087
 37.AZ320197 POWER PACK:TTS :H
 41.D0895887 (x2) PANEL:INTERFAC E
 43.D0BH5676 PCB:SERVICE 201907-04 O/O
 35.AX640236 FAN:MM60X15

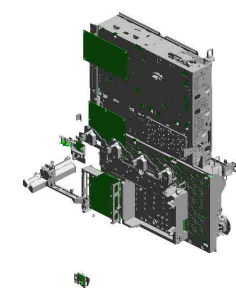

46.D1495703 BRACKET:MICRO SWITCH



31.AA061128 TENSION SPRING: SAFETY SWITCH:R IGH T



49.D1495714 SHAFT:ARM:SAFE TY SWITCH



47.D1495711 BRACKET:ARM:SA FETY SWITCH:FR ON T



48.D1495713 ARM:SAFETY SWI TCH:FRONT



39.B2231317 (x3) SCREW



30.AA061127 (x2) TENSION SPRING: SAFETY SWITCH:F RONT



44.D1421805 (x2) SHAFT:SCALE



33.AA143848 (x4) STEPPED SCREW - M3



38.AZ320233 [A] POWER PACK:CB: H 201911-05 O/O

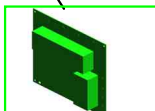

34.AA161167 (x4) BUSHING:HDD



45.D1465786 BRACKET:HDD

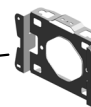

42.D0BH5114 BCU:TYPE:H3:ASS Y



28.14078389 EEPROM:BR24T12 8-W

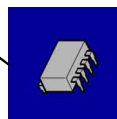

32.AA143592 SCREW- M4X6



23.11050760 (x40) CLAMP:LWSM-051 1A



24.11050762 (x15) CLAMP:LWS-0711A

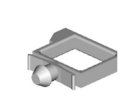

25.11050764 (x7) CLAMP:LWS-1316A



26.11050765 (x5) CLAMP:LWS-2218A

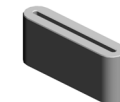

29.16072525 FERRITE CORE:K3 FF 35.00X14.60X7. 70X1.40

1.03530060N(x 1) BIND SCREW - M3X6
 4.04513008N(x14) TAPPING SCREW - M3X8

U001	U002	U003	U004	U005	U006	U007	U008	U009	U010	U011	U012	U013	U014	U015	U016	U017	U018	U019	U020
------	------	------	------	------	------	------	------	------	------	------	------	------	------	------	------	------	------	------	------

U016 ELECTRICAL

64.D2415192 PCB:MSSENS2
 53.D1495776 COVER:USB:SMALL
 62.D2415112 PCB:IOB:ENGINE
 68.D2415796 RACK:MIDDLE
 54.D1495810 BRACKET:RACK:UPPER

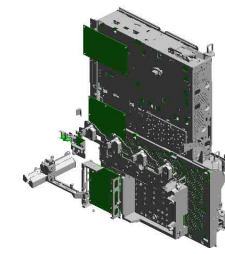

63.D2415190 (x2)
PCB:MSSENS1

51.D1495718 TORSION SPRING: SAFETY SWITCH

50.D1495717 BASE:SAFETY SWITCH

52.D1495726 LEVER:SAFETY SWITCH:RIGHT

61.D2415110 PCB:IOB:TRANSPORT

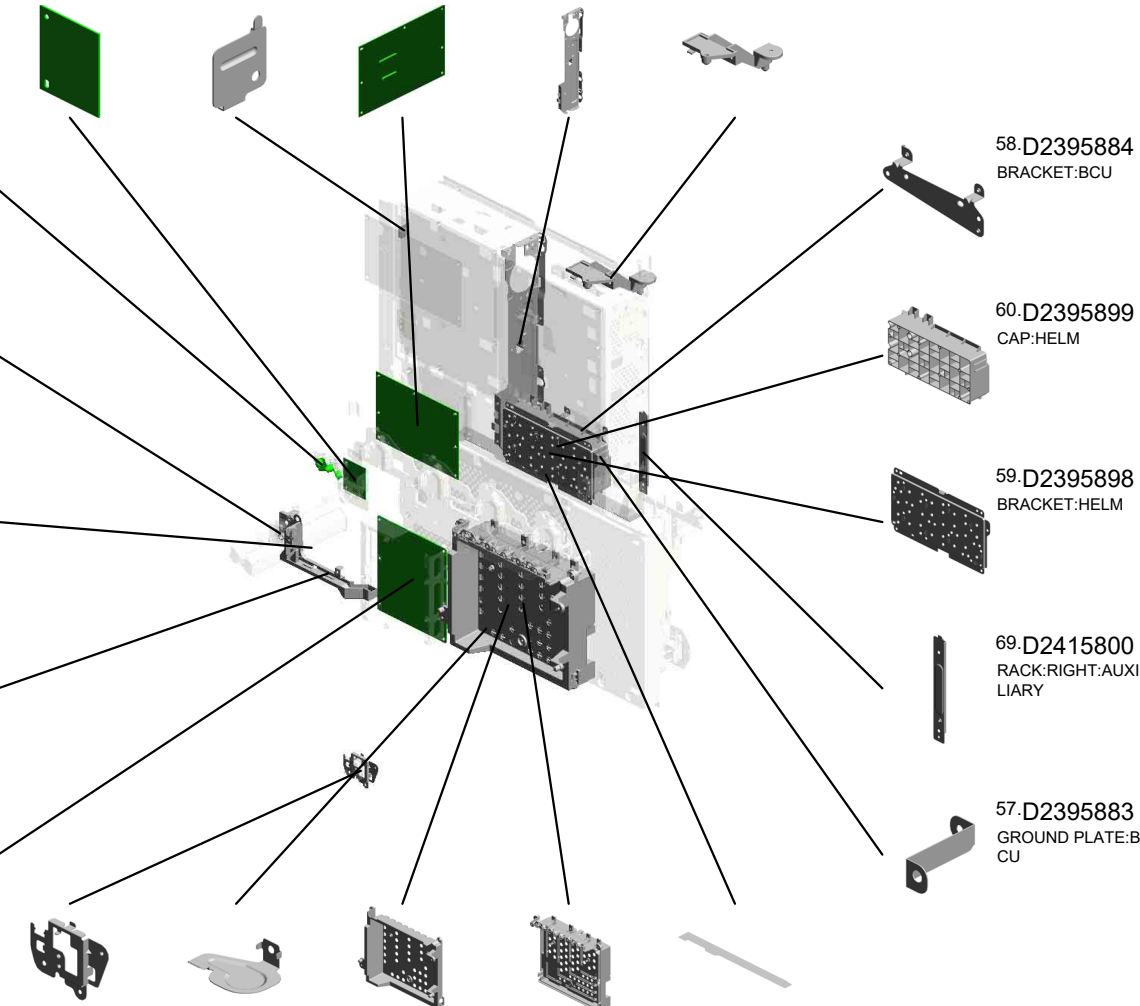

65.D2415737 BRACKET:MAIN SWITCH
 56.D1495824 COVER:CONNECTOR:HEATER:0.4MM
 67.D2415765 CASE:POWER PACK:CB
 66.D2415764 COVER:POWER PACK:CB
 55.D1495818 SPACER:FFC

58.D2395884 BRACKET:BCU

6. 04543006N (x 6)
TAPPING SCREW:ROUND POINT:3X6

7. 04543006Q (x12)
TAPPING SCREW - M3X6

8. 04543008Q (x 2)
TAPPING SCREW:3X8

11. 04583008N (x 5)
HEXAGON HEAD TAPPING SCREW:3X8

60.D2395899 CAP:HELM

59.D2395898 BRACKET:HELM

69.D2415800 RACK:RIGHT:AUXILIARY

57.D2395883 GROUND PLATE:BCU

U016 ELECTRICAL

74.D2415831 (x4) CAP:GUIDE:WIRE
 76.D2415841 BASE:GUIDE:WIRE
 72.D2415803 GUIDE:HARNESS:C/T BOX
 70.D2415801 COVER:RACK:REAR
 71.D2415802 GUIDE:FFC:SCANNER

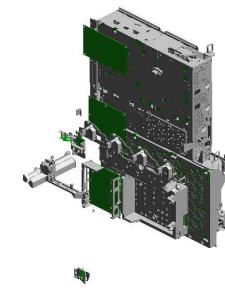

75.D2415832 (x4) CAP:GUIDE:COIL SPRING

84.D2415856 WIRE:CHARGE:Y

85.D2415857 WIRE:DEVELOPMENT:Y

83.D2415855 WIRE:DEVELOPMENT:M

82.D2415854 WIRE:CHARGE:M

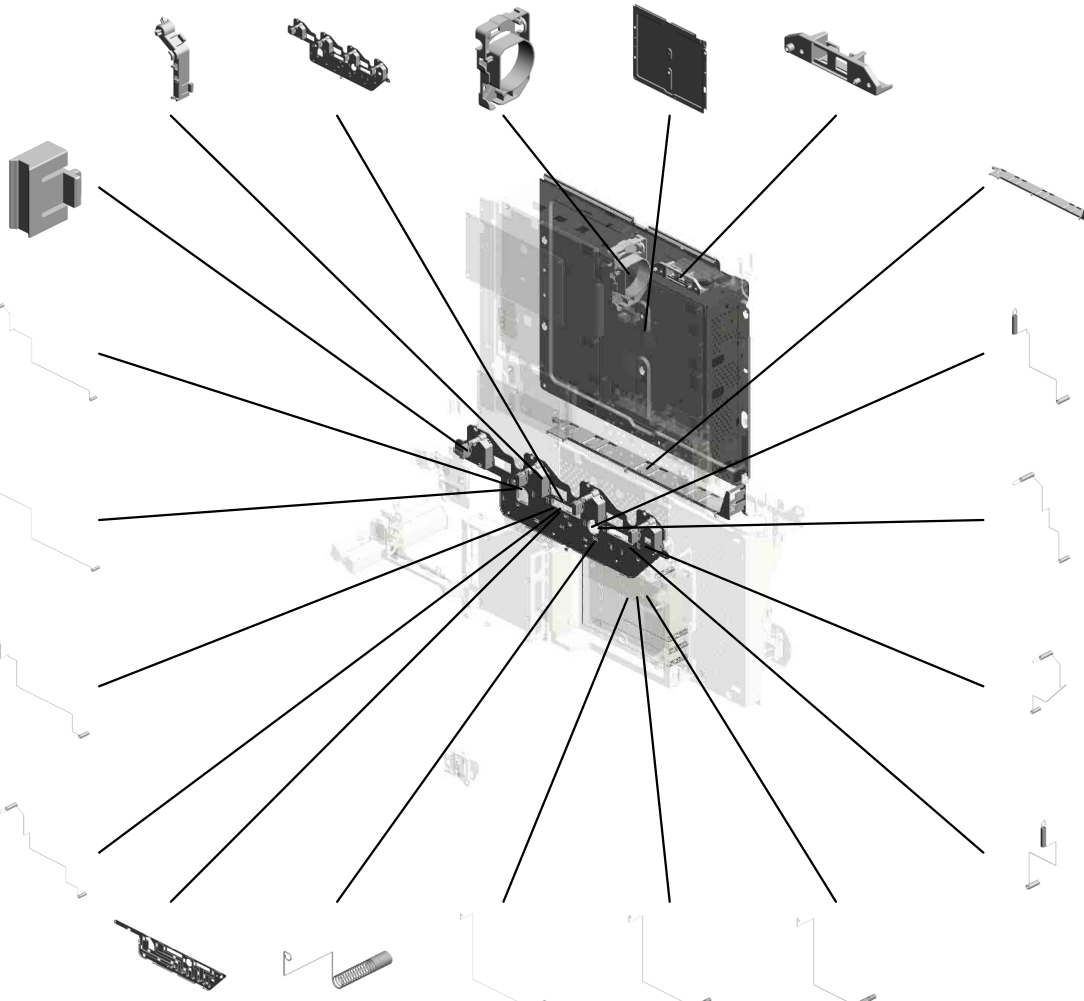

73.D2415817 GUIDE:FFC:2

81.D2415853 WIRE:DEVELOPMENT:C

80.D2415852 WIRE:CHARGE:C

78.D2415850 WIRE:CHARGE:K

79.D2415851 WIRE:DEVELOPMENT:K

77.D2415842 COVER:GUIDE:WIRE
 86.D2415875 (x4) WIRE:CHARGE:CB
 87.D2415876 WIRE:DEVELOPMENT:CB:K
 88.D2415877 WIRE:DEVELOPMENT:CB:C
 89.D2415878 WIRE:DEVELOPMENT:CB:M

U001	U002	U003	U004	U005	U006	U007	U008	U009	U010	U011	U012	U013	U014	U015	U016	U017	U018	U019	U020
------	------	------	------	------	------	------	------	------	------	------	------	------	------	------	------	------	------	------	------

U016 ELECTRICAL

93.D2425605 PCB:DDR3-DIMM:R
C-C:2GB:ASS'Y

94.D2425646 PCB:IMAGE PROC
ESSING UNIT

91.D2415889 SPRING PLATE:IM
AGE PROCESSING
UNIT

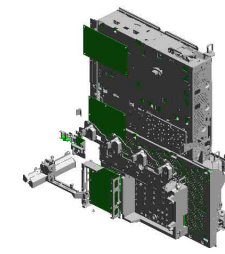

95.D2429591
TOTAL COUNTER

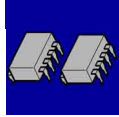

97.M4445201
HDD:320GB:AQUA
RIUS

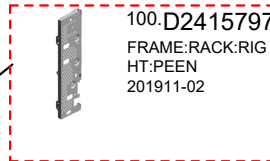
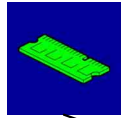
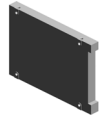

100.D2415797
FRAME:RACK:RIG
HT:PEEN
201911-02

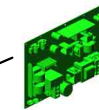

98.AZ240315
(NA):DC POWER S
UPPLY



99.D2425184
(NA):AC CONTROL
BOARD



96.D2445730
PCB:DCSW



90.D2415879
WIRE:DEVELOPME
NT:CB:Y



AZ320216
[A]
POWER PACK:CB:
H
201911-05 O/O

U001	U002	U003	U004	U005	U006	U007	U008	U009	U010	U011	U012	U013	U014	U015	U016	U017	U018	U019	U020
------	------	------	------	------	------	------	------	------	------	------	------	------	------	------	------	------	------	------	------

U017.MAIN FRAME

U017_S001
D1497935
CASE:FILTER:ASSY

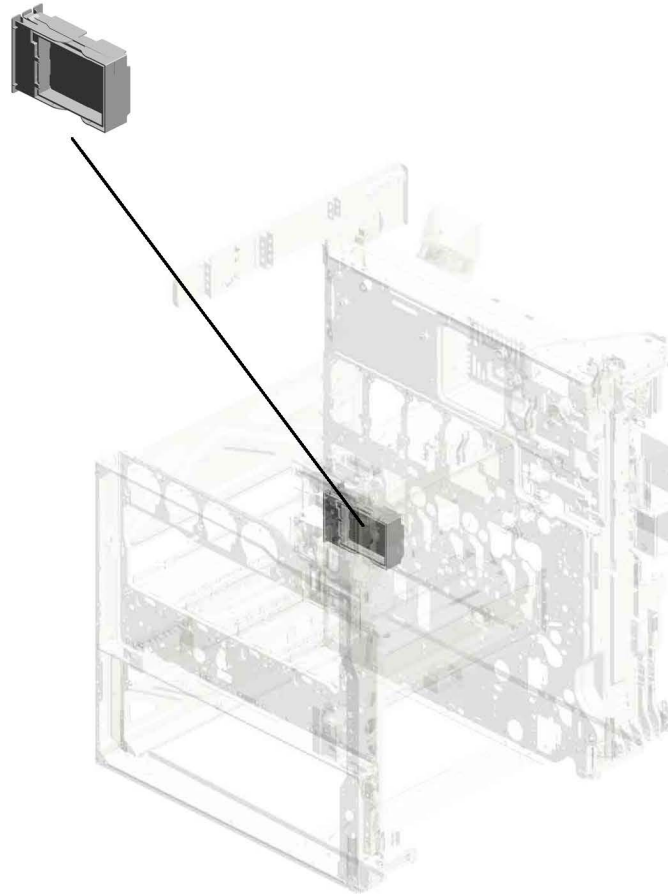

U001	U002	U003	U004	U005	U006	U007	U008	U009	U010	U011	U012	U013	U014	U015	U016	U017	U018	U019	U020
------	------	------	------	------	------	------	------	------	------	------	------	------	------	------	------	------	------	------	------

U017 MAIN FRAME

- 11.08025328 (x2) HEXAGON HEAD TAPPING SCREW:3X40
- 16.AX660015 (x2) DC FAN MOTOR:SI ROCCO:DC24V:PW M
- 5.04543006N (x2) TAPPING SCREW: ROUND POINT:3X6
- 19.D1175303 THERMISTOR
- 13.AX640199 (x2) FAN:MM80:25MM:D C 2.16W

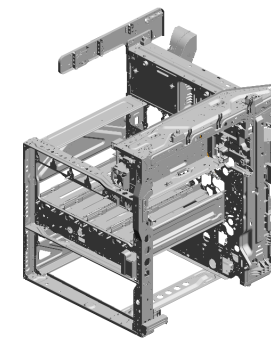

- 1.04503025N (x2) TAPPING SCREW: 3X25

- 15.AX640236 FAN:MM60X15

- 9.04583008N (x54) HEXAGON HEAD TAPPING SCREW:3X8

- 21.D1491099 (x2) COVER:GRIP:LEFT

- 6.04543006Q (x228) TAPPING SCREW - M3X6

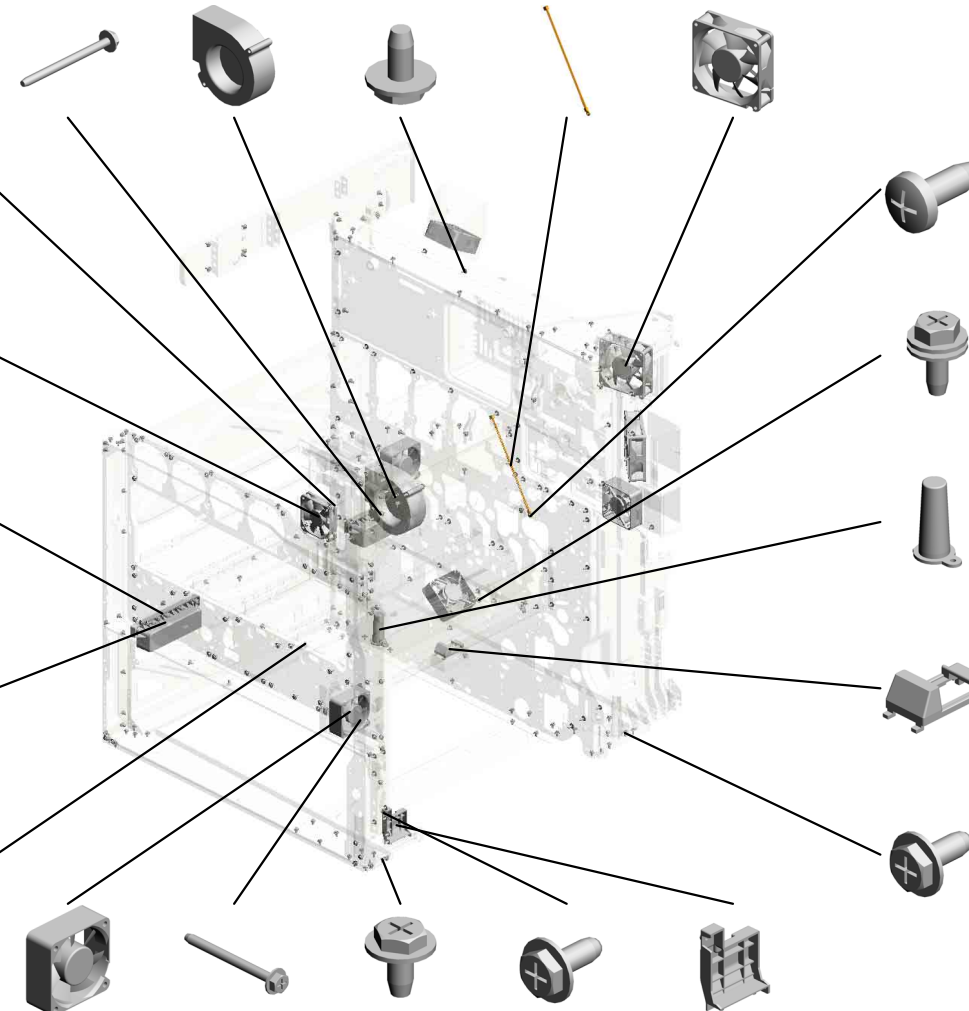

- 14.AX640219 (x5) DC FAN MOTOR:D C24V:MM60:25MM
- 2.04503035N (x2) TAPPING SCREW: 3X35
- 3.04513006N (x6) TAPPING SCREW - 3X6
- 7.04543008N TAPPING SCREW: ROUND POINT:3X8
- 22.D1491338 GUIDE PLATE:PAPER FEED TABLE:FRONT

- 4.04533008N BINDING SELF TAPPING SCREW:3X8



- 10.08025299 TAPPING SCREW - M3X8

- 9.04583008N (x 4) HEXAGON HEAD TAPPING SCREW:3X8

- 18.B2381089 COVER - POSITIONING PIN

- 17.B2381088 COVER - CONNECTOR

- 8.04543008Q (x20) TAPPING SCREW: 3X8

U001	U002	U003	U004	U005	U006	U007	U008	U009	U010	U011	U012	U013	U014	U015	U016	U017	U018	U019	U020
------	------	------	------	------	------	------	------	------	------	------	------	------	------	------	------	------	------	------	------

U017 MAIN FRAME

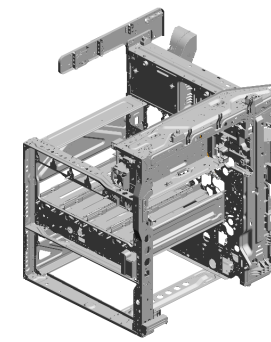

- 39.D1497973 DUCT:EXHAUST:R EAR:C
- 38.D1497972 DUCT:EXHAUST:R EAR:B
- 37.D1497971 DUCT:EXHAUST:R EAR:A
- 29.D1497951 DUCT:SUPPLY:A
- 30.D1497952 DUCT:SUPPLY:B

- 40.D1497981 DUCT:POWER SUPPLY UNIT:EXHAUST

- 32.D1497954 DUCT:SUPPLY:D

- 31.D1497953 DUCT:SUPPLY:C

- 25.D1497931 DUCT:DEVELOPMENT:EXHAUST

- 26.D1497932 DUCT:PCU:EXHAUST

- 23.D1497922 COVER:FAN:DEVELOPMENT:RIGHT LOWER
- 24.D1497923 DUCT:DEVELOPMENT:RIGHT LOWER
- 41.D1497982 DUCT:POWER SUPPLY UNIT
- 42.D1497983 BRACKET:FAN:POWER SUPPLY UNIT
- 43.D1497986 GUIDE:THERMISTOR

- 33.D1497955 DUCT:SUPPLY:FAN:UPPER

- 34.D1497956 DUCT:SUPPLY:FAN:LOWER

- 44.D1501095 (x2) BRACKET:POSITIONING:FUSING UNIT:M3

- 35.D1497957 DUCT:DRIVE:COOLING:A

- 36.D1497958 DUCT:DRIVE:COOLING:B

U001	U002	U003	U004	U005	U006	U007	U008	U009	U010	U011	U012	U013	U014	U015	U016	U017	U018	U019	U020
------	------	------	------	------	------	------	------	------	------	------	------	------	------	------	------	------	------	------	------

U017 MAIN FRAME

47.D2417943 DUCT:EXHAUST:U PPER:C
 45.D2417941 DUCT:EXHAUST:U PPER:A
 46.D2417942 DUCT:EXHAUST:U PPER:B

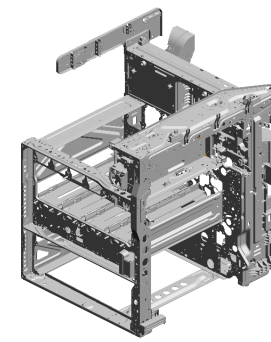

48.D2417944 DUCT:EXHAUST:U PPER:D

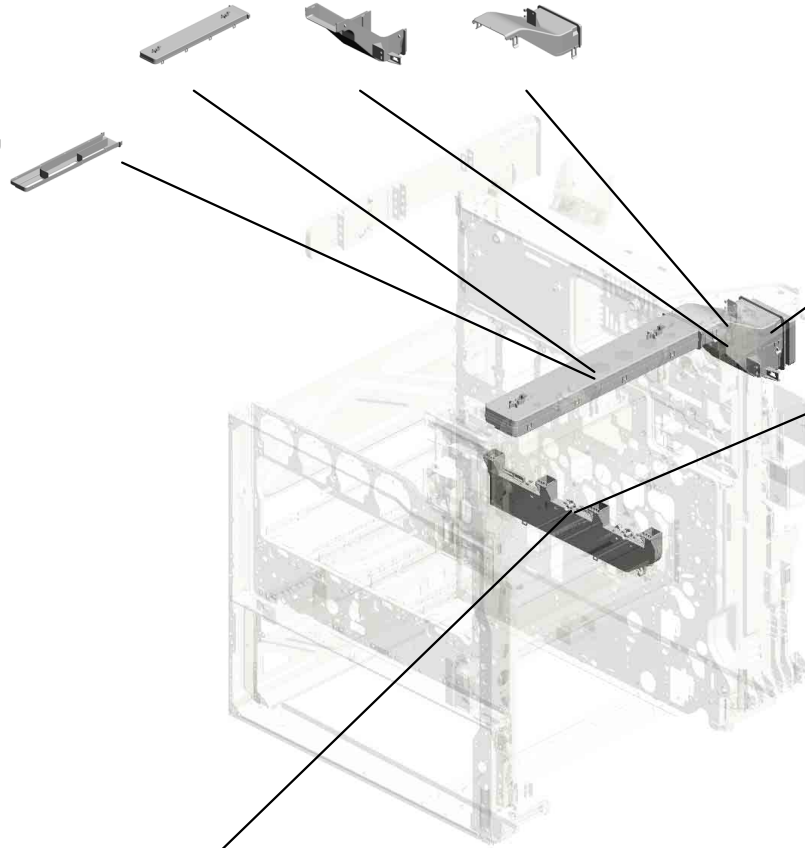

49.D2417945 DEODORIZE FILTER

51.D2417984 DUCT:DEVELOPMENT:REAR:B

50.D2417983 DUCT:DEVELOPMENT:REAR:A

U001	U002	U003	U004	U005	U006	U007	U008	U009	U010	U011	U012	U013	U014	U015	U016	U017	U018	U019	U020
------	------	------	------	------	------	------	------	------	------	------	------	------	------	------	------	-------------	------	------	------

U017_S001
CASE:FILTER:ASS'Y

20.D1477937
FILTER:PREVENTF
ENCE:10

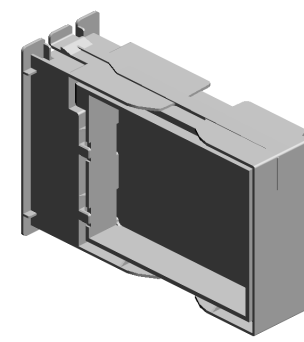

27.D1497935
CASE:FILTER:ASS'
Y

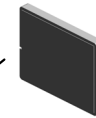
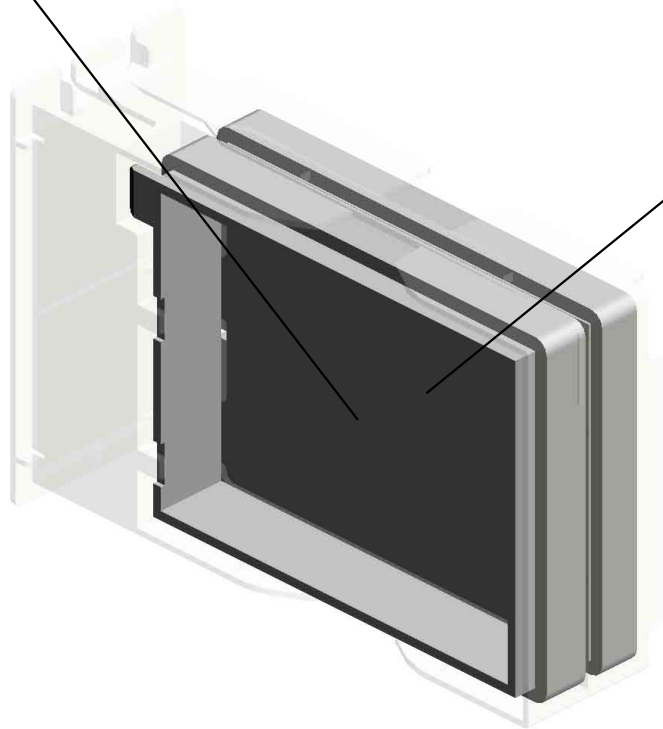
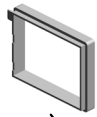

28.D1497938
OZONE FILTER

U001	U002	U003	U004	U005	U006	U007	U008	U009	U010	U011	U012	U013	U014	U015	U016	U017	U018	U019	U020
------	------	------	------	------	------	------	------	------	------	------	------	------	------	------	------	------	------	------	------

U018 Anti-Condensation Heater (Scanner, PCDU)

5-D3BR2201 4-D2380073
(NA):HEATER:PHO (NA):HEATER:SCA
TOCONDUCTOR:A NNER:120V:ASSY
SS'Y

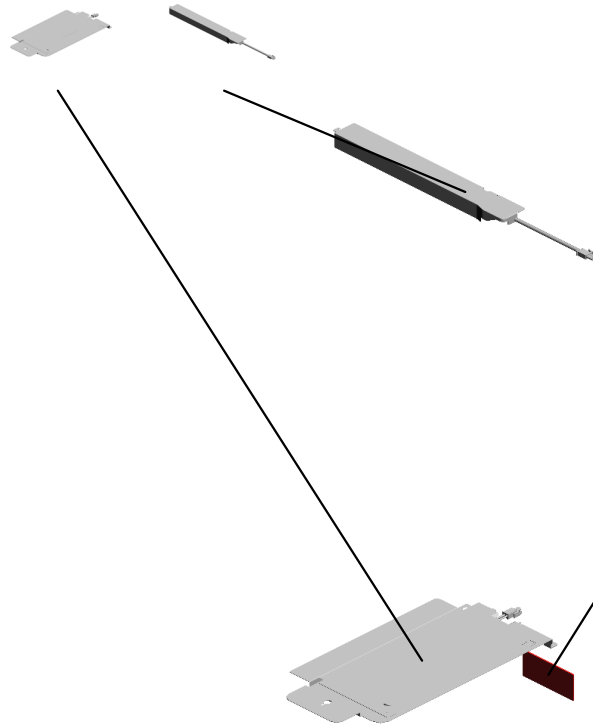

2-D2386650
HEATER:SCANNE
R:PCU:ELECTRICA
L COMPONENTS S
ECTION:ASSY

U001	U002	U003	U004	U005	U006	U007	U008	U009	U010	U011	U012	U013	U014	U015	U016	U017	U018	U019	U020
------	------	------	------	------	------	------	------	------	------	------	------	------	------	------	------	------	------	------	------

U019 Anti-Condensation Heater for Paper Feed Trays

3-D2386630
(NA):HEATER:PAP
ER TRAY:120V:AS
S'Y

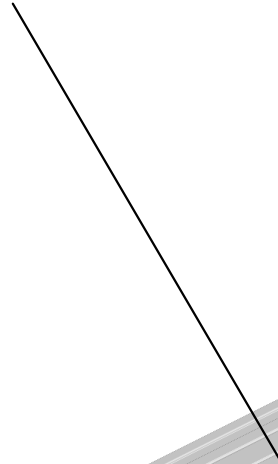

4-D2386661
(NA):HEATER:PAP
ER TRAY:ELECTRI
CAL COMPONENT
S SECTION:ASS'Y

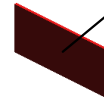

U001	U002	U003	U004	U005	U006	U007	U008	U009	U010	U011	U012	U013	U014	U015	U016	U017	U018	U019	U020
------	------	------	------	------	------	------	------	------	------	------	------	------	------	------	------	------	------	------	------

U020.ACCESSORIES

U020 S001
D2414472
END FENCE:TRAY:EXIT:ASS'
Y

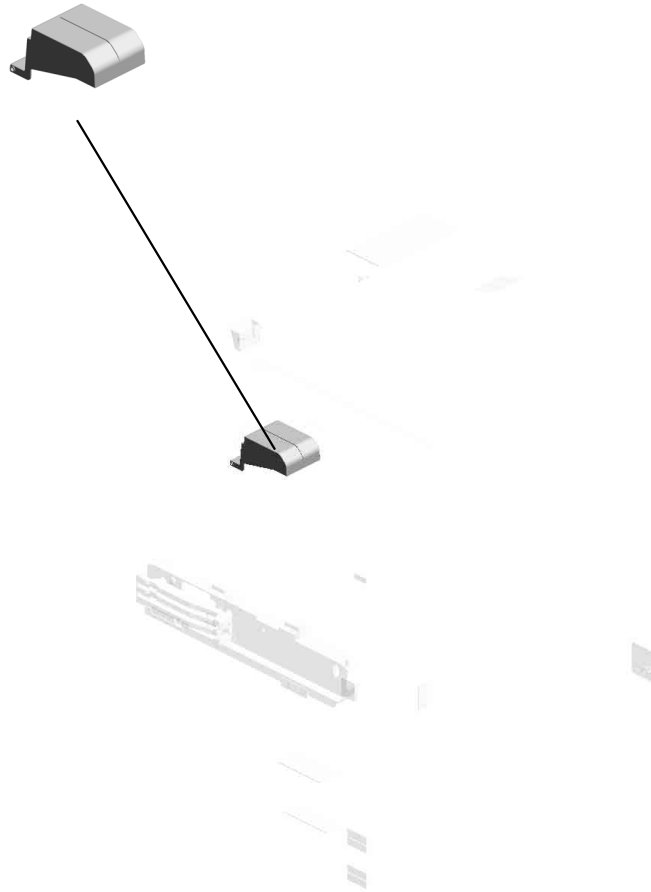

U001	U002	U003	U004	U005	U006	U007	U008	U009	U010	U011	U012	U013	U014	U015	U016	U017	U018	U019	U020
------	------	------	------	------	------	------	------	------	------	------	------	------	------	------	------	------	------	------	------

U020 ACCESSORIES

- 18.D2411788 (x2) CAP:COVER:POSITIONING
- 22.D2581317 HOLDER:GLASS:CLEANER:ASS'Y
- 28.D0BQ6766 DECAL:CAUTION:ORIGINAL:ENGLISH 201811-06 O/O
- 23.D3B06323 DECAL:CAUTION:ORIGINAL:MANY LANGUAGES
- 24.D6836031 DECAL:SET:ORIGINAL TABLE

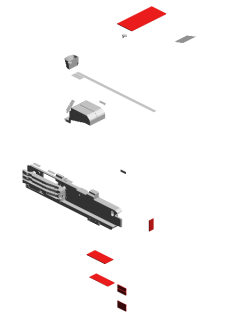

13.D1491553
SHEET:LOGO



4.14078552
INTERFACE HIC:CTPA1216R



21.D2557798
DECAL:BLUETOOTH



12.D1491324
DECAL:TONER BOTTLE:Y



11.D1491323
DECAL:TONER BOTTLE:M



17.D2411299
GUIDE PLATE:SCANNER

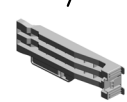

16.D2231381
DECAL:GLASS:CLEANING



5.AA001564
PLATE:LOGO:TYPE:RIC



29.M0AJ6856
DECAL:INKJET:EN:MANUAL FEED 201901-03 O/O



7.D0BH6862
DECAL:SIZE INDICATION:PAPER TRAY

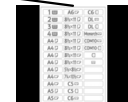

27.D1496851 (NA):DECAL:MAIN SWITCH:ON-STANDBY:ENGLISH

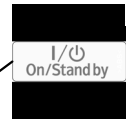

10.D1491322
DECAL:TONER BOTTLE:C

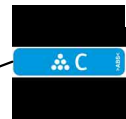

9.D1491321
DECAL:TONER BOTTLE:BK

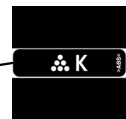

20.D2416335
COVER:INTERMEDIATE TRANSFER



8.D1491264
CAP:ROCKER SWITCH

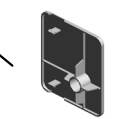

6.B0651374
CLOTH - DF EXPOSURE GLASS

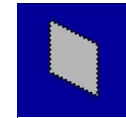

1.04583008N(x 2)
HEXAGON HEAD TAPPING SCREW:3X8

26.11500440(x 1)
(NA):POWER SUPPLY CODE:120V:15A

U020_S001
END FENCE:TRAY:EXIT:ASS'Y

2-08050103
RETAINING RINGS
-E:SILENCER:DIA3

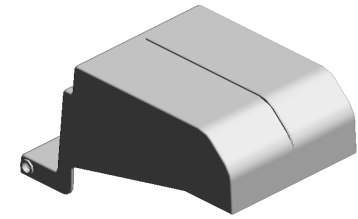

19.D2414472
END FENCE:TRAY:
EXIT:ASS'Y

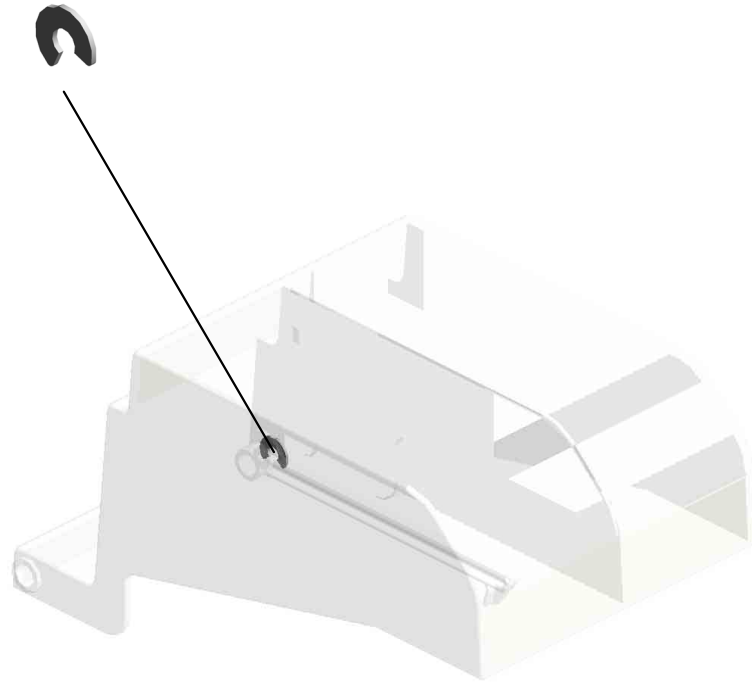

U001	U002	U003	U004	U005	U006	U007	U008	U009	U010	U011	U012	U013	U014	U015	U016	U017	U018	U019	U020
------	------	------	------	------	------	------	------	------	------	------	------	------	------	------	------	------	------	------	------

SPECIAL TOOLS



1.52039502
Silicon Grease G-501

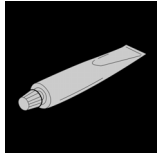

2.A2579300
Grease Barrierta S552R

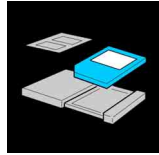

3.B6455020
SD Card (1GB)

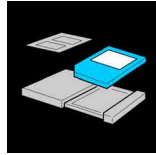

4.B6455060
SD Card (16GB)



5.C4019503
20X Magnification Scope



6.VSSG9002
FLUOTRIBO MG GREASE: 100G

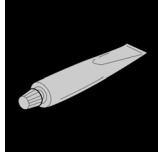

7.VSSG9008
FLOIL-G348 GREASE 20G



8.VSST9003
C-5Y COLOR TEST CHART(2 SHEET
S X 3/SET)

Exclusive Parts

Number	Part Name	Group	ID
52039502	Silicon Grease G-501	SPECIAL TOOLS	1
52062686	SNAP RING	U001	5
		U003_S001	28
		U006_S006	13
		U006_S007	13
52152621	SNAP RING - M6	U003_S001	29
		U010	7
		U014	18
54472681	SNAP RING	U003_S001	30
		U003_S001_S004	30
		U010	8
		U014	19
A2324666	CUSHION - STEPPER MOTOR	U013_S001	12
A2579300	Grease Barrierta S552R	SPECIAL TOOLS	2
A4181158	SPACER - M6.5X1	U003_S001_S004	31
A4221063	SEAL - 0.7X13X20	U003_S001	32
A5482139	PULLEY	U003_S001	33
A6281225	BUSHING - 8MM	U003_S001_S004	34
A8061163	GUIDE PLATE CUSHION	U003_S001_S004	35
		U003_S001_S004_S001	35
A8592112	DRIVE SHAFT - PAPER FEED BELT	U003_S001_S004	36
A8592319	BASE CUSHION	U003_S001_S004	37
A8597211	STEPPED SCREW	U003	38
AA001564	PLATE:LOGOTYPE:RIC	U020	5
AA021031	MAGNETIC CATCH	U001	6
AA043000	SYNCHRONOUS BELT:40S3M192	U015	14
AA043328	TIMING BELT:40S2M130	U003_S001_S004	39
AA043339	TIMING BELT:PAPER EXIT:40S2M122	U003_S001	40
		U013_S001	13
AA043623	TIMING BELT - B40S2M180	U015	15
AA043632	TIMING BELT - 40S2M126	U003_S001	41
AA043681	SYNCHRONOUS BELT:40S2M108	U003_S001	42
AA043682	SYNCHRONOUS BELT:60S1.5M150	U003_S001	43
AA043683	SYNCHRONOUS BELT:60S1.5M204	U003_S001	44

Number	Part Name	Group	ID
AA043684	SYNCHRONOUS BELT:60S1.5M390	U003_S001	45
AA043685	SYNCHRONOUS BELT:40S2M258	U003_S001	46
AA043694	SYNCHRONOUS BELT:B40S2M202	U003_S001	47
AA043698	SYNCHRONOUS BELT:40S1.5M300	U003_S001	48
AA043710	SYNCHRONOUS BELT:40S2M158	U003_S001	49
AA043980	TIMING BELT:30S2M300	U014_S001	20
AA060842	TENSION SPRING	U003_S001	50
AA061127	TENSION SPRING:SAFETY SWITCH:FRONT	U016	30
AA061128	TENSION SPRING:SAFETY SWITCH:RIGHT	U016	31
AA061207	TENSION SPRING:BRACKET:IDLER	U012	19
AA061208	TENSION SPRING:STRIPPER PLATE	U012_S001	20
AA061209	TENSION SPRING:GATE PAWL	U012_S001	21
AA061211	TENSION SPRING:HOLDER:FUSING EXIT	U012_S001	22
AA063435	COMPRESSION SPRING:PAPER FEED:JOINT	U003_S001_S004	51
AA063732	COMPRESSION SPRING:PRESSURE ROLLER	U012_S001	23
AA063942	COMPRESSION SPRING:REGISTRATION:DRIVE	U010	9
AA063943	COMPRESSION SPRING:GUIDE PLATE:REGISTRATION:4N	U010	10
AA080252	BUSHING - M4	U013_S001	14
AA080346	BUSHING:FLANGE TYPE:DIA6	U003_S001	52
		U010	11
		U011_S001	9
		U015	16
AA080347	BUSHING - 8MM	U003_S001	53
AA080387	PLAIN SHAFT BEARING:EXIT ROLLER:FUSING EXIT:RIGHT:FRONT	U012_S001	24
AA080388	PLAIN SHAFT BEARING:EXIT ROLLER:FUSING EXIT:RIGHT:REAR	U012_S001	25

Exclusive Parts

Number	Part Name	Group	ID
AA082101	BUSHING - 6X10X6	U003_S001	54
		U003_S001_S001	54
		U003_S001_S004	54
		U009	11
		U009_S001	11
		U009_S002	11
		U009_S003	11
AA082144	BUSHING - 8X12X7	U003_S001	55
		U010	12
AA082170	PLAIN SHAFT BEARING:DIA4XDIA8X5:EG-1	U013_S001	15
		U014_S001	21
		U014_S001_S003	21
AA082171	PLAIN SHAFT BEARING:6X10X6	U014_S001_S003	22
AA082173	PLAIN SHAFT BEARING:6X10X6	U006	14
		U006_S006	14
		U006_S007	14
		U013_S001	16
		U014_S001	23
		U014_S001_S003	23
AA082174	PLAIN SHAFT BEARING:6X10X9	U006_S006	15
		U006_S007	15
AA082175	PLAIN SHAFT BEARING:8X12X7	U006	16
AA082187	BUSHING:DIA6XDIA10X9:EG-1	U014_S001_S003	24
AA083014	ONE-WAY CLUTCH	U014_S001	25
AA083018	ROLLER CLUTCH - 6X14X10	U014_S001	26
AA100014	RETAINING RING C - SEPARATE	U006_S006	17
		U006_S007	17
		U014_S001_S003	27
AA100016	RETAINING RINGS-C:DIA3	U012_S001	26
AA100018	STEPPED SCREW:FIX:FUSING	U012_S001	27
AA132013	SPACER	U003_S001_S004	56
AA132208	SPACER - M6	U009_S001	12
AA143219	STEPPED SCREW	U012	28
AA143537	SCREW:M3:BLACK	U001	7
		U004	17
AA143579	SCREW - M3	U014_S001_S003	28
AA143592	SCREW- M4X6	U016	32
AA143595	STEPPED SCREW:M3	U001	8

Number	Part Name	Group	ID
AA143788	PIN:GUIDE PLATE:PAPER FEED	U003_S001	57
AA143789	SHAFT:CLEANER	U003_S001	58
AA143807	SCREW:A	U014_S001	29
AA143842	SCREW:DIA6:14.5:M4	U003_S001	59
AA143846	TAPPING SCREW:M3X6	U003_S001	60
AA143848	STEPPED SCREW - M3	U016	33
AA148871	SHAFT:GEAR:IDLER:WORM GEAR	U012	29
AA161167	BUSHING:HDD	U016	34
AB010156	GEAR:SEPARATE:DRIVE	U014_S001_S003	30
AB010157	GEAR:SEPARATE:DRIVEN	U014_S001_S003	31
AB011252	GEAR - 20Z	U014_S001_S003	32
AB011571	GEAR:Z19:DRIVE:REGISTRATION	U010	13
AB011572	GEAR:Z19:DRIVEN:REGISTRATIO N	U006	18
		U006	19
AB011573	GEAR:REGISTRATION:NO.2	U006	19
AB012099	GEAR:ON-OFF:PRESSURE ROLLE R	U012_S001	30
		U012	31
AB012102	GEAR:IDLER:WORM GEAR	U012	31
AB012104	GEAR:IDLER:LIGHT SHIELDING PL ATE	U012	32
		U012_S001	33
AB012107	GEAR:IDLER:EXIT:FUSING EXIT:1	U012_S001	34
AB012108	GEAR:IDLER:EXIT:FUSING EXIT:2	U012_S001	34
AB012109	GEAR:IDLER:EXIT:FUSING EXIT:3	U012_S001	35
AB012110	GEAR:EXIT ROLLER:FUSING EXIT: RIGHT	U012_S001	36
		U012_S001	37
AB012111	GEAR:PRESSURE ROLLER:EXIT	U012_S001	37
AB012116	GEAR:DRIVE:FUSING UNIT	U012_S001	38
AB012119	GEAR:PRESSURE ROLLER	U012_S001	39
AB012120	GEAR:IDLER:PRESSURE ROLLER	U012_S001	40
AE020261	PRESSURE ROLLER:DIA32	U012_S001	41
AE030074	BALL BEARING:DIA17XDIA26X5	U012_S001	42
AF013016	BOTTOM PLATE PAD	U014_S001	33
AF013019	PAD:TRAY BOTTOM PLATE	U006_S001_S001	122
		U006_S002_S001	122
AF030049	PICK-UP ROLLER	U014_S001_S003	34
AF030094	PAPER FEED ROLLER:PICKUP	U006_S006	21
		U006_S007	21
AF031046	FEED ROLLER - MANUAL FEED	U014_S001_S003	35

Exclusive Parts

Number	Part Name	Group	ID
AF031094	PAPER FEED ROLLER:FEED	U006_S006	22
		U006_S007	22
AF032046	SEPARATION ROLLER - MANUAL FEED	U014_S001_S003	36
AF032094	PAPER FEED ROLLER:SEPARATE	U006_S006	23
		U006_S007	23
AF040571	GUIDE ROLLER	U013_S001	17
AG070513	MAGNET CATCH	U001	9
AG070514	MAGNET CATCH	U011	10
AW010147	PHOTO REFLECTION SENSOR	U013_S001	18
AW010150	PHOTO REFLECTION SENSOR:ORIGINAL TRAY	U003_S001	61
AW010151	PHOTO REFLECTION SENSOR:PS122TL1-A	U003_S001	62
AW010155	ORIGINAL SENSOR:66MM:3.3V	U004	18
AW010200	PAPER FEED SENSOR:FUSING EXIT	U010	14
AW020190	PHOTOINTERRUPTOR	U003_S001	63
		U012	43
AW020198	PHOTOINTERRUPTOR:LG2A14NL1	U011	11
AW020234	PHOTOINTERRUPTOR:GP1A173LCS5F	U003_S001	307
		U006_S006	125
		U006_S007	125
		U009	44
		U010	55
		U013_S001	69
		U014_S001	192
U014_S001_S003	192		
AW020249	PHOTOINTERRUPTOR:FLAT:PICH2MM:M4	U004	19
AW100180	NON-CONTACT TYPE THERMISTOR:FUSING	U012_S001	44
AW100181	THERMISTOR:PRESSURE:FRONT	U012_S001	45
AW100182	THERMISTOR:PRESSURE:MIDDLE	U012_S001	46
AW100183	THERMOPILE	U012	47
AW110111	THERMOSTAT:MIDDLE	U012_S001	48
AW110112	THERMOSTAT:REAR	U012_S001	49

Number	Part Name	Group	ID
AW140026	TEMPERATURE & HUMIDITY SENSOR	U009	14
AW500039	ROTARY SWITCH:PAPER SIZE SENSOR:CW	U014_S001	39
AW500044	PUSH SWITCH:PAPER SIZE SENSOR	U006	26
AW500049	PUSH SWITCH:SW1AG-550	U006	123
		U011	36
		U014	189
		U014_S001	189
AX040199	DC MOTOR:RISING TRAY:ASS'Y	U003_S001	65
AX040273	DC MOTOR:RISING TRAY:ASS'Y:1.007W:BRUSH	U006	27
AX060435	DC MOTOR:GEAR:10W:BRUSHLESS	U015_S001	17
AX060464	DC MOTOR:ENCODER:NO:10W:GEAR:BRUSHLESS	U014	41
		U014_S001	41
		U015	18
U015_S002	18		
AX060519	DC POLYGON MIRROR MOTOR	U005_S001	3
AX061001	DC BRUSHLESS MOTOR:40W:NMB	U015	19
AX061101	DC BRUSHLESS MOTOR:25W:NMB	U015	20
AX061201	DC BRUSHLESS MOTOR:25W:NID:DEVELOPMENT:BLACK	U015	21
AX061202	DC BRUSHLESS MOTOR:25W:NID:FUSING UNIT	U015_S002	22
AX640199	FAN:MM80:25MM:DC 2.16W	U017	13
AX640219	DC FAN MOTOR:DC24V:MM60:25MM	U017	14
AX640236	FAN:MM60X15	U016	35
		U017	15
AX660015	DC FAN MOTOR:SIROCCO:DC24V:PWM	U017	16
AZ240315	(NA):DC POWER SUPPLY	U016	98
AZ320197	POWER PACK:TTS:H	U016	37
AZ320233	POWER PACK:CB:H	U016	38

Exclusive Parts

Number	Part Name	Group	ID
B0434645	SPRING - 2N	U003_S001	66
B0651374	CLOTH - DF EXPOSURE GLASS	U020	6
B2231099	FLAT SCREW	U014_S001	42
B2231317	SCREW	U016	39
B2233241	SPRING:SHUTTER:PUMP UNIT	U007	12
B2234552	BUSHING:DIA4	U014_S001	43
B2236069	JOINT:DRIVE:INTERMEDIATE TRANSFER	U009_S001	15
B2236476	BUSHING - DIA5	U011	13
B2342864	PAD:CLEANER	U006_S001_S002	28
		U006_S001_S003	28
		U006_S002_S003	28
		U006_S002_S004	28
B2381088	COVER - CONNECTOR	U017	17
B2381089	COVER - POSITIONING PIN	U017	18
B3863320	SPRING:BELT:PAPER FEED:8N	U003_S001_S004	67
B3871951	SPRING - PAPER SIZE SENSOR	U003_S001	68
B3872113	ROLLER - PAPER FEED BELT	U003_S001_S004	69
B4772227	PICKUP ROLLER:COUPLING	U003_S001_S004	70
B4772622	DISCHARGE BRUSH:L11	U003_S001	71
B4774117	SPRING	U003_S001	72
B4774129	SPRING - 12N	U003_S001	73
B4774131	SPRING	U003_S001	74
B6455020	SD Card (1GB)	SPECIAL TOOLS	3
B6455060	SD Card (16GB)	SPECIAL TOOLS	4
B6521133	SHAFT:SLIDER	U003_S001	75
B6521134	COMPRESSION SPRING	U003_S001	76
B6523174	TENSION SPRING	U003_S001	78
B7003305	TIMING BELT:B40S2M152	U003_S001	79
B7061859	SCREW:SLIDER:LOCK	U003_S001	80
B7892114	PAPER FEED BELT ROLLER	U003_S001_S004	81
B8022532	SPRING PLATE:SIDE FENCE	U003_S001	82
B8022536	SLIDER:SIDE FENCE	U003_S001	83
B8024711	SOUND PROOFING MATERIAL	U003_S001_S009	84
		U003_S001_S010	84
B8024712	SOUND PROOFING MATERIAL:COVER:REAR	U003_S001_S009	85
		U003_S001_S010	85
B8041180	DISCHARGE BRUSH:PUNCH UNIT	U003_S001	86

Number	Part Name	Group	ID
B8301135	SCREW	U003_S001	87
B8303504	TIMING BELT - 40S2M100	U006_S006	29
		U006_S007	29
B8722524	SPACER:DIA9	U003_S001	88
C4019503	20X Magnification Scope	SPECIAL TOOLS	5
D0092573	PULLEY - VERTICAL TRANSPORT	U014_S001	44
D0092574	PULLEY - IDLER	U014_S001	45
D0094407	FEELER - OVERFLOW	U013_S001	20
D0094455	CUSHION - DC SOLENOID	U013	21
		U013_S001	21
		U014_S001	46
D0094485	BUSHING - GATE	U014_S001	47
D0094487	COMPRESSION SPRING - GATE	U014_S001	48
D0292677	TRANSPORT BELT:DRIVEN:VERTICAL TRANSPORT	U014_S001	49
D0392993	SHAFT:TRANSPORT BELT:PULLEY	U014_S001	50
D0394525	COMPRESSION SPRING:SHAFT:GUIDE PLATE:EXIT	U014_S001	51
D0394529	STOPPER:GUIDE PLATE:ROLLER:DRIVEN	U014_S001	52
D0394597	TENSION SPRING:DRIVEN ROLLER	U014_S001	53
D0394925	ROLLER:REVERSE:DRIVEN	U013_S001	22
D0394927	COMPRESSION SPRING:PRESSURE:REVERSE:DRIVEN	U013_S001	23
D0892764	GEAR:FEED	U006_S006	30
		U006_S007	30
D0895824	COVER:SD-CARD:D086/D087	U016	40
D0895887	PANEL:INTERFACE	U016	41
D0A46099	SHEET:PRESSURE PLATE:SMALL	U003_S001_S012	89
D0AC1415	OPERATION SUB-UNIT:ASS'Y	U002_S001	6
D0AC1640	OPTICAL READING UNIT:CARRIAGE:SCANNER	U004_S001	20
D0AD1244	COVER:FRONT:RIGHT UPPER:MAIN	U001	10
D0AF1290	COVER:SCANNER:UPPER:REAR	U001	11
D0BH1233	COVER:UPPER:INNER BACK:IDG	U001	12
D0BH1234	COVER:UPPER:INNER BACK:MIDDLE	U001	13

Exclusive Parts

Number	Part Name	Group	ID
	LE:IDG		
D0BH1235	COVER:UPPER:INNER BACK:BIN:IDG	U001	14
D0BH1237	COVER:UPPER:INNER BACK:LEFT LOWER:IDG	U001	15
D0BH1241	COVER:FRONT:A4	U001	16
D0BH1242	PLATE:COVER:FRONT	U001	17
D0BH1281	COVER:SCANNER:FRONT:IDG	U001	18
D0BH1284	COVER:SCANNER:LEFT:IDG	U001	19
D0BH1287	COVER:SCANNER:RIGHT:IDG	U001	20
D0BH1739	(NA):SCALE:REAR:PRINTING:INCH	U004	60
D0BH1816	EXPOSURE GLASS:MASK	U004	23
D0BH2800	PAPER TRAY:NO.1:ASS'Y	U006_S001	31
D0BH2805	PAPER TRAY:NO.2:ASS'Y	U006_S002	32
D0BH2848	DECAL:SIZE INDICATION:END FENCE:NO.2:FRONT	U006_S002	33
D0BH2849	DECAL:SIZE INDICATION:END FENCE:NO.2:REAR	U006_S002	34
D0BH2854	BRACKET:GRIP:PAPER TRAY	U006_S001	35
		U006_S002	35
D0BH2855	HOLDER:GRIP:PAPER TRAY	U006_S001	36
		U006_S002	36
D0BH2856	GRIP:PAPER TRAY	U006_S001	37
		U006_S002	37
D0BH2865	COVER:PAPER TRAY:NO.1	U006_S001	38
D0BH2866	COVER:PAPER TRAY:NO.2	U006_S002	39
D0BH2869	DECAL:SIZE INDICATION:SIDE FENCE:NO.2	U006_S002	40
D0BH2872	INNER COVER:PAPER TRAY	U006_S002	41
D0BH4517	DUPLEX UNIT:ASS'Y	U014_S001	54
D0BH5114	BCU:TYPE-H3:ASS'Y	U016	42
D0BH5676	PCB:SERVICE	U016	43
D0BH6862	DECAL:SIZE INDICATION:PAPER TRAY	U020	7
D0BH7911	DUCT:DEVELOPMENT:FRONT	U001	21
D0BQ1230	COVER:UPPER	U001	22
D0BQ1232	COVER:UPPER:EXIT:IDG	U001	23
D0BQ1255	COVER:LEFT:INTERFACE	U001	24

Number	Part Name	Group	ID
D0BQ1288	COVER:SCANNER:UPPER:RIGHT	U001	25
D0BQ1309	MAGNET CATCH:COVER:FRONT	U001	70
D0BQ1678	SHEET:FFC:LOWER	U004	32
D0BQ1713	SYNCHRONOUS BELT:890ST55-4.0	U004	24
D0BQ2071	CHARGE UNIT:ASS'Y	U008_S001_S001	29
		U008_S002_S001	29
		U008_S003_S001	29
		U008_S004_S001	29
D0BQ2379	DUCT:GEAR:DEVELOPMENT:SUB-ASS'Y	U008_S001_S002	21
		U008_S002_S002	21
		U008_S003_S002	21
		U008_S004_S002	21
D0BQ2600	MANUAL FEED UNIT:ASS'Y	U014_S001_S003	193
D0BQ2608	SHAFT:SEPARATOR:DRIVEN:ASS'Y	U014_S001_S003	194
D0BQ2619	SHAFT:SEPARATOR:DRIVE:ASS'Y	U014_S001_S003	195
D0BQ2637	PAPER STOPPER:MANUAL FEED	U014_S001_S003	196
D0BQ2653	COIL SPRING:PRESSURE:SEPARATOR	U014_S001_S003	197
D0BQ2711	PAPER FEED UNIT:NO.1:ASS'Y	U006_S006	126
D0BQ2712	PAPER FEED UNIT:NO.2:ASS'Y	U006_S007	127
D0BQ2840	END FENCE:PAPER TRAY:ASS'Y	U006_S001_S004	128
		U006_S002_S002	128
D0BQ2873	TRAY BOTTOM PLATE:NO.2:ASS'Y	U006_S002_S001	124
D0BQ3219	DRIVE UNIT:TONER BOTTLE:ASS'Y	U007_S001	14
		U007_S002	14
		U007_S003	14
		U007_S004	14
D0BQ3240	TONER HOPPER:TONER SUPPLY: BK:ASS'Y	U007_S009	33
D0BQ3270	TONER HOPPER:TONER SUPPLY: C:ASS'Y	U007_S010	34
D0BQ3280	TONER HOPPER:TONER SUPPLY: M:ASS'Y	U007_S011	35
D0BQ3310	TONER HOPPER:TONER SUPPLY: Y:ASS'Y	U007_S012	36
D0BQ4102	DRIVEN ROLLER:FUSING EXIT:AS	U012_S001	60

Exclusive Parts

Number	Part Name	Group	ID
	S'Y		
D0BQ4214	EXIT ROLLER:FUSING EXIT:RIGHT	U012_S001	71
D0BQ4631	SIDE PLATE:REAR:DUPLEX:PEEN	U014_S001	198
D0BQ4644	GEAR:MECHANICAL ROLLER CLU TCH	U014_S001	199
D0BQ4654	SHAFT:LEVER:LOCK	U014_S001	200
D0BQ5172	PCB:TCB	U007	13
D0BQ6060	TRANSFER ROLLER:FC:ASS'Y	U009_S001	45
D0BQ6141	CLEANING UNIT:BELT CLEANING: ASS'Y	U009_S003	42
D0BQ6766	DECAL:CAUTION:ORIGINAL:ENGLI SH	U020	28
D1124264	DECAL:WARNING (HIGH TEMPER ATURE):FUSING	U012_S001	50
D1175303	THERMISTOR	U017	19
D1175916	STEPPED SCREW:M3X8:SECOND KIND	U009	16
D1185170	PCB:DIODE	U010	16
D1292783	TORQUE LIMITER MECHANICAL C LUTCH:40MM:DIA18	U006_S006 U006_S007 U014_S001_S003	42 42 55
D1421805	SHAFT:SCALE	U016	44
D1441085	STEPPED SCREW:M3	U001 U009_S001	26 17
D1444183	SCREW:M3	U004	25
D1444484	SHOULDER SCREW - M3	U013_S001	24
D1444489	STOPPER:DRIVEN ROLLER	U014_S001	56
D1465786	BRACKET:HDD	U016	45
D1471805	EXPOSURE GLASS:DOCUMENT F EEDER:APPLY	U004	26
D1472734	GUIDE PLATE:SEPARATE	U006_S006 U006_S007	43 43
D1472737	LEVER:PRESSURE:SEPARATE	U006_S006 U006_S007	44 44
D1472738	LINK:RELEASE	U006_S006 U006_S007	45 45
D1472752	SHAFT:SEPARATE:ASS'Y	U006_S006 U006_S007	46 46

Number	Part Name	Group	ID
D1473281	HOUSING:TONER CARTRIDGE:BK: ASS'Y	U007_S005	15
D1473282	HOUSING:TONER CARTRIDGE:CM Y:ASS'Y	U007_S006 U007_S007 U007_S008	16 16 16
D1473287	TRANSPORT SCREW:NOZZLE:BK: ASS'Y	U007_S013	17
D1473288	TRANSPORT SCREW:NOZZLE:CM Y:ASS'Y	U007_S014 U007_S015 U007_S016	18 18 18
D1473325	TORSION SPRING:STOPPER:TON ER CARTRIDGE:4.8N	U007_S005 U007_S006 U007_S007 U007_S008	19 19 19 19
D1477937	FILTER:PREVENTFENCE:10	U017_S001	20
D1482702	SPACER:TRANSPORT ROLLER	U006_S006 U006_S007	47 47
D1482751	ARM:PRESSURE:SEPARATE	U006_S006 U006_S007	48 48
D1482755	COIL SPRING:RELEASE:SEPARAT E	U006_S006 U006_S007	49 49
D1484690	TORSION SPRING:LINK	U014_S001	57
D1491099	COVER:GRIP:LEFT	U017	21
D1491168	BRACKET:DRIVE:COLLECTION BO TTLE:ASS'Y	U011	14
D1491173	GEAR:IDLER:TONER BOTTLE	U011	15
D1491174	GEAR:COLLECTION BOTTLE	U011	16
D1491194	PULLEY:PAPER FEED:FEED:NO.1: MECHANICAL ROLLER CLUTCH	U015	23
D1491195	GEAR:IDLER:PAPER FEED:FEED	U015	24
D1491196	GEAR:PAPER FEED:FEED:NO.2:M ECHANICAL ROLLER CLUTCH	U015	25
D1491197	GEAR:IDLER:PAPER FEED:GRIP:N O.1	U015	26
D1491199	DRIVE UNIT:ON-OFF:TRANSFER	U015	27
D1491243	COVER:FRONT:UPPER:OPERATIO N SUB-UNIT	U001	27
D1491248	HINGE:COVER:FRONT:USED TON	U001	28

Exclusive Parts

Number	Part Name	Group	ID
	ER		
D1491252	COVER:LEFT:UPPER:REAR	U001	29
D1491257	CAP:34X55	U001	30
D1491264	CAP:ROCKER SWITCH	U020	8
D1491274	INNER COVER:FRONT:USED TONER	U001	31
D1491278	TORSION SPRING:COVER:USED TONER	U001	32
D1491291	CAP:HARNESS	U001	33
D1491305	CAP:TOTAL COUNTER	U001	34
D1491307	SPRING PLATE:BAND	U001	35
D1491321	DECAL:TONER BOTTLE:BK	U020	9
D1491322	DECAL:TONER BOTTLE:C	U020	10
D1491323	DECAL:TONER BOTTLE:M	U020	11
D1491324	DECAL:TONER BOTTLE:Y	U020	12
D1491338	GUIDE PLATE:PAPER FEED TABLE:FRONT	U017	22
D1491351	DRIVE UNIT:REGISTRATION:ASS'Y	U015_S001	28
D1491352	BRACKET:DRIVE UNIT:REGISTRATION:ASS'Y	U015_S001	29
D1491355	GEAR:REGISTRATION:NO.1	U015_S001	30
D1491387	GROUND PLATE:DRIVE UNIT:ENGINE	U015	31
D1491392	FLANGE:PAPER FEED:FEED	U015	32
D1491394	GROUND PLATE:DRIVE UNIT:FUSING/PAPER EXIT UNIT	U015	33
D1491397	TORQUE LIMITER MECHANICAL CLUTCH:49MM:DIA14	U015_S002	34
D1491553	SHEET:LOGO	U020	13
D1491706	SYNCHRONOUS BELT:138ST1.5-4.0	U004	27
D1491798	SEAL:SHEET THROUGH:DOCUMENT FEEDER	U004	28
D1491804	HOLDER:EXPOSURE GLASS:SCANNER	U004	29
D1491833	SHEET:GLASS	U004	30
D1492557	GUIDE:REGISTRATION:ENTRANCE:REAR	U014_S001	58

Number	Part Name	Group	ID
D1492558	GUIDE:REGISTRATION:ENTRANCE:FRONT	U014_S001	59
D1492562	COLLAR:REGISTRATION ROLLER	U006	50
D1492566	CASE:REMOVE PAPER DUST:ASS'Y	U006	51
D1492582	GUIDE PLATE:REGISTRATION:FRONT RIGHT	U010	17
D1492584	COLLAR:SHAFT:REGISTRATION ROLLER	U010	18
D1492585	GUIDE:REGISTRATION:REAR RIGHT	U010	19
D1492586	GUIDE:REGISTRATION:FRONT RIGHT	U010	20
D1492612	ROLLER:GRIP:DRIVEN	U014_S001_S003	60
D1492613	SHAFT:GRIP:DRIVEN	U014_S001_S003	61
D1492614	TENSION SPRING:GRIP:PRESSURE	U014_S001_S003	62
D1492633	SHAFT:FEED:MANUAL FEED	U014_S001_S003	64
D1492635	TRANSPORT ROLLER:MANUAL FEED	U014_S001_S003	65
D1492638	LINK:PAPER STOPPER:MANUAL FEED	U014_S001_S003	66
D1492639	SHAFT:PAPER STOPPER	U014_S001_S003	67
D1492642	SHAFT:LINK:PAPER STOPPER	U014_S001_S003	68
D1492655	FEELER:PAPER END SENSOR	U014_S001_S003	69
D1492656	TORSION SPRING:PAPER END SENSOR	U014_S001_S003	70
D1492658	COVER:PAPER FEED ROLLER	U014_S001_S003	71
D1492686	WIRE:MANUAL FEED TABLE:TC075	U014_S001	72
D1492688	TENSION SPRING:WIRE	U014_S001	73
D1492692	ARM:MANUAL FEED:FRONT UPPER	U014_S001	74
D1492693	STOPPER:MANUAL FEED TABLE	U014_S001	75
D1492694	COMPRESSION SPRING:STOPPER:MANUAL FEED TABLE	U014_S001	76
D1492712	SHEET:GUIDE PLATE:SWIVEL	U006_S005	52
D1492713	GUIDE PLATE:SWIVEL:NO.1	U006_S005	53

Exclusive Parts

Number	Part Name	Group	ID
D1492721	GUIDE PLATE:SWIVEL:NO.2	U006	54
D1492739	LEVER:PRESSURE RELEASE	U006_S006	55
		U006_S007	55
D1492772	ARM:PICKUP	U006_S006	56
		U006_S007	56
D1492773	PULLEY:PICKUP:MECHANICAL ROLLER CLUTCH	U006_S006	57
		U006_S007	57
D1492774	PULLEY:IDLER:PICKUP	U006_S006	58
		U006_S007	58
D1492775	SHAFT:FEED:ASS'Y	U006_S006	59
		U006_S007	59
D1492777	COIL SPRING:PRESSURE:PICKUP	U006_S006	60
		U006_S007	60
D1492780	GROUND WIRE:SENSOR:PAPER FEED	U006_S006	61
		U006_S007	61
D1492781	GROUND PLATE:PAPER FEED UNIT	U006_S006	62
		U006_S007	62
D1492787	BRACKET:SUPPORT:COVER	U006	63
D1492788	INNER COVER:HARNESS:PAPER FEED UNIT	U006	64
D1492812	ROLLER:PAPER TRAY:DIA19	U006_S001	65
		U006_S002	65
D1492813	PIN:STRETCH:TRAY	U006_S001	66
		U006_S002	66
D1492814	COIL SPRING:EARTH	U006_S001	67
		U006_S002	67
D1492816	SHAFT:RISE:ASS'Y	U006_S001	68
		U006_S002	68
D1492818	LEVER:RISE	U006_S001	69
		U006_S002	69
D1492824	LEVER:STOPPER:FRONT	U006_S001_S002	70
		U006_S002_S003	70
D1492826	COMPRESSION SPRING:SIDE FENCE:PLATE:FRONT	U006_S001_S002	71
		U006_S002_S003	71
D1492827	COMPRESSION SPRING:SIDE FENCE:POSITIONING	U006_S001_S002	72
		U006_S002_S003	72
D1492828	SIDE FENCE:FRONT:NO.1:ASS'Y	U006_S001_S002	73
D1492834	GUIDE:FEELER:PAPER END	U006_S001_S003	74

Number	Part Name	Group	ID
D1492835	RACK:SIDE FENCE	U006_S001	75
		U006_S002	75
D1492836	GEAR:Z20	U006_S001	76
		U006_S002	76
D1492838	SIDE FENCE:REAR:NO.1:ASS'Y	U006_S001_S003	77
D1492842	LEVER:END FENCE	U006_S001_S004	79
		U006_S002_S002	79
D1492843	CLICK:END FENCE	U006_S001_S004	80
		U006_S002_S002	80
D1492845	COMPRESSION SPRING:END FENCE:LEVER:5N	U006_S001_S004	81
D1492846	DECAL:SIZE INDICATION:END FENCE:NO.1:FRONT	U006_S001	82
D1492847	DECAL:SIZE INDICATION:END FENCE:NO.1:REAR	U006_S001	83
D1492850	TRAY BOTTOM PLATE:ASS'Y	U006_S001_S001	84
D1492863	DECAL:PAPER SET DIRECTION:TRAY:NO.1	U006_S001	85
D1492864	DECAL:PAPER SET DIRECTION:TRAY:NO.2	U006_S002	86
D1492872	LINK:END FENCE:PAPER SIZE SENSOR	U006_S002	87
D1492886	COVER:TRAY:REAR RIGHT:NO.1	U006	89
D1492887	COVER:TRAY:REAR LEFT:NO.1	U006	90
D1492888	COVER:TRAY:REAR RIGHT:NO.2	U006	91
D1492889	COVER:TRAY:REAR LEFT:NO.2	U006	92
D1492903	SUPPORTER:RIGHT:NO.2:ASS'Y	U006_S004	93
D1492905	SUPPORTER:RIGHT:NO.1:ASS'Y	U006_S003	94
D1492918	SUPPORTER:LEFT UPPER:NO.1	U006	95
D1492923	ROLLER:SUPPORTER:PAPER TRAY	U006_S004	96
D1492924	STOPPER:PAPER TRAY	U006_S003	97
		U006_S004	97
D1492925	SUPPORTER:LEFT:NO.2	U006	98
D1492928	ROLLER:SUPPORTER:PAPER TRAY:LEFT	U006	99
D1492930	SUPPORTER:LEFT LOWER:NO.1:PEEN	U006	100

Exclusive Parts

Number	Part Name	Group	ID
D1492952	DECAL:SIDE FENCE:PAPER VOLU ME	U006_S001_S003	101
		U006_S002_S004	101
D1492954	DECAL:SIDE FENCE:PAPER VOLU ME:ENVELOPE	U006_S002_S004	102
D1492956	ROLLER:SUPPORTER:PAPER TRA Y	U006_S003	103
D1492958	ROLLER:SUPPORTER:PAPER TRA Y:LEFT	U006	104
D1492990	PLAIN SHAFT BEARING:DRIVE:RE GISTRATION ROLLER	U010	21
D1493210	DC MOTOR:TONER BOTTLE:ASS'Y :5.28W:BRUSH	U007_S001	20
		U007_S002	20
		U007_S003	20
		U007_S004	20
D1493256	BASE:TONER HOPPER:REAR:ASS' Y	U007_S017	22
D1493321	DUCT:VERTICAL TRANSPORT:TO NER SUPPLY	U007	26
D1493322	SHUTTER:DUCT:TONER SUPPLY	U007	27
D1493330	SEAL:CONNECTION:CARTRIDGE: TONER SUPPLY	U007	28
D1493331	COVER:GEAR:TONER SUPPLY SU B-UNIT	U007	29
D1493350	DC STEPPER MOTOR:TONER SUP PLY	U007_S009	30
		U007_S010	30
		U007_S012	30
D1494202	ENCODER:ON-OFF:PRESSURE R OLLER	U012_S001	51
D1494205	BRAKE:CAM	U012_S001	52
D1494207	PLATE:CAM	U012_S001	53
D1494208	CAM:ON-OFF:PRESSURE ROLLER	U012_S001	54
D1494209	SHAFT:ON-OFF:PRESSURE ROLL ER	U012_S001	55
D1494235	STEPPED SCREW:M3	U012_S001	56
D1494335	ELECTRODE PLATE:CONNECTING :THERMOSTAT	U012_S001	57
D1494421	GEAR:EXIT ROLLER	U013_S001	25
D1494422	GEAR:REVERSE ROLLER	U013_S001	26

Number	Part Name	Group	ID
D1494425	DC STEPPER MOTOR:REVERSE:S UB-ASS'Y	U013_S001	27
D1494427	STUD:PULLEY:BRACKET:DC STEP PER MOTOR	U013_S001	28
D1494428	GROUND PLATE:PAPER EXIT UNI T	U013_S001	29
D1494429	PULLEY:GEAR:REVERSE	U013_S001	30
D1494434	TENSION SPRING:LEVER:GATE P AWL	U013_S001	31
D1494463	GROUND WIRE:SENSOR:REVERS E	U013_S001	32
D1494468	SHAFT:DRIVEN:REVERSE ROLLE R	U013_S001	33
D1494469	SPRING PLATE:ROLLER:DRIVEN: REVERSE ROLLER	U013_S001	34
D1494471	SHAFT:DRIVEN:REVERSE ROLLE R:OUTER	U013_S001	35
D1494484	TORSION SPRING:LEVER:GATE P AWL	U013_S001	36
D1494492	TRAY:REVERSE	U001	36
D1494623	GROUND WIRE:BRACKET:ENTRA NCE:DUPLEX	U014	77
D1494638	GUIDE:WIRE	U014_S001	78
D1494645	SYNCHRONOUS BELT:30S2M118	U014_S001	79
D1494646	SYNCHRONOUS BELT:30S2M262	U014_S001	80
D1494647	SYNCHRONOUS BELT:30S2M212	U014_S001	81
D1494653	TENSION SPRING:SWIVEL	U014_S001	82
D1494656	HOOK:STOPPER:DUPLEX UNIT:FR ONT	U014_S001	84
D1494657	HOOK:STOPPER:DUPLEX UNIT:RE AR	U014_S001	85
D1494658	COIL SPRING:LEVER:DUPLEX	U014_S001	86
D1494662	DIFFUSION PLATE:LED	U010	22
D1494672	COMPRESSION SPRING:DRIVEN	U014_S001	87
D1494675	COVER:PUSH SWITCH	U014_S001	88
D1494688	LINK:DUPLEX:MAIN	U014_S001	89
D1494695	LINK:FRONT	U014_S001	90
D1494711	DECAL:SIDE FENCE:MANUAL FEE	U014_S001_S002	91

Exclusive Parts

Number	Part Name	Group	ID
	D		
D1494715	DECAL:GRIP:Z	U014_S001	92
D1494717	PLATE:SIDE FENCE:FRONT	U014_S001_S001	93
D1494718	TORSION SPRING:SIDE FENCE:FRONT	U014_S001_S001	94
D1494720	PLATE:SIDE FENCE:REAR	U014_S001_S002	95
D1494721	TORSION SPRING:SIDE FENCE:REAR	U014_S001_S002	96
D1494731	COMPRESSION SPRING:RACK:MANUAL FEED	U014_S001	97
D1494755	BRACKET:HINGE:DUPLEX:FRONT	U014	98
D1494777	COMPRESSION SPRING:FLAT CONVEYER BELT:DRIVEN	U014_S001	100
D1494850	ARM:PUSH SWITCH	U014_S001	101
D1494883	ARM:MANUAL FEED:FRONT LOWER	U014_S001	102
D1494884	ARM:MANUAL FEED:REAR LOWER	U014_S001	103
D1495703	BRACKET:MICRO SWITCH	U016	46
D1495711	BRACKET:ARM:SAFETY SWITCH:FRONT	U016	47
D1495713	ARM:SAFETY SWITCH:FRONT	U016	48
D1495714	SHAFT:ARM:SAFETY SWITCH	U016	49
D1495717	BASE:SAFETY SWITCH	U016	50
D1495718	TORSION SPRING:SAFETY SWITCH	U016	51
D1495726	LEVER:SAFETY SWITCH:RIGHT	U016	52
D1495776	COVER:USB:SMALL	U016	53
D1495810	BRACKET:RACK:UPPER	U016	54
D1495818	SPACER:FFC	U016	55
D1495824	COVER:CONNECTOR:HEATER:0.4MM	U016	56
D1495883	KEYTOP:MAIN SWITCH	U001	37
D1495884	COMPRESSION SPRING:KEYTOP	U001	38
D1496030	CAM:ON-OFF:COLLAR	U009_S001	18
D1496036	CAM:ON-OFF:BK	U009_S001	19
D1496037	STOPPER:RIGHT:INTERMEDIATE TRANSFER	U009_S001	20

Number	Part Name	Group	ID
D1496038	LEVER:ON-OFF:BK	U009_S001	21
D1496112	ROLLER:FLAT BELT-TRANSFER:FRONT:ASS'Y	U009_S001	22
D1496133	VIBRATING PLATE:FRONT:PEEN	U009_S001	46
D1496136	VIBRATING PLATE:REAR:PEEN	U009_S001	47
D1496172	BRACKET:BELT CLEANING:FRONT	U009	23
D1496173	BRACKET:BELT CLEANING:REAR	U009	24
D1496177	HOLDER:DISCHARGE USED TONER:ASS'Y	U009_S002	25
D1496179	GEAR:IDLER:DISCHARGE USED TONER	U009_S002	26
D1496192	LEVER:DISCHARGE USED TONER	U009_S002	27
D1496194	SHAFT:LEVER:DISCHARGE USED TONER	U009_S002	28
D1496195	CAM:DISCHARGE USED TONER	U009_S002	29
D1496226	LEVER:TRANSFER/SEPARATION UNIT:FRONT	U010	23
D1496227	LEVER:SET:FRONT	U010	24
D1496228	TORSION SPRING:LEVER:SET:FRONT	U010	25
D1496229	TENSION SPRING:LEVER:SET	U010	26
D1496231	LEVER:TRANSFER/SEPARATION UNIT:REAR	U010	27
D1496232	LEVER:SET:REAR	U010	28
D1496233	TORSION SPRING:LEVER:SET:REAR	U010	29
D1496242	COMPRESSION SPRING:PRESSURE:TRANSFER ROLLER	U010	30
D1496243	RECEIVE PLATE:COMPRESSION SPRING:TRANSFER ROLLER	U010	31
D1496245	GROUND PLATE:TRANSFER/SEPARATION UNIT	U010	32
D1496248	CAP:LED	U010	33
D1496254	DECAL:GRIP:B:LOWER	U010	34
D1496257	GROUND PLATE:REGISTRATION ROLLER	U010	35
D1496290	GUIDE:SET:TRANSFER/SEPARATION	U010	36

Exclusive Parts

Number	Part Name	Group	ID
	ON UNIT:FRONT		
D1496291	GUIDE:SET:TRANSFER/SEPARATI ON UNIT:REAR	U010	37
D1496295	COVER:HARNESS:TRANSFER/SE PARATION UNIT	U010	38
D1496309	SHAFT:ON-OFF:COLLAR:MAIN	U009	30
D1496310	BRACKET:ON-OFF:COLLAR	U009	31
D1496311	GEAR:ON-OFF:COLLAR:OUTPUT	U009	32
D1496312	JOINT:ON-OFF:COLLAR	U009	33
D1496318	DC STEPPER MOTOR:ON-OFF	U007_S011	31
D1496320	TERMINAL:BIAS:INTERMEDIATE T RANSFER:MAIN	U009	34
D1496321	HOLDER:TERMINAL:INTERMEDIAT E TRANSFER:MAIN	U009	35
D1496336	TRANSFER ROLLER:ASS'Y	U009_S001	36
D1496370	TONER OUTLET UNIT:BELT CLEA NING:ASS'Y	U009_S002	37
D1496552	GEAR:IDLER:Z30	U011	17
D1496553	GEAR:IDLER:Z61	U011	18
D1496554	GEAR:PULLEY:IDLER:Z16	U011	19
D1496555	GEAR:IDLER:Z21	U011	20
D1496556	TENSION SPRING:BELT TENSION ER	U011	21
D1496557	SYNCHRONOUS BELT:40S3M564	U011	22
D1496561	PULLEY:USED TONER	U011	23
D1496562	BRACKET:TIGHTENER:USED TON ER	U011	24
D1496571	BRACKET:PULLEY:IDLER:USED T ONER	U011	25
D1496574	GEAR:PULLEY:IDLER:Z18	U011	26
D1496575	FLANGE:IDLER:USED TONER	U011	27
D1496581	SHAFT:DRIVE:USED TONER:RIGH T	U011	28
D1496582	GEAR:USED TONER:RIGHT	U011	29
D1496583	GEAR:USED TONER:INPUT	U011	30
D1496586	SHAFT:DRIVE:USED TONER:LEFT	U011	31
D1496587	GEAR:USED TONER:LEFT	U011	32
D1496592	RAIL:COLLECTION BOTTLE	U011	33

Number	Part Name	Group	ID
D1496851	(NA):DECAL:MAIN SWITCH:ON-ST ANDBY:ENGLISH	U020	27
D1496859	DECAL:CLEANING:SHIELD GLASS	U001	39
D1496893	DECAL:PCU:BLACK	U001	40
D1496894	DECAL:PCU:CYAN	U001	41
D1496895	DECAL:PCU:MAGENTA	U001	42
D1496896	DECAL:PCU:YELLOW	U001	43
D1497922	COVER:FAN:DEVELOPMENT:RIGH T LOWER	U017	23
D1497923	DUCT:DEVELOPMENT:RIGHT LOW ER	U017	24
D1497931	DUCT:DEVELOPMENT:EXHAUST	U017	25
D1497932	DUCT:PCU:EXHAUST	U017	26
D1497935	CASE:FILTER:ASS'Y	U017_S001	27
D1497938	OZONE FILTER	U017_S001	28
D1497951	DUCT:SUPPLY:A	U017	29
D1497952	DUCT:SUPPLY:B	U017	30
D1497953	DUCT:SUPPLY:C	U017	31
D1497954	DUCT:SUPPLY:D	U017	32
D1497955	DUCT:SUPPLY:FAN:UPPER	U017	33
D1497956	DUCT:SUPPLY:FAN:LOWER	U017	34
D1497957	DUCT:DRIVE:COOLING:A	U017	35
D1497958	DUCT:DRIVE:COOLING:B	U017	36
D1497971	DUCT:EXHAUST:REAR:A	U017	37
D1497972	DUCT:EXHAUST:REAR:B	U017	38
D1497973	DUCT:EXHAUST:REAR:C	U017	39
D1497981	DUCT:POWER SUPPLY UNIT:EXH AUST	U017	40
D1497982	DUCT:POWER SUPPLY UNIT	U017	41
D1497983	BRACKET:FAN:POWER SUPPLY U NIT	U017	42
D1497984	DUCT:REAR:POWER SUPPLY UNI T	U001	44
D1497986	GUIDE:THERMISTOR	U017	43
D1501095	BRACKET:POSITIONING:FUSING UNIT:M3	U017	44
D1501250	COVER:LEFT	U001	45
D1501282	COVER:SCANNER:UPPER:FRONT	U001	46

Exclusive Parts

Number	Part Name	Group	ID
D1502666	GEAR:SIDE FENCE:MANUAL FEED TABLE	U014_S001	104
D1751377	GEAR:PRESSURE RELEASE:NO.3	U015_S002	35
D1754737	PLAIN SHAFT BEARING:DUPLEX:EXIT	U014_S001	106
D1771302	CLEANER:SHIELD GLASS:ASS'Y	U001	47
D2021143	JOINT:DRIVE	U015	36
D2021152	BRACKET:DRIVE UNIT:PAPER FEED:ASS'Y	U015	37
D2021191	GEAR:GRIP:NO.1	U015	38
D2021193	STUD:PAPER FEED:GRIP:ASS'Y	U015	39
D2021195	PULLEY:GRIP:NO.2	U015	40
D2021196	HOUSING:DRIVE UNIT:PAPER FEED:ASS'Y	U015	41
D2022614	COIL SPRING:RELEASE:PICKUP:MANUAL FEED	U014_S001_S003	107
D2022617	ARM:PICKUP:MANUAL FEED	U014_S001_S003	108
D2022618	SHEET:PICKUP	U014_S001_S003	109
D2022619	TORSION SPRING:PICKUP	U014_S001_S003	110
D2022620	SHOE:TORSION SPRING:PICKUP	U014_S001_S003	111
D2022624	COVER:PAPER END	U014_S001_S003	112
D2022638	FEELER:PAPER SIZE SENSOR:MANUAL FEED	U014_S001	113
D2022640	EXTENSION TRAY:NO.1	U014_S001	114
D2022641	EXTENSION TRAY:NO.2	U014_S001	115
D2022642	PULLEY:WIRE:MANUAL FEED TABLE	U014_S001	116
D2022646	ARM:MANUAL FEED:REAR UPPER	U014_S001	117
D2022669	COVER:MANUAL FEED TABLE	U014_S001	118
D2022676	DECAL:SCALE:MANUAL FEED:MIDDLE	U014_S001	119
D2022778	FEELER:PAPER END	U006_S006	105
		U006_S007	105
D2024477	REVERSE ROLLER	U013_S001	37
D2024673	FEELER:DUPLEX:ENTRANCE SENSOR	U014_S001	120
D2024674	TORSION SPRING:DUPLEX:ENTRANCE SENSOR	U014_S001	121

Number	Part Name	Group	ID
D2024679	DRIVEN ROLLER:DIA16:DUPLEX	U014_S001	122
D2024680	BRACKET:DRIVEN ROLLER:PRESURE	U014_S001	123
D2024682	DRIVEN ROLLER:DIA16	U014_S001	124
D2024684	GROUND WIRE:BRACKET:DRIVEN ROLLER	U014_S001	125
D2024692	SHAFT:PRESSURE:GUIDE PLATE:UPPER	U014_S001	126
D2024721	BRACKET:LINK:DUPLEX	U014_S001	127
D2024722	LINK:DUPLEX	U014_S001	128
D2024726	TORSION SPRING:LINK:CONTACT POINT	U014_S001	129
D2026255	DECAL:GRIP:B	U010	39
D2231381	DECALOSURE GLASS:CLEANING	U020	16
D2380073	(NA):HEATER:SCANNER:120V:ASS'Y	U018	4
D2386630	(NA):HEATER:PAPER TRAY:120V:ASS'Y	U019	3
D2386650	HEATER:SCANNER:PCU:ELECTRICAL COMPONENTS SECTION:ASS'Y	U018	2
D2386661	(NA):HEATER:PAPER TRAY:ELECTRICAL COMPONENTS SECTION:ASS'Y	U019	4
D2391265	COVER:RIGHT:REAR	U001	48
D2392224	PCDU:K	U008_S001	10
D2392244	PCU:K	U008_S001_S001	27
D2395883	GROUND PLATE:BCU	U016	57
D2395884	BRACKET:BCU	U016	58
D2395898	BRACKET:HELM	U016	59
D2395899	CAP:HELM	U016	60
D2411113	GUIDE:HARNESS:RIGHT	U015	42
D2411115	GUIDE:HARNESS:LEFT	U015	43
D2411117	DRIVE UNIT:ENGINE:ASS'Y	U015	44
D2411242	COVER:MAIN SWITCH	U006_S001	106
D2411245	COVER:FRONT:UPPER	U001	49
D2411251	COVER:LEFT:UPPER	U001	50
D2411256	CAP:COVER:INTERFACE	U001	51

Exclusive Parts

Number	Part Name	Group	ID
D2411260	COVER:REAR:LOWER	U001	52
D2411261	COVER:REAR	U001	53
D2411263	CAP:LOUVER:DEODORIZE FILTER	U001	54
D2411266	COVER:RIGHT:FRONT LOWER	U001	55
D2411273	INNER COVER:FRONT:LOWER	U001	56
D2411275	INNER COVER:FRONT:RIGHT LOWER	U001	57
D2411285	COVER:SCANNER:UPPER:LEFT	U001	58
D2411297	BRACKET:COVER:LEFT UPPER REAR	U001	59
D2411298	INNER COVER:RIGHT	U001	60
D2411299	GUIDE PLATE:SCANNER	U020	17
D2411308	BAND:STOPPER:DOOR	U001	61
D2411309	MAGNET CATCH	U001	62
D2411357	DRIVE UNIT:FUSING/PAPER EXIT UNIT:ASS'Y	U015_S002	45
D2411378	GEAR:FUSING:NO.3	U015_S002	46
D2411396	HOLDER:TORQUE LIMITER MECHANICAL CLUTCH:PRESSURE RELEASE	U015_S002	47
D2411591	BRACKET:OPERATION SUB-UNIT:PEEN	U002	7
D2411598	COVER:BRACKET:OPERATION SUB-UNIT:LOWER	U002	8
D2411599	COVER:BRACKET:OPERATION SUB-UNIT:UPPER	U002	9
D2411671	PROTECTION:CARRIAGE:SCANNER	U004	31
D2411680	GUIDE ROD	U004	33
D2411681	STAY:GUIDE ROD	U004	34
D2411684	COVER:HARNESS:SCANNER	U004	35
D2411685	SPRING PLATE:GUIDE ROD	U004	36
D2411686	CLAMP:STAY:GUIDE ROD	U004	37
D2411688	SHEET:GLASS:LARGE	U004	38
D2411689	HOLDER:EXPOSURE GLASS	U004	39
D2411697	SLIDE RAIL	U004	40
D2411698	COVER:BASE:SCANNER	U004	41
D2411701	PULLEY:IDLER:LEADING EDGE	U004	42

Number	Part Name	Group	ID
D2411702	CAP:PULLEY:IDLER:LEADING EDGE	U004	43
D2411708	TIGHTENER:DIA8	U004	44
D2411710	PULLEY:IDLER:TRAILING EDGE	U004	45
D2411711	CAP:IDLER:TRAILING EDGE	U004	46
D2411712	TENSION SPRING:TIGHTENER:TENSION:4N	U004	47
D2411715	PULLEY:DRIVE	U004	48
D2411716	CAP:PULLEY:DRIVE:UPPER	U004	49
D2411717	CAP:PULLEY:DRIVE:LOWER	U004	50
D2411719	DC STEPPER MOTOR	U004	51
D2411722	TENSION SPRING:TENSION:11N	U004	52
D2411727	SHEET:GAP:ASS'Y	U004	53
D2411733	COVER:SHEET THROUGH:DOCUMENT FEEDER	U004	54
D2411734	(NA):SCALE:LEFT:INCH:ASS'Y	U004	61
D2411741	BRACKET:DOCUMENT FEEDER:LEFT	U004	55
D2411742	BRACKET:DOCUMENT FEEDER:RIGHT	U004	56
D2411744	DOCUMENT FEEDER:CABLE:BRACKET	U004	57
D2411767	PLAIN SHAFT BEARING:90ANG	U004_S001	58
D2411788	CAP:COVER:POSITIONING	U020	18
D2411855	OPTICAL WRITING UNIT	U005_S001	4
D2412559	SHAFT:REGISTRATION ROLLER:DRIVEN	U006	107
D2412576	GUIDE PLATE:REGISTRATION:FRONT LEFT	U006	108
D2412583	REGISTRATION ROLLER:DRIVE	U010	40
D2412612	DC SOLENOID:PICKUP:ASS'Y	U014_S001_S003	130
D2412622	COVER:DAMPER	U014_S001_S003	131
D2412634	RACK:MANUAL FEED	U014_S001	132
D2412641	COVER:PAPER STOPPER:MANUAL FEED	U014_S001_S003	134
D2412643	ARM:LINK:PAPER STOPPER	U014_S001_S003	135
D2412644	TORSION SPRING:LINK:PAPER STOPPER	U014_S001_S003	136

Exclusive Parts

Number	Part Name	Group	ID
D2412652	GROUND PLATE:SHAFT:FEED	U014_S001_S003	137
D2412657	GROUND WIRE:MANUAL FEED UNIT:REAR	U014_S001_S003	139
D2412673	GUIDE PLATE:VERTICAL TRANSPORT:NO.1:DRIVEN	U014_S001	140
D2412674	GUIDE PLATE:VERTICAL TRANSPORT:NO.2:DRIVEN	U014_S001	141
D2412676	HOLDER:DRIVEN:BELT	U014_S001	142
D2412678	SHAFT:FLAT CONVEYER BELT:DRIVEN	U014_S001	143
D2412682	STAY:REAR:MANUAL FEED TABLE	U014_S001	144
D2412685	DECAL:PAPER SET DIRECTION:MANUAL FEED	U014_S001	145
D2412690	SIDE FENCE:FRONT:ASS'Y	U014_S001_S001	146
D2412691	SIDE FENCE:REAR:ASS'Y	U014_S001_S002	147
D2412731	STOPPER:GUIDE PLATE:SWIVEL	U006	111
D2412754	COIL SPRING:PRESSURE:SEPARATE	U006_S006	112
		U006_S007	112
D2412759	TRANSPORT ROLLER:VERTICAL TRANSPORT:ASS'Y	U006_S006	113
		U006_S007	113
D2412875	SIDE FENCE:FRONT:ASS'Y	U006_S002_S003	114
D2412880	SIDE FENCE:REAR:ASS'Y	U006_S002_S004	115
D2412906	LEVER:STRETCH:PAPER TRAY:ASS'Y	U006	116
D2412991	PLAIN SHAFT BEARING:INNER:DRIVE:REGISTRATION ROLLER	U010	41
D2412993	STOPPER:REGISTRATION ROLLER	U010	42
D2412994	COMPRESSION SPRING:REGISTRATION:INNER:DRIVE	U010	43
D2414023	HOLDER:DRIVEN ROLLER:FUSING EXIT:FRONT	U012_S001	58
D2414024	HOLDER:DRIVEN ROLLER:FUSING EXIT:REAR	U012_S001	59
D2414108	GUIDE:FUSING EXIT:LEFT	U012_S001	61
D2414113	BRACKET:THERMISTOR:PRESSURE ROLLER	U012_S001	62
D2414121	INNER COVER:PRESSURE ROLLER	U012_S001	63

Number	Part Name	Group	ID
	R:REAR		
D2414122	INNER COVER:PRESSURE ROLLER:FRONT	U012_S001	64
D2414123	DISCHARGE BRUSH:PRESSURE ROLLER	U012_S001	65
D2414137	LEVER:PRESSURE:FRONT:PEEN	U012_S001	66
D2414140	HOLDER:PRESSURE:FRONT:ASS'Y	U012_S001	67
D2414155	HOLDER:PRESSURE:REAR:ASS'Y	U012_S001	68
D2414160	LEVER:PRESSURE:REAR:PEEN	U012_S001	69
D2414212	GATE PAWL:FUSING EXIT	U012_S001	70
D2414215	GUIDE:FUSING EXIT:RIGHT:ASS'Y	U012_S001	72
D2414218	LINK:GATE PAWL:FUSING EXIT	U012_S001	73
D2414219	DECAL:C:GUIDE PLATE:FUSING EXIT	U012_S001	74
D2414221	STRIPPER PLATE:FUSING EXIT:ASS'Y	U012_S001	75
D2414252	FUSING ENTRANCE GUIDE PLATE	U012_S001	76
D2414261	FUSING COVER:UPPER	U012_S001	77
D2414317	GUIDE:HARNESS:DRAWER:PRESS FIT	U012_S001	78
D2414332	HOUSING:THERMOSTAT	U012_S001	79
D2414334	COVER:HOUSING:THERMOSTAT	U012_S001	80
D2414337	TERMINAL:THERMOSTAT:DRAWER	U012_S001	81
D2414338	TERMINAL:THERMOSTAT:HEATER	U012_S001	82
D2414342	HOUSING:NON-CONTACT TYPE THERMISTOR	U012_S001	83
D2414365	HOLDER:THERMOPILE	U012	84
D2414366	BRACKET:THERMOPILE	U012	85
D2414367	STOPPER:THERMOPILE	U012	86
D2414406	PAPER EXIT UNIT:ASS'Y	U013_S001	38
D2414441	GUIDE PLATE:EXIT:UPPER	U013_S001	39
D2414448	SHAFT:FEELER:OVERFLOW	U013_S001	40
D2414458	GUIDE:COVER:UPPER	U001	63
D2414461	GUIDE PLATE:REVERSE:UPPER	U013_S001	41
D2414466	GUIDE PLATE:REVERSE:LOWER	U013_S001	42
D2414472	END FENCE:TRAY:EXIT:ASS'Y	U020_S001	19

Exclusive Parts

Number	Part Name	Group	ID
D2414476	EXIT ROLLER	U013_S001	43
D2414481	GATE PAWL:EXIT	U013_S001	44
D2414483	LEVER:GATE PAWL	U013_S001	45
D2414494	TRAY:AUXILIARY:EXIT	U013	46
D2414499	COMPRESSION SPRING:BASE:TRAY:EXIT	U013	47
D2414617	TRANSPORT ROLLER:DUPLEX:2:DIA8	U014_S001	148
D2414627	COVER:DUPLEX	U014_S001	149
D2414628	GUIDE PLATE:DUPLEX:EXIT	U014_S001	150
D2414635	SHEET:CUSHION	U014_S001	152
D2414640	TRANSPORT ROLLER:EXIT:DIA8	U014_S001	153
D2414642	TRANSPORT ROLLER:DUPLEX:1	U014_S001	154
D2414643	TRANSPORT ROLLER:ENTRANCE	U014_S001	155
D2414652	GEAR:PULLEY:SWIVEL	U014_S001	157
D2414660	GUIDE PLATE:UPPER:RIGHT:DUPL LEX	U014_S001	158
D2414673	GUIDE PLATE:DRIVEN	U014_S001	159
D2414676	LEVER:PRESSURE:DUPLEX	U014_S001	160
D2414677	COMPRESSION SPRING:EXIT:UPP ER	U014_S001	161
D2414681	BRACKET:MOTOR:PEEN	U014_S001	162
D2414684	GEAR:OUTPUT	U014_S001	163
D2414692	INNER COVER:REAR:DUPLEX	U014_S001	164
D2414693	INNER COVER:FRONT:DUPLEX	U014_S001	165
D2414694	CAP:BELT:DUPLEX	U014_S001	166
D2414697	GROUND WIRE:EXIT SENSOR:DU PLEX	U014_S001	167
D2414707	GEAR:FEED:MANUAL FEED:DRIVE	U014_S001	168
D2414708	GEAR:SEPARATOR:MANUAL FEE D:DRIVE	U014_S001	169
D2414709	GEAR:TRANSPORT ROLLER:MAN UAL FEED	U014_S001	170
D2414710	GEAR:IDLER	U014_S001	171
D2414750	BRACKET:MOTOR:DUPLEX	U014	172
D2414755	GEAR:OUTPUT:DUPLEX:ENTRAN CE	U014	173
D2414757	SPACER:DC MOTOR:DUPLEX	U014	174

Number	Part Name	Group	ID
D2414761	DRIVEN ROLLER:DIA16	U014_S001	175
D2414762	DRIVEN ROLLER:DIA18	U014_S001	176
D2414763	GUIDE:HARNESS:ENTRANCE SEN SOR:DUPLEX	U014_S001	177
D2414765	PULLEY:T26	U014_S001	178
D2414766	PULLEY:T26/T26	U014_S001	179
D2414899	SHEET:RACK:MANUAL FEED	U014_S001	180
D2414921	COVER:GUIDE PLATE:DRIVEN	U014_S001	181
D2414923	STAY:CONTACT POINT:DUPLEX	U014_S001	182
D2414929	DC SOLENOID:FUSING EXIT:ASS'Y	U013	48
D2414936	INNER COVER:EXIT	U013	49
D2414937	TENSION SPRING:GATE:REVERS E	U013_S001	50
D2414938	TENSION SPRING:LINK:DC SOLEN OID:FUSING EXIT	U013	51
D2414941	GATE PAWL:REVERSE:FRONT MI DDLE	U013_S001	52
D2414942	GATE PAWL:REVERSE:REAR MID DLE	U013_S001	53
D2414943	GATE PAWL:REVERSE:REAR	U013_S001	54
D2414946	SHAFT:GATE PAWL:REVERSE	U013_S001	55
D2414947	GATE PAWL:REVERSE:FRONT	U013_S001	56
D2414948	GUIDE:HARNESS:REVERSE	U013_S001	57
D2414950	ROLLER:EXIT:PRESSURE:2TYPE: ASS'Y	U013_S001_S001	58
D2414955	HOLDER:ROLLER:EXIT:PRESSUR E:2TYPE	U013_S001	59
D2414971	LINK:PLATE:EXIT	U013	60
D2414972	GUIDE:PLATE:EXIT	U013	61
D2414981	COIL SPRING:ROLLER:PRESSURE :EXIT	U013_S001	62
D2414992	DISCHARGE BRUSH:EXIT	U013_S001	63
D2414994	GUIDE PLATE:EXIT:LOWER	U013_S001	64
D2414995	GUIDE PLATE:UPPER	U014_S001	183
D2414996	DC SOLENOID:ASS'Y	U013_S001	65
D2414998	CUSHION:DC SOLENOID:4MM	U013_S001	66
D2415110	PCB:IOB:TRANSPORT	U016	61
D2415112	PCB:IOB:ENGINE	U016	62

Exclusive Parts

Number	Part Name	Group	ID
D2415190	PCB:MSSENS1	U016	63
D2415192	PCB:MSSENS2	U016	64
D2415711	COVER:HUMAN DETECTION SENSOR:CONNECTOR	U001	64
D2415737	BRACKET:MAIN SWITCH	U016	65
D2415764	COVER:POWER PACK:CB	U016	66
D2415765	CASE:POWER PACK:CB	U016	67
D2415796	RACK:MIDDLE	U016	68
D2415797	FRAME:RACK:RIGHT:PEEN	U016	100
D2415800	RACK:RIGHT:AUXILIARY	U016	69
D2415801	COVER:RACK:REAR	U016	70
D2415802	GUIDE:FFC:SCANNER	U016	71
D2415803	GUIDE:HARNESS:C/T BOX	U016	72
D2415817	GUIDE:FFC:2	U016	73
D2415831	CAP:GUIDE:WIRE	U016	74
D2415832	CAP:GUIDE:COIL SPRING	U016	75
D2415841	BASE:GUIDE:WIRE	U016	76
D2415842	COVER:GUIDE:WIRE	U016	77
D2415850	WIRE:CHARGE:K	U016	78
D2415851	WIRE:DEVELOPMENT:K	U016	79
D2415852	WIRE:CHARGE:C	U016	80
D2415853	WIRE:DEVELOPMENT:C	U016	81
D2415854	WIRE:CHARGE:M	U016	82
D2415855	WIRE:DEVELOPMENT:M	U016	83
D2415856	WIRE:CHARGE:Y	U016	84
D2415857	WIRE:DEVELOPMENT:Y	U016	85
D2415875	WIRE:CHARGE:CB	U016	86
D2415876	WIRE:DEVELOPMENT:CB:K	U016	87
D2415877	WIRE:DEVELOPMENT:CB:C	U016	88
D2415878	WIRE:DEVELOPMENT:CB:M	U016	89
D2415879	WIRE:DEVELOPMENT:CB:Y	U016	90
D2415889	SPRING PLATE:IMAGE PROCESSING UNIT	U016	91
D2416003	TRANSFER UNIT:INTERMEDIATE TRANSFER:ASS'Y	U009_S001	43
D2416097	FLAT BELT-TRANSFER:INTERMEDIATE TRANSFER:TT	U009_S001	39
D2416212	TRANSFER ROLLER:SECOND:ASS	U010_S001	44

Number	Part Name	Group	ID
	'Y		
D2416240	LEVER:PRESSURE:TRANSFER ROLLER:FRONT:DIA19.5	U010	45
D2416241	LEVER:PRESSURE:TRANSFER ROLLER:REAR:DIA19.5	U010	46
D2416244	GROUND PLATE:SEPARATION	U010	47
D2416250	GROUND WIRE:BRACKET:ENTRANCE SENSOR	U010	48
D2416256	GROUND PLATE:GUIDE:TRANSPORT	U010	49
D2416258	COVER:TRANSFER/SEPARATION UNIT	U010	50
D2416275	SHEET:ENTRANCE:TRANSFER	U010	51
D2416290	LED:RED	U010	52
D2416335	COVER:INTERMEDIATE TRANSFER	U020	20
D2417913	DUCT:OPTICAL WRITING UNIT	U001	65
D2417941	DUCT:EXHAUST:UPPER:A	U017	45
D2417942	DUCT:EXHAUST:UPPER:B	U017	46
D2417943	DUCT:EXHAUST:UPPER:C	U017	47
D2417944	DUCT:EXHAUST:UPPER:D	U017	48
D2417945	DEODORIZE FILTER	U017	49
D2417983	DUCT:DEVELOPMENT:REAR:A	U017	50
D2417984	DUCT:DEVELOPMENT:REAR:B	U017	51
D2421231	COVER:UPPER:FRONT	U001	66
D2421247	COVER:FRONT:USED TONER	U001	67
D2421267	COVER:RIGHT:UPPER	U001	68
D2422225	PCDU:C	U008_S002	12
D2422226	PCDU:M	U008_S003	13
D2422227	PCDU:Y	U008_S004	14
D2422245	PCU:CMY	U008_S002_S001	26
		U008_S003_S001	26
		U008_S004_S001	26
D2422389	COVER:PCU:FRONT:SUB-ASS'Y	U008	16
D2423091	DEVELOPMENT UNIT:K	U008_S001_S002	17
D2423092	DEVELOPMENT UNIT:C	U008_S002_S002	23
D2423093	DEVELOPMENT UNIT:M	U008_S003_S002	24
D2423094	DEVELOPMENT UNIT:Y	U008_S004_S002	25

Exclusive Parts

Number	Part Name	Group	ID
D2424041	(NA):SLEEVE:FUSING:120V	U012_S001_S001	93
D2424055	(NA):FUSING UNIT:120V	U012_S001	94
D2424262	FUSING COVER:LOWER	U012_S001	89
D2424382	DC STEPPER MOTOR:ASS'Y	U012	90
D2424383	BRACKET:IDLER:DC STEPPER MOTOR	U012	91
D2424386	BRACKET:DC STEPPER MOTOR	U012	92
D2425184	(NA):AC CONTROL BOARD	U016	99
D2425605	PCB:DDR3-DIMM:RC-C:2GB:ASS'Y	U016	93
D2425646	PCB:IMAGE PROCESSING UNIT	U016	94
D2426400	COLLECTION BOTTLE:ASS'Y	U011_S001	34
D2426511	PIPE:ASS'Y	U011	35
D2429591	TOTAL COUNTER	U016	95
D2445730	PCB:DCSW	U016	96
D2557798	DECAL:BLUETOOTH	U020	21
D2581317	HOLDER:GLASS:CLEANER:ASS'Y	U020	22
D2894655	GRIP:DUPLEX UNIT	U014_S001	201
D2951508	COVER:REAR:M3	U002	10
D3AZ1762	BRACKET:MOTOR:MIDDLE	U003_S001	90
D3B01320	HINGE:LEFT:ASS'Y	U003_S001	300
D3B01350	HINGE:RIGHT:ASS'Y	U003_S001	301
D3B01766	DC MOTOR:10W:NIDEC:ASS'Y	U003_S001	91
D3B02200	SHAFT:SEPARATION:ASS'Y	U003_S001_S004	92
D3B02510	GUIDE PLATE:PAPER FEED:LOWER:ASS'Y	U003_S001	93
D3B02622	DISCHARGE BRUSH:L11	U003_S001	94
D3B03390	GUIDE PLATE:SCANNING:NON-CO NTACT:PEEN	U003_S001	308
D3B03662	GUIDE PLATE:CONTACT IMAGE S ENSOR:ENTRANCE:ASS'Y	U003_S001_S005	96
D3B04212	COVER:UPPER REAR	U003_S001	98
D3B04310	GUIDE:PAPER FEED:UPPER:SUB- ASS'Y	U003_S001_S011	99
D3B04324	SHEET:BRACKET:GUIDE:PAPER F EED	U003_S001	100
D3B04443	SPONGE:TRAY:EXIT	U003_S001	101
D3B04711	GUIDE PLATE:PRESSURE PLATE: LEFT:ASS'Y	U003_S001_S012	102

Number	Part Name	Group	ID
D3B04720	PRESSURE PLATE:ASS'Y	U003_S001_S012	103
D3B04722	CUSHION:TAPE:SMALL	U003_S001_S012	104
D3B04724	CUSHION:PRESSURE PLATE:LAR GE	U003_S001_S012	105
D3B04725	CUSHION:PRESSURE PLATE:SMA LL	U003_S001_S012	106
D3B04751	CUSHION:COVER:PAPER FEED:U PPER:1	U003_S001_S010	107
D3B04752	CUSHION:COVER:PAPER FEED:U PPER:2	U003_S001_S010	108
D3B04753	SOUND PROOFING MATERIAL:CO VER:PAPER FEED:UPPER:FRONT	U003_S001_S010	109
D3B04754	SOUND PROOFING MATERIAL:CO VER:PAPER FEED:UPPER:INNER BACK	U003_S001_S010	110
D3B04755	COVER:PAPER FEED:UPPER:ASS' Y	U003_S001_S010	111
D3B04761	SOUND PROOFING MATERIAL:CO VER:REAR:LOWER:1	U003_S001_S009	112
D3B04762	SOUND PROOFING MATERIAL:CO VER:REAR:LOWER:2	U003_S001_S009	113
D3B04763	SOUND PROOFING MATERIAL:CO VER:REAR:LOWER:3	U003_S001_S009	114
D3B04764	SOUND PROOFING MATERIAL:CO VER:REAR:LOWER:4	U003_S001_S009	115
D3B04765	SOUND PROOFING MATERIAL:CO VER:REAR:UPPER	U003_S001_S009	116
D3B04771	SOUND PROOFING MATERIAL:GUI DE:PAPER FEED:UPPER:1	U003_S001_S011	117
D3B04772	SOUND PROOFING MATERIAL:GUI DE:PAPER FEED:UPPER:2	U003_S001_S011	118
D3B04773	SOUND PROOFING MATERIAL:GUI DE:PAPER FEED:UPPER:3	U003_S001_S011	119
D3B04774	SOUND PROOFING MATERIAL:GUI DE:PAPER FEED:UPPER:4	U003_S001_S011	120
D3B04775	SOUND PROOFING MATERIAL:GUI DE:PAPER FEED:UPPER:5	U003_S001_S011	121
D3B04776	SOUND PROOFING MATERIAL:GUI	U003_S001_S011	122

Exclusive Parts

Number	Part Name	Group	ID
	DE:PAPER FEED:UPPER:6		
D3B04781	CUSHION:BRACKET:PICKUP:FRO NT	U003_S001_S004	123
D3B04782	CUSHION:COVER:PAPER FEED:PI CKUP	U003_S001	124
D3B05100	PCB:MAIN CONTROL	U003_S001	125
D3B05860	CONTACT IMAGE SENSOR:ASS'Y	U003_S001	126
D3B05869	SHIELD PLATE:CONTACT IMAGE SENSOR:FRONT	U003_S001	127
D3B06321	DECAL:CAUTION:CONTACT IMAG E SENSOR	U003_S001	128
D3B06323	DECAL:CAUTION:ORIGINAL:MANY LANGUAGES	U020	23
D3B07010	ADF:ASS'Y	U003_S001	129
D3BR2201	(NA):HEATER:PHOTOCONDUCTO R:ASS'Y	U018	5
D3FF1221	SHEET:HINGE:GUIDE:LEFT	U003_S001	302
D3FF1222	SHEET:HINGE:GUIDE:RIGHT	U003_S001	303
D3FF1386	SHEET:HINGE:LEFT	U003_S001	304
D3FF1387	SHEET:HINGE:RIGHT	U003_S001	305
D3FF2219	GUIDE:PAPER FEED BELT:FRONT	U003_S001_S004	306
D3FF4210	COVER:REAR:ASS'Y	U003_S001_S009	309
D4122653	BUSHING:DIA6	U003_S001	130
D4122669	TENSION SPRING:GUIDE PLATE:P RESSURE:2N	U003_S001	131
D4123145	TENSION SPRING:LEVER:MISFEE D REMOVAL	U003_S001	132
D5224906	STEPPED SCREW:M3:DIA6:1.7MM: ROUND POINT	U003_S001	133
D5406121	FULL DUG POINT SCREW:FIX:HIN GE	U003	134
D5412241	REVERSE ROLLER:PAPER FEED	U003_S001	135
D5431313	COMPRESSION SPRING:HINGE:LE FT	U003_S001	136
D5431625	GEAR:Z24:SEPARATION	U003_S001	137
D5431717	SHAFT:PULLEY:SCANNING:EXIT	U003_S001	138
D5431821	TIMING PULLEY:T33/Z24	U003_S001	139
D5431822	FLANGE:DIA24	U003_S001	140

Number	Part Name	Group	ID
D5433314	SHEET:SCANNING:ENTRANCE:MI DDLE	U003_S001_S008	141
		U003_S001_S011	141
D5433631	ROLLER:SCANNING:BEHIND:ASS' Y	U003_S001	142
D5433635	GEAR:ROLLER:SCANNING:BEHIN D	U003_S001	143
D5434382	COMPRESSION SPRING:PULL OU T	U003_S001	144
D5434393	CUSHION:GUIDE PLATE:ENTRAN CE:PAPER FEED:INNER BACK	U003_S001	145
D5435125	SPRING PLATE:CABLE:CONTACT I MAGE SENSOR	U003_S001	146
D6421454	FEELER:APS	U003_S001	147
D6831362	COMPRESSION SPRING:HINGE:RI GHT	U003_S001	150
D6831385	BRACKET:SAFETY SWITCH:PAPE R FEED	U003_S001	151
D6831386	SHAFT:CONTACT POINT:ON OFF DETECTOR:PAPER FEED	U003_S001	152
D6831387	TENSION SPRING:ON OFF DETEC TOR:PAPER FEED	U003_S001	153
D6831413	BRACKET:SAFETY SWITCH	U003_S001	154
D6831414	SPRING PLATE:SAFETY SWITCH	U003_S001	155
D6831415	FEELER:SENSOR:ON OFF DETEC TOR	U003_S001	156
D6831451	HOLDER:FEELER:APS	U003_S001	157
D6831614	BRACKET:MOTOR:PAPER FEED	U003_S001	158
D6831615	STAY:MOTOR:PAPER FEED	U003_S001	159
D6831617	DC MOTOR:ASS'Y:20W:BRUSHLE SS	U003_S001	160
D6831620	SHAFT:SEPARATION:DRIVE:INPU T:SUB-ASS'Y	U003_S001_S001	161
D6831632	SHAFT:REVERSE ROLLER:SUB-A SS'Y	U003_S001_S002	162
D6831635	GEAR:REVERSE ROLLER:DRIVE	U003_S001	163
D6831640	SHAFT:INPUT:PAPER FEED:SUB-A SS'Y	U003_S001_S003	164
D6831642	TIMING PULLEY:IDLER:PULL OUT	U003_S001	165

Exclusive Parts

Number	Part Name	Group	ID
D6831643	GEAR:INPUT:PAPER FEED	U003_S001	166
D6831644	SPACER:SHAFT:INPUT:PAPER FEED	U003_S001	167
D6831671	BRACKET:MOTOR:PICK UP	U003_S001	168
D6831675	DC STEPPER MOTOR:DIA42:T15:S2M:ASS'Y	U003_S001	169
D6831680	CAM:PICKUP	U003_S001	170
D6831682	TIMING PULLEY:PICKUP:DRIVE	U003_S001	171
D6831691	GEAR:PAPER FEED:COUPLING	U003_S001	172
D6831711	BRACKET:MOTOR:PULL OUT	U003_S001	173
D6831718	STAY:MOTOR:PULL OUT	U003_S001	174
D6831766	DC MOTOR:10W:BRUSHLESS	U003_S001	175
D6831811	BRACKET:MOTOR:SCANNING:EXIT	U003_S001	176
D6831813	TIMING PULLEY:COUPLING:SCANNING:INNER BACK	U003_S001	177
D6831814	TIMING PULLEY:COUPLING:EXIT	U003_S001	178
D6831822	DC MOTOR:20W:SCANNING:20W:BRUSHLESS	U003_S001	179
D6831841	BRACKET:TENSIONER:SCANNING:INNER BACK	U003_S001	180
D6831845	PULLEY:IDLER:DIA14	U003_S001	181
D6831851	BRACKET:TENSIONER:SCANNING:FRONT	U003_S001	182
D6831855	TIMING PULLEY:TENSIONER:SCANNING:FRONT	U003_S001	183
D6831856	TENSION SPRING:TENSION:SCANNING:FRONT	U003_S001	184
D6831912	BRACKET:HINGE:RIGHT	U003_S001	185
D6832110	ROLLER:PULL OUT:DRIVE	U003_S001	186
D6832112	TIMING PULLEY:ROLLER:PULL OUT:DRIVE	U003_S001	187
D6832210	ROLLER:MIDDLE:DRIVE	U003_S001	188
D6832215	SHAFT:SEPARATION:DRIVE	U003_S001_S004	189
D6832221	GEAR:IDLER:Z18	U003_S001_S004	190
D6832222	STOPPER:SHAFT:SEPARATION:DRIVE	U003_S001	191
D6832224	GUIDE:PAPER FEED:ENTRANCE:FRONT	U003_S001_S004	192

Number	Part Name	Group	ID
	FRONT		
D6832228	PICKUP ROLLER	U003_S001_S004	193
D6832229	TIMING PULLEY:GEAR:T19/Z23	U003_S001_S004	194
D6832231	BRACKET:PICKUP	U003_S001_S004	195
D6832232	TIMING PULLEY:PICKUP:T21	U003_S001_S004	196
D6832233	BRACKET:PAPER FEED BELT	U003_S001_S004	197
D6832235	SHAFT:PICKUP:SUB-ASS'Y	U003_S001_S004	198
D6832236	SHEET:BRACKET:PICKUP:INNER BACK	U003_S001_S004	199
D6832239	COVER:PICKUP ROLLER	U003_S001_S004	200
D6832240	GUIDE:PAPER FEED:ENTRANCE:INNER BACK:ASS'Y	U003_S001_S004_S001	201
D6832272	LEVER:PICKUP ROLLER:RISE	U003_S001_S004	202
D6832311	TORQUE LIMITER MECHANICAL CLUTCH:SEPARATOR	U003_S001	203
D6832393	HOLDER:ORIGINAL TABLE	U003_S001	204
D6832415	SHEET:SEPARATION:ENTRANCE	U003_S001	205
D6832417	SHEET:ENTRANCE:SEPARATION PAD	U003_S001	206
D6832724	COVER:LOWER:BASE	U003_S001	207
D6832728	STOPPER:RELEASE:SHAFT:BASE	U003_S001	208
D6832729	JOINT:RISING TRAY:AUXILIARY	U003_S001	209
D6832733	FEELER:SENSOR:ORIGINAL SENSOR	U003_S001	210
D6832735	BRACKET:SENSOR:ORIGINAL SENSOR	U003_S001	211
D6832742	CUSHION:STOPPER PAWL	U003_S001	212
D6832743	SHEET:CUSHION:STOPPER PAWL	U003_S001	213
D6832746	SIDE FENCE:ORIGINAL TABLE	U003_S001	214
D6832747	PAD:SIDE FENCE:SMALL	U003_S001	215
D6832748	PAD:SIDE FENCE:LARGE	U003_S001	216
D6832752	LEVER:RISE:BASE	U003_S001	217
D6832755	SHAFT:RISE:BASE:SUB-ASS'Y	U003_S001	218
D6832756	RAIL:SIDE FENCE	U003_S001	219
D6832771	ORIGINAL TABLE	U003_S001	220
D6832781	ORIGINAL TABLE:BEHIND	U003_S001	221
D6832912	FEELER:PAPER SIZE SENSOR	U003_S001	222
D6832913	SHEET:SENSOR:SEPARATION	U003_S001	223

Exclusive Parts

Number	Part Name	Group	ID
D6832914	GUIDE PLATE:PULL OUT:LOWER	U003_S001	224
D6833111	ROLLER:SCANNING:ENTRANCE:DRIVE	U003_S001	225
D6833150	ROLLER:SCANNING:EXIT:DRIVE:ASSY	U003_S001_S007	226
D6833155	TIMING PULLEY:ROLLER:SCANNING:EXIT:DRIVE	U003_S001	227
D6833221	GUIDE:SCANNING:UPPER	U003_S001	228
D6833251	GROUND PLATE:ROLLER	U003_S001	229
D6833260	SHEET:SCANNING:EXIT:UPPER:ASSY	U003_S001	230
D6833311	BRACKET:GUIDE:SCANNING:UPPER	U003_S001	231
D6833361	SPRING PLATE:GUIDE PLATE:SCANNING	U003_S001	232
D6833421	BASE:SCANNING:ENTRANCE:LOWER	U003_S001	233
D6833422	LEVER:PRESSURE RELEASE	U003_S001	234
D6833461	GUIDE:SCANNING:ENTRANCE:NON-CONTACT:SUB-ASSY	U003_S001_S008	235
D6833510	SHAFT:LEVER:MISFEED REMOVAL:ASSY	U003_S001	236
D6833511	HOOK:OPTICAL READING UNIT:FRONT	U003_S001	237
D6833616	BRACKET:DISCHARGE BRUSH	U003_S001	238
D6833621	GUIDE:EXIT:LOWER:SUB-ASSY	U003_S001	239
D6833641	GUIDE:CONTACT IMAGE SENSOR:EXIT:LOWER:ASSY	U003_S001_S006	240
D6833643	COMPRESSION SPRING:CONTACT IMAGE SENSOR:EXIT	U003_S001_S006	241
D6833644	SHEET:GUIDE:CONTACT IMAGE SENSOR:EXIT:LOWER	U003_S001_S006	242
D6833645	ROLLER:MIDDLE:DRIVEN	U003_S001 U003_S001_S006	243 243
D6833651	COVER:SCANNING:EXIT	U003_S001	244
D6833666	LEVER:GUIDE PLATE:CONTACT IMAGE SENSOR:FRONT	U003_S001_S005	245
D6833667	LEVER:GUIDE PLATE:CONTACT I	U003_S001_S005	246

Number	Part Name	Group	ID
	MAGE SENSOR:REAR		
D6833668	SPACER:GUIDE PLATE:CONTACT IMAGE SENSOR:ENTRANCE	U003_S001_S005	247
D6833710	ROLLER:CONTACT IMAGE SENSOR:EXIT:DRIVE:PRESS FIT	U003_S001	248
D6833714	TIMING PULLEY:ROLLER:CIS:EXIT:DRIVE	U003_S001	249
D6833715	TIMING PULLEY:ROLLER:CIS:EXIT:FRONT	U003_S001	250
D6833811	GUIDE PLATE:EXIT:UPPER	U003_S001	251
D6833812	DISCHARGE BRUSH:EXIT	U003_S001 U003_S001_S005	252 252
D6833911	ROLLER:EXIT:DRIVE	U003_S001	253
D6833915	TIMING PULLEY:ROLLER:EXIT:DRIVE	U003_S001	254
D6834111	COVER:FRONT	U003_S001	255
D6834112	COVER:FRONT RIGHT	U003_S001	256
D6834313	CUSHION:STOPPER:FEELER:ORIGINAL SENSOR	U003_S001	257
D6834323	SHAFT:CONTACT POINT:GUIDE:PAPER FEED	U003_S001	258
D6834329	SHEET:BASE:SEAL:PAPER FEED	U003_S001	259
D6834341	BRACKET:PULL OUT:DRIVEN	U003_S001	260
D6834342	BRACKET:PRESSURE:PICKUP	U003_S001	261
D6834343	PRESSURE PLATE:PICKUP	U003_S001	262
D6834344	COMPRESSION SPRING:PICKUP:2.1N	U003_S001	263
D6834345	DISCHARGE BRUSH:EXIT:L37	U003_S001	264
D6834346	SHIELD PLATE:ENTRANCE:PAPER FEED	U003_S001	265
D6834347	SEAL:ENTRANCE:PAPER FEED	U003_S001	266
D6834350	DRIVEN ROLLER:PULL OUT	U003_S001	267
D6834351	LINK:STOPPER:COVER:PAPER FEED	U003_S001	268
D6834361	SHAFT:CONTACT POINT:GRIP	U003_S001	269
D6834367	GROUND PLATE:HOOK:INNER BACK	U003_S001	270
D6834372	HOOK:CONTACT POINT:FRONT:G	U003_S001	271

Exclusive Parts

Number	Part Name	Group	ID
	RIP		
D6834374	HOOK:CONTACT POINT:INNER BACK:GRIP	U003_S001	272
D6834394	GUIDE PLATE:ENTRANCE:PAPER FEED:UPPER	U003_S001	273
D6834395	CUSHION:GUIDE PLATE:ENTRANCE:PAPER FEED:FRONT	U003_S001	274
D6834396	CUSHION:GUIDE PLATE:ENTRANCE:PAPER FEED:STOPPER	U003_S001	275
D6834412	TRAY:EXIT:AUXILIARY:LARGE	U003_S001	276
D6834413	TRAY:EXIT:AUXILIARY:SMALL	U003_S001	277
D6834414	SPACER:EXIT ROLLER	U003_S001	278
D6834421	SHAFT:EXIT:DRIVEN	U003_S001	279
D6834430	ROLLER:EXIT:DRIVEN	U003_S001	280
D6834441	HOLDER:CUSHION:PRESSURE PLATE	U003_S001	281
D6834442	TAPE:PRESSURE PLATE	U003_S001	282
		U003_S001_S013	282
D6834510	COVER:LOWER RIGHT:ASS'Y	U003_S001_S013	283
D6834611	COVER:LEFT LOWER	U003_S001	284
D6834616	SHEET:BASE:SEAL:LEFT LOWER	U003_S001	285
D6834617	SEAL:LEFT LOWER	U003_S001	286
D6835111	GUIDE:HARNESS:MAIN	U003_S001	287
D6835121	GUIDE:HARNESS:SUB	U003_S001	288
D6836011	DECAL:SIZE:ORIGINAL	U003_S001	289
D6836031	DECAL:SET:ORIGINAL TABLE	U020	24
D6836041	DECAL:DESIGN SKETCH:MISFEED REMOVAL	U003_S001	290
D6836051	DECAL:BASE:ORIGINAL	U003_S001	291
D6842171	PAPER FEED BELT	U003_S001_S004	292
D6842412	PAD:STOPPER:ORIGINAL	U003_S001	293
D6866128	SPONGE:COVER:FRONT:SMALL	U003_S001	294
D6902425	DISCHARGE BRUSH:SHORT:FRONT	U003_S001	295
D6932867	SUPPORTING PLATE:COVER:FRONT:PAPER TRAY	U006_S002	117
D7316241	DECAL:STOPPER:SEPARATION UNIT	U003_S001	296

Number	Part Name	Group	ID
G0602652	BUSHING - M4	U003_S001	297
		U003_S001_S006	297
G0652767	LEVER - FEED	U006_S006	118
		U006_S007	118
GA143003	SCREW:MM5:2.5MM	U006	119
		U010	53
GW010007	PHOTO REFLECTION SENSOR:EXIT	U006	120
		U006_S006	120
		U006_S007	120
		U013_S001	67
		U014_S001	184
GW010009	DENSITY SENSOR	U009	41
GW020024	PHOTOINTERRUPTOR:LG2A24BL1:GF	U004	62
		U014_S001	190
GW230008	TONER END SENSOR	U007_S009	32
		U007_S010	32
		U007_S011	32
		U007_S012	32
H0602126	BUSHING - M6X7	U003_S001_S004	298
M0662743	FRICTION PAD:MANUAL FEED TABLE:18X7.5	U014_S001	185
M0662749	OIL DAMPER:STRAIGHT:30N	U014_S001_S003	186
M0AJ1276	INNER COVER:TONER BOTTLE	U001	69
M0AJ4497	TRAY:EXIT	U013	68
M0AJ6856	DECAL:INKJET:EN:MANUAL FEED	U020	29
M0BW6246	LINK:TRANSFER/SEPARATION UNIT:MO	U010	54
M1095857	HEXAGON HEAD TAPPING SCREW:3X10:DIA10	U006_S002	121
		U014_S001	188
M3644131	TIMING BELT:B40S2M160	U003_S001	299
M4445201	HDD:320GB:AQUARIUS	U016	97
Note	See 2D parts catalog for the components of the Smart Operation Panel.	U002_S001	11
VSSG9002	FLUOTRIBO MG GREASE: 100G	SPECIAL TOOLS	6
VSSG9008	FLOIL-G348 GREASE 20G	SPECIAL TOOLS	7
VSST9003	C-5Y COLOR TEST CHART(2 SHEETS X 3/SET)	SPECIAL TOOLS	8

Standard Parts



03130060N
SCREW - M3X6



03140120N
SCREW - M4X12

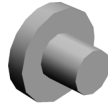

03530030N
SCREW:M3X3

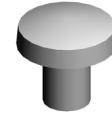

03530040N
SCREW - M3X4

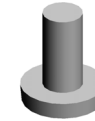

03530060N
BIND SCREW - M3X6

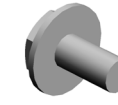

03603006N
SCREW - M3X6



03603016N
SCREW - M3X16

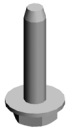

04503014N
TAPPING SCREW:M3X14



04503025N
TAPPING SCREW:3X25

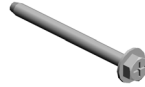

04503035N
TAPPING SCREW:3X35



04513006N
TAPPING SCREW - 3X6



04513008N
TAPPING SCREW - M3X8

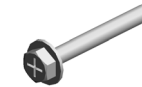

04513025N
TAPPING SCREW:M3X25



04533008N
BINDING SELF TAPPING SCREW:3X8



04543005N
HEXAGON HEAD TAPPING SCREW:ROUND POINT:3X5

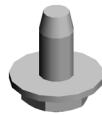

04543006N
TAPPING SCREW:ROUND POINT:3X6



04543006Q
TAPPING SCREW - M3X6



04543008N
TAPPING SCREW:ROUND POINT:3X8

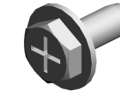

04543008Q
TAPPING SCREW:3X8



04543010Q
TAPPING SCREW:3X10



04543014Q
TAPPING SCREW:3X14

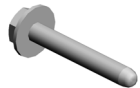

04543020Q
TAPPING SCREW::3X20



04583008N
HEXAGON HEAD TAPPING SCREW:3X8



04583010N
HEXAGON HEAD TAPPING SCREW:3X10



04593008N
BINDING HEAD TAPPING SCREW:3X8



04593010N
BINDING HEAD TAPPING SCREW:3X10

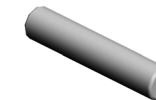

06320100G
PIN - 2X10MM



06330100G
PARALLEL PIN - 3X10

Standard Parts



07074060N
BUSHING: DIA4X6



07200020G
RETAINING RING - M2



07200025E
RETAINING RING - M2.5



07200030E
RETAINING RING - M3



07200040E
RETAINING RING - M4



07200060E
RETAINING RING - M6



07250170E
RETAINING RING C - M17



07403808
BALL BEARING - 8X16X5MM



07433806
RADIAL BALL BEARING: DIA6
XDIA13X5

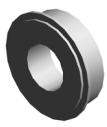

07433808
RADIAL BALL BEARING: DIA8
XDIA16X5



08025299
TAPPING SCREW - M3X8



08025328
HEXAGON HEAD TAPPING S
CREW: 3X40

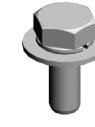

08046123
HEXAGONAL BOLT: W/WASH
ER: M3X8



08050089
RETAINING RING - M4



08050100
RETAINING RING - M2.5



08050103
RETAINING RINGS-E: SILENC
ER: DIA3



08050104
RETAINING RINGS-E: SILENC
ER: DIA4



08050106
RETAINING RINGS-E: SILENC
ER: DIA6

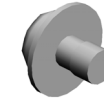

09543005N
SCREW: POLISHED ROUND/
SPRING: M3X5



09573010N
SCREW: SMALL ROUND/SPRI
NG: M3X10

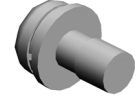

09574008N
SCREW: SMALL ROUND/SPRI
NG: M4X8



11050409
CARD SPACER- 6.4MM



11050487
HARNESS CLAMP



11050488
HARNESS CLAMP



11050508
HARNESS CLAMP - LWS-071
1



11050655
CLAMP: LWSR-1816S



11050692
CLAMP: LES-0503



11050713
CLAMP: LWSM-0306H GRAY

Standard Parts



11050723
CLAMPS:WES-0507

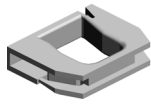

11050724
CLAMPS:WES-1210



11050725
CLAMPS:WES-1117



11050726
CLAMPS:WES-2217

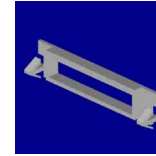

11050752
SADDLE:EDS-3005LS-V0



11050758
CLAMP:LWSM-0306A



11050759
CLAMP:LWSM-0605A



11050760
CLAMP:LWSM-0511A



11050762
CLAMP:LWS-0711A

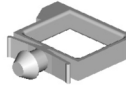

11050764
CLAMP:LWS-1316A



11050765
CLAMP:LWS-2218A

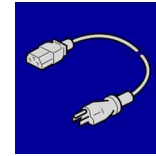

11500440
(NA):POWER SUPPLY CODE:
120V:15A



12042612
MICRO SWITCH:D3V-16506-3
C25

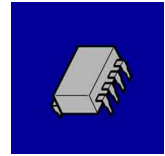

14078389
EEPROM:BR24T128-W



14078552
INTERFACE HIC:SCTPA1216
R

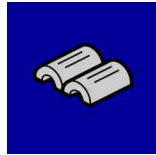

16072249
FERRITE CORE:K3 NF-70-A(
N)BK0

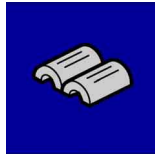

16072251
FERRITE CORE:K3 NF-75(N)
BK0

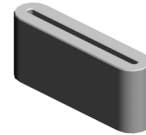

16072525
FERRITE CORE:K3 FF 35.00X
14.60X7.70X1.40

PM Part List

Number	Part Name	Num	Group	ID
AE020261	PRESSURE ROLLER:DIA32	1	U012_S001	41
AE030074	BALL BEARING:DIA17XDIA26X5	2	U012_S001	42
D0BQ6141	CLEANING UNIT:BELT CLEANING:ASS'Y	1	U009_S003	42
D1477937	FILTER:PREVENTFENCE:10	1	U017_S001	20
D2392244	PCU:K	1	U008_S001_S001	27
D2416003	TRANSFER UNIT:INTERMEDIATE TRANSFER:ASS'Y	1	U009_S001	43
D2416212	TRANSFER ROLLER:SECOND:ASS'Y	1	U010_S001	44
D2422245	PCU:CMY	3	U008_S002_S001	26
			U008_S003_S001	26
			U008_S004_S001	26
D2423091	DEVELOPMENT UNIT:K	1	U008_S001_S002	17
D2423092	DEVELOPMENT UNIT:C	1	U008_S002_S002	23
D2423093	DEVELOPMENT UNIT:M	1	U008_S003_S002	24
D2423094	DEVELOPMENT UNIT:Y	1	U008_S004_S002	25
D2424041	(NA):SLEEVE:FUSING:120V	1	U012_S001_S001	93
D2426400	COLLECTION BOTTLE:ASS'Y	1	U011_S001	34

Design Change List

Number	Title	Set	Old Part		New Part		Index No.		Q'ty	Interchg		Reason	Cut-in S/N
			P/N	Name	P/N	Name	Group	ID		Indiv.	Set		
201911-01	1911 Modification	-	D0BQ2051	CHARGE UNIT:A SS'Y	D0BQ2071	CHARGE UNIT:A SS'Y	U008_S001 _S001	29	1	O/O			
			D0BQ2051	CHARGE UNIT:A SS'Y	D0BQ2071	CHARGE UNIT:A SS'Y	U008_S002 _S001	29	1	O/O			
			D0BQ2051	CHARGE UNIT:A SS'Y	D0BQ2071	CHARGE UNIT:A SS'Y	U008_S003 _S001	29	1	O/O			
			D0BQ2051	CHARGE UNIT:A SS'Y	D0BQ2071	CHARGE UNIT:A SS'Y	U008_S004 _S001	29	1	O/O			
201911-02	1911 Modification	-			D2415797	FRAME:RACK:RI GHT:PEEN	U016	100	1				
201911-03	1911 Modification	-			D1496133	VIBRATING PLAT E:FRONT:PEEN	U009_S001	46	1				
201911-04	1911 Modification	-			D1496136	VIBRATING PLAT E:REAR:PEEN	U009_S001	47	1				
201911-05	1911 Modification	-	AZ320216	POWER PACK:C B:H	AZ320233	POWER PACK:C B:H	U016	38	1	O/O			
201911-06	1911 Modification	-	D2414102	DRIVEN ROLLER :FUSING EXIT:AS S'Y	D0BQ4102	DRIVEN ROLLER :FUSING EXIT:AS S'Y	U012_S001	60	1	O/O			
201911-07	1911 Modification	-	D2414214	EXIT ROLLER:FU SING EXIT:RIGH T	D0BQ4214	EXIT ROLLER:FU SING EXIT:RIGH T	U012_S001	71	1	O/O			
201911-08	1911 Modification	-	AE020238	PRESSURE ROL LER:DIA32	AE020261	PRESSURE ROL LER:DIA32	U012_S001	41	1	O/O			
201909-01	1909 Modification	-	D0BH4515	DUPLEX UNIT:AS S'Y	D0BH4517	DUPLEX UNIT:AS S'Y	U014_S001	54	1	O/O			
201909-02	1909 Modification	-	AW020207	PHOTOINTERRU PTOR:FLAT:PICH 2MM:M4	AW020249	PHOTOINTERRU PTOR:FLAT:PICH 2MM:M4	U004	19	1	O/O			
201909-03	1909 Modification	-	D2414404	PAPER EXIT UNI	D2414406	PAPER EXIT UNI	U013_S001	38	1	O/O			

Design Change List

Number	Title	Set	Old Part		New Part		Index No.		Q'ty	Interchg		Reason	Cut-in S/N
			P/N	Name	P/N	Name	Group	ID		Indiv.	Set		
		-		T:ASS'Y		T:ASS'Y							
201908-01	1908 Modification	-	AX060492	DC POLYGON MIRROR MOTOR	AX060519	DC POLYGON MIRROR MOTOR	U005_S001	3	1	O/O			
201908-02	1908 Modification	-	D2423086	DEVELOPMENT UNIT:C	D2423092	DEVELOPMENT UNIT:C	U008_S002_S002	23	1	O/O			
201908-03	1908 Modification	-	D2423087	DEVELOPMENT UNIT:M	D2423093	DEVELOPMENT UNIT:M	U008_S003_S002	24	1	O/O			
201908-04	1908 Modification	-	D2423088	DEVELOPMENT UNIT:Y	D2423094	DEVELOPMENT UNIT:Y	U008_S004_S002	25	1	O/O			
201907-01	1907 Modification	-	D2422244	PCU:CMY	D2422245	PCU:CMY	U008_S002_S001	26	1	O/O			
			D2422244	PCU:CMY	D2422245	PCU:CMY	U008_S003_S001	26	1	O/O			
			D2422244	PCU:CMY	D2422245	PCU:CMY	U008_S004_S001	26	1	O/O			
201907-02	1907 Modification	-	D2411678	SHEET:FFC:LOWER	D0BQ1678	SHEET:FFC:LOWER	U004	32	1	O/O			
201907-03	1907 Modification	-	D2423064	DEVELOPMENT UNIT:K	D2423091	DEVELOPMENT UNIT:K	U008_S001_S002	17	1	O/O			
201907-04	1907 Modification	-	D0BH5673	PCB:SERVICE	D0BH5676	PCB:SERVICE	U016	43	1	O/O			
201907-05	1907 Modification	-	D1473269	DRIVE UNIT:TONER BOTTLE:ASS'Y	D0BQ3219	DRIVE UNIT:TONER BOTTLE:ASS'Y	U007_S001	14	1	O/O			
			D1473269	DRIVE UNIT:TONER BOTTLE:ASS'Y	D0BQ3219	DRIVE UNIT:TONER BOTTLE:ASS'Y	U007_S002	14	1	O/O			
			D1473269	DRIVE UNIT:TONER BOTTLE:ASS'Y	D0BQ3219	DRIVE UNIT:TONER BOTTLE:ASS'Y	U007_S003	14	1	O/O			
			D1473269	DRIVE UNIT:TONER BOTTLE:ASS'Y	D0BQ3219	DRIVE UNIT:TONER BOTTLE:ASS'Y	U007_S004	14	1	O/O			

Design Change List

Number	Title	Set	Old Part		New Part		Index No.		Q'ty	Interchg		Reason	Cut-in S/N
			P/N	Name	P/N	Name	Group	ID		Indiv.	Set		
		-		ER BOTTLE:ASS'Y		ER BOTTLE:ASS'Y							
201907-06	1907 Modification	-	M0AJ2379	DUCT:GEAR:DEV ELOPMENT:SUB- ASS'Y	D0BQ2379	DUCT:GEAR:DEV ELOPMENT:SUB- ASS'Y	U008_S001 _S002	21	1	O/O			
			M0AJ2379	DUCT:GEAR:DEV ELOPMENT:SUB- ASS'Y	D0BQ2379	DUCT:GEAR:DEV ELOPMENT:SUB- ASS'Y	U008_S002 _S002	21	1	O/O			
			M0AJ2379	DUCT:GEAR:DEV ELOPMENT:SUB- ASS'Y	D0BQ2379	DUCT:GEAR:DEV ELOPMENT:SUB- ASS'Y	U008_S003 _S002	21	1	O/O			
			M0AJ2379	DUCT:GEAR:DEV ELOPMENT:SUB- ASS'Y	D0BQ2379	DUCT:GEAR:DEV ELOPMENT:SUB- ASS'Y	U008_S004 _S002	21	1	O/O			
201906-01	1906 Modification	-	D2392243	PCU:K	D2392244	PCU:K	U008_S001 _S001	27	1	O/O			
201906-02	1906 Modification	-	D2422062	CHARGE UNIT:A SS'Y	D0BQ2051	CHARGE UNIT:A SS'Y	U008_S001 _S001	28	1	O/O			
			D2422062	CHARGE UNIT:A SS'Y	D0BQ2051	CHARGE UNIT:A SS'Y	U008_S002 _S001	28	1	O/O			
			D2422062	CHARGE UNIT:A SS'Y	D0BQ2051	CHARGE UNIT:A SS'Y	U008_S003 _S001	28	1	O/O			
			D2422062	CHARGE UNIT:A SS'Y	D0BQ2051	CHARGE UNIT:A SS'Y	U008_S004 _S001	28	1	O/O			
201905-01	1905 Modification	-	D1493270	TONER HOPPER :TONER SUPPLY :C:ASS'Y	D0BQ3270	TONER HOPPER :TONER SUPPLY :C:ASS'Y	U007_S010	34	1	O/O			
201905-02	1905 Modification	-	D1493280	TONER HOPPER :TONER SUPPLY :M:ASS'Y	D0BQ3280	TONER HOPPER :TONER SUPPLY :M:ASS'Y	U007_S011	35	1	O/O			

Design Change List

Number	Title	Set	Old Part		New Part		Index No.		Q'ty	Interchg		Reason	Cut-in S/N
			P/N	Name	P/N	Name	Group	ID		Indiv.	Set		
201905-03	1905 Modification	-	D1493310	TONER HOPPER :TONER SUPPLY :Y:ASS'Y	D0BQ3310	TONER HOPPER :TONER SUPPLY :Y:ASS'Y	U007_S012	36	1	O/O			
201905-04	1905 Modification	-	D3B03380	GUIDE PLATE:S CANNING:NON-C ONTACT:PEEN	D3B03390	GUIDE PLATE:S CANNING:NON-C ONTACT:PEEN	U003_S001	308	1	X/O			
201905-05	1905 Modification	-	D3B04210	COVER:REAR:AS S'Y	D3FF4210	COVER:REAR:AS S'Y	U003_S001 _S009	309	1	X/O			
201904-01	1904 Modification	-	M0BW2602	MANUAL FEED U NIT:ASS'Y	D0BQ2600	MANUAL FEED U NIT:ASS'Y	U014_S001 _S003	193	1	O/O			
201904-02	1904 Modification	-	D1492840	END FENCE:PAP ER TRAY:ASS'Y	D0BQ2840	END FENCE:PAP ER TRAY:ASS'Y	U006_S001 _S004	128	1	O/O			
			D1492840	END FENCE:PAP ER TRAY:ASS'Y	D0BQ2840	END FENCE:PAP ER TRAY:ASS'Y	U006_S002 _S002	128	1	O/O			
201904-03	1904 Modification	-	D1496336	TRANSFER ROL LER:ASS'Y	D0BQ6060	TRANSFER ROL LER:FC:ASS'Y	U009_S001	45	1	O/O			
			D1496336	TRANSFER ROL LER:ASS'Y	D0BQ6060	TRANSFER ROL LER:FC:ASS'Y	U009_S001	45	1	O/O			
			D1496336	TRANSFER ROL LER:ASS'Y	D0BQ6060	TRANSFER ROL LER:FC:ASS'Y	U009_S001	45	1	O/O			
201904-04	1904 Modification	-	D1493240	TONER HOPPER :TONER SUPPLY :BK:ASS'Y	D0BQ3240	TONER HOPPER :TONER SUPPLY :BK:ASS'Y	U007_S009	33	1	O/O			
201904-05	1904 Modification	A	D1494655	GRIP:DUPLEX U NIT	D2894655	GRIP:DUPLEX U NIT	U014_S001	201	1	X/X			
201904-06	1904 Modification	A	D1754654	SHAFT:LEVER:L OCK	D0BQ4654	SHAFT:LEVER:L OCK	U014_S001	200	1	X/X			
201904-07	1904 Modification	A	D2412637	PAPER STOPPE R:MANUAL FEED	D0BQ2637	PAPER STOPPE R:MANUAL FEED	U014_S001 _S003	196	1	X/O			
201904-08	1904 Modification	B	D1492619	SHAFT:SEPARAT	D0BQ2619	SHAFT:SEPARAT	U014_S001	195	1	X/X			

Design Change List

Number	Title	Set	Old Part		New Part		Index No.		Q'ty	Interchg		Reason	Cut-in S/N
			P/N	Name	P/N	Name	Group	ID		Indiv.	Set		
				OR:DRIVE:ASS'Y		OR:DRIVE:ASS'Y	_S003						
201904-09	1904 Modification	B	D1494770	SHAFT:SEPARAT OR:DRIVEN:ASS' Y	D0BQ2608	SHAFT:SEPARAT OR:DRIVEN:ASS' Y	U014_S001 _S003	194	1	X/X			
201904-10	1904 Modification	B	D2412653	COIL SPRING:PR ESSURE:SEPAR ATOR	D0BQ2653	COIL SPRING:PR ESSURE:SEPAR ATOR	U014_S001 _S003	197	1	X/X			
201904-11	1904 Modification	C	D2414631	SIDE PLATE:REA R:DUPLEX:PEEN	D0BQ4631	SIDE PLATE:REA R:DUPLEX:PEEN	U014_S001	198	1	X/X			
201904-12	1904 Modification	C	D2414644	GEAR:MECHANI CAL ROLLER CL UTCH	D0BQ4644	GEAR:MECHANI CAL ROLLER CL UTCH	U014_S001	199	1	X/X			
201903-01	1903 Modification	-	AW020224	PHOTOINTERRU PTOR:GP1A173L CSVF	AW020234	PHOTOINTERRU PTOR:GP1A173L CS5F	U003_S001 U006_S006 U006_S007 U009 U010 U013_S001 U014_S001 U014_S001 _S003	307 125 125 44 55 69 192 192	9 2 2 1 1 1 1 1	O/O			
201903-02	1903 Modification	-	D2412713	PAPER FEED UN IT:NO.1:ASS'Y	D0BQ2711	PAPER FEED UN IT:NO.1:ASS'Y	U006_S006	126	1	O/O			
201903-03	1903 Modification	-	D2412714	PAPER FEED UN IT:NO.2:ASS'Y	D0BQ2712	PAPER FEED UN IT:NO.2:ASS'Y	U006_S007	127	1	O/O			
201902-01	1902 Modification	-			D3FF1221	SHEET:HINGE:G UIDE:LEFT	U003_S001	302	1				
201902-02	1902 Modification	-			D3FF1222	SHEET:HINGE:G UIDE:RIGHT	U003_S001	303	1				
201902-03	1902 Modification	-			D3FF1386	SHEET:HINGE:L	U003_S001	304	1				

Design Change List

Number	Title	Set	Old Part		New Part		Index No.		Q'ty	Interchg		Reason	Cut-in S/N
			P/N	Name	P/N	Name	Group	ID		Indiv.	Set		
		-				EFT							
201902-04	1902 Modification	-			D3FF1387	SHEET:HINGE:RIGHT	U003_S001	305	1				
201902-05	1902 Modification	-	B6522215	GUIDE:PAPER FEED BELT:FRONT	D3FF2219	GUIDE:PAPER FEED BELT:FRONT	U003_S001_S004	306	1	O/O			
201902-06	1902 Modification	-	M0BW2601	MANUAL FEED UNIT:ASS'Y	M0BW2602	MANUAL FEED UNIT:ASS'Y	U014_S001	191	1	O/O			
201902-07	1902 Modification	-	D2416141	CLEANING UNIT: BELT CLEANING: ASS'Y	D0BQ6141	CLEANING UNIT: BELT CLEANING: ASS'Y	U009_S003	42	1	O/O			
201902-08	1902 Modification	-	D2416001	TRANSFER UNIT:INTERMEDIATE TRANSFER:ASS'Y	D2416003	TRANSFER UNIT:INTERMEDIATE TRANSFER:ASS'Y	U009_S001	43	1	O/O			
201902-09	1902 Modification	-	D6831350	HINGE:RIGHT:ASS'Y	D3B01350	HINGE:RIGHT:ASS'Y	U003_S001	301	1	X/O			
201901-01	1901 Modification	-	D1492873	TRAY BOTTOM PLATE:NO.2:ASS'Y	D0BQ2873	TRAY BOTTOM PLATE:NO.2:ASS'Y	U006_S002_S001	124	1	O/O			
201901-02	1901 Modification	-	D2422061	CHARGE UNIT:ASS'Y	D2422062	CHARGE UNIT:ASS'Y	U008_S001_S001	28	1	O/O			
			D2422061	CHARGE UNIT:ASS'Y	D2422062	CHARGE UNIT:ASS'Y	U008_S002_S001	28	1	O/O			
			D2422061	CHARGE UNIT:ASS'Y	D2422062	CHARGE UNIT:ASS'Y	U008_S003_S001	28	1	O/O			
			D2422061	CHARGE UNIT:ASS'Y	D2422062	CHARGE UNIT:ASS'Y	U008_S004_S001	28	1	O/O			
201901-03	1901 Modification	-	M0AJ6861	DECAL:INKJET:MULTI-LANGUAGE:EN	M0AJ6856	DECAL:INKJET:EN:MANUAL FEED	U020	29	1	O/O			

Design Change List

Number	Title	Set	Old Part		New Part		Index No.		Q'ty	Interchg		Reason	Cut-in S/N
			P/N	Name	P/N	Name	Group	ID		Indiv.	Set		
201812-01	1812 Modification	-	D6831320	HINGE:LEFT:ASS 'Y	D3B01320	HINGE:LEFT:ASS 'Y	U003_S001	300	1	X/O			
201812-02	1812 Modification	-	D2392242	PCU:K	D2392243	PCU:K	U008_S001	27	1	O/O			
201811-01	1811 Modification	-	AW500040	PUSH SWITCH:S W1AG-550:10MA	AW500049	PUSH SWITCH:S W1AG-550	U006	123	2	O/O			
							U011	36	1				
							U014	189	1				
							U014_S001	189	1				
201811-02	1811 Modification	-	D2422243	PCU:CMY	D2422244	PCU:CMY	U008_S002	26	1	O/O			
			D2422243	PCU:CMY	D2422244	PCU:CMY	U008_S003	26	1	O/O			
			D2422243	PCU:CMY	D2422244	PCU:CMY	U008_S004	26	1	O/O			
201811-03	1811 Modification	-	GW020022	PHOTOINTERRU PTOR:LG2A24BL 1	GW020024	PHOTOINTERRU PTOR:LG2A24BL 1:GF	U004	62	1	X/O			
201811-04	1811 Modification	-	D2411309	MAGNET CATCH	D0BQ1309	MAGNET CATCH :COVER:FRONT	U001	70	1	O/O			
201811-05	1811 Modification	-	AW020198	PHOTOINTERRU PTOR:LG2A14NL 1	GW020024	PHOTOINTERRU PTOR:LG2A24BL 1:GF	U014_S001	190	1	O/O			
201811-06	1811 Modification	-	D1496766	DECAL:CAUTION :ORIGINAL:ENGL ISH	D0BQ6766	DECAL:CAUTION :ORIGINAL:ENGL ISH	U020	28	1	O/O			
201809-01	1809 Modification	-	AF013006	BOTTOM PLATE PAD	AF013019	PAD:TRAY BOTT OM PLATE	U006_S001	122	1	O/O			
							U006_S002	122	1				
201809-02	1809 Modification	-	D2423065	DEVELOPMENT UNIT:C	D2423086	DEVELOPMENT UNIT:C	U008_S002	23	1	X/O			
201809-03	1809 Modification	-	D2423066	DEVELOPMENT UNIT:M	D2423087	DEVELOPMENT UNIT:M	U008_S003	24	1	X/O			
201809-04	1809 Modification	-	D2423067	DEVELOPMENT	D2423088	DEVELOPMENT	U008_S004	25	1	X/O			

Design Change List

Number	Title	Set	Old Part		New Part		Index No.		Q'ty	Interchg		Reason	Cut-in S/N
			P/N	Name	P/N	Name	Group	ID		Indiv.	Set		
		-		UNIT:Y		UNIT:Y							
201809-05	1809 Modification	-			D2422061	CHARGE UNIT:A SS'Y	U008_S001	22	1				
							U008_S002	22	1				
							U008_S003	22	1				
							U008_S004	22	1				

