

# D146/D147 POINT TO POINT DIAGRAM (1/4)

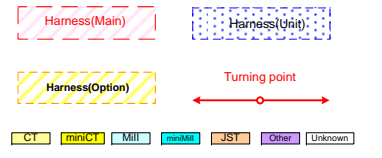

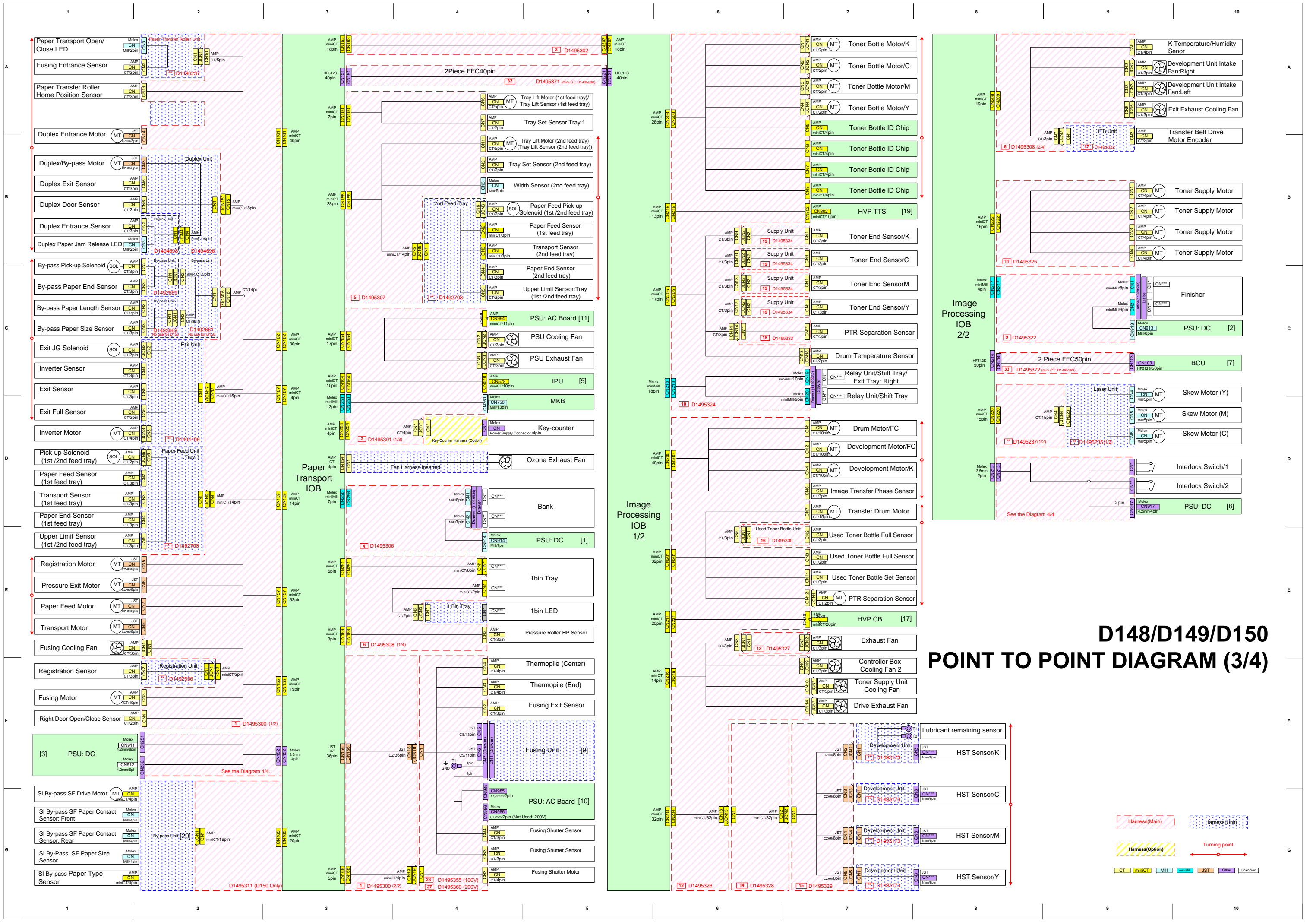



# D148/D149/D150 POINT TO POINT DIAGRAM (3/4)

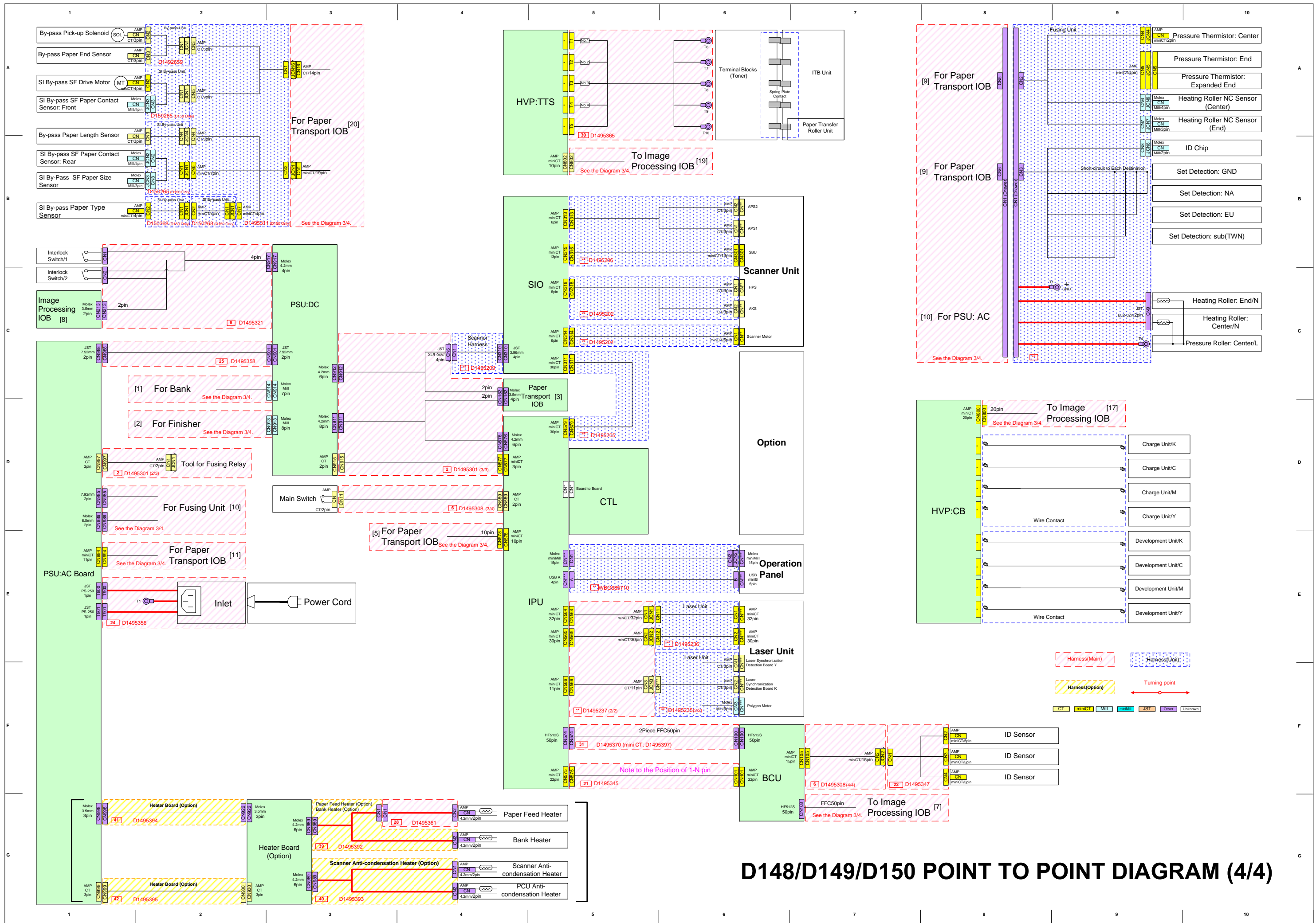

**D148/D149/D150 POINT TO POINT DIAGRAM (4/4)**

# D685 POINT TO POINT DIAGRAM

MOLEX Connector  
55949 18P

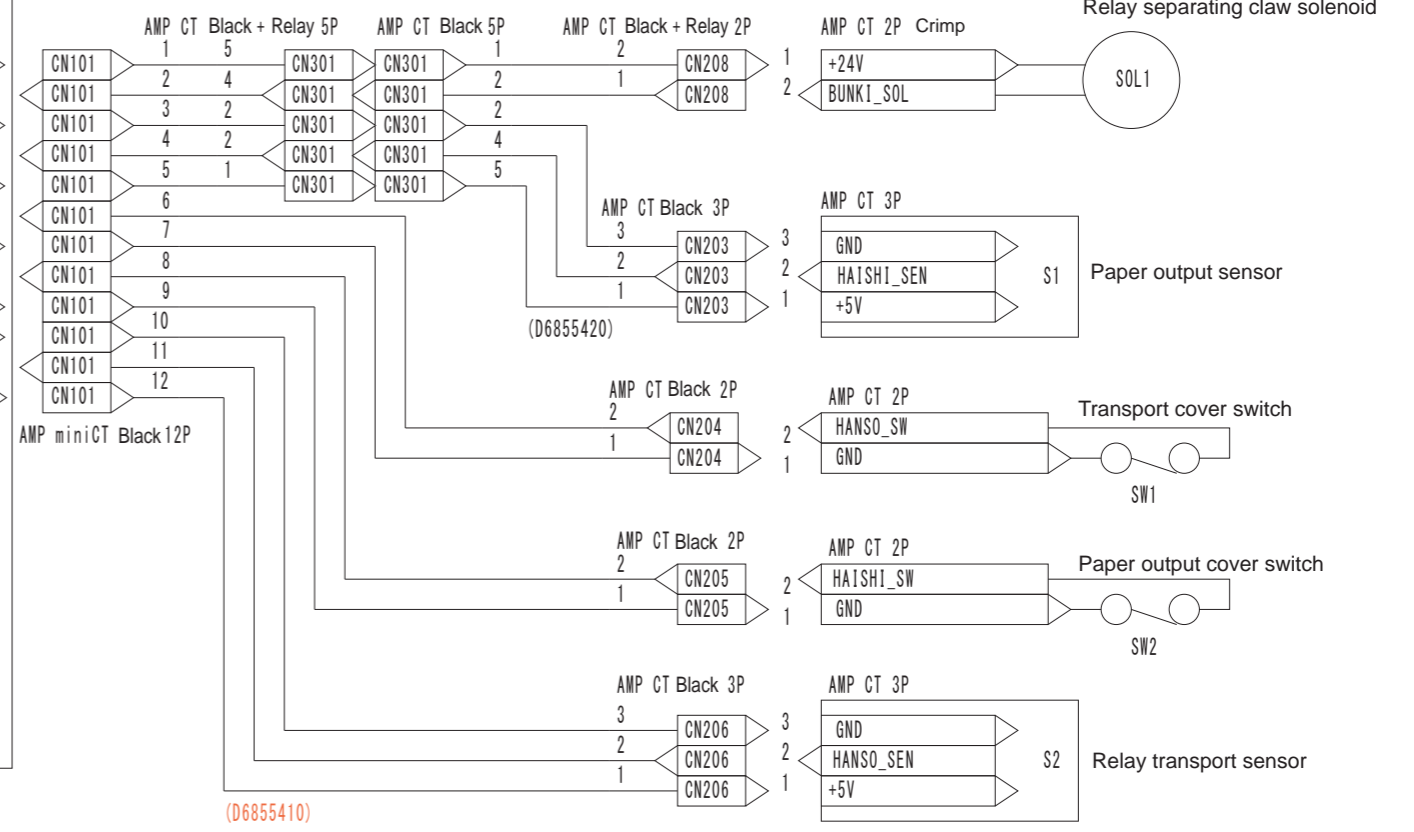
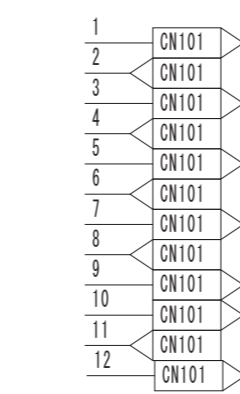
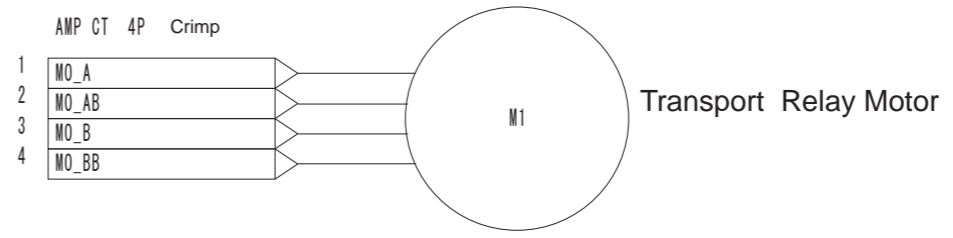
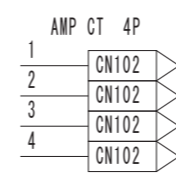
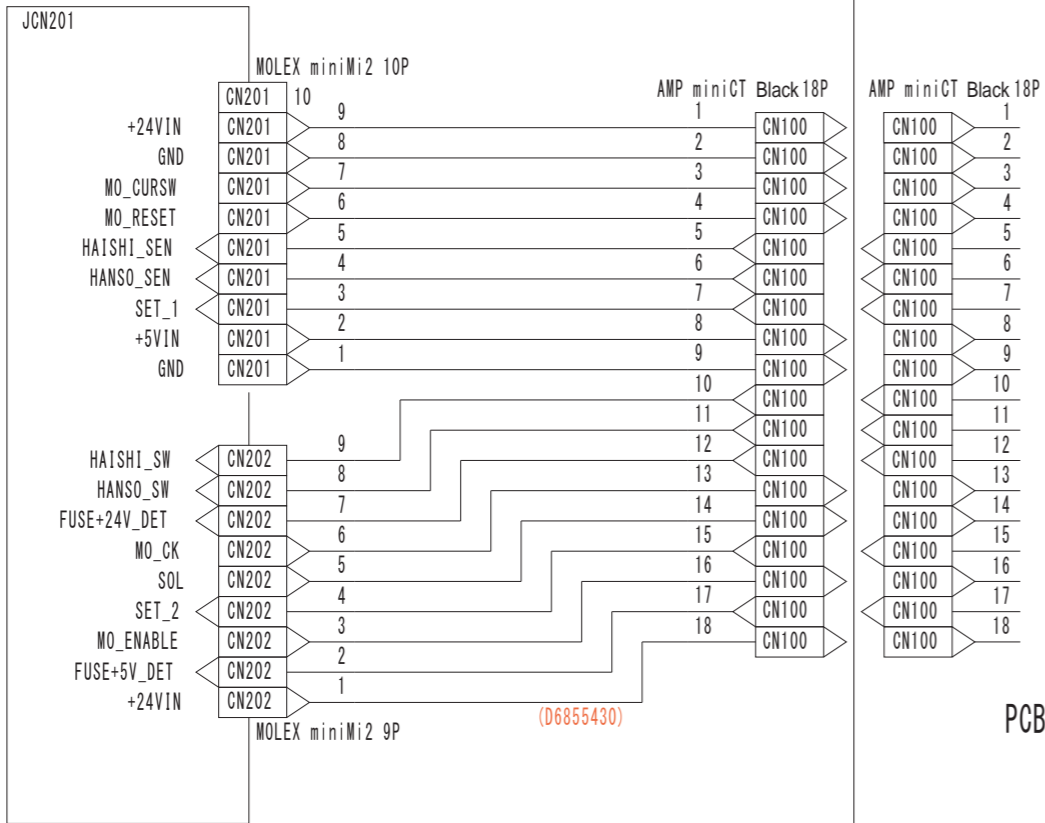

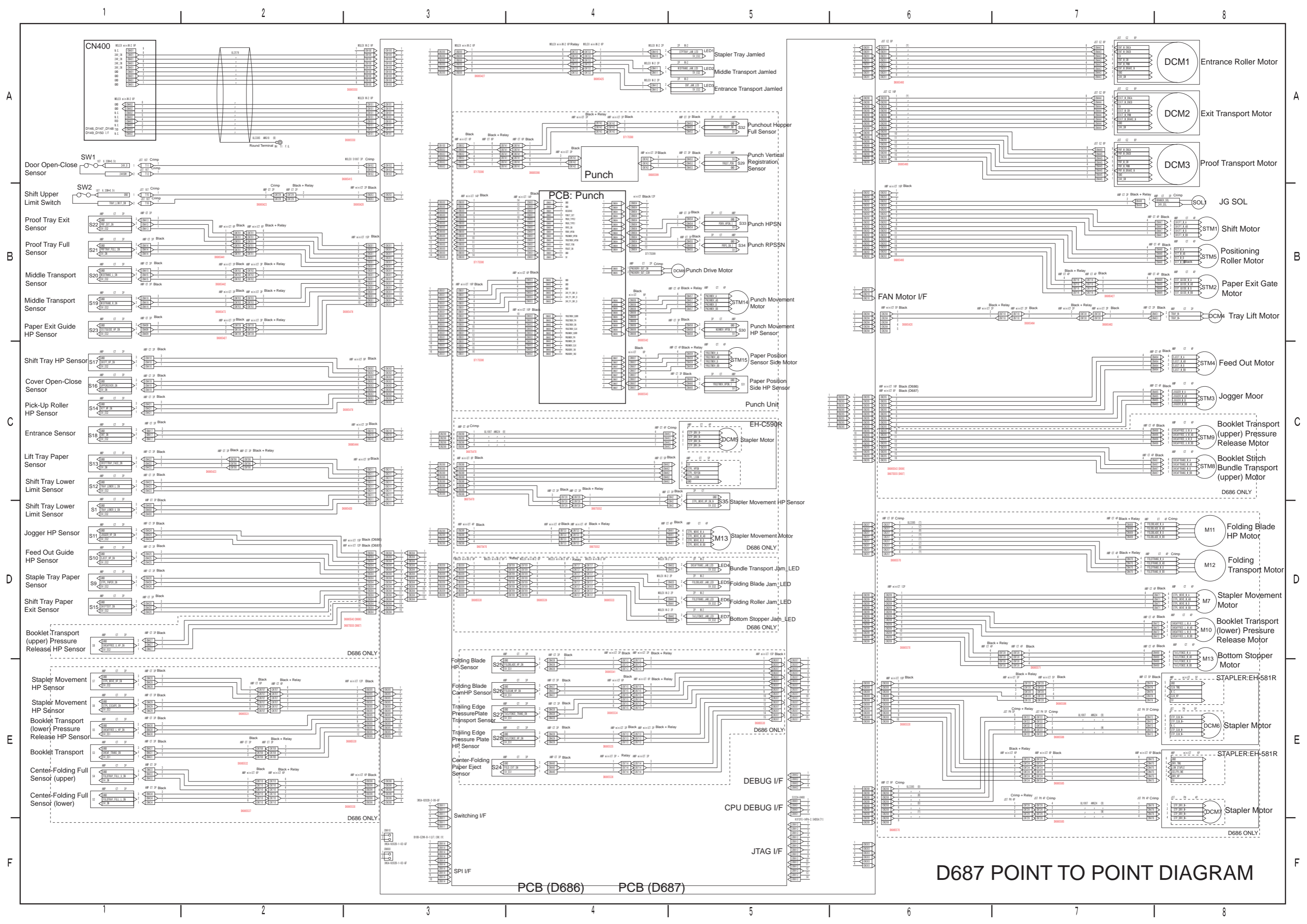

D687 POINT TO POINT DIAGRAM







# D688 POINT TO POINT DIAGRAM

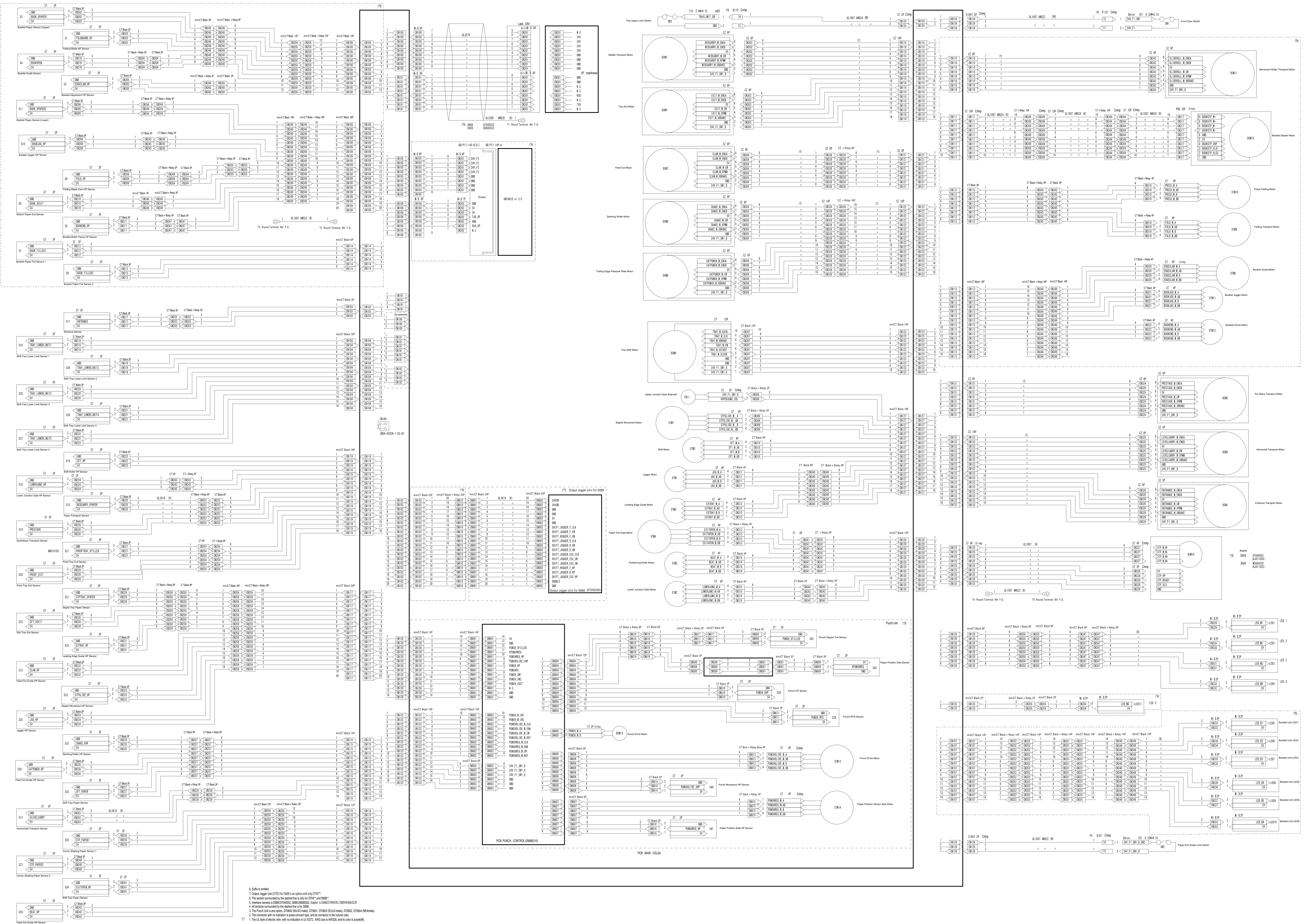

# D691 POINT TO POINT DIAGRAM

MOLEX Connector  
55949 18P

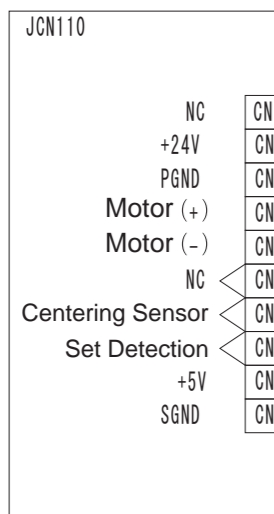

MOLEX miniMi2 10P

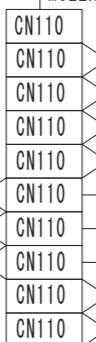

(D6915401)

AMP CT Black 9P

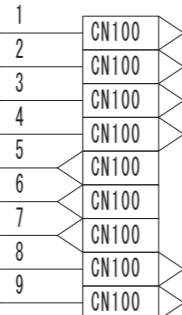

AMP CT Black 9P

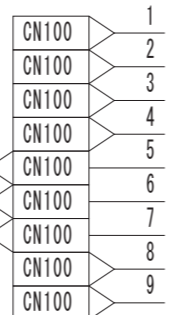

PCB: SHIFT

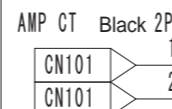
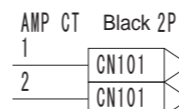

(D6915402)

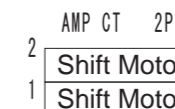
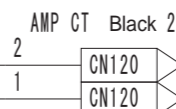

M1

# D692 POINT TO POINT DIAGRAM

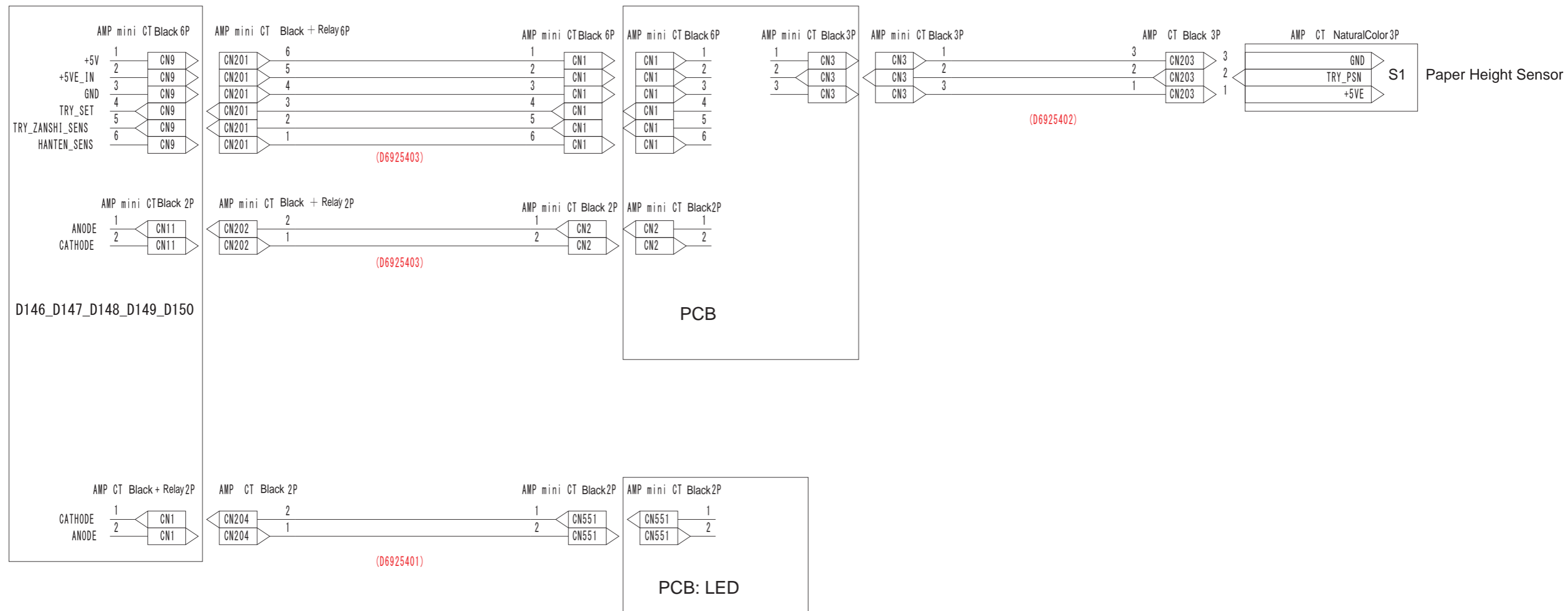

# D693 POINT TO POINT DIAGRAM

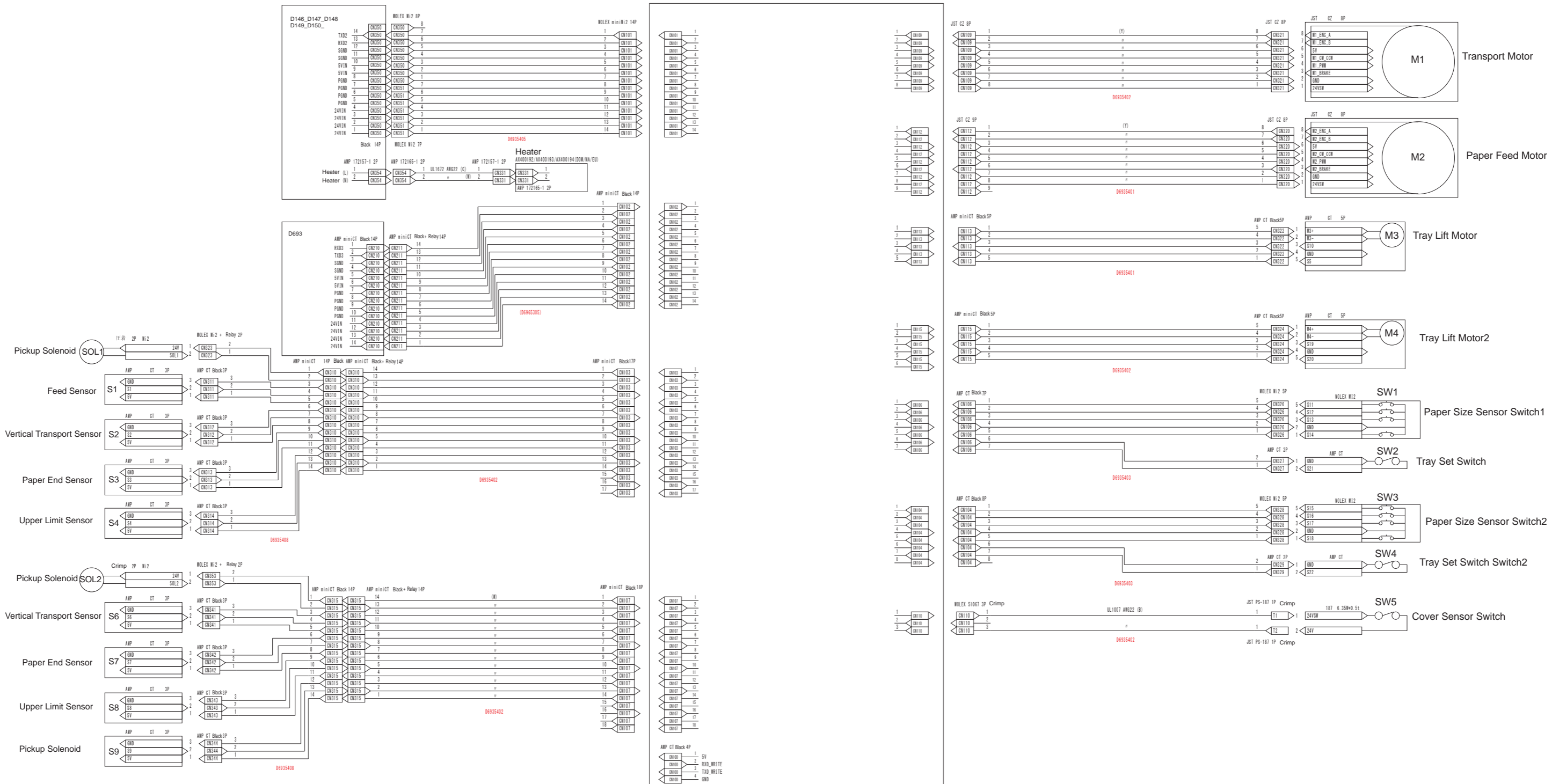

PCB: MAIN CONTROL





# D696 POINT TO POINT DIAGRAM

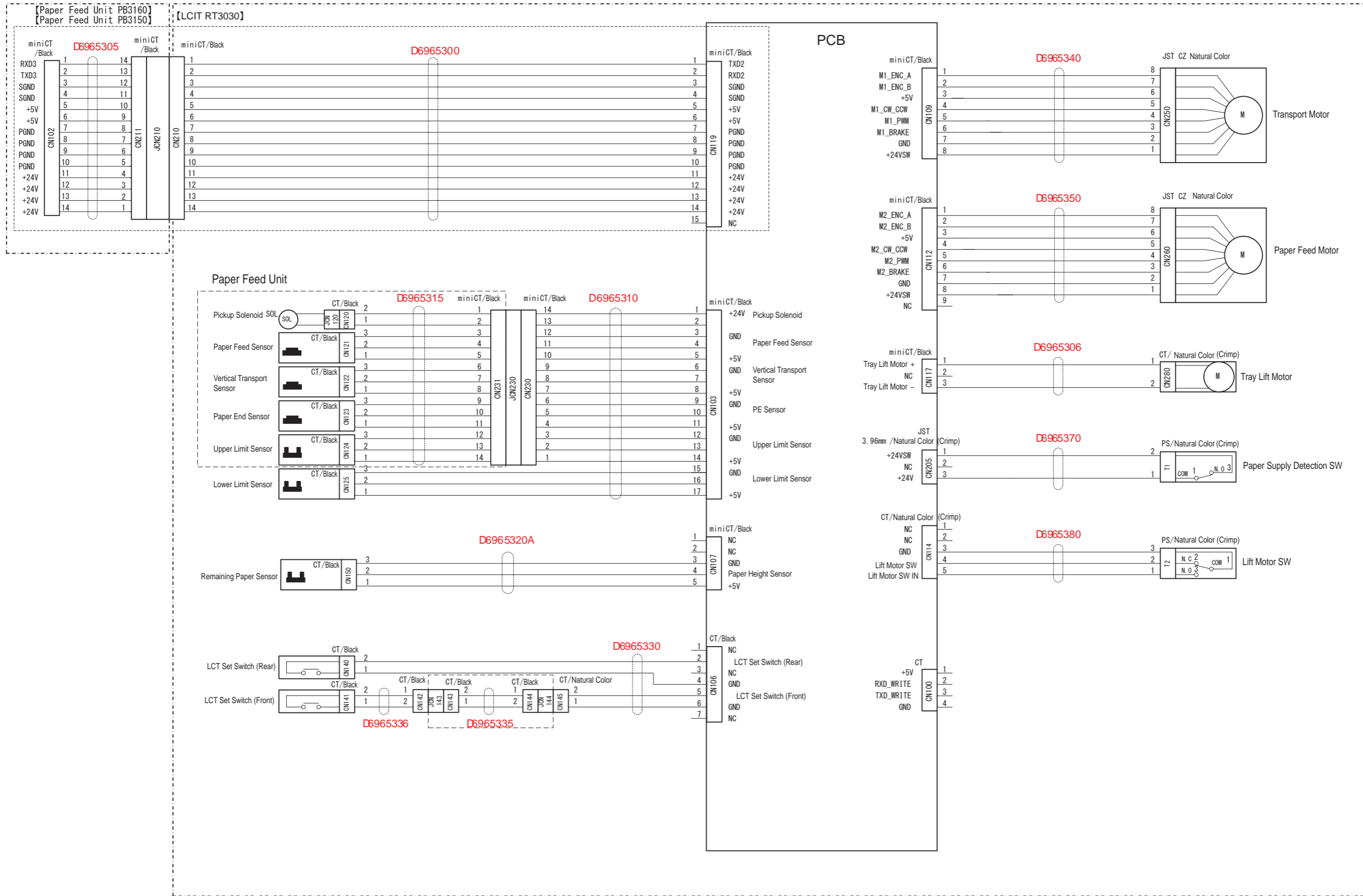

# D779 POINT TO POINT DIAGRAM

